



## Durham E-Theses

---

### *Teaching Primary Science with Computer Simulation – an Intervention Study in State of Kuwait*

ALFAJJAM, HASAN,M.,H.,F.,A

#### How to cite:

---

ALFAJJAM, HASAN,M.,H.,F.,A (2013) *Teaching Primary Science with Computer Simulation – an Intervention Study in State of Kuwait*, Durham theses, Durham University. Available at Durham E-Theses Online: <http://etheses.dur.ac.uk/8493/>

#### Use policy

---

The full-text may be used and/or reproduced, and given to third parties in any format or medium, without prior permission or charge, for personal research or study, educational, or not-for-profit purposes provided that:

- a full bibliographic reference is made to the original source
- a [link](#) is made to the metadata record in Durham E-Theses
- the full-text is not changed in any way

The full-text must not be sold in any format or medium without the formal permission of the copyright holders.

Please consult the [full Durham E-Theses policy](#) for further details.



# Teaching Primary Science with Computer Simulation – an Intervention Study in State of Kuwait

By

Hasan Alfajjam

Thesis submitted to Durham University in fulfillment of the requirements for  
the degree of Doctor of Philosophy

School of Education

Durham University

July 2013

## DECLARATION

This thesis is as a result of my research and has not been submitted for any other degree in any other university.

Copyright © 2013 ALFAJJAM, Hasan. All rights reserve

## Abstract

This thesis describes an investigation into use of interactive computer simulations software in primary science education. The research questions are what effects teaching with interactive computer simulations have on students' achievement, their conceptual change in particular science topics and on their attitudes. The question was investigated in an intervention study that tested use of simulations in two different pedagogical environments. The first environment used simulations in a computer laboratory, with students using blended learning (combining computer-based learning with non-computer learning). In this environment students worked independently on the computer. The second environment is class teaching. In this environment, the simulation was used on one computer, controlled by the teacher, in front of the class. The study also investigated ease of use and looked into practical consideration of computer-based teaching expressed by students and teachers. Three science topics were studied.

The novelty of the research is using computer simulations in an Arabic nation, which has widespread use of traditional didactic-oriented pedagogy. Recent educational reforms have made demand for more student-oriented teaching, with use of practical experiments in primary science. This major change is difficult to implement for practical reasons, and the study therefore asks if computer simulations may work as an alternative approach to reach the same aims.

The theoretical frameworks for the study are constructivism, conceptual change and cognitive multi-media theory. The first of these looks at the role of the student in learning, the second takes into consideration that students enter school with intuitive knowledge about natural phenomena and the last explains learning with use of computers. The theoretical frameworks were used to guide development of the simulation software and the intervention.

The participants were 365 students in year five (10-11 year olds) and eight science teachers in Kuwait, located at eight different primary schools. All schools were single sex, with half

the schools of each gender. All teachers were female. The study used a quasi-experimental design and separated the students into two experimental groups and two control groups. The first experimental group, which used simulations in computer labs, had 91 students in four primary schools (two boys' and two girls' schools). A matching control group with the same number of students was established in the same schools. The other experiment group had 92 students using simulations in the classroom. This group was also matched with an appropriate control group. The eight teachers taught both experimental and control group students. The control groups used traditional teaching. The experiment was carried out in the academic year 2010-2011.

The study measured effects of the interventions with pre- and post achievement tests and attitude questionnaires. Students in the experimental groups also answered a usability questionnaire. A sub-sample of students and all teachers were interviewed for triangulation of the questionnaire data and to learn more about experiences with using the simulation software.

The results of the study revealed no statistically significant difference (at the 0.05 level) in achievement or attitude between the students who used computer simulations in the computer laboratory. Students, however, who were taught with simulations in the classroom scored significantly higher on both achievement tests and attitude questionnaires. This benefit applied also to conceptual change of specific topics. In general, the interviews revealed that science teachers and students were satisfied with the simulation program used in science teaching and learning. However, the interviews indicated that there were some problems related to infrastructure and use of computers in the teaching that might have influenced the outcome of the study. These problems are relevant also to use of computer simulations in science teaching more widely.

## Acknowledgement

First, I would like to express my gratitude to the almighty God, the gracious and the merciful, for giving me the power and the will to finish this task. I also wish to thank my supervisors, **Dr Per Kind** and **Prof. Steve Higgins** for their unabated advice, unlimited support, and guidance. I also extend my thanks to the science teachers and students in the state of Kuwait for their participation and cooperation. In addition, I thank **Mr. Charles**, web-application developer and chairman at "Edumedia-sciences Company" for providing the simulation program, as well as for his support and useful advice. I must also thank my wife, **Tasneem**, and my children, **Mohammed**, **Abdulmohsen**, **Khaled**, and **Lateefah**, for being supportive and patient with me during this study. I offer my thanks, as well, to members of my extended family, particularly my mother, my sisters, and my brother, for their encouragement, support, and sustaining prayers for my success. Also, I cannot forget to say thanks to my friends, Sulaiman Al-Obaidly and Ahmad Al-Muwaizri, who pushed and encouraged me to succeed when I was away from my home and family. Finally, Thanks also to the Faculty of Education, Durham University which offered me the chance to complete my PhD thesis and benefit from its facilities.

Last but not least I would like to thank all those who helped and advised me whom I have not been able to name.

## TABLE OF CONTENTS

<b>CHAPTER ONE: INTRODUCTION TO THE STUDY .....</b>	<b>1</b>
<b>1.1 Introduction .....</b>	<b>1</b>
<b>1.2 Educational reforms in science teaching in Kuwait .....</b>	<b>1</b>
<b>1.3 Challenges for science teaching in Kuwait—statement of the problem .....</b>	<b>3</b>
<b>1.4 The role of information and communication technology simulation in overcoming science teachers’ challenges in Kuwait .....</b>	<b>6</b>
<b>1.5 The aim of the study .....</b>	<b>7</b>
<b>1.6 Research questions .....</b>	<b>7</b>
<b>1.7 The Hypotheses .....</b>	<b>9</b>
<b>1.8 Significance of the study .....</b>	<b>10</b>
<b>1.9 Definitions of terms .....</b>	<b>11</b>
<b>1.10 Overview of the thesis .....</b>	<b>12</b>
<b>CHAPTER TWO: THEORETICAL FRAMEWORK .....</b>	<b>15</b>
<b>2.1 Introduction .....</b>	<b>15</b>
<b>2.2 The Constructivist Theory of Learning.....</b>	<b>17</b>
<b>2.3 Conceptual Change Model by Computer Simulation Programs .....</b>	<b>27</b>
<b>2.4 Cognitive Theory of Multimedia Learning .....</b>	<b>34</b>
<b>CHAPTER THREE: PREVIOUS STUDIES THAT USE COMPUTER SIMULATION IN SCIENCE TEACHING .....</b>	<b>41</b>
<b>3.1 Introduction .....</b>	<b>41</b>
<b>3.2 Using computer simulation for improving students’ academic achievement</b>	<b>43</b>
<b>3.2.1 Discussion on studies using simulation to improve academic achievement</b>	<b>57</b>
<b>3.3 Using computer simulations to enhance conceptual change.....</b>	<b>60</b>
<b>3.3.1 Discussion on studies using simulations to enhance conceptual change .....</b>	<b>68</b>
<b>3.4 Using computer simulation as a replacement for laboratory .....</b>	<b>71</b>
<b>3.4.1 Discussion on studies using simulation as replacement lab teaching .....</b>	<b>80</b>
<b>3.5 Arabic studies .....</b>	<b>82</b>
<b>3.5.1 Discussion and analysis of the Arabic studies .....</b>	<b>86</b>
<b>3.6 Summary .....</b>	<b>87</b>
<b>CHAPTER FOUR: THE INTERVENTION - TEACHING SCIENCE WITH ICSS.</b>	<b>98</b>
<b>4.1 Introduction .....</b>	<b>98</b>

4.2	Description of the interactive computer simulation software .....	98
4.3	Limitations and risks of using simulation software as a new intervention ..	102
4.4	Procedure of development and design of the interactive computer simulation software.....	104
4.4.1	Identify the characteristics and nature of users.....	105
4.4.2	The facilities and equipment available (hardware) .....	106
4.4.3	Availability of interactive computer simulation software as an intervention program.....	108
4.4.4	Ascertain the topics to be taught through the interactive computer simulation software .....	110
4.4.5	Evaluation phase.....	113
4.5	The Intervention .....	113
<b>CHAPTER FIVE: METHODOLOGY OF STUDY .....</b>		<b>115</b>
5.1	Introduction .....	115
5.2	Study design .....	115
5.3	Rationale for the design .....	119
5.4	Data gathering instruments.....	123
5.4.1	Achievement tests.....	123
5.4.2	Attitude questionnaire.....	126
5.4.3	Questionnaire for usability of simulation software .....	128
5.4.4	Teachers and students interview .....	130
5.4.5	Teachers' self-report.....	134
5.5	Procedures for translating the measuring tools.....	134
5.6	Method of data analysis .....	135
5.6.1	Analysis of quantitative data .....	135
5.6.2	Analysis of qualitative data.....	138
5.7	Population and sample of the study .....	139
5.7.1	Sample selection from the population of the study.....	140
5.8	Reflection on reliability and validity .....	144
5.8.1	Validity.....	145
5.8.2	Reliability.....	146
5.9	Ethical consideration.....	148
5.10	Pilot study.....	150



5.11	Organisation and implementation of the research .....	151
5.11.1	Research groups .....	151
5.11.2	Implementation of using simulation in computer lab .....	152
5.11.3	Implementation of using simulation in classroom .....	152
<b>CHAPTER SIX: RESULTS AND DATA ANALYSIS.....</b>		<b>154</b>
6.1	Introduction .....	154
6.2	Students' number who attended and participated actually in study.....	155
6.3	Normality test .....	156
6.4	Comparing the pre-tests between groups .....	158
6.5	Results in achievement post tests .....	160
6.5.1	Research question 1:Effect of using simulation in the computer lab versus traditional teaching method .....	160
6.5.2	Rresearch question 2: Effect of using simulation in the classroom versus traditional teaching method .....	162
6.5.3	Research question 3: Effect of using simulation in the computer lab versus using in the classroom .....	162
6.6	Effect size of students' academic achievement .....	164
6.6.1	Effect sizes <i>within</i> the different groups from pre-test to post-test.....	164
6.6.2	Effect sizes <i>between</i> groups in the post-test. ....	167
6.7	Research question 4: Effect of using simulation on conceptual change	170
6.7.1	Conceptual change of using simulation in computer lab versus traditional teaching about the Circulatory and Digestive System topic ...	171
6.7.2	Conceptual change of using simulation in classroom versus traditional teaching about the Electric Circuit topic.....	175
6.8	Result of attitude toward science .....	179
6.8.1	Research question 5: Effect of using simulations in students' attitude toward teaching and learning science in each of using simulation in the computer lab and using simulation in classroom compared to traditional teaching method	179
6.8.2	Research question 6: Effect of using simulations in students' attitudes towards science teaching and learning between using simulation in the computer lab and using simulation in classroom.....	181

6.9	Research question 7: Students' opinions and experiences about usability of interactive computer simulation software in science education through usability questionnaire and interviews .....	182
6.9.1	Students' Questionnaire of Simulation Program Usability .....	182
6.9.2	Students interviews to discuss their opinions or impressions about using simulation software in science learning.....	190
6.10	Research question 8: Teachers' experiences with using the simulation in the teaching.....	194
6.10.1	Science teachers' interviews before experiment.....	194
6.10.2	Science teachers' interviews after experiment .....	197
<b>CHAPTER SEVEN: DISCUSSION OF RESULTS .....</b>		<b>204</b>
7.1	Introduction .....	204
7.2	Summary of the experimental groups outcomes .....	204
7.3	Teacher computer skills and technical help.....	209
7.4	Technology equipment availability at school (science classroom) .....	212
7.5	Teacher skills development in science education methods .....	214
7.6	Learning science topics by computer simulation software .....	217
7.7	Practical implications.....	219
7.7.1	Implication for decision makers .....	219
7.7.2	Implication for further study in Kuwait.....	220
<b>CHAPTER EIGHT: CONCLUSIONS AND IMPLICATIONS .....</b>		<b>223</b>
8.1	Introduction .....	223
8.2	Aims of the study .....	223
8.3	Research question, study design, data gathering and main findings.....	223
8.3.1	Research question .....	223
8.3.2	Design study.....	224
8.3.3	Data gathering.....	224
8.3.4	Main findings.....	225
8.4	Recommendations .....	225
8.5	Implications for future research .....	226
<b>REFERENCES .....</b>		<b>228</b>
<b>Appendices .....</b>		<b>240</b>
Appendix 1: Education History of Kuwait .....		241

<b>Appendix 2:</b> The Educational Research and Curricula sector, curricula development department letter .....	245
<b>Appendix 3:</b> Letter from the first primary school which involved in second experimental group .....	246
<b>Appendix 4:</b> Letter from the second primary school which involved in first experimental group .....	247
<b>Appendix 5:</b> Letter from the third primary school which involved in first experimental group .....	248
<b>Appendix 6:</b> Letter from the fourth primary school which involved in first experimental group .....	249
<b>Appendix 7:</b> Letter from the fifth primary school which involved in first experimental group .....	250
<b>Appendix 8:</b> Letter from the sixth primary school which involved in second experimental group .....	251
<b>Appendix 9:</b> Letter from the seventh primary school which involved in second experimental group .....	252
<b>Appendix 10:</b> Letter from the eighth primary school which involved in second experimental group .....	253
<b>Appendix 11:</b> Letter from the edu-media company (www.edumedia-sciences.com) which has been deal with them in the use of interactive computer simulation software (ICSS) in science education in this study.....	254
<b>Appendix 12:</b> Food chain lesson test (In Arabic) .....	255
<b>Appendix 12:</b> Food chain lesson test (In English).....	256
<b>Appendix 13:</b> Circulatory & digestive system lesson test (In Arabic) .....	257
<b>Appendix 13:</b> Circulatory & digestive system lesson test (In English).....	258
<b>Appendix 14:</b> Electric circuit lesson test ( In Arabic) .....	259
follow of electric circuit lesson test .....	260
<b>Appendix 14:</b> Electric circuit lesson test (In English) .....	261
<b>Appendix 15:</b> The pre and post of questionnaire (in Arabic) for the students to measure the attitude for them toward science teaching and learning.....	263
<b>Appendix 15:</b> The pre and post of questionnaire (in English) for the students to measure the attitude for them toward science teaching and learning.....	265
<b>Appendix 16:</b> The pre and post of questionnaire (in Arabic) for the students who used simulation to measure the usability of interactive computer simulation software in science teaching and learning .....	267

<b>Appendix 16:</b> The pre and post of questionnaire (in English) for the students who used simulation to measure the usability of interactive computer simulation software in science teaching and learning .....	271
<b>Appendix 17:</b> The Interview protocol for science teachers and students .....	274
<b>Appendix 18:</b> A letter to the assessors of the (achievement test / questionnaires).....	276
<b>Appendix 19:</b> Letter from (my) supervisor to my sponsor (Kuwait culture office) to let me conducted the experiment in state of Kuwait in primary school .....	277
<b>Appendix 20:</b> Approval letter (in English) from my sponsor (PAAET) to conduct the experiment in state of Kuwait in primary school.....	278
<b>Appendix 20:</b> Approval letter (in Arabic) from my sponsor (PAAET) to conduct the experiment in state of Kuwait in primary school.....	279
<b>Appendix 21:</b> The letter from college of basic education (in English) to ministry of education (assistant undersecretary for public education) to facilitate the task of experimental for this study in primary school .....	280
<b>Appendix 21:</b> The letter from college of basic education (in Arabic) to ministry of education (assistant undersecretary for public education) to facilitate the task of experimental for this study in primary school .....	281
<b>Appendix 22:</b> The approval letter (in English) from assistant undersecretary for public education ministry of education after approval of science general instructor to conduct the experiment in primary school in all sector.....	282
<b>Appendix 22:</b> The approval letter (in Arabic) from assistant undersecretary for public education ministry of education after approval of science general instructor to conduct the experiment in primary school in all sector.....	283
<b>Appendix 23:</b> Booklet guide (in Arabic) for the science teachers in how to use of interactive computer simulation software (ICSS) in science teaching in this study.....	284
<b>Appendix 23:</b> Booklet guide (in English) for the science teachers in how to use of interactive computer simulation software (ICSS) in science teaching in this study.....	293
<b>Appendix 24:</b> The simulation lesson of how flower reproduce the seeds and fruits as pilot study before conducted the main experiment .....	302
<b>appendix 25:</b> The worksheet for lesson of how flower reproduce the seeds and fruits as pilot study before conducted the main experiment.....	303
<b>appendix 26:</b> The Q-Q Plots normality test.....	304

### List of Tables

Table 1.....	30
Table 2.....	31

Table 3.....	42
Table 4.....	90
Table 5.....	92
Table 6.....	94
Table 7.....	95
Table 8.....	121
Table 9.....	139
Table 10.....	143
Table 11.....	143
Table 12.....	144
Table 13.....	144
Table 14.....	147
Table 15.....	148
Table 16.....	155
Table 17.....	156
Table 18.....	157
Table 19.....	158
Table 20.....	159
Table 21.....	159
Table 22.....	160
Table 23.....	161
Table 24.....	161
Table 25.....	162
Table 26.....	163
Table 27.....	164
Table 28.....	166
Table 29.....	167
Table 30.....	168
Table 31.....	171
Table 32.....	172
Table 33.....	174
Table 34.....	175
Table 35.....	177
Table 36.....	178
Table 37.....	179
Table 38.....	180
Table 39.....	182
Table 40.....	183
Table 41.....	185
Table 42.....	187
<b>Table 43.....</b>	<b>195</b>

## List of Figures

<i>Figure 1.</i> Piaget's perspective for concept formation in an individual' mind.....	23
<i>Figure 2.</i> The three types of interactions in an educational environment.....	33
<i>Figure 3.</i> Dual-channel theory which are eyes and ears .....	35
<i>Figure 4.</i> Limited capacity theory on receiving information into both channels (eyes and ears).....	35
<i>Figure 5.</i> Learner engaging leads to comparing the preconceptions with new conceptions in formal education.....	36
<i>Figure 6.</i> Cognitive theory of multimedia learning model (Mayer, 2009) .....	36
<i>Figure 7</i> The benefit of using simulation is bridge the gap between theory and reality.....	71
<i>Figure 8.</i> Some instructional models for science topics with simulation software .....	99
<i>Figure 9.</i> Model of experiment of “natural changes in matter” (Source: edumedia-sciences.com) .....	100
<i>Figure 10.</i> Lesson of moon phases by computer simulation program.....	100
<i>Figure 11.</i> Design and development steps of the interactive computer simulation software .....	105
<i>Figure 12.</i> The three-way model applied to computer-initiated interactivity (Evans & Sabry, 2003) .....	109
<i>Figure 13.</i> Food Chain topic .....	110
<i>Figure 14.</i> Circulation and Digestive System topics .....	112
<i>Figure 15.</i> Electrical Circuit topic .....	112
<i>Figure 16.</i> The two different pedagogical environments used simulation software.....	114
<i>Figure 17.</i> The students' distribution in simulation in computer lab group and traditional teaching group.....	116
<i>Figure 18.</i> The students' distribution in simulation in classroom group and traditional teaching group.....	117
<i>Figure 19.</i> The current study design .....	118
<i>Figure 20.</i> Pre and post-test distribution for two experimental groups with control group.....	119
<i>Figure 21.</i> The research method of measurement tools to collect data in this study.....	123
<i>Figure 22.</i> Factors lead to the success of the interview .....	133
<i>Figure 23.</i> State of Kuwait map.....	140
<i>Figure 24.</i> Total of student by numbers and students in percentages.....	141
<i>Figure 25.</i> State of Kuwait map and the distribution of educational districts .....	142
<i>Figure 26.</i> Pre to post-test effect size for simulation in computer lab and using traditional teaching .....	165
<i>Figure 27.</i> Pre to post-test effect size for simulation in classroom and using traditional teaching .....	166
<i>Figure 28.</i> The effect size of the difference between using simulation in computer lab and control; group .....	168
<i>Figure 29.</i> The effect size of the difference between using simulation in classroom and using traditional teaching .....	169
<i>Figure 30.</i> Question 4; which measured the change of Artery understanding.....	173

*Figure 31.* Question 5; which measured the flow direction of a current through conductors ..... 177

*Figure 32.* The effect size estimates between simulation in computer lab and using traditional teaching..... 180

*Figure 33.* The effect size estimates between simulation in classroom and traditional teaching ..... 181

*Figure 34.* The effect size estimates between first experimental group and second experimental group..... 182

*Figure 35.* Aida’s use of showroom of school ..... 202

*Figure 36.* The TV screen used in traditional science lab. As used by Mariam ..... 202

# **CHAPTER ONE: INTRODUCTION TO THE STUDY**

## **1.1 Introduction**

This chapter describes today's educational reforms in science education in Kuwait, followed by challenges to teachers when it comes to implementing the aims of science education reform. It also describes the aims of the study, the research questions, the hypotheses and the significance of the study. In addition, it defines some terms.

## **1.2 Educational reforms in science teaching in Kuwait**

The State of Kuwait is one of many nations around the world that have attempted to improve the quality of education, including primary education, to keep up with global competition (see Appendix 1). At the beginning of the twenty-first century, we are entering a new era of reform in science education. Both the content and pedagogy of science teaching and learning are being considered, investigated and scrutinised, and there have been international projects and efforts to establish standards to shape and rejuvenate science education. For example, the National Science Education Standards (NRC, 1996) and the 2061 project (American Association for the Advancement of Science [AAAS], 1990) reaffirm the conviction that inquiry in general, and inquiry in the context of practical work through scientific processes (e.g., observing, measuring, manipulating and so forth) in science education, are essential to the achievement of scientific literacy (Hofstein & Naaman, 2007). A project by the National Science Teachers Association (NSTA) entitled *Scope, Sequence & Coordination*, included ten main ideas about science teaching derived from contemporary educational theories. Among these are mentioned constructivism, conceptual change and inquiry teaching.

The State of Kuwait has recently made some essential reforms in science education in primary schools, under the responsibility of the Department of Curriculum Development in the Ministry of Education (MOE). MOE has worked on changing the science curriculum for all the primary stages in order to improve and develop science education. A new curriculum started in the academic year 2008/2009 (see Appendix 2). In relation to this, MOE developed a document entitled a National Document to Construct the Science



Curriculum in the State of Kuwait (NDCSC, 2011), in partnership with science education researchers from the Educational Researches and Curriculum Department. The document highlights the key aims and concepts of science teaching in the new science curriculum in primary schools and gives advice on how it should be implemented

The general aim of the curriculum is described in the NDCSC document as “to prepare a generation equipped with scientific and technological knowledge, which is capable of dealing with developments with confidence and competence; able to continue learning in a variety of scientific disciplines and prepared to support national scientific efficiencies in order to meet the needs of the local labour market in the field of scientific disciplines” (NDCSC, 2011, p. 25).

Five bases, namely, the philosophical, psychological, social, cognitive and pedagogical base, are put forward as fundamental. The pedagogical base has most interest for the current study. It suggests science teachers should adopt two particular strategies in their teaching. First, they should use scientific inquiry and practical work to provide students with grounding in scientific processes such as observation, measurement, setting the hypotheses and learning the skills needed to conduct experiments. Second, they should adapt ‘constructivist’ teaching and focus on ‘conceptual change’. Meadows (2004) asserted that constructivism is one of the most important theoretical perspectives in primary school science teaching today, describing how every learner constructs ideas from their daily observations and social interactions. Conceptual change theory (Posner, Strike, Hewson, & Gertzog, 1982) aligns with constructivism and sees learning as models in continuous development (both perspectives will be described more in-depth later).

Together these two strategies are supposed to transform the science classroom from didactic, traditional teaching to student-centred teaching that supports active learning. A long list of hoped-for outcomes is described (NDCSC, 2011, p. 45):

1. Motivation of students and increased interest in studying science.
2. Improvement of student’s performance and attainment.
3. Development of students’ creativity and scientific imaginations.
4. Conceptual development and changes to students’ misconceptions

5. Encouragement of scientific thinking when presenting science topics.
6. Opportunities for self-learning and development of life-long learning skills
7. Teaching that builds on and links learning with preconceptions or previous knowledge of science topics.
8. Active learning in which students conduct their own search for information rather than receiving it from the teacher.
9. Use of cooperative education methods in dialogue and experimental work.
10. Use of inquiry and critical thinking in science teaching

The strategies are supported also by Barrak, the General Supervisor for Science (2008). He sees development of students' inquiry skills, with inference, manipulation and interpretation of experimental data through practical work in the laboratory, as a key route to achieve both understanding of basic scientific concepts and problem-solving in the real world. In addition, he maintains that students' involvement and engagement in experiments leads them to develop and improve their observation skills and therefore play an important role in facing and changing misconceptions.

The strategies and the intended outcome suggested in the support document are desirable but raise two important questions. Firstly, how easily they are implemented into educational practice and, secondly, if they will have the hoped for effects

### **1.3 Challenges for science teaching in Kuwait—statement of the problem**

Putting the ideals aside and looking at the current situation in science education in the primary classrooms in Kuwait gives a very different picture. This is accepted also by the Ministry of Education, which describes science teaching in Kuwait as follows:

- Students are encouraged to memorise scientific facts without linking them to the concepts and general frameworks;
- The method of inquiry that encourages and develops scientific thinking is ignored;

- The teaching does not link science with their everyday lives and students are proven not to use scientific terminology out of school;
- Students demonstrate decreasing attitudes toward science teaching and learning through the school years and,
- Some teachers have negative attitudes toward the science curriculum and teaching of science (NDCSC, 2011, p. 24).

Shabaan and Abdelrazik (2008) conducted a survey to examine the views of science teachers and academic experts regarding the educational reform in science education and asked if they thought it would be possible to achieve its aims. Their findings suggest there are two main challenges that need to be overcome.

The first challenge is the strong position of traditional didactic teaching methods in Kuwait, which allows teachers to be in control of the teaching. 'Constructivist' teaching and student active learning demand that teachers give away this control and become facilitators and assistants to students' learning. In the new regime, they should direct questions to the students and then watch and listen to discern their experiences and preconceptions of the topic. This new approach means a fundamental change of attitude and introduction of a new educational culture that both teachers and students will have to learn. Teachers who participated in Shabaan and Abdelrazik's survey also claimed that there are practical reasons they hold on to traditional teaching. These include the large number of students in the science class, limited teaching time and preventing engagement with all students; deficiencies in educational equipment and teaching aids, as well as the large number of administrative tasks science teachers have to perform. Shabaan and Abdelrazik concluded that teachers use the traditional teaching methods to enable them to overcome the classroom management problems that are likely to occur at any time due to the large number of students. They also use traditional methods because it helps them cover topics very quickly and to finish curriculum topics in time for the summative assessment. The teachers, however, acknowledge that this prevents them from taking into account individual differences among students.

The second challenge is that primary schools are ill prepared to provide students with practical work and investigations. The survey by Shabaan and Abdelrazik points towards

several reasons for this. The main reasons are lack of equipment and materials and the high number of students in each class. Doing practical work with many students under the age of 11 years, teachers claimed, raises safety issues. It also makes a problem with enough time to teach all topics. Some of the science teachers in the survey also pointed towards teachers' competency and the need for professional development and training to deal with practical work and the new science curriculum in general. They added that the Ministry of Education has offered a one-week training course on how to deal with the new science curriculum exclusively for the Head of the Science Department, but that this training has not benefited the ordinary teacher. It is therefore insufficient as a preparation for the teachers who are expected to deal with the new science curriculum.

My own experience in primary science and from visiting many schools and discussing these issues with teachers and educators, although informally, supports Shabaan and Abdelrazik's findings. Firstly, many problems can be related to the high number of students in the classroom, which is normally controlled by one teacher alone. The student ratio raises classroom management problems for practical work teaching and makes it difficult for science teachers to observe every student during experiments. It also gives few opportunities to listen to and answer students' questions. Secondly, teachers frequently mention the limited time for lessons. For example, they find it impossible to carry out experiments in the limited amount of time and still teach all topics; science teachers therefore rely on oral explanations and make use of science textbooks as the only source of information. They also exclude field trips for the same reason. Thirdly, visits to schools confirm the lack of equipment and tools for practical work. Primary schools may have a science laboratory but this is poorly equipped and insufficient to serve the high number of classes. There is no tradition for laboratory assistants to arrange or prepare the laboratory work. Fourthly, the visits to school and conversations with teachers also confirm the worries about safety and security standards. There is, for example, rarely a first aid kit in the laboratory for the primary level. The teachers, therefore, do not want to bear any responsibility for an accident, as the laboratory may contain substances that are unsafe for use by primary school students. It is also relevant that 92% of science teachers in primary schools are women (Educational Statistical Group, MOE, 2009/2008). The social attitudes toward women in Kuwait may have an influence on conducting of experiments, especially in light of the unsuitable and uncomfortable laboratories.

Overall, it is clear that the obstacles and problems for introducing the new science curriculum with focus on practical work and constructivist teaching are fundamental and not easy to overcome. Adding to these problems is research which generally suggests expectations for practical work are often raised too high. Millar and Driver (1987) demonstrate how many science educators in the 1970s and 80s had a naïve belief in ‘discovery teaching’ and students’ use of ‘science processes’ as the best routes to learning. However, as they explain, these pedagogical ideas were set in faulty understanding of both learning and science methods. Few studies, if any, could prove that training in science processes actually improved students’ conceptual learning. Twenty years later, Abrahams and Millar (2008) have suggested practical work is often carried out without the promised effect on students’ learning. The problem, they claim, is not spending enough time to reflect on methods and findings. Practical work too often becomes ‘hands on’ but not ‘minds on’. If practical work is to work efficiently, “Teachers need to devote a greater proportion of the lesson time to helping students use ideas associated with the phenomena they have produced, rather than seeing the successful production of the phenomena as an end in itself” (Abrahams and Millar, 2008, p. 1967).

#### **1.4 The role of information and communication technology simulation in overcoming science teachers’ challenges in Kuwait**

This contrast between, on one side, the positive belief in constructivist teaching and practical work in science education and, on the other hand, the difficulties of making these strategies work in practice, paves the way for the topic of this research study, which looks at the role of ICT simulations. The contention of the study is that ICT simulations serve as an alternative tool that is less demanding than practical work but which can still support many of the ideals for constructivist teaching. The study is not a comparison between practical work and ICT teaching, but rather an investigation into ICT simulations as a teaching tool that can fill some of the roles practical work is *intended* to have in the new science curriculum. There is a rich research basis to suggest that ICT simulations generally have a potential to support students’ learning of science as well as their attitudes towards the subject (Bell & Trundle, 2008; Cepni, Tas, & Kose, 2006; Chang, 2001; Farrokhnia & Esmailpour, 2010; Taskin & Kandemir, 2010; Tekos & Solomonidou, 2009; Trundle & Bell, 2010; Windschitl & Andre, 1998; Zacharia, 2005, 2007; Zacharia & Anderson, 2003).

The question, however, is if this tool has the same potential to overcome the challenges in primary science in Kuwait. As already mentioned, the Kuwaiti educational system has a strict didactic teaching culture and using practical work to introduce constructivist teaching and support conceptual change faces many social and practical obstacles. ICT simulations may therefore serve as an alternative that may fulfil, if not all, at least some of the intentions of the Ministry of Education for renewing the science curriculum.

The current study, therefore, attempts to contribute to implementation of the science education reform in Kuwait by using Interactive Computer Simulation Software (ICSS) in the teaching. The objective is to determine whether such simulation software will help and motivate primary students to learn science within the cultural context of Kuwait and within the pedagogical ideals put forward by the Ministry of Education. The main research question can be formulated as follows: What effect does the use of ICSS, as compared to the traditional, didactic teaching methods, have on students' academic achievement and their attitude toward science teaching and learning? A particular interest is supporting students' conceptual change in science and making the simulation software work as a tool that stimulates constructivist teaching. The study is based on intervention research, but takes a broad perspective by including opinions and impressions of the science teachers and students in addition to effects on students' achievement.

### **1.5 The aim of the study**

This study aims to investigate interactive computer simulation software as a tool for implementing new curriculum ideas, improving academic achievement, supporting conceptual change and improving attitudes toward science teaching and learning of the students in Grade 5 in primary school in the State of Kuwait. The study regards ICSS as an alternative to practical work and suggests many of the aspired aims by MOE can be achieved with appropriate use of ICT.

To achieve the aim of this study, full cooperation and agreement were achieved by the officials of science teaching development in MOE and the science teachers in eight primary schools in the State of Kuwait (see appendices 3, 4, 5, 6, 7, 8, 9 and 10).

### **1.6 Research questions**

The main research questions are: What effect does the use of ICSS, compared to the traditional teaching method in science teaching and learning, have on students' academic achievement, on changing misconceptions, and on improving attitudes toward science teaching and learning? In addition, to discuss the opinions and impressions of the science teachers and students in the experimental group of the use of simulation software in science teaching and learning in Grade 5 in primary schools in Kuwait.

The study will investigate ICSS used in two different pedagogical contexts. The first using simulation in a computer lab; where both teacher and students use ICSS in a computer laboratory through blended learning which involves a mixture of group instruction (teacher-centred approach) and individual learning (constructivist student-centred). The teacher would explain the topic using the ICSS in 20 minutes of time followed by 20 minutes of self-study by students using the ICSS with the worksheet and science textbook (total lesson time of 40 minutes). I will refer to this as "Using simulation in the computer lab". The second is using ICSS in the classroom. Here the teacher uses the ICSS in a classroom as an educational tool throughout a whole class to illustrate the science subject for students as a supplement to the traditional method. I will refer to this as "Using simulation in the classroom". Each of them is matched with a control group (Cg) using traditional teaching where the teacher used the science textbook, 'chalk and talk' method, without computer simulation, commonly known as the traditional didactic teaching method, because there is neither a computer laboratory nor any equipment in the school for teaching and learning science. I will refer to this as "Traditional teaching". Therefore, the sub research questions are:

RQ1: How does using ICSS affect the science students' academic achievement in *using simulation in the computer lab* compared to *traditional teaching methods*?

RQ2: How does using ICSS affect the science students' academic achievement in *using simulation in the classroom* compared to *traditional teaching methods*?

RQ3: Do the students who are using ICSS *simulation in the computer lab* demonstrate better academic achievement than the students who used ICSS *simulation in the classroom*?

RQ4: How does ICSS affect students' misconceptions in science *using simulation in the computer lab* and *using simulation in the classroom* compared to *traditional teaching methods*?

RQ5: How does using ICSS affect students' attitudes towards science teaching and learning in terms of *using simulation in the computer lab* and *using simulation in the classroom* compared to *traditional teaching methods*?

RQ6: How does using ICSS affect students' attitudes towards science teaching and learning as regards *using simulation in the computer lab* and *using simulation in the classroom*?

RQ7: What are primary school students' opinions of and experiences with science teaching using ICSS? In other words, do they prefer science teaching and learning with the ICSS method or with the traditional instruction method?

RQ8: What are primary school science teachers' opinions of and experiences with science teaching using ICSS?

### **1.7 The Hypotheses**

Based on the research questions, and when using ICSS in science teaching and learning under good and appropriate conditions, the hypotheses for this study will be as follows:

H1: Regarding the post-test of students' academic achievement, I suppose that there is a statistically significant difference (at the 0.05 level) between students who use simulation in a computer lab and students who use traditional teaching methods, with regard to the post-test of students' academic achievement in favour of students who use simulation in a computer lab.

H2: Regarding the post-test of students' academic achievement, I suppose that there is a statistically significant difference (at the 0.05 level) between students who use simulation in the classroom and students who use traditional teaching methods, with regard to the post-test of students' academic achievement in favour of students who use simulation in the classroom.

H3: Also, when comparing the experimental groups, I suppose that there is a statistically significant difference (at the 0.05 level) between students who use simulation in the computer lab and students who use simulation in the classroom, with regard to the post-test of students' academic achievement in favour of the students who use simulation in the computer lab.



H4: Regarding students' understanding and conceptual change from misconceptions to correct scientific conceptions, the study supposes that using ICSS appropriately in science teaching and learning, whether it uses simulation in the computer lab or in the classroom, will effectively support an increase in students' understanding and conceptual change from misconceptions to correct scientific conceptions more effectively than traditional teaching method.

H5: Regarding students' attitudes towards science learning, this study supposes that there is a statistically significant difference (at the 0.05 level) between students who use simulation in a computer lab and who use simulation in the classroom, compared with who use traditional teaching methods, with regard to the students' attitudes towards science learning in favour of students who use simulation in both the computer lab or the classroom (experimental groups).

H6: Also, when comparing experimental groups, I suppose that there is a statistically significant difference (at the 0.05 level) between students who use simulation in the computer lab and students who use simulation in the classroom with regard to the students' attitudes towards science in favour of the students who use simulation in the computer lab.

H7: Moreover, students' opinions or impressions of science teaching and learning with ICSS will be positive, and they will enjoy the learning and teaching of science through using ICSS. As well, science teachers' opinions on, or impressions of, using ICSS in science teaching will be regarded as positive and they will notice that students enjoy the lessons based on how well they learn science.

### **1.8 Significance of the study**

This study is important because it uses the interactive computer simulation software, as an alternative to real practical work in science laboratories or in a science classroom to overcome the current obstacles in science teaching in the school system. It offers a remedy for teaching in Kuwait, which has aimed for student centred pedagogy but lacks facilities and traditions for doing this.

This study is also important because it is the first experimental study using simulation software in two different pedagogical methods - using simulation in the computer lab and using simulation in the classroom - in the State of Kuwait to investigate the effects of using

simulation software as an alternative to practical work in actual science laboratories. The results of the study are therefore expected to help clarify this issue for policy-makers in MOE. It is expected that the results of this study will clarify the extent to which simulation software might promote students' academic achievement and positive attitudes. Moreover, this study will pave the way for more research and studies in the future in areas such as the use of modern technology in primary schools, which is in high demand and a current trend in the State of Kuwait.

### **1.9 Definitions of terms**

- **Interactive computer simulation software**

Computer software for science teaching provides models of real-world processes. These processes include natural phenomena (e.g. the water cycle, climate change and the lunar eclipses), precise chemical experiments (including chemical and physical changes such as freezing and corrosion), experiments with molecules and nuclear fission, and human biological processes (such as the digestive system and the functioning of the heart) (Almosa, 2005). Simulation software allows learners to manipulate and change initial conditions and immediately see the impact of these changes (Zacharia, 2005). The terms of the interaction means that the student can control and manipulate by using a simulation program. I will refer to this as "*ICSS program or simulation*"

- **Traditional teaching**

Also called "conventional teaching", the simple definition of the traditional teaching method is face-to-face teaching. It means the teacher explains the lesson orally and students learn through listening with only a science textbook. Science teachers use this method in the classroom. In this study, the students meet with the teacher in class, and they rely on the teacher for traditional or didactic teaching method and a science textbook to give them the knowledge, concepts and information they need (without ICT).

- **Blended teaching**

Blended teaching is considered to be any combination of methods, strategies or modes used for teaching and learning. These include the use of the traditional face-to-face approach in combination with some form of technology, such as a computer-based simulation (Duhaney, 2012). It has been defined as the combination of e-learning tools, such as simulation teaching environments, with face-to-face teaching (i.e., traditional teaching)

(Graham, 2004; Welker and Berardino, 2006). It is also defined as an integration or mixture of two methods whereby, for example, the traditional method is integrated with computer-based activities. This allows students to benefit from both methods (Abood, 2007). In the current study blended teaching will be a mixture of a traditional teacher-centered style and a constructivist student-centered style supported by simulation program (ICSS). 20 minutes are spent on each method (total lesson time of 40 minutes). The goal of this is to reduce student dependence on science teachers in the educational environment, allowing them the opportunity to construct knowledge by using simulation.

- **Attitude**

Kind, Jones, & Barmby (2007) defined *attitude* as the, “Student’s feeling about an object (such as science learning) depending on his beliefs about that object (science teaching and learning)”. It is not a physical thing, but a set of beliefs that the object is either good or bad (Culbertson, 1968). It is a response toward an object that produces either a favourable or an unfavourable feeling (Fishbein & Ajzen, 1975). In this study, *attitude* refers to the feeling students had about using the interactive computer simulation software in science teaching and learning. The students either liked it (favourable) or disliked it (unfavourable).

## **1.10 Overview of the thesis**

- **Introductory chapter**

The first chapter is the introduction and includes a discussion of the significance of the study and a presentation of the research aims and questions, the scope of the study and a brief explanation of the terms used in the study.

- **Theoretical framework**

Chapter 2 presents the theories underlying the design and implementation of the current study. One key focus is constructivism and conceptual change because the study tries to understand how a child develops knowledge through use of simulations in science. Another focus is multimedia learning, which explains how students learn through using multiple senses

- **Previous study**

Due to the lack of similar studies in Kuwait or in other Arab countries that examine the effectiveness of the use of simulation in science education, Chapter 3 relies mostly on

previous studies from other countries. Studies will be reviewed and classified according to: (a) simulation that aims to improve students' academic achievement; (b) simulation supporting conceptual change; (c) simulation used as an alternative to a real science lab to raise students' achievement and improve students' attitudes toward science learning and teaching and (d) some Arabic studies with use of ICT.

- **The intervention - teaching science with ICSS**

Chapter 4 shows the main rationale behind the use of ICSS as an educational tool for use in science teaching in Kuwait primary schools and how the current study was presented. Followed by the outline of the development process or procedure that was used in designing and implementing the ICSS properly and appropriately of the Kuwait education environment in the teaching of science in the Kuwaiti primary schools environment.

- **Methodology**

Chapter 5 presents the methodology used to investigate the impact and effectiveness of ICSS as an intervention or treatment tool in primary school science teaching in Kuwait. Therefore, this chapter begins with a presentation of design and then explains the methods of data gathering and then there follows a presentation of data analysis. These sections will be followed by an explanation of how samples were selected from the population, followed by the validity and reliability of measurement tools in addition to ethical and organisational considerations in order to examine the effect of ICSS in the three main dependent variables, which were: students' academic achievement in science; students' conceptual change and students' attitude toward science teaching and learning. Furthermore, the effect that computer simulations have on science teaching and learning is also investigated.

- **Data analysis**

Chapter 6 presents the analysis of data. It starts with a normality test to decide which kind of test to use in SPSS (i.e. parametric or non-parametric) and with comparing test groups at the baseline (pre-test) of the intervention study. Thereafter, the chapter includes data presentation and analysis of all the research questions mentioned above.

- **Data discussion**

Chapter 7 presents the discussion of the results, with findings of the current study for all the research questions, and presentation of major implications that have significance for both

decision makers at the MOE and researchers at the local (Kuwait) and international level, in the field of educational computer-based simulation programs in science education.

- **Conclusion & Implication**

Chapter 8 provides the study conclusion, including a summary of the results obtained in this research. Furthermore, the chapter reviews the strengths and weaknesses of the current study in order to add important recommendations and proposals for implications for future research in this field, as suggested by the findings.

## **CHAPTER TWO: THEORETICAL FRAMEWORK**

### **2.1 Introduction**

In this chapter, I will outline the theoretical framework underlying the design and implementation of the current study. As mentioned, a background for the study is demand of officials in MOE in Kuwait for science teachers to focus on conceptual change through using constructivist teaching. I will therefore begin by presenting constructivist theory and related issues in science education. Focus will be in particular students entering formal science education carrying with them considerable alternative knowledge or beliefs about phenomena and concepts, called preconceptions or pre-knowledge. The formation of these preconceptions can be explained through two major perspectives; the first being Piaget's perspective cognitive constructivist view emphasizing the unique way knowledge is configured and evolves within the individual learner. The second is Vygotsky's sociocultural constructivist view emphasizing the development of shared knowledge through social interaction; these two perspectives complement each other (Cobb, 1994). Thus, the constructivist view describes how every learner constructs ideas from their daily observations and social interactions (Selley, 2004). Richardson (1997) suggests that individuals create their new understandings through the interaction of what they already know and believe, and the phenomena or ideas with which they come into contact. Such preconceptions, or pre-knowledge, are formed and stored in the students' minds (in long-term memory). The majority of these preconceptions are poorly articulated, internally inconsistent, and highly context-dependent; hence, they are considered misconceptions, but they offer powerful explanations to the students. These preconceptions usually influence what students learn through teaching, and they are also resistant to change (Jaakkola & Nurmi, 2007; Tekos & Solomonidou, 2009); from this phenomenon emerged the conceptual change theory (Posner, Strike, Hewson, & Gertzog, 1982).

Therefore, if a science teacher – in a primary school in Kuwait, for instance - aims to change the students' misconceptions, they should take into account the students' experiences and preconceptions about the topic which is being taught. This happens when science teachers adopt a constructivist approach teaching instead of a traditional approach,

which based on that learning occurs when learners are actively involved in a process of meaning and knowledge construction as opposed to passively receiving information, but teachers must motivate students by asking them questions and discussing with them their responses with an aim to determine their misconceptions and find the best way to remedy those misconceptions.

Thus, teachers should use evidence to convince students that the concepts that they possess may be scientifically wrong and need to be remedied. Such evidence can come from educational aids and tools. In science, practical work offers evidence in order to obtain scientific knowledge, where students individually or by groups to perform an experiment and then come together as a classroom to discuss the results with each other and with the teachers as well, and this considered one of the forms of constructivist classrooms activities. In other words, students can achieve the objectives of the lesson through the use of physical objects, incorporating scientific ideas to guide their actions and help them reflect upon the data they collect, but on condition providing sufficient time for students to reflect on the results of the data obtained (Abraham & Millar, 2008). Consequently, students will be able to judge between their previous concepts - which they constructed before entering school - and what they see and observe in the classroom and they will be more willing to confront discrepant events that contradict their preconceptions. Ideally, once the students realise that their pre-existing ideas are incorrect or require amendment, over time their ideas will be transformed into correct scientific concepts. Indeed, this is what is called conceptual conflict, and it leads to conceptual change. This is what is missing in science education in Kuwait.

This chapter will also address learning theories used to support computer simulation in education. Computer simulation sends information in two forms One form is visually in static images, animation, graphics, or printed text, that display on a computer screen. The other form is sound, either with, music, sound effect or human voice. By sending information to the student through multiple senses, simulation can be an effective tool for teaching the science topics which in new science curriculum in Kuwait. In order to promote and develop the students' cognitive learning processes through the design and implementation of the instructional simulation (or instructional ICSS) included adoption of the twelve principles of the cognitive theory of multimedia learning (CTML) (Mayer,

2009). And to avoid any negative impact on teaching processes resulting from the use of simulation as an ICT.

## **2.2 The Constructivist Theory of Learning**

Constructivism is a view of learning which believes that learners create or construct new knowledge (Glaserfeld, 1984). Windschitl and Andre (1998) define the term constructivism by saying that learners construct their knowledge and conceptions through daily experiences individually or interpersonally, and by reasoning about those experiences. Rovai (2007) reiterates that learned information or knowledge is constructed by the individual through interaction with the environment surrounding him or her. In other words, constructivism focuses on “how people learn” or “how people obtain knowledge or concepts”. Hence, from the constructivist perspective, the learner is an active processor of information and knowledge.

Two main contributors to the constructivist learning theory are: Piaget, who suggests that the cognitive development of children takes place during the adaptation with the world around them through processes of assimilation and accommodation during their stages of growth. The second, Vygotsky, agrees with Piaget’s theory. However, Vygotsky adds that knowledge construction occurs within a social-cultural context, with other people, such as parents or peers (i.e., someone who is knowledgeable), having an influence. Emphasis is placed upon social interaction between the learner and others through dialogue (language).

The current study adopts both Piaget’s and Vygotsky’s perspectives of constructivist learning theory. The reason for this is that, as Cobb (1994) points out, they complement each other in constructing knowledge. Piaget's cognitive constructivism includes two major parts: The first part is the *developmental stage theory*, which predicts what children can and cannot understand at different ages; the second part is the *adaptation theory*, which describes how learners develop cognitive abilities through adaptation to new situations or events around them. During this adaptation, processes of assimilation and accommodation occur, leading to the development of constructs of knowledge; this is the heart of constructivist thinking. Adaptation relates to the stage theory, which describes how the abilities of children develop, leading children to develop more concepts and to adapt further to the world - through feeling the need to gain more knowledge. In light of this, teachers,



especially at the primary level, should know students' characteristics in how they construct knowledge before and after they enter formal education, in order to select the appropriate educational tools and ways to teach them. Piaget divided growth into four phases; the focus in the current study will be on the second (2 to 7 years old) and third (7 to 11 years old) phases, since the second phase addresses students' characteristics in gain and construct knowledge before they enter formal education and the third phase addresses students' characteristics in the early years of school. The children in the sample population in the current study are 10 to 11 years old, in Piaget's third phase.

In the stage theory, Piaget suggests that children's cognitive development takes place during the stages of growth (i.e., through the child's intellectual development). Piaget divided the growth phases into four phases, of which the important phase for this study is the second phase, which is from two to seven years of age. It is during this phase that children have own imaginative world and intuitive thought to draw on their experience of the world around them in many different forms, by themselves (e.g. use trial and error with limited knowledge) or by asking of help to know something from person who is not a specialist in this thing (informal education), in attempt to work to make sense of what they perceive in order to build knowledge and conceptions of what is around them before they enter formal education. Thus, the majority of such knowledge and concepts are misconceptions, or not scientifically valid of what characterizes a child at this stage on egocentrism and animism in add to imaginative and intuitive thought (more details below). The four growth phases (Pritchard, 2005; Yacoob, 1982) are categorised as follows:

- **First phase** - Birth to two years of age, called the sensory-motor phase:

In this phase, infants construct an understanding of the world by using sensory experiences, such as; seeing and hearing, and also motor actions such as reaching and touching. Piaget believed that in the beginning of this stage, infants show little more than reflexive patterns to adapt to the world. By the end of the stage, they display far more complex sensorimotor patterns.

- **Second phase** - Two to seven years, the pre-operational phase:

The pre-operational phase is more symbolic than sensorimotor thought. It is egocentric and intuitive rather than logical. This phase can be subdivided into two sub-phases: *symbolic function* and *intuitive thought*. Symbolic function sub-phase occurs mostly between two

and four years of age. The young child gains the ability to mentally represent an object that is not present. Also, expanded use of language and the emergence of pretend play are other examples of an increase in symbolic thought during this sub-stage. The young child has their own imaginative world that appears through their use of scribbled designs to represent people, houses, cars, clouds, and many other aspects of the world. Their drawings are imaginary and inventive with blue Suns, green cars, floating cars, and so on.

Despite young children making distinctive progress, their pre-operational thought still has two important limitations: the first is *egocentrism*. The child in this phase is finding it difficult to distinguish between their own perspective and someone else's perspective. The second is *animism*, which means that the child believes that inanimate objects have "lifelike" qualities and are capable of action. For example a child may say, "That tree pushed the leaf off and it fell down".

The Intuitive thought sub-phase starts at around four years old, lasting until the child is about seven. In this period, the child (four to seven years) begins using primitive reasoning and wants to know the answers to all sorts of questions. One of the characteristic of this phase - by about five years - is the child asking a lot of questions to parents or peers with "why?". "Why?" questions signal the emergence of the child's interest in figuring out why things are the way they are. Piaget suggests that children seem so sure about their knowledge and understanding, but are unaware of how and what they know. That is, they say they know something but know it without the use of rational thinking.

- **Third phase** - Seven to eleven years, the concrete operations phase:

In this phase children begin to use logical reasoning to replace intuitive reasoning, but only in concrete situations. Classification skills are present, but abstract problems are difficult. I will examine this phase in more detail in the section on conceptual change.

- **Fourth and final phase** - 11 and older, the formal operations phase:

Children are able to think hypothetically and abstractly, although this is limited by lack of depth and breadth in knowledge.

Regarding the development of cognitive abilities, Piaget's theory of cognitive development proposes that humans cannot be given information which they immediately understand and use, because they do not master the necessary cognitive processes therefore learners

constructing their own knowledge. They build their knowledge through experience. Experiences enable them to create schemas (i.e., mental models of the world), and these schemas are changed, enlarged, and made more sophisticated through two complimentary processes: *assimilation* and *accommodation* (Pritchard, 2005).

According to Piaget's view, the learning process occurs when all the growth phases in children are aimed at adjustment or adaptation to the environmental changes and effects which surround them. Therefore, the learning process is a permanent, continuous, and active process within the individual. But, although strength of Piaget's theory is that he accounted for both biological and environmental factors in the development of intelligence. These factors are: Maturation of the brain and Interaction with the environment. However, in the last two decades, there have been some objections raised against Piaget's stage theory. For example Donaldson (1978), a critic of Piaget's, claims that the three mountains task - which Piaget's used to test whether children were egocentric or not - was unrealistic and not related to a child's everyday experience. She claims that Hughes' study, where children had to hide a doll from policemen was more realistic. In this study 90% of 3 and half to 5 year olds were able to hide the doll successfully. Also, a study of egocentrism by Marvin (1975) found that some 4 year olds chose present that were suitable for their mothers, and not suitable for themselves.

The current study will focus on the phase preceding the child's enrolment in school, namely the second phase (from two to seven years) because this stage (2-7 years old) precedes the target group stage (aged 10-11 years). In the current study and it is necessary to knowing the characteristics of the students before they enter formal education in order to find best way in teaching them through dealing with their preconceptions and pre-knowledge.

As mentioned above, in this phase, especially during the age between five to seven years children are becoming able to use their primitive reasoning and imagination in an attempt to understand and interpret phenomena, events, and situations which occur around them, or the problems which face them. Hence, using imagination and primitive reasoning leads to the formation of many new concepts and "schemas" - as Piaget called them. Pritchard (2005) describe a schema as a:

“theoretical multidimensional store for almost innumerable items of knowledge which located in the long-term memory in children minds. It seems as a framework

with numerous nodes and even more numerous connections between nodes. At each node, there is a discrete piece of information or an idea. The piece of information can be in any one of a range of different forms such as image, sound, smell, feeling and so on. Each node is connected to many other and the connections are made as a result of there being a meaningful link between the connected items.” (p. 26)

Because of different understanding of topics or ideas between the children, it is natural that schema can be different between them.

The schemas grow and link with each other. It is this process of adding items to schemas and connecting them to other items that constitutes adaptation process and then constructivist.

But, how do schemas grow and link to each other? Or in other words, what is behind the cognitive development of humans in gaining more knowledge? Before I answer this question it is useful to look more closely on schemas and their characteristics. Mayer (1983) describes schemas using four factors: the first is *general*; meaning they are used in an extensive variety of situations as a framework for understanding incoming information. The second is *knowledge*; they exist in long-term memory as something that a person knows. The third is *structure*; a schema is organised around some theme. The fourth is *comprehension*; schemas contain slots which are filled in by specific information.

Pritchard (2005, P. 27) similarly explains that schemas are:

- Based on our general world knowledge and experiences.
- Generalised knowledge about situations, objects, events, feelings, and actions.
- Incomplete and constantly evolving.
- Personal.
- Not usually totally accurate representations of a phenomenon.
- Typically contain inaccuracies and contradictions (misconceptions).
- Provide simplified explanation of complex phenomena.
- Contain uncertainty but are used even if incorrect.
- Guide our understanding of new information by providing an explanation of what is happening, what it means, and what is likely to result.

An existing schema represents the sum of a young child's current state of knowledge and

understanding of a particular topic, event, action, etc., is considered as prior-knowledge or preconceptions when entering into formal education. So prior-knowledge or preconceptions exist within the schemas. In the next paragraph I will use the words "prior-knowledge or preconceptions" instead of referring to schemas, and I will discuss how schemas grow or expand through cognitive development in humans, and hence how learning takes place in the mind, according to Piaget's perspective.

Prior knowledge is essential and plays a key role in constructivist learning. The process of cognitive development through Piaget's perspective is continuous, permanent, and active throughout the growth of children in order to help them adapt to the environment surrounding them. In a situation where the child faces a specific problem, or observes a specific phenomenon or event occurring which cannot be solved using the pre-knowledge and pre-information, disequilibrium or instability occurs. Consequently, the child must find an interpretation for the specific problem, phenomenon, or event which s/he faced. Hence, this situation urges the child on and motivates his/her curiosity, and causes the child to seek answers or make enquiries through questions like "why?" and "how?" and experiments – with the aim of reaching the solution or the interpretation necessary to reach the equilibrium phase or stability by himself. If s/he does not find a suitable answer or interpretation through previous experience and experimentation, s/he seeks to others such as parents, siblings, peers, instructors, books, or any possible technological means, to get the necessary solution or interpretation for the problem or event which caused him/her to feeling disequilibrium or instability, and return to the equilibrium state. Piaget summarized the state from disequilibrium to equilibrium as a learning process (i.e., process of cognitive development) of adjustment (adaptation) to environmental influence (Pritchard, 2005). During the process of changing the child's state from disequilibrium to equilibrium, adaptation to the surrounding environment occurs. New concepts or information are formed or created, and these changes happen through one of the two main processes inside the child's mind, namely: assimilation and accommodation (Alqmdy, 2005; Henriques, 1997; Talib, Matthews, & Secombe, 2005) (see Figure 1).

**Assimilation:** Described as weak conceptual change, the process whereby new knowledge is incorporated into existing mental structures. This means the knowledge bank is expanded or increased to include new information. In brief, it is new knowledge or concepts added to

the existing model (schema). In other words, it involves the addition of new knowledge without the involvement, changing, linking, or interaction of existing concepts (Talib et al., 2005).

**Accommodation:** Described as strong conceptual change, is the process whereby mental structure has to be altered in order to cope with a new experience that has contradicted the existing model; this means creating new knowledge or concepts in the mind. This is real learning because existing knowledge is changed. In other words, the child's existing concepts are inadequate to understand some new phenomena successfully, hence the child must replace or reorganise his/her central concepts (Talib et al., 2005).

The result of the two processes (assimilation and accommodation) is the same; that is, the child achieve knowledge equilibrium. Namely, the child reaches stability, at which point there is no longer conflict between new information and what already existed. *Equilibration* (adaptation) is the process of arriving at a stable state where there is no longer conflict between new and existing knowledge.

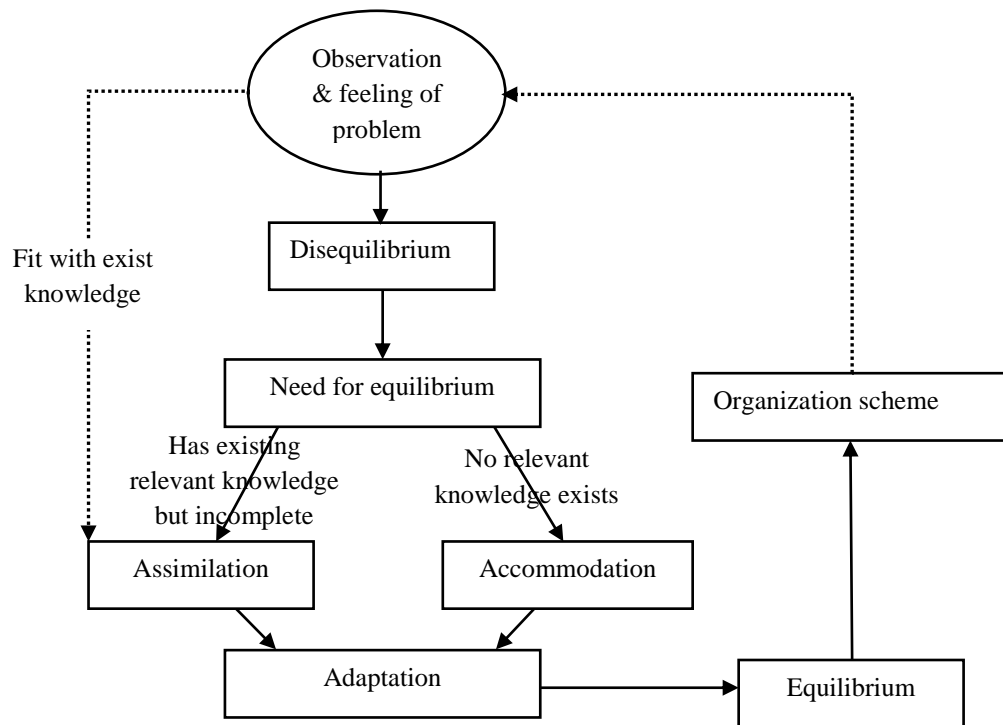

Figure 1. Piaget's perspective for concept formation in an individual' mind

Turning to Vygotsky's perspective, this agrees with many of Piaget's views but gives priority to language (as a sociocultural component of learning) in the process of intellectual development. He adds that dialogue becomes the vehicle by which ideas are considered, shared, and developed.

Understanding and constructing of new knowledge or concepts in the student's mind occurs when conversing with someone more knowledgeable on the subject of discussion. Vygotsky created the concept of the zone of proximal development (ZPD), which depicts an area or situation in which a student would have trouble solving a problem on his/her own (i.e., their pre-knowledge is not sufficient), but would be able to do so with help and support from someone more knowledgeable (e.g., a teacher). Vygotsky calls this support "scaffolding", and defines it as the process of giving support to students at the appropriate time and level of sophistication to meet the need of the individual (Becker, 2002; Pritchard, 2005). Bissell (1998) reveals that this support (scaffolding) can be in the form of cooperative learning among peers, guidance from teachers, well-structured learning environments, or strategies for helping students organize new material and relate it to prior knowledge and conceptions.

'Scaffolding' has become a term which is commonly used in research on teaching and learning in schools, and is often used loosely to describe all kinds of support that teachers may offer (Pea, 2004). But it means more specifics as Becker says, "rather than the provision of generalized support, scaffolding learning suggests actively and temporarily providing learners with just the right amount of cognitive support to bring them closer to a state of independent competence" (Becker, 2002, p.3).

There are different ways to present "scaffolding", but common methods are through discussions and through the provision of materials; supplying practical equipment to help students to solve simple problems in arithmetic or science.

The teacher may use the above methods of scaffolding during the lesson in order to engage the students (groups or individuals) in dialogue in order to understand the students' experiences of the topic which is being taught, and then provide the appropriate materials or educational aids aiming to explain the topic in a clearly way for students to create what is called a contradiction, conceptual conflict, or disequilibrium. This contradiction is between the students' own knowledge about the topic which is being taught and what they

observe and hear about the same topic during the lesson with support from teacher or educational tool, in order to makes the students to reach to a new level of understanding in the end of the lesson.

We need to take into account that “understanding” is used in many contexts and with many meanings in education. In this thesis it is defined as the product of mental processes that take place within the student’s mind and may include (Newton, 2012, P.12-13):

1 – Previous information or prior knowledge that is held by the student on the subject to be taught. Any possible topic contains ideas, elements or concepts and the student should think about the nature and the relationship between these ideas or elements or concepts and make a connection between them through the use of his or her own pre-information with the support of the teacher to reach the understanding.

2 – The student’s feeling and emotions toward the topic. This may have an effect on thinking and then of understanding. Piaget (1962) for example, noted that there is no thought without emotion.

3 – The student’s ability in thinking with and use knowledge flexibly. I mean that there are some students have learning slow or learning disorders and this need special education

4 – The student’s behaviour toward the topic (or what do students want to know?) is something related to practical skills or theoretical thinking skills. Some students understanding through hand-on work than a theory side.

In conclusion, in the importance of pre-knowledge in learning, from Piaget’s view, and the "scaffolding" idea from Vygotsky’s work, teachers have a good roadmap for teaching science. That is, to expose students to a specific problem for a particular topic, or to observe a specific phenomenon or event occurring that students cannot easily explain with their pre-knowledge and pre-information, may lead to disequilibrium or conceptual conflict. This condition prepares students to construct new knowledge or concepts that resolve the apparent conflict; this resolution returns them to a state of equilibrium.

The perspectives presented so far outlines the objectives Kuwaiti officials in MOE have in mind for science education when suggesting science teachers should focus on conceptual change using constructivist teaching. Further details, however, can be added about the issue of pre- and misconceptions.



Before encountering formal education, children have already been reflecting on, for example, how do plants grow? How does rain fall down? How does a lamp (electrical circle) operate? How does a human grow? Where does food go in the human body? How is blood transferred from the heart to the entire body? Why does a ship float on water? The answers and interpretations that children have established through imagination and explanation are the prior knowledge or preconceptions that give educators a basis on which to build knowledge. Many of these preconceptions are at least partially incorrect or scientifically unacceptable (Jaakkola & Nurmi, 2008), and then deemed misconceptions. Other have preferred to call them “alternative conceptions” (Driver, 1983; Driver, Guesne, & Tiberghien, 1985; Jimoyiannis & Komis, 2001). Hewson and Hewson (1984), however, assert that prior knowledge or preconceptions held in students’ minds are generally inadequate in terms of understanding and coherence; they are ambiguous and imprecise, and they are less extensive than accepted scientific knowledge. Moreover, Hewson and Hewson cite Champagne, Klopfer, & Gunstone (1982) and Windschitl and Andre (1998) pointing out that prior knowledge and preconceptions as having certain characteristics in the student’s mind: (a) be obtained from informal instruction in the subject; (b) poorly articulated (i.e. not clear and not in scientific terms); (c) internally inconsistent or incoherent and not match with generally accepted views on the subject; (d) be consistent across different groups of concepts; (e) be significantly resistant to change in response to traditional instruction methods; and (f) greatly dependent on context. Nevertheless, these characteristics are dominant in students’ minds and offer explanatory power.

As a consequence, such construction of misconceptions needs to change or to be amended to become acceptable and correct scientific concepts; hence, there emerged what is called the conceptual change theory.

One of the most prominent contributions to conceptual change theory comes from Posner et al (1982) who proposed the conceptual change model (CCM). The current study adopted this model of conceptual change and merged it with interactive computer simulation software in order to examine the remedy of misconceptions through utilization of computer simulation software, instead of through traditional science teaching methods that are dominant today in Kuwait.

### **2.3 Conceptual Change Model by Computer Simulation Programs**

Posner et al. (1982) introduced the concept of “conceptual change” they attempted to simplify the term of conceptual change; they agreed that a student’s conceptual ecology (i.e., something that exists naturally) is grounded in conceptual change because “Without [preconceptions of phenomena] it is impossible for the learner to ask a question about the phenomena, to know what would count as an answer to the question, or to distinguish relevant from irrelevant features of the phenomenon.” (p. 212).

DiSessa (2006) states that conceptual change refers to a process in which students build new ideas or concepts in the context of their current understanding. Liu, Hmelo-Silver (2007) state that in science education the ideal conceptual change involves students’ shifting from their initial preconceptions to scientific conceptions (i.e., scientific beliefs, ideas, or ways of thinking)

The current study concentrates on changing the concepts of science students from 10 to 11 years old; this age group is part of the third phase from Piaget’s perspective of cognitive development (7- 11 years). Therefore, the students in this age group have difficulty understanding abstract concepts or problems, I find that the new science curriculum in primary schools in Kuwait contain an abundance of abstract (i.e. intangible) concepts and new scientific terminology in various topics. These abstract concepts (such as the flow direction of electric current in the electric circuit lesson or the state of air molecules or plant pollination) are not easy for students to understand through traditional didactic teaching. This method is insufficient, and teachers need appropriate educational tools that can describe and explain to the students what is meant by these abstract concepts.

Scientific concepts are opposed or offset by pre-existing concepts and information in the mind of the student. These pre-existing concepts are characterised by strong resistance to conceptual change, and this affects the student’s ability to receive new information during the education process. At the same time, the use of traditional teaching methods is the dominant style of science teachers in primary schools in Kuwait, where the common practice is to use oral explanations, with pictures from the school’s science textbook, without trying to engage the majority of students in discussion during the lesson (see the first chapter’s “Educational reforms in science teaching in Kuwait”). Therefore the product

of science education in Kuwaiti primary schools is rote learning; this means that the learner demonstrates good retention (memorisation) and poor understanding (Mayer, 2009). In rote learning, learning depends on retaining the concepts and new information of the science subject and recalling them during tests, without initiating cognitive conflict and then changing or modifying the misunderstandings to get meaningful learning (Loveless & Ellis, 2001). This conflict on which learning can be based is the conflict between knowledge acquired before entering school and the new, correct scientific concepts that a student must learn in school; the aim is to revise the former by remedying them with the latter to obtain meaningful learning instead of rote learning (Tekos & Solomonidou, 2009).

In order to create conceptual conflict and make students dissatisfied with preconceptions the Posner et al - through CCM - suggests new scientific concepts in the learning process must include the following three conditions or characteristics:

1. New knowledge or concepts should have *intelligibility*; intelligibility means the new concept/information must be clear and understandable and make sense to students.
2. New knowledge or concepts should have *plausibility*; plausibility means the new concept/information must be reasonable and true, must match students' personal standards of knowledge, and must be consistent with students' existing conceptions.
3. New knowledge or concepts should have *fruitfulness*; the new concept should have the capacity to solve problems or predict phenomena more easily than the existing concept.

Posner and his colleagues assume that in order to successfully effect conceptual change, the three conditions for a new concept should be met and occur during the learning process. A major aim is to establish or create conceptual conflict to make students *dissatisfied*, which is akin to Piaget's disequilibrium view of existing conceptions. Many researchers therefore put dissatisfaction as a fourth condition, but I support Ozdemir and Clark (2007) in that the dissatisfaction should be the result of the three conditions above, applied during the learning process.

Several studies (e.g., Skoumios & Hatzinikita, 2005; Cindy & Silver, 2007) have shown that the use of the cognitive conflict approach supports the achievement and enhancement of conceptual change and then helps students to construct or modify old knowledge. This

means cognitive conflict creates opportunities for students to confront conflicting concepts and information on the target topic, and hence, the concepts and information are discrepant or unlike the prior knowledge they hold of the concept and their beliefs on the same topic. Thus, cognitive conflict arises when students face experimental results that are inconsistent with their expectations, which results in dissatisfaction and leads students to re-evaluate their existing knowledge.

There are, of course, limitations that science teachers are facing, and that limits or hinder the application of the constructivism approach and scaffolding in science classrooms or shift the science classroom from traditional to constructivist (see table 1) as one of the most important aims in science educational reform in Kuwait . Also, science teachers lack the necessary resources and materials that can help them present the desired concepts to students in form of intelligibility, plausibility and fruitfulness – as proposed by Posner et al - so as to make science lessons interesting and engage students in the learning process and achieve a conceptual conflict and then the conceptual change, these are some of the challenges that were cited and demanded by the officials of science education methods development in Kuwait for science education reform. Therefore, science teachers have embarked on using traditional teaching methods and science teacher role is the controlling and dominating on the classroom.

The current study attempts to use interactive computer simulation software, in applying the constructivist method, instead of traditional methods. In the other words, the study changes traditional science classrooms to constructivist classrooms through adopting a conceptual change model (Posner et al., 1982), in providing the desired concepts and information, which is thought to be more interesting for students when it comes to understand the new concepts and attempting to get meaningful learning (not rote learning). Use ICSS merged with the conceptual change model (CCM) proposed by Posner et al. (1982), an increasingly important approach used in many of the various branches of science education (as will be demonstrated by the literature review in the next chapter). The CCM has proved effective at contradicting students' early-phase misconceptions.

**Table 1***The Difference between a Traditional Classroom and a Constructivist Classroom*

Factors	Traditional Classroom	Constructivist Classroom
Curriculum	<ul style="list-style-type: none"> <li>Curriculum is presented part to whole, with emphasis on basic skills.</li> <li>Strict adherence to fixed curriculum is highly valued.</li> </ul>	<ul style="list-style-type: none"> <li>Curriculum is presented whole to part, with emphasis on big concepts.</li> <li>Pursuit of student questions is highly valued.</li> </ul>
Curricular Activities	Rely heavily on textbooks and workbooks.	Rely heavily on primary sources of data and manipulative materials [simulation program].
How Students are Viewed	Students are viewed as blank slates onto which information is etched by the teacher.	Students are viewed as thinkers with emerging theories about the world.
Teacher	<ul style="list-style-type: none"> <li>Generally behave in a didactic manner, disseminating information to students.</li> <li>Teachers seek the correct answer to validate student learning.</li> </ul>	<ul style="list-style-type: none"> <li>Teachers generally behave in an interactive manner, mediating the environment for students.</li> <li>Teachers seek the students' point of view in order to understand students' present conceptions for use in subsequent lessons.</li> </ul>
Assessment	Assessment of student learning is viewed as separate from teaching and occurs almost entirely through testing.	Assessment of student learning is interwoven with teaching and occurs through teacher observation of students at work and through student exhibitions and portfolios.
How Students Work	Students primarily work alone.	Students primarily work in groups.

**Source:** Brooks, J & Brooks, M (1993). *In search of understanding: The case for constructivist classrooms*. Alexandria, VA: ASC

Because of the huge capabilities and advantages available in computer simulation programmes (Wellington, 1985), they can provide non-traditional educational situations. Papadourisa and Constantinoub (2009) agree with Jimoyiannis and Komis (2001) that computer simulations have enormous capabilities and can provide students with several opportunities (see Table 2). Simulation programmes has potential to achieve the conditions

of conceptual change suggested by Posner and his colleagues. They use words (as printed on the screen or spoken text), static graphics (photos, maps, or illustrations) and animations (as dynamic graphics and video) and these make available of the three characteristics of intelligibility, plausibility, and fruitfulness.

Thus, showing the intelligibility, plausibility, and fruitfulness in the desired new information, knowledge, and concepts of science topics which be taught in simulation program, may be help to taught in a way that creates dissatisfaction in the students toward the prior knowledge which they hold about the same topic.

**Table 2**

*The Contribution to Science Teaching and Learning which may be Provided by the Capabilities of Computer Simulation*

The capabilities which computer simulation software can provide	Potential contribution to the science teaching and learning
Run animated/dynamic simulations of physical phenomena and systems.	<ul style="list-style-type: none"> <li>• Visualization of complex and abstract physical systems and phenomena.</li> <li>• Development of mental models to represent abstract and inferred concepts.</li> <li>• Clear and quick collection of pseudo-experimental data.</li> <li>• Evaluation of the validity of mental models and gradual improvement.</li> <li>• Generation of cognitive conflicts.</li> </ul>
Virtually conduct experiments that would normally require ideal conditions.	<ul style="list-style-type: none"> <li>• Evaluation of the validity of theoretical principles in conditions that cannot be naturally established.</li> </ul>
Explore more than one representations of a physical phenomenon.	<ul style="list-style-type: none"> <li>• Gain deeper understanding of underlying physical phenomena.</li> <li>• Translate ideas from one representation to another.</li> <li>• Evaluation of alternative representation formats.</li> <li>• Development of the skill to select and combine appropriate representation formats to communicate certain ideas.</li> <li>• Development of awareness with respect to the characteristics of effective communication.</li> </ul>
Variable control and isolation by interactivity	<ul style="list-style-type: none"> <li>• Foster skills with respect to the conduction of valid experiments through the appropriate control of variables by manipulating variables.</li> <li>• Identify causal relationships and irrelevant parameters.</li> </ul>

Many tools may be able to satisfy the three conditions of Posner et al (1982) regarding the teaching of new concepts to students. For example educational television introduces new concepts in a dynamic form, and provokes students to reflect, creating the conceptual conflict between students' prior knowledge or pre-concepts and the correct scientific concepts to which they have been exposed. Given that, what is new in simulation? How is simulation different from other tools?

The one unique characteristic of computer simulation software as an educational tool that distinguishes it from other education tools is interactivity or the potential for interactivity. Interactivity enables students to manipulate variables of an experiment or phenomenon. It can show the student the impact of this manipulation as *immediate feedback*. Such interactions between the student and the simulation program are not available and cannot be provided with the any other education tools.

From a learning perspective there are three types of interactions (see Figure 2) in the formal setting (Evans and Sabry, 2003). These may occur in the classroom or other instructional environment, they are:

- a) Interactions between students (students-student interaction): These types of interactions in science education in Kuwaiti primary schools happen very rarely between students, on the occasion that there is discussion about the topic being taught.
- b) Interaction with tutors (teacher-student interaction): This type of interaction rarely happen in science lessons in primary school in Kuwait and if it happens, happens with smart students in the classroom without taking into account individual differences among students. What predominantly happens is one-way information transfer from science teachers to students in order to provide information on the topic being taught. The reason for this is that science teachers in primary schools in Kuwait face many obstacles that prevent them from using this type of interaction (see Chapter One).
- c) Interactions with teaching material itself (student-content interaction): This type of interaction, through adoption and utilisation of ICSS as educational tool, as addressed in the current study, may achieve some of the goals of using this type of interaction in practical work with the real materials during experiment conduct.

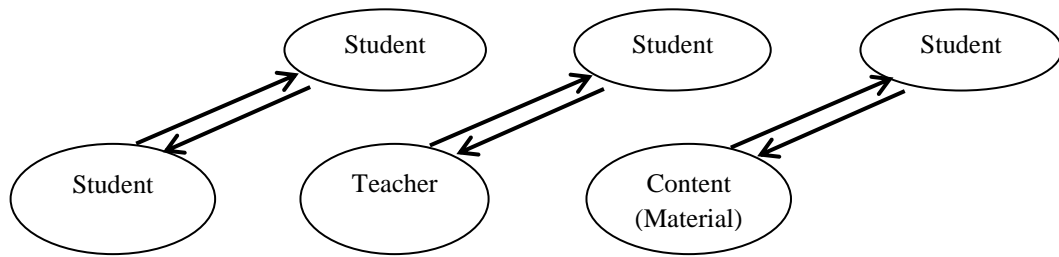

*Figure 2.* The three types of interactions in an educational environment

The current study is focusing on interactivity between the students and ICSS program and aims is to create an active educational environment that will facilitate students being involved and participating in the educational process, as well as providing students with ample opportunity to develop information through investigation in the context of the interactivity of a ICSS program. Thus, the students will work on constructing scientific knowledge and concepts by examining (i.e. testing or checking) their previous knowledge or concepts through manipulating and controlling the scientific experiments or the natural phenomena displayed by the program. This added forum for exploration does not detract in any way from the role of the teacher as a guide, advisor, and facilitator of student learning.

In conclusion, the functionality and characteristics available in an interactive computer simulation software may include the following: First, it can display or introduce a lesson in a simple and interesting way, as well as being able to display concept in a form that is intelligible, plausible, and fruitful through introduced the scientific concepts, experiment or phenomenon in animations - dynamic graphics - (Posner et al, 1982, of conditions of new conception teaching), in order to give students the opportunity to notice things that couldn't be seen in the traditional laboratory. This opportunity facilitates conceptual change. Second, it is possible for students to interact with a simulation program and enable them to manipulate the conditions of the scientific experiment or natural phenomena, as well as to receive immediate feedback on the impact of such manipulation. These characteristics may contribute to meeting these prescribe an active educational environment with concentration on constructivist learning and modifying pre-concepts (or misconceptions) through students engage in process education.



Through using the characteristics of dynamic graphics in the form of animations, and illustrations, many researchers – as can we see in the literature review chapter - (such as Jaakkola & Nurmi, 2008; Tekos & Solomonidou, 2009; Ozmen, 2011) have shown that computer simulations are particularly effective at fostering conceptual change on a variety of topics (e.g., electric current and circuits, light reflection and diffusion, and the nature of matter) because in these environments, students can engage with simulated phenomena and review their actions as they formulate and test alternative hypotheses, receive feedback, and reconcile the discrepancies between their pre-existing ideas and their observations.

## 2.4 Cognitive Theory of Multimedia Learning

The current study adopted Mayer's theory which is Cognitive Theory of Multimedia Learning (CTML) as another rationale when designing interactive computer simulation software of the current study. In order to avoid any factor in design may impact to the student comprehension and assimilation capabilities during presentation of science information topics through computer screen- i.e. how students learn - during the lesson through use interactive computer simulation.

Mayer (2009) established twelve principles about how people learn in the CTML. He links these into how students learn through using multimedia and because the learning process is an active process, the goal of CTML theory is to show how use computer software - such as the simulation software (as one multimedia tool) in the current study - through a combination of words and pictures, without violating cognitive processes or learning processes in order to offer meaningful learning, by taking into account these twelve principles during design any multimedia educational tool such as interactive computer simulation software in the current study.

Mayer's theory (CTML) depends on three assumptions derived from three views of a theory - in create the twelve's principles -, as follows:

- a) **Dual-channel:** this refers to the students' having separate channels for information processing (eyes and ears), one for visual (pictorial) subject matter, and the other for auditory subject matter (Austin, 2009). This assumption is based on the dual-coding theory of Paivio (1986, 2006), and Clark and Paivio (1991) (see Figure 3).

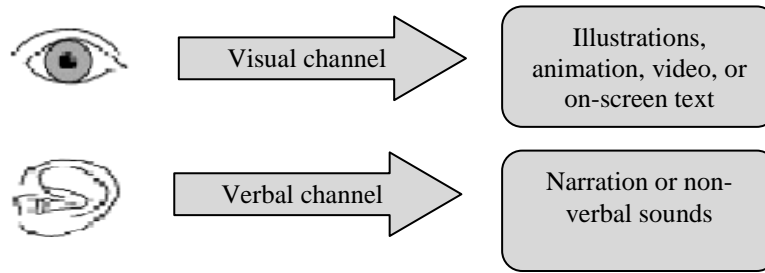

Figure 3. Dual-channel theory which are eyes and ears

b) **Limited capacity:** this refers to the fact that the amount of information that can be processed by each channel (eyes and ears) at one time is limited (see Figure 4). This means the amount of information presented by the computer screen and/or speaker in various types of information (such as animation, sound, text comments, and charts) at the same time will exceed the learner’s processing capacity, thus making the student unable to understand or interpret the information of the topic. This makes the learner scatterbrained and unfocused. This is considered the most important assumption because it focuses on the capacity of student’s working memory (Baddeley, 1992, 2002).

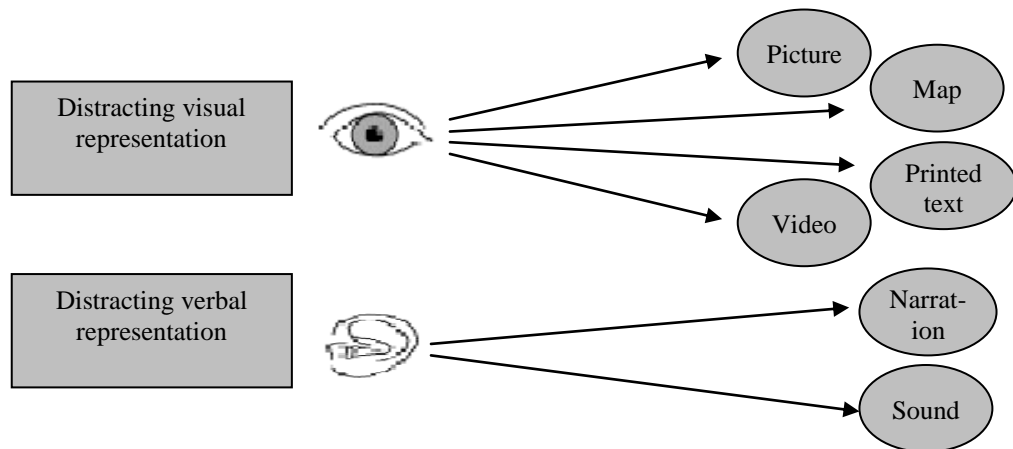

Figure 4. Limited capacity theory on receiving information into both channels (eyes and ears)

c) **Active processing:** this refers that meaningful learning occurs only when the learner engages in appropriate cognitive processing during the learning process (see Figure 5). Atkinson and Mayer (2004) state that through active learning during

lessons, students understand the presented materials under the three following conditions; (a) they pay *attention* to the relevant material; (b) they *organise* it into a coherent mental structure; and (c) they *integrate* it with their prior knowledge.

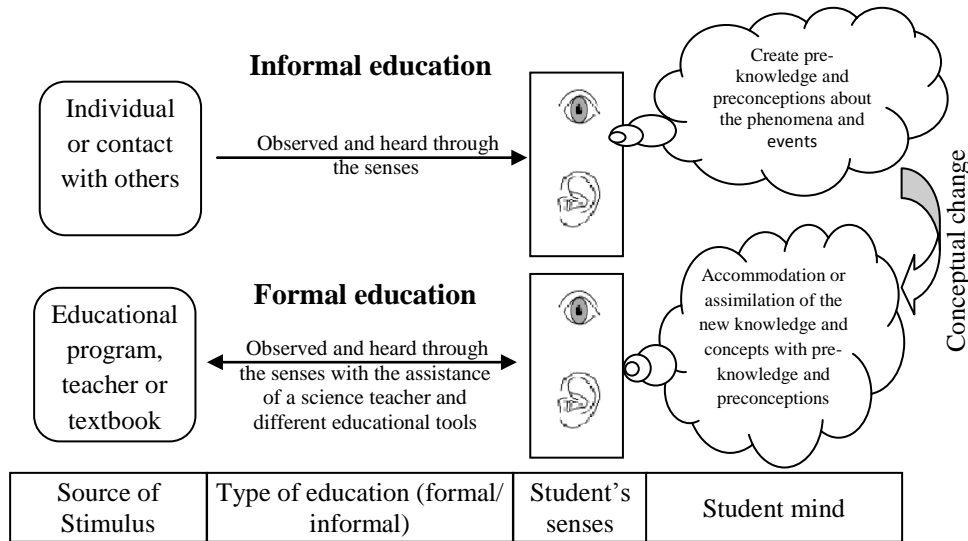

Figure 5. Learner engaging leads to comparing the preconceptions with new conceptions in formal education

Based on these three assumptions of learning theories, Mayer established the CTML model (see Figure 6) which consists of four parts. The first part consists of sending the information from the outside world. According to Mayer's CTML model the learning will be meaningful when the learner includes or practices three kinds of active cognitive processing during the learning process:

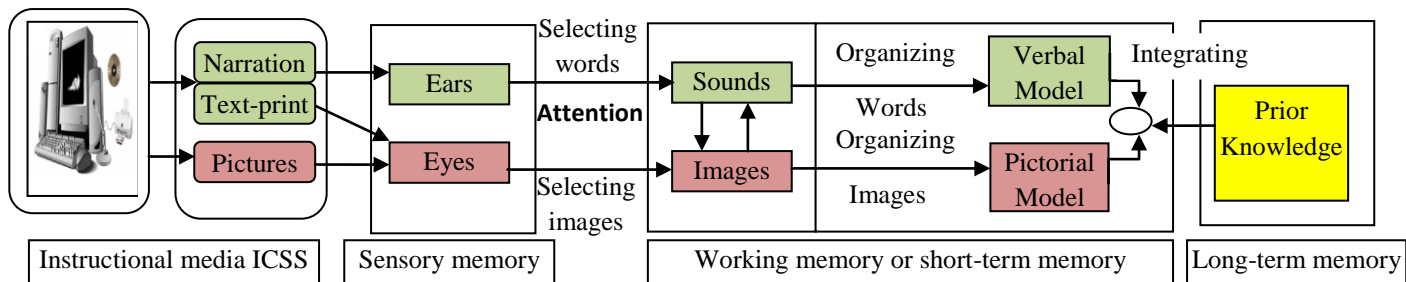

Figure 6. Cognitive theory of multimedia learning model (Mayer, 2009)

**Selecting:** this occurs in the sensory memory stage, when the student pays attention to the lesson to the computer screen, and directs attention to and choose information on computer using the senses. Thus the eyes select information in the following forms: static pictures, or animation and printed text. The ears select information as background sounds or narration; therefore, this information is conveyed to the system memory, or the short-term memory. This process is transferred from the external world to the memory of the student.

**Organizing:** this occurs in the “working memory” or “short-term memory” stage. After the student select information, they start an internal organization process of the selected words to create a coherent verbal mode. For example, if the sound of a cat is played for the learner without a picture, the sound coming out from the computer and being processed by the ears will enter the memory, which in turn will change the sound from a verbal model to a pictorial model, depending on the student’s previous knowledge of this sound. Therefore, if a student knows what the sound represents, the image of a cat will be created in the student’s imagination and vice versa.

**Integrating:** this process occurs when the student retrieves the previous information and concepts from the long-term memory to compare and integrate them with the new information which has been placed in their short-term memory. If the new information and concepts that the student receives conflict with and challenge what was expected according to previous concepts and information on the same topic, this will result in cognitive conflict and possible conceptual change occur and construct new knowledge. In this way, the student may obtain meaningful learning from the educational process.

One challenge of the current study is to integrated pictures with all their fixed and animated forms as well as the printed text and narration. The limited capacity theory of students’ memory should be taken into consideration through good design of the program. For example, it is not useful to present a digestive system lesson using animation at the top of the computer screen with printed information about the digestive system in the lower part of the computer screen. This kind of design will lead to the information entering from only the visual sense, because the student sees the animation and reads the text, while the other sense, hearing, is neglected. Second challenge is the distance between the two information forms (animation and printed text) obliges the students to move their eyes up and down to make connections between the animation and the text. Thus there will be cognitive

overload because of the eyesight representation shift from the pictorial model to the verbal model and back again.

Mayer's twelve design principles are divided into three cognitive fields: *extraneous cognitive processing*, *essential cognitive processing*, and *generative cognitive processing*. Principles in the two first fields are focus on reducing the overload on the cognitive memory working (i.e., limited capacity theory). Principles in the third field encourage and foster the students to effectively engage in active learning.

The first cognitive field is related to reducing "extraneous cognitive processing" which means there are materials or forms displayed on the computer screen that are not related to the taught topic or objective. This may occur as a result of poor design of the instructional program. To handle the problem, the following five principles should be taken into consideration:

- a) **Coherence:** students learn better when any extraneous processes such as words, pictures, sounds, music, and symbols included in multimedia presentation program are deleted, as these are not needed to achieve the lesson's goals. Austin (2009) also asserts that this improves the students' performance.
- b) **Signalling:** this involves highlighting new information or concepts through indications. The goal of the lesson should be clear in the outlines and headings. Program – as ICSS in the current study - should contain: (a) an outline sentence, (b) headings (a phrase or short sentence), (c) vocal emphasis (saying key words louder and slower), and (d) pointer words (e.g., insert transitional words such as first...second...etc.).
- c) **Redundancy:** Students learn better from pictures (animation or illustrations) in combination with narration, than from pictures combination with, narration, and printed text. Because there will be overload on the eye channel in receiving information (from animation or illustrations and printed text) more than from the ear channel (just from narration or spoken).
- d) **Spatial contiguity:** in order to enhance student learning using pictures and words, corresponding words and pictures should be near each other on the screen.

- e) **Temporal contiguity:** when corresponding words and pictures are presented at the same time the students learn better than when they are presented at different times.

The second cognitive field relates to “essential cognitive processing” (ECP): this is aimed at mentally representing the presented material, depending on its complexity, and corresponding to the cognitive process of selecting information easily on a computer screen. In other words, overload occurs more easily when the essential subject matter is complex and unfamiliar to the student. Sweller (1999) refers to this as “intrinsic cognitive load”. To overcome the ECP overload, Mayer (2009) suggests the following three principles:

- a) **Segmenting:** students learn better when the material presentation is broken into appropriate pieces. Students can hold and represent the new information in their working memory, they click on the play or continue button. The program in the current study offers an opportunity for the teacher and the student to control the material presentation, first to give students enough time to hold and represent the new information step by step by offering time between each segment, and second to provide opportunities for students to interact with the program by controlling and running the play, stop, and return buttons at any time, which further encourages and assists the learner in synthesizing and organizing new information (Kluit, 2006).
- b) **Pre-training:** when the teacher presents introductory information about the new concepts before the main lesson. The students are familiar with the new knowledge and this leads to better learning.
- c) **Modality:** the modality principle is related to the selection of the new information from sensory memory, which is then sent to working memory. Mayer argues that animation accompanied by narration is better for student learning than animation and printed text.

The final cognitive field is “Generative Cognitive Processing”, which is aimed at making sense of the material, initiated by the motivation of the student, and corresponding to the cognitive processes of organizing and integrating. Hence, the students’ motivation and engagement in active learning play a key role in generative cognitive processing. Mayer

established four principles to foster Generative Cognitive Processing and to make students engaged in active learning:

- a) **Multimedia:** subject matter combining words and pictures allows students to learn better than from words alone, because these offer students the opportunity to construct verbal and visual representations and build connections between them.
- b) **Personalization Principle:** People learn better from a multimedia presentation when the words are in conversational style rather than in formal style.
- c) **Voice:** using a human voice in narration with the same accent as the students leads to better learning and encourages a sense of social presence in the computer interaction.
- d) **Image:** adding the image of a teacher can support the social benefits or encourage a social environment. In this case, Mayer stated that some researchers argue that the addition of the image of a teacher might cause students to engage in “extraneous cognitive processing”, as the students will pay attention to the teacher’s face instead of focusing attention on the content or new information.

Mayer and his colleagues have conducted many empirical studies to prove the effectiveness of these principles. These are not a topic of interest for the current study, but can be studied in Clark & Mayer (2003) and Mayer (2009)

The 12 principles of Mayer's which derive from the three learning theories: the dual-coding theory of Paivio (1986, 2006); the working memory theory of Baddeley (1992, 2002); and the learning as generative process theory of Wittrock (1974 & 1992) The 12 principles of Mayer in consideration when designing the ICSS.

## **CHAPTER THREE: PREVIOUS STUDIES THAT USE COMPUTER SIMULATION IN SCIENCE TEACHING**

### **3.1 Introduction**

Due to lack of previous studies in Kuwait or in other Arab countries that study simulation, this study relies mostly on previous research from other countries. Except for some Arabic studies that concerned the use of the Internet and some technological programs such as PowerPoint, there are no known studies on simulation.

Studies of the impact of computer-based simulation software in education began more than four decades ago (Smetana and Bell, 2011). This long period of investigating the effectiveness of simulation underlines the importance computer simulation software in the field of science education. The reason for the continuing search of the utilization of computer simulation software is because of the ongoing development of characteristic, features, and advantages of ICT in general and the computer simulation software specifically. As well as the probability of success in possibility or ability to computerize - or model - scientific experiments and natural phenomena in virtual laboratory applications, (Tatli and Ayas, 2010). Also, real equipments by simulation can be replaced by digital (or virtual) 'manipulatives' (Triona & Klahr, 2003).

Among the reviewed studies, it was very rare to find a study aimed at investigating the effectiveness of computer simulations in primary schools and Oloruntegbe and Alam, (2010) confirms this in their study. The majority of studies were about middle or high school students, undergraduate students, and pre-service science teachers. Thus, this gives importance to the current study.

Since that the current study investigates use of simulation program to improvement students' academic achievement and supporting the conceptual change and because it relates to using simulations as an alternative of practical work, the literature from studies in all these fields will be reviewed. Literature will be classified as follows (see also Table 3 for number of studies in each category):



- 1- Studies including interventions aimed at improving academic achievement for science students through using a simulation program and comparing these to the traditional teaching.
- 2- Studies aimed at using the simulation program to enhance students' conceptual change in science and comparing with traditional teaching.
- 3- Studies aimed at using the simulation program as an alternative to (or integrated with) the traditional science lab to improve students' academic achievement and develops attitudes towards science learning and teaching. These type of studies typically also look at features of computer simulation software that minimize amount of time necessary for conducting experiments and reducing costs of infrastructure necessary to conduct the experiments.
- 4- Arab studies aimed at using computer applications and software (e.g. PowerPoint and Internet) to enhance academic achievement for science students.

This classification will be used to compare results from previous studies and to compare and later to discuss results of the current study. Some studies classified in more than one category.

**Table 3**  
*The Classification of Previous Studies*

No	Classification Studies	No of studies
1	Studies comparing effect of teaching using interactive computer simulation software versus (or combination with) traditional teaching on improving students achievement.	16
2	Studies comparing teaching using interactive computer simulation software versus (or in combination with) the traditional teaching enhancing a conceptual change.	10
3	Studies using interactive computer simulation software as a replacement for a traditional laboratory versus (or in combination with) the traditional laboratory method and its impact on students' achievement and attitudes towards learning science	10
4	Arab studies using various applications of the computer (e.g. PowerPoint, Internet)	9

### **3.2 Using computer simulation for improving students' academic achievement**

Huppert, Lomask, & Lazarowitz (2002) conducted a study to investigate use of computer simulation in computer-assisted learning (CAL) in high school. The aim was to investigate impact on students' academic achievement and mastery of science process skills, and consider their cognitive developmental stage. The sample consisted of 181 students from five tenth-grade classes (15 year-olds) in Israel. Students were distributed to an experimental group (two classes; N=82: 68 girls and 14 boys) and a control group (three classes; N=99: 80 girls and 19 boys). The experimental group studied in the CAL mode of instruction and used a blended method with laboratory experiments and computer-simulated experiments. The control group followed the traditional classroom/laboratory method. The software program used is called 'The Growth Curve of Microorganisms' (TGCM) developed by Huppert and Lazarowitz (1986) based on an approach devised by Daley and Hillier (1981). Furthermore, in each group, one laboratory assistant and one technician were available for technical assistance. The computer simulation was integrated into the teaching of the topic of microorganisms and the laboratory work. Although using different learning modes, the experimental group and control group studied the same learning material. The control group, however, did not experience working with the microcomputers and instead performed experiments as presented in their textbook. Both groups studied the topic over a similar length of time. Data were collected from three biology tests: (a) an academic achievement test was used as a pretest and posttest to measure students' knowledge on the topic of microorganisms, (b) a videotaped group test (VTGT) was used to measure students' cognitive stages (concrete, transitional, and formal), and (c) a biology test of science processes (BTSP) was used to measure students' science process skills on the topic of microorganisms.

The results of the study indicate that higher cognitive learning can be enhanced with computer-simulated experiments. The students in the simulated CAL learning environment exhibited complex and integrative reasoning, which often proves to be very difficult for tenth-grade students doing laboratory work. Regarding the students' cognitive stages, results showed that students in the concrete and transitional operational stages in the experimental groups achieved significantly higher than their counterparts in the control group, with effect sizes of 2.66 and 2.83, respectively. No significant differences were

found on the mean scores between the two groups (experimental and control) of students in the formal operational stage. Thus, the simulation proved more effective for the lower cognitive groups only.

Teachers who taught in the experimental groups reported that students displayed confidence and positive attitudes towards the use of the CAL unit, but attitudes and self-esteem were not investigated systematically in this study.

Marbach-Ad, Rotbain, & Stavy. (2008) conducted a study to investigate the effectiveness of computer simulations, compared with traditional teaching, and used high school students' achievement on the topic of molecular genetics. They created three groups. The first group was a control group (CG) containing 116 students; the second was an experimental group of 61 students who conducted computer simulation (animation) activities. The third group of 71 students used static illustrations (models and pictures) together with a hands-on activity, but no computer. Participants were all taught the same science content.

The study used three measuring tools. The first was a test with multiple-choice items to test understanding of knowledge. The second measure was a test with open-ended written questions. The third measure was personal interviews. The first two instruments which were multiple-choice and open-ended written questions were given to the students after the molecular genetics instruction. The questions in both instruments were grouped under three categories of subtopics and the results were as following:

1. The structure of DNA and RNA.

The average scores for the computer (81%) and the illustration (77%) groups were similar, but significantly higher than the average score of the control group (69%) for multiple-choice items. The same result was obtained for questions in the open-ended written questionnaire which showed no significant differences between the computer (82%) and the illustration (76%) groups, but both scores significantly higher than the average score of the control group (60%). In interviews students were asked to characterize the structure of DNA, about 72% of the interviewees from each of the computer and the illustration groups referred to the components of the nucleotides in details, whereas only 19% of the interviewees from the control group referred to the components of the nucleotides only.

The conclusion in this subtopic, they found that integration of the computer model or illustration activity in the instruction of the structures of DNA and RNA molecules enhanced students' achievement in similar ways.

## 2. The molecular processes of DNA replication, transcription, and translation.

The average scores in the multiple-choice questions concerned molecular processes. These show a similar pattern to the one found in the first subtopic: the average scores for the computer and the illustration groups were similar, but significantly higher than the average score of the control group. But the open-ended questions of this subtopic revealed a difference among the three groups. The average scores of the computer group (69%) were higher than those of the illustration group (56%), and each of these scores were significantly higher than the average score of the control group (40%). In the interviews concerning the processes of transcription and translation, students were asked to answer the question: How are proteins synthesized according to the genetic code? A complete answer should refer to both processes of transcription and translation, In all groups a low percentage of students referred to both processes (lower than 31%). when asked; How is DNA replicated? a majority of students from the computer group (95%) and from the illustration group (82%) correctly explained the semi-conservative mechanism of replication, whereas only 42% of the students did so in the control group.

Overall, findings concerning the second subtopic show that achievement with regard to processes was lower than with regard to structure compared to the first subtopic this all applied to both instruments, and all groups. Note that the open-ended questions in this subtopic reveal that the students who used the computer simulation in teaching outscored those who studied with use the illustration model.

## 3. The conceptual relationships between genetic material and its products.

In the multiple-choice questionnaire, the average scores in both computer (77%) and the illustration (78%) groups were similar, but significantly higher than the average score of the control group (69%). In the average scores of the open-ended questions revealed that the computer group (48%) scored higher than the illustration group (37%) and the control group (35%); there were no significant differences between the illustration and the control groups.

In the interviews students were asked to answer the question: How is the genetic information in DNA coded? Completely correct answers should refer to the structural

aspect of the genetic code—three nucleotides (codon)—and to its functional aspect, which is the relationship between the codon and the amino acid. Analysis of the responses showed that 79% of the interviewees from the computer group and 73% from the illustration group referred to the nucleotide triplet or the nucleotides sequence, whereas, only 46% of the interviewees referred to triplets of nucleotides or to the relationship between the sequence of nucleotides and amino acids.

A summary of the findings concerning the third subtopic It seems that it was easier for students to choose the correct answer to the multiple-choice questions than to articulate correct responses to the open-ended questions and this is obvious through the average scores on the open-ended questionnaires were much lower than those on the multiple-choice questionnaire, for all groups.

Summary for the findings of three subtopics, found that in the multiple-choice items to test understanding of knowledge showed that the average scores of the computer simulation and the illustration groups were similar (74 and 70, respectively) but that both were better than the control group (at 61). Whereas in the open-ended written questions showed that the students who used computer simulation achieved significantly higher scores ( $p < 0.01$ ) than the two other groups.

The authors use interviews also to asked students; How the type of learning program they used contributed to their learning of the genetic topic. Regarding students' visualization of DNA structure and the processes of DNA replication, transcription, and translation, 95% of the students in the computer group referred to the computer animation. One student explained that '[with a computer] we can see exactly how the process [transcription and translation] occurs and it is easy to translate that into words' (p. 284) and continued by saying that the activities 'broke the routine of the traditional lecture format' (p. 285). A majority of students who used the computer simulation mentioned that they enjoyed the activity very much and would like to do it more, in other biology topics as well. In the illustration group, 54% of students recorded an impression similar to, 'I saw the illustrations from the booklet; in the booklet that we received we were asked to complete figures, and that helped me see things in a more visual way' (p. 284). Moreover, in response to the question of whether molecular genetics was more difficult than other topics in biology, students in the computer group said that the use of the program made the genetic topic easier to understanding. As percentage, 38% of students who used simulation

program said that the molecular genetics lesson was not difficult in versus 58% of students who used traditional method said it was difficult.

Marbach-Ad et al. concluded that the results revealed that learning via computer animation was in some knowledge or concepts more effective than learning via the illustration activity. But certainly in the majority use computer simulation or animation is better than use tradition method of learning. This proves the impact of the computer simulation or animation model on students' understanding, especially in teaching about a dynamic process such as molecular genetics topic.

Stieff and Wilensky (2003) investigated the impact of a computer simulation program on understanding and applying chemistry concepts for six undergraduate chemistry students (four fourth-years and two third-years). The software offered an opportunity for students to observe and discover interactions in a simulated environment that enables them to develop a deeper understanding of chemistry concepts and processes in the classroom and laboratory. This study focused on the concept of chemical equilibrium.

Stieff and his colleague used the observation and interview method, and they commented (pre-interview) that there was a misconception about chemical equilibrium. They used observation and interview to measure whether there were any improvements in:

- a) Defining equilibrium for a chemical system,
- b) Characterizing factors affecting equilibrium, or
- c) Transitioning between sub-, micro-, macro-, and symbolic levels during problem solving.

The results showed that the students improved in defining chemical equilibrium, distinguishing factors that affect equilibrium, and in problem solving. In general, using computer simulation for chemistry is helpful in promoting conceptual reasoning.

Stern, Barnea, & Shauli (2008) examined the influence of computer simulation on the understanding of kinetic molecular theory (a chemistry lesson) on seventh-grade students at a middle school. The participants were three teachers, and each teacher taught one experimental class and one control class. They created three control groups (N= 18, 20, and 24 in a total of N=62 student distributors in three classrooms) and the three experimental groups (N= 26, 21, and 24 in a total of N=71 student distributors in three classrooms). The three teachers each taught one experimental class and one control class. The computer

simulation program, called 'A Journey to the World of Particles' was applied in combination with other conventional learning activities. For this exam, the researchers used a pretest and posttest and semi-structured personal interviews designed to probe beyond students' initial responses; they interviewed four of five students from each group (15 minutes).

Because no significant differences were found between the pretest scores of the three experimental classes and the three control classes, the authors pooled the results from the three experimental classes into one experimental group and pooled the three control classes into one control group.

The result showed improvement was more considerable in the experimental group than in the control group. Whereas the students in the experimental group improved their scores between pre and post test by 29 points, on average, students in the control group gained only 12 points. Furthermore, students in the experimental group (total of all three classrooms) scored significantly higher in the posttests than students in the control group (total of all three classrooms) ( $M=58.56$  and  $M=38.60$ , respectively). In interviews, interviewees from both the experimental group and the control group attained similar scores when responding to written questions during the interview, but there were more students from the control group who expressed the incorrect idea in regard to kinetic molecular theory, such as that students think that particles are still and start to move only upon heating. Therefore, the difference might be attributed to that the computerized simulation clearly shows for the students in experimental group that particles are constantly moving.

They concluded that the computerized simulation enhanced the understanding of the particulate nature of matter of seventh graders. Moreover, they concluded that using computer simulation as a supplementary tool to promote meaningful learning is better than using it alone. They added that kinetic molecular theory has been one of the most difficult scientific theories to accept. Some research suggests that representations—especially dynamic representations—can help make these abstract ideas intelligible for students. They said 'Many studies done over the past few decades clearly show that learning of abstract ideas in science requires the use of effectual and diverse instructional strategies. Amongst these are the role of prior knowledge, the use of relevant phenomena for making scientific ideas plausible, conditions that facilitate the transfer of knowledge, and the importance of guiding students' interpretation of their learning experience' (p. 312)

In (2004) Kiboss, Ndirangu, & Wekesa conducted a study in the secondary classes to investigate the effectiveness of a Computer Mediated Simulations (CMS) Program on students' learning outcomes. The purpose of this study was to investigate the effectiveness of a CMS Instruction Program in improving secondary school pupils' learning outcomes in cell theory lessons.

A total of 102 secondary school students from three secondary schools served as the participants of the study. The participants (N= 59 males and N= 43 females) were randomly selected from three classrooms situated in three schools. They were three groups. The first was experimental group one (EX1 took a pretest), the second was experimental group two (EX2 did not take a pretest), and the third was a control group (CG). Both EX1 and EX2 groups were taught biology course content using computer simulations, and participants in the CG were exposed to the same biology course content but through the regular teacher-directed mode.

Kiboss and his colleagues used three measuring instruments, which are a biology achievement test, a classroom environment questionnaire, and a student's attitude questionnaire. Before the beginning of the intervention, the EX1 and CG both received the pretest, whereas EX2 was denied the pretest. After that, at the end of the biology course on cell theory, the instruments of measurement were administered to all the groups (EX1, CG, and EX2).

The finding of this study demonstrated higher mean scores for the two experimental groups (EX1 and EX2) than for the control group (CG). Also, the mean scores of the two treatment groups (EX1 and EX2) were not significantly different (28.03 and 29.03, respectively). The researchers attributed the lack of significant difference between the posttest mean scores of EX1 and EX2 to the fact that both experimental groups were exposed to the same CMS program.

Generally, this study demonstrated that the use of well-designed computer simulations in learning environments are effective in improving pupils' knowledge and performance in the biology course on cell theory, as well as their perceptions of the classroom environment and attitudes towards the subject. Furthermore, the results of this study confirmed earlier findings that the use of computers promoted positive attitudes and perceptions of the classroom environment amongst students.



Zacharia (2003, 2005) and his colleagues (2008) studied student science teachers and currently employed science teachers taking a conceptual-based physics course. They undertook a series of investigations considering the combined use of traditional instructional tools and computer simulations. Zacharia, Olympiou, & Papaevripidou (2008) investigated the effectiveness of using interactive computer simulation (called Virtual Manipulative [VM]) in combination with a traditional laboratory (called Physics Manipulative [PM]) to achieve a conceptual understanding of heat and temperature in physics. The experimental group used a mixture of the methods (PM and VM), and the control group used just PM.

The study sample consisted of undergraduate elementary school student teachers (N= 62); the experiment took place at a university in Cyprus. Participants were divided into two groups. The control group of 31 students (CG) used only PM, and the experimental group of 31 students (EX) used PM and VM. Zacharia and his colleagues adopted the prediction, observation, and explanation (POE) strategy, in which the purpose is to make a cognitive conflict when information is presented through experiments. The students are asked to use a POE strategy to (a) recognize their conceptions or beliefs (through observation and prediction), (b) evaluate the value of these beliefs (i.e. their prediction), and (c) at a group and personal level, decide whether or not to reconstruct their preconceptions or beliefs (explanation step).

Two kinds of pretests and posttests were conducted for each group. The first test measured students' conceptual understanding of temperature and changes in temperature, and the second tested only the students' understanding of the concept of changes in temperature.

The results showed that the two groups were equivalent before conducting the experiment. But after the experiment, the first posttest determined that significant differences existed between the experimental group and the control group, in favour of the experimental group ( $p < 0.001$ ), and this supported the hypothesis that the use of a combination of PM and VM had a stronger effect on undergraduate students' conceptual understanding of temperature and changes in temperature than the use of PM alone. Furthermore, the results revealed differences between the second posttest scores of the two groups regarding students' understanding of the concept of changes in temperature in favour of the experimental group

as well, with  $p < 0.001$ . These results indicated that EX seemed to better promote the students' conceptual understanding of changes in temperature than the CG.

Wu, Krajcik, & Soloway (2001) found that a chemistry simulation's visualization tools may have aided students in developing an understanding of chemical representations. This result was found after investigating how students in public high school developed an understanding of chemical representations with the aid of a computer-based visualizing tool. The sample of this study was 71 students ( $N = 35$  females and  $N = 36$  males) from the same high school.

Measurement tools for this study were a pre- and posttest and observation. After a six-week period, the results found an improvement between student outcomes in the pre- and posttest, in favour of the posttest ( $p < .001$ , effect size  $d = 2.68$ ). The analysis of video recordings of students' performance revealed that several features in the computer-based chemistry visualizing tool helped students construct models and translate representations. And this made referential linkages between visual and conceptual aspects of the representations. This may have deepened their understanding of chemical representations and concepts.

Kumar and Sherwood (2007) evaluated the effectiveness of using instruction with a multimedia simulation on student teachers' conceptual understanding of environmental topics. The topics addressed in this study were classes of organisms that form a river ecosystem, dissolved oxygen, macro invertebrates, composition of air, and graph-reading skills. To conduct this study, they used the simulation software called River of Life. Foundational principles in choosing this program, according to the researchers, were as follows: (1) The use of multimedia as an anchor helps to provide students with an authentic environment for presenting information for problem solving in the form of challenges, (2) the availability of multimedia reference resources as technology-based tools for deeply exploring the problem context, and (3) the flexibility of the learner to view the problem from multiple perspectives. The number of participants were ( $N = 83$ ), all of them undergraduate students. The outcome measures were pre-, posttest, and delayed posttest.

The results reveal a significant increase in mean scores from the pretest to the posttests ( $p < 0.05$ ; mean scores 38.86 and 75.30, respectively). Furthermore, there is high

significance between the pretest and the delayed posttest in favour of the delayed posttest ( $p < 0.05$ ; mean scores 38.86 and 83.97, respectively). The limitation of this study was the limited sample size.

Cepni et al. (2006) conducted a study aimed to assess the effect of the computer-assisted instruction material (CAIM) in regards to the topic of photosynthesis on students' misconceptions, understanding of photosynthesis concepts, and attitudes towards science. They used a photosynthesis achievement test (PAT) for three levels of cognitive domain (knowledge, comprehension, and application) both before and after intervention for the two groups, one experimental and one a control group, each group containing (N=26) students (i.e. the total was 52 students in eleventh grade in high school).

The result for PAT in the posttest showed a statistically significant difference between the experimental group and the control group in favour of the experimental group (M= 70.81 for experimental, M = 59.69 for control). For the cognitive domain, the result showed that the students who used CAIM got higher cognitive levels of learning compared with the control group except at the knowledge level.

In order to assess the misconception, ten questions similar to those on the achievement test were asked both before and after the treatment. The result found that misconceptions decreased in the experimental group better than in the control group for all questions.

Regarding attitude towards learning science after treatment, there was a statistically significant difference between the two groups, in favour of the experimental group (before M = 1.70 and after M = 2.64) and the control group (before M = 1.79 and after M = 2.09).

Vartacnik et al. (2000) conducted a study on an interactive multimedia tutorial unit and its effects on the understanding of chemical concepts. The purpose of this study was to investigate the effects of using an interactive tutorial multimedia unit on the understanding of selected chemical concepts and students' perception of the new teaching-learning environment. The hypotheses were: (a) the experimental group will achieve better posttest results than the control group, (b) there will be significant differences between the experimental and the control group in the total number of scores achieved in the posttest and pretest, and (c) the visualization elements of the teaching unit will have an impact on better understanding of the selected chemical concepts

The students participating in this study were 50 students in high school. They were divided into an experimental group (N=26 students) and a control group (N=24 students) based on scores achieved on the pretest. In the study, the experimental group was presented with the computer-multimedia tutorial teaching unit supported with written materials. They spent five sessions, each of 45 minutes duration. The control group took part in traditional teaching sessions on the same topic of the same duration but without computer-multimedia. Pretest and posttests were conducted to measure the effect of the intervention.

Results showed that students in the experimental group performed better in the posttest than students in the control group; students in the experimental achieved, on average, 20.5% better than those in the control group. Moreover, there was a statistically significant difference in understanding of the selected chemical concepts between the two groups in total scores achieved in the pre- and posttest, in favour of the experimental group.

Regarding the benefit of a visual presentation of the chlorophyll spectrum and the written explanation about absorption, as well as animation of the absorption phenomena shown on the CD-ROM, it contributed significantly to a better understanding of the phenomenon, and students were better able to apply their knowledge in solving questions about the topic. On the other hand, in this study, all hypotheses were accepted as valid, but the multimedia teaching unit has promising effects on the students' acquisition of knowledge.

Sherwood and Hasselbring (1986) examined the effectiveness of using computer simulation for ecological concepts focusing on various presentation methods of a computer-based science simulation as related to student content knowledge of the simulation concepts. The sample was 145 students in sixth grade, divided into three groups: (a) pairs of students working with the computer simulation, (b) a total class (the whole classroom) working with the computer simulation, and (c) a non-computer list game-type setting for the simulation.

The measurement tool was the content achievement test on the science content (posttest only) containing two parts, the first nine multiple choice questions covering the concepts of the ecological, and the second exercise to complete a 'food pyramid' of the ecological simulation setting. This test was administrated after completion of the course (immediate posttest) and six weeks later (delayed posttest).

After doing the immediate posttest, results showed a statistically significant posttest achievement in part one (ecological concepts) in favour of group two, which was the total

class working with the computer simulation in the first part, but in the second part there were no statistically significant results. Regarding the delayed posttest (after six weeks), there were no statistically significant results between groups. However, in conclusion, there is some indication—although it needs to be investigated further—that large group instruction (i.e. whole class) using simulation may be slightly more beneficial than other methods. Moreover, researchers attributed the cause of this result to the small sample and weak measurement tools.

Chang (2001) conducted a study comparing using a problem-based computer-assisted instruction (PBCAI) and the direct-interactive teaching method (DITM) on the impacts of enhancing students' achievement (knowledge, comprehension, and application levels) in the subject of earth science. The study sample was 159 tenth-grade high school student divided into two groups, an experimental group (N=84 students) using or exposed to the problem-based computer-assisted instruction (PBCAI) and a control group (N=75 students) using a traditional method represented as a direct-interactive teaching method (DITM) along with regular computer-Internet usage.

For gathering data, Chang used a pre- and posttest for each group, testing pre- for both and post-after two weeks for both. For analysis of data, confidence level was 5% level, using ANCOVA to detect any significant difference between the two groups (experimental and control). Two weeks after the experiment, results indicated, in general, that there was a higher significant difference of achievement test results between students who used PBCAI and students who used DITM, in favour of PBCAI (in  $p = .028$ ,  $p < .05$ ). In particular, in cognitive domain of knowledge and comprehension level, the students in the PBCAI group also revealed significantly greater gains than did those in the DITM group ( $p = .006$ ,  $p < .05$  and  $p = .017$ ,  $p < .05$ , respectively). But in the application level there was no significant difference between students in the PBCAI group compared to those in the DITM group ( $p = .787$ ,  $p > .05$ ). In conclusion, Chang said this study showed that incorporating problem-based instruction into CAI and putting it into a science classroom has been determined to be fruitful and beneficial in promoting science achievement and enhancing pupils' learning.

White, Kahrman, Lubrice, & Idleh (2010) evaluated the effectiveness of using computer-simulation software for learning a protein structure versus the use of visualization.

Freshman undergraduate students were the sample of the study (N= 477), divided into two groups, one that used a visualization lab (N=161) and the second that used a simulation lab (N=316). The survey administered in both groups both before and after the experiment consisted of two questions to determine misconceptions.

The result for comparison of learning gains with visualization and simulation lab activities and analysis of videotape of students using visualization and simulation showed no statistically significant differences between the two groups. Regarding students' opinions of simulation and visualization in learning protein structure, the students mentioned that they felt that the simulation taught them slightly more than the visualization; this effect was very small but statistically significant.

Taskin and Kandemir (2010) evaluated the advantages and the effectiveness of using computer-based simulation applications during science education to cover the subject of energy conservation in academic achievement and attainments of seventh-grade students. The study was conducted during the 2009–2010 academic year for seventh grade students. Total participants were 40 students divided into two groups, (N=20) in the experimental group and the other (N=20) in the control group. For data collecting tools in this study, they used a pretest and posttest consisting of 20 multiple choice questions for both groups and gathered data in the SPSS system to analyse data.

The result of the pretest before the experiment found that the prior knowledge of students about the science subject was equal between the two groups. Therefore, there was no significant statistical different between the groups ( $p>.05$ ). But after the experiment, the result showed a high difference of average points on the achievement test between students in the experimental group and those in the control group, in favour of the experimental group.

In conclusion, results showed that the average post-testing points of students in the experimental group who were taught with a simulation-based method were higher than the average points of students in the control group who were taught using traditional methods. Thus, it can be said that education with computer-based simulations works to improve and increase students' academic achievement in the field of science and increases their learning skills.

Manlove, Lazonder, & Jong (2006) investigated the effectiveness of regulatory guidelines (planning, monitoring, and evaluating) within using computer simulation in promoting student learning and thus student outcomes in the topic of fluid dynamics. The participants were 17 students in high school, distributed in two groups. The experimental group (N=8) used computer simulation with regulative directions guidelines, and the second control group (N=9) used the same program but without regulative directions guidelines.

After the experiment, results showed that the experimental group significantly outperformed the control group in learning outcomes, planning and cognitive (M=96.88 Vs M= 21.98 & M=12.56 Vs M=7.03 respectively) Monitoring and evaluation were comparable in both groups.

Sun, Lin, , & Wang (2009) created a sun and moon system model as an instructional tool to conduct a study on the effectiveness of this system model of the sun and moon to help fourth-grade students understand of astronomical concepts in elementary school science. In addition, he investigated their feelings (satisfaction) towards using the sun and moon system model in learning science.

The sample was 128 students from four classrooms in elementary schools, divided into two groups; the experimental group (N=63) were taught the sun and moon system using the proposed information technology (IT) application in a computer classroom. The control group (N=65) students were taught using traditional teaching that used photographs in a natural science classroom.

The instruments of data collection were a pretest and posttest (40 minutes for each) on the concept of moon phases and positions. Moreover, the attitude questionnaire tested how students in the experimental group felt about using the sun and moon system model.

After four weeks, results from the posttest showed a statistical significance in favour of the experimental group ( $p < .05$ ). This indicated that students in the experimental group outperformed students in the control group. Whereas, the result for the attitude questionnaire for the students who used the sun and moon system revealed that more than two-thirds of the students—responding by agree or strongly agree on the questionnaire—preferred using the system model incorporated into science teaching, and they mentioned the system model had real potential to increase their interest and their engagement in learning science. Also, the students were willing to use and recommend the sun and moon

system to their classmates for learning, and they think the IT application is a positive learning tool for science topics.

### **3.2.1 Discussion on studies using simulation to improve academic achievement**

The previous studies, shown above, aimed at using the simulation program to improve the academic achievement outcome for students. There were a total of 16 studies distributed over four educational stages: one study conducted in the primary school stage for the fourth grade (Sun et al., 2009), four studies conducted in the middle school stage (Taskin and Kandemir, 2010; Stern et al., 2008; Kiboss et al., 2004 and Sherwood and Hasselbring, 1986), seven studies executed in the high school stage (Marbach-Ad et al., 2008; Manlove et al., 2006; Cpeni et al., 2006; Huppert et al., 2002; Chang, 2001; Wu et al., 2001, and Vartacnik et al., 2000), and four studies applied to undergraduate students (White et al., 2010; Stieff and Wilensky, 2003; Zacharia et al., 2008, and Kumar & Sherwood, 2007).

The computer simulation used in several disciplines on natural sciences was investigated to determine the extent of the effectiveness and suitability of using simulation programs for science teaching in order to improve students' academic achievement. In most studies results were positive and simulation programs improvement of students' academic achievement in topics such as earth sciences (sun, moon, earth, and their movements); life science: energy conservation, photosynthesis and river ecosystem environment); chemistry (kinetic molecular theory, interactions of molecules in different levels, symbolic and molecular representations and chemical change); biology (cell theory, molecular genetics, and the growth curve of microorganisms); and physics (fluid dynamics and heat and temperature). On the other studies, simulation programs failed to achieve positive results on topics such as protein structure lessons in biology and ecological lessons in life science.

This could suggest that computer simulation may be suitable in some topics and not in others. It is not obvious why this would be, but there are obvious difficulties involved in representing or imitating some topic in a simulation program.

Studies with positive results typically attributed this to appropriately designed simulation programs for the topics. For example, Huppert et al. (2002) said, about the biology topic in their study, that 'computer simulation renders the problem investigated concrete by displaying the process of counting cells, manipulation of the variables, diluting the growth



sample, and presenting the outcomes on graphs visually and immediately' (p. 819). They added that the simulation helps simplify complicated science processes for students, as they can immediately receive feedback to know whether steps and actions they took are correct or not. Other studies highlighted the idea that the opportunity to repeat the experiment many times within a short time period allowed the students to compare the results they achieved with other results through manipulating and changing variables, hence, giving students sufficient time to reflect of the data they gained and comparison with their previous experience for this experiment.

Still other studies suggested that, for a simulation program to explain the topic of science adequately, it must display the topic in dynamic forms that allow students to benefit from trial and error and to repeat the experiment over and over again without losing lesson time; this cannot be done with the traditional method, which uses still or static photos as illustrations. Many studies pointed to the importance of engaging students in an interactive way during the use of computer simulation. For example, Marbach-Ad et al. (2008) say 'Using visualization effectively is to make visualization interactive and to increase active student involvement in learning' (p. 288). Other elements mentioned for positive results, were the program users' efficiency, whether they are students or teachers; pedagogical support (i.e., instructional approaches; learning strategies; the simulations' learning environment (i.e., dynamic, visual, realizable and multiple-representational instructional environment; instructional capabilities) and students' attitudes toward the computer. For example, Taskin and Kandemir (2010) said that even if the simulation software was perfectly designed for the students and lessons, the teacher who teaches the lessons remains the key element for effective teaching with computer simulations. They therefore suggest that teachers should be given in-service courses on computer-based education by experts. Moreover, the study by Sun et al (2009) suggests that possibility to use the simulation to stimulate a constructivist learning environment that allows students to construct new concepts and integrate these concepts or accommodate prior conceptual in order to change of misconceptions and get good understanding. In addition, some studies suggests that there are insufficient educational materials for explaining and clarifying science subjects and the resultant inability to foster students' understanding of science topics thus it favors the use of simulation programs in science teaching. For example, Stern et al. (2008) mentioned that most of the available materials in the intermediate schools in the United States are

insufficient for properly teaching scientific concepts and this enhances the use of simulation programs as an alternative.

As for the studies that had negative results, they found that there are many factors that may be to blame: for example, bad simulation program design that is either not fit for sample study or that does not represent (i.e. simulate) the topic lesson properly; inefficiency of the users, whether students or teachers, in using a computer simulation program; the difficulty of the topic itself; and, finally, the weakness of measurement instruments used. Sherwood and Hasselbring (1986) had measurement instruments for collecting the data from an achievement test that were very weak. They did not check the reliability and validity of the study instrument to know if it would achieve the aim of their study, and they did not make a pre-test to verify that the groups were comparable. In addition to the difficulty of the topic, some concepts in the topic such as topics of the ecological and food pyramid, which are difficult for the students in the sixth grade for the intermediate stage to grasp it. as well it is difficult to represent or simulated them properly in a simulation program. Also, some study used old version of simulation software such as study of Sherwood and Hasselbring (1986) used a simulation titled Odell Lake, which was designed or established in 1981 and was not updated. Note that there was five years between the design of the simulation program and the start of the study, therefore, and in this period maybe the program was updated and it was still not fit for the study sample. Therefore, it is necessary to use a fitting simulation program and to conduct the study properly.

In the same context, some studies attributed the negative finding to the practical activity learning used in the study. For example, White et al. (2010) did not find any statistical difference between students who used lectures along with illustrative photos in the lab and those who used a simulation program. He attributed the reason to the fact that the two groups were doing the same practical activity

It is noticeable from the studies presented above that there is one study out of the 16 that was done on the primary schools stage. The reason for this may be related to the nature of the simulation program itself, since it requires a high level of computer skills to enable the students to manipulate variables in an experiment that displays on the computer screen, and these skills may found only in students who are in the intermediate, secondary, or university stages. Also, in these stages the students' cognitive ability, according to Piaget,

exceeds the cognitive ability of students in the primary schools stage. There is also a difference in capabilities in dealing with simulation program as a new intervention for the educational research in terms of manipulate of variables.

Regarding the impression of the students when using simulation programs for science topics teaching, many studies (such as Cpeni et al, 2006; Marbach–Ad et al, 2008; Sun et al, 2009) revealed that the students enjoyed participating. Also, these studies conclude that the students' attitude toward learning science was improved more among students who use the simulation program. Table 4 shows all the studies in brief.

### **3.3 Using computer simulations to enhance conceptual change**

Trundle and Bell (2010) examined the influence of computer simulation in conceptual change on the science topic of moon phases. The sample was student science teachers (N=157 of the 182). These students were distributed into three groups. Group one (N=50) used a computer simulation 'Starry Night'. The second group (N=61) students used the computer simulation 'Starry Night' for 6 weeks and observation in nature for 3 weeks. The third group (N=46) used natural observation only to gather moon data.

The study used before and after a test in order to observe change in conceptual understanding of moon phases. The results found that no statistically significant differences amongst the three groups in achieving a desired conceptual change, they attribute this due to use active instruction among three groups. In regard to the content knowledge of the concept of waxing and waning, however, there was a significant difference between those who only used computer simulation 'Starry Night' and only used natural observation ( $p < .011$ ), There was no differences between used computer simulation 'Starry Night' and Starry Night + Nature Group ( $p = .162$ ) also there is no different between Starry Night + Nature Group and the Nature Only Group ( $p = .198$ ) was not statistically significant. Moreover, in case of asking the participants to draw the scientific moon phases compared to pre instruction they found that the participants who used computer simulation 'Starry Night' only gained highest score (98.0%) compared to both groups Starry Night™ + Nature = 86.9% and Nature only = 76.1% .

Trundle and Bell attributed the success of computer simulation to the good design of the three-dimensional modeling of the earth–moon–sun system, which reinforced and extended participants' experiences with the data they collected from the simulation which used, thus,

that the teacher didn't need to worry to think about extraneous variables of local geography, such as; weather, or clouds that can obscure vision Moon, and these extraneous variables could be hinder the students' to observations or data collection about Moon.

Furthermore, computer simulations can providing good quality support structures, including training on how to use the simulation, scaffolding and feedback about decisions and actions, these support structures may be embedded within the simulation itself through the interactive, or may be provided by the teacher. They added using computer simulation provide opportunities for students to reflect upon and reconstruct their original conceptions and prompting students to explain and justify their actions and findings promotes conceptual understanding as well as saved time as, in this study. Total class time for the computer simulation-based data collection was substantially less than for the natural observation approach.

Jaakkola & Nurmi (2008) carried out a study to answer the question: Is a combination of computer simulation and real laboratory activities more beneficial than using them separately in fostering students' understanding of simple electricity (electric circuit)?

They established three groups from 64 elementary students (10–11 years old) divided into three different learning environments:

- a) The Computer Simulation Environment including 20 students was located in a computer suite where students solved assignments with an online simulation, the 'Electricity Exploration Tool', where students can interact with the program by setting up various circuits by dragging wires, moving bulbs and resistors into desired points in the circuits; and change battery voltage. Moreover, the students could conduct different electric measurements, and the simulation also visualized the current flow within the circuit. After making a certain configuration with the circuit, students could observe the effects of their actions and get immediate feedback.
- b) Laboratory Environment only: including 22 students who solved circuit assignments in a normal classroom, with laboratory equipment kits that included real batteries, bulbs, wires, switches, and a multimeter.
- c) Students in the Combination Environment (using both computer simulation and laboratory): this including 22 students used both the simulation of 'Electricity

Exploration Tool' and laboratory equipment kits. Students were first asked to complete the assignment using the simulation and then, after succeeding with the simulation, were asked to repeat the assignment with the laboratory equipment kits that were located right next to the computer.

To measure the effect, the researchers used one pre-test for all students in order to sure that students in all three learning environments were equal at the baseline and allocating them in the three groups according to their pre-test score. The post-tests used were the same questions as the pretest (these be called post-test basic questions) and they added four more challenging questions (these be called post-test advanced) these questions were not included into pretest. They will be referred to as basic and advanced post-test.

The results indicated that there was significant pre-test to post-test development within each learning environment ( $P < 0.05$ ) this applied both types of post-tests (basic and advance). In the case of the pairwise comparisons, the results were:

1. Between *combination* versus *laboratory*: The results showed that there a statistical significance ( $p < .05$ ) difference, with students working in the combination environment outperforming students working in the laboratory in all post-tests questions (basic, advanced, and score total of basic and advance).
2. Between *combination* versus *simulation*: The students in the combination environment outperformed students in the simulation environment on the advanced post-test and in the score total of basic and advance ( $p < .05$ ). But not in the basic post-test t ( $p > .05$ ).
3. Between *simulation* versus *laboratory*: There was no statistical differences between two environments in any of the post-tests, basic, advanced, or total ( $p = .418, .467$  and  $.273$ , respectively).

The researchers suggest that the benefit of using a combination of computer simulation and hands-on laboratory was due to the simulation helping students to understand information theoretically before applying it in reality, in other words, that the simulation fills a gap between theoretical knowledge and practical work.

Ozmen (2011) conducted a study aimed at identifying computer animation-enhanced conceptual change texts (CCT-CA) and their effectiveness on students' learning and understanding of the particulate nature of matter (PNM) as a topic in chemistry in the primary school science curricula. In the study, a quasi-experimental design was used, and

the sample was 51 students in sixth grade (age range of 12–13 years). These students were distributed into two groups. One experimental group (N=26 students) had a teacher with 8 years of experience in teaching science, and the second was a control group (N=25 students) that had a science teacher who had 11 years of experience. Both groups had a mixture of girl and boy students.

The measurement tools consisted of two different tests, one for the tested concept of Particulate Nature of Matter (ParNoMaC) and another test for the transformation of Matter Statement Test (ToMaSaT). Both tests used were as a pretest, posttest, and delayed test in order to collect data.

The results showed that there was no statistically significant difference between the two groups in the pretest ( $p=.924$ ), and this indicated that both groups were similar in prior knowledge for the nature of matter. But after the experiment, posttest results demonstrated that the students who received computer animation with conceptual change texts (CA-CCT) instruction were more successful than students who worked in the traditional instruction. Statistically there was a great significant in the posttest results between the experimental group and the control group, in favour of the experimental group ( $p=.0001$ ).

A delayed test was used to examine the retention of knowledge in both groups, and results showed a statistical significance for students retaining their knowledge, in favour of the experimental group ( $p < 0.001$ ).

In Ozmen's conclusion, he said the result of this study suggests that combining the methods of computer animation with conceptual change texts (CA-CCT) may be a helpful method for teaching natural matter and the transformations that occur during phase changes. Furthermore, he insisted that it is impossible to declare that computer animation with conceptual change texts instruction is the most ideal approach for teaching science.

Baser (2006) carried out a study using a computer simulation in both treatment groups (control and experimental). The aim of this study was to investigate whether a conceptual change model with computer simulation promoted and enhanced the understanding of direct current electric circuits for student elementary school teachers.

The sample of this study consisted of 89 students, divided into two groups, an experimental group (N=48 students) who used a conceptual change model with simulation (CCS) and a control group (N=41 students) who used a traditional confirmatory simulation (TCS).

There were four kinds of instruments for gathering data; the first was a test for Determining and Interpreting Resistive Electric Circuit Concepts (DIRECT), and this test was conducted for both groups both before and after the experiment. The second was a Physics Attitude Scale (PAS). The aim of this scale was to measure students' attitudes towards physics as a school subject. The third was a Science Process Skill Test (SPST) taken to measure the control students' science process skills. Finally, the fourth was a Computer Attitude Scale (CAS) to measure attitudes towards computers. The second, third, and fourth measure tools were applied before the experiment for all students.

According to achievement related to direct current electricity concepts, the results showed that there was a significant difference in the posttest mean scores of the experimental group (CCS) and the control group (TCS), in favour of the experimental group (CCS) ( $M_{cca}=17.23$  and  $M_{tcs}=12.73$ ). Also, there was a significant difference between the experimental group and the control group in mean scores of the pretest and posttest for both groups (average  $M_{cca}=10.97$  in pre- to  $17.23$  in post- /  $M_{tcs}=9.78$  in pre- to  $12.73$  in post-).

According to the second, third, and fourth tools, the researcher measured the contribution of students' (attitude towards physics matter) previous understanding, science process skills, and their attitudes towards the computer to the variation in their achievements test of direct current electricity concepts. The results showed a statistical significance. Therefore, it can be said that previous understanding (attitude towards physics matter), science process skills, and attitudes towards the computer account for or explain variations in achievement related to direct current.

Windschitl and Andre (1998) examined the effectiveness of using a computer simulation to enhance the conceptual change for the human cardiovascular system as an instructional tool into two groups, one as an experimental group with the constructivist environment (exploratory) and the second as a control group with an objectivist learning environment (confirmatory), both of which use computer simulation. The participants were approximately 250 college freshmen students. Divided into two groups as mentioned before, each group had 7 sections of approximately 15 students each (i.e. total of 14 sections). The instrument of measure was a multiple-choice pretest and posttest, focusing on six common misconceptions relevant to the human cardiovascular system.

The results showed that students who used the computer simulation in a constructivist environment showed significant differences compared to students who used a computer simulation in an objectivist environment approach for 2 of 6 commonly held alternative conceptions. The other four showed no significant differences between them. In addition, the results found in this study supported the idea that computer-based simulations offer a suitable cognitive environment within which to test learners' self-resolution of alternative conceptions, achievement, and general responses to constructivist instruction.

Talib et al. (2005) used a constructivist method with computer-animated instruction (CAI) to examine the effect of its use in the conceptual change progress by teaching complex, abstract, and dynamic (CAD) concepts of electrochemistry compared with conventional learning.

Eighty-five students entered the study, distributed into (N= 45) in the experimental group and (N= 40) in the control group. The data instruments were a pretest and a posttest and open-ended questionnaires, all of which were used to analyze the participants' conceptual change and their perceptions.

The results show a statistically significant difference in the posttest mean scores for the students exposed to the computer-animation in comparison to the students who were exposed to the conventional method (M=13.6, M=10.2, respectively).

According to open-ended questionnaires, students who used computer animations responded positively, mentioning that using computer animation gives the ability to concretely and explicitly portray topics and concepts that are complex, abstract, and dynamic (CAD).

Finally, they said that use of computer animation as instruction enhanced and facilitated the subjects' conceptual change progress. Furthermore, it served as an alternative replacement to static illustrations printed on transparencies (or drawn on the whiteboard) as practiced in conventional instruction. Moreover, engaging the students in presenting clear sequences of animations as learning tools with constructivist instructional activities seemed not only effective in significantly improving the conceptual change and the understanding of science concepts, but also affected students' positive perceptions and attitude towards learning and teaching science.



During the academic year 2006–2007, Tekos and Solomonidou (2009) conducted an experiment in four Greek Elementary Schools to investigate the use of ICT regarding the optic concepts of light reflection and diffusion and vision using constructivist learning and teaching. The sample of this study was 140 students (aged 11–12 years). (N=81) joined the experimental group where teaching was within a constructivist and collaborative learning environment with the use of ICT tools and activities, and (N=59) students in the control group were taught using standard textbooks and teacher presentations on the blackboard. Researchers used the questionnaire tool to elicit misconceptions and ideas about the optic topic before the ICT intervention.

With five initial student misconceptions on the topic of optics, which are (a) the nature of light, (b) distinguishing light reflection and light diffusion, (c) understanding the geometrical model, (d) light diffusion in the atmosphere, and (e) vision.

The study results indicated that teaching with the use of ICT tools and activities had positive learning results in the experimental group. The differences in students' answers between the experimental group (EG) and the control group (CG) showed an increased percentage from pretest to posttest in all five of the students' misconceptions, in favour of students who used ICT (i.e. experimental group). Based on the above, there were statistically significant differences between the two groups, in favour of the experimental group ( $p < .05$ ). In conclusion, Tekos and Solomonidou attributed this success of the characteristics of the software to the understanding of the geometrical model, as an example, which may be due to:

- (a) Students' engagement in real problem-solving activities,
- (b) Prediction, testing, and confirmation of their own models,
- (c) Use of analogies referring to everyday situations,
- (d) Appearance of appropriate feedback messages whenever the student answered either correctly or incorrectly, and
- (e) Allowing students to engage in problem-solving activities in a virtual geometric optics laboratory.

All of these results allowed the researcher to acknowledge the influence of the learning materials of ICT on students' conceptual change and comprehension of the phenomena.

Jimoyiannis and Komis (2001) conducted a study on computer simulations in physics teaching and learning. The purpose of this study was to investigate the role of computer simulations in the development of functional understanding of the concepts of velocity and acceleration in projectile motions. For this purpose, a total of (N=90) students attending the first year of high school (15 and 16 years old) participated in the research. The students were distributed in control and experimental groups. The control group consisted of (N=60) students, who were attending courses in two different high schools. The experimental group consisted of (N=30) students, who were attending courses in another high school. The experimental group was taught using computer simulations, whereas the control group was taught in a traditional way without computers.

The results of this research showed that the experimental group showed significant improvement on the achievement test. It seems that working with computer simulations helps students to overcome their cognitive constraints. The students from the control group who received a traditional type of instruction had no improvement in their achievements. It is evident in this study that both the groups face serious understanding and comprehension problems concerning the principle of the independence of the horizontal and vertical components of the velocity.

Researchers concluded that the results presented above show that computer simulation could be used complementary or alternatively to other instructional tools in order to facilitate students' understanding of velocity and acceleration as a science concept.

Tao and Gunstone (1999) conducted research to find a conceptual change in science through collaborative learning by using computer simulation programs. The purpose of this classroom study was to investigate whether and how collaborative learning at the computer promotes conceptual change in mechanics. This was integrated into a 10-week physics instruction of a tenth-grade science class at a high school. The class contained 14 students where pairs of students worked together. For collection of data, a conceptual test was administered to the class as a pretest and posttest to determine students' conceptual change. Students in the class worked collaboratively in couples with the computer simulation program.

This study showed that the computer simulation program supported collaborative learning and provided students with experiences of co-construction of shared understanding and

peer conflicts that led to a conceptual change for those who were cognitively engaged in the tasks and prepared to reflect on and reconstruct their conceptions.

At the final interview, students who achieved a conceptual change indicated that they were aware of their alternative conceptions and could clearly state the conceptual change they had undergone. They also claimed that they constantly tried to understand and make sense of what they learned.

Zacharia (2007) conducted a study to investigate the efficacy of interactive computer simulation in virtual experimental (VE) with respect to changes in students' conceptual understanding of the electric circuit. To achieve this, a pre–post comparison study design was used. Participants were 88 undergraduate students (student elementary school teachers) divided into two groups: an experimental group (N=45) used both real experimental (RE) and virtual experimental (VE) for an electric circuit. And the other, the control group (N=43), used real experimental (RE) only.

A conceptual electric circuit test was administered to both groups before, during, and after to assess students' understanding related to the three concepts of behavior of simple electric circuits, measurements of current, and resistance and measurement of voltage.

After the experiment, the results of the posttest (for the conceptual electric circuit test) showed that students in the experimental group had significantly higher scores than students in the control group ( $F_{1,85} = 10.6, P < 0.001$ ). This finding suggests that the combination of RE and VE had a stronger effect on undergraduate students' conceptual understanding of electric circuits (behavior of simple electric circuits, measurements of current and resistance, and measurement of voltage) than RE alone.

In conclusion, evidence from the result of this study indicated that the use of combination VE and RE promote enhanced students' conceptual understanding more than RE in relation to the topic of electric circuits.

### **3.3.1 Discussion on studies using simulations to enhance conceptual change**

It is noticeable how the number of vary among the different stages of education. For example, there is one study only in primary schools, two studies in middle schools, two studies in high school students but, five studies on at undergraduate level.

Because the current study focus in primary stage, we may conclude that there are many reasons of scarcity of studies at the primary school level, such as the fact that working with simulation program through a computer requires skills in dealing with computer components such as the keyboard, the mouse, etc... In order to achieve interactivity with the simulation program, also have skills to deal with sudden problems and solve it that could occur during using the program in a lesson, especially if the teacher was not acquainted with how to deal with the computer.

Furthermore, the researcher is afraid that the skills shortage in the primary students' may affect the study results or that the majority of young students in the primary stage will not care or deal seriously with the measurement tool (i.e. a questionnaire), so the collected data may be inaccurate or unable to be generalized. Therefore, the researchers may prefer to use students of the intermediate, secondary, and university stages.

The studies show that simulation programs were used to support conceptual change in a variety of scientific concepts. We find electricity with electricity circuit optics with light reflection and diffusion lessons; the nature of matter change and phase changes; force and motion; electrochemistry; astronomy with moon phases; and the human body with the cardiovascular system.

The majority of studies found that a simulation program helps students to review and comparing their prior knowledge and concepts with what they observe through use of simulation. For example, a study by Tekos and Solomonidou (2009) mentions that using information and communication technology (ICT) is widely used and effectively contributes to teaching science, particularly if the educational program, such as a simulation, it particularly effective when it is based on research into the various prior misconceptions that students have, thus, aiming at assisting the students and creating challenges for them through offering an appropriate opportunity for students to review the prior ideas and concepts and comparing them with what is introduced for them by the simulation program. Then they work to revise the misconceptions or build new scientific concepts.

They added that the simulation make students (a) engagement in real problem solves activities, (b) prediction, testing, and confirmation of their own models, (c) use of analogies

referring to everyday situations, and (d) appearance of appropriate feedback messages whenever the student answered either correctly or incorrectly.

One of the studies, Jaakkola & Nurmi (2008), concluded that using simulation programs integrated with the real laboratory enhances students' conceptual change more effectively than working only with the simulation program or in the laboratory. This was demonstrated through the advanced test which included new questions which were not included in the pretest, which means that combining computer simulation and a real lab through using simulation first and then use real lab makes the student to understanding and promote the conceptual change. Researchers attributed their result to the simulation software providing two distinguishing features: (a) providing a idealized model of the electrical circuit, and (b) visualising circuit functioning, a matter that first helped students to understand the theoretical principles of electricity. Then the students went to the real lab to apply what they had seen through the software in a real experiment. This study had some negative points, as results cannot be predicted if the students use a real laboratory first and then the simulation program. Also, in the basic test, there was no significant statistical difference between students who used the simulation integrated with the real laboratory and those who used the simulation only. The same of this conclusion was found it in Zacharia's study (2007) when he use of combination virtual experimental (VE) with real experimental (RE) in the laboratory.

In conclusion, most of studies shows that we can benefit of characteristics and features of simulation software in simplify complicated scientific processes, clarify some concepts that cannot be showed in the real lab, and offer the opportunity for the students to observe through repeat experiments many times, change and manipulate variables or elements, and prediction and reflect in a results of these variables to compare with what they already hold of preconceptions for the same topic. These features could help to fill the gap between the information theoretically in the classroom and hands-on laboratory activities. Thus, the benefits of combination or using simulation along with hands-on laboratory activities can bridge the gap between theory and reality (see figure 7), through help students to first understand the theoretical principles of topic and then in order to promote conceptual change, it is necessary to challenge further students' intuitive conceptions by demonstrating through testing that the laws and principles that are discovered through a simulation use before or with combined apply in reality. Table 5 shows all the studies in brief.

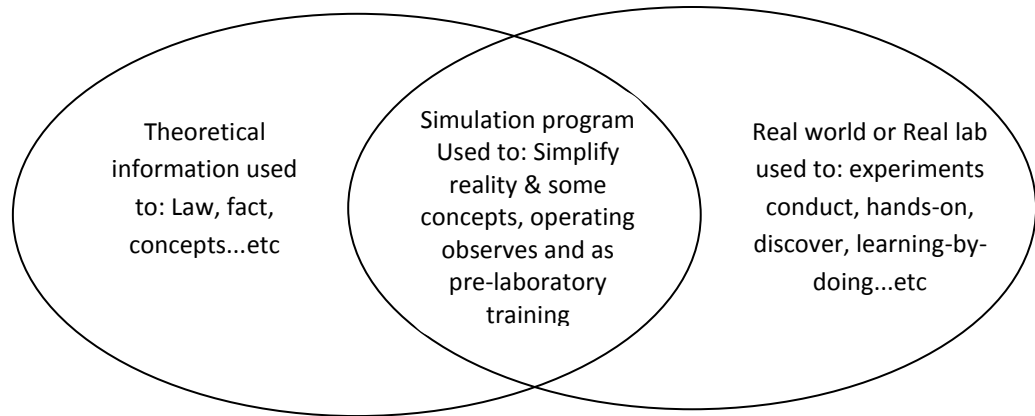

*Figure 7* The benefit of using simulation is bridge the gap between theory and reality

### **3.4 Using computer simulation as a replacement for laboratory**

One of the most important studies conducted by Oloruntegbe and Alam (2010) has been much debated in the research literature. They investigated and debated in many articles in different branches (such as; using the websites in the university e-journal include Springer links, Informal world, ProQuest, Science Direct-Elsevier, Questia, IEEEExplore, Journals consulted include Computer and Education, International Journal of Science Education, International Journal of Science and Technology Education, Science Educators, Science Education, International Journal of Engineering Education, Chemistry Central Journal, Conference like those of SIGCSE, SIGITE and WCCCE.) of education on whether using a virtual laboratory and simulation (3d-aimintion) in science teaching was useful for improving and enhancing student outcomes of cognitive, skills, and attitudes.

A study revealed that there was evidence of learning improvement and performance enhancement and in over eighty-five percent (85%) of the studies data revolved around affective dispositions of satisfaction, interest, enjoyment, and fun in use of simulation. With this, the authors concluded that there was no sufficient evidence yet to determine the pedagogical effectiveness of this state-of-art technology. The authors, however, appreciate the newness of this field of human endeavor and are of the opinion that sufficient time, spread, and focus are required to make a valid evaluation possible.

In general, the authors concluded that the literature consulted and used was dispersed across science disciplines. Many were not used because the domain of interest could not be attributed to education. Some could not be cited because they were not affiliated. Another important observation was that these efforts were mainly from universities and research institutes in America and Europe. Only sporadic efforts were reported from Asia, and none from Africa. Most were designed with university undergraduates serving as subjects in case studies. The efforts have not gone down to the secondary and primary levels of education. While we appreciate the fact that the field is a relatively new one that requires more time and spread for a valid evaluation, the conclusion of this study is that there was insufficient data on the pedagogical effectiveness of 3D environments and virtual realities beyond affective disposition.

Bakar and Zaman (2007) assessed the effectiveness of a virtual laboratory (VL) used when teaching chemistry. First a questionnaire was distributed to 14 chemistry teachers and 100 students to find out the difficult topics in chemistry. From analysis, they found that topic salt was the most difficult concept for teachers to explain and for students to understand. Next, they created a virtual laboratory software for teaching and learning a salt lesson and using this software with the constructivism-cognitivism-contextual approach in learning and teaching to enhance and strengthen cognitive skills for participants in this study.

Two groups in this study, first experimental group included 4 students used a virtual laboratory with constructive, cognitive, and contextual methods, and the second was a control group included 4 students used conventional methods. For data gathering, they used a pre- and a post achievement test to evaluate student performance containing two sections, a section A to evaluate cognitive-level knowledge, understanding, application, and analysis. Section B questions involved a higher level such as analysis, application, synthesis, and evaluation.

The results in the posttest found the average test performance for the experimental group was 47.00% (13.53% in the pretest) while the control group was 29.23% (14.10% in the pretest). That meant there was a statistically significant difference between the experimental group and the control group, in favour of students in the experimental group. In conclusion, the researchers found that teachers and students who used (VL) thought it was very useful in science teaching and learning.

Gibbons, Evans, Payne, Shah, & Griffin (2004) conducted a study to compare students who used a virtual laboratory with students who used a real laboratory in regard to students' knowledge of basic genetics (chromosome analysis). Forty-seven undergraduate students from Brunel University were divided into two groups. The control group undertook the traditional approach to learning the skill of chromosome analysis involving a photograph, scissors, and glue. The experimental group used a computer-based simulation approach called KaryoLab as a virtual laboratory. In addition to an achievement test for data gathering, the students' opinion of the use of the KaryoLab computer simulation was evaluated by the questionnaire as well.

Although the results show that the students in the experimental group scored 4% higher in assessment than the control group, there was no statistically significant difference between both groups. But in regard to the opinion of students for using the computer simulation, responses were positive. The most notable response was that 100% of the students polled would have preferred to complete the KaryoLab over the real lab with the scissors and glue method.

The tutor also reported that it was much easier to perform practical classes with KaryoLab than with the scissors and glue approach. Moreover, students in the experimental group were able to complete the sections faster than the control group both in the practice session and in the assessment ( $p$  value  $< 0.05$ ). They concluded that results showed that the KaryoLab virtual laboratory can achieve a substantial reduction in study time without any significant effect on student performance in assessment.

Martinez, Pontes-Pedrajas, Polo, & Climent-Bellido (2003) conducted an educational project involving the development, application, and evaluation of a virtual chemistry laboratory (VCL) used as a simulation program. Their aim was to investigate whether using the VCL program as a complement to traditional teaching methods improved student performance in a chemistry laboratory experiment with respect to four goals: (a) knowledge about the apparatus, (b) basic operations in the laboratory, (c) solving practical problems, and (d) solving theoretical practical questions. To find this out, they compared the results of two groups, a control group and an experimental group, for a period of two years for first-year undergraduate students ( $N=274$ ). The control group ( $N=139$ ) used traditional methods, and the experimental group ( $N=135$ ) used traditional methods and VCL as a complementary tool to introduce them to the real laboratory.



The results found that there was a statistically significant difference between the two groups, in favour of the experimental group, with respect to improving and enhancing students' knowledge, basic operations in the laboratory, and skills necessary for solving practical problems. There was no significant difference between the two groups regarding the fourth goal.

In conclusion, they asserted that the students involved in the experimental group achieved a higher level of learning than students in the control group and that the VCL program was helpful in improving the learning process in the real laboratory. They also added that the use of VCL especially contributed to improving the work of those students who had the greatest learning deficiency. In general the use of virtual Laboratories as a complementary tool may help students to introduce them to work the real laboratory.

Farrokhnia and Esmailpour (2010) examined the influence of using virtual manipulations (VM) through the use of interactive computer-based simulations as a pedagogical tool in students' 'conceptual understanding of the subject of DC electric circuits'. The participants were 100 undergraduate students distributed in three different groups. The first group was called the real group (N=30) who used physical materials such as wire, bulb lamp, key, etc. The second group, called the virtual group (N=35) used only a computer-based simulation. The third group, the comprehensive group (N=35) used a combination of physical and virtual materials to conduct their experiments.

Researchers used a pretest and a posttest to gather data about the extent of the impact of computer simulation on students' conceptual understanding and skills on the subject of electric circuits. After the experiment, results from the posttest indicated that scores for the students in the comprehensive group were better than those of students in the real group, and there was a statistically significant difference between them, in favour of the comprehensive group. And between the comprehensive group and the virtual group, there was no statistical significance, while the mean score was slightly better in the comprehensive group. There was no statistical significance between the real group and the virtual group. In relation to skills, results found that all groups were equal in level of knowledge about using real electric tools for assembling circuits. The interesting result was that students in the virtual group built the circuit by real materials correctly and measured the demanded quantities in less time compared to other groups.

In conclusion, the researchers found good evidence that working with the interactive computer simulation during the laboratory classes eliminated the confusion amongst students in setting up electrical circuits and, consequently, they could better get familiar with the placement or arrangement of electrical pieces in circuits (parallel and series) and closely observe the movement of electrons across the circuit.

Kennepohl (2001) investigated the effect of computer laboratory simulation software for a chemical course on students' performance and their experience with use of a computer simulation compared to a real laboratory method. The researcher designed two groups for gathering data and used a performance test and questionnaire to gather data about students' experiences. The first group containing (N=72) students was an experimental group that used computer laboratory simulation, and the second group containing (N=82) used a traditional laboratory without simulation.

The results found no statistical significance between the two groups in relation to performance tests overall, while students in the experimental group performed slightly better than the other group on the lab quizzes (74.5% and 67.5%, respectively) that tested practical laboratory knowledge. Regarding the students' experiences and their opinions on using the computer laboratory simulation, there was a positive attitude in the following elements: simulations were easily accessed on the computer (76%), instructions were clear and easy to follow (84%), the quizzes in the program reflected well the information presented in the simulations (88%), and quizzes strongly reinforced the course material (82%). However, there was a low percentage in how interesting the laboratory simulation was and the ability of these simulations to help them prepare for real laboratory work (68% and 46%, respectively).

In conclusion, in this study, the use of laboratory simulation to supplement a real laboratory did not seem to affect the overall performance of students in their chemistry course. The combination of simulations and real laboratory was useful, however, in saving time.

Bilek and Skalicka (2010) conducted a study to investigate whether combining a virtual laboratory (computer simulation software) with a real laboratory led to improve students' experimental activities in studying laboratory pH in a general chemistry course. The sample was 85 students in eleventh grade in high school. Divided into two groups, the first group used simulation before a real experiment to explain its principle and for training the activity. The second group used simulation after a real experiment for explaining its

principle and helping for fixing knowledge. After students finished their lessons, their worksheets were analyzed on three levels; two levels of the three were relevant to this study of the task of measuring pH.

The level-one results in pH values collected from real and virtual pH-meters found no statistically significant differences. In level two, which focused on problem-solving tasks based on previous activities and students' common experience, found no statistical significance either.

In conclusion, the results indicated that real experimentation should not in any way be eliminated from school laboratory practice; moreover, forming and improving manual skills (measuring by available laboratory instruments, working with laboratory systems, constructing from common subjects of everyday use, working with safe substances), which are an important part of natural science education, cannot be fully replaced by practicing through a monitor and keyboard.

Tuysuz (2010) felt that hands-on experiments were rarely performed in public schools because of the lack of laboratories in schools or not enough in instruments in the laboratories. Therefore, he designed a virtual laboratory related to the topic of separation of matter to investigate its effects on students' achievements and attitudes towards learning chemical science.

The method was quasi-experimental for research design. The sample was from ninth graders in high school (N=341) divided into two groups, a control group (N=167) that used a traditional method to teach the unit on separation of matter and an experimental group (N=174) that was taught by a constructivist-based instructional approach that was enriched by computer animations at the computer laboratory. Through eight weeks, the experimental group conducted 16 virtual experiments. The instruments used for data collection were a pre- and posttest for both a knowledge scale test (KS) and a chemistry attitude scale (CAS) test.

After the experimental period was finished, results found that in the pretest the level of knowledge in both groups was the same at  $p=0.941$ , so there was no statistical significance. After the posttest, results indicated that the mean value increased for both groups, which was interesting because the mean of the experimental group was twice that of the control

group's mean value ( $m=10.62$  and  $m=5.40$ , respectively). These results indicated that there was statistical significance in favour of the experimental group ( $p=0.01$ ).

Regarding the students' attitude towards teaching and learning chemistry science (CAS), the results indicated that teaching the chemistry topics in a virtual laboratory by using virtual experiments affected students' attitudes towards chemistry positively. Through the (CAS) mean scores, it is seen that EG's mean scores were higher than those of the CG's ( $M=103, 64$ ;  $M=75, 65$ , respectively). In other words, there was statistical significance between the two groups, in favour of the experimental ( $P=0.01 < 0.5$ ).

Tuysuz concluded that the use of a computer in science instruction is useful, especially when the content of science is taken into consideration. Amongst the reasons for this suitability and helpfulness is that it allows teachers to use lesson software enriched with visual and sound presentations to make complex and abstract scientific concepts and phenomena concrete and understandable through appropriate instructional methods.

Sun, Lin, & Yu (2008) conducted a study on learning effects amongst different learning styles in a Web-based virtual laboratory of science for elementary school students. The purpose of this study was to explore learning effects related to different learning styles in a Web-based virtual science laboratory for elementary school students.

This study was administrated to over 113 students - from 132 students - from four fifth-grade classes in an elementary school, randomly selected from different districts in Taiwan and divided into two groups. ( $N=56$ ) students from two of the classes were assigned to the experimental group, where they received information-integrated, Web-based virtual science laboratory teaching, while the other ( $N=57$ ) students from the other two classes were assigned to the control group, where they received traditional classroom teaching. The instruments for data gathering were: (a) questionnaire surveying learning styles, (b) pre- and posttest achievement test of science, and a (c) questionnaire on Web-based lab teaching.

After finished the treatment, the results of this experimental teaching method demonstrated that: a) students in the experimental group using the online virtual lab achieved better grades than those in the control group under traditional class instruction, b) a Web-based virtual science laboratory learning environment is suitable to accommodate various learning styles, and c) the attitude of the students showed that nearly three-fourths of the students

were willing and preferred using the Web-based virtual laboratory over reading textbooks only.

Sun and his colleagues concluded that some powerful points emerged according to the study results:

- Interest in learning sciences was promoted via simulated experiments.
- Individualized learning and teaching occur easily because it is easy for students to click on the computer rather than ask the teacher, thus eliminating the feeling of being embarrassed when asking the teacher.
- The possibility of repeating operations powers cognition and helps build science conceptions more easily.
- Science learning is enhanced over the traditional teaching method.
- The science-simulated laboratory is able to accommodate learners with different learning styles.
- Problems related to rooms, equipment, and limited time for laboratory class are eliminated.
- The object-directing design simplifies the management and maintenance of the virtual lab.

According to problems facing science teachers, school administrators, educators, and the scientific community regarding ethical controversies over animal dissection in traditional laboratory or classrooms, Akpan and Andre (2000) examined the influence of a prior dissection simulation of frog dissection in improving students' actual dissection performance and learning of frog anatomy and morphology.

The sample in this study was seventh graders (N=127) in middle schools; after many factors the number was reduced to 65 students, divided into three experimental conditions as following: *First condition*—students (N=21) used a computer simulation before completing an actual frog dissection (SBD); *second condition*—students (N=28) used a computer simulation after completing an actual frog dissection (DBS); *third condition*—students (N=16) used an actual frog dissection only (DO).

The tools for gathering data were three: pre- and posttest on anatomy and morphology and attitudes towards frog dissection. Dissection performance was evaluated during the

experiment through observation and a checklist (right/wrong) by the researcher and worksheets by students.

The results of the study indicated that students who used condition one SBD performed significantly better than students who used DBS and DO on both the actual dissection and knowledge of anatomy and morphology. Between DBS and DO, there was no significant difference. Regarding students' attitudes towards the use of animals for dissection, there was no significant difference in pre- and post-attitudes between and within groups.

In conclusion, the researcher thought of two possible reasons why simulation after dissection had no effect: one, the complexity of dissection is such that students are unable to form a good memory prior to instruction; and two, because students believe they already know what the simulation covers and pay less attention to it. The results of the present study suggest that presentation of a computer simulation before the actual dissection may provide an experiential base that enhances learning and performance of students on the actual frog dissection. This study also supports the idea that computer-based simulations can offer a suitable cognitive environment when students search for meaning.

Regarding expenses in terms of equipment, consumables, and time required of academic and technical staff in real laboratory practice in chemistry, in addition to the seriousness of some of the chemical solutions, Limniou, Papadopoulos, Giannakoudakis, Roberts, & Otto (2007) conducted a study to investigate student achievement when using the computer simulation laboratory on the topic of viscosity, and their opinion was that removing or reducing obstacles of laboratory practice added to the lab's impact.

The sample in this study was undergraduate students (N=88) divided into groups: an experimental group (N=44) where students in this group used their own PCs in the prelaboratory session and performed virtual experiments using the viscosity simulator, and after that they went to the real laboratory and performed the same experiment. Students in the second group (N=44) used a traditional method of a real laboratory.

The instrument for data collection was a questionnaire containing two parts: the first part measured students' content knowledge, and the second was students' opinions towards use of simulation as a prelaboratory educational tool.

The results found there was a statistical significance between the two groups relating to the content knowledge, in favour of the experimental group, also a difference between the two groups' means (from 23% to 29%). On other hand, opinions of the students who used the

virtual prelaboratory expressed that they felt more confident, understood the theory behind the experiment, and had more of an opportunity to question the teacher before attending the real laboratory; their responses on the questionnaire were 82% to 91%, a very high percentage.

The control group (CG) students' responses were unfavorable. They complained that they repeated the experiment several times to no use; moreover, routine procedures like repositioning and cleaning of the capillary were tiresome and boring.

In conclusion, students in the experimental group found it more constructive and less tiresome to spend time in both the prelaboratory and laboratory sessions to overcome problems that the control group faced.

### **3.4.1 Discussion on studies using simulation as replacement lab teaching**

This section has reviewed studies that used simulation software as an alternative or complementary to real science lab. The subjects investigated included were chemistry, anatomy, and physics. I think there is two reasons can concluded through the previous studies for using computer simulation software as an education tool that is an alternative or complementary to a real science lab, the first reason is included some problem may prevents the use of real laboratory such as; limited time (i.e., insufficient time) for the lesson, the lack of some means or equipment to conduct scientific experiments, and the danger involved in conducting some scientific experiments in the school. Therefore, the characteristics of simulation may solve these problems or obstacles, Gibbons et al. (2008) shed light on the abilities, advantages, and benefits of programs based on computer use, e.g. simulation software. These advantages include:

- 1- Flexibility of time (students can complete the virtual laboratory at a time convenient to them).
- 2- Flexibility of location (students can complete the virtual laboratory in a location other than the teaching laboratory).
- 3- Control of learning pace (students can take as long as required to understand the concepts with the virtual laboratory). So, in the context of students not having to rush to vacate the laboratory, they can work at their own pace (p. 263).

Other studies refer to that virtual laboratories, i.e., simulation programs, offer an additional set of potential advantages. For example, they can reduce testing time, because simulations can be developed to perform tests through a computer-based assessment and then results can be sent directly to the tutor electronically. And, finally, their use could lead to reduced infrastructure costs (it is not necessary to spend funds on laboratory equipment, reagents, consumables, and laboratory staff). Virtual laboratories have been seen to cut the costs of running a practical class significantly (see Gibbons et al. 2008, p. 264).

The second reason is that some studies (Akpan and Andre, 2000; Farrokhnia and Esmailpour, 2010; Limniou et al, 2007; Martinez et al, 2003) that suggest the use of virtual laboratory such as computer simulation as an educational aid, complementary or as pre-laboratory to training in the activity and these may help students to reflect on the how experiment conducting in the real laboratory. Such as by permitting the self-training of students through their individual work by simulation, either to clarify and observe the experiment or as a training task in itself through simulation before introduced to real laboratory. Also it can reduce the gap between the theoretical information and hands-on in real laboratory.

It could also help solve the problem of overcrowding in lecture halls, especially in introductory courses that often have 150–200 students per lecturer. In addition, it allows instructors to focus on the explanation of basic theories and reduces the time devoted to instrument operation and technique (see Martinez et al., 2003 p. 352).

Some studies show that there are some negative points to the simulation software, including the fact that simulations or representations of natural phenomena or scientific experiments are not exactly like reality. There are elements affecting this phenomenon that cannot be observed through using simulation software but only through real practical work of the process, but that may be impossible to apply in schools that need to cut costs.

In general, whatever of a benefit of virtual laboratory such as computer simulation, the real experimentation should not in any way be eliminated from school laboratory practice.

See Table 6 shows all the studies in brief.



### 3.5 Arabic studies

Al-huthaify (2008) conducted a study to investigate the differential impact of using e-learning on student achievement, mental abilities, and attitudes in science learning at middle school in the seventh grade. To achieve this, the sample was 60 students divided onto two groups, an experimental group of (N=29) students (we used a private school in the Kingdom of Saudi Arabia) and (N=31) students in control groups. The researcher used pre and post achievement tests and mental abilities, as well as an attitude questionnaire.

The results showed a significant difference in the posttest of students' achievement between the two groups, in favour of the experimental group that used e-learning. No significant differences were found between the two groups in mental abilities or in attitudes towards science.

Overall, the mean score for the experimental group was slightly higher than the control group both in mental abilities and in attitudes towards science. However, this rise is important in that it has statistical meaning. The limitation of this study was that the researcher did not apply the experience to public schools but instead used a private school because of the availability of computers. Moreover, the students in the experimental group were taught by the researcher himself, so the bias factor may impact results.

A comparative study of Al-Dael (2002) found a statistical significance between students who used a computer in learning the three skills of arithmetic operations (addition, subtraction, and multiplication) of math in both a pretest (Meg=10.71, Mcg=09.00) and a posttest (Meg=14.15, Mcg=11.02).

The results above were found when he applied the experiment at the Institute of Capital Model in second grade for 40 students distributed into two groups, one an experimental group (N=21) that used a computer laboratory for teaching and learning math, and a control group (N=19) that used a traditional method. The period of the experiment was two weeks for both groups. A pre- and post achievement test was administered for both groups to investigate the effect of using the computer in teaching and learning addition, subtraction, and multiplication in math.

The limitation of this study is the small sample size and that the experiment was applied in a private institute, not a public school in the Kingdom of Saudi Arabia.

In the Sultanate of Oman, specifically at the Faculty of Education, Ali (2002) conducted a study aimed to investigate the effect of using information technology on the Internet for student math teachers on their academic achievement and their attitude towards using the Internet in teaching.

The sample was 50 second-year undergraduate students. A pre- and posttest of students' achievement was conducted, as well as an attitude questionnaire.

The results found a statistical difference between the pre- and post-achievement test ( $p=.01$ ,  $p<.05$ ) in favour of the posttest. However, there was no statistical significance of the attitude towards using the Internet for teaching math. The effect size in this study is very high at 1.3. The researcher attributed the negative attitude to using the Internet in teaching to the shortness of the experimental period.

PowerPoint computer software was used by Sulaiman (2007) to examine the effectiveness in students' achievement and attitude towards using it in the teaching of art education, specifically artistic taste, at a middle school in the Kingdom of Saudi Arabia.

Participants (N=120) students were divided into two groups, one an experimental group (N=60) who used a PowerPoint program to teach artistic taste, while the second control group (N=60) used a traditional method. For gathering data, students' achievement test and an attitude questionnaire were administered to both groups.

The result indicated that in the posttest, students who used the PowerPoint program outperformed the students who used the traditional method; therefore, there was statistical significance between the two groups taking the posttest, in favour of the experimental group. Moreover, there was a great difference between the mean scores pre- and post-attitude towards using the computer to teach art, in favour of post-attitudes (M pre=61.6, M post=79.7). Also, there was a statistical significance for the posttest.

Sobhi & Abdullah (2003) conducted a study to investigate the effects of using computer assisted-learning (CAL) in Islamic education to improve the rules of Tajweed in the reading of the Holy Quran for tenth graders in high school in the Hashemite Kingdom of Jordan.

One hundred and fifteen participants divided into 57 students (N= 32 male and N= 25 female) as a control group used a traditional method, and 58 students (N= 33 male and N= 25 female) as an experimental group used CAL.

The instrument of data collection was a pre- and post-Tajweed test. After the experiment concluded, results showed that the students who used CAL performed better both in an oral

and theoretical test than students in the control group. Also, there was statistical significance between them in favour of the experimental group, while there was no significant difference between the two groups in relation of sex (male or female).

Fathallah (2006) conducted an experiment with a group of undergraduate students (N=117 student teachers) at the College of Education in the Kingdom of Saudi Arabia and divided them into three groups. Group one was the first experimental group (N=41) that used the PowerPoint software for topic presentation. The second experimental (N=38) group of students used PowerPoint software plus video clips for topic presentation. Finally, the control group (N=38) of students used a traditional method. The aim of this was to investigate whether using PowerPoint software alone or PowerPoint for presentation with video clips improved or developed students' achievement of understanding, skills, and attitudes towards use educational means and techniques in teaching.

For data collection, a pre- and a posttest for students' achievement and an attitude questionnaire were administered; moreover, observation cards to measure skills in the use of technologies were used as well during the teaching.

The results revealed significant differences between the three groups with regard to achievement tests, in favour of the first experimental group. Also, the second experimental group had a statistically significant difference compared to the control group, a big difference between the first and second experimental group compared to the control group ( $d = 23.91, 19.02, \text{ and } 5.01$ , respectively). According to skills scales, there was statistical significance between the three groups. What was striking was that students in the second experimental group performed better on skills scales than those in the first experimental group. On the other hand, the second experiment was better than the first with regard to attitudes towards using means and techniques in teaching; thus there was statistical significance between the three groups, in favour of the second experimental group. Effect sizes for all were (EC one=24.62; EC two=15.64; and finally CG=5.54).

Due to the development of students' skills and attitudes towards using means and techniques in teaching through use of video clips integrated to a PowerPoint presentation on the topic, the researcher recommended using this teaching method to demonstrate the importance of means and techniques on education.

Al-Karsh (1996) conducted a study to investigate the effects of computers in math to improve students' achievement and skill in an engineering unit for ninth grade in high school in Egypt. Two groups were created, one an experimental group (N=35) and the second a control group (N=34). For both groups, an achievement test and a skills test were conducted.

Results revealed that students who used a computer in math did better than students who used a traditional method. Thus, there was statistical significance in favour of the experimental group. Also, students who used the computer got a high efficiency in the skills of mathematical proof compared to the students in the control group.

The researcher recommended generalizing the use of the computer program in teaching to the engineering unit. But the weakness of this argument to generalize the method (i.e. use computer software) is that the sample is very small.

In (2007) Beshayrah and Manzalawy made a study to investigate the impact of computer-assisted learning (CAL) versus cooperative learning in students' achievement on the topic of earth's history for seventh graders in middle school in Jordan.

The participants were 115 students (57 male and 58 female). Divided into two experimental groups, experimental group one (N=59) used computer-assisted learning for learning earth history. The other was experimental group two (N=56) that used a cooperative learning method without a computer. Pre- and posttests were administered for both groups for gathering data.

After the experiment finished, in spite of results showing that the mean scores for students (both male and female) who used CAL (Ec1) were slightly better than students who used cooperative learning (Ec2), there was no statistical significance between the two groups (CAL or cooperative learning) with regard to posttest achievement.

The researcher attributed this result to two reasons: first was that the two methods (i.e. CAL and cooperative learning) were new methods for seventh-grade students, which led to an increased motivation to learn science. The second reason was that the experimental period was very short. I think investigating the effect of using both methods, whether CAL or cooperative learning and comparing to the traditional method, is more beneficial than seeking the achievement and attitude towards using them.

Alttamar and Sulaiman (2006) conducted a study to investigate the effect of computer-assisted learning (CAL) in developing achievement of first-degree equations amongst seventh-grade students in State of Kuwait.

The sample was 124 students divided into two groups: one a control group (N=62) that used a traditional method in teaching the method unit, and the second an experimental group (N=62) that used computer-assisted learning for the same topic. The pre and posttest to assess achievement was administered to both groups.

The results showed a statistical significance between the two groups, in favour of the experimental groups, regarding students' comprehension and application levels and ability to solve equations of one degree in one variable, while there was no statistical significance for the remember level. The limitations of this study are that the method (CAL) was applied on only one topic and for a short period of time. Thus, generalizing the results needs more study.

### **3.5.1 Discussion and analysis of the Arabic studies**

There have been many attempts in Arab studies to use computer applications (e.g. PowerPoint and Word) in various scientific fields, although there is no Arab study (to the best of my knowledge) that covers or examine the ability of simulation software in improve academic achievement for students or enhancing conceptual change or supporting students' attitudes towards science learning either together or each separately. Two studies of nine found that it used computer program in science field, first study for Al-huthaify (2008) who used e-learning for science teaching and his result was positive in the student's academic achievement in favor of students who exposed to e-learning, but he did not mentioned the science topic or concept, also he did not refer to kind of software which was used in his study and finally he conducted his study in a private school and not public or a government, thus we cannot to be generalized. The second is for Beshayrah & Manzalawy (2007) used educational program for teaching earth history for students in seventh grade and they found that there was no statistical significance between the experimental and control groups, the researchers attributed this finding to the short duration of the experiment and the educational program and cooperative learning was new method for the students. Also they did not mention what kind of computer program which they was used their study, as well as any topic specifically the history of the earth in science. Therefore, as these of limitations in

the Arabic studies do not make you study discusses in the impartial or objective form. But these previous studies give an impression that there is an inclination or trend to use computer software in optimizing learning in Arab countries.

Many studies recommended that those responsible for education process in the Arab countries to pay attention to technology and attempt to benefit from its enormous and rapid development in the field of education. For example, Al-Huthaify (2008) recommended that educational leaders should use electronic education within the education processes in general and in science teaching especially, also that they should work to involve electronic education within the pre-service science teacher's education in the College of Education, as well teaching science teachers to use computer to teach science during their training programs. Aldeal (2002) recommends conducting many studies on the influence of computer teaching subjects at the primary stage to develop problem solving and creative thinking by providing educational programs in schools at the primary stage. In conclusion, it is noticed that there are recommendations in all of the studies to call the attention of education officials to the idea that ICT should be associated with the education process. This indicates that there is a trend to use technological education tools in teaching and learning. Table 7 shows all the studies in brief.

The current study, as an experimental study, attempts to contribute to replenishing the Arab studies by using simulation software as a replacement for practical work in the primary school in Kuwait.

### **3.6 Summary**

Previous studies have been classified in this chapter into three categories according to the aim of the use of simulation software. The aim of these categories is the goal of that when come to discussion of the results of the current study (later in the discussion chapter) the results will be easier to compares them with previous studies that are mentioned in this chapter.

Through a review of the previous studies, many important observations can be drawn, as following:

1. The majority of the previous studies have agreed on the possibility of computer simulation software to be an efficient education tool in science learning because of its advantages and characteristics.
2. Some studies show that there are some factors that may affect the effective use of simulation programs. For example;
  - a) Appropriate design of the simulation program so that it is: suitable for the study sample, can achieve the aims of the study, and represents the topic properly and as close as possible to reality.
  - b) Teacher efficiency and teacher experiences in technology and computers.
  - c) Students' skills in computer use.
  - d) The nature and difficulty of the topic difficulty.
3. Studies show that using simulation programs could help to overcome or eliminate the problems related to science labs, such as; the lack of materials and time limitation as well as reduced infrastructure cost.
4. Although there are positive outcomes in some previous studies towards using simulation in science teaching and learning, many researchers acknowledge that there are risks in relying solely on a simulation program in science education.
5. Previous studies show the possibility of utilizing computer simulation software to use for a diversity of teaching methods, such as: as a support for traditional methods; as a supplement or enhancement of the real science laboratory; in cooperative learning; for self-education; and finally as an alternative to a real science lab.
6. Using the software leads to an educational environment that is more flexible than didactic traditional method of learning or science lab in the various ways of learning (whole-class learning, constructivist learning, cooperative learning, or individual learning).
7. Using the simulation explained and clarified some of the concepts that are usually difficult for students to understanding using a traditional method only

8. The majority of previous studies show that science teachers observe that using the simulation software increases the attitude and motivation of students to learn science.
9. There are very few (rare) previous studies investigating the effectiveness of using computer simulation software on primary school students.
10. No Arabic study investigates the effectiveness of the computer simulation software on primary school students, but there are Arabic studies investigating the effectiveness of applying other ICT tools in education.
11. Although positive outcomes in some previous studies point towards using simulation in science teaching and learning; however, many researchers demand more research and investigation in this area.



**Table 4**

*Using Computer Simulation to Improve Students' Academic Achievement (Arranged by Educational Level of the Sample)*

NO	Author (year)	Science lesson topic	Sample (Grade level)	Study groups	Data collection	Result
1	Sun et al. (2009)	Sun, moon, earth and their movements/ Astronomy	128 (4th grade) Elementary school	Experimental group used sun & moon system model in computer & Control group used traditional photograph	Pre-posttest of achievement and attitude questionnaire for students felt using computer	Statistical significance in favour of the experimental group in posttest. More than two-thirds of students preferred using a computer system model and felt this was more interesting, enjoyable, and engaging.
2	Taskin and Kandemir (2010)	Energy Conservation	40 (7th grade) Middle school	Experimental simulation-aided teaching methods & Control groups traditional education	Pretest and posttest	Statistically significant differences in the achievement test favouring the experimental group during the combination of the computer simulation with lecture.
3	Stern et al. (2008)	Kinetic molecular theory/ Chemistry	133 (7th grade) Middle school	Experimental & Control groups	Pretest and posttest and interviews for five students from each group (15 min).	There was significantly higher improvement of content knowledge in favour of the experimental group
4	Kiboss et al. (2004)	Cell theory/ Biology	102 Middle school	Three groups; Two group use Computer simulation one take pretest the other no. third use traditional (control)	Pre- post achievement test + classroom environment and attitude questionnaire	In both experimental groups, there was a higher mean score in achievement test and positive attitudes and perception of the classroom environment.
5	Sherwood and Hasselbring (1986)	Ecological topic	145 (6th grade) Middle school	Three groups; (1) Small group (pairs) use Computer simulation. (2) Mass (total class) use Computer simulation (3) Use traditional (control).	Post- achievement test only (immediate and delay)	There was no significant difference between groups. It was recommended that teacher use computer simulation with a large screen monitor for the whole classroom because it's more beneficial
6	Marbach-Ad et al. (2008)	Molecular Genetics	248 High school	Three groups; (1) Use Computer simulation, (2) Use traditional (control), (3) use illustration	Multiple-choice (pre-posttest) and open ended (post only) questionnaire + interview	Achievement outcomes for students who used computer simulation were slightly better than students who used illustration, and much better than the control group. And they said the simulation was enjoyable and helpful.
7	Manlove et al.	Fluid dynamics /	17	Experimental use	Pre- and posttest and	Results showed that the experimental group

	(2006)	physic	High school	computer simulation with regulatory guidelines & Control groups same program no guidelines	observation	in learning outcomes, cognitive, and planning significantly outperformed control group. Monitoring and evaluating were comparable in both groups.
8	Cpeni et al. (2006)	Photosynthesis	52 (11th grade) High school	Experimental & Control groups	Pre- and posttest and attitude questionnaire scale	Better in students' achievement test in favour of experimental group and got higher cognitive level than expected in knowledge level. Positive attitude towards science in favour of experimental group as well.
9	Huppert et al. (2002)	Biology	181 (10th grade) High school	Experimental & Control groups	Pretest and posttest	Improvement in concrete and transitional operational in favour of experimental (effect size 2.66 and 2.84); no significant difference between groups of formal operation.
10	Chang (2001)	Earth science subject	159 (10th grade) High school	Experimental & Control groups	Pre-and post-achievement test	There was statistical significant difference in achievement test and knowledge and comprehension level between groups, favouring the experimental group while no statistically significant differences in application level.
11	Wu et al. (2001)	Chemistry	71 (11th graders) High school	One experimental group	Pre- and posttest and observation & interview	There was significant difference between pre- and posttest. Computers positively affected chemistry learning effect. Students preferred computer.
12	Vartacnik et al. (2000)	Chemistry	50 High school	Experimental & Control groups	Pre-and post-achievement test	Experimental group doing better in posttest than students in control group and better in understanding of the phenomena.
13	White et al. (2010)	Protein structure	477 Undergraduate student	Experimental use simulation & Control groups use visualization	Questionnaire survey pre- and post	No statistical significance, while in opinion of use simulation, students said simulation taught them slightly better than visualization.
14	Stieff and Wilensky (2003)	Chemistry	six Undergraduate student	One experimental group	Pre- and post-interview and observation	High improvement eliminates misconceptions in chemical equilibrium.
15	Zacharia et al. (2008)	Heat and temperature/ Physics	62 pre-service elementary school teachers	Experimental group use real and virtual instruments & Control group real instruments	Pretest and post test	Experimental group had statistical significance in better promoting students' conceptual understanding of changes in temperature than the control group.

16	Kumar and Sherwood (2007)	River ecosystem / Environmental topic	83 pre-service elementary school teachers	One experimental group	Pre- and posttest in additional delay posttest	There was significant difference in increase in mean score from pretest to posttest, also in delayed posttest.
----	---------------------------	---------------------------------------	---	------------------------	--	--

**Table 5**  
*Using Computer Simulation to Enhance the Conceptual Change*

NO	Author (year)	Scientific concept	Sample (Grade level)	Study groups	Data collection	Result
1	Jaakkola & Nurmi (2008)	Simple electricity (electric circuit)	64 (primary school)	Three groups; (1) Computer simulation environment, (2) Laboratory environment only (control), (3) combination CS & L environment	Pre-and posttest (basic) and (posttest advanced) for conceptual understanding	Students working in the combination environment outperformed students working in the laboratory environment in all three posttest scores. They also outperformed students in the simulation environment in posttest advanced and total scores but not in the posttest basic point. with statistically significant difference in favour of a combination environment.
2	Tekos and Solomonidou (2009)	Optics concepts of light reflection and diffusion,	140 (60 fifth grade & 80 sixth grade)	Experimental & Control groups	Pretest and post-written questionnaires	The students of the experimental group achieved statistically better performance in conceptual change in all light concepts lessons, whereas students in the control group presented only a slight evolution in their initial ideas but still some misconceptions remained.
3	Ozmen (2011)	Nature of matter /Chemistry	51 ( sixth-grade)	Experimental & Control groups	Pre- and posttest in additional delay posttest	There was a great significant in the posttest (immediate & delay) between experimental group and control group in favour of the experimental group ( $p=.0001$ ).
4	Jimoyiannis and Komis (2001)	Velocity and acceleration in motion in earth's gravitational / Physics	90 students high school	Experimental use computer simulation& Control group traditional method	Questionnaire based on open-ended questions.	The results presented that the students using simulation exhibited significantly higher scores in improved achievement test and subsequently improved their understanding of concepts.
5	Tao and Gunstone (1999)	Force and motion/ Physics	14 high school	One experimental (Students in the class worked collaboratively in	Pre- and post conceptual test and delay posttest	The results showed that computer simulation supported a conceptual change approach of a collaborative learning style.

				couples form used computer simulation)		
6	Talib et al. (2005)	abstract and dynamic (CAD) concepts of Electrochemistry	85 (undergraduate students)	Experimental computer animation & Control groups using transparencies	Pretest and posttest and open-ended questionnaires	There was statistically significant difference in posttest, also positive in open-ended questionnaires in favour for experiment group in understanding concepts.
7	Windschitl and Andre (1998)	Human cardiovascular system	250 (undergraduate students in university)	Experimental ( use computer simulation with constructivist method) & Control group (use computer simulation with objectivist method )	Pretest and posttest	Two of six misconceptions of students in constructivist environment who used simulation (experimental) outperformed students in objectivist environment who used simulation as well. Whereas with the other four misconceptions there were no statistically significant differences.
8	Trundle and Bell (2010)	Moon phases concepts/ Earth Science	157 ( pre-service science teachers)	Three groups; (1) Computer simulation environment, (2) Observation in nature environment (control), (3) combination use CS & observation in nature environment	Before and after semi-structured interview	There was no statistical significant difference amongst three groups in achieving a desired conceptual change. Just in regarding of content knowledge concept of (waning and waxing) there was a significant difference between the computer simulation 'Starry Night' only and observation in nature only.
9	Zacharia (2007)	Electric circuit topic	88 pre-service elementary school teachers	Experimental use virtual then real experiments & Control group use real experiments	Pre- post conceptual EC test	Students of the experimental group had significantly higher scores than the students of the control group ( $P < 0.001$ ). Use of VE alone also useful.
10	Baser (2006)	Direct current electric circuits	89 ( pre-service primary school teachers)	Experimental group use simulations based on conceptual change & Control group use traditional confirmatory simulations	Pre- and post for (concepts test, skills test and attitude scale) and after treatment computer attitude scale	There is statistical significance in favour of the experimental group in the posttest (immediate & delay), and also there is a statistically significant relationship between the attitude towards physics matter and science process skills and attitudes towards computer in raising the students' achievement test.

**Table 6**

*Using Computer Simulation in Lab as Replacement of the Traditional Laboratory to Enhance the Students' Academic Achievement and Conceptual Change and Attitude toward Science Learning*

NO	Author (year)	Science discipline	Sample (Grade level)	Study groups	Data collection	Result
1	Sun et al. (2008)	Acid and Alkali and 'The Operation of a Microscope'.	113 Elementary school	Experimental-based virtual laboratory & Control group traditional method	Pre- post achievement test and two questionnaire (opinion & surveying learning)	Statistical significant in posttest achievement and positive in accommodator learning style, and 75% of students preferred to used VL than reading textbook only.
2	Bakar and Zaman (2007)	Salt / Chemistry	100 students & 14 teachers	Experimental virtual laboratory (VL) & Control group	Pre- and post-achievement test	There was a statistical significant difference between the experimental group and control group in favour of students in experimental. Teachers and students in experimental group think that VL very useful.
3	Akpan and Andre (2000)	Frog dissection/ Biology	65 students at middle schools	Three groups; Simulation before real lab, second Simulation after real lab, and third real lab only	Performance test and pre post achievement test and attitude questionnaire	Used simulation before real lab was great significant from both groups in performance and achievement test. Attitude there was no change between pre & post for all groups.
4	Bilek and Skalicka (2010)	pH measuring / Chemistry	85 students at 11th high schools	Combining virtual and real laboratory in different method, one using virtual before real lab & other after	Evaluation of laboratory worksheets of participants	No statistically significant differences between two methods in collected pH data & problem-solving tasks.
5	Tuysuz (2010)	Separation of Matter	341 9th grade high school	Experimental constructivist based virtual laboratory & Control group traditional method	Pre and post knowledge scale test (KS) and chemistry attitude scale (CAS)	There was statistical significance in favour of experimental group ( $p=0.01$ ) regarding knowledge test. Positive attitude towards use computer simulation in science.
6	Farrokhnia and Esmailpour (2010)	DC electric circuits/ Physics	100 students undergraduate	Three groups; One Real lab group, Second Virtual lab group and third comprehensive group (both real & virtual)	Pre- and post-achievement test	There was statistically significant difference between comprehensive and real lab groups in favour of comprehensive group. But there was no significance between comprehensive & virtual groups or between real and virtual groups.

7	Limniou et al. (2007)	Viscosity topic / Chemistry	88 students undergraduate	Experimental group used pre-virtual then real laboratory & Control group traditional method	Content knowledge test and opinion questionnaire	There was significance in favour of experimental group in test content knowledge and in positive opinion.
8	Gibbons et al. (2004)	Genetics (Chromosome Analysis)/ Biology	47 undergraduate students	Experimental use virtual lab & Control groups	Pre- and post-achievement test and students opinion	There was no statistically significant difference between both groups. Positive opinion and fast in practice (decreased study time).
9	Martinez et al. (2003)	Chemistry	274 undergraduate students	Experimental Virtual chemistry lab & Control group traditional lab	Pre- and post-evaluation test and students opinion	There was statistical significance to enhance students in the knowledge and basic operations and skills necessary for the solving practical problems. No significance in solving theoretical practical questions. A positive impression from both teachers and students.
10	Kennepohl (2001)	Chemistry topic	154 students in first year university	Computer laboratory simulation vs. traditional lab	Postperformance test only with questionnaire	No statistical significance between two groups in relation to performance test. Positive in easy to use & reinforce subject. Good in saving time.

**Table 7**

*The Arabic Studies Which Interest or Concerned of Use Variety of computer application and Software for Teaching and Learning in Different Disciplines.*

NO	Author (year)	Science discipline	Sample (Grade level)	Study groups	Data collection	Result
1	Al-Dael (2002)	Addition, subtraction and multiplication / Math	40 students Primary school	Experimental group use computer lab & Control group traditional method	Pre and post achievement test	There was statistical significant in favour of students who used computer lab.

2	Al-huthaify (2008)	Science topic	60 / 7th grade in middle school	Experimental use e-learning & Control group traditional method	Pre- and post-achievement test & mental ability & attitude questionnaire	There was a statistical significant difference in achievement test between the experimental group and control group in favour of students in experimental. No significance relating to mental ability and attitude.
3	Sulaiman (2007)	Artistic taste / Art lesson	120 students Middle school	Experimental group use PowerPoint, second traditional method	Pre- and post-achievement test & attitude questionnaire	There was statistical significance between two groups in posttest and attitude, in favour of experimental group.
4	Beshayrah & Manzalawy (2007)	Earth history/ science	115 students seventh grade in middle school	Experimental group use CAL & Control group cooperative learning method	Pre- and post-achievement test	There was no statistical significance between two groups (CAL or cooperative learning).
5	Alttamar and Sulaiman (2006)	First degree equations/ Math	124 students Middle schools	Experimental group use CAL & Control group traditional method	Pre- and post-achievement test	There was statistical significance in favour of experimental groups with regard to students of comprehension and application levels and solving equations of one degree in one variable, while no statistical significance for remember level.
6	Sobhi & Abdullah (2003).	Islamic education	115 10th grade in high school	Experimental group use computer & Control group traditional method	Pre- and post- reading skills (Tajweed) test	There was statistical significance in favour of experimental group.
7	Al-Karsh (1996)	Math	69 students 9th grade on high school	Experimental group used computer & Control group traditional method	Pre- and post-achievement test & skills scale	There was statistical significance in favour of experimental group, also got a high efficiency in the skills of mathematical proof than control group.
8	Fathallah (2006)	Courses of importance of means and techniques in teaching	117 pre-service teachers	Three groups; First students use PowerPoint, second students use PowerPoint plus video clips, and third traditional method	Pre- and post-achievement test & attitude questionnaire & skills scale	There was statistical significance in favour of first experimental group in achievement test. Regarding skills, scales, and attitude, there was statistical significance in favour of second experimental.

9	Ali (2002)	Engineering relations / Math	50 undergraduate students ( pre-service math teachers)	One experimental group using Internet	Pre- and post-achievement test & attitude questionnaire	The result found there was statistical differences between pre- and post achievements test ( $P=.01$ , $p<.05$ ) in favour of posttest. No significance of the attitude towards using Internet in teaching math.
---	------------	------------------------------	--	---------------------------------------	---	--



## **CHAPTER FOUR: THE INTERVENTION - TEACHING SCIENCE WITH ICSS**

### **4.1 Introduction**

This chapter presents the ICSS program and the intervention used in the current study. It starts by a general discussion about ICSS programs before describing the process that was taken to design the software in the study and the final intervention. .

### **4.2 Description of the interactive computer simulation software**

According to the previous studies, computer simulation programs have potential and characteristics to help students learning science through the ability to model and simulate many scientific concepts, scientific experiments and natural phenomena. In other words, its can transform real scientific experiments and natural phenomena into digital forms, which allows the representation and modeling of these experiments and phenomena similar to reality, but is cheaper than implementing them in reality. These programs for example, can simulate the pollination process or the photosynthesis system in plant growth (Cepni et al., 2006), electrical currents and simple electric circuits (Zacharia, 2007; Jaakkola & Nurmi, 2008) physical changes in matter or kinetic molecular theory (Stern et al., 2008), the workings of the human digestive system, as well as other natural phenomena such as cloud formation, moon phases, and rainfall. All of these are displayed in a clear and simplified way and are explained step-by-step so students can work at their own pace, including explanations of all the tools or elements needed for the experiment and/or the elements involved in each phenomenon. Thus, the problem of a lack or unavailability of tools or materials can be solved through ICSS (see Figure 8).

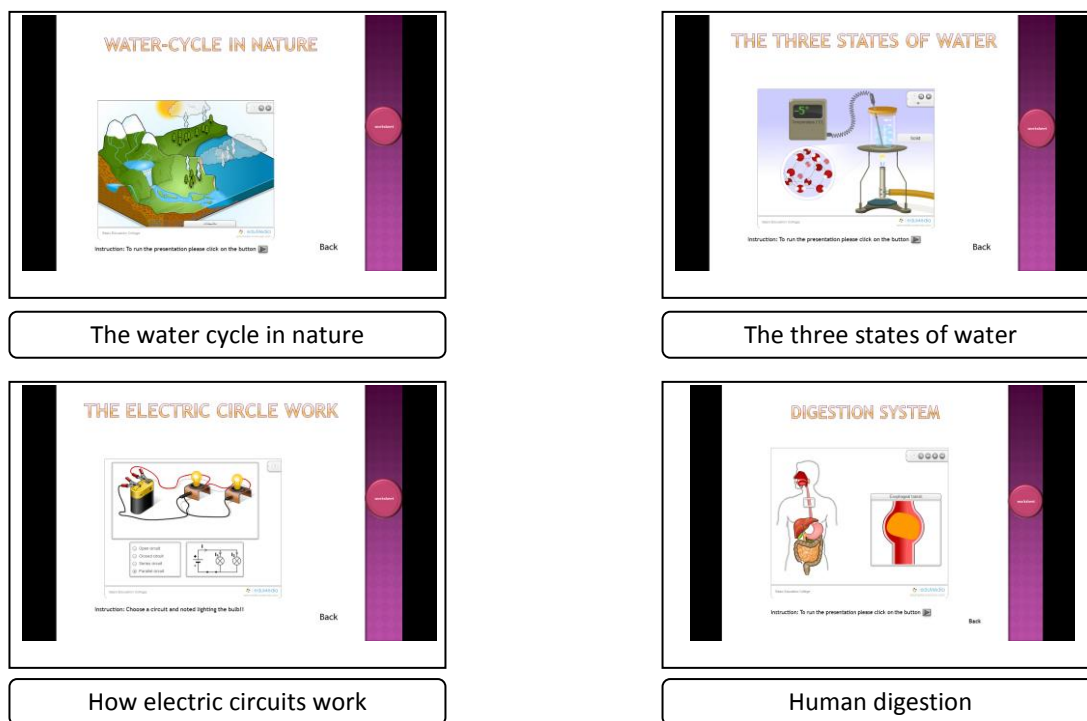

Figure 8. Some instructional models for science topics with simulation software

Abood (2007, P:199), Wellington (1985, P: 60) and Wellington (2000, P: 201) determine empirically that simulation software saves money by replacing such equipment as Bunsen burners, test tube racks, test tubes and thermometers (see Figure 9). This happens through the imitation of such tools in digital form by displaying them on the computer screen, with the advantage of allowing the student to control them. Moreover, the students can work with confidently without risk. Thus, obstacles that may pose a danger to students in some of the experiments may be removed. For example, in a lesson on natural changes in matter, students need to heat a solid using a flame to convert it to a liquid state and then to a gas state (see Figure 9).

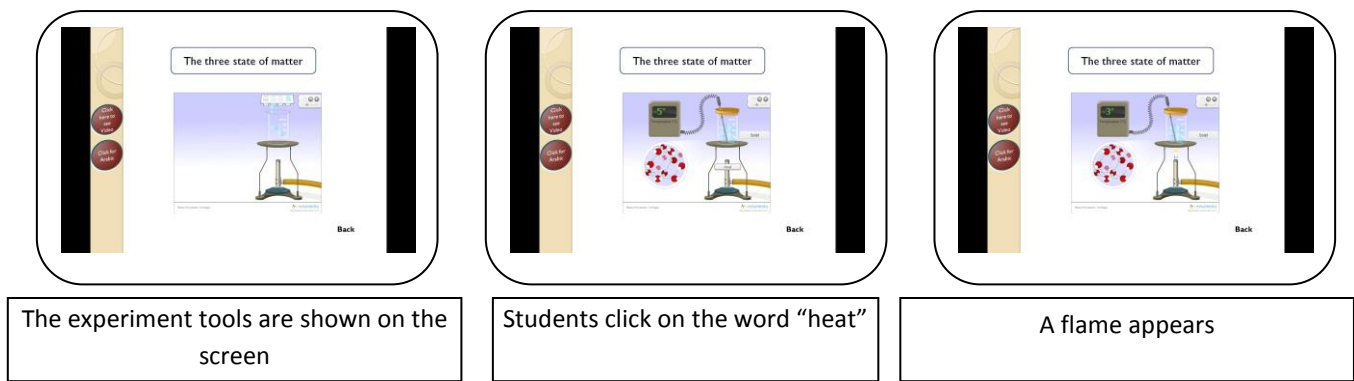

Figure 9. Model of experiment of “natural changes in matter” (Source: edumedia-sciences.com)

Also if the time and place are not suitable for the lesson objectives, such as moon phases lessons (see Trundle and Bell, 2010), the simulation software can create the environment and help to achieve the objectives desired from this lesson (see Figure 10)

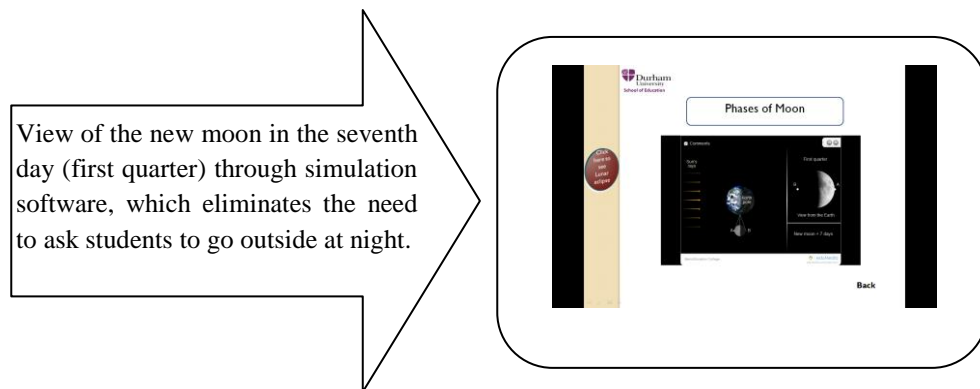

Figure 10. Lesson of moon phases by computer simulation program

Time is a main obstacle to conducting scientific experiments or doing field trip. When a teacher wants to conduct an experiment, he/she needs a great deal of time to prepare the components, substances, and so forth, and distribute them on the bench; check his or her work before lessons and after finishing the experiments, clean the components and return the tools to their storage place, the traditional role of the teacher - the current situation in Kuwait in case the material is available - is dominant in conducting the experiment in front of the students as a demonstration and the role of the students is only to notice the results. Also there is insufficient time to repeat an experiment for the students who do not understand or cannot see because of space limitations and student overcrowding. Abrahams and Millar (2008) suggest that there is insufficient time after experiments are conducted to discuss the results with students and

link the experiment with the main idea in the lesson. Therefore, the outcomes of practical work on the students are positive in a hands-on sense, but poor in a “minds-on” scientific thinking sense.

By contrast, a click of a button in the simulation program on the computer screen can solve such problems. In this way, computer simulation may eliminate the problem of redoing an experiment several times for students in less than a minute. Moreover, the models of scientific experiments and natural phenomena can be kept on small discs (i.e., CD-ROMs (Compact Discs, read-only-memory)) and can be easily distributed to students whatever their number, carried anywhere and started at any time, because there is no need to be connected to the internet. Thus, ICSS program helps to overcome the problem of limited time allotted for the lesson. With taking into account some limitation and risk in overuse of using simulation which will mention later in this chapter.

Learning is an active process in Piaget’s view (including physical action and mental processes) and students should be involved and engaged in the educational process to construct knowledge. In science education, practical work is considered an active learning method depending on hands-on activity (House of Commons Science and Technology Committee [HCSTC], 2002). In addition to the characteristics of ICSS as mention above, it is also distinct from other educational tools in that it possesses interactive characteristics. This interactivity not only enables students to observe or listens in order to reflect on what is introduced to them on the computer screen about scientific experiments or natural phenomenon, interactivity also enables students to manipulate the variables of the experiment or phenomenon. After the manipulation, computer simulation can then show the student the impact of this manipulation, a feature named "immediate feedback."

Through this interaction between the student and the computer simulation software supported by teacher scaffolding, the active learning desired by officials in MOE by science teachers can be achieved.

Interactive computer simulations software can display the idea or concepts in scientific experiments or natural phenomena in way that allows students to see details that cannot be seen or that are invisible during experiments in a real science lab (Jaakkola & Nurmi, 2008), and with the opportunity for students to manipulate the variables of the displayed experiments. This gives students the opportunity to engage in active learning, where and when the simulation starts to display the topic desired to be taught through the computer screen. The student then starts to retrieve prior knowledge or preconceptions from long-term memory that relate to the topic displayed in front of him or her through the computer screen, and this allows the students to make a comparison between what can be expected

or predicted based on their previous experiences and the new scientific concepts and information provided to them (through the simulation program). If their prior knowledge and preconceptions are inconsistent with what they are presented as correct scientific concepts during the lesson, a cognitive conflict will be created and the students will feel dissatisfied with their previous knowledge or preconceptions, and thus they will feel the need to restructure, or change and correct their misconceptions (see Jimoyiannis and Komis, 2001).

To ensure the success of using interactive computer simulation to achieve conceptual change through teacher scaffolding, I adopt the conceptual change model proposed by Posner et al. (1982), in which they pointed out that to achieve a change in student misconceptions, the new concept should have three conditions or features: (a) intelligibility, (b) plausibility and (c) fruitfulness (see chapter two).

Interactive simulation software provides these conditions of the conceptual change model by showing the desired new concepts to be taught in different forms through the computer screen (see Talib et al, 2005). As these forms may comprise of a mixture of words (as printed on the screen or spoken text) and pictures (as dynamic graphics in the form of animations and video), or static graphics (photos, maps, or illustrations) and these forms depend on the eyes and ears of students to sense them, therefore the current study adopted the multimedia cognitive theory of multimedia learning (CTML) proposed by Mayer (2009). CTML analyses how to use multimedia through combining words and pictures without cognitive load occurring during the display of the interactive simulation software in science education. For example, using dynamic picture plus printed words or the teacher speaking (sound) at the same time leads to distraction of the student focus and attention (see Chapter 2).

In conclusion, both rationales (the conceptual change and the CTML) support using characteristics and features of interactive computer simulation software to represent and modeling scientific experiments and natural phenomena, whether they are dangerous or complex, in a simplified and clear way for students. Also, the teacher should support this process by acting as a facilitator and guide by using scaffolding (Jimoyiannis & Komis, 2001; Al-Enezy, 2009). All of these benefits formed my conviction and encouraged me to use interactive computer simulation software as an education tool in the intervention in current study.

#### **4.3 Limitations and risks of using simulation software as a new intervention**

Although there are many features and abilities of the ICSS program, many studies suggest that there is a risk in overusing it as an alternative to the real laboratory as this can lead to undesirable educational

impacts. Wellington (1985), for example, says that it is probable that using simulation programs may cause flawed concepts instead of correcting them, such as a student believing, when using the simulation software, that variables of any natural phenomenon or scientific process can be easily controlled or manipulated and separated from each other. In fact, variables are not as easily controlled as depicted in the simulation software, and using simulation requires teachers to control and change some specific elements in the natural phenomena or scientific processes and neglect others in order to focus on the desired elements to be learnt or taught. The students in Kuwait are not different than the other students in the world, thus, the science teacher in Kuwait primary school should draw the students' attention to the following shortcomings:

- A. What is shown and displayed in the simulation programs are only models of natural phenomena or scientific experiments, and they differ from the real forms of these phenomena or experiments, and thus are not perfect or ideal.
- B. Models of natural phenomena and scientific experiments and operations displayed through simulation concentrate on some specific factors and objectives related to them (i.e., scientific phenomenon and experiments) in order to achieve the purposes of the lesson. There are other factors that could affect this phenomenon or scientific experiment, but they may not be necessary for students to learn at this stage.

Consequently, science teachers should caution students when using simulation software (Crook, 1994; Steinberg, 2000; Couture, 2004) that the ICSS program which presents scientific experiments, phenomena and events may have the following limitations:

1. Some experimental learning in a simulation occurs in a fundamentally different way than it does in an authentic environment. Because there are some elements in the experiment cannot be represented or modeling by simulation program and it could be important elements and dangerous but its not scheduled to knowing it the primary stage.
2. Simulations can oversimplify systems that are very complex in nature or in reality.
3. Students do not always believe that the laws and principles that a simulation displays will also apply in the real world (See also Wellington, 1985). This so a student do not be thought that experience is easy to applied in reality word and then expose himself to danger.

Moreover, one of the disadvantages of using simulation programs is that students will be neglecting training in using real lab tools, such as microscopes and anatomy tools, and they will lose their knowledge of proper ways to use such equipment and how to take care of them.

Accordingly, these limitations above took into account by primary school science teachers in Kuwait and pay attention to students who using the ICSS program about the simulation disadvantages during the experiment in the current study.

#### **4.4 Procedure of development and design of the interactive computer simulation software**

In reviewing the literature, factors that have an effect on the use of simulation software was examined. A number of factors could affect the application of simulation programs in educational theories, such as Mayer's CTML discussed in the theoretical chapter; practical factors may likewise affect the application of simulation software on the ground. These practical factors consist of two parts: the first part is related to material resources hardware such as computer, printer...etc and software such as educational programs and the second part is related to preparing human resources development to deal with this hardware and software such as skills development, computer literacy...etc.

Crosier, Cobb, & Wilson (2002) suggest successive considerations that are necessary in developing computer software for education These are, firstly, the users and their experience using the information and communication of technology (ICT) or technology program (efficiency of users), secondly, the facilities and equipment available to apply the program (i.e., infrastructure) and finally the program usability to achieve the aim. Using a similar approach, the current study adapted Crosier et al.'s considerations into a five stage development process (see Figure 11):

- 1- Identify nature, characteristics and experiences of the user for simulation program (whether students or science teachers in Kuwait primary schools).
- 2- Consider the facilities and equipment available in the primary schools (e.g., computer laboratory, equipment of classrooms, data display, etc.).
- 3- Search for available simulation software that is suitable for the users' characteristics and facilities available in the primary schools.
- 4- Identify the scientific topics in the science curricula of the fifth grade, such topics can be applied and modeled in the simulation program.
- 5- Evaluate the program to know and rectify points of weakness.

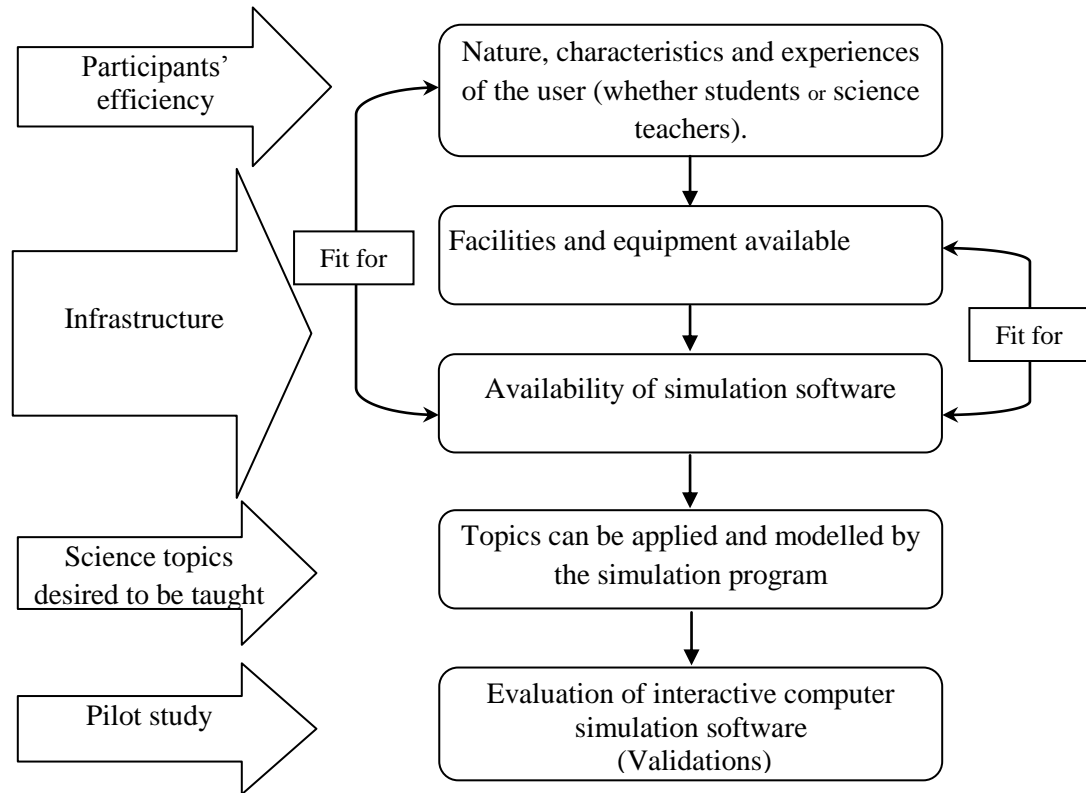

Figure 11. Design and development steps of the interactive computer simulation software

Each stage will be described more in detail.

#### 4.4.1 Identify the characteristics and nature of users

The first step was to identify the users of the ICSS program. This involve of understanding the characteristics and nature of the users and design an appropriate ICSS based on their computer skills and experiences. For generally, while designing the program - particularly for the primary stage - , it was important to know if it is easy for the users to use a keyboard or mouse to manipulate variables or control them.

In this study, there were two kinds of users: the first is fifth grade students in public school; and the second is their science teachers.



The targeted students were in age 10 to 11 years old. These would normally have approximately four years of experience and formal education gained from the computer literacy curriculum in primary schools that was introduced in 2004/2005. They typically would have computer skills, including:

- Starting computers (i.e., turning them on and off)
- Identifying computer keyboard functions
- Being able to use a word-processing program and a painting program
- Being able to create, save or print any document from the computer screen.

They had the same scientific content (syllabus) as in previous academic years. The students studied the old syllabus textbook in first and second grade, and the new syllabus textbook since the 2008-2009 academic year. Thus, the users in both experiment groups had experience under the same educational and computational.

Science teachers were the second group of users. The science teachers were similar in terms of scientific certificates and teaching experience, and had skills in dealing with the computer through obtained certification. All teachers have either an International Computer Driving License (ICDL) or Certificate of Cambridge IT Skills, in accordance with the ministerial decree of the Ministry of Education (number: 359/2002, dated 03/08/2002; and 2834/2004, dated 19/10/2004), which required all teachers in Kuwait to have at least one of these certificates. Generally, acquiring the certificate requires skills and appropriate knowledge of seven basic computer programs, including word-processing, Microsoft Excel, Microsoft PowerPoint, and Internet browsers.

#### **4.4.2 The facilities and equipment available (hardware)**

The second step considered was the availability of facilities and equipment (i.e., computer specification and location at the primary schools). Some of Kuwait's primary schools were visited to check the facilities and equipment and software available. Higgins et al. (1999) point out that ICT is suitable for use in science curriculum in a variety ways, such as an experimental tool, for gathering and exploring information, recording information and presenting ideas, and supporting basic concepts.

To achieve the above, 10 guidelines, which were created by Higgins, Packard, & Race (1999), were adopted in this part. For example, of the 10 guidelines, teachers or researchers must (a) Find out what

sort of hardware he/she has available. (b) Find out what sort of software he/she has available. (Higgins et al, 1999, p.42-43).

After the meeting with the science teachers was finished, visits were made to some public primary schools in the state of Kuwait to consider the facilities and equipment available in classrooms and computer laboratories. The key points that were taken into account at this stage were:

- The computer laboratory design: The room should be designed especially as a computer lab, to protect the equipment from damage. The data display must be visible to the user. Furthermore, electrical extensions must be safe.
- Number of computers: It was thought that the number of computers available might affect whether the computer simulation software would be used by individual students or groups.
- The location of computers: Whether the computer room or lab is far from the classroom or located on a different floor. This would affect time consumed to move students.
- The number of printer machines, data display presentation equipment, electric conductive points and light degrees.
- Computer specification: Brand, quality, sound cards and graphics capability input devices.

After the visits finished, it was discovered that all primary schools did not have computers or data display facilities in the classroom, but there were computer laboratories. Access to the computer lab was granted with a permit from the head of the Computer Learning Section (CLS), and was used to teach students the basic skills of using a computer, as one lesson a week was provided for grades one to three, and two lessons a week for grades four and five.

It is important to point out that the computer curriculum (i.e., computer literacy) was introduced in primary schools in the 2004-2005 academic years. Notably, the primary schools in Kuwait are located in very old buildings, and the cost to create new computer laboratories is quite high. For that reason, the Ministry of Education converted some classrooms to computer labs. These labs had a number of negatives, for example, large windows that allow dust inside the lab and damaged equipment, as well as sunlight that creates a glare on the computer screen. Also, it was observed that the computers used were old models. These factors were seen as limitations or extraneous variables (Borg, Gall, & Gall, 1993). Some of them were controlled through temporary measures during experimentation.

#### **4.4.3 Availability of interactive computer simulation software as an intervention program**

The third step was seeking the appropriate simulation software for user characteristics that is also convenient for the facilities and equipment which were available at the primary schools (i.e., hardware). For the most part, there was no Internet or local network between the science section and the classrooms or the computer laboratory. School computers in teaching normally have version 2003.

There is no interactive simulation program at the time of this study for science teaching and learning available in science sections at primary schools in Kuwait. Moreover, there were no Kuwaiti company offering or providing simulation software in science education to students in primary school, whether through the government or local commercial marketing. Thus, it was necessary to conduct this study using international commercial companies to develop and create interactive computer simulation software for teaching science. To achieve this, a contact was established within the international commercial company named “eduMedia” “[www.edumedia-sciences.com](http://www.edumedia-sciences.com)” to develop and create the ICSS for some of science topics (See Appendix 11). This company specializes in science lessons and is characterized by the following:

- All simulation programs can be used offline, so Internet is not needed.
- Arabic language is available as the language in the software.
- Software can be used with other program, such as PowerPoint presentation.
- Possibility, ease and freedom of controlling the run and stop, and rerun and speed control of science lesson simulations.
- Possibility of manipulate with the variables making the program interactive.

Bransford, Brown, & Cocking (1999) said “Interactivity [in computer instruction] makes it easy for students to revisit specific parts of the environments [topic or lessons] to explore them more fully, to test ideas, and to receive feedback” (p.209).

The current study I did link between the simulation software with the Power-Point software to science topics presentation, because by Power-Point software its ease of browsing and moving from topic to topic for both teachers and students. To make the simulation program more interactive I adopted the interaction model proposed by Evans and Sabry (2003) and applied this with PowerPoint (See Figure 12). This included three stages:

1. Computer starts; present button or control to the student.
2. Student responses (engages); student presses button or uses control.
3. Computer gives feedback; presents new information or concept to the student.

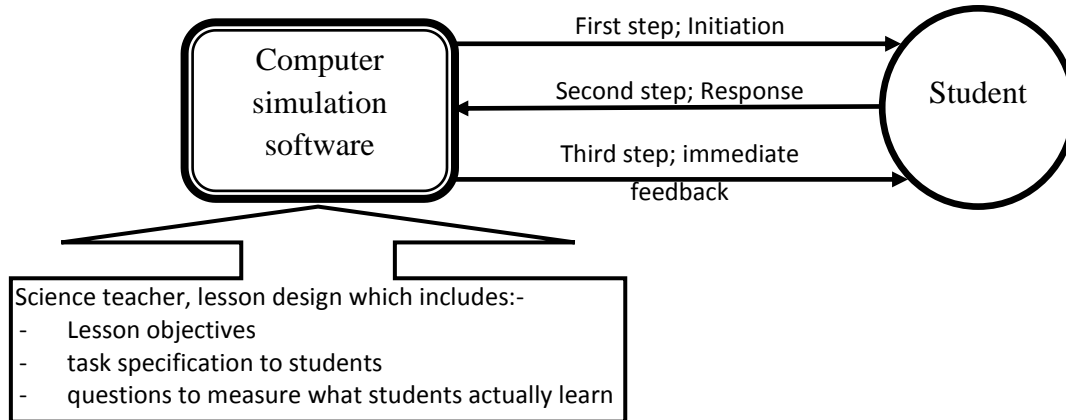

Figure 12. The three-way model applied to computer-initiated interactivity (Evans & Sabry, 2003)

Science textbooks for Grade 5 containing 13 chapters were divided into four units; therefore, the pages were created using PowerPoint. The number of pages was 14, and each contained one chapter from the science syllabus. Each chapter contained two to four lessons according to the science textbook contents.

Each topic contained many photos related to a certain topic in science to enable students to click on the pictures to displays the objectives, information and concepts of the subject on the computer screen.

On the right side of each page, there were two button functions for students. The first button used to show and print worksheets and the second button to show the concepts behind the topic. In addition, buttons in the program enabled students to run, stop, and click back or forward on dynamic images; and helped the student provide feedback any time for any part of the process. Also, students can repeat the lesson several times in a short time. A helpful section aided them in answering the worksheets (See Figure 13 as example).

The school software in the schools that were visited was not compatible to running of the simulation program (Windows version 2003). This problem was solved by contacting the Information and Computer Centre (ICC) in the Ministry of Education (MOE) with a letter from the Assistant Undersecretary for General Education in MOE, to ask them to facilitate the functions to implement of the current study in the elementary schools selected for the study..

#### 4.4.4 Ascertain the topics to be taught through the interactive computer simulation software

The fourth step was started after selecting the ICSS and agreeing with the designer or programmer to modify and determine some topics to be taught through the ICSS program. These should be consistent with the Kuwait science curriculum for the primary stage (House of education, first edition 2009a, 2009b). Three topics were selected from the fifth grade science textbook. The reason for this was that the simulation software was a new educational tool in the teaching process for both teachers and students. Therefore when using it for the first time, science teachers and students may face problems in the first lesson, so they have an opportunity to avoid these problems in the next lesson. The topics were as follows:

1. Food chain (FC): This topic is taught as part of Energy in Ecosystems in Life Sciences (see Figure 13)

The aim of this topic is that by the end of teaching this topic the students should be able to:

- Explore the food chain
- Classify some of the food web
- Discover some of the reasons of the food web changes
- Interpret the importance of saving the environment
- Know the meaning of following concepts; food chain, predator, prey and food web

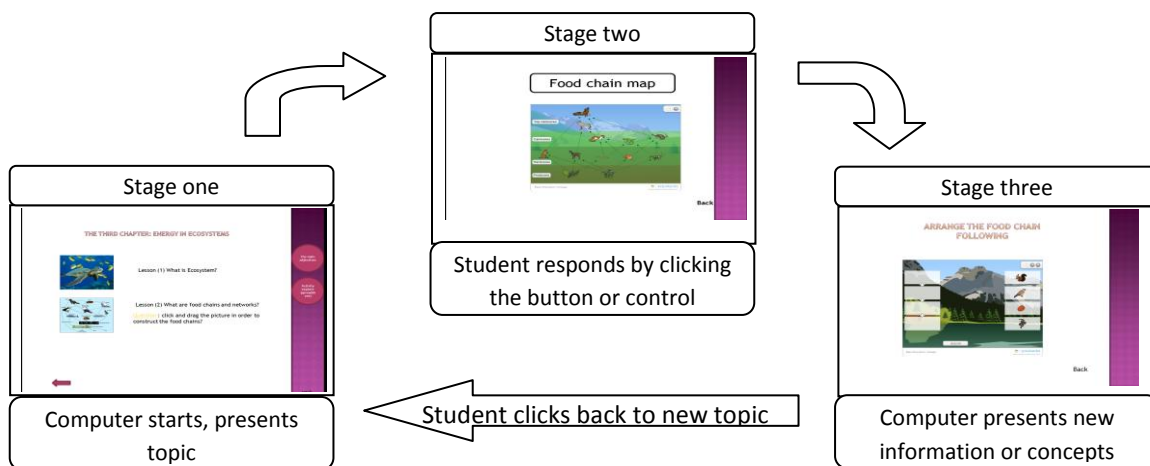

Figure 13. Food Chain topic

2. Circulation and digestive system (C&DS): This topic is taught as part of Digestive System, Circulation System and Nervous System, under the second unit of Human Body (see figure 14).

The aim of the digestive topic is that by the end of teaching this topic the students should:

- Cite the digestive function
- Discover digestive process steps
- Know the meaning of the following concepts: saliva, enzyme, esophagus and small intestine.

The aim of the circulation topic is that by the end of teaching this topic the students should:

- Designate parts and functions of blood,
- Define the three parts of the vascular system,
- Identify the route of blood through the heart, and
- Know the meaning of the following concepts: plasma, red and white blood cells, platelets, artery, vein and capillaries.

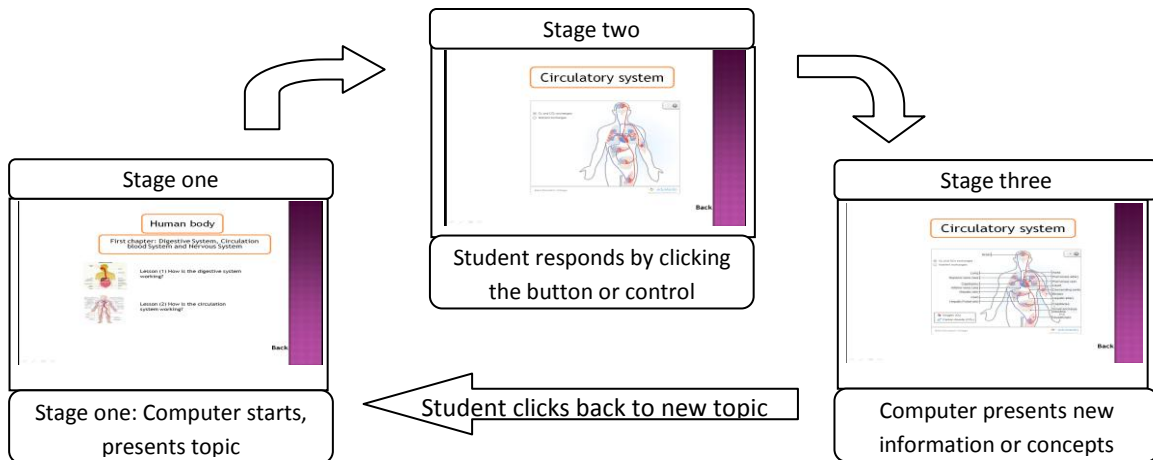

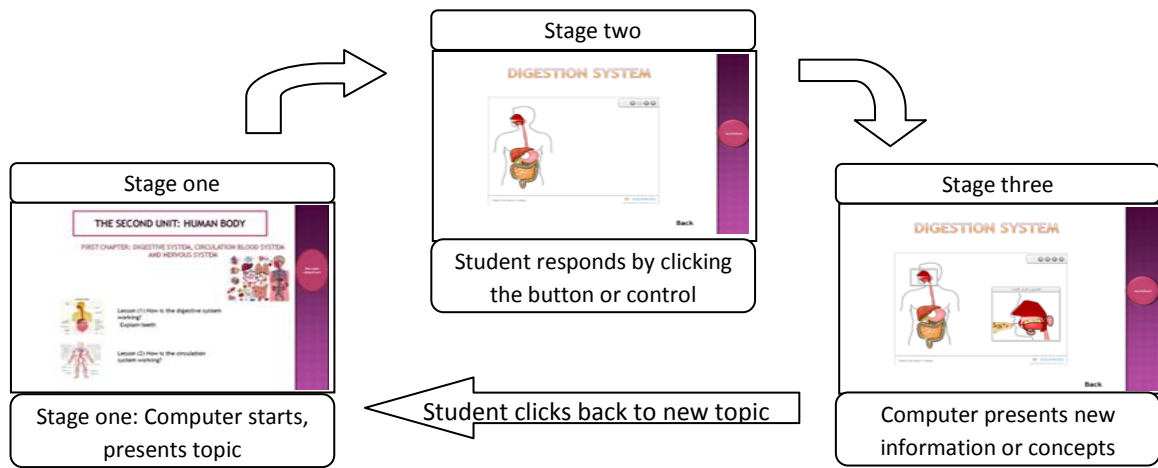

Figure 14. Circulation and Digestive System topics

3. Electric circuit (EC): This topic this topic is taught as part of Electricity and Magnetism, under the third unit of Physical Science (see Figure 15).

The aim of the circulation topic is that by the end of teaching this topic the students should:

- Identify the path of the electric current
- Cite types of circuits (series circuit and parallel circuit)
- Discover how to use electricity safely
- Know the meaning of the following concepts; conductor, insulator, resistance, series circuit and parallel circuit.

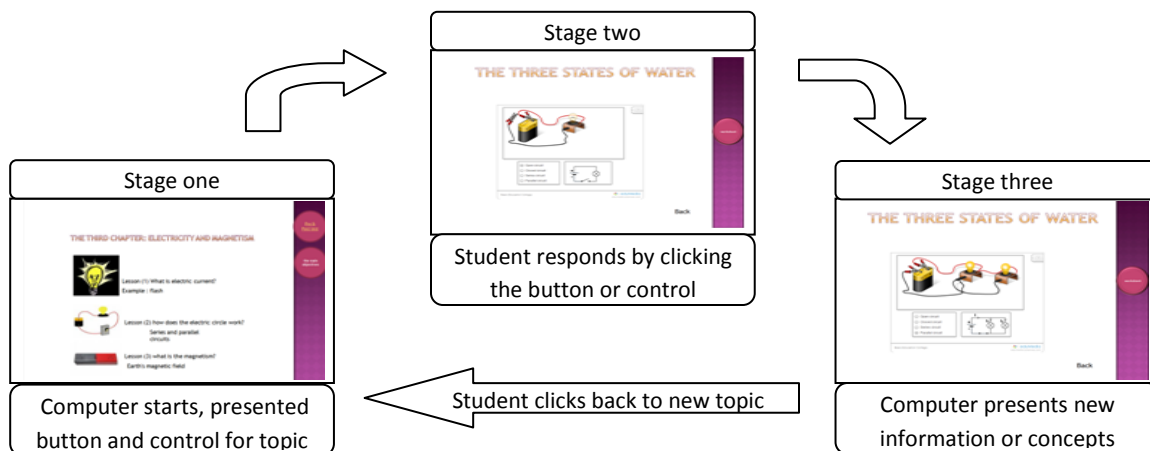

Figure 15. Electrical Circuit topic

According to the Curriculum Development Department (CDD) of the Ministry of Education, the science syllabus has been revised as of 2009/2010 (See Appendix 2).

#### **4.4.5 Evaluation phase**

The fifth step was trailing the ICSS in order to investigate any difficulties teachers or Year five students would have in using or dealing with it. For this, a pilot study was conducted at two primary schools with two science teachers. From the pilot study, a list of points was taken into account, such as:

- 1- Appropriate use of computer keyboard or mouse
- 2- Clarity of scientific terminologies shown on the computer screen
- 3- Clarity of instruction on the screen (i.e., play, back, stop...etc.)
- 4- Ease of browsing

After finishing the pilot study, the feedback and observations were taken from the science teachers who used the ICSS, and I took into account this feedback to make the ICSS more suitable for this study (See the pilot in chapter methodology).

#### **4.5 The Intervention**

The simulation software was used in two learning environments (see figure 16). In both of learning environments I attempt to create active learning through adoption of constructivism and scaffolding method in science teaching and provide students with practical work and investigations through using simulation software.

In first learning environment was teachers and students used interactive computer simulation software in a computer laboratory (ICSS-L). The intention was to create blended learning, with a mixture of teacher-centred (teacher talking to the class) and student-centred (student working on the computer) teaching. 20 minutes was spent on each of these in lessons lasting 40 minutes. This will be referred to as "using simulation in computer lab".

The second learning environment was teachers used interactive computer simulation software in a classroom (ICSS-C). In this case, there was one computer only and a big screen that could be seen by all students in classroom. The teacher was in control of the computer, but students were involved with asking questions and had a say on what actions they wanted the teacher to take. This will be referred to as "using simulation in classroom"



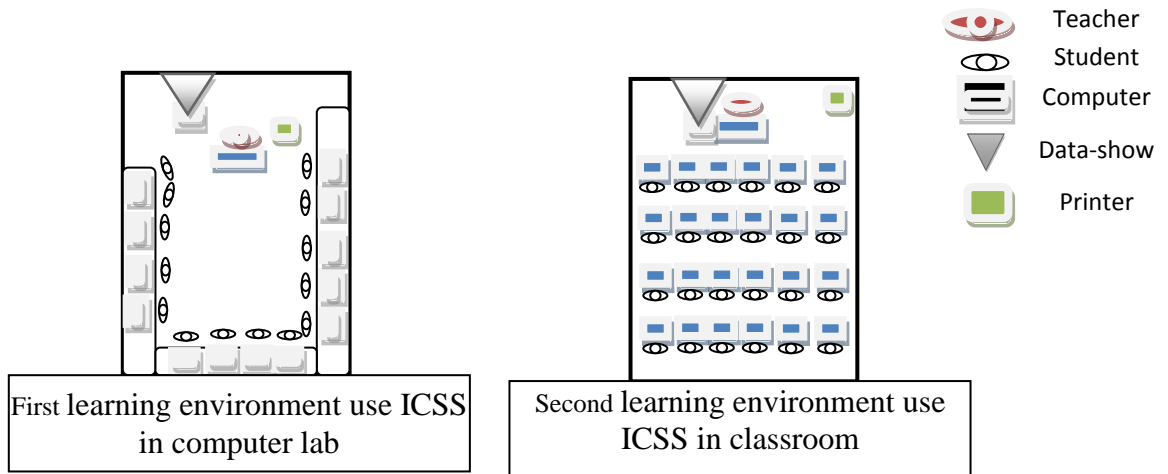

Figure 16. The two different pedagogical environments used simulation software

## CHAPTER FIVE: METHODOLOGY OF STUDY

### 5.1 Introduction

This chapter presents the methodology used to investigate the impact and effectiveness of ICSS – as intervention or treatment tool - in primary school science teaching in the State of Kuwait. Three main dependent variables were addressed: students' academic achievement in science; students' conceptual change; and students' attitude toward science teaching and learning.

### 5.2 Study design

The study used a quasi-experimental design. The reason for this was that in a school it is rarely neither practical nor feasible to assign samples randomly to treatments, where classes are formed at the start of the academic year (Ross & Morrison, 2004). Many researchers have defined the term experiment. Mosteller (1990), for example, suggests “in an experiment the investigator controls the application of the treatment”. Yaremko, Harari, Harrison, & Lynn (1986, p.72) describe the experiment as where “one or more independent variables are manipulated to observe their effects on one or more dependent variables”. Finally, Shadish, Cook, & Campbel (2002, p.12) describe the experiment as “a study in which an intervention is deliberately introduced [to] its effects”.

The quasi-experimental design allowed for the investigation of the impact and effectiveness of using ICSS program in primary school to improve students' academic achievement and attitudes. In addition, the perspectives of students and science teachers toward science teaching and learning with use of ICSS were taken into consideration. Leading on from this, the independent and dependent variables were as follows:

A. The independent variables (IV)

Using simulation program (i.e. ICSS) as a treatment to improve science education in two different learning environments.

B. The dependent variables (DV):

- Students' academic achievement
- Students' conceptual change of selected concepts

- Students' attitudes toward teaching and learning science,
- Students' and teachers' perspective (opinion or impression) toward using ICSS as a program and tool in teaching and learning science topics.

The study investigated two different ways of using ICSS in the teaching. Two experimental groups were therefore designed.

**In the first experimental group (Exg1)** teachers and students used interactive computer simulation software in a computer laboratory environment (ICSS-L). The intention was to create blended learning, with a mixture of teacher-centred (teacher talking to the class) and student-centred (student working on the computer) teaching. 20 minutes was spent on each of these in lessons lasting 40 minutes. This will be referred to as "using simulation in computer lab". An outline of the classroom (computer laboratory) is presented in figure 17.

The activities of the students in the control groups were as follows:

**Control group (Cg):** Teacher used traditional teaching method, without using computer or other science. This will be referred to as "using traditional teaching".

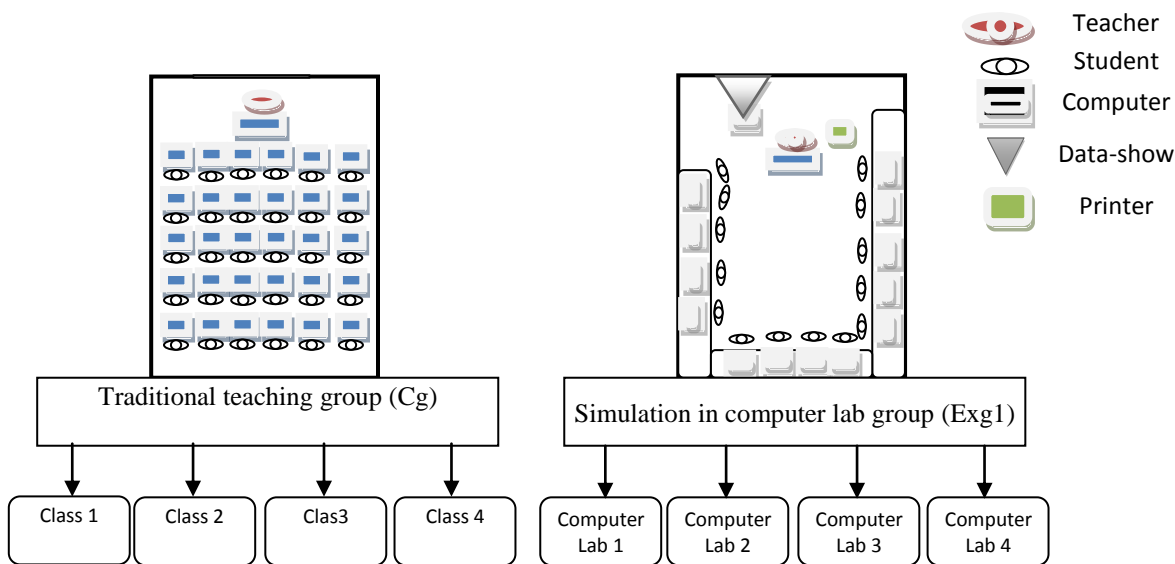

Figure 17. The students' distribution in simulation in computer lab group and traditional teaching group

**The second experimental group (Exg2)** used interactive computer simulation software in a classroom environment (ICSS-C). In this case, there was one computer only and a big screen that could be seen by

all students in classroom. The teacher was in control of the computer, but students were involved with asking questions and had a say on what actions they wanted the teacher to take. This will be referred to as "using simulation in classroom"

The teacher in the *control group* used a traditional teaching method, without using computer or other science equipment. This will be referred to as "using traditional teaching". See figure 18

There were four classes in each of the experimental groups and different control groups were made to match each of these (four classrooms with traditional teaching for each experimental group). Figures 17 & 18 illustrates experimental and control groups.

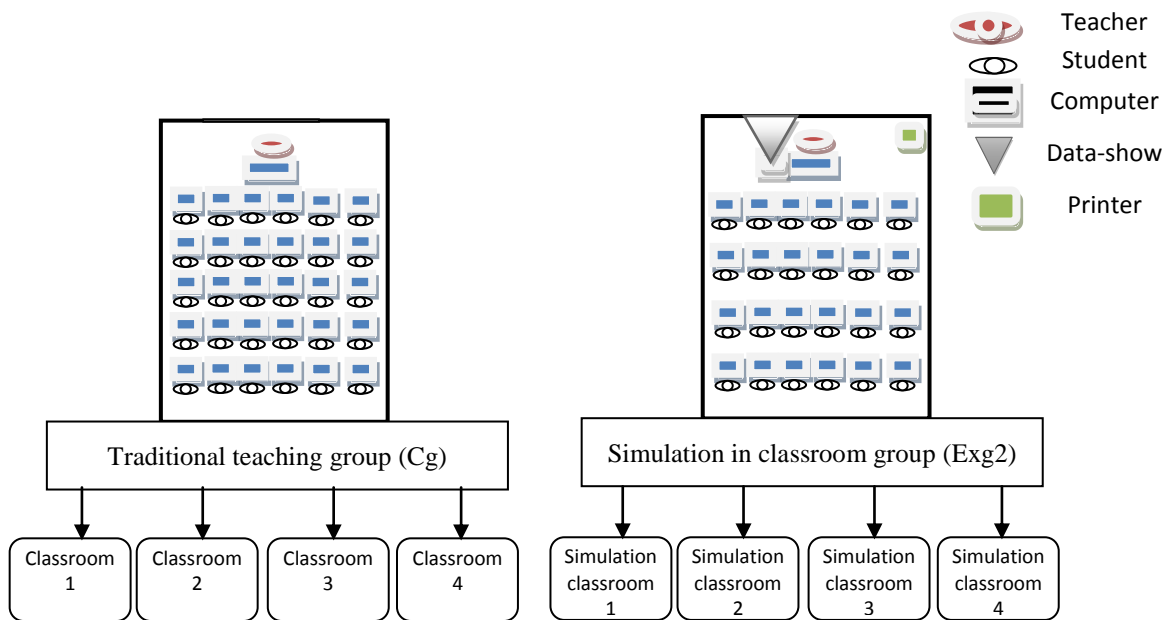

Figure 18. The students' distribution in simulation in classroom group and traditional teaching group

The design further included a series of pre- and post-tests to measure students' knowledge, pre- and post-questionnaires to measure attitudes, a usability questionnaire to students, interviews with teachers and students and observations/self-reports from teachers. Figure 19 illustrates this design.

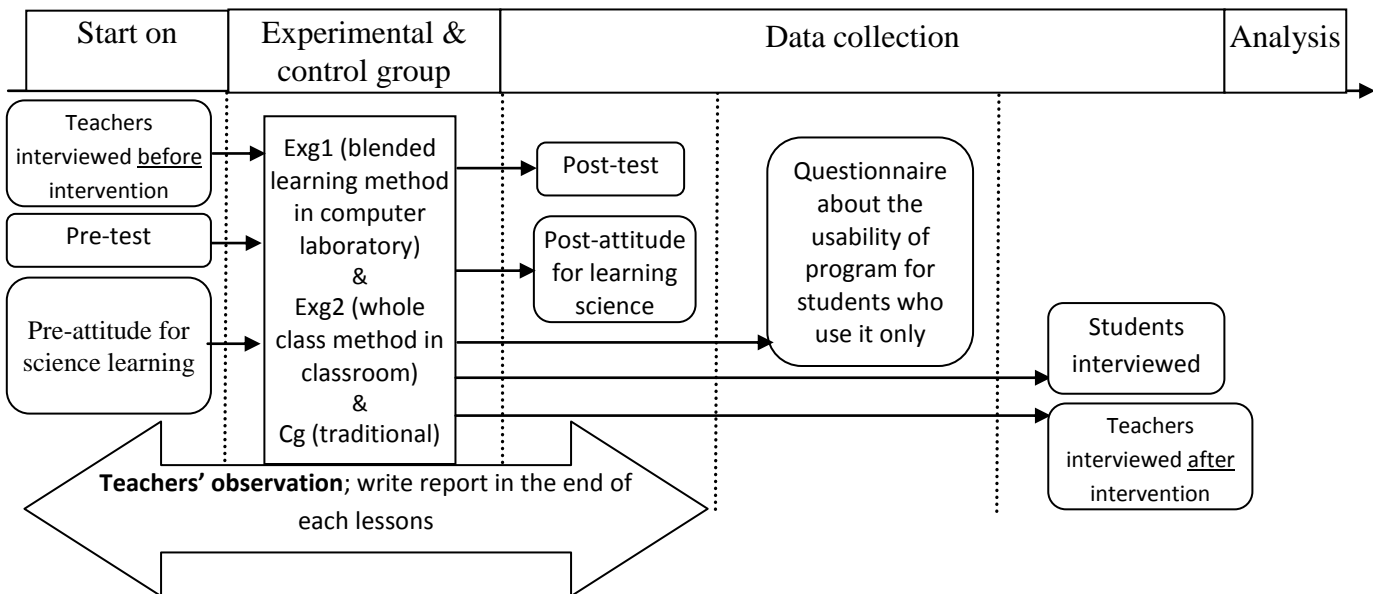

Figure 19. The current study design

The pre-tests were distributed to half of the classrooms in both the experimental and control groups (see Figure 20). The reason for this was the short period between the pre- and post-tests, which may give the pre-test a positive effect on the outcome of the post-test. According to the Solomon design (Krathwohl, 1998, p. 511), two schools (one male and the other female) in both experimental groups took the pre-test and post-test and the others took just the post-test. After the intervention, the post-test was distributed to all sixteen classes in experimental and control groups (Figure 20).

As explained in the previous chapter, three topics taught in this experiment included Food chain, the Circulation & digestive system and Electric circuits. Pre- and post-testing was carried out separately for each topic, and distributed before and immediately after the teaching.

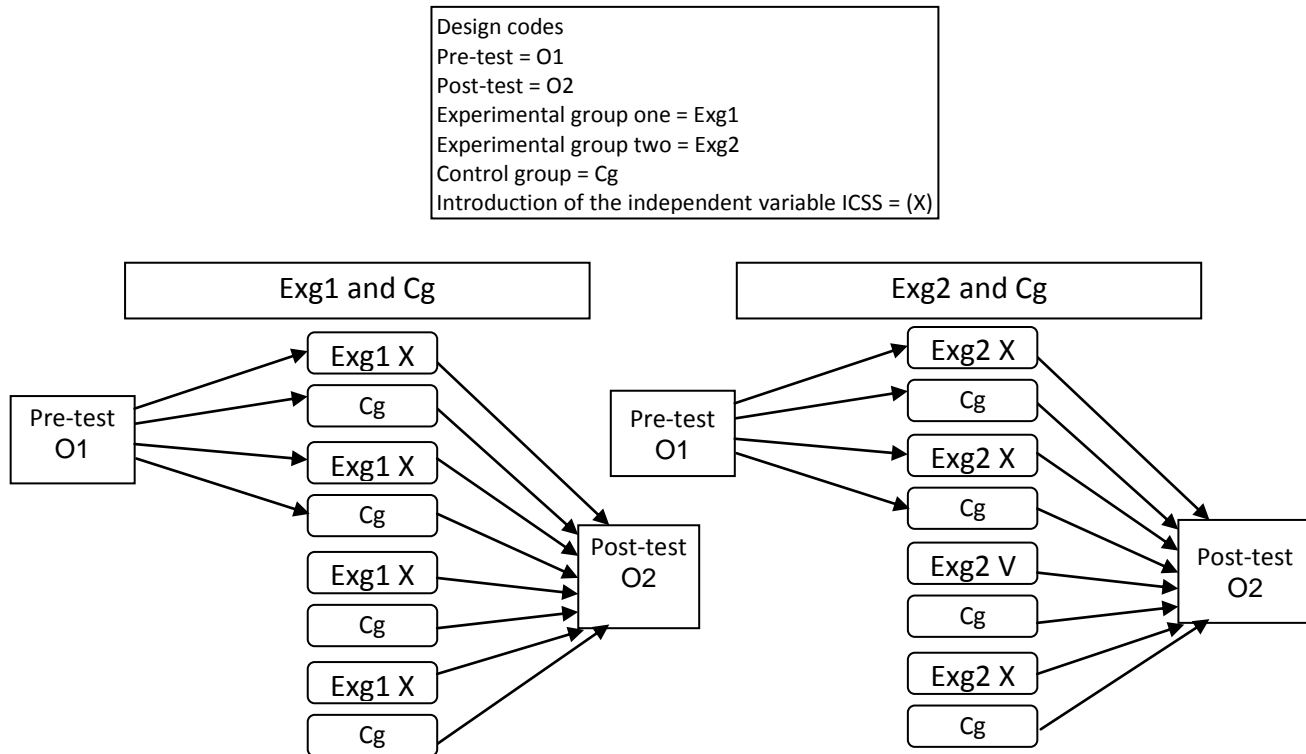

Figure 20. Pre and post-test distribution for two experimental groups with control group

As for measuring the students' attitude toward science teaching and learning, pre -and post-questionnaires were used before teaching of the first topic and after teaching of the final topic. The same questionnaire was used in both occasions. As noted in (Figure 19), the pre-questionnaire was distributed to all students in all classrooms in all groups.

The usability questionnaire was distributed only to the students in the experimental groups (Exg1 and Exg2) to exam the suitability and ease of use of ICSS for science teaching and learning. it was handed out after the teaching of the final topic.

In the end, a group of students were interviewed to examine their opinion and impression of the use of the ICSS program in science teaching and learning. All teachers involved in the study were also interviewed. All interviewed were carried out after the teaching of the last topic.

Teachers were asked to keep a 'diary' with observations and reflections made during the intervention. They were asked to do this after each lesson.

### 5.3 Rationale for the design

The rationale behind the design was, firstly, to have comparable and accurate measures of the effect of the intervention, and secondly, to have authentic and rich data. Quantitative measures provided a base to compare between groups of students in terms of improvement the knowledge, concepts and understanding of topic (Chang, 2001; Frailich, Kesner, & Hofstein, 2009; Cepni, et al., 2006; Sun, et al., 2008; Talib, et al., 2005). Educational studies in the ‘real world’, however, are complicated and make it difficult to have high validity in quantitative measurements alone. The study, therefore, combined the traditional (quasi) experimental design, using quantitative measures, with qualitative data gathering. Patton (1990, p.14) suggests quantitative and qualitative methodology have different advantages:

“The advantage of a quantitative approach is that it is possible to measure the reactions of a great many people to a limited set of questions, thus facilitating comparison and statistical aggregation of the data. This gives a broad, generalizable set of findings, presented succinctly and parsimoniously. By contrast, qualitative methods typically produce a wealth of detailed information [and can support the quantitative result] about a much smaller number of people and cases. This increases understanding of the cases and situation studied but reduces generalizability”

According to Bryman (2006) studies that are based on a combination of qualitative and quantitative research are referred to as both ‘multi-method’ and ‘mixed-method’ designs. What is most important, however, is the *purpose* of using a combination of method.

Most recently, Collins, Onwuegbuzie, & Sutton (2006, p. 76) identified the following four justifications for conducting mixed research:

- 1- participant enrichment: e.g., mixing quantitative and qualitative research to optimize the sample, using techniques that include recruiting participants, engaging in activities
- 2- instrument fidelity: e.g., appraising the appropriateness and utility of existing instruments, creating new instruments, and monitoring the performance of participant instruments;
- 3- treatment integrity: i.e., assessing the fidelity of an intervention
- 4- Significance enhancement: e.g., facilitating the thickness and richness of data and improve the interpretation and usefulness of the outcomes.

Greene, Caracelli, & Graham (1989) suggest these purposes can be put in five categories: triangulation, complementarity, development, initiation and expansion (see table 8 for an expansion on these).

**Table 8**

*Source: Greene, J. C., Caracelli, V. J., & Graham, W. F. (1989)*

<i>Purposes for mixed-method evaluation designs</i>		
Types of mix-method	Purpose	Rational
Triangulation	Seeks convergence, corroboration, correspondence of results from the different methods	To increase the validity of constructs and inquiry results by counteracting or maximizing the heterogeneity of irrelevant sources of variance attributable especially to inherent method bias but also to inquirer bias, bias of substantive theory, biases of inquiry context.
Complementarity	Seeks elaboration, enhancement, illustration, clarification of the results from one method with the results from the other method	To increase the interpretability, meaningfulness, and validity of constructs and inquiry results by both capitalizing on inherent method strengths and counteracting inherent biases in methods and other sources.
Development	Seeks to use the results from one method to help develop or inform the other method, where development is broadly construed to include sampling and implementation, as well as measurement decisions	To increase the validity of constructs and inquiry results by capitalizing on inherent method strengths.
Initiation	Seeks the discovery of paradox and contradiction, new perspectives of frameworks, the recasting of questions or results from one method with questions or results from the other method	To increase the breadth and depth of inquiry results and interpretations by analyzing them from the different perspectives of different methods and paradigms.
Expansion	Seeks to extend the breadth and range of inquiry by using different methods for different inquiry components	To increase the scope of inquiry by selecting the methods most appropriate for multiple inquiry components.

The current study sought the two first of these.

Complementarity, which refers to use the quantitative and qualitative research paradigms combined in order to more fully explain the results of analysis. in addition use the strengths of an additional method to overcome weaknesses in another (Sale, Lohfeld, & Brazil, 2002).



Denzin (1978) defines triangulation as “the combination of methodologies in the study of the same phenomenon” (p.291). This combination commonly uses quantitative and qualitative methods, which must be implemented at the same time and with equal weight (Creswell & Plano, 2007).

Jick (1979) suggest the following advantages and reasons why triangulation is important: (a) it allows researchers to be more confident of their outcomes; (b) it motivates the development of creative ways of gathering data; (c) it can lead to deeper, richer data; (d) it can lead to the synthesis or integration of theories and (e) it can uncover contradictions.

In combination, Schutez, Chambless, & DeCulir (2004) and Greene et al. (1989) offer many reasons why triangulation is important. For example, it provides corroboration and correspondence of results from different methods. Triangulation allows researchers an opportunity to find compatible results between these methods. What is needed is that one result has the same or a similar conclusion to other results using different methods, and this lends credibility to the research study. Triangulation also elaborates on and enhances the results from one method with the results from another method used in the same phenomenon or study. Schutez et al. explain in the following way:

There are a variety of combinations and advantages to combining methods in this way. A quantitative study may also employ a qualitative dimension to guide the sample selection or to help explain unusual results. A qualitative study may implement a quantitative dimension to guide sampling or help determine what to pursue in depth or to help generalize results to different samples and test emerging theories. (2004, p. 277)

Moreover, the triangulation method helps to increase the interpretability, meaningfulness and validity of constructs and inquiry results, both by capitalising on inherent method strengths and by counteracting inherent biases in the methods and in other sources. Triangulation also makes it possible to use the results from one method to revise those obtained from another. It is then possible to use the results from one method to direct the development of a later stage of the research in sampling, measurement, or both. Triangulation also makes it possible to use a combination of methods to increase the potential of proposed claims and results in question, by means of utilising different method strengths. It helps when questions are posed from one method and can be answered by another. In the same way, a number of results from one method can be restated in light of another. Finally, certain components of questions are better addressed through a certain method. Using a number of methods increases the scope of inquiry if they are suitable for measuring multiple question components.

The current study used triangulation by comparing results from qualitative and quantitative instruments as illustrated in figure 21 Frailich, et al. (2007) indicated that “the diverse range of data collected enabled triangulation of the results obtained from the conversations between the students during the activities, the achievement tests, and the interviews with the students and teachers” (p.295).

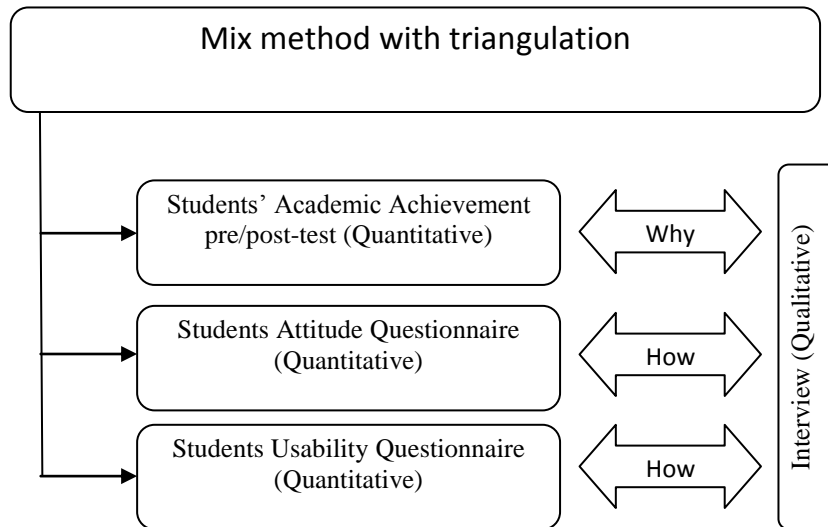

Figure 21. The research method of measurement tools to collect data in this study

#### 5.4 Data gathering instruments

The study used the following data gathering tools

- Academic achievement test of each one of science topics selected; Pre-test and Post-test of students' academic achievement test.
- Questionnaire for students' attitude toward science teaching and learning; pre and post questionnaire.
- Questionnaire for students about the usability and usefulness of ICSS in science teaching and learning, used after the experiment for students who were involved in experiment groups.
- Interview: students' and science teachers' perspectives of ICSS in two learning environments.

##### 5.4.1 Achievement tests

Design knowledge and concepts pre-test and post-test. The science textbook for 5<sup>th</sup> grade students was revised in the academic year 2009/2010, and the Department Direction of Science did so with the advice of experts with more than 12 years teaching experience in science. They created a Questions Bank for the new science textbook and sent it to all primary schools in Kuwait to be of benefit to science teachers who added the exam results to the Ministry website <http://www.moe.edu.kw/sitepages/exam.aspx>.

The items for the achievement test were selected from this questions bank, and were classified or grouped into the three levels of the cognitive domain (knowledge, comprehension/conception, and application) based on Bloom's taxonomy (Ellington, et al., 1993, p.53).

**Knowledge:** These items emphasise remembering concepts. Ellington, et al. (1993) mention that Bloom considered these the lowest level of cognitive objectives. So the learning outcomes in this domain include:

- Name parts of an object
- Identify a component
- State a definition
- List causes of an effect

**Comprehension:** These items measured students' understanding of ideas or concepts in science. Ellington, et al. (1993) mention that this can be regarded as the simplest level of understanding activities demonstration; learning outcomes in this domain include:

- Select an example which demonstrates a phenomenon
- Give reasons explaining an observation
- Classify objects into categories
- Translate word into symbolic expressions

**Application:** Items require students to apply acquired knowledge to an apropos or new situation, or involved students applying existing knowledge to different situations. In this domain, Ellington, et al. (1993) mentions this covers the links between theory and practice; examples include:

- Perform a specified task
- Calculate a mathematical result
- Apply a given set of rules or procedures
- Predict the result of a proposed course of action

As described earlier, three tests were developed; one for each taught topic. Items in these tests were organised into ‘testlets’ (which will be referred to as questions) with one to six items in the following way. The three tests were:

a) Food chain test (FC) (four questions)

- First question: true or false items (4 items)
- Second question: Complete the following statements with the appropriate scientific word (4 items)
- Third question: What do you expect to happen if? (2 items)
- Fourth question: Arrange food chain in ascending way (1 item)

The total number of items is 11 (see appendix 12).

b) Digestive and circulation system (D&CS): This test consisted of five questions as follow;

- The first question true or false (6 items)
- Second question: Complete the following statements with the appropriate scientific word (5 items)
- Third question: What do you expect to happen if? (2 items)
- Fourth question: Select scientifically correct answer for each of the following statements (2 items)
- Fifth question: Write the names of digestive system parts (5 items)

The total number of items is 20 (see appendix 13).

c) Electric circuit (EC): This test consisted of five questions as follow;

- The first question: Circle the correct answer to the situation of bulb (1 item)
- Second question: Complete data on the following chart (5 items)
- Third question: Complete the following statements with the appropriate scientific word (4 items)
- Fourth question: What do you expect to happen if? And why? (2 items)
- Fourth Question: What is the correct status for current electric flow (1 item)

The total number of items is 13( see appendix 14).

In each of the three topics the same set of test questions for knowledge and concepts (i.e. same test use for before and after) were conducted for pre-test for some groups in both experimental and control groups and post-test for all groups as mentioned in the study design section.

For the conceptual change measurement questions for certain concepts were selected to compare the performance of the students in the pre-test and post-test with regard to their ability to grasp the concept. Some of these topics where students are known to have misconceptions.

#### **5.4.2 Attitude questionnaire**

Osborne, Simon, & Collins (2003) pointed out five methods to measure the attitude:

- a) Subject preference studies: Asking students to rank their preference of school subjects, to know the measure of student attitudes towards science as a subject.
- b) Interest inventories: Asking students to choose the items that they are interested in from a list.
- c) Subject enrolment: The data collected on enrolments to subjects.
- d) Qualitative methods: Using student interviews and focus group interviews.
- e) Attitude scales: This is a common method of measuring attitudes. The students selected one from a differential scale for the statements that reflect their attitude toward the object. Likert scale items are the usually used in this kind of measure.

The current study used the last of these options and made attitude scales from a closed questionnaire.

According to Cohen, Manion, & Morrison (2000) “closed questions prescribe the range of responses from which the respondent may choose”. They mention that there are three kind or types of closed questionnaires: (a) Dichotomous question, which is “yes” or “no” response; (b) Multiple-choice question, where the variety of choices is designed to capture the likely range of responses to given statements; and (c) Rating scales or a Likert scale (named after its deviser, Rensis Likert, 1932), which provide a degree of responses to a given question or statement (Cohen, et al., 2000, p.248-254).

In general, closed questions (dichotomous, multiple-choice and rating scales) are quick to complete and straightforward to code (e.g. for computer analysis), and do not discriminate unduly on the basis of how articulate the respondents are (Wilson & McLean, 1994, p.21). The respondent may choose from a list of definite answers. Asker, Jamea, alfar, & Hawana (2003, p.207) mention some of advantages of this kind of questionnaire:

- a) Easier for data analysis;
- b) Reduce the number of individual non-respondents;
- c) Lead to the elimination of inappropriate responses;
- d) Facilitate the process of answering automatically by computer;
- e) Low cost and rapid access to data required.

Oppenheim (1992) adds that this kind of question is useful for testing specific hypotheses, especially where there is no extended writing. However, there are some of disadvantages in using close-ended questionnaires. They do not often reveal the reasons that lead the respondent for selecting a certain answer; and the answer in most cases does not provide sufficient or extensive information. This may oblige respondents to adopt a definite attitude that has not crystallised in their mind yet and force them to give responses that do not express their ideas (ibid, p.207-208). Therefore, this was the main reason to adopt the interview method (mentioned below) in this study to overcome these issues.

In the current study, a close-ended questionnaire was used because it generates frequencies of response amenable to statistical treatment and analysis. This enabled comparisons to be made across groups in the sample.. Using a closed questionnaire, of course has some disadvantages compared to open-ended questionnaires. The open-ended questionnaire allows the respondents to answer with complete freedom

and in their own words without obliging them to choose a response, Therefore, Asker, et al. (2003) point out that this type allows individuals to express their views and tendencies. It also allows them to define and offer the reasons behind their responses (p.204). The main disadvantage, however, in this type is the difficulties of data analysis, and sometimes difficulties of response reading from respondents. In addition, the age of the participants in this study (fifth grade students) would have made it difficult to obtain information in open-ended questions. Their limited writing skills could give rise to many errors in the expression of their perception addition, open-ended questions do not direct the respondents, which may make them unintentionally omit important information (ibid, p.205)

According to Kind, et al. (2007, P.873) attitudes can be defined as “students’ feeling about an object depend[ing] on his beliefs about that object”. In this study, the attitude objects were learning *science at school* and *participating in science in the future*. For each of these, Likert scale items were developed with statements and five response alternatives: strongly agree, agree, neither agree nor disagree, disagree, strongly disagree. The questionnaire statements to measure these attitudes were adopted from “developing attitudes towards science measures study” (Kind, et al., 2007). The attitude towards science learning scale had 11 statements and the attitudes towards participating in science in the future had six statements (See Appendix 15).

Because of the students’ age factor, the difficulty of reading questionnaire items and save time, asked teachers to read the pre and post all questionnaires items for the students and the students’ answers of each item.

#### **5.4.3 Questionnaire for usability of simulation software**

There are three common scales when measuring the usability if ICT software in a questionnaire: usefulness, satisfaction and ease of use. Lund (2001) points out that these dimensions came to light strongly to the improvement of the use of the questionnaire to new programme usability measure. Lund also underlines that there are strong correlation between the measuring of usefulness and ease of use. The current study used these scales and have been modified and reworded to be appropriate for the purposes of the study. The usability questionnaire was divided into three scales which are:

- Students opinions about the program in general
- Simulation software usability, measure the students satisfaction in ease of using computer simulation software itself; this was called program technical measure. The reason for this measure was that this study contained new program or software innovation in teaching science,

and this kind of measure helped to improve and develop it to be more useable in the future. This was through the analyses of data which was gathered from the respondents. (Chin, Diehl, & Norman, 1988; Kirakowski, 2000; Lund, 2001).

- Simulation software usability in science education, measure the students satisfaction and extent of benefit of using computer simulation software in understanding information and concepts of science topics. In this way, the items for usefulness and satisfaction were related to the program in science teaching and learning. This was called the benefit measure in teaching science from the program (Sun, et al., 2009).

The usability questionnaire items have been validate by two software engineers in Kuwait (see validity section)

The questionnaire was very simple because of the age of students (10 – 11 years old) as mentioned above. It consisted of Likert-type scales, with five point response scales:

1. Strongly agree
2. Agree
3. Neither agree
4. Disagree
5. Strongly disagree (Sun, et al., 2009).

The questionnaire consisted of 32 statements or questions, distributed across two main sections; the first was program usability measure (as program) and the second was to measure the influence and benefit of the computer simulation software in using for science teaching (as tool in science teaching and learning).

**The first section** usability measure contained two parts:

- A) **In the first part**, it sought to measure the students' satisfaction (as user) in using the computer simulation software. In other words, student attitudes toward using the computer simulation software program as tool. This part contains six statements or questions.
- B) **The second part** measured the computer simulation software effectiveness (usefulness plus ease for use) on the students' perspective or opinions. This part contains 12 statements.



**The second section** measured the influence and benefit of the program for teaching science and contained 14 statements as follows:

- A) **The first part** sought to measure the students' satisfaction in using the interactive computer simulation software for teaching and learning of science topics. This part contains six statements or questions
- B) **The second part** sought extent of ICSS usefulness in science teaching from students' perspective or opinions. This part contains eight statements or questions (See Appendix 16).

### **The participants in simulation program usability questionnaire**

The students that engaged in this questionnaire were all students in the both experimental groups, and it was conducted after experimentation was completed (see Figure 19).

Also because the students' age factor, the difficulty of reading questionnaire items and save time, asked teachers to read the usability questionnaire for the students and the students' answers of each item, as same as in the student attitude questionnaire.

#### **5.4.4 Teachers and students interview**

An interview is a process in which a researcher and participant engage in a conversation focused on questions related to a research study (Demarrais & Lapan, 2004, p.54).

The interview is a widely used method of data collection in educational research. Interviews are very important and useful for getting the story behind a participant's experiences. McNamara (1999) stated that the interviewer can pursue in-depth information around the subject. Interviews may be useful as a follow-up to certain respondents of questionnaires, e.g. to further investigate their responses (McNamara, 1999). Anderson and Arsenault (1998) defined the interview as a specialised form of communication between people for a specific purpose associated with some agreed subject matter. Thus, the interview is a highly purposeful task, which goes beyond mere conversation (Anderson & Arsenault, 1998, p.190).

Oppenheim (1992) points out that the interview requires interpersonal skills of a high order: (a) Putting the respondent at ease and comfortable position; (b) Asking questions in an interested manner; (c) Noting down the responses without upsetting the conversational flow; and (d) Giving support without introducing bias (ibid, p.65).

There are commonly three types of interviews: structured, semi-structured and unstructured (Cohen et al., 2000). As the present study intended to gather information about science teachers and students' experiences from the intervention the semi-structured interview was found most appropriate. In this, the interviewer prepares a series of questions, generally open-ended, which are then posed to the interviewees. He or she must have strong listening skills to be able to know how and when to follow up with probes seeking further detail and description about what has been said (Roulston, 2010, p.14-15).

More specifically the aims of the interviews were

- To provide further information students' attitudes towards and experiences with using ICSS in the science teaching
- To investigate in more detail the science teachers' experiences with using ICSS in the teaching and to their observations of students' motivation and learning.

Both sets of information provided a ground for triangulation with the information from the questionnaires

The science teachers interviews were conducted before and after the intervention the simulation software. Interview before experiment was aimed to know the personal information of science teachers', experiences, skills and their perspective of using ICT in education. Interview after experiment was aimed to consider the science teachers observations of the students during and after using ICSS in terms of students' feelings; simulation influence on students understanding of the science topics; usability of simulation for them in science teaching, external factors that affected on the efficiency of the simulation program usability and teachers' impressions of differences between using the simulation program or the traditional method in teaching science. The interviewed acted for about 30 minutes for each science teacher.

According to students interview it was conducted after simulation intervention for two students from each experimental group (n=16), were selected through the post-test outcomes (e.g. students who received high scores in tests and some who received low scores). Interview time total for each student was no more than 15 minutes. The aim of students interview to consider their tendencies toward technological devices; their opinions on using simulation program in learning science and their preferences between using a simulation program or traditional lab science for conducting scientific experiments (See appendix 17 interview protocol).

All science teachers and students were interviewed separately

Many factors influence the success of an interview (Asker, et al., 2003). Therefore, when conducting the interviews was considered:

1. The interview situation, including the time, place and community attitudes. If the place and time were suitable, and if the positive tendencies between the interviewer and the interviewee were available, the interview would be successful.
2. The interviewer characteristics. There is no doubt that the success of the interview depends greatly on the social skills that the researcher has, such as good reception, interaction with the situation, the verbal and non-verbal interactions related to this, as well as the degree of his/her reality regarding the topic of the interview.
3. The respondent characteristics. Such as the social characteristics that he/she has along with his/her ability and desire to answer the questions addressed to him/her. Because the respondents in this study are children (10 -11 years old) and Female teachers the shyness character expect from them during the interview due to the society culture.
4. The content of the study, with all of the sensitivity and excitement in relation to the interviewee and the difficulties in answering the questions. Therefore, some of respondent may have reservations about its opinion about some questions, these reservations may creates due to lack of confidence of interview confidential with interviewer, so to avoid this the interviewer should informs the respondent importance of this study in order to develop the education process and ensure the confidentiality of the interview.

The following (Figure 22) illustrates these factors

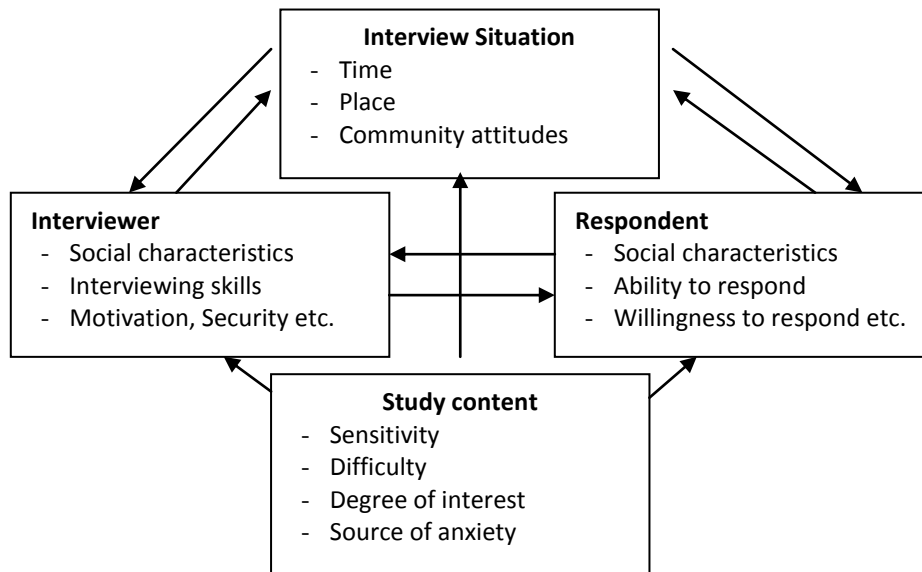

**FIGURE 22.** Factors lead to the success of the interview

(Warwick, D.s Lininger,c. The sample survey: theory and practice, London McGraw hill book co.,1975, p.184)

There were also other points that the interviewer needed to take into account in the construction of the interview guide. What they wanted to talk about and how best to engage participants in these conversations, all this must be clear on the interviewer mind. The interviewer considered the following guidelines form DeMarrais & Lapan (2004) :

1. When the question is short and clear it leads to detailed responses from interviewee. It is mean; a good focused question goes a long way toward encouraging the interviewee to present a detailed narrative.
2. Questions that ask the interviewee to recall specific events or experiences in detail encourage fuller narratives.
3. Fewer open-ended questions work better than a long series of closed-ended questions (DeMarrais & Lapan, 2004. p.61-62).

From the above advice, a private room with private characteristics was requested from the school manager; this was to avoid critics the science teacher maybe facing from colleague or head teachers through the interview. In addition, a consent letter was sought from the science teacher and permission was given for the audio-taping during the interview and this was an optional. This was for two main

reasons the first was ethical, and the second was that the registration for the responses by audio-tape, makes interviewer focus on the responses answers instead of writing answers by hand-written. But all science teachers preferred that the interview not be recorded.

#### **5.4.5 Teachers' self-report**

Three science lessons were taught (i.e. food chain (FC), circulatory and digestive systems (C&DS) and electric circuit (EC)) due to the length of the period for application of the experiment in the current study, which began 15 Oct 2010 and continued until April of 2011. Science teachers were asked to write a report at the end of each lesson. They were asked to include their observations regarding:

- 1- Students' feelings during the lesson using the ICSS program (happy, enjoyable, bored and active)
- 2- Usability of the ICSS program (clear, easy. etc.)
- 3- External obstacles that affected the benefit of using the ICSS program properly (such as; computer-problems, place, lighting, skills...etc)

The report had two aims. First, if any of the teachers faced any technical problems, I to try to overcome them. Second, it uses to serve as documentation to discussion during the interview with teachers in the end of the experiment.

#### **5.5 Procedures for translating the measuring tools**

The study was carried out in the State of Kuwait. The following steps were conducted to translate instruments from English to Arabic correctly:

1. A professional translation company translated - subsidiary to Kuwait University - the instruments (questionnaire and interview question) from English to Arabic.
2. The Arabic version of the instrument was attached to the original English version, and then sent to the English Department in the College of Basic Education. A comparison was made of the original English version of the instrument with the Arabic translation by the Kuwaiti professors, which helped to identify any items in the Arabic version that might need revision.
3. Recommendations of the Kuwaiti professors were used to modify or eliminate any items.

## 5.6 Method of data analysis

### 5.6.1 Analysis of quantitative data

The quantitative data was analysed using IBM SPSS Statistics version 19.0, and the significance level was decided by taking p-values into consideration where  $p > 0.05$  meant there was not a meaningful difference, and  $p < 0.05$  meant there was a statistically significant difference.

I started with uses the uses an independent samples t-test in SPSS for the total scores of pre-test for the three topics (food chain topic (FC), circulation and digestive system topic (C&DS) and electrical circuit (EC). Mean scores are compared between each experimental groups with control group and b=compared between both experimental groups and between the two experimental groups in order to measure that students in all groups were equal at the baseline.

With regard to the analysis of the students' academic achievement results, the independent-samples T-test was used for the post-test for comparing the extent of the effect of ICSS in the post-test of students' academic achievement to the three topics separately, the reason of this that the simulation program as intervention tool (or treatment tool) is new for both science teachers and students and the expected to the test results of the second topic better than the first topic and the test result for the third topic better than the second topic because getting used to use the program by both science teacher and student. The post-test of students' academic achievement analysis will be as follows:

- Comparing students' outcomes (in post-test) between students who used simulation in the computer lab (Exg1) and those who use traditional teaching (Cg)
- Comparing students' outcomes (in post-test) between students who used simulation in the classroom (Exg2) and those who used traditional teaching (Cg)
- Comparing students' outcomes (in post-test) between students who used simulation in the computer lab (Exg1) and those who used simulation in the classroom (Exg2)

Effect size (ES) was used to measure impact on measurement tools results which conducted before and after between and within all groups in this study, Effect size is not an isolated test, but rather a complement to previous significant statistics for the hypotheses, the significant statistic for hypothesis (p-value) is not practically significant. Because p-value merely represents the probability that a finding is due to chance, does not reveal the effect size. Therefore, the reason to use this test is to consider the importance of findings aside from statistical significance (see Lecroy & Krysik, 2007).

Coe (2002) defines the effect size test as quantifying the size of the difference between two groups, experimental and control.

Akers (2001) defines the effect size testing as:

“Convey the magnitude of difference in standard units between the mean of the experimental group and the mean of the control group. Used in conjunction with sample size, alpha level, and direction of the statistical hypothesis to select a value for power.” (p. 332).

Callahan, & Reio (2006) in simple terms, defined an effect size test as the extent to which the objects of study are different; it is the magnitude of the result the researcher observes in a sample.

There is semi-universal agreement that the reports of statistical procedures, such as null hypothesis significance tests, should be accompanied by an appropriate measure of the magnitude of the effect size, this was confirmed by Boguley (2009). In addition, the American Educational Research Association (AERA, 2006) asks for empirical research that the effect size test is run for every essential statistical result. This is also the stance advocated by Cohen, an expert in statistical power, who argued that “the primary product [or result] of a research inquiry is one of measures of effect size, not p values” (1988, p. 12).

There are many different types of effect size (Huberty, 2002; Lecroy & Krysik, 2007). Huberty (2002) refers to three common types of effect size measures:

1. Effect size through the correlations between variables in a sample;
2. Effect size through standardised difference between the means of two groups; and
3. Effect size through the group overlap; the distributions of two compared groups overlap.

In the current study, the standardised difference between the means of two groups was used for effect size result.

According to Baguley (2009), the standardised mean difference includes two scales: Cohen’s d and Hedge’s g. This study used Cohen’s d, which used a formula i.e., the difference between the mean value for two groups;  $M1 - M2$  (e.g. experimental and control) divided by an estimate of the population standard deviation ( $Sd1 + Sd2/2$ ). To get an accurate result estimate of standard deviation, the pooled standard deviation used was better than using only standard deviation (Coe, 2004).

As the effect size in standardised mean difference indicates the magnitude of treatment affect (or the significant statistic for the p-value), Cohen (1988, p. 25) provided d. values for effect size in standardized mean difference. These are:

- Small effect  $d \geq 0.2$
- Medium effect  $d \geq 0.5$
- Large effect  $d \geq 0.8$

In the current study, the effect size for standardized mean difference is conducted as follows:

A. Between groups, the effect size of the post-test results of students' academic achievement:

- Between simulation in the computer lab group (Exg1) and the traditional teaching group (Cg);  
and
- Between simulation in the classroom (Exg2) and the traditional teaching group (Cg).

B. Within groups, the effect size of the pre-test versus post-test results of students' academic achievement was evaluated as follows:

- Within simulation in the computer lab group (Exg1) versus the traditional teaching group (Cg);  
separately for each lesson
- Within simulation in the classroom (Exg2) versus the traditional teaching group (Cg).

With regard to analysis of students' understanding of the objectives of the lesson, the pre- and post-test test score was divided into four levels of understanding (low, medium, good and very good) according to science teachers' categorisation - i.e. teacher test correction. Then, students' test scores were distributed across the four levels of understanding. Frequency and percentage table was used to compare the distribution of students in each level of understanding, using pre- and post-test scores for each experimental (Exg1 & Exg2) separately and comparing with control group.

For conceptual change, questions for certain concepts were selected to compare the performance of the students in the pre-test and post-test with regard to their ability to grasp the concept. Some of these topics were topics where students are known to have misconceptions

With regard to the usability questionnaire, the Likert-scale was evaluated (Strongly Agree = 5, Agree = 4, Neither Agree nor Disagree = 3, Disagree = 2, Strongly Disagree = 1) and then, the frequency and



percentage table was produced for each item on the questionnaire. The aim was to calculate the mean (average) of each item and compare the value of the item to the cut-off values shown in the table. This served as data verification for each item as follows: if the item mean (or average) was between 5 and 4, the students' responses were very positive on this item, and if the item mean was between 3.99 and 3, the students' responses were positive, and from 2.99 to 2 negative, and finally from 1.99 to 1 is very negative.

### **5.6.2 Analysis of qualitative data**

The qualitative measurement tool in this study was the interview. Analysis means interpreting the information provided by the informant and relating it to the main objectives of the study. All the science teachers refused to use tape recorders; thus, information was gathered by writing notes manually (i.e. hand-written notes) instead of tape-recording.

Science teacher interviews were conducted in two parts; First interview was before simulation intervention started - the aim to request the personal information of science teachers, in addition to their attitude in general toward ICT in education. Second interview was conducted after finished for the experimental - i.e. after finished of simulation intervention - the aim was to explore teachers' impressions and opinions of the use of the ICSS program in science teaching. The interview for each teacher lasted for nearly, but- not more than - 30 minutes.

While the students' interviews were held in a meeting room of the school, and recording was not used in order to allow students to talk freely. These interviews aim to examine their post-test scores and their responses to questionnaires – i.e. their attitude toward science and simulation program usability in science teaching and learning - by asking how and why, as open questions, and observing the students' gesticulations is very important during the interview for analysis. School management provided the phone numbers of parents to make them familiar with this issue and to help parents trust to the interviewer and allow an interview with their children to learn their opinions about the usage of the simulation program. The interview would not be more than 15 minutes in length.

To conduct the interview analysis, I started with identifying desired topics from the interview; an example being teachers' trends and opinions about benefits of ICT in the education process in general and for science education in particular; students' feelings while using ICSS according to their observations during lessons. And for the students' interview themes: student trends in technology, their opinion of the ICSS program in regard to usage as both a user and as an educational tool for lesson

display. Then after I finished the interview, I read the interviews several times to write down any impressions from the data that may be relevant to each topic or theme, and which may be useful later was conducted. After that distribution of responses for both science teachers and students under each topic or theme has been conducted. Finally, the responses for both science teachers and students were shown using the narrative (transcript) method under each topic or theme, taking into account the need to show the participant responses in a coherent and sequential form to achieve the objective of the interview.

### 5.7 Population and sample of the study

The target population for the current study was students of public primary schools Grade 5 (10 -11 old years) in the State of Kuwait.

According to the latest Education Statistical Group from the Ministry of Education (ESG of MON, 2008-2009), the number of public primary schools distribution in six education districts was 249 and the number of Grade 5 students was 26,192, distributed in 1,141 classrooms (See Table 9).

**Table 9**

*Ministry Of Education: Planning Sector and Information Technology, Planning Department Monitoring the Follow-Up Environmental Variables -Educational*

Districts	Al-Ahmade			Al-Farwaniya			Al-Asema			Al-Jahra			Hawalli			Mubarak Al-Kabeer			
	primary school number	students number	classes number	primary school number	students number	classes number	primary school number	students number	classes number	primary school number	students number	classes number	primary school number	students number	classes number	primary school number	students number	classes number	
Male	MT	7	941	38	3	526	21	3	411	16	3	445	18	3	349	14	0	14	0
	FT	22	2054	93	20	2183	93	18	1345	65	16	1814	80	16	1553	69	15	1303	60
	Total	29	2995	131	23	2709	114	21	1756	81	19	2259	98	19	1902	83	15	1317	60
Female students		26	3101	126	23	2787	121	23	1803	87	19	2300	99	17	1939	80	15	1324	61
Total		55	6096	257	46	5496	235	44	3559	168	38	4559	197	36	3841	163	30	2641	121
schools primary Total					249														
Classrooms Total					1141														
Total for Students Grade 5					26192														

Note. (MT) = Male teacher, (FT) = Female teacher

The State of Kuwait is characterised as small geographically, at 17,818 square kilometres or approximately seven thousand (7000 Msq) square miles, and the majority of the Kuwaiti population is concentrated in Kuwait City and its suburbs, especially in areas adjacent to the coast of the Arabian Gulf. Therefore, the area inhabited is just 8% per cent of the total area of the State of Kuwait. In the other word, 98.3% per cent of Kuwait’s population live in cities (see Figure 23).

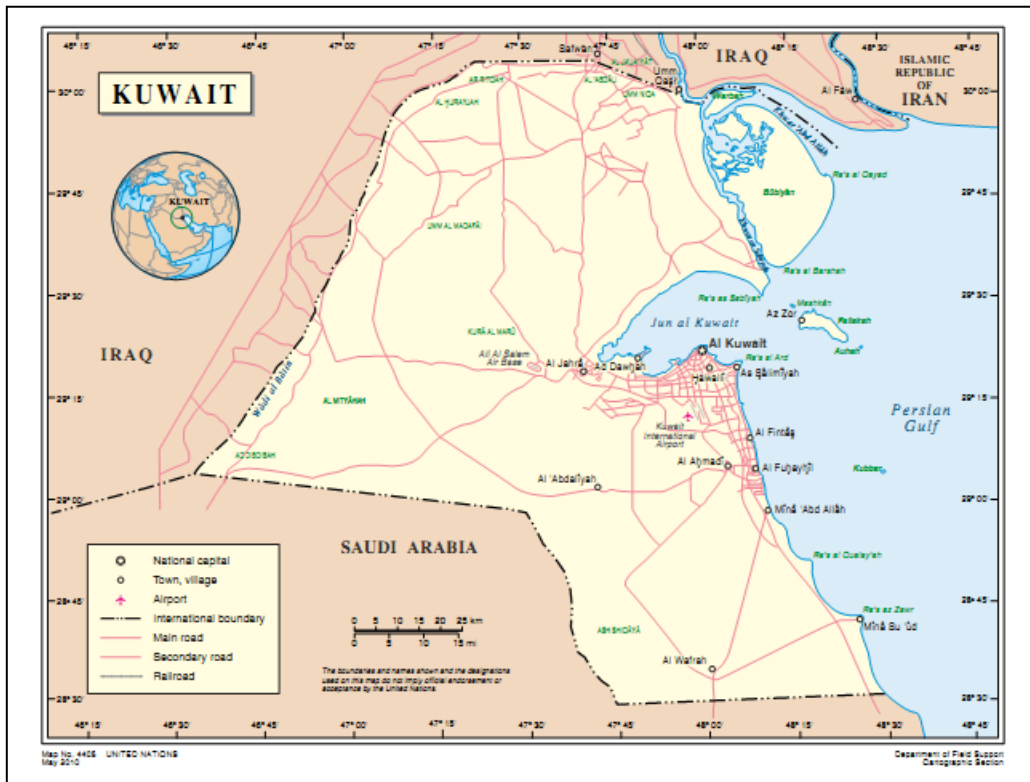

Figure 23. State of Kuwait map

The socioeconomic conditions of the population in the State of Kuwait is mostly the same in each district, therefore, the standard of living for the students (male and female) is also same, making sample choice easier for the research

### 5.7.1 Sample selection from the population of the study

The students (male and female) in Kuwait - in all educational stages - are distributed in six education districts which are; Al-Ahmade; Al-Farwaniya; Al-Jahra; Hawalli; Al-Asema; and finally Mubarak Al-Kabeer. and as mentioned above all socioeconomic conditions of the students in all education

districts are in majority the same. The order of numbers is respectively from the most to least: (1) Al-Ahmade 23.3%; (2) Al-Farwaniya 21%; (3) Al-Jahra 17.4%; (4) Hawalli 14.7%; (5) Al-Asema 13.6%; and finally (6) Mubarak Al-Kabeer 10.1% (See Figure 24).

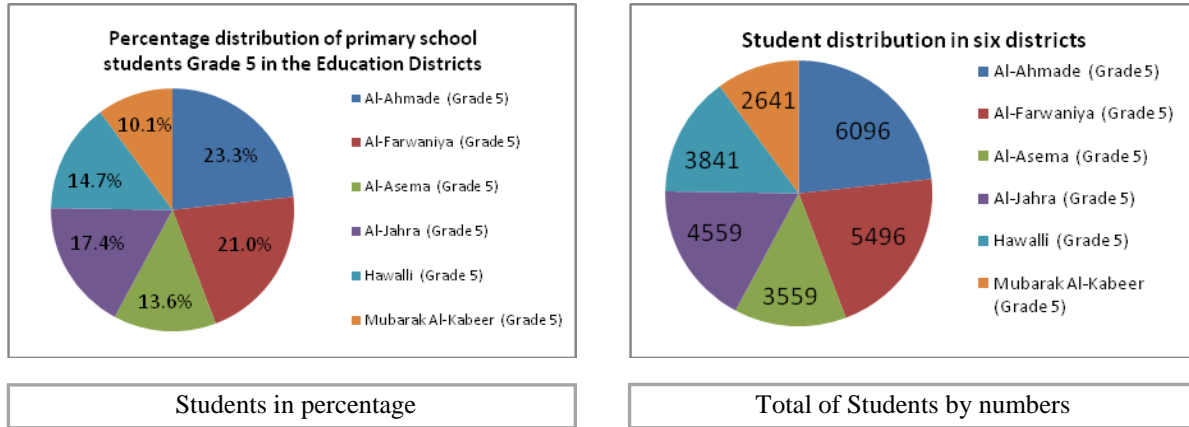

Figure 24. Total of student by numbers and students in percentages

There are several types of probability samples (Asker, et al., 2003; Krathwohl, 1998), including:

- A) Simple random sample
- B) Systematic random sample
- C) Cluster sample
- D) Stratified sample
- E) Non- random samples

This study adopted and used the cluster sampling which considered as a random sample, but used makes if the population is very big, and advantage of cluster sampling saved time, cost and implementation procedures (Asker et al, 2003). Hence, eight primary schools randomly according to the distribution of students in the education districts. The eight primary schools were divided into four male primary schools and four female primary schools. In each school (from the eight primary schools) two classrooms for fifth grade students were selected, one's classroom represents the control group and the other represents the experimental group across eight primary schools in different Kuwaiti educational districts (see figure 25).

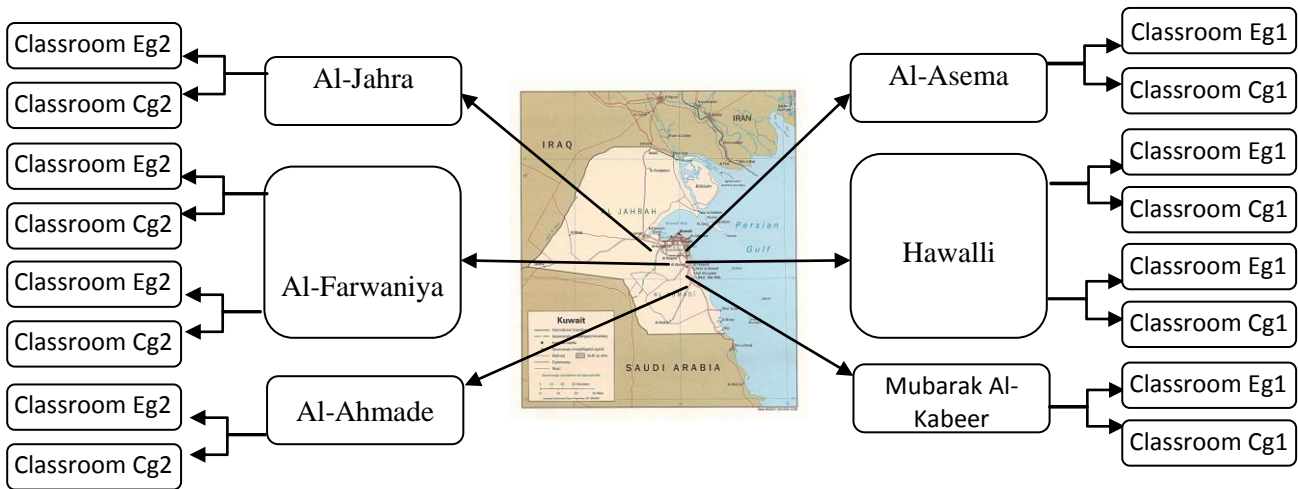

Figure 25. State of Kuwait map and the distribution of educational districts

As mentioned earlier, this study contains two experimental groups (Exg1 and Exg2) (See Figure 17 & 18). Therefore, the eight primary schools were divided randomly in two experimental groups (Exg1 and Exg2), each group contained four primary schools (two male and two female schools), and each school included two classrooms one experimental group and one control group, and were distributed as following:

- **Experimental group 1**

These included two males and two females' schools. Each school had one experimental group (Exg1) and one control group (Cg1), with one science teacher teaching both groups (total 4 science teachers see table 10). Thus, the total of number was four classes as experimental group (Exg1) and four classes as control group (Cg1). The students who were involved in the experimental group in these schools used ICSS in the computer lab (or computer room) with blended learning (mixture method). Numbers are shown in table 11.

**Table 10**

*The Professional Information for Participant Science Teachers Who Used Simulation in the Computer Lab*

N	Place of experiment	Science teacher name	Nationality	Teaching experience	Teacher qualifications	Using computer in teaching science	Obtained IC DL
1	Use simulation in Computer lab	Amirah	KW	8	Bachelor	Rare	All of them have International computer driving license (ICDL)
2		Asraa	KW	10	Bachelor	Rare	
3		Marwa	Egy	8	Bachelor	No	
4		Elham	Egy	13	Bachelor	No	

Note. KW= State of Kuwait, Egy= Arab Republic of Egypt (anonymous names for teachers)

**Table 11**

*The Students Sample for Simulation in computer lab (Exg1) and Traditional Teaching (Cg1)*

Type of groups	Simulation in computer Lab (Exg1)	Traditional teaching (Cg1)	
The students number in classrooms in each schools in experimental group one (Exg1) and control group (Cg1)	School A/F	29	27
	School B/M	20	20
	School C/F	19	20
	School D/M	23	24
	<b>Total</b>	91	91
	182		

Note. F= Female, M= Male

- **Experimental group 2**

These included two males and two females' schools. Each school had one experimental group (Exg2) and one control group (Cg2), with one science teacher teaching both groups (total 4 science teachers see table 12). Thus, the total of number was four classes as experimental group (Exg2) and four classes as control group (Cg2). The students who were involved in the experimental group in these schools used the ICSS in the classroom with the science teacher using a laptop and data-projector. Numbers are shown in table 13.

**Table 12**

*The Professional Information for Participant Science Teachers Who Used Simulation in the Computer Lab*

N	Place of experiment	Science teacher name	Nationality	Teaching experience	Teacher qualifications	Using computer in teaching science	Obtained ICDL
5	Use simulation in classroom	Madeha	KW	10	Bachelor	No	All of them have
6		Suaa'd	KW	6	Bachelor	Rare	International
7		Aydah	Egy	9	Bachelor	No	computer driving license
8		Nohad	Egy	14	Bachelor	No	(ICDL)

Note. KW= State of Kuwait, Egy= Arab Republic of Egypt (anonymous names for teachers)

**Table 13**

*The Students Sample for Simulation In Classroom (Exg2) And Traditional Teaching (Cg2)*

Type of groups		Simulation in classroom (Exg2)	Traditional teaching (Cg2)
The students number in classrooms in each schools in experimental group two (Exg2) and control group (Cg2)	School A/F	29	28
	School B/M	24	22
	School C/F	22	23
	School D/M	17	18
	<b>Total</b>	91	92
		183	

Note. F= Female, M= Male

### 5.8 Reflection on reliability and validity

The current study, similar to other studies in the educational field, uses the different instruments of measurement, such as academic achievement tests and questionnaires. While the purpose of these tests is to provide set of motivators for the examined (i.e., participants) aiming for quantitative responses, on which judgment on a person or a group is depends on these responses. Therefore, the tests are designed to describe and measure a specific thing. For example, to measuring improvement level in understanding and comprehension by the students after being applied by an experiment for pretest and post – test to measure students understanding improvement, not improve their writing (Asker 2003, Cohen 2000)

Therefore, the measurement instruments must be assured that they are achieving its objective of use in the study and test validity and test reliability shall be tested.

### **5.8.1 Validity**

Fraenkel & Wallen (2008) suggest that the validity is defined as “the appropriateness, meaningfulness and usefulness of the specific inferences researchers make based on the data they collect” (p. 153). Thus, test validity mean is extent of the test ability to measure its scope of design. According to Asker, et al. (2003) there are many types of validity, for example, face validity, content validity, internal validity and validity of assessors (or trustees) (p.239). The current study adopted the validity of trustees.

The achievement tests for all topics which have been included in the current study selected from the questions bank which prepared by experts science teachers at MOE, therefore it were already had a validity certified and documented through the administration of the overall direction of science at <http://www.moe.edu.kw>.

Moreover, the research pre and post tests were validated by an expert panel consisting of three experienced teachers and two science education researchers. Where a letter was sent to them contained a copy of two of measurement tools (academic achievement test and students attitude questionnaire), the research questions, and the aim of the current study to arbitrators (See Appendix 18). It asked them to check all the measurements tools which were used in this study. The measurement tools were introduced to three experts of science teachers and two science education researchers to check if these measurement tools (academic achievement test and questionnaires) were appropriate for the aim of the current study. They were asked in particular to look at the following:-

1. If the questions were compatible with the science topics of the syllabus for the science textbook in 5th grade.
2. If the questions were well phrased and clear.
3. If the questions had a variety of difficulty levels between easy, medium and hard and took into account individual differences among students.
4. If the questions covered the full range of levels in Bloom taxonomy (Bloom, Engelhart, Furst, Hill, & Krathwohl, 1956).



Feedback and comments were taken into account and used to improve the instruments.

The usability questionnaire was sent to two experts of software engineers in Kuwait, who checked if the questions were appropriate to the purpose of the survey

The ICSS program was validated through a pilot study and has been presented to expert science teachers to make sure that it consistent with the curriculum objectives for the teaching.

### **5.8.2 Reliability**

According to Cohen et al (2000), reliability is a test of accuracy and consistency. The test should give the same results if it is used several times in the same condition. For example, if a person obtain a specific mark and he, then is subject to a similar test or the same test again, he should obtain the same or close to the same mark. There are many methods to obtain test reliability such as test – retest method, alternate – forms method, and split half method (Asker, et al, 2003). The current study used the Statistical Package for the Social Sciences (SPSS) program to test the reliability of academic achievement test, students' attitude questionnaire and usability of ICSS program.

The results are presented in Tables 14 and 15 showing Cronbach's alpha and a number of items.

- **Achievement test**

There were three science topics achievement test. Food chain (FC); circulatory and digestive systems (C&DS) and electric circuit (EC) The total number of question were 14 includes all topics (see table 14).

As shown in Table 14, Cronbach's alphas of the pre-test questions for the whole sample for the pre-test, gave a Cronbach's alpha value of 0.698. This is commonly regarded as sufficiently high reliability in a low-stake testing.

For the post-test, the Cronbach's alphas for the whole sample for the post test gave a Cronbach's alpha value of 0.787. This again is sufficiently high to conclude that the test questions were reliable.

**Table 14***Cronbach's Alpha for Pre and Post- Achievement Test*

Test	Group type (experimental or control)	Cronbach's Alpha	N of Items
<b>Pre test</b>	Simulation in computer lab (Exg1)	0.698	14
	Simulation in classroom (Exg2)		
	Traditional teaching (Cg)		
<b>Post test</b>	Simulation in computer lab (Exg1)	0.787	14
	Simulation in classroom (Exg2)		
	Traditional teaching (Cg)		

- **Attitude toward science questionnaire**

There were 11 items in the questionnaire that solicited information on the attitudes of students towards learning science at school and 6 items asking about studying science in the future. Cronbach alpha values for the pre-attitude questionnaires for learning science at school and studying science in the future were 0.797 and 0.788 respectively. For the post-attitude questionnaires the similar values were 0.774 and 0.788 respectively.. These values suggest the questionnaire were reliable for assessing the attitude of the students towards the learning science at school and learning science in future. See Table 15 for details.

- **Usability questionnaire**

There were 32 items in the questionnaire that solicited information of the perception of the usability of computer simulation programs, divided into six items asking the students' opinion about the program, 12 items asking about experiences with using the program and finally 14 items asking about learning science from the program. The Cronbach's alphas were 0.796 for the first scale, 0.730 for the second and 0.741 the last. Including all 32 items into one scale had Cronbach's alpha 0.844. This is sufficiently high to conclude that the questionnaire was suitable for assessing the usability of the computer simulation programs as learning tools. See Table 15 for details.

**Table 15**

*Cronbach's Alpha of Attitude Questionnaire and Usability of Computer Simulation Program Questionnaire*

<i>Instruments</i>		<i>Cronbach's Alpha</i>	<i>Number of items</i>	<i>Cronbach's Alpha</i>	<i>Number of items</i>
<i>Pre Attitude Questionnaire</i>	<i>learning science at school</i>	<i>0.797</i>	<i>11</i>	<i>0.871</i>	<i>17</i>
	<i>studying science in the future</i>	<i>0.778</i>	<i>6</i>		
<i>Post Attitude Questionnaire</i>	<i>learning science at school</i>	<i>0.774</i>	<i>11</i>	<i>0.859</i>	<i>17</i>
	<i>studying science in the future</i>	<i>0.788</i>	<i>6</i>		
<i>Usability of Computer Simulation Programs</i>	<i>opinion about the program</i>	<i>0.796</i>	<i>6</i>	<i>0.844</i>	<i>32</i>
	<i>experiences with using the program</i>	<i>0.730</i>	<i>12</i>		
	<i>learning science from the program</i>	<i>0.741</i>	<i>14</i>		

## **5.9 Ethical consideration**

According to Cohen et al (2000), educational research using should consider protecting and respecting individuals.

The current study occurred outside the United Kingdom (UK) in the State of Kuwait but the researcher adhered to the same ethical standards as research in the UK (British Educational Research Association (BERA), 2011). The sets of guidelines were under the following themes:

- Responsibilities to Participants, such as concern to; voluntary informed consent; privacy; detriment arising from participation in research; children, vulnerable young people and vulnerable adults; right to withdraw; and openness and disclosure.
- Responsibilities to Sponsors of Research, such as methods and publication.
- Responsibilities to the Community of Educational Researchers, such as misconduct and authorship.
- Responsibilities to Educational Professionals, Policy Makers and the General Public, such as publicising the results and communicating their findings, and the practical significance of their

research, in a clear, straightforward fashion and in language judged appropriate for the intended audience.

Thus, before the experiment was carried out, the following procedure was followed:

1. Supervisor at Durham University, United Kingdom, issued a letter stating the aim of the study, time for data gathering and the level of participating schools (See Appendix 19). This letter was sent to the Kuwait Cultural office in London. The Kuwait Cultural office issued another letter which was addressed to the PhD student sponsor of The Public Authority for Applied Education and Training (PAAET). Then PAAET was sent the letter to the College of Basic Education, at the Kuwait Cultural office in London to approve the experiment in Kuwait (See Appendix 20).
2. Based on the supervisor's letter, the Dean of the College of Basic Education sent another letter to Assistant Undersecretary for General Education in the Ministry of Education asking for permission to enter the primary schools and apply the experimental method in Grade 5 for the science subject (See Appendix 21).
3. The Assistant Undersecretary for General Education in the Ministry of Education sent these letters to the General Supervisor of Science. The General Supervisor of Science requested information about: What the researcher wanted to do? What kind of tools (program) the researcher would be using in the study? Would the experiment conflict with the academic annual plan for the science syllabus? To answer these questions, a meeting was arranged between the General Supervisor of Science and the researcher. After extensive debate, answers were arrived at. As well as this, a form was presented that stated that the researcher would keep all papers confidential and take note of the ethical issue in educational research. Following Cohen, et al. (2000) the researcher took into account:
  - The participants' consent to participate freely and with conviction.
  - Their right and freedom to withdraw at any time or not to complete particular items in the questionnaire.
  - The benefit they may get from the research, the guarantees that the research will cause them no harm.
  - The guarantees of confidentiality; and the anonymity and non-traceability of the research).

- Punctuality of measurement tools as well as the time of the interviews.

After that, the General Supervisor of Science sent his approval to the Assistant Undersecretary for General Education (See Appendix 22).

4. Based on the General Supervisor of Science's approval to conduct the experiment, the final step was that the Assistant Undersecretary for General Education sent a letter to all the directors of general education in the six districts in State of Kuwait (Al-Asema, Hawalli, Al-Farwaniya, Al-Jahra- Al-Ahmade and Mubarak Al-Kabeer ), to ask them to facilitate the functions of the researcher in the elementary schools for students of Grade 5 in the science subject (See Appendix 22).
5. As mentioned previously, the computer lab is monitored by the Computer Department and not the Science Department. Therefore, it was necessary to send a letter to them to ask permission for the science teachers to use the computer laboratory for this study. Agreement was given from the heads of computer department in eight primary schools, and the science teachers coordinated with computer teachers at least two days before experimentation.
6. To solve the problem of computer software, as was mentioned in above paragraph (4.3.1.1.2), an update from Windows 2003 to Windows 2007 was needed, to run the ICSS. A meeting with the Administrator in the Information and Computer Centre (ICC) in the Ministry of Education was conducted, to inform them of the specifications of the ICSS and the need to change the software in the computer laboratory from Windows 2003 to Windows 2007. In addition, to add some software (e.g. sound card) to run ICSS. The approval was given after the researcher presented the aims of the study and its contribution developing methods of teaching science. A technician was sent to the eight primary schools to download all the software needed for the current study.

### **5.10 Pilot study**

A pilot study was conducted to assess the intervention software and measurement instruments used in the study.

First of all, the ICSS was presented to a class of fifth grade students in two primary schools to investigate any difficulties in using or dealing with it. The first chapter in the fifth grade science

textbook “Flowers Structure and Function” lesson (3) which questioned “How does the flower reproduce the seeds and fruits?” was used to investigate the appropriateness and clearness of the ICSS program. A guide was given to the teachers to know how to run and deal the simulation program and ask them to give feedback if there is any points unclear (See appendix 23, 24 and 25). For example, the appropriate use of computer keyboard or mouse, clarity of scientific terminologies shown on the screen, clarity of instruction on the screen (i.e. play, back, stop...etc.), ability and ease of browsing, etc. The student feedback and observations regarding the clarity of the ICSS program, using keyboards and the colours were all recorded to improve the implementation of the program for the real experiment. As well as that, a questionnaire of students’ attitude was distributed before and after to assess the clarity of statements (items) for student’s attitude toward learning a science subject. Also, after using the program, the questionnaire was distributed to measuring the clarity of statements (items) which look for their attitude toward using and the usefulness of simulation program. Cohen, et al. (2000) emphasised that piloting is very important for the questionnaire in refining its contents (p.129).

The students’ notes regarding the clarity and simplicity of the questionnaire items were all recorded. The pilot study revealed 15 minutes was sufficient to fill in the questionnaire.

## **5.11 Organisation and implementation of the research**

### **5.11.1 Research groups**

In this paragraph, the organisation of the implementation for the two experimental groups (Exg1 & Exg2) and control group is presented.

The current study used two experimental groups and two control groups. The first, experimental group (Exg1) used ICSS in a computer lab with blended learning method (i.e. mix-method; teacher-centred approach and student-centred approach). It consisted of four classrooms (two males and two females). The control groups (Cg1) consisted of four classrooms (two males and two females). As I mentioned before the first experimental group will refer to "Using simulation in the computer lab".

The second experimental group used ICSS in the classroom through the group instruction method; the science teacher used the ICSS program by himself or solo and it consisted of four classrooms (two males and two females). The control groups (Cg2) consisted of four classrooms (two males and two females). As I mentioned before the second experimental group will refer to "Using simulation in the classroom".

In each experimental group teachers were asked to pay attention to students about the simulation disadvantages and risk between the experiments in reality and simulate during the experiment in the current study which mentioned in previous chapter.

### **5.11.2 Implementation of using simulation in computer lab**

This experimental comparison study was conducted during the academic year 2010-2011 at public primary schools in the State of Kuwait.

In the first experimental group (Exg1) (see figure 17) , ICSS was used in the computer laboratory with the blended learning method and ask to science teacher to change the teaching method from traditional to constructivism at the computer lab (see table 1 in the chapter two); for example, the science teacher in one primary school teaching two science classrooms, the first classroom as experimental group in the computer laboratory where the science teacher and students use the program respectively in lab. The teacher would explain the topic using the ICSS in 20 minutes of time followed by 20 minutes of a self-study with the worksheet and science textbook. This approach is called the blended learning method and combines the teacher-centred approach in group instruction method (or whole class) and the student-centred approach in individual learning method. The role of the teacher was as a facilitator, guide, co-coordinator, and observer during the second half of the lesson. In the second classroom, the same teacher teaching the students used the traditional method. This was conducted in four schools (two males and two females).

One week before the intervention, the pre-test and pre-attitude questionnaire was distributed to students in both groups. And then, one week after completion of the topic explanation, the same test and questionnaire was distributed as a post-test and post-attitude questionnaire for all students. This procedure applied for all three topics that were selected for this study (See figure 19).

The usability questionnaire was conducted just for the students who were involved in the experimental group (i.e. who used interactive computer simulation) at the end of the taught topics (i.e. in the end of the experimental).

### **5.11.3 Implementation of using simulation in classroom**

This experiment (see figure 18) comparison for group study was conducted during the academic year 2010-2011 at public primary schools in the State of Kuwait (Synchronized with the first experimental group (Exg1)).

For example, the ICSS used in the classroom through the science teacher only was used as an instructional tool for teaching and learning science and to help the teacher to explain and illustrate the science topics (i.e. teacher-centred approach supporting of simulation software). And the students used the worksheet and textbook; students could also use the program during the lesson if there was enough time.

The procedures of the pre/post-test, pre/post-attitude questionnaire and usability questionnaire in experimental group two (Exg2) were the same as done in experimental group one (Exg1).



## CHAPTER SIX: RESULTS AND DATA ANALYSIS

### 6.1 Introduction

This chapter presents data analysis. It starts with the number of students who attended research groups (Exg1, Exg2 and Cg) followed by a normality test to decide which kind of test to be used in SPSS (i.e., parametric or non-parametric) it then compares test groups at the baseline (pre-test) of the intervention study. Thereafter, data presentation and analysis follow the research questions. The first three research questions relate to the effectiveness of the simulation program in improving students' academic achievement:

- Effect of using simulation in the computer lab (Exg1) versus traditional teaching method (Cg);
- Effect of using simulation in the classroom (Exg2) versus traditional teaching method (Cg); and
- Effect of using simulation in the computer lab (Exg1) versus using simulation in the classroom (Exg2).

Answering these questions will include both hypothesis testing to see if there are significant differences between the groups and analysis of effect sizes to see how big the differences are.

The fourth question is about the effects of using a simulation program on students' conceptual understanding of specific concept. This is investigated by comparing pre and post-test answers for each experimental group (Exg1 & Exg2) versus pre and post-test answers for the control group (Cg) on specific questions

The fifth question is about students' attitude toward science teaching and learning and will be analysed through the questionnaires that were distributed to the students in the two experimental groups and the control group, to compare between each experimental group (Exg1 and Exg2) versus control group (Cg1 and Cg2). As well as compared between students who were in first experimental group (Exg1) and students who were in second (Exg2) experimental groups

The sixth research question will be analysed with regard to the students' opinions of and experiences with science teaching using ICSS through the usability questionnaire and by interviewing of some of students.

Finally, the seven research question, analysis will be of interviews with science teachers. The aim of these interviews for both of science teachers and students was to get contextual information and to ‘triangulate’ results in the questionnaires as well as the achievement test outcomes.

Quantitative data have been analysed in the statistical software IBM/ SPSS/PC version 19.0. Significance level when testing hypotheses is set to  $p < 0.05$  for rejecting null hypotheses.

## 6.2 Students’ number who attended and participated actually in study

After completed the study experiment the actual attendance of students in each experimental group as followed:-

In the first experimental group (Exg1), the number of students who attended and participated in science topics, in both groups (i.e. the experimental group and the control group), is shown in the table 16 (after the experiment was completed):

**Table 16**

*The Number of Students Who Attended In First Experimental Group (Exg1)*

Type of groups		Simulation in computer Lab (Exg1)			Traditional teaching (Cg1)		
The students number in classrooms in each schools in (Exg1) and (Cg1)	School A/F	29			27		
	School B/M	20			20		
	School C/F	19			20		
	School D/M	23			24		
<b>Total</b>		91			91		
182							

**The number of students who participated in science topics in both groups (after the experiment was completed)**

Science topics	FC	C&D	EC	FC	C&D	EC
<b>Students number</b>	77	81	78	82	84	72

**Note.** (FC) = Food chain topic, (C&DS) = Circulation & digestive system topic, (EC)= Electric circus topic, F= Female, M= Male

In the second experimental group (Exg2), the number of students who attended and participated in science topics, in both groups (i.e. the experimental group and the control group) is shown in the table 17 (after the experiment was completed):

**Table 17***The Number of Students Who Attended In Second Experimental Group (Exg2)*

Type of groups		Simulation in classroom (Exg2)			Traditional teaching (Cg2)		
The students number in classrooms in each schools in (Exg2) and (Cg2)	School A/F	29			28		
	School B/M	24			22		
	School C/F	22			23		
	School D/M	17			18		
<b>Total</b>		92			91		
183							
<b>The number of students who participated in science topics in both groups (after the experiment was completed)</b>							
<b>Science topics</b>		FC	C&D	EC	FC	C&D	EC
<b>Students number</b>		83	82	85	83	73	82

**Note.** (FC) = Food chain topic, (C&DS) = Circulation & digestive system topic, (EC)= Electric circus topic, F= Female, M= Male

### 6.3 Normality test

The tests of normality for the six total scores are shown in Table 18. The Shapiro-Wilk test is most appropriate, because of the low sample size. This test indicates that topic 1 food chain (FC) post-test, topic 2 Circulation & digestive system (C&DS) pre-test and topic 3 Electric circuits (EC) pre-test were significantly different from a normal distribution, with p-values in the last column smaller than 0.05. Consequently, a non-parametric test is recommended for inferential statistical testing when these scores are involved (Cohen, Manion & Morrison, 2000 and 2004). However, post-tests are normally distributed for two topics (C&DS) and (EC), allowing parametric tests to be used. This is important, because post-tests are used to test the hypotheses after pre-tests have been compared.

In situations where tests do not fully satisfy the criterion for normal distribution it is common to run both parametric and non-parametric tests and compare the outcomes. This approach was taken in the current study since two of the three topics only were normality distributed. In the first data tables for testing hypotheses both sets of statistics will be presented. As will be shown, the outcome was the same in both types of tests (Norusis, 1998, p263) . Because the parametric test is more familiar to many researchers and somewhat easier to interpret and understand, further tables presents the parametric test only. All hypotheses, however, have been tested with both types of tests (See Appendix 26 for more details).

**Table 18***The Test of Normality*

<i>Total score for each topic in pre and pro-test</i>	<i>Group type</i>	<i>Kolmogorov-Smirnov</i>			<i>Shapiro-Wilk</i>		
		<i>Statistic</i>	<i>Df</i>	<i>Sig.</i>	<i>Statistic</i>	<i>Df</i>	<i>Sig.</i>
<i>Topic 1 (FC) pre-test</i>	<i>Control</i>	<i>.110</i>	<i>49</i>	<i>.188</i>	<i>.966</i>	<i>49</i>	<i>.170</i>
	<i>Experimental</i>	<i>.148</i>	<i>47</i>	<i>.012</i>	<i>.973</i>	<i>47</i>	<i>.329</i>
<i>Topic 1 (FC) post-test</i>	<i>Control</i>	<i>.157</i>	<i>49</i>	<i>.004</i>	<i>.923</i>	<i>49</i>	<i>.004</i>
	<i>Experimental</i>	<i>.181</i>	<i>47</i>	<i>.001</i>	<i>.905</i>	<i>47</i>	<i>.001</i>
<i>Topic 2 (C&amp;DS) pre-test</i>	<i>Control</i>	<i>.162</i>	<i>49</i>	<i>.003</i>	<i>.905</i>	<i>49</i>	<i>.001</i>
	<i>Experimental</i>	<i>.077</i>	<i>47</i>	<i>.200*</i>	<i>.980</i>	<i>47</i>	<i>.601</i>
<i>Topic 2 (C&amp;DS) post-test</i>	<i>Control</i>	<i>.086</i>	<i>49</i>	<i>.200*</i>	<i>.966</i>	<i>49</i>	<i>.161</i>
	<i>Experimental</i>	<i>.115</i>	<i>47</i>	<i>.145</i>	<i>.972</i>	<i>47</i>	<i>.303</i>
<i>Topic 3 (EC) pre-test</i>	<i>Control</i>	<i>.166</i>	<i>49</i>	<i>.002</i>	<i>.949</i>	<i>49</i>	<i>.035</i>
	<i>Experimental</i>	<i>.153</i>	<i>47</i>	<i>.008</i>	<i>.909</i>	<i>47</i>	<i>.001</i>
<i>Topic 3 (EC) post-test</i>	<i>Control</i>	<i>.100</i>	<i>49</i>	<i>.200*</i>	<i>.963</i>	<i>49</i>	<i>.123</i>
	<i>Experimental</i>	<i>.113</i>	<i>47</i>	<i>.172</i>	<i>.975</i>	<i>47</i>	<i>.414</i>

**Note.** (FC) = Food chain topic, (C&DS) = Circulation & digestive system topic, (EC)= Electric circus topic,  
F= Female, M= Male

In regards to students' attitude questionnaire, table 19 shows all sample size (df >50) thus the Kolmogorov-Smirnov statistic was used for the same reason as in the achievement test. As seen from the table, there was no significant difference in the first experimental or the second experimental group or in the second control group, so all of these are normal distributed. In the first control group however non-normality was found, with p=0.001.

Because three from four groups were normal distributed and only one of the groups is not normal, it is still possible to use parametric test as similar as in achievement test as above.

**Table 19***Tests of Normality for Students Attitude Questionnaire*

<i>Groups type</i>	<i>Kolmogorov-Smirnov</i>			<i>Shapiro-Wilk</i>		
	<i>Statistic</i>	<i>df</i>	<i>Sig.</i>	<i>Statistic</i>	<i>df</i>	<i>Sig.</i>
<i>First experiment simulation in computer lab</i>	<i>0.051</i>	<i>87</i>	<i>0.2</i>	<i>0.98</i>	<i>87</i>	<i>0.211</i>
<i>Second experiment simulation in classroom</i>	<i>0.081</i>	<i>88</i>	<i>0.2</i>	<i>0.961</i>	<i>88</i>	<i>0.01</i>
<i>First Control group for lab</i>	<i>0.139</i>	<i>84</i>	<i>0.001</i>	<i>0.94</i>	<i>84</i>	<i>0.001</i>
<i>Second Control group for classroom</i>	<i>0.076</i>	<i>89</i>	<i>0.02</i>	<i>0.974</i>	<i>89</i>	<i>0.073</i>

#### **6.4 Comparing the pre-tests between groups**

This analysis uses an independent samples t-test in SPSS for the total scores of pre-test for the three topics (food chain topic (FC), circulation and digestive system topic (C&DS) and electrical circuit (EC). Mean scores are compared between experimental group using simulation in the computer lab (Exg1) and control group (Cg) in Table 20, between experimental group using simulation in classroom (Exg2) and control group (Cg) in Table 21, and between the two experimental groups in Table 22

Table 20 shows that the mean scores for experimental and control groups were not significantly different in the first (FC) and third (EC) topics of pre-test of students' academic achievement. In the second topic (C&DS) the difference is significant, with the control group having the highest score. With two out of three topics not being significantly difference, it is reasonable to conclude that students in the two groups were equal at the baseline. However, the significantly higher score on the second topic will be considered when analyzing the post-test.

**Table 20***Simulation in Computer Lab vs. Traditional Teaching*

Topics	Groups	N	Mean	Std. Deviation	Std. Error Mean	P-value
<b>Topic 1 (FC) pre-test</b>	Simulation in computer lab (Exg1)	43	11.33	3.734	.569	.534
	Traditional teaching (Cg)	46	10.76	4.762	.702	
<b>Topic 2 (C&amp;DS) pre-test</b>	Simulation in computer lab (Exg1)	41	12.32	3.784	.591	.007
	Traditional teaching (Cg)	45	15.04	5.244	.782	
<b>Topic 3 (EC) pre-test</b>	Simulation in computer lab (Exg1)	39	7.23	2.096	.336	.516
	Traditional teaching (Cg)	38	7.61	2.862	.464	

Table 21 shows that the mean scores in all topics of the pre-test for the second experimental group and the matching control group. None of these scores were significantly different. Thus, I can conclude that students in the groups were equal at the baseline.

**Table 21***Simulation in Classroom vs. Traditional Teaching*

Topics	Groups	N	Mean	Std. Deviation	Std. Error Mean	P-value
Topic 1 (FC) pre-test	Simulation in classroom (Exg2)	47	7.49	3.562	.520	.894
	Traditional teaching (Cg)	49	7.59	3.973	.568	
Topic 2 (C&DS) pre-test	Simulation in classroom (Exg2)	37	8.00	3.923	.645	.613
	Traditional teaching (Cg)	42	8.40	3.029	.467	
Topic 3 (EC) pre-test	Simulation in classroom (Exg2)	46	3.30	3.444	.508	.648
	Traditional teaching (Cg)	40	3.58	1.893	.299	

Table 22 shows that there were significantly different mean scores, in all topics of the pre-test, which were in favor of the first experimental group. These results can be attributed to the fact that students in each group were from different schools and had different science teachers. The significantly higher score between the two groups will be considered when analyzing the post-test.

**Table 22**  
*Simulation in Computer Lab vs. Simulation in Classroom*

Topics	Groups	N	Mean	Std. Deviation	Std. Error Mean	P-value
<b>Topic 1 (FC) pre-test</b>	Simulation in computer lab (Exg1)	43	11.33	3.734	.569	.001
	Simulation in classroom (Exg2)	47	7.49	3.562	.520	
<b>Topic 2 (C&amp;DS) pre-test</b>	Simulation in computer lab (Exg1)	41	12.32	3.784	.591	.001
	Simulation in classroom (Exg2)	37	8.00	3.923	.645	
<b>Topic 3 (EC) pre-test</b>	Simulation in computer lab (Exg1)	39	7.23	2.096	.336	.001
	Simulation in classroom (Exg2)	46	3.30	3.444	.508	

## 6.5 Results in achievement post tests

### 6.5.1 Research question 1: Effect of using simulation in the computer lab versus traditional teaching method

To answer the first research question, the differences between post-test mean scores were compared for all topics. As mentioned, both parametric and non-parametric tests were used and the results are therefore presented in two tables. Table 23 presents outcome of the non-parametric Mann-Whitney test, and Table 24 presents an independent-samples t-test.

The two tables show similar results and suggest that none of the topics have significant differences to 5% level. In all topics, however, groups using the simulation have higher ranks in the non-parametric test and higher means in the parametric test. The biggest difference is in the topic *circulation and digestive system*, where the experimental group had a mean score of 19.25 and the group with traditional teaching had 17.61. On this topic, the control group had significant higher score on the pre-test. Since that is not a significant difference in the post-test, however, the conclusion from the test is to keep the null hypothesis and reject the alternative hypothesis that simulations give higher achievement.

Note that the p value trend nearly to reach to the .05 after second science topic - i.e. C&DS - and this what I expected, but strangely, that the p value rising from p= 0.095 in second topic to .886 in the third

topic. After the investigation of this result shows that science teachers faced technical problems in the computer lab (Show later in detail in discussion chapter)

**Table 23**

*The Post-test Score Comparison between Using Simulation in a Computer lab (Exg1) and using Traditional Teaching (Cg) (Non-parametric Test)*

Test	Group	N	Mean rank	Mann Whitney U	Sig (p-value)
FC post-test	<i>Using Simulation in computer lab (Exg1)</i>	77	85.11	2764	0.172
	<i>Traditional teaching(Cg)</i>	82	75.20		
C&DS post-test	<i>Using Simulation in computer lab (Exg1)</i>	81	89.39	2885	0.091
	<i>Traditional teaching(Cg)</i>	84	76.84		
EC post-test	<i>Using Simulation in computer lab (Exg1)</i>	78	76.05	2765	0.871
	<i>Traditional teaching(Cg)</i>	72	74.90		

**Note.** (FC) = Food chain topic, (C&DS) = Circulation & digestive system topic, (EC)= Electric circus topic,

**Table 24**

*The Post-Test Score Comparison between Using Simulation in a Computer Laboratory (Exg1) and Using Traditional Teaching (Cg) (Parametric Test)*

Test	Group	N	Mean Score	Std. Deviation	Std. Error	p-value
FC post-test	<i>Using Simulation in computer lab (Exg1)</i>	77	15.18	4.055	0.462	0.417
	<i>Traditional teaching(Cg)</i>	82	14.68	3.641	0.402	
C & DS post-test	<i>Using Simulation in computer lab (Exg1)</i>	81	19.25	5.902	0.656	0.095
	<i>Traditional teaching(Cg)</i>	84	17.61	6.626	0.723	
EC post-test	<i>Using Simulation in computer lab (Exg1)</i>	78	12.22	4.614	0.522	0.886
	<i>Traditional teaching (Cg)</i>	72	12.11	4.486	.529	

**NOTE.** (FC) = Food chain topic, (C&DS) = Circulation & digestive system topic, (EC)= Electric circus topic.



### 6.5.2 Rresearch question 2: Effect of using simulation in the classroom versus traditional teaching method

The second research question was answered by testing the differences between the second experimental group (Exg2), using simulation in the classroom, and the control group of students, using traditional teaching methods (Cg). The analysis followed the same procedure as above with non-parametric and parametric testing, but only the parametric test is presented (Table 25). This time the means are significantly different in favour of the experimental group for all three topics. The null hypothesis is therefore rejected and simulation is found to be more efficient than traditional teaching. Note again that the highest mean score difference between two groups was in the second topic (C&DS), with 19.56 for the experimental group and 17.51 for the control group.

**Table 25**

*The Post-Test Score Comparison between Experimental Group Who Used Simulation in a Classroom and the Control Group Who Use Traditional Method*

Test	Group	N	Mean	Std. Deviation	Std. Error	t statistic	p-value
FC post-test	Using Simulation in Classroom (Exg2)	83	14.45	4.351	0.478	2.428	0.016
	Traditional teaching(Cg)	83	12.88	3.949	0.433		
C & DS post-test	Using Simulation in Classroom (Exg2)	82	19.56	5.495	0.607	2.418	0.017
	Traditional teaching(Cg)	73	17.51	5.080	0.595		
EC post-test	Using Simulation in Classroom (Exg2)	85	12.88	4.565	0.495	2.287	0.024
	Traditional teaching(Cg)	82	11.20	4.965	0.548		

**Note.** (FC) = Food chain topic, (C&DS) = Circulation & digestive system topic, (EC)= Electric circus topic.

### 6.5.3 Research question 3: Effect of using simulation in the computer lab versus using in the classroom

The third research question regarded the difference between the two experimental groups. Group 1, using the simulations in the computer laboratory, was expected to have higher achievement than Group 2, using the simulation in the classroom. This was because the usage of the simulation program in

computer lab give good opportunities for the student to work individually to construct new concepts according to its pace, with science teachers helping as a guide for the student.

The parametric test (Table 26) through independent-samples T test was used, as mentioned before, and the results are presented in Table 18. It shows that none of the mean scores for the two experimental groups were significantly different. Note that the mean score in the first topic is higher for the first experimental group, while the mean scores in the second and third topics are higher for the second experimental group. The biggest difference is in the food chain topic, where the group that used simulation in the computer lab had a mean score of 15.18 and the group that used simulation in the classroom had 14.45. The conclusion is to keep the null hypothesis and reject the alternative that simulations used in computer lab result in higher achievement than using simulation in classroom. However, back to comparing the result of pre-test between two experimental groups (see Table 22) it was seen that the first experimental group - using simulation in lab - was significantly different mean scores than experimental group two - use simulation in classroom. But, now there was no significantly different between both experimental groups, this shows that the second experimental group has improved.

**Table 26**

*The Post-Test Score Comparison between both Experimental Groups Who Used Simulation in Computer Lab (Exg1) and Classroom (Exg2)*

Test	Group	N	Mean	Std. Deviation	Std. Error	t- statistic	p-value
<b>FC post-test</b>	Using simulation in computer lab (Exg1)	77	15.18	4.055	0.462	1.105	0.270
	Using simulation in Classroom (Exg2)	83	14.45	4.351	0.478		
<b>C&amp;DS post-test</b>	Using simulation in computer lab (Exg1)	81	19.25	5.902	0.656	0.352	0.726
	Using simulation in classroom (Exg2)	82	19.56	5.495	0.607		
<b>EC post-test</b>	Using simulation in computer lab (Exg1)	78	12.22	4.614	0.522	0.923	0.357
	Using simulation in classroom (Exg2)	85	12.88	4.565	0.495		

**Note.** (FC) = Food chain topic, (C&DS) = Circulation & digestive system topic, (EC)= Electric circus topic, F= Female, M= Male

## 6.6 Effect size of students' academic achievement

Effect sizes complement the testing of significance above and inform how big the differences are (Lecroy & Krysik, 2007). Effect sizes are analysed both within groups (how much they have improved in the post-test compared to the pre-test) and between groups (how big is the difference between the different groups in the post-test).

As measure for effect size is used Cohen's *d* (Cohen (1988, p. 25), which has the following standards:

- Small effect  $d \geq 0.2$
- Medium effect  $d \geq 0.5$
- Large effect  $d \geq 0.8$

### 6.6.1 Effect sizes *within* the different groups from pre-test to post-test

Table 27 shows effect sizes for the group using simulations in the computer laboratory. As can be seen, in all three topics the effect size is higher for the experimental group than the control group. Biggest difference is in topic 2, where the experimental group has 'large effect size' 1.49 while the control group has 0.32, which is medium effect size. In topic 1, the effect size for both groups is quite similar 1.55 for Exg1 and 1.10 for Cg. For topic 3, both groups are within the large interval of Cohen's standard ( $<0.8$ ). However, the effect size of Exg1 is a little higher than Cg (also see Figure 26).

**Table 27**

*The Effect Sizes from pre to post-test scores within groups using simulation in computer lab (Exg1) and traditional teaching (Cg1)*

<i>(Exg1 vs. Cg1)</i>	<i>DATA ENTRY</i>						<i>STANDARDISED EFFECT SIZE</i>			
	post-test			pre-test			Effect Size	Confidence interval for effect size		
	Mean	N	SD	Mean	N	SD		lower	upper	
<b>Exg1 lab pre post-test (FC) topic 1</b>	16.41	39	2.613	11.33	43	3.734	1.55	1.06	2.04	
<b>Cg pre post-test (FC) topic 1</b>	15.11	44	2.755	10.76	46	4.762	1.10	.066	1.55	
<b>Exg1 lab pre post-test (C&amp;DS) topic 2</b>	19.14	44	5.137	12.32	41	3.784	1.49	1.01	1.97	
<b>Cg lab pre post-test (C&amp;DS) topic 2</b>	16.72	43	5.147	15.04	45	5.244	0.32	-0.10	0.74	

<b>Exg1 lab pre post-test (EC) topic 3</b>	11.34	44	4.690	7.23	39	2.096	1.10	0.64	1.56
<b>Cg pre post-test (EC) topic 3</b>	11.11	36	4.406	7.61	38	2.862	0.94	0.46	1.42

**Note.** (FC) = Food chain topic, (C&DS) = Circulation & digestive system topic, (EC)= Electric circus topic, F= Female, M= Male

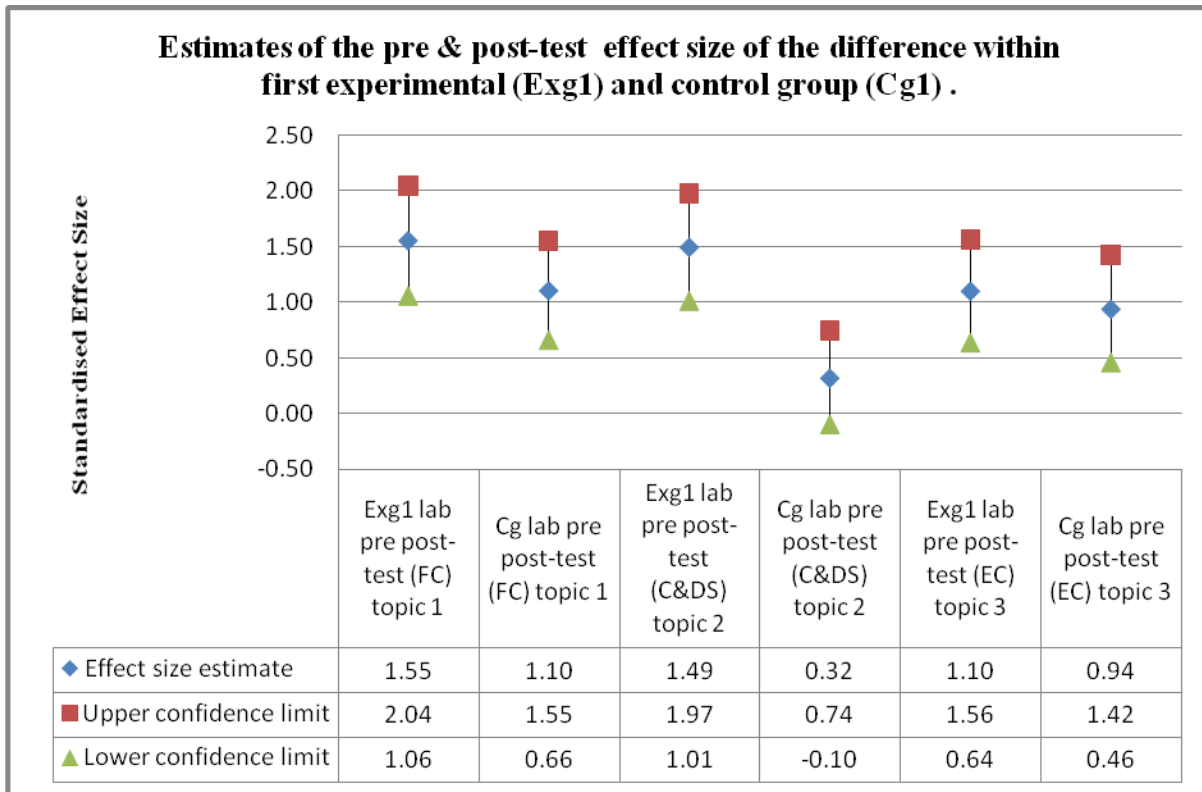

Figure 26. Pre to post-test effect size for simulation in computer lab and using traditional teaching

Table 28 shows the similar effect sizes for the group using simulations in the classroom. As can be seen, in all of three topics the effect size in the experimental group is higher than the control group.

The third topic (EC) had the biggest difference in effect sizes, with the experimental group having an effect size 0.9 higher than the control group. In topic 1 (FC), the experimental group has 1.77, while the control group has 1.22. In topic 2 (C&DS), the difference is smaller but still with a higher effect size for the experimental group. Over all, both groups are within the large interval of Cohen’s standard (<0.8) (see Figure 27).

**Table 28**

The Effect Size Pre to Post-Test Score Comparison within Groups for Simulation in Classroom (Exg2) and Used Traditional Teaching (Cg2)

(Exg2 vs. Cg2)	DATA ENTRY						STANDARDISED EFFECT SIZE		
	post-test			pre-test			Effect Size	Confidence interval for effect size	
	Mean	N	SD	Mean	N	SD		lower	upper
<b>Exg2 pre post-test (FC) topic 1</b>	14.60	47	4.357	7.49	47	3.562	1.77	1.29	2.25
<b>Cg pre post-test (FC) topic 1</b>	12.57	44	4.100	7.59	49	3.973	1.22	0.78	1.67
<b>Exg2 pre post-test (C&amp;DS) topic 2</b>	17.16	45	4.517	8.00	37	3.923	2.13	1.59	2.67
<b>Cg lab pre post-test (C&amp;DS) topic 2</b>	15.25	36	4.031	8.40	42	3.029	1.92	1.39	2.46
<b>Exg2 pre post-test (EC) topic 3</b>	10.96	47	4.021	3.30	46	3.444	2.03	1.53	2.53
<b>Cg pre post-test (EC) topic 3</b>	8.53	45	5.679	3.58	40	1.893	1.13	0.67	1.59

**Note.** (FC) = Food chain topic, (C&DS) = Circulation & digestive system topic, (EC)= Electric circus topic, F= Female, M= Male

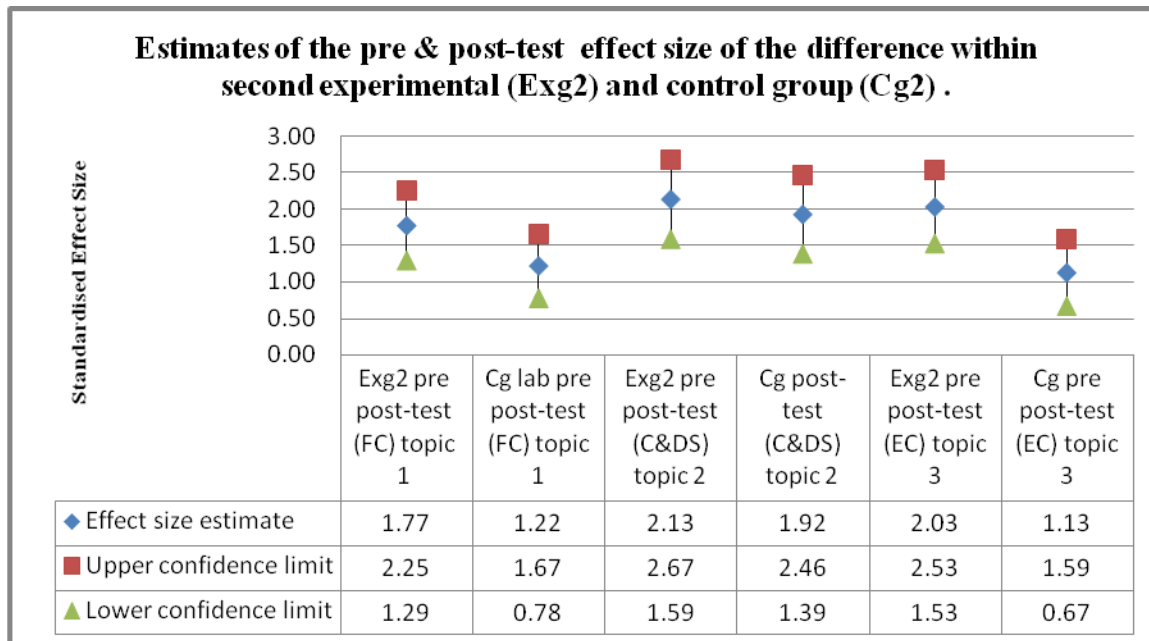

Figure 27. Pre to post-test effect size for simulation in classroom and using traditional teaching

### 6.6.2 Effect sizes *between* groups in the post-test.

**Table 29**

*The Effect Size between groups using simulation in the computer lab (Exg1) and traditional teaching (Cg1)*

<i>(Exg1 vs. Cg1)</i>	<i>DATA ENTRY</i>						<i>STANDARDISED EFFECT SIZE</i>		
	<i>Used simulation in computer Lab (Exg1)</i>			<i>Traditional teaching (CG1)</i>			<i>Effect Size</i>	<i>Confidence interval for effect size</i>	
	<i>Mean</i>	<i>n</i>	<i>Std</i>	<i>Mean</i>	<i>n</i>	<i>Std</i>		<i>lower</i>	<i>upper</i>
<i>Exg1 &amp; Cg post-test (FC) topic 1</i>	<i>15.18</i>	<i>77</i>	<i>4.055</i>	<i>14.68</i>	<i>82</i>	<i>3.641</i>	<i>0.13</i>	<i>-0.18</i>	<i>0.44</i>
<i>Exg1 &amp; Cg post-test (C&amp;DS) topic 2</i>	<i>19.25</i>	<i>81</i>	<i>5.902</i>	<i>17.61</i>	<i>84</i>	<i>6.626</i>	<i>0.26</i>	<i>-0.05</i>	<i>0.57</i>
<i>Exg1 &amp; Cg post-test (EC) topic 3</i>	<i>12.22</i>	<i>78</i>	<i>4.614</i>	<i>12.11</i>	<i>72</i>	<i>4.486</i>	<i>0.02</i>	<i>-0.30</i>	<i>0.34</i>

**Note.** (FC) = Food chain topic, (C&DS) = Circulation & digestive system topic, (EC)= Electric circus topic, F= Female, M= Male

Table 29 shows the effect sizes when comparing post-test scores between experimental and control group. As mentioned earlier, these differences were not significant. Two out of three topics have effect size in the small interval of Cohen’s standard (<0.2). The first (FC) and the third (EC) have 0.13 and 0.02 respectively. The effect size for the second topic (C&DS) was 0.26, which is slightly bigger than (>0.2) of Cohen’s standard. To see the differences between the two groups in effect size for each topic, Figure 28 is helpful.

In general, the result shows that teaching science in the computer laboratory has had little effect compared to traditional teaching.

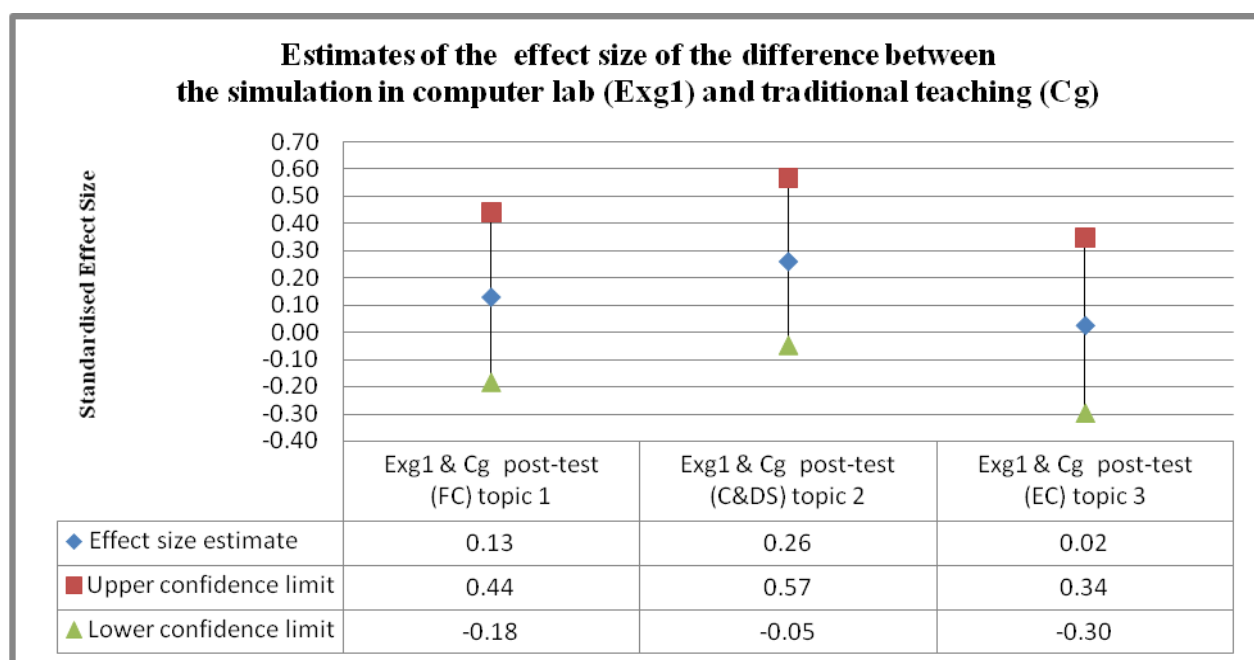

Figure 28. The effect size of the difference between using simulation in computer lab and control; group

**Table 30**

The Effect Size between groups using Simulation in Classroom (Exg2) and Used Traditional Teaching (Cg2)

<i>(Exg2 vs. Cg2)</i>	<i>DATA ENTRY</i>						<i>STANDARDISED EFFECT SIZE</i>		
	<i>Simulation in classroom (Exg2)</i>			<i>Traditional teaching (Cg2)</i>			<i>Effect size</i>	<i>Confidence interval for effect size</i>	
	<i>Mean</i>	<i>n</i>	<i>Std</i>	<i>mean</i>	<i>n</i>	<i>Std</i>		<i>lower</i>	<i>upper</i>
<i>Exg2 &amp; Cg post-test (FC) topic 1</i>	<i>14.45</i>	<i>83</i>	<i>4.351</i>	<i>12.88</i>	<i>82</i>	<i>3.949</i>	<i>0.38</i>	<i>0.07</i>	<i>0.68</i>
<i>Exg2 &amp; Cg post-test (C&amp;DS) topic 2</i>	<i>19.56</i>	<i>82</i>	<i>5.492</i>	<i>17.51</i>	<i>73</i>	<i>5.080</i>	<i>0.39</i>	<i>-0.07</i>	<i>0.70</i>
<i>Exg2 &amp; Cg post-test (EC) topic 3</i>	<i>12.88</i>	<i>85</i>	<i>4.565</i>	<i>11.20</i>	<i>82</i>	<i>4.965</i>	<i>0.35</i>	<i>0.05</i>	<i>0.66</i>

**Note.** (FC) = Food chain topic, (C&DS) = Circulation & digestive system topic, (EC)= Electric circus topic, F= Female, M= Male

As shown earlier, students who used simulation in the classroom (Exg2) score significantly different on the post test from the students who used traditional teaching method (Cg). Table 30 shows the effect sizes for these groups. For topic one (FC) the effect size is 0.38, which is slightly less than the medium according to Cohen’s standard scale. The other two topics, C&DS and EC, rate similar to the first topic in effect size, with 0.39 for C&DS and 0.35 for EC.

As an example, a 0.5 effect size corresponds to the difference between the heights of 14-year-old and 18-year-old girls which is quite visible to the naked eye (Cohen, 1969, p23).

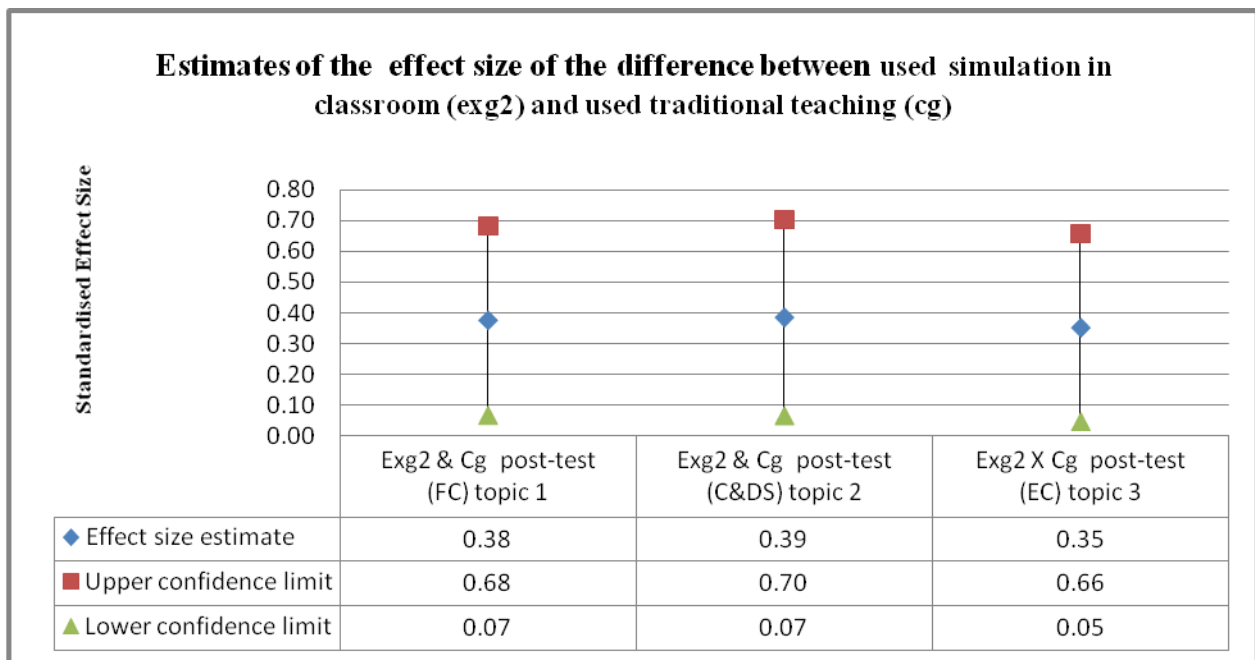

*Figure 29.* The effect size of the difference between using simulation in classroom and using traditional teaching

Figure 29 shows the effect sizes with confidence intervals. The values for upper confidence intervals between the three topics are 0.68, 0.70 and 0.66 for topic one (FC), topic two (C&DS) and topic three (EC), respectively. The lower confidence intervals are 0.07, 0.07 and 0.05 for the three topics in order.



## **6.7 Research question 4: Effect of using simulation on conceptual change**

As mentioned in the literature review, each student starts or enters school with informal ideas (misconceptions or alternative conceptions) about scientific phenomena or topics. This section presents results for the effect of ICSS to shift such ideas. Information was gathered about students' conceptual changes of specific concepts or ideas in the pre- and post tests.

Two topics are selected for analysis. The circulatory and digestive System lesson was selected for the first experimental group (Exg1), which used simulation in the computer lab to compare with traditional teaching group (Cg1). The reason why the second topic was selected was that science teachers were faced with many problems during the implementation of the third topic; i.e., the electric circuits lesson (see the first research question analysis). The electric circuits lesson was selected for the second experimental group (Exg2), which used simulation in the classroom to compare with traditional teaching group (Cg2).

From a review study of children's conception of the organisation of the body, Carey (1985) has shown that children at the age of 10 appear to understand that the body contains numerous organs which function together in maintaining life. Driver et al. (1994) in their review reports a common misconception is to give egocentric explanations for parts of the body, as in 'my hair is for washing'. By the end of primary school children most explain functions of organs in terms of causal relationships, and between 7 and 9 children commonly move for a holistic, human-centred view to recognition that different functional parts of the body are working together. The ideas tested were therefore if students can explain both functions of individual organs and how they work together. In electric circuits, a key concept is the complete circuit (Driver, Guesne and Tiberghien, 1985). Children mostly enter school with a 'consumer model', that electricity is used by the light bulb. This model develops step-wise towards the circuit model taught in science, but research shows that even in secondary school many students still hold on to a variant of the consumer model. An item with various models for electric circuits was used in the pre- and post-tests and will be analysed. Further details about the topics are given below.

The data analysis starts with presenting progress of students' attainment in different score bands and then moves to looking at individual items. As in the previous sections, the aim is to compare the different ways of using simulations in the teaching,

### 6.7.1 Conceptual change of using simulation in computer lab versus traditional teaching about the Circulatory and Digestive System topic

I will start by presenting the understanding or achievement level analysis between students in Exg1 and Cg1 groups, and then the conceptual change analysis in understanding the "Artery" as a specific concept or idea when teaching the circulatory topic.

Because the C&DS test consisted of 20 items distributed across 5 questions, the total mark that a student could score on this test was 30. In order to grasp the extent a student understood the science topics, grades were rated as follows: scoring 7 or below was classified as 'low understanding type', greater than 7 but less than or equal to 14 as 'medium type of understanding', greater than 14 but less than or equal to 21 as 'good understanding type' and finally greater than 21 as 'very good understanding type' (see Table 31).

**Table 31**

*The Final Score For Pre And Post-Test Comparison Between Using Simulation In Computer Lab And Using Traditional Teaching (Cg) With Respect To Students Understanding The Concepts Of Circulatory And Digestive System Lesson*

C&DS test	Understanding level standard	Percentage/ Number	First Learning Environment			
			<i>Using Simulation in computer lab (Exg1)</i>		<i>Traditional teaching (Cg)</i>	
			C&DS topic pre-test	C&DS topic post-test	C&DS topic pre-test	C&DS topic post-test
<b>Understanding types for circulatory and digestive system lesson (C&amp;DS) topic</b>	0-7 Low Understanding type	% Students count	15.4% 6	0% 0	4.8% 2	0% 0
	8-14 Medium Understanding type	% Students count	53.8% 21	20.5% 8	38.1% 16	38.1% 16
	15-21 good Understanding type	% Students count	30.8% 12	38.5% 15	42.9% 18	42.9% 18
	22-30 Very good Understanding type	% Students count	0% 0	41.0% 16	14.3% 6	19.0% 8
	<b>Total of students</b>		39	39	42	42

**Note:** C&DS=circulatory and digestive system lesson

able 31 shows that 15.4% of the students using simulation in the computer lab (Exg1), were classified as showing low understanding in at the pre-test stage. In the post-test no student was classified as showing low understanding. Furthermore, that the pre-test stage, not a single student was classified as showing a very good understanding, while in the post-test 41% of the students were classified at this level. There was also a decrease in the number of students who were classified as having medium understanding, from 53.8% to 20.5%. In contrast, for the control group there was less change in the understanding level of students between pre-test and post-test For instance at pre-test stage only 5% were classified as showing low understanding, while at post-test, no student was classified as showing low understanding. Just over 38% of students were classified as showing medium understanding at pre-test and a similar percentage was shown at post-test. At the higher conceptual level of understanding i.e., ‘good’ and ‘very good’, the percentage of students at pre and post-test stages is very similar; 42.9% vs. 42.9% and 14.3% vs. 19.0% respectively.

There are many objectives within the circulatory system topic (see Table 32). One of the objectives is: Knowing how blood transfers from the heart to the body parts. Windschitl and Andre (1998) suggest that the students in fifth, eighth and tenth grade, as well as some college freshmen have many of misconceptions and limited about the conceptualization of how the circulatory system works and heart function or how many chamber in the heart?. The say "When asked to select an illustration that describes the path of blood in the body, the students’ most frequent response was an incorrect pattern in which blood flowed from the heart to an extremity then back to the heart, not including any flow to the lungs" (p. 146).

**Table 32**  
*The Lesson Objectives for Circulatory System Lesson*

The topic	Lesson objectives
	At the end of the circulatory system topic, the student must:
<b>Circulatory system</b>	<ul style="list-style-type: none"> <li>- Know the parts of the blood and function of each.</li> <li>- Define the blood vessels types.</li> <li>- Describe the route of blood through the heart to all of body parts.</li> <li>- Compare between each of the three types of blood vessels through its function.</li> </ul>

The students' preconceptions about how the blood is transferred from the heart to the entire body, according to the science teachers, were as follows:

- There is one hose ("they mean blood vessels as scientific term") out from the heart and back to it; its function is distributing the blood to the entire human body.
- When the human moves, the heart works and then it will distribute blood to the entire human body through the heart hose (blood vessels is the scientific term).

One of the aims of the circulatory system lesson is that students should know the types of blood vessels and the function of each type. The artery is one of the three types of blood vessels and its function is transfer the blood from the heart to the all of body parts.

Item number 4 at the pre and post-test stages for the circulatory system topic (see Appendix 13) was measured to grasp the students' level of understanding of the term artery. Therefore, Table 33 shows the result of student responses (Figure 30). According to the science teacher, the conceptual change achieved when the students knows the function and the meant by "Artery" concept. Therefore, conceptual change level was calculated as follows: If a student selected one wrong choices such as; A, C or D no change has occurred, and if student chooses two answers such as; right answer with an alternative concept (such as B with A, D or C) the change is rated at 'medium level', but if students selected the correct answer (i.e. B only) the change of understanding is rated at 'high level'.

Question four; Select scientifically correct answer for each of the following statements by ticking (✓):

1. What part(s) of the circulatory system transfer(s) blood from the heart to the body parts:

A Vein       B Artery       C Capillaries       D Food

Figure 30. Question 4; which measured the change of Artery understanding

**Table 33**

*The Final Score For Question 4 In Pre And Post-Test Comparison Between Using Simulation In Computer (Exg1) And Using Traditional Teaching (Cg) With Respect To Students' Conceptual Change Of The Artery Concept*

Artery concept	Circulatory system Conceptual level standard of the Artery term	Percentage/ Number	First Learning Environment			
			Using simulation in computer lab (Exg1)		Traditional teaching (Cg)	
			(CS) topic pre-test	(CS) topic post- test	(CS) topic pre-test	(CS) topic post- test
<b>Conceptual level for Q4 for (C&amp;DS) Conceptual Change Of The Artery concept</b>	0= No conceptual understanding	% Students	87.18% 34	17.95% 7	83.33% 35	33.33% 14
	1= Some conceptual understanding	% Students	5.13% 2	7.69% 3	7.14% 3	9.52% 4
	2= Good conceptual understanding	% Students	7.69% 3	74.36% 29	9.52% 4	57.14% 24
<b>Total of students</b>			39	39	42	42
<b>Total of percentage of conception level</b>			100%	100%	100%	100%

*Note:* (CS) = circulatory system lesson

Table 33 shows the conceptual level of students after they finish question four in the C&DS topic test. As revealed in the first row under the experimental column, the percentage of students who have no experience or idea about "Artery" concept in the pre-test is 87.18% (this means high in misconceptions) and this percentage decreased very significantly post-test to 17.95% (from 34 students to 7 students only). Therefore, comparing experimental with control groups in same level, the percentage for Cg is larger than Exg1 in post-test, which equal 33.33% in post-test after it was 83.33% in pre-test. What is interesting to note is that the percentage in conceptual understanding or change is increasing in both groups from pre-test to post-test: 74.36% for Exg1 and 57.14% for Cg. It appears that the difference of percentages between groups is 15% in favour of student who use simulation in the computer lab. No important change in the level of some conceptual understanding was shown between pre-test and post-test in either group (Exg1 and Cg).

### 6.7.2 Conceptual change of using simulation in classroom versus traditional teaching about the Electric Circuit topic

The electric circuit (EC) topic was selected to compare between Exg2 and Cg2 in the understanding or achievement level analysis between students in both groups and then the conceptual change analysis in understanding the "electric current flow" as a specific concept or idea during the teaching the electric circuit topic.

The EC test consisted of 13 items distributed across 5 questions to assess the students' understanding of the topic goals. The total possible score of this test is 22, and the standard of conceptual understanding was established by science teachers as follows: the level 0-6 = low understanding level, 7-11 = medium level of understanding, 12-16 = good understanding level and finally 17-22 = very good understanding level (see Table 34).

**Table 34**

*The Final Score For Pre Post-Test Comparison between Using Simulation In Classroom (Exg1) And Using Traditional Teaching (Cg) With Respect To Students Understanding The Concepts Of Electrical Circuit Lesson*

EC test	Understanding type standard	Percentage/ Number	Second Learning Environment			
			Using simulation in classroom (Exg2)		Traditional teaching(Cg)	
			EC topic pre-test	EC topic post-test	EC topic pre-test	EC topic post-test
Understanding types for electrical circuit lesson (EC) topic	0-6 Low Understanding type	% Students count	82.9% 34	9.8% 4	74.4% 29	33.3% 13
	7-11 Medium Understanding type	% Students count	17.1% 7	41.5% 17	25.6% 10	35.9% 14
	12-16 good Understanding type	% Students count	0.0% 0	36.6% 15	0.0% 0	20.5% 8
	17-22 Very good Understanding type	% Students count	0% 0	12.2% 5	0.0% 0	10.3% 4
	<b>Total of students</b>		41	41	39	39

---

Note: ES = electrical circuit lesson

Table 34 explains the understanding levels of students after they finish all questions in the electric circuit (EC) test. As found in the first row the second experimental (Exg2) column, the percentage of students with low understanding in pre-test is 82% and this percentage decreases very significantly in the post-test to 9.8% (from 34 students to 4 students only). Therefore, in comparing experimental with control groups at the same level, the percentage for Cg is larger than Exg2 in post-test, which stands at 33.3%, after what was 74.4% in pre-test. What is interesting to note is that in the pre-test for Exg2, there is 0% in the 'good' and 'very good' categories of understanding, but in post-test there is 36.6% and 12.2% in the level of 'good' and 'very good' respectively. Also, at the medium level, Exg2 students rose from 17.1% to 41.5% compared to 25.6% to 35.9% in Cg.

There are many objectives within the electric circuit topic (see Table 35). One of such is: Knowing the flow direction of an electrical current through a conductor. Jaakkola & Nurmi (2008) suggest that "in the domain of electricity, there is a large body of research evidence that shows that students in all school levels have severe difficulties and misconceptions in their understanding of electric circuits even after formal instruction has taken place" (p. 271).

The students' preconceptions for the direction of flow for an electrical current through a conductor, according to the science teachers, were as follows:

- The current flows in one wire only from battery to bulb.
- The current in both wires is flowing towards the lamp.
- Less current is flowing back to the battery than to the lamp.

One of the aims of the electric circuit lesson is that students should know the flow direction of an electrical current through a conductor in circuit. Electric current flow without a break is very important to light a bulb.

**Table 35**

*The Lesson Objectives for Electric Circuit Lesson*

The topic	Lesson objectives
<b>Electric circuit lesson (EC)</b>	By the end of the electric circuit lesson, the student must: <ul style="list-style-type: none"><li>- Know the flow direction of an electrical current through a conductor.</li><li>- Define the terms of resistance, conductor and insulator.</li><li>- Describe what happens in close electric circuit.</li><li>- Describe two kinds of series circuit &amp; parallel circuits.</li><li>- Compare between series circuit &amp; parallel circuit.</li><li>- Differentiate between of series circuit &amp; parallel circuit.</li></ul>

Question 5 in pre and post-tests within the EC topic (see Appendix 14) measured the students' level of understanding in the lesson. Therefore, Table 36 shows the result of student responses for this question (Figure 31) According to the science teacher, the conceptual change level was calculated as follows: If a student selected one wrong choice such as; A, B or C, no change occurred, and if student chose two answers, such as the right answer with an alternative concept (such as D with A, B or C) the change is rated 'medium level', but if students selected the correct answer (i.e. D only) the change of concept is rated at 'high level'

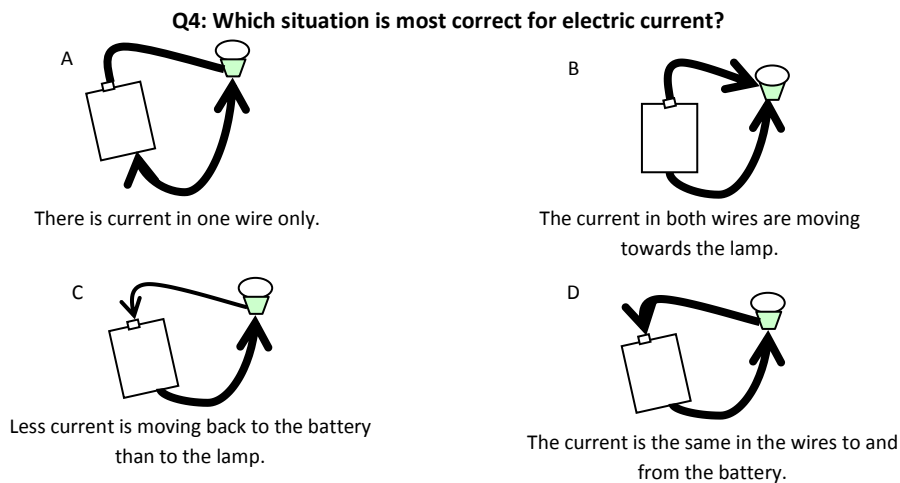

*Figure 31. Question 5; which measured the flow direction of a current through conductors*



**Table 36**

*The Final Score For Question 5 In Pre And Post-Test Comparison Between Using Simulation In Classroom (Exg2) And Using Traditional Teaching (Cg) With Respect To Students' Conceptual Change Of The Electric Current*

Electric current concept	Conceptual level standard of the electric current term	Percentage/ Number	Second Learning Environment				
			Using simulation in classroom (Exg2)		Traditional teaching (Cg)		
			EC topic pre-test	EC topic post-test	EC topic pre-test	EC topic post-test	
<b>Conceptual level for Q5 for (EC) Conceptual Change Of The Electric Current</b>	0= No conceptual understanding	%	95.1%	46.30%	82.10%	64.10%	
	Student selected A, B or C	Students count	39	19	32	25	
	1= Some conceptual understanding	%	2.40%	22.00%	15.40%	15.40%	
	Student selected D with C	Students count	1	9	6	6	
	2= Good conceptual understanding	%	2.40%	31.70%	2.60%	20.50%	
	Student selected D	Students count	1	13	1	8	
	<b>Total of students</b>			41	41	39	39
	<b>Total of percentage of conception level</b>			100%	100%	100%	100%

**Note:** EC = electrical circuit lesson

Table 36 shows the conceptual understanding level of students after they finish question four in the EC topic test. As found in the first row under the experimental column, the percentage of students who experienced no conceptual understand in the pre-test is 95.1% (high in misconceptions) and this percentage decreases very significantly in the post-test to 46.3% (from 39 students to 19 students only). Therefore, the percentage for Cg is greater than for Exg2 in post-test, which equals 64.1% after what was 82.1% in pre-test. What is interesting to note is that in the pre-test for experimental group there was 2.4% in the 'some conceptual understanding' and 'good conceptual understanding' categories, but by the post-test there was 22% and 31.7% respectively. In Cg, the 'some conceptual understanding' percentage was same pre and post, equaling 15.4% for each, but the 'good conceptual understanding'

level of change in post-test rises from 2.6% to 20.5%. Despite this, the students in Exg2 experienced a high percentage conceptual change, greater than that of Cg students.

## 6.8 Result of attitude toward science

### 6.8.1 Research question 5: Effect of using simulations in students' attitude toward teaching and learning science in each of using simulation in the computer lab and using simulation in classroom compared to traditional teaching method

To test the attitude hypotheses towards learning science, the parametric test by independent-samples t t-test was conducted to find if there any significant statistical difference (p-value). In addition, differences of effect size were placed in the same table. The questionnaire included two attitude scales, attitude towards learning science at school and attitudes towards further studies in science. Results are presented separately for the two experimental groups compared to the control groups and for comparing the two experimental groups with each other.

**Table 37**

*The Students' Attitude Comparison between Using Simulation in Computer Laboratory and Using Traditional Teaching (Cg) Toward Learning Science*

Post – Attitude scales	Type of group	Mean	N	Std. Deviation	Std. Error Mean	t statistic	p-value	effect size
<b>Learning science at school</b>	Using simulation in computer lab (Exg1)	3.90	88	0.56	0.06	.951	.343	0.15
	Traditional teaching (Cg)	3.79	84	0.82	0.09			
<b>Studying science in the future</b>	Using simulation in computer lab (Exg1)	3.66	88	0.90	0.10	.470	.639	0.07
	Traditional teaching (Cg)	3.59	84	1.13	0.12			

Table 37 presents the results of students' attitudes for first experimental group using simulations in the laboratory. The t-test revealed no significant difference between the groups in their attitude towards learning science at school. ( $p > 0.05$ ). The mean values are 3.90 for Exg1 and 3.79 for Cg 1. For studying science in the future, the result is the same ( $p = 0.64 > 0.05$ ). The effect sizes (ES) are small, with d value 0.15 and 0.07 respectively (Cohen's standards  $d \leq 0.2$ ) (see also Figure 32) the conclusion to the sixth hypothesis therefore to keep the null hypothesis.

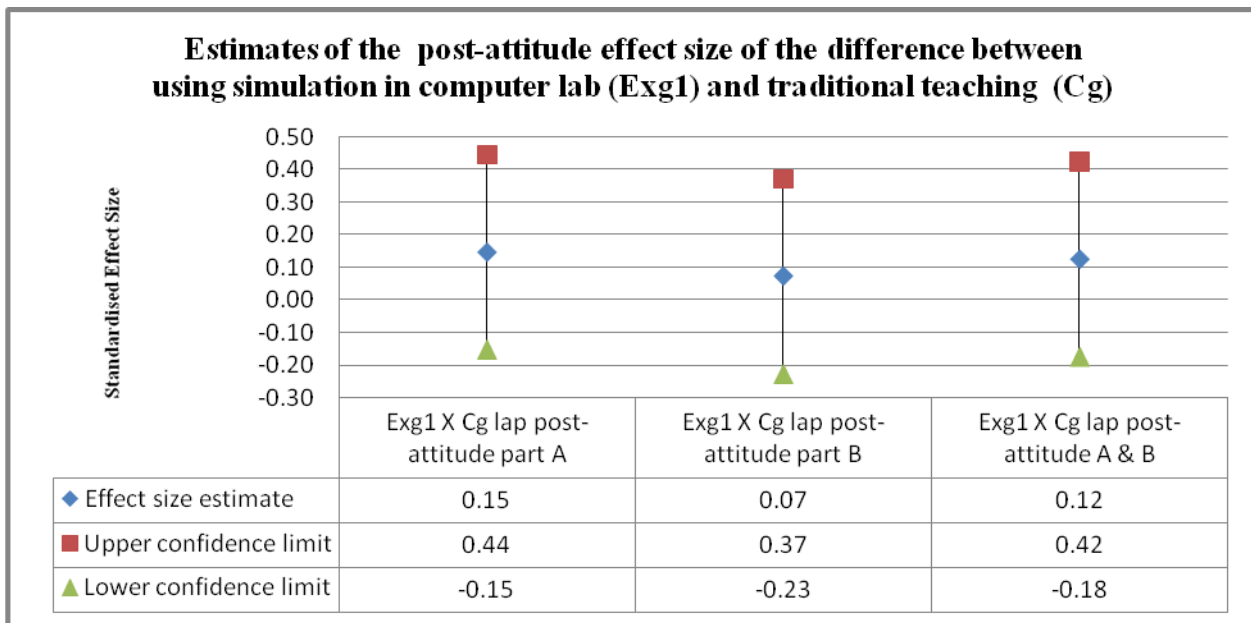

Figure 32. The effect size estimates between simulation in computer lab and using traditional teaching

**Table 38**

*The Attitude Comparison between Second Experimental Group Who Used Simulation in Classroom and Traditional Teaching toward Learning Science*

Post – Attitude scales	Type of group	Mean	N	Std. Deviation	Std. Error Mean	t statistic	p-value	effect size
<b>Learning science at school</b>	Using Simulation in Classroom (Exg2)	4.21	88	0.48	0.05	5.886	.001	0.91
	Traditional teaching(Cg)	3.62	90	0.81	0.09			
<b>Studying science in the future</b>	Using Simulation in Classroom (Exg2)	3.85	88	1.03	0.11	3.373	.001	0.51
	Traditional teaching(Cg)	3.32	90	1.07	0.11			

Table 38 shows the mean attitude scores for the second experimental and control group (Exg2 and Cg). Here we see a statistically significant p-value of 0.001 ( $>0.05$ ) for both scales. Mean values are 4.21 for learning science at school and 4.08 for studying science in the future for the experimental group.

Effect sizes (see Figure 33) are 0.91 and 0.51, In other words, a large effect in Cohen's (1969) description for the first scale. The second scale has a smaller effect size somewhat smaller, but still at a medium level in Cohen's categorization.

The findings, therefore, support the seventh hypothesis that attitudes are higher when using simulations in the teaching.

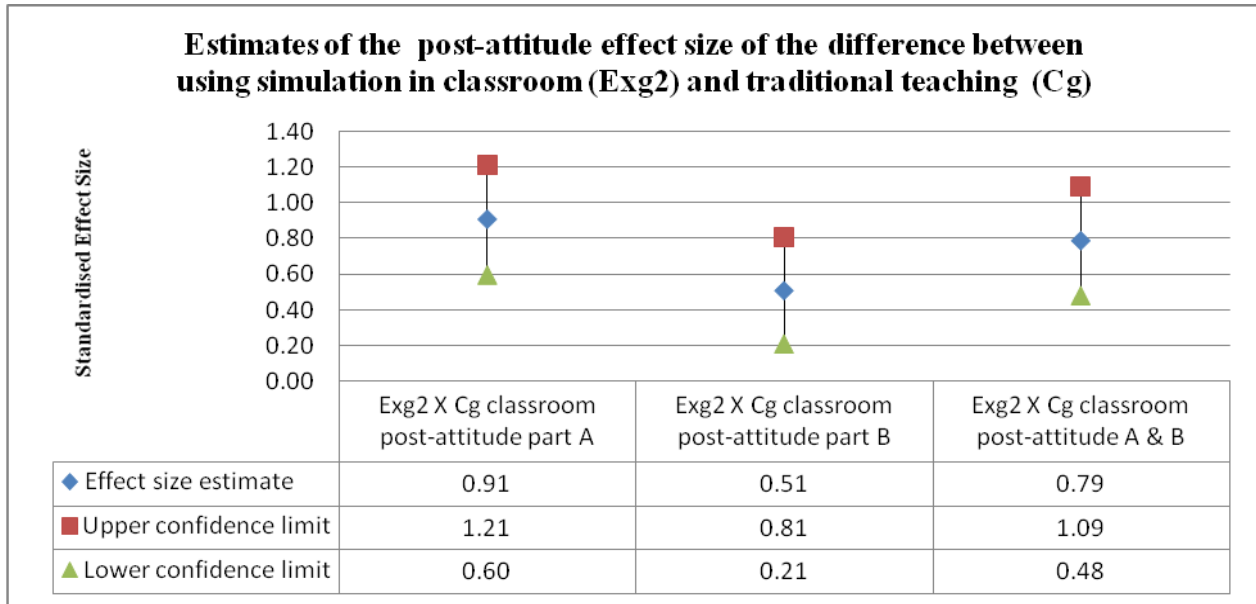

Figure 33. The effect size estimates between simulation in classroom and traditional teaching

### 6.8.2 Research question 6: Effect of using simulations in students' attitudes towards science teaching and learning between using simulation in the computer lab and using simulation in classroom

Table 39 compares the two experimental groups. It reveals that there is significant statistical difference in the attitude towards learning science at school. The difference is in favour of the second experimental group using simulations in the classroom. The t-value is -3.95 and the p-value of 0.001 the effect size of this difference is 0.6 which is above medium under Cohen's standard. For attitude towards studying science in the future, there is no significant between the two experimental groups. The p-value is 0.2 and the effect size,  $d=0.19$ , is small (see Figure 34).

The overall result therefore suggests that using the simulation program in the classroom developed the best attitude among the students, but that this is most efficient or attitude towards learning science at school

**Table 39**

*The Attitude Comparison between both Experimental Groups Who Used Simulation in Computer Lab (Exg1) and Classroom (Exg2)*

Post –Attitude scales	Type of group	Mean	N	Std. Deviation	Std. Error Mean	t statistic	p-value	effect size
<b>Learning science at school</b>	Using Simulation in Computer Lab (Exg1)	3.90	88	0.56	0.06	-3.95	.001	0.60
	Using Simulation in Classroom (Exg2)	4.21	88	0.48	0.05			
<b>Studying science in the future</b>	Using Simulation in Computer Lab (Exg1)	3.66	88	0.90	0.11	-1.29	.200	0.19
	Using Simulation in Classroom (Exg2)	3.85	88	1.03	0.10			

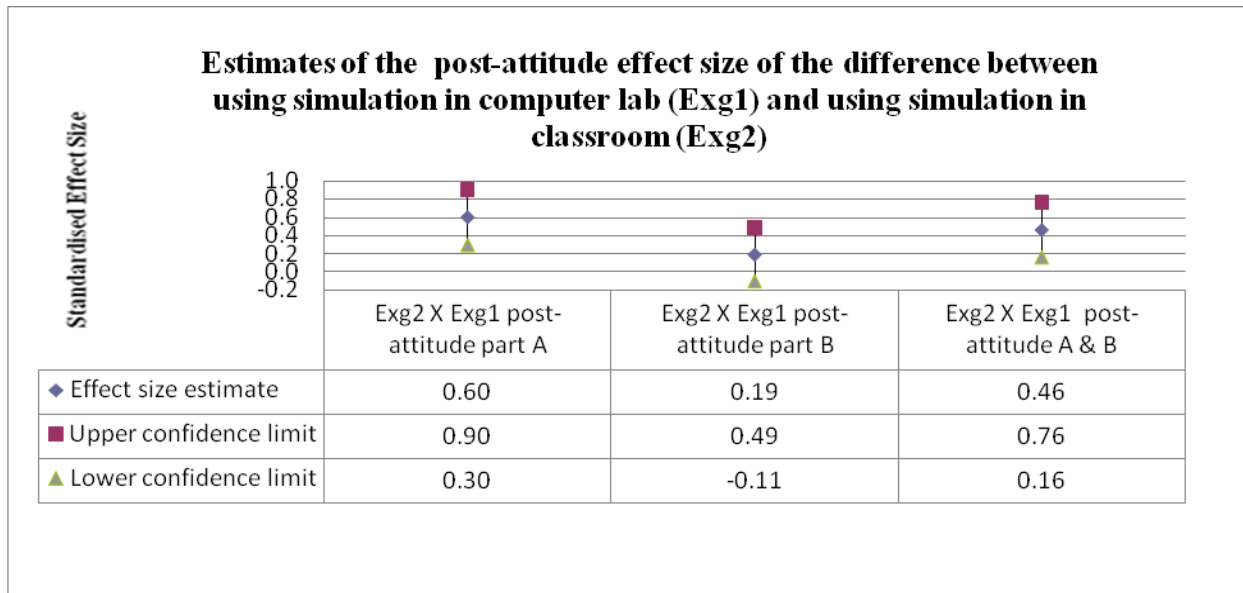

Figure 34. The effect size estimates between first experimental group and second experimental group

## 6.9 Research question 7: Students’ opinions and experiences about usability of interactive computer simulation software in science education through usability questionnaire and interviews

### 6.9.1 Students’ Questionnaire of Simulation Program Usability

A questionnaire was given to the students from the two experimental groups. There were 32 items in the questionnaire to solicit information of the usability of interactive computer

simulation software. These were divided into three topics of groups of questions. The first topic contained six items asking the students about their “opinion about the program”. The second topic included 12 items asking about “experiences with using the program”, and finally the third topic contained 14 items asking about “learning science from the program”. The research question was also answered by interviewing two students from each of the schools participating in the study.

Results will be presented for items separately, with frequencies of responses for each item and the mean value for the item. When calculating the means, categories have been scored 5 for strongly agree, 4 for agree, 3 for neither agree or disagree, 2 disagree and 1 for strongly disagree. To make it easier to compare mean values for the item, negatively phrased statements have been coded in reverse. This means higher mean values reflect more positive opinions.

**Table 40**

*The Usability Attitude for All Students’ In Experimental Group Who Used Simulation for 6 Items Asking the Students’ "opinion about the program"*

N	Item	Experimental Groups	Number / percentage	Strongly agree	Agree	Neither agree nor disagree	Disagree	Strongly disagree	mean
1	It is wonderful to use	Simulation in computer lab	Frequency %	63 75.0	16 19.0	1 1.2	2 2.4	2 2.4	4.62
		Simulation in classroom	Frequency %	68 88.3	10 13.0	1 1.3	0 0.0	2 2.6	4.75
		All	Frequency %	131 79.4	26 15.8	2 1.2	2 1.2	4 2.4	4.68
2	I feel I need to have it	Simulation in computer lab	Frequency %	46 54.8	16 19.0	15 17.9	5 6.0	2 2.4	4.18
		Simulation in classroom	Frequency %	51 66.2	22 28.6	2 2.6	1 1.3	5 6.5	4.40
		All	Frequency %	97 58.8	38 23	17 10.3	6 3.6	7 4.2	4.28
3	It is fun to use it at home.	Simulation in computer lab	Frequency %	45 53.6	25 29.8	5 6.0	6 7.1	3 3.6	4.23
		Simulation in classroom	Frequency %	56 72.7	13 16.9	4 5.2	3 3.9	5 6.5	4.38
		All	Frequency %	101 61.2	38 23	9 5.5	9 5.5	8 4.8	4.3
4	I enjoy working with it	Simulation in computer lab	Frequency %	55 65.5	15 17.9	5 6.0	3 3.6	6 7.1	4.31
		Simulation in	Frequency	58	20	0	1	2	4.62

		classroom	%	75.3	26.0	0.0	1.3	2.6	
		All	Frequency	113	35	5	4	8	4.46
			%	68.5	21.2	3	2.4	4.8	
5	I am favour using it more than a textbook	Simulation in computer lab	Frequency	41	8	8	11	16	3.56
			%	48.8	9.5	9.5	13.1	19.0	
		Simulation in classroom	Frequency	45	19	7	3	7	4.14
			%	58.4	24.7	9.1	3.9	9.1	
		All	Frequency	86	27	15	14	23	3.84
			%	52.1	16.4	9.1	8.5	13.9	
6	I would recommend it to a friend	Simulation in computer lab	Frequency	45	21	9	2	7	4.13
			%	53.6	25.0	10.7	2.4	8.3	
		Simulation in classroom	Frequency	56	15	2	3	5	4.41
			%	72.7	19.5	2.6	3.9	6.5	
		All	Frequency	101	36	11	5	12	4.27
			%	61.2	21.8	6.7	3	7.3	

The first scale tests - or the set of question - the students' opinions about the simulation software. Table 40 shows that all items in general are rated very positively (the mean ranges from 4 to 5). The two lowest rated items in mean scores are item 5, which asked if "the student favoured using the program more than a textbook," with a mean score of 3.84 (3.56 for simulation in computer lab, and 4.24 for simulation in classroom) and item 6, which asked if "the student would recommend the simulation program to a friend," where the mean score was 4.27 (4.13 for simulation in computer lab, and 4.41 for simulation in classroom). The two highest rated items are item 1, which asked if "the simulation program is wonderful to use," where the mean score was 4.68 (4.62 for simulation in computer lab, and 4.75 for simulation in classroom), and item 4, which asked students if "they enjoy working with it," where the mean score was 4.46 (4.31 for simulation in computer lab, and 4.62 for simulation in classroom).

Obviously, the students' opinions toward the program were very positive and they were satisfied with it.

**Table 41**

*The Usability Attitude for All Students' In Experimental Group Who Used Simulation for 12 Items Asking About "EXPERIENCES WITH USING THE PROGRAM"*

No	Item	Experimental Groups	Number / percentage	Strongly agree	Agree	Neither agree nor disagree	Disagree	Strongly disagree	mean
1	It is hard to use	Simulation in computer lab	Frequency %	14 16.7	2 2.4	9 10.7	18 21.4	41 48.8	3.83
		Simulation in classroom	Frequency %	13 16.9	8 10.4	3 3.9	9 11.7	48 62.3	3.88
		All	Frequency %	27 16.4	10 6.1	12 7.3	27 16.4	89 53.9	3.85
2	Icons on the computer screen are easy to understand	Simulation in computer lab	Frequency %	49 58.3	13 15.5	11 13.1	5 6.0	6 7.1	4.12
		Simulation in classroom	Frequency %	57 74.0	13 16.9	5 6.5	0 0.0	6 7.8	4.42
		All	Frequency %	106 64.2	26 15.8	16 9.7	5 3	12 7.3	4.27
3	Information on the screen is clear	Simulation in computer lab	Frequency %	53 63.1	14 16.7	7 8.3	3 3.6	7 8.3	4.23
		Simulation in classroom	Frequency %	60 77.9	14 18.2	2 2.6	2 2.6	3 3.9	4.56
		All	Frequency %	113 68.5	28 17	9 5.5	5 3	10 6.1	4.39
4	Presentation of choices is easy to understand	Simulation in computer lab	Frequency %	50 59.5	12 14.3	8 9.5	4 4.8	10 11.9	4.05
		Simulation in classroom	Frequency %	62 80.5	14 18.2	1 1.3	0 0.0	4 5.2	4.60
		All	Frequency %	112 67.9	26 15.8	9 5.5	4 2.4	14 8.5	4.32
5	Informative on the computer screen let me work without problem.	Simulation in computer lab	Frequency %	50 59.5	14 16.7	8 9.5	2 2.4	10 11.9	4.10
		Simulation in classroom	Frequency %	64 83.1	9 11.7	4 5.2	2 2.6	2 2.6	4.62
		All	Frequency %	114 68.5	23 17	12 5.5	4 3	12 6.1	4.35
6	Terminology is related to the task which I am doing. (Pack, start, etc)	Simulation in computer lab	Frequency %	43 51.2	15 17.9	18 21.4	3 3.6	5 6.0	4.05
		Simulation in classroom	Frequency %	47 61.0	8 10.4	6 7.8	13 16.9	6 7.8	3.91
		All	Frequency %	90 54.9	23 14	24 14.6	16 9.8	11 6.7	4.01
7	It is easy to browse and	Simulation in computer lab	Frequency %	53 63.1	8 9.5	12 14.3	6 7.1	5 6.0	4.17



	run this program through the press buttons	Simulation in classroom	Frequency %	68 88.3	6 7.8	4 5.2	1 1.3	2 2.6	4.69	
		All	Frequency %	121 73.3	14 8.5	16 9.7	7 4.2	7 4.2	4.42	
8	It is easy to use the program without any help	Simulation in computer lab	Frequency %	38 45.2	19 22.6	12 14.3	5 6.0	10 11.9	3.83	
		Simulation in classroom	Frequency %	49 63.6	15 19.5	9 11.7	4 5.2	4 5.2	4.25	
		All	Frequency	87	34	21	9	14		
			%	52.7	20.6	12.7	5.5	8.5		4.04
9	It was difficult for me to understand the messages shown on the screen	Simulation in computer lab	Frequency %	24 28.6	4 4.8	14 16.7	20 23.8	22 26.2	3.14	
		Simulation in classroom	Frequency %	16 20.8	9 11.7	13 16.9	5 6.5	38 49.4	3.37	
		All	Frequency	40	13	27	25	60		
			%	24.2	7.9	16.4	15.2	36.4		3.32
10	I saved time by quick browsing	Simulation in computer lab	Frequency %	47 56.0	14 16.7	8 9.5	6 7.1	9 10.7	4.00	
		Simulation in classroom	Frequency %	64 83.1	12 15.6	2 2.6	1 1.3	2 2.6	4.67	
		All	Frequency	111	26	10	7	11		
			%	67.3	15.8	6.1	4.2	6.7		4.33
11	The program works the way I prefer	Simulation in computer lab	Frequency %	43 51.2	20 23.8	10 11.9	2 2.4	9 10.7	4.02	
		Simulation in classroom	Frequency %	57 74.0	10 13.0	8 10.4	2 2.6	4 5.2	4.41	
		All	Frequency	100	30	18	4	13		
			%	60.6	18.2	10.9	2.4	7.9		4.21
12	I do many clicks to reach to task	Simulation in computer lab	Frequency %	23 27.4	10 11.9	16 19.0	9 10.7	26 31.0	3.06	
		Simulation in classroom	Frequency %	25 32.5	4 5.2	4 5.2	8 10.4	40 51.9	3.30	
		All	Frequency	48	14	20	17	66		
			%	29.1	8.5	12.1	10.3	40		3.24

Table 41 presents the students' experiences using the program. In general, most of the results for the 12 items show that the students had good experiences using the simulation program. As you can see, the three items which have the highest mean scores are item 7, which asked if the students found it "easy to browse and run this program through the press buttons," where the mean score was 4.42; item 3, which asked if the "Information on the screen is clear," where the mean score was 4.39; and item 5, which asked if the "informative (assistance phrases) on the computer screen let me work without problem," where the mean score was 4.34.

In contrast, the two items which have the lowest mean scores were item 12, which asked if students during simulation used "many clicks to reach to task," where the mean score was 3.24, and item 9, which asked if "it was difficult for me to understand the messages shown on the screen," which had a mean score of 3.32.

Overall, in the 12 items that measure the "experiences with using the program," the outcomes seem very positive. There were two items with low scores, items 12 and 9, but these were negatively phrased, which means that when a student selected "strongly disagree," it was a positive answer, hence many students may be confused when answering a question such as this.

**Table 42**

*The Usability Attitude for All Students' In Experimental Group Who Used Simulation for 14 Items Asking About "LEARNING SCIENCE FROM THE PROGRAM"*

N	Item	Experimental Groups	Number / percentage	Strongly agree	Agree	Neither agree nor disagree	Disagree	Strongly disagree	mean
1	It is good using the program for learning science	Simulation in computer lab	Frequency %	60 71.4	12 14.3	7 8.3	0 0.0	5 6.0	4.45
		Simulation in classroom	Frequency %	58 75.3	16 20.8	0 0.0	2 2.6	5 6.5	4.48
		All	Frequency %	118 71.5	28 17	7 4.2	2 1.2	10 6.1	4.47
2	It is better than learning science from a text book	Simulation in computer lab	Frequency %	35 41.7	10 11.9	14 16.7	7 8.3	18 21.4	3.44
		Simulation in classroom	Frequency %	32 41.6	34 44.2	4 5.2	5 6.5	6 7.8	4.00
		All	Frequency %	67 40.6	44 26.7	18 10.9	12 7.3	24 14.5	3.72
3	This program made me like learning science	Simulation in computer lab	Frequency %	46 54.8	15 17.9	9 10.7	4 4.8	10 11.9	3.99
		Simulation in classroom	Frequency %	65 84.4	10 13.0	2 2.6	0 0.0	4 5.2	4.63
		All	Frequency %	111 67.3	25 15.2	11 6.7	4 2.4	14 8.5	4.3
4	I would recommend it to a friend	Simulation in computer lab	Frequency %	52 61.9	15 17.9	6 7.1	5 6.0	6 7.1	4.21
		Simulation in classroom	Frequency %	60 77.9	11 14.3	1 1.3	1 1.3	8 10.4	4.41
		All	Frequency %	112 67.9	26 15.8	7 4.2	6 3.6	14 8.5	4.31
5	All students	Simulation in	Frequency	40	22	12	3	7	4.01

	should learn science this way	computer lab	%	47.6	26.2	14.3	3.6	8.3	
		Simulation in classroom	Frequency	64	7	2	3	5	4.51
		All	%	83.1	9.1	2.6	3.9	6.5	
			Frequency	104	29	14	6	12	4.25
			%	65.4	17.3	8.3	2.6	6.4	
<b>6</b>	The program is not a good support in learning science	Simulation in computer lab	Frequency	15	2	8	10	49	3.90
			%	17.9	2.4	9.5	11.9	58.3	
		Simulation in classroom	Frequency	18	2	3	19	39	3.73
			%	23.4	2.6	3.9	24.7	50.6	
		All	Frequency	33	4	11	29	88	3.82
			%	19.9	1.3	5.8	17.3	55.8	
<b>7</b>	I rather prefer a traditional method without using a computer	Simulation in computer lab	Frequency	24	8	15	7	30	3.13
			%	28.6	9.5	17.9	8.3	35.7	
		Simulation in classroom	Frequency	18	4	18	7	34	3.43
			%	23.4	5.2	23.4	9.1	44.2	
		All	Frequency	42	12	33	14	64	3.28
			%	26.3	6.4	19.9	7.7	39.7	
<b>8</b>	The program made science interesting	Simulation in computer lab	Frequency	52	12	9	2	9	4.14
			%	61.9	14.3	10.7	2.4	10.7	
		Simulation in classroom	Frequency	66	7	2	1	5	4.58
			%	85.7	9.1	2.6	1.3	6.5	
		All	Frequency	118	19	11	3	14	4.36
			%	71.5	11.5	6.7	1.8	8.5	
<b>9</b>	The program was easy to use at home	Simulation in computer lab	Frequency	43	14	12	4	11	3.88
			%	51.2	16.7	14.3	4.8	13.1	
		Simulation in classroom	Frequency	64	8	3	0	6	4.53
			%	83.1	10.4	3.9	0.0	7.8	
		All	Frequency	107	22	15	4	17	4.2
			%	64.8	13.3	9.1	2.4	10.3	
<b>10</b>	I did not learn anything new from the program	Simulation in computer lab	Frequency	24	5	10	8	37	3.35
			%	28.6	6.0	11.9	9.5	44.0	
		Simulation in classroom	Frequency	17	4	8	4	48	3.77
			%	22.1	5.2	10.4	5.2	62.3	
		All	Frequency	41	9	18	12	85	3.55
			%	24.8	5.5	10.9	7.3	51.5	
<b>11</b>	The program gave me better understanding of something I already knew	Simulation in computer lab	Frequency	51	16	9	2	6	4.24
			%	60.7	19.0	10.7	2.4	7.1	
		Simulation in classroom	Frequency	64	9	3	0	5	4.57
			%	83.1	11.7	3.9	0.0	6.5	
		All	Frequency	115	25	12	2	11	4.4
			%	69.7	15.2	7.3	1.2	6.7	
<b>12</b>	The program helped me to understand new concepts introduced in	Simulation in computer lab	Frequency	49	16	12	1	6	4.20
			%	58.3	19.0	14.3	1.2	7.1	
		Simulation in classroom	Frequency	67	10	1	0	3	4.70
			%	87.0	13.0	1.3	0.0	3.9	
		All	Frequency	116	26	13	1	9	4.45

	science		%	70.3	15.8	7.9	0.6	5.5	
<b>13</b>	The program did not allow me to observe things in science. For example, plants grow or moon phases.	Simulation in computer lab	Frequency	24	4	17	12	27	3.17
			%	28.6	4.8	20.2	14.3	32.1	
		Simulation in classroom	Frequency	16	1	13	7	44	3.77
			%	20.8	1.3	16.9	9.1	57.1	
		All	Frequency	40	5	30	19	71	
		%	24.2	3	18.2	11.5	43	3.46	
<b>14</b>	The program will help me get a better grade in science	Simulation in computer lab	Frequency	58	10	6	4	6	4.31
			%	69.0	11.9	7.1	4.8	7.1	
		Simulation in classroom	Frequency	63	13	1	0	4	4.62
			%	81.8	16.9	1.3	0.0	5.2	
	All	Frequency	121	23	7	4	10	4.46	
		%	73.3	13.9	4.2	2.4	6.1		

Table (42) shows students' responses to the items that measure the usefulness of the simulation program in science learning. This consists of 14 items; 5 out of the 14 items got mean scores of less than 4. For example, item No. 7, which measures the students' preference to use traditional education without using a computer, got a mean score of 3.28. For students who used the simulation in the computer lab, the mean score was 3.13 and for students who used the simulation in classroom, it was 3.43. Item 13, which pointed out that the program does not allow observation of scientific phenomena such as plant growth and moon phases, got a 3.46 mean score; the students who were in the first experimental group got 3.17 and the students who were in the second experimental group got 3.77. Item 10, which asks students if they did not learn anything through the use of the program, got a 3.55 mean score.

By contrast, 9 out of the 14 items got a mean score above 4. For example, the highest ranked was item 1, which asks students whether the simulation program was good for teaching science; this item got a mean score of 4.47. Students who used the simulation in the computer lab got a mean score of 4.45 and students who used the simulation in classroom got 4.48. Next was item 14, which asks if the program helps students get a better mark in science. This item got a mean score of 4.46; the students who were in the first experimental group got 4.31 and the students who were in the second experimental group got 4.62. Item 12, which measures the usefulness of the simulation program in helping students to understand new concepts, got a mean score of 4.45. Students who used the simulation in the computer lab got a mean score of 4.20 and students who used the simulation in the classroom got a 4.70 mean score.

In conclusion, the questionnaire shows that majority of the students had positive responses to the usefulness of the simulation program in science learning. Also note that the students' responses show that the simulation program made them love learning science and also that they prefer to use the simulation for learning science, as shown in items 3 and 5.

### **6.9.2 Students interviews to discuss their opinions or impressions about using simulation software in science learning**

After finished the distribution and receipt of usability questionnaire, the students' interviews were conducted after the completion of the intervention with two students from each experimental group (16 students in all), each student interview took not more than 15 minutes and the interviews were conducted in Arabic language and then the responses were later translated into the English through professional translation company - subsidiary to Kuwait University. Three topics were focused during the interviews that are; students' tendencies toward technological devices, students' opinions on using simulation program in learning science and students' preferences between using a simulation program or traditional lab science for conducting scientific experiments. Under each topic there were some prepared questions and during the interview appear new questions by listening to the interviewers' responses in order to get more information or examples from interviewers.

#### **Topic 1: Students' tendencies toward technological devices**

The aim of this topic was to find the students' trends and their interest in using technological devices in their own lives. The students were asked the following question: "Now in the market there are many kind of technology such as computers, iPod, iPad, and smart phones. Do you think it's interesting to use them?"

The students' answers let you feel they know all kinds of the technology, where everyone has a computer at home, and like using it especially when they play games and sometimes when they print out homework (which is rare). Fahd is a student, who revealed: "I know very well how to use the computer, better than my father does in terms of printing, saving files and others". The majority of students who were interviewed had iPod devices at their disposal. Saad was a student who had gotten a low mark in the exam, but said: "I like using computers very much and I enjoy playing games on computer".

Lateefah said "I like to use the computer laptop to solve homework, in addition to games".

Everyone, without exception, liked and enjoyed using technology especially computers, some of them say "I like to use internet but my dad prevents me to using the internet on my computer any time" which meant there was a willingness and tendency to use the technology.

**Topic 2:** Students opinions on using simulation program in learning science

The aim of this topic was to find the students opinion - for both students who have got high and low marks in the test - through using simulation program to explain the lesson objectives, where been asked the students the following question: You've dealt with the ICSS program, what do you think of the program in terms of explaining the science topic objectives?

Firstly the interview was conducted with students who have got high marks in the test. They confirmed that the simulation program is excellent in displaying the topics and natural phenomena, as it helps them to focus on the main objective of the lesson and observe the finer things that are difficult to notice through traditional experimentation, it also assists them in looking for the scientific fact. For instance, when the program displays a topic about the digestive system it evoked many questions that would not have arisen through the traditional method of using pictures in textbook or static models.

For example Khalid, one of the students, said: "I often ask my teacher but through using the program a lot of concepts became clearer for me, such as the concepts of the digestive process, saliva, enzyme and oesophagus. They became clearer as a result of displaying these concepts in a vital and dynamic way, and now I can know the concept of any device or an organ in the human body by clicking on the definitions button or moving the mouse to the organ. So I don't need to ask teacher to know or understand these concepts".

Researcher: If the teacher asked you: do you prefer using the simulation program or a textbook for learning science, what would your answer be?

"Absolutely, I select simulation, but with new computers. The computers in the school are very old and always stopped or there was no voice sometimes, with the program not working", he said.

Hamad confirmed Khalid's words and says "the program has helped me a lot to answer the worksheet without referring to the science teacher or help from one of my colleagues, but because of the age of the computer model there were many computers that didn't work, so some of my colleagues were sitting watching me".

Hoda, another student, said “when I used the program with my colleagues, we were facing difficulties in dealing with the program. But, after we used it several times it became easy to deal with it”.

Researcher: Are all your classmates familiar with the simulation program in the computer lab?

HODA revealed: “not all of them, but for some of them the computer is not working. For some of them, the screen is not working and then the teacher allowed them to sit with other students”.

Same question were repeated but for the students who have got low mark in the test, but in a slightly different format, where been asked the students the following question: You’ve dealt with the program on the computer, what do you think of the program in terms of explaining the science lessons’ objectives? If your answer is positive, why is your grade low?

Jassem, one of the students who got a low grade, says “the program is excellent and demonstrates the scientific concepts of lesson like connecting electric circuit in series or parallel and the difference between them and my marks are low because I knew that the test was not included in the scientific achievement [not formal] and it was limited to measure our experience through using the simulation program” Saad is compatible with Jassim's words.

Researcher: How do you know that the test is just to measure the effect of the simulation program in science teaching?

Jassem said, “Me and my colleagues told our science teacher that we didn’t study well for the test, because she didn’t tell us about the exam, and then she told us this test is just for testing the simulation program not formal”.

Ali and Metab, students who did not originally like science, now enjoy dealing with the simulation program in learning the subject and they are entertained while using this program, in addition to recommending using it.

Researcher: you mention that you enjoyed using ICSS. Can you tell me why your mark is low?

They said we were not informed with the test and it was unexpected, actually this is the general opinion of those who have low marks in the test.

All students involved in the interview believe that the program is excellent, but strangely, the majority of them knew that the result of this test would not be included in the final marks of the certificate, when the teachers were asked “why you informed them?”, the reason for this action is that teachers were

afraid of the parents' reactions if they are not informed about results to the tests that their son / daughter took, especially when the student tells his parents he was tested today.

**Topic 3:** Students' preferences between using a simulation program or traditional lab science for conducting scientific experiments

The aim of this topic was to find the students' preferences between using a simulation program for conduct the scientific experiment and using the traditional real science lab. The students were asked the following question: "Do you prefer using the computer simulation or the traditional science laboratory in conducting the experiments?"

Some students prefer the combination of both, but they have a tendency to use the computer laboratory because some experiments need materials and equipment that are not provided at the school in the traditional laboratory. Therefore, the science teacher in the traditional science laboratory conducted one experiment in front of all students as a result of the lack of materials or lack of time. Ahmed says that "I cannot see the experiments that are conducted by the science teacher, because of the large number of students around the table in the laboratory". Khaled revealed that "we conduct some experiments in the form of groups and there are six or more students in the group, only one or two conduct the experiment and the others are just looking and there is no chance to ask the science teacher".

Hoda prefers computers because "I conduct the experiment without any fear of making any mistakes and thus can repeat the experiment another time without causing any damage to the materials". She added "in the real science laboratory some of the materials can only be seen by the naked eyes without touching them, even as not to cause any damage or a problem and then the science teacher would be responsible for this problem". Lateefah agrees with her.

Jassem said: "I do not prefer the real science laboratory, as I feel bored. I enjoyed dealing with simulation software to watch experiments" Ali said: "we do not go to the science lab a lot and do not do experiments. We only see what the teacher's do in the experiment and usually it is not clear and boring, but the program is good and I prefer to use it".

The aim of this question was to understand the opinion the students had about the program and if it changed during the experiment. Some students prefer using both computer and real science laboratories, but they tend to use the computer more as some experiments need materials and equipment that are unavailable at the school. The teacher performs one scientific experiment before the



students, due to absence of materials or because of a shortness of time and therefore some students may not see the experiments clearly.

## **6.10 Research question 8: Teachers' experiences with using the simulation in the teaching.**

### **Analyses of interview**

The participants included all the eight science teachers participating in the study. The teachers were interviewed twice. The first interview was conducted before the experiment started—i.e., before simulation intervention – and the aim was to gather personal information from the teachers, in addition to their attitude toward ICT in education. The second interview was conducted after the experiment finished—i.e., after simulation intervention.

Seven topics were focused during the teachers interviews that are; science teachers' perspectives' of using ICT in education, the students' feelings while using ICSS through teachers' observation, simulation program influence on students' understanding of the science topics, usability of simulation for teachers in science teaching, external factors that affected on the efficiency of the simulation program usability and finally teachers' impressions of differences between using the simulation program or the traditional method in teaching science. Under each topic there were prepared questions and during the interview appear new questions by listening to the teachers' responses in order to get more information, explain or examples.

All the science teachers preferred that the interview not be recorded; the reason for this is the culture and nature of Arab and Islamic society. Consequently, the researcher had to take hand-written notes to write their responses to the interview questions. Each teacher was interviewed for about 30 minutes. The interviews were conducted in Arabic and responses were later translated into the English through professional translation company - subsidiary to Kuwait University.

### **6.10.1 Science teachers' interviews before experiment**

Data about the eight science teachers are presented in Table 43. We see that all of them have International computer driving license (ICDL) and they have same qualification - bachelor in science teaching. As can show that there are differ between science teachers' experiences, the cause return to comply with the conditions that require there a one science teacher teach two science classrooms in the

same school (one's be experimental group and other control group) and availability of suitable computer laboratory

**Table 43**

*Science Teachers Personal Information*

N	Intervention	Fictive Name	Nationality	Years of teaching experience	Teacher qualification	Experience in computer applications
1	Use simulation in Computer lab	Amirah	KW	8	Bachelor	All of them have International computer driving license (ICDL)
2		Elham	Egy	13	Bachelor	
3		Marwa	Egy	8	Bachelor	
4		Asraa	KW	10	Bachelor	
5	Use simulation in classroom	Madeha	KW	10	Bachelor	
6		Suaa'd	KW	6	Bachelor	
7		Aydah	Egy	9	Bachelor	
8		Nohad	Egy	14	Bachelor	

Note. KW= State of Kuwait, Egy= Arab Republic of Egypt (anonymous names for teachers)

**Topic 1;** Science teachers’ perspective of using ICT in education

The first topic is the science teachers’ views about using ICT in education in general and specifically in science education. The teachers were asked the following question: “In your opinion, does the available technology make it possible to promote and improve the teaching process and learning in general, as well as, promote and improve the teaching and learning of science in elementary school?” The question had a ‘hidden’ purpose in gaining information about the teachers’ attitudes toward the use of ICT in education.

All teachers supported the significance of ICT in education, and in science, and gave answers with many common elements. **Amira** said “that the way computer applications today have been developed, means every teacher can use their own program without the need of a technician or specialist. So the applications of computer can be used to improve learning process for explaining in general and for the science subject in particular, as this subject includes many images and experiments that can be displayed for students, especially the experiments that are difficult to be applied and explained in the

classroom or laboratory, which can take a long time”. Asked to give examples of experiments that are difficult to apply, she responded “I mean sometimes it is dangerous for the students in primary school, such as the natural changes of the matter, we should use the fire. Also, when we teach about the moon phases or motion, I have to use only static picture to explanation the lesson. Through the animation or simulation program of the computer, the students can observe many things that they cannot observe in a static picture”.

**Souad**, another teacher, confirmed her colleague’s words with “the great development in technology makes the combination of technology and education much easier, especially in sciences. And since the computer has been characterised by its small size and light weight, it is easily carried whether in the class or laboratory”. She added that “another advantage of using the computer in education is the large applications and programs that run audio, video, remote control, and its accessories like Data Show devices”.

**Nohad** believed that the whiteboard and student textbook cannot stand alone without using technology in education; the reason for this, she said, is “because the traditional teaching methods are unable to help the student understand the science topics, especially with the abstract concepts”. Asked her to give examples or explain this what mean by say "traditional methods are unable to help the student understand the science topics or abstract concept", she responded “Yes, for example of the pollination process" by saying that it “takes place within the flower and it is not possible for the student to see how the pollination process occurs”. Thus she added “we have to use static picture to explain, and we offer an opportunity to use the imagination to the students; so the understanding of the pollination process depends on what the student absorbed through the oral explanation of the lesson. So technology contributed effectively in the learning process”.

**Madiha** found that introducing the technology as a computer software on education process as an educational tool is not difficult or strange to students, she said that “nowadays students in the primary stage are using and talking the language of computers as a result of the engagement of technology in their homes, before engagement in schools, so it wouldn’t be difficult for the student to deal with computers as an educational tool in school or at home”.

### 6.10.2 Science teachers' interviews after experiment

The aim of this interview was to consider science teachers' observations during and after experimental implementation through using ICSS. They were first asked about students' feelings while using ICSS through teachers' observation (this is represents the **topic 2**)

All teachers reported a positive atmosphere among the students.

**Amira**, for example, said "I faced in using the simulation program in the computer lab. However, after explaining the subject to students with this program, they were very amused while using this program in the computer lab", and **Esraa** confirmed Amira's words, saying "that the students were very happy with the new method and most of them wondered if they would keep using this program in learning science". Asked them, as you used the blended learning method in the computer lab; If you had the choice to select between traditional teaching (i.e. mass instruction) and the blended learning method with a simulation program, which would you prefer and why?

**Esraa** revealed that "the use of blended learning is good but needs efforts and skill by the teacher and the student, and also because of the number of students needs an assistant teacher to help in answering the queries of students. So I prefer to use the traditional teaching method with the simulation as a supplement and supported educational tool". **Marwa** added that "the blended education devoted the second half of lesson time's to the student to deal with the simulation program individually (solely) in trying to make the student constructs new information by himself, but what is happening is that half of the students were asking a lot about how to run the program more than those asking about lesson objectives, therefore , the time allotted for students to learn through the simulation program was majorly consumed with questions relating to the program." She asserted "I think that because of weak computer skills, I prefer to use the program with the traditional teaching method in the classroom where students can be controlled better than the use of the computer lab". **Amira** supports the words of **Marwa**.

The teachers who used the simulation program in the classroom (Exg2) were consistent in their answers with the predecessors with regards to simulation (i.e. the science teachers in Exg1) as they found the pleasure and entertainment in students' eyes. **Madiha** says "the program has attracted the students, so you cannot find any disturbance in the classroom as they concentrate on what the program has been showing".

**Topic 3:** Simulation influence on students' understanding of the science topics

The aim of the third topic is to look the effect of simulation program on students' understanding of the science topics that are taught in the current study, through the teachers observation and their reports about the students during lesson. The teachers were asked the following question: "Through your observations during the experiment (i.e., using simulation in computer lab or classroom), to which level has this educational method affected students' understanding of the science subject compared to the traditional teaching group?"

The science teacher answers in both groups--i.e., those who use simulation in the computer lab and those who use it in the classroom--indicate that the simulation program makes new concepts clear when they are displayed on screen, and the students become more motivated to engage in the lesson, so they asked many questions; this means that they were comparing their pre-knowledge about the topic with what they know now. Such as the what **Elham** teacher say the she looks satisfied about the influence of using this simulation program, she says "this program could display the concepts that can't be clear or seen by the naked eyes (such as electric current, (+&-) molecules, digestive juice in the human body, blood flow from the heart to the body through artery, and blood back flow in veins). Through using this program, students can learn the concept of blood flow in the body clearly, unlike the traditional methods of explaining these subjects orally where the student used to conceive or imagine the concept as he understood, but this program doesn't let students imagine what the concept may be". She added, "The simulation program is displaying experiments without causing any damage to the student or environment, or asking students to go outside [unsafely place]."

**Amira** teacher confirmed **Elham's** teacher thoughts, and said "in traditional teaching, the teacher asks students and tries to motivate them to engage in the lesson, but the simulation program already raises many questions in students' minds about the lesson topic and its objectives. So the students compare between what they have seen in the simulation program with their previous experience [pre-concepts or pre-knowledge]", and she goes on to say "through using this program the students started to ask me before I ask them such as; how and why and what if? And these questions from students make the lesson much more enjoyable and they can learn the concepts and the aim of the lesson clearly and quickly".

**Esraa** teacher added good point, and said "through the worksheets distributed to students during the class, the student referred to the program to answer the worksheet, and this method assists the students who are embarrassed about asking questions in front of their colleagues, so they use the program to get the answer from it".

The teachers who have used the program in the classroom have the same words as their colleagues who use the simulation in the computer lab. **AyDAH** teacher said that “after using this program, I saved some time to review the lesson and the students became more concentrated on the classroom as a result of the amused way of displaying the natural phenomena and scientific topics by using simulation program”. **Madiha** revealed: “after the completion of the scientific concepts through using this program, I find that most if not all students have participated effectively in the classroom, whether in answering the oral questions or worksheet; unlike the traditional teaching way”.

#### **Topic 4:** Usability of simulation for teachers in science teaching

The usability or the ease of use of the simulation program for teachers and students in teaching science from the perspective of teachers during the lessons was aimed of this topic. The teachers were asked the following question: “Have you found the program complicated for you as a teacher and for your students as well? If yes, what is the difficulty?”

The majority of teachers confirmed that they had no difficulty in dealing with the simulation program, especially because of the accompanying guide-booklet (see Appendix 23). But teachers such as **Nohad** and **Elham** said: “the simulation program is easy to work with it, but the problem is if something happens in the computer and the program does not operate we cannot fix it or know what is wrong, so we ask help from others and this costs lesson time”. Asked them is the deal with computer application difficult or the simulation software itself, **Nohad** said” I am work and use in word-process and excel software in good way, but if the computer is not working or need restart or stop or hung suddenly I need help I cannot fix it” **Elham** answer such as **Nohad** response.

The teachers who used simulation in the computer lab said “there’s some difficulty for students, especially in the first lesson as the simulation program is new for them but afterwards some students become familiar with using it but others need help”.

This question shows that there is a failure or weakness in dealing with computer skills, whether by involving teachers or students. All teachers who used the computer lab mentioned, through the interview, that the simulation program in general is easy to use, but it may be difficult for students. **Amira** said, "I think the poor quality of the computer in lab impacted negatively on used simulation program in an appropriately way in a student’s especially" **Esraa** said, "majority of the students in the computer lab need help to use the program and this means that students lack the necessary skills to

work with computers, and that they have a weakness in reading the instructions or terminologies on the computer screen"

Teachers who use the simulation program in classroom do not feel that it is fit for students because teachers only use it.

It was indicated that there is a difficulty in dealing with the simulation program by some teachers and students especially of who used simulation in computer lab and these impacted on their result of measurement tools of the current study.

**Topic 5:** External factors that affected on the efficiency of the simulation program usability

The aim here is to find if there any external factors that may have affected the efficiency of the simulation program usability during its use in the current study. The teachers were asked the following question: "Are there external factors (except the ICSS program) that may have affected the efficiency of the program and its level of benefit? What are these factors and what are your recommendations?"

The teachers who used the simulation in the computer lab had many answers that were similar about the external factors that they believed had impacted the simulation program and thus to the result. These factors were; first factor was the place (i.e. computer lab place): all teachers who use computer lab agreed that, because the computer laboratory is linked to (or follow) the Computer Department, they found it sometimes difficult to get access to the lab for science teaching, because all the students in the school use it. For example **Esraa** said, "I cannot enter or freely access the computer lab, and because of this I cannot prepare for a lesson, such as check the computer operation, program, etc." And this caused a problem in applying the third lesson (electric circuitry) for most. Some science teachers said about the third lesson: "When we wanted to start teaching the third topic, we were surprised that maintenance (formatting computer) was done to all computers in the laboratory, thus the simulation program was not working properly. Therefore, we tried to use our laptop computer to teach the third topic and we used a few of the computers in the laboratory that can present the ICSS properly." So, this topic was not applied properly, and this affected the outcome of the study in this phase of experiment. Second factor was the design of computer lab; technically, the labs were not appropriate for use as computer labs, due to large windows that impact the visibility of the computer screen to students through rays of the sun. **Marwa** said, "with the presence of curtains, but still the light effects in a clarity of simulation or animation which show in computer screen because of the large of windows"

The third factor was that the computer Windows and software were old: due to the fact that these computers are used specifically for the curriculum of computer studies and its primary applications, they use Windows 2003, which cannot host the relevant programs that this ICSS program required. Electrical extensions (wiring) in the computer laboratory also been as a fourth factor; they are old and they obstruct the learning process or teachers' movement. The fifth factor was a computer devices' life which be the important factor; teachers mentioned that the computers are very old and slow to open, and in most cases, they crashed. Lack of data show came as sixth factor: all teachers agreed that there are no upper monitors or periodic maintenance of devices by the ministry. seventh factors was the way of distributing the computer tables and finally, lack of technical help available for any emergency in the computer laboratory was eighth factor; they mean any technical problem with the computer, printer, or display, they do not find any one (technical man) to fix it.

They all proposed there should be a computer laboratory for the science department, equipped with the most modern computers to use the applications of modern programs (such simulation). They also requested an upper monitor, big screen and remote control in order to help the teacher to move easily while teaching the lesson or to equip the science lab with five to 10 computers. Also, they proposed that the program include the natural phenomena and all topics of the subject that exist in the student science textbook, because the significant role of this program in explaining and displaying the lesson objectives easily and effectively, which the student book can't explain and display these objectives alone.

The science teachers, who used simulation in the classroom such as **Aida** teacher, said "since I used my own laptop, I didn't face any problems in running this program, but the main problem is that there's no upper monitor in the classrooms, and this problem has been resolved by using the showroom of the school" (see the picture in Figure 35). **Madiha** says, "I used the data show which exist in the computer lab to overcome this problem", while Ms. **Mariam** revealed "due to the significance of this program and to overcome the problem of lack of data show as well, I using the alternative screen which is a 52 – inch screen TV and hung it on the wall of the classroom" (see the picture in Figure





Figure 35. Aida's use of showroom of school



Figure 36. The TV screen used in traditional science lab. As used by Mariam

And they all suggested installing a data show device in the science laboratory and in the case of high expense, it would be at least a data show device for all subjects.

The purpose of this question is to know whether there are external factors affecting the outcome of the aim of using the simulation program. The teachers who have used the simulation program in the computer lab indicated the problems they faced and believe that it affected the results of the current study.

**Topic 6:** Teachers' impressions of differences between using the simulation program or the traditional method in teaching science

The aim of this topic was to look on teachers' impressions of differences between using the simulation program and going back to traditional method. Teachers were asked the following question: "In general, after your experience in the current study, if you were asked to choose between using the simulation program (or similar programs) or traditional teaching, what would you choose? And why?"

All science teachers preferred to use the program, but two who were involved in the first experimental group (using simulation in computer lab with the blended learning method) said "Yes, I prefer to use simulation but as a supplement to the traditional teaching method." They gave as the reason, "There is not enough time during the lesson to give students time to self-learn, and students always ask for help and you can imagine dealing with more than 25 students in the lab?"

**Amira and Esraa** said, "using the simulation program is a good thing, but the students are accustomed to listening and receiving information. Yes we need such a simulation program to make students more active, but using the simulation program as a complement to the traditional teaching method is better (until the students are able to learn how to search for knowledge by themselves). It will take time for students to gain and acquire skills of learning by themselves."

All science teachers without any hesitation said that the program played an important role in motivating students' tendencies to know how the natural phenomena occurred through the animations, especially if the student is able to control the phenomenon, and predict what will happen in the future through the display of these animations.

In addition to the usage of educational method such as the mass or cooperative learning, self-learning and others in the classroom, these programs can be used at home to help the students to conduct scientific experiments without any fear of carrying dangerous materials or equipment, especially for students at primary stage.

# CHAPTER SEVEN: DISCUSSION OF RESULTS

## 7.1 Introduction

The current study was designed to determine the effectiveness of using ICSS within two different learning environments of primary school education, and to compare the findings with matching control groups. The first experimental group (Exg1) used simulation in a computer lab with blended teaching. The second experimental group (Exg2) used simulation in the classroom in support of traditional education. The control group (Cg) used a traditional teaching method without computers. The effects of teaching intervention were investigated by looking at the students' academic achievement tests, conceptual change or understanding, and their attitudes towards science. In addition, the research investigated the opinions and experiences of the science teachers and students who took part in the experimental groups.

The intervention consisted of three science topics: Food Chain (FC), Circulation & Digestive System (C & DS) and Electric Circuit work (EC). This is the first study of its kind in Kuwait, and the use of a simulation program to teach science in primary education is new for both science teachers and students.

This chapter presents a summary of the results, followed by a discussion on what was learned from the current study, and how it may contribute towards the development of research and practice in science education, both in Kuwait and more widely. In particular, it assesses how computer simulations can make a positive contribution to science education.

## 7.2 Summary of the experimental groups outcomes

After analysing the data, the conclusion shows the research hypotheses were only partly accepted. Specifically, in terms of improving the students' academic achievement, or their attitude towards science teaching and learning, the data revealed there was no statistically significant difference between the first experimental group (Exg1), which used simulation in a computer lab with blended teaching, and the first control group (Cg1). The results showed a small improvement in the conceptual understanding of students who used the simulation program. However, the data showed there was a statistically significant difference in both academic achievement and attitudes towards science teaching and learning in the second experimental group compared to the control groups. This second group used simulation in the classroom to support traditional teaching techniques. Furthermore, the results revealed

there was an improved understanding of particular targeted concepts in the experimental group compared to the control group.

Through interviews with both teachers and students, it seems clear that the majority of students in both experimental groups enjoyed using the computer simulations. They became more engaged in the teaching process and motivated to learn science.

The current study is considered the first study of its kind in Kuwait, as it looks for an alternative to using a real science lab while engaging in practical work. There are obstacles in primary schools that prevent the implementation of practical work where students can conduct scientific experiments. Interactive computer simulation can be used to overcome these obstacles, thereby allowing some of the goals and objectives of practical work to be achieved. Furthermore, this study can provide evidence to decision makers and planners in the Ministry of Education of Kuwait that using new methods to teach science – such as interactive simulation software or educational technology programmes – is beneficial to learners.

After conducting the experiment with the measuring tools and gathering the data, an analysis of the results of the hypotheses showed the following -

In terms of the *first hypothesis* there was no statistically significant difference at the 0.05 level of the academic achievement between students who used simulation in the computer lab (Exg1), and those who followed traditional teaching methods (Cg). Although there was a noticeable improvement in favour of the experimental group using the simulation software in the second lesson, I expect there would have been a difference in the third lesson because students and teachers would have attained mastery over the teaching method by that time. However, teachers and students in each school using simulation in the computer lab faced a number of problems. For example, the computer lab was not the responsibility of the science department (i.e. the science teachers could not access it freely) and there was a defect in the program, as computer maintenance work occurred during the mid-school year holiday without the knowledge of the science teachers. This resulted in the rejection of the first hypothesis. Although there was no statistical difference in the results, however there was a very small improvement in effect size between first experimental and control groups at the posttest in the academic achievement in favour of students who used simulation in the computer lab (Exg1) in second topic (Circulation & digestive system topic), compared to those who followed traditional teaching methods (Cg). While there was no effect size meaningful according to of Cohen's standard in both first

and third science topics. But the effect size within the groups (pretest - posttest) was above 0.3 and this is normality according to Hattie (1999).

In contrast, in the *second hypothesis*, the findings proved that significant differences in the results support the claim that students who used the simulation program (Exg2) performed better in academic achievement tests than students who were exposed to traditional teaching methods (Cg). This is because of two factors. First, the teaching method did not change for the science teachers, and second, they were supported by the use of the simulation program as a new educational tool and had already mastered the use of a traditional educational environment. Therefore, there was better control over the classroom when the simulation software was used. In addition, there was a difference in the average effect size above 0.3 (0.38, 0.39 and .035 sequentially for the three topics) which is slightly less than the medium according to Cohen's standard scale between the two groups in favour of the second experimental group and this consistent with what have been found in Hattie's (1999) meta-analysis in effect-sizes in computer use in learning such as simulation.

The results also refuted the *third hypothesis*. The hypothesis claimed there would be significant differences between the two experimental groups (Exg1 and Exg2) in favour of the first experimental group (Exg1). The hypothesis suggested students in the first experimental group would perform better in academic tests, because the new teaching method would give students the opportunity to engage in self-learning and become more active through using the simulation program under the supervision and guidance of a science teacher. The reasons for the rejection of this hypothesis were the same as for the rejection of the first hypothesis.

Regarding the *fourth hypothesis*, there was no significant difference between students who used the simulation in computer lab and students who were exposed to traditional teaching methods. However, the findings did show that understanding and conceptual change was better in students who used simulation in the computer lab, compared to traditionally taught students. This was particularly noticeable in students studying topics on the circulatory and digestive system (C & DS) and concept of the "artery".

There was also evidence in the second experimental group of a difference between students who used simulation in the classroom, and those exposed to traditional teaching, in terms of their understanding and conceptual change. Students who used simulation in the classroom showed improved results compared to those who were exposed to traditional teaching. This was particularly noticeable in the

lesson on the electric circuit (EC) and the concept of the “electric current”. Therefore, this hypothesis was supported.

The *fifth hypothesis* was rejected. This proposed that students’ attitudes towards learning science would positively increase in favour of those using the simulation in the computer lab (Exg1), over those being traditionally taught (Cg). The results indicated there were no significant differences to support this hypothesis. On the contrary, there were significant differences in the second experimental group, in students’ attitudes toward science teaching and learning. Attitudes positively increased in favour of students using simulation in the classroom (Exg2) over those who studied science by traditional teaching methods (Cg).

As for the *sixth hypothesis*, analysis of the results indicated significant differences in the attitudes of students towards science teaching and learning. These were in favour of the students who used the simulation in the classroom (Exg2), over students who used the simulation in the computer lab in the first experimental group (Exg1) in part A, in relation to ‘learning science at school’. On the other hand, there was no significant difference between the two groups in part B, ‘studying science in the future’. Therefore, this hypothesis was accepted given the importance of Part A in the questionnaire.

The validity of the *seventh hypothesis* was verified from using the usability questionnaire results. The analysis showed that the response of students (in both experimental groups) regarding their opinions and satisfaction with the simulation program, and its benefits in learning science and illustrating scientific concepts, was very positive. To support the results of this questionnaire, interviews were conducted with all science teachers who took part in the study, and with some students in the experimental groups. The results of interviews with the teachers supported the students responded in usability questionnaire, where the teachers observed that, when the simulation program was used, students enjoyed learning about the scientific topics.

The teachers taking part in the simulation in the computer lab (Exg1) faced certain problems concerning the teaching method and technical matters. However, this did not prevent them from acknowledging that the simulation software motivated and encouraged the students to ask questions. This indicated that the simulation software increased student involvement and engagement in lessons (i.e. in the educational process) compared to traditional methods. The teachers added that the simulation program addressed certain negative behaviours, which appear when the traditional method is used, such as fear or embarrassment on the part of some students when asking questions during the lessons. Therefore, when students used the simulation program they could have their questions

answered without feeling self-conscious. Thus, the teachers supported the use of the simulation program; with the condition that suitable space and all tools (i.e. a separate computer lab for the science department) are provided. They preferred to use simulation to support traditional teaching in primary schools.

The students reported that they had enjoyed using the simulation program, as it explained and clarified many scientific concepts they had previously found confusing. On the other hand, they also reported some difficulties in dealing with the computer simulation.

Before discussing the findings of the hypotheses, the strengths and weaknesses of the current study should be reviewed. In terms of strengths, it is considered to be one of the few studies in Kuwait – if not the only one – that has used three different groups from the same educational environment for comparison (i.e. grade 5 in primary school), including two experimental groups (see figure 17 and 18) with two different educational or teaching methods against a control group. The aim of this approach was to obtain acceptable, reasonable results that could be used by decision makers and educational planners in the Ministry of Education of Kuwait, to determine the extent to which simulation software is suitable as an alternative to a real science lab in teaching science.

Although steps were taken to ensure objectivity and accurate results when designing the study, there were points of weakness. Some elements or factors may have affected the results when it came to verifying the validity of some of the study's hypotheses. For example, for simulation in the computer lab (Exg1), the computer lab used was not under the control of the science department. Moreover, the computers were old, with older operating systems, and no technician was available to repair or troubleshoot problems with the equipment or programs. All of these points affected the ability of the simulation program to operate in a suitable way for the first experimental group from a technical perspective.

Another element that affected the results, relates to the teaching method. A blended teaching method (i.e. a mixture between a traditional teacher-centred style and a constructivist student-centred one) was applied in the first experimental group. This was a new teaching method for both science teachers and students. Therefore, they could not fully engage in the new style because they were accustomed to traditional teaching, and it took time to master the new blended teaching approach. In the second experimental group (Exg2), where students used simulation in the classroom, the lack of computers and equipment to demonstrate the data in the classroom and science lab affected how the simulation software could be used in a suitable or appropriate way. Finally, the age of the target sample of students

in the current study (10 years old) may have affected the results, as it was possible the participants did not take the tasks seriously when it came to completing tests or filling in questionnaires.

The lack of previous studies, and their limitations, in both Kuwait and other Arab countries, that aimed to investigate both the effectiveness of computer simulation programs in the academic achievement of primary school students, and attitudes towards science teaching, may also have affected the results. This study's adopted approach has only been used in foreign studies (i.e. students from Europe [the UK, the Netherlands], the United States and East Asia [Malaysia, Singapore]). Evans (2002) stated that academic achievement differs between countries; therefore, it may not be correct to use foreign standards to look at the performance of Kuwaiti students.

Thus, many valuable conclusions can be drawn and lessons learned from the results mentioned above.

Important questions to ask are; first, what factors contribute towards making simulation an efficient tool for science teaching and learning and, second, to what extent are computer simulations a solution to the reform and development of science education in Kuwait. The discussion will start by looking at the first of these questions. During the study four factors have been established. These will be presented in turn.

### **7.3 Teacher computer skills and technical help**

A key factor affecting the use of computers is the technical skill and/or the assistance required when something goes wrong. The teachers who participated in this study were all experienced teachers, with eight to thirteen years of teaching experience. All had obtained a certificate in the Information Computer Driving License (ICDL) see tables 11 & 13 in chapter four.

The teachers, however, had little or no experience of using computers in teaching. Though a computer lab was available in the school, the science teachers (and other teachers) were not allowed to use it. The lab was only for teachers in the Computer Learning Section at the school.

Obviously, if teachers do not have practical experience of using a computer over a long period - i.e. using a computer in their field of study - they will lose their computer skills and not keep up-to-date with computer applications and software. This lack of current practical experience may have affected the result of the experimental group who used a simulation program in the lab, as they faced a simple technical problem they could not solve. An additional shortcoming was the lack of encouragement to set-up training courses for the in-service teachers, and to train them in the latest software and new teaching aids.



Due to a shortfall in the number of Kuwaitis majoring in science education, and a lack of science teachers, the MOE recruits science teachers from other countries where socioeconomic, educational and living standards are much lower than Kuwait. Few of these teachers are experienced in using computers, or own a computer. Consequently, they have limited skills in how to use simulation software or browse the Internet. If a technical problem occurs during a lesson or experiment they have few strategies on how to resolve the problem.

Before and during the study I met with the teachers and taught them how to use and run the simulation programs; they were positive about this. However, during lessons some teachers were unable to help students solve technical problems. This led to the teachers feeling embarrassed if students asked for help running a program. Some teachers stated they asked students to follow along with a classmate on another computer, rather than trying to solve the questions or problem. This lack of knowledge influenced the teaching method and also the outcome of the current study.

During the interview, some teachers expressed a need for the school to provide a computer laboratory technician. The science teachers attributed the lack of success of the simulation program used in the lab, in science education or in any other disciplines, to technicians not being available to help teachers when technical problems occurred. The existing procedure to call for technical help required the completion of an application form to make an appointment for a technician to attend and fix or repair any defect, and this procedure takes time. Installation of the programs in the computer laboratory (approximately 25 to 30 PCs in each computer lab at the school) took more than a week. Therefore, the science teachers did not wait until the technicians arrived to fix problems, and this may lead to delays in the study plan due to the link with the date of final tests. Thus, the teachers reverted to teaching with the ICSS program. Obviously, the unavailability of technicians to resolve computer problems during lessons will affect the use of education technology, such as computers, in the teaching process. Huppert et al. (2002), in their study, allocated one laboratory assistant and one technician for technical assistance to each treatment group, and this affected the results in a positive way. These results show that a technician is very important in both computer and traditional laboratories.

In fact, the majority of technical problems affecting the simulation program in the lab, as well as in the classroom, can be solved if the science teachers have good skills and experience. According to my experience, when I visited a school following a call from a teacher about a problem with a program or computer, I observed that the majority of problems were simple, and the problem was often related to the teacher's computer skills.

The teachers also stated that the long period between each topic in the current study (four weeks, or more than one month), meant both teachers and students forgot how to correctly use the software for the next topic. The reason for this gap between topics was the simulation software's inability to model all science topics, as some topics were difficult to simulate. Therefore, only the three most appropriate topics were selected in this study. This can be considered a limitation of the current study.

In conclusion, it is very important to focus on improving and developing the computer skills of teachers, as this might help increase the contribution simulation software can make in science education. A study conducted by Smeets (2005) found that a teacher's skills in the use of ICT affected the outcome of using ICT in class; teachers who were more confident about their ICT skills were more likely to use skills-based ICT applications in their classroom. Consequently, if teachers have good skills in using computer applications, such as interactive computer simulation software, these skills could contribute to the positive impact of its use. However, the problem is not only a lack of the teachers' computer skills; teachers should have other related skills, such as how to integrate computers as an educational tool to teach scientific topics properly and actively. Krysa (1998) suggests that in-service teachers should be trained to make use of technology and how to insert it into the curriculum, and further claims that the most important factor is to concentrate on teachers' understanding of how that technology is effective in pedagogy.

Moreover, teachers must possess other attributes, such as a positive attitude towards using technology in teaching; teacher attitude is one factor that affects computer usage. For example, if the teacher has a positive attitude towards using a computer, this will encourage him/her to develop his/her skills to use a computer in teaching (Kluever, Lam, Hoffman, Green, & Swearinges, 1994). Harrison and Rainer (1992) claim that teachers with negative attitudes do not move or work to develop themselves, nor enrol in courses to improve their computer skills; therefore, they have weak computer skills. They added that, to solve this problem, teachers' computer skills should be developed and their competence increased via training courses to change their negative attitudes to positive attitudes in using a computer. Thus, providing appropriate courses that develop teachers' computer skills, and how to integrate them into the curriculum to improve teachers' attitudes towards using computers, increases their level of technological familiarity and knowledge (Krysa, 1998; Afshari, Abu-Bakar, Luan, Abu-Samah, & Fooi, 2009).

In brief, a good training course for in-service teachers is one that demonstrates the characteristics and benefits of the computer software, and how to integrate it into the education process (in science or other

subjects). This will lead to improvements in teacher attitudes towards the use of technology, and thus he or she will wish to improve and develop his or her computer skills.

#### **7.4 Technology equipment availability at school (science classroom)**

One of the demands from MOE officials for the reform of science education was that science teachers should use scientific inquiry and practical work to provide students with scientific processes. These include observation, measurement, setting the hypotheses, and learning the skills needed to conduct experiments. To achieve this aim, scientific equipment and the appropriate tools should be provided to science teachers, whether in the classroom or in traditional science labs. However, in reality, there is still a lack of scientific equipment and tools to achieve this aim, and this has been a motivation behind this study investigating the use of computer simulations. The computer simulations replace real equipment with digital (or virtual) ‘manipulatives’ (Triona & Klahr, 2003).

The use of a simulation program, as an alternative to practical work, requires material resources, such as an appropriate room, modern computers, projectors with large screens for display, and importantly, good instructional program design. All of these factors, if available in schools, could increase the success of simulation software in science education. On the contrary, if they are lacking the outcome could be negative. This was clear on many occasions in the study.

In addition to a lack of updated computers and projectors, other factors that may negatively influence the use of simulation in a computer lab (Exg1) were revealed during interviews with the teachers. Assuming the lack of technological equipment (i.e. modern computers and projectors) is solved through the provision of new equipment, other factors could affect the effective use of a simulation program. For example, the location of a computer lab and its dependency on a school’s administrative rules for entry, and whether access is restricted or freely available at any time.

According to the teachers’ statements during interviews for this study, some factors can be conclude that it may led to negative results through the use of simulation in computer lab (Exg1). Because there is not computer lab, or equipment such as computer, projectors private to science section, therefore, as mentioned in chapter four “the intervention” of the current study used the computer laboratory, which is dedicated to or private to the Learning Computer Section (LCS) and not to the Science Section. A quick look at the mean scores of the three topics of the first experimental group, who used the simulation lab, shows the mean score of the second topic was better than the mean score of the first topic. This might be because teachers and students are familiar with, or have adapted to, using the

simulation program; therefore, it was expected that students' learning in the third topic would improve over the second topic. However, this did not happen. The reason for this, and the cause for this drop in the results of the third topic, was lacking equipment (i.e. computers and projectors) in the school's Science Section. So, I used of a place dependence of the computer lab, where it follows the rules, under management and control of another department's (i.e., the Computer Section) and not the Science Section. Therefore, the science teachers did not have control over the laboratory, such as permission or authorisation for freely available access, or the use of any computer. In addition, the third topic was conducted after the school spring holiday (two weeks). During this time the computer department at the MOE (and at all schools) undergoes maintenance work (through private computer companies that have contract with MOE). This includes formatting all computers to prepare for the second semester. This led to the deletion of all previous programs, except basic programs such as Word and Excel. As a result, when the students came to study the third topic in the computer labs they found that the simulation program had disappeared from the majority of computers. Therefore, some teachers were forced to revert to traditional teaching methods, thus affecting the results of this study.

The use of older computers also affected both the efficiency of teaching with simulation programs, and outcomes of the study, because the older computers are used to teach students basic computer skills. The simulation programs require new or modern computer software. In addition, the computer laboratories were not originally intended or designed to be computer laboratories. In terms of space (computer location), lighting, electrical wiring and the distribution of computers in the lab, all of these elements obstructed the movement of teachers among the students, leading to negative results in the first experimental group.

It is possible to conclude from the above that providing modern technology or educational tools in the computer lab, and allowing science teachers to use these freely, could help produce more positive learning outcomes and positively impact on the effectiveness of simulation programs. However, from a broader perspective, we find that this is insufficient in ensuring the success of simulation use. Krysa (1998) suggests that a limited number of computer labs in a school, and their location far from the classroom, will lead to limitations and difficulties in accessing the hardware. In particular, the existence of a large number of students in a class (thirty in total) leads to increased difficulties of physical movement in a computer lab, and a limited amount of time for lessons, where time may be lost through movement from classroom to computer lab. All of these factors can negatively affect and diminish the learning benefits of instructional programs, even if the equipment in a computer lab is modern.

Chigona and Chigona (2010) conclude that even if high quality technology equipment is available, other factors may affect the use of computers in teaching. For example, the school administration should play a positive role in supporting and encouraging teachers to use ICT through the provision of facilities and to use the technology freely and entering and using any technology available in the school computer lab or classroom, as well as factors relating to providing enough educational programs for all topics.

Accordingly, the support, belief and attitude of decision-makers in the MOE towards using technology in the teaching process, as well as providing sophisticated computers with projectors and large screens in each classroom, may help the simulation program contribute towards effective science teaching.

### **7.5 Teacher skills development in science education methods**

Officials in the MOE noted and acknowledged that traditional teaching methods are still dominant in the primary school science classroom (see chapter one, NDCSC, 2011), even following the introduction of the new science curriculum in the 2008-2009 academic year. Therefore, they asked science teachers to reform over-used conventional teaching methods, and to instead use ‘constructivist’ teaching by creating active learning environments to make students more active in science classrooms. To achieve this change in teaching methods, the role of both science teachers and students should be changed. The role of the science teacher must change from being the only source and deliverer of information to students, to that of serving as a guide, advisor, and facilitator of access to information that enables student learning. The students’ role should change from a passive receiver of information, memorising facts for tests, to being a researcher, explorer, and observer of information. Furthermore, once they understand knowledge and concepts they must develop their ability to illustrate the results and construct the knowledge in their minds, rather than just memorise information.

For the first experimental group of teachers, who used simulation in the computer lab along with blended teaching, the current study attempted, through the use of a simulation program, to offer an opportunity for both science teacher and students to change their current role (i.e. teacher = sender of information and dominant controller in the classroom, and students = recipients). However, as traditional teaching is rooted in the classroom, and the vast majority of teachers still use traditional methods, a number of teachers used a method similar to the theory of behaviourism as proposed by Skinner. This recommends using rewards and punishments as learning reinforcement (Pritchard, 2005). As noted by the science teachers, this type of traditional teaching method dominates the teaching of science in primary schools in Kuwait (see chapter one).

The teachers' statements - during interview - suggest it may be difficult in a short time to change to the new roles in a constructivist classroom, where the teacher serves as guide, advisor, and facilitator of access to information, while the student's role is that of researcher, explorer, and observer of information and knowledge construction. To achieve this change, both teachers and students need time to become familiar with the new teaching style. They must also have the skills and knowledge of how to use constructivist classrooms (see table 1 in chapter two). Hartel's xyZET (2000) conducted a study over a two-year period to give teachers and students the opportunity to cope with the new teaching method through the use of simulation software, and to achieve the study goals of self-learning using simulation.

Statements of some teachers in the experimental group (Exg1), indicate that the reason for the lack of success of simulation software in improving science teaching was the large number of students in the computer lab. The first 20 minutes of lesson time was described as good, because the role of the science teachers was to demonstrate the use of the simulation program and explain the topic through the use of scaffolding. However, during the second half of the lesson, when the students used the simulation program on their own (i.e. self-learning), a vast majority asked for help in finding information about the topic, and how to use and run the simulation programs. This was due to problems with the computer technology or a lack of skill in using the computer, and this wasted time during lessons. The majority of teachers in this group were forced to return to traditional teaching methods, through simulation in computer labs, and repeat the lesson for the students to gain a better understanding of the topic being taught. Of course, all of these factors affected the outcomes of the first experimental group.

Many previous studies have succeeded in their goals by applying constructivist theory to the use of simulation programs (Bakar & Zaman, 2007; Baser, 2006; Talib et al., 2005; De Jong & van Joolingen, 1998; Jimoyiannis & Komis, 2001; Limniou et al., 2007; Sun et al., 2008; Tekos & Solomonidou, 2009). In my opinion, there are many reasons why the use of simulation programs was a success in these studies.

First, is the vast difference between the educational environment in the current study (Kuwait) and other advanced educational environments (Finland, the Netherlands and Taiwan), in terms of education, culture, and the improvement and development of the education process. Where the teachers and students still have conventional roles in the teaching process at Kuwaiti schools; where science teachers are accustomed to being dominant and in control, are only source of knowledge delivery in the classroom, and where students are accustomed to receiving information and ideas from the teachers,

this is because a large number of students can save time finishing a topic lesson. Therefore, changing the role of teachers and students takes and needs a long time, during which teachers will need in-service training to develop sufficient skills in how to manage classrooms and use various teaching methods.

Secondly, the young age (10 to 11 years) of the primary school students affected their ability to use or manipulate the simulation programs. The simulation programs displayed buttons on the screen's surface for interaction (buttons for play, back or stop, change variables or values) and these could be difficult for the young students to use. This will affect how successful the students were in using the computer simulation, and any benefits gained in their learning experience. In addition, teachers observed weaknesses in the students' ability to read instructions on the computer screen. This caused students in the first experimental group to ask many questions while using the simulation program in the second half of the lesson, and led to a loss of time reading through the instructions on the computer screen. Therefore, I think the reason for the success of the vast majority of previous studies on simulation programs is that the users were older students (middle school, secondary school and undergraduate). Therefore, they encountered fewer problems with reading instructions on the computer screen or operating the keyboard or mouse, reflecting the different abilities between students at the primary level and above.

In conclusion, with regard to the experimental group that used simulation programs in the computer lab with blended teaching, a change in the roles of both teacher and student requires a long period of time. In addition, teachers require in-service training to develop their skills in managing lessons through the use of scaffolding and discussions in the classroom. Teachers should also learn how to use a variety of teaching methods within an integrated educational program, and there should be focus on developing the reading and computer skills of primary level students. Otherwise, applying self-study methods in order to use constructivism with simulations, or other educational programs, will not succeed.

In contrast, the simulation program made a positive contribution to the results of students in the second experimental group. Teachers who taught this group used simulation as an educational tool to support traditional teaching. I think the cause was that the teachers' role had not changed. They remained the dominant teacher in the classroom. They were not the only source of information, as the simulation program served as another source of information in the classroom. The presentation of the science topics through visual means gained the students' admiration and attention during the lesson, and made them more active and engaged with the teacher

Generally, one shortcoming or limitation highlighted by the current study, in the failure of simulation programs to improve student learning, was the attempt to change the role of the teacher without providing training in classroom management in constructivist teaching.

Providing training sessions with an educational basis for teachers increases the advantages of using technology. It also improves teachers' knowledge of computers, as well as developing their skills and confidence. In addition, time management methods in using computers for teaching can present opportunities to create various methods of teaching, as well improving the understanding of subjects to achieve pedagogical objectives (Schaffer & Richardson, 2004). These training sessions positively affect the attitudes of teachers and their views towards using computers in teaching. It removes their fear of using computers, a feeling Cox and his colleagues called "computer-phobic" (Cox, M., Preston, & Cox, K., 1999). In Kuwait, the role of the Department of Development and In-service Training in the MOE is very important, and should play an active role in developing and supporting all teachers in the use of educational methods that create an active learning environment. In such an environment, students are the centre and their role should be as a researcher and explorer of information and knowledge, facilitating knowledge construction in their minds to better understand information, not simply memorising information.

### **7.6 Learning science topics by computer simulation software**

Many studies recommend the use of computer-based educational programs in science teaching and present many justifications and scenarios for their use. For example, Leonard (1992) claims that microcomputer-based technology in science education offers many benefits: it is more economical than using real laboratory facilities and materials; it saves on instruction time; it makes self-learning possible; it provides rapid evaluation of student responses and gives feedback; the simulation program is interactive; it can provide or furnish more concrete representations of abstract concepts through vision and sound; and it can model events, phenomena or experiments not usually conducted in a normal classroom.

However, the importance and benefits of using educational computer-based programs - as above shown - are not inadequate to be factor for educational program success. Hsu and Thomas (2002) conclude the advantages that simulations bring into the classroom are not reaped automatically, but only come as a result of good and careful planning during the display of science topics on a computer screen. Thus, the good design of educational programmes - as simulations in the current study - may be an influential factor in the success of a simulation program's contribution to science education.



As mentioned in the theoretical chapter, the simulation software – or any computer-based educational programme – depends on two senses of the student: the eyes and the ears (dual-channel). Each of these senses has a limited capacity to receive information. Thus, if there is a lot of information and knowledge (i.e. words) displayed on the computer screen, as well as images and sounds, students cannot receive all this information at the same time, rather it will lead to dispersion and a lack of concentration. This happens because of a lack of coordination between presentation modes (verbal and pictorial knowledge) and sensory modalities (ears for auditory and eyes for visual). The way of presenting the topic to be taught, either by pictures (in form of a printed text, static graphic or dynamic graphic), or in the form of sound (spoken by teacher or automated voice such as the sound of by computer-speakers) should be consistent and coordinated. Therefore, as Mayer proposed in the Multimedia Theory of Cognitive Learning (MTCL, 2009), the design of the simulation program is very important.

Because of a lack of interactive simulation software in Kuwait, the current study resorted to hiring a specialist company called “EduMedia-science” ([www.edumedia.science.com](http://www.edumedia.science.com)) to produce the educational simulation programs, including some science topics for primary school level (see appendix 11 and chapter four for further details). The company was hired in an attempt to create an appropriate program for this experimental study (i.e. ICSS).

According to statements given by the teachers in interviews, and reports during lessons, students in each experimental group who were exposed to a simulation program were better at conceptual understanding than students exposed to traditional methods. For example, the results of students who used simulation in the lab in the "Circulation & Digestive system (C & DS)" test showed they had a better conceptual understanding than students taught by traditional methods of teaching. The "artery concept" in the circulation system test was selected as a specific concept to examine the effect of simulation programs on the conceptual understanding of students. The results of students who used simulation in the classroom in the "Electrical Circuit (EC)" test showed they had a higher level of conceptual understanding than students who were subject to traditional teaching methods. The topic of the "Electric Current" in the electrical circuit test was selected as a specific concept to examine the effect of a simulation program on student's conceptual understanding. The results show students who use simulation, whether in a computer lab or in a classroom, achieve a better level of conceptual understanding than students taught by traditional teaching methods. However, it should be clear that the simulation program might clearly show or illustrate some specific science concepts, but not all

concepts on the same topic or on other topics, as found in previous studies on ecology, genetics and protein structure (Sherwood & Hasselbring, 1986; Gibbons et al., 2004 and White et al., 2010).

I assume the results reflect the success of simulation software to visualise science topics (see Abood, 2007, p.199; Wellington, 1985, p.60; Wellington, 2000, p.201). For example, the digestive system path process - i.e. starting from the mouth and ending in the large intestine – 0 that computer simulation might be especially useful for helping students see structure in phenomena and processes that are traditionally invisible to students, such as the electrical current in this study. A process can be invisible if it is too small (e.g. pollination of flowers), too big (e.g. solar system), too fast (e.g. chemical reactions), or too slow (e.g. plant growth). Visualisations can make these processes accessible, so learners can perceive the important structures. Also, de Jong & van Joolingen (1998), in comparing simulation-based instruction with textbooks and lectures, said that simulation offers the opportunity for students to learn in a relatively realistic problem-solving environment, through practicing task performance without any stress.

Moreover, the teachers added that the simulation program made the students more attentive than when solely exposed to traditional teaching. The practice has been for the teacher to initiate the question, but once the programs were running, students began to ask about what they observed. Therefore, the simulation program made students more attentive and increased their curiosity to learn.

In conclusion, the characteristics and features of educational programmes such as interactive computer simulation cannot automatically offer meaningful learning into the classroom. However, the simulation program - or any educational programme - requires good design and it should be consistent with the idea of how students learn, and how the student gets or receives knowledge for it to be efficient in an educational process (Mayer, 2009).

## **7.7 Practical implications**

According to the findings of the current study, and after reviewing factors that may impact on the results of the current study, there are several major implications that have significance for both decision makers at the MOE, and researchers at the local (Kuwait) and international level, in the field of educational computer-based simulation programs in science education.

### **7.7.1 Implication for decision makers**

The results of the current study attempt to show clearly the potential contribution interactive simulation programs can make to the reform and development of science education in primary schools in Kuwait.

To achieve this, the Ministry of Education in Kuwait should pay greater attention in preparing training courses in response to some of the issues highlighted, and should put these at the top of its agenda.

1- Preparation of training courses for in-service science teachers

The Ministry of Education in Kuwait, through the Department of Development and Training, should provide the follow training course:

- A. An ICT skills training course. This aims to increase the opportunities of science teachers to be trained in ICT. At the end of this course teachers should know;
  - a- How to deal with computer software applications,
  - b- How to fix simple problems they may face,
  - c- How to use computer software properly in the teaching process.
- B. Education methods and educational programmes. The aim of this course is to provide teachers instruction in;
  - a- The types of educational programmes (teaching programs such as Drill and practice; learning programs such as simulation and adventure games),
  - b- The most suitable teaching method for each type of educational programme.

2- Provide technology equipment in science classrooms

Despite a lack of technology equipment in the classroom and a science section to use for computer simulation in the classroom with support of school administration. However, this study found that use of a simulation the positively contributed in the classroom in supporting science teaching. Therefore, if the MOE provides the necessary equipment (such as modern computers and projectors with a large screen) I think this may help students learn and understand science topics in a more enjoyable way.

It is financially very costly to provide modern computers with large screens displaying data in all school classrooms. Therefore, a good solution is to purchase an appropriate number of computer laptops and projectors for the Science Section. Electrical extensions and connections should also be provided in each classroom to allow teachers to connect their own laptops.

### **7.7.2 Implication for further study in Kuwait**

Lack of studies in Kuwait (or any in other Arab country with a similar educational environment) in examine how effective computer simulations are in primary school science teaching. Therefore, we

need additional studies to determine what factors may support or hinder the application of computer simulations in science education. As mentioned in previous chapters, the limitations and problems faced in this study are as follows:

- 1- The absence (none that I can find) of previous studies in Kuwait, or in other Arab countries, that have studied simulation.
- 2- The scarcity of previous studies examining the effectiveness of using computer simulations in primary school science education.

In addition, several studies covering different cultures and education systems, mentioned in the literature review chapter, were similar and consistent with the findings of the current study (Akpan & Andre, 1999; Bilek & Skalicka, 2010; Kiboss et al., 2004; Stern et al., 2008; Sun et al., 2009, Taskin & Kandemir, 2010). However, comparison with these studies may be unfair for several reasons, for example, (a) the difference in the students' level of education (middle school, high school or undergraduate), and (b) the level of educational development between the current study environment and other study environments (such as the UK, the USA, Finland, the Netherlands and Taiwan). Another important reason is that there are no - during my research- studies in Kuwait or other Arab countries (i.e. similar to the Kuwaiti educational environment) that use simulation within a constructivist classroom to benefit from its results and to avoid its problems that faced the researcher.

Therefore, to determine how effective simulation software is in primary school science education requires further research. This should focus on:

- a) Teacher attitudes towards the use of simulation
- b) How supportive the school administration is in using ICT
- c) Teacher qualification and skills in using ICT (such as simulation program)

The research has also revealed contradictions between current classroom practices in Kuwait and the constructivist approaches that are necessary to make efficient use of ICT teaching. Besides research, an implication therefore is to include more Continuing Professional Development (CPD) for science teachers. Such training, besides training ICT skills, should:

- a) Support science teachers in enhancing their professional skills by learning more about:
  - Contemporary scientific ideas
  - Experimenting with effective teaching methods

- Modern scientific techniques.
- b) Help teachers to motivate pupils by providing them with a more exciting, intellectually stimulating and relevant science education, enabling them to achieve the knowledge and the understanding they need - both as the citizens and as the scientists of the future
  - d) Encourage the students to use self-education
  - e) Develop teachers' questioning skills (i.e. How, Why, What if?) and their ability to handle student active classroom discourse, to use discussion method to stimulate students to pursue knowledge on their own or to develop critical thinking skills in students.

## **CHAPTER EIGHT: CONCLUSIONS AND IMPLICATIONS**

### **8.1 Introduction**

This chapter provides the study conclusion, including aims of the current study followed by a summary of the research questions, study design and data gathering. As well as the results obtained in this research. Furthermore, the chapter reviews the strengths and weaknesses of the current study in order to add important recommendations and proposals for future research in this field, as suggested by the findings.

### **8.2 Aims of the study**

The goal and purpose of this study were to identify the effectiveness of using ICSS program in science education in primary school in Kuwait in terms of improving students' academic achievement; addressing students' misconceptions and changing them to correct scientific concepts; and improving students' attitude toward learning science. Furthermore, this study aimed to contribute to the field in helping to achieve the goal of educational reforms in the state of Kuwait, represented in changing the science curricula for primary school students starting from the 2008–2009 academic year (see Appendix 2).

### **8.3 Research question, study design, data gathering and main findings**

#### **8.3.1 Research question**

The study problem was summarised in the following research question:

What effects does the use of interactive computer simulation software as compared to traditional methods in the teaching of science have on students' academic achievement, on changing their misconceptions and on improving their attitude towards science teaching and learning? in addition to, what are the opinions and impressions of science teachers and students involved in the experimental group concerning the use of simulation software in science teaching and learning in grade 5 in primary schools in Kuwait?

### **8.3.2 Design study**

The current study adopted a quasi-experimental design to answer the research question; three groups were established in different educational environments in primary school for fifth grade, two experimental groups and one control group. The first experimental group (Exg1) used simulation in computer lab with use blended teaching; the second experimental group (Exg2) used simulation in the classroom as a supportive of the traditional education. Both of them offset by the control group (Cg) had similar teaching but use a traditional teaching method without computers.

Eight schools were involved distribution in the two experimental groups two schools of boys' and two schools for female in each experimental groups

The simulation program use as an intervention (i.e. ICSS) was applied in the academic year 2010–2011 in grade fifth in three science topics: the food chain (FC), circulation and the digestive system (C&DS) and electrical circuit (EC). The purpose of using three topics was to provide the teachers and students an opportunity to be familiar with in using the ICSS, as well as to avoid any mistakes may occurring during use simulation program in the first topic (i.e. lesson one which is food chain (FC)) and avoided it into next topic, the aim of obtaining more accurate results. The groups are described in detail below.

### **8.3.3 Data gathering**

Three measurement tools were used to verify the hypotheses. After ascertaining their validity and reliability, the following measurements were used:

- 1- Pre and post achievement tests on the knowledge and concepts covered in the lessons: Pre-tests were distributed to half of the students participating (for two primary schools – one male and one female), whereas post-tests were distributed for all the students participating in the experimental and control groups; each topic was covered separately (FC, C&DS and EC).
- 2- Questionnaires on students' pre- and post-intervention attitude toward science teaching and learning: Questionnaires were distributed to all the students participating.
- 3- Questionnaire on the usability and usefulness of the simulation programme in science teaching and learning: This questionnaire was only distributed to students who used simulation in the experimental groups to measure their attitudes concerning the usability of the simulation software, as well as the usefulness of and their satisfaction in science learning.

### **8.3.4 Main findings**

After conducting the experiment with the measuring tools and gathering the data, an analysis of the results showed that in the first experimental group there was no statistically significant difference between the students who used the simulation in the computer lab (Exg1) and those who followed the traditional teaching method (Cg1) In terms to academic achievement and students attitude toward teaching and learning science. In the second experimental group there was statistically significant differences indicate that students who used the simulation programme in the classroom (Exg2) were performed better on academic achievement tests and in their attitude toward teaching and learning science than students who were exposed to the traditional teaching method (Cg2). Both students in experimental groups were better in conceptual understanding in a specific topics and concepts than students who in control groups. According to science teachers statements through interviews, simulation program make students more motivated and involved during the lesson and they feel enjoy with it.

### **8.4 Recommendations**

In light of the review of the literature and the findings of the current study, the following educational recommendations can be given:

A- With regard to educational programmes and equipment:

- 1- It is important to make use of the extensive technological development in computer programmes such as simulation, which was used in the current study to more clearly represent processes, experiments and scientific phenomena related to abstract scientific concepts for the benefit of primary students.
- 2- Specialists in the field of educational design should be made available to assist science teachers in designing and developing their teaching practice, helping with all the academic decisions relating to science software according to the modern educational theories and methods.
- 3- The most up-to-date computers and equipment should be provided in real science labs or the classroom to ensure the success of simulation programmes or any other educational programme.
- 4- A technician should be present in the school or be made available to conduct a training course for science teachers on how to fix any basic emergent troubles that



might occur while using the educational programmes, whether this is a simulation programme or any other programme, to ensure that the lesson continues as it should.

B- With regard to the teachers:

- 1- Teachers should be urged to develop their computer skills by completing training courses in this area.
- 2- Training courses should be organised for science teachers that look at how to develop various modern teaching methods, such as the blended teaching method, and consider the preconceptions of the students through the simulation programme and any simple programmes available on the computer.
- 3- Teachers' attitudes towards the use of educational programmes such as simulators should be investigated, and efforts should be made to develop these attitudes or orientations in a positive direction.
- 4- The teachers should be urged to enhance the concept of self-learning amongst the students through designing and providing scientific syllabuses that make use of simulation programmes in a completely interactive way, from the student entering the order (input) to accessing feedback (output).

### **8.5 Implications for future research**

According to the results concluded in the current study, proposals can be set out for further studies that can help to build upon the results of this research, including the following:

- 1- A similar study can be conducted for intermediate-stage students (aged 12–15 years), with care taken to avoid the points of weakness in the current study.
- 2- A study could be conducted to verify the extent to which the infrastructure is provided in primary schools with regard to using educational programmes such as simulators.
- 3- A similar study should be conducted with care taken to ensure that the teachers of the experimental groups have the necessary skills related to using modern approaches in terms of the blended teaching method, or any other modern learning or teaching techniques.
- 4- Studies should be conducted on whether the computer curriculum in grade 5 at the primary level encourages the students to apply self-learning through the development of Internet search skills and highlights the importance of computers in learning other materials (science, mathematics).

- 5- Research can be pursued on the attitudes of decision makers in the Ministry of Education with regard to developing the science curriculum, and specifically in changing and designing the scientific experiments included electronically in the science curriculum simulation software or in another form.

In conclusion, the current study attempted to contribute to the modern technological progress represented in the use of computer simulation programmes to face the challenges relating to science teaching in general and in primary schools in Kuwait in particular. Simulation software for science education was used in an attempt to achieve official the Ministry of Education requirements related to developing the science curriculum and using modern educational methods and theories as part of the reformed science education in Kuwait. In the light of the challenges and obstacles preventing science teachers from applying the science teaching approaches highlighted by officials, it was considered that simulation software could contribute to removing or allowing teachers to overcome some of these obstacles to bring about more meaningful learning.

## REFERENCES

- Abood, H. (2007). *The Computer in Education*. Amman: Dar Wa'ael.
- Abrahams, I., & Millar, R. (2008). Does Practical Work Really Work? A Study of the Effectiveness of Practical Work as a Teaching and Learning Method in School Science. *International Journal of Science Education*, 30(14), 1945-1969.
- Abu-Hakima, A. (1983) *The modern history of Kuwait*, London, Luzac & Company.
- Afshari, M., Abu-Bakar, K., Luan, W. S., Abu-Samah, B., & Fooi, F. S. (2009). Factors Affecting Teachers' Use of Information and Communication Technology. *International Journal of Instruction*, 2(1), 77 -104.
- Akpan, J. P., & Andre, T. (1999). The Effect of a Prior Dissection Simulation on Middle School Students' Dissection Performance and Understanding of the Anatomy and Morphology of the Frog. *Journal of Science Education and Technology*, 8(2), 107-121.
- Al-Abdulghafoor, F. (1983) *The development of education in Kuwait 1912 - 1972*. MA thesis, University of Kuwait.
- Al-Dael, S. (2002). The impact of the use of computers in teaching mathematics on achievement second grade students. *Journal of Educational and Psychological Sciences*, 6(3), 46-61.
- Al-Enezi, T. (2009). *The Effect of Simulation in E-Learning in Misconceptions and Motivation toward Learning*. Arabic Gulf University, Bahrain.
- Al-huthaify, K. (2008). The impact of the use of e-learning at the academic achievement level and mental abilities and the attitude towards science in middle school students. *Journal of King Saud University, Educational Sciences and Islamic Studies*, 3, 675-715.
- Ali, M. (2002). Effectiveness of use of the Internet in the Acquisition of students of the Faculty of Education in Nizwa school mathematics. *Journal of Educational and Social Studies*, 8(4), 189-234.
- Al-Jasem, N. . (1992) Education in Kuwait 1939-1943 in light of Adrian Valence's two reports. *Journal of the Gulf and Arabian Peninsula Studies*, 17 (66), 28- 33.
- Al-Karsh, M. (1996). The impact of teaching engineering unit through computer-aided in the achievement and develop the skills of mathematical proof among students in a first grade secondary. P. 15-50.
- Al-Mosa, A. (2005). *The use of computers in education* (Vol. 3046). KSA: King Fahad national library.
- Alqamdy, H. (2005). *Cognitive direction: Piaget's theory of cognitive development*. Department of Psychology, University of Umm al-Qura.
- Al-Reshead, A. (1971) *Kuwait History*, Beirut Dar Maktabat Al-Hayat.
- Al-Shamlan, S. (1969) *Views from kuwait history: Abdullatef Al-Othman*. Kuwait: Kuwait Television.
- Al-ttamar, J., & Sulaiman, M. (2006). Effectiveness of Using Computer Assisted Instruction (CAI) in Developing Achievement of First Degree Equations Among Seventh Grade Students in the State of Kuwait. *Journal of Educational and Social Studies*, 8(4), 14-39.

- American Association for the Advancement of Science. (1990). Benchmarks for science literacy, *New York: Oxford University Press*.
- American Educational Research Association. (2006). Standards for reporting on empirical social science research in AERA publications, *Educational Researcher* (Vol. 35, pp. 33-40).
- Anderson, G., & Arsenault, N. (1998). Fundamentals of educational research. London: Falmer Press.
- Asker, A., Jamea, H., alfar, F., & Hawana, W. (2003). *Introduction to Scientific Research*. Kuwait: Alfalah bookshop.
- Atkinson, C., & Mayer, R. E. (2004). Five ways to reduce PowerPoint overload. *1*, 1-15.
- Austin, K. A. (2009). Multimedia learning: Cognitive individual differences and display design techniques predict transfer learning with multimedia learning modules. *Computers & Education*, 53(4), 1339-1354.
- Baddeley, A. (1992). Working Memory. *Science*, 255(5044), 556-559.
- Baddeley, A. D. (2002). Is Working Memory Still Working?. *European Psychologist*, 7(2), 85-97.
- Baguley, T. (2009). Standardized or simple effect size: what should be reported? *British journal of psychology (London, England: 1953)*, 100(Pt 3), 603.
- Bakar, H., & Zaman, H. (2007). *Development of V Lab-Chem for Chemistry Subject Based on Constructivism Cognitivism Contextual Approach*. Paper presented at the Proceedings of the International Conference on Electrical engineering and informatics institute Technology Bandung, Indonesia.
- Barakat, K. (1967) Kuwait: extra-curricular activities. Paris: UNESCO.
- Barrak, B. (2008). Aim of new science curriculum. *Al-Qabas*.
- Baser, M. (2006). Effects of Conceptual Change and Traditional Confirmatory Simulations on Pre-Service Teachers' Understanding of Direct Current Circuits. *Journal of Science Education and Technology*, 15(5/6), 367-381.
- Becker, K. (2002). Constructivism and the use of technology. *The Technology Teacher* (electronic journal).
- Bell, R. L., & Trundle, K. C. (2008). The use of a computer simulation to promote scientific conceptions of moon phases. *Journal of Research in Science Teaching*, 45(3), 346-372.
- Beshayrah, Z & Manzalawy, O. (2007). The impact of cooperative education and computerized educational program in the student's academic achievement of the seventh grade in science Aqaba Governorate. *Journal of Educational Issue* 13. P. 231- 254.
- Bilek, M., & Skalicka, P. (2010). Combination of Real and Virtual Environment in Early Chemistry Experimental Activities. *Science and Technology Education* 1-8.
- Bissell, J. (1998). Cognitive development and learning. [On-line lecture #2, Ed 173, University of California Irvine], Available. [www.gse.uci.edu/ed173](http://www.gse.uci.edu/ed173).
- Bloom, B.S., Engelhart, M.B., Furst, E.J., Hill, W.H., & Krathwohl, D.R. (1956). Taxonomy of educational objectives: The classification of educational goals. Handbook 1: Cognitive domain. New York: Longmans Green.

- Borg, W. R., Gall, J. P., & Gall, M. D. (1993). *Applying educational research* (3rd ed.). New York: Longman
- Bransford, J. D. E., Brown, A. L. E., Cocking, R. R. E., & National Academy of Sciences - National Research Council, W. D. C. (1999). *How People Learn: Brain, Mind, Experience, and School*: National Academy Press.
- Brooks, J.G., and Brooks, M.G. (1993). *In search of understanding: The case for constructivist classrooms*. Alexandria, VA: ASC
- Bryman, A. (2006). Integrating quantitative and qualitative research: how is it done? *Qualitative Research*, 6(1), 97-113.
- Callahan, J. L., & Reio, T. G., Jr. (2006). Making Subjective Judgments in Quantitative Studies: The Importance of Using Effect Sizes and Confidence Intervals. *Human Resource Development Quarterly*, 17(2), 159-173.
- Carey, S. (1985). *Conceptual change in childhood*. Cambridge, MA: MIT Press
- Center of Historic Documentations (2013) - Al Diwan Al Al Amiri, <http://www.da.gov.kw/eng/aboutkuwait/independence.php>
- Cepni, S., Tas, E., & Kose, S. (2006). The effects of computer-assisted material on students' cognitive levels, misconceptions and attitudes towards science. *Computers & Education*, 46(2), 192-205.
- Champagne, A. B., Klopfer, L. E., & Gunstone, R. F. (1982). Cognitive Research and the Design of Science Instruction. *Educational Psychologist*, 17(1), 31-53.
- Chang, C.-Y. (2001). Comparing the Impacts of a Problem-Based Computer-Assisted Instruction and the Direct-Interactive Teaching Method on Student Science Achievement. *Journal of Science Education and Technology*, 10(2), 147-153.
- Chigona, a. & Chigona., w. (2010). *An Investigation of Factors Affecting The Use of ICT for Teaching in the Western Cape Schools*. Paper presented at the European Conference on Information.
- Chin, J., Diehl, V., & Norman, K. (1988). *Development of an instrument measuring user satisfaction of the human-computer interface*.
- Cindy, L., Silver, E. (2007). *Computer-supported Collaborative Learning and Conceptual Change*. Paper presented at the CSCL'07 Proceedings of the 8th international conference on Computer supported collaborative learning.
- Clark, J. M., & Paivio, A. (1991). Dual coding theory and education. *Educational Psychology Review*, 3(3), 149-210.
- Clark, R. & Mayer, R. (2003). *E-learning and the Science of Instruction. Proven Guidelines for Consumers and Designers of Multimedia Learning* (Vol. 322): Pfeiffer.
- Cobb, P. (1994). Where is the mind? Constructivist and sociocultural perspectives on mathematical development. *Educational Researcher*, 23, 13–20.
- Coe, R. (2002). It's the Effect Size, Stupid. What effect size is and why it is important. Paper presented at the Conference of the British Educational Research Association.

- Coe, R. (2004). Issues arising from the use of effect sizes in analyzing and reporting research. In: I. Schagen, & K. Elliot, Ed. *But what does it mean? The use of effect size in educational research. UK, National Foundation for Educational Research.*
- Cohen, J. (1988). *Statistical power analysis for the behavioral sciences*. Hillsdale, N.J: L. Erlbaum Associates.
- Cohen, L., Manion, L. and Morrison, K. (2004) *Research Methods in Education*, London:
- Cohen, L., Manion, L., & Morrison, K. (2000). *Research methods in education*. New York: Routledge Falmer.
- Collins, K. M. T., Onwuegbuzie, A. J., & Sutton, I. L. (2006). A model incorporating the rationale and purpose for conducting mixed methods research in special education and beyond. *Learning Disabilities: A Contemporary Journal*, 4, 67-100.
- Couture, M. (2004). Realism in the design process and credibility of a simulation-based virtual laboratory. *Journal of Computer Assisted Learning*, 20(1), 40-49.
- Cox, M., Preston, C., & Cox, K. (1999). *What Factors Support or Prevent Teachers from Using ICT in their Classrooms?* Paper presented at the The British Educational Research Association.
- Creswell, J. W., & Plano Clark, V. L. (2007). *Designing and conducting mixed methods research*. Thousand Oaks, Calif: SAGE Publications.
- Crook, C. (1994). *Computers and the Collaborative Experience of Learning*. London: Routledge.
- Crosier, J. K., Cobb, S., & Wilson, J. R. (2002). Key lessons for the design and integration of virtual environments in secondary science. *Computers & Education*, 38(1), 77-94.
- Culbertson, H. M. (1968). What is an attitude? *Journal of Extension (JOE)*, 6(2), 79-85.
- D.S Lininger, C. (1975). *The Sample Survey: Theory And Practice*: London McGraw Hill Book Co.
- De Jong, T., & van Joolingen, W. R. (1998). Scientific Discovery Learning with Computer Simulations of Conceptual Domains. *Review of Educational Research*, 68(2), 179-201.
- DeMarrais, K., & Lapan, S. D. (2004). *Foundations for Research: Methods of Inquiry in Education and the Social Sciences*.
- Denzin, N. K. (1978). *The research act: a theoretical introduction to sociological methods*: McGraw-Hill.
- Department of Curriculum Development. (2011). *National Document to Constructing the Science Curriculum in the State of Kuwait (NDCSC)*.
- DiSessa, A. A. (2006). A history of conceptual change research: Threads and fault lines. In R. K. Sawyer (Ed.), *Cambridge handbook of the learning sciences* (pp. 265-282). New York: Cambridge.
- Donaldson, M. C. (1978). *Children's minds*. London: Croom Helm
- Driver , R. (1983). *The pupil as scientist?* Milton Keynes, England: The Open University Press.
- Driver , R., Guesne, E., & Tiberghien, A. (1985). *Children's ideas in science*. Philadelphia, PA: Open University Press.

- Driver, R., Asoko, H., Leach, J., Mortimer, E & Scott, Ph. (1994) Constructing Scientific Knowledge in the Classroom. *Educational Researcher*, Vol. 23, No. 7. pp. 5-12.
- Duhaney, D. (2012). Blended Learning and Teacher Preparation Programs. *International Journal of Instructional Media*, 39, 179.
- Ellington, H., Percival, F. and Race, P. (1993) *Handbook of Educational Technology*, 3rd Edition, London: Kogan Page Ltd.
- Evans, C., & Sabry, K. (2003). Evaluation of the Interactivity of Web-Based Learning Systems: Principles and Process. *Innovations in Education and Teaching International*, 40(1), 89-99.
- Farrokhnia, M., & Esmailpou, A. (2010). A study on the impact of real, virtual and comprehensive experimenting on students' conceptual understanding of DC electric circuits and their skills in undergraduate electricity laboratory. *Procedia Social and Behavioral Sciences*, 2, 5474–5482
- Fathallah, M. (2006). Advanced effective style of presentation (Power Point) alone and with educational videos via closed-circuit television in the development of the achievement of teachers' students (pre-service) and their skills and attitude towards using methods and techniques of education in teaching. *Journal of Educational Sciences*, 3, 49-112.
- Fishbein, M., & Ajzen, I. (1975). *Belief, attitude, intention and behavior: an introduction to theory and research*. London (etc.): Addison-Wesley.
- Fraenkel, J. R., & Wallen, N. E. (2008). *How to design and evaluate research in education* (7th ed.). Boston ; London: McGraw-Hill Higher Education.
- Frailich, M., Kesner, M., & Hofstein, A. (2009). Enhancing Students' Understanding of the Concept of "Chemical Bonding" by Using Activities Provided on an Interactive Website. *Journal of Research in Science Teaching*, 46(3), 289-310.
- Gibbons, N. J., Evans, C., Payne, A., Shah, K., & Griffin, D. K. (2004). Computer simulations improve university instructional laboratories. *Cell biology education*, 3(4), 263-269.
- Glaserfeld, E. V. (1984). *An Introduction to Radical Constructivism*. In P. Watzlawick (Ed.), *The Invented Reality: How do we know what we believe we know?* (pp. 17-40). New York: Norton & Company, Inc.
- Graham, C. (2004). *Blended Learning Systems: Definition, Current Trends, And Future Directions*: Pfeiffer - An Imprint of Wiley.
- Greene, J., Caracelli, V. & Graham, W. . (1989). Toward a Conceptual Framework for Mixed-Method Evaluation Designs. *Educational Evaluation and Policy Analysis*. American Educational Research Association, 11(3), 255-274..
- Harrison, A. W. & Rainer, R. K. (1992). The Influence of Individual Differences on Skill in End-User Computing. *Journal of Management Information Systems*, 9(1), 93-111.
- Härtel, H. (2000). xyZET: A Simulation Program for Physics Teaching. *Journal of Science Education and Technology*, 9(3), 275-286.
- Hattie, J. (1999). *Influences on student learning*. University of Auckland.
- Henriques, L . (1997). *Constructivist Teaching And Learning*. California State University, Long Beach. *Faces of Constructivism*. Abstracted with author's permission from *A Study to*

- Define and Verify a Model of Interactive Constructive Elementary School Science teaching (1997, May). Unpublished Ph.D. Dissertation, University of Iowa. Iowa City. IA USA.
- Hewson, P. W., & Hewson, M. G. A. B. (1984). The Role of Conceptual Conflict in Conceptual Change and the Design of Science Instruction. *Instructional Science*., 13(1), 1-13.
- Higgins, S., Packard, N., & Race, P. (1999). *500 ICT Tips for primary teachers*. London. UK.: Kogan Page Limited.
- Hofstein, A & Mamlok-Naaman, R. (2007) The laboratory in science education: the state of the art. *Chemistry Education Research and Practice*, 2007, 8 (2), 105-107.
- House of Commons Science and Technology Committee. (2002). Third report. Science education from 14 to 19. London: HMSO. Retrieved February 27, 2007, from <http://www.publications.parliament.uk/pa/cm200102/cmselect/cmsctech/508/50802.htm>.
- House of Education. (2009a). Science textbook in Primary school in Kuwait. First edition, Weberson education. ISBN: 978-9953-495-02-6.
- House of Education. (2009b). Science textbook in Primary school in Kuwait. First edition, Weberson education. ISBN: 978-9953-495-03-3
- Hsu, Y.-S., & Thomas, R. A. (2002). The impacts of a web-aided instructional simulation on science learning. *International Journal of Science Education*, 24(9), 955-979.
- Huberty, C. J. (2002). A history of effect size indices. *Educational and Psychological Measurement*., 26, 227–240.
- Huppert, J., Lomask, S. M., & Lazarowitz, R. (2002). Computer Simulations in the High School: Students' Cognitive Stages, Science Process Skills and Academic Achievement in Microbiology. *International Journal of Science Education*, 24(8), 803-821.
- Jaakkola, T., & Nurmi, S. (2008). Fostering elementary school students' understanding of simple electricity by combining simulation and laboratory activities. *Journal of Computer Assisted Learning*, 24(4), 271-283.
- Jick, T. D. (1979). Mixing qualitative and quantitative methods: Triangulation in action. *Administrative Science Quarterly*, 24, 602-611.
- Jimoyiannis, A., & Komis, V. (2001). Computer simulations in physics teaching and learning: a case study on students' understanding of trajectory motion. *Computers & Education*, 36(2), 183-204.
- Kennepohl, D. K. (2001). Using computer simulations to supplement teaching laboratories in chemistry for distance delivery. *Journal of Distance Education*, 16(2), 58.
- Kiboss, J. K., Ndirangu, M., & Wekesa, E. W. (2004). Effectiveness of a Computer-Mediated Simulations Program in School Biology on Pupils' Learning Outcomes in Cell Theory. *Journal of Science Education and Technology*, 13(2), 207-213.
- Kind, P., Jones, K., & Barmby, P. (2007). Developing Attitudes towards Science Measures. *International Journal of Science Education*, 29(7), 871-893.
- Kluever, R. C., Lam T. C., Hoffman, E. R., Green, K. E., & Swearinges, D. L. . (1994). the Computer Attitude Scale: Assessing Changes in Teachers' Attitudes toward Computers. *Journal of Educational Computing Research*, 11(3), 251-261.



- Kluit, N. (2006). Multimedia Learning Theories and Online Instruction. *College & Research Libraries* 67 no 4. P. 364-9
- Krathwohl, D. R. (1998). *Methods of Educational & Social Science Research: An Integrated Approach. Second Edition*: Addison Wesley Longman, Inc.
- Krysa, R. (1998). Factors Affecting the Adoption and Use of Computer Technology in Schools. *Educational Communications and Technology*.
- Kumar, D. D., & Sherwood, R. D. (2007). Effect of a Problem Based Simulation on the Conceptual Understanding of Undergraduate Science Education Students. *Journal of Science Education and Technology*, 16(3), 239-246.
- Kuwait Information Office. (2006) Kuwait education overview [Online]. Mumbai: Kuwait Information Office. Available: [http://www.kuwait-info.com/sidepages/state\\_ministries\\_education.asp](http://www.kuwait-info.com/sidepages/state_ministries_education.asp).
- Kwiatkowski, J. (2000). *Questionnaires in Usability Engineering*. Cork, Ireland. 2nd edition. Human Factors Research Group..
- LeCroy, C. W., & Krysiko, J. (2007). Understanding and Interpreting Effect Size Measures. *Social Work Research*, 31(4), 243-243.
- Leonard, W.H. (1992) A comparison of student performance following instruction by interactive videodisc versus conventional laboratory, *Journal of Research in Science Teaching*, 29, pp. 93-102.
- Limniou, M., Papadopoulos, N., Giannakoudakis, A., Roberts, D., & Otto, O. (2007). Integration of a viscosity simulator in a chemistry laboratory. *Chemistry Education Research and Practice*, 8(2), 220-231.
- Liu, L., Hmelo-Silver, C. (2007). Computer-supported Collaborative Learning and Conceptual Change. Rutgers, the State University of New Jersey. p. 454-463
- Loveless, A. & Ellis, V. (2001) *ICT, Pedagogy and the Curriculum*. First published by RoutledgeFalmer.
- Lund, A. (2001). Measuring Usability with the USE Questionnaire. *STC Usability SIG Newsletter*.
- Manlove, S., Lazonder, A. W., & Jong, T. (2006). Regulative support for collaborative scientific inquiry learning. *Journal of Computer Assisted Learning*, 22(2), 87-98.
- Marbach-Ad, G., Rotbain, Y., & Stavy, R. (2008). Using computer animation and illustration activities to improve high school students' achievement in molecular genetics. *Journal of Research in Science Teaching*, 45(3), 273-292.
- Martinez-Jimenez, P., Pontes-Pedrajas, A., Polo, J., & Climent-Bellido, M. S. (2003). Learning in chemistry with virtual laboratories. *Journal of Chemical Education*, 80(3), 346.
- Marvin, M (1975). Patrick H. Winston, ed. *A Framework for Representing Knowledge* (The Psychology of Computer Vision ed.). New York: McGraw-Hill
- Mayer, R. E. (1983). *Thinking: Problem solving and Cognition*. New York. H. Freeman & Co.
- Mayer, R. E. (2009). *Multimedia Learning. Second Edition*: Cambridge University Press.
- McNamara, C. (1999). *General Guidelines for Conducting Interviews*. Minnesota University, Minnesota.

- Meadows, J. (2004). *Science and ICT in the primary school: a creative approach to big ideas*. London: David Fulton.
- Millar, R. & Driver, R. (1987). Beyond Processes, *Studies in Science Education*, 14:1, p. 33-62
- Mosteller, F. (1990). Improving research methodology: an overview. In L. Sechrest, E. Perrin, & J. Bunker (Eds.). *Research Methodology: Strengthening Causal Interpretations of Nonexperimental Data*. Department of Health and Human Services, Public Health Service, Agency for Health Care Policy and Research. Washington, D.C.: U.S., 105-114.
- National Research Council (NRC). (1996). National Science Education Standards. *Washington, DC: National Academy Press*.
- Norusis, M. J. (1998) *SPSS 8.0 Guide to Data Analysis*. Prentice Hall
- Oloruntegbe, K. O., & Alam, G. M. (2010). Evaluation of 3d environments and virtual realities in science teaching and learning: The need to go beyond perception referents. *Scientific Research and Essays*, 5(9), 948-954.
- Oppenheim, A. N. (1992). *Questionnaire design, interviewing and attitude measurement*. London: Continuum.
- Osborne, J., Simon, S., & Collins, S. (2003). Attitudes towards science: A review of the literature and its implication. *International Journal of Science Education*, 25(9), 1049–1079
- Ozdemir, G., & Clark, D. B. (2007). An Overview of Conceptual Change Theories. *Eurasia Journal of Mathematics, Science & Technology Education*, 3(4), 351-336.
- Ozmen, H. (2011). Effect of animation enhanced conceptual change texts on 6th grade students' understanding of the particulate nature of matter and transformation during phase changes. *Computers & Education*, 57(1), 1114-1126.
- Paivio, A. (1986). *Mental representations: A dual-coding approach*: New York: Oxford.
- Paivio, A. (2006). *Dual Coding Theory and Education*. Paper presented at the Pathways to Literacy Achievement for High Poverty Children, The University of Michigan School of Education.
- Papadouris, N., & Constantinou, C. P. (2009). A Methodology for Integrating Computer-Based Learning Tools in Science Curricula. *Journal of Curriculum Studies*, 41(4), 521-538.
- Patton, M. Q. (1990). *Qualitative evaluation and research methods*. Newbury Park, CA: Sage.
- Pea, R. D. (2004). The social and technological dimensions of scaffolding and related theoretical concepts for learning, education, and human activity. *The Journal of the Learning Sciences*, 13(3), 423-451.
- Piaget, J. & Inhelder, B. (1969). *The Psychology of the Child*. Translated from the French by Helen Weaver Basic Books. New York.
- Piaget, J. (1962). *Play, dreams and imitation in childhood*. New York: Norton. press
- Planning Department. (2009-2008). *Educational Statistical Group*. Ministry of Education. Kuwait.
- Posner, G. J., Strike, K. A., Hewson, P. W., & Gertzog, W. A. (1982). Accommodation of a scientific conception: Toward a theory of conceptual change. *Science Education*, 66, 211-227.

- Pritchard, A. (2005). Ways of Learning: Learning Theories and Learning Styles in the Classroom. *David Fulton Publishers*.(Journal Article).
- Richardson, V. (1997). Constructivist teaching and teacher education: Theory and practice. In V. Richardson (Ed.), *Constructivist Teacher Education: Building New Understandings* (pp. 3-14). Washington, DC: Falmer Press
- Ross, S. M. & Morrison. G. R. (2004). Experimental research methods, In D. J. Jonassen (Ed). *Handbook of research on educational communications and technology*, 2nd Ed., (pp. 1021-1043). Mahwah, NJ: Lawrence Erlbaum Associates, Publishers.
- Roulston, K. (2010). *Reflective interviewing: a guide to theory and practice*. London: SAGE. Routledge.
- Rovai, Al. (2007) A constructivist approach to online college learning. *Internet and Higher Education*, 7. 79–93
- Sale, J. E.M., Lohfeld, L.H.,&Brazil,K. (2002).Revisiting the quantitative-qualitative debate: Implications for mixed-methods research. *Quality & Quantity*, 36, 43-53.)
- Schaffer, S. P., & Richardson, J. C. (2004). Supporting Technology Integration within a Teacher Education System. *Journal of Educational Computing Research*, 31(4), 423-435.
- Schutez , P. A., Chambless, C., B , & DeCulir, J., T. (2004). Multi-methods research. University of Georgia. *Foundations for Research: Methods of Inquiry in Education and the Social Sciences” chapter (16)*. Lawrence Erlbaum. Mahwah, NJ.
- Selley, N. (2004). *The art of constructivist teaching in the primary school*: David Fulton Publishers.
- Shabaan, L., & Abdulrazik, E. (2008). Newly Science and math curriculum and educational dilemma. *Al-Qabas*.
- Shadish, W. R., Cook, T. D., & Campbel, D. T. (2002). *Experimental and Quasi-experimental Designs for Generalized Causal Inferenc.* . Paper presented at the Boston: Houghton-Mifflin.
- Sherwood, R. D., & Hasselbring, T. (1986). A Comparison of Student Achievement across Three Methods of Presentation of a Computer-Based Science Simulation. *Computers in the Schools.*, 2(4), 43-50.
- Skoumios, M., & Hatzinikita, V. (2005). The Role of Cognitive Conflict in Science Concept Learning. . *International Journal of Learning.*, 7(12), 186-194.
- Smeets, E. (2005). Does ICT contribute to powerful learning environments in primary education? *Computers & Education*, 44(3), 343-355.
- Smetanaa, L. & Bell, R. (2011). Computer Simulations to Support Science Instruction and Learning: A critical review of the literature. *International Journal of Science Education*, 1–34.
- Sobhi, T., & Abdullah, Z. (2003). Impact of learning with use a computer-assisted how to master the provisions Tajweed of talented students. *Journal of Educational Sciences*, 4, 89 - 124.
- Steinberg, R. N. (2000). Computers in teaching science: To simulate or not to simulate? *Phys. Educ. Res., Am. J. Phys. Suppl.* 68, 16-24.

- Stern, L., Barnea, N., & Shauli, S. (2008). The Effect of a Computerized Simulation on Middle School Students' Understanding of the Kinetic Molecular Theory. *Journal of Science Education and Technology*, 17(4), 305-315.
- Stieff, M., & Wilensky, U. (2003). Connected Chemistry: Incorporating Interactive Simulations into the Chemistry Classroom. *Journal of Science Education and Technology*, 12(3), 285-302.
- Sulaiman, A. (2007). Effective use of presentations in the teaching of artistic taste on cognitive achievement of middle school students in the city of Medina. *Journal of Educational and Social Studies*, 13(1), 96-125.
- Sun, K.-T., Lin, C.-L., & Wang, S.-M. (2009). A 3-D Virtual Reality Model Of The Sun And The Moon For E-Learning At Elementary Schools. *International Journal of Science and Mathematics Education*, 8(4), 689-710.
- Sun, K.-t., Lin, Y.-c., & Yu, C.-j. (2008). A study on learning effect among different learning styles in a Web-based lab of science for elementary school students. *Computers & Education*, 50(4), 1411-1422.
- Sweller, J. (1999). *Instructional Design in Technical Areas*. *Australian Education Review*, No. 43: PCS Data Processing.
- Talib, O., Matthews, R., & Secombe, M. (2005). Constructivist Animations for Conceptual Change: An Effective Instructional Strategy in Understanding Complex, Abstract and Dynamic Science Concepts. *Journal of Instructional Technology*, 2(3), 78-87.
- Tao, P. K., & Gunstone, R. F. (1999). The process of conceptual change in force and motion during computer-supported physics instruction. *Journal of Research in Science Teaching*, 36(7), 859-882.
- Taskin, N., & Kandemir, B. (2010). The affect of computer supported simulation applications on the academic achievements and attainments of the seventh grade students on teaching of science. *Procedia Social and Behavioral Sciences*, 9, 137-1384.
- Tastan, O., Yalcinkaya, E., & Boz, Y. (2008). Effectiveness of Conceptual Change Text-oriented Instruction on Students' Understanding of Energy in Chemical Reactions. *Journal of Science Education and Technology*, 17(5), 444-453.
- Tatli, Z., & Ayas, A. (2010). Virtual laboratory applications in chemistry education. *Procedia Social and Behavioral Sciences*, 9 P. 938–942.
- Tekos, G., & Solomonidou, C. (2009). Constructivist Learning and Teaching of Optics Concepts Using ICT Tools in Greek Primary School: A Pilot Study. *Journal of Science Education and Technology*, 18(5), 415-428.
- Triona L.M. & Klahr D. (2003) Point and click or grab and heft: comparing the influence of physical and virtual instructional materials on elementary school students' ability to design experiments. *Cognition and Instruction* 21, 149–173.
- Trundle, K. C., & Bell, R. L. (2010). The use of a computer simulation to promote conceptual change: A quasi-experimental study. *Computers & Education*, 54(4), 1078-1088.
- Tuysuz, C. (2010). The Effect of the Virtual Laboratory on Students' Achievement and Attitude in Chemistry. *International Online Journal of Educational Sciences*, 2(1), 37-53.

- Vrtacnik, M., Sajovec, M., Dolnicar, D., Pucko-Razdevsek, C., Glazar, A., & Brouwer, N. Z. (2000). An Interactive Multimedia Tutorial Teaching Unit and Its Effects on Student Perception and Understanding of Chemical Concepts. *Westminster Studies in Education*, 23(1), 91-105.
- Welker, J., & Berardino, L. (2006). Blended Learning: Understanding the Middle Ground between Traditional Classroom and Fully Online Instruction. *Journal of Educational Technology Systems*, 34(1), 33-55.
- Wellington, J. (1985). *Children, Computers and Curriculum, An introduction to information technology and education*. London: Harper & Row.
- Wellington, J. J. (1998). *Practical work in school science: which way now?* London: Routledge.
- Wellington, J. J. (2000). *Teaching and learning secondary science: contemporary issues and practical approaches*. London: Routledge.
- White, B., Kahriman, A., Luberice, L., & Idleh, F. (2010). Evaluation of Software for Introducing Protein Structure: Visualization and Simulation. *Biochemistry and Molecular Biology Education*, 38(5), 284-289.
- Wilson, N., McClean, S. I., & Information Technology Training, I. (1994). *Questionnaire design: a practical introduction*. Newtownabbey, Co. Antrim: University of Ulster.
- Windschitl, M., & Andre, T. (1998). Using Computer Simulations To Enhance Conceptual Change: The Roles of Constructivist Instruction and Student Epistemological Beliefs. *Journal of Research in Science Teaching*, 35(2), 145-160.
- Wu, H. K., Krajcik, J. S., & Soloway, E. (2001). Promoting understanding of chemical representations: Students' use of a visualization tool in the classroom. *Journal of Research in Science Teaching*, 38(7), 821-842.
- www.edumedia-sciences.com. Interactive simulations for science teaching.
- Yacoob, Q. (1982). *Child Development at Piaget*. Lebanese Book House. Beirut
- Yaremko, R. M., Harari, H., Harrison, R. C., & Lynn, E. (1986). *Handbook of Research and Quantitative Methods in Psychology: For Students and Professionals*: Lawrence Erlbaum Associates, Hillsdale, NJ.
- Zacharia, Z. (2003). Beliefs, attitudes, and intentions of science teachers regarding the educational use of computer simulations and inquiry-based experiments in physics. *Journal of Research in Science Teaching*, 40(8), 792-823.
- Zacharia, Z. C. (2005). The Impact of Interactive Computer Simulations on the Nature and Quality of Postgraduate Science Teachers' Explanations in Physics. *International Journal of Science Education*, 27(14), 1741-1767.
- Zacharia, Z. C. (2007). Comparing and combining real and virtual experimentation: an effort to enhance students' conceptual understanding of electric circuits. *Journal of Computer Assisted Learning*, 23(2), 120-132.
- Zacharia, Z. C., Olympiou, G., & Papaevripidou, M. (2008). Effects of experimenting with physical and virtual manipulative on students' conceptual understanding in heat and temperature. *Journal of Research in Science Teaching*, 45(9), 1021-1035.

Zacharia, Z., & Anderson, O. (2003). The effects of an interactive computer-based simulation prior to performing a laboratory inquiry-based experiment on students' conceptual understanding of physics. *American Journal of Physics*, 71, 618.

# **APPENDICES**

## APPENDIX 1: EDUCATION HISTORY OF KUWAIT

Before starting to review the history of education in Kuwait, it would be useful to present - in brief - a general picture of the country describing the location and historical emergence of the state of Kuwait. In order to explore the educational system of Kuwait from a historical perspective, we shall begin by describing the traditional educational system – informal education. This will then be followed by a detailed account of the establishment of modern, formal educational institutions in Kuwait.

### 1. Kuwait's Location and History

The State of Kuwait is located in the north-western corner of the Arabian Gulf (or Persian Gulf). It is bounded in the east by the Arabian Gulf, in the south and west by the Kingdom of Saudi Arabia, and in the north and the west by the Republic of Iraq.

The total area of Kuwait is 17,818 square kilometres (km) or approximately 7,000 square miles (Ministry of Planning, 2005, Statistics).

Historians have differing accounts about the origins of the State of Kuwait. According to one historian, a letter sent by Sheikh Mubarak Al-Sabah (1896-1942) to the British Resident mentioned that “Kuwait is a poor land, our grandfather Sabah came in 1022 (A.H.) corresponding to 1613 (A.D).” Although six rulers starting in 1776 (A.D.) ruled Kuwait before him, with many events and incidents contributing to the establishment of the State of Kuwait, Sheikh Mubarak Al-Sabah, who ruled Kuwait from 1896-1915, is considered the founding father of the State of Kuwait. In order to forestall attempts by neighbours (in particular, the Ottoman Empire) and certain tribes to take over Kuwait, Sheikh Mubarak entered into an agreement with Great Britain on 23 January 1899. This agreement stated that Kuwait is a self-governing country under British protection. At that time, the inhabitants (or peoples) of Kuwait were working in fishing, trading and pearl diving. Britain sent consultants to establish a burgeoning modern bureaucracy. (Center of Historic Documentations - Al Diwan Al Amiri, 2013)

Though Kuwait had been an independent political entity for more than two centuries, it only gained international recognition as a sovereign state in June 1961, a few weeks after which it joined the Arab League, and in 1963 became the 111th member to join the United Nations (Abu-Hakima, 1983; Al-Reshead, 1971).

In 1962, a Constituent Assembly passed the country's first constitution. Article 6 of the Kuwait Constitution states that:

“The system of Government in Kuwait shall be democratic, under which sovereignty is resident in the people, the source of all powers. Sovereignty shall be exercised in the manner specified in the constitution” (The Constitution of Kuwait, 2000).

### 2. History of Education Development in Kuwait

The history of education in Kuwait can be divided into two categories: informal education and formal education. The following is a brief overview of both types up to present-day modern formal education.

#### 2.1 Informal Education (1887 – 1911)

Kuwait, similar to the other Islamic countries, began education through taking an interest in teaching its people Islamic values. Therefore, the mosque was considered the main centre for teaching Islamic



principles, such as the method of prayers and religious education, including learning and memorising certain verses of the Qur'an and sayings of the Prophet Mohammed (hadiths). Oral education and learning were the main methods used for this purpose. Hence, it is clear that the students were not taught reading and writing skills in the correct way in order to become fully literate.

This early teaching system in mosques was dominant until the establishment of a new place and style of teaching known as Al-Kut'tab. "Alkatateeb" is a plural Arabic verbal noun literally meaning, places of writing, and hence places of teaching and schooling. This system was created by those who had memorised the Holy Qur'an and by other knowledgeable people in the religious and juridical sciences; they called the system for teaching males "Almullaah" and the system for teaching females "Almutawwa'a" – both are represented as the teacher in this day. Al-Kut'tab's importance lies mainly in being centres for teaching literacy, basic mathematics and recitation of the Holy Qur'an. It is important to point out that the state was not responsible for funding or establishing such places; this responsibility fell upon wealthy people who made (Awqaf) trusts to finance these Alkatateeb. These places, which played the role of primary schools in our current education system, had a very important position (Al-Shamlan, 1969).

During this period, some citizens who received a good education and those interested in education found that the Alkatateeb system of education must evolve because the Katateeb were unable to keep pace with modern life and the demands of the newly emerging Kuwaiti society. Therefore, they decided to establish an entirely new set of educational institutions that could provide more organised and formal schooling – instead of Katateeb – involving competent teachers who could properly teach children reading, writing and several branches of knowledge and compulsory attendance. This idea was presented to wealthier citizens and merchants who were asked to make donations to establish formal schools. Because these Kuwaiti citizens believed in the importance of education, they raced to donate. So, for example, someone (Hamad Alkhaled Alkhoder) donated his land for the building of a school, while other wealthy individuals provided financial support for school construction. And that is how formal education was launched in Kuwait (Ibid, 1969 ).

## **2.2 Formal Education (1911 – 1961)**

Through donations made by Kuwait's wealthier citizens and merchants, the first school was established in Kuwait in 1911 and was named Al-Mubarekiyah School. In the beginning, only reading, writing and basic mathematics were taught there. Afterward, Al-Ahmediyah School was opened in 1921 in the era of Sheikh Ahmad Al-Jaber, in which the English language was taught in addition to mathematics, reading and writing. Subsequently, many other schools were opened, such as Al-Saadah School, which focused on educating poorer children and orphans. The number of schools kept increasing due to the support of wealthier citizens and merchants. In the 1920s, the Kuwaiti economy suffered a serious collapse of its pearl trade. This crisis also affected education more generally as support dwindled and led to the closure of some schools and a decline in the standards of others. Wealthy donors were unable to provide funding or other forms of support to schools, such as buildings, furniture and books, which probably led to a decline in education. Therefore, educators and citizens called on the government to support education. In 1936, Kuwaiti ruler Sheikh Ahmad Al-Jaber ordered the establishment of the "Al-Ma'arf" Council (i.e. Council of Education or Knowledge). This council laid the foundations for the Ministry of Education and consisted of 12 elected members and was presided over by a member of the ruling family. Its objectives were as follows:

1. To provide education under the supervision of the government
2. To draw up plans and organize education development
3. To specify the financial resources required for operating educational institutions

After education became subject to government supervision, teachers were recruited from neighboring countries, such as Palestine and Egypt, in order to benefit from their administrative and educational experience. Many schools were established, including the first school for girls, called Al-Westia School, which was opened in 1937, followed by the Al-Qabilyah School. Education made substantial progress between 1936 and 1973 through the addition of new subjects to the curriculum, such as Islamic history, principles of geography and principles of mathematics, which included geometry and integral calculus, as well as basic subjects like reading and writing. In the 1945-1946 academic year, there were 12 schools that were under the supervision of Council of Education: a secondary school for boys, seven primary schools for boys, and four primary schools for girls in which there were 2,815 boy students and 820 girl students taught by 108 male teachers and 34 female teachers, all of them separately – boys' schools are separate from girls' schools to this day.

In 1955, after a huge expansion in the number of schools and their types and levels, the education process was reorganised and the educational ladder or scale was rearranged as follows:

- Two years of kindergarten (optional not obligatory): 5 – 6 years old
- Four years of primary stage (obligatory): 7 – 10 years old
- Four years of intermediate stage (obligatory): 11 – 14 years old
- Four years of secondary stage (optional): 15 – 18 years old

This scale continued to be used until Kuwait gained independence in 1961 (Barakat, 1967, Al-Abdulghafoor, 1983, Al-Jasem, 1992).

### **2.3 Establishment of the Ministry of Education (1962)**

After Kuwait became independent in 1961, the first Ministry of Education was established and the basic objectives of the Ministry were stipulated in 1967. With the population growth in Kuwait, the number of students and schools increased. Ministry of Education statistics referred to a huge increase in the number of the students from 600 in 1936 to 561,826 in 2009. This increase was accompanied by an expansion in the number of schools, rising to 1,359 for all stages in 2009. Also, the number of teachers increased from 26 in 1936 to 67,015 in 2009. Moreover, due to the persistent efforts of the Ministry, illiteracy rates in Kuwait were reduced from 57% in 1965 to less than 4.1% among men and 6% among women in 2009. These rates attest to the strong interest of the State of Kuwait in developing education among its citizens.

The first governmental university called “Kuwait University” was established in 1966. This was followed by the establishment of the Public Authority for Applied Education and Training (PAEET) in 1982. Under its auspices, the Institute of Teachers was established, which became the College of Basic Education in 1993 for qualifying specialised teachers for the primary stages of various subjects, such as the Arabic language, Islamic religion, history, physical education, art education and the English language. Each teacher taught subject a separate (there is no comprehensive teacher for classroom in all educational stages)

### **2.4 Changing Educational Scale Policy (2004-2005)**

To cope with the new, modern educational systems both at the global and local levels, the Ministry of Education introduced a new educational ladder or scale in 2004-2005 to replace the old one (four years each of primary, intermediate, and secondary, which had been applicable since 1955). The new educational ladder or scale consists of:

- Two years of kindergarten (optional not obligatory): 5 – 6 years old
- Five years of primary stage (obligatory): 7 – 11 years old
- Four years of intermediate stage (obligatory): 12 – 15 years old
- Three years of secondary stage (optional): 16 – 18 years old

**The reasons behind the change of the educational scale:**

1. To take into account children’s growth characteristics and students’ needs at different stages (childhood, adolescence and youth); in particular, to provide a proper educational environment to children in primary school as well as in late childhood, which ranges from ages 6 to 11 and has its specific social, physical, mental and psychological growth characteristics.
2. To provide an attractive environment for growth, so that students are transferred to the intermediate stage at a proper age unlike the old educational ladder or scale.
3. To add one year to obligatory education, making it nine years (five years of primary and four of intermediate) instead of eight years in the old educational scale (four years of primary and four of intermediate).
4. To assist students in completing the intermediate stage after selecting the proper type of secondary education that satisfies their desires and capabilities, and ensure that students are mature enough to make this selection after nine years of education.

**2.5 Change Science Curriculums for Primary School (2008 -2010)**

After changing the education ladder or scale, textbooks were developed and revised to accord with the new educational ladder and learners’ growth. The science curriculum was one of the areas targeted for improvement given that science teaching had not changed in 20 years (the old curriculum was added in 1987). The new curriculum began to be followed in the 2008-2009 academic year for the first three grades and in the 2009-2010 academic year for the fourth, fifth, sixth and seventh grades.

This study attempts to achieve the aim of changing the science curriculum, particularly for the fifth grade, through seeking possibilities of benefiting from simulation program characteristics to develop and improve the academic achievement of students, challenge misconceptions, and change students’ attitudes towards learning science.

APPENDIX 2: The Educational Research and Curricula sector, curricula development department letter

The Educationl Research and Curricula Sector		قطاع البحوث التربوية والمنهاج
Curricula Development Department	وزارة التربية	إدارة تطوير المناهج

التاريخ : / / ١٤	الرقم : وت / 360 / ٣٦
الموافق 2009/11/24	مرفقات:

**To Whom Concern**

This is to inform you that the science curriculums in the State of Kuwait has been changed as following:

- 1- Grades (1,2,3) for the school year 2008/2009.
- 2- Grades (4,5,6,7) for the school year 2009/2010 .
- 3- Grades (8,.....etc) will change later on .

Sincerely ,  
Head Director of Curricula Development Department

Dr. squd Alharbi

  
مديرة إدارة تطوير المناهج  
وزارة التربية  
إدارة تطوير المناهج

Copy to:  
- File .  
- science unit.

ص.ب : ٧ الصفاة - الرمز البريدي 13001 الكويت - هاتف : ٤٨٤٢٤٠٥ - فاكس : ٤٨٣٧٨٩٨ P.O.Box : 7 Safat - Code No. 13001 KUWAIT - Tel.: 4842405 - Fax : 4837898 www.moe.edu.ku manahij@moe.edu.kw
---

**APPENDIX 3: Letter from the first primary school which involved in second experimental group**

**AL-CANADY**  
Translation Co.

  
**الكندي**  
State of Kuwait

**شركة  
الكندي  
للترجمة**

**Ministry of Education**  
**Al Jahra Educational Area**

**Rahiyah School A/ for Girls** corresponding to:21/12/2011

**To Whom It May Concern**

You are kindly informed that that /Mr. / Hasan M Alfajjam, Ph.D Student at Durham University, has visited our school : Rahiyah School A/ for Girls for the academic year 2010/2011 to make an experiment in our school using Data Show for searching to what extent the use of Simulation Program in teaching the science subject for the fifth grade has an effect on the scientific collection of the students and their attitude in learning the science subject.

**School's Principal**  
**Awatef Al Hadeb**  
**(Sealed and Signed)**

Seal: State of Kuwait, Ministry of Education, Public Department of Al Al Jahra Educational Area, Rahiyah School A/ for Girls

هذه ترجمة صحيحة للنص المرفق  
باللغة العربية  
Certified True and Correct Translation  
of The Attached Text in English

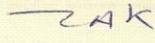
  
27/12



الكويت - حولي - شارع ابن خلدون الرئيسي - مجمع الغريب - بجانب بنك بيت التمويل الكويتي - تلفون: ٢٢٦٤٤٣٥٠ - ٢٢٦٤٤٣٥٥ (+٩٦٥)  
Kuwait - Hawalli - Ibn Khaldoon St. - Al-Ghareeb Commercial Complex - Beside KFH Branch - Tel.: (+965) 22644350 - 22644355  
E-mail: al-canady\_translation@hotmail.com

**APPENDIX 4: Letter from the second primary school which involved in first experimental group**

**AL-CANADY**  
Translation Co.

  
الكندي  
State of Kuwait  
Ministry of Education

شركة  
الكندي  
للترجمة

**Public Department of Mubarak Al Kabeer Educational Area**

**Abdulwahab Al Fares School A/ Boys**  
**Thursday corresponding to 15/12/21011**

**To Whom It May Concern**

The Department of Abdulwahab Al Fares School A/ Boys certifies that / Mr. / Hasan M Alfajjam , Ph.D Student at Durham University, has made an experiment in our school for the academic year 2010/2011 using Computer Lab for searching to what extent the use of Simulation Program in teaching the science subject for the fifth grade has an effect on the scientific collection of the students and their attitude in learning the science subject.

**School's Principal**  
**(Sealed and Signed)**

Seal: State of Kuwait, Ministry of Education, Public Department of Mubarak Al Kabeer Educational Area. Abdulwahab Al Fares School A/ Boys

هذه ترجمة صحيحة للنص المرفق  
باللغة العربية  
Certified True and Correct Translation  
of The Attached Text in Arabic

  
ZAK  
27/12

الكويت - حولي - شارع ابن خلدون الرئيسي - مجمع الغريب - بجانب بنك بيت التمويل الكويتي - تلفون: ٢٢٦٤٤٣٥٥ - ٢٢٦٤٤٣٥٠ (+٩٦٥)  
Kuwait - Hawalli - Ibn Khaldoon St. - Al-Ghareeb Commercial Complex - Beside KFH Branch - Tel.: (+965) 22644350 - 22644355  
E-mail: al-canady\_translation@hotmail.com

**APPENDIX 5: Letter from the third primary school which involved in first experimental group**

**AL-CANADY**  
Translation Co.

  
**الكندي**  
State of Kuwait  
Ministry of Education  
Public Department of Capital Educational Area

**شركة الكندي للترجمة**

**Eshbilyah Elementary School for Girls**  
**Date: 19/12/2011**

**To Whom It May Concern**

Eshbilyah Elementary School For Girls certifies that / Mr. / Hasan M Alfajjam , Ph.D Student at Durham University, has made an experiment in our school for the academic year 2010/2011 using Computer Lab for searching to what extent the use of Simulation Program in teaching the science subject for the fifth grade has an effect on the scientific collection of the students and their attitude in learning the science subject.

**School's Principal**  
**Fawziyah Al Shatti**  
**(Sealed and Signed)**

Seal: State of Kuwait, Ministry of Education, Public Department of Al Capital Educational Area, Eshbilyah Elementary School for Girls



هذه ترجمة صحيحة للنص المرثق  
باللغة .....  
Certified True and Correct Translation  
of The Attached Text in English

— ZAK  
28/12



الكويت - حولي - شارع ابن خلدون الرئيسي - مجمع الغريب - بجانب بنك بيت التمويل الكويتي - تلفون: ٢٢٦٤٤٣٥٠ - ٢٢٦٤٤٣٥٥ (+٩٦٥)  
Kuwait - Hawalli - Ibn Khaldoon St. - Al-Ghareeb Commercial Complex - Beside KFH Branch - Tel.: (+965) 22644350 - 22644355  
E-mail: al-canady\_translation@hotmail.com

**APPENDIX 6: Letter from the fourth primary school which involved in first experimental group**

**الكندي**  
للترجمة  
شركة

**الكندي**  
State of Kuwait

**Ministry of Education**  
**Public Department of Hawally Educational Area**

**Mohamed Al Shaiji Elementary School – Boys**  
**Date: 18/12/2011**

**To Whom It May Concern**

The Department of Mohamed Al Shaiji Elementary School for Boys certifies that / Mr. / Hasan M Alfajjam, Ph.D Student at Durham University, has made an experiment in our school for the academic year 2010/2011 using Computer Lab for searching to what extent the use of Simulation Program in teaching the science subject for the fifth grade has an effect on the scientific collection of the students and their attitude in learning the science subject.

**School's Principal**  
**Roqaiyah Sayed Muslim**  
**(Sealed and Signed)**

Seal: State of Kuwait, Ministry of Education, Public Department of Al Hawally Educational Area, Mohamed Al Shaiji Elementary School – Boys

هذه ترجمة صحيحة للنص المرفق  
باللغة العربية  
Certified True and Correct Translation  
of the Attached Text in Arabic

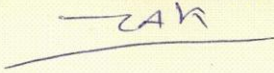



الكويت - حولي - شارع ابن خلدون الرئيسي - مجمع الغريب - بجانب بنك التمويل الكويتي - تلفون: ٢٢٦٤٤٣٠٠ - ٢٢٦٤٤٣٥٥ (+٩٦٥)  
Kuwait - Hawally - Ibn Khaldoon St. - Al-Ghareeb Commercial Complex - Beside KFH Branch - Tel.: (+965) 22644350 - 22644355  
E-mail: al-canady\_translation@hotmail.com



**APPENDIX 7: Letter from the fifth primary school which involved in first experimental group**

**AL-CANADY**  
Translation Co.

  
الكندي  
State of Kuwait

شركة  
الكندي  
للترجمة

**Ministry of Education**  
**Public Department of Hawally Educational Area**

**Arwa Bent Al Hareth School / for Girls**  
**Member of Schools' network Affiliating to UNSECO**

**To Whom It May Concern**

The School's Department certifies that / Mr. / Hasan M Alfajjam ,  
Ph.D Student at Durham University, has made an experiment in our  
school for the academic year 2010/2011 using Computer Lab for  
searching to what extent the use of Simulation Program in teaching the  
science subject for the fifth grade has an effect on the scientific  
collection of the students and their attitude in learning the science subject.

**School's Principal**  
**Baderiya Al Badiah**  
**(Sealed and Signed)**

Seal: State of Kuwait, Ministry of Education, Public Department of Al  
Hawally Educational Area, Arwa Bent Al Hareth School / for Girls

هذه ترجمة صحيحة للنص المرفق  
باللغة العربية  
Certified True and Correct Translation  
of The Attached Text in Arabic

  
27/12



الكويت - حولي - شارع ابن خلدون الرئيسي - مجمع الغريب - بجانب بنك بيت التمويل الكويتي - تلفون: ٢٢٦٤٤٣٠ - ٢٢٦٤٤٣٥ (+٩٦٥)  
Kuwait - Hawalli - Ibn Khaldoon St. - Al-Ghareeb Commercial Complex - Beside KFH Branch - Tel.: (+965) 22644350 - 22644355  
E-mail: al-canady\_translation@hotmail.com

**APPENDIX 8:** Letter from the sixth primary school which involved in second experimental group

**AL-CANADY**  
Translation Co.

**الكندي**  
للترجمة

**الكندي**  
State of Kuwait  
Ministry of Education

**Al Farwaniya Educational Area**  
**Al Omariya Elementary School for Boys**

**To Whom It May Concern**

School's Department certifies that /Mr. ./ Hasan M Alfajjam , Ph.D Student at Durham University, has made an experiment in our school for the academic year 2010/2011 using Data Show for searching to what extent the use of Simulation Program in teaching the science subject for the fifth grade has an effect on the scientific collection of the students and their attitude in learning the science subject.

**School's Principal**  
**Hanadi Al Mahmoud**  
**(Sealed and Signed)**

Seal: State of Kuwait, Ministry of Education, Public Department of Al Farwaniya Educational Area, Al Omariya Elementary School for Boys

هذه ترجمة صحيحة للنص المرفق  
باللغة العربية  
Certified True and Correct Translation  
of The Attached Text in Arabic

**ZAK**  
**27/12**

الكويت - حولي - شارع ابن خلدون الرئيسي - مجمع الغريب - بجانب بنك بيت التمويل الكويتي - تلفون: 22644350 - 22644355 (+965)  
Kuwait - Hawalli - Ibn Khaldoon St. - Al-Ghareeb Commercial Complex - Beside KFH Branch - Tel.: (+965) 22644350 - 22644355  
E-mail: al-canady\_translation@hotmail.com

APPENDIX 9: Letter from the seventh primary school which involved in second experimental group

**AL-CANADY**  
Translation Co.

**الكندي**  
للترجمة

شركة  
الكندي  
للترجمة

State of Kuwait  
Ministry of Education  
Public Department of Al Ahmadi Educational Area

Maryam Hamad Bodi School A/ for Girls Monday: 19/12/2011

**To Whom It May Concern**

School's Department certifies that /Mr./ Hasan M Alfajjam, Ph.D Student at Durham University, has made an experiment in our school for the academic year 2010/2011 using Data Show for searching to what extent the use of Simulation Program in teaching the science subject for the fifth grade has an effect on the scientific collection of the students and their attitude in learning the science subject.

School's Principal  
Eman Al Shatti  
(Sealed and Signed)



Seal: State of Kuwait, Ministry of Education, Public Department of Al Ahmadi Educational Area, Maryam Hamad Bodi A/ for Girls

هذه ترجمة صحيحة للنص المرافق  
باللغة العربية  
Certified True and Correct Translation  
of The Attached Text in Arabic

— ZAK  
27 / 12

الكويت - حولي - شارع ابن خلدون الرئيسي - مجمع الغريب - بجانب بنك بيت التمويل الكويتي - تلفون: ٢٢٦٤٤٣٥٠ - ٢٢٦٤٤٣٥٥ (+٩٦٥)  
Kuwait - Hawalli - Ibn Khaldoon St. - Al-Ghareeb Commercial Complex - Beside KFH Branch - Tel.: (+965) 22644350 - 22644355  
E-mail: al-canady\_translation@hotmail.com

**APPENDIX 10:** Letter from the eighth primary school which involved in second experimental group



**الكندي**  
للترجمة

**الكندي**  
Translation Co.

**الكندي**  
للترجمة

**شركة**

**To Whom It May Concern**

Department of Fahad Al Askar Elementary School for Boys certifies that Mr./ Hasan M Alfajjam , Ph.D Student at Durham University , has made an experiment in our school for the academic year 2010/2011 using the data show for searching to what extent the use Simulation Program in teaching science subject for the fifth grade has an effect on the scientific collection of the students and their attitude in learning science subject.

School's Principal  
Nora Al Ojman  
(Sealed and Signed)

Seal: state of Kuwait, Ministry of Education, Educational Capital Area,  
Fahad Al Askar Elementary School for Boys.

هذه ترجمة صحيحة للنص المرفق  
باللغة العربية  
Certified True and Correct Translation  
of The Attached Text in Arabic

ZAK  
27/12



الكويت - حولي - شارع ابن خلدون الرئيسي - مجمع الغريب - بجانب بنك بيت التمويل الكويتي - تلفون: ٢٢٦٤٤٣٥٠ - ٢٢٦٤٤٣٥٥ (+٩٦٥)  
Kuwait - Hawalli - Ibn Khaldoon St. - Al-Ghareeb Commercial Complex - Beside KFH Branch - Tel.: (+965) 22644350 - 22644355  
E-mail: al-canady\_translation@hotmail.com

**APPENDIX 11:** Letter from the edu-media company (www.edumedia-sciences.com) which has been deal with them in the use of interactive computer simulation software (ICSS) in science education in this study



05/02/2010

Charles Sol  
director  
41 rue Sofie  
33300 Bordeaux  
Tel. : 33 (0) 651 851 392  
Fax. : 33 (0) 557 871 292

sol@edumedia-sciences.com

**To whom it may concern,**

---

I, Charles Sol, certify that PhD student Hasan Alfa<sup>j</sup>am from Durham University UK, has register to eduMedia online teaching content. I support him to apply to the PhD dealing with the Effectiveness of Computer Simulation in Science Education (ECSSE) to enhance conceptual change and student academic achievement in primary schools.

eduMedia has developed a specific website for primary level (<http://junior.edumedia-sciences.com/en/rt-about>). Because eduMedia content is downloadable, it allows teachers and researchers to embed the content in various environments.

Best regards

A handwritten signature in blue ink, consisting of several loops and vertical strokes, representing the name Charles Sol.

Charles Sol  
Director

APPENDIX 12: Food chain lesson test (In Arabic)

**الإجابة النموذجية**

اختبار علوم للصف الخامس للدراس  
الثاني من الفصل الثالث (الموطن  
البيئي للكائنات الحية) الفصل  
الدراسي الأول



وزارة التعليم  
المملكة العربية السعودية

---

الاسم: .....

الصف الخامس / .....

منطقة: .....

مدرسة: .....

---

**السؤال الأول:** ضع علامة (✓) أمام العبارة الصحيحة وعلامة (✗) أمام العبارة الغير صحيحة:

- 1- (✓) الموطن الطبيعي هو توفر الحاجات الأساسية لحياة الكائن الحي. ✓
- 2- (x) القوارض لها فرصة ضئيلة في الحياة في حالة نقص عدد النباتات. ✓
- 3- (✓) إذا كثرت الأمطار في أي بيئة فإن عدد الحيوانات يزيد. ✓
- 4- (x) إذا قل عدد الحيوانات اللاحمة في أي سلسلة غذائية فإن عدد الحيوانات (الحيثية) يقل. ✓

---

**السؤال الثاني:** أكمل الجارات التالية بالكلمة العلمية المناسبة:

4

- الضفدع يتغذى على ..... الحشرات.....
- .....النبات..... هي أول حلقة في السلسلة الغذائية.
- مصدر طاقة النباتات هي .....الشمس.....
- السلسلة الغذائية الكثيرة تسمى .....الشبكة الغذائية.....

---

**السؤال الثالث:** ماذا توقع أن يحدث؟

- إذا رشحت المحقول الزراعية بالمبيدات الحشرية
- ✓ يقل عدد الحشرات في البيئة المحيطة
- ✓ تنوثر الموطن الطبيعي للقران
- ✓ يقل عدد القوارض

---

**السؤال الرابع:** رتب السلسلة الغذائية تصاعدياً:

5

20

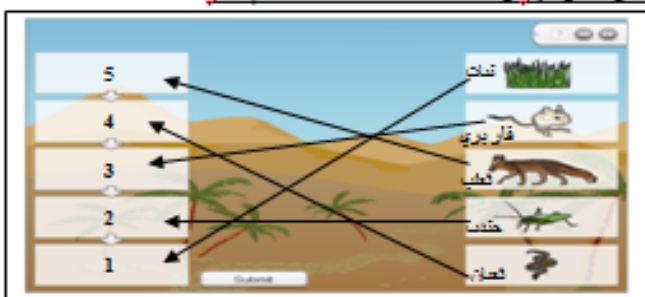

APPENDIX 12: Food chain lesson test (In English)



Science Examination for Fifth Grade  
 Second Lesson of Third Chapter  
 (Environmental Home of Living Creature)  
 First Semester

District:   
 School:

Name:   
 Class 5:

**First Question: Put (True) or (False)**

- 1- The natural homeland is providing the basic living requirements for the living creature ( )
- 2- Rodents have a little chance in live in case of reducing the plants. ( )
- 3- If the rains are more in any environment, the number of animals will increase. ( )
- 4- If number of carnivorous animals is more in any food chain, the number of herbivore animals is less. ( )

8

**Second Question: Fill in spaces:**

- The frog is feeds on ----- insects .....
- ----- Plants ----- is the first episode in the nutrition chain.
- Source of the plants energy is ----- the sun .....
- The nutrition chains are called ----- nutrition cycle.

4

**Third Question: What do you expect in the following cases:**

- If the agricultural fields are sprayed by the insecticide.  
 .....
- Pollution of the natural homeland for the rats.

3

**Fourth Question: Arrange ascending of the nutrition chain:**

5

20

APPENDIX 13: Circulatory & digestive system lesson test (In Arabic)

**الإجابة الصحيحة**

مادة الحياة

المعلم: .....  
الصف: (.....)

المعلم: .....  
الصف: (.....)

السؤال الأول: ضع علامة (✓) أمام العبارة الصحيحة وعلامة (✗) أمام العبارة الغير صحيحة:

1- (✓) أسنان الإنسان مثله.

2- (✓) يتم التخلص من الفضلات عن طريق الأمعاء الدقيقة.

3- (✓) يتكون الدم من كريات دم حمراء وبيضاء فقط.

4- (✓) الذي يساعد على توقف النزيف لدى الإنسان هو كريات الدم البيضاء.

5- (✓) الدم يفرغ من القلب إلى المعدة.

6- (✓) القلب يتكون من عضلات ودم.

---

السؤال الثاني: أكمل العبارات التالية بالكلمة العلمية المناسبة:

أهم جزء من أجزاء الجهاز الهضمي هو المعدة.

الرئة تضع غز الدم في شرايين الدم.

يتنقل الدم إلى جميع أجزاء الجسم بمساعدة القلب.

الإنزيمات تساعد الفم على تقطيع وطحن الطعام.

تنقل المغذيات من الأمعاء الدقيقة إلى الدم عن طريق الشعيرات الدموية.

---

السؤال الثالث: ماذا تتوقع أن يحدث؟

- إذا قلت نسبة كريات الدم البيضاء في الجسم.

..... يتعرض الإنسان لأمراض لأنها تحيط بالجرح وتمنع دخولها.....

- إذا حدث انسداد بالشرايين.

..... لا يصل الدم إلى جميع أجزاء الجسم.....

---

السؤال الرابع: اختر الإجابة الصحيحة علمياً لكل من العبارات التالية:

1- جزء من أجزاء الجهاز الهضمي ينقل الطعام من الفم إلى المعدة

أ. الأمعاء الدقيقة      ب. الأمعاء الغليظة      ج. المريء      د. اللسان

2- جزء من أجزاء الجهاز الدوري يقوم بنقل الدم من القلب إلى أجزاء الجسم

أ. شريان      ب. ورع      ج. شعيرات دموية      د. الطعام

السؤال الخامس: اكتب أسماء أجزاء الجهاز الهضمي:

5

30



**APPENDIX 13: Circulatory & digestive system lesson test (In English)**



State of Kuwait  
Ministry of Education

**Science Examination for Fifth Grade**  
**Second Unit**  
**(First Chapter – Digestive and Circulatory System)**

Name:   
Class 5:

District:   
School:

**First Question: True or False**

- The man's teeth are similar ( )
- The wastes are got rid of through large intestine ( )
- The blood is consisting of white and red cells only ( )
- The white cells are assisting to cease hemorrhage ( )
- The esophagus is taking the food of the mount to the stomach ( )
- The heart consists of ventricles and arteries ( )

**Second Question: Complete the sentence with the proper expression**

- The important part of the digestive system is ( )
- The lung pushes ( ) to the blood arteries.
- The blood is transferred to all the body parts with assistance of ( )
- ( ) are assisting the mouth to cut and grind the food.
- The nutrients are transferred from the intestine to the blood through ( )

**Third Question: What do you expect in the following cases:**

- If the white cells are reduced in the blood
- If a blockage is occurred in the arteries.

**Fourth Question: Select the correct answer**

- A part of the digestive system is transferring the food from the mouth to the stomach:  
a) Small intestine    b) Large intestine    c) esophagus    d) Tongue
- A part of the circulatory system transfers the blood to the remaining human parts:  
a) Artery    b) Veins    c) bloody capillary    d) food

**Fifth Question: Write the Part's Name:**

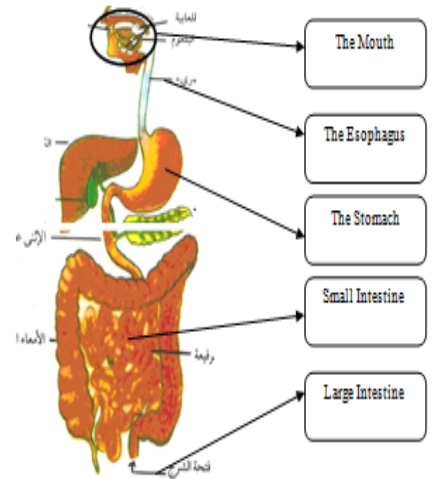

APPENDIX 14: Electric circuit lesson test ( In Arabic)

اسم الطالب: \_\_\_\_\_  
 الصف: \_\_\_\_\_  
**اختبر 1 الدارة الكهربائية**  
**قبل التجربة**

السؤال الأول: ضع دائرة على الإجابة الصحيحة لعدة المصباح :-

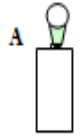
A 

6

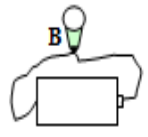
B  لا يضيء / يضيء

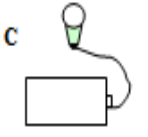
C  لا يضيء / يضيء

D  لا يضيء / يضيء

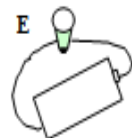
E  لا يضيء / يضيء

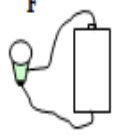
F  لا يضيء / يضيء

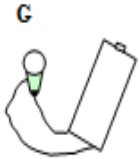
G  لا يضيء / يضيء

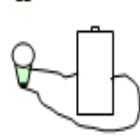
H  لا يضيء / يضيء

I  لا يضيء / يضيء

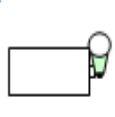
J  لا يضيء / يضيء

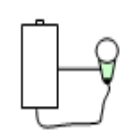
K  لا يضيء / يضيء

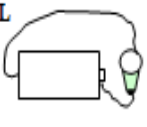
L  لا يضيء / يضيء

السؤال الثاني: أتمم المخططات على الرسم التالي:

1 - تامل الصورة التالية دائرة كهربائية، وهي دائرة التوصيل على .....

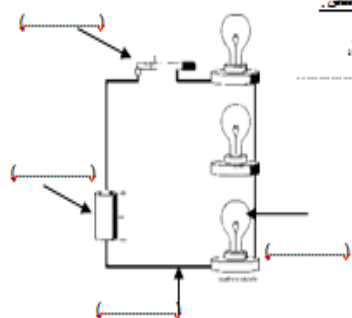

5

السؤال الثالث: أجب عن المطلوب فيما يلي:

1- قمت بإجراء التجربة الموضحة بالرسم في المختبر، ومنها تم تسجيل النتائج التالية

- الدارة الأكثر استخدامًا في حياتنا يرمز لها بالرمز ..... وتسمى بدارة .....
- إذا قمت بإطفاء أحد المصابيح في النموذج ب، ستكون الدارة .....
- إذا أضفت مصباحًا رابعًا لكل الدوائر، ستكون الإضاءة ضعيفة في الدارة .....
- الدارة (ب) تسمى توصيل .....

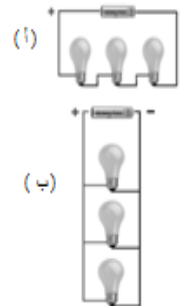

البيوت الرابع: أجب عن المطلوب فيما يلي:

1- أمانك دائرة توصيل كهربائية مكونة من (3 مصابيح، أسلاك، بطارية).

• ماذا تلاحظ على الدارة الكهربائية عند احتراق أحد المصابيح؟

• ما هو استنتاجك؟

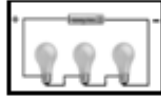

4

السؤال الخامس: ما هو الوضع الصحيح بالنسبة لسريان التيار الكهربائي؟

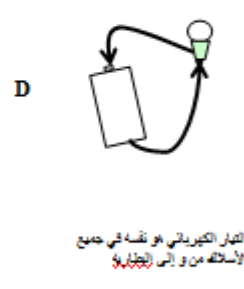
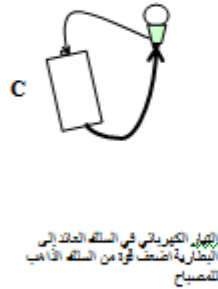
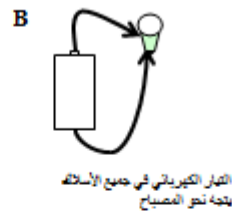
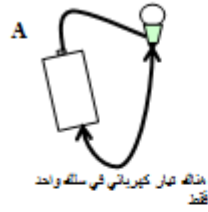

2

22

منهنا لكم بالتوفيق

# APPENDIX 14: Electric circuit lesson test (In English)



Science Examination for Fifth Grade  
Electric Circle

District: \_\_\_\_\_  
School: \_\_\_\_\_  
Name: \_\_\_\_\_  
Class 5: \_\_\_\_\_

**First Question: Select the Correct Answer**

 A	 B	 C	<div style="border: 1px solid black; width: 20px; height: 20px; display: flex; align-items: center; justify-content: center;">6</div>
Lighting/ Not Lighting	Lighting/ Not Lighting	Lighting/ Not Lighting	
 D	 E	 F	
Lighting/ Not Lighting	Lighting/ Not Lighting	Lighting/ Not Lighting	
 G	 H	 I	
Lighting/ Not Lighting	Lighting/ Not Lighting	Lighting/ Not Lighting	
 J	 K	 L	
Lighting/ Not Lighting	Lighting/ Not Lighting	Lighting/ Not Lighting	

**Second Question:**

2. The following picture is representing an electric circuit and it connecting circuit on .....

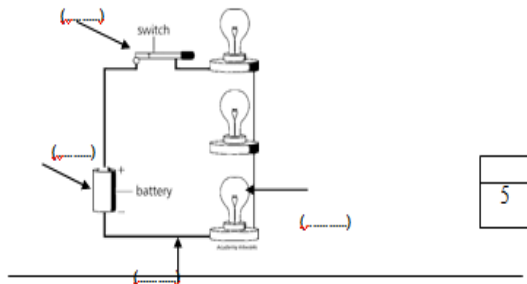

5

**Third Question: Answer the following:**

- You have conducted the shown experiment on the diagram in the laboratory, and you have registered the following notes:
  - The circuit the most usable in our life is symbolizing by: ..... and it is called .....
  - If you turn off any of the lights mentioned in diagram b, the circle will be .....
  - If you add a fourth light for the both circle, the light will be weak in the circle .....
  - Circle no. b is called ..... connection

5

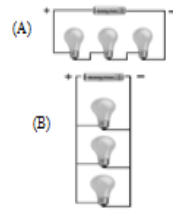

**Fourth Question: What is the correct position for the electric current flow.**

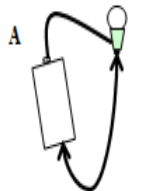

There is only electric current in one cable only.

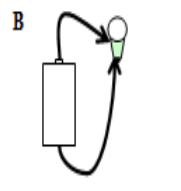

The Electric current in all cables go to the light

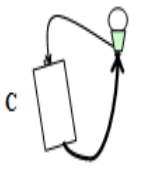

The electric current in the cable attribute to the battery is weaker than the cable's strentheminz in the cable

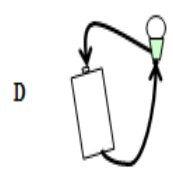

The electric current is the same in all cables to the

2

**The Fifth Question: Answer the Following**

- Here is an electric circle consisting of 3 lambs, wires and battery:
  - What are your notes of the electric circle when burning of any lambs?
  - What is your conclusion

4

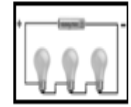

22

Good luck

**APPENDIX 15:** The pre and post of questionnaire (in Arabic) for the students to measure the attitude for them toward science teaching and learning

اسم الطالب (اختياري): .....

الصف: الخامس/ .....

**تقييم قياس اتجاهات الطلبة في تعلم العلوم للصف الخامس (قبلي / بعدي)**

بناء على الوضع الحالي في تعلم العلوم، تحتوي هذه الاستبانة على مجموعة من العبارات التي تعبر عن مدى اهتمام الطالب بمادة العلوم.

ضع في عين الاعتبار أن هذه استبانة وليست اختبار فالإجابات لا تحمل الخطأ أو الصواب. نريد أن نعرف ما هو رأيك؟ لذا يرجى اختيار

واحدة من الخياران الخمسة كما هو موضح بالجدول.

تعلم مادة العلوم بالمدرسة						
هل أنت موافق على تلك الآراء؟ (الرجاء اختيار واحدة من الخيارات الخمس)						
الرقم	العبارة (البند)	أوافق بشدة	أوافق	محايد	غير موافق	لا أوافق بشدة
1	نحن نتعلم أشياء ممتعة في درس العلوم					
2	دروس العلوم ممتعة					
3	أود أن أتعلم الكثير عن العلوم بالمدرسة					
4	أحب مادة العلوم أكثر من باقي المواد الدراسية					
5	مادة العلوم مملة					
6	أجد صعوبة في مادة العلوم					
7	أتعلم مادة العلوم بسهولة					
8	أنا احصل على درجات جيدة في مادة العلوم					
9	أفهم (استوعب) كل ما يدرس في حصة العلوم					

					مادة العلوم واحدة من أفضل المواد	10
					أشعر بالضعف (بالعجز) عند دراستي للعلوم	11

خطتك المستقبلية						
هل أنت موافق على تلك الآراء؟ (الرجاء اختيار واحدة من الخيارات الخمس)						
الرقم	العبارة (البنود)	أوافق بشدة	أوافق	محايد	غير موافق	لا أوافق بشدة
						
1	أود دراسة مادة العلوم بشكل أكثر بالمستقبل					
2	أود دراسة مادة العلوم في الجامعة					
3	أحب أن اعمل وظيفة متعلقة بالعلوم					
4	مادة العلوم ليست مهمة في حياتي					
5	أود أن أصبح عالما في المستقبل					
6	أود أن أصبح مدرس لمادة العلوم					

شكرا لتعاونكم





**APPENDIX 15:** The pre and post of questionnaire (in English) for the students to measure the attitude for them toward science teaching and learning

### The Attitude Scale for Learning Science (grade fifth)

Note: Please put circle (pre / post)

According to your current situation in learning science, this questionnaire has statements about you and your interest in science.

Keep in your mind this is a survey NOT a test, so there are no 'right' or 'wrong' answers. *We want to know what you think.* Please choose one of the following five options (Strongly agree, Agree, Neither agree or disagree, Disagree, Strongly disagree) as applies to you.





<b>Learning science at school</b>						
<i>Do you agree with these views? (Please tick only one box in each row)</i>						
<b>Number</b>	<b>Statement</b>	<b>Strongly agree</b> 	<b>Agree</b> 	<b>Neither agree or disagree</b> 	<b>Disagree</b> 	<b>Strongly disagree</b> 
1	We learn interesting things in science lessons					
2	Science lessons are exciting					
3	I would like to do more science at school					
4	I like Science better than most other subjects at school					
5	Science is boring					
6	I find science difficult					
7	I learn science quickly					
8	I get good mark in science.					



9	In my Science class, I understand everything					
10	Science is one of my best subjects					
11	I feel helpless when doing science					

### Your plans for the future

*Do you agree with these views? (Please tick only one box in each row)*

Number	Statement	Strongly agree	Agree	Neither agree or disagree	Disagree	Strongly disagree
						
1	I would like to study more science in the future					
2	I would like to study science at university.					
3	I would like to have a job working with science					
4	Science is not important for my life.					
5	I would like to become a scientist.					
6	I would like to become a science teacher.					

#### Scoring Directions:

Each positive item receives the score based on points

A = 5      B = 4      C = 3      D = 2      E = 1

The scoring for each negative item should be reversed

A = 1      B = 2      C = 3      D = 4      E = 5

**APPENDIX 16:** The pre and post of questionnaire (in Arabic) for the students who used simulation to measure the usability of interactive computer simulation software in science teaching and learning

## ما رأيك في برنامج المحاكاة في الحاسب الآلي لتعليم العلوم؟

الرجاء ضع دائرة على (قبلي / بعدي)

ضع في عين الاعتبار أن هذه استبانته وليست اختبار فالإجابات لا تحمل الخطأ أو الصواب نريد أن نعرف ما هو رأيك؟ لذا يرجى اختيار واحدة من الخياران الخمسة كما هو موضح بالجدول.

ما هو رأيك في البرنامج؟ (الرجاء اختيار واحدة من الخيارات الخمس)						
الرقم	العبارة (البند)	أوافق بشدة	أوافق	محايد	غير موافق	لا أوافق بشدة
1	استخدام هذا البرنامج شيء رائع					
2	اشعر بأنني بحاجة إلى هذا البرنامج					
3	استخدام هذا البرنامج بالمنزل يضيف جوا من المتعة					
4	استمتع في استخدام هذا البرنامج					
5	أفضل استخدام هذا البرنامج أكثر من قراءة الكتاب المدرسي					
6	أود أن أوصي صديقي باستخدام هذا البرنامج					

استخدام البرنامج						
هل أنت موافق على تلك الآراء؟ (الرجاء اختيار واحدة من الخيارات الخمس)						
الرقم	العبارة (البند)	أوافق بشدة	أوافق	محايد	غير موافق	لا أوافق بشدة
1	هذا البرنامج صعب الاستخدام					
2	الأيقونات الموجودة على الشاشة سهلة الفهم					

					طريقة عرض المعلومات واضحة على الشاشة	3
					طريقة عرض الخيارات على الشاشة سهلة الفهم	4
					العبارات المساعدة على الشاشة في البرنامج تجعلني لا أواجه أي مشكلة أثناء استخدامي للبرنامج	5
					ترتبط المصطلحات الموجودة بالمهمة التي أقوم بها (مثال: ابدأ، العودة...)	6
					سهولة التشغيل و التنقل من خلال الضغط على لوحة المفاتيح	7
					من السهل استخدام هذا البرنامج دون الطلب للمساعدة	8
					من الصعب علي استيعاب الرسائل التي تظهر على الشاشة	9
					استخدام البرنامج بشكل سهل جعلني أوفر الوقت في الحصة	10
					البرنامج يعمل بالطريقة التي أفضلها	11
					اضغط على العديد من الأزره للوصول للمهمة (للدرس)	12

تعلم مادة العلوم من خلال البرنامج المحاكاة  
هل أنت موافق على تلك الآراء؟ (الرجاء اختيار واحدة من الخيارات الخمس)

الرقم	العبارة (البند)	أوافق بشدة	أوافق	محايد	غير موافق	لا أوافق بشدة
						
1	انه من الجيد استخدام هذا البرنامج لتعلم العلوم					
2	استخدام هذا البرنامج لتعلم العلوم أفضل من استخدام الكتاب المدرسي					
3	هذا البرنامج جعلني أحب تعلم العلوم					
4	أود أن أوصي أصدقائي باستخدام هذا البرنامج					
5	يجب على الطلبة تعلم العلوم من خلال هذا البرنامج					
6	هذا البرنامج غير نافع لتعلم مادة العلوم					
7	أفضل الطريقة التقليدية لدراسة العلوم فضلا عن استخدام هذا البرنامج					
8	استخدام هذا البرنامج يجعل مادة العلوم مادة ممتعة					
9	البرنامج سهل الاستخدام في المنزل					
10	لم أتعلم شيء جديد في العلوم من خلال هذا البرنامج					
11	استخدام هذا البرنامج جعلني افهم المعلومات السابقة بشكل أوضح					
12	استخدام هذا البرنامج جعلني افهم المفاهيم الجديدة المتعلقة بمادة العلوم					
13	لا يسمح لي هذا البرنامج بملاحظة بعض الدروس بالعلوم مثل: عملية الهضم، نمو النبات، مراحل القمر...					
14	استخدام هذا البرنامج ساعدني على تحصيل درجات أفضل					

شكرا لتعاونكم

**APPENDIX 16:** The pre and post of questionnaire (in English) for the students who used simulation to measure the usability of interactive computer simulation software in science teaching and learning





## What do you think about the Interactive computer simulation software (ICSS) program?

Note: Please put circle (pre / post)





After your experience current in learning science with using ICSS, this questionnaire has statements about you and your interest in learning science with using ICSS.

Keep in your mind this is a survey NOT a test, so there are no 'right' or 'wrong' answers. We want to know what you think. Please choose one of the following five options (Strongly agree, Agree, Neither agree or disagree, Disagree, Strongly disagree) as applies to you.

### Your opinion about the program





Number	Statement	Strongly agree 	Agree 	Neither agree or disagree 	Disagree 	Strongly disagree 
1	It is wonderful to use					
2	I feel I need to have it					
3	It is fun to use it at home.					
4	I enjoy working with it					
5	I am favor using it more than a textbook					
6	I would recommend it to a friend					

### Using the program

Number	Statement	Strongly agree 	Agree 	Neither agree or disagree 	Disagree 	Strongly disagree 
1	It is hard to use					
2	Icons on the computer screen are easy to understand					
3	Information on the screen is clear					
4	Presentation of choices is easy to understand					

5	Informative on the computer screen let me work without problem.					
6	Terminology is related to the task which I am doing. (Pack, start..etc)					
7	It is easy to browse and run this program through the press buttons					
8	It is easy to use the program without any help					
9	It was difficult for me to understand the messages shown on the screen					
10	I saved time by quick browsing					
11	The program works the way I prefer					
12	I do many clicks to reach to task					

### Learning science from the program

Number	Statement	Strongly agree	Agree	Neither agree or disagree	Disagree	Strongly disagree
						
1	It is good using the program for learning science					
2	It is better than learning science from a text book					
3	This program made me like learning science					
4	I would recommend it to a friend					
5	All students should learn science this way					
6	The program is not a good support in learning science					
7	I rather prefer a traditional method without using a computer					
8	The program made science interesting					
9	The program was easy to use at home					
10	I did not learn anything new from the program					
11	The program gave me better understanding of something I already knew					
12	The program helped me to understand <b>new</b> concepts introduced in science					

13	The program did not allow me to observe things in science. For example, plants grow or moon phases.					
14	The program will help me get a better grade in science					



## Interview protocol

### First; Science teachers' interview

1. **Interview before start intervention; the main topic is;** Science teachers' perspective of using ICT in education

#### 1.1 Personal information:

Name (optional): A

Experience in teaching science (number of years): .....

From where you graduated: Kuwait university, college of basic education, others  
..... (In / out of State of Kuwait).

What are you qualification: Diploma, Bachelor, Master, Doctoral.

Interview before experiment was aimed to know the personal information of science teachers, experiences, skills and their perspective of using ICT in education.

#### 1.2 General question:

1. In which extent you believe that the ICT is very important in our life this day?
2. How you using the ICT in your privet work?
3. In your opinion in which range do you think that the ICT is useful to use it in the instructional or education?
4. Do you have ICDL?
5. If yes (Q4), so you're fit to dealing with ICT (computer software's and internet browsing) what kind of software you good working with it?
6. When you were pre-service teachers (student in Education College) do you take courses about the benefit of integrated or incorporated the ICT with curriculum or using as tool in teaching?

### 2. Interview after intervention

You were involved in the experimental and you used computer simulation software in teaching science in **computer lab / classroom** and in the same time or in parallel you using the traditional method. What I want to know your observations and perspective (feeling and attitude to use it as education tool) in regarding:

**Topic 1:** The students' feelings while using ICSS through teachers' observation

**Topic 2:** Simulation influence on students' understanding of the science topics

**Topic 3:** Usability of simulation for teachers in science teaching

**Topic 4:** External factors that affected on the efficiency of the simulation program usability

**Topic 5:** Teachers' impressions of differences between using the simulation program or the traditional method in teaching science

**Second; Students' interview:**

You were involved in the experimental and you used computer simulation software in learning science in computer lab / classroom. What I want to know your feeling and attitude in regarding

**Topic 1:** Students' tendencies toward technological devices

**Topic 2:** Students opinions on using simulation program in learning science

**Topic 3:** Students' preferences between using a simulation program or traditional lab science for conducting scientific experiments

**APPENDIX 18: A LETTER TO THE ASSESSORS OF THE (ACHIEVEMENT TEST / QUESTIONNAIRES)**

His Excellency /

Asalam Alikum (peace upon you)

The researcher is studying for PhD degree at the School of Education in Durham University, UK. The title of his thesis is

“The Effectiveness of Using of Interactive Computer Simulation Software in Science Teaching and Learning, on the Students achievement and attitude for the fifth Grade at Kuwait Primary schools”.

Given your unchallenged knowledge and expertise in the area of science education, I am submitting to you the aims and the contents of the Three topics of Science which are (The Food Chain, The Circulatory & Digestive System, and The Electrical Circuit), together with the (achievement test and two of questionnaires) which I intend to use before and after the study, given that this test has been prepared in accordance with the aims of the each lessons, and taken of the questions bank in the Ministry of Education in Kuwait.

Your advice and comments regarding the suitability and clarity of achievement test questions will be of great benefit to me in my research. Please use the attached form to write down your comments as appropriate.

Thank you for your cooperation.

The PhD students

Hasan Alfajjam

**APPENDIX 19:** Letter from (my) supervisor to my sponsor (Kuwait culture office) to let me conducted the experiment in state of Kuwait in primary school



Shaped by the past, creating the future

August 1<sup>st</sup> 2010

**To: Head of Kuwait Cultural Office**

This letter is to confirm that Hasan Al-Fajjam is a doctorate (PhD) student at Durham University undertaking research on the use of ICT in primary science. Hasan is planning an intervention study testing the effect of teaching science using computer simulation software in science education in Kuwait. The research is an important contribution to science and computer education internationally and will help to develop understanding of ways to improve education in Kuwait.

To carry out his research Hasan will need to contact a number of schools and work closely with teachers. The research is designed not to affect any pupil negatively and full anonymity will be ensured in all published data. The proposal has been reviewed by the ethics committee in the School of Education and approved.

The experiment will be conducted over two periods of time in the schools. The first will start in October (2010) and end in December (2010). The second will start in March (2011) and will end in May (2011). The reason why two periods are required is that there are some lessons within the experiment which will need to be taught during the first term and the others during the second term according to the curriculum plan for science.

I sincerely hope that you will be able to support Hasan with his research and that you will be able to assist him in undertaking his planned research, but please do not hesitate to get in contact with me should you require further information.

Yours faithfully,

A handwritten signature in black ink that reads "S. G. Higgins".

Professor Steven Higgins  
School of Education  
Durham University  
Leazes Road, Durham, DH1 1TA  
Tel: 0191 334 8359 (Durham)

**APPENDIX 20:** Approval letter (in English) from my sponsor (PAAET) to conduct the experiment in state of Kuwait in primary school

Embassy of the State of Kuwait  
Cultural Office  
London



سفارة دولة الكويت  
المكتب الثقافي  
لندن

Date: 05/10/2010 2010  
Ref: SB/IM/GPA332

**Dear Mr. Hasan Alfajjam**

Further to your request for approval to carry out a field trip in Kuwait from 01/10/2010 to 31/12/2010 and from 01/03/2011 to the end of May 2011.

We would like to inform you that we have received a letter dated 29/09/2010 from your sponsor (PAAET) in which they have approved your request, on condition that the field trip should be one trip only for three months extendable for two more months after the approval.

Wish you all the Best



Yours Sincerely,

  
**Mr. Saif Basheer**  
Head of Postgraduate Department

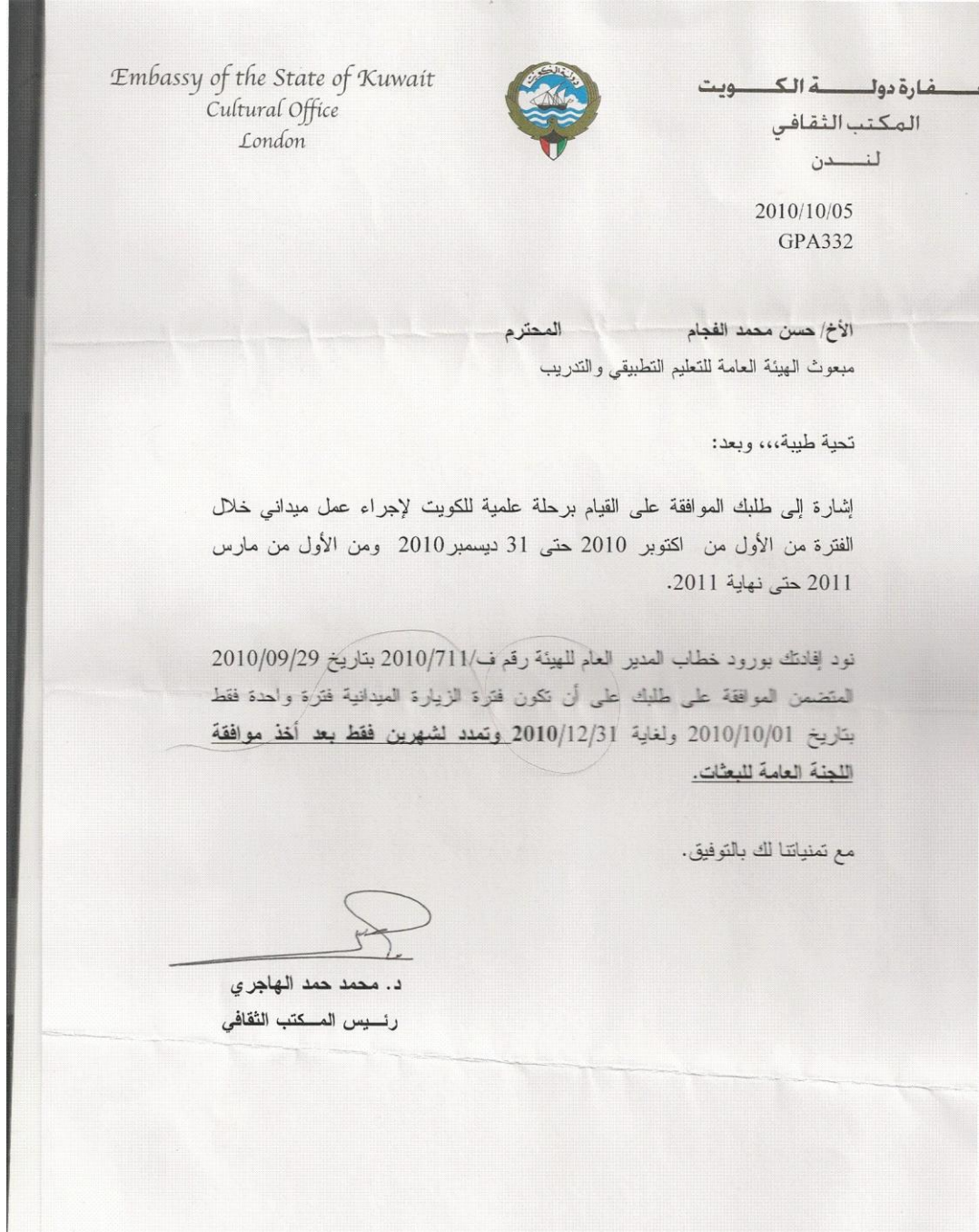
**APPENDIX 20:** Approval letter (in Arabic) from my sponsor (PAAET) to conduct the experiment in state of Kuwait in primary school



**APPENDIX 21:** The letter from college of basic education (in English) to ministry of education (assistant undersecretary for public education) to facilitate the task of experimental for this study in primary school

**The Public Authority  
For Applied Education & Training  
Faculty of Basic Education**

Mr. / Assistant Undersecretary of The Ministry of Education for Public Education.      Respectable .....

Date: 23/09/2010  
Peace Be Upon You

**Subject: Concerning Facilitating the task of Mr. Hassan Mohamed Al Fajjam.**

**Researcher in Ph.D - Major: Curricula and Methodologies**

In the frame of cooperation between us to serve the educational and learning objects, you are kindly informed to take what is necessary concerning facilitating the tasks of Mr. / Hassan Mohamed Al Fajjam, researcher at Ph.D , Division: Curricula and Methodology, Faculty of Basic Education who study in Dorham University – Britain in applying the academic questionnaire on the students of the elementary students , fifth grade which serve his study in Ph. D stage under the title

The effect of using Computer Simulation Program – CSP in science subject on scientific collection and enhancing the concepts of the elementary students, fifth elementary stage.

We hope to assist the applicant his scientific task

Kind regards

Dean of the faculty  
Professor/ Abdullah Mohana Al Mohana  
(sealed and signed)



هذه ترجمة صحيحة للنص المرفق  
بالتة: .....  
Certified True and Correct Translation  
of The Attached Text is: .....  
www.RAMy.com

التشريف - عملي - شارع ابن خلدون الرئيسي - مجمع الدوريات - وزارة التعليم العالي الكندي - القبول - 00114330 - 220-1133  
Kuala - Kuala - Be Eldham St. - Al-Dhahab Commercial Complex - Block 424H Branch - Tel. (+960) 22044330 - 220-1133  
E-mail: al-canady\_translation@fermail.com

**APPENDIX 21:** The letter from college of basic education (in Arabic) to ministry of education (assistant undersecretary for public education) to facilitate the task of experimental for this study in primary school

  
 THE PUBLIC AUTHORITY  
 FOR APPLIED EDUCATION & TRAINING.

المملكة العربية السعودية  
 وزارة التربية والتعليم

**كلية التربية الأساسية**

المرجع: أ. د. عبدالله مشعل الحفنا  
 التاريخ: 1 / 1 / 1434  
 الموافق: 19 / 9 / 2012

**السيد الأستاذ/ وكيل وزارة التربية المساعد للتعليم العام المحترم**

سلام عليكم ورحمة الله وبركاته - وبعد -

**الموضوع: بشأن تسهيل مهمة السيد/ حسن محمد الفخام  
 معيد بعثة الدكتوراه - تخصص مناهج وطرق تدريس**

في إطار التعاون القائم بيننا لخدمة الأهداف التربوية والتعليمية يرجى التفضل بالإحاطة والإيماء لمن يلزم في شأن تسهيل مهمة الأستاذ/ حسن محمد الفخام معيد بعثة الدكتوراه بقسم المناهج وطرق التدريس بكلية التربية الأساسية والذي يدرس بجامعة نور هلم - بربنداليا وذلك في تطبيق استبيان أكاديمي على طلبة المرحلة الابتدائية لطلبة الصف الخامس والذي يخدم أبحاثه في مرحلة الدكتوراه بعنوان-

أثر استخدام برنامج المحاكاة (Computer Simulation Program - CSP) في مادة العلوم على التحصيل العلمي وتعزيز المفاهيم لطلاب المرحلة الابتدائية للصف الخامس.

ولنا ومليد الأمل في مساعدة صاحب المصلحة في مهمته العلمية.

**مع خالص الشجبة والتقدير،،،**

**عهد الكلية**  
**أ. د. عبدالله مشعل الحفنا**

  
 19/9/2012



نسخة:  
 - السيد  
 - هلال عمر

P.O. Box 50127 54447 (TADMM) Jeddah - Tel: 2644000 Fax: 2622015



**APPENDIX 22:** The approval letter (in English) from assistant undersecretary for public education ministry of education after approval of science general instructor to conduct the experiment in primary school in all sector



**APPENDIX 22:** The approval letter (in Arabic) from assistant undersecretary for public education ministry of education after approval of science general instructor to conduct the experiment in primary school in all sector

7M3DWE/ACC/5829610V/0001

دولة الكويت

Ministry of Education  
Office Of Under Secretary

مكتب الوكيل المساعد للتعليم العام

Ref : \_\_\_\_\_

Date : \_\_\_\_\_

الرجوع : 5/1/2010  
تاريخ : 10/1/2010

المادة / مديري عموم المناطق التعليمية ،  
تحية طيبة ، وبعد ،،،  
المحترمين .

الموضوع : الباحث / حسن محمد حسن اللخام - تسهيل مهمة

بالإشارة إلى كتاب الهيئة العامة للتعليم التطبيقي والتدريب المؤرخ :  
٢٠١٠/٩/٢٢ م ، وإلى الموافقة الموجهة الفنى العام للعلوم في : ٢٠١٠/٤/١١ م  
بعد الإطلاع على خطة البحث ومضمونه ، بشأن الموضوع أعلاه .  
يرجى الإيعاز إلى من يلزم لتسهيل مهمة الباحث "حسن محمد اللخام"  
اتطبيق دراسته على طلبة وطالبات الصف الخامس من مدارس المرحلة  
الابتدائية في مختلف المناطق التعليمية .  
مع خالص التحية .

الوكيل المساعد للتعليم العام

دولة الكويت - عميل المساعد للتعليم العام  
ش.م.م. - وزارة التعليم  
A3532

حسن محمد حسن اللخام  
الوكيل المساعد للتعليم العام

**APPENDIX 23:** Booklet guide (in Arabic) for the science teachers in how to use of interactive computer simulation software (ICSS) in science teaching in this study

### دليل استخدام برنامج المحاكاة لتدريس العلوم (بالقرص المدمج)

هذا المشروع لدراسة الدكتوراه (2010-2011) للتحقيق في مدى تأثير وفعالية استخدام برنامج المحاكاة في الحاسب الآلي على التحصيل العلمي للطلبة واتجاهاتهم في تعلم العلوم في تدريس العلوم بالمرحلة الابتدائية بدولة الكويت.

تحت اشراف:

البروفوسور . ستيف هيكينز

د. بير كيند

الطالب/ حسن الفجام

## مقدمة

هذا الدليل يعرض كيفية استخدام برنامج المحاكاة لتعلم العلوم وتدريبه للصف الخامس بالمرحلة الابتدائية.

للاستفسار لا تتردد في الاتصال على:

هاتف - المملكة المتحدة : 00447553160423

هاتف - الكويت : 0096599023358

البريد الإلكتروني: h.m.h.f.alfajjam@durham.ac.uk  
alfajjam@yahoo.com

الطالب/ حسن محمد الفجام

## صفحة المقدمة



اضغط هنا  
للبدأ

هذه صفحة الغلاف تحتوي على:-

- اسم المشرف على البحث العلمي
- اسم الطالب
- خطاب من الشركة المنتجة لبرامج المحاكاة لتدريس العلوم

## المحتوى (الفهرس)

### المحتويات (الفهرس)

#### الجزء الثاني

##### الوحدة الثالثة: العلوم الفيزيائية

- الفصل الأول: قياس المادة
- الفصل الثاني: القوى والحركة
- الفصل الثالث: الكهرباء والمغناطيسية
- الفصل الرابع: الضوء والصوت

##### الوحدة الرابعة: علوم الأرض

- الفصل الأول: قياس الطقس
- الفصل الثاني: بنية الأرض
- الفصل الثالث: حركات النظام الشمس

#### الجزء الأول

##### الوحدة الأولى: علوم الحياة

- الفصل الأول: بنية النباتات ووظيفتها
- الفصل الثاني: بنية الحيوانات ووظيفتها
- الفصل الثالث: الطاقة في الأنظمة البيئية
- الفصل الرابع: القدرة على العيش في المحيط البيئي

##### الوحدة الثانية: جسم الإنسان

- الفصل الأول: الجهاز الهضمي وجهاز دوران الدم والجهاز العصبي
- الفصل الثاني: المحافظة على صحة أجهزة الجسم

ارجع

اضغط على الفصل الأول:-

بنية النباتات ووظيفتها

اضغط هنا للرجوع

للصفحة رقم 3

هذه الصفحة تحتوي على محتويات (الفهرس) لمنهج العلوم للصف الخامس

## الوحدة الأولى: علوم الحياة

### الفصل الأول : بنية النباتات ووظيفتها

**الوحدة الأولى : علوم الحياة**  
**الفصل الأول: بنية النباتات ووظيفتها**

الدرس (١): كيفية تقسيم النباتات؟  
الدرس (٢): ما هي أجزاء الزهرة؟  
الدرس (٣): كيف تنتج الأزهار بذورا و ثمارا؟  
الدرس (٤): ما هي دورة حياة النباتات الزهرية؟

أستراتيجية اختبار الفصل الأول  
الأهداف الرئيسية للفصل الأول  
مفاهيم أو خبرات الفصل

A  
B  
C

ارجع

اضغط هنا لعرض المحاكاة لموضوع الدرس الثاني

اضغط هنا للرجوع للصفحة رقم 4

هذه الصفحة تعرض دروس الفصل الأول للوحدة الأولى.

A  
أسئلة الاختبارات القبلية و البعدية

B  
الأهداف الرئيسية للفصل الأول

C  
المفاهيم الرئيسية للفصل الأول

## الدرس الثاني للفصل الأول باستخدام المحاكاة

**THE FLOWER PARTS**

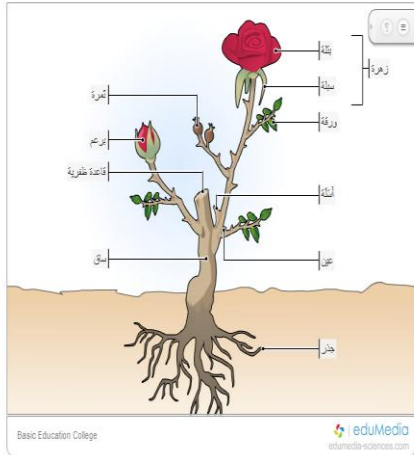

رجوع

A

B

اضغط هنا للرجوع  
للصفحة رقم 5

هذه الصفحة في البرنامج تعرض درس أجزاء الزهرة

لطباعة ورقة عمل للتلميذ

عرض مفاهيم (مصطلحات) أجزاء الزهرة ووظائفها



## مفاهيم (مصطلحات) الدرس الثاني للفصل الأول

### مفاهيم و وظائف أجزاء الزهرة



النبات	هي الأجزاء الملونة من الزهرة و هي تجذب الحشرات والقرشات و الطيور و كائنات حية مختلفة
Sepal - سبله	أحد الأجزاء الورقية الشكل التي تحمي بوجع الزهرة و التي تكون عادة خضراء.
مباغ (عضو التكاثر في الأزهر) Pistil -	جزء من الزهرة ينتج البويضات التي تنمو لتصبح بذورا.
سداة (العضو الذكرى في الأزهر) Stamen -	جزء من الزهرة ينتج حبار اللقاح (حبوب اللقاح)
حبار اللقاح (حبوب اللقاح) - Pollen	حيبات دقيقة تنتج بذورا عند اتحادها ببويضه الزهرة.
تلقيح - Pollination	انتقال حبوب اللقاح من السداة الى المباغ
مبيض - Ovary	الجزء السفلي من المباغ حيث تتشكل البذور
بويضه - Ovule	الجزء الداخلي من المبيض و الذي يحتوي على بويضه
إخصاب - Fertilization	اتحاد خليه نكريه من حبيبه اللقاح ببويضه لتشكل بذرة

رجوع

اضغط هنا للرجوع  
للصفحة رقم 6

هذه الصفحة بالبرنامج تعرض مفاهيم أجزاء الزهرة و وظيفتها

هذه الصفحة تعرض عند الضغط على **B** في صفحة 6

## ورقة عمل لدرس أجزاء الزهرة

اضغط هنا للطباعة

اضغط هنا للخروج لصفحة 6

activity explore plant Arabic [Compatibility Mode] (Preview) - Microsoft Word

Print Preview

Print Options Margins Orientation Size Zoom 100% Page Width One Page Two Pages Show Ruler Magnifier Next Page Previous Page Close Print Preview

Page: 1 of 1 At: 3.3cm Line: 2 Words: 61 Arabic (Kuwait)

Press here to start... Document1 - Mic... activity explore pl... CD - Science Microsoft PowerP... PowerPoint Slide... AR 04:10

عندما تضغط على **A** صفحة 6 تظهر هذه الصفحة

النهاية

**APPENDIX 23:** Booklet guide (in English) for the science teachers in how to use of interactive computer simulation software (ICSS) in science teaching in this study

The handbook for the Science Simulation Program (SSP) CD-ROMs

This is the Project for PhD study (2010-2011) to investigate the impact and effectiveness of using computer simulation software, in students' learning outcomes and attitude, in primary science teaching in the State of Kuwait.

Supervisors

Prof. Steve Higgins

Dr. Per Kind

PhD student: Hasan Alfajjam

School of Education

Durham University

United Kingdom

## Introduction

This guide or handbook is showing you How to use the program for science simulation to teaching or learning science fifth grade for age 9 - 11.

For any questions please do not hesitate to contact the:

UK Mobile: 0044(0)7553160423

Kuwait mobile: 00965 99023358

Or by E-mail: [h.m.h.f.alfajjam@durham.ac.uk](mailto:h.m.h.f.alfajjam@durham.ac.uk)  
[alfajjam@yahoo.com](mailto:alfajjam@yahoo.com)

This program under supervision:

Prof. Steve Higgins

Dr. Per Kind

School of Education

Durham University

United Kingdom

Student: Hasan Alfajjam

## The Introduction Page



Press to  
"Start"

This the first page in the program

This page including:

- The name of the supervisors
- The name of students
- The company which provided the simulation

## Content (index)

### المحتويات (الفهرس)

#### الجزء الثاني

##### الوحدة الثالثة: العلوم الفيزيائية

- الفصل الأول: قياس المادة
- الفصل الثاني: القوى والحركة
- الفصل الثالث: الكهرباء والمغناطيسية
- الفصل الرابع: الضوء والصوت

##### الوحدة الرابعة: علوم الأرض

- الفصل الأول: قياس الطقس
- الفصل الثاني: بنية الأرض
- الفصل الثالث: حركت النظام الشمس

#### الجزء الأول

##### الوحدة الأولى: علوم الحياة

- الفصل الأول: بنية النباتات ووظيفتها
- الفصل الثاني: بنية الحيوانات ووظيفتها
- الفصل الثالث: الطاقة في الأنظمة البيئية
- الفصل الرابع: الفترة على العيش في المحيط البيئي

##### الوحدة الثانية: جسم الإنسان

- الفصل الأول: الجهاز الهضمي وجهاز دوران الدم والجهاز العصبي
- الفصل الثاني: المحافظة على صحة أجهزة الجسم

ارجع

Press here to go to  
the plants and its  
functions chapter

Press "Back" to  
go page 1

This page in the program including the CONTENTS of text science book for fifth grade

# The first unit

## Chapter I: The plants and functions unit

**الوحدة الأولى : علوم الحياة**  
**الفصل الأول: بنية النباتات ووظيفتها**

الدرس (١): كيفية تقسم النباتات؟  
الدرس (٢): ما هي أجزاء الزهرة؟  
الدرس (٣): كيف تنتج الأزهار بذورا و ثمارا؟  
الدرس (٤): ما هي دورة حياة النباتات الزهرية؟

أستقل اختبار الفصل الأول (A)  
الهدف الرئيسي للفصل الأول (B)  
مفاهيم أو خبرات الفصل (C)  
ارجع

Click here to view a simulation of the subject of the second lesson  
Press "Back" to go page 2

This page shows the lessons of the first chapter of the first unit:

A

Test questions before and after tests

B

The main objectives of the first chapter

C

The Key concepts for the first semester



The second lesson the first chapter presented in a way that the simulation

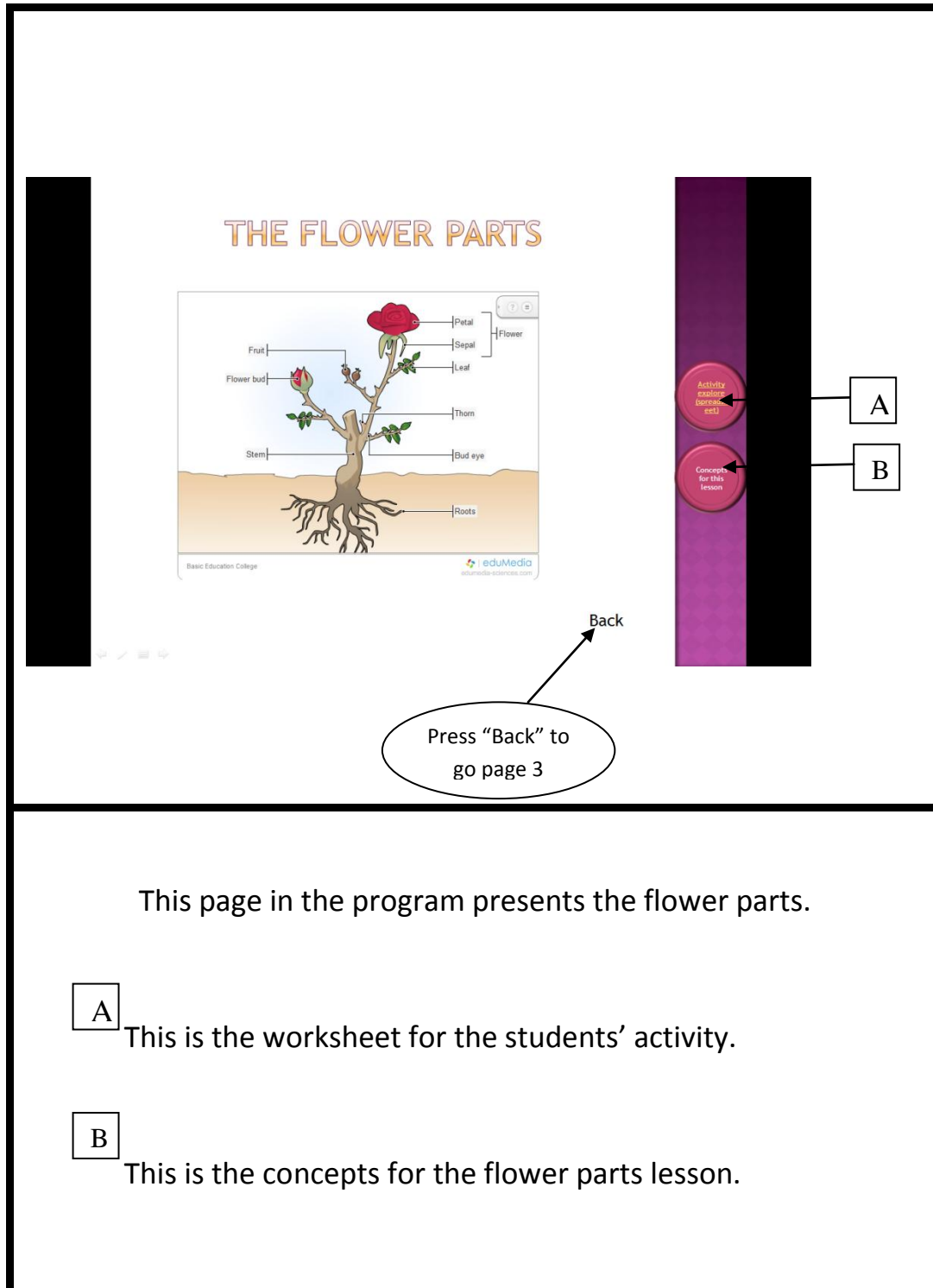

The screenshot shows a digital interface for a lesson on flower parts. The main content is a diagram of a rose with labels: Fruit, Flower bud, Stem, Petal, Sepal, Leaf, Thorn, Bud eye, and Roots. The diagram is titled "THE FLOWER PARTS" and includes the "eduMedia" logo. To the right of the diagram is a vertical purple sidebar with two buttons: "Activity (worksheets)" and "Concepts for this lesson". These buttons are linked to boxes labeled "A" and "B" respectively. Below the diagram, there is a "Back" button and a callout bubble that says "Press 'Back' to go page 3".

This page in the program presents the flower parts.

**A** This is the worksheet for the students' activity.

**B** This is the concepts for the flower parts lesson.

# The concepts for lesson two in chapter one

**FLOWERS PARTS CONCEPTS**

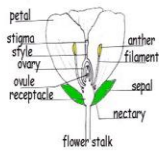

<b>Petal</b>	Petals are used to attract insects into the flower, they may have guidelines on them and be scented.
<b>Stigma</b>	Is covered in a sticky substance that the pollen grains will adhere to.
<b>Style</b>	The style raises the stigma away from the Ovary to decrease the likelihood of pollen contamination. It varies in length.
<b>Ovary</b>	This protects the ovule and once fertilization has taken place it will become the fruit.
<b>Receptacle</b>	This is the flower's attachment to the stalk and in some cases becomes part of the fruit after fertilization e.g. strawberry.
<b>Sepal</b>	Sepals protect the flower whilst the flower is developing from a bud.
<b>Filament</b>	This is the stalk of the Anther.
<b>Anther</b>	The Anthers contain pollen sacs. The sacs release pollen on to the outside of the anthers that brush against insects on entering the flowers. The pollen once deposited on the insect is transferred to the stigma of another flower or the same flower. The ovule is then able to be fertilized.

Please note:  
The stigma, style, ovary, and ovule are often known collectively as the **carpel** or female parts of the flower.

The filament and the Anthers are collectively known as the **Stamen** or the male parts of the plant.

←

Back

Press "Back" to go page 4

This page in the program presents the concepts for the flower parts, this page showing when you press B in page 3.

## Worksheet for the flower parts lesson

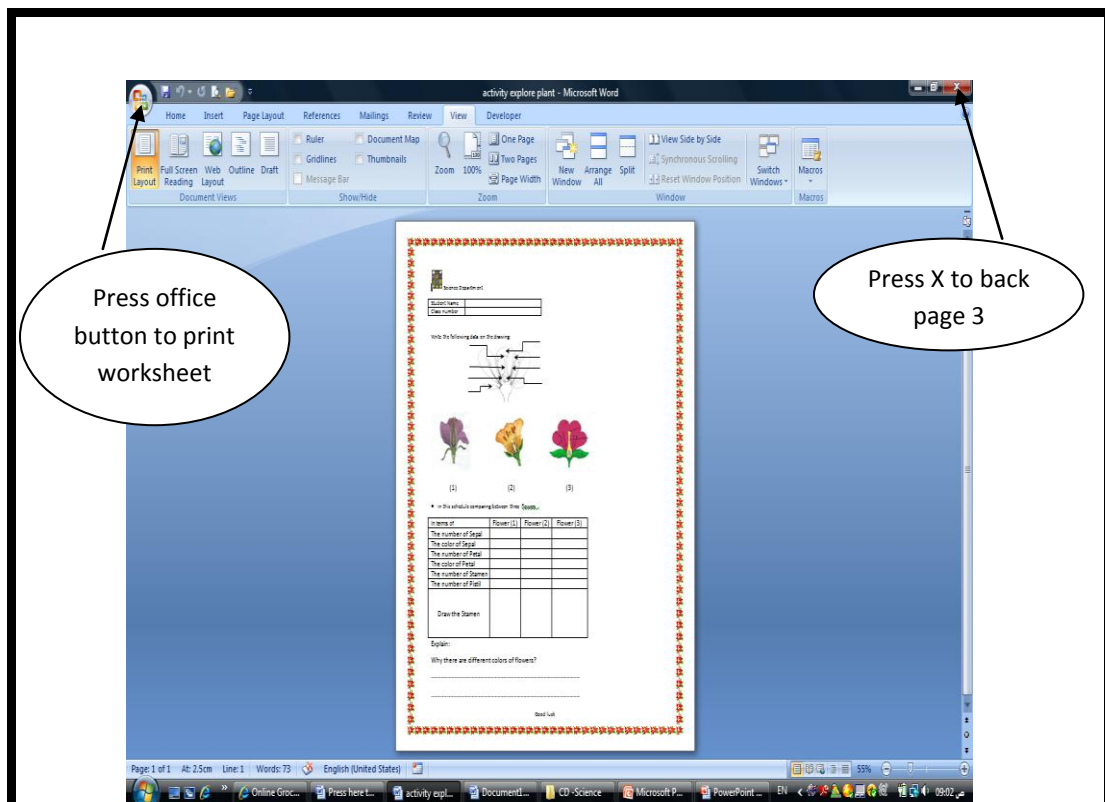

When you press A ( see page 3) this page in the worksheet for the flower parts lesson.

The End

**APPENDIX 24:** The simulation lesson of how flower reproduce the seeds and fruits as pilot study before conducted the main experiment

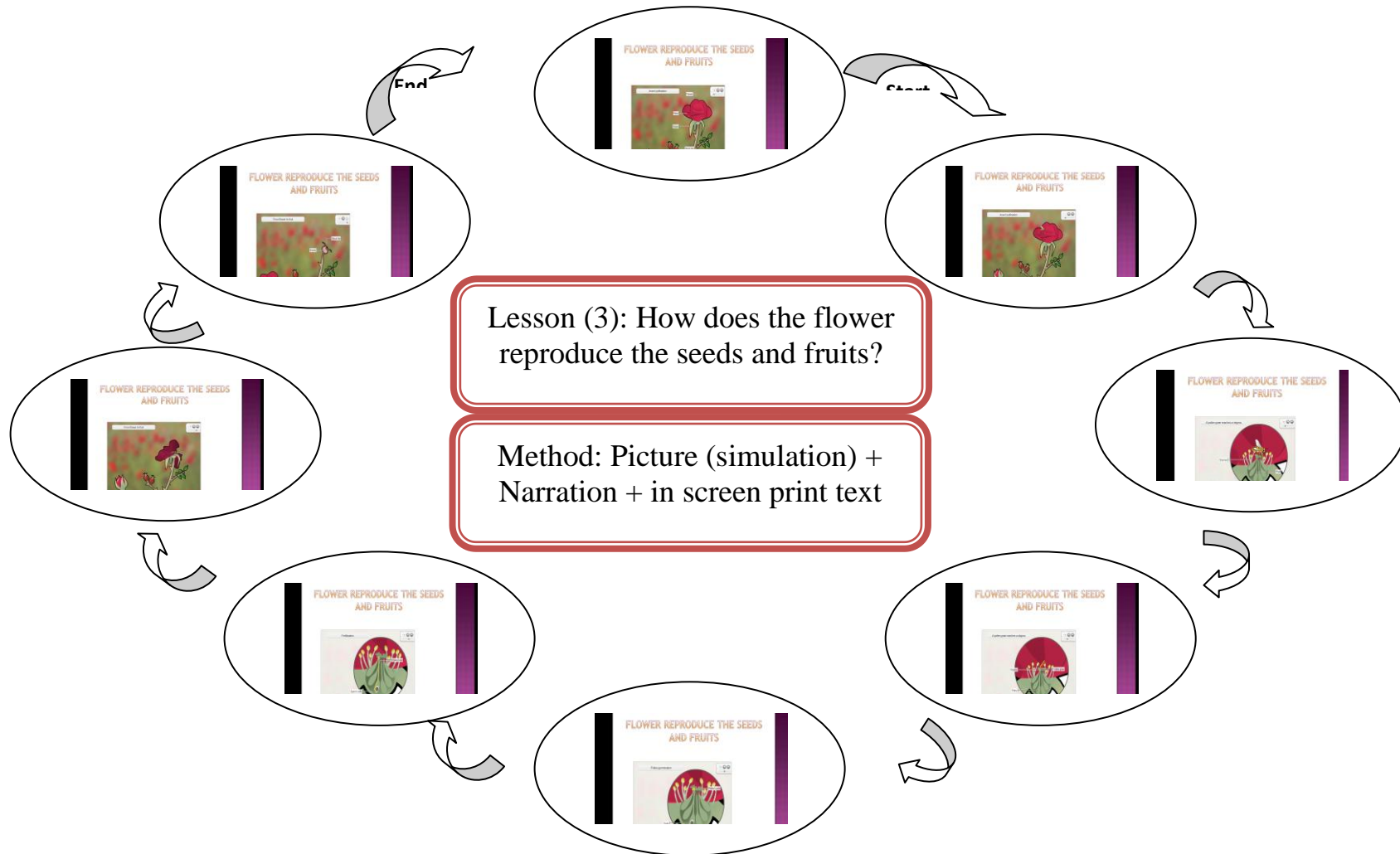

**APPENDIX 25:** The worksheet for lesson of how flower reproduce the seeds and fruits as pilot study before conducted the main experiment



Science Department

Student Name	
Class number	

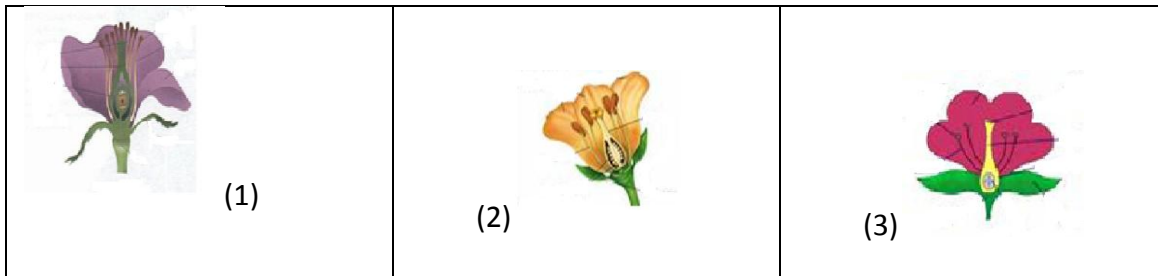

In this schedule comparing between three flowers .

In terms of	Flower (1)	Flower (2)	Flower (3)
The number of Sepal			
The color of Sepal			
The number of Petal			
The color of Petal			
The number of Stamen			
The number of Pistil			
Draw the Stamen			
Draw the Stamen			

Explain:

Why there are different colors of flowers?

.....

.....

Good luck

## APPENDIX 26: The Q-Q Plots normality test

