



Durham E-Theses

On the topological charges of the affine toda solitons

McGhee, William Alexander

How to cite:

McGhee, William Alexander (1994) *On the topological charges of the affine toda solitons*, Durham theses, Durham University. Available at Durham E-Theses Online: <http://etheses.dur.ac.uk/5482/>

Use policy

The full-text may be used and/or reproduced, and given to third parties in any format or medium, without prior permission or charge, for personal research or study, educational, or not-for-profit purposes provided that:

- a full bibliographic reference is made to the original source
- a [link](#) is made to the metadata record in Durham E-Theses
- the full-text is not changed in any way

The full-text must not be sold in any format or medium without the formal permission of the copyright holders.

Please consult the [full Durham E-Theses policy](#) for further details.

The copyright of this thesis rests with the author.
No quotation from it should be published without
his prior written consent and information derived
from it should be acknowledged.

On the topological charges of the affine Toda solitons

by

William Alexander McGhee.

A thesis submitted for the degree
of Doctor of Philosophy.

Department of Mathematical Sciences,
University of Durham,
May 1994.



12 SEP 1994

To Cass & Peaches

On the topological charges of the affine Toda solitons

by

William Alexander McGhee.

Abstract

This thesis investigates the two dimensional, integrable field theories known as the affine Toda field theories, which are based on the Kac-Moody algebras with zero central extension. In particular, the construction of static solitons in these theories and their topological charges are considered.

Following a general overview of the affine Toda theories and the Kac-Moody structure which underlies them, the construction of solitons in the $a_n^{(1)}$ theory using Hirota's method, originally used by Hollowood, is generalized and extended to the remaining theories. The soliton masses are calculated and general expressions presented for the twisted as well as the untwisted theories.

The major results of this work concern the calculation of topological charge, one of the infinite number of conserved quantities that each theory possesses. Firstly, the $a_n^{(1)}$ model is considered. An expression for the number of charges associated with each soliton, as well as a general expression for the charges themselves, is constructed. The previously alluded to connection between the charges and the associated fundamental representations is proven showing that the charges are, in general, a subset of the weights lying in these representations. For the $a_n^{(1)}$ theory, the charges associated with each soliton can be derived from just one by making use of the cyclic symmetry of the model's extended Dynkin diagram. Further, the action of this symmetry on the set of charges is synonymous with the action of a Coxeter element. It is found that the ordering of the Weyl reflections which make up this element is important (except when the end-point solitons are considered) – the familiar “black-white” ordering doesn't work. The multisolitons of the theory are considered and it is shown that when the individual solitons are sufficiently well separated their topological charges simply add together. Multi-solitons can be constructed having topological charge equal to each of the simple roots, and can therefore be used to construct

further solitons filling the entire weight lattice.

Next, the topological charges of the remaining affine Toda theories are investigated. For the infinite series of algebras the number of topological charges and expressions for the charges themselves are derived. For the remaining cases, the charges are calculated explicitly.

This thesis concludes with some comments on more recent work into the theory of quantum solitons and considers further lines of enquiry.

Preface

This thesis is based on research by the author, carried out between September 1991 and May 1994. The material presented has not been submitted previously for any degree in either this or any other University.

No claim of originality is made for the work contained in either Chapter One or Chapter Two. Chapters Three [46] and Four [47] are based on papers by the author, the first in collaboration with Niall J. MacKay. Both these papers have been published in the International Journal of Modern Physics A. Chapter Five contains unpublished work (and so, to a certain extent, do chapters Three and Four). Chapter Six contains review material and a discussion of future lines of enquiry.

I would like to thank all of those with whom I've had discussions over the past two years, in particular: Nick Myers for comments on the use of Hirota's method in Chapter Three; Michael Young for a variety of comments relating to the work in Chapter Four; and Patrick Dorey for carrying out a number of checks on the topological charges of the $e_6^{(1)}$, $e_7^{(1)}$ and $e_8^{(1)}$ theories. Also, the following are gratefully acknowledged for a number of comments and questions: Richard Hall, Ulrich Harder, Alexander Iskandar, Niall Mackay, Gérard Watts, and in particular, my supervisor Ed Corrigan.

Finally, my thanks go to the Engineering and Physical Sciences Research Council (formerly the Science and Engineering Research Council) for financially supporting this work.

Statement of Copyright

The copyright of this thesis rests with the author. No quotation from it should be published without his prior written consent and information derived from it should be acknowledged.

Contents

1	Introduction	1
2	The Toda models	5
2.1	Introduction	6
2.2	Lie algebras	6
2.3	The affinization of the simple Lie algebras.	12
2.4	The conformal Toda model	15
2.4.1	The solution of the conformal Toda model	16
2.4.2	From conformal Toda to affine Toda	17
2.5	The conformal affine Toda model	18
2.5.1	The equations of motion	19
2.5.2	The solution of the (conformal) affine Toda models	20
2.6	Affine Toda field theory	21
2.6.1	Masses and couplings in affine Toda theory	21
2.6.2	S -matrix theory	25
2.7	Affine Toda solitons	28
2.7.1	The algebraic soliton solution	28

2.7.2	The Backlund transformations of the A_n affine Toda field theory.	30
3	Classical Affine Toda Solitons	34
3.1	Introduction	35
3.2	The equations of motion	36
3.3	Affine Toda solitons for simply-laced algebras	39
3.3.1	The $a_n^{(1)}$ theory	39
3.3.2	The $d_n^{(1)}$ theory	42
3.3.3	The $e_6^{(1)}$ theory	44
3.3.4	The $e_7^{(1)}$ theory	44
3.3.5	The $e_8^{(1)}$ theory	45
3.4	Folding and the non-simply-laced algebras	46
3.4.1	Solitons in the untwisted theories.	47
3.4.2	Solitons in the twisted theories.	51
3.5	The soliton masses	56
4	The Topological Charges of the $a_n^{(1)}$ theory.	59
4.1	Introduction.	60
4.2	Topological Charge.	61
4.2.1	The $a_n^{(1)}$ theory	62
4.2.2	An explicit formula for the charges.	66
4.2.3	The highest charge and its fundamental representation.	67
4.2.4	The Topological charges, the Coxeter element and the fundamental representations.	69

4.2.5	The other $a_n^{(1)}$ automorphisms	72
4.2.6	Multisoliton solutions.	74
4.2.7	Multisolitons and representation theory.	76
5	The Topological Charges of the remaining theories.	77
5.1	Introduction	78
5.2	The remaining simply-laced theories.	79
5.2.1	The $d_4^{(1)}$ theory	79
5.2.2	The $d_n^{(1)}$ theory	80
5.2.3	The $e_6^{(1)}$ theory	88
5.2.4	The $e_7^{(1)}$ theory	89
5.2.5	The $e_8^{(1)}$ theory	90
5.3	The non-simply-laced untwisted theories	91
5.3.1	The $c_n^{(1)}$ theory	91
5.3.2	The $b_n^{(1)}$ theory	94
5.3.3	The $g_2^{(1)}$ theory	95
5.3.4	The $f_4^{(1)}$ theory	96
5.4	The twisted theories	96
5.4.1	The infinite classes	97
5.4.2	The exceptional twisted cases	99
6	Discussion and conclusions	101
6.1	Introduction	102
6.1.1	Quantum mass corrections	102

	0
6.2 The soliton S -matrix	103
6.2.1 Conclusions	104
A Hirota's method	107
A.1 Hirota's method	108
B Diagrams and Tables	109
Bibliography	125

Chapter 1

Introduction

This dissertation is based on the study of a particular class of massive, integrable, two-dimensional field theories, known as affine Toda field theories. Their study was begun over a decade ago [4, 21, 52]. However, after a suggestion by Zamolodchikov that conformal field theories may remain integrable and continue to possess an infinite number of conserved quantities following certain deformations, it was natural that attention should be turned to the integrable conformal Toda models. Subsequently, it was shown [22, 35] that affine Toda field theories could be obtained as particular integrability-preserving deformations of these Toda field theories.

Active research into the affine Toda models has provided expressions for the masses of the fundamental quantum particles, firstly explicitly [4, 10, 11] and subsequently algebraically [25, 26], and their associated three-point couplings [10, 11, 12, 26]. One of the tools used by Zamolodchikov, the S -matrix bootstrap, was used subsequently together with the crossing and unitarity conditions to conjecture exact S -matrices for ATFT's based on any Lie algebra. This extended the previous work [4] on the $a_n^{(1)}$ theory.

The affine Toda Lagrangian density is given by

$$\mathcal{L} = \frac{1}{2}(\partial_\mu\phi) \cdot (\partial^\mu\phi) - \frac{m^2}{\beta^2} \sum_{j=0}^r n_j (e^{\beta\alpha_j \cdot \phi} - 1). \quad (1a)$$

When the coupling constant is imaginary, it is seen that the potential term has many minima as opposed to the real coupling case where the only (real) minimum occurs for $\phi = 0$. It is expected, therefore, that for imaginary coupling the theory possesses solitons. In [32] the complex coupling $a_n^{(1)}$ theory, a generalization of the sine-Gordon model, was considered. The solitons solutions which were found possessed many surprising properties. The number of solitons was equal to the rank of the underlying Lie algebra, with the soliton mass ratios being the same as the unrenormalized mass ratios of the fundamental quantum particles in the real coupling theory. This allowed for an association of each soliton with a point on the unextended A_n Dynkin diagram in a similar manner to that done for the quantum particles in [11]. Also, one of the conserved charges of the solitons – that of topological charge – was found for those solutions associated with the end points of the A_n diagram. Here the charges filled the fundamental representations at those points, although for other solitons they seemed only to partially fill the associated fundamental

representations. Solitons for the simplest of the $d_n^{(1)}$ theories, that of $d_4^{(1)}$, were obtained but the generalization to all other theories was unclear.

The dissertation is laid out as follows.

Chapter two : The aim of this chapter is to provide a comprehensive survey of the research carried out on the Toda models, as well as their underlying algebraic structures, that will be of use in this thesis. Firstly the simple Lie algebras and their generalizations, the Kac-Moody algebras are considered. Following a discussion of the conformal Toda model and its algebraic solution, the affine Toda model is obtained as a integrability preserving perturbation of this model. The second approach is from the conformal affine Toda model which has been used to obtain the algebraic solution to the affine Toda model. The masses, couplings and S -matrices of the fundamental particles are looked at, as they are found to be closely related to those of the solitons. The work of other authors in constructing the affine Toda solitons is considered, in particular the use of the Leznov Saveliev construction and Bäcklund transformations.

Chapter three : The work of Hollowood is extended to all of the remaining theories and explicit formulae for all of the single solitons are presented. The number of solitons is again equal to the rank of the algebra. A case-by-case deduction of a formula for the soliton masses is given, in agreement with that first proposed in [53], for the untwisted theories:

$$M_a = \frac{4mh}{\beta^2 \alpha_a^2} \sqrt{\lambda_a}. \quad (1b)$$

Also, a formula is given for the masses of the solitons in the twisted theories. This chapter, although based on work carried out by the author in collaboration with Niall J. MacKay [46], gives the expressions for all of the single solitons in all of the theories and so contains many results not previously reported in the literature. This chapter also includes a short discussion of static multisoliton configurations which, although not appearing in the sine-Gordon theory, are found to exist in the more general $a_n^{(1)}$ and other affine Toda theories.

Chapter four : Returning again to the simplest of the affine Toda theories, that of $a_n^{(1)}$, the topological charges of the solitons are investigated. The number of charges of the a^{th}

soliton is found to be

$$\tilde{h}_a = \frac{h}{\gcd(a, h)}, \quad (1c)$$

where h is the Coxeter number. As \tilde{h}_a is a divisor of the Coxeter number, it may be thought that the Coxeter element (a product of Weyl reflections in the simple roots) may provide the link between the charges. This is found to be the case and so allows all of the topological charges for each soliton to be deduced from just one (and so provides a general formula for the charges), as well as proving that the topological charges for each soliton lie in the same representation. This is found for the a^{th} soliton to be the a^{th} fundamental representation, confirming the original conjecture by Hollowood.

Chapter five : Here the work carried out on the $a_n^{(1)}$ theory, as regards the number of charges and their expressions, is extended to the other theories. It is possible to calculate the number of topological charges of each single soliton in all the theories by counting the number of poles of the solution, in a similar, though rather more complicated, way to that of Chapter four. It is found that these numbers do not divide the Coxeter number, implying that the charges do not form an orbit under the action of any power of the Coxeter element. It seems that the presence of the Coxeter element in the analysis of the $a_n^{(1)}$ theory is therefore a peculiarity of that theory. Formal and explicit expressions are given for each soliton's topological charges in the infinite and exceptional algebras, respectively. The representations in which the charges lie are discussed – for the exceptional algebras these representations can be identified by explicit calculation, however, for the infinite theories the expressions for the charges are not sufficiently simple to allow for such a calculation to take place. The chapter contains a number of examples illustrating the formulae which have been derived.

Chapter six : In the final chapter, the work of the thesis is critically assessed and further unanswered questions are discussed. As well as this, the directions of other authors in the quantum theory are looked at.

Chapter 2

The Toda models

2.1 Introduction

This chapter will provide an overview of the area in which the present work lies. Before considering the three types of Toda model – conformal Toda, affine Toda and conformal affine Toda – it is necessary to have a firm grasp of the algebraic structure underlying each of them. For only then can it be hoped that a fundamental understanding of the work in this thesis, and indeed the parallel work of other authors, be achieved.

As a result, the next section of this chapter will look at the the simple Lie algebras which underlie the conformal Toda model, before moving onto their generalizations, the Kac-Moody algebras, which underpin both the affine and conformal affine models (the algebraic distinction being that the first corresponds to zero central extension of the algebra whilst the latter corresponds to non-zero central extension). The second half of this chapter will consider the Toda models themselves and, as well as discussing the work now well established in the literature such as quantum masses and couplings, consider the soliton constructions of other authors.

2.2 Lie algebras

In this section the simple Lie algebras, studied and classified towards the end of the last century by E. Cartan and W. Killing, will be considered. Much of the material and concepts will be of use throughout this dissertation, as well as being of particular use in the generalization from Lie to Kac-Moody algebras. For further details see [36, 7].

Definition: A Lie algebra \mathfrak{g} is a vector space upon which is defined a bilinear operation called the bracket,

$$[,] : \mathfrak{g} \otimes \mathfrak{g} \rightarrow \mathfrak{g}.$$

The bracket is endowed with the following properties:

$$[X, Y] = -[Y, X]$$

$$[[X, Y], Z] + [[Y, Z], X] + [[Z, X], Y] = 0, \quad \forall X, Y, Z \in \mathfrak{g},$$

the latter property is called the Jacobi identity. Choosing a basis $\{T_a\}$ ($a = 1, \dots, n$), then

$$[T_a, T_b] = c_{abc}T_c$$

where the c_{abc} are the structure constants of the algebra satisfying

$$c_{abc} = c_{bac} \quad \text{and} \quad c_{bca}c_{deb} + c_{bda}c_{ecb} + c_{bea}c_{cdb} = 0.$$

A representation of the Lie algebra \mathfrak{g} acting on a vector space V_k of dimension k is a linear map $d : \mathfrak{g} \rightarrow M_k$ (all $k \times k$ matrices) preserving the bracket i.e.

$$d([X, Y]) = [d(X), d(Y)] \quad \forall X, Y \in \mathfrak{g}.$$

One particular representation of \mathfrak{g} which is useful in deriving many of the algebra's properties is that of the adjoint representation, defined by

$$(adX)Y = [X, Y].$$

An explicit matrix form for ad can be found and is given in terms of the basis elements by $(adT^a)_{lm} = c_{alm}$ – this is of use when the Cartan Killing form is defined on the algebra.

A representation is called reducible if the vector space V upon which it acts has an invariant subspace $W \in V$ ($W \neq \{0\}, V$) i.e. $d(\mathfrak{g})W \subset W$. If there is no such subspace then d is said to be irreducible.

The Killing form: It is possible to define an associative inner product on \mathfrak{g} , known as the (Cartan) Killing form

$$K(X, Y) = Tr(adXadY).$$

From the previous matrix formulation of the adjoint action, a symmetric matrix is obtained

$$K_{ab} = K(T_a T_b) = Tr(adT_a adT_b) = c_{ade}c_{bed}.$$

K is associative in the sense that

$$K(X, [Y, Z]) = K([X, Y], Z).$$

If $\det K \neq 0$ then the metric is called nondegenerate. Further, if in some basis $K_{ab} = -\delta_{ab}$ then \mathfrak{g} is said to be of compact type and the structure constants are totally antisymmetric.

A Lie algebra of compact type can be shown to have, up to conjugation by its associated Lie group, a unique Cartan subalgebra (maximal abelian subalgebra) whose dimension is called the rank of \mathfrak{g} . The algebra \mathfrak{g} can be decomposed into simple Lie algebras of compact type

$$\mathfrak{g} = \mathfrak{g}_1 \oplus \mathfrak{g}_2 \oplus \dots \oplus \mathfrak{g}_p,$$

\mathfrak{g} being called semisimple if $p > 1$. If the only ideals of \mathfrak{g} are $\{0\}$ and \mathfrak{g} itself, then the algebra is called simple.

It was the simple Lie algebras which attracted the attention of Cartan, who showed that they fell into four infinite classes and five exceptional cases denoted by A_n , B_n , C_n , D_n and G_2 , F_4 , E_6 , E_7 and E_8 respectively.

When \mathfrak{g} is a simple Lie algebra, a basis is obtained by starting with the Cartan subalgebra $\{H^i\}$ ($i = 1, \dots, r$) where

$$[H^i, H^j] = 0 \tag{2.2a}$$

and extending to the whole of \mathfrak{g} by finding elements E^α such that

$$[H^i, E^\alpha] = \alpha^i E^\alpha. \tag{2.2b}$$

The real non-zero r -dimensional vector α is called a root, and E^α is called the step operator corresponding to α . Indeed, for each root α the corresponding root space is one-dimensional, and $k\alpha$ is not a root for any k unless $k = \pm 1$, the root $-\alpha$ corresponding to the step operator $E^{-\alpha} = E^{\alpha\dagger}$. The set of roots is denoted by Φ .

The commutator of two step operators is root dependent, and is given by

$$\begin{aligned} [E^\alpha, E^\beta] &= \epsilon(\alpha, \beta) E^{\alpha+\beta} \quad \text{if } \alpha + \beta \text{ is a root,} \\ &= \frac{2\alpha \cdot H}{\alpha^2} \quad \text{if } \alpha = -\beta, \\ &= 0 \quad \text{otherwise.} \end{aligned} \tag{2.2c}$$

The above basis, with the commutators (2.2a), (2.2b), and (2.2c), is a modified version of the Cartan-Weyl basis.

To each root α it is possible to associate a $su(2)$ algebra defined by the generators E^α , $E^{-\alpha}$, and $2\alpha \cdot H/\alpha^2$ which are isomorphic, in the usual notation, to I_+ , I_- and $2I_3$ which

satisfy

$$[I_+, I_-] = 2I_3, \quad [I_3, I_{\pm}] = \pm I_{\pm},$$

with the hermicity conditions $I_+^\dagger = I_-$ and $I_3^\dagger = I_3$. From the well known representation theory of $su(2)$, the eigenvalues of $2\alpha \cdot H/\alpha^2$ are integral in any unitary representation. The adjoint representation of \mathfrak{g} is one such representation where $2\alpha \cdot H/\alpha^2$ has eigenvalues $2\alpha \cdot \beta/\alpha^2$ ($\beta \in \Phi$) and zero r times. Therefore

$$\frac{2\alpha \cdot \beta}{\alpha^2} \in \mathbb{Z}, \quad \forall \alpha, \beta \in \Phi.$$

Also in the adjoint representation, the step operators $E^{\beta+m\alpha}$ ($m \in \mathbb{Z}$) must form a $su(2)$ multiplet and so there must be a member of the multiplet with opposite $2\alpha \cdot H/\alpha^2$ -eigenvalue, i.e.

$$\frac{2\alpha \cdot \beta}{\alpha^2} + 2m = -\frac{2\alpha \cdot \beta}{\alpha^2}$$

for some $\beta + m\alpha$ a root. Then

$$\beta + m\alpha = \beta - \frac{2\alpha \cdot \beta}{\alpha^2}\alpha \equiv \sigma_\alpha(\beta),$$

σ_α being a linear operator which corresponds to reflection in the plane perpendicular to the root α . Thus σ_α ($\alpha \in \Phi$) permutes the set of roots and also generates a finite group $W(\mathfrak{g})$, known as the Weyl group of \mathfrak{g} .

In general, the set of roots is linearly dependent and so does not form a basis for the root space. The basis elements commonly chosen are $\alpha_1, \alpha_2, \dots, \alpha_r$ such that for any root α ,

$$\alpha = \sum_{i=1}^r n_i \alpha_i$$

where each $n_i \in \mathbb{Z}$, and either $n_i \geq 0 \forall i$, in which case the root is called positive, or $n_i \leq 0 \forall i$, in which case the root is called negative. Under the action of members of the Weyl group, all other such simple root bases are obtained. The Weyl group $W(\mathfrak{g})$ can be shown to be generated by σ_{α_i} , where α_i is a simple root.

There are two equivalent ways of representing the simple root systems – either by the algebra's Cartan matrix, or by its Dynkin diagram.

The Cartan matrix of \mathfrak{g} is the $r \times r$ array with entries

$$C_{ij} = \frac{2\alpha_i \cdot \alpha_j}{\alpha_j^2},$$

which from the above discussion, are all integers. The diagonal entries of C are equal to 2 whilst the off-diagonal entries are zero or negative. From C , the simple roots can be reconstructed (up to scalar multiplication or orthogonal transformation of the Cartan subalgebra) and hence all the roots and structure constants, and finally \mathfrak{g} itself.

Further, the information in C can be expressed in the form of a Dynkin diagram which has points representing the simple roots, joined by $C_{ij}C_{ji}$ lines with an arrow pointing to the shorter of any two adjacent points. If \mathfrak{g} is simple, there can be at most only two root lengths. If all the roots are of the same length, the algebra is called simply-laced. The ability to obtain C from its Dynkin diagram means that the latter is also sufficient to describe the algebra. The Dynkin diagrams of the simple Lie algebras are given in Table B1 of Appendix B.

Given a finite dimensional representation of \mathfrak{g} , a basis $\{|\mu\rangle\}$ can be chosen so that each H^i is diagonal:

$$H^i|\mu\rangle = \mu^i|\mu\rangle.$$

The r -dimensional vector $\mu = (\mu^1, \mu^2, \dots, \mu^r)$ is called a weight vector, and again by $su(2)$ representation theory $2\alpha \cdot H/\alpha^2$ is integral when acting on $|\mu\rangle$, $\forall \alpha \in \Phi$, and so

$$\frac{2\alpha \cdot \mu}{\alpha^2} \in \mathbb{Z}.$$

Indeed, all such μ satisfying the above equation constitute the weight lattice $\Lambda_W(\mathfrak{g})$, which contains the root lattice $\Lambda_R(\mathfrak{g})$. A basis of the weight lattice is given by those λ_j satisfying

$$\frac{2\alpha_i \cdot \lambda_j}{\alpha_j^2} = \delta_{ij}, \quad 1 \leq i, j \leq r,$$

with any weight $\lambda \in \Lambda_W(\mathfrak{g})$ of the form

$$\lambda = \sum_{i=1}^r n_i \lambda_i \quad (n_i \in \mathbb{Z}).$$

If $n_i \geq 0 \forall i$, λ is called a dominant weight. For each finite dimensional representation of \mathfrak{g} , there exists a highest weight state $|\mu_0\rangle$, satisfying

$$E^\alpha|\mu_0\rangle = 0, \quad \alpha > 0.$$

The term ‘highest’ originates in the ability to express $\mu_0 - \mu$, where μ is any other weight of the representation, as a sum of positive roots. The weights of the adjoint representation are in fact the roots Φ , with highest root denoted by ψ .

Returning to the modified Cartan-Weyl basis constructed previously, it is advantageous for algebraic purposes to replace this by the Chevalley basis with generators

$$e_\alpha = \sqrt{\frac{2}{\alpha^2}} E^\alpha, \quad h_\alpha = \frac{2\alpha \cdot H}{\alpha^2}.$$

Then, concentrating on the simple roots which will be of use in the subsequent discussions, denote

$$e_{\alpha_i} = e_i, \quad e_{-\alpha_i} = f_i, \quad \text{and} \quad h_{\alpha_i} = h_i.$$

The commutation relations are therefore

$$[h_i, h_j] = 0, \quad [h_i, e_j] = C_{ji} e_j, \quad [h_i, f_j] = -C_{ji} f_j, \quad [e_i, f_j] = \delta_{ij} h_j,$$

where, in the last equation, the fact that for simple roots $\alpha_i - \alpha_j$ cannot be a root is used.

As any root α can be written in the form

$$\alpha = \sum_{j=1}^r p_j \alpha_j,$$

for all p_j integers, the height of the root is defined as

$$\text{ht}\alpha = \sum_{j=1}^r n_j.$$

Further, defining the operator T^3 by

$$T^3 = \frac{1}{2} \left(\sum_{+ve \text{ roots}} \frac{2\alpha \cdot H}{\alpha^2} \right),$$

it is found that T^3 grades \mathfrak{g} , in the sense that

$$[T^3, E^\alpha] = (\text{ht}\alpha) E^\alpha. \quad (2.2d)$$

It is possible to re-express (2.2d) in terms of a multiplicative action through the use of $S = \exp\left(\frac{2\pi i T^3}{h}\right)$ (where h , known as the Coxeter number, is the height of the highest root ψ). Then

$$S E^\alpha S^{-1} = \exp\left(\frac{2\pi i}{h} \text{ad} T^3\right) E^\alpha = \exp\left(\frac{2\pi i}{h} (\text{ht}\alpha)\right) E^\alpha = \omega^{\text{ht}\alpha} E^\alpha,$$

with ω being the h^{th} root of unity. As a result the algebra \mathfrak{g} exhibits a \mathbb{Z}_h grading:

$$\mathfrak{g} = \mathfrak{g}_0 \oplus \mathfrak{g}_1 \oplus \dots \oplus \mathfrak{g}_{h-1},$$

with subscripts denoting the height of the root associated with each operator. In particular \mathfrak{g}_0 is the Cartan subalgebra, and $\mathfrak{g}_1 = \{E_{\alpha_1}, \dots, E_{\alpha_r}, E_{-\psi}\}$.

2.3 The affinization of the simple Lie algebras.

In this subsection the untwisted affine algebras (obtained via the affinization of the simple Lie algebras) are considered. The untwisted affine algebras are associated to the generalized Cartan matrices, or the extended Cartan matrices, of the simple finite dimensional Lie algebras discussed in the previous section. Effectively they are formed from the algebra's usual Cartan matrix by adding a row and column, or equivalently by adding a point to the algebra's Dynkin diagram.

These algebras will now be constructed as central extensions of the loop algebras, in a similar manner to that of [38].

Denote by $\mathcal{L} = \mathbb{C}[\lambda, \lambda^{-1}]$ the algebra of Laurent polynomials in λ . Upon \mathcal{L} is defined the bilinear \mathbb{C} -valued function φ given by

$$\varphi(P, Q) = \text{Res} \frac{dP}{dt} Q, \quad \forall P, Q \in \mathcal{L},$$

which satisfies the following two properties

$$\begin{aligned} \varphi(P, Q) + \varphi(Q, P) &= 0, \\ \varphi(PQ, R) + \varphi(QR, P) + \varphi(RP, Q) &= 0, \quad (P, Q, R \in \mathcal{L}). \end{aligned}$$

The *loop algebra* $\mathcal{L}(\mathfrak{g}) = \mathcal{L} \otimes_{\mathbb{C}} \mathfrak{g}$ is an infinite dimensional complex Lie algebra with bracket

$$[P \otimes g_1, Q \otimes g_2] = PQ \otimes [g_1, g_2] \quad (P, Q \in \mathcal{L}; g_1, g_2 \in \mathfrak{g}).$$

A bilinear \mathcal{L} -form is defined on $\mathcal{L}(\mathfrak{g})$ through the extension of the form defined on \mathfrak{g} :

$$(P \otimes g_1 | Q \otimes g_2) = PQ(g_1 | g_2).$$

Also a derivation D defined on \mathcal{L} can be extended to a derivation on \mathcal{L} by

$$D(P \otimes g_1) = D(P) \otimes g_1.$$

Defining a ‘ \mathbb{C} -valued 2-cocycle’ on $\mathcal{L}(\mathfrak{g})$, ψ by

$$\psi(a, b) = \text{Res} \left(\frac{da}{dt} \middle| b \right) = (g_1, g_2) \varphi(P, Q) \quad \text{where } a = P \otimes g_1, b = Q \otimes g_2 \in \mathcal{L}(\mathfrak{g}),$$

i.e. a bilinear \mathbb{C} -valued function satisfying

$$\psi(a, b) = -\psi(b, a),$$

$$\psi([a, b], c) + \psi([b, c], a) + \psi([c, a], b) = 0,$$

then $\tilde{\mathcal{L}}(\mathfrak{g})$ is defined as the one-dimensional central extension of $\mathcal{L}(\mathfrak{g})$ associated to ψ . That is, $\tilde{\mathcal{L}}(\mathfrak{g}) = \mathcal{L}(\mathfrak{g}) \oplus \mathbb{C}K$ with bracket

$$[a + \mu K, b + \eta K] = [a, b] + \psi(a, b)K \quad (a, b \in \mathcal{L}(\mathfrak{g}), \mu, \eta \in \mathbb{C}).$$

Finally, the affine algebra $\hat{\mathfrak{g}}$ is obtained by adding to $\tilde{\mathcal{L}}(\mathfrak{g})$ the derivation $d = \lambda d/d\lambda$ which when acting on K gives zero and which commuted with $\lambda^m \otimes g_1$ ($g_1 \in \mathfrak{g}$) gives

$$[d, \lambda^m \otimes g_1] = m\lambda^m \otimes g_1$$

thereby providing the so-called homogeneous grading. The affine algebra $\hat{\mathfrak{g}}$ is therefore given by

$$\hat{\mathfrak{g}} = \tilde{\mathcal{L}}(\mathfrak{g}) \oplus \mathbb{C}d = \mathcal{L}(\mathfrak{g}) \oplus \mathbb{C}K \oplus \mathbb{C}d.$$

Its bracket is defined by

$$\begin{aligned} & [(\lambda^m \otimes g_1) \oplus \mu_1 K \oplus \eta_1 d, (\lambda^n \otimes g_2) \oplus \mu_2 K \oplus \eta_2 d] \\ & = (\lambda^{m+n} \otimes [g_1, g_2] + \eta_1 n \lambda^n \otimes g_2 - \eta_2 m \lambda^m \otimes g_1) \oplus m \delta_{m, -n} (g_1 | g_2) K. \end{aligned}$$

The Cartan subalgebra of $\hat{\mathfrak{g}}$ is $(r+2)$ -dimensional (where r is the rank of \mathfrak{g}), and given by

$$\hat{\mathfrak{h}} = \mathfrak{h} \oplus \mathbb{C}K \oplus \mathbb{C}d.$$

To this algebra it is once again possible to form a Chevalley basis by defining

$$h_i \equiv \lambda^0 \otimes H^{\alpha_i}, \quad e_i \equiv \lambda^0 \otimes E^{\alpha_i}, \quad f_i \equiv \lambda^0 \otimes E^{-\alpha_i} \quad (i \neq 0),$$

$$h_0 \equiv \lambda^0 \otimes H^{-\psi} + K, \quad e_0 \equiv \lambda^1 \otimes E^{-\psi}, \quad f_0 \equiv \lambda_{-1} \otimes E^{\psi}$$

where the elements of \mathfrak{g} are the Chevalley generators discussed at the end of the last section. As a result the Chevalley generators of $\hat{\mathfrak{g}}$ satisfy the following commutation relations:

$$[h_i, h_j] = 0, \quad [h_i, e_j] = K_{ji}e_j, \quad [h_i, f_j] = K_{ji}f_j, \quad [e_i, f_j] = \delta_{ji}h_j.$$

These, together with the Serre relations

$$(ade_i)^{1-K_{ji}}e_j = 0, \quad (adf_i)^{1-K_{ji}}f_j = 0, \quad (i \neq j),$$

characterize the algebra. The matrix K is the extended Cartan matrix defined analogously to C but with zeroth row and column corresponding to the extended root $\alpha_0 = -\psi$, where ψ is the highest root of \mathfrak{g} . The extended Dynkin diagrams arising from these Cartan matrices are given in table B2. Those corresponding to the twisted algebras, in table B3, will be discussed later in the context of folding.

There exists a grading structure on the basis when expressed in terms of Chevalley generators. The element d' is defined to have the property that

$$[d', h_i] = 0, \quad [d', e_i] = e_i, \quad [d', f_i] = -f_i.$$

It is related to d by $d' = hd + \lambda_0 \otimes T^3$. Together with the h_i , d' spans the Cartan subalgebra. Defining the integers to be the lowest for which

$$\sum_i K_{ji}m_i = 0 \quad \text{and} \quad \sum_i n_i K_{ij} = 0,$$

then the m_i 's and n_i 's are related via

$$n_i = \frac{\psi^2 m_i}{\alpha_i^2}.$$

The Coxeter and dual Coxeter numbers are defined as $h = \sum_i n_i$ and $\tilde{h} = \sum_i m_i$, respectively. It is also straightforward to show that the quantity $x = 2k/\psi^2$ is central, in that it commutes with the rest of the algebra.

In a similar manner to the simple Lie algebras, the affine Kac-Moody algebras have highest weight representations, provided the central extension is non-zero. As before, the representations are formed from a highest weight state $|\Lambda \rangle$, acted on by an arbitrary number

of negative step operators. The highest weight state is characterized by the action of h_i , i.e.

$$h_i|\Lambda \rangle = \Lambda(h_i)|\Lambda \rangle = \frac{2\Lambda \cdot a_i}{a_i^2}|\Lambda \rangle.$$

In a similar manner to that corresponding to the simple Lie algebras, $su(2)$ representation theory can be used to show that the above eigenvalue is a non-negative integer. As a result, the eigenvalue of the quantity $x = 2k/\psi^2$ acting on the highest weight state $|\Lambda \rangle$,

$$\Lambda(2k/\psi^2) = \sum_i m_i \Lambda(h_i) = x$$

is also an integer. It is called the integer level. The weight lattice Λ_W is the set of points such that $2\Lambda \cdot a_i/a_i^2$ is an integer. It is generated by the fundamental weights Λ_j which satisfy

$$\frac{2\Lambda_j \cdot a_i}{a_i^2} = \delta_{ij}.$$

The root space can be viewed as that of the corresponding simple Lie algebras, but with two extra dimensions dual to k and d . The simple roots are given by

$$a_i = (\alpha_i, 0, 0) \quad (i \neq 0), \quad \text{and} \quad a_0 = (-\psi, 0, 1).$$

The inner product between any two roots is defined as

$$(\beta_1, c_1, d_1) \cdot (\beta_2, c_2, d_2) = \beta_1 \cdot \beta_2 + c_1 d_2 + c_2 d_1.$$

The fundamental weights are chosen (in the sense that the final component is arbitrary) to take the form

$$\Lambda_i = (\lambda_i, m_i \psi^2/2, 0) \quad (i \neq 0), \quad \Lambda_0 = (0, \psi^2/2, 0).$$

2.4 The conformal Toda model

The (conformal) Toda field theory Lagrangian density corresponding to the simple Lie algebra \mathfrak{g} is given by

$$\mathcal{L} = \frac{1}{2}(\partial_\mu \Phi) \cdot (\partial^\mu \Phi) - \frac{\lambda}{\beta^2} \sum_{i=1}^r e^{\beta \alpha_i \cdot \Phi}$$

where r is the rank of the algebra \mathfrak{g} , Φ is an r component real scalar field and the α_i 's are the simple roots of the algebra. As well as being a conformally invariant theory, the Toda model is integrable in that there exists a Lax pair, infinitely many conserved quantities and it is exactly soluble.

The equations of motion corresponding to the above density are

$$\partial^2 \Phi_j + \lambda \beta \sum_{i=1}^r \hat{C}_{ji} e^{\beta \Phi_i} = 0 \quad (2.4a)$$

where $\Phi_i = \alpha_i \cdot \Phi$ and \hat{C} is the 'Cartan' matrix with $(i, j)^{th}$ component $\alpha_i \cdot \alpha_j$. In the original equations considered by Toda [57] the Φ_j were only time dependent and corresponded to the relative displacement of the points of an infinite linear lattice. In that case \hat{C} was the Cartan matrix of $SU(r+1)$ with r going to infinity.

The simplest case to consider is when $r = 1$, and the Cartan matrix is simply the number 2, corresponding to the $SU(2)$ algebra. The theory then corresponds to the Liouville equation

$$\partial^2 \Phi = -\frac{2\lambda}{\beta} e^{\beta \Phi}.$$

The Toda model can therefore be looked upon as a generalization of the Liouville equation.

2.4.1 The solution of the conformal Toda model

The starting point for the solution of the Toda theories is the work of Leznov and Saveliev [41] who considered the zero curvature condition for the Toda model, and subsequently derived the general solution of this model via path ordered exponentials. The Toda theories are two dimensional integrable field theories with zero curvature condition

$$[\partial_\mu + W_\mu, \partial_\nu + W_\nu] = 0, \quad (2.4.1a)$$

which is equivalent to the field equations. The gauge potentials W_μ are functions of the field Φ . The above condition is in fact a consequence of the linearized equation

$$(\partial_\mu + W_\mu)T = 0,$$

for some group element T . T can therefore be written as a path ordered exponential thus:

$$T = P \exp \left[- \int_Q^P W_\mu dx^\mu \right],$$

the condition (2.4.1a) guaranteeing that the above is independent of the path of integration. As a result, equating the expressions for moving along the light cone at constant x^+ followed by x^- with the expression for moving firstly along x^- then x^+ gives the solution to the conformal Toda theory as

$$e^{-\beta\lambda_j\cdot\Phi} = e^{-\beta\lambda_j\cdot\Phi_0} \langle \lambda_j | U(x^+) V(x^-) | \lambda_j \rangle,$$

where Φ_0 is a free field, λ_j are the fundamental weights of the simple Lie algebra \mathfrak{g} with associated highest weight states $|\lambda_j\rangle$, and $U(x^+)$, $V(x^-)$ are chiral group elements satisfying

$$\partial_+ U = -\mu \left(e^{\beta\Phi_0^+ \cdot H} \sum_{i=1}^r E^{\alpha_i} e^{-\beta\Phi_0^+ \cdot H} \right) U \quad (2.4.1b)$$

$$\partial_- V = -V \mu \left(e^{-\beta\Phi_0^- \cdot H} \sum_{i=1}^r E^{-\alpha_i} e^{\beta\Phi_0^- \cdot H} \right). \quad (2.4.1c)$$

2.4.2 From conformal Toda to affine Toda

As a starting point, consider again the Toda field theory Lagrangian density corresponding to a simple Lie algebra \mathfrak{g} :

$$\mathcal{L} = \frac{1}{2} (\partial_\mu \Phi) \cdot (\partial^\mu \Phi) - \frac{\lambda}{\beta^2} \sum_{j=1}^r n_j e^{\beta\alpha_j \cdot \Phi}. \quad (2.4.2a)$$

The potential term in the Lagrangian density (2.4.2a) does not have a classical minimum, and is zero for $\alpha_j \cdot \Phi \rightarrow -\infty$. Also the theory is conformal, a property that has been studied by a number of authors [45, 27, 8].

It is possible to add a perturbation to the above Lagrangian density, so introducing a finite minimum. If the integrability of the theory is to be preserved, then it is necessary to take the perturbation of the form:

$$\delta V(\Phi) = \frac{\epsilon\lambda}{\beta^2} e^{\beta\alpha_0 \cdot \Phi},$$

where α_0 is the ‘extended root’, converting the usual Dynkin diagrams into the affine diagrams. For the untwisted theories, α_0 is simply the negative of the highest root ψ . The potential term now has a minimum at $\Phi^{(0)}$ satisfying

$$\sum_{i=1}^r \alpha_i e^{\beta\alpha_i \cdot \Phi^{(0)}} = -\epsilon\alpha_0 e^{\beta\alpha_0 \cdot \Phi^{(0)}}. \quad (2.4.2b)$$

On shifting the field Φ by replacing it with $\Phi = \Phi^{(0)} + \phi$, then

$$V(\phi) = \frac{\lambda}{\beta^2} \left[\sum_{i=1}^r e^{\beta\alpha_i \cdot \phi} e^{\beta\alpha_i \cdot \Phi^{(0)}} + \epsilon e^{\beta\alpha_0 \cdot \Phi^{(0)}} e^{\beta\alpha_0 \cdot \phi} \right].$$

From (2.4.2b),

$$\sum_{i=1}^r \hat{C}_{ji} e^{\beta\alpha_i \cdot \Phi^{(0)}} = -\epsilon \alpha_j \cdot \alpha_0 e^{\beta\alpha_0 \cdot \Phi^{(0)}},$$

where \hat{C}_{ij} , defined above, is an invertible and symmetric matrix, so that

$$e^{\beta\alpha_i \cdot \Phi^{(0)}} e^{-\beta\alpha_0 \cdot \Phi^{(0)}} = -\epsilon \sum_{j=1}^r (\hat{C}^{-1})_{ij} \alpha_j \cdot \alpha_0.$$

Therefore the potential term can be re-expressed as

$$\begin{aligned} V(\phi) &= \frac{\epsilon\lambda}{\beta^2} e^{\beta\alpha_0 \cdot \Phi^{(0)}} \left[e^{\beta\alpha_0 \cdot \phi} - \sum_{i,j=1}^r e^{\beta\alpha_i \cdot \phi} \hat{C}_{ij} \alpha_j \cdot \alpha_0 \right] \\ &= \frac{\epsilon\alpha}{\beta^2} e^{\beta\alpha_0 \cdot \Phi^{(0)}} \left[e^{\beta\alpha_0 \cdot \phi} + \sum_{i=1}^r n_i e^{\beta\alpha_i \cdot \phi} \right] \equiv \frac{m^2}{\beta^2} \sum_{i=0}^r n_i e^{\beta\alpha_i \cdot \phi} \end{aligned}$$

by making use of $\alpha_0 = -\sum_{i=1}^r n_i \alpha_i$, $n_0 = 1$ and the definition $m^2 = \epsilon\lambda e^{\beta\alpha_0 \cdot \Phi^{(0)}}$.

The Lagrangian density giving rise to the affine Toda field equations can then be written in the form

$$\mathcal{L} = \frac{1}{2} (\partial_\mu \phi)(\partial^\mu \phi) - \frac{m^2}{\beta^2} \sum_{j=0}^r n_j (e^{\beta\alpha_j \cdot \phi} - 1). \quad (2.4.2c)$$

the final part of the summation being added to ensure that $V(\phi = 0) = 0$.

2.5 The conformal affine Toda model

Historically, the conformal affine Toda model was the last of the three Toda models to be constructed [3, 6]. It came about as a generalization of the affine Toda model which, whilst retaining integrability, regained conformal invariance via the addition of two new fields.

In the derivation of the algebraic solution to the affine Toda model [53], and indeed in the construction of solitons by Hirota's method along the lines of Aratyn, Constantinidis, Ferreira, Gomes and Zimmerman in [15, 1, 2], this model plays a prominent rôle. As a result, it shall be discussed here for completeness.

2.5.1 The equations of motion

The conformal affine Toda equations can be viewed as the analogous equations of motion to those of the conformal Toda model, but this time corresponding to the affine algebra $\hat{\mathfrak{g}}$ as opposed to the simple Lie algebra \mathfrak{g} . They can be written

$$\partial^2 \Phi + \frac{4\mu^2}{\beta} \sum_{i=0}^r H^{a_i} e^{\beta a_i(\Phi)} = 0$$

where $\Phi = \phi \cdot H + \xi k + \eta d'$ lies in the Cartan subalgebra of $\hat{\mathfrak{g}}$, and the a_i 's are its simple roots. The above equations can be obtained as the vanishing of a zero curvature condition.

The potentials W^\pm , also lying in $\hat{\mathfrak{g}}$, are defined as

$$\begin{aligned} W^\pm &= \pm \frac{\beta}{2} \partial_\pm \Phi \pm \mu e^{\pm \frac{\beta}{2} \Phi} \hat{E}_{\pm 1} e^{\mp \frac{\beta}{2} \Phi} \\ &= \pm \frac{\beta}{2} \partial_\pm \Phi \pm \mu e^{\pm \frac{\beta}{2} \text{ad} \Phi} \hat{E}_{\pm 1}, \end{aligned}$$

where

$$\hat{E}_{\pm 1} = \sum_{i=0}^r \sqrt{m_i} E^{\pm \alpha_i}. \quad (2.5.1a)$$

The vanishing of the curvature, i.e.

$$[\partial_+ + W_+, \partial_- + W_-] = 0,$$

gives the equations for the conformal affine Toda model. The above curvature can be written as

$$-\beta \partial_+ \partial_- \Phi - \mu^2 [e^{\frac{\beta}{2} \text{ad} \Phi} \hat{E}_{+1}, e^{-\frac{\beta}{2} \text{ad} \Phi} \hat{E}_{-1}] = 0. \quad (2.5.1b)$$

Using the expression for the adjoint action of $\pm \Phi$ on $\hat{E}_{\pm 1}$,

$$[\pm \Phi, \hat{E}_1] = \frac{\beta}{2} \sum_{i=0}^r \sqrt{m_i} (\eta + \phi \cdot \alpha_i) E^{\alpha_i},$$

then, in terms of the components of Φ , equation (2.5.1b) reduces to the system:

$$\begin{aligned} \partial_- \partial_- \phi + \frac{4\mu^2}{\beta \psi^2} e^{\beta \eta} \sum_{i=1}^r (n_i \alpha_i e^{\beta \phi \cdot \alpha_i} - \psi e^{-\beta \phi \cdot \psi}) &= 0, \\ \partial_- \partial_+ \xi + \frac{4\mu^2}{\beta \psi^2} e^{\beta \eta} e^{-\beta \psi \cdot \phi} &= 0, \end{aligned} \quad (2.5.1c)$$

$$\partial_+ \partial_- \eta = 0,$$

where $n_i = m_i \psi^2 / \alpha_i^2$ has been used. If $x^\pm \rightarrow f(x^\pm)$ then

$$\phi(x^\pm) \rightarrow \phi(f(x^\pm)), \quad \xi(x^\pm) \rightarrow \xi(f(x^\pm)), \quad \text{and} \quad \eta(x^\pm) \rightarrow \eta(f(x^\pm)) - \ln \left(\frac{d\xi^+}{dx^+} \frac{d\xi^-}{dx^-} \right)$$

showing that the equations are conformally invariant. In particular if $\eta = 0$, (2.5.1c) reduces to the equations under study in this dissertation, those of affine Toda field theory:

$$\partial^2 \phi + \frac{m^2}{\beta} \sum_{j=0}^r n_j \alpha_j e^{\beta \alpha_j \cdot \phi} = 0. \quad (2.5.1d)$$

The discussion of an algebraic solution of the conformal affine Toda field equations will be returned to later when the work of Olive, Turok and Underwood is reviewed.

2.5.2 The solution of the (conformal) affine Toda models

It is possible to apply the methods of Leznov and Saveliev to the conformal affine Toda model and obtain the general algebraic solution. Indeed, this has been done and is presented in [53]. However, due to the similarities between this model and that of the conformal Toda model, in respect of the highest weight representations of both \mathfrak{g} and $\hat{\mathfrak{g}}$, it is possible to deduce the Leznov-Saveliev solutions as [53]

$$e^{-\beta \Lambda_i(\Phi)} = e^{-\beta \Lambda_i(\Phi_0)} \langle \Lambda_i | U(x^+) V(x^-) | \Lambda_i \rangle,$$

where $\Phi = \phi \cdot H_0 + \xi k + \eta d'$, Φ_0 is a free field and $U(x^+)$, $V(x^-)$ are the $\hat{\mathfrak{g}}$ -analogues of (2.4.1b) and (2.4.1c), respectively.

In the last subsection, it was shown that the equations of motion of the conformal affine Toda model reduce to those of the affine Toda model if $\eta = 0$. Putting this condition into the above solution [53],

$$e^{-\beta(\lambda_i \cdot \Phi + \xi k)} = e^{-\beta(\lambda_i \cdot \Phi_0 + \xi k)} \langle \lambda_i | U(x^+) V(x^-) | \lambda_i \rangle,$$

for $i \neq 0$, and dividing by the $i = 0$ solution

$$e^{-\beta \xi \psi^2 / 2} = \langle \lambda_0 | U(x^+) V(x^-) | \lambda_0 \rangle,$$

raised to the appropriate power to remove the dependence on ξ , the affine Toda solution is obtained:

$$e^{-\beta\lambda_i\cdot\phi} = e^{-\beta\lambda_i\cdot\phi_0} \frac{\langle \lambda_i | U(x^+) V(x^-) | \lambda_i \rangle}{\langle \lambda_0 | U(x^+) V(x^-) | \lambda_0 \rangle^{m_i}}, \quad (2.5.2a)$$

with the $U(x^+)$, $V(x^-)$ satisfying $\partial_+ U = -\tilde{\mu}U$, $\partial_- V = -V\tilde{\nu}$ where

$$\begin{aligned} \tilde{\mu}(x^+) &= \mu e^{\beta\phi_0^+ \cdot H_0} \hat{E}_1 e^{-\beta\phi_0^+ \cdot H_0} \\ \tilde{\nu}(x^-) &= \mu e^{-\beta\phi_0^- \cdot H_0} \hat{E}_{-1} e^{\beta\phi_0^- \cdot H_0} \end{aligned}$$

with $\hat{E}_{\pm 1}$ being given by (2.5.1a). It should be noted that this formula was first obtained by Mansfield in the case of the sine-Gordon model [44]. As will be seen in the section after next, this solution has been exploited to prove algebraically many of the interesting properties possessed by the affine Toda solitons.

2.6 Affine Toda field theory

2.6.1 Masses and couplings in affine Toda theory

Through a case-by-case study of the affine Toda theories, the masses of the quantum fluctuations about the vacuum solution in each of the models were calculated [49, 11]. Further, for the untwisted theories, these masses were found to be proportional to the entries of the Perron-Frobenius eigenvector of the Cartan matrix of \mathfrak{g} – that is, the right eigenvector corresponding to the lowest eigenvalue. In the quantum theory a generalization of this was found, in that the values of the conserved charges are proportional to the components of the remaining eigenvectors.

The case-by-case analysis proceeds as follows. Expanding the potential term in the Lagrangian density,

$$V(\phi) = \frac{m^2}{\beta^2} \sum_{i=0}^r n_i (\alpha_i \cdot \phi) + \frac{m^2}{2} \sum_{i=0}^r n_i (\alpha_i \cdot \phi)^2 + \frac{m^2 \beta}{6} \sum_{i=0}^r n_i (\alpha_i \cdot \phi)^3 + \dots,$$

the first term at order β^{-2} vanishes by virtue of $\alpha_0 = -\sum_{i=1}^r n_i \alpha_i$, whereas at order zero in β a (mass)² matrix is obtained:

$$(M^2)^{ab} = m^2 \sum_{i=0}^r n_i \alpha_i^a \alpha_j^b \quad a, b = 1, \dots, r.$$

At order β the three point couplings appear, and are given by

$$C^{abc} = \beta m^2 \sum_{i=0}^r n_i \alpha_i^a \alpha_i^b \alpha_i^c \quad a, b, c = 1, \dots, r.$$

For each of the simply-laced algebras the above masses were computed, along with the three point couplings in [11]. The following rather remarkable results were found. Firstly, the classical masses form an eigenvector of the associated Lie algebra's Cartan matrix corresponding to the lowest eigenvalue, $\lambda_{min} = 2 - 2 \cos \frac{\pi}{h}$ (where h is the Coxeter number). By the Perron-Frobenius theorem, all the components of this eigenvector can be taken as positive, in keeping with their interpretation as particle masses. As a result the masses can be assigned to particular points on the algebra's Dynkin diagram. As will be seen later, these mass ratios are identical to those of the single soliton solitons of the simply-laced theories allowing also for an identification between each soliton and a point on the Dynkin diagram.

The three point couplings when expressed in a basis of mass eigenstates were found to be related to the area of a triangle with sides of length equal to the masses of the respective particles. Explicitly, the relationship found was

$$|C^{abc}| = \frac{4\beta}{\sqrt{h}} \Delta^{abc} = \frac{2\beta}{\sqrt{h}} m_a m_b \sin U_{ab}^c,$$

where Δ^{abc} is the area of the aforementioned triangle and U_{ab}^c are the 'fusing angles'. These results are also analogous to those for the soliton solutions where a double soliton can, at a certain rapidity difference of the contributing solitons, reduce to that of a single soliton. These rapidity differences are the same as those in the real coupling theory related to the above fusing angles [53, 30].

In the quantum theory it is found that to first order in β the masses of the simply-laced particles renormalize in the same way, and so leave the mass ratios unchanged. However this seems not to be the case in the non-simply-laced theories.

There was an attempt to obtain the above results by purely algebraic methods originally by Freeman [25], and later extended by Fring, Liao and Olive [26]. In the work of Freeman [25], the affine Toda equations (with $\beta = 1$),

$$\partial^2 \phi + m^2 \sum_{i=0}^r n_i \alpha_i e^{\alpha_i \cdot \phi} = 0,$$

are expressed in the more algebraic form

$$\partial^2 \phi + m^2 \left[e^\phi \left(\sum_{i=0}^r c_i E_{\alpha_i} \right) e^{-\phi}, \left(\sum_{i=0}^r \bar{c}_i E_{-\alpha_i} \right) \right] = 0.$$

This expression is valid provided the numbers c_i , and \bar{c}_i satisfy $c_i \bar{c}_i = n_i$. Further, the solution $\phi = 0$ exists only if

$$\sum_{i=0}^r c_i E_{\alpha_i} \quad \text{and} \quad \sum_{i=0}^r \bar{c}_i E_{-\alpha_i}$$

commute. This happens provided all of the c_i and \bar{c}_i are non-zero. In the terminology of Kostant [23] the element $\sum c_i E_{\alpha_i}$ is called *regular*, and commutes with a number of other elements of the algebra to form a second Cartan subalgebra, denoted h' . This alternative description of the algebra with associated step operators has been seen to play a major rôle, not only in the calculation of masses and couplings by algebraic means, but also in the algebraic construction of the soliton solutions.

Considering this Cartan subalgebra further, if the action of $S = \exp(2\pi i T^3/h)$ is applied to both $\sum c_i E_{\alpha_i}$ and $\sum \bar{c}_i E_{-\alpha_i}$ they are found to have eigenvalues ω and ω^{h-1} , respectively, where ω is the h^{th} root of unity. In fact the basis of h' can be chosen to be the eigenvectors of the above action [23], with eigenvalues ω^{k_i} where the k_i are the exponents of \mathfrak{g} (these are listed for the simply-laced theories in Table 1 below [60]). The restriction of the action of S to h' is found to be a Coxeter transformation.

Algebra	Exponents
A_n	$1, 2, 3, \dots, n \pmod{(n+1)}$.
D_n	$1, 3, 5, \dots, 2n-3, 2n-1 \pmod{2(n-1)}$.
E_6	$1, 4, 5, 7, 8, 11 \pmod{12}$.
E_7	$1, 5, 7, 9, 11, 13, 17 \pmod{18}$.
F_4	$1, 5, 7, 11 \pmod{12}$.
G_2	$1, 5 \pmod{6}$.

Table 1: The exponents of the simply-laced theories.

This reformulation of the algebra is useful as it makes use of the connection between the eigenvalues and eigenvectors of the Coxeter transformation and those of the Cartan matrix. In particular, if λ is an eigenvalue of the Coxeter transformation then $2 - \lambda^{1/2} - \lambda^{-1/2}$ is an

eigenvalue of the Cartan matrix. Also, if \mathbf{x} is an eigenvector of the Coxeter transformation then its components are, up to phases, those of an eigenvector of the Cartan matrix.

From the equations of motion, the mass-squared matrix is given by the action of

$$m^2 \text{ad} \left(\sum_{\alpha \in \bar{\Delta}} \bar{c}_\alpha E_{-\alpha} \right) \text{ad} \left(\sum_{\alpha \in \bar{\Delta}} c_\alpha E_\alpha \right),$$

where ϕ lies in \mathfrak{h} . It is convenient to choose the basis $\{\phi'_i \equiv R_{\alpha'_i} \dots R_{\alpha'_{i+1}} \alpha'_i\}$ [23], where $R_{\alpha'_j}$ is a Weyl reflection in the simple root α'_j , as opposed to the simple roots themselves. For each of the roots ϕ'_i the step operators

$$E'_{\phi'_i}, E'_{\gamma(\phi'_i)}, \dots, E'_{\gamma^{h-1}(\phi'_i)},$$

form an orbit under the action of S , with the simple roots α of the form $\gamma^k(\phi_i)$ for some k and i [23]. Therefore, a basis for \mathfrak{h} can be chosen as

$$\sum_{k=0}^{h-1} E'_{\gamma^k(\phi_i)} \quad i = 1, \dots, r$$

since these are the elements fixed under the action of S . As a result, it can be shown that

$$\text{ad} \left(\sum_{\alpha \in \bar{\Delta}} \bar{c}_\alpha E_{-\alpha} \right) \text{ad} \left(\sum_{\alpha \in \bar{\Delta}} c_\alpha E_\alpha \right) \sum_{k=0}^{h-1} E'_{\gamma^k(\phi_i)} = \phi'_i \left(\sum_{\alpha \in \bar{\Delta}} c_\alpha E_\alpha \right) \phi'_i \left(\sum_{\alpha \in \bar{\Delta}} \bar{c}_\alpha E_{-\alpha} \right) \sum_{k=0}^{h-1} E'_{\gamma^k(\phi_i)}$$

where

$$\left(\text{ad} \sum_{\alpha \in \bar{\Delta}} c_\alpha E_\alpha \right) E'_{\phi'_i} = \phi'_i \left(\sum_{\alpha \in \bar{\Delta}} c_\alpha E_\alpha \right) \sum_{k=0}^{\tau} E'_{\phi'_i}.$$

The $\sum_{k=0}^{\tau} E'_{\phi'_i}$ are therefore a basis of mass eigenstates with (mass)² given by the above eigenvectors. However, as $\sum c_\alpha E_\alpha$ is an eigenvector of the Coxeter transformation with eigenvalue ω (and so the lowest eigenvalue of the Cartan matrix), its components are, up to phases, those of the Perron-Frobenius vector.

In the case of the three point couplings, it was shown in [25] that for three particles of masses m_i, m_j , and m_k , corresponding to the roots ϕ'_i, ϕ'_j , and ϕ'_k , there is a non-zero coupling only if

$$\gamma^a(\phi'_i) + \gamma^b(\phi'_j) + \gamma^c(\phi'_k) = 0$$

for some numbers a, b and c . This result was also noted independently by Dorey [20].

The work of Freeman, summarized above, has been extended by Fring, Liao and Olive [26] who showed that the masses are given by $m_i = \beta x_i \alpha_i^2 \sin(\pi/h)$ where x_i is the i^{th} component of the left-eigenvector of the Cartan matrix and the three point coupling is given by

$$c_{ijk} = \frac{4i\epsilon(i, j, q)}{\sqrt{h}} \Delta_{ijk}$$

with Δ_{ijk} being the area of the triangle with sides m_i , m_j and m_k . If ψ is the highest root then $(\sqrt{2/\psi^2})\epsilon(i, j, q) = \pm 1$, unless i, j, k all correspond to short roots in which case $\epsilon(i, j, q) = \pm 1/\sqrt{2}$ for the algebras B_n , C_n and F_4 , and $\pm 2/\sqrt{3}$ for the algebra G_2 .

2.6.2 S-matrix theory

Another aspect of the quantum theory of the affine Toda model that has been considered in detail is that of the quantum S -matrix [56, 61]. In fact, S -matrices has been calculated for all of the algebras of affine Toda field theory [4, 11, 16, 9]. More recently there has been an attempt to extend the work of the Zamolodchikovs [61] and construct the S -matrices for quantum solitons. Therefore S -matrix theory will, for completeness, be briefly reviewed here with a review of the soliton S -matrix left to the conclusion of this thesis.

The momentum of a particle in two dimensions can be written in terms of the particle's rapidity, θ_a , as

$$p_a = m_a(\cosh \theta_a, \sinh \theta_a)$$

where the velocity is given by $v = \tanh \theta_a$. In an integrable theory such as affine Toda field theory there are an infinite number of locally conserved operators of which a single particle state must be a simultaneous eigenvector. If a locally conserved operator Q_s is acted upon adjointly by the Lorentz transformation L then

$$(\text{ad}L)Q_s = sQ_s.$$

In this case the operator is said to have spin s . For each spin there exists a conservation law leading to the following rule [61]:

- the number of particles of mass m_a is the same in both an in- and out-state,
- the set of in-going momenta is the same as the out-going momenta.

As a result, there is no particle production and the S -matrix is assumed to be factorizable. It is therefore only necessary to consider two-particle S -matrices at any one time. The factorizability of the S -matrix leads to a constraint in that the two pictures below have identical total S -matrix.

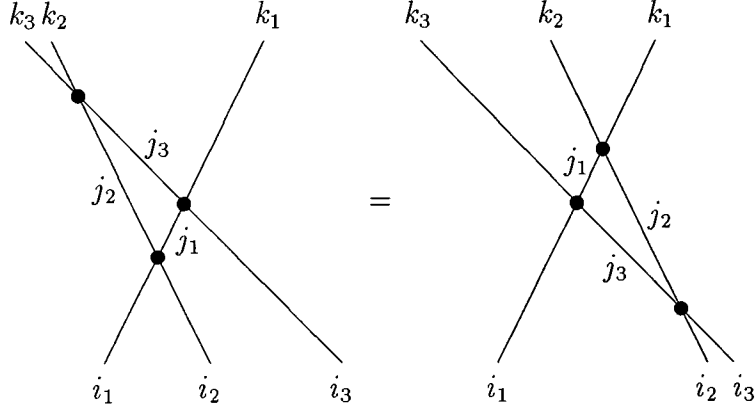

Figure 1: Factorization of the S -matrix.

The above leads to the Yang-Baxter equation

$$S_{j_2 j_3}^{k_3 k_2}(\theta_{23}) S_{j_1 i_3}^{k_1 j_3}(\theta_{13}) S_{i_1 i_2}^{j_1 j_2}(\theta_{12}) = S_{j_1 j_2}^{k_2 k_1}(\theta_{12}) S_{i_1 j_3}^{k_3 j_1}(\theta_{13}) S_{i_2 i_3}^{j_3 j_2}(\theta_{23})$$

where the indices denote the particle labels and $\theta_{ab} = \theta_a - \theta_b$. There are further conditions that can be placed on the S -matrix:

Unitarity

The probability that a two-particle scattering results in a final state is unity, therefore

$$S_{ab}^{kl}(\theta) S_{kl}^{cd}(-\theta) = \delta_a^c \delta_b^d.$$

Crossing symmetry

In the scattering process $a + b \rightarrow c + d$ there can be either s or t channel scattering. For the S -matrix to be symmetrical under $s \leftrightarrow t$, or equivalently $\theta \leftrightarrow (i\pi - \theta)$, then

$$S_{ab}^{cd}(\theta) = S_{c\bar{b}}^{a\bar{d}}(i\pi - \theta)$$

where \bar{b} and \bar{d} are the anti-particles of b and d , respectively.

Returning briefly to the masses and couplings of the fundamental particles, if two particles a and b can fuse to a third \bar{c} then the two particle S -matrix for a and b will have a pole at $\theta_{ab}^{\bar{c}}$ where $\theta_{ab}^{\bar{c}}$ is obtained from the equation

$$m_{\bar{c}}^2 = m_a^2 + m_b^2 + 2m_a m_b \cosh \theta_{ab}^{\bar{c}}.$$

Similarly b and c can fuse to \bar{a} , and c and a can fuse to \bar{b} . This can be expressed in the form of a 'mass triangle' triangle mentioned earlier and visualized as

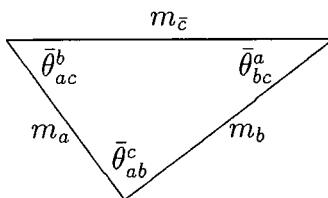

Figure 2: The mass triangle.

where $\bar{\theta} = \pi - \theta$ and so

$$\theta_{ab}^c + \theta_{ac}^b + \theta_{bc}^a = 2\pi.$$

The final constraint that can be imposed on the S -matrices comes from the bootstrap principle. If two particles a and b scatter purely elastically, and their S -matrix has a pole at θ_{ab}^c then the bound state particle \bar{c} can appear for some time during the scattering process. This can be visualized, for the three particle scattering process, as

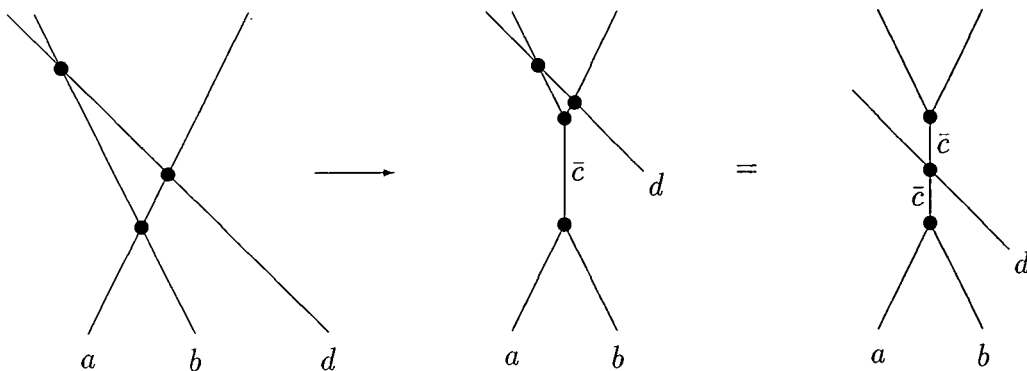

Figure 3: The bootstrap principle.

and leads to the following final constraint on the S -matrix:

$$S_{d\bar{c}}(\theta) = S_{da}(\theta - i\bar{\theta}_{ac}^b) S_{db}(\theta + i\bar{\theta}_{bc}^a).$$

Following the calculation of the S -matrix for the $a_n^{(1)}$ theory [4], the S -matrices for the remaining untwisted theories were constructed [11]. The extension to the twisted theories is given in [16, 9].

2.7 Affine Toda solitons

It has long been known that the familiar sine-Gordon equation possesses localized mass configurations known as solitons. There are two fundamental solitons, the soliton and antisoliton, each distinguished by their topological charge. As the sine-Gordon model is the simplest of the $a_n^{(1)}$ affine Toda models it is reasonable to speculate that solitons exist in these more general theories.

As such, Hollowood used Hirota's method to investigate the complex coupling $a_n^{(1)}$ theories [32]. There it was found that there were $r = \text{rank } \mathfrak{g}$ solitons which, although having complex energy density, possessed real mass. In fact these mass ratios were the same as those obtained for the fundamental Toda particles. This led to an association between the solitons and points on the unextended Dynkin diagram A_n . Further, the topological charges of the solitons associated with the end-points of the diagram were calculated and found to be the complete set of weights of the associated fundamental representation. It was claimed that for the remaining solitons, the topological charges lay within the corresponding fundamental representations but did not fill them.

At that point there were two immediate questions. Firstly, could the use of Hirota's method be extended to the remaining affine Toda theories, twisted as well as untwisted, and secondly is there a general description and explanation of the location of the topological charges both within the $a_n^{(1)}$ representations and correspondingly for other theories. The next chapter, based on [46], addresses the first question with the following two chapters considering topological charges for the $a_n^{(1)}$ [47] and other theories.

2.7.1 The algebraic soliton solution

This section briefly touches upon the work of Kneipp, Olive, Turok and Underwood [53,

54, 39, 58]. They have considered in detail the general algebraic solution to affine Toda field theory, (2.5.2a), obtained from the conformal affine Toda model, as discussed in §2.5.2

Recalling that,

$$e^{-\beta\lambda_i\cdot\phi} = e^{-\beta\lambda_i\cdot\phi_0} \frac{\langle \lambda_i | U(x^+) V(x^-) | \lambda_i \rangle}{\langle \lambda_0 | U(x^+) V(x^-) | \lambda_0 \rangle^{m_i}}.$$

then if ϕ_0^\pm are constant and lie in $\frac{2\pi i}{\beta} \Lambda_W(\hat{\mathfrak{g}}^\nu)$ then the Chiral equations for $U(x^+)$ and $V(x^-)$ can be trivially integrated to give

$$U(x^+) V(x^-) = e^{-\beta\hat{E}_1 x^+} g(0) e^{-\beta\hat{E}_{-1} x^+}$$

where $g(0)$ is a Kac-Moody group element. The above solution therefore reduces to the form

$$e^{-\beta\lambda_i\cdot\phi} = \frac{\langle \Lambda_i | e^{-\beta\hat{E}_1 x^+} g(0) e^{-\beta\hat{E}_{-1} x^+} | \Lambda_i \rangle}{\langle \Lambda_0 | e^{-\beta\hat{E}_1 x^+} g(0) e^{-\beta\hat{E}_{-1} x^+} | \Lambda_0 \rangle^{m_i}}.$$

Making use of the alternative Cartan subalgebra and associated step operators as discussed in §2.6.1, the element $g(0)$ can be parameterized, in the case of N solitons, by coordinates and momenta and expressed in the form

$$g(0) = e^{Q_1 \hat{F}(\alpha_1, \rho_1)} e^{Q_2 \hat{F}(\alpha_2, \rho_2)} \dots e^{Q_N \hat{F}(\alpha_N, \rho_N)}.$$

The Kac-Moody generators $\hat{F}(\alpha_i, \rho_i)$ have the property that

$$[\hat{E}_M, \hat{F}(\alpha_i, \rho_i)] = q([M]) \cdot \alpha_i \rho^M \hat{F}(\alpha_i, \rho_i).$$

Each $\hat{F}(\alpha_i, \rho_i)$ can therefore be viewed as creating a soliton with momentum $p^\pm |q(1) \cdot \alpha_i \rho^{\pm 1}|$ at position $\ln |Q_i|$. The imaginary part of Q is interesting for the purposes of this thesis as it determines the soliton's topological charges.

For the untwisted theories, the soliton energy-momentum was calculated in [53] giving the soliton masses as

$$M(\text{soliton}, \alpha) = \frac{4h\bar{M}(\text{particle}, \alpha)^2}{\beta^2 \alpha^2}.$$

This work has been extended in a number of directions. Firstly, in [54] examples of the more generalized single solitons of the non simply-laced theories are presented, as well as a Vertex Operator construction of the $\hat{F}^i(z) \equiv \hat{F}(\gamma_i, z)$. This has the important consequence of providing a classical version of Dorey's fusing rule for the untwisted theories.

As well as this, the algebraic construction of solitons has been discussed in the context of general integrable systems [55].

2.7.2 The Backlund transformations of the A_n affine Toda field theory.

In this section the investigation into affine Toda solitons, in particular the reality of their energy, by Bäcklund transformations [43] is reviewed.

In theories possessing topological solitons it is often found that the classical energy density is equal to a topological surface term, provided certain first order differential equations are satisfied. These differential equations are called the ‘Bogomolny’ equations. For the sine-Gordon theory, the relevant first order equations, the Bäcklund transformations, have been known since the 1800’s. These have been generalized to the case of the A_n affine Toda theories by Fordy and Gibbons [24].

With the affine Toda Lagrangian density written in the usual form, but with $\beta \rightarrow i\beta$,

$$\mathcal{L} = \frac{1}{2}(\partial_\mu \phi) \cdot (\partial^\mu \phi) + \frac{m^2}{\beta^2} \sum_{i=0}^r n_i \left(e^{i\beta \alpha_i \cdot \phi} - 1 \right),$$

it is convenient, for the purposes of this discussion, to write the extended simple roots as $\alpha_i = e_i - e_{i+1}$ where $\{e_1, e_2, \dots, e_r, e_{r+1} \equiv e_0\}$ is a set of orthonormal basis vectors. The field ϕ , which lies in the r dimensional subspace spanned by the simple roots, is written as $\phi = \sum_i e_i \phi_i$ so that $\phi_i = e_i \cdot \phi$ and $\sum_i \phi_i = 0$. The equations of motion are then expressible in the form

$$F_j(\phi) \equiv \partial^2 \phi_j - \frac{im^2}{\beta} \left(e^{i\beta(\phi_j - \phi_{j+1})} - e^{i\beta(\phi_{j-1} - \phi_j)} \right) = 0 \quad (2.7.2a).$$

The vector fields ϕ and $\tilde{\phi}$ are defined to be orthogonal to $\sum_i e_i$ and to satisfy

$$\partial_+(\phi_j - \tilde{\phi}_j) = \frac{m}{\sqrt{2}\beta} A \left(e^{i\beta(\tilde{\phi}_j - \phi_{j+1})} - e^{i\beta(\tilde{\phi}_{j-1} - \phi_j)} \right), \quad (2.7.2b)$$

$$\partial_-(\phi_j - \tilde{\phi}_{j-1}) = \frac{m}{\sqrt{2}\beta} A^{-1} \left(e^{i\beta(\phi_j - \tilde{\phi}_j)} - e^{i\beta(\phi_{j-1} - \tilde{\phi}_{j-1})} \right), \quad (2.7.2c)$$

where $x^\pm = (t \pm x)/\sqrt{2}$ are the light-cone variables, and A is known as the parameter of the Bäcklund transformation. Differentiating (2.7.1a) wrt x^- and (2.7.1b) wrt x^+ then using both (2.7.1a) and (2.7.1b) to remove the derivatives of the fields in front of the exponentials, gives

$$F_j(\phi) = F_j(\tilde{\phi}) \quad \text{and} \quad F_j(\phi) = F_{j-1}(\tilde{\phi}).$$

These equations are satisfied for all j and so all the functions F_j are equal. Therefore,

$$F_j(\phi) = F_j(\tilde{\phi}) = \frac{1}{h} \sum_{i=0}^r F_i = 0,$$

the last equation being true by virtue of the expression for F_i in (2.7.1a). As a result, integrability of equations (2.7.1b) and (2.7.1c) imply the equations of motion hold. Therefore the above coupled equations map one solution $\tilde{\phi}$ into another ϕ .

The trivial solution $\tilde{\phi} = 0$ reduces the Bäcklund transformations to the form

$$\partial_+ \phi_j = \frac{m}{\sqrt{2}\beta} A(e^{-i\beta\phi_{j+1}} - e^{-i\beta\phi_j}) \quad (2.7.2d)$$

$$\partial_- \phi_j = \frac{m}{\sqrt{2}\beta} A^{-1}(e^{i\beta\phi_j} - e^{i\beta\phi_{j-1}}) \quad (2.7.2e)$$

Defining $B_j = A^{-1}e^{i\beta\phi_n}$ the above equations become

$$\partial_+ \phi_j = \frac{m}{\sqrt{2}\beta} (B_{j+1}^{-1} - B_j^{-1}) \quad (2.7.2f)$$

$$\partial_- \phi_j = \frac{m}{\sqrt{2}\beta} (B_j - B_{j-1}) \quad (2.7.2g)$$

In order to find static single solitons it is assumed that $\partial_t \phi = 0$, so that $(\partial_+ + \partial_-)\phi = 0$, i.e.

$$\sum_{j=0}^r e_j (B_{j+1}^{-1} - B_j^{-1}) + \sum_{j=0}^r e_j (B_j - B_{j-1}) = \sum_{j=0}^r \alpha_j (B_{j+1}^{-1} - B_n) = 0.$$

Since the extended sum of simple roots vanishes $B_{j+1}^{-1} + B_j = c$, $\forall j$, where c is some constant. Therefore once one B_j is determined, the rest are then known. The recurrence relation for the B_j can be used to give $c = 2 \cos(\theta/2)$ where $\theta = 2\pi a/h$, $a = 1, \dots, r$. The resulting Bäcklund transformations simplify to

$$\frac{dB_j}{dx} = -im(B_j - e^{i\theta/2})(B_j - e^{-i\theta/2}).$$

Upon integrating, and imposing the condition $B_{j+1}^{-1} + B_j = c$, the static soliton solution is obtained:

$$B_j = e^{i\theta/2} \frac{e^{i(j-1)\theta} Q e^{2mx \sin \theta/2} - 1}{e^{ij\theta} Q e^{2mx \sin \theta/2} - 1},$$

Q being a complex constant, the magnitude of which is the exponential of the centre of mass and the phase of which determines the soliton topological charge. Defining $\sigma = 2m \sin \theta/2$,

$\xi = \ln Q - i\pi$, $\Phi = \sigma x + \xi$ and $\omega_a = e^{i\theta}$ then

$$e^{i\beta\phi_j} = A\omega^{1/2} \frac{1 + \omega_a^{j-1} e^\Phi}{1 + \omega_a^j e^\Phi},$$

and so the field $\phi_{(a)}$ can be written in the form

$$\phi_{(a)} = -\frac{1}{i\beta} \sum_{j=1}^r \alpha_j \ln \left(\frac{1 + \omega_a^j e^\Phi}{1 + e^\Phi} \right),$$

in agreement with the expression first obtained by Hollowood [32] and calculated using Hirota's method in the next chapter. Having obtained the single static soliton it is possible to put this into the Bäcklund transformation and so obtain the two soliton. By repeating this process the general N -soliton solution can be built up. However it is possible to use properties of the transformation which simplify the calculation. This is explored in further detail in [43] and shall not be discussed here.

It is also possible at this point to obtain expressions for the soliton masses. The energy and momentum densities are given by

$$\begin{aligned} \mathcal{E} &= \frac{1}{2} \sum_n [(\partial_+ \phi_n)^2 + (\partial_- \phi_n)^2] + V(\phi), \\ \mathcal{P} &= \frac{1}{2} \sum_n [(\partial_+ \phi_n)^2 - (\partial_- \phi_n)^2], \end{aligned}$$

respectively. From the definition of B_j and the Bäcklund transformations

$$\partial_+ B_j = \frac{im}{\sqrt{2}} (B_{n+1}^{-1} B_n - 1) = \partial_- B_{n+1}^{-1},$$

and so defining $B = \sum_j B_j$ and $\tilde{B} = \sum_j B_n^{-1}$ then $\partial_+ B = \partial_- \tilde{B}$. The potential term can therefore be written,

$$V(\phi) = -\frac{m^2}{\beta^2} \sum_{j=0}^r n_j (e^{i\beta \cdot \phi} - 1) = -\frac{m^2}{\beta^2} \sum_{j=0}^r (B_{j+1}^{-1} B_j - 1) = -\frac{m}{i\sqrt{2}\beta^2} (\partial_+ B + \partial_- \tilde{B})$$

and the kinetic term is expressed via the equations

$$\frac{1}{2} \sum_{j=0}^r (\partial_+ \phi_j)^2 = \frac{m}{i\sqrt{2}\beta^2} \partial_+ \tilde{B} \quad \text{and} \quad \frac{1}{2} \sum_{j=0}^r (\partial_- \phi_j)^2 = \frac{m}{i\sqrt{2}\beta^2} \partial_- B.$$

The energy and momentum densities are therefore

$$\mathcal{E} = \frac{m}{i\beta^2} \frac{d}{dx} (\tilde{B} - B) \quad \text{and} \quad \mathcal{P} = \frac{m}{i\beta^2} \frac{d}{dx} (\tilde{B} + B).$$

The light-cone components of the momentum are therefore

$$P^+ \equiv \frac{E + P}{\sqrt{2}} = \frac{\sqrt{2}m}{i\beta^2} \left(\lim_{x \rightarrow \infty} - \lim_{x \rightarrow -\infty} \right) \tilde{B}$$

$$P^- \equiv \frac{E - P}{\sqrt{2}} = -\frac{\sqrt{2}m}{i\beta^2} \left(\lim_{x \rightarrow \infty} - \lim_{x \rightarrow -\infty} \right) B.$$

From the expression for B_j above, $B_j \rightarrow e^{\mp\theta/2}$ as $x \rightarrow \pm\infty$, and as a result, the mass squared of the soliton can be written as

$$2P^+P^- = \left(\frac{4mh}{\beta^2} \sin \left(\frac{(n_+ - n_-)\pi}{h} \right) \right)^2$$

for some integers n_{\pm} . This is in agreement with the result first obtained by Hollowood in [32].

Chapter 3

Classical Affine Toda Solitons

3.1 Introduction

The study of solitons in affine Toda field theory was initiated in the work of Hollowood [32]. In that original work, Hirota's method was used to show that the $a_n^{(1)}$ theory possessed n static single solitons each of mass

$$M_a = \frac{2mh}{\beta^2} \sqrt{\lambda_a},$$

where $1 \leq a \leq n$ associates each soliton with a spot on the Dynkin diagram, h is the Coxeter number, and λ_a is the a^{th} eigenvalue of the matrix NC (see later for details). The first remarkable property of the solitons is that their mass ratios are equal to those of the fundamental particles found in the 'real-coupling' quantum theory. Secondly, the topological charges of the single soliton corresponding to $a = 1$ (or equivalently $a = n$) were calculated and found to fill up the corresponding fundamental representations. For the other solitons it appeared that the topological charges, although lying in their associated fundamental representations, did not fill them. The study of the topological charges of this and the remaining theories will be taken up in Chapters 4 and 5, respectively.

A variety of methods have been applied by a number of authors to construct affine Toda solitons. The methods of Hollowood have been generalized [46], Hirota's method has been applied to the conformal affine Toda model [15, 1, 2] and from it the solitons of the affine Toda model deduced, Bäcklund transformation have been used to generate the A_n solitons [43], and finally the methods of Leznov and Saveliev [41] who constructed a general solution to the conformal Toda model, have been used to construct a general algebraic solution to the affine Toda model [53, 54, 39, 58].

It is the generalization of Hollowood's methods, the majority of which has been published in [46], that will be considered here. Further, static soliton configurations will be discussed. That is, in the sine-Gordon equation the only static soliton (in the sense that time dependence can be removed by moving into the rest frame of the soliton) is that of either the soliton (which has topological charge $+1$) or the antisoliton (which has topological charge -1). In the more general A_n theory, the increased number of different types of soliton (each with a number of different topological charges) allows for static multisoliton configurations to occur as a specialization of the general multisoliton solution. In these

cases, each soliton making up the static solution must be of a different type (otherwise the interaction constant between two solitons of the same type vanishes, thereby resulting in a single soliton solution of that type). This topic shall be touched upon in its own right as well as providing a means of constructing solitons which are preserved under the folding process and so exist as solutions of the folded theory.

3.2 The equations of motion

With regard to the Lagrangian density of affine Toda field theory (2.4.2c), if the coupling constant β is replaced by $i\beta$, the potential term becomes

$$V(\phi) \sim \sum_{j=0}^r n_j (e^{i\beta\alpha_j \cdot \phi} - 1).$$

In the real coupling case, upon considering real fields, this is zero only for $\phi = 0$, whereas in the complex coupling regime the potential has zeros for $\phi \in \frac{2\pi i}{\beta} \Lambda_W^*$, (Λ_W^* being the co-weight lattice). The appearance of many minima of the potential is an indication that soliton solutions, interpolating from one minimum at $x = -\infty$ to another at $x = +\infty$, may exist. The change in the field between $x = \pm\infty$ is therefore proportional to an element of the co-weight lattice.

Setting the coupling constant β to be purely complex, the equations of motion are rewritten

$$\partial^2 \phi - \frac{im^2}{\beta} \sum_{j=0}^r n_j \alpha_j e^{i\beta\alpha_j \cdot \phi} = 0. \quad (3.2a)$$

The ansatz used in [32] to generate the $a_n^{(1)}$ solitons is found to be problematic when applied to the non-simply-laced theories, implying the need to modify it. The modification required appears to be to rescale each of the roots by a numerical constant. The new ansatz for the field $\phi(x, t)$ which will be considered is

$$\phi = -\frac{1}{i\beta} \sum_{i=0}^n \eta_i \alpha_i \ln \tau_i \quad (3.2b)$$

which, when substituted into (3.2a), gives

$$\sum_{j=0}^r \alpha_j Q_j = 0$$

where

$$\begin{aligned} Q_j &= \left(\frac{\eta_j}{\tau_j^2} (\ddot{\tau}_j \tau_j - \dot{\tau}_j^2 - \tau_j'' \tau_j - \tau_j'^2) - m^2 n_j \left(\prod_{k=0}^r \tau_k^{-\eta_k \alpha_k \cdot \alpha_j} - \mu_1 \right) \right) \\ &= \left(\frac{\eta_j}{2\tau_j^2} (D_t^2 - D_x^2) \tau_j \cdot \tau_j - m^2 n_j \left(\prod_{k=0}^r \tau_k^{-\eta_k \alpha_k \cdot \alpha_j} - \mu_1 \right) \right). \end{aligned}$$

and μ_1 is, without loss of generality, completely arbitrary. In the second expression, the Hirota derivatives D_x and D_t , defined by

$$D_x^m D_t^n f \cdot g = \left(\frac{\partial}{\partial x} - \frac{\partial}{\partial x'} \right)^m \left(\frac{\partial}{\partial t} - \frac{\partial}{\partial t'} \right)^n f(x, t) g(x', t') \Big|_{\substack{x=x' \\ t=t'}},$$

have been used as they make the subsequent calculations much easier. A brief review of Hirota derivatives and their properties is given in appendix A.1. In general, $Q_j = \mu_2 n_j$ (for some constant μ_2) and for the Hirota equations to hold at lowest order in ϵ , it is required that $\mu_1 - \mu_2 = 0$. Therefore $Q'_j = 0$ where

$$Q'_j = \left(\frac{\eta_j}{2\tau_j^2} (D_t^2 - D_x^2) \tau_j \cdot \tau_j - m^2 n_j \left(\prod_{k=0}^r \tau_k^{-\eta_k \alpha_k \cdot \alpha_j} - 1 \right) \right).$$

(Note that the existence of $n + 1$ τ -functions (compared to the n -component field ϕ) can be traced back to the ξ field in the CAT model [15]). The equations of motion can now be reduced to the form,

$$\eta_j (D_t^2 - D_x^2) \tau_j \cdot \tau_j - 2m^2 n_j \left(\prod_{k=0}^r \tau_k^{-\eta_k \alpha_k \cdot \alpha_j} - 1 \right) \tau_j^2 = 0. \quad (3.2c)$$

In the spirit of Hirota's method for finding soliton solutions [31], it is assumed that

$$\tau_j = 1 + \delta_j^{(1)} e^{\Phi} \epsilon + \delta_j^{(2)} e^{2\Phi} \epsilon^2 + \dots + \delta_j^{(p_j)} e^{p_j \Phi} \epsilon^{p_j}$$

where $\Phi = \sigma(x - vt) + \xi$ and $\delta_j^{(k)}$ ($1 \leq k \leq p_j$), σ, v and ξ are arbitrary complex constants. The constant p_j is a positive integer and ϵ a dummy parameter. The method employed is to solve (3.2c) at successive orders in ϵ . In general the series terminates leaving a relatively simple solution. The smallest value of p_j for which the series terminates gives the single solitons, whereas the multisoliton solutions correspond to greater p_j .

At first order in ϵ the equation (3.2c) is expressible in the form

$$\sum_{j=0}^r E_{ij} \delta_j^{(1)} = \frac{\sigma^2(1-v^2)}{m^2} \delta_i^{(1)}$$

so that the vector formed from the $\delta_i^{(1)}$'s i.e. $\delta^{(1)} = (\delta_0^{(1)}, \delta_1^{(1)}, \dots, \delta_r^{(1)})^T$, is an eigenvector of the matrix E which has components

$$E_{ij} = \frac{\eta_j}{\eta_i} n_i \alpha_i \cdot \alpha_j. \quad (3.2d)$$

In the simply-laced theories the corresponding eigenvalues are, up to a factor, the unrenormalized masses of the fundamental particles in the real coupling theory. This can be seen as follows: define the matrices

- $\eta = \text{diag}(\eta_0, \eta_1, \dots, \eta_r)$
- $N = \text{diag}(n_0, n_1, \dots, n_r)$,
- $(C)_{ij} = \alpha_i \cdot \alpha_j, \quad 0 \leq i, j \leq r.$

Then rewriting (3.2d) in matrix form

$$\eta E \eta^{-1} = NC,$$

showing the E and NC are similar and so share the same eigenvalues λ which satisfy

$$\sigma^2(1 - v^2) = m^2 \lambda. \quad (3.2e)$$

Indeed for the simply-laced theories it has been shown [11] that the squared masses of the fundamental Toda particles are eigenvalues of NC so proving the correspondence stated above. This result is used later to show that for the simply-laced theories the mass ratios are the same as those in the real coupling theory. For the non-simply-laced theories, the eigenvalues of NC are up to a constant equal to a subset of eigenvalues of the mass matrix of the simply-laced theory from which it is obtained by folding (see later), as in the real coupling theory. However, the mass ratios in the untwisted theories are *not* the same as the unrenormalized mass ratios of the real coupling theory. This is due to the solitons of these theories in some cases* being multisolitons of the corresponding simply-laced theory. This will be discussed at the end of the chapter.

It is important that the solitons are bounded at $x = \pm\infty$ in order that the energy and momentum be finite. With this restriction a relationship is found relating p_j , η_j , n_j ,

*i.e. when a mass degeneracy occurs between the solitons associated with the points of the Dynkin diagram giving rise to the folding.

namely

$$n_0 \eta_j p_j = n_j \eta_0 p_0.$$

Further, in order that each τ_j in the Hirota equations be raised to a non-negative power, and so allowing the perturbative expansion to be performed, the η_j 's must be related to the simple roots via

$$\eta_j = \frac{2}{\alpha_j \cdot \alpha_j}.$$

i.e. Hollowood's ansatz is generalized by expanding $\phi(x, t)$ in terms of co-roots as opposed to roots. Note that for the simply-laced cases $\eta_j = 1$ and the τ -function perturbative series for the single solitons terminate at $p_j = n_j$.

Finally, the matrix NC has an eigenvalue $\lambda = 0$, but it is unnecessary to consider the corresponding solution as it is always $\phi = 0$.

3.3 Affine Toda solitons for simply-laced algebras

In this section the single soliton solutions will be explicitly constructed for all of the simply-laced theories. It turns out that for each of the theories the number of solitons is equal to the rank of the algebra and in a similar manner to [12, 11] each soliton can be associated to a spot on the algebra's Dynkin diagram via the eigenvalues of the matrix NC .

3.3.1 The $a_n^{(1)}$ theory

The simplest of all the affine Toda theories is that associated to the algebra $a_n^{(1)}$. The soliton solutions to this theory were first discussed in [32]. In the special case of $a_1^{(1)}$, $\alpha_0 = -\alpha_1$ and so $\phi \equiv \phi_1 \alpha_1$, the equations of motion reducing to

$$\partial^2 \phi_1 + \frac{2m^2}{\beta} \sin(2\beta \phi_1) = 0$$

i.e. those of the well known sine-Gordon model. These equations have solution

$$\phi_1(x, t) = \frac{2}{\beta} \tan^{-1}(e^{\sigma(x-vt)+\xi}) \equiv -\frac{1}{i\beta} \ln \left(\frac{1 - e^{\sigma(x-vt)+\bar{\xi}}}{1 + e^{\sigma(x-vt)+\bar{\xi}}} \right).$$

with $\sigma^2(1 - v^2) = 4m^2$. The solution has been expressed in terms of a logarithm, as this is the form of the solution which generalizes under the Hirota method.

Turning now to the $a_n^{(1)}$ theory in general, the equations of motion, with $\eta_j = 1$, take the Hirota form

$$(D_t^2 - D_x^2)\tau_j \cdot \tau_j = 2m^2(\tau_{j-1}\tau_{j+1} - \tau_j^2).$$

The matrix NC has non-zero eigenvalues given by

$$\lambda_a = 4 \sin^2 \left(\frac{\pi a}{n+1} \right) \quad a = 1, \dots, n.$$

For the single solitons $p_j = 1$ giving the solution in terms of τ -functions as

$$\tau_j = 1 + \omega^j e^\Phi$$

where ω is an $(n+1)^{th}$ root of unity. There are n non-trivial solutions [32] (equal to the number of fundamental particles) with $\omega_a = \exp 2\pi i a / (n+1)$ ($1 \leq a \leq n$). These n solutions to $a_n^{(1)}$ can be written in the form

$$\phi_{(a)} = -\frac{1}{i\beta} \sum_{k=1}^n \alpha_k \ln \left(\frac{1 + \omega_a^k e^\Phi}{1 + e^\Phi} \right).$$

It was shown in [32] that $\phi_{(a)}$ ($1 \leq a \leq n$) can be associated with the a^{th} fundamental representation of $a_n^{(1)}$, and that different values of $Im \xi$ give rise to different topological charges. The topological charges are found to be weights of the particular representation. Therefore, strictly speaking the results presented here correspond to representatives from each class of solution, as the value of ξ and so the topological charge, is not specified. The general N -soliton solution can be built up from the single soliton solutions, having τ -functions given by [32],

$$\tau_j(x, t) = \sum_{\mu_1=0}^1 \cdots \sum_{\mu_N=0}^1 \exp \left(\sum_{p=1}^N \mu_p \omega_p^j \Phi_p + \sum_{1 \leq p < q \leq N} \mu_p \mu_q \ln A^{(pq)} \right) \quad (3.3.1a)$$

where

$$A^{(pq)} = -\frac{(\sigma_p - \sigma_q)^2 - (\sigma_p v_p - \sigma_q v_q)^2 - 4m^2 \sin^2 \frac{\pi}{h} (a_p - a_q)}{(\sigma_p + \sigma_q)^2 - (\sigma_p v_p + \sigma_q v_q)^2 - 4m^2 \sin^2 \frac{\pi}{h} (a_p + a_q)} \quad (3.3.1b)$$

is the ‘interaction constant’.

In the classical theory of sine-Gordon solitons there are considered to be two static configurations, corresponding to the soliton and its anti-soliton, each distinguished by their opposite topological charges. In the context of this discussion this pair will be viewed as *the* sine-Gordon soliton which possesses two topological charges. The distinction is important for, as will be seen, the $a_n^{(1)}$ theory can have static multisoliton configurations composed of different solitons i.e. with different a , not just different topological charges. Therefore there are $\binom{n}{k}$ static k -soliton solutions and

$$\sum_{k=1}^n \binom{n}{k} = 2^n - 1$$

static configurations in total. Before considering double solitons solutions composed of solitons of different types, consider a ‘static’ ($v_1 = v_2$) double soliton composed to two type ‘a’ single solitons. It is necessary to fix $\sigma_1 = \sigma_2$, and not $\sigma_1 = -\sigma_2$ which the identification of velocities would allow. The reason for this is that the latter choice of $\sigma_1 = -\sigma_2$ results in solitons having topological charges corresponding to a type ‘a’ and type ‘h-a’ being considered. Therefore, considering $\sigma_1 = \sigma_2$ the interaction parameter is zero, leaving the j^{th} tau function as

$$\begin{aligned} \tau_j &= 1 + e^{\sigma_1(x-v_1t)+\xi_1} + e^{\sigma_2(x-v_2t)+\xi_2} \\ &= 1 + e^{\sigma_1(x-v_1t)}(e^{\xi_1} + e^{\xi_2}) \equiv 1 + e^{\sigma_1(x-v_1t)+\xi_3}, \end{aligned}$$

for some complex constant ξ_3 , i.e. that corresponding to a static single soliton. When occurring in a more general multisoliton solution, solitons of identical type and velocity similarly collapse to a single soliton.

As an example, which will be useful later when the $c_n^{(1)}$ solitons are discussed, now consider the static double soliton which takes the form

$$\tau_j(x, t) = 1 + \omega_{a_1}^j e^{\Phi_1} + \omega_{a_2}^j e^{\Phi_2} + A^{(12)} \omega_{a_1}^j \omega_{a_2}^j e^{\Phi_1 + \Phi_2}.$$

In the solitons’ rest frame, from (3.2e), $\sigma_1 \sqrt{\lambda_2} = \sigma_2 \sqrt{\lambda_1}$, and so

$$\Phi_2 = \sqrt{\frac{\lambda_2}{\lambda_1}}(\Phi_1 - \xi_1) + \xi_2. \quad (3.3.1c)$$

When the coefficient of Φ_1 in (3.3.1c) is a positive integer then these solutions arise directly from the Hirota method – that is when

$$\sin^2\left(\frac{a_1\pi}{h}\right) = k^2 \sin^2\left(\frac{a_2\pi}{h}\right).$$

These special cases were first considered in [1] where it was found that the above equation is satisfied for $h = 2p$ and $h = 6p$. The resulting ‘mass degenerate’ solitons were viewed as different from those constructed by Hollowood. In fact, as has been seen, they are nothing more than the static multisoliton solutions derivable via Hirota’s method but nonetheless lying within the general N -soliton solution (3.3.1a).

If $a_2 = h - a_1$, then

$$A^{(12)} = \cos^2\left(\frac{a_1\pi}{h}\right) = 1 - \frac{1}{4}\lambda_{a_1}$$

and after the shift $\Phi_1 \rightarrow \Phi_1 + \xi_1$,

$$\tau_j(x, t) = 1 + y_1\omega_{a_1}^j e^{\Phi_1} + y_2\omega_{-a_1}^j e^{\Phi_1} + y_1y_2\left(1 - \frac{1}{4}\lambda_{a_1}\right) e^{2\Phi_1}$$

where $y_1 = e^{\xi_1}$, and $y_2 = e^{\xi_2}$. Notice that when $y_1=0$ (or $y_2 = 0$), that is when the first (or second) soliton is sent off to infinity, the above solution reduces to a that of a single soliton. It is this solution which is important in the study of the $c_n^{(1)}$ theory.

3.3.2 The $d_n^{(1)}$ theory

The $d_4^{(1)}$ theory, whose Dynkin diagram is shown below, is slightly different to that of the general $d_n^{(1)}$ theory in that it has a rather larger degree of symmetry. As a result, its Hirota equations are different to those of the general theory and so will be considered first.

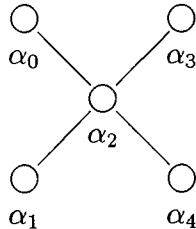

Figure 4: Affine Dynkin diagram for $d_4^{(1)}$.

In this case, the eigenvalues of the matrix NC are $\lambda = 2, 2, 2$ and 6 . With $\eta_j = 1 \forall j$, the single soliton has $p_j = n_j \forall j$ and satisfies

$$\begin{aligned} (D_t^2 - D_x^2)(\tau_j \cdot \tau_j) &= 2m^2(\tau_2 - \tau_j^2) \quad (j \neq 2), \\ (D_t^2 - D_x^2)(\tau_2 \cdot \tau_2) &= 4m^2(\tau_0\tau_1\tau_3\tau_4 - \tau_2^2). \end{aligned}$$

If $\lambda=2$, three solutions are obtained [32]:

$$\tau_0 = \tau_3 = 1 + e^\Phi, \quad \tau_2 = 1 + e^{2\Phi}, \quad \text{and} \quad \tau_1 = \tau_4 = 1 - e^\Phi,$$

as well as cycles of the indices (1,3,4). If $\lambda=6$, one solution is obtained:

$$\tau_0 = \tau_1 = \tau_3 = \tau_4 = 1 + e^\Phi, \quad \text{and} \quad \tau_2 = 1 - 4e^\Phi + e^{2\Phi}.$$

In the more general case of $d_n^{(1)}$ the eigenvalues of the matrix NC are

$$\begin{aligned} \lambda_a &= 8 \sin^2 \vartheta_a \quad \text{where} \quad \vartheta_a = \frac{a\pi}{2(n-1)} \quad (1 \leq a \leq n-2), \\ &\text{and} \quad \lambda_{n-1} = \lambda_n = 2. \end{aligned}$$

Again, as in all of the simply-laced theories, $\eta_j = 1 \forall j$, so that for the single solitons $p_j = n_j, \forall j$. The solutions to the equations of motion in this case are not as straightforward as those for the $a_n^{(1)}$ theory. However, recursive relations are found relating the $\delta_j^{(1)}$'s. Explicitly, the equations of motion take the form

$$\begin{aligned} (D_t^2 - D_x^2)\tau_0 \cdot \tau_0 &= 2m^2(\tau_2 - \tau_0^2), \\ (D_t^2 - D_x^2)\tau_1 \cdot \tau_1 &= 2m^2(\tau_2 - \tau_1^2), \\ (D_t^2 - D_x^2)\tau_2 \cdot \tau_2 &= 4m^2(\tau_0\tau_1\tau_3 - \tau_2^2), \\ (D_t^2 - D_x^2)\tau_j \cdot \tau_j &= 4m^2(\tau_{j-1}\tau_{j+1} - \tau_j^2) \quad (3 \leq j \leq n-3), \\ (D_t^2 - D_x^2)\tau_{n-2} \cdot \tau_{n-2} &= 4m^2(\tau_n\tau_{n-1}\tau_{n-3} - \tau_{n-2}^2), \\ (D_t^2 - D_x^2)\tau_{n-1} \cdot \tau_{n-1} &= 2m^2(\tau_{n-2} - \tau_{n-1}^2), \\ (D_t^2 - D_x^2)\tau_n \cdot \tau_n &= 2m^2(\tau_{n-2} - \tau_n^2), \end{aligned}$$

with solution corresponding to $\lambda = 2$ being

$$\delta_0^{(1)} = -\delta_1^{(1)} = 1, \quad \delta_j^{(1)} = 0, \quad \delta_j^{(2)} = (-1)^j \quad (2 \leq j \leq n-2),$$

$$\delta_{n-1}^{(1)} = -\delta_n^{(1)} = \pm 1 \text{ (n even), } \delta_{n-1}^{(1)} = -\delta_n^{(1)} = \pm i \text{ (n odd),}$$

and for $\lambda = \lambda_a$ ($1 \leq a \leq n-2$), whether n is even or odd,

$$\begin{aligned} \delta_0^{(1)} = \delta_1^{(1)} = 1, \quad \delta_{n-1}^{(1)} = \delta_n^{(1)} = (-1)^a, \\ \delta_j^{(1)} = \frac{2 \cos((2j-1)\vartheta_a)}{\cos \vartheta_a}, \quad \delta_j^{(2)} = 1 \text{ (} 2 \leq j \leq n-2 \text{)}. \end{aligned}$$

The only multisoliton of interest here, as far as folding to the non-simply-laced theories is concerned, is that double soliton formed from the solutions related to the points on the forks at the end of the unextended diagram. This will be discussed later when the $b_n^{(1)}$ theory is considered.

3.3.3 The $e_6^{(1)}$ theory

There are three exceptional simply-laced algebras, the first of which is the $e_6^{(1)}$ theory. Here the eigenvalues of the matrix NC are given by

$$\begin{aligned} \lambda_1 = \lambda_6 = 3 - \sqrt{3}, \quad \lambda_2 = 2(3 - \sqrt{3}), \\ \lambda_3 = \lambda_5 = 3 + \sqrt{3}, \quad \lambda_4 = 2(3 + \sqrt{3}). \end{aligned}$$

As in the other simply-laced cases, $\eta_j = 1$ and $p_j = n_j \forall j$ giving the equations of motion

$$\begin{aligned} (D_t^2 - D_x^2)\tau_a \cdot \tau_a = 2m^2(\tau_b - \tau_a^2), \\ (D_t^2 - D_x^2)\tau_b \cdot \tau_b = 4m^2(\tau_a\tau_4 - \tau_b^2), \\ (D_t^2 - D_x^2)\tau_4 \cdot \tau_4 = 6m^2(\tau_2\tau_3\tau_5 - \tau_4^2), \end{aligned}$$

where (a,b)=(0,2),(1,3) and (6,5). A summary of the δ -values for the six single soliton solutions is given in Table B3 of Appendix B. The various symmetries of these solutions will be discussed later in both the context of folding and of topological charges.

3.3.4 The $e_7^{(1)}$ theory

In this case and the next, the expressions for the eigenvalues although known, are rather complicated. The non-zero eigenvalues of the matrix NC are given by

$$\lambda_1 = 8\sqrt{3} \sin\left(\frac{\pi}{18}\right) \sin\left(\frac{2\pi}{9}\right), \quad \lambda_4 = 8\sqrt{3} \sin\left(\frac{7\pi}{18}\right) \sin\left(\frac{4\pi}{9}\right), \quad \lambda_6 = 8\sqrt{3} \sin\left(\frac{5\pi}{18}\right) \sin\left(\frac{\pi}{9}\right),$$

$$\lambda_2 = 8 \sin^2 \left(\frac{2\pi}{9} \right), \quad \lambda_3 = 8 \sin^2 \left(\frac{\pi}{3} \right), \quad \lambda_5 = 8 \sin^2 \left(\frac{4\pi}{9} \right), \quad \lambda_7 = 8 \sin^2 \left(\frac{\pi}{9} \right).$$

In general, when solving the equations of motion, the δ 's are found to be polynomials in the eigenvalues of quite high degree. However, the $e_7^{(1)}$ calculation can be simplified by using the characteristic polynomial of NC , which for $\lambda = \lambda_2, \lambda_5, \lambda_7$, is

$$\lambda^3 - 12\lambda^2 + 36\lambda - 24 = 0,$$

and for $\lambda = \lambda_1, \lambda_4, \lambda_6$, is

$$\lambda^3 - 18\lambda^2 + 72\lambda - 72 = 0.$$

Therefore, the δ 's can be written as polynomials in λ of degree less than or equal to 2. The results are given in table B4 of appendix B.

3.3.5 The $e_8^{(1)}$ theory

The last of the simply-laced theories is that of $e_8^{(1)}$. The eigenvalues of NC , calculated in [12] are

$$\begin{aligned} \lambda_1 &= 32\sqrt{3} \sin \left(\frac{\pi}{30} \right) \sin \left(\frac{\pi}{5} \right) \cos^2 \left(\frac{\pi}{5} \right), \\ \lambda_2 &= 128\sqrt{3} \sin \left(\frac{\pi}{30} \right) \sin \left(\frac{\pi}{5} \right) \cos^2 \left(\frac{\pi}{5} \right) \cos^2 \left(\frac{7\pi}{30} \right), \\ \lambda_3 &= 8\sqrt{3} \sin \left(\frac{7\pi}{30} \right) \sin \left(\frac{2\pi}{5} \right), \\ \lambda_4 &= 512\sqrt{3} \sin \left(\frac{\pi}{30} \right) \sin \left(\frac{\pi}{5} \right) \cos^2 \left(\frac{2\pi}{15} \right) \cos^4 \left(\frac{\pi}{5} \right), \\ \lambda_5 &= 8\sqrt{3} \sin \left(\frac{13\pi}{30} \right) \sin \left(\frac{2\pi}{5} \right), \\ \lambda_6 &= 8\sqrt{3} \sin \left(\frac{11\pi}{30} \right) \sin \left(\frac{\pi}{5} \right), \\ \lambda_7 &= 32\sqrt{3} \sin \left(\frac{\pi}{30} \right) \sin \left(\frac{\pi}{5} \right) \cos^2 \left(\frac{\pi}{30} \right), \\ \lambda_8 &= 8\sqrt{3} \sin \left(\frac{\pi}{30} \right) \sin \left(\frac{\pi}{5} \right). \end{aligned}$$

As in the previous case, the characteristic polynomial of NC can be used to simplify the expressions for the δ -values. For $\lambda = \lambda_1, \lambda_2, \lambda_4, \lambda_7$ it is

$$\lambda^4 - 30\lambda^3 + 240\lambda^2 - 720\lambda + 720 = 0,$$

and for $\lambda = \lambda_3, \lambda_5, \lambda_6, \lambda_8$ it is

$$\lambda^4 - 30\lambda^3 + 300\lambda^2 - 1080\lambda + 720 = 0.$$

This factorization of the characteristic polynomial was also noted in [12]. As such the expressions for the δ 's can be simplified to order of at most three. The results are given in Table B5.

3.4 Folding and the non-simply-laced algebras

It would be possible to proceed in the same manner as in the previous sections and construct the solitons for the non-simply-laced theories. However, all the necessary information has essentially been gathered. This follows from the idea that the Dynkin diagrams for the non-simply-laced theories may be obtained from those of the simply-laced theories by the 'folding' procedure of Olive and Turok [52] which exploits the symmetries of the simply-laced diagram.

The affine Toda equations have a symmetry if a permutation p of the simple roots, acting on the field ϕ , leaves the equations invariant in the sense that if ϕ is a solution, then so too is $p(\phi)$. This is guaranteed if the Cartan matrix also possesses this symmetry *i.e.*

$$K_{ij} = K_{p(i)p(j)},$$

which is true if and only if the structure of the Dynkin diagram corresponding to K is preserved by the permutation. There are two types of non-simply-laced diagram – those that are untwisted and those that are twisted. The untwisted diagrams are obtained by exploiting symmetries of both the extended and the unextended diagram whereas the twisted diagrams are obtained by exploiting a symmetry of the extended diagram only. The relationships between the simply-laced and non-simply-laced diagrams can be summarized as follows:

Untwisted	Twisted
$d_{n+1}^{(1)} \rightarrow b_n^{(1)}$	$d_{2n}^{(1)} \rightarrow a_{2n-1}^{(2)}$
$a_{2n-1}^{(1)} \rightarrow c_n^{(1)}$	$d_{n+2}^{(1)} \rightarrow d_{n+1}^{(2)}$
$d_4^{(1)} \rightarrow g_2^{(1)}$	$e_7^{(1)} \rightarrow e_6^{(2)}$
$e_6^{(1)} \rightarrow f_4^{(1)}$	$e_6^{(1)} \rightarrow d_4^{(3)}$
	$d_{2n+2}^{(1)} \rightarrow a_{2n}^{(2)}$
	$d_4^{(1)} \rightarrow a_2^{(2)}$

In the following subsections, the simple roots of the non-simply-laced diagrams $\{\alpha'_i\}$ will be expressed in terms of those of the corresponding simply-laced theory $\{\alpha_i\}$. So that if

$$\alpha'_i = \sum_{j \in U_i} \lambda_j \alpha_j$$

then a solution of the simply-laced theory is also a solution of the non-simply-laced theory provided the τ -functions τ_j are identical for all $j \in U_i$, with the τ -functions in the non-simply-laced theory being $\tau'_i = \tau_j$. It will be found that the single solitons already constructed do not, in general, provide a complete set of solutions for the non-simply-laced theories due to them not, in general, possessing the required symmetry from which the non-simply-laced diagram is obtained. As will be shown, following the suggestion in [53], in these cases it is the static multi-soliton configurations of the simply-laced theories which are the single solitons of some of the non-simply-laced theories. It is found that the multi-soliton configurations need to be considered when the solitons associated with the simple roots which take part in the folding process are mass degenerate.

In the following subsections the single solitons of all the non-simply-laced theories will be derived.

3.4.1 Solitons in the untwisted theories.

The $c_n^{(1)}$ theory.

Consider first obtaining the $c_n^{(1)}$ theory from that of $a_{2n-1}^{(1)}$. It is easily seen that the $a_{2n-1}^{(1)}$ Dynkin diagram is invariant under the unextended diagram symmetry $\alpha_i \rightarrow \alpha_{2n-i}$, where it is understood that the labeling on the simple roots is modulo h .

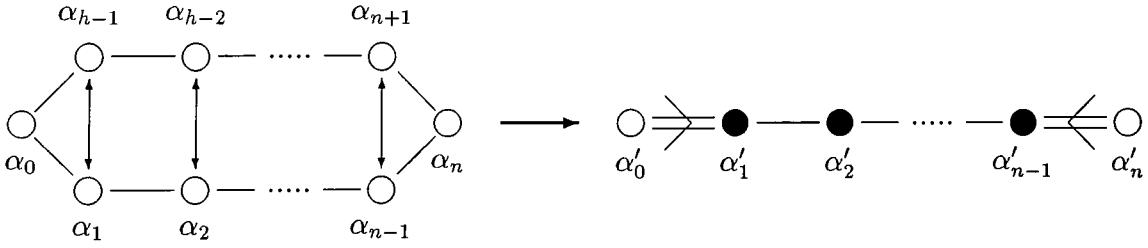
 Figure 5: The folding of $a_{2n-1}^{(1)}$ to $c_n^{(1)}$.

The simple roots of the $c_n^{(1)}$ theory, $\{\alpha'_i\}$, are therefore given in terms of those of $a_{2n-1}^{(1)}$ by

$$\alpha'_0 = \alpha_0, \quad \alpha'_i = \frac{1}{2}(\alpha_i + \alpha_{2n-i}) \quad (1 \leq i \leq n-1), \quad \alpha'_n = \alpha_n,$$

and so as discussed above, the solitons of the $c_n^{(1)}$ theory are those of the $a_{2n-1}^{(1)}$ theory with

$$\tau'_0 = \tau_0, \quad \tau'_n = \tau_n, \quad \text{and} \quad \tau'_j = \tau_j = \tau_{2n-j} \quad (1 \leq j \leq n-1). \quad (3.4a)$$

The problem that is run into here is that there is only one single soliton of the $a_{2n-1}^{(1)}$ theory with the property $\tau_i = \tau_{2n-i}$ – that corresponding to $a = n$. The other solutions, which will now be constructed, are those static double solitons composed of an $(i, 2n-i)$ -soliton pair, $(i = 1, \dots, n-1)$.

Recall now the static double soliton derived at the end of §3.3.1 which corresponded to $a_2 = h - a_1$. In this case with $\xi_1 = \xi_2$,

$$\tau_j(x, t) = 1 + 2 \cos\left(\frac{2\pi a_1 j}{h}\right) e^{\Phi_1} + \cos^2\left(\frac{\pi a_1}{h}\right) e^{2\Phi_1}.$$

The solitons with $a = a_1 = 1, \dots, n-1$ possessing these τ -functions are left invariant under the symmetry (3.4a) and so constitute the remaining solutions of the $c_n^{(1)}$ theory. Indeed the above solution with $a_1 = n$ and an appropriate shift in ξ_2 reduces to the $a = n$ single soliton. Therefore, the single solitons of the $c_n^{(1)}$ theory are given by

$$\phi_{(a)}(x, t) = -\frac{1}{i\beta} \sum_{j=0}^n \frac{2\alpha'_j}{\alpha'_j \cdot \alpha'_j} \ln \tau'_j(x, t) \quad (a = 1, \dots, n),$$

where

$$\tau'_j(x, t) = 1 + 2 \cos\left(\frac{2\pi a j}{h}\right) e^{\Phi} + \cos^2\left(\frac{\pi a}{h}\right) e^{2\Phi}.$$

The $b_n^{(1)}$ theory.

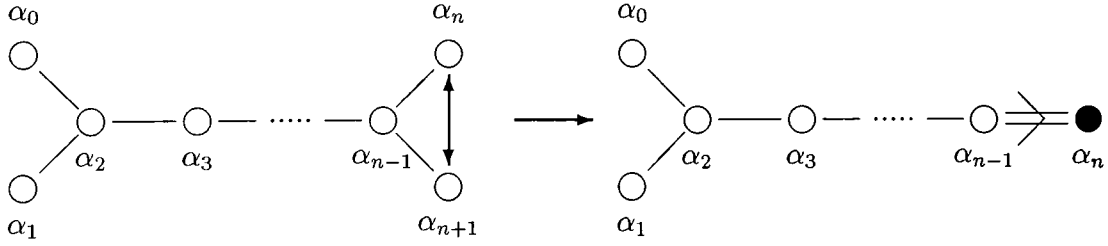

Figure 6: The folding of $d_{n+1}^{(1)}$ to $b_n^{(1)}$.

The unextended diagram symmetry under which the $d_{n+1}^{(1)}$ diagram is left invariant is that corresponding to the interchange of the prongs at the fork, as show in Figure 6 above. The corresponding relationship between the simple roots of the $b_n^{(1)}$ and $d_{n+1}^{(1)}$ theories is:

$$\alpha'_i = \alpha_i \quad (0 \leq i \leq n-1), \quad \alpha'_n = \frac{1}{2}(\alpha_n + \alpha_{n+1}),$$

and so the solitons of $d_{n+1}^{(1)}$ which survive the folding procedure to become solitons of the $b_n^{(1)}$ theory are those having $\tau_n = \tau_{n+1}$. From the results of §3.3.2 it is found that there are $n-1$ such single solitons which give the τ -functions in the $b_n^{(1)}$ theory corresponding to those solitons with $a = 1, \dots, n-1$ as

$$\tau'_0 = \tau'_1 = 1 + e^\Phi, \quad \tau'_n = 1 + (-1)^a e^\Phi,$$

$$\text{and } \tau'_j = 1 + \frac{2 \cos((2j-1)\vartheta_a)}{\cos \vartheta_a} e^\Phi + e^{2\Phi} \quad (j = 1, \dots, n-1)$$

where $\vartheta_a = a\pi/2n$.

In the same manner as in the previous subsection, the remaining soliton of $b_n^{(1)}$ corresponding to the short root is the static double soliton of the $d_{n+1}^{(1)}$ theory made up of the $(n, n+1)$ soliton pair. When expressed in terms of the $b_n^{(1)}$ theory, the soliton corresponding to the short root is characterized by

$$\tau'_0 = 1 + 2\sqrt{n}e^\Phi + e^{2\Phi}, \quad \tau'_1 = 1 - 2\sqrt{n}e^\Phi + e^{2\Phi}, \quad \tau'_n = 1 + (-1)^n e^\Phi,$$

$$\text{and } \tau'_j = 1 + 2(-1)^j(1 + 2(n-j))e^\Phi + e^{2\Phi}, \quad (j = 2, \dots, n-1).$$

The $g_2^{(1)}$ theory.

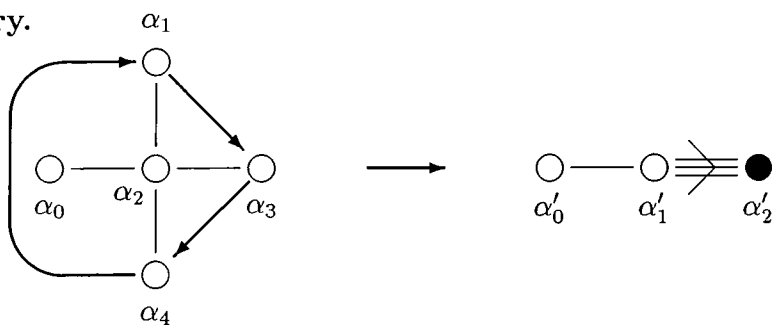

Figure 7: The folding of $d_4^{(1)}$ to $g_2^{(1)}$.

The unextended D_4 Dynkin diagram possesses a three fold symmetry corresponding to a rotation of the diagram, or in other words, the rotation of the simple roots corresponding to the three equal mass solitons. The relationship between the simple roots of the $d_4^{(1)}$ and $g_2^{(1)}$ theories are as follows:

$$\alpha'_0 = \alpha_0, \alpha'_1 = \alpha_2, \text{ and } \alpha'_2 = \frac{1}{3}(\alpha_1 + \alpha_3 + \alpha_4);$$

and so the required solitons of the $g_2^{(1)}$ theory are those of $d_4^{(1)}$ with $\tau_1 = \tau_3 = \tau_4$. There is only one such single soliton – that corresponding to the central spot of the Dynkin diagram. The remaining $g_2^{(1)}$ soliton is the triple static soliton solution of the $d_4^{(1)}$ theory composed of the solitons having $a = 1$, $a = 3$ and $a = 4$. The resulting solitons of the $g_2^{(1)}$ theory have τ -functions given in table B7 of Appendix B.

The $f_4^{(1)}$ theory.

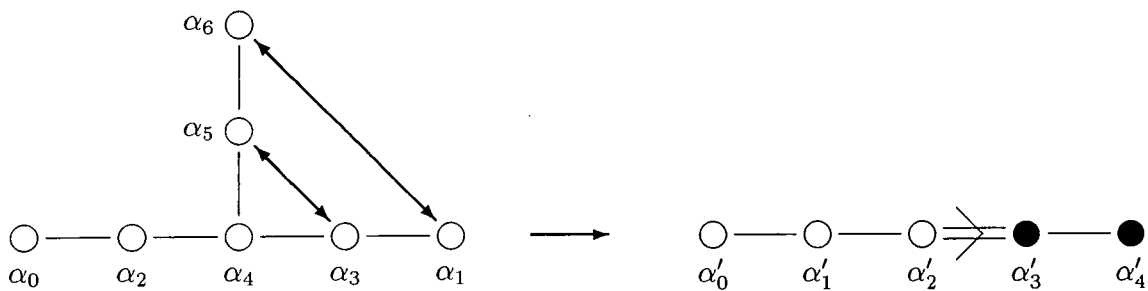

Figure 8: The folding of $e_6^{(1)}$ to $f_4^{(1)}$.

The symmetry of the unextended E_6 diagram which gives rise to the $f_4^{(1)}$ diagram is that which interchanges the two long legs of the diagram. The corresponding relationship

between the simple roots of the theories is

$$\alpha'_0 = \alpha_0, \alpha'_1 = \alpha_2, \alpha'_2 = \alpha_4, \alpha'_3 = \frac{1}{2}(\alpha_3 + \alpha_5), \text{ and } \alpha'_4 = \frac{1}{2}(\alpha_1 + \alpha_6).$$

There are two single soliton solutions with $\tau_3 = \tau_5$ and $\tau_1 = \tau_6$. These are the solitons associated with α_2 and α_4 . The remaining solitons of the $f_4^{(1)}$ theory are the (3, 5) and (1, 6) double solitons of the $e_6^{(1)}$ theory. The τ -functions are summarized in table B6 of Appendix B.

3.4.2 Solitons in the twisted theories.

The twisted theories require a slightly more delicate handling than their untwisted counterparts – the reason being that the folding procedure resulting in the twisted theories involves the extended root α_0 , which is rescaled. As a result, the eigenvalues of NC in the twisted theories are a rescaled subset of those found in the corresponding simply-laced theory. The Hirota equations of the twisted theory are therefore not simply those of the corresponding non-simply-laced theory with certain τ -functions identified, but rather a slightly modified version of them. As will be seen, however, this problem is easily overcome – the result being that the τ -functions of the twisted theories do correspond to τ -functions of solitons in the corresponding simply-laced theory but with the appropriate rescaled NC -eigenvalues satisfying (3.2e).

It is important to note that for those theories obtained by folding the $e_6^{(1)}$ and $e_7^{(1)}$ Dynkin diagrams, namely $d_4^{(3)}$ and $e_6^{(2)}$, where the soliton τ -functions are written in terms of the eigenvalues of NC , these solutions survive the folding process and so do not change. As a result these formulae have to be re-expressed in terms of the eigenvalues of the twisted theory.

The folding procedure will be illustrated in detail for the $a_{2n-1}^{(2)}$ theory.

The $a_{2n-1}^{(2)}$ theory.

Figure 9 below shows the symmetry that is exploited to form the $a_{2n-1}^{(2)}$ Dynkin diagram from that of $d_{2n}^{(1)}$.

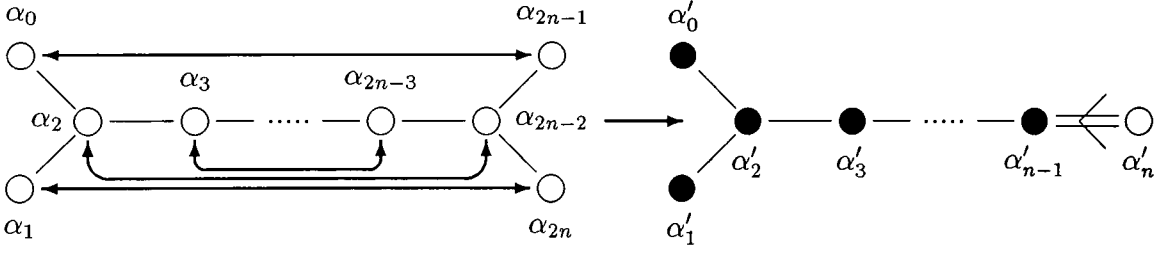
 Figure 9: The folding of $d_{2n}^{(1)}$ to $a_{2n-1}^{(2)}$.

The roots of $a_{2n-1}^{(2)}$ are obtainable from those of $d_{2n}^{(1)}$ via

$$\alpha'_0 = \frac{1}{2}(\alpha_0 + \alpha_{2n-1}), \quad \alpha'_1 = \frac{1}{2}(\alpha_1 + \alpha_{2n}), \quad \alpha'_n = \alpha_n$$

and

$$\alpha'_i = \frac{1}{2}(\alpha_i + \alpha_{2n-i}) \quad (2 \leq i \leq n-1).$$

If the Hirota equations of the $a_{2n-1}^{(2)}$ theory are explicitly derived, they are found to be of the form:

$$\begin{aligned} (D_x^2 - D_t^2)\tau'_0 \cdot \tau'_0 &= m^2(\tau'_2 - \tau_0'^2), \\ (D_x^2 - D_t^2)\tau'_1 \cdot \tau'_1 &= m^2(\tau'_2 - \tau_1'^2), \\ (D_x^2 - D_t^2)\tau'_2 \cdot \tau'_2 &= 2m^2(\tau'_0\tau'_1\tau'_3 - \tau_2'^2), \\ (D_x^2 - D_t^2)\tau'_j \cdot \tau'_j &= 2m^2(\tau'_{j-1}\tau'_{j+1} - \tau_j'^2) \quad (j = 3, \dots, n-1), \\ (D_x^2 - D_t^2)\tau'_n \cdot \tau'_n &= 2m^2(\tau_{n-1}'^2 - \tau_n'^2). \end{aligned}$$

These equations are the Hirota equations of the $d_{2n}^{(1)}$ theory with $m^2 \rightarrow \frac{1}{2}m^2$, and the expected τ -functions identified i.e.

$$\tau'_0 = \tau_0 = \tau_{2n-1}, \quad \tau'_1 = \tau_1 = \tau_{2n}, \quad \tau'_n = \tau_n \quad \text{and} \quad \tau'_i = \tau_i = \tau_{2n-i} \quad (2 \leq i \leq n-1). \quad (3.4.2a)$$

As a result, the soliton solutions of the $a_{2n-1}^{(2)}$ theory are those of the $d_{2n}^{(1)}$ theory with τ -functions given by (3.4.2a) and eigenvalue $\lambda^{(sl)}$ satisfying

$$\sigma^2(1 - v^2) = \frac{1}{2}m^2\lambda^{(sl)}.$$

As was mentioned in the preamble to this subsection, the eigenvalues of NC in the non-simply-laced theory are rescaled upon folding to the associated twisted diagram, and with

the current root convention of the longest root being of length $\sqrt{2}$, it turns out that $\lambda^{(sl)} = 2\lambda^{(tw)}$; $\lambda^{(tw)}$ being an eigenvalue of NC for $a_{2n-1}^{(2)}$ theory. Therefore, $\sigma^2(1 - v^2) = m^2\lambda^{(tw)}$.

The $a_{2n-1}^{(2)}$ theory has n solutions corresponding to

$$\lambda_a^{(tw)} = 4 \sin^2 \left(\frac{a\pi}{2n-1} \right) \quad (1 \leq a \leq n-1) \text{ and } \lambda_n^{(tw)} = 1.$$

Explicitly, the τ -functions of the theory, corresponding to the eigenvalues $\lambda = 1$ and $\lambda = \lambda_a^{(tw)}$ ($1 \leq a \leq n-1$) respectively, are

$$\begin{aligned} \tau'_0 &= 1 + e^\Phi, \quad \tau'_1 = 1 - e^\Phi, \quad \tau'_j = 1 + (-1)^j e^{2\Phi} \quad (j = 2, \dots, n), \\ \tau'_0 = \tau'_1 &= 1 + e^\Phi, \quad \tau'_j = 1 + 2 \frac{\cos[(2j-1)\vartheta_a]}{\cos \vartheta_a} e^\Phi + e^{2\Phi} \quad (j = 2, \dots, n). \end{aligned}$$

where $\vartheta_a = a\pi/(2n-1)$.

This procedure generalizes to the other twisted algebras.

The $d_{n+1}^{(2)}$ theory.

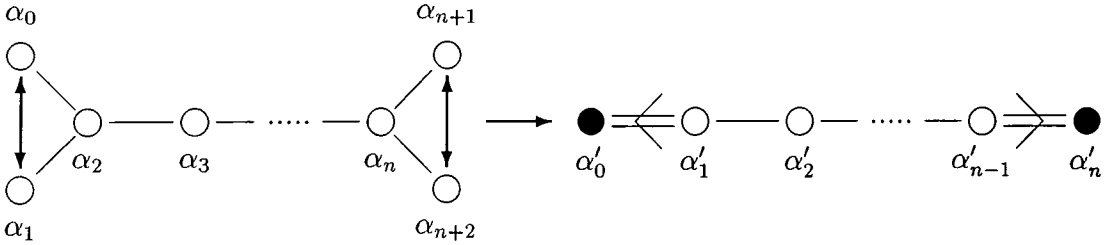

Figure 10: The folding of $d_{n+2}^{(1)}$ to $d_{n+1}^{(2)}$.

The simplest symmetry of the extended $d_{n+1}^{(2)}$ diagram is that which flips over the two forks and leaves everything else unchanged. The resulting relationship between the simple roots of the simply-laced and corresponding twisted diagram is

$$\alpha'_0 = \frac{1}{2}(\alpha_0 + \alpha_1), \quad \alpha'_j = \alpha_{j+1} \quad (j = 1, \dots, n-1), \quad \alpha'_n = \frac{1}{2}(\alpha_{n+1} + \alpha_{n+2}).$$

The solitons of the $d_{n+1}^{(2)}$ theory are the n solitons of $d_{n+2}^{(1)}$ with $\tau_0 = \tau_1$ and $\tau_{n+1} = \tau_{n+2}$ corresponding to modified eigenvalues. Explicitly, $\lambda_a^{(tw)} = 4 \sin^2 \vartheta_a$ ($a = 1, \dots, n$) where $\vartheta_a = a\pi/2(n-1)$, with corresponding τ -functions given by

$$\tau'_0 = 1 + e^\Phi, \quad \tau'_j = 1 + 2 \frac{\cos[(2j+1)\vartheta_a]}{\cos \vartheta_a} e^\Phi + e^{2\Phi} \quad (j = 1, \dots, n-1), \quad \tau'_n = 1 + (-1)^n e^\Phi.$$

The $e_6^{(2)}$ theory.

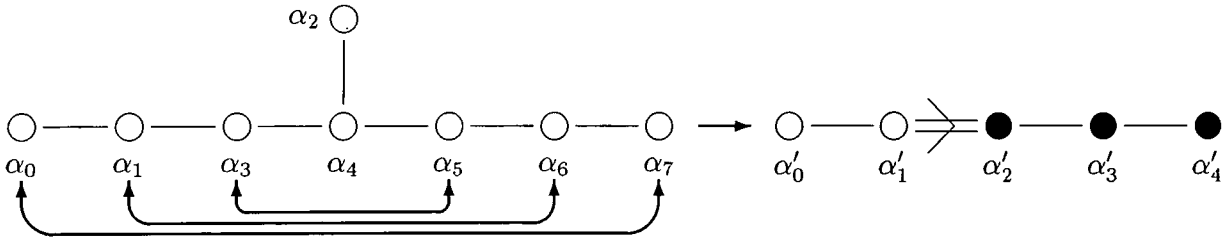

Figure 11: The folding of $e_7^{(1)}$ to $e_6^{(2)}$

The $e_6^{(2)}$ theory is obtained from that of $e_7^{(1)}$ by making use of the only symmetry which the $e_7^{(1)}$ theory possesses – that which flips over the two long legs. The simple roots are related via

$$\alpha'_0 = \alpha_2, \alpha'_1 = \alpha_4, \alpha'_2 = \frac{1}{2}(\alpha_3 + \alpha_5), \alpha'_3 = \frac{1}{2}(\alpha_1 + \alpha_6), \alpha'_4 = \frac{1}{2}(\alpha_0 + \alpha_7),$$

and so the solutions of the $e_6^{(2)}$ theory are those of the $e_7^{(1)}$ theory with $\tau_0 = \tau_7, \tau_1 = \tau_6$ and $\tau_3 = \tau_5$. As there are no mass degeneracies, there are four such solitons, as expected.

They correspond to eigenvalues

$$\begin{aligned} \lambda_1^{(tw)} &= 4\sqrt{3} \sin\left(\frac{\pi}{18}\right) \sin\left(\frac{2\pi}{9}\right), & \lambda_3^{(tw)} &= 4 \sin^2\left(\frac{\pi}{3}\right), \\ \lambda_4^{(tw)} &= 4\sqrt{3} \sin\left(\frac{7\pi}{18}\right) \sin\left(\frac{4\pi}{9}\right), & \lambda_6^{(tw)} &= 4\sqrt{3} \sin\left(\frac{5\pi}{18}\right) \sin\left(\frac{\pi}{9}\right) \end{aligned}$$

and their δ -parameters are summarized in table B9 of Appendix B.

The $d_4^{(3)}$ theory.

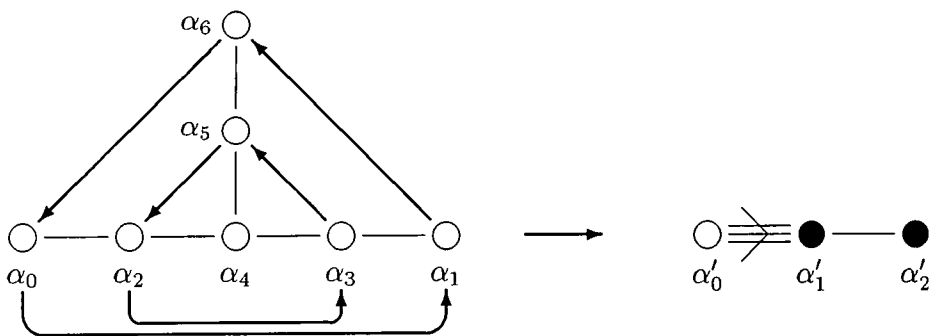

Figure 12: The folding of $e_6^{(1)}$ to $d_4^{(3)}$

The symmetry of the $e_6^{(1)}$ theory, not present in its non-affine counterpart, is that which rotates the diagram as a whole as shown in figure 12. The roots of $d_4^{(3)}$ can then be written as

$$\alpha'_0 = \alpha_4, \quad \alpha'_1 = \frac{1}{3}(\alpha_2 + \alpha_3 + \alpha_5), \quad \text{and} \quad \alpha'_2 = \frac{1}{3}(\alpha_0 + \alpha_1 + \alpha_6),$$

and the solutions of $d_4^{(3)}$ are the two solutions of $e_6^{(1)}$ associated with the second and fourth spots of the Dynkin diagram, except now they are associated with the eigenvalues

$$\lambda_2^{(tw)} = \frac{2}{3}(3 - \sqrt{3}), \quad \text{and} \quad \lambda_4^{(tw)} = \frac{2}{3}(3 + \sqrt{3}).$$

The δ -parameters are given in table B8 of Appendix B.

The $a_{2n}^{(2)}$ theory.

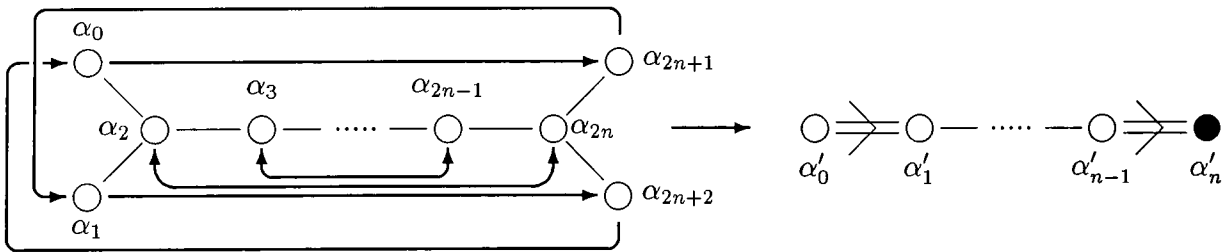

Figure 13: The folding of $d_{2n+2}^{(1)}$ to $a_{2n}^{(2)}$.

Now consider the extended Dynkin diagram $d_{2n+2}^{(1)}$ and the symmetry shown in figure 13. The relationship between the roots of this theory and that of $a_{2n}^{(2)}$ are:

$$\alpha'_n = \frac{1}{4}(\alpha_0 + \alpha_1 + \alpha_{2n+1} + \alpha_{2n+2}), \quad \text{and} \quad \alpha'_j = \frac{1}{2}(\alpha_{n-j} + \alpha_{n+j}) \quad (j = 0, \dots, n-1).$$

The resulting τ -functions are

$$\tau'_j = 1 + 2 \frac{\cos[(2(n-j)-1)\vartheta_a]}{\cos \vartheta_a} e^\Phi + e^{2\Phi} \quad (j = 0, \dots, n-1), \quad \text{and} \quad \tau'_n = 1 + e^\Phi$$

where $\lambda_a^{(tw)} = \sin^2 \vartheta_a$, with $\vartheta_a = a\pi/(2n+1)$ ($a = 1, \dots, n$). An alternative way in which to arrive at the $d_{2n}^{(2)}$ theory is by exploiting the residual symmetry of the $a_{2n+1}^{(2)}$ Dynkin diagram, shown in Figure 14 below, by the usual methods.

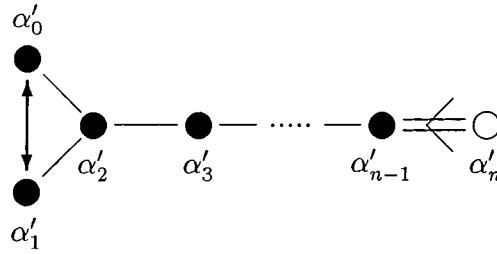

Figure 14: The folding of $d_{2n}^{(1)}$ to $a_{2n-1}^{(2)}$.

The $a_2^{(2)}$ theory.

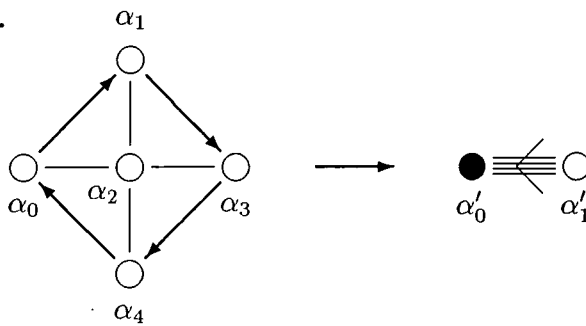

Figure 15: The folding of $d_4^{(1)}$ to $a_2^{(2)}$.

The final theory to consider is that of $a_2^{(2)}$ obtained from the symmetry possessed by only $d_4^{(1)}$ in the $d_n^{(1)}$ series – the symmetry corresponding to a 90° rotation of the $d_4^{(1)}$ diagram.

The resulting twisted theory with simple roots

$$\alpha'_0 = \frac{1}{4}(\alpha_0 + \alpha_1 + \alpha_3 + \alpha_4), \text{ and } \alpha'_1 = \alpha_2$$

has τ -functions

$$\tau_0 = 1 + e^\Phi, \text{ and } \tau_1 = 1 - 4e^\Phi + e^{2\Phi}$$

corresponding to $\lambda^{(tw)} = 1$.

3.5 The soliton masses

In [32] it was shown that the masses of the $a_n^{(1)}$ solitons are given by

$$M_a = \frac{2mh}{\beta^2} \sqrt{\lambda_a}, \tag{3.5a}$$

M_a being the mass of the soliton corresponding to eigenvalue λ_a , or equivalently, associated to the a^{th} spot on the algebra's Dynkin diagram, and h is the Coxeter number. Since the masses of the fundamental Toda particles equal $\sqrt{\lambda}$, the ratios of the soliton masses are equal to the ratios of the fundamental particles.

By considering the soliton momentum,

$$M\gamma(v)v = - \int_{-\infty}^{\infty} dx \dot{\phi} \cdot \phi'$$

where $\gamma(v) = (1 - v^2)^{-\frac{1}{2}}$ it is straightforward to confirm (case-by-case) that (3.5a) holds for the solitons of the remaining simply-laced algebras.

Consider now the solitons belonging to the other non-simply-laced algebras. The twisted and untwisted theories are slightly different and as a result need to be handled separately.

Firstly, the untwisted theories. The single solitons here are in general multisolitons of the corresponding simply-laced theory. As seen from the previous case-by-case analysis the number of contributing solitons making up the multiple configuration is equal to $2/\alpha'_a{}^2$. The masses of the solitons in the non-simply-laced theories, and as it turns out for the simply-laced solitons as well, are therefore

$$M_a = \frac{4mh}{\beta^2 \alpha_a'^2} \sqrt{\lambda_a}. \quad (3.5b)$$

This is the formula first presented in [53] for the soliton masses in the untwisted theories. As noted in [53], the division by the square of a root converts the masses from right Perron-Frobenius vector to left Perron-Frobenius vector, so highlighting the 'duality' symmetry of affine Toda field theory – that is the left Perron-Frobenius vector of \mathfrak{g} is the right Perron-Frobenius vector of \mathfrak{g}^v which has as roots the co-roots of \mathfrak{g} . All of the simply-laced algebras are self-dual, in the sense that they are left invariant under $\alpha_j \rightarrow 2\alpha_j/\alpha_j^2$. The remaining theories are transformed as follows: $b_n^{(1)} \leftrightarrow a_{2n-1}^{(1)}$, $c_n^{(1)} \leftrightarrow d_{n+1}^{(1)}$, $f_4^{(1)} \leftrightarrow e_6^{(2)}$ and $g_2^{(1)} \leftrightarrow d_4^{(3)}$.

In the twisted theories, both the Coxeter number and the NC eigenvalues are rescaled by the same amount i.e.

$$h^{(tw)} = \frac{\alpha_0'^2}{2} h^{(st)} \quad \text{and} \quad \lambda^{(tw)} = \frac{\alpha_0'^2}{2} \lambda^{(st)}.$$

Therefore, the masses of the twisted solitons in terms of their Coxeter number and eigenvalues are given by

$$M_a = \frac{4mh^{(sl)}}{\beta^2} \sqrt{\lambda^{(sl)}} = \frac{2mh^{(tw)}}{\beta^2} \left(\frac{2}{\alpha_0'^2} \right)^{3/2} \sqrt{\lambda^{(tw)}}.$$

Therefore for the twisted theories the mass ratios are again the same as the unrenormalized mass ratios of their fundamental particle counterparts in the corresponding simply-laced theory.

Chapter 4

The Topological Charges of the $a_n^{(1)}$ theory.

4.1 Introduction.

Ever since solitons were first discovered by Hollowood in the $a_n^{(1)}$ affine Toda field theory, there has been great interest in their topological charges. The topological charge is effectively the change in the soliton field between its spatial limits, $x = \pm\infty$. In [32] the topological charges were found to be dependent upon the imaginary part of the parameter ξ , and for those solitons corresponding to the end-points of the A_n Dynkin diagram, the charges were the weights of the associated fundamental representations. It was also pointed out that for the other solitons the topological charges also seemed to be weights of the associated representation but there appeared to be an insufficient number to fill it.

As will be shown, the major problems faced with the topological charges are the difficulties in calculating them, and in understanding what is the relationship between the charges if it is not that they fill the fundamental representations. As a starting point, the $a_n^{(1)}$ theory deserves much closer attention, if only to confirm the results hinted at in [32]. The $a_n^{(1)}$ theory is rather different from the other theories in the sense that it has an immense amount of symmetry, and it is this symmetry that allows many results relating to the $a_n^{(1)}$ topological charges to be deduced. For this reason the $a_n^{(1)}$ theory fills the whole of this chapter, with an investigation of the extension of its properties to the other theories taken up in the next.

It is possible to put an upper bound on the number of topological charges associated with each soliton, which is later shown to be the actual number of charges. For the a^{th} soliton it is found to be

$$\tilde{h}_a = \frac{h}{\gcd(a, h)}$$

where h is the Coxeter number. The origin of this formula lies in the dependence of the analytic expression for the soliton on the a^{th} power of an h^{th} root of unity. From studying the soliton solutions, the relationship between the topological charges is deduced to be the map

$$\tau : \alpha_j \rightarrow \alpha_{(j-1) \bmod h} \quad (0 \leq j \leq h-1), \quad (4.1a)$$

which is also an automorphism of the extended Dynkin diagram, $\Delta(a_n^{(1)})$. Therefore, for each soliton, once one topological charge is calculated the rest immediately follow by ap-

plication of (4.1a). The map τ has the same effect as the action of the Coxeter element [18] with the following ordering:

$$\omega_{tc} = r_n r_{n-1} r_{n-2} \dots r_3 r_2 r_1.$$

The Coxeter element has been shown to play an important rôle in quantum affine Toda field theory, however as far as topological charges are concerned its appearance in the $a_n^{(1)}$ theory does not generalize to the other theories. A reason for this may be the high degree of symmetry which the $a_n^{(1)}$ theory possesses, though a complete algebraic understanding of its occurrence is missing. It is a welcome coincidence in that it immediately shows that the topological charges lie in the same representation, which for the a^{th} soliton turns out to be the a^{th} fundamental representation. The expression for the topological charges themselves is also derived, and found to be given by

$$t_a^{(k)} = \sum_{j=1}^n \frac{a(h-j) \bmod h}{h} \alpha_j - \sum_{l=1}^{k-1} \sum_{j=1}^n \delta_{a(h-j) \bmod h, h-l \gcd(a,h)} \alpha_j \quad (4.1b)$$

where $k = 1, \dots, \tilde{h}_a$. This allows calculation of charges to be carried out much more easily than through the use of τ .

When there are widely separated solitons it is intuitive to expect the total topological charge to be the sum of the topological charges of the individual solitons. This statement is proved to be true. Using this result, a double soliton composed of solitons whose topological charges fill up the first and n -th fundamental representations can be constructed, which has charges filling up the adjoint representation, and in particular has $\{\pm\alpha_1, \pm\alpha_2, \dots, \pm\alpha_n\}$ as topological charges. Making use of this double soliton, further combinations of solitons can therefore be constructed which fill up the fundamental representations and the entire weight lattice itself.

4.2 Topological Charge.

The topological charge of the solitons is defined by

$$t = \frac{\beta}{2\pi} \int_{-\infty}^{\infty} dx \partial_x \phi = \frac{\beta}{2\pi} \left(\lim_{x \rightarrow \infty} - \lim_{x \rightarrow -\infty} \right) \phi(x, t),$$

which, using the ansatz (3.2b), can be written in the following form:

$$\begin{aligned}
t &= -\frac{1}{2\pi i} \sum_{j=0}^r (\lim_{x \rightarrow \infty} - \lim_{x \rightarrow -\infty}) \ln \tau_j(x, t)^{\eta_j} \alpha_j \\
&= -\frac{1}{2\pi i} \sum_{j=1}^r (\lim_{x \rightarrow \infty} - \lim_{x \rightarrow -\infty}) \ln \left(\frac{\tau_j(x, t)^{\eta_j}}{\tau_0(x, t)^{\eta_0 n_j}} \right) \alpha_j \\
&= -\frac{1}{2\pi i} \sum_{j=1}^r (\lim_{x \rightarrow \infty} - \lim_{x \rightarrow -\infty}) \ln f_j(x, t) \alpha_j \\
&= -\frac{1}{2\pi i} \sum_{j=1}^r (\lim_{x \rightarrow \infty} - \lim_{x \rightarrow -\infty}) (\ln |f_j(x, t)| + i \arg f_j(x, t)) \alpha_j
\end{aligned}$$

where $f_j(x, t) = \tau_j(x, t)^{\eta_j} / \tau_0(x, t)^{\eta_0 n_j}$. Therefore as $x \rightarrow \pm\infty$, $|f_j(x, t)| \rightarrow 1$, this being a property of the solutions constructed in the previous chapter. Therefore the topological charge can be written in the final form

$$t = -\frac{1}{2\pi} \sum_{j=1}^r (\lim_{x \rightarrow \infty} - \lim_{x \rightarrow -\infty}) \arg f_j(x, t) \alpha_j.$$

4.2.1 The $a_n^{(1)}$ theory

Turning to the specific case of the $a_n^{(1)}$ theory, $\eta_j = n_j = 1$, and so $f_j(x, t)$ is simply given by

$$f_j(x, t) = \frac{\tau_j(x, t)}{\tau_0(x, t)} = \frac{1 + \omega_a^j e^\Phi}{1 + e^\Phi}.$$

In order to calculate the topological charges it is essential to understand the behavior of the complex functions $f_j(x, t)$. At $t = 0$ (assuming throughout that $\sigma > 0$), with $\xi = \xi_1 + i\xi_2$, it is convenient to write

$$e^{\sigma x + \xi_1 + i\xi_2} = y e^{i\xi_2},$$

where $y \rightarrow 0$ as $x \rightarrow -\infty$, $y \rightarrow \infty$ as $x \rightarrow \infty$, and ξ_2 is chosen such that $-\pi < \xi_2 \leq \pi$. It is also convenient to write

$$\omega_a^j = e^{i\mu_j} \quad \text{where } \mu_j = \frac{2\pi a j}{h} \bmod (2\pi) \in [0, 2\pi).$$

The idea behind the calculation of the topological charges is as follows. The function

$$f_j(x, t) = \frac{1 + y e^{i(\mu_j + \xi_2)}}{1 + y e^{i\xi_2}}$$

has zeros whenever $\mu_j + \xi_2 = \pi$ and $y = 1$, and is undefined when $\xi_2 = \pi$ and $y = 1$. In either case, $\phi(x, t)$ is undefined. The range of ξ can then be divided into sectors whose boundaries are the values of ξ_2 for which $f_j(x, t)$ is either zero or undefined. The topological charge is obtained by evaluating the change in the argument of $f_j(x, t)$ as x goes from $-\infty$ to $+\infty$. Therefore the topological charge can change only when the curve traced out by $f_j(x, t)$ in the complex plane, is either (i) undefined, or (ii) passes through the origin. The implication, therefore, is that the topological charge of the soliton is constant on each of the sectors in the range of ξ_2 mentioned above. Indeed, it will be shown that the topological charge takes on a unique value in each sector. An expression for topological charge in one particular sector, that of the *highest charge*, is calculated and from it (in the following subsection) an expression for the remaining charges is deduced.

The number of sectors, denoted \tilde{h}_a , which the range of ξ_2 is divided into is equal to the number of different values that $e^{i\mu_j}$ ($0 \leq j \leq h - 1$) can take, i.e. the smallest value of q for which

$$\frac{2\pi i q a}{h} = 2\pi i k \quad \text{where } q, k \in \mathbb{N}.$$

Rewriting this as

$$q\tilde{a} = k\tilde{h}_a \quad \text{where } \tilde{a} = \frac{a}{\gcd(a, h)} \quad \text{and} \quad \tilde{h}_a = \frac{h}{\gcd(a, h)}$$

are coprime, then $q = \tilde{h}_a$ and $k = \tilde{a}$. So an upper bound on the number of topological charges of the a^{th} soliton is

$$\tilde{h}_a = \frac{h}{\gcd(a, h)}.$$

The angular width of each region is $2\pi/\tilde{h}_a$ and so $(-\pi, \pi)$ is subdivided by the regions given by

$$I_p = \left(-\pi + \frac{2\pi p}{\tilde{h}_a}, -\pi + \frac{2\pi(p+1)}{\tilde{h}_a} \right)$$

with $0 \leq p \leq \tilde{h}_a - 1$. Consider now the transformation

$$\xi_2 \rightarrow \left(\xi_2 + \frac{2\pi a}{h} \right) \bmod (2\pi) \in [-\pi, \pi). \quad (4.2.1a)$$

If ξ_2 originally resides in the region I_0 then repeated application of (4.2.1a) will send ξ_2 to each of the other regions in turn, before returning to I_0 on the \tilde{h}_a^{th} application. As will

now be shown, the above transformation is equivalent to a cyclic permutation of the simple roots $\{\alpha_j\}$ plus the extended root α_0 . The a^{th} soliton solution takes the form

$$\phi_{(a)}(x, t) = -\frac{1}{i\beta} \sum_{j=0}^n \alpha_j \ln(1 + \omega_a^j y e^{i\xi_2})$$

which, under the above transformation, becomes

$$\phi_{(a)}(x, t) = -\frac{1}{i\beta} \sum_{j=0}^n \alpha_j \ln(1 + \omega_a^{j+1} y e^{i\xi_2}) = -\frac{1}{i\beta} \sum_{j=0}^n \alpha_{j-1} \ln(1 + \omega_a^j y e^{i\xi_2}),$$

the labeling of the roots being modulo h . Therefore, to calculate the full set of topological charges of a single soliton, all that is required is to calculate the topological charge for one value of ξ_2 and then cyclically permute the labeling on the α_j ($0 \leq j \leq h-1$) to generate the others. The cyclic permutation of $\{\alpha_0, \alpha_j\}$ is an automorphism of the extended Dynkin diagram $\Delta(a_n^{(1)})$ and, as will be shown later in this chapter as well as the next, there is a correspondence between this map and the sets of topological charges (see Table 2).

Consider now the function $f_j(x, t)$. Splitting it up into its real and imaginary parts,

$$f_j(x, t) = \frac{1 + y [\cos(\mu + \xi_2) + \cos \xi_2] + y^2 \cos \mu}{|1 + y e^{i\xi_2}|^2} + i \frac{y [\sin(\mu + \xi_2) - \sin \xi_2] + y^2 \sin \mu}{|1 + y e^{i\xi_2}|^2}.$$

The imaginary part is zero for $y = 0$ (i.e. at $x = -\infty$) and at one other point given by

$$y = -\frac{\sin(\mu + \xi_2) - \sin(\xi_2)}{\sin \mu} \quad (\text{provided } y > 0),$$

where $\mu \neq 0, \pi$. If $\xi_2 = -\pi + \epsilon$, where $\epsilon > 0$ is an infinitesimal. Then,

$$\begin{aligned} \text{Im}(f_j(x, t)) = 0 \quad \text{for} \quad y &= 1 - \frac{(1 - \cos \mu)}{\sin \mu} \epsilon + O(\epsilon^2), \\ \text{and } \text{Re}(f_j(x, t)) |1 + y e^{i\xi_2}|^2 &= \frac{2\epsilon}{\sin \mu} (1 - \cos \mu) + O(\epsilon^2). \end{aligned}$$

Therefore the complex function $f_j(x, t)$ crosses the real axis positively for $0 < \mu < \pi$ and negatively for $\pi < \mu < 2\pi$. Also, for small positive y ,

$$\text{Im}(f_j(x, t)) |1 + y e^{i\xi_2}|^2 = -y \sin \mu + (\text{higher order terms})$$

i.e. the function starts off with negative imaginary part for $0 < \mu < \pi$ and positive imaginary part for $\pi < \mu < 2\pi$. Finally, if $\mu = 0$ then $f_j = 1$ and contributes zero to

the topological charge, whereas if $\mu = \pi$, the change in the function's argument is $+\pi$. Therefore the change in the argument of each $f_j(x, t)$ is simply μ_j , and so the topological charge in this sector is given by

$$\begin{aligned} t_a^{(1)} &= -\frac{1}{2\pi i} \sum_{j=0}^n \left(\frac{2\pi i a j}{h} \bmod 2\pi i \right) \alpha_j \\ &= \sum_{j=0}^n \frac{a(h-j) \bmod h}{h} \alpha_j. \end{aligned}$$

This topological charge will be called the 'highest charge' since the difference between it and all subsequent topological charges, is proportional to a sum of positive roots. The remaining charges are therefore generated under $\tau : \alpha_j \rightarrow \alpha_{(j-1) \bmod h}$. The order of τ acting on the highest charge is the smallest value of q such that

$$a(h - (j + q)) \bmod h = a(h - j) \bmod h,$$

i.e. the smallest value of q such that $aq \bmod h = 0$. This is given by $q = \tilde{h}_a$, confirming that \tilde{h}_a is in fact equal to the number of charges for the a^{th} soliton. The topological charges associated with each soliton in the theories $a_2^{(1)}$ to $a_6^{(1)}$ are given, as an example, in Figure 16 below.

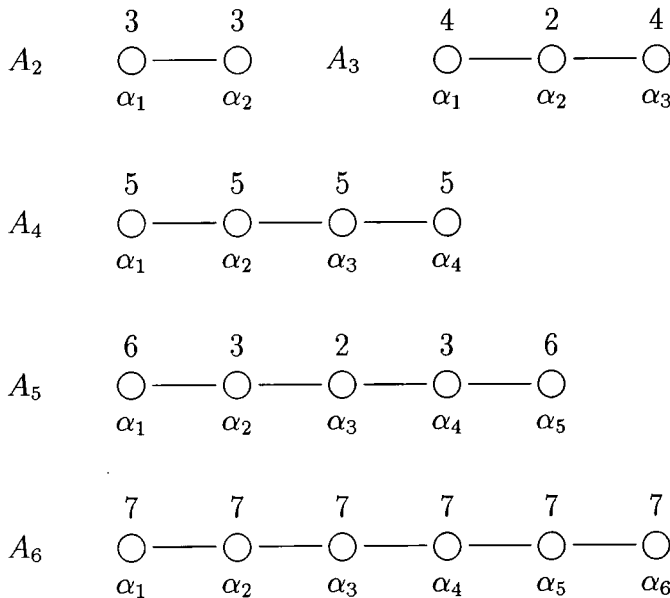

Figure 16: The number of topological charges: theories $A_2 - A_6$

4.2.2 An explicit formula for the charges.

Consider the highest charge, which is written for convenience in the following form:

$$t_a^{(1)} = \lambda_0 \alpha_0 + \lambda_1 \alpha_1 + \cdots + \lambda_n \alpha_n.$$

Each λ_j is equal to one of $0, 1/\tilde{h}_a, 2/\tilde{h}_a, \dots, (\tilde{h}_a - 1)/\tilde{h}_a$. The other $\tilde{h}_a - 1$ charges are obtained by cyclically permuting the labeling of the simple roots so that

$$\lambda_0 = 1/\tilde{h}_a, \lambda_1 = 2/\tilde{h}_a, \dots, \lambda_{\tilde{h}_a-1} = (\tilde{h}_a - 1)/\tilde{h}_a.$$

Consider now, the permutation that results in $\lambda_0 = k/\tilde{h}_a$ where $(1 \leq k \leq \tilde{h}_a - 1)$. This is in effect equivalent to adding, modulo h ,

$$\frac{k}{\tilde{h}_a}(\alpha_0 + \alpha_1 + \cdots + \alpha_n)$$

to the highest charge. Therefore,

$$\lambda_j \rightarrow \begin{cases} \lambda_j + k/\tilde{h}_a, & \text{if } \lambda_j + k/\tilde{h}_a < 1; \\ \lambda_j + k/\tilde{h}_a - 1, & \text{if } \lambda_j + k/\tilde{h}_a \geq 1. \end{cases}$$

Using (2.4b) to set λ_0 equal to zero, the overall effect of the permutation is the subtraction of 1 from λ_j where $\lambda_j + k/\tilde{h}_a \geq 1$. The expression for the topological charges is therefore deduced to be

$$t_a^{(k)} = \sum_{j=1}^n \frac{a(h-j) \bmod h}{h} \alpha_j - \sum_{l=1}^{k-1} \sum_{j=1}^n \delta_{a(h-j) \bmod h, h-l \gcd(a,h)} \alpha_j$$

where $k = 1, \dots, \tilde{h}$. Examples of the use of this formula to calculate the charges in the $a_3^{(1)}$ and $a_4^{(1)}$ theories are given below.

The $a_3^{(1)}$ theory.

$$A_3 \quad \begin{array}{ccc} 4 & 2 & 4 \\ \bigcirc & \text{---} & \bigcirc & \text{---} & \bigcirc \\ \alpha_1 & & \alpha_2 & & \alpha_3 \end{array}$$

$$\begin{array}{lll} a = 1 : & \frac{3}{4}\alpha_1 + \frac{1}{2}\alpha_2 + \frac{1}{4}\alpha_3 & a = 2 : & \frac{1}{2}\alpha_1 + \frac{1}{2}\alpha_3 & a = 3 : & \frac{1}{4}\alpha_1 + \frac{1}{2}\alpha_2 + \frac{3}{4}\alpha_3 \\ & -\frac{1}{4}\alpha_1 + \frac{1}{2}\alpha_2 + \frac{1}{4}\alpha_3 & & -\frac{1}{2}\alpha_1 - \frac{1}{2}\alpha_3 & & \frac{1}{4}\alpha_1 + \frac{1}{2}\alpha_2 - \frac{1}{4}\alpha_3 \\ & -\frac{1}{4}\alpha_1 - \frac{1}{2}\alpha_2 + \frac{1}{4}\alpha_3 & & & & \frac{1}{4}\alpha_1 - \frac{1}{2}\alpha_2 - \frac{1}{4}\alpha_3 \\ & -\frac{1}{4}\alpha_1 - \frac{1}{2}\alpha_2 - \frac{3}{4}\alpha_3 & & & & -\frac{3}{4}\alpha_1 - \frac{1}{2}\alpha_2 - \frac{1}{4}\alpha_3 \end{array}$$

The $a_4^{(1)}$ theory.

$$A_4 \quad \begin{array}{cccc} 5 & 5 & 5 & 5 \\ \bigcirc & \text{---} & \bigcirc & \text{---} & \bigcirc & \text{---} & \bigcirc \\ \alpha_1 & & \alpha_2 & & \alpha_3 & & \alpha_4 \end{array}$$

$$\begin{array}{ll} a = 1 : & \begin{array}{l} \frac{4}{5}\alpha_1 + \frac{3}{5}\alpha_2 + \frac{2}{5}\alpha_3 + \frac{1}{5}\alpha_4 \\ -\frac{1}{5}\alpha_1 + \frac{3}{5}\alpha_2 + \frac{2}{5}\alpha_3 + \frac{1}{5}\alpha_4 \\ -\frac{1}{5}\alpha_1 - \frac{2}{5}\alpha_2 + \frac{2}{5}\alpha_3 + \frac{1}{5}\alpha_4 \\ -\frac{1}{5}\alpha_1 - \frac{2}{5}\alpha_2 - \frac{3}{5}\alpha_3 + \frac{1}{5}\alpha_4 \\ -\frac{1}{5}\alpha_1 - \frac{2}{5}\alpha_2 - \frac{3}{5}\alpha_3 - \frac{4}{5}\alpha_4 \end{array} & a = 4 : & \begin{array}{l} \frac{1}{5}\alpha_1 + \frac{2}{5}\alpha_2 + \frac{3}{5}\alpha_3 + \frac{4}{5}\alpha_4 \\ \frac{1}{5}\alpha_1 + \frac{2}{5}\alpha_2 + \frac{3}{5}\alpha_3 - \frac{1}{5}\alpha_4 \\ \frac{1}{5}\alpha_1 + \frac{2}{5}\alpha_2 - \frac{2}{5}\alpha_3 - \frac{1}{5}\alpha_4 \\ \frac{1}{5}\alpha_1 - \frac{3}{5}\alpha_2 - \frac{2}{5}\alpha_3 - \frac{1}{5}\alpha_4 \\ -\frac{4}{5}\alpha_1 - \frac{3}{5}\alpha_2 - \frac{2}{5}\alpha_3 - \frac{1}{5}\alpha_4 \end{array} \\ \\ a = 2 : & \begin{array}{l} \frac{3}{5}\alpha_1 + \frac{1}{5}\alpha_2 + \frac{4}{5}\alpha_3 + \frac{2}{5}\alpha_4 \\ \frac{3}{5}\alpha_1 + \frac{1}{5}\alpha_2 - \frac{1}{5}\alpha_3 + \frac{2}{5}\alpha_4 \\ -\frac{2}{5}\alpha_1 + \frac{1}{5}\alpha_2 - \frac{1}{5}\alpha_3 + \frac{2}{5}\alpha_4 \\ -\frac{2}{5}\alpha_1 + \frac{1}{5}\alpha_2 - \frac{1}{5}\alpha_3 - \frac{3}{5}\alpha_4 \\ -\frac{2}{5}\alpha_1 - \frac{4}{5}\alpha_2 - \frac{1}{5}\alpha_3 - \frac{3}{5}\alpha_4 \end{array} & a = 3 : & \begin{array}{l} \frac{2}{5}\alpha_1 + \frac{4}{5}\alpha_2 + \frac{1}{5}\alpha_3 + \frac{3}{5}\alpha_4 \\ \frac{2}{5}\alpha_1 - \frac{1}{5}\alpha_2 + \frac{1}{5}\alpha_3 + \frac{3}{5}\alpha_4 \\ \frac{2}{5}\alpha_1 - \frac{1}{5}\alpha_2 + \frac{1}{5}\alpha_3 - \frac{2}{5}\alpha_4 \\ -\frac{3}{5}\alpha_1 - \frac{1}{5}\alpha_2 + \frac{1}{5}\alpha_3 - \frac{2}{5}\alpha_4 \\ -\frac{3}{5}\alpha_1 - \frac{1}{5}\alpha_2 - \frac{4}{5}\alpha_3 - \frac{2}{5}\alpha_4 \end{array} \end{array}$$

4.2.3 The highest charge and its fundamental representation.

In this section it will be shown that the topological charge of the a^{th} soliton lies in the a^{th} fundamental representation. This will be used in the next section when the remaining solitons will be shown to lie in the same representation as the highest charge and so imply that all the topological charges lie in the same fundamental representation.

It will be convenient to write $a = h - b$, $b = \tilde{b} \gcd(b, h)$, and $h = \tilde{h} \gcd(b, h)$.

Due to the symmetry of the $a_n^{(1)}$ theory under $\alpha_i \rightarrow \alpha_{h-i}$ for $1 \leq i \leq n$, it is necessary only to consider

$$b \leq \begin{cases} \frac{1}{2}(h-1), & \text{if } h \text{ is odd;} \\ \frac{1}{2}h, & \text{if } h \text{ is even.} \end{cases}$$

The highest charge is then given by

$$t_a^{(1)} = \sum_{j=1}^n \frac{bj \bmod h}{h} \alpha_j.$$

The inner products of $t_a^{(1)}$ with each of the simple roots will be considered and shown to be transformable via Weyl reflections to the highest weight of the a^{th} fundamental representation. Consider firstly the case when $\gcd(b, h) = 1$ i.e. b and h are coprime. The restriction on the value of b implies that $b/h \leq 1/2$. This rather trivial statement allows the following to be deduced:

- $t_a^{(1)} \cdot \alpha_j = +1$ if $\frac{bj \bmod h}{h} + \frac{b}{h} \geq 1$,
- $t_a^{(1)} \cdot \alpha_j = -1$ if $\frac{bj \bmod h}{h} - \frac{b}{h} < 0$,
- $t_a^{(1)} \cdot \alpha_j = 0$ otherwise.

Since both the first and second conditions cannot hold at the same time, then defining

$$\Omega(k) = \left\lfloor \frac{hk}{b} \right\rfloor$$

where [...] denotes the integer part, the following is obtained:

$$t_a^{(1)} \cdot \alpha_j = \begin{cases} 1 & \text{for } j = \Omega(k), \quad \text{where } k = 1, \dots, b-1, \\ -1 & \text{for } j = \Omega(k) + 1, \text{ where } k = 1, \dots, b-1, \\ 1 & \text{for } j = h-1, \\ 0 & \text{otherwise.} \end{cases}$$

Also, $\Omega(k) + 1 < \Omega(k+1)$ for $k = 1, \dots, b-2$, and $\Omega(b-1) < h-1$. Therefore, in general, $t_a^{(1)}$ has inner products with the simple roots of the form

$$t_a^{(1)} \cdot \{\alpha_j\} = (0, 0, \dots, 0, 1, -1, 0, \dots, 0, 1, -1, 0, \dots, 0, 0, 1), \quad (4.2.3a)$$

the notation indicating that the j^{th} component of the row vector is given by $t_a^{(1)} \cdot \alpha_j$. There are two things that can be immediately shown to be true. Notice that if a weight, w has inner products with the simple roots given by

$$w \cdot \{\alpha_j\} = (\dots, 0, 1, -1, 0, 0, \dots)$$

then under a Weyl reflection in the root which has inner product -1 with w , $w \rightarrow \tilde{w}$, where

$$\tilde{w} \cdot \{\alpha_j\} = (\dots, 0, 0, 1, -1, 0, \dots).$$

Applying this to the case of $t_a^{(1)}$, then a series of Weyl reflections will result in $t_a^{(1)} \rightarrow \hat{t}_a^{(1)}$ where

$$\hat{t}_a^{(1)} \cdot \{\alpha_j\} = (0, \dots, 0, 1, -1, 1, -1, \dots, 1, -1, 1).$$

If a weight w has inner product with the simple roots now given by

$$w \cdot \{\alpha_j\} = (\dots, 1, -1, 1, \dots)$$

then again performing a Weyl reflection in the simple root which has inner product -1 with w , $w \rightarrow \hat{w}$ where

$$\hat{w} \cdot \{\alpha_j\} = (\dots, 0, 1, 0, \dots).$$

This last procedure combined with the previous one, can be applied to $\hat{t}_a^{(1)}$ to finally give $\bar{t}_a^{(1)}$ which is expressed via

$$\bar{t}_a^{(1)} \cdot \{\alpha_j\} = (0, \dots, 0, 1, 0, \dots, 0)$$

with the 1 appearing in the d^{th} position, d being given by,

$$d = n - [b - 1] = h - b = a.$$

Therefore, $t_a^{(1)}$ lies in the same representation as $\bar{t}_a^{(1)}$, i.e. the a^{th} fundamental representation.

The generalization to the case of $\gcd(b, h) \neq 1$ is straightforward. If $\tilde{t}^{(1)}$ is the highest charge, in the theory with Coxeter number \tilde{h} , of the $\tilde{a} = \tilde{h} - \tilde{b}$ soliton, then the highest charge of the soliton in the theory with Coxeter number h is given by

$$t^{(1)} = (\tilde{t}^{(1)}, 0, \tilde{t}^{(1)}, 0, \dots, \tilde{t}^{(1)}),$$

the zeros occurring for $j = \tilde{h}, 2\tilde{h}, \dots, (\gcd(b, h) - 1)\tilde{h}$. Then by the results of the above discussion, the inner products of $t^{(1)}$ with the simple roots is also of the form (4.2.3a), with the highest charge lying in the d^{th} fundamental representation where

$$d = n - [\tilde{b} \gcd(b, h) - 1] = h - b = a$$

i.e. the highest charge lies in the a^{th} fundamental representation.

4.2.4 The Topological charges, the Coxeter element and the fundamental representations.

In the last two subsections, the topological charges of the a^{th} soliton were calculated, with the highest charge shown to lie in the a^{th} fundamental representation. In this subsection

it will be shown that the cyclical permutation of the roots used to connect the topological charges is in fact equivalent to the application of the Coxeter element

$$\omega_{tc} = r_n r_{n-1} r_{n-2} \dots r_3 r_2 r_1,$$

where r_i is a Weyl reflection in the i^{th} simple root α_i . The subscript “tc” indicates that this ordering is special for the case of topological charge, as the ordering of the Weyl reflections is not arbitrary – other orderings do not necessarily connect the charges (except in the 1st and n^{th} fundamental representations where any ordering of the factors composing Coxeter element generates all the weights in the Weyl orbit of the highest weight). Indeed for the other theories when the number of charges is calculated, they are found not to divide the Coxeter number and so the charges cannot be generated via the Coxeter element (recall $\omega^h = 1$). However the establishment of the above result has an important corollary for the association of the topological charges to fundamental representations.

Firstly, consider the effect of ω_{tc} on the set of simple roots $\{\alpha_j\}$ and the extended root α_0 . It can be shown

$$\begin{aligned} \alpha_0 &\rightarrow \alpha_0 + \alpha_1 + \alpha_2 + \dots + \alpha_{n-1} + 2\alpha_n, \\ \alpha_1 &\rightarrow -\alpha_1 - \alpha_2 - \alpha_3 - \dots - \alpha_n, \\ \text{and } \alpha_i &\rightarrow \alpha_{i-1} \text{ for } 2 \leq i \leq n. \end{aligned}$$

Therefore an arbitrary linear combination of the simple roots plus the extended root

$$u = \lambda_0 \alpha_0 + \lambda_1 \alpha_1 + \lambda_2 \alpha_2 + \dots + \lambda_n \alpha_n$$

is transformed thus:

$$\begin{aligned} u &\rightarrow \lambda_0 \alpha_0 + (\lambda_0 - \lambda_1 + \lambda_2) \alpha_1 + \dots + (\lambda_0 - \lambda_1 + \lambda_n) \alpha_{n-1} + (2\lambda_0 - \lambda_1) \alpha_n \\ &= \lambda_1 \alpha_0 + \lambda_2 \alpha_1 + \lambda_3 \alpha_2 + \dots + \lambda_n \alpha_{n-1} + \lambda_0 \alpha_n \end{aligned}$$

by equation (2.4b). Using the notation

$$\lambda_0 \alpha_0 + \lambda_1 \alpha_1 + \lambda_2 \alpha_2 + \dots + \lambda_n \alpha_n \equiv (\lambda_0, \lambda_1, \lambda_2, \dots, \lambda_n),$$

then

$$\omega_{tc}(\lambda_0, \lambda_1, \lambda_2, \dots, \lambda_{n-1}, \lambda_n) = (\lambda_1, \lambda_2, \lambda_3, \dots, \lambda_n, \lambda_0),$$

i.e. the action of the Coxeter element cyclically permutes the λ_j 's. This invariance of the set of topological charges under the action of the Coxeter element means that the topological charges lie in the same representation as the highest charge i.e. the a^{th} fundamental representation.

It is perhaps worth considering for a moment the rôle of the Coxeter element in this discussion. As it was said above, as far as the representations corresponding to the 1st and n^{th} representations are concerned, the ordering of the factors comprising Coxeter element is irrelevant – there is one orbit containing the complete representation. For the other fundamental representations, this is not the case. This can be seen most easily by considering an example in the context of topological charges.

Consider the case of the $a_5^{(1)}$ theory under the action of the Coxeter element

$$w = r_4 r_2 r_5 r_3 r_1$$

on the Weyl orbit of the second fundamental weight $\lambda_{(2)}$ of the $a_5^{(1)}$ theory (this ordering is the familiar ‘black-white’ ordering of [18] i.e. the sets of simple roots $\{\alpha_1, \alpha_3, \alpha_5\}$ and $\{\alpha_2, \alpha_4\}$ corresponding to $\{r_1, r_3, r_5\}$ and $\{r_2, r_4\}$ are composed of elements which are orthogonal to each other). The Weyl orbit is partitioned into three Coxeter orbits, say C_+ , C_- , and C_0 .

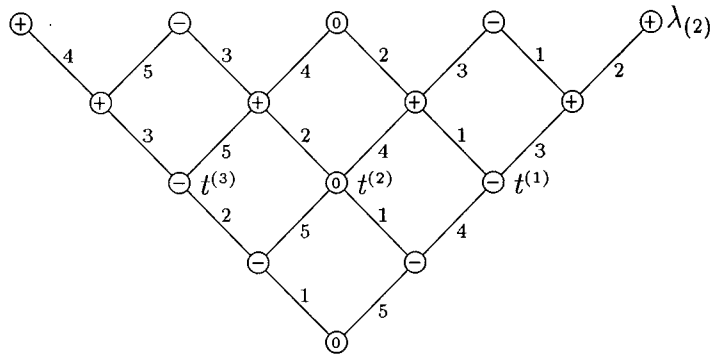

Figure 17 : Partition of Weyl orbit of $\lambda_{(2)}$.

This is visualized in Figure 17 where

- each spot corresponds to a weight in the Weyl orbit of $\lambda_{(2)}$,

- if two spots are joined by a line, they are Weyl reflections of each other in the simple root α_j where j is the number on the line,
 - spots with the same labeling (either +, −, or 0) lie in the same Coxeter orbit.
- Therefore, whereas $t^{(1)}$ and $t^{(3)}$ lie in the same Coxeter orbit, $t^{(2)}$ lies in a different one.

4.2.5 The other $a_n^{(1)}$ automorphisms

In subsection 4.2.1 it was shown that the set of topological charges corresponding to each soliton was invariant under the automorphisms of the extended Dynkin diagram which cyclically permute the elements of the extended root system. There are other automorphisms of the extended diagram for $a_n^{(1)}$. In this subsection, the effect of these mappings will be considered. It is found that the symmetries possessed by the unextended diagram map the topological charges of one soliton into that of another, whereas for basic symmetries of the extended diagram (this will become clear in what follows) the topological charges of individual solitons are permuted. The combination of both of these types of mapping exhaust all possible automorphisms of the extended diagram.

The automorphism of the unextended diagram in which

$$\alpha_j \rightarrow \alpha_{h-j} \quad (j = 1, \dots, n)$$

when applied to a soliton solution, keeping all parameters fixed, results in

$$\phi_{(a)} \rightarrow \phi_{(h-a)} \quad (a = 1, \dots, n).$$

Combining this with the map of cyclic permutations of the extended root system, τ , it is found that the set of topological charges of each soliton is invariant under

$$\sigma_k : \alpha_j \rightarrow \alpha_{(k-j) \bmod h} \quad (0 \leq j, k \leq h-1).$$

These mappings are related to the automorphisms of the extended Dynkin diagrams which reflect the diagram in a line splitting it in two as shown in figure 18, below.

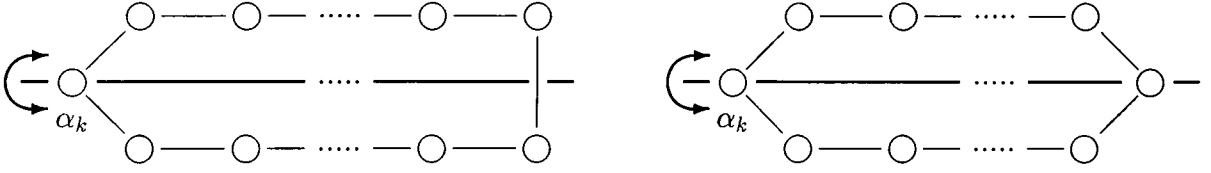

$a_n^{(1)}$ when n is even.

$a_n^{(1)}$ when n is odd.

Figure 18: Reflection symmetry of the $a_n^{(1)}$ Dynkin diagram.

The reader may question why a distinction has been made between evidently the same automorphism of the extended and unextended. The reason is that this way of looking at the automorphisms and associating those relating to the extended diagram to a change in ξ_2 generalizes to the remaining simply-laced cases.

Sending $\xi_2 \rightarrow -\xi_2$ in the soliton solution is equivalent to evaluating the topological charge in region $I_{\tilde{h}_a-1-p}$ rather than I_p where $0 \leq p \leq \tilde{h}_a - 1$. The form of the a^{th} soliton solution is

$$\phi_{(a)}(x, t) = -\frac{1}{i\beta} \sum_{j=1}^n \alpha_j \ln \left(\frac{1 + \omega_a^j y e^{-i\xi_2}}{1 + y e^{-i\xi_2}} \right) = -\frac{1}{i\beta} \sum_{j=1}^n \alpha_j \ln \left(\omega_a^j \frac{1 + \omega_a^{h-j} y^{-1} e^{i\xi_2}}{1 + y^{-1} e^{i\xi_2}} \right).$$

The last expression can be recast into the form

$$\phi_{(a)}(x, t) = -\frac{1}{i\beta} \sum_{j=1}^n \alpha_{h-j} \ln \left(\omega_a^{h-j} \frac{1 + \omega_a^j y^{-1} e^{i\xi_2}}{1 + y^{-1} e^{i\xi_2}} \right).$$

The topological charge in region $I_{\tilde{h}_a-1-p}$ is therefore obtained from the topological charge in region I_p ($1 \leq p \leq \tilde{h}_a - 1$) via the mapping

$$\sigma_o : \alpha_j \rightarrow -\alpha_{h-j}.$$

The symmetry $\xi_2 \rightarrow -\xi_2$ is possessed by all of the solitons in all of the theories.

Automorphism of extended diagram	Automorphism of set of charges	Change in ξ_2	Change in $\phi_{(a)}$
$\alpha_j \rightarrow \alpha_{h-j}$ ($j \neq 0$)	$\alpha_j \rightarrow \alpha_{h-j}$ ($j \neq 0$)	–	$\phi_{(a)} \rightarrow \phi_{(h-a)}$
$\alpha_j \rightarrow \alpha_{(j-1) \bmod h}$ ($\forall j$)	$\alpha_j \rightarrow \alpha_{(j-1) \bmod h}$ ($\forall j$)	$\xi_2 \rightarrow \left(\xi_2 + \frac{2\pi a}{h_a} \right) \bmod 2\pi$	–
–	$\alpha_j \rightarrow -\alpha_{h-j}$ ($\forall j$)	$\xi_2 \rightarrow -\xi_2$	–

Table 2: Symmetries of the $a_n^{(1)}$ topological charges.

From these basic automorphisms the effect of all the others on the sets of topological charges can be deduced.

4.2.6 Multisoliton solutions.

In this section, a multisoliton configuration composed of N widely separated solitons is considered. In this large separation approximation the topological charge of the configuration as a whole is found to be the sum of the topological charges of the individual solitons. This will be done via an inductive argument. In [32] the τ -functions of the multisolitons were found to be

$$\tau_j(x, t) = \sum_{\mu_1=0}^1 \cdots \sum_{\mu_N}^1 \exp \left(\sum_{p=1}^N \mu_p \omega_p^j \Phi_p + \sum_{1 \leq p < q \leq N} \mu_p \mu_q \ln A^{(pq)} \right)$$

where

$$A^{(pq)} = - \frac{(\sigma_p - \sigma_q)^2 - (\sigma_p v_p - \sigma_q v_q)^2 - 4m^2 \sin^2 \frac{\pi}{n+1} (a_p - a_q)}{(\sigma_p + \sigma_q)^2 - (\sigma_p v_p + \sigma_q v_q)^2 - 4m^2 \sin^2 \frac{\pi}{n+1} (a_p + a_q)}$$

is the ‘interaction constant’. Relabeling the solitons, if necessary, then

$$\sigma_1 v_1 < \sigma_2 v_2 < \dots < \sigma_{N-1} v_{N-1} < \sigma_N v_N. \quad (4.2.6a)$$

It will be convenient to write $e^{\sigma_i(x-v_it+\xi^{(i)})} = y e^{-\mu_i(t)} e^{i\xi_2^{(i)}}$, where $\mu_i(t) = \sigma_i v_i t - \xi_1^{(i)}$. If $t = T$ is fixed for sufficiently large T , then write $\mu_i(T) = \mu_i$ so that

$$\mu_1 \ll \mu_2 \ll \dots \ll \mu_{N-1} \ll \mu_N. \quad (4.2.6b)$$

It is worthwhile to find the range of y for which the soliton field $\phi(x, t)$ has its most rapid variation (and so where the soliton is located). This is done via the parameter $k \gg 1$, and the imposition that

$$\frac{1}{k} < |\omega_{a_i}^j y^{\sigma_i} e^{-\mu_i} e^{i\xi_2^{(i)}}| < k,$$

since below the lower limit $\tau_j/\tau_0 \sim 1$, and above the upper limit $\tau_j/\tau_0 \sim \omega_{a_i}^j$. The corresponding limits in the range of y are:

$$y \sim \left(\frac{1}{k} e^{\mu_i} \right)^{1/\sigma_i} \quad \text{for} \quad |\omega_{a_i}^j y^{\sigma_i} e^{-\mu_i} e^{i\xi_2^{(i)}}| \sim \frac{1}{k},$$

and

$$y \sim (k e^{\mu_i})^{1/\sigma_i} \quad \text{for} \quad |\omega_{a_i}^j y^{\sigma_i} e^{-\mu_i} e^{i\xi_2^{(i)}}| \sim k.$$

The point in time considered T , can be chosen large enough so that each of the above regions are far apart, that is

$$\left(\frac{1}{k}e^{\mu_1}\right)^{1/\sigma_1} < (ke^{\mu_1})^{1/\sigma_1} \ll \left(\frac{1}{k}e^{\mu_2}\right)^{1/\sigma_2} < (ke^{\mu_2})^{1/\sigma_2} \ll \dots \\ \dots \left(\frac{1}{k}e^{\mu_{N-1}}\right)^{1/\sigma_{N-1}} < (ke^{\mu_{N-1}})^{1/\sigma_{N-1}} \ll \left(\frac{1}{k}e^{\mu_N}\right)^{1/\sigma_N} < (ke^{\mu_N})^{1/\sigma_N}.$$

The scene is now set for a straightforward calculation of the multisoliton topological charge.

Consider the two soliton solution

$$\frac{\tau_j}{\tau_0} = \frac{1 + \omega_{a_1}^j y^{\sigma_1} e^{-\mu_1} e^{i\xi_2^{(1)}} + \omega_{a_2}^j y^{\sigma_2} e^{-\mu_2} e^{i\xi_2^{(2)}} (1 + A_{12} \omega_{a_1}^j y^{\sigma_1} e^{-\mu_1} e^{i\xi_2^{(1)}})}{1 + y^{\sigma_1} e^{-\mu_1} e^{i\xi_2^{(1)}} + y^{\sigma_2} e^{-\mu_2} e^{i\xi_2^{(2)}} (1 + A_{12} y^{\sigma_1} e^{-\mu_1} e^{i\xi_2^{(1)}})}.$$

Here the first soliton is located in the range $\left(\frac{1}{k}e^{\mu_1}\right)^{1/\sigma_1} \leq y \leq (ke^{\mu_1})^{1/\sigma_1}$, and the second in the range $\left(\frac{1}{k}e^{\mu_2}\right)^{1/\sigma_2} \leq y \leq (ke^{\mu_2})^{1/\sigma_2}$. Outside these regions τ_j/τ_0 is effectively constant and equal to (in order of increasing y), 1, $\omega_{a_1}^j$, and $\omega_{a_1}^j \omega_{a_2}^j$, respectively. In the range $\left(\frac{1}{k}e^{\mu_1}\right)^{1/\sigma_1} \leq y \leq (ke^{\mu_1})^{1/\sigma_1}$,

$$\frac{\tau_j}{\tau_0} \sim \frac{1 + \omega_{a_1}^j y^{\sigma_1} e^{-\mu_1} e^{i\xi_2^{(1)}}}{1 + y^{\sigma_1} e^{-\mu_1} e^{i\xi_2^{(1)}}}$$

(i.e. it is effectively the j^{th} component of the first soliton) which contributes to the topological charge by t_1 . Finally, for $\left(\frac{1}{k}e^{\mu_2}\right)^{1/\sigma_2} \leq y \leq (ke^{\mu_2})^{1/\sigma_2}$,

$$\frac{\tau_j}{\tau_0} \sim \omega_{a_1}^j \frac{1 + A_{12} \omega_{a_2}^j y^{\sigma_2} e^{-\mu_2} e^{i\xi_2^{(2)}}}{1 + A_{12} y^{\sigma_2} e^{-\mu_2} e^{i\xi_2^{(2)}}}$$

which contributes t_2 to the topological charge. Therefore the topological charge of the double soliton is given by

$$t = t_1 + t_2.$$

Suppose now that the $(N-1)$ -soliton solution has topological charge given by

$$t_{(N-1)} = t_1 + t_2 + \dots + t_{(N-1)}.$$

If $\tau_j^{(p)}$ is the j^{th} τ -function of the p -soliton solution, then for $0 < y \leq (ke^{\mu_{N-1}})^{1/\sigma_{N-1}}$,

$$\frac{\tau_j^{(N)}}{\tau_0^{(N)}} \sim \frac{\tau_j^{(N-1)}}{\tau_0^{(N-1)}},$$

contributing $t_{(N-1)}$ to the topological charge.

In the regions $(ke^{\mu_{N-1}})^{1/\sigma_{N-1}} < y < (\frac{1}{k}e^{\mu_N})^{1/\sigma_N}$, and for $y > (ke^{\mu_N})^{1/\sigma_N}$, the functions $\tau_j^{(N)}/\tau_0^{(N)}$ are effectively constant and equal to $\omega_{a_1}^j \omega_{a_2}^j \dots \omega_{a_{N-1}}^j$ and $\omega_{a_1}^j \omega_{a_2}^j \dots \omega_{a_{N-1}}^j \omega_{a_N}^j$ respectively. For $(\frac{1}{k}e^{\mu_N})^{1/\sigma_N} \leq y \leq (ke^{\mu_N})^{1/\sigma_N}$,

$$\frac{\tau_j^{(N)}}{\tau_0^{(N)}} \sim \omega_{a_1}^j \omega_{a_2}^j \dots \omega_{a_{N-1}}^j \frac{1 + A_{a_1 a_2} \dots A_{a_N a_{N-1}} \omega_{a_N}^j y^{\sigma_N} e^{-\mu_N} e^{i\xi_2^{(N)}}}{1 + A_{a_1 a_2} \dots A_{a_N a_{N-1}} y^{\sigma_N} e^{-\mu_N} e^{i\xi_2^{(N)}}}$$

which contributes t_N to the topological charge. Therefore the topological charge of the N -soliton solution is

$$t = t_1 + t_2 + \dots + t_{N-1} + t_N.$$

This result still holds if the strict inequalities of (4.2.6a) are relaxed to allow for solitons to have $\sigma_i v_i$ equal, provided $\xi_1^{(i)}$ is large enough so that (4.2.6b) holds.

4.2.7 Multisolitons and representation theory.

Having established in the previous subsection that the topological charges of a multisoliton configuration are the sums of the topological charges of its constituent solitons, the representations in which these topological charges lie will be discussed.

Denote the set of topological charges of the N -soliton solution, which is composed of the $\{a_1, a_2, \dots, a_N\}$ -solitons, and the a^{th} fundamental representation by

$$\mathcal{T}_{(a_1, \dots, a_N)} \quad \text{and} \quad \mathcal{R}_a$$

respectively. As the topological charges of two widely separated solitons are equal to the pairwise sums of the topological charges of the individual solitons, then these charges are weights of the tensor product of the corresponding fundamental representations. For the special case of a double soliton composed of the single solitons associated to the first and n -th fundamental representations (recall these are filled), the resulting topological charges are the weights of the tensor product representation $\mathcal{R}_1 \otimes \mathcal{R}_n$. However, this tensor product of representations contains the adjoint representation, and so contains $\{\pm\alpha_1, \pm\alpha_2, \dots, \pm\alpha_n\}$. As a result, further multisoliton configurations can be constructed that employ these solitons having charges equal to the simple roots, and so fill up all the fundamental representations as well as the entire weight lattice.

Chapter 5

The Topological Charges of the remaining theories.

5.1 Introduction

The $a_n^{(1)}$ theory differs from the other theories in a number of important ways. The critical values of ξ_2 for each soliton are equally spread within the range of zero to 2π , there being one critical value for each τ -function. Also, the $a_n^{(1)}$ theory possesses a great deal of symmetry, so allowing for all of the topological charges to be deduced from just one. In the theories that will now be discussed the critical values of ξ_2 are not as conveniently spread as in the previous case and so make for more difficult calculations. However, the theories do have differing degrees of symmetry, and the sets of topological charges associated with each soliton in these theories do respect them. The degree of symmetry is alas too small to allow for a complete description of the charges – currently an outstanding problem.

Each of the theories, both twisted and untwisted, will be discussed in turn starting with the $d_n^{(1)}$ theory. In this and the other infinite theories it is possible to evaluate the number of topological charges associated with each soliton, and indeed deduce a general formula for them. There are numerous examples throughout the chapter making use of the final results. It still remains, however, to link the charges to their fundamental representations.

In the case of the exceptional algebras the lack of a general soliton formula from which the topological charges can be extracted means that for these algebras it is necessary to calculate the topological charges of each soliton individually. The method of calculation (although for clarity the details will be omitted) is to identify the values of ξ_2 for which the τ -functions are zero at some point in space. This, as in the previous case splits the range of ξ_2 into regions with the topological charge constant on each region. All that remains to be done is to choose a value of ξ_2 in each region and evaluate the topological charge there – this has been carried out by the author using the mathematical package *Matlab*TM.

In a similar manner to the previous section, much information is deduced for the non-simply-laced theories from their simply-laced counterparts. In particular, once the topological charges of the static solitons in the simply-laced theories are calculated, the charges of the solitons surviving the folding are immediately given, whereas the remaining solitons of the non-simply-laced theory will have their topological charges explicitly constructed. As in the $a_n^{(1)}$ theory, these results have not yet been deduced from the more general algebraic

methods available, and so provides a set of results which are not yet explainable at the fundamental level.

5.2 The remaining simply-laced theories.

5.2.1 The $d_4^{(1)}$ theory

As in Chapter 3, it is necessary to consider separately the case of the $d_4^{(1)}$ theory. The topological charges can be calculated explicitly, the most direct method being to ascertain the critical values of ξ_2 and calculate the charge for ξ_2 away from these points. The number of charges associated with each soliton is given in the following diagram:

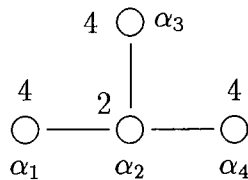

Figure 19: Dynkin diagram for D_4

For the soliton corresponding to $a = 2$, the topological charges are $\pm\alpha_2$ which lie in the associated fundamental representation. For $a = 1$ the charges are

$$\pm \left(\alpha_2 + \frac{1}{2}(\alpha_3 + \alpha_4) \right), \quad \text{and} \quad \pm \frac{1}{2}(\alpha_3 + \alpha_4),$$

with those corresponding to the remaining solitons being generated by cycles of the indices $(1, 3, 4)$. In each case the charges lie in the relevant fundamental representation.

There are two basic symmetries possessed by the above diagram. The first is the interchange of the simple roots α_1 and α_4 which leaves the fields $\phi_{(2)}$ and $\phi_{(3)}$ unchanged, and interchanges $\phi_{(1)}$ with $\phi_{(4)}$. The second symmetry is that which cyclically permutes the simple roots $(\alpha_1, \alpha_4, \alpha_3)$ which corresponds to a cyclic permutation of $(\phi_{(1)}, \phi_{(4)}, \phi_{(3)})$. The remaining symmetries of the unextended diagram can be constructed from these two. The effect of the symmetries of the extended diagram (for $\phi_{(1)}$ only) are summarized along with the above results in Table 3, as different symmetries effect different solitons.

Automorphism of extended diagram	Automorphism of set of charges	Change in ξ_2	Change in $\phi_{(a)}$
$\alpha_1 \rightarrow \alpha_4 \rightarrow \alpha_3 \rightarrow \alpha_1$	$\alpha_1 \rightarrow \alpha_4 \rightarrow \alpha_3 \rightarrow \alpha_1$	–	$\phi_{(1)} \rightarrow \phi_{(4)} \rightarrow \phi_{(3)} \rightarrow \phi_{(1)}$
$\alpha_1 \leftrightarrow \alpha_4$	$\alpha_1 \leftrightarrow \alpha_4$	–	$\phi_{(1)} \leftrightarrow \phi_{(4)}$
$(\alpha_0, \alpha_1) \leftrightarrow (\alpha_3, \alpha_4)$	$(\alpha_0, \alpha_1) \leftrightarrow (\alpha_3, \alpha_4)$	$\xi_2 \rightarrow (\xi_2 + \pi) \bmod 2\pi$	–
–	$\alpha_j \rightarrow -\alpha_j$	$\xi_2 \rightarrow -\xi_2$	–

Table 3: Symmetries of the $d_4^{(1)}$ topological charges.

5.2.2 The $d_n^{(1)}$ theory

The first aim in this section is to calculate the number of topological charges corresponding to each of the $d_n^{(1)}$ solitons. The results obtained along the way will allow for a general formula to be derived for these charges.

Consider firstly those solitons with $1 \leq a \leq n-2$. From §3.3.2 they have τ -functions given by

$$\tau_j = 1 + 2 \frac{\cos((2j-1)\vartheta_a)}{\cos \vartheta_a} e^\Phi + e^{2\Phi} \quad (2 \leq j \leq n-2),$$

$$\tau_0 = \tau_1 = 1 + e^\Phi, \quad \tau_{n-1} = \tau_n = 1 + (-)^a e^\Phi.$$

For $j = 1$, $\tau_{j=1} = 1 + 2e^\Phi + e^{2\Phi} = (1 + e^\Phi)^2$, and for $j = n-1$

$$\begin{aligned} \tau_{j=n-1} &= 1 + 2 \frac{\cos((2(n-1)-1)\vartheta_a)}{\cos \vartheta_a} e^\Phi + e^{2\Phi} \\ &= 1 + 2(-)^a e^\Phi + e^{2\Phi} = (1 + (-)^a e^\Phi)^2 \end{aligned}$$

and so all the critical values of ξ_2 for which $\phi(x, t)$ is undefined are obtained by studying the zeros of

$$\tau_j = 1 + 2 \frac{\cos((2j-1)\vartheta_a)}{\cos \vartheta_a} e^\Phi + e^{2\Phi} \quad (1 \leq j \leq n-1). \quad (5.2.2a)$$

As in the case of the $a_n^{(1)}$ theory, it is convenient to change variables from (x, ξ_2) to (y, ξ_2) , and to consider

$$f_j = \frac{\tau_j}{\tau_0^2} = 1 + 2 \left(\frac{\cos((2j-1)\vartheta_a)}{\cos \vartheta_a} - 1 \right) \frac{y e^{i\xi_2}}{1 + 2y e^{i\xi_2} + y^2 e^{2i\xi_2}}.$$

The function f_j is real for $e^{-i\xi_2} + y^2 e^{i\xi_2}$ real *i.e.* $\sin \xi_2 = 0$, and $y = 1$, as well as $y = 0$ and $\cos((2j-1)\vartheta_a) = \cos \vartheta_a$ (this latter case only occurring for $j = 1$).

Again, as in the $a_n^{(1)}$ theory, the transformation $\xi_2 \rightarrow -\xi_2$ leaves the set of topological charges invariant – corresponding to $\alpha_j \rightarrow -\alpha_j$, $\forall j$ – and so it is sufficient to consider $\xi_2 \in (0, \pi)$. There are other symmetries of the sets of topological charges, and these will be discussed later.

When $\sin \xi_2 \neq 0$, f_j is real only for $y = 0$ and $y = 1$. When $y = 1$,

$$f_j = \frac{1 + 2 \frac{\cos((2j-1)\vartheta_a)}{\cos \vartheta_a} e^{i\xi_2} + e^{2i\xi_2}}{1 + 2e^{i\xi_2} + e^{2i\xi_2}} = \frac{\cos \xi_2 + \frac{\cos((2j-1)\vartheta_a)}{\cos \vartheta_a}}{\cos \xi_2 + 1}.$$

Denoting the number of distinct values of $\cos \xi_2$ lying in $(-1, 1)$ such that

$$\cos \xi_2 + \frac{\cos((2j-1)\vartheta_a)}{\cos \vartheta_a} = 0$$

by p_a , then provided ϕ is undefined for $\xi_2 = 0$, the number of critical values of ξ_2 and so the number of topological charges is given by $\tilde{h}'_a = 2(p_a + 1)$. The reason for this is that if $\xi_{crit}^{(j)}$ is a critical value for $\tau_j(x, t)$, then $f_j(x, t)$ crosses the real axis positively for $\xi_2 < \xi_{crit}^{(j)}$ and negatively for $\xi_2 > \xi_{crit}^{(j)}$. Each $\tau_j(x, t)$ has only one such critical value and so coupled to the fact that for ξ_2 arbitrarily close to zero the topological charge is non-zero, the number of charges is $2(p_a + 1)$.

Before proceeding, it is necessary to investigate the above proviso. Suppose $\xi_2 = 0$. Then rescaling y ,

$$\tau_j = 1 + 2 \cos((2j-1)\vartheta_a)y + \cos^2 \vartheta_a y^2 \quad (2 \leq j \leq n-2).$$

Now $\tau_j = 0 \iff \cos((2j-1)\vartheta) < 0$ and $\cos^2((2j-1)\vartheta_a) \geq \cos^2 \vartheta_a$ since y is both real and positive. Restrictions are therefore placed on the possible values of j as follows:

$$\begin{aligned} \cos((2j-1)\vartheta_a) < 0 &\iff (2p + \frac{1}{2})\pi + \vartheta_a \leq 2j\vartheta_a \leq (2p + \frac{3}{2})\pi + \vartheta_a, \\ \cos^2((2j-1)\vartheta_a) \geq \cos^2 \vartheta_a &\iff p\pi \leq 2j\vartheta_a \leq p\pi + 2\vartheta_a. \end{aligned}$$

Combining these two equations

$$\frac{(n-1)}{a}(2p+1) \leq j \leq \frac{(n-1)}{a}(2p+1) + 1 \quad p \in \mathbb{N} \text{ (since } j > 0).$$

Choosing $p = 0$,

$$0 < \frac{(n-1)}{a} \leq j \leq \frac{(n-1)}{a} + 1 < n-2$$

and so τ_j certainly has a zero for some j .

The calculation of \tilde{h}'_a will be broken into two parts:

- (i) the evaluation of the number of distinct values of $\frac{\cos((2j-1)\vartheta_a)}{\cos\vartheta_a}$,
- (ii) the evaluation of the number of these values either < -1 or > 1 .

Then $p_a = (\text{the result of (i)}) - (\text{the result of (ii)})$.

Part (i): The number of distinct values of $\cos((2j-1)\vartheta_a)/\cos\vartheta_a$ is the same as that of $\cos((2j-1)\vartheta_a)$. When $j = 0$ or 1 , $\cos((2j-1)\vartheta_a) = \cos\vartheta_a$. The next smallest value of j for which this happens is when $\sin(j\vartheta_a) = 0$ i.e. when $j\tilde{a} = 2k(\widetilde{n-1})$ where $\tilde{a} = a/\gcd(a, n-1)$ and $\widetilde{n-1} = (n-1)/\gcd(a, n-1)$.

If \tilde{a} is even, then $j = \widetilde{n-1}$ and is odd; if \tilde{a} is odd, then $j = 2(\widetilde{n-1})$ and is even. The number of distinct values of $\cos((2j-1)\vartheta_a)$ when \tilde{a} is even is $(\widetilde{n-1} + 1)/2$ and when \tilde{a} is odd, $\widetilde{n-1}$.

These results can be summarized via the formula

$$(\widetilde{n-1})\left(1 - \frac{1}{2}\delta_{0,\tilde{a}\bmod 2}\right) + \frac{1}{2}\delta_{0,\tilde{a}\bmod 2}.$$

Part (ii): Now consider the number of times $\cos((2j-1)\vartheta_a) \geq \cos\vartheta_a$ or $\cos((2j-1)\vartheta_a) \leq -\cos\vartheta_a$. It is straightforward to show that

$$\begin{aligned} \cos((2j-1)\vartheta_a) \geq \cos\vartheta_a &\iff p\pi \leq j\vartheta_a \leq p\pi + \vartheta_a, \\ \cos((2j-1)\vartheta_a) \leq -\cos\vartheta_a &\iff \left(p + \frac{1}{2}\right)\pi \leq j\vartheta_a \leq \left(p + \frac{1}{2}\right)\pi + \vartheta_a, \end{aligned}$$

for some $p \in \mathbb{Z}$, and so $k\pi \leq 2j\vartheta_a \leq k\pi + 2\vartheta_a$ ($k \in \mathbb{Z}$) giving

$$\frac{(\widetilde{n-1})}{\tilde{a}}k \leq j \leq \frac{(\widetilde{n-1})}{\tilde{a}}k + 1. \quad (5.2.2b)$$

When \tilde{a} is even, the different values of $\cos((2j-1)\vartheta_a)$ occur for $j = 1, \dots, (\widetilde{n-1} + 1)/2$. When $k = 0$ equation (5.2.2b) gives $0 \leq j \leq 1$ and when $k = \tilde{a}/2$ it gives $(\widetilde{n-1})/2 \leq j \leq (\widetilde{n-1} + 2)/2$. The number of values of j that need to be removed is therefore $(\tilde{a} + 2)/2$.

When \tilde{a} is odd, the different values of $\cos((2j-1)\vartheta_a)$ now occur for $j = 1, \dots, \widetilde{n-1}$. Again, when $k = 0$ equation (5.2.2b) gives $0 \leq j \leq 1$ and when $k = \tilde{a}$ it gives $\widetilde{n-1} \leq j \leq \widetilde{n-1} + 1$. Therefore, the number of values that need to be removed in this case is $\tilde{a} + 1$.

Rewriting this into one formula, the total number of values to be removed is

$$(\tilde{a} + 1)\left(1 - \frac{1}{2}\delta_{0,\tilde{a}\bmod 2}\right) + \frac{1}{2}\delta_{0,\tilde{a}\bmod 2}.$$

Therefore the number of singularities of $\phi(x, t)$ occurring in the region $0 < \xi_2 < \pi$ is

$$(n - 1 - \tilde{a} - 1)\left(1 - \frac{1}{2}\delta_{0,\tilde{a}\bmod 2}\right),$$

giving the number of distinct topological charges for the a^{th} soliton of the $d_n^{(1)}$ theory as

$$2(n - 1 - \tilde{a} - 1)\left(1 - \frac{1}{2}\delta_{0,\tilde{a}\bmod 2}\right) + 2.$$

It is shown later that for the remaining solitons lying on the prongs at the fork, then number of topological charges in each case is four. This, coupled with the above formula is used to generate Figure 20 overleaf which gives the number of charges in each of the theories D_5 to D_8 .

Turning now to an expression for the topological charges themselves, enough information has been gathered to deduce the final result via simple calculations. Unlike the $a_n^{(1)}$ theory where the ‘highest charge’ was calculated (i.e. the topological charge corresponding to $\xi_2 = -\pi + \epsilon$) and all others deduced, use of the fact that if t is a topological charge, then so too is $-t$ allows consideration to be restricted only to $0 < \xi_2 < \pi$. It will be of use to consider firstly the topological charge corresponding to $\xi_2 = \epsilon$. The first task is to find out the sign of each component of the charges. Recalling from the previous discussion that for $\xi_2 \neq 0$ each f_j has vanishing imaginary part for only one point other than $y = 0, \infty$, the coefficients of the simple roots in the topological charge expressions are either $0, \pm 1, \pm 1/2$ (the latter being the components of α_{n-1} and α_n). It is found that the coefficients are negative (or zero) when $0 < \xi_2 < \pi$ and positive (or zero) when $-\pi < \xi_2 < 0$. This is then used, when the nonzero components of the charges corresponding to $\xi_2 = \pm\epsilon$ are determined, to give an expression for the topological charges at these values of ξ_2 .

The components of the topological charges occurring as coefficients of α_{n-1} and α_n are straightforward to calculate, and so attention will now be restricted to those j 's lying in the range $0 \leq j \leq n-2$. It is found that each f_j possesses the symmetry that $y \rightarrow 1/y$

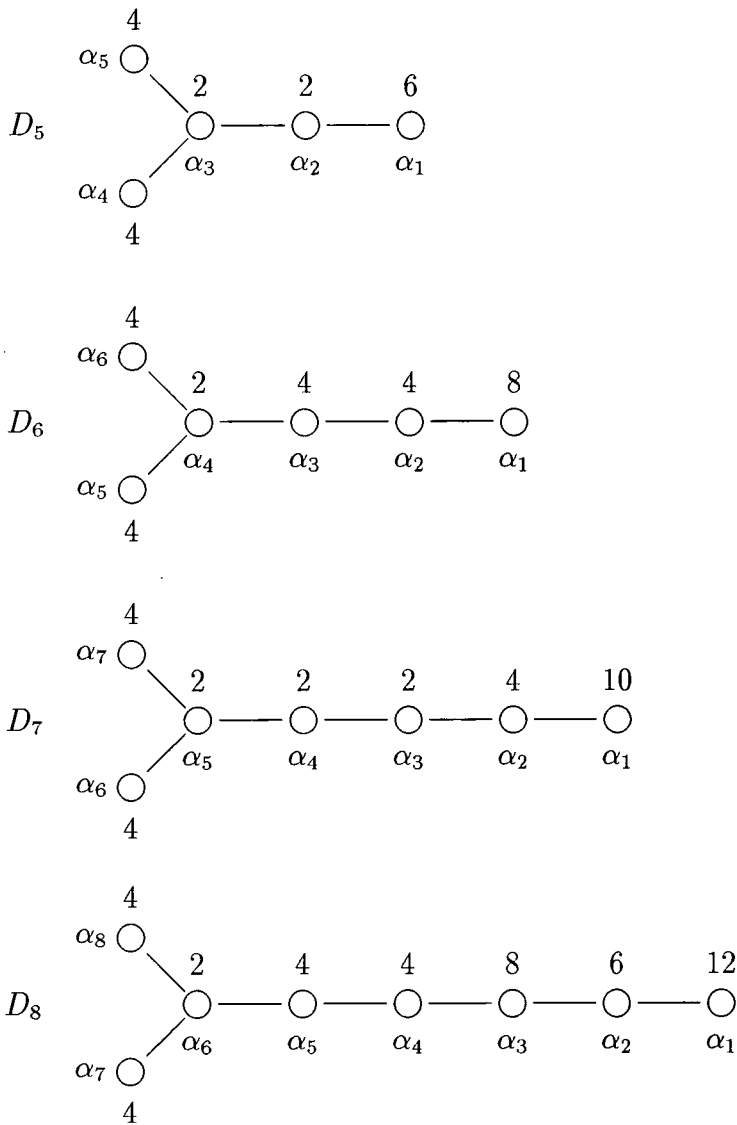

Figure 20: The number of topological charges: theories D_5 – D_8

results in $\text{Im} f_j \rightarrow -\text{Im} f_j$. The function f_j therefore crosses the real axis at the point with $y = 1$. Here the expression for f_j reads

$$f_j = \frac{\cos \xi_2 + \frac{\cos((2j-1)\vartheta_a)}{\cos \vartheta_a}}{\cos \xi_2 + 1}. \quad (5.2.2c)$$

For those components contributing to the topological charge, the numerator of (5.2.2c) will

be less than or equal to zero. In these cases, for y small, it is found that

$$\text{Im}f_j \sim y \left(-1 + \frac{\cos((2j-1)\vartheta_a)}{\cos \vartheta_a} \right) \sin \xi_2.$$

The bracketed term is strictly less than the numerator of (5.2.2b) and is therefore strictly negative. The result is thus deduced: the nonzero coefficients of the topological charge are negative for $0 < \xi_2 < \pi$ and positive for $-\pi < \xi_2 < 0$. If $y = 1$ and $\xi_2 = 0$ then

$$f_j = \frac{1}{2} \left(1 + \frac{\cos((2j-1)\vartheta_a)}{\cos \vartheta_a} \right). \quad (5.2.2d)$$

In order, therefore, to calculate the topological charge at $\xi_2 = \epsilon$ an infinitesimal, the values of j for which $f_j \leq 0$ in (5.2.2c) are important. In fact for $y = 1$ and $\xi_2 = \epsilon$ expression (5.2.2b) gives

$$f_j = \frac{1 + \frac{\cos((2j-1)\vartheta_a)}{\cos \vartheta_a} - \frac{\epsilon^2}{2!} + O(\epsilon^4)}{2 - \frac{\epsilon^2}{2!} + O(\epsilon^4)} < 0 \iff f_j \leq 0 \text{ for } \xi_2 = 0, y = 1.$$

The values of j satisfying this are those for which

$$(k' + \frac{1}{2})\pi \leq j\vartheta_a \leq (k' + \frac{1}{2})\pi + \vartheta_a, \quad (k' \text{ an integer}),$$

$$\text{i.e.} \quad k \frac{\widetilde{n-1}}{\widetilde{a}} \leq j \leq k \frac{\widetilde{n-1}}{\widetilde{a}} + 1, \quad (k \text{ an odd integer}).$$

Their actual values are

$$p_k = \left[k \frac{\widetilde{n-1}}{\widetilde{a}} \right] + 1, \quad k = 1, 3, \dots, a-1 \quad (k \text{ odd}), \quad (5.2.2e)$$

and when $\widetilde{a} \neq a$ is odd

$$p'_k = k(\widetilde{n-1}), \quad k = 1, \dots, \text{gcd}(a, n-1) \quad (k \text{ odd}). \quad (5.2.2f)$$

The topological charges corresponding to $\xi_2 = \pm\epsilon$ are therefore

$$\pm t_0 = \pm \left[\sum_{\substack{k=1 \\ k \text{ odd}}}^{a-1} \alpha_{p_k} + \sum_{\substack{k=1 \\ k \text{ odd}}}^{\text{gcd}(a, n-1)} \alpha_{p'_k} \delta_{1, \widetilde{a} \bmod 2} (1 - \delta_{\widetilde{a}, a}) + \frac{1}{2} \delta_{1, \widetilde{a} \bmod 2} (\alpha_{n-1} + \alpha_n) \right]. \quad (5.2.2g)$$

The next task is to append to the above expression the information given in parts (i) and (ii) of the previous discussion, and so generate the remaining charges.

The procedure is straightforward: identify those values of $\cos((2j-1)\vartheta_a)$ for which $\phi(x, t)$ is undefined, arrange them in order of increasing value, then successively add on to t_0 the simple roots corresponding to each value. All the topological charges are then generated. As ever, the details are slightly different for \tilde{a} even and \tilde{a} odd. In order to ease notation it will be necessary to remove $j = 1$ from the following discussion – this is done without loss of generality as $j = 1$ contributes to both parts (i) and (ii).

First consider part (i). It was shown that the values of $\cos((2j-1)\vartheta_a)$ are distinct for $j = 2, \dots, (\widetilde{n-1}+1)/2$, if \tilde{a} is even, and $j = 2, \dots, \widetilde{n-1}$ if \tilde{a} is odd, thereafter being repeated for all other j . These collections of values of $\cos((2j-1)\vartheta_a)$ will be denoted

$$I_1^{(even)} = \bigcup_{k=2}^{(\widetilde{n-1}+1)/2} \{\cos((2k-1)\vartheta_a)\} \quad \text{and} \quad I_1^{(odd)} = \bigcup_{k=2}^{\widetilde{n-1}} \{\cos((2k-1)\vartheta_a)\}.$$

Now consider part (ii). It was shown that the values within the sets $I_1^{(even)}$ and $I_1^{(odd)}$ not contributing to the topological charge were those with j satisfying

$$k \frac{\widetilde{n-1}}{\tilde{a}} \leq j \leq k \frac{\widetilde{n-1}}{\tilde{a}} + 1, \quad (k \text{ any integer}),$$

their being $\tilde{a}/2$ and \tilde{a} such values of j for \tilde{a} even and odd, respectively. Defining

$$q'_k = \left\lceil k \frac{\widetilde{n-1}}{\tilde{a}} \right\rceil + 1, \quad (5.2.2h)$$

the relevant collections of values of $\cos((2j-1)\vartheta_a)$ to be discarded are given by

$$I_2^{(even)} = \bigcup_{k=1}^{\tilde{a}/2} \{\cos((2q'_k-1)\vartheta_a)\}$$

and $I_2^{(odd)} = \left(\bigcup_{k=1}^{\tilde{a}-1} \{\cos((2q'_k-1)\vartheta_a)\} \right) \cup \{\cos((2(\widetilde{n-1}-1)-1)\vartheta_a)\}.$

The objects of interest in calculating the topological charges are $I^{(even)} = I_1^{(even)} - I_2^{(even)}$ and $I^{(odd)} = I_1^{(odd)} - I_2^{(odd)}$. Before giving an expression for the charges it is necessary to enumerate the members of these sets by defining $p_1^{(even)} = \min I^{(even)}$, $p_1^{(odd)} = \min I^{(odd)}$,

$$q_k^{(even)} = \min \left(I^{(even)} - \bigcup_{l=1}^{k-1} \{q_l^{(even)}\} \right), \quad \text{and} \quad q_k^{(odd)} = \min \left(I^{(odd)} - \bigcup_{l=1}^{k-1} \{q_l^{(odd)}\} \right)$$

where $k = 2, \dots, (1 - \frac{1}{2}\delta_{0, \tilde{a} \bmod 2})(\widetilde{n-1} - \tilde{a} - 1)$. Finally, the charges can be expressed by the formula

$$\pm t_l = \pm \left(t_0 + \sum_{k=1}^l \sum_{j=2}^{n-2} \alpha_j (\delta_{0, \tilde{a} \bmod 2} \delta_{\cos((2j-1)\vartheta_a), q_k^{(even)}} + \delta_{1, \tilde{a} \bmod 2} \delta_{\cos((2j-1)\vartheta_a), q_k^{(odd)}}) \right)$$

where $l = 1, \dots, (1 - \frac{1}{2}\delta_{0, \tilde{a} \bmod 2})(\widetilde{n-1} - \tilde{a} - 1)$, giving the expected total number of charges.

It remains to calculate the topological charges corresponding to $a = n-1, n$. They have τ -functions given by

$$\tau_0 = 1 + e^\Phi, \quad \tau_1 = 1 - e^\Phi, \quad \tau_j = 1 + (-)^j e^{2\Phi} \quad (2 \leq j \leq n-2),$$

$$\text{as well as } \tau_{n-1} = 1 \pm e^\Phi \quad \text{and } \tau_n = 1 \mp e^\Phi \quad \text{if } n \text{ is even,}$$

$$\text{or } \tau_{n-1} = 1 \pm ie^\Phi \quad \text{and } \tau_n = 1 \mp ie^\Phi \quad \text{if } n \text{ is odd.}$$

The number of topological charges in each case is four, and are given by

$$\text{for } n \text{ even : } \pm \left(\frac{1}{2}\alpha_1 + \sum_{j=1}^{\frac{1}{2}n-1} \alpha_{2j} + \sum_{j=1}^{\frac{1}{2}n-2} \frac{1}{2}\alpha_{2j+1} + \frac{1}{2}\alpha_n \right), \quad \pm \left(\frac{1}{2}\alpha_1 + \sum_{j=1}^{\frac{1}{2}n-2} \frac{1}{2}\alpha_{2j+1} + \frac{1}{2}\alpha_n \right),$$

$$\text{for } n \text{ odd : } \frac{1}{2}\alpha_1 + \sum_{j=1}^{\frac{1}{2}n-1} \alpha_{2j} + \sum_{j=1}^{\frac{1}{2}n-2} \frac{1}{2}\alpha_{2j+1} + \frac{3}{4}\alpha_{n-1} + \frac{1}{4}\alpha_n,$$

$$\frac{1}{2}\alpha_1 + \sum_{j=1}^{\frac{1}{2}n-2} \frac{1}{2}\alpha_{2j+1} - \frac{1}{4}\alpha_{n-1} + \frac{1}{4}\alpha_n,$$

$$-\frac{1}{2}\alpha_1 - \sum_{j=1}^{\frac{1}{2}n-2} \frac{1}{2}\alpha_{2j+1} - \frac{1}{4}\alpha_{n-1} + \frac{1}{4}\alpha_n,$$

$$-\frac{1}{2}\alpha_1 - \sum_{j=1}^{\frac{1}{2}n-1} \alpha_{2j} - \sum_{j=1}^{\frac{1}{2}n-2} \frac{1}{2}\alpha_{2j+1} - \frac{1}{4}\alpha_{n-1} - \frac{3}{4}\alpha_n,$$

as well as the above with $\alpha_{n-1} \leftrightarrow \alpha_n$. These expressions will be of use later when the non-simply laced theories obtained from the d -theories via folding are discussed.

Finally, the effect of the unextended and extended diagram automorphisms are considered. As usual those of the former permute the solitons whilst those of the latter permute the charges. The result are summarized in Table 4 below.

Automorphism of extended diagram	Automorphism of set of charges	Change in ξ_2 $1 \leq a \leq n - 2$	Change in $\phi_{(a)}$ $a = n - 1, n$
$\alpha_{n-1} \leftrightarrow \alpha_n$	—	—	$\phi_{(n-1)} \leftrightarrow \phi_{(n)}$
$\alpha_0 \leftrightarrow \alpha_{n-1}$	$\alpha_0 \leftrightarrow \alpha_{n-1}$	$\xi_2 \rightarrow \xi_2$ (a even)	—
$\alpha_1 \leftrightarrow \alpha_n$	$\alpha_1 \leftrightarrow \alpha_n$	—	—
$\alpha_j \leftrightarrow \alpha_{n-j}$	$\alpha_j \leftrightarrow \alpha_{n-j}$	$\xi_2 \rightarrow \xi_2 + \pi$ (a odd)	—
$\alpha_0 \leftrightarrow \alpha_{n-1}$	$\alpha_0 \leftrightarrow \alpha_{n-1}$	—	$\xi_2 \rightarrow \xi_2$ (n even)
$\alpha_1 \leftrightarrow \alpha_n$	$\alpha_1 \leftrightarrow \alpha_n$	—	or $\xi_2 \rightarrow \xi_2 + \pi$ (n even)
$\alpha_j \leftrightarrow \alpha_{n-j}$	$\alpha_j \leftrightarrow \alpha_{n-j}$	—	$\xi_2 \rightarrow \xi_2 \pm \pi/2$ (n odd)
—	$\alpha_j \rightarrow -\alpha_j$	$\xi_2 \rightarrow -\xi_2$	—

Table 4: Symmetries of the $d_n^{(1)}$ topological charges.

The expression for the topological charges in this theory is not of a sufficiently simple form for results relating to which representation the charges lie in to be generally derived. However, using the mathematical package *Maple VTM* the $d_n^{(1)}$ theories have been considered up to and including the $n = 50$ case. It has been found that as well as lying in the representation associated with the soliton number, the charges lie in the Weyl orbit of the highest weight, in keeping with the result corresponding to the $a_n^{(1)}$ theory. It is reasonable to speculate that this result holds true for all n .

5.2.3 The $e_6^{(1)}$ theory

As is now familiar, there is a relationship between the symmetries of the Dynkin diagrams and the topological charges of the solitons. The topological charges of the $e_6^{(1)}$ theory are listed in table B10 of Appendix B with the number corresponding to each soliton shown in the diagram below.

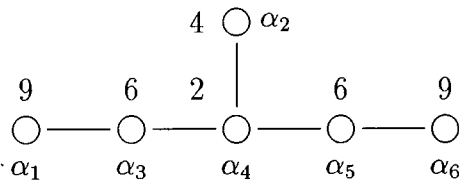

Figure 21: The E_6 Dynkin diagram.

The symmetry of the unextended diagram which interchanges the two long legs i.e. $\alpha_1 \leftrightarrow \alpha_6$ and $\alpha_3 \leftrightarrow \alpha_5$, when imposed on the solitons, results in the interchange of the corresponding solitons. As for the extended diagram, its rotational symmetry corresponds to a phase shift of the constants ξ_2 for those solitons of degenerate mass. These results are summarized in Table 5 below.

Automorphism of extended diagram	Automorphism of set of charges	Change in ξ_2	Change in $\phi_{(a)}$
$\alpha_1 \leftrightarrow \alpha_6$ $\alpha_3 \leftrightarrow \alpha_5$	$\alpha_1 \leftrightarrow \alpha_6$ $\alpha_3 \leftrightarrow \alpha_5$	- -	$\phi_{(1)} \leftrightarrow \phi_{(6)}$ $\phi_{(3)} \leftrightarrow \phi_{(5)}$
$\alpha_0 \rightarrow \alpha_1 \rightarrow \alpha_6 \rightarrow \alpha_0$ $\alpha_2 \rightarrow \alpha_5 \rightarrow \alpha_3 \rightarrow \alpha_2$ $\alpha_4 \rightarrow \alpha_4$	$\alpha_0 \rightarrow \alpha_1 \rightarrow \alpha_6 \rightarrow \alpha_0$ $\alpha_2 \rightarrow \alpha_5 \rightarrow \alpha_3 \rightarrow \alpha_2$ $\alpha_4 \rightarrow \alpha_4$	$\xi_2 \rightarrow (\xi_2 + \frac{2\pi}{3}) \bmod 2\pi$ (a=1,2,5,6) ξ_2 unchanged (a=3,4)	-
$\alpha_1 \leftrightarrow \alpha_6, \alpha_3 \leftrightarrow \alpha_5$ $\alpha_0 \rightarrow \alpha_0, \alpha_2 \rightarrow \alpha_2$ $\alpha_4 \rightarrow \alpha_4$	$\alpha_1 \leftrightarrow -\alpha_6, \alpha_3 \leftrightarrow -\alpha_5$ $\alpha_0 \rightarrow -\alpha_0, \alpha_2 \rightarrow -\alpha_2$ $\alpha_4 \rightarrow -\alpha_4$	$\xi_2 \rightarrow -\xi_2$	-

Table 5: Symmetries of the $e_6^{(1)}$ topological charges.

5.2.4 The $e_7^{(1)}$ theory

Next attention is turned to the $e_7^{(1)}$ theory. The number of topological charges corresponding to each soliton are shown in the table below:

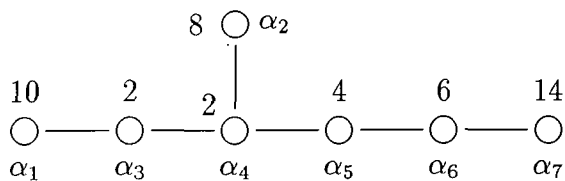

Figure 22: Dynkin diagram for E_7

with their actual values given in table B11 of Appendix B. As well as the symmetry corresponding $\xi_2 \rightarrow -\xi_2$ the $e_7^{(1)}$ theory has topological charges invariant under the interchange of the simple plus extended roots that give rise to the $e_6^{(2)}$ theory. The unextended diagram,

however, has no symmetries and so there is no relationship between the solutions and their respective topological charges. The symmetries are summarized as follows:

Automorphism of extended diagram	Automorphism of set of charges	Change in ξ_2
$\alpha_0 \leftrightarrow \alpha_7, \alpha_1 \leftrightarrow \alpha_6$ $\alpha_3 \leftrightarrow \alpha_5$	$\alpha_0 \leftrightarrow \alpha_7, \alpha_1 \leftrightarrow \alpha_6$ $\alpha_3 \leftrightarrow \alpha_5$	ξ_2 unchanged ($a=1,3,4,6$)
$\alpha_2 \rightarrow \alpha_2, \alpha_4 \rightarrow \alpha_4$	$\alpha_2 \rightarrow \alpha_2, \alpha_4 \rightarrow \alpha_4$	$\xi_2 \rightarrow (\xi_2 + \pi) \bmod 2\pi$ ($a=2,5,7$)
--	$\alpha_j \rightarrow -\alpha_j$	$\xi_2 \rightarrow -\xi_2$

Table 6: Symmetries of the $e_7^{(1)}$ topological charges.

5.2.5 The $e_8^{(1)}$ theory

The lack of a general formula for the $e_8^{(1)}$ solitons means that the calculations of the topological charges have to be done on a case-by-case basis. The diagram below summarizes the number of charges associated with each soliton, shown once again that the number of charges does not in general divide the Coxeter number, and so the Coxeter element cannot be used to relate them.

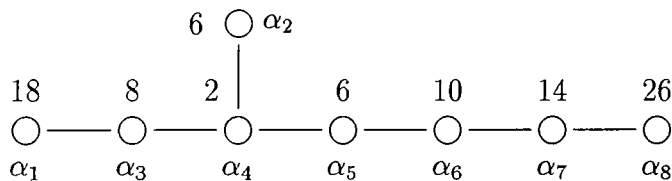

Figure 23: Affine Dynkin diagram for $e_8^{(1)}$

The actual values of the topological charges for each soliton are listed in the appendix. It is at this point that a curious property of the topological charges of the $e_8^{(1)}$ reveals itself. In the $a_n^{(1)}$, $e_6^{(1)}$, $e_7^{(1)}$ theories, as well as the first few members of the $d_n^{(1)}$ theory which have been checked, the topological charges are found not only to lie in the fundamental representation associated with each soliton, but to lie in the *Weyl orbit* of the highest weight of the particular representation. In the case of the $e_8^{(1)}$ theory, although all of the topological charges lie in the appropriate fundamental representation, they *do not* lie in the

Weyl orbit of the representation's highest weight. For example, in the fifth fundamental representation, the highest weight is given by

$$8\alpha_1 + 12\alpha_2 + 16\alpha_3 + 24\alpha_4 + 20\alpha_5 + 15\alpha_6 + 10\alpha_7 + 5\alpha_8$$

and is of length 20. However, the second topological charge of the fifth soliton,

$$\alpha_2 + 2\alpha_3 + \alpha_4 + 2\alpha_6 + \alpha_8$$

has length 16 and so lies in a different Weyl orbit. This charge does lie in the root string of the first charge,

$$\alpha_2 + 2\alpha_3 + 3\alpha_4 + 2\alpha_6 + \alpha_8,$$

in the direction α_4 and so is still a member of the fundamental representation. Those charges lying outside the Weyl orbit of the highest weight are indicated with a '*' in Table B12.

There are no automorphisms of either the extended or unextended diagram, leaving the charges invariant only under the essentially trivial transformation $\xi_2 \rightarrow -\xi_2$ which results in $\alpha_j \rightarrow -\alpha_j, \forall j$.

5.3 The non-simply-laced untwisted theories

5.3.1 The $c_n^{(1)}$ theory

It was shown in the previous chapter that the single solitons of the $c_n^{(1)}$ theory are expressible via the τ -functions

$$\tau_j = 1 + 2 \cos\left(\frac{\pi a j}{n}\right) e^\Phi + \cos^2\left(\frac{\pi a}{2n}\right) e^{2\Phi}.$$

This expression is very similar to that of the $d_n^{(1)}$ τ -functions given in (5.2.2a), and so the calculation of the number of topological charges related to each of the $c_n^{(1)}$ single solitons proceeds in the same way as that of $d_n^{(1)}$. There are however, some subtle differences between the two calculations, as will now be explained.

Firstly, in part (i) of the calculation there are three possibilities for the number of distinct values, in this case, of $\cos\left(\frac{\pi a j}{n}\right)$, namely

$$\begin{aligned} & \frac{1}{2}(\tilde{n} + 1) && \text{if } \tilde{a} \text{ is even,} \\ & (\tilde{n} + 1) && \text{if } \tilde{a} \neq a \text{ is odd, and} \\ & \tilde{n} && \text{if } \tilde{a} = a \text{ is odd.} \end{aligned}$$

These results are summarized as

$$(\tilde{n} + 1)\left(1 - \frac{1}{2}\delta_{0,\tilde{a}\bmod 2}\right) - \delta_{\tilde{a},a}\delta_{1,\tilde{a}\bmod 2}.$$

In part (ii), there are again three possibilities for the number of distinct values of $\cos\left(\frac{\pi a j}{n}\right)$ outside the range $(-1, 1)$. They are

$$\begin{aligned} & \frac{1}{2}(\tilde{a} + 2) && \text{if } \tilde{a} \text{ is even,} \\ & (\tilde{a} + 1) && \text{if } \tilde{a} \neq a \text{ is odd, and} \\ & \tilde{a} && \text{if } \tilde{a} = a \text{ is odd.} \end{aligned}$$

These can be summarized as

$$(\tilde{a} + 1)\left(1 - \frac{1}{2}\delta_{0,\tilde{a}\bmod 2}\right) + \frac{1}{2}\delta_{0,\tilde{a}\bmod 2} - \delta_{\tilde{a},a}\delta_{1,\tilde{a}\bmod 2}.$$

The resulting number of topological charges is therefore

$$2(\tilde{n} - \tilde{a} + 1)\left(1 - \frac{1}{2}\delta_{0,\tilde{a}\bmod 2}\right).$$

The numbers of topological charges for the first few members of the C_n series are given in Figure 24, overleaf.

The calculation of the topological charges is again similar in character to that of the $d_n^{(1)}$ theory and proceeds as follows. Firstly, the components of the topological charge are positive/negative depending on whether $-\pi < \xi_2 < 0$ or $0 < \xi_2 < \pi$. The topological charge at $\xi_2 = \epsilon$ is determined by those j satisfying

$$\frac{n}{a}k - \frac{1}{2} \leq j \leq \frac{n}{a}k + \frac{1}{2}, \quad (k \text{ an odd integer}).$$

The resulting topological charge is easily obtained, and is given by

$$\pm t_0 = \pm \left[\sum_{\substack{k=1 \\ k \text{ odd}}}^{a-1} \alpha_{p_k} + \delta_{1,\frac{\tilde{a}}{2}\bmod 2} \sum_{\substack{k=1 \\ k \text{ odd}}}^{2\gcd(a,n)-1} \alpha_{p'_k} + \frac{1}{2}\alpha_n \right]$$

where

$$p_k = \left[\frac{k\tilde{n}}{\tilde{a}} + \frac{1}{2} \right] \quad \text{and} \quad p'_k = \frac{1}{2}(k\tilde{n} + 1).$$

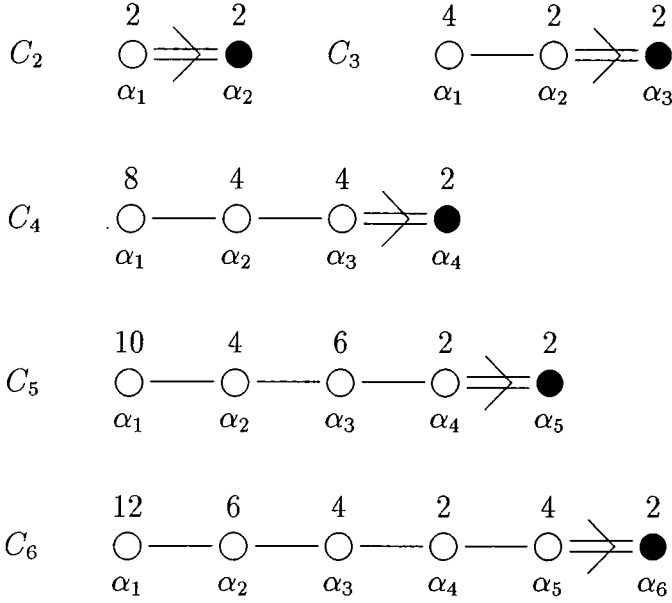
 Figure 24: The number of topological charges: theories $C_2 - C_6$

The distinct values of $\cos\left(\frac{\pi a j}{n}\right)$ give rise, as in the $d_n^{(1)}$ theory, to the sets $I_1^{(even)}$ and $I_1^{(odd)}$ as follows:

$$I_1^{(even)} = \bigcup_{k=0}^{\frac{1}{2}(\tilde{n}-1)} \left\{ \cos\left(\frac{\pi a j}{n}\right) \right\},$$

$$\text{and } I_1^{(odd)} = \bigcup_{k=1}^{\tilde{n}} \left\{ \cos\left(\frac{\pi a j}{n}\right) \right\} \cup (1 - \delta_{a,\tilde{a}}) \delta_{1,\tilde{a} \bmod 2} \{1\}.$$

From these two sets have to be removed those elements corresponding to any j satisfying

$$\frac{k\tilde{n}}{\tilde{a}} - \frac{1}{2} \leq j \leq \frac{k\tilde{n}}{\tilde{a}} + \frac{1}{2} \quad (k \text{ an integer}),$$

so leading to the following definitions for $I_2^{(even)}$ and $I_2^{(odd)}$:

$$I_2^{(even)} = \bigcup_{k=0}^{\frac{1}{2}\tilde{a}} \left\{ \cos\left(\frac{\pi a q'_k}{n}\right) \right\},$$

$$I_2^{(odd)} = \bigcup_{k=1}^{\tilde{a}} \left\{ \cos\left(\frac{\pi a q'_k}{n}\right) \right\} \cup (1 - \delta_{a,\tilde{a}}) \delta_{1,\tilde{a} \bmod 2} \{1\},$$

where

$$q'_k = \left[\frac{k\tilde{n}}{\tilde{a}} + \frac{1}{2} \right].$$

The subtraction of the latter sets from the previous ones give $I^{(even)}$ and $I^{(odd)}$ which are then ordered to give the numbers q_k . The resulting general expression for the topological charges is

$$\pm t_l = \pm \left(t_0 + \sum_{k=1}^l \sum_{j=1}^{n-1} \alpha_j (\delta_{0, \bar{a} \bmod 2} \delta_{\cos(\frac{\pi a j}{n}), q_k^{(even)}} + \delta_{1, \bar{a} \bmod 2} \delta_{\cos(\frac{\pi a j}{n}), q_k^{(odd)}}) \right)$$

where $l = 1, \dots, (\tilde{n} - \tilde{a})(1 - \frac{1}{2}\delta_{0, \bar{a} \bmod 2}) - \frac{1}{2}\delta_{0, \bar{a} \bmod 2}$, giving the expected total number of charges. There is one extended diagram symmetry of the $c_n^{(1)}$ theory corresponding to a reflection in the central spot (if n is odd) or mid-way between the two middle spots (if n is even). As ever $\xi_2 \rightarrow -\xi_2$ is also a symmetry. These results are summarized below.

Automorphism of extended diagram	Automorphism of set of charges	Change in ξ_2
$\alpha_j \rightarrow \alpha_{n-j}$	$\alpha_j \rightarrow -\alpha_{n-j}$	$\xi_2 \rightarrow \xi_2$ (if a is even) $\xi_2 \rightarrow \xi_2 + \pi$ (if a is odd)
–	$\alpha_j \rightarrow -\alpha_j$	$\xi_2 \rightarrow -\xi_2$

Table 7: Symmetries of the $c_n^{(1)}$ topological charges.

5.3.2 The $b_n^{(1)}$ theory

The information already gathered for the $d_n^{(1)}$ solitons allows the number topological charges for each of the $b_n^{(1)}$ solitons to be read off from that of $d_n^{(1)}$ by replacing n with $n + 1$. Therefore, the a^{th} soliton ($1 \leq a \leq n - 1$) has

$$2(\tilde{n} - \tilde{a} - 1)(1 - \frac{1}{2}\delta_{0, \bar{a} \bmod 2}) + 2$$

such charges.

For the solitons that survive the folding from $d_{n+1}^{(1)}$ to $b_n^{(1)}$, the topological charges are immediately given by

$$\pm t_l = \pm \left(t_0 + \sum_{k=1}^l \sum_{j=2}^{n-1} \alpha'_j (\delta_{1, \bar{a} \bmod 2} \delta_{\cos((2j-1)\vartheta_a), q_k^{(even)}} + \delta_{1, \bar{a} \bmod 2} \delta_{\cos((2j-1)\vartheta_a), q_k^{(odd)}}) \right)$$

where $l = 1, \dots, (1 - \frac{1}{2}\delta_{0, \bar{a} \bmod 2})(\tilde{n} - \tilde{a} - 1)$, and

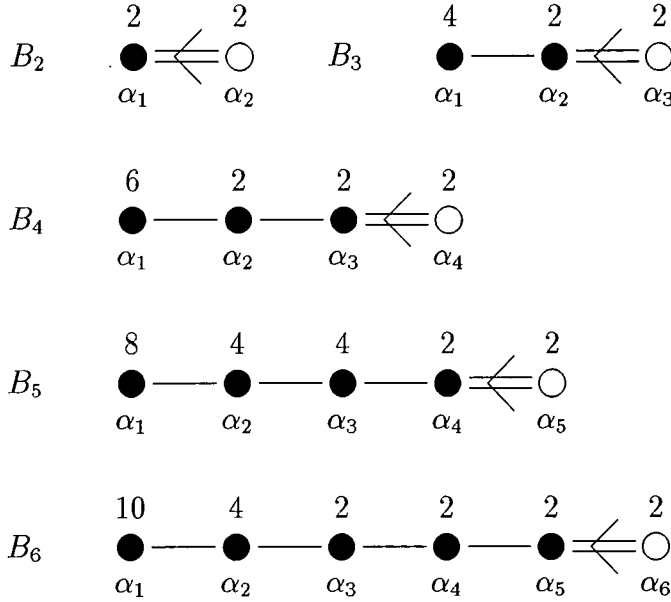
 Figure 25: The number of topological charges: theories $B_2 - B_6$

$$\pm t_0 = \pm \left[\sum_{\substack{k=1 \\ k \text{ odd}}}^{a-1} \alpha'_{p_k} + \sum_{\substack{k=1 \\ k \text{ odd}}}^{\gcd(a,n)-1} \alpha'_{p'_k} \delta_{0,\bar{a} \bmod 1} (1 - \delta_{\bar{a},a}) + \delta_{1,\bar{a} \bmod 2} \alpha'_n \right].$$

The constants p_k , p'_k and q'_k are also modified, being given by (5.2.2d), (5.2.2e) and (5.2.2g), respectively, where n is replaced by $n + 1$.

Finally, the soliton corresponding to $a = n$ with τ -functions given by (3.4.1a) is found to have two topological charges which are written

$$\begin{aligned} & \pm(\alpha'_1 + \alpha'_3 + \dots \alpha'_n) && \text{if } n \text{ is odd, and} \\ & \pm(\alpha'_1 + \alpha'_3 + \dots \alpha'_{n-1}) && \text{if } n \text{ is even.} \end{aligned}$$

As usual the number of charges for each soliton in the first few theories have been constructed and are given in Figure 25.

5.3.3 The $g_2^{(1)}$ theory

In this theory the soliton with $\lambda = 2$ has six charges, whereas the soliton corresponding to $\lambda = 6$ (the soliton of the $d_4^{(1)}$ theory corresponding to the central spot) has two charges.

They are listed in table B13 of the Appendix. In this case it is straightforward to calculate the representations in which the charges lie. The two charges corresponding to $\lambda = 6$ are found in the first fundamental representation $(1, 0)$ (and also in the Weyl orbit of the highest charge), whereas the six charges corresponding to $\lambda = 2$ are found to lie in the representation $(0, 3)$ (with four in the Weyl orbit of the highest charge) or when viewed from the $d_4^{(1)}$ theory, the $(1, 0, 1, 1)$ representation of D_4 . The last result isn't too surprising upon recalling that the $\lambda = 2$ soliton of $g_2^{(1)}$ is formed from a triple soliton configuration in $d_4^{(1)}$.

The only symmetry of the theory is that which interchanges the overall sign of the topological charges, corresponding to a change of sign of ξ_2 .

5.3.4 The $f_4^{(1)}$ theory

The results of the calculation of the topological charges in the $f_4^{(1)}$ theory are given in Table B14. In a similar manner to the $g_2^{(1)}$ theory, those single solitons which survive the folding process have topological charges lying in the two fundamental representations $(1, 0, 0, 0)$ and $(0, 1, 0, 0)$, and also in the Weyl orbit of the highest charge. For the remaining two solitons, their charges are found in the higher dimensional representations $(0, 0, 2, 0)$ and $(0, 0, 0, 2)$, and in general not inside the Weyl orbit of the highest charge. Again, the origin of this lies in the $e_6^{(1)}$ representations in which the charges of the double solitons giving rise to the $f_4^{(1)}$ single solitons are found.

This theory only possesses the symmetry of the change in sign of ξ_2 and correspondingly the charges themselves.

5.4 The twisted theories

As in the discussion of folding from simply-laced theories to the twisted theories in Chapter 3, the results of this section can be deduced directly from those of the simply-laced theories without any unnecessary extra work. The information for the twisted theories is obtained by re-expressing all the formula pertaining to the simply-laced theory in terms of the rank

and simple roots of the twisted theory. The following results are split into the cases of the infinite algebras and the exceptional algebras.

5.4.1 The infinite classes

The cases considered in this subsection are those of $a_{2n-1}^{(2)}$, $d_{n+1}^{(2)}$ and $a_{2n}^{(2)}$ which are formed from the $d_{2n}^{(1)}$, $d_{n+2}^{(1)}$ and $d_{2n+2}^{(1)}$ theories, respectively.

The $a_{2n-1}^{(2)}$ theory

The $a_{2n-1}^{(2)}$ solitons with $\lambda = \lambda_b^{(tw)}$ ($b = 1, \dots, n-1$) are those of $d_{2n}^{(1)}$ corresponding to $a = 2b$. As a result $\gcd(a, 2n-1) = 1$ giving $\tilde{a} = a$ and $(2n \widetilde{-} 1) = 2n-1$. The number of topological charges is therefore $2n - a = 2(n-b)$.

Defining

$$p_k = \left[k \frac{2n-1}{2b} \right] + 1, \quad k = 1, 2, \dots, 2b-1 \quad (k \text{ odd}),$$

then the topological charges at $\xi_2 = \pm\epsilon$ are simply

$$\pm t_0 = \pm \left[\sum_{\substack{k=1 \\ k \text{ odd}}}^{2b-1} \alpha_{p_k} \right].$$

Proceeding as usual, $I = I_1 - I_2$ where

$$I_1 = \bigcup_{k=2}^n \{\cos((2k-1)\vartheta_b)\} \quad \text{and} \quad I_2 = \bigcup_{k=1}^b \{\cos((2q'_k-1)\vartheta_b)\},$$

where $\vartheta_b = b\pi/(2n-1)$ and $q'_k = [k(2n-1)/2b] + 1$. The set I is enumerated, giving q_k ($k = 1, \dots, n-b-1$) and topological charges

$$\pm t_l = \pm \left(t_0 + \sum_{k=1}^l \sum_{j=2}^{n-2} \alpha_{2j} \delta_{\cos((2j-1)\vartheta_b), q_k} \right),$$

where $l = 1, \dots, n-b-1$. The charges of the remaining soliton, corresponding to $b = n$, are:

$$n \text{ even :} \quad \pm \left(\alpha'_1 + 2 \sum_{j=1}^{\frac{1}{2}n-1} \alpha'_{2j} + \sum_{j=1}^{\frac{1}{2}n-1} \alpha'_{2j+1} + \alpha'_n \right), \quad \pm \left(\alpha'_1 + \sum_{j=1}^{\frac{1}{2}n-1} \alpha'_{2j+1} \right),$$

$$n \text{ odd : } \pm \left(\alpha'_1 + 2 \sum_{j=1}^{\frac{1}{2}(n-1)} \alpha'_{2j} + \sum_{j=1}^{\frac{1}{2}(n-3)} \alpha'_{2j+1} + \alpha'_n \right), \pm \left(\alpha'_1 + \sum_{j=1}^{\frac{1}{2}(n-3)} \alpha'_{2j+1} + \frac{1}{2} \alpha'_n \right).$$

The symmetries of this theory, corresponding to the interchange of the roots on the prongs, and the change in sign of ξ_2 are given below.

Automorphism of extended diagram	Automorphism of set of charges	Change in ξ_2
$\alpha_0 \leftrightarrow \alpha_1$	$\alpha_0 \leftrightarrow \alpha_1$	$\xi_2 \rightarrow \xi_2 \quad (b = 1, \dots, n-1)$ $\xi_2 \rightarrow \xi_2 + \pi \quad (b = n)$
-	$\alpha_j \rightarrow -\alpha_j$	$\xi_2 \rightarrow -\xi_2$

Table 8: Symmetries of the $a_{2n-1}^{(2)}$ topological charges.

The $d_{n+1}^{(2)}$ theory

The n solitons of the $d_{n+1}^{(2)}$ theory are those of the $d_{n+2}^{(1)}$ theory corresponding to $a = 1, \dots, n$. There is no simplification in the expression for the number of topological charges, which is

$$2(n \widetilde{+} 1 - \widetilde{a} - 1) \left(1 - \frac{1}{2} \delta_{0, \widetilde{a} \bmod 2} \right) + 2.$$

The topological charges are then those of the $d_{n+2}^{(1)}$ theory re-expressed in terms of the roots $\{\alpha'_i\}$ *i.e.*

$$\pm t_0 = \pm \left(\sum_{\substack{k=1 \\ k \text{ odd}}}^{a-1} \alpha'_{p_k-1} + \sum_{\substack{k=1 \\ k \text{ odd}}}^{\gcd(a, n+1)} \alpha'_{p_k-1} \delta_{1, \widetilde{a} \bmod 2} (1 - \delta_{a, \widetilde{a}}) + \delta_{1, \widetilde{a} \bmod 2} \alpha'_n \right),$$

corresponding to $\xi_2 = \pm \epsilon$, and

$$\pm t_l = \pm \left(t_0 + \sum_{k=1}^l \sum_{j=2}^n \alpha'_{j-1} (\delta_{0, \widetilde{a} \bmod 2} \delta_{\cos((2j-1)\vartheta_a), q_k^{(even)}} + \delta_{1, \widetilde{a} \bmod 2} \delta_{\cos((2j-1)\vartheta_a), q_k^{(odd)}}) \right),$$

where $l = 1, \dots, (1 - \frac{1}{2} \delta_{0, \widetilde{a} \bmod 2})(n \widetilde{+} 1 - \widetilde{a} - 1)$, $\vartheta_a = a\pi/(2(n+1))$, and the rest of the parameters are those of §5.2.2 with n replaced by $n+2$. The symmetries of this theory are given in Table 9, below.

Automorphism of extended diagram	Automorphism of set of charges	Change in ξ_2
$\alpha_j \rightarrow \alpha_{n-j}$	$\alpha_j \rightarrow \alpha_{n-j}$	$\xi_2 \rightarrow \xi_2$ (a even) $\xi_2 \rightarrow \xi_2 + \pi$ (a odd)
–	$\alpha_j \rightarrow -\alpha_j$	$\xi_2 \rightarrow -\xi_2$

Table 9: Symmetries of the $d_{n+1}^{(2)}$ topological charges.

The $a_{2n}^{(2)}$ theory

Finally consider the $a_{2n}^{(2)}$ theory, viewed as the folding of the $a_{2n+1}^{(2)}$ theory. The solitons of the former theory are those of the latter with $\tau_0 = \tau_1$. There are n such solutions corresponding to $a = 1, \dots, n$. The number of topological charges associated with each soliton is $2(n + 1 - b)$. The resulting topological charges are, for $b = 1, \dots, n$,

$$\pm t_0 = \pm \left[\sum_{\substack{k=1 \\ k \text{ odd}}}^{2b-1} \alpha'_{p_{k-1}} \right]$$

corresponding to $\xi_2 = \pm\epsilon$ and

$$\pm t_l = \pm \left(t_0 + \sum_{k=1}^l \sum_{j=2}^{n-2} \alpha_{j-1} \delta_{\cos((2j-1)\vartheta_b), q_k} \right)$$

otherwise, where $l = 1, \dots, n - b$, and the parameters are those of $a_{2n+1}^{(2)}$.

The only symmetry of this theory is that of $\xi_2 \rightarrow -\xi_2$, resulting in $\alpha_j \rightarrow -\alpha_j$, $\forall j$.

5.4.2 The exceptional twisted cases

To conclude, the topological charges of the remaining exceptional twisted theories have been calculated. It is not clear how to associate these charges with a representation of the twisted theory itself, however when viewed from the parent theory used in the folding process, the charges are seen to lie in fundamental representations of the parent theory.

The $e_6^{(2)}$ theory

As with the all the other exceptional twisted algebras, the topological charges are obtained directly from an untwisted theory. In this case the theory is that of $e_7^{(1)}$. The charges are given in Table B15 of Appendix B. The only symmetry of the theory is that under $\xi_2 \rightarrow -\xi_2$.

The $d_4^{(3)}$ theory

This theory is obtained from folding $e_6^{(1)}$, and so the topological charges are obtained directly from that theory. They are given in Table B16 of Appendix B. It possesses the usual symmetry under $\xi_2 \rightarrow -\xi_2$.

The $a_2^{(2)}$ theory

Finally, consider the $a_2^{(2)}$ theory. Its one soliton has two topological charges given by $\pm\alpha'_1$ which are related by the ξ_2 -symmetry.

Chapter 6

Discussion and conclusions



6.1 Introduction

This thesis covers only a small part of the research that has been carried out in recent years into affine Toda solitons since the analysis by Hollowood of the $a_n^{(1)}$ theory. As well as consideration being given to the classical theory some authors have looked at what happens in the quantum regime. As well as first order mass corrections in the $a_n^{(1)}$ and $c_n^{(1)}$ theories being carried out, quantum group methods have been used by Hollowood to propose an S -matrix for the $a_n^{(1)}$ theory. Further, there has been recent developments in construction the representations of quantum groups with an aim of explaining the occurrence of topological charges. These areas will be reviewed with varying degrees of detail in the next section. This thesis concludes with critical discussion of the research material presented and addresses outstanding questions.

6.1.1 Quantum mass corrections

In the real coupling affine Toda theories it is found that there are n particles with classical masses given by

$$m_a^{cl} = 2m \sin\left(\frac{\pi a}{n+1}\right).$$

When the theory is quantized the spectrum is preserved, except for an overall mass renormalization independent of the particular particle concerned. From a one-loop Feynmann diagram calculation it can be shown that

$$m_a^q = m_a^{cl} \left[1 - \frac{\beta^2}{4n} \cot\left(\frac{\pi}{n}\right) + O(\beta^4) \right].$$

In the simplest of the complex coupling affine Toda theories, that of the sine-Gordon theory, the classical mass and its quantum correction give the overall quantum mass as

$$M^q = M^{cl} + \Delta M = \frac{8m}{\sqrt{2}\beta^2} - \frac{\sqrt{2}m}{\pi}.$$

This can alternatively be written in the form $M^q = M^{cl}(\beta'^2)$ where

$$\beta'^2 = \frac{\beta^2}{1 - \beta^2/4\pi}.$$

This expression can be shown via other quantization schemes to be exact. The extension of this work to the general $a_n^{(1)}$ theory was presented in the original work on solitons [32], and discussed in more detail in a subsequent publication [33]. As well as proving that the single solitons are classically stable, the first order mass correction is given by

$$M_a^q = 2nm_a \left[\frac{1}{\beta^2} - \frac{1}{4\pi} + \frac{1}{4n} \cot\left(\frac{\pi}{n}\right) + O(\beta^2) \right],$$

the first term being the classical mass. It is unclear as to whether the above is exact or not. If it is then the soliton mass ratios survive quantization in this theory.

The only other theory for which mass corrections have been calculated is that of the non-simply-laced $c_2^{(1)}$ theory [59]. In this model there are two solitons having classical masses

$$M_I^{cl} = -\frac{8\sqrt{2}m}{\beta^2} \quad \text{and} \quad M_{II}^{cl} = -\frac{8m}{\beta^2}.$$

It is found that the masses, at least to one loop quantum correction, are not rescaled by the same amount, but take the form

$$M_I^q = -\frac{8\sqrt{2}m}{\beta^2} - \frac{3\sqrt{2}\mu}{2\pi} \quad \text{and} \quad M_{II}^q = -\frac{8m}{\beta^2} - \frac{3\mu}{2\pi} + \frac{\mu}{4}.$$

Watts has pointed out that this may cause difficulties in the R -matrix approach to constructing soliton S -matrices as this method relies on the ratios of the quantum masses to be that of the classical theory. It is clear that this example, as well as the other non-simply-lace theories, requires further understanding.

6.2 The soliton S -matrix

Following the construction of the $a_n^{(1)}$ solitons and their first order quantum mass corrections, Hollowood considered the construction of a soliton-soliton S -matrix [33]. This is done as follows. As the classical solitons can, via their topological charges, be associated with a fundamental representation it is expected that, in the quantum theory, the asymptotic state representing the soliton carries two quantum numbers – velocity and topological charge. As a result, each of these external states can be viewed as a vector in one of the

fundamental modules of the theory. If the module associated with the a^{th} fundamental representation is denoted V_a , then the two-body S -matrix acts as the interwiner

$$S^{a,b} : V_a \otimes V_b \rightarrow V_b \otimes V_a.$$

As the theory is integrable, the general N -particle S -matrix is factorizable into $\frac{1}{2}N(N-1)$ two-body S -matrices. Upon imposing the usual constraints of S -matrix theory – unitarity, crossing symmetry, analyticity and the bootstrap equations – the soliton-soliton S -matrix is obtained with the quantum group $U_q(A_n)$ and Hecke algebras playing an important rôle.

From this proposed S -matrix a number of results are deduced. Most importantly, it is stated that at the quantum S -matrix has simple poles in the physical strip which correspond not only zero topological charge periodic ‘breathers’, which are familiar in the sine-Gordon theory, but that ‘breathing’ solitons exist which although being periodic bound states carry a non-zero topological charge. The solutions then have charges filling up the fundamental representations. It is important to note that no such explicit solutions have been presented to which these claims can be tested.

This work is supported by the recent paper by Delius and Zhang [17] in which finite dimensional representations of quantum affine algebras are constructed providing the necessary mathematical background for the extension of Hollowood’s S -matrix work.

6.2.1 Conclusions

The major results of this work are those concerning the topological charges of the affine Toda models. Although significant progress has been made in that they can be calculated for any theory using the expressions in this thesis, there still remains many outstanding questions.

If the material appearing in chapter four is considered in isolation, then a number of conclusions could be drawn. The topological charges, as well as lying in the fundamental representations, lie in the Weyl orbit of the highest weight. They are connected by a Coxeter element from which all charges corresponding to each soliton can be deduced from just one. As a result the number of topological charges is a divisor of the Coxeter number h , its precise expression for the a^{th} soliton being $h/\gcd(a, h)$.

As consideration is given firstly to the simply-laced theories and then the others, the situation becomes decidedly less clear. Consider first the simply-laced theories. The charges are found for the exceptional algebras, and up to the $d_{50}^{(1)}$ member of the $d_n^{(1)}$ theories, to lie in the fundamental representation associated to each soliton. It is reasonable to expect this to be true for all the $d_n^{(1)}$ theories, though it is not clear how this can be proven from the expression for the charges in that theory presented here. The use of a Coxeter element to connect the charges immediately breaks down at this point as can be seen in the simplest of the theories, $d_4^{(1)}$, though the high degree of symmetry present in the $a_n^{(1)}$ theory may explain the presence of the Coxeter element there. Perhaps the most surprising result is that although for all the simply-laced theories considered, it is only in the $e_8^{(1)}$ theory that there exist charges lying outside the Weyl orbit of the highest charge. There seems to be no immediate explanation of this phenomenon.

On moving to the untwisted non-simply-laced theories of $g_2^{(1)}$ and $f_4^{(1)}$ it is no longer possible to associate, in general, the topological charges with a fundamental representation. It is only the topological charges of the solitons surviving the folding procedure which remain in the fundamental representations. For the twisted theories, all single solitons are single solitons of the parent theory surviving the folding. The representations to which the corresponding charges should be associated seems to be the fundamental representations of the parent theory in which they trivially lie.

How then should the topological charges be understood? The method that has provided the most algebraic approach is that of Olive et al. in their series of papers. Recalling the form of the solution which they obtain

$$e^{-\beta\lambda_i\cdot\phi} = \frac{\langle \Lambda_i | e^{-\beta\hat{E}_1 x^+} g(0) e^{-\beta\hat{E}_{-1} x^+} | \Lambda_i \rangle}{\langle \Lambda_0 | e^{-\beta\hat{E}_1 x^+} g(0) e^{-\beta\hat{E}_{-1} x^+} | \Lambda_0 \rangle^{m_i}},$$

it is important to note that calculations lead to an expression for the exponential of ϕ and so the topological charge, for example, can be calculated modulo $2\pi\Lambda_R/\beta$, where Λ_R is the root lattice. There is no such problem in the calculations carried out in the previous chapters.

An ideal may be to combine the known results for the $a_n^{(1)}$ theory with the results of Olive et al. The phase shift in the complex parameter relating one charge to another is known

and the effect of such a shift on the elements $\hat{F}^i(z)$ (recalling that the Kac-Moody group element creating a soliton of species i is $\exp Q \hat{F}^i(z)$ [54]) could give some insight into an algebraic interpretation of the charges. This would also perhaps explain the expression for the number of charges associated with any particular soliton.

Whatever the future developments in the study of affine Toda solitons are, the questions relating to the topological charges must be addressed. When progress is made in that direction, this thesis will provide the necessary material against which any such results can be tested.

Appendix A

Hirota's method

A.1 Hirota's method

This is a direct means of obtaining soliton solutions. The basis of the method is a change of dependent variable which transforms the soliton equation into its Hirota form.

Definition: Let f and g be sufficiently differentiable functions of x and t . Define the operators D_x and D_t by

$$D_x^m D_t^n f \cdot g = \left(\frac{\partial}{\partial x} - \frac{\partial}{\partial x'} \right)^m \left(\frac{\partial}{\partial t} - \frac{\partial}{\partial t'} \right)^n f(x, t) g(x', t') \Big|_{\substack{x=x' \\ t=t'}}.$$

These are *Hirota derivatives*.

Remark: $F(D_x, D_t)$ may be defined provided F has a Taylor expansion, for example

$$F(D_x, D_t) = \exp(\epsilon D_x) = 1 + \epsilon D_x + \frac{\epsilon^2}{2!} D_x^2 + \dots$$

Properties: Assume f and g are sufficiently differentiable, then

- (1) $D_x^m D_t^n f \cdot g = (-)^{m+n} D_x^m D_t^n g \cdot f$
- (2) $D_x^m D_t^n a f \cdot g = D_x^m D_t^n f \cdot a g = a D_x^m D_t^n f \cdot g$
- (3) $D_x^m D_t^n (f_1 + f_2) \cdot g = D_x^m D_t^n f_1 \cdot g + D_x^m D_t^n f_2 \cdot g$
- (4) $\exp(\epsilon D_x + \delta D_t) f \cdot g = f(x + \epsilon, t + \delta) g(x - \epsilon, t - \delta)$
- (5) $\ln(\cosh(\epsilon D_x + \delta D_t) f \cdot f) = 2 \cosh \left(\epsilon \frac{\partial}{\partial x} + \delta \frac{\partial}{\partial t} \right) \ln f$
- (6) $(2 \ln f)_{xx} = (D_x^2 f \cdot f) / f^2$ and $(2 \ln f)_{xt} = (D_x D_t f \cdot f) / f^2$
- (7) $D_x^m D_t^n f \cdot a = a \frac{\partial^m}{\partial x^m} \frac{\partial^n}{\partial t^n} f$
- (8) $D_x^m D_t^n e^{(\alpha_1 x + \beta_1 t)} \cdot e^{(\alpha_2 x + \beta_2 t)} = (\alpha_1 - \alpha_2)^m (\beta_1 - \beta_2)^n e^{((\alpha_1 + \alpha_2)x + (\beta_1 + \beta_2)t)}$

Properties (1)–(3), (7) and (8) are proved from the definition of Hirota derivative, whereas (4) and (5) are proved by Taylor expansions of the respective left hand sides – property (6) being obtained at orders ϵ^2 and $\epsilon\delta$ of (5) respectively.

Appendix B

Diagrams and Tables

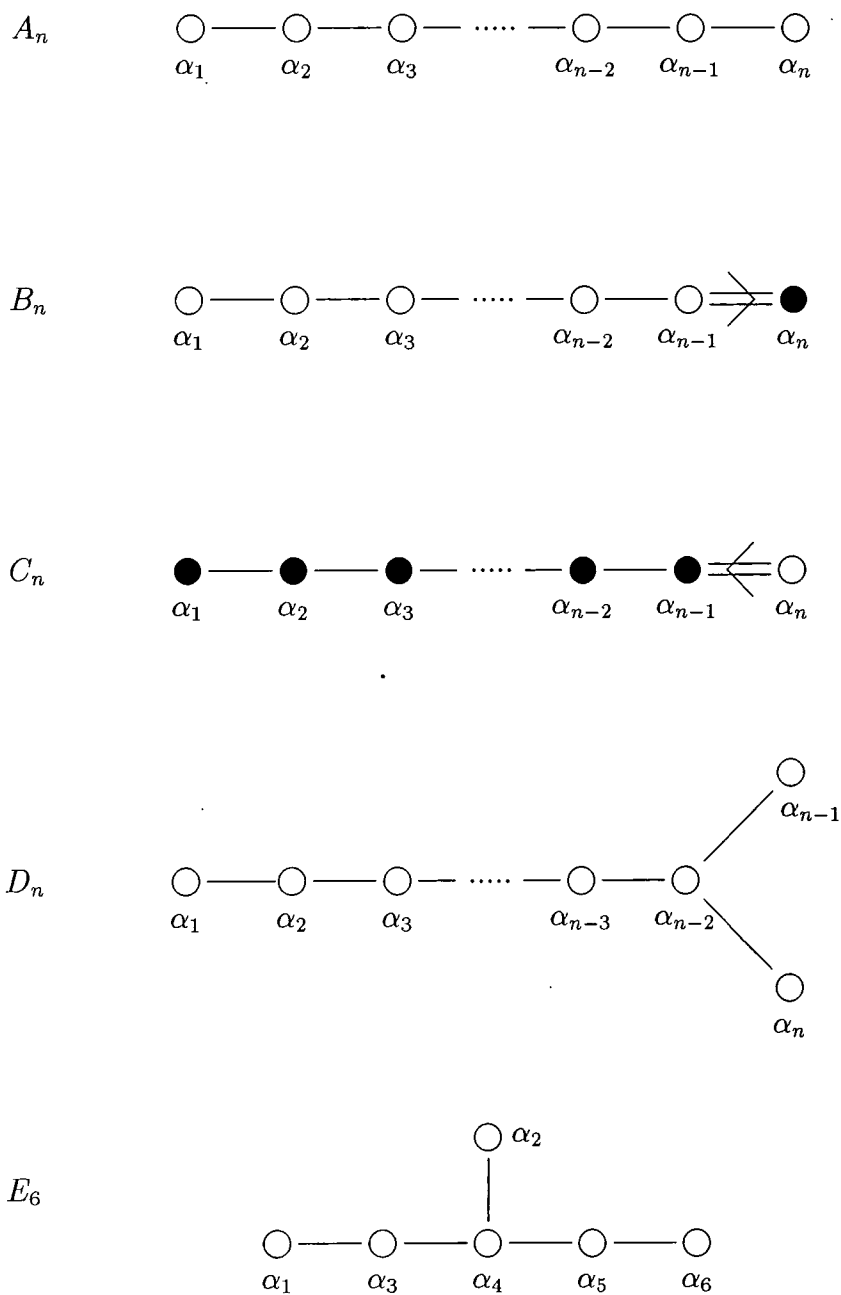

Table B1: Dynkin diagrams of the simple Lie algebras.

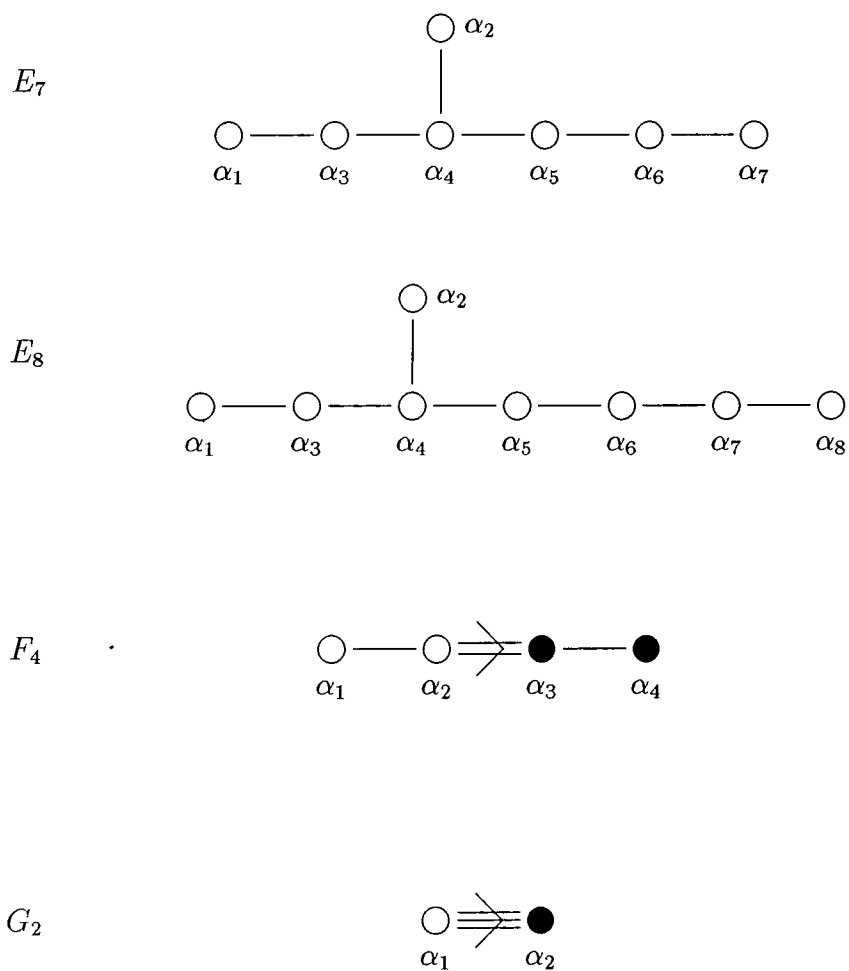

Table B1, continued.

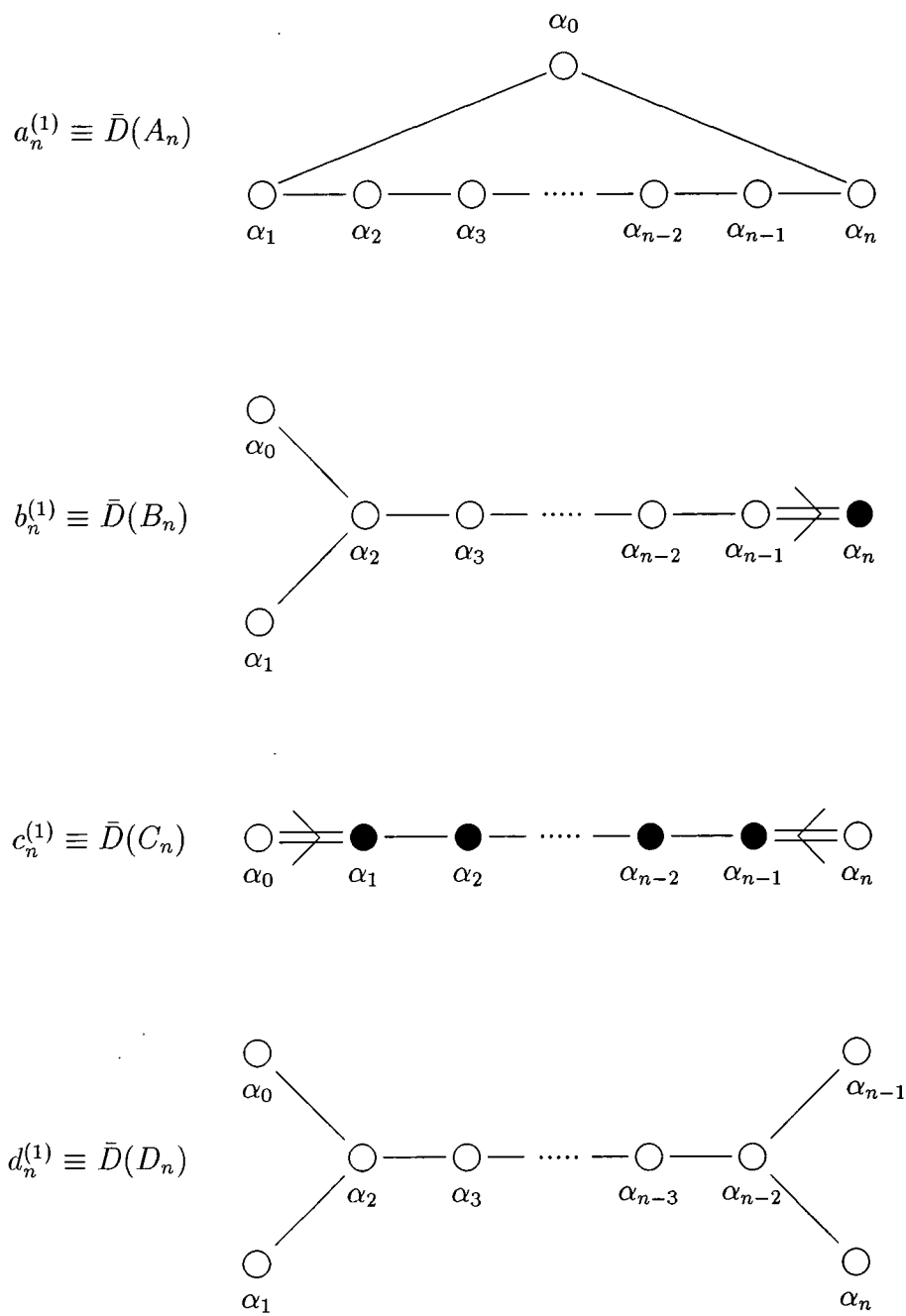

Table B2: Untwisted affine Dynkin diagrams.

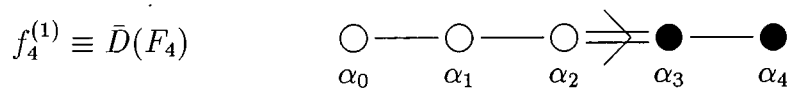
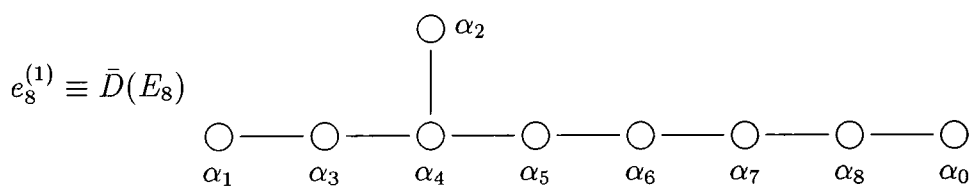
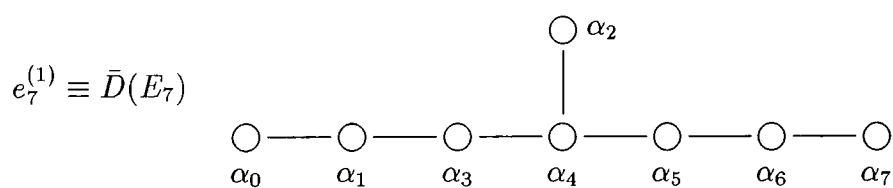
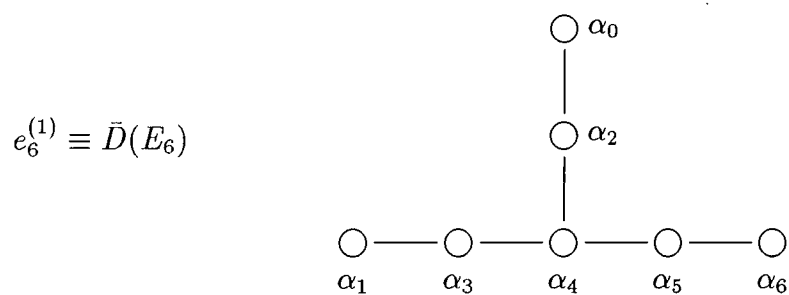

Table B2, continued.

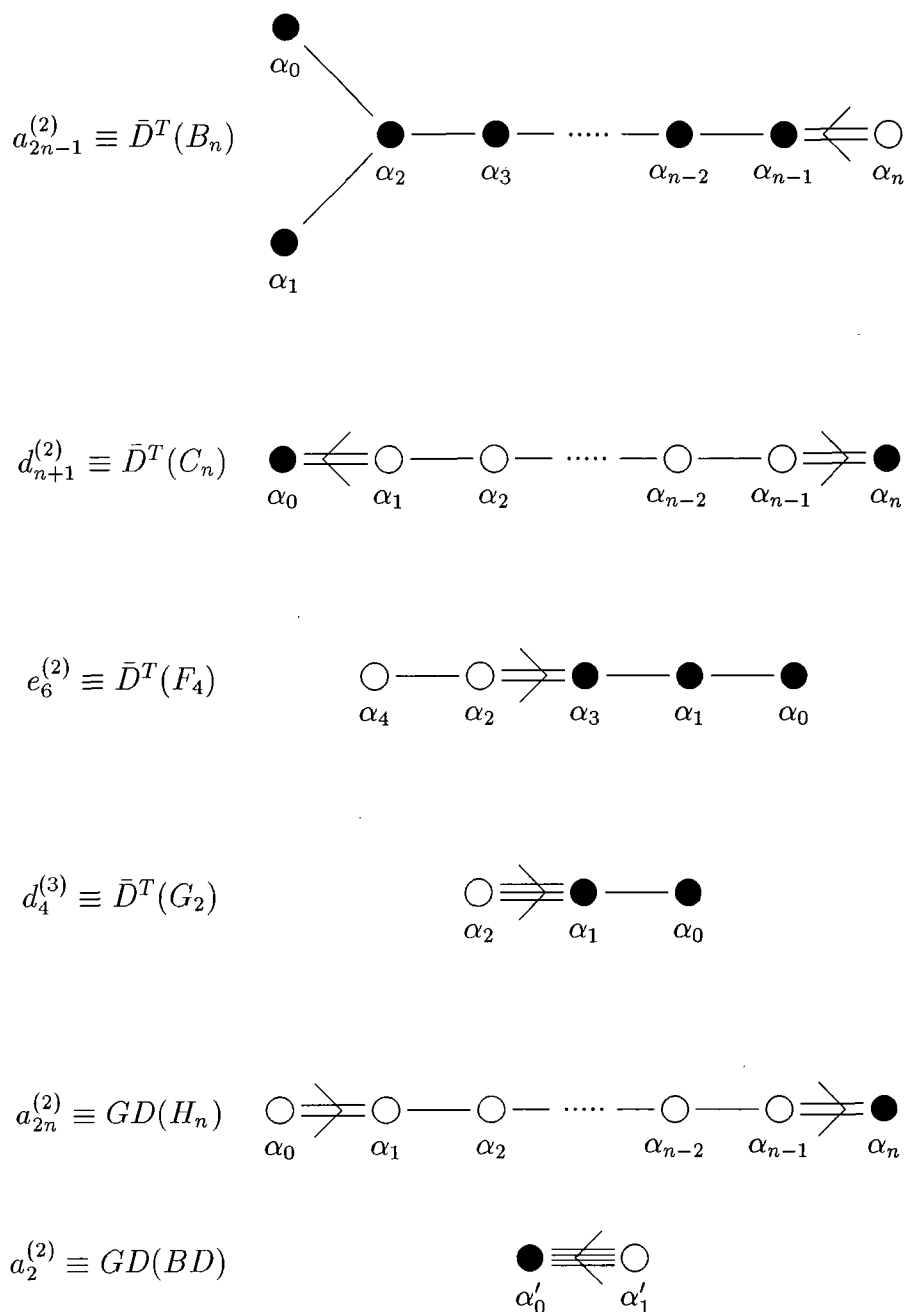

Table B3: Twisted affine Dynkin diagrams.

λ	$3 - \sqrt{3}$	$3 - \sqrt{3}$	$2(3 + \sqrt{3})$	$2(3 - \sqrt{3})$	$3 + \sqrt{3}$	$3 + \sqrt{3}$
$\delta_0^{(1)}$	1	1	1	1	1	1
$\delta_1^{(1)}$	ω	ω^2	1	1	ω	ω^2
$\delta_2^{(1)}$	$-(\lambda - 2)$	$-(\lambda - 2)$	$-(\lambda - 2)$	$-(\lambda - 2)$	$-(\lambda - 2)$	$-(\lambda - 2)$
$\delta_2^{(2)}$	1	1	1	1	1	1
$\delta_3^{(1)}$	$-\omega(\lambda - 2)$	$-\omega^2(\lambda - 2)$	$-(\lambda - 2)$	$-(\lambda - 2)$	$-\omega(\lambda - 2)$	$-\omega^2(\lambda - 2)$
$\delta_3^{(2)}$	ω^2	ω	1	1	ω^2	ω
$\delta_4^{(1)}$	0	0	$3(\lambda - 3)$	$3(\lambda - 3)$	0	0
$\delta_4^{(2)}$	0	0	$3(\lambda - 3)$	$3(\lambda - 3)$	0	0
$\delta_4^{(3)}$	1	1	1	1	1	1
$\delta_5^{(1)}$	$-\omega^2(\lambda - 2)$	$-\omega(\lambda - 2)$	$-(\lambda - 2)$	$-(\lambda - 2)$	$-\omega^2(\lambda - 2)$	$-\omega(\lambda - 2)$
$\delta_5^{(2)}$	ω	ω^2	1	1	ω	ω^2
$\delta_6^{(1)}$	ω^2	ω	1	1	ω^2	ω

Table B3: δ -values for $e_6^{(1)}$ single solitons.

λ	λ_3	$\lambda_2, \lambda_5, \lambda_7$	$\lambda_1, \lambda_4, \lambda_6$
$\delta_0^{(1)}$	1	1	1
$\delta_1^{(1)}$	-4	$-(\lambda - 2)$	$-(\lambda - 2)$
$\delta_1^{(2)}$	1	1	1
$\delta_2^{(1)}$	-4	0	$2(\lambda - 2)$
$\delta_2^{(2)}$	1	-1	1
$\delta_3^{(1)}$	3	$\frac{1}{2}(\lambda^2 - 6\lambda + 6)$	$\frac{1}{2}(\lambda^2 - 6\lambda + 6)$
$\delta_3^{(2)}$	3	$\frac{1}{2}(\lambda^2 - 6\lambda + 6)$	$\frac{1}{2}(\lambda^2 - 6\lambda + 6)$
$\delta_3^{(3)}$	1	1	1
$\delta_4^{(1)}$	4	0	$-(\lambda^2 - 6\lambda + 8)$
$\delta_4^{(2)}$	6	$2(\lambda - 1)$	$2(2\lambda^2 - 9\lambda + 9)$
$\delta_4^{(3)}$	4	0	$-(\lambda^2 - 6\lambda + 8)$
$\delta_4^{(4)}$	1	1	1
$\delta_5^{(1)}$	3	$-\frac{1}{2}(\lambda^2 - 6\lambda + 6)$	$\frac{1}{2}(\lambda^2 - 6\lambda + 6)$
$\delta_5^{(2)}$	3	$\frac{1}{2}(\lambda^2 - 6\lambda + 6)$	$\frac{1}{2}(\lambda^2 - 6\lambda + 6)$
$\delta_5^{(3)}$	1	-1	1
$\delta_6^{(1)}$	-4	$(\lambda - 2)$	$-(\lambda - 2)$
$\delta_6^{(2)}$	1	1	1
$\delta_7^{(1)}$	1	-1	1

Table B4: δ -values for $e_7^{(1)}$ single solitons.

λ	$\lambda_1, \lambda_2, \lambda_4, \lambda_7$	$\lambda_3, \lambda_5, \lambda_6, \lambda_8$
$\delta_0^{(1)}$	1	1
$\delta_1^{(1)}$	$-\frac{1}{6}(\lambda^3 - 24\lambda^2 + 132\lambda - 192)$	$\frac{1}{3}(\lambda^3 - 21\lambda^2 + 114\lambda - 84)$
$\delta_1^{(2)}$	1	1
$\delta_2^{(1)}$	$\frac{1}{4}(\lambda^3 - 18\lambda^2 + 84\lambda - 108)$	$\frac{1}{4}(\lambda^3 - 24\lambda^2 + 144\lambda - 108)$
$\delta_2^{(2)}$	$\frac{1}{4}(\lambda^3 - 18\lambda^2 + 84\lambda - 108)$	$\frac{1}{4}(\lambda^3 - 24\lambda^2 + 144\lambda - 108)$
$\delta_2^{(3)}$	1	1
$\delta_3^{(1)}$	$\frac{1}{6}(\lambda^3 - 6\lambda^2 + 24)$	$-\frac{1}{6}(5\lambda^3 - 102\lambda^2 + 540\lambda - 384)$
$\delta_3^{(2)}$	$\frac{2}{3}(5\lambda^3 - 60\lambda^2 + 225\lambda - 261)$	$-\frac{2}{3}(\lambda^3 - 24\lambda^2 + 135\lambda - 99)$
$\delta_3^{(3)}$	$\frac{1}{6}(\lambda^3 - 6\lambda^2 + 24)$	$-\frac{1}{6}(5\lambda^3 - 102\lambda^2 + 540\lambda - 384)$
$\delta_3^{(4)}$	1	1
$\delta_4^{(1)}$	$-\frac{1}{2}(\lambda - 2)(\lambda^2 - 6\lambda + 6)$	$\lambda^2 - 9\lambda + 6$
$\delta_4^{(2)}$	$64\lambda^3 - 668\lambda^2 + 2214\lambda - 2325$	$3\lambda^3 - 50\lambda^2 + 234\lambda - 165$
$\delta_4^{(3)}$	$-(303\lambda^3 - 3186\lambda^2 + 10614\lambda - 11180)$	$-2(3\lambda^3 - 54\lambda^2 + 267\lambda - 190)$
$\delta_4^{(4)}$	$64\lambda^3 - 668\lambda^2 + 2214\lambda - 2325$	$3\lambda^3 - 50\lambda^2 + 234\lambda - 165$
$\delta_4^{(5)}$	$-\frac{1}{2}(\lambda - 2)(\lambda^2 - 6\lambda + 6)$	$\lambda^2 - 9\lambda + 6$
$\delta_4^{(6)}$	1	1
$\delta_5^{(1)}$	$\frac{5}{12}(\lambda^3 - 12\lambda^2 + 48\lambda - 60)$	$\frac{5}{12}(\lambda^3 - 18\lambda^2 + 84\lambda - 60)$
$\delta_5^{(2)}$	$\frac{5}{4}(11\lambda^3 - 116\lambda^2 + 384\lambda - 400)$	$\frac{5}{4}(\lambda - 8)(3\lambda^2 - 26\lambda + 20)$
$\delta_5^{(3)}$	$\frac{5}{4}(11\lambda^3 - 116\lambda^2 + 384\lambda - 400)$	$\frac{5}{4}(\lambda - 8)(3\lambda^2 - 26\lambda + 20)$
$\delta_5^{(4)}$	$\frac{5}{12}(\lambda^3 - 12\lambda^2 + 48\lambda - 60)$	$\frac{5}{12}(\lambda^3 - 18\lambda^2 + 84\lambda - 60)$
$\delta_5^{(5)}$	1	1
$\delta_6^{(1)}$	$-\frac{1}{6}(\lambda^3 - 12\lambda^2 + 36\lambda - 24)$	$-\frac{1}{6}(\lambda^3 - 12\lambda^2 + 36\lambda - 24)$
$\delta_6^{(2)}$	$\frac{1}{6}(7\lambda^3 - 78\lambda^2 + 288\lambda - 324)$	$\frac{1}{6}(7\lambda^3 - 108\lambda^2 + 468\lambda - 324)$
$\delta_6^{(3)}$	$-\frac{1}{6}(\lambda^3 - 12\lambda^2 + 36\lambda - 24)$	$-\frac{1}{6}(\lambda^3 - 12\lambda^2 + 36\lambda - 24)$
$\delta_6^{(4)}$	1	1
$\delta_7^{(1)}$	$\frac{1}{2}(\lambda^2 - 6\lambda + 6)$	$\frac{1}{2}(\lambda^2 - 6\lambda + 6)$
$\delta_7^{(2)}$	$\frac{1}{2}(\lambda^2 - 6\lambda + 6)$	$\frac{1}{2}(\lambda^2 - 6\lambda + 6)$
$\delta_7^{(3)}$	1	1
$\delta_8^{(1)}$	$-(\lambda - 2)$	$-(\lambda - 2)$
$\delta_8^{(2)}$	1	1

Table B5: δ -values for $e_8^{(1)}$ single solitons.

λ	$2(3 + \sqrt{3})$	$2(3 - \sqrt{3})$	$3 - \sqrt{3}$	$3 + \sqrt{3}$
$\delta_0^{(1)}$	1	1	$4(1 - \sqrt{3})$	$4(1 + \sqrt{3})$
$\delta_0^{(2)}$	-	-	1	1
$\delta_1^{(1)}$	$-(\lambda - 2)$	$-(\lambda - 2)$	$-4(1 - \sqrt{3})^2$	$-4(1 + \sqrt{3})^2$
$\delta_1^{(2)}$	1	1	$2(27 - 14\sqrt{3})$	$2(27 + 14\sqrt{3})$
$\delta_1^{(3)}$	-	-	$-4(1 - \sqrt{3})^2$	$-4(1 + \sqrt{3})^2$
$\delta_1^{(4)}$	-	-	1	1
$\delta_2^{(1)}$	$3(\lambda - 3)$	$3(\lambda - 3)$	0	0
$\delta_2^{(2)}$	$3(\lambda - 3)$	$3(\lambda - 3)$	$\frac{9}{4}(1 - \sqrt{3})^4$	$\frac{9}{4}(1 + \sqrt{3})^4$
$\delta_2^{(3)}$	1	1	$16(1 - \sqrt{3})^3$	$16(1 + \sqrt{3})^3$
$\delta_2^{(4)}$	-	-	$\frac{9}{4}(1 - \sqrt{3})^4$	$\frac{9}{4}(1 + \sqrt{3})^4$
$\delta_2^{(5)}$	-	-	0	0
$\delta_2^{(6)}$	-	-	1	1
$\delta_3^{(1)}$	$-(\lambda - 2)$	$-(\lambda - 2)$	$2(1 - \sqrt{3})^2$	$2(1 + \sqrt{3})^2$
$\delta_3^{(2)}$	1	1	$2(3 - 2\sqrt{3})$	$2(3 + 2\sqrt{3})$
$\delta_3^{(3)}$	-	-	$2(1 - \sqrt{3})^2$	$2(1 + \sqrt{3})^2$
$\delta_3^{(4)}$	-	-	1	1
$\delta_4^{(1)}$	1	1	$-2(1 - \sqrt{3})$	$-2(1 + \sqrt{3})$
$\delta_4^{(2)}$	-	-	1	1

Table B6: δ -values for $f_4^{(1)}$ single solitons.

λ	6	6
$\delta_0^{(1)}$	1	9
$\delta_0^{(2)}$	-	9
$\delta_0^{(3)}$	-	1
$\delta_1^{(1)}$	-4	0
$\delta_1^{(2)}$	1	27
$\delta_1^{(3)}$	-	-16
$\delta_1^{(4)}$	-	27
$\delta_1^{(5)}$	-	0
$\delta_1^{(6)}$	-	1
$\delta_2^{(1)}$	1	-3
$\delta_2^{(2)}$	-	-3
$\delta_2^{(3)}$	-	1

Table B7: δ -values for $g_2^{(1)}$ single solitons.

λ	$\frac{2}{3}(3 + \sqrt{3})$	$\frac{2}{3}(3 - \sqrt{3})$
$\delta_0^{(1)}$	$9(\lambda - 1)$	$9(\lambda - 1)$
$\delta_0^{(2)}$	$9(\lambda - 1)$	$9(\lambda - 1)$
$\delta_0^{(3)}$	1	1
$\delta_1^{(1)}$	$-(3\lambda - 2)$	$-(3\lambda - 2)$
$\delta_1^{(2)}$	1	1
$\delta_2^{(1)}$	1	1

Table B8: δ -values for $d_4^{(3)}$ single solitons.

λ	λ_3	$\lambda_1, \lambda_4, \lambda_6$
$\delta_0^{(1)}$	-4	$4(\lambda - 1)$
$\delta_0^{(2)}$	1	1
$\delta_1^{(1)}$	4	$-4(\lambda^2 - 3\lambda + 2)$
$\delta_1^{(2)}$	6	$2(8\lambda^2 - 18\lambda + 9)$
$\delta_1^{(3)}$	4	$-4(\lambda^2 - 3\lambda + 2)$
$\delta_1^{(4)}$	1	1
$\delta_2^{(1)}$	3	$(2\lambda^2 - 6\lambda + 3)$
$\delta_2^{(2)}$	3	$(2\lambda^2 - 6\lambda + 3)$
$\delta_2^{(3)}$	1	1
$\delta_3^{(1)}$	-4	$-2(\lambda - 1)$
$\delta_3^{(2)}$	1	1
$\delta_4^{(1)}$	1	1

Table B9: δ -values for $e_6^{(2)}$ single solitons.

$\lambda = \lambda_1$	$(\frac{1}{3}\alpha_1 + \alpha_2 + \frac{2}{3}\alpha_3 + \alpha_4 + \frac{4}{3}\alpha_5 + \frac{2}{3}\alpha_6)$
	$(\frac{1}{3}\alpha_1 + \alpha_2 + \frac{2}{3}\alpha_3 + \alpha_4 + \frac{1}{3}\alpha_5 + \frac{2}{3}\alpha_6)$
	$(\frac{1}{3}\alpha_1 + \frac{2}{3}\alpha_3 + \alpha_4 + \frac{1}{3}\alpha_5 + \frac{2}{3}\alpha_6)$
	$(\frac{1}{3}\alpha_1 + \frac{2}{3}\alpha_3 + \frac{1}{3}\alpha_5 - \frac{1}{3}\alpha_6)$
	$(\frac{1}{3}\alpha_1 - \frac{1}{3}\alpha_3 + \frac{1}{3}\alpha_5 - \frac{1}{3}\alpha_6)$
	$(\frac{1}{3}\alpha_1 - \frac{1}{3}\alpha_3 - \frac{2}{3}\alpha_5 - \frac{1}{3}\alpha_6)$
	$(-\frac{2}{3}\alpha_1 - \frac{1}{3}\alpha_3 - \alpha_4 - \frac{2}{3}\alpha_5 - \frac{1}{3}\alpha_6)$
	$(-\frac{2}{3}\alpha_1 - \alpha_2 - \frac{1}{3}\alpha_3 - \alpha_4 - \frac{2}{3}\alpha_5 - \frac{1}{3}\alpha_6)$
	$(-\frac{2}{3}\alpha_1 - \alpha_2 - \frac{4}{3}\alpha_3 - \alpha_4 - \frac{2}{3}\alpha_5 - \frac{1}{3}\alpha_6)$
$\lambda = \lambda_6$	$(\frac{2}{3}\alpha_1 + \alpha_2 + \frac{4}{3}\alpha_3 + \alpha_4 + \frac{2}{3}\alpha_5 + \frac{1}{3}\alpha_6)$
	$(\frac{2}{3}\alpha_1 + \alpha_2 + \frac{1}{3}\alpha_3 + \alpha_4 + \frac{2}{3}\alpha_5 + \frac{1}{3}\alpha_6)$
	$(\frac{2}{3}\alpha_1 + \frac{1}{3}\alpha_3 + \alpha_4 + \frac{2}{3}\alpha_5 + \frac{1}{3}\alpha_6)$
	$(-\frac{1}{3}\alpha_1 + \frac{1}{3}\alpha_3 + \frac{2}{3}\alpha_5 + \frac{1}{3}\alpha_6)$
	$(-\frac{1}{3}\alpha_1 + \frac{1}{3}\alpha_3 - \frac{1}{3}\alpha_5 + \frac{1}{3}\alpha_6)$
	$(-\frac{1}{3}\alpha_1 - \frac{2}{3}\alpha_3 - \frac{1}{3}\alpha_5 + \frac{1}{3}\alpha_6)$
	$(-\frac{1}{3}\alpha_1 - \frac{2}{3}\alpha_3 - \alpha_4 - \frac{1}{3}\alpha_5 - \frac{2}{3}\alpha_6)$
	$(-\frac{1}{3}\alpha_1 - \alpha_2 - \frac{2}{3}\alpha_3 - \alpha_4 - \frac{1}{3}\alpha_5 - \frac{2}{3}\alpha_6)$
	$(-\frac{1}{3}\alpha_1 - \alpha_2 - \frac{2}{3}\alpha_3 - \alpha_4 - \frac{4}{3}\alpha_5 - \frac{2}{3}\alpha_6)$
$\lambda = \lambda_2$	$\pm(\alpha_2 + \alpha_3 + \alpha_4 + \alpha_5)$ $\pm\alpha_4$
$\lambda = \lambda_4$	$\pm(\alpha_2 + \alpha_3 + \alpha_5)$

Table B10: The topological charges of the $e_6^{(1)}$ single solitons

$\lambda = \lambda_3$	$(\frac{1}{3}\alpha_1 + \alpha_2 + \frac{5}{3}\alpha_3 + \alpha_4 + \frac{1}{3}\alpha_5 + \frac{2}{3}\alpha_6)$
	$(\frac{1}{3}\alpha_1 + \alpha_2 - \frac{1}{3}\alpha_3 + \alpha_4 + \frac{1}{3}\alpha_5 + \frac{2}{3}\alpha_6)$
	$(\frac{1}{3}\alpha_1 + \alpha_2 - \frac{1}{3}\alpha_3 + \frac{1}{3}\alpha_5 - \frac{1}{3}\alpha_6)$
	$(\frac{1}{3}\alpha_1 - \alpha_2 - \frac{1}{3}\alpha_3 + \frac{1}{3}\alpha_5 - \frac{1}{3}\alpha_6)$
	$(-\frac{2}{3}\alpha_1 - \alpha_2 - \frac{1}{3}\alpha_3 - \alpha_4 + \frac{1}{3}\alpha_5 - \frac{1}{3}\alpha_6)$
	$(-\frac{2}{3}\alpha_1 - \alpha_2 - \frac{1}{3}\alpha_3 - \alpha_4 - \frac{5}{3}\alpha_5 - \frac{1}{3}\alpha_6)$
$\lambda = \lambda_5$	$(\frac{2}{3}\alpha_1 + \alpha_2 + \frac{1}{3}\alpha_3 + \alpha_4 + \frac{5}{3}\alpha_5 + \frac{1}{3}\alpha_6)$
	$(\frac{2}{3}\alpha_1 + \alpha_2 + \frac{1}{3}\alpha_3 + \alpha_4 - \frac{1}{3}\alpha_5 + \frac{1}{3}\alpha_6)$
	$(-\frac{1}{3}\alpha_1 + \alpha_2 + \frac{1}{3}\alpha_3 - \frac{1}{3}\alpha_5 + \frac{1}{3}\alpha_6)$
	$(-\frac{1}{3}\alpha_1 - \alpha_2 + \frac{1}{3}\alpha_3 - \frac{1}{3}\alpha_5 + \frac{1}{3}\alpha_6)$
	$(-\frac{1}{3}\alpha_1 - \alpha_2 + \frac{1}{3}\alpha_3 - \alpha_4 - \frac{1}{3}\alpha_5 - \frac{2}{3}\alpha_6)$
	$(-\frac{1}{3}\alpha_1 - \alpha_2 - \frac{5}{3}\alpha_3 - \alpha_4 - \frac{1}{3}\alpha_5 - \frac{2}{3}\alpha_6)$

Table B10, continued.

$\lambda = \lambda_1$	$\begin{aligned} &\pm(\alpha_1 + \alpha_2 + \alpha_3 + 2\alpha_4 + \alpha_5 + \alpha_6) \\ &\pm(\alpha_1 + \alpha_2 + \alpha_3 + \alpha_4 + \alpha_5 + \alpha_6) \\ &\quad \pm(\alpha_2 + \alpha_3 + \alpha_4 + \alpha_5) \\ &\quad \quad \pm(\alpha_3 + \alpha_4 + \alpha_5) \\ &\quad \quad \quad \pm\alpha_4 \end{aligned}$
$\lambda = \lambda_2$	$\begin{aligned} &\pm(\alpha_1 + \frac{1}{2}\alpha_2 + \alpha_3 + 2\alpha_4 + \frac{1}{2}\alpha_5 + \alpha_6 + \frac{1}{2}\alpha_7) \\ &\pm(\alpha_1 + \frac{1}{2}\alpha_2 + \alpha_3 + 2\alpha_4 + \frac{1}{2}\alpha_5 + \frac{1}{2}\alpha_7) \\ &\pm(\alpha_1 + \frac{1}{2}\alpha_2 + \alpha_3 + \frac{1}{2}\alpha_5 + \frac{1}{2}\alpha_7) \\ &\quad \pm(\frac{1}{2}\alpha_2 + \alpha_3 + \frac{1}{2}\alpha_5 + \frac{1}{2}\alpha_7) \end{aligned}$
$\lambda = \lambda_3$	$\pm(\alpha_1 + \alpha_2 + \alpha_6)$
$\lambda = \lambda_4$	$\pm(\alpha_1 + 2\alpha_4 + \alpha_6)$
$\lambda = \lambda_5$	$\begin{aligned} &\pm(\alpha_1 + \frac{1}{2}\alpha_2 + 2\alpha_4 + \frac{3}{2}\alpha_5 + \frac{1}{2}\alpha_7) \\ &\pm(\alpha_1 + \frac{1}{2}\alpha_2 + \frac{3}{2}\alpha_5 + \frac{1}{2}\alpha_7) \end{aligned}$
$\lambda = \lambda_6$	$\begin{aligned} &\pm(\alpha_1 + \alpha_3 + 2\alpha_4 + \alpha_5 + \alpha_6) \\ &\pm(\alpha_1 + \alpha_3 + \alpha_5 + \alpha_6) \\ &\quad \pm(\alpha_3 + \alpha_5) \end{aligned}$
$\lambda = \lambda_7$	$\begin{aligned} &\pm(\alpha_1 + \frac{1}{2}\alpha_2 + \alpha_3 + 2\alpha_4 + \frac{3}{2}\alpha_5 + \alpha_6 + \frac{1}{2}\alpha_7) \\ &\pm(\alpha_1 + \frac{1}{2}\alpha_2 + \alpha_3 + \alpha_4 + \frac{3}{2}\alpha_5 + \alpha_6 + \frac{1}{2}\alpha_7) \\ &\quad \pm(\frac{1}{2}\alpha_2 + \alpha_3 + \alpha_4 + \frac{3}{2}\alpha_5 + \alpha_6 + \frac{1}{2}\alpha_7) \\ &\quad \pm(\frac{1}{2}\alpha_2 + \alpha_3 + \alpha_4 + \frac{1}{2}\alpha_5 + \alpha_6 + \frac{1}{2}\alpha_7) \\ &\quad \pm(\frac{1}{2}\alpha_2 + \alpha_4 + \frac{1}{2}\alpha_5 + \alpha_6 + \frac{1}{2}\alpha_7) \\ &\quad \pm(\frac{1}{2}\alpha_2 + \alpha_4 + \frac{1}{2}\alpha_5 + \frac{1}{2}\alpha_7) \\ &\quad \pm(\frac{1}{2}\alpha_2 + \alpha_4 + \frac{1}{2}\alpha_5 + \frac{1}{2}\alpha_7) \end{aligned}$

Table B11: The topological charges of the $e_7^{(1)}$ single solitons

$\lambda = \lambda_1$	$\begin{aligned} &\pm(\alpha_1 + \alpha_2 + \alpha_3 + 3\alpha_4 + 2\alpha_5 + 2\alpha_6 + \alpha_7 + \alpha_8) \\ &\pm(\alpha_1 + \alpha_2 + \alpha_3 + \alpha_4 + 2\alpha_5 + 2\alpha_6 + \alpha_7 + \alpha_8) \\ &\quad \pm(\alpha_2 + \alpha_3 + \alpha_4 + 2\alpha_5 + 2\alpha_6 + \alpha_7 + \alpha_8) \\ &\quad \pm(\alpha_2 + \alpha_3 + \alpha_4 + 2\alpha_5 + \alpha_6 + \alpha_7 + \alpha_8) \\ &\quad \pm(\alpha_2 + \alpha_3 + \alpha_4 + 2\alpha_5 + \alpha_6 + \alpha_7) \\ &\quad \pm(\alpha_2 + \alpha_3 + \alpha_4 + \alpha_6 + \alpha_7) \\ &\quad \quad \pm(\alpha_3 + \alpha_4 + \alpha_6 + \alpha_7) \\ &\quad \quad \quad \pm(\alpha_4 + \alpha_6 + \alpha_7) \\ &\quad \quad \quad \quad \pm(\alpha_4 + \alpha_7) \end{aligned}$
$\lambda = \lambda_2$	$\begin{aligned} &\pm(\alpha_2 + \alpha_3 + 2\alpha_4 + \alpha_5 + \alpha_6 + \alpha_7 + \alpha_8) \\ &\pm(\alpha_2 + \alpha_3 + 2\alpha_4 + \alpha_5 + \alpha_6 + \alpha_7) \\ &\pm(\alpha_2 + \alpha_3 + 2\alpha_4 + \alpha_5 + \alpha_6) \end{aligned}$
$\lambda = \lambda_3$	$\begin{aligned} &\pm(\alpha_1 + \alpha_2 + 3\alpha_4 + 2\alpha_5 + 2\alpha_6 + \alpha_8) \\ &\pm(\alpha_1 + \alpha_2 + \alpha_4 + 2\alpha_5 + 2\alpha_6 + \alpha_8)^* \\ &\pm(\alpha_1 + \alpha_2 + 2\alpha_5 + 2\alpha_6 + \alpha_8) \\ &\pm(\alpha_1 + \alpha_2 + 2\alpha_5 + \alpha_8) \end{aligned}$
$\lambda = \lambda_4$	$\pm(\alpha_1 + \alpha_4 + 2\alpha_6 + \alpha_8)$
$\lambda = \lambda_5$	$\begin{aligned} &\pm(\alpha_2 + 2\alpha_3 + 3\alpha_4 + 2\alpha_6 + \alpha_8) \\ &\pm(\alpha_2 + 2\alpha_3 + \alpha_4 + 2\alpha_6 + \alpha_8)^* \\ &\pm(\alpha_2 + 2\alpha_3 + 2\alpha_6 + \alpha_8) \end{aligned}$
$\lambda = \lambda_6$	$\begin{aligned} &\pm(2\alpha_3 + 3\alpha_4 + 2\alpha_5 + 2\alpha_6 + \alpha_8) \\ &\pm(2\alpha_3 + 3\alpha_4 + 2\alpha_5 + \alpha_8) \\ &\pm(2\alpha_3 + \alpha_4 + 2\alpha_5 + \alpha_8) \\ &\pm(\alpha_3 + \alpha_4 + 2\alpha_5 + \alpha_8)^* \\ &\pm(\alpha_3 + \alpha_4 + \alpha_5 + \alpha_8)^* \end{aligned}$

Table B12: The topological charges of the $e_8^{(1)}$ single solitons

$\lambda = \lambda_7$	$\pm(\alpha_1 + \alpha_2 + 2\alpha_3 + 3\alpha_4 + \alpha_5 + 2\alpha_6 + \alpha_7 + \alpha_8)$
	$\pm(\alpha_1 + \alpha_2 + 2\alpha_3 + \alpha_4 + \alpha_5 + 2\alpha_6 + \alpha_7 + \alpha_8)$
	$\pm(\alpha_1 + 2\alpha_3 + \alpha_4 + \alpha_5 + 2\alpha_6 + \alpha_7 + \alpha_8)$
	$\pm(\alpha_1 + 2\alpha_3 + \alpha_4 + \alpha_5 + \alpha_7 + \alpha_8)$
	$\pm(\alpha_1 + \alpha_4 + \alpha_5 + \alpha_7 + \alpha_8)$
	$\pm(\alpha_1 + \alpha_4 + \alpha_5 + \alpha_7)$
	$\pm(\alpha_1 + \alpha_5 + \alpha_7)$
$\lambda = \lambda_8$	$\pm(\alpha_1 + \alpha_2 + 2\alpha_3 + 3\alpha_4 + 2\alpha_5 + 2\alpha_6 + \alpha_7 + \alpha_8)$
	$\pm(\alpha_1 + \alpha_2 + 2\alpha_3 + 2\alpha_4 + 2\alpha_5 + 2\alpha_6 + \alpha_7 + \alpha_8)$
	$\pm(\alpha_1 + \alpha_2 + 2\alpha_3 + 2\alpha_4 + 2\alpha_5 + \alpha_6 + \alpha_7 + \alpha_8)$
	$\pm(\alpha_1 + \alpha_2 + 2\alpha_3 + 2\alpha_4 + 2\alpha_5 + \alpha_6 + \alpha_7)$
	$\pm(\alpha_1 + \alpha_2 + \alpha_3 + 2\alpha_4 + 2\alpha_5 + \alpha_6 + \alpha_7)$
	$\pm(\alpha_1 + \alpha_2 + \alpha_3 + 2\alpha_4 + \alpha_5 + \alpha_6 + \alpha_7)$
	$\pm(\alpha_1 + \alpha_2 + \alpha_3 + 2\alpha_4 + \alpha_5 + \alpha_6)$
	$\pm(\alpha_2 + \alpha_3 + 2\alpha_4 + \alpha_5 + \alpha_6)$
	$\pm(\alpha_2 + \alpha_3 + \alpha_4 + \alpha_5 + \alpha_6)$
	$\pm(\alpha_2 + \alpha_3 + \alpha_4 + \alpha_5)$
	$\pm(\alpha_3 + \alpha_4 + \alpha_5)$
	$\pm(\alpha_4 + \alpha_5)$
	$\pm \alpha_4$

Table B12, continued.

$\lambda = 6$	$\pm\alpha_1$
$\lambda = 2$	$\pm(3\alpha_1 + 3\alpha_2)$ $\pm(\alpha_1 + 3\alpha_2)$ $\pm 3\alpha_2$

Table B13: The topological charges of the $g_2^{(1)}$ single solitons

$\lambda = 2(3 + \sqrt{3})$	$\pm(\alpha_1 + 2\alpha_3)$
$\lambda = 2(3 - \sqrt{3})$	$\pm(\alpha_1 + \alpha_2 + 2\alpha_3)$ $\pm \alpha_2$
$\lambda = 3 - \sqrt{3}$	$\pm(2\alpha_1 + 2\alpha_2 + 4\alpha_3 + 2\alpha_4)$ $\pm(2\alpha_1 + 2\alpha_2 + 2\alpha_3 + 2\alpha_4)$ $\pm(2\alpha_2 + 2\alpha_3 + 2\alpha_4)$ $\pm(2\alpha_3 + 2\alpha_4)$ $\pm 2\alpha_3$
$\lambda = 3 + \sqrt{3}$	$\pm(2\alpha_1 + 2\alpha_2 + 2\alpha_3 + 2\alpha_4)$ $\pm(2\alpha_1 + 2\alpha_2 + 2\alpha_4)$ $\pm(2\alpha_1 + 2\alpha_4)$

Table B14: The topological charges of the $f_4^{(1)}$ single solitons

$\lambda = \lambda_1$	$\pm(2\alpha_1 + \alpha_2 + 4\alpha_3 + \alpha_4)$ $\pm(\alpha_1 + \alpha_2 + 4\alpha_3 + \alpha_4)$ $\pm(\alpha_1 + \alpha_2 + 2\alpha_3 + \alpha_4)$ $\pm(\alpha_1 + 2\alpha_2)$ $\pm\alpha_1$
$\lambda = \lambda_3$	$\pm(2\alpha_1 + 3\alpha_2 + \alpha_4)$
$\lambda = \lambda_4$	$\pm(2\alpha_1 + 2\alpha_3)$
$\lambda = \lambda_6$	$\pm(2\alpha_1 + 2\alpha_2 + 2\alpha_3)$ $\pm(2\alpha_2 + 2\alpha_3)$ $\pm 2\alpha_2$

Table B15: The topological charges of the $e_6^{(2)}$ single solitons

$\lambda = \frac{2}{3}(3 + \sqrt{3})$	$\pm 3\alpha_1$
$\lambda = \frac{2}{3}(3 - \sqrt{3})$	$\pm(2\alpha_1 + \alpha_2)$ $\pm(\alpha_1 - \alpha_2)$

Table B16: The topological charges of the $d_4^{(3)}$ single solitons

Bibliography

- [1] H. Aratyn, C. P. Constantinidis, L. A. Ferreira, J. F. Gomes, and A. H. Zimmerman, *Nucl. Phys.* **B406** (1993), 727.
- [2] H. Aratyn, C. P. Constantinidis, L. A. Ferreira, J. F. Gomes, and A. H. Zimmerman, “Construction of Affine and Conformal Affine Toda solitons by Hirota’s methods”, IFT-P/020/93, hep-th 9304080.
- [3] H. Aratyn, L.A. Ferreira, J.F. Gomes and A.H. Zimerman, *Phys. Lett.* **254B** (1991) 372.
- [4] A. E. Arinshtein, V. A. Fateev and A. B. Zamolodchikov, *Phys. Lett.* **B87** (1979), 389.
- [5] O. Babelon and D. Bernard, *Int. J. Mod. Phys.* **A8** (1993), 507.
- [6] O. Babelon and L. Bonora, *Phys. Lett.* **244B** (1990) 220.
- [7] G. G. A. Bäuerle and E. A. de Kerf, “Lie algebras” (Part I), *North-Holland*.
- [8] E. Braaten, T. Curtright, G. Ghandour and C. Thorn, *Phys. Lett.* **B125** (1983), 301.
- [9] E. Corrigan, P.E. Dorey, R. Sasaki *Nucl. Phys.* **B408** (1993),579.
- [10] H. W. Braden, E. Corrigan, P. E. Dorey and R. Sasaki, *Phys. Lett.* **B227** (1989), 411.
- [11] H. W. Braden, E. Corrigan, P.E. Dorey and R. Sasaki, *Nuclear Physics* **B338** (1990), 689.
- [12] H.W. Braden, E. Corrigan, P.E. Dorey and R. Sasaki, *Nuclear Physics* **B356** (1991), 469.

- [13] D. G. Caldi and Z. Zhu, “Multi-soliton Solutions of Affine Toda Models”, UB-TH-0193, hep-th 9307175.
- [14] D. G. Caldi and Z. Zhu, “Reality of complex affine Toda solitons”, UBTH-0494, hep-th 9404097.
- [15] C. P. Constantinidis, L. A. Ferreira, J. F. Gomes, and A. H. Zimmerman, *Phys. Lett.* **B298** (1993) 88.
- [16] G.W. Delius, M.T. Grisaru, D. Zanon, *Nucl. Phys.* **B382** (1992), 365.
- [17] G.W. Delius and Y.-Z. Zhang, “Finite dimensional representations of quantum affine algebras”, hep-th 9403162.
- [18] P.E. Dorey, *Nucl. Phys.* **B358** (1991) 654.
- [19] P.E. Dorey, “The exact S -matrices of affine Toda field theory”, *University of Durham thesis*, (1990) .
- [20] P.E. Dorey, *Nucl.Phys.* **B358** (1991), 654.
- [21] V. G. Drinfel’d and V. V. Sokolov, *J. Sov. Math.* **30** (1984), 1975.
- [22] T. Eguchi and S-K. Yang, *Phys. Lett.* **B224** (1989), 373.
- [23] B. Kostant, *Am. J. Math.* **81** (1959), 973.
- [24] A. P. Fordy and J. Gibbons, *Commun. Math. Phys.* **77** (1980), 21.
- [25] M. D. Freeman, *Phys. Lett.* **B261** (1991), 57.
- [26] A. Fring, H. C. Liao and D. I. Olive, *Phys. Lett.* **B266** (1991), 82.
- [27] J.-L. Gervais and A. Neveu, *Nucl. Phys.* **B226** (1983), 329.
- [28] P. Ginsparg in “Champs, Cordes et Phénomènes Critiques: Fields, Strings and Critical Phenomena”, eds. E. Brezin and J. Zinn-Justin, *Elsevier 1989*.
- [29] P. Goddard and D. I. Olive, *Int. J. Mod. Phys.* **A1** (1986), 303.
- [30] R.A. Hall, “Affine Toda solitons and fusing rules”, *University of Durham thesis*, (May 1994).

- [31] R. Hirota, "Direct methods in soliton theory", in "Soliton" page 157; ed. R.K. Bullough and P.S. Caudrey (1980).
- [32] T. J. Hollowood, *Nucl. Phys.* **B384** (1992), 523.
- [33] T. J. Hollowood, *Int. J. Mod. Phys.* **A8** (1993), 947.
- [34] T. J. Hollowood, *Phys. Lett.* **B300** (1993), 73.
- [35] T. J. Hollowood and P. Mansfield, *Phys. Lett.* **B226** (1989), 73.
- [36] J. E. Humphreys, "Introduction to Lie Algebras and Representation Theory", *Springer-Verlag*.
- [37] A. A. P. Iskandar and U. K. F. Harder, *private communication*.
- [38] V. G. Kac, "Infinite dimensional Lie algebras" (3rd edition), *Cambridge University Press*.
- [39] M. A. C. Kneipp and D. I. Olive, *Nucl. Phys.* **B408** (1993), 565.
- [40] M. A. C. Kneipp and D. I. Olive, "Solitons and Vertex Operators in twisted affine Toda field theories", SWAT-93-94-19, hep-th 9404030.
- [41] A.N. Leznov and M.V. Saveliev, *Lett. Math. Phys.* **3** (1979), 485.
- [42] A.N. Leznov and M.V. Saveliev, "Group methods for the integration of nonlinear dynamical systems", translated from Russian, Birkhauser Verlag 1992.
- [43] H. C. Liao, D. I. Olive and N. Turok, *Phys. Lett* **B298** (1993) 95.
- [44] P. Mansfield, *Commun. Math. Phys.* **98** (1985), 525.
- [45] P. Mansfield, *Nucl. Phys.* **B222** (1983), 419.
- [46] N. J. MacKay and W. A. McGhee, *Int. J. Mod. Phys.* **A8** (1993), 2791.
- [47] W. A. McGhee, *Int. J. Mod. Phys.* **A8** (1994), No. 15.
- [48] W.G. McKay and J. Patera, "Tables of dimensions, indices, and branching rules for representations of simple lie algebras", *Lecture Notes in Pure and Applied Mathematics (Volume 69)*, Dekker.

- [49] A.V. Mikhailov, M.A. Olshanetsky and A.M. Perelomov, *Commun. Math. Phys.* **79** (1981), 473.
- [50] M. R. Niedermaier, "The spectrum of the conserved charges in Affine Toda field theories", DESY 92-105, ISSN 0418-9833.
- [51] D.I. Olive and N. Turok, *Nucl. Phys.* **B257** [FS14] (1985) 277.
- [52] D.I. Olive and N. Turok, *Nuclear Physics* **B215** [FS7] (1983) 470.
- [53] D. I. Olive, N. Turok and J. W. R. Underwood, *Nucl. Phys.* **B401** (1993), 401.
- [54] D. I. Olive, N. Turok and J. W. R. Underwood, *Nucl. Phys.* **B409** (1993), 509.
- [55] D. I. Olive, M.V. Saveliev, and J. W. R. Underwood, "On a solitonic specialization for the general solutions of two-dimensional completely integrable systems", IMPERIAL-TP-92-93-13.
- [56] R. Rajaraman, *Instantons and solitons*, (1982) North Holland .
- [57] M. Toda *Phys. Reports* **18** (1975), 1; Theory of nonlinear lattices, *Springer Series in Solid State Physics* **20** (Springer, Berlin, 1981).
- [58] J. W. R. Underwood, "On the Topological Charges of Affine Toda Solitons", Imperial/TP/92-93/38.
- [59] G.M.T. Watts, "Quantum mass corrections for $c_2^{(1)}$ affine Toda solitons", DAMTP-94-27, hep-th 9404065.
- [60] G.Wilson, *Ergod. Th. and Dynam. Sys.* **1** (1981) 361.
- [61] A.B. Zamolodchikov and Al.B. Zamolodchikov, *Ann. Phys.* **120** (1979), 253.

