



Durham E-Theses

Evaluating the potential of internet GIS technology for managing and sharing diverse spatial information: A case study of the National Trust for Scotland

Petchey, Sarah Elizabeth Haidee

How to cite:

Petchey, Sarah Elizabeth Haidee (2007) *Evaluating the potential of internet GIS technology for managing and sharing diverse spatial information: A case study of the National Trust for Scotland*, Durham theses, Durham University. Available at Durham E-Theses Online: <http://etheses.dur.ac.uk/2417/>

Use policy

The full-text may be used and/or reproduced, and given to third parties in any format or medium, without prior permission or charge, for personal research or study, educational, or not-for-profit purposes provided that:

- a full bibliographic reference is made to the original source
- a [link](#) is made to the metadata record in Durham E-Theses
- the full-text is not changed in any way

The full-text must not be sold in any format or medium without the formal permission of the copyright holders.

Please consult the [full Durham E-Theses policy](#) for further details.

Evaluating the potential of Internet GIS technology for managing and sharing diverse spatial information: A case study of the National Trust for Scotland

The copyright of this thesis rests with the author or the university to which it was submitted. No quotation from it, or information derived from it may be published without the prior written consent of the author or university, and any information derived from it should be acknowledged.

By

Sarah Elizabeth Haidee Petchey

A thesis presented for the degree of Master of Science

University of Durham

Department of Geography

2007



12 JUN 2008

DECLARATION

The work contained in this study has not been submitted elsewhere for any other degree of qualification and that unless otherwise referenced is the author's own work.

STATEMENT OF COPYRIGHT

The copyright of this thesis rests with the author. No quotation from it should be published without prior written consent and information derived from it should be acknowledged.

Acknowledgements

I would like to thank my main supervisor, Dr. Danny Donoghue, for his support throughout this research project and encouragement to present my work at conferences.

Thanks also goes my second supervisor, Dr. Yongqiang Zong, for his contribution to the scoping out of this research and for his comments that were especially important during the later stages of writing this thesis.

I would like to express my gratitude to all the staff at the National Trust for Scotland for being generous with their time and participating in the interview and evaluation processes. I would especially like to thank Dr. Christopher Brooke for his advice and guidance and without whom this research would not have been possible.

I would like to thank my 'honorary supervisor', Dr. Patrice Carbonneau, for mentoring and coaching me on my presentation skills and for giving me the confidence to stand up in front of a lot of people!

A huge thank you goes to Shaun O'Callaghan and Rob Dunford for giving up their own precious time to provide technical support and programme the demonstration systems.

Finally, a special thanks go to my family and friends for keeping me sane and pulling me through the difficult periods of the past year.

Abstract

Emerging Internet GIS technology offers an attractive solution to some data interoperability problems by incorporating existing Internet framework standards, providing familiar web browsers as user interfaces and enabling access to data anywhere at anytime. This study investigates the capability of Internet GIS technology for managing and sharing data using the specific example of the National Trust for Scotland (NTS) as an internationally recognised non-governmental organisation uniquely responsible for the protection and conservation of both the cultural and natural heritage of Scotland.

This research first looks at the organisation and evaluates their perceived requirements through semi-structured interviews conducted at selected NTS properties and regional and central offices. The second stage demonstrates how these requirements can be addressed using Internet GIS technology, through the creation of three demonstration systems using two software packages, ArcIMS and ASPMap. ArcIMS was selected as an example of a commercial GIS software product and ASPMap as an example of a bespoke system. NTS staff then evaluated these demonstration systems through questionnaires and during a face-to-face feedback and evaluation session.

The specific case study is used to broach common sets of issues such as data access and interoperability, which are shared throughout many research sectors and are becoming more important with the fast developing nature of the Internet. The importance of interoperability and the benefits of adhering to metadata guidelines and open standards are discussed in conjunction with internal and external data sharing. Recent advancements in web service technology and their potential for inter-organisational data exchange are also discussed.

If pitched practically to address user's needs, an Internet GIS would be invaluable for a spatially oriented organisation like NTS. Results indicated that users required basic GIS functionality and favoured a bespoke approach, both for financial and practical reasons.

Table of Contents

DECLARATION.....	ii
STATEMENT OF COPYRIGHT.....	iii
ACKNOWLEDGEMENTS.....	iv
ABSTRACT.....	v
TABLE OF CONTENTS.....	vi
LIST OF FIGURES.....	ix
LIST OF TABLES.....	x
GLOSSARY OF TERMS.....	xi
CHAPTER 1: INTRODUCTION.....	1
1.1 RATIONALE.....	1
1.2 AIMS.....	3
1.3 OBJECTIVES.....	3
1.4 LITERATURE REVIEW.....	3
1.4.1 CONTEXTUALISING GIS.....	3
1.4.2 GIS: A SYSTEM OR A SCIENCE?.....	5
1.4.3 SOCIAL CONTEXT OF GIS.....	7
1.4.4 PROGRESSION OF GIS AND THE RISE OF 'INTERNET GIS'.....	9
1.5 BACKGROUND RESEARCH ON EXISITING INTERNET GIS: SYSTEMS AND APPROACHES.....	11
1.5.1 ACADEMIC LITERATURE.....	12
1.5.2 ONLINE EXAMPLES.....	13
1.5.3 DIRECT COMMUNICATION WITH ORGANISATIONS.....	14
1.6 SUMMARY.....	16
CHAPTER 2: METHODOLOGY.....	18
2.1 THE NTS CASE STUDY.....	19
2.1.1 PROPERTY SELECTION.....	20
2.2 INTERVIEWS.....	22
2.2.1 INTERVIEW SCHEDULES.....	25
2.2.2 CATEGORISING KEY REQUIREMENTS.....	27
2.3 NTS DIGITAL DATA COLLECTION.....	27
2.4 DEMONSTRATION MODELS.....	28
2.4.1 ASPMAP.....	29
2.4.2 ARCIMS.....	30
2.5 SYSTEM EVALUATION.....	32
2.6 SUMMARY.....	35

CHAPTER 3: INTEROPERABILITY IN THE CONTEXT OF GIS.....	36
3.1 DATABASES.....	36
3.2 METADATA.....	42
3.2.1 REVIEW OF THE 'PINTS' METADATA STANDARD.....	42
3.3 CENTRALISED AND DISTRIBUTED DATABASE DESIGN.....	45
3.4 CLIENT/SERVER ARCHITECTURE.....	47
3.5 STANDARDS.....	51
3.6 SOA AND WEB SERVICES APPROACHES.....	53
3.7 SUMMARY.....	54
CHAPTER 4: RESULTS AND INTERPRETATION.....	56
4.1 USER REQUIREMENTS.....	56
4.2 DESIGN AND IMPLEMENTATION OF DEMONSTRATION SYSTEMS.....	61
4.2.1 SEARCHING.....	63
4.2.2 IDENTIFYING AND SELECTING FEATURES.....	66
4.2.3 RASTER LAYERS AND IMAGES.....	67
4.2.3.1 ORDNANCE SURVEY MAPS.....	67
4.2.3.2 HISTORICAL MAPS.....	68
4.2.3.3 IMAGES.....	70
4.2.4 EXTERNAL DATA.....	72
4.3 PROPRIETARY VS. BESPOKE.....	74
4.3.1 EVALUATION OF THE SOFTWARE.....	74
4.3.1.1 ARCIMS – SYSTEM I.....	75
4.3.1.2 ARCIMS – SYSTEM II.....	76
4.3.1.3 ASPMAP.....	77
4.3.1.4 COMPARISON OF ARCIMS AND ASPMAP.....	78
4.3.1.4.1 STORAGE SPACE REQUIREMENTS.....	78
4.3.1.4.2 FUNCTIONALITY.....	79
4.3.1.4.3 PROGRAMMING AND CODING.....	80
4.3.1.4.4 FLEXIBILITY.....	81
4.3.1.4.5 INTERFACE DESIGN.....	81
4.3.2 EVALUATION OF THE APPROACH.....	83
4.4 CRITIQUE OF INTERNET GIS FOR NTS.....	88
4.4.1 ORGANISATIONAL.....	88
4.4.2 PUBLIC PARTICIPATION.....	89
4.4.3 CORPORATE MEMORIES.....	90
4.4.4 DATA INTEGRITY.....	91
4.5 SUMMARY.....	92

CHAPTER 5: DISCUSSION.....	93
5.1 DATA SHARING.....	93
5.1.1 INTEGRATING WEB SERVICES.....	94
5.2 CRITIQUE OF INTERNET GIS FOR PPGIS AND DECISION-MAKING.....	96
5.2.1 ACCESSIBILITY.....	97
5.2.2 USABILITY/INTERFACE DESIGN.....	98
5.2.3 USER PREFERENCE.....	99
5.3 LIMITATIONS.....	99
5.3.1 CRITIQUE OF THE METHODOLOGY.....	99
5.3.2 TECHNICAL ISSUES.....	102
5.3.3 OS MAPS.....	103
5.4 THE FUTURE OF GIS?.....	105
5.5 SUMMARY.....	107
CHAPTER 6: CONCLUSION.....	108
6.1 FUTURE RESEARCH DIRECTIONS.....	111
REFERENCES.....	112
APPENDIX I.....	121
APPENDIX II.....	124
APPENDIX III.....	128

List of Figures

<i>Figure 1.1</i>	New definition for GIS.....	6
<i>Figure 1.2</i>	Screen capture of the PastMap Internet GIS.....	14
<i>Figure 2.1</i>	Three-tier physical structure of NTS.....	19
<i>Figure 2.2</i>	Location map of Balmacara Estate.....	20
<i>Figure 2.3</i>	Location map of Newhailes House and gardens.....	22
<i>Figure 2.4</i>	(a) Architecture of ASPMap.....	30
	(b) Overarching Internet architecture	
<i>Figure 2.5</i>	Architecture of ArcIMS.....	31
<i>Figure 2.6</i>	Aspects and major implications of usability.....	33
<i>Figure 3.1</i>	Holiday cottages renting database set to 2NF.....	39
<i>Figure 3.2</i>	The five main components of a database management system environment.....	40
<i>Figure 3.3</i>	Possible hardware architecture for establishing a distributed database framework with NTS.....	46
<i>Figure 3.4</i>	The relationship between first generation specifications and web Services.....	53
<i>Figure 4.1</i>	Screen capture of the results of a search query executed in the first ArcIMS demonstration system.....	63
<i>Figure 4.2</i>	Screen capture showing a customised task for searching by PINTS code for Newhailes property data.....	65
<i>Figure 4.3</i>	OS map resolution for Balmacara Estate.....	68
<i>Figure 4.4</i>	Screen capture showing the linking of images to the collections database in the ASPMap demonstration system.....	70
<i>Figure 4.5</i>	Screen capture illustrating the hyperlink feature connecting NTS and SNH data.....	73
<i>Figure 4.6</i>	A typical GIS productivity curve.....	84
<i>Figure 5.1</i>	A logical representation of a service-oriented integration architecture.....	94
<i>Figure 5.2</i>	Two screen captures indicating display differences between web browsers.....	103

List of Tables

<i>Table 2.1</i>	Key features of the Balmacara Estate property.....	21
<i>Table 3.1</i>	Holiday cottages to rent at Balmacara and Brodick.....	37
<i>Table 3.2</i>	Bookings for holiday cottages to rent at Balmacara and Brodick properties.....	38
<i>Table 3.3</i>	Metadata elements for geographic datasets.....	44
<i>Table 3.4</i>	Differences between applets and plug-ins.....	49
<i>Table 3.5</i>	Strengths and weaknesses of server-side and client-side approaches.....	50
<i>Table 4.1</i>	Grid chart of user requirement results.....	59
<i>Table 4.2</i>	Summary table showing the comparison of key features between ArcIMS and ASPMap.....	82

Glossary of Terms

ECW – *Enhanced Compression Wavelet*

Enables image files to be compressed whilst retaining their spatial projections

GIF – *Graphics Interchange Format*

An 8-bit-per-pixel bitmap image format that uses the LZW compression technique

GML – *Geography Markup Language*

An XML-based encoding for transport and storage of spatial and non-spatial geographical information

HTML – *HyperText Markup Language*

Describes how each element should be displayed on the web browser. Cannot be used to code spatial features

HTTP – *HyperText Transfer Protocol*

Stateless communication protocol between web browser and web server

JPEG – *Joint Photographic Experts Group*

Standardised image compression mechanism for full-colour (24 bit) or grey-scale digital images

KML – *Keyhole Markup Language*

A language based on the XML standard that uses a tag-based structure with nested elements and attributes. Specifically used for Google

SOAP – *Simple Object Access Protocol*

A particular type of XML message

SVG – Scalable Vector Graphics

An XML-based language that describes images, particularly how they should be displayed in the web browser

UDDI – Universal Discovery, Description and Integration

A searchable registry database or network directory containing web service descriptions

WMS – Open GIS Web Map Server

Provides three operations: GetCapabilities (defines what types of map a server can deliver), GetMap (defines how to request and provide a map as a picture or set of features) and GetFeatureInfo (defines how to get information about the contents or features of a map)

WSDL – Web Services Definition Language

Describes the contents and functions of individual web services

XML – Extensible Markup Language

A general purpose markup language, primarily used to facilitate the sharing of structured data between systems and across the Internet

Chapter 1: Introduction

1.1 Rationale

Common problems of data sharing and interoperability are becoming increasingly apparent in today's modern environment where instantaneous information retrieval is commonplace, particularly through the virtual and global medium of the Internet. Often, as organisations have evolved, they have accumulated large datasets with no clear guidelines as to how the data should be managed and recorded, which has resulted in data being stored in multiple formats. Equally, the software packages that have been used over time to store the data have no overarching standards to comply with and are regularly incompatible with each other. This means that exchanging datasets both within as well as between organisations can be extremely difficult. As more technology and associated standards are being constantly introduced and extended, it is essential to conduct research into this.

The National Trust for Scotland (NTS) is an excellent organisation to use as a case study to explore issues of data management and interoperability. It is an internationally recognised non-governmental organisation with public responsibility for the protection and conservation of both the cultural and natural heritage of Scotland. In this respect it is unique as most organisations are concerned with either one or the other and it is this interdisciplinary nature that fuels academic interest as well as the enthusiasm of around 300,000 members that presently subscribe to the Trust. NTS is custodian to a wide variety of properties, including islands, coastland, countryside, gardens, castles, estate houses and so forth, so consequently needs to manage an extremely diverse set of data for this large portfolio of properties.

However, there is currently no single point of entry into the data, as it is stored in a variety of software packages, from Microsoft Word, Excel and Access to paper documents and emails. As NTS have to make spatially-based management decisions on a daily basis, it is essential that all relevant data is easily accessible so that decisions are as informed and accurate as possible. One occasion when these issues were exposed was when the potentially severe error of bracken spraying that was scheduled to take place within the vicinity of nesting sea eagles was averted more by



accident than design. If all the data was standardised and held in a central location so that it was easily accessible, oversights like this would not occur.

This need to manage diverse spatial data makes NTS a prime candidate to utilise a GIS. Increasingly, people are adopting GIS solutions as the developments in computer and information technology are becoming more and more impressive, particularly in relation to the extension of GIS on to the Internet (Yong *et al*, 2005). As NTS is a registered charity it has a greater opportunity for using GIS now that the software can be disseminated across the Internet, removing the need to purchase multiple desktop licenses (Peng and Zhang, 2004). Additionally, by placing GIS on to the Internet all the fundamental and essential standards that are written for this environment, such as HTML and HTTP, have to be immediately adopted within the GIS framework. This instantly removes part of the problems associated with interoperability and compatibility (Chang and Park, 2006).

Whilst the reason for many organisations wanting to integrate an Internet GIS is clear, their potential is often seriously underused, especially by UK organisations (Davies and Medyckyj-Scott, 1996) that have not thought through their implementation properly. This can be both because people don't know enough about the technology and therefore do not see the potential of GIS (Alterkawi, 2005) or conversely, because people try to do too much with the system that it becomes impractical to use. So, whilst the huge potentials are very attractive, it is important that the use of the technology and its implementation is not guided by what it can do but focuses on what users actually need (Appleton and Lovett, 2003).

Therefore this project will look at some current Internet GIS technologies and the various possibilities for developing them for an organisation that needs to manage and share diverse spatial conservation information, taking into account user needs and requirements. This research provides the unique opportunity to work with an organisation that can provide an honest and critical assessment of the technologies and provide an insight into the possible effects of integrating a GIS into the organisation. This is something that is rather unusual in the published literature for two reasons. First, a large proportion of previous research has focused on technological advances of GIS rather than the environment into which the system is

being introduced (Reeve and Petch, 1999). Secondly, it will concentrate more on the actual effect a system could have on an organisation for assisting staff in their roles, rather than the typical descriptive studies of the use of GIS in multiple application areas (Davis and Medyckyj-Scott, 1996).

1.2 Aims

The main aim of this project is to evaluate the potential of current proprietary and bespoke Internet GIS technologies for managing and sharing diverse spatial information, in terms of their technical capabilities and usability in an institutional context.

1.3 Objectives

To achieve these aims there are more specific objectives, which are:

1. Establish the needs of the organisation and the background for change
2. Obtain user needs and requirements
3. Create demonstration models using two Internet GIS technologies
4. Evaluate the software and the different approaches used
5. Evaluate the potential of using the Internet/Intranet for data sharing
6. Consider database design and briefly review the NTS metadata standard 'PINTS'

1.4 Literature Review

1.4.1 Contextualising GIS

“Geographical Information Systems (GIS) is much more than just an automated mapping system, as its real power comes from its ability to store and manipulate spatially related information” (Heikkila, 1998, p. 351). Whilst the ‘power of maps’ has long been realised (Kitchen and Tate, 2000), it is the multi-dimensionality of GIS that has captured and held widespread attention since its emergence as a new technology in the 1970’s.

Traditionally GIS has been placed within the geography discipline, although in reality it actually integrates concepts and methods from a wider variety of equally distinct subjects, such as spatial analysis, cartography and database management (Unwin, 1991). It is because of this interdisciplinary nature that people find it difficult to define and is partly the reason why it is still widely researched. As the responsibility fell to geographers they attempted to place GIS within an existing geographical framework, noting that GIS is inherently linked with the positivist philosophy (Lake, 1993). It is unhelpful that the term 'positivism' is shrouded in ambiguity, but essentially it utilises quantitative methods with the aim of identifying general laws by looking for order and regularity. In other words, "it emphasises, via mapping and spatial analysis, what is observable and measurable" (Fotheringham 2006, p.5). It is this link with positivist thinking which initiated the first major wave of criticism of GIS between 1990 and 1994, with fears of a 'naïve empiricism' flooding the geography discipline (Taylor, 1990). Whilst this debate occurred specifically within geography and does not reflect large-scale feeling it is important to understand the wider underlying concepts behind GIS so that we do not go through the practical motions without appreciating the motivations behind them (Unwin, 1991).

In parallel to the geography perspective, the analytical power and versatility of GIS meant that many other sectors were progressing with the development of GIS technology. This is reflected by four overlapping stages with varying rates of progression (Coppock and Rhind, 1991). The first stage was the pioneer/research frontier in the 1950's-1975, closely followed by formal government-funded research into the early 1980's. As the value of GIS was realised the commercial phase took over. However, as the competition between vendors is ever increasing this is giving way to a new stage of user dominance, giving people more control. These stages mirror the very different motivations for GIS development over the years and depending which of these angles are taken GIS can be seen as either a valuable technology or a set of concepts (Unwin, 1991).

Where the focus has been on GIS as a technology, the primary aims have been to train in its use or work towards furthering its technological capability. Conversely, in sectors where GIS is viewed more as a group of concepts, particularly within the academic arena, the primary focus has been to promote education in its underlying

philosophy. However both of these are also inherently linked, since the development of GIS capability is connected to rapid technological advances (Morrison, 1991), which is also being aided now by increased data availability.

1.4.2 GIS: A system or a science?

From its inception, GIS was relatively easy to define. The predominant motivation behind GIS was to be able to transfer paper maps into digital form on the computer, thus creating the system by which to achieve this *was* the science (Gold, 2006). However, the incorporation of many sub-disciplines and sectors into this rapidly developing research area widened the views of what a GIS is, from a substitute for paper maps into a repository for geographical data and on to representing a model of reality (Egenhofer and Kuhn, 1999). So as GIS has evolved, the system alone is now no longer enough and there has been a substantial shift in placing the emphasis on the underlying science.

This shift has been clearly noted within the academic literature, with the well-known journal '*International Journal of Geographical Information Systems*' being renamed '*Science*' in 1998. As academic journals provide a chronological record of changing ideas over time, a cross-section through this journal between 1987 and 2006 can reveal that the general subjects being researched altered in focus over the years, from technical database and information systems articles to begin with into modelling, design approach and interoperability. So, the emphasis has been taken away from developing systems for specific isolated applications to re-focus on the core concepts and fundamental capabilities of GIS and how these can link systems together (Chrisman, 1999). Obviously that is not to say that the technical considerations and advances are less important, in fact almost the opposite is true since concepts such as interoperability are by nature highly technical, so it is simply that a more considered and rounded approach is now being favoured.

In re-focussing the boundaries of GIS, a revised definition is required that encompasses these aspects. Many definitions exist for an interdisciplinary subject like GIS, as have already been discussed, but defining the term is an essential, though

often undervalued necessity required for communication across such vastly different sectors.

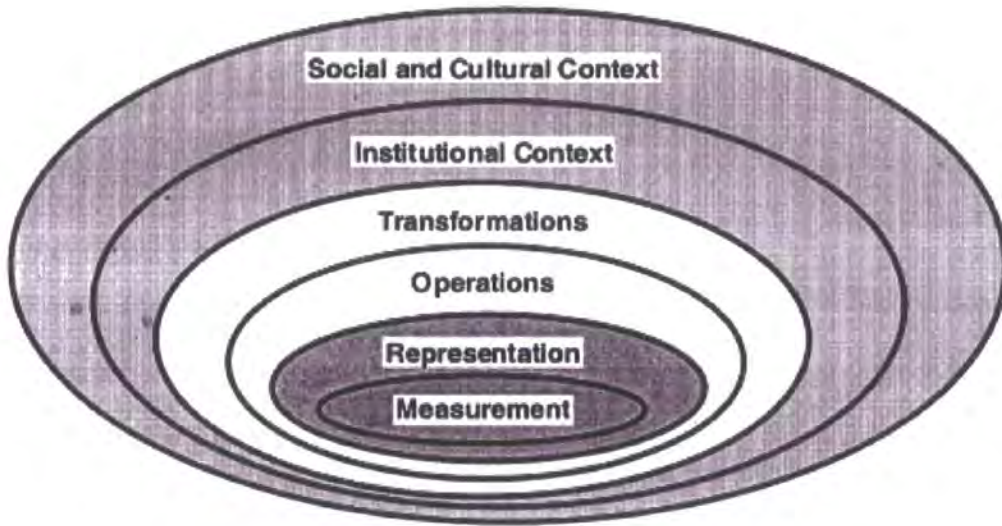

Figure 1.1: New definition for GIS: Nested rings that embed the decisions involved in operating a GIS. Each ring encapsulates the more technical decisions inside, mobilising them in a more complex structure (Chrisman, 1999, p. 184)

Figure 1.1 illustrates a new definition for GIS proposed by Chrisman (1999). This clearly illustrates the shift away from the core systems view of GIS and encompasses the dynamic interplay between disparate geographical phenomena and processes and their representation and inter-relationships. The outer rings demonstrate the changing focus from an isolated GIS to incorporating the wider social and institutional contexts.

Whilst it is essential for GIS to evolve and its boundaries be redefined, it is important that the justification for this is clearly expressed and that all components are fully integrated. If this procedure is not followed, there is a risk of fragmenting GIS into 'social' and 'technical' components, which then operate independently of each other. This is not unlike the physical vs. human divide that exists within 'geography', which some believe will ultimately lead to a split in the discipline (Fotheringham, 2006) and the formation of multiple sub-disciplines. A division would be disastrous for GIS since its success is dependent on its ability to seamlessly integrate and appeal across many subjects. Therefore, the changing definition of GIS to a 'science' should not mean that the 'system' is forgotten, but that the system is just once aspect that needs to be considered within the context of the science behind GIS.

1.4.3 Social context of GIS

The social context of GIS has become more important in recent years for a couple of reasons. Firstly, as more focus has been directed on the scientific concepts behind GIS it has been increasingly recognised that GIS cannot be divorced from the social context of its creation (Aitken and Michel, 1995). In other words, political, economic and social motivations affect all levels of GIS development and as such, hidden power structures and complex relationships will be contained within the GIS design. By encompassing multiple ideologies and ways of thinking into the whole development process of creating the system, GIS should therefore be considered as a social construction (Aitken and Michel, 1995). Even the data itself which the system is based around has been created by someone and as it is commonly recognised that a GIS is only as good as the data in which it is derived from (Aitken and Michel, 1995), it seems that the social context of its creation is indeed something that cannot be ignored.

Secondly, in recognising the social construction and context of GIS there has been a change in the perception of the host 'organisation'. Reeve and Petch (1999) outline three key shifts in thinking. The first phase was a period of 'technical determinism' whereby the inherent superiority of any new technology was believed to guarantee its acceptance within an organisation. 'Managerial rationalism' followed this by which point some consideration was given to the complexity of the organisation and it was recognised that implementing a new technology would require some internal adjustment. However, the overriding view was still that the organisation would be amenable to any new system.

The current mode of thinking is termed 'social interactionism' and appreciates that the 'organisation' contains very complex social structures and therefore any new technology must be developed with this in mind, as a system will not be automatically accepted (Reeve and Petch, 1999). This is a very important concept to bear in mind then since it is the organisation that will ultimately decide the success or failure of a GIS. Therefore, if an organisation's needs are not considered when designing the system it will become little more than 'expensive junk' (Reeve and Petch, 1999). This changing perception of the importance of the 'organisation' ties in with the shift in

thinking of GIS as a science rather than a system, thereby justifying the inclusion of the 'institutional context' and 'social and cultural context' components to the new definition of GIS (*Figure 1.1*).

As the definition of GIS changes to include the social and institutional contexts as well as the system itself, methodological approaches to GIS studies must also change in order to facilitate a combined assessment. A revised interdisciplinary framework that includes social science research methodologies alongside traditional information technology assessments is therefore required. Consequently the methodology for this study focuses on the dynamics of the organisation and user requirements of its staff alongside a technical assessment of demonstration systems.

Finally, as GIS has become a powerful force in planning practice (Aitken and Michel, 1995) its potential for aiding public participation practices has been recognised. Traditionally, public participation has been limited to three levels: 'the right to know', 'informing the public' and 'the public's right to object'. However, GIS enables people to incorporate and integrate spatially their local knowledge of an area and interact dynamically with the GIS to analyse policy making and planning decisions (Sieber, 2006). This sense of being able to voice their opinions provides empowerment to individuals and groups and can also benefit policymakers, enabling them to make more informed decisions using the wealth of local knowledge.

Although many people do recognise the advantages that GIS has to contribute to public participation, its ability to overcome existing limitations of the process is often overstated (Barndt, 2002). Public Participation GIS (PPGIS) is seen by some to be removing the elitist criticism of GIS, but at the same time can be argued to be entrenching GIS within an increasingly positivist framework, another former criticism of GIS. It requires users to quantify their opinions and reduce complex social processes into points, lines and areas (Sieber, 2006). In spite of these concerns, the evolution of Internet GIS has highlighted the possibilities of broadening the engagement of public involvement in decision-making by making GIS more accessible (Sieber, 2006). By transferring this process into a public arena like the Internet, a higher level of participation is achieved that works across the boundaries between public and private sectors (Aitken, 2002).

One of the main reasons why transferring PPGIS projects onto the Internet has been successful is because it fits into the social context of modern life, whereby practically everyone either has a computer or access to one and almost everything is available on the Internet at the touch of a button. Having recognised and used this context, an Internet PPGIS is able to reach the maximum number of people in a way that is already familiar to them, reinforcing the importance of considering the social contexts of the target audience. Furthermore, as it appears to be just another website, people do not realise they are actually using a GIS. Many examples of this exist, including software packages like Google Earth, which is discussed further in chapter five. On the one hand, it is a significant improvement for people to be able to use the system without specialist training in GIS software. However, there comes a point when the user will need to understand the underlying science behind the system in order for it to be of practical use. This further reinforces the importance of considering GIS as a science as well as a system.

1.4.4 Progression of GIS and the rise of 'Internet GIS'

Unsurprisingly, as the recognition of the potential and flexibility of GIS increased, the demand for access to it rose sharply in many sectors, rendering the traditional desktop GIS or 'personal GIS' insufficient (Heikkila, 1998). In this scenario, every user who wished to have access to GIS was required to purchase a desktop software package and was unable to access their information from anywhere other than that desktop computer. For the general public and any small organisations that lacked the necessary resources, this was entirely impractical and was what helped to fuel the criticism that GIS is an elitist technology (Peng and Zhang, 2004). Additionally, the complex user interface of the software resulted in a steep learning curve for users, further narrowing the scope of potential users to those with at least some knowledge of GIS. A final limitation of desktop GIS was the lack of interoperability between the various software packages, preventing data sharing, as each commercial group creates their programmes in isolation to the particular standards they chose to adopt.

In response to these issues, researchers began looking into the option of 'Internet GIS' as a progression and improvement to the traditional personal system. By transferring this technology on to the Internet many of the limitations of desktop GIS were

eliminated. Users could now have access to their geospatial data anywhere at anytime, which is highly desirable considering the ever-increasing pace of modern life and shift into more virtual and global work environments. Also, by utilising the more familiar Internet web browsers as user interfaces, it removed part of the complexity of GIS systems instantly, enabling easier manoeuvrability around the system (Martin *et al*, 1998; Peng and Zhang, 2004). Naturally, in moving the system on to the Internet, all the fundamental and essential standards that are written for this environment had to be immediately adopted within the GIS framework, removing some of the problems associated with interoperability and compatibility. Placing the software on to a system that is more accessible went a long way to making people aware of GIS and popularising its use (Carver *et al*, 1997).

However, whilst this development offered many solutions to existing problems, it is by no means a perfect ready-made environment for GIS and presents many challenges of its own. Firstly, putting GIS technology on to the Internet is not entirely straightforward. For example, the existing framework of the Internet was believed to aid interoperability, but the two major web technologies that Internet GIS had to rely on: HyperText Markup Language (HTML) and HyperText Transfer Protocol (HTTP) are insufficient for the specialised software. In response to this, client-side applications have been developed such as plug-ins and Java applets and specifications like Extensible Markup Language (XML) have been used to create more geography-specific computer criteria. Both Geography Markup Language (GML) and Scalable Vector Graphics (SVG) are based on the XML schema. GML “enables modelling, transport and storage of geographic information, including both spatial and non-spatial properties” and SVG improves image display in web browsers (www.opengeospatial.org).

Secondly, as is the tendency with a lot of new and emerging technologies, there is confusion arising from the inconsistent use of evolving terminologies. Although the term ‘Internet GIS’ has so far been used when referring to this development, there are actually four separate terms that are often used interchangeably, which although they look reasonably similar, actually have slightly different meanings. The term ‘Internet GIS’ refers to the use of the Internet as a means of exchanging data, performing GIS analysis and presenting results (Mathiyalagan *et al*, 2005). ‘Web-based GIS’ is

specifically referring to the use of the World Wide Web (WWW), a networking application that runs on top of the Internet using HTTP (Peng and Tsou, 2003). 'Distributed Geographical Information' actually includes 'Internet GIS', using Internet technologies to distribute information, removing the need to install GIS programmes on to user desktops. Finally, 'Web GIS' is a GIS distributed across a computer network, disseminating geographical information across the WWW (Peng and Tsou, 2003). Although it is important to be aware and understand these variations in meanings, we need to be careful that we don't over-complicate the situation and end up arguing about the meaning of every single term. For the purposes of this project the general term 'Internet GIS' will be used, although any necessary distinctions will be made within chapter four.

'Internet GIS' is not therefore by any means a final product and is constantly changing and improving. Despite several obstacles that still need to be addressed, many scholars see the Internet as the arena for future development within the field of GIS. In the public and private sectors of the UK too, Internet GIS is expected to play a major role in policy as up to 80% of decision-making here is based on spatial analysis of one sort or another (Peng and Zhang, 2004), and desktop GIS is certainly not going to meet these needs. The wide reaching nature of this technology over so many sectors throughout the UK has even led to the suggestion of a 'digital democracy' emerging in the not too distance future (Carver *et al*, 1997). This is mirrored though by concerns of GIS becoming yet another tool for government surveillance (Sieber, 2006), as some systems integrate and analyse personal information on individual's beliefs, possessions and lifestyle (Curry, 1998). Although these are important ideas to consider, Goodchild (1995) warns that presenting these dramatic debates may overshadow the potential benefits and applications of GIS.

1.5 Background research on existing Internet GIS: systems and approaches

As the popularity of GIS has increased over the last decade more and more organisations have taken the opportunity to invest in a system. Researching and evaluating what organisations with similar needs and issues to NTS have already done provides a firm foundation of knowledge and an insight into some existing practical applications. It is difficult for organisations to learn about GIS due to a lack of accessible literature. Even within the academic environment, few peer-reviewed

papers are readily and easily available as they often appear within grey literature published in conference proceedings.

1.5.1 Academic literature

Academic literature provides an excellent record of the changing attitudes towards the approach to GIS over the years. The changing perception of 'organisations' has already been discussed and practical examples of this transition have been documented within the literature. Tulloch (2002) discusses this very thing using an example from New Jersey. The New Jersey Department of Environmental Protection (NJDEP), founded in 1997, started to distribute specially attained licenses of ESRI's ArcView software package to local government agencies and environmentally orientated NGO's. However, it was recognised that these organisations would require help in understanding and using the software, so the New Jersey Non-Profit GIS Community (NGC) was founded by a GIS specialist and offers non-profit organisations "facilities with technical and conceptual support for projects requiring the use of GIS technology" (Tulloch, 2002, p. 197). This type of set-up where a specialist external organisation is called on to provide technical support and advice on GIS for non-profit organisations would be particularly valuable for a charity like NTS and may well be the scenario which will emerge in the future.

Another example within the literature that focuses on the organisations needs and has close ties to the NTS situation is discussed by Tsou (2004). In this example, the desired Internet GIS system was for environmental monitoring and natural resource management and ArcIMS was the software selected. Rangers and habitat monitors required the system in order to conduct tasks like querying the location of sensitive species and efficiently updating the databases, which ties very closely to the property management tasks within NTS. It would be highly useful if selected people were able to update the information, thus retaining data integrity. Additionally, using the Internet for their system removed the need to install expensive software and enabled people to access the system anywhere, another requirement for a decentralised organisation like NTS. An Internet system was also recognised as being a valuable tool for education and public learning, which again is a target for NTS.

Finally, a more recent paper by Jankowski *et al* (2006) presented a methodology for a user-based design and evaluation of a collaborative spatio-temporal decision support system (C-SDSS). This interdisciplinary methodology is very similar to the one employed in this study. The fact that it is published within a leading GIS journal is testimony to the increasing importance that is being placed on this approach and will hopefully encourage other similar research projects.

1.5.2 Online examples

The academic literature provides an overall research approach to GIS and Internet GIS, but it is interesting to search the Internet for existing systems and to consider approaches from a commercial perspective. Geowise is a company that can be commissioned to help organisations set-up Internet GIS solutions and on their website (www.geowise.co.uk) are two demonstration case studies, English Nature and UK Forestry Commission. The Geowise report states that English Nature wanted an intuitive web mapping tool that was fully integrated into their website so that members of the public could easily view the locations of designated sites for conservation, aiding public participation and learning. The report also highlighted that English Nature, like NTS, was interested in exploring the possibility of data sharing with their partners (like DEFRA) and therefore required interoperable links.

The second case study on the Geowise website, UK Forestry Commission, is unlike NTS in that the report states the organisation already possessed a number of ArcIMS-based web mapping applications, but similar because they have a relatively small in-house GIS team and wanted to maximise staff time in order to rapidly disseminate a large number of applications throughout the organisation. Geowise developed an Internet Mapping Framework (IMF), which primarily is a method for making centrally held spatial datasets available to a wide range of users but also enables complex spatial and attribute queries to be performed. Both of these examples used ArcIMS software and are reported as successful on the website.

These two examples are very interesting and the fact that they can be found by conducting a simple Internet search means that they are easily accessible to any organisation wishing to find out more about Internet GIS. However, because this information is usually found on commercial vendors websites it is likely to be

somewhat biased. The website also does not provide the opportunity to access the systems in order to test the functionality.

One example that can be tested online however is an Internet GIS system called PastMap (figure 1.2), which is a joint venture between Historic Scotland and the Royal Commission on the Ancient and Historical Monuments of Scotland (RCAHMS).

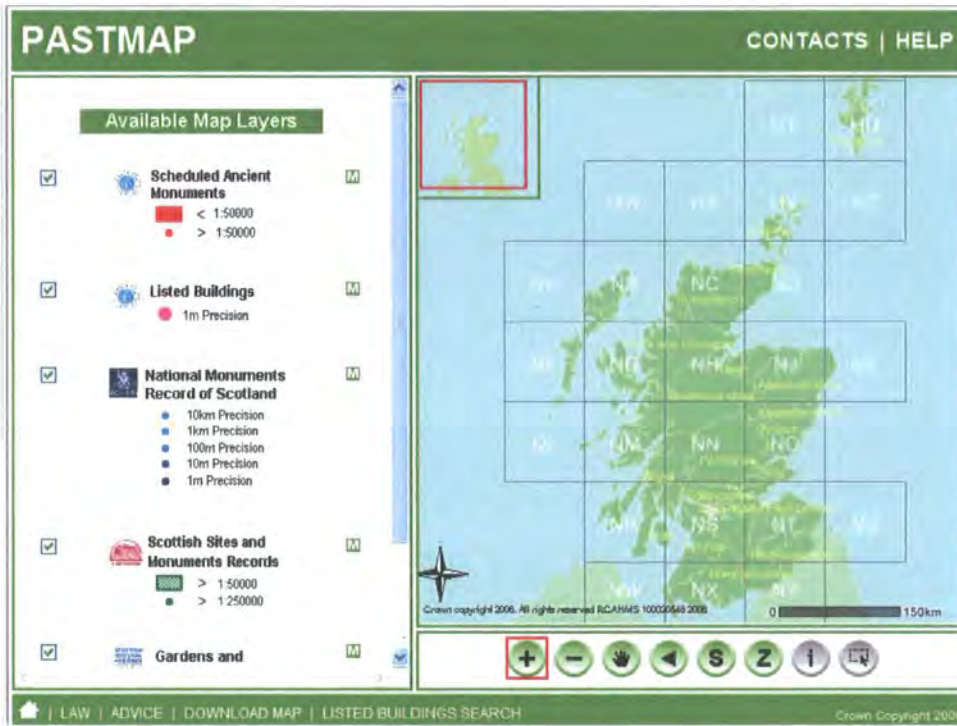

Figure 1.2: Screen capture of the PastMap Internet GIS system (www.pastmap.org.uk)

These two organisations have selected to use the ESRI ArcIMS software, but have opted to heavily customise it for their purpose. From using the system, it provides easy access to a wealth of information held by both the RCAHMS and Historic Scotland and provides some GIS functions to allow basic querying of the underlying database. Although it is extremely beneficial to be able to register and test this system from a public user perspective, it still doesn't answer the question as to whether the system actually achieves the goals that were set out at the start of the project.

1.5.3 Direct communication with organisations

Direct communication with the organisations themselves is therefore preferable. As part of this research two informants from RCAHMS and Historic Scotland were

interviewed and the PastMap website was discussed. The main objective behind the project was to make a wide range of information available and promote access to it, so it is evident that the functionality of this Internet GIS system does fulfil the requirements. Feedback these organisations have received from the public however is mixed. Some people can use the system daily without any problems, whereas others are reluctant to use the GIS tools, possibly because they are unfamiliar and seem complex. This would suggest that the system has been pitched quite well at its audience as many people can easily utilise it, but that it could possibly benefit from some more detailed instructions, as there will always be people who are not used to the functionality.

In terms of software, the choice of using ArcIMS was made through convenience as RCAHMS can receive ESRI products through the CHEST agreement. When the joint venture with Historic Scotland commenced, ArcIMS was the obvious choice. However, Historic Scotland had little experience with the commercial package, therefore, in a similar way to the New Jersey example discussed earlier (Tulloch, 2002), a GIS officer from RCAHMS provided technical support for Historic Scotland until they were comfortable using the system. As these two organisations have a direct association with NTS, this sharing of technical experience and skills as well as data is liable to be extremely important in the near future.

Another organisation that NTS may want to share data with is the Royal Society for the Protection of Birds (RSPB). As part of this research, a meeting between RSPB and NTS was attended to discuss their experiences. Although their GIS has not yet been disseminated on to the Internet, their experience does provide a useful case study. Their system has the commercial software MapInfo as the front end and a customised database behind it to provide a more user-friendly entrance into the system. However, one of the issues in this example is the time it takes to create a GIS and get all the data into the correct format. It took RSPB ten years to create their system and even then there have been later enhancements and there are now further plans to re-develop the system to take advantage of newly emerging technology, especially for the Internet. This clearly highlights the rapid pace of development within this sector and emphasises the need for organisations to communicate about technological issues in

order to ensure that the systems they are now creating have the ability to be interoperable.

Reviewing the experience of other organisations is invaluable as a means of discovering the general themes and issues have arisen already. Although each source of information has its benefits, even information obtained from direct communication with organisations is liable to be presented uncritically, as people have a vested interest in their own systems. Even academic research within this field, which is more neutral in its motivation, has its own obstacles and associated problems. Researchers can only visit those organisations that are willing to participate but the effectiveness of these visitations are limited by the levels of staff co-operation and time available (Davies and Medyckyj-Scott, 1996). This raises the question of how to get a meaningful critique and illustrates the value of this project in being able to work closely within an organisation and obtain an honest and critical evaluation of the Internet GIS demonstration systems.

1.6 Summary

This chapter has sought to provide an overview and introduction into the shifting concepts of GIS. It is important to review the current thoughts and ideas surrounding any topic, but especially one like GIS that is rapidly evolving, before undertaking a project on it so that an informed research design is selected. Emerging revisions of the definition of GIS clearly indicate the increasing importance of considering the social and institutional contexts into which the system is integrated, as this will strongly impact on the success or failure of the initiative. Therefore, an interdisciplinary methodology that addresses this finding has been selected for this study.

Internet GIS has been clearly shown to offer valuable benefits over desktop GIS solutions, as it can be distributed across the network to all users, removing the need to purchase multiple expensive desktop licenses, as well as offering a more user-friendly entrance into previously exclusive specialist software. This is also reflected in the decision to place PPGIS projects onto the Internet. However, it is often difficult to ascertain reliable information on the relative success of existing Internet GIS ventures though, as illustrated by the lack of peer-reviewed academic literature and the bias of Internet-based vendor reports. This study aims to address this and in accordance with

the aims and objectives set out in this chapter, the specific methodology selected for this project will now be discussed in the following chapter.

Chapter 2: Methodology

The previous chapter discussed the shift in thinking of GIS as a science rather than a system, thereby placing increasing emphasis on considering the social and institutional context into which it is being applied. This changing philosophy has consequently impacted on the way that research into GIS is being conducted.

This research project focuses on information systems and the way they can be used to manage spatial data. However, in light of the findings outlined in the previous chapter, any research project into GIS needs to move away from a purely technical analysis and also consider the user's interaction with the system. Therefore, in addition to the technical evaluations of the demonstration system, another important component of this methodology was the consideration of Human-Computer Interaction (HCI) and system usability.

The working definition of HCI is "a discipline concerned with the design, evaluation and implementation of interactive computing systems for human use and with the study of major phenomena surrounding them" (Haklay and Tobón, 2003, p. 578). Research within this discipline therefore focuses on designing and implementing a GIS based upon the needs and capabilities of prospective users. Adopting this multidisciplinary approach recognises the fact that the technology and the environment into which it is being placed are intrinsically linked. It also means that several research techniques, from social science to information technology studies, can be fused together, thus strengthening the framework in which this research operates.

The methodology for this research therefore consisted of three key stages. This began with attendance at Core Data Model meetings at central office in order to get an understanding of the organisation. One-to-one semi-structured interviews were also conducted with key users to ascertain their requirements for an Internet GIS. The second stage was to create demonstration systems using data from two selected NTS properties in two Internet GIS software packages: ASPMap and ArcIMS. ASPMap was chosen as an example of a bespoke approach and ArcIMS as it is currently the leading commercial Internet GIS software package. The final stage was the evaluation

of these demonstration systems by NTS staff to help inform an analysis of the software packages and their suitability for integration into an organisation like NTS to meet user requirements.

As the nature of the organisational set-up of NTS directly impacted the way these methods were implemented, the structure of NTS shall be briefly discussed and then used to justify the selection of the two NTS properties chosen for this study. Further discussion of the actual methods themselves shall then follow.

2.1 NTS case study

The organisational structure of NTS is based on a three-tier system (*figure 2.1*).

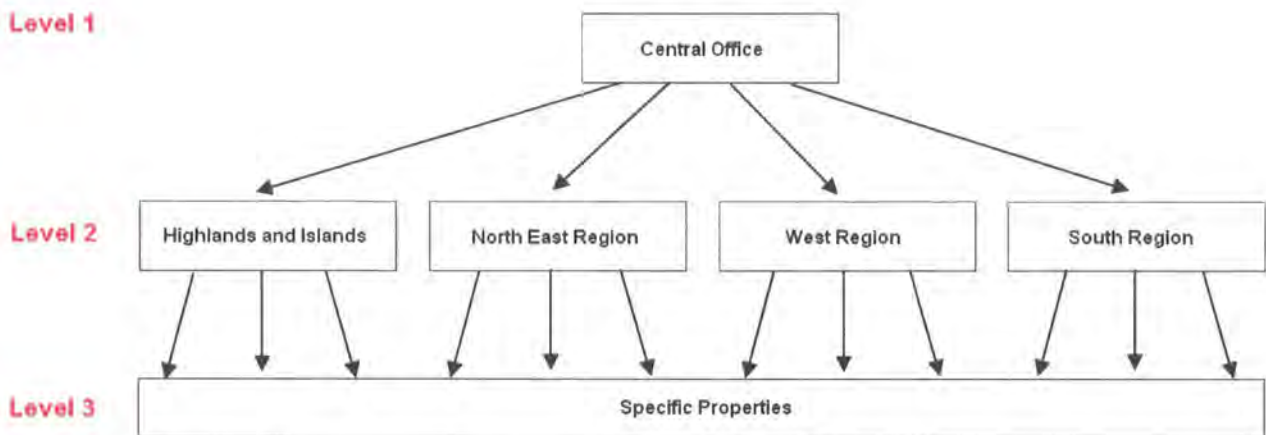

Figure 2.1: Three-tier organisational structure of NTS

A total of eighty-seven NTS properties are located throughout Scotland, including sixteen islands, 76,000 hectares of countryside, twenty-six castles, four battle sites and a world heritage site (www.nts.org.uk). For management and administrative purposes, they are each allocated to one of four regional offices depending on their location, which all link to central office in Edinburgh. The purpose of central office is to establish the core principles and strategic policies of the Trust and set appropriate standards to achieve these. The regional offices are there to help properties to implement these policies and to provide advice and support on specific management and conservation issues. The properties are then responsible for the day-to-day management tasks, which align to the strategy.

It is crucial to understand the key principles and core values of the organisation before attempting to introduce new technologies such as a GIS (Tomlinson, 2003). Therefore, five Core Data Model meetings at central office were attended, which enabled the wider and overarching principles of the Trust to be ascertained and established the background and need for change. Although this helped to build up an overview of the case study and the various problems and issues, a more in-depth understanding of groups of users and their needs was required in order to construct a meaningful and useful set of demonstration systems. Taking the structure of NTS into consideration, seven one-to-one semi-structured interviews at central office and two at south regional office were conducted in order to understand the user requirements of people managing policy and supporting the properties. Finally, two NTS properties, Balmacara Estate and Newhailes, were selected as specific case studies. Four interviews were conducted at each property to gain the requirements of users who need to practically manage a property on a daily basis. The spatial information associated with these two properties was then used as the data input for creating the demonstration systems.

2.1.1 Property selection

Balmacara Estate is diverse highland crofting estate located at the extreme western end of the Lochalsh peninsula (*figure 2.2*).



Figure 2.2: Location map of Balmacara Estate

The estate covers an area of 3,550 hectares that includes land now owned by the Forestry Commission, for which the Trust retains the right to be consulted on land management decisions. The diverse nature of this property consequently means that there are many aspects and features that need to be managed and conserved, as illustrated in *table 2.1*.

Natural Heritage	Cultural Heritage	The Landscape	Social and Economic	The Visitor
Geology – Moine Thrust	Archaeology	Context/setting	The communities	Visitor facilities
Coastal areas	Buildings and Infrastructure	Cultural imprint		Transport
Inbye land	Crofting	Settlements		Footpaths
Common Grazings	Lochalsh Woodland Garden			Interpretation
Semi-natural woodlands	Designed Landscapes			The Ranger Service
Dynamic system				

Table 2.1: Key features of the property that are considered to be of greatest significance (taken from the NTS Management Plan 2001-2006 for Balmacara Estate)

Table 2.1 lists the many components, primarily natural and cultural, that need to be managed on this property, which provides a wide range of data that can be used in this study. This property was also selected as a case study because it is one of the only properties held by NTS that is already using a desktop GIS to help manage and analyse spatial data. Therefore, there is also the opportunity here to examine the system that is already in place and to be able to talk to people who have some working knowledge of GIS and the experience of using one within the Trust.

The second selected property, Newhailes, provides a different set of problems for data management, as there is currently no GIS in place and very little digital spatial data. Newhailes is a great estate situated near Musselburgh, just outside of Edinburgh (*figure 2.3*), which consists of a house that was originally built in 1686 with subsequent extensions and designed gardens added in the eighteenth century.



Figure 2.3: Location map of Newhailes House and Gardens

Because there is currently no GIS used at Newhailes, this provides a blank canvas and the opportunity to explore user requirements where staff have no pre-conceived ideas or impressions of GIS. Additionally, this property has further components that need to be considered that are not covered in the Balmacara Estate case study alone. For example, the estate house in Newhailes provides the opportunity to include some detailed buildings and collections data. Also, Newhailes is a relatively new property for the Trust, having been acquired in 1997 and so ideas about how NTS wants to preserve and manage it are still very much at the forefront of discussions. Here a greater sense of the interaction between a property and its overseeing regional office, in this case the south region, can be ascertained. This provides an opportunity to study user requirements from all three levels of NTS management.

2.2 Interviews

In order for an information management system to be practical and fit for purpose it needs to be tailored to its requirements, since it does not follow that just because GIS is being used, the output is automatically authoritative and right (Martin, 1997). Consequently, it is essential to conduct in-depth interviews with the hands-on users (Bernhardsen, 1999).

In-depth interviews are a crucial component of this research methodology as they establish the current level of knowledge and empower those people who are providing the data by giving them a personal insight into the research topic (Dunn, 2000). It may also educate the researcher as issues maybe raised that had not been considered and

will also tell the researcher if any questions are misplaced (Valentine, 1997; Dunn, 2000). Collecting a diversity of user opinions, ideas and experiences from all levels of the Trust will help provide meaning to the system that is created and the data it contains, a former criticism of traditional positivist GIS methods (Holden, 2005).

There are a number of ways these ideas could be collated, through questionnaires for example, but this project offered the rare opportunity for the researcher to gain full access to the organisation as an affiliated member of staff. This provided the opportunity to gain a richer insight into the organisation that would be wasted on an impersonal and stringent technique like a questionnaire. Therefore semi-structured, one-to-one in-depth interviews were used for this research since they have a predetermined useful structure, but at the same time are flexible enough to allow the informant to express their information in their own words, producing more meaningful answers (Valentine, 1997). One criticism of this technique is that interviewee selection is conducted through 'gate keepers' (Valentine, 1997). Therefore success will be partly measured on what these 'gate keepers' perceive the research to be about, since this is how they will select the appropriate informants. This was demonstrated at an early stage, where it was thought that interviewing a secretary would be futile, but in reality this provided constructive and relevant information. On the other hand, using the 'gate keeper' method to select informants for interviews can also be extremely useful, as the gate keepers have additional knowledge as to who would be most beneficial to talk to receive constructive feedback.

Selecting interviewees from across all three tiers of the organisation (*figure 2.1*) meant that a wide range of opinions and experience could be captured. All the informants from central office were either head of departments or the sole member of staff responsible for a specific department and therefore had been with the Trust for at least a few years. Equally, informants from regional and property levels had also been within the organisation for a while, so all informants had a good working knowledge of NTS and the needs of the organisation as a whole as well as the requirements for their individual roles. The departments/groups within which at least one informant was interviewed are displayed in *table 4.1*. No member of the senior management team was interviewed due to staff availability, although it is unlikely that this would

have significantly added anything to the user requirements that would not have been identified from other informants.

The experience and knowledge informants had of GIS however was varied, ranging from those that are part of the small working group within NTS (Core Data Model group) and are heavily involved in driving an efficient GIS initiative, to others who have little or no knowledge of GIS. Interviewing staff from across a broad spectrum though was a crucial part of this research, since if NTS are looking to integrate an Internet GIS throughout the whole organisation, the final system will need to address a range of requirements from users with varying degrees of GIS experience and expertise. Furthermore, if a GIS initiative is to be successful, it needs to engage and involve all users from an early stage. Often staff with no GIS knowledge are not aware of the benefits a GIS could have on their work or recognise the valuable input they could have with the design of the system. The majority of informants knew there was a better way to manage their data, but not all could identify what that system might be.

Each interview was recorded, with the informant's permission, which produced a more accurate and detailed record of the conversation that could be re-listened to afterwards to ensure that all the important points had been noted. Recording also allowed the researcher to concentrate on the interview without the pressure of having to transcribe every word (Valentine, 1997; Longhurst, 2003). Despite the obvious advantages to recording the interviews, notes were also taken throughout. This provided a security if any technical difficulties occurred or if the informant preferred not to be recorded (Valentine, 1997; Dunn, 2000). Having a rough outline of the contents of the conversation was also useful when re-listening to the recording, since if it was not too clear the notes provided a prompt as to what the next point was. Both the recordings and the notes were used in conjunction with personal comments noted by the researcher immediately after each interview, which included any initial reactions and thoughts about key issues that were brought to light and may be useful to follow up (Cook and Crang, 1995).

2.2.1 Interview Schedules

Four 'interview schedules' were created for each group being interviewed: central office, south regional office, Balmacara Estate and Newhailes. An interview schedule consists of a few carefully worded questions that can then be asked in what is deemed the most suitable order as the interview progresses (Dunn, 2000). By adopting this approach it ensures that the necessary questions are asked coherently, which will allow for comparisons between answers, but it does not have to be followed exactly, which provides the flexibility to follow through any interesting comments from the informant when they arise (Longhurst, 2003).

An interview schedule is made up of essentially two types of questions: primary, which are opening questions to initiate discussions on a new topic or theme and secondary questions, which are the follow-up questions that prompt expansion on a response (Dunn, 2000). Primary questions are then sub-divided further into descriptive, structural and thoughtful questions (Valentine, 1997). It is important to include a variety of question types within an interview schedule (Dunn, 2000). It is suggested that all questions asked are open-ended, with the opening question being particularly broad, as that allows the informant to answer in his or her own words (Valentine, 1997). Therefore, in all of the interview schedules the initial primary question was "Tell me about..." that produced a descriptive response, which enabled the researcher to obtain some background knowledge and eased the informant into the interview. Encouraging a descriptive response also sends out the signal to the informant that they should talk freely, rather than providing basic 'yes' or 'no' answers (Valentine, 1997).

Whilst a broad range of questions is necessary, the ordering of these questions is an essential consideration as it directly influences the resulting conversation and hence the quality of material being collected (Dunn, 2000). The first interview schedule, written for interviews at Balmacara Estate employed the 'pyramid interviewing strategy' (Dunn, 2000). This technique suggests beginning with easy questions about people's duties and responsibilities and then moving on to more abstract and reflective questions, before ending with general questions at the end to draw the interview to a close (Dunn, 2000). In keeping with this, descriptive questions about

the existing GIS system at Balmacara were asked first, followed by how the informant viewed their role within the organisation. This was expanded with secondary questions to determine what decisions need to be made, day-to-day duties and so on. The middle of the schedule comprised more thoughtful questions on how informants perceive a new GIS system could change their role and their thoughts and ideas on interoperability. Finally, general questions on what data people require were included at the end.

Although each of the interview schedules had to be altered slightly to fit the group of people being interviewed, the interviews at Balmacara Estate, being the first ones conducted, provided the researcher with useful experience. As such the ordering of the questions on the interview schedules for subsequent interviews naturally evolved. In light of this, the following interview schedules were based more on a combination of the 'pyramid interviewing strategy' and the 'funnelling' technique (Dunn, 2000). This involves beginning with all the general questions on the organisational structure of NTS and easy to answer questions about people's roles, before moving onto more abstract and reflective questions. Employing this technique was found to produce a conversation that flowed a lot better as it was more of a natural progression, especially towards the end of the interview. As well as the ordering of the questions, the first few interviews highlighted the fact that just because a GIS existed at Balmacara did not mean that everyone there knew what a GIS was. Therefore, knowledge questions like "What do you understand by the term GIS?" were added in later interview schedules to ascertain a level of knowledge to begin with.

All of these interviews and their associated schedules were pitched to answer the objective of obtaining user needs and requirements. However, two interviews at the Royal Commission on the Ancient and Historical Monuments of Scotland (RCAHMS) and Historic Scotland were also conducted to ascertain the experiences of people who have already developed an Internet GIS. Ways of approaching data sharing in the future with an organisation like NTS were also discussed, addressing one of the key aims of this research. The schedule for these interviews again followed the combination of the 'pyramid interviewing strategy' and the 'funnelling' technique. Easy questions about the organisation and the current Internet GIS were asked at the start, moving onto more reflective and abstract questions about the approach they took

in designing the system, assessing whether the system meets its requirements and what they had learnt from the experience. The results from these interviews will be addressed later on in chapter four.

A general discussion on the selection of question type and ordering has been presented here, but for more detail please refer to the two annotated interview schedules in Appendix I.

2.2.2 Categorising key requirements

Once all the interviews had been completed, the key user requirements for an Internet GIS were then extracted and placed into two categories. The first category was common datasets that people wanted access to and the second category consisted of the main tasks or functionality that people wanted the system to be able to perform. The informants were then categorised according to the departments they represented, which in most cases corresponded to two informants per department although in a few cases were either one or three informants. All this information was placed into a grid chart and the departments were then rated as either a major, occasional or minor/non user of the key datasets and main functionality requirements (chapter four, *table 4.1*). Although the selected rating was based on the collective interview results for that department, it was ultimately a subjective quantification. This information was then directly used with NTS data to create the demonstration systems.

One point to note is that not all of the core data and functionality requirements were implemented in every demonstration system, as it was deemed that this would be unnecessary repetition. However it was noted in every case whether both software packages had the ability to implement each requirement.

2.3 NTS digital data collection

In conjunction with the interview results, data from the two NTS properties, Balmacara Estate and Newhailes, was collected. As Balmacara Estate already has all its key GIS layers within a MapInfo system, .tab files were obtained directly from the property and then converted into shapefiles in ArcMap and aligned to British National Grid. Ordnance Survey (OS) maps were downloaded from the Edina Digimap website

(<http://edina.ac.uk/digimap/>) and were again set to British National Grid to provide base maps for both properties.

In contrast to Balmacara Estate, Newhailes has no GIS and very little digital data; therefore the GIS layers were created from scratch. The NTS property boundary and point and polygon shapefiles of known features on the estate, such as the house, shell grotto, teahouse and woodland areas, were created from paper map plans. In addition to the data held at property level, some information kept at south regional office and central office was also incorporated into the Newhailes GIS dataset. Raster data, consisting of scanned floor plans of the main house and a historical map of the estate were obtained from the south regional office. In order for these jpeg images to be incorporated into the GIS they were geo-referenced in the ERDAS Imagine software programme, using common features recognisable from the OS map to align these images into the correct location. These raster files were then saved as spatially referenced jpegs, tiffs or compressed into ecw files, depending on the format required for Internet dissemination from the specific software packages.

In addition to the digitising of features from paper maps, some information from the tree database obtained from the south regional office was also incorporated into the GIS. This database held no spatial references that could be transferred onto a GIS, so for the purpose of this study these references were created by the researcher. This information was then imported into ArcMap as XY point data. This same technique of providing an XY point location was also used to incorporate a snapshot of the collections data for Newhailes house that is held in a database in central office.

The more general information on the properties themselves and the boundaries of the four NTS regions: Highlands and Islands, North East, South and West, were taken from the NTS website (www.nts.org.uk).

2.4 Demonstration models

Once the user requirements had been ascertained from the interviews and the NTS data for Balmacara Estate and Newhailes had been compiled, this information was then used to create demonstration systems in two Internet GIS software packages:

ASPMap and ArcIMS. The purpose of these demonstration systems was not to create a fully functional final GIS product that could be practically used by NTS, but to showcase the functionality and illustrate an example of a bespoke and proprietary approach to creating an Internet GIS.

ASPMap was chosen as the example of a bespoke approach as it had already been used and was installed at the geography department at Durham University. ArcIMS was selected as the second package as it is currently the leading commercial Internet GIS software. The inclusion of another software package, such as the open source MapServer was also investigated. However, this option was decided against due to the in-house technical expertise available to the researcher and the steep learning curve that would have been required to programme a system using this software.

2.4.1 ASPMap

ASP stands for active server pages and is a server-side mapping component for embedding spatial data access, display and analysis capabilities in web applications and services that has been developed by VDS Technologies. Whilst it is not a free piece of software, it is relatively inexpensive. An ASPMap 3.0 Developer License costs \$799 to download and includes a one-year maintenance plan offering a year of free updates and support (http://www.vdstech.com/aspmap3_order.asp). Creating a system using this software requires heavy programming using HTML, Java and .ASP languages.

As ASPMap has been designed specifically for the Internet it therefore has a native Internet architecture. The architecture of ASPMap (*Figure 2.4a*) is all contained within the web server (*Figure 2.4b*).

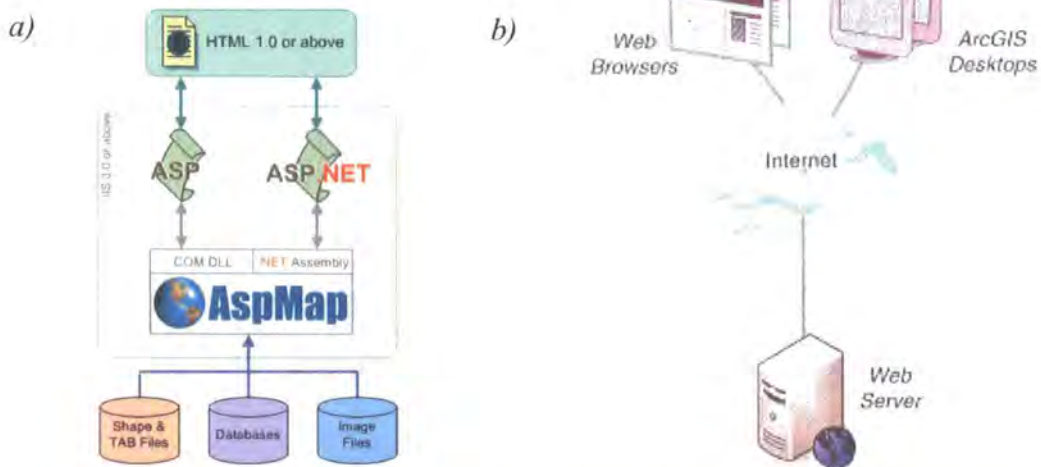

Figure 2.4: a) Architecture of ASPMap (<http://www.vdstech.com/pdf/aspmap.pdf>),
 b) Overarching Internet architecture (modified from ArcGIS 9: ArcGIS Server Administrator and developer guide, ESRI 2004, p.73)

When a request is made from the client web browser it goes directly to the web server, via the Internet and the output is sent back to the client. As all the processes are executed on the server there are no plug-ins or components that need to be downloaded.

2.4.2 ArcIMS

ArcIMS is part of the ESRI suite of GIS software. It has a multi-tiered architecture comprising the presentation tier, the business logic tier and the ArcIMS Management tier (figure 2.5).



Figure 2.5: Architecture of ArcIMS

(<http://www.esri.com/library/whitepapers/pdfs/arcims9-architecture.pdf>)

This model requires many components to work together and run simultaneously in order to create the map data that is then delivered by the web server (ArcIMS 9, ESRI handbook, 2004). As with ASPMap, all transactions are passed through the web server (Figure 2.4b). When the client makes a request, this first goes to the web server and is then passed through one of the connectors to the application server and spatial server for processing, before the output is transferred back through the web server and displayed in the client browser (ESRI White Paper, 2004). Communication between these components is achieved using ArcXML.

The ArcIMS management tier used to create an Internet GIS application is composed of three components. The first is 'Author', where the GIS layers are added and decisions are made as to their order, symbology, labelling and so on. The output file is saved as an .axl file (ArcXML) and is used in 'Administrator' to create the 'service' that the website will run on. The final stage is then executed in 'Designer', where a few decisions on the design of the interface can be made and the final website is published. This is the basic method, using the default settings to create a website for the dissemination of spatial information. A single demonstration model was created in this way.

However, in the newest version of the software, ArcIMS 9.2, the Application Developer Framework (ADF) has been extended. This framework still uses 'Author' and 'Administrator' to create the .axl file and the service, but makes the customisation process a little more user friendly, using a design window where tasks and processes

can be dragged and dropped onto the screen. The coding for the specific task is generated automatically, with the designer needing only to identify the data to be used and set any necessary parameters. The developer can interchange between this viewer and the programming window, which displays the asp.NET and HTML coding. A second model was also created in ArcIMS using this facility.

2.5 Systems evaluation

Once the demonstration models had been completed, the final stage of this methodology was to evaluate them. Feedback from end users is crucial, since even a technically 'good' system, if perceived to be 'poor' from a user perspective, is a 'poor' system (Ives *et al*, 1983).

A two-hour presentation and feedback session was held at NTS central office in Edinburgh. During this session key features of the three systems were shown to staff in a live IT demonstration. Informants were provided with the opportunity to express views of the demonstration systems and comment on the potential benefits and problems of developing and integrating an Internet GIS within NTS. Again, this feedback session was recorded and notes were taken to enable further analysis afterwards.

As part of the evaluation process, staff were also asked to experiment and test the demonstration systems in their own time to get a better idea of what they would be like to use on a day-to-day basis and then provide their feedback by answering a short questionnaire. A questionnaire was selected for this process as it provided a means for users to record their opinions in a way that enabled them to be easily analysed.

The structure of the questionnaire was based on the objectives outlined at the start of this project. The first section concentrated on the demonstrated functionality of the software packages and specifically the ease with which people could interact with each system in order to extract the information they required. This idea of usability evaluation (*figure 2.6*) is integral to ensuring that the systems have met user requirements and is a key component of any HCI project (Haklay and Tobón, 2003).

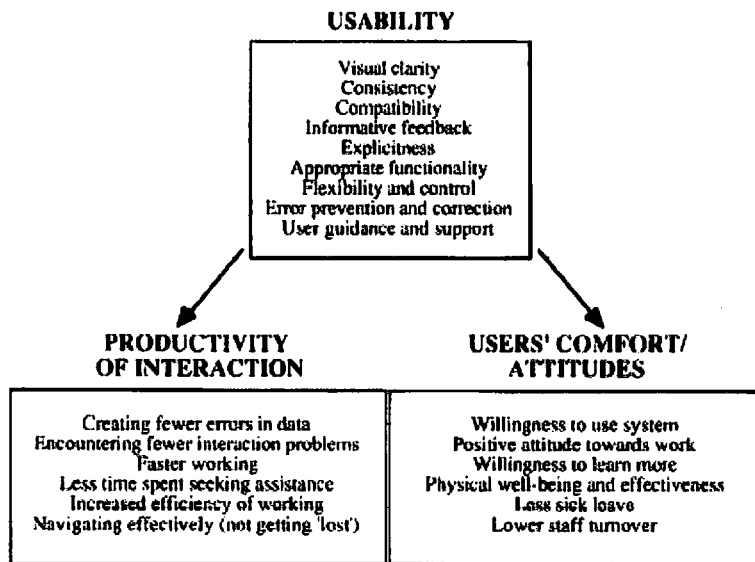

Figure 2.6: Aspects and major implications of usability (Davies and Medyckyj-Scott, 1996, p. 366)

Focusing on usability has resulted in some negative comments though, especially from systems developers, who liken it to ‘user friendliness’, which can constitute ‘long-windedness’ through creating additional prompts and highly structured user interfaces (Davies and Medyckyj-Scott, 1996). Although developing a system for inexperienced GIS users may require user guidance and support, not all institutions will fit into this context, requiring this type of simplified design in order for the system to be considered ‘usable’. In other cases, it may involve compatibility or the flexibility to have more control over the systems processes (*figure 2.6*), for more experienced users. Therefore usability, in the context of considering the social and institutional frameworks into which a GIS needs to fit, should be seen as simply aiding the design process of a GIS so that it suits the end users themselves, as they will ultimately decide the success or failure of a GIS within an organisation.

This research differs from traditional usability projects though in that the systems that have been created here are for demonstration purposes only and are not designed to be fully operational. Therefore, the degree to which user interaction with the systems can be measured and assessed is not as high as when a fully functional system is implemented.

The questions were framed with reference to the Ravden and Johnson (1989) usability checklist (Davies and Medyckyj-Scott, 1996), which requires users to rate the conformance of the system to various aspects. For example, one question asked users to rate the consistency of the data within each system from a selection of five standardised responses, ranging from 'very good' to 'very poor'. There was also a less restrictive 'comment' opportunity to allow people to put their response into words or elaborate on the rating that they selected (McLafferty, 2003).

The second section focussed more on the proprietary and bespoke approaches illustrated by the demonstration systems and the relative opportunities and limitations these options might produce if integrated into an organisation like NTS. These questions were more open-ended and required users to give their own considered opinion. Splitting the questionnaire into two sections and providing informants with the option of answering through a set of standardised multiple-choice responses and/or by general comment produced a more diverse set of results. When combined with the feedback session responses, this wider range of information and ideas provided a more in-depth evaluation.

The questionnaire was piloted on a couple of volunteers before being given to NTS staff to ensure that the questions were not confusing or unclear. They were also asked if there were any additional questions that would be valuable to add. Based on this the questionnaires were then revised and adjusted.

The questionnaires were discussed at the end of the evaluation session in Edinburgh and paper copies were administered to all staff that were present. The following day, a digital copy of the questionnaire was e-mailed to all NTS staff. This not only ensured that the maximum number of responses would be received, but more specifically that informants who had taken part in an interview but could not make the evaluation session had the opportunity to provide their feedback. An example of a filled out questionnaire can be found in Appendix II.

2.6 Summary

This chapter has presented a methodology of mixed approaches taken from traditional information technology projects and social science research. With the ideas about GIS evolving to consider the social and institutional contexts into which the system is being integrated, this type of interdisciplinary methodology that considers human as well as technical elements is required. As discussed in this chapter, the human aspect is comprised of two elements. Ascertaining user requirements from staff is key to constructing a system that is fit for purpose and addresses all users needs, but essentially, in order to actually fulfil the requirements the final system has to be usable. What makes the system 'usable' is defined by the institutional context into which the system is being applied.

Some of the technical components, such as the architectural set-up of the two selected software packages, have been touched on in section 2.4. The following chapter will develop this to consider the benefits and disadvantages of server-side architectural set-up and will seek to expand this into a wider discussion on the technical frameworks and requirements that a system needs to be able to work on, particularly in reference to facilitating interoperability.

Chapter 3: Interoperability within the context of GIS

Interoperability can be defined as the “ability of two or more systems or components to exchange information and to use that information that has been exchanged” (Frehner and Brändli, 2006, p. 1545). As NTS is an organisation seeking to improve internal data sharing and set up information exchanges with external organisations, interoperability is a crucial concept requiring in-depth consideration. Some of the general concepts surrounding interoperability, particularly in relation to Internet GIS technologies, have already been discussed in the introduction chapter; however interoperability within the context of GIS requires the compatibility of multiple technical frameworks and components to be considered together in detail. Several types of interoperability can be defined, ranging from data interoperability, which means that the program can use whatever format the data is in, through to program interoperability, which means that any program can use the dataset (Laurini, 1998). This integrated complexity is why interoperability is often described as “a dream for users and a nightmare for systems developers” (Laurini, 1998, p. 400).

This differentiation between the data at the back end of a GIS and the presentation of that information by the GIS at the front end suggests that these two aspects need to be considered separately as well as together, in order to achieve a fully interoperable system. With this in mind, the structure of this chapter will be split into two. The first part will look specifically at the database, from the organisation and structure of the data, through to data about the data itself, including a brief review of the NTS current metadata standard ‘PINTS’. The second part of this chapter will then focus on the importance of standards for interoperability and the possible architectures for an Internet GIS, from the traditional client/server-side approaches through to Service-Orientated Architectures (SOA). The chapter will consist of a combination of both the theory and related specific discussion of the NTS case study where appropriate.

3.1 Databases

Database systems provide the engines for GIS, facilitating the storage, modification, analysis and sharing of data (Worboys, 1999). A database is a collection of logically coherent data (Elmasri and Navathe, 1989; Connolly *et al*, 1999). Incorporating all

data into databases holds many advantages, including reducing data redundancy, maintaining data integrity and quality and avoiding any inconsistencies (<http://ioc.unesco.org/oceanteacher>). There are several types of specific data model, including hierarchical, network and object-oriented that could be used (Connolly *et al*, 1999), but the most common model used to implement database systems is the relational database model. This model is easy to use, as it only requires the user to know the table name and not understand the complexities of how the data is structured and stored in order to be able to use it. The relational model was first introduced in 1970 by Codd (Connolly *et al*, 1999) and the fundamental principle behind this design is to replace repeating data with relations using ‘primary’ and ‘foreign’ keys (Elmasri and Navathe, 1989). Related data can then be extracted from multiple tables, thereby also decreasing the amount of storage space required. The approach most commonly used to identify relations is the process of ‘normalisation’.

Normalisation is “a technique for producing a set of relations with desirable properties, given the data requirements of an enterprise” (Connolly *et al*, 1999, p. 192), based on the primary keys and functional dependencies that exist amongst the attributes. The best way to illustrate this principle is through an example using some NTS data. *Table 3.1* is a snapshot of data held in the ‘PINTS’ database relating to the holiday cottages available to rent at Balmacara and Brodick properties and *table 3.2* contains their associated bookings.

Property code	Property	Region	Subject code	Subject	Fixed rent
BAL	Balmacara	Highlands and Islands	BAL/03	Ardview Cottage, Reraig	300
BAL	Balmacara	Highlands and Islands	BAL/05	Ferry Cottage, Claick	320
BRO	Brodick	West	BRO/10	Hostel	260
BRO	Brodick	West	BRO/13	Base camp	240

Table 3.1: Holiday cottages to rent at Balmacara and Brodick properties. All information except the ‘fixed rent’ prices, which have been created for demonstration purposes, is taken from the PINTS database.

Subject	Name of occupier	NTS membership no	Details	Start date	Finish date	Payable rent
Ardview Cottage, Reraig, Balmacara	Mr and Mrs Green	565	16, Square Gardens Musselburgh MU21 7AR	01/11/2007	08/11/2007	300
	Mr Clement	972	The Cottage North Road Ballater BL35 5PQ	12/11/2007	26/11/2007	600
Ferry Cottage, Claick, Balmacara	Mr and Mrs Smith	non-member	29, Sutton Road Aberdeen AB6 4FT	02/12/2007	09/12/2007	320
Hostel, Brodick	John Terry	1658	5, Warcroft Avenue Dundee DE78 9WG	03/11/2007	10/11/2007	260
	James Taylor	non-member	21B, St. Andrew's Street St. Andrew's Street Inverness IV4 6HY	24/11/2007	01/12/2007	260
Base camp, Brodick	Sarah Carter	2504	3, Ivy Cottages Glasgow GS10 2TV	27/10/2007	03/11/2007	240
	Jessica Clew	non-member	54, Pans Lane Edinburgh ED74 8CL	14/12/2007	28/12/2007	480

Table 3.2: Bookings for the holiday cottages to rent at Balmacara and Brodick. All this information has been created for demonstration purposes only.

Currently, these two sets of information (*tables 3.1* and *3.2*) are stored at separate locations across the Trust, with the PINTS database held at central office and the renting information kept locally at each property. This not only results in repetition of data but also means that valuable spatial links cannot be easily drawn and analysed across the whole organisation.

Firstly, the data itself is not in a computer-friendly format. *Table 3.2* is an example of data in an unnormalised form (UNF) as it contains NULL values (fields without any data). *Table 3.1* is currently in first normal form (1NF), as there is one and only one value contained at the intersection of each row and column (Connelly *et al*, 1999). This second dataset is already far more usable by a computer system as it now contains a value in each and every field. However, there are many repeating components that can now be identified and these should be replaced by relational links. For example, the repetition of entries within the PINTS database (*table 3.1*) can be condensed into separate Region, Property and SubjectsToRent tables. As the subjects that can be rented are repeated in the bookings for holiday rents (*table 3.2*), this SubjectsToRent table can then be linked to the occupier information. The resultant model combining both datasets by relational links is shown in *figure 3.1*.

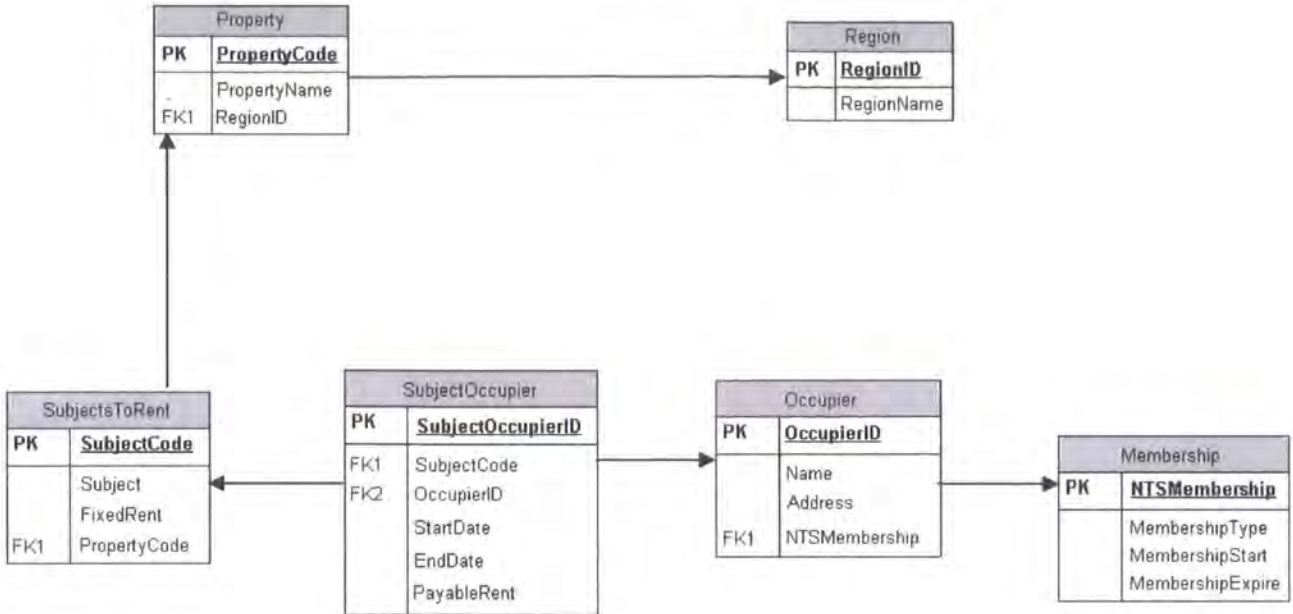

Figure 3.1: Holiday cottages renting database set to 2NF, with the data divided into six separate parent and child tables (NB. The FixedRent is the amount of rent that can be charged for a subject and the PayableRent is amount due for the duration the subject is occupied)

This dataset is now set to second normal form (2NF), where every non-primary key attribute is functionally dependent on the primary key (Connolly *et al*, 1999). Should the occupier of the subject not be an NTS member, then this data model is designed to assign a default ‘non-member’ numeric code to the NTSMembership field in the Occupier table. This default code would correspond to a generic ‘non-member’ entry in the MembershipType field in the Membership table, ensuring that the NTSMembership primary key code in the Membership table is never a NULL value and maintaining the Occupier-Membership relationship. The number of occasions when a non-member rents a holiday cottage could then be queried and this information used to assess the success any advertising of the holiday cottages has had in reaching beyond NTS members and even which areas of Scotland are more popular, all of which could help direct a marketing policy.

This process of normalisation could be continued into third normal form, whereby there are no attributes that are not dependent on the primary key in each table. In this case the PayableRent attribute in the SubjectOccupier table is dependent on the StartDate and EndDate fields, which would need to be changed in order for the data model to comply with the rules of third normal form. It may be though that users are

likely to want this information together for the work they need to do. Therefore in some cases it is advisable to use common sense and adopt the concept of ‘controlled redundancy’. This idea promotes the importance of keeping some information together when the rules of normalisation would separate them off. A classic example of this might be the storing of an address. Since the postcode is dependent on the address itself the rules of normalisation would imply that the postcode should be sectioned off from the main address. However, in doing this the number of table joins that would need to be created when executing a search query to find a full address on the database would increase, but by adopting the principle of controlled redundancy this can be reduced, thus saving time. This example is only an illustration and it may be that if this data model were practically implemented in NTS, design adjustments would need to be made to accommodate extra information.

As well as the technical advantages, there is also the accessibility and user friendliness of the database design that needs to be considered. As the data effectively ‘bridges the gap’ between the computer and the users themselves, representing that data as logically as possible will make the database more acceptable and usable, (figure 3.2).

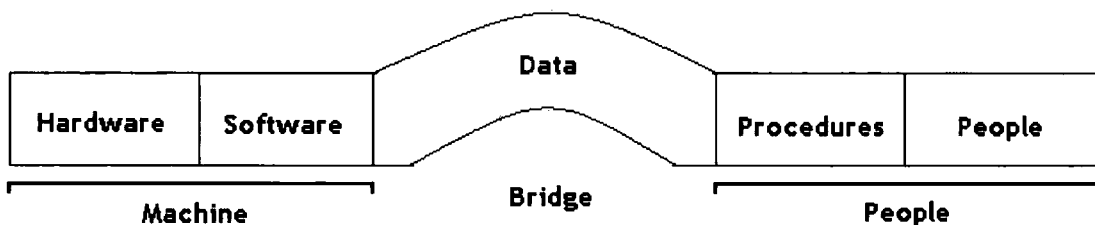

Figure 3.2: The five main components of a database management system environment (Connolly et al, 1999)

The inclusion of people and the organisation as part of the database management environment ties closely back to the changing definitions of GIS to incorporate the social context into which the system is being placed, as discussed in chapter one.

Whilst the pure relational model is excellent for managing information, which is key when creating a GIS (Reeve and Petch, 1999), there are several shortcomings of this approach when using it as the basis for handling geographical information within a GIS (Worboys, 1999). The relational model works best when it manages relatively

simplistic data. However geographical information is often more structurally complex and detailed. Additionally, relational databases are often optimised for retrieving small quantities of data, whereas geographical data is typically composed of large quantities of information and often requires complex, multi-dimensional searches (Reeve and Petch, 1999). Therefore, vendors adopted a 'dual architecture' model for GIS software in order to specifically handle this complex geographical data. Although this practice began several years ago, it is still very much in evidence today, being embedded in commercial software names like 'ArcINFO', which is still a dominant product (Reeve and Petch, 1999). 'Arc' is the specialist GIS software written by ESRI, but the 'INFO' component represents the incorporation of the principle of the relational model that ESRI included to handle attribute information (Reeve and Petch, 1999). Indeed, this evolution of the relational model for handling geographical information within a GIS is still ongoing today.

ArcSDE is a relatively new ESRI product, which complements the relational database model by adding a spatial component so that geographical features can be more easily stored within the database (ArcGIS 9, ESRI handbook, 2004). ArcSDE spatially indexes features in each feature class, which enables them to be rapidly searched and retrieved. Standard Query Language (SQL) is currently the main database sub-language, which enables the user to interface with the database (Cannan and Otten, 1993) and has long been the backbone of the relational database model (Sondheim *et al*, 1999). ArcSDE takes this long established standard and extends it, by providing the tools for SQL to interface with the spatial data (ArcGIS 9, ESRI handbook, 2004). Although ArcSDE can be seen to have greatly developed the principles and practice of working with spatial data, there is still the disadvantage that using products like this locks the users into proprietary formats (Saunt, 2006), which ultimately limits interoperability.

Having looked at an overview of databases, particularly the relational database model and its appropriateness for GIS, the internal interoperability issues within the data itself will now be considered.

3.2 Metadata

Metadata is essentially ‘data about data’, which is used to give a high level of description to data collection (Sondheim *et al*, 1999). As well as documenting the data, it produces a precise definition of the structure and organisation of the data, which provides a solid basis for browsing and searching the database (Sondheim *et al*, 1999). In order for systems to be interoperable, an appropriate metadata standard needs to be selected and then strictly adhered to when adding or changing any aspect of the system. Now that applications are seeking to work with multiple information sources, the importance of adhering to a robust metadata standard is rapidly increasing (Chang and Park, 2006).

Property Information in the National Trust for Scotland (‘PINTS’) is the current metadata standard used by NTS. Although it does not comply with national standards at present, as it is still very much an embryonic system, it could be made to comply with UK GEMINI specifications in the future.

3.2.1 Review of the ‘PINTS’ standard

The fundamental principle behind PINTS begins with each property having its own unique three-letter code. So for example, for the two properties being investigated in this study, Balmacara Estate’s unique property code is ‘BAL’ and for Newhailes it is ‘NEH’. The PINTS standard then drills down into each property to a ‘subject’ level, where each subject on that property is allocated its own unique extension to the property code. So for example, the first subject at Newhailes (NEH) is Newhailes House, which is given the unique identifier NEH/01. The PINTS standard then drills down to a third and final level within each of the specified subjects at a property to identify individual ‘elements’. So, the ‘subject’ Newhailes House (NEH/01) is broken down into three ‘elements’: the Exhibition House, the attic flat and the workshop/store, each then ascribed the unique codes NEH/01/01, NEH/01/02 and NEH/01/03 respectively. The ultimate aim of the PINTS standard in the future is to be able to drill down even further within these elements in order to uniquely identify, for example, a specific painting on a certain wall within a particular room.

The primary advantage of using the PINTS standard is that it enables all the information regarding a particular property or feature on that property to be retrieved by a single search, as every NTS database would be compliant with the PINTS standard. For an organisation like NTS that needs to manage large and diverse datasets, this is a key requirement. This standard is also fairly simple in its concept and therefore is easily understandable and usable and hence liable to be successful (Ioanid and Bowman, 2001). Although it is recognised that PINTS is still an evolving standard, there are currently some significant limitations.

Firstly, although PINTS has been established as the NTS metadata standard, not all departments within the organisation are currently adhering to it. Indeed some people are unaware that the PINTS system even exists. As has been already discussed, for any metadata standard to succeed it needs to be strictly enforced throughout all datasets, otherwise the power of being able to link data together is lost.

Secondly, as some departments are beginning to look seriously into the detail of the PINTS standard in order to implement it within their databases, major problems are being identified. It has been recognised that one or two of the NTS properties have been given the same unique three-letter code by mistake, which is a fundamental problem that has immediately raised concerns. Additionally, within each property, not all of the expected subjects and elements have been allocated a unique identifier. Again, this raises some concerns about the integrity of the standard that needs to be investigated further. Property managers at each NTS property should be consulted as to what key features should be included within the PINTS standard and this should then be cross referenced with the needs and requirements of each department at regional and central levels to make sure that all relevant features are included. The standard should ultimately aim to include multiple feature types, from the natural as well as the built environment.

A final and major limitation of the current standard is that it fails to include a satisfactory spatial component for the data, which is key for geographical data, especially if it is to be included within an Internet GIS. The existing spatial information that is contained within the PINTS system consists of a location, postcode, OS grid reference, total area (ha) and total inalienable area (ha). Although

this information is probably adequate for houses or small properties managed by NTS, this is not enough information for the larger estates, nature reserves and islands. As well as aiding effective management, from a legal perspective it is essential for NTS to have the appropriate spatial information on the location of the boundaries to their properties. In terms of a metadata standard too, this spatial information is crucial. *Table 3.3* shows the required metadata elements that need to be recorded for a geographical dataset, as outlined by the UK GEMINI standard.

Element number	Element name	Obligation	Number of occurrences
1	Title	M	1
2	Alternative title	O	N
3	Dataset language	M	N
4	Abstract	M	1
5	Topic category	M	N
6	Subject	M	N
7	Date	M	1
8	Dataset reference date	M	1
9	Originator	O	N
10	Lineage	O	1
11	West bounding coordinate	M	1
12	East bounding coordinate	M	1
13	North bounding coordinate	M	1
14	South bounding coordinate	M	1
15	Extent	M	N
16	Vertical extent information	O	N
17	Spatial reference system	M	1
18	Spatial resolution	O	1
19	Spatial representation type	O	N
20	Presentation type	O	N
21	Data format	M	N
22	Supply media	O	N
23	Distributor	M	N
24	Frequency of update	M	1
25	Access constraint	O	N
26	Use constraints	O	N
27	Additional information source	O	1
28	Online resource	O	N
29	Browse graphic	O	N
30	Date of update of metadata	M	1
31	Metadata standard name	O	1
32	Metadata standard version	O	1

Table 3.3: Metadata elements for geographic datasets. The obligation shows whether the element is mandatory (M) or optional (O) (UK GEMINI Standard, 2004, Version 1.0: A Geo-spatial Metadata Interoperability Initiative, e-Government Unit, Cabinet Office, p.5)

The UK GEMINI standards state that bounding co-ordinates and hence the extent of the spatial feature are compulsory (shown by the dashed red box on *table 3.3*). Therefore, regardless of the obvious need to include this information for management purposes and inclusion into an Internet GIS, if the PINTS metadata standard is to be made compliant to UK GEMINI metadata standards, as is hoped in the future to enable external data sharing, it will need to include this spatial information anyway. Other additional information would also have to be included within this process, although that is beyond the scope of this project.

3.3 Centralised and distributed database design

Having looked closely at the organisation of the data within the relational model and the internal metadata standard requirements, the design of the overall database needs to be considered, particularly with reference to its physical location. The traditional approach has been to have a single repository of data, so that it is defined once and then maintained so that various users can then access it (Elmasri and Navathe, 1989). This eliminates the possibility of repeating the data files and reduces the amount of storage space required.

However, an alternative method of distributing the data is presented by Laurini (1998), which involves federating the data into multiple databases stored at different sites, which he argues is taking the first step towards seamless GIS data interoperability. *Figure 3.3* shows the possible architecture that could be used for NTS, with database servers located at central office and at each of the four regional offices.

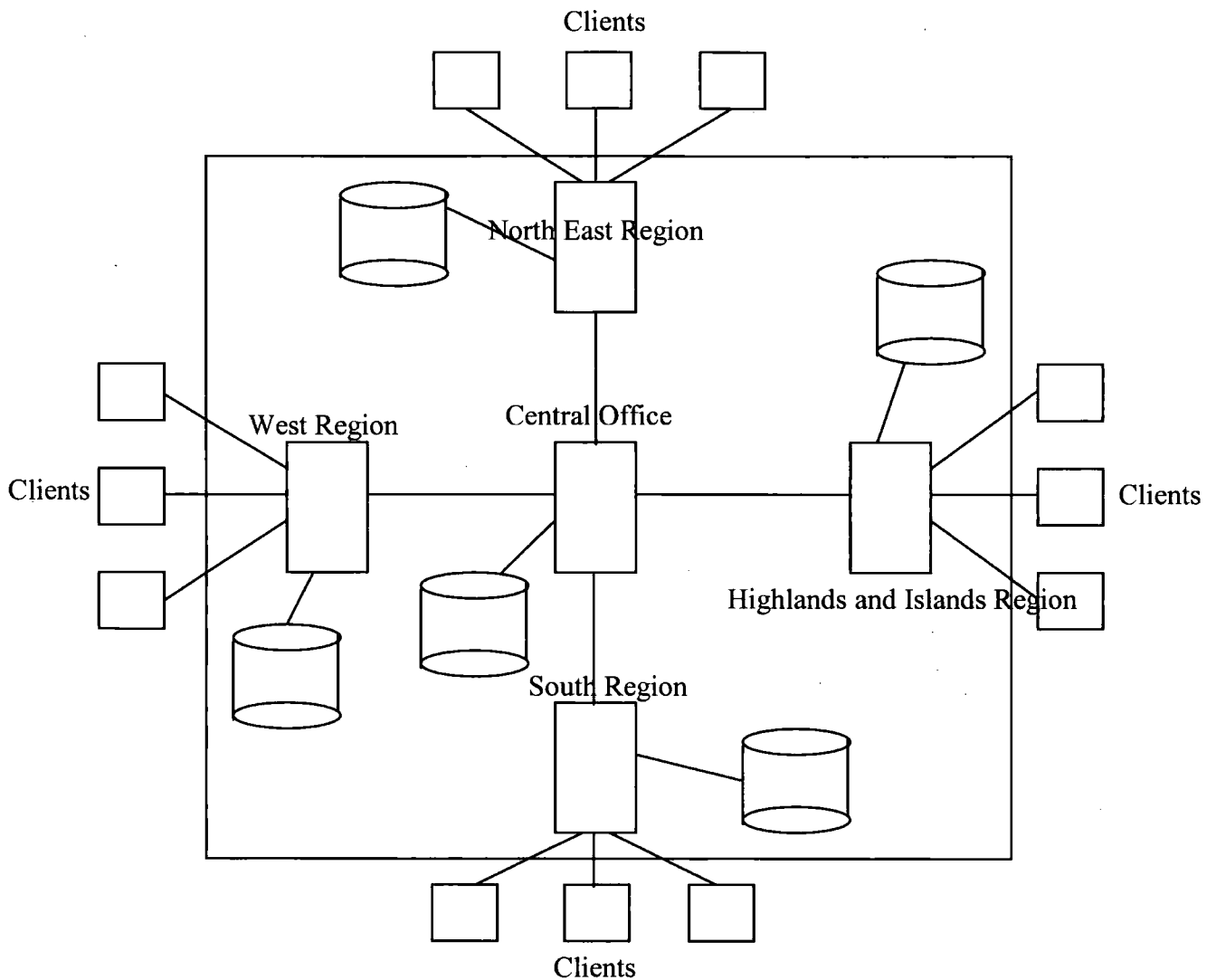

Figure 3.3: Possible hardware architecture for establishing a distributed database framework with NTS (modified in reference to Connolly et al, 1999 and Laurini, 1998)

This could be a useful technique for NTS, as it would enable the various properties to take over their own data, updating the databases at each regional office, whilst being able to access other databases too. This is made particularly easy through the medium of the Internet, as long as the same metadata standards are adhered to. One drawback of this method is time and complexity, as the organisation would essentially have to start from scratch, beginning with federating existing databases. However, this would only be a major consideration if a significant amount of work had already gone into transforming the system.

Having a distributed database system could lead to the formation of regional working groups and the creation of multiple GIS applications accordingly. This may be of particular value with project work, which requires close consultation between the property and corresponding regional office. However, this is likely to be something to consider in the future once a GIS is successfully implemented and is well established. For this, a centralised database system that brings together information from various sources is likely to be most advantageous to the organisation at present. Although a distributed design could be used for this, drawing together all databases into a single location will establish what data actually exists within the organisation. As an initial GIS is likely to include more basic information, there is unlikely to be a need for regular detailed updates from a property level, so centralising the data would not cause any major problems for maintaining data integrity. Additionally, data warehouses and clearinghouses are more effectively implemented using a centralised approach (Barndt, 2002) and these may benefit an organisation like NTS that has a large archive of data.

Whether the database design is centralised or distributed, the current trend of accessing the information is to distribute it across the Internet. Therefore, when developing an Internet GIS it is important to consider the dynamics between the database and the web browser and the way data is passed to the user.

3.4 Client/server architecture

Architecture is one of the key technical considerations with all Internet GIS. The two main approaches to this place dominance on either the server-side or client-side. Initial Internet GIS were 'thin client/thick server' systems. This was fundamentally due to the characteristics of the two major web technologies, HTML and HTTP, which, as discussed in the chapter one, were the main standards around at the time. The HTTP/1.1 protocol is stateless, meaning the server 'forgets' about the client as soon as the transaction is complete and the two are only connected for the duration of the transaction (Vatsavai *et al*, 2006). Additionally, the client browser was unable to distinguish geographical information; therefore all processes had to be executed on the server and then the output transformed into a JPEG, GIF or other image file in order to be sent and displayed in the client viewer (Vatsavai *et al*, 2006). This issue of

statelessness was also a problem with the Common Gateway Interface (CGI) wrappers that were incorporated into standalone software used in early Internet GIS, as this meant that every request was considered 'new' by the application (Vatsavai *et al*, 2006).

As well as these limitations concerning the interaction between the server and the client, placing all the data onto the server meant they often became over-burdened, resulting in poor performance (Chang and Park, 2006). Along with interoperability, improving performance of Internet GIS applications is a major problem (Yong *et al*, 2005) due to the bandwidth of the Internet and the large volume of data that needs to be transmitted (Vatsavai *et al*, 2006). So in response to this, there was a greater focus on the development of client-side applications, which led to the evolution of a more 'thin server/thick client' architecture.

Applets are one such application designed to be able to run in any modern client viewer. The applet is written once and then resides on the server to be loaded onto the browser along with the data request (Andrienko *et al*, 1999; Vatsavai *et al*, 2006). The applets can then access information stored on the server using the HTTP protocol as well as provide a more advanced user interface. Although applets do offer many improvements and potential for the client-side browsers, they also have their limitations. Some applets run rather slowly on certain hardware and software platforms and the scope of possible functionality for an Internet GIS may be seriously impeded with the downloading of larger applets (Andrienko *et al*, 1999). Furthermore, other software can access the database files that the applets have access to, so security cannot be guaranteed (Andrienko *et al*, 1999).

Another development for client-side web browsers are plug-ins, which are software programmes that extend the capabilities of the browser in a set way. Although both applets and plug-ins facilitate the construction of this 'thin server/thick client' architecture, they are different from each other (*table 3.4*).

Applets	Plug-ins
Machine and operating system independent programmes	Specifically designed for particular platforms, operating systems and browsers
Loaded with data on request	Must first be installed on client machine
Restricted access to resources on both the client and the server for security reasons	Can access local data

Table 3.4: Differences between applets and plug-ins (Vatsavai et al, 2006)

In terms of aiding interoperability, incorporating applets seems to be most beneficial, as they are independent of the systems on which they are operating and can be loaded as and when data is requested. However, plug-ins can provide more specific extensions to the functionality of the browser that are required by certain applications. Care should be taken when incorporating any proprietary client-side applications though, as they are often written to conform to their respective servers meaning different client-side applications are not interoperable with each other (Peng and Zhang, 2004). This results in ‘vendor dependency’ and will be discussed further in section 3.5.

Although these developments on the client-side have addressed some of the failings of the server-centric approach, such as limited user interface capability and overloading of servers, there are also issues with a client-centric architecture. For example, it is often very time consuming to download data and data processing on the client-side is restricted to simple tasks. The relative advantages and disadvantages of both approaches are summarised in *table 3.5*.

Approach	Strengths	Weaknesses
Server-side (Server does the task and sends the results to the client)	<ul style="list-style-type: none"> ✓ Outputs available on any web browser ✓ Minimises client user requirements 	<ul style="list-style-type: none"> ○ Poor performance and interactions ○ Limited user interfaces ○ Over-loaded servers for many requests ○ Insufficient quality map graphics
Client-side (Data is sent to the client and they do all the processing tasks)	<ul style="list-style-type: none"> ✓ Improved performance and interactions ✓ Advanced user interfaces ✓ High quality map graphics 	<ul style="list-style-type: none"> ○ Internet traffic problems ○ Inefficiency in complex data processing ○ Time-consuming during download

Table 3.5: Strengths and weaknesses of server-side and client-side approaches for Internet GIS (Chang and Park, 2006)

Rather than having to choose between these approaches and trying to compensate for the associated weaknesses of the selected architecture, the ideal structure is to have balanced client/server architecture. By adopting this balance, it enables the coupling of the strengths of both approaches, as tasks are split between the client and the server depending on size, task requirements and so forth (Chang and Park, 2006). For example, to balance the client/server system and reduce the communication cost for a geo-spatial analysis function the following rule can be applied:

“Apply geo-spatial analysis function (f_g) on server, (i) if the computational cost (t_f) is less than communication cost (t_c), (ii) if the resultant data (d_o) is less than input data (d_i), otherwise apply the f_g on client.”

(Example of load balancing rule, designed for the open source software MapServer taken from Vatsavai et al, 2006, p. 405)

In this case, the system decides where to execute the processing task (f_g), which is dependent on the cost of carrying out the operation on the server and transmitting the results compared with transferring the raw data to the client along with the applet required to execute the task. By being able to allocate specific tasks to either the client or the server, an optimal working environment is produced that will enable more complex tasks to be executed across the Internet. Although it is recognised that this is an ideal situation, designing a system that calculates whether it would be more

efficient to execute a task on the server or client requires a lot of thought and further research is currently ongoing in this area to ascertain optimal methods to do this.

3.5 Standards

The standards to which any system adheres to is a vital aspect that will dictate whether that system is interoperable. One of the main problems with proprietary Internet GIS packages is that they are created in isolation and so are not generally developed to conform to any common standards. Indeed they often have their own design, architecture and database structures and formats (Chang and Park, 2006) as well as their own proprietary standards. Some vendors do fundamentally incorporate general standards but manipulate them so that they become a language that is associated directly with the proprietary package.

One example of this can be seen in the ArcIMS software, where ArcXML, essentially an XML standard, is used as the basis for communication between ArcIMS connectors and for creating the 'service'. Although it appears to be XML, it has been altered so it is effectively a proprietary programming language (Tsou, 2004). This results in 'vendor dependency', as mentioned previously, since although other systems could read in the ArcXML service files it would be difficult, as it would probably require an XML parser to be specially written (O'Callaghan, pers. com). This ensures that an organisation or individual is then tied into that particular software. The problem of vendor dependency is now being addressed though as commercial software organisations are beginning to incorporate open standards; for example, ESRI has now extended ArcIMS to incorporate the Open GIS Web Map Server (WMS) specifications (Tsou, 2004).

Alongside the WMS standard, the Open GIS Consortium (OGC) have developed additional open standards to address this issue of common standards and interoperability, as well as to deal with the restricted capability of established Internet standards to deal with geographical information. Two such standards that have been developed are GML and SVG.

GML is based on the XML schema and allows for the “modelling, transport and storage of geographical information, including both the spatial and non-spatial properties of geographical features” (www.opengeospatial.org). GML allows the user the freedom to create their own descriptive tags and elements, which is an improvement on the fixed or limited options available with HTML (Peng and Zhang, 2004). Whilst this standard describes the contents of the files, it does not include how they should be visually displayed (Peng and Zhang, 2004). For this the GML data has to be transformed into a geographical format, like SVG.

Again, SVG is “an XML-based language used to describe an image, especially for display in the web browser” (Peng and Zhang, 2004, p.100). The smaller size of SVG files compared to raster images means they can be transmitted across the Internet a lot faster. Additionally, unlike raster images that merge with the web page, the SVG file still contains text and is therefore searchable, thus providing greater potential for Internet GIS (Peng and Zhang, 2004). Finally, both GML and SVG files are XML files, which means that they are interoperable within the Internet environment.

All of these benefits mean that GML and SVG have the potential to be very important in the development of Internet GIS (Peng and Zhang, 2004). Indeed, it has been suggested that GML in particular may be where the future lies for data sharing between organisations and the ability to link geographical databases (Vatsavai *et al*, 2006). However, whilst these standards have their uses and go some way to promoting interoperability between systems, they are just two of many standards that have been produced in recent years and given the fluidity of the Internet environment and the drive to develop GIS applications on the Internet, there are liable to be more standards written in a short space of time. Whilst it looks as though GML will be approved as an international standard, other standards are developed by commercial organisations that are then exclusive to their products. For example, Google has created Keyhole Markup Language (KML) as a follow on from the GML standard. If large Internet GIS initiatives are based on standards that are not ever fully adopted and accepted by the larger Internet and GIS communities, there is a danger of effectively ‘building on sand’ that will ultimately result in any Internet GIS needing to be frequently altered to comply to the next generation of open standards.

3.6 SOA and web services approaches

The concept of web services has existed for a while. However it is now being increasingly considered by more and more organisations (The Economist, 2004), as the importance of interoperability is becoming ever more apparent. The necessity of adhering to open standards along with creating a more flexible architecture that can then be tailored to the requirements of an organisation, are reflected within the web services concept.

Services are independent building blocks that can be grouped together to form an application environment (Erl, 2004). Open Internet standards can be used to identify and access these services (*figure 3.4*).

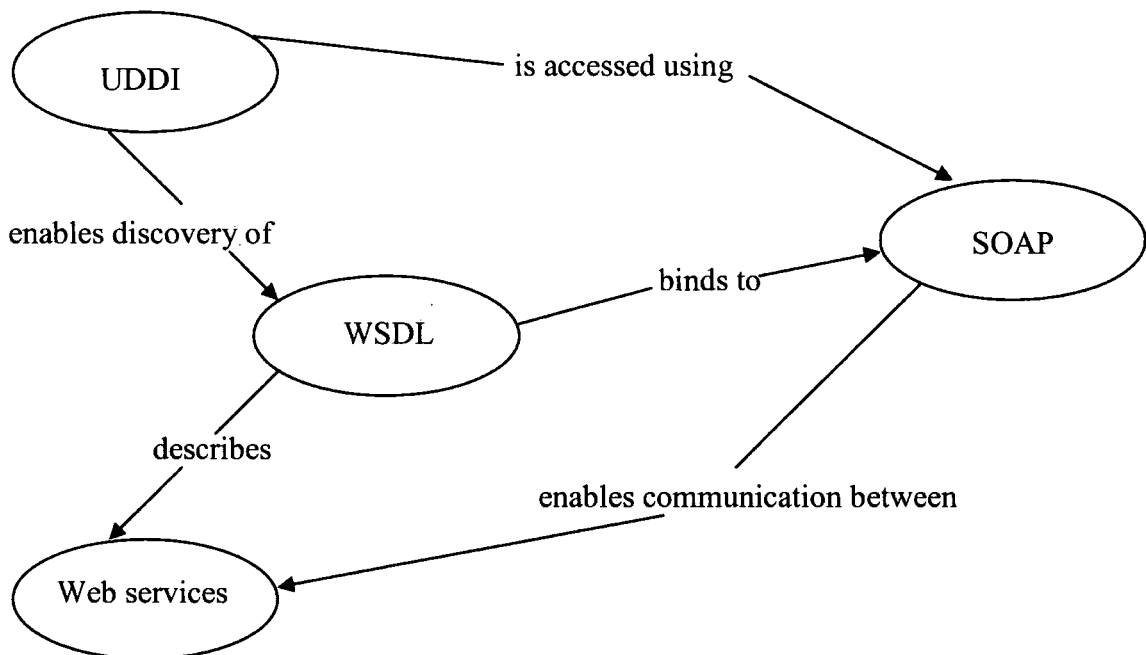

Figure 3.4: The relationship between first generation specifications and web services (Erl, 2004).

As each service is independent, it can be accessed using XML formatted SOAP messages and then incorporated into any application at any time. This makes them independent of any hardware or software platforms and programming languages (Chang and Park, 2006). As a result of this, web services can be used as a substitute

for proprietary database management systems for example, by being positioned at a central access point to retrieve the stored data when requested by a client, thereby removing dependency on vendor-based software (Erl, 2004). Although ArcIMS creates services that then run the application websites, these are based on ArcXML, which is a proprietary programming language. Therefore these web services are not truly interoperable between different systems.

When a client engages a service, that client then also becomes a service during the course of the transaction (Erl, 2004). In this way, web services can be seen not to conform to the traditional client/server model, as discussed in section 3.4, but function in a more open environment. Operating outside of this structure means that the web service has greater flexibility as it can be incorporated into any existing Internet GIS, regardless of whether its architecture is server or client-centric.

Conversely, rather than having applications that can occasionally incorporate a service, a Service-Oriented Architecture (SOA) can be established within an organisation. This design encapsulates application logic within services that then interact through common protocols (Erl, 2004). A web-based SOA extends this concept into an Internet environment to imply interaction between web services. It is important to note that web services are a specific method of implementing a SOA, not SOA itself.

For an Internet GIS with multiple applications, common functions of these applications can be grouped into web services and then distributed onto multiple servers and then only the necessary components need to be extracted and combined to complete a specific application (Chang and Park, 2006). As well as functions, these web services can also be used to exchange geospatial data in the form of GML and SVG files, making data exchange efficient and aiding interoperability (Chang and Park, 2006). The idea of creating a SOA for organisations like NTS will be discussed further in chapter five.

3.7 Summary

This chapter has discussed in detail the key components of both the back and front end of any Internet GIS that need to be considered in order to produce a fully

interoperable system. The value of relational database models in the context of GIS has been evaluated along with a review of the PINTS metadata standard, one of the original objectives outlined at the start of this project. It is essential that all future databases, IT systems and standards be fully integrated into and interoperable with a GIS, so they can regularly and automatically update the system with the most recent data. Failure to do this will result in a standalone GIS that will very quickly become of very little use to anyone.

The merits and failings of client and server-side architectures have also been considered, but the benefits of these approaches will be reviewed further in relation to the ASPMap and ArcIMS demonstration systems in the following results and interpretations chapter.

Chapter 4: Results and Interpretation

The previous chapter looked at the technical contexts and frameworks in which an Internet GIS would be required to operate. This chapter will now focus on the construction and evaluation of the Internet GIS demonstration models. The structure of this chapter will firstly look at the user requirements ascertained from the one-to-one semi-structured interviews conducted at central office, south regional office and the Balmacara Estate and Newhailes properties. It will then be shown how the interviews influenced the design and construction of the three demonstration systems. The following section will assess the options of a proprietary or bespoke Internet GIS solution for an organisation like NTS. This evaluation will be sub-divided into two sections. First, the functionality and implementation requirements of the two software packages will be considered. Second, the benefits and issues associated with adopting and integrating a proprietary or bespoke based approach into existing frameworks will be assessed from an organisational viewpoint. Finally, a critical evaluation of the value of an Internet GIS for an organisation like NTS will be undertaken.

The format of this chapter will consist of a combination of both results and interpretation, since the nature of this project means that the two are intrinsically linked. Presenting them together will help to enrich the arguments and understand the evaluations.

All direct quotes from the interviews, questionnaires and the evaluation session are highlighted in blue font. Attributions have also been added to each quotation to indicate the source of the information: 'A' for interviews, 'B' for questionnaire findings and 'C' for the comments recorded during the evaluation session. Each informant that has been directly quoted has also been allocated a numeric code, e.g. Informant A1, to protect his or her identity.

4.1 User requirements

Overall, the combined requirements collected from the interviews conducted across all levels of NTS indicated that the majority of informants wanted "a simplified system that could be developed" (Informant A1). Users applied the term 'simplified'

to both the data they wanted to be included in the system as well as the required functionality with an Internet GIS.

The user requirements ascertained from the interviews were for the inclusion of basic and general datasets in a system, such as boundaries, Sites of Special Scientific Interest (SSSI), listed buildings and other key features that are typically present across NTS properties. Users felt that a system should not try to incorporate too many datasets, as it would then become overcomplicated and difficult to use. Only including key datasets on a Trust wide Internet GIS will still involve a large amount of data, without considering the many more detailed and specific databases held by particular departments. Although it is argued that a GIS is only as good as the data that it is derived from (Aitken and Michel, 1995), too much data can slow the system, thereby lowering the performance rate. Therefore, selecting the right amount of data is a very important consideration, since informants recognised that the user's first impression of the system was key. One informant said people would "lose faith (Informant A2)" if the system did not do what it was meant to and would more than likely cease any future use of it. This view was reinforced during general discussions with other staff.

The main functionality requirement highlighted by informants was to utilise the ability of a GIS to manage large volumes of spatial and attribute data. There was little mention generally of more complex geospatial analysis, except for one or two members of staff who use a desktop GIS on a daily basis, including an informant at Balmacara Estate who manages the existing GIS. As the majority of people who were interviewed had limited or no understanding and experience of both GIS concepts and software packages it could have been that they did not know the full capabilities of a GIS. However, the researcher explained the potential of GIS, using examples where necessary, but the decision was made not to present informants with a tick list of possible functionality. This ensured a real user's perspective was obtained and informants focused on their actual needs, rather than being guided by the capabilities of the latest piece of technology (Appleton and Lovett, 2003). Furthermore, this finding did not contradict the results from other studies, which indicate that many organisations initiating a GIS tend to focus on the 'information management' aspect of the system and usually require only limited spatial analysis capabilities (Reeve and

Petch, 1999). Several informants agreed that there “is always the scope to extend the functionality at a later stage” (Informant A1) once the system is established.

Although these findings only represent a proportion of the whole organisation, there is significant evidence to indicate that, from a GIS viewpoint, the institutional environment is at the very early stages of development. Consequently, a system design that is fairly simplistic will best suit this context. However, that is not the whole story and to fully address the institutional setting, two additional components need to be taken into account. Firstly, although the vast majority of interviewees had little or no experience of GIS, there were a few users, and there will be more throughout the organisation, which will require more complex GIS structures in place. This indicates that although the initial system design must be simplistic, there needs to be an openness of design and element of flexibility integrated into the system from the beginning to allow specialist departmental sub-applications to be developed that enhance rather than replace the main corporate system.

Secondly, linking to that is the fact that institutional environments do not remain static, but will develop and evolve. Although, in this case, an initial system may need to be simplistic in order to be usable, once it is implemented and staff become more efficient and knowledgeable with the system and software, the skill set and knowledge of all staff will inevitably increase. This knowledge will be retained within the social structure of the organisation, being transferred to new members of staff and may even be a pre-requisite for certain positions/jobs in the future. The importance of fully integrating a GIS initiative into corporate IT structures was outlined in chapter three, but in much the same way it is equally important that it be amenable to shifting staff skills and social dynamics of the institution.

Having considered the overall result, a more detailed analysis can be undertaken by categorising the data and user requirements by department using a grid chart (Reeve and Petch, 1999). This provides a graphic interpretation to help visualise these qualitative results.

		Property Managers	Estate Officers	Secretaries	Land Agents	Education and Interpretation	Archives and Property Information	Management Planning	Buildings	Nature Conservation	Interiors and Collections	Policy and Planning
Data	PINTS	Major	Minor	Minor	Major	Minor	Major	Major	Major	Major	Major	Major
	Environmental surveys	Major	Major	Minor	Minor	Minor	Major	Minor	Minor	Major	Major	Major
	Building surveys	Major	Major	Minor	Minor	Minor	Major	Minor	Major	Major	Major	Major
	Conditions surveys	Major	Major	Minor	Minor	Minor	Major	Minor	Major	Major	Major	Major
	OS maps	Major	Major	Minor	Minor	Minor	Major	Minor	Major	Major	Major	Major
	Historical maps	Minor	Major	Minor	Major	Major	Minor	Minor	Major	Major	Major	Major
	Images	Minor	Major	Minor	Major	Major	Minor	Minor	Major	Major	Major	Major
	Planning applications	Major	Major	Minor	Minor	Minor	Major	Minor	Major	Major	Major	Major
	Project work	Major	Major	Minor	Minor	Minor	Major	Minor	Major	Major	Major	Major
	Legal data	Major	Minor	Major	Major	Minor	Minor	Minor	Major	Major	Major	Major
	Visitor numbers	Major	Major	Major	Minor	Major	Minor	Minor	Major	Major	Major	Major
	Research papers	Minor	Major	Minor	Major	Major	Minor	Minor	Major	Major	Major	Major
	Management plans	Major	Major	Minor	Minor	Minor	Major	Minor	Major	Major	Major	Major
	Designated areas	Major	Major	Minor	Minor	Minor	Major	Minor	Major	Major	Major	Major
	External data	Major	Major	Minor	Minor	Minor	Major	Minor	Major	Major	Major	Major
GIS Functions	Browse maps	Major	Major	Minor	Major	Major	Minor	Minor	Major	Major	Major	Major
	Print maps	Major	Major	Minor	Major	Major	Minor	Minor	Major	Major	Major	Major
	Query GIS data	Major	Major	Minor	Major	Major	Minor	Minor	Major	Major	Major	Major
	Quantification	Major	Major	Minor	Major	Major	Minor	Minor	Major	Major	Major	Major
	Buffer zones	Major	Major	Minor	Major	Major	Minor	Minor	Major	Major	Major	Major
	Geospatial layer analysis	Major	Major	Minor	Major	Major	Minor	Minor	Major	Major	Major	Major

Table 4.1: Grid chart of user requirement results, in reference to GIS data and functionality

KEY	
Major user	Occasional user
Minor or non user	

This grid chart (table 4.1) shows the general departments that were included in the study and the key datasets and GIS functions identified during the course of the interviews. The importance of both the datasets and functionality to a specific department was then recorded using a three-colour code, indicating either major, occasional or minor/non use (refer to the key above and back to chapter two, section 2.2.2). By structuring the grid in this way, certain features can be extracted from the results.

Reading along the rows indicates what datasets need to be accessed by multiple departments and therefore are key candidates for inclusion within a corporate Internet GIS (Reeve and Petch, 1999). For example, information contained within the current PINTS database is core data that all but three of the departments contained within this grid chart stated they needed some regular or permanent access to. In addition to this, all survey information, OS maps, management plans, project details, designated areas and external data all feature highly as information that multiple departments require access to. Planning applications also appear to be important across all departments from the grid chart, however, the reason for this high value is due to informants wanting to know what work and activities are taking place on certain properties rather than the full detail of all planning applications.

In the same way that reading across the rows highlights key datasets, looking down the columns of the grid chart allows the identification of departments that are heavily dependent on spatial data (Reeve and Petch, 1999). Whilst conducting this exercise produces expected departments such as property managers, nature conservation and policy and planning to name a few, it also identifies less obvious departments such as archives and property information. Although this department does not fundamentally rely on and use spatial information, it is responsible for handling and archiving data like the surveys and management plans that are inherently spatial, in that they are tied to specific properties.

As well as identifying departments that heavily require spatial data, studying the patterns contained in the columns of the grid chart also highlights clusters of departments that have similar data and functionality requirements. Distinguishing these clusters is therefore a useful technique for detecting departments that could provide the focus for a shared or departmental GIS application (Reeve and Petch, 1999). A distinct cluster can be seen in *table 4.1* around the major use of historical maps and images data between the education and interpretation and archives and property information departments, as well as the interiors and collections department to a lesser degree. The main functionality requirements from all of these departments are the abilities to browse and query the data. It may be then that these departments would benefit from a shared historical Internet GIS application, containing historical

records, images and maps, structured by property, which can be browsed and queried by members of the public and researchers as well as staff from these departments.

This would most likely be a sub-component of a primary corporate Internet GIS though that would be developed at a later stage, since the overwhelming response stated by the majority of informants during the interviews was that they required a “central system that draws together all the core information into one place” (Informants A1, A3 and A4). Feedback from the evaluation session supported this and identified up to fourteen isolated systems that have been developed in the Trust to date, including the desktop GIS at Balmacara Estate, which is currently fragmenting NTS and making it impossible to obtain an overview of the Trust’s data and collections. It is this concept of a corporate Internet GIS containing core and essential data that has been used as the basis for creating the demonstration systems.

To summarise, requirements ascertained from the interviews indicate that users want a system that provides access to the core datasets and contains basic functionality to enable viewing and querying of the data (as identified in *table 4.1*). Informants recognised that the system needs to be flexible enough to be extended, especially for more experienced users, who require the ability to develop specialist sub-applications to the main Internet GIS for individual departmental use; although users recognised these would be created once the initial system has been installed and finalised.

4.2 Design and implementation of demonstration systems

In accordance with user requirements ascertained through the analysis of the interviews, the demonstration systems were designed to provide easy access to centralised data and core GIS functionality, identified in *table 4.1*. Existing Internet GIS websites (including PastMap) were researched on the Internet to provide possible general ideas for the overall layout of the demonstration systems, which were then used in conjunction with these requirements from NTS to produce a final design structure. For example, the organisational requirement from NTS to be able to drill down from an overview of many properties into one specific property prompted the structured design of the ASPMap demonstration system, beginning with an overview of the properties throughout Scotland and then the option to select a particular region and then specific property and its features.

As suggested by the grid chart (*table 4.1*), key GIS datasets to be incorporated at a local level included property and designed area boundaries, listed buildings and collection condition surveys, all of which were therefore included in the design of the demonstration systems. As discussed in chapter two, section 2.3, GIS layers for Balmacara were obtained directly from the property's desktop GIS, whereas the GIS data for Newhailes was digitised and assembled by the researcher. Desired raster datasets consisted of OS and historical maps and collections imagery and additional key information included PINTS data, property management plans and access to external data sources, all of which were included in the demonstration systems.

Users required the facility for greater awareness of activities and future project work occurring at property level, which prompted the inclusion of projects and pending work GIS layers into the design, in addition to the more obvious features. This need was particularly obvious through the interviews conducted at Newhailes and its corresponding regional office (south), as well as some of the interviews with staff at central office.

It should be noted that whilst the design of all the demonstration systems was carried out by the researcher, in accordance with the findings from the interviews, the actual coding and programming of the ASPMap and customised ArcIMS systems was undertaken by two other colleagues. The researcher maintained a heavy involvement throughout the whole production and implementation of these systems though, providing clear instruction as to the layout, structure and functionality for the systems. On a few occasions where the programmer was unable to code the systems exactly to the specification, the researcher adjusted the design slightly in order to accommodate the skills of the programmer. The researcher produced and published the first ArcIMS demonstration system, as it required no programming skills.

To reiterate, the purpose of these demonstration models was not to provide fully functional final Internet GIS products, but to demonstrate features, approach and functionality of bespoke and proprietary software packages that could be evaluated by users. With this in mind, key functionality requirements from the interviews will be

discussed in turn, with reference to how they were achieved in the demonstration systems and how users in the evaluation questionnaires received them.

4.2.1 Searching

Searching the data is an essential requirement for any Internet GIS; therefore all the demonstration systems contained a searching tool. The search engines in both the default settings for ArcIMS and in the ASPMap demonstration systems followed Boolean logic, using ‘AND’ and ‘OR’ operators to compose a simple or complex query string (*figure 4.1*). Upon execution in the client browser the search query was transferred to the web server (and then spatial server for ArcIMS) and the results were sent back for display in the viewer, using the map as a presentation medium and their spatial context as a referencing mechanism (Egenhofer and Kuhn, 1999). The programming of this search function within both of these demonstration systems meant that only a single activated layer could be searched at any one time.

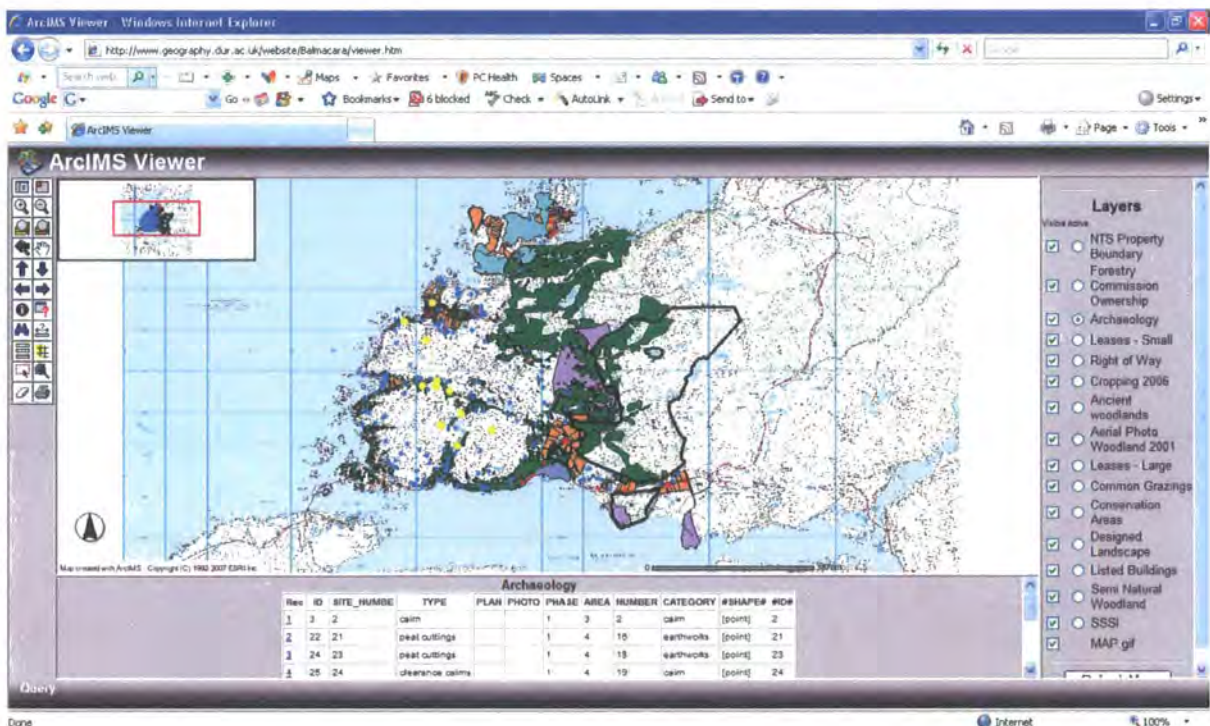
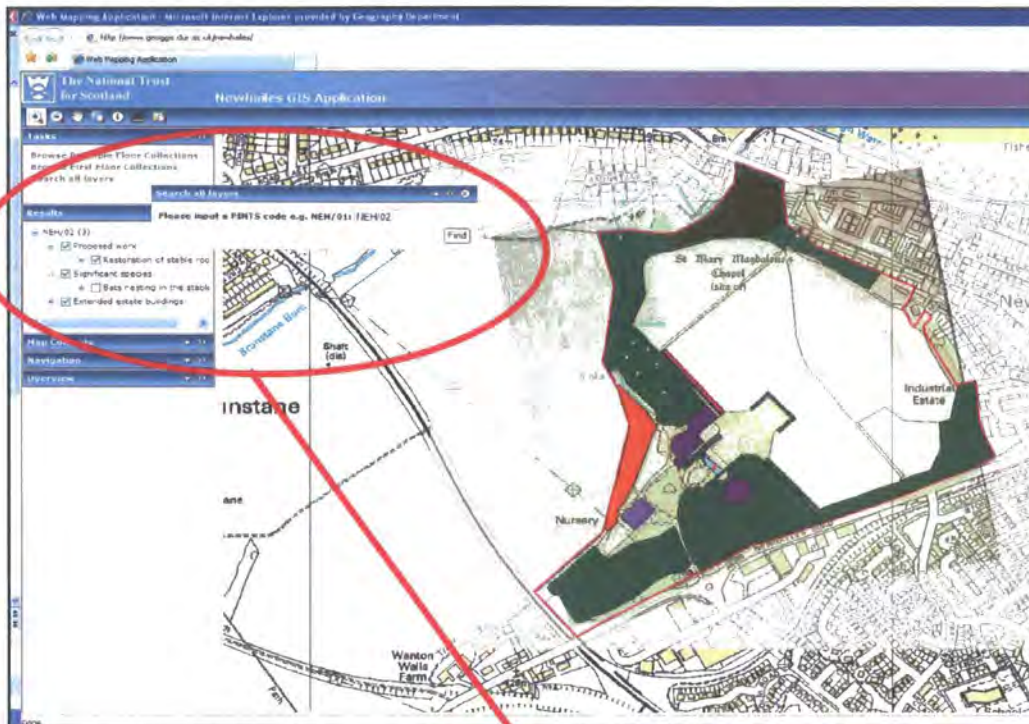

Figure 4.1: Screen capture showing the results of a search query executed in the first ArcIMS demonstration system. The features are highlighted on the map and the attribute table is displayed below. The query was carried out on the archaeology layer for Balmacara to find all the cairns and earthworks (CATEGORY = "cairn" OR CATEGORY = "earthworks")

Feedback from users about this search function was mixed. Users with previous knowledge of GIS gave opposing evaluations in the questionnaire feedback of the search function in the first ArcIMS demonstration system. On one side one user “could not work out how to use the search function” (Informant B1) whilst another claimed that this system had the “best search function” (Informant B2) of all three systems with the ability to instantly navigate to returned results from a search being “extremely beneficial”(Informant B2).

The ability to search within a particular layer is adequate if it is something exclusively related or specific to that layer. However a more likely scenario for users is that data from multiple sources needs to be searched and this is where a GIS would greatly benefit NTS. In order to demonstrate this, a customised search task was programmed into the second ArcIMS system that searched all the databases for Newhailes for any record containing a specific PINTS code.



**General search for NEH/02
[Stables on Newhailes Estate]**

Extended estate buildings		
Owner	Dated	PINTS code
Sir David Dalrymple	Early 18th Century	NEH01
Christian Dalrymple	Between 1792-183	NEH02

Buildings data

Proposed work		
Purpose	Schedule	PINTS code
Restoration of stable roof	Work scheduled to begin 20/11/2007 for two weeks	NEH02
Removal of selected trees from the Longwalk	Work scheduled to begin 10/8/2007 for one week	

Projects/work data

Significant species	
Importance	PINTS code
Bats nesting in stable roof	NEH02
Habitat for regionally significant butterflies	
Nesting birds in the spring/summer	

Species/conservation data

Figure 4.2: Screen capture (top) showing customised task for searching by PINTS code on the Newhailes property data. The tree diagram below is a visual representation of the process that identifies three entries from separate databases, all holding different information for the stables on the estate (PINTS code NEH/02)

The search task presented in *figure 4.2* has identified three databases containing information on the stables, two of which immediately highlight a problem. The project/work data shows that restoration of the stable roof has been approved; yet the species and conservation data clearly states that the roof contains nesting bats.

Although some of the data used here is hypothetical, this type of oversight has already occurred at NTS when the spraying of bracken was scheduled within the vicinity of sea eagle nests. This potentially severe error was averted only by luck and has brought to the attention of staff the importance of awareness across the Trust, which can be facilitated through centralised access to key datasets. In addition, this example also illustrates the value of adhering to a metadata standard across all NTS datasets. Ensuring that the correct PINTS code is allocated to all records and that the pre-determined database structure is upheld for all data throughout the Trust makes the information far more searchable. One informant stated in the questionnaire that principle of creating these customised tasks held “great potential” (Informant B2), which was supported by several informants at the evaluation session, who could see that they “could be tailored to suit individual management requirements”(Informant C1) and could be there for the user to perform daily when they first log on to the system.

4.2.2 Identifying and selecting features

In the same way that being able to search the data is an essential requirement, so too is the ability to identify features contained on an Internet GIS. The identification tools built into the ASPMap and first ArcIMS demonstration systems work in a similar way to the search tool, in that the layer that requires interrogation needs to be activated first before clicking on the map and bringing up the associated attribute data.

It is unpractical though to expect users who require the ability to easily query multiple layers to repeat the same query to each layer individually. Therefore the researcher designed the select by point tool (identify) in the second ArcIMS demonstration system to return results from all layers that overlapped that point on the map and the programmer coded this customisation into the system. This is a significant step up from the default settings, providing a larger amount of information quickly.

The default settings in ArcIMS also provided functions for selecting features by line, rectangle or polygon as well as by point. This is a useful extension for management, particularly for the larger properties like Balmacara, as investigation of the data is likely to be required at larger spatial scales, better represented by polygons than points on a map. However, the disadvantage of these functions is that only one layer can be

activated at any one time, so these spatial queries will produce very limited results as the system will only return the affected records in the activated layer, even if other features are clearly included within the defined area. This was seen as a significant limitation during the evaluation session. These functions could be improved though through the customisation process. Although these tools were demonstrated in the ArcIMS software, ASPMap can also be programmed to provide this functionality.

4.2.3 Raster layers and images

4.2.3.1 Ordnance Survey maps

OS maps were without question the preferred base maps for an Internet GIS. Landline and more recently MasterMap have been used as the basis for paper maps and desktop GIS work to date within the Trust, so it is the most familiar presentation medium for staff. Therefore, the 1:25,000 scale colour raster for Balmacara and the 1:10,000 scale raster for Newhailes were downloaded from the EDINA Digimap website as the two key base maps for all demonstration systems.

The OS map files were compressed and transformed into ecw files using ArcGIS Plug-in with ECW JPEG 2000 Compressor for use in the ASPMap demonstration system. Despite this compression the maps retained a very high resolution. The clarity of these images within the ASPMap demonstration system enabled people to “accurately zoom into the properties” (Informant B1), which was well received by several users and noted in the questionnaire feedbacks. Although this level of detail is ideal for larger geographical features, the larger map scales used are not sufficient for zooming into smaller sections of the larger properties in particular. In the evaluation feedback, one user instead recommended having a “greater range of OS maps”(Informant B3) to choose from, the same approach used in RCAHMS and Historic Scotland’s PastMap application. Increasingly higher resolution maps can then be viewed when drilling down from large-scale regional overviews into specific properties to view their features. This raises further issues of data availability though that relate to licensing and ownership of OS maps, particularly for a charity such as NTS. These will be discussed further in chapter five.

When the same OS maps were used for the first demonstration system in ArcIMS, the map did not appear in the web browsers with the GIS layers. This was strange considering the OS data appeared without any problems in the ‘Author’ management programme and it was only when the final service was ready to be viewed on the Internet that the problem arose. In order to display the OS map at all in the first ArcIMS demonstration system, the GIF map file had to be significantly compressed and this caused much of the resolution to be lost.

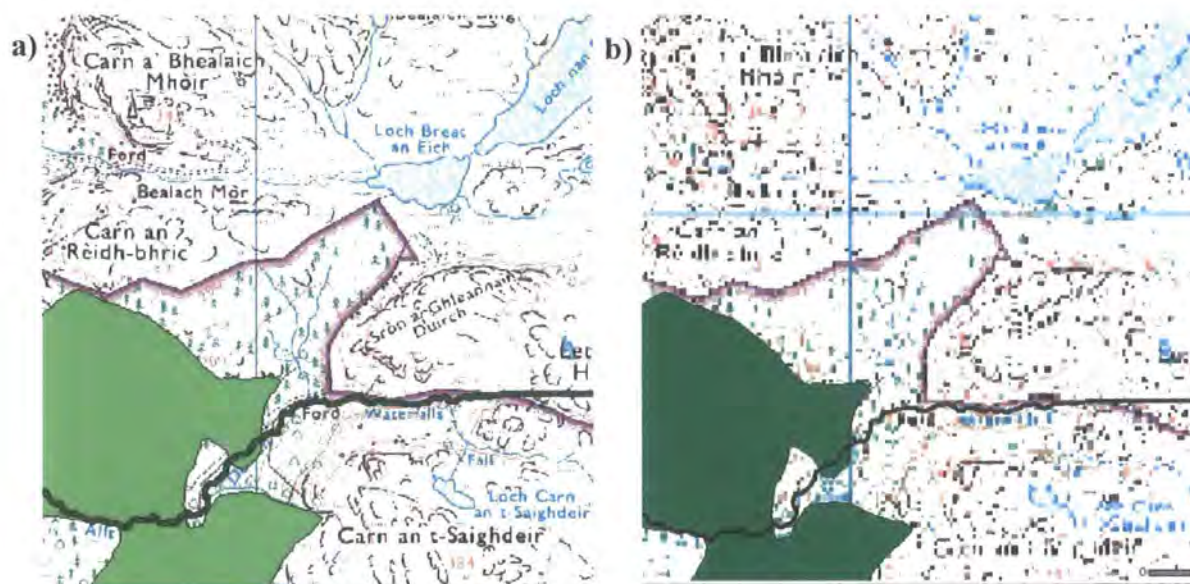

Figure 4.3: OS map resolution for Balmacara Estate (a) in the ASPMap demonstration system and (b) in the first ArcIMS demonstration system (using the default settings)

Figure 4.3 illustrates this difference in clarity between the first and second image. The exact cause of this was never ascertained. However, since the OS map displayed in the ‘Author’ management programme prior to the map publication onto the Internet, it is likely that this is a technical problem within the product itself and will probably be corrected in later versions of the software. These errors within commercial packages need to be addressed, since users identified high-resolution map presentation on the Internet as a basic and essential requirement.

4.2.3.2 Historical maps

In addition to OS maps, users identified historical maps as a useful further base map for inclusion within an Internet GIS, particularly for a great house and estate such as Newhailes. Here, for example, historical maps have been used to identify the original

features of the designed landscape gardens surrounding the house. Interviews conducted at Newhailes identified that users wanted to be able to make reference to these historical maps and visualise the evolution of the property over time.

The 1798 paper map of Newhailes Estate recorded by Robert Bauchop was scanned and used in both the ASPMap and second customised ArcIMS demonstration systems. Within ASPMap the historical map can be selected as an additional background file to overlay the OS map from a drop down box. In order to address the user requirement to visualise the changes across the property over time, the researcher developed the concept of 'phase buttons' that were designed to clearly identify a four-stage evolution of the site, that could be used in conjunction with either the historical or OS maps. The buttons represent time periods from pre 1680, 1680-1790, 1791-1960 and 1960-Now and each contains the GIS layers of features that appeared on the estate within those time frames. The instructions on where these buttons should appear on the system and how they should work (i.e. to turn on specific layers when clicked) were then passed to the programmer who wrote the coding into the ASPMap demonstration system. Features no longer visible today, such as the designed landscape gardens can then be viewed in the context of the other features present at that time.

The same historical map was also integrated into the customised ArcIMS demonstration system, except the transparency function available in ArcIMS was applied to the map here. This made it easier to compare features on the historical and OS maps and its value would increase further if multiple historical maps were incorporated into the application. ASPMap also has the capabilities to support a transparency function.

Although they could not be included in this study, other historical maps that would be of particular use for property managers and land agents, but also as a basic reference point for all staff, are the original title deeds of NTS properties. These are often hand drawn and date back to pre-OS map data.

4.2.3.3 Images

Images and photographs are considered an important component of the collections dataset, but at present are held in separate folders on a single PC, detached from the corresponding record of that object in the database. The requirement of linking object records and images together was coupled with the ultimate aim for a GIS, of being able to drill down to within a single room inside a house and find the location of a particular painting on one of the walls and was incorporated into the design of the ASPMap demonstration system.

The floor plans for the lower and upper levels of Newhailes house were geo-corrected, converted into ecw files and imported into the system. A point shapefile of selected objects from the collections database was created, indicating the spatial location of the item on the floor plan. The hyperlink function in ASPMap was then used to create a link to the image from its attribute data, bringing up the image in the web browser when clicked (*figure 4.4*).

The screenshot shows the ASPMap demonstration system interface. The browser title is 'National Trust for Scotland WebGIS'. The URL is 'http://www.geography.dur.ac.uk/ForestSAFE/Database/Newhailes_ASP.asp'. The interface includes a search panel on the left, a central image of a painting, and an information panel on the right. The information panel contains a table with the following data:

ID	ZP	QUANTITY	OBJECT	CLASS	DATE	ARTIST
1728		1	Portrait	Picture	1728	Ramsay, Allan

The table also includes a 'DESCRIPTION' field: 'Agnes Murray Kymmond, dr of Hugh Ramsay Murray Kymmond, wife of Rev. Dr. John, Sir Gilbert Elliot of Minto, Bt., MP, full length, in pink dress with white lace sleeves & apron, blue wrap.' The 'LOCATION_1' is 'Window Sitting Room' and 'LOCATION_2' is 'Above fireplace'. The 'CONDITION' is 'Good'. The 'EXHIBITION' is 'NCS, (Leithlyth, SNP, Edinburgh)'. The 'DATE OF EX' is '1803-1802'. A red circle highlights the 'Click for image' link, with a red arrow pointing to the painting image on the left.

Figure 4.4: Screen capture showing the linking of images to the collections database in the ASPMap demonstration system. A point on the principle floor plan of the house, which was then queried, indicated the location of this painting and the associated information for the painting contained within the database was displayed on the left-hand side of the screen.

This provides an excellent example of the way in which typically aspatial data can be structured spatially within an Internet GIS and was highly praised by one user in the questionnaire feedback as an excellent tool to “help [us] distribute and receive images within the NTS”(Informant B4). It also clearly demonstrates the power of being able to drill down from an overview of PINTS subjects and elements across a property to focusing onto small-scale single objects within them. The PINTS code could be extended to encompass these smaller scale features and another user identified this within the evaluation questionnaires as the area “where the future NTS GIS system will benefit [us] enormously”(Informant B5).

Whilst this example was very popular with users and did demonstrate some key advantages of drawing together data within a GIS, it also provoked some important points for consideration. Firstly, one informant worried that the example contained too much information for release on the Internet, amounting to the “answer to a thief’s prayer”(Informant B6), yet too little information to be of use to departments working with this data daily. Security is certainly a factor that needs careful consideration. However in relation to the second point, user requirements were for a corporate GIS containing all essential and core data. Therefore, any one department would not be expected to rely exclusively on this GIS data alone, as it will not contain the necessary level of specific departmental information. This is where individual departmental applications can be developed to address these more specific requirements.

Secondly, the problem of data quantity was also raised. One user voiced the concern that this approach may be “suitable for data from a single property”(Informant B6), however when multiplied up to all NTS properties such a large quantity of small objects will “give rise to difficulties”(Informant B6). This is indeed an issue as the Trust holds more than 46,000 records for collections alone and several other informants also raised this concern during the evaluation session. The inclusion of this level of detail would not be necessary on a corporate GIS though, as some items should never be moved and others move freely from property to property. These items will require careful monitoring, so may be this can be used as a criterion to decide which items need to be incorporated on an Internet GIS and which can be kept and maintained within the department database.

These hyperlinks to images from the collections database were also included in the customised ArcIMS demonstration. Note that these had to be specifically programmed within this system though, as they are not supported by default.

Inclusion of additional types of imagery such as aerial photography and remotely sensed data were not considered to be essential for a corporate GIS, although they may be of use intermittently to specific departments or users. Therefore, this may be an area where data sharing between external organisations proves beneficial. RCAHMS for example manage an extensive aerial photo collection and it may be possible that access to certain parts of this archive could be granted to NTS.

4.2.4 External data

Previously, data sharing with external organisations and consultants involved exchanging paper maps and documents. As computer technology and GIS applications developed, data was recorded in a digital format instead. Rather than exchanging these digital GIS files, NTS receives the majority of this data as hard copy prints of the digital information. Since one of the major problems recognised by NTS is that much of their data is not yet digitised, receiving new data also in paper format is adding to this problem, not to mention the fact that this also hinders internal data sharing and data analysis.

Informants recognise that having access to external data sources would greatly complement their own data and in light of this an example was built into the ASPMap demonstration system. The attribute data for the SSSI's on Balmacara Estate contained all the basic information needed, including name and type of designation. However, when the user required more information on why the site has been designated, a hyperlink was added that directed the user to the appropriate SNH web page (*figure 4.5*).

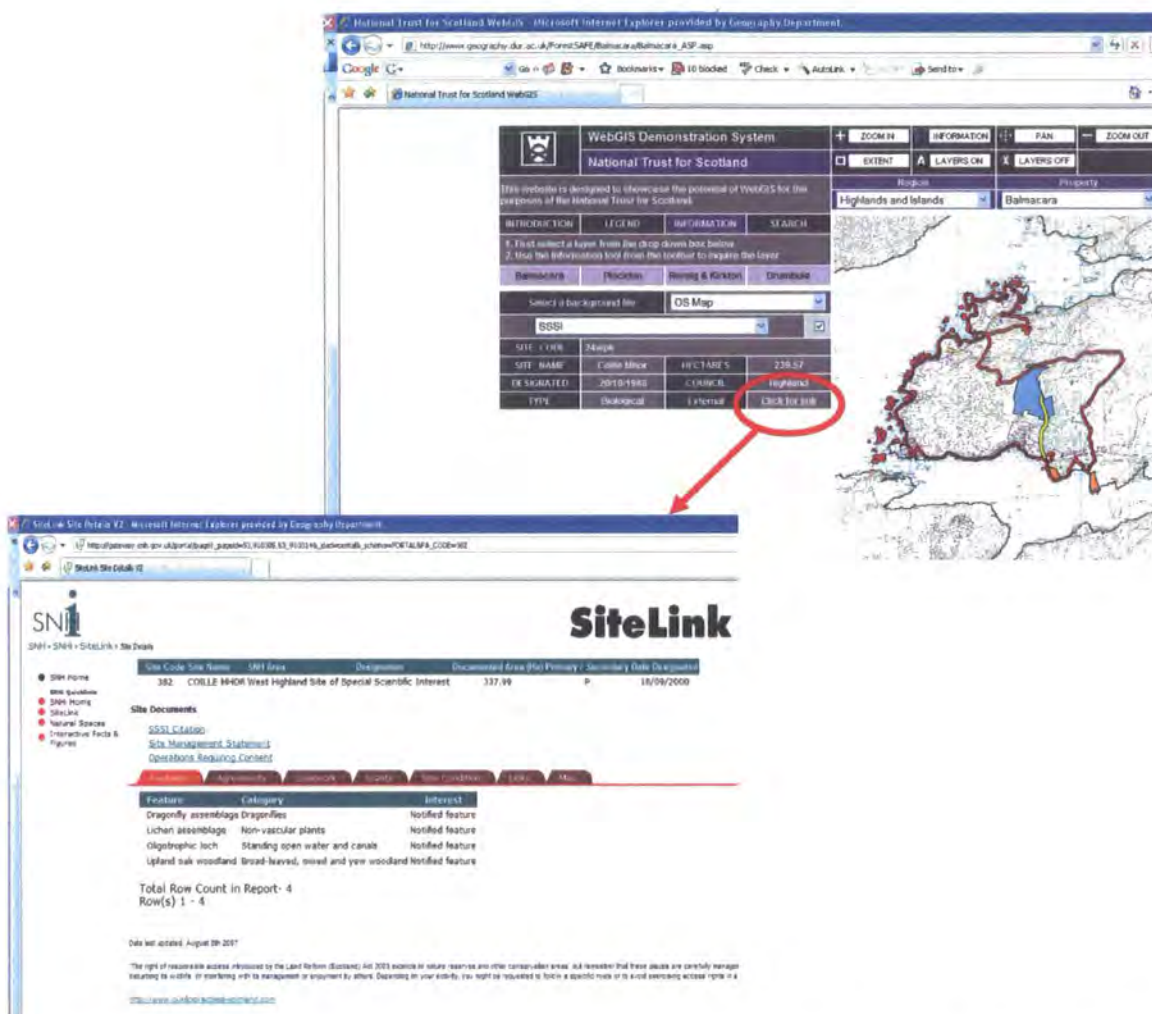

Figure 4.5: Screen capture illustrating the hyperlink feature connecting the NTS data on the Coille Mhor SSSI in the ASPMap demonstration system to the detailed record of the same site held by SNH

It is not suggested that this is by any means the optimal way of incorporating external data; indeed NTS foresee ‘live linking’ as a prospective approach for data sharing and from the interviews with RCAHMS and Historic Scotland, web services are envisaged as the future mechanism. It does serve the purpose though of demonstrating the value of additional information and also raises the point that data need not be replicated in both organisations, but held and managed by the external organisation, thereby lessening the quantity of data that NTS need to oversee. This raises further points concerning data ownership and retaining data integrity. This will be discussed in more detail in chapter five.

4.3 Proprietary vs. bespoke solutions

In order to analyse the proprietary and bespoke options illustrated in the demonstration models, this section will first present an evaluation of the software itself. Each of the demonstration systems will be discussed in turn, followed by a direct comparison of the actual ArcIMS and ASPMap software. The second part of this section will then concentrate on the approach.

Whilst it is recognised that literature on the performance assessment of systems does exist, this is often an evaluation of the software product itself, in terms of the available functionality and new developments and features that have been included. As discussed in chapter one, there are few peer-reviewed papers that are easily accessible, which provide an unbiased evaluation of software that has been used to address a specific problem. This study not only provided the researcher with the chance to do just that, but also offered the unique opportunity to receive feedback from the organisation itself, whose real life problems the systems/software were attempting to address. Furthermore, NTS is unlike other organisations that may have a vested interest in a specific vendor or package, due to pre-existing license agreements, and is therefore also able to provide an unbiased opinion based only on user requirements and the degree to which each demonstration system and software package can meet these. With this in mind, this evaluation will specifically focus on the user analysis by NTS and an assessment of how easy it would be for an organisation like NTS to implement the systems/software.

4.3.1 Evaluation of the software

All three models created in the two software packages were successful in demonstrating the value of an Internet GIS for bringing together and structuring spatial data for NTS properties from multiple departments. Staff recognised that an Internet GIS would be useful for assisting management responsibilities, without removing the need to consult colleagues and seek specialist opinions. In this respect there would be a good balance between the level of computer technology and human interpretation. The evaluation questionnaires provided more detailed feedback on the specific software packages and systems.

4.3.1.1 ArcIMS – System I

The first demonstration system in ArcIMS was created to show the functionality available by default in the leading commercial Internet GIS software package. Following the simple wizard-based step-by-step guide in the ‘Designer’ component of the ArcIMS Management suite of products provides a very quick and easy way for non-developers to set up a website to disseminate spatial information across the Internet. However, not all of the functionality required by users is contained within this default design. Some specific examples have already been discussed in section 4.2, but include support for hyperlinks that have been used to create links to images and external organisation’s websites (*figure 4.4 and 4.5*) and the ability to search and select features from multiple GIS layers. As these are core requirements identified from the interviews for an Internet GIS this lack of flexibility to select additional functions when creating the website would produce problems if this system was practically implemented within the organisation.

In terms of usability, the general trend identified from the evaluation questionnaires was that users with no previous experience of GIS discovered they needed prior knowledge of the signs and symbols in order to use this system. However, informants who had used a GIS before found the system easier to navigate, which may be due to the fact that the icons used to represent the functionality tools in this system and the general layout of the page are more similar to a desktop package than the other two demonstration systems. One experienced GIS user classified it as the “most usable system”(Informant B2) but recognised that this is “possibly because it is most like PastMap”(Informant B2). The PastMap system was also created in ArcIMS and is a system this user accesses regularly. Both of these points indicate that system preference is largely dictated by previous familiarisation with the software or similar systems and therefore this is a very important factor when analysing software usability (Barndt, 2002).

Even though some users liked this system, several functions, highly rated within the other systems, are not included in the default settings for ArcIMS. There is little scope to customise the HTML viewer, so the Application Developer Framework (ADF) in ArcIMS 9.2 was used to create the second system to address some of these

shortcomings. It should be remembered that whilst the ADF facilitates the customisation of ArcIMS, once the software is customised in any way a knowledgeable programmer who can operate within the coding is required.

4.3.1.2 ArcIMS – System II

This system successfully demonstrated that customising the software could eliminate many of the disadvantages of the first ArcIMS system. For example the default settings did not support hyperlinks but these could be programmed into the customised system. However, the main purpose of this second system was to showcase the additional features available in the ADF facility of ArcIMS that could be tailored to meet NTS requirements. The tools of particular value were the tasks that could be programmed to search either one or all GIS layers (*figure 4.2*), for example searching by PINTS code across all databases. Several users appreciated the ability to be able to easily search one or all GIS layers and could see how this principle of pre-determined tasks could be “extended to other applications”(Informant B2).

These search functions, combined with the design and layout of the information displayed in the web browser made this system more accessible to non-experienced users. However there was still a feeling that knowledge of the signs and symbols in Arc would have been an advantage. The nature of the collapsible lists and pop-out search boxes were also deemed by a couple of informants to be “difficult to navigate and easy to miss”(Informant B2). However, one non experienced user said that this website was “naturally intuitive”(Informant B4) and another commented that the pin icon in particular, used for highlighting results of searches, enabled easy visual identification of the results. One explanation of this may be connected to the fact that the general layout, the pin icons and the style of panning contained within this system are not dissimilar to that of Google Earth. Many people by now have some experience of using Google Earth and so will naturally be slightly familiar with the system and therefore be able to apply this knowledge, to some degree, to the customised ArcIMS demonstration system. Again, this relates back to the importance of familiarity with similar systems.

4.3.1.3 ASPMap

This system was created in order to evaluate whether the requirements of an organisation needing to handle diverse spatial information could be met using a bespoke rather than proprietary solution. The results from the interviews indicated that users required basic GIS functionality and this demonstration system met or could be programmed to meet all the key functions illustrated in section 4.2.

All users appreciated the clear structure into the data, achieved by having a front-page overview of Scotland divided into the four NTS regions and then the ability to focus in on the GIS data for a specific property. However, evaluation feedback for this system indicated a clear division of opinion between experienced and non-experienced GIS users. One informant with no previous experience thought this system “seemed very intuitive and looked to have the most potential to be easy to use”(Informant B7) and another stated that “no prior knowledge of signs and symbols”(Informant B5) was required to use it. An introduction page with instructions was included in the design and all the GIS tools have their function written on them, as opposed to traditional GIS symbols and icons that are more naturally intuitive to experienced users. Interestingly, an experienced user did not consider this a simplified GIS for inexperienced users but found the system “intimidating”(Informant B1), as there was not enough distinction between different sections of the toolbars. This comment is worth noting, since it is usually commercial systems that are seen to be intimidating and less accessible (Haklay and Tobón, 2003). Again, familiarisation with software is the likely explanation for this since the ASPMap system has a distinctly different feel from a desktop GIS.

From the evaluation questionnaires, both systems that were tailored to purpose, the ASPMap and second ArcIMS models were most favoured by users. This contradicts the argument from other usability studies that customisation does little to improve user’s attitudes towards Internet GIS usability (Davies and Medyckyj-Scott, 1996). Broadly speaking, the vast majority of users preferred one out of the two customised demonstration systems to the default ArcIMS system.

4.3.1.4 Comparison of ArcIMS and ASPMap

4.3.1.4.1 Storage space requirements

ArcIMS software itself requires 500MB of space on the server for the core product with an additional 500-600MB for supporting files such as the connectors (O'Callaghan, pers. comm), compared with 23MB of disk space and 64MB of memory for ASPMap software (http://www.vdstech.com/aspmap3_details.htm). Even though this is significantly less than ArcIMS, when coupled with the large amount of data that NTS needs to manage across all properties, a significant amount of space on the server is still going to be required. Overburdening the server with data is likely to lower system performance, affecting user perception of the system, since the interviews revealed that users view the computer as “only another tool to do the job”(Informant A2) and if it does not work or is too slow, people will simply “not bother to use it”(Informant A2). This principle was proved even in the evaluation stage of this research, where a user found the customised ArcIMS system very frustrating and gave up trying to use it as it was “difficult and slow to obtain any kind of information”(Informant B6), with the system collapsing at regular intervals, “displaying error messages stating that it needed to close”(Informant B6). As both of these software packages adopt a server-side approach this issue of poor performance due to large datasets will apply to both, since ideally a balanced client/server architecture is required (Vatsavai et al, 2006).

One point that should be noted here though is that twice the volume of data was contained within the ASPMap compared to the customised ArcIMS system, so this result is unlikely to be solely due to data size, although it does help illustrate the point. Technical errors are more likely to be the cause, since during the construction of the ArcIMS models the researcher found the software to be very error prone and temperamental, frequently requiring adjustment and resetting. As users in the questionnaires recorded a few technical issues with this system, it is likely that further errors have developed that are slowing system performance.

4.3.1.4.2 Functionality

As illustrated in section 4.2, both software packages were able to meet the functionality requirements from users, although for ArcIMS certain functions were not available by default and had to be specifically programmed in. On this basis either product could potentially provide the solution for an Internet GIS. However, user requirements were for an initial corporate GIS that has the potential to be extended, so the software's potential functionality should also be considered. There are other functions available in ASPMap that may be useful for users and could be integrated into an established Internet GIS application, such as thematic mapping and labelling and the ability to interact more with the data by drawing polygons and text strings directly onto maps. It should be noted though that these functions are not exclusive to ASPMap. ArcIMS can go further and provide access to more advanced complex geospatial analysis by extending its architecture to include the powerful capabilities of the ArcGIS Server.

The most advanced server, in addition to spatial analysis functions, also supports web application functionality with client-side editing capabilities and is interoperable, enabling GIS web service integration. Whilst this offers a huge scope of potential functionality, it is user requirements as opposed to technical capability that must drive Internet GIS developments (Appleton and Lovett, 2003) and this level of functionality is unlikely to be required by NTS, even for future applications, although this would require further research. Additionally, some of these functions should be approached with caution, since the ability for users to edit data in the client browser, for example, would present problems for maintaining data integrity.

Whilst academic comparative functionality studies have been done before, they generally appear within specific conference proceedings and are therefore difficult to obtain, although a collection of selected papers are sometimes published in a book. The inaccessibility of these papers has already been raised as an issue in chapter one, section 1.5.

4.3.1.4.3 Programming and coding

The wizard style approach in the default ArcIMS settings is very effective for enabling users with no programming skills to quickly publish websites for disseminating spatial information. Equally, this similar style adopted in the ADF for ArcIMS was helpful for automated code generation and was visually a lot clearer to understand in comparison to the pages of HTML, JavaScript and asp coding controlling the ASPMap system. Although this facility does simplify the process of programming and customisation to a degree, the user would still need to possess programming skills to create an application this way. Additionally, whilst this wizard-based approach and automated code generation saved some time in the short run, customisation of some functions took longer than when they were coded from scratch in ASPMap, where there were no pre-determined design boundaries. This is assuming though that the programmer is already competent using the ASPMap software, otherwise the lack of supporting coding documentation results in a steep learning curve.

The skills of the programmers did occasionally result in the need to alter, only slightly, the way the demonstration systems were designed. Whilst this is certainly a point to note when assessing the systems/software, it in fact mirrors the same real life issues that would arise when any organisation attempts to implement an Internet GIS. Currently for NTS, as there is no in-house IT team and the findings from this study indicate that at least some customisation and programming would be required to create a usable system, this process would more than likely need to be outsourced to an external contractor, unless technical staff were employed in-house. As shown in this study, if the programming is 'outsourced' it is crucial that the designer/user maintain a heavy involvement throughout the whole process to ensure the system remains fit for purpose.

All system web browsers were written in HTML, removing the need to download any plug-ins or applets to view them. Although ASPMap uses the Microsoft .asp language, as most people use Microsoft software this application should be reasonably compatible with other systems. The option for utilising Java viewers in ArcIMS was

explored, which highlighted the fact that a Java plug-in would need to be downloaded on the client computer prior to opening the application.

4.3.1.4.4 Flexibility

The structure of ArcIMS is not very flexible for allowing the addition of GIS layers into a pre-existing application, requiring the service to be deactivated and re-created and the whole map application re-published. This is a slow and laborious process requiring the existing web directory to be completely re-written each time. On the other hand, in ASPMap, GIS layers can be added into the system at anytime and when the page is refreshed they are displayed. This demonstration system was programmed so that an array could identify the display name, file type, colour and so on of a file simply from the structured file name. Although this is not an ideal approach technically, as the system should be able to recognise the file type, it does mean that users can add additional layers into the system without requiring programming skills, so long as the same file name structure is adhered to each time. Writing codes like this into a system may be an important consideration if NTS opted for a bespoke system to be developed externally rather than in-house.

Some users felt that the outward appearance of both the ArcIMS and ASPMap systems would be “too inflexible”(Informants B3 and B6) for their needs. However, this is likely to be due to the fact that users had access only to the web page itself rather than to the full system that they are more used to having. Any visual indications of inflexibility can probably be attributed to the design of the system rather than representing any issues with the software itself.

4.3.4.5 Interface design

The absence of any guidelines for the design of GIS-specific interfaces has meant that a variety of layouts have been developed, thereby lowering the possibility of any user being able to transfer the knowledge of one system to another (Egenhofer and Kuhn, 1999). The evidence from the user questionnaire evaluations showing that the usability of the first ArcIMS demonstration system was determined by the fact that the informant could transfer their knowledge and experience of a similar Internet GIS (PastMap) clearly illustrates the importance of the interface design. Since the purpose of transferring GIS onto the Internet and utilising web browsers as interfaces was in

part to make the software more accessible to non-experienced users, it seems that promoting design guidelines to facilitate knowledge transfer would be a obvious extension to lowering the learning curve for new users. Even within ArcIMS itself there are many options for interface design, which can be seen by comparing the layout of the two ArcIMS demonstration systems created in this study.

In many ways this is an even greater problem with bespoke systems like ASPMap, since they are even less pre-structured in design and layout. Screen variables are set out at the start of the asp coding, which enable the programmer to decide the exact size and location of every item to be displayed on the web page. Obviously this does little to promote unity in interface design, but it can also present problems with data display. Part of the allocated web page space was used to show field titles and example data values to aid the construction of search strings. Longer length data examples such as the property website ID's were too long to fit into the allocated boxes and had to be abridged, making the information useless to the user. In spite of this, being able to adopt this approach does provide the designer and programmer with greater flexibility, which was utilised by structuring the ASPMap demonstration system with a regional overview before drilling down into the properties.

A summary of the key features of ArcIMS and ASPMap are shown in *table 4.2*.

ArcIMS	ASPMap
500MB plus 500-600MB required	23MB plus 64MB required
Server-side approach	Server-side approach
Complex architecture	Simple architecture
Error prone system	Robust system once debugged
Good supporting online documentation and help	Poor supporting documentation for coding resulting in steep learning curve for programmer
Large scope for extending the system to include diverse and complex functionality	Small scope for extending functionality

Table 4.2: Summary table showing the comparison of key features between ArcIMS and ASPMap.

Having considered the software, the relative merits of proprietary and bespoke approaches will now be considered.

4.3.2 Evaluation of the approach

The overwhelming opinion from both the evaluation session and the questionnaires was that a bespoke rather than a proprietary approach would be the favoured option for an organisation like NTS. The vision identified and agreed in the evaluation session would be to have a “system distributed via the Internet with bespoke applications on individual staff desktops”(Informant C1). Informants from the interviews stated that the NTS Intranet would be the most likely distribution medium, since its integration into the Trust has already greatly improved communication throughout the organisation. Intranets tend to be favoured by organisations for efficiently disseminating information within companies as they provide private and internal equivalents of the Internet (Reeve and Petch, 1999), thereby providing a preliminary level of security. The favouring of a bespoke approach over a commercial solution is due to two factors.

Firstly, despite the fact that users liked the customised ArcIMS demonstration system, commercial software is likely to be too expensive for a charitable organisation such as NTS. Commercial software typically has high server set-up costs (Carver *et al*, 2004), whereas bespoke software like ASPMap is a much cheaper solution and easy to implement. Informants did however recognise significant investment into a GIS initiative would be required in order to secure the future benefits. Productivity rates would also mirror this pattern of short-term sacrifice for long-term gain, as staff recognised that they would need training in the software. This productivity curve hypothesis is illustrated in *figure 4.6*.

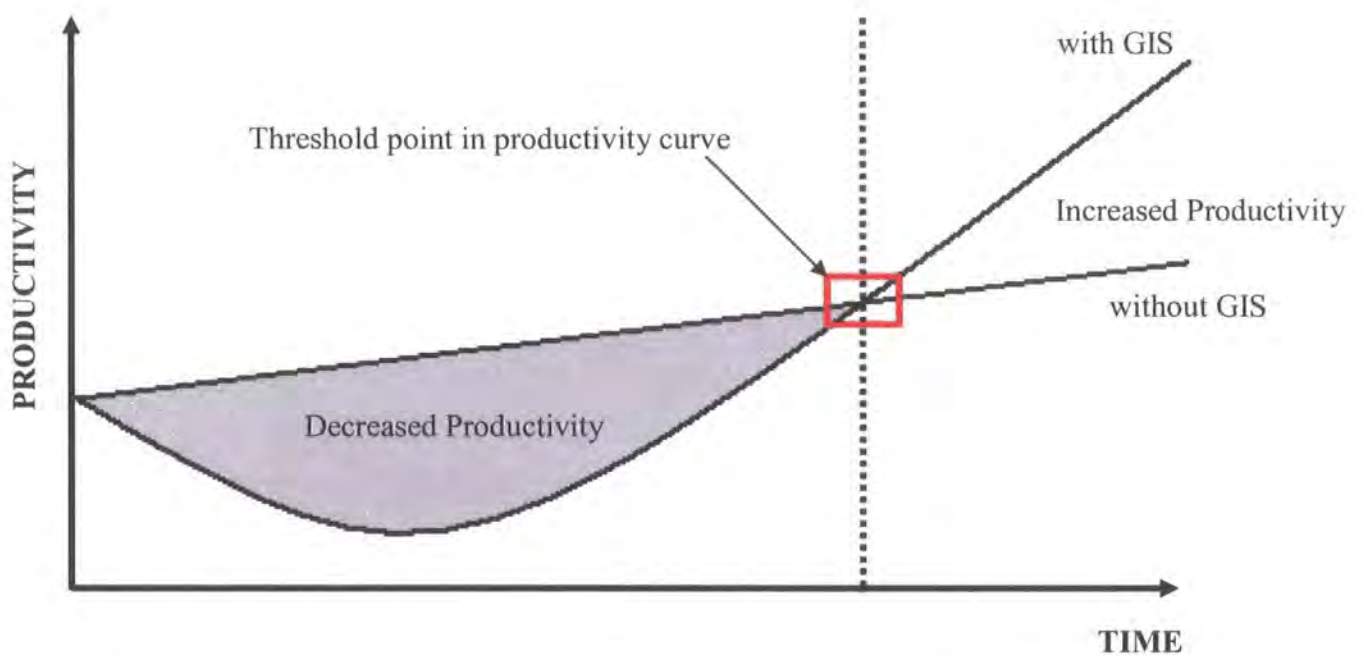

Figure 4.6: A typical GIS productivity curve illustrating generalised scenarios with and without an implemented GIS solution (modified from <http://bgis.sanbi.org>)

Although the hypothesis illustrated in *figure 4.6* could not be directly tested in this study, one informant provided evidence to support it, based on their previous experience working within another organisation that invested in a GIS. In this case staff took time out from their usual duties in order to be trained in the system and gain experience in using it, thereby decreasing the normal productivity rate of the organisation. However, once this initial learning curve was passed and the threshold point reached, the organisation recorded a 95% productivity improvement, measuring a task that had previously taken two hours to complete now taking only five minutes. This real life example clearly shows that it is necessary to “spend money in order to save money”(Informant C1); although the fact that NTS is a charity is undoubtedly a significant factor that will favour a bespoke approach.

From the interview conducted with RCAHMS, financial cost was also identified as one of the main driving factors behind their decision to buy into ArcIMS commercial software. RCAHMS had a site licence for ESRI, obtained through the CHEST agreement, so when looking to expand their GIS onto the Internet, it made sense, purely from a financial viewpoint to stay with ESRI products. Were it not for this

arrangement, the full cost of buying into commercial software may not have made this an option.

Considering the fact that the bespoke demonstration system created in this study did not lack any of the key functionality also available in the commercial software, selecting a bespoke approach would be a viable option to meet NTS functionality requirements. As previously discussed, future functionality requirements should also be considered though.

The second factor influencing the preference for a bespoke rather than commercial approach is based on practical requirements. Opting for a bespoke system, most users felt, would ensure the “most usable and efficient systems”(Informants B2 and B4) and if NTS were going to invest time and money into a system it “should be designed exclusively to meet NTS requirements”(Informant B4). Furthermore, users could envisage how a bespoke Internet GIS application could be practically integrated into current NTS IT strategies. The Organisational Management System (OMS) currently being developed is hoped to reflect the same design principles as the MyNTS system proposed in a recent report commissioned by NTS (Gittings and Batcheller, 2007).

MyNTS has a geocollaborative system design, drawing together emails, blogs, internal and external news-feeds and web mapping applications. This principle of geocollaboration combines GIS and computer-supported co-operative work (CSCW), providing a dynamic service that enables distributed groups to co-ordinate their work (Schafer *et al*, 2005). This type of design would include a bespoke Internet GIS application as well as progress reports on the status of property project work that would help raise awareness within the Trust, which was an area informants thought could be improved. Additionally, a system like this could be used as a tool to encourage public participation in NTS activities by incorporating discussion boards and bespoke public Internet GIS applications.

It could be that if a set of dynamic tools that are inherently map-enabled is sufficient to meet the requirements of NTS, a full GIS is not in fact required in this situation. However, whilst that solution may be adequate up to a point, the findings from across the interviews and evaluation feedback, both from experienced GIS users and

informants who have only recently learnt about GIS, suggests individuals would prefer and would benefit the most from a GIS-based approach.

Although the term 'Internet GIS' has been used throughout this study, including a bespoke Internet GIS application into a geocollaborative system across the Intranet would technically be classified more as a 'Distributed GI'. This is in reference to the distribution of geographical information in a variety of forms, which would include a 'web-based GIS' component (Mathiyalagan *et al*, 2005).

When informants were asked in the questionnaires whether this bespoke approach should be out-sourced to an external contractor or developed in-house there was a mixed response. Several users felt that an application should be developed in-house since this would be the best way to ensure that "primary users can tailor the system to [their] needs and changes can easily be made if required"(Informant B2). Others believed that it would most likely be out-sourced, as this would "guarantee that the people who are implementing and developing the system are skilled, trained, technical people who understand GIS inherently"(Informant B4). However, several informants also recognised that "there is a lot of expertise and knowledge within the Trust and it would be a shame not to use that"(Informant B5) and the project would only be successful "if NTS staff could be involved in the process"(Informant B5). Out-sourcing is likely to be an expensive option and some of the pitfalls of dividing the management of IT resources have already been experienced first-hand, with essentially all NTS IT responsibilities being out-sourced to Northgate. However, if these resources were to be handled in-house, NTS would need to spend money employing IT technicians and GIS developers capable of programming a bespoke GIS.

One possible solution identified by an informant in the evaluation questionnaire was to use "an external contractor to develop and maintain the system but working for a consortium of like-minded bodies"(Informant B3). It was argued that this would be more economically viable and would facilitate cross-referencing and data sharing between like-minded organisations. This type of approach is already being implemented, as can be seen by the partnership of RCAHMS and Historic Scotland for producing the PastMap application, which was a knowledge transfer process as

well as a data sharing exercise. NTS are not alone in currently trying to scope out or update a GIS initiative. One informant identified Scottish Natural Heritage (SNH) during the evaluation session as an example of an organisation still designing a GIS system capable of answering more basic types of questions. Other organisations that are starting up or modifying their GIS approaches have also been mentioned throughout the course of this project, within interviews and Core Data Model meetings. Therefore, this idea of a consortium of organisations is likely to be well received by many organisations.

Regardless of the exact approach decided on though, any Internet GIS initiative must have upper management support to ensure its success, as this will improve organisational co-ordination and communication and make sure that sufficient resources are allocated to the project (Sieber, 2000). The interview with an informant from Historic Scotland confirmed this view that senior management should “buy-in to the GIS and know what it is, how much it will cost and the impact it will have on business areas and organisational procedures”(Informant A5). The importance of this level of support for ensuring the success of an initiative has already been demonstrated within the Trust, since the initial push for a GIS made at Balmacara Estate has so far received no upper management support and has now been ongoing for 8-9 years with very little progress. Considering the fact that the Trust has fourteen MapInfo licences, either a clear strategy for their implementation should be outlined and promoted by senior management or the subscription should be re-thought.

As well as ensuring that initiatives are economically viable, obtaining upper management support would ensure from the start that a GIS initiative was fully integrated into the corporate IT strategy. Therefore, corporate specifications for data management, storing and archiving would be written such that all data could easily be integrated into the GIS at any point. This would not only promote interoperability and remove the current issue of insular projects and lack of joined-up thinking, but would also ensure that the GIS does not become a useless standalone system. Additionally, adopting a top-down approach will ensure that terms such as ‘interoperability’ and ‘core data’ are defined for all staff, since it was discovered from the interviews that although informants had heard of these terms they did not fully understand their meanings.

4.4 Critique of Internet GIS for NTS

Having considered the arguments for a proprietary and bespoke solutions, both in terms of the software and the approach, this final section provides a critique of the value of implementing an Internet GIS solution for an organisation like NTS.

4.4.1 Organisational

Adopting an Internet as opposed to desktop GIS solution would have two important advantages from an organisational perspective. Firstly, as a large proportion of informants approached for interview during this project had no previous experience of GIS, the web browser interface offered by an Internet GIS would provide a simpler and more intuitive gateway into the system (Newton *et al*, 1997). Indeed questionnaire feedback indicates that a couple of inexperienced GIS users found the web browsers easier to navigate as “it looked familiar, like a website...something a non-technical member of staff ought to be able to navigate and use”(Informant B7). Conversely, an experienced user, although they believed the browser-based systems would be better “for less experienced users and for across-Trust use”(Informant B3) found this approach rather inflexible when compared to their desktop systems that allow full access to a range of functionality and uses. This demonstrates the need for multiple levels of access into an Internet GIS, as heavier, more experienced users would require greater flexibility and access to up-date information, whereas infrequent users would prefer only upper level access. It also raises the point that “there will always be a need for more detailed uses”(Informant B3) for a system, which further emphasises the possibility of having departmental Internet GIS applications at a later stage.

The second advantage of utilising Internet GIS is that it removes the need to purchase multiple desktop GIS licenses as the applications are distributed via the network to any desktop computer. This cheaper solution is obviously more preferable for a charity like NTS. However, no one Internet GIS can yet achieve the full functionality of a desktop GIS package (Carver *et al*, 2004) and several desktop licenses would still be required for the development and maintenance of an Internet GIS. None of the demonstration systems in this study could have been created without having access to

desktop GIS packages. Despite this, an Internet GIS would still be more economical and practical than a desktop GIS solution and it would fit more readily into the management framework of an organisation that needs material to be quickly available to all staff desktops (Barndt, 2002).

4.4.2 Public participation

Public participation is an important aspect to consider since NTS is a membership organisation that relies heavily on public subscription. One of the Trust's core aims is to increase community involvement in conservation management activities and engage more with the public, particularly "people living and working within the immediate environment of Trust properties"(NTS Corporate Plan, 2006). On Balmacara Estate this is currently being addressed through the regular production of newsletters. However, an Internet GIS could be used another approach to meet this core aim, as it only requires the user to have access to the Internet. Several informants could see a public Internet GIS as a tool for education, promoting and providing members with conservation techniques and "good working practices"(Informant A1), including preservation tips and guidelines "that everyone can relate to"(Informant A1) and could be applied to individual's property and possessions.

Obviously certain information the Trust holds is confidential and as such this would not appear on a public interface. However, as NTS is an organisation charged to keep important sites in trust for the nation, some of their information, like the property statements and management plans, are public property. Currently, these are sent out as paper copies to anyone who requests them, but placing them in a publicly accessible system would save staff time, prevent multiple duplication of the documents and would promote the properties themselves and the Trust's work.

At a smaller scale, a public Internet GIS could be used to communicate with the communities that occupy NTS properties. If information is required from a property, all staff will currently "ring someone up or send an email"(Informants A3 and A6). However with the need to contact NTS staff scattered throughout Scotland and farmers and tenants living on properties this can become difficult. If this style of communication fails, staff sometimes have to travel to the property and "if the information is not forthcoming from the manager...go and ask the people on the

property” by “knocking on the doors of farmers”(Informant A6). Again, this is an area where a public Internet GIS could be a useful tool to facilitate this type of communication. Additionally, visitor books are available in NTS holiday houses and people often take this opportunity to record any birds or animals they have seen. An Internet GIS application could be created specifically to allow visitors to record their sightings, which can then be followed up by estate officers. Allowing the public to participate in this way will add to the highly valued volunteer work, as well as fuelling public interest and raising the profile of the Trust.

This idea of public participation GIS (PPGIS) will be discussed further in chapter five.

4.4.3 Corporate memories

Informants have noted that staff that have been involved with a property or dataset for a number of years build up a significant ‘corporate memory’, carrying all the information around in their head rather than recording it. Significant problems are then caused when this member of staff leaves, as there are no documented records. Even if some files have been created, as there are currently few guidelines identifying how information should be recorded, people are using whatever programmes and formats they are used to, which may not be understood by others and are not interoperable. One informant noted in the interviews that “unfortunately, because of the high staff turnover, a lot of people with a lot of corporate memory have now gone” and it is “only now that [we] are finding out some of the gaps”(Informant A3), a problem which came up again in discussions with other staff. Additionally, since NTS as an organisation relies so heavily on volunteers, this means there is an even higher turnover of people during the course of a year with potentially many more approaches to data entry, which reinforces the need to develop and enforce the PINTS metadata standard.

This concept of ‘corporate memories’ also impacted on the type of data that some people thought should be included on an Internet GIS. Informants with extensive local knowledge of an area or property felt there were some features and details that were not necessary for inclusion in a GIS, since the system would not tell them anything

they did not already know (Barndt, 2002) and they would “never need to look at it more closely” (Informant A7). However, staff that are responsible for managing these same features from a physically separated location, like at the central or regional office, did require these features to be displayed. Furthermore, although the current property manager may know every detail about the site, new managers moving to a property will not have the same level of knowledge. In this study, the property manager for Newhailes had only just taken the position and therefore was only just getting to know the property, whereas the property manager for Balmacara had been there many years. Including all the key information about each property on an Internet GIS would help to ensure that ‘corporate memories’ would be captured.

4.4.4 Data integrity

Since a system is only as good as the data it is derived from (Aitken and Michel, 1995) it is essential that all the information is correct and accurate, as it will be used as a basis for management decisions. It is often difficult to see evidence of a bad GIS product though, especially as more Internet GIS applications are being produced (Couclelis, 2003) and images are appearing more realistic (Kingston, 2002).

The demonstration models created in this study were based on a combination of actual NTS GIS data and data constructed by the researcher to illustrate specific uses, both of which were noted to have limited accuracy. In the evaluation session, a concern was raised that “people should not be swayed by a ‘pretty’ system”(Informant C2) and the quality of data contained in an Internet GIS must be ensured. Staff agreed upon this at the session and went on to point out that any GIS initiative would need to begin by checking and organising the data; otherwise any system would simply produce “automated garbage”(Informant C3). Utilising local knowledge could be one way of clearing up errors in such large datasets (Barndt, 2002), again promoting the advantages of encouraging public participation. It also reinforces the need to have different levels of access into an Internet GIS, so that a selected number of people are responsible for updating the information contained in an Internet GIS, maintaining data integrity.

4.5 Summary

This chapter has explored the options of commercial and bespoke solutions for an Internet GIS venture, from the angle of software and approach. Assessments have been made based on user requirements, evaluation feedback and the researcher's experience with creating the demonstration models. Informants believed a bespoke approach would be favoured for a charity like NTS, which would most likely be developed externally but with constant staff input. Some of the points that have been raised in this chapter will now be expanded in the following discussion chapter.

Chapter 5: Discussion

The aim of this chapter is to draw together aspects from the methodology and results and interpretations chapters, both of which reinforced the interdisciplinary nature of this research, crosscutting information technology and social science boundaries. Whereas discussion within these chapters has focussed more specifically on the NTS case study, this chapter will take a more general perspective. Firstly, the concept of data sharing will be reviewed with reference to web services and the Service-Oriented Enterprise (SOE) approach. Then a more general critique of the value of Internet GIS for public participation GIS (PPGIS) and decision-making will follow. The third section of this chapter will consider some of the limitations of this study, from both the viewpoint of the chosen methodology and also in terms of technical and data issues. Finally, the possible future direction of GIS will be explored, specifically in reference to the recent advancements of Google.

5.1 Data sharing

The importance of data sharing with external organisations was identified from the results of the interview process and an example was built into the ASPMap demonstration model (*figure 4.5*) to illustrate a way that an NTS Internet GIS could be linked to an external organisation's website. However, it was noted in the discussion of this example that there are more practically efficient methods to share data. One such method is utilising web services to create a Service-Oriented Architecture (SOA), discussed previously in chapter three, section 3.6.

Web services are currently the most exciting developments within Internet GIS technology (Tsou, 2004). They have the ability to simplify even the most complex legacy systems to make them interoperable, all within the user-friendly browser-based environment of the Internet. Many organisations are increasingly favouring the web service approach as it radically simplifies existing internal datasets as well as providing a mechanism for facilitating external data exchange (The Economist, 2004). Two such organisations that see web services as the future for GIS and data exchange are RCAHMS and Historic Scotland, both of which have strong ties to NTS. These two organisations have paved the way towards external data sharing through the creation of the commonly shared PastMap application. However, the method of

updating the information contained in this application, through periodic static downloads by each organisation, is not ideal. Live updates, through the transfer of web services between organisations would be a far more effective way to approach this.

5.1.1 Integrating web services

Sharing and integrating web services is made possible by the fact that they are wrapped by interoperable common standards, as depicted previously in chapter three, *figure 3.4*. As well as providing an interoperable platform, these standards also provide the tools for discovering and integrating web services. WSDL is used to describe the contents and functions of the individual service. These descriptions are then posted on a searchable registry database (UDDI) or network directory, which other computers can then browse (Peng and Tsou, 2003). When a user finds an appropriate service, it is then requested from the registry and can be integrated into the client application. This concept of integrating web services within a SOA is illustrated in *figure 5.1*.

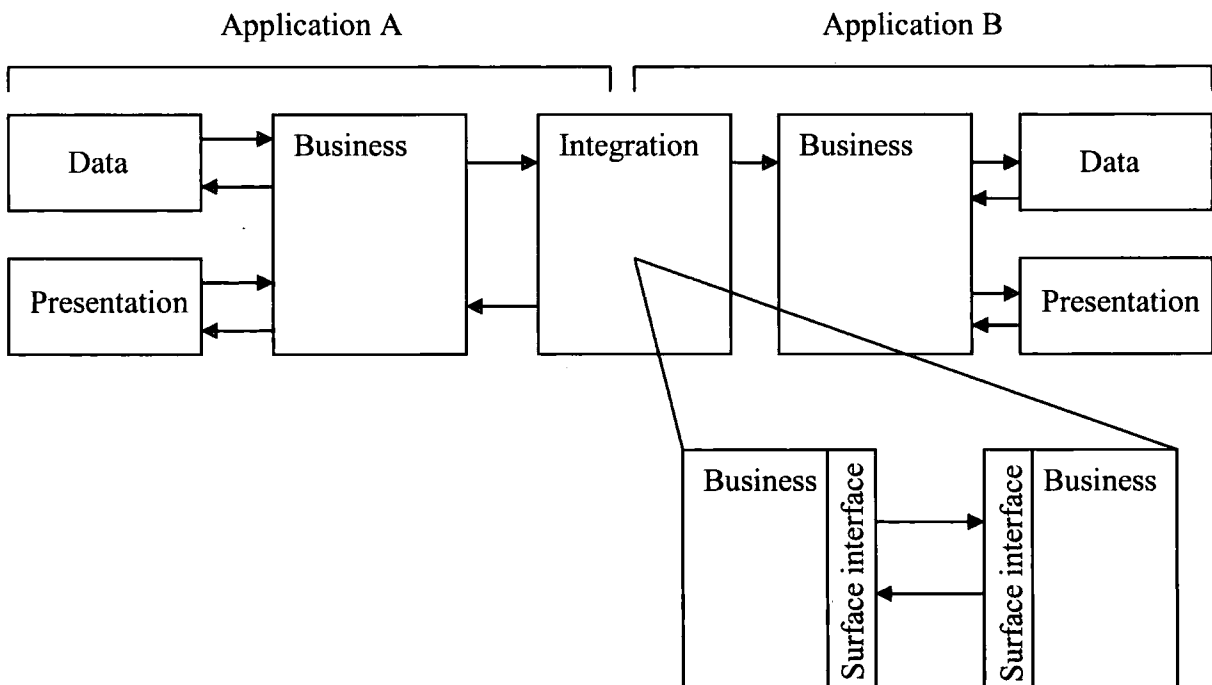

Figure 5.1: A logical representation of a service-oriented integration architecture (Erl, 2004, p. 53)

Applications A and B depicted in *figure 5.1* could be either internally or externally based, however once web services have been utilised for this type of cross-application integration, they become part of the enterprise infrastructure (Erl, 2004). In other words, once multiple SOA applications are established, at that point SOA itself becomes one of many services within a Service-Oriented Enterprise (SOE) (Erl, 2005). Initiating a SOE naturally increases design complexities (Erl, 2004), although once established, the same communication mechanisms can be used between applications within a single organisation and distributing data between participating organisations. Interoperable web services and the loosely-coupled design of the SOE are the two factors that make this approach appealing and technically viable for inter-organisational data sharing.

In order for web service networks to be a practically viable method for external data exchange, a significant number of organisations are required to join the network. As more organisations join, the use of the network has been seen to rise exponentially, thereby attracting further members (The Economist, 2004). An established and well-used web service network would remove the need to replicate large datasets between organisations, as the appropriate web service can be accessed whenever required and integrated into an application. The owner of a particular dataset would have the responsibility of updating it, although with such free and open exchange of data, retaining ownership is more difficult. It should be remembered though that this concept of external information exchange by sharing UDDI registries is still very much a developing rather than established idea. Indeed, the development of Internet technology is still moving at a rapid pace, with new ideas and products constantly emerging. As a large re-structuring would be required in order for an organisation to conform to a SOA, they would need assurances that this method is viable in the long-term.

Some organisations are drawing this idea of an integrated network of web services to its logical conclusion, whereby if all that is required is the data, they should not have to create the data centre (The Economist, 2004). Instead the required software is rented from an application service provider (ASP) as a service. This removes the need for organisations to buy into software solutions and integrate them into their existing

structures, as this would be done by the external ASP. This concept links to the previously mentioned idea of having an external organisation consortium, where technical maintenance is effectively out-sourced to an external specialist. Although not a direct web services example, this idea is very similar to the specialist GIS support community NGC discussed previously in chapter one, section 1.5.1, who provide technical and conceptual support for organisations. This may well be the future of Internet GIS as the International Data Corporation (IDC) estimates that the overall revenues gained from ASP's will increase from \$3 billion in 2003 to \$9 billion by 2008 (The Economist, 2004).

5.2 Critique of Internet GIS for PPGIS and decision-making

The idea of using Internet GIS to aid public participation (PPGIS) was broached in the previous chapter (section 4.5.2), although this was discussed primarily from a specifically NTS perspective. The public view of NTS has not been looked at in great detail since it is not a major part of this research. However as NTS is a membership organisation, data sharing through public participation is still an important factor to consider. This section will expand this debate from a strictly NTS viewpoint to focus on the wider and more general opportunities Internet GIS technology can provide for PPGIS and decision-making processes.

The incorporation of GIS into public participation practices provides a unique approach for enabling the public to use their local knowledge to dynamically interact with and analyse complex spatial information (Sieber, 2006). It should be noted though that if the restrictions with current public participation projects are due to limited resources and small local organisations with non-professional staff, GIS might not fully address these problems (Barndt, 2002).

In terms of environmental decision-making, integrating GIS into the process provides an ideal template for users to explore the decision problem, experiment with a selection of options, formulate their own decision and then submit their opinion or evaluation (Kingston, 2002). These benefits of incorporating GIS into public participation and decision-making practices will only be realised if the tools can be easily access by the maximum number of people. The obvious medium that is

generally considered to be the best for this purpose is the Internet, although it is not a perfect ready-made solution.

5.2.1 Accessibility

Firstly, by placing a PPGIS onto the Internet, the physical constraints of traditional stand-alone systems are immediately removed (Carver *et al*, 1997), as the system can be accessed anywhere at anytime. The rise of this idea of '24/7' participation (Kingston *et al*, 2000) provides participants with greater flexibility as they are no longer restricted by the physical location and times of meetings. Furthermore, extending the amount of time the data is available to the public increases the amount of potential feedback, both in quantity and quality, that users can provide for a specific decision or problem (Carver *et al*, 1997).

Whilst the Internet does offer an attractive vehicle for PPGIS dissemination, vastly improving public accessibility to the data, it should be remembered that not everyone can easily access the Internet. A definition of PPGIS refers to an "inclusive and non discriminatory tool that focuses on the possibility of reducing the marginalisation of societies" (Jankowski *et al*, 2001, p.6). Although many people now have a computer in their home, in order to reach out to all sectors of society, additional access points to the Internet need to be provided in communal and public areas (Kingston, 2002).

Although physical access is most definitely an important issue requiring consideration, 'grounded social relations' will also impact upon whether an Internet PPGIS is accessible. This concept involves considering the social context from which people would be accessing the system and how they disseminate (or not) information in their everyday lives, since this social and technical background will dictate how they interact with and use an Internet system (Niles and Hanson, 2001). In other words 'virtual accessibility' identifies the combined spatial and social locations of access as the 'context' that will determine whether a user is "able to find, make sense of, and apply information on the Internet" (Niles and Hanson, 2001, p. 6). Niles and Hanson (2001) go on to argue that in order for a system to be deemed truly accessible all these contexts from which a users approaches a system need to have been considered.

5.2.2 Usability and interface design

The benefits of utilising a web browser as opposed to a traditional GIS interface for users with no previous experience of GIS have already been discussed and again these advantages apply for Internet-based PPGIS. Providing a more user friendly entry into GIS that is accessible to a larger number of people has led many to believe that the previous criticisms of GIS as an elitist technology are no longer valid (Carver *et al*, 1997; Kingston, 2002; Caldeweyher *et al*, 2006). A well-designed Internet PPGIS interface removes the need for users to have an understanding of GIS technology, since information prompts and simplified menu options can be incorporated to guide the user through the information (Carver *et al*, 2004). To some extent this principle was illustrated by the ASPMap demonstration system, where instructions and visually simplified GIS tools aided non-experienced GIS users to understand and operate the system.

Another point raised in the previous chapter (section 4.4) was the idea of a geocollaborative system design, including discussion boards, e-mails and blogs that could be used as a tool to encourage public participation. Indeed, websites where interfaces have been designed to incorporate these novel ways for the public to interact with the information have been classified as more participatory (Smith and Craglia, 2003). There is also the hope that providing a diverse set of modern tools for people to use for expressing their opinions will encourage participation at all levels, but more especially with younger members of society (Smith and Craglia, 2003). Graffiti walls, message boards and chatrooms are closely tied to the social environment of the younger generation, so including this familiar style of interaction on a PPGIS will further widen its accessibility and usability.

One potential drawback of simplifying the information to go onto the Internet is that the decision-making process is complex and by re-designing data some key points and additional detail could be lost (Carver *et al*, 1997). However, it is important to remember here that an environmental decision will not be based exclusively on public feedback from an Internet PPGIS.

5.2.3 User preference

The advantage Internet PPGIS has of removing the need for participants to physically travel to meetings has already been mentioned. However removing the need for people to attend meetings holds a further benefit. Using an Internet-based approach enables participants to express their opinions and provide comments relatively anonymously and in a non-confrontational way (Kingston *et al*, 2000; Kingston, 2002). Providing this facility is likely to encourage more people who prefer to communicate their views in a low-key way to participate in the decision-making process.

Whilst the Internet does provide an easily accessible alternative to more traditional approaches to public participation, it should be remembered that it does not suit every one. Smith and Craglia (2003) reference a survey that revealed around 27% of non-users “are not interested in the Internet or do not want to use it” (p.52). Therefore any Internet PPGIS should be developed in harmony with more traditional approaches rather than attempting to replace them.

5.3 Limitations

5.3.1 Critique of the methodology

A combination of social geography research techniques and technical demonstrations were used within this study in order to provide a two-sided evaluation of Internet GIS technology. Whilst this approach was essential for obtaining rounded and balanced results, there are some inherent limitations associated with this choice of methodology.

Firstly, it is widely documented that a successful GIS initiative needs to concentrate on user requirements for a system (Martin, 1997; Bernhardsen, 1999; Haklay and Tobón, 2003; Jankowski *et al*, 2006) and as such, interviews with perspective users, as conducted in this study, is an essential first stage. The subjectivity of the interviews, evaluation session and questionnaires used in this study is an advantage, as it provided a mechanism for users to express their thoughts and feelings. Since social and institutional environments are impacting more on the design of new GIS

initiatives, these inherently subjective social research methods are extremely valuable. Naturally, the way a researcher interprets the thoughts and opinions of the informants will be shaped by their own experiences and ideas, which may be very different to the informants. However, this is not necessarily a limitation, particularly as only one researcher has interpreted all results in this study, thereby maintaining an internal consistency, as is good practice. Also this prompted some wide ranging and more in-depth discussions during the course of the interviews, as the researcher and informant exchanged and explained their sometimes very different views and opinions, which proved very useful.

Although the subjective techniques adopted in this study produced extremely valuable results that could not have been achieved through more objective approaches, including some objective analysis could enhance this methodology further. Other usability studies have incorporated quantitative performance measures into their research alongside subjective evaluation from users. Davies and Medyckyj-Scott (1996) conducted a subjective survey which suggested that customisation of systems did little to improve user's attitudes towards GIS usability. However, quantitative analysis recording the number of errors and cancelled actions made by the user when using a customised GIS, described as 'snag time', identified a significant reduction in comparison to other systems. This demonstrates the value of considering both subjective and practical analysis in order to obtain a true indication of system success. Furthermore, the real life example of one informant's experience of incorporating GIS into an organisation and the practical improvements in productivity that followed, (discussed in section 4.4), illustrates that quantification is an important aspect to consider.

A quantification component was not added to this methodology primarily because, unlike other usability-based studies, the demonstration models were never designed to be fully operational, but to showcase the software, functionality and approach. Therefore, the ability to assess its practical use for specific tasks would have been very limited. Additionally, user requirements for an Internet GIS were for improved data management and easier access to diverse spatial datasets. The faster access to key information provided by all the demonstration systems in comparison to the multiple phone calls and paper documents currently required was obvious to users without the

need for quantification. As such, although quantitative analysis would have been interesting, it was not considered essential to this study.

The second limitation of this research methodology is linked to the high interaction and reliance on an organisation. Issues of working with organisations on research projects have been documented before (Ives *et al*, 1983; Davies and Medyckyj-Scott, 1996), which include lack of flexibility and limited interaction time with staff. This study was not subjected to these normal restrictions, since the researcher was provided the unique opportunity to work closely within the organisation throughout the project. Despite these improvements though, some basic limitations were still evident.

Informants were very accommodating in booking out a set period of their time when the interviews were being scheduled. When staff were given a deadline to fill out the evaluation questionnaires though, responses were rather limited. A total of one departmental and six individual completed evaluation questionnaires were received back. There are several reasons for this, including sickness and busy staff timetables that are to be expected, yet as the majority of results and analysis in this study is based on user feedback, lack of responses will significantly limit the strength of any conclusions that are drawn. This problem of non-response may also produce a bias within the results (McLafferty, 2003). These questionnaire results were used in conjunction with feedback from the evaluation session, which gave the arguments more weight. Ideally more written responses were required though.

Finally, the third limitation of this methodology is connected to the GIS data itself. Originally, this data was to be obtained from NTS properties. However as discussed in section 2.3, there was no available GIS data for the Newhailes property, so this was created by the researcher for use in the demonstration systems. Due to time constraints, the most efficient way to achieve this was to digitise features from a paper map by eye, using OS maps as a reference point. Whilst the small scale of the property and nature of the surrounding land meant that land boundaries were fairly obvious, this is by no means the most reliable method. Additionally, it was also discovered that much of the Balmacara GIS data was also created in a similar way, so the precise accuracy and quality of all the data is questionable. One way this could be



improved would be for a GPS survey to be conducted on the properties, to ensure that land ownership boundaries in particular are marked in the correct location, as this has legal implications.

5.3.2 Technical issues

Moving on from considering the precision associated with the digitisation of the data layers, there were also several technical issues connected to transferring and receiving the Balmacara GIS data. Firstly, in the process of saving the files from the source computer onto disk and then opening them, many of the files had been corrupted and could not be used. Secondly, the files were transferred in .tab format, as they were extracted from a MapInfo application, which were not immediately compatible with Arc software. For some file types, additional plug-ins had to be downloaded and installed into ArcMap to enable the software to read them. Thirdly, when the layers had been created they had not been set to the correct projection and were therefore displaced when they were overlaid on the OS maps. For the majority of the files the projection could be re-set, which although time consuming did not pose any problems. However, some layers were set to a specific MapInfo projection that would not allow a straightforward adjustment. Instead these files had to be transformed into project shapefiles and then set to British National Grid. However, they often still did not appear to be located in the correct position.

The other general technical consideration is linked to information display across the Internet. Microsoft's Internet Explorer was used as the web browser for all demonstration systems, which is a fairly flexible viewer. So the programming of the ASPMap demonstration system was done exclusively within an Internet Explorer web viewer. This is an important point since, as described in section 4.3.1.4.5, screen variables are set out at the start of the asp coding that determine dimensions and design of the web page itself. When this completed system was then viewed within a different browser, such as Mozilla Firefox for example, a difference in viewer display can be noticed.

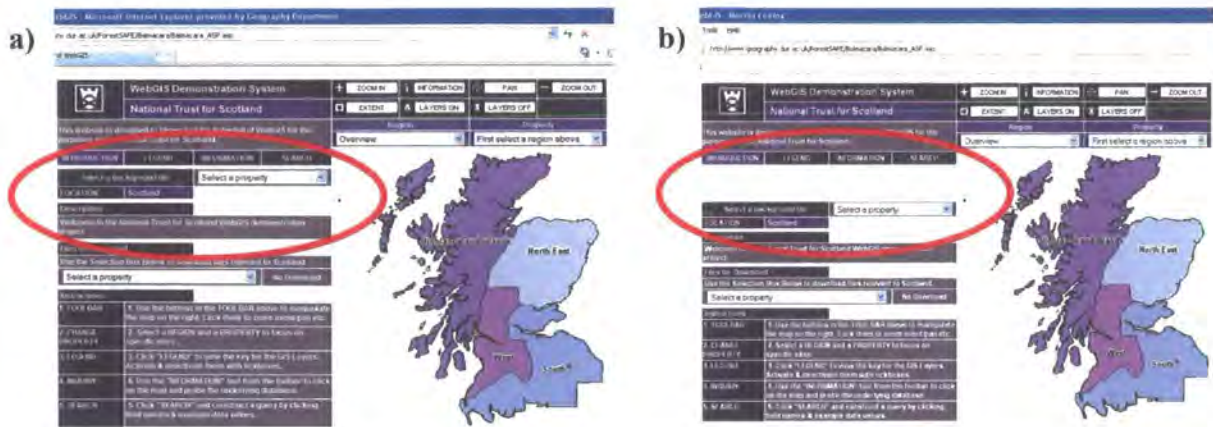

Figure 5.2: Two screen captures of the ASPMap demonstration system taken in (a) Internet Explorer and (b) Mozilla Firefox web browsers. The display difference has been circled in red.

The blank space appearing in the Mozilla Firefox web browser (circled in figure 5.2) is likely to be a result of the fact that Firefox closely adheres to display and presentation standards. Therefore, when the system was displayed in this browser, standards that were more flexible in Internet Explorer were upheld in Firefox, forcing the viewer to display within these strict guidelines and consequently exposing a gap in between text boxes.

This is by no means a criticism of the ASPMap software itself, since these browser differences were also noted when creating the customised ArcIMS demonstration system. Indeed, rather than being a problem, the web browser software that potential users will use to view a web page is a technical point to consider when designing and creating an Internet GIS. This also applies to the type of computer on which the user is displaying the system, as older computers will have small screen sizes and might therefore require the user to frequently scroll up and down in order to view the whole screen.

5.3.3 OS maps

Within this study itself, the accessibility of OS maps for inclusion within an Internet GIS was not an issue, since they could be downloaded from the Edina Digimap website (<http://edina.ac.uk/digimap/>) free of charge in accordance with the university subscription. However, this luxury is not extended to many non-profit organisations

like NTS and since this project is concerned with researching the issues surrounding the creation and incorporation of an Internet GIS within organisations this is an issue outside of the research environment that should be considered.

As NTS is a non-governmental organisation it falls outside of the Pan-Government Agreement (PGA) and is therefore immediately restricted in the OS data it can access. The fact that NTS is a charity adds further complications, since OS licensing agreements are expensive. In addition to this direct implication, there is also the indirect issue of data ownership when NTS exchanges data with external organisations (Kingston *et al*, 2000), since they are likely to have used OS data as base maps. One solution for this problem suggested by Kingston (2002) was that encryption and coding software could be applied to the OS data so that it is transmitted in a form that cannot be imported into proprietary GIS software. However, in terms of the wider problem of organisations requiring base maps for their information, there are several possible options besides using OS data.

Firstly, the idea of conducting GPS surveys of NTS properties in order to map key features has already been mentioned in section 5.3.1, but this concept could be extended and applied to the creation of a base map for the property. OS maps are updated every couple of years, although for the more isolated and extreme corners of the UK this process is conducted less frequently. Considering the fact that a significant proportion of NTS properties are likely to be included in these rural and isolated spots, in-house GPS surveys will definitely be more accurate than OS maps.

Although having the most up-to-date maps available is generally preferable, fewer significant changes are likely to have occurred in these rural locations in comparison to urban environments. Therefore, a second possible option is to use out-of-copyright OS data, published prior to 1957, as base maps (Gittings and Batcheller, 2007). These maps should be thoroughly checked for any changes and should be used to provide context for present day data. These images could also be used as part of a historical archive to illustrate changes over time.

A final possible option is to look into alternative sources of map information, such as Google for example. In addition to standard maps, the inclusion of Google Earth

facilities would also make aerial photography and some topographic visualisation available, thus removing the need for the organisation to store and manage these large imagery files itself. It should be remembered though that the user has access only to the general image as it appears on screen, rather than any of the underlying data. Therefore, this is no substitute for the raw data, particularly if the imagery needs to be processed or enhanced (Beck, 2006). Whilst licensing restrictions are still going to apply for organisations like Google, it is still worth considering since a more favourable agreement in comparison to OS data licensing may be obtained for an organisation.

5.4 The future of GIS?

The traditional view of GIS was that it was a specialist tool that should remain largely in the hands of experienced users. However, the increased emergence of Internet-based GIS applications has provided users with an easy way into GIS and has done much to popularise its use in everyday life (Carver *et al*, 1997). It is not merely moving GIS onto the Internet itself that has had this effect though, but the achievement of software companies like Google making remotely sensed imagery and GIS applicable and interesting to everyone.

Google Earth provides users with an easy way to zoom right the way down from a global perspective of the earth to individual street level, with imagery resolution sharp enough for people to identify their own house and even individual cars and people. This globally appealing application combined with the easy accessibility and installation process for the software has resulted in 250 million people to date downloading Google Earth free of charge on to their personal computers (Parsons *pers com*, RSPSoc 2007). In light of these factors, some GIS specialists believe that “just as the PC democratised computing, so systems like Google Earth will democratise GIS” (Butler, 2006, p.777).

Whilst there is no denying that Google Earth has done much to encourage greater awareness and improve public perception of GIS, it has not followed that this has also furthered public understanding. Although to some degree this is not essential, for example a user need not have a thorough knowledge of the technology they are using, some fundamental principles have been lost. The main concern has been that people

believe the imagery in Google Earth shows a real time representation, when in reality the data is often a few years old. This misunderstanding has helped to fuel public concern of increasing government surveillance (Sieber, 2006) throughout the UK and fears of being 'watched'. This is something that should be addressed, since these false user perceptions may ultimately end up hindering GIS initiatives, especially if they are aimed at increasing public participation in decision-making processes.

Although Google Earth has been a champion for publicising GIS, it is not designed to replace professional GIS software, as the system contains no analytical functionality (Butler, 2006). A recent addition to the Google family, the new map initiative Google My Maps, is however envisaged to ultimately make some software services redundant (Smith, 2007). This application enables users with no technical background to create their own custom maps, including text, photos and embedded videos. In addition to this, there is also the slightly different edition, Google Maps API, which is available for developers with programming knowledge and Google Maps for the Enterprise that is geared towards large organisations. Providing a variety of facilities means there is a solution to suit all sectors of the market and this will only fuel the rivalry between Google and leading commercial vendors like ESRI. This competition has already led to ESRI releasing ArcGIS Explorer, a free visualisation tool that allows not only specific ESRI formatted data to be imported into it, but also data conforming to open standards, thereby promoting interoperability. This software can then be used as a platform to fuse together multiple web services to create a custom application. Therefore, this new tool holds the advantage of being free, but has the additional analytical GIS functionality that is absent from current Google applications (Butler, 2006).

Finally, as well as being a powerful force in driving Internet GIS software developments, Google has also been involved in developing and promoting open standards and interoperability. Google developed Keyhole Markup Language (KML) for disseminating geographical information that could be used to extract GIS data from proprietary desktop packages and import and view them in Google Earth. As increased interest was shown in this standard, Google passed it on to the Open Geospatial Consortium so it could be established as an open standard for general use (Parsons pers com, RSPSoc 2007).

There is little doubt that the future of GIS is going to unfold within an Internet environment (Peng and Zhang, 2004) with increasing numbers of Internet GIS applications frequently emerging. The general aim of making GIS accessible to as many people as possible means that software systems are liable to become easier to use and modify, whilst at the same time the underlying technology appears to be becoming increasingly more complex (Heikkila, 1998). The recognition of the importance of adhering to open standards to aid interoperability is likely to induce a move away from strictly proprietary GIS solutions. Indeed, the developing interest in integrating Google and open source software into Internet GIS solutions is causing commercial vendors to re-think some of their strategies. However, whilst there is still a need for off-the-shelf desktop GIS packages, whether due to their unrivalled powerful analytical functionality or to create Internet GIS applications, there will still be a market for proprietary solutions.

5.5 Summary

This chapter has presented discussions about some of the more overarching aspects surrounding Internet GIS and its integration into organisational frameworks. A web service based SOE has been presented as a possible alternative architecture for organisational data management and as a mechanism to create Internet GIS applications that improve internal and external data sharing. Whilst the technical aspect of Internet GIS appears to be becoming increasingly complex, simplicity is favoured for the front end of a system. This is primarily to increase the usability of Internet GIS, to popularise its incorporation into public participation practices and everyday life. Google has been presented here as an organisation that has done much to promote GIS, but other GIS tools such as car satellite navigation systems are also a lot more commonplace now, although people often do not realise they are using a GIS.

Chapter 6: Conclusion

This project has demonstrated the potential of Internet GIS for managing and sharing diverse spatial information. Utilising the Internet provides an easily accessible vehicle for data and software dissemination and many organisations are now looking towards Internet GIS technologies for guiding general data and IT solutions and frameworks.

The first two objectives of this research were to establish the needs of the organisation and the background for change and to obtain user needs and requirements. These were achieved through attendance at Core Data Model meetings at central office alongside visits and one-to-one semi-structured interviews with members of staff at central office, south regional office, Balmacara Estate and Newhailes. Results indicated that informants wanted a system that was capable of basic GIS functionality and held all the key datasets in a central location in order to improve awareness throughout the Trust and facilitate internal data flow.

Specific departmental data and functionality requirements, identified during the interviews, were placed into a grid chart to ascertain what were considered by users to be 'key datasets' and 'basic functionality'. This technique identified 'PINTS' information, management plans, survey data, designated areas and OS maps as some of the key datasets and the ability to browse and query maps and quantify information as some of the basic GIS functionality requirements. This information was then directly used to address the third objective of creating three demonstration systems: two in ArcIMS and one in ASPMap. The first ArcIMS system was to demonstrate the type of functionality and website layout that could be achieved if the default settings programmed into ArcIMS were used to create an application. The second ArcIMS system was to illustrate some of the options available should the user choose to customise an application. The demonstration system created in ASPMap was an example of a bespoke application.

The fourth objective of this research was to evaluate these demonstration systems in terms of the usability of the software and the feasibility of a proprietary or bespoke approach to an Internet GIS solution for an organisation like NTS. This assessment

was produced through a face-to-face feedback and evaluation session conducted at central office and evaluation questionnaires completed by users.

Both software packages had the capabilities and necessary functionality to form the basis of an Internet GIS solution for NTS. In terms of software usability, users who had no previous experience of GIS found the ASPMap demonstration system the easiest to understand, as it was clearly presented and did not rely on the user having an understanding of GIS signs and symbols. Conversely, experienced GIS users found the ASPMap demonstration system 'intimidating' and preferred features of the ArcIMS systems. This would seem to indicate that user's perception of system usability is dictated by software and applications they are used to dealing with. The point that was agreed on by all users both at the evaluation session and in the questionnaire feedback was that at least some customisation of the system is necessary in order for the requirements to be met.

This result leads into the second aspect, evaluating the approach, since if at least some customisation is required clearly a commercial package cannot simply be bought off-the-shelf and instantly and successfully integrated into an organisation. When an organisation, like NTS, has very little in-house IT support, it may be tempting to buy a proprietary package off-the-shelf, believing it is a ready-made product that simply requires rolling out. However, in light of the findings of this research this clearly is not a viable option. Therefore, some programming expertise sourced either externally or from within the organisation would need to be sought.

Although both commercial and bespoke approaches can be customised and tailored to purpose, users felt that a bespoke approach would be most highly favoured, with the ultimate aim of having bespoke applications on each user's desktop. The financial implication was identified as the final factor that would decide an organisation's approach to an Internet GIS solution. This was noted from the interviews conducted with Historic Scotland and RCAHMS as well as from NTS feedback. Importantly however an organisation would still need to invest in several desktop GIS licenses. The creation of the Internet GIS demonstration systems within this study would not have been possible without access to desktop GIS software. Additionally, for the handful of experienced GIS users, more complex geospatial analysis functionality that

was not included on an initial corporate Internet GIS would need to be easily accessible.

The fifth objective was to evaluate the use of the Internet and Intranet for internal and external geographical data sharing. In terms of internal data sharing, staff that were interviewed specifically identified the Intranet as a logical and reasonably secure medium for disseminating data throughout the organisation. Furthermore, distributing the GIS software across the Intranet or Internet removes the need to purchase multiple desktop GIS licences for every user who needs any form of access to the GIS data, which is a valuable advantage for a non-profit organisation such as NTS.

In addition to internal data sharing, the Internet is also a prime candidate for inter-organisational information exchange. The interviews conducted at RCAHMS and Historic Scotland were conducted in part to ascertain how these organisations envisage future data sharing with other like-minded bodies. The findings indicated that both organisations believed this would be done through web services. Web services provide the tools for creating an interoperable solution that focuses on adhering to key standards and providing an open and flexible environment for data exchange. Although ArcIMS creates a service that runs the application website, this service is based on ArcXML, which is a proprietary programming language and therefore not easily interoperable. This is likely to be where future Internet GIS advances for organisations will occur.

The final objective was to consider database design and provide a brief review of the current NTS metadata standard 'PINTS'. From the interviews with staff, it was evident that not everyone was adhering to the PINTS standard and that some were even unaware of its existence. Implementing and keeping to a metadata standard is essential for both internal and external data sharing and interoperability. Furthermore, when assessed against the nationally recognised UK GEMINI standard it was clear that PINTS required further development, particularly in terms of incorporating a spatial component.

This project offered a unique opportunity to work within an organisation and has presented an evaluation of Internet GIS technologies in terms of functionality and

more specifically, addressing user requirements, which plays a significant role in deciding the system that will integrate best within an organisational framework. Currently, it is very difficult for organisations to learn about GIS from a neutral perspective and in the academic environment too, there is a lack of available peer-reviewed papers on this topic. This study seeks to fill this void by considering and evaluating the technology from both a technical and human/social perspective. Since greater emphasis is now being placed on the social environment into which a GIS initiative is being incorporated, rather than a strictly technical assessment of success, further interdisciplinary research like this needs to be conducted.

6.1 Future research

A possible next stage for this research project would be to create some operational demonstration systems that could then be used for quantitative as well as qualitative assessments. This would provide a more comprehensive set of software usability results. One of these systems should include an example of an open source alternative, since this approach is likely to be highly favoured by organisations seeking an inexpensive solution. From a technical viewpoint, this research could be extended to incorporate a working application using the XML web service methodology, as this appears to be highly favoured by organisations as a future approach to Internet GIS and data sharing solutions.

This research has identified that in order to create a system that can manage and share data as well as being easily usable by users with a range of GIS knowledge and skills, the programming and underlying data structures are often complex whilst the front end is relatively simplistic. This is mirrored by the advancements of organisations such as Google that have made vast quantities of remotely sensed data quickly and easily accessible to users around the world. Although these applications are impressive and individual Internet systems can always be developed and improved, ultimately, unless the system and its data is interoperable, management and data sharing will remain an elusive goal.

References

- Aitken, S. C. 2002. Public Participation, technological discourses and the scale of GIS. In: Craig, W. J, Harris, T. M and Weiner, D (Eds.) *Community Participation and Geographic Information Systems*, Taylor and Francis, UK, p. 357-366
- Aitken, S. C and Michel, S. M. 1995. Who contrives the “Real” in GIS? Geographic Information, Planning and Critical Theory, *Cartography and Geographic Information Systems*, **22**, 17-29
- Alterkawi, M. M. 2005. Measures towards a comprehensive municipal GIS – the case of Ar-Riyadh Municipality, *Habitat International*, **29**, 689-698
- Andrienko, G, Andrienko, N, Voss, H and Carter, J. 1999. Internet mapping for dissemination of statistical information, Computers, *Environment and Urban Systems*, **23**, 425-441
- Appleton, K and Lovett, A. 2003. GIS-based visualisation of rural landscapes: defining ‘sufficient’ realism for environmental decision-making, *Landscape and Urban Planning*, **65**, 117-131
- ArcGIS 9. 2004. *Understanding ArcSDE*, ESRI Handbook, USA
- ArcIMS 9. 2004. Architecture and Functionality, *ESRI White Paper*
www.esri.com/library/whitepapers/pdfs/arcims9-architecture.pdf – accessed 7/2/07
- ArcIMS 9. 2004. *Getting Started with ArcIMS*, ESRI Handbook, USA
- Barndt, M. 2002. A model for evaluating public participation GIS. In: Craig, W. J, Harris, T. M and Weiner, D (Eds.) *Community Participation and Geographic Information Systems*, Taylor and Francis, UK, p. 346-356

- Beck, A. 2006. Google Earth and World Wind: remote sensing for the masses? *Antiquity*, **80**, <http://www.antiquity.ac.uk/projgall/beck>
- Bernhardsen, T. 1999. Choosing a GIS. In: Longley, P. A, Goodchild, M. F, Maguire, D. J and Rhind, D. W (Eds.) *Geographical Information Systems Volume 2: Management Issues and Applications*, Wiley, USA, p. 589-600
- Butler, D. 2006. The web-wide world, *Nature*, **439**, 776-778
- Caldeweyher, D, Zhang, J and Pham, B. 2006. OpenCIS – Open source GIS-based web community information system, *International Journal of Geographical Information Science*, **20**, 885-898
- Cannan, S and Otten, G. 1993. *SQL: The Standard Handbook, based in the new SQL standard (ISO 9075: 1992 (E))*, McGraw-Hill Book Company, UK
- Carver, S, Blake, M, Turton, I and Duke-Williams, O. 1997. Open spatial decision-making: Evaluating the potential of World Wide Web. In: Kemp, Z (Eds.) *Innovations in GIS 4, selected papers from the Fourth National Conference on GIS Research UK (GISRUK)*, Taylor and Francis, UK, p. 267-278
- Carver, S, Evans, A and Kingston, R. 2004. Developing and testing an online tool for teaching GIS concepts applied to spatial decision-making, *Journal of Geography in Higher Education*, **28**, 425-438
- Chang, Y-S and Park, H-D. 2006. XML Web-service-based development model for Internet GIS applications, *International Journal of Geographical Information Science*, **20**, 371-399
- Chrisman, N. R. 1999. What does 'GIS' mean? *Transactions in GIS*, **3**, 175-186
- Connolly, T, Begg, C and Strachan, A. 1999. *Database systems: A practical approach to design, implementation and management*, Addison Wesley, USA

- Cook, I and Crang, M. 1995. *Doing Ethnographies: Concepts and Techniques in Modern Geography (CATMOG)*, p. 36-56
- Coppock, J. T and Rhind, D. W. 1991. The history of GIS. In. Maguire, D. J, Goodchild, M. F. and Rhind, D. W (Eds.) *Geographical Information Systems, Principles and Applications Volume 1*, Longman Scientific and Technical, UK, p. 21-43
- Couclelis, H. 2003. The certainty of uncertainty: GIS and the limits of geographical knowledge, *Transactions in GIS*, 7, 165-175
- Curry, M. R. 1998. *Digital Places: Living with geographic information technologies*, Routledge, UK
- Davis, C and Medyckyj-Scott, D. 1996. GIS users observed, *International Journal of Geographical Information Systems*, 10, 363-384
- Dunn, K. 2000. Interviewing. In. Hay, I (Eds.) *Qualitative Research Methods in Human Geography*, Oxford University Press, Singapore, p. 50-82
- Egenhofer, M. J and Kuhn, W. 1999. Interacting with GIS. In. Longley, P. A, Goodchild, M. F, Maguire, D. J and Rhind, D. W (Eds.) *Geographical Information Systems Volume 1: Principles and Technical Issues*, Wiley, USA, p. 401-412
- Elmasri, R and Navathe, S. B. 1989. *Fundamentals of Database Systems*, World Student Series, The Benjamin/Cummings Publishing Company Inc., USA
- Erl, T. 2004. *Service-Oriented Architecture: A field guide to integrating XML and web services*, Prentice Hall, USA
- Erl, 2005. *Service-Oriented Architecture: Concepts, Technology and Design*, Prentice Hall, USA

- Fotheringham, A. S. 2006. Quantification, evidence and positivism. In Aitken, S. C and Valentine, G (Eds.) *Approaches to Human Geography*, SAGE Publications, UK, p. 237-250
- Frehner, M and Brändli, M. 2006. Virtual database: spatial analysis in a web-based data management system for distributed ecological data, *Environmental modelling and software*, **21**, 1544-1554
- Gittings, B, M and Batcheller, J. K. 2007. *Connecting the Future: A data strategy for the National Trust for Scotland*
- Gold, C. M. 2006. What is GIS and what is it not? *Transactions in GIS*, **10**, 505-519
- Goodchild, M. F. 1995. In Pickles, J. (Eds.) *Ground Truth: The Social Implications of Geographic Information Systems*, The Guildford Press, USA, p. 31-50
- Haklay, M and Tobón, C. 2003. Usability evaluation and PPGIS: towards a user-centred design approach, *International Journal of Geographical Information Science*, **17**, 577-592
- Heikkila, E. J. 1998. GIS is dead; long live GIS! *Journal of American Planning Association*, **64**, 350-367
- Holden, J. 2005. *An Introduction to Physical Geography and the Environment*, Prentice Hall, Spain
- Ioanid, A and Bowman, V. 2001. Data and metadata: An overview of organization in Searchable Full-Text Databases. In. Still, J. M (Eds.) *Creating Web-Accessible Databases: case studies for libraries, museums and other non profits*, Thomas H. Hogan, Sr, USA, p. 143-156
- Ives, B, Olson, M. H and Baroudi, J. J. 1983. The Measurement of User Information Satisfaction, *Communications of the ACM*, **26**, 785-793

- Jankowski, P, Jankowski, M. A and Stasik, M. 2001. A Map Browser for an Internet-based GIS data repository, *Transactions in GIS*, **5**, 5-18
- Jankowski, P, Nyerges, T, Robischon, S, Ramsey, K and Tuthill, D. 2006. Design considerations and evaluation of a collaborative, spatio-temporal decision support system, *Transactions in GIS*, **10**, 335-354
- Kingston, R. 2002. Web-based PPGIS in the United Kingdom. In. Craig, W. J, Harris, T. M and Weiner, D (Eds.) *Community Participation and Geographic Information Systems*, Taylor and Francis, UK, p. 101-112
- Kingston, R, Carver, S, Evans, A and Turton, I. 2000. Web-based public participation geographical information systems: an aid to local environmental decision-making, *Computers, Environment and Urban Systems*, **24**, 109-125
- Kitchen, R and Tate, N. J. 2000. *Conducting Research in Human Geography: Theory, Methodology and Practice*, Prentice Hall, Singapore
- Lake, R.W. 1993. Planning and applied geography: positivism, ethics, and geographic information systems, *Progress in Human Geography*, **17**, 404-413
- Laurini, R. 1998. Spatial multi-database topological continuity and indexing: a step towards seamless GIS data interoperability, *International Journal of Geographical Information Science*, **12**, 373-402
- Longhurst, R. 2003. Semi-structured interviews and focus groups. In. Clifford, N. J and Valentine, G (Eds.) *Key Methods in Geography*, Sage Publications, UK, p. 117-132
- Martin, D. 1997. Geographical Information Systems and spatial analysis. In. Flowerdew, R and Martin, D (Eds.) *Methods in Human Geography: a guide for students doing a research project*, Longman, Malaysia, p. 213-229

- Martin, D, Harris, J, Sadler, J and Tate, N. J. 1998. Putting the census on the web: lessons from two case studies, *Area*, **30**, 311-320
- Mathiyalagan, V, Grunwald, S, Reddy, K. R and Bloom, S. A. 2005. A WebGIS and geodatabase for Florida's wetlands, *Computers and Electronics in Agriculture*, **47**, 69-75
- McLafferty, S. L. 2003. Conducting questionnaire surveys. In. Clifford, N. J and Valentine, G (Eds.) *Key Methods in Geography*, Sage Publications, UK, p.87-100
- Morrison, J. L. 1991. The organisational home for GIS in the scientific professional community. In. Maguire, D. J, Goodchild, M. F. and Rhind, D. W (Eds.) *Geographical Information Systems, Principles and Applications Volume 1*, Longman Scientific and Technical, UK, p. 91-100
- Newton, A, Gittings, B and Stuart, N. 1997. Designing a scientific database query server using the World Wide Web: the example of Tephabase. In. Kemp, Z (Eds.) *Innovations in GIS 4, selected papers from the Fourth National Conference on GIS Research UK (GISRUK)*, Taylor and Francis, UK, p. 251-266
- Niles, S and Hanson, S. 2001. A new era of accessibility: or is it? *Workshop on Access to Geographical Information and Participatory approaches using Geographical Information*, Spoleto, Italy, 1-20
- Peng, Z-R and Tsou, M-H. 2003. *Internet GIS: Distributed Geographic Information Services for the Internet and Wireless Networks*, Wiley, USA
- Peng, Z-R and Zhang, C. 2004. The roles of geography markup language (GML), scalable vector graphics (SVG), and web feature service (WFS) specifications in the development of Internet geographic information systems (GIS), *Journal of Geographical Systems*, **6**, 95-116

- Reeve, D and Petch, J. 1999. *GIS, Organisations and People: A socio-technical approach*, Taylor and Francis, UK
- Saunt, M. 2006. Web data access, *GEOconnexion Magazine*
- Schafer, W. A, Ganoë, C. H, Xiao, L, Coch, G and Carroll, J. M. 2005. Designing the next generation of distributed, geocollaborative tools, *Cartography and Geographic Information Science*, **32**, 81-100
- Schuurman, N. 2000. Trouble in the heartland: GIS and its critics in the 1990's, *Progress in Human Geography*, **24**, 569-590
- Sieber, R. E. 2000. Conforming (to) the opposition: the social construction of geographic information systems in social movements, *International Journal of Geographical Information Science*, **14**, 775-793
- Sieber, R. 2006. Public Participation Geographic Information Systems: A literature review and framework, *Annals of the Association of American Geographers*, **96**, 491-507
- Smith, R. S and Craglia, M. 2003. Digital Participation and access to Geographic Information: A case study of local government in the United Kingdom, *URISA Journal*, **15**, 49-54
- Smith, S. 2007. Google My Maps for the Non-Technical User, *GIS Weekly Review*, GIS Cafe Newsletter
- Sondheim, M, Gardels, K and Buehler, K. 1999. GIS interoperability. In. Longley, P. A, Goodchild, M. F, Maguire. D. J and Rhind, D. W (Eds.) *Geographical Information Systems Volume 1: Principles and Technical Issues*, Wiley, USA, p. 347-358
- Taylor, P.J. 1990. GKS, *Political Geography Quarterly*, **9**, 211-212

- The Economist, October 28th 2004. If in doubt, farm it out, *The Economist*, Print edition
- Tomlinson, R. 2003. *Thinking about GIS: Geographic Information System Planning for Managers*, ESRI Press, USA
- Tsou, M-H. 2004. Integrating web-based GIS and image processing tools for environmental monitoring and natural resource management, *Journal of Geographical Systems*, **6**, 155-174
- Tulloch, D, L. 2002. Environmental NGO's and community access to technology as a force for change. In. Craig, W. J, Harris, T. M and Weiner, D (Eds.) *Community Participation and Geographic Information Systems*, Taylor and Francis, UK, p. 192-204
- UK GEMINI Standard, 2004, Version 1.0: A Geo-spatial Metadata Interoperability Initiative, e-Government Unit, Cabinet Office
- Unwin, D. J. 1991. The academic setting of GIS. In. Maguire, D. J, Goodchild, M. F. and Rhind, D. W (Eds.) *Geographical Information Systems, Principles and Applications Volume 1*, Longman Scientific and Technical, UK, p. 81-90
- Valentine, G. 1997. Tell me about...using interviews as a research methodology. In. Flowerdew, R and Martin, D (Eds.) *Methods in Human Geography: a guide for students doing a research project*, Longman, Malaysia, p. 110-126
- Vatsavai, R. R, Shekhar, S, Burk, T. E and Lime, S. 2006. UMN-MapServer: A high-performance, interoperable, and open source web mapping and geo-spatial analysis system, *Geographic Information Science, proceedings lecture notes in Computer Science*, **4197**, 400-417
- Worboys, M. F. 1999. Relational databases and beyond. In. Longley, P. A, Goodchild, M. F, Maguire. D. J and Rhind, D. W (Eds.) *Geographical Information Systems Volume 1: Principles and Technical Issues*, Wiley, USA, p. 373-384

Yong, C, Wong, D. W, Yang, R, Kafatos, M and Li, Q. 2005. Performance-improving techniques in web-based GIS, *International Journal of Geographical Information Science*, **19**, 319-342

Websites

World Wide Web Consortium (W3C) – accessed 7/10/06

Geowise: www.geowise.co.uk/imf - accessed 18/10/06

Example of web-based GIS with a case study of English Nature:

www.geowise.co.uk/services/case_studies/wm_notm.html - accessed 16/10/06

Example of web-based GIS with a case study of UK Forestry Commission:

www.geowise.co.uk/products/imf/case_studies/imf_fc.html - accessed 17/10/06

PastMap:

www.pastmap.org.uk

Open Source website: www.opensource.org – accessed 16/10/06

Databases:

http://ioc.unesco.org/oceanteacher/OceanTeacher2/02_InfTchSciCmm/01_CmpTch/02_Databases/DatabaseManagement.html - accessed 13/10/06

ASPMAP:

<http://www.vdstech.com/pdf/aspmmap.pdf> - accessed 8/6/07

Edina:

<http://edina.ac.uk/digimap>

NTS website:

www.nts.org.uk

Appendix I

Interviewed with key literature

Sarah Petchey

an 'interview schedule' - list of carefully worded qus (Dunn, 2000) Balmacara Estate

program of changes

Interview Themes

start with descriptive qus signal want info viewed or built freely (VU, 1997)

- effective - let them explain in own words (VU, 1997)
- storytelling
- Questions posed allow an open response (Dunn, 2000)
- primary qus - descriptive
- secondary qus
- prompts - encourage expansion
- formal
- primary qus - knowledge (Dunn, 2000)

- ↓ Tell me about the current GIS system → primary qus - descriptive
- What software programmes are used? (Dunn, 2000)
- What data is stored within it? → secondary qus
- ↓ How is the current system used?
- What tasks need to be completed?
- Timescale of tasks?
- Repetitive or one-off?
- Who has access to the current system and associated databases?

primary qus storytelling / descriptive (Dunn, 2000)

descriptive thoughtful qus (VU, 1997)

- ↓ How do you see your role within this department/organisation? → primary qus - knowledge (Dunn, 2000)
- What decisions have to be made?
- What has to be achieved?
- What has to be produced?
- ↓ How do you use the current GIS system to carry out these tasks? [repeat back to them some of the specific tasks they have just mentioned]
- ↓ Can you see your role changing if a new GIS system is brought in? - hypothetical qus (Dunn, 2000)
- ↓ How does this department fit into the context of the whole organisation?

primary opinion qus (Dunn, 2000)

- ↓ Is there anything that the current system doesn't provide that maybe useful to improve efficiency etc?
- ↓ Is there anything the current system offers that in reality never really gets fully utilised?
- ↓ The NTS have said that they would like greater interoperability within the organisation to freely enable data sharing, common language between departments etc, but what do you take this to mean and how do you envisage it happening? - primary qus - structural / opinion (Dunn, 2000)
- Are there any departments in particular that you work very closely with?
- [Establish GIS knowledge]

thoughtful qus (VU, 1997)

general GIS -> personal (role + interp)

- ↓ What data is held at Balmacara estate? - descriptive primary qus (Dunn, 2000)
- Format?
- Any sensitive information?
- ↓ What (if any) of the core datasets held at Edinburgh is used?
- If so what data and how is it needed?
- ↓ What is the data used for and how often is particular data required?
- I. e. daily, monthly, yearly etc.
- ↓ Where is the data from and how was it collected?

* combination of funneling + pyramed interviewing

strategy (Dunn, 2000)

- ↓ Is there anything else that I haven't mentioned that you would like to add?
- ↳ closing off question - let interviewee know interview is ending (if that VU, 1997)
- ↳ abstract qus to start + more easy answers at start (dunn) -> reflection (interp) then changes role -> general qus at end (dunn)

- schedule doesn't have to be followed exactly - used as a checklist (Ling, 2003)
- participants selected on basis of experience ('purposeful sampling') (Ling, 2003) but also as many as poss - since don't always know all best people to talk to
- used clarifier secondary qus within the interviews - asking them to explain things they had said (Dunn, 2000)
- also some summarising of responses (Dunn, 2000)

* Schedule shown to him first - could comment on it (has most GIS knowledge) (Kearns, 1991 + Dunn, 2000) - Answers were queried when necessary - not just taken at face value (Cook + Ling, 1995)

Interview with key interviewee!

Think together with BML + NTH interviewees
relationships between data
(assessment + interview)
(Kitchen + Take, 2000)

Head Office
Edinburgh

2

start with a
descriptive q -
signal want
interviewee
to talk freely
(Val, 1997)

Interview Schedule

- effective - let them explain
or draw models (Val, 1997)
- primary q - storytelling descriptive
questions call open response
(Dunn, 2000)
- ↓ Tell me about the main aims and ambitions of NTS and the operations undertaken here at head office
- ↓ How do you see your role within the NTS both as a department in the wider organisation and as an individual with the department? → primary q - knowledge (Dunn, 2000)
- ↓ What decisions do you have to make?

→ decision
stage to go
on the school
ground -
taking some
of the staff
→ trips on
school grounds
→ some of
the staff
→ some of
the staff
(Val, 1997)

- ↓ What data do you use to make these decisions? → primary q - moving on to look at specific data - descriptive (Dunn, 2000)
- Who 'owns' the data?
- How do you know the data is right?
- How is it updated?
- ↓ How do you use the data?] what: each q - a couple of prompts - identified q's (Dunn, 2000)
- ↓ Is there any data, both internally and externally that is currently not readily accessible that would enhance management tasks if it were more easily accessible? } some clarification secondary q's are used throughout (Dunn, 2000)
- Internal meaning what other colleagues are creating and using
- External meaning what other organisations have and use
- ↓ Would you benefit from having access to any core data?
- Core data - essentially 'fixed' or that is updated by the organisation due to factors that are out of its control/key organisation decisions need to be made

thoughtful
q's
(Val, 1997)
ambitions of
business
(Dunn, 2000)

- primary q - update (Dunn, 2000)
- ↓ What do you understand by the term GIS? - establish current level of knowledge
- Geographical Information Systems - on a basic output level it essentially produces maps, but much greater potential managing, analysing and querying spatial information } internal prompt (Dunn, 2000)
- ↓ How do you think GIS could be used to help your management role and that of your department?
- ↓ Do you see the way you carry out your role changing with the incorporation of GIS and if so how? } hypermetical q (Dunn, 2000)
- Do you feel that you would require any training?

thoughtful
q's
(Val, 1997)

- ↓ The NTS have said that they would like greater interoperability within the organisation to freely enable data sharing, common language between the departments etc, but what do you take this to mean and how do you envisage it happening? - establish current level of knowledge } primary q } structural / open (Dunn, 2000)
- Interoperability - common language between datasets, single point of entry into these datasets, compatibility. Needs to be external as well as internal in order to facilitate inter-organisational data sharing
- ↓ What work would be required in order to make your data interoperable? } primary q open (Dunn, 2000)

thoughtful
q's
(Lung, 2000)

- ↓ One of the aims of NTS is to increase public involvement and aid education. If there was a public interface to an Internet GIS system what kind of information do you think would be valuable to include? Do you foresee any security issues? } added after BML
- Other than general property details, e.g. opening times, contact details, historical information and more detailed archival and technical data
- ↓ Are there any other specific initiatives or goals within the NTS that you feel would benefit from a GIS system and how? } only for LO

thoughtful
q's
(Val, 1997)

- ↓ Is there anything else that I have not mentioned that you would like to add? } closing off - indicator to interviewee (Val, 1997)

Changes made after the BML
→ focus more on data q's - work out the process - future - each person has
→ next year it really is about the real life of the school - they may not care about - practical
→ should have been q - about what underpins the NTS - only had really know / uses at
→ changed style - more larger / bracketed NTS q's - if - interviewee will force

Appendix II

Evaluation Questionnaire

System evaluation

1. Do you have any previous experience with GIS?

NO

2. Are the systems easy to use and understand?

Very good / Good / Average / Poor / Very Poor

1 2 3 4 5

3- Average. I thought ASPMap set up was much clearer than the other two systems and the map was slightly clearer than the other maps, and I also found it easier to navigate. I wasn't too impressed with ArcIMS as the map was very fuzzy and the colour-coding of the different layers very confusing. The map on the geogis was quite clear and I like the hierarchical system of information, although the information I requested didn't come up! However, it's only a trial system and very early days.

3. Is the data clear and well-organised?

Very good / Good / Average / Poor / Very Poor

1 2 3 4 5

3 – Average – See above

4. Is the data available accurate and informative enough for your needs?

Very good / Good / Average / Poor / Very Poor

1 2 3 4 5

If not, what else would you like to see included?

3 – Average again. I did like the information on the paintings in ASP map, and I think this is where the future NTS GIS system will benefit us enormously.

5. Within each system, do you feel there is consistency throughout the data and the systems?

Very good / Good / Average / Poor / Very Poor

1 2 3 4 5

2 – Good. Some of the data that I did manage to extricate was clear and consistent.

6. Do you like the feel of the site?

As mentioned I much preferred the ASPmap site as the layout was clear and you didn't need to have prior knowledge of the signs and symbols as shown in the ArcIMS system.

7. Are the systems flexible enough for your needs?

Very good / Good / Average / Poor / Very Poor

1 2 3 4 5

Can't really comment as yet as would need a greater input of information into the system in order to get out of it what you want.

8. What specific features (both those included in the demos and other known functionality tools) do you think are most useful for you to carry out your roles? Please explain the reasons for your choices.

I would need access to historical information, so as long as there is the capacity to store this then it will be absolutely wonderful. Locations of collections, ground plans of the buildings and other historical data would help me enormously.

9. Did you find any technical problems with the system?

See above.

10. Which system(s) do you prefer and why?

ASPmap for reasons outlined above.

GIS initiative for the Trust

11. In what ways can you see an Internet GIS system helping with both your own role and the wider aims and objectives of the organisation?

I think it is essential to get the right system in the first place, and once that has been decided it would benefit the Trust greatly, by having greater access to information. It would help staff do their jobs better, it would save staff time and money in retrieval of information, it would stop duplication of information in different place and it could also have a great benefit to NTS members and members of the public, who cannot physically access our properties, but would like to know more about them.

For me personally it would help me in my role as I receive a number of research enquiries, so anything that makes retrieval of (accurate) information easier, is greatly welcomed.

12. What do you think is the best approach for NTS – bespoke systems, commercial software etc?

I'm not knowledgeable enough to make a decision on that, although I know bespoke software would be more expensive than open source software. In these financially stringent times, I think the latter is better, but only if there is a dedicated support system in place. I also think there are enough software systems around to enable us to get our jobs done more efficiently.

13. What is the reason for this choice? For example, is it for practical and management reasons or more focused on the financial costs?

See above

14. If you were to develop an Internet GIS system, would you choose to keep the development in-house or out-source the work and why?

I would use a mixture of both. Out-sourcing the work would probably be better but only if NTS staff could be involved in the process. There is a lot of expertise and knowledge within the Trust and it would be a shame not to use that. I also think there should be a great deal of cooperation and discussion between both parties in order to get the right system in place.

15. Do you have any further points you would like to add?

I really think the NTS should go down the road of a GIS, in order to house and share the information the Trust holds. At present we don't really know what we have in the way of data, and having a data warehouse with accurate, up-to-date information which could be then uplifted onto a GIS as and when required, is essential to help us to do our jobs properly.

16. Do you have any additional comments on this project?

This has been a wonderful project and greatly appreciated by many of us in the Trust. Thank you for all your work and I hope to still be here when this comes to fruition!

Appendix III

URL addresses for the three demonstration systems

1) ASPMap demonstration system:

http://www.geography.dur.ac.uk/ForestSAFE/Balmacara/Balmacara_ASP.asp

Username: NTS

Password: NTS

2) ArcIMS default demonstration:

<http://www.geography.dur.ac.uk/website/Balmacara/viewer.htm>

3) ArcIMS customised demonstration system:

<http://www.geoggis.dur.ac.uk/newhailes>

NOTE: The websites were last updated around 1/8/2007, so some minor faults may have developed within the systems.

