

Durham E-Theses

The electrical conductivity of cellulosic derivatives in the presence of moisture

Hussain, Mazher C.

How to cite:

Hussain, Mazher C. (1974) *The electrical conductivity of cellulosic derivatives in the presence of moisture*, Durham theses, Durham University. Available at Durham E-Theses Online:
<http://etheses.dur.ac.uk/9950/>

Use policy

The full-text may be used and/or reproduced, and given to third parties in any format or medium, without prior permission or charge, for personal research or study, educational, or not-for-profit purposes provided that:

- a full bibliographic reference is made to the original source
- a [link](#) is made to the metadata record in Durham E-Theses
- the full-text is not changed in any way

The full-text must not be sold in any format or medium without the formal permission of the copyright holders.

Please consult the [full Durham E-Theses policy](#) for further details.

The Electrical Conductivity of
Cellulosic Derivatives in the Presence of Moisture

by

Mazher C. Hussain

(B.Sc. Punjab)

Thesis submitted for the degree of Master of Science in the
Faculty of Science, University of Durham.

February 1974



ABSTRACT

The work presented in this thesis consists of a review of previous work on cellulosic materials and related polymers, and the results of an experimental investigation into the electrical conductivity of cellulosic derivatives (cellulose acetate, cellulose acetate butyrate) in the presence of moisture.

The experimental work for the present investigation has been carried out in three parts. The first part concerns the preparation of thin films of cellulose acetate and cellulose acetate butyrate from the raw material using a casting technique. The second and major part of the experimental work concerns electrical measurements, including the measurement of dielectric constant dielectric loss and volume conductance under different conditions of humidity and contamination, etc. These follow the experiments made by Barker and Thomas on the effect of moisture and high electric fields on conductivity in alkali-halide doped cellulose acetate. The third and the final part of the experimental work deals with the sorption measurements, i.e. the sorption isotherms for the materials and their correlation with the electrical measurements. This part is incomplete.

The results obtained are in agreement with the results of Barker and Thomas and the two materials have given similar results. However the work has been extended beyond the original work of Barker and Thomas and significant disagreement has been found with their work. In particular results obtained at different humidity do not support the theory proposed by Barker and Thomas.



The surface conductance of the specimens was measured and was found to be negligible at all humidities. It is concluded that there is no surface conduction on these materials.

Acknowledgements

The author wishes to express his sincere gratitude to Dr. E. C. Salthouse, his supervisor, for his guidance, encouragement and continued help throughout the work.

Thanks are also due to the Technical Staff of the Electrical Laboratory of the Engineering Science Department for their help in building the necessary equipment, and to Mrs. M. Pearce, for typing the thesis.

I am indebted to my brother, Dr. A. C. Hussain, for providing financial support.

<u>Contents</u>	<u>Page</u>
1.0 Introduction	1
1.1 Polymeric materials	2
1.2 Cellulosic materials	6
1.2.1 Manufacture of regenerated cellulosic compounds	7
1.2.2 Cellulose esters	8
1.3 General properties of polymeric materials	10
2.0 Sorption of water vapours by polymers	12
2.1 Adsorption	13
2.1.1 Physical adsorption	13
2.1.2 Chemical adsorption	14
2.2 Sorption isotherms	15
2.2.1 Langmuir theory	16
2.2.2 The B.E.T. theory	18
2.3 Absorption and permeation	24
2.4 Sorption in cellulosic materials	28
3.0 Electrical properties of polymers	35
3.1 D.C. characteristics, insulation resistance, volume and surface resistances	35
3.1.1 Insulation resistance	35
3.1.2 Volume resistivity	36
3.1.3 Surface resistivity	37
3.1.4 Measurements of volume and surface resistivity	38
3.2 A.C. characteristics, dielectric constant, dielectric loss	39
3.2.1 Dielectric constant	39

	<u>Page</u>
3.2.2 Dielectric loss	40
3.3 Effect of moisture on electrical properties of polymers	42
3.3.1 Effect of humidity of surface conductance	42
3.3.2 Initial increase in surface conductance	47
3.3.3 Effect of contamination on surface resistance	47
3.4 The effect of humidity on volume conductance	50
3.4.1 Time dependence of volume conductivity following exposure to humid atmosphere	50
3.4.2 Conduction mechanism	53
3.4.3 Ionic dissociation theories	57
4.0 Experimental technique	64
4.1 Materials	64
4.2 Film preparation	65
4.2.1 Details of casting methods	68
4.2.2 Film properties	69
4.3 Humidity and temperature control	71
4.4 Electrode system	72
4.5 Electrical measurements	75
4.5.1 A.C. measurements	75
4.5.2 D.C. measurements	77
5.0 Experimental results and discussion	79
5.1. Introduction	79
5.2 Effect of humidity on dielectric constant, a.c. conductance and d.c. conductance	81
5.3 Comparison of the results with the dissociation theory of Barker and Thomas	83
5.3.1 Doping of specimens and electrical measurements	86

	<u>Page</u>	
5.3.2	Variation of dielectric constant and dielectric loss with frequency	88
5.3.3	Surface and volume conductance	89
6.0	Conclusion	90
7.0	References	93
8.0	Appendices	101

List of symbols used in the thesis

A	—	area
b	—	width
C	—	capacitance
c	—	concentration, constant (sec.2.2.2)
D	—	diffusion coefficient (sec.2.3), dissipation factor (sec.4.5.1)
E	—	potential gradient
e	—	electronic charge
f	—	frequency
G	—	conductance, Gibb's potential (sec.3.4.3)
g	—	gap (separation between electrodes)
H	—	heat of adsorption
h	—	humidity (3.27)
I	—	current
i	—	ions
J	—	current density
K	—	Boltzmann's constant
K	—	dissociation constant
L	—	intercept, constant (3.24)
l	—	thickness
M	—	mass
m	—	moisture content
N _m	—	number of molecules
n _i	—	number of ions
p	—	pressure
Q	—	rate of penetration
q	—	heat evolved during the time of molecules adsorption, critical distance (sec.3.4)

R	—	resistance
r	—	radius
d_r	—	thickness (sec.3.4)
S	—	adsorption sites, solubility (sec.2.3)
S	—	shape factor
T	—	temperature
t	—	time
U	—	dissociation energy
V	—	applied voltage
w	—	weight
W	—	work
Z	—	impedance
α_c	—	condensation coefficient
β	—	constant of proportionality
γ	—	activity coefficient
δ	—	thickness of water film on surface
λ	—	fringing constant
ρ	—	resistivity
σ	—	conductivity
μ_i	—	mobility of ions
θ	—	fraction of surface covered with adsorbed molecules
ϵ'	—	dielectric constant
ϵ''	—	dielectric loss
ϕ	—	fractional dissociation
a, d, x, y	—	are constants

1.0 Introduction

The aim of this work is to examine the effect of sorbed moisture on the electrical properties of cellulose acetate, cellulose acetate butyrate and regenerated cellulose acetate butyrate. It is well known that sorbed moisture causes an increase in the dielectric constant and conductivity of polymers. The effect of moisture on the electrical conductivity of cellulose acetate has been studied in some detail by Barker and Thomas (1), who proposed that the increase in conductivity is a consequence of the dissociation of molecules into ions and that the amount of dissociation depends on the dielectric constant. Their work is similar to that of Fuoss and Kraus (2) and Bjerrum (3) on the dissociation of strong electrolytes. The present work shows that a similar behaviour exists in cellulose acetate butyrate and seeks to examine the effect of humidity and contamination on the process. The increase in volume conductivity and dielectric constant with the amount of moisture sorbed by the materials has been confirmed.

It has been suggested that such materials could be used as the basis of a humidity transducer element. Misevich (4) used cellulose acetate butyrate and proposed that this material is ideal for capacitive humidity transducers. He found that with a one per cent change in relative humidity, there was a one per cent change in capacitance in the nanofarad range. The element exhibited good linearity and stability over normal environmental ranges. Thoma (5) developed a cellulose acetate butyrate resistance type humidity sensor and concluded that the material was excellent for this purpose.



The arrangement of the subject in this thesis is as follows. First there is a general description of polymeric materials and this is followed by a discussion on the sorption of moisture by polymers. This is followed by a review of the effects of sorbed moisture on the electrical properties. The experimental work is then described and discussed.

1.1 Polymeric Materials

The plastic industry began with the discovery of nitrocellulose in 1864 by Alexander Parkes. Parkes did not pursue his discovery commercially and it was not until some ten years later that the possibility of the utilization of the material was realized. Since then the importance of plastics has grown enormously. They are no longer just useful materials for the fabrication of toys and kitchenware, nor are they alternatives or substitutes, but represent a very important and versatile group of engineering materials. The word plastic means different things to different people, but a plastic defined by the American Society for Testing Materials and the Society of the Plastic Industry Inc. is "a material that contains as an essential ingredient an organic substance of large molecular weight." A more general definition of plastics from the point of view of the chemical structure is that they are polymeric materials which defines them in terms of the arrangement of their atoms, within the material. A polymeric material consists of a small group of atoms (6), combined in a given way called a "Mer". A large number of these groups when combined

with one another give a large molecule known as polymer. The most important classification of polymers from a user's point of view is considered as the division into thermoplastic and thermosetting polymeric materials, but this distinction is becoming less definite. Thermoplastic materials may become thermosetting (7) by the addition of small amounts of unsaturated compounds or on being irradiated with certain rays.

Generally thermoplastic materials are those which undergo no permanent change on heating. They flow and may be moulded into a shape which they retain on cooling. This process can be repeated but on the other hand, thermosetting materials are capable of a high degree of crosslinking. They are moulded in a partially polymerized state so that they will flow when heated. During moulding process further polymerization occurs and the polymer becomes highly crosslinked, hence losing its ability to flow. Thermosetting materials in the partially polymerized state are usually called resins. Strictly speaking, plastic is short for thermoplastic and should only be used to describe such materials. The word is often used more generally. The group of thermoplastic materials includes all such substances which are normally formed by polymerization and certain natural materials. These are polystyrenes, Polyvinyls, acrylic acid derivatives, cellulose esters, rubber, bitumen, etc. The members of thermosetting group are formed by condensation or reaction. These include phenol formaldehyde, urea formaldehyde, malamine formaldehyde, etc. Hybrid polymers are those which have some of the properties of each group and known particularly among the synthetic resins used in paint.

The difference in structure between thermoplastic and thermo-setting materials is such that it is usually impossible to apply the same conditions to both. Depending on the pattern of distribution of molecular chains, polymers are subdivided into amorphous and crystalline. A solid differs from liquid and a gas in that it has a definite volume and shape. The distribution of molecules within a liquid is completely random and the molecules move relative to one another, the thermal energy being sufficient to overcome the intermolecular forces. For materials consisting of small molecules, the change from liquid to solid is a change from disorder to order. In solids, intermolecular forces are large enough to hold the molecules in an ordered array, and despite the thermal energy which causes them to vibrate about their equilibrium position in that array, the molecular arrangement is regular throughout. Such solids are crystalline and melt at a fixed temperature, corresponding to the thermal energy just sufficient to overcome the intermolecular forces. When the atoms are disordered and chaotic, characteristic of amorphous substances, the solids have the same properties in all directions. The properties of amorphous polymers should be considered in relation to temperature, which exerts an influence on the interconnections between the molecular chains and the physical properties. The characteristic physical conditions of polymers correspond to a definite temperature range. There are three such conditions (8), glassy or vitreous, highly elastic and the state of fluidity or plastic flow. The solid state of amorphous substances is called vitreous, it is characterised by a very large force of cohesion between the molecules.

A typical example of such a substance at room temperature is "PERSPEX". In the highly elastic state, small forces cause the polymers to undergo large deformation. For example, a small force will stretch rubber ten or more times. The temperature at which the vitrified polymer changes to the high elasticity state (or the temperature of conversion from the highly elastic state to the vitreous state) is called the vitrification temperature. The high elasticity state is midway between solid and liquid because the movement of part of the chains influenced by thermal movements makes this state approximate to the liquid but the molecule bond which prevents the movements of whole molecules is characteristic of solids. On heating a substance in the highly elastic state to a certain temperature the forces of cohesion which secure individual parts of macromolecules disappear and the latter are able to change places with one another. This corresponds to a state of fluidity or plastic flow, and the temperature at which this change occurs is known as fluidity temperature.

Crystalline polymers are partly amorphous and partly crystalline. They have two constants, melting point of crystalline part and vitrification point of the amorphous part hence such polymers are often described as semicrystalline. If the amorphous part of the polymer at a given temperature is in the highly elastic state, the material is elastic and pliable, but a vitreous state of amorphous part on the other hand causes hardness and brittleness in the polymer. A good example of a crystalline polymer is polytetrafluoroethane. The small size of fluorine atoms enables the polytetrafluoroethane chains to crystallise close to one another.

A new group of crystalline polymers has recently been discovered which is called stereoregular polymers. They are formed when the links of macromolecular chain, having side groups, repeat regularly in space.

1.2 Cellulosic Materials

Cellulose is a naturally occurring polymeric material found in many plants, and usually obtained from cotton linters or wood pulp. The raw cellulose is converted to a water soluble form and then purified, and finally regenerated by the action of a suitable reagent. The process is designed so that the polymer can be drawn off in the form of fibre or sheet as it is regenerated. The intermolecular forces are strong due to hydrogen bonding and the polymer is water insoluble, highly crystalline and chars before it melts. Fibres made from regenerated cellulose are the basis of a large industry. A wide range of fibres can be made and they are classified as Rayons. The physical structure of cellulose is important both in considering its properties and in the manufacture of its derivatives. In general one can find natural cellulose as consisting mainly of long fine fibres of largely crystalline character. The insolubility of cellulose is also due to hydrogen bonding which must therefore be overcome if a soluble derivative is required. This can be achieved by substituting sufficient hydroxyl groups by other groups to prevent the reformation of hydrogen bonds.

The empirical formula for cellulose is $(C_6H_{10}O_5)_n$. Cellulose fibres are formed of groups of roughly parallel chains held together by bonding, varying from weak Van der Waals forces through varying degrees of hydrogen

bonding. The resulting fibres have both crystalline and amorphous areas. Cellulose undergoes the following reactions involving the OH-groups, formation of esters, such as nitrates, acetates, propionates etc. Formation of alkyl ethers, such as ethyl and methyl cellulose, hydroxy ethers and other esters, and the formation of additional compounds with alkalies, acids and salts. Cellulose also hydrolyses to Glucose.

1.2.1 Manufacture of regenerated cellulosic compounds

Regenerated cellulose is produced by converting cellulose wholly or partially into a derivative and converting it back to cellulose. This results in a product of lower molecular weight and different physical character from the original cellulose. Commercial regenerated cellulose products are cellophane, viscose rayon etc. Regenerated cellulose has a degree of polymerization of about 600 compared to about 1200 in purified wood pulp. The fact that cellulose could be dissolved in an ammoniacal solution of copper oxide and regenerated by dilution with water weak acids or bases was discovered by Schweitzer (9) in 1857 and formed the basis of his cuprammonium rayon process. In 1892, another means of producing regenerated cellulose was discovered by Cross, Bevon, and Beadle (9). This process, which is known as the "xanthate process", provided the foundation stone for the cellulose film and viscose rayon industries. A method for coagulation and regeneration of xanthated cellulose was patented by Stern in 1898, but the person chiefly responsible for the development of equipment for the continuous production of cellulose film was Brandenberger to whom patents were first issued in 1911.

In order to make regenerated cellulose film, cellulose in the form of cotton linters or wood pulp is steeped in a 17-21% aqueous solution of NaOH for about an hour at room temperature. The excess alkali is pressed out and the alkali cellulose is shredded in a mixer and allowed to age at room temperature, for two to three days. During this time the alkali cellulose absorbs oxygen from air and the length of the cellulose chain is shortened; this being necessary to reduce the viscosity of the resultant xanthate solution. The aged alkali cellulose is next fed to xanthating drums which rotate slowly on the horizontal axis while carbon disulphide is sprayed on the pulp. As the xanthating reaction is exothermic, cooling of the drums is necessary. The resultant solution is known as viscose. The viscose is filtered and is then passed into a vessel where it is allowed to ripen for a period of from four to five days. During ripening, slow hydrolysis takes place. Air bubbles in the solution are removed by vacuum prior to delivery to the casting hopper. Similar techniques are used for the production of cellulose esters and cellulose ethers.

1.2.2 Cellulose esters

Cellulose esters are formed when various acids react with the OH-group of the cellulose; cellulose acetate is commonly made by mixing cellulose with acetic anhydride, acetic acid and sulphuric acid in a mixer for about three hours. For triacetate, it is precipitated with dilute acetic acid and for secondary acetate, the triacetate is partially hydrolyzed by adding water before precipitating. Cellulose nitrate or nitrocellulose is obtained by the action of nitric acid on cellulose in the presence of sulphuric acid as a catalyst. In the preparation of nitrocellulose, highly pure cotton

is used as starting materials. The composition of the nitration mixture is roughly 62% sulphuric acid, 20% nitric acid and 18% water.

Cellulose acetate butyrate is produced by reacting cellulose with a mixture of acetic and butyric anhydrides. The resulting product has about one acetyl group and two butyl groups per glucose unit of the cellulose. Cellulose propionate is produced by reacting propionic anhydride with cellulose by procedures similar to those used for the acetate. The resultant product is dimensionally very stable and hard.

1.2.3 Cellulose ethers

Ethyl cellulose is the ether which is most commonly manufactured out of the cellulose ethers, i.e. methyl, ethyl, benzyl etc. Ethers of cellulose are usually represented by the following formula

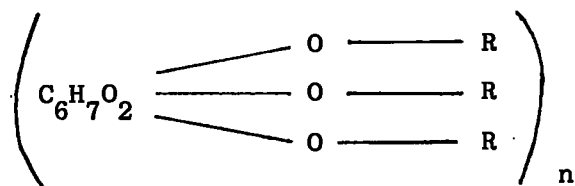

where R is the methyl, ethyl and benzyl or other radicals.

In the production of cellulose ethers, first alkali cellulose is made by treatment of lintners or pulp with 50% caustic soda. The excess alkali is pressed out, the alkali cellulose broken up to a 'crumb' and dried in a vacuum oven. The crumb is then conveyed to reactors, where ethyl chloride, methyl chloride and benzyl chloride are added respectively for the production of ethyl cellulose, methyl cellulose and benzyl cellulose at the required temperature and pressure. By

varying temperature reaction time, pressure and ratios of the raw materials, it is possible to control the viscosity of the resultant ether.

1.3 General Properties of Polymeric Materials

There is a wide range of variation in properties among the polymeric materials, which makes it difficult to discuss the advantages and disadvantages of polymers as a group, compared with other materials. Some generalizations may be made, but they are not applicable to all polymers.

Polymers are light materials and can be fabricated into items with quite intricate shapes, using special techniques. They are not as strong as metals, and dimensional changes usually occur under stress, nevertheless they are much more dense than metals. Polymers are very good thermal insulators. They are much more resistant to corrosion and chemical attack than metals. They can be produced in a wide range of colours and are in some cases transparent. Very few polymers are water soluble, mostly they are insoluble in water but absorb or adsorb it to some extent. The effectiveness of the polymer reduces with the sorption of water which produces changes in properties. The presence of water molecules within or on the polymer often has a profound effect on its electrical, chemical and physical properties. In order to assess the feasibility of using a polymer in a given environment, some information is always required: the rate of penetration of the sorbant through the polymer, the magnitude and mode of sorption and finally the effect of the penetrant on the physical, chemical and electrical properties.

Polymers are used as electrical insulation in many applications from small electronic components to high voltage cables. The electrical properties of plastics are measured for several purposes; to determine performance in electrical applications, to provide control in manufacture, to provide a research tool in developing the theory of molecular structure etc. Dielectric research is vital in the establishment of the theoretical foundation upon which an understanding of the electrical properties is based.

Cellulose esters have good mechanical and dielectric strength. Films are used in packaging and photographic film and tapes. Cellulose nitrate has got a greater flammability than any other ester. Water absorption of cellulose esters is reasonably high. Ethyl cellulose is very tough material with excellent electrical properties. It is dimensionally stable and water absorption is lower than cellulose esters. It is used in making footballs, helmets, flashlight cases etc. It is widely used in coating compositions with other resins, where it improves toughness and flexibility.

2.0 Sorption of water vapours by Polymers

Sorption may be defined as the total uptake of vapour molecules by a material. It is a process in which vapour molecules attach to sites in the material. The vapour can be either water or any other gas and the sites may be distributed throughout the bulk of an amorphous or partially crystalline solid. The word sorption is used in conformity with current phraseology to signify the combined effect of adsorption and absorption. The word was first introduced by McBain (10) in 1909, to describe a system where absorption or adsorption or both occur at the same time.

The term absorption is used for systems where the uptake of water or gas is confined to the bulk of the material and such materials are called absorptive materials. In the case of true adsorption, only the surface regions of the materials are considered to be involved, in other words, the uptake of the molecules is confined to the surfaces of the materials and the materials are known as adsorptive materials.

The nature of the two processes is basically related to the nature of the molecules of the material and their chemical arrangement. Generally hard solids have high surface energies, the values being higher the greater the hardness and the higher the melting point. Soft solids, on the other hand, have much lower melting point and their surface energies are lower. Most of the solid polymers have low surface energies. Sorption processes necessarily result in a decrease of free energy of the system and are accompanied by an increase in entropy (11).

Sorption measurements are concerned with three major factors, (1) the rate of sorption (2) the mode and magnitude of sorption and (3) the effect of sorption on physical, chemical, mechanical and electrical properties of the material. Adsorption and absorption are discussed in the following section. The effect of sorption on the electrical properties of polymers is discussed in a separate Chapter.

2.1 Adsorption

Adsorption is a spontaneous process which occurs at the surface of a solid which has a high surface energy and results in a reduction of the energy. It is a consequence of the fact that the molecules of the gases and vapours are capable of saturating some of the unbalanced forces existing in the surface of the solid thereby decreasing the surface free energy of the system (11). In the case of porous materials, adsorption occurs on the internal surfaces.

Adsorption is divided into two classes. If the interaction between the gas and solid is weak, the process is called physical adsorption. If there is a strong interaction, the process is called chemical adsorption.

2.1.1 Physical adsorption

Physical adsorption is also termed Van der Waals adsorption. The forces bringing about physical adsorption are classified as those associated with permanent dipole moments in the adsorbed molecules, short range repulsive forces and dispersion forces. Dispersion forces arise

from mutually induced inphase components in the oscillation of the electron clouds. The existence of dispersion forces between pairs of atoms or molecules was first recognised by London (13). Such forces are always present and, unless the adsorbate molecule possesses a strong dipole moment, will represent the major contribution to the total energy of adsorption. In ionic crystals or metallic solids, there are electrostatic forces in addition to the dispersion forces. An ionic crystal or metallic solid has an external electric field which induces a dipole in the gas molecule.

2.1.2 Chemical adsorption

Chemical adsorption or chemisorption, occurs due to the chemical forces which arise when vapours or gas molecules come in contact with the surface of a solid. An exchange of electrons between the solid and adsorbed molecules takes place and hence the formation of a chemical bond.

Generally the distinction between physical and chemical adsorption can be made on the basis of heat of adsorption, the thickness of the molecular layers, the temperature conditions and the type of adsorbent. The heat of adsorption of chemisorption is much greater than the heat of adsorption of physical adsorption. The effect of temperature on chemisorption is such that it increases rapidly with increasing temperature, but physical adsorption, being a non activated process, is faster than chemisorption at all temperatures, even at very low ones. The thickness of the adsorbed layer is always confined to a single atomic or molecular layer in chemisorption, but in physical adsorption, the

layer though monomolecular at low pressures will become multimolecular at high relative pressures. Chemisorption is highly specific, i.e. certain adsorbents are only sorbed by certain materials, whereas physical adsorption is essentially non specific.

2.2 Sorption Isotherms

Isotherms are essentially plots of the amount of gas adsorbed as a function of relative pressures at constant temperature. In the literature of the subject sorption isotherms are recorded for a wide variety of solids, but nevertheless, the majority of those isotherms which result from physical adsorption may be grouped into five classes. These five classes were proposed by Brunaur, Emmett and Teller (14) and are shown in Figure 2.1. Type I are associated with the systems where adsorption does not proceed beyond a monomolecular layer. Type II and Type III represent mono and multilayer adsorption and Types IV and V represent mono and multilayer plus capillary condensation. The Type IV also possesses a hysteresis loop which represents the measurements obtained by progressive addition of vapour to the system in the initial stages and progressive withdrawal in the final stages. Besides the major five types of isotherms there are borderline cases which, as in most classifications, are difficult to assign to one group rather than another. The phenomenon of hysteresis found in sorption-desorption measurements has been explained by many workers in different ways, but it is generally accepted that during sorption some of the molecules of adsorbent stick to the adsorbate molecules permanently, and they do not evaporate during desorption, which causes such effect. Bridgeman (15),

FIG. 2.1

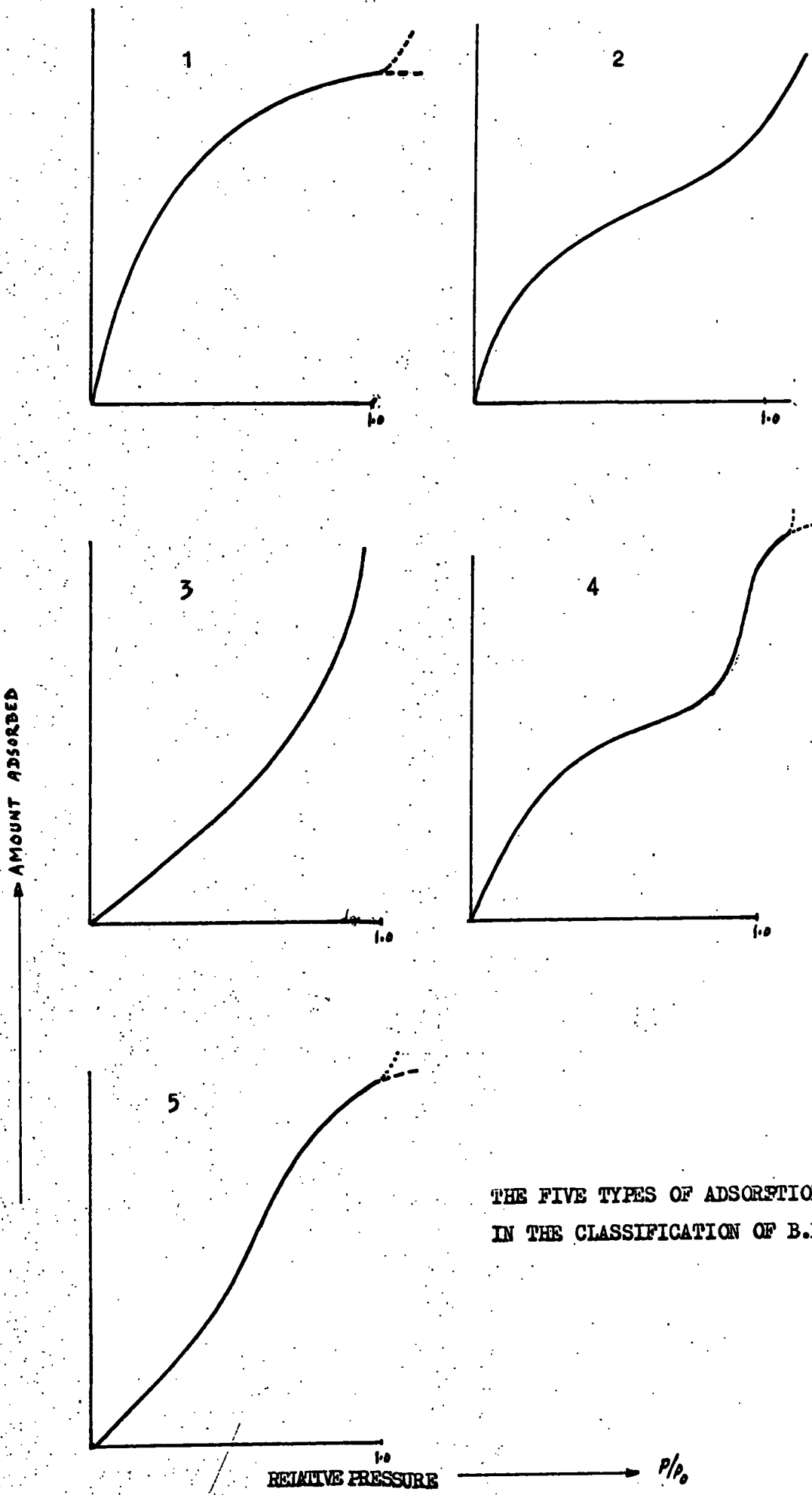

THE FIVE TYPES OF ADSORPTION ISOTHERM
IN THE CLASSIFICATION OF B.E.T.

found in his high pressure experiments that the volume did not immediately settle to its new equilibrium value when the solid underwent a phase change, but slowly drifted towards it. It suggested that the hysteresis in adsorption is, sometimes at any rate, to be ascribed to a kind of supersaturation effect, in which the rearrangement of and reorientation of the adsorbed molecules suffers delay analogous to that of a delayed phase change.

The phenomenon encountered in the study of physical adsorption of gases or vapours by solids has been described by several theories. Most well known are the Langmuir, B.E.T and Gibbs theories (16, 14, 17).

2.2.1 Langmuir theory

Langmuir was the first person to describe a theoretical relationship between ^{the} amount of gas or vapour adsorbed and the equilibrium pressure of that gas or vapour at that temperature. The basic assumption in his theory was that adsorption was limited to a unimolecular layer. The process was regarded as dynamic. Water or gas molecules when they strike the surface are adsorbed on the surface for some time and then evaporate. At equilibrium when the amount of water or gas has reached a definite value at the surface, the rate at which these molecules condense, is equal to the rate at which they evaporate from the surface. The number of molecules striking per unit area of surface per unit time is given by the kinetic theory of gases.

$$u = \frac{p}{(2\pi MKT)^{1/2}} \quad \dots\dots\dots (2.1)$$

where p is pressure, M is the mass of molecule, K is Boltzmann's constant and T is an absolute temperature. Molecules which are adsorbed on the surface are those which strike the bare surface, whereas those which strike an already adsorbed molecule are elastically reflected back into gas phase without being held by the surface forces for a finite time. This is a consequence of short range forces on the surface. The rate of adsorption of molecules per unit area of surface is therefore given by

$$R_a = \alpha_0 (1 - \theta) \mu \dots\dots\dots (2.2)$$

θ is the fraction of surface covered with adsorbed molecules, and α_0 is the condensation coefficient on the bare surfaces. The condensation coefficient is defined as the ratio of the inelastic collisions resulting in adsorption to the total number of elastic collisions of gas molecules with the surface.

The number of adsorbed molecules evaporating from unit area of surface per unit time is dependent on the binding energy between the gas or vapour molecules and the surface. The rate of desorption per unit area of surface is given by,

$$R_d = \nu \theta \dots\dots\dots (2.3)$$

where ν is the number of adsorbed molecules evaporating from unit area of surface per unit time and is given by,

$$\nu = K_0 \exp(-q/KT)$$

q is the heat evolved during the adsorption.

At equilibrium,

$$\alpha_0 (1-\theta)\mu = \nu\theta$$

or

$$\theta = \alpha_0 (1-\theta)\mu / \nu$$

or

$$\theta = \alpha_0 \mu / \nu - \alpha_0 \mu \theta / \nu$$

$$\alpha_0 \mu / \nu = \theta (1 + \alpha_0 \mu / \nu)$$

or

$$\theta = \frac{\alpha_0 \mu / \nu}{1 + \alpha_0 \mu / \nu}$$

If

$$\alpha_0 \mu / \nu = bp$$

$$\theta = \frac{bp}{1+bp}$$

$$b = \left(\frac{\theta}{1-\theta}\right)^{1/p} = \frac{\alpha_0}{\nu (2\pi MKT)^{1/2}} \dots\dots\dots (2.4)$$

Langmuir's derivation applies to a monolayer adsorption system and it holds only if b is constant. It applies to adsorption on an energetically uniform surface on which the adsorbed molecules do not interact with each other.

2.2.2. The B.E.T. theory

The B.E.T. theory is the multimolecular adsorption theory of Brunauer, Emmett and Teller. The approach to the adsorption problem is again made kinetically and is based on the Langmuir theory. This

theory retains the concept of fixed adsorption sites, but allows for the formation of an adsorbed layer more than one molecule thick; the state of 'dynamic equilibrium' is assumed to hold for each successive molecular layer. Assuming that each first layer adsorbed molecule serves as a site for the adsorption of a molecule onto the second layer and so on, so s_1, s_2, \dots, s_i represents the number of adsorption sites which are covered by 0, 1, 2, ..., i layers of adsorbed molecules respectively. At equilibrium the rate of condensation on s_0 is equal to the rate of evaporation from s_1 , that is

$$a_1 p s_0 = b_1 s_1 \exp(-H_1/KT) \quad \dots\dots\dots (2.4)$$

H_1 is the heat of adsorption in the first layer, a_1 and b_1 are constants. The above equation is similar to Langmuir's equation. Similarly the equilibrium between the first and second molecule is expressed by

$$a_2 p s_1 = b_2 s_2 \exp(-H_2/KT) \quad \dots\dots\dots (2.5)$$

by extending the treatment.

$$\begin{aligned} a_3 p s_2 &= b_3 s_3 \exp(-H_3/KT) \\ \vdots & \\ a_i p s_{i-1} &= b_i s_i \exp(-H_i/KT) \quad \dots\dots\dots (2.6) \end{aligned}$$

The total number of adsorbing sites is given by,

$$N_s = \sum_{i=0}^{i=\infty} s_i \quad \dots\dots\dots (2.7)$$

and the total number of molecules adsorbed is

$$N_m = \sum_{i=0}^{i=\infty} i S_i \dots\dots\dots (2.8)$$

The total weight of adsorbate is,

$$W = W_m N_m \dots\dots\dots (2.9)$$

where W_m is the weight of adsorbate when each adsorbing site is covered by just one molecule, then

$$W_m = W_{1m} / N_s \dots\dots\dots (2.10)$$

$$W/W_1 = \frac{W_m N_m}{W_m N_s} = \frac{N_m}{N_s} = \frac{\sum_{i=0}^{i=\infty} i S_i}{\sum_{i=0}^{i=\infty} S_i} \dots\dots\dots (2.11)$$

Adsorption forces are assumed to be Van der Waal's forces, but the argument is not invalidated if, in addition, hydrogen-bond formation also occurs (11). Such forces have a short range of action and therefore the effect of the surface forces of the adsorbent is probably quite small already in the second layer, so that in this and in the higher adsorbed layers the properties of the molecules are practically the same as those ^{in the} liquid state. The key to B.E.T. solution lies in the simplifying assumptions that

$$H_2 = H_3 = \dots\dots\dots H_i = H_L \dots\dots\dots (2.12)$$

H_L is the heat of liquification or the latent heat of condensation, and that

$$b_2/a_2 = b_3/a_3 \dots\dots\dots = b_i/a_i \dots\dots\dots (2.13)$$

In other words, the properties of all those layers adsorb^{ed} on the surface, except the first one, are the same as those of the 'surface of the bulk' liquid.

Equation (2.4) may be written,

$$S_1 = \gamma S_0 \dots\dots\dots (2.14)$$

where $\gamma = (a_1/b_1) p \exp (H_1/KT)$

Similarly using equations (2.12) and (2.13), equation (2.5) may be written,

$$S_2 = \chi S_1 \dots\dots\dots (2.15)$$

where $\chi = (a_2/b_2) p \exp (H_2/KT)$

and in general case,

$$S_i = S_{i-1} = \chi^{i-1} S_1 = \gamma \chi^{i-1} S_0 = \chi^i \gamma S_0 \dots\dots\dots (2.16)$$

$$e = \gamma/\chi = \frac{a_1 b_2}{a_2 b_1} \exp (H_1 - H_2)/KT \dots\dots\dots (2.17)$$

substitution of equation (2.16) in (2.11) yields

$$w/w_1 = e S_0 \frac{\sum_{i=1}^{i=\infty} i \chi^i}{S_0 (1 + e \sum_{i=1}^{i=\infty} \chi^i)} \dots\dots\dots (2.18)$$

the summation in the denominator of equation (2.18) is the sum of an infinite geometrical progression, which is given

$$\sum_{i=1}^{i=\infty} \chi^i = \frac{\chi}{1-\chi} \dots\dots\dots (2.19)$$

and numerator can be evaluated as follows:-

$$\sum_{i=1}^{i=\infty} i x^i = x \frac{\partial}{\partial x} \sum_{i=1}^{i=\infty} x^i = \frac{x}{(1-x)^2} \dots\dots\dots (2.20)$$

substituting the results in equation (2.18) gives

$$w/w_1 = \frac{cx}{(1-x)(1-x+cx)} \dots\dots\dots (2.21)$$

On the free surface, the amount adsorbed at saturation is infinite, thus at $p = p_0$ in order to make $w = \infty$, x must be equal to unity in equation (2.21), from the equation where the value of x is given

when $x = p/p_0$ $x = (a_2/b_2) p \exp H_2/KT = 1$

equation (2.21) becomes, $w = w_1 c p / (p_0 - p) (1 + (c-1) p/p_0)$ (2.22)

If the adsorption does not take place on a free surface but is limited by the space available or by some other means, the summation of the series in equation (2.18) is carried out to a finite number of terms (n) only, in which case,

$$w = w_1 c x / (1-x) \left(\frac{1 - (n+1)x^n + n x^{n+1}}{1 + (c-1)x - c x^{n+1}} \right) \dots\dots\dots (2.23)$$

If $n = 1$, equation (2.23) reduces to,

$$w = w_1 c/p_0 \cdot p / \left(1 + c/p_0 \cdot p \right)$$

which is identical with Langmuir's equation for unimolecular adsorption.

Equation (2.21) can be put into the form

$$p/w(p_0-p) = 1/w_1L + \frac{(L-1)p}{w_1Lp_0} \dots\dots\dots (2.24)$$

Equation (2.24) is B.E.T. equation which shows that a plot of

$p/w(p_0-p)$ against p/p_0 should yield a straight line having slope $(L-1)/w_1L$ and intercept $1/w_1L$.

Some criticisms have been made *with* regard^{to} the limited validity of the assumptions used in B.E.T equation. The assumption that the adsorbate after the first layer has liquid like properties and the heat of adsorption of all those layers built up on the first layer is equal to the latent heat of condensation. The fact^{is} that both porous and planar solids when exposed to a saturated vapour pressure sometimes take up a strictly limited amount only and not an indefinite quantity as postulated by B.E.T. The B.E.T. model neglects the horizontal interactions between the molecules in the adsorbed layer and only considers the vertical interactions, i.e. those molecules which are sitting on one another perpendicular to the surface. In bulk liquid, each molecule has twelve nearest neighbours on the average. B.E.T. model assumes that every molecule that condenses in any layer except the first one gives out its full latent heat of liquification whether it has horizontal neighbours or not. But, in the absence of horizontal neighbours there would be only two or three vertical neighbours so the heat evolved should be only a fraction of the latent heat and should never exceed half the latent heat.

Another criticism of the model is that the number of adsorbed molecular layers become infinite when the saturated vapour pressure is reached; there are cases in which the number of molecular layers is

finite even at saturation and gives good agreement with practical observations.

2.3 Absorption and Permeation

Absorption is a process by which the penetration of a substance i.e. gas or water vapours, takes place into the body of another substance. The penetration of gas or water vapours through polymers occurs by an activated diffusion process. In activated diffusion gas or vapour dissolves into the polymer at the surface and diffuses into the polymer under a concentration gradient. If the polymer is in the form of a film separating two regions with different gas concentration, then there will be steady diffusion of the gas through the polymer so long as the gas concentrations in the two regions do not change. This process is called permeation. The rate of transmission or penetration depends on the solubility of the penetrant and the diffusivity of the dissolved penetrant in the polymer medium. After a comparatively short build up period the steady stage is reached only if the pressure difference across two sides is kept constant. The rate of penetration is defined as the amount of penetrant passing during unit time through a surface of unit area at constant temperature and pressure under steady state conditions. Fick's law (19) is found to hold and the transmission follows the relationship.

$$Q = -D \cdot \frac{\partial c}{\partial x} \quad \dots\dots\dots (2.25)$$

where Q is the rate of penetration, D is diffusion coefficient at concentration c of the diffusing material. $\frac{\partial c}{\partial x}$ is the concentration

gradient across thickness ∂x . The above equation can be integrated across the total thickness l ,

$$Q \partial x = -D \partial c$$

$$Q \int_{x=0}^{x=l} \partial x = -D \int_{c_1}^{c_2} \partial c$$

$$Q = D(c_1 - c_2)/l \quad \dots\dots\dots (2.26)$$

c_1 and c_2 are concentrations at two surfaces. Concentrations c_1 and c_2 are directly related to the partial pressures p_1 and p_2 and according to Henry's law,

$$c = \xi p \quad \dots\dots\dots (2.27)$$

where ξ is the solubility coefficient of the penetrant in the polymer. When Henry's law is obeyed a linear relationship between concentration and pressure is found.

ξ being constant equation (2.26) becomes

$$Q = D\xi (p_1 - p_2)/l \quad \dots\dots\dots (2.28)$$

The product $D\xi$ is referred to as permeability constant,

$$P \equiv D\xi = Ql/(p_1 - p_2) \quad \dots\dots\dots (2.29)$$

The above treatment applies to the system where D is independent of concentration, but in many penetrant-polymer systems, D is not constant but is a function of concentration. In such cases Fick's 2nd law holds,

$$D = D(c) \quad \partial c / \partial t = \partial / \partial x (D(c) \partial c / \partial x) \quad \dots\dots\dots (2.30)$$

A mean value of diffusion coefficient can be calculated over the concentration range c_1 to c_2 ,

$$D_{Avg} \equiv \frac{\int_{c_2}^{c_1} D(c) \partial c}{\int_{c_2}^{c_1} \partial c} = \int_{c_2}^{c_1} D(c) \partial c / (c_1 - c_2) \dots\dots\dots (2.31)$$

The dependence of $D(c)$ on concentration can be generally found by assuming $c_2 = 0$

$$D_{Avg} = \left(\frac{1}{c_1} \right) \int_0^{c_1} D(c) \partial c \dots\dots\dots (2.32)$$

As described before, p_1 and p_2^0 are pressures corresponding to the two surfaces of the polymer membrane with concentrations c_1 and c_2 respectively. Assuming pressure p_2 equal to zero, the solubility coefficient \bar{S} reduces to,

$$\bar{S} = (c_1 - c_2) / (p_1 - p_2) = \frac{c_1}{p_1} \dots\dots\dots (2.33)$$

Generally the method for studying diffusivity and solubility in a penetrant-polymer system is to measure the rate of sorption and desorption of ^{the} penetrant in ^{the} solid medium. In this case there is no steady state as there is no second region at a different gas concentration. The gas penetrates through the solid and the gas concentration in the solid rises with time rapidly at the surfaces and slowly in the interior. Until equilibrium is reached, there will be a concentration gradient across the solid. In practice the change in weight of the sample is

measured with time as the sample is exposed to a known humid atmosphere at constant temperature and pressure. Data are usually plotted as M_t/M_∞ against t/l^2 where M_t and M_∞ are weights at time t , and at infinity respectively, l is the thickness of the sample. The initial stage of sorption and desorption is often found to agree with Boltzmann's solution for diffusion in semi-infinite medium, i.e. M_t/M_∞ against \sqrt{t}/l is initially linear and diffusion equation reduces to (20)

$$M_t/M_\infty = \left(\frac{4}{\sqrt{\pi}}\right) \left(Dt/l^2\right)^{1/2} \dots\dots\dots (2.34)$$

D , the diffusion coefficient can be calculated,

$$\bar{D} = \left(\frac{\pi}{16}\right) K^2 \dots\dots\dots (2.35)$$

K is the initial gradient of sorption or desorption curve

$$K = \partial(M_t/M_\infty) / \partial(t^{1/2}/l) \dots\dots\dots (2.36)$$

The transport of water molecules through polymers has been considered in terms of mechanisms depending on the structure of the polymers. The activated diffusion process is a highly specific process which depends both on the mobility and solubility of the penetrant in the polymer. Another process is convective or capillary flow which occurs in highly porous media such as paper, glassine, and certain cellulosic polymers etc.

2.4 Sorption in cellulosic materials

Long and Thompson (21) studied the diffusion of water vapour in polymers, i.e. polyvinyl acetate, cellulose acetate, cellulose nitrate, 6-10 nylon and polyvinyl alcohol, with emphasis on the study of the concentration dependence of the diffusion coefficient and on the extent of agreement of the results with Fick's laws of diffusion. Polymer films were made by a casting technique and sorption measurements were carried out by following the weight change (sorption and desorption) as a function of time. Their studies revealed three different classes of behaviour: (a) Fickian diffusion with a diffusion coefficient independent of concentration, (b) approximately Fickian diffusion with an initially constant D and (c) anomalous diffusion. Out of all those polymers which were studied, polyvinyl acetate fell in class (a), cellulose acetate, cellulose nitrate and 6-10 nylon fell in class (b) and polyvinyl alcohol in class (c).

For all experiments, diffusion, whether Fickian or non Fickian, was judged by agreement with the equation,

$$M_t/M_\infty = K \left(\frac{t^{1/2}}{l} \right) \quad \dots\dots (2.37)$$

where K is the initial slope.

The plots of M_t/M_∞ against $t^{1/2}/l$ and $\log(M_\infty - M_t)$ against time for the materials in the three classes, for sorption and desorption, showed the diffusion character. The plots are shown in Figure 2.1.A, 2.1.B

FIG. 2.1A

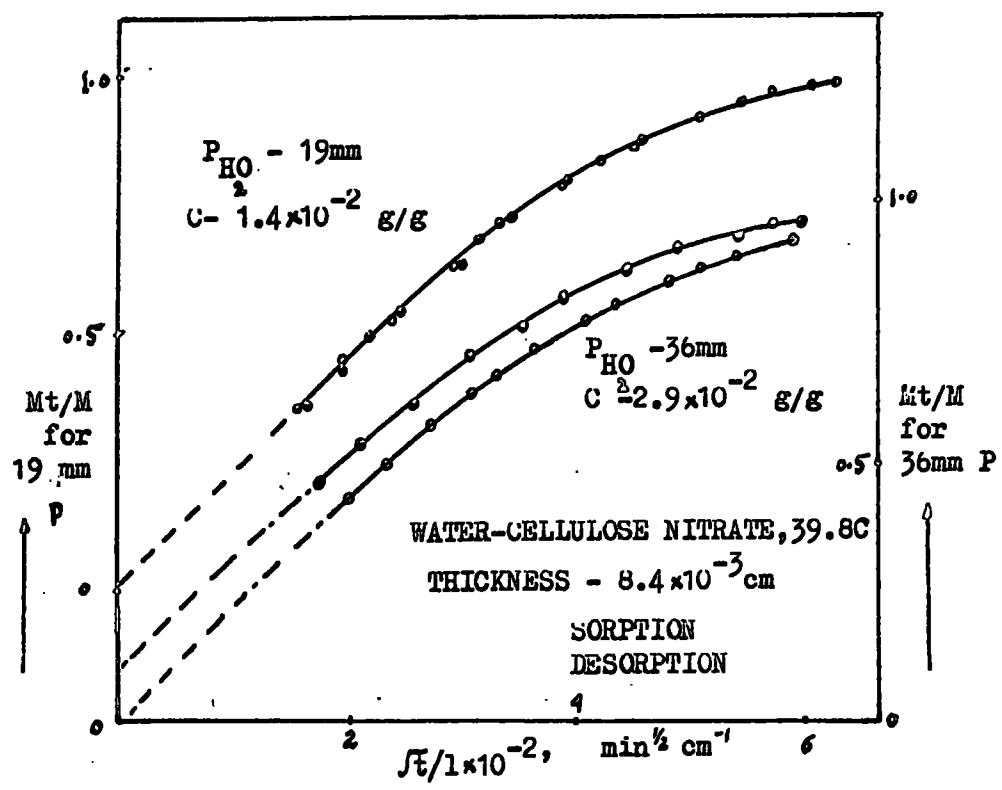

SORPTION AND DESORPTION OF WATER VAPOUR IN CELLULOSE NITRATE (12%)

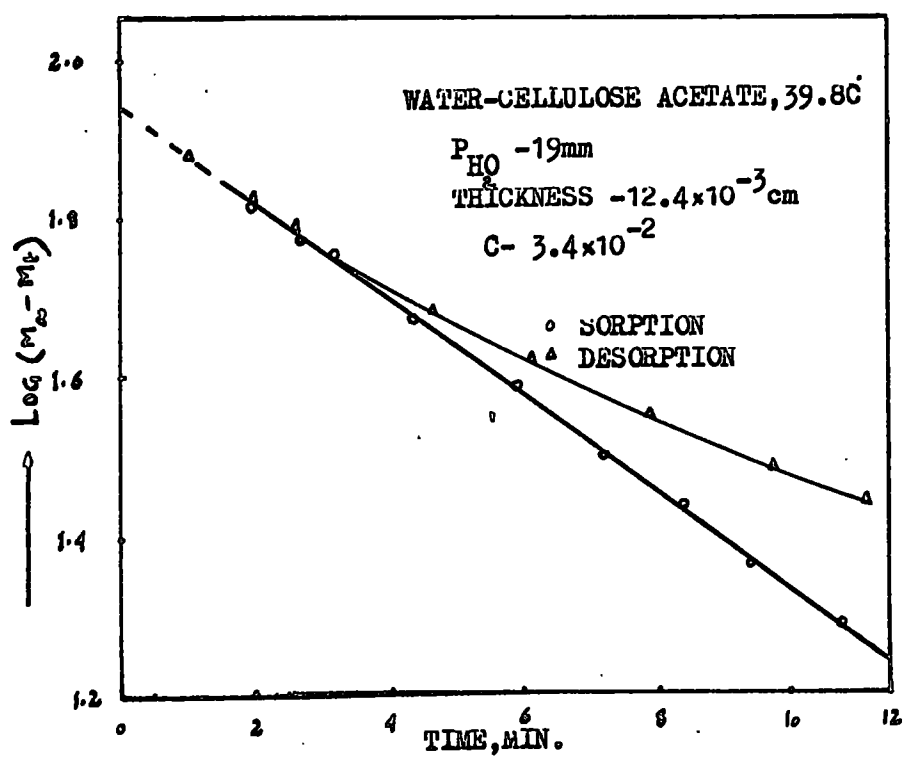

DIFFUSION OF WATER VAPOUR IN CELLULOSE ACETATE (37.9%acetyl)

(Long of Thompson)

FIG. 2.1 B

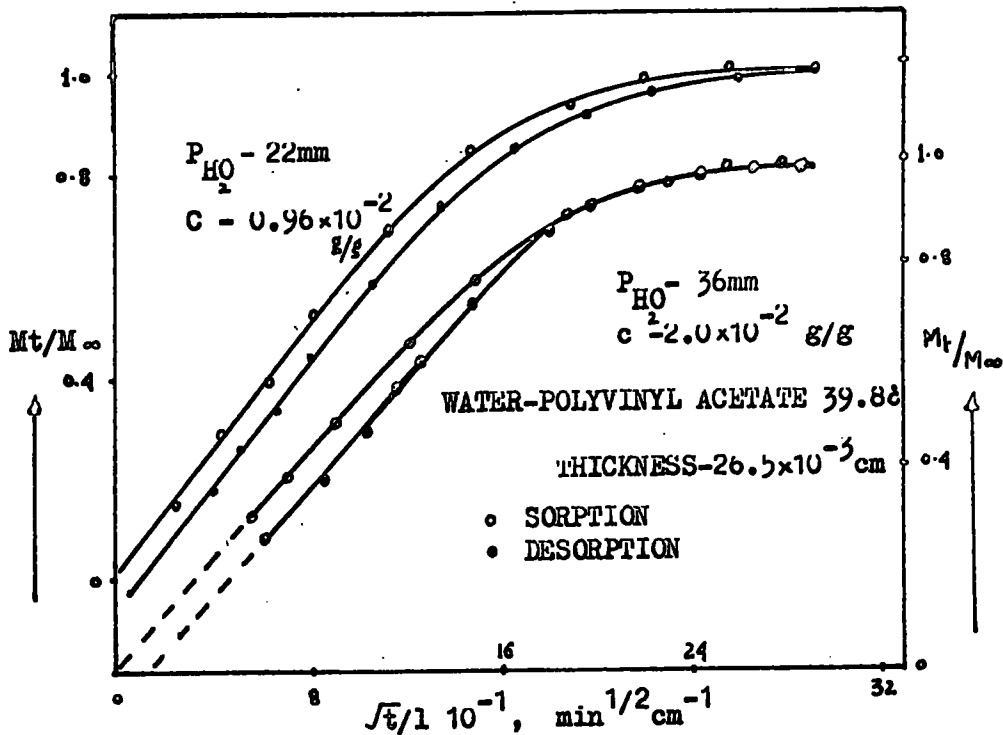

SORPTION AND DESORPTION OF WATER VAPOUR IN P.V.A.

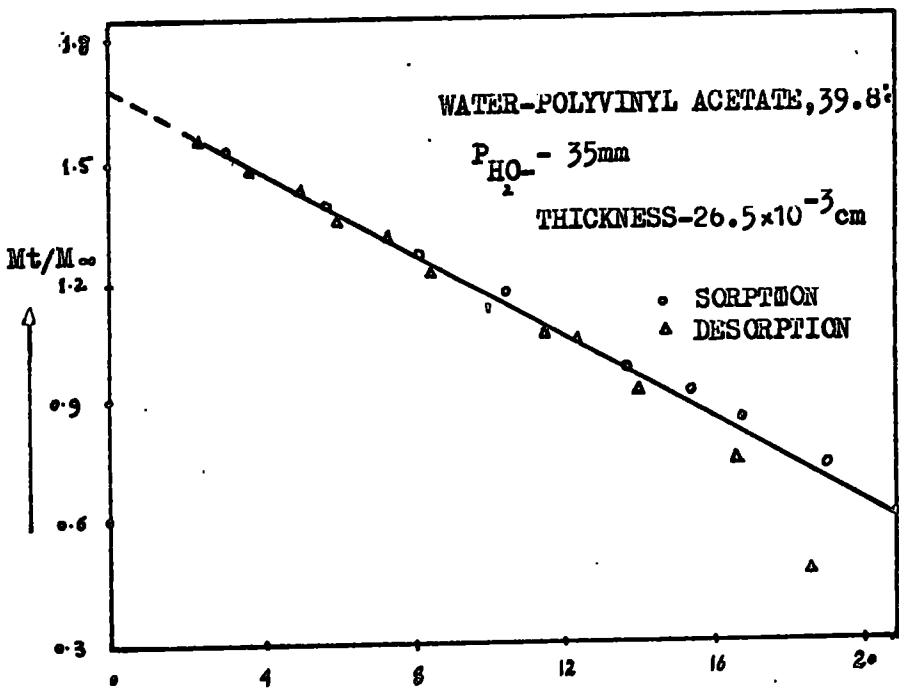

DIFFUSION OF WATER VAPOUR IN P.V.A.

(Long et Thompson)

Thomas (11) studied moisture permeability, diffusion and sorption in organic film-forming materials. He found that the sorption and desorption rate curves for perspex, cellulose acetate and baked linseed films at relative humidities below 75% were linear. The diffusion constants for sorption and desorption were equal and independent of the concentration of sorbed water. At relative humidities above 75% the sorption rate curve ceased to be linear and the curves for sorption and desorption differed considerably in shape. The difference in sorption and desorption curves at high humidities was described as either being due to a decrease of diffusion constant with a decrease of the water content or due to the formation of a surface layer of low permeability. It was supposed that if the rate of formation of this layer was of the same order as the rate of decrease of diffusion into the film, the sorption rate curve was more or less in accordance with Fick's law, but the derived diffusion constant was less than the true value. Otherwise the formation of a surface layer of low permeability will have caused the sorption rate to decrease as sorption progressed. In desorption, the rate became linear quickly which indicated a rapid removal of the surface layer; the initial lower rate shown by cellulose acetate and perspex in figure 2.2 indicated a rather slow removal.

Rouse (22) studied the diffusion of vapour in films of organic materials in order to investigate the dependence of the diffusion coefficient upon the concentration of the vapour in the film. Since the knowledge of the behaviour of diffusion coefficients provided useful information concerning the nature of the association of the

FIG. 2.2

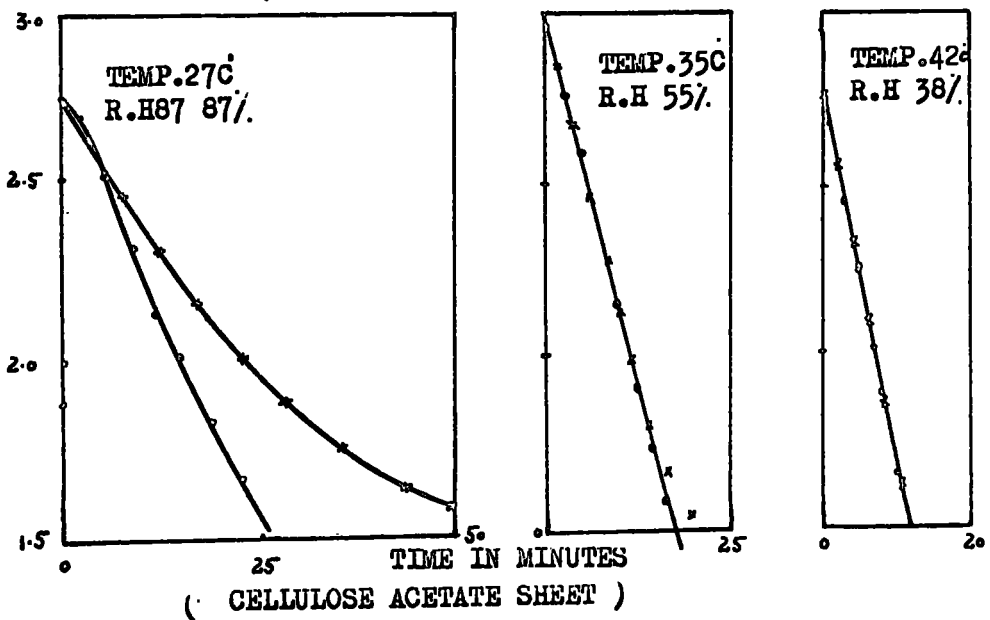
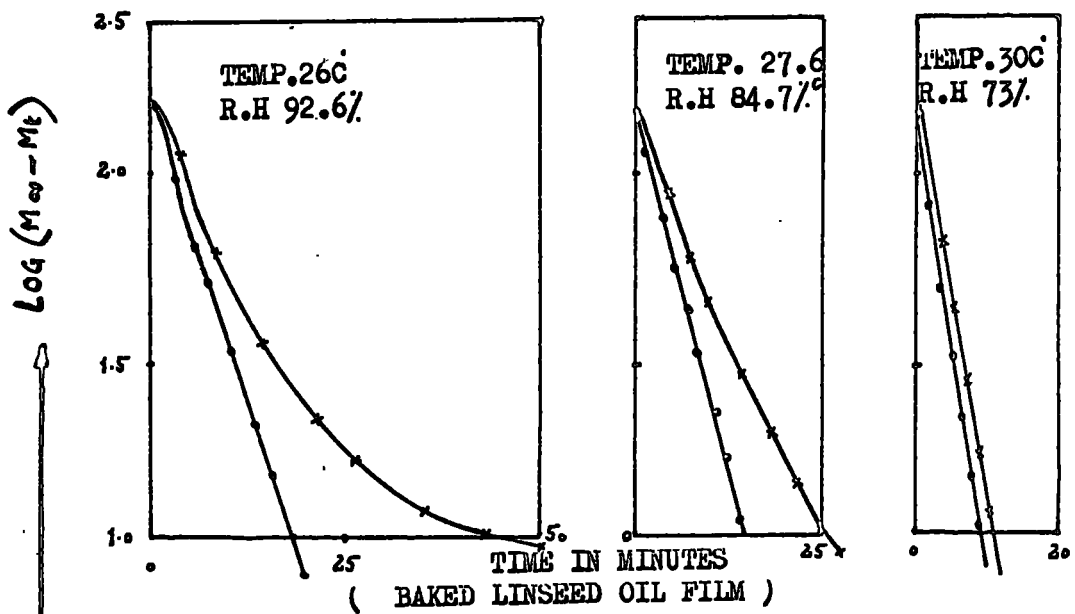
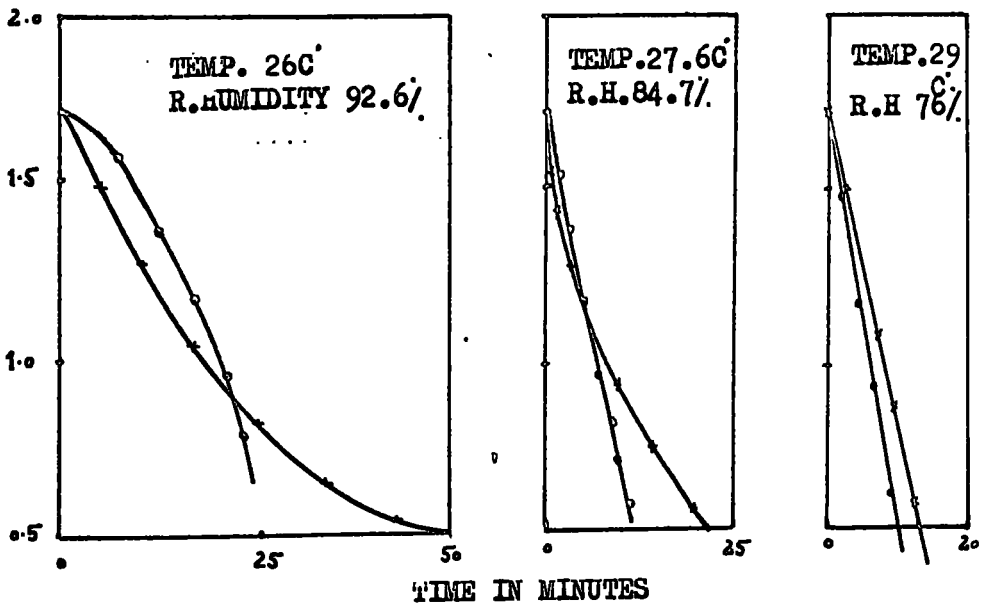

(Thomas)

vapour with film, following the equation (23, 24),

$$D = \ell^2/6L \quad \dots\dots\dots (2.38)$$

where ℓ is the thickness of the film and L is the intercept of the straight line representing the steady state upon the time axis related to the diffusion coefficient D ; they suggested that for a polymer-vapour system the rate of transmission of water vapour was not directly proportional to the vapour pressure difference. For such systems it was obvious that the diffusion coefficient was not a constant and the method used avoided the assumptions that the film was uniform and that the surfaces were at equilibrium with the vapour were retained.

Sheppard and Newsman (25,26) did a great deal of work concerning; the sorption of water and other solvent vapours by cellulose and its derivatives. Sorption measurements were made using a McBain-Bakr quartz fibre, spring balance at 30^oC. They used cellulose acetate films of various thicknesses and found that the rate of sorption decreased and equilibrium time increased as the thickness of the film increased regardless of the nature of the solvent. Table 2.1 shows the effect of thickness on sorption, for cellulose acetate films. A rapid increase in sorption was noticed in the neighbourhood of saturation. The sorption of water vapour by hydrate cellulose and regenerated cellulose was also determined. Hydrate cellulose was made by soaking cellulose in the strong solutions of caustic alkalis and then washing in distilled water to remove any surface deposits. Regenerated cellulose was made from cuprammonium solutions by precipitation with sulphuric acid and alkali

followed by thorough washing. An increase in the sorption of water by hydrate and regenerated cellulose was noticed and it was suggested that the increase was due to the decrease in viscosity of the materials. The fine chemical structure difference between hydrate or regenerated cellulose and non-regenerated (native) cellulose was visualised with an X-ray spectroscope. The difference revealed that disorientation occurred in the material during the regeneration process and this resulted in a greater attraction of hydroxyls.

Sheppard and Newsome (27) also studied the sorption of alcohol vapours by cellulose and cellulose acetates. The relative rate of sorption of alcohols by cellulosic materials in general at saturation was found to be independent of the acetyl content, but the maximum sorption varied greatly with the acetyl content as shown in Figure 2.3. The difference in the rate of sorption of different alcohols by the materials indicated that the rate of sorption decreased as the grade of alcohol went up. However, it was suggested that higher alcohols were sorbed more slowly than the lower alcohols because of lower vapour pressure and greater molecular size.

Sorption of vapours of acetone and methanol into cellulose acetate films was measured by Bagley and Long (28). They concluded that the diffusion of organic vapours into cellulose acetate was non-Fickian or anomalous. They found that two stage sorption and desorption phenomenon occurred when M_t/M_∞ against $\sqrt{t/l}$ was plotted. In the initial stages of sorption and desorption, the rate was fast, whereas in the

FIG. 2.3

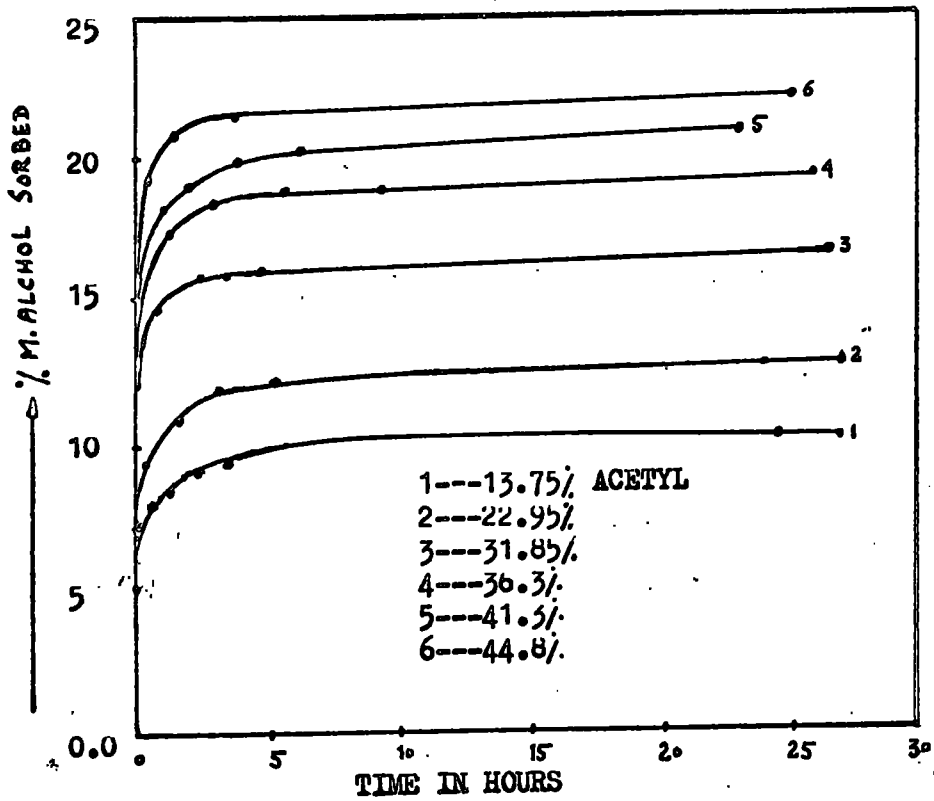

RATE OF ADSORPTION OF METHYL ALCOHOL BY CELLULOSE ACETATE.
 AT 30c° SATURATION PRESSURE

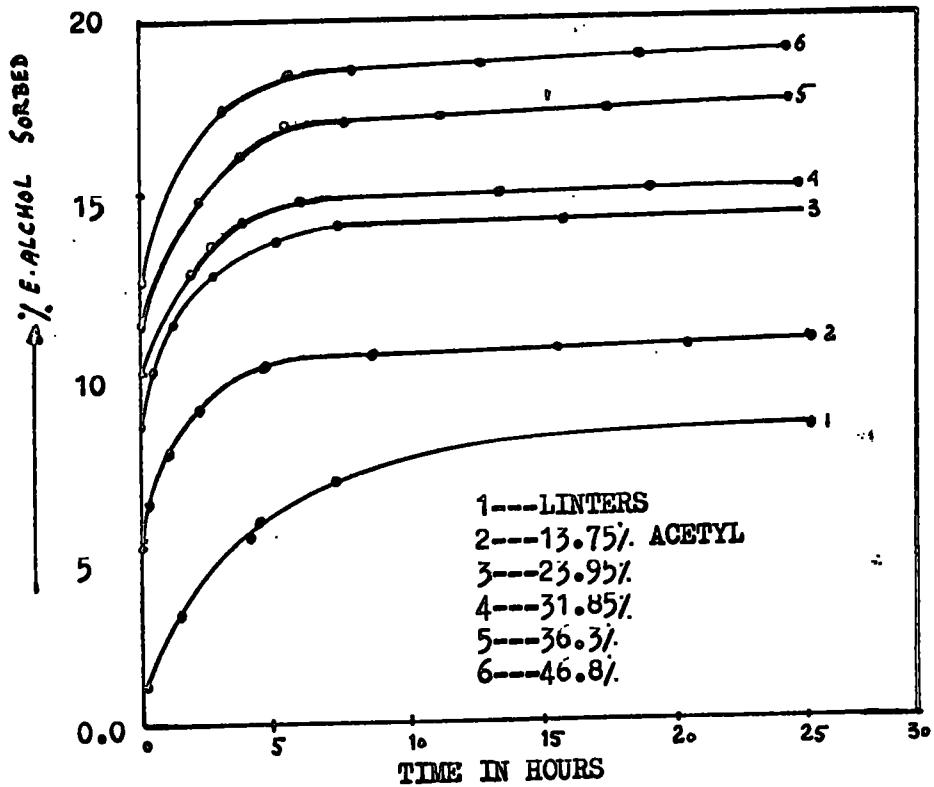

RATE OF ADSORPTION OF ETHYL ALCOHOL BY CELLULOSE ACETATE
 AT 30c° SATURATION PRESSURE

(Sheppard & Newsome)

latter stages, the rate was slow as shown in figure 2.4. An explanation given for such behaviour was that, during the fast initial stages of sorption and desorption, the vapour penetrated the entire polymer film to give a quasi-equilibrium concentration of vapour which amounted to 10% of the true equilibrium value. Initial stages involved Fickian diffusion with a diffusion coefficient which was dependent on the material, the nature of penetrant and its concentration. In contrast the latter stages were independent of the concentration of the penetrant in the material. The reason that the rate of sorption and desorption in the initial stages increased with concentration, whereas in the latter stages it did not, was explained by the fact that the initial stage did not enter below a fairly definite minimum concentration but it did in the latter stages. Another explanation for such behaviour with regard to the structure of cellulose acetate material was that cellulose acetate is characterized by inter-chain bonds ('effective' cross-links) which prevented rapid macromovement of one chain relative to another yet permitted elastic expansion of the network. In the second stage of sorption and desorption, a macro arrangement of the polymer network could presumably occur only by breaking interchain bonds and the rate of breaking interchain bonds was taken to be essentially independent of the amount of penetrant present.

A detailed study, on the rate of sorption of organic vapours, i.e. the vapours of methylene chloride and acetone by films of cellulose acetate as a function of vapour pressure, film thickness and temperature was done by Mandel Kern and Long (29). Films were prepared by casting from dilute solutions in acetone and their thickness was changed by

FIG. 2.4

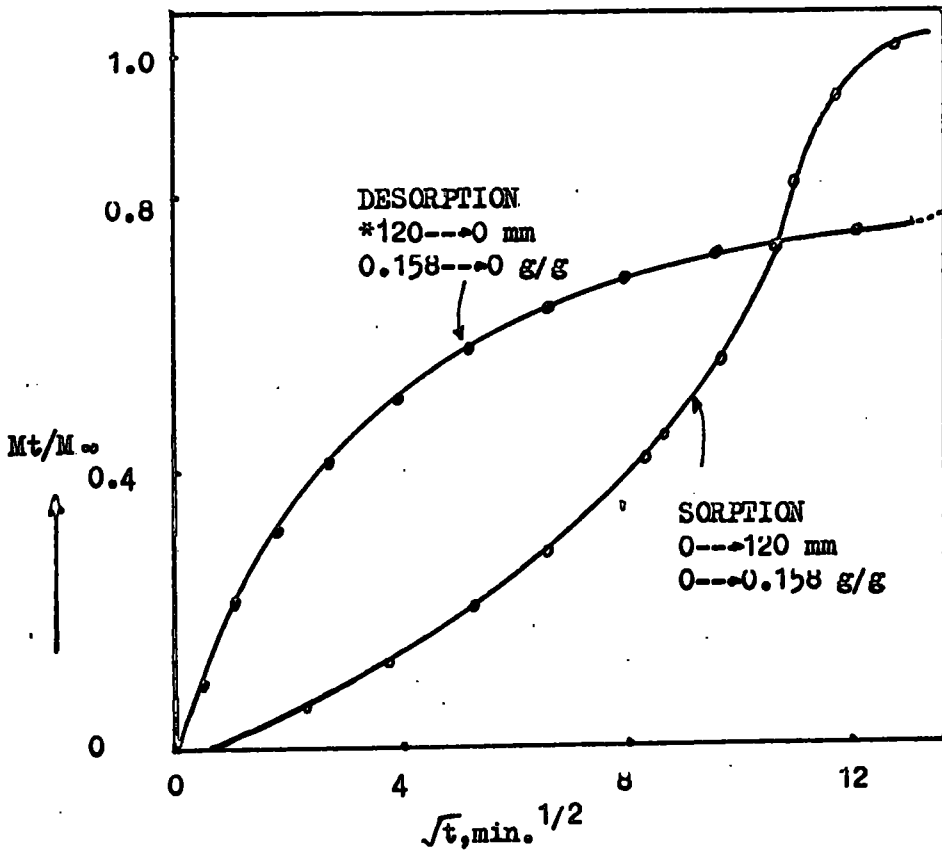

INTEGRAL SORPTION AND DESORPTION OF ACETONE IN CELLULOSE ACETATE AT 30°C. FILM THICKNESS IS 4×10^{-3} cm

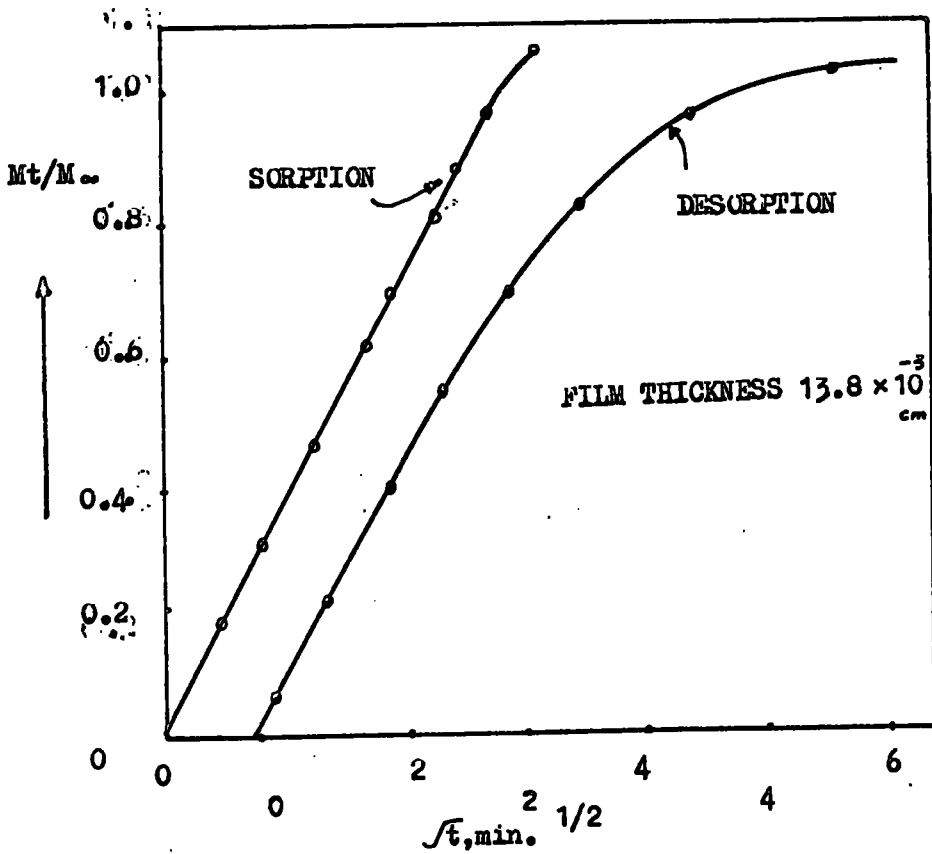

SORPTION AND DESORPTION OF ACETONE TO AND FROM QUASI-EQUILIBRIUM, 30°C
 (Bagley, Long)

varying the concentration of the casting solution. It was found that the method of film preparation and conditioning greatly influenced the kinetics of sorption. There was a considerable difference in sorption characteristics between the cellulose films cast on glass and otherwise similar films cast on mercury. It was evident that the vapour take-up by mercury-cast films was slower than the glass-cast films, and moreover mercury-cast films showed an inversion of slope, i.e. an S-shaped curve which was not shown on the glass-cast films. Qualitative observations indicated that the film cast on mercury shrunk in area by about 20% during drying, whereas a film cast on glass maintained its original area due to strong cohesion forces between solution and surface. Thus glass-cast films were characterized by an unstable orientation of the molecules, while the mercury-cast films were probably in a thermodynamically stable state. The experimental data and the attempts at interpretation made, indicated that the sorption mechanism was very complex and the results obtained were entirely unexpected. In general the sorption of organic vapours by thin films was more than thick films for a large time interval.

The studies of sorption of water vapours and other organic vapours in different polymers have been made by other workers, McCall (30) studied the diffusion of benzene and n-hexane in ethylene polymers, Starkweather (31), the sorption of water by nylons, Taylor (32) the sorption of water by organic insulating materials, i.e. phenol plastic and rubbers, Spencer and Ibrahim (33) the diffusion coefficient for a water vapour-hydrophilic polymer system (polyvinyl alcohol as a hydrophilic polymer), Shirokshina, Suykovskaya and Pogodava (34), the diffusion of

water vapour through fluo-organic polymer films, Park (35) an experimental study of the influence of various factors on the time dependent nature of diffusion in polymers. It is believed that the sorption-desorption mechanism and the dependence of the diffusion coefficient on concentration of the adsorbate in the system is significantly dependent on the method of making films, the amount of acetone and acetyl content in the film, thickness of the films, techniques to measure sorption and desorption rates, nature and grade of adsorbate. However, it is generally understood that in the water vapour-cellulosic polymers system, diffusion coefficient is independent of concentration and initial slopes of M_t/M_∞ against \sqrt{t}/l are linear for both sorption and desorption.

3.0 Electrical Properties of Polymers

The basic function of any insulating material is to act as a barrier to the flow of electricity and consequently the properties used by engineers merely represent the behaviour of the material as an electrical barrier. Electrical properties of an insulating material consist of insulation resistance, dielectric constant, dielectric strength etc. The relative importance of these properties depend on the use to which the material is to be put. The properties are measured for several purposes, under different conditions of temperature, humidity, contamination, frequency, voltage etc. For the purpose of this research, interest is centred on the volume and surface resistances of the material for direct applied voltages and on the dielectric constant and loss factor, for alternating applied voltages.

3.1 D.C. Characteristics, insulation resistance, volume and surface resistances

3.1.1 Insulation resistance

Consider a specimen of a polymer with two electrodes attached to it. If a direct voltage is applied across these electrodes, a small current flows, and the insulation resistance is defined as the ratio of applied voltage to the total current (36,37)

$$R_i = \frac{V}{I} \quad \dots\dots\dots (3.1)$$

where V is applied voltage in volts and I is total current in amps. Clearly there are two separate current paths between the electrodes, one

through the bulk of the material and the other across the surface. If the currents are I_v and I_s respectively, then the volume resistance is defined as

$$R_v = V/I_v \quad \dots\dots\dots (3.2)$$

and surface resistance as,

$$R_s = V/I_s \quad \dots\dots\dots (3.3)$$

In measuring the properties of materials, care must be taken to eliminate one or other current path from the measurements; this is usually done by using a guard ring.

3.1.2 Volume resistivity

This is the property of an insulating material which describes the flow of electricity through its volume and is equal to the ratio of the potential gradient parallel to the current in the material, to the current density. (36, 37).

$$\rho_v = E_v/J_v \quad \dots\dots\dots (3.4)$$

The measurement of the volume resistivity of a specimen involves measuring the resistance between two parallel opposite faces of that specimen, using electrodes of known area and neglecting end effects.

$$\rho_v = R_v \cdot A/l \quad \dots\dots\dots (3.5)$$

where A is the area of electrodes and l is the thickness of the specimen.

3.1.3 Surface resistivity

The electrical properties of a material which adsorbs moisture are often defined in terms of surface conductivity or surface resistivity (36, 37, 38). The surface resistivity of a material is the ratio of the potential gradient parallel to the current along its surface to the current per unit width of the surface.

$$\rho_s = E_s / J_s \dots\dots\dots (3.6)$$

E_s is potential gradient and J_s is current density.

For current flow between two parallel electrodes with separation g , and width b .

$$\rho_s = R_s \cdot b/g \text{ ohms} \dots\dots\dots (3.7)$$

R_s is the surface resistance of rectangular film.

The relation between the surface conductivity and volume conductivity of surface film in the rectangular electrodes system is given by (38).

$$\sigma_s = \delta \sigma_{v2} \dots\dots\dots (3.8)$$

where δ is the film thickness and σ_{v2} the volume conductivity of surface film.

So defined, the quantity ρ_s is dependent on the thickness of adsorbed film and is not a true resistivity. Basically it defines the resistance of the moisture film adsorbed on the material, but as both the thickness of the film at given humidity and surface contamination depend largely on the adsorbent, it is usual to refer to the surface resistance of glass, polythene, etc.

3.1.4. Measurements of volume and surface resistivity

When measuring either the volume or the surface resistance, care must be taken to ensure that stray currents do not influence the measurements. For this reason it is usual to use a three electrode system. (See, for example, Figure 3.1), in which one electrode is a guard electrode. Guarding depends on interposing in all critical paths, a guard conductor which intercepts the stray currents. Figure 3.2 shows the basic measurement connections using the system shown on Figure 3.3, for the volume resistance measurements and for surface resistance measurements.

The connection between the measuring electrode and current measuring instrument, usually an electrometer, should be very carefully screened and as short as possible.

Amey and Hamberger (39) have studied the effect of the shunt path through the bulk of the material between electrodes, 1 and 2 (Figure 3.4) on surface resistance measurements; they concluded that:

- (1) If only two electrodes are used, increasing the electrode separation with respect to specimen thickness is detrimental rather than helpful in reducing the effect of the volume path. Further, large reductions in ^{the} electrode width with respect to the thickness of the specimen do little to reduce the effect of volume path.
- (2) If three electrode system is used, increasing the ratio of electrode separation to specimen thickness beyond 0.3, reduces the effect of volume path considerably. This reduction is independent of the electrode width, if the latter is equal to or greater than the twice the specimen thickness.

FIG. 3-1

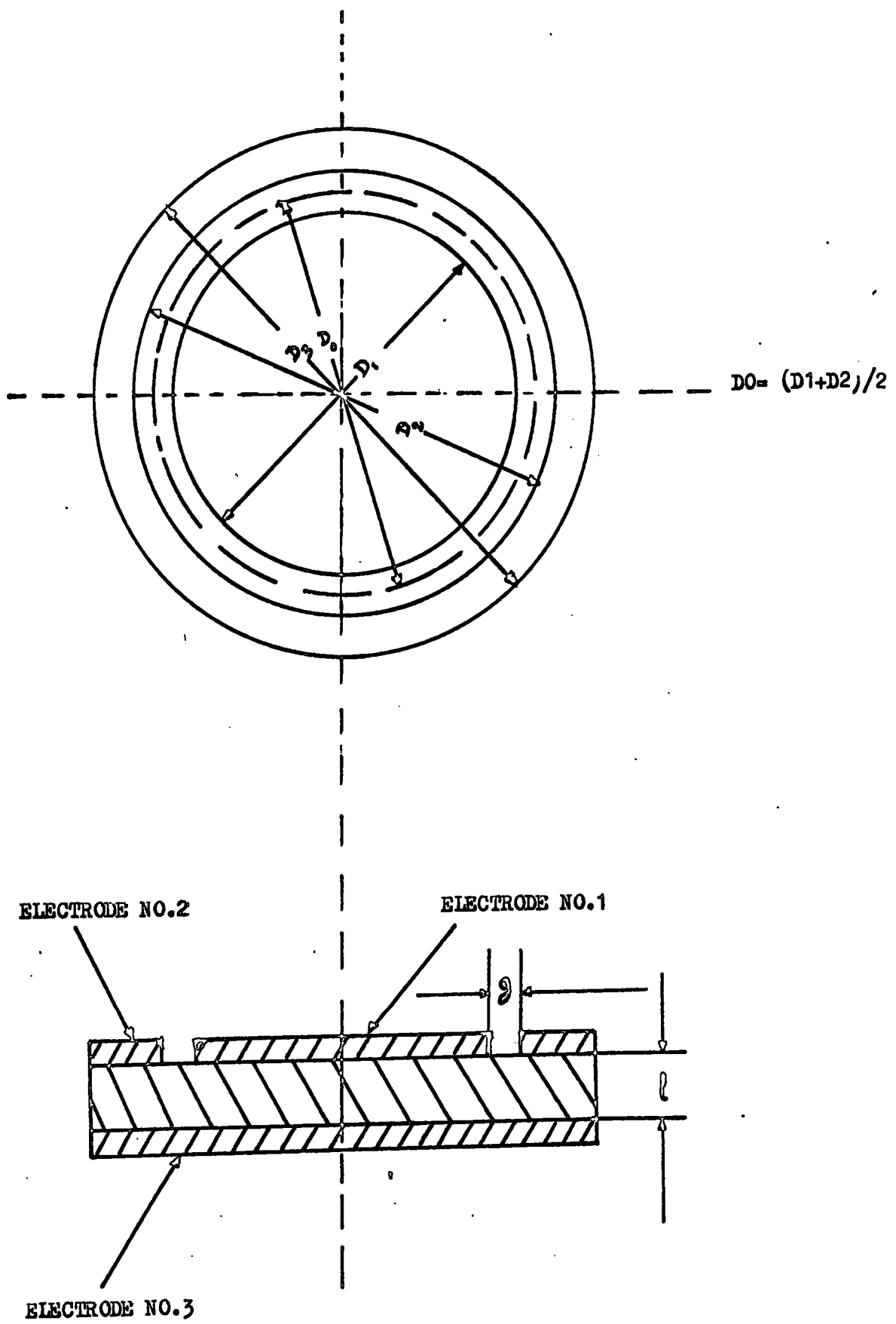

FLAT SPECIMEN FOR MEASUREMENT OF VOLUME RESISTANCE PERPENDICULAR TO THE SPECIMEN FACE AND SURFACE RESISTANCE.

FIG. 3.2

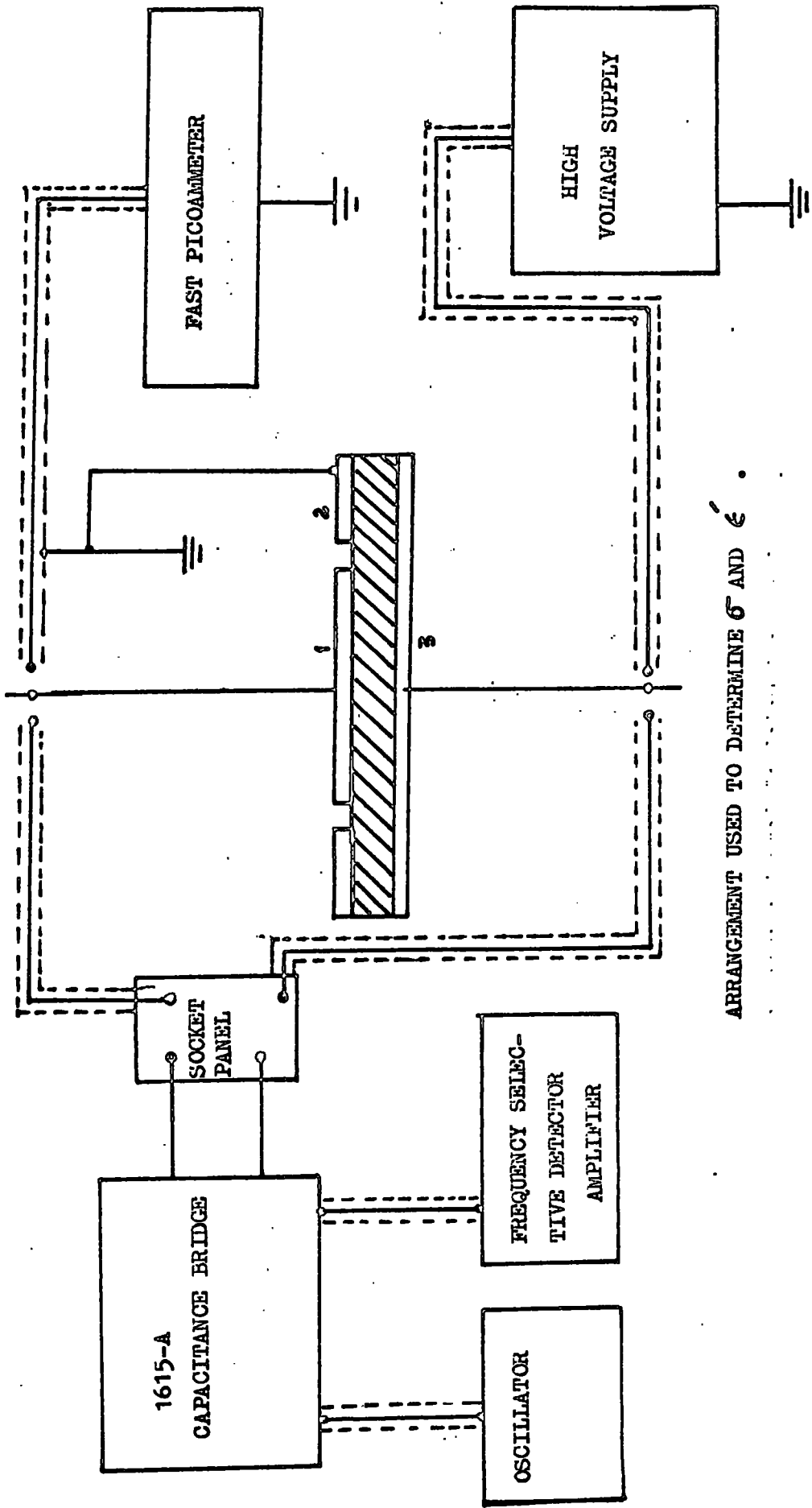

ARRANGEMENT USED TO DETERMINE σ AND ϵ

FIG. 3-3

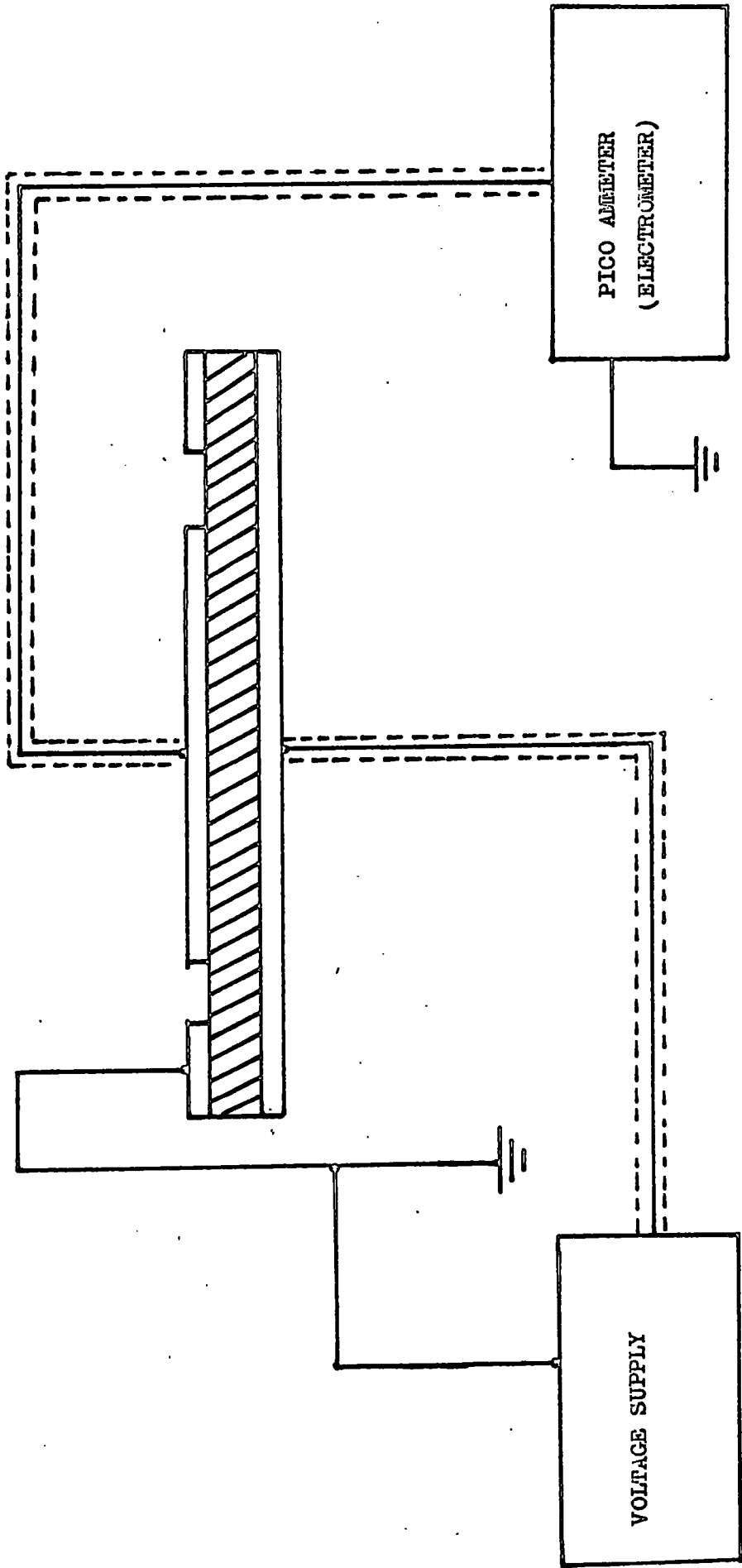

VOLUME MEASUREMENT

FIG. 3-4

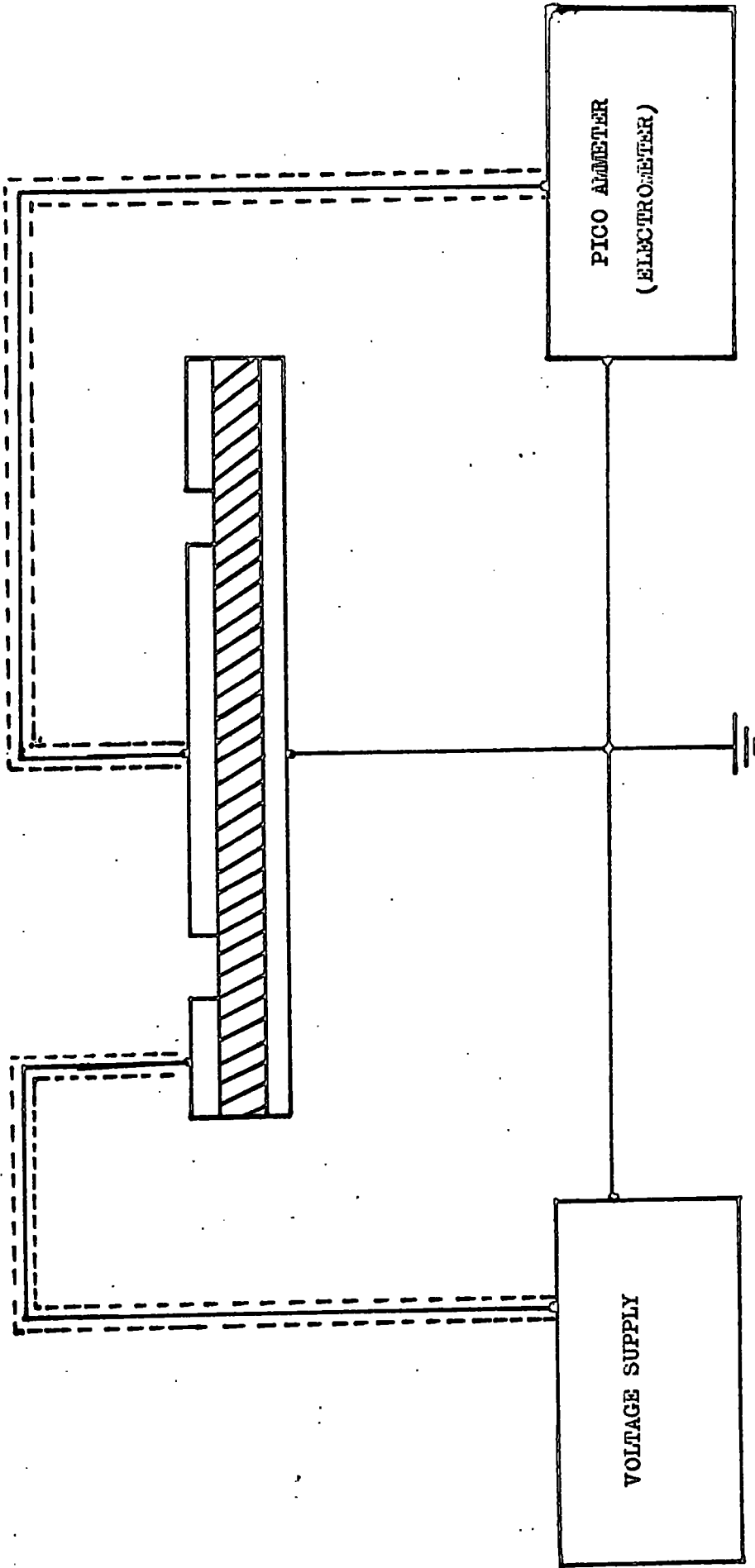

SURFACE MEASUREMENT

3.2 A.C. characteristics, dielectric constant, dielectric loss

3.2.1 Dielectric constant

Consider a parallel plate capacitor with a vacuum between the plates, when an alternating source is connected across the plates, an alternating current flows, given by:

$$I = j\omega C_0 V \epsilon_r \quad \dots\dots\dots (3.9)$$

where C_0 is the capacitance (in vacuum), V is the applied alternating voltage, neglecting fringing effects.

$$C_0 = \epsilon_0 \cdot A/l \quad \dots\dots\dots (3.10)$$

where A is the area of the plates, l is the separation between two plates and ϵ_0 is the permittivity of free space. If the space between the plates is filled with an insulating material (dielectric) then the value of capacitance becomes

$$C = \epsilon \cdot A/l \quad \dots\dots\dots (3.11)$$

where ϵ is the permittivity of the insulating material. From equation (3.10) and equation (3.11) dielectric constant or relative permittivity of any material is calculated as

$$\epsilon_r = \epsilon/\epsilon_0 = C/C_0 \quad \dots\dots\dots (3.12)$$

Dielectric constant of any material in a usual way is defined as the ratio of the capacitance of a capacitor with material in between the two plates, to the same capacitor with a vacuum between the plates.

3.2.2 Dielectric loss

Theoretically for a perfect dielectric material, when voltage is applied, the resulting current always leads the applied voltage by a phase angle of 90° ; but in practice, since no insulating material is perfect, a resistive current also flows, hence the angle becomes less than 90° . This effect is due to imperfect nature of the dielectric material and is considered as a property of the material. To give a general description without considering the origin of resistive current, a complex permittivity is defined as

$$\epsilon_y = \epsilon' - j\epsilon'' \dots\dots\dots (3.13)$$

Substituting (3.13) in equation (3.9), the current in the capacitor becomes

$$\begin{aligned} I &= j\omega C_0 V (\epsilon' - j\epsilon'') \\ \text{or} \quad I &= j\omega C_0 V \epsilon' + \omega C_0 V \epsilon'' \\ \text{or} \quad &= \omega C_0 V \epsilon'' + j\omega C_0 V \epsilon' \dots\dots\dots (3.14) \end{aligned}$$

where ϵ'' is the dielectric loss factor.

An insulating material can be represented by a combination of resistances and capacitors in many ways, i.e. a resistor and a capacitor in series, a resistor and a capacitor in parallel or the combination of both. In order to understand the relation between dielectric constant and dielectric loss to some extent, usually a model with a capacitor in parallel to a resistor is presented as shown in Figure 3.5.

$$I = I_C + I_R \dots\dots\dots (3.15)$$

FIG. 3.5

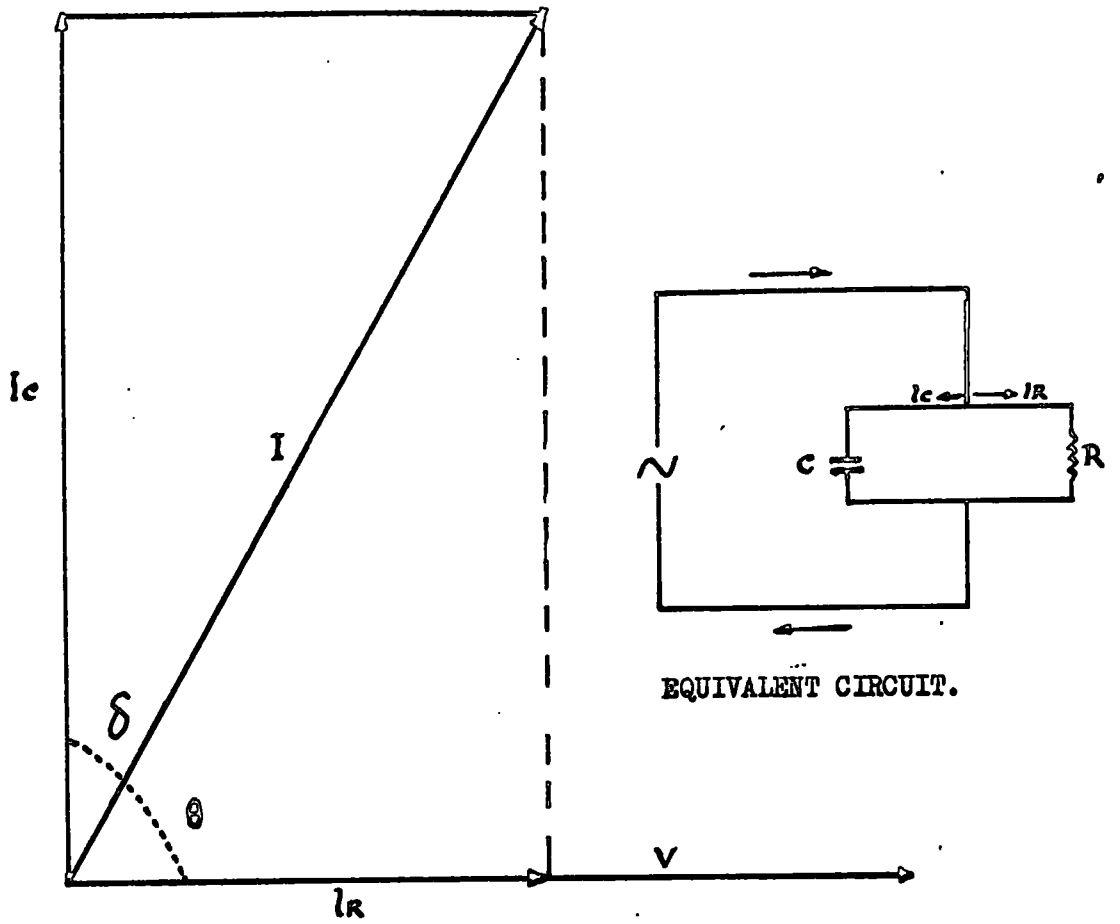

CHARGING CURRENT I_c AND LOSS CURRENT OR RESISTIVE CURRENT I_r OF AN IMPERFECT DIELECTRIC MATERIAL. (GENERAL CASE)

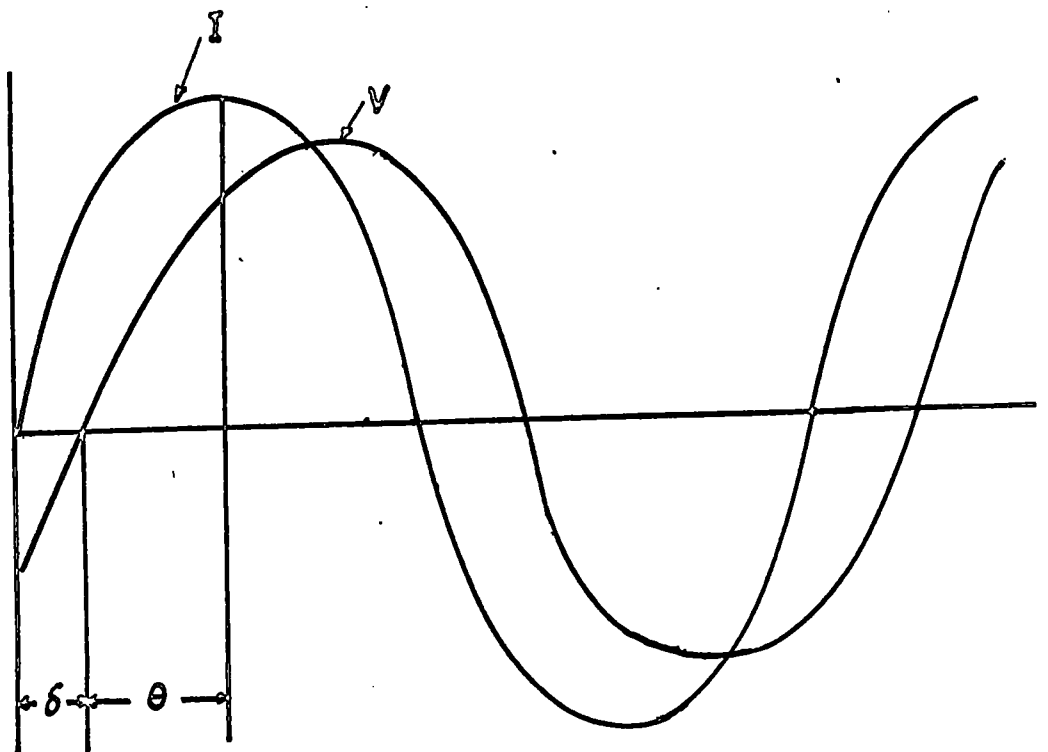

$$I_C = j\omega C V \quad I_R = \omega \epsilon'' C_0 V$$

from the Figure 3.5, it is clear that

$$|I| = \sqrt{|(I_C)|^2 + |(I_R)|^2}$$

$$\tan \delta = \frac{|I_R|}{|I_C|} = \frac{\omega \epsilon'' C_0 V}{\omega \epsilon' C_0 V} = \frac{\epsilon''}{\epsilon'} \dots \dots \dots (3.16)$$

Tan δ is called the loss tangent.

3.2.3 A.C. surface relations.

Similar measurements can be made on the surfaces of materials in the same way as surface resistance on d.c. side. When a material sorbs moisture, its conductance and capacitance increases. For a material which is purely absorptive, the surface capacitance and conductance both remain constant at any humidity unless there is any leakage path through the material between electrode (1) and (2). For adsorptive materials, when a layer of moisture takes place on the surface, capacitance measurement becomes

$$C_s = \epsilon \frac{b}{g} \dots \dots \dots (3.17)$$

again b is the width and g is the gap or separation between the electrodes.

$$C_s = \delta C_{vs} \dots \dots \dots (3.18)$$

C_{vs} is the volume capacitance of the film and δ the thickness of the film.

3.3 Effect of moisture on electrical properties of polymers

The effect of relative humidity on the electrical properties of polymers is often quite pronounced. Generally the conductance and capacitance of the material increase with the increase in humidity. Usually with materials which absorb moisture, the effect is on their volume properties, whereas in the case of adsorptive materials the effect is on their surface properties. To assess the nature of a material from this point of view, surface and volume measurements are carried out as a function of humidity.

3.3.1 Effect of humidity on surface conductance

When discussing the surface conductance or surface resistance of a material, it is important to look at the nature of the surface. The presence of foreign substances, i.e. contamination on the surface, plays a vital part in the surface conductance of the material, particularly surfaces which are highly susceptible to the contamination. Semnov and Chirkov (40) studied the surface conductivity of different materials including polymers. They found that a carefully cleaned specimen of any material had no significant surface conductance even at high humidities. A change in conductance was noted after the specimens had been contaminated with acids or bases. It was found that quartz, mica, methylmethacrylate, had a definite humidity dependent surface conductance, once there was some sort of contamination on their surfaces. The relationship between the surface conductivity and relative humidity was given by,

$$\sigma_s = 10^{-4} \exp \left(d \frac{p}{p_s} \right) \text{ mho} \dots\dots\dots (3.19)$$

where κ and d are constants depending on the material and P/P_s the relative vapour pressure. They concluded that for surface conductance of a material, there must be a continuous film on the surface which acts as a solvent and a source of suitable ions, which might arise on the surface as contamination. The effect of humidity in increasing the surface conductance of the material with contaminated or non-contaminated surfaces may be explained in the light of the work carried out by many workers such as Purdon and Morton (41), Kallweit (42), Warfield and Petree (43, 44) among others. It has been generally accepted that electrical conduction (surface, volume) is a function of the mobility of ions and the number of ions,

$$\sigma = \sum_i i \mu_i n_i e_i \dots\dots\dots (3.20)$$

where n is the number of ions and μ is the mobility of ions, and e is the electronic charge.

Chirkov (45) calculated the surface conductivity of quartz and mica specimens by assuming that, on exposure to HCl fumes, a monolayer of acid molecules formed on the surface, that all the acid molecules in that monolayer were subsequently dissociated in the physically adsorbed moisture film and that the mobilities of the dissociated ions had the values obtained from measurements on bulk electrolytes. The conductivity had a calculated value which was 1000 times greater than measured value. To check their reasoning, they then deposited accurately measured quantities of oxalic acid or NaOH, on the surfaces of mica plates. Making the same assumption as above, on ionic mobilities and dissociation, it was found again that the theoretical surface

conductance was considerably greater than the measured value, by a factor of 10^4 to 10^5 . Though it follows that one or both assumptions on ionic mobility and dissociation must be incorrect, it is not clear how to distinguish between the two effects. The thickness of the water layer increases with increasing humidity and similarly the surface conductance increases. The close similarity between curves relating surface conductance to relative humidity and those relating film thickness to relative humidity was pointed out by Yager and Morgan (46). Their results were very similar to those of McHaffie and Lenher (47), who studied the adsorption of water vapour on glass and platinum. The dependence of film thickness on surface conductance was not linear over the whole range of humidity. Koji Kawasaki (48) studied the variation of electrical resistance of polymers as a function of the extent and nature of sorbed water. He presented an equation which expresses the variation of the conduction current with the sorption of water vapour:

$$\log I/I_0 = \beta m \quad \dots\dots\dots (3.21)$$
$$I/I_0 = \sigma/\sigma_0 \quad \text{or} \quad \log \sigma/\sigma_0 = \beta m$$

where I and I_0 are currents in the sample with sorbed and unsorbed moisture respectively, m is moisture content in weight per cent.

β is a constant of proportionality. The above equation holds only in the cases of low moisture content, i.e. when the thickness of water film has not reached to a critical value. After the film thickness has exceeded a critical value, surface conductance increases linearly with film thickness as shown in Figure 3.6. The expression given for this

FIG. 3.6

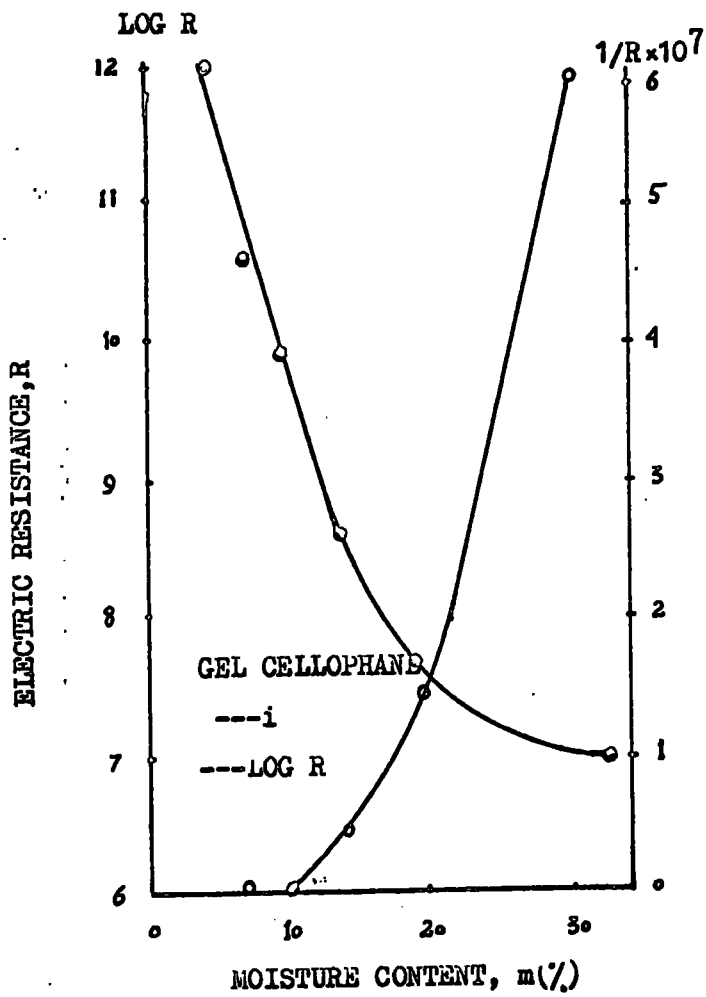
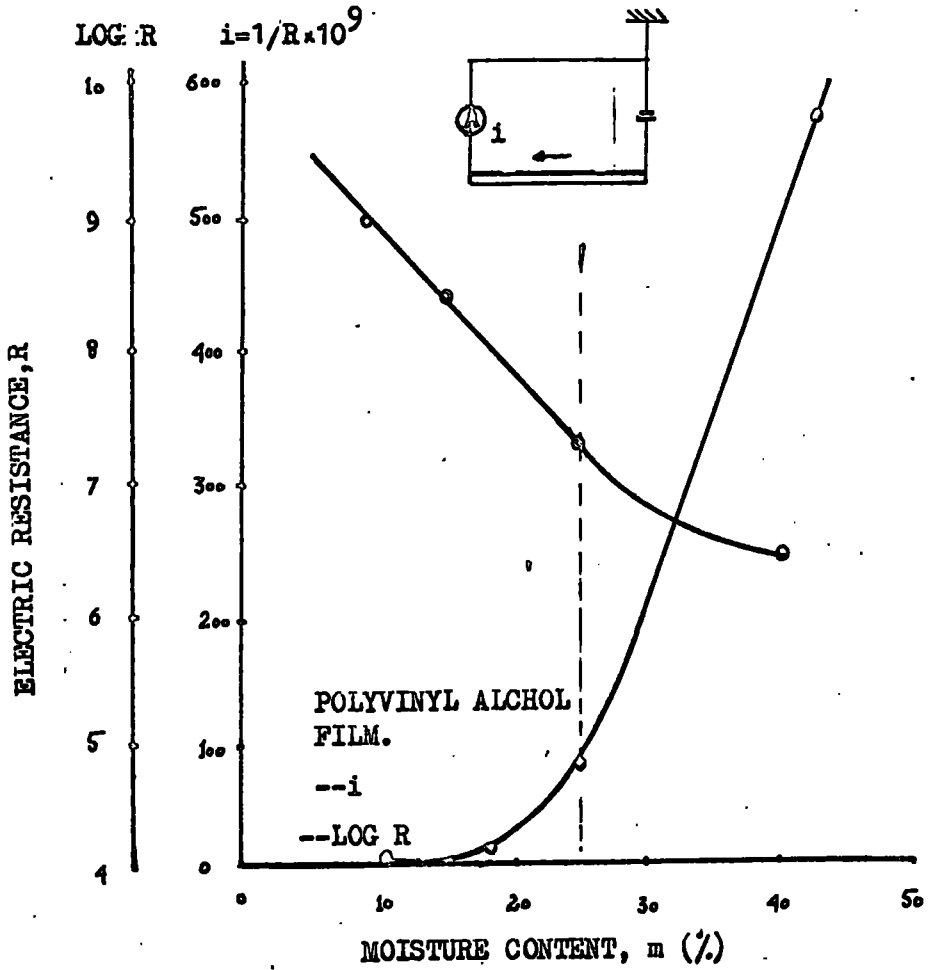

(Koji Kawasaki)

this stage was

$$I/I_0 = 1 + \alpha_m \dots\dots\dots(3.22)$$

where α is constant.

It is not clear from Kawasaki's paper whether the moisture was in fact adsorbed on the surface or absorbed by the bulk of the material. He used two electrode geometry and this measures insulation resistance but does not eliminate bulk conduction. There is insufficient information in the paper on this point.

Wakuni and Calderwood (49) studied the water vapour adsorption and surface conductivity of cellulose acetate, quartz and Teflon at various humidities. The relationship between the surface electrical conductivity and the adsorption of water molecules on the surface was measured, after the specimens had been carefully cleaned. It was found from the results that the amount of water vapour adsorbed on the surface of the material was dependent on the nature of the surface of the material and the conductivity varied accordingly. As shown in Figure 3.7, the conductivity of a quartz specimen increases slowly till the completion of the first layer, after that the increase is linear with the number of layers. In the case of Teflon (polytetrafluoroethylene), increase in conductivity is linear throughout. They concluded that as electrical conduction in polymers is a function of the number of ions and their mobility, on quartz, the conduction before the completion of a monolayer may be due to those ions which are always present on the surface. Initially, these ions are bound to the surface i.e. they are not mobile due to the interaction of forces between the ions and solid molecules of quartz. The number of ions increases with

FIG. 3.7

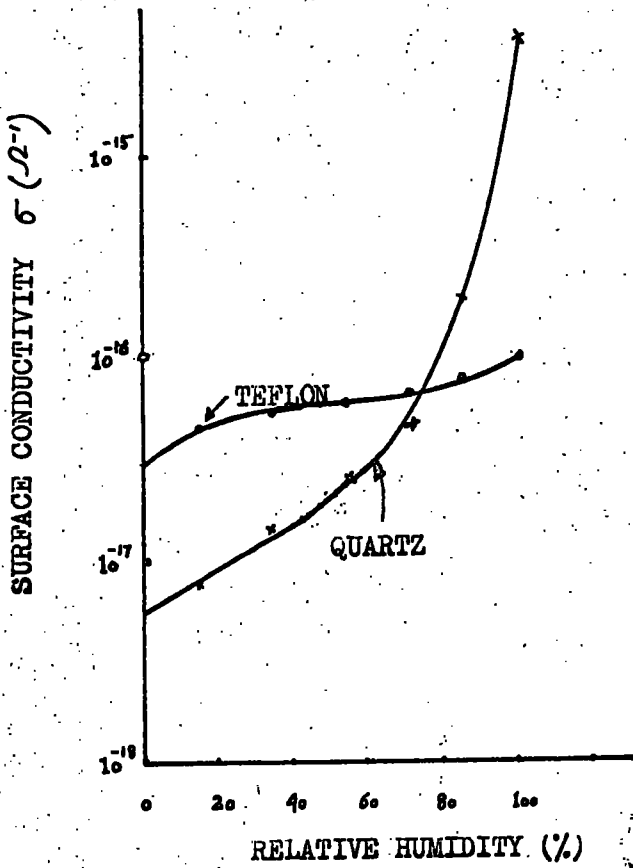

SURFACE CONDUCTIVITY OF TEFLON AND QUARTZ AS A FUNCTION OF R.H. AT 23°C

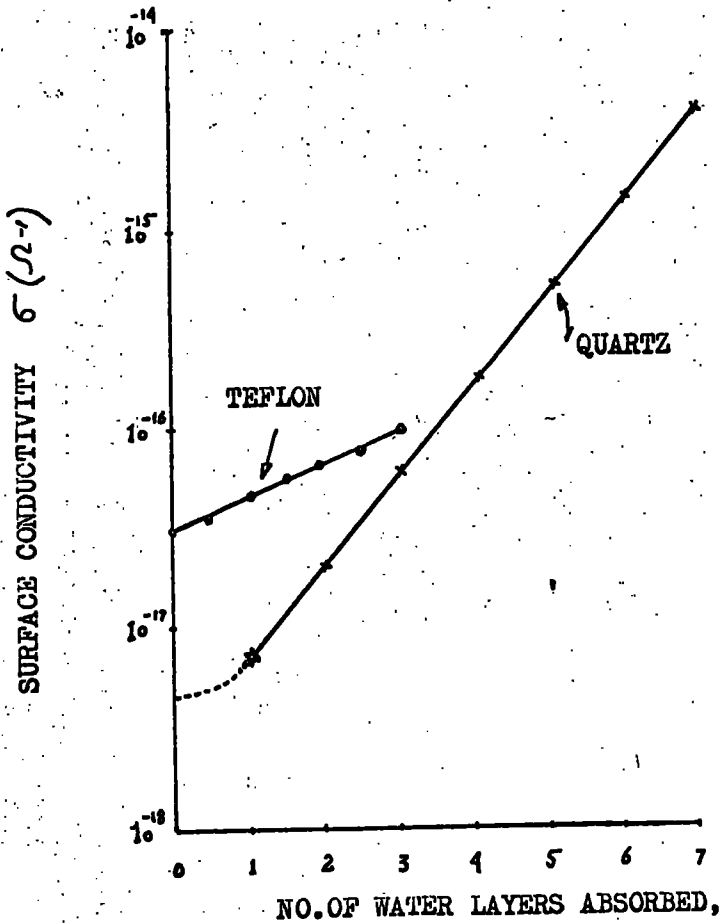

SURFACE CONDUCTIVITY OF TEFLON AND QUARTZ AS A FUNCTION OF THE NUMBER OF WATER LAYERS ADSORBED.

(WAKUNI AND CALDERWOOD)

the adsorption of water molecules on the surface and hence the conductivity increases. Until the completion of one layer, the mobility of ions on the quartz surface is very small. In the case of Teflon, they concluded that the interaction between water molecules and the Teflon surface is negligible so that as soon as the water molecules come in contact with the surface, conductivity starts increasing linearly with the number of water molecules or the number of layers. At equilibrium with nearly 100% relative vapour pressure, quartz adsorbed about seven layers of water molecules whereas Teflon adsorbed only three.

The use of BET (Brunauer, Emmett and Teller, 14) equation by Wakuni and Calderwood is interesting and their results certainly suggest a clear distinction between behaviour at surface coverages below one monolayer and above. However, there is some doubt (Gregg and Sing, 50) about the validity of the BET expression for the monolayer capacity of water. The results on the Teflon are difficult to understand. The figures of 5×10^{-16} ohms at zero humidity is considerably lower than that of 10^{-18} ohms which is normally associated with this material. The completion of one or two monolayers on Teflon would raise the surface free energy of the system by nearly an order of magnitude, and this is difficult to justify. Teflon is well known for the variability of its electrical properties and its susceptance to contamination (51).

3.3.2 Initial increase in surface conductance

The increase in surface conductance with time for materials having negligible volume absorption when abruptly exposed to high humidities has been studied by Field (52), who found that the conductance increased to a value of 10% of its final value in one minute after the sample was exposed to 100% relative humidity, and afterwards the increase in conductance was gradual till the equilibrium stage. He believed that the conductivity was due to the moisture film on the surface and when the humidity was dropped to zero, the thin water film evaporated in seconds or less, and so the conductivity decreased as shown in Figure 3.8. Field assumed that the reason for many plastics reaching equilibrium, i.e. the final conductance value attained within an hour, was that their surfaces had been greatly influenced by contaminations. He also studied the surface resistivity for materials which absorb relatively large amounts of water. The decrease in resistance with time is shown in Figure 3.10. This difference in behaviour between the two types of material gives a clear indication of whether the increase is due to the adsorption on the surface or absorption into the bulk of the material.

3.3.3 Effect of contamination on surface resistance

Killam (53) measured the effect of humidity on the surface and volume resistance of a variety of materials. He took particular trouble to ensure that the surfaces were scrupulously clean. His conclusions were:-

FIG. 3.8

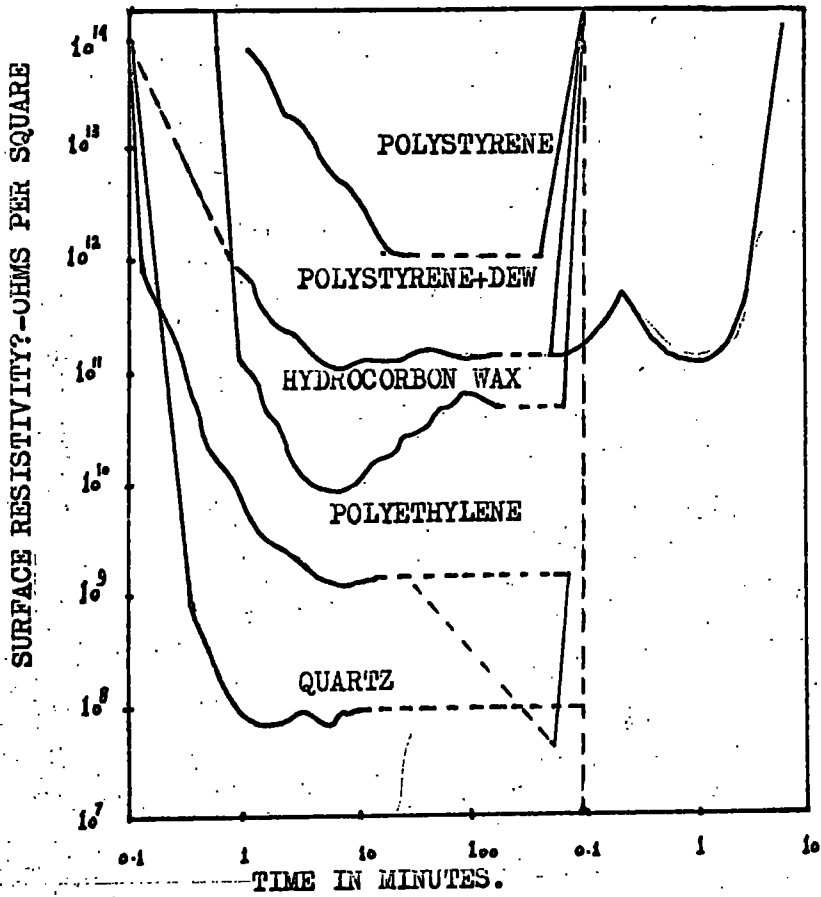

← 100% R.H. → 0% R.H.

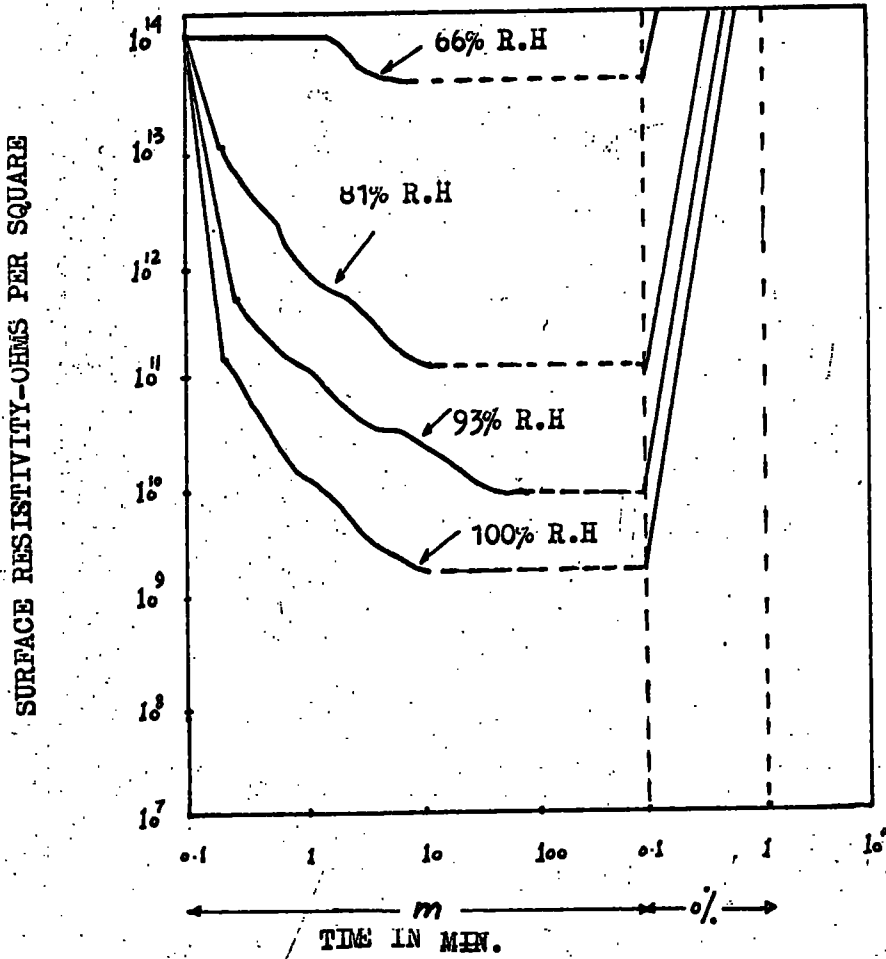

← m → %

TIME IN MIN.

(FIELD)

FIG. 3.9

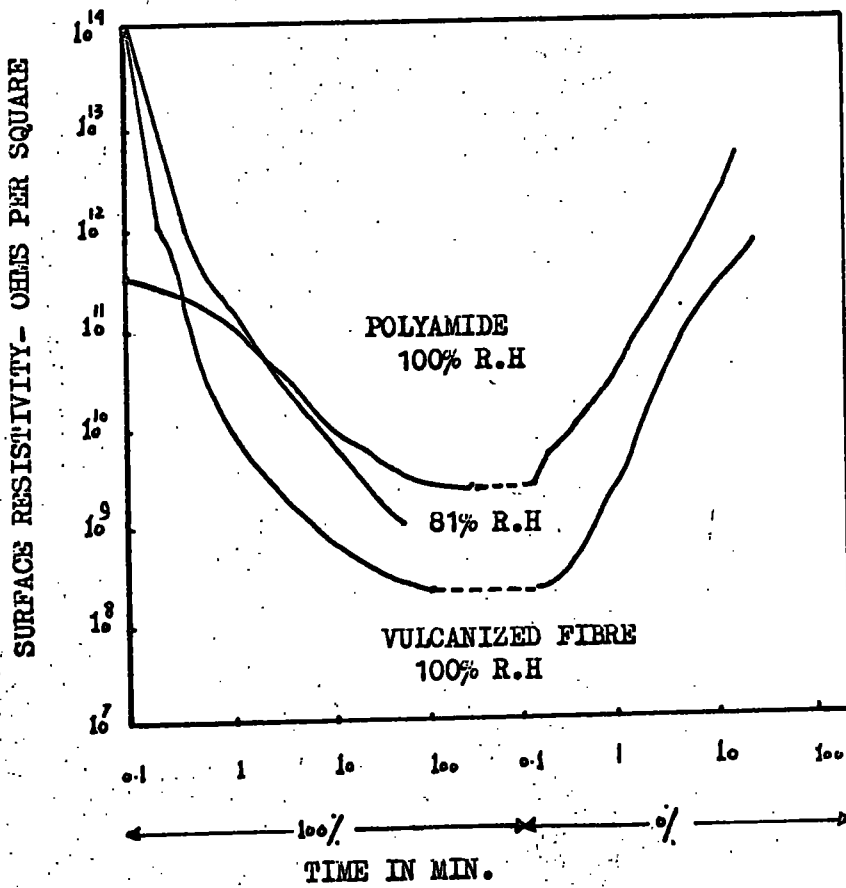
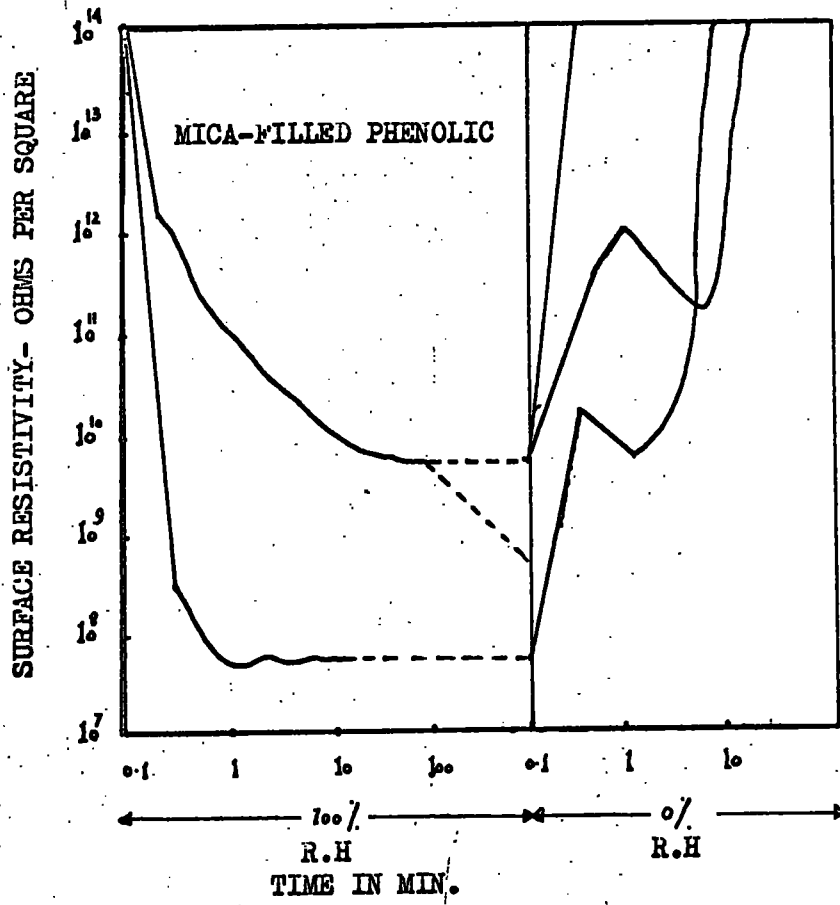

(Field)

- (1) When a material is exposed to high humidity, i.e. 90%, its resistivity is reduced by up to 2.5 decades.
- (2) A decrease in surface resistivity of a material which adsorbed no moisture when exposed to a humid atmosphere was probably due to the leakage current which passed through the bulk of the material between two measuring electrodes; in other words, surface resistivity measurement was volume resistivity measurement adjacent to the surface.
- (3) The water-repellent materials like polythene had highest resistivities, lower dielectric constants and the smallest water vapour sorptions. The similarity in change in capacitance and resistance of surface and volume confirmed that water permeated the bulk of these materials. It is possible that if the surfaces of such materials are contaminated, there may not be any similarity in change of capacitance and resistance along the surface and of volume, because of the fact that contamination will provide a new passage for the current to flow through during surface measurements.

The surface resistivities recorded by Killam were higher for some materials than those quoted by Field. This is perhaps due to the cleaning technique adopted by Killam. It is well known that ionic contamination, e.g. a finger print or perspiration etc. greatly influence the surface conductance of susceptible materials.

It is quite likely that contamination on the surface, apart from providing a plentiful supply of ions, increases the adsorption capacity of the surface. Lieste (54) found that the surface conductance of clean, untouched pressed amber at 50% relative humidity was one fifth of that touched by hand. The effect of contamination on the surface

resistance increases as the humidity increases. A detailed study of the effects of perspiration contamination on modern insulating materials has been carried out by Williams and Herrman (55). The effects of contamination have also been studied by Chaikin (56). The effects of finger prints, printed circuit processing chemicals, solder flux, sodium chloride aerosol and dust on synthetic resins ~~were~~ studied. Particular attention was paid to printed circuit contaminants. It was found, using a probe technique, that the surface conductivity could vary by a factor of 4000 over the surface of a panel at 97% relative humidity. A method was developed to detect iron impurities on the surface and an unsuccessful attempt made to correlate the surface conductance to excess iron on the surface. The idea of silver migration between silver electrodes on a dielectric surface was also investigated by Williams (55) and Herrman and Chaikin (56). They suggested that although the migrating silver appears to come from the negative electrode, anodic silver is oxidised, the oxide dissolved and the resulting cations migrate across the inter-electrode gap to the cathode where they are reduced to metallic silver and deposited adjacent to the electrode.

The growth of fungi was observed by Dryden and Wilson (57) when materials were exposed to a prolonged period at high humidities.

The work of Field, Kawasaki, Killam, among others, has emphasised the importance of surface resistance of polymers at high humidities. Surface resistance measurement is a quick way of detecting the response of a material at high humidities.

3.4 The effect of humidity on volume conductance

The effect of humidity on the volume conductance of absorptive materials is as marked as the effect of humidity on the surface conductance of adsorptive materials. In discussing the surface conductance, the nature of the surface was considered the most important factor, whereas in the volume conductance of a material, the nature of the material itself, i.e. the type of molecules, the molecular arrangement and the presence of impurities in it, are important. Adsorption is an instantaneous process which takes place in seconds or less, but absorption may take from hours to days or even more, depending on the material. Generally, polymers can absorb and adsorb water at the same time. The best way to describe which factor (absorption or adsorption) is dominant is to use a three electrode system. In porous materials which adsorb the moisture on the surface of the pores, it is difficult to distinguish between the two processes.

Cellulosic materials are highly absorptive materials and consequently their electrical conductivity changes appreciably with exposure to a humid atmosphere, but materials like polyethelene do not.

3.4.1 Time dependence of volume conductivity, following exposure to humid atmosphere

Because of diffusion as discussed in Section 2.3, sorption is a time dependent process and the conductivity changes with time in a similar way. The very long periods which are usually required for any

absorptive material to reach equilibrium are quite interesting. Normally equilibrium time of a material increases as its thickness increases. Thompson (58) presented a model to explain the distribution of moisture across the thickness of an infinite panel. He suggested that when a thick absorptive sample is exposed to humidity, the amount of moisture is highest on the faces of the sample and decreases slowly towards the centre. The equilibrium stage occurs when the amount of moisture at any point in the sample is constant. When the humidity is dropped to zero, a similar mechanism takes place except that in the latter case, the amount of moisture is highest at the centre and lowest at the faces. The important point to note in the drying process is how volume resistance continues decreasing even after the humidity is dropped to zero. Such effects are usually found among the thick wet polymer laminates when they are oven dried. In fact, the moisture diffusion accelerates at elevated temperatures, so both drying and wetting occur much more rapidly (59).

The variation of volume conductance with moisture content in the materials was found to agree with an empirical relationship developed by Mathes (59),

$$(R - R_e)^{\eta} t = K \quad \dots\dots (3.23)$$

$R = R$ — resistivity
 $R_e = R_e$ — equilibrium value of resistivity
 t — time
 K and η are constants.

Green (60), without making any attempt to measure volume or surface resistance on phenolic laminates and cellulose acetate films separately,

found that the insulation resistance was a function of moisture sorbed by the materials until the sample reached equilibrium. He concluded that volume resistance was the controlling resistance of the materials, i.e. it was water absorption rather than water adsorption. For cellulose acetate samples he found a continuous drop in resistance until equilibrium with the moisture chambers was obtained, at which time a temporary levelling off was observed. Cellulose acetate samples were exposed to 97% relative humidity and the resistance measured after 24 hours was 2.4×10^4 meg.ohms. After more than 4000 additional hours the resistance was 7.5×10^3 meg.ohms. He suggested that the sample had reached equilibrium as far as moisture pick up was concerned, and the additional drop must have been caused by some internal change in the material. Field (61) observed this phenomenon for cellulose acetate butyrate and suggested that sometimes the water is held initially in the material in unconnected pockets, but eventually the water in the isolated pockets joins and provides volume resistance. A relationship developed between the resistance and the percentage moisture absorption for materials is:

$$R = \frac{K}{m^n} \quad \dots\dots (3.24)$$

where R is the resistance, m the percentage moisture absorbed, and n and K are constants.

3.4.2 Conduction mechanism

The conduction mechanism in moist polymers has been discussed by Rosenberg (62), King and Medley (63), Hearl (64), Barker and Thomas (1). Rosenberg studied the electrical conductivity of a crystalline bovine haemoglobin (a solid protein), using a two electrode system. He measured an increase in conductivity with time due to water sorption from the atmosphere (57% relative humidity) and an increase in weight with time due to water sorption. Conductivity reached equilibrium in about 4 hours and sorption took the same time, ^{as} shown in Figure 3.12. He concluded that the increase in conductance was in accordance with the sorption of moisture in the material. Referring to previous work (65) which presented the results of an experiment designed to distinguish between ionic and electronic conduction in a protein, he assumed that if a protein containing 7.5% sorbed water shows ionic conduction then the water must be electrolyzed and the water content of protein should diminish with time. Since the magni^{tude} of current was found to have an exponential dependence upon the water content, the current should diminish with time according to,

$$1/I_t = 1/I_0 + \alpha \beta t \quad \dots\dots (3.25)$$

$$\begin{matrix} I_t & - & \sigma \\ I_0 & - & \sigma_0 \end{matrix}$$

where I_t is the current at time t and I_0 is the current at zero time, α, β are constants. If the conduction process is electronic, there should be no time variation in the current. Rosenberg found from his

FIG. 3-10

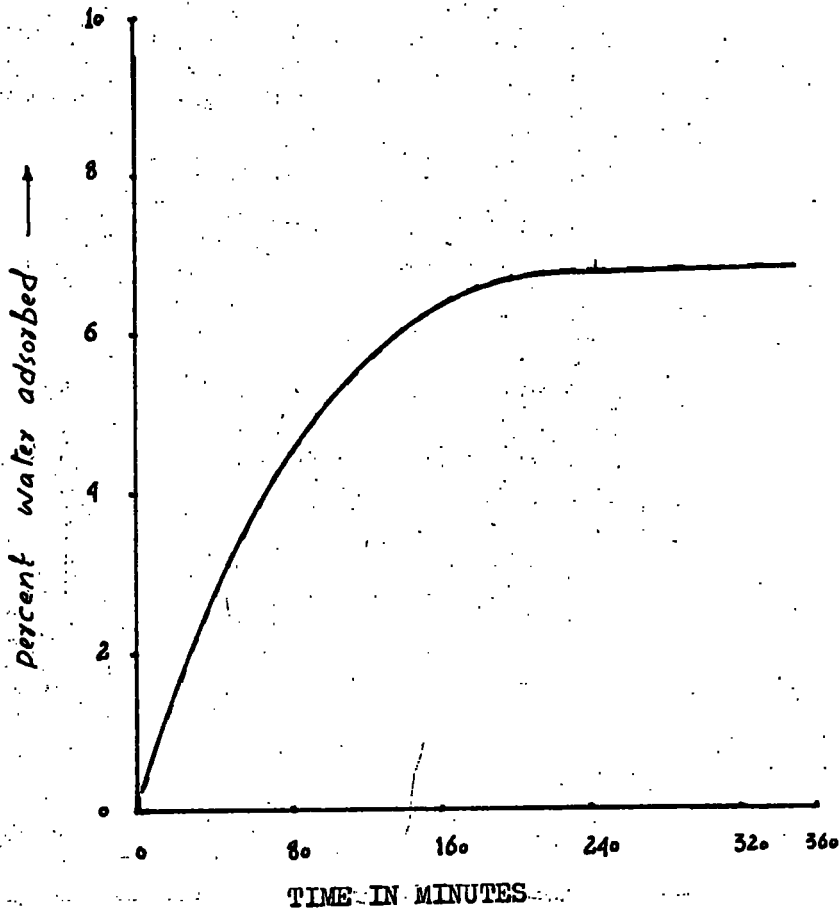

INCREASE IN WEIGHT (PERCENT) OF CRYSTALLINE BOVINE HAEMOGLOBIN WITH TIME DUE TO WATER ADSORPTION FROM THE ATMOSPHERE (R.H = 57%)

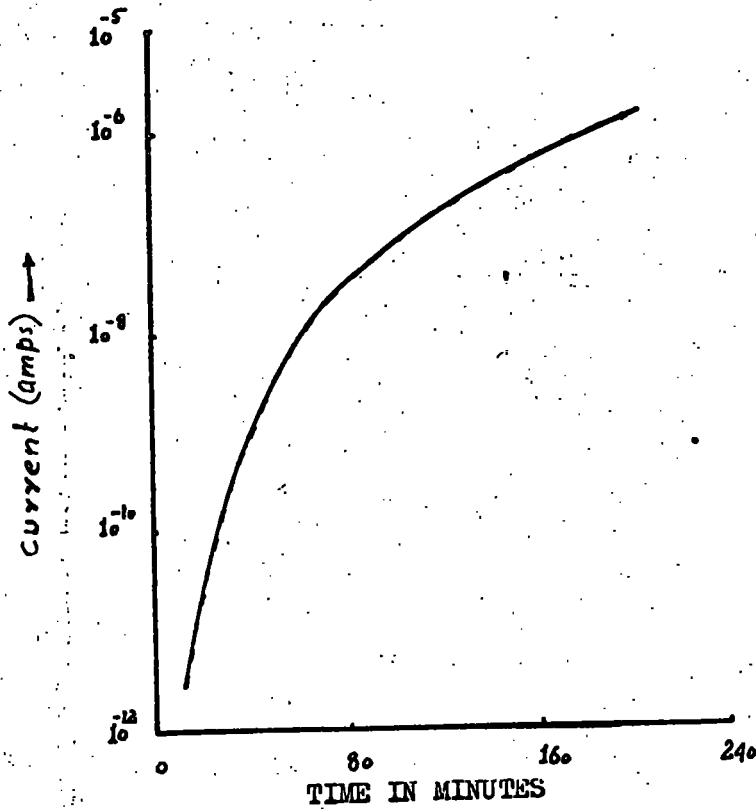

INCREASE IN CONDUCTIVITY WITH TIME DUE TO WATER ADSORPTION (Rosenberg)

experimental results that the current was constant in time. Therefore he believed that the conduction process in proteins (wet proteins in particular), was electronic and not ionic. The evidence from the experiments indicates that the only effect of water was to decrease the activation energy for semiconduction. The activation energy of a number of proteins and protein structures in the dry state have been measured, which is roughly the same for every one. An additional evidence in favour of electronic conduction was found; when log of current against the reciprocal absolute temperature was plotted, it produced straight lines. The straight lines indicated that haemoglobin crystals are semiconductors and the slope of the lines was the activation energy.

The two major features which emerge from Rosenberg's work needing more explanation are (1) the sorption of water molecules on the proteins, and (2) the electronic conduction.

Rosenberg (62) uses the term adsorption throughout his work but clearly the time taken to reach equilibrium indicates that it is a bulk process. It is more likely adsorption on pores. Generally a crystal of bovine haemoglobin does not absorb any moisture, but it adsorbs on the surface (66). As seen from Rosenberg's experimental material, the crystals of bovine haemoglobin were pressed into a sandwich cell to make a sample, so the adsorption must have occurred in the bulk and on the surface of the individual crystals. The electrical measurements were made with two electrodes and consequently no attempt was made to distinguish between volume and surface conductance.

Rosenberg considered that the conduction mechanism was electronic in proteins. This is in contradiction to the view of King and Medley (63), Hearl (64) and Barker and Thomas (1). Baxter (67) also suggested that conduction in wool was electronic. The products of electrolysis have been observed experimentally on materials such as cellulose and keratin films. It seems unlikely that electrons contribute to conduction except possibly in exceptional cases.

Discussing conduction mechanism, Hearl (68) concluded that *the* variation of resistance in fibres, either with moisture content or with the type of fibre, could be explained in terms of variations in the dielectric constant. If the dielectric constant is low, there will be strong attractive forces between electric charges, and most of the ions will be associated together as neutral ion pairs which are not available to carry current. But if the dielectric constant is high, the ion pairs will dissociate and the free ions can carry current.

King and Medley (63) studied the influence of sorbed salts on d.c. conductivity of polar polymers by using water and other salt solutions as adsorbates. They concluded that impurities in the polymers play a vital part in increasing the conductivity. The results obtained on conduction of some of the polymers by impregnating them with salts of high and low dissociation constant, showed that the conductivity relations were analogous to those for solutions of electrolytes in solvents of low dielectric constant. Hearl (68) treating the problem theoretically, derived an equation for the conduction (or resistance) in the fibres, i.e. silk, cotton, wool, viscose, acetate and nylon,

$$\log R = \frac{a}{\epsilon'} + b \quad \dots\dots (3.26)$$

where R is the resistance, ϵ' is the dielectric constant and a, b are constants. The above equation is discussed in the following section. The expression was based on the idea put forward by King and Medley (63), that the effect of moisture on the conductivity of a material is to increase the dielectric constant ϵ' , by reducing electrostatic attraction forces between ion pairs.

Various empirical relations relating resistance to moisture condition have been proposed, one of the first was that of Murphy and Walker (69) for cotton;

$$\log R = -0.085h + a \quad \dots\dots (3.27)$$

where h is relative humidity (per cent) and a is a constant, the value of which depends on the sample, the electrode system, and whether the specimen is absorbing or desorbing.

Barker and Thomas (1) have considerably extended the work of King and Medley (63) in their study on cellulose acetate. They used the Fouss and Kraus (2) approach to ionic dissociation and derived the following relation which is similar to that of King and Medley. If the measured value of $\log \sigma$ is plotted as a function of $\frac{1}{\epsilon'}$, then a straight line result would confirm the hypothesis. Figure 3.10 shows typical results obtained by Barker and Thomas for cellulose acetate. Clearly there is some agreement between the theory and experiment.

FIG. 3-11

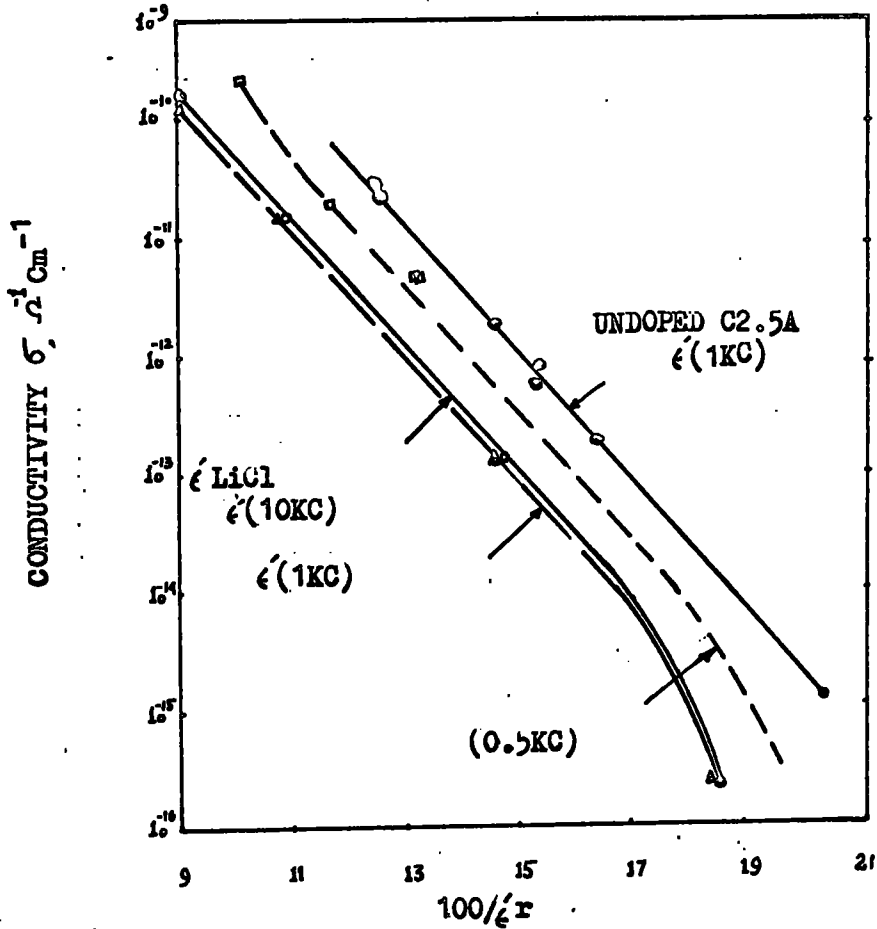

D.C. CONDUCTIVITY OF C2.5A vs RECIPROCAL PERMITTIVITY

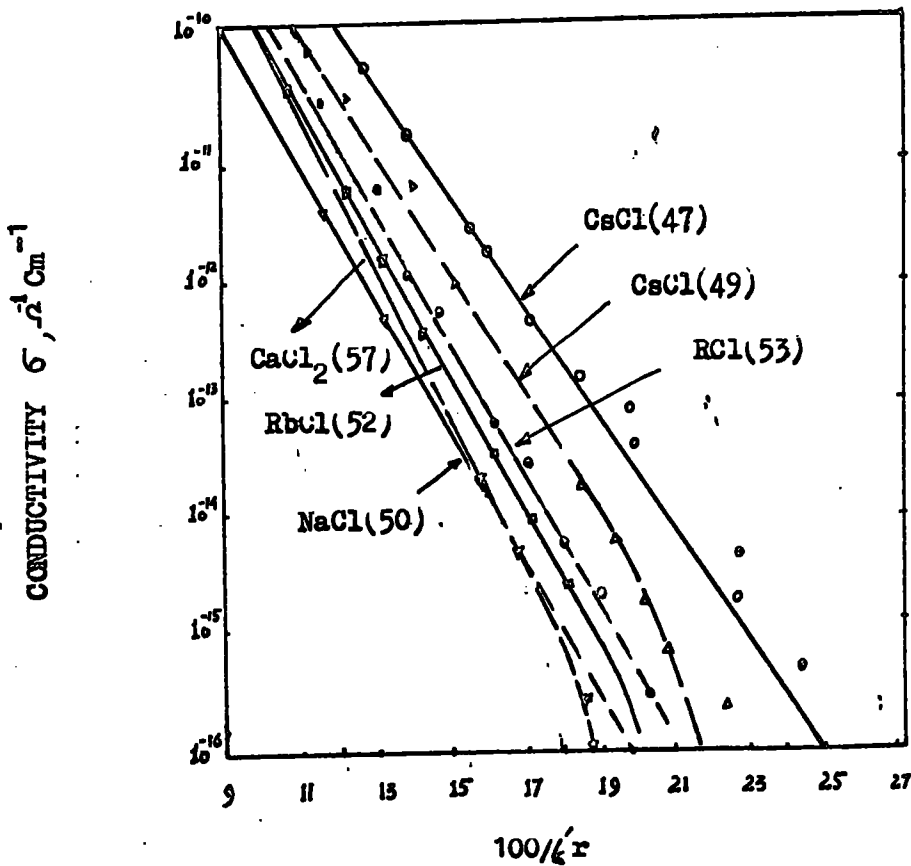

(Barker and Thomas)

3.4.3 Ionic dissociation theories

Because of the importance of the ionic dissociation theory to the present work, the relations between equations derived by King and Medley, Hearl and Barker and Thomas, are considered in terms of the dissociation hypotheses of Bjerrum (3) and Fuoss and Kraus (2). Bjerrum's theory develops from the consideration of the factors which determine the extent of ionic association under the influence of coulombic forces. The idea of Bjerrum that the average effect of ion pair formation may be calculated on the basis that all oppositely charged ions within a certain distance of one another are associated into ion pairs, led to a proposal that the critical distance should be chosen as

$$q = \frac{|z_1 z_2| e^2}{2 \epsilon K T} \dots\dots\dots (3.27)$$

q is the distance at which the energy of separation of ions is 2KT and z_1, z_2 are ion charges. According to Boltzmann's distribution law, the number of ions in a spherical shell of radius r and dr thickness dr , surrounding a specified ion, is given by

$$\partial n_i = n_i 4\pi r^2 \exp(-W/KT) dr \dots\dots\dots (3.28)$$

- where
- ∂n_i number of ions of i th kind
 - n_i number of ions of i th kind in unit volume
 - W work done to separate an ion from the central one
 - K Boltzmann's constant
 - T Absolute temperature

Central ion is supposed to be positive ion, whereas surrounding ions carry negative charge. Ions are separated by a medium with an effective dielectric constant equal to that of solvent. The work required to separate an ion from the distance γ to infinity, W is given by

$$W = \frac{z_+ z_- e^2}{\epsilon' \gamma} \dots\dots (3.29)$$

$z_+ e$ positive charge
 $z_- e$ negative charge

substituting the value of W in equation (3.28),

$$\partial n_i = n_i 4\pi \gamma^2 \exp\left(\frac{-z_+ z_- e^2}{DKT}\right) \dots\dots (3.30)$$

King and Medley restated the results of the theory as follows,

$$\alpha = \frac{N_{\pm}}{V} \int_{\gamma_i}^q 4\pi \gamma^2 \exp\left(\frac{z^2 e^2}{DKT}\right) \cdot d\gamma \dots\dots (3.31)$$

γ_i The closest distance of ionic approach
 q The closest distance of approach for free ions
 N_{\pm} The total number of ions of each type in volume

Working on the basis of Bjerrum's theory of ionic dissociation, they obtained a reasonable agreement between experimental measurements of resistance and dielectric constant for keratin and nylon films.

However, in view of the doubt about the dielectric constant a simpler,

though cruder approach had been made by Hearle (64), that

$$\alpha / (1 - \alpha) = a'/n' \exp(-U/KT) \dots\dots (3.32)$$

where α is the degree of dissociation into free ions, n' is the total number of the dissociating molecules per unit volume, U is energy required to separate the ions and a' is constant.

According to Coulomb's law, when the separation of two ions of opposite charges takes place in a medium of dielectric constant ϵ' ,

$$U = U_0 / \epsilon'$$

U_0 is the energy required to separate the charges in the vacuum.

For $\epsilon' < 20$ or $\epsilon' < 15$ it is quite reasonable to assume that $\alpha \ll 1$ and therefore:

$$\alpha^2 / (1 - \alpha) \approx \alpha^2$$

equation (3.32) becomes,

$$\alpha^2 = a'/n' \exp(-U/KT) \dots\dots (3.33)$$

or
$$\alpha = \sqrt{a'/n' \exp\left(\frac{-U}{2KT}\right)} \dots\dots (3.34)$$

or
$$\alpha = \sqrt{a'/n' \exp\left(\frac{-U_0}{2\epsilon'KT}\right)} \dots\dots (3.35)$$

but the resistance is inversely proportional to the number of free ions, i.e. to the degree of dissociation. Therefore:

$$\begin{aligned} \log R &= \text{Const.} - \log \alpha \\ &= \text{Const.} + \frac{U_0 \log \exp. 1/\epsilon'}{2KT} \\ &= a/\epsilon' + b \dots\dots (3.36) \end{aligned}$$

Barker and Thomas studied the effect of moisture and high electric field on conductivity in alkali halide doped cellulose acetate. Theories of ionic dissociation have been presented by different workers. The main idea emphasised concerning the effect of moisture on the conductivity of cellulose acetate polymer is that water increases the dielectric constant of the medium by reducing the effective dissociation energy from its maximum value to a very low value and hence the concentration of ions. They concluded from their experimental and theoretical work that conductivity in terms of ion concentrations and mobilities, is given as

$$\sigma = \sum_i n_i \mu_i e$$

They considered that when polymer film was doped in the salt solution the number of salt molecules in a unit volume of the film was n_0 . Dissociation of salt molecules at equilibrium was defined as

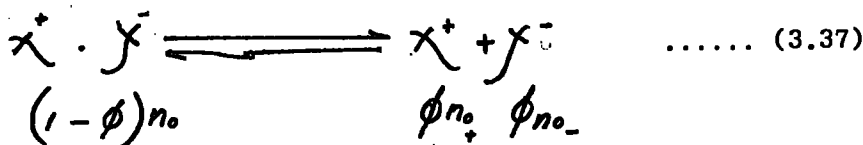

where ϕ is fractional dissociation, ϕn_0 is the number of salt molecules obtained after dissociation had taken place, and $(1-\phi)n_0$ is a salt molecule before dissociation. The dissociation constant was given by

$$K = \frac{(x^+)(y^-)}{(x^+ \cdot y^-)} = \frac{\phi \cdot \phi \cdot n_0}{(1-\phi)} \quad (3.38)$$

where () represents activity, γ^2 is the product of activity coefficients and ϕ is the fractional dissociation. An activity coefficient may be defined as the ratio of active mass of the solute to the concentration of the solution per gram molecule in 1000 grams of water. With the dissociation of salt molecules, there may occur a change in thermodynamics of the system, i.e. change in pressure or temperature etc. hence K was also defined as

$$K = K_0 \exp(-\Delta G/RT) \approx K_0 \exp(-U/RT) \dots \dots (3.39)$$

ΔG is the Gibbs potential in the system. When heat is evolved during the process a negative sign is used, but when heat is added it is vice versa. From equation (3.38)

$$K = \gamma^2 \phi^2 n_0 / (1-\phi)$$

$$K/n_0 = \gamma^2 \phi^2 / (1-\phi)$$

$$1-\phi \approx \text{negligible}$$

$$\text{or } \frac{K}{n_0} = \gamma^2 \phi^2$$

$$\text{or } \left(\frac{K}{n_0}\right)^{1/2} = \gamma \phi \quad \phi = \left(\frac{K}{n_0}\right)^{1/2} \gamma^{-1} \dots \dots \dots (3.40)$$

conductivity as stated before,

$$\sigma = \sum_i i \mu_i n_i e = \sum_i i \phi_i n_i \mu_i e \dots \dots \dots (3.41)$$

If only one kind of ion pair is involved,

$$\sigma \approx \phi n_0 e (\mu_+ + \mu_-) \dots\dots (3.42)$$

substitution of ϕ from equation (3.40) into equation (3.42),

$$\sigma \approx \left(\frac{\kappa}{n_0}\right)^{1/2} \bar{\gamma}^{-1} n_0 e (\mu_+ + \mu_-) \dots\dots (3.43)$$

Assuming $U' \approx U'_0/\epsilon'$, U'_0 as an effective dissociation energy,

$$\sigma \approx \bar{\gamma}^{-1} (\kappa_0 n_0)^{1/2} \exp(-U'_0/2\epsilon'KT) (\mu_+ + \mu_-) e$$

$$\begin{aligned} \log \sigma &= \left(\log(\bar{\gamma}^{-1} \kappa_0^{1/2})\right) + \frac{1}{2} \log n_0 + \log((\mu_+ + \mu_-)e) \\ &\quad - \left(\frac{U'_0}{4.605KT}\right) \left(\frac{1}{\epsilon'}\right) \dots\dots\dots (3.44) \end{aligned}$$

The major points that emerge from Barker and Thomas's work are that (1) at 25°C, σ for a dry sample of C2.5A whether or not it contains salt molecules, is in the order of $10^{-18} \Omega^{-1} m^{-1}$, (2) for measurements at ordinary ambient humidities on a typical sample which is not bone dry σ increase by a factor of about 2 during a 1-3 hour period, after which a gradual decrease is noted, (3) the moisture which enters during the latter stages of sorption is apparently more efficient in increasing ϵ' than the initially sorbed water, (4) σ is not proportional to n_0 rather $\sigma \propto n_0^{1/2}$ and finally $\log \sigma$ is a linear function of $1/\epsilon'$ and the slope is proportional to U'_0 .

The work of Fuoss and Krauss, King and Medley and Barker and Thomas is concerned with the ionic dissociation theory which was basically produced by Bjerrum. An adequate description of the conduction phenomena has been given which proves that the conduction process in polymers is ionic and its magnitude is dependent on the number and mobility of the ions.

4.0 Experimental Technique

The present work is concerned with the determination of the effect of humidity on films of C.A. and C.A.B. The films were prepared by a casting technique and subsequently mounted in a three terminal electrode system in a sealed humidity chamber. The humidity chamber was maintained at constant temperature and the humidity changed by using different saturated salt solutions. Measurements of the capacitance, a.c. conductance and d.c. conductance were made for different humidities. The effect of doping the films with ionic contaminants was examined.

Some measurements were made of the moisture sorption characteristics of the films, but these were incomplete due to the uncertain characteristics of the sorption apparatus.

4.1 Materials

Materials used in the present work were obtained from Eastman Kodak. Cellulose acetate (acetyl 40.0%, ASTM visc 25) and cellulose acetate butyrate (17% butyryl, ASTM visc 15), were in the form of fine powder and white flakes respectively.

4.2 Film Preparation

Two techniques of preparation of specimens were examined, hot compression and cold casting. The latter was finally chosen as it produced thinner and better quality films. Further it is more likely to be used in the manufacture of humidity elements.

Compression moulding involves the use of a heated press to raise the material above its melting point and then to apply pressure. The material is squeezed into the shape of the mould containing it. Charles and Barker (70) successfully used a moulding technique to prepare specimens of cellulose acetate. They used the same material as above. Specimens of 0.01 m thick were made by compression without a plasticizer. For 0.02 m diameter, 0.21 grams of cellulose acetate powder was used for each specimen. Details of the method are as follows: the cellulose acetate powder was first pressed at 4.2 MN/m^2 and then placed between two platens at 210°C and preheated for 10 minutes. After preheating a pressure of 1.87 MN/m^2 was maintained for two minutes, followed by 15 MN/m^2 for 3 minutes. The samples were then cooled slowly at 32.8 MN/m^2 until they reached 180°C . Water cooling was used afterwards to cool to 40°C and the samples were taken out of the mould.

Attempts were made to use compression moulding to make cellulose acetate and cellulose acetate butyrate specimens. A measured quantity of the material was heated in the lower part of the mould to a temperature which was controlled automatically just above the melting point of the material. The upper part of the mould which had been heated to the

same temperature was brought over the lower one as soon as the material started melting. After 2-3 minutes, pressure was applied by 30 ton press at 65.4 MN/m^2 for a film of 0.076 m diameter. The heating was switched off and as the temperature dropped below 100°C water cooling was used. The pressure was released as the temperature reached near 20°C .

Several problems were faced, when carrying out this process, first during the initial heating of the films. Fumes were observed leaving the mould, and secondly, it was extremely difficult to separate the specimen from the mould at the end. In several cases the material had clearly deteriorated as the films had shown signs of burning. Finally, the films were brittle and broke easily.

Various attempts were made to overcome these difficulties, including the use of mould release agents and plasticizers. However, as the specimens were clearly inferior to those produced by cold casting, the method was abandoned.

Considerably more success was achieved using a cold casting technique. This method depends on the fact that C.A. and C.A.B. are soluble in acetone and other solvents. The resulting solution can be poured onto a suitable surface from which the film is subsequently stripped once the solvent has evaporated. Long and Thompson (21) in their work on the diffusion of water vapour in polymers made films of polyvinyl acetate, cellulose acetate, cellulose nitrate and polyvinyl alcohol by casting. They used acetone as the solvent for all materials and the films were cast on a mercury surface. Spencer and Ibrahim (33)

made polyvinyl alcohol films for sorption measurements by casting on a glass sheet from 5% aqueous solutions of du pont Elvanol 71-30. The dried films were stripped from the glass and kept at 80^o C. For the experimental study of the influence of various factors on the time dependent nature of diffusion in polymers, Park (35) prepared thin films of polystyrene and cellulose acetate by a casting technique. The solvents used for polystyrene and cellulose acetate films were methylene chloride and acetone respectively. Casting was carried out on the glass plates after the films had been peeled off the glass plates. In order to ensure that there were not traces of the solvent in the films, they were heated before being used for experiments. Patel and Patel (71) used a casting technique to prepare uniform films of polyethylene, polypropylene, polybutene, polyacrylonitrile and cellulose triacetate. (The same technique had been used by Carnell (72) to prepare films of uniform thickness). Details of the procedure are given in their paper. A glass tube 0.7 meters in length and 0.015 m inside diameter and sealed at the lower end, was placed in an air oven held at constant temperature (within $\pm 0.5^{\circ}\text{C}$). The tube contained 10 ml of polymer solution. The solution was allowed to reach thermal equilibrium. A glass slide suspended by a string was allowed to reach thermal equilibrium and then immersed in the solution. After half an hour the slide was raised at a constant rate of 0.01 m per minute. After it has been completely withdrawn from the solution, the slide was left above the solution for about one hour. The films were subsequently floated off on water.

4.2.1 Details of casting method

The technique used to manufacture the films in the present work is as follows. This is based on preliminary experimentation and the work of Patel and Patel. The method demonstrated the need to carry out the whole process in as dry an atmosphere as possible. If the acetone contains water, the resulting films are opaque and milky. Sheppard and Newsome found that such films have a microscopically porous structure and show much more absorption than a transparent film. Using dry acetone and taking care that the air in contact with the solution and film was as dry as possible, clear transparent films are obtained.

The raw material (cellulose acetate or cellulose acetate butyrate) was dried in an oven at 60°C overnight. Known amounts of the material and dry acetone were mixed in a large beaker. A lid was made which was used during mixing so as not to allow wet air to reach the mixture. After the solution was ready, the mixer was taken out carefully and the beaker covered with another air-tight lid. The solution was left for a half hour to get rid of the air bubbles (see Figure 4.1). Films were subsequently made by casting on to glass plates 0.152 m x 0.05 m. When the solution was free of air bubbles, it was poured into a small beaker which was placed in a larger beaker containing activated silica gel. The silica gel indicated the dryness of the air around the system. Three similar glass plates were used for casting. Firstly holes were drilled through them and they were mounted on a threaded rod. This was connected to the pulling system by a rigid copper rod. The plates hanging on the copper rod were brought into the chamber over

FIG. 4.1

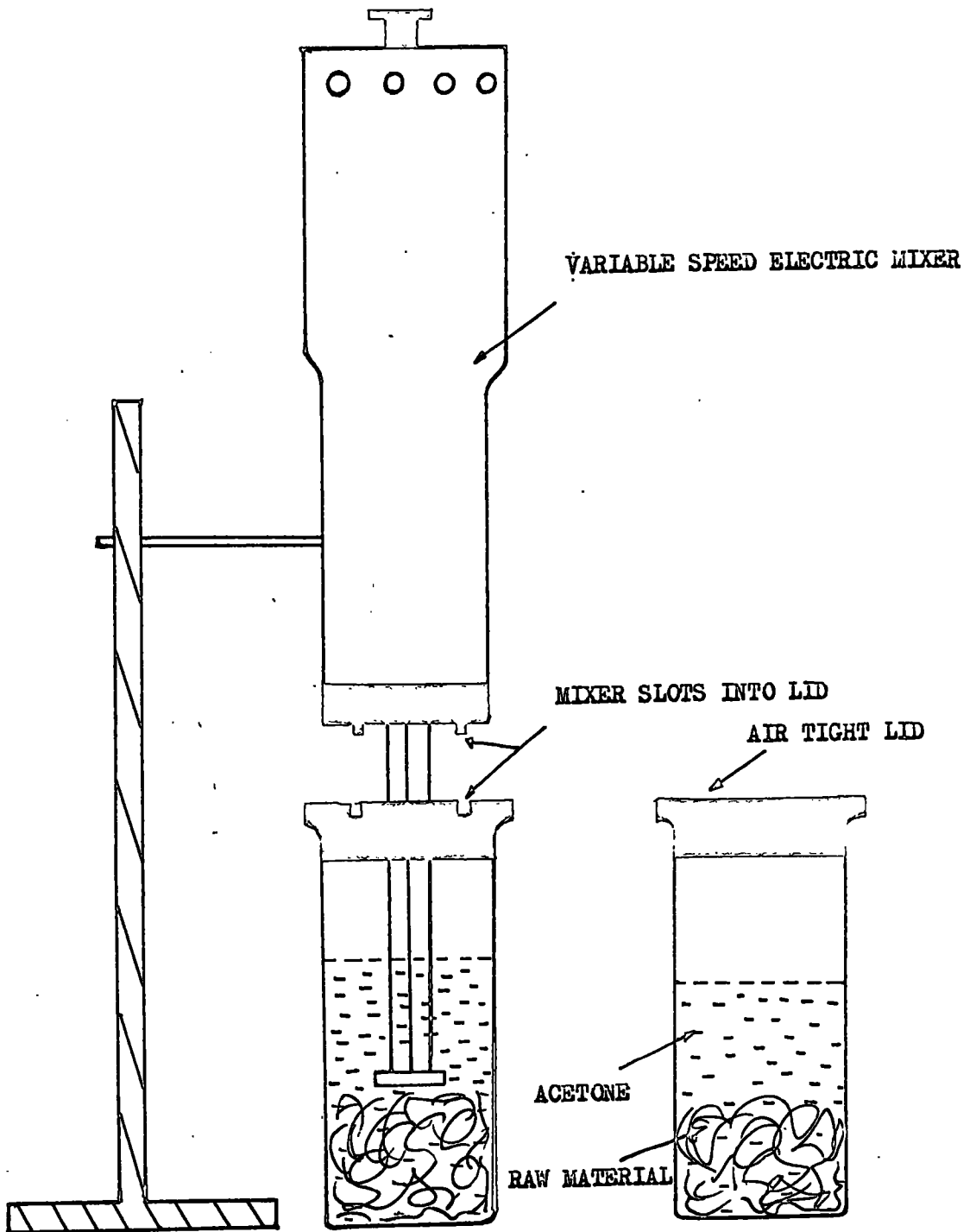

MIXING OF RAW MATERIALS WITH ACETONE TO MAKE SOLUTIONS

the solution, and left there for 15 minutes to allow them to reach thermal equilibrium. They were then dipped into the solution and kept there for half an hour before they were pulled out. The films were partially dried over the solution by leaving the glass plates there for an hour. The glass plates with the films on were then taken out of the chamber and put into another beaker which contained activated silica gel, for further drying. The process was continued by placing another set of glass plates in the chamber while the first set was drying. After about an hour, when the films had completely dried, they were peeled off the plates by marking the sides with a razor blade. ^{See Figure (4-1A)}

Peeling off the films required great delicacy, as many films, particularly very thin ones 2.54×10^{-6} to 2.54×10^{-5} meters thick, tore while peeling them off. An idea of dipping the glass plates in water for a few minutes was tried, which happened to be highly successful. The films came off the plates and floated on the surface of the water. Very thin film took a little longer before they floated off onto the surface. To ensure a uniform film, the plates had to be drawn out of the solution slowly and steadily. The drive motor had a variable output speed in the range 1 to 100 r.p.m. This was connected to a lead screw which drew the specimens out of the solution. The rate of pulling was 1×10^{-3} meters per minute to 3.3×10^{-2} meters per minute.

4.2.2. Film properties

Films of variable thicknesses were made by varying the concentration of the solution and the pulling rate. To find out how the film thickness depended on the concentration of the material in the solution, a series

FIG. 4.1A

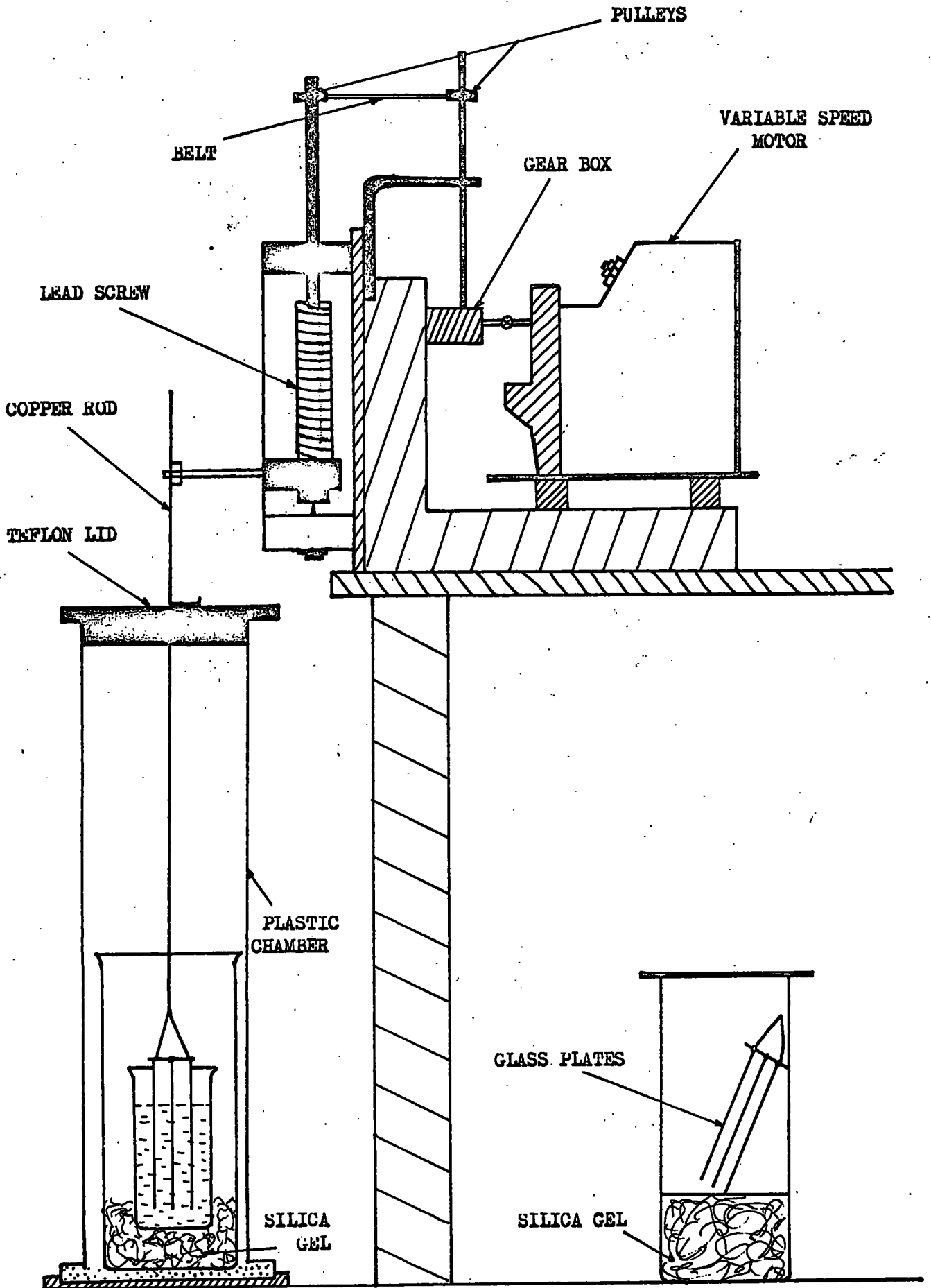

PULLING OF GLASS PLATES FROM SOLUTION

of films were made at the same pulling rate but using different concentrations. The concentration was measured by taking a small amount of solution from the beaker and weighing it carefully. It was then left open to let the acetone evaporate. After the acetone had completely left the solution, the remainder was weighed and the concentration was calculated. In general, the thickness of the films increased with the increase in concentration of the solution as shown in Figure 4.2. Similarly the relationship between the pulling rate of the glass plates and the thickness of the films was measured at a constant concentration. The thickness of the films was found to increase as the speed increased, as shown in Figure 4.3. The reason that the thickness of the film increased with increasing speed was due to the fact that at high speeds of withdrawal, the solution dried quickly on the plates and did not run off, whereas at lower speeds, the solution ran off the plates and thinner films were formed. To confirm this, glass tubes of 0.02 m diameter (internal) were dipped into the solution and raised up, instead of the glass plates. After they had dried, the two films, the inside and outside one, were significantly different in thickness. The film cast on the outside of the tube was thicker than the one obtained from inside. It was concluded that dry space (area) affects the thickness of the film.

FIG.4.2

INCREASING THICKNESS OF THE FILMS WITH CONCENTRATION OF THE SOLUTION

FULLING RATE 1 Cm/Min

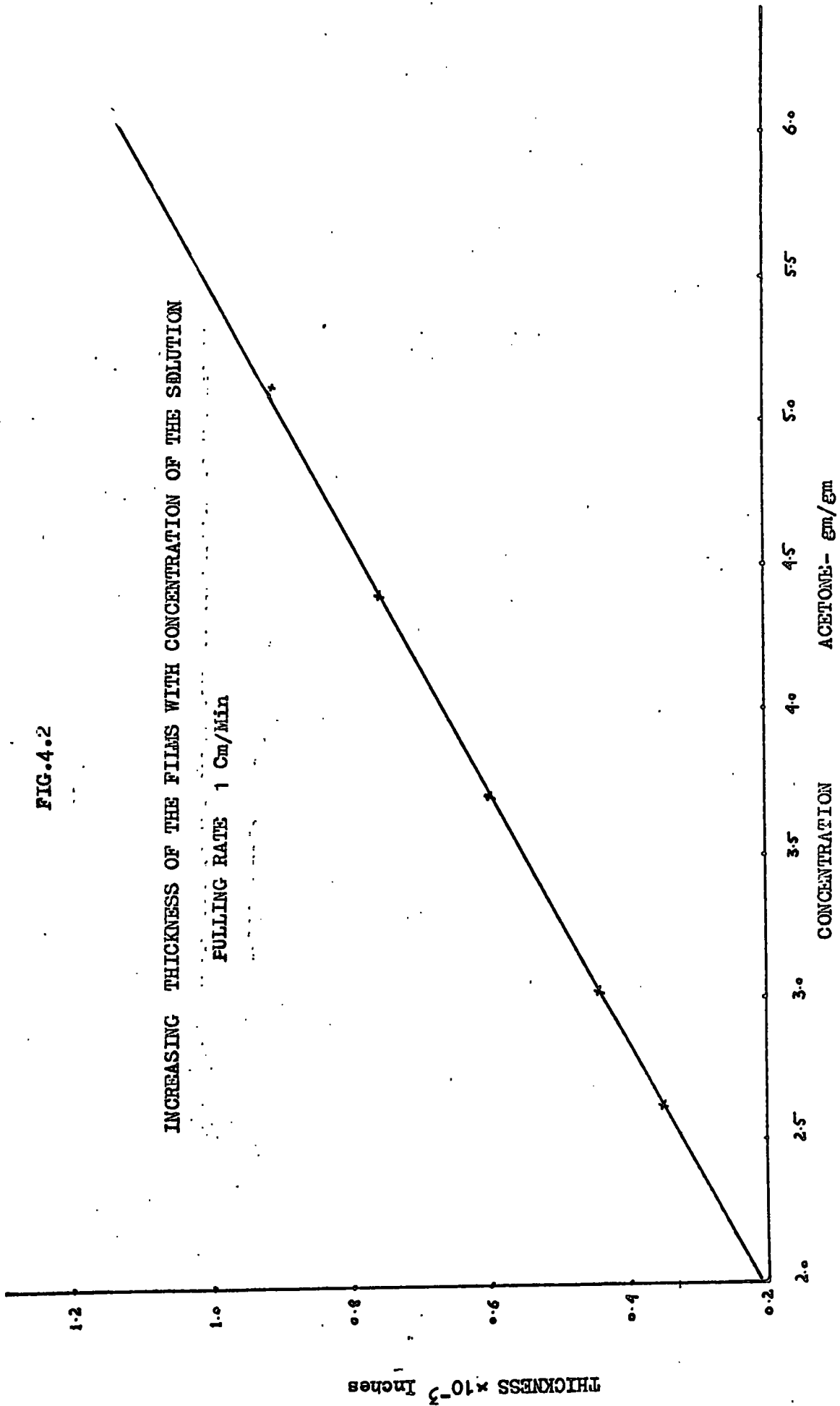

FIG. 4.3

INCREASING THICKNESS OF THE FILMS WITH PULLING RATE

CONCENTRATION OF THE SOLUTION

ACETONE - 2.54 gm/gm

THICKNESS $\times 10^3$ Inches

PULLING RATE --- Cm/Min

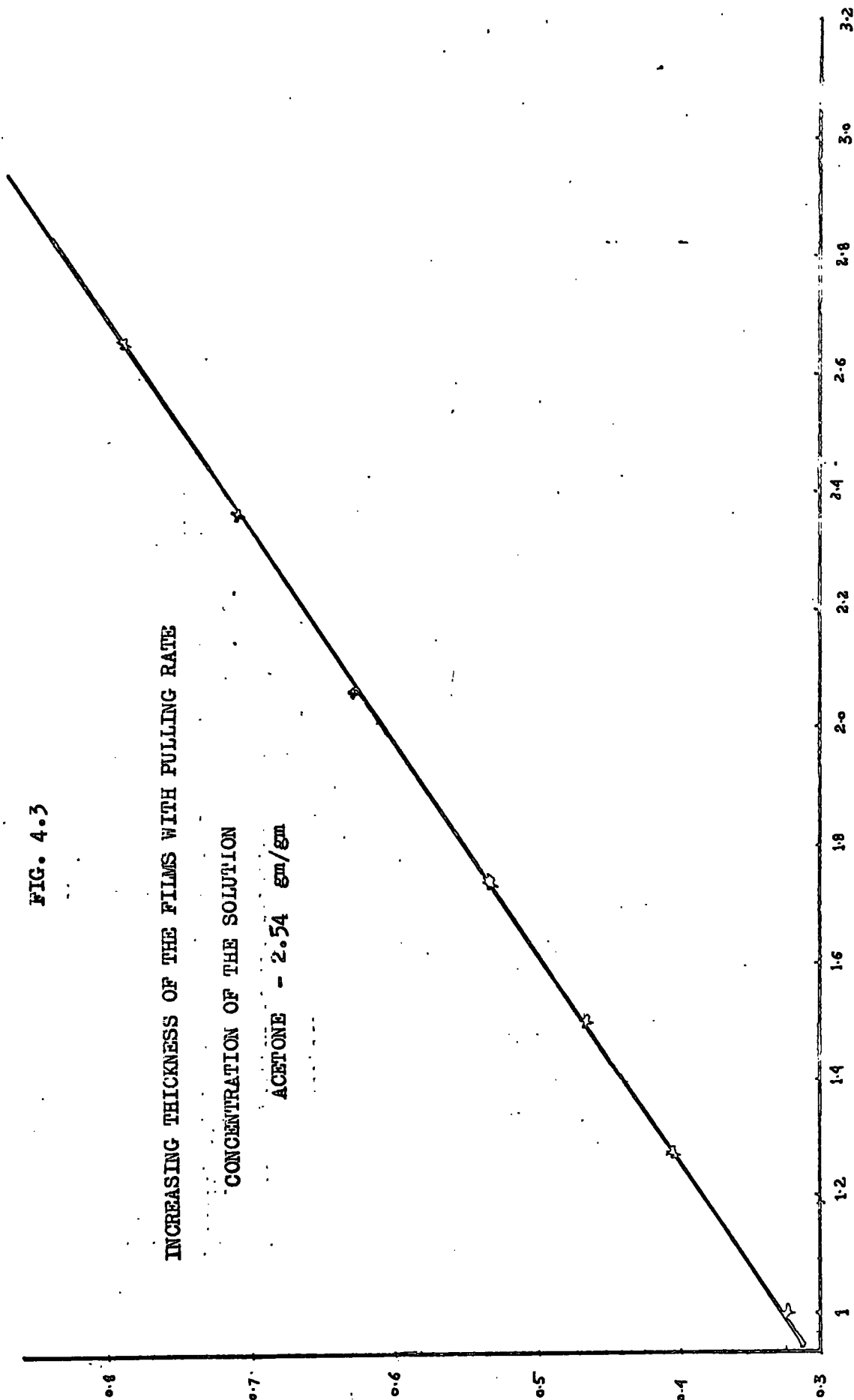

4.3 Humidity and temperature control

The electrodes and specimens were mounted in a humidity chamber which was in turn mounted in a water bath. The temperature of the water bath was controlled to $\pm 0.5^{\circ}\text{C}$ by a mercury thermometer. Throughout the tests, the bath temperature was maintained at 25°C . The humidity chamber was made from a solid block of aluminium 0.177 m deep and 0.177 m in diameter (internal). It had a thick wall of 0.0254 m. The massive construction ensured that small variations in the bath temperature were not transmitted to the specimen. The lid was sealed to the chamber using an O ring and was clamped down to achieve metal to metal contact and good thermal conductivity from the base to the lid. (see Figure 4.4).

The humidity inside the chamber was controlled using saturated salt solutions. The method of humidity control has been discussed by Fionnuala and O'Brien (73). Details of the salts used and the corresponding values of humidity are shown in Table 4.1. There are three requirements for satisfactory operation: the humidity chamber must be carefully sealed to prevent air leaks, the air must be continuously circulated within the chamber, and temperature should remain constant. Provided that these conditions are satisfied, the humidity within the chamber is very stable. This is of considerable importance in measurements of electrical conduction where a small change in humidity can cause a large change in conductance. The method has the disadvantages that the humidity cannot be changed easily, from one value to another, and it requires a long settlement time following a change.

FIG. 4.4

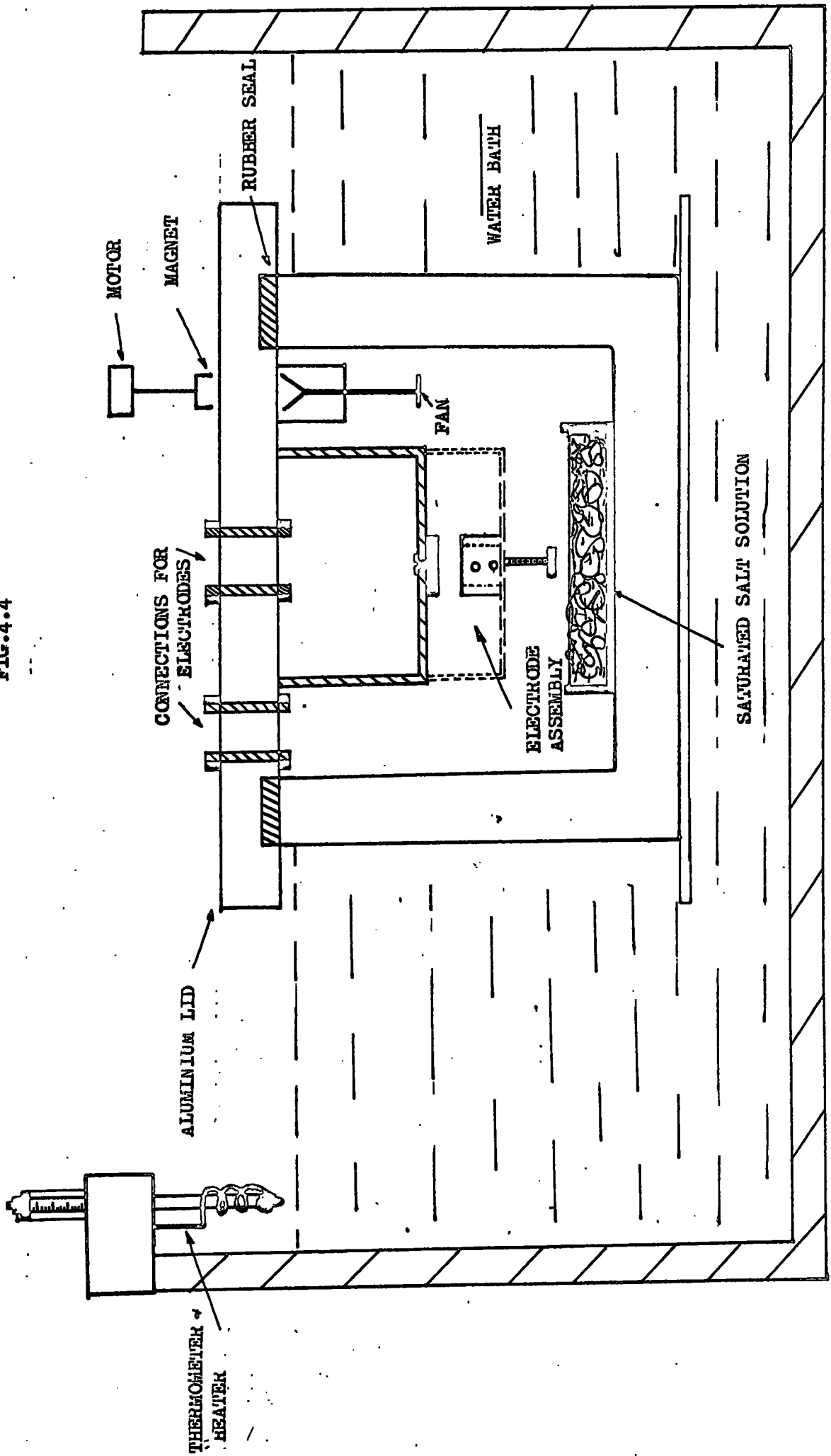

To ensure that the chamber was air-tight, all seals were of the vacuum O ring type. To circulate the air a small fan was mounted inside the chamber. This was driven through a magnetic link ensuring an airtight seal to avoid air leaks along the shaft. The drive motor must be mounted outside the chamber.

4.4 Electrode System

As pointed out in the discussion on the effects of moisture on the electrical properties of polymers, many workers have made measurements using a simple two electrode geometry. This does not allow any distinction to be made between surface and volume conduction. As one of the particular aims of this work was to investigate the existence of separate surface conduction on these materials, the decision was taken early in the work to use a three electrode geometry. The third electrode is used as a guard electrode and serves to define the nature of the measurement more clearly. Figures ^{3,3,34} 4,5 shows the basic arrangement and the electrode connections for volume and surface resistance measurements.

Amey and Hamberger (39) have investigated this system in some detail and have shown in particular, that the effect of the volume current path on measurements of surface conductance is greatly reduced by the presence of the guard electrode. For such systems, Amey and Hamberger gave the following expression for the volume resistance between electrodes 1 and 2;

$$R_{12} = \frac{\rho_v}{S_{12}} \dots\dots\dots (4.1)$$

where S_{12} is the disk (film) shape factor for the volume path between electrodes 1 and 2.

$$S_{12} = \gamma_0 \left(2 \log_e \cdot \tanh \left(\frac{\pi d}{2l} \right) \right) \dots\dots\dots (4.2)$$

$$d = (\gamma_2 - \gamma_1) / 2$$

and for volume resistance between electrodes 1 and 3

$$R_{13} = \frac{\rho_v l}{\pi (\gamma_0 - \lambda)^2} \dots\dots\dots (4.3)$$

where λ is fringing constant

$$\lambda \cong l \left(2/\pi \log_e \cosh \left(\frac{\pi d}{2l} \right) \right) \dots\dots\dots (4.4)$$

These equations hold so long as the following assumptions are justified:-

$$\begin{aligned} \gamma_1 / l &> 2 \\ (\gamma_3 - \gamma_2) / l &> 2 \\ d / \gamma_0 &< 0.5 \end{aligned}$$

where $\gamma_0 = (\gamma_1 + \gamma_2) / 2$

The actual electrode system is shown on Figure (4.5). The electrode pattern was sprayed onto the polymer film which was then clamped between the electrodes using the thumb screw. Holes were drilled in the top electrode to ensure free ventilation and rapid sorption of moisture by the polymer. The electrodes were of stainless steel, and the rest of system was of brass. Polytetrafluoroethylene was used to insulate the electrodes from earth. The electrode system was mounted in the humidity chamber above the saturated salt solution and adjacent to the fan. The electrodes were connected to three coaxial terminals on the lid of the humidity chamber which was earthed.

Similar expressions hold for the capacitance and a.c. conductance between electrode 1 and 3.

$$\begin{aligned} C_{013} &= \epsilon_0 \pi (\gamma_0 - \lambda)^2 && \dots\dots (4.5) \\ C_{13} &= \epsilon' C_{013} \\ G_{13} &= \omega \epsilon'' C_{013} \end{aligned}$$

For the electrode system used in the experiment,

$$\begin{aligned} \gamma_1 &= 13.5 \text{ mm} \\ \gamma_2 &= 17.5 \text{ mm} \\ \gamma_3 &= 21.5 \text{ mm} \end{aligned}$$

λ , the fringing constant is a function of the specimen thickness. The maximum specimen thickness was 0.028 mm and the minimum 0.018 mm. The corresponding values of λ are 1.9 and 2.0 mm.

FIG. 4.5

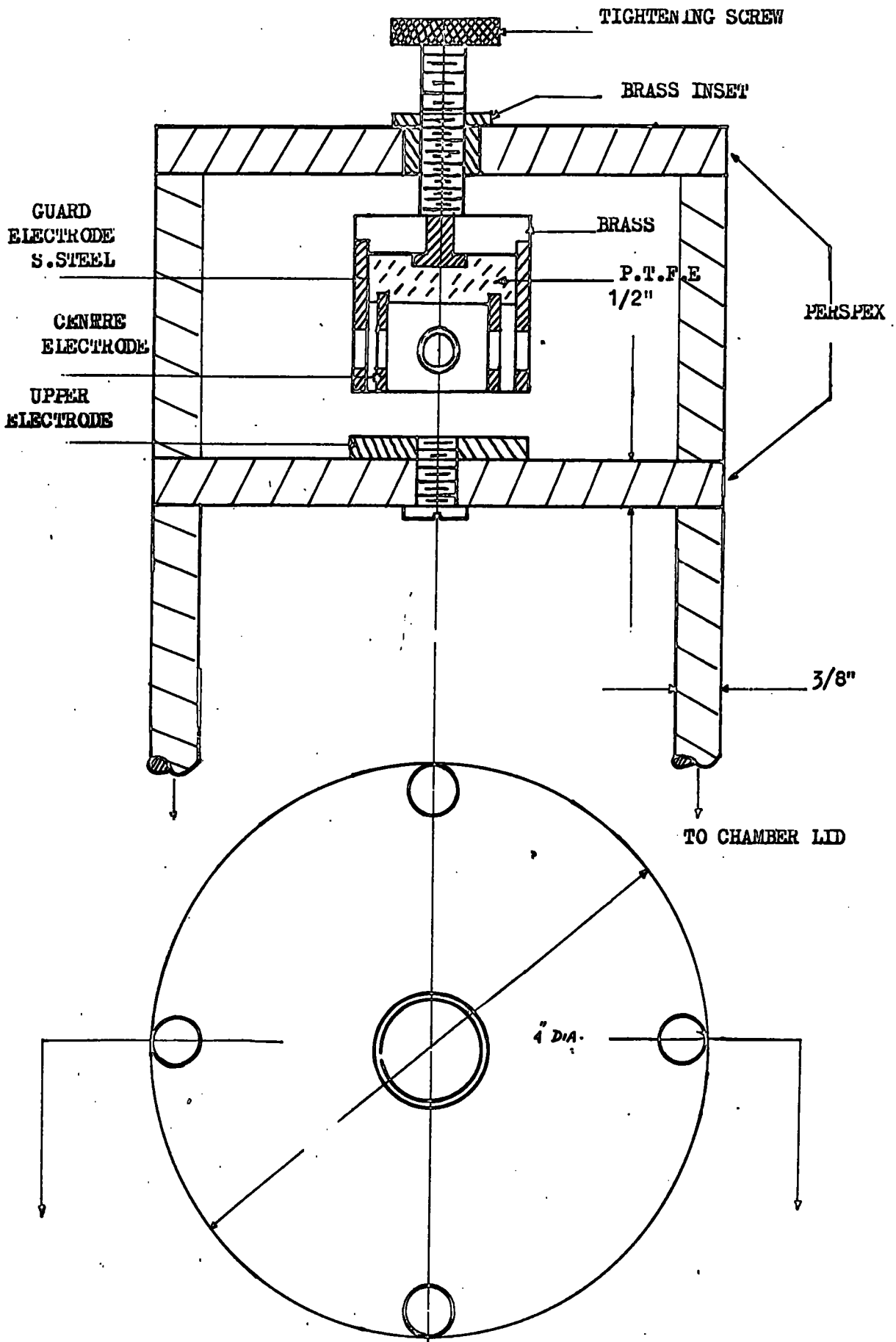

THE TOP ELECTRODE ASSEMBLY IS FREE TO ROTATE

The shape factor, S_{12} , becomes

$$\begin{aligned} S_{12} &= \gamma_0 \left(2 \log_e \cdot \tanh \left(\frac{\pi D}{2l} \right) \right) \\ &= \gamma_0 \left(2 \log_e \cdot (1.0) \right) = 0 \end{aligned}$$

$$\text{and } R_{13} = \frac{l P_v}{\pi (\gamma_0 - \lambda)^2} \approx \infty$$

Consequently in any surface measurements, the effect of the shunt path can be neglected any measureable current will be a genuine surface current and not a volume current.

4.5 Electrical measurements

Measurement of specimen capacitance, a.c. conductance (normally at one frequency, but also at variable frequencies), and d.c. conductance were made. The dielectric constant ϵ' and d.c. conductivity σ were then calculated.

4.5.1. A.C. measurements

The specimen capacitance and conductance were measured by a 1615-A capacitance bridge (General Radio Company). This is a transformer ratio arm bridge which measures capacitance from a maximum of 10^{-6} Farads to 10^{-17} Farads with an accuracy of $0.01\% \pm 0.00003$ picofarads at 1 KHz.

Additional errors are introduced at high and low frequencies. The conductance is measured from 0.1 μ mho to 10 P mho with an accuracy of 0.01% over the whole range of frequency. Large conductance measurements can be made in terms of dissipation factor and converting them into conductance using the expression,

$$G = D \times 2\pi f \times C \quad \mu\text{mho}$$

(from equation 3.14 and 3.16)

c =capacitance in picofarads.

The advantages of using a transformer ratio arm bridge for these measurements are,

- (1) The high measurement accuracy obtainable,
- (2) The ability to measure a very small capacitance with no effects from the shunt capacitance of long cables,
- (3) The measurement of a very wide range of impedances.

The bridge was supplied from a variable frequency oscillator (Phillips L.F. Generator) which had a range of 14 Hz to 150 KHz. The error signal from the bridge was measured by a Tansley detector amplifier (Type 5710 tuned amplifier) which had a tunable frequency range from 10 Hz to 100 KHz and a sensitivity such that 0.1 microvolts could be detected over the whole range. In practice, the oscillator was tuned to give maximum detector deflection before balancing the bridge. The detector frequency read-out was calibrated against a digital counter and found to be within

$\pm 1\%$ of actual frequency. The minimum frequency at which satisfactory results could be made was 30 Hz and the maximum frequency was 10 KHz.

4.5.2 D.C. measurements

The d.c. conductance of the specimen was measured by a fast picoammeter (Vacuum Generators' Ltd., Model DC1). The instrument consists of a transistor d.c. amplifier preceded by a balanced pair of electrometer valves. It is in effect a millivoltmeter in having a very high input resistance. Current can be measured in two different ways. In the slow mode of operation current is measured by passing it through a standard high resistance and recording the voltage drop. For the present work the fast mode of operation was used. With this connection, a standard resistance is connected between the input and output of the amplifier and the current to be measured is applied to the "virtual earth" input thus formed. The fast mode of operation reduces the effect of shunt capacitance at the input socket on the response time of instrument. The picoammeter measures current from maximum of 3×10^{-5} amps to a minimum of 10^{-13} amps, full scale. The maximum response time in the fast mode of operation is shown in the following table,

<u>Amperes full scale</u>	<u>No added capacitance</u>	<u>50 μF added capacitance</u>
10^{-13}	250 ms	300 ms
10^{-12}	30 ms	35 ms
10^{-11}	5 ms	5 ms
10^{-10}	2 ms	2 ms
10^{-9}	2 ms	2 ms
10^{-8}	2 ms	2 ms

The drift is negligible after the instrument has warmed up. In practise the instrument was warmed up for an hour before any measurements were made. The average value of current was recorded from the current readings for positive and negative supply voltages. The accuracy of the instrument is $\pm 4\%$ of full scale, exclusive of noise and drift. The voltage applied to the specimen was obtained from a switched high voltage supply (Keithley Instruments) with a voltage range of 0-1200 volts. When the voltage is applied to the electrodes, the resulting current through the volume of the material decreases with time to a limiting value. Usually after one minute, the current is substantially constant. The time interval between the application of voltage and the measurement of current is called the electrification time. The limiting value of current is the conduction current, and current in excess of the conduction current is called the absorption current. The electrification time cannot be prolonged indefinitely, particularly at high humidities, as electrolysis may occur.

5.0. Experimental results and discussion

5.1 Introduction

The measurements of dielectric constant and d.c. conductivity described above were made on films of cellulose acetate and cellulose acetate butyrate. Two techniques were adopted to determine the effect of sorbed moisture on these properties of the materials. In the first, measurements were made as a function of time following an abrupt change in the humidity in the chamber and in the second, measurements of the equilibrium values as a function of humidity were recorded.

Following the application of the electrodes to the specimen using the spray gun, the specimen was baked in the oven at 60°C for twelve hours to remove the paint solvent. It was then mounted between the electrodes and placed in the chamber over a desiccant. Silica gel (activated) was normally used. Phosphorous pentoxide (P_2O_5) and molecular sieves were tried but very little difference in the initial dry properties of the film were recorded. The desiccant was kept in the chamber in the water bath overnight, and a readings of the dry specimen properties were taken in the morning, prior to its exposure to any humidity. The relative humidity in the chamber was produced by substituting a tray containing the required saturated salt solution for silica gel. The time at which the film was exposed to the humid atmosphere was taken as the initial time and measurements of the a.c. and d.c properties were made continuously one after the other for the first hour or so. The time for each set of readings, e.g. capacitance,

a.c. conductance and d.c. conductance was carefully noted. The parameter values and the associated time at which these values were recorded, were used to compute a new set of parameters at predetermined time intervals using a curve fitting program available on the university computer. The program was modified to calculate $1/\epsilon'$ and $\ln \sigma$ as required. In this way it was possible to compare values of $1/\epsilon'$ and $\ln \sigma$ at the same point in time. Equilibrium values were either obtained at the end of a time run or by leaving the specimen over the saturated salt for some seventeen hours overnight after it had been changed. Previous experience had shown that this was sufficient time for equilibrium to be attained. The salts were changed such that the humidity increased or decreased steadily throughout the run and the specimen was not dried between different humidity values so that hysteresis, if present, could be correctly observed.

5.2 Effect of humidity on dielectric constant, a.c. conductance and d.c. conductance.

The effect of humidity on the dielectric constant, a.c. conductance and d.c. conductance of the specimens was to increase the values of these parameters. In the time response runs following the exposure to a humid atmosphere of an initially dried specimen the dielectric constant a.c. conductance and d.c. conductance of the specimens increased with time until the equilibrium stage was reached. In the initial stages the values of dielectric constant and d.c. conductance increased rapidly but the rate of change fell off with time. Figures 5.1 to 5.3 show these increases following an initial abrupt change of humidity in the chamber. Comparing the initial dry values with the final equilibrium values at 43% relative humidity, capacitance increases by a factor of 1.3 or 1.1, a.c. conductance by a factor of 1.05 or 1.0 and d.c. conductance by a factor of 10^{+3} or $10^{+2.5}$ for cellulose acetate or cellulose acetate butyrate respectively. This characteristic has been noticed previously by many workers (1, 63, 64) who studied the effect of sorbed moisture on dielectric properties of these materials. At higher humidities the changes are much greater. For example with cellulose acetate at 96% relative humidity capacitance increases by a factor of 1.8 and d.c. conductance by a factor of 10^{+6} .

If the equilibrium values of the specimen parameters are plotted against humidity (%) the curves are shown on figures 5.4 to 5.7 are obtained. The increases in the capacitance, a.c. conductance and d.c. conductance are similar to those obtained in the time response run. In addition these curves show marked hysteresis which is to be expected.

FIG.5.1

VARIATION OF DIELECTRIC CONSTANT WITH TIME
CELLULOSE ACETATE FILM THICKNESS 1.778×10^{-5} m

CELLULOSE ACETATE BUTYRATE

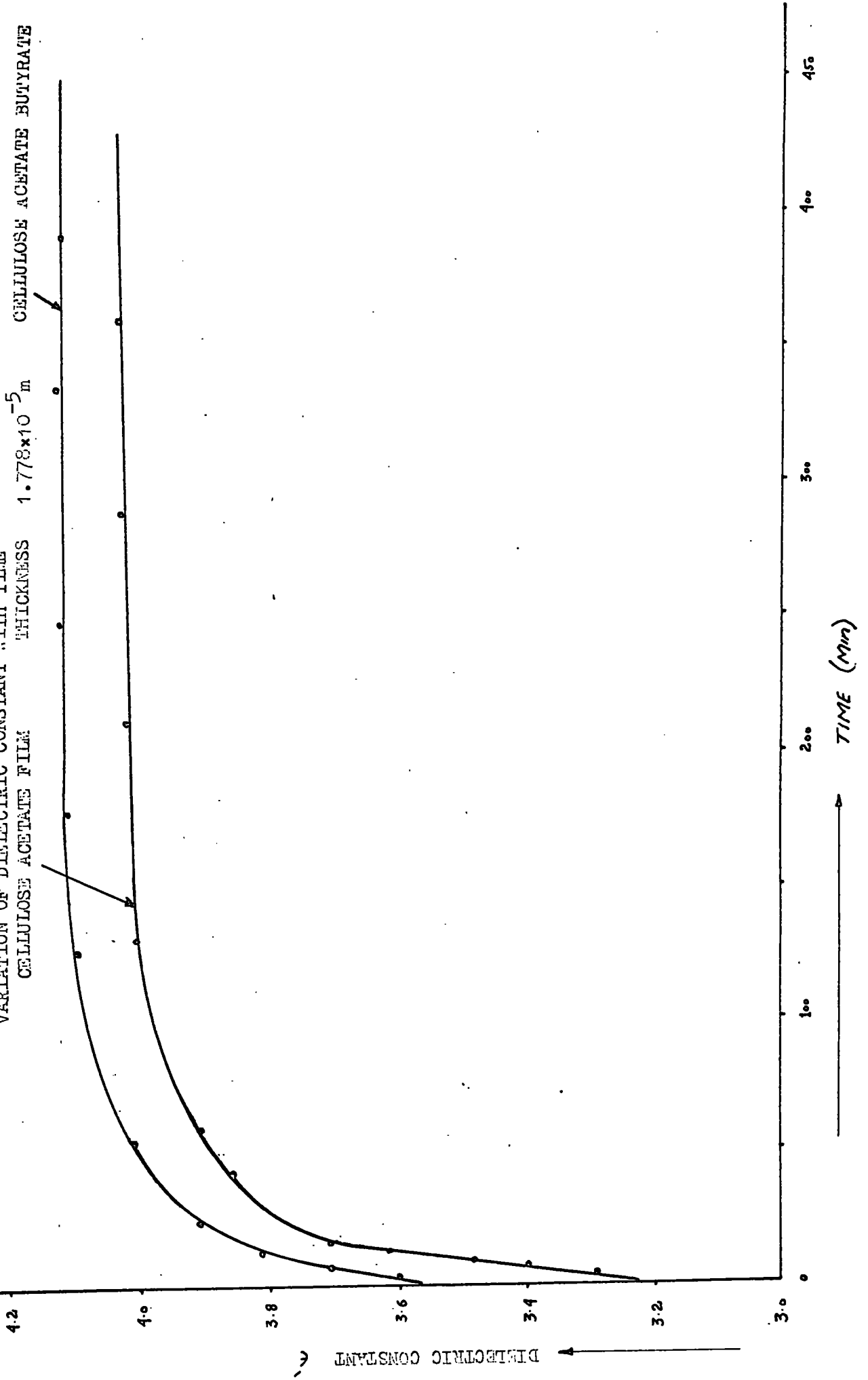

FIG. 5.2.

VARIATION OF CONDUCTANCE (p.c) WITH TIME
CELLULOSE ACETATE FILM THICKNESS 1.778×10^{-5} m
AND CELLULOSE ACETATE BUTYRATE

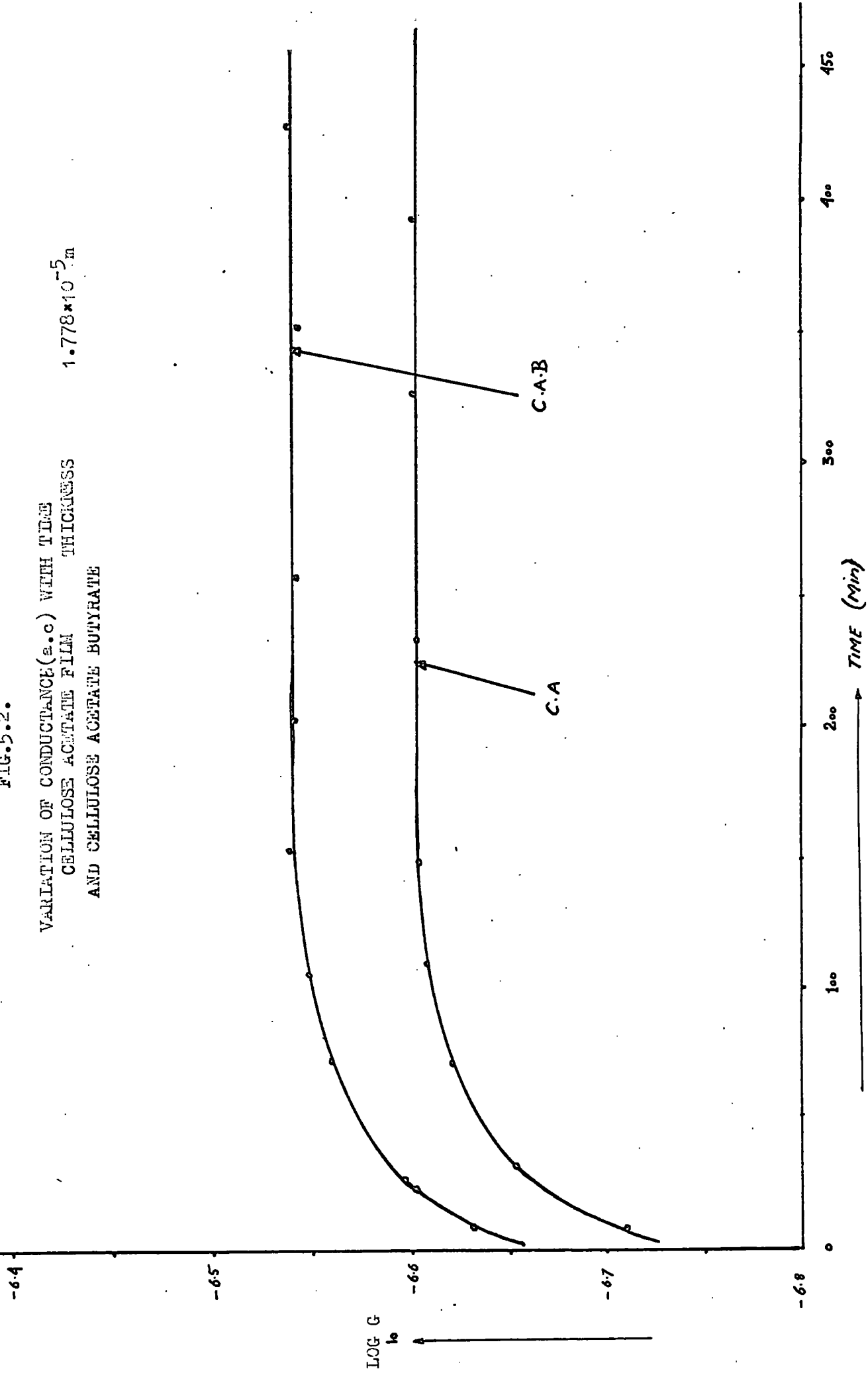

FIG.5.3.

CELLULOSE ACETATE FILM THICKNESS 1.778×10^{-5} m

CELLULOSE ACETATE BUTYRATE

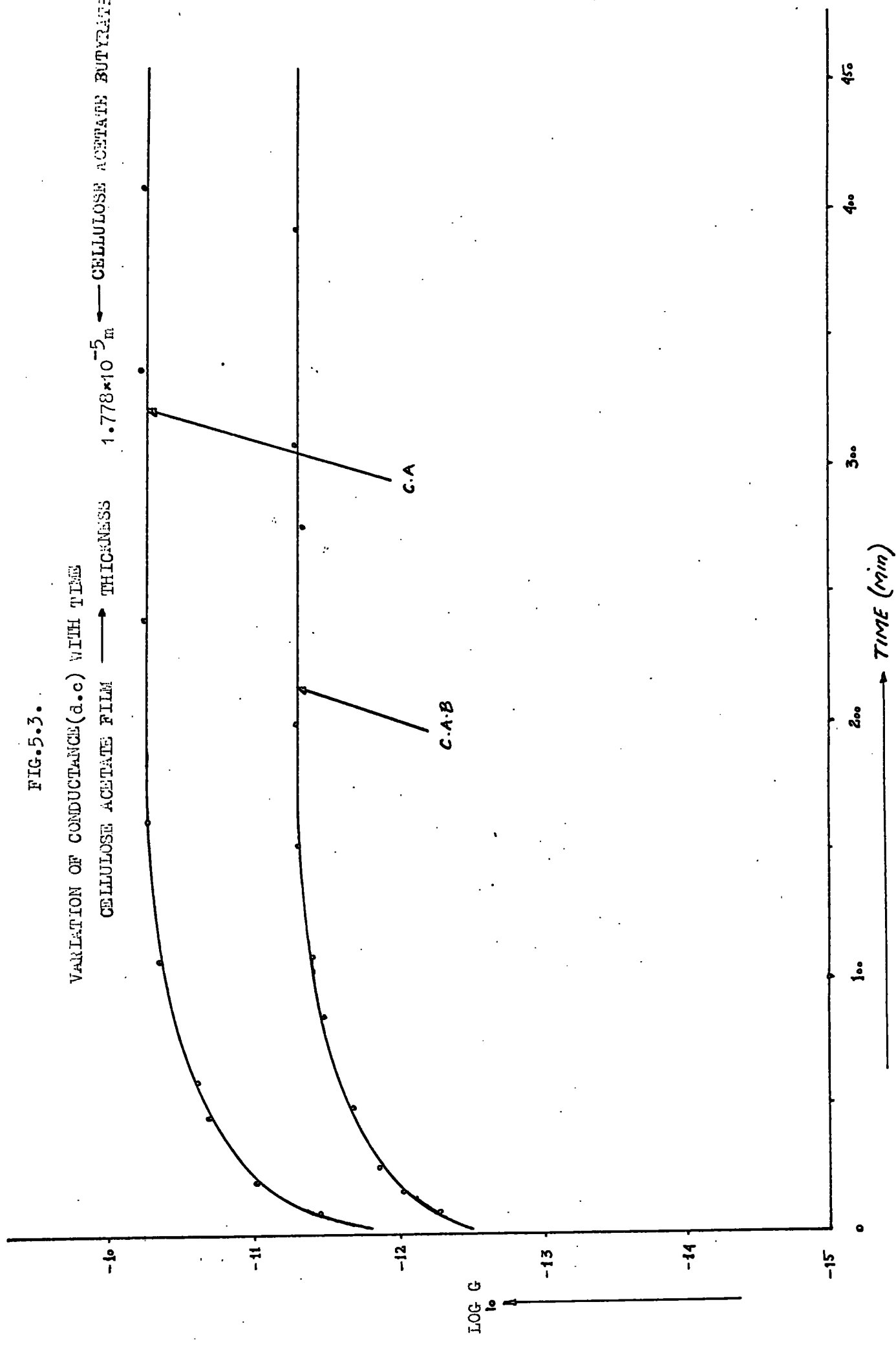

FIG. 5.4

CELLULOSE ACETATE FILM

THICKNESS 1.778×10^{-5} m

CHARACTERISTIC HUMIDITY DEPENDENCE.

CAPACITANCE VS RELATIVE HUMIDITY.

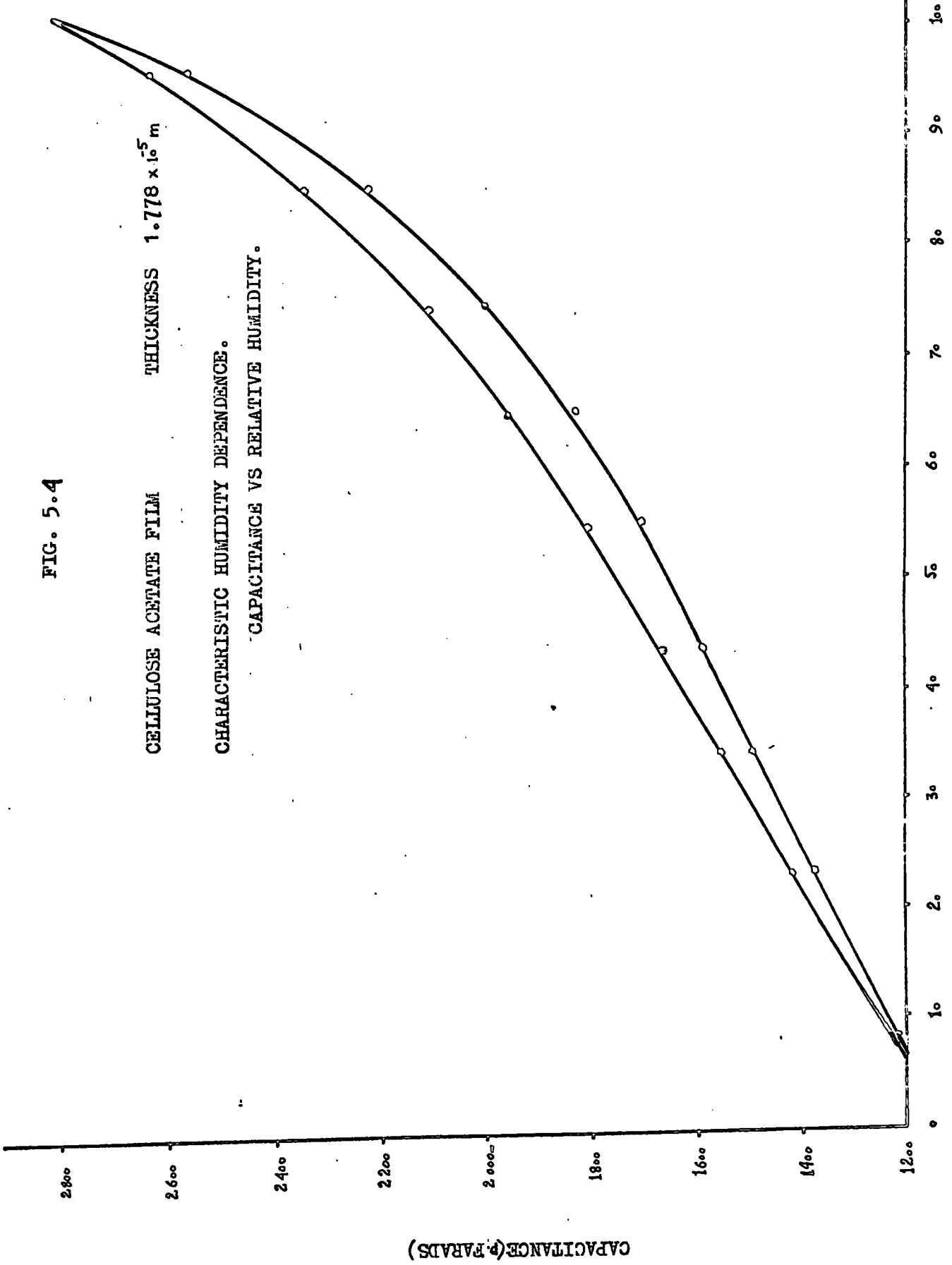

FIG. 5.5

CELLULOSE ACETATE BUTYRATE FILM THICKNESS 1.778×10^{-3}

CHARACTERISTIC HUMIDITY DEPENDENCE.
CAPACITANCE VS RELATIVE HUMIDITY.

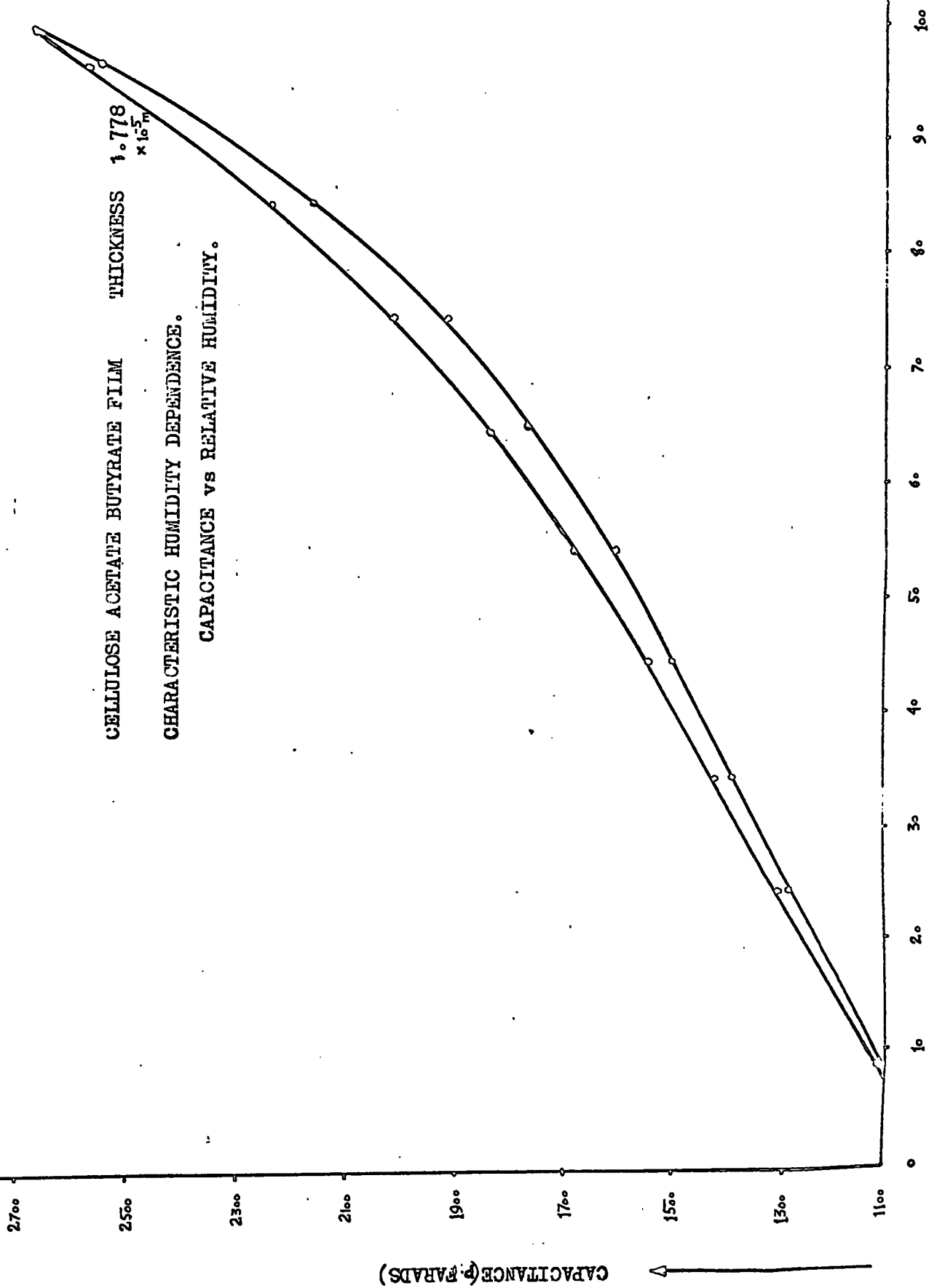

FIG. 5.6

CELLULOSE ACETATE FILM THICKNESS 1.778×10^{-5} m

CHARACTERISTIC HUMIDITY DEPENDENCE.

CONDUCTANCE vs RELATIVE HUMIDITY.

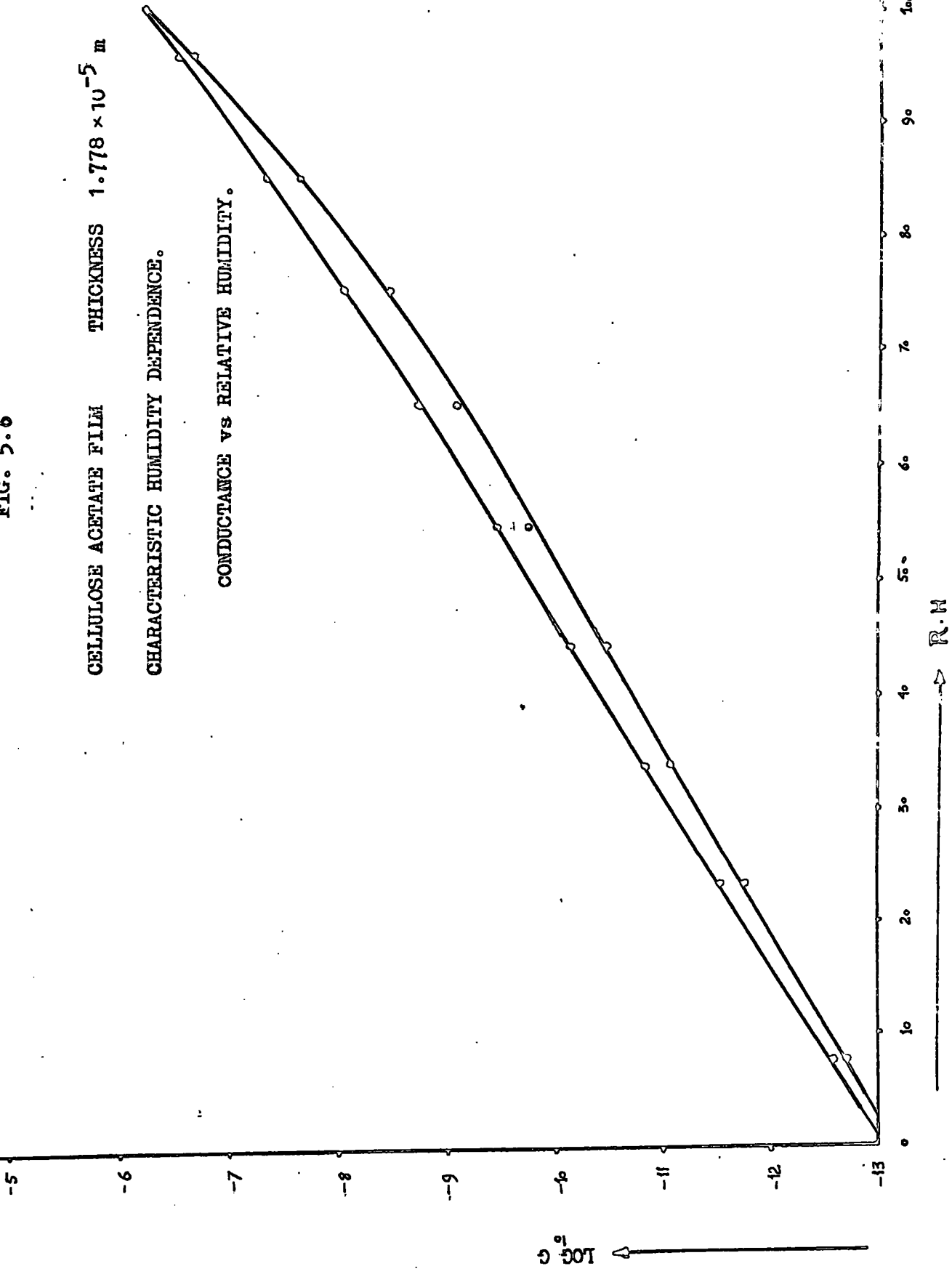
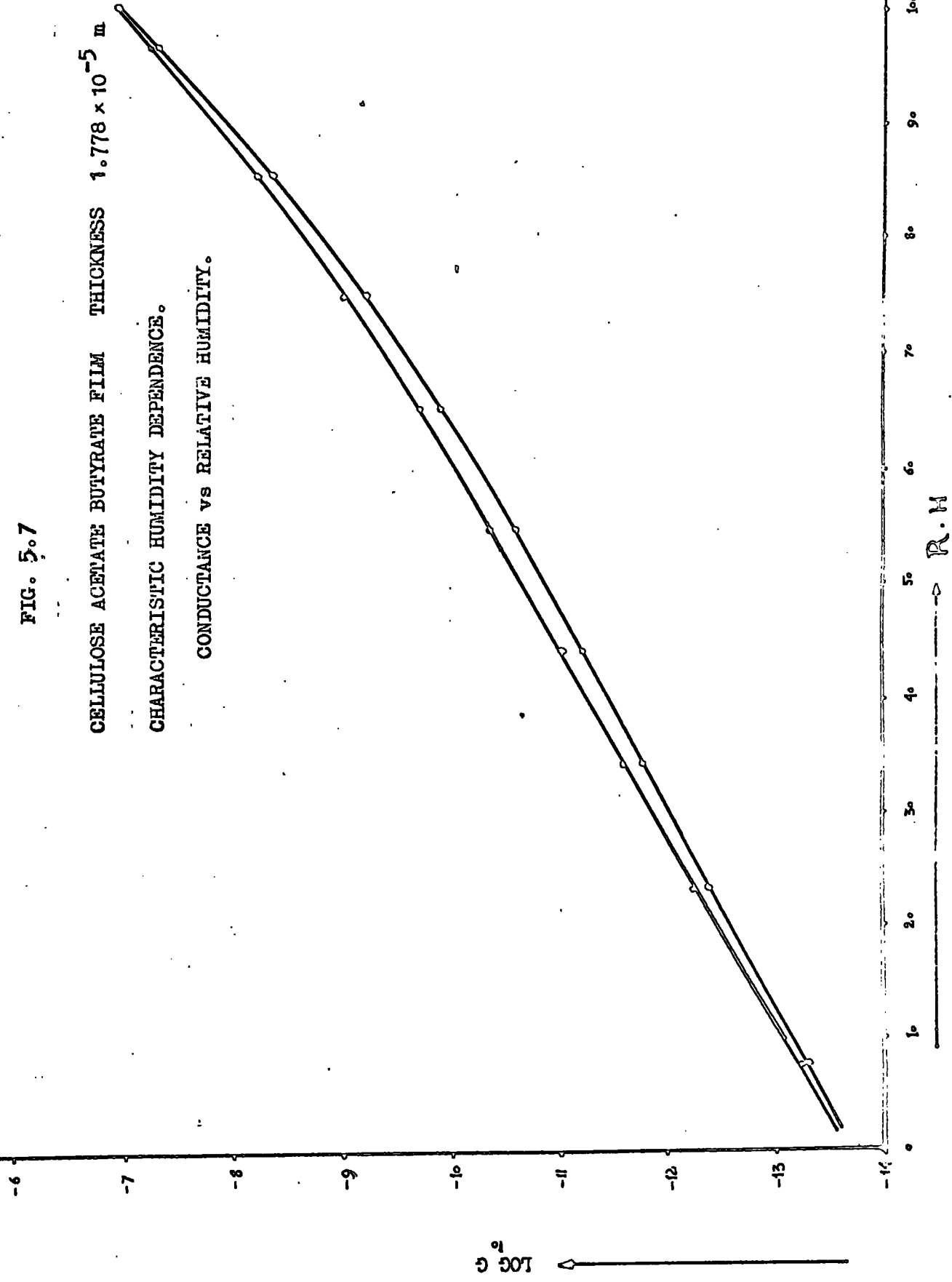

FIG. 5.7

CELLULOSE ACETATE BUTYRATE FILM THICKNESS 1.778×10^{-5} m.

CHARACTERISTIC HUMIDITY DEPENDENCE.

CONDUCTANCE vs RELATIVE HUMIDITY.



As pointed out in section 2.4, hysteresis is a characteristic of the sorption process.

An attempt was made to determine the sorption isotherms for the materials used in the above tests. Figure 5.8 shows the results obtained for cellulose acetate. This can be interpreted as an indication of the sorption characteristic of the material, but as the temperature control was not functioning satisfactorily, the results may be in error. For the same reason, it was not possible to obtain sorption characteristics of cellulose acetate butyrate which sorbs less moisture. Nevertheless the results agree with those published by Wakuni and Calder Wood (49), among others. It is interesting to compare the sorption characteristics of cellulose acetate with the electrical characteristics plotted above. It is noted that capacitance, and a.c. conductance increased nearly linearly with the amount of moisture sorbed whereas d.c. conductance increases exponentially with the sorption, as shown in figures 5.9 , 5.10. The authors reviewed previously have reported very few direct comparisons of sorption and electrical characteristics. Rosenberg (62) found that the conductivity in haemoglobin crystals increased exponentially with the amount of moisture sorbed. The results are very similar, however, to those obtained by various authors (see McIntosh (12)) for the increase in capacitance due to the physical adsorption of water and other solvents on materials such as silica gel. McIntosh suggests that for systems such as the one reported above where the water mixes continuously through the solid dielectric, the dielectric constant of the system may be found by adding dielectric constant of the constituent on the volume fraction basis,

FIG. 5.8.

SORPTION ISOTHERM

CELLULOSE ACETATE FILM

THICKNESS $1.778 \times 10^{-5} \text{ m}$

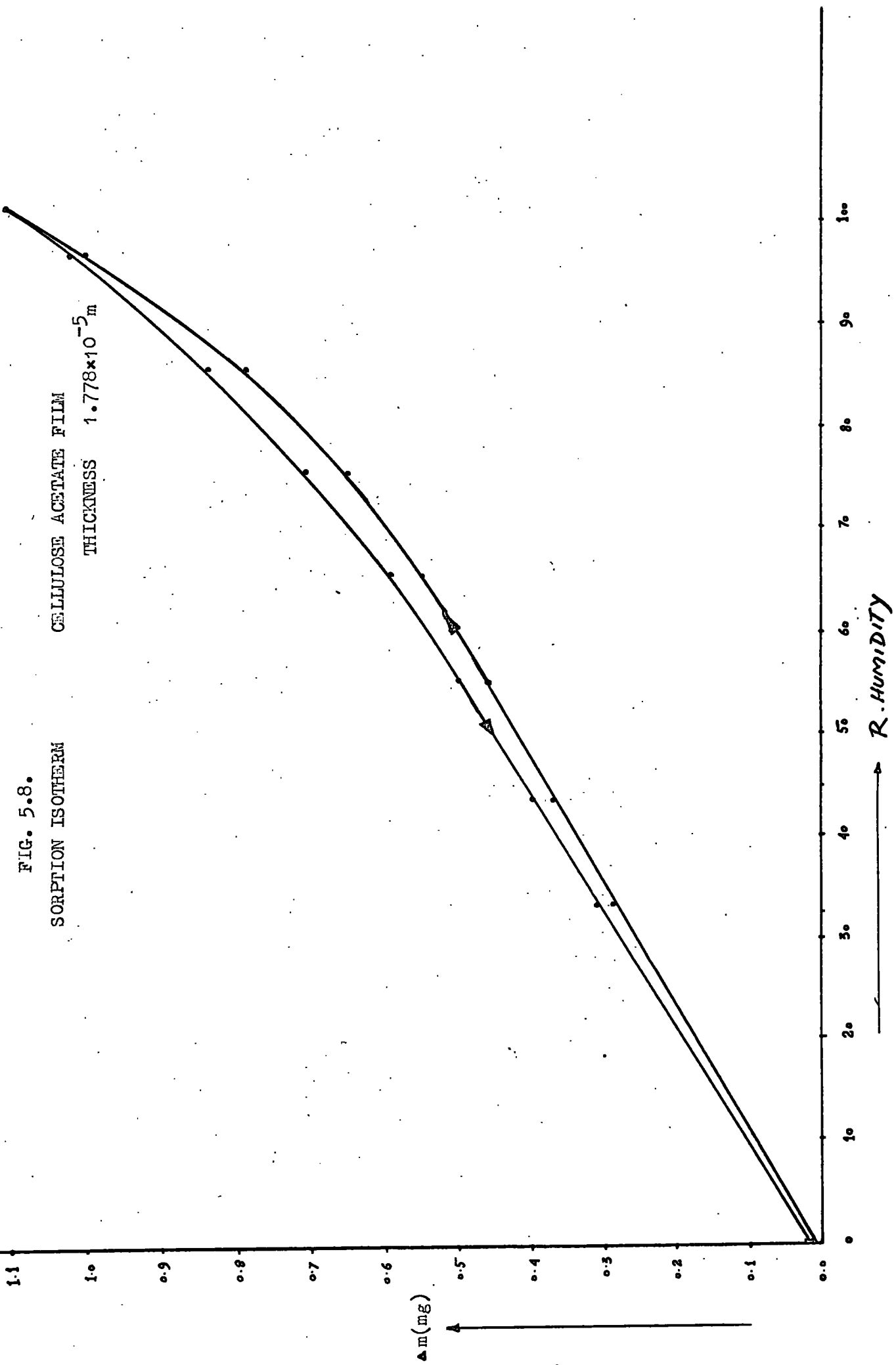

FIG. 5.9.

VARIATION OF CAPACITANCE WITH THE AMOUNT OF MOISTURE SORBED
CELLULOSE ACETATE FILM THICKNESS $1.778 \times 10^{-5} \text{ m}$

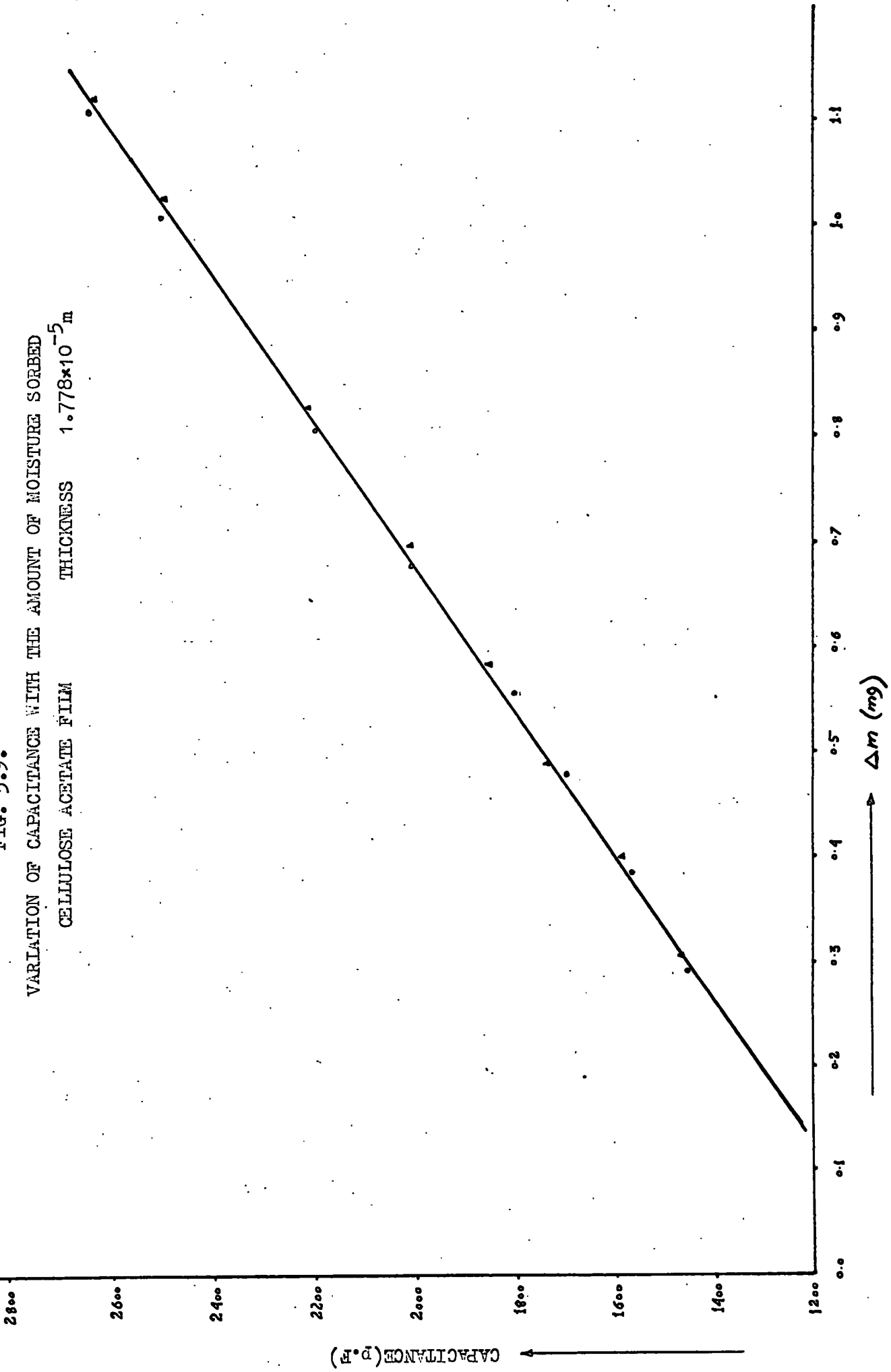
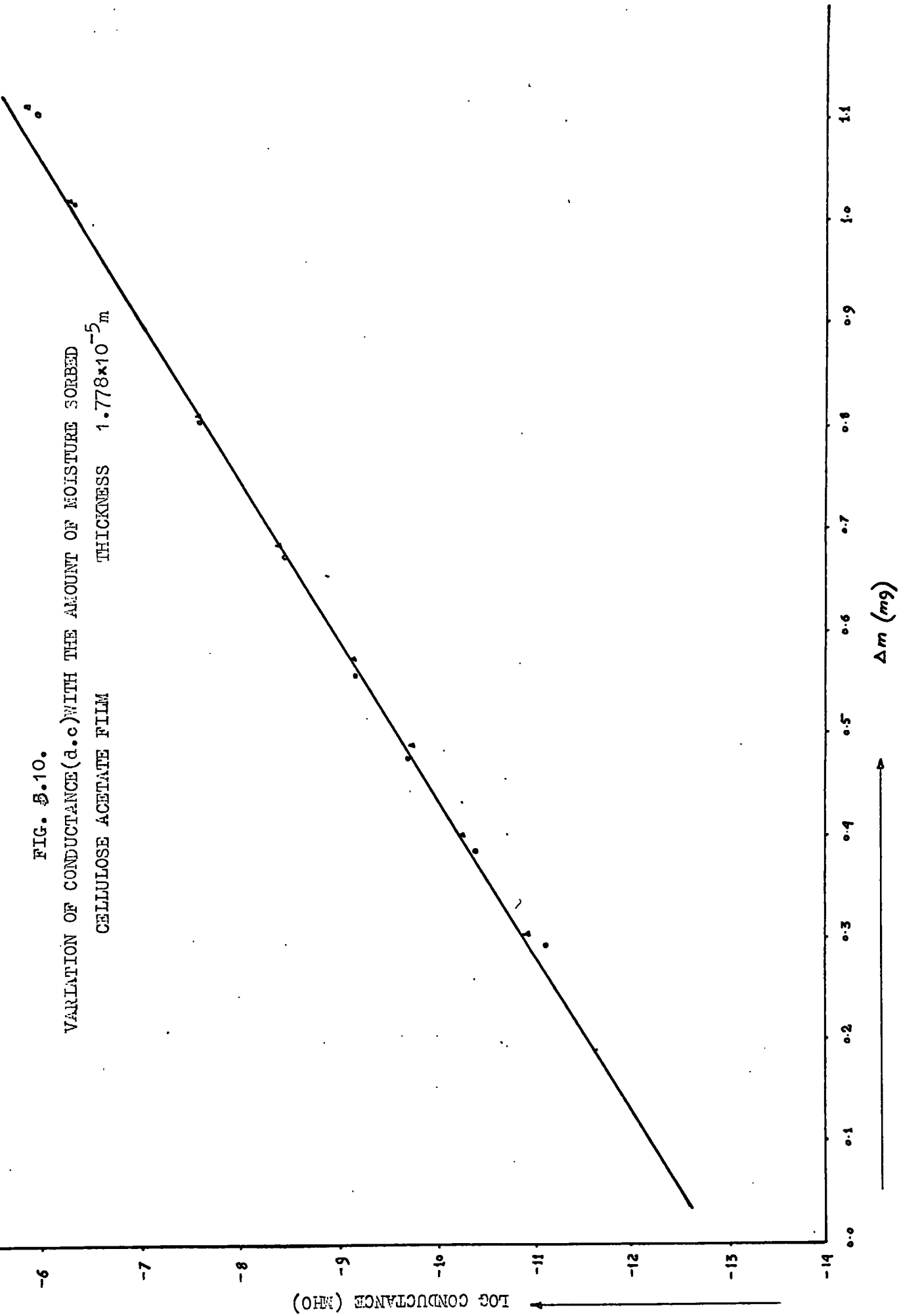

FIG. 5.10.

VARIATION OF CONDUCTANCE(d.c) WITH THE AMOUNT OF MOISTURE SORBED
CELLULOSE ACETATE FILM THICKNESS $1.778 \times 10^{-5} \text{ m}$



$$\epsilon' = \sum \epsilon'_i \delta_i \quad \dots (5.1)$$

where ϵ_i and δ_i are the dielectric constants and the volume fraction of the i th phase. Figures (5.11) show the actual variation in ϵ' with the amount of moisture sorbed by the material and also the values calculated using equation (5.1), these results clearly disagree. McIntosh suggests alternative approaches to the calculation of ϵ' for mixtures but these apply mainly to porous solids.

5.3 Comparison of the results with the dissociation theory of Barker and Thomas

As has already been pointed out, the very large increase in d.c. conductance compared with the changes in the a.c. properties of the specimens led King and Medley (63), Hearl (64) and Barker and Thomas, to suggest that ionic dissociation plays a large part in the conduction process. Clearly according to the Nernst- Thompson rule when a solvent of high dielectric constant such as water enters the material, it reduces electrostatic attraction between the ion pairs in that material and hence increases the number of ions. As seen from equation (3.20) the electrical conduction in polymers is expressed by the relation,

$$\sigma = \sum n_i \mu_i e$$

The sorption of water by the specimens only produces ions or current carriers n_i which in turn increase the conductivity of the specimens but the mobility μ_i of these ions virtually remain constant. The dissociation theory of Barker and Thomas (1), reviewed previously in section (3.4.3) leads to the following equation for the d.c. conductance,

FIG. 5.11.

VARIATION OF DIELECTRIC CONSTANT WITH THE AMOUNT OF
MOISTURE SORBED.

CELLULOSE ACETATE FILM THICKNESS 1.778×10^{-5} m

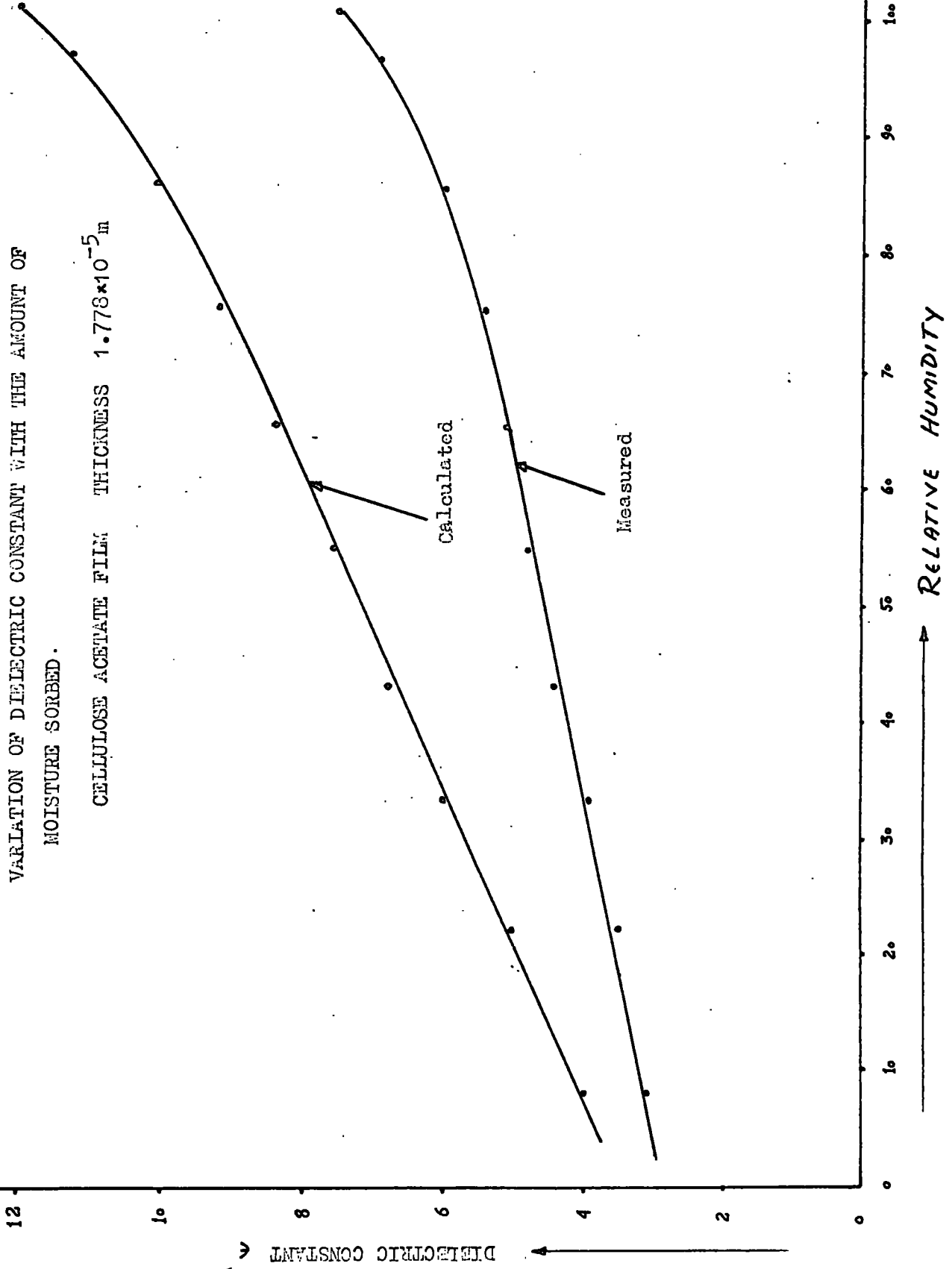

$$\sigma = \gamma^{-1} (K n_0)^{1/2} \exp(-U_0 / 2\epsilon K T) (\mu_+ + \mu_-) e$$

$$\text{or } \log \sigma \approx \log(\gamma^{-1} K) + 1/2 \log n_0 - (U_0 / 4 \cdot 605 K T)^{1/\epsilon'}$$

$$\log \sigma \approx a + b \cdot 1/\epsilon'$$

$$a = \log \left((\gamma^{-1} (K^{1/2} n_0^{1/2})) (\mu_+ + \mu_-) e \right) \quad b = (-U_0 / 4 \cdot 605 K T)$$

which indicates a linear relationship between the logarithm of conductivity and the reciprocal of the dielectric constant of a specimen and proportionality between the conductivity and the square root of the number of ions in the specimen.

Following the method of Barker and Thomas who plotted $\log \sigma$ against $1/\epsilon'$ for a specimen of cellulose acetate, the results obtained from the present work for cellulose acetate and cellulose acetate butyrate specimens are plotted on figures (5.12 and 5.19). The results are based on time response data obtained following an abrupt change in the humidity in the chamber. Figures (5.13 - 5.18; 5.20 - 5.25) show the variation of the parameters $1/\epsilon'$ and $\ln \sigma$ with time at different humidities for C.A. and C.A.B. materials. The points on the figures represent the actual results obtained from three experiments and the average of the three corresponding computer outputs for each humidity. These figures show the spread in the experimental results. The average of the three computer outputs clearly lies between the experimental values. Barker and Thomas used only one humidity in their experiments, but in the present work three different humidities were used in each case. As seen on the figures (5.12 and 5.19) the values for $\ln \sigma$ against $1/\epsilon'$ for each humidity lie on a straight line and have the same slope except for the initial values. These initial values were taken within 10 to 20 minutes after the film was exposed to the humid atmosphere. The changes in the values of capacitance and conductance during this period

were quite rapid and on the reflection, the effective starting time for each run may not have been exactly the same from one run to the next due to delay in closing the chamber. In the present work the straight lines have same slope but different intercepts. In the case of the time response run made at 22% relative humidity on a C.A.B. film, the straight line does not have the same slope as the lines obtained for 43% and 65% relative humidity. It is considered that 22% relative humidity is very low humidity and the results obtained at this humidity may not be directly comparable with results obtained at higher humidities. According to Barker and Thomas theory, the results obtained at any humidity should lie on the same straight line.

FIG. 5-12

FINE RESONANCE PILING ON CELLULOSE ACETATE FILM OF 0.003 CM THICKNESS

$\ln \sigma$ vs $1/\epsilon'$

FILM THICKNESS 0.003 CM

RELATIVE HUMIDITIES

x — 43%

Δ — 75%

● — 96%

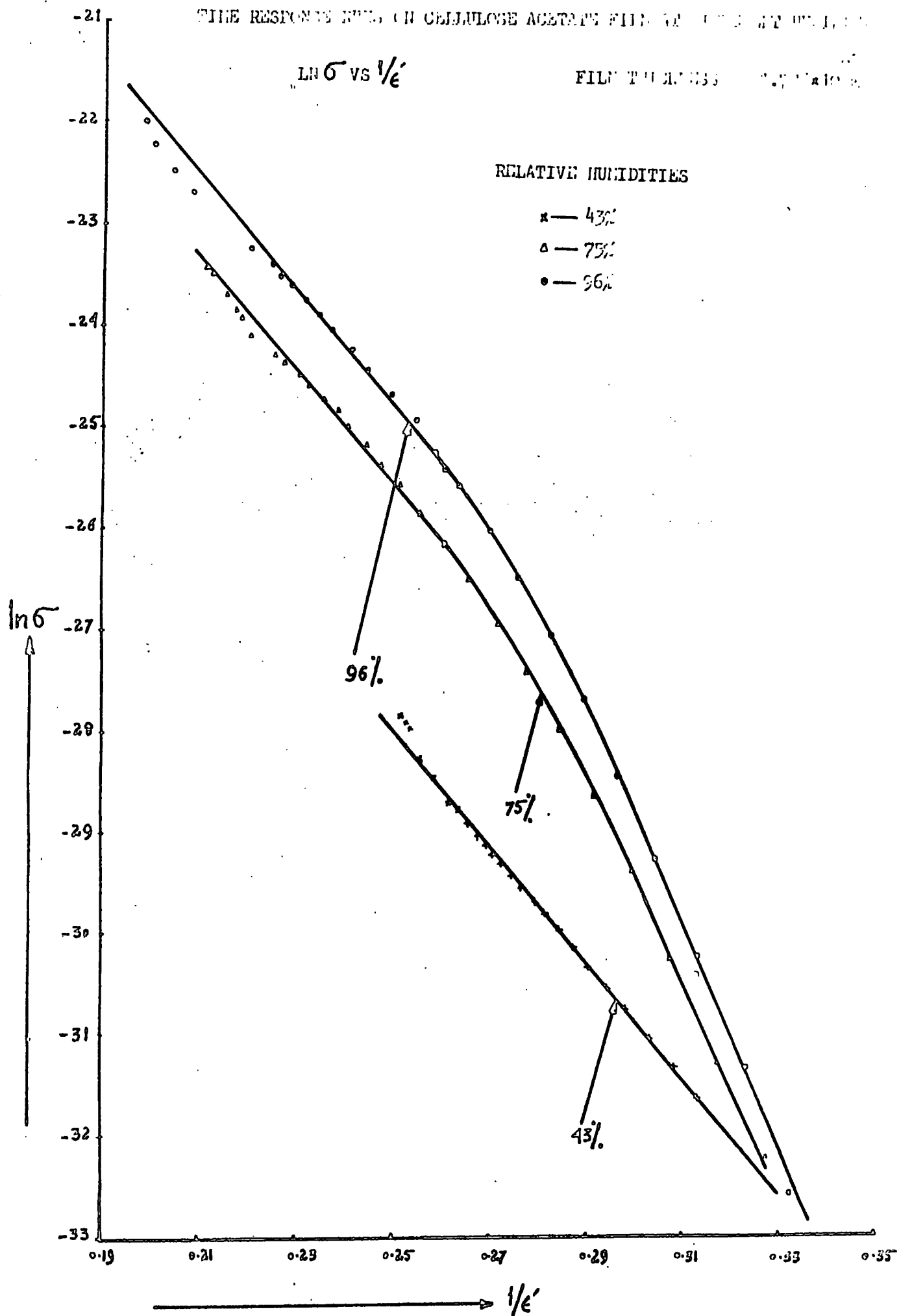

FIG. 5-13

VARIATION OF $\frac{1}{\epsilon}$ WITH TIME DURING TIME RESPONSE RUNS ON CELLULOSE ACETATE FILM AT 450 RELATIVE HUMIDITY.

FILM THICKNESS 1.778×10^{-5}

Δ 1st Run
 \circ 2nd Run
 \times 3rd Run

— EXPERIMENTAL

\bullet — AVERAGE OF THREE COLLECTED POINTS

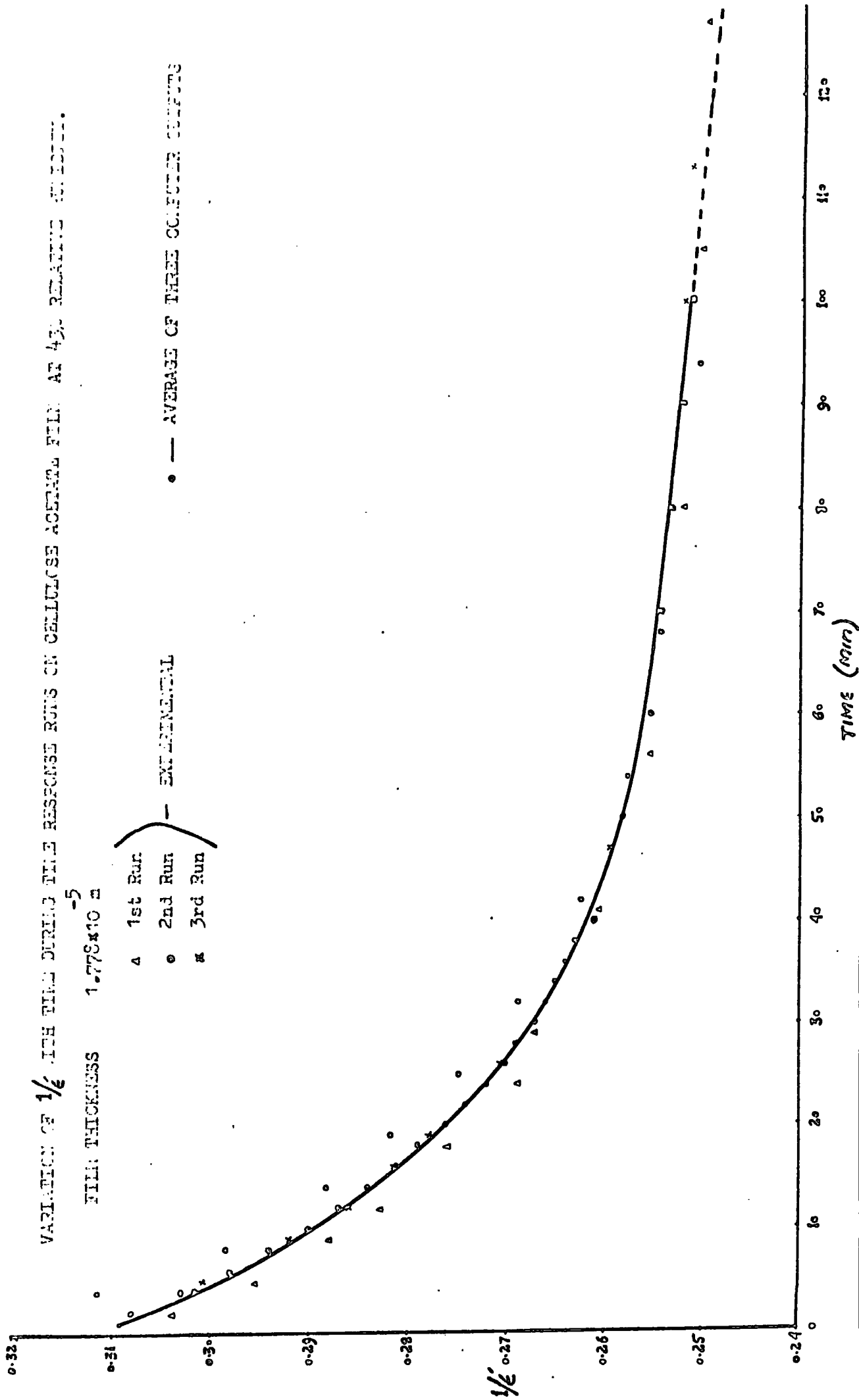

FIG. 5-14

VARIATION OF $\ln \sigma$ WITH TIME DURING TIME RESPONSE RUNS ON CELLULOSE ACETATE FILM AT 43% RELATIVE HUMIDITY.

FILM THICKNESS 1.778 * 10 mm -5

A 1st Run
o 2nd Run
x 3rd Run
--- EXPERIMENTAL
o --- AVERAGE OF THREE COMPUTER OUTPUTS

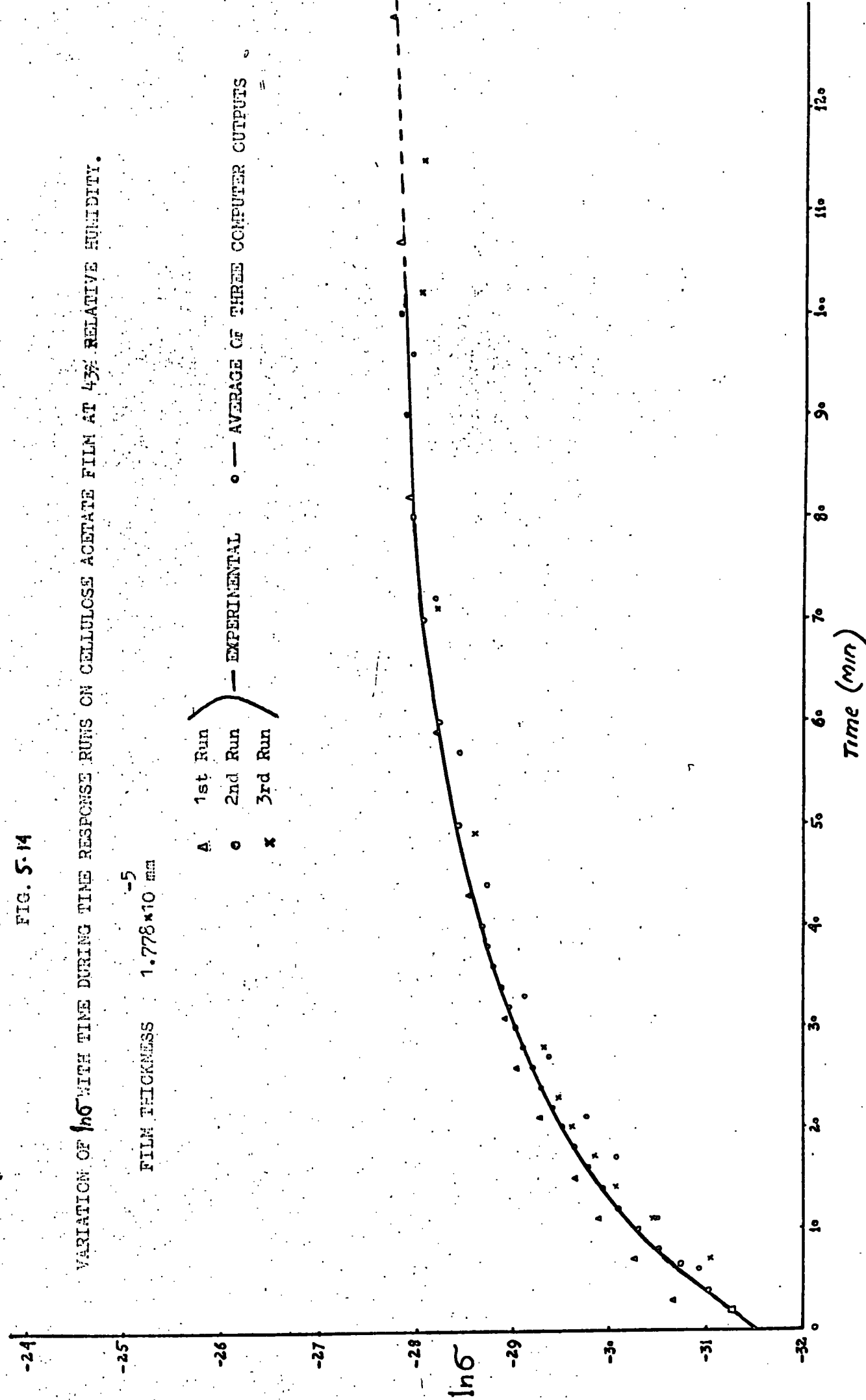

FIG. 5-15

VARIATION OF $1/\epsilon$ WITH TIME DURING TIME RESPONSE RUNS ON CELLULOSE ACETATE FILM AT 75% RELATIVE HUMIDITY.

FILM THICKNESS 1.778×10^{-5} IN

- △ 1st Run
- 2nd Run
- × 3rd Run
- AVERAGE OF THREE COMPUTER OUTPUTS
- EXPERIMENTAL

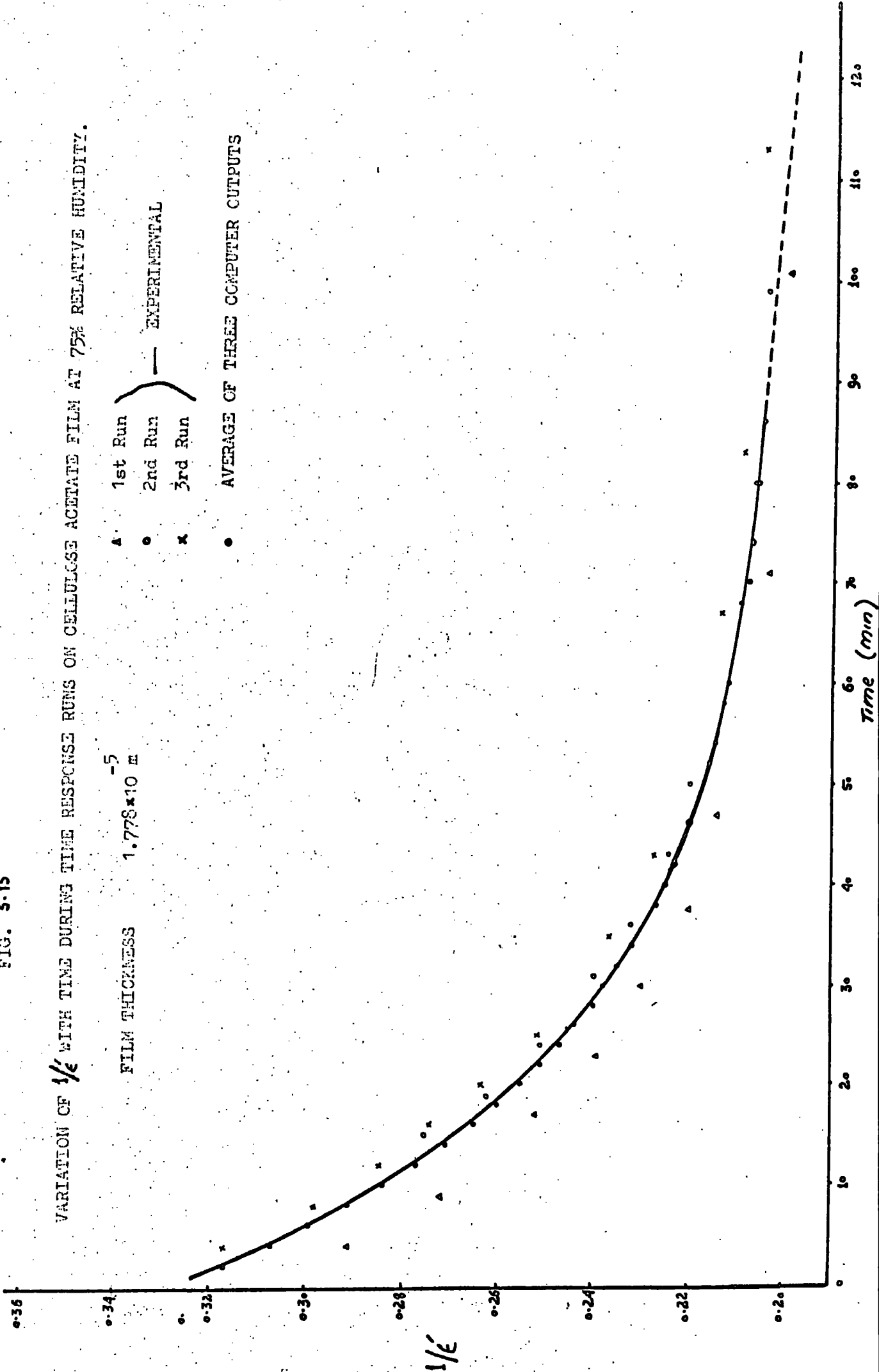

FIG. 5-16

VARIATION OF $\ln \sigma$ WITH TIME DURING TIME RESPONSE RUNS ON CELLULOSE ACETATE FILM AT 75% RELATIVE HUMIDITY.

FILM THICKNESS 1.778×10^{-5} IN

- Δ 1st Run
 - \circ 2nd Run
 - \times 3rd Run
 - \bullet AVERAGE OF THREE COMPUTER OUTPUTS
- EXPERIMENTAL

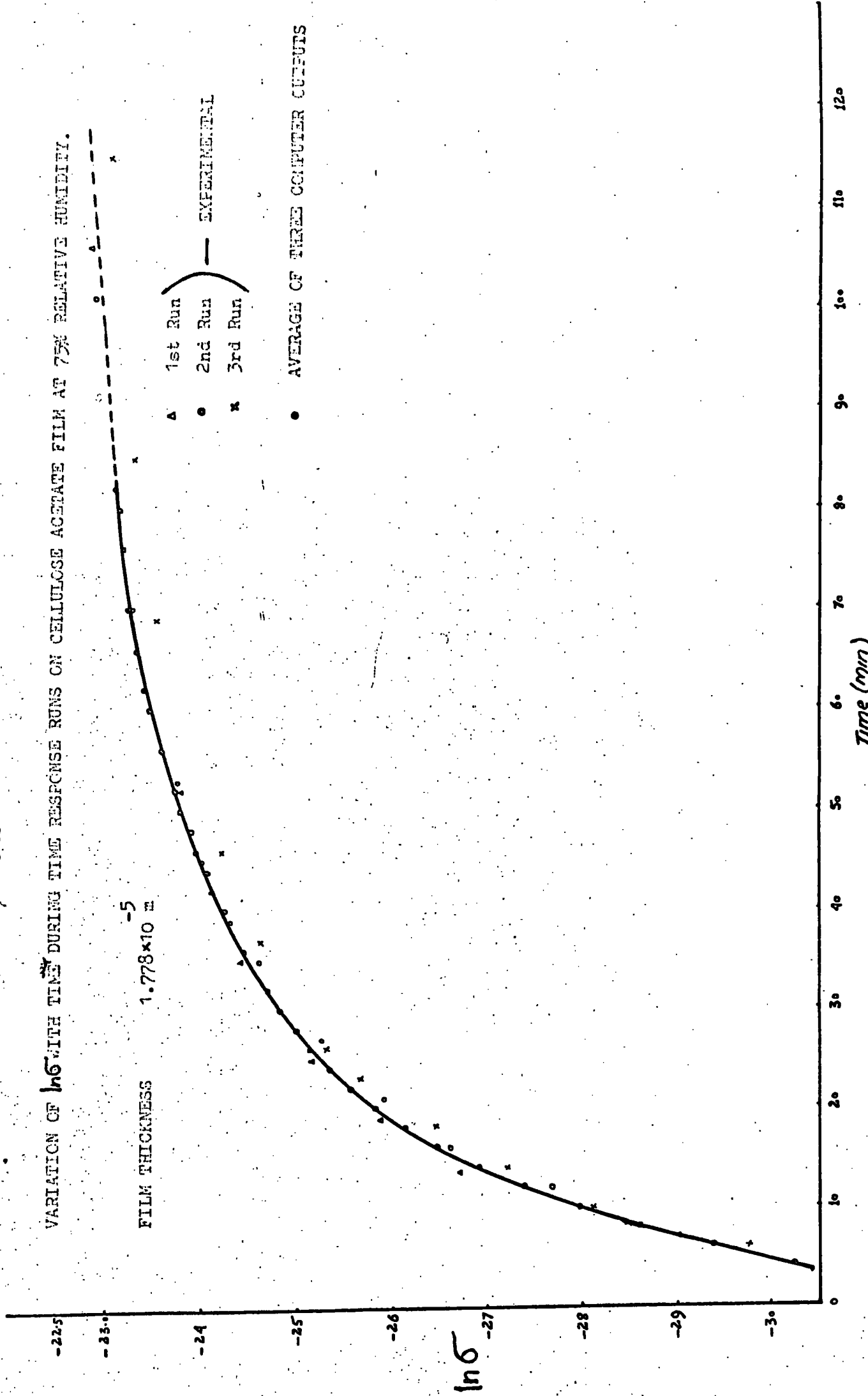

FIG. 5-17

VARIATION OF $1/\epsilon$ WITH TIME DURING TIME RESPONSE RUNS ON CELLULOSE ACETATE FILM AT 96% RELATIVE HUMIDITY.

FILM THICKNESS 1.778×10^{-5} m

▲ 1st Run
 ● 2nd Run
 × 3rd Run
 — EXPERIMENTAL
 ● AVERAGE OF THREE COMPUTER OUTPUTS

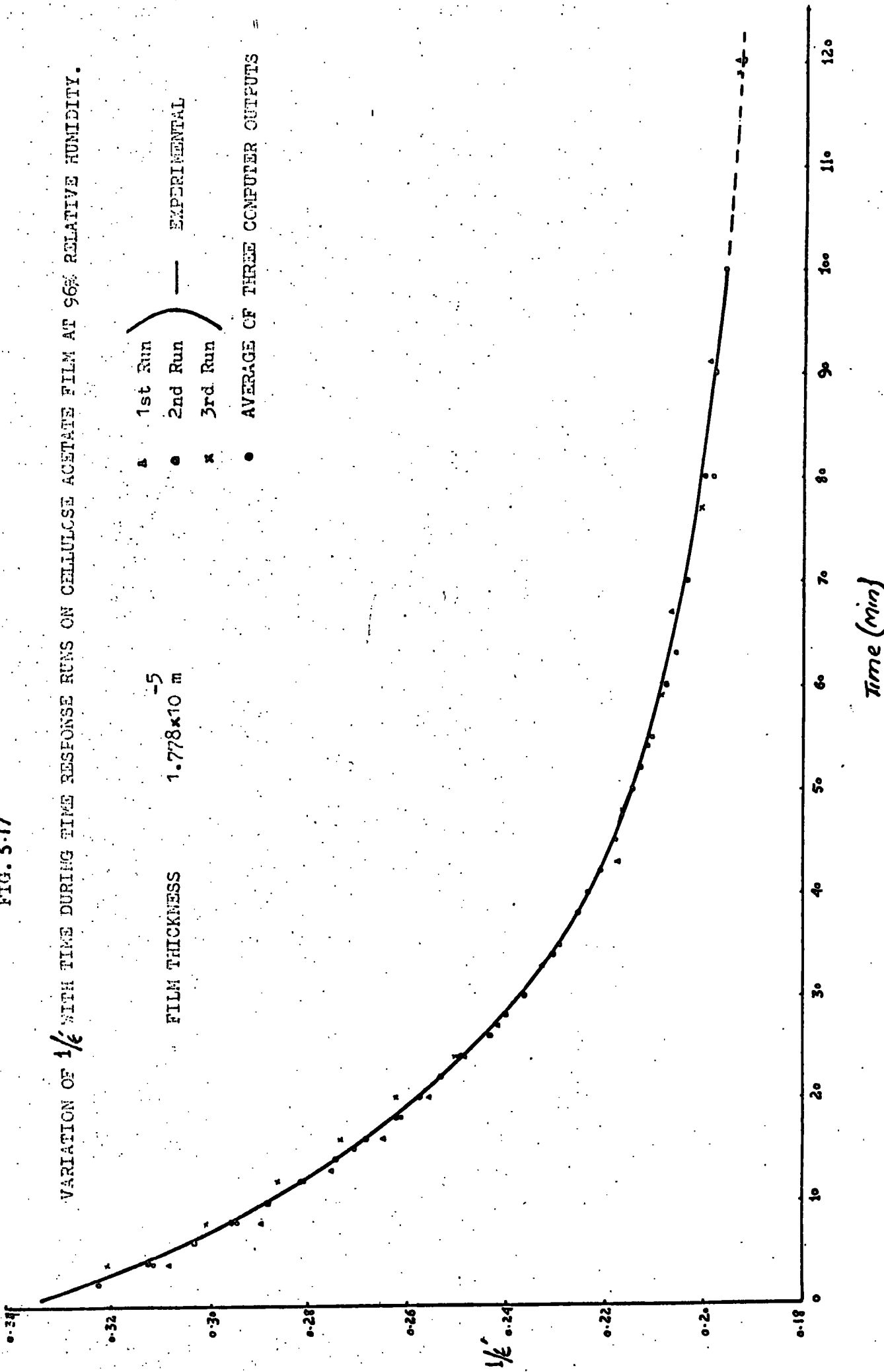

FIG. 5-18

VARIATION OF $\ln C$ WITH TIME DURING TIME RESPONSE RUNS ON CELLULOSE ACETATE FILM.

RELATIVE HUMIDITY 96%

FILM THICKNESS 1.778×10^{-5} m

▲ 1st Run
● 2nd Run
× 3rd Run
● AVERAGE OF THREE COMPUTER OUTPUTS.

EXPERIMENTAL

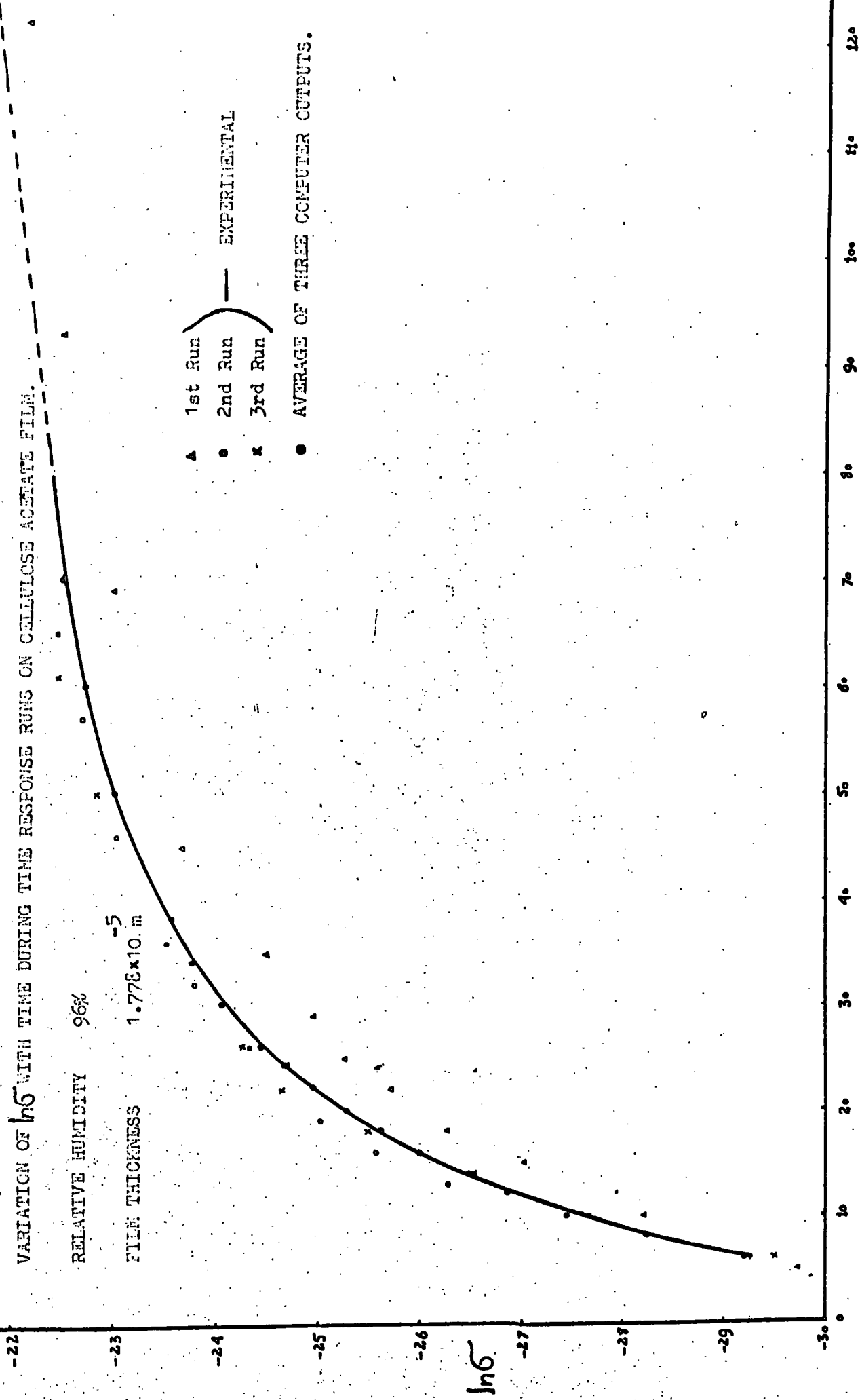

FIG. 5.19

TIME RESPONSE RUNS ON CELLULOSE ACETATE BUTYRATE FILM AT DIFFERENT HUMIDITIES

LN σ vs $1/\epsilon$

FILM THICKNESS 1.778×10^{-5} m

RELATIVE HUMIDITIES

- x — 22%
- ▲ — 43%
- — 65%

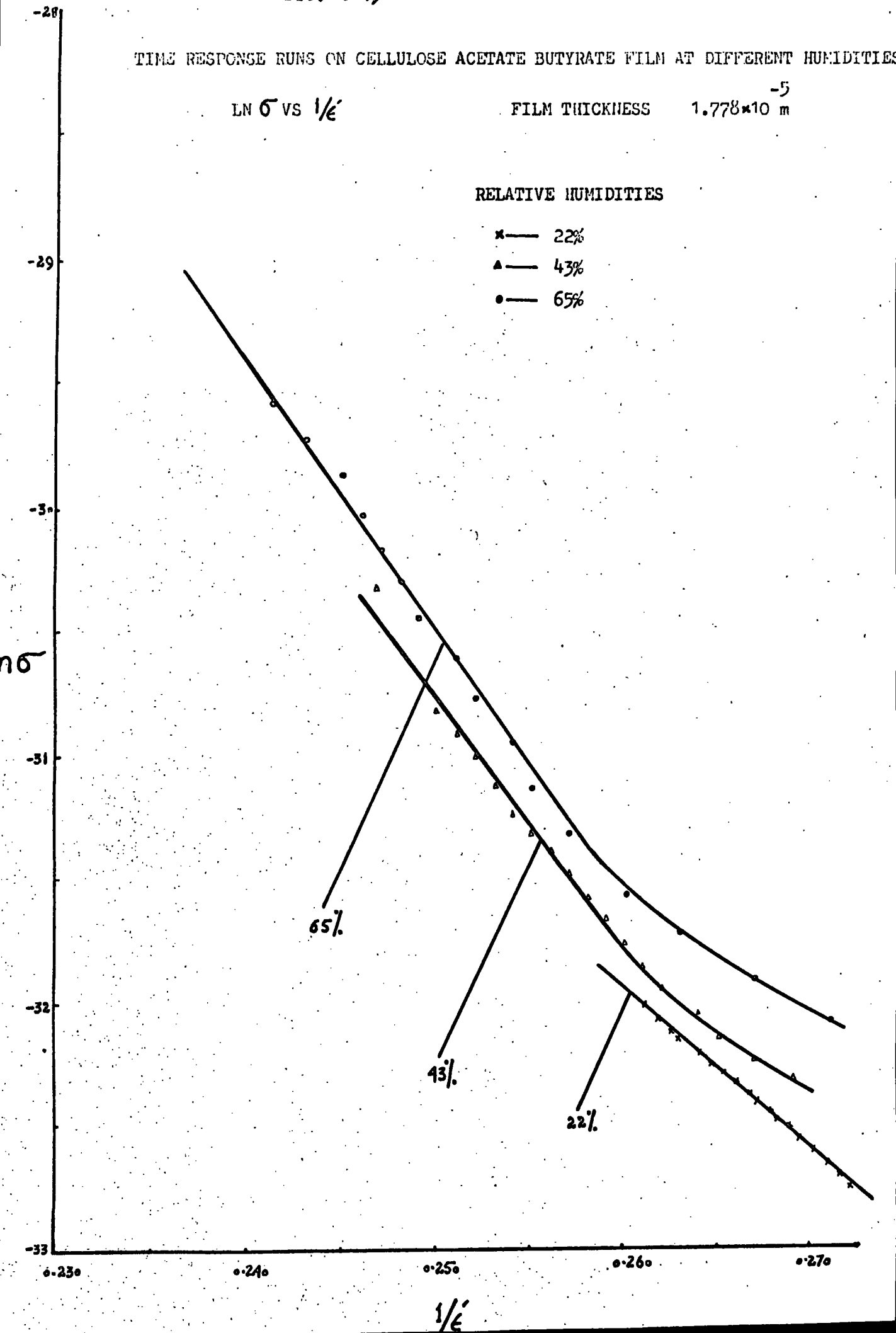

FIG. 5.2.

VARIATION OF $1/\epsilon$ WITH TIME DURING TIME RESPONSE RUNS ON CELLULOSE ACETATE BUTYRATE FILM AT 22% RELATIVE HUMIDITY.

FILM THICKNESS 1.773×10^{-5} m

- Δ 1st Run
 - \circ 2nd Run
 - \times 3rd Run
 - \bullet AVERAGE OF THREE COMPUTER OUTPUTS.
- EXPERIMENTAL

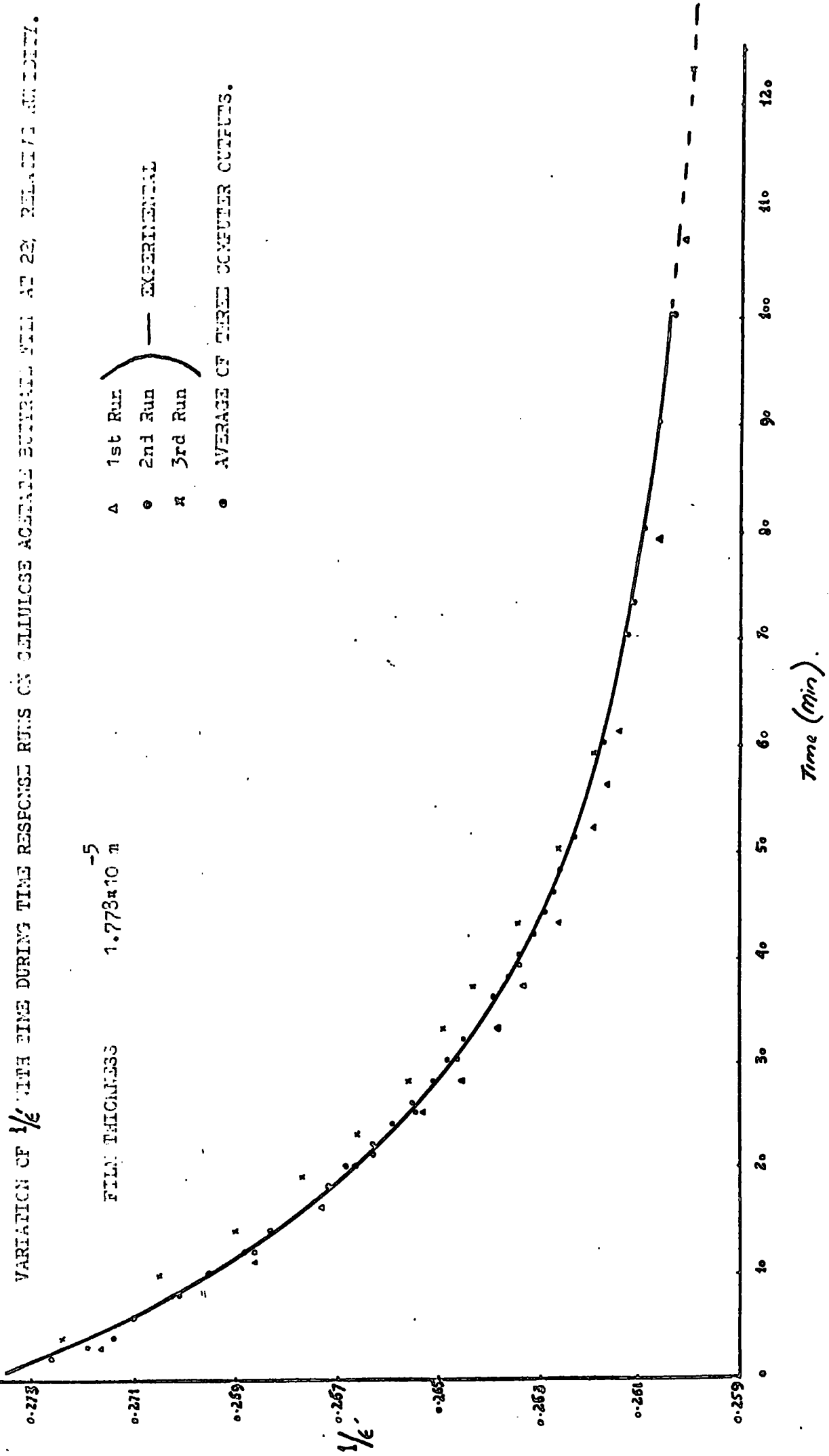

FIG. 5-21

VARIATION OF $\ln \delta$ WITH TIME DURING TIME RESPONSE RUNS ON CELLULOSE ACETATE BUTYRATE FILM AT 22% RELATIVE HUMIDITY.

FILM THICKNESS 1.778 \times 10⁻⁵

Δ 1st Run
 \circ 2nd Run
 \times 3rd Run
 \bullet AVERAGE OF THREE COMPUTER OUTPUTS

— EXPERIMENTAL

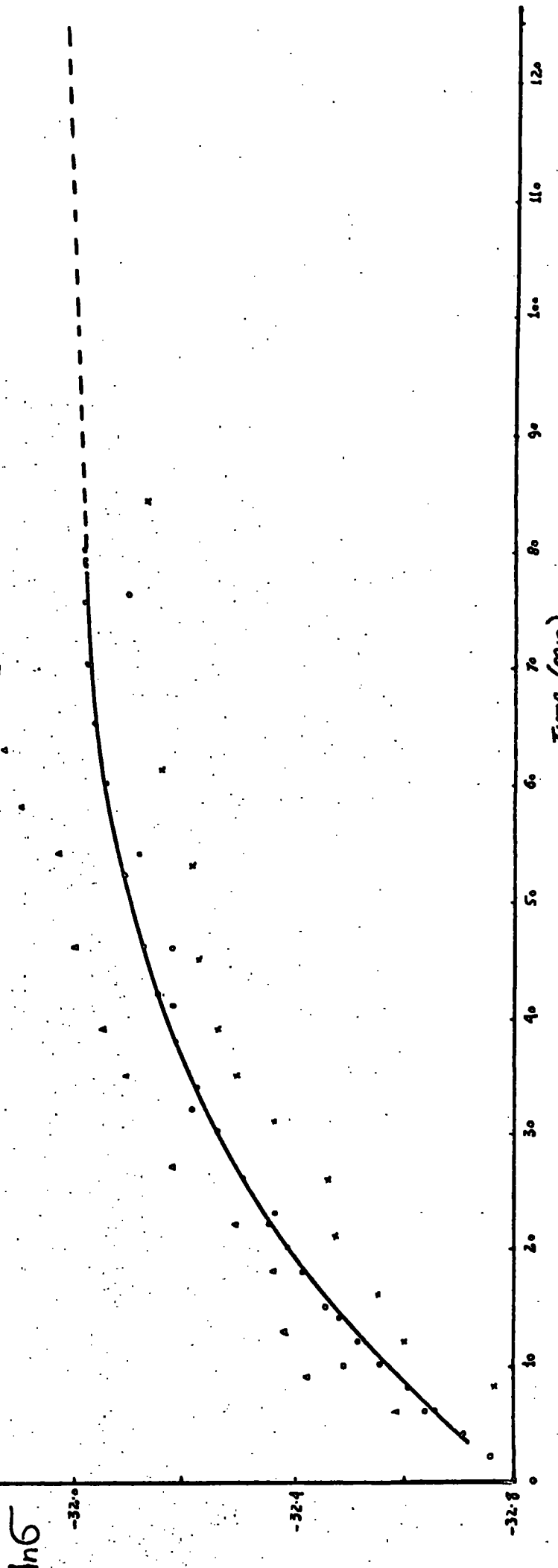

FIG. 5-22

VARIATION OF $1/\epsilon$ WITH TIME DURING TIAL RESPONSE RUNS ON CELLULOSE ACETATE BUTYRATE FILM AT 43% RELATIVE HUMIDITY.

FILM THICKNESS 1.793×10^{-5} L

- Δ 1st Run
 - \circ 2nd Run
 - \times 3rd Run
 - \bullet AVERAGE OF THREE COMPUTER OUTPUTS
- EXPERIMENTAL

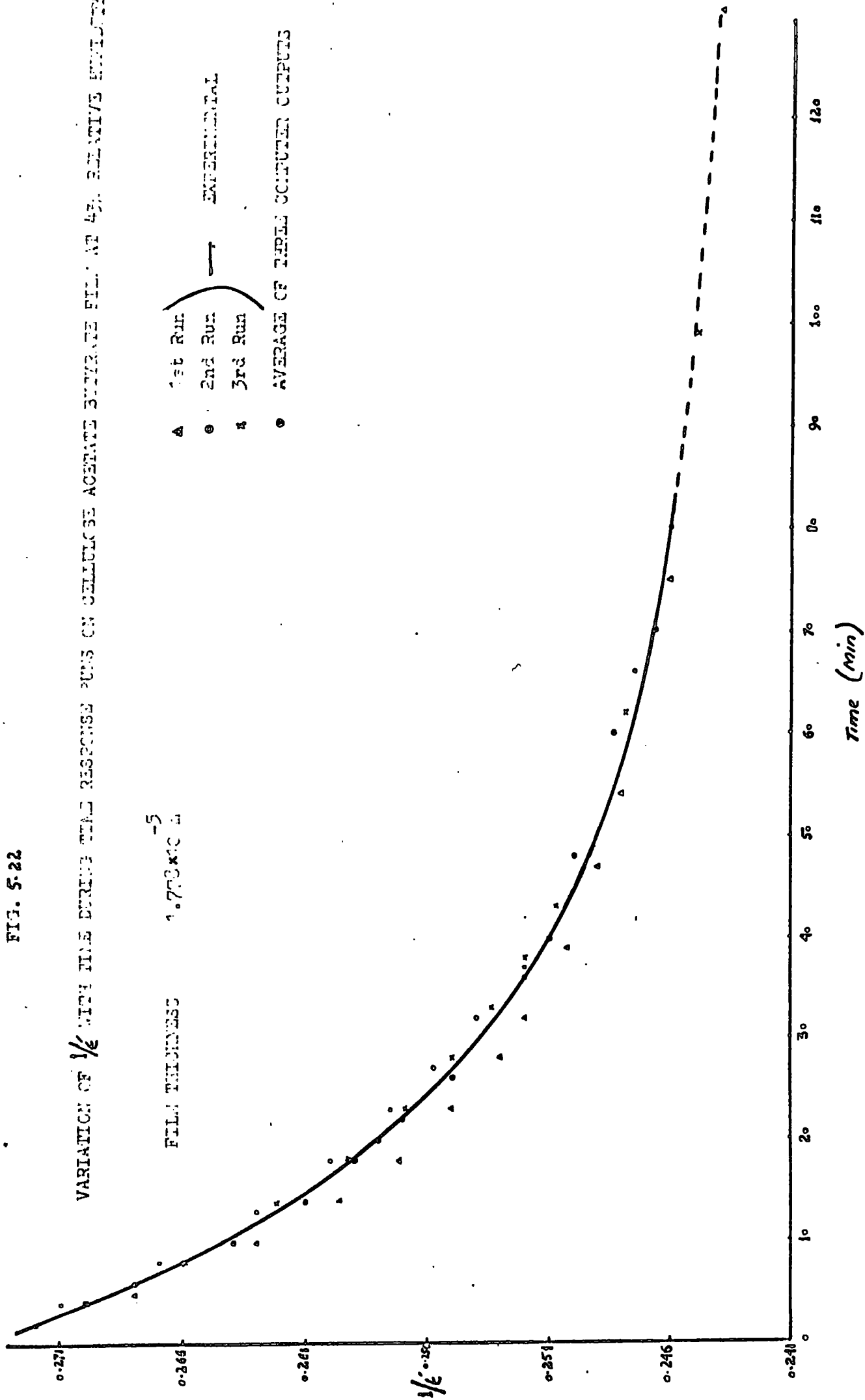

FIG. 5.23

VARIATION OF $\ln \sigma$ WITH TIME DURING TIME RESPONSE RUNS ON CELLULOSE ACETATE BUTYRATE FILM AT 45% RELATIVE HUMIDITY

FILM THICKNESS 1.778×10^{-5} m

▲ 1st Run
● 2nd Run
x 3rd Run
● AVERAGE OF THREE COMPUTER OUTPUTS
— EXPERIMENTAL

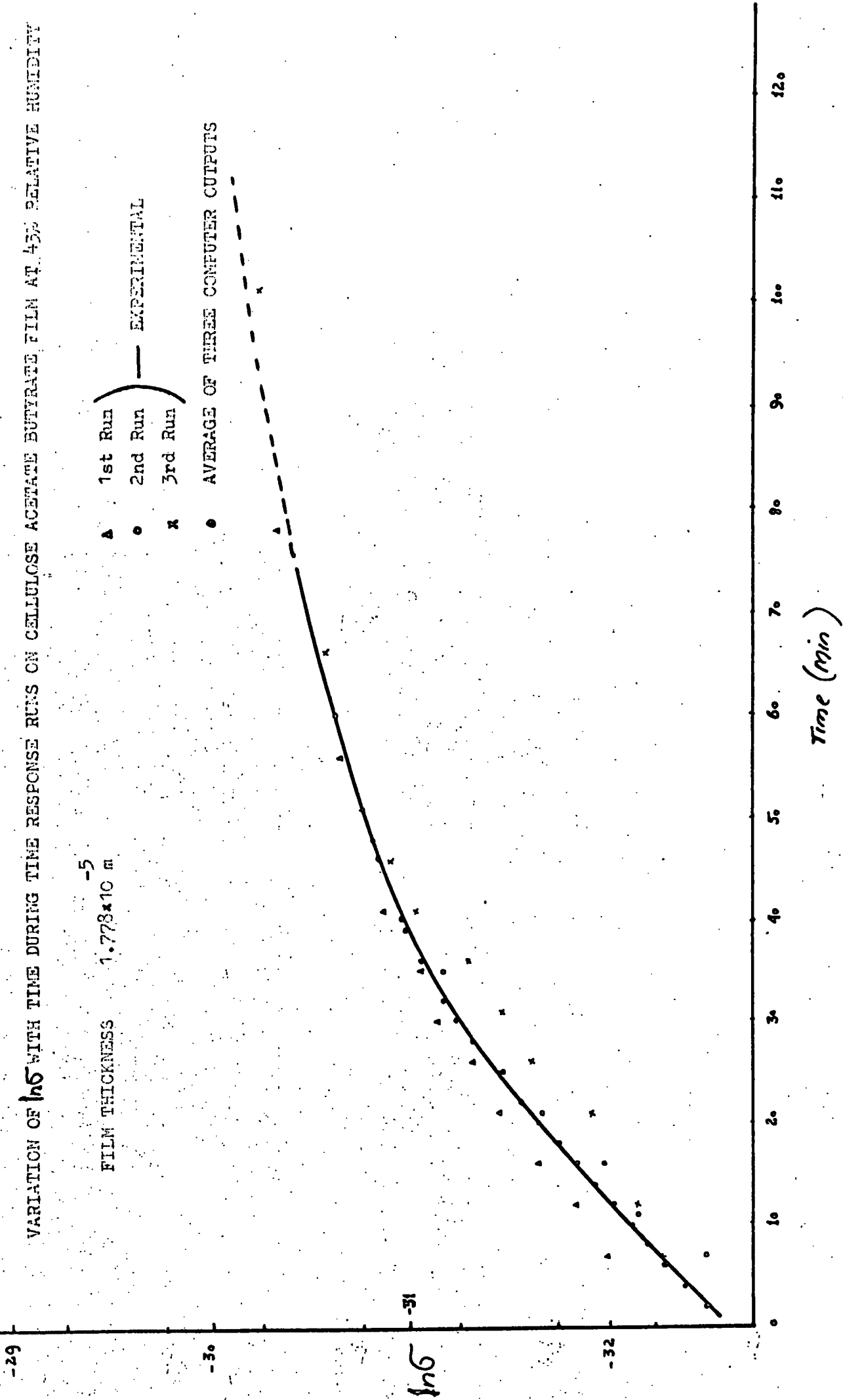

FIG. 5-24

VARIATION OF $1/\epsilon$ WITH TIME DURING TIME RESPONSE RUNS ON CELLULOSE ACETATE BUTYRATE FILM AT 65% RELATIVE HUMIDITY.

FILM THICKNESS 1.778×10^{-5} m

▲ 1st Run
● 2nd Run
x 3rd Run
— AVERAGE OF THREE COMPUTER OUTPUTS.

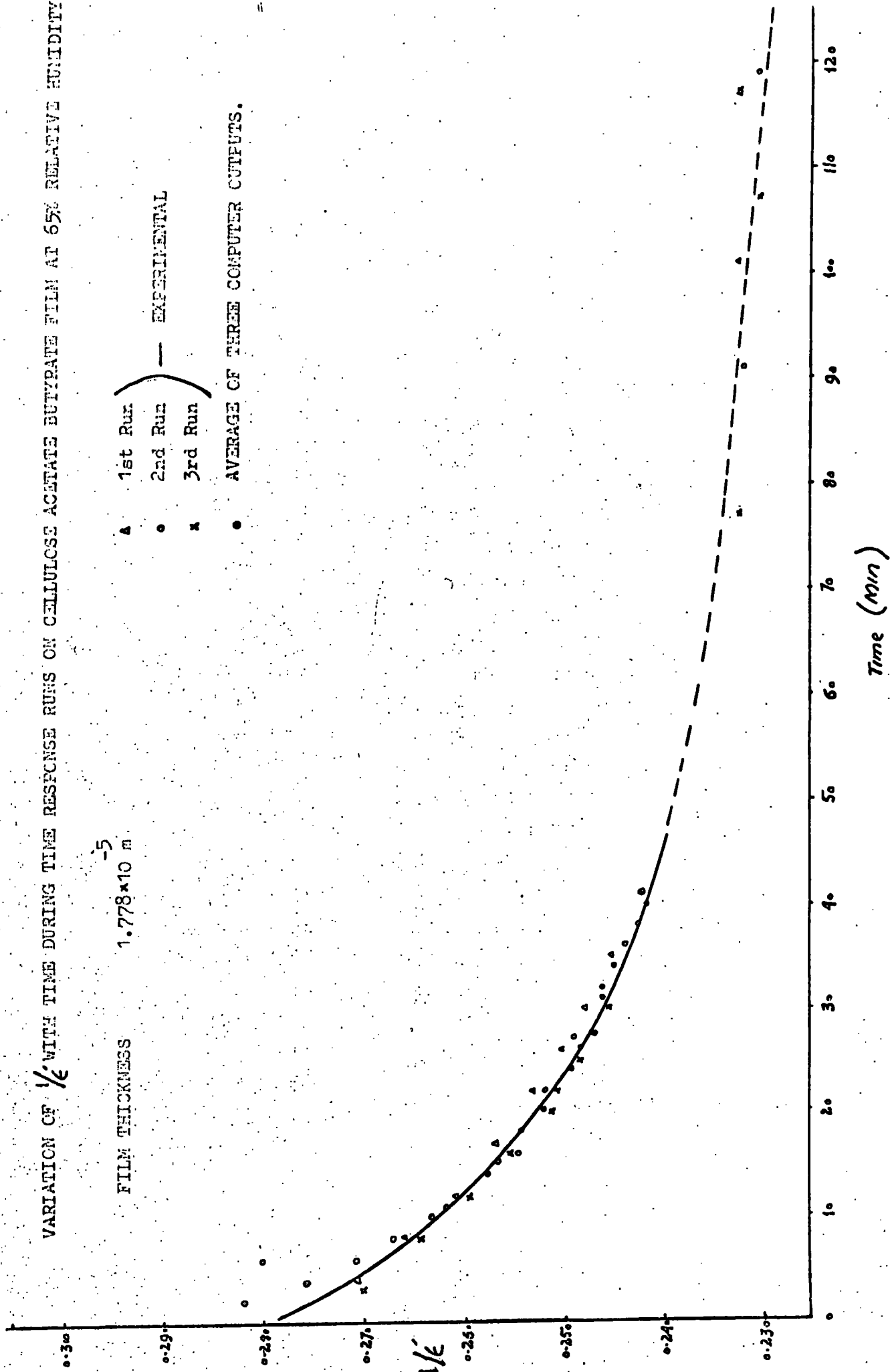
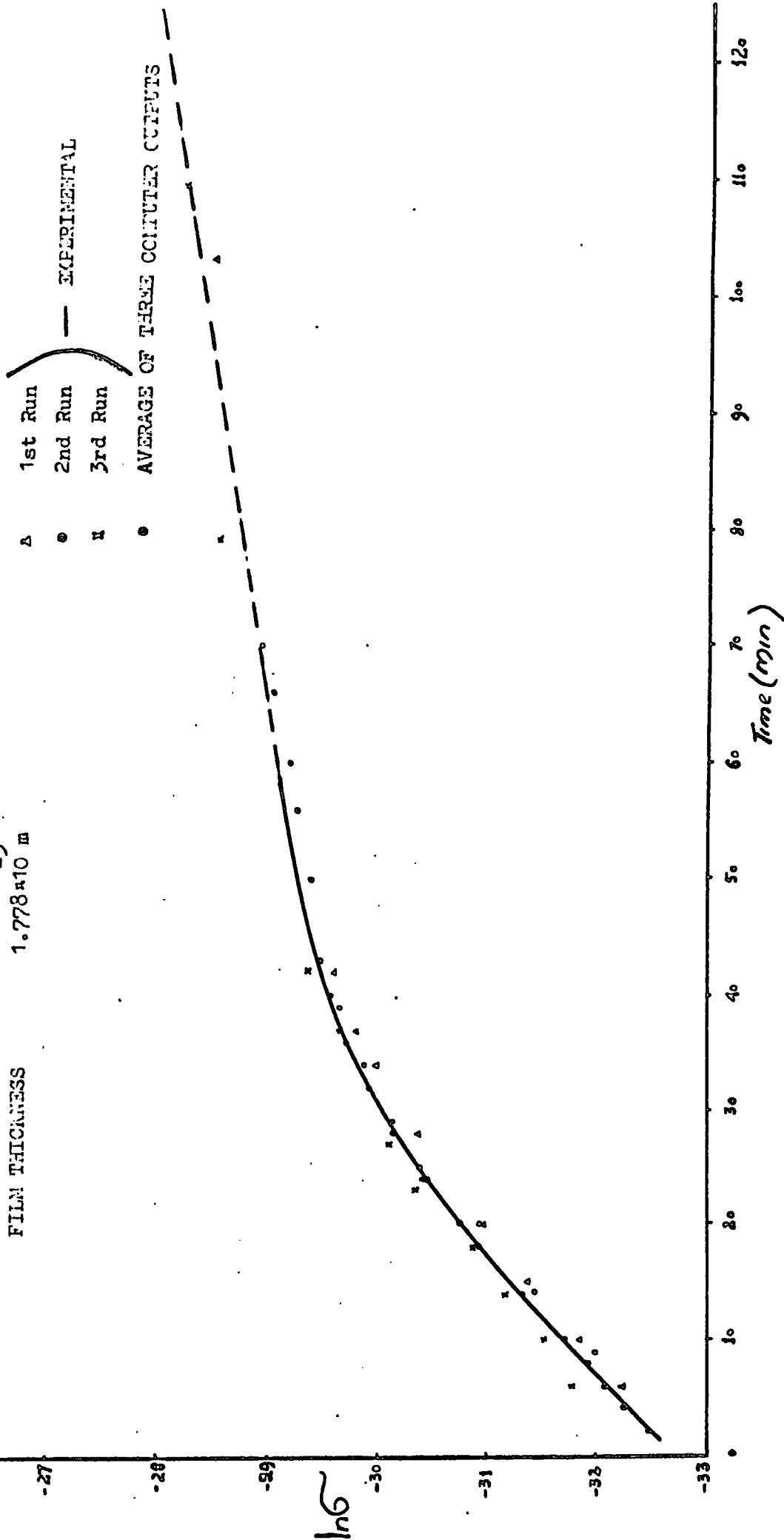

FIG. 5-25

VARIATION OF $\ln G$ WITH TIME DURING TIME RESPONSE RUNS ON CELLULOSE ACETATE BUTYRATE FILM AT 65% RELATIVE HUMIDITY.

FILM THICKNESS 1.778×10^{-5} m



The expression for 'a' given above involves a series of constants i.e. γ , the activity coefficient, K , the dissociation constant, n_0 the number of salt molecules, μ the mobility of ions, and e , the electronic charge, which are independent of humidity.

The expression for slope also contains humidity independent constants such as Boltzmann's constant K , and absolute temperature T . However the results suggest that 'a' is a function of humidity, and that 'b' is not. On the other hand, if the equilibrium values are plotted in the same way, then the intercepts and slopes are different to those obtained in the time response runs.

The most obvious reason for this disagreement between the results obtained from the present work and the theory of Barker and Thomas is that the moisture distribution in the specimen, must be changing continuously during the measurements in the time response runs. Figure (5.26) shows a model which suggests how the moisture distribution across the thickness of the film (specimen) between the electrodes, changes with time as sorption proceeds, assuming that the humidity in the chamber reaches its equilibrium value fairly rapidly. As discussed in section (3.4.1), the amount of moisture is highest at each face but lowest in the middle. Such a moisture distribution is likely to occur in absorptive materials (58) and this must be reflected in the electrical measurements. The specimen could be considered as a set of capacitors of different values in series. From a simple consideration of two capacitors in series with widely different values, the measured capacitance will reflect the value of the lower of the two capacitors.

FIG. 5.8.6

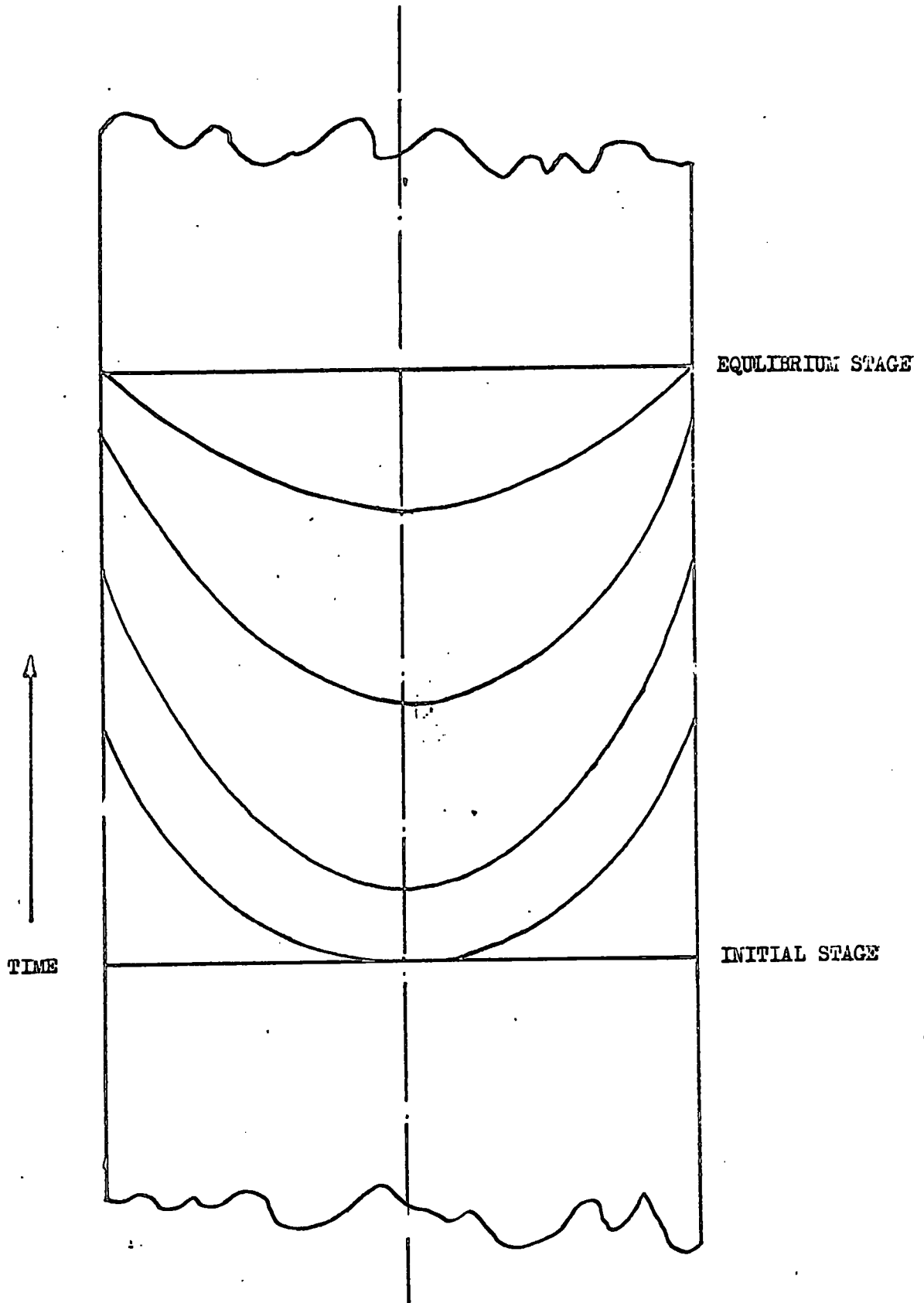

MOISTURE DISTRIBUTION ACROSS AN ABSORPTIVE FILM.

As this represents the capacitance of the dry material in the centre of the specimen, the measured result is not a good indication of the behaviour of the material. Some confirmation of this view is given by the fact that the time taken for the electrical properties to reach equilibrium is similar to that taken for sorption to reach equilibrium. From the information given by Barker and Thomas in their paper it would look as though their results would show the same effect. The results obtained in this work agree well with the results of Barker and Thomas, i.e. cellulose acetate shows the same slope in their results and in the results shown above. Unfortunately, Barker and Thomas did not publish results at different humidities and consequently a fuller comparison is not possible. Regenerated cellulose has been used by Misevich (4) and Thoma (5) in the development of a humidity transducer. Figure (5.27) shows the results are similar to those already obtained.

5.3.1 Doping of specimens and electrical measurements

In section (5.0) it has been explained how experiments were carried out to measure the electrical properties of undoped specimens. In addition to those experiments specimens were doped with NaCl in order to determine the effect of doping with an ionic solid on the electrical properties of the specimens. Briefly, doping was carried out by soaking the specimens in a known solution of NaCl for a period of 48 hours. The specimens were then washed thoroughly in distilled and deionized water to reduce possible surface deposits and dried overnight at 60°C. The

FIG. 5.27

TIME RESPONSE RUNS ON REGENERATED CELLULOSE ACETATE BUTYRATE FILM
AT DIFFERENT HUMIDITIES.

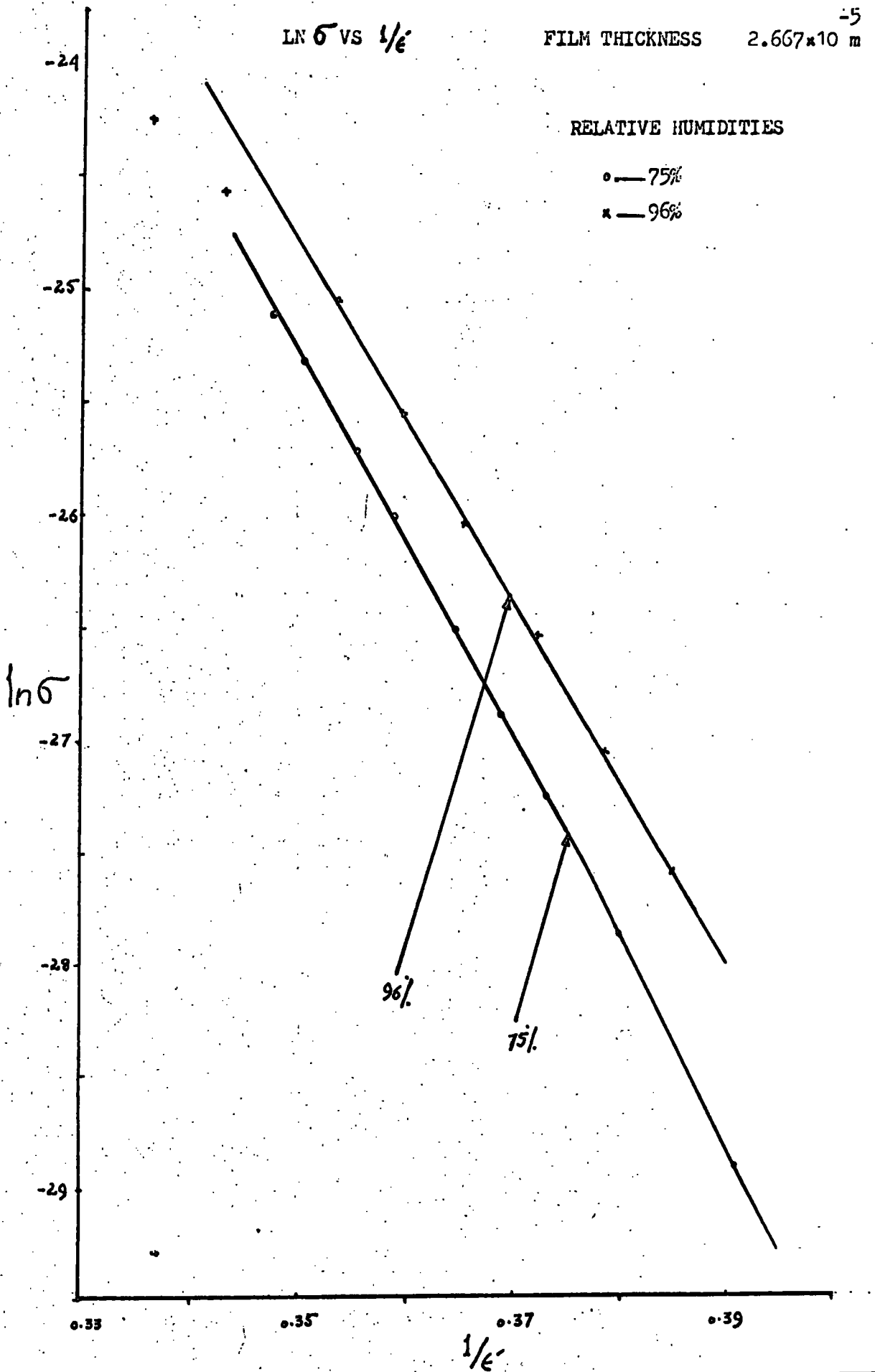

procedure is similar to that used by Barker and Thomas (1).

Doping produces ions or current carriers in the specimen and hence the conductivity of the specimen increases. From Barker and Thomas the expression for conductivity is also defined as,

$$\sigma \approx \sigma_1 \exp \left(-U_0 / 2RT \right) \dots\dots\dots (5.2)$$

where σ_1 depends on the square root of salt concentration N_0 .

The presence of the salt molecules in the specimen in the dry state has no effect on the conductivity of the specimen, but with water sorbed by the material, the salt molecules dissociate into ions which consequently increase the conductivity of the specimens according to equation (3.20). Figures (5.28 and 5.29) show the results of time response runs done on the doped specimens. The intercept of the lines changes as the concentration of the salt solution in which the specimens were doped changes. As seen from the expression for a in section (5.3)

$$a = \log \left(\delta^{-1} \left(K_0^k n_0^{1/2} \right) \right) (\mu_+ + \mu_-) e$$

N_0 is the only variable factor in the equation which varies the conductivity of the specimen. Barker and Thomas measured the number of salt molecules in the specimen using an x-ray technique and correlated the conductivity with the number of ions. It was found that,

$$\sigma \propto n_0^{1/2} \dots\dots\dots (5.3)$$

In the present work the concentration of salt molecules in the specimens could not be determined as the necessary equipment was not available.

FIG. 5-28

TIME RESPONSE RUNS ON DOPED FILM OF CELLULOSE ACETATE AT 85% RELATIVE HUMIDITY.

$\ln \sigma$ vs $1/\epsilon'$

FILM THICKNESS

2.286×10^{-5} m

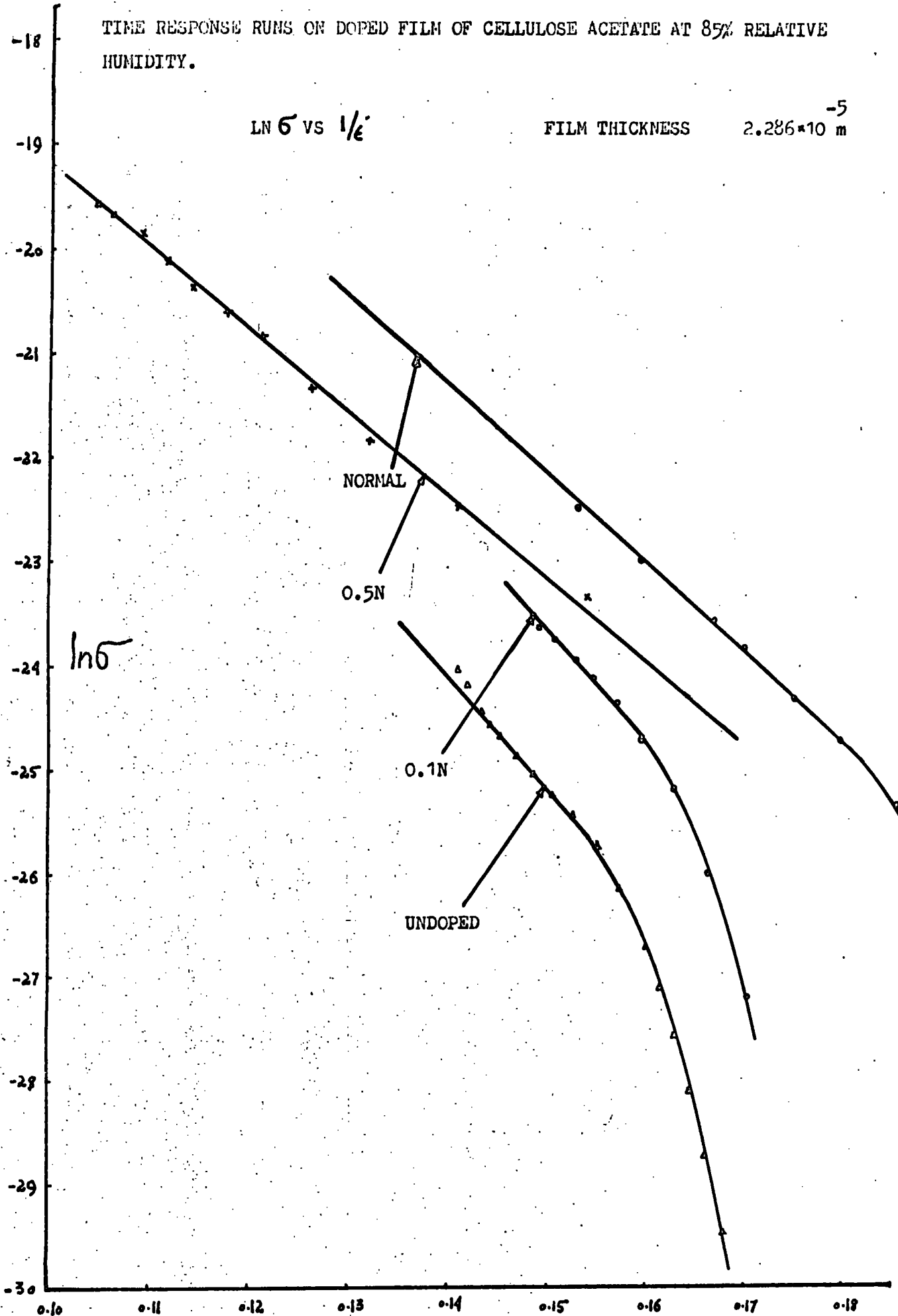

FIG. 5-29

TIME RESPONSE RUNS ON DOPED FILM OF CELLULOSE ACETATE BUTYRATE AT 35% RELATIVE HUMIDITY

$\ln \sigma$ vs $1/\epsilon'$

FILM THICKNESS

2.235×10^{-5} m

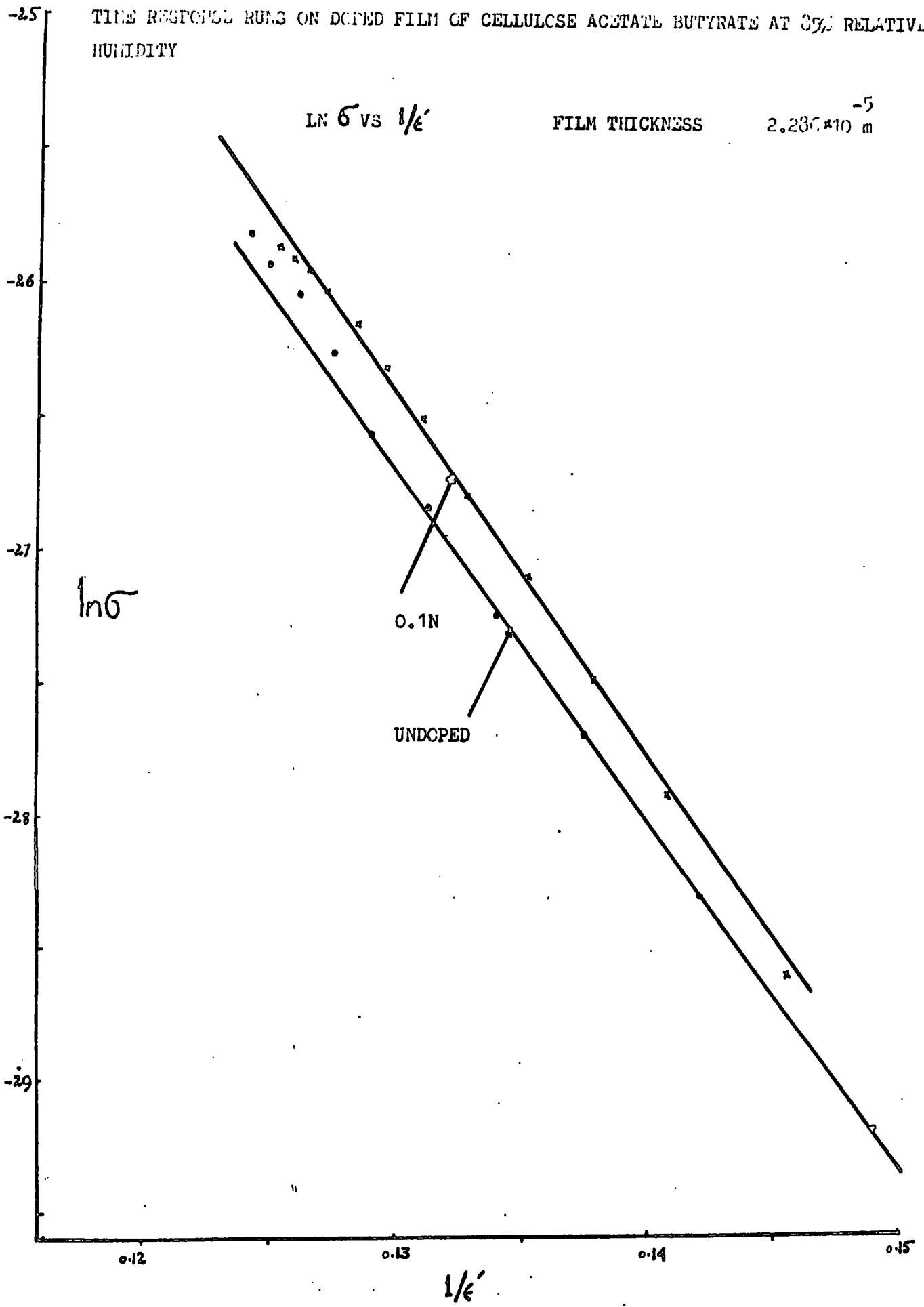

Nevertheless, assuming that the number of salt molecules in the material is proportional to the concentration of the doping solution, it looks as though equation (5.3) is obeyed. The slope of the graphs is the same as in previous time response runs. Equilibrium values were not recorded because of specimen deterioration and the time required.

5.3.2 Variation of dielectric constant and dielectric loss with frequency

The variation of the dielectric constant ϵ' and dielectric loss ϵ'' of specimens with frequency were determined by measuring values of C and G of the specimens at different frequencies, ranged from 300 Hz to 100 KHz. The effect of humidity on ϵ' and ϵ'' was determined by using different saturated salts to vary humidity. The results obtained from these tests are plotted on figures (5.30) and 5.31). The dielectric constant of the specimens decreases slightly as the frequency of the applied field increases. The dielectric constant increases as the humidity increases but there is no noticeable change in the form of graphs. The results are plotted for cellulose acetate butyrate specimens only, but cellulose acetate gave similar results. The dielectric loss of the specimens on the other hand increases with increasing frequency of the applied field. The increase is quite steady up to 10KHz, but after that it flattens out. Figure (5.30) shows no clear relaxation frequencies. The dielectric loss of the specimens increases with the increase in humidity, the water molecules in the specimens producing the loss due to their dipolar character. These results agree with the results shown for example, by Hartshorn and Rushton (18), and Barker and Thomas (1).

FIG. 5.30

CELLULOSE ACETATE BUTYRATE FILM THICKNESS 2.794×10^{-5} m

VARIATION OF DIELECTRIC CONSTANT WITH FREQUENCY.

- 1----- 33% R.H.
- 2----- 44% "
- 3----- 65% "
- 4----- 75% "

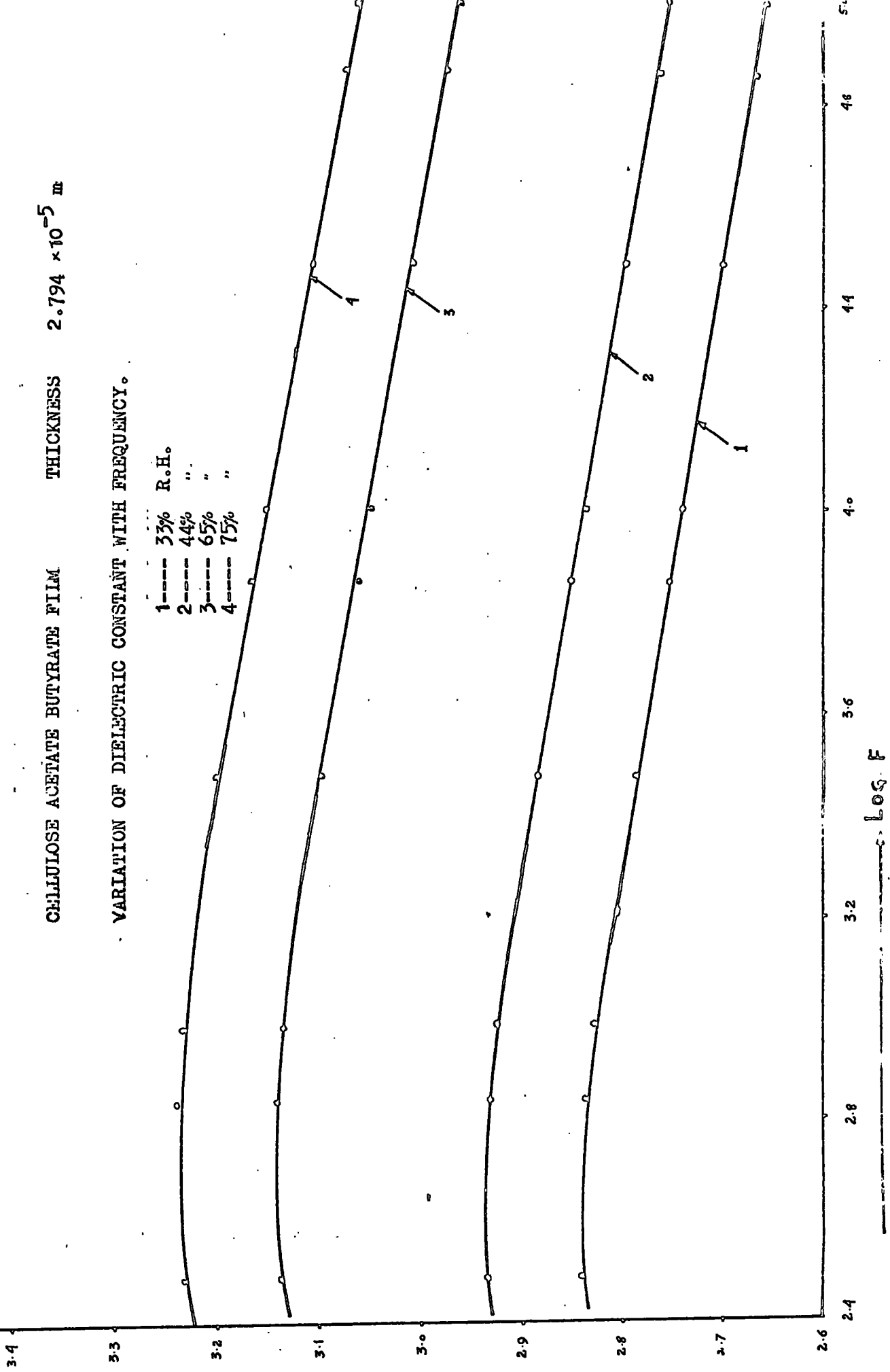
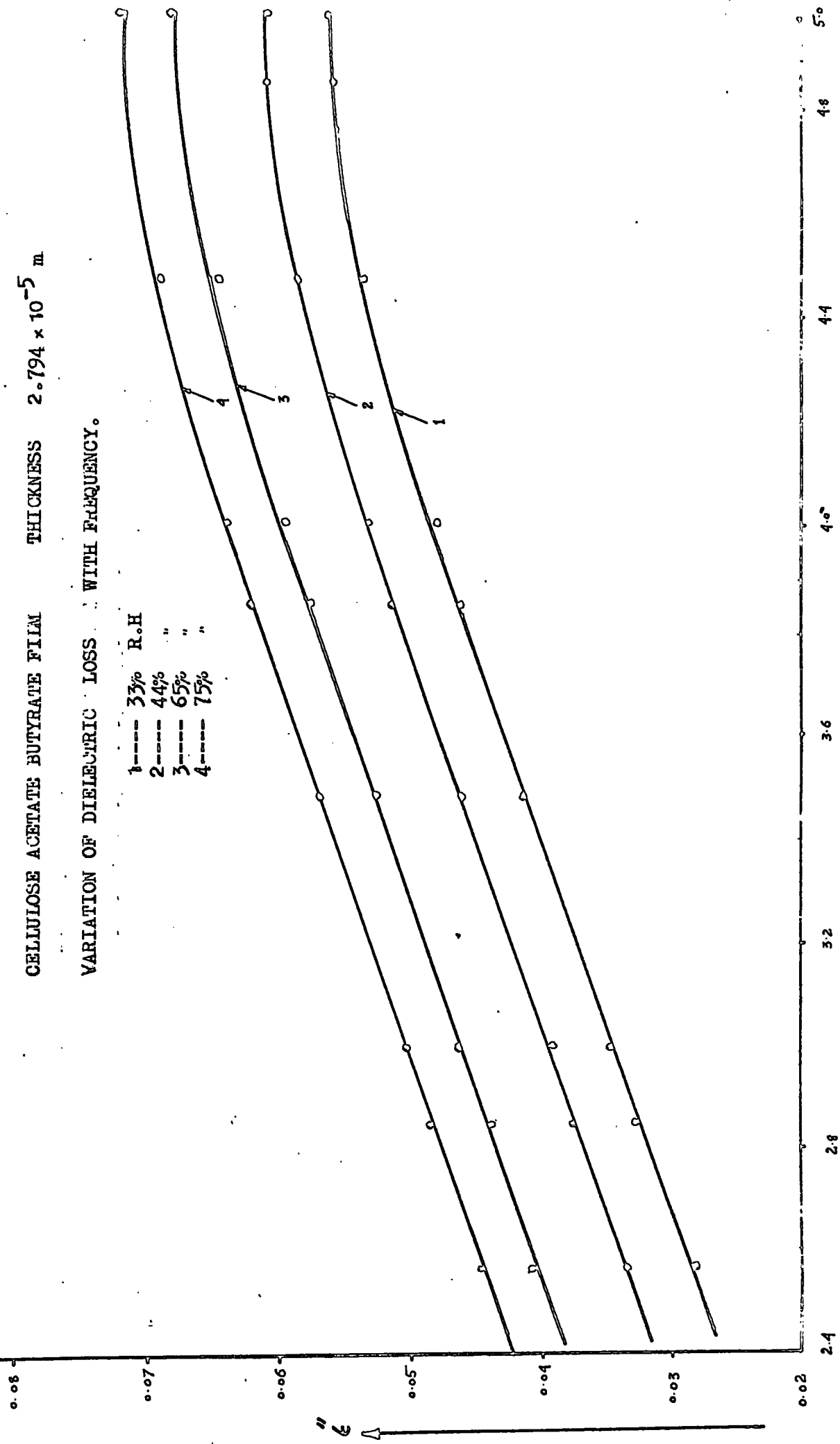

FIG. 5.31

CELLULOSE ACETATE BUTYRATE FILM THICKNESS 2.794×10^{-5} m

VARIATION OF DIELECTRIC LOSS WITH FREQUENCY.

- 1----- 33% R.H
- 2----- 44% "
- 3----- 65% "
- 4----- 75% "



LOG F

2.4 2.8 3.2 3.6 4.0 4.4 4.8 5.0

If the capacitance and d.c. conductance are measured following an abrupt change in humidity as described in the section (5.3), but at different frequencies, the results are a set of parallel straight lines agreeing with the Barker and Thomas results, see figures (5.32)

Surface and volume conductance

The effect of humidity on the surface and volume conductance of different polymeric materials has been previously reviewed in sections (3.31 and 3.4). The effect of humidity on the surface and volume conductance of cellulose acetate and cellulose acetate butyrate was observed in the present work. The experiments carried out consisted of measurements of both surface and volume resistance on the same specimen using a three electrode assembly. As shown in section (4.4), using the equations observed by Amey and Hamberger (39), the volume conductance between the coaxial electrodes on the upper surface of the specimen is negligible. Consequently any change in the conductance measured between these two electrodes with humidity would constitute a genuine surface current. No such change was observed, the current remaining substantially negligible at all humidities. It is concluded that there is no surface conduction and therefore no adsorption on the surface.

FIG. 5.32

TIME RESPONSE RUNS ON CELLULOSE ACETATE FILM AT DIFFERENT FREQUENCIES

LN σ vs $1/\epsilon'$

FILM THICKNESS 2.286×10^{-5} m

RELATIVE HUMIDITY 85%

ln σ

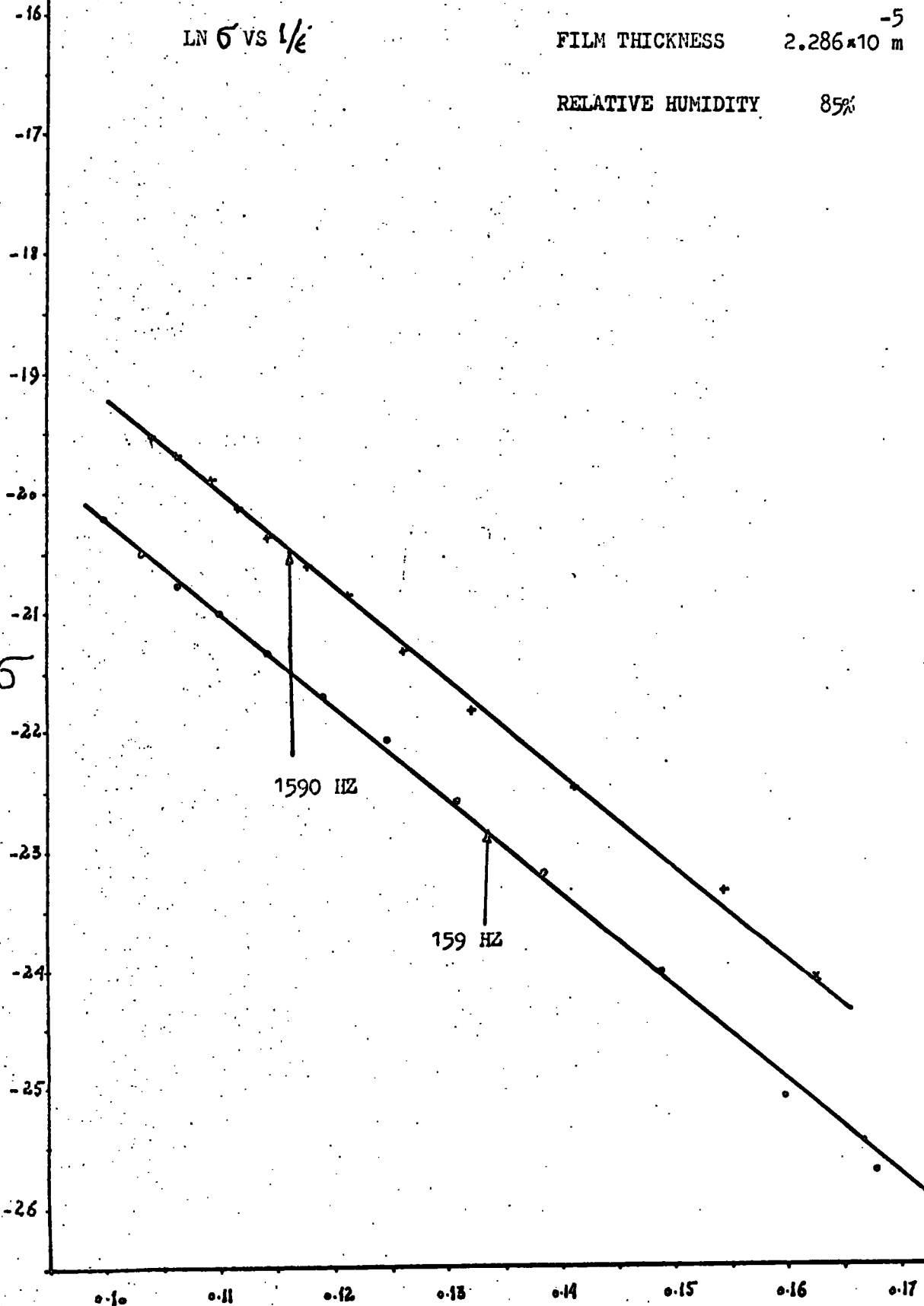

$1/\epsilon'$

6.0 Conclusions

Cellulose and its derivatives are hydrophilic polymers and absorb moisture when they are exposed to a humid atmosphere. The properties of cellulose and its derivatives, i.e. cellulose acetate, cellulose acetate butyrate, cellulose nitrate and ethyl cellulose change with the absorption of moisture. A general survey of the electrical properties of cellulose acetate and cellulose acetate butyrate under different conditions of humidity has been made. In particular, work on the effect of humidity on electrical conduction has been reviewed. The experimental work of Barker and Thomas has been extended to consider the behaviour of cellulose acetate and cellulose acetate butyrate at different humidities. Similar results were obtained for both materials. Following Barker and Thomas, the capacitance, a.c. conductance and d.c. conductance of the specimen were recorded as a function of time following an abrupt change in humidity. In addition these parameters were recorded as a function of humidity once equilibrium had been obtained. Similar experiments were carried out with the specimen doped with sodium chloride and at different frequencies. It was found that cellulose acetate butyrate had similar electrical properties to cellulose acetate. This is to be expected as both materials are similar chemically. In general capacitance and d.c. conductance were slightly higher in the case of cellulose acetate when these parameters were measured at equilibrium. Both materials showed hysteresis with respect to humidity, electrical properties being greater for decreasing humidity than for increasing humidity. This effect is due to hysteresis in the sorption process. It was found to be less with cellulose acetate butyrate than with cellulose acetate.

The results were compared with the work of Barker and Thomas. The dissociation theory of conduction developed by these authors suggests that a plot of $\log \sigma$ against $1/\epsilon'$, should be linear. This was found to be so for both cellulose acetate and cellulose acetate butyrate. In both cases the slope of the plots was ^{close} the same as published by Barker and Thomas when the experiment was carried out in the same way. However, there were some significant differences. The intercepts with $1/\epsilon' = 0$ axis increased with humidity which is not predicted by the theory. Further the slope and intercepts for a plot of $\log \sigma$ against $1/\epsilon'$, for the equilibrium values differs significantly from the values obtained in the time response runs. This disagreement is expected from the difference in intercepts with humidity. This difference was attributed to the non-uniform distribution of moisture across the specimen during sorption.

The effect of doping is as expected, the conductivity increasing considerably. These results were in agreement with Barker and Thomas. They were however obtained using time response runs and these, in view of the above disagreement, are suspect. Nevertheless, it would appear that the conductance intercept is a function of the square root of the number of ions (salt molecules). Further work should be based on the measurement of equilibrium values.

A specific attempt was made to compare surface and volume conductance on the same specimen, but there was no detectable surface conductance.

From the view point of developing a humidity transducer, cellulose acetate butyrate shows less hysteresis than cellulose acetate and is to be preferred for this reason. On the other hand, the total change in capacitance for a change in humidity from zero to 100% is less with cellulose acetate butyrate than with cellulose acetate. Despite the thinness of the film used in this work, the time required for capacitance and conductance to reach their final values was apparently long. It is difficult to estimate this but it is probably of the order of an hour. Much of it may be due to the effect of the electrodes.

In conclusion, the main points which require further work are as follows,

- (1) The application of Barker and Thomas theory to equilibrium results should be extended and an attempt made to find out the exact reason for the difference between the results obtained using time response runs tests and equilibrium tests. The equilibrium tests should be extended to cover doping tests.
- (2) The results should be compared to those results obtained on other hygroscopic polymers, for example, nylon 6, polystyrene and polymethylmethacrylate, etc.
- (3) It would be useful to compare the changes in electrical properties with the amount of moisture sorbed by material.

7.0 References

- (1) Barker, R.E. and Thomas, C.R.
Effects of moisture and high electric fields on
conductivity in alkali-halide-doped cellulose acetate
Journal of Applied Physics, Vol. 35, No.11, 3203-3215, Nov.(1964)
- (2) Fuoss, R.M. and Charles, A.K.
Properties of electrolytic solutions. III The dissociation
constant
Journal of American Chemical Society 55, 1019, (1933)
- (3) Bjerrum, Z.
Kgl. Danske Vidensk, Selskab; 7, No.9 (1926); Falkenhagen,
"Electrolyte". Verlag von S. Hirzel, Leipzig (1932) P.257.
- (4) Misevich, K.W.
Capacitive humidity transducer
I.E.E.E. Transactions on Industrial Electronics and Control
Instrumentation (1969).
- (5) Thoma, P.E.
A resistance humidity sensing transducer
I.E.E.E. Transactions on Industrial Electronics and Control
Instrumentation, Vol. IECI - 19, No.2, May (1972)
- (6) Palin, G.R.
Plastics for Engineers. Pergamon Press (1967).
- (7) Arnold, L.K.
Introduction to plastics, London: George Allen and Unwin Ltd.
The Iowa State University Press (1968).
- (8) Mayofis, I.M.
Plastic insulating materials. London; Iliffe Books Ltd. (1966)
- (9) See Miles, D.C. and Briston, J.H.
Polymer Technology. Temple Press Books (1965) p.274

- (10) McBain, J. W.
The sorption of gases and vapours by solids.
Routledge, London (1932)
- (11) Thomas, A.M.
Moisture permeability, Diffusion and sorption in organic
film-forming materials.
Journal of Applied Chemistry; 1st April (1951)
- (12) McIntosh, R.L.
Dielectric behaviour of physically adsorbed gases
Edward Arnold (1966) p.15
- (13) London, F.Z.
Physics, 63, 245, (1930)
- (14) Brunauer, S., Emmett, P.H. and Teller, E.
Journal of American Chemical Society, 60, 309, (1938)
Adsorption of gases in multimolecular layers
- (15) Bridgeman, P.W.
Physics of high pressure. Macmillan (1950)
- (16) Langmuir, I.
Journal of American, Chemical Society, 1918, 40, 1361.
The adsorption of gases on plane surfaces of glass, mica,
and platinum
- (17) Gibbs, J.W.
Commentary on the scientific writings
Yale University Press (1936)
- (18) Hartshorn, L. and Rushton, E.
The dielectric properties of cellulose acetate
Report (Ref.L/T49) of the British Electrical and Allied Industries
Research Association (1938)
- (19) Fick, A.
Ann. Physick. 94, 59 (1955)
- (20) Rogers, C.E.
Permeability and chemical resistance
"Engineering Design for Plastics" edited by Baer (1964)

- (21) Long, E.A. and Thompson, L.J.
Diffusion of Water Vapour in Polymers
Journal of Polymer Science, Vol.XV (1955) p.413-426
- (22) Rouse, P.E.
Diffusion of vapours in films
Journal of American Chemical Society, 69, 1068-73 (1947)
- (23) Daynes, H.
Proc. Royal Society (London) A 97, 286 (1920)
Proceedings of Royal Society
- (24) Barrer, R.M.
Trans. Farad. Soc., 35, 628, (1939)
Permeation, diffusion and solution of gases in organic polymers
- (25) Sheppard, S.E. and Newsome, P.T.
The sorption of water vapour by cellulose and its derivatives
Journal of Physical Chemistry, 33, 1817, (1929)
- (26) Sheppard, S.E. and Newsome, P.T.
The sorption of water vapour by cellulose and its derivatives
Journal of Physical Chemistry, 34, 1158 (1930)
- (27) Sheppard, S.E. and Newsome, P.T.
The sorption of alcohol vapours by cellulose and cellulose acetates
Journal of Physical Chemistry, 33, 2306 (1932)
- (28) Bagley, E. and Long, F.A.
Two stage sorption and desorption of organic vapours in cellulose acetates
Journal of Chemical Physics, Vol.77 p.2172 (1955)
- (29) Mandelkern, L. and Long, F.A.
Rate of sorption of organic vapours by films of cellulose acetate
Journal of Polymer Science, Vol. VI No.4, p.457, (1951)

- (30) McCall, H.W.
Diffusion in ethylene polymers
Journal of Polymer Science, Vol.XXVI, P.151 (1957)
- (31) Starkweather, H.W.
The sorption of water by nylons
Journal of applied polymer science, Vol.11 No.5 p.129 (1959)
- (32) Taylor, R.L.
Sorption of water by organic insulating materials
Bell Laboratories Record, Vol.17, p.370 (1939)
- (33) Spencer, H.G. and Ibrahim, I.M.
Diffusion coefficients in water vapour polyvinyl alcohol systems
Journal of Polymer Science, Part A-2, Vol.6, p.2067 (1968)
- (34) Shirokshina, Z.V., Suykovshaya, N.V. and Pogodayev, A.K.
The diffusion of water vapour through polymer films
Optical Technology, Vol.37, No.1, p.42 (1970)
- (35) Park, G.S.
An experimental study of the influence of various factors on
the time dependent nature of diffusion in polymers
Journal of Polymer Science, Vol X1, No.2, p.97 (1953)
- (36) ASTM D257-61
Electrical resistance of insulating materials
- (37) Curtis, H.L.
Insulating properties of solid dielectrics
Vol.1, p.214, Bulletin of the Bureau of Standards, 11, p.359 (1915)
- (38) Scott, A.H.
National Bureau of standards "Testing of Polymers"
John Wiley and Sons, Inc. (1965)

- (39) Amey, W.G. and Hamberger, F.
A method of evaluating the surface and volume resistivities
of solid dielectric materials.
Proceedings of American Society for Testing Materials,
49, p.1079 (1949)
- (40) Semenov, N.N. and Chirkov, N.M.
On the surface electrical conductance of dielectrics
Comptes Rendues (Doklady) de l'academic des sciences de l'U.R.S.S.
51, p.39 (1946)
- (41) Purdon, J.R. and Morton, M.T.
Journal of Polymer Science, 57, 453, (1962)
Molecular weight of polymer from electrical resistivity of
solutions
- (42) Kallweit, J.H.
Kunststoffe, 47, 651, (1957)
- (43) Warfield, R.W. and Petree, M.C.
SPE Trans. 1, 80, (1961)
- (44) Warfield, R.W. and Petree, M.C.
Makromol, Chem. 58, 139, (1962)
- (45) Chirkov, N.M.
Contribution to the problem concerning the surface
conductivity of solid dielectrics
Zhurnal Fizicheskoi Khimii, 21, p.1303 (1947)
- (46) Yager, W.A. and Morgan, S.O.
Surface leakage of pyrex glass
Journal of Physical Chemistry, 35, p.2026 (1931)
- (47) Mchaffie, J.R. and Lenher, S.
The adsorption of water from the gas phase on place surfaces
of glass and platinum
Journal of Chemical Society, 127, p.1559 (1925)

- (48) Kawasaki, K.
On the variation of electrical resistance of a polymer
as a function of the extent and the nature of sorbed water
Journal of Colloid Science , 16, p.405 (1961)
- (49) Wakuni, Y. and Calderwood, J.H.
Water vapour adsorption and surface conductivity in solids
Journal of Phys.D. Appl. Physics. Vol.5, (1972)
- (50) Gregg, S.J. and Sing, K.S.W.
Adsorption, Surface area and porosity
Academic Press, p.43 (1967)
- (51) Petze, C.L.
Dielectric requirements in microwave equipments
Journal of Elec. Mfg. 64, 128, (1959)
- (52) Field, R.F.
The formation of ionized water films on dielectrics under
conditions of high humidity.
Journal of Applied Physics, 17, 318, (1946)
- (53) Killam, D.L.
Surface effects on electrical insulation
Ontario Hydro Research Quarterly, 15, 28 (1963)
- (54) Lieste, E.
The electrical surface conductivity of pressed amber
Zeitschrift for Physik, 62, p.646 (1930)
- (55) Williams, J.C. and Herrman, D.B.
Surface resistivity of non porous ceramic and organic
insulating materials at high humidities with observations of
associated silver migration.
Transactions of the Institute of Radio Engineers on
reliability and quality control. No.PGRQC p.11 (1956)

- (56) Chaiken, S.W.
Surface contamination of dielectric materials
Transactions of the Institute of Radio Engineers on
reliability and quality control. No.PGRQC-6 p.57 (1956)
- (57) Dryden, J.S. and Wilson, P.T.
The influence of moisture films on glazed porcelain
Philosophical Magazine, 18, p.63 (1934)
- (58) Thompson, B.
General Engineering Laboratory, General Electric Company.
Scheneclady, N.Y. (Reported at intervals to subc. XII, A.S.T.M.
See BAER (20) p.9)
- (59) Mathes, K.N.
Electrical properties of plastics
Engineering Design for Plastics, p.515, Chapman and Hall Ltd.,
London.
- (60) Green, H.J.
Grading of sheet plastics by moisture absorption and
insulation resistance measurements.
Modern Plastics, p.166 December 1948
- (61) Field, R.
How Humidity Affects Insulation
General Radio Experimenter 20 No.243, 11
- (62) Rosenberg, B.
Electrical conductivity of proteins, II Semiconduction in
crystalline bovin haemoglobin
Journal of Chemical Physics Vol.36, No.3 (1962)
- (63) King, G. and Medley, J.A.
The influence of temperature and adsorbed salts on the
d.c. conductivity of polar polymer adsorbate systems.
Journal of Colloid Science 4, 9. (1949)

- (64) Hearle, J.W.S.
Journal of Textile Instrumentation 44 T117 (1953)
- (65) Rosenberg, B.
Biophysics, Electrical Conductivity of Proteins
Nature, Vol. 193, p.364 (1962)
- (66) Eley, D.D. and Leslie, R.B.
Hydration of solid proteins with special reference to
haemoglobin
Recent Advance Food Science, Vol.3, p.215 (1963)
- (67) Baxter, S.
Transactions of Faraday Society, 39, 207, (1943)
Electrical conduction of textiles
- (68) Hearle, J.W.S.
Fibres and Textiles
Modern dielectric materials , Ed. Birks, J.B.
Heywood and Co.Ltd., 1960, p.231
- (69) Murphy, E.J. and Walker, A.C.
Journal of Physical Chemistry, 32, 1761, (1928)
- (70) Charles, T.R. and Barker, R.E.
Moisture and ion sorption in cellulose acetate
Journal of applied polymer science, Vol. 7, p.1933 (1963)
- (71) Patel, G.N. and Patel, R.D.
Single crystals of high polymers by film formation
Journal of polymer science, Part A-2, Vol.8, p.47 (1970)
- (72) Carnell, P.H.
Journal of Applied Polymer Science 9, 1863 (1965)
- (73) Fionnuala, E.M. and O'Brien, M.A.
Control of humidity by saturated salt solutions
Journal of Scientific Instrumentation 25, p.73 (1948)

8.0 Appendices

Appendix A

Table 2.1

The values of maximum sorption of water vapours by cellulose acetate films of different thickness.

<u>Thickness</u>	<u>Maximum Adsorption</u>
0.0405 mm	14.95% at 600 min
0.0850 mm	14.49% at 1320 min
0.1320 mm	10.60% at 1290 min
0.1702 mm	10.79% at 1440 min

Appendix B

Table 4.1

The values of relative humidity from saturated salt solutions at a temperature of 25^oC.

<u>Type of Salts</u>	<u>Relative Humidity</u>
Potassium sulphate	96%
Potassium chloride	86.5%
Sodium chloride	75.6%
Sodium nitrate	65%
Sodium dichromate	54%
Potassium carbonate	43%
Magnesium chloride	33%
Potassium acetate	22%
Lithium chloride	12%

Appendix C

Calculation of results from time response run

The following illustrates the program used to compute the data used in conjunction with two other computer runs, to plot figure (5.12). This calculation is for one run on cellulose acetate for a step change in humidity from zero % to 43%. Three such runs were calculated for each humidity.

The results were fitted using a polynomial of degree 5.

Input data

<u>Time</u>	<u>Capacitance (p.f)</u> $C_0 = 375.871$	<u>d.c. conductance (mho)</u>
9.50	(sample was exposed to humidity)	
9.52	1236.7	
9.53		2.25×10^{-12}
9.55	1272.0	
9.57		3.30×10^{-12}
9.59	1305.3	
10.01		4.875×10^{-12}
10.02	1329.0	
10.05		0.622×10^{-11}
10.08	1362.5	
10.11		0.90×10^{-11}
10.14	1396.6	
10.16		1.125×10^{-11}

<u>Time</u>	<u>Capacitance</u>	<u>d.c. conductance</u>
10.19	1407.1	
10.21		1.275×10^{-11}
10.31	1442.4	
10.33		1.850×10^{-11}
10.46	1471.5	
10.49		2.60×10^{-11}
11.10	1492.7	
11.12		3.450×10^{-11}
11.35	1502.5	
11.37		3.90×10^{-11}
11.57	1506.0	
11.59		4.20×10^{-11}

These values were fitted to a polynomial of degree 5, although in many cases a lower degree was sufficient and a good agreement was obtained. The polynomial coefficients for the calculation of $1/\epsilon'$ from capacitance results were,

$$\begin{aligned}
 a_0 &= 0.3089443 \text{ D } 00 \\
 a_1 &= -0.2861919 \text{ D } -02 \\
 a_2 &= 0.7148045 \text{ D } -04 \\
 a_3 &= -0.9919628 \text{ D } -06 \\
 a_4 &= 0.6899543 \text{ D } -08 \\
 a_5 &= -0.1851538 \text{ D } -10
 \end{aligned}$$

$$1/\epsilon' = a_0 + a_1 t + a_2 t^2 + a_3 t^3 + a_4 t^4 + a_5 t^5$$

Similarly the coefficient for the calculation of $\ln \sigma$ were,

$$b_0 = \pm 0.3093211 \text{ D } 02$$

$$b_1 = 0.1285538 \text{ D } 00$$

$$b_2 = - 0.2909374 \text{ D } - 02$$

$$b_3 = 0.3983394 \text{ D } - 04$$

$$b_4 = \pm 0.2795332 \text{ D } - 06$$

$$b_5 = 0.7564205 \text{ D } - 09$$

$$\ln \sigma = b_0 + b_1 t + b_2 t^2 + b_3 t^3 + b_4 t^4 + b_5 t^5$$

Computed values of $1/\epsilon'$ and $\ln \sigma$ at one time interval

<u>Time</u>	<u>$1/\epsilon'$</u>	<u>$\ln \sigma$</u>
0.0	0.3089	-30.932
8.0	0.2901	-30.070
14.0	0.2804	-29.603
20.0	0.2734	-29.248
26.0	0.2683	-28.975
32.0	0.2646	-28.760
38.0	0.2619	-28.585
44.0	0.2597	-28.438
50.0	0.2578	-28.309
56.0	0.2562	-28.193
62.0	0.2548	-28.089
68.0	0.2535	-27.995
74.0	0.2524	-27.912
80.0	0.2515	-27.843

