



## Durham E-Theses

---

### *Design investigations on some welded mild steel plate girders*

Litton, Eric

#### How to cite:

---

Litton, Eric (1967) *Design investigations on some welded mild steel plate girders*, Durham theses, Durham University. Available at Durham E-Theses Online: <http://etheses.dur.ac.uk/9910/>

#### Use policy

---

The full-text may be used and/or reproduced, and given to third parties in any format or medium, without prior permission or charge, for personal research or study, educational, or not-for-profit purposes provided that:

- a full bibliographic reference is made to the original source
- a [link](#) is made to the metadata record in Durham E-Theses
- the full-text is not changed in any way

The full-text must not be sold in any format or medium without the formal permission of the copyright holders.

Please consult the [full Durham E-Theses policy](#) for further details.

THE UNIVERSITY OF DURHAM

THESIS FOR THE DEGREE OF M.Sc. IN APPLIED SCIENCE

DESIGN INVESTIGATIONS ON SOME WELDED MILD STEEL PLATE  
GIRDERS,

by

ERIC LITTON, B.Sc., A.M.I.C.E., C.Eng.

VOLUME 1

JANUARY, 1967.



## LAYOUT OF THESIS

---

The thesis is in two volumes.

### Vol.1.

Written script, this being the text of the thesis. Diagrams, graphs, illustrations and appendices are included.

(All tables of data are excluded).

### Vol.2.

Tables of data. .

This volume comprises essentially of computer input and output, from which the graphs in Vol.1 have been prepared.

### Note:

References are occasionally made in Vol.1 to specific points which can best be shown in tabular form. In such cases it will be necessary to refer to Vol.2 (e.g. Chapter 3).

---

**ABSTRACT OF THESIS**

---

**"Design Investigations on Some Welded Mild Steel  
Plate Girders",**

**by E. Litton, B.Sc., A.M.I.C.E., C.Eng.**

---

The thesis gives details of a series of design investigations carried out on mild steel, welded, plate girders, having a constant I section and supported laterally and torsionally only at the ends of the span.

The main aim is to establish a General Method for expediting the design calculations for obtaining the optimum cross sectional dimensions of such a girder, essentially in accordance with the regulations as laid down in the British Standard Specification (B.S.449), while observing some rules for efficient or economical design. Here Minimum Weight Design has been chosen as the criterion of efficiency, though the methods devised can readily be extended or adapted to deal with other criteria. The moment of resistance, as reduced by lateral buckling, is deemed to be the significant factor in each design, though the various

other effects are considered as well.

A review of the problem is given, and an empirical investigation is then carried out to obtain the sectional dimensions of girders at Minimum Weight, spanning 100 feet, and resisting various moments.

This work is then extended to a wider application by means of a theoretical analysis, and a General Method is obtained. Suggestions are made as to how this Method may be applied, viz: by the construction of charts and tables or by the writing of an all embracing computer programme to give automatic design.

Various additional effects are described and finally an outline is given as to how this work can be extended to deal with more complicated practical girders.

-----

## CONTENTS

	<u>Page No.</u>
LAYOUT OF THESIS.	1
ABSTRACT OF THESIS.	11
CONTENTS.	iv - vii
NOTATION.	viii- xii
-----	
<u>CHAPTER 1:- BACKGROUND INFORMATION.</u>	1.
INTRODUCTION.	1.
DETAILS OF CONSTRUCTION:-	4.
Notes on Welding.	6.
Notes on Web Stiffening.	8.
DESIGN PROBLEMS:-	9.
Problem 1.	9.
Problem 2.	9.
Problem 3.	9.
DESIGN PROCEDURE:-	12.
Determination of the Permissible Stress $p_{bc}$ .	12.
Restrictions to Section Sizes.	16.
Determination of the Permissible Tensile Stress $p_{bt}$ .	19.
Determination of the Permissible Shear Stresses $p_q$ and $p'_q$ .	19.
Determination of the Maximum Permissible Deflection.	20.
Determination of the Moment of Resistance $M_R$ for a given section.	21.
Determination of the Maximum Shearing Force $S_{max}$ .	25.

CONTENTS (cont'd).

	<u>Page No.</u>
<b>EXAMPLE:-</b>	27.
Example No. 1.1	27.
Notes.	38.
<b><u>CHAPTER 2:- EMPIRICAL SEARCH FOR A METHOD.</u></b>	40.
<b>OUTLINE.</b>	40.
<b>DETAILS OF PRACTICAL INFORMATION.</b>	44.
<b>THE COMPUTER PROGRAMMES:-</b>	51.
Programme No. ABEL 1.	51.
Example No. 2.1	53.
<b>PILOT SCHEME:-</b>	54.
Selection of Numerical Data.	55.
Run No. 1.	57.
Discussion of Results from Run No.1.	58.
Run No. 2.	59.
Discussion of Results from Run No.2.	62.
Run No. 3.	63.
Discussion of Results from Run No.3.	64.
<b>SUMMARY OF RESULTS.</b>	64.
<b>CONCLUSIONS.</b>	65.
Definition of a Zone.	66.
<b><u>CHAPTER 3:- DETAILED INVESTIGATION ON AN                     EMPIRICAL BASIS.</u></b>	67.
<b>PROCEDURE:-</b>	67.
Discussion of Results.	69.
<b>THE CONTOUR:-</b>	72.
Definition of a Contour.	72.
Empirical Investigation on the Properties of Contours.	74.

CONTENTS (cont'd)

	<u>Page No.</u>
Data.	77.
Properties of a Contour.*	78.
(Definition of a Set of Contours)	79.
Effect of Varying the Width of the Compression Flange.	96.
*Properties of a Contour - Additions to the List.	99.
THE MINIMUM WEIGHT BOUNDARY:-	105.
Investigation at the Lower End of the Boundary.	105.
Data.	107.
Definition of an Inverted Contour.	108.
Discussion of Results.	108.
Synthesis of the Minimum Weight Boundary.	111.
CONCLUSIONS.	114.
<u>CHAPTER 4:- THEORETICAL JUSTIFICATION.</u>	117.
EQUATION OF A CONTOUR:-	117.
Formation of the Equation when $R \geq 1$ .	118.
Formation of the Equation when $R \leq 1$ .	121.
PROPERTIES OF A CONTOUR:-	126.
Properties of a Contour .... $R \geq 1$ .	126.
Negative Intercept c.	127.
Gradient m.	129.
Conclusions for $R \geq 1$ .	134.
Properties of a Contour .... $R \leq 1$ .	136.
VARIATION OF $p_{bc}$ :-	141.
Variation of $p_{bc}$ within a Set of Contours.	142.
Variation of $p_{bc}$ between Different Sets of Contours.	149.
THE STRESS RATIO R.	151.



CONTENTS (cont'd).

	<u>Page No.</u>
<u>CHAPTER 5:- A GENERAL METHOD.</u>	155.
PROCEDURE.	155.
APPLICATIONS:-	160.
1) Preparation of Charts and Tables.	161.
2) Automatic Design for Minimum Weight.	162.
<u>CHAPTER 6:- ADDITIONAL EFFECTS.</u>	164.
EFFECTS INVOLVING A POSSIBLE CHANGE OF SECTION:-	164.
Critical Shearing Forces.	166.
Deflection.	167.
EFFECTS REQUIRING NO CHANGE OF SECTION:-	167.
Web Stiffening.	167.
Welding.	168.
FURTHER EFFECTS:-	169.
Notes on $K_1$ and $\lambda$ .	169.
Comparison with the Bridge Specification B.S.153.	170.
<u>CHAPTER 7:- SUGGESTED FUTURE WORK.</u>	172.
Suggested Investigations.	173.
Discussion.	174.
ACKNOWLEDGEMENTS.	179.
REFERENCES.	180.
APPENDIX NO. 1. (Details of Practical Sizes, etc.)	182.
APPENDIX NO. 2. (List of Special Computer Programmes).	193.

## NOTATION

---

A list of the more common symbols used throughout the thesis, given in alphabetical order.

- A - a function of  $\frac{1}{r_y}$  and  $\frac{D}{T}$ , as given in Table 7 of B.S.449.
- A' - the cross sectional area. (in.<sup>2</sup>) (A' = A<sub>1</sub> + A<sub>2</sub> + A<sub>3</sub>)
- A'<sub>CT</sub> - that value of A' at which  $y_c = y_t = \frac{D}{2}$
- A<sub>1</sub> - the area of the compression flange. (in.<sup>2</sup>)
- A<sub>2</sub> - the area of the tension flange. (in.<sup>2</sup>)
- A<sub>3</sub> - the area of the web plate. (in.<sup>2</sup>)
- a<sub>1</sub> - the area of an element of cross section. (in.<sup>2</sup>)
- B - a function of  $\frac{1}{r_y}$ , as given in Table 7 of B.S.449.
- B<sub>1</sub> - the width of the compression flange. (ins.)  
See Fig.5.
- B'<sub>1</sub> - that value of B<sub>1</sub> along an inverted contour at which  $\frac{\partial r_y}{\partial B_1} = 0$
- B<sub>2</sub> - the width of the tension flange. (ins.) See Fig.5.
- B'<sub>2</sub> - that value of B<sub>2</sub> along a contour at which  $\frac{\partial r_y}{\partial B_2} = 0$

- $B''_2$  - that value of  $B_2$  on a contour at which  $\frac{\partial r_y}{\partial t_2} = 0$ .
- $B'''_2$  - that value of  $B_2$  along a contour at which  $A' = A'_{CT}$
- $BM_{max}$  - the maximum bending moment on the span due to the applied loading and the self weight of the girder. (ton.ft.)
- $C_s$  - the critical stress in the compression element as given in Clause 20 of B.S.449. (tons/in.<sup>2</sup>)
- $c$  - the negative intercept which the linear portion of a contour produced makes on the  $M_R$  axis in the  $M_R \sim A'$  diagram. (ton.ft.)
- $D$  - overall depth of section. (ins.) See Fig.5.
- $d$  - depth of web plate. (ins.) See Fig.5.
- $e_1$  - the gradient of the  $\frac{I_x}{y_t} \sim A'$  line for a given contour.
- $e_2$  - the negative intercept on the  $\frac{I_x}{y_t}$  axis of the  $\frac{I_x}{y_t} \sim A'$  line for a given contour.
- $f_{bc}$  - maximum compressive stress in the compression flange under the applied loading and self weight of the girder (tons/in.<sup>2</sup>)
- $f_{bt}$  - maximum tensile stress in the tension flange under the applied loading and self weight of the girder (tons/in.<sup>2</sup>)
- $f_q$  - maximum local intensity of shear stress in the web under the applied loading and self weight of the girder (tons/in.<sup>2</sup>)
- $f'_q$  - maximum value of the average shear stress in the web under the applied loading and self weight of the girder (ton/in.<sup>2</sup>)

- $g_1$  - the intercept on the  $\frac{I_x}{y_c}$  axis of the  $\frac{I_x}{y_c} \sim \frac{1}{A'}$  line for a given contour.
- $g_2$  - the negative gradient of the  $\frac{I_x}{y_c} \sim \frac{1}{A'}$  line for a given contour.
- $I_K$  - Second moment of area of the section about the KK axis. (in.<sup>4</sup>)
- $I_o$  - second moment of area of each element of area about an axis through its own centroid and parallel to the XX axis. (in.<sup>4</sup>)
- $I_x$  - second moment of area of the section about the XX axis. (in.<sup>4</sup>)
- $I_y$  - second moment of area of the section about the YY axis. (in.<sup>4</sup>)
- $K_1$  - a function of  $N$ , as given in Table 5 of B.S.449.
- $K_2$  - a function of  $M$ , as given in Table 6 of B.S.449.
- $L$  - span in feet.
- $l$  - effective length of the compression flange in feet. ( $l = \lambda L$ )
- $M$  - a quantity depending on sectional parameters, as defined on page 30 of B.S.449.
- $M_R$  - maximum moment of resistance of the section. (ton.ft).
- $m$  - the gradient of the linear portion of a contour.
- $N$  - a quantity depending on sectional parameters, as defined on page 30 of B.S.449.

- $P_{bc}$  - maximum permissible compressive stress, as given in Tables 2 and 8 of B.S.449. (tons/in<sup>2</sup>).
- $P_{bt}$  - maximum permissible tensile stress, as given in Table 2 of B.S.449. (tons/in<sup>2</sup>)
- $p_q$  - maximum permissible shear stress, as given in Table 10 of B.S.449 (tons/in<sup>2</sup>)
- $p'_q$  - maximum permissible value of the average shear stress, as given in Table 11 of B.S.449 (tons/in<sup>2</sup>)
- $R$  - the Stress Ratio =  $\frac{P_{bc}}{P_{bt}} \div \frac{f_{bc}}{f_{bt}}$
- $r_y$  - "radius of gyration" of the section about the YY axis. (ins.)
- $T$  - effective thickness of the compression flange, as defined on page 30 of B.S.449. (ins.)
- $t_1$  - thickness of the compression flange. (ins.)  
See Fig.5.
- $t_2$  - thickness of the tension flange. (ins.) See Fig.5.
- $t_3$  - thickness of the web plate. (ins.) See Fig.5.
- $\alpha$  - the inverse of the sectional area. (i.e.  $\frac{1}{A}$ )
- $y$  - distance from the centroid of each element of area to the XX axis of the section. (ins.)
- $y_c$  - distance from the XX axis to the extreme fibre of the compression flange. (ins.)
- $y_t$  - distance from the XX axis to the extreme fibre of the tension flange. (ins.)
- $\lambda$  - a quantity depending upon the nature of support of the compression flange, as given in Clause 26 of B.S.449. (Here  $\lambda = 1$ )

- $\mu$  - a function of the sectional parameters, as defined in Chapter 4 of the Thesis.
- $\phi$  - a function of the sectional parameters, as defined in Chapter 4 of the Thesis.

## CHAPTER 1

### BACKGROUND INFORMATION

#### INTRODUCTION

Plate girders have been used by engineers for many years to support moderate loads over long spans or to support high loads over shorter spans. The main actions on the girder are due to the applied loading which produces bending moments and shearing forces, and it has to be ensured that the maximum vertical deflections are kept below a limiting value. In addition, there are local effects involving the design of stiffeners, welding, splices, and connections; these can generally be allowed for by additional calculations after the basic cross section has been chosen, though the engineer must naturally ensure at the outset that the scantlings of such a section are a possible practical solution.

The problems of resisting the applied shearing force and restricting the deflection within the acceptable limits can generally be dealt with in a straightforward manner by choosing a suitable web plate (i.e. depth and thickness), and the design engineer would not normally experience any great difficulty in making this selection.

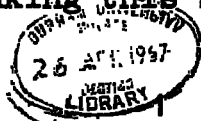

Certainly the stiffening of the web plate is a more complicated affair, and ROCKEY (1) has carried out much experimental work in this field, yielding a recommended design procedure; it is not intended to pursue this matter further in this investigation, except to indicate briefly in Chapters 6 and 7 (q.v.) how this can be done.

However the action of the bending moment at a given section of a plate girder does present the design engineer with a more complex problem, due to the lateral buckling of the compression flange and subsequent torsion of the section. This effect can be contained within acceptable proportions under working load conditions if the permissible stress in the compression flange is reduced, and if the girder is supported in a specified manner.

This problem has occupied the attention of various research workers for several years, and many experiments have been carried out. A comprehensive report on this work has been published by the Institution of Civil Engineers (2), embodying the work of KERENSKY, FLINT, and BROWN, regarding the basis of design, and of LONGBOTTOM and HEYMAN with respect to experimental verification. This report (2) includes an extensive bibliography of other publications on the subject.



This work has been adopted as the basis for design of welded girders in Great Britain, and has been embodied in two British Standard Specifications (3 and 4); these Standards are also frequently used by other countries which do not possess their own Codes of Practice.

The procedure laid down in these Standards (3 and 4) for obtaining the permissible compressive stress in the flange of the plate girder is both complicated and lengthy. Most design engineers, therefore, adopt a "trial and error" technique, choosing suitably proportioned sections from experience, and then checking that the permissible stresses are not exceeded on application of the working loads. This process may have to be repeated several times until a suitable section has been obtained. However, even at this stage, the final section may not be the most economical from the point of view of overall cost or weight of steel used.

The cost is a complex quantity and is partly affected by the weight of the girder and consequently by the amount of steel used, though it is generally more directly related to the cost of labour, delivery dates, availability of certain material, workshop capacity, fabricating techniques, transportation, erection, and the cost of living.

Nevertheless, taking all these factors into account, the structural steelwork designer and contractor will normally aim for MINIMUM WEIGHT DESIGN, using efficient, up-to-date production techniques available in a well equipped structural workshop.

The aim of this thesis therefore is to provide the design engineer and contractor with a series of techniques and calculations carried out on welded, mild steel girders in order to find the sectional dimensions of girders at MINIMUM WEIGHT necessary to withstand a specified bending moment (and shearing force) on a given span. This is a fundamental step, and suggested future work is outlined in Chapter 7. (q.v.).

#### DETAILS OF CONSTRUCTION

The main work of the investigation has been carried out on welded, mild steel (including the notch-ductile variety) plate girders having a uniform, I shaped cross section throughout. The girders are simply supported at the two ends, and effective lateral and torsional restraints are provided only at the ends of the span, so that the compression flange is free to buckle laterally between supports, i.e. the effective length of the compression flange is equal to the span of the girder. (The effects of intermediate lateral supports and changes in the cross sectional area will be briefly dealt with in Chapters 6 and 7).

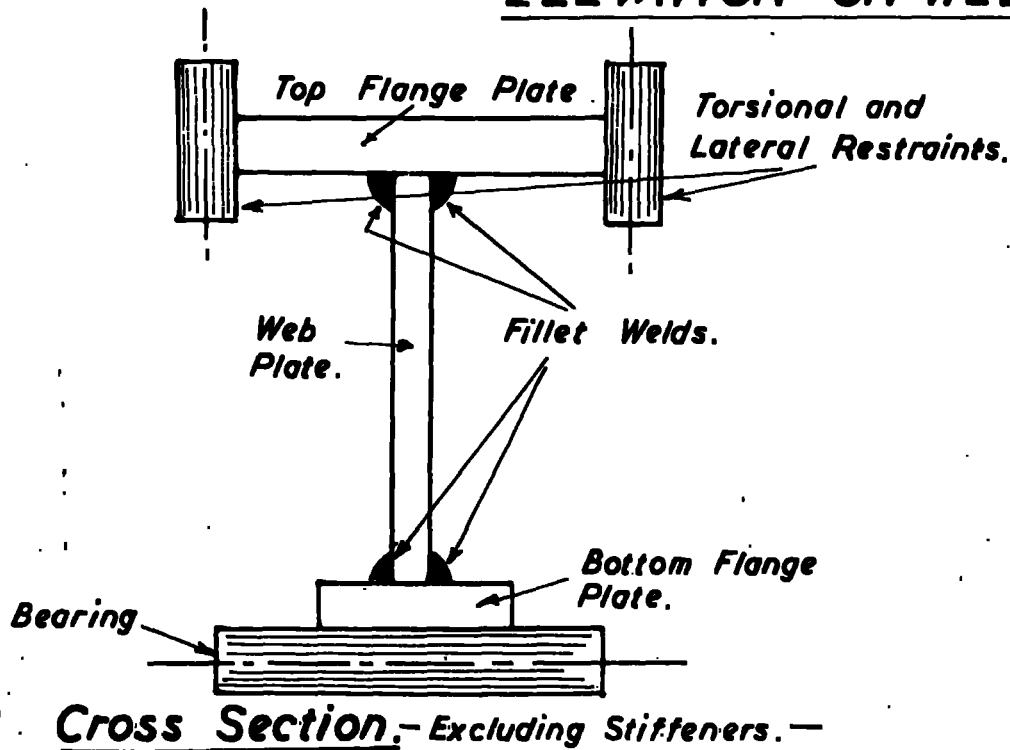
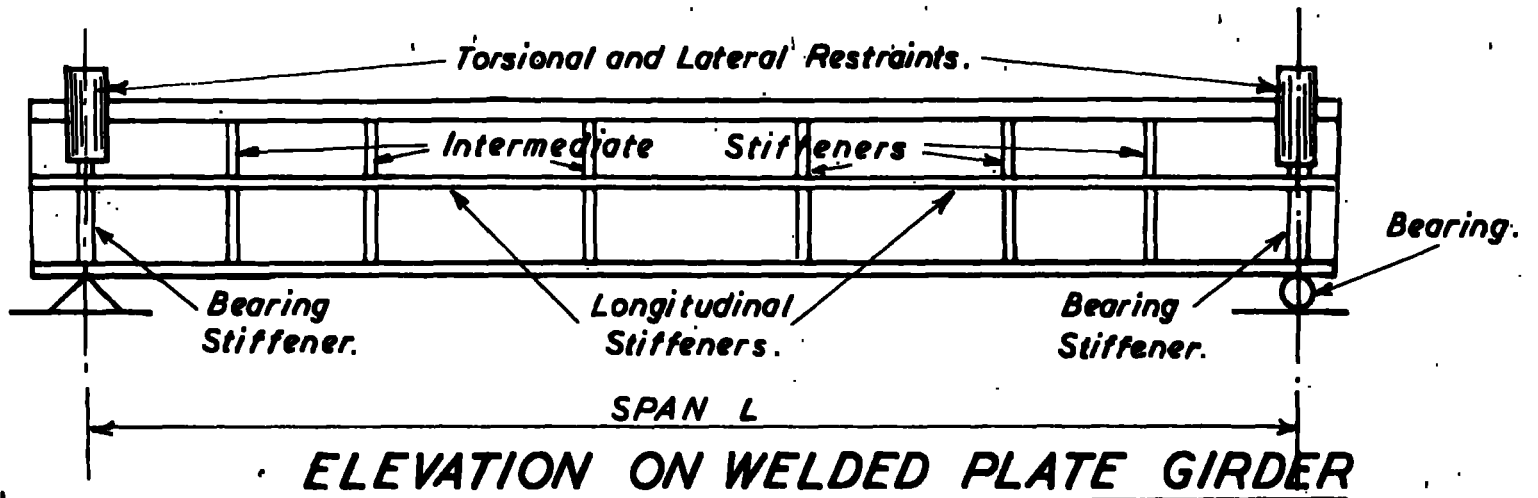

**DETAILS OF PLATE GIRDER**

**FIG. I.**

A typical elevation and cross section of a girder is shown in Fig. 1. The top and bottom flanges are connected to the web plate by means of fillet welds, normally effected in the plating shops by an automatic process. For a girder simply supported at the two ends the top flange will be in compression and the bottom flange in tension when a vertical, downward load is applied. The web plate is normally reinforced by intermediate and bearing stiffeners as shown in Fig. 1. Because of practical limitations it is frequently necessary to splice the web and flange plates using a welded detail; these joints can present an opportunity for changing the sectional dimensions. However curtailment of the section, while apparently reducing the weight of the girder, also reduces the permissible compressive stress at the section, thus reducing the value of the bending moment which can be resisted; this effect applies only to curtailment of the flange plates and not to any reduction in the web plate.

Finally, for girders having a deep web plate, longitudinal stiffeners are required as shown in Fig. 1.

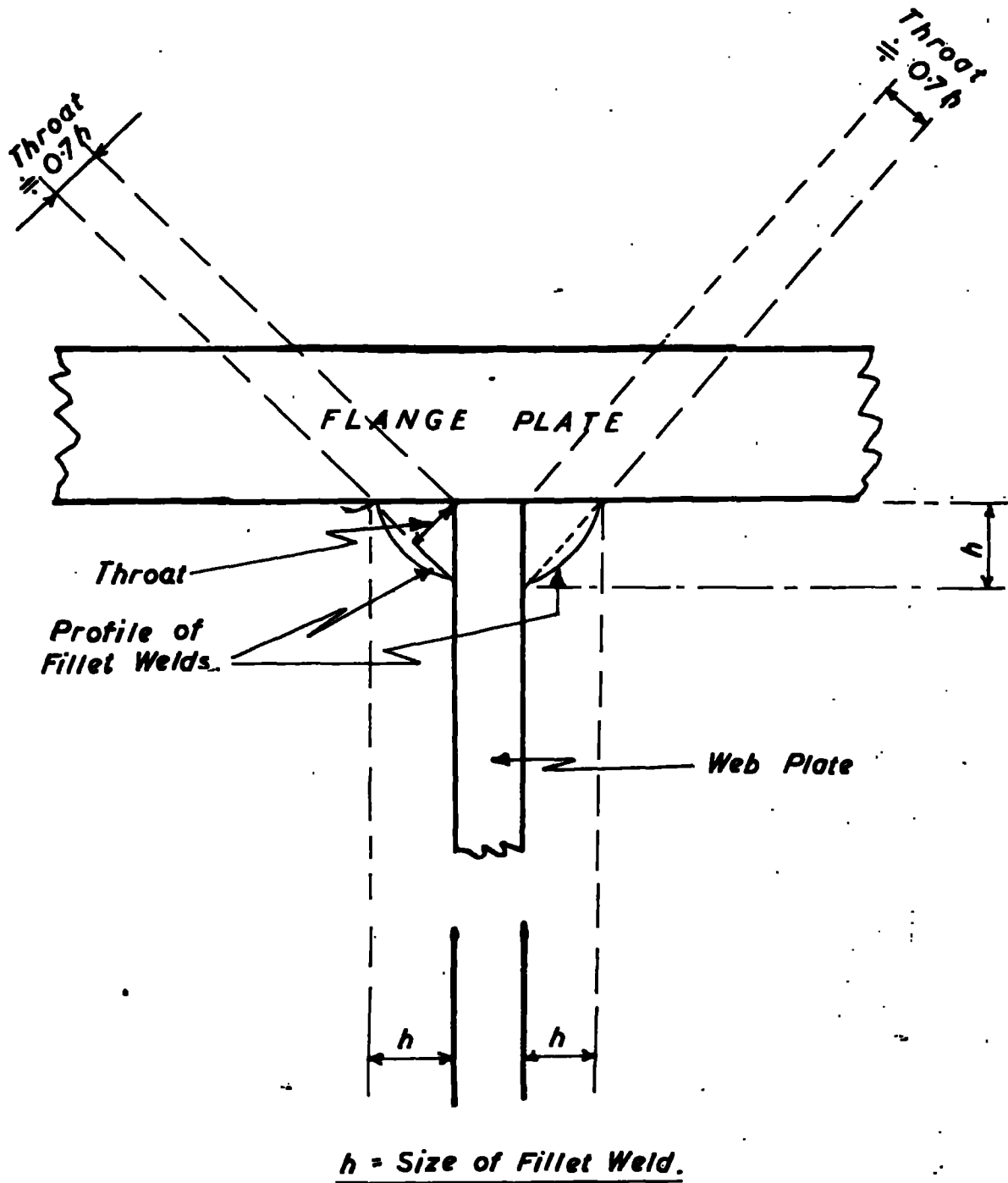

DETAIL OF FILLET WELDS

FIG. 2.

## Notes on Welding

The welding of the flanges to the web plate is usually carried out using fillet welds as shown in Fig.1. The size of such a weld is specified by the dimension  $h$  (inches) as shown in Fig.2, and the plane of failure envisaged is through the throat of the weld, this being the minimum dimension as shown.

There is a minimum permissible size of fillet weld which depends upon the maximum thickness of plate to be joined; this is essentially due to the adverse chilling action of the thick plate on the weld metal and subsequent possible brittle fracture, and numerical details are given in Chapter 2.

The maximum size of fillet weld must not be greater than the thickness of the thinner plate in the joint. In the case of the flange to web welding, the web is welded on both sides and it is usual practice then to ensure that the sum of the two throat dimensions is less than, or equal to, the thickness of the web plate, thus :-

$0.7h \leq \frac{t_3}{2}$ . In addition the web plate is never made

thicker than either flange, so that  $t_3 \leq t_1$  and

$t_3 \leq t_2$ .

These considerations thus restrict the choice of practical sections which can be selected.

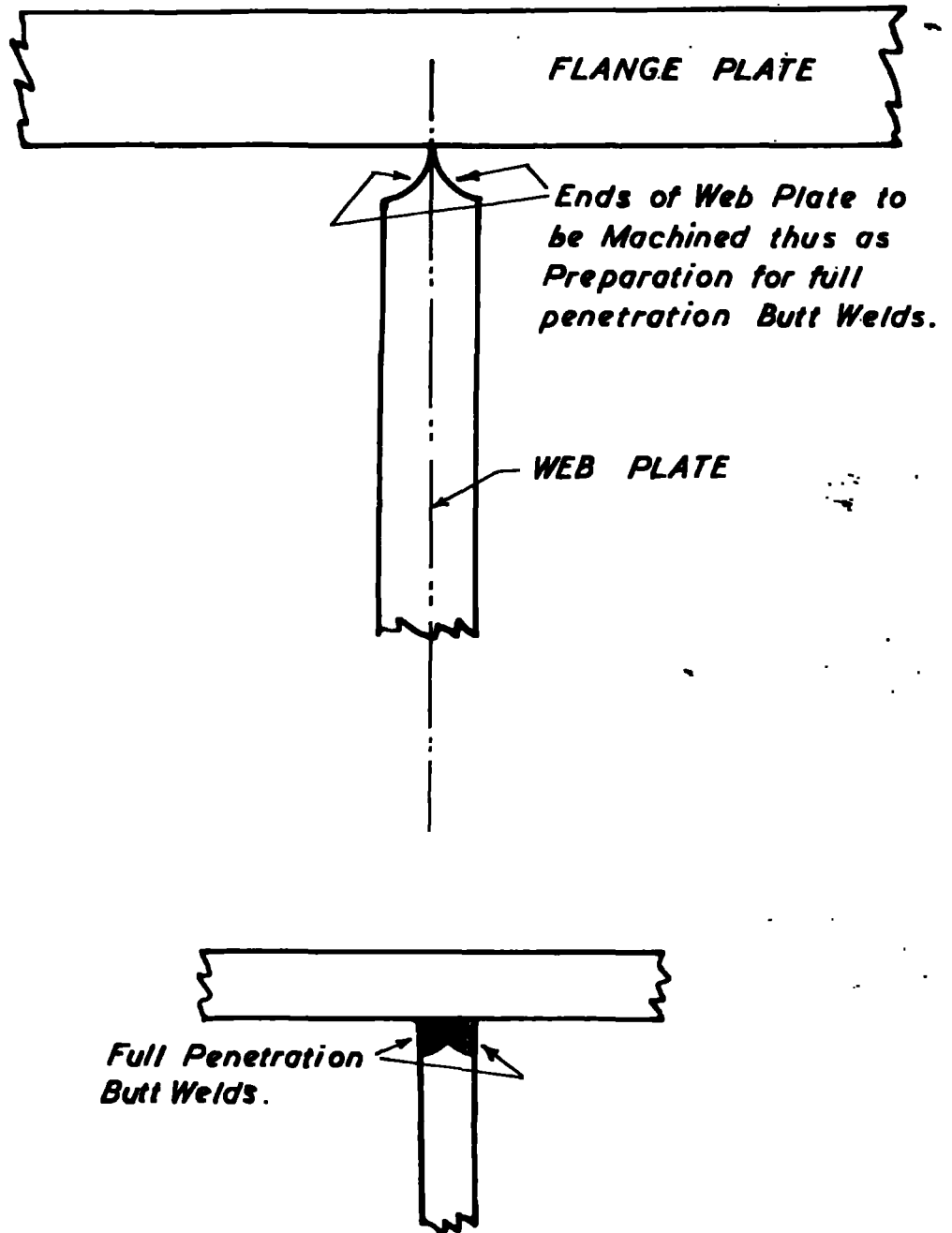

**DETAILS OF FULL PENETRATION BUTT WELDS.**

**FIG. 3.**

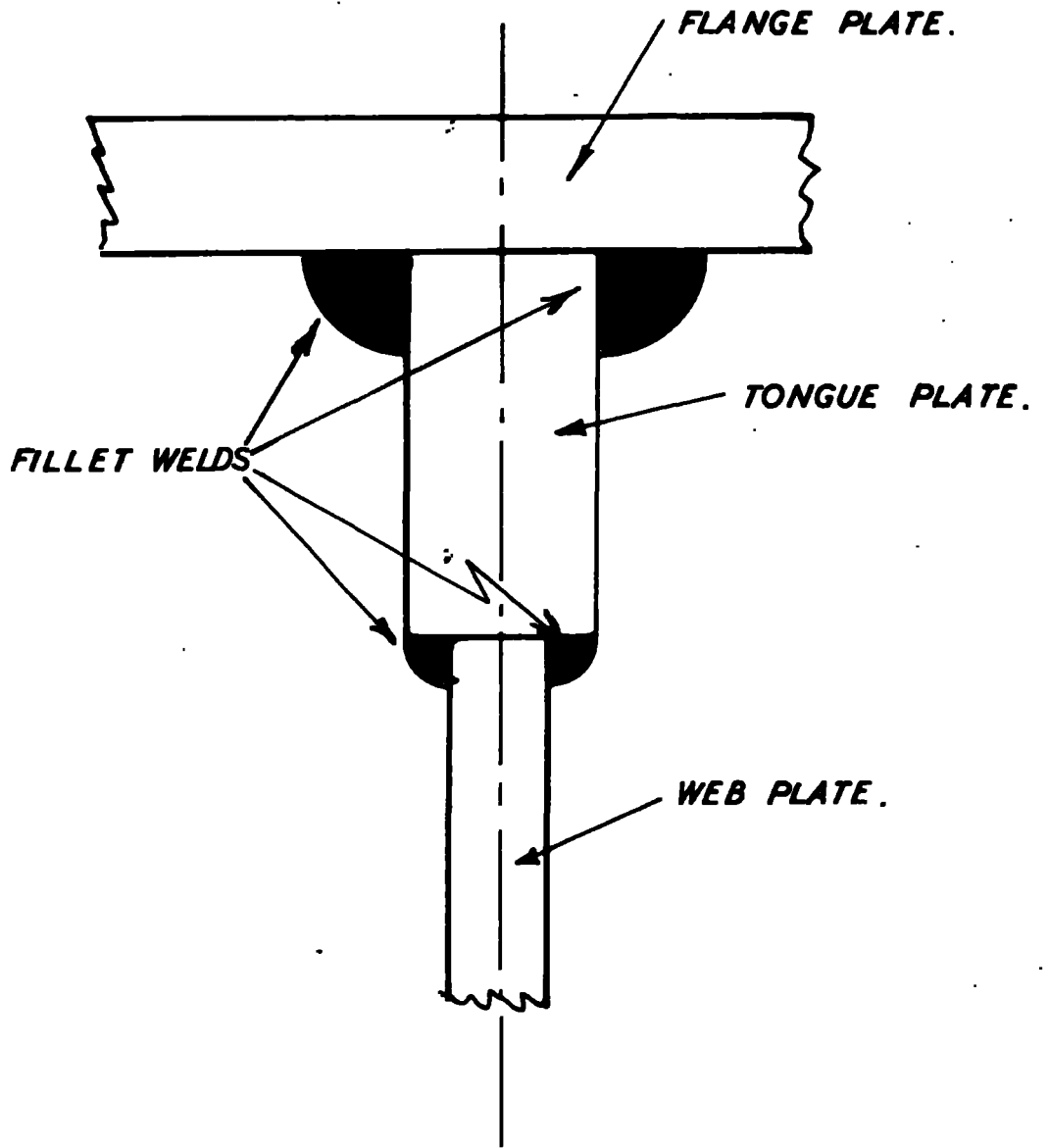

TONGUE PLATE DETAIL

FIG.4.



Moreover these fillet welds and the web plate must be strong enough to resist the shearing force which is applied to the section. Indeed if this resistance to shear is insufficient, the section will be unsatisfactory. However if it proves to be the welding which would be insufficiently strong, rather than the web plate, an immediate strengthening can be gained by using a full penetration butt weld. This type of weld is shown in Fig.3 and will involve the machining of the ends of the web plate at increased cost, but the resulting joint will be as strong as the parent metal and will therefore be no longer critical in design as the web plate has its maximum intensity of shear stress at the Neutral Axis. Such a change in the type of welding will not alter the weight of girder but will increase the fabrication costs.

The use of tongue plates is sometimes employed if it is required to extend the choice to enable thicker flange plates to be connected to thinner web plates. This device is shown in Fig.4. However much more welding is now required which will increase the fabricating costs, and the section will have a different shape which would not usually be maintained constant throughout the span. For these reasons this type of construction will only be considered briefly in Chapter 7.

## Notes on Web Stiffening

The British Standard B.S.449 gives details as to when web stiffening is required; this information is given later in the Chapter (see DESIGN PROCEDURE). When web stiffeners are used, the weight of the girder will be increased as indeed will be the cost. Since it is only logical to compare like with like, the various categories of web stiffening must be kept separately in the first instance; later a comparison can be made among the categories, considering the overall weight of the girder.

Girders with stiffened webs generally have a smaller cross sectional area; this apparent saving in weight is however reduced by the weight of the stiffeners and there is naturally an associated change in the cost, which will not be considered further here.

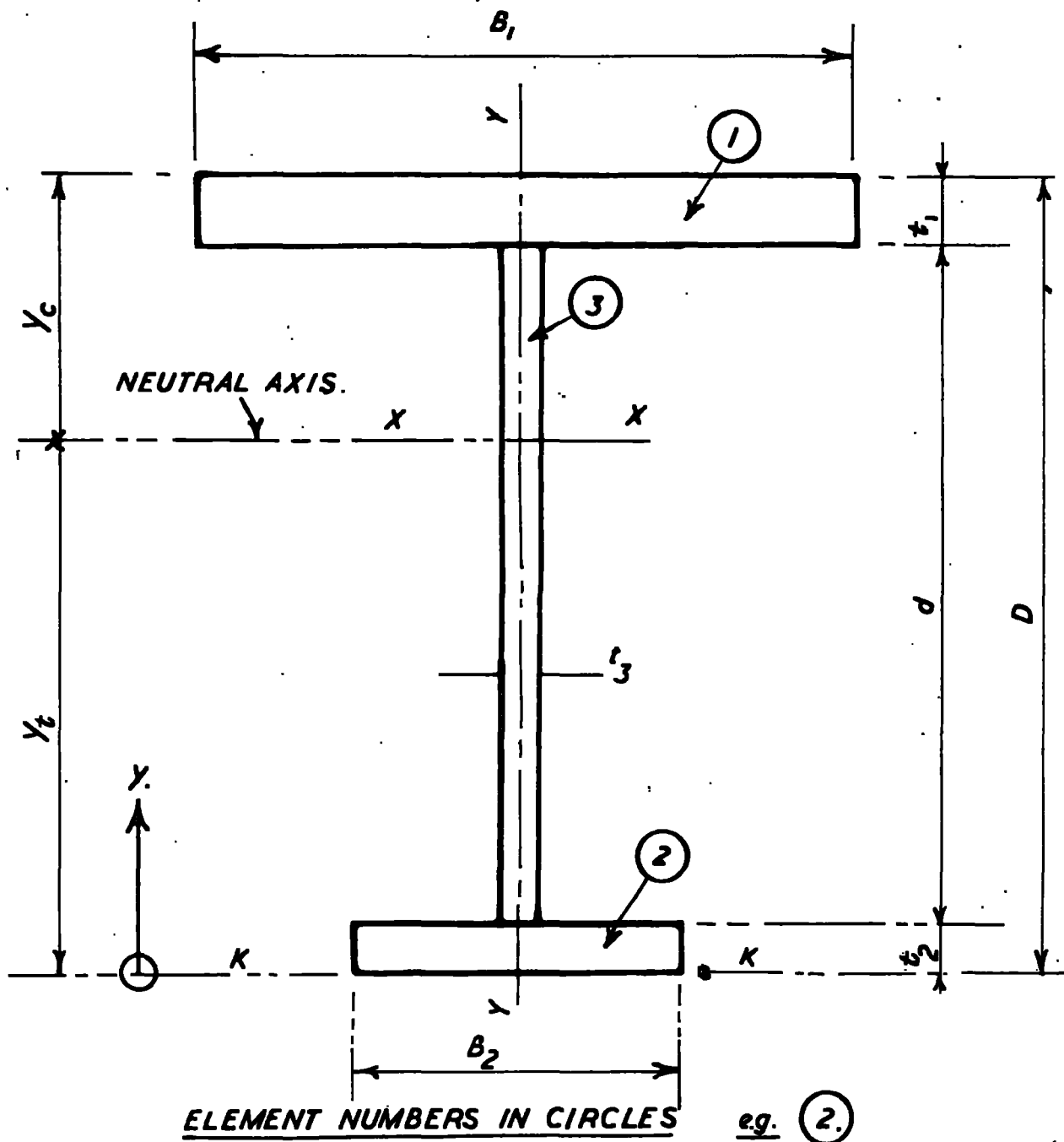

**CROSS SECTION DIMENSIONS**

**FIG. 5.**

## DESIGN PROBLEMS

Details of the more common design problems will now be outlined. In all cases it is required to find the complete cross sectional dimensions, as shown in Fig.5, so that the permissible stresses are not exceeded on application of the working load, while observing some rule of efficiency.

### Problem 1.

Given the span and the applied loading, it is required to obtain suitable cross sectional dimensions  $B_1$ ,  $B_2$ ,  $t_1$ ,  $t_2$ ,  $t_3$ , and  $D$ . (Fig.5).

This is the most common design problem.

### Problem 2.

Given the span, the maximum overall depth of section  $D$  and the applied loading, it is required to obtain suitable cross sectional dimensions.

In this case, the depth of section is restricted because of headroom, distance between floor and ceiling, or because of some other clearance.

### Problem 3.

Given the span, the maximum depth of section (or maximum depth of web plate  $d$ , Fig.5), the thickness of the web plate  $t_3$ , and the applied loading, it is required to obtain suitable cross sectional dimensions.

In this problem the applied shearing force can be specially allowed for - this is the reason for specifying the two web dimensions  $d$  and  $t_3$ . Moreover the type of web stiffening required can be categorised here as this depends upon the thickness of the web plate  $t_3$ .

( There are four categories of web stiffening, and these will be described later. (See DESIGN PROCEDURE). )

There are further design problems in which it is required to draw from a given, limited, stock of material which is immediately available, and obtain the most suitable cross sectional dimensions. These type of problems are less important, and knowledge for their best solution can generally be gained from Problems 1, 2, and 3.

Most design engineers are satisfied when a section has been obtained which obeys the following rules of efficiency:-

- (a) That standard, readily available, plate has been used, with the proportions of the section being conventional within the experience of the profession.
- (b) That the stresses under the working load are equal to, or just less than, the permissible stresses, which should not have been excessively reduced from their maximum limiting values.

- (c) That the maximum deflection under the applied loading is less than the stipulated limit.
- (d) That the thicknesses of all plate chosen are such as to enable the correct size of fillet welding, as required by strength considerations, to be carried out.

Naturally some engineers will regard some of these rules as being more important than others.

e.g. The designer employed by a contractor and tendering for work, will operate much nearer to all the limits in general. The consulting engineer, on the other hand, envisaging possible increases in loads or possible future extensions, will be more inclined to use greater reserves of strength and thus use heavier sections.

However, even when these rules of efficiency have been observed, there still remains a large number of possible solutions, and it is now suggested that the girder with MINIMUM WEIGHT should be adopted. This choice cannot easily be obtained by the design engineer because of the large number of possibilities, the complex nature of the calculations, and the "trial and error" or "hit and miss" approach generally followed.

It is felt that a closer understanding of the factors governing Minimum Weight Design of the girders

will be an important step towards achieving Minimum Cost Design as described briefly previously and also in Chapter 7.

The main problem in the design calculations is to know the value of the permissible compressive stress for a given section. Unfortunately this depends upon the material, the sectional dimensions (Fig.5), the span, the nature of support, and whether the girder is of uniform section throughout or not.

#### DESIGN PROCEDURE

The procedure as laid down in B.S.449:1959(3) will be used as the basis of design, and the process to be followed is given below; the notation used has been fully defined earlier. (see NOTATION).

#### Determination of the Permissible Compressive Stress $p_{bc}$

This process is in the form of a check calculation - it is assumed that  $B_1$ ,  $B_2$ ,  $t_1$ ,  $t_2$ ,  $t_3$ ,  $D$ ,  $L$ ,  $\lambda$ , and  $K_1$  are known. (see Fig.5).

$$\text{Area of Cross Section} = A' = B_1 t_1 + B_2 t_2 + d t_3$$

$$\text{Overall depth of section} = D = d + t_1 + t_2$$

In no case should  $p_{bc}$  be taken as greater than 10 tons/in<sup>2</sup> for  $t_1 \leq \frac{3}{4}$ " , or greater than 9.5 tons/in<sup>2</sup> for  $t_1 > \frac{3}{4}$ " .

Derivation of Second Moments of Area:-

Element	Area $a_1$	$y$	$a_1 y$	$a_1 y^2$	$I_0$
1	$B_1 t_1$	$D - \frac{t_1}{2}$			
2	$B_2 t_2$	$\frac{t_2}{2}$			
3	$d t_3$	$t_2 + \frac{d}{2}$			
$A' = \sum a_1$			$\sum a_1 y$	$\sum a_1 y^2$	$\sum I_0$

Then :-  $y_t = \frac{\sum a_1 y}{A'}$  and  $y_c = D - y_t$

$I = \sum a_1 y^2 + \sum I_0$

Therefore  $I_x = I_K - A' y_t^2$

and  $I_y = \frac{1}{12} \left( t_1 B_1^3 + d t_3^3 + t_2 B_2^3 \right)$

therefore  $r_y = \sqrt{\frac{I_y}{A'}}$

and  $l = \lambda L =$  effective length of the compression flange.



In this case,  $\lambda = 1$

∴ Slenderness Ratio =  $\frac{1}{r_y} > 300$  (Clause 25 of B.S.449).

Derivation of Ratio  $\frac{D}{T}$  : Now  $T = K_1 t_1$  where

$K_1 =$  a function of  $N$  (Table 5 of B.S.449).

Since it is intended in this investigation to consider girders having a constant cross sectional area throughout the span, then  $N = 1$

and ∴  $K_1 = 1$  (Table 5)

Moreover the value of  $T$  is restricted by B.S.449

to:  $\frac{1}{3} \leq \frac{T}{t_2} \leq 3$ .

Thus the Ratio  $\frac{D}{T}$  can be obtained.

-----  
Three different classes of section will now be considered:

1. Where the flanges have equal moments of inertia about the Y Y axis, (termed "U" for identification on computer calculations).
2. Where the moment of inertia of the compression flange about the Y Y axis of the girder exceeds that of the tension flange, (termed "V" for identification on computer calculations).

3. Where the moment of inertia of the tension flange about the Y Y axis exceeds that of the compression flange, (termed "W" for identification on computer calculations).

Class 1. (i.e. U) Here  $\frac{1}{12} t_1 B_1^3 = \frac{1}{12} t_2 B_2^3$

when  $\frac{T}{t_3} \leq 2$  and  $\frac{d}{t_3} \leq 85$ ,  $C_s = 1.2 A \text{ tons/in}^2$

In all other cases in Class 1,

$$C_s = A \text{ tons/in}^2$$

where  $C_s$  = the critical stress in the compression element.

Class 2. (i.e. V) Here  $\frac{1}{12} t_1 B_1^3 > \frac{1}{12} t_2 B_2^3$

In this case  $C_s = A + K_2 B \text{ tons/in}^2$ .

Class 3. (i.e. W) Here  $\frac{1}{12} t_1 B_1^3 < \frac{1}{12} t_2 B_2^3$

In this case  $C_s = (A + K_2 B) \cdot \frac{y_c}{y_t} \text{ tons/in}^2$

In all three Classes:

$$A = \frac{170,000}{\left(\frac{1}{r_y}\right)^2} \sqrt{1 + \frac{1}{20} \left(\frac{1}{r_y} \cdot \frac{T}{B}\right)^2}$$

i.e. A is a function of the slenderness ratio  $\frac{l}{r_y}$  and the ratio  $\frac{D}{T}$ , (See Table 7 of B.S.449) and can therefore be determined.

In Classes 2 and 3,  $B = \frac{170,000}{\left(\frac{l}{r_y}\right)^2}$

i.e. B is a function of  $\frac{l}{r_y}$  (See Table 7 of B.S.449) and can also be determined.

Thus  $C_s$  can be obtained for all sections. Now  $p_{bc}$  is a function of  $C_s$  (given in a tabular form in Table 8 of B.S.449), and can therefore now be determined.

-----  
Restrictions to Section Sizes

In addition to the limits given in the previous work, the following restrictions to sectional dimensions are laid down in B.S.449:

1. No plate must be thinner than 1/4", i.e.  $t_1, t_2$ , and  $t_3$  should be not less than 1/4" (See page 20 of B.S.449).
2. The maximum outstand of the top flange =  $\frac{B_1 - t_3}{2} \times 16t_1$   
 and the maximum outstand of the bottom flange =  $\frac{B_2 - t_3}{2} \times 20t_2$   
 (See Table 14 of B.S.449)

3. As a precaution against brittle fracture, where welded elements are subject to tension, the use of normal structural mild steel to B.S.15(5) shall be restricted to thicknesses not greater than  $1\frac{1}{2}$  inches. (See Clause 3 of Amendment No. 6 of B.S.449).

However the notch - ductile variety of structural mild steel to B.S.2762(6) can be used in such cases up to a thickness of 2 inches as specified at present, and it is suggested that thicknesses in excess of 2 inches, although at present outwith the scope of the specification, can be used provided a suitable impact test is carried out. (See Amendment No. 6 of B.S.449).

4. Finally restrictions are imposed on sectional sizes depending upon the type of Web Stiffening which has been employed. There are four categories of web stiffening; these depend essentially upon the minimum thicknesses of web plates:-

A. Unstiffened Webs.

No stiffeners are required.

In this case  $t_3 \leq \frac{d}{85}$

**B. Vertically Stiffened Webs.**

Only vertical stiffeners should be used in this category

Then:

$$t_3 \leq \frac{y_c - t_1}{100} \quad \text{and} \quad t_3 \leq \frac{d}{180}$$

(This latter restriction assumes that the vertical stiffeners are not closer than  $d$  inch centres; only such girders will be considered in the investigation).

**C. Webs Stiffened Vertically and Horizontally.**

A single horizontal stiffener is used in this category in addition to the vertical stiffeners. Then:

$$t_3 \leq \frac{y_c - t_1}{125} \quad \text{and} \quad t_3 \leq \frac{d - 0.4(y_c - t_1)}{270}$$

**D. Webs Stiffened Vertically and Horizontally.**

Two or more horizontal stiffeners are used here in addition to the vertical stiffeners. Then:

$$t_3 \leq \frac{y_c - t_1}{200} \quad \text{and} \quad t_3 \leq \frac{d - (y_c - t_1)}{270}$$

(See Clause 27, Amendment No. 2 of B.S.449).

It should be noted that category B would normally only be adopted if A is unsatisfactory, that C would normally only be used if A and B are both unsatisfactory, and that D would only be used if A, B, and C were all unsatisfactory.

This completes the restrictions to sectional dimensions as laid down in B.S.449. Further restrictions will be enumerated in Chapter 2 in order to conform with good practical proportions, and to ensure that all necessary welding can be accomplished.

-----

**Determination of the Permissible Tensile Stress  $p_{bt}$ .**

-----

The value of the permissible stress  $p_{bt}$  in the tension flange depends only on the thickness of that flange.

Thus  $p_{bt} = 10 \text{ tons/in}^2$  if  $t_2$  (and  $t_3$ )  $\leq 3/4$  inch.

and  $p_{bt} = 9.5 \text{ tons/in}^2$  if  $t_2$  (and  $t_3$ )  $> 3/4$  inch.

(See Table 2 of B.S.449)

-----

**Determination of the Permissible Shear Stresses  $p_q$  and  $p'_q$ .**

-----

The permissible value of the maximum shear stress  $p_q$  is:-

$p_q = 7 \text{ tons/in}^2$  (See Table 10 of B.S.449)

The permissible value of average shear stress  $p'_q$  is:-

$p'_q = 6 \text{ tons/in}^2$  if  $t_3 \leq 3/4$  inch

and  $p'_q = 5.5 \text{ tons/in}^2$  if  $t_3 > 3/4$  inch, (See Table 11 of B.S.449)

for plate girders with unstiffened webs, and in accordance with the reducing tabulated values of Table 12 of B.S.449 for stiffened webs.

Moreover the British Standard states, that compliance with the limit on the average shear stress  $p_q$  shall be deemed to satisfy the requirements of the maximum shear stress  $p_q$ . (See page 37 of B.S.449).

Determination of the Maximum Permissible Deflection.

No special reference is made in the British Standard regarding the permissible deflections in plate girders, though in Clause 15 of Amendment No. 4, the deflections of beams under live load should not exceed  $\frac{1}{360}$  of the span L.

In the case of plate girders considerable care should be taken by the engineer in specifying a permissible deflection, especially when severe dynamic loading is anticipated, when such a limit should be reduced.

In this investigation a brief analysis is given in Chapter 6.

This completes the procedure necessary in order to obtain the limiting values of the permissible stresses and deflections as specified in B.S.449.

It should be noted on passing that most of the foregoing work can apply equally well to the Bridge Specification B.S.153(4). This will be discussed in Chapter 6.

Determination of the Moment of Resistance  $M_R$  for a given section.

The maximum applied bending moment (BM max.) should be less than, or equal to, the maximum moment of resistance of the section. Moreover the working stresses  $f_{bc}$  and  $f_{bt}$  under the maximum applied bending moment should be less than, or equal to,  $p_{bc}$  and  $p_{bt}$  respectively.

Thus from the well-known Engineers' Theory of

Bending :- 
$$\frac{f}{y} = \frac{M}{I} ,$$

and therefore 
$$\frac{f_{bc}}{f_{bt}} = \frac{y_c}{y_t} \dots\dots\dots 1.1$$

Also 
$$f_{bc} \leq p_{bc} \dots\dots\dots 1.2$$

and 
$$f_{bt} \leq p_{bt} \dots\dots\dots 1.3$$

Then in the limit when BM max =  $M_R$  ,



$$M_R = \frac{f_{bc} I_x}{y_c} \dots\dots\dots 1.4$$

and  $M_R = \frac{f_{bt} I_x}{y_t} \dots\dots\dots 1.5$

In order to consider all cases of stress conditions on a given section it is convenient to introduce the concept of the Stress Ratio R, defined thus :-

$$R = \frac{p_{bc}}{p_{bt}} = \frac{f_{bc}}{f_{bt}} = \frac{f_{bt}}{p_{bt}} = \frac{f_{bc}}{p_{bc}}$$

There are three stress conditions possible for  $M_R$  to attain its maximum value.

1. Compression flange fully stressed and tension flange under-stressed. For this condition:  $f_{bc} = p_{bc}$  and  $f_{bt} < p_{bt}$

Hence from equation 1.4  $M_R = \frac{p_{bc} I_x}{y_c} \dots\dots\dots 1.6$

and  $R = \frac{f_{bt}}{p_{bt}} < 1$

2. Tension flange fully stressed and compression flange understressed. For this condition:

$$f_{bt} = p_{bt} \text{ and}$$

$$f_{bc} < p_{bc}$$

Hence from equation 1.5  $M_R = \frac{p_{bt} I}{y_t}$  .....1.7

and  $R = 1 \div \frac{f_{bc}}{p_{bc}} > 1.$

3. Both tension and compression flanges fully stressed simultaneously. For this condition

$$f_{bc} = p_{bc}$$

and  $f_{bt} = p_{bt}$

Hence from equations 1.4 and 1.5

$$M_R = \frac{p_{bc} I}{y_c} \quad \text{or} \quad M_R = \frac{p_{bt} I}{y_t}$$

i.e. both equations 1.6 and 1.7 apply simultaneously, and  $R = 1.$

-----

Only one of these three stress conditions can apply to a given section. Each condition can be recognised according to whether the Stress Ratio R is less than, equal to, or greater than unity. Thus when  $R < 1.00$ , the tension flange is understressed and the compression flange is fully stressed.

∴  $f_{bt} < p_{bt}$ ,  $f_{bc} = p_{bc}$ , and  $M_R = \frac{p_{bc} I}{y_c}$

When  $R = 1.00$ , both the tension and compression flanges are full stressed simultaneously.

$$\therefore f_{bt} = p_{bt}, f_{bc} = p_{bc}, \text{ and } M_R = \frac{p_{bc} I_x}{y_c}$$

$$\text{or } M_R = \frac{p_{bt} I_x}{y_t}$$

When  $R > 1.00$ , the tension flange is fully stressed and the compression flange is understressed.

$$\therefore f_{bt} = p_{bt}, f_{bc} < p_{bc}, \text{ and } M_R = \frac{p_{bt} I_x}{y_t}$$

Equation 1.1 can be used to find the values of the corresponding stresses in the understressed flanges,

$$\text{viz., when } R < 1.00, f_{bt} = \frac{y_t}{y_c} p_{bc}$$

$$\text{and when } R > 1.00, f_{bc} = \frac{y_c}{y_t} p_{bt}$$

This means that the moment of resistance  $M_R$  can be obtained for a given span and a given section, and this is the limiting value of the maximum bending moment  $BM_{max}$  which may be applied. It would appear from intuition that the girder of minimum weight will occur when  $R = 1.00$ , or, if this cannot be achieved with a practical section, when  $R$  is close to unity. It remains to be seen if this is so.

## Determination of the Maximum Shearing Force S' max.

There are four criteria which must be satisfied in order that a specified shearing force may be applied to a section. Two of these conditions depend upon the shear strength of the web, and the other two on the top and bottom flange to web welding. The four criteria are:

1. Local intensity of shear stress in the web.

$p_q > 7 \text{ tons/in}^2$ , and it can be shown that the

maximum shearing force in this case is equal to

$S_1 \text{ max.}$ , where:

$$S_1 \text{ max} = \frac{7 t_3 I_x}{\left[ B_1 t_1 \frac{(y_c - t_1)}{2} + \frac{t_3 (y_c - t_1)^2}{2} \right]}$$

2. Average shear stress in the web. The maximum shearing force in this case is equal to

$S_2 \text{ max.}$ , where:

$$S_2 \text{ max} = 6 d t_3 \quad \text{when } t_3 \leq 3/4", \text{ and}$$

$$S_2 \text{ max} = 5.5 d t_3 \quad \text{when } t_3 > 3/4".$$

Web stiffeners should be spaced in such a way as to ensure that  $p_q' = 6 \text{ tons/in}^2$  if  $t_3 \leq 3/4"$ , and that  $p_q' = 5.5 \text{ tons/in}^2$  if  $t_3 > 3/4"$ . If this cannot be done,  $S_2 \text{ max.}$  must be reduced. (Table No.12 of B.S.449).

3. Welding of compression flange to web plate.

In this case it can be shown that the maximum shearing force which may be applied to the section is equal to  $S_3 \text{ max.}$ ,

$$\text{where } S_3 \text{ max} = \frac{4.9 t_3 I_x}{B_1 t_1 (y_c - \frac{t_1}{2})}$$

4. Welding of tension flange to web plate.

Here the maximum shearing force is  $S_4 \text{ max.}$ , where:

$$S_4 \text{ max} = \frac{4.9 t_3 I_x}{B_2 t_2 (y_t - \frac{t_2}{2})}$$

-----  
The critical shearing force  $S \text{ max.}$  must then be not greater than the smallest value obtained for  $S_1 \text{ max.}$ ,  $S_2 \text{ max.}$ ,  $S_3 \text{ max.}$ , or  $S_4 \text{ max.}$

i.e.  $S \text{ max.} \rightarrow S_1 \text{ max.}, S_2 \text{ max.}, S_3 \text{ max.}, \text{ and } S_4 \text{ max.}$

It can be observed that  $S_1 \text{ max.}$  and  $S_2 \text{ max.}$  can generally only be increased by increasing  $t_3$  or  $d$ , and therefore by increasing the weight. (See Problem 3) If either  $S_3 \text{ max.}$  or  $S_4 \text{ max.}$  prove to be the critical limit, then it is possible to increase this value by using a full penetration butt weld without increasing the weight of the girder, as indicated earlier.

**EXAMPLE**

**Example No. 1.1**

Typical design calculations will now be given as a solution to the following design problem:

Find a suitable section for a welded plate girder spanning 70 feet and carrying a superimposed load of 2.8 tons per foot run over the entire span. Torsional and lateral restraints should be provided only at the ends.

**Solution**

Super. load = 2.8 tons/ft.

Dead load = 0.2 tons/ft (say)

∴ Total load = 3.0 tons/ft.

max. bending moment (at mid span) =  $\frac{3 \times 70 \times 70}{8}$   
= 1840 ton.ft.

Max. shearing force (at a support) = 105 tons.

The notation for sectional parameters shown in Fig.5 will be used. In absence of any restriction to overall depth, assume

$\frac{\text{SPAN}}{\text{DEPTH}} = 12$  ∴ D = 70 inches, say 72"

∴ Adopt overall depth D = 72"

Web Plate d = 69" and assume  $p_q = 6 \text{ tons/in}^2$

∴  $t_3 = \frac{105}{6 \times 69} = 0.254 \text{ inches}$

For a Vertically Stiffened Web (Category B),

$$t_3 \text{ min} = 69 \div 180 \\ = 0.384 \text{ ins.}$$

Hence Adopt a web 7/16" thick i.e.  $t_3 = 0.4375$  ins,

-----  
with vertical stiffeners  
-----

Notes:

1. It is possible to use up to 1/4" fillet welds with this thickness of web plate, and it is felt that this size of weld will certainly be adequate, though strength calculations must be made later.
2. An Unstiffened web plate (Category A) would require to be  $69 \div 85 = 0.812$  inches thick at least, and this is far in excess of the thickness required from the strength calculation and would be excessively heavy.

Flanges

Assume distance between flange centroids = 70"

$$\text{Then flange force} = \frac{1840 \times 12}{70} = 316 \text{ tons.}$$

Tension Flange

$$\text{Assume } p_{bt} = 9.5 \text{ tons/in}^2.$$

∴ Area of tension flange =  $A_2 = 316 \div 9.5 = 33.3 \text{ in}^2$ .

If width of tension flange =  $B_2 = 34$  inches, then:

$\frac{L}{B_2} = 24.8$  and  $\frac{B_2}{D} = 0.473$ . These proportions would

be satisfactory. Hence try as a first Approximation for the tension flange a plate 34" x 1" (area=34in<sup>2</sup>.)

#### Compression Flange

Assume  $p_{bc} = 7 \text{ tons/in}^2$ .

∴ Area of compression flange =  $A_1 = 316 \div 7 = 45.2 \text{ in}^2$ .

If  $t_1 = 1 \frac{1}{4}$ ", then  $B_1 = 36.2$ " and  $\frac{L}{B_1} = 23.3$  and

$\frac{B_1}{D} = 0.5$  These proportions would be satisfactory. Hence:

try as a first approximation for the compression flange a plate 1 1/4" x 36"  
(area = 45 in<sup>2</sup>.)

#### Note:

It is permissible to weld 1" and 1 1/4" flanges to a 7/16" thick web using 1/4" size fillet welds and so the proposed first approximation is a practical possibility.



Thus the first approximation is as shown in the diagram and it is now necessary to establish whether the maximum stresses under the total load are less than the actual permissible stresses, using the precise calculations described in the Design Procedure.

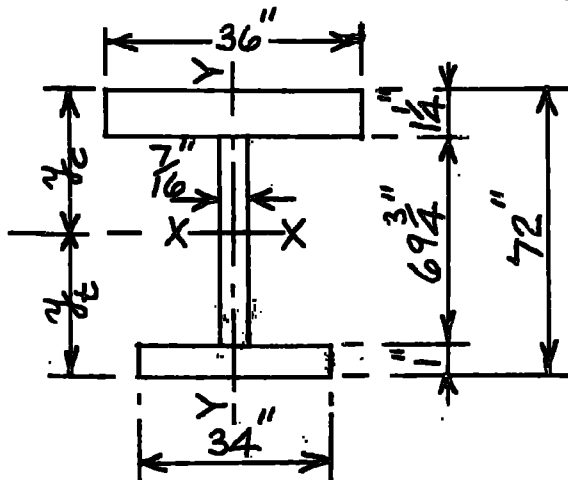

First Approximation

All dimensions in ton-inch units.

Elt.	Area a	y	a y	a y <sup>2</sup>	I <sub>o</sub>	I <sub>y</sub>
1	45	71.375	3,210	229,000	-	4,860
2	30.5	35.875	1,092	39,200	12,380	-
3	34	0.5	17	9	-	3,275
	$\Sigma = 109.5$		$\Sigma = 4,319$	$\Sigma = 268,209$	$\Sigma = 12,380$	$\Sigma = 8,135$
				12,380		
				280,589		

$$y_t = 4,319 \div 109.5 = 39.5'' \text{ and } y_c = 32.5''$$

$$I_K = 280,589 \text{ in}^4$$

$$\therefore I_x = 280,589 - 109.5 \times 39.5^2 = 109,789 \text{ in}^4$$

and

$$I_y = 8,135 \text{ in}^4$$

Hence

$$f_{bc} = 1840 \times 12 \times 32.5 \div 109,789 = 6.54 \text{ tons/in}^2.$$

and

$$f_{bt} = 1840 \times 12 \times 39.5 \div 109,789 = 7.95 \text{ tons/in}^2.$$

Also

$$p_{bt} = 9.5 \text{ tons/in}^2.$$

$$\text{To determine } p_{bc} : r_y = \sqrt{\frac{8135}{109.5}} = 8.62''$$

$$\frac{l}{r_y} = 70 \times 12 \div 8.62 = 97.5$$

$$\frac{D}{T} = 57.6$$

$$\therefore A = 19.17 \quad \text{and} \quad B = 17.9$$

$$\text{Now } M = 4860 \div 8135 = 0.598 \quad \text{and} \quad \therefore K_2 = 0.1$$

$$\therefore C_B = 19.17 + (0.1 \times 17.9) = 20.96 \text{ tons/in}^2.$$

$$\therefore p_{bc} = 6.45 \text{ tons/in}^2.$$

$$\therefore f_{bc} = 6.54 \text{ tons/in}^2 \quad \text{and} \quad p_{bc} = 6.45 \text{ tons/in}^2.$$

$$f_{bt} = 7.95 \text{ tons/in}^2 \quad \text{and} \quad p_{bt} = 9.5 \text{ tons/in}^2.$$

Hence the compression flange is over-stressed and the section is unsatisfactory. As the tension flange is under-stressed the second approximation will now involve increasing the area of  $A_1$  and reducing the area of  $A_2$ .

Second Approximation

Flange force = 316 tons

with  $p_{bc} = 6.45 \text{ tons/in}^2$  and  $p_{bt} = 9.5 \text{ tons/in}^2$

$$B_1 = 316 \div (1.25 \times 6.45) = 39.2", \text{ say } 38"$$

and

$$B_2 = 316 \div (1 \times 9.5) = 33.3", \text{ say } 33"$$

Hence the suggested section is as shown

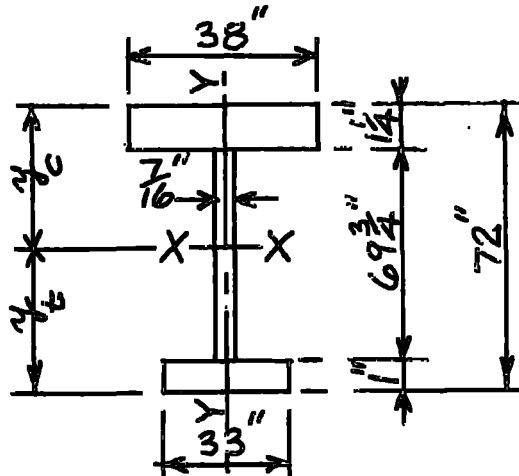

2ND. APPROX.

Second Approximation (cont'd).

Elt.	Area a	y	ay	ay <sup>2</sup>	I <sub>o</sub>	I <sub>y</sub>
1.	47.5	71.375	3,390	241,800	-	5,720
2	30.5	35.875	1,092	39,200	12,380	-
3	33.0	0.5	17	8	-	2,990
	Σ=111.0		Σ=4,499	Σ=281,008	Σ=12,380	Σ=8,710
				12,380		
				Σ=293,388		

$$y_t = 4,499 \div 111 = 40.5'' \quad \text{and} \quad y_c = 31.5''$$

$$I_K = 293,388 \text{ in}^4 \quad \text{and} \quad \therefore \quad I_x = 111,388 \text{ in}^4$$

$$\text{Hence } f_{bc} = 6.24 \text{ tons/in}^2 \quad \text{and} \quad f_{bt} = 8.04 \text{ tons/in}^2.$$

Since  $p_{bt} = 9.5 \text{ tons/in}$  it is clear that, while the stresses in this section may not exceed the permissible, the section will be understressed and hence wasteful, therefore UNSATISFACTORY.

Third Approximation

Let  $A_2 = 33 \times 8.04 \div 9.5 \doteq 28\text{in}^2$ , say  $29\text{in}^2$   
 and increase the compression flange to  $39'' \times 1\frac{1}{4}''$ .

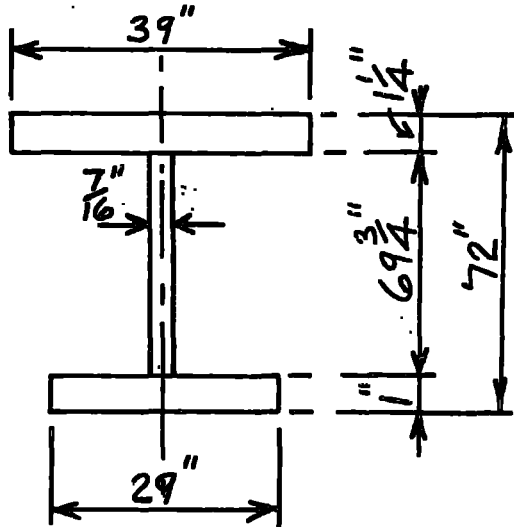

Repeating the process as shown for the first approximation, it can be shown that:

$$f_{bc} = 76.2 \text{ tons/in}^2 \text{ and}$$

$$P_{bc} = 7.0 \text{ tons/in}^2$$

$$f_{bt} = 8.89 \text{ tons/in}^2 \text{ and}$$

$$P_{bt} = 9.5 \text{ tons/in}^2.$$

3rd Approx.

Here the section is strong enough but is understressed on both flanges to a marked extent, therefore reduce area of both flanges.

#### Fourth Approximation

---

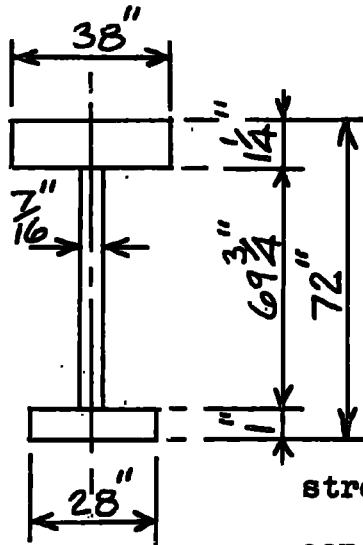

In this case :-

$$f_{bc} = 6.32 \text{ tons/in}^2 \text{ and}$$

$$p_{bc} = 6.7 \text{ tons/in}^2$$

$$f_{bt} = 9.05 \text{ tons/in}^2 \text{ and}$$

$$p_{bt} = 9.5 \text{ tons/in}^2.$$

The section is still under-stressed and the areas of both flanges can be still further reduced.

#### Fifth Approximation

---

Since this section proves to be satisfactory, fuller details will once more be given.

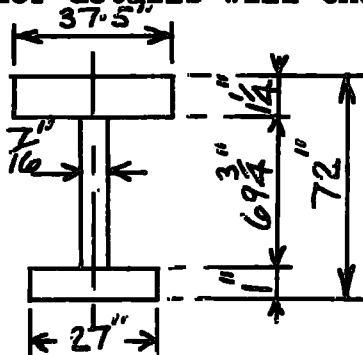

$$y_t = 42.5'' \text{ and } y_c = 29.5''$$

$$I_x = 100,687 \text{ in}^4$$

$$I_y = 7,142 \text{ in}^4$$

$$A' = 104.38 \text{ in}^2$$

$$r_y = 8.28''$$

#### Suggested Section

---

$$\frac{l}{r_y} = 101.5 \text{ and } \frac{D}{T} = 57.6$$

Hence  $A = 17.76$  and  $B = 16.56$

$M = 0.771$  and  $\therefore K_2 = 0.271$

$\therefore C_s = 22.24 \text{ tons/in}^2$  and  $\therefore p_{bc} = 6.65 \text{ tons/in}^2$ .

$\therefore f_{bc} = 6.47 \text{ tons/in}^2$  and  $p_{bc} = 6.65 \text{ tons/in}^2$ .

$f_{bt} = 9.34 \text{ tons/in}^2$  and  $p_{bt} = 9.5 \text{ tons/in}^2$ .

These stresses are satisfactory, hence

Adopt the section in the Fifth Approximation

Check on Self Weight

Weight of girder, excluding stiffeners = 10.93 tons  
and splices

Weight of Stiffeners, say = 3.07 tons  
therefore Total self weight = 14 tons.

Self weight estimated initially =  $0.2 \times 70 = 14$  tons.

Therefore Self weight estimate is satisfactory.

Welding of Compression Flange to Web.  $q_t = \frac{S}{I} A \bar{y}$

Horizontal shear per inch =  $\frac{105 \times 46.875 \times 28.875}{100,687}$

= 1.411 tons/inch

Hence size of fillet weld required =  $h = \frac{1.411}{2 \times 0.7 \times 5.5} = 0.1835$ "

But minimum permissible size of weld = 0.25"

Hence Adopt 1/4" size fillet welds, and these may be intermittent if the particular regulations permit.

Welding of Tension Flange to Web.

$$\text{Horizontal shear per inch} = \frac{105 \times 27 \times 42}{100,687} = 1.184 \text{ tons/inch}$$

Hence Adopt 1/4" size fillet welds (intermittent if permitted).

Check on Maximum Deflection

Max. deflection (at mid span) under total load =  $\delta$

$$\text{where } \delta = \frac{5 w l^4}{384 EI} = 1.2 \text{ inches}$$

$$\text{Now } \frac{\text{SPAN}}{360} = 2.34 \text{ inches, or}$$

$$\frac{\delta}{\text{SPAN}} = \frac{1}{700}$$

Hence deflection is satisfactory

Maximum Intensity of Shear Stress,  $f_g$ .

The maximum intensity of shear stress in the web of the girder occurs at the neutral axis at a support. It has been pointed out earlier that if the average shear stress is less than the permissible average shear stress, then, by B.S.449, the maximum intensity is deemed to be satisfactory. However in this case the value will be determined.



$$f_q = \frac{105 \times 1729}{100,687 \times 0.4375} = 4.12 \text{ tons/in}^2.$$

$$p_q = 7 \text{ tons/in}^2.$$

Hence satisfactory.

Intermediate and bearing stiffeners should now be designed, though it is not intended to do so here.

Notes:

As a result of the above calculations, the following points are worthy of note:

1. The size of fillet welds required should be estimated as soon as a reasonable approximation has been reached in order to ascertain whether the section is a practical possibility before proceeding any further with the calculations.
2. The calculations are arduous and lengthy, though a competent, skilled design engineer should require few attempts of the trial and error process.
3. Each square inch of section is equivalent to 0.1 ton of structural steel; this gives an indication of the economy to be gained by persisting in reducing the sectional area.

4. Even after these calculations have been carried out, the solution arrived at is by no means unique and is unlikely to be the one giving Minimum Weight or Minimum Cost, though it should be near these limits since conventional proportions have been adopted throughout. A large number of further solutions can be obtained by varying the span to depth ratio from 12 and by varying the other sectional dimensions shown in Fig.5.

It is hoped that the techniques described in the following chapters will provide the design engineer with the basis for obtaining the girder of minimum weight and related properties in a more competent way.

## CHAPTER 2

### EMPIRICAL SEARCH FOR A METHOD

#### OUTLINE

It has been shown that the main problem facing the engineer is to obtain numerical values for the cross sectional dimensions, shown in Fig. 5, to withstand a given applied bending moment on a specified span while observing reasonable economy. The criterion of efficiency to be employed here will be Minimum Weight and since, for girders of a given span, the self weight is proportional to the cross sectional area, then the search is for the dimensions of the cross section which has the Minimum Area among all the practical possibilities available. Naturally if web stiffeners are employed the weight of the girder will be increased, and so it will be necessary to consider each of the four categories of stiffening separately.

It is considered that the dimensions of the cross section of girders at minimum weight will tend to conform to a pattern regardless of the span. Thus it is proposed to choose a given span and to calculate the moments of resistance  $M_R$  for a wide

$L = \text{CONSTANT.}$   
 $D = \text{CONSTANT.}$   
 $t_3 = \text{CONSTANT.}$

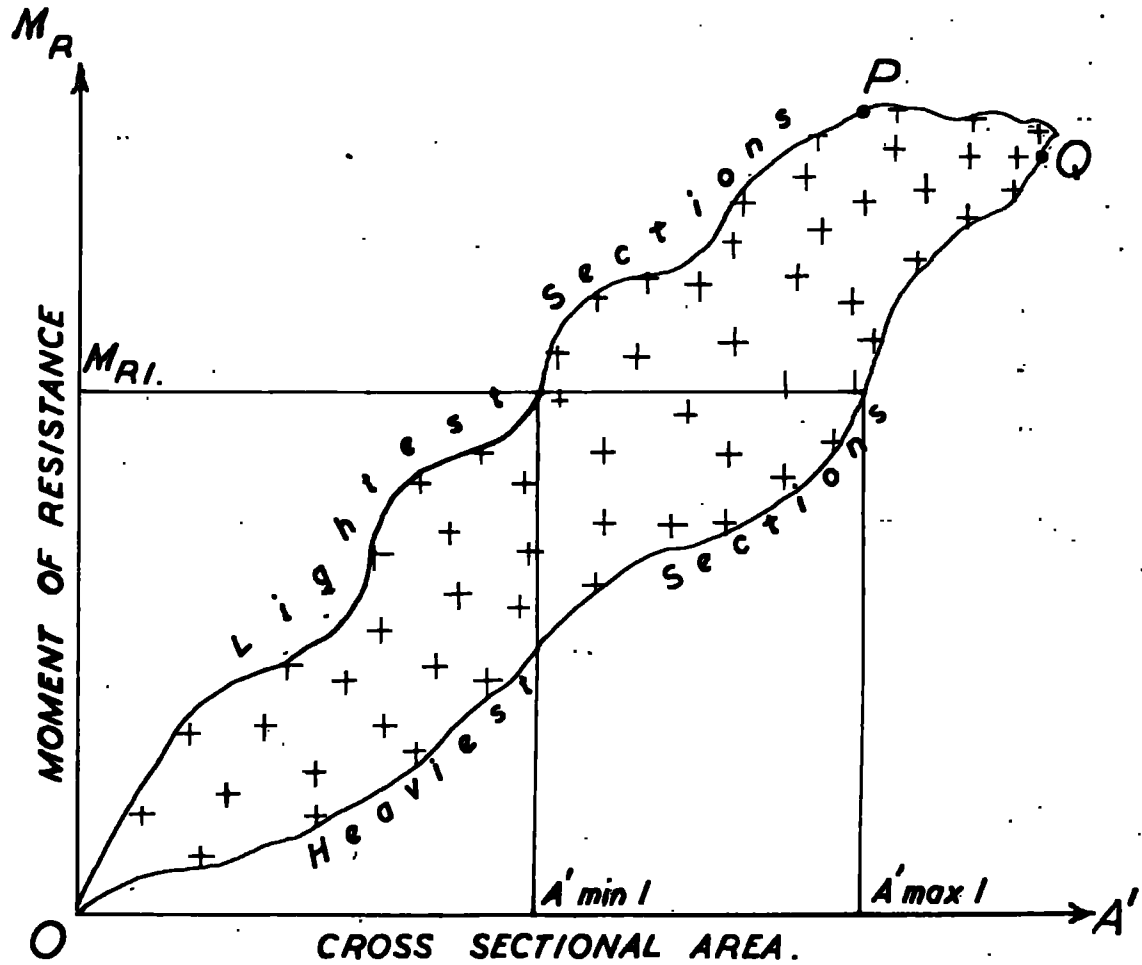

DIAGRAMMATIC REPRESENTATION OF  
THE PLOT OF  $M_R$  AGAINST  $A'$

FIG. 6.

variety of sections obtained by varying the sectional dimensions incrementally between their maximum and minimum practical values. Moreover if the depth  $D$  and web plate thickness  $t_3$  are also kept at a constant value while the remaining sectional parameters, viz  $B_1$ ,  $t_1$ ,  $B_2$ , and  $t_2$ , are varied, it will then be possible to search for the solutions to Design Problems 1, 2, and 3 as described in Chapter 1, simultaneously. The entire process can then be repeated as many times as necessary for other values of  $D$  and  $t_3$ .

When the values of the moment of resistance  $M_R$  and sectional area  $A'$  have been obtained, the results can be plotted on a  $M_R \sim A'$  graph as shown diagrammatically in Fig. 6. In this diagram  $OP$  is the boundary of minimum areas and hence of minimum weights to provide various values of  $M_R$  over the entire practical range.  $OQ$  is the boundary of maximum areas and therefore of the heaviest sections. The ratio of the maximum to the minimum area at a given  $M_R$  is then a measure of the range of weights of practical girders available to the engineer.

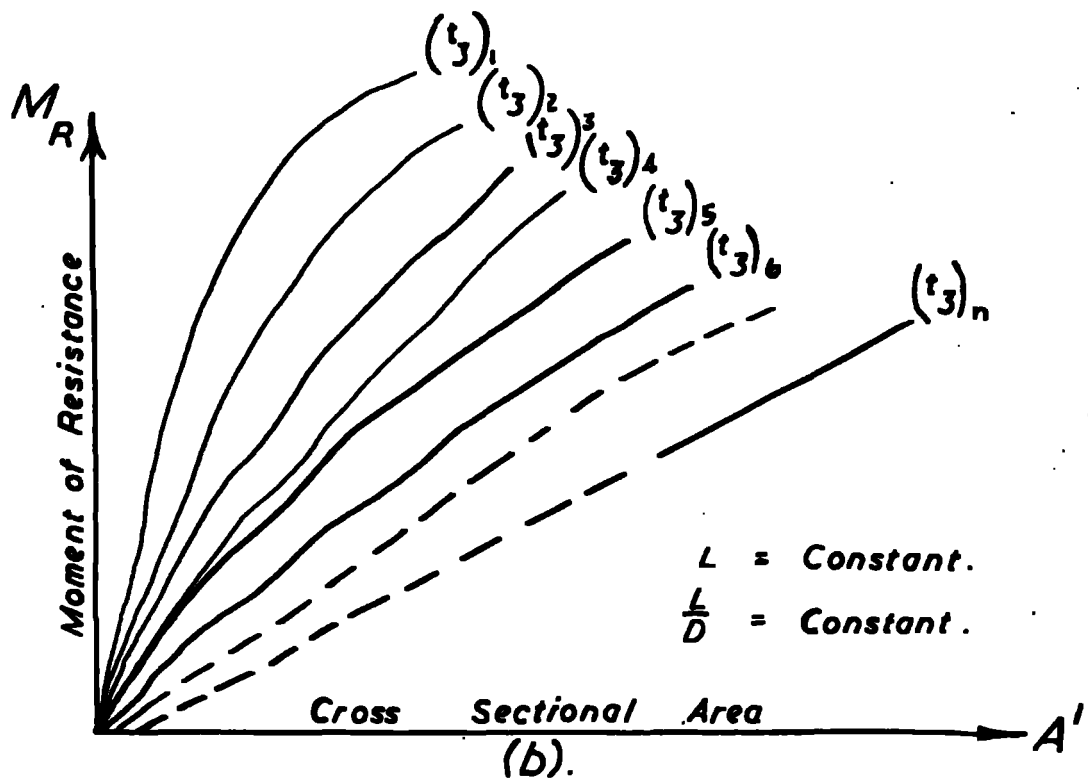
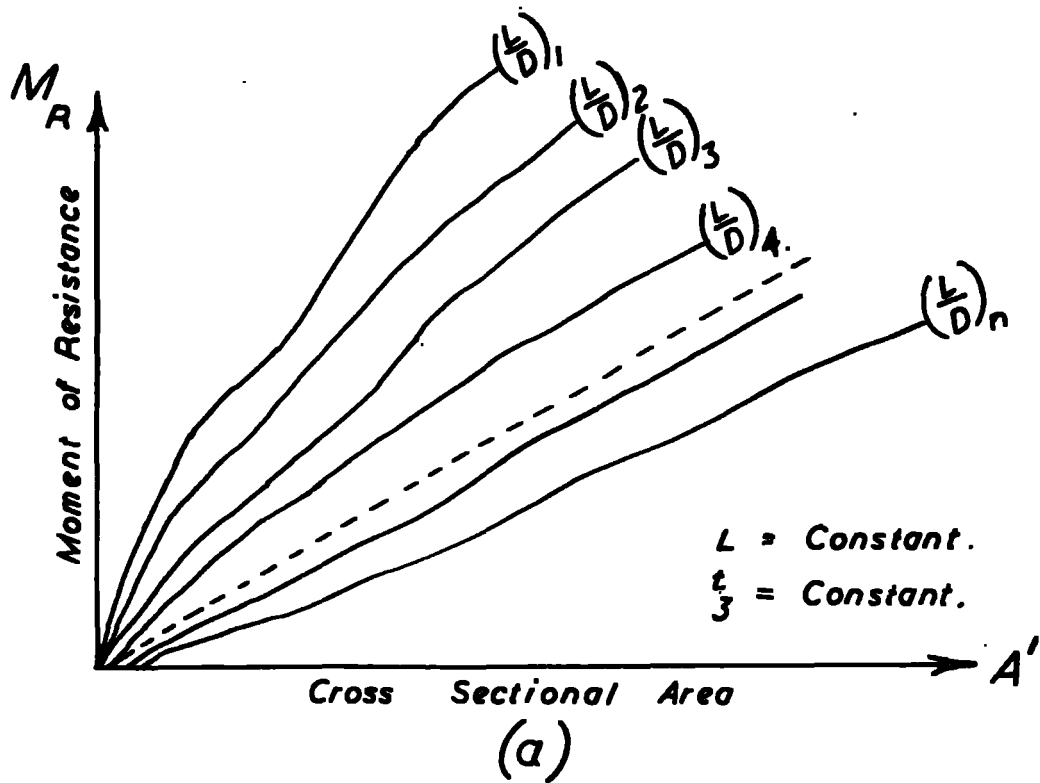

DIAGRAMMATIC REPRESENTATION OF THE  
MINIMUM WEIGHT BOUNDARIES ON THE  
 $M_R \sim A'$  GRAPHS.

**FIG. 7.**

In this investigation the sections of minimum area, i.e. on the boundary OP, will only be considered further.

The values of the sectional dimensions  $B_1$ ,  $t_1$ ,  $B_2$ , and  $t_2$  can now be tabulated along with  $M_R$  and  $A'$  for all sections along the minimum weight boundary OP as  $A'$  increases incrementally from its minimum to its maximum value. These dimensions can then be examined to see whether a mathematical pattern, or series of patterns, has emerged.

This process can then be repeated for various values of  $t_3$  and  $D$  which also can be varied incrementally over their entire practical range. The minimum weight boundary can then be obtained in each case and these can be superimposed on the one graph as shown diagrammatically in Figs. 7a and 7b.

A graph of the type shown in Fig 7a shows the effect of varying the depth of section while maintaining the span  $L$  and web plate thickness  $t_3$  constant. If necessary this graph could be repeated for various values of  $t_3$ .

Fig. 7b on the other hand would show the effect of varying the thickness of the web plate  $t_3$  while

maintaining the span and overall depth of section D constant. This graph could be repeated for various values of D.

Since the category of web stiffening depends essentially on  $t_3$  in relation to D, the boundaries between such categories could be superimposed in Figs. 7a and 7b, thus enabling design conclusions to be made in all cases.

-----

It is hoped by this means to obtain a pattern as to what constitutes Minimum Weight Design. If so, empirical and theoretical techniques will then be used to establish a General Method for any practical section on any span. If on the other hand no mathematical pattern emerges it is clear that this empirical technique will still be a rational approach, giving a solution to the design problems in a particular case, and attempts would then be made to streamline the process.



## DETAILS OF PRACTICAL INFORMATION

In proceeding with the investigation it is essential that only sections which are a possible practical solution should be considered; this can be modified slightly to suggest or anticipate future trends in design. Indeed it is hoped that by this work plate girders and built-up sections generally will be popularised and put to new usage.

Accordingly Messrs. Dorman Long (Bridge and Engineering) Limited, Middlesbrough, were approached by the author and asked for details of the ranges of sizes used for practical sections. This information was generously provided by Mr. T.V. Thompson, M.I. Struct.E., the Chief Design Engineer, and full details are given in APPENDIX 1. In addition information was obtained from the Dorman Long Handbook (7) regarding the lengths, widths, and thicknesses of manufactured structural steel plate and other practical details.

The more important facts from this practical information are:

1. Maximum Span, L ----- 120 feet \*
2. Maximum Depth, D ----- 192 inches\*
3. Span to Depth Ratio,  $\frac{L}{D}$  -----  $7.5 \leq \frac{L}{D} \leq 30^*$

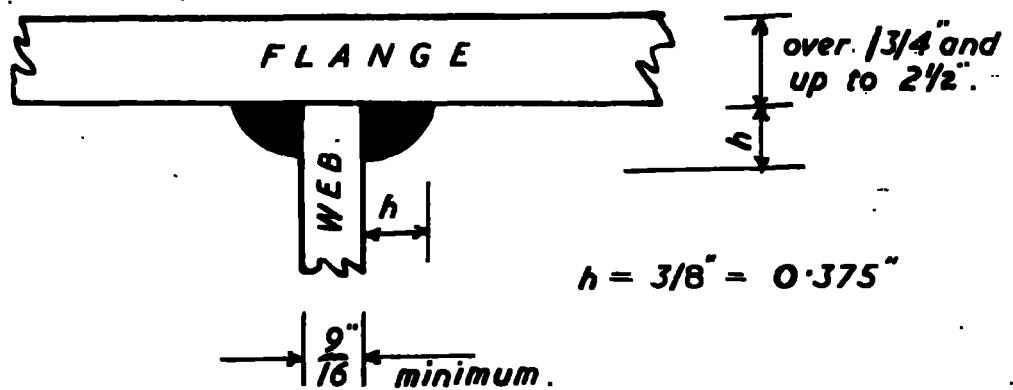
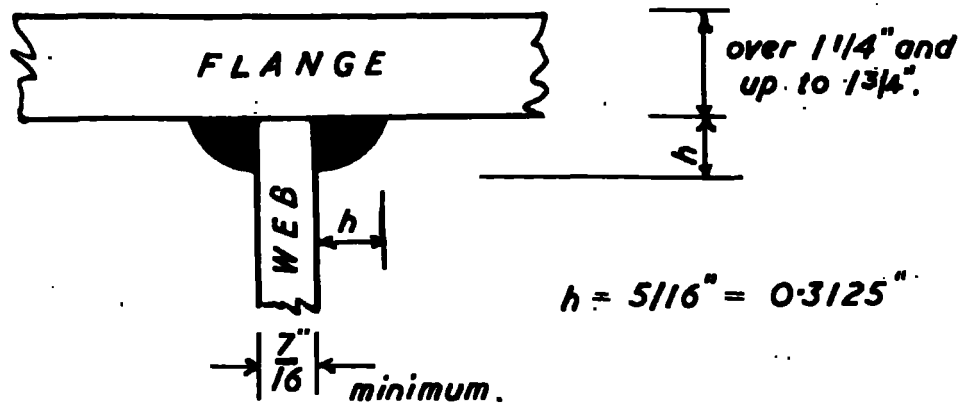
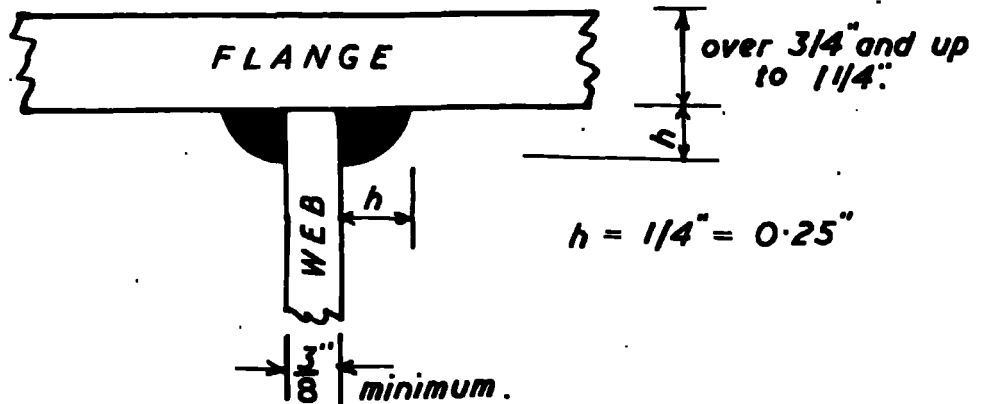
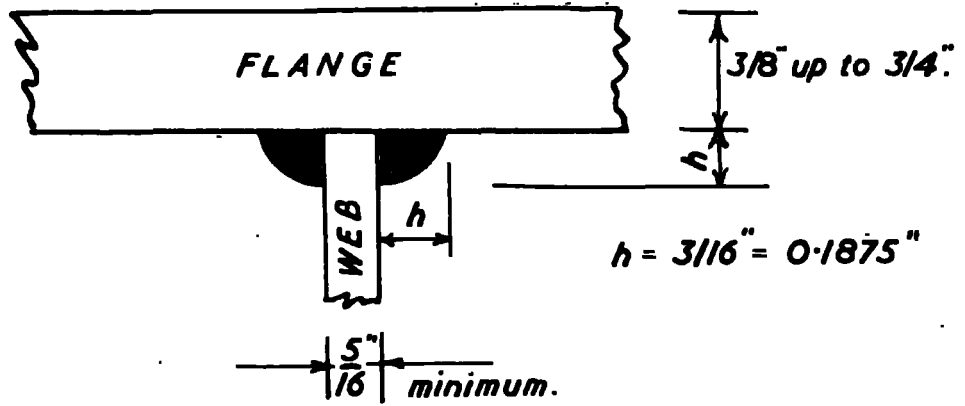

**MINIMUM SIZES OF FILLET WELDS & WEB PLATE THICKNESSES.**  
**FIG. 8.**

4. Span to Width of Compression Flange

$$\text{----- } 12 \leq \frac{L}{B_1} \leq 50 *$$

5. Span to Width of Tension Flange

$$\text{----- } 20 \leq \frac{L}{B_2} \leq 50 *$$

6. Maximum and Minimum Thicknesses

of plates.

Compression and tension flanges

$$\text{----- } 4'' \text{ to } 3/8''$$

Web.

$$\text{----- } 1\frac{1}{2}'' \text{ to } 1/4''$$

(Tongue plates would normally be used when the flanges are thicker than  $2\frac{1}{2}''$ , so that in this investigation the maximum thickness will be  $2\frac{1}{2}''$ ).

7. Sizes of fillet welds. The minimum sizes of welds and web plate thicknesses are shown in Fig. 8 and depend upon the thickness of the flange plates used:

Flange Plate Thickness	Minimum Size of:	
	Web Plate	Fillet Weld
3/8" to 3/4"	5/16"	3/16"
over 3/4" to 1 1/4"	3/8"	1/4"
over 1 1/4" to 1 3/4"	7/16"	5/16"
over 1 3/4" to 2 1/2"	9/16"	3/8"

(See also: Notes on Welding in Chapter 1).

8. The thicknesses of manufactured rolled steel plate vary by 1/16" increments up to 1" and by 1/8" increments thereafter.
9. The maximum widths of manufactured rolled steel plate vary with the thickness, thus:

Thickness of Plate	Max. Width
3/8"	100"
7/16"	105"
1/2" to 2"	108"
2 1/4" to 3"	106"

(In many cases the web plate will require to be fabricated from two plates connected by a longitudinal butt weld in order to make up the necessary depth required. Welded splice details will frequently be required in order to make up a given length of girder. This workmanship will increase the fabricating costs but will not increase the overall weight of the girder and so will not be considered further in this particular investigation).

\*As a result of studying this information it was decided that the design investigation should be extended to deal with sizes above and below the values given in items 1 to 5 inclusive. There are two reasons for this step:

- a) If reasonable economy or efficiency can be achieved, it is hoped by this work to encourage engineers to use plate girders on longer spans.
- b) The extension of the range will show the variation in the efficiency of sections as less conventional proportions are chosen.

Accordingly it is proposed to modify items 1 to 5 as shown:

1. Maximum Span, L ----- 200 feet
2. Maximum Depth, D ----- 200 inches
3. Span to Depth Ratio,  $\frac{L}{D}$  ---  $5 \leq \frac{L}{D} \leq 35$

4. Span to Width of Compression Flange

$$\text{----- } 10 \leq \frac{L}{B_1} \leq 55$$

5. Span to Width of Tension Flange

$$\text{----- } 10 \leq \frac{L}{B_2} \leq 55$$

In addition to these restrictions it is intended to impose the following limits in order to ensure that no anomalies in the sizes or proportions of sections can occur:

a) The Flange Width to Depth Ratios  $\frac{B_1}{D}$  and

$\frac{B_2}{D}$  shall have a maximum value of unity,

(and not the value of 3.5 as would appear possible from the previous information).

b) Minimum dimensions.

Minimum span	-----	30 feet
Minimum depth	-----	36 inches
Minimum flange width	---	8 inches

Dimensions less than these can be extensively provided for by using universal beams and columns; such rolled sections will also in fact overlap with the range of plate girders at the bottom end of the scale.

Only sections which comply with all the above practical proportions and with the restrictions laid down in B.S.449 (see Chapter 1) should be considered further, thus substantially reducing the number of possibilities.

#### THE CALCULATIONS

Since the calculations are lengthy and arduous they will be carried out on a computer to a high degree of accuracy and the same consistency for all results.

The nature of the problem first suggests that an analogue computer would be most suitable. However a permanent record of the results will be required, to be used, for example, as design charts in an engineer's office, and this would generally involve resorting to an expensive photographic process and dealing with a vast amount of data. Unfortunately no suitable analogue computer was available locally.

The next possibility is the use of an electronic digital computer, which could be used to prepare tables of results. Two Elliott 803 computers were readily available in the neighbourhood, one at Sunderland Technical College and the other at the University of Durham, and these computers were both

to be supplemented by off-line automatic graph plotters at an early future date. This has since been effected in both cases. The graphs from these machines can be obtained on tracing paper, and further tracings or photographic prints can therefore be easily made. (In addition the author had been informed that a Probing Device was to be installed at the University of Durham which would enable any co-ordinates of points on a graph to be automatically transferred to digital tape for subsequent future use as input to the computer. This equipment has now been installed).

It was therefore decided to proceed with the calculations by preparing special programmes for use on the Elliott 803 Computers. Since it is anticipated that all such programmes may have wider usage, these will be written in ALGOL (8) so that they can readily be adapted for use on other makes of computers.

All the computer programmes in this investigation have been written and tested by A. BERGSON (9), using the information contained in this thesis which has been obtained or devised by the author, (viz. E. LITTON), who also satisfied himself as to the accuracy and validity of the results obtained.



It was also agreed that A. BERGSON would operate the computer, using the special programmes, to obtain the results as requested by the author, who then used such results to develop the techniques described in this thesis. By this arrangement the author - an engineer - has been able to concentrate on the subject matter of the investigation, knowing that the numerical results of the calculations have been responsibly and efficiently obtained for him by A. Bergson - a mathematician.

#### THE COMPUTER PROGRAMMES

Full details of all the programmes will be given in A. Bergson's Thesis (9). A complete list is given in APPENDIX 2 at the end of this thesis.

In order to proceed with the "Empirical Search for a Method" it is necessary to give brief details of the main programme used, namely ABEL 1.

#### Programme No. ABEL 1.

Given the span  $L$ , sectional dimensions  $B_1$ ,  $t_1$ ,  $B_2$ ,  $t_2$ ,  $D$ , and  $t_3$ , and constants  $\lambda$  and  $K_1$ , it is required to obtain  $M_R$ ,  $A'$ ,  $D_{bc}$ ,  $f_{bc}$ ,  $f_{bt}$ ,  $\frac{1}{r_y}$ , and  $R$ , with section identification in the output.

The programme follows the Design Procedure described in Chapter 1 and has the following features:

- a) The three classes of section U, V, and W are automatically allowed for and the output indicates which class has been used.
- b) All sections which do not comply with the restrictions laid down in B.S.449 are automatically rejected and the reason for this rejection is given in the output.
- c) The output indicates which of the four categories of web stiffening is required, (viz. A, B, C, or D).

In this programme the output is given in a tabular form. It can be seen that there are nine basic parameters necessary to define a girder, viz:  $L$ ,  $B_1$ ,  $t_1$ ,  $B_2$ ,  $t_2$ ,  $D$ ,  $t_3$ ,  $\lambda$ , and  $K_1$ , and that this programme gives a "check" calculation for any girder.

Care has been taken to ensure that this, and all other special programmes can have as wide an application as possible, if this is feasible. Thus in this case provision has been made to enable  $K_1$  and  $\lambda$  to be varied even although both these values will be unity for most of the work in the investigation.

Example.

Example No. 2.1

Check calculations will be made on the five approximations given in Example No. 1.1, using Programme No. ABEL 1.

Input to Computer:  $L = 70$  feet;  $\frac{L}{D} = 11.666667$

or  $D = 72''$ ;

$t_1 = 1.25''$ ;  $t_2 = 1.00''$ ;  $t_3 = 0.4375''$ ;  $K_1 = 1$ ;  $\lambda = 1$ ;

Approx. No.	$B_1$	$\frac{L}{B_1}$	$B_2$	$\frac{L}{B_2}$
1	36''	23.3333	34''	24.70
2	38''	22.10	33''	25.45
3	39''	21.55	29''	28.97
4	38''	22.10	28''	30.00
5	37.5''	22.40	27''	31.10

Note: Programme No. ABEL 1 has been written to accept  $\frac{L}{D}$ ,  $\frac{L}{B_1}$ , and  $\frac{L}{B_2}$  as input rather than  $D$ ,  $B_1$ , and  $B_2$ .

The input to and the output from the computer are shown in Table No. 2.1. The results from this Table can be compared with those given in Example No. 1.1 which were obtained using a slide rule.

It can be seen that the section adopted for the design, viz. Approximation No. 5, has a moment of resistance of 1,863.91 tonft which is still slightly greater than the maximum applied bending moment of 1,840 tonft, and so it would be possible to reduce the area further, though the value of the Stress Ratio  $R$  of 1.02 indicates that this final section is within 2% of the fully stressed condition aimed at in the Example No. 1.1.

Finally it should be borne in mind that the values of  $f_{bc}$  and  $f_{bt}$  given in Example No. 1.1. for each approximation are sustained on application of a moment of 1,840 tonft, whereas the values given in Table No. 2.1 correspond to the varying values of maximum moments which may be applied to each section.

#### PILOT SCHEME

At this stage all the necessary preparatory work has been done and it is now possible to proceed with the "Empirical Search for a Method" by using a range of practical sections as described in the Outline.

This is essentially a first step and by no means a complete answer in itself, though it is hoped, as stated previously, to "steer" the investigation to a general solution by this empirical search.

Selection of Numerical Data.

A span  $L$  of 100 feet has been chosen, together with an overall depth  $D$  of 120 inches, i.e.  $\frac{L}{D} = 10$ , and a web plate thickness  $t_3$  of 1 inch. In addition,  $K_1 = 1$  and  $\lambda = 1$  since all girders to be considered here will have constant cross sectional area and an effective length of compression flange equal to the span.

All of these dimensions will be kept constant throughout this Pilot Scheme. It is intended that these should portray the proportions of typical long span girders.

The web plate thickness of 1 inch ensures that a reasonably large shearing force can be carried by all girders, that only vertical web stiffeners will be required, i.e. all Category B, and that an adequate range of practical weld sizes, viz.  $1/4''$  up to  $11/16''$ , are available. The span to depth ratio of 10 should ensure that no section will exceed the permissible deflection as well as

assisting in the resistance to the shearing force.

It can thus be seen that every effort has been made to ensure that the moment of resistance  $M_R$ , as restricted by lateral buckling, should be the critical feature of the design in all cases.

The cross sectional dimensions which can be varied are  $B_1$ ,  $t_1$ ,  $B_2$ , and  $t_2$ .

$t_1$  and  $t_2$  can vary by  $1/8$ " increments from 1" to  $2\ 1/2$ ".

$\frac{L}{B_1}$  and  $\frac{L}{B_2}$  can vary from 10 to 55, i.e.  $B_1$  and  $B_2$

can vary from 120" to 21.8 inches in decrements of  $1/16$ ", provided that the maximum widths do not exceed the maximum outstands of the flanges. (See Chapter 1). The computer programme number ABEL 1 would reject all sections which do not comply with this requirement, but as it is considered that the maximum permissible widths of flange plates may be important, these have been determined and the values are given in Table No. 2.2.

It is clear that all the possible permutations of sections over the specified ranges of dimensions will be a very large number, and therefore it is proposed to reduce this number by increasing the

increments through the range of each variable. Further calculations can then be made later to supplement these by choosing other increments or by concentrating on a particular part of any range, should the initial choice yield any immediate result. Care has been taken throughout to ensure that no preconceived ideas as to what constitutes Minimum Weight Design will affect the initial selection of sections.

Run No. 1.  
-----

The values of the sectional parameters chosen for the first run on the computer to determine the  $M_R \sim A'$  values for each section using Programme

No. ABEL 1 are :-

$$L = 100\text{ft}; t_3 = 1 \text{ inch}; \frac{L}{D} = 10; K_1 = 1; \lambda = 1$$

$$\frac{L}{B_1} = 18.5, 20, 30, 40, 50, 55.$$

$$\frac{L}{B_2} = 14.8, 20, 30, 40, 50, 55.$$

$$t_1 = 1", 1.25", 1.5", 1.75", 2".$$

$$t_2 = 1", 1.25", 1.5", 1.75", 2".$$

These values were permuted to give 900 possible sections and the results are given in Table No. 2.3. Both the input to and the output from the computer are given.

## Discussion of Results from Run No. 1.

-----

It can be seen that :

1. Approximately 50% of the sections were rejected mainly because the maximum outstand of either flange was exceeded.
2. Very few sections provided a moment of resistance greater than 4,000 ton.ft which can be considered as a reasonable minimum value to be required of plate girders spanning 100 feet.
3. The moment of resistance  $M_R$ , the permissible compressive stress in bending  $p_{bc}$ , and the stress ratio  $R$ , decrease as  $\frac{L}{B_1}$  is increased, i.e. as  $B_1$  is reduced.

Indeed when  $\frac{L}{B_1}$  equals or exceeds 40, most moments are less than 1,000 tonft, and the few moments greater than this value require a cross sectional area much in excess of that necessary from sections in which  $\frac{L}{B_1}$  is less than 40. In addition, when  $\frac{L}{B_1}$  equals or exceeds 40, the permissible stress  $p_{bc}$  is never greater than



3.16 tons/sq.inch, as compared with the maximum possible values of 9.5 to 10.0 tons/sq.inch which should be aimed at, even if not actually achieved, in a good design.

It is therefore recommended that:

1. The  $M_R \sim A'$  graph should not be plotted in this case, and further calculations should be made choosing sectional parameters within the original specified ranges yet more likely to produce results which can be regarded as possible solutions to typical design problems.
2. The wastage of computer time should be reduced by altering the form of presenting the input.

These recommendations have been embodied in

Run No. 2.

Run No. 2.

In this run,  $\frac{L}{B_1}$  and  $\frac{L}{B_2}$  are restricted to a maximum value of 40, and  $t_1$  and  $t_2$  are extended to deal with plate thicknesses up to 2.5" in an effort to increase the values of the moments to be obtained. The different values of  $t_1$  and  $t_2$  are now treated as separate pieces of input to the computer while  $\frac{L}{B_1}$

and  $\frac{L}{B_2}$  are varied from their minimum possible values, which vary with  $t_1$  and  $t_2$  respectively as shown in Table No. 2.2, to their maximum value of 40 in all cases. By this means no sections having flange widths exceeding the permissible outstands will be used, thereby avoiding the wastage in computer time encountered in Run No. 1.

Full details of the input and output for this second run of the Pilot Scheme are given in Table No. 2.4. The input details can be summarised thus:

$$L = 100\text{ft}; \quad \frac{L}{D} = 10; \quad t_3 = 1"; \quad K_1 = 1; \quad \lambda = 1$$

$$\frac{L}{B_1} \quad \text{and} \quad \frac{L}{B_2} = \text{minimum value, } 20, 30, \text{ and } 40.$$

$$t_1 = 2.5", 2.25", 2", 1.875", \text{ and } 1.75".$$

$$t_2 = 1", 1.25", 1.5", 1.75", 2", 2.25", \text{ and } 2.5".$$

All these dimensions have been permuted to give 140 possible sections.

By examining Table No. 2.4 it can be seen that:

1. Very few sections have been rejected.
2. Most moments of resistance are greater than 4,000 ton.ft.
3. The value of the stress ratio R can be either greater or less than unity, with several values in close proximity to unity.

PILOT SCHEME

(RUNS. 2&3)

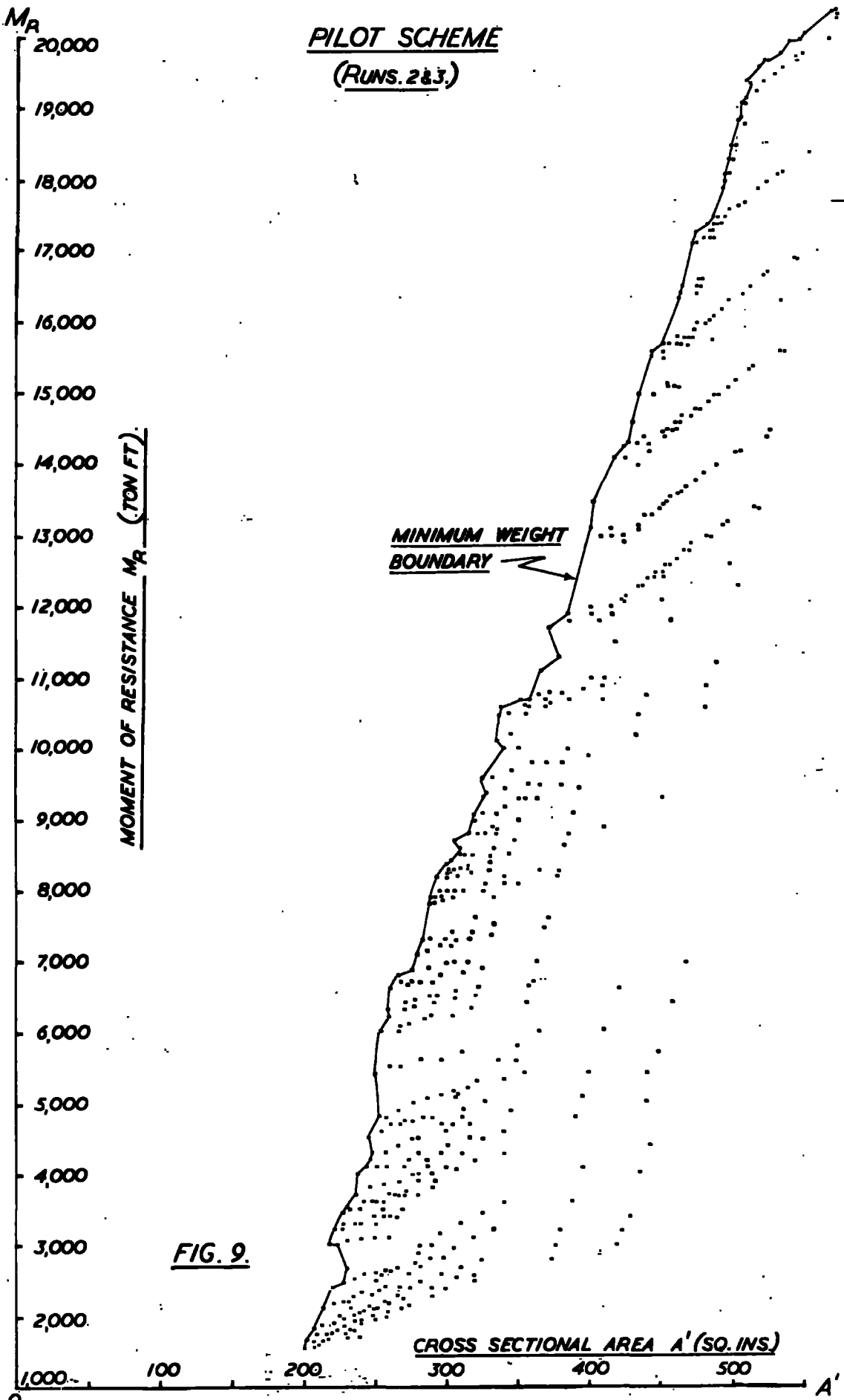

FIG. 9.

CROSS SECTIONAL AREA  $A'$  (SQ. INS.)

1,000 200 300 400 500  $A'$

It can be concluded therefore that the sections used will realistically portray a series of girders which can be regarded as various possible solutions to the design problems in the practical range, and so the method described in the Outline may now be continued by plotting the  $M_R \sim A'$  points for all the values.

The plot of the points on the graph of  $M_R$  against  $A'$  is shown in Fig.9, and it can be seen that the moments vary from 1,500 tonft to 20,500tonft approximately with a wide scatter in cross sectional areas throughout this range.

The boundary of sections of minimum weight has been drawn on the graph, and this does not appear to have a smooth mathematical form. However the irregularities may be due to the fact that insufficient sections have been considered and it is therefore still possible that such a shape, or series of shapes, may exist.

The co-ordinates of points on the minimum weight boundary were then read off the graph from the maximum to the minimum area in consecutive order, and the results are shown in Table No. 2.5. These sections were then identified by scanning the results in Table No. 2.4 and the values of the sectional parameters

$\frac{L}{B_1}$ ,  $\frac{L}{B_2}$ ,  $t_1$ , and  $t_2$  obtained;

the results of this process have also been included in Table No. 2.5.

Discussion of Results from Run No. 2.

By examining the sectional dimensions of girders on the minimum weight boundary as given in Table No. 2.5, it would appear that a mathematical pattern has begun to emerge, having the following properties:

1) The boundary consists of a series of zones, each of which has a constant value of compression flange thickness  $t_1$ .

2) As  $M_R$  and  $A'$  decrease along the boundary, the value of  $t_1$  reduces decrementally on passing from one zone to the next adjacent one.

3) In each zone of constant  $t_1$ , the ratio  $\frac{L}{B_1}$  increases gradually from its minimum possible value as  $M_R$  and  $A'$  decrease along the boundary, and no such values of  $\frac{L}{B_1}$  are far removed in

magnitude from this minimum one. This means that  $B_1$  appears to vary from its maximum value over a limited range in each zone.

No mathematical sequence appears to exist for the values of the tension flange dimensions  $B_2$  and  $t_2$ .

Run No. 3.

In order to check the property quoted in 2) above, a supplementary run was made in which all sections were confined to the one zone by keeping  $t_1 = 2.5''$  throughout.

This particular value of  $t_1$  was chosen since at this stage of the Pilot Scheme only two points had been obtained on the minimum weight boundary for this zone.

$\frac{L}{B_1}$  was varied over a short range now, from its minimum

value of 14.82 up to 20.

Full details of the sections in this run are:

$L = 100\text{ft.}; \frac{L}{D} = 10; t_3 = 1\text{inch}; K_1 = 1; \lambda = 1; \text{ and } t_1 = 2.5''$

$\frac{L}{B_1} = 20, 19, 18, 17, 16, 15 \text{ and } 14.82.$

with  $t_2 = 2.125''$ ,  $\frac{L}{B_2} = 19, 18, 17, 16, 15, 14 \text{ and } 13.91$

with  $t_2 = 2.25''$ ,  $\frac{L}{B_2} = 19, 18, 17, 16, 15, 14 \text{ and } 13.19$

with  $t_2 = 2.375''$ ,  $\frac{L}{B_2} = 18, 17, 16, 15, 14, 13 \text{ and } 12.51.$

and with  $t_2 = 2.5''$ ,  $\frac{L}{B_2} = 17, 16, 15, 14, 13, 12, \text{ and } 11.89.$

All these dimensions were then permuted to give 196 possible sections. The input to and the output from the computer have been included in Table No. 2.4 and the results have been plotted on Fig.9. The additional

co-ordinates on the minimum weight boundary were then read off and included in Table No. 2.5.

### Discussion of Results from Run No. 3.

These results have been included with those from Run No.2, and it can be seen from Table No. 2.5 and Fig.9 that many more points on the minimum weight boundary have now been obtained for the zone in which  $t_1 = 2.5''$ .

These additional results would appear to confirm that, as  $M_R$  and  $A'$  decrease along the boundary, the ratio  $\frac{L}{B_1}$  increases gradually from its minimum possible value over a narrow range.

### SUMMARY OF RESULTS

It should again be noted that the results of the Pilot Scheme in this Summary are by no means a complete answer to the problem of establishing a method for the Minimum Weight Design of mild steel welded plate girders, but are rather a first step in this direction, pointing the way for subsequent work which will be both empirical and theoretical.

The results of the Pilot Scheme appear to indicate that:

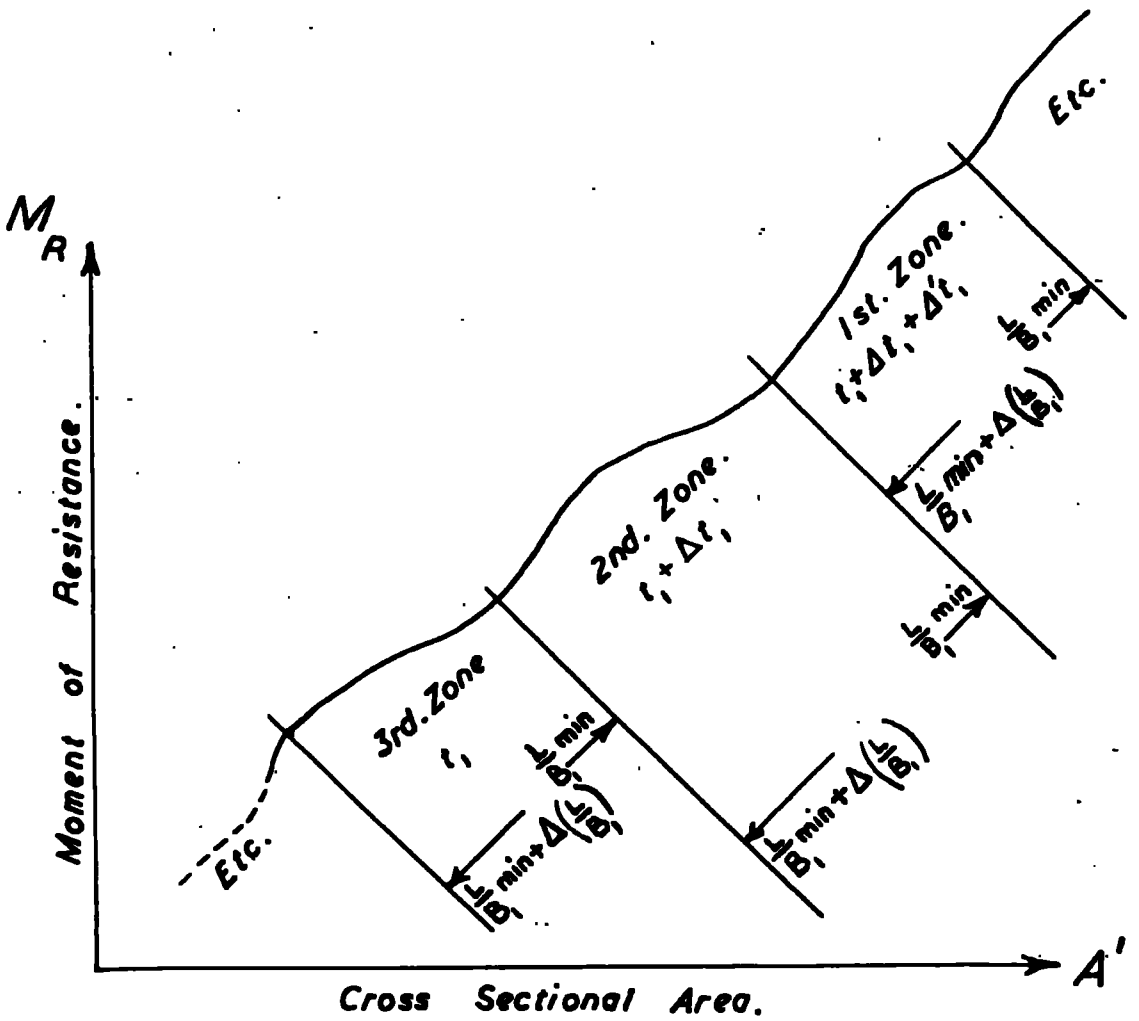

**DIAGRAMMATIC REPRESENTATION OF THE RESULTS FROM THE PILOT SCHEME.**

**FIG. 10.**



- 1) The minimum weight boundary consists of a series of zones each of which has a constant value of compression flange thickness  $t_1$ .
- 2) As  $M_R$  and  $A'$  decrease along the boundary, the value of  $t_1$  reduces decrementally on passing from one zone to the next adjacent one.
- 3) In each zone of constant  $t_1$ , the ratio  $\frac{L}{B_1}$  increases gradually from its minimum possible value as  $M_R$  and  $A'$  decrease along the boundary, and no such values of  $\frac{L}{B_1}$  are far removed in magnitude from this minimum one. This means that  $B_1$  appears to vary from its maximum value over a limited range in each zone.

These results are portrayed diagrammatically in Fig.10.

#### CONCLUSIONS

Now that some basic properties of points on the minimum weight boundary of the  $M_R \sim A'$  curve appear to be known, the search for a method of minimum weight design can be continued by investigating in detail the variation of points concentrated on, or tending to approach this limit.

The number of possibilities has been substantially reduced by the pilot scheme and the subsequent empirical and theoretical investigations can confirm or deny the validity of the results given.

The concept of a zone on the minimum weight boundary will be used continually in this future work, defined thus :-

Definition  
-----

All points having the same value of  $t_1$  constitute a zone on the  $M_R \sim A'$  graph.

The studies in the variations in web plate thickness  $t_3$  and overall depth  $D$ , as described in the Outline, need not now be embarked on at this stage, and these will be considered later in Chapters 4 and 5.

## CHAPTER 3.

### DETAILED INVESTIGATION ON AN EMPIRICAL BASIS

The search for a general method of minimum weight design of welded mild steel plate girders having constant cross sectional area and torsional and lateral restraints only at the ends of the span is continued in this chapter on an empirical basis. A typical long span is chosen and sectional dimensions are selected embodying the characteristics discovered from the Pilot Scheme of Chapter 2. It is re-emphasised that, by this means, it is hoped to find solutions to the three design problems described in Chapter 1, applying to all spans in the practical range.

#### PROCEDURE

A zone of the  $M_R \sim A'$  diagram was chosen, i.e.  $t_1$  constant, together with several values of the ratio  $\frac{L}{B_1}$ , increasing from its minimum value over a narrow range.  $L$ ,  $\frac{L}{D}$ ,  $t_3$ ,  $K_1$  and  $\lambda$  were kept constant throughout, leaving only  $\frac{L}{B_2}$  and  $t_2$ , the tension flange dimensions, to be varied.

The numerical values chosen were essentially the same as those for the Pilot Scheme; this was done so that a direct comparison of the results could be made if required. The sizes were:

$$L = 100\text{ft}; \frac{L}{D} = 10; t_3 = 1 \text{ inch}; K_1 = 1; \lambda = 1;$$

$$t_1 = 2.5 \text{ inches}$$

$\frac{L}{B_1} = 14.815(\text{min.})$ , (Also values greater than this at a later stage)

$t_2 = 2.5''$  down to  $1''$  in decrements of  $0.125''$ .

$\frac{L}{B_2} = \text{approx. min. value, seven intermediate values, and } 55(\text{max.})$ .

In the first instance the value of  $\frac{L}{B_1}$  was held constant at its minimum value of 14.815, while, for each practical value of  $t_2$ ,  $\frac{L}{B_2}$  was varied in nine stages from its minimum to its maximum value.

With this form of presentation of data, Programme No. ABEL 1 was used to obtain the values of  $M_R$ ,  $A'$ ,  $p_{bc}$ ,  $R$ , etc., for each section. The input to and the output from the computer for this investigation are given in Table No. 3.1a. and the plot of the  $M_R \sim A'$  points for all of these sections is shown in Fig. 11a.

## Discussion of Results

It can be seen from Fig. 11a that when points on the plot of  $M_R$  against  $A'$  having the same value of tension flange thickness  $t_2$  are connected by a continuous line, a smooth mathematical curve is obtained. Moreover, the curves so formed appear to possess characteristics which will be investigated more fully later.

Some of the characteristics appear to be:

1. Each line on the graph of  $M_R \sim A'$  connecting points having the same value of  $t_2$  consists of a smooth curve which is partly linear and partly non linear.
2. The sectional area  $A'$  is varied along such a curve only by altering the width of the tension flange  $B_2$ ; all other sectional dimensions are kept constant. Thus  $\frac{L}{B_2}$  can be regarded as the only variable along such a curve.
3. For all sections on the linear portion the stress ratio  $R$  is greater than unity, while, for all sections on the non linear portion,  $R$  is less than unity, and the two portions intersect smoothly at a point on the curve where  $R$  is equal to unity.

4. The maximum value of  $M_R$  occurs when  $\frac{L}{B_2}$  is at its minimum value, and the minimum value of  $M_R$  occurs when  $\frac{L}{B_2}$  is at its maximum value. Moreover  $M_R$  appears to have its maximum value on the non linear portion of the curve and its minimum value on the linear portion.
5. The linear portions of curves having different values of the tension flange thickness  $t_2$  and the same values of all other sectional parameters appear to be co-linear, although each such linear portion starts and finishes at different points along the common line.
6. As  $t_2$  decreases from its maximum value, the linear portion starts at a smaller value of  $M_R$  and ends at a value of  $M_R$  which increases to a maximum and then decreases, so that more of the range of the curve becomes linear. It is clear, then, that, as  $t_2$  is further reduced, the entire practical range covered will eventually become linear. In this case this occurs when  $t_2 = 2.125"$  (see Table No. 3.1a.).

7. On the other hand, as  $t_2$  increases from its minimum value with all other sectional parameters held constant (other than  $\underline{L}$ ), the  $B_2$  linear portion starts at a greater value of  $M_R$  and finishes at a value of  $M_R$  which increases to a maximum and then decreases, so that less of the range of the curve is linear. As  $t_2$  is further increased, the entire range covered will eventually become non linear. (Extra work shows that this will occur when  $t_2 > 7''$  which is outside the imposed practical range).
8. It can be seen from Table No. 3.1a that, as  $\underline{L}$  is increased along a curve, it is possible  $B_2$  for the transition from Class 3 through Class 1 to Class 2 to take place (see Chapter 1), i.e. from W through U to V to take place, and this can occur on the linear or non linear portion of the curve. The abrupt change may well produce discontinuities on the profile of the curve and this should be investigated further.

The above eight characteristics apply only at this stage to particular numerical values in a particular zone of the  $M_R \sim A'$  graph. Nevertheless the mathematical form obtained suggests that these may well apply to all such lines no matter what numerical values are chosen. Moreover it would now appear possible that the minimum weight boundary on the  $M_R \sim A'$  graph can be built up from a series of such curves intersecting one another along the entire boundary, rather than consisting of a series of points as obtained in the Pilot Scheme of Chapter 2. Such a curve will now be termed a contour, and its general properties will now be investigated.

### THE CONTOUR

#### Definition

A contour is a continuous line on the  $M_R \sim A'$  graph in which  $\frac{L}{B_2}$  is varied from its minimum to its maximum value while all other sectional parameters are kept constant. Thus the cross sectional area  $A'$  of sections along a contour is varied only by changing  $B_2$  (or by changing the ratio  $\frac{L}{B_2}$  where  $L$  is a given span).



The contour will now be regarded as the unital element to be used in the formation of the minimum weight boundary. The results obtained from the Pilot Scheme of Chapter 2 regarding points on this boundary can now readily be applied to contours, thereby giving continuous variations rather than the intermittent isolated points previously used. Thus in accordance with the results of the Pilot Scheme, these contours having a constant value of  $t_1$  and different values of  $\frac{L}{B_1}$  at and just above the minimum value of this ratio should be regarded as the unital elements in a zone of the minimum weight boundary; the same procedure can then be used for all other zones using the appropriate value of  $t_1$  in each case until the entire boundary has been formed. The envelope of the minimum values of  $A'$  to provide a given  $M_R$  throughout the practical range of  $M_R$  can then be obtained from these intersecting contours, and this will be the Minimum Weight Boundary.

In order to proceed in this way it will be essential to ensure that any contour can be accurately obtained for all possible numerical values;

all discontinuities along the profile should be readily detected and defined, yet it will be desirable to avoid an excessive amount of computation. Thus the properties of contours will be investigated in detail, on an empirical basis in this chapter, followed by a theoretical analysis in Chapter 4, before stating the General Method in Chapter 5.

Empirical Investigation on the Properties of  
Contours

This investigation has already been started with earlier work in the chapter dealing with the zone in which  $t_1 = 2.5$  inches. All other zones in the practical range will now be considered by varying  $t_1$  from 2.5 inches down to 1 inch in decrements of 0.125 inch. In each case  $\frac{L}{B_1}$

will be kept at its minimum value, and it will be arranged that the results associated with each value of  $t_2$  will be tabulated separately.

Thus in each zone  $\frac{L}{B_1}$  and  $t_1$  will be held constant,

and, for each value of  $t_2$  in turn,  $\frac{L}{B_2}$  will be

varied in steps from its minimum to its maximum value;

this is a particularly convenient way of processing the data since the minimum values of  $\frac{L}{B_2}$  which depend on  $t_2$  can be readily handled in the input, and since the output will give the values of  $M_R$  against  $A'$  along a contour for each value of  $t_2$  in sequence.

Moreover, in view of the possible importance of the result along each contour for the section in which the stress ratio  $R$  is unity, the value of  $\frac{L}{B_2}$  at which this occurs should be included in the

data. This can readily be done by a process of successive approximation, realising that as  $\frac{L}{B_2}$  increases, the tension flange area reduces and thus  $R$  increases (see also later); all the values in this process can be given in the table of results and can be efficiently used to plot the contour.

In addition, since it is possible for the three types of Class, viz. 1, 2, and 3, to occur along the one contour, it will be desirable to be able to observe exactly where the transition takes place. It has been shown in Chapter 1 that Class 1 (or U) occurs when :-

$$\frac{1}{12} t_1 B_1^3 = \frac{1}{12} t_2 B_2^3 \quad \dots\dots\dots 3.1$$

∴

$$B_2 = B_1 \left( \frac{t_1}{t_2} \right)^{\frac{1}{3}} \quad \dots\dots\dots 3.2$$

Since  $\frac{L}{B_2}$  is the only independent variable along a contour, equation No. 3.2 can be used to determine that value of  $B_2$  at which Class 1 occurs, and thus the corresponding value of  $\frac{L}{B_2}$  can be obtained.

There is only one such value of  $\frac{L}{B_2}$  along each contour, and this may or may not be in the practical range. Thus a computer programme was compiled (Programme No. ABEL 2) to give the values of  $\frac{L}{B_2}$  at which Class 1 occurs. The results are given in Table No. 3.2 which also gives other critical values of  $\frac{L}{B_2}$  which will be explained in Chapter 4.

Where such values appeared in the practical range,

these, and other values of  $\frac{L}{B_2}$  in close proximity, were included in the input data to be used to determine a contour. Finally it should be noted that, as  $\frac{L}{B_2}$  increases, R increases, (see also later) and the transition will take place from Class 3 (i.e. W) through the unique value in Class 1 (i.e. U) to Class 2 (i.e. V).

Data

$$L = 100\text{ft}; \frac{L}{D} = 10; t_3 = 1 \text{ inch}; K = 1; \lambda = 1$$

$$t_1 = 2.5", 2.375", 2.25", \text{-----} 1"$$

$\frac{L}{B_1}$  = the minimum value, depending on  $t_1$ . (See Table No. 2.2)

$$t_2 = 2.5", 2.375", 2.25", \text{-----} 1"$$

$\frac{L}{B_2}$  = minimum value, various intermediate values, 55.

Full details of input and output data are shown in Table Nos. 3.1a, 3.1b, 3.1c, ..... 3.1m, which were obtained by using Programme No. ABEL 1.

All the contours on the  $M_R \sim A'$  graphs were then plotted from this data, and these are shown in Figs. 11a, 11b, 11c, ..... 11m.

## Properties of a Contour

Based purely on the results of this empirical investigation, as given in Table No. 3.1 and Fig.11, the following properties of a contour begin to emerge:- It would appear that :-

1. A contour may be entirely linear\* or non linear, or partly linear and partly non linear over its practical range, and each possibility depends upon the values of the Stress Ratio R.
2. The Stress Ratio R is greater than unity for all sections on the linear portion (should this exist), and is less than unity for all sections on the non linear portion (should this exist). Moreover, when both linear and non linear portions exist, these intersect smoothly at a point where R is equal to unity.
3. The Stress Ratio R increases as  $\frac{L}{B_2}$  increases for most values of R, from which it can be deduced that A' reduces as R increases. However exceptions to this rule do occur when R is small, say less than 0.6 as is shown in Table No. 3.1m.

It is unlikely that this exception will appear on any Minimum Weight Boundary, which would generally be associated with values of R near unity, though this remains to be seen. This exception will be looked into more fully in Chapter 4.

4. The linear portions of contours (when they exist) having different values of the tension flange thickness  $t_2$  and the same values of all other sectional parameters are co-linear to a good engineering approximation,\* although each such linear portion starts and finishes at different points along the common line. Such a collection of contours will henceforth be termed a set of contours.

(Definition: A collection of contours having different values of the tension flange thickness  $t_2$  and the same values of all other sectional parameters is defined as a Set of Contours).

5. The minimum value of  $A'$  for a set of contours occurs on that contour having the minimum value of the tension flange thickness  $t_2$ , and the maximum value of  $A'$  for a set of

contours occurs on that contour having the maximum value of  $t_2$ . Such maximum and minimum values of  $A'$  may lie on either the linear or non linear portion of a contour.

6. When a contour is totally or partly linear,  $M_R$  increases with  $A'$  on the straight line portion without any discontinuities. The maximum value of  $M_R$  and the corresponding value of  $A'$  on the straight line portion are important; these occur when  $R$  is equal to unity if this value can be attained in the practical range. Otherwise these occur when  $R$  has its minimum value which must then be greater than unity, and in this case the contour will be totally linear and will terminate at this point. Moreover this value of  $M_R$  increases as  $t_1$  increases.
7. The maximum value of  $M_R$  and the corresponding value of  $A'$  on the co-linear portions of a set of contours are also important and it is vital for Minimum Weight Design to be able to



indicate on which contour of a set, i.e. which value of  $t_2$ , these values occur. This depends upon whether the Class 1 section (i.e. U) occurs when R is less than, or greater than unity.

a) When the Class 1 section occurs when R is less than unity.

This is the more common of the two possibilities and in this case the maximum value of  $M_R$  and the corresponding value of  $A'$  on the co-linear portions of a set of contours generally occur for the minimum value of  $t_2$  for which  $R = 1$ . In fact the values of  $M_R$  for which  $R = 1$  increase steadily as  $t_2$  is reduced. However, in addition, as indicated in property No. 6 above, it is possible for a contour to terminate with R being greater than unity, and so the maximum values of  $M_R$  and  $A'$  on the straight line portions of the next few contours having decrementally lower values of  $t_2$  should also be obtained and compared with those previous ones to see which of these gives the critical value of  $M_R$ .

This state of affairs is clearly illustrated in Table No. 3.1e and in Fig. 11e for the set of contours in the zone  $t_1 = 2$  inches. In this case the minimum value of  $t_2$ , for which unity is achieved by  $R$ , is 1.625 inches, and yet the maximum value of  $M_R$  and the corresponding value of  $A'$  on the co-linear portions of this set of contours occur when  $t_2 = 1.5$  inches, which is the next decrementally lower value of  $t_2$  and for which the minimum value of  $R$  is 1.01. It can also be seen that the next lower value of  $t_2$ , viz. 1.375 inches, does not provide the critical value of  $M_R$ . Thus in this case the critical value is  $M_R = 10,596.41$  tonft., when  $A' = 338.0$  sq.ins., and this occurs on the contour for which  $t_2 = 1.5$  inches and  $R = 1.01$  (the minimum possible practical value here). Further information is given in property No.8 below.

b) When the Class 1 section occurs when  $R$  is greater than unity.

This possibility only occurred on one set of contours, viz. when  $t_1 = 2.5$  inches as shown in Fig. 11a and Table No. 3.1a in the empirical investigation, though

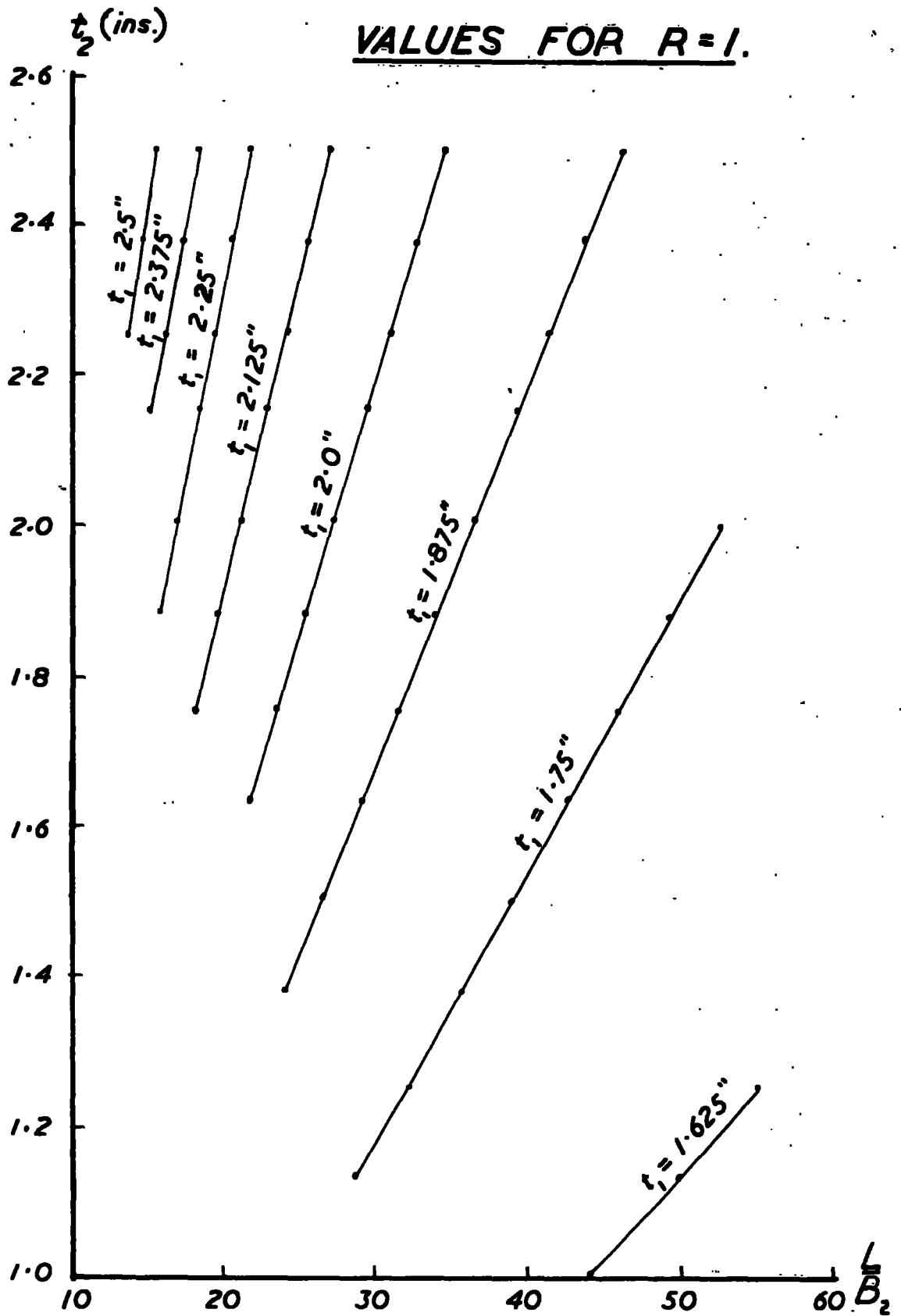

FIG.12.

it may well occur more frequently with other choices of data. In this case the maximum value of  $M_R$  and the corresponding value of  $A'$  on the co-linear portions of a set of contours need not occur for the minimum value of  $t_2$  for which  $R = 1$ , though such value is not far removed from the maximum. A trial and error search for the critical value of  $M_R$  should therefore be adopted. However a more sophisticated approach and an explanation of this phenomenon will be given in the Theoretical Justification in Chapter 4.

8. Relationship between  $\frac{L}{B_2}$  and  $t_2$  for all sections for which  $R = 1.00$ .

From the data given in Table No. 3.1 the variations in  $\frac{L}{B_2}$  with  $t_2$  have been plotted in Fig.12

for all sets of contours in the investigation. It can be seen that the graph of such points in each set is a straight line.\* This property can provide a means of determining the value of  $\frac{L}{B_2}$  for which

$R = 1.00$  on a given contour, thus:- the values of  $\frac{L}{B_2}$

for which  $R = 1.00$  should be obtained accurately for two contours in a set, using programme No. ABEL 1 and the process of successive approximation as indicated previously. This establishes the straight line, and the minimum practical value of  $t_2$  for which  $\frac{L}{B_2}$

is greater than or equal to its minimum value can then be read off. All the sectional dimensions are now known and programme No. ABEL 1 can then be used to obtain the values of  $M_R$  and  $A'$ . Moreover the value of  $R$  is also given and it can be verified that this is unity.

This device can also be used in the investigation into the sensitivity of  $R$ . (See property No. 11 below).

9. Discontinuities. Discontinuities can occur on the non linear portion of a contour in which the value of  $M_R$  suddenly increases or decreases at a particular value of  $A'$ , as  $A'$  increases. These happen frequently throughout Fig.11 and are due to the occurrence of the Class 1 section (U) on the non-linear portion.

Thus if the Class 1 section is located where  $R < 1$ , such a discontinuity will be formed. There are two types:-

a) A sharp increase in  $M_R$  at the Class 1 section value of  $A'$ , as  $A'$  increases. This occurs when  $\frac{y_c}{y_t} > 1$  and has the effect of increasing the value of  $C_s$  in the Class 3 (W) range of sections, (see Chapter 1) producing an increase in  $p_{bc}$  and therefore in  $M_R$ .

b) A sharp decrease in  $M_R$  at the Class 1 section value of  $A'$ , as  $A'$  increases. This occurs when  $\frac{y_c}{y_t} < 1$  and has the effect of decreasing the value of  $C_s$  in the Class 3 range of sections, producing a decrease in  $p_{bc}$  and therefore in  $M_R$ .

Both these types of discontinuities are illustrated throughout Fig.11 and can occur on two different contours in a given set. For example, in Fig.11d where  $t_1 = 2.125''$ , type a) occurs on the contours for which  $t_2 = 2.25''$ ,  $2.375''$ , and  $2.5''$ , whereas type b) occurs on the contours for which  $t_2 = 1.875''$  and  $2''$ .

It follows then that it would be theoretically possible for the case to occur in which  $y_c = y_t$  exactly at the Class 1 section, and this in fact does happen when  $t_2 = 2.125'' (= t_1)$ ; there is no discontinuity in this special case.

The values of  $\frac{L}{B_2}$  along all of the contours in the investigation for which  $\frac{y_c}{y_t} = 1$  have been tabulated

as  $\frac{L}{B_2}$  in Table No. 3.2. Full details as to how

this has been done are given in Chapter 4.

10. The slopes of all the straight line portions of all contours in this empirical investigation are the same to a good engineering approximation.\* This infers essentially that these slopes are independent of  $B_1$ ,  $t_1$ , and  $t_2$ ; this matter will be more fully dealt with in Chapter 4.

11. Sensitivity in the value of R. This property is best illustrated by referring to Table No. 3.1f in which the set of contours for which  $t_1 = 1.875''$  is defined.

It has already been stated in property number 7a) that the maximum value of  $M_R$  on the co-linear portions of a set of contours generally occurs for the minimum value of  $t_2$  for which  $R = 1$ , provided that the Class 1 section occurs when  $R$  is less than unity. However this at first sight does not appear to be the case from the results given in Table No. 3.1f; the values of  $M_R$  and  $A'$  for which  $R = 1.00$  have been taken from this table and have been listed in Table No. 3.3 in order of reducing  $t_2$ . In this table the letter V in each line indicates that for each value of  $t_2$  the section given is in Class 2. It can be seen that the cross sectional areas are within 2% of one another and that the moments are within 7%, indicating that there is no substantial difference between any of the values.

Nevertheless it can be seen that these values of  $M_R$  and  $A'$  given in Table No. 3.3 do not apparently conform to the pattern which otherwise exists, namely, that  $M_R$  and  $A'$  increase steadily as  $t_2$  reduces.



Even so this apparent deviation is well within 1% which can be considered very small.

However this apparent anomaly is due to the fact that all the values listed in Table No. 3.3 have been obtained by considering R to be equal to unity correct to three significant figures; this means essentially that R is within 1% of its exact value since the adjacent values of R will be 0.99 and 1.01 in this scale of sensitivity. It can therefore be concluded that R should be made equal to unity to a greater degree of accuracy.

None of the values given in Table No. 3.3 have been determined more accurately than to three significant figures and so all values given will have some degree of error, though the values given for  $t_2 = 2.125''$  would appear to have the greatest. For this reason the technique outlined in property No. 8 will now be used. Thus :-

A modified version of Programme No. ABEL 1, namely, No. ABEL 1A, was used to find the more accurate values of  $\frac{L}{B_2}$  for which  $R = 1.000000$  for the two contours in which  $t_2 = 2.5''$  and  $1.375''$ .

The input to and the output from the computer are shown in Table No. 3.4 and these have also been added to Table No. 3.3. These two accurate results establish the straight line on the  $t_2 \sim \frac{L}{B_2}$

graph, and the values of  $\frac{L}{B_2}$  for all of the intermediate values of  $t_2$  shown in Table No. 3.3 can now be obtained by linear interpolation. All sections obtained by this process were then analysed using Programme No. ABEL 1A and the results are tabulated in Table No. 3.3.

It can be seen that the values of  $M_R$  and  $A'$  now increase in order as  $t_2$  is reduced and that the values of the Stress Ratio  $R$  are now all within 0.52% of unity. This indicates in this case the magnitude of the error in the linearity of  $t_2 \sim \frac{L}{B_2}$  though clearly at this stage more accurate values of  $\frac{L}{B_2}$  could now be obtained by successive approximation, rather than by a random hit and miss approach which could be so easily embarked on with no guarantee of success.

It can also be seen by comparing the approximate and the accurate values in Table No. 3.3 that if the results for which  $t_2 = 2.125''$  had been the only accurate ones to be determined, the values of  $M_R$  and  $A'$  would still not have been in order. Nevertheless this contour does reveal the greatest error in  $\frac{L}{B_2}$  when  $R$  is unity :-

$$\text{Error in } \frac{L}{B_2} = \left( \frac{39 - 38.417381}{38.417381} \right) \times 100 = 1.52\%$$

This represents a change in the dimension  $B_2$  of about 0.4" which can be greater than the minimum practical increment.

However none of the approximate values of  $M_R$  and  $A'$  given in Table No. 3.3 have been altered by more than 1% by the more accurate ones and, if this small error persists for other choices of data, it could well be decided that such precision in the practical problem would be unnecessary. Such precision will be necessary, though, if a technique of automatic design is compiled from this work, since the wrong contour would then be selected and the errors could be significant for sections remote from the value of  $R$  at unity.

It should also be noted that the sensitivity of  $R$  cannot be used to explain the phenomenon described as a special case in property No. 7b. It can be seen from Table No. 3.1a that there are three contours in which the value of  $R$  equal to unity is obtained, namely, when  $t_2 = 2.5''$ ,  $2.375''$ , and  $2.25''$ .

These values were then analysed more accurately using Programme No. ABEL 1A, and the results are shown in Table No. 3.5. It can be seen that  $M_R$  and  $A'$  still do not increase in ascending order as  $t_2$  is reduced. However it is interesting to note that the value of  $R$  equal to unity occurs in Class 2 (i.e. V), Class 1 (i.e. U), and Class 3 (i.e. W) when  $t_2 = 2.5''$ ,  $2.375''$ , and  $2.25''$  respectively in this particular set of contours. The results for the contour in which  $t_2 = 2.375''$  do not actually include the letter U which indicates Class 1. However it can be seen that the transformation from W to V has taken place when  $\frac{L}{B_2}$  is changed from 14.56384 to 14.56385, i.e. by an extremely small amount. Moreover by referring to Table No. 3.2 it can be seen that the Class 1 section

on this contour in which  $t_2 = 2.375$  should occur when

$\frac{L}{B_2} = 14.564$ . This latter value is clearly not sensi-

tive enough to locate the single point on the contour which in this case coincides with the point at which R is equal to unity. In fact the actual two corresponding values of R from Table No. 3.5 are 0.997227 and 1.004080, and it was found that the value of R equal to unity, correct to seven significant figures, could not be obtained on the computer;  $\frac{L}{B_2}$  would have to be

varied more minutely than by the seven digit increment chosen, and this process then begins to reach the capacity of the computer used.

There is no real practical significance in this phenomenon as the design engineer will certainly never work to this accuracy. Nevertheless it is worthy of note to realise that when Programme Nos. ABEL 1 and ABEL 1A were compiled, the condition for the Class 1 section was not given as :-  $\frac{1}{12} t_1 B_1^3 = \frac{1}{12} t_2 B_2^3$ , but was rather given as :-  $\left| t_1 B_1^3 - t_2 B_2^3 \right| = 10^{-8}$  in order to give a small finite tolerance.

The increments of  $\frac{L}{B_2}$  then make it a fortuitous

business as to whether the value falls within the tolerance, and it can be seen that the letter U seldom appears on the sheets of Table No. 3.1, even although this was specifically intended. However the Class 1 section can be regarded as a limit which can be approached from the Class 3 range by increasing  $\frac{L}{B_2}$  or which can be approached from

the Class 2 range by reducing  $\frac{L}{B_2}$ . The actual limit

will, as indicated above, be seldom obtained, being generally overshoot in this process. Nevertheless the profile of the contour at this discontinuity can be clearly defined by obtaining values of  $M_R$  and  $A^\circ$  around this limit.

12. The rate of change of  $M_R$  with  $A^\circ$  is generally substantially reduced for all sections on the non-linear portion of a contour, i.e. when  $R < 1$ . An exception to this rule occurs at the discontinuity described in property No. 9 above when this rate =  $\pm \infty$ , though this is a local effect.

This means that, for a given increment in cross sectional area, a much smaller increase in  $M_R$  is obtained when  $R < 1$  than when  $R > 1$ . Indeed as  $t_1$  is reduced the rate of change of  $M_R$  with  $A'$  becomes very small when  $R < 1$ ; this is clearly illustrated in Fig.11 and suggests that it becomes more and more wasteful to provide increases in  $M_R$  on a given set of contours as  $t_1$  is reduced, for sections where  $R < 1$ . This is particularly the case in Fig. 11m where  $t_1 = 1"$ .

This property would suggest that it is desirable to choose sections on that part of a contour where  $R \geq 1$  where, as pointed out in Chapter 1, the tension flange is fully stressed and the compression flange is either fully or understressed. It remains to be seen, however, if this is always feasible in Minimum Weight Design. (See also additional items later in the chapter)

---

\* It may well be wondered as to what is the degree of linearity or co-linearity, etc., as described in the text, or what is the percentage error in "a good engineering approximation". Numerical answers could be obtained for this, and other, empirical investigations by obtaining, analytically, the slopes and intercepts of lines on the  $M_R \sim A'$  graph passing through points whose co-ordinates are given in Table No. 3.1, or from a similar table for different data.

However this has not been done here as such matters will be investigated on a broader, more general, and theoretical basis in Chapter 4. Nevertheless it is worth recording that the original graphs of Fig.11 were plotted on imperial size graph paper to scales of 1"  $\equiv$  1,000 tonft and 1"  $\equiv$  10 sq.ins, and the properties given at this stage were inferred graphically from these large scale plots.

-----

These properties of contours have been deduced from the empirical investigation and certainly fully apply to this data. As suggested earlier in the chapter, it would appear that most or all of these



properties will also apply to any contour. This generalisation will therefore be examined on a theoretical basis in Chapter 4, before stating the General Method in Chapter 5.

The "Detailed Investigation on an Empirical Basis" can now be completed here by looking into the effect of varying  $\frac{L}{B_1}$  as indicated earlier and

then proceeding to build up the Minimum Weight Boundary on the  $M_R \sim A'$  graph by superimposing suitable contours.

#### Effect of Varying the Width of the Compression Flange

It has been established from the Pilot Scheme of Chapter 2 that the points lying on the Minimum Weight Boundary of the  $M_R \sim A'$  graph consist of sections in which the width of the compression flange ( $B_1$ ) is at or near its maximum value, or, in other words, in which the ratio  $\frac{L}{B_1}$  is at or near its minimum value.

The concept of critical points on the Minimum Weight Boundary has now been replaced by that of

critical contours, and so the effect of varying  $\underline{L}$  must be considered with respect to a contour.  $B_1$

All the contours in the empirical investigation described above and illustrated in Fig.11 are for sections in which  $\underline{L}$  is held at its minimum  $B_1$

value in each zone. It is now intended to vary  $\underline{L}$  over the entire range of practical values in  $B_1$

a particular zone and to observe the effect of this increase on representative contours. This step can be regarded as an addition to the empirical investigation and should yield further items to the list of "Properties of a Contour".

Accordingly the following data was selected :-

$$L=100; \underline{L} = 10; t_3=1"; K_1=1; \lambda =1; t_1=2.5"$$

$\underline{L}$  = minimum value, the value for which  $R=1.00$  (if  $B_2$  applicable), and various values up to the maximum of 55.

$$t_2 = 1", 2.5"$$

$\frac{L}{B_1} = 15, 15.2, 15.4, 15.585, 16.439, 17.392,$   
 $18.462, 19.673, 21.053, 22.642, 30, 40,$   
 $55,$  and those values of  $\frac{L}{B_1}$  at which

$R=1.00$  when  $\frac{L}{B_2}$  has its minimum and  
 maximum values.

It should be noted that the sizes chosen for  $\frac{L}{B_1}$

consist of values which are:-

a) just above the minimum (i.e. just above 14.815 which has already been given in Table No.3.1a). This is in accordance with the results of the Pilot Scheme.

b) equal to the minimum sizes given in all other zones, as given in Table No.3.1.

These values which apply here to a compression flange thickness  $t_1=2.5''$  can then be compared with the corresponding values in Table No.3.1 for different values of  $t_1$  to see which will give the Minimum Weight Boundary.

MOMENT OF RESISTANCE  $M_R$  (TON FT.)

$M_R$   
TON.FT.

20000  
19000  
18000  
17000  
16000  
15000  
14000  
13000  
12000  
11000  
10000  
9000  
8000  
7000  
6000  
5000  
4000  
3000  
2000  
1000  
0

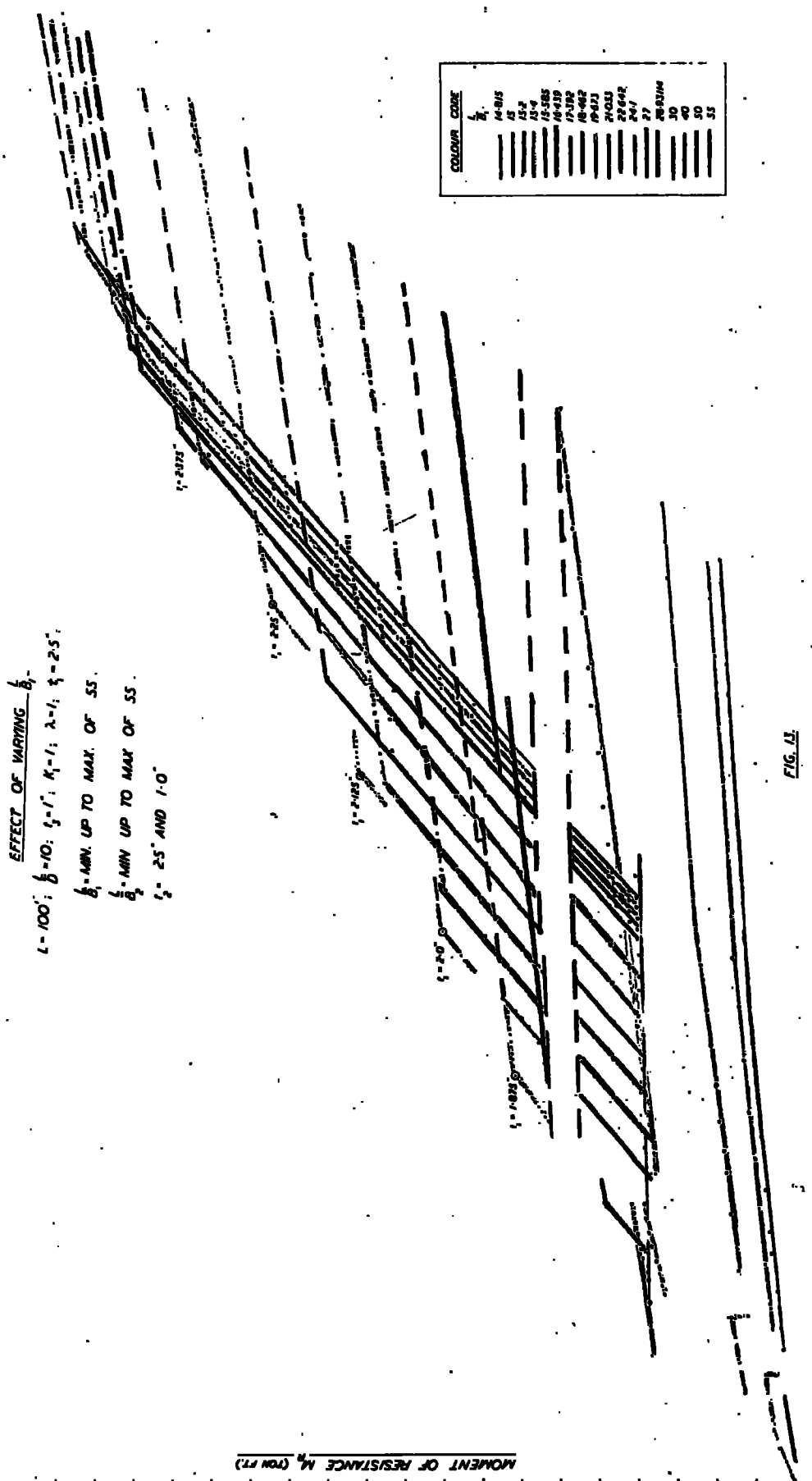

COLOUR CODE	
$\lambda$	$\xi$
14-815	
15	
15.2	
15.4	
15.585	
16-419	
17-392	
18-462	
19-513	
21-013	
22-642	
24.1	
27	
28-8316	
30	
40	
50	
55	

EFFECT OF VARYING  $\frac{b}{b_1}$

$L=100'$ ;  $\beta=10$ ;  $\xi_1=1'$ ;  $K_1=1$ ;  $\lambda=1$ ;  $\xi=2.5'$

$\frac{b}{b_1}$  - MIN. UP TO MAX. OF SS.

$\frac{b}{b_1}$  - MIN UP TO MAX OF SS.

$\xi_2 = 2.5'$  AND  $1.0'$

FIG. 13

CROSS SECTIONAL AREA  $A$  (SQ. IN.)

0 100 200 250 270 280 290 300 310 320 330 340 350 360 370 380 390 400 410 420 430 440 450 460 470 480 490 500 510 520 530 540 550 560 570

c) at other intermediate stages up to the maximum of 55.

The contours on the  $M_R \sim A'$  graph from these results have been plotted in Fig.13, and these can now be examined and compared with those plotted in Fig.11.

It can be seen that all the contours shown in Fig.13 exhibit some or all of the properties listed above with no contradictions, and yield the following additional properties.

Properties of a Contour - Additions to the List

13. The slopes of the linear portions of contours having different values of  $\underline{L}$  and the same values of  $B_1$

of other sectional parameters remain essentially constant, being approximately equal to the slopes of the linear portions of all the contours shown in Fig.11.

This appears to substantiate the suggestion made earlier in item No.10 that the slope of a contour is independent of  $B_1$ .

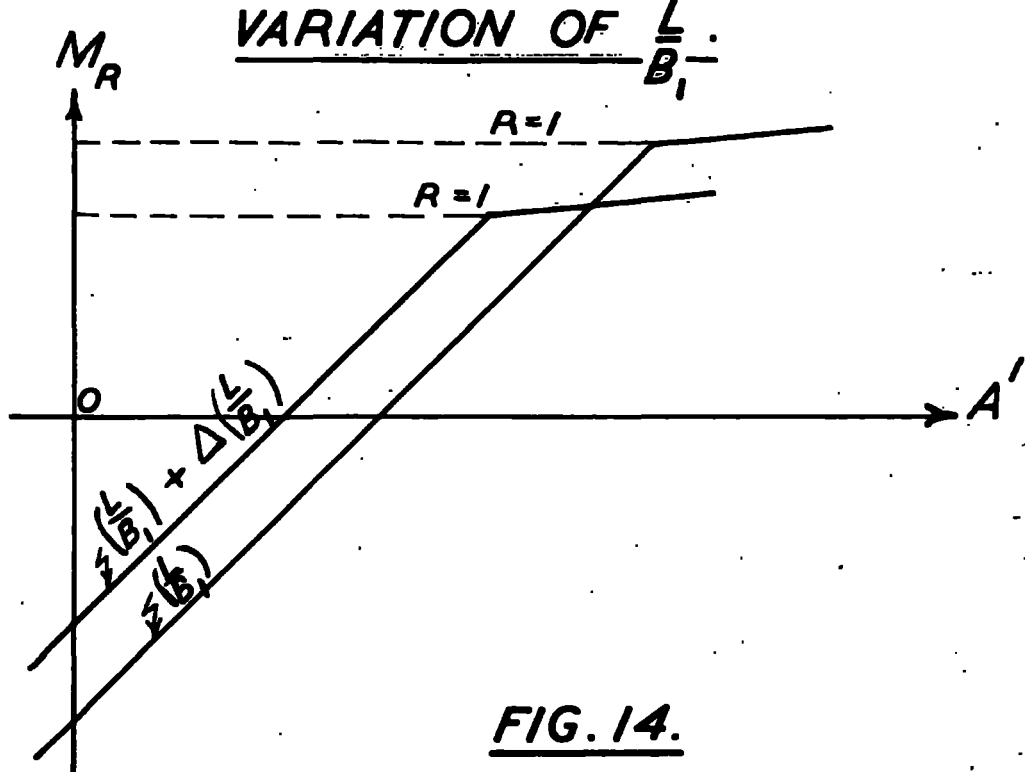

FIG. 14.

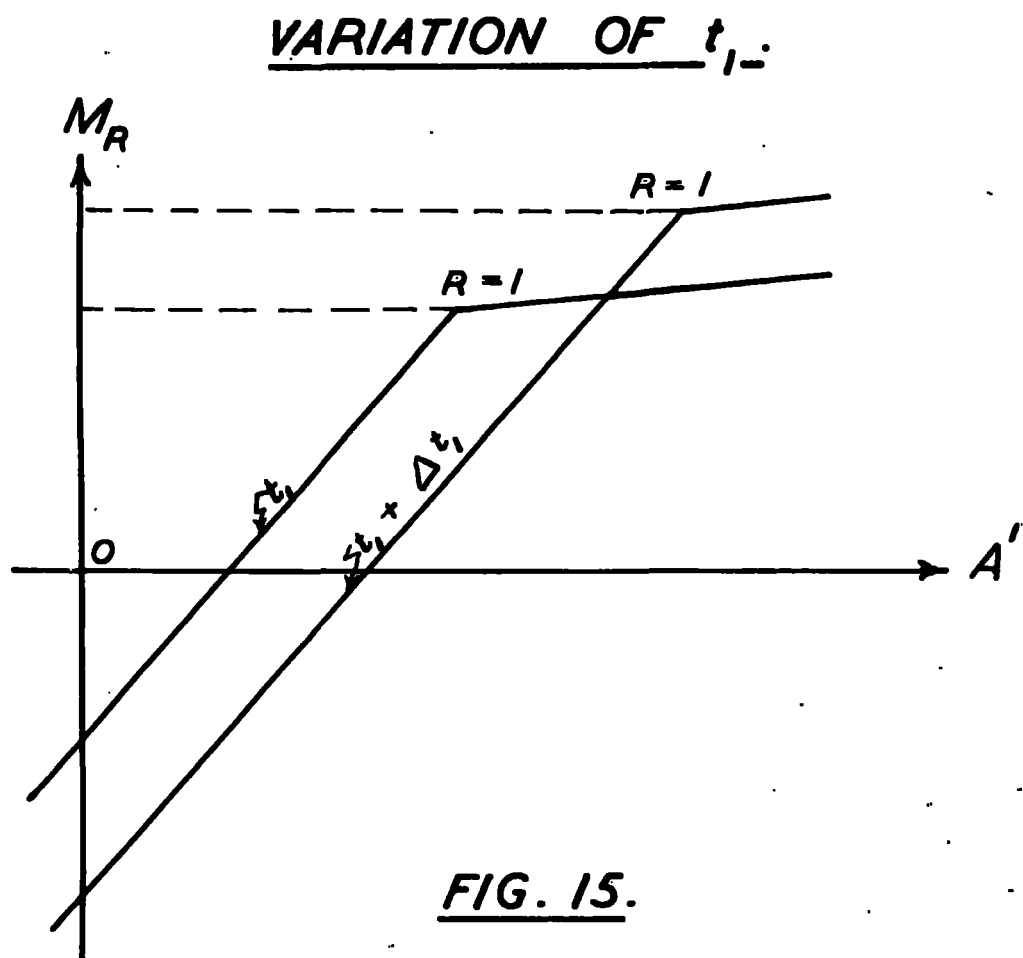

FIG. 15.

14. The intercepts on the  $M_R$  axis formed by extending the linear portions of contours increase algebraically as  $\frac{L}{B_1}$  increases.

15. The value of  $M_R$  on a contour at which  $R$  is unity decreases as  $\frac{L}{B_1}$  increases.

These three properties (13, 14, and 15) can be expressed diagrammatically as shown in Fig. 14. It is clear then that a greater value of  $M_R$  at a given  $A'$  will occur on the contour having the greatest value of  $\frac{L}{B_1}$ , provided that the Stress

Ratio  $R$  is greater than, or equal to, unity; it can therefore be deduced that the maximum limiting value of  $M_R$  at a given  $A'$  will tend to occur when  $R$  tends to unity provided always that this can be achieved in the practical range of sizes. This can be verified by considering any numerical value of  $A'$  in Fig. 13.

This is an important discovery which will be continually used in the formation of the Minimum Weight Boundary.

16. For any value of  $\frac{L}{B_2}$  the Stress Ratio  $R$  decreases on passing from one contour to another in which  $\frac{L}{B_1}$  is greater, while all other sectional parameters remain constant.

This means that, as  $\frac{L}{B_1}$  increases, the contours eventually become non linear, since  $R$  will become less than unity for all sections on the contour.

From this property it can be deduced that the minimum value of  $M_R$  at which  $R$  is unity will occur on any contour where  $\frac{L}{B_2}$  is equal to the maximum value

of 55. It is then possible to determine that value of  $\frac{L}{B_1}$  at which this occurs for a given value of  $t_2$ . Thus for the two values of  $t_2$  used in Fig.13:-

when  $t_2=1''$ ;  $\frac{L}{B_1}=28.93114$ ;  $\therefore M_R=4738.27$  tonft and

$$A' = 242.01 \text{ sq. ins.}$$

and when  $t_2=2.5''$ ;  $\frac{L}{B_1}=24.1$ ;  $\therefore M_R=7355.88$  tonft and

$$A' = 294.03 \text{ sq. ins.}$$



For both these sections  $R = 1.00$ ;  $\frac{L}{B_2} = 55$ ;  $L = 100'$ ;

$\frac{L}{D} = 10$ ;  $K_1 = 1$ ;  $\lambda = 1$ ;  $t_3 = 1''$ ; and  $t_1 = 2.5''$ .

These sections then denote practical lower limits at which the properties Nos. 13, 14, and 15, as illustrated in Fig. 14, will cease to apply, and, of these, the section for which  $t_2 =$  the minimum value of  $1''$ , is critical.

The characteristics of sections on the Minimum Weight Boundary, as discovered from the Pilot Scheme of Chapter 2, may therefore cease to apply when the unital contours have values of  $R$  less than unity; this will occur at lower values of  $M_R$  and a short investigation will be made later in the chapter to study this effect.

17. Contours having different values of  $t_1$  and the same values of  $\frac{L}{B_1}$  and of all other sectional parameters,

exhibit similar properties to those described in items 13, 14, and 15, which refer to contours having different values of  $\frac{L}{B_1}$  and the same values of  $t_1$  and all other sectional parameters, viz :-

- a) The slopes of linear portions are constant and are approximately equal to those slopes of contours shown in Fig.11.
- b) The intercepts on the  $M_R$  axis increase algebraically as  $t_1$  decreases.
- c) The value of  $M_R$  on a contour at which R is unity decreases as  $t_1$  decreases.

These properties can also be expressed diagrammatically as shown in Fig.15, and the similarity with those properties shown in Fig.14 is then quite apparent.

This item can be illustrated numerically by referring to Fig.13, where it can be seen that those parts of contours around the value of R equal to unity have been superimposed from the data given in Table No.3.1 and Fig.11, for five values of  $t_1$  between 1.875" and 2.5". When these superimposed portions of contours are compared with the contours having the corresponding values of  $\frac{L}{B_1}$  with  $t_1 = 2.5"$ , it can be seen that the points made in a), b), and c), are confirmed.

This item is also important as this means that at a given value of  $A'$  the maximum value of  $M_R$  will generally occur where  $R$  is unity on that contour having the minimum value of  $t_1$  which can produce this state of affairs.

This explains also why, in the Pilot Scheme, the sections on the Minimum Weight Boundary in a given zone have values of  $\frac{L}{B_1}$  at, or near, the

minimum. As  $\frac{L}{B_1}$  is increased in a given zone, the

values of  $M_R$  and  $A'$  eventually overlap with those in the adjacent zone having the next lower practical value of  $t_1$ , and these latter values are superior, giving a greater value of  $M_R$  for a given value of  $A'$

---

## THE MINIMUM WEIGHT BOUNDARY

The properties of contours have now been investigated fully on an empirical basis and it should now be possible to build up the Minimum Weight Boundary on the  $M_R \sim A'$  graph for this data, viz; for  $L = 100$  ft;  $\frac{L}{D} = 10$ ;  $t_3 = 1$  inch,  $K_1 = 1$ , and  $\lambda = 1$ , using portions of contours as the unital elements. However, before doing so, it is intended to examine more closely the characteristics of sections likely to appear on this boundary at the lower values of  $M_R$ . (< 5,000 tonft.).

### Investigation at the Lower End of the Boundary

The problem here has been referred to above in item 16 in the list of "Properties of a Contour".

It can be seen from Fig.11 and Table No.3.1 that values of the Stress Ratio  $R$  greater than, or equal to unity, only appear on contours in which  $t_1 \geq 1.625$ ".

Since the minimum area  $A'$  on any contour having a linear portion occurs when  $\frac{L}{B_2} = 55$  and  $t_2 = 1$ "; it is possible to obtain the minimum area on the boundary

at which  $R = 1$ , using also the properties illustrated in Fig.14. This amounts to searching for that value of  $\frac{L}{B_1}$  which will just make  $R$  equal to unity when the

other sectional parameters are :-

$L=100'$ ;  $\frac{L}{D} = 10$ ;  $t_3=1''$ ;  $K_1=1$ ;  $\lambda=1$ ;  $t_1=1.625''$ ; and

$$\frac{L}{B_2} = 55.$$

This was done by successive approximation using Programme No. ABEL 1A, and the result was :-

$R = 1.000000$  when  $\frac{L}{B_1} = 23.44822$

where  $M_R = 4,632.34$  tonft(V) and  $A' = 222.36$  sq.ins.

Hence sections on the Minimum Weight Boundary having cross sectional areas less than 222.36 sq.ins. must lie on contours in which  $R < 1$  throughout. Moreover, by examining such contours in Figs.11 and 13 it can be seen that the rate of change of  $M_R$  with  $A'$  is very small, so that by increasing the cross sectional area along a contour the weight of the girder will be appreciably increased, with little increase in  $M_R$  in return. Furthermore, it can be particularly observed in Figs 11i to 11m inclusive that the maximum value

of  $M_R$  at a given value of  $A'$  will occur in this range when  $t_2 =$  minimum value of 1" and  $\frac{L}{B_2} =$  maximum value

of 55; only intermittent values are shown here, but these do tend to indicate the significant characteristics which will now be investigated further.

It is clear then that to obtain intermediate values on the Minimum Weight Boundary in this lower range, it is only possible to vary  $\frac{L}{B_1}$  and  $t_1$ .

Accordingly this was done for all practical values of  $t_1$  and for incremental values of  $\frac{L}{B_1}$  throughout

the entire range.

#### Data

$L = 100'$ ;  $\frac{L}{D} = 10$ ;  $t_3 = 1''$ ;  $K_1 = 1$ ;  $\lambda = 1$ ;  $t_2 = 1''$ ;  $\frac{L}{B} = 55$ .

$t_1 = 1''$  up to 2.5" in steps of 0.125"

$\frac{L}{B_1} =$  minimum value, intermediate values, and the maximum value of 55.

These sections were then analysed on the computer using Programme No. ABEL 1, though these results are not shown in the thesis. All points on the  $M_R \sim A'$  graph

EFFECT OF VARYING  $\frac{L}{B_1}$  FOR SMALL VALUES OF  $M_R$  (ie. < 5000 ton.ft)

$L = 100'$ ;  $\frac{L}{D} = 10$ ;  $t_3 = 1''$ ;  $K_1 = 1$ ;  $\lambda = 1$

$t_2 = 1''$ ;  $\frac{L}{B_2} = 55$ ;  $\frac{L}{B_1} = \text{MIN. TO MAX.}$

$t_1 = 1''$  UP TO 2.5"

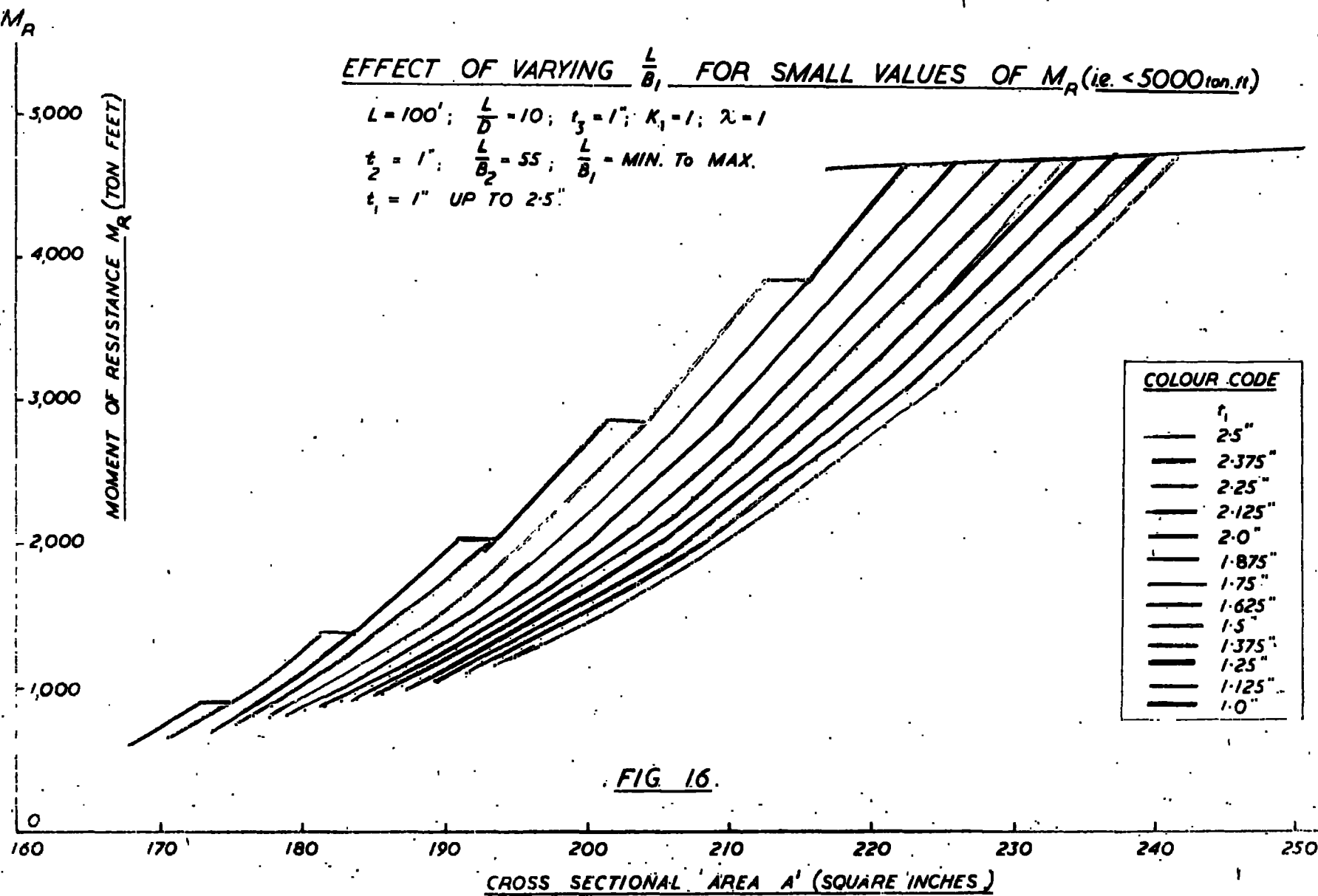

COLOUR CODE	
$t_1$	
—	2.5"
—	2.375"
—	2.25"
—	2.125"
—	2.0"
—	1.875"
—	1.75"
—	1.625"
—	1.5"
—	1.375"
—	1.25"
—	1.125"
—	1.0"

FIG 16.

were then plotted in Fig.16. This time, however, it was not possible to draw contours, since only one point was known on each contour. However it was convenient to draw smooth lines through points representing sections having different values of  $\frac{L}{B_1}$  and the same values of all other sectional parameters. Such lines will now be termed "Inverted Contours".

Definition An inverted contour is a continuous line on the  $M_R \sim A'$  graph in which  $\frac{L}{B_1}$  is varied from its minimum to its maximum value while all other sectional parameters are kept constant.

#### Discussion of Results

Only brief comments will be made here as it would appear that the sections in this range are considerably understressed and are therefore uneconomic and unlikely to be regarded as suitable practical solutions to the three design problems of Chapter 1; nevertheless some comments are necessary in order to be complete.



It would appear that :-

1. Inverted contours consist of curves which can be either partly or totally linear or non linear (though no example of total linearity was obtained from this data). Such possibilities depend upon the value of the Stress Ratio  $R$ .
2. When both linear and non linear portions exist, these intersect smoothly and the Stress Ratio  $R$  is equal to unity at this point;  $R > 1$  on the linear portion and  $R < 1$  on the non linear portion.
3. All linear portions are co-linear and the minimum area  $A'$  on this line is the critical value of 222.36 sq.ins., as calculated previously.
4. There are no discontinuities; this is due to the fact that all sections are in Class 2, (i.e. V)
5. The minimum value of  $A'$  on each inverted contour is generally obtained when  $\frac{l}{r_y} =$  maximum permissible value of 300, which can occur before  $\frac{L}{B_1}$  reaches its maximum value.

6. The maximum value of  $M_R$  for a given value of  $A'$  occurs on that inverted contour having the minimum value of  $t_1$ , which will provide a valid section. It can be seen that some inverted contours stop abruptly before  $R$  can attain the value of unity; this is due to the fact that  $\frac{L}{B_1}$  has reached its minimum practical value. Thus the Minimum Weight Boundary will be stepped as shown in Fig.16.

-----

These are the main characteristics as to what constitutes Minimum Weight Design for small values of  $M_R$ . It is interesting to note on passing that it would appear feasible to be able to use inverted contours as the unital element in the construction of the Minimum Weight Boundary throughout the entire range; however a more detailed analysis of the properties would then be required, and it is not intended to do so here since contours, rather than inverted contours, will be used.

# THE MINIMUM WEIGHT BOUNDARY

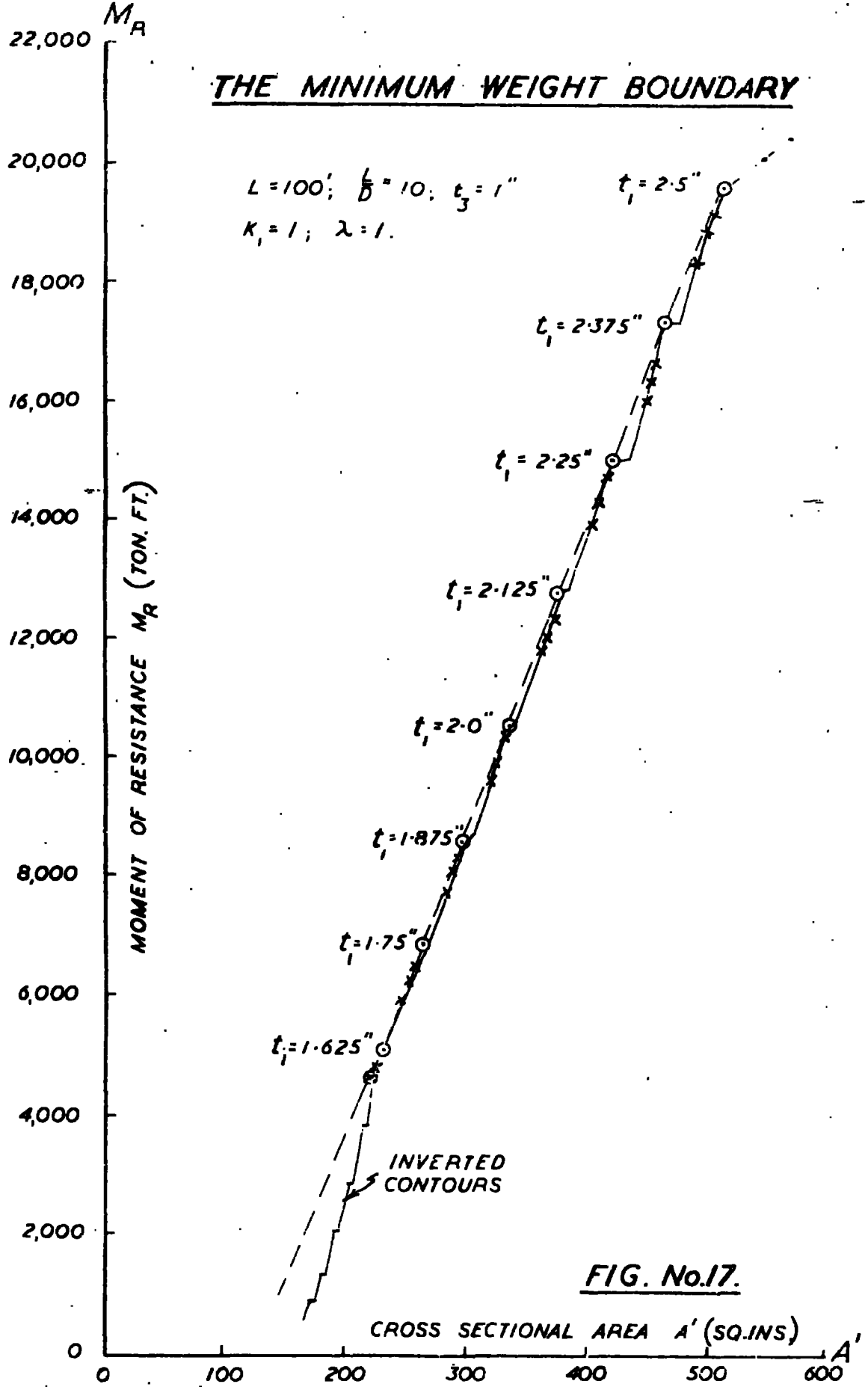

FIG. No.17.

## Synthesis of the Minimum Weight Boundary

The Minimum Weight Boundary for the empirical investigation can now be built up in the form of an envelope from the contours and inverted contours shown in Figs. 11, 13, and 16, supplemented by intermediate values which will be obtained as the Boundary begins to take shape. This Boundary is shown in Fig. 17; the relevant contours can either be re-plotted from the Tables of data given above, or can be traced directly in the case of those taken from Figs. 11 and 13 since these have all been plotted to the same scale.

Those contours taken from Fig. 11 can be regarded as the "bones" or "skeleton" of the Boundary, comprising as they do of one contour in each zone (i.e. of  $t_1$ ) in which  $\underline{L}_{B_1}$  is at its minimum value; the most favourable value of  $t_2$  has been chosen in each case by using the "Properties of a Contour".

The continuous plot of the Boundary at low values of  $M_R$  (i.e. less than 5,000 ton.ft. approximately), can be obtained completely from Fig. 16.

The intermediate values in each zone can now be determined by increasing  $\frac{L}{B_1}$ ; this has been done in the first instance throughout the range by reducing  $B_1$  each time by 1 inch and determining the critical values of  $t_2$  and  $\frac{L}{B_2}$  which will give the optimum values of  $M_R$  and  $A'$  for  $R \geq 1.000000$ . (In this sense the "optimum values" of  $M_R$  and  $A'$  are either the maximum value of  $M_R$  at a given  $A'$  or the minimum value of  $A'$  at a given  $M_R$ ; both of these alternatives are equivalent and provide points on the Minimum Weight Boundary for a given span and category of stiffening). Care has been taken to ensure that these are indeed points on the Minimum Weight Boundary by comparing results with adjacent possible values of  $t_2$ . Further points on each contour were then obtained for  $R$  just greater and just less than unity by varying  $\frac{L}{B_2}$ . Full details of these calculations are given in Table No. 3.6, and the parts of the contour have been inserted in Fig.17.

This is the completed Minimum Weight Boundary when the decremental change in  $B_1$  is 1 inch, and it

# DETAILS OF A "STEP" ON THE MINIMUM WEIGHT BOUNDARY

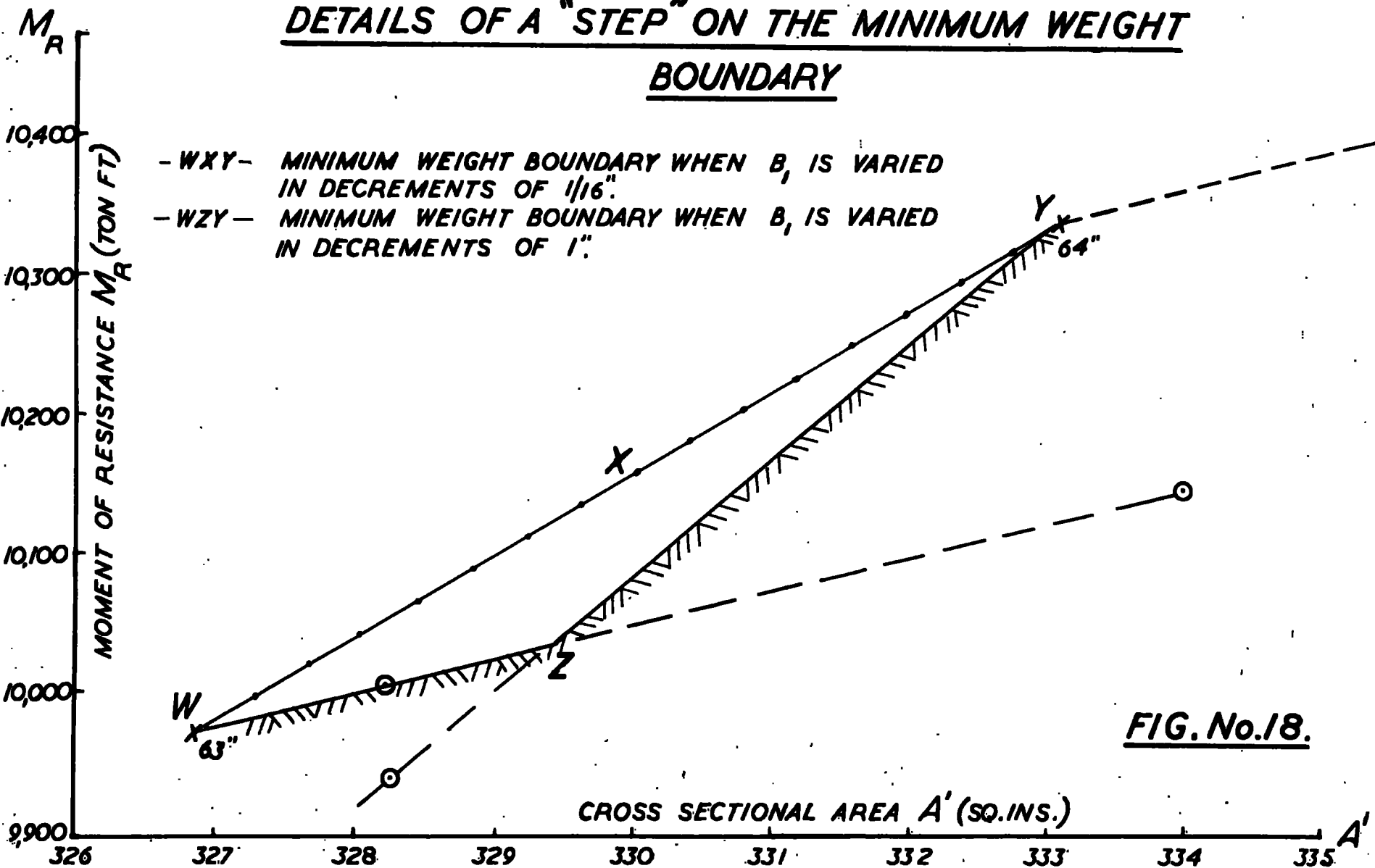

FIG. No.18.

can be seen that a "stepped" profile has been obtained. However these "steps" can be smoothed by reducing the decremental change in  $B_1$  which could be taken down to an apparent practical minimum of 0.0625". This has been done for one "step" on the Boundary in which  $t_1 = 2"$  and  $B_1$  is varied from 64" to 63" in decrements of 0.0625". The results are shown in Table No. 3.7, and these have been plotted to a large scale in Fig.18.

It can be seen from Fig.18 that the one "step" due to the 1 inch decrement of  $B_1$  has been filled in by sixteen smaller steps, thus making the transition from one end to the other more gradual. This could be done for all other steps on the Boundary, making the envelope tend to approach the ideal as indicated by the broken line in Fig.17. However at the present time manufacturers of rolled plate require a tolerance on the width of plate which can be as great as 0.75" over the nominal specified value for thick plates, due to the shearing technique used; the actual width supplied would then be used and thus it would appear that a likely practical minimum decrement would be

0.5" say.

With greater quality control this decrement could be reduced and made to approach the minimum.

### CONCLUSIONS

The Minimum Weight Boundary has now been obtained for the Empirical Investigation in which :-

$L=100\text{ft}$ ;  $\frac{L}{D} = 10$ ;  $t_3=1"$ ;  $K_1=1$ ; and  $\lambda=1$ .

The boundary starts at the point at which  $M_R = 595.43 \text{ tonft}$  and  $A' = 167.71 \text{ sq.ins.}$ , and extends to the point at which  $M_R = 20,400.60 \text{ tonft}$  and  $A' = 569.98 \text{ sq.ins}$ ; these two points then define the range of values of Moments of Resistance which can be provided by practical sections. Nevertheless it would appear that the economical minimum section will be at the point where  $M_R = 4,632.34 \text{ tonft}$  and  $A' = 222.36 \text{ sq.ins}$ , since all sections below this value tend to have low values of the Stress Ratio  $R$  and of the permissible bending stress in compression  $p_{bc}$ ; this would suggest in this case, and possibly in all others, that plate girders are an unsatisfactory form of construction for all sections below the minimum



value of  $A'$  for which  $R \geq 1.00$ . Lattice girders would possibly then become more economical.

At the top end of the Boundary the maximum value of  $M_R$  for which  $R = 1.00$  is 19,587.44 tonft. and the corresponding value of  $A'$  is 513.31 sq.ins; the few sections on the Boundary above this point have values of  $R$  less than unity and consequently, as can be seen in Fig.16, become less competitive, since a smaller increase in  $M_R$  is then obtained for each unital change in  $A'$  up to the maximum cross sectional area of 569.98 sq.ins.

The range of values of  $M_R$  can only be efficiently extended by increasing  $t_1$  above the value of 2.5". However, as explained in Chapter 1, this would provide considerable difficulties in welding techniques and might necessitate the use of tongue plates at greater expense; nevertheless this does highlight what must be done if higher loads are to be carried.

It has therefore been demonstrated that a method can be established to obtain the Minimum Weight Boundary with sectional identification which will solve the Design Problem No. 3 of Chapter 1.

The range of values of  $M_R$ ,  $A'$ , and hence self weight for a given span, can also be given. Certainly in the case of other sizes great care must be exercised in case any of the properties of a contour, which have been derived empirically, cease to apply, but it is nevertheless suggested that, even at this stage, the method could now be used for any other data. (See also Chapters 4 and 5).

The Design Problems 1 and 2 of Chapter 1 can now be solved by obtaining the necessary contours on the graphs shown diagrammatically in Figs. 7a and 7b, using the method described in the Outline in Chapter 2.

-----

No further empirical, numerical work will be carried out here, however, since, as pointed out earlier, it is intended to justify the general method by a theoretical approach. This will be done in the next chapter, followed by the General Method in Chapter 5.

## CHAPTER 4

### THEORETICAL JUSTIFICATION

It has been demonstrated in Chapter 3 that it is possible to build up the Minimum Weight Boundary on the  $M_R \sim A'$  graph in a particular numerical case by using contours as the unital elements. The selection of the relevant contours depends upon their Properties; these have been derived empirically and therefore strictly refer only to the particular data used. Nevertheless it has been suggested that such properties might well apply to all contours, so that a General Method of Minimum Weight Design might be obtained. It is therefore intended in this chapter to try and justify this possible generalisation by using a theoretical, analytical, approach.

#### EQUATION OF A CONTOUR

It has been shown in Chapter 1 in equations 1.6 and 1.7 that :-

$$\text{when } R \leq 1, \quad M_R = P_{bc} \cdot \frac{I_x}{J_c} \quad \text{and}$$

$$\text{when } R \geq 1, \quad M_R = P_{bt} \cdot \frac{I_x}{J_t}$$

These two equations are the starting points in the formation of the equation of a contour, and, being different, must be considered separately.

Formation of the Equation when  $R \geq 1$ .

$$M_R = P_{bt} \cdot \frac{I_x}{y_t}$$

$p_{bt}$  is constant along a contour since  $t_2$  is constant, and is either 10 tons/sq.in. or 9.5 tons/sq.in. according to whether  $t_2 \leq 0.75''$  or  $t_2 > 0.75''$  respectively.

Then from Fig. 5 :-

$$y_t = \frac{t_2}{2} + \frac{A_1(2D - t_1 - t_2) + A_3(D - t_1)}{2A'}$$

where  $A_1 = B_1 t_1$ ;  $A_2 = B_2 t_2$ ; and  $A_3 = (D - t_1 - t_2) t_3$

$$\text{Also } A' = A_1 + A_2 + A_3$$

$$\therefore y_t = \frac{t_2}{2} + \frac{\mu}{A'} \dots\dots\dots 4.1$$

$$\text{where } \mu = \frac{A_1(2D - t_1 - t_2) + A_3(D - t_1)}{2}$$

Now

$$I_x = A_1 \left[ D - y_t - \frac{t_1}{2} \right]^2 + A_2 \left[ y_t - \frac{t_2}{2} \right]^2 + \frac{1}{12} t_3 d^3 + A_3 \left[ t_2 + \frac{d}{2} - y_t \right]^2$$

Hence from equation 4.1

$$I_x = A_1 \left[ D - \frac{\mu}{A'} - \frac{(t_1+t_2)}{2} \right]^2 + \left[ A' - A_1 - A_3 \right] \frac{\mu^2}{(A')^2} + A_3 \left[ \frac{D-t_1-t_2}{2} \right]^2 + A_3 \left[ \frac{(D-t_1)}{2} - \frac{\mu}{A'} \right]^2$$

..... 4.2

But from equation 4.1:  $y_t \doteq \frac{\mu}{A'}$ , provided  $\frac{t_2}{2}$  is small

compared with  $\frac{\mu}{A'}$ .

Hence

$$\frac{I_x}{y_t} \doteq \left[ \frac{2D \left\{ A_1(D-t_1-t_2) + \frac{A_3(2D-4t_1-t_2)}{6} \right\}}{\left\{ A_1(2D-t_1-t_2) + A_3(D-t_1) \right\}} \right] \cdot A'$$

$$- \left[ A_1 \left( \frac{D-t_1}{2} - \frac{t_2}{2} \right) + A_3 \left( \frac{D-t_1}{2} \right) \right] \dots\dots\dots 4.3$$

Thus in equation 4.3 :-  $\frac{I_x}{y_t}$  varies linearly with  $A'$ , the

cross sectional area, for all values of R, provided that  $\frac{t_2}{2}$  is small compared with  $\frac{\mu}{A'}$ . It can be seen that

$B_2$ , which varies along a contour, does not appear in this equation; all other sectional parameters are constant for a given contour.

Now when, and only when,  $R \geq 1.00$ ,

$f_{bt} = P_{bt} = \text{constant for a given contour and}$

$M_R = P_{bt} \cdot \frac{I_x}{y_t}$ . Hence from equation 4.3

$$M_R = m A' - c \quad \dots\dots\dots 4.4$$

$$\text{where } m = P_{bt} \cdot \left[ \frac{2D \left\{ A_1(D-t_1-t_2) + \frac{A_3(2D-4t_1-t_2)}{6} \right\}}{\left\{ A_1(2D-t_1-t_2) + A_3(D-t_1) \right\}} \right]$$

$$\text{and } c = P_{bt} \cdot \left[ \frac{A_1(D-t_1-t_2)}{2} + \frac{A_3(D-t_1)}{2} \right]$$

i.e.  $m$  and  $c$  are positive for all values of the sectional parameters. Thus  $M_R$  varies linearly with  $A'$  provided that  $\frac{t_2}{2}$  is small compared with  $y_t$ .

This is certainly true for most plate girders. The maximum error in linearity will therefore occur when  $t_2$  is at its maximum (i.e. 2.5") with  $D$  at its minimum (i.e. 36").

Equation 4.4 is therefore the equation of a contour when  $R \geq 1.00$ .

Formation of the Equation when  $R \leq 1.00$

$$M_R = P_{bc} \cdot \frac{I_x}{y_c} = P_{bc} \cdot \frac{I_x}{y_t} \cdot \frac{y_t}{y_c}$$

$P_{bc}$  varies slightly along a contour, being dependant on  $B_2$ . This variation will be considered later.

From eqn. 4.3 :-  $\frac{I_x}{y_t} = e_1 A' - e_2$  where  $e_1$  and  $e_2$

are constants for a given contour.

$$\left[ e_1 = \frac{m}{P_{bt}} \quad \text{and} \quad e_2 = \frac{c}{P_{bt}} \right]$$

$$\therefore M_R = P_{bc} (e_1 A' - e_2) \cdot \frac{y_t}{y_c} = P_{bc} (e_1 A' - e_2) \frac{(D - 1)}{y_c}$$

$$\text{i.e. } M_R = P_{bc} (e_1 A' - e_2) \left( \frac{D}{y_c} - 1 \right) \dots\dots\dots 4.5$$

Now  $y_c = D - y_t = D - \frac{t_2}{2} - \frac{\mu}{A'}$  If

$\frac{t_2}{2}$  is small compared with  $D - \frac{\mu}{A'}$ , then

$$y_c \doteq D - \frac{\mu}{A'} = D \left( 1 - \frac{\mu}{DA'} \right)$$

$$\therefore \frac{D}{y_c} = \left( 1 - \frac{\mu}{DA'} \right)^{-1} = 1 + \frac{\mu}{DA'} + \left( \frac{\mu}{DA'} \right)^2 + \dots$$

Since  $\frac{\mu}{DA'} < 1$ .

$\therefore$  Eqn. 4.5 becomes

$$M_R = p_{bc} (e_1 A' - e_2) \left[ \frac{\mu}{DA'} + \left( \frac{\mu}{DA'} \right)^2 + \left( \frac{\mu}{DA'} \right)^3 + \dots \right]$$

$$\doteq p_{bc} \cdot \frac{\mu}{D} \cdot \left[ e_1 + \frac{1}{A'} \left\{ \frac{\mu e_1}{D} - e_2 \right\} \right] \text{ to a first}$$

approximation.

This equation can now be replaced by  $M_R \doteq p_{bc} \left[ g_1 - g_2 \left( \frac{1}{A'} \right) \right]$

..... 4.6



where  $g_1 = \frac{\mu e_1}{D}$  and  $g_2 = \frac{\mu}{D} \left\{ \frac{\mu e_1}{D} - e_2 \right\}$

$\therefore g_1 = A_1(D-t_1-t_2) + \frac{A_3}{6} (2D - 4t_1 - t_2)$

and  $g_2 = \frac{1}{D} \left[ \frac{A_1(t_1+t_2)}{2} + \frac{A_3(D-t_1-t_2)}{6} \right] \left[ \frac{A_1(D-t_1-t_2)}{2} + \frac{A_3(D-t_1)}{2} \right] +$

Hence  $g_1$  and  $g_2$  are positive for all values of the sectional parameters, and are independent of  $B_2$ .

Since  $M_R = P_{bc} \cdot \frac{I_x}{y_c} = P_{bc} \left[ g_1 - g_2 \left\{ \frac{1}{A'} \right\} \right]$

then  $\frac{I_x}{y_c} = g_1 - g_2 \left\{ \frac{1}{A'} \right\}$  ..... 4.7

Hence  $\frac{I_x}{y_c}$  varies hyperbolically with  $A'$ , although

$\frac{I_x}{y_c}$  does vary linearly with  $\frac{1}{A'}$ , correct to a first approximation.

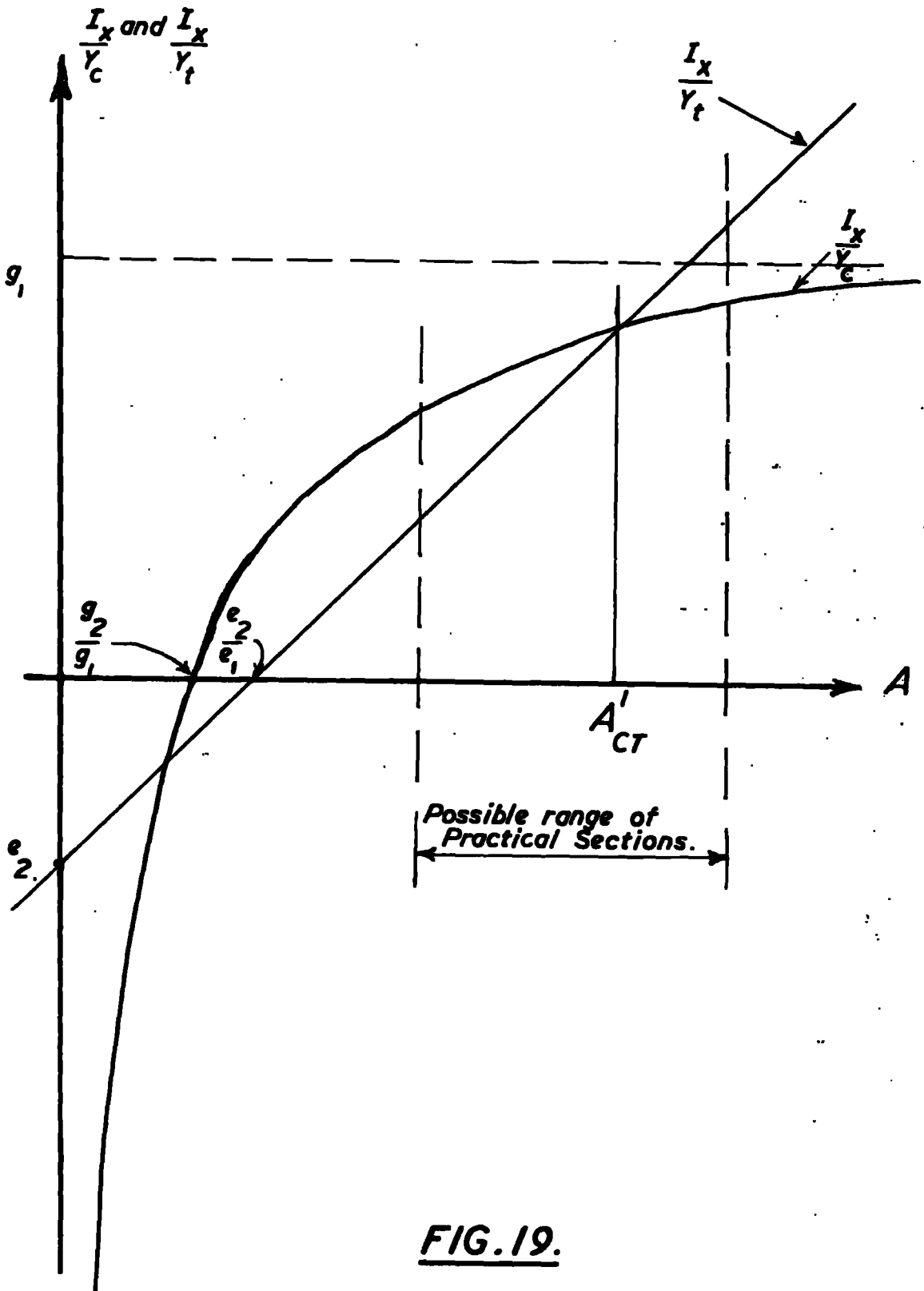

**FIG. 19.**

Thus the equation of the contour when  $R \leq 1.00$  is equation 4.6, viz:  $M_R = p_{bc} \left[ g_1 - g_2 \left\{ \frac{1}{A'} \right\} \right]$ , and this is non linear, with  $p_{bc}$  varying slightly along the contour.

From equation 4.7:  $\frac{\partial \left\{ \frac{I_x}{y_c} \right\}}{\partial A'} = + g_2 \left\{ \frac{1}{A'} \right\}^2$ , and this

is zero when  $A' \rightarrow \infty$ . Hence  $\frac{I_x}{y_c}$  increases with  $A'$ , there is zero slope when  $A' \rightarrow \infty$ , and there is infinite slope when  $A' \rightarrow 0$ .

$$\text{When } A' \rightarrow \infty \quad ; \quad \frac{I_x}{y_c} \rightarrow g_1$$

$$\text{When } A' \rightarrow 0 \quad ; \quad \frac{I_x}{y_c} \rightarrow -\infty$$

$$\text{and when } \frac{I_x}{y_c} = 0 \quad ; \quad A' = \frac{g_2}{g_1}$$

The graphs of  $\frac{I_x}{y_c}$  and  $\frac{I_x}{y_t}$  against  $A'$  can now be drawn

for the general case, as shown in Fig. 19.

These graphs may, or may not, intersect in the practical range of sections.  $A'$  is varied by changing  $B_2$  alone, and so the common value of  $A'$  at the intersection =  $A'_{CT}$ , can be determined thus:-  $\frac{I_x}{y_c} = \frac{I_x}{y_t}$  and

$$\text{therefore } y_c = y_t = \frac{D}{2}$$

$$\text{Whence } B_2''' = \frac{A_1(D-t_1) + A_3(t_2-t_1)}{t_2(D-t_2)}$$

$$\text{and } A'_{CT} = \frac{A_1(2D-t_1-t_2) + A_3(D-t_1)}{(D-t_2)}$$

These values can be determined for a given contour and it can then be established whether  $B_2'''$  is within the practical range or not. (The value of  $\frac{I_x}{y_c}$  for a given contour was included in Programme No. ABEL 2, and these values were included in the Empirical Investigation described in Chapter 3, being shown in Table No. 3.2).

An alternative method of obtaining  $A'_{CT}$  would be to solve equations 4.3 and 4.7 simultaneously. However this method is not accurate and is not to be recommended since the equations are approximate, and ill conditioning can arise if the gradients of the two curves at the point of intersection are nearly equal.

PROPERTIES OF A CONTOUR

The equations for both portions of a contour have now been obtained and it has been verified that when  $R \geq 1$  the contour is linear and when  $R < 1$  the contour is non linear.

Each portion will now be considered separately and particular care will be paid to those properties which are most important in the derivation of the Minimum Weight Boundary.

Properties of a Contour .....  $R \geq 1$

The equation of the contour in this range is :-

$$M_R \stackrel{\circ}{=} m A' - c, \text{ ..... 4.4}$$

provided that  $\frac{t_2}{2}$  is small compared with  $y_t$ , where

$$m = p_{bt} \cdot D \left[ \frac{A_1 (D - t_1 - t_2) + \frac{A_3}{3} (D - 2t_1 - \frac{t_2}{2})}{A_1 (D - \frac{t_1}{2} - \frac{t_2}{2}) + \frac{A_3}{2} (D - t_1)} \right]$$

$$\text{and } c = p_{bt} \left[ A_1 (D - \frac{t_1}{2} - \frac{t_2}{2}) + \frac{A_3}{2} (D - t_1) \right]$$

From these expressions the following partial derivatives can be obtained;  $\frac{\partial m}{\partial t_1}$ ,  $\frac{\partial m}{\partial t_2}$ ,  $\frac{\partial m}{\partial t_3}$ ,  $\frac{\partial m}{\partial B_1}$ ,  $\frac{\partial m}{\partial D}$ ,  $\frac{\partial m}{\partial p_{bt}}$

$$\text{and } \frac{\partial c}{\partial t_1}, \frac{\partial c}{\partial t_2}, \frac{\partial c}{\partial t_3}, \frac{\partial c}{\partial B_1}, \frac{\partial c}{\partial D}, \frac{\partial c}{\partial p_{bt}}.$$

These partial derivatives will show whether m or c increase, decrease, or have turning values throughout their entire practical range, and whether these rates are high or negligibly small.

Negative Intercept c. It can be shown that :-

$$\frac{\partial c}{\partial t_1} = p_{bt} (B_1 - t_1) (D - t_1 - \frac{t_2}{2}) > 0 \text{ for all values,}$$

$$\frac{\partial c}{\partial t_2} = \frac{p_{bt}}{2} (B_1 t_1 + D t_3 - t_1 t_3) < 0 \text{ for all values,}$$

and is a quantity independent of  $t_2$ .

$$\frac{\partial c}{\partial t_3} = \frac{p_{bt}}{2} \left[ D(D - 2t_1 - t_2) + t_1^2 + t_1 t_2 \right] > 0 \text{ for all values,}$$

$\frac{\partial c}{\partial B_1} = p_{bt} \cdot t_1 \left( D - \frac{t_1}{2} - \frac{t_2}{2} \right) > 0$  for all values, and is a quantity independent of  $B_1$ .

$\frac{\partial c}{\partial D} = p_{bt} \cdot t_1 (B - t_3) + p_{bt} \cdot t_3 \left( D - \frac{t_2}{2} \right) > 0$  for all values,

and

$\frac{\partial c}{\partial p_{bt}} = A_1 \left( D - \frac{t_1}{2} - \frac{t_2}{2} \right) + \frac{A_3}{2} (D - t_1) > 0$  for all values.

Thus  $c$  increases as  $t_1$ ,  $t_3$ ,  $B_1$ ,  $D$ , and  $p_{bt}$  increase and  $c$  decreases as  $t_2$  increases.

However the maximum range of  $t_2$  is 2.125", and this will never be achieved by any one set of contours for  $R > 1$ ; the likely practical range of  $t_2$  in this context will be 1 inch.

Then: Change in  $c$  due to change in  $t_2 = \frac{\partial c}{\partial t_2} \cdot \delta t_2$

$$= -\frac{p_{bt}}{2} \left[ B_1 t_1 + D t_3 - t_1 t_3 \right] \times 1$$

Hence the maximum change in  $c$  with  $t_2$  will occur when

$B_1$ ,  $D$ ,  $t_1$ , and  $t_3$  have their maximum values. Thus max.

change in  $c$  with  $t_2 = 188$  tonft, and the corresponding

value of  $c = 11,320$  tonft.

$$\text{Hence error} = \left( \frac{188 \times 100}{11,320} \right) \% = 1.66 \%$$

However it will be shown later that contours of different  $t_2$  converge as  $A'$  increases, while the practical values of  $M_R$  are of the order of 12,000 tonft, so that the error in the practical value of  $M_R$  neglecting the change due to  $t_2$  will probably be not greater than 1%.

Gradient m. It can be shown that :-

$$\frac{\partial m}{\partial t_1}, \quad \frac{\partial m}{\partial B_1}, \quad \frac{\partial m}{\partial D}, \quad \text{and} \quad \frac{\partial m}{\partial P_{bt}} > 0 \text{ for all values}$$

$$\text{and} \quad \frac{\partial m}{\partial t_2} \quad \text{and} \quad \frac{\partial m}{\partial t_3} < 0 \text{ for all values.}$$

The algebraic expressions for these derivatives are extremely complex and will not be given, although these have in fact been obtained by the author and checked by BERGSON.

Instead, the variation of the gradient  $m$  can be illustrated thus :-

$$\text{It can be shown that } m = D p_{bt} (1 - \phi)$$



$$\text{where } \phi = \frac{\begin{array}{c} \text{1st TERM} \quad \text{2nd TERM} \quad \text{3rd TERM} \\ \left[ \frac{1}{6} D^2 t_3 \right] + \left[ \frac{1}{2} B_1 t_1 (t_1 + t_2) \right] + \left[ \frac{1}{3} t_1^2 t_2 + \frac{1}{6} t_1 t_2 t_3 + \frac{1}{6} t_2^2 t_3 \right] \end{array}}{\begin{array}{c} \text{1st TERM} \quad \text{2nd TERM} \quad \text{3rd TERM} \\ \left[ \frac{1}{2} D^2 t_3 \left\{ 1 - \frac{2}{D} \left( t_1 + \frac{t_2}{2} \right) \right\} \right] + \left[ B_1 t_1 \left( D - \frac{t_1}{2} - \frac{t_2}{2} \right) \right] + \left[ \begin{array}{c} t_1^2 t_3 + \\ t_1 t_2 t_3 \end{array} \right] \end{array}}$$

By comparing corresponding terms on the numerator and the denominator it can be seen that :-

- 1)  $\phi$  is always positive and less than unity,  $\phi < 1$
- 2)  $\phi$  varies most with  $D$ , then with  $B_1$ , and least of all with  $t_2$ .

When  $D$  is large (200" approx.),  $\phi$  can vary from 0.240 to 0.035 and when  $D$  is small (36" approx.),  $\phi$  can vary from 0.294 to 0.061, for all practical values of the sectional parameters.

Thus  $m$  can vary from  $0.706 D p_{bt}$  up to  $0.965 D p_{bt}$ , indicating that  $D$  affects the slope most.

$\phi$  varies little with  $t_2$  and hence  $m$  will remain essentially constant as  $t_2$  is varied; since both  $c$  and  $m$  vary by a negligible amount with  $t_2$ , then contours

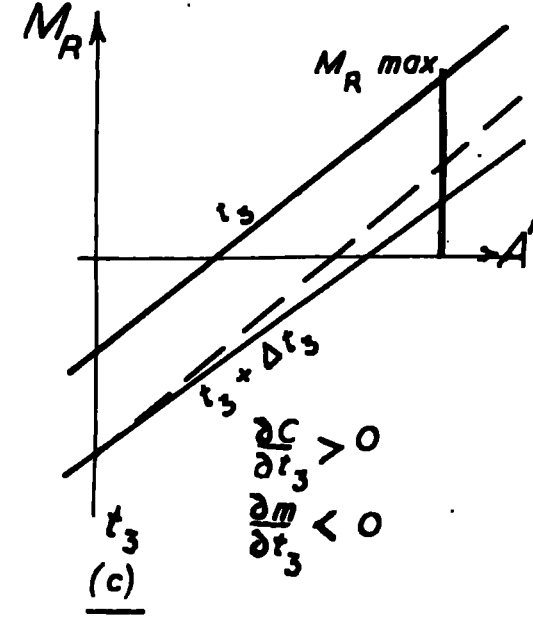
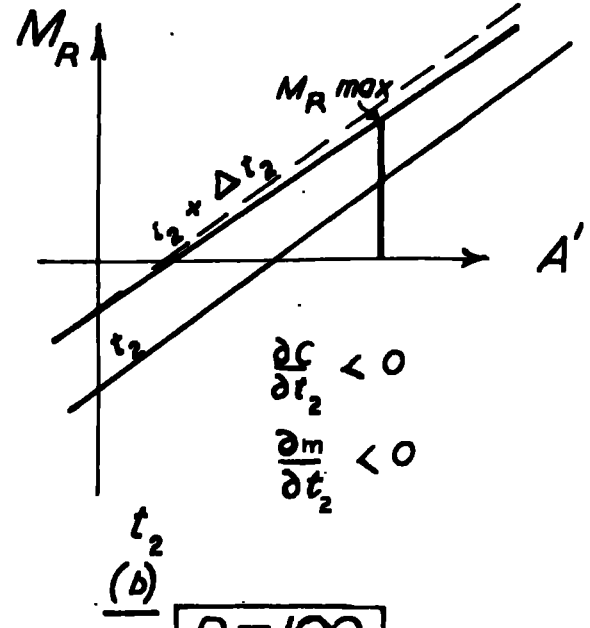
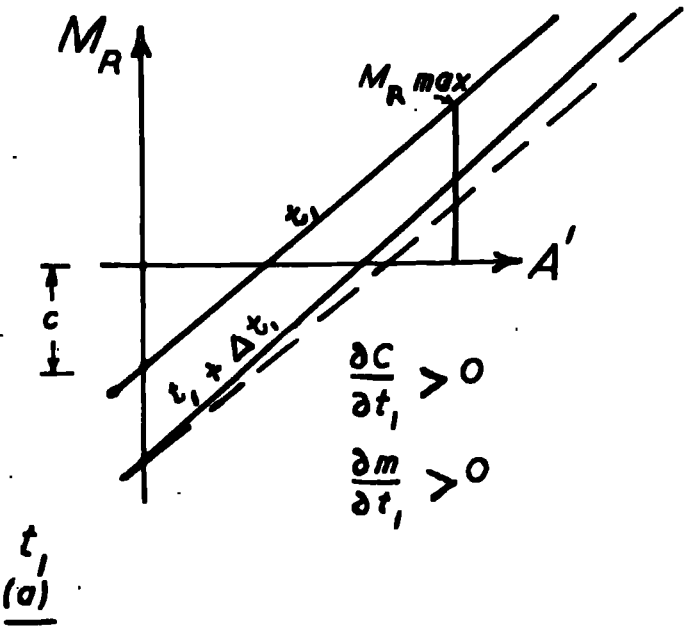

$R \cong 100$

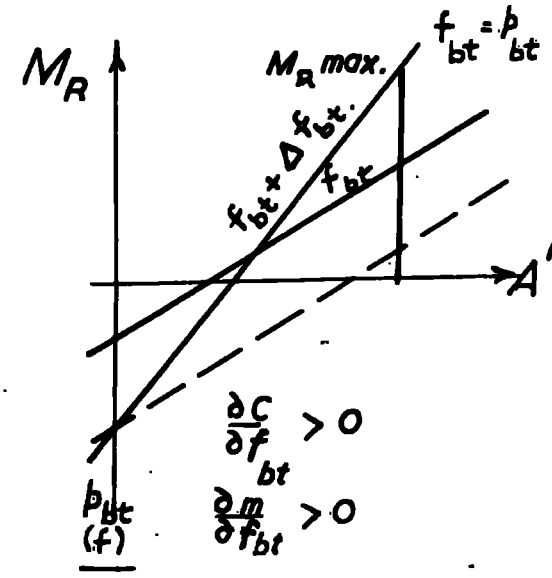
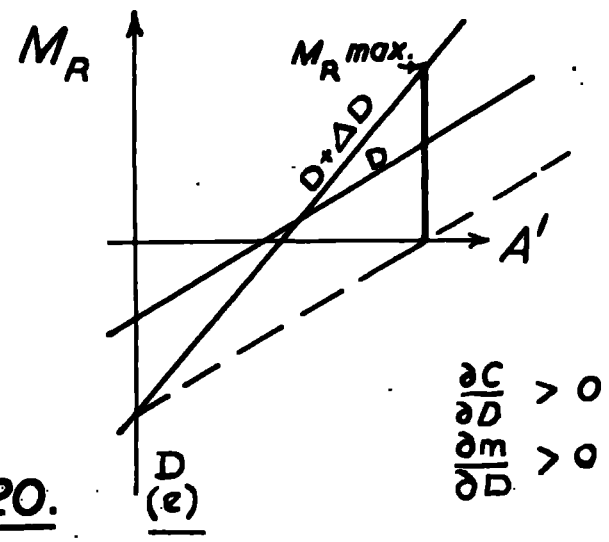
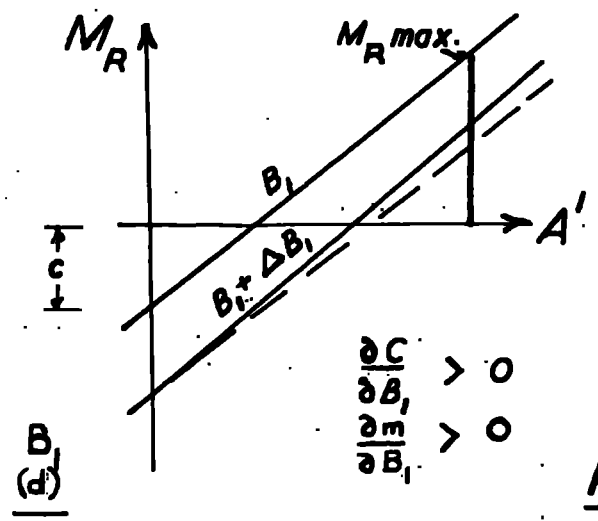

FIG. 20.

in a set will be co-linear for all practical sizes.

-----

These results have been illustrated diagrammatically in Fig. 20. This diagram shows how to vary the sectional parameters in order to obtain the Minimum Weight Boundary when  $R > 1$ . Thus for any value of  $A'$  in the practical range, the maximum value of  $M_R$  will be obtained when :-  $t_1$ ,  $t_3$ , and  $B_1$  are at their minimum values, and  $t_2$ ,  $D$ , and  $p_{bt}$  are at their maximum values.

It can be seen that the pairs of contours diverge as  $A'$  increases in Figs. 20c, e, and f, indicating that the statement made above is manifestly true for values of  $t_3$ ,  $D$ , and  $p_{bt}$  in the practical range.

However it can be seen that the pairs of contours converge as  $A'$  increases in Figs. 20a, b, and d, and it might be thought possible that these pairs of contours could intersect within the practical range of  $A'$ ; if this were to happen the statement made above regarding  $t_1$ ,  $t_2$ , and  $B_1$  would be incorrect, being then only partly true. The variation due to  $t_2$  has been considered earlier and is negligibly small and need not be considered further,

# VARIATION OF $A'$

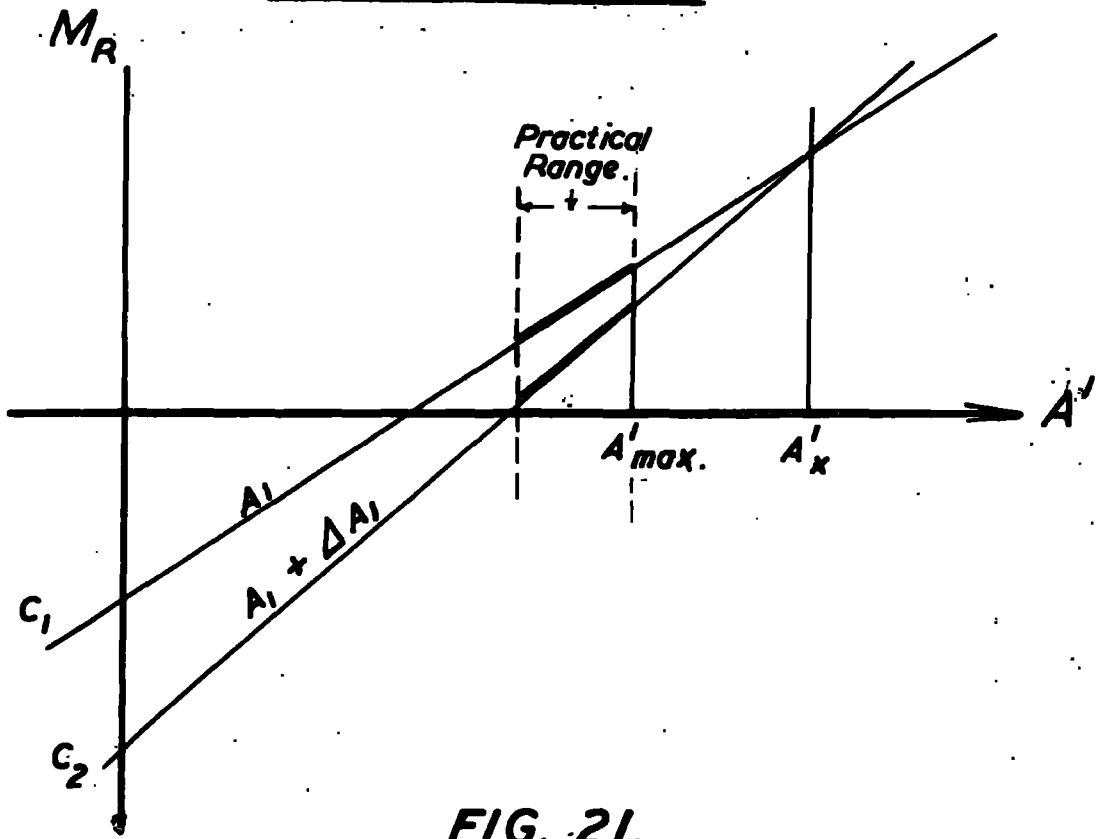

FIG. 21.

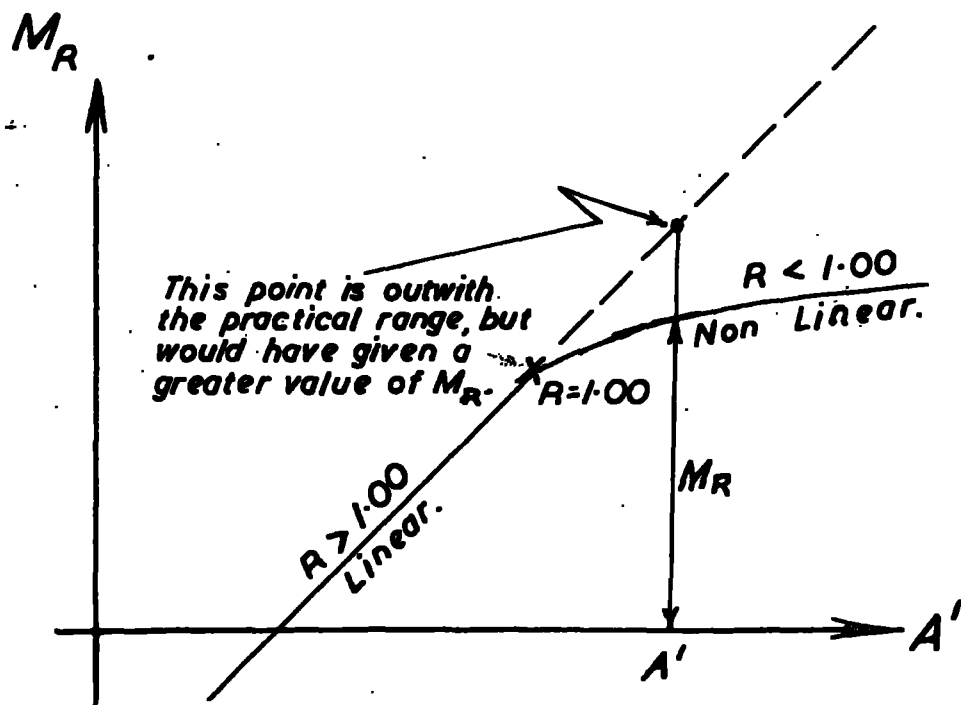

FIG. 22.

though those due to  $t_1$  and  $B_1$  do demand further attention.

Consider the case where  $t_1$  and  $t_2$  are small compared with  $D$ . Then  $D \doteq d$ ;  $A_3 \doteq D t_3$ ; etc., and equation 4.4 becomes :-

$$M_R \doteq p_{bt} D \left( \frac{A_1 + \frac{1}{3} A_3}{A_1 + \frac{1}{2} A_3} \right) A' - p_{bt} D (A_1 + \frac{1}{2} A_3) \dots\dots\dots 4.8$$

$$\left. \begin{aligned} \text{with } m &\doteq p_{bt} D \left( \frac{A_1 + \frac{1}{3} A_3}{A_1 + \frac{1}{2} A_3} \right) \\ \text{and } c &\doteq p_{bt} D (A_1 + \frac{1}{2} A_3) \end{aligned} \right\} \begin{array}{l} \text{Approximate} \\ \text{Values.} \end{array}$$

This means that for a given value of  $p_{bt}$ ,  $D$ , and  $t_3$ ,  $m$  and  $c$  will vary only with  $A_1$ , the area of the compression flange. Thus the variations due to  $t_1$  and  $B_1$  can be considered together here as a variation due to  $A_1$ .

Then referring to Fig. 21 :-

Equation of contour with compression flange area  $A_1$  is

$$M_{R1} = m_1 A' - c_1$$

Equation of contour with compression flange area  $A_1 + \Delta A_1$  is

$$M_{R2} = m_2 A' - c_2$$

These contours intersect where  $A' = A'_x$ . Thus :-

$$m_1 A'_x - c_1 = m_2 A'_x - c_2$$

$$\text{and therefore } A'_x = \frac{c_2 - c_1}{m_2 - m_1}$$

$$\text{Now } c_2 - c_1 \doteq p_{bt} D_0 (\Delta A_1)$$

$$\text{and } m_2 - m_1 \doteq \frac{p_{bt} D A_3 (\Delta A_1)}{6 (A_1 + \frac{1}{2} A_3 + \Delta A_1) (A_1 + \frac{1}{2} A_3)}$$

$$\text{Hence } A'_x \doteq 6 (A_1 + \frac{1}{2} A_3 + \Delta A_1) \left\{ \frac{1}{2} + \frac{A_1}{A_3} \right\}$$

$$\text{i.e. } A'_x \doteq 6A_1 + 1.5A_3 + \frac{6A_1^2}{A_3}, \text{ as } \Delta A_1 \rightarrow 0$$

The maximum practical value of  $A' = A'_{\max}$ ,

$$\text{where } A'_{\max} \ll A_3 + 2.25A_1$$

Thus  $A'_{\max} \ll A'_x$  for all practical values, and the contours shown in Fig. 21 will not intersect within the practical range of values. This now means that the maximum value of  $M_R$  at any  $A'$  will occur when  $t_1$  and  $B_1$  are at their minimum values when  $R > 1$  (within the scope of this approximation).

It should be noted that some care should be exercised when applying these findings to girders having shallow depths ( $D < 48''$  say) and thick flanges ( $t_1$  and  $t_2 > 2''$  say), since the approximation will then have its maximum error.

Conclusions for  $R \geq 1$ .

1. The contours are linear for all practical values, provided that  $\frac{t_2}{2}$  is small compared with  $y_t$ . Thus the greatest error in linearity will occur when  $D = 36''$  and  $t_2 = 2.5''$ ; when the gradients of straight lines between any two points on the contour will vary by not more than about 5%.
2. The contours in a set are co-linear to within about 1% in all practical cases.
3. The maximum value of  $M_R$  for a given  $A'$  will occur when  $D$ , and  $p_{bt}$  are at their maximum possible values and when  $t_1$ ,  $t_3$ , and  $B_1$  are at their minimum possible values within the practical range of sizes.
4.  $M_R$  will decrease as  $p_{bt}$  is reduced. However when  $R > 1$ ,  $p_{bt}$  is constant on a given contour and can

only have one of two values depending on  $t_2$ , viz. when  $t_2 \leq 0.75''$ ,  $p_{bt} = 10$  tons/sq.inch, and when  $t_2 > 0.75''$ ,  $p_{bt} = 9.5$  tons/sq.inch.

Thus care should be taken when the contours in a set have values of  $t_2$  above and below 0.75 inch.

-----

However when  $R < 1$ ,  $f_{bt}$  is no longer equal to  $p_{bt}$  and equation 4.4 becomes:-  $M_R = \frac{f_{bt}}{p_{bt}} (mA' - c)$

$f_{bt}$  then decreases along a contour as  $\frac{L}{B_2}$  decreases, so

that the actual value of  $M_R$  is less than that which would have been obtained by extending the linear portion beyond its permissible range (see Fig.22). Thus the tension flange becomes understressed and the compression flange is now fully stressed, so that  $f_{bc} = p_{bc}$ , and  $p_{bc}$  is a variable along a contour, (unlike  $p_{bt}$ ,) depending on the geometry of the section (which also varies along a contour) and on other factors as described previously. This explains why the linearity of a contour ceases when  $R < 1$ , with the values of  $M_R$



at a given value of  $A'$  being then less favourable (see Fig.22), i.e. the rate of change of  $M_R$  with  $A'$  is less when  $R < 1$  than when  $R > 1$ .

Properties of a Contour .....  $R \leq 1$ .

The equation of the contour in this range is :-

$$M_R = p_{bc} \left[ g_1 - g_2 \left\{ \frac{1}{A'} \right\} \right] \dots\dots\dots 4.6$$

where  $g_1 = A_1(D-t_1-t_2) + \frac{A_3}{6} (2D-4t_1-t_2)$

$$g_2 = \frac{1}{D} \left[ \frac{A_1(t_1+t_2)}{2} + \frac{A_3(D-t_1-t_2)}{6} \right] \left[ A_1 \left( \frac{D-t_1}{2} - \frac{t_2}{2} \right) + \frac{A_3(D-t_1)}{2} \right],$$

and  $p_{bc}$  varies along a contour.

Moreover the equation 4.7:-  $\frac{I_x}{y_c} = g_1 - g_2 \left\{ \frac{1}{A'} \right\}$ , can be

written in a linear form by replacing  $\frac{1}{A'}$  by  $\chi$ .

Thus  $\chi = \frac{1}{A'}$  and  $\frac{I_x}{y_c} = g_1 - g_2 \chi \dots\dots\dots 4.9$

Unfortunately this time the straight lines so formed do not reveal a clearly defined pattern as the sectional parameters are varied.

However the problem here is essentially reduced to finding which contour in a set will provide the maximum value of  $M_R$  for a given  $A'$ , i.e. which value of  $t_2$  should be chosen from a set.

Accordingly the values of  $\frac{\partial g_1}{\partial t_2}$  and  $\frac{\partial g_2}{\partial t_2}$  were

obtained and found to be :-

$$\frac{\partial g_1}{\partial t_2} = -t_1 \left( B_1 - \frac{t_3}{6} \right) - \frac{t_3}{2} \left( D - \frac{2}{3} t_2 \right) < 0$$

for all values, and

$$\frac{\partial g_2}{\partial t_2} = \frac{d}{D} \left[ \frac{1}{2} A_1^2 - \frac{1}{6} A_1 A_3 - \frac{1}{4} A_3^2 \right] \text{ to a close}$$

approximation. Unfortunately, however,  $g_2$  has a turning value when  $t_2$  alone is varied. The details of this phenomenon can be obtained by solving the equation :-

$$\frac{1}{2} A_1^2 - \frac{1}{6} A_1 A_3 - \frac{1}{4} A_3^2 = 0 \dots\dots\dots 4.10$$

The solution of this quadratic equation gives  $\frac{A_3}{A_1} = 1.12$ ,

so that  $\frac{\partial g_2}{\partial t_2} = 0$  when  $\frac{A_3}{A_1} = 1.12$ , and it can be

seen that

VARIATION OF  $\frac{\partial g_1}{\partial t_2}$  and  $\frac{\partial g_2}{\partial t_2}$

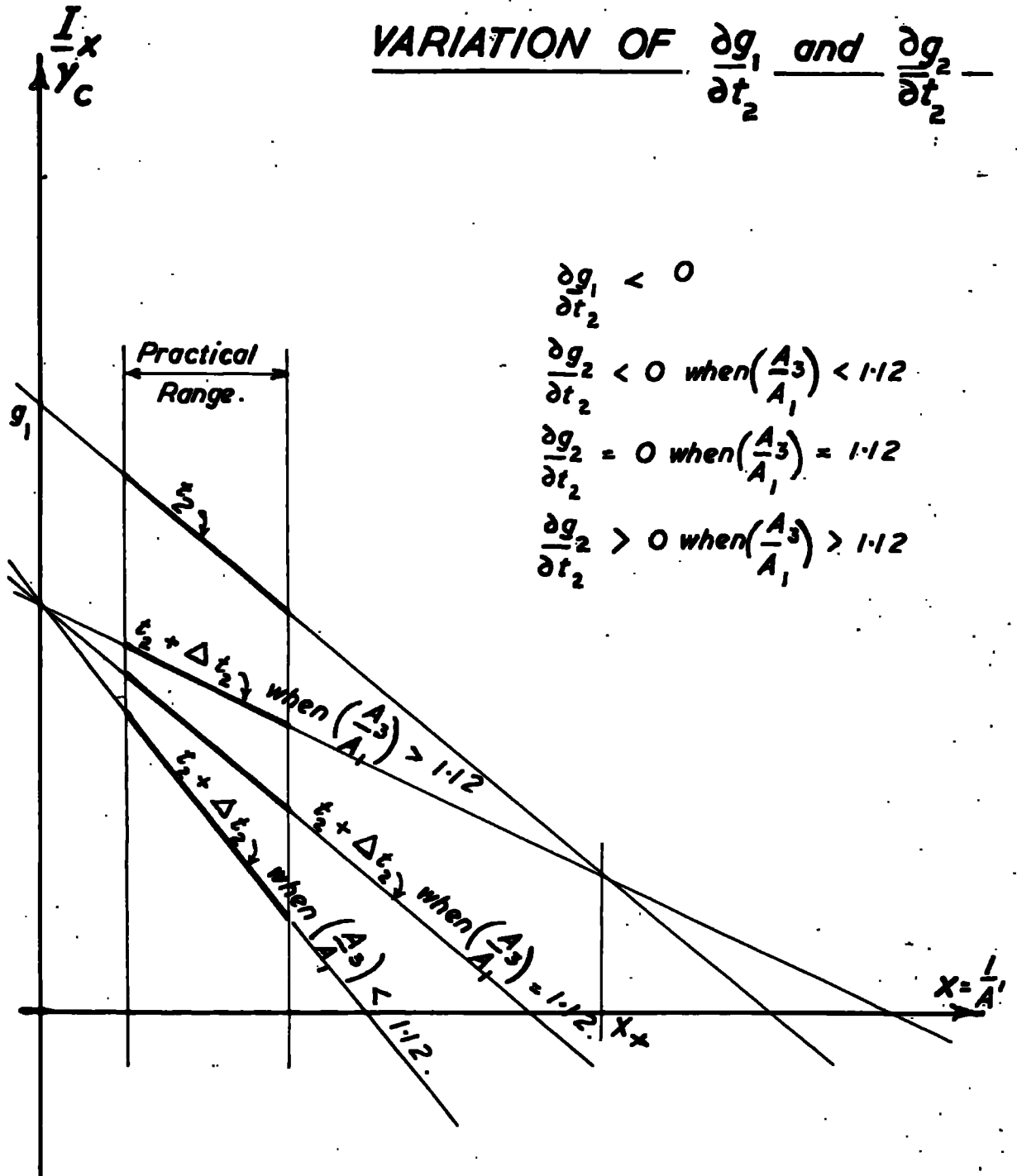

FIG. 23.

$$\frac{\partial g_2}{\partial t_2} < 0 \text{ when } \frac{A_3}{A_1} > 1.12, \text{ and}$$

$$\frac{\partial g_2}{\partial t_2} > 0 \text{ when } \frac{A_3}{A_1} < 1.12.$$

Now  $\frac{A_3}{A_1} = \frac{Dt_3}{B_1 t_1}$ , and this ratio can have a maximum

$$\text{value} = \frac{200 \times 1}{40 \times 1} = 5, \text{ and a minimum value}$$

$$= \frac{36 \times \frac{1}{4}}{36 \times \frac{3}{4}} = 0.33 \text{ in the practical range of}$$

sections, so that the turning value of  $g_2$  with  $t_2$  can occur within the practical range. This is illustrated diagrammatically in Fig. 23.

It can be seen that when  $\frac{A_3}{A_1} \leq 1.12$  the contours

having tension flange thickness  $t_2$  and  $t_2 + \Delta t_2$  are parallel or diverge as  $\mathcal{X}$  increases, showing that the maximum value of  $\frac{I_x}{y_c}$  for a given  $\mathcal{X}$  will then occur when

$t_2$  is at its minimum value.

However when  $\frac{A_3}{A_1} > 1.12$ , the two contours converge

as  $\chi$  increases, and it may well be wondered if these will intersect at a value of  $\chi$  within the practical range.

Thus in Fig. 23:-

Eqn. of  $\frac{I_x}{y_c} \sim \chi$  for tension flange thickness  $t_2$  is

$$\frac{I_x}{y_c} = g_1 - g_2 \chi$$

and eqn. of  $\frac{I_x}{y_c} \sim \chi$  for tension flange thickness  $t_2 + \Delta t_2$  is

$$\frac{I_x}{y_c} = g_1' - g_2' \chi$$

These lines intersect where  $\chi = \chi_x = \frac{g_1' - g_1}{g_2' - g_2} =$

$$= \frac{\Delta g_1}{\Delta g_2} = \frac{\frac{\partial g_1}{\partial t_2}}{\frac{\partial g_2}{\partial t_2}}$$

$$\chi_x = \frac{-\left\{A_1 + \frac{1}{2} A_3\right\}}{\frac{d}{D} \left\{ \frac{1}{2} A_1^2 - \frac{1}{6} A_1 A_3 - \frac{1}{4} A_3^2 \right\}} = \frac{-\left[ 1 + \frac{1}{2} \left\{ \frac{A_3}{A_1} \right\} \right]}{A_1 \left[ \frac{1}{2} - \frac{1}{6} \left\{ \frac{A_3}{A_1} \right\} - \frac{1}{4} \left\{ \frac{A_3}{A_1} \right\}^2 \right]}, \text{ where } \frac{A_3}{A_1} > 1.12$$

The minimum value of  $\chi_x$  in the practical range will occur when  $\frac{A_3}{A_1} = 5$ , where  $A_1 = 40$  sq.ins.

$$\therefore (\chi_x) \text{ min.} = \frac{1}{75.3}$$

i.e. Intersection will not take place when  $\chi_x < \frac{1}{75.3}$ , or

intersection will not take place when  $A' > 75.3$  sq.ins.

No practical section on this Minimum Weight Boundary has a cross sectional area  $A'$  less than 200 sq.ins. Therefore no intersection is possible in the practical range of sections, and hence the maximum value of  $\frac{I_x}{y_c}$  for a given

$\chi$  will occur when  $t_2$  is at its minimum value.

$$\text{Now in eqn. 4.6:- } M_R = P_{bc} \left[ g_1 - g_2 \left\{ \frac{1}{A'} \right\} \right] = P_{bc} \cdot \frac{I_x}{y_c}$$

Thus when  $R < 1$ , the maximum value of  $M_R$  at a given  $A'$

depends on both  $\frac{I_x}{y_c}$  and  $p_{bc}$ . However it can be seen

from Table No. 3.1 that  $p_{bc}$  does not vary by much in a set of contours, provided that all the sections in the set are in Class 2(V). This is by far the most common Class

to occur in a set of contours, and it therefore appears from eqn. 4.6 that the maximum value of  $M_R$  for a given  $A'$  when  $R < 1$  will occur on that contour of a set which has the minimum value of  $t_2$ , provided that all sections are in Class 2(V).

Nevertheless Classes 1(U) and 3(W) do occur in the practical range of sections, resulting in discontinuities on the  $M_R \sim A'$  graphs with corresponding discontinuities in the values of  $p_{bc}$ . For this reason it is now necessary to consider the variation of  $p_{bc}$  within and between sets of contours.

#### VARIATION OF $p_{bc}$

This is a large problem in itself and its complete solution is not necessary for Minimum Weight Design. The difficulties are explained, though not all are solved; in such cases, however, which occur rarely on the Minimum Weight Boundary, a brief trial and error process can be readily used, and it should be borne in mind in this context that special interest need only then be focussed on a contour near the value of  $R = 1$ .

Variation of  $p_{bc}$  within a Set of Contours.

---

This analysis applies to all values of R.

The two sectional parameters which can be varied here are  $B_2$  and  $t_2$ .  $B_2$  varies along a contour and  $t_2$  varies between different contours in the same set, while all other sectional parameters remain constant.

$$\text{Now } r_y = \left[ \frac{t_1^3 B_1^3 + t_2^3 B_2^3}{12 (t_1 B_1 + t_2 B_2 + t_3 d)} \right]^{\frac{1}{2}}$$

$$\frac{\partial r_y}{\partial B_2} = \frac{3\sqrt{3} t_2^2 B_2^2 (t_1 B_1 + t_2 B_2 + t_3 d)^{\frac{1}{2}} - \sqrt{3} t_2 (t_1^3 B_1^3 + t_2^3 B_2^3)^{\frac{1}{2}}}{12 (t_1 B_1 + t_2 B_2 + t_3 d)^{\frac{3}{2}}}$$

and

$$\frac{\partial r_y}{\partial B_2} = 0 \text{ when } B_2^3 + \frac{1.5(dt_3 + B_1 t_1)}{t_2} \cdot B_2^2 - \frac{t_1}{2t_2} \cdot B_1^3 = 0$$

..... 4.11



This cubic equation in  $B_2$  can be solved, giving  $B_2 = B'_2$ .

$$\text{When } B_2 > B'_2, \quad \frac{\partial r_y}{\partial B_2} > 0 \quad \text{and}$$

$$\text{when } B_2 < B'_2, \quad \frac{\partial r_y}{\partial B_2} < 0.$$

Hence  $r_y$  has a minimum turning value along a contour when

$$B_2 = B'_2, \quad \text{or } \frac{1}{r_y} \text{ has a maximum turning value when } \frac{L}{B_2} = \frac{L}{B'_2}.$$

In a similar manner it can be shown that

$$\frac{\partial r_y}{\partial t_2} = 0 \quad \text{when } B_2 = B''_2 = B_1 \left[ \frac{1}{1 + \left\{ \frac{A_3}{A_1} \right\}} \right]^{\frac{1}{2}}, \quad \text{so that}$$

$$B''_2 < B_1.$$

$$\text{Also, when } B_2 > B''_2, \quad \frac{\partial r_y}{\partial t_2} > 0$$

$$\text{and when } B_2 < B''_2, \quad \frac{\partial r_y}{\partial t_2} < 0$$

Hence  $r_y$  has a minimum turning value between different

contours in a set when  $B_2 = B''_2$ , or  $\frac{1}{r_y}$  has a maximum

$$\text{turning value when } \frac{L}{B_2} = \frac{L}{B''_2}.$$

When  $\frac{L}{B_2} > \frac{L}{B_2'}$ ,  $\frac{1}{r_y}$  increases as  $t_2$  increases, and  
 when  $\frac{L}{B_2} < \frac{L}{B_2'}$ ,  $\frac{1}{r_y}$  decreases as  $t_2$  increases, between  
 different contours in a set.

These values of  $\frac{L}{B_2}$  and  $\frac{L}{B_2'}$  may or may not occur

in the practical range in any particular case. Thus it  
 was arranged that Programme No. ABEL 2 should calculate  
 $\frac{L}{B_2}$  and  $\frac{L}{B_2'}$ . Numerical values of these ratios were

obtained for the Empirical Investigation in Chapter 3,  
 are shown in Table No. 3.2, and have been included in  
 Table No. 3.1 and Fig.11.

From Chapter 1,

$$C_s = A + K_2 B \text{ for Classes 1 and 2.}$$

Here  $K_2 > 0$  and increases as  $\frac{L}{B_2}$  increases.

$$\text{Also } C_s = \frac{y_c}{y_t} (A + K_2 B) \text{ for Class 3.}$$

Here  $K_2 < 0$ , and its numerical value reduces as  $\frac{L}{B_2}$   
 increases.

# VARIATION OF $A$ , $B$ , & $K_2$

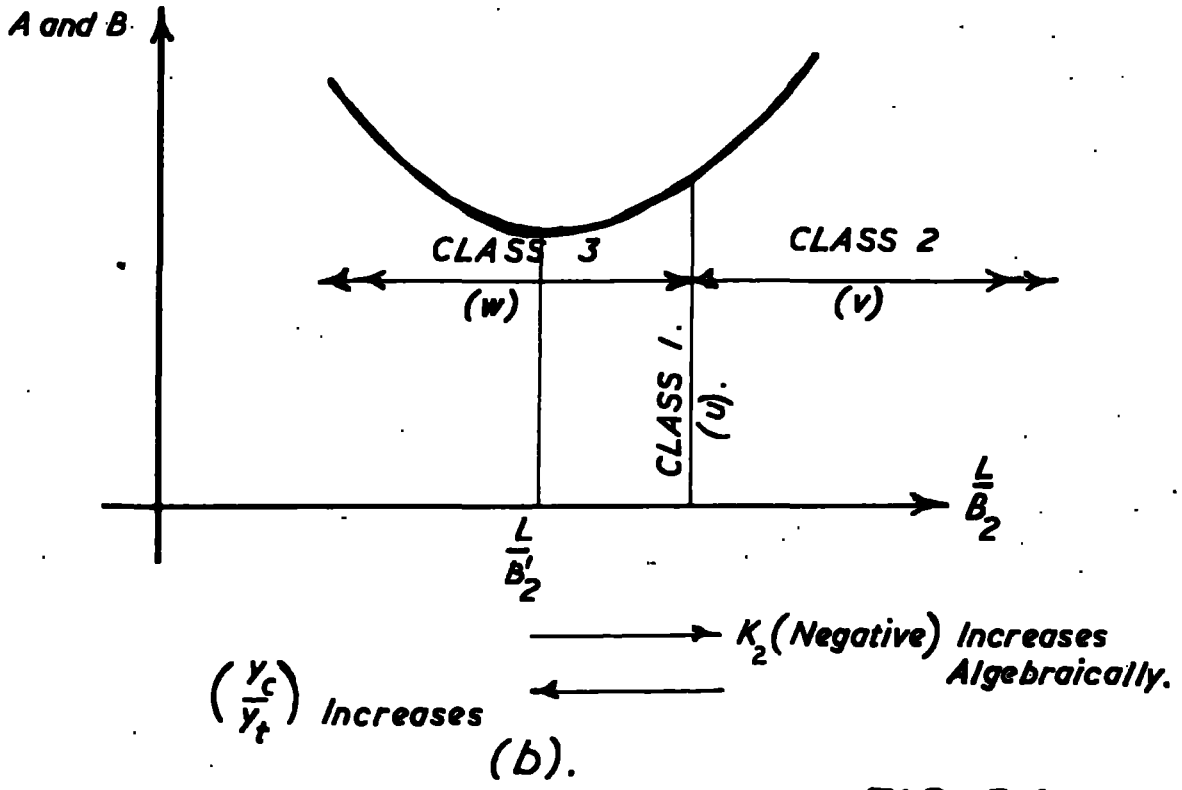
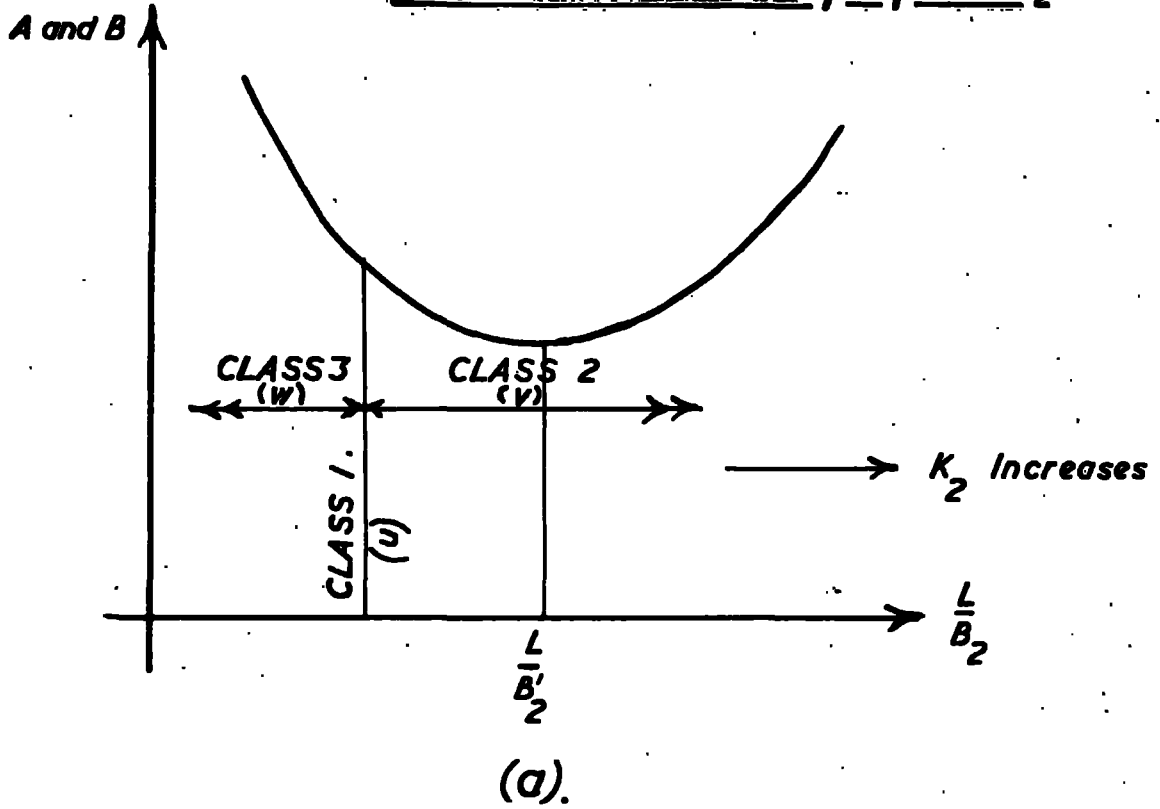

**FIG. 24.**

Since  $\frac{D}{t_1} = \text{constant}$  within a set of contours,  $A$  and  $B$

decrease only as  $\frac{L}{r_y}$  increases, both having a minimum

value along a contour when  $\frac{L}{B_2} = \frac{L}{B'_2}$ , and both having a

minimum value between different contours in a set when

$\frac{L}{B_2} = \frac{L}{B'_2}$ . Because of the different values of  $K_2$ ,

Classes 1, 2, and 3 must now be considered separately.

a) When the section is in Class 2. The variations of  $A$  and  $B$  are shown diagrammatically in Fig. 24a.

When  $\frac{L}{B_2} \geq \frac{L}{B'_2}$ ,  $A, B$ , and  $K_2$  increase as  $\frac{L}{B_2}$  increases

∴  $C_s$  and  $p_{bc}$  increase as  $\frac{L}{B_2}$  increases, from their

minimum values which occur at  $\frac{L}{B'_2}$ .

When  $\frac{L}{B_2} \leq \frac{L}{B'_2}$ ,  $K_2$  increases, but  $A$  and  $B$  reduce as

$\frac{L}{B_2}$  increases. Thus it cannot be said with complete

certainty in this range that  $p_{bc}$  has its minimum value

where  $\frac{L}{B_2} = \frac{L}{B_2'}$ , since it is just possible for the increase

in  $K_2$  to offset the reductions in A and B. Therefore it

is recommended here that the values of  $p_{bc}$  be obtained

for  $\frac{L}{B_2}$  = the value at Class 1, an intermediate value,

and  $\frac{L}{B_2'}$ , and these should be inspected to see which is

the minimum. Nevertheless it is quite clear that all values of  $p_{bc}$  in this range will lie very close to one

another.

b) When the section is in Class 3. The variations of A and B are shown diagrammatically in Fig. 24b.

$$C_s = \frac{Y_c}{Y_t} (A + K_2 B)$$

It has already been stated that when  $\frac{L}{B_2} = \frac{L}{B_2''}$ , then

$\frac{Y_c}{Y_t} = 1$ , and these values can be obtained from Programme

No. ABEL 2.  $\frac{L}{B_2''}$  may or may not be in the practical

range, and  $\frac{Y_c}{Y_t}$  decreases as  $\frac{L}{B_2}$  increases.

When  $\frac{L}{B_2} < \frac{L}{B'_2}$ , A and B decrease and  $K_2$  increases as

$\frac{L}{B_2}$  increases. (Here  $K_2 < 0$  and so its numerical value

decreases). It is therefore not possible to state

immediately how  $A + K_2 B$  varies here; however  $\frac{Y_c}{Y_t}$  also

decreases as  $\frac{L}{B_2}$  increases and so it would appear very

likely that  $C_s$  and  $p_{bc}$  decrease as  $\frac{L}{B_2}$  increases.

When  $\frac{L}{B_2} > \frac{L}{B'_2}$ , A and B increase,  $K_2$  increases

algebraically, and  $\frac{Y_c}{Y_t}$  reduces as  $\frac{L}{B_2}$  increases. Again

it is not possible to state how  $C_s$  and  $p_{bc}$  vary.

It is recommended therefore for all sections in Class 3 that  $\frac{L}{B_2}$  be made equal to the minimum value, an

intermediate value, and  $\frac{L}{B'_2}$ , and the corresponding values

of  $p_{bc}$  obtained and inspected to see which is the

minimum. It is unlikely that these values of  $p_{bc}$  will

vary by much.

c) When the section is in Class 1. There is only one section on a contour which can be in Class 1. This section can be regarded as a limit to be approached from Class 3 or Class 2 by increasing or decreasing  $\frac{L}{B_2}$  respectively.

In this way two values for  $p_{bc}$  at this section will generally be obtained, causing a discontinuity.

If  $\frac{L}{B_2}$  at Class 1  $<$   $\frac{L}{B_2''}$ , the discontinuity will be such that there is a sharp decrease in  $p_{bc}$  as  $\frac{L}{B_2}$

increases. If  $\frac{L}{B_2}$  at Class 1  $>$   $\frac{L}{B_2''}$ , the discontinuity will be such that there is a sharp increase in  $p_{bc}$  as

$\frac{L}{B_2}$  increases. When  $\frac{L}{B_2}$  at Class 1  $= \frac{L}{B_2''}$ , then  $\frac{y_c}{y_t} =$

1 and there will be no discontinuity; this occurs when  $t_1 = t_2$  and  $B_1 = B_2$ .

Note:- When  $\frac{L}{B_2}$  at the Class 1 section occurs when

$R = 1$ , or within a close tolerance of this limit, there will be a discontinuity giving two values of  $p_{bc}$  and  $M_R$  at this value of  $A'$ .

Since the point at which  $R = 1$  is important in the formation of the Minimum Weight Boundary, great care and accuracy should be used in this case.

Thus to sum up :-

- (i)  $p_{bc}$  can have a minimum turning value along a contour or between different contours in the same set.
- (ii) The value of  $p_{bc}$  in a set of contours does not vary much, provided all the sections are in the same Class. However further work should be done to clarify the problems discussed above.
- (iii) There is a sharp discontinuity in  $p_{bc}$  along a contour at the section at Class 1.

-----

#### Variation of $p_{bc}$ between Different Sets of Contours

-----

Here the two variables on the one Minimum Weight Boundary are  $t_1$  and  $B_1$ .

As  $A'$  reduces down the Boundary it has been shown that  $t_1$  and  $B_1$  reduce - therefore  $\frac{D}{T}$  increases and hence  $A$  reduces ( $T = t_1$ )



By mathematical induction equation 4.11 can be changed to deal with the variation in  $B_1$ . Then :-

$$\frac{\partial r_y}{\partial B_1} = 0 \text{ when } B_1^3 + \frac{1.5(dt_3 + B_2 t_2)}{t_1} B_1^2 - \frac{t_2 \cdot B_2^2}{2t_1} = 0$$

..... 4.12

The solution of this equation is  $B_1 = B_1'$

When  $B_1 > B_1'$ ,  $\frac{\partial r_y}{\partial B_1} > 0$  and

when  $B_1 < B_1'$ ,  $\frac{\partial r_y}{\partial B_1} < 0$ , with all other sectional

parameters remaining constant. Hence  $r_y$  has a minimum turning value between different sets of contours when  $B_1 = B_1'$ .

However all practical values of  $B_1 > B_1'$ , and hence  $r_y$  increases as  $B_1$  increases, or  $\frac{1}{r_y}$  reduces as  $\frac{1}{B_1}$

decreases. (Programme No. ABEL 2 can be used to give  $\frac{1}{B_1}$  in any particular case).

$\frac{1}{B_1}$

Hence as  $A'$  reduces down the Boundary,  $t_1$  and  $B_1$  reduce and  $\frac{D}{T}$  and  $\frac{1}{r_y}$  increase. Therefore  $A, B,$  and  $K_2$

reduce, and so  $p_{bc}$  in Class 2 reduces as  $A'$  reduces.

However in Class 3,  $\frac{y_c}{y_t}$  increases as  $t_1$  and  $B_1$  reduce and so it is possible for  $p_{bc}$  to increase slightly, though it is very unlikely that such sections will provide points on the Minimum Weight Boundary. It is recommended that spot checks be made in this case.

#### THE STRESS RATIO R.

From Chapter 1 :-

$$R = \frac{\left\{ \frac{f_{bt}}{P_{bt}} \right\}}{\left\{ \frac{f_{bc}}{P_{bc}} \right\}} = \frac{\left\{ \frac{P_{bc}}{P_{bt}} \right\}}{\left\{ \frac{f_{bc}}{f_{bt}} \right\}} = \frac{\left\{ \frac{P_{bc}}{P_{bt}} \right\}}{\left\{ \frac{y_c}{y_t} \right\}}$$

Consider the variation of  $R$  along a contour.  $p_{bt}$  is constant, and, if the sections are all in the same Class,  $p_{bc}$  will not vary by much. Hence in this case the trend is for  $R$  to increase as  $\frac{y_c}{y_t}$  reduces. It has been shown earlier that it is advantageous to have  $R \gg 1$ , so that the contour is linear; therefore it is desirable to see what variations in sectional parameters will increase the value of  $R$ , especially when  $R < 1$ .

$$\text{Now } \frac{y_c}{y_t} = \frac{D}{y_t} - 1,$$

$$\text{and from equation 4.1, } y_t = \frac{t_2}{2} + \frac{\mu}{A'}.$$

If  $\frac{t_2}{2}$  is small compared with  $\frac{\mu}{A'}$ , then

$$y_t \doteq \frac{\mu}{A'} = \frac{A_1 \{2D - t_1 - t_2\} + A_3 \{D - t_1\}}{2A'}$$

$$\text{and } \therefore \frac{y_c}{y_t} = \frac{A'D}{A_1 \left(D - \frac{t_1}{2} - \frac{t_2}{2}\right) + \frac{A_3}{2} (D - t_1)} - 1$$

..... 4.13

Therefore, for a given  $A'$ ,  $\frac{y_c}{y_t}$  is at a minimum when

$A_1$  and  $A_3$  are at a maximum, and, to a much lesser extent, when  $t_2$  is at a minimum.

(Since  $A_1 = B_1 t_1$  it is clear from eqn. 4.13 that it is slightly better to increase  $B_1$  rather than  $t_1$  if possible. If  $t_1$  and  $t_2$  are small compared with  $D$ , then

$$\text{eqn. 4.13 can be written as : } - \frac{y_c}{y_t} \doteq \frac{A'}{A_1 + \frac{1}{2}A_3} - 1,$$

# VARIATION OF R BETWEEN CONTOURS

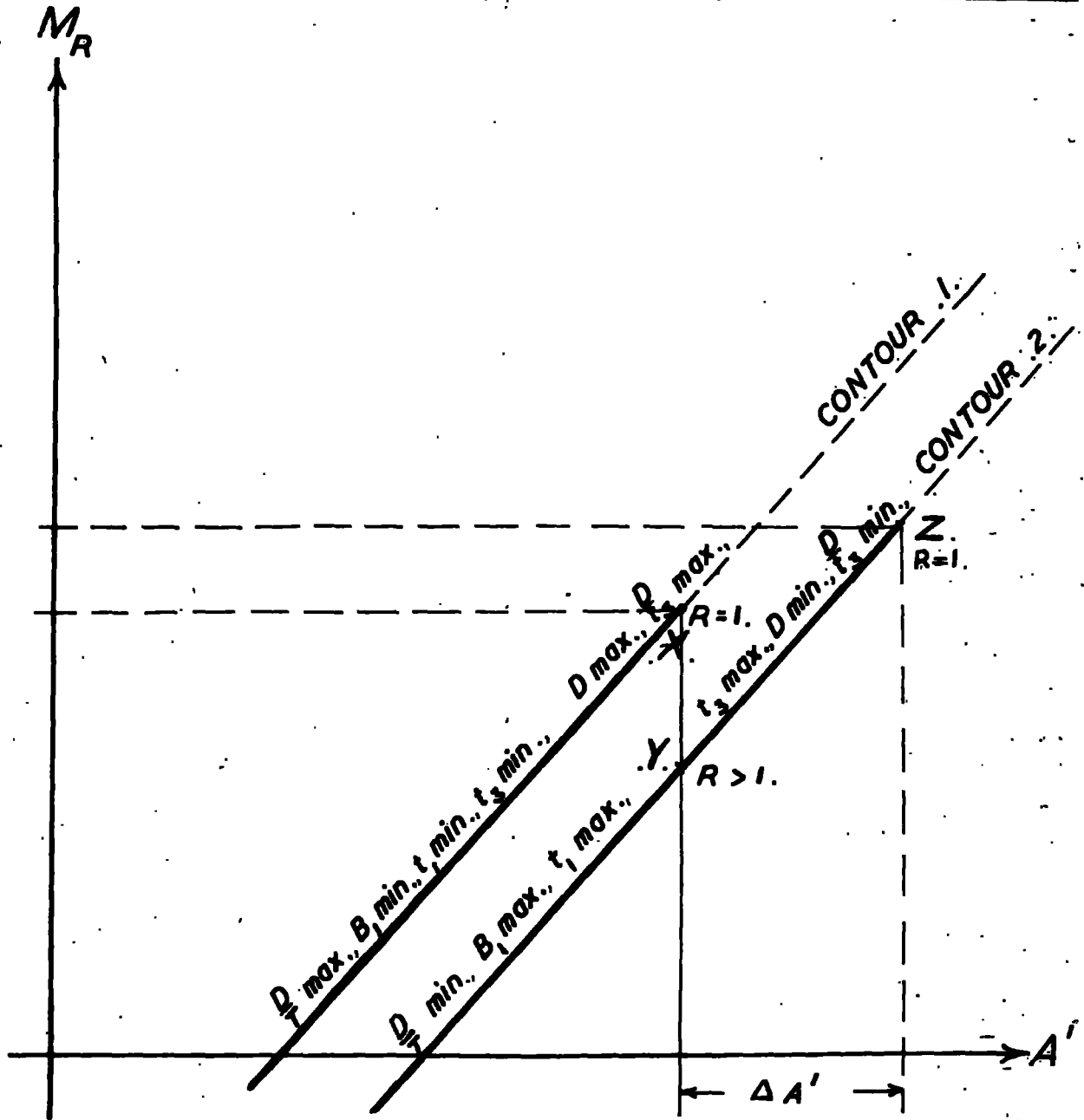

FIG. 25.

though it is not necessary in this instance to use this approximation).

Hence when changing from one set of contours to another, the value of  $R$  can best be increased by increasing  $B_1$  and  $t_1$ . This is shown diagrammatically in Fig. 25.

When  $R > 1$ , the maximum value of  $M_R$  at a given  $A'$  has been shown to occur on that contour having the smaller values of  $B_1$  and  $t_1$ , so that, for example,

$$M_R \text{ at } X \text{ on contour 1} > M_R \text{ at } Y \text{ on contour 2.}$$

It has now been shown that if  $R$  at  $X = 1$  then  $R$  at  $Y > 1$ ; moreover  $R$  reduces along a contour as  $A'$  increases, and so  $R = 1$  on contour 2 at  $Z$ , where  $A'$  at  $Z$  on contour 2  $> A'$  at  $X$  on contour 1.

From eqn. 4.8, the equation of contour 1 is :-

$$M_R = P_{bt} D \left[ \frac{\left( \frac{A_1}{A_1 + \frac{1}{2} A_3} + \frac{1}{3} \frac{A_3}{A_3} \right)}{\left( \frac{A_1}{A_1 + \frac{1}{2} A_3} + \frac{1}{2} \frac{A_3}{A_3} \right)} \cdot A' - \left( A_1 + \frac{1}{2} A_3 \right) \right], \text{ and}$$

the equation of contour 2 is :

$$M_R + \Delta M_R = P_{bt} D \left[ \frac{\left( \frac{A_1 + \Delta A_1}{A_1 + \Delta A_1 + \frac{1}{2} A_3} + \frac{1}{3} \frac{A_3}{A_3} \right) \cdot (A' + \Delta A') - \left( A_1 + \Delta A_1 + \frac{1}{2} A_3 \right)}{\left( \frac{A_1 + \Delta A_1}{A_1 + \Delta A_1 + \frac{1}{2} A_3} + \frac{1}{2} \frac{A_3}{A_3} \right)} \right]$$

Now  $\Delta A_1 = \Delta A'$ , and therefore it can be shown that :-

$$\Delta M_R = \frac{P_{bt} D A_3 \Delta A_1 \left( A_2 + \frac{1}{2} A_3 \right)}{6 \left( A_1 + \Delta A_1 + \frac{1}{2} A_3 \right) \left( A_1 + \frac{1}{2} A_3 \right)} > 0, \text{ for all values.}$$

Hence  $M_R$  at Z  $>$   $M_R$  at X,

i.e. By increasing  $B_1$  and  $t_1$  from contour 1 to contour 2 the values of  $M_R$  and  $A'$  on contour 2 at  $R = 1$  are greater than those on contour 1 at  $R = 1$ , for all values of the sectional parameters within the limits of the approximation implied in eqn. 4.8. (See Fig.25).

Note:- This applies only when all sections concerned are in the one Class. When Classes 1, 2, and 3 all appear, there can be the sharp discontinuities in  $P_{bc}$ , and so  $R$  need not then increase as  $\frac{y_c}{y_t}$  reduces.

Note:- It is again emphasised that this process only applies to sections in the same Class. If the transition from Class 2 to Class 3 occurs during this operation near where  $R = 1$ , then it is possible for the process to break down. A brief trial and error process can then be effectively used for these rare cases.

-----

This completes the Theoretical Justification undertaken on this work. By virtue of both the Empirical Investigation and the Theoretical Justification, a General Method of Minimum Weight Design can now be stated; this is dealt with in the next Chapter.

$L, \frac{L}{D}, t, K_1, \text{ \& } \lambda$  Are Constant.

$M_R$

- $P - x$
- $Q - \odot$
- $S -$  CONTINUOUS PART OF A CONTOUR.
- $M - \otimes$

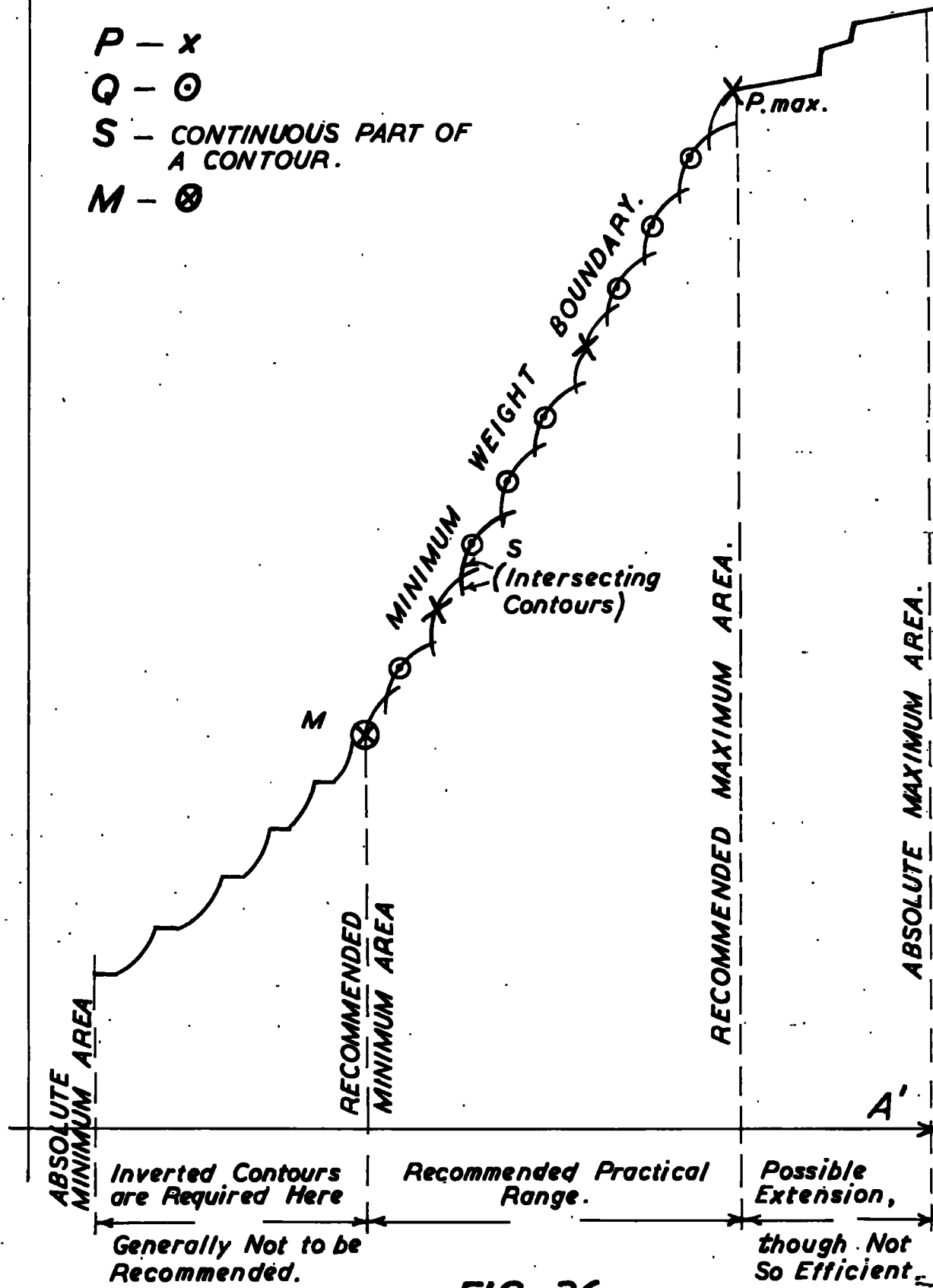

**FIG. 26.**

## CHAPTER 5

### A GENERAL METHOD

From the results obtained in Chapters 3 and 4 it is now possible to state a General Method of obtaining the Minimum Weight Boundary for any numerical data in the practical range.

The method is shown diagrammatically in Fig. 26 and indicates how to obtain the Minimum Weight Boundary for a given span  $L$ , span to depth ratio  $\frac{L}{D}$ , and web plate thickness  $t_3$ . This is the solution to Design Problem 3 of Chapter 1; the cross sectional area is constant along the span, and torsional and lateral restraints are provided only at the ends of the span, i.e.  $K_1 = 1$  and  $\lambda = 1$ . In addition, however, as indicated in Chapter 2, the answers to Design Problems 1 and 2 can also be obtained by choosing different values of  $\frac{L}{D}$  and  $t_3$  throughout the practical range and then superimposing these on the one diagram as shown in Figs. 7a and b.

PROCEDURE. This is described with reference to Fig. 26.



1) To obtain the points marked P on the boundary. These points give the maximum value of  $M_R$  in each zone of  $t_1$  and can be regarded as the "bones" or "skeleton" of the boundary. In all cases  $R \geq 1$ , with the equality being by far the more common.

To obtain these points marked P, find, for each practical value of  $t_1$ , with  $\frac{L}{B_1}$  held at its minimum value in each zone, the maximum value of  $M_R$  and the corresponding value of  $A'$  for which  $R \geq 1$  in the set of contours. This is done by varying  $\frac{L}{B_2}$  at different values of  $t_2$ . (SEE ALSO BELOW).

2) To obtain the points marked Q on the boundary. These can be obtained by varying  $\frac{L}{B_1}$  in each zone between those values (of  $\frac{L}{B_1}$ ) used to obtain the points P. For each such value of  $\frac{L}{B_1}$ , find the maximum value of  $M_R$  and the corresponding value of  $A'$  for which  $R \geq 1$  in each set of contours. In this process  $B_1$  can be varied by any specified decrement down to the minimum one of, say, 0.5 inch.

In obtaining the points marked P and Q,  $t_2$  should be chosen such that, in any set of contours, the maximum value of  $M_R$  and the corresponding value of A' are obtained for  $R \geq 1$ .

When the sections are in Class 2,  $t_2$  is generally at its minimum value for which  $R = 1$  can be obtained, or at its next lower value in the practical range with  $\frac{L}{B_2}$  now at its minimum value and  $R > 1$ . The alternative which gives the greater value of  $M_R$  provides the points P and Q.

When the sections are in Class 3 there is no clearly defined rule, and a simple trial and error process should then be followed, checking the various possible values of  $t_2$ , particularly near the minimum.

When the sections are in Class 1, or tend to approach this limit, great care should be taken because of the discontinuity in the contour. In this case it is recommended that  $\frac{L}{B_2}$  be varied around the value at Class 1 on the contour, thereby defining the limit more clearly. This will rarely occur.

Thus in the process of obtaining points P and Q it is necessary to find that value of  $\frac{L}{B_2}$  on a contour at which  $R = 1$  to a high degree of accuracy (say  $R = 1.000000$ ). Since  $\frac{L}{B_2}$  increases with R around this value, a further programme was written, Programme No. ABEL 3, to give this value of  $\frac{L}{B_2}$  on any contour and the corresponding values of  $M_R$  and  $A'$ ; this programme is based on successive approximation and the calculation follows the process given in Programme No. ABEL 1A. Provision has been made to indicate whether the section obtained is at or near the value at Class 1. In this way all possible values of  $t_2$  can be checked and the maximum value of  $M_R$  obtained in each occasion.

3) To obtain the points marked S on the boundary. These points all lie on the contours passing through the points P and Q and can be obtained by varying  $\frac{L}{B_2}$  above and below the values used to obtain P and Q in all cases. The intersection of these contours will complete the boundary in the recommended practical range, giving a continuous profile. It should be noted that the points S will have values of the Stress Ratio R above and

below, but not equal to, unity in all cases.

4) To obtain the point marked M on the boundary. This point provides the minimum value of  $M_R$  in the recommended practical range.

This can be obtained by taking the minimum value of  $t_1$  for which  $R = 1$  and, with  $t_2$  and  $B_2$  at their minimum values, finding the maximum value of  $\frac{L}{B_1}$  for which  $R = 1$ .

This completes the Minimum Weight Boundary for the recommended range of sections.

However, it is possible to increase the value of  $M_R$  by drawing contours above the point  $P_{max}$  by reducing  $\frac{L}{B_2}$  and choosing different values of  $t_2$  up to the maximum. In this range  $M_R$  will increase with  $A'$  much less rapidly than in the recommended range,  $R$  will be less than unity, and the absolute maximum will occur when  $t_2$  and  $B_2$  are at their maximum values. Such values are not so efficient, but do provide valid sections. The efficiency in this range can best be raised by increasing the maximum value of  $t_1$  (or of  $B_1$ );

this presents problems in welding, but does suggest that practical research into the welding of thicker plates would be useful.

Values of  $M_R$  below the recommended minimum value at point M can be obtained by using inverted contours. Here  $t_1 \leq$  the minimum value as used for point M,  $\frac{L}{B_2} =$  maximum value,  $t_2 =$  minimum value, and  $\frac{L}{B_1}$  is varied over its practical range. These sections, however, will generally be wasteful since  $p_{bc}$  will be considerably reduced from its maximum value of 10 tons/sq. inch because of lateral buckling; other forms of construction in steel will certainly be more efficient in this range, e.g. lattice girders.

#### APPLICATIONS

There are two important ways in which the General Method can be used :-

- 1) To prepare large scale charts and tables for use in a structural engineer's design office.
- 2) As the basis for Automatic Design at Minimum Weight. A special computer programme could now be written to give the numerical answers to Design Problems 1,2, and 3 direct in any particular case.

**FIG. 27.**

**MINIMUM WEIGHT BOUNDARIES**

(SHOWING VARIATION OF  $\frac{L}{D}$  AT A GIVEN  $t_3$ ).

$L=100'$ ;  $t_3=1''$ ;  $K_1=1$ ;  $\lambda=1$ .

$\frac{L}{D}=5$  (min.) up to 26 (max. possible here).

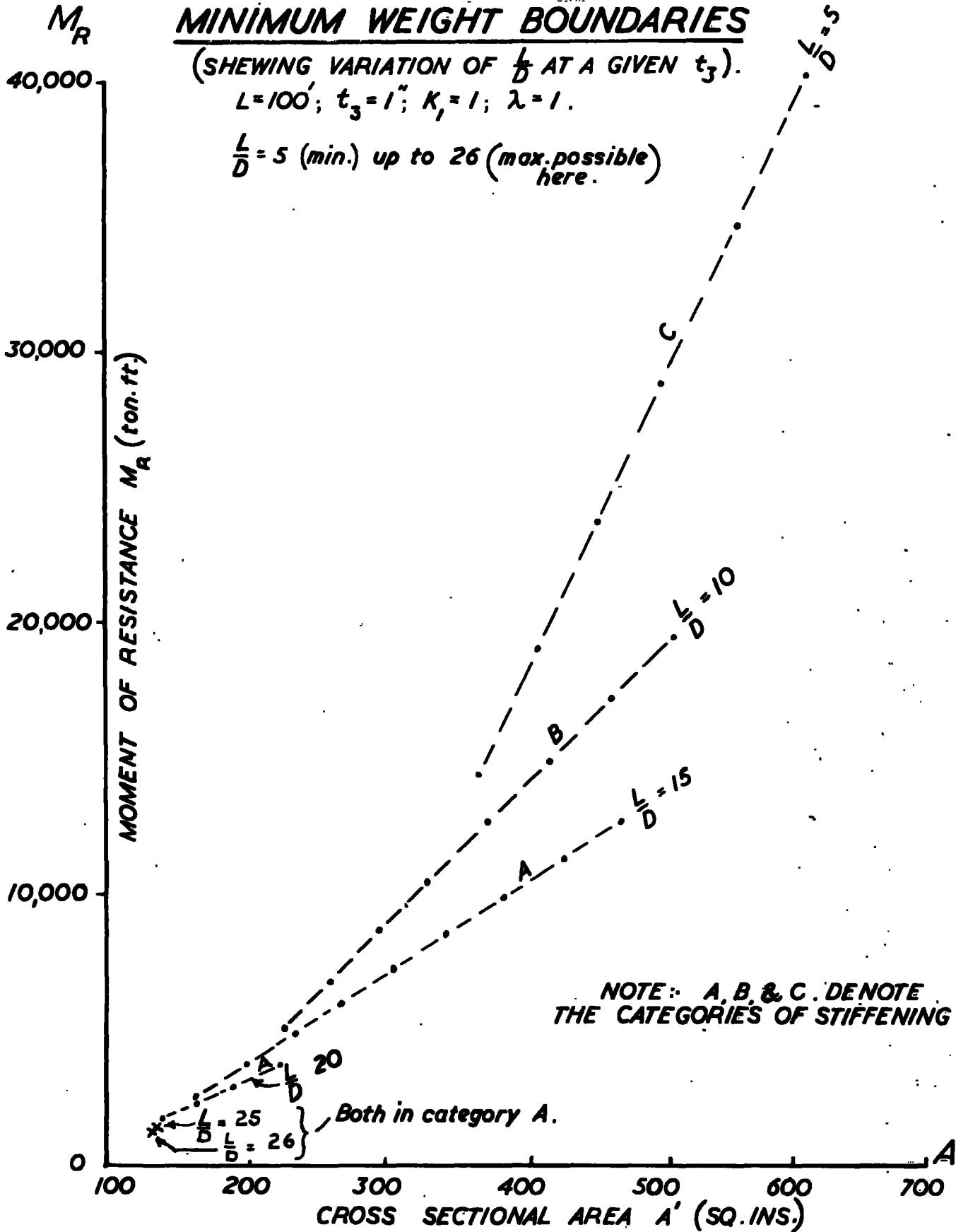

# MINIMUM WEIGHT BOUNDARIES

(Showing Variation of  $t_3$  at A  
Given  $\frac{L}{D}$ ).

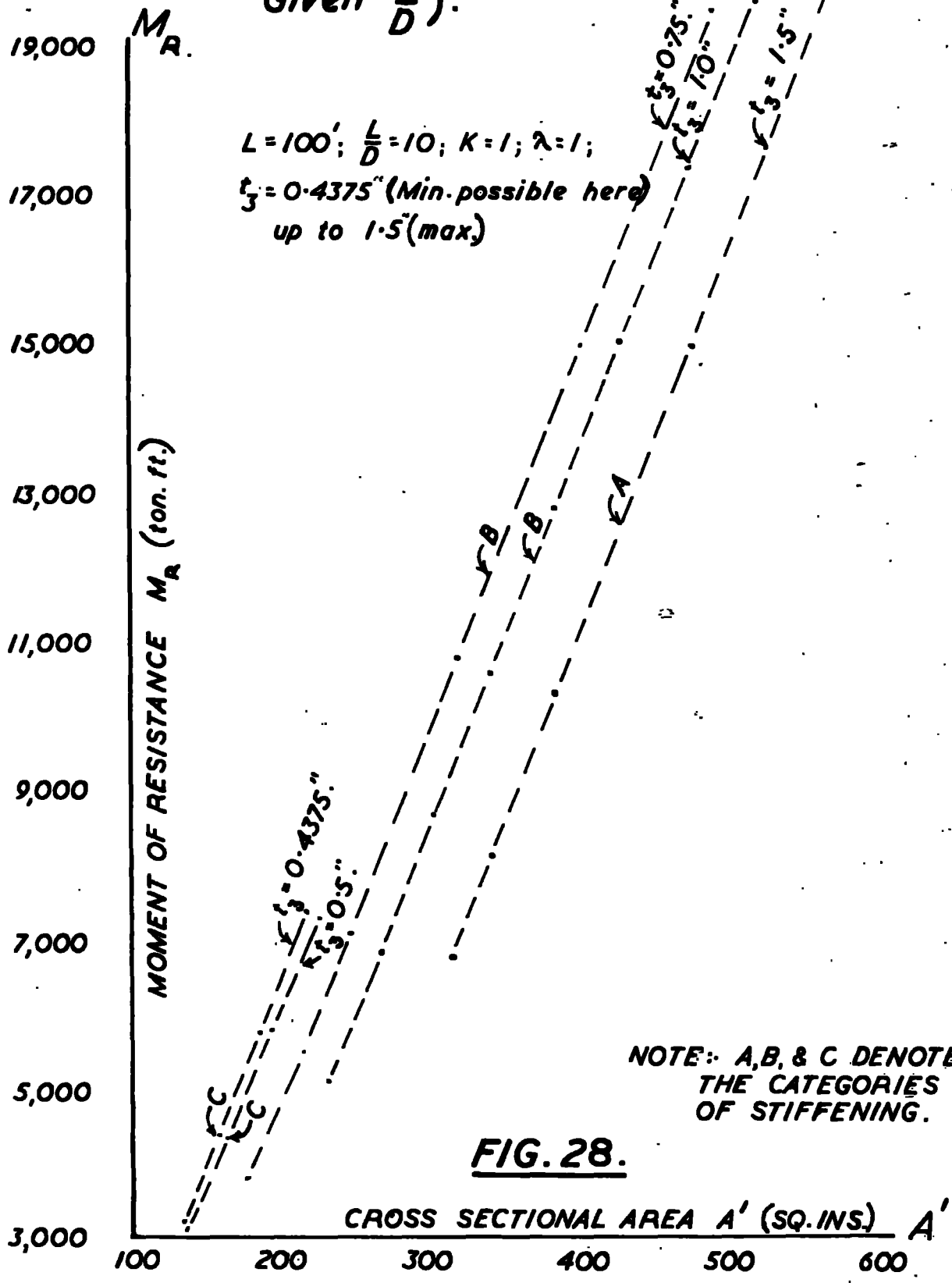

**FIG. 28.**

These will be discussed briefly here.

1) Preparation of Charts and Tables Examples of the charts which may now be prepared are shown in Figs. 27 and 28. These refer to a span of 100 feet.

Fig. 27 shows the Minimum Weight Boundaries for different values of  $\frac{L}{D}$  while  $t_3$  is kept constant at 1", while Fig. 28 shows the boundaries for different values of  $t_3$  while  $\frac{L}{D}$  is kept constant at 10. Only some of the points marked P and the point marked M have been obtained in each case, though it is clearly possible to insert more values as required.

These graphs could be supplemented by Tables giving sectional identification, category of stiffening,  $p_{bc}$ , etc. Such graphs would then provide the full cross sectional dimensions of the plate girder at Minimum Weight to withstand a given bending moment. A choice could be made as to which category of web stiffening should be used, realising that the self weights of girders will be increased by the weight of stiffeners if used.



Such charts will give the engineer a closer understanding of his design, as he can readily see what happens on passing along the boundary. This is a fundamental step, but, from it, all sorts of elaborations are possible to suite the particular requirements of any establishment e.g. the effect of varying  $\lambda$  and  $K_1$ . These refinements are outwith the scope of the present investigation, but will be briefly dealt with in Chapters 6 and 7.

2) Automatic Design for Minimum Weight. This application is being explored further by BERGSON (9). It is envisaged that a special, all-embracing, computer programme could be compiled to give the sectional dimensions of a girder at Minimum Weight to withstand a given bending moment. It is very likely that the errors in the properties of a contour would now require to be more critically appraised.

Thus enquiries, even on the telephone, could be answered very quickly. Indeed a steel stockholder could be encouraged to keep adequate supplies of suitable plate out of which the particular plate girders could be fabricated, or the engineer, at a very early stage, could place his order for material.

This suggested programme would only give the engineer a bare answer as compared with the use of the charts described in 1) which would provide a 'feel' for the job. This answer would either have to be accepted or rejected at its face value, though any section could be subsequently checked using Programme Nos. ABEL 1 or 1A.

These two basic applications could now be used in a wide variety of ways, and these will be outlined in Chapter 7. However before this is done the design process must be completed, and this will be done in the next chapter.

## CHAPTER 6

### ADDITIONAL EFFECTS

#### EFFECTS INVOLVING A POSSIBLE CHANGE OF SECTION

It has been inferred throughout the investigation that the moment of resistance  $M_R$ , as restricted by lateral buckling, is the main design problem in all cases, and it was suggested in Chapter 1 that all the other effects could be attended to once the basic Minimum Weight Section, based on  $M_R$  being critical, had been obtained.

However there are four effects which could render this section unsatisfactory. These are :-

- 1) The shear stresses (or compound stresses - see B.S.449, Clauses 14c and d, page 22) in the web plate under the total applied loading may exceed the permissible values (See Chapter 1).
- 2) The maximum size of fillet weld required for the flange to web welding may be insufficiently strong. (Full penetration butt welds, however, would always be satisfactory - see Chapter 1).

- 3) The maximum deflection under the total applied loading may exceed the permissible value (See Chapter 1).
- 4) The section or welding may not be sufficiently strong to withstand any specified dynamic, impact, or fatigue loading which may be applied. In the case of the welding, continuous full penetration butt welds will seldom, if ever, be critical in this respect.

If it transpires that these four effects are not critical, or if they can be attended to as suggested above, there is no problem and the basic section can then remain unchanged.

If, however, this is not the case, then the basic Minimum Weight Section will be unsatisfactory and must be changed. This can best be done in the case of items 1, 2, and 3 by increasing  $d$ , or  $t_3$ , or both. The use of charts as illustrated in Figs. 27 and 28 would be most valuable, and the Minimum Weight Section, with respect to all criteria, could then be obtained.

**FIG. 29.**  
**CRITICAL SHEARING FORCES.**

$L = 100'$ ;  $K_1 = 1$ ;  $\lambda = 1.$

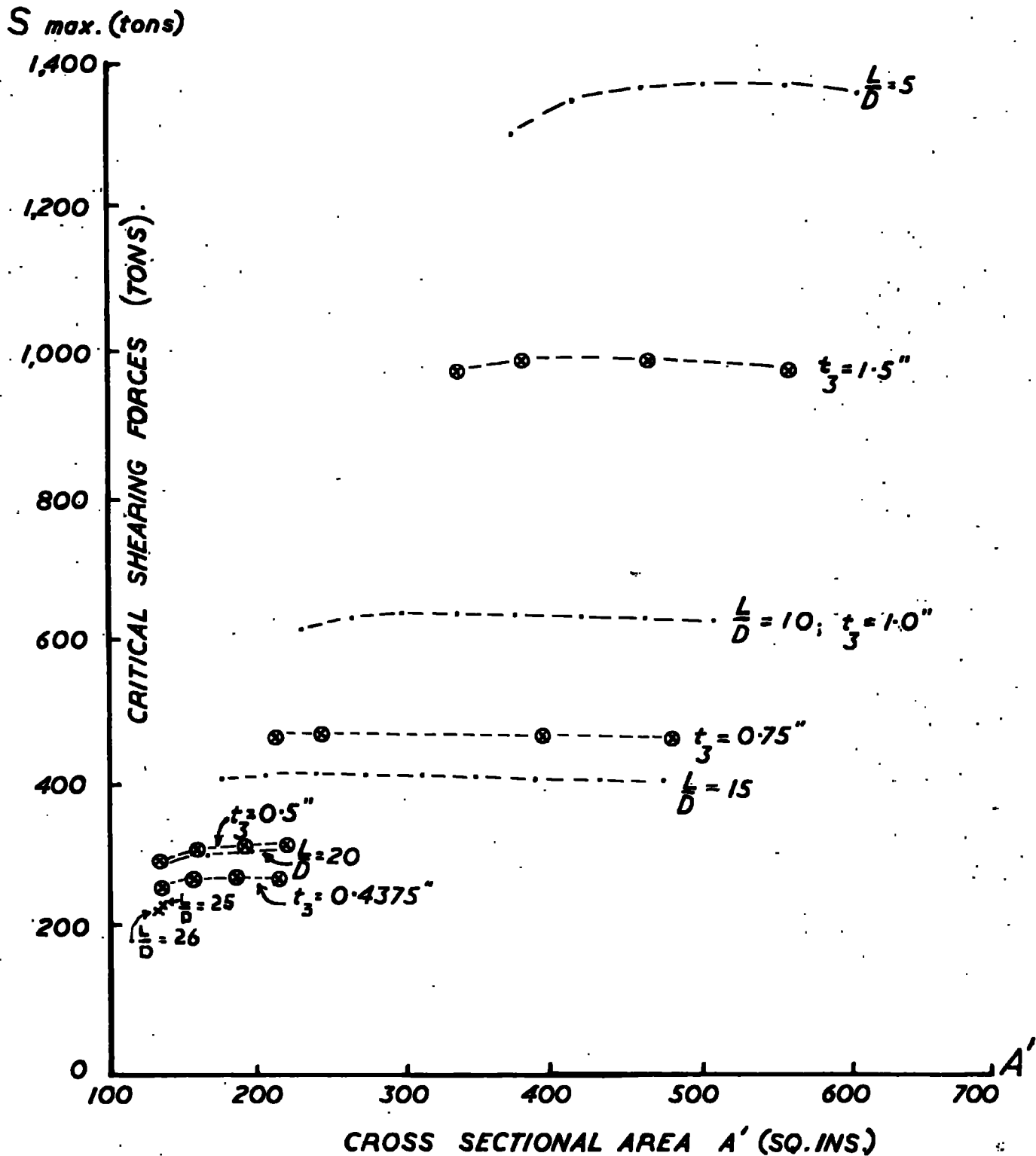

In the case of item 4, it is suggested that an approach could be made by interpreting the dynamic load as an equivalent static load in the first instance, and then obtaining the basic section for this loading. It is appreciated that this will not always be possible; there could be a problem here and there is clearly scope for further research.

-----

It is now necessary to be able to find out the importance of these additional effects in any given case once the basic section, based on  $M_R$  being critical, has been determined.

#### Critical Shearing Forces

A computer programme was written (Programme No. ABEL 4) to give the values of  $S_1$  max.,  $S_2$  max.,  $S_3$  max., and  $S_4$  max., (see Chapter 1) for any given section, indicating which of these is the critical S maximum.

This programme was used to find the values of the critical shearing forces for the sections shown in Figs.27 and 28. The results are shown in Table No.6.1, and these have been plotted in Fig.29. The value marked with the asterisk is S max. for each section, and these should be <sup>greater</sup> than or equal to the applied shearing force.

Deflection. The maximum deflection  $\delta$  of the girder under the total applied loading depends upon the magnitude, distribution, and configuration of the applied loading  $W$ , the span  $L$ , and the second moment of area  $I_x$  (which has already been calculated).

$$\text{Thus :- } \delta = f(W, L, I_x)$$

where  $f(W, L, I_x)$  is generally a simple function.

Typical examples of  $\delta$  are given in the Steel Designer's Manual (10) for the more common distributions of applied loading. A simple computer programme could be written to give  $\delta$ , and this value could be compared with  $\frac{L}{360}$ .

However this will not be done here since the distribution and configuration of the applied loading have not been specified, and it would seem undesirable to impose any such restriction at this late stage of the Investigation.

#### EFFECTS REQUIRING NO CHANGE OF SECTION

##### Web Stiffening

a) Intermediate stiffeners, (vertical and horizontal).

The output from Programme No. ABEL 1 indicates which category of web stiffening, if any, is required in a given case.

Full details as to how the intermediate stiffeners can be provided are contained in B.S. 449 on pages 38, 49, and 50. On no occasion, however, will this process render the basic section unsatisfactory, although the weight of the stiffeners will affect the overall self weight of the girder.

The efficient layout of intermediate stiffeners is another problem, and this cannot be covered here, though brief details as to what is involved will be given in Chapter 7.

b) Bearing stiffeners. These should be provided on plate girders in the proximity of severe concentrated loads in accordance with the instructions given in B.S. 449 on pages 48 and 49.

The efficient design of bearing stiffeners is yet another problem which could be profitably investigated. Welding. Much has already been written on this matter in Chapter 1. However, if  $S_3$  and  $S_4$  are considerably less than the critical shearing force  $S_{max}$  or the applied shearing force, then it may well be possible to use a smaller size of continuous fillet welding, or to use a certain amount of intermittent fillet welding, if this is permissible.



Intermittent fillet welding is generally undesirable in this type of construction if severe dynamic loads have to be withstood. Full details for the design of such welds are given in the Steel Designer's Manual (10) or in the Institute of Welding's Handbook for Welded Structural Steelwork (11).

Welding will not affect the self weight of the girder, but could well be an important item in Minimum Cost Design.

-----

#### FURTHER EFFECTS

Notes on  $K_1$  and  $\lambda$ .  $K_1$  is a function of  $N$  (Table 5 of B.S.449), and throughout this work has been held at the constant value of unity. This implies that the cross sectional dimensions of the flanges of the girder in each case are constant throughout the span, or can be varied slightly provided that  $N \geq 0.8$ .

It should be noted that  $K_1$  is independent of the web plate dimensions  $d$  and  $t_3$ ;  $t_3$  in particular could be varied along the span without affecting  $p_{bc}$ , thereby achieving a saving in weight, though care

should then be taken to ensure that the necessary welding and web stiffening can then be provided at any such change. In this case the Shearing Force Diagram and the Bending Moment Diagram will now be required.

The effective length of the compression flange is  $l = \lambda L$ , where  $L$  is the span. The value of  $\lambda$  depends on how the ends of the compression flange are restrained, and whether any intermediate lateral supports have been provided. Here  $\lambda$  has been held constant at unity throughout, indicating that the girders are restrained only at the ends of the span, both laterally and torsionally, but not rotationally.

Provision has been made in the computer programmes for  $K_1$  and  $\lambda$  to be varied; this will be discussed in the next chapter.

#### Comparison with the Bridge Specification B.S.153.

The design procedure used throughout the investigation has been based on B.S.449 as indicated in Chapter 1. However it is worthy of note to realise that, certainly as far as welded mild steel plate girders are concerned, there is a very close agreement between the two specifications, so that

most of the foregoing work could readily be made to apply to bridge girders.

One prominent difference is the requirement for fatigue loading stipulated in B.S.153 yet not in B.S.449. It would be essential, however, if this recommendation is pursued, to inspect both Specifications carefully to see what other differences do exist.

## CHAPTER 7

### SUGGESTED FUTURE WORK

A General Method has now been devised for the Minimum Weight Design of mild steel, welded, plate girders having a constant I section and supported laterally and torsionally only at the ends of the span.

However, it was pointed out in Chapter 1 that this is a fundamental step; such a girder can be regarded as a datum, on to which all sorts of practical complications and refinements can now be added as required. Indeed the basic concept of the contour or the inverted contour as the unital element can now be applied to a wide variety of practical problems, not only with regard to Minimum Weight, but also to the formation of other design boundaries. The "properties of a contour" will be very important in this context.

A list of possible follow-up work will now be given, and some of the items will be discussed briefly.

## Suggested Investigations

1. Minimum Cost, or other criteria for efficient design.
2. The Use of Other Codes of Practice, (British and foreign).
3. Comparison with other forms of construction.
4. Feasibility studies for unconventional sizes.
5. The use of High Yield Steel.
6. Riveted construction.
7. Box girders.
8. The effect of lateral supports.
9. The use of non uniform sections.
10. The efficient layout and design of web stiffeners.
11. The effect of changes in the Codes of Practice or in the basis of design, (e.g. Use of Plastic Theory).
12. The allowance for self weight.
13. Shop fabrication of the girders - improvements in techniques and in the use of the girders.
14. A detailed study of  $p_{bc}$ , deflection, errors, static and dynamic applied loads, compound stress, and of the entire welding process.
15. Automatic design and the preparation of design office charts.
16. Crane gantry girders.
17. Composite construction.

Discussion. Not all items in the list will be covered.

1. Minimum Cost or other criteria for efficient design.

These have been discussed in Chapter 1, and further information has been provided by Messrs. Dorman Long and Company Limited, as given in Appendix 1. All the items on the list could be tackled on the basis of this or any other design criterion.

2. The use of other Codes of Practice (British and Foreign)

When  $R \geq 1$ , the contours will be linear no matter which Code of Practice, from any country, is used. Most of the other properties of contours as given in Chapters 3 and 4 will also apply, though there will naturally be different numerical values.

It would therefore be possible to compare on a cost or weight basis, various designs of girders manufactured in different countries to see how competitive the products from any one country might be.

4. Feasibility studies for unconventional sizes.

It is suggested that plate girders could carry greater loads over longer spans, exceeding all the present ideas of maximum dimensions.

The methods developed in the Investigation,

are particularly suitable for large, deep, girders, and the efficient design dimensions could be obtained and the resulting practical engineering problems analysed. The steel manufacturers and welding technologists could then be presented with specific problems with a clear incentive to obtain a solution. Such large, long, girders would normally be unsuitable for resisting wind vibrations on exposed sites.

#### 8. The effect of lateral supports.

As  $\lambda$  is reduced from unity down to zero,  $R$  increases for all points on a contour, so that more of the contour becomes linear, until, in many cases, the entire contour will become linear. There is no displacement of the straight line as  $\lambda$  is varied - only the location of the point at which  $R = 1$  is altered, though still along the same straight line. The value of  $M_R$  where  $R = 1$  increases as  $\lambda$  reduces and vice versa.

Lateral supports have the effect of reducing  $\lambda$  and therefore of improving the efficiency of the design. This type of investigation can be readily carried out using contours and the computer programmes already compiled.

When  $\lambda$  is increased above unity, R decreases for all points and then more of the contour becomes non linear.

9. The use of non uniform sections.

The flanges or web plate could be reduced in cross sectional area in an endeavour to achieve economy, though this attempt would be offset by the extra cost of workmanship. An investigation of this effect would be useful, extended to deal with large cut-outs, holes, splices, connections, tongue plates, and haunched ends, etc.

10. The efficient layout and design of web stiffeners

The stiffeners can have various types of cross sections, and it is possible to use either heavy sections spaced well apart or lighter sections closer together, thus providing a large number of valid solutions. These could all be investigated in terms of Minimum Weight or Cost, or any other criterion.

A detailed comparison of the overall self weights of the girders in the four different categories of web stiffening could then be carried out.



13. Shop fabrication of the girders - improvements in techniques and in the use of the girders.

---

It is suggested that the steel manufacturers could produce the necessary plate and fabricate the welded sections including stiffeners in two closely related operations, supplying clients with efficient built-up beams of specified spans and loading. The scantlings of the sections required could be speedily obtained using an automatic programme or charts.

These could replace rolled sections, and there would be no need to stock the various sizes of plate which could now be rolled to closer decimal tolerances on thickness by adjusting the rollers in the mill. An adjustable jig could be constructed for the handling, fabrication and welding of the girders.

It would appear that this process would be particularly suitable for larger sizes - the girders would be precision, factory made products, and these could be erected in inclement weather, competing with prestressed concrete construction, etc.

15. Automatic design and the preparation of design office charts.

---

These have been discussed previously in Chapter 5, though it may now be appreciated why these have not been carried out by this stage. There is clearly a need for consultation with various bodies as to what information the computer programme or charts should provide; different establishments will have different requirements involving many items given in the list, or perhaps not even thought of yet by the author.

Nevertheless in all cases the basic approach has been clearly described in the thesis, to be used as required.

## A C K N O W L E D G E M E N T S

---

The author would like to thank his supervisor, Professor R. Hoyle, B.A., Ph.D., M.I.Mech.E., Hon. A.C.G.I., for all his guidance and advice so graciously and generously given.

His thanks are further due to Mr. A. Bergson for writing the computer programmes and providing the computer data as requested, and to Mr. T.V. Thompson, M.I.Struct.E., Chief Design Engineer of Messrs. Dorman Long (Bridge and Engineering) Limited, Middlesbrough, for supplying details of the practical proportions and construction of plate girders.

Finally the author thanks Miss D.A. Davison for typing the script, Mr. T. McKitterick for drawing the diagrams and Mr. E.C. Elliott of Messrs. Addressograph - Multigraph Limited for so generously providing the duplicated copies of the script of the thesis.

## REFERENCES

---

1. **ROCKEY, K.C.**  
Web buckling and the design of webplates  
The Structural Engineer - Vol. XXXVI No. 2.  
February 1958.
2. **KERENSKY, O.A., FLINT, A.R., and BROWN, W.C.**  
The Basis for Design of Beams and Plate Girders  
in the Revised British Standard 153. Structural  
Paper No. 48.  
  
**LONGBOTTOM, E., and HEYMAN, J.**  
Experimental Verification of the Strengths of  
Plate Girders designed in accordance with the  
Revised British Standard 153: Tests on Full-  
Size and on Model Plate Girders. Structural  
Paper No. 49.  
  
Published by The Institution of Civil Engineers,  
1956.
3. **BRITISH STANDARD 449: 1959**  
(with Amendments Nos. 1 - 6 inclusive)  
The Use of Structural Steel in Building.
4. **BRITISH STANDARD 153: 1958**  
Steel Girder Bridges.
5. **BRITISH STANDARD 15: 1948**  
Structural Steel.
6. **BRITISH STANDARD 2762: 1956**  
Notch Ductile Steel for Bridges and General  
Building Construction.

References (cont'd.)

7. DORMAN LONG AND COMPANY LIMITED  
Handbook for Constructional Engineers. 1964.
8. WOOLDRIDGE R., and RACTLIFFE, J.F.  
An Introduction to Algol Programming.  
English Universities Press 1963.
9. BERGSON A.  
M.Sc. Thesis, University of Durham.  
(to be published).
10. GRAY C.S., KENT L.E., MITCHELL W.A., and GODFREY G.B.  
Steel Designers' Manual.  
Published by Crosby Lockwood and Son, Ltd., 1955.
11. INSTITUTE OF WELDING.  
Handbook for Welded Structural Steelwork.

APPENDIX NUMBER 1.

DETAILS OF PRACTICAL SIZES AND PROCEDURES, AS  
PROVIDED BY MESSRS. DORMAN LONG (Bridge and  
Engineering) Ltd.

---

The author sent off the following questionnaire:-

In order to carry out a detailed investigation of plate girders by computer, I would be very grateful if you would answer the following questions, the answers to which will ensure that only practical sections will be considered.

1. The variation of span/depth ratio  $\frac{L}{D}$ , giving upper and lower limits. Also please give the maximum span and the maximum depth for H.Y. and M.S.
2. Span/width of top flange  $\frac{L}{B_1}$ , upper and lower limits.
3. Span/width of bottom flange  $\frac{L}{B_2}$ , upper and lower limits.
4. Minimum and maximum thicknesses of :-
  - a) Top flange  $t_1$ .
  - b) Bottom flange  $t_2$ .
  - c) Web plate  $t_3$ .
5. Limitations on sizes of fillet welds to connect flange plates to web. Please give maximum and minimum size of fillet welds and relate these to  $t_1$ ,  $t_2$  and  $t_3$ . Are staggered welds permitted for this work?
6. Any details of flange curtailment procedure, e.g. how many times would you curtail the flange and is there a relationship between adjacent flange thicknesses?

7. Do you use longitudinal web stiffeners -  
 a) Alone?  
 or b) With vertical stiffeners?
8. Will any of your answers to questions 1 to 7 be affected by using high yield steel rather than mild steel?

If the answer is yes, please give details.

The following answers were received :-

1. MAX. SPAN H.Y.S. and M.S.

120 ft. could be regarded as a reasonable limit - a good many gantry girders of this span have been made in recent years - though girders of larger span can be built if suitable arrangements are made for manipulating during welding and for erecting. The span applies equally to H.Y.S. and M.S.

2. MAX. DEPTH H.Y.S. and M.S.

192 ins. This however is very dependent upon method of fabrication. If the job contained a large number of identical girders it would be worth building a manipulator in which to fabricate the girders and, provided the flanges did not require to be too thick, the tendency would be to restrict the depth to a maximum of 150 to 160 ins.

3. THE VARIATION OF SPAN/DEPTH RATIO  $\frac{L}{D}$  GIVING UPPER AND LOWER LIMITS.

$\frac{1}{72} : 1$  to  $30 : 1$

4. SPAN/WIDTH OF TOP FLANGE  $\frac{L}{B_1}$  UPPER AND LOWER LIMITS.

$12 : 1$  to  $50 : 1$  Crane rail fixings often dictate the width of flanges of short span gantry girders.

5. SPAN/WIDTH OF BOTTOM FLANGE  $\frac{L}{B_2}$  UPPER AND LOWER LIMITS.

20 : 1 to 50 : 1

The bottom flange may be thrown into compression when erecting, so that it is generally prudent not to make it too narrow if the span is large.

6. MAX. and MIN. THICKNESSES.

- a) Top Flange  $t_1$  4" to 3/8"
- b) Bottom Flange  $t_2$  4" to 3/8"
- c) Web Plate  $t_3$  say  $1\frac{1}{2}$ " to 1/4"

Web plates thicker than 1" are not frequent and usually occur in shallow girders. If the flange plates of deep girders are thick (e.g. 3" to 4") tongue plates would be most likely used in order to avoid a disparity of thicknesses at junction of web and flange.

7. LIMITATIONS ON SIZES OF FILLET WELDS TO CONNECT FLG. PLS. TO WEB. MAX. and MIN. SIZE  $\nabla$  RELATE TO  $t_1$ ,  $t_2$  and  $t_3$ .

Weld sizes are highly variable and apart from the general rule that minimum or maximum welds should be commensurate with the thickest and thinnest material joined together, no very defined pattern can be given.

As a guide to ensure welding is commensurate with thickness (e.g. to avoid cracking because of too rapid heat dissipation if small welds are used on thick material) Table 18 of B.S.449:1948 is useful, viz.,



### Minimum Size of Fillet Welds

Thickness of Thicker part	3/8" up to and including 3/4"	Over 3/4" up to and including 1 1/4"	Over 1 1/4"
Minimum size of fillet weld	$\frac{3}{16}$ "	$\frac{1}{4}$ "	$\frac{5}{16}$ "

Since 1948 much more welding of plates upwards of 2" thick bar became common practice. Fillet welding, however, demands that the components fit closely together without gaps (e.g. flange plate must abutt on web all along its length). Recently a deliberate gap (by inserting a copper wire) was recommended for fillet welding a very high yield steel, no doubt to allow contraction to take place during the process of welding. To achieve this condition it becomes necessary to machine the flange plate if the thickness is too great for mangling flat; in this event it is generally preferable to abandon fillet welding in favour of butt welding.

Two further considerations influence the use and size of fillet welding

- (a) cost rises steeply if each fillet cannot be laid in one run: the maximum one-run is 5/16" Laid in horizontal position.
- (b) the size of fillets should not be too great for the thinner element welded (e.g. the web in the present case) otherwise burning and 'blow' through' may occur.

Bearing in mind the various points mentioned above, a reasonable general guide would be as follows:

Flanges	3/8" to 3/4"	Minimum Fillet Weld	3/16
	3/4 to 1 1/4	"	1/4
	1 1/4 to 1 3/4	"	5/16
	1 3/4 to 2 1/2	"	3/8

These provisions to be modified for special types of girders such as gantry girders, girders having heavy loads on top flanges, etc.

Webs: Aggregate throat thickness of two fillet welds not to exceed thickness of web.

(For Welding of Gantry Girders, please see separate notes forwarded previously)

Welding would also require special consideration if forces on the girder are likely to cause 'fatigue'; butt welds would be used. The welding of Autofab Beams is in effect deep penetration fillet welding by an automatic process in which two welds, one to each flange, is laid simultaneously; the girder is then turned over and the other two welds are laid. For web plates up to 3/8" thick complete penetration can be achieved thus providing the equivalent of a butt weld.

## 8. Flange Curtailment

If a flange can readily be obtained from the mills in one piece and is not too long for satisfactory transport, resort to curtailment would not generally be made.

Reference to pages 30-32 of the D.L. Handbook will show, however, that the maximum length of thick plates obtainable is limited; e.g. a plate 30"x2 1/4" is limited to 40ft., - if therefore a girder say 70ft. long required at the centre 30x2 1/4 flange plates, the designer would check whether curtailment was permissible at each end of a 40ft length (or less, depending upon the bending moment diagram) and if permissible, he would introduce thinner flanges, say 30x1 1/2, at the ends. Double at preparation would

8 (cont'd).

be adopted for the butt weld of 1 1/2" thickness and the 2 1/4" plate would be chamfered to a slope not exceeding 1 : 5. The chamfering is introduced in order

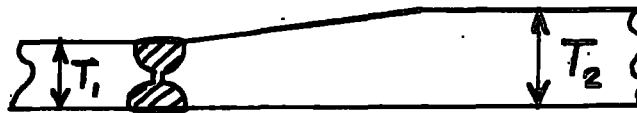

to reduce stress concentrations and promote more even stress flow.  $T_2$  may vary from  $1.2T_1$  to  $1.6T_1$  generally.

Please refer also to my previous notes on curtailment.

9. Do you use longitudinal web stiffeners

- a) alone - No
- b) with vertical stiffeners - Yes

10. Will answers to 3 to 9 be affected by using H.Y.S.

No except that deflections and stability must be watched more carefully; also allowable stresses in thick material.

In addition the following information was also given.

#### Notes on Welded Plate Girders

Generally, plate girders fall into two categories, those required to support a system of primary beams, plus perhaps a relatively small proportion of directly applied load, and those which are to function as gantry girders or are required to support highly concentrated loads on the top flange.

In the first category, the welding attaching flanges to web is, as a rule, not subject to transverse and vertical forces, so that fillet welding will usually suffice and, provided the flanges are not made/

excessively thick in relation to the web, resort to tongue plates need not be made.

It will be evident therefore that girders of considerable depth (e.g. 3ft. wide flange, 17ft. deep x 130ft. span) and span can readily be made from three plates. The web plate in large girders would possibly consist of plates butt welded together at mid-depth and, depending upon span, butt welded vertically either at mid-span or say 3rd points of span (in the latter case, the middle third may be thinner than the two outer thirds). The flange plates in a large girder are likely to have a large area and hence rolling and machining limits may dictate that each plate be formed from two or more plates butt welded; if more than two, advantage would be taken of the opportunity to reduce the thickness of the two outer portions Fig.I. This method, generally, is preferable to adding curtailed plates by fillet welding one plate to another as in Fig.II.

Theoretically and practically the stresses in the welds are very high at each end of the curtailed plate and to reduce this effect as far as possible it is necessary to taper the curtailed plate Fig.III. In addition, web to flange welding tends to arch the flange plate Fig.IV; hence, unless the flange plate is pre-set so as to become flat after welding, there may be a gap at the edges of the curtailed plate, making fillet welding suspect.

Schools of thought vary as to whether stiffeners may be welded to the flanges (especially tension flanges) - some say it is permissible both 'with' and 'across' the grain of the flange material, others say it is permissible only 'with' the grain (i.e. parallel to the length of the flange.) I think the investigator is right who argued that it is equally dangerous or equally permissible to weld 'with' and/or 'across' depending on whether the welder is careful or is not careful to avoid notching the flange. Very often concentrated loads, eccentric loads and the like make it imperative to weld to flanges, though I think it is good practice to avoid welding to the tension flange (except at bearings) whenever possible.

In practice stiffeners welded to flanges add to torsional stiffness of the girder.

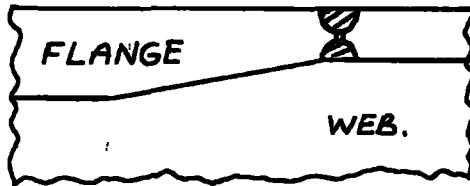

FIG I

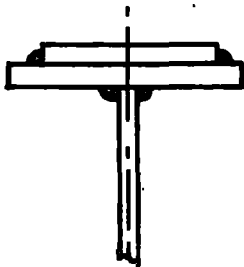

FIG. II

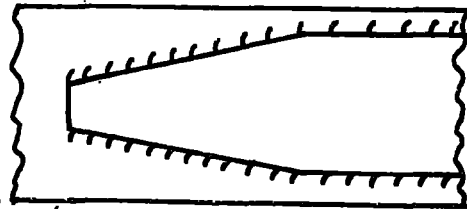

FIG III.

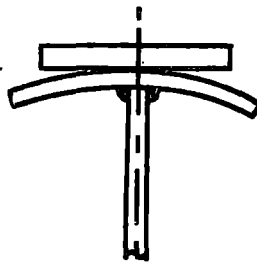

FIG IV

Welded Gantry Girders  
and other dynamically loaded  
Girders

A number of failures of gantry girders by cracking or fracture of the welding joining the top flanges to the web have been reported from various parts of the country.

This welding is subject to a rather complex combination of forces viz.

- (1) Horizontal shear.
- (2) Transverse forces, particularly where there is no surge girder, or where attachment of surge girder is badly maintained.
- (3) Vertical forces from crane wheels.
  - (1) can be calculated in the ordinary way from flexure formula.
  - (2) is due to surge, any out of alignment of cranes or gantry, etc., and may produce a tendency to rotate the top flange about the axis of the web.
  - (3) although the flanges are clamped to web, while either welding or tack welding, the butt is not absolute and cannot be relied upon to function in direct bearing. This means that local loads from wheels are transmitted via the weld to the web and therefore subject to severe local stress as well as fatigue.

Arising from these points designers should observe the following recommendations.

(1) LIGHT DUTY GANTRY GIRDERS.

This category includes workshops and other gantries where the crane is not part of the actual production cycle.

- (a) Machine welding should be used as far as possible.
- (b) Fillet welds may be used if the size of fillet can be proportioned to take a combination of the local effect of the wheel load as well as the horizontal and transverse shear stresses due to flexure and surge; also the fillet welds should be returned around the ends of the girder to form a continuous weld.
- (c) The web may be required to be thicker than the minimum called for in the design of the web itself.
- (d) Stiffeners should be welded to the top flange as well as the web and, where necessary, supplemented by shorter stiffeners not extending the full depth of the web.
- (e) Surge girder and diaphragm attachments should be by rivets or high strength friction grip bolts properly torqued, or other device in which attachment is unlikely to become loose. This applies also to attachment of crane rails.
- (f) Fillet welds will be adequate for attaching the bottom flange to the web, but may need to be increased locally at the bearings.

(2) HEAVY DUTY GANTRY GIRDERS.

This category includes cranes in steelworks and in similar plants where the crane forms part of the production cycle and is therefore in continuous operation.

- (a) Machine welding is preferable for securing the flange plates to the web.
- (b) Full strength welds with U preparation of the web to ensure full penetration over the thickness of the web plus some reinforcement; in some cases it will be necessary to consult the shops in regard to distortion control. The welds should be 'run off' in order to avoid notch effect at the end.
- (c) Web thickness must be commensurate with the welding required and, if necessary, tongue plates introduced.
- (d) In order to provide against the effects of fatigue, it is suggested that the stress should be reduced by a percentage of the normal permitted stress, depending upon the job. The attention of the Chief Designer to any particular job, however, should be drawn before proceeding on the basis of a stress reduction.
- (e) Additional short length stiffeners should be provided to minimise the rotation of the top flange.
- (f) 'Rubber' mountings under rails reduces the effect of impact and, in some cases, may be recommended.
- (g) Special attention to security of attachments should be given as in the case of Light Duty Girders mentioned above.
- (h) The welding of the bottom flange to the web will not need the same size of welds though special attention should be given at the bearings.

Where clients specify their requirements the drawings should be followed and quantities taken off accordingly, unless it is thought that the client should be advised to make modifications, particularly to the welding.



APPENDIX NUMBER 2

LIST OF SPECIAL COMPUTER PROGRAMMES

(These have been written and tested by A. BERGSON (9), using the information contained in this thesis which has been obtained or devised by E. LITTON. Full details of the programmes will be given in Bergson's thesis).

<u>Programme No.</u>	<u>Title or Description</u>
ABEL 1.	The basic programme to obtain $M_R$ , $D_{bc}$ , $A'$ , $f_{bc}$ , $f_{bt}$ , $R$ and $\frac{1}{r_y}$ for a given section.
ABEL 1A.	Modified version of ABEL 1, giving greater accuracy in $R$ .
ABEL 2.	Critical Values of $B_2$ .
ABEL 3.	A programme based on ABEL 1A which finds that section on a given contour at which $R = 1$ .
ABEL 4.	Critical Shearing Forces.

