



Durham E-Theses

Investigations of the ecosystem energetics of an English woodland

Hughes, Malcolm K.

How to cite:

Hughes, Malcolm K. (1969) *Investigations of the ecosystem energetics of an English woodland*, Durham theses, Durham University. Available at Durham E-Theses Online: <http://etheses.dur.ac.uk/9551/>

Use policy

The full-text may be used and/or reproduced, and given to third parties in any format or medium, without prior permission or charge, for personal research or study, educational, or not-for-profit purposes provided that:

- a full bibliographic reference is made to the original source
- a [link](#) is made to the metadata record in Durham E-Theses
- the full-text is not changed in any way

The full-text must not be sold in any format or medium without the formal permission of the copyright holders.

Please consult the [full Durham E-Theses policy](#) for further details.

Investigations of the Ecosystem Energetics
of an English Woodland

by

Malcolm K. Hughes, B.Sc. (University College)

Being a thesis presented in candidature for the degree of
Doctor of Philosophy of the University of Durham. 1969.



ACKNOWLEDGMENTS

My thanks are due to Dr. John Phillipson for introducing me to the study of ecosystem energetics and for supervising and encouraging this work.

I am very grateful to Professor D. Barker for the use of the Zoology Department facilities and for taking a plant ecologist into his department.

Of the many who have helped by discussing this work and ecology in general, particular thanks are due to Professor F.B.O'Connor of Molslaboratoriet, Denmark and Drs. Bellamy and Wignarajah of Durham.

Invaluable practical help was given by Mr. Eric Lincoln and his colleagues in the Electronics Workshop who were responsible for the design of the amplifier circuit described in Section X of this thesis. Mr. J. Ollason of the Zoology Department wrote the MEANWTS programme used in Section VII. Dr. H. Lister of the University of Newcastle kindly lent the Moll solarimeter used in Section X. The Technical staffs of both the Zoology and Botany Departments gave much assistance and Mrs. R. Reed showed extraordinary forbearance and patience whilst typing this thesis.

My wife, Pat, has made the work possible by keeping me sane, happy and well, and made it worthwhile for me by putting it in its proper social perspective.

The Wynyard Estate kindly allowed the use of their land and the Forestry Commission gave ready co-operation and invaluable advice.

SUMMARY

INVESTIGATIONS OF THE ECOSYSTEM ENERGETICS OF AN ENGLISH WOODLAND

1. Energy flow and accumulation in the aboveground parts of an alder-birch woodland in County Durham were studied between April 1966 and April 1968. Dry matter transfers and accumulations were measured and converted to energetic data by the use of calorific equivalents. It was shown that only calorific values appropriate to a particular category of material and season provide adequate calorific equivalents.
2. Tree net aboveground primary production was $3574\text{Kcal/m}^2/\text{year}$. $2417\text{Kcal/m}^2/\text{year}$ (68.0%) was wood, $901\text{Kcal/m}^2/\text{year}$ (25.0%) canopy leaves, $232\text{Kcal/m}^2/\text{year}$ (6.4%) other parts, and $24\text{Kcal/m}^2/\text{year}$ (0.6%) loss to herbivores.
3. Tree litter fall was approximately $1450\text{Kcal/m}^2/\text{year}$ in both study years. 66.0% was alder and birch leaves, 19.2% small wood, and 14.3% other litter. Seasonal changes in canopy biomass, biocontent and Leaf Area Index were demonstrated.
4. Ground vegetation net aboveground primary production was $1016\text{Kcal/m}^2/\text{year}$ in 1966-7 and $1142\text{Kcal/m}^2/\text{year}$ in 1967-8. Ground vegetation litter was 40% to 50% of total litter production. This component was measured by a modified Paired Plots Technique.

5. Forest Floor Litter disappearance was normally $2500\text{Kcal/m}^2/\text{year}$.
6. Total ecosystem plant biocontent (without roots) was near $86,000\text{Kcal/m}^2$, 54% was stored as wood, 42% as litter and soil organic matter. Net accumulation of energy was established only in tree wood ($+2,200\text{Kcal/m}^2/\text{year}$).
7. Insolation was measured by Monteith solarimeters and an integrator developed in this study. Incident shortwave radiation was $818,490\text{Kcal/m}^2/\text{year}$. Net photosynthetic efficiency (aboveground) was 0.58%. The tree stratum fixed 0.64% of energy incident in its growth season; lower strata fixed 0.52% of the energy reaching them.
8. Net Primary Production (aboveground) was approximately $4750\text{Kcal/m}^2/\text{year}$. Net Ecosystem Production was normally near $2300\text{Kcal/m}^2/\text{year}$ (48.9% of NPP).
9. The methods used were critically appraised and perspectives for future work outlined.

CONTENTS

	Page
<u>Chapter I. Introduction and Basic Data</u>	
Section I. Introduction	
I.i Ecosystem Energetics	1
I.ii The basic approach	3
I.iii The choice of study ecosystem	4
I.iv The plan of this thesis	5
Section II. The Study Area	
II.i Position and Topography	6
II.ii Geology, soil and forest floor	7
II.iii Climate	9
II.iv Vegetation	11
II.v. History of the Study Area	14
Section III. Calorific Determinations	
III.i Introduction	16
III.ii Collection and preparation of materials	17
III.iii Results	19
III.iv Discussion	24
<u>Chapter II. Tree biocontent and net production</u>	
Section IV. Tree Wood Biomass and Biomass Change	
IV.i Introduction	26
IV.ii Methods for determining wood biomass and production	30
IV.iii Results	33
(a) Birch	34
(b) Alder	38
(c) The Tree age-distributions and the history of the Study Area	40
Section V. Tree Litter and Canopy Biomass	
V.i Introduction	43
V.ii Methods	48
(a) The estimation of litter fall other than large branches and tree stems	49
(b) The estimation of the fall of large branches and tree stems	52
(c) The estimation of canopy biomass, biocontent and Leaf Area Index	52

		Page
V.iii	Results of Tree Litter fall studies	54
	(a) Biomass 	54
	(b) Biocontent 	57
V.iv	Results of Canopy studies 	59
V.v	Discussion 	66
Section VI.	The calculation of Tree net production	
VI.i	Introduction 	74
VI.ii	Methods 	74
VI.iii	Results - Biomass 	77
VI.iv	Results - Biocontent 	77
VI.v	Discussion 	78
 <u>Chapter III. Ground Vegetation and the Forest Floor</u>		
	General Introduction 	80
Section VII.	Serial Cropping	
VII.i	Introduction 	80
VII.ii	Serial cropping methods	82
	(a) Method of cropping	82
	(b) Size of Quadrats 	83
	(c) Number of Quadrats and their location	89
	(d) Frequency of cropping 	92
VII.iii	Results April 1966 to March 1967 	92
	(a) Green Ground Vegetation and Bryophytes	92
	(b) Ground Vegetation Litter	93a
	(c) Tree Litter 	95
	(d) Quadrat apportionment for 1967-8 as calculated from 1966-7 data 	96
	(e) Test of effectiveness of mapping the Grid into Alder and Birch Zones	97
VII.iv	Results April 1967 through April 1968	98
	(a) Green Ground Vegetation and Bryophytes	99
	(b) Ground Vegetation Litter	107
	(c) Tree litter 	110
	(d) Comparison of Grid data for 1966-7 and 1967-8 	112
	(e) Relative reliability of the 1966-7 and 1967-8 biomass estimates	114
VII.v	Results - Biocontent 	115
VII.vi	Discussion 	117
Section VIII.	Disappearance	
VIII.i	Introduction 	122
VIII.ii	Methods 	126
VIII.iii	Results - Biomass 	128
	(a) 1966-7 	128
	(b) 1967-8 	130

					Page	
	VIII.iv	Results as Biocontent	133
	VIII.v	Discussion	134
Section IX.		Ground Vegetation Net Primary Production				
	IX.i	Introduction	140
	IX.ii	Methods	143
	IX.iii	Results - biomass	144
	IX.iv	Results - biocontent	146
	IX.v	Discussion	146
<u>Chapter IV. Ecosystem Energetics</u>						
Section X.		Insolation				
	X.i	Introduction	148
	X.ii	Methods	149
	X.iii	Performance of the Integrator		152
	X.iv	Calibration of the Solarimeter - Integrator Assemblies	153
	X.v	Field Use of the Solarimeter - Integrator Assemblies	155
	X.vi	Results	156
	X.vii	Discussion	159
Section XI.		Energy Flow and Accumulation				
	XI.i	Ecosystem biomass and biocontent	...			161
	XI.ii	Net Primary Production, Heterotroph Respiration and Net Ecosystem Production				162
	XI.iii	The utilisation of insolation	...			165
	XI.iv	Ecosystem Energy Flow and Accumulation				165
	XI.v	Conclusion	172
References			176
Appendix						

CHAPTER I

INTRODUCTION AND BASIC DATA

Section I Introduction

1. Ecosystem Energetics

The processes by which biological systems retain their integrity are energy-requiring. Ecosystems are the most complex level of biological organization, representing the totality of the myriad interrelationships between and within the biota and physical environment in a given area. The quantitative study of energy fixation, partition and dissipation by ecosystems is thus of fundamental importance and interest to biology.

In particular, an understanding of the energetics of long-term change in ecosystems is essential for the development of a predictive theory of environmental management. The development of such a theory depends not only on information on natural successions, but also on those chains of events starting with catastrophe or management. In fact the evidence presented by Raup (1964) suggests that rarely, if ever, does the ecosystem standing on any substantial tract of land or water reach or maintain a state which may be described as a climax. The reason for this is the irregular but frequent (on an ecological time-scale) occurrence of natural catastrophes such as hurricane, fire and pestilence. Man's actions often seem to act in a similar way, for example in shifting cultivation.

Thus real ecosystems do not usually represent a simple time-series of successional stages from a pioneer to a climax ecosystem. Rather they represent the interaction between the causal relationships implied by ecosystem energetics and the consequences of the latest natural catastrophe or management practice, in terms of mineral supply, radiation climate and viable species available within the relevant area.

With the advent of global pollution it seems unlikely that any real situation with which ecology will be concerned will not be either the product of a 'natural' catastrophe or of 'management'. Therefore it is important to obtain data for energy fixation, partition and dissipation in real ecosystems at various stages of development from various starting points. Only when such data are available can the causal relationships implied by the energetics of the ecosystem be elucidated.

In order to understand the changes taking place in the trophic energetics of an ecosystem it is necessary to define its important components and to measure their contributions to energy accumulation and flow (both to other parts of the ecosystem and to the heat sink). This is because the stresses imposed on the ecosystem by catastrophe or other changes are rarely equal in their impact on all parts of the ecosystem (e.g. fire in the Brookhaven Forest, Whittaker & Woodwell 1969). It is reasonable to predict that the resilience of an ecosystem will depend, at least in part, on the availability of energy and nutrients from

its stores and on the time-scale of this availability. Therefore, the various forms in which energy and nutrients are stored in the several components of an ecosystem are of fundamental relevance to a theory of ecosystem development.

The problem is, how are the parameters relating to energy accumulation and flow to be measured?

I.2 The basic approach

It is clear that methods for the measurement of energy flow and accumulation must depend on the nature of the system concerned. Thus the methods adopted for a nanoplankton system (Odum et al 1959) differ widely from those for a woodland (Whittaker & Woodwell 1969). However, certain considerations derived from woodland studies (Whittaker & Woodwell, op cit) are of general relevance. Thus considering first the plant community

$$NPP = GP - R_{s_A} \quad (\text{kcal}/\text{m}^2/\text{yr})(1)$$

where NPP is net primary production,

GP is gross primary production

and R_{s_A} is respiration of the plant community.

For the entire ecosystem

$$NEP = GP - (R_{s_A} + R_{s_H}) \quad (\text{kcal}/\text{m}^2/\text{yr}) \quad (2)$$

where NEP is net ecosystem production

and R_{s_H} is respiration of heterotrophs.

Hence,

$$NEP = NPP - R_{s_H} \quad (\text{kcal}/\text{m}^2/\text{yr})$$

NEP is a measure of ecosystem energy accumulation. The sum $(Rs_A + Rs_H)$ is a measure of rate of energy dissipation.

Whilst Rs_A will vary with ecosystem bulk and radiation climate, Rs_H relative to NEP is a measure of the relative importance of dissipation of stored energy in the trophic scheme. Therefore it is valuable to differentiate between Rs_A and Rs_H . In fact, the basis of an ecosystem energetics study must be the measurement of rate of storage (NPP), net rate of accumulation (NEP) and heterotroph respiration (Rs_H). Autotroph respiration (Rs_A) is more difficult to measure and it is possible to construct a preliminary sketch of energy-flow relevant to ecosystem development theory without it. It must eventually be measured, but its measurement will not figure in this thesis.

The currently accepted basis for the calculation of NPP, NEP and Rs_H is the measurement of dry matter production and loss and the subsequent conversion of this data to energy terms by the use of caloric equivalents. This approach was used here, and its validity will be re-examined in Section XI.

1.3 The choice of study ecosystem

It is a commonplace observation that steady-state ecosystems are difficult or impossible to find, even if a satisfactory definition of them is thought to be available. More important are ecosystems representative of commonly existing types, or of types likely to increase in importance. The practice

of sustained coppicing of woodland in England has existed for several hundreds of years. Consequently considerable areas of woodland exist which are still being managed in this way, or have recently been so. It was of interest to examine a woodland where this practice had stopped and where there was no evidence of previous cultivation other than coppice management. Thus a coppice woodland standing on a soil profile showing no evidence of tillage, but rather of a low moor succession before forestry (Hornung, pers.comm.), was chosen. This woodland was also the site of intensive studies of the energetics of forest floor and soil invertebrates being carried out concurrently by members of the Zoology Department. This afforded opportunities for common environmental observations and collation of data on an ecosystem basis.

I.4 The plan of this thesis

The thesis contains four chapters. The first contains this Introduction and basic data relating to the Study Area and the caloric content of plant material. Chapter Two gives the data for tree biomass and net production, Chapter Three for ground vegetation and the forest floor; Chapter Four is a summary of the ecosystem energetics of this system as far as the data obtained allow and an assessment of the validity of the conclusions reached.

Section II The Study Area

II.1 Position and Topography

The study area, on Lord Londonderry's Estate at Wynyard, 19km southeast of Durham City, County Durham, was located in the section known as Newton Hanzard Plantations (National Grid Reference NZ425288). This land belonged to the Wynyard Estate for at least 120 years. Since 1952 a large part of the estate, including Newton Hanzard, has been managed by the Forestry Commission, although the Estate retains overshooting rights. Most of the 4,940 hectares managed by the Forestry Commission comprises mixed woodland, much of it, including the Study Area, managed solely as shooting cover. The Study Area was some distance from the public roads and was thus free from unwanted human interference.

The Study Area was bounded on two sides by a forest ride, on another by a boundary fence next to arable land, and on the fourth side by a 20 year old plantation of birch. Its area was approximately 2ha. A grid of eight 20 by 20m squares (area 0.32ha) was marked out near the northern end of the Study Area. The squares were separated and surrounded by 2m wide paths. Within this grid much of the destructive and other sampling was carried out, both in this study and in those on various animal populations.

The Study Area was at approximately 67.1 metres (220ft) above O.D. and lay in a slight hollow in the undulating landscape

of southeast Durham with a slight eminence 1km to the W.N.W. and a deep ravine running N.S. 300m to the east. A stream ran down the ravine. Fig.1 shows the topography of the Grid giving 0.2m contours upwards from an arbitrary level (0.0) near its southern edge. The ground sloped gently down from the north-eastern corner of the Grid towards the south. A drainage ditch cut through the Study Area, just southwest of the Grid, and flowed most of the former's length, and joined the ditch which drained the ride forming the southern boundary of the Study Area. A few metres from 'H', a 13m high scaffolding tower was erected; this is described in Section IX.

On all sides the Grid was buffered by a belt of Study Area. This belt was 70m wide to the west, where the outer boundary was with arable land. To the south it was 150m wide, to the east it was only 14-20m wide, but the boundary here was only a narrow forest ride separating the Study Area from a very similar vegetation. To the north the belt was 23m wide, and again no great edge effects were expected as the plantation of young birch was 5 to 6m high and extremely dense.

II.2 Geology, soil and forest floor

Magnesian limestone formed the rock layer beneath the thick deposit of boulder clay which is characteristic of the region. To determine the extent of soil structure variation within the Grid, pits were dug to a depth of approximately 1m

Figure 1.

Topography of the Grid. Contours at 0.2m upwards from an arbitrary level (0.0).

NEWTON HANZARD STUDY AREA

20 M

1.2
1.0
0.8
0.6
0.4
0.2
0

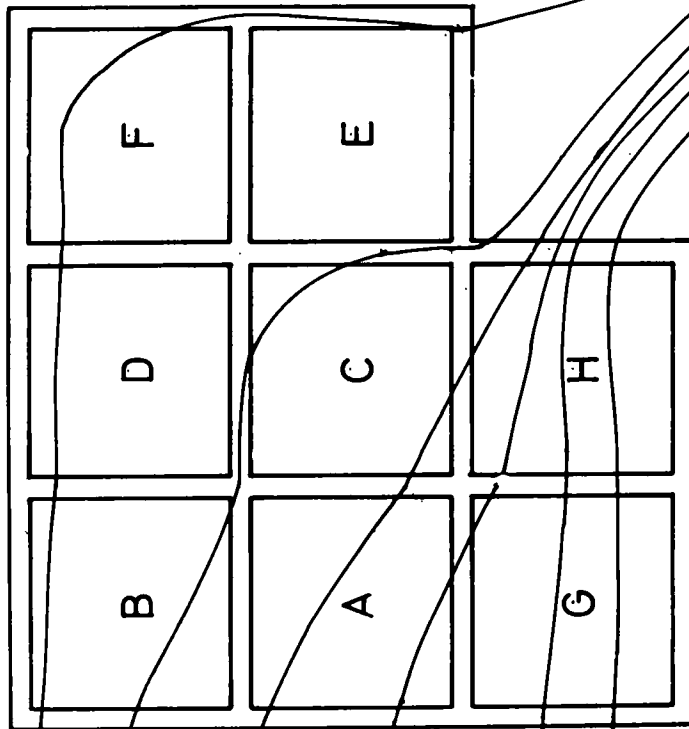

DITCH

TOWER → X

RIDE

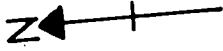

to expose the soil profiles beneath the main vegetation types. For this purpose the types were 'Dryopteris/Rubus' under predominantly alder cover, and 'Dryopteris/Rubus', 'Grassy' and 'Pteridium' under predominantly birch cover. Although 'Pteridium' was not widespread in the Study Area, this soil profile was described because of its differences from the others investigated. Using the classification of Taylor & Pohlen (1962) the profiles are characterized in Table I.

Depths were measured from the surface of the discernable maximum litter cover. The soil profile for 'Dryopteris/Rubus' under predominantly birch tree cover was similar to that under alder although the A_1 horizon was a lighter coloured soil of higher clay content. The Grassy type under birch cover did not show a distinct O_2 horizon, the dead grass material forming a dense matt along with bryophytes, upper roots and birch debris. The 'Pteridium' type showed well-developed O_1 and O_2 horizons lying directly on a heavily gleyed boulder clay.

The water table lay between 15 and 30cm below the soil surface for most of the year (P.J. Bolton, pers.comm.) although during the wetter periods, particularly in winter, it often reached the surface. This may account for the total lack of an A_2 horizon on the Grid.

In summary, throughout most of the Grid the soil was largely an upper clay or clayey loam lying on a gleyed boulder clay. A more exhaustive description of the soils of the Grid

TABLE I. SOIL PROFILES

ALDER COVER		BIRCH COVER			
<u>DRYOPTERIS/RUBUS TYPE</u>		<u>GRASSY TYPE</u>			
LAYER	DEPTH	COMMENTS	LAYER	DEPTH	COMMENTS
O ₁ or L	: 0 to 0/1.5cm;	depth varies according to season. Plant debris.	O ₁ + O ₂	: 0 to 4/7cm;	Dead grass material and sparse Birch debris
O ₂ (F+H)	: 0/1.5cm to 1.5cm;	Variab!e depth, never extensive	A ₁	: 4/7cm to 14/16cm;	Lighter coloured clay soil
A ₁	: 1.5cm to 14/16cm;	Dark clay loam	A ₂	: ABSENT	
A ₂	: ABSENT		A ₃ + B ₁	: 14/16cm to 25/30cm;	Transitional
A ₃ + B ₁	: 14/16cm to 20/22cm;	Transitional	B ₂	: 25/30cm + ;	Heavily gleyed Boulder clay
B ₂	: 20/22cm +	Gleyed Boulder clay			
BIRCH COVER			BIRCH COVER		
<u>DRYOPTERIS/RUBUS TYPE</u>			<u>PTERIDIUM TYPE</u>		
O ₁ or L	: 0 to 0/1.5cm;	depth varies according to season. Plant debris.	O ₁	: 0 to 4cm;	Dead fronds of Pteridium
O ₂ (F+H)	: 0/1.5cm to 1.5cm;	Variable depth, never extensive	O ₂	: 4cm to 9/12cm;	Slowly decomposing fronds
A ₁	: 1.5cm to 14/16cm;	Lighter coloured clay soil	A ₁	: ABSENT	
A ₂	: ABSENT		A ₂	: ABSENT	
A ₃ + B ₁	: 14/16cm to 20/22cm;	Transitional	A ₃ + B ₁	: ABSENT	
B ₂	: 20/22cm + ;	Gleyed Boulder clay	B ₂	: 9/12cm + ;	Heavily gleyed Boulder clay

was made by P.J. Bolton (1969) with whom the soil profile studies were carried out.

The Forest Floor (Ovington 1954) was rather complex, being composed of the decaying remains of the various parts of several dozen plant species. As in a mull, the tree leaf litter disappeared almost completely within one year. As in a ~~mor~~, the dead parts of several species, and fallen wood, persisted for several years. Whilst somewhat patchy, the forest floor could be described as a mor, consisting of a dense carpet of plant remains. There was a more or less marked boundary between the organic material and the mineral soil. This boundary was intermittently interrupted by mull-like patches, where an intricate mixture of humus and mineral soil was observed, but such patches were neither common nor extensive.

Samples of the Forest Floor from each soil type were taken to the laboratory so that the pH determinations might be made. The measurements were made on a pulp consisting of 100gms. Forest Floor material and 50mls distilled water. Ten replicates were used for each soil ^{kind} type. Table II shows the mean pH \pm 1 SE, for each soil ^{kind} type. The Forest Floor under 'Pteridium' was most acid; under the predominant 'Dryopteris/Rubus' type throughout the grid it was only slightly less acid, and under grass cover it was markedly less acid.

II.3 Climate

Complete meteorological records were not available for

TABLE II. FOREST FLOOR pHs

<u>FOREST FLOOR TYPE</u>	<u>Means of 10 pH detns. \pm 1 S.E.</u>
1. DRY OPTERIS/RUBUS (ALDER COVER)	4.70 \pm 0.04
2. DRYOPTERIS/RUBUS (BIRCH COVER)	4.75 \pm 0.02
3. GRASSY (ALDER COVER)	5.00 \pm 0.06
4. GRASSY (BIRCH COVER)	5.50 \pm 0.05
5. PTERIDIUM (BIRCH COVER)	4.50 \pm 0.05

the Study Area. However, measurements of incident short-wave radiation were made from 1st May 1967 to 1st May 1968 and these are described in Section X. Rainfall records kept by the Hartlepool Water Company at the Crookfoot Reservoir 2km distant from Wynyard were used to supplement the more complete records kept by the Durham University Observatory. The Durham University Observatory is 102.4m (336ft) above O.D.; the rain gauge at Crookfoot 89.3m (293ft) above O.D.; and the Study Area 67.1m (220ft) above O.D. Table III summarizes the meteorological data for 1966 and 1967 and compares them with the long term averages. These averages of temperature, rainfall and sunshine refer to the standard period 1906-1935. Average wind speeds are for 1938-1947. Figures show mean temperature, sunshine and rainfall at Durham in 1966 and 1967 (after DUO Daily Meteorological Observations, 1966 and 1967).

The climate of central and southeastern County Durham is much as one would expect in the cool temperate zone. The region lies to the east of the Pennines, so that rainfall at Durham and Crookfoot is relatively low. The two stations showed similar rainfalls and extreme conditions rarely occur; it thus seems reasonable to assume that even the fluctuations in conditions noted at the meteorological stations will be less marked within the woodland vegetation of the Study Area.

TABLE III. SUMMARY OF METEOROLOGICAL DATA FOR THE YEARS 1966 & 1967 COMPARED WITH AVERAGE

	Durham University Observatory		Crookfoot Reservoir	
	1966	1967 Av.	1966	1967 Av.
<u>Temperature (°C)</u>				
Mean daily maximum	11.7	12.4	-	-
Mean daily minimum	4.7	4.8	-	-
Mean	8.1	8.6	-	-
No. of ground frosts	128	95	-	-
<u>Rainfall (inches)</u>				
Annual total	30.04	28.26	31.85	24.90
No. of rain days	212	184	221	197
No. of days with snow lying at 0900hrs	33	9	-	-
<u>Sunshine (hrs)</u>				
Total for year	1124.3	1371.1	-	-
Mean daily amount	3.08	3.76	-	-
No. of days with no recorded sunshine	93	61	-	-
<u>Wind (m.p.h.)</u>				
Mean wind speed	9.7	10.6	-	-

Figure 2.

Mean temperature, sunshine and rainfall at Durham, 1966.
(After DUO Daily Meteorological Observations)

Mean Temperature, Sunshine and Rainfall Durham, 1966

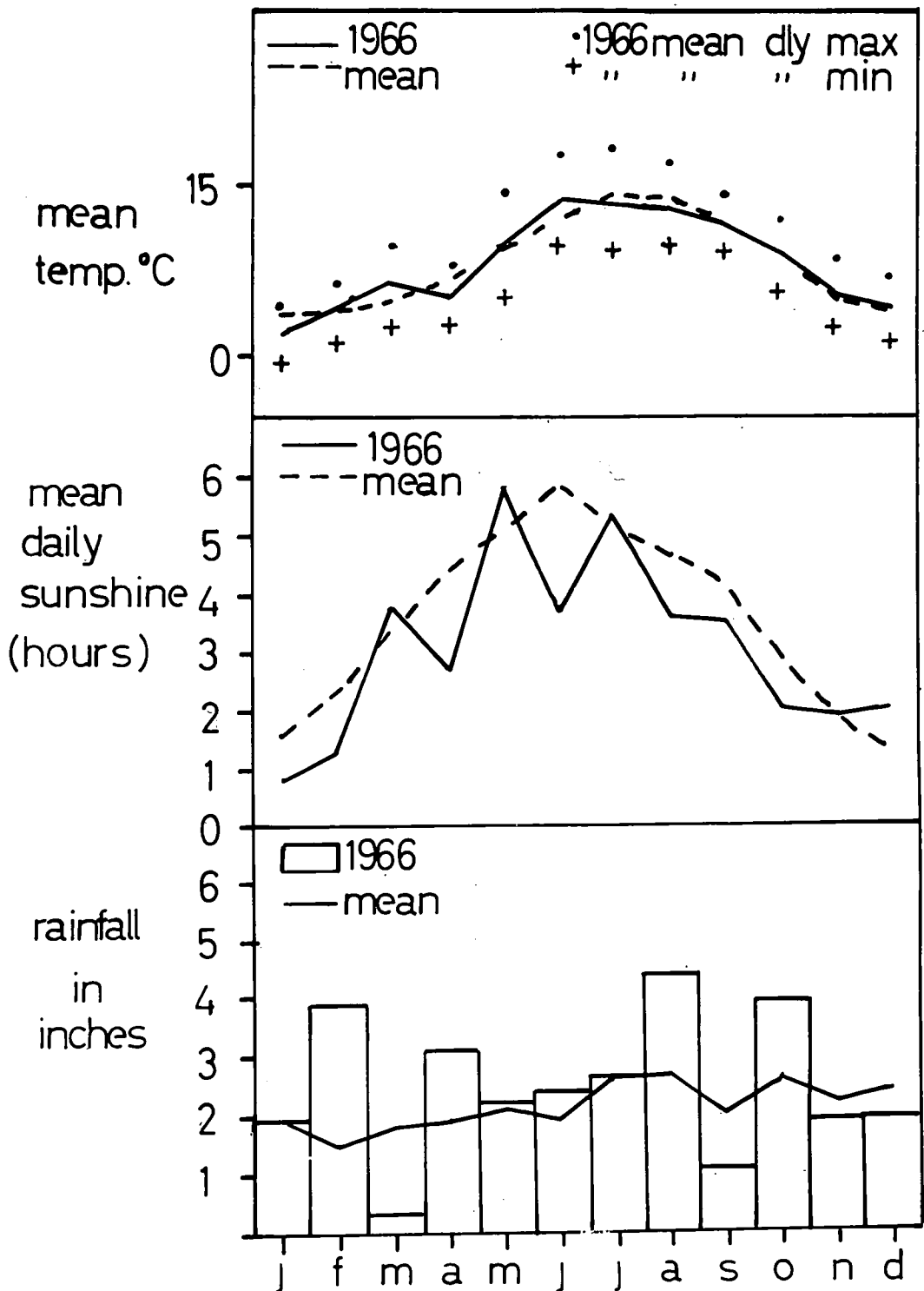
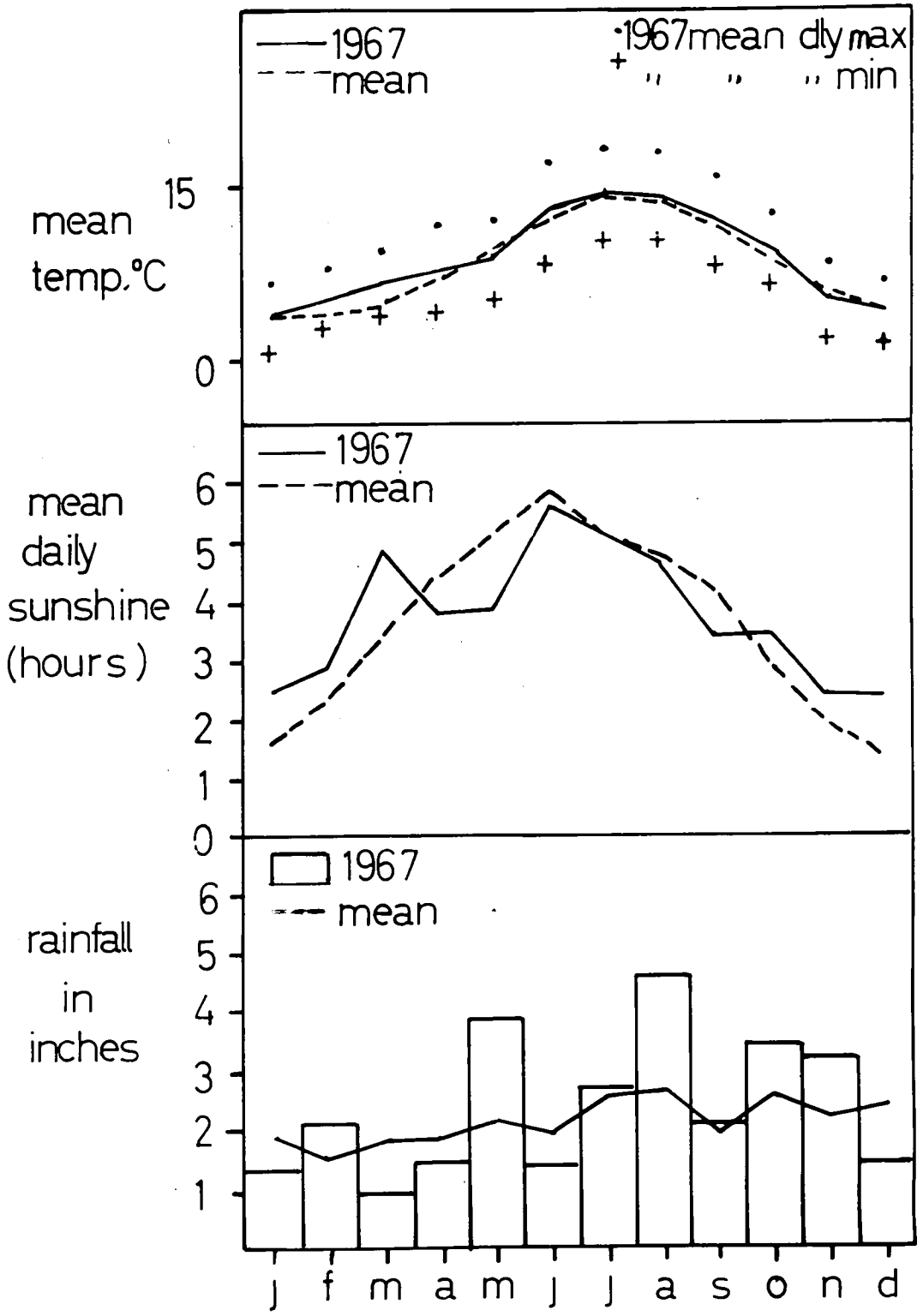

Figure 3.

Mean temperature, sunshine and rainfall at Durham, 1967.
(After DUO Daily Meteorological Observations)

Mean Temperature, Sunshine and Rainfall Durham, 1967



More detailed observations of the soil and forest floor temperatures were made by P.J. Bolton and S. Wignarajah respectively.

II.4 Vegetation

The vegetation in the Study Area could be called loosely an alder/birch wood. That is, the most numerous tree species were Alnus glutinosa (L) Gaetn. and Betula pendula Roth., Acer pseudoplatanus L. was present in small numbers. The Understorey consisted of widely dispersed young B.pendula Roth., Crataegus monogyna Jacq, Sambucus nigra L., Rosa canina agg. and Quercus robur L.. The field and ground layers, or Ground Vegetation as termed in this work, contained many more species than the upper strata. On inspection, the most important plants according to cover/abundance criteria were Dryopteris filix-mas (L) Scop. Rubus fruticosus L., sensu lato, Chamaenerion angustifolium (L) Scop. and several grass species. Also present were a variety of woodland herbs, including Mercurialis perennis L., Viola riviniana Rchb and Ciraea lutetiana L..

The Ground Vegetation was very well developed and constituted an important physiognomic characteristic of the woodland.

The detailed description of the vegetation of the Grid was carried out in two steps. Firstly, the tree species were enumerated and the diameter of the trunk at 1.3m above ground (d.b.h.) was measured for each tree where d.b.h. was greater than 2cm.

Secondly, cover/abundance estimates were made for the Understorey and Ground Vegetation species in each of the eight 20 x 20 metres squares. The species were listed according to their life-form.

Fig.4 shows the frequency distribution of the d.b.h.

of

a) Non-coppiced stems

b) Coppiced stems, for the 281 Alder stems on the Grid. 116

arose from 43 coppiced stools. Fig.5 shows similar data for

Birch. Of the 226 Birch stems on the grid, 77 arose from

32 coppiced stools. The most striking feature of the Alder data

was the wide range of diameters in this woodland. Alder normally

grows in even-aged stands; therefore a narrow diameter distribution

could reasonably be expected. In Section IV, data on the relation-

ship between tree diameter and age are presented; these data cast

further light on the recent history of the tree populations.

From the relatively wide range of diameter data it may be deduced

that the coppicing of the population of alder led to regeneration

at several times in the life of the oldest trees. The opening

up of the alder canopy in the Study Area by coppicing is considered

a necessary precondition of alder regeneration. The wide diameter-

distribution for birch was not so noteworthy as it is already known

that :-

1) even-aged birch trees may have widely different d.b.h's.

2) birch regenerates well, within birch woods, which provide an open canopy for this light-requiring species.

Figure 4.

Frequency distribution of alder diameter by 2 cm. classes.

Upper - coppiced shoots.

Lower - uncoppiced shoots.

DIAMETER DISTRIBUTION OF ALDER

NO.
TREES

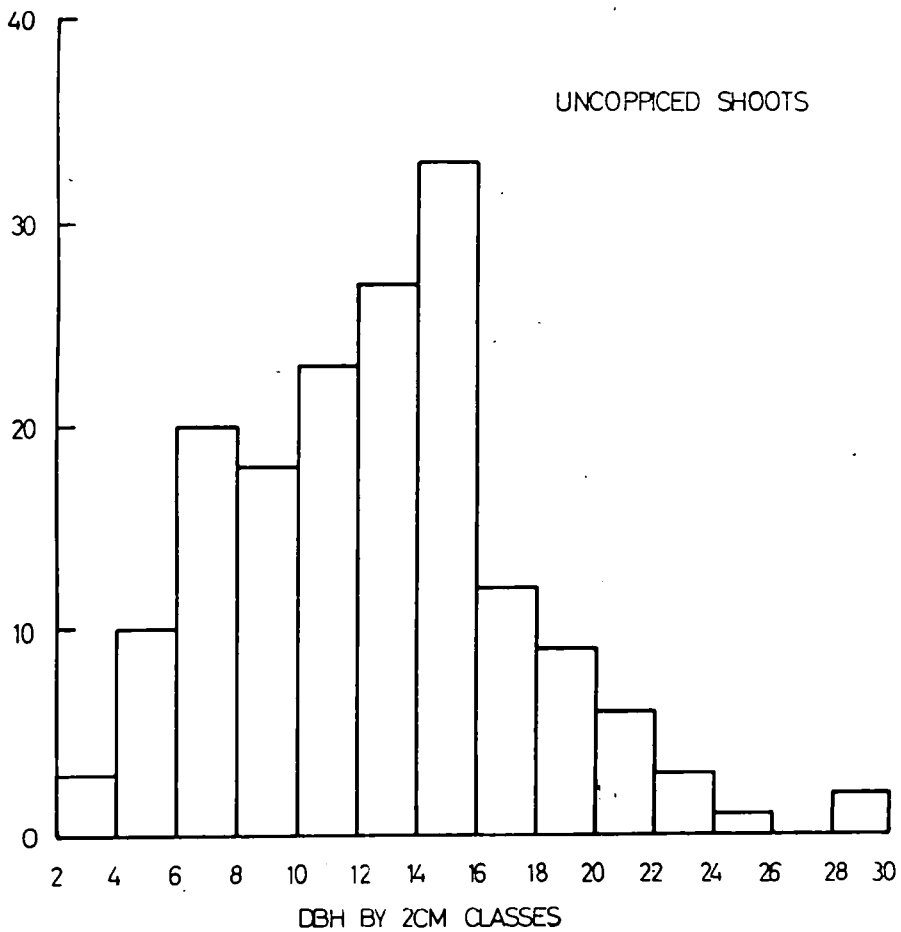

Figure 5.

Frequency distribution of birch diameter by 2 cm. classes.

Upper - coppiced shoots.

Lower - uncoppiced shoots.

DIAMETER DISTRIBUTION OF BIRCH

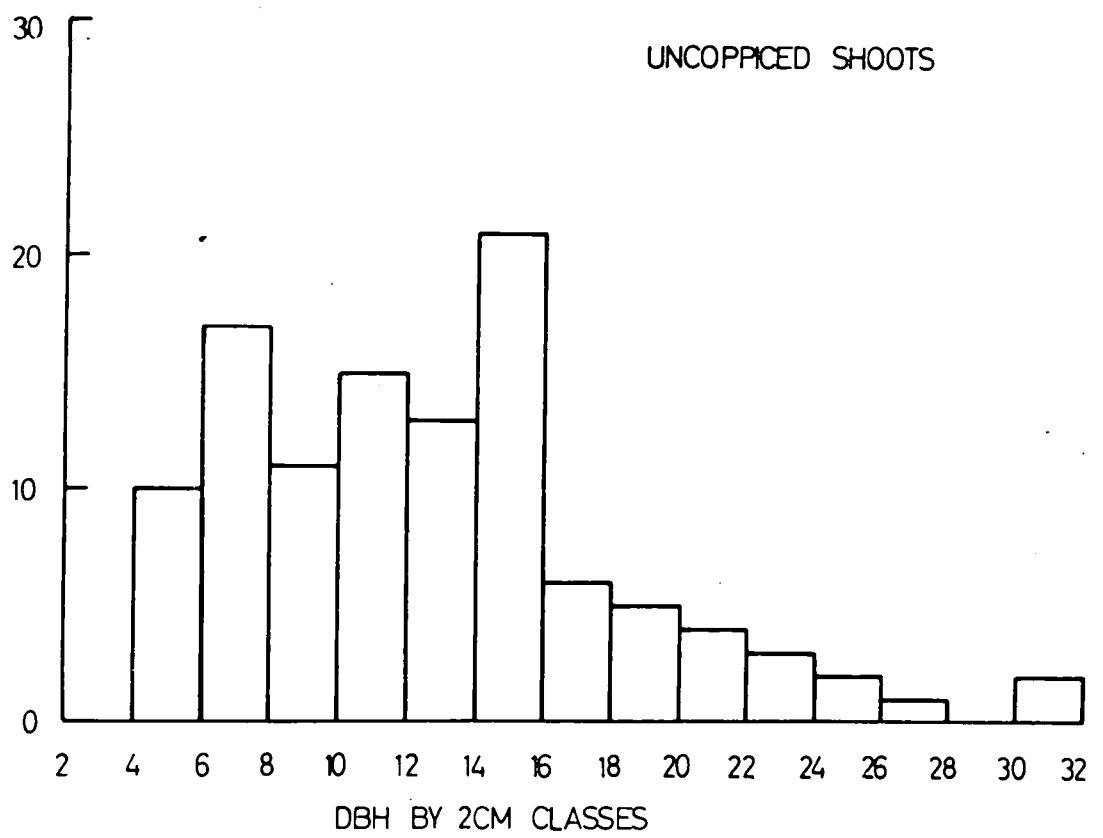
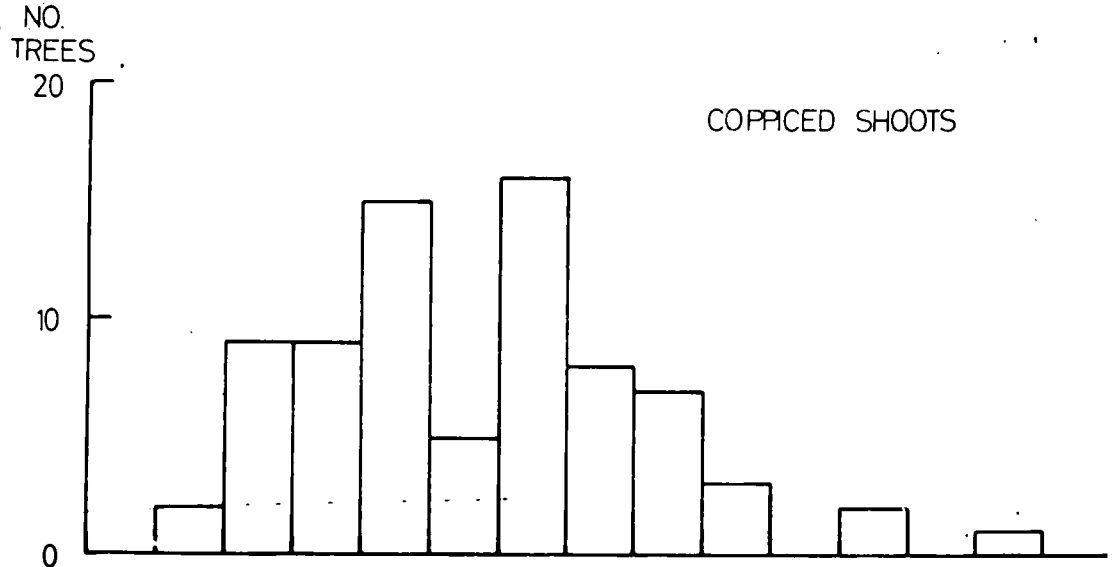

Figure 6.

Alder shoots per 10m² on the Grid. In each square the upper number is total shoots, the number in brackets coppiced shoots.

Figure 7.

Birch shoots per 10m² on the Grid. In each square the upper number is total shoots, the number in brackets coppiced shoots.

ALDER - SHOOTS/10M²

-	-	-	10 (10)	-	4 (2)
13 (11)	10 (9)	10 (8)	-	-	-
18 (5)	29 (8)	7 (2)	2 (0)	3 (3)	-
18 (2)	26 (8)	17 (12)	21 (12)	8 (2)	-
10 (2)	20 (5)	13 (8)	8 (2)		
7 (2)	15 (4)	12 (2)	11 (4)		

BIRCH - SHOOTS/10M²

7 (2)	11 (0)	8 (3)	14 (8)	4 (2)	20 (16)
6 (2)	7 (2)	6 (2)	9 (0)	21 (7)	17 (11)
1 (0)	1 (0)	11 (8)	13 (10)	5 (2)	4 (0)
-	1 (0)	2 (0)	2 (0)	4 (2)	4 (0)
-	2 (0)	5 (3)	4 (0)		
-	-	-	-		

Figure 8.

The division of the Grid into Alder and Birch Zones.

NEWTON HANZARD GRID
ZONE BOUNDARY

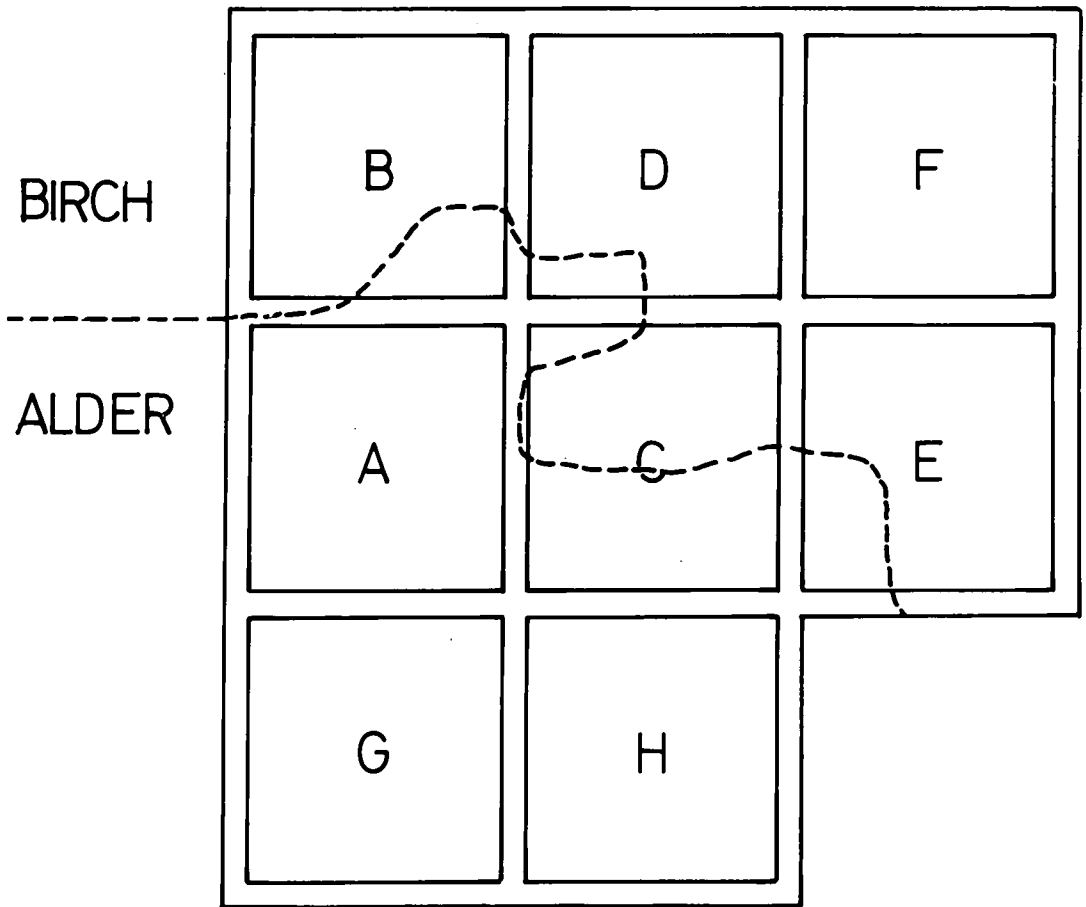

Figures 6 and 7 show the numbers of alder and birch stems respectively in the 32 10 x 10m squares which made up the Grid. In A, C, G and H, alder was most numerous, whereas in B, D, F, and E, birch was most numerous. Throughout the Grid the canopy rose to about 12m. In the predominantly alder areas it was almost completely closed. In the predominantly birch areas it was much more open. On the whole Grid there were 281 Alder stems, 226 Birch stems and 8 Sycamore stems. Thus the tree density on the Grid was 1609 trees/ha.

Figs. 6 and 7 show that the Grid was divided into two areas, the Birch Zone and the Alder Zone. Birch was generally more important to the northeast of the Grid, Alder to the southeast of the Grid. Both species were present throughout the Study Area in almost equal numbers, but in the Grid a fairly clear pattern emerged. The Grid was mapped into Alder and Birch Zones on the basis of tree distributions and physiognomic changes in the Ground Vegetation (Fig.8). The winter and summer aspects of the birch and alder zones are shown in Fig.9 and 10.

Table IV shows Braun-Blanquet cover/abundance estimates for Understorey and Ground Vegetation Species in each of the 20 x 20m squares in each zone. The species are listed according to Raunkaer's (1934) life-form classification as given by Clapham, Tutin & Warburg (1962). Leaving aside the mosses and leafy liverworts there were 21 Understorey and Ground Vegetation species in the Birch Zone, 20 in the Alder Zone; whilst 14 occurred

Figure 9.

The Alder Zone.

Upper - winter aspect.

Lower - summer aspect.



Figure 10.

The Birch Zone.

Upper - winter aspect.

Lower - summer aspect.



TABLE IV

KEY

Life-form Classifications (From CTW, Flora of the British Isles,
after Raunkaer)

Phanerophytes - woody plants with buds more than 25cm above soil level.

- MM - mega and mesophanerophytes - from 8m upwards
- M - microphanerophytes - 2 - 8m
- N - nannophanerophytes - 25cm - 2m

Chamaephytes (Ch) - woody or herbaceous plants with buds above the
soil surface but below 25cm.

- Chw - woody chamaephytes
- Chh - herbaceous "
- Chc - cushion plants

Hemicryptophytes (H) - herbs (very rarely woody plants) with buds
at soil level

- H_p - protohemicryptophytes - with uniformly leafy stems,
but the basal leaves usually smaller than the rest.
- H_s - semi-rosette hemicryptophytes - with leafy stems
but the lower leaves larger than the upper ones
and the basal internodes shortened.
- H_t - rosette hemicryptophytes, with leafless flowering
stems and a basal rosette of leaves

Geophytes (G) - herbs with buds below the soil surface

- Gb - with bulbs
- Gr - with buds on roots
- Grh - with rhizomes
- Grt - with root tubes
- Gt - with stem tubers and corms

Therophytes (Th) - annuals

CTW - Clapham, Tutin + Warburg (1962)

in both zones. Four moss and liverwort species were recorded in the Birch Zone and these and seven others occurred in the Alder Zone. There were more Phanerophyte individuals in the Understorey of the Birch Zone than of the Alder Zone. This was probably due in part to the open nature of the Birch canopy, but also to the falling out of Birch trees, making room for regeneration by other species.

Fig.11 shows the life-form spectrum of the flora of the Grid compared with those of a deciduous woodland in Germany and a Tropical Rain Forest in Guyana. The plants of the Rain Forest have their buds exposed, whereas those of the German and English Forests more often have protected renewal organs. The differences between the Birch and Alder Zones are attributable to the canopy structure of the two species. What was remarkable was the relative lack of Geophytes at Wynyard, when compared with the deciduous woodland in Germany. This was probably due in large part to the high water table in the Study Area.

II.5 History of the Study Area

So far as can be discovered, no trees have been planted in the Study Area. Both alder and birch were common on the Wynyard Estate and probably 'drifted' into the Study Area without human interference. The presence of alder suggests that the area was open or clear-felled quite recently (within, say, 100 years). Alder does not usually regenerate itself, but coppicing and some

Figure 11.

Life-form spectra of the flora of the Grid compared with a rainforest in Guyana and a deciduous forest in Germany (Richards 1952).

Key: E - Epiphytes.
P - Phanerophytes.
C - Chamaephytes.
H - Hemi-cryptophytes.
G - Geophytes.
T - Therophytes.

The figures against each life-form give the percentage of the flora it represents.

LIFE-FORM SPECTRA

ALDER ZONE, WYNYARD

BIRCH ZONE, WYNYARD

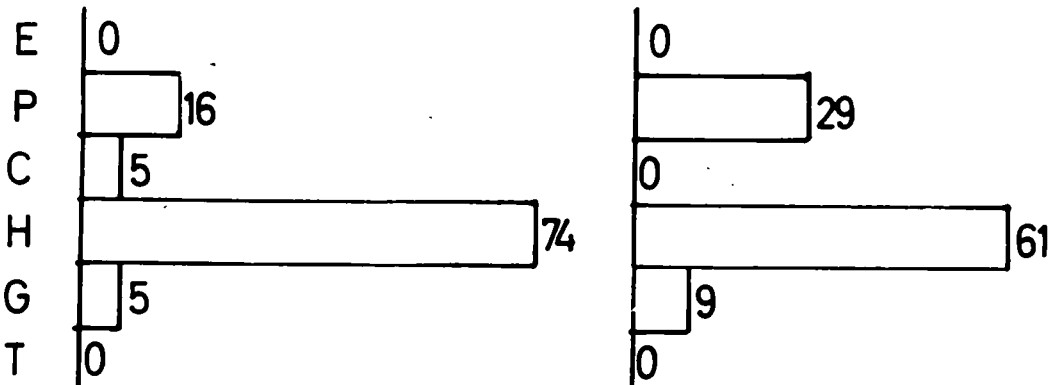

RAIN FOREST, GUYANA

GRID, WYNYARD

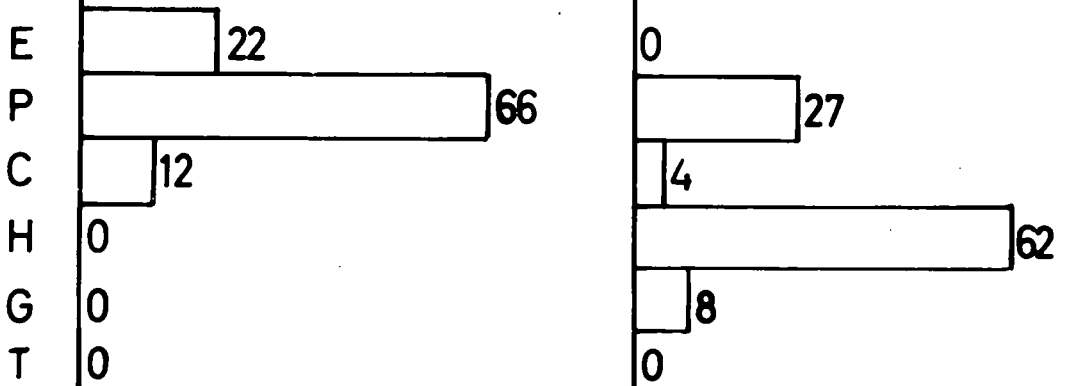

DECIDUOUS WOODLAND, GERMANY

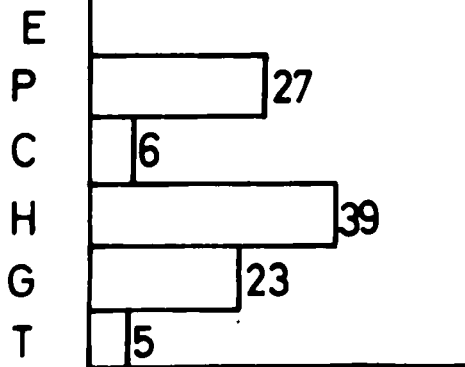

thinning has made this possible by opening up the canopy. The ubiquitous birch probably drifted in at various times. One very large birch (d.b.h. 32.5cm) was found in the southern part of the Study Area and as it was dead, it was felled. Ring counts put its age at at least 110 years and it had probably been dead for 10 years. The birch was generally, though not exclusively, found in the drier parts of the Study Area.

The data on tree population age-structure are presented and discussed in Section IV.

Since 1952, when the Forestry Commission took over the management of the Study Area, it has remained untouched. Thus the Ground Vegetation is an untampered with response to the conditions existing in the alder/birch woodland.

Section III Calorific Determinations

III.1 Introduction

Determination of the calorific values of ecological materials has received considerable attention (Cummins 1967; Golley 1961; Hadley & Kieckhefer 1963; Ivlev 1934; Kieckhefer 1962; Newbould 1967; Paine 1964; Phillipson 1964; Scott 1965; Slobodkin & Richman 1960; Teal 1957; Ovington 1961; Ovington & Lawrence 1967). Many authors determined calorific values in the course of ecological studies, but few made a critical assessment of the validity of using such values in ecological work. Scott (1965) pointed out that what is measured in these determinations is Heat of Combustion, the relevance of which to biology is that it represents the maximum energy which could be realised if the material were completely degraded by another organism. It gives a good estimate of the energy available in a non-conservative growth reaction. It is not a strictly accurate estimate, as it is derived under conditions of constant volume and temperature in an oxygen bomb calorimeter is used, whereas biological reactions take place at approximately constant pressures and temperatures.

In studies of the trophic energetics of ecosystems, or ecosystem components, the calorific content of materials, along with dry matter data, may be used to investigate the accumulation of energy at loci in the trophic matrix and the transfer of energy between such loci. This is the main use made of calorific values in this study.

Cummins (1967) pointed out the narrow range of calorific values possible for living material and within this range documented the variation in calorific values both within and between species dependent on season of collection, reproductive condition, and other factors. The errors involved in dry matter determinations of the kind outlined in I.2 are often large. It has been argued (Newbould 1967) that it may be most realistic to use a median calorific value, for example for plant material. In studies where an overall estimate of, for example, energy accumulation is required, this may be an adequate approach. However, if the study of energy transfer between 'Trophic levels' is envisaged, or if some indication of the phenology of energy transfer is required, it is clear that calorific determinations should be carried out on the relevant ecosystem components at all appropriate times.

In this study per gram dry weight calorific values (referred to below as Gross Calorific values) are used for the conversion of dry weight data to energy data; per gram ash-free dry weight data (referred to below as Ash-Free Calorific Values) are used for the comparison of materials from various ecological positions and taxa, and the tracing of the phenology of certain energy transfers, both within and between ecosystem components.

III.2 Collection and preparation of materials

The materials used in calorific determinations were collected in the course of the dry-weight determinations described

in later chapters. The principles applied in the choice of materials were as follows. Firstly, in the case of materials where there was a high standing crop and a good chance of seasonal changes in calorific value, samples were taken at intervals during the season (alder and birch canopy leaves, falling leaves, forest floor litter and the more important ground vegetation species). Those materials not important in terms of dry matter accumulation or transfer were dealt with only once (i.e. other trees, bryophytes, forbs and minor litter components). The most persistent materials were dealt with only once as no great seasonal change in calorific values was expected (i.e. bole and branch materials). Litter materials with a long residence time were analysed on only one or two occasions (fern, grass and bramble litter). As the Ground Vegetation litter of previous years comprised a large part of these latter materials no marked seasonal changes in calorific values were expected.

After collection the bryophyte material was dried for 24 hours at 85°C; the woody material was dried at 105°C to constant weight; the other materials were dried for 24 hours at 105°C. The lower temperature was used for bryophytes so as to reduce the loss of, for example, lipids which form a greater part of their weight than for other plants. The dry material was milled to a fine powder in a Wiley mill and passed

through a 40 mesh-to-the-inch sieve. After thorough mixing the plant powder was stored in a desiccator until required for analysis. It was then dried for a further 24 hours at the appropriate temperature and cooled in a desiccator. Three pellets were made for each material, each weighing approximately one gramme

Each pellet was burned in a Gallenkamp Adiabatic Bomb Calorimeter. The procedure followed was as detailed in the manual for the Gallenkamp Adiabatic Bomb Calorimeter, excepting that after combustion the crucible and its contents were dried and weighed. Thus the proportion of the material that was incombustible was calculated. This is presented below as % ash and should be viewed with some caution, for this method of ash determination does not have the accuracy of the muffle furnace method. For any one material three replicates were usually sufficient to give consistent gross and ash-free calorific values.

III.3 Results

The results are listed according to the category of plant material rather than according to the subsequent chapters in which they are used.

Tree material - Alder

Table V shows the gross calorific value, % ash and ash-free calorific value of the various alder materials according to plant part, method of collection, and time of collection.

TABLE V. CALORIFIC VALUES FOR ALDER MATERIAL (\pm 1 S.D.)

	Gross calorific value	% Ash	Ash-free calorific value
<u>BOLE</u>			
<u>TREE HARVEST</u>			
<u>SPRING 1968</u>	4540 \pm 20	0.5	4565 \pm 46
<u>BRANCH</u>			
<u>TREE HARVEST</u>			
<u>SPRING 1968</u>	5005 \pm 22	1.1	5062 \pm 34
<u>LEAVES</u>			
<u>DEFOL. STUDY</u>			
29. 5.67	5228 \pm 23	4.2	5635 \pm 45
29. 6.67	5179 \pm 18	4.5	5423 \pm 32
3. 8.67	4951 \pm 19	3.7	5141 \pm 27
17.10.66	4874 \pm 18	4.7	5092 \pm 22
<u>LEAVES, GREEN</u>			
<u>LITTER TRAPS</u>			
5. 8.66	4877 \pm 18	4.2	5090 \pm 37
17.10.66	4840 \pm 17	4.8	5088 \pm 33
7.11.66	4716 \pm 14	3.6	5052 \pm 24
<u>LEAVES, BROWN</u>			
<u>LITTER TRAPS</u>			
19. 9.66	4923 \pm 19	4.3	5145 \pm 32
17.10.66	5056 \pm 21	0.5	5323 \pm 25
7.11.66	5133 \pm 23	3.7	5333 \pm 40
17.11.66	5080 \pm 19	3.4	5261 \pm 19
<u>LITTER</u>			
<u>LEAVES S/C</u>			
Oct. 66	4874 \pm 25	5.8	5174 \pm 31
Dec. 66	4590 \pm 18	8.0	4991 \pm 27
Feb. 67	4900 \pm 19	6.3	5229 \pm 22
May 67	4676 \pm 19	8.5	5111 \pm 23
<u>SCALES</u>			
<u>LITTER TRAPS</u>			
	6096 \pm 27	3.2	6296 \pm 30
<u>CONES</u>			
<u>LITTER TRAPS</u>			
8.11.66	5479 \pm 22	1.9	5585 \pm 25

Figure 12.

Seasonal changes in ash-free calorific values of alder leaves.

Key: open circles - canopy leaves.
closed circles - falling leaves - brown.
plus signs - falling leaves - green.
crosses - forest floor litter.

95% confidence limits are shown.

ASH-FREE CALORIFIC VALUES OF ALDER LEAVES

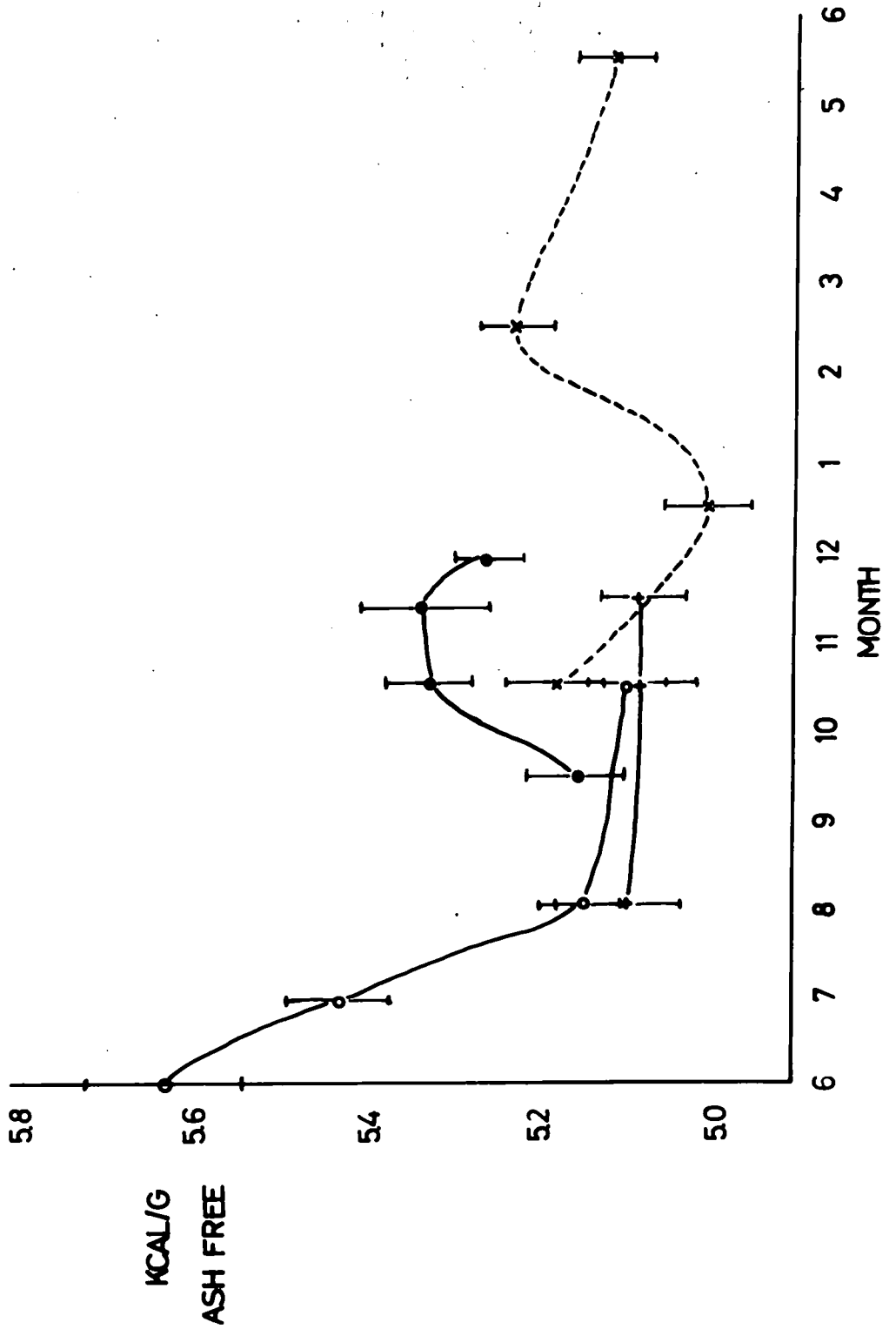

Each value is accompanied by one standard deviation. The branch wood had a markedly higher calorific value than the bole. This had the effect of increasing the relative importance of the branches as an energy store. The reproductive structures and scales also had high calorific values; this can be explained by their high lipid content. Fig.12 shows the seasonal changes in ash-free calorific value of alder leaves. The most dramatic change was the decrease in calorific value of the leaves on the canopy through the season. Morrison (1949) reported that in many plants the percentage of crude protein in the green foliage decreased, that of crude fibre (largely carbohydrate) and nitrogen-free extract increased, while that of ether extract (partly fat) remained constant throughout the growing season. Hence the calorific value of the foliage should be higher in the spring than in the autumn. This was clearly the case.

The ash-free calorific value of those leaves which fell green corresponded closely to that of those remaining in the canopy. However, at the time of maximum leaf-fall (October - November), the calorific value of brown leaves falling was considerably higher than that of leaves remaining in the canopy. That is, the processes associated with abscission brought with them an increase in the calorific value of leaf material.

Once on the ground (forest floor litter, collected during S/C determinations) the ash-free calorific value of the leaves at first decreased and then increased during January and

February. As the complex processes of leaching and decomposition are not well understood it would be rash to hazard any detailed explanation here. It may be suggested that the first decrease was due to the normal processes of microbial decomposition but that the low temperatures in December, January and February slowed these down. During this period the selective loss of low energy compounds by leaching became more important so that the ash-free calorific value increased. In the late spring the balance was reversed and the calorific value again fell.

Tree material - Birch

Values are presented in Table VI.

As in Alder the calorific value (both gross and ash-free) of the branch wood was higher than that of the bole wood. Both the scales and reproductive structures had lower calorific values than in the alder. Fig.13 shows the seasonal changes in ash-free calorific value of birch leaves. The pattern was similar to that for alder, although the general level of calorific values was lower. The most obvious difference from the alder was the higher ash-free calorific value of both brown and green falling leaves as compared with those remaining in the canopy. As will be shown in Section V, leaves falling green were much less important to litter fall in birch than in alder.

Tree material - Other

The other tree species were not important in dry matter accumulation in the Study Area and in general a value

TABLE VI. CALORIFIC VALUES FOR BIRCH MATERIAL (± 1 S.D.)

		Gross calorific value g.cals/g.	% Ash	Ash-free calorific value g.cals/g.
Bole, tree harvest, Nov.67	4723	± 15	0.8	4810 ± 50
Branch, " "	5144	± 19	1.2	5211 ± 30
Canopy leaves Defol. Study				
29. 5.67	5002	± 19	4.2	5217 ± 59
5. 6.67	4715	± 54	4.0	4906 ± 78
17. 8.66	4477	± 25	3.3	4632 ± 21
27.10.66	4475	± 25	3.9	4654 ± 15
Falling leaves - green - litter traps				
10. 7.67	4997	± 4	3.5	5177 ± 5
5. 8.67	5168	± 8	2.7	5312 ± 7
Falling leaves - brown - litter traps				
10. 7.67	5255	± 2	2.5	5389 ± 5
18. 8.67	5231	± 42	2.4	5369 ± 25
25. 9.67	5177	± 45	3.4	5366 ± 30
17.10.67	5112	± 20	3.2	5289 ± 11
17.11.67	5029	± 4	3.2	5178 ± 4
Forest floor litter S/C:				
10.66	4693	± 19	6.2	5010 ± 12
12.66	4531	± 6	5.9	4814 ± 25
2.67	4809	± 8	3.5	4986 ± 2
4.67	4793	± 31	6.4	5137 ± 72
8.67	4776	± 7	6.4	5097 ± 7
Scales - litter traps				
12/66 - 1.67	5247	± 2	3.2	5426 ± 2
10. 6.67	4847	± 2	5.4	5127 ± 21
Reproductive Structures	10. 6.67	5072 ± 11	3.2	5240 ± 6

Figure 13.

Seasonal changes in ash-free calorific values of birch leaves.

Key: open circles - canopy leaves.

closed circles - falling leaves - brown.

plus signs - falling leaves - green.

crosses - forest floor litter.

95% confidence limits are shown.

ASH-FREE CALORIFIC VALUES OF A BIRCH LEAVES

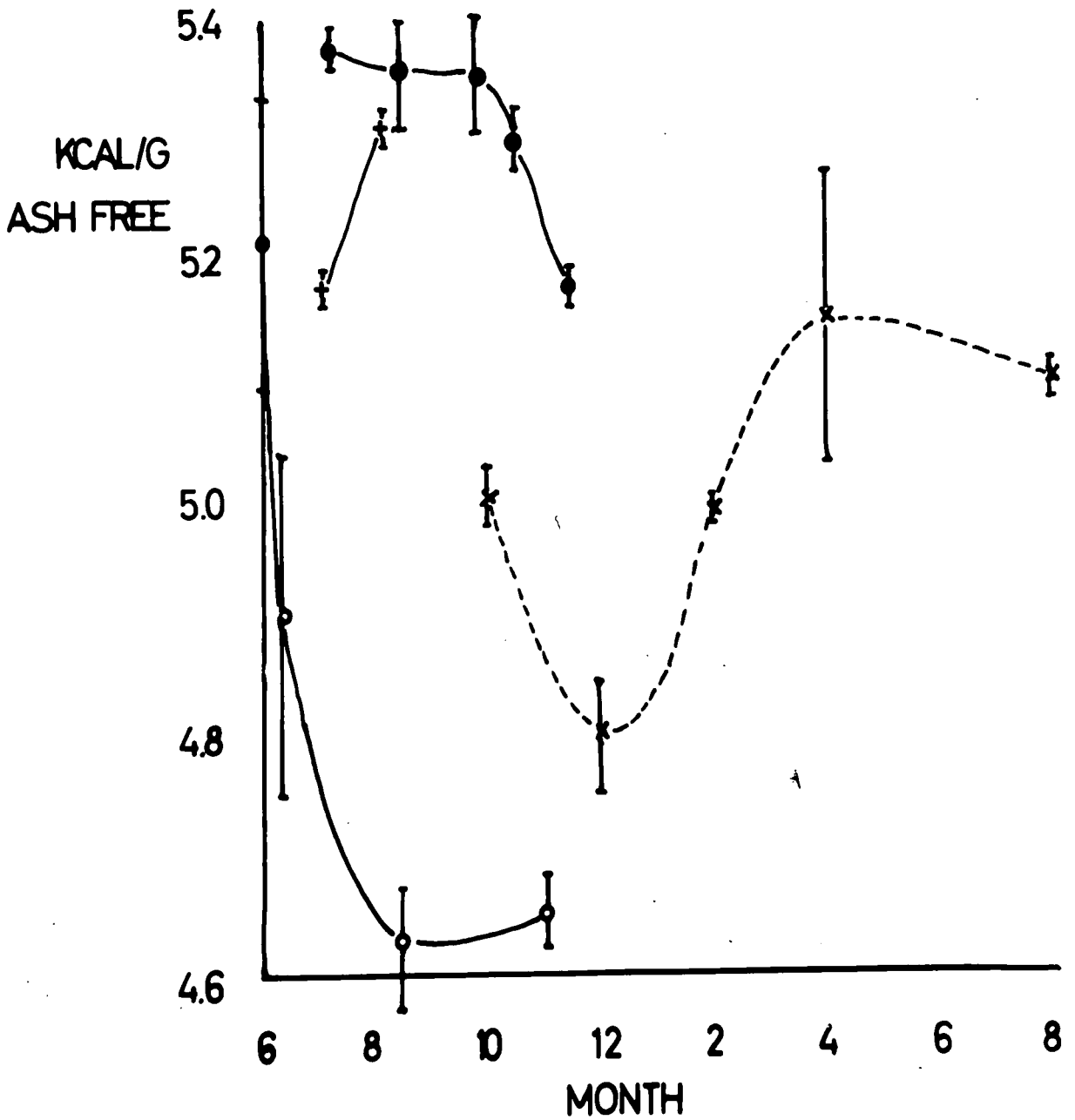

of 4.700Kcal/g dry weight was used (Newbould 1967). However, a calorific value for falling leaves was determined. This was 4.471Kcals/g dry weight, 3.8% ash, and therefore 4.649Kcals/g ash-free dry weight.

Ground Vegetation Material - Ferns

Table VII gives the calorific and ash data for fern materials. The gross calorific values of both live and dead fern material fell within the range 3.951 to 4.317Kcals/g. This range was lower than that for canopy leaves.

Fig.14 shows the seasonal changes in ash-free calorific value of live Dryopteris filix-mas and fern litter. The May sample consisted of young shoots, only partially extended. By June the fronds had opened out and the plant was probably growing by using the current year's photosynthate rather than drawing on the subterranean energy store. The highest ash-free calorific value was reached in August. Thereafter it decreased during die-back and the downward transfer of energy to the subterranean energy store. The summer and winter ash-free calorific values for fern litter were very similar and were considerably higher than the values for live fern material. This was thought to be the result of differential loss of low-energy compounds from the litter by leaching.

Ground Vegetation material - Rubus agg.

Table VIII gives the calorific and ash data for Rubus materials. The gross calorific values of both live and

TABLE VII CALORIFIC VALUES FOR FERN MATERIAL (\pm 1 S.D.)

		Gross CV gcals/g.	% Ash	Ash-free CV gcals/g.
Dryopteris filix-mas, live, S/C	5.67	3951 \pm 12	4.8	4158 \pm 12
	6.67	4001 \pm 8	6.7	4344 \pm 13
	8.67	4317 \pm 1	4.6	4517 \pm 20
	10.67	4036 \pm 13	7.0	4342 \pm 12
Fern Litter, S/C	1.67	3963 \pm 42	16.6	4755 \pm 49
	7.67	4130 \pm 7	13.4	4772 \pm 44

TABLE VIII CALORIFIC VALUES FOR RUBUS AGG. MATERIAL (\pm 1 S.D.)

		Gross CV gcals/g.	% Ash	Ash-free CV gcals/g.
Rubus Agg., live, S/C	2.67	4089 \pm 10	3.7	4246 \pm 11
	5.67	4050 \pm 64	2.7	4170 \pm 69
	8.67	4322 \pm 82	1.3	4361 \pm 72
	10.67	4128 \pm 6	2.6	4245 \pm 16
Rubus Litter, S/C	7.67	4158 \pm 16	5.2	4387 \pm 18
	12.67	4285 \pm 6	4.8	4500 \pm 4

TABLE IX CALORIFIC VALUES FOR GRASS MATERIAL (\pm 1 S.D.)

		Gross CV gcals/g.	% Ash	Ash-free CV gcals/g.
Agrostis Tenuis, live, S/C	4.67	4266 \pm 6	4.6	4473 \pm 7
	8.67	3913 \pm 30	8.1	4260 \pm 65
Deschampsia caespitosa, live, S/C	6.67	4059 \pm 24	5.1	4278 \pm 28
Holcus spp., live, S/C	5.67	3955 \pm 9	7.8	4290 \pm 10
Holcus mollis, live, "	7.67	3899 \pm 8	8.6	4274 \pm 8
Holcus lanatus, " "	7.67	3496 \pm 6	20.0	4371 \pm 23
Grass Litter, S/C	5.67	4029 \pm 44	17.5	4555 \pm 10
	10.67	3813 \pm 3	14.4	4457 \pm 24

Figure 14.

Seasonal changes in ash-free calorific values of fern materials.

Key: Open circles - live Dryopteris filix-mas.
Crosses - fern litter.

ASH-FREE CALORIFIC VALUES OF
FERN MATERIAL

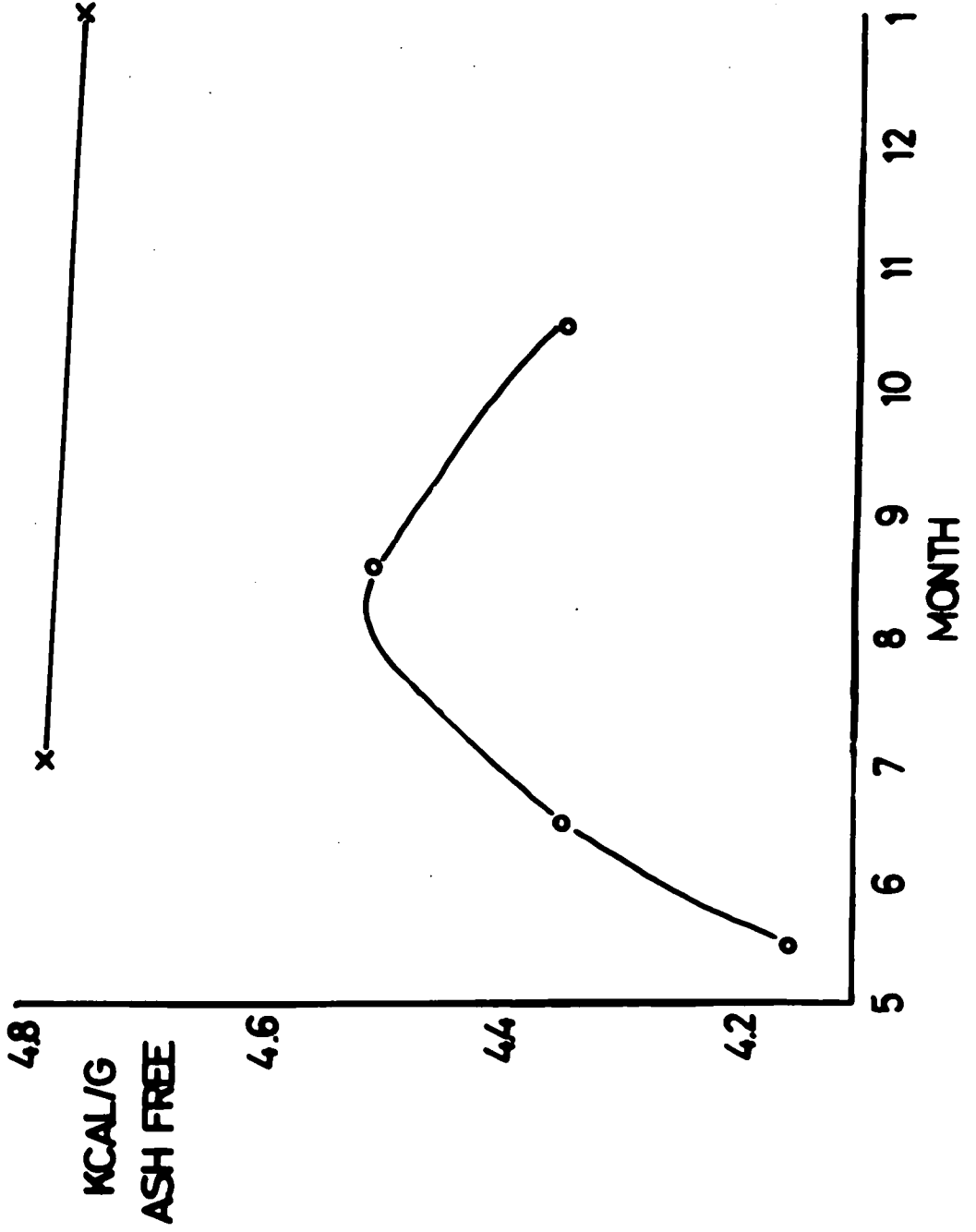

dead Rubus materials lay in the range 4.050 to 4.322Kcals/g dry weight, a range similar to that for ferns.

Fig.15 shows the seasonal changes in ash-free calorific values of live Rubus material and Rubus litter. The changes here were not as great as those in canopy or fern materials. The February and October values represent the overwintering material. The May value represents the early part of the growth season, and the August value shows a peak before die-back and transfer of energy to the roots. The total change represents less than 5% of the highest value.

The ash-free calorific values for Rubus litter were higher than those for live material. The newly-fallen litter in December had a slightly higher ash-free calorific value than that sampled in July. As in other materials, the first major loss was probably the leaching out of low-energy compounds, giving the litter its high calorific value.

Ground Vegetation material - Grasses

Table IX gives the calorific and ash data for grass materials. Apart from the high value for Agrostis tenuis in April and the low value for Holcus lanatus in July, all the gross calorific values live and dead fell within the range 3.813 to 4.059Kcal/g dry weight. This was lower than the ranges for canopy leaves, ferns and Rubus agg. materials.

The ash-free calorific values for live grasses fell between 4.260 and 4.473Kcal/g ash-free weight. In fact, only

Figure 15.

Seasonal changes in ash-free calorific values of Rubus material.

Key: open circles - live Rubus material.
crosses - Rubus litter.

ASH-FREE CALORIFIC VALUES OF
RUBUS MATERIAL

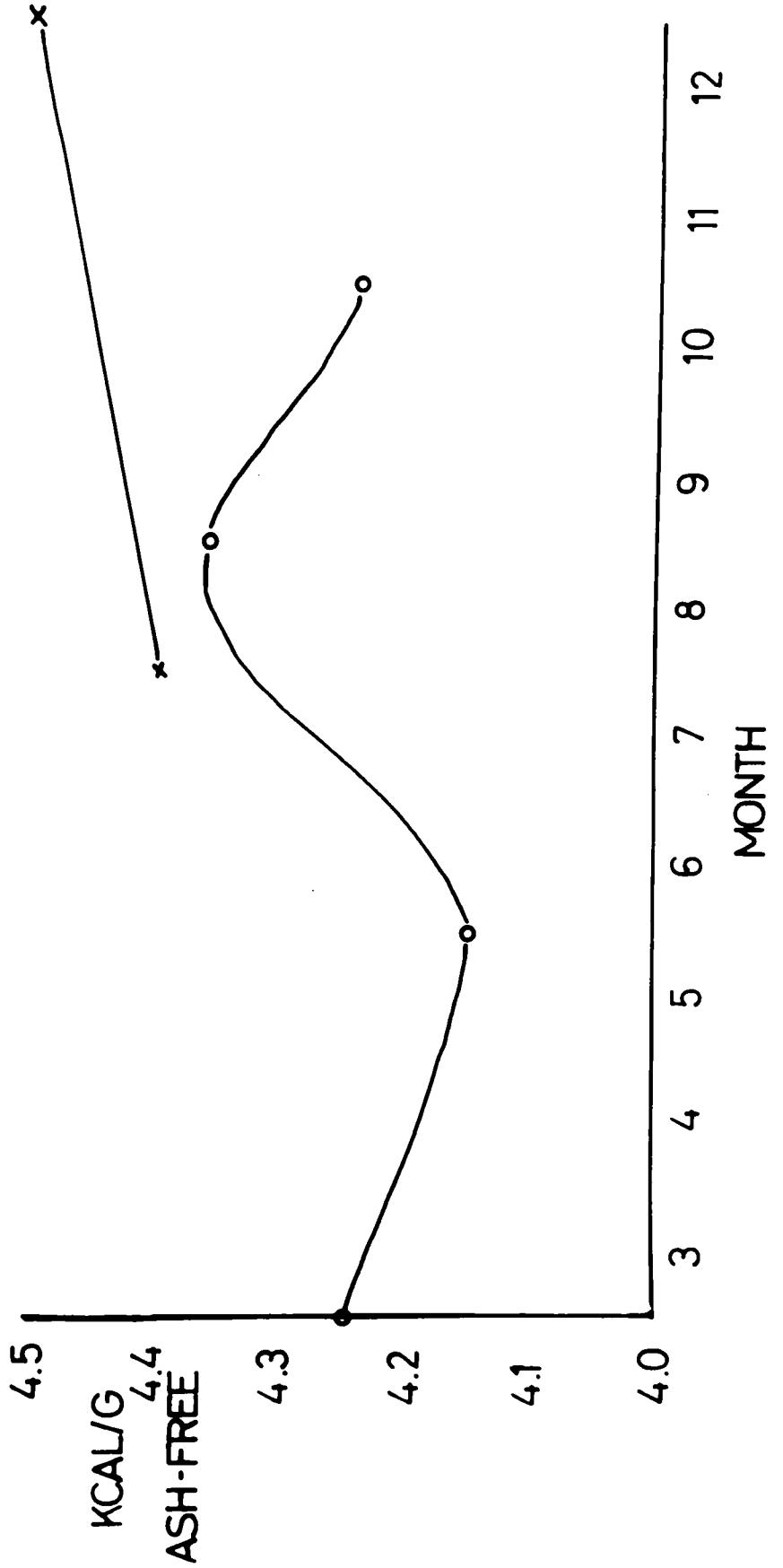

the April value for Agrostis tenuis and the July value for Agrostis tenuis fell outside the range 4.260 to 4.290Kcal/g ash-free dry weight.

The ash-free calorific values of grass litter, 4.457 and 4.555Kcal/g ash-free dry weight, were above the general range for live materials. The explanation of this is probably similar to that for other persistent litters.

Ground Vegetation materials and Bryophytes

Table X gives the calorific and ash data for the other Ground Vegetation Materials and the Bryophytes. The gross calorific values for Chamaenerion angustifolium and the forbs fell within the range of the other live ground vegetation materials. The gross calorific value of the Bryophytes was much lower.

This pattern was reversed in the case of the ash-free calorific values, where the Bryophyte value was higher than any given for live Ground Vegetation. This reversal was caused by the high ash-content of the Bryophyte powder and was probably the result of soil particles adhering to the Bryophyte material.

III.4 Discussion

The different gross calorific values determined for various species, plant parts and seasons suggest that it may be important to use a calorific equivalent for each of these categories rather than a single equivalent for them all, or even for a major group of them.

TABLE X CALORIFIC VALUES FOR OTHER GV CATEGORIES + BRYOPHYTES
(\pm 1 S.D.)

		Gross CV gcals/g.	% Ash	Ash-free CV gcals/g.
Chamaenerion angustifolium, live, S/C	1967	4245 \pm 8	2.3	4346 \pm 20
Forbs, live S/C	1967	3905 \pm 62	8.4	4277 \pm 22
Bryophytes	12.67	3507 \pm 31	26.6	4774 \pm 29

TABLE XI GENERAL RANGES OF CALORIFIC VALUES

	Gross CV gcals/g.	Ash-free CV gcals/g.
Canopy leaves	4475 - 5228	4632 - 5635
Wood	4540 - 5144	4565 - 5211
Live Ground Vegetation	3899 - 4322	4158 - 4517
Ground Vegetation Litter	3813 - 4285	4387 - 4772
Forest Floor Tree Litter	4513 - 4900	4814 - 5229
Falling Leaves	4716 - 5255	5088 - 5389

Table XI gives the overall ranges of the calorific values of the major groups of materials. If ash-free calorific values are considered, then the range for live Ground Vegetation was lower than any other. None of the tree material ranges overlapped it. The ranges of the other live categories, tree wood and canopy leaves, were progressively higher and wider.

Of the litter categories, the Ground Vegetation Litter range was the lowest, ranging through canopy forest floor litter to falling canopy litter.

Whilst generally characteristic of position in the woodland stratification and ecological position, these ranges are broad. Only calorific values appropriate to a particular category of material provide adequate calorific equivalents for the conversion of dry weight data to energy data. This is particularly evident in the case of falling birch litter; the use of the wrong equivalent (that for canopy leaves) could decrease the estimate of this important category's energy contribution to the litter by 12%. There seems little reason to add to the errors of dry weight estimation by this amount. The differences observed between the calorific values of the various materials will have the effect of emphasising the role of the trees as against the ground vegetation in energy accumulation and transfer.

CHAPTER II - SECTION IV

Tree Wood Biomass and Biomass Change

IV. i. Introduction

As reported in Chapter I, Section II, the tree stratum was physiognomically an important component of the vegetation of the Study Area. Much has been written on the influence of tree stratum on vegetation (Ovington 1968) but these general considerations are not of direct relevance to this study. The aim was to gain some understanding of the role of the trees in the woodland as an energy-fixing, - storing and - dissipating system. The approach that was adopted was to estimate biomass (and hence biocontent) and dry matter transfers (and hence trophic energy transfers) within the woodland ecosystem. No attempt was made to estimate the biomass and growth of the below ground parts of the vegetation.

For the tree stratum, the following estimates were made :-

- i. Biomass of the above-ground parts of the trees
- ii. Net annual above-ground primary production by trees.

With the calorific equivalents presented in Section III these were converted to energy data. There were obvious mechanical problems associated with sampling the tree stratum, both with the size of trees and the scale of woodland pattern. These problems have been discussed extensively in the forestry and ecological literature summarized by Newbould (1967).

Estimation of tree stratum biomass is usually carried out in two stages. First, the individual trees in the study area are enumerated and various external dimensions, most commonly diameter at breast height (dbh), are noted. Second, a smaller destructive sample is taken so that the weight of trees or their separate components may be directly related to the external dimensions noted for the whole population, or to some function of them. It is in the choice of the small destructive sample and the method of relating the data thus obtained to the whole tree population that most variation between authors is found. Ratios between tree or component weight and external dimensions or functions of them may be determined for samples of dominant trees (Whittaker et al 1963), or selected 'mean' trees (Ovington & Pearsall 1956; Ovington 1957; Ovington & Madgwick 1959; Peterken & Newbould 1966). Ovington & Madgwick (1959b) and Baskerville (1965) pointed out inadequacies in these approaches, even when used for single-aged plantations. In the Study Area neither of these methods was possible. The wide diameter-distribution of the trees was indicative of the 'continuous variation' in size and form displayed. Clearly the selection of 'dominant' or 'mean' trees was neither practicable nor desirable in this many-aged stand. Instead, destructive samples were used to derive regression equations for the relationship between tree or component weight and external dimensions or

functions of them. Using these regression equations for the relationship between tree or component weight and external dimensions or functions of them, plus the census data, the dry weight of the woody parts of each tree on the Grid was estimated. Hence woody biomass was calculated. This approach, or the closely related stand table approach, has been used successfully by other workers (Whittaker & Woodwell 1968; Baskerville 1965).

In the estimation of net production of woodlands two approaches have been widely used. These have been described in detail by Kira & Shidei (1967) and Newbould (1967). The first approach (Newbould's Method I) is to estimate the biomass of a plant community at time t_1 , biomass at a later date t_2 , and to estimate net production as :-

$$P_n = \Delta B + L + G,$$

where P_n = net production during $t_1 - t_2$

ΔB = Biomass change during $t_1 - t_2$

L = Plant losses by death and shedding during $(t_1 - t_2)$

G = Plant losses to consumer organisms during $(t_1 - t_2)$

The second approach (Newbould's Method II) is to harvest the plants only once, at the end of the growing season (t_2) and to separate the plant matter into current year organs and older parts. Thus the amount of plant matter formed in the latest one year period is estimated. Thus, net production,

$$P_n = B_{2N} + L_N + G_N$$

where $P_n =$ net production that year

$B_{2N} =$ apparent growth increment

$L_N =$ part of P_n which dies and is lost from the biomass

$G_N =$ part of P_n which is lost to consumer organisms.

Method I requires that biomass be estimated some years apart (Ovington & Madgwick 1959a; Ovington & Pearsall 1956; Ovington 1957; Muller & Nielsen 1965; Kira et al 1967). This was not practicable in this case where only two, consecutive, field seasons were available. Method II involves a complex sampling procedure requiring considerable resources of manpower at the time of sampling (Whittaker, Cohen & Olsen 1963; Whittaker & Woodwell 1968; Ovington, Heitkamp & Lawrence 1963). As extensive studies were simultaneously made of tree litter fall and ground vegetation biomass, net production and litter formation, and as the labour of more than one person was only available for very limited periods of time, this approach (Method II) was also ruled out. However, in the course of determining tree above-ground biomass, tree sections were used to investigate the relationship between the diameter (dbh) at the time of sampling (t) and that 5 years before ($t - 5$). Should this relationship prove suitable, the diameter 5 years before sampling was to be calculated for each tree on the Grid. Then biomass 5 years before sampling could be calculated using the regressions derived from the

destructive samples. The assumption made was that the relationship between external dimensions and tree or component weights did not change during the five-year period. Given this, the two estimates of biomass should allow the calculation of tree wood biomass change during the five-year period. From this, an annual value may be obtained. To calculate wood net production this value must be corrected for the loss, during the period, of wood which has grown during the period and for death of material included in the first biomass estimate. This is essentially a modification of Newbould's Method I.

IV. ii. Methods for determining wood biomass and production

A. Non-destructive measurements

As described in Section II, a complete enumeration of the tree stems on the Grid was carried out during the winter of 1967-8. The diameter of each stem was measured at 1.3m above ground on the uphill side of the tree. Thus the stems have been listed according to position on the grid, species, dbh and whether or not they arose from coppiced stools. A summary of these data was presented in Section II.

B. Destructive measurements

Each individual tree stem and the branches and other structures it carries above the soil surface is called a shoot in this study.

(i) Birch. During the last two weeks of November 1967, thirteen birch shoots were harvested. They were chosen to represent the range of diameters as completely as possible. The sample shoots were taken from that part of the Study Area immediately surrounding the Grid. They included both coppiced and uncoppiced shoots. Separate analysis of coppiced and uncoppiced shoots would have required a much more extensive sampling programme than was possible.

The procedure used for each shoot was as follows :- Using a power saw, the stem was cut off at the lowest possible level; when fallen, a tape was stretched from the base of the shoot to the top of the leading branch and the tree height was recorded. Then the stem was cut into sections at breast height (1.3m above ground) and every 2m above this. In addition a 2cm thick disc was cut from the stem at breast height and at each 2m interval. Care was taken to cut these discs at right angles to the stem. The tree sections and their appropriate discs were then labelled and carefully carried to an open space where a set of platform scales was set up. These weighed up to 3cwt in 1oz intervals. The weights were subsequently converted to the metric scale. First the discs were weighed and their fresh weights recorded. Then starting with the lowest section the branches were cut off as near the stem as possible, put in a bag for each section, and weighed. Then the stem sections

were weighed. Thus, for each shoot the fresh weights of the branches and boles by height sections were obtained. The intersection discs were transported to the laboratory along with five branch subsamples of approximately 400g each for each shoot. An attempt was made to ensure that these subsamples were representative; by chopping up branch material into small pieces, placing in a large sack, shaking vigorously and then pouring out the required amount of wood.

In the laboratory the following procedure was adopted. The branch subsamples were cut into yet smaller fragments and initially dried for one week in clothes driers. Then they were transferred to ovens and dried to constant weight at 105°C . The discs from all levels above 1.3m were cut into small segments, the sawdust being carefully collected for each, and dried to constant weight at 105°C . The discs from the 1.3m or dbh discs, as they will be called, were sanded on one side so that the annual rings might be examined. As far as possible, the dust produced by sanding was collected for each disc. Four radii were drawn at 90° to one another on the sanded surface. Using these, outside diameter, diameter inside bark and bark thickness were carefully measured. A cross-checked ring count was carried out using a binocular microscope. Then the diameters every 5th ring were measured. Thus the age and diameter of the tree at the time of sanding was determined and estimates of its inside bark diameter at 5 year intervals recorded.

(ii) Alder. During the last two weeks of May 1968, twelve alder shoots were harvested. It was originally intended that this sampling be carried out immediately after litter fall. Unfortunately this was not possible and certain modifications were made in the harvest and mensuration techniques. The choice of sample shoots was made on the same basis as for birch. The treatment of the materials was as for birch, except for the branches. Here the branches on each stem section were tallied into basal girth classes (10cm and above this at 5cm girth intervals) before being cut off. For sample branches of each major size group, all the leaves were stripped into bags and taken to the laboratory where the number of leaves per bag (and so per branch) was determined by weighing the fresh leaves and then applying a weight/leaf number factor derived on the same day. Thus it was possible to calculate the number of leaves carried by each shoot sampled.

IV. iii. Results

A summary of the data obtained in the destructive sampling is given in Appendix I. Not all of these data were used in the computation of wood biomass and biomass change. They were incidentally obtained in the course of the sampling procedure. In addition, it is evident that the data presented below could have been used in a number of other ways. The sole aim of this study was to investigate energy accumulation and

transfer within this woodland ecosystem. Therefore no attempt was made to use the data obtained for any other purpose.

a. Birch

Diameter at breast height (dbh) was the external dimension obtained for each tree shoot on the Grid and so the weight data were related to this. For the twelve sample shoots, the constants A and h in the allometric equation (Kira & Shidei 1967)

$$w = AD^h, \text{ where } w = \text{dry weight,}$$

$$D = \text{dbh}$$

were determined for w_b = branch dry weight

$$w_r = \text{bole dry weight}$$

$$w_s = \text{whole shoot dry weight}$$

In addition the correlation coefficient (r) and the relative error of estimate (E or e) were determined. In a logarithmic regression E is the antilogarithm of the standard error of estimate. In a linear regression e is the ratio of standard error of estimate to y, (Whittaker & Woodwell 1968).

These values are given in Table XII, and the data shown in Figures 16a, b, and c. The form of the three expressions is very similar, the only great difference between them being in the proportional constant A, as would be expected. For all three the correlation coefficient, r, is high, but as Whittaker & Woodwell (op cit) have pointed out this is not a particularly good indicator of the reliability of the equation for use in

Figure 16.

- a. Birch branch dry weight (kg.), vs. diameter squared (cm^2).
- b. Birch bole dry weight (kg.), vs. diameter squared (cm^2).
- c. Birch shoot dry weight (kg.), vs. diameter squared (cm^2).

BIRCH BRANCH DRY WEIGHT VS DIAMETER SQUARED

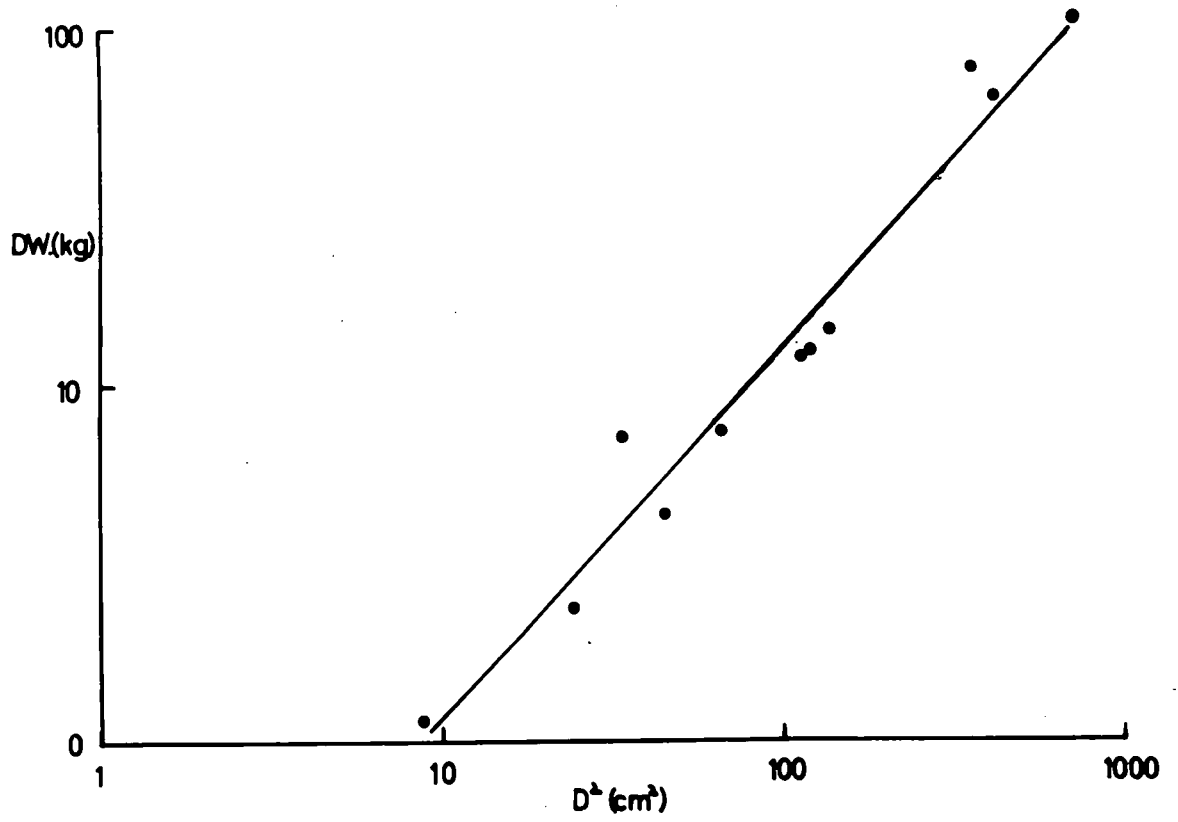

BIRCH BOLE DRY WEIGHT VS DIAMETER SQUARED

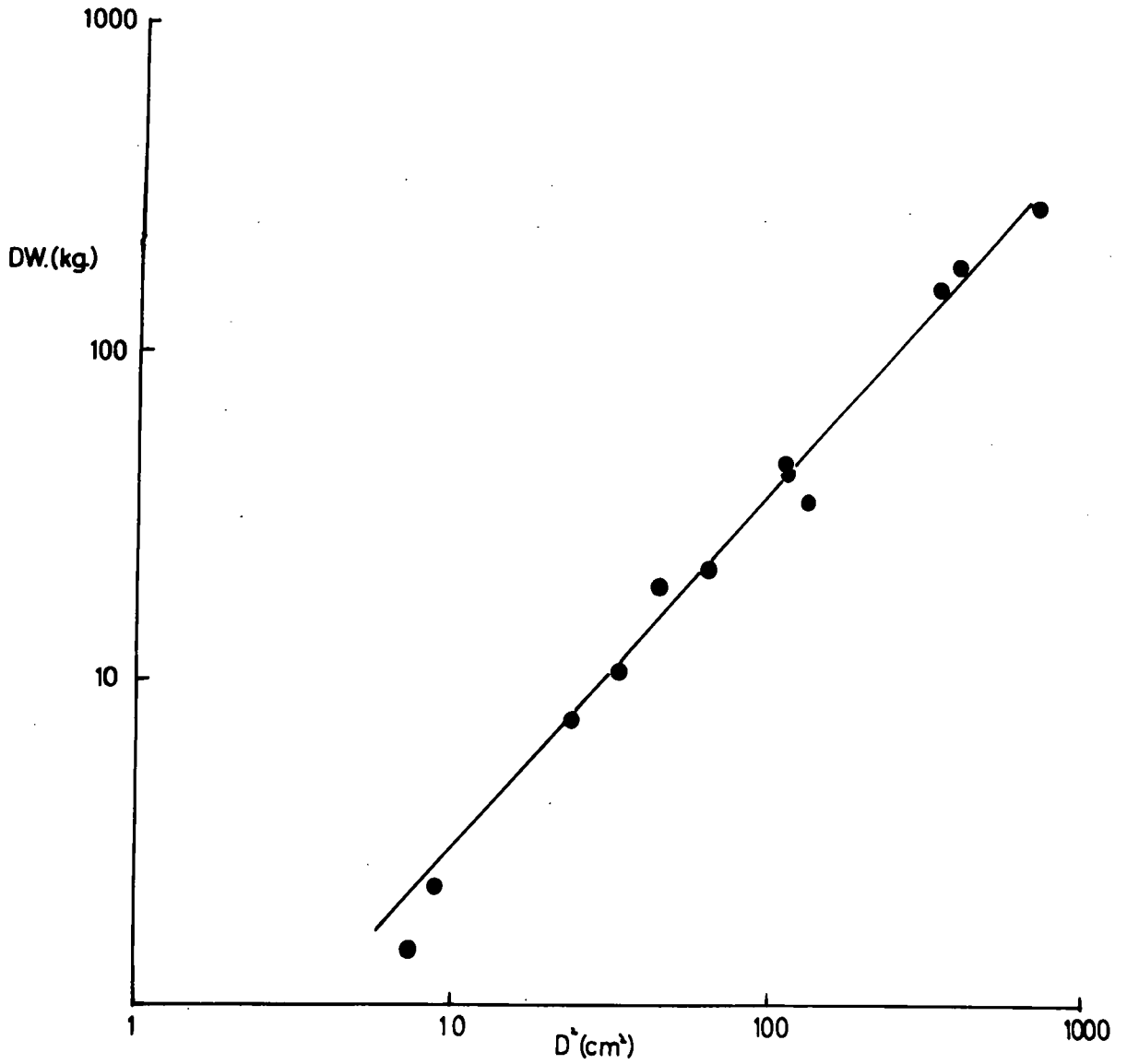

BIRCH SHOOT DRY WEIG.:r VS DIAMETER SQUARED

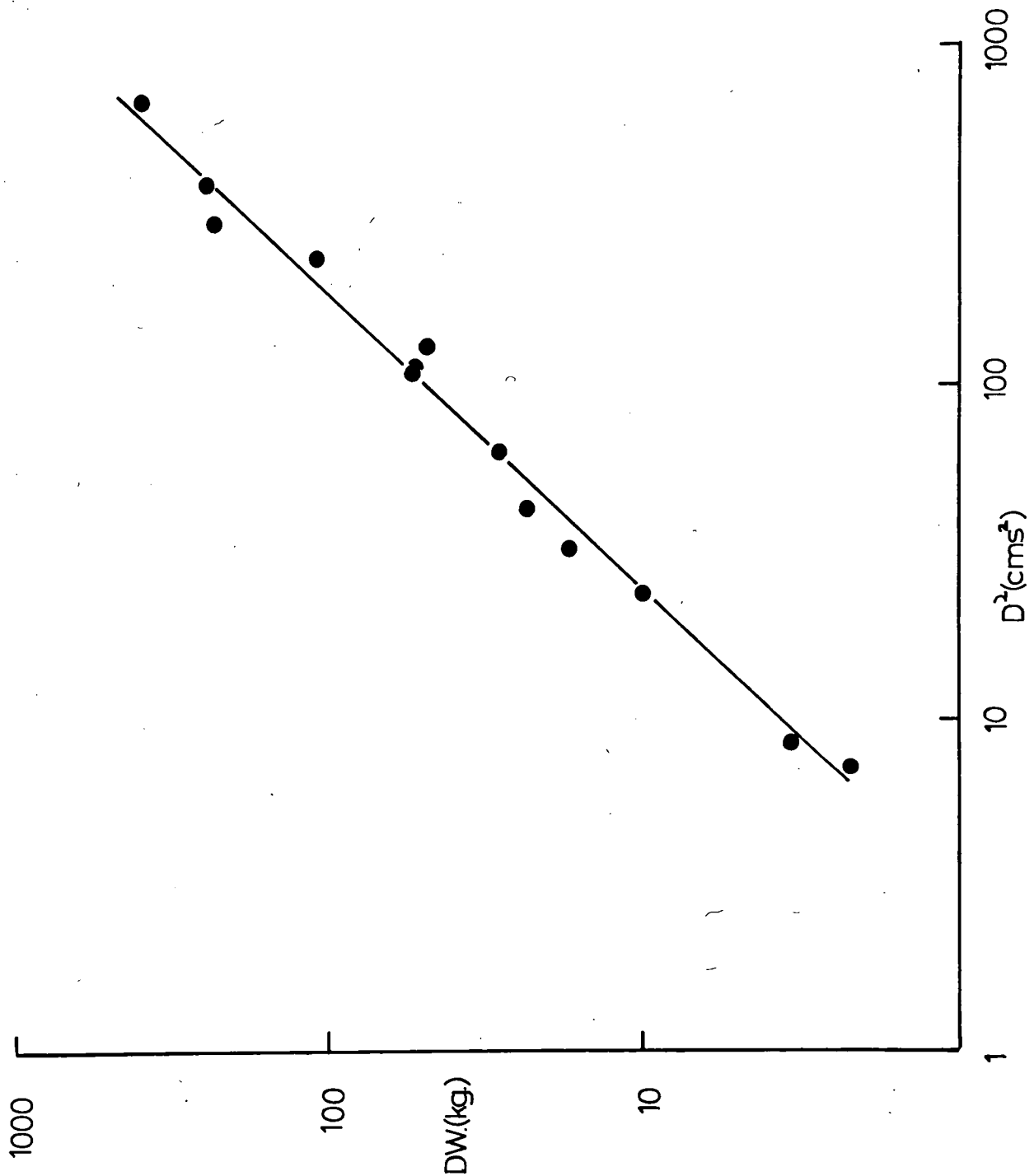

TABLE XIIEquations for Birch allometry

	A	h	r	E
w_B	0.07422	2.24079	0.9899	1.2226
w_S	0.19938	2.24910	0.9946	1.1765
w_t	0.25137	2.28654	0.99253	1.2151

where $w = AD^h \times$ or $\div E$.

TABLE XIIIBiomass and Biocontent of Birch Boles and Branches

	Biomass	Biocontent
BIRCH ZONE	11,883.4g/m ² (9,779.8 - 14,439.5)	57,623.2Kcal/m ²
ALDER ZONE	1,212.7g/m ² (998.0 - 1,473.6)	5,880.3Kcal/m ²
GRID	6,432.9g/m ² (567.8 - 7568.3)	31,193Kcal/m ²

The figures in brackets are biomass \times or $\div E$.

interpolation. E is lowest for w_T - bole weight vs dbh and highest for w_B - branch weight. That for w_S - whole shoot weight, is intermediate. All three values lie near the lower end of the range ($E = 1.109$ to 1.725) calculated for similar expressions for the Brookhaven Forest (Whittaker & Woodwell, op cit). Knowing E for each equation and the proportion of shoot weight attributable to the branches, it was possible to calculate the relative reliabilities of the two methods of calculating shoot dry weight. These methods are the direct method using $w_S = AD^h$, or the indirect method by adding w_B and w_T , determined by the relevant equations. For the extreme case of branch weight being 40% of shoot weight, the direct method gives a possible range of from 82.3 to 121.5% of the estimated shoot weight; the indirect method gives a range of 83.7 to 119.5%. For the other extreme case, where the branch weight is 18% of shoot weight, the indirect method gives a range of 84.4% to 118.5%. Thus the use of the indirect method is unlikely to improve the reliability of the estimate by more than 2 or 3% in any possible case. Therefore the biomass of woody birch shoots on the Grid was calculated from the Census data and the shorter, direct method using

$$w_S = AD^h \text{ for each shoot.}$$

Table XIII shows the biomass of birch boles and branches for the Grid, the Alder Zone and the Birch Zone as g/m^2 . The range

of biomass x or $\pm E$ is given in brackets; the size of the errors indicated here ($\pm 20\%$ of the mean) should be viewed with caution. E is a relative rather than an absolute estimate of error. However, the most that can be said is that the biomass estimates in Table XIII may be within 20% of the true values. Table XIII also shows the biocontent estimates derived from these biomasses.

From the measurements made on the dbh discs, the outside diameter of the tree concerned 5 years before sampling ($t - 5$) was estimated. A graph of bark thickness against inside dbh was drawn. Total bark thickness rarely exceeded 10% of diameter and so a 20% error here only gave rise to 2% error in the outside diameter estimate. The outside diameter at ($t - 5$) was estimated as inside diameter at ($t - 5$) plus calculated bark thickness. Figure 17 shows the relationship between D - dbh at time of sampling, and $D(t - 5)$ - dbh five years before. The regression equation takes the form :

$$D(t - 5) = 0.9401 \frac{D}{D} - 0.5368$$

$$r = 0.9987, \quad e = 2.8\%$$

This made it possible to calculate the dbh of a stem at ($t - 5$) with some confidence. Dbh at ($t - 5$) was calculated for each birch shoot on the Grid. Then, using the allometric equation for w_s derived in the destructive sampling, the biomass of wood in birch shoots at ($t - 5$) was calculated. These figures

Figure 17.

Diameter at time of sampling ($D(t)$) (cms) vs. diameter five years before ($D(t-5)$) (cms.) for birch.

BIRCH

25

20

$D(t-5)$ cms.

10

0

•

•

•

•

•

•

•

10

20

30

$D(t)$ cms.

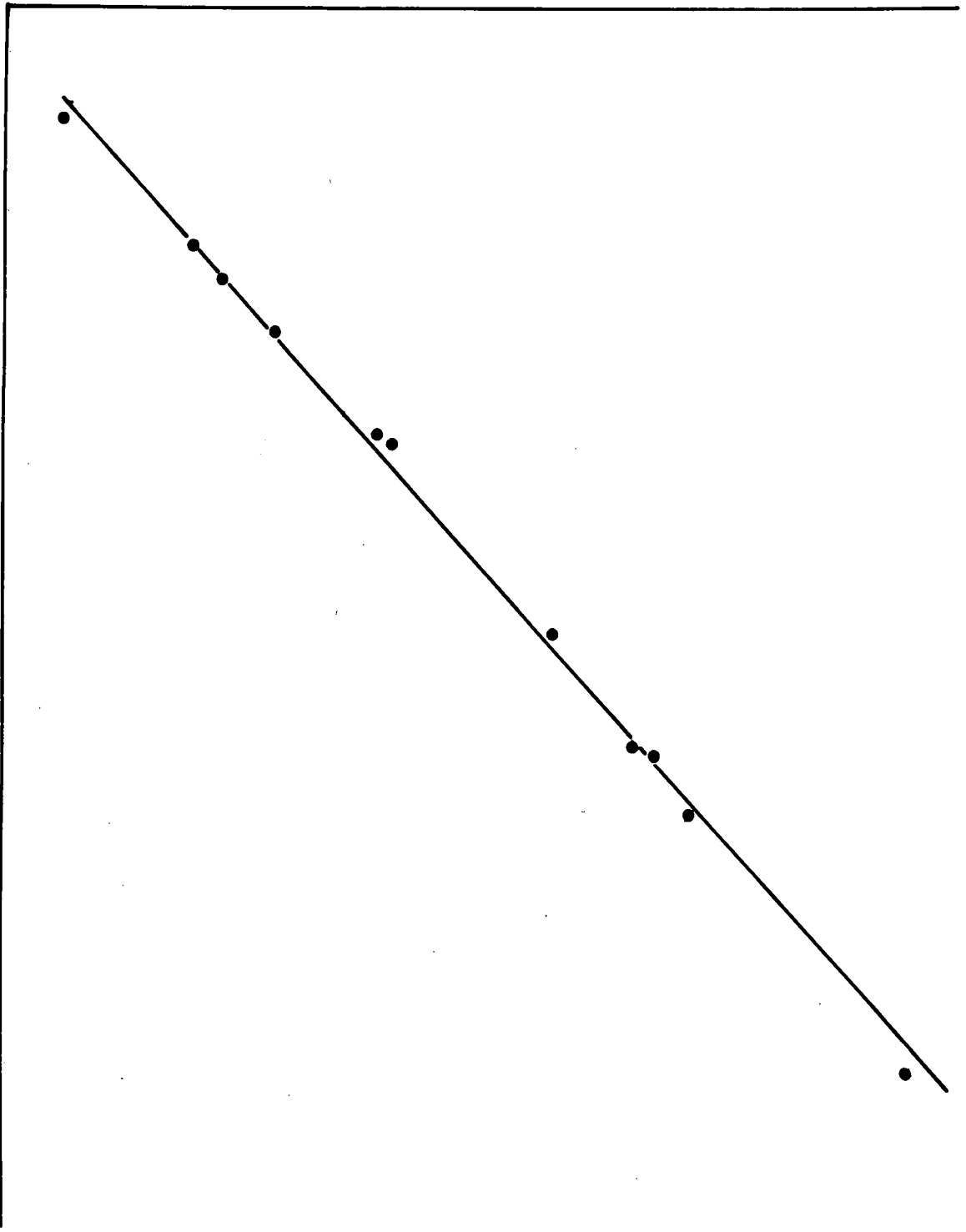

TABLE XIV Biomass and Biocontent of Birch Boles and Branches
at (t - 5)

	BIOMASS (g/m ²)	BIOCONTENT (Kcal/m ²)
BIRCH ZONE	9,319.5 (7,669.7 - 11,324.1)	45,190
ALDER ZONE	1,048.2 (8,626.4 - 1,273.7)	5,083
GRID	5,094.5 (4,192.6 - 6,190.3)	24,703

The figures in brackets are biomass \times or \div E.

TABLE XV Annual Change in Biomass and Biocontent of Birch Boles
and Branches

	Biomass Change (g/m ² /yr)	Biocontent Change (Kcal/m ² /yr)
BIRCH ZONE	512.8	2,486
ALDER ZONE	32.9	159
GRID	267.7	1,298

TABLE XVI Equations for Alder allometry

	A	h	r	E
w _B	0.01465	2.51919	0.92451	1.3797
w _S	0.08598	2.35371	0.98509	1.2800
w _T	0.08419	2.45014	0.99166	1.2106

Where $w = AD^h \times$ or \div E.

are presented in Table XIV as biomass and biocontent. Thus it was possible to calculate the change in biomass of birch woody shoots from $(t - 5)$ to (t) , the time of sampling. This five year figure may then be used to derive a figure of annual change as in Table XV. This was taken as a simple annual average. An assumption of linear rather than exponential growth was implicit in this calculation. As the tree populations on the Study Area were many-aged and only a few of the older trees were likely to be in an exponential growth phase, it seemed wisest to assume linear growth for the populations as a whole. No reliable criterion was available for the division of shoots into those in a linear growth phase and those in an exponential growth phase. It was impractical to place realistic limits on the size of the errors in this determination. It may be said that if the two biomass estimates are in error, that error is probably not due to any change in the equation for w_s on D during the short period of 5 years. Hence, it seems reasonable to assume that the errors in both cases will be of the same order and in the same direction. Therefore the estimate of biomass change is reasonably reliable.

The ratio of annual biomass change to biomass of boles and branches at time of sampling was 0.043 for the Birch Zone, 0.027 for the Alder Zone and 0.042 for the Grid as a whole.

The data on the relationship between birch shoot age dbh is presented in paragraph (c) along with that for Alder.

(b) Alder

The alder woody shoot data are presented in the same form as those for birch. Table XVI and Fig. 18a, b, c, show the relationship between w_B (branch dry weight) w_T (bole dry weight), w_S (shoot dry weight) and dbh. The equations are basically similar in form to those for birch, h generally being a little higher, and A considerably lower. This means that for most of the diameter range an alder tree will be lighter than a birch with the same dbh. The correlation coefficient r is a little lower than for the corresponding birch equations. The values for E fall into the same range as Whittaker & Woodwell's (op cit), that for w_B being considerably higher than those for w_S and w_T . The relative reliabilities of estimates of shoot dry weight either directly or indirectly were estimated as for birch. For the extreme case of branch weight being 38% of shoot weight, the indirect method gives a possible range of from 75.9% to 132.0%. If branch weight is 8% of shoot weight, the range is from 77.7% to 128.8%. The direct method gives a range of from 82.3% to 121.5%. Thus the direct method is the more reliable and therefore the biomass of woody alder shoots on the Grid has been calculated from the Census data by the direct method using :-

Figure 18.

- a. Alder branch dry weight (kg.) vs diameter (cms).
- b. Alder bole dry weight (kg.) vs diameter (cms).
- c. Alder shoot dry weight (kg.) vs diameter (cms).

ALDER ALLOMETRIES

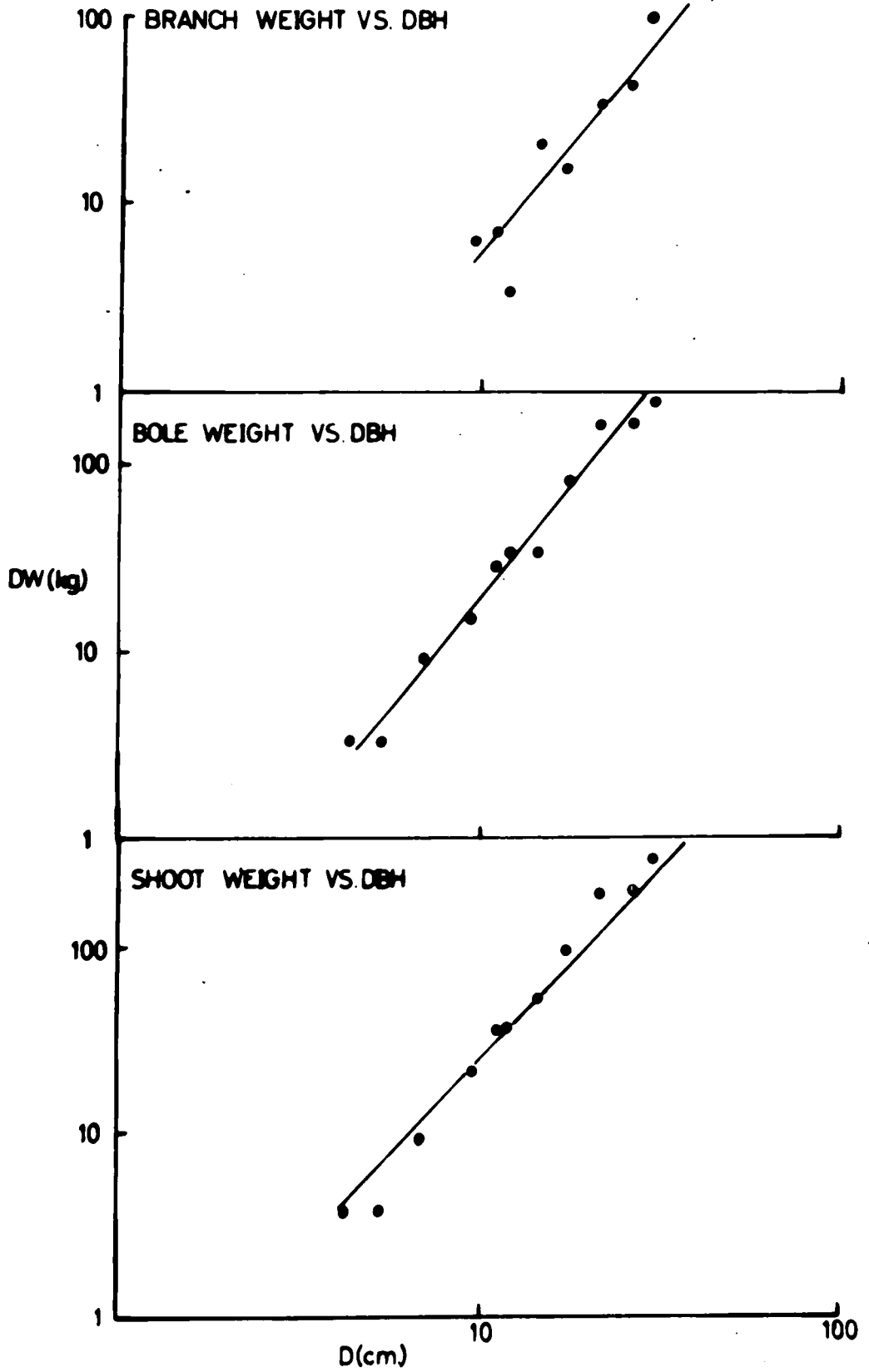

$$w_s = \cancel{0.08419D}^{45014} 0.08548 D^{235371}$$

Table XVII shows the biomass and biocontent of the alder boles and branches for the Grid, Alder Zone and Birch Zone. The range of biomass x or $\frac{x}{E}$ is given in brackets. As with birch, the ranges shown (about 20%) may not represent a realistic estimate of errors. The biomass and biocontent of alder boles and branches represented 66% and 63% respectively of those for birch.

The relationship between $D(t)$ and $D(t-5)$ was derived in the same way as for birch. Figure 19 shows the relationship between $D(t)$ and $D(t-5)$. The regression equation takes the form

$$D(t-5) = 0.9799D(t) - 1.1675$$

$$r = 0.9939 \text{ and } e = 4.3\%$$

Using this equation, $D(t-5)$ was calculated for each alder shoot on the Grid. The error was probably of the order 5%. Then w_s at $(t-5)$ was calculated for each stem by the direct method. These figures are presented in Table XVIII. The figures for annual bole and branch biomass and biocontent change are given in Table XIX. The same comments apply to the reliability of these estimates as to those for birch.

The ratio of annual bole and branch biomass change to biomass at the time of sampling in alder was 0.0372 for the Alder Zone, 0.0772 for the Birch Zone and 0.0371 for the Grid.

Figure 19.

Diameter at time of sampling ($D(t)$) (cms.) vs. diameter five years before ($D(t-5)$) (cms.) for alder.

ALDER $D(t-5)$ VS. $D(t)$

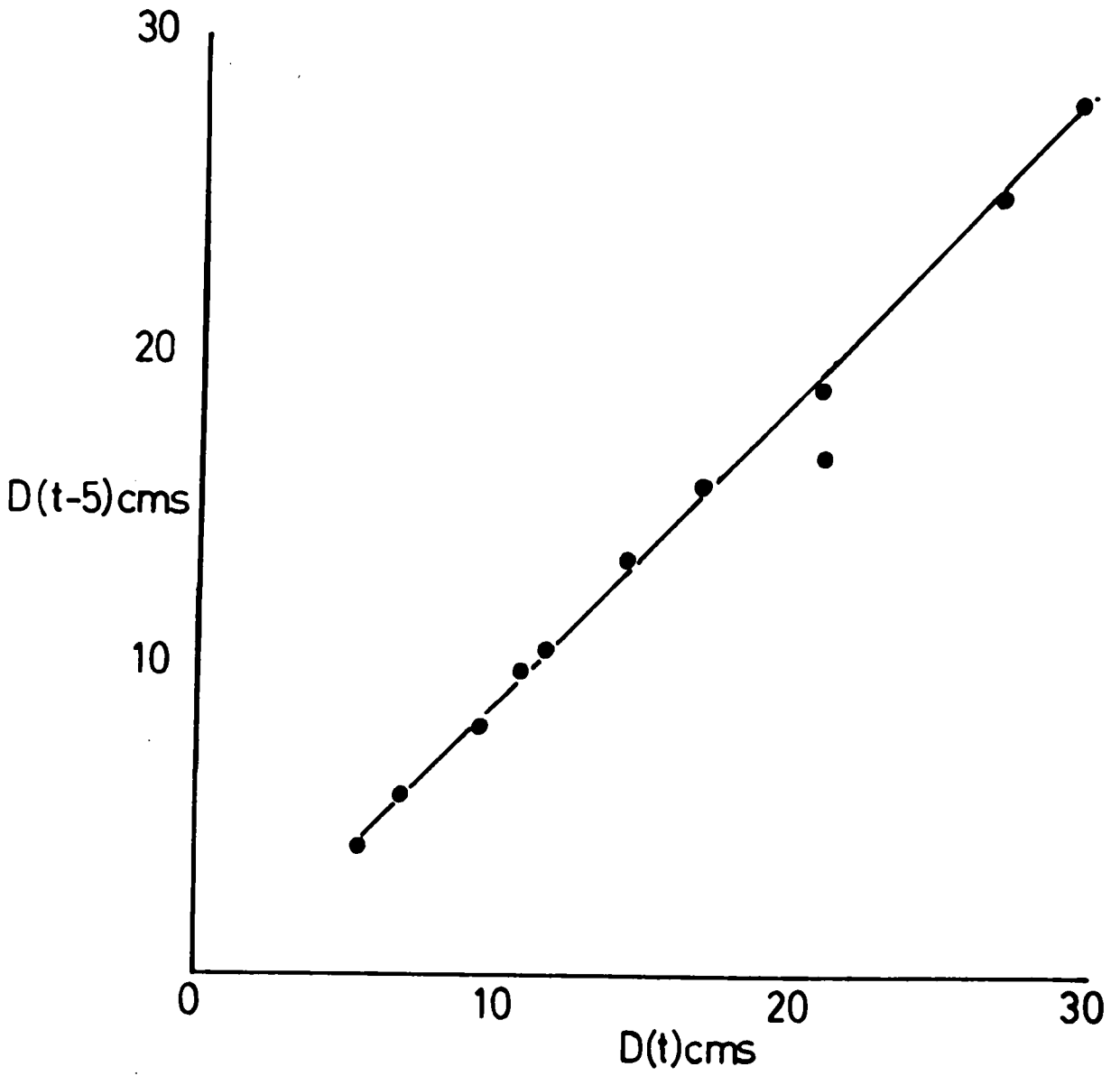

TABLE XVII Biomass and Biocontent of Alder Boles and Branches
1967-8

	BIOMASS (g/m ²)	BIOCONTENT (Kcal/m ²)
ALDER ZONE	7,418.1 (6,126.8 - 8,980.3)	34,363.4
BIRCH ZONE	956.1 (789.8 - 1,157.4)	4,429.6
GRID	4,256.3 (3,515.8 - 5,152.7)	19,719.4

The figures in brackets are biomass x or ÷ E.

TABLE XVIII Biomass and Biocontent of Alder Boles and Branches

	BIOMASS (g/m ²)	BIOCONTENT (Kcal/m ²)
ALDER ZONE	6,038.0 (4,987.6 - 7,309.6)	27,974.0
BIRCH ZONE	777.9 (642.6 - 941.7)	3,604.0
GRID	3,261.0 (2,693.7 - 3,947.8)	15,108.2

The figures in brackets are biomass x or ÷ E.

TABLE XIX Annual change in Biomass and Biocontent of Alder
Boles and Branches

	BIOMASS ($\text{g}/\text{m}^2/\text{yr}$)	BIOCONTENT ($\text{Kcal}/\text{m}^2/\text{yr}$)
ALDER ZONE	275.8	1,277.8
BIRCH ZONE	35.6	164.9
GRID	158.3	733.4

(c) The tree Age-distributions and the History of the Study Area

A detailed history of the Study Area is not available. However, using data obtained in the course of destructive sampling for woody biomass, it was possible to make a partial reconstruction of the history of the Study Area. This information was of value in understanding the current situation, even though it was not possible to calculate a production history of the Study Area.

From the sample birch shoots a regression equation for shoot age on dbh was derived -

$$\text{Shoot Age} = 4.529D^{0.80308}$$

$$r = 0.9530; \quad E = x \text{ or } \pm 1.1970$$

Ovington & Madgwick (1959) noted wide variation in dbh for birch trees of one age. Using the above equation, the ages of shoots at the limits of individual dbh classes in Fig. Section II, were calculated. Graphs of cumulative frequency by age for coppiced and uncoppiced birch shoots were drawn (Fig. 20a, and b, and from these the frequency distribution by age of the birch shoots was constructed (Fig. 21a and b). Despite the possible errors involved in each stage of this construction, it gives some indication of the history of this population of trees. The most striking characteristic of the age distribution was the wide age-range of the shoots. An individual shoot 120 or more years old was found in the Study Area. This was dead when found indicating that birch has been

Figure 20.

Cumulative frequency by age - birch.

a. coppiced.

b. uncoppiced.

CUMULATIVE FREQUENCY BY AGE - BIRCH

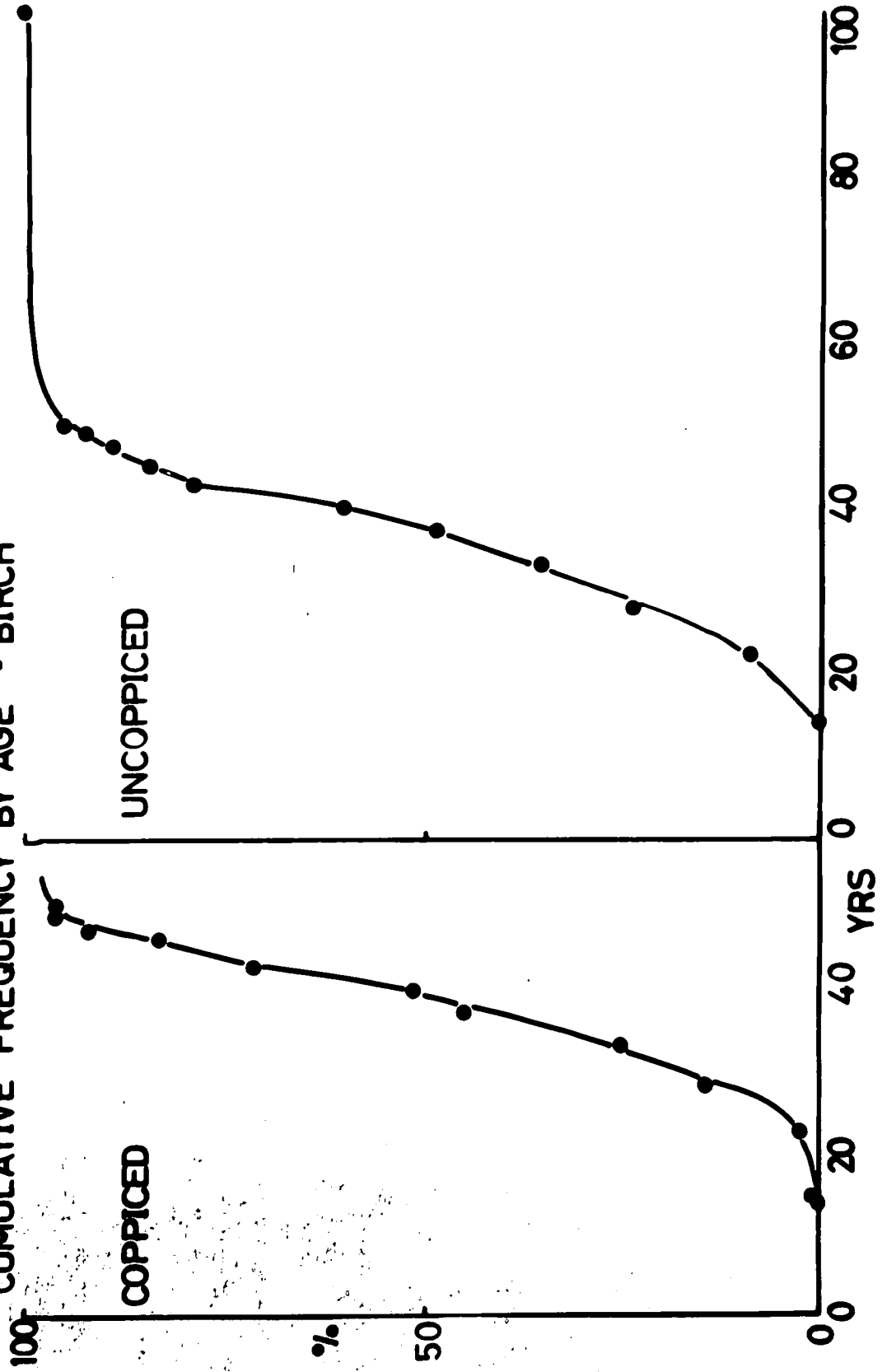

Figure 21.

Frequency distribution by age - birch.

a. coppiced.

b. uncoppiced.

FREQUENCY DISTRIBUTION BY AGE - BIRCH

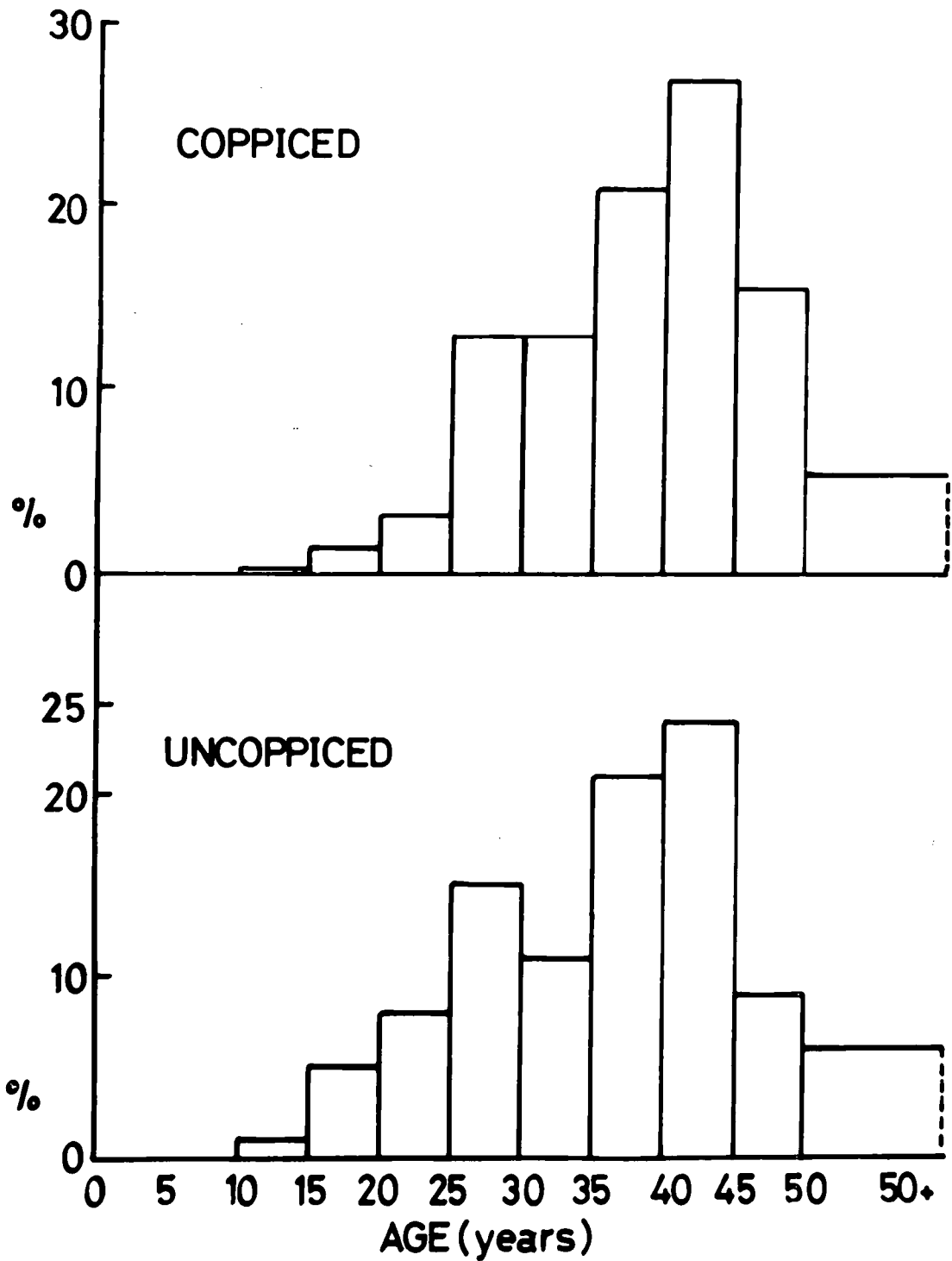

present for at least that period of time. In fact half or more of the birch shoots were between 35 and 45 years of age. If the age-distribution of coppiced shoots is compared with that of uncoppiced shoots, some light may be thrown on the development of the stand. The two distributions were quite similar, suggesting that birch stools were already available for coppicing at about the same time as the oldest extant trees began growth. Coppicing has the initial effect of opening up the canopy and most probably leads to increased regeneration by sexual means. Very little coppicing, if any, of birch has taken place in the last 25 years.

In the case of alder, age may be derived from diameter by a simple graphical method (Fig.22). Thereafter the construction of age-distribution for alder follows that for birch (Fig.23a and b, and Fig.24a and b). Alder is often seen as even-aged stands (McVean 1953). Thereafter the wide age-range here is at first sight surprising. The explanation is that the canopy in the Study Area has been opened periodically by coppicing, for example, 65 - 60 years ago, and 30 - 20 years ago. In the first case the coppicing was followed in the subsequent 5 - 10 years by an increase in sexual reproduction. Sporadic coppicing possibly took place from 80 to 16 years ago. Figure 25 summarizes the history of the Study Area as indicated by the tree age-distributions. The successional condition has been maintained by management

Figure 22.

Diameter squared (cm²) vs. age - alder.

D^2 VS. AGE -ALDER

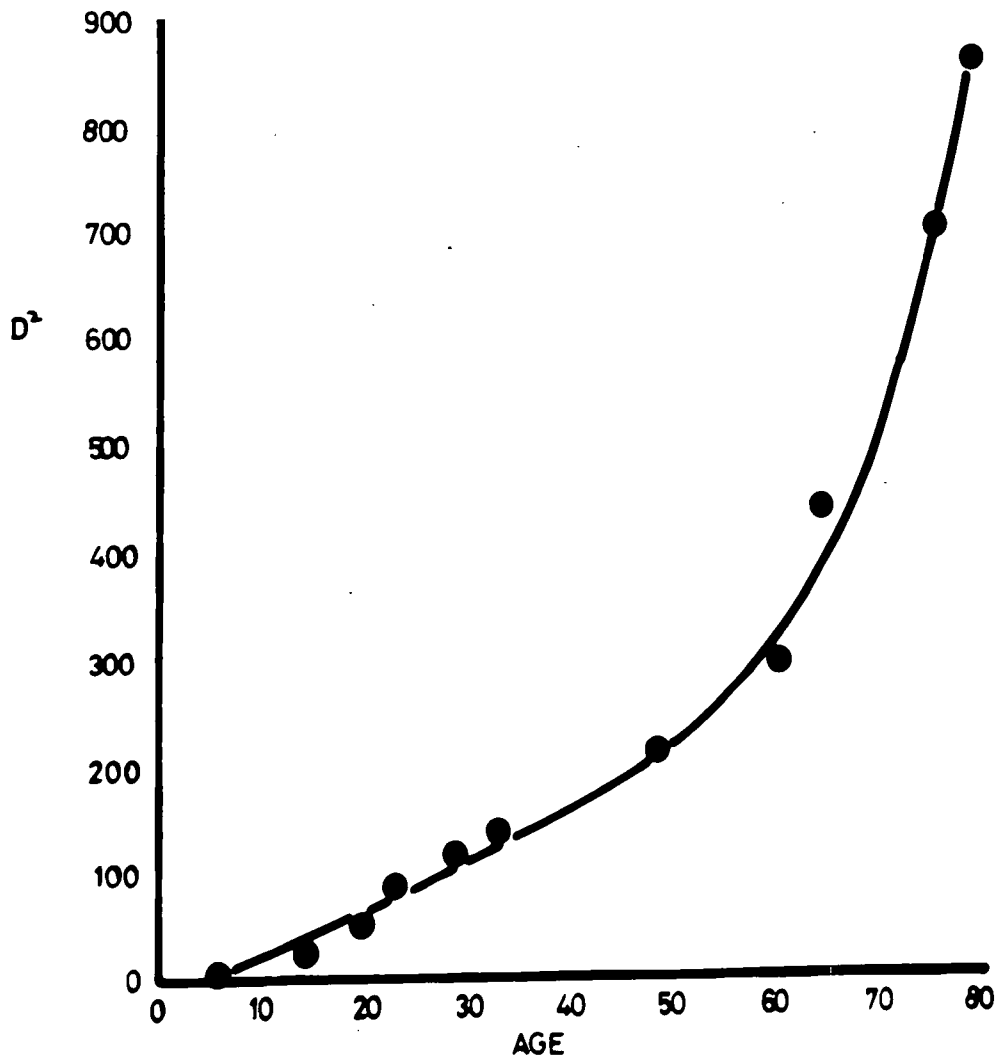

Figure 23.

Cumulative frequency by age - alder.

a. coppiced.

b. uncoppiced.

CUMULATIVE FREQUENCY BY AGE - ALDER

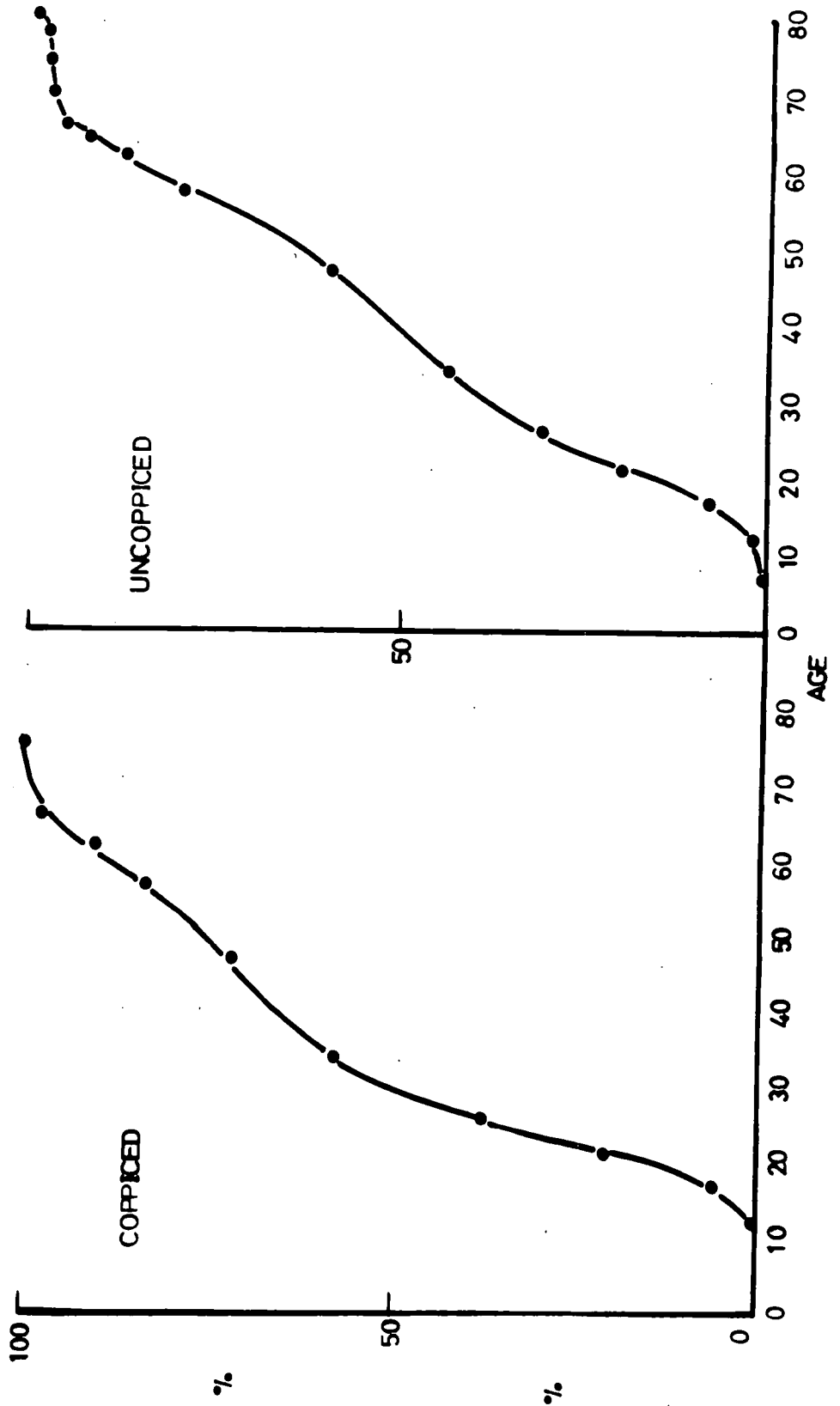

Figure 24.

Frequency distribution by age - alder.

a. coppiced.

b. uncoppiced.

FREQUENCY DISTRIBUTION BY AGE - ALDER

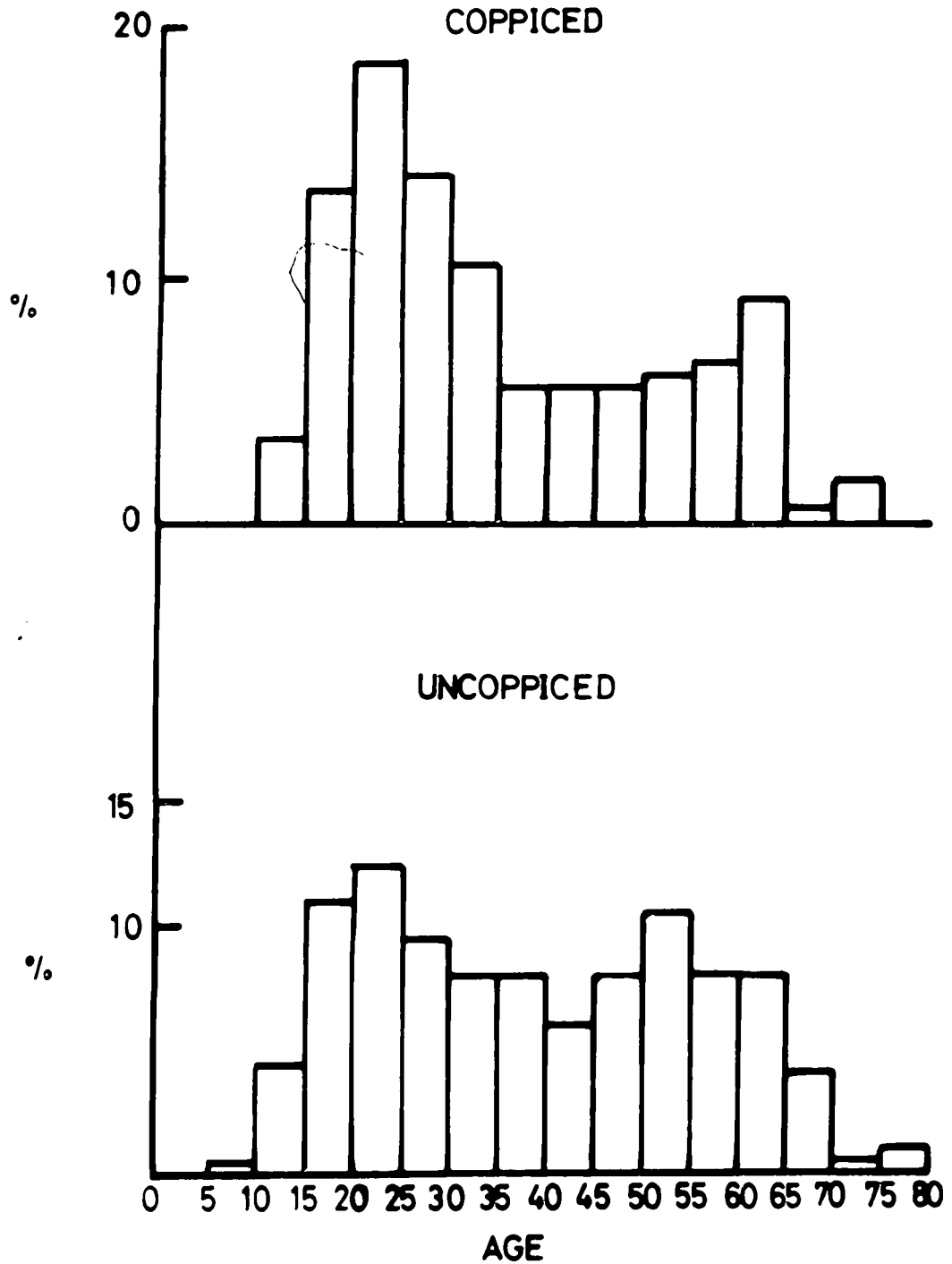

Figure 25.

The history of the Study Area as indicated by tree age-distribution.

STUDY AREA HISTORY

DATE	ALDER	BIRCH
1865		<u>PRESENT</u>
1875	? <u>PRESENT</u>	
1885		
1895		
1905	EXTENSIVE COPPICING -REGENERATION	
1915		EXTENSIVE COPPICING - REGENERATION
1925		↓
1935	EXTENSIVE COPPICING -REGENERATION	
1945		REGENERATION
1955	FORESTRY COMMISSION MANAGEMENT	
1965	STUDY PERIOD	

practices. Since 1952 these practices have ceased and already other tree species are gaining ground in the understorey of the Birch Zone.

Unfortunately, there are no records of material removed from the Study Area, and the calculation of the production history of the extant trees would tell little about the development of the vegetation.

CHAPTER II - SECTION V

Tree Litter and Canopy Biomass

V. i. Introduction

Without doubt, the most striking and fascinating series of changes taking place in a deciduous woodland is the annual appearance, growth, colour change and eventual fall of tree leaves. These events have an aesthetic appeal which is only outstripped for the ecologist by their a priori importance in forest processes. The opening of buds and the subsequent increase in leaf area and biocontent represent the sum of many complex chains of events that end in leaf browning, abscission, and the fall of newly-fixed carbon to the soil, returning with it other materials originally derived from the soil. It is here that the interdependence of the two main ecosystem processes, that is, energy flow and mineral cycling, may be seen most clearly. In order to demonstrate the connection it is sufficient to trace the life-history of a single leaf. Its primordia come from the tree's stored energy and material; it acts as a part of the forest's photosynthetic machinery, a role which demands very specific nutrient supplies; it changes its role to become a transfer agent, its chemistry changing for the part; and then falls to the ground so that the return of the nutrients to the soil and eventually back into the plants may begin. That is, the trees sacrifice a major portion of the energy they have fixed during the summer so as to support

those organisms essential to the release and recirculation of the nutrients on which they, the trees, depend. These organisms are not only concerned directly with nutrient recirculation but also with the whole complex of tasks resulting in the maintenance of soil conditions suitable for a massive ecosystem.

In short, the circulation of minerals in an ecosystem is, in large part, work-requiring. All free energy in the ecosystem has been fixed by the trees and other autotrophs. All free energy available to a major part of the biota, essential to mineral cycling, is in the form of tree litter biocontent. Tree litter does not consist only of leaves, but contains dead and fallen materials from other tree organs, e.g. twigs, bark, fruits and indeed whole stems. Any study of litter fall must include these components.

The importance of litter fall in forests has been recognized by many workers in diverse fields. A review of this work was produced by Bray & Gorham (1964). The field is a wide one and the review cited comprehensive; therefore no attempt is made to review it here. It is, however, possible to summarize certain methodological conclusions from the literature. First, the obvious means by which to estimate litter fall is to catch the falling litter on, or in, a series of trapping devices presenting a known horizontal area. What is seldom stated explicitly in the literature is whether litter falling from

the trees is to be measured, or material arriving on a given ground area in known time. Whilst in many cases these two quantities are probably identical, under certain conditions, for example where a substantial wind-blow of fallen material takes place, it is possible that they could differ (Ovington 1963). Therefore care must be taken in trap design and placement to achieve one or other measurement, and the aim should be explicitly stated.

Second, a number of types of trapping devices have been used to measure falling litter including a cleared soil surface; a metal or plastic screen just above soil surface; metal, wood or plastic boxes or buckets with free drainage, often containing a cloth lining; deep cloth bags suspended from a hoop 1m or so above ground; large plastic funnels and so on. Newbould (1967) has listed eight requirements a trap for falling litter should meet. With one modification (No.vi) these may be stated thus :-

- i. that litter should drop into the trap without any aero-dynamic effects preventing this.
- ii. that the trap opening should be well above soil surface.
- iii. that the trap be large enough both for (i) and for sampling purposes.
- iv. that the rim be level.
- v. that the rim be well-defined.

vi. that material from the ground should not get in (including tree litter blowing across the ground, M.K.H.).

vii. that litter should not drop or blow out of the trap again.

viii. that litter in the trap should not decompose before being collected.

It should be added to requirement (ii), where applicable, that the trap opening should be well above the ground vegetation. Requirements (i) to (v) are concerned with the trap actually catching the litter that would normally fall through the horizontal area presented by the trap if the trap were absent. Requirements (iii) to (v) are also concerned with the precision of the estimate made by sampling a small proportion of the litter falling through the horizontal plane at the level of the trap tops. Requirements (vi) to (viii) are concerned with the addition to or loss from the trap of material other than by litter fall and clearance by the observer. Requirement (viii) may be met as much by frequent clearance as by trap design.

The third main methodological conclusion may be drawn from the literature on the measurement of litter fall in forests concerns the size and number of traps used. Medwecka-Kornas (in press) has pointed out that the size and number of traps used must be related to the scale of pattern in the woodland

studied and the degree of precision required for the litter fall estimate. It being impossible to collect all the litter falling in a large area, it is necessary to depend on a sample consisting of a smaller area. This could either comprise one or few large sample units, or a larger number of more widely distributed small sample units. Because of the lateral heterogeneity of most woodland systems, most workers have taken the latter course (e.g. Ovington 1963; Bray & Gorham 1964; Carlisle, Brown & White 1966; Scott 1955; Lindquist 1938). It is of course necessary to reconcile the need for a large number of small traps and the need for large traps discussed above (requirement (iii) in the discussion of trap design).

The fourth methodological conclusion on litter fall studies concerns the period and frequency of litter fall sampling. Ovington (1963) has clearly demonstrated that litter fall should be measured all the year round if a serious underestimate is to be avoided. This is because several litter components fall at times other than in the autumn. Such components, for example, flowers and seeds or branches and twigs, may form a large part of the litter fall. In order to prevent the accumulation of large amounts of material in a litter trap at any time of year, frequent emptying of the traps is important. If this is not done it is possible that humidity in the trap may rise and decomposition of the trapped materials accelerate.

Fifthly, Bray & Gorham (1964) have clearly established that the size of litter fall may change quite markedly from year to year. Therefore, in order to characterize litter fall at a given stage in the development of a woodland, it should be measured over several years.

In addition to the study of litter fall, the biomass, biocontent, number and area of the canopy leaves were studied. This work is described in this Section. The basic technique uses the numbers of leaves per unit area derived from the litter trap data and periodic sampling of canopy leaves for the relevant attributes. This method assumes that the total number of leaves falling corresponds to the number of leaves actually present in the canopy from bud-burst to leaf-fall. Whether or not this was actually the case is discussed along with the presentation of the data.

V. ii. Methods

The methods described here are for :-

- a) the estimation of litter fall other than large branches and tree stems
- b) the estimation of the fall of large branches and tree stems
- c) the estimation of canopy biomass, biocontent and Leaf Area Index. This is dealt with third because it depends on certain litter fall data being available.

These will be described in turn.

a) the estimation of litter fall other than large branches and tree stems. It is with this estimation that most of the studies cited in the Introduction (V.i) to this section have been concerned. As falling litter was measured, a trap design meeting the eight requirements listed above was needed. The type used is shown in Figure 26. It consisted of a calico bag suspended from a galvanized iron hoop of ^{radius} diameter 28.2cms and depth 8cms. The bag, which was 1.28m deep, hung 1.10m from the hoop, presenting a horizontal opening of $0.25m^2$. The bag was sewn in such a way that there were no corners inside it where material might stick. The bag was tied, by sewn-on tapes, to the hoop so that the rim presented to falling litter was well-defined. The hoop was supported as shown in Figure 26 at 1.3m above the ground by a 5 x 5cm stake, driven a further 30cm into the ground. The bottom of the bag was tied firmly to the stake by tapes. Such a trap, with a well-defined rim and steep, deep sides, allowed litter to drop in without hindrance from aerodynamic effects. It was well above the soil and ground vegetation and appeared to be large enough for aerodynamic purposes. The stout hoop and fixing kept the rim well-defined. With such a deep bag there was little likelihood of material from the ground getting in. Neither could material blow or drop out. The material was freely water-permeable and so, providing that the trap was cleared frequently enough, too much decomposition did not take place in the trap. Thus this type of trap met all the conditions suggested by Newbould (1967).

Figure 26.

Litter trap. An explanation is given on page 49.

LITTER TRAP

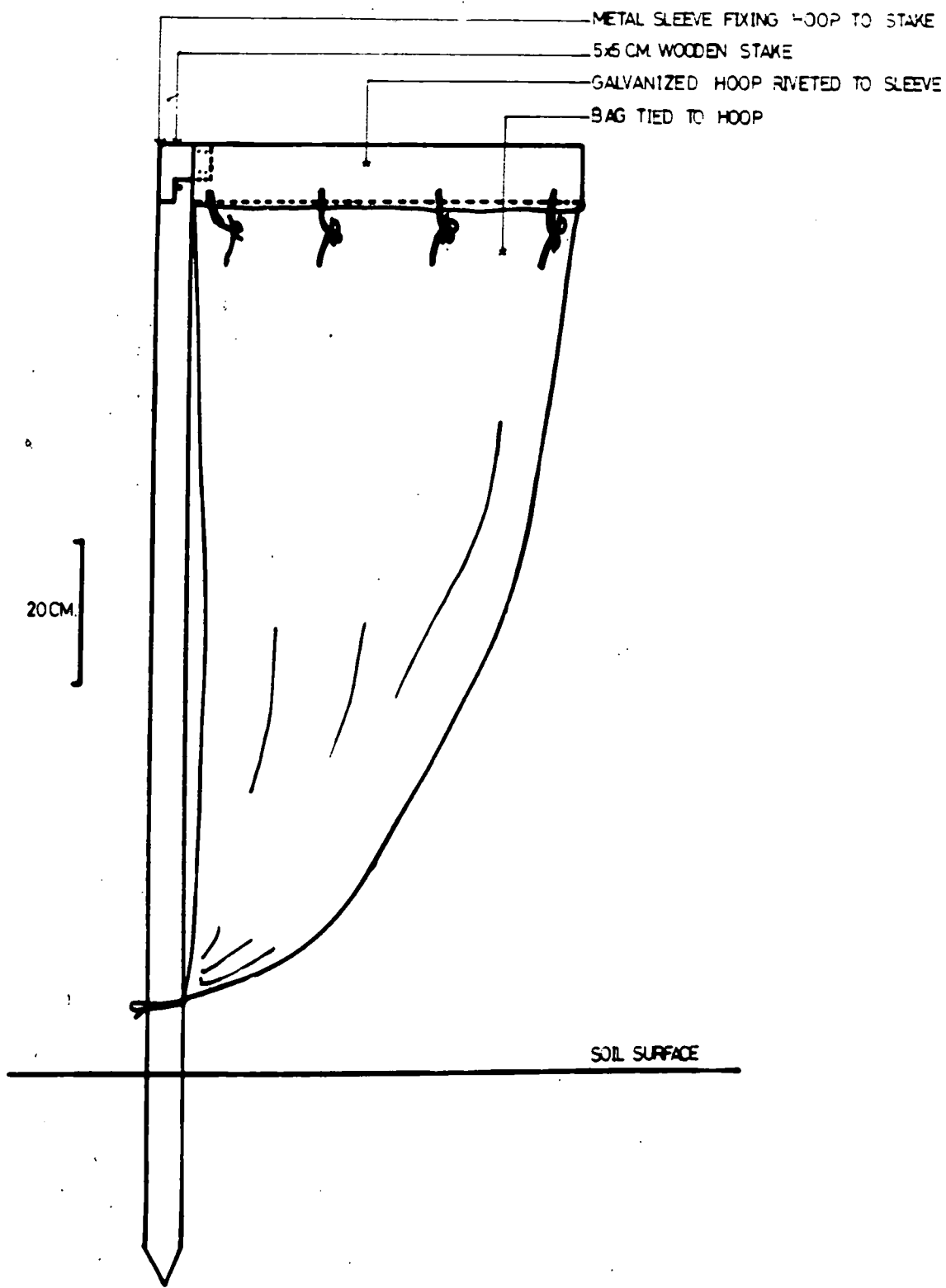

In May 1966 three such traps were erected at random in each of the eight 20 x 20m squares making up the Grid (Fig.27). Thus the 24 traps each presenting an area of 0.25m^2 made up a total sample area of 6m^2 on the $3,200\text{m}^2$ Grid, these traps being placed in a stratified random manner. As little information on woodland pattern was available at this time, a stratified random distribution of the traps was chosen as being the most likely to yield reasonable data for the area studied. The number of traps was determined in part by the time available to deal with collected material and by the need to keep down the number of regularly visited points in the Grid area.

From May 30 1966 until May 25 1968 the traps were visited and cleared as frequently as possible. Due to transport difficulties traps could not be visited with absolute regularity. Excepting in winter, the traps were rarely left more than three weeks and were usually cleared fortnightly. On each occasion the contents of each trap were emptied into a separate labelled polythene bag. The calico bag was turned inside out and its bottom end shaken inside the polythene bag to remove any material sticking to the trap. All woody material of diameter greater than 2.5cms was discarded. That part of any branch or twig found lying across the trap which had a smaller diameter than this was cut at the rim of the trap and placed in the polythene bag. All the traps were inspected on each clearance occasion and faulty parts repaired or replaced.

Figure 27.

Litter trap positions on the Grid.

NEWTON HANZARD GRID
LITTER TRAP POSITIONS

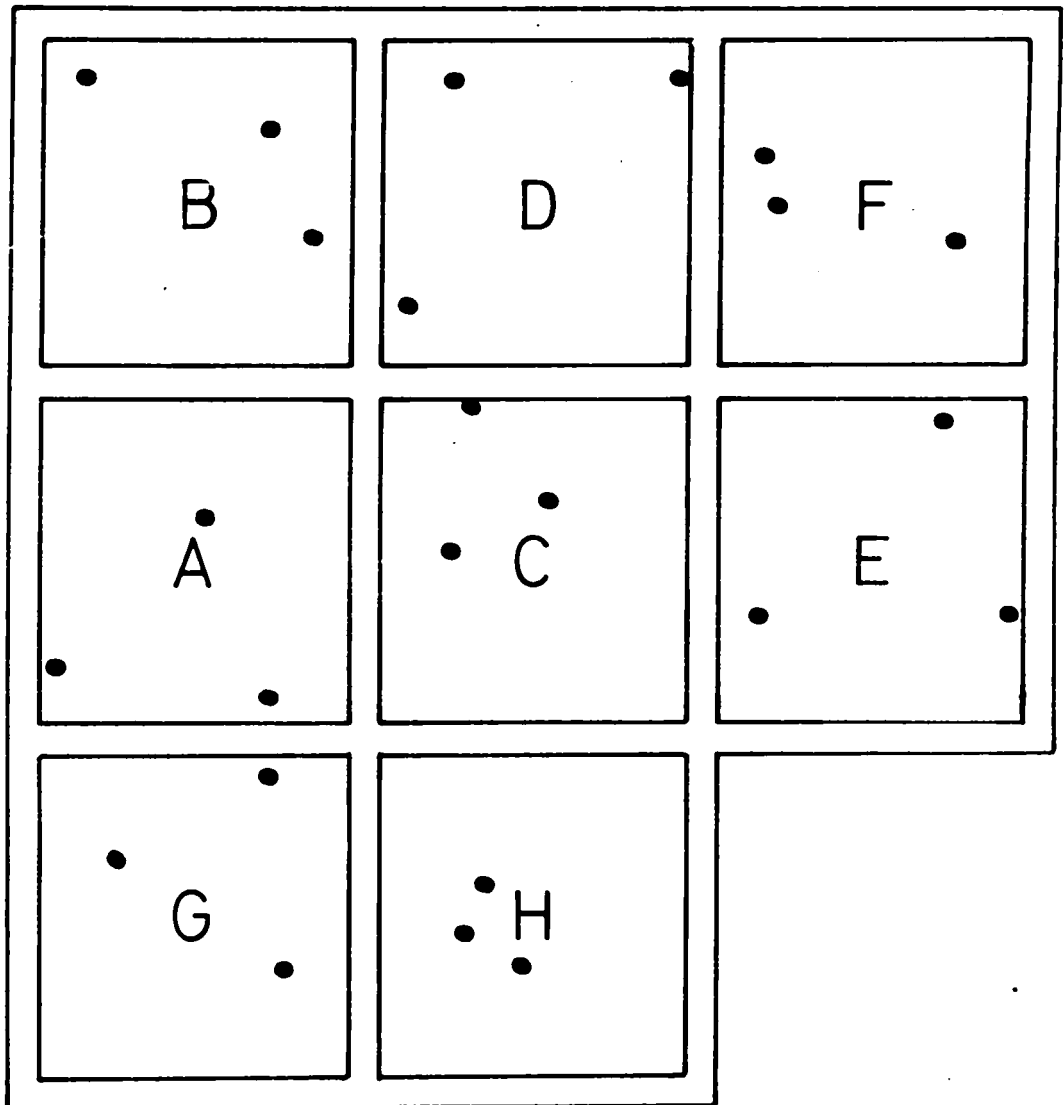

LITTER TRAP - •

In the laboratory the material collected from each trap was sorted as soon as possible. If any delay arose, the material was stored in a deep-freeze cabinet. The material was sorted into the following categories :-

completely green alder leaves
 mottled or brown alder leaves
 completely green birch leaves
 mottled or brown birch leaves
 litter of other tree species
 Alder female reproductive structures
 Alder male reproductive structures
 Birch female reproductive structures
 Birch male reproductive structures
 Woody material smaller than 2.5cm diam.
 Bud scales and detritus larger than 1mm dia.
 Detritus smaller than 1mm diam.

In fact, the contents of each polythene bag were emptied onto a 1mm sieve and the various types of material lifted off. The alder and birch leaves were counted in 1966-7, but not 1967-8. After sorting, each category of material from each trap was placed in an unglazed paper bag and dried at 105°C for 24 hours. Then the materials were weighed to 1mg on a Mettler balance. Thus the mean weight of each category of litter cleared from the 24 traps on each occasion and through the whole

year could be calculated. After drying, a subsample of each category of material was milled and pelleted for calorific analysis (cf. Section III).

b) The estimation of the fall of large branches and tree stems. The 20 x 20m square marked 'C' in the diagram of the Grid (Fig.1, Section II) was used for this estimation. All the branches and stems of diameter greater than 2.5cm lying on the Forest Floor were marked with two circles of red paint at their thickest end in April 1967. In April 1968 all unmarked fallen branches of this size in that area were picked up and weighed fresh, using a spring balance. Subsamples were taken and dried at 105°C to constant weight. Thus an estimate of the total dry weight of branch material of diameter greater than 2.5cms falling onto this 400m area was obtained.

Throughout the period April 1966 - April 1968 the fall of any trees on the Grid was noted and their diameter at breast height so that, using the allometries described in Section Iv, the dry weight of the fallen tree might be calculated.

c) The estimation of canopy biomass, biocontent and Leaf Area Index. In the summer of 1966, leaves were collected from the tree canopy on several occasions by climbing trees and picking all the leaves from a branch. Thus, on each occasion, 100 leaves of birch and 100 of alder were picked. Of each hundred, 25 were taken from a branch 9 - 12m above ground, 25 from 6 - 9m,

25 from 3 - 6m, and 25 from 0 - 3m. Each branch was on a different tree. The trees from which the sample branches were taken lay on the periphery of the Grid. Four numbers of outer corner posts were chosen at random and a branch taken from the nearest alder and birch tree to each, outside the Grid. The lowest sample was taken from the first position to come up for birch, the highest for alder. Then higher samples for birch and lower for alder were taken from each successive position. For each branch all the leaves were placed in opaque polythene bags, which were shaken thoroughly before the sample of 25 was pulled out. The remaining leaves from all the branches were bulked, shaken up and used for calorific analysis (see Section III). The sample leaves were taken to the laboratory and contact prints made of them. The area of each leaf was determined from its print by counting using a transparent 1mm grid placed over the print. All 1mm squares half or more white were counted in the leaf area. Then the sample leaves were dried at 105°C for 24 hours in unglazed paper bags. The dried leaves were weighed in tens to 1mg on a Mettler balance. Hence the mean dry weight, biocontent and area per leaf was determined. The lower leaves may have been over-represented because a simple bulking of leaves from the four height zones was used. However, these 'per leaf' data were combined with the leaf number data from the litter trap studies so that canopy biomass, biocontent, and Leaf Area Index could be calculated.

In the summer of 1967 the same procedure was adopted, using the weight /litter leaf data from the previous year, excepting that the branches from which the sample leaves were obtained were cut down using a 10m aluminium extension pruner.

V. iii. Results of Tree Litter Fall Studies

(a) Biomass

First the litter fall data by clearing date and trap ~~are~~ given for 1966-7 and then for 1967-8. The data for large litter fall ~~is~~ ^{are} then presented.

Table XX shows the mean dry weight of each category of material cleared from the 24 traps on each occasion from 20 May 1966 to 20 May 1967. The seasonal pattern of litter fall will be discussed with the biocontent results. Table XXI shows the mean and standard error of the total dry weight of each category of litter falling into the 24 traps during the whole period 20 May 1966 to 20 May 1967. Of the total of $263.288 \pm 11.687\text{g/m}^2$, the alder and birch leaf fall ($185.353 \pm 7.889\text{g/m}^2$) contributed 70.78%. Of the remaining 29.22%, almost exactly half fell as wood litter, the other 15% or so of the total fell as flowers and fruits, scales and detritus smaller than 1mm, along with the litter of the other tree species.

Table XXII shows the mean dry weight of each category of material cleared from the 24 traps on each occasion from

TABLE XX Litter trap data by occasion of clearing 1966-7 mg/m² (1 S.E.)

CATEGORY	DATE									
	20/5	15/6	6/7	5/8	17/8	10/9	19/9	4/10	17/10	25/10
Alder leaves, green	-	151.8 (44.9)	22007.6 (376.0)	3865.8 (839.6)	6505.3 (2586.6)	6251.2 (1231.6)	897.8 (97.9)	-	179.2	674.4 (245.5)
Alder leaves, brown	-	-	-	-	-	-	3165.6 (678.3)	10000 (1820.0)	25392.0 (4303.6)	16160 (2460)
Birch leaves, green	-	448.4 (85.2)	2326.0 (443.6)	2519.5 (422.4)	2742.0 (428.0)	7318.0 (1453.6)	343.3 (110.9)	-	34.5	-
Birch leaves, brown	-	-	-	-	-	-	4732.6 (1003.6)	14840.0 (29200.0)	18028.0 (3379.0)	10026.0 (1804.0)
Other Tree Litter	-	16.9 (5.96)	167.0 (106.0)	9.7	38.0 (15.0)	37.2 (17.2)	53.2 (21.2)	3.1	4.9	44.4 (22.1)
Alder rep ♀	-	-	-	15.4 (54.0)	-	298.0 (70.0)	73.3 (25.0)	39.9 (10.5)	73.5 (19.2)	7.8 (5.2)
Alder rep ♂	-	-	372.0 (135.0)	-	1021.7 (370.4)	-	39.7 (15.2)	93.7 (32.1)	-	98.0 (25.2)
Birch rep ♀	-	-	-	-	-	-	25.6 (19.2)	-	90.1 (29.2)	52.8 (21.1)
Birch rep ♂	-	19.3 (9.5)	-	25.4 (8.7)	102.0 (36.0)	66.8 (28.5)	91.2 (32.1)	69.8 (22.1)	-	42.2 (21.1)
Scales	-	776.5 (75.9)	1158.0 (123.0)	905.0 (71.8)	797.0 (69.0)	1026.4 (93.2)	432.2 (51.2)	171.6 (34.7)	42.2 (8.6)	56.7 (8.3)
Micro	-	148.5 (65.9)	236.5 (43.0)	44.9 (7.8)	36.0 (10.0)	154.8 (25.6)	66.0 (8.96)	23.7 (5.1)	1.51 (-)	9.30 (2.66)
Wood	-	529.0 (202.4)	2314.0 (578.8)	1265.2 (425.7)	16804.0 (5712)	992.4 (88.0)	902.8 (437.4)	35.9 (11.0)	2.6	124.5 (42.6)

Contd. overleaf.....

TABLE XX (Contd.) Litter trap data by occasion of clearing 1966/7 mg/m² (1 S.E.)

CATEGORY	7/11	17/11	5/12	13/12	11/1	10/2	22/3	10/4	8/5	20/5
Alder leaves, green	3107.8 (504.0)	420.8 (121.1)	866.7	5.4	-	-	-	-	29.7	39.6
Alder leaves, brown	13720.0 (2580.0)	16864.4 (3356.4)	-	-	18.1	21.8	-	110.5	2.6	19.7
Birch leaves, green	-	-	-	-	-	-	-	-	314.9	235.3
Birch leaves, brown	8952.0 (1306.0)	2812.0 (574.2)	165.5	-	0.5	5.3	-	1.6	-	-
Other tree litter	2319.2 (432.1)	3172.7 (223.1)	559.9 (210.1)	43.8 (21.1)	39.7 (15.3)	-	-	2.4	6.4	-
Alder rep ♀	216.0 (97.2)	1083.8 (210.1)	643.3 (221.1)	7.8	296.8 (31.1)	37.6 (11.1)	1330.0 (311.1)	29.1 (20.0)	-	26.6 (21.2)
Alder rep ♂	173.9 (81.2)	204.6 (71.1)	407.7 (110.7)	85.2 (11.1)	50.4 (42.2)	61.3 (11.5)	1675.0 (210.1)	1671.7 (192.5)	710.4 (151.8)	92.1 (42.5)
Birch rep ♀	37.2 (16.3)	-	7.7	-	53.6 (9.3)	-	80.0 (26.7)	81.9 (50.0)	-	128.3 (26.6)
Birch rep ♂	33.2 (11.1)	87.7 (17.7)	71.9 (31.2)	-	135.1 (21.1)	22.5 (8.5)	458.3 (123.7)	213.1 (10.1)	903.8 (172.2)	320.2 (100.1)
Scales	52.9 (12.6)	101.1 (25.3)	767.7 (62.0)	85.6 (15.2)	95.3 (20.1)	192.0 (32.2)	936.7 (111.5)	336.7 (71.1)	3461.9 (710.1)	3914.8 (159.9)
Micro	2.8 (0.9)	8.0 (1.1)	198.5 (36.0)	27.0 (8.0)	9.8 (1.4)	216.8 (42.2)	310.0 (52.5)	107.5 (8.8)	35.7 (10.0)	363.2 (61.1)
Wood	1367.7 (675.2)	2024.0 (610.2)	5500.2 (1017.2)	50.7 (15.0)	2297.6 (811.8)	461.0 (235.5)	16595.0 (16101.1)	1135.4 (511.1)	776.5 (113.3)	1205.3 (511.1)

TABLE XXI Composition of Tree Litter 1966-7 (mg/m² ± 1 S.E.)

Alder leaves	Green	25,103.3	±	4,792.2
"	"	Brown	±	4,263.6
Birch	"	Green	±	2,514.0
"	"	Brown	±	9,483.2
Other Tree leaves		6,519.9	±	1,793.6
Alder rep.	♀	5,047.0	±	1,239.6
"	"	♂	±	1,229.2
Birch	"	♀	±	260.0
"	"	♂	±	572.4
Scales		15,305.0	±	460.4
Micro		2,000.5	±	95.6
Wood		38,479.6	±	7,127.2
	TOTAL	263,288.0	±	11,687.3

20 May 1967 to 30 May 1968. Table XXIII shows the mean and standard error of the total dry weight of each category of litter falling into the 24 traps during the whole period 20 May 1967 to 30 May 1968. The total ($272.497 \pm 9.546\text{g/m}^2$) was not significantly different from the 1966-7 total. The alder and birch leaves contributed a smaller proportion of the total (63.05%) than in the first year. The wood litter again came to about half of the remaining 36.95%.

The standard error of the total dry weight of litter falling into the traps was 4.43% and 3.50% of the mean in 1966-7 and 1967-8 respectively. Thus the 95% confidence limits of the total litter trapped as dry weight fell well within the $\pm 10\%$ range which Newbould (1967) suggests as desirable. The corresponding figures for total alder and birch leaf fall were 4.23% and 5.13% respectively. The standard errors of the individual components were larger, and whilst sampling intensity was great enough to obtain reliable totals, it was not great enough to give 95% confidence limits of less than $\pm 10\%$ for most of the components.

If the map of litter trap positions (Fig.27, this Section) is compared with the map of the two vegetation zones (Fig.8, Section II 13 of the litter traps may be seen to lie in the Alder Zone and 11 in the Birch Zone. Thus it was possible to calculate litter fall for each of the zones separately although the validity of these estimates must be limited because the positions of the traps were

TABLE XXIII

Composition of Tree Litter, Grid 1967-8(mg/m² ± 1 S.E.)

Alder leaves	Green	7,822.6	±	1,717.2
"	"	Brown	±	14,782.4
Birch leaves	Green	10,790.2	±	2,092.8
"	"	Brown	±	9,905.7
Other Tree leaves		5,779.8	±	2,780.8
Alder rep.	♀	4,903.1	±	1,198.4
"	"	♂	±	1,592.3
Birch	"	♀	±	284.9
"	"	♂	±	687.6
Scales		21,846.8	±	1,489.8
Micro		3,807.9	±	412.9
Wood		51,538.8	±	4,606.4
TOTAL		272,497.6	±	9,546.4

TABLE XXIV Composition of Tree Litter, Alder Zone 1967-8(mg/m² ± 1 S.E.)

Alder leaves	Green	7,025.6	±	1,033.2
"	"	Brown	±	13,891.6
Birch leaves	Green	444.0	±	93.6
"	"	Brown	±	7,333.6
Other Tree leaves		3,056.9	±	1,962.8
Alder rep	♀	9,189.3	±	1,514.0
"	"	♂	±	1,737.2
Birch rep	♀	153.5	±	146.4
"	"	♂	±	233.2
Scales		18,601.0	±	716.8
Micro		3,189.2	±	313.6
Wood		46,315.3	±	6,579.2
TOTAL		269,945.7	mg/m ²	

not decided with reference to the vegetation zones. However, the data may be instructive. Tables XXIV and XXV show the means of trap totals for Alder and Birch Zones respectively. The two calculated totals are within $5\text{g}/\text{m}^2$ of one another. The total alder and birch leaf fall in the Alder Zone was $173.784\text{g}/\text{m}^2$, and in the Birch Zone $169.923\text{g}/\text{m}^2$. However, in the Alder Zone about 80% of this was as alder leaves and in the Birch Zone a slightly smaller proportion than this was birch leaves. The litter of other tree leaves was more than twice as important in the Birch Zone as in the Alder Zone. The fall of scales, micro-litter and wood were greater in the Birch Zone, but that of fruits and other reproductive parts was much greater in the Alder Zone. This was largely due to Alder 'catkins'.

When these estimates were combined to give an estimate for the Grid where the between-zones sum of squares is excluded from the calculation of standard error (Table XXVI), much smaller standard errors than in Table XXIII resulted. It would not be valid to use these estimates because the positioning of the traps was not appropriate, but they do indicate that particular care should be taken in the positioning of litter traps relative to woodland pattern.

The total fall of new branch material on square 'C' in 1967-8 was 4,075.32 grams, or $10.188\text{g}/\text{m}^2$. This material did

TABLE XXV Tree Litter, Birch Zone 1967-8 (mg/m² ± 1 S.E.)

Alder Leaves	Green	8,588.5	±	3,547.4
"	"	27,217.4	±	9,060.8
Birch Leaves	Green	20,730.5	±	610.4
"	"	113,387.9	±	3,688.8
Other Tree Leaves		8,395.9	±	5,480.8
Alder rep	♀	785.2	±	396.0
"	"	3,234.7	±	831.6
Birch rep	♀	1,307.2	±	502.8
"	"	5,195.1	±	826.4
Scales		24,965.3	±	2,414.4
Micro		4,402.4	±	683.4
Wood		56,557.4	±	5,951.6
TOTAL		274,757.5	mg/m ²	

TABLE XXVI Composition of Tree Litter, Grid 1967-8

Calculated from alder and birch zone data

mg/m² ± 1 S.E.)

Alder Leaves	Green	7,791.4	±	1,815.2
"	"	83,162.0	±	8,360.0
Birch Leaves	Green	10,384.3	±	302.8
"	"	70,554.4	±	1,313.2
Other Tree Leaves		5,779.8	±	226.6
Alder rep	♀	5,071.2	±	796.0
"	"	8,974.7	±	974.8
Birch	"	718.8	±	257.6
"	"	3,238.3	±	118.8
Scales		21,719.4	±	1,238.0
Micro		3,783.7	±	370.8
Wood		51,333.9	±	4,443.6
TOTAL		272,511.9		

not appear to have undergone any substantial decomposition before collection. Square 'C' contained parts of both vegetation zones. One tree fell on the Grid during the period April 1966 to April 1968. This was a birch of dbh 10.5cms blown over by strong winds in April 1967. The root system was not completely severed, and an apparently full complement of leaves was formed in 1967 and 1968; this tree could not be included in the estimate of litter fall. Thus almost 85% of the wood litter in the period April 1967 - April 1968 fell as branches or twigs of diameter less than 2.5cms.

(b) Biocontent

First the litter fall biocontent data by clearing date and cumulatively is given for 1966-7 and then for 1967-8.

Table XXVII shows the mean biocontent as Kcals/m² of each category cleared from the 24 traps on each occasion from 20 May 1966 to 20 May 1967. The seasonal pattern of biocontent fall is best seen by an examination of Table XXVIII which shows cumulative litter biocontent fall. The total fall of 1,422.906 Kcal/m² came at all times of year (Fig.28), but the major part of it (75%) fell in the months of August to November inclusive. Most (65%) of the total fall was made up of Alder (553.697 Kcal/m²) and Birch (388.002Kcal/m²) leaves. These leaves fell (Fig.29) largely in October (almost 50% of the totals of each) and September in Birch, November in Alder. The 35% other than Alder and Birch leaves fell a little more

TABLE XXII

Litter Trap Data by occasion of clearing 1967-8
(mg/m² ± 1 S.E.)

CATEGORY	DATE									
	20/5	10/6	10/7	31/7	18/8	6/9	25/9	11/10	26/10	
Alder leaves, green	-	122.8	180.8	180.8	38.3	1461.8	1745.0	709.1	1614.9	
Alder leaves, brown	-	58.5	1229.5	4310.1	3074.1	3606.0	7733.6	4525.0	22227.6	
Birch leaves, green	-	369.2	97.5	81.6	11.5	292.7	-	41.2	-	
Birch leaves, brown	-	-	7133.4	1850.5	1606.3	5752.5	7298.0	7299.7	8206.9	
Other tree litter	-	-	37.0	23.3	8.0	24.0	-	449.7	611.6	
Alder rep ♀	-	86.8	56.7	-	5.3	341.8	-	786.2	590.0	
Alder rep ♂	-	53.8	-	46.5	-	117.8	61.7	-	228.3	
Birch rep ♀	-	417.5	9.3	18.2	49.1	106.4	-	61.5	-	
Birch rep ♂	-	57.8	3.8	14.3	134.5	400.3	37.3	-	-	
Scales	-	2729.1	2436.4	413.5	368.3	3805.6	327.6	957.8	1278.3	
Micro	-	610.2	735.8	43.0	16.4	705.1	13.0	119.4	-	
Wood	-	1762.8	861.8	2693.7	1977.0	4924.8	15.0	2590.0	3185.0	
<hr/>										
	14/11	27/11	18/1	20/2	20/3	10/4	8/5	25/5		
Alder leaves, green	145.0	1489.1	-	-	-	-	24.4	30.1		
Alder leaves, brown	30562.7	9265.6	-	-	-	46.2	-	-		
Birch leaves, green	-	-	-	-	-	-	282.7	-		
Birch leaves, brown	14166.2	1293.1	-	-	-	68.2	-	-		
Other tree litter	3421.6	928.1	15.0	-	-	-	-	-		
Alder rep ♀	821.6	5.0	1298.4	353.3	866.9	33.7	-	-		
Alder rep ♂	406.7	43.3	516.7	4503.1	1177.2	869.4	657.8	646.3		
Birch rep ♀	-	20.3	-	-	-	-	-	-		
Birch rep ♂	60.0	-	-	80.0	358.2	170.2	798.7	996.0		
Scales	938.3	16.8	-	1243.9	643.1	288.3	3115.4	2960.1		
Micro	-	-	-	701.5	324.3	119.4	26.6	327.9		
Wood	5193.5	70.9	10554.8	4833.0	10179.3	1729.8	300.5	137.9		

TABLE XXII Litter Trap Data by occasion of clearing 1967-8 (mg/m² ± 1 S.E.)

CATEGORY	D A T E									
	20/5	10/6	10/7	31/7	18/8	6/9	25/9	11/10	26/10	
Alder leaves, green	-	122.8	180.8	180.8	38.3	1461.8	1745.0	709.1	1614.9	
Alder leaves, brown	-	58.5	1229.5	4310.1	3074.1	3606.0	7733.6	4525.0	22227.6	
Birch leaves, green	-	369.2	97.5	81.6	11.5	292.7	-	41.2	-	
Birch leaves, brown	-	-	7133.4	1850.5	1606.3	5752.5	7298.0	7299.7	8206.9	
Other tree litter	-	-	37.0	23.3	8.0	24.0	-	449.7	611.6	
Alder rep ♀	-	86.8	56.7	-	5.3	341.8	-	786.2	590.0	
Alder rep ♂	-	53.8	-	46.5	-	117.8	61.7	-	228.3	
Birch rep ♀	-	417.5	9.3	18.2	49.1	106.4	-	61.5	-	
Birch rep ♂	-	57.8	3.8	14.3	134.5	400.3	37.3	-	-	
Scales	-	2729.1	2436.4	413.5	368.3	3805.6	327.6	957.8	1278.3	
Micro	-	610.2	735.8	43.0	16.4	705.1	13.0	119.4	-	
Wood	-	1762.8	861.8	2693.7	1977.0	4924.8	15.0	2590.0	3185.0	

	14/11	27/11	18/1	20/2	20/3	10/4	8/5	25/5
Alder leaves, green	145.0	1489.1	-	-	-	-	24.4	30.1
Alder leaves, brown	30562.7	9265.6	-	-	-	46.2	-	-
Birch leaves, green	-	-	-	-	-	-	282.7	-
Birch leaves, brown	14166.2	1293.1	-	-	-	68.2	-	-
Other tree litter	3421.6	928.1	15.0	-	-	-	-	-
Alder rep ♀	821.6	5.0	1298.4	353.3	866.9	33.7	-	-
Alder rep ♂	406.7	43.3	516.7	4503.1	1177.2	869.4	657.8	646.3
Birch rep ♀	-	20.3	-	-	-	-	-	-
Birch rep ♂	60.0	-	-	80.0	358.2	170.2	798.7	996.0
Scales	938.3	16.8	-	1243.9	643.1	288.3	3115.4	2960.1
Micro	-	-	-	701.5	324.3	119.4	26.6	327.9
Wood	5193.5	70.9	10554.8	4833.0	10179.3	1729.8	300.5	137.9

TABLE XXVII
Litter Trap Data by occasion of clearing 1966-7 (Kcal/m²)

CATEGORY	D A T E										
	20/5	15/6	6/7	5/8	17/8	10/9	19/9	4/10	17/10	7/11	
Alder leaves, green	-	0.7404	9.791	19.3412	31.7264	30.4876	4.3786	-	0.8673	14.6564	
Alder leaves, brown	-	-	-	-	-	-	15.338	49.624	128.382	70.425	
Birch leaves, green	-	2.241	11.623	13.021	14.171	37.251	1.774	-	0.178	-	
Birch leaves, brown	-	-	-	-	-	-	24.499	76.827	92.210	45.040	
Other tree litter	-	0.076	0.747	0.043	0.169	0.175	0.238	0.014	0.022	10.369	
Alder rep ♀	-	+	2.038	0.829	5.598	1.633	0.402	0.219	0.403	1.183	
Alder rep ♂	-	-	-	-	-	-	0.217	0.513	-	0.953	
Birch rep ♀	-	0.099	+	0.129	0.517	0.339	0.130	-	0.457	0.189	
Birch rep ♂	-	-	-	-	-	-	0.462	0.354	-	0.168	
Scales	-	4.248	6.335	4.951	4.360	5.821	2.451	0.973	0.239	0.300	
Micro	-	0.742	1.182	0.224	0.180	0.774	0.330	0.118	0.008	0.014	
Wood	-	2.684	11.741	6.420	85.263	5.035	4.581	0.182	0.013	6.940	

	17/11	5/12	13/12	11/1	10/2	23/3	10/4	8/5	20/5
Alder leaves, green	1.9845	4.0873	0.0255	-	-	-	-	0.1401	0.1867
Alder leaves, brown	85.671	-	-	0.092	0.111	-	0.561	0.013	0.100
Birch leaves, green	-	-	-	-	-	-	-	1.752	1.176
Birch leaves, brown	14.141	0.832	-	0.002	0.027	-	0.004	-	-
Other tree litter	14.183	2.503	0.196	0.177	-	-	0.011	0.029	-
Alder rep ♀	5.938	3.525	0.043	1.626	0.206	7.287	0.159	-	0.201
Alder rep ♂	1.121	2.234	0.467	0.276	0.336	9.177	9.159	3.892	0.505
Birch rep ♀	-	0.039	-	0.272	-	0.406	0.415	-	0.651
Birch rep ♂	0.445	0.365	-	0.685	0.114	2.324	1.081	4.584	6.696
Scales	0.573	4.354	0.400	0.445	0.897	5.125	1.842	18.940	21.418
Micro	0.040	0.992	0.135	0.049	1.084	1.550	0.537	0.178	1.816
Wood	10.270	27.908	0.257	11.657	2.339	84.203	5.761	3.940	6.116

TABLE XXVIII

Cumulative Litter Trap biocontent data 1966-7 (Kcals/m²)

CATEGORY	15/6	6/7	5/8	17/8	10/9	19/9	4/10	17/10	25/10	7/11
Alder leaves green	0.740	10.531	29.872	61.598	92.085	96.464	96.464	97.331	100.595	115.251
Alder leaves brown	-	-	-	-	-	64.962	64.962	193.344	275.049	345.474
Birch leaves green	2.241	13.864	26.885	41.056	78.307	80.081	80.081	80.259	80.259	80.259
Birch leaves brown	-	-	-	-	-	101.326	101.326	193.536	244.789	289.809
Other Tree Litter	0.076	0.823	0.866	1.035	1.210	1.462	1.462	1.484	1.682	12.051
Alder rep ♀	+	2.038	2.867	8.465	10.098	10.719	10.719	11.122	11.165	12.348
Alder rep ♂	-	-	-	-	-	0.217	0.730	0.730	1.267	2.220
Birch rep ♀	0.099	0.099	0.228	0.745	1.084	1.214	1.214	1.671	1.939	2.128
Birch rep ♂	-	-	-	-	-	0.462	0.816	0.816	1.036	1.198
Scales	4.248	10.583	15.534	19.894	25.715	28.166	29.139	29.378	29.699	29.999
Micro	0.742	1.924	2.148	2.328	3.102	3.432	3.550	3.558	3.604	3.618
Wood	2.684	14.425	20.845	106.108	111.143	15.724	115.906	115.919	116.551	123.491
Total canopy leaves	2.981	24.395	56.757	102.654	170.392	216.382	342.833	564.470	700.692	830.793
Total other litter	5.165	15.467	21.643	32.467	41.209	45.439	47.630	48.759	50.392	63.562
Grand Total	10.930	54.287	99.245	241.429	322.774	377.545	506.369	729.148	867.335	1017.846

CATEGORY	17/11	5/12	13/12	11/1	10/2	22/3	10/4	8/5	20/5
Alder leaves green	117.235	121.322	121.348	121.348	121.348	121.348	121.348	121.488	121.675
Alder leaves brown	431.145	431.145	431.145	431.237	431.348	431.348	431.909	431.922	432.022
Birch leaves green	303.950	304.782	304.782	304.784	304.811	304.811	304.815	82.011	83.187
Birch leaves brown	26.234	28.737	28.933	29.110	29.110	29.110	29.121	304.815	304.815
Other Tree Litter	18.286	21.811	21.854	23.480	23.686	30.973	31.132	29.150	29.150
Alder rep ♀	3.341	5.575	6.042	6.318	6.654	15.831	24.990	31.132	31.333
Alder rep ♂	2.128	2.167	2.167	2.439	2.439	2.845	3.260	28.882	29.387
Birch rep ♀	1.643	2.008	2.008	2.693	2.807	5.131	6.212	3.260	3.911
Birch rep ♂	30.572	34.926	35.324	35.771	36.668	41.793	43.635	10.796	17.492
Scales	3.658	4.650	4.785	4.834	5.918	7.468	8.005	62.575	83.993
Micro	133.761	161.669	161.926	173.583	175.922	260.125	265.886	8.183	9.999
Wood	932.589	937.508	937.534	937.628	937.766	937.766	938.331	269.826	275.942
Total canopy leaves	85.862	99.874	101.108	104.645	107.282	133.151	146.355	940.236	941.699
Total other Litter	1152.212	1199.051	1200.568	1215.856	1220.970	1331.042	1350.542	173.978	205.265
Grand Total	1152.212	1199.051	1200.568	1215.856	1220.970	1331.042	1350.542	1384.040	1422.906

N o c h a n g e

Figure 28.

Monthly % of total litter fall biocontent, 1966-7.

Figure 29.

Monthly % of alder and birch leaf fall biocontent.

Key: open circles - birch.

plus signs - alder.

MONTHLY % OF TOTAL LITTER FALL BIOCONTENT 1966-7

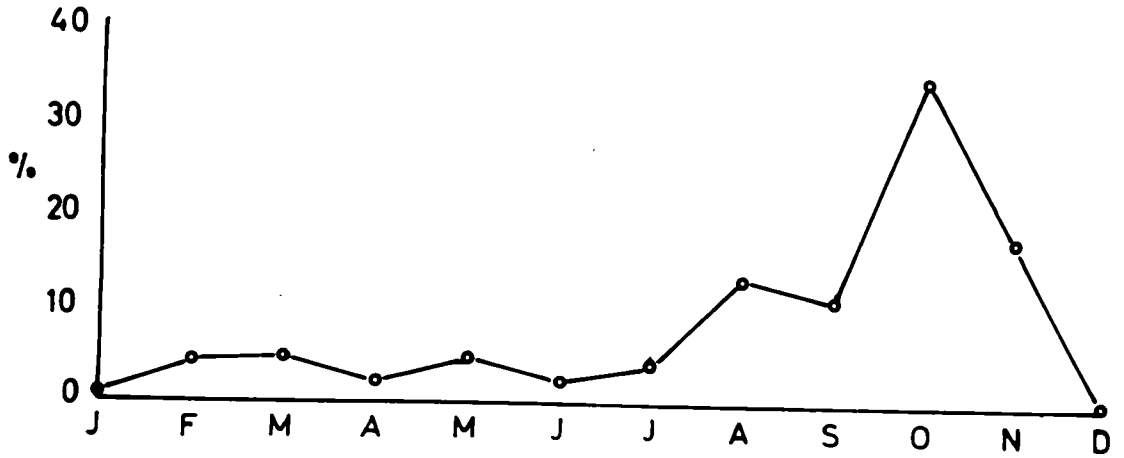

MONTHLY % OF ALDER AND BIRCH LEAF FALL BIOCONTENT

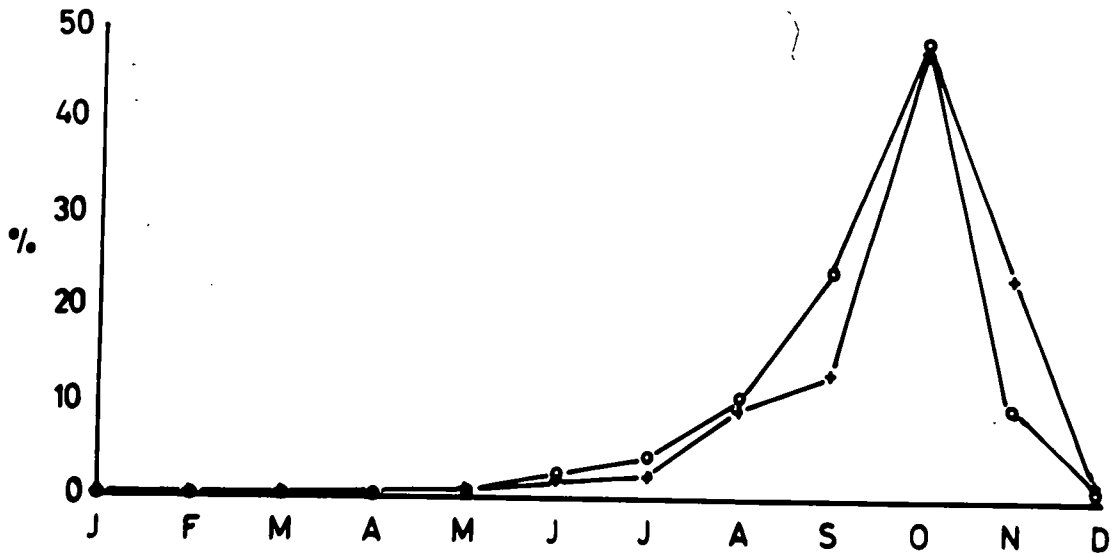

evenly through the year. The litter of other tree species (mainly leaves) fell almost entirely in November. The reproductive categories fell fairly constantly after the end of July, except for a December-January lull in Alder. The most marked exception to this were the Birch male reproductive parts which fell largely in late winter and spring. The fall of scales was greatest in April and May, but continued through the summer till September. The micro-material fell evenly excepting from September to January. Wood fall was by far the most sporadic, over 60% of the fallen wood biocontent being collected on two occasions (17 August 1966 and 22 March 1967).

The contribution of Alder and Birch leaves to biocontent was slightly less important (66%) than their contribution to biomass (71%). The contribution of wood (smaller than 2.5cm diameter) litter fall to biocontent was 19.2% whereas that to biomass was 14.5%. Similarly the contribution of the other categories to biocontent was 14.3%, almost the same (14.5%) as to biomass. Thus the use of biocontent rather than biomass emphasizes the importance of woody litter as against leaf litter, although the latter remains the dominant category of material.

Table XXIX shows the mean biocontent as Kcals/m² of each category cleared from the 24 traps on each occasion from 20 May 1967 to 25 May 1968. As for 1966-7 the data have been shown as cumulative litter fall biocontent in Table XXX.

TABLE XXIX
Litter Trap Data by occasion of clearing 1967-8 (Kcal/m²)

CATEGORY	20/5	10/6	10/7	31/7	18/8	6/9	25/9	11/10	26/10
Alder leaves green	-	0.598	0.887	0.881	0.186	7.140	8.500	3.420	7.830
Alder leaves brown	-	0.288	6.070	21.300	15.200	17.801	38.110	22.998	112.753
Birch leaves green	-	1.840	0.486	0.407	0.053	1.460	-	0.213	-
Birch leaves brown	-	-	37.510	9.720	8.430	27.537	37.501	37.305	142.303
Other Tree Litter	-	-	0.164	0.104	0.036	0.107	-	2.020	2.721
Alder rep ♀	-	0.474	0.310	-	0.029	0.188	-	4.310	3.233
Alder rep ♂	-	0.295	-	0.255	-	0.640	0.337	-	1.231
Birch rep ♀	-	2.120	0.047	0.092	0.249	0.539	-	0.312	-
Birch rep ♂	-	0.292	0.019	0.072	0.682	2.080	0.289	-	-
Scales	-	14.870	13.250	2.255	2.010	20.850	1.791	5.320	7.000
Micro	-	3.050	3.680	0.215	0.082	3.502	0.065	0.598	-
Wood	-	8.900	4.351	13.650	10.001	24.999	0.076	13.110	16.171

CATEGORY	14/11	20/11	18/1	30/2	20/3	10/4	8/5	25/5
Alder leaves green	0.685	7.020	-	-	-	-	0.119	0.146
Alder leaves brown	157.292	46.935	-	-	-	0.235	-	-
Birch leaves green	-	-	-	-	-	-	1.453	-
Birch leaves brown	71.223	6.520	-	-	-	0.345	-	-
Other Tree Litter	15.310	4.140	0.067	-	-	-	-	-
Alder rep ♀	4.500	0.027	7.110	1.933	4.749	0.185	-	0.505
Alder rep ♂	2.230	0.149	2.830	24.701	6.400	4.761	3.650	3.536
Birch rep ♀	-	0.106	-	-	-	-	-	-
Birch rep ♂	0.304	-	-	0.405	1.850	0.867	4.041	5.055
Scales	5.135	0.091	-	6.811	3.521	1.576	17.000	16.210
Micro	-	-	-	3.520	1.620	0.597	0.134	1.641
Wood	26.250	0.359	53.401	24.499	52.410	8.790	1.539	7.000

TABLE XXX Cumulative Litter Trap biocontent data 1967-8 (Kcal/m²)

CATEGORY	20/5	10/6	10/7	31/7	18/8	6/9	20/9	11/10	26/10
Alder leaves green	-	0.598	1.479	2.350	2.536	9.676	18.176	21.596	29.426
Alder leaves brown	-	0.288	6.358	27.658	42.858	60.659	98.769	121.767	234.520
Birch leaves green	-	1.840	2.326	2.733	2.786	4.246	4.246	4.459	4.459
Birch leaves brown	-	-	37.510	47.230	55.660	83.197	120.698	158.003	300.306
Other Tree Litter	-	-	0.164	0.268	0.304	0.411	0.411	2.431	5.152
Alder rep ♀	-	0.474	0.784	0.784	0.813	1.001	1.001	5.311	8.544
Alder rep ♂	-	0.295	0.295	0.550	0.550	1.190	1.527	1.527	2.758
Birch rep ♀	-	2.120	2.167	2.259	2.508	3.047	3.047	3.359	3.359
Birch rep ♂	-	0.292	0.311	0.383	1.065	3.145	3.434	3.434	3.434
Scales	-	14.870	28.120	30.375	32.385	53.035	54.826	60.146	67.146
Micro	-	3.050	6.730	6.945	7.027	10.529	10.594	11.192	11.192
Wood	-	8.900	12.251	25.901	35.902	60.901	60.977	74.087	90.259
Total canopy leaves	-	2.726	47.663	79.971	103.840	157.778	241.889	305.825	568.71
Total other Litter	-	20.901	36.481	41.564	43.662	72.358	74.840	87.400	101.585
Ground Total	-	32.527	96.395	147.436	183.404	291.037	377.706	467.312	760.555
CATEGORY	14/11	27/11	18/1	20/2	20/3	10/4	8/5	28/5	
Alder leaves green	29.711	36.731	36.731	36.731	36.731	36.731	36.850	36.996	
Alder leaves brown	391.812	438.747	438.747	438.747	438.747	438.982	438.982	438.982	
Birch leaves green	4.459	4.459	4.459	4.459	4.459	4.459	5.912	5.912	
Birch leaves brown	371.529	378.049	378.049	378.049	378.049	378.394	378.394	378.394	
Other Tree Litter	20.462	24.602	24.669	24.669	24.669	24.669	24.669	24.669	
Alder rep ♀	13.044	13.071	20.181	22.114	26.863	27.048	27.048	27.553	
Alder rep ♂	4.988	5.137	7.967	32.668	39.068	43.829	47.479	51.015	
Birch rep ♀	3.359	3.465	3.465	3.465	3.465	3.465	3.465	3.465	
Birch rep ♂	3.738	3.738	3.738	4.143	5.993	6.860	10.901	15.956	
Scales	72.281	72.372	72.372	79.183	82.704	84.280	101.280	117.490	
Micro	11.192	11.192	11.192	14.712	16.332	16.929	17.063	18.704	
Wood	116.509	116.868	170.269	194.768	247.178	255.968	257.507	264.507	
Total canopy leaves	797.511	857.986	857.986	857.986	857.986	858.566	860.138	860.284	
Total other Litter	129.064	132.977	143.584	180.954	199.094	206.880	231.905	258.192	
Ground Total	1043.084	1107.831	1171.839	1233.708	1304.258	1319.414	1349.550	1382.983	

The total litter fall biocontent for 1967-8 ($1,382.983\text{Kcal/m}^2$) was within 40Kcal/m^2 of the 1966-7 value, as would be expected from the biomass data. There was no important difference in the seasonal pattern, providing that green and brown alder and birch leaves were not considered separately. In 1966-7 almost all the leaves which fell before the beginning of September were green, whereas in 1967-8 a high proportion of the leaves falling before September were sorted as brown. It is not possible to say whether this was a real effect or an artefact of technique.

The 1967-8 litter fall biocontent measured by litter traps was made up as follows :- alder and birch leaves, 62.2%, wood smaller than 2.5cms, 19.1%, other litter 18.7%. Thus whilst the importance of the canopy leaves had decreased slightly, that of material other than small twigs had increased. This increase was largely as Alder male reproductive structures, scales and micro-litter.

In addition to the litter trap data, the large litter fall must be included in the estimate of biocontent of litter fall. This was only measured once, and must be included in the estimate for both years. Table XXXI shows the summary of biocontent of litter fall for the two study years.

V. iv. Results of Canopy Studies

The Leaf Area Index, biomass and biocontent of the Alder and Birch canopy components are given in Table XXXII

(a) and (b) for 1966-7 and Table XXXIII (a) and (b) for 1967-8. The sources of these data were as follows. The number of leaves in the canopy on any sampling occasion was calculated by assuming that all leaves were derived from buds opening more or less simultaneously at the end of April. It was assumed that no significant number of leaves was derived from buds opening later in the season. This was consistent with field observations. Thus the number of leaves remaining in the canopy at a given time was calculated as the total number of leaves that fell during the whole season less the number that had fallen up to the date in question. The data for area per leaf, dry-weight per leaf and biocontent per leaf were obtained as described in the Methods section. For each sampling occasion each of these three values was multiplied by the estimated number of leaves per square metre so that Leaf Area, biomass and biocontent might be expressed on a per square metre basis.

The Leaf Area Index (LAI) may be seen in Figures 30 (a) and (b). In both years the total LAI rose sharply from late April to a peak in early July, that in 1966-7 being rather higher ($3.635\text{m}^2/\text{m}^2$) than that in 1967 ($3.053\text{m}^2/\text{m}^2$). This early summer increase was due to the expansion and growth of individual leaves. After early July the total LAI fell steadily until early December. This decline was largely due to leaf fall, although some of it was accounted for by a decrease in the area per leaf

TABLE XXXII

Canopy Area, biomass and biocontent, 1966-7

<u>ALDER</u>	No. of leaves /m ²	Area /LF (cm ²)	LAI m ² /m ²	mg/ LF	G/2 m ²	Kcal/LF	Kcal/m ²
1. 5.66	1,778.4	1.16 [±] 0.17	0.207	?	?	?	?
25. 5.66	1,776.0	6.97 [±] 0.31	1.240	31.2 [±] 1.5	55.4	0.164	292.0
22. 6.66	1,776.0	9.82 [±] 0.62	1.745	47.5 [±] 2.7	84.2	0.245	437.0
6. 7.66	1,743.8	11.87 [±] 0.84	2.080	53.7 [±] 3.8	93.8	0.275	480.0
17. 8.66	1,576.1	9.17 [±] 0.52	1.442	53.1 [±] 3.0	83.9	0.264	416.0
17.10.66	988.3	9.01 [±] 0.67	0.847	50.1 [±] 4.1	47.0	0.244	228.0
<u>BIRCH</u>							
1. 5.66	3,284.6	1.16 [±] 0.08	0.379	?	?	?	?
25. 5.66	3,466.9	3.62 [±] 0.36	1.183	18.2 [±] 1.0	59.5	0.091	295.0
22. 6.66	3,266.9	3.76 [±] 0.34	1.227	19.7 [±] 0.9	64.3	0.093	304.5
6. 7.66	3,174.9	4.88 [±] 0.31	1.555	21.3 [±] 1.4	67.8	0.100	317.5
17. 8.66	2,966.7	4.67 [±] 0.25	1.363	25.8 [±] 1.4	76.6	0.116	344.0
17.10.66	942.6	4.65 [±] 0.27	0.439	23.5 [±] 2.1	22.1	0.096	90.3
27.10.66	552.8	4.67 [±] 0.30	0.258	21.9 [±] 4.0	12.1	0.098	54.2

LF = leaf

G/m² = grams / sq. metre

Figure 30.

Canopy Leaf Area Index (m^2/m^2).

a. 1966-7.

b. 1967-8.

Key: open circles - total LAI.

closed circles - alder LAI.

plus signs - birch LAI.

CANOPY LEAF AREA INDEX (m^2/m^2)

1966-7

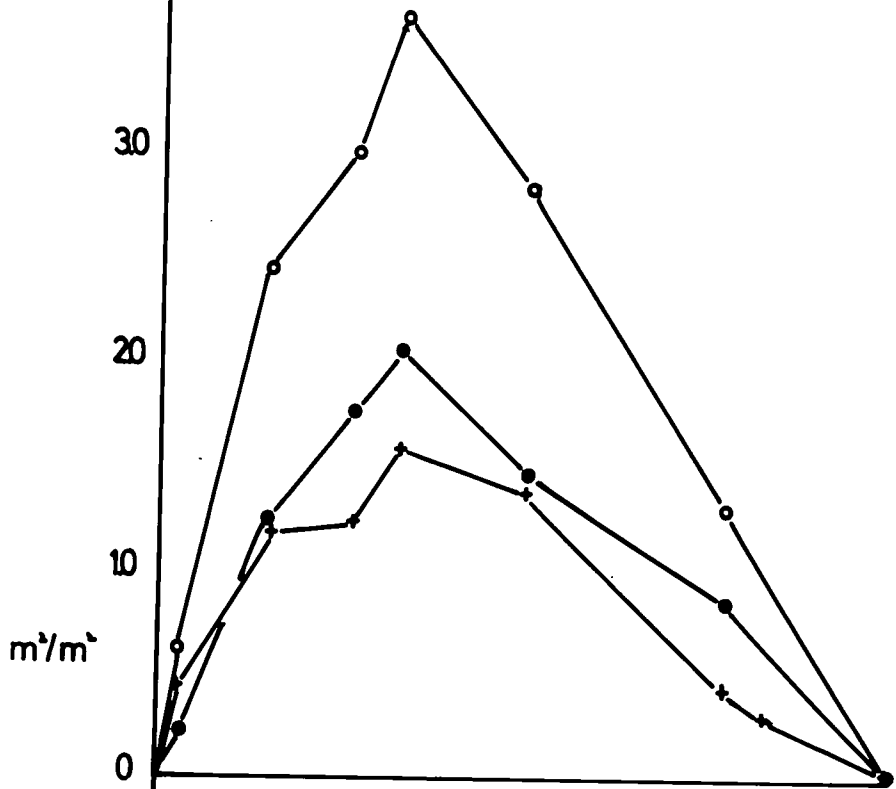

1967-8

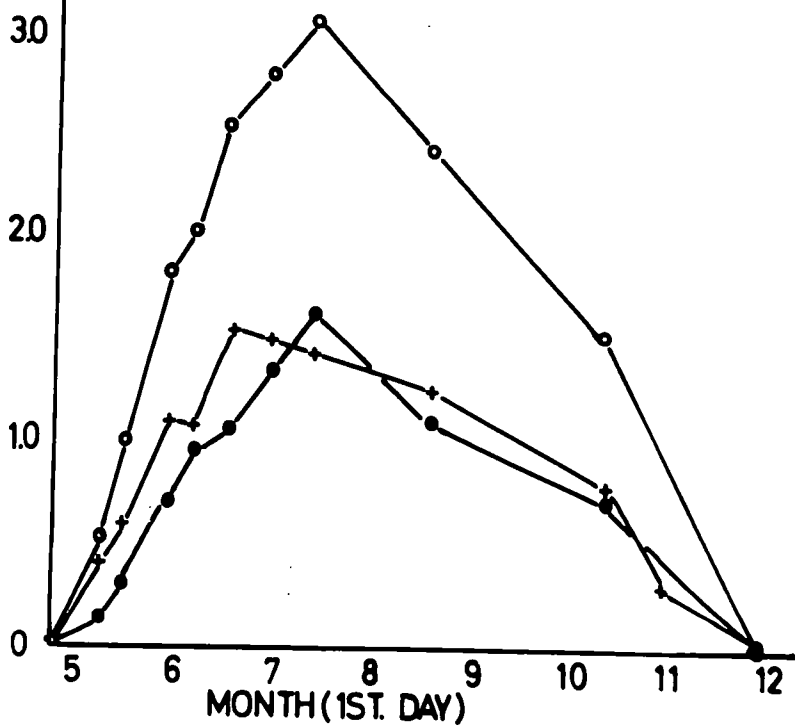

of both species after high summer. Defoliation and differential leaf fall may have been factors here. Alder taken individually peaked in early July both years, the 1966 peak being the highest ($2.080\text{m}^2/\text{m}^2$ as against $1.650\text{m}^2/\text{m}^2$ in 1967-8). Birch had a maximum LAI of $1.555\text{m}^2/\text{m}^2$ in early July 1966 and $1.519\text{m}^2/\text{m}^2$ in mid-June 1967. In both years the birch LAI remained close to its maximum, at least until mid-August although the alder LAI had fallen away markedly by this time. These data are referred to below, particularly in Chapter IV.

The biomass data will not be examined in detail, those for biocontent being more relevant to the purpose of this investigation. For both species, canopy biomass showed a seasonal pattern generally similar to that for LAI. The peak alder canopy biomass was $93.8\text{g}/\text{m}^2$ in early July 1966 and $74.8\text{g}/\text{m}^2$ in early July 1967. For birch, the 1966 peak was $76.6\text{g}/\text{m}^2$ in mid-August and in 1967 $69.8\text{g}/\text{m}^2$ in mid-August. The birch canopy biomass in both years was above $60\text{g}/\text{m}^2$ from late May until the peak. In both years the alder canopy peak biomass was about $15\text{g}/\text{m}^2$ less than the alder litter fall. The peak Birch canopy biomass was almost the same as the birch leaf litter fall in 1966, but $13\text{g}/\text{m}^2$ less than in 1967. In the case of alder, it was not possible to explain the discrepancy by litter fall before peak canopy biomass, this being negligible. In birch, there was a considerable litter fall before peak canopy biomass in both years,

this being 7.79g/m^2 in 1966 and 11.15g/m^2 in 1967. This clearly does not explain the difference between the two years' data. It is possible that we are working within the range of observational errors and the variability of the data here.

The biocontent data will be examined in rather greater detail. It is clear from Tables XXXII and XXXIII that canopy biocontent showed seasonal patterns basically similar to biomass, although certain modifications due to calorific value changes may be noted. Thus a slightly higher birch canopy biocontent was calculated for early July 1967 than for mid-August when the biomass peak occurred. In every case except birch 1967, litter fall biocontent was greater than peak canopy biocontent. For alder the difference was 70.5 and 86.5Kcal/m^2 in 1966 and 1967 respectively. In birch the difference was 15.0 and -17.5Kcal/m^2 in 1966 and 1967 respectively. This effect might have been explained by litter fall prior to peak canopy biocontent, but as the alder figures for this were only 10.5 and 7.8Kcal/m^2 in 1966 and 1967 respectively, this possibility was rejected for alder. In the case of birch in 1966 when litter fall was greater than peak canopy biomass, there was no litter fall before peak canopy biomass. This peak was not a sharp one, rather a plateau, and 28.5Kcal/m^2 litter had fallen by its end on 29 June 1966. This would overcompensate for the difference between a peak canopy biocontent and litter fall. In 1967, when

birch peak canopy biomass exceeded litter fall, 41.0 Kcal/m^2 litter fell before the peak. Even bearing the inherent uncertainty of the data in mind, the differences between peak canopy biocontent and litter fall are not explicable in terms of early litter fall, particularly in the case of Alder.

Figures ³¹5 and ³²6 show, first, canopy biomass^{content} calculated assuming no litter fall (A); second, canopy biomass^{content} assuming litter fall (B) as in Tables XXXII and XXXIII; and third, the first line (canopy biomass^{content} calculated assuming no litter fall) less the litter fall biocontent (C) actually recorded (i.e. A - C). It is clear that in every case actual litter fall biocontent was greater than the product of total leaf number and biocontent per canopy leaf during the period of fall, i.e. $C > A - B$. This was because the calorific value of almost all falling leaf materials was greater than the calorific value of corresponding canopy leaf materials (cf. Section III, Tables V and VI) during the period of fall.

Summation shows that

	ALDER	BIRCH	
$\Sigma C - [A(\text{terminal}) - B(\text{terminal})]$	127.5	63.0	1966
	130.5	38.5	1967
	in Kcal/m^2		

These were all greater than litter fall minus peak canopy biocontent (B max) excepting for Birch 1967.

Figure 31.

Canopy biocontent (Kcal/m²) 1966-7.

Key: open circles - A, canopy biocontent assuming no litter
fall.

plus signs - B, canopy biocontent assuming litter fall.

closed circles - C = A minus recorded litter fall.

CANOPY BIOCONTENT (kcal/m²) 1966-7

ALDER

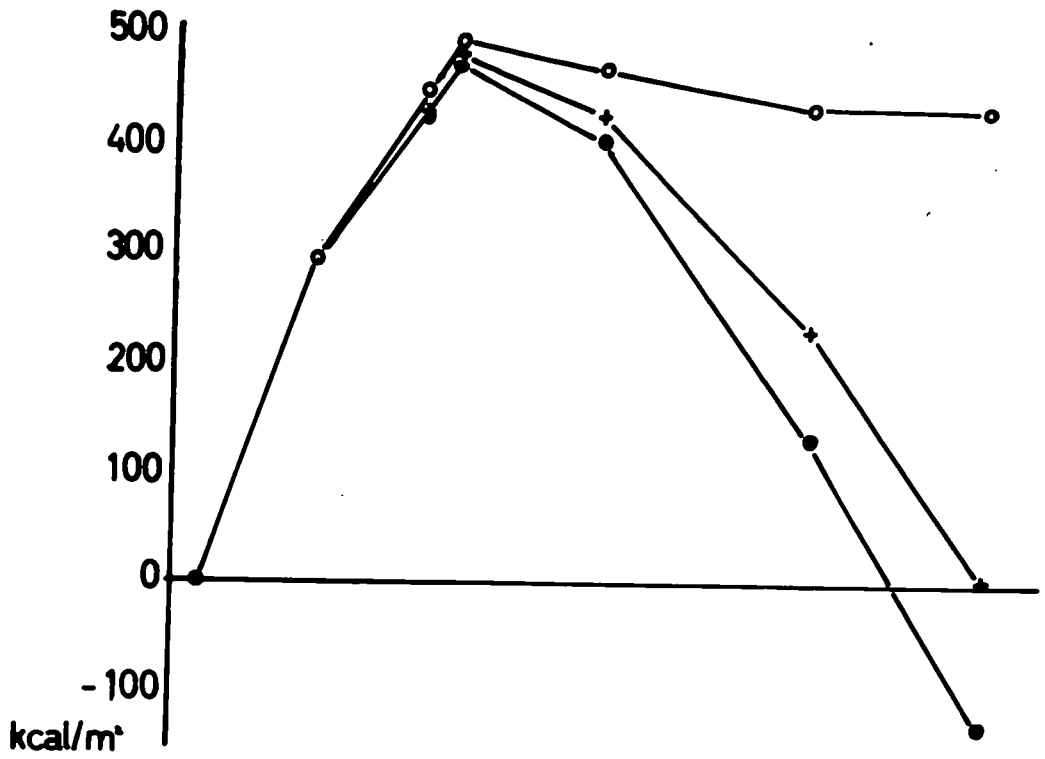

BIRCH

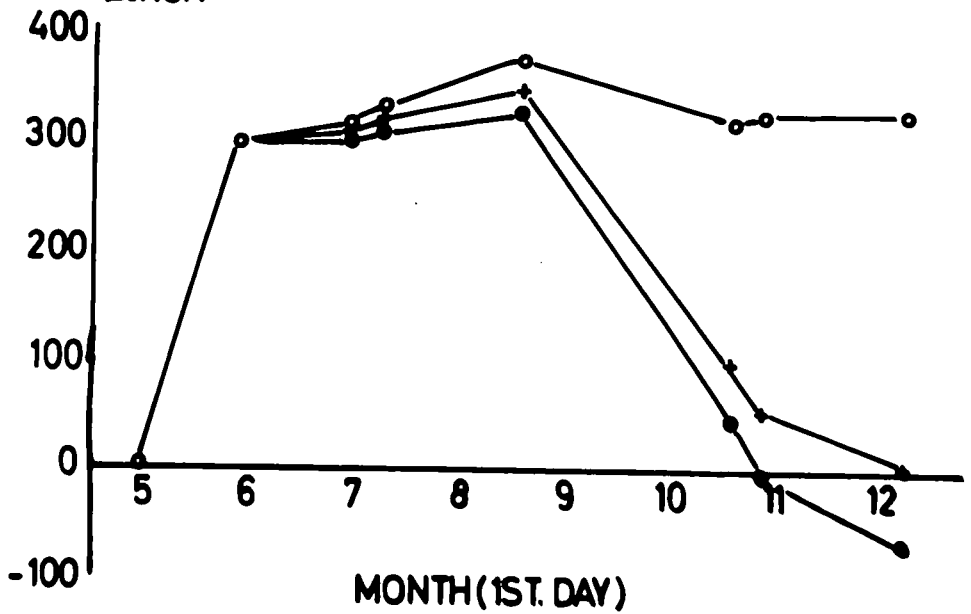
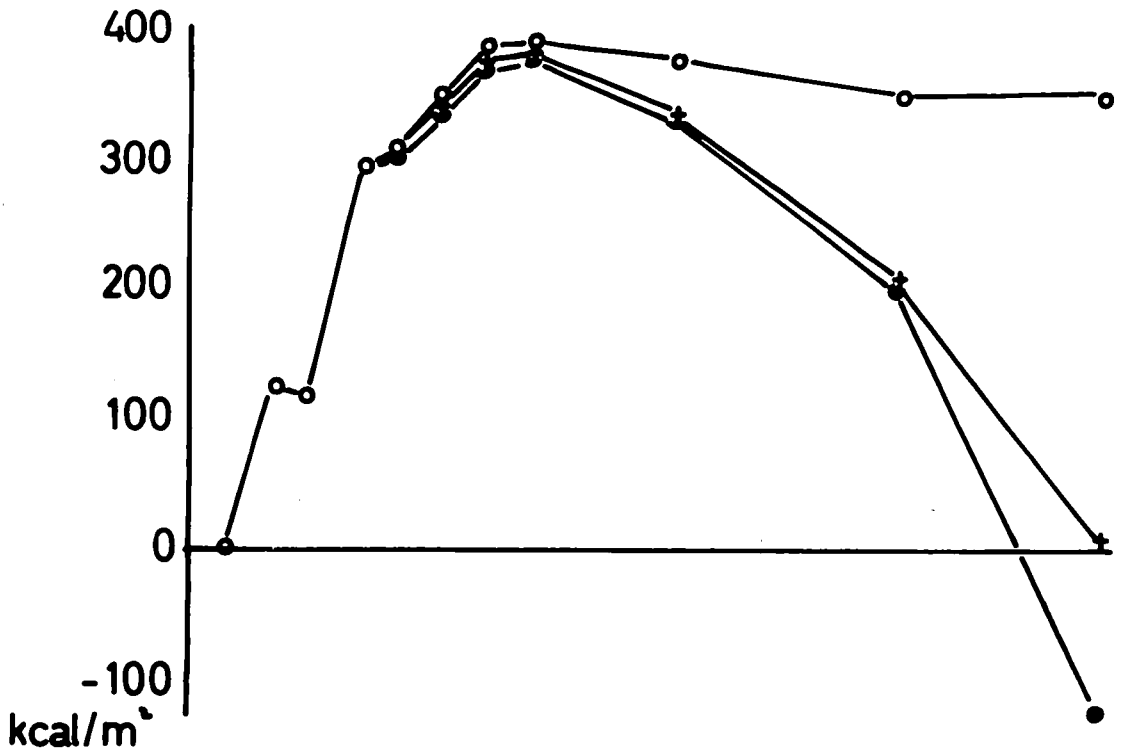

Figure 32.

Canopy biocontent (Kcal/m²) 1967-8.

Key: open circles - A, canopy biocontent assuming no litter fall.
plus signs - B, canopy biocontent assuming litter fall.
closed circles - C, = A minus recorded litter fall.

CANOPY BIOCONTENT (kcal/m³) 1967-8
ALDER



BIRCH

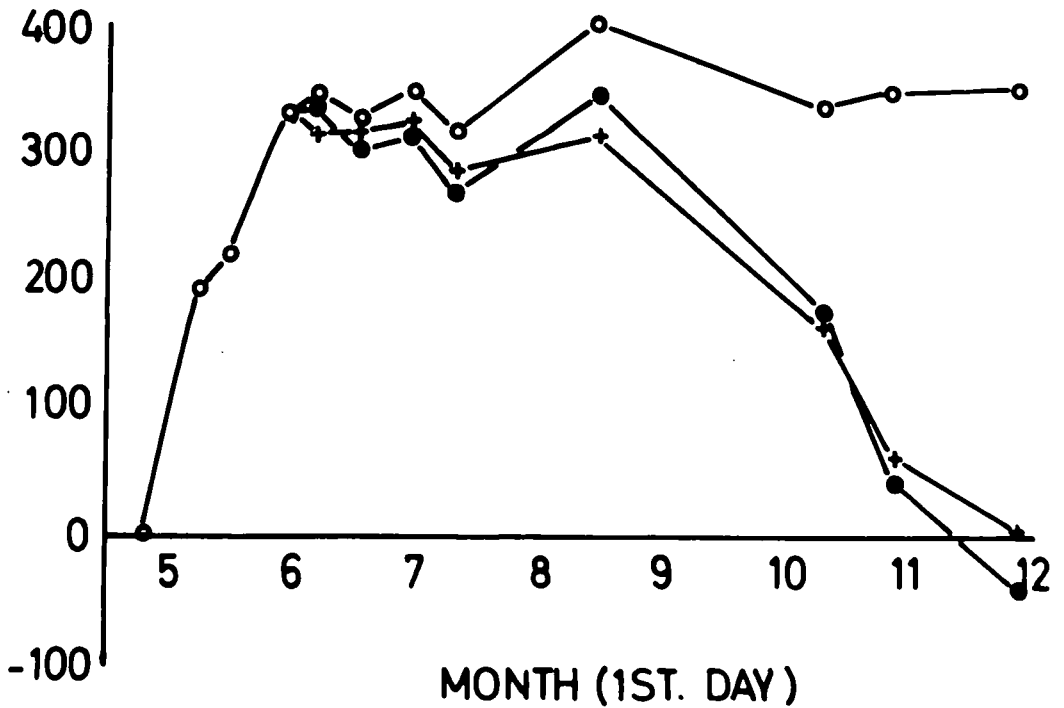

The difference between $C - B_{\max}$ and $C - (A - B)$ is given by the post-peak decline of A (i.e. $A_{\max} - A_{\text{Terminal}}$). This corresponds to the decrease in the value of Kcals/leaf for canopy leaves.

Thus it is possible to say that the difference between peak canopy biocontent (B_{\max}) and litter fall (C) is given by the excess of the biocontent of leaves that actually fall over the biocontent loss from the canopy by leaf fall, less the decrease of canopy biocontent due to the post-peak decline in Kcals/leaf on the canopy.

It is possible to present three simple models of canopy biocontent change. All three assume that products of photosynthesis not destined for storage or degradation in the canopy leaves are instantaneously translocated out of the leaves on production, instantaneously here meaning in an interval much shorter than that between samples. In all three the changes in biocontent may be explained by the following inputs :- upward transfer from the wood store.

- net photosynthesis whose products are not transported out of the leaf.

and outputs :- downward transfer to the wood store.

- litter fall.

Model I has leaf growth commenced by a small upward energy transfer in late April (bud-opening) followed by period of no

losses, in which leaf biocontent climbs rapidly to its peak. Thereafter energy is lost by downward transfer to the wood store and by litter fall. Just prior to abscission there is a marked increase in leaf weight and biocontent as a result of a major upward transfer from the wood store. Thus litter fall can be greater than peak canopy biocontent. This model assumes a homogeneous canopy leaf population.

Model II is essentially similar, excepting that the difference between calorific values for canopy leaves and falling leaves is explained by canopy heterogeneity, i.e. heavy leaves fall first. This model demands that peak canopy biocontent equals litter fall biocontent.

Model III is an extension of either of these by which a difference between litter fall and peak canopy biocontent is explained by a pre-peak fall of leaves.

It is possible to reject Model III immediately for alder. It may apply in the case of birch. Similarly with Model II. The very simple Model I would seem to be an adequate representation of reality for the purpose of this study so far as alder canopy biocontent is concerned, with the modification that some of the post-peak decline of canopy biocontent is probably due to defoliators.

These conclusions are supported by an examination of Tables XXXIV and XXXV. These show canopy and falling leaf dry weight and biocontent for alder and birch respectively. The data

TABLE XXXIVAlder leaf data 1967

	CANOPY LEAVES		FALLING LEAVES			
	mg/LF	Kcals/LF	mg/LF		Kcals/LF	
			Green	Brown	Green	Brown
8. 5.67	17.0	0.089	-	-	-	-
15. 5.67	15.5	0.081	-	-	-	-
29. 5.67	39.7	0.207	-	-	-	-
5. 6.67	41.0	0.214	-	-	-	-
17. 6.67	46.9	0.243	-	-	-	-
29. 6.67	52.8	0.272	-	-	-	-
10. 7.67	53.7	0.275	-	-	-	-
18. 8.67	53.1	0.264	62.4	-	0.298	-
6. 9.67	-	-	48.0	-	0.229	-
25. 9.67	-	-	42.1	45.3	0.201	0.223
11.10.67	50.1	0.244	35.2	62.7	0.168	0.317
26.10.67	-	-	50.3	76.4	0.238	0.394
14.11.67	-	-	56.4	83.6	0.266	0.424

TABLE XXXVBirch leaf data 1967

8. 5.67	12.0	0.060	-	-	-	-
15. 5.67	13.6	0.068	-	-	-	-
29. 5.67	21.0	0.106	-	-	-	-
5. 6.67	21.1	0.099	-	-	-	-
17. 6.67	21.5	0.101	-	-	-	-
29. 6.67	21.6	0.110	-	-	-	-
10. 7.67	21.3	0.100	-	-	-	-
31. 7.67	-	-	-	-	-	-
18. 8.67	25.8	0.116	25.3	-	0.130	-
6. 9.67	-	-	22.2	-	0.114	-
25. 9.67	-	-	24.5	19.7	0.126	0.102
11.10.67	23.5	0.096	28.7	23.2	0.147	0.119
26.10.67	21.9	0.098	-	25.7	-	0.132

LF = leaf

for 1967 are shown. It is clear that although leaf weight may be the same or even less in falling leaves, the calorific content per leaf of the important category of falling leaves, green or brown, depending on time of fall, is always markedly greater than the calorific content per leaf of leaves remaining attached. At the time of greatest fall in both species, the Kcals/leaf were much greater in falling leaves than they ever were in attached canopy leaves. In alder this was effected largely by an increase in leaf weight as well as calorific equivalent; in birch largely by an increase in calorific equivalent. The vast bulk of alder leaves fell in this heavier, more calorie-rich condition; these data thus strongly support Model I above. The changes in birch were much less simple and may well only be explicable by a combination of all three models, with the introduction of other factors, such as defoliators. The data available do not permit so complex an analysis.

V. v. Discussion

(a) Tree Litter Fall. The total fall of tree litter in 1966-7 was 273.476g/m^2 and in 1967-8 was 282.685g/m^2 . Bray & Gorham (1964) computed a mean value from the data then available to them for the Cool Temperate Zone (Angiosperms and Gymnosperms) of 350g/m^2 . This figure was for total litter, whereas those given here are for tree litter alone. If the Wynyard tree

litter data are plotted onto Bray & Gorham's (op.cit.) graph of total litter production vs. Latitude, they fall close to the line through the zonal means. In a later section of this thesis litter production by ground vegetation will be shown to be appreciable. Thus the points for total litter production at Wynyard lie well above Bray & Gorham's line.

Canopy leaf fall accounted for 65% and 61% of total tree litter in 1966-7 and 1967-8 respectively. This compares with Bray & Gorham's mean of 79% for the Cool Temperate Zone. The figures of around 18% for wood fall considerably exceed the range (12-15%) calculated from work by five authors. Subsequent work by Carlisle, Brown & White (1966) and Traczyk (1967) has given figures of 30.2% and 6.78 - 20.83% respectively. In the second of these the fraction contained all non-leaf litter but fruits. In both cases litter was collected throughout the year. Many authors have not collected litter throughout the year, whilst others have not estimated stem or large branch fall. It seems likely that the difference between the Wynyard figures and the zonal Angiosperm mean percentage leaf litter may be as much due to the improved method used as to any other factor. This conclusion is supported by an examination of the data of Carlisle, Brown & White who collected litter right through the year. They found leaf litter to be 55.1% of total.

Litter fall was sharply seasonal, 35% of its biocontent falling in the month of October and 75% in the months August to November inclusive. The seasonal pattern of fall of the leaves of the two important tree species, alder and birch, was similar, although the birch fall declined rather more rapidly than the alder after peak. Although a significant proportion of the leaves of both species fell green, the July peak of green-leaf fall noted for Alnus glutinosa by Witkamp & Van der Drift (1961) in Holland was not observed in this case. The total litter fall in the second year was very similar to that in the first, excepting for the differences in percentage composition noted above. It would have been desirable to continue the litter fall studies for longer, but in any case the two years' results obtained were entirely consistent with one another.

The data available justify the statement that tree litter fall at Wynyard in 1966 and 1967 was lower (around $1,450\text{Kcal/m}^2$) than is generally the case in Angiosperms in the Cool Temperate Zone. For example, Carlisle et al (1966) report a tree litter fall of $1,863\text{Kcal/m}^2$ in a mature Quercus petraea woodland in North-West England. Traczyk (1967) reports values of $1,780\text{Kcal/m}^2$ and $1,623\text{Kcal/m}^2$ for a Carici elongatae-Alnetum and Tilio-Carpinetum respectively in Poland. His values may be an underestimate as he used the single value

of 4.35Kcal/m^2 culled from Wiegert & Evans (1964) rather than making direct calorific determinations as in the work of Carlisle et al (op.cit.) and this study. It is clear that a truly meaningful comparison between litter fall data from various studies cannot be made without reference to the developmental stage or management history of the woodland being studied, and to the contribution of other strata. This will be dealt with further in Section VIII.

The canopy studies showed that maximum Leaf Area Index (1966, $3.635\text{m}^2/\text{m}^2$; 1967, $3.053\text{m}^2/\text{m}^2$) was near the bottom of the range for European Angiosperms as shown by Carlisle et al (1966)'s Table I. For such stands the total range of LAI was 2.24 to 8.44. The lowest values were usually for younger stands, the highest for older stands. The Wynyard LAI values fell well within the range for field crops (Black & Watson 1960) of 2 to 5, although they were not strictly comparable as not all photosynthesising surfaces were included in them. It should further be noted that the maximum figures given here only represent LAI for a very short part of the year. As shown in this section, tree LAI changes dramatically during the summer in deciduous trees, the period of high LAI being short in species where litter fall starts early, as in alder and birch. It is to be expected that the low level of tree LAI will be related to high Ground Vegetation production. This effect is particularly marked in early summer and perhaps in a large part of the autumn (see Sections IX and X).

Not surprisingly, the maximum canopy biomass's estimated at Wynyard (1966, $161.6\text{g}/\text{m}^2$; 1967, $137.1\text{g}/\text{m}^2$) are near the bottom of the range of Bray & Gorham's collected data (their Table XIX) of 120 to $530\text{g}/\text{m}^2$ for temperate angiosperms. This range becomes 170 to $520\text{g}/\text{m}^2$ of stands younger than 20 years are excluded. They quote a mean of $260\text{g}/\text{m}^2$ for two Alnus sites (neither of them A.glutinosa) and $240\text{g}/\text{m}^2$ for eight Betula sites (three of them for Japanese species). The most comparable are Ovington & Madgwick's (1959) data for 24-55 year old Betula verrucosa at Peterborough, England. The figure given by Bray & Gorham (op.cit.) is $170\text{gms}/\text{m}^2$.

As with LAI, canopy biomass at Wynyard changed dramatically throughout the season and as Bray & Gorham (op.cit.) comment, there is a need for direct studies of maximum canopy biomass (they use the term 'leaf production') and leaf litter fall within one forest. This has been attempted in a small way in this study. It is clear that intrinsic changes in leaf weight or biocontent are important in this matter. Mitchell (1936) reported for North American Hickory, Viro (1955) for several European Angiosperms, a decrease in leaf weight between high summer and autumn. Similarly, Bray & Gorham (ibid) report experiments in which they weighed leaflets of Tamarindus indica before and after the formation of an abscission plane, but before they fall. The leaflets with abscission layers were yellow and weighed on average 19% less than the other green leaves.

The same authors found a similar relationship using leaf discs of Ficus.

In this study the weight per leaf of green attached leaves did fall from August to October in both species (cf. Tables XVI and XV). At all times of significant litter fall, however, the weight of brown, falling leaves was greater than that of leaves remaining on the canopy, contrary to the findings of the authors quoted above. The same was true for falling green alder leaves when they were important in early autumn, but not for falling green birch leaves in early autumn. Falling green birch leaves were heavier than those remaining on the canopy in late autumn. This observation is consistent with the fact that litter fall was greater than peak canopy biomass at Wynyard, contrary to Bray & Gorham's (op.cit.) expectation.

The calorific values reported in Section III indicated that this effect would be even more marked when biocontent rather than biomass was considered, because of the higher calorific values of falling as against canopy leaf material. The biomass effect could perhaps be explained in terms of extrinsic factors such as defoliation, differential abscission and so on, as discussed in this Section. A reference back to Section III, Figures 13 and 14, will lend support to the explanation of canopy biocontent change in the terms of Model I given in this Section (V. iv). In particular, there is strong

evidence of a transfer of energy-rich material into the leaves of both species just before fall. If this simple model is valid, which seems more likely for alder than birch, it implies that most of the photosynthetic product bound for the non-leaf parts of the tree is instantaneously translocated out of the leaf on production. This would be a finding of importance for the type of analysis proposed by Olson (1964). It may imply that energy input to non-leafy parts of the tree depends directly on the rate of photosynthesis whereas energy accumulation in the leaf mass behaves in a modified exponential manner of the type discussed by Nichiporovich (1960), excepting for changes at the beginning and end of the summer imposed by net transfers from the rest of the tree. It is clear that further research into the growth of alder leaves in particular would be profitable in this context.

In summary, the methods used have enabled estimates of canopy biomass, biocontent and Leaf Area Index to be made. It has been possible to reconstruct seasonal changes of these quantities in such a way as to permit informed speculation on their causal basis. The estimates have allowed the characterization of the canopy, and will be used to examine its effect on other ecosystem components in subsequent sections of this thesis. Furthermore, the canopy data have been compared with the litter fall data (on which they were partly dependent).

This comparison leads to the conclusion that for the purposes of an estimate of net primary production, litter fall, rather than maximum or other canopy biomass, should be used. Thus the inclusion of the same quantity twice in one summation may be avoided.

It is clear that litter fall represents a major proportion of the ecosystem's fixed energy. In both study years it was close to $1,450\text{Kcal/m}^2$, the total accumulation as wood and branch material calculated in Section IV being $2,031.4\text{Kcal/m}^2$. To return to the point made in the introduction to this section, the scale of the contribution of above-ground tree-parts to the energy required for the processes of mineralization and recycling has been estimated. It is clearly a very large contribution, and must represent a major fraction of total tree net production.

CHAPTER II - SECTION VI

The calculation of Tree Net Production

VI. i. Introduction

The measurement of wood increment and litter fall were dealt with in Sections IV and V. This Section comprises a collation of the data necessary to estimate measurable above-ground tree net primary production.

VI. ii. Methods

As already described in IV. i. the basic method is a modification of Newbould's (1967) Method I, where net primary production is the sum of biomass change and losses to consumers, either decomposers or herbivores. Biomass (and hence biocontent) change data were obtained as described in Section IV for alder and birch. Litter fall, and hence loss to decomposers, was determined as described in Section V.

Loss to herbivores was not measured as a main part of this study, although preliminary data were obtained in May - June 1967. The data were based on the study of the winter-moth caterpillar Operophtera brumata on birch and the bugs Psyllus alni and Psyllus forsteri on alder. In both cases population samples were taken with a high pruner on 29 May, 5 June and 15 June 1967. These were chosen as for the leaf samples (cf. Section V) and put onto a large white sheet. Hence the number of animals per leaf was calculated. The ingestion of leaf material per animal per

day was calculated for animals of various dry weights. In fact, the populations of all three species concerned were almost synchronous in the relevant period. In the case of O. brumata 20 individual caterpillars were placed on birch twigs in jars under field conditions and the area of leaf missing after one week measured. Using area/weight ratios determined on fresh material and calorific values from Section III, this allowed the calculation of Kcal/ingested/caterpillar/day. This, and the population data, gave an estimate of ingestion by the population of O. brumata.

The Psyllid bugs are not leaf-eaters but sucking bugs, apparently living off translocate ambushed from the phloem of leaf veins and petioles in alder. They produce waxy threads containing a honey-dew like substance. These threads form a white fluff which was a characteristic feature of the Study Area in May and June. The problems of determining their ingestion directly were rather complex and therefore an indirect estimate was made. The weight distribution of the population on each of the sampling dates was determined by weighing fifty specimens which had been dried under a vacuum at 60°C. From this data growth was calculated following Wiegert (1964) in his study of meadow spittle bugs. Respiration data were available for individuals of various dry weights at 10°C (J. Richards, pers. comm.). These data were obtained using a simple capillary

respirometer. Hence population respiration was calculated, again following Wiegert (1964). Assuming that the sum of growth and respiration represented 35% of the total ingestion by the psyllid population, these figures were used to calculate energy taken from the alder by these bugs.

The period 29 May to 15 June 1967 represented the greater part of the time the first generation of psyllid bugs spent on the alder leaves. Subsequent generations were very much less noticeable. Similarly, in the case of birch, other observations suggest that little loss of leaf area to defoliators took place after this period, once the leaves were fully grown and harder. In fact, it is possible that much of the defoliation apparent at the end of the season is merely the result of the growth of holes made early in the season. Thus it is likely that the measurement of ingestion by O.brumata between 29 May and 15 June 1967 represents a significant proportion of the total defoliation of birch. Thus the total ingestion for O.brumata, P.alni and P.forsteri between 29 May and 15 June 1967 will be used as a minimum estimate of loss from trees to herbivores. It is clear that the unassimilated fraction of the O.brumata ingestion was also measured as part of the micro-litter, therefore this is excluded from the loss to herbivore term in Newbould's Method I. The unassimilated and excreted fractions were not separable in the Psyllids. They were not previously

measured, and therefore Psyllid ingestion is included in toto in the estimate of net primary production.

Detailed production analyses were not made for the trees and large shrubs of other species than alder or birch present in the Study Area. Instead ratios of litter fall to total net primary production were calculated for the two main species. These were applied to the litter fall data for the other species and hence the wood accumulation by these other species was calculated.

VI. iii. Results - Biomass

Table XXXVI gives a summary of the biomass production data for the two study years, not including the estimates of loss to herbivores. The mean of the two years' figures was 713.6g/m^2 of which 435.5g/m^2 or 61% was as bole and branch biomass change.

VI. iv. Results - Biocontent

The results of the defoliator project are given here because there is no reason to express trophic transfers in other than energy terms. Table XXXVII is a summary of these data.

The total loss to these herbivores in the 18 day period 29 May 1967 to 15 June 1967 was 25.9Kcal/m^2 , or $1.44\text{Kcal/m}^2/\text{day}$. If this rate was maintained through May, June, July and August, the total loss in this way would have been

TABLE XXXVI Summary of tree above-ground net primary
production-biomass

g/m^2	1966-7	1967-8
Alder wood	158.3	158.3
biomass		
change.		
Birch wood	267.7	267.7
biomass		
change.		
Litter fall	273.5	282.7
Other tree	8.9	10.2
wood biomass		
change.		
TOTAL	708.4	718.9 g/m^2

TABLE XXXVII

Herbivore energetics(a) Operophtera brumata on birch

Date	Caterpillars /leaf	Caterpillars /m ²	Ingestion (Kcal/caterpillar /day)	Total ingestion Kcal./m ² /day
29 May- 5 June	0.02	62.94	0.00264	0.165
5 June-15 June	0.02	62.94	0.00264	0.165
18 day total	-	-	-	2.96Kcal/m ²

Assuming 20% assimilation efficiency, the addition from this source to the total estimate of net primary production should be

$$\underline{0.59\text{Kcal./m}^2}$$

(b) Psyllus alni and P.forsteri on alder

Date	Psyllids /leaf	Psyllids /m ²	Biomass mg/m ²	Growth Kcal/m ² / day	Respiration Kcal/m ² / day	ϵ
29/5	1.772	2,500.0	175.0)	0.165	0.337	0.502
5/6	0.964	1,358.0	247.0)			
15/6	0.502	710.0	395.0)	0.208	0.198	0.406
18 day total	-	-	-	3.400	4.680	8.080

Assuming 35% assimilation efficiency, total ingestion =

$$\underline{23.00\text{Kcal./m}^2}$$

177.50Kcal/m². The loss to herbivores minus O.brumata faeces during the 18 day period was 23.59Kcal/m² or 1.32Kcal/m²/day. If this had continued through May - August the total correction to the net primary production estimate would be 162Kcal/m². It is clear that the figure based on the 18 day period only must be an underestimate, whilst that based on extrapolation to a four months period may be an overestimate. In neither case was the consumption by the other species of herbivores present included. The data justify a tentative addition of between 23 and 160Kcal/m² to the net primary production estimate.

Table XXXVIII summarises the biocontent production data for the tree stratum at Wynyard. If the minimum correction for herbivory is applied, it represents only 0.6% of the total. The maximum correction represents 4.4% of the total. In the interests of caution the total corrected for minimum herbivory is accepted. This was close to 3,575Kcal/m² of which bole and branch biocontent change contributed 2,090Kcal/m² (58%).

VI. v. Discussion

Of the mean biomass net production of 713.6g/m², 490.7g/m² (68.5%) was as wood production (wood accumulation plus wood fall). 179.1g/m² (25.0%) was as alder and birch leaves; 43.8g/m² (6.5%) as reproductive structures, bud scales, micro-litter and leaves of other woody species. (These figures are means for the two years).

TABLE XXXVIII

Summary of tree above-ground net primary
production - biocontent

Kcal/m ²	1966-7	1967-8
Alder wood biocontent change	733.4	733.4
Birch wood " "	1,298.0	1,298.0
Other tree wood " "	62.1	55.4
Litter fall	1,479.9	1,440.1
Total before herbivory correction	3,574.4	3,526.9
minimum " "	3,598.0	3,550.5
maximum " "	3,736.4	3,688.9

The total of just over $700\text{g}/\text{m}^2$ compares with the mean of $880\text{g}/\text{m}^2$ quoted by Bray & Gorham (1964) for ten deciduous angiosperms. Of their total, $280\text{g}/\text{m}^2$ (32%) was as leaf production, compared with 25% in this study. The difference may be due partly to the careful measurement of minor components in this study and partly to the developmental stage of the woodland in question. That is, one would expect a higher proportion of net primary production to be put into long-term store (i.e. wood) in a developing woodland than in a mature, equilibrated forest. The fact that the tree above-ground net primary production for the Wynyard site was somewhat lower than the figures given by Bray & Gorham may be related to the well-developed nature of the ground vegetation at Wynyard.

The distribution of biocontent production amongst the various components was rather similar to that of biomass. Of the mean total of $3,574.2\text{Kcal}/\text{m}^2$, $2,417\text{Kcal}/\text{m}^2$ (68%) was as wood, $901.0\text{Kcal}/\text{m}^2$ (25.0%) as alder and birch leaves, $231.7\text{Kcal}/\text{m}^2$ (6.4%) as other litter and $23.6\text{Kcal}/\text{m}^2$ (0.6%) as loss to herbivores. These data will be examined further in the discussion of energy flow and accumulation in Section XI.

CHAPTER III

Ground Vegetation and the Forest Floor

General Introduction

The role of the Ground Vegetation and the Forest Floor in the trophic energetics of the Study Area are dealt with in three sections. In the first of these, Section VII, Serial Cropping, the basic biomass and biocontent studies are described. In the second, Section VIII, Disappearance, the loss of material from the Forest Floor by decomposition and other processes is examined. In the third, Section IX, Ground Vegetation Net Primary Production, a description is given of the determination of the net primary production of the above-ground parts of the ground vegetation. The ground vegetation and Forest Floor were physically intermeshed on the Study Area. At the same time, the methods of estimating biomass and accumulation for these two (ground vegetation and Forest Floor) were interdependent. Therefore they have been examined together in this chapter.

Section VII Serial CroppingVII. i. Introduction

In order to characterize the role of the ground vegetation in the ecosystem energetics of this woodland it was necessary to investigate the changes in biocontent of the ground vegetation and the transfer of material and energy from the ground vegetation to the Forest Floor. In addition, information

was required on the changes in biocontent of tree litter on the Forest Floor. As the ground vegetation and Forest Floor are closely intermeshed, a sampling technique dealing with both simultaneously was considered desirable.

To elucidate the relationships between ground vegetation biocontent changes, litter fall and Forest Floor biocontent changes, estimates of biocontent were required at regular intervals throughout the year. The approach adopted was to sample a number of small areas (quadrats) within the Study Area (actually, on the Grid), throughout the year. The Forest Floor and above-ground ground vegetation materials thus obtained were dried and weighed. For each category of material the mean of the weights for the set of quadrats was taken as dry weight per unit area on that sampling occasion. The variance and standard error of the mean were also calculated. This technique of serial cropping has been used by many workers in studies of primary production (Golley 1965; Golley & Gentry 1966; Hadley & Kieckheffer 1964; Odum 1960; Traczyk 1967a; Traczyk 1967b; Wiegert & Evans 1964). The key decisions to be made in its application are :-

- a. method of cropping
- b. size of quadrats
- c. number of quadrats and their location
- d. frequency of cropping

As elsewhere (Frankland et al 1963) the Forest Floor and Ground Vegetation on the Study Area were extremely heterogeneous and these decisions had to be made with considerable care. The bases for these decisions are discussed in Sub-Section VII ii.)

VII. ii. Serial Cropping Methods

a). Method of Cropping. No studies of roots were made. Therefore the adopted procedure was as follows. At each sampling position a square metal quadrat of the appropriate internal dimensions (cf. VII ii. (b)) was placed horizontally on the vegetation. Any material, such as Rubus fruticosus, that was preventing the quadrat from lying on the Forest Floor was cut with secateurs on the inside edge of the metal quadrat so that the quadrat fell to the ground. Then all other standing Ground Vegetation whose shoots emerged from the mineral soil within the quadrat was cut off at the soil surface. For Rubus fruticosus all material lying across and within the quadrat was harvested. Wherever possible materials were clipped separately by species from July 1966 on. Following this, the remaining part of the Forest Floor was cut with secateurs along the inside edge of the quadrat and all recognizable plant parts in the form of litter removed from within the quadrat. All cropped and cleared materials were placed in labelled polythene bags and taken to the laboratory. Once there, the material from each quadrat was sorted into the following categories : Green ground vegetation

by species or species groups; ground vegetation litter, including attached dead (after December 1966 this was subdivided into fern litter, Rubus litter, grass litter and Chamaenerion litter);

Current and old alder and birch leaves;
Alder and birch reproductive parts;
Litter from other trees and shrubs;
Woody material of diameter less than 2.5cm;
and bryophytes.

If any delay arose before sorting, the material was stored in a deep-freeze cabinet. Once sorted, the material of each category from each quadrat was placed in an unglazed brown paper bag and dried for 24 hours at 105⁰C, excepting the bryophyte material which was dried at 85⁰C (cf. Section III). After drying, the material was weighed on a torsion balance to 0.01 grams. The dry weight of each category of material in each quadrat was recorded. The dried materials were subsampled for calorific analysis as described in Section III.

b). Size of Quadrats. The selection of optimal quadrat size for each category of material cropped was made using Wiegert's (1962) methods. On 6 and 7 March 1966 sixteen sets of nesting quadrats were clipped and cleared on the Grid. Their positions were determined in a stratified, random manner so that two lay within each of the 20 x 20 metre squares.

A set of nesting quadrats is shown in Figure 35. The smallest quadrat had an area of 0.0156m^2 (1), the next 0.0312m^2 (2), and the largest 0.1250m^2 (8). As may be seen from Figure 35 this gave by addition the following ratios of quadrat sizes for analysis :- 1, 2, 6, 7, 8. The cropped material was treated as in VII ii(a).

The data thus obtained were used to calculate the mean and variance of the dry weight of each category of material for each quadrat size. Each mean and variance was multiplied to give mean and variance of dry weight per m^2 .

In addition to the weight determinations, the time involved in clipping, sorting and weighing the materials from each quadrat size was noted throughout the whole operation. Hence the relative time-cost of using each quadrat size was calculated. Taking the time-cost for the smallest quadrat size as unity, the following graphs were then plotted :-

- relative mean against quadrat size (x), taking the mean for size 1 as unity (Fig.36a & b).
- double-log plot of relative variance against quadrat size (Fig.37a & b).
- the product of relative variance (V_r) and relative time-cost (C_r) against quadrat-size (Fig.38a & b).

Using these graphs the optimal quadrat size for each category of material was determined as follows :-

Figure 35.

Nesting quadrats. An explanation is given on page 84.

NESTING QUADRATS

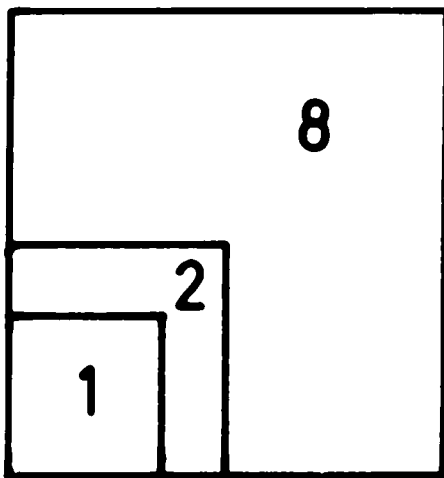

Figure 36.

Relative mean against quadrat size (x).

- a. Other litter and vegetation.
- b. tree litter.

- Key:
- 1 - alder leaves.
 - 2 - birch reproductive structures.
 - ② - birch wood.
 - 3 - other tree litter.
 - 4 - birch leaves.
 - ⑤ - alder wood.
 - 6 - ground vegetation litter.
 - 7 - ground vegetation.
 - 8 - bryophytes.

RELATIVE MEAN VS QUADRAT SIZE (x)

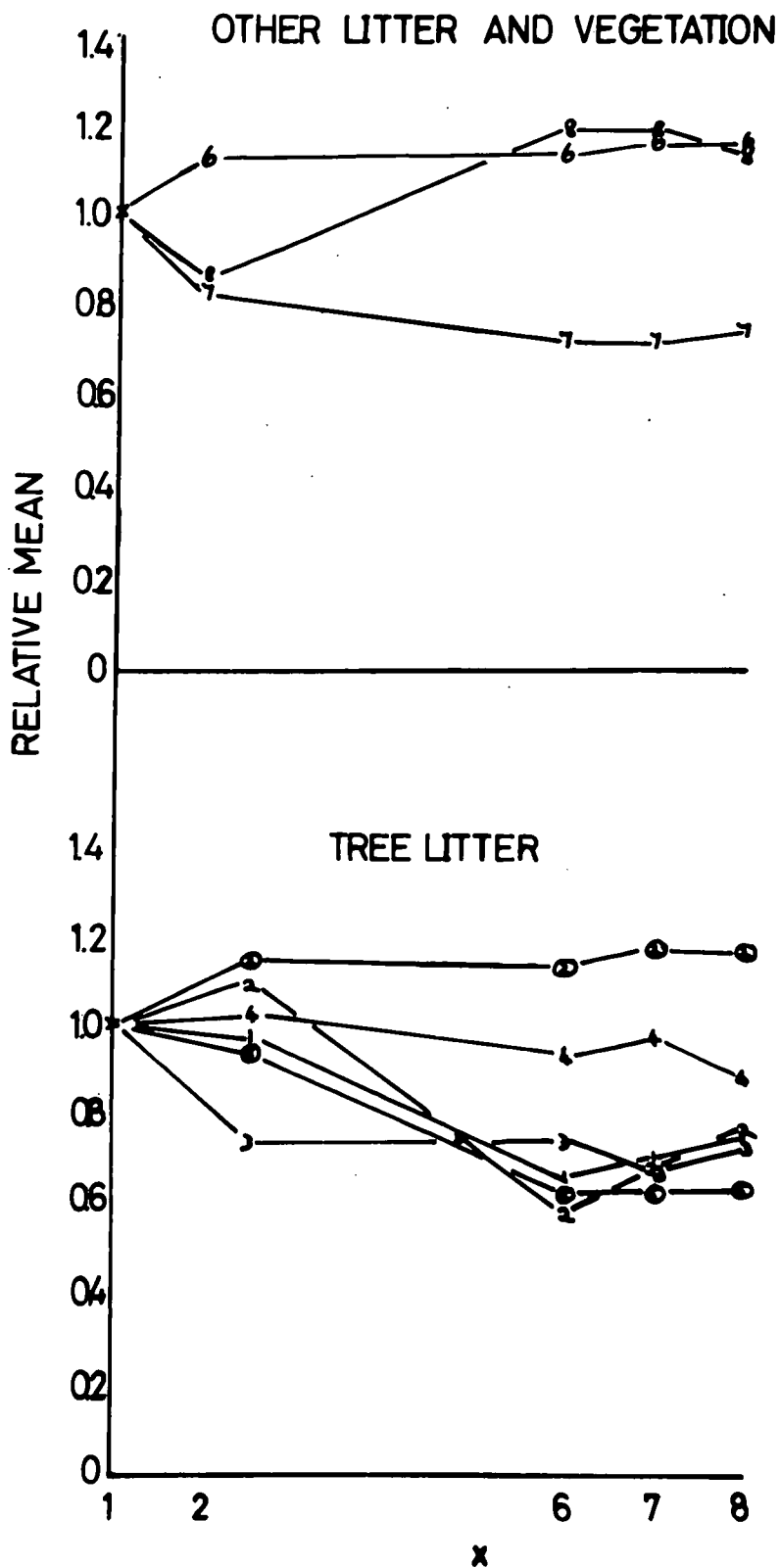

Figure 37.

Relative variance (V_r) against quadrat size (x).

a. Tree litter.

Key: - open circles - birch leaves.
closed circles - birch rep.
open triangles - alder wood.
closed triangles - alder leaves.
open squares - other tree litter.
plus signs - birch wood.

b. Ground vegetation and ground vegetation litter.

Key: - open circles - bryophytes.
open triangles - GV litter.
plus signs - ground vegetation.

V_r vs X

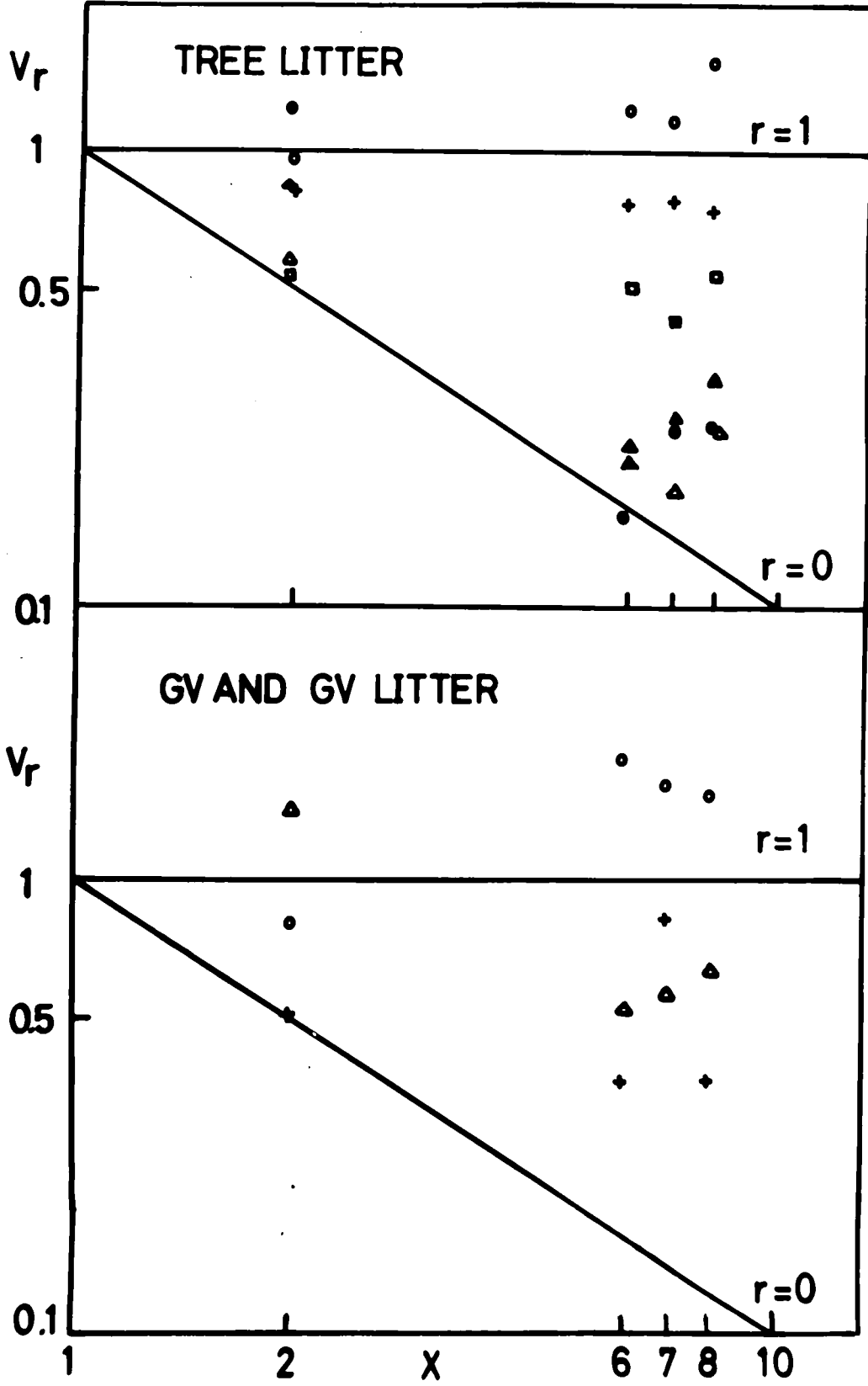

Figure 38.

The product of relative variance (V_r) and relative time-cost (C_r) against quadrat size.

a. Other litter and vegetation.

b. tree litter.

Key as in Figure 36.

TABLE XXXIXOptimal Quadrat Sizes

MATERIAL	(i)	(ii)	(iii)	(iv)
ALDER LEAVES	6	1, 2 out	6	6
ALDER REPRODUCTIVE	6	1, 2 out	6	6
ALDER WOOD	1	1 out	2	2
OTHER TREE LITTER	2	1 out	2	2
BIRCH LEAVES	1	1, 2 out	6	6
BIRCH WOOD	6 + 7	1, 2 out	6	2
GROUND VEGETATION LITTER	1	1 out	6 or 2	2
GREEN GROUND VEGETATION	2	1, 2 out	6	6
BRYOPHYTES	1	1, 2 out	2	2

An explanation is given in the text.

Wiegert's optimal quadrat size technique was used to help the construction of a sampling programme in which the least possible variance of each mean may be obtained in the time available. However, it should not be assumed that a more and more extensive sampling programme with more and bigger quadrats would lead to ever decreasing variances. In populations showing marked clumping, sample variance is at least in part a factor of the relationship between quadrat size, quadrat number and clump size and distribution, or 'scale of pattern'. Therefore, in the design of a biomass sampling programme, and in the evaluation of its results, this should be borne in mind.

The graph of relative variance (V_r) against quadrat size (x), Fig.37, can be used to examine the dispersion of the ground vegetation and litter categories on the Grid. In his treatment of similar data, Wiegert (op.cit.) constructs two hypothetical cases. In one there was no correlation between the biomass of a category in one quadrat and that in the next quadrat. In this case, random dispersal, relative variance (V_r) may be expected to decrease with increases in quadrat size (x). This hypothetical case is represented in Fig.37 by the line marked $r = 0$. In the other case, clumped dispersal, there was a high correlation between biomass in one quadrat and the next. Thus relative variance (V_r) did not change with increases in quadrat size (x). The extreme of this case is

represented by the line $r = 1$ in Figure 37. Wiegert shows that where quadrat size (x) is equal to or smaller than clump size for a given category the relationship between V_r and x will approach that for $r = 1$. Once x is larger than clump size, the relationship should correspond to that for $r = 0$. Information on clump size can be of use at various stages of sampling programme design.

If tree litter categories are considered first it may be seen that the relationship between V_r and x corresponds to that for $r = 0$ (random dispersal) for birch wood up to $x = 7$ (0.1092m^2). Above $x = 7$ it departs markedly from $r = 0$. This may be explained either by a decrease in sampling efficiency above this size, or by some real pattern effect. On the other hand the relationship for alder wood corresponds closely to $r = 1$. That is, alder wood has a clumped dispersal, clump size probably being greater than $x = 10$ (0.1560m^2). Birch wood litter consisted largely of very small twig fragments, whereas alder wood litter was composed to a greater extent of fallen branches. Above $x = 2$ (0.0312m^2) the relationship between V_r and x for alder reproductive structures corresponds to $r = 0$. Therefore clump size for this category is smaller than 0.0312m^2 . The relationship for birch leaves approaches that for $r = 1$, that is birch leaves are highly clumped on the Forest Floor, and their clump size is greater than 0.1560m^2 . On the other hand, alder leaves

appear to have a clump size between $x = 1$ and $x = 2$, and also shows an increase in V_r above $x = 6$ ($0.0936m^2$). This phenomenon of increases in V_r at higher values of x was noted by Justeson (1932) working on field crops and Wiegert (op.cit.) working on an old field. Whether it is an artefact of inadequate observational technique or the product of the real dispersal characteristics of the materials concerned is not a question that can be definitively answered here. The only tree litter category that does not show this effect at all is alder wood.

The relationship between V_r and x for ground vegetation litter suggests a clump size below $x = 2$ ($0.0312m^2$) and again an increase in V_r above $x = 6$ is shown. The behaviour of the ground vegetation itself is more complex. Up to $x = 2$ it corresponds closely to $r = 0$, from $x = 2$ to $x = 6$ it approaches $r = 1$, and then V_r increases and decreases sharply. Ground vegetation is an aggregate category, including many species of plants with many clump sizes and indeed many dispersal patterns. The key to the understanding of the dispersal of most of the other categories probably lies in this, the least clear case. The dispersal of green ground vegetation biomass will change for each species through the year and will no doubt dictate the three-dimensional structure of the Forest Floor.

Examination of Figure 37 shows the complexity of biomass dispersal on the Grid. Almost all the categories

cropped show clumping on at least one level of pattern; if not on several. Therefore no sampling technique can be reasonably expected to give estimates of mean biomass with small confidence limits for any ground vegetation or Forest Floor category. However, the following conclusions were drawn. First, when considered in isolation, limited confidence should be placed in the results of serial cropping on the Grid. Second, as many quadrats as possible should be clipped so as to give some indication of spatial variation of biomass. Third, any calculations based on serial cropping results should be cross-checked by independent methods wherever possible.

c) Number of quadrats and their location. The question of how many quadrats should be clipped was dealt with in part in VII ii(b). It was decided to take only that number of quadrats which could be dealt with in one or one and a half days field work and five or six days laboratory work. For this reason sixteen quadrats were clipped on each sampling occasion from April 1966 to March 1967 inclusive.

During this period the quadrat positions were chosen as follows. Each of the eight 20 x 20m squares comprising the Grid was divided into four 10 x 10m squares, which were subdivided into 100m squares, which were subdivided into 100m squares, which were subdivided into $0.25m^2$ (Fig.39). Each 10 x 10m square was labelled by a single digit - 1, 2, 3 or 4.

On its North-South and West-East side it was marked off at each metre, being labelled 0 to 9. Within each square metre each quarter was labelled 1 - 4. Thus any 0.25m^2 on the Grid could be designated by a letter (A - H for the 20 x 20m square) and a four digit number. On each sampling occasion, two such positions were chosen within each 20 x 20m square using a table of random numbers (Snedecor 1956) to obtain the four-digit place-number. In the field the positions were found by using the posts marking the Grid and a system of marked cross-strings. Within the quarter-metre the size 6 quadrat was placed in the centre. The size 2 quadrat was placed within the size 6 quadrat and to its south-east corner, these being the two quadrat sizes chosen (cf. Table XXXIX, column iv). If some obstacle, such as a tree, was found at the chosen position, the position was moved one metre to the west. If still obstructed, it was moved one metre north, and so on. All square metres from which any sample had been taken were marked on a full chart of the Grid. Future selection of that square metre as a sampling position was ruled out.

It will be noted that this method of stratified random sampling did not take cognizance of the differentiation of the Grid into Alder and Birch Zones. From April 1967, due to experience in clipping and sorting of material, it was possible to increase the number of quadrats clipped on each occasion

Figure 39.

A Grid square (A - H).

An explanation is given on page 89.

20 x 20 METRE SQUARE (A-H)

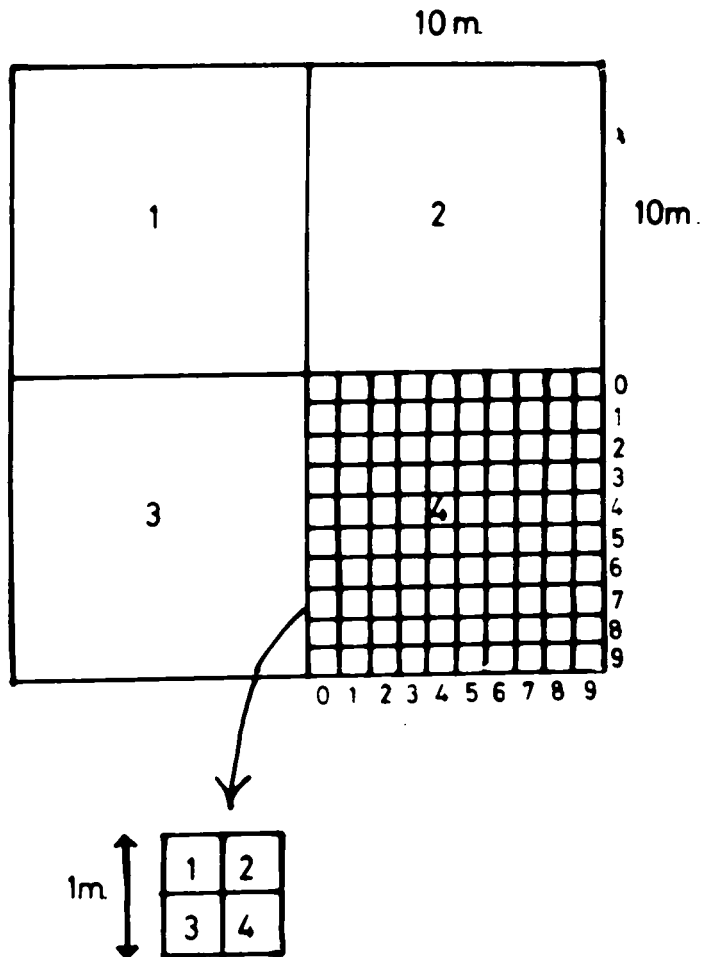

squares from the calculation of biomass variance. The results of this calculation are given in VII iii. The data thus obtained allowed the calculation of biomass mean, variance and standard error for the Alder and Birch Zones considered separately, and when combined, with appropriate weighting, for the two zones taken together, that is the Grid. Whenever biomass data are reported for the Grid from April 1967 on, they refer to a combination of the data from the Alder and Birch Zones achieved in this way.

d) Frequency of cropping. From April 1966 through September 1967 cropping was carried out as near monthly as possible. Thereafter it was done bi-monthly until April 1968. More frequent cropping would have been desirable, but because of the limited time available, this was not possible.

VII. iii. Results, April 1966 to March 1967

a) Green Ground Vegetation and Bryophytes. Table XXXX shows the mean biomass and standard error for each of the sorted categories on each sampling occasion. Unfortunately, the ground vegetation material was not separated into species or species groups until July 1966. Thereafter it was sorted into the categories shown in Table XXXX, "Forbs" being a residual category for the several species of herbs only represented by occasional small individuals.

TABLE XXXX BIOMASS OF GREEN GROUND VEGETATION AND BRYOPHYTES 1966-7 (BIOMASS G.O.DWT/M² (1 S.E.))

DATE	FERNS	RUBUS	CHAMAENERION ANGUSTIFOLI- IUM	FORBS	DESCHAMPSIA CAESPITOSA	AGROSTIS TENUIS	H.LANATUS	H.MOLLIS	TOTAL	BRYOPHYTES
20. 4.66	-	-	-	-	-	-	-	-	25.17 (7.90)	13.76 (5.92)
16. 5.66	-	-	-	-	-	-	-	-	55.54(12.20)	9.92 (3.70)
10. 6.66	-	-	-	-	-	-	-	-	99.90(14.79)	17.60 (8.74)
1. 7.66	25.90 (10.30)	45.60 (12.90)	6.30	4.90	-	-	12.76 (4.80)	22.60	117.38 (14.05)	49.41 (15.94)
1. 8.66	75.26 (27.36)	31.90 (9.50)	4.78	0.71	-	3.52	4.82	16.12	137.70 (25.30)	17.18 (8.80)
5. 9.66	36.89 (29.27)	56.14 (14.78)	9.73	2.21	3.05	9.58	3.92	7.97	129.56 (28.53)	22.75 (6.34)
5.10.66	34.36 (15.31)	51.78 (14.78)	0.81	0.53	0.12	1.73	3.73	10.30	104.27 (19.31)	18.20 (8.99)
31.10.66	27.88 (14.67)	49.06 (5.65)	-	2.04	0.13	3.56	1.73	12.36 (7.05)	97.02 (17.02)	14.88 (6.08)
1.12.66	0.26	22.01 (8.42)	-	1.37	1.55	1.43	-	1.51	28.29 (8.40)	14.18 (6.50)
16. 1.67	+	19.73 (4.79)	-	+	-	+	-	4.45	25.96 (5.05)	18.66 (8.92)
15. 2.67	+	14.85 (5.53)	-	0.79	-	-	3.25 (1.56)	1.57	20.59 (5.21)	20.70 (8.22)
15. 3.67	-	12.68 (4.19)	-	+	-	-	3.34	-	16.05 (4.94)	14.89 (7.02)

Figure 40a shows the change in green ground vegetation biomass and bryophyte biomass through the 12 month period. The ground vegetation biomass showed a clear seasonal pattern, with a peak in August declining to a low figure in April 1967. The bryophyte biomass lay between 10 and 20g/m² for most of the year, only deviating sharply in July when it approached 50g/m². This change was not significant at the 95% level and may simply be the result of quadrat location. For most of the summer, apart from July, the bryophyte biomass amounted to less than 18% of the green ground vegetation biomass (of which it did not form a part). During the winter, from December through March, the two were almost equal.

Figures 40b, c and d show the changes in biomass of ferns and Rubus, Chamaenerion and forbs, and the grass species respectively. The highest biomass reached by each species or species group here may not represent peak biomass, for this may have occurred before July. However, the data did show certain peaks, and these did not all coincide with the overall peak ground vegetation biomass in August. The highest recorded values for Forbs, Holcus lanatus and Agrostis tenuis fell in July. Those for Rubus fruticosus, Chamaenerion angustifolium, Deschampsia caespitosa and Holcus mollis came in September, whereas that for Ferns fell in August. Thus the apparently simple changes in total green ground vegetation biomass

Figure 40.

Biomass (g/m^2) 1966-7.

- a. top left - total ground vegetation (crosses) and bryophytes (open circles).
- b. top right - ferns (plus signs) and Rubus (open circles).
- c. bottom right - forbs.
- d. bottom left - total grasses.

BIOMASS (g/m²) 1966-7

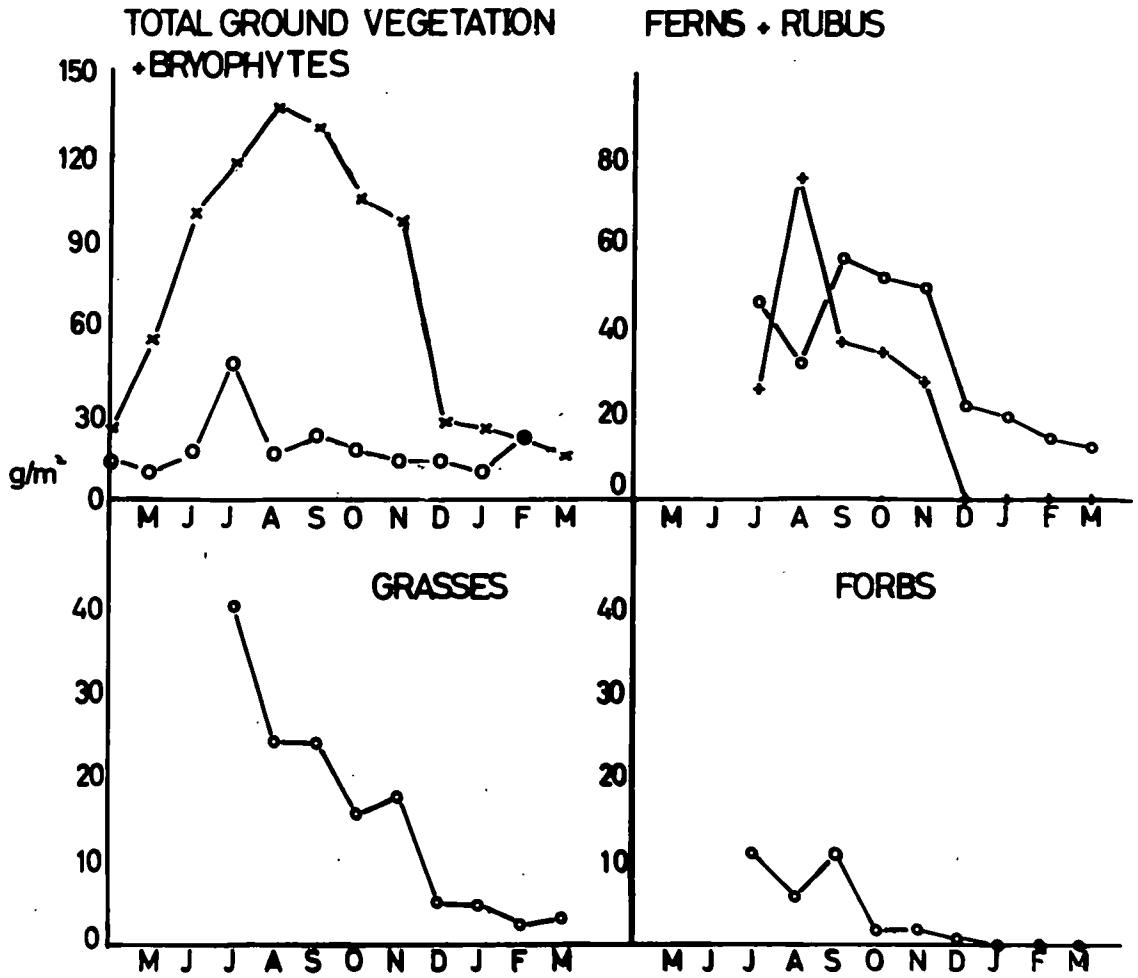

concealed a complex pattern of species and species group biomass changes. However, the confidence limits of many of the species and species group biomass estimates were wide, and only limited trust can be placed in them. The confidence limits placed on the estimate of overall green ground vegetation biomass were more acceptable, one standard error usually representing 20% or less of the mean. These figures were comparable to those of Frankland et al (1963) and Whittaker (1962), obtained in similarly heterogeneous vegetation.

Although the Fern category showed the highest peak biomass, Rubus fruticosus formed the most consistently important biomass component. It formed the major part of the overwintering material because of its persistent woody shoots. In July the grasses contributed 29% of the green ground vegetation biomass, but by December they had fallen to 5%.

b) Ground Vegetation Litter. Table XXXI shows the mean biomass and its standard error for the ground vegetation litter on each sampling occasion. Figure 41 shows the changes in ground vegetation litter biomass through a 12 month period. The biomass dropped from nearly $450\text{g}/\text{m}^2$ in th April to just over $200\text{g}/\text{m}^2$ in July. After an increase in August and another in October, it remained between 200 and $250\text{g}/\text{m}^2$ for the rest of the study period. It is of interest to note that the winter of 1965-6 was particularly hard, snow covering the ground for

TABLE XXXXI

Biomass of Ground Vegetation Litter 1966-7
(g/m² + 1 S.E.)

DATE	TOTAL	FERN	RUBUS	GRASS
20. 4.66	448.00 (51.90)	-	-	-
16. 5.66	373.44 (59.10)	-	-	-
10. 6.66	284.38 (37.94)	-	-	-
1. 7.66	207.01 (41.15)	-	-	-
1. 8.66	288.32 (47.36)	-	-	-
5. 9.66	257.32 (42.72)	-	-	-
5.10.66	284.45 (53.18)	-	-	-
31.10.66	217.15 (31.65)	-	-	-
1.12.66	225.57 (26.72)	-	-	-
16. 1.67	250.83 (38.43)	133.25 (40.82)	88.02 (23.73)	29.57 (17.07)
15. 2.67	229.69 (46.89)	137.82 (48.18)	50.79 (14.71)	42.08 (13.91)
15. 3.67	229.96 (35.43)	143.16 (43.36)	48.34 (5.19)	37.94 (17.98)

many weeks. These severe conditions probably slowed up the breakdown of ground vegetation litter formed in 1965. The litter surplus thus formed was broken down once spring conditions arrived. The increase in ground vegetation litter biomass from 1 August 1966 to 1 September 1966 was probably due to the die-back of those species known to have an early peak biomass, e.g. Agrostis tenuis and Holcus lanatus. The high October value was probably due to the mortality of species having September peaks, for example, Rubus fruticosus, Chamaenerion angustifolium, Deschampsia caespitosa and Holcus mollis. The ground vegetation litter biomass figures do not reflect any decrease in Fern biomass from 1 August 1966 to 5 September 1966. The standard error of the ground vegetation litter biomass estimate as a percentage of the mean ranged from 11.60% to 20.52%, the period average of this statistic being 15.95%. For green ground vegetation the range was 11.95% to 31.14%, the period average being 21.80%. Because the lowest value of ground vegetation litter biomass was much higher than the highest value of green ground vegetation biomass, the narrower confidence limits of the former probably represented greater amounts of material than the broader limits of the latter.

From January 1967 the ground vegetation litter was sorted into Fern and Chamaenerion litter, Rubus litter, and Grass litter. The Fern and Chamaenerion litter formed 53%

Figure 41.

Biomass (g/m^2) 1966-7. Total ground vegetation litter.

BIOMASS (g/m²) 1966-7

GROUND VEGETATION LITTER



of this litter in January, and rose to 62% in March. The Rubus litter formed 35% in January, and fell to 21% in March, whereas the Grass proportion rose from 12% to 16%. The Fern material clearly comprised the most important ground vegetation Litter component, followed by Rubus, and then the grasses. This order of importance followed that for the green ground Vegetation categories' peaks and suggests that the persistence on the Forest Floor of each of these three types of material was of the same order of magnitude.

c) Tree Litter. Table XXXXII shows mean biomass and standard error for each tree litter category on the Forest Floor on each sampling occasion. Figures 42a,b,c and d show respectively the changes in biomass of alder leaves and birch leaves; reproductive structures and other tree litter; and wood through this period.

It was possible to separate the fallen tree leaves into old (1965 crop) and new (1966 crop) on the basis of colour, texture and fragility. In the case of alder the old leaves were usually highly skeletonised, whilst in birch, the old leaves were mid-brown and very brittle. It is clear from Figures 42b and c that the seasonal changes in Forest Floor tree Leaf Litter biomass corresponded to autumnal leaf fall, and the subsequent disappearance of almost all the year's leaf fall within twelve months. However, the estimate of the old leaf biomass after new leaf fall had begun may have been an underestimate, because of sorting inefficiency. The alder

TABLE XXXXII Biomass of Tree Litter on the Forest Floor, 1966-7 ($\text{g/m}^2 \pm 1 \text{ S.E.}$) Grid

DATE	ALDER LEAVES - NEW	ALDER LEAVES - OLD	ALDER REP	OTHER TREE	BIRCH LEAVES - NEW	BIRCH LEAVES - OLD	BIRCH REP	WOOD
20. 4.66	-	35.67 (9.30)	11.50 (4.60)	1.28 (0.80)	-	50.10 (10.70)	-	239.00 (55.75)
16. 5.66	-	19.76 (7.45)	6.66 (2.86)	1.60 (0.84)	-	53.24 (13.11)	-	254.08 (43.93)
10. 6.66	-	26.52 (12.10)	9.82 (3.57)	2.19 (-)	-	23.46 (8.76)	-	278.78 (92.80)
1. 7.66	1.16 (0.17)	7.28 (3.05)	9.62 (3.22)	2.59 (-)	1.75 (0.50)	20.66 (8.48)	-	221.79 (48.16)
1. 8.66	3.60 (0.86)	10.70 (4.70)	6.70 (2.90)	0.33 (-)	3.40 (0.24)	16.70 (5.80)	-	411.52 (78.72)
5. 9.66	9.47 (3.07)	1.40 (0.65)	2.67 (0.83)	+	8.23 (2.11)	13.26 (6.16)	0.35 (0.15)	298.37 (64.77)
5.10.66	27.15 (6.10)	9.29 (4.23)	3.44 (1.13)	4.06 (-)	34.85 (7.27)	2.83 (1.10)	0.73 (-)	342.30 (67.07)
31.10.66	69.39 (16.38)	0.96 (-)	5.20 (2.04)	5.08 (-)	75.89 (19.37)	0.62 (-)	0.98 (-)	182.69 (42.85)
1.12.66	97.58 (21.05)	-	6.27 (2.28)	23.06 (-)	71.02 (18.25)	-	0.19 (-)	180.86 (40.51)
16.1.67	76.89 (23.04)	-	3.78 (1.31)	5.39 (2.23)	46.62 (13.26)	-	0.34 (-)	318.57 (80.03)
15.2.67	50.24 (14.48)	-	3.79 (1.49)	11.24 (7.69)	69.54 (16.23)	-	0.75 (0.21)	215.23 (45.38)
15.3.67	25.53 (8.79)	-	5.91 (2.49)	1.74 (-)	51.12 (13.42)	-	0.77 (-)	231.90 (29.04)

Forest Floor leaf litter biomass reached a peak of 97.58g/m^2 at the beginning of December, and declined steadily from this time through to March. The birch leaf peak of 75.89g/m^2 was reached at the beginning of November. Although some fluctuations took place, due no doubt to quadrat location, no great decrease took place until after the middle of February. These data are compared with the litter fall and disappearance data in Section VIII. The biomass of alder reproductive structures on the Forest Floor (Fig.42c) remained between 6.5 and 11.5g/m^2 from April to August. From September to March it lay between 2.6 and 6.3g/m^2 . No birch reproductive structures were recorded between April and August, but from September to March a small biomass of less than 1g/m^2 was recorded. The other tree litter (also Fig.42c) showed a peak of 23.06g/m^2 in December and declined to around 1g/m^2 the following spring. These data are considered further in Section VIII.

The wood litter biomass fluctuated greatly around a figure of approximately 250g/m^2 . The confidence limits of each of the monthly figures were large, the standard error representing from 12.5% to 33.3% of the mean, the period average of this statistic being 21.7%. There was little difference (7.10g/m^2) between the wood litter biomass estimates for April 1966 and March 1967. The disappearance of wood litter is dealt with in Section VIII.

d) Quadrat apportionment for 1967-8 as calculated from 1966-7 data. The apportionment of quadrats for clipping between the Alder and Birch Zones from April 1967 on was decided on the basis of Snedecor's (1956)

Figure 42.

Biomass (g/m^2) 1966-7.

Forest floor tree litter.

- a. top left - alder leaves, old (plus signs) and new (open circles).
- b. top right - birch leaves, old (plus signs) and new (open circles).
- c. bottom left - miscellaneous litter;
alder rep. (open circles).
other tree (closed circles).
birch rep. (plus signs).
- d. bottom right - wood litter.

BIOMASS (g/m²) 1966-7

FOREST FLOOR LITTER

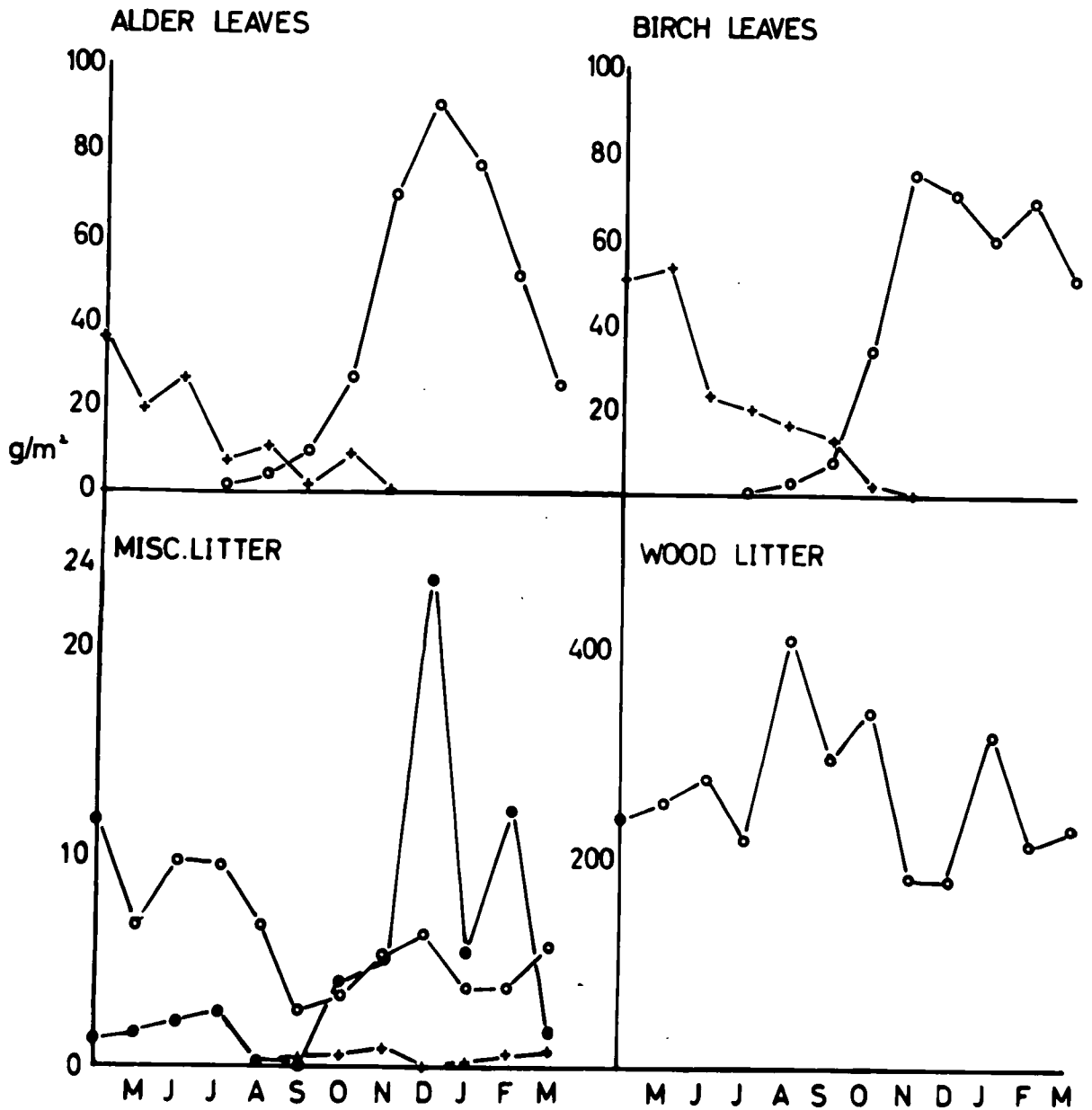

method (see Section VII ii(c)). The data obtained by serial cropping from April 1966 to March 1967 were used. An example using the biomass data for green ground vegetation on 10.6.66 is given below. In this case, δ_h and hence relative "variance", may be calculated for the Alder and Birch Zones as follows :-

	δ_h	W_h	$W_h \delta_h$	$\frac{W_h \delta_h}{\sum W_h \delta_h}$
ALDER ZONE	12.42	0.51	6.21	0.529
BIRCH ZONE	11.05	0.49	5.52	0.471
			<u>11.73</u>	<u>1.000</u>

$$\therefore 24 \frac{\delta_A W_A}{\sum \delta_h W_h} = 24 \times 0.529 = 12.69$$

$$\text{and } 24 \frac{\delta_B W_B}{\sum \delta_h W_h} = 24 \times 0.471 = 11.31$$

The calculations indicate that 13 quadrats should be clipped in the Alder Zone and 11 in the Birch Zone. The same calculations on data for different categories of material on different sampling occasions gave the same result. Therefore, from April 1967 to April 1968 13 quadrats were clipped in the Alder Zone of the Grid and 11 in the Birch Zone of the Grid.

e) To test the effectiveness of mapping the Grid into the Alder and Birch Zones. This was done using the results of serial cropping from April 1966 to March 1967. The percentage deviation from the monthly mean biomass for each category of material in each quadrat was calculated using an Elliott 805 computer. This made possible

the mapping of the positions of quadrats where the percentage deviation for a particular category of material was greater than 20%. This was essentially the same technique as that used by Golley (1965). Figure 43 shows the distribution of these positions for Forest Floor alder leaves, Forest Floor birch leaves and green Agrostis tenuis. Locations where percentage deviation exceeded + 20% for alder leaves and -20% for birch leaves were most common in the Alder Zone. The reverse was true in most of the Birch Zone. All but three of the Agrostis tenuis locations lay in the Birch Zone, so that this acted as a reasonably reliable indicator species. This map suggests that the physiognomic division of the Grid into Alder and Birch Zones effectively reflects the differentiation of the vegetation and its biomass structure into two main types.

VII iv. Results, April 1967 through April 1968

Using the data obtained by serial cropping during the second year of sampling mean biomass, variance and standard error were calculated for each category of material for the Alder and Birch Zones separately on each sampling occasion. These values were weighted according to the relative areas of the Alder and Birch Zones and hence mean biomass and standard error for each category of material calculated for the two zones taken together, that is, the Grid taken as a whole. The reasons for adopting this procedure were given in VII ii (c). These calculations were carried out on the Northumbrian Universities

Distribution. Location is given on pages 97-100.

Key:	> + 20	> - 20
<u>Agrostis tenuis</u>	●	○
Forest floor alder leaves	◐	◑
Forest floor birch leaves	◒	◓

BIOMASS DISTRIBUTION

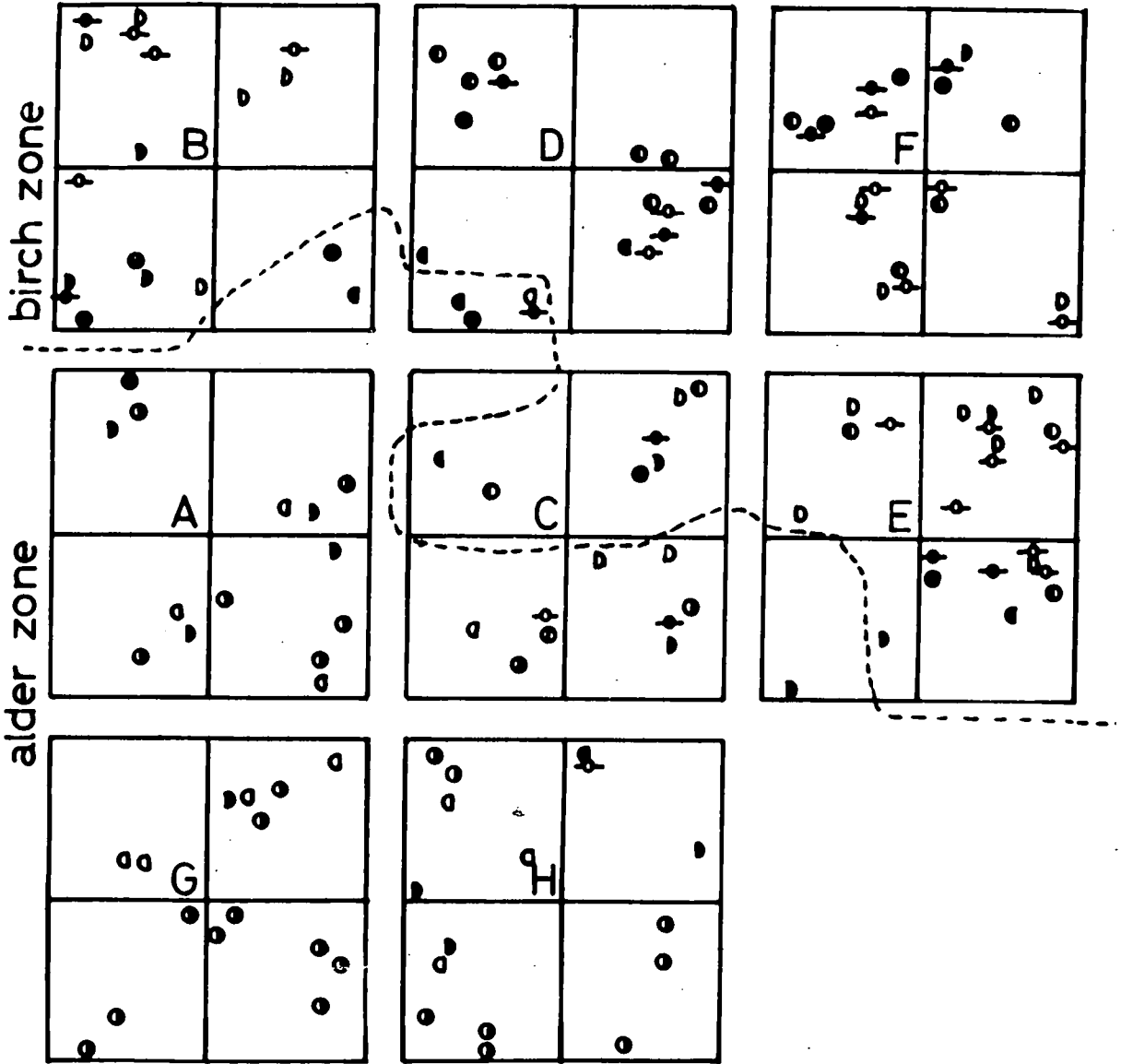

Multiple Access Computer (NUMAC), IBM 360/375. The programme, 'MEANWTS', was written for this purpose in Programme Language One by J. Ollason of the Department of Zoology, University of Durham. Appendix II contains a specimen of the print-out, and a description of the punched-card format of the data input.

During the 1967-8 sampling period, the subdivision of ground vegetation litter into Fern + Chamaenerion, Rubus, and grass litter was continued. Some of the green ground vegetation categories were further subdivided. In particular, the Fern category was split into Dryopteris, Polystichum and Pteridium. Although the collection and handling of the serial cropping data in this period was different to that in 1966-7, it is possible to compare biomasses on the Grid taken as a whole for the two periods.

a) Green Ground Vegetation and Bryophytes, Alder Zone, Birch Zone and whole Grid, 1967-8. Table XXXXIII shows the serial cropping data for the green ground vegetation and bryophytes from April 1967 through April 1968. The data for the Alder and Birch Zones are dealt with separately, and then the resulting values for the whole Grid are discussed.

i. Alder Zone. Figure 44a shows the changes of green ground vegetation biomass and bryophyte biomass for the Alder Zone. The green ground vegetation biomass showed a clear seasonal pattern, rising to a peak of 104.66g/m^2 in July and showing a secondary peak of 78.67g/m^2 in October. It then declined to a winter value of

TABLE XXXXIII

Biomass of Green Ground Vegetation and Bryophytes 1967-8

A : Alder Zone B : Birch Zone E : Grid as a whole (Biomass G.O.D.WT/M² (1 S.E.))

CATEGORY	APRIL	MAY	JUNE	JULY	AUGUST	SEPTEMBER	OCTOBER	DECEMBER	FEBRUARY	APRIL
DRYOPTERIS	A 1.81 (1.37)	20.67 (12.53)	25.35 (14.66)	31.69 (24.68)	34.22 (18.30)	35.32 (15.32)	48.46 (35.30)	3.23 (2.23)	-	-
	B 1.70 (0.73)	11.74 (5.89)	20.79 (15.31)	25.68 (17.47)	47.27 (47.27)	54.16 (50.13)	70.97 (64.68)	0.37 (0.37)	-	-
	E 1.76 (0.78)	16.30 (7.20)	23.12 (10.59)	28.75 (15.22)	40.78 (17.85)	44.93 (20.23)	59.71 (29.47)	1.84 (1.15)	-	-
POLYSTICHUM	A -	-	-	8.72 (7.56)	1.19 (0.76)	0.93 (-)	1.07 (0.51)	0.67 (0.67)	-	-
	B 0.33 (0.19)	0.37 (0.28)	0.38 (0.18)	1.03 (0.66)	2.31 (2.31)	-	0.62 (0.49)	-	0.56 (0.38)	-
	E 0.17 (0.09)	0.19 (0.12)	0.19 (0.08)	4.96 (3.87)	1.75 (1.20)	0.46	0.84	0.33	0.28	-
PTERIDIUM	A -	-	-	-	0.15 (0.15)	-	-	-	-	-
	B -	-	-	-	8.75 (8.75)	-	-	-	-	-
	E -	-	-	-	4.53	-	-	-	-	-
RUBUS	A 37.63 (10.88)	25.83 (8.10)	21.62 (7.61)	41.64 (14.20)	30.22 (11.85)	29.50 (6.90)	28.72 (6.72)	17.95 (5.15)	18.97 (4.59)	20.71 (6.13)
	B 8.60 (3.61)	43.95 (17.73)	30.31 (9.42)	26.13 (14.22)	20.34 (5.50)	20.50 (8.89)	20.74 (8.94)	7.99 (6.10)	23.78 (9.50)	15.30 (4.25)
	E 23.41 (5.82)	34.89 (15.72)	25.88 (6.03)	33.73 (10.20)	25.38 (6.62)	24.90 (5.01)	24.56 (5.03)	13.08 (3.99)	21.33 (5.21)	17.95 (3.56)
C. ANGUSTIFOLIUM	A -	-	0.87 (0.87)	5.31 (5.15)	-	-	-	-	-	-
	B -	0.43 (+)	0.86 (0.86)	-	7.98 (5.68)	-	-	-	-	-
	E -	0.21 (+)	0.87 (0.62)	2.60	4.07	-	-	-	-	-
FORBS	A -	0.49 (+)	0.30 (0.30)	4.41 (4.19)	1.72 (1.47)	0.32 (0.25)	0.07 (0.05)	0.23 (0.23)	0.04 (0.04)	0.54 (0.54)
	B 2.94 (1.86)	0.51 (+)	2.24 (0.87)	-	1.83 (1.00)	1.03 (0.76)	0.70 (0.44)	0.45 (0.45)	0.70 (0.70)	0.22 (0.22)
	E 1.50 (0.92)	1.00 (+)	1.25 (0.45)	2.16	1.78 (0.89)	0.68	0.39 (0.22)	0.34 (0.25)	0.37 (0.34)	0.39 (0.29)
VIOLA	A -	-	0.02 (0.02)	0.06 (0.04)	0.05 (0.05)	-	0.08 (+)	-	0.15 (0.15)	0.07 (0.07)
	B 0.71 (0.71)	0.24 (+)	1.18 (0.90)	-	0.34 (0.26)	-	-	-	-	-
	E 0.36 (0.35)	0.12 +	0.59 (0.44)	0.03	0.19 (0.13)	-	0.04	-	0.07	0.03
D. CAESPITOSA	A -	-	10.95 (1.41)	-	-	-	-	-	-	-
	B 0.82 (0.56)	0.26 (0.26)	-	-	-	-	0.38 (0.38)	-	0.16 (0.16)	1.13 (0.81)
	E 0.42 (0.28)	0.13 (-)	5.37	-	-	-	0.19	-	0.82	0.58
AGROSTIS TENUIIS	A 0.03 (0.03)	0.46 (0.45)	6.02 (2.50)	-	-	-	0.02 (0.02)	1.24 (1.23)	0.01 (0.01)	0.24 (0.16)
	B 2.92 (2.49)	11.13 (4.84)	10.17 (7.12)	44.84 (22.33)	32.52 (19.20)	16.50 (7.42)	3.18 (1.19)	0.47 (0.42)	-	0.13 (0.12)
	E 1.45 (1.22)	5.68 (1.01)	8.14	22.87	16.58	8.41	1.57 (0.58)	0.87 (0.66)	-	0.19 (0.10)
H. LANATUS	A -	10.73 (4.10)	9.81 (3.80)	12.83 (5.92)	5.29 (2.09)	3.20 (1.80)	0.25 (0.11)	-	-	-
	B -	7.52 (3.62)	10.87 (6.09)	0.33 (0.22)	6.21 (4.56)	2.90 (1.51)	0.01 (0.01)	-	-	-
	E -	9.12 (3.97)	10.33 (3.56)	6.71 (3.02)	5.74 (2.45)	3.05	0.14 (0.06)	-	-	-
H. MOLLIS	A 3.47 (1.92)	3.44 (1.81)	9.35 (4.88)	-	2.56 (1.83)	0.90 (0.53)	-	0.01 (0.01)	0.71 (0.16)	2.82 (1.52)
	B 5.63 (2.77)	3.77 (1.92)	4.77 (2.89)	9.94 (5.82)	1.74 (1.31)	1.10 (0.91)	0.12 (0.12)	0.58 (0.55)	3.33 (1.78)	1.79 (1.19)
	E 4.35 (1.67)	3.60 (1.75)	7.11 (2.87)	5.07	2.17 (1.14)	1.00	0.06	0.29 (0.27)	2.05	2.27 (0.94)
TOTAL G.V.	A 42.97 (10.71)	61.62 (14.52)	84.29 (14.57)	104.66 (28.02)	75.40 (18.35)	70.17 (15.30)	78.67 (28.57)	23.33 (4.45)	19.88 (4.59)	24.38 (5.96)
	B 23.68 (5.57)	79.92 (12.97)	81.57 (13.03)	107.95 (31.83)	129.29 (28.22)	96.19 (25.20)	96.72 (62.90)	9.86 (6.14)	28.53 (8.95)	18.48 (4.98)
	E 33.13 (6.11)	70.95 (9.97)	82.90 (9.85)	106.33 (21.48)	102.89 (17.52)	83.44 (14.52)	87.88 (34.48)	16.46 (3.68)	24.29 (4.99)	21.37 (4.35)
BRYOPHYTES	A 8.19 (4.10)	19.35 (8.81)	18.38 (10.71)	12.72 (9.71)	15.45 (7.40)	12.82 (9.72)	7.60 (4.29)	5.16 (3.28)	6.10 (3.78)	5.90 (2.73)
	B 16.31 (10.17)	6.66 (3.51)	17.77 (6.41)	13.06 (9.30)	11.14 (4.05)	12.99 (9.20)	12.88 (8.83)	12.27 (4.43)	9.86 (4.62)	1.57 (0.70)
	E 12.18 (5.41)	13.13 (5.53)	18.09 (6.31)	12.89 (6.73)	13.34 (4.26)	12.90 (6.74)	10.19 (4.85)	8.65 (2.74)	7.94 (2.98)	3.78 (1.44)

19.88g/m² in February 1968. The bryophyte biomass showed a peak of 19.35g/m² in May, staying between this value and 12.70g/m² until September. For the rest of the year bryophyte biomass in the Alder Zone lay between 5.16 and 8.19g/m². The bryophyte biomass never amounted to more than 31% of the green ground vegetation biomass (i.e. of green ground vegetation without bryophytes). The bryophytes had the greatest relative importance in May 1967 (31%) and February 1968 (30%). On the first occasion this was due to low green ground vegetation biomass.

Figure 44b shows the biomass changes of the Fern categories in the Alder Zone. For Dryopteris there was a steady rise from near zero in April to 48.46g/m² in October. Following this, the Dryopteris biomass declined almost to zero by December. No Polystichum was recorded in the Alder Zone until July, when a 'peak' value of 8.72g/m² was recorded. After that, Polystichum biomass remained at approximately 1g/m². The July value was almost certainly the product of quadrat location. Pteridium was only recorded once in the Alder Zone, with a very low value of 0.15g/m².

Figure 44c shows the biomass changes of Rubus fruticosus and Chamaenerion angustifolium in the Alder Zone. The Rubus biomass was between 17.9g/m² and 30.2g/m² for the whole year excepting April (37.63g/m²) and July (41.64g/m²), when it peaked. The April high value was probably due to the superimposition of new growth on the second-year material. The die-back of second-year material could

account for the May - June trough, only to be overtaken by new growth to form the July peak. The confidence limits were wide, and so any conclusions drawn from these data must be viewed with caution. The Rubus biomass contributed 39% of the green ground vegetation in July, when both peaked, and over 85% from December to April. Thus Rubus provided the most important overwintering component of green ground vegetation. When compared with Rubus, Chamaenerion was a much less prominent component of the green ground vegetation biomass in the Alder Zone. It was only recorded twice, in June and July. In June the biomass was less than $1\text{g}/\text{m}^2$ and in July a higher value of $5.31\text{g}/\text{m}^2$ was recorded. The standard error in July was almost as great as the mean. Thus the sampling method was not adequate to deal with species such as Chamaenerion angustifolium represented by a few widely dispersed individuals in the Alder Zone.

Figure 44d shows the biomass of Viola riviniana and the other forb categories in the Alder Zone. The biomass of the two combined never exceeded $4.47\text{g}/\text{m}^2$, the July figure. Apart from the forb figure for August ($1.72\text{g}/\text{m}^2$) and this, neither exceeded $0.49\text{g}/\text{m}^2$ at any time in the year, usually approaching zero. In spite of limitations in the sampling technique, it seems reasonable to suppose that these species contributed little to the biomass of the green ground vegetation of the Alder Zone in 1967-8.

Figure 44.

Biomass (g/m^2) 1967-8. Alder Zone.

- a. top left - total ground vegetation (open circles) and bryophytes (plus signs).
- b. top right - ferns; total ferns (plus signs) and Dryopteris filix-mas.
- c. middle left - Rubus fruticosus (open circles) and C.angustifolium (plus signs).
- d. middle right - forbs.
- e. bottom - grasses; Holcus spp. (open circles), D. caespetosa (closed circles) and Agrostis tenuis (plus signs).

BIOMASS(g/m²) 1967-8 ALDER ZONE

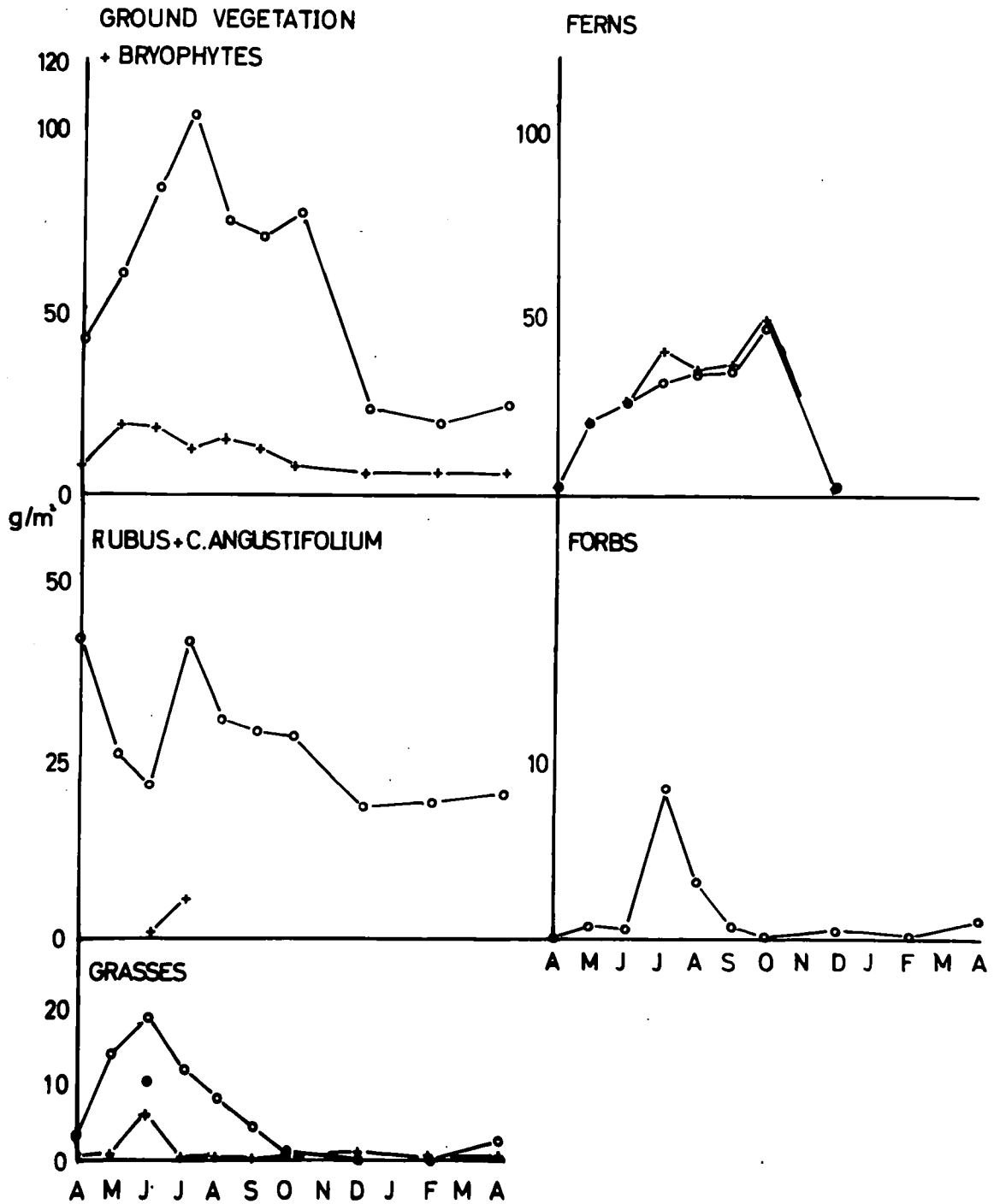



Figure 44e shows the biomass changes of the grass species in the Alder Zone. Apart from a single, high value for Deschampsia caespetosa in June, the two Holcus spp. always contributed the major part of the grass biomass. It was only possible to sort the Holcus into Holcus mollis and Holcus lanatus from May to October inclusive. During this period Holcus lanatus showed values around 10g/m^2 from May to July, reaching a peak of 12.83g/m^2 in July. After that it steadily declined to near zero in October; H. mollis showed more erratic behaviour, with a peak of 9.35g/m^2 in June. A simpler pattern appeared when Holcus was considered as one. It increased to a peak of 19.16g/m^2 in June, decreasing to near zero in October. Agrostis tenuis was much less important than Holcus in the Alder Zone. It reached a peak of 6.02g/m^2 in June, showing values of around 1g/m^2 or less for the rest of the year. The grasses contributed 43% of the green ground vegetation biomass of the Alder Zone in June, but less than 10% for most of the year.

ii. Birch Zone. Figure 45a shows the changes in green ground vegetation biomass and bryophyte biomass for the Birch Zone from April 1967 through April 1968. As in the Alder Zone, the green ground vegetation showed a clear seasonal pattern reaching a higher peak of 129.29g/m^2 in August, one month later. It declined to 96g/m^2 in September and October and then fell sharply to a December value of 9.86g/m^2 . The February and April figures were higher (28.53g/m^2 and 18.48g/m^2), but the difference was not significant at the 95% level.

The bryophyte biomass peaked at 16.31g/m^2 and 17.77g/m^2 in April and June respectively. Apart from a very low value (1.57g/m^2) in April 1968, bryophyte biomass lay between 6.66g/m^2 and 13.06g/m^2 for the rest of the year. The bryophyte biomass was greater (124%) than the green ground vegetation biomass in December, and amounted to 66% of it in April 1967, thereby showing a marked contrast with the Alder Zone situation. For the rest of the year Bryophyte biomass was between 8% and 35% the size of the green ground vegetation biomass.

Figure 45b shows the biomass changes of the Fern categories in the Birch Zone. For Dryopteris the pattern was much as in the Alder Zone, excepting that the October peak was much higher (70.97g/m^2). Polystichum appeared more frequently in the cropped quadrats than in the Alder Zone, showing a low peak of 2.31g/m^2 in August. Pteridium was cropped on a single occasion, August, when a single quadrat contained a clump of Pteridium giving a mean biomass estimate of 8.75g/m^2 . At the time of the Dryopteris peak in October the Fern categories contributed 74% of the green ground vegetation biomass in the Birch Zone.

Figure 45c shows the biomass changes of Rubus fruticosus and Chamaenerion angustifolium in the Birch Zone. The Rubus biomass in the Birch Zone showed much greater fluctuation than in the Alder Zone. It rose from 8.60g/m^2 in April to a peak of 43.95g/m^2 in May. Then it declined to around 20g/m^2 in August, September and October. A low value of 7.99g/m^2 was recorded in December, rising to 23.78g/m^2

and 15.30g/m^2 in February and April respectively. It seems likely that these winter fluctuations were largely the result of quadrat location. The Rubus biomass came to 55% of green ground vegetation biomass in May and between 81% and 83% from December through April. It contributed between 16% and 36% for the rest of the year. Thus Rubus was the most important contributor to the winter biomass of green ground vegetation, in the Birch Zone as in the Alder Zone. Chamaenerion angustifolium appeared only sporadically in the serial cropping of the Birch Zone, the highest biomass (7.88g/m^2) being recorded in August.

Figure 45d shows the biomass of Viola riviniana and the other forb categories in the Birch Zone 1967-8. As in the Alder Zone these biomasses were very low. The forbs showed peaks in April and June as did Viola riviniana.

Figure 45e shows the biomass changes of the grass species in the Birch Zone. Deschampsia caespitosa was only sporadically recorded, almost all values being less than 1g/m^2 . Agrostis tenuis was by far the most important contributor to grass biomass in the Birch Zone, peaking at 44.84g/m^2 in July. The Holcus species showed complex changes of biomass when considered separately. H. lanatus showed a peak in June and H. mollis in July, both being close to 10g/m^2 . As in the Alder Zone, a clearer pattern emerged when these two species were considered together, rising to a maximum of 15.64g/m^2 in June.

Figure 45.

Biomass (g/m^2) 1967-8. Birch Zone.

- a. top left - total ground vegetation (crosses) and bryophytes (open circles).
- b. top right - ferns; D.filix-mas (crosses), Pteridium aquilinum (closed circle) and Polystichum setiferum (open circles).
- c. middle left - Rubus (crosses) and C.angustifolium (open circles).
- d. middle right - V.riviniana (crosses) and other forbs (circles).
- e. bottom - grasses; D.caespetosa (crosses), Agrostis tenuis (open circles), Holcus lanatus (plus signs), H.mollis (closed circles).

**BIOMASS (g/m²) 1967-8. GROUND VEGETATION AND BRYOPHYTES
BIRCH ZONE**

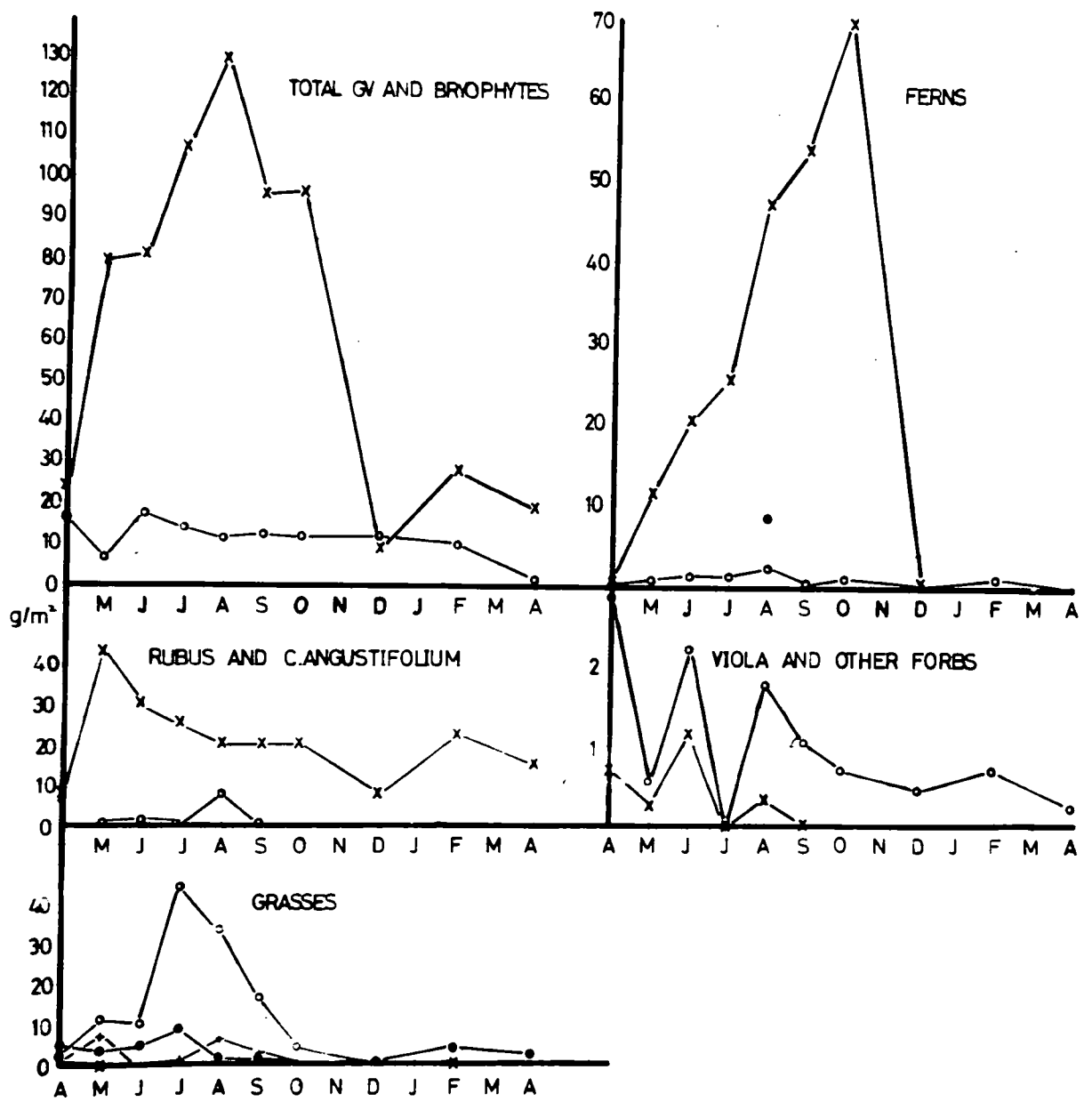

The grasses contributed 51% of the green ground vegetation biomass of the Birch Zone in June, between 28% and 40% for the rest of the summer and less than 21% from September on. The grasses were, overall, more important contributors to the green ground vegetation biomass in the Birch Zone than in the Alder Zone.

iii. Grid. The values presented here were calculated from those for the Alder and Birch Zones as outlined at the beginning of VII iv. Therefore, they will be intermediate between those of the two Zones.

Figure 46a shows the changes in green ground vegetation biomass for the whole Grid (referred to below as simply the Grid). The peak biomass of green ground vegetation was recorded in July, at the same time as the Alder Zone green ground vegetation biomass peak. A secondary peak occurred in October, again as in the Alder Zone. This secondary peak was probably due to the increase in Dryopteris biomass, which occurred in October in both zones. The winter biomass (December and February) lay between 16.46g/m^2 and 24.29g/m^2 as did that for April 1968, although it should be noted that the April 1967 figure was 33.13g/m^2 . For most of the year Bryophyte biomass was between 10.19g/m^2 and 13.34g/m^2 . In June it peaked at 18.09g/m^2 and from December on it lay below 10g/m^2 . When considered for the whole Grid, the bryophytes did not achieve the winter importance they had in the Birch Zone taken alone. Their biomass was equal to 11.6% to 21.0% of that of the green ground

vegetation biomass in all months except April 1967 and December and February, when it lay between 32.7% and 52.6%.

Figure 46b shows the biomass changes of the Fern categories for the Grid in 1967-8. As explained above, the Grid biomass values are necessarily intermediate between those for the Alder Zone and the Birch Zone. Thus the pattern for Dryopteris was similar to that observed in both zones. Due to the method employed (i.e. the scattered nature of the zone data), Polystichium was more consistently present and reached a peak of just under 5g/m^2 in July. Pteridium was only present in August. During the Dryopteris peak in October the Fern categories contributed 69% of the green ground vegetation biomass on the Grid taken as a whole.

Figure 46c shows the biomass changes of Rubus fruticosus and Chamaenerion angustifolium on the Grid. The fluctuations in Rubus biomass were, of course, less marked than in either zone taken alone. The Rubus biomass lay between 23.41g/m^2 and 33.73g/m^2 from April 1967 until October. From December until April 1968 it lay between 13.08g/m^2 and 21.33g/m^2 . In April 1967 the Rubus biomass was 71% of the green ground vegetation biomass. It fell to 49% in May and lay between 25% and 32% until December. From December through April 1968 it lay above 79% of green ground vegetation biomass. Rubus was the most important green ground vegetation biomass component in winter over the whole Grid. Chamaenerion was relatively unimportant,

the highest value being just over 4g/m^2 .

Figure 46d shows the biomass of Viola riviniana and the other forb categories on the Grid. Neither of these was of much importance, the highest values being 0.59g/m^2 (Viola) and 2.16g/m^2 (forbs).

Figure 46e shows the biomass changes of grass species for the whole Grid. Deschampsia caespitosa occurred only sporadically, with a peak value of 5.37g/m^2 in June. Agrostis tenuis was the most important single species, peaking at 22.87g/m^2 in July. The Holcus species taken separately showed peaks of 10.33g/m^2 (H.lanatus) and 7.11g/m^2 (H.mollis) in June. Taken together, they rose to a peak of 17.44g/m^2 in June. Expressed as a percentage of green ground vegetation biomass, grass biomass rose to a peak of 37% in June, and then fell steadily to 2% in October. It then climbed back to 14% by April 1968, that is to say, the grasses do not form an important part of the overwintering green ground vegetation biomass.

b) Ground Vegetation Litter; Alder Zone, Birch Zone and whole Grid 1967-8. Table XXXXIV shows the biomass changes of ground vegetation litter categories of material from April 1967 through April 1968. The data for the Alder and Birch Zones are dealt with separately and then those for the whole Grid are discussed.

i. Alder Zone. Figure 47a shows the biomass changes of ground vegetation litter in the Alder Zone. The total fell from almost 180g/m^2 in April 1967 until June. Then it increased in June - July

TABLE XXXIV Biomass of Ground Vegetation Litter g/m^2 (± 1 S.E.) 1967-8

	APRIL	MAY	JUNE	JULY	AUGUST	
Fern	A	130.43 (75.69)	75.02 (25.25)	60.03 (16.91)	58.14 (27.92)	43.19 (20.74)
	B	94.19 (54.66)	87.32 (39.67)	85.49 (39.67)	67.37 (41.96)	73.86 (59.30)
	E	112.68 (46.98)	81.29 (22.34)	72.51 (21.27)	62.66 (25.01)	58.22 (30.92)
Rubus	A	34.60 (10.72)	35.30 (10.72)	36.89 (11.28)	79.65 (30.34)	40.46 (16.18)
	B	42.44 (13.02)	51.49 (20.12)	101.00 (31.50)	117.14 (57.99)	57.86 (24.29)
	E	38.54 (7.65)	43.35 (11.50)	69.52 (19.56)	98.03 (32.36)	48.99 (14.48)
Grass	A	8.24 (3.81)	10.32 (3.90)	12.40 (3.74)	9.69 (4.46)	22.03 (7.82)
	B	27.89 (9.09)	41.89 (20.19)	41.07 (14.28)	49.71 (20.66)	57.25 (19.04)
	E	17.87 (4.86)	26.42	26.45 (7.25)	29.31 (10.38)	39.29 (10.15)
<i>C. angustifolium</i>	A	4.38 (3.31)	-	-	-	-
	B	8.58 (7.04)	1.44	0.58 (0.58)	-	-
	E	6.44 (3.84)	0.73	0.29	-	-
Total	A	177.67 (69.98)	120.64 (22.93)	109.34 (12.84)	147.49 (33.45)	105.69 (22.68)
	B	173.10 (55.48)	182.14 (65.30)	228.14 (46.11)	234.23 (56.45)	188.97 (77.26)
	E	175.34 (43.96)	152.00 (35.59)	169.93 (28.27)	190.00 (32.49)	146.50 (39.59)

	OCTOBER	DECEMBER	FEBRUARY	APRIL	
Fern	A	58.06 (21.74)	88.31 (31.22)	73.23 (25.25)	64.66 (27.56)
	B	39.15 (26.83)	67.25 (29.53)	99.72 (55.59)	132.88 (54.96)
	E	48.80 (17.20)	77.57 (21.72)	86.21 (30.14)	98.09 (30.38)
Rubus	A	45.78 (10.97)	34.14 (13.49)	26.43 (8.63)	31.70 (8.73)
	B	29.93 (10.19)	44.77 (12.45)	63.21 (18.73)	26.93 (8.79)
	E	38.02 (7.50)	39.35 (9.20)	44.46 (10.18)	29.37 (6.20)
Grass	A	12.84 (5.59)	31.50 (21.40)	38.62 (11.13)	23.67 (8.76)
	B	93.00 (32.29)	84.59 (25.52)	90.61 (22.40)	61.55 (22.68)
	E	52.12 (16.08)	57.52 (16.60)	64.10 (12.36)	42.24 (11.98)
<i>C. angustifolium</i>	A	2.26 (1.72)	-	0.09 (0.09)	0.07 (0.07)
	B	-	-	0.61 (0.41)	-
	E	1.11	-	0.35 (0.21)	0.03
Total	A	121.42 (22.93)	151.53 (27.25)	138.38 (23.38)	119.38 (21.05)
	B	162.09 (20.99)	196.61 (35.61)	257.07 (44.97)	221.38 (55.09)
	E	141.35 (18.78)	174.52 (22.34)	196.54 (25.06)	169.36 (29.05)

A Alder Zone
 B Birch Zone
 E Grid

Figure 46.

Biomass (g/m^2) 1967-8. Grid.

- a. top left - total ground vegetation (crosses) and bryophytes (circles).
- b. top right - ferns; D.filix-mas (crosses), Polystichum setiferum (open circles), Pteridium aquilinum (closed circles).
- c. middle left - Rubus (crosses) and C.angustifolium (circles).
- d. middle right - V.riviniana (crosses) and other forbs (circles).
- e. bottom - grasses; A.tenuis (open circles), H.lanatus (plus signs), H.mollis (closed circles) and D.caespitosa (crosses).

BIOMASS(g/m²) 1967-8 GROUND VEGETATION AND BRYOPHYTES GRID

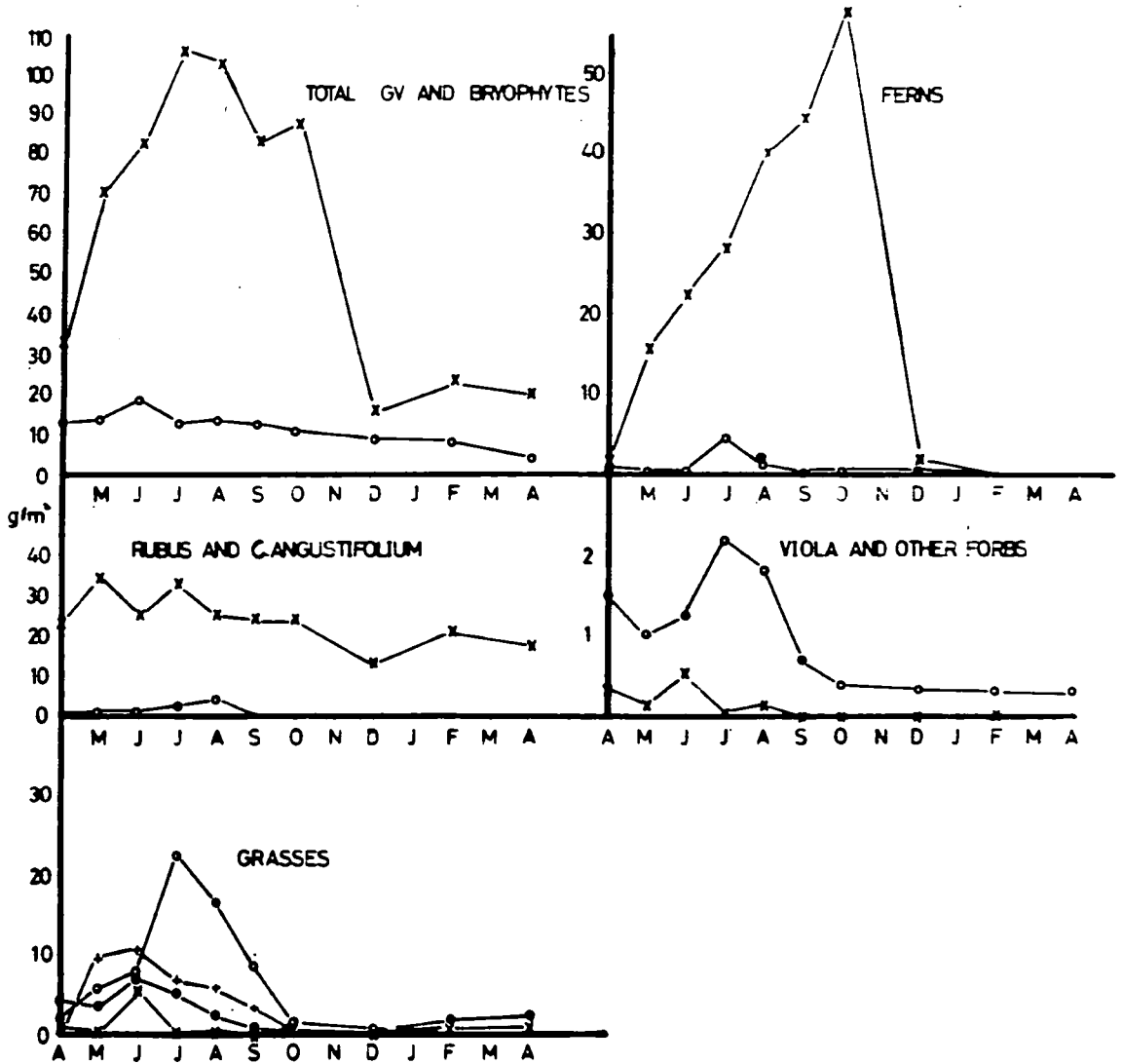

and decreased in July - August. Figures are not available for September 1967, due to mechanical failure of the storage facilities containing the ground vegetation litter samples. The total ground vegetation litter biomass in the Alder Zone increased from August to December, when it just exceeded 150g/m^2 , followed by a slow decline until April 1968. A greater understanding of the biomass change processes may be gained from an examination of biomass changes in the three components of the ground vegetation litter. The April - June decline can be accounted for by a decrease in fern litter biomass. The July peak was almost entirely made up of an increase in Rubus litter biomass and was probably due to the die-back of overwintered Rubus parts, despite the fact that the increase in litter occurred later than the decrease in green Rubus biomass. The increase in total ground vegetation litter, August to December, can be explained by the increases in fern and grass litter biomasses. These increases did coincide with decreases in green fern and grass biomasses. Despite the fluctuations of the three litter components, the ground vegetation litter biomass remained between 105g/m^2 and 178g/m^2 throughout the year. There was a net decrease of 58.29g/m^2 between April 1967 and April 1968.

ii. Birch Zone. The biomass changes of ground vegetation litter in the Birch Zone are shown in Figure 47b. The total rose to almost 235g/m^2 in July and then fell to near 160g/m^2 by October. It then

rose to almost $260\text{g}/\text{m}^2$ in February, declining in the spring to just over $220\text{g}/\text{m}^2$ in April. The general level was higher than in the Alder Zone and the fluctuations were greater. As in the Alder Zone, the April to July increase in ground vegetation litter biomass can be attributed to die-back of Rubus and was correlated with the decrease in green Rubus biomass from May to July. There was a steady decline in Fern litter from April to October, and in Rubus litter from July to October. The increase in total ground vegetation litter biomass from October to February corresponded with the increase in Fern and Rubus litter biomass during this period. The grass litter biomass rose to a plateau in October - February, after which it declined, as did the Rubus litter, between February and April 1968. There was a net increase of $48.28\text{g}/\text{m}^2$ in the total ground vegetation litter biomass between April 1967 and April 1968.

iii. Grid. Biomass changes in ground vegetation litter biomass on the whole Grid in 1967-8 are shown in Figure 47c. There was a net decrease of only $5.98\text{g}/\text{m}^2$ in the ground vegetation litter biomass on the grid between April 1967 and April 1968. Neither in the data for the zones taken separately, nor together as the Grid, was it always possible to relate biomass changes of live and dead categories of material on a month to month basis. Although, on a seasonal basis the two sets of data show consistent relationships with one another and the known natural history of the Study Area.

Figure 47.

Biomass (g/m^2) 1967-8. Grid. Ground Vegetation Litter.

- a. top left - Alder Zone.
- b. top right - Birch Zone.
- c. bottom - Grid.

Key:- open circles - total.
closed circles - Rubus litter.
crosses - fern litter.
plus signs - grass litter.

BIOMASS (g/m²) 1967-8

GROUND VEGETATION LITTER

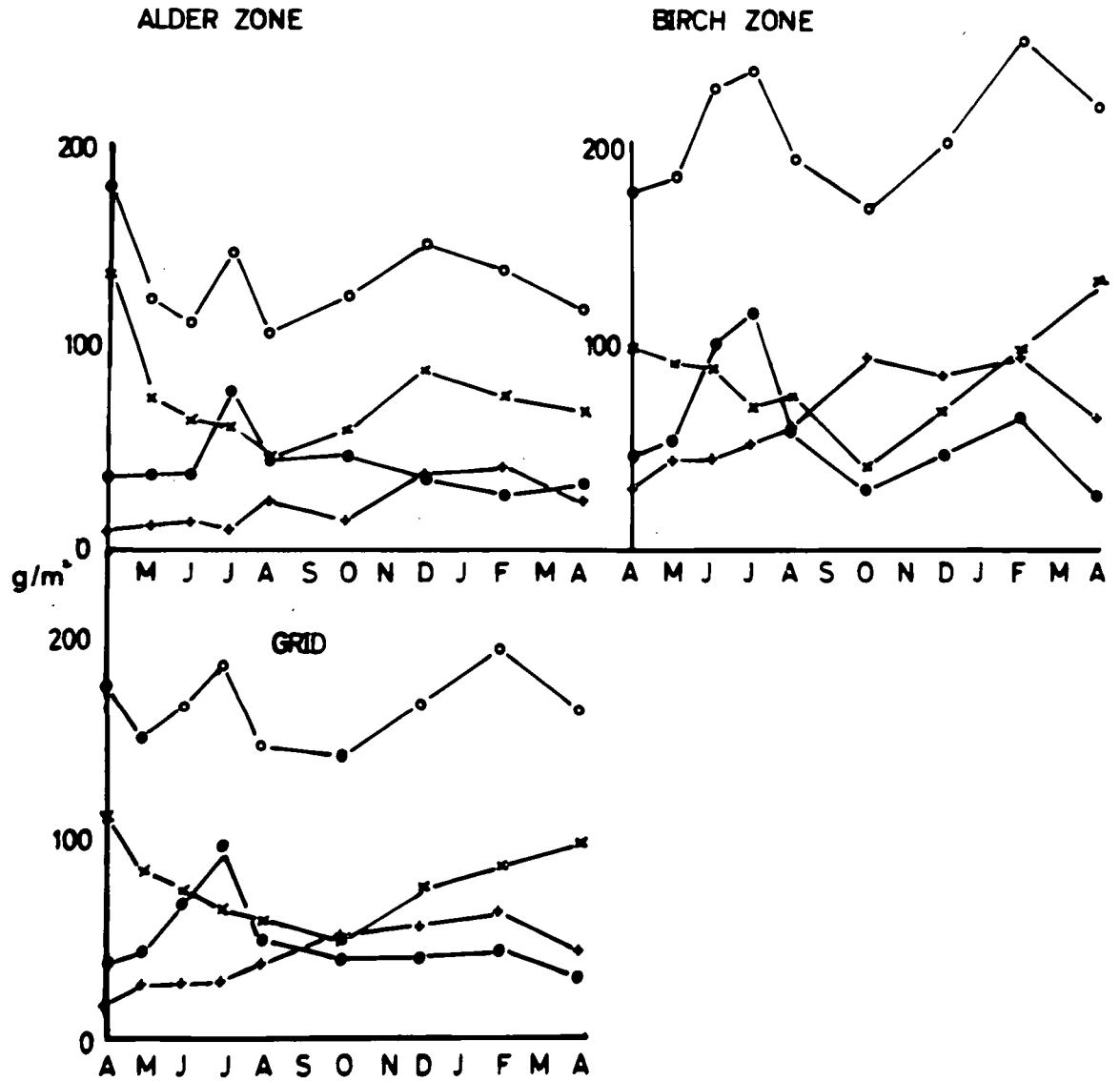

c) Tree Litter; Alder Zone, Birch Zone and the whole Grid, 1967-8. Table XXXXV shows the biomass of tree Litter on the Forest Floor from April 1967 through April 1968. The data for the Alder and Birch Zones are dealt with separately and then the figures for the Grid taken as a whole are dealt with.

i. Alder Zone. Figures 48a,b, show the biomass changes of alder leaves, birch leaves,

The expected seasonal pattern emerged quite clearly for alder leaves. The newly fallen leaves began to accumulate in June, reaching a peak of almost 120g/m^2 in February, rather later than might be expected from the litter trap data. The choice of quadrat location no doubt intruded here, and the December figure of 101.31g/m^2 may well represent a more realistic estimate of peak standing crop. After February there was a rapid decline in alder leaf biomass and it is clear that the greater part of a year's alder leaf fall appears to break down within 12 months of fall. The biomass of birch leaves in the Alder Zone (Fig. 48b) was, as might be expected, much smaller than that of alder leaves, reaching a peak of under 25g/m^2 in December - February. The litter of other trees showed two peaks, one (23.23g/m^2) in October, the other (41.40g/m^2) in February. Birch reproductive structures were almost completely absent until April 1968, when a high value of 2.63g/m^2 was recorded. Alder reproductive structures were much more important, peaking at over 16g/m^2 in May 1967 and April 1968.

TABLE XXXV
 Biomass of Tree Litter Categories (g/m²) ± 1 S.E. 1967-8

	APRIL	MAY	JUNE	JULY	AUGUST	OCTOBER	DECEMBER	FEBRUARY	APRIL	
Old Alder leaves E.	23.67(6.63) 1.71(0.78) 12.92(3.41)	6.30(1.49) 1.77(1.05) 4.08(0.55)	11.76(5.08) 0.46(0.28) 6.23(2.59)	14.96(5.77) 1.01(0.69) 8.13(2.96)	8.56(2.35) 0.14(0.1) 4.26(1.22)	- - -	- - -	- - -	- - -	- - -
New Alder leaves E.	- - -	- - -	- - -	7.45(2.60) 0.26(0.26) 3.93(1.37)	17.50(10.63) 19.31(18.84) 18.42(10.70)	67.34(9.90) 29.93(11.52) 49.01(7.57)	101.31(23.75) 36.91(24.92) 69.76(17.20)	119.72(22.54) 21.49(10.63) 71.59(12.62)	48.71(14.41) 4.30(2.31) 26.95(7.44)	- - -
Other Tree Litter	0.14(0.09) 1.07(0.95) 0.60(0.47)	0.48(0.37) 1.16(0.48) 0.82(0.39)	1.59(1.20) 1.71(1.22) 1.65(0.86)	0.22(0.19) 0.23(0.23) 0.23(0.15)	1.50(1.46) 0.40(0.27) 0.96(0.76)	23.23(15.63) 8.46(3.4) 15.99(8.15)	11.91(9.40) 21.29(16.82) 16.51(9.54)	41.40(18.48) 2.93(1.31) 22.56(9.45)	9.32(4.94) 2.79(2.16) 6.13(2.73)	- - -
New Birch leaves E.	7.26(3.57) 36.21(10.88) 21.45(5.64)	10.62(3.50) 25.31(18.20) 18.11(9.29)	3.19(1.93) 19.51(7.65) 11.19(3.88)	1.77(1.24) 15.70(7.70) 8.60(3.83)	- 2.26(2.26) 1.15(1.15)	- - -	- - -	- - -	- - -	- - -
New Birch leaves E.	- - -	- 0.14(0.68) 0.07	- 0.98(0.52) 0.50	3.24(2.33) 2.47(1.09) 2.87(1.31)	6.44(3.99) 32.40(19.13) 19.17(9.59)	16.24(5.40) 126.66(19.67) 70.35(10.00)	22.89(7.77) 94.77(10.81) 58.11(6.62)	25.08(8.71) 109.84(15.43) 66.62(8.77)	8.66(1.89) 114.79(16.77) 60.67(8.28)	- - -
Wood Alder Rep E.	167.03(40.93) 202.00(51.13) 184.17(32.61)	241.99(29.91) 160.04(40.61) 200.19(25.01)	219.76(57.63) 138.96(26.51) 180.17(32.14)	270.15(45.97) 122.99(35.64) 198.05(29.24)	130.70(27.19) 188.88(78.40) 159.21(40.85)	230.25(65.90) 126.34(34.57) 179.34(37.64)	195.39(51.90) 105.68(28.34) 151.44(29.89)	240.98(50.94) 189.64(30.87) 215.83(30.06)	206.10(32.06) 133.06(17.32) 170.31(18.43)	- - -
New Alder Rep E.	10.59(2.64) 2.30(1.41) 6.53(1.52)	16.76(4.91) 1.21(2.18) 8.79(2.47)	7.47(2.04) 1.03(0.57) 4.31(1.08)	8.97(2.85) 0.45(0.36) 4.80(1.47)	3.30(1.14) 0.95(0.48) 2.15(0.63)	4.52(1.06) 0.92(0.31) 2.76(0.56)	5.91(2.42) 1.75(0.96) 3.88(1.32)	12.87(3.69) 2.32(1.22) 7.70(1.98)	17.62(5.18) 0.45(0.31) 9.21(2.65)	- - -
New Birch Rep E.	0.14(0.10) 1.03(0.46) 0.58(0.23)	- 1.00(0.20) 0.51	- 0.73(0.29) 0.37	0.01(0.01) 0.15(0.10) 0.08(0.05)	0.05(0.05) - 0.03(0.03)	0.48(0.48) 0.65(0.30) 0.56(0.29)	0.07(0.01) - 0.03	0.18(0.18) 0.19(0.16) 0.19(0.12)	2.63(1.33) 0.33(0.22) 1.51(0.69)	- - -

A Alder Zone
 B Birch Zone
 E Grid

Figure 48.

Biomass (g/m^2) 1967-8. Alder Zone. Alder and birch leaves.

a. Alder leaves.

b. Birch leaves.

Key: plus signs - old crop.

circles - new crop.

BIOMASS(g/m²) 1967-8 ALDER ZONE

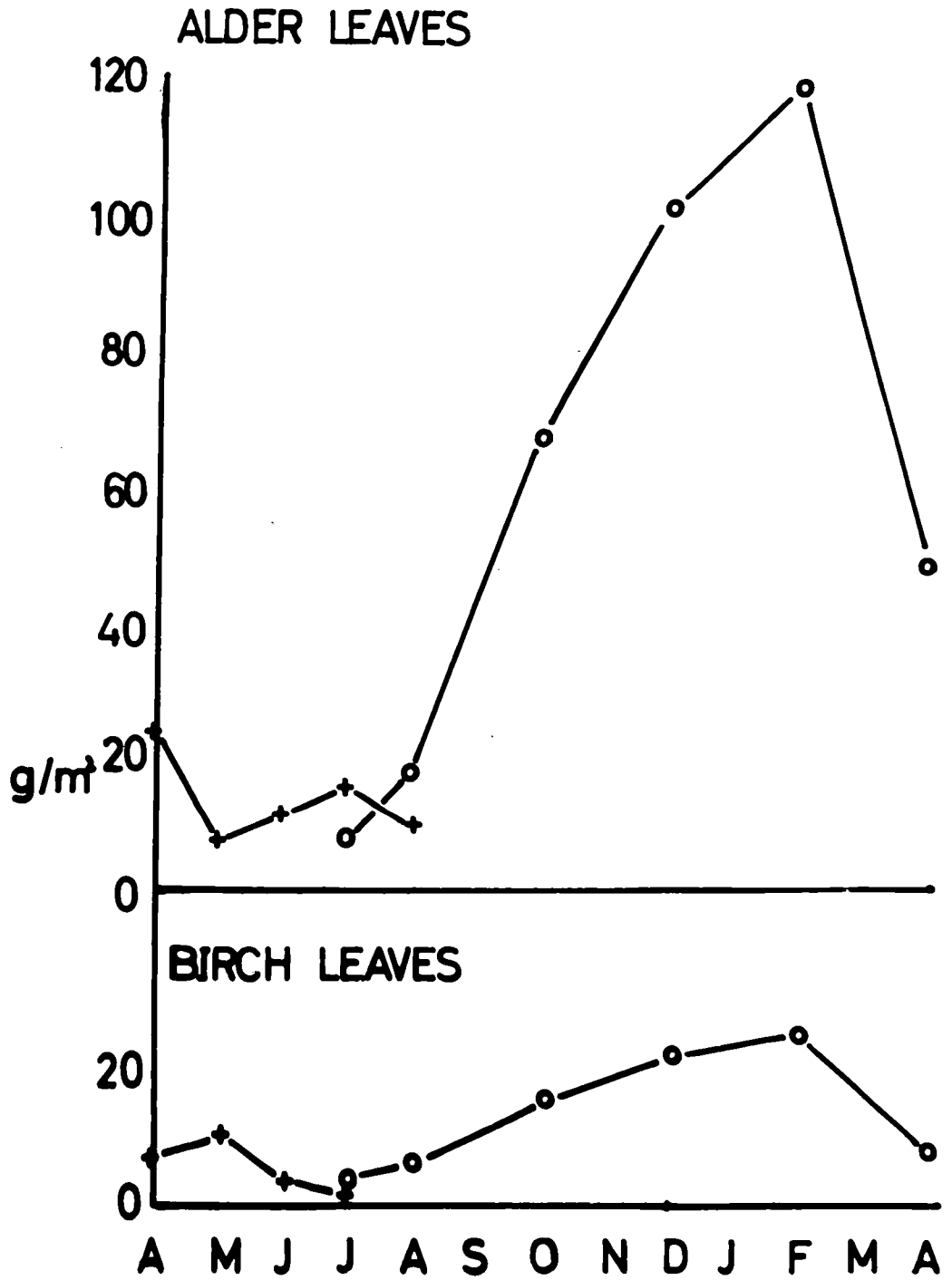

There was a marked decline from May to August, a steady increase until December, and a sharp increase to April 1968. The wood litter showed erratic variations around 220g/m^2 , and was always the most important tree litter category on the Forest Floor of the Alder Zone.

ii. Birch Zone. Figures 49a,b, for the Birch Zone can be compared with Figure 48 for the Alder Zone. Alder leaves were much less important than birch leaves. Their respective peak values were 26.91g/m^2 and 126.66g/m^2 . The alder leaves reached a peak in December, the birch in October. There were fluctuations in birch leaf biomass after October, which would only have been due to sampling error, probably through quadrat location. It is possible that the aggregation pattern of fallen leaves could have changed through the autumn, increasing the probability of sampling errors. That is, fallen leaves may have been blown into small depressions in the ground, or against small obstacles, forming patches of high biomass. After this, it is possible that the leaves in these aggregations may have disappeared at a different rate to those not so aggregated. This would accentuate the clumping of biomass. The litter of other trees reached a peak of 21.20g/m^2 in December but had almost gone by April. The biomass of birch reproductive structures only once (April 1967) exceeded 1g/m^2 , whereas that of alder reproductive structures exceeded 2g/m^2 on two occasions (April 1967 and February 1968). The biomass of wood litter varied erratically as in the Alder Zone, but around a lower level of about 140g/m^2 .

Figure 49.

Biomass (g/m^2) 1967-8. Birch Zone. Alder and Birch leaves.

a. Alder leaves.

b. Birch leaves.

Key: plus signs - old crop.

circles - new crop.

BIOMASS(g/m²) 1967-8 BIRCH ZONE

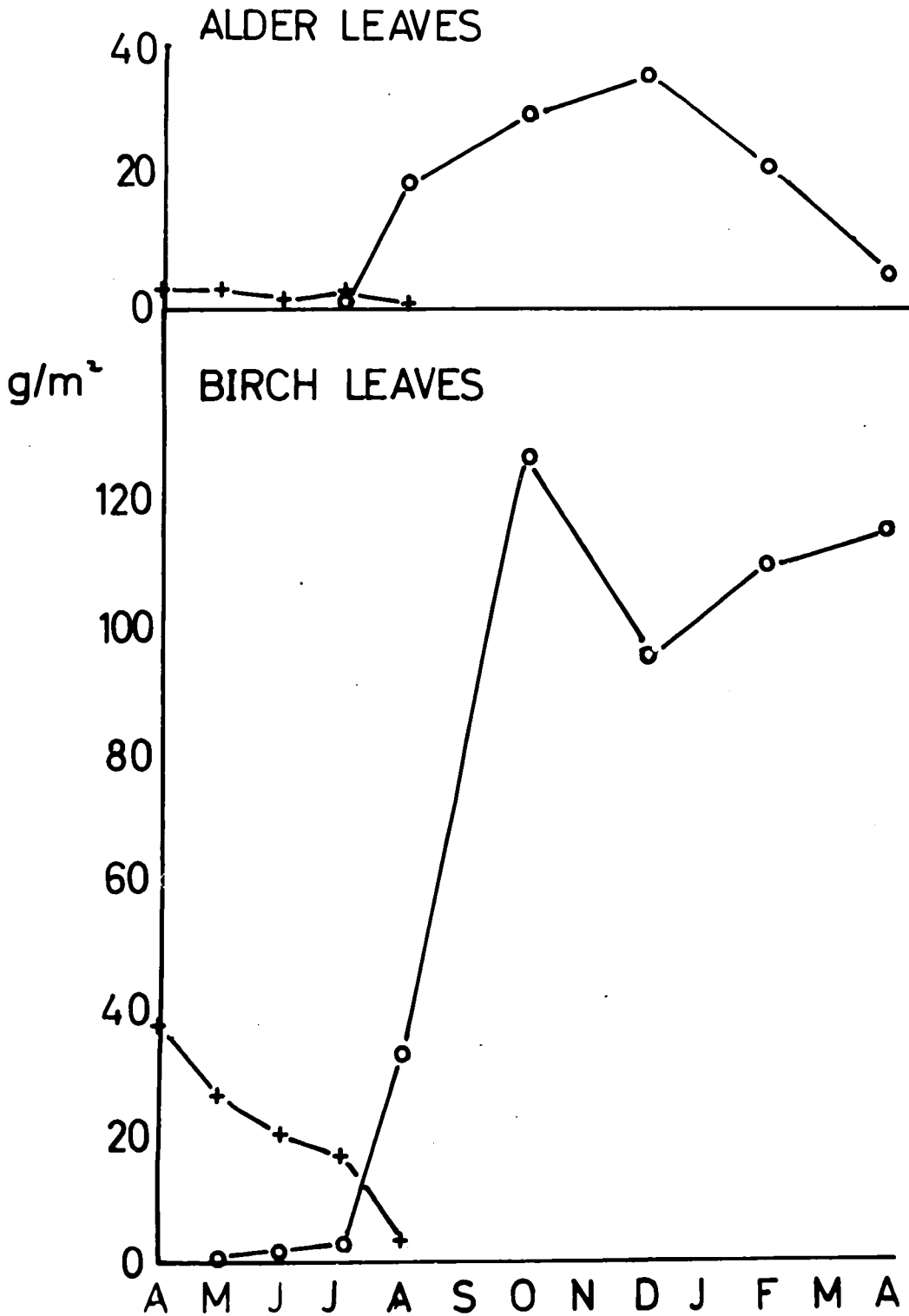

iii. Grid. Figures 50a,b, correspond to Figures 48 and 49. Alder leaves reached a peak of 71.59g/m^2 in February although the December value was within 2g/m^2 of this. The birch leaves showed a peak of 70.35g/m^2 biomass in October. Thus, for the Grid as a whole, both alder and birch leaf litter contributed about 70g/m^2 each to the litter biomass on the Forest Floor. The litter of other trees reached a peak of 22.56g/m^2 in February along with the alder leaves. The biomass of fallen birch reproductive structures was 1.5g/m^2 or less, whereas that of alder reproductive structures showed a seasonal decline from around 8g/m^2 in late spring to near 2g/m^2 in August and October. Then it increased to over 9g/m^2 by April 1968. As for the zones considered separately, the biomass of wood litter on the Forest Floor of the Grid as a whole fluctuated greatly from month to month, although some of the fluctuations were less marked. The level around which wood litter biomass fluctuated was 180g/m^2 .

d) Comparison of Grid data for 1966-7 and 1967-8.

The data obtained for the whole Grid during the two sampling years are comparable. Comparing Figures 46 and 40, it can be seen that the peak biomass of green ground vegetation was greater (137.70g/m^2) in 1966 than in 1967 (103.33g/m^2). The 1966 peak was recorded on 1st August, the 1967 peak two weeks earlier on 17th July. The bryophyte biomass did not show a sharp summer peak in 1966 as it did in 1967. In 1966 the Fern biomass peak (75.26g/m^2)

Figure 50.

Biomass (g/m^2) 1967-8. Grid. Alder and birch leaves.

a. Alder leaves.

b. Birch leaves.

Key: plus signs - old crop.

circles - new crop.

BIOMASS (g/m²) 1967-8 GRID
ALDER LEAVES

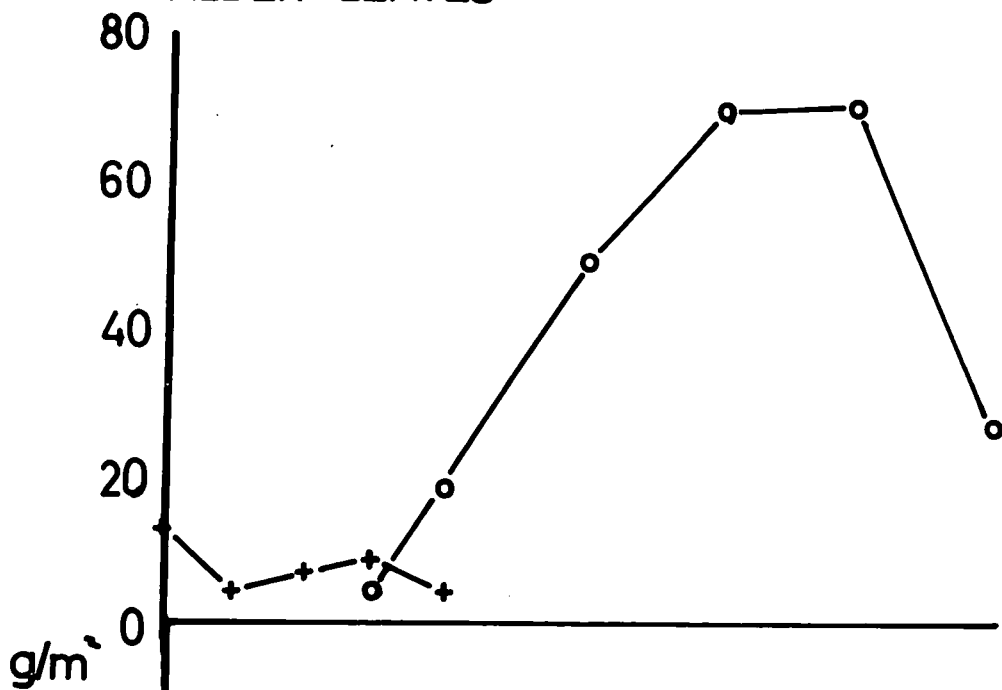

BIRCH LEAVES



came in August but in 1967 it came in October (59.71g/m^2). No separate Rubus data were recorded before July 1966, but the peak Rubus biomasses in 1967 were reached in May and July. In 1966 a peak was reached in September. Green grass biomass reached a peak (34.65g/m^2) in July 1967, which closely corresponded to the highest value in 1966. This was 35.36g/m^2 in July. The same holds true for Agrostis tenuis, although the Holcus species showed peaks in June 1967, and as division into species was not started until July 1966, a direct comparison was not possible between the two years' data for these species.

If the data for ground vegetation litter (Figs. 41 & 47c) for the two periods are compared, a general decrease in biomass from 448.00g/m^2 in April 1966 to 169.36g/m^2 in April 1967 will be noted. The reasons for the decrease during 1966-7 have already been discussed (VII iii (b)). It can only be supposed that the excess litter accumulated in the winter of 1965-6 was not all broken down in 1966-7 and equilibrium was not reached until 1967-8. Alternatively, the decrease represented a genuine decrease in litter production by the ground vegetation, and perhaps a decrease in that proportion of it made up of more persistent materials. This in turn demands that ground vegetation mortality was markedly lower during the sampling period than some point in the recent past.

Figures 42 and 50 show the data for tree litter biomass on the Forest Floor. The pattern was quite similar in both years.

Birch leaf biomass reached a slightly higher peak one month later in 1966 than in 1967. Alder leaves reached a higher peak in December 1966 as compared with December 1967 - February 1968. The litter of other trees reached a similar peak two months earlier in 1966 than in 1967. The biomasses of fallen reproductive structures were similar during the two periods. Wood litter biomass showed similarly large fluctuations in both periods, its general level being a little higher in 1966-7 than in 1967-8.

e) Relative Reliability of the 1966-7 and 1967-8 biomass estimates.

The purpose of the changes made in the serial cropping sampling procedure from April 1967 on (increased number of quadrats, apportionment by vegetation zone rather than Grid blocks etc.) was to increase the reliability of the biomass estimate. Bearing in mind the discussion of the relationship between biomass dispersal and sampling in VII ii (b), the relative size of the standard error should provide some indication of the reliability of an estimate. Table XXXXVI shows the standard error as a percentage of the mean biomass of green ground vegetation on comparable occasions in the two sampling periods. Apart from the values for July and October, the 1967-8 values based on the revised sampling technique showed lower standard errors than those for 1966-7. In most cases, however, this improvement was not particularly great. To make a fair comparison between the two sampling programmes, e.g. using the ground vegetation

TABLE XXXXVI Standard error as % of mean for Grid biomass

Total green ground vegetation

	1966-7	1967-8
20. 4.66/6.7.68	31.7	18.4/20.3
16. 5.66	22.0	-
20. 5.67	-	14.1
10. 6.66	14.8	-
18. 6.67	-	11.9
1. 7.66	12.0	-
17. 7.67	-	20.2
1. 8.66	18.4	-
2. 8.67	-	17.1
5. 9.66	22.0	-
21. 9.67	-	17.4
5.10.66	18.5	-
23.10.66	-	39.2
31.10.66	17.6	-
1.12.66	29.7	-
18.12.67	-	22.3
16. 1.67	19.5	-
15. 2.67	25.3	-
26. 2.68	-	20.5
15. 3.67	30.8	-

litter data, occasions must be chosen when the biomass estimates approached one another at a corresponding time of year. This was the case for July, when standard error represented 19.9% of the mean in 1966 and 17.7% of a slightly lower mean in 1967. Similarly, in February the 1967 value was 20.4% and the 1968 value (from a lower mean) 12.8%.

It is clear that some advantage was gained from the increased number of quadrats clipped and their stratal apportionment by vegetation zones rather than by Grid blocks. In addition, it should be borne in mind that the revised technique made possible a comparison of biomass and biomass change in the two vegetation zones. The standard error of a biomass estimate was usually higher for either zone than for the whole Grid; because of the smaller number of quadrats clipped, 11 or 13 as against 24 for the whole Grid, these biomass estimates were more subject to fluctuations caused by quadrat location. However, the separate biomass estimates for the two zones pointed to the different dynamics of growth, mortality and disappearance which pertained in the two zones. These data also made possible an analysis of the different species - distribution of the biomass in the two zones.

VII v. Results - Biocontent

The biomass results were converted to biocontent results using the calorific equivalents given in Section III. The results for green ground vegetation biocontent and bryophyte biocontent for

the Grid taken as a whole are given in Table XXXXVII. The information is summarized in graph form in Figure 51 and shows that the seasonal pattern of biocontent change is very similar to that for biomass change. The peak biocontent reached in 1966 was just under 600Kcal/m^2 , whereas that in 1967 was about 430Kcal/m^2 . The relative roles of the species groups as biomass contributors were similar in both years. In both winters the green ground vegetation biocontent lay between 75 and 115Kcal/m^2 , and consisted largely of Rubus material. The relative importance of the bryophytes was reduced in the biocontent analysis, because of the low calorific equivalent used for them.

Table XXXXVIII gives the biocontent data for tree litter and ground vegetation litter for the whole Grid. The information is summarized in Figure 52. The overall litter biocontent was between 5 and 20 times that of the green ground vegetation. The sharp fluctuations in litter biocontent in the first period (20.4.66 to 20.4.67) can be accounted for by the changes in the wood litter biocontent. The pattern of total litter biocontent change in the second period (20.4.67 to 22.4.68) was largely determined by the normal seasonal march of tree litter fall and ground vegetation die-back. The large fluctuations in wood litter biomass and hence biocontent during the first period were possibly due to quadrat location effects. In spite of these fluctuations it was possible to discern a general decline in the litter biocontent through the first period, this being most marked from April 1966 to July 1966. The possible causes of this were discussed in VII iv.(d). The ground vegetation litter

TABLE XXXXVII Green Ground Vegetation Biocontent (Kcal/m²) 20.4.66 to 22.4.68 GRID

1966/67

	20/4	16/5	10/6	1/7	1/8	5/9	5/10	31/10	1/12	16/1	15/2
<u>Fern</u>	?	?	?	103.6	324.9	159.2	138.7	112.5	1.0	-	-
<u>Rubus</u>	?	?	?	197.1	138.0	231.7	213.7	202.5	89.9	80.7	60.7
<u>Forbs</u>	?	?	?	26.7	20.3	41.3	3.4	8.0	5.3	-	3.1
<u>D.caespitosa</u>	?	?	?	19.1	2.8	8.6	2.1	0.5	6.3	-	-
<u>Agrostis tenuis</u>	?	?	?	-	-	12.4	0.5	48.4	5.9	17.4	6.1
<u>Holcus spp.</u>	?	?	?	88.4	63.1	31.2	40.3	20.9	5.6	-	12.8
Total	97.6	226.7	367.6	485.4	581.3	537.8	420.3	392.8	114.0	98.1	82.7
<u>Bryophytes</u>	48.2	34.8	61.7	173.3	60.2	79.8	63.8	52.2	49.7	65.4	72.6
<u>Fern</u>	15/3	20/4	20/5	18/6	17/7	21/8	21/9	23/10	18/12	26/2	22/4
	-	7.6	65.1	93.3	145.5	203.1	195.9	244.4	8.8	1.1	-
<u>Rubus</u>	51.8	95.7	141.3	104.8	145.8	109.7	107.6	101.4	53.9	87.2	72.7
<u>Forbs</u>	-	-	0.9	3.7	11.0	17.3	-	-	-	-	-
			7.3	4.4	7.2	7.7	2.6	1.7	1.3	1.7	1.5
<u>D.caespitosa</u>	-	1.7	0.5	21.8	-	-	-	0.8	-	3.3	2.3
<u>Agrostis tenuis</u>	-	6.2	24.2	8.1	89.5	64.9	32.9	6.1	3.4	-	0.7
<u>Holcus spp.</u>	13.2	17.2	50.3	69.0	46.6	24.7	16.0	0.8	1.1	8.1	9.0
Total	65.0	128.4	289.6	305.1	445.6	427.4	355.0	355.2	68.5	101.4	86.2
<u>Bryophytes</u>	52.2	42.7	46.0	63.4	45.2	46.8	45.2	35.7	30.3	27.8	13.2

TABLE XXXXVIII

Litter (Forest Floor) Biocontent (Kcal/m²) 20.4.66 to 20.4.68

GRID

1966/67

	20/4	16/5	10/6	1/7	1/8	5/9	5/10	31/10	1/12	16/1	15/2
Ground veg.litter	-	-	-	-	-	-	-	-	-	528.1	458.9
Rubus	-	-	-	-	-	-	-	-	-	377.2	217.6
Grass	-	-	-	-	-	-	-	-	-	119.1	169.5
C.angustifolium	-	-	-	-	-	-	-	-	-	-	85.9
Total ground veg.litter	184.84	1535.9	1165.4	854.7	1185.6	1058.1	1132.4	864.5	915.4	1024.4	931.9
Tree litter-Alder lvs.	166.8	92.4	124.0	39.5	67.3	52.9	177.6	342.9	447.8	376.8	246.2
Birch "	240.1	255.2	112.4	107.0	95.9	102.6	176.8	359.1	321.8	224.2	334.4
Other tree	5.7	7.1	9.8	11.6	1.5	-	18.1	22.7	103.1	24.1	50.2
Alder rep	60.9	35.3	52.0	50.9	35.5	14.1	18.2	27.6	33.2	20.0	20.1
Birch rep	-	-	-	-	-	1.8	3.7	4.9	0.9	1.7	3.8
Wood	1195.0	1270.4	1393.9	1108.9	2057.6	1691.6	1711.5	913.5	904.3	1592.8	1076.1
Total Tree Litter	1668.5	1660.4	1692.1	1317.8	2257.8	1663.0	2105.9	1670.7	1811.1	2239.6	1730.8
Total Litter (Forest Floor)	3516.9	3196.3	2857.5	2172.5	3443.4	2721.1	3238.3	2535.2	2720.5	3264.0	2662.7

1967/68

	15/3	20/4	20/5	18/6	17/7	21/8	21/9	23/10	18/12	26/2	20/4
Ground veg.litter	539.4	465.4	335.7	299.5	258.8	240.4	-	201.5	320.3	341.6	405.1
Rubus	207.1	160.2	180.2	289.1	407.6	203.7	-	158.1	168.6	190.5	122.1
Grass	152.8	72.0	106.4	106.6	118.1	158.3	-	198.7	219.3	244.4	170.2
C.angustifolium	28.2	25.8	2.9	1.2	-	-	-	4.4	-	1.4	0.1
Total ground veg.litter	927.5	723.4	625.2	696.4	784.5	602.4	-	562.7	708.2	777.9	697.5
Tree litter-Alder lvs.	125.1	60.4	29.1	19.1	56.4	106.0	-	239.0	320.2	350.8	126.0
Birch "	244.9	102.8	87.1	56.0	54.8	97.0	-	330.1	263.3	301.9	290.8
Other tree	7.8	2.7	3.7	7.4	1.0	4.3	-	71.5	73.8	100.9	27.4
Alder rep	31.3	34.6	46.6	22.8	25.4	11.4	-	14.6	20.6	40.8	48.8
Birch rep	3.9	2.9	2.6	1.9	0.4	0.1	-	2.8	0.1	0.9	1.7
Wood	1159.5	920.8	1000.9	900.8	990.2	796.0	-	896.7	757.2	1079.1	851.6
Total Tree Litter	1572.5	1124.2	1432.2	1008.0	1128.2	1014.8	-	1554.7	1435.5	1874.4	1346.3
Total Litter (Forest Floor)	2500.0	1847.6	2057.4	1704.4	1912.7	1617.2	-	2117.4	2143.7	2652.3	2043.8

Figure 51.

Ground Vegetation biocontent (Kcal/m²), 20/4/66 to 22/4/68.

Key: crosses - Rubus.

closed circles - Rubus + forbs.

plus signs - Rubus + forbs + grasses.

open circles - Rubus + forbs + grasses + ferns.

Figure 52.

Forest Floor litter biocontent (Kcal/m²), 20/4/66 to 22/4/68.

Key: closed circles - ground vegetation litter.

plus signs - GV litter + leaf litter.

open circles - GV litter + leaf litter + woody litter.

BIOCONTENT(kcal/m²) FOREST FLOOR LITTER

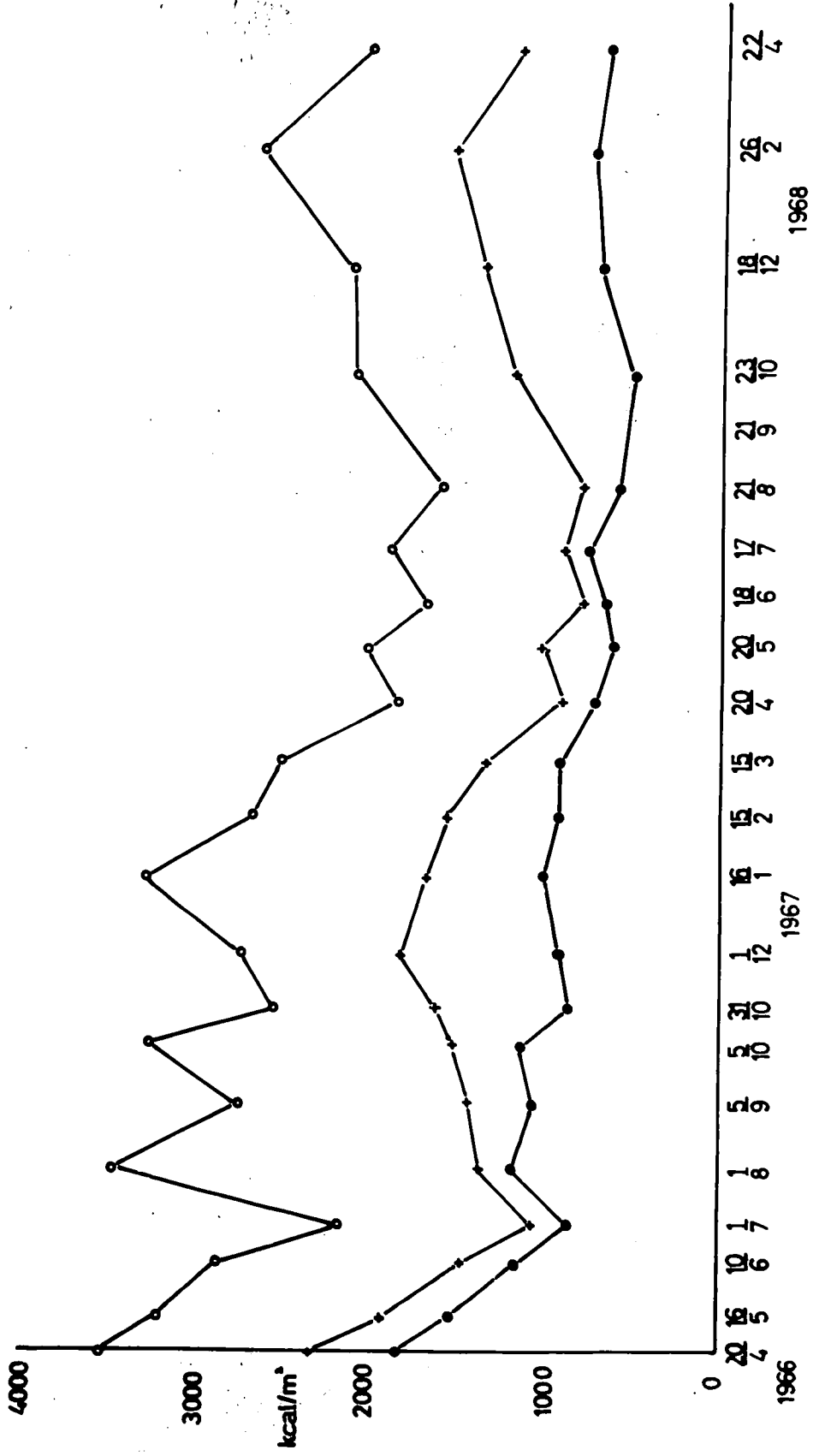

came to between 25% and 35% of the total litter biocontent, excepting for the period April 1966 to July 1966. The wood litter made up most of the tree litter biocontent, only being approached in importance by the leaf litter at and after the time of leaf fall.

Tables ~~XXXXIX~~ and L give the biocontent data for the Alder and Birch Zones from April 1967 through April 1968. These data are summarized in Figures 53a & b, and 54a & b. As for the Grid taken as a whole, the patterns were essentially similar to those for biomass. The differences between the zones corresponded to those for biomass. The total litter biocontent was quite similar in both, but wood litter was more important in the Alder Zone than in the Birch Zone, whereas the opposite was the case for ground vegetation litter.

VII vi. Discussion

The basic problem of estimating quantities such as those dealt with in this Section is that the samples, however, apportioned, however processed, represent only a diminutive fraction of the area studied. For example, the 16 quadrats clipped on each occasion up to March 1967 had a total area of 1.54m^2 . In the second year the 24 quadrats had an area of 2.30m^2 . Thus the total area clipped was only 0.048% and 0.072% of the Grid area on each occasion in 1966-7 and 1967-8 respectively. Quadrat size and number were limited by the time available for processing cropped material. On the other hand, the technique of serial cropping required that the quadrats

TABLE XXXIX

Biocontent (Kcal/m²) - Alder Zone

Ground vegetation	20.4.67	20.5.67	18.6.67	17.7.67	21.8.67	21.9.67	23.10.67	18.12.67	26.2.68	22.4.68
FERNS	7.2	81.7	101.4	161.7	152.9	156.5	199.9	15.7	-	-
RUBUS	152.4	104.6	87.6	179.9	130.6	127.5	118.6	74.1	78.3	83.9
FORBS	-	1.9	4.8	39.9	6.91	1.2	0.6	0.9	0.7	2.4
D.CAESPITOSA	-	-	44.4	-	-	-	-	-	-	-
AGROSTIS TENUIS	0.1	1.9	25.7	-	-	-	0.1	4.8	-	0.9
HOLCUS Spp.	13.7	56.0	75.8	44.8	31.0	16.2	1.0	+	2.8	11.1
TOTAL	173.4	246.1	339.7	426.3	383.6	301.4	320.2	95.5	81.8	98.3
Ground vegetation litter										
FERNS	538.7	309.8	247.9	240.1	178.4	-	239.8	364.7	290.2	267.0
RUBUS	143.9	146.8	153.4	331.2	168.2	-	190.3	141.9	113.3	131.8
GRASS	33.2	41.6	49.9	39.0	88.7	-	48.9	120.1	147.3	95.4
CYANGUSTIFOLIUM	17.5	-	-	-	-	-	9.0	-	0.4	0.3
TOTAL	733.3	498.2	451.2	610.3	435.3	-	488.0	626.7	551.2	494.5
BRYOPHYTES	28.7	67.9	64.5	44.6	54.2	44.9	26.6	18.1	21.4	20.7
Tree litter										
ALDER LEAVES	110.7	29.5	54.9	104.8	121.8	-	328.2	465.0	586.6	227.8
OTHER TREE	6.3	2.1	7.1	1.0	6.7	-	103.9	53.2	185.1	41.7
BIRCH LEAVES	34.8	50.9	15.3	23.9	30.8	-	76.2	107.4	120.6	41.5
WOOD	835.2	1,209.9	1,098.8	1,350.7	653.5	-	1,151.2	976.9	1,204.9	1,030.5
ALDER REP	56.1	88.8	39.6	47.5	17.5	-	23.9	31.3	68.2	93.4
BIRCH REP	0.7	-	-	+	0.2	-	2.4	0.4	0.9	13.3
TOTAL TREE LITTER	1,043.8	1,381.2	1,215.7	1,527.9	830.5	-	1,685.8	1,634.2	2,166.3	1,448.2
TOTAL LITTER	1,777.1	1,879.4	1,666.9	2,138.2	1,265.8	-	2,173.8	2,260.9	2,717.5	1,942.7

Birch Zone biocontent (Kcal/m²)

TABLE I

	20.4.67	20.5.67	10.6.67	17.7.67	21.8.67	21.9.67	23.10.67	18.12.67	26.2.68	22.4.68
<u>Ground Vegetation</u>										
FERN	8.0	47.8	84.7	106.9	251.8	233.8	288.9	1.5	2.3	-
RUBUS	34.8	177.9	122.7	105.8	87.9	88.6	85.6	32.9	97.2	61.9
FORBS	14.2	2.9	13.3	-	8.5	4.0	2.7	1.8	2.7	0.9
V. RIVINIANA		1.8	3.6	-	33.9					
D. GAESPITOSA	3.3	1.1	-	-	-	-	1.6	-	0.6	4.6
AGROSTIS. TENUIS	12.5	47.5	43.4	175.5	127.3	64.6	12.4	1.8	-	0.5
HOLCUS Spp.	22.3	44.7	61.8	40.6	31.4	15.8	0.5	2.3	13.2	6.7
TOTAL	95.1	323.7	329.5	428.8	540.8	406.8	391.7	40.3	116.0	74.6
<u>Ground Vegetation Litter</u>										
FERN	373.3	360.6	353.1	278.2	305.0	-	155.1	266.4	395.2	526.6
RUBUS	176.5	214.1	419.9	487.1	240.6	-	128.2	191.8	270.8	115.4
GRASS	112.4	168.8	165.5	200.3	230.6	-	354.6	322.5	345.5	234.7
C. AUGUSTIFOLIUM	34.3	57.6	2.3	-	-	-	-	-	2.4	-
TOTAL	696.5	801.1	940.8	965.6	776.2	-	637.9	780.7	1,013.9	876.7
<u>BRYOPHYTES</u>										
	57.2	23.4	62.3	45.8	39.1	45.6	45.2	43.0	34.6	55.1
<u>Tree Litter</u>										
ALDER LEAVES	8.0	8.3	2.1	5.9	90.9	-	145.9	169.4	105.3	20.1
OTHER TREE	4.8	5.2	7.6	1.0	1.8	-	37.8	95.2	13.1	12.5
BIRCH LEAVES	173.6	121.9	98.2	86.8	165.5	-	594.4	429.4	528.2	550.2
WOOD	1,010.0	800.2	694.8	614.9	944.4	-	631.7	528.4	948.2	665.3
ALDER REP	12.2	6.4	5.5	2.4	5.0	-	4.9	9.3	12.3	2.4
BIRCH REP	5.2	5.1	3.7	0.8	-	-	3.4	-	1.0	1.7
TOTAL	1,213.8	947.1	811.9	711.8	1,207.8	-	1,418.1	1,231.7	1,608.1	1,252.2
<u>TOTAL LITTER</u>										
	1,910.3	1,748.2	1,752.7	1,677.4	1,984.0	-	2,056.0	2,264.7	2,622.0	2,128.9

Figure 53.

Biocontent (Kcal/m²). Alder Zone 1967-8.

a. Ground vegetation.

Key: crosses - Rubus.

closed circles - Rubus + forbs.

plus signs - Rubus + forbs + grasses.

open circles - Rubus + forbs + grasses + ferns.

b. Forest Floor litter.

Key: closed circles - ground vegetation litter.

plus signs - GV litter + leaf litter.

open circles - GV litter + leaf litter + woody litter.

BIOCONTENT (kcal/m²) 1967-8 ALDER ZONE

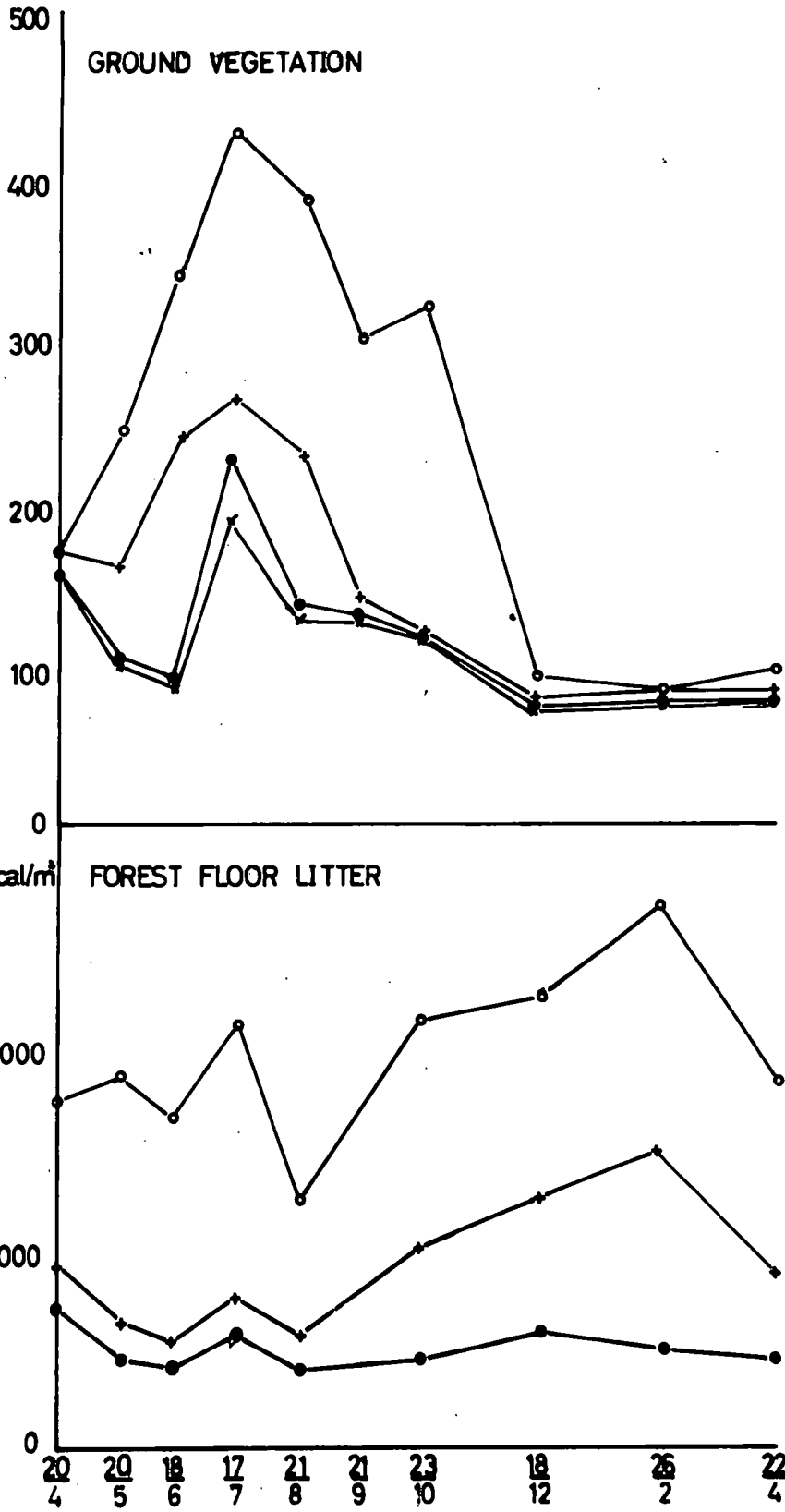

Figure 54.

Biocontent (Kcal/m²). Birch Zone 1967-8.

- a. Ground Vegetation.
- b. Forest floor litter.

Keys as in Figure 53.

BIOCONTENT (kcal/m²) 1967-8 BIRCH ZONE
GROUND VEGETATION

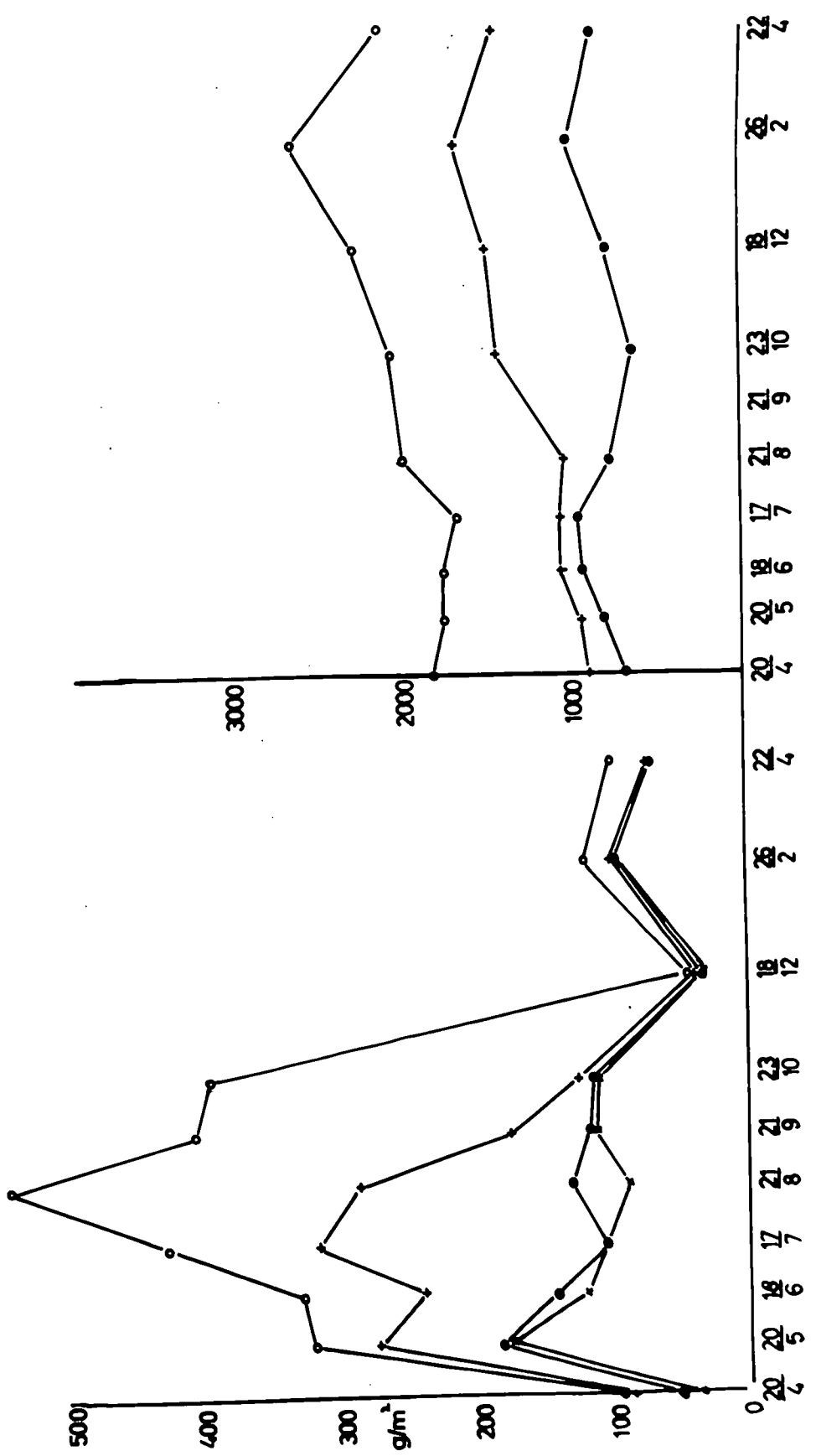

FOREST FLOOR LITTER

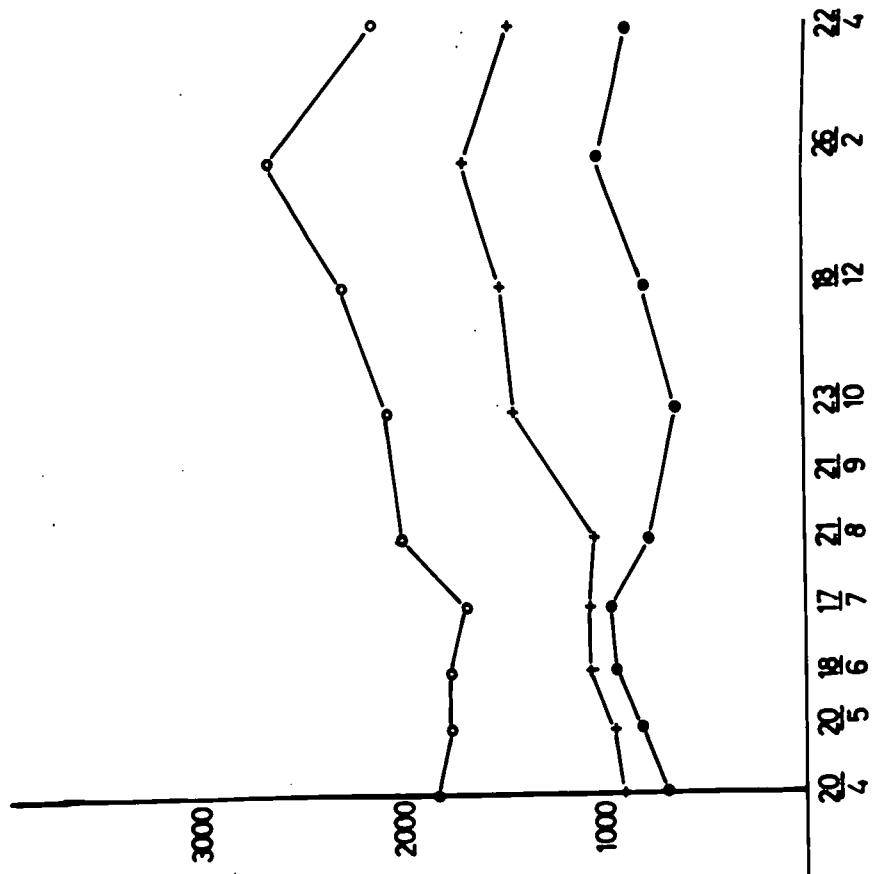

should be small relative to the area studied, so that it was possible to sample on successive occasions without the taking of one set of samples affecting the results of subsequent sampling. The combination of vegetational heterogeneity and the inherent limitations of the serial cropping technique resulted in estimates with rather wide confidence limits. This gave rise to two problems of interpretation. Firstly, how closely does an individual calculated biomass approximate to that actually existing in the field at the time of sampling? Secondly, do these successive calculated biomasses correspond closely enough to reality for the cycle of changes they show to bear any close relationship to the annual sequence of events in the field? In particular, is the use of differences between successive estimates in calculations in any way justified? This particular problem is dealt with further in Section IX. The relationship between changes in biomass estimate and annual cycles of biomass is determined in a two-fold way. On the one hand there is the question of the reliability of the estimates at the time they were made. On the other hand there is the question of sample timing. That is, the biomass estimates may be extremely accurate, but made at inappropriate times. The answer is clearly very frequent sampling, but there are practical difficulties here, and a monthly sampling was the most frequent possible.

These criticisms of the serial cropping technique are, indeed, very serious. However, an ecologist should have more than statistical criteria in his critical armoury. The reasonableness

of the biomass and biocontent estimates made in this Section may be assessed by relating the changes in biomass indicated to the known natural history of the Study Area (this Section); to the observed phenology of litter-fall and die-back (this Section and Section V); and to other estimates of input and output for the litter components (Sections V and VIII). In particular, the simultaneous estimation of green ground vegetation biomass (by species or species groups) and ground vegetation litter biomass (by species groups) made possible a further examination for internal consistency in these data (this Section). The subdivision of the Grid into Alder and Birch Zones made possible a more detailed analysis of this kind.

Throughout this Section the data have been examined in these ways. No glaring discrepancies appeared and it thus seems reasonable to assume that the biomass and biocontent estimates presented in this Section bear a close relation to those actually taking place in the Study Area.

The litter of the Forest Floor may be seen as an aggregate energy store, whose total size does not fluctuate greatly during the year. The most important seasonal changes are probably those in its physical and chemical composition. These must be closely related to its species composition. The study has indicated in which forms (as wood, leaves, woody ground vegetation, or grass litter etc.) this energy is locked up and therefore an examination of this data should give first information about the role of the litter in ecosystem

energetics. It seems likely that the litter formed a medium term energy store (see Section VIII) existing above the longer-term humus energy-store. A large number of food types for decomposer organisms were present in a whole range of conditions, being formed over a large part of the year.

The ground vegetation species litter was a large part of the total litter for much of the year and although dominated by a few species, added greatly to the diversity of forms of stored energy in the litter.

Existing in close physical relationship with the Forest Floor was the ground vegetation. Its biomass and biocontent was made up of Rubus fruticosus and some grasses in winter, with the emergence of other grasses, forbs and Dryopteris filix-mas as very important parts of the biocontent in spring and summer. There appeared to be little or no accumulation of green ground vegetation biomass and biocontent from year to year, almost all of a year's increment falling the few centimetres to the Forest Floor. If the sharp decline of ground vegetation litter biomass in spring 1966 was assumed to be atypical, it would seem that there is little, if any, accumulation or loss of energy or material by the litter from year to year. Therefore, unlike the tree stratum, the ground vegetation did not appear to be accumulating energy either in itself or its litter on an annual basis.

Clearly, the views expressed are based on two years' sampling only and the conclusions can only be applied to the two years in question, although the present picture might reflect a longer term situation for woods of similar age and structure.

CHAPTER III

Section VIII Disappearance

VIII. i. Introduction

This section is concerned with the loss of material from the Forest Floor and although this certainly took place in several ways, e.g., by microbial breakdown, leaching etc., it will be assumed that the total disappearance from the Forest Floor equalled the total energy released by the breakdown of litter formed by the above-ground parts of the vegetation. For this to be the case there must be no significant change in the biocontent of organic matter derived from this litter in lower horizons.

The concept of the 'Forest Floor' is commonly taken to include the L, F, and H layers. Both the lateral heterogeneity of the Forest Floor in the Study Area (cf. Section II) and the practicalities of sampling (cf. Section VII) led to the restriction of the use of this term to the L layer in this study.

There is a vast literature concerned with the breakdown of litter on and in soils in various ecosystems. Much of it is concerned with qualitative analysis of the chemistry of decomposition and humus formation (for example, many papers in the IAEA symposia 'The Use of Isotopes in Soil Organic Matter Studies' 1966 and 'Isotopes and Radiation in Soil Organic Matter Studies' 1968). Another approach used by several workers has been to estimate fractional disappearance of litter of various types under varying

conditions using some kind of mesh enclosure (Attiwill 1968; Bockock & Gilbert 1957; Heath et al 1964; Kucera, Dahlman & Koelling 1967; Mikola 1954, Shanks & Olson 1961; Thomas 1968; Witkamp & Olson 1963; Wittich 1939). A few workers have attempted to make an absolute measure of litter decomposition as part of an ecosystem study (Golley 1965; Kucera et al 1967; Ovington 1961; Wiegert & Evans 1964; Witkamp & van der Drift 1966). In most of these studies, litter decomposition was estimated as either the residual term in an energy budget, or as the sum of input to the litter and the litter biocontent or biomass change. Wiegert & Evans (1964) and Witkamp & van der Drift (1961) measured litter breakdown directly. Wiegert & Evans (op.cit.) compared the mesh bag method and the Paired Plots technique, and it is discussed in detail below. Witkamp & van der Drift (op.cit.) weighed dried litter from permanent plots in December, replaced the material and weighed it again the following September; they also weighed fresh litter monthly from permanent quadrats. Attiwill (1968) used both the mesh bag method and the determination of an annual decomposition constant, k , (Jenny et al 1949) from litter fall and soil organic matter data. In a Eucalyptus forest in Victoria he determined k as 16.3% by Jenny et al's (1949) method, but as 10% by the mesh bag method. He attributed this lower value to incomplete incorporation of the bagged material into the L layer. This point was also emphasized by Witkamp & Olson (1963).

An alternative approach was suggested by Jenkinson (1966) and attempted by Dutch & Stout (1968). This utilizes an increase in C^{14} incorporated into plant material in the early 1960s as a result of atom bomb fall-out. Thus the flow of the C^{14} pulse from foliage leaves through the various soil horizons may be traced. However, the authors found considerable disparities between this method and results from other methods. Clearly there is a possibility of C^{14} input to the soil from the tree roots as well as in falling litter.

In their 'paired-plots method' Wiegert & Evans (op.cit.) removed the dead material from a given area of a field and weighed (W_0) at a time t_0 . At time t_1 they removed the dead material (W_1) from a second area identical in size. Thus they calculated the 'instantaneous rate of disappearance' of dead material as :-

$$r = \frac{\ln(W_0/W_1)}{t_0 - t_1}$$

where r = disappearance rate in g/g/day and $t_0 - t_1$ is in days.

This equation assumes that the rate of disappearance from the two plots are equal; that the biomass and species composition of the dead material on the two plots is identical; that no additional material can be added to the dead material of the second quadrat during the interval $t_0 - t_1$. In order to justify these assumptions, Wiegert & Evans (op.cit.) took two small contiguous plots whose dead vegetation appeared to be identical. To prevent the addition of newly dead material the living vegetation was removed from both plots at the

beginning of the procedure. In addition to this 'Paired-Plots' method, mesh-bag studies were also made. The authors pointed out that in both cases a considerable disturbance to the system takes place, but that in the case of fairly sparse vegetation this will be of less importance than in a dense vegetation in the case of the paired-plots method. It was their opinion that the 'rates of disappearance measured with paired-plots appear to approximate the natural condition better than do rates of disappearance measured with litter bags'.

In the case of litter on the Forest Floor, there seems good reason to use the Paired Plots method. It seems unlikely that the removal of the living ground vegetation will have as drastic an effect on litter microclimate as would be the case in a grassland. Moreover, the Paired Plots technique allows the study of disappearance rate of litter mixed up with that of other species, rather than separated off into an enclosure of abnormal homogeneity. Two important problems exist. First, how to 'pair' plots effectively. Second, how to adapt the method for fall of litter during the experiment.

The other parameter on which this estimate of disappearance is based is the standing crop of litter. The standing crop data must be precise so that the calculation of disappearance is accurate and reliable in that it may reasonably be used in the study of ecosystem energetics. The considerations discussed in VII v. & vi suggest that this may be true in this study; thus a modified version of the

Wiegert & Evans Paired Plot technique was used to estimate the disappearance of various types of Forest Floor Litter in 1966-7 and 1967-8.

VIII. ii. Methods

The standing crop data used in the calculation of disappearance were obtained as described in VII ii. The instantaneous rate of disappearance of ground vegetation litter and tree litter categories was estimated by a modification of the Paired Plots technique (Wiegert & Evans *op.cit.*).

First, a square metre was selected at random in each of the eight $20 \times 20\text{m}^2$ squares of the Grid. Secondly, an apparently homogeneous area of Forest Floor was chosen within it. Then two 0.0312m^2 plots were marked out contiguously within that area as in Figure 55. On the first sampling occasion (t_0) the following procedure was adopted :-

- (1) All green vegetation was clipped from the two plots and discarded.
- (2) One of the plots was chosen by tossing a coin. This was Plot I.
- (3) All litter was carefully harvested from Plot I. It was then taken to the laboratory, sorted, dried for 24 hours at 105°C and weighed. Hence the weight, W_0 , of litter on Plot I on this occasion - time t_0 - was found. On the second sampling occasion, t_1 , the following procedure was used :-

Fig. 55

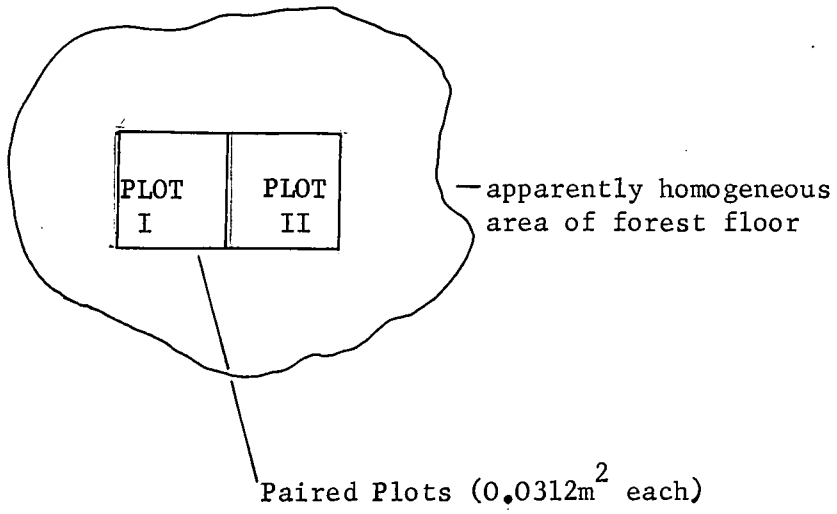

- (1) All litter that had fallen onto Plot I since t_0 was harvested, sorted, dried and weighed. This was W_A .
- (2) All litter was harvested from Plot II, taken to the laboratory, sorted, dried and weighed. This was W_B .
- (3) It was assumed that W_A represents the amount of litter that was also deposited on Plot II and that it disappeared at the same rate as that on Plot II. Hence $W_B - W_A = W_1$.

Assuming that :

- (a) at t_0 the weight and composition of litter on Plots I and II was identical
- (b) the litter on Plot II disappeared at the same rate as if Plot I had not been cleared and the live material had not been removed.
- (c) the correction for deposition of material on the plots during $(t_1 - t_0)$ was valid, then the ^{mean} instantaneous rate of disappearance (g/g/day) of the litter was calculated as follows :-

$$r = \frac{\ln (W_1/W_0)}{t_1 - t_0}$$

At (t_1) a new set of plots was chosen and harvested as on the first sampling occasion (t_0) . One of the most important criticisms of this technique is that plots are seldom correctly paired. In this study the correlation co-efficient for the weights of litter cleared from the randomly assorted components of pair is 0.913 for sets of

eight pairs. Hence $t = 5.49$, $df7$, $P < 0.01$, > 0.001 . This suggests effective pairing.

The amount of litter disappearing during an interval was calculated as the product of the mean standing crop in g/m^2 , the time in days and the ~~instantaneous~~^{mean} rate of disappearance in $g/g/day$.

The paired plots procedure was carried out at intervals usually of about two months from April 1966 until May 1968.

VIII. iii. Results - Biomass

The results for disappearance in terms of biomass are given first for 1966-7. In that year data for total ground vegetation litter (undivided), alder and birch leaves were obtained. For the period 1967-8, the ground vegetation litter was divided into Rubus, Fern, and grass litter, as in the serial cropping. Rates of disappearance were calculated from the Forest Floor litter biomass estimates for both alder and birch zones as well as from the whole Grid biomass estimates.

(a) 1966-7. Table LI. shows the ~~instantaneous~~^{mean} rates of disappearance of ground vegetation litter and the amounts of material disappearing as calculated from these and the ground vegetation litter standing crops from 20.4.66 to 20.4.67. The total disappearance of ground vegetation litter during that period was $544.14 gms/m^2$; this was not evenly spread through the year. Large amounts of material disappeared in the period 20.4.66 to 10.6.66, the period after this until 1.8.66 being marked by very low rates of disappearance. From 1st August to 1st December

TABLE LI Ground vegetation disappearance data 1966-7

DATE	INTERVAL	MEAN INSTANTANEOUS RATE (mg/g/day)	DISAPPEARANCE (gms.O.D.wt/m ²)
20/4	-	-	-
16/5	26	7.19	76.77
10/6	25	7.19	59.12
1/7	22	1.30	7.02
1/8	31	1.30	9.98
5/9	36	6.30	61.88
5/10	30	6.30	51.21
31/10	26	10.37	67.60
1/12	32	10.37	73.44
16/1	46	0	0
15/2	30	4.66	33.59
15/3	28	4.66	29.99
20/4	33	11.00	73.56

TOTAL DISAPPEARANCE OF GROUND VEGETATION LITTER = 544.14gms/m²

the rates were similar to those in early summer, falling to zero in the period 1st December to 16th January. In February, March and April the rate of disappearance once again increased. In fact the period 20.4.66 to 1.7.66 was marked by a fall of almost 250g/m^2 in the ground vegetation litter biomass although the total calculated disappearance for this period was only 142.91g/m^2 . The standard errors of the biomass estimates were wide enough to allow this smaller amount as a possibility, if not a probability. The high spring rates of disappearance were thus associated with high litter biomass, and the summer low perhaps with drying out of the litter.

Table LII shows similar data for Forest Floor alder and birch leaves for the period 20.4.66 to 20.4.67. For alder, the total disappearance was 109.47g/m^2 , for birch, 140.81g/m^2 . Litter fall estimates (Section V) for that year were 110.61g/m^2 for alder and 75.74g/m^2 for birch. There was a decline of 22.75g/m^2 and 28.65g/m^2 in the Forest Floor biomass of alder and birch leaves respectively in the year concerned. Disappearance calculated as the sum of fall and Forest Floor decline was 133.36g/m^2 for alder and 104.39g/m^2 for birch, making a total of 237.75g/m^2 as compared with 250.28g/m^2 by the paired plots method. Assuming the estimate from litter fall and decline of biomass to be the more correct, the paired plots estimate for alder leaves was an underestimate of 23.89g/m^2 (18.2%) and an overestimate of 36.42g/m^2 (34.0%) for birch.

TABLE LIT Calculation of Disappearance for Tree-leaf material
Grid 1966-7

ALDER LEAVES

DATE	DAYS	RATE (mg/g/day)	DISAPPEARANCE (g/m ²)
20. 4.66	-	-	-
16. 5.66	26	3.68	2.65
10. 6.66	25	8.97	5.19
1. 7.66	22	16.90	6.50
1. 8.66	31	16.90	5.96
5. 9.66	36	6.27	3.83
5.10.66	30	6.27	4.45
31.10.66	26	6.27	8.70
1.12.66	32	3.14	8.45
16. 1.67	46	3.14	12.62
15. 2.67	30	23.01	43.88
15. 3.67	28	4.27	4.53
20. 4.67	33	4.27	2.71
	365		109.47

Net change in S/C = -22.75 .°. Estimate of Alder leaf fall = 86.72g/m²

BIRCH LEAVES

20. 4.66	-	-	-
16. 5.66	26	7.21	9.69
10. 6.66	25	9.61	9.21
1. 7.66	22	13.20	6.66
1. 8.66	31	13.20	8.70
5. 9.66	36	13.20	9.88
5.10.66	30	13.20	11.72
31.10.66	26	12.46	18.50
1.12.66	32	7.01	16.54
16. 1.67	46	7.01	18.96
15. 2.67	30	7.45	12.98
15. 3.67	28	4.40	7.43
20. 4.67	33	8.80	10.54
	365		140.81

Net change in S/C = -28.65 .°. Estimate of Birch leaf fall = 112.16g/m²

.°. from disappearance + S/C, estimated leaf fall = 196.88g/m²

The weakness of paired plots estimates for tree litter lies in the relatively small amounts of tree litter present for much of the year. Just as the biomass estimates of forest floor tree litter had large standard errors, so there were greater possibilities of error in the paired plots experiment than for ground vegetation litter. Even so, the estimate for alder leaves did not appear to be wildly wrong, and that for birch leaves was of the right order of magnitude.

Total disappearance of other categories of forest litter could only be calculated from their litter fall and forest floor biomass change. In 1966-7 these two figures were 76.94g/m^2 and 59.90g/m^2 . The total disappearance of this material was thus 136.84g/m^2 .

If the paired plots estimate is taken as correct for both ground vegetation and alder and birch leaf litter, the total disappearance from the forest floor from 20.4.66 to 20.4.67 was 931.26g/m^2 . If the alternative, more reliable estimate of alder and birch leaf litter disappearance is used, the total was 918.73g/m^2 . There was a net loss of 385.56g/m^2 from the Forest Floor during this year, so that an input of 545.70g/m^2 is implied.

(b) 1967-8. Table LIII shows the ^{mean} instantaneous rate of disappearance of total ground vegetation litter and the amount of this material disappearing as calculated from these and the total ground vegetation litter standing crops from 20.4.67 to 20.4.68. The total disappearance

TABLE LIII Disappearance of total ground vegetation ^{litter} from the Grid
1967-8

DATE	DAYS	RATE (mg/g/day)	DISAPPEARANCE (g/m ²)
20/ 4/67	-	-	-
20/ 5	31	11.00	55.81
18/ 6	28	4.52	20.37
17/ 7	29	1.54	8.37
21/ 8	35	6.86	40.39
21/ 9	31	6.86	30.60
23/10	32	1.00	4.60
18/12	56	5.74	50.74
26/ 2/68	70	0.50	6.49
20/ 4	54	8.16	80.57
			<hr/>
		<u>TOTAL</u>	297.94

of ground vegetation litter as calculated by this method was 297.94g/m^2 . This method used the Grid values for biomass and treated the ground vegetation litter as though undivided.

Similar estimates were made using the biomass data for the Alder and Birch Zones taken separately. The total disappearance of ground vegetation litter for the Alder Zone was given as 235.03g/m^2 , whilst that for the Birch Zone was much higher at 361.61g/m^2 . The weighted mean of these two estimates, 299.58g/m^2 , was very close to that obtained directly from the Grid biomass data. Table LIV shows disappearance of ground vegetation litter from the Grid calculated by species group. The total of 331.71g/m^2 was higher than that calculated from total ground vegetation standing crop data. During some intervals the disappearance estimated in this way was greater than that estimated from undivided litter. During other intervals it was less. This was largely because the proportional composition of the litter in the eight paired plots need not have been the same as that in the site as a whole at the same time. However, the overall difference was only 11% between the two estimates. Fern, Rubus and Grass litter made up 47, 30 and 23% respectively of the decomposition of total ground vegetation litter calculated for the grid as a whole.

If the two zones are considered separately (Table LV), the total disappearance of ground vegetation litter in the Alder Zone, calculated from species groups, was 276.03g/m^2 ; of this, Fern, Rubus

TABLE LIV Disappearance of ground vegetation litter by species groups from the Grid 1967-8 (g/m²)

DATES	DAYS	<u>FERN</u>		<u>RUBUS</u>		<u>GRASS</u>		<u>TOTAL</u>
		RATE (mg/g/day)	DISS. (g/m ²)	RATE (mg/g/day)	DISS. (g/m ²)	RATE (mg/g/day)	DISS. (g/m ²)	
20/4	-	-	-	-	-	-	-	-
20/5	31	13.80	41.49	12.40	15.74	5.40	3.71	60.94
18/6	28	5.50	11.84	4.89	7.73	6.36	4.71	24.28
17/7	29	7.98	15.64	1.42	3.45	7.20	5.82	24.91
21/8	35	8.96	18.95	6.86	17.65	8.51	10.22	46.82
21/9	31	8.96	15.52	6.86	9.83	8.51	11.21	36.56
23/10	32	7.58	12.41	5.34	6.97	8.51	13.32	32.70
18/12	56	7.58	26.82	5.34	11.57	1.00	3.07	41.46
26/2	70	0.93	5.33	0.62	1.82	0.10	0.43	7.58
20/4	<u>54</u>	1.86	<u>9.26</u>	12.40	<u>24.72</u>	7.85	<u>22.54</u>	<u>56.52</u>
TOTAL	366		157.26		<u>99.48</u>		75.03	<u>331.77</u>

TABLE LVSummary of disappearance of ground vegetation
litter by species groups from Alder and Birch
Zones, 1967-8

$g/m^2/yr$	FERN	<u>RUBUS</u>	GRASS	TOTAL
ALDER ZONE	155.21	84.43	36.39	276.03
BIRCH ZONE	161.47	114.89	116.82	393.18
		mean of totals		<u>333.50</u>

and Grass litter contributed 56, 31 and 13% respectively. In the Birch Zone the total was 393.18g/m^2 , apportioned among the same three groups as 41, 29 and 30%. It is clear that the grasses were much more important in the litter disappearing from the Birch Zone than the Alder Zone.

Table LVI shows the data for decomposition of alder and birch leaf litter for the whole Grid in 1967-8. The ~~instantaneous~~^{mean} rates were taken from the 1966-7 Paired Plots data, as those for 1967-8 were on several occasions improbably large. The total disappearance of alder leaves was 62.03g/m^2 . The first estimate for birch leaves was 137.24g/m^2 . However, 54.11g/m^2 of this total appeared to disappear between 18.12.67 and 20.4.68, a period in which there was no change in litter standing crop and no addition of litter by fall, therefore a corrected total of 83.13g/m^2 was used. This gave a total disappearance of alder and birch leaves of 145.16g/m^2 . The alternative estimates calculated from litter fall and litter standing crop change were 74.76g/m^2 for alder, 43.80g/m^2 for birch, giving a total of 118.56g/m^2 .

The estimate of decomposition of other litter components was made in the same way as for 1966-7. Their litter fall was 100.68g/m^2 , and their biomass declined by 4.72g/m^2 . Thus their disappearance from the litter layer was estimated as 95.96g/m^2 .

When paired plots estimates were used, as in 1966-7, the estimate of total disappearance in the period 20.4.67 to 20.4.68 was

TABLE LVI

Calculation of Disappearance of Tree-leaf material
Grid 1967-8

ALDER LEAVES

DATE	DAYS	RATE (mg/g/day)	DISAPPEARANCE (g/m ²)
20/4	-	-	-
20/5	31	3.68	0.97
18/6	28	8.97	1.29
17/7	29	16.90	4.47
21/8	35	6.27	3.81
21/9	31	6.27	6.97
23/10	32	6.27	7.19
18/12	56	3.14	10.44
26/2	70	3.14	15.53
20/4	54	4.27	11.36
Total	365		62.03

Net change in S/C = + 14.03 .*. estimate of Alder leaf fall = 76.06g/m²

BIRCH LEAVES

20/4	-	-	-
20/5	31	7.21	4.43
18/6	28	9.61	4.02
17/7	29	13.20	4.43
21/8	35	13.20	7.34
21/9	31	13.20	18.55
23/10	32	13.20	19.15
18/12	56	7.01	25.21
26/2	70	7.01	(30.60)
20/4	54	6.84	(23.51)
	366		(137.24)(83.13)

Using 83.13g/m² as disappearance, net change in S/C = + 39.22

.*. Estimate of Birch leaf fall = 122.35g/m²

539.06g/m² (A). If the same figures were used, but with the disappearance of ground vegetation litter calculated by species group, the total was 573.83g/m² (B). If the litter fall/standing crop estimates of tree leaf litter disappearance were used, these two estimates became 512.26g/m² (C) and 556.03g/m² (D) respectively. There was a net addition of 42.55g/m² to the Forest Floor in this year, and so an input of 598.58g/m² was implied when estimate (D) was used. If (A) was used, because it was directly comparable with the 1966-7 figure, the input to the Forest Floor was calculated as 581.61g/m². The input figures for the two years were rather similar however calculated, the ratio between the two most comparable estimates being 1966 : 1967 - 0.94 : 1.00. The excess of disappearance over input of 385.56g/m² in 1966-7 was due to the breakdown of the large excess of litter in spring 1966 remaining from the previous autumn.

VIII. iv. Results as Biocontent

Table LVII gives a summary of the calculation of the biocontent of disappeared material. The values for ground vegetation method (A) were calculated using the mean calorific content of this material. The method (B) estimates were multiplied by the appropriate calorific value for each category of material. The tree litter figure C + D) was calculated from the total litter fall biocontent (cf. Section V) and the net change in biocontent of the forest floor

Table LVII Biocontent (Kcal/m²) of disappeared material

	1966-7	1967-8
Ground Vegetation Litter	2210.84 ^a	1210.53 ^a (1350.37 ^b)
Tree Litter	<u>1924.21</u> ^c 4134.65	<u>1217.88</u> ^c 2428.41 ^{a + c} (2568.25 ^{b + c})

a - paired plots

b - paired plots with litter divided

c - Litter fall + change in forest floor biocontent

	1966-7	1967-8
INPUT TO FOREST FLOOR =	2465.35	2624.61 ^{a + c} (2764.45) ^{b + c}

tree litter (cf. Section VII). As expected from the biomass data the disappearance in 1966-7 was much greater than in 1967-8. If net increase in Forest Floor biocontent is subtracted from total disappearance, an estimate of input to the Forest Floor is obtained. In both years this was in the region of $2,500\text{Kcal/m}^2$. In 1966-7, 985.44Kcal/m^2 or 40% of this came from the ground vegetation. In 1967-8 1184.63Kcal/m^2 or 45% came from the ground vegetation using method (A), or 1324.47Kcal/m^2 (48%) using method (B).

VIII. v. Discussion

The loss of trophic energy from the L - layer is the sum of energy dissipated by heterotrophs in the litter and energy lost to lower soil horizons, by leaching, commination or other means. If there is no net accumulation or loss of energy from these horizons, the loss of trophic energy from the L - layer (as calculated from disappearance) equals the total dissipation of energy by the decomposer component of the ecosystem, at least so far as detritus formed above ground is concerned.

If a simple model of litter decay such as that proposed by Jenny et al (1949) or Olson (1963) is adopted, ~~instantaneous~~ decay rates may be calculated using the formula

$$k = \frac{L}{L+A}, \text{ where } \begin{array}{l} L = \text{annual litter fall} \\ A = \text{biomass of litter layers} \end{array}$$

If L+A is taken after the time of Tree litter fall (October) k is

calculated as

$$\frac{2465.35}{3264.00} \text{ in 1966-7} = 0.76$$

$$\text{and } \frac{2624.61}{2652.30} \text{ in 1967-8} = 1.00$$

using estimate (a) of input. If estimate (b) is used, the value of k is given as 1.02. k may also be calculated for total Forest Floor organic matter. In February 1968 twenty-four 0.01m x 10cm soil cores were taken, three at random in each of the eight 20 x 20m² of the Grid. From subsamples after drying, the organic matter content was determined using a muffle furnace at 500°C for 24 hours, root material having been carefully removed. The volatile matter was 7761.12g/m²; taking a calorific value of 4.5Kcal/g for this ash-free material (see Table XI) (Section III), the soil organic matter biocontent came to 34925.26 Kcal/m². Adding the litter layer to this, k is calculated as 0.068. If time necessary for 95% breakdown ($3/k$) is calculated from these values, it is three years for the litter layer, but 44 years in the whole Forest Floor system.

It is likely that k for the whole Forest Floor is an underestimate and 95% breakdown time an overestimate, because the estimate of input to the litter plus soil organic matter biocontent did not contain an estimate of root mortality. If the simple exponential model of litter decay does apply to this system, the data suggest that a period of the order of 74 years ($5/12$) with litter production and decay of approximately the same order as at present would be necessary for the soil organic matter and litter fall

to have reached equilibrium. It is possible (cf. Sections II & IV) that such conditions have existed.

Along with biomass and biocontent data for the Forest Floor, it is possible, using the paired plots data, to calculate input to the Forest Floor by the ground vegetation, that is, its litter production. Bray & Gorham (1964) summarised much of the data available for ground vegetation litter production but they cite no case where this litter contributed more than 28% of total litter; this maximum figure was for a very young stand of Robinia (Auten 1941). Also quoted was a figure of 25% of total litter for an old open stand of Eucalyptus (Ashton 1964). The other figures cited average 9% of total litter.

Table LVIII shows data (Ashton 1964; Auten 1941; Ovington 1959; P'Yavchenko 1961; Scott 1955; Witkamp & van der Drift 1961) from several woodlands.

It should be noted that the Eucalyptus data may contain litter fall from lower storey trees. The data from P'Yavchenko contain an estimate of die-back of roots.

Where known, the method of measuring ground vegetation litter production has been shown. The method commonly used has been to harvest the ground vegetation at some more or less appropriate time of year. The standing crop of ground vegetation calculated from this has been taken as an estimate of ground vegetation litter production. This is only a valid method if the amount of material harvested is the same as that falling into the litter. This will not be the case if :

TABLE LVIII

Ground Vegetation Litter in various woodlands

Source	Woodland	Age	Ground vegetation litter (10g/m ² /yr)(% of total litter)	Method
	<u>Young</u>			
Auten 1941	Robinia pseudoacacia	9	1.1	Mid-summer green clip
	Sassafras albidum	12	0.2	Mid-summer green clip
Ashton 1964	Eucalyptus regnans	25	0.8	-----
	<u>Mature</u>			
Ovington 1959	Pinus sylvaticus	33-55	2.4	October green clip
P'Yavchenko 1961	Bog and grass Spruce forest	100-200	1.4	September green clip
	Low shrub and sphagnum pine forest	120	1.31	September green clip
Ashton 1964	Eucalyptus regnans	200	2.0	-----
Scott 1955	Acer saccharum	-	0.3	Single clip
	Pinus strobus	-	0.3	Single clip
Witkamp & van der Drift 1961	Quercus robur	-	0.14	August green clip
	Mixed angiosperms	-	0.83	August green clip

- (1) There is any net transfer of dry matter between the above and below ground parts of the ground vegetation after harvesting and before litter formation
- (2) there is growth of ground vegetation in this time interval
- (3) any ground vegetation dies back and forms litter before harvesting. These situations may well be common.

In this study the estimate of ground vegetation litter production was total annual disappearance of ground vegetation litter, with a correction for the net change in its standing crop over the year. This met the criticisms made above. If other methods had been used, an underestimate would have resulted. For example, in 1966-7 the overall green ground vegetation dry matter increment was 113.53gms/m^2 (a). The sum of species dry matter increments (estimate b) was 178.94gm/m^2 . The total annual disappearance, with a correction for the net change in ground vegetation litter standing crop (c), (the estimate used) was 269.88g/m^2 .

Of these estimates, the lowest (a) was more accurate than would be obtained if it were based on a single summer clipping. (b) was markedly higher, as it took into account the spread of the peak standing crops of the individual species through a large part of the year. It did not, however, recognize the passage of materials from the above ground to the below ground parts of plants that may occur after peak standing crop. Nor did it account for pre-peak mortality and post-peak growth in grasses. The highest estimate (c)

was based on the calculation by difference of the total input of dry matter to the litter by the ground vegetation. The estimate was dependent only on the instantaneous rate of disappearance and standing crop changes in the ground vegetation litter. It was not affected by the transfer of material between the above and below ground parts of plants. It accounted for mortality before peak green standing crop and disappearance of litter before peak mortality for the species concerned.

The work of Wiegert & Evans (1964) suggests that the peak standing crop of grasses represents at most 50% of the total litter production by the grasses. In this study grass litter disappearance in 1967-8 was calculated as 75.03g/m^2 . The net change in grass biomass in that year was $+24.37\text{g/m}^2$. Therefore grass litter production was 99.40g/m^2 . The sum of grass species increments was 45.62g/m^2 . The ratio of litter production to this was 1 : 0.45. If the grass contribution in estimate (b), 1966-7, is multiplied by 2.2, estimate (d), 232.94g/m^2 , results. If the 1967-8 data had not been used, but merely Wiegert & Evans' indication, a very similar estimate would have resulted. This would be completely independent of estimate (c), but close to it.

In this study evidence has been obtained for high ground vegetation litter production. If the method of summer clipping had been used a gross under-estimate would have resulted. The calculation of ground vegetation litter production from measurements of disappearance was adopted because :-

- (a) it measures mortality that occurs before peak green standing crop and disappearance of litter before peak mortality for the species concerned.
- (b) it is not rendered invalid by growth after peak green standing crop.
- (c) the transfer of material between the above and below ground parts cannot affect it.

This particular method may not be suitable for other woodlands, but nevertheless attention should be paid to the three points mentioned above.

In summary, the data presented in this section indicate that the annual addition of energy-rich material to the Forest Floor of the Study Area was around 2500Kcal/m^2 with the study period. Of this 40 to 50% was contributed by the ground vegetation. Annual disappearance equalled this, excepting in the first study year when an excess of material from 1965 was broken down in the spring of 1966. As maximum litter biocontent was around 2500Kcal/m^2 , and total Forest Floor organic matter (to 10cms depth) around $37,000\text{Kcal/m}^2$, 95% breakdown times of 3 and 4 years respectively were indicated.

Thus the litter layer may be seen as a medium-term energy store, the soil organic matter as a longer-term energy store. What was not revealed in this investigation was what fraction of the total decomposition actually took place in the L layer as distinct from lower horizons. However, an indication of the size of energy flow through the decomposer component of the ecosystem was obtained.

CHAPTER III

SECTION IX. Ground Vegetation Net Primary Production

IX. i. Introduction

The data presented in Sections VII and VIII suggest an important role for the ground vegetation in the biocontent structure, litter formation and breakdown of the system under study. In this section estimates of above-ground net primary production of ground vegetation will be presented.

Many authors give estimates of ground vegetation biomass (Auten 1941; Baskerville 1965; Frankland et al 1963; Scott 1955; Sviridova 1960; Tamm 1953; Traczyk 1967; Traczyk & Traczyk 1967; Ovington & Heitkamp 1960; Ovington, Heitkamp & Lawrence 1963; Whittaker 1961; Whittaker 1963). There have been rather fewer attempts to make detailed analyses of net primary production by this stratum. Of these, Tamm (1953) worked on carpets of forest moss, not directly comparable with the vegetation investigated here. In most other cases ground vegetation net primary production has been equated with the standing crop on one arbitrarily chosen occasion, or at best as the peak of a biomass curve based on infrequent samples. The criticisms levelled at this approach by Wiegert & Evans (1964) and in Section VIII of this thesis are relevant here, too.

A modified approach was used by Traczyk (1967) and Traczyk & Traczyk (1967), involving analysis of density and the calculation of an index of average individual increment for individuals

of each species. The individual increment was based on the separation of current from previous years increment at the time of fructification. This approach takes cognisance of the complex spatial distribution of individuals of a species, and bases the separation of current from previous years increment on reliable phenological and anatomical indicators. However, it assumes no death of new parts before fructification, and no net increment after it. For many of the forest herbs these are probably reasonable assumptions, but do not hold true for grasses (cf. Section VIII) and certain other perennial plants. Moreover, it is impossible to know what transfers between the above-ground parts and below ground parts have taken place and such transfers could well affect an estimate made in this way. Nevertheless, the work at Kampinos represents the most detailed consideration of ground vegetation primary production in the literature to date.

An important characteristic of the ground flora of forests in the cool temperate zone is that it contains few annual species, and few individuals of those that are present (Richards 1952; Traczyk & Traczyk 1967; Section II of this thesis). Thus we are concerned almost entirely with perennial plants, in which transfer between above and below ground parts must affect any but a perfectly timed production estimate. That is to say, a full knowledge of the timing, nature and magnitude of energy and material transfer between the various organs of each species concerned would be necessary before

it could be decided which apparent increment is to be taken as the estimate of net primary production. This matter is confused and the problem intensified further where only above ground net primary production is being measured. Where root studies are carried out, caloric phenology may help to define transfers between organs (Kieckhefer 1962; Hadley & Kieckhefer 1963). For reasons of labour shortage and the nature of the soil at Wynyard this was not possible in this study.

The apparently necessary division of net primary production into that taking place above ground and that below may lead to confusing simplifications. Where root studies are impracticable it is more profitable to distinguish between the products of net primary production that may be measured above or below the soil surface. Thus net primary production measurable above ground equals the sum of net above ground biomass change, losses to decomposers, losses to herbivores and losses in solution. Net primary production measurable below ground equals the sum of net transfer from above ground minus below ground respiration and this in turn equals biomass change plus a series of loss terms analogous to those for above ground parts.

In order to solve for net primary production (either total or for the above or below ground components) it is necessary to measure the net change in biomass for the period concerned plus the periodic integrals of the loss rates indicated. Thus even where only a partial

estimate is possible, it may be clearly defined in terms related to the realities of dry-matter energy accumulation and trophic transfer. This avoids the pitfall of abstraction about nature being over-determined by inadequate observational techniques (e.g. the range management research practice of taking total above ground dry matter as an index of production). It does not, of course, obviate inaccuracy due to technique or uncertainty due to the heterogeneity of the material.

In this study net primary production of the ground vegetation was only measured above the mineral soil surface, as for the tree stratum. Losses to herbivores, and in solution, were not measured. Thus net primary production was estimated as the sum of net change in biomass and loss to decomposers. Both of these parameters were measured above the mineral soil surface only.

IX. ii. Methods

The methods used in the collection of the data presented in this section have been described in Sections VII and VIII.

Changes in biomass and biocontent are taken from Section VII, whilst loss to decomposers is taken as the input to the Forest Floor from the ground vegetation calculated in Section VIII.

IX. iii. Results - biomass

Table LIX shows details of the calculation of net primary production for 1966-7. The mortality term is the sum of disappearance and ground vegetation litter standing crop increase. The growth term is the sum of mortality and green ground vegetation standing crop increase. The two most comparable estimates, that is, those based on disappearance calculated for undivided litter, are within 1% of one another for the two years. The figure calculated from the disappearance of separated litter is higher, but less reliable (see Section VIII). Of this 43.0, 27.5 and 29.5% of the growth is attributed to the Ferns, Rubus and Grasses respectively. In the separation of ground vegetation litter it was not possible to identify those species with less persistent litter. In the case of undivided litter this was clearly not a problem. For this and other reasons (cf. Section VIII) the estimate based on the disappearance of undivided litter is accepted. This net primary production of the ground vegetation measured above ground was 277.86g/m^2 in 1967-8.

These figures may be compared with data analogous to those on which other authors have based primary production estimates (Table LX). The peak standing crop of a largely perennial vegetation is not a measure of its net primary production, nor is the difference between the maximum and minimum biomass a good estimate of net primary production. The sum of species dry matter increments is more realistic, for not all species show peak or minimum biomass in

TABLE LIX Calculation of Ground Vegetation Net Primary Production
 (g/m²)

	Mortality	Change in green biomass	Growth
1966-7 Total	269.90	+ 7.96	277.86
<hr/>			
1967-8			
Ferns	142.67	- 1.93	140.74
<u>Rubus</u>	95.31	- 5.46	89.85
Grasses	99.40	- 2.97	96.37
Total of these	337.38	- 10.36	327.16
1967-8 Total	291.96	- 11.76	280.20
<hr/>			

TABLE LX Biomass Various net primary production calculations
(g/m²) for ground vegetation

	1966-7	1967-8
Peak standing crop	137.70	106.23
Dry matter increment	113.53	89.87
Sum of spp. dry matter increments	178.94	143.17
Sum of spp. increments + grass	223.88	188.85
Estimate from Table LIX	277.86	280.20
Table LIX estimate by spp. groups	-	327.16

the same months. This estimate is made more realistic by the doubling of the grass contribution (cf. Section VIII). Even so, it is considerably less than the estimate based on disappearance and green biomass change (19.5% less in 1966-7, and 32.5% in 1967-8). This implies that there must be considerable loss to litter before peak biomass or growth after peak biomass in a species other than grasses. An examination of the 1967-8 biomass data suggest that this may be the case for Rubus, where there was an increase of litter biomass in the month after peak green biomass that was not fully accounted for by the decrease in living biomass. This suggests a dying off of overwintered material after the new year's shoots were well established but not fully grown. The total discrepancy for the months of May to July was 53.52g/m^2 .

For the Ferns, the peak biomass of the main species, Dryopteris filix-mas, occurred at the end of the season, and was followed by an increase in litter biomass. Thus it seems likely that the major discrepancy between species increment and net primary production that one might expect, apart from the grasses, is the case of Rubus. The discrepancy here appeared to be of the order of the summer standing crop of the species, or greater. Thus it is reasonable to assume that the real net primary production of the vegetation in question was $30 - 40\text{g/m}^2$ greater than the sum of species dry matter increments plus the grass contribution. This gave figures of the order of $250 - 260\text{g/m}^2$ in 1966-7 and $220 - 230\text{g/m}^2$ in 1967-8.

These data are not inconsistent with the net primary production estimates based on disappearance and total biomass change, although essentially independent of them.

IX. iv. Results - biocontent

Table LXI corresponds to Table LX and gives various biocontent data for primary production of ground vegetation measured above ground. Similar comments apply to the various biocontent data as to the biomass data. In addition, it should be noted that there is less difference between the species group disappearance based estimate and the total disappearance based estimate than for biomass (13.8% as against 16.8%). Thus it is reasonable to assume that the net primary production of the ground vegetation that may be measured above ground lay between 900 and 1300Kcal/m² for the two study years. In fact, the accepted estimates were 1016.2Kcal/m² for 1966-7 and 1142.4Kcal/m² for 1967-8.

IX. v. Discussion

The net primary production of the ground vegetation measured above ground (circa 1000Kcal/m²/yr) was not much smaller than the total litter fall from the trees (circa 1450Kcal/m²). These two figures are comparable in that they approximate to the production of photosynthetic parts, and their immediate support organs, by the strata they represent. The difference between the two strata is the

TABLE LXI Biocontent Various net primary production calculations
(Kcal/m²) for ground vegetation

	1966-7	1967-8
Peak standing crop	581.3	445.6
Dry matter increment	516.3	380.6
Sum of spp. dry matter increments	678.9	534.0
Sum of spp. increments + grass	833.1	714.6
Estimate from Table IX	1016.2	1142.4
Table IX estimate by spp. groups	-	1280.8

production of large amounts of long-term storage by the tree stratum (2000Kcal/m²/year or more).

It is clear that the cost of maintaining a smaller photosynthetic machinery for a longer growth season was relatively greater than the cost of maintaining the tree canopy from early May to October. A major contributor to this energy cost must have been the replacement of old tillers of perennial grasses through a large part of the year. It is possible that the position would be reversed if fine root production and loss were also included as a running cost charged against dry matter accumulation.

The role of the ground vegetation in the woodland ecosystem is discussed further in the last Section of this thesis.

CHAPTER IV

Section X. Insolation

X. i. Introduction

Ecologists see incident solar radiation, or more strictly the sun, as the ecosystem's energy source. Apart from the small amounts of energy which are thought to be fixed chemically, the ecosystem must gain all the energy dissipated in its life-processes by fixing the energy of incident solar radiation. Therefore, in any study of ecosystem energetics this must be a key measurement. Extra-terrestrial solar radiation has wavelengths from 0.2 to 3.0 microns (a very small fraction of its energy lies beyond 3.0 microns). However, that which is of use in photosynthesis lies between 0.4 and 0.7 microns. If the primary purpose of this study was to compare the photosynthetic efficiency of different plants or vegetation strata, radiation between these wavelengths would have to be measured. However, a measure of total incident short wave radiation is required so that net primary production and net ecosystem production may be expressed as fractions of the total available energy. In essence, measurements in the waveband 0.4 to 0.7 microns allow for the present state of evolution of the photosynthetic machinery, whereas total short wave (SW) radiation measurements do not.

In this study SW radiation above the tree canopy was measured over a period of one year. So that SW radiation records

might be compared with those for growth, canopy closure etc., they were obtained in the form of integrated weekly totals. In addition, SW radiation at points in and beneath the canopy was measured. These latter measurements were carried out more in order to test the apparatus than to define irradiation incident on the lower vegetation strata. As will be seen below, much more extensive instrumentation would have been required for this purpose.

X. ii. Methods

To avoid compensation for the present state of evolution of the photosynthetic machinery, and because of our relative ignorance of its evolutionary characteristics, SW radiation should be measured by an instrument that does not have a differential spectral-sensitivity.

Tricket, Mouldsley & Edwards (1957) were among the first to suggest that the most appropriate instruments for measuring total short wave radiation are those based on the principle of the thermopile. Reliable instruments of this kind are available commercially but are, in the main, expensive. However, several cheap but effective solarimeters have been developed (Monteith 1959; Szeicz, Monteith & dos Santos 1964; Szeicz 1966). In this study a commercial version of the Monteith 6cm Dome solarimeter (Monteith 1959) was used. For the measurement of irradiation within and beneath the canopy, the tube type of solarimeter (Szeicz, Monteith & dos Santos 1964) would have been most appropriate. These are not available commercially, and as time was limiting, the dome type of solarimeter was used in this

part of the study also. The glass dome acts as a filter which cuts off at 0.28 microns and 3.0 microns.

A method of integrating the solarimeter output was required. Of those described in the literature (Trickett et al 1957, Monteith & Szeicz 1962) the required components are not always readily available, or cheap. In this study, a simple inexpensive integrator for use with solarimeters and other devices with a similar output was developed.

The Integrator

Two main approaches have been adopted in the integration of solarimeter output; either it is integrated directly by means of a sensitive summation device such as an inverted burette (e.g. the Siemens meter) or ~~the amplification~~^{ed} and ~~subsequent~~^{then} integration^{ed} of ~~the output~~ (Trickett et al 1957; Monteith & Szeicz 1962). In this study the second course was adopted.

It was clear that transistorized amplifiers would be most convenient for field use but a serious problem was encountered in the temperature dependence of the transistor base-emitter bias voltage. The difficulty appears to have been overcome in a circuit described by Holford 1962 where a long-tailed pair circuit was used to measure small voltages over a number of ranges. In this system the signal is applied differentially between the base terminals of two similar transistors whose emitters are common. If the temperature

dependence of the two base-emitter bias voltages were identical there would be complete compensation for temperature change. In practice, using silicon P-N-P junction transistors BCZ11, Holford found this compensation to be usually better than 99% over a 20 degree centigrade range (op.cit.).

The multirange input and the output sections of Holford's circuit have been modified for simple input and output and the circuit adjusted to operate at 9V (Fig.56). The circuit values were calculated with reference to the output data for the type of solarimeter used (Monteith 1959) and the nature of the integrator (Tanner et al. 1963). A shunt was inserted across the output so that it could be adjusted to a suitable range for the integrator at a given time of year.

The output from the transistorized amplifier was integrated by a simple electrolytic coulometer (Tanner et al 1963; Macfadyen & Webb 1968). It consists of a glass capillary tube containing a mercury thread interrupted by a bubble of electrolyte. Terminals are sealed into the ends of the tube. As a small current (not greater than 150μ A) is passed, mercury electroplates from one side of the bubble to the other, so that the bubble is proportional to the integral of the current passed through the coulometer per unit time. This meter (available commercially as the 'Mercron' or the 'Curtis meter') is inexpensive. The movement of the meniscus of the mercury was measured accurately using a microscope with a calibrated mechanical stage. (A calliper micrometer could equally well have been used).

Figure 56.

The modified amplifier circuit. An explanation is given on pages 150-1.

FIELD AMPLIFIER CIRCUIT

-9V

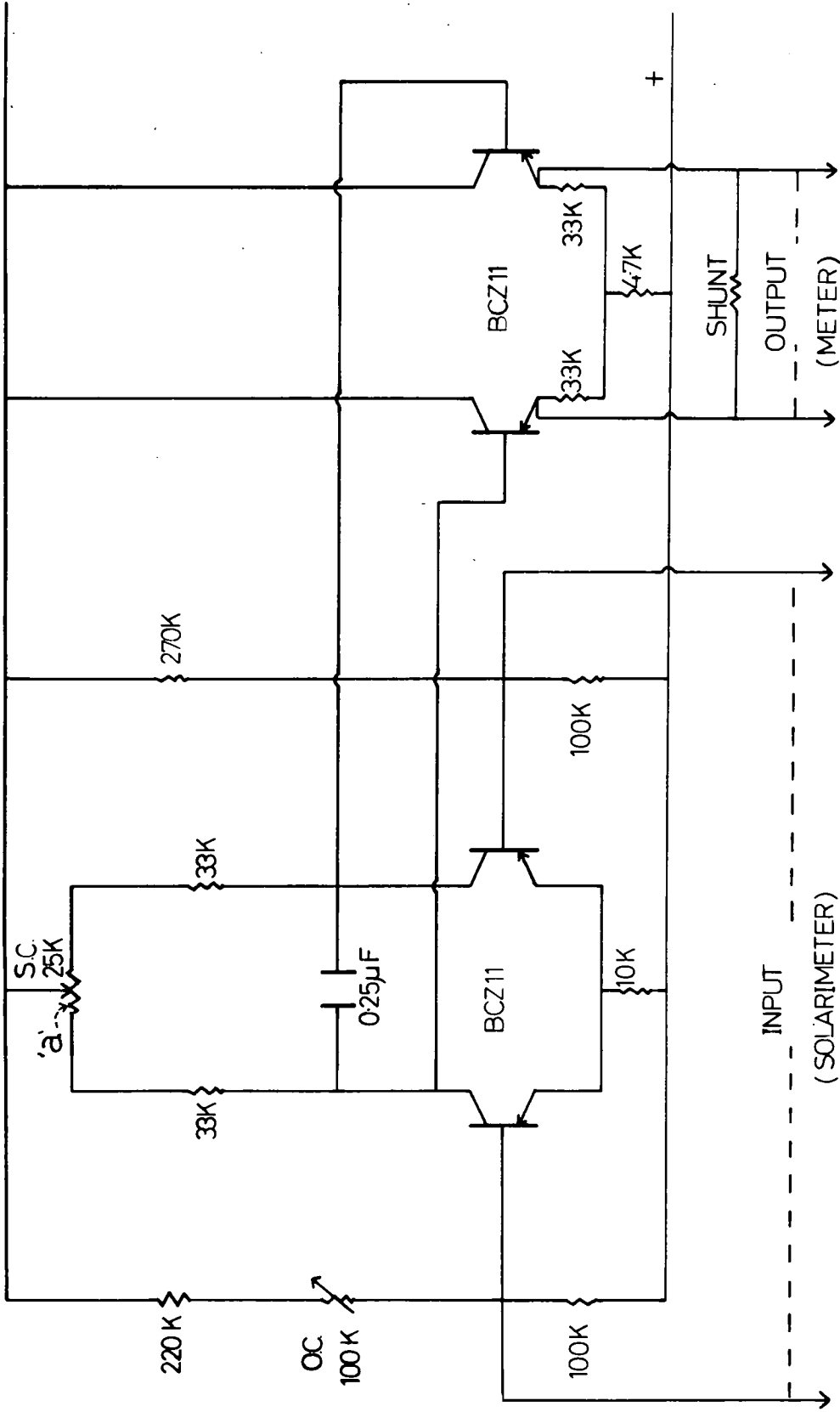

X. iii. Performance of the Integrator

The transistorized amplifier produced a small current output when the input was zero; however, this was minimized by adjustment of the potentiometer shown as 'a' in Fig.56. Fig.57 shows that the present amplifier provided an effective linear amplification of the output of the Monteith solarimeter. The amplifier output was correlated with the irradiance measured by a Moll pile as follows in this case :

Coefficient of correlation, $r = 0.983$

Degrees of freedom $df = 59$

Probability of non-linearity, $P < 0.001$

The rate of movement of the coulometer mensicus was shown to bear a linear relationship to the current passing through it (Fig.58).

The whole assembly (Monteith solarimeter-amplifier-coulometer) was tested against a Moll pile for 12 days in March - April 1967. The total insolation (radiation in the wave-band 0.28μ to 3μ) recorded by this assembly is highly correlated with the integrated output of the Moll pile (Fig.59). The reading of the meter came within 3% of the integrated output of the Moll pile. More extensive trials than were possible would be necessary to assess adequately the percentage error of the solarimeter - integrator assembly with reference to the integrated output of the Moll pile. However, from Fig.57, the maximum deviation of the output of the solarimeter amplifier assembly from that of the Moll pile is 14.3%.

Figure 57.

Amplifier output (μA) against irradiance ($10^4 \text{ Kcal/m}^2/\text{min.}$)
Solarimeter 1.

AMPLIFIER OUTPUT VS. OUTPUT OF MOLL PILE
SOLARIMETER I

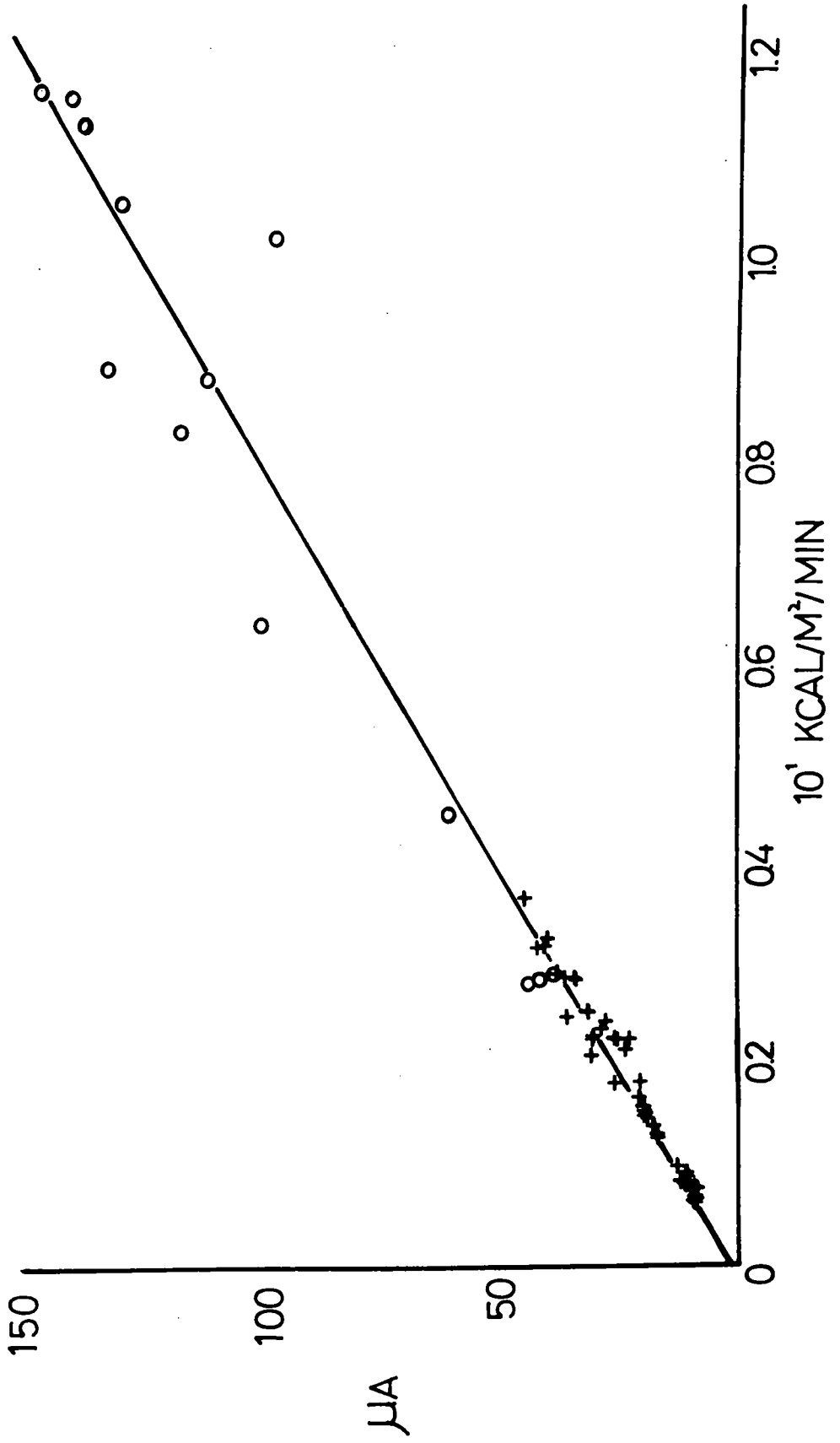

Figure 58.

Rate of meniscus movement (10^{-3} mm/hr) through Mercron 2
against current passed (μ A).

RATE OF MENISCUS MOVEMENT VS. CURRENT
MERCURON 2

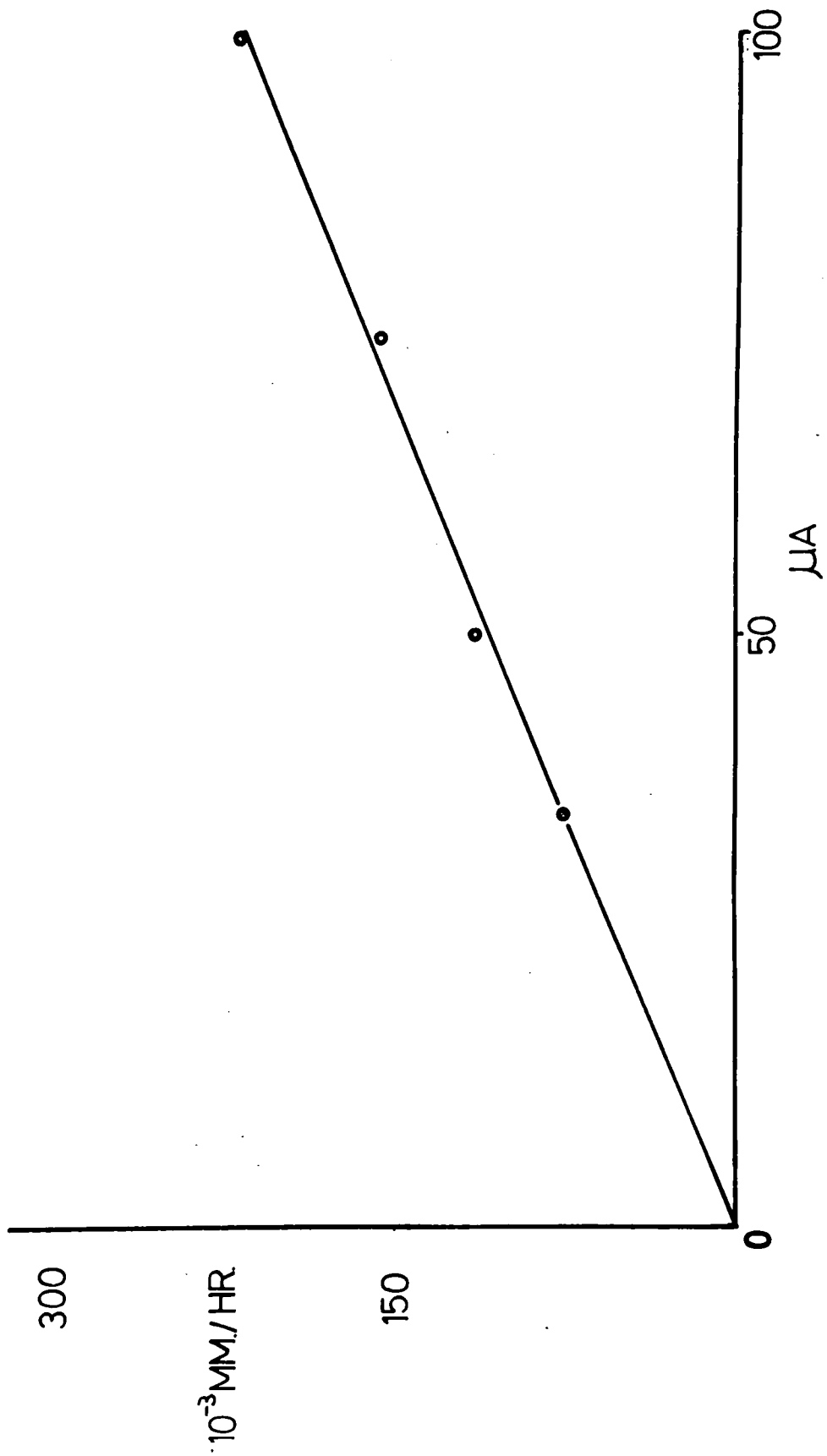
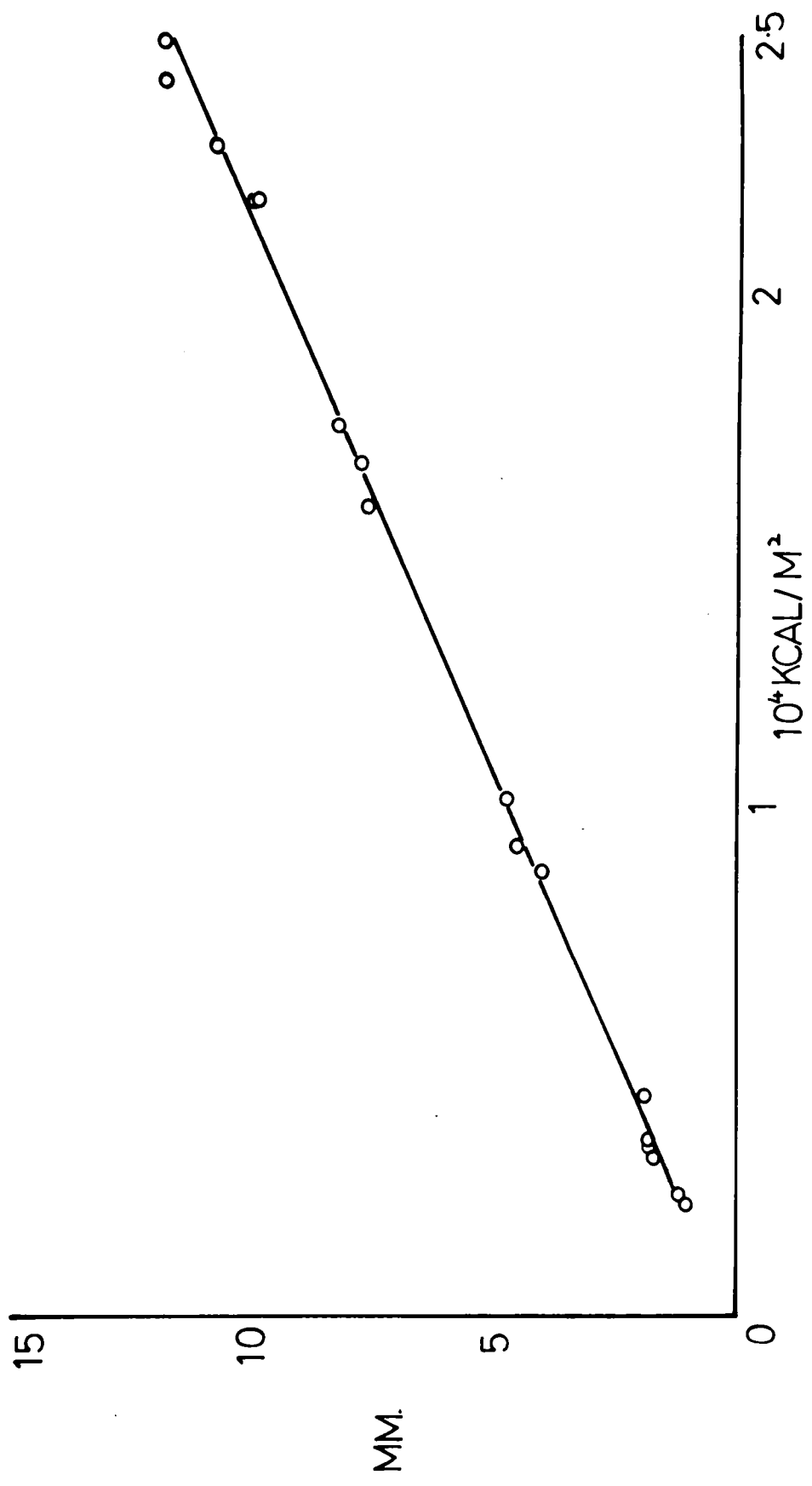

Figure 59.

Meniscus movement (m.m.) in solarimeter-integrator against integrated irradiance (10^4 Kcal/m²).

MENISCUS MOVEMENT VS. INTEGRATED OUTPUT OF MOLL PILE



Macfadyen & Webb (op.cit.) attribute an accuracy of $\pm 1\%$ to the electrolytic coulometer and so it seems unlikely that percentage errors will exceed $\pm 15\%$. In fact, an examination of Fig.59 suggests that the actual errors are considerably less than this. Whole assemblies were tested under constant light conditions at 5, 15, 19, and 24 degrees centigrade air temperature for two weeks. There was no change in output with temperature.

X. iv. Calibration of the Solarimeter-Integrator Assemblies

Three alternative calibration procedures may be followed for these assemblies. Firstly, it is possible to disconnect the solarimeter and connect a calibration circuit in place of it. This is a device to provide a known small signal from a source of known impedance (Tricket et al 1957). This approach depends on accurate knowledge of the calibration of the solarimeter.

Secondly, the whole assembly may be run alongside a standard or sub-standard high quality instrument, such as a Moll pile. Then the movement of the meniscus may be plotted against the integrated output of the Moll pile so that a calibration factor can be derived. This method allows for calibration under field conditions if some means of integrating the output of the Moll pile is available.

Thirdly, known currents may be passed through the coulometers and a calibration factor for these derived. This may be done using a voltage regulator, decade resistor and high quality microammeter,

in series with the coulometer. Then the solarimeter-amplifier assembly may be calibrated by plotting the current output of the amplifier against the output of the Moll pile as measured by a portable potentiometer. Thus a series of spot readings under various conditions can be obtained. Hence the relationship between meniscus movement and total short wave radiation can be derived.

For the assemblies constructed, the third procedure was followed. Figs. 57, 60, 61 and 62 show the output of the amplifier vs short wave radiation measured by the Moll pile for Solarimeters 1, 2, 3, and 4 respectively. For each the regression of short wave radiation on current output provides a calibration equation as follows :-

Solarimeter 1.

$$x = 0.4716zd + 0.7630$$

where x = short wave radiation ($10\text{Kcal}/\text{m}^2/\text{day}$)

z = calibration factor for coulometer ($\mu\text{Ahrs}/\text{mm}$)

d = daily average of distance moved by meniscus (mm)

Solarimeter 2.

$$x = 0.4638zd + 12.41$$

Solarimeter 3.

$$x = 0.3078zd + 40.22$$

Solarimeter 4.

$$x = 0.2868zd - 56.86$$

Figure 60.

Amplifier output (μA) against irradiance ($10^4 \text{ Kcal/m}^2/\text{min}$).
Solarimeter 2.

AMPLIFIER OUTPUT VS. OUTPUT
OF MOLL PILE
SOLARIMETER 2

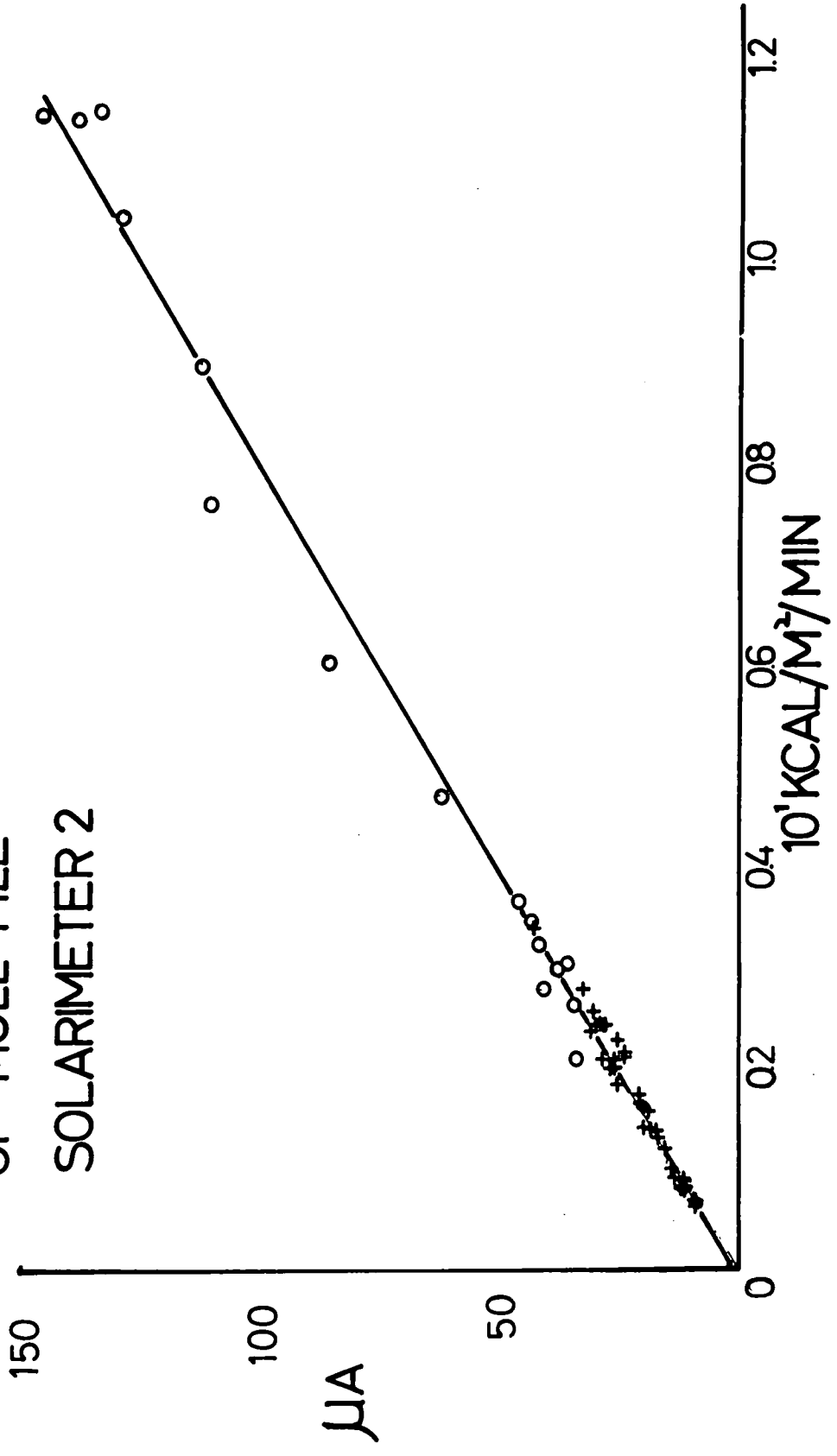

Figure 61.

Amplifier output (μA) against irradiance ($10^4 \text{ Kcal/m}^2/\text{min}$).
Solarimeter 3.

AMPLIFIER OUTPUT VS. OUTPUT
OF MOLL PILE
SOLARIMETER 3

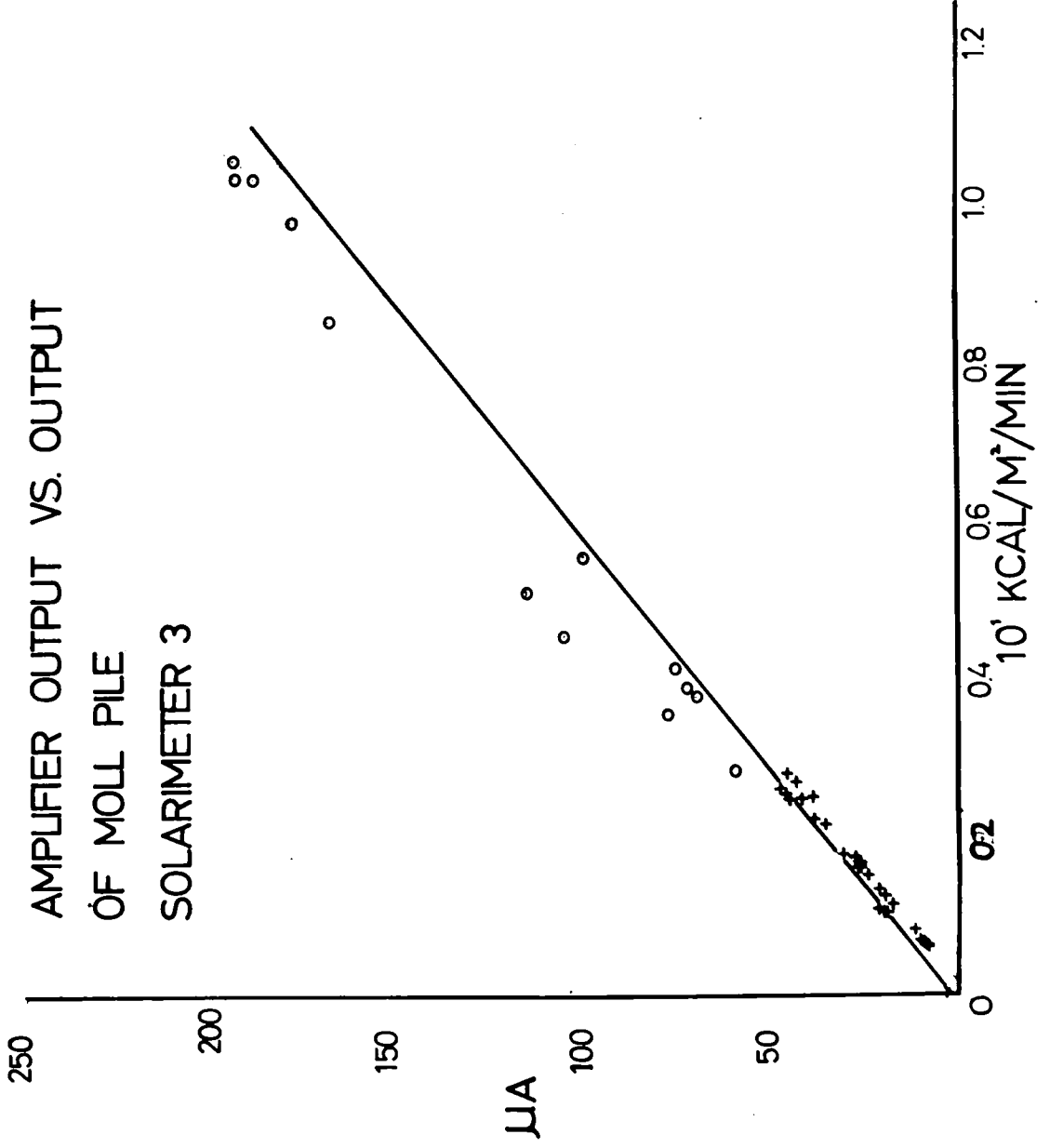
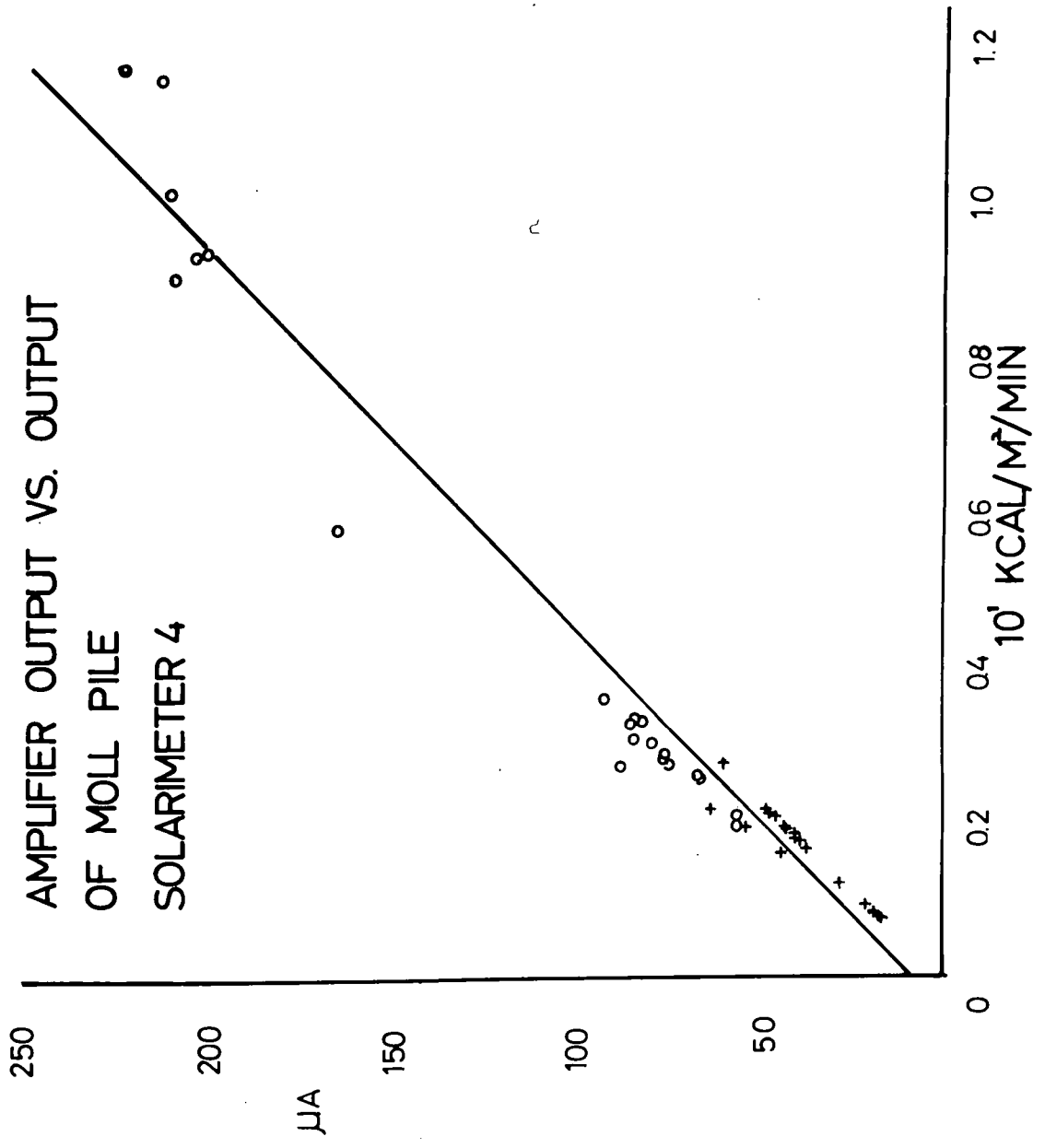

Figure 62.

Amplifier output (μA) against irradiance ($10^4 \text{ Kcal/m}^2/\text{min}$).
Solarimeter 4.

AMPLIFIER OUTPUT VS. OUTPUT
OF MOLL PILE
SOLARIMETER 4



Coulometer calibration factors were as follows :-

$$1 = 419.8\mu\text{A hrs /m.m.}$$

$$2 = 439.2\mu\text{A hrs /m.m.}$$

$$3 = 426.1\mu\text{A hrs /m.m.}$$

$$4 = 409.0\mu\text{A hrs /m.m.}$$

X. v. Field Use of the Solarimeter-Integrator Assemblies

The amplifier circuits were encased in a metal box, which also contained their power source and a quantity of silica gel. The power source was 9v cells that had been stabilized in the laboratory (Figs. 63a & b). The coulometer was mounted in a Perspex casing of identical length and width to a microscope slide. The connection with the amplifier was made through a pair of pin sockets. So that the output of the amplifier might be monitored without removing the coulometer, a jack-socket was inserted so that when it was in use the coulometer was removed from the circuit.

The box containing the circuit was enclosed in an air-tight polyethylene container. Around the metal box and coulometer was a 2.5cm thick layer of polystyrene foam. This was further wrapped in aluminium foil within the polyethylene container. Thus, in effect, the integrator was encased in a white box. A scaffolding tower (Fig. 64) was erected in the Study Area (see Section II). Solarimeter 1 was exposed above the canopy on a vertical extension of this 13m above ground. Solarimeter 2 was initially exposed 10m above ground,

Figure 63.

The solarimeter-integrator assembly.

a. closed.

b. open.

solarimeter

mercron

circuit box

circuit board

mercron mount

battery points

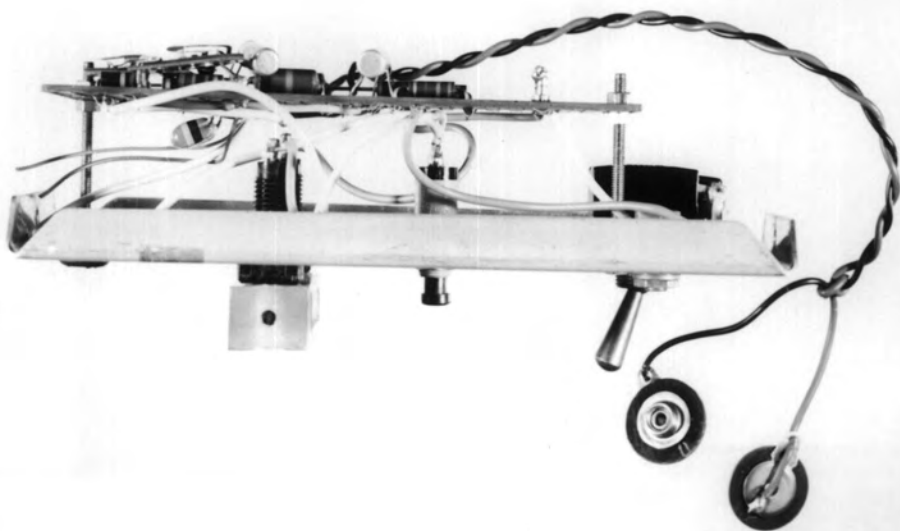
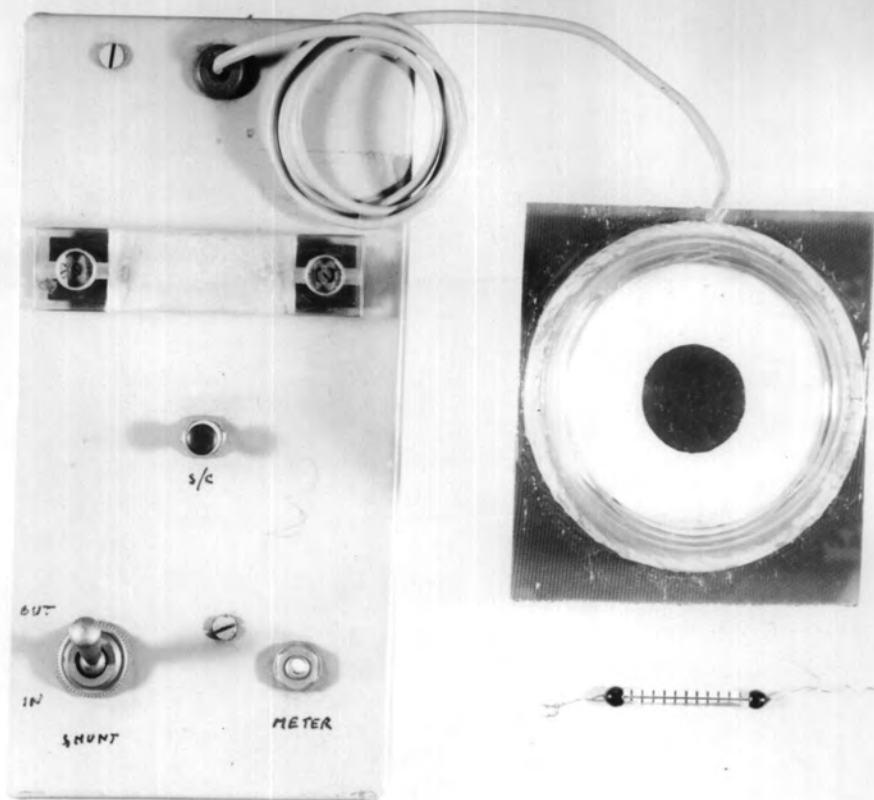

Figure 64.

The scaffolding tower (position shown in Fig.1).

The positions (1,2,3) of three solarimeters are shown.

DIAGRAM OF TOWER

1M

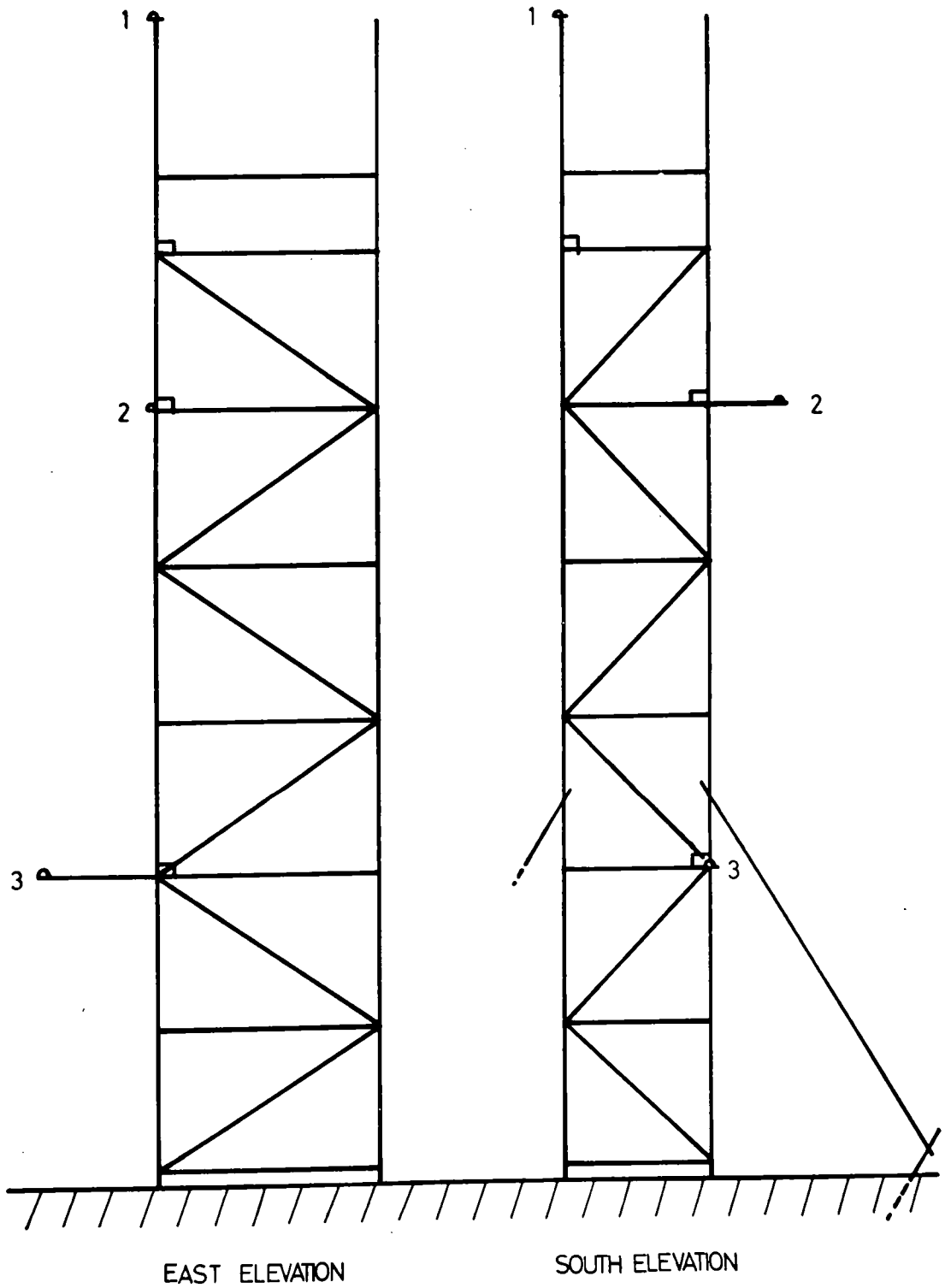

solarimeter 3 at 4m as in Fig.64. Solarimeter 4 was exposed at 30cms above ground some metres in from the tower.

The disposition of solarimeters below solarimeter 1 was clearly inadequate for a survey of short wave radiations at various levels bearing in mind the complexities of the woodland light climate (Evans 1939, 1956; Evans & Coombe 1957, 1965, 1966; Anderson 1964a,b,c, 1966a & b; etc.). However, in order to test the effectiveness of the solarimeter-integrator assemblies under a variety of field conditions they were placed as described. Although crude, this instrumentation yielded some useful information on energy input to the various woodland strata.

The procedure adopted was as follows. The assemblies were normally visited at weekly intervals. Each solarimeter was examined for alignment, misting over and obstructions. The coulometer was removed, the meniscus position determined and recorded, and then replaced. The current output of the assembly was checked, and the condition and output of the battery noted. Batteries were replaced at least every six weeks. In the event of any assembly being faulty, it was either immediately repaired or replaced by the spare. A substandard was kept against which each assembly was check-calibrated every three months.

X. vi. Results

Table LXII gives daily rates and periodic totals of short wave radiation as measured by each solarimeter from 1st May 1967 to

TABLE LXII Daily + Periodic Totals of Short-wave Radiation (10 Kcal/m²)

DATE	DAYS	D A I L Y				P E R I O D I C			
		SOL 1	SOL 3	SOL 4	SOL 1	SOL 3	SOL 4	SOL 1	SOL 3
1/5	7	375	265	279	2625	1860	1950		
8/5	7	215	137	172	1505	959	1204		
15/5	7	560	105	348	3920	735	2436		
22/5	7	570	75	242	3990	525	1694		
29/5	7	667	350	203	4669	2450	1421		
5/6	7	596	212	175	4172	1484	1225		
12/6	7	571	211	113	3997	1477	791		
19/6	7	369	133	74	2583	931	518		
26/6	7	449	171	49	3143	1197	343		
3/7	7	427	145	46	2989	1015	322		
10/7	7	371	127	43	2597	889	301		
17/7	7	396	142	27	2772	994	189		
24/7	7	336	77	18	2352	539	126		
31/7	7	347	116	15	2429	812	105		
7/8	7	154	96	10	1078	672	70		
14/8	7	84	40	8	588	280	56		
21/8	7	168	67	15	1176	469	105		
28/8	7	415	158	33	2905	1106	231		
4/9	7	407	155	27	2849	1085	189		
11/9	7	238	92	15	1666	644	105		
18/9	7	205	80	13	1435	560	91		
25/9	7	225	84	24	1575	588	168		
2/10	7	207	87	71	1449	609	497		
9/10	7	153	69	49	1071	483	343		
16/10	7	163	85	61	1141	595	427		
23/10	7	278	99	90	1946	693	630		
30/10	7	179	81	88	1253	567	616		
6/11	7	104	67	87	728	469	609		
13/11	7	80	56	65	560	392	459		
20/11	7	32	31	29	224	217	203		
27/11	7	38	37	36	266	259	252		
4/12	7	55	53	50	385	371	350		
11/12	7	53	50	49	371	350	343		
18/12	21	50	46	48	1050	966	1008		
8/1	7	52	50	47	364	350	329		
15/1	7	51	50	45	357	350	315		
22/1	7	55	52	50	383	364	350		
29/1	14	57	55	49	798	770	686		
12/2	7	59	56	45	413	392	315		
19/2	7	59	54	58	413	378	406		
26/2	7	58	52	52	406	364	364		
4/3	7	59	56	55	413	392	385		
11/3	7	71	69	62	497	483	434		
18/3	7	80	78	72	560	546	504		

Continued overleaf.....

TABLE LXII (Contd.)

DATE	DAYS	D A I L Y				P E R I O D I C			
		SOL 1	SOL 3	SOL 4	SOL 1	SOL 3	SOL 4		
25/3	7	80	79	75	560	553	525		
1/4	7	147	132	130	1029	924	910		
8/4	14	280	274	275	3920	3836	3850		
22/4	7	461	424	418	3227	2968	2926		
29/4	3	350	322	320	1050	966	960		

1st May 1968. These can be more readily seen in Figs. 65, 66 and 67.

Solarimeter 2 was damaged early in the season and no results were obtained. Table LXIII shows the annual totals for solarimeters 1, 3 and 4. The total for solarimeter 1 was more than twice that for solarimeter 3, just below the canopy, and 2.1/8th times that for solarimeter 4, near ground level. The seasonal march of radiation above the canopy was much as expected, but that beneath the canopy and near the ground was, as expected, quite different. For example, 48% of the short wave radiation received by solarimeter 4 came in April and May.

Figs. 68 & 69 show radiation received by solarimeters 3 and 4 as a percentage of that received by solarimeter 1. This is a measure of penetration which is a function of solar elevation, atmospheric conditions, canopy structure and depth, leaf inclination, reflectivity, transmissivity and so on. Although controlled by many complex factors, the seasonal pattern of penetration is fairly simple and shows a direct relationship to canopy development and leaf fall. In particular, the SW fraction penetrating to near the ground (solarimeter 4) decreased sharply during May and June as the Alder buds opened and the leaves grew. For part of July and most of August and September it was less than 10%. In October and November, as leaf fall progressed, the fraction penetrating rose again towards 100%. Throughout the winter and spring until the end of April it stayed just short of 100%. The simplicity of this pattern can be accounted for by the Alder Zone's nearly closed

TABLE LXIIIAnnual Totals of Short-Wave Radiation (Kcal/m²)

Solarimeter	Position	Total
1	15m above ground - above canopy	818,490
3	4m above ground - just below canopy	408,450
4	30cms above ground - at top of ground vegetation	339,120

Figure 65.

Weekly totals (10^4 Kcals/m²) of short-wave radiation at solarimeter 1 (above tree canopy).

WEEKLY TOTALS OF SHORT-WAVE
RADIATION AT SOLARIMETER 1

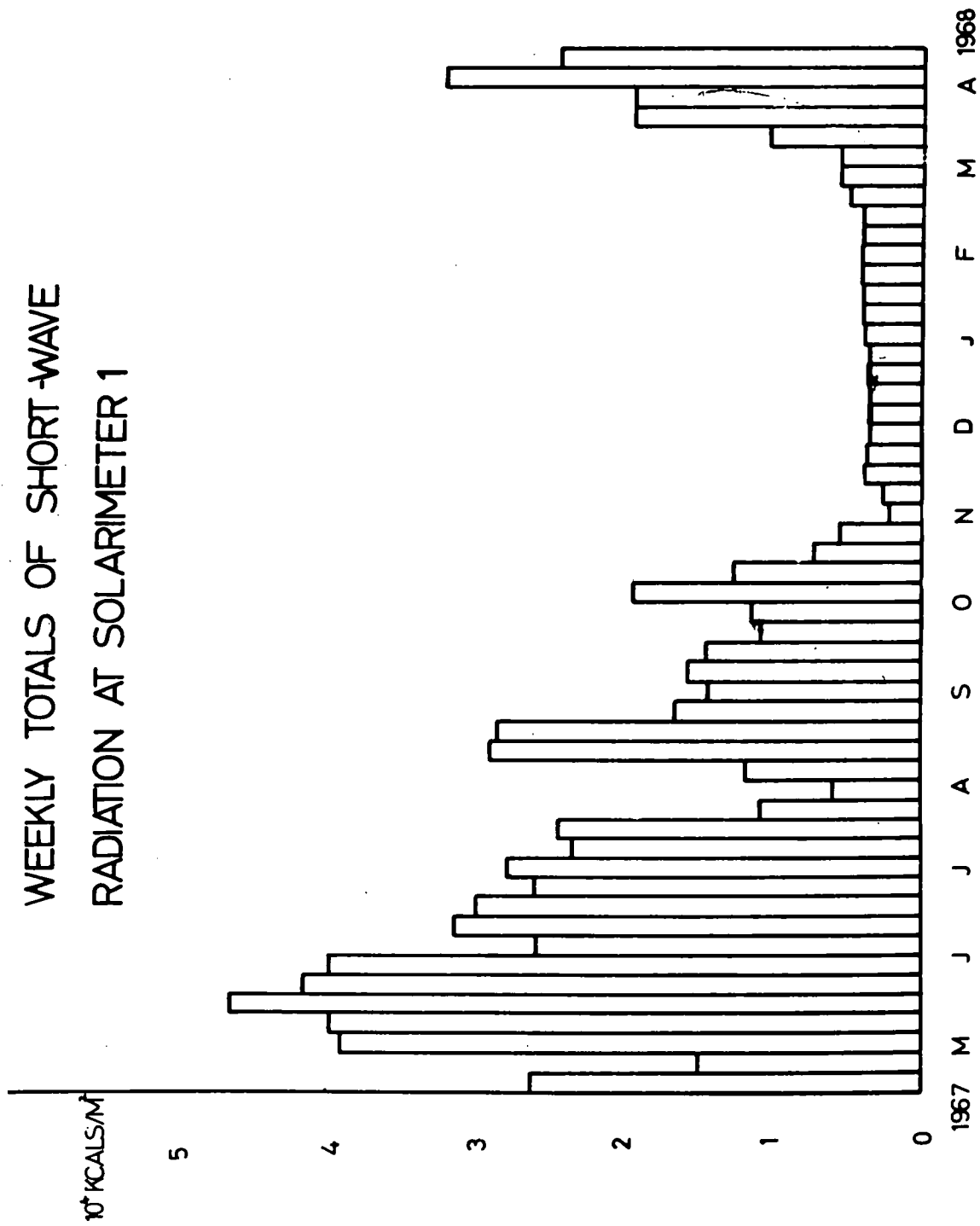

Figure 66.

Weekly totals (10^4 Kcals/m²) of short-wave radiation at solarimeter 3 (just below canopy).

WEEKLY TOTALS OF SHORT-WAVE
RADIATION AT SOLARIMETER 3

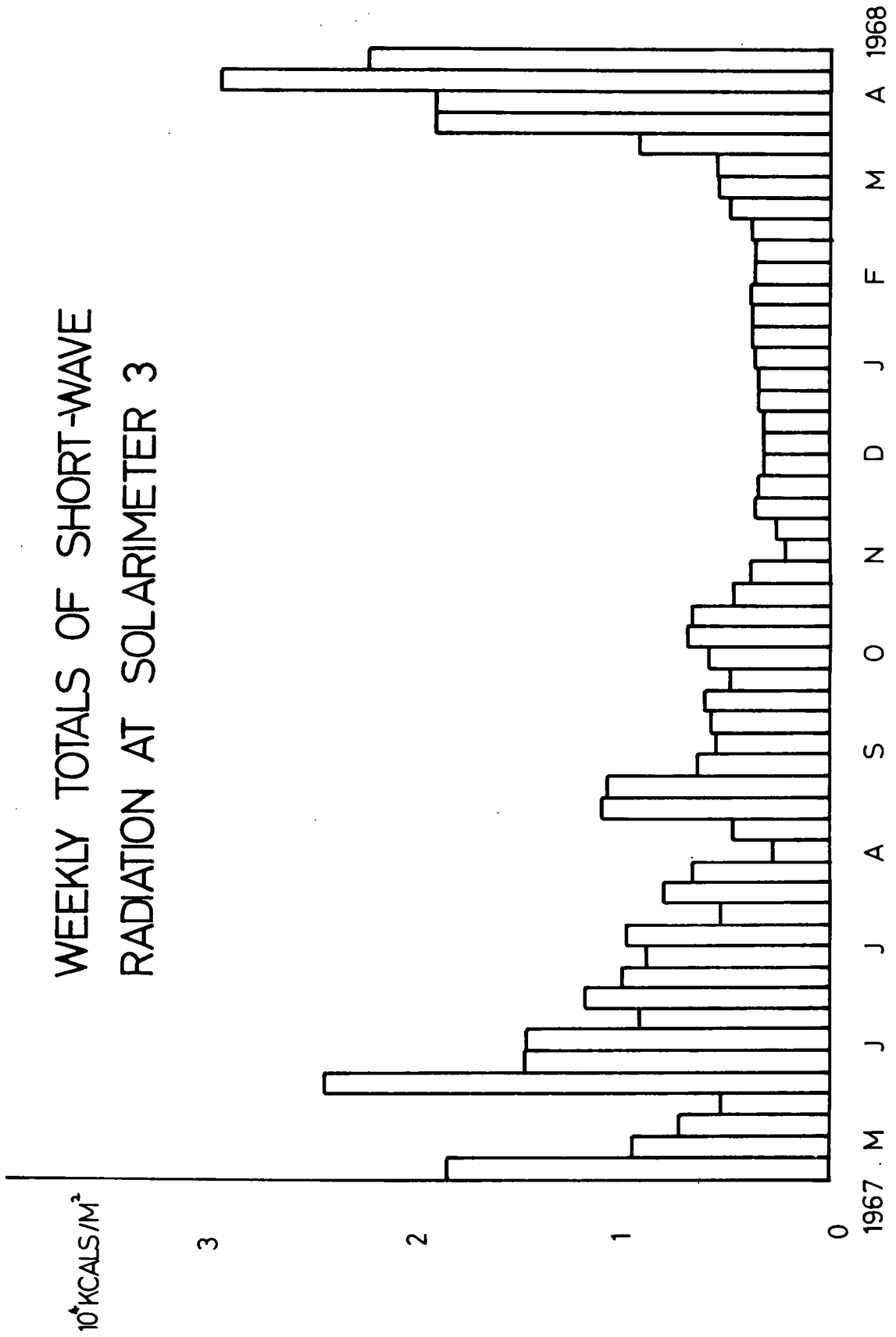

Figure 67.

Weekly totals (10^4 Kcals/m²) of short-wave radiation at solarimeter 4 (just above ground).

canopy, its opaque leaves, their large area and horizontal inclination. It is reasonable to expect that a more complex pattern would be found in the Birch Zone.

The seasonal pattern of penetration is less marked just under the canopy (Sol.3). In May, less radiation was reaching this solarimeter than solarimeter 4. This was probably due to its being directly obscured by a leafy twig for part of this month. For most of the summer, 30-40% of the short wave radiation penetrated to this solarimeter. Some higher values were recorded in August. These coincided with periods of very low short wave radiation above the canopy. The fraction penetrating to this level began to increase in October at the time of leaf-fall. Through the winter and spring it was very similar to that reaching solarimeter 4.

If the values obtained for solarimeters 1 and 4 are in any sense representative of the vegetation strata above which they are placed, it may be of interest to calculate the totals of short wave radiation reaching them in certain growth seasons. If, for the tree stratum, the growth season is taken as 1st May to 30th September, the total short wave radiation incident at solarimeter 1 was $560,562\text{Kcal/m}^2$. If the ground vegetation growth season is taken as 1st April to 16th October, total SW radiation incident on solarimeter 4 was $230,126\text{Kcal/m}^2$. Of this latter, $200,081\text{Kcal/m}^2$ came in the months of April, May and June.

Figure 68.

Radiation at solarimeter 3 (just below canopy) as a % of that at solarimeter 1 (above canopy).

% PENETRATION OF SHORT-WAVE RADIATION TO SOLARIMETER 3

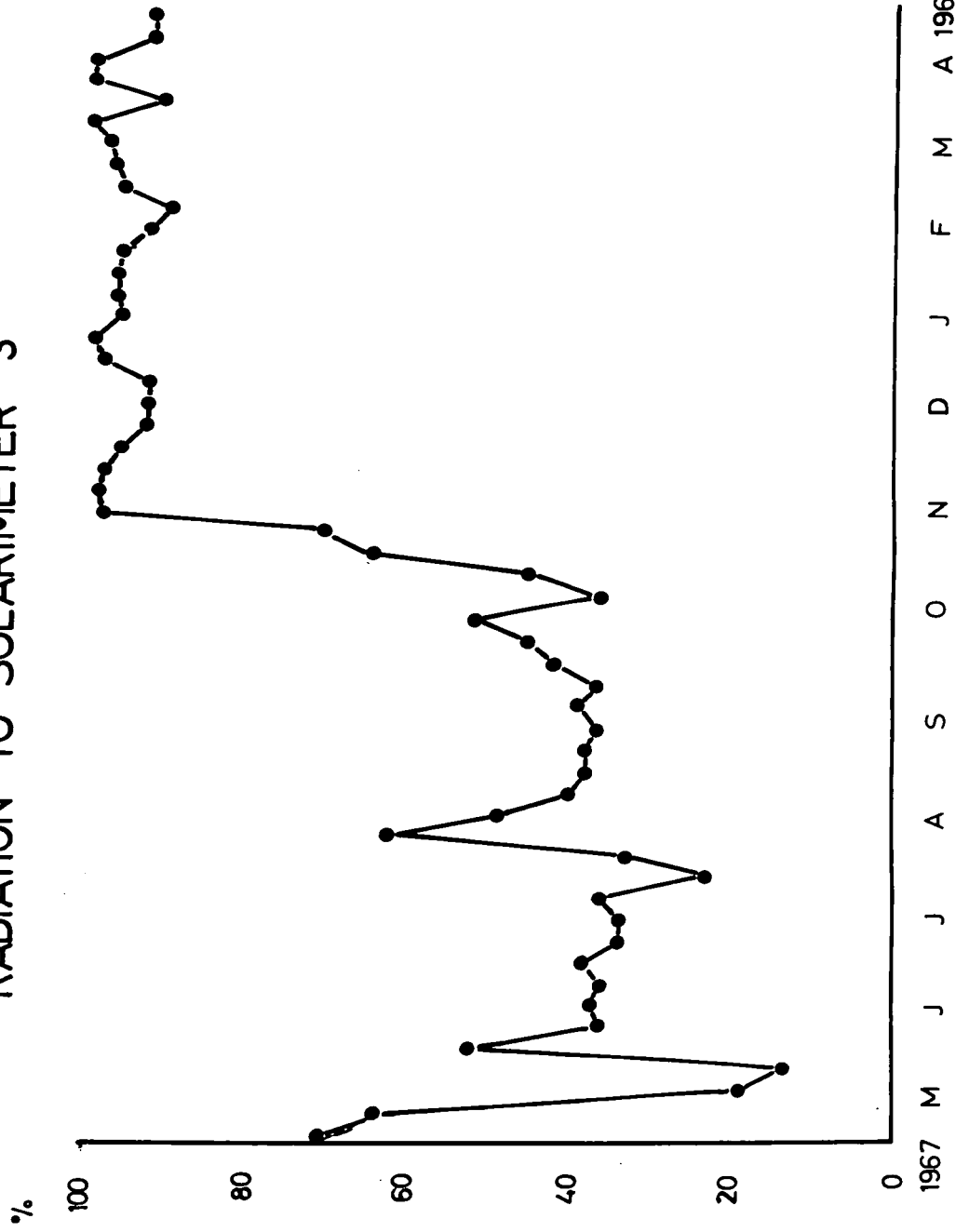
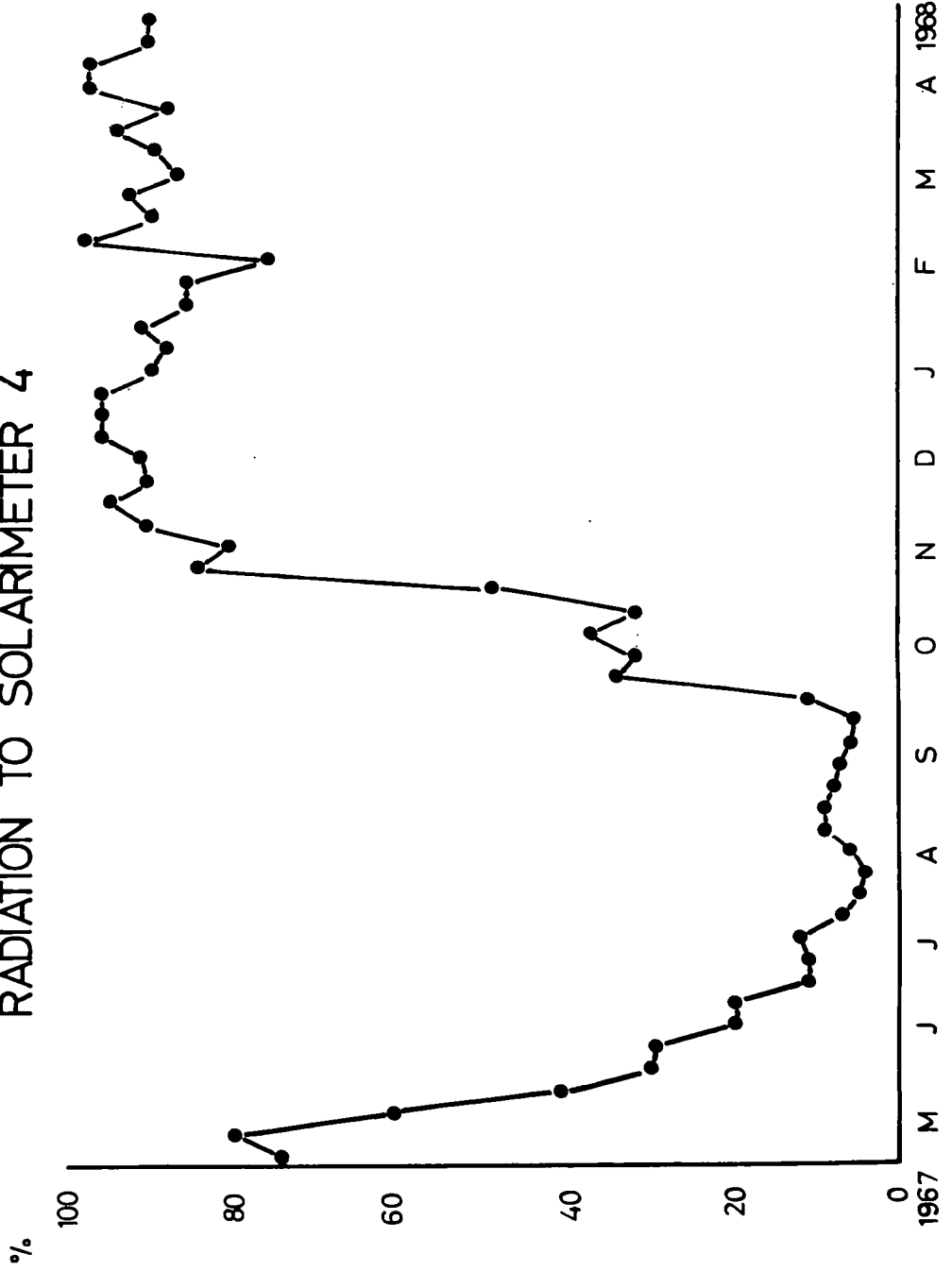

Figure 69.

Radiation at solarimeter 4 (just above ground) as a % of that at solarimeter 1 (above tree canopy).

% PENETRATION OF SHORT-WAVE
RADIATION TO SOLARIMETER 4



X. vii. Discussion

Ovington (1961), Blackman & Black (1959) and Penman (1948) calculated annual totals of short-wave (R_c) from Angot's calculated values of radiation received through a perfectly transparent atmosphere (R_a). They used an equation of the form :-

$$R_c/R_a = a + b \frac{n}{N}$$

where $\frac{n}{N}$ is the ratio actual/possible hours of sunshine, and a and b are constants.

Day (1961) has calculated values of a and b for various stations in the British Isles where both SW radiation and sunshine records are kept. Using $a = 0.14$ and $b = 0.68$, with the sunshine records from Durham University Observatory, the annual total of short wave radiation at Durham (from 1st May 1967 to 1st May 1968) was calculated as $847,900\text{Kcal/m}^2$, and approximated the figure obtained at Wynyard by direct measurement $-818,490\text{Kcal/m}^2$.

Conclusion of Section X

This calculation supports the direct measurement for total short wave radiation above the canopy. There is less reason to take the estimates at lower levels as representative for those levels. One small sensor is hardly an adequate sampling of woodland light climate. Nevertheless, the results obtained are consistent with changes in tree leaf area index and changes in total insolation above the canopy (compare Fig.69 with Fig.30). This concurrence may have

been partly fortuitious. The data for lower levels must be viewed with considerable caution.

The data do justify the conclusion that during the earlier part of the ground vegetation's growth season, i.e. April - May, levels of incident radiation were not very different from those in the open and there is little reason to suppose that its spectral composition differed markedly, either. Of the growth season total of $230,126\text{Kcal/m}^2$, $87,050\text{Kcal/m}^2$ or 26% was received in April and May.

Section XI. Energy Flow and Accumulation

XI. i. Ecosystem biomass and biocontent

Tables LXIV and LXV are summaries of ecosystem biomass and biocontent data respectively. Unfortunately it is necessary for comparative purposes to give biomass data because many authors have not given biocontent data. The biomass and biocontent columns in these two tables give extreme ranges of biomass or biocontent each year for the components listed. The net change columns were calculated from April to April. All dead material has been included in the litter category.

Total ecosystem plant biomass or biocontent (without roots) in 1966-7 was close to $18,500\text{g/m}^2$ or $86,000\text{Kcal/m}^2$. Of this approximately 55% was included in the living matter. For most of the year the vast bulk of the living matter was made up of tree branches and boles. Of the total ecosystem biocontent (without roots) almost 54% was stored as wood and approximately 42% as litter and soil organic matter.

Although ecosystem biomass and biocontent were a little higher in 1967-8, the pattern of their distribution was very similar.

Comparable figures for total ecosystem biocontent (without roots) are difficult to find, but figures for above-ground biomass are more easily available. Table LXVI gives some of these, all for allegedly natural systems or the unmanaged products of secondary

TABLE LXIV

Biomass + Biomass changes (g/m²)

	1966-7		1967-8	
	Biomass	Net Change	Biomass	Net Change
<u>Trees</u> Branch + Bole Wood	9856.2-	10291.1 + 434.9	10291.1-	10727.3 + 436.2
Canopy leaves	0 - 168.1	-	0 - 142.9	-
Other	0 - 70.4	-	0 - 94.9	-
<u>Ground Vegetation</u>	16.0 - 137.7	+ 7.9	16.5 - 106.3	- 11.8
<u>Bryophytes</u>	9.9 - 49.4	- 1.6	3.8 - 18.1	- 8.4
<u>Total Living matter (AG)</u>	9882.1-	10716.7 + 441.2	10311.4-	11089.5 + 416.0
<u>Litter</u>	401.5-	795.6 - 385.6	461.9-	471.2 + 42.6
<u>Soil Organic Matter</u>	7761.2	?	7761.2	?
<u>Ecosystem Total</u>	18044.8-	19273.5 + 56.0 (+)	18534.5-	19324.9 + 458.6

TABLE LXV

Biocontent and Biocontent Changes (Kcal/m²)

	1966-7		1967-8	
	Biocontent	Net Change	Biocontent	Net Change
Trees				
Wood	46,922.6 -		49016.1 -	
Canopy leaves	49,016.1	+ 2093.5	51102.9	+ 2086.8
Other (new parts)	0 - 828.1	-	0 - 732.2	-
	0 - 507.6	-	0 - 552.5	-
Ground Vegetation	82.7 -		68.5 -	
	581.3	+ 30.8	445.6	- 42.2
Bryophytes	34.8 -		13.2 -	
	173.3	- 5.5	63.4	- 29.5
Total Living material	47,040.1 -		49,097.8 -	
	51,106.4	+ 2118.8	52,896.6	
Litter	1,847.6 -		1,617.2 -	
	3,516.9	- 1666.3	2,652.3	+ 196.2
Soil Organic Matter	34,925.3	?	34,925.3	?
Ecosystem Total (without roots)	83,813.0 -		85,640.3 -	
	89,548.6	+ 452.5	90,474.2	+ 2211.3

TABLE LXVILiving above ground biomass of various ecosystems
(g/m²)

<u>Plant Community</u>	<u>Stage</u>	<u>Biomass</u>	<u>Author</u>
Tall grass prairie	-	3 - 100	Ovington et al (1963)
Old - Field	Broomsedge	circa 300	Golley (1965)
Savannah		3400	Ovington et al (1963)
Oak - Pine Forest	-	6561	Whittaker & Woodwell (1969)
Birch Wood	Young	7590	Smirnova & Gorodentseva (1958)
Birch Wood	Young	7640	Ovington & Madgwick (1959)
Populus davidiana	Middle stage	12880	Satoo et al (1956)
Oakwood	Middle	16500	Ovington et al (1963)
Birchwood	Mature	18490	Smirnova & Gorodentseva (1958)
Birchwood	Mature	19350	Ovington & Madgwick (1959)
Birchwood	Mature	22270	Smirnova & Gorodentseva (1958)
Oakwood	Mature	27500	(Mina (1955) & Remezov et al (1959))
Cove forest	Mature	50065	Whittaker & Woodwell (1969)

successions. There is a clear increase in biomass (of living matter) from a few hundred grams/m² for grassland to tens of thousands for older woodlands. The grassland figures are not strictly comparable with those for woodland, because their major above ground storage may well be as standing dead (Golley 1965; Ovington et al 1963). Moreover, their below ground parts are probably of greater importance as storage organs (Dahlman 1968; Kucera & Dahlman 1967) than is the case for woodlands (Whittaker & Woodwell 1969). It is clear that the above ground living biomass on the Study Area (circa 10,000g/m²) lies in the range observed for other comparable woodlands.

Organic matter accumulated in the litter and upper horizons of the soil almost doubles the ecosystem biomass when added to the living material. This is hardly surprising in an ecosystem which has been woodland for over 100 years and before that was probably a wet grassland with a large accumulation of soil organic matter.

The low value for total ecosystem biomass net change in 1966-7 was the result of the high accumulation of litter in spring 1966. It is reasonable to assume that this was an unusual state of affairs and that the annual net change in biomass or biocontent for the ecosystem is close to that for tree branches and boles. If so, the figure will be around +460g/m² or +2,200Kcal/m².

XII. Net Primary Production, Heterotroph Respiration and Net Ecosystem Production

Tables LXVII and LXVIII summarise Net Primary Production, Decomposition and Litter Production data for the Alder-Birch woodland at Wynyard in biomass and biocontent terms respectively.

TABLE LXVIINet primary production (g/m²/yr)

	1966-7	1967-8
<u>Trees</u>		
Wood	434.9	436.2
Litter	273.5	282.7
Total	708.4	718.9
<hr/>		
<u>Ground Vegetation</u>	277.9	280.2
<hr/>		
<u>Bryophytes</u>	39.5	14.3
<hr/>		
Total Net Primary Production	<u>1025.8</u>	<u>1013.4</u>
<hr/>		
Litter production	545.7	574.6
<hr/>		
Decomposition	918.7	512.3
<hr/>		

TABLE LXVIIINet Primary Production (Kcal/m²/yr)

	1966-7	1967-8
<u>Trees</u> Wood	2093.5	2086.8
Litter fall	1479.9	1440.1
Herbivory (minimum)	23.6	23.6
Total	3598.0	3550.5
<hr/>		
<u>Ground Vegetation</u>	1016.2	1142.4
<hr/>		
<u>Bryophytes</u>	138.5	50.2
<hr/>		
Total Net Primary Production	<u>4752.7</u>	<u>4743.1</u>
<hr/>		
Litter Production	2465.3	2624.6
<hr/>		
Decomposition	4134.6	2428.4
<hr/>		

The data for ground vegetation were given in **Section IX**, for the tree stratum in **Section VI** and for decomposition in **Section VIII**. Net primary production of bryophytes was calculated as the maximum increment of bryophyte material for the year in question. In both years NPP was close to 1kg/m^2 or 4750Kcal/m^2 . This is to the lower end of the range for above ground net production for woodlands, which is overlapped by the range for grassland (Table LXIX). If the assumptions outlined in **Section VIII** are valid, decomposition or decomposition plus respiration by herbivores equals R_{H} . Therefore

$$\begin{aligned} \text{Net Ecosystem Production} &= \text{NPP} - R_{\text{H}} = 4752.7 - 4142.6 \\ &= 610.1\text{Kcal/m}^2 \\ &\text{or } 107.1\text{g/m}^2 \text{ in } \underline{1966-7} \\ \text{and} & \qquad \qquad \qquad 4743.1 - 2436.4 \\ &= 2306.7\text{Kcal/m}^2 \\ &\text{or } 501.1\text{g/m}^2 \text{ in } \underline{1967-8} \end{aligned}$$

both on an above ground basis.

For reasons given above, the 1967-8 figures are considered more representative of this development stage of this woodland.

Net Ecosystem Production as a percentage of Net Primary Production (biocontent) was 12.8% in 1966-7 and 48.9% in 1967-8. That is, under normal conditions this woodland was storing almost half its yearly net above ground primary production. For purposes of comparison figures of biomass net primary production and decomposition are more readily available. Table LXIX summarises some of the available

data. Where authors have not specifically measured decomposition, litter production has been taken as a measure of this so long as it seemed reasonable to assume no net annual accumulation of litter or soil organic matter. Decomposition as a percentage of net primary production is an indicator of whether or not accumulation of dry matter is taking place. Thus the ratio tends to 100% when the ecosystem is at a stable stage. The series runs from a Sphagnum hummock, where decomposition is negligible, through old-fields (where it tends to 100% as age increases) to tall-grass prairie where decomposition is almost 100% of net primary production. These are followed by a group of three woodlands (the Brookhaven Forest, Meathop Wood and Wynyard) where decomposition is around half of net primary production. Meathop and Wynyard have been managed by coppicing - a practice which removes the above ground parts of trees whilst leaving much of the root system intact. Brookhaven is a fire forest and fire is thought to have had a similar effect here to coppicing.

Thus each of these three woodlands had a root system older than the above ground parts and probably much better developed than if it had been the same age as the above ground parts. Thus it is possible that the ratio decomposition/NPP calculated on an above ground basis for these ecosystems might wrongly estimate the importance of decomposition. The data from Brookhaven, which are for the whole ecosystem, suggest that this need not be the case. Thus these three ecosystems, all the

TABLE LXIX

Plant Community	Location	Net Primary Production and Decomposition (g/m ² /annum)			Decomposition as a % of Net Primary Production		
		Net Primary Production A/G	Total	Decomposition A/G	Total	A/G	Total
1. Sphagnum fuscum hummock	Westmorland, England	269	-	0	-	- 0	-
2. Old field (broomsedge)	S. Carolina, U.S.A., Michigan, U.S.A.,	493	650	296	?	60.0	?
3. Old field (grass-forb) Upland (a) Swale (b)	U.S.A.,	320	463	297	440	92.8	95.0
4. Tall grass Prairie	Missouri, U.S.A., Long Island, U.S.A.,	1064	1422	874	1232	82.1	86.6
5. Oak-Pine Forest	U.S.A., Wynyrd, England	500	950	500	950	- 100	- 100
6. Alder-Birch Wood	England	859	1195	?	571	?	47.8
7. Mixed deciduous wood	Meathop, England	1013	?	512	?	50.5	?
8. Beech forest	England	8613	?	5122	?	59.5	?
9. Beech forest	Poland	1017	?	307	?	30.2	?
10. Oak forest	Denmark	990	1130	370	390	37.4	34.5
11. Deciduous cove forest	U.S.S.R., Tennessee, U.S.A.,	-	900	-	650	-	72.2
12. Tulip Tree forest	U.S.A.,	1911	?	- 1911	?	- 100	?
13. Rain Forest	" Thailand	2408	?	- 2408	?	- 100	?
		-	2444	-	2322	-	85.5

Authors

1. Bellamy & Rieley 1967
2. Golley 1965
3. Wiegert & Evans 1964
4. Dahlman 1968, Kucera & Dahlman 1967
5. Whittaker & Woodwell 1969
6. This work
7. Pers.comm. - data as Kcal/m²/annum

8. Medwecka - Koronas 1967
9. Møller, Müller & Nielsen 1954
10. Mima (1955)
11. Whittaker 1966
12. Whittaker 1966
13. Kira, Ogawa, Yeda & Ogira 1967

A/G - above ground

subject of recent events of catastrophic scale, are now going through a period of very rapid energy accumulation. The Beech forests in Poland and Denmark (8 & 9) have been managed for the same purpose. The older forests of the U.S.S.R. and U.S.A. have presumably reached or closely approached the size where energy storage is maximal and if the rate of energy dissipation is to increase, a breakdown of the existing storage will be necessary.

It is clear from the work at the Savanna River Project (Odum 1960; Golley 1965; Golley & Gentry 1967) that a state of low or no net accumulation of energy does not necessarily imply that the maximal rate of energy storage for the site has been reached, but rather that a further increase awaits the completion of changes in the biotic and physical environment being effected by the currently existing biota. Alternatively, catastrophe (e.g. fire), or management, or indirect human effects, may prevent the further development of the ecosystem. In marginal environments a combination of these factors and the availability of ecologically variable species may hold up ecosystem development (Bellamy et al 1969).

XIII. The Utilisation of Insolation

All the trophic energy of the ecosystem is derived from fixation by autotrophic organisms. Therefore a consideration of photosynthetic efficiencies is of relevance to a study of ecosystem energetics. Table LXX summarises the data obtained.

TABLE LXXThe utilization of insolation

Net Photosynthetic Efficiency		1966-7	1967-8
$\frac{\text{NPP} \times 100}{\text{Insolation}} \%$			
NPP	Insolation		
1. Total A/G	Annual total above canopy	0.58	0.58
2. Tree A/G	" " " "	0.44	0.43
3. Tree A/G	Total non-transmitted	0.56	0.56
4. GV + Bryophytes A/G	Total transmitted	0.34	0.35
5. Tree A/G	Total above canopy in growing season	0.64	0.64
6. GV + Bryophytes A/G	Total below canopy in growing season	0.51	0.52
7. Tree A/G	Growing season PAR (43% of total)	1.02	1.01
8. GV + Bryophytes A/G	Growing season PAR (25% of transmitted)	2.04	2.08
9. Ecosystem net accumulation	Annual total above canopy	0.06	0.27
10. Decomposition	" " " "	0.50	0.29

GV = ground vegetation

A/G = above ground

PAR = photosynthetically active radiation

The most relevant and generally comparable efficiency for the whole ecosystem is Net Photosynthetic Efficiency as total above ground Net Primary Production over total shortwave radiation incident on the top of the canopy in one year (1). The value of 0.58% obtained does not differ greatly from those of 0.65% for pine plantation (Minderman 1967), 0.26% for a small oak wood (Bray 1962) and 1.3% for pine (Ovington 1962). The data for pine included root production. Similarly, Wassink (1948) reported a range of 0.23 - 1.10% for well-cultivated field crops in the temperate zone. The Wynyard value is markedly higher than the 0.16 - 0.20% reported by Golley (1965) for the old-field stage.

The most remarkable fact about all these systems is the extremely small fraction of incident energy that they are able to fix. It should be pointed out that they do utilize rather more but in this case we are concerned with net rather than gross primary production.

An examination of other net photosynthetic efficiencies is informative. Of the total of 0.58% of the total annual insolation that made up net above ground primary production, 0.43% may be attributed to the tree stratum and 0.15% to the ground vegetation and bryophytes. The tree stratum fixed 0.56% of the energy that did not reach the ground vegetation (3), whereas the ground vegetation and bryophytes fixed 0.35% of that reaching a level 30cms above ground (4). In their respective growing seasons (cf. Section IX) the tree and

lower strata fixed 0.64% and 0.52% respectively of the energy available to them (5 and 6). This narrowing of the efficiency gap between the two strata is largely a result of the lower stratum's longer growth season.

It is difficult to make meaningful comparisons between the NPEs of vegetation strata unless allowance is made for the differing spectral composition of energy incident at differing levels. If the total short wave energy contains 43% Photosynthetically Active Radiation (Szeicz 1966) and it is assumed that the energy reaching the ground vegetation contains 25% PAR in the growth season, NPEs for the growth seasons of the trees and lower strata were 1.01 and 2.08 respectively. Whilst no data are available to support the assumption about the quality of light below the canopy, it seems a reasonable assumption to make if the tree canopy intercepts around 70 - 80% of the PAR at that level. If these assumptions are at all reliable, it is clear that the ground vegetation was very much more efficient as an energy-fixing system than the tree stratum. If this is the case it might be explained in terms of nutrient availability and perhaps carbon dioxide levels near the Forest Floor as well as in terms of high climate. However, before any such conclusions may be drawn, investigations of incident PAR at the ground vegetation must be made along with measurements of the nutrient and CO₂ parameters. Only then will suitable experiments be designed to examine the basis, if any, of differing NPEs for different vegetation strata.

In order to place trophic energetics in the perspective of radiation energetics it should be pointed out that the net annual above ground accumulation of energy by the alder/birch woodland was only 0.27% of total insolation, and the total above ground decomposition 0.29% of total short wave insolation.

X. iv. Ecosystem Energy Flow and Accumulation

For the purposes of energetics analysis the alder/birch wood ecosystem at Wynyard will be considered to have comprised the following components :-

1. Photosynthetic Machinery

- (a) Tree Canopy
- (b) Ground Vegetation
- (c) Bryophytes

2. Living Energy Stores

- (a) Tree Boles and Branches
- (b) Tree roots
- (c) Ground Vegetation Roots

3. Dead Energy Stores

- (a) Litter layer
- (b) Soil Organic Matter

4. Consumers

- (a) Consumers in the Herbivore component
- (b) Consumers in the Decomposer component

Figure 70.

Ecosystem components and transfers. Components are as listed on page 168. Suitable data were not obtained for the transfers and components shown as broken lines. Certain transfers (eg. 1a to 2a, 1a to 2b, 1b to 2c) may be two-directional.

ECOSYSTEM COMPONENTS AND TRANSFERS (OR THE PARTITION OF NPP)

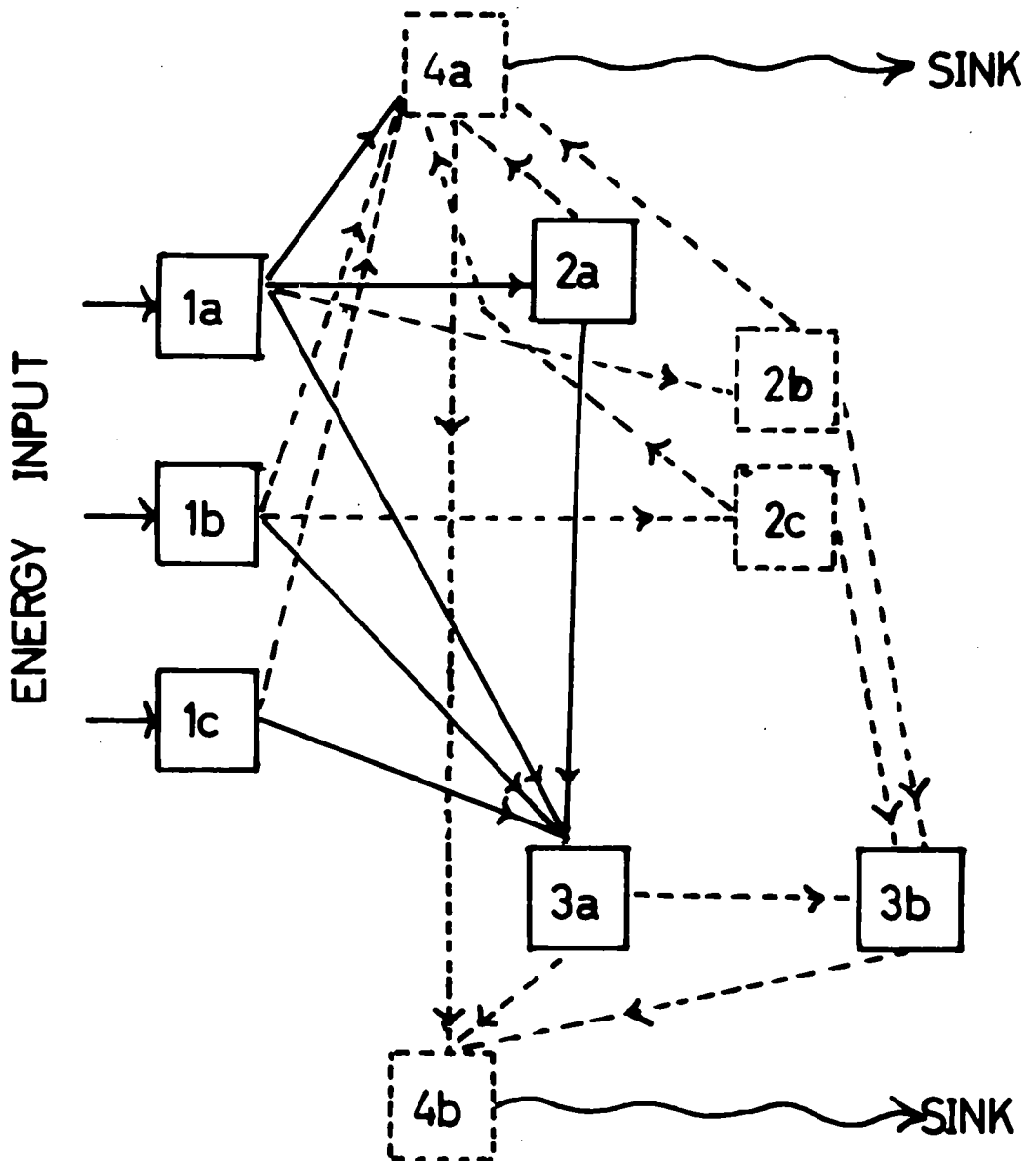

Fig.70 is a block diagram showing these components and the main possible directions of transfer between them. The model represented by this block diagram is concerned only with net primary production and dissipation by consumers. It assumes that the only input to tree roots is directly from the canopy.

It is clear that the major gap in this study (as in many others) was the lack of data for biomass net production and mortality of below ground parts of the vegetation. Without this data transfer functions for the photosynthetic machinery (output/input) can only be minimal estimates (see photosynthetic efficiencies, this section). Similarly, for the relationship between decomposer respiration and plant death (i.e. the transfer function for the dead energy stores). It would be possible to construct a complete energy-flow model if certain assumptions commonly found in the ecological literature were made; for example, that the relationship between net primary production and biomass below ground is the same as that above ground, or that biomass below ground approximates to a fixed fraction (e.g. 20%) of above ground biomass. Even if these assumptions are in some cases correct, it is less likely that this is the case for coppiced or fire woodlands. Although the data available are not complete for the alder/birch woodland, it seems better to present them as they are than to detract from what validity they may have by erecting a superstructure of dubious assumptions on them. Thus it can be said that the net photosynthetic efficiencies given in this Section are underestimates (without doubt) and that a transfer function for the dead energy store

derived merely from litter disappearance and fall may not be reliable.

What is possible with the data available for the alder/birch woodland is a characterisation of the predominantly above ground components in ecosystem energy flow and accumulation. In Table LXXI Net Primary Production, net biocontent accumulation overwinter biocontent and summer biocontent (peaks) are given for the measured components as a percentage of the total above ground (living biocontent and litter layer). The last column represents maximum residence time for the component concerned. For photosynthetic components this corresponds to the time from commencement of growth to litter fall; similarly, for the living energy stores. For tree boles and branches this must correspond to the longevity of that part of the species concerned on the Study Area. For the dead energy stores, maximum residence time was taken as 98% breakdown time according to the exponential model (cf. Section VIII). In the case of consumer organisms, maximum residence time must correspond to longevity of the species concerned.

An examination of Table LXXI supports the division of the alder/birch woodland into the components chosen. Basically three sub-systems may be discerned. Firstly, the photosynthetic machinery, comprising only a small fraction of the biocontent. However, the whole ecosystem energy flow passes through this and energy rich compounds rarely reside in it longer than a year, usually for much less.

TABLE LXXI

Ecosystem Parameters

		as % of total above ground				Maximum residence (yrs)
Component	NPP	Net accumulation	Overwinter storage	Summer Biocontent		
1. Photosynthetic Machinery	100.0	-	- 0.1	2.3	Circa 1	
(a) Tree Canopy	74.8	-	-	1.4	0.6	
(b) Ground Vegetation	24.1	-	0.1	0.8	- 1	
(c) Bryophytes	1.1	?	- 0	0.1	?	
2. Living Energy Stores						
(a) Tree boles & branches	-	94.6	94.8	92.7	50 - 100	
3. Dead Energy Stores						
(a) Litter layer	-	5.4	5.1	3.7	5	
(b) Soil Organic Matter	-	? -0	68.0	66.0	74	
4. Consumers						
(a) Herbivore	-	-	- 0	- 0	days - 1 - ?	
(b) Decomposer	-	-	- 0	- 0	mins - 7 - ?	

Secondly, there are the energy stores. The vast bulk of the measured biocontent is in these, and apart from the small fraction represented by the litter layer, the maximum residence time for this subsystem is of the order of several decades. All incorporated energy passes through these stores, but annual input and output represents only a small fraction of them so that only particularly violent changes in the operation of other components will change their state.

Thirdly, the whole consumer component may be seen as having a common role; that is, the release of stored materials for recycling at the cost of a very rapid dissipation of stored energy. Both herbivores and decomposers operate in this way for energy stored as invertebrate tissue, for example, may be considered more available to decomposers than that stored as woody tissue. The biocontent of the consumers may be negligible, but a major proportion of the net primary production of the ecosystem passes through them (more than half on an above ground basis for the alder/birch wood). Generally speaking, the maximum residence time for fixed energy in consumer organisms is of the order of hours (microflora) days and months rather than years.

It is possible to argue that the ecosystem will tend to store as much of its fixed energy as possible in the least assailable form. Hence it will store in the form which will bring with it least increase in heterotroph respiration as well as least

autotroph maintenance respiration. Whilst grassland may have a large and persistent energy-store in the soil (Kucera 1968 etc.) woodland has in addition to this the woody materials. The large and persistent lignaceous component of the woody parts of trees may hold fixed energy for 50-100 years, and it may well be a further 70-80 years after death and fall before this energy is all dissipated by decomposers.

The present study would have been enhanced in value considerably if the following data had been collected :-

- (1) Chemical composition (e.g. hemicelluloses, celluloses, lignins) of newly produced material.
- (2) Chemical composition of live and dead storage materials.
- (3) The energy content of each type of material, according to chemical composition, and
- (4) The rate of decomposition of the various chemical constituents.

Were these data available for this and other systems, it might be possible to further the critical examination of various theories of ecosystem energetics. Clearly any analysis of energy flow and accumulation should include knowledge of the nature (chemical) of transfer agents and storage forms, in addition to their taxonomic and morphological identities.

X. v. Conclusion

In this thesis data for net annual above-ground primary production, litter fall and decomposition, energy accumulation and

insolation have been presented for an alder-birch woodland at Wynyard, Co. Durham. These data have been compared with those available from other studies throughout this thesis. In particular, a basic framework of ecosystem energetics is presented (cf. Tables LXV, LXVIII, LXX and LXXII, this section). Such a study would need to have been wider, more intensive and longer if it were to test adequately any ecological theory. However, it has added to the small pool of relevant data available.

This study has also made basic data available to workers investigating other aspects of the alder/birch woodland at Wynyard, particularly litter-dwelling invertebrates.

The fact remains that few complete ecosystem energetics studies have been carried out to date. A number are now in progress under the auspices of the International Biological Programme and it is to be hoped that they will avoid the pitfalls into which their predecessors have fallen. The most striking lesson the author has learnt in this study has been that a vast, perhaps inappropriate, amount of time and effort is required to produce relatively few data. Moreover, these data, whilst illuminating, are neither as precise nor as reliable as one might hope. These shortcomings, which have been discussed at length in almost every section of this thesis, and by many others, notably Trazcyk (1968), are characteristic of the dry-matter production and accumulation approach to the measurement of energy flow in ecosystems.

Whether or not this approach can be improved, or the difficulties it presents circumvented by new methods is difficult to see. As the technology of gas exchange measurement advances (Eckhardt 1968; Woodwell & Dykeman 1966), the dry matter approach may become obsolete. Even so, the major problem of investigating below ground processes remains. Furthermore, it is increasingly clear that if causal relationships between soil components of the ecosystem are to be established, the functions of each group of organisms must be investigated separately, and soil metabolism partitioned in detail.

Whilst these approaches may yield more and better data than the dry-matter production approach, they will necessarily involve a rapidly increasing expenditure of money and labour. Therefore it is of prime importance that their theoretical objectives be clearly stated and well based. Rather than study the so-called 'regional climax' or most 'productive' ecosystems, it would be most valuable to apply these approaches to ecosystems at various times after major stresses have been applied. In this way predictive models of ecosystem function may be built so as to guide future manipulation on scientific lines.

Despite their shortcomings, studies such as this one, based on the dry-matter production approach to ecosystem energetics, do provide a firm basis for general statements about ecosystems, when considered together. They may also provide basic descriptive data necessary to more advanced investigations of ecosystem function. Finally, in their own right, they have brought the ecologist to look

very closely and carefully at the ecosystem and to consider what and how it is.

REFERENCES

- ANDERSON, M.C. 1964. Light relations of Terrestrial plant communities and their measurement. *Biol.Rev.* 39 : 425-86.
- " 1964. Studies of the woodland light climate.
- I. Photographic computation of light conditions.
J.Ecol., 52 : 27-41.
- II. Seasonal variation in the light climate.
J.Ecol., 52 : 643-63.
- " 1966. Some problems of simple characterization of the light climate in plant communities. Light as an Ecological Factor, 6th Symposium of The British Ecological Society : 77-90.
- " 1966. Stand structure and light penetration.
- II. A theoretical analysis. *J.appl.Ecol.*, 3 : 41.54.
- ASHTON, D.H. 1964. Pers.comm. in Bray & Gorham 1964.
- ATTIWILL, P.M. 1968. The loss of elements from decomposing litter.
*Ecol.*49 : 142-144.
- AUTEN, J. 1941. Black locust, pines and sassafras as builders of forest soil. *Tech. notes Cent.St.For.Exp.Sta.*32.
- BASKERVILLE, G. 1965. Dry matter production in immature balsam fir stands; roots, lesser vegetation and total stand.
Forest Sci. 11.
- " 1965. Estimation of dry weight of tree components and total standing crop in conifer stands. *Ecol.* 46 : 867-9.

BELLAMY, D.J., BRIDGEWATER, P., MARSHALL, C. & TICKLE, W.M. 1969.

Status of the Teesdale rarities. Nature 222 : 238-43.

BELLAMY, D.J. & RIELEY, J. 1967. Some ecological statistics of a

"miniature bog". Oikos 18 : 33-40.

BLACK, J.N. & WATSON, D.J. 1960. Photosynthesis and the theory of

obtaining high crop yields by A.A. Niciporovic. Abstract

and commentary. Fld.Crop.Abstr.13 : 169-175.

BLACKMAN, G.E. & BLACK, J.N. 1959. Physiological and ecological

studies in the analysis of plant environment. XI. A

further assessment of the influence of shading on the

growth of different species in the vegetative phase.

Ann. Bot. N.S. 23 : 51-63.

BOCOCK, K.L. & GILBERT, O.J.W. 1957. The disappearance of leaf litter

under different woodland conditions. Plant and Soil.

9 : 179-85.

BRAY, J.R. 1962. The primary productivity of vegetation in central

Minnesota, U.S.A. and its relation to chlorophyll content and albedo.

Die Stoffproduktion der Pflanzendecke, H.Lieth, editor, 102-109.

Gustav Fischer Verlag, Stuttgart.

BRAY, J.R. & GORHAM, E. 1964. Litter production in forests of the

world. Adv.Ecol.Res.2 : 101-198.

CARLISLE, A., BROWN, A.H.F. & WHITE, E.J. 1966. Litter fall, leaf

production and the effects of defoliation by Tortrix viridana

in a sessile oak (Quercus petraea) woodland. J.Ecol.54 : 65-85.

- CLAPHAM, A.R., TUTIN, T.G. & WARBURG, E.F. 1962. Flora of the British Isles. 2nd edition. pp.1269. Cambridge.
- COOMBE, D.E. 1966. The seasonal light climate and plant growth in a Cambridgeshire wood. Light as an Ecological Factor, 6th Symposium of The British Ecological Society : 148-166.
- CUMMINS, K.W. 1967. Calorific Equivalents for Studies in Ecological Energetics. Duplicated. 52 pp.
- DAHLMAN, R.C. 1968. Root production and turnover of carbon in the root-soil matrix of a grassland ecosystem. Methods of Productivity Studies in Root Systems : 11-21. Leningrad.
- DAY, G.J. 1961. Distribution of total solar radiation on a horizontal surface over The British Isles and adjacent areas. Met.Mag., London. 90 : 269-284.
- DUTCH, M.E. & STOUT, J.D. 1968. The carbon cycle in a beech forest ecosystem in relation to microbial and animal populations. Trans. 9th int.Congr. Soil Sci. II : 37-48.
- ECKARDT, F.E. 1968. Techniques de mesure de la photosynthese sur le terrain basees sur l'emploi d'enceintes climatisees. Functioning of terrestrial ecosystems at the primary production level (Proceedings of the Copenhagen symposium, Paris, UNESCO (Natural resources research, V)) : 289-320.
- EVANS, G.C. 1939. Ecological studies on the rain forest of Southern Nigeria II. The atmospheric environmental conditions. J.Ecol., 27 : 436-32.

- EVANS, G.C. 1956. An area survey method of investigating the distribution of light intensity in woodlands with particular reference to sun flecks. *J.Ecol.* 44 : 391-428.
- EVANS, G.C. 1966. Model and measurement in the study of woodland light climates. *Light as an Ecological Factor*, 6th Symposium of The British Ecological Society : 53-76.
- EVANS, G.C. & COOMBE, D.E. 1959. Hemispherical and woodland canopy photography and the light climate. *J.Ecol.* 47 : 103-113.
- FRANKLAND, J., OVINGTON, J.D. & MACRAE, 1963. Spatial and seasonal variation in soil litter and ground vegetation in some Lake District woodlands. *J.Ecol.* 51 : 97-112.
- GOLLEY, F.B. 1961. Energy values of ecological materials. *Ecol.* 42 : 581-584.
- GOLLEY, F.B. 1965. Structure and function of an old-field broomsedge community. *Ecol. Mono.* 35 : 113-137.
- GOLLEY, F.B. & GENTRY, J. 1966. A comparison of variety and standing crop of vegetation in a one-year and a twelve-year abandoned field. *Oikos* 15 : 185-199.
- HADLEY, E.B. & KIECKHEFFER, B.J. 1963. Productivity of two prairie grasses in relation to fire frequency. *Ecol.* 44 : 389-395.
- HEATH, G.W., EDWARDS, C.A. & ARNOLD, M.V. 1964. Some methods for assessing the activity of soil animals in the breakdown of leaves. *Pedobiologia* 4 : 80-87.
- HOLFORD, K. 1961. Transistor Multirange D.C. Millivoltmeter. *Mullard Tech.Comm.* 5 : 48.

- IVLEV, V.S. 1934. Eine Mikromethode zur Bestimmung des Kaloriegehalts von Nahrstoffen. *Biochem. Zischt.* 275 : 49.55.
- JENKINSON, D.S. 1966. The turnover of organic matter in soil. IAEA symposium "The use of isotopes in soil organic matter studies". : 187-198.
- JENNY, H., GESSEL, S.P. & BINGHAM, F.T. 1949. Comparative study of decomposition rates of organic matter in temperate and tropical regions. *Soil Sci.* 68 : 419-432.
- JUSTESEN, H.S. 1932. Influence of size and shape of plots on the precision of field experiments with potatoes. *J.Agri.Sci.* 22 : 365-372.
- KIECKHEFER, B.J. 1962. Correlation between phenology and caloric content in forest herbs. *Trans.Ill.Acad.Sci.* 55 : 215-223.
- KIRA, T., OGAWA, H., YODA, K. & OGINO, K. 1967. Comparative ecological studies in three main types of forest vegetation in Thailand IV. Dry matter production with special reference to the Khao Chong rain forest. *Nature and Life in S.E. Asia.* 5 : 149-74.
- KIRA, T. & SHIDEI, T. 1967. Primary production and turnover of organic matter in different forest ecosystems of the Western Pacific. *Jap.J.Ecol.* 17 : 70-87.
- KUCERA, C.L., DAHLMAN, R.C. & KOELLING, M.R. 1967. Total net productivity and turnover on an energy basis for Tallgrass prairie. *Ecol.* 48 : 536-541.
- LINDQVIST, B. 1938. Dalby Soderskog. *Acta phytogeogr.Suec.* 10 : 273 pp.

- McVEAN, D.C. 1953. Biological Flora of the British Isles :
Alnus glutinosa (L.) Gaertn. J.Ecol. 41 : 447-466.
- MACFADYEN, A. & WEBB, N.R.C. 1968. An improved temperature integrator
for use in ecology. Oikos. 19 : 19-27.
- MEDWECKA-KORNAS, A. 1967. Estimation of primary production as a basis
for studies of secondary production. Secondary productivity
in terrestrial ecosystems. Warsaw. 1 : 83,93.
- MIKOLA, P. 1954. Kokeellisia Tutkimuksia metsäkarikkeiden hajaant-
umisnopendesta. Summary - Experiments on the rate of
decomposition of forest litter. Commun.Inst.For.Fenn. 43 : 1.
- MINA, V.N. 1955. Cycle of N and ash elements in mixed oakwoods of
the forest-steppe. Pochvovedeme 6 : 32-44.
- MINDERMAN, G. 1967. The production of organic matter and the
utilization of solar energy by a forest plantation of
Pinus nigra var. austriaca. Pedobiologia. 7 : 11-22.
- MITCHELL, H.L. 1936. Trends in the nitrogen, phosphorous, potassium
and calcium content of the leaves of some forest trees
during the growing season. Black Rock.For.Pap. 1 : 30-44.
- MONTEITH, J.L. 1959. Solarimeter for field use. J.Sci.Instrum.
36 : 341-46.
- MONTEITH, J.L. 1962. Measurement and interpretation of carbon dioxide
fluxes in the field. Netherlands J.Agr.Sci. 10 : 334-36.
- MONTEITH, J.L. & SZEICZ, G. 1962. Simple devices for radiation
measurement and integration. Arch.Met., Wien, B, 11 : 491-500.

- MORRISON, F.B. 1949. Feeds and Feeding. Morrison Publ.Co.
Ithaca. 1201 pp.
- MULLER, D. & NIELSEN, J. 1965. Production brute, pertes par respiration
et production nette dans la foret ombrophile tropicale.
Det. forstlige Forsøgsvæsen i Danmark. 29 : 69-160.
- NEWBOULD, P.J. 1967. Methods for estimating the primary production
of forests. IBP handbook No.2. pp.62. Blackwell, Oxford.
- ODUM, E.P. 1960. Organic production and turnover in old field
succession. Ecol. 41 : 34-49.
- ODUM, H.T., BEYERS, R.J. & ARMSTRONG, N.E. 1963. Consequences of
small storage capacity in nanoplankton pertinent to
measurement of primary productivity in tropical waters.
J.Mar. Res. 21 : 191-198.
- OLSON, J.S. 1963. Energy storage and the balance of producers and
decomposers in ecological systems. Ecol. 44 : 322-31.
- OLSON, J.S. 1964. Gross and net production of terrestrial vegetation.
J.Ecol. 52 : Supplement : 99-118.
- OVINGTON, J.D. 1954. Studies on the development of woodland conditions
under different trees. II. The Forest Floor. J.Ecol.42 : 71-80.
- OVINGTON, J.D. 1957. Dry-matter production by plantations of *Pinus
sylvestris* L. Ann.Bot. N.S. 21 : 287.
- OVINGTON, J.D. 1959. Mineral content of plantations of *Pinus sylvestris*.
Ann.Bot. N.S. 23 : 75.

- OVINGTON, J.D. 1961. Some aspects of energy flow in plantations of *Pinus sylvestris*. L. *Ann.Bot.* 25 : 12-20.
- OVINGTON, J.D. 1962. Quantitative ecology and the woodland ecosystem concept. *Adv.Ecol.Res.* 1 : 103-92.
- OVINGTON, J.D. 1963. Flower and seed production - a source of error in estimating woodland production, energy flow and mineral cycling. *Oikos.* 14 : 148-53.
- OVINGTON, J.D. 1965. Woodlands. pp.154. English Universities Press Ltd., London.
- OVINGTON, J.D. & HEITKAMP, D. 1960. The accumulation of energy in forest plantations in Britain. *J.Ecol.* 48 : 639-646.
- OVINGTON, J.D., HEITKAMP, D. & LAWRENCE, D.B. 1967. Plant biomass and productivity of prairie, savanna, oakwood and maize field ecosystems in central Minnesota. *Ecol.* 44 : 52-63.
- OVINGTON, J.D. & LAWRENCE, D.B. 1967. Comparative chlorophyll and energy studies of prairie, savanna, oakwood and maize field ecosystems. *Ecol.* 48 : 515-524.
- OVINGTON, J.D. & MADGWICK, H.A.I. 1959. a. The growth and composition of natural stands of birch. 1. Dry matter production. *Plant and Soil* X (3) : 271-283.
- OVINGTON, J.D. & MADGWICK, H.A.I. 1959. b. Distribution of organic matter and plant nutrients in a plantation of Scots Pine. *Forest Sci.* 5 : 344-55.

- OVINGTON, J.D. & PEARSALL, W.H. 1956. Production ecology II. Estimates of average production by trees. *Oikos* 7 : 202-205.
- PAINE, R.T. 1964. Ash and calorie determinations of sponge and Opisthobranch tissues. *Ecol.* 45 : 384-387.
- PENMAN, H.L. 1948. Natural evaporation from open water, bare soil and grass. *Proc.Roy.Soc.A.* 193 : 120.
- PETERKEN, G.F. & NEWBOULD, P.J. 1966. Dry matter production by *Ilex aquifolium* L. in the New Forest. *J.Ecol.* 54 : 143-151.
- PHILLIPSON, J. 1964. A miniature bomb calorimeter for small biological samples. *Oikos*, 15 : 130-9.
- P'YAVCHENKO, N.I. 1961. The biological cycle of nitrogen and mineral substances in bog forests. *Pochvovedenie* 6 : 21.32 (1960 in Russian).
- RAUNKAIER, C. 1934. The life form of plants and statistical plant geography. Clarendon Press, Oxford.
- RAUP, H.M. 1964. Some problems in ecological theory and their relation to conservation. *J.Ecol.* 52 : Suppl. : 19-28.
- REMEZOV, N.P. et al. 1959. Uptake and turnover of nitrogen and ash elements in the forest of the European part of the U.S.S.R. Moscow. (In Russian).
- RICHARDS, P.W. 1952. The tropical rain forest. Cambridge University

ADDENDUM

SATOO, T., KUNUGI, R., and KUMEKAWA, A. (1956) Materials for the studies of growth in stands, 3. Amount of leaves and production of wood in an aspen (*Populus davidiana*) second growth in Hokkaido. *Bull. Tokyo Univ. For.* 52:33-58.

- SCOTT, D. 1965. The determination and use of thermodynamic data in ecology. *Ecol.* 46 : 673-680.
- SHANKS, R.E. & OLSON, J.S. 1961. First-year breakdown of leaf litter in southern Appalachian forests. *Science* 134 : 194-195.
- SLOBODKIN, L.B. & RICHMAN, S. 1960. The availability of a miniature bomb calorimeter for ecology. *Ecol.* 41 : 784.
- SMIRNOVA, K.M. & GORODENTSEVA, G.A. 1958. The consumption and rotation of nutritive elements in birch woods. *Bull.Soc. Nat. Moscou (biol.)* 62 : 135-147.
- x SNEDECOR, G.W. 1962. Statistical methods. †
- SVIRIDOVA, L.K. 1960. (English 1961). Role of improvement cuttings in raising forest soil fertility. *Pochvovedenie* 4 : 68-73. (English 401-405).
- SZEICZ, G. 1966. Field measurements of energy in the 0.4 - 0.7 micron range. *Light as an Ecological Factor*, 6th Symposium of the British Ecological Society : 41-52.
- SZEICZ, G., MONTEITH, J.L. & DOS SANTOS, J.M. 1964. Tube solarimeter to measure radiation among plants. *J.appl.Ecol.*, 1 : 169-174.
- TAMM, C.O. 1953. Growth, yield and nutrition in carpets of a forest moss (*Hyloconium splendens*). *Medd.Stat.Skogsforskningsinst.* 43.
- TANNER, C.B., THURTELL, G.T. & SWANN, J.B. 1963. Integration systems using a commercial coulometer. *Soil Sci.Am.Proc.* 27 : 478-481.
- TAYLOR, N.H. & POHLEN, I.J. 1962. Soil survey method. *N.Z. Soil Bur.Bull.* 25.

- TEAL, J.M. 1957. Community metabolism in a temperate cold spring.
Ecol.Mono. 27 : 283-302.
- THOMAS, W.A. 1968. Decomposition of Loblolly Pine needles with and
without addition of dogwood leaves. Ecol. 49 : 568-71.
- TRACZYK, H. & TRACZYK, T. 1967. Tentative estimation of the
production of herb layer. Ecol.Pol.A. 5 : 823-835.
- TRACZYK, T. 1967. Studies on herb layer production estimate and
the size of plant fall. Ekol.Pol.A. 15 : 837-867.
- TRACZYK, T. 1967. Propozycja nowego sposobu oceny produkcji runa.
A proposed new way of estimating the production of the
forest herb layer. Ekol.Pol.B. 133 : 241-247.
- TRACZYK, T. 1968. Studies on the primary production in meadow
community. Ekol.Pol.A.16 : 59-100.
- TRICKETT, E.S., MOULSLEY, L.J. & EDWARDS, R.I. 1957. Measurements of
solar and artificial radiation with particular reference to
agriculture and horticulture. J.Agr.Engng.Res. 2 : 86-110.
- WASSINK, E.C. 1948. De lichtfactor in de fotosynthese en zijn
relatie tot andere milieufactoren. Meded.Dir.Tuinb.11 : 503-513.
- WHITTAKER, R.H. 1961. Estimation of net primary production of forest
and shrub communities. Ecol. 42 : 177-80.
- WHITTAKER, R.H. 1962. Net production relations of shrubs in the
Great Smoky Mountains. Ecol. 43 : 357-77.

ADDENDUM

- WHITTAKER, R.H. (1966) Forest dimensions and estimated production
in the Great Smoky Mountains. Ecol. 47:103-121.

- WHITTAKER, R.H., COHEN, N. & OLSON, J.S. 1963. Net production relations of three tree species at Oak Ridge, Tennessee. *Ecol.* 44 : 806-10.
- WHITTAKER, R.H. & WOODWELL, G.M. 1968. Dimension and production relations of trees and shrubs in the Brookhaven Forest, New York. *J.Ecol.* 56 : 1-26.
- WHITTAKER, R.H. & WOODWELL, G.M. 1969. Structure, production and diversity of the oak-pine forest at Brookhaven, New York. *J.Ecol.* 57 : 155-174.
- WIEGERT, R.G. 1962. The selection of an optimum quadrat size for sampling the standing crop of grasses and forbs. *Ecol.* 43 : 125-129.
- WIEGERT, R.G. 1964. Population energetics of Meadow Spittle Bugs (*Philaenus spumarius* L.) as affected by migration and habitat. *Ecol.Monogr.* 34 : 217-241.
- WIEGERT, R.G. & EVANS, F.C. 1964. Primary production and the disappearance of dead vegetation in an old field in southeastern Michigan. *Ecol.* 45 : 49-63.
- WITKAMP, M. & OLSON, J.S. 1963. Breakdown of confined and non-confined oak litter. *Oikos* 14 : 138-147.
- WITKAMP, M. & VAN DER DRIFT, J. 1961. Breakdown of forest litter in relation to environmental factors. *Plant and Soil* 15 : 295-311.
- WITTICH, W. 1939. Untersuchungen über den Verlauf der Streuzersetzungen auf einem Boden mit Mullzustand 1. *Forstarchiv.* 15 : 96-111.

WOODWELL, G.M. & DYKEMAN, 1966. Respiration of a forest measured by
CO₂ accumulation during temperature inversions.
Science 154 : 1031-1034.

VIRO, P.J. 1955. Investigations on forest litter. Commun.Inst. for
Fin. 45 : 65.



APPENDIX II

The programme MEANWTS

- (a) Programme print-out enclosed.
- (b) Punch-card input was thus:-

First card

Month	Zone	Plotsize	Setno	Catno
(1-30)	(Alder or Birch)	(2 or 6)	(11 or 13)	(up to 18)

where Month = date of sample

Zone = Alder or birch zone

Plotsize = Quadrat size

Setno = Number of sample units taken in that zone

Catno = Number of categories of material harvested.

Subsequent cards

Weights were typed in to the nearest

10 mg thus:- 0.12 0.35 0.72 etc.

For the sake of clarity a new card was started for each category.

APPENDIX I

DATA FOR THE HARVESTED TREES

AIDER Age (years)	D(t) (cms)	D(t-5) (uncorrected) (cms)	D(t-5) (corrected) (cms)	Fresh wts (Kg)			Dry Weights (Kg)		
				Bole	Branches	Whole shoot	Bole	Branches	Whole shoot
6	1.75	--	--	--	1.01	1.01	--	0.45	0.45
14	4.27	--	--	7.40	1.01	8.41	3.30	0.45	3.75
14	5.65	3.75	4.04	6.80	0.90	7.70	3.03	0.61	3.64
20	6.90	5.25	5.65	19.00	+	19.00	9.10	+	9.10
23	9.45	7.35	7.92	28.30	9.10	37.40	14.60	6.10	20.70
29	10.95	9.15	9.85	51.20	10.20	61.40	29.50	6.80	36.30
33	11.85	9.65	10.39	62.50	4.70	67.20	33.90	3.20	37.10
49	14.45	12.25	13.19	60.30	29.90	90.20	32.20	20.00	52.30
62	17.05	14.70	15.83	138.30	23.10	161.10	79.60	15.20	94.80
64	21.10	17.20	18.52	271.70	52.20	323.90	162.30	34.40	196.70
75	26.45	23.15	24.92	311.20	64.40	375.60	164.50	42.50	207.00
79	29.35	26.00	27.99	424.00	153.00	577.00	213.00	96.40	309.14

APPENDIX I (cont.)

<u>BIRCH</u>	Age (years)	D(t) (cms)	D(t-5) (Uncorrected) (cms)	D(t-5) (corrected) (cms)	Bole	<u>Freshwts (Kg)</u>			<u>Dry Weights (Kg)</u>		
						Branches	Whole shoot	Bole	Branches	Whole shoot	
	8	2.73	1.30	1.46	1.93	0.85	2.78	1.48	0.68	2.16	
	9	2.95	-	-	2.84	1.47	4.31	2.30	1.18	3.48	
	15	4.87	-	-	9.33	3.04	12.37	7.58	2.43	10.01	
	23	5.75	4.50	4.82	13.04	8.84	21.88	10.60	7.07	17.67	
	24	8.00	6.65	7.05	26.76	9.52	36.28	21.74	7.61	29.35	
	28	6.65	5.25	5.59	24.15	5.44	29.59	19.62	4.35	23.97	
	29	15.35	13.70	14.45	100.24	34.47	134.47	81.45	27.55	109.00	
	31	11.45	-	-	42.10	18.27	60.37	34.21	14.60	48.81	
	34	10.80	9.60	10.12	51.82	15.76	67.58	42.11	12.60	54.71	
	37	10.55	9.05	9.55	52.16	15.65	67.81	42.38	12.51	54.89	
	47	20.00	17.15	18.01	223.62	82.10	305.72	181.69	65.61	247.31	
	49	18.50	16.30	17.16	190.06	99.11	289.17	154.42	79.21	233.63	
	50	26.30	22.65	23.75	335.21	141.07	476.28	272.35	112.74	385.09	

Key. D(t) outside diameter (dbh) at time of sampling.

D(t-5) (uncorrected) inside diameter 5 years before sampling.

D(t-5) (corrected) outside diameter 5 years before sampling.

```
38 IF MEAN(A,B) = 0 THEN
39 PUT EDIT (B, 'THIS CATEGORY IS ABSENT.')
40 (SKIP(2), F(4), CCOLUMN(25), A)
41 ELSE
42 PUT EDIT (B, MEAN(A,B), VAR(A,B), SEM(A,B))
43 (SKIP(2), F(4), CCOLUMN(27), F(9,2), CCOLUMN(60),
44 F(9,2), COLUMN(94), F(9,2))
45 END
46 FREE X
47 END
48 PUT PAGE EDIT('COMBINED PLOTS, LOADED MEANS ETC.',
49 'TOTAL MEAN', 'TOTAL STANDARD ERROR')
50 (SKIP(3), A, SKIP(3), COLUMN(30), A, COLUMN(55), A)
51 DC B = 1 TC CATNC
52 A = 1
53 IF MEAN(A,B) = 0 THEN
54 DC
55 PUT EDIT (B, 'ONE OR BOTH SAMPLES LACK ANY VALUES',
56 'THEREFORE THIS CATEGORY IS IGNORED.')
57 (SKIP(2), F(4), CCOLUMN(25), A, X(1), A)
58 GOTC FIN
59 END
60 ELSE
61 DC
62 MARK1 = MEAN(A,B)
63 MARK2 = VAR(A,B)
64 MARK3 = CHEK(A)
65 A = 2
66 IF MEAN(A,B) = 0 THEN
67 DC
68 PUT EDIT (B, 'ONE OR BOTH SAMPLES LACK ANY VALUES',
69 'THEREFORE THIS CATEGORY IS IGNORED.')
70 (SKIP(2), F(4), CCOLUMN(25), A, X(1), A)
71 GO TC FIN
72 END
73 END
74 ELSE
75 DC
76 SIGMEAN(B) = ((MARK1 * 0.49) + (MEAN(A,B)
77 * 0.51))
78 SIGMERR(B) = Sqrt(((0.49 ** 2) * MARK2) / MARK3)
79 + (((0.51 ** 2) * VAR(A,B)) / CHEK(A))
80 PUT EDIT (B, SIGMEAN(B), SIGMERR(B))(SKIP(2), F(4),
81 COLUMN(25), F(9,4), CCOLUMN(60), F(9,4))
82 END
83 END
84 FIN
85 END
86 FREE MEAN, SEM, VAR, SIGMEAN, SIGMERR, SUBAR
87 GO TO S
88 END
```

```

1  MEANWTS  PRCC OPTIONS (MAIN)
/* PROGRAMME TO CALCULATE MEANS AND STANDARD ERRORS OF SAMPLES
FROM DIFFERENT ZONES AND DIFFERENT AREA MAGNITUDES*/
2  DECLARE (MCNTH, PLCTSIZE, SETNC, CATNC, B, A, C, D)FIXED BIN,
ZONE CHAR(5),
(CHECK, MARK1, MARK2, MARK3, CHEK(2)) FLCAT,
(MEAN(2,CATNC), SEM(2,CATNC), VAR(2,CATNC), SIGMEAN(CATNC),
3  SIGMERR(CATNC), SUBAR(SETNC), X(CATNC,SETNC))FLCAT CCNTRCLED
S DC A = 1 TO 2
/* ITERATES THIS BLOCK TWICE*/
4  GET LIST (MCNTH)
5  GET EDIT ( ZONE, PLCTSIZE, SETNC, CATNC)
(A(5), X(1), F(1), X(1), F(2), X(1), F(2))
6  PUT PAGE EDIT (A, MONTH, ZONE, 'PLCT SIZE = ', PLCTSIZE,
'NO OF SETS = ', SETNC, 'NO OF CATEGORIES = ', CATNC,
'MEAN', 'VARIANCE', 'STANDARD ERRCR')
(SKIP(2), F(2), C(2), F(2), C(2), F(2), C(2), F(2), C(2), F(2),
7  SKIP(2), A, C(2), F(2), C(2), F(2), C(2), F(2), C(2), F(2), C(2), F(2),
F(4), SKIP(2), A, C(2), F(2), C(2), F(2), C(2), F(2), C(2), F(2), C(2),
8  C(2), F(2), C(2), F(2), C(2), F(2), C(2), F(2), C(2), F(2), C(2), F(2),
C(2), F(2), C(2), F(2), C(2), F(2), C(2), F(2), C(2), F(2), C(2), F(2),
9  C(2), F(2), C(2), F(2), C(2), F(2), C(2), F(2), C(2), F(2), C(2), F(2),
CHEK(A) = SETNC
10  ALLOCATE X
IF A = 1 THEN ALLOCATE MEAN, SEM, VAR, SIGMEAN,
11  SIGMERR, SUBAR
12  GET LIST (X)
DO B = 1 TO CATNC
13  SUBAR = X(B,*)
14  CHECK = SUM(SUBAR)
/*CHECK ALLOWS A CHECK TO BE MADE ON THE CONTENTS OF
15  THE ARRAY IN QUESTION.*/
IF CHECK = 0 THEN
16  DO
17  MEAN(A,B) = 0
18  SEM(A,B) = 0
19  VAR(A,B) = 0
20  END
21  ELSE
22  DO
23  MEAN(A,B) = CHECK / SETNC
VAR(A,B) = (SUM((SUBAR - MEAN(A,B)) **2))
/(SETNC - 1)
SEM(A,B) = SQRT(VAR(A,B) / SETNC)
24  END
25  IF PLCTSIZE = 2 & MEAN(A,B) = 0 THEN
26  DO
27  MEAN(A,B) = MEAN(A,B) * 32
28  VAR(A,B) = VAR(A,B) * 1024
29  SEM(A,B) = SEM(A,B) * 32
30  END
31  ELSE
32  IF PLCTSIZE = 6 & MEAN(A,B) = 0 THEN
33  DO
34  MEAN(A,B) = MEAN(A,B) * 10.4
35  VAR(A,B) = VAR(A,B) * 108.1
36  SEM(A,B) = SEM(A,B) * 10.4
37  END

```