



## Durham E-Theses

---

### *Electrical conduction in dielectric liquids*

Kahan, E.

#### How to cite:

---

Kahan, E. (1964) *Electrical conduction in dielectric liquids*, Durham theses, Durham University.  
Available at Durham E-Theses Online: <http://etheses.dur.ac.uk/9536/>

#### Use policy

---

The full-text may be used and/or reproduced, and given to third parties in any format or medium, without prior permission or charge, for personal research or study, educational, or not-for-profit purposes provided that:

- a full bibliographic reference is made to the original source
- a [link](#) is made to the metadata record in Durham E-Theses
- the full-text is not changed in any way

The full-text must not be sold in any format or medium without the formal permission of the copyright holders.

Please consult the [full Durham E-Theses policy](#) for further details.

ELECTRICAL CONDUCTION IN DIELECTRIC LIQUIDS

by

E. Kahan B.Sc.

Presented in candidature for the degree of Doctor of Philosophy  
of the University of Durham

October 1964



### Acknowledgements.

The author wishes to thank Professor D. A. Wright for allowing the use of the facilities of the Department of Applied Physics and expresses his gratitude to Dr. M. J. Morant for many helpful discussions and supervising this work.

The author would also like to thank Mr. F. Spence and his staff for constructing the chromatography apparatus and other equipment, Mrs. N. Boucher for typing this thesis and Miss. R. Noble for the help given with the reproduction of the diagrams.

A maintenance grant from the Department of Scientific and Industrial Research is gratefully acknowledged.

### Abstract of thesis.

Conduction current measurements have been carried out in a variety of highly degassed hydrocarbon liquids using plane and spherical electrodes, at field strengths between 50kV/cm and breakdown. These liquids have been analysed by means of a high resolution chromatography apparatus and a marked dependence of the reproducibility of the results and the purity of the liquid was found.

Steady currents in the region of  $10^{-6}$ A have been recorded, these being greater by several orders of magnitude than those found by other investigators under similar conditions. This high value of current has been established to be due to the high degree of degassing of the liquids used in this project.

Measurements were made on the instability of the current, fast pulses in the microsecond region, particle movement and breakdown. No relationship was found between any of the electrical properties of the gap and the state of the electrode surfaces or the material used, although there was a marked change in the maximum value of the conduction current and some variation in the pattern of the instability when different liquids were tested.

When using 3mm diameter, stainless steel, parallel plane electrodes the breakdown strength was found to be approximately 400kV/cm and independent of the liquid used.

A mechanism has been proposed, based on realignment of the liquid molecules under the influence of the high electric field, and appears to be well able to explain the majority of the experimental observations.

## Contents.

### Page No.

1	1.	<u>Introduction.</u>
3	2.	<u>Experimental apparatus and procedure</u>
3	2.1.	Chromatography.
3	2.1.1.	Introduction.
4	2.1.2.	Description of the chromatography apparatus.
6	2.1.3.	Filling the capillary tube.
7	2.1.4.	The detector and its electrical circuit.
8	2.1.5.	Attainment of the maximum resolution.
9	2.2.	The degassing apparatus and the procedure.
9	2.2.1.	The degassing apparatus.
10	2.2.2.	Degassing rate of the system.
11	2.2.3.	Rough degassing of the liquid.
12	2.2.4.	Final degassing.
14	2.3.	The test cell filling and flushing system.
15	2.3.1.	The test cell and preparation of the electrodes.
17	2.4.	Electrical equipment.
18	2.5.	Standard procedure for the current-voltage measurements.
19	2.6.	Observation of particles.
20	2.7.	The viscometer.
21	3.	<u>Experimental results.</u>
21	3.1.	Introduction.

22	3.2.	Chromatography.
23	3.2.1.	Hexane (Special for Spectroscopy Grade, Supplied by B.D.H.).
25	3.2.2.	Pure hexane.
26	3.2.3.	Cyclohexane.
26	3.2.4.	Cyclopentane.
27	3.3.	Results obtained in spectroscopic grade hexane using spherical electrodes.
27	3.3.1.	Introduction.
28	3.3.2.	The current-voltage characteristic and reproducibility of the results.
30	3.3.3.	Dependence of the current-voltage characteristic on the age of the liquid.
31	3.3.4.	Dependence of the characteristic on gap length.
33	3.3.5.	Effect of prestressing the gap.
36	3.3.6.	The effect of settling time on the current-voltage characteristic.
38	3.4.	Plane electrodes in spectroscopic grade hexane.
38	3.4.1.	Introduction.
39	3.4.2.	The (I,V) characteristic.
40	3.4.3.	Reproducibility of the results.
40	3.4.4.	Dependence of the (I,V) characteristic on the age of the liquid.
41	3.4.5.	Dependence of the (I,V) characteristic on the gap length.
41	3.4.6.	The effect of prestressing on the (I,V) characteristic.
42	3.4.7.	The effect of settling time on the (I,V) characteristic.

- 43 3.4.8. Polarity reversal tests with one electrode roughened.
- 44 3.5. Air-saturated spectroscopic grade hexane.
- 46 3.6. Plane electrodes in high purity hexane.
- 46 3.6.1. Introduction.
- 46 3.6.2. The (I,V) characteristic and the reproducibility of the results.
- 48 3.6.3. Effect of the electrode material, age of the liquid, the gap width and prestressing on the (I,V) characteristic
- 49 3.7. Cyclohexane.
- 49 3.7.1. Introduction.
- 50 3.7.2. The (I,V) characteristic of cyclohexane.
- 51 3.8. Cyclopentane.
- 51 3.8.1. Introduction.
- 51 3.8.2. The (I,V) characteristic of cyclopentane.
- 52 3.9. The (I,V) characteristic of air-saturated cyclopentane.
- 53 3.10. 3-methyl pentane.
- 54 3.11. Particles.
- 54 3.11.1. Particle movement with spherical electrodes.
- 55 3.11.2. Dependence of particle movement on electrode geometry.
- 55 3.11.3. Dependence on liquid.

- 56 3.11.4. Dependence of the current, stability and pulses on particles.
- 56 3.11.5. Particles and breakdown.
- 57 3.12. Stability of the current level.
- 57 3.12.1. Introduction.
- 58 3.12.2. Dependence of the instability on the field strength.
- 59 3.12.3. Dependence of the instability on the purity of the liquid.
- 60 3.12.4. Dependence of the instability on the current level.
- 60 3.12.5. Dependence of the instability on various parameters.
- 60 3.12.5.1. Age of the liquid.
- 60 3.12.5.2. Gap length.
- 61 3.12.5.3. Prestressing the liquid.
- 61 3.12.5.4. Hydrostatic pressure.
- 61 3.12.5.5. Settling the liquid.
- 61 3.12.5.6. Electrode material and surface finish.
- 61 3.12.5.7. Length of application of the applied voltage.
- 62 3.12.6. Stability of the current in air-saturated hexane.
- 62 3.12.7. Stability of the current in cyclohexane.
- 62 3.12.8. Stability of the current in cyclopentane.
- 63 3.12.9. Stability of the current in air-saturated cyclopentane.



- 63 3.12.10. Stability of the current in 3-methyl pentane.
- 63 3.13. Pulses.
- 63 3.13.1. Introduction.
- 64 3.13.2. Dependence of the pulses on current and voltage.
- 65 3.13.3. Pulse length and field strength.
- 65 3.13.4. Pulse length and mobility.
- 66 3.13.5. Pulse length and gap width.
- 66 3.13.6. Pulses and instability.
- 67 3.13.7. Pulses and particle movement.
- 67 3.13.8. Pulses and electrode material and surface finish.
- 67 3.13.9. Pulses and the purity of the liquid.
- 67 3.14. Breakdown.
- 67 3.14.1. Introduction.
- 68 3.14.2. Breakdown strength and electrode geometry.
- 69 3.14.3. Breakdown strength and liquid composition.
- 69 3.14.4. Air-saturated liquid.
- 70 3.14.5. The effect of pre-breakdown current on breakdown.
- 70 3.14.6. Dependence on the degree of polish of the electrode surfaces.
- 71 3.14.7. Particles and breakdown.

71	3.14.8.	Damage to the electrodes.
72	3.15.	Viscosity tests.
72	3.15.1.	Introduction.
73	3.15.2.	Results.
74	3.16.	Miscellaneous tests and observations.
74	3.16.1.	Pressure dependences of the high currents.
76	3.16.2.	Time dependence of the high currents.
76	3.16.3.	Discharge currents.
77	3.16.4.	Elimination of spurious discharges as a cause of the high currents.
78	3.17.	Summary of the experimental results.
83	4.	<u>Review of previous work.</u>
83	4.1.	High field conduction.
88	4.2.	Mobility.
92	4.3.	Breakdown.
94	4.4.	Relevant experimental results.
95	4.5.	Instability.
97	4.6.	Miscellaneous relevant observations.
98	5.	<u>Discussion.</u>
98	5.1.	Introduction.
99	5.2.	Structure of liquids.
101	5.3.	Transport phenomena in liquids.
104	5.4.	A possible mechanism for the explanation of several high field phenomena in dielectric liquids.

104	5.4.1.	Explanation of the high currents.
106	5.4.2.	Explanation of the (I,V) characteristic in pure hexane.
108	5.4.3.	Instability.
108	5.4.4.	Pulses.
110	5.4.5.	Effect of the purity of the liquid.
114	5.4.6.	The effect of air on the electrical conductivity of hexane.
115	5.4.7.	The effect of dissolved air on the viscosity of spectroscopic grade hexane.
117	5.4.8.	Dependence of the high currents on molecular structure.
119	5.4.9.	Explanation of the difference between plane and spherical electrodes.
120	5.5.	Other possible mechanisms of the high currents.
120	5.5.1.	Space charge mechanism.
122	5.5.2.	Bubble theory.
122	5.5.3.	Ionization by collision.
123	5.5.4.	High field dissociation of the molecules.
123	5.5.5.	Electron hopping process.
124	5.6.	Discussion of the results of other workers having a direct bearing on the present work.
127	5.7.	The source of the carriers.
130	5.8.	Breakdown.

133	6.	Conclusions and suggestions for further work.
136		Appendix A.
137		Appendix B.
142		Appendix C.
146		References.

## 1. Introduction.

Until recently the breakdown strength of hexane was believed to be about 1 - 1.2MV/cm. However, in 1960 Sletten (1) found that this high electric strength could only be obtained in liquid containing a large quantity of dissolved air, and when this was reduced the electric strength fell to about 800kV/cm. The current was then too erratic to be measured. Further work by Morant (2) in which the gas content of the liquid was further reduced, showed that the breakdown strength of hexane is as low as 500kV/cm. The current in this highly degassed liquid was still erratic, and varied between several levels even though a constant voltage was maintained. The maximum value of the current was in the region of  $10^{-6}$  A.

The present work is in fact a continuation of that initiated by Morant, using his original apparatus with several small modifications. The main emphasis has been on attempting to obtain steady currents and reproducible results in highly degassed liquid. At the same time experiments were carried out with the object of explaining the dependence of the current on air content.

The enormous effect that dissolved air has on the conduction current in hexane can be seen from the results shown plotted in Fig. 1. These have been plotted on a log. scale for convenience, and for easy comparison with published work, they have been replotted on a log. linear scale, since much of the published work has been plotted in this manner. Curve 1 in these graphs refers to results obtained by House (3)



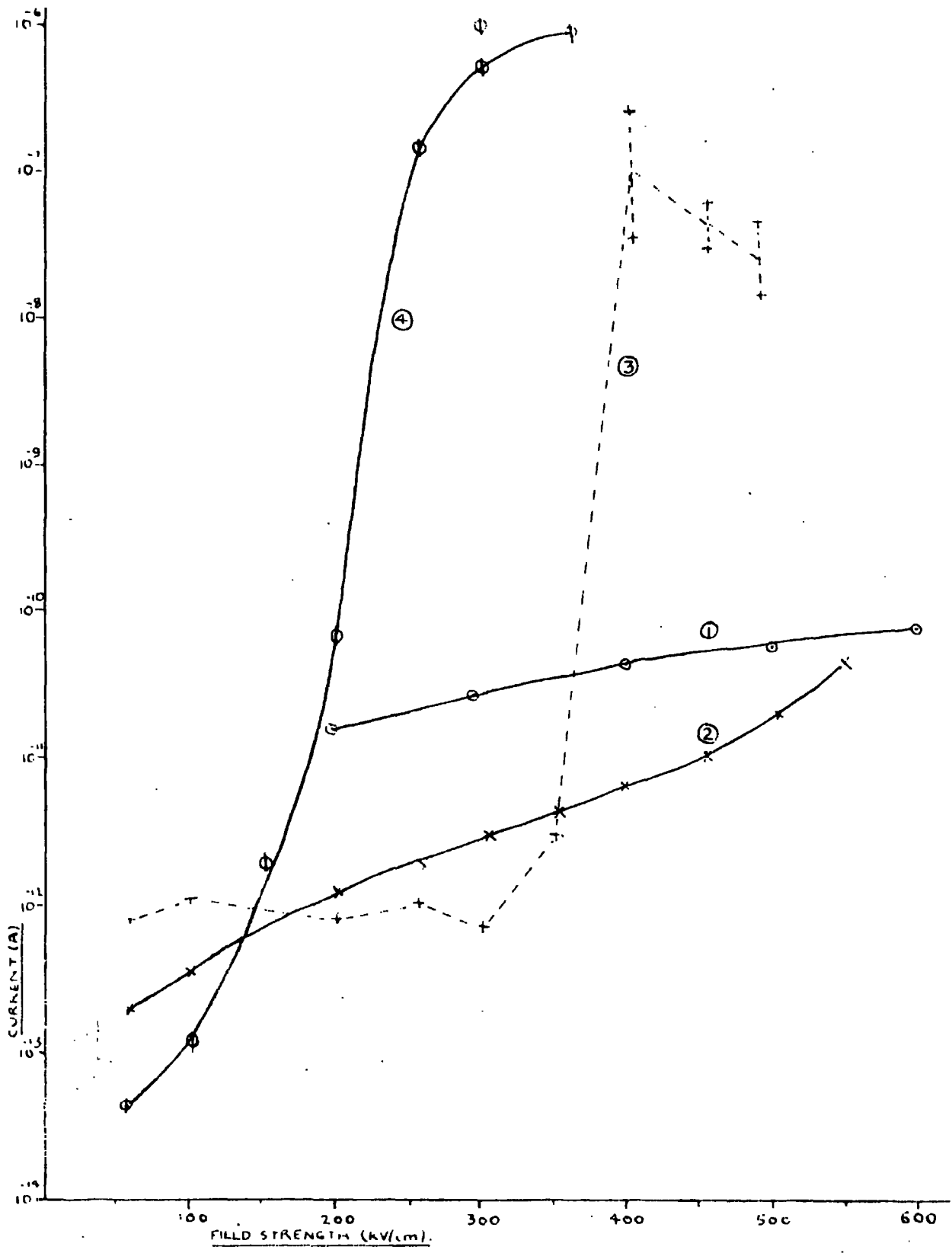

FIG. 1A. THE RESULTS OF FIG. 1. REPLOTED ON A LOG.-LINEAR SCALE.



using spherical electrodes in hexane with a relatively high air content. This is seen to be similar to Curve 2 which refers to a test done in the present project with plane electrodes in air-saturated hexane. Curve 3 shows typical results obtained in the degassed liquid in the earlier part of this work. The progress made in obtaining a smooth current-voltage curve can be seen on comparing curves 3 and 4, the latter being obtained towards the end of this project.

The results have been presented, as far as possible, in the order in which the experiments were carried out, since in most cases each experiment naturally followed the preceding one.

Although, as already mentioned, the main object of this work was the examination and explanation of the high currents obtained in degassed liquid, measurements were also made in a variety of liquids on particle movement, fluctuations in the current, fast pulses in the microsecond region, electrode effects and breakdown.



## 2. Experimental apparatus and procedure.

### 2.1. Chromatography.

#### 2.1.1. Introduction.

Chromatography, in its present form, is one of the most powerful tools available to the analytical chemist. Sensitive apparatus is readily obtainable which can analyse a mixture accurately to one part in a million. The name is derived from early experiments in which it was found that when a solution of Chlorophyll was applied to one end of a tube packed with pulverized calcium carbonate the components of the solution separated out into distinctive colour bands.

In Gas chromatography the substance to be analysed is vaporized and carried through a column by a stream of carrier gas. The different components of the sample take different times to traverse the length of the column, so that when they leave the far end they are separated out and can then be analysed by means of a suitable detector.

The mechanism of chromatography is as follows. The sample is introduced into the gas stream, flows into the coated tube and part of it is absorbed by the stationary phase as it enters portion 1 of the column, fig. 2. In equilibrium the ratio of the quantity absorbed in the stationary phase to that remaining in the gas stream is fixed. However, the unabsorbed sample is swept away by the gas stream to be reabsorbed by the stationary phase a little further up the column, portion 2 say, and the equilibrium in portion 1 is upset. The sample previously absorbed is then

desorbed into the gas stream and reabsorbed in portion 3. That in portion 2 is desorbed by the same process and this is repeated until the sample leaves the column. The time taken for a component to travel the length of the column depends on the affinity of the stationary phase for it, so that when the sample emerges from the column it is separated out into its components, the degree of separation depending on the particular sample, the working temperature etc.

#### 2.1.2. Description of the chromatography apparatus.

For the chromatography apparatus built in this project it was decided to use a capillary column in preference to a packed column because of its superior resolution and the fact that it can be used satisfactorily without any specialized knowledge of chromatography. A schematic diagram of the apparatus, which is an almost exact copy of that constructed by I. Halasz and G. Schreyer (4) is shown in Fig. 3. Here an argon ionization detector, rather than a flame ionization, was used, because detailed drawings were available for the former. Since the apparatus is not original it will only be described briefly here; for fuller details it is necessary to refer to the original publication.

The explanation of the diagram is as follows. A is a cylinder of the carrier gas (99.999% pure argon). Gas flows from this cylinder through a cooled tube, B, containing Linde Molecular Sieve, grade 5A, in order to remove impurities from the gas stream, and then through a copper spiral, C, immersed in a freezing mixture of

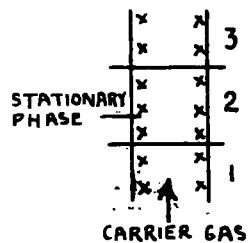

FIG. 2. SMALL PORTION OF THE COATED CAPILLARY TUBE.

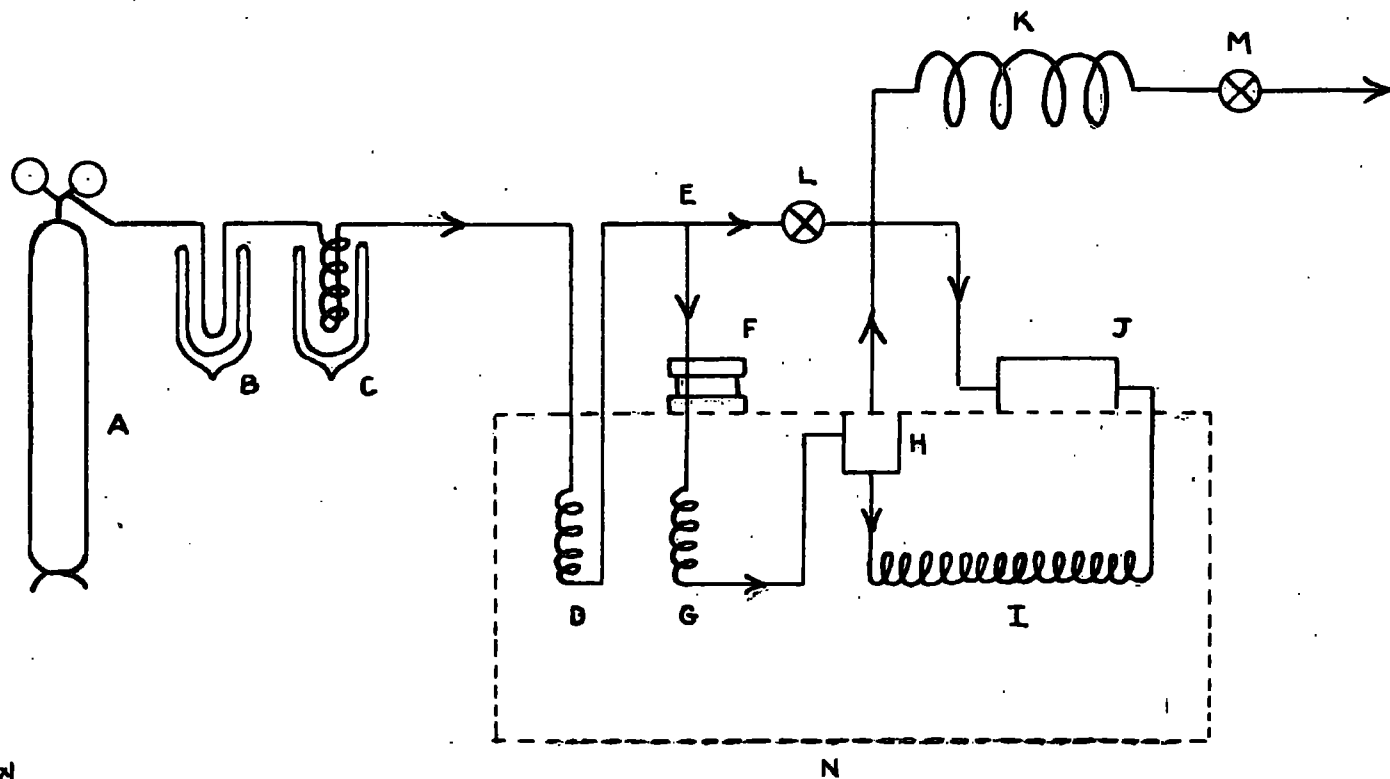

FIG. 3. SCHEMATIC DIAGRAM OF CHROMATOGRAPHY APPARATUS.

solid carbon dioxide and methylated spirits in order to remove moisture. These were later discarded as their presence produced no noticeable improvement. From C the gas flows through a preheating column D immersed in the thermostatically controlled, constant temperature bath which preheats the carrier gas and helps to vaporize the sample.

Before the gas reaches the sample dispenser F some of it is bled off via the tee-junction E and needle valve L to the ionization cell in order to flush it out. The necessity of this is made clear in Sec. 2.1.4. The sample to be analysed is introduced into the carrier gas flow by means of the dispenser F and is carried into a splitter H via a second preheating column G. H is filled with glass wool and this, together with the two preheating columns, ensures that the sample is fully vaporized before it reaches the detector. F injects a standard amount of 1.3  $\mu$  litres into the system, and since this is more than the cell can cope with, the majority of the sample is disposed of into the atmosphere by means of the splitter H, the exact proportion removed being controlled by the needle valve M.

K is a length of wide bore tubing which acts as a buffer volume and maintains the pressure at the head of the capillary column I during the short interval in which the gas supply is interrupted when the dispenser is operated. The sample finally passes through the column into the cell where the components are resolved.

### 2.1.3. Filling the capillary tube.

The ultimate resolving power of the apparatus depends upon the capillary tube and this must be correctly coated for optimum results. A 100 ft. length of 0.1 mm bore copper tubing was used and filled according to the recommendations of Halasz and Schreyer (4). The tube was first washed by forcing through a quantity of petroleum ether. A 10% solution of squalane and petroleum ether was made up and forced through the tube at a pressure of approximately 700lbs./sq.in. until the first drops of the solution appeared at the far end. The capillary tube was then connected into the apparatus and argon passed through at a pressure of 2 atmospheres, the column being kept in the constant temperature bath at a temperature of 70°C. This evaporated the petroleum ether and left the squalane behind in the correct thickness to act as the stationary phase.

In order to fill the column easily and safely at the high pressure required a special pump was constructed. A cross-sectional drawing of this is shown in Fig. 4. A is the vessel into which the solution is poured and B is a plunger to which is attached a P.T.F.E. washer C. To operate the pump the solution is poured into A with one end of the capillary tube already soldered into the nozzle F. The plunger is then inserted until the clamp D makes contact with the liquid. The clamp is tightened by means of the nut E and this forces out the washer C to make a leak-free seal. The whole is then placed in an hydraulic press and the liquid forced through at the required pressure. This system contains

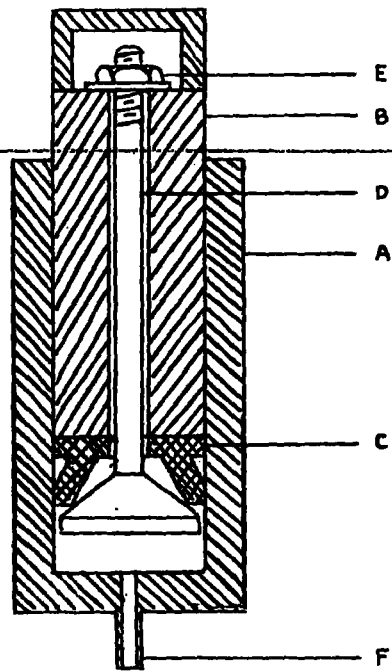

FIG. 4. CROSS-SECTIONAL DIAGRAM OF PUMP.

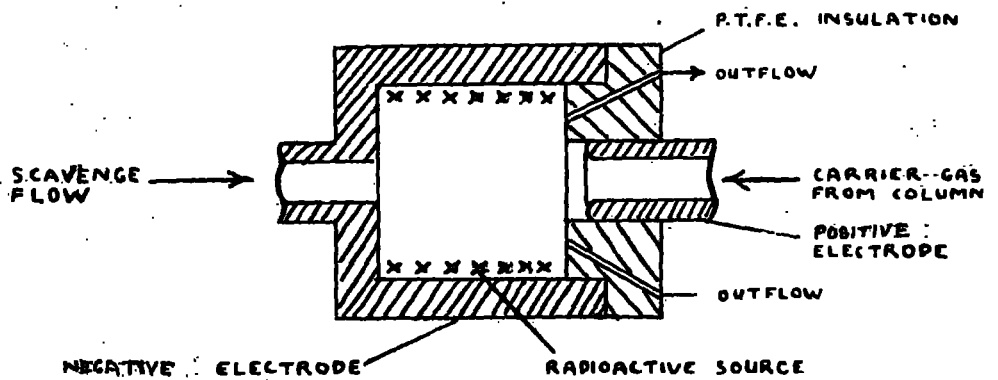

FIG. 5. SCHEMATIC DIAGRAM OF DETECTOR CELL.

no compressed gas and is therefore quite safe even if a fracture occurs.

#### 2.1.4. The detector and its electrical circuit.

The detector employed was an argon ionization detector modelled on the one developed by Lovelock (5). A simplified version of it is shown in Fig. 5. The principle of action of this cell is as follows. Argon, which is the carrier gas, flows into the cell and its atoms are excited into metastable states of 11.6eV energy. The separated-out components of the sample which emerge from the end of the capillary column are swept into the cell by the carrier gas and are immediately ionized there by transfer of energy from the metastable argon atoms. These ions are collected by the electrodes, which are maintained at a high potential, and are recorded as current in the external circuit. The response of the cell is an approximately linear function of the quantity of the sample passing through it, so that a good estimate of the relative quantities of the different components in a substance can be obtained by simply measuring the area under each peak in the chromatogram.

The purpose of the scavenge flow is to remove excess ions and so prevent a build up of space charge which would otherwise diminish the sensitivity of the cell.

It will be understood from the above that the cell is limited to the detection of substances having ionization potentials not greater than 11.6eV. However, the majority of organic substances do in fact have ionization potentials smaller than this

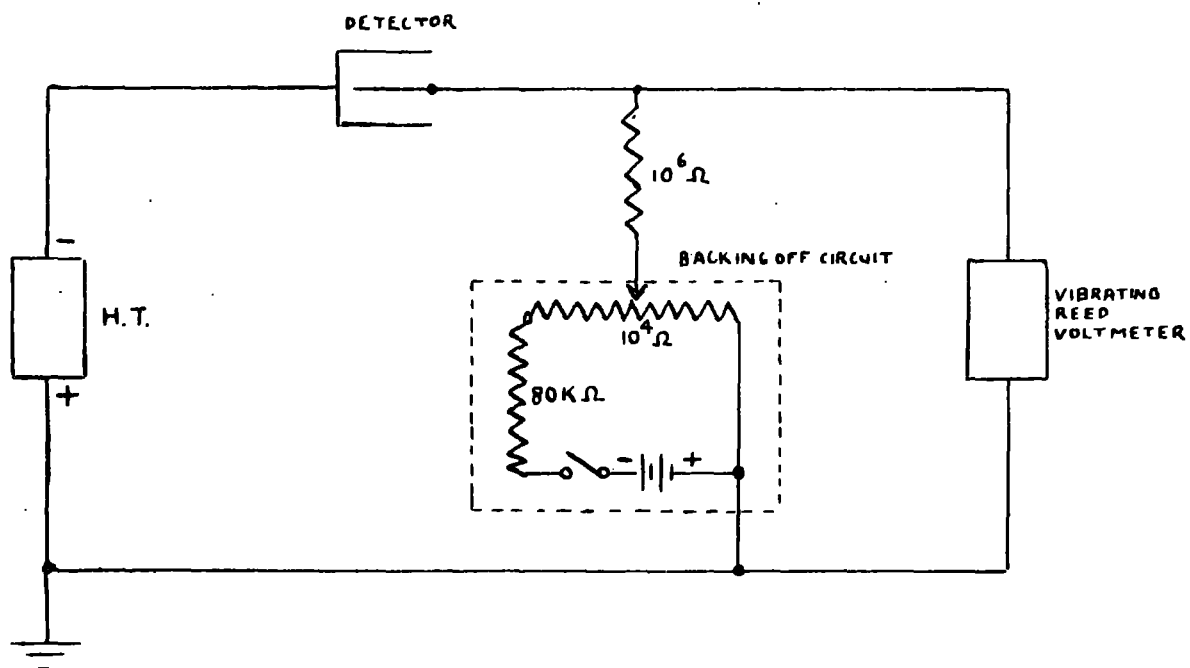

FIG. 6. ELECTRICAL CIRCUIT FOR THE CHROMATOGRAPHY DETECTOR CELL.

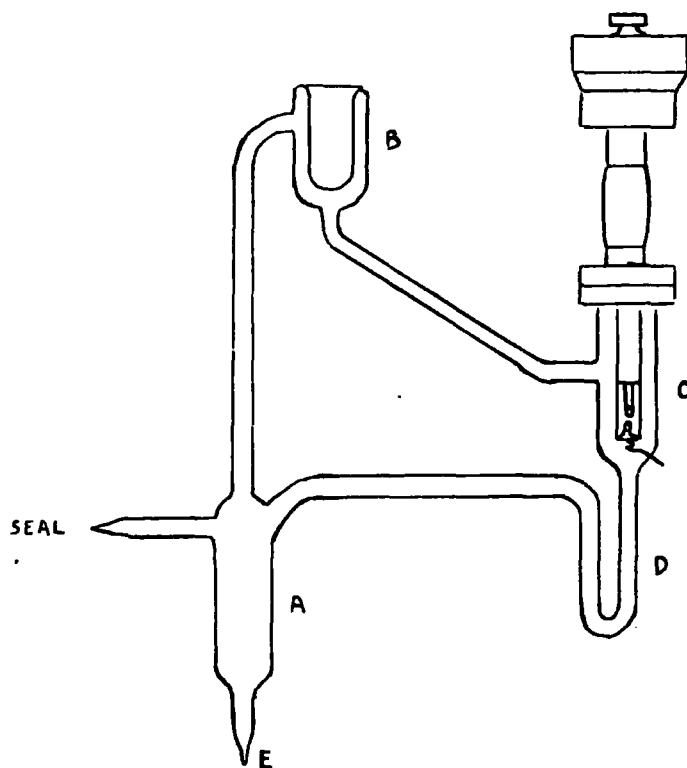

FIG. 8. TEST CELL FILLING AND FLUSHING SYSTEM.



figure, so that this limitation is not a serious drawback as far as the analysis of hydrocarbons is concerned.

The electrical circuit is shown in Fig. 6. and is self explanatory. The backing off circuit is made necessary by the fact that the standing current is approximately  $10^{-6}$  A whereas the smallest signal required to be observed is of the order of  $10^{-10}$  A.

#### 2.1.5. Attainment of the maximum resolution.

The attainment of the maximum resolution was a matter of some difficulty as it is a function of the pressure of the carrier gas, the temperature of the column, the scavenge flow, the setting of the needle valve M, Fig.3. and the voltage applied to the cell. Except for the temperature and the cell voltage, these variables were interdependent and the optimum settings had to be found by a long process of trial and error.

The optimum temperature is approximately the boiling point of the substance to be analysed. A lower temperature, provided that it is not so low that the sample does not vaporize, increases separation of the peaks but increases the time of the analysis. A higher temperature decreases the time necessary for the analysis but also decreases the spacing between the peaks.

The optimum voltage to be applied to the cell is the highest which can be applied without the electrical noise due to the radioactive source becoming comparable with the signal. Both the noise level and the standing current were found to be approximately 2 orders of magnitude higher than the values quoted for

the best cells of this type (6). Faulty insulation was at first suspected but this was ruled out by a process of elimination. The radioactive source was removed and the noise disappeared. It was then concluded that the noise was due to the statistical nature of emission of the radioactive source; this gave the limit of resolution of the apparatus.

The precise resolving power of the apparatus was not measured because it was not required in the present work. However, an idea of the resolution of the instrument can be obtained from Fig. 14. in which it can be seen that the area of peak 1, the smallest peak, is approximately 1,600th of the total area. Since the area encompassed by each peak is approximately proportional to the amount of substance present, this particular component is present in the ratio of approximately 1; 1,600 to the total, i.e. less than 0.1%.

## 2.2. The degassing apparatus and the procedure.

### 2.2.1. The degassing apparatus.

The degassing apparatus which was used to purify all the liquids used in this work, is drawn approximately to scale in Fig. 7. This is basically the apparatus used in earlier work by Morant (2) but with small improvements made during the course of the present work.

In this apparatus the liquid undergoes a three stage vacuum distillation process at gradually reducing temperatures with the object of removing as much of the dissolved gas content as possible. ~~All the taps were originally of the usual greased variety~~

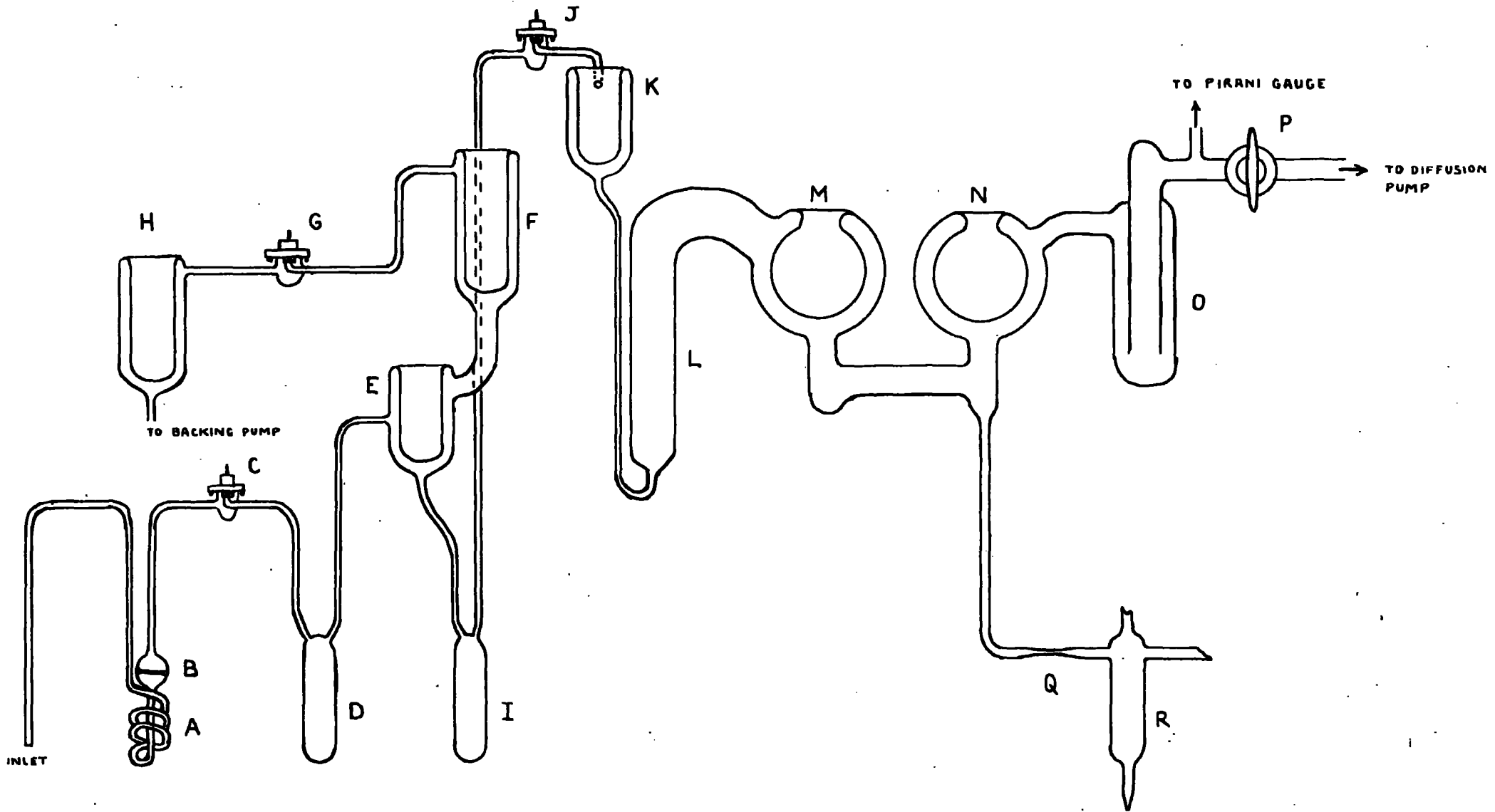

FIG. 7. DEGASSING APPARATUS.

~~but it was noticed that hexane reacted with the silicone grease in these taps. They were therefore replaced with~~ <sup>G</sup>greaseless taps manufactured by G. Springham and Co. which have "Viton A" as the sealing material. <sup>were used.</sup> As far as is known this material is inert with respect to hexane. However, tap P was of the greased variety because at that point a large bore pipe was required in order to obtain sufficient pumping speed, and a greaseless tap of sufficiently large diameter (approximately 2.5cms.) was not available. Contamination from this tap was reduced to a minimum by placing it in a position as far away as possible from the liquid being degassed and protecting it with cold traps.

The purpose of each component of the apparatus is made clear in the sections on the degassing procedure, Secs. 2.2.3 and 2.2.4.

The backing pump was an oil-filled rotary pump manufactured by Edwards High Vacuum Ltd. model 1SC50B, capable of producing an ultimate vacuum of  $5 \times 10^{-3}$  torr. A 20litre/sec. capacity mercury diffusion pump of G.E.C. design, capable of producing an ultimate vacuum of the order of  $10^{-6}$  torr provided the high vacuum. A high pumping speed was ensured by using the largest diameter tubing practicable.

### 2.2.2. Degassing rate of the system.

After the test cell was replaced after the electrode polishing, see Sec. 2.3.1, the whole of the apparatus was pumped out before the liquid was introduced for degassing. When the pumping was discontinued by closing tap P, the pressure in the system rose due to

the degassing of the metal parts of the system and desorption of vapour from the glassware. It is possible to differentiate between these two by cooling trap O with liquid air or nitrogen. Emitted vapour then condenses on the inside of this trap as a solid and is not recorded by the Pirani gauge. The Pirani gauge then measures the degassing rate only. Without liquid air on O, the sum of the degassing rate and the rate of evolution of vapour is measured.

Before a distillation was commenced the whole of the apparatus was evacuated using the diffusion pump until the degassing rate was of the order of  $10^{-7}$  lusecs. A rate of vapour evolution about 10 times this magnitude was tolerated since in any case the majority of the <sup>vapour</sup> evolved was from liquid absorbed in the apparatus from the previous test. The importance of the degassing rate is that later the liquid was sealed off in the cell and it was required to remain degassed for as long as possible.

### 2.2.3. Rough degassing of the liquid.

The first <sup>stage</sup> of the degassing was done as follows. A mixture of ground solid carbon dioxide and methylated spirit was placed around reservoir D, Fig.7. A small amount of the cooling mixture was also put into trap H in order to prevent oil from the backing pump from entering the system during the degassing and so contaminating the liquid. Tap G was opened and the low vacuum side of the apparatus evacuated by means of the backing pump. The inlet was cleaned with a piece of filter paper soaked in the liquid to be degassed and the bottle containing the sample clamped over it. A

Dewar containing some of the cooling mixture mentioned above was placed over the spiral A and filter B, and when they were sufficiently cooled, tap C was opened to allow the liquid to flow into the reservoir D, the apparatus being pumped continuously through tap G. It was assumed that any moisture present in the liquid would freeze and be filtered out by the fine filter B which was of  $1\mu$  pore size.

When sufficient liquid had collected in D, tap C was closed, traps E and F filled with the cooling mixture and the dewar removed from D. Liquid then began to drip off E and fill reservoir I, and since this was a fairly slow procedure taking approximately 90 mins. for the 50 ccs. of liquid contained in D to distil over, it was reasonably well degassed at a pressure of the order of  $10^{-3}$  torr.

#### 2.2.4. Final degassing.

The final degassing, which was done at a pressure of  $10^{-5}$  -  $10^{-6}$  torr, consisted of two stages, a fairly rapid distillation between room temperature and  $-182^{\circ}\text{C}$  (the temperature of liquid air) and the last stage being a very slow distillation between the temperature of solid carbon dioxide ( $-79^{\circ}\text{C}$ ) and  $-182^{\circ}\text{C}$ . For the first of these stages G was closed and liquid air poured into trap K. A Dewar containing solid carbon dioxide and methylated spirit cooling mixture was placed around L and a small quantity of liquid air poured into the spherical trap M in order to prevent mercury from the diffusion pump from contaminating the liquid and the liquid from contaminating the large greased tap P. The high vacuum side of the apparatus

had, until this time, been pumped by means of the diffusion pump in preparation for this distillation.

Tap J was opened and the liquid allowed to vapourize from I and condense as a solid on the inside surface of K, pumping meanwhile with the diffusion pump, and checking the pressure continually by means of the Pirani gauge.

When all the liquid had been removed from I, taps J and P were closed, the liquid air removed from K and M and the liquid allowed to collect in L. It was then ready for the last stage of degassing. For this, trap N was filled with cooling mixture and a little was also placed around trap O. This served to protect both the liquid and the tap P as mentioned above. With the cooling mixture still surrounding L, a little liquid air was poured into M and the tap P immediately opened to the diffusion pump. There then followed a slow distillation of the liquid from L which was at the temperature of the surrounding cooling mixture ( $-79^{\circ}\text{C}$ ) to M, which was at the temperature of the liquid air contained in it ( $-182^{\circ}\text{C}$ ). This process took approximately 4 hrs. after which, the liquid was quite thoroughly degassed at a pressure of the order of  $10^{-6}$  torr.

To fill the test cell reservoir R, the liquid air was removed from M and the solid shell which had formed round the inside of it allowed to liquify, pumping meanwhile until the last possible moment. Tap P was closed, the liquid sample flowed into the vicinity of N and from there ran, mainly under the influence of gravity, into R, around which a Dewar containing liquid air was placed. The small amount of liquid which

condensed into O was allowed to remain there. The cooling mixture was removed from N, liquid air placed around O, and when the liquid had solidified in both O and R, tap P was opened to the diffusion pump once more. The test cell system was then sealed off at the pressure of the diffusion pump, i.e. approximately  $10^{-6}$  torr.

### 2.3. The test cell filling and flushing system.

In work on conduction in liquids it is desirable to have a circulating system so that the liquid in the test cell can be changed, and the electrodes flushed between tests to present a new sample to the electrodes. Violent flushing clears the gap of particles which are sometimes attracted to the electrodes during a test and will also remove breakdown products if it is desired to carry out further measurements after a breakdown.

The present system, which was designed and constructed by Morant (2), is made entirely of glass and metal so that contamination of the sample is reduced to a minimum. In order to ensure a system which will maintain the high vacuum necessary in this work ( $10^{-6}$  torr) for periods up to several days, conventional taps were not used.

The system is shown in Fig.8 and it is operated as follows. To fill the cell C from the reservoir A (A in this diagram corresponds to R in Fig.7) a little of the cooling mixture mentioned in Sec. 2.2.3. is placed in trap B. Liquid condenses onto the inside of B, drips off into C and is prevented from leaving by a block of solidified sample which has previously



been frozen into the U-bend D by surrounding it with a Dewar containing liquid air. To flush the cell the liquid air is removed from D and the solid block allowed to unfreeze. Because the whole is under vacuum, the liquid flows out of the cell with a flushing action sufficiently violent to remove any troublesome large particles which might be lodged in the gap.

### 2.3.1. The test cell and preparation of the electrodes.

The test cell was of the demountable type and so constructed that the gap length could be varied while the cell was under vacuum. As mentioned in the previous section, it was made entirely of glass and metal in order to reduce the possibility of contamination of the liquid. Good insulation was ensured by suspending the lower electrode on long glass rods, Fig.9. The upper electrode is fixed to a metal spring-bellows and movement of this electrode is controlled by a micrometer head so that the gap length could be adjusted to any value required within  $\pm 1\mu$ . The electrodes are shielded from the glass walls by a metal screen in order to prevent interference with the current measurements from static charge which accumulates on the glass walls during distillation.

The high vacuum seal between the upper demountable part of the cell and the lower half is made by means of a copper sealing ring tightly clamped between two flanges. This ring is grooved on both its upper and lower faces so that in effect it has a double sealing edge (see the diagram), and in order to reduce the leak rate of the seal the space between the two edges was

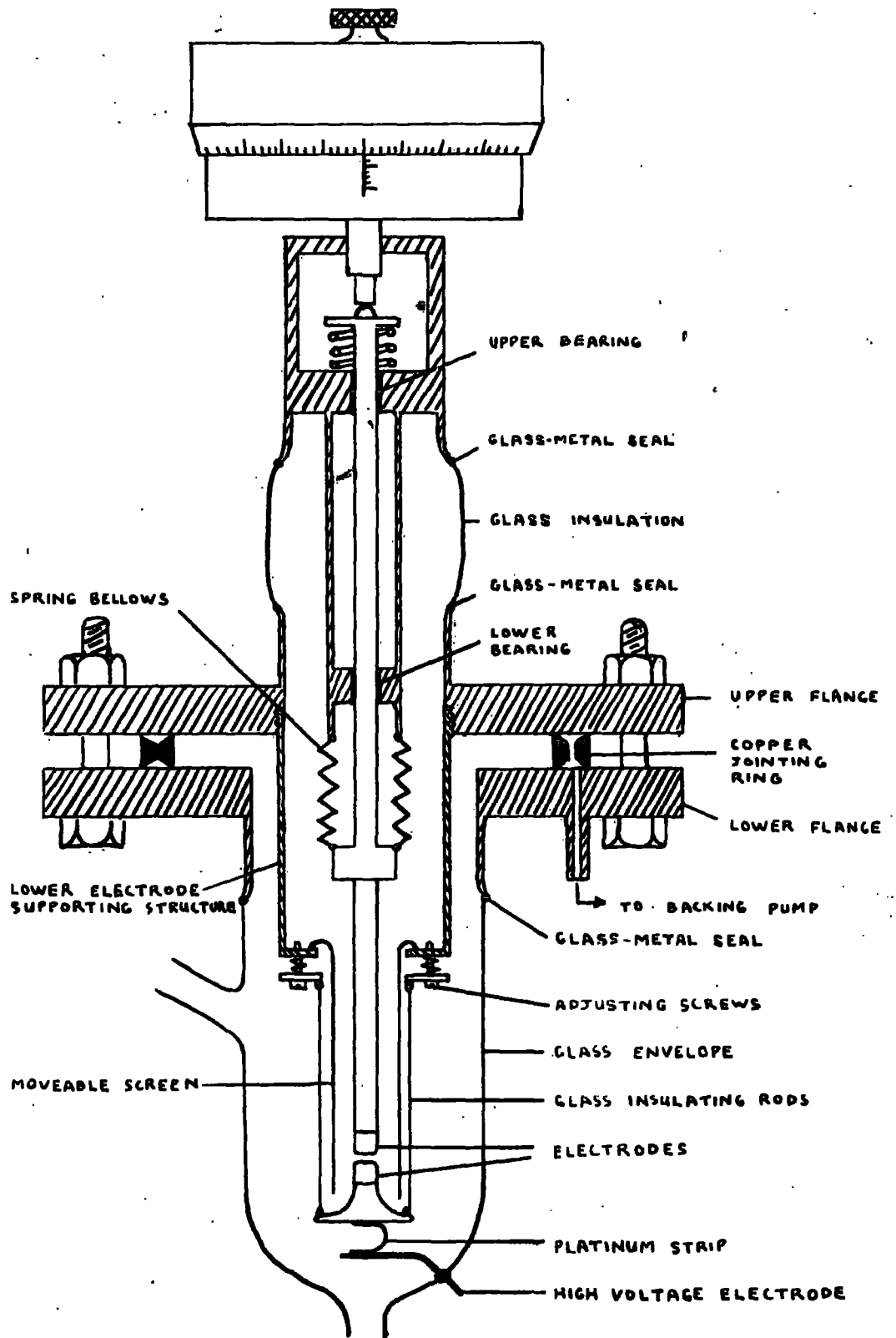

**FIG. 9. TEST CELL**

pumped down to a pressure of the order of  $10^{-3}$  torr by means of the backing pump.

This cell was in fact designed by Morant (2) and used in his work on spherical electrodes. It was later slightly modified in order to align the plane electrodes used for part of the present work.

To prepare the cell for a test, the cell assembly was removed from the lower glass bulb, the lower electrode supporting structure unscrewed and the electrodes removed for polishing. This was done mechanically using fine diamond paste on microcloths which were firmly clamped to flat glass discs. For the final surface  $1\mu$  grade diamond paste was used and conditions were carefully controlled to exclude atmospheric dust as far as possible. The aim was to prepare a surface upon which no scratches could be seen when viewed through a 100 x metallurgical microscope. However, this was never achieved because a few minute scratches were always present which could not be removed, and were probably caused by minute particles from the polishing enclosure which settled on the polishing cloths. To polish plane electrodes a special jig, Fig.10, was constructed to prevent rounding of the plane surfaces during polishing.

After the electrodes were polished they were cleaned separately in a Soxhlet extractor, mounted on their respective supports and cleaned again in the same manner. With plane electrodes it is necessary to ensure that they are as accurately parallel as possible and this was done as follows. The electrodes were assembled, their separation was adjusted to about 10 microns and a 100 x magnification microscope, with

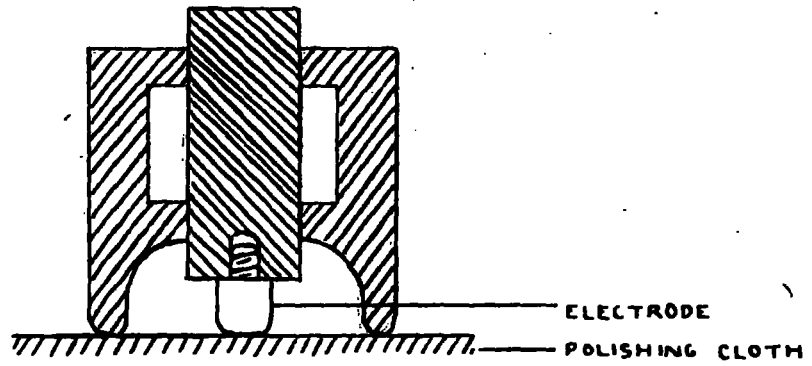

FIG. 10. ELECTRODE POLISHING JIG.

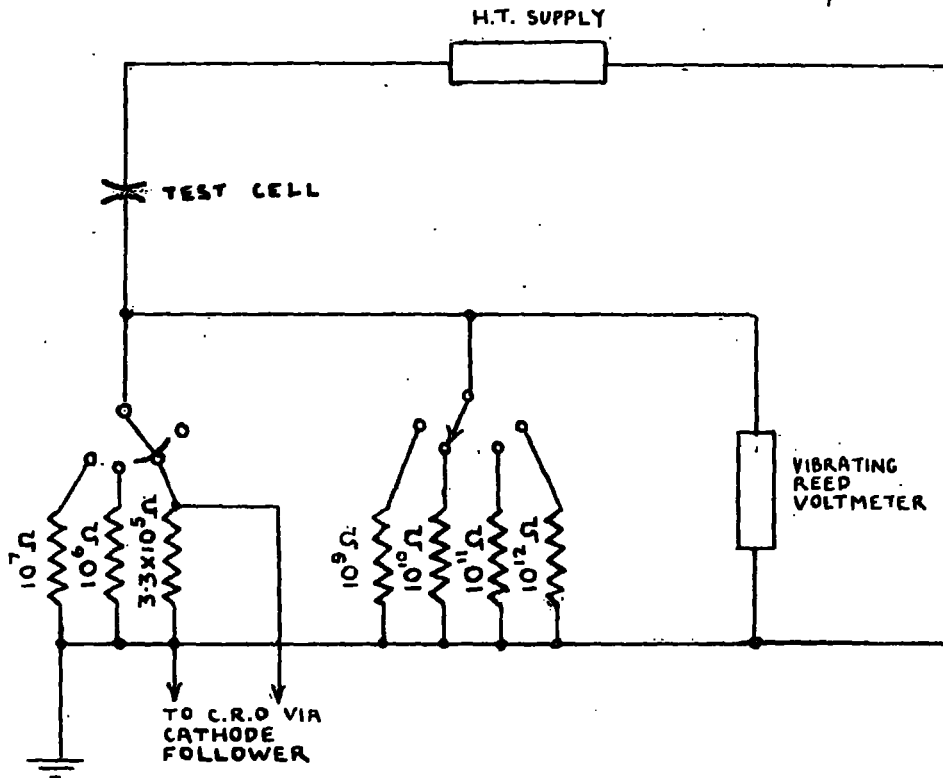

FIG. 11. CONDUCTION CURRENT MEASURING CIRCUIT.

a fine eyepiece graticule, was focussed on the edge of the gap. Readings of the gap length were taken on the eyepiece graticule at three points on the electrode edges spaced  $120^\circ$  apart and by means of the adjusting screws (see Fig.9) the electrodes were adjusted until the readings on the graticule were the same at all three points. By this method the electrodes could be made parallel to one another so that the gap length at diametrically opposite points of the gap did not differ by more than 2 microns (the effective diameter of the electrodes was about  $3 \times 10^3 \mu$ ).

Before replacing the test cell assembly in the glass bulb a jet of hexane was forced through the gap in order to remove any large solid particles which might have settled on the electrodes during the adjustment. The condenser was removed from the Soxhlet extractor and the assembled cell inserted in its place upto its flange. Hexane condensed on the inside of the cell and dripped off to give the final cleaning. After the cell had been bolted back in position, the apparatus was pumped by means of the diffusion pump for a period of between one and two weeks until the quantity of vapour remaining in the apparatus, as measured with the Pirani gauge, was negligible.

#### 2.4. Electrical equipment.

The voltage source was a high stability commercial powerpack (Dynatron, Type N103) capable of supplying a continuously variable voltage from 300 to 3,300V, with a maximum low frequency ripple of  $150 \mu\text{V}$  peak to peak. Current was measured by measuring the voltage drop across a resistor placed between the low voltage

electrode and earth, Fig.11. For this a commercial vibrating reed electrometer was used (Vibron, Model 33C manufactured by Electronic Instruments Ltd.) in conjunction with a bank of measuring resistors ranging from  $3 \times 10^5$  to  $10^{12}$  ohms. The  $10^9$  to  $10^{12}$  ohm resistors were included in the Vibron electrometer head (Type B33C) and the  $3 \times 10^5$  to  $10^7$  ohm resistors were contained in a screened box and designed to be make before break so that the desired resistor could be selected without interrupting the voltage supply. The voltage range which the electrometer covered was  $10^{-4}$  to 1V and when used with the  $10^{12}$  and the  $3.3 \times 10^5$  ohm resistors the smallest and largest currents which the electrometer could cope with were  $10^{-16}$  and  $3 \times 10^5$  A respectively. For permanent records a pen recorder operated from the electrometer was used.

For examination of fast pulses in the microsecond range, a Tektronix oscilloscope (Model 545A) was used. This had a maximum sensitivity of 0.005V/cm and a bandwidth of 35Mc/sec. The pulses were fed through the  $3.3 \times 10^5$  ohm measuring resistor and hence into a cathode follower for matching into a cable connection to the oscilloscope.

#### 2.5. Standard procedure for the current-voltage measurements.

The standard procedure adopted for the current - voltage measurements is set out below and this was used throughout the project (unless otherwise stated).

After the cell was filled with liquid the gap was closed until the electrodes just made contact (the point of contact was measured with an electronic gap setter) and the required gap length obtained by

adjustment of the micrometer head. Readings of the current were taken after five minutes application of the voltage. This was a purely arbitrary time and was chosen simply because the majority of transient phenomena which occur when first switching on had disappeared by this time, and the interval also allowed sufficient time to take miscellaneous observations such as particle movement etc.. To change the voltage the electrometer controls were set to "Set Zero" and the powerpack put on "Standby". This, in effect, placed a  $10^7$  ohm resistor across the gap while the voltage was being changed. The required voltage was then selected, the powerpack switched on to the desired polarity and the electrometer controls set on the correct range. This procedure took approximately 2 secs..

#### 2.6. Observation of particles.

Even though great care was taken to keep the inside of the apparatus and cell dust free, a certain number of solid particles were always present in the gap. These were most probably dust particles which settled on the electrodes from the atmosphere when the cell was opened for electrode polishing. They were extremely small and could only be seen by means of scattered light. The system used to observe them is shown in Fig.12. Light from the lamp A is focussed into the gap B through a hole in the metal screen C. Light scattered from the particles is observed by means of the microscope E, fitted with a long focus objective, which is mounted so that it is able to move in three mutually perpendicular directions; this enables the whole of the gap to be scanned.

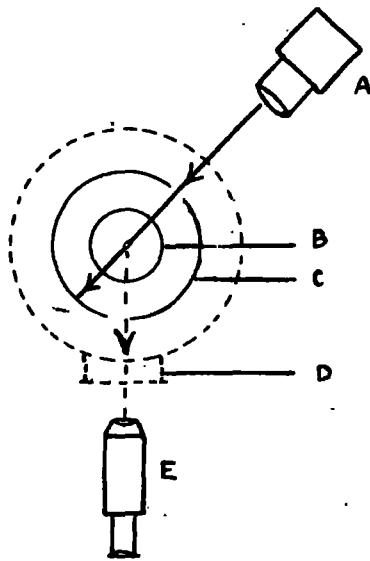

FIG.12. SYSTEM FOR VIEWING PARTICLES IN THE GAP.

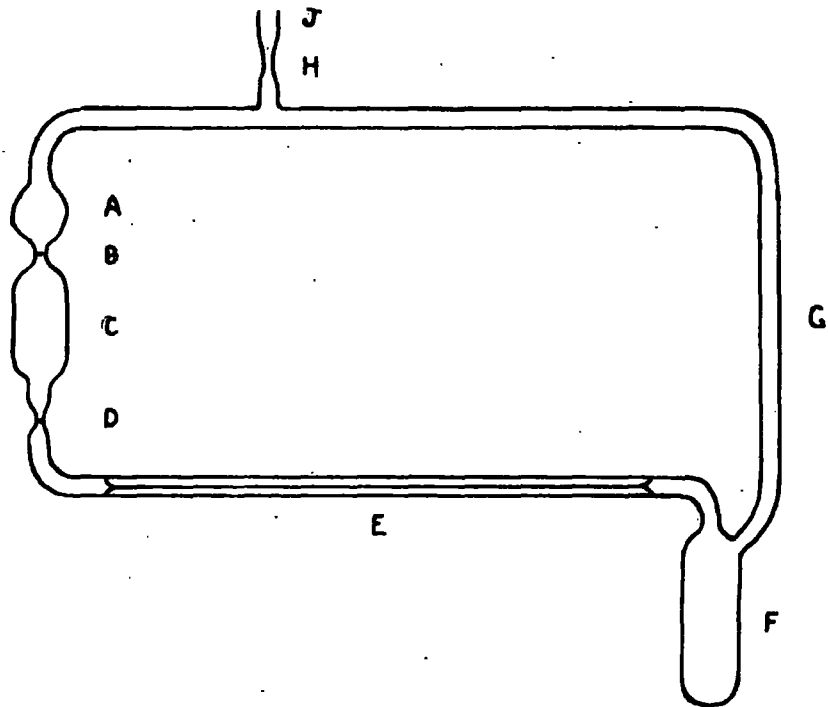

FIG.13. VISCOMETER.



## 2.7. The viscometer.

For comparing the viscosity of degassed and air-saturated hexane, the viscometer shown in Fig.13 was constructed. In this, A, C and F are reservoirs, and E is a horizontal capillary tube. B and D are narrow necks so that the velocity of flow of liquid past these points is comparatively high and enables the time taken for the liquid to flow past scratches on these necks to be measured with great accuracy. The connecting tube G ensures that the pressure due to the vapour above the surface of the liquid in A is the same as that above the liquid in F. This is made necessary by the fact that the pressure driving the liquid through the capillary tube is only of the order of 2mm Hg so that the difference in vapour pressures due to even a small difference of temperatures in the reservoirs could affect the results.

Viscosity is very temperature dependent and in order to avoid errors which would be caused by a variation of temperature the measurements were carried out with the viscometer immersed in a constant temperature bath. This consisted of a tank containing a large quantity of ice and water which was continuously stirred by means of a mechanical stirrer. Precise positioning of the viscometer for each measurement was ensured by placing it in a specially constructed rigid frame.

To fill the viscometer with degassed liquid it was connected to a suitable point on the high vacuum side of the degassing apparatus by means of the connection J. The liquid was degassed using the procedure described in Secs. 2.2.3 and 2.2.4 and then brought into the reservoir F by placing a Dewar full of liquid air round it. The viscometer was then sealed off at H and removed.

### 3. Experimental results.

#### 3.1. Introduction.

The experiments carried out are described in this chapter, as far as possible in the order they were carried out. The main aim of this project i.e. the examination and explanation of the high currents obtained, has already been described elsewhere, Sec. 1. Observations were made over a fairly wide range of conditions and it is necessary to give here a brief outline of all the experiments undertaken in order to show the connection between the facts presented. Before each section a further brief introduction is added so that it will not be necessary to refer back to a previous section to understand the reason for performing each particular experiment.

It is well known that many of the properties of solids, particularly the electrical conductivity of semiconductors, are greatly influenced by their impurity content. It was therefore thought necessary to analyse the liquids used in this project and a high resolution chromatography unit was built for this purpose. A grade of hexane which is known to have been widely used in this country for this type of work (Hexane, Special for Spectroscopy, Supplied by B.D.H.) was analysed with this apparatus and found to be only 80% pure.

Preliminary work on conduction, breakdown, particle movement, etc. was carried out in this liquid using spherical electrodes, mainly in order to reproduce the results obtained by Morant (2) who used the same apparatus. These conditions were, of course, far from

ideal and as soon as sufficient work had been done on spherical electrodes, plane electrodes were substituted. This was one step forward in the direction of simplicity. As soon as good purity hexane became available commercially in this country it was used, and the results became remarkably more reproducible.

At this stage it was suspected that the high currents might be linked with the shape of the liquid molecules. It was therefore considered necessary to carry out tests on liquids with similar chemical properties but with widely different molecular structures, and for this purpose cyclohexane, cyclopentane and 3-methyl pentane were chosen. The reason for this particular choice is made clear in Secs. 3.7.1., 3.8.1. and 3.10., in which the experimental work on these liquids is described, and in the discussion which follows, Sec. 5.4.8.

Viscosity measurements were carried out on degassed and air-saturated hexane because it was hoped that further information on the part played by absorbed air on the quenching of the high currents in hexane could be gathered from these measurements. Although throughout this project the main aim was to obtain an insight into the mechanism of the high currents, observations of the following phenomena were also made. (a) particle movement, (b) stability of the current, (c) measurements on microsecond pulses, (d) electrode effects, i.e. dependence of the current etc. on the electrode material and surface finish and (e) breakdown.

### 3.2. Chromatography.

All the liquids for which results are described in

this chapter have been analysed using the gas chromatography apparatus described in Secs. 2.1.2 and 2.1.4. The results of these analyses are given below.

3.2.1. Hexane (Special for Spectroscopy Grade, Supplied by B.D.H.).

A chromatogram of this liquid is shown in Fig.14. It can be seen to consist of 7 peaks, the largest of them, peak 5 being n-hexane, the others being impurities. From the ratio of the area beneath the impurity peaks to that beneath the hexane peak the ratio of impurity present to n-hexane is about 0.25, and the percentage of impurity present as a fraction of the whole liquid is approximately 20%. This is an important fact to bear in mind since much of the work published in this country as having been carried out in n-hexane is known to have been done in this grade of liquid and these published results must be viewed in this light.

By comparison with a chromatogram of a similar liquid made by Halasz and Schreyer (4), Fig.15, a guess at the identity of the impurities was made. A direct comparison could not be attempted because their column was coated with Apiezon grease and the one used here was coated with squalane, so that the relative retention times of the stationary phases of the two columns were different. On comparing the two Chromatograms, Figs.14 and 15, it is seen that the impurities in the spectroscopic grade hexane are most probably the hexane isomers i.e. 2,2 dimethyl butane, 2,3 dimethyl butane, 2-methyl pentane and 3-methyl pentane. Chromatograms were therefore taken of these

liquids and these are shown in Figs.16,17,18 and 19. The large peak in each case corresponds to the liquid stated, and the small peaks are impurities.

When the retention times of these liquids are compared with those of the impurity peaks shown in Fig.14, it can be seen that peak 4 corresponds to 3-methyl pentane, peak 3 can correspond to both 2,3 methyl butane and 2-methyl pentane and 2,2 methyl butane is not present at all. These were then identified by the standard chromatographic procedure of adding a small quantity of the suspected compound and seeing if the peak of the new compound coincides with that of the unknown peak. A small quantity of one of the isomers was added to the hexane and a chromatogram taken. This was repeated for all the isomers and their chromatograms are shown in Figs. 20,21,22 and 23. Thus it is seen that 3-methyl pentane coincides with peak 4 and both 2-methyl pentane and 2,3 methyl butane with peak 3.

Fig.20 shows a chromatogram of spectroscopic grade hexane with an equal quantity of 2,2 dimethyl butane added. This chromatogram has eight peaks and reading from left to right the peaks are as follows:

- 6 n-hexane
- 5 3-methyl pentane
- 4 2-methyl pentane or 2,3 methyl butane  
or both.
- 3 2,2 methyl butane,

and comparing this with the chromatogram shown in Fig.15, it would seem that peak 2 is n-pentane.

The same method of testing was then carried out for pentane as for the isomers and its chromatogram and

that of the mixture are shown in Figs.24 and 25 respectively. This establishes peak 2 as n-pentane. The similarity between the chromatograms shown in Figs.15 and 20 is now seen to be very strong and the remaining peaks can with reasonable certainty be stated to be the following :-

- 1 iso-pentane
- 6 2,4 dimethyl pentane
- 7 methyl-cyclopentane.

A table is given below of the estimated percentage present of each substance in the mixture.

Iso-pentane	0.1%
n-pentane	1.6%
2 methyl-pentane or 2,3 methyl butane or both	3.8%
3 methyl-pentane	5.1%
n-hexane	77.0%
2,4 dimethyl-pentane	11.7%
methylcyclopentane	0.7%

It must be emphasised that other impurities might be present to which the detector is insensitive i.e. those which have ionization potentials greater than 11.6eV (see Sec. 2.1.4.) so the above analysis gives the minimum impurity content.

### 3.2.2. Pure hexane.

The purer grade of hexane used in this work was supplied by L. Light and Co. and it is believed that

they in turn obtained it from Philips Petroleum Co., U.S.A. It is claimed by the suppliers to be not less than 99% pure, and may be as good as the best Philips n-hexane which is claimed to be 99.9% pure. The chromatogram taken of this liquid is shown in Fig. 26, and has two impurity peaks, 1 and 3. From a comparison with the chromatogram of the spectroscopic grade hexane, Fig. 14, these are seen to be 3 methyl-pentane and 2,4 dimethyl pentane respectively. The estimated percentage of each of these impurities is about 0.034% so that the total impurity content is approximately 0.07%. This is roughly ten times more pure than is claimed by the suppliers so that in actual fact there are probably other impurities which have not been detected in the analysis.

### 3.2.3. Cyclohexane.

The cyclohexane used was supplied by Hopkin and Williams Ltd., with a specified boiling range 95% minimum between 79 and 81°C. Its chromatogram is shown in Fig. 27. It can be seen to have a double impurity peak 1, besides the large peak 2 which corresponds to cyclohexane. The exact nature of the impurities is not known since they do not coincide with any of the peaks in the chromatogram of spectroscopic grade hexane, and a separate analysis was not attempted. From the area beneath the peaks the estimated impurity content is 0.5%.

### 3.2.4. Cyclopentane.

The cyclopentane was obtained from L. Light and Co. and was stated to be 95% pure. Its chromatogram is shown in Fig. 28. The single impurity shown in the

NOTE: ALL THE CHROMATOGRAMS SHOWN HERE HAVE BEEN TRACED FROM THE ORIGINALS.

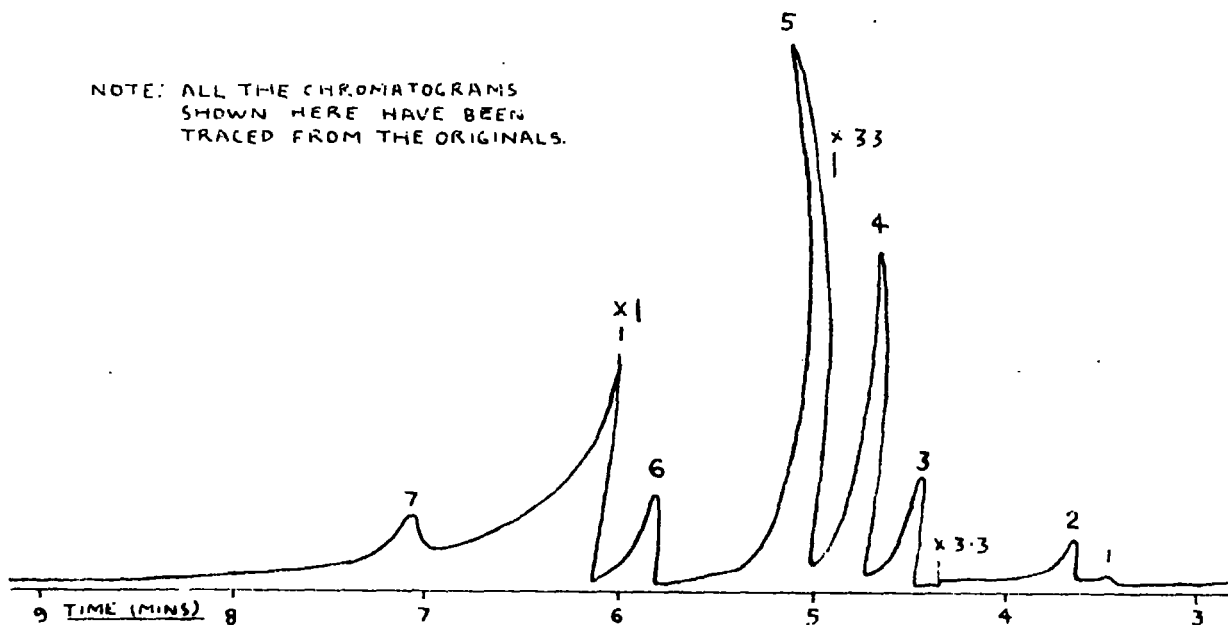

FIG. 14. CHROMATOGRAM OF HEXANE (SPECIAL FOR SPECTROSCOPY, SUPPLIED BY B.D.H.)

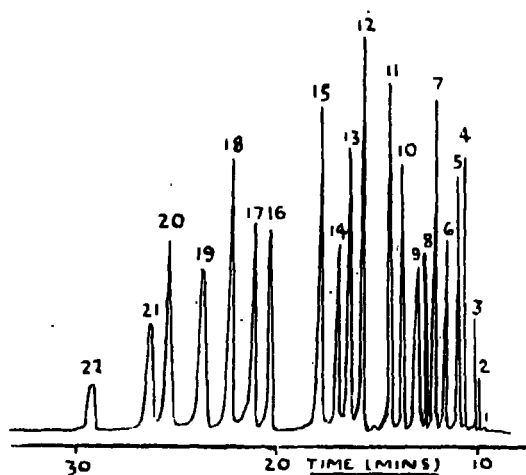

FIG. 15. CHROMATOGRAM OF A MIXTURE OF HYDROCARBONS (TAKEN FROM THE ORIGINAL BY HALASZ AND SCHREYER).

- 1) PROPANE
- 2) ISO-BUTANE
- 3) n-BUTANE
- 4) ISO-PENTANE
- 5) n-PENTANE
- 6) 2,2-DIMETHYLBUTANE
- 7) 2-METHYLPENTANE AND 2,3-DIMETHYLBUTANE
- 8) 3-METHYLPENTANE
- 9) n-HEXANE
- 10) 2,4-DIMETHYLPENTANE
- 11) METHYLCYCLOPENTANE
- 12) 2,3-DIMETHYLPENTANE
- 13) 2,2,4-TRIMETHYLPENTANE
- 14) n-HEPTANE
- 15) 2,2,4-TRIMETHYLPENTANE
- 16) METHYLCYCLOHEXANE
- 17) 2,3,4-TRIMETHYLPENTANE
- 18) 2,2,5-TRIMETHYLHEXANE
- 19) OCTEN . 1
- 20) n-OCTANE
- 21) CIS-1,4-DIMETHYLCYCLOHEXANE
- 22) TRANS-1,4-DIMETHYLCYCLOHEXANE



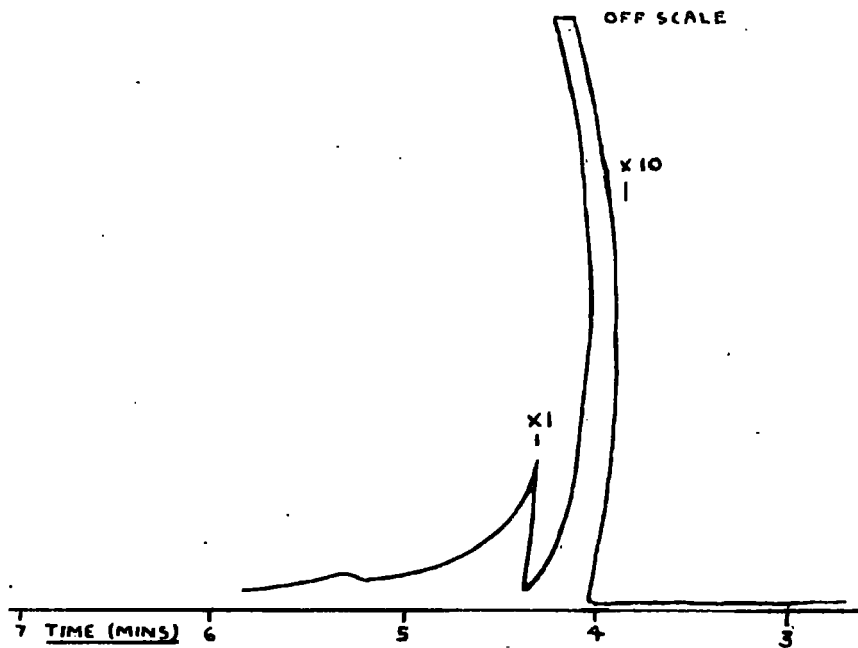

FIG. 16. CHROMATOGRAM OF 2,2-DIMETHYLBUTANE.

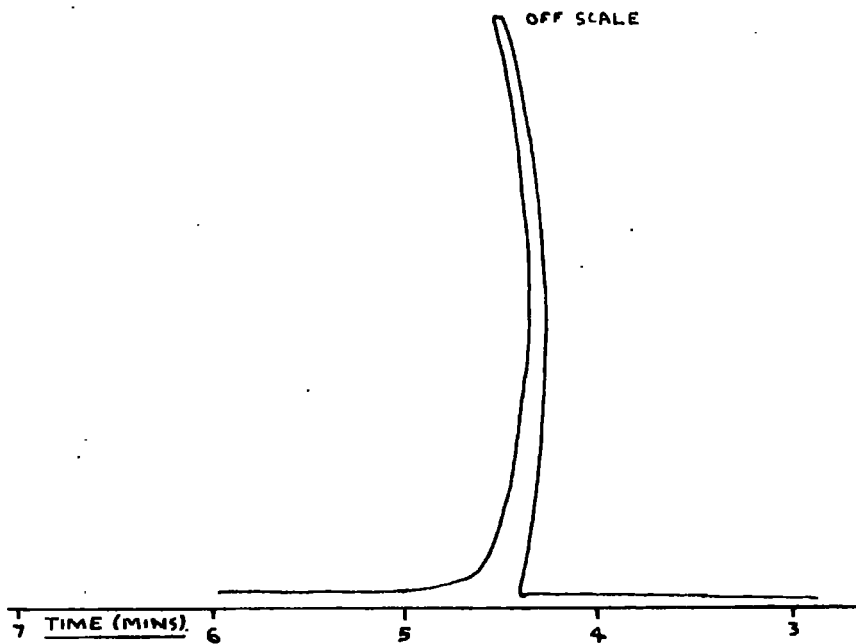

FIG. 17. CHROMATOGRAM OF 2,3-DIMETHYLBUTANE.

ST ANDREWS UNIVERSITY LIBRARY  
INTER-LIBRARY LOANS

\*\*\*\*\*

30 MAY 1996

UN90274

If not collected return to:  
INTER-LIBRARY LOANS  
UNIVERSITY LIBRARY

RESTRICTED ACCESS

The following item has been lent to us on the condition that it is consulted only in the LIBRARY. Please call at the SERVICE DESK with this notification before 06 JUN 1996. Also, bring this notification on each subsequent visit. If you do not renew the item within 3 days of DATE DUE BACK, it will be returned.

£2.00 Renewal fee.

DUE BACK: 16 JUL 1996 (CAN BE RENEWED)

KAHAN, E  
Ph.D. UNIV DURHAM 1964

To:  
MR M CHAAR  
RADIATION BIOPHYSICS  
THE OBSERVATORY  
(SCHOOL OF PHYSICS &  
ASTRONOMY)

CHAAR

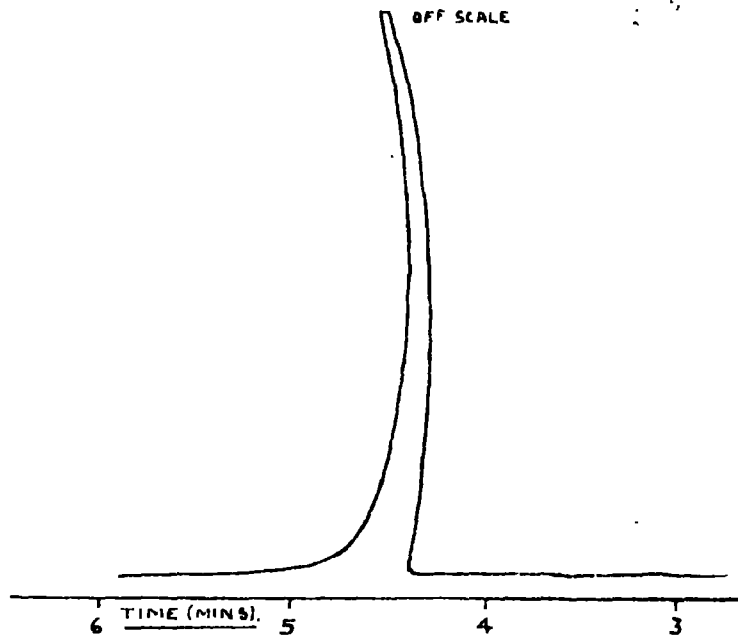

FIG. 18. CHROMATOGRAM OF 2-METHYLPENTANE.

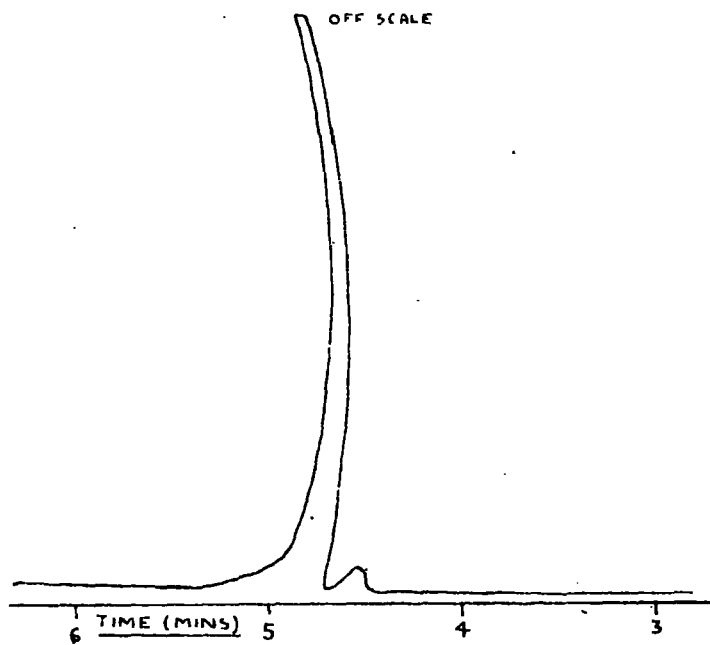

FIG. 19. CHROMATOGRAM OF 3-METHYLPENTANE.

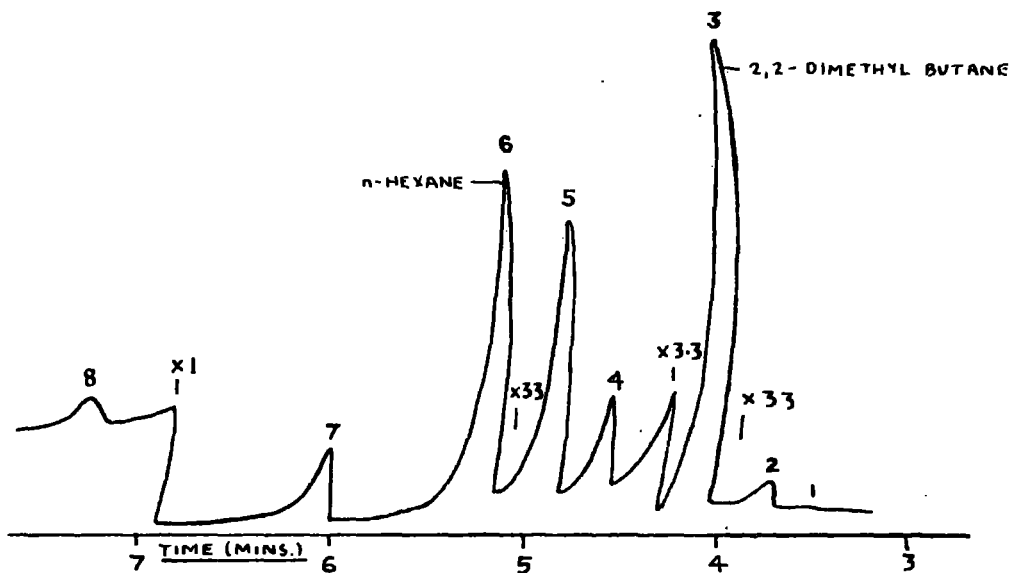

FIG. 20. CHROMATOGRAM OF HEXANE + 2,2-DIMETHYL BUTANE.

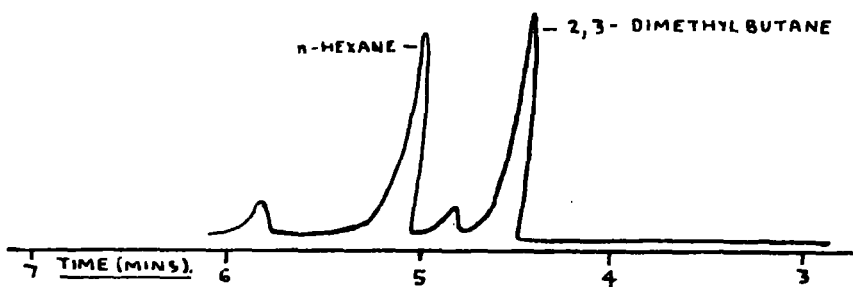

FIG. 21. CHROMATOGRAM OF HEXANE + 2,3-DIMETHYL BUTANE.

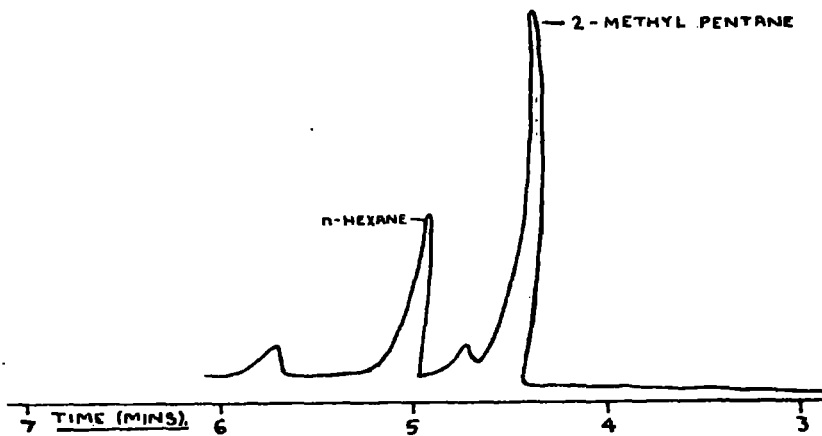

FIG. 22. CHROMATOGRAM OF HEXANE + 2-METHYL PENTANE

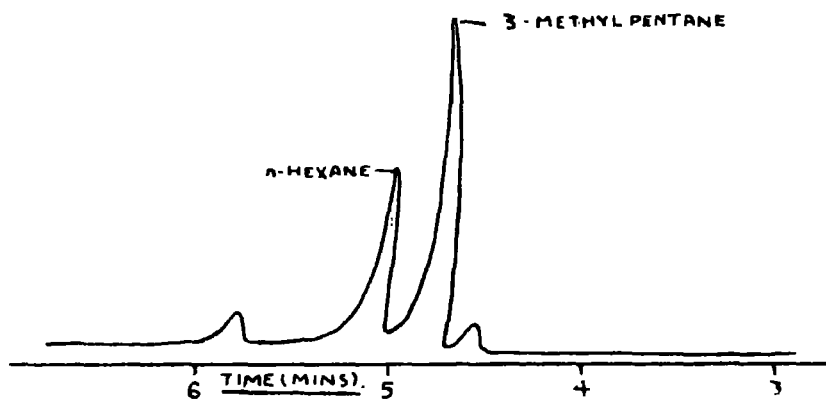

FIG. 23. CHROMATOGRAM FOR HEXANE + 3-METHYL PENTANE.

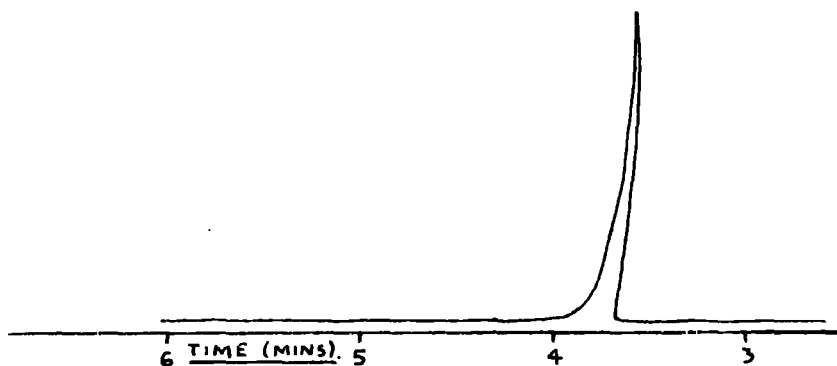

FIG. 24. CHROMATOGRAM FOR n-PENTANE.

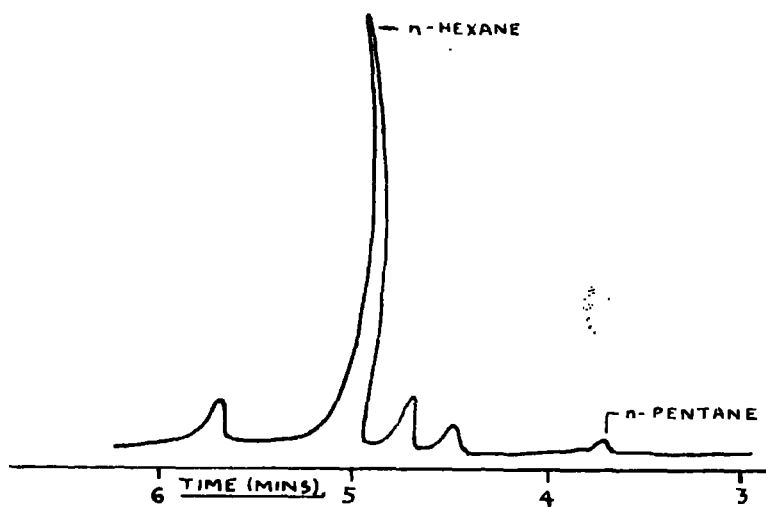

FIG. 25. CHROMATOGRAM FOR HEXANE + n-PENTANE.

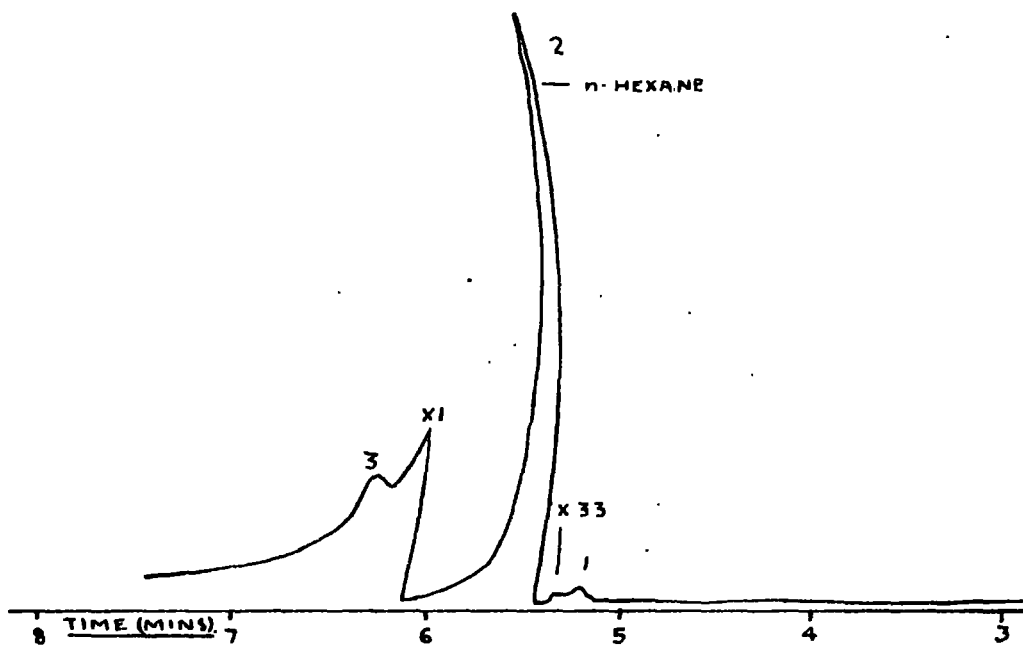

FIG. 26. CHROMATOGRAM OF HIGH PURITY HEXANE  
(99% PURE, SUPPLIED BY L. LIGHT AND CO.).

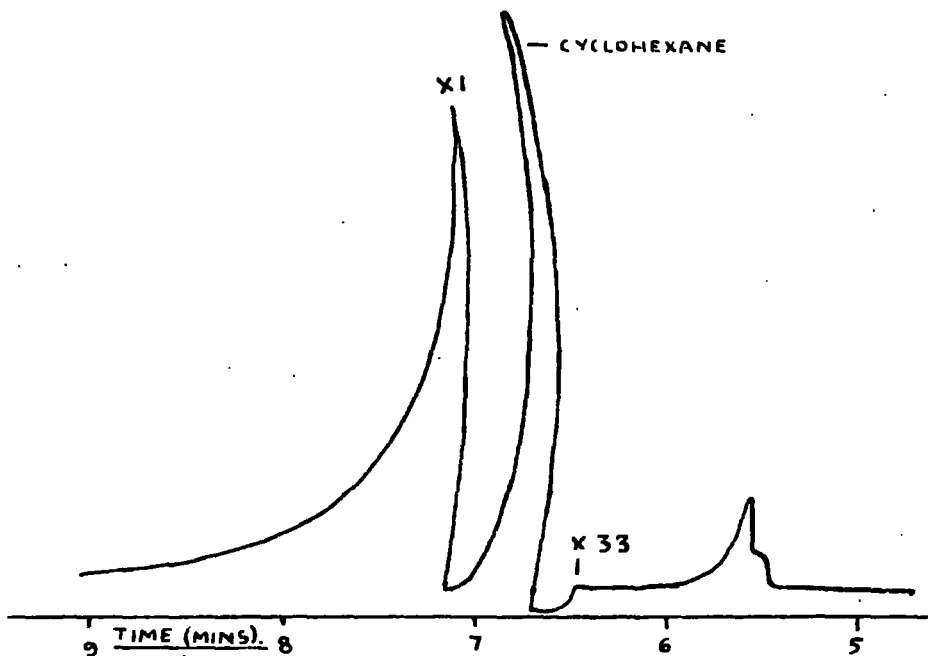

FIG. 27. CHROMATOGRAM OF CYCLOHEXANE (SUPPLIED BY  
HOPKIN AND WILLIAMS LTD.).

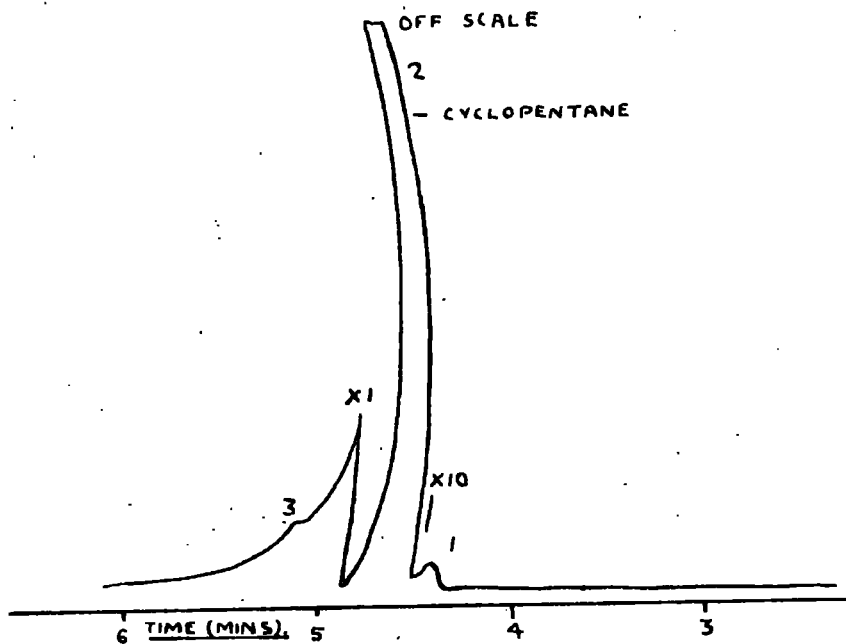

FIG. 28. CHROMATOGRAM OF CYCLOPENTANE.  
(SUPPLIED BY L. LIGHT AND CO.)

chromatogram has not been positively identified, but by comparison with the chromatogram of the spectroscopic grade hexane it appears to be either 2,3 dimethyl butane or 2-methyl pentane or a mixture of both. The proportion of this impurity is of the order of 0.25% i.e. very much less than 5% quoted by the suppliers. It is just possible that there are other impurities present which cannot be analysed by the chromatography apparatus used here.

### 3.3. Results obtained in spectroscopic grade hexane using spherical electrodes.

#### 3.3.1. Introduction.

It has already been mentioned in Sec. 3.1. that this work is a continuation of that done by Morant (2), who used 1 cm diameter, chromium-plated, spherical electrodes in spectroscopic grade hexane, and a certain amount of preliminary work was therefore done under these conditions to repeat Morant's work. This also served as a useful starting point to compare the present results with those of other investigators e.g. House (3) and Sletton (1), who used similar conditions, and showed quite clearly the enormous difference in currents obtained in this project and that found by other workers. Although the results obtained under these conditions were only of a preliminary nature they are described in full detail since many of the later measurements are similar.

All the results in the following pages refer to liquid samples purified and distilled using the standard procedure described in Secs. 2.2.3 and 2.2.4. and with the standard electrode preparation,



Sec. 2.3.1., except where otherwise stated. It must be emphasized that the results refer to highly degassed liquid sealed off in a non-contaminating test cell under high vacuum, and for that reason are thought to be more characteristic of the pure state than previously published work.

### 3.3.2. The current-voltage characteristic and reproducibility of the results.

Fig. 29 shows the general dependence of the current on the applied voltage. This merely shows a typical set of results because, as it will be soon made clear, the reproducibility was extremely poor and the scatter was too great to be certain about the intrinsic conductivity of the liquid at any point of the characteristic. In all the current-voltage graphs in this work the current has been plotted against field strength assuming this to be  $E = V/d$  where  $V$  is the applied voltage and  $d$  is the gap length. Unless otherwise stated, the points refer to the value of the current five minutes after the application of the voltage as described in Sec. 2.5.

In spectroscopic grade hexane the  $(I,V)$  characteristic can be divided into what appears to be two distinct regions, (1) a region in which the current lies between  $10^{-14}$  and  $10^{-10}$  A, and (2) a region in which the current is of the order of  $10^{-7}$  to  $10^{-6}$  A, with only occasional points lying in between these two regions. For ease of reference these two regions will be referred to as the low current and the high current regions respectively.

In the low current region even though increasing the voltage did not always produce an increase in

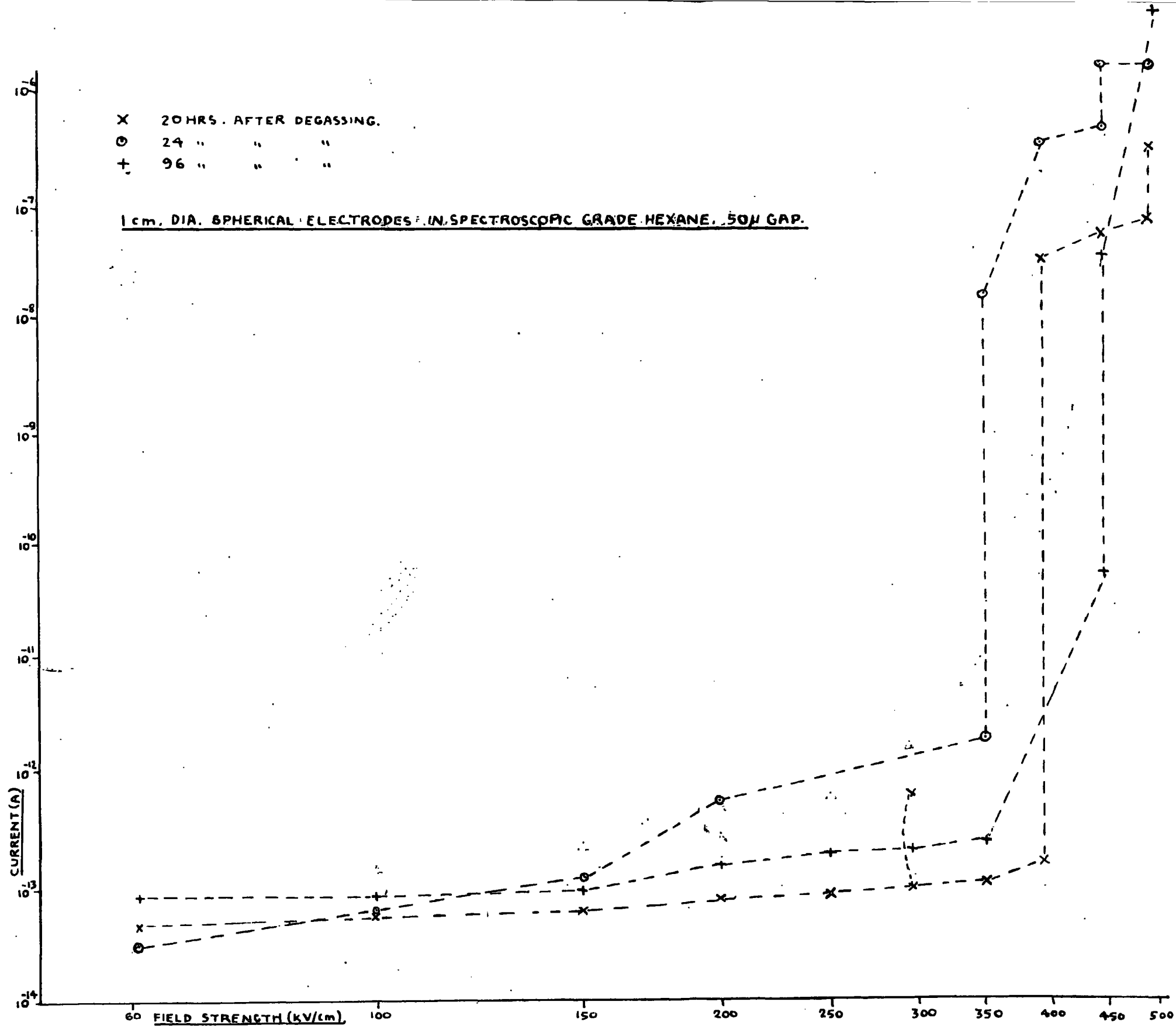

FIG. 29. DEPENDENCE OF THE (I,V) CHARACTERISTIC FOR SPHERICAL ELECTRODES IN SPECTROSCOPIC GRADE HEXANE ON THE AGE OF THE LIQUID.

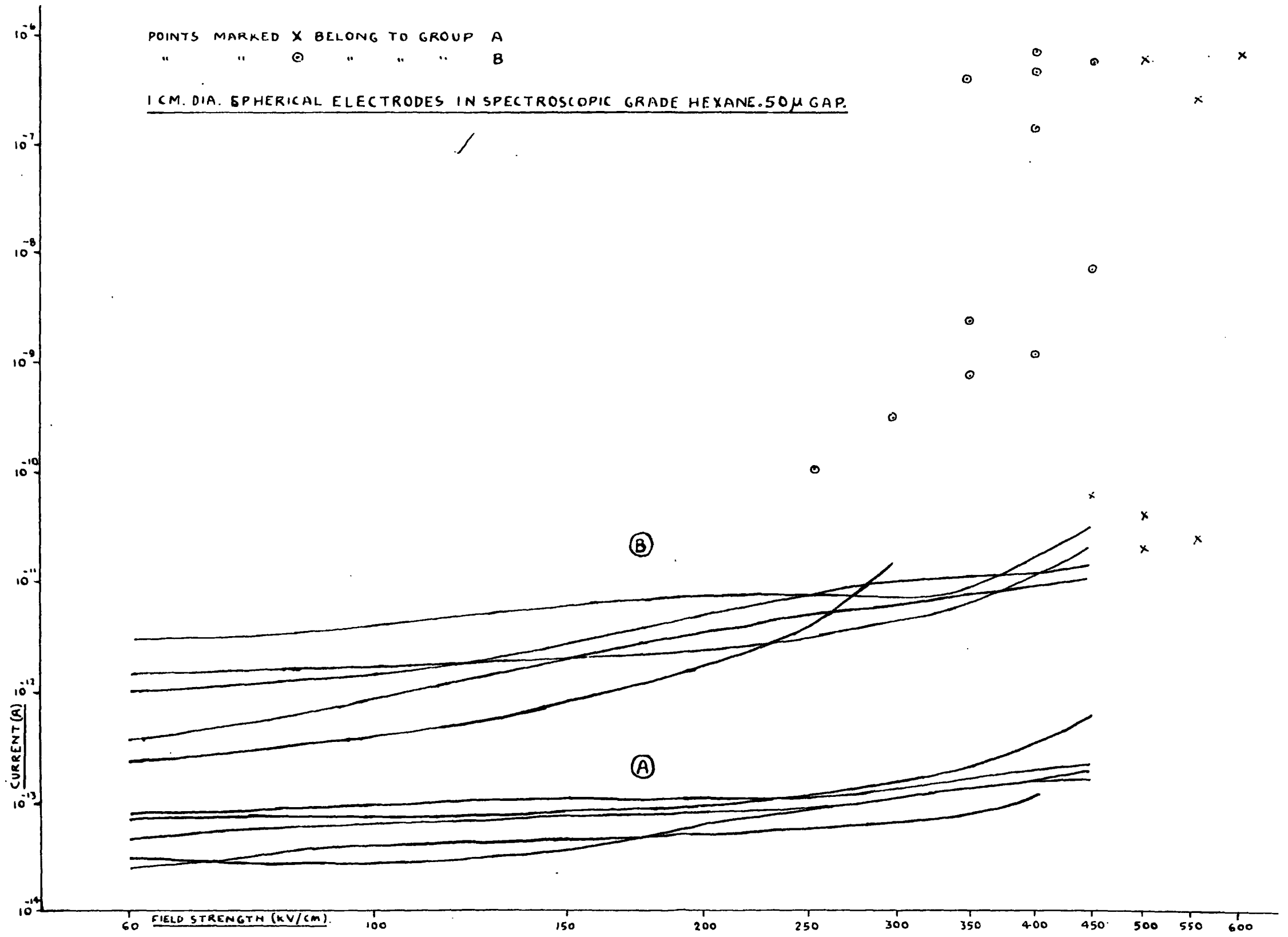

FIG. 30. THE REPRODUCIBILITY OF THE (I,V) CHARACTERISTIC FOR SPHERICAL ELECTRODES IN SPECTROSCOPIC GRADE HEXANE.

current, there was nevertheless a relationship between voltage and current, see Figs. 29 and 30. However, in the high current region, except for the fact that the current was in this region, there appeared to be no relationship between the current and the voltage; this is particularly evident in Figs. 29 and 31.

The transition from the low to the high current region was discontinuous and could take place either suddenly or over a period of several seconds, even though the voltage was kept constant. The field strength at which this transition occurred varied from test to test but was never lower than about 350kV/cm. When a high current was established its value was not always constant but could vary by as much as 2 or 3 orders of magnitude, staying at each level for as much as several minutes at a time.

The order of reproducibility of the results can be seen from Fig. 30. Two sets of results for two typical series are shown, these particular sets having been chosen because of the wide divergence of current values in the low current region. For the sake of clarity individual points have not been drawn on the curves in the low current region.

In the low current region the current did not vary by more than a factor of 10 in a particular series of tests. However, between different series the range of variation could be as large as 3 orders of magnitude. From the tests carried out with plane electrodes, where a record was kept of the number of tests which were done on liquid from a particular bottle, it seems that the variation is due to the difference between the liquids in the different bottles, (see

Sec. 3.4.3. for fuller details). On the other hand the maximum value of the high currents is in the region of  $10^{-7}$  to  $10^{-6}$  A irrespective of the difference in the low current values. In spite of the reproducibility of the maximum value of the high currents, the intermediate values of current in this region were not reproducible and there were several occasions on which there were no high currents at all even though they were present in other tests on the same sample.

### 3.3.3. Dependence of the current-voltage characteristic on the age of the liquid

The current - voltage characteristic might be expected to depend on the age of the liquid i.e. the time after sealing it off in the testing system. There could be several possible reasons for this. One could be variation of the electrode surfaces caused either by oxidation or by contamination by impurities from the liquid. Another possibility is a change in the liquid itself caused by its exposure to light while it is in the transparent testing system. Even though this is unlikely in the hexane itself, the exact nature of the impurities is unknown and these might well be susceptible to damage from visible radiation. Damage to the chemical structure of the liquid by the high field is also a possibility which cannot be ruled out, although such a change could not be detected in the present cell because of the minute fraction of the liquid which is exposed to the field during a test.

It can be seen from Fig. 29 that there is no correlation between the age of the liquid and the

characteristic i.e. the values of the low and high currents, the field strength at which the high currents commence and the smoothness of the curves in both the high and low current ranges. This is an important result because it took several days to carry out each series of tests, and any change due to the age of the liquid would have affected the interpretation of the results. This also demonstrates that the testing system is capable of maintaining a good vacuum for a considerable period of time since the presence of air would have resulted in the disappearance of the high currents (see Sec. 3.5.).

In spite of this, a series of tests was never prolonged beyond several days after the distillation because there was no absolute check of the vacuum in the test cell once it had been disconnected from the main system.

#### 3.3.4. Dependence of the characteristic on gap length.

Although there is some controversy as to whether or not there is a dependence of the characteristic on gap length, (3), (7), (9), there has never been any evidence to suggest such a dependence at the field strengths used in this investigation i.e. up to about 500kV/cm. However, the present series of tests is unique in the attainment of prolonged high currents and it was considered important to see if a relationship could be observed between these high currents and the length of the gap. In particular, if the high currents are due to heating effects in the bulk of the liquid it would be expected that high currents would be established at lower field strengths when a

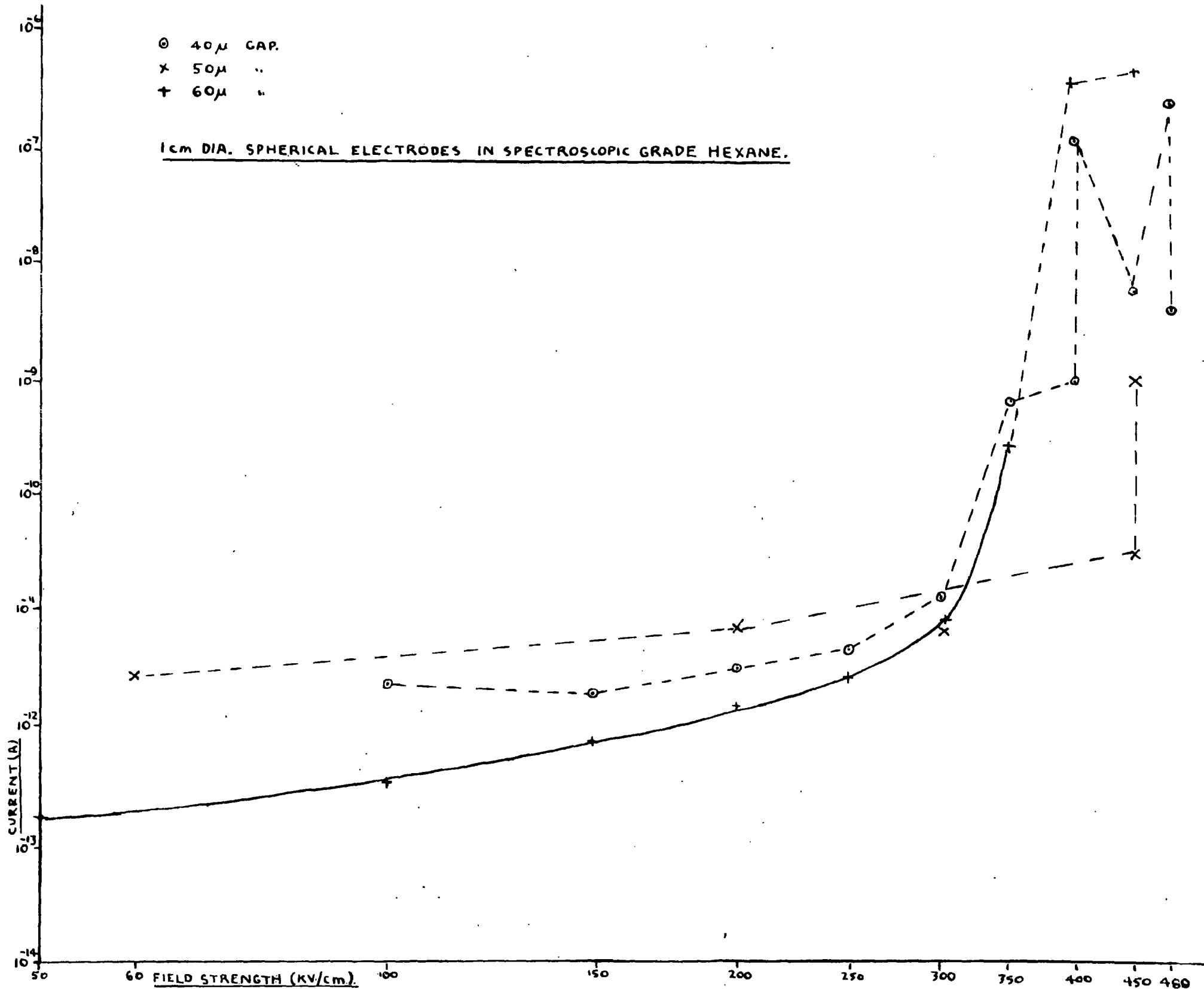

FIG. 31 THE DEPENDENCE OF THE (I,V) CHARACTERISTIC FOR SPHERICAL ELECTRODES IN SPECTROSCOPIC GRADE HEXANE ON GAP LENGTH.

greater gap length is used, since with a longer gap a larger quantity of heat is generated at a given field strength and current. This follows immediately from the simple relationship  $W = VI = EdI$  where  $W$  is the power dissipated in the gap,  $V$  is the applied voltage,  $I$  is the current,  $E$  is the field strength and  $d$  is the gap length.

In Fig. 31 results are shown for a single sample of liquid for gap lengths of  $40\mu$ ,  $50\mu$  and  $60\mu$ . The lower limit of the gap length was set by solid particles. It was found that with a gap length of less than about  $40\mu$ , solid particles would often bridge the gap, and, although they did not cause a breakdown, the current became high and erratic (see Sec. 3.11.5.) and were obviously not a measure of any intrinsic property of the liquid. In fact, even if the particle did not bridge the gap but was large enough to be comparable with the gap length, the measurements were considered suspect. The upper limit was simply set by the maximum voltage output of the voltage supply, which was 3,300V.

As can be seen from Fig. 31 there is no noticeable change in any part of the characteristic. In particular, the field strength at which the transition from low to high current takes place shows no dependence on gap length. With the  $50\mu$  gap the high currents are about one order of magnitude lower than those of the  $40\mu$  gap, while the currents in the high current region for the  $60\mu$  gap are a little higher than those for the  $40\mu$  gap. These conclusions are well borne out by other tests and the results shown in Fig. 31 are typical.



### 3.3.5. Effect of prestressing the gap.

Prestressing the gap with a steady voltage is known to alter the breakdown strength of liquid dielectrics (8). With regard to conduction House (3) used prestressing to obtain reproducible results at very high fields. In fact he found that he could not proceed beyond a field strength of approximately 200kV/cm without a breakdown occurring if the liquid had not been previously stressed. It is quite possible that the applied stress itself changes the liquid in some way and any measurements taken after such prestressing are thus open to question. However, they have been included here because they may help to throw light on the basic processes of conduction.

Fig. 32, curve 1 shows the usual characteristic obtained from a sample which had not been previously stressed and with the cell freshly filled from the reservoir. Curve 2 was obtained by prestressing the gap at a field strength of 400kV/cm for approximately 30 mins. before the commencement of the test. The measurements were then taken in the normal manner, starting at 60kV/cm and increasing the voltage at regular 5 minute intervals up to 480kV/cm. There is a striking difference in the continuity of the two curves. Curve 1 follows the usual irregular and discontinuous pattern found with the unstressed liquid whereas curve 2 is regular and continuous. Insufficient readings were taken over the part shown broken in curve 2 for it to be drawn with certainty, although the curve has been drawn as shown on the strength of the results obtained under identical

conditions with plane electrodes (see Sec. 3.6.3.). The high currents may appear at a somewhat lower field strength in the stressed liquid but this may not be significant in view of the poor reproducibility. It is interesting to note that the point on curve 2 at 480kV/cm still lies on the curve even though the liquid was only prestressed at 400kV/cm. However, there is insufficient evidence to show whether this is a reproducible result or not.

The curves shown in Fig. 33 were produced by a slightly different type of prestressing. Curve 1 in this figure was obtained in the usual manner without any prestressing. For curve 2, the liquid was not removed from the cell after the previous test but the gap was increased from 40u to 60u and approximately 15 minutes later a second test was carried out. The prestressing in this case was in fact the voltage applied during the previous test. It is seen that curve 2 in Fig. 33 closely follows that for the stressed liquid in Fig. 32, particularly in the high current region. Since the results shown in Figs. 32 and 33 were obtained from two different series of tests the fact that they differ in magnitude in the low current region is not significant (see Sec. 3.3.2).

A third type of prestressing is shown in Fig. 34. In this the current - voltage curve was first taken in the forward direction in the normal manner, and still using the same liquid in the cell, values of current for a series of reducing voltage steps were recorded. The curve is again smooth for the stressed liquid with a possible discontinuity at 200kV/cm. However this curve does not seem to be typical in view

of the fairly large number of curves later obtained in this manner with plane electrodes (see Sec.3.4.6). Since this procedure was only carried out once with spherical electrodes it is difficult to estimate what weight is to be ascribed to this particular set of results.

Comparing the results obtained by prestressing the liquid it seems that the effect of prestressing is associated with the liquid rather than with the electrodes. If it were an electrode effect it might be expected that it would still be present when the cell is refilled from the reservoir, since merely running the liquid out of the cell is unlikely to affect the structure of the electrodes. In Fig. 31 even though for each test other than the first the liquid had been prestressed by the application of voltage during the previous test (in fact the process used to produce the results in Fig. 33 in which a marked effect was produced by prestressing) no effect of this prestressing was observed.

It might be inferred from the results obtained by prestressing the gap and then increasing its length, that the effects of prestressing are localised at the electrodes, for otherwise the extra liquid flowing into the gap when it is increased would destroy any prestressing effect in the bulk of the liquid. However, this would only be true if the liquid redistributes itself as shown in Fig. 35A. What might well happen is that the liquid redistributes itself as shown in Fig. 35B, so that as far as the high field region of the gap is concerned the majority of the liquid present has in fact been prestressed.

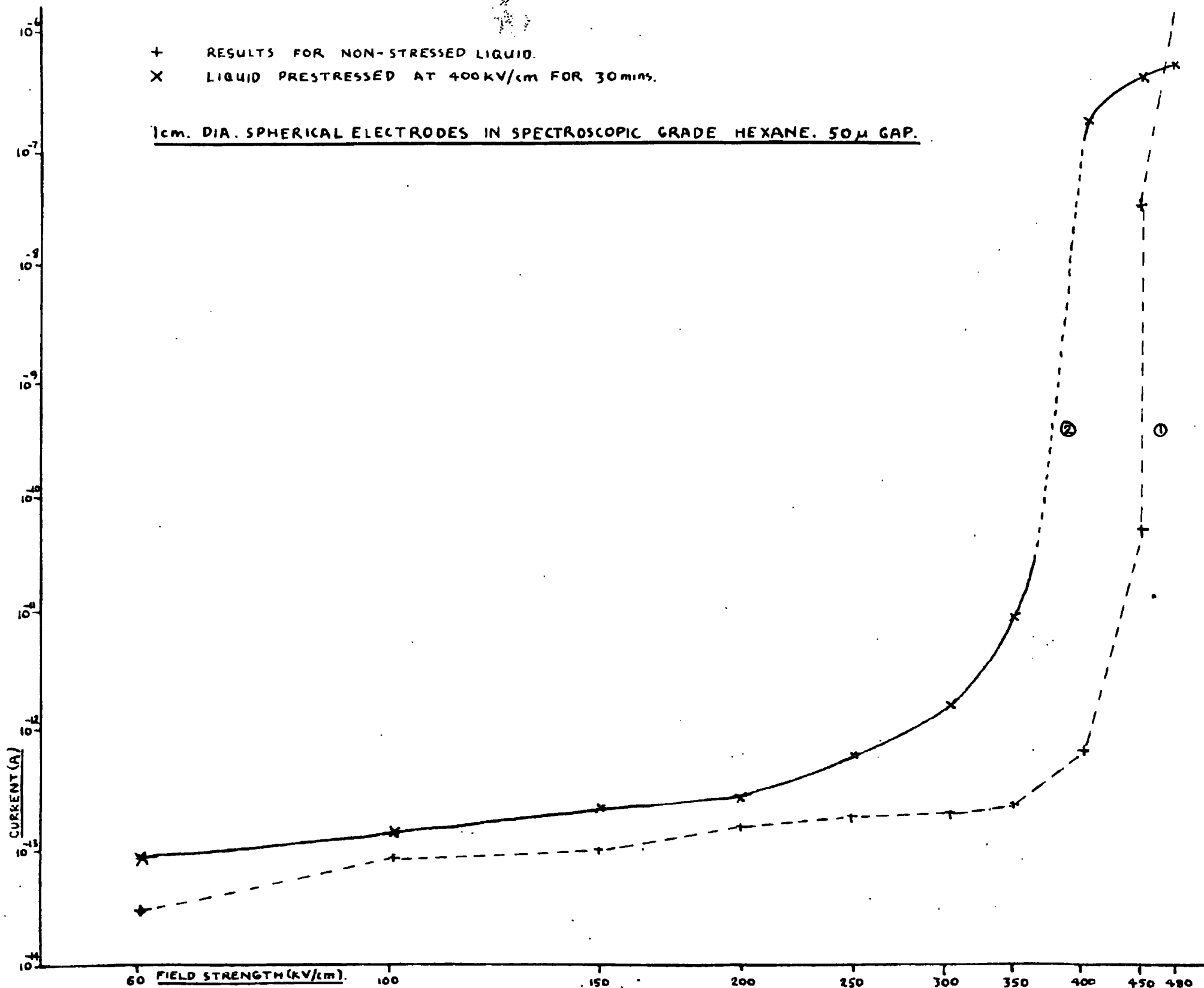

FIG. 32. THE (I,V) CHARACTERISTIC FOR SPECTROSCOPIC GRADE HEXANE PRESTRESSED AT 400 kV/cm FOR 30 mins.

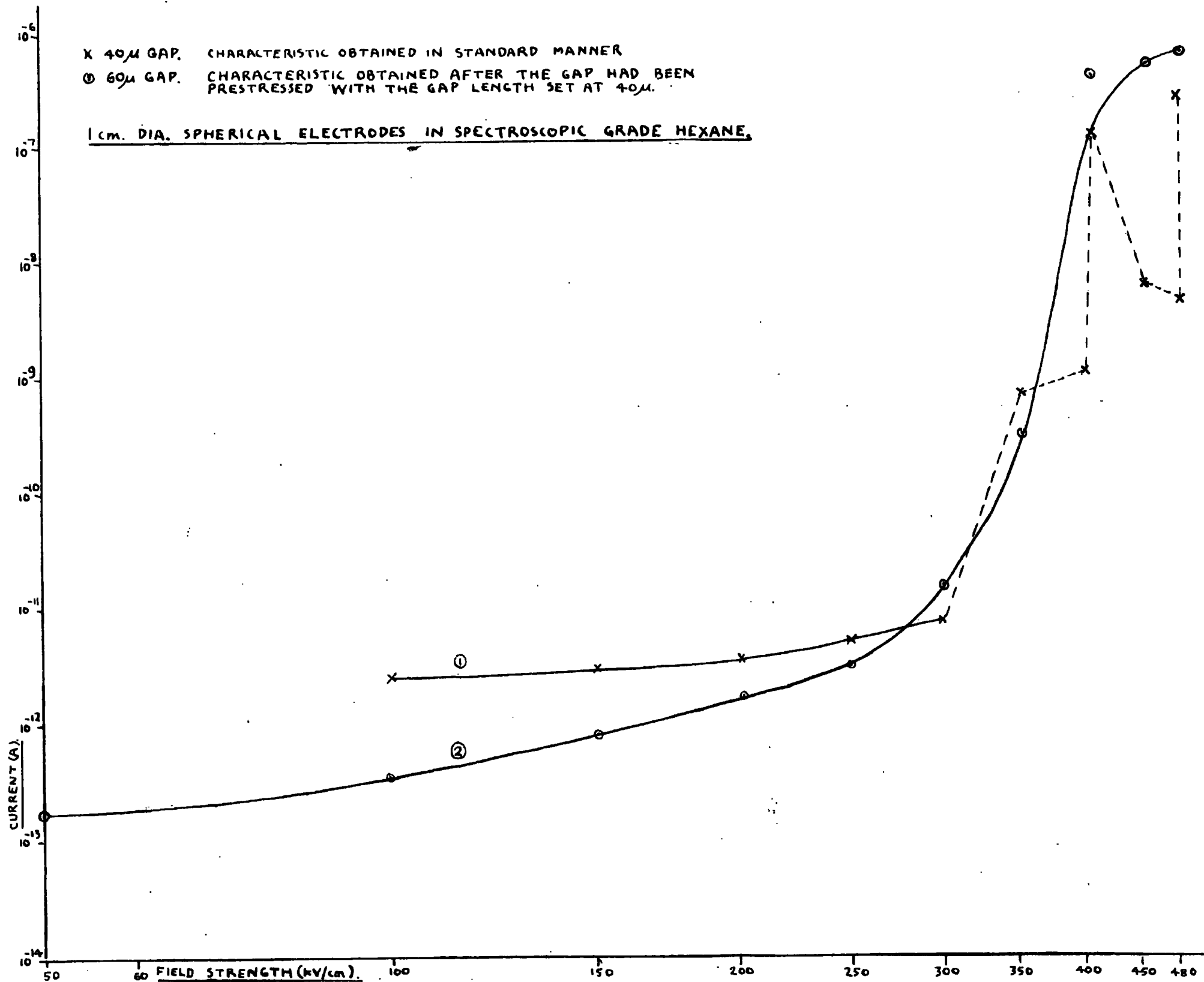

FIG. 33. THE EFFECT ON THE (I,V) CHARACTERISTIC OF INCREASING THE GAP LENGTH AFTER PRESTRESSING.

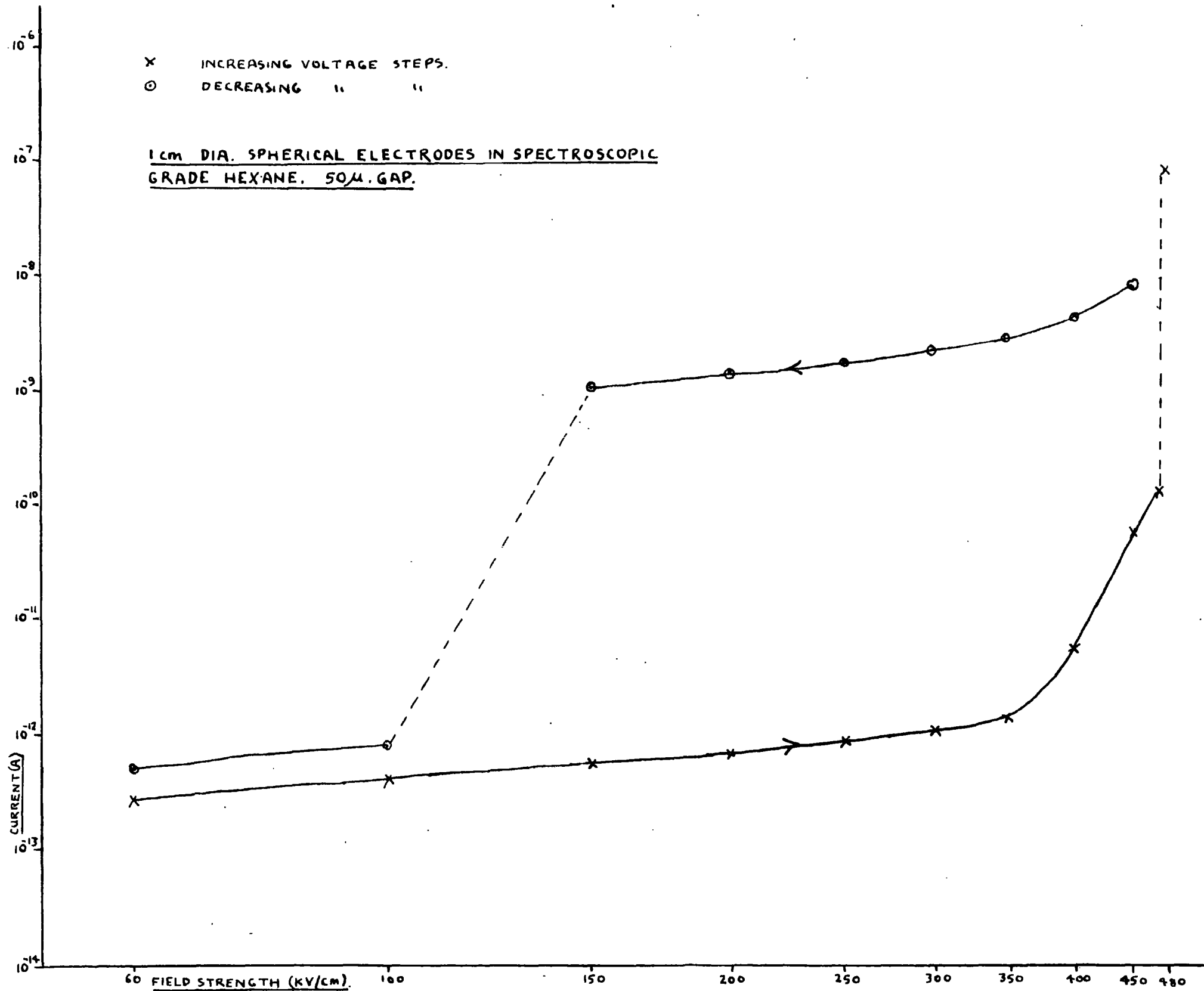

FIG. 34. THE (I,V) CHARACTERISTIC FOR INCREASING AND DECREASING VOLTAGE STEPS.

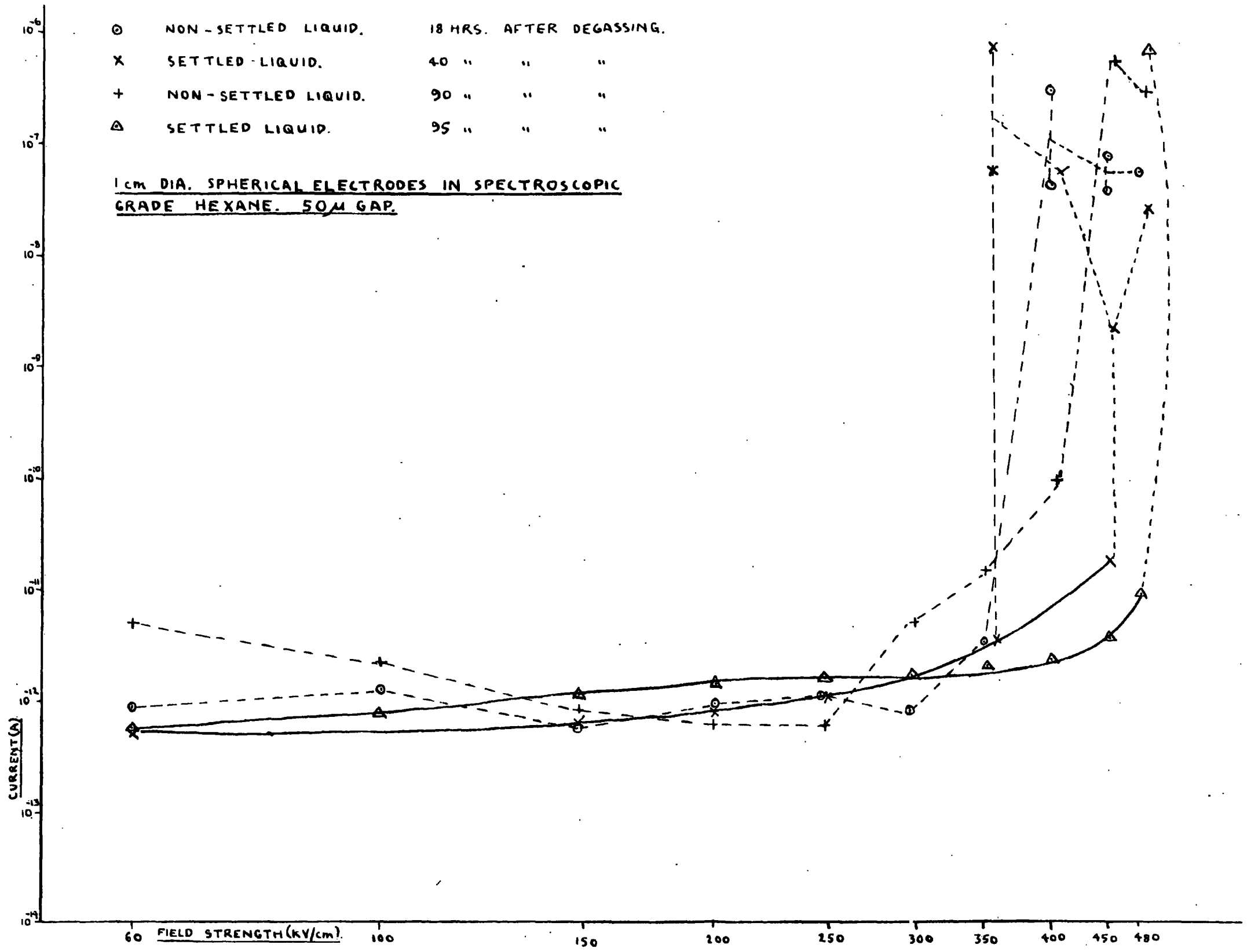

FIG. 37. THE EFFECT OF SETTLING ON THE (I,V) CHARACTERISTIC FOR SPHERICAL ELECTRODES IN SPECTROSCOPIC GRADE HEXANE.

○ 3 HRS. AFTER DEGASSING.  
 X " " "  
 + " " "  
 △ " " "

3 MM PLANE ELECTRODES IN SPECTROSCOPIC  
GRADE HEXANE . 50μ GAP.

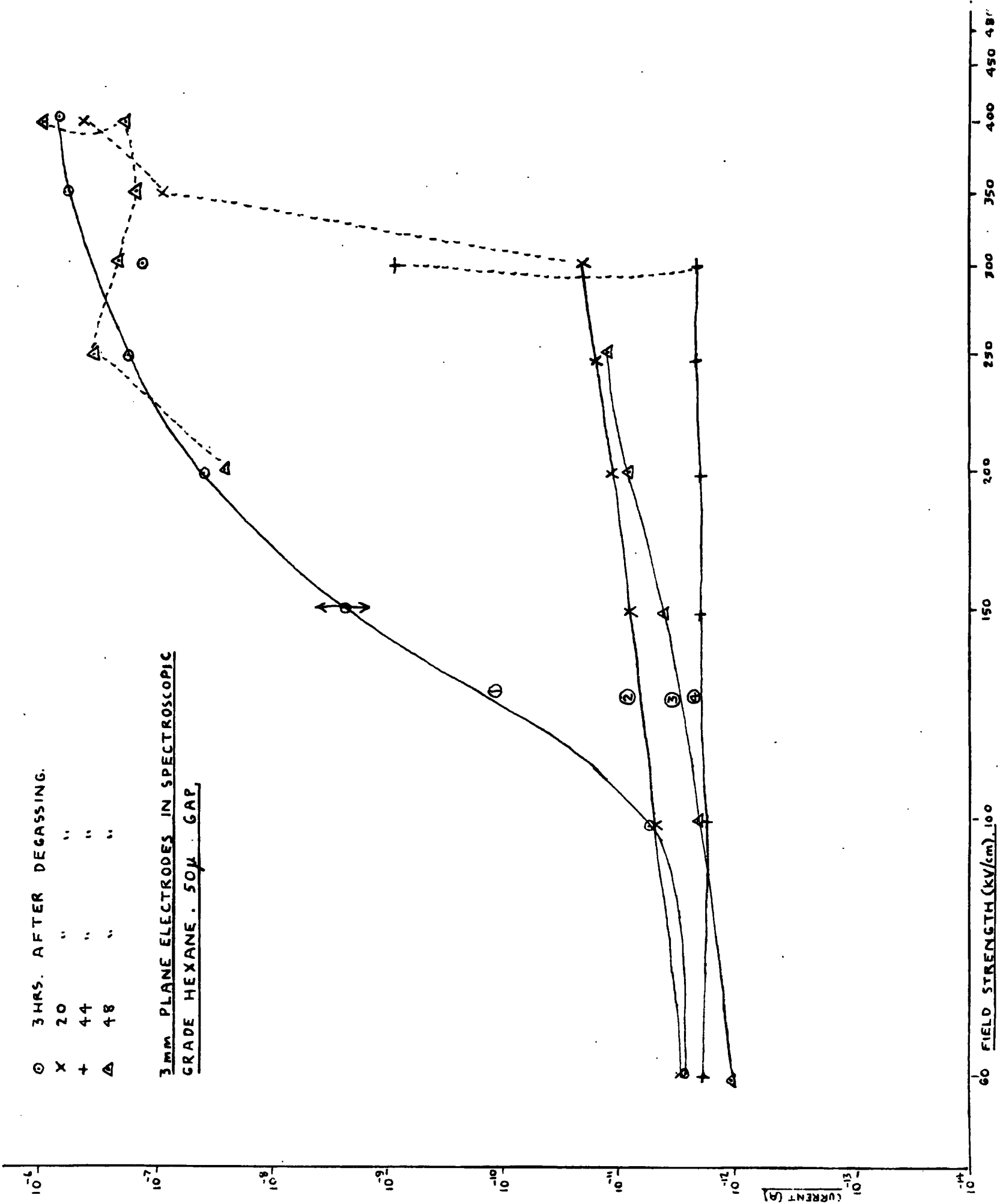

FIG. 39. THE (I,V) CHARACTERISTIC FOR PLANE ELECTRODES IN SPECTROSCOPIC GRADE HEXANE.



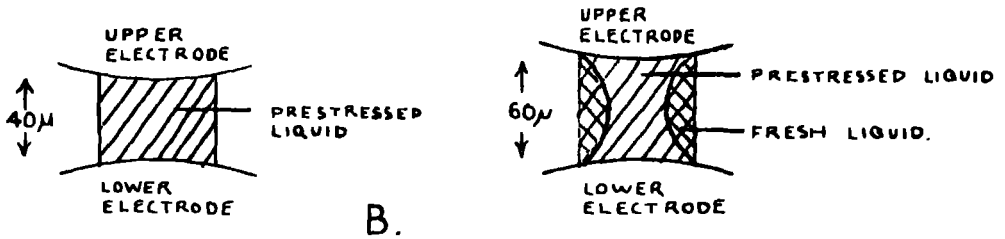
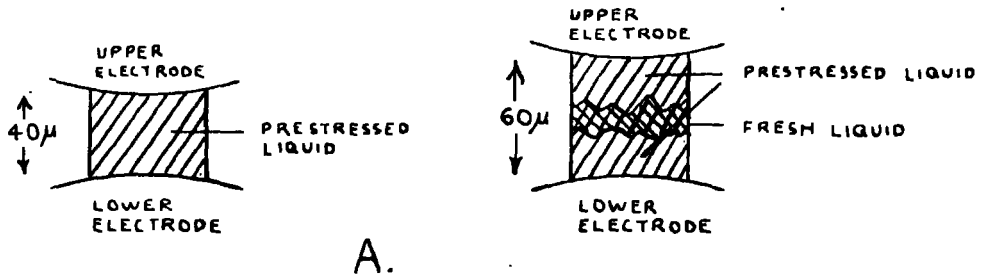

FIG. 35. POSSIBLE REARRANGEMENTS OF THE LIQUID IN THE GAP WHEN THE GAP LENGTH IS ALTERED.

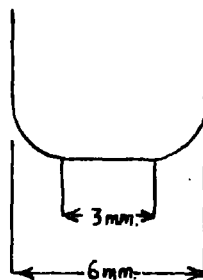

FIG. 38. PROFILE OF THE PLANE ELECTRODES.

It is obvious that much work could be done on the effects of prestressing but this line of research was not pursued here for the reasons mentioned above.

### 3.3.6. The effect of settling time on the current - voltage characteristic

When the liquid was allowed to settle in the cell for a period of an hour or two between filling and first applying the voltage, a considerable improvement in the continuity of the (I,V) characteristic in the low current region was obtained, compared with that for the non-settled liquid. When the liquid was not allowed to settle, the current - voltage curve often appeared to be discontinuous, even in the low current region as in Figs. 29 and 31, an increase in voltage often producing a decrease in current. The explanation of this apparently paradoxical phenomenon is as follows. When the voltage applied to the cell was changed the current was not constant but decreased with time as shown in Figs. 36A and 36B. The rate of fall of current progressively diminished, and after about five minutes the current - time curve was almost, but not quite, parallel with the time axis. In the non-settled liquid, after the usual five minute application of the lower voltage the current was still decreasing, and even though initially an increase of voltage did produce an increase of current, after a further period of five minutes the decay of current with time was sufficient to produce a net decrease when measured at that time.

The effects of allowing the liquid to settle are shown in Fig. 37. These curves were obtained by carrying out tests alternately on non-settled and

settled liquid in order to be certain that the differences were due to the effect of settling and not to any other cause e.g. a leak in the system. The improvement produced in the continuity of the (I,V) characteristic in the low current region by allowing the liquid to settle is immediately apparent. There was, however, no improvement whatsoever in the high current region.

An improvement was also found in the stability of the current when plotted against time when the liquid was allowed to settle. Figs. 36A and 36B show typical current - time curves for the settled and non-settled liquid respectively, and it can be seen that even though both curves show a decrease of current with time, the decrease in curve 1 is smooth whereas that of curve 2 is non-uniform and consists of a series of waves.

It appears that the above phenomena are probably due to electrical charge generated in the liquid by mechanical means when the cell is filled from the reservoir by distillation. Thus, in the non-settled liquid there is often a fairly high density of electrical charge and this appears as a very high current, which decays rapidly when the voltage is first applied. Quite often this decay of the current caused by recombination of charge masks the increase caused by the increased voltage and the net result is a decrease in current, even though the voltage is increased.

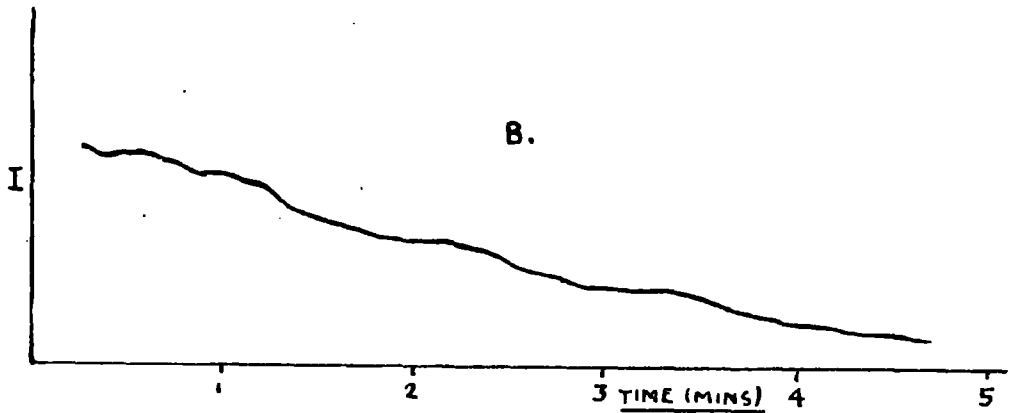
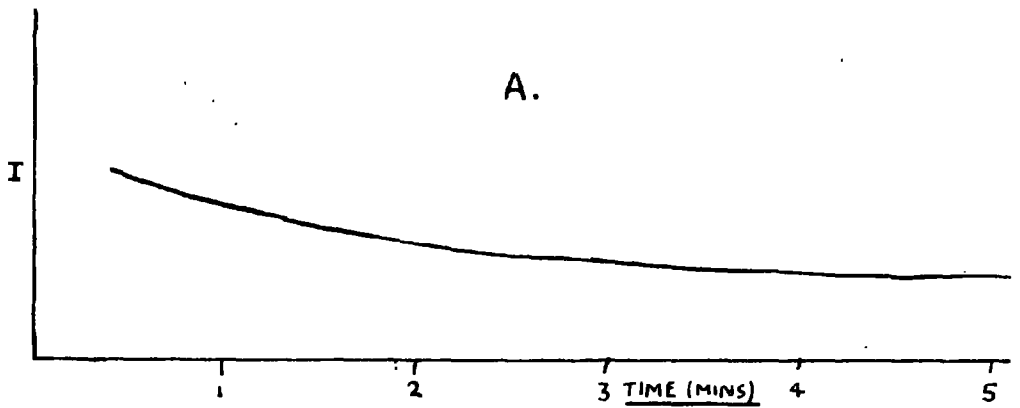

FIG. 36. IMPRESSION OF THE VARIATION OF CURRENT WITH TIME IN THE LOW CURRENT REGION.  
A. SETTLED LIQUID; B. NON-SETTLED LIQUID.

### 3.4. Plane electrodes in spectroscopic grade hexane.

#### 3.4.1. Introduction.

As soon as the preliminary tests with spherical electrodes in spectroscopic grade hexane were completed, the electrodes were replaced with a pair of plane geometry. These have the advantage that, in the absence of space charge, the field in the gap is known. Further more, any difference in the results due to altering the gap length is a true gap length effect and not a product of the redistribution of the electric field as it will be with spherical electrodes.

The plane electrodes used were made of stainless steel rod approximately 6mm in diameter, the actual electrode faces being only 3mm in diameter, An accurate Rogowski profile was not used although the electrodes were shaped so that the transition from the plane part of the electrodes was gradual, Fig. 38. It was assumed that in this way the edge effects were reduced to a factor below the reproducibility of the experiment.

Where no difference could be seen between the results with spherical and plane electrodes the experiments are only briefly mentioned. Nevertheless, more weight can be given to these results because a greater amount of work was done using plane electrodes than with spheres and more experience had been gained in the techniques involved. Where the results differed, or a new type of experiment was tried, greater detail has been given.

### 3.4.2. The (I,V) characteristic.

The general picture of the (I,V) characteristic is similar to that obtained with spherical electrodes, except for one or two small differences. Several typical curves are shown in Fig. 39. They are less scattered in the low current region than the curves shown for spherical electrodes in Fig. 29, but a true comparison cannot be made between these two curves as the present ones were obtained by allowing the liquid to settle in the cell after filling. An important difference is that occasionally a smooth continuous curve was obtained as in curve 1 without any kind of prestressing; a result never achieved with spherical electrodes. A further point is that the field strength at which the high currents first appeared was approximately 200 - 250kV/cm, which is approximately 100kV/cm lower than with spherical electrodes. The characteristic was not taken beyond the region of 400kV/cm because of the low breakdown strength found with planes.

The fact that the results with plane electrodes were little different from those with spheres is somewhat surprising. It might have been expected that currents approximately 10 times greater would be obtained with the plane electrodes since their area was roughly that amount greater than effective high field area of 1cm diameter spheres and a 50u gap (see Appendix A). Although a difference of this magnitude could not be detected in the low current region due to the lack of reproducibility between the different series of tests, it might have just been

detectable in a variation of the maximum current in which there was much better reproducibility.

#### 3.4.3. Reproducibility of the results.

The reproducibility of the results using planes was the same as that obtained using spherical electrodes. However, with the plane electrodes a record was kept of the number of tests carried out using liquid from the same bottle, and a considerable difference was found in the low current part of the (I,V) characteristic between liquids from different bottles. (The spectroscopic grade liquid was bought in 500cc bottles and this was sufficient for about five series of tests).

Fig. 40 shows typical results of 4 different series of tests. For two of these, the liquid came from one bottle, and liquid from a second bottle was used for the other two. As can be seen, the average current in the low current region differs by almost 2 orders of magnitude between the tests done on the different batches, whereas the variation in the average low currents between the different series of tests done with the same liquid batch is no greater than in any one given series of tests. This shows that the main variation in the low currents between different series of tests is probably due to the slight differences in composition of the liquids.

As can be seen from the graph, there was no variation in the high currents when different liquid samples were used.

#### 3.4.4. Dependence of the (I,V) characteristic on the age of the liquid.

No change was noticed when the liquid had been in the testing system for several days, and this confirms

the results obtained with spherical electrodes. This was of course to be expected since the geometry of the electrodes would be unlikely to have any effect in this connection, but, as it was pointed out in Sec. 3.4.1., more weight can be attached to the results obtained with plane electrodes and the lack of dependence on age found here has been briefly mentioned for this reason.

#### 3.4.5. Dependence of the (I,V) characteristic on gap length.

Fig. 41 shows curves obtained in the same series of tests, one with a gap width of  $50\mu$  and the other of  $75\mu$ . As can be seen, there is little difference between the two curves, the low and high currents, and the field strength at which the high currents first appeared, being approximately the same.

#### 3.4.6. The effect of prestressing on the (I,V) characteristic

It has already been mentioned in connection with the work on spherical electrodes, that a characteristic obtained by means of prestressing was not considered to be an intrinsic property of the liquid and the effects of prestressing were therefore not thoroughly investigated. The only type of prestressing carried out with plane electrodes was to take the characteristic with reducing voltage steps after a test had already been carried out on the same filling of the cell in the usual manner. Fig. 42 shows two such tests and, as with the spherical electrodes, a continuous curve was obtained when the measurements were taken for decreasing voltages.

Fig. 43 shows two further (I,V) characteristics,



one taken for increasing and the other for decreasing voltages. The liquid was not allowed to settle on this occasion and the curves are discontinuous. There were no high currents in the test for increasing voltages, and it is worth noting that there were also no high currents in the test taken for decreasing voltages. It is possible to infer from this that a smooth continuous curve can be obtained with prestressing only when the original prestressing produced high currents.

#### 3.4.7. The effect of settling time on the (I,V) characteristic.

Although the improvement in the continuity of the (I,V) characteristic in the low current region obtained by allowing the liquid to settle in the cell was quite marked, it was not as great as that found for spherical electrodes under similar conditions. Fig. 44 shows the (I,V) characteristics produced by allowing the liquid to settle for periods varying between 30 and 150 mins. A curve for the non-settled liquid is also shown for comparison. It can be seen that the curves for the settled liquid in the low current region are smoother than that for the non-settled liquid, although at some point in each of the curves the characteristic is negative, i.e. an increase of voltage produces a decrease of current. However, the liquid which had been settled for 150 minutes showed the greatest improvement and it would therefore seem that if the liquid were allowed to settle for a sufficient length of time, a smooth curve would be obtained, even with plane electrodes. The longer time

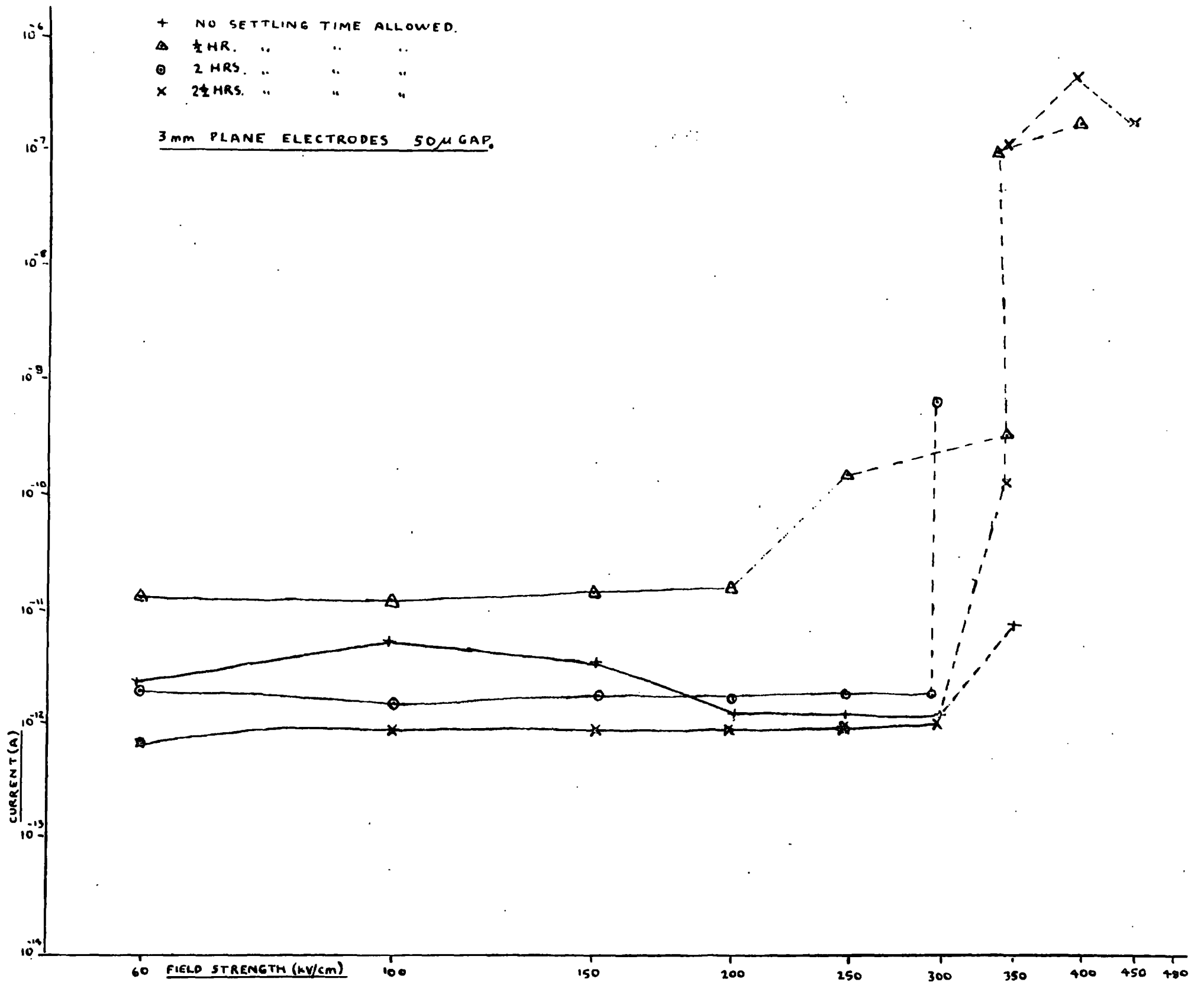

FIG. 44. THE EFFECT OF SETTLING TIME ON THE (I,V) CHARACTERISTIC FOR PLANE ELECTRODES  
 IN SPECTROSCOPIC GRADE HEXANE.

required with plane electrodes is probably due to the charge taking longer to diffuse out of the gap in this case, (see Sec. 3.3.6.).

#### 3.4.8. Polarity reversal tests with one electrode roughened.

Several theories of conduction and breakdown have been proposed based upon field intensification at asperities on the electrode surfaces. Watson and Sharbaugh (47) have proposed that breakdown in dielectric liquids under pulse conditions is initiated by bubbles of vapour formed at asperities on the electrode surfaces because of the high energy density at these points. If the high currents are in fact also produced by this mechanism a dependence of current on the quality of the finish of the electrode surfaces might be expected. A series of tests was therefore carried out in which one electrode was polished with diamond paste of 6 $\mu$  grain size and the other with paste of 1 $\mu$  grade. The finish on the rough electrode was such that its surface appeared to the naked eye to be uniformly covered with scratches, whereas the well polished electrode had the usual optical finish, and was virtually scratch free even when viewed under a metalurgical microscope using 100x magnification.

The results for several reversals of polarity of the test voltage are shown in Fig. 45. Within the limits of reproducibility of the measurements no change could be observed upon reversing the polarity. In particular the highest current obtained was of the order of  $10^{-7}$  -  $10^{-6}$ A and the first appearance of high current was at a field strength of approximately 250kV/cm, both of these values being normal. Prior

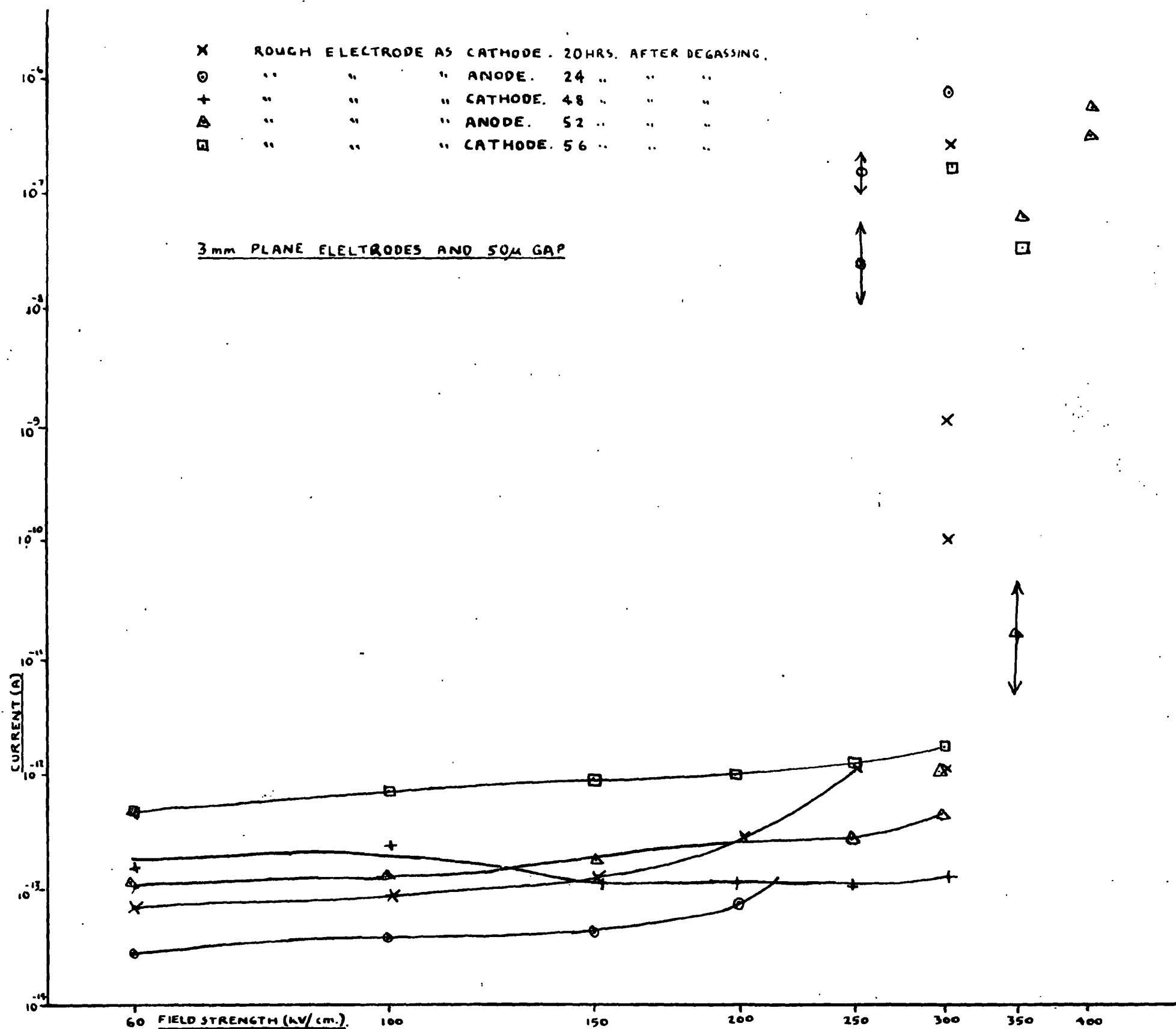

FIG.45. POLARITY REVERSAL TESTS WITH ONE ELECTRODE ROUGHENED.

to this series of tests several polarity reversal tests had been carried out with identical surface finish on both electrodes and no polarity effect was found. These polarity tests are not plotted here as they were practically identical to the results found in the high purity hexane as shown in Fig. 48. The reversal tests with identical electrodes rule out any possibility that the electrode effects might have been influenced by the cell itself.

The results with roughened electrodes are, however, not entirely conclusive, since asperities capable of producing the necessary degree of field intensification are probably smaller than those that can be seen with a microscope, even with under a magnification of 100X. Furthermore, with the polishing technique used, even the most highly polished electrodes contained several small scratches which could not be removed, and these on their own might have been sufficient to cause the high currents.

Although no relationship was found between the finish on the electrode surfaces and the electrical measurements, in all further tests the electrodes were polished to the best finish possible in order to standardise the conditions under which the tests were carried out.

### 3.5. Air-saturated spectroscopic grade hexane.

Although it was assumed from the work done by Sletten (1), in which he found a strong dependence of the conduction current on the air content of the liquid, that the high currents were due to the refined degassing technique used, it was still thought necessary to establish this beyond any shadow of doubt

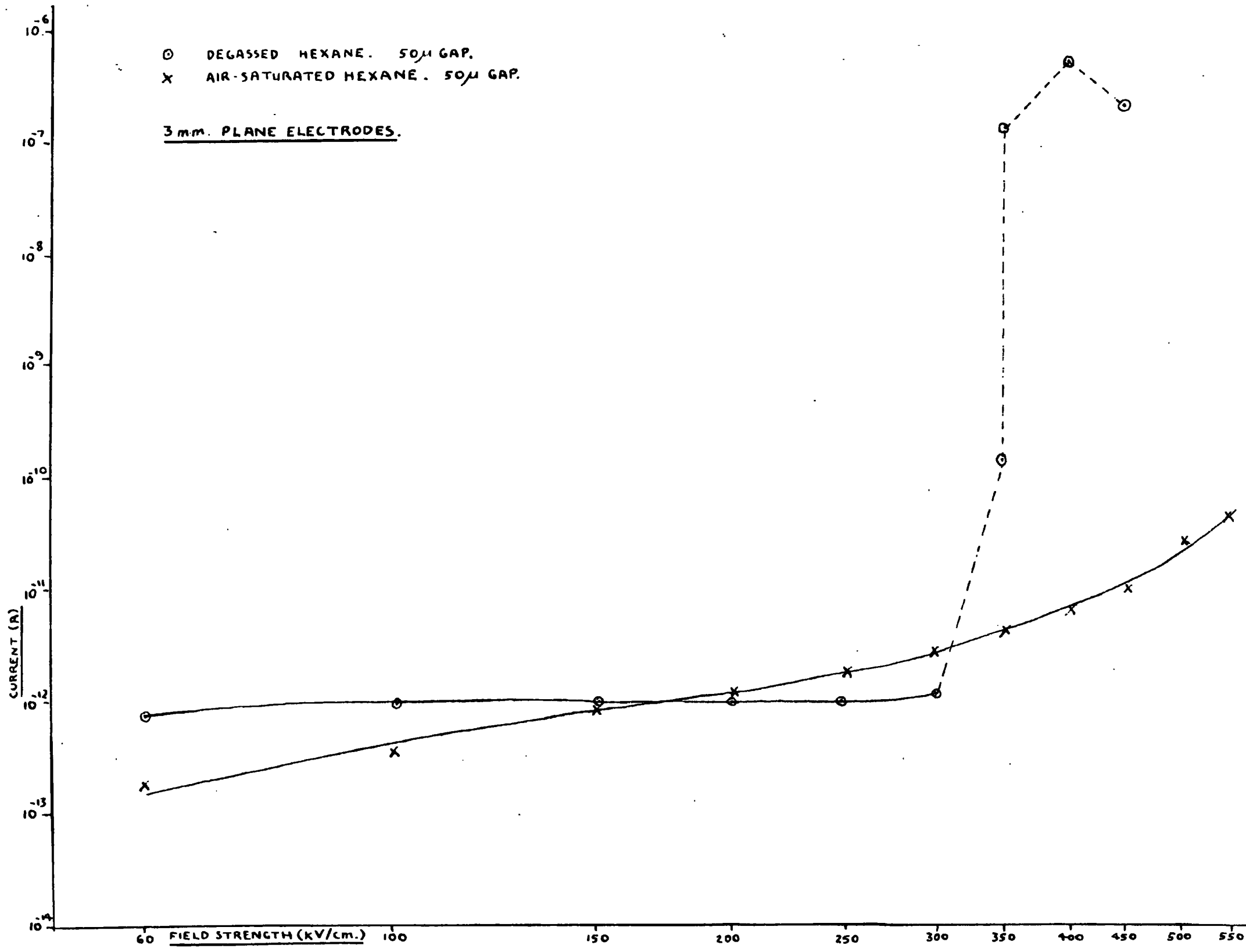

FIG. 46. THE (I,V) CHARACTERISTICS FOR DEGASSED AND AIR-SATURATED SPECTROSCOPIC GRADE HEXANE.

and a few tests were therefore carried out in air-saturated hexane. To do this, after several tests had been performed in liquid which had been degassed in the usual manner, the flange connecting the electrodes and their supporting structure to the glass bulb, Fig. 9, was loosened just sufficiently for air to be able to seep slowly past the seal. In this way air was admitted to the system with the minimum of dust particles. Later the bolts were completely loosened off and the liquid allowed to stand for several days so that it became completely air-saturated.

A comparison is made in Fig. 46 between air-saturated and degassed liquid. The curve has only been plotted for fields upto 550kV/cm. At higher fields the current was highly unstable and because of this its value could not be estimated with sufficient accuracy to be included in the curve. No attempt was made to reduce this instability since the prime interest in this work was in the intrinsic conduction of the liquid and absorbed air was considered to be an impurity. In general, however, upto about 1MV/cm the current was of the order of  $10^{-9}$ A with bursts of current as large as  $10^{-6}$ A. Comparing the pattern of the stability with that in degassed hexane, (see Sec. 3.12.1) it appeared that if the liquid could maintain a sufficiently high field there would in fact be high currents in air-saturated hexane also.

The breakdown strength of air-saturated hexane was about 1MV/cm and this is in agreement with values quoted elsewhere (1).

### 3.6. Plane electrodes in high purity hexane.

#### 3.6.1. Introduction.

Towards the end of the project high purity hexane became available; the analysis of this liquid is discussed in Sec. 3.2.2. This liquid was used in conjunction with the plane electrodes and constituted a second major step towards the simplification of the test conditions (see Sec. 3.1.). On using this liquid the superior reproducibility of the (I,V) characteristic was immediately apparent, and it then became necessary to repeat as many of the previous tests as possible in order to search for effects which could not be seen previously due to lack of reproducibility.

#### 3.6.2. The (I,V) characteristic and the reproducibility of the results.

Figs. 47 and 48 show the (I,V) characteristics taken in two different series of tests, the liquid for each being taken from a different bottle. When these curves are compared with those obtained for spectroscopic grade liquid the improvement in their smoothness and continuity is at once apparent, although the same general features are shown. In this case, however, the transition from the low to the high current is not sudden as in the impure liquid. Although transitions from one current level to another did occur without any change in the applied voltage, they were very infrequent and the difference in the two levels was only about one order of magnitude compared with steps of upto 3 orders of magnitude which occurred quite frequently in the spectroscopic grade liquid.



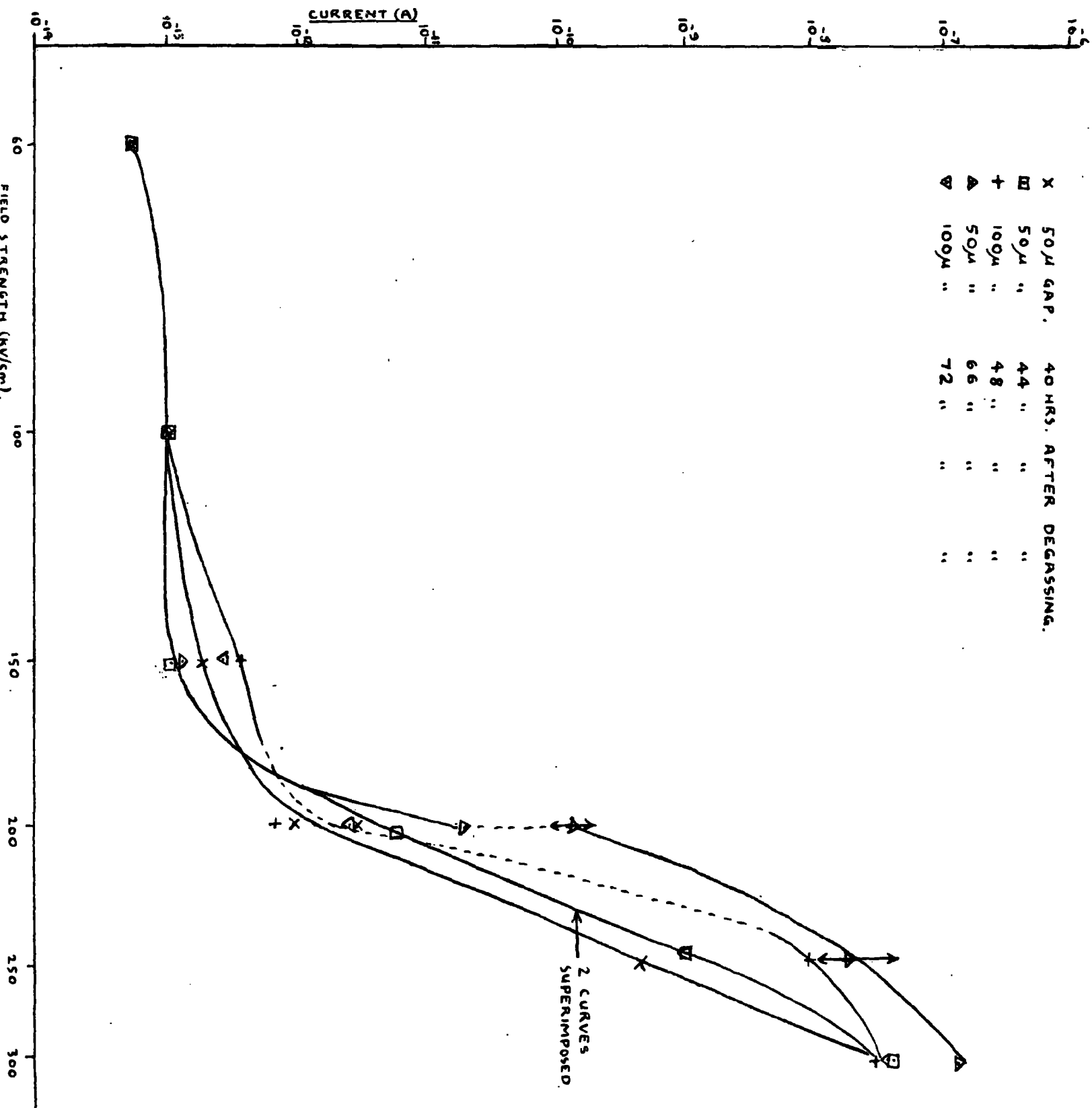

FIG. 47. THE (I,V) CHARACTERISTIC FOR PURE n-HEXANE

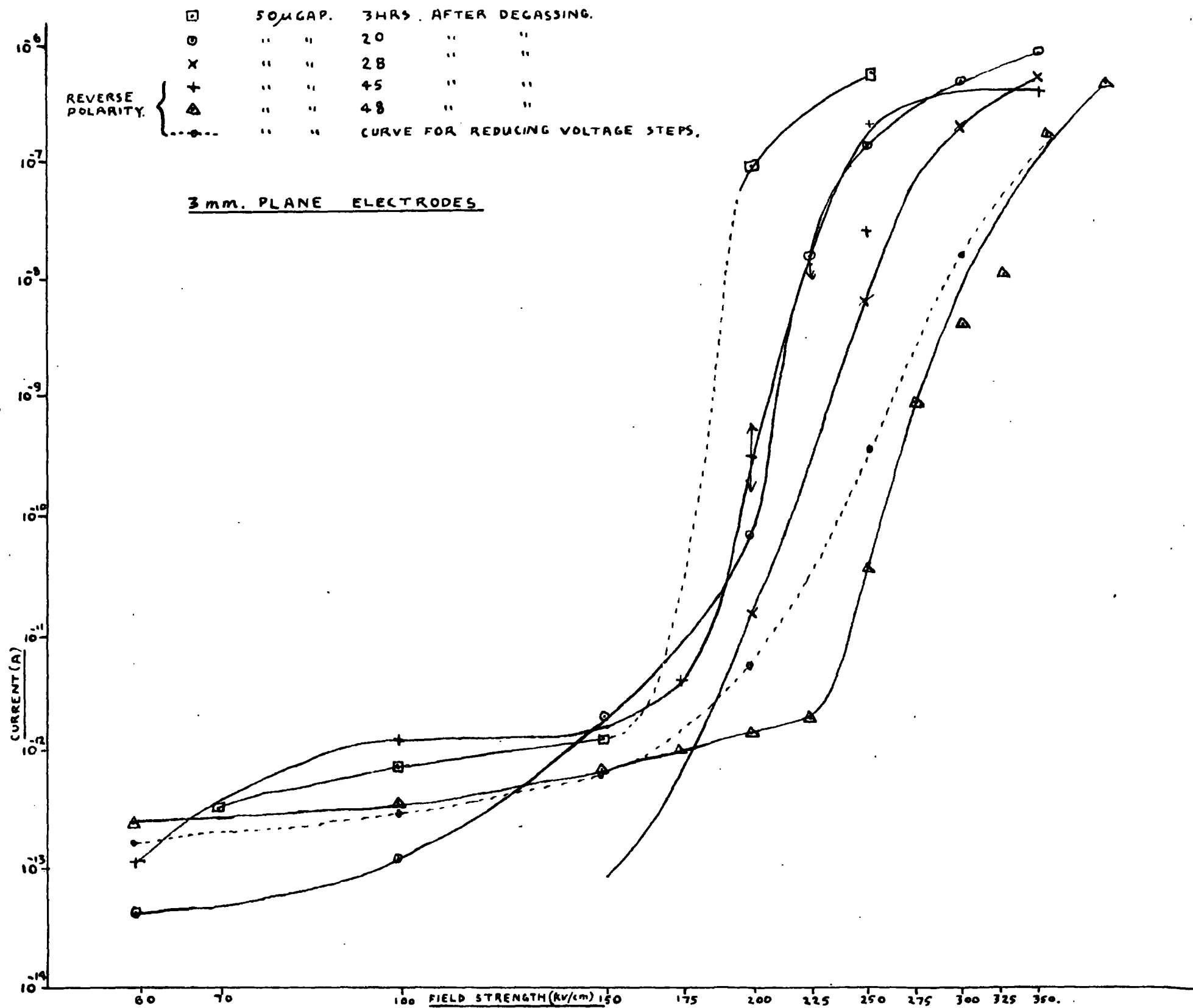

FIG. 48. THE (I,V) CHARACTERISTIC FOR PURE n-HEXANE AND THE EFFECT OF REVERSING THE ELECTRODE POLARITY

Fig. 47 shows perfect reproducibility in the low current region but this is not repeated in Fig. 48, the results of which were obtained from a different bottle, as mentioned previously. The value of the low currents is in the region of  $10^{-13}$ A with a spread between the two different series of tests of only one order of magnitude compared with a spread of 3 orders in the spectroscopic grade hexane. This reproducibility was repeated in tests on liquid from a third bottle in which electrodes of different materials were used, Sec. 3.6.4.

It is worth noting that the general shape of curve is repeated in all 10 sets of results shown in Figs. 47 and 48, and that high currents were always obtained. This contrasts sharply with results for the impure liquid in which identical test conditions were used, (see Secs. 3.2.2. and 3.4.3.). The maximum current was again in the region of  $10^{-7}$  and  $10^{-6}$ A. (In Fig. 47 the level is nearer  $10^{-7}$ A because the field strength was not increased beyond 350kV/cm ).

A confirmation was accidentally obtained that the improvement in the reproducibility was due to the different grade of the liquid and not, perhaps, to some other factor unwittingly introduced in the preparation of the cell and electrodes. When a third test was attempted it was found that the results were not reproducible and that the (I,V) characteristic showed the typical discontinuity of the spectroscopic grade liquid. A chromatogram was taken of this liquid and its composition was indeed found to be very similar to that of the spectroscopic grade liquid. It was later confirmed by the suppliers that the wrong grade of liquid had been supplied in this bottle.

### 3.6.3. Effect of the electrode material, age of the liquid, the gap width and prestressing on the (I,V) characteristic.

The effect of changing the electrode material has already been investigated previously (see Sec. 3.10 ) with virtually negative results. It was nevertheless thought worthwhile to try such a test in this project because of the good working conditions i.e. highly degassed liquid, plane electrodes and good purity liquid. For this test gold was chosen as the new electrode material because it is a non-oxidizable material and it was thought that the stainless steel electrodes, with their unavoidable oxide layer, might possibly be acting as a blocking electrode and thus limit the maximum value of the current. Further, examination of the (I,V) characteristic, in which it appears to approach a plateau in the high current region, suggested that the high currents might be saturation currents i.e. unlimited by space charge. A difference in cathode emission due to different cathode surfaces would therefore show itself as a difference in the maximum value of the high currents.

Fig. 49 shows the results for three tests with the gold and stainless steel electrodes. The first test was with the gold electrode as the anode, the second with this electrode as the cathode, and the third a check test with the gold electrode again as the anode. It can be seen from these curves that there is no significant difference in the (I,V) characteristic on reversing the polarity. Also when these results are compared with those obtained with stainless steel electrodes, they are identical within

○ ANODE GOLD, CATHODE STAINLESS STEEL.  
 X CATHODE " ANODE " "  
 + ANODE " CATHODE " "

3 mm. DIA. PLANE ELECTRODES IN PURE n-HEXANE. 100μ GAP.

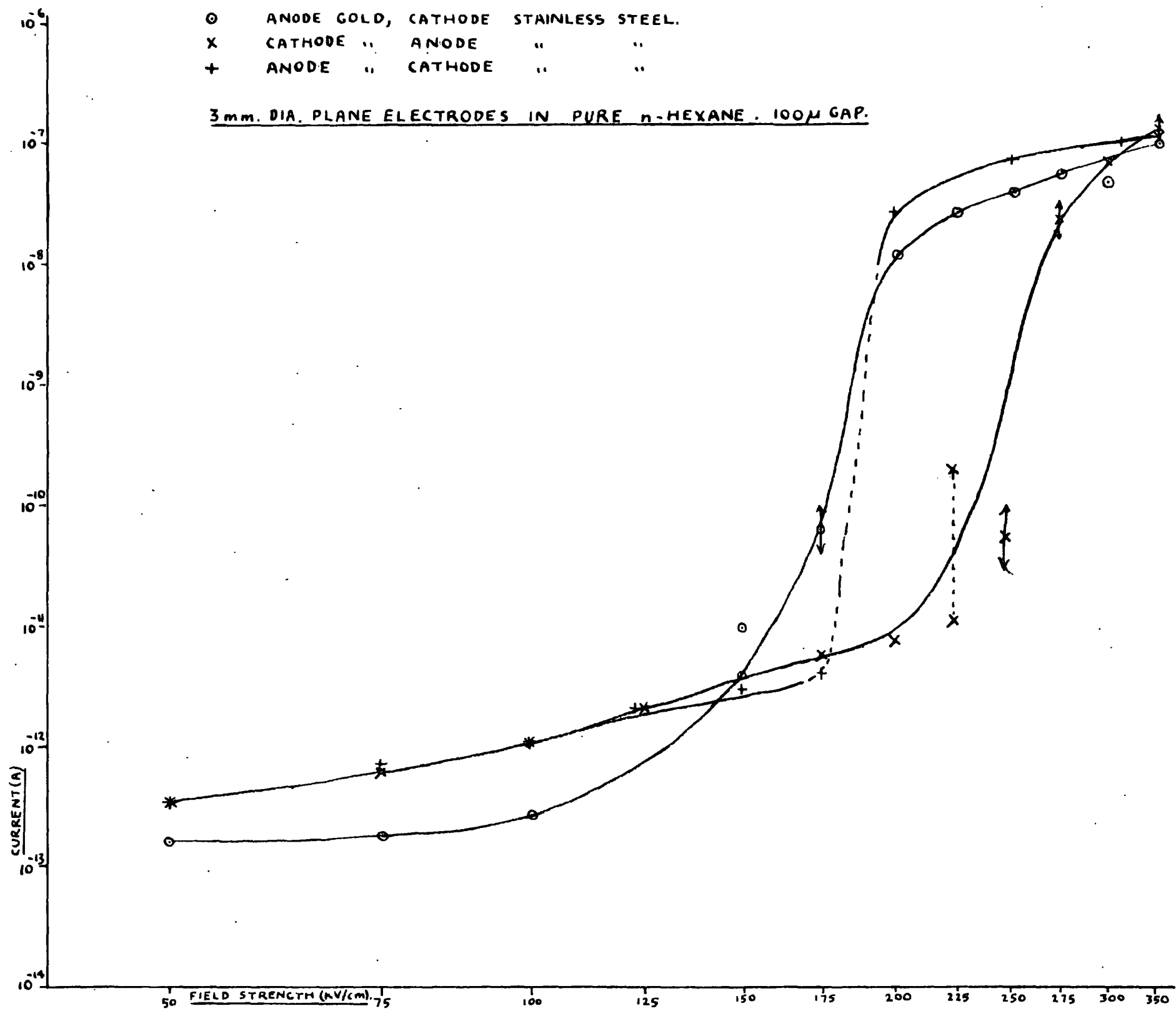

FIG. 49. POLARITY REVERSAL TESTS USING GOLD AND STAINLESS STEEL ELECTRODES IN PURE HEXANE.

the limits of reproducibility i.e. both the low and high currents are the same and the knee in the characteristic occurs at roughly the same field strength. As with the spectroscopic grade hexane, no change could be seen when the age of the liquid increased or when the gap width was altered, thus confirming the previous results.

When the (I,V) characteristic was taken by reducing the voltage in a prestressed liquid (the liquid in the cell was not changed in this test so that in effect the prestressing was the voltage applied during the previous test) a slight difference in shape was obtained. The knee at about 150-250kV/cm present in the non-stressed curves was absent. In fact, the shape of the curve for the prestressed liquid was very similar to that obtained in spectroscopic grade liquid.

### 3.7. Cyclohexane.

#### 3.7.1. Introduction.

It was suspected that the magnitude of the high currents might be influenced by the molecular structure of the liquid. It was therefore considered necessary to obtain the current-voltage characteristic with a liquid having virtually identical chemical properties to those of hexane yet with a greatly different molecular structure; the natural choice was cyclohexane.

The structures of hexane and cyclohexane molecules are shown in Figs. 50A and 50B respectively. The difference between cyclohexane and hexane is that in the former the two hydrogen atoms which are at the end of the carbon chain in the hexane molecule are missing

NOTE: THIS SKETCH IS NOT STRICTLY ACCURATE. IN ACTUAL FACT THE CARBON ATOMS DO NOT LIE ON THE SAME STRAIGHT LINE.

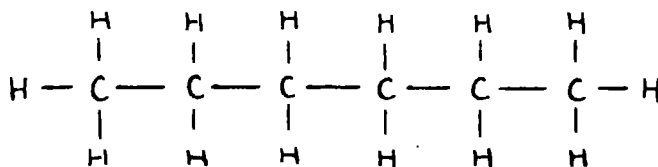

FIG. 50.A. STRUCTURE OF THE HEXANE MOLECULE.

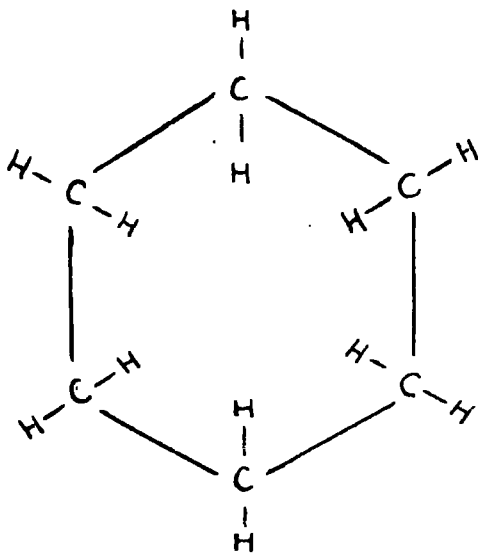

FIG. 50.B. STRUCTURE OF THE CYCLOHEXANE MOLECULE.

and the two free bonds are joined end to end to form the cyclohexane ring. Thus, as in the hexane molecule, there are no vacant bonds and it has the same property of being chemically rather inert.

The measurements taken in cyclohexane are, however, of doubtful validity for three reasons. Firstly, its freezing point is  $9^{\circ}\text{C}$  so that the spiral and filter of the inlet of the apparatus (Fig. 7, B and A) could not be cooled sufficiently to freeze out water, and thus, any moisture which might have been present in the liquid could not be removed. Secondly, when the final distillation was done, this being at liquid air temperature, the liquid froze solid. It then passed from L to M, Fig. 7, in the form of solid flakes. There was the possibility that dissolved air was included in the flakes and it was not certain that the liquid was thoroughly degassed. Lastly, it was later found that the powerpack was faulty in these tests and, although the points shown in the graphs in Fig. 51 were later confirmed by spot checks, the results are still open to question.

The results for cyclohexane are nevertheless briefly mentioned here as they might in fact be perfectly valid, and may be confirmed if better degassing techniques produce the same results.

### 3.7.2. The (I,V) characteristic of cyclohexane.

The (I,V) characteristic of cyclohexane is shown in Fig. 51. (For the chromatographic analysis of this liquid see Sec. 3.2.3.) The most marked feature is that no high currents were found. The current varied smoothly from around  $10^{-12}\text{A}$  at  $50\text{kV/cm}$  to about  $10^{-9}\text{A}$  at  $300\text{kV/cm}$ . The shape of the curve is very similar





to that for air-saturated spectroscopic grade hexane shown in Fig. 46. The curves are noticeably reproducible, the spread in the value of any one measurement being less than one order of magnitude.

### 3.8. Cyclopentane.

#### 3.8.1. Introduction.

Because of the doubt mentioned in Sec. 3.7.1. about the validity of the results obtained in cyclohexane it became necessary to repeat the experiment in a liquid which could be properly degassed in the existing apparatus. Cyclopentane has a molecular construction very similar to that of cyclohexane, the difference being that it has five carbon atoms in its ring instead of the six in cyclohexane. Both of these molecules are stable (11). The chromatographic analysis of the liquid used is given in Sec. 3.2.4. When the liquid was distilled in the degassing apparatus a thick oily substance separated out and this tended to confirm the comments made in that section on the purity of the liquid.

#### 3.8.2. The (I,V) characteristic of cyclopentane.

Fig. 52 shows typical (I,V) characteristics obtained in cyclopentane with the same stainless steel plane electrodes used in the previous tests. It can be seen that the curves are smoother than those obtained for spectroscopic grade hexane under identical conditions but less continuous than in the 99% pure hexane. However, the high-field currents are lower than those found in hexane by a factor of 10, being in the range of  $10^{-8}$  to  $10^{-7}$ A compared with  $10^{-7}$  to  $10^{-6}$ A found in hexane.

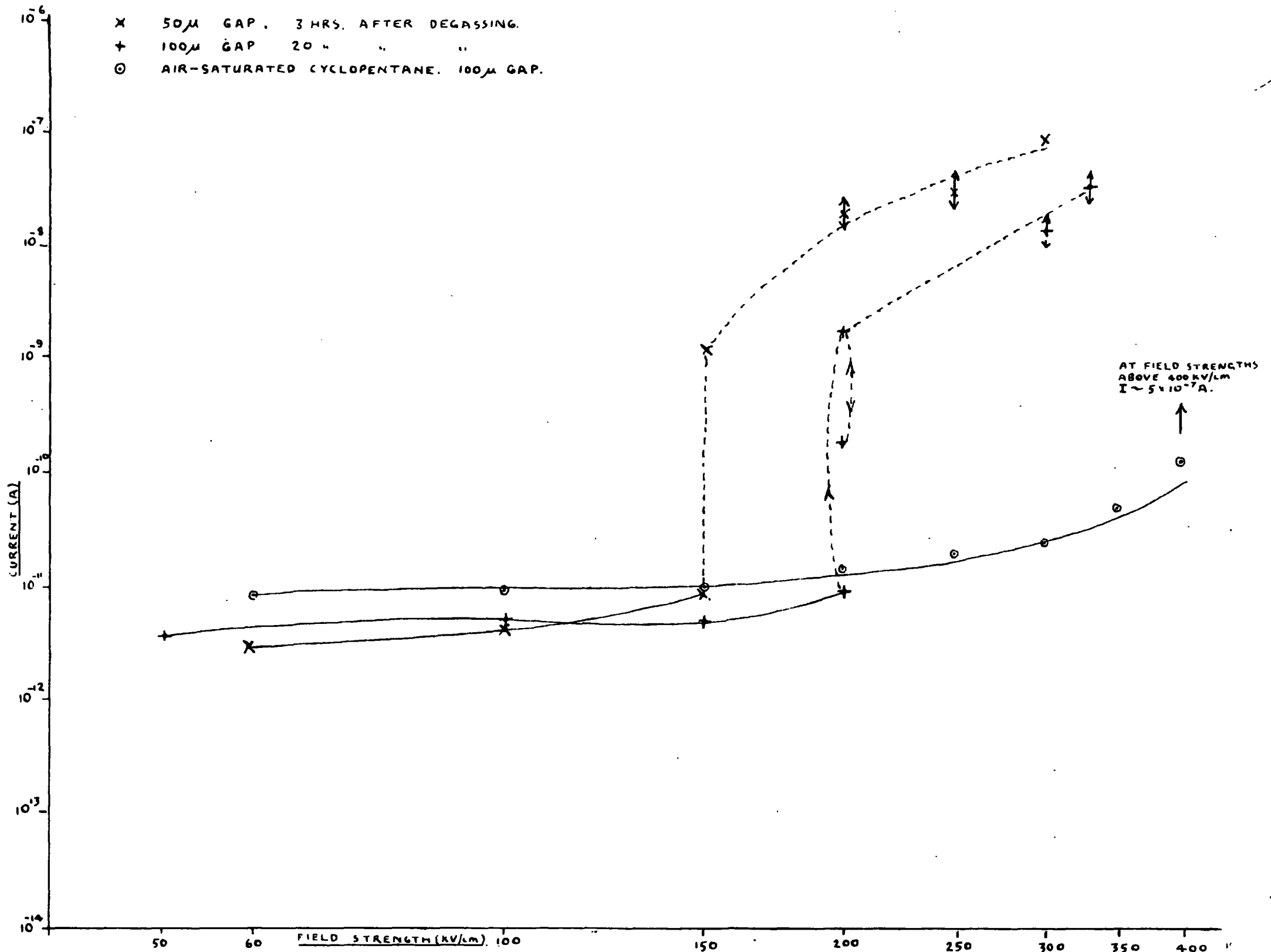

FIG. 52. THE (I,V) CHARACTERISTIC FOR CYCLOPENTANE.

### 3.9. The (I,V) characteristic of air-saturated cyclopentane.

The (I,V) characteristic of air-saturated cyclopentane is shown in Fig. 52 and this can be compared with the other curves which were taken in the degassed liquid. The method of allowing the liquid to become air-saturated was the same as that used to air-saturate hexane (see Sec. 3.5.) From the tests in air-saturated hexane it appeared possible that if the liquid could support a high enough field without breaking down, it would show high currents similar to those found in the degassed liquid. Because the high currents appeared at a lower field strength in cyclopentane than in hexane, it was thought possible that the expected high currents mentioned above, might be found at pre-breakdown field strengths in cyclopentane.

The curve has only been plotted upto 400kV/cm. After that the current suddenly moved into the high current region. The exact value of the current was not known at these points because the three lowest value measuring resistors (see Fig. 11) were later found to be disconnected, and the lowest value of resistance still in the circuit was  $10^9$  ohms. It could only be stated with certainty that at field strengths above 400kV/cm the current was in excess of  $10^{-9}$  A. However, a check was later made at field strengths above 400kV/cm and the current was found to be in the region of 2 to  $3 \times 10^{-7}$  A.

### 3.10. 3-methyl pentane.

It has been shown in Sec. 3.6.2. that the lack of reproducibility of the high currents in the spectroscopic grade hexane was an inherent property of that liquid and not due to a fault in the experimental technique. It was therefore decided to test one of the known impurities in spectroscopic grade hexane to see if high currents could also be obtained in it. For this test 3-methyl pentane was chosen (see Sec. 3.2.5. for the chromatographic analysis of this liquid) because its boiling point is closer to that of hexane than any of the other impurities, and it was thought to be the most likely to have an influence on the high currents. A fuller explanation of why this impurity was chosen is given in Sec. 5.4.8.

The (I,V) characteristic obtained for this liquid using the identical conditions used in the previous tests is shown in Fig. 53. The most important feature of this test is that although there was no significant difference in the low current of the (I,V) characteristic in this liquid, the high currents were approximately 1 order of magnitude higher than in hexane and about 2 orders of magnitude higher than in cyclopentane.

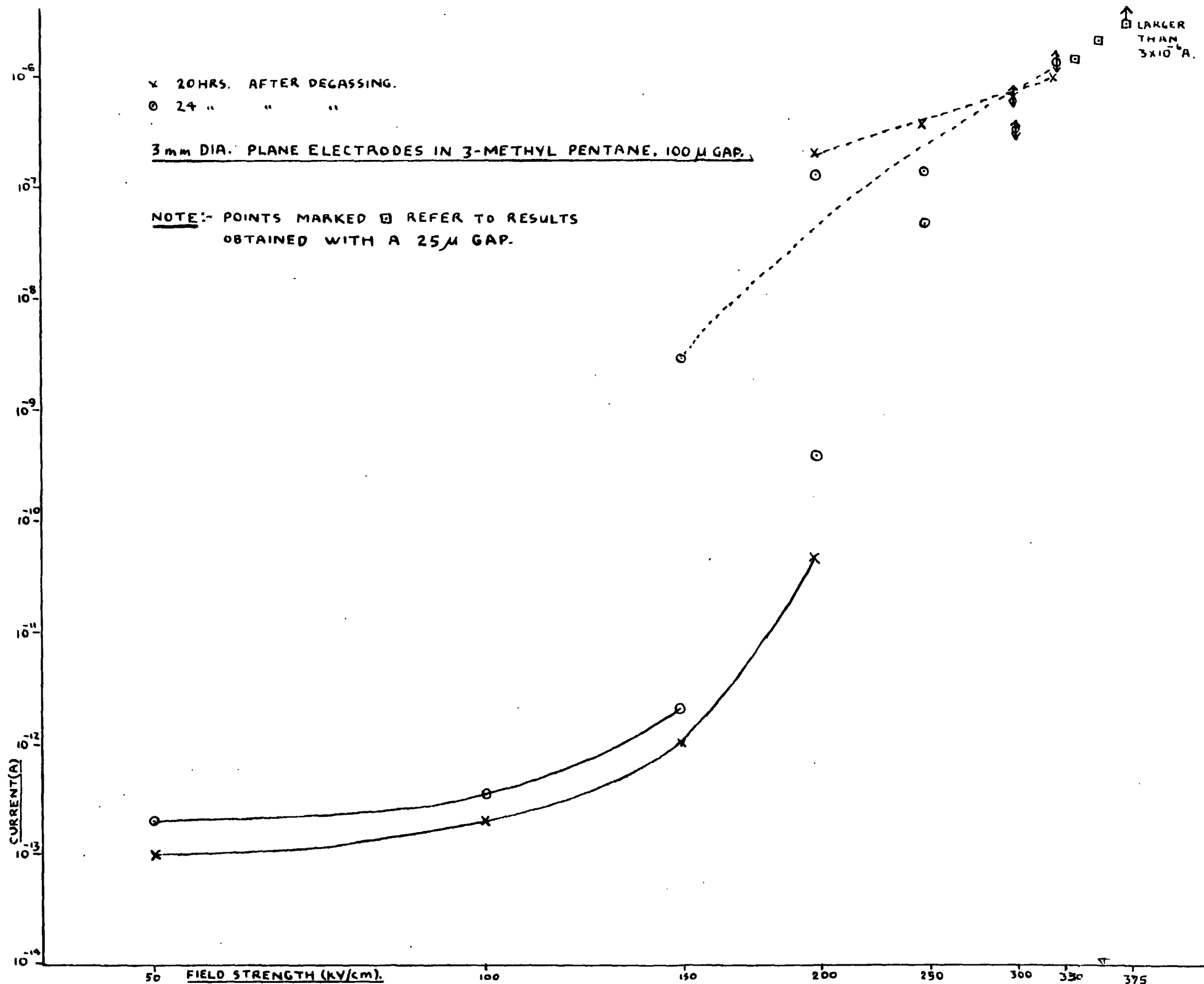

FIG. 53. THE (I,V) CHARACTERISTIC FOR 3-METHYL PENTANE.

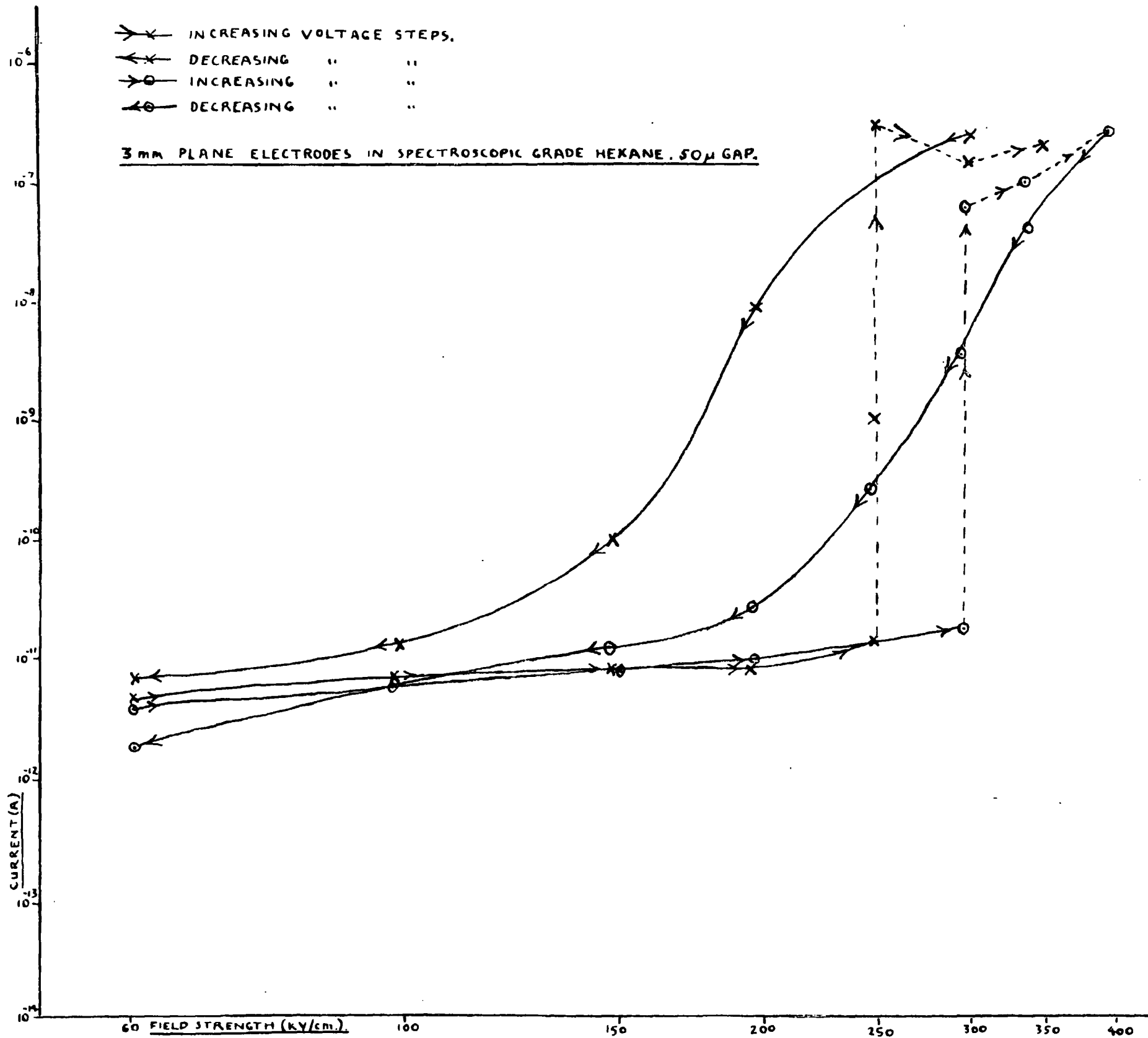

FIG. 42. THE (I,V) CHARACTERISTIC FOR INCREASING AND DECREASING VOLTAGE STEPS.

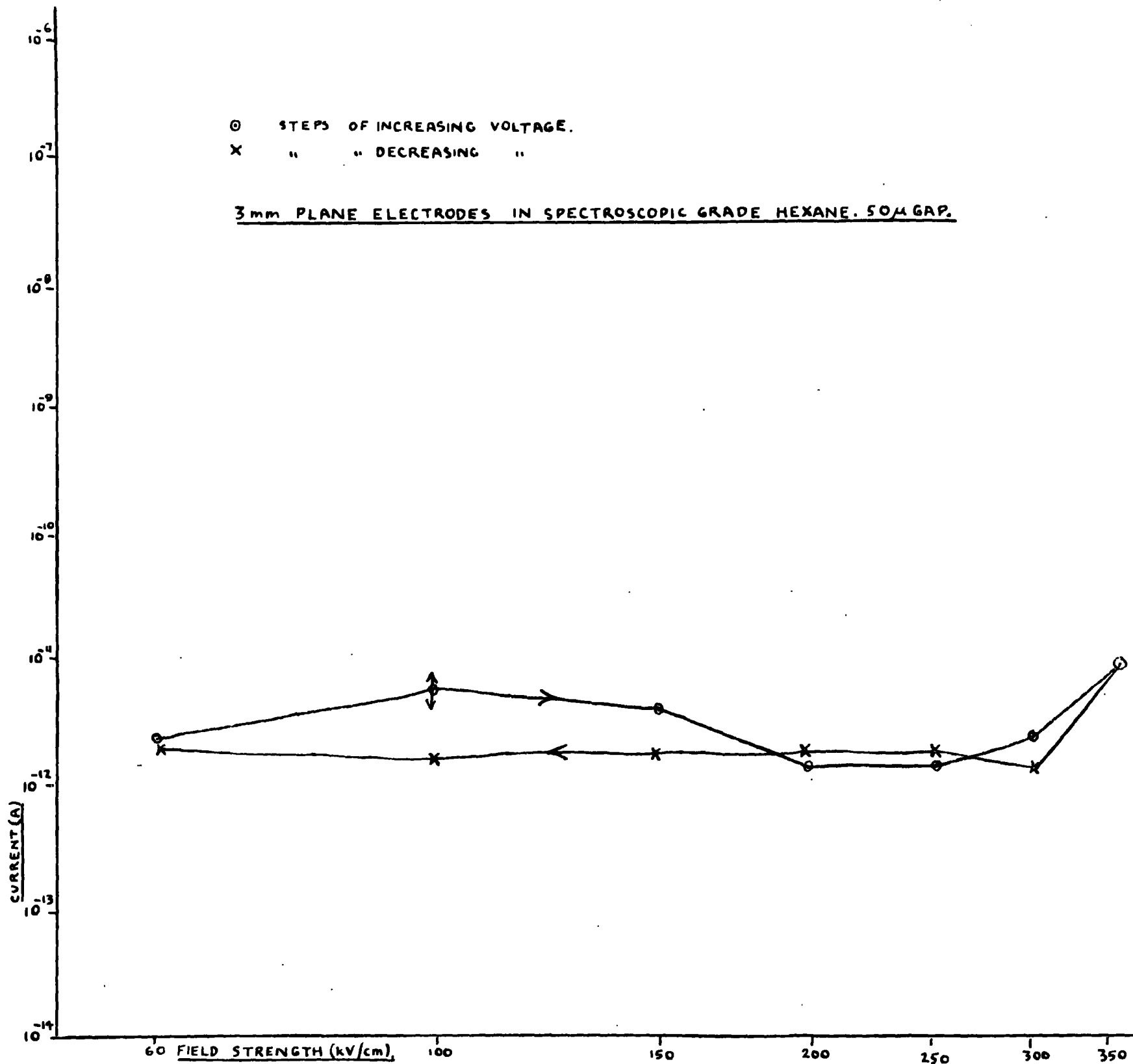

FIG. 43. THE (I, V) CHARACTERISTIC FOR INCREASING AND DECREASING VOLTAGE STEPS,





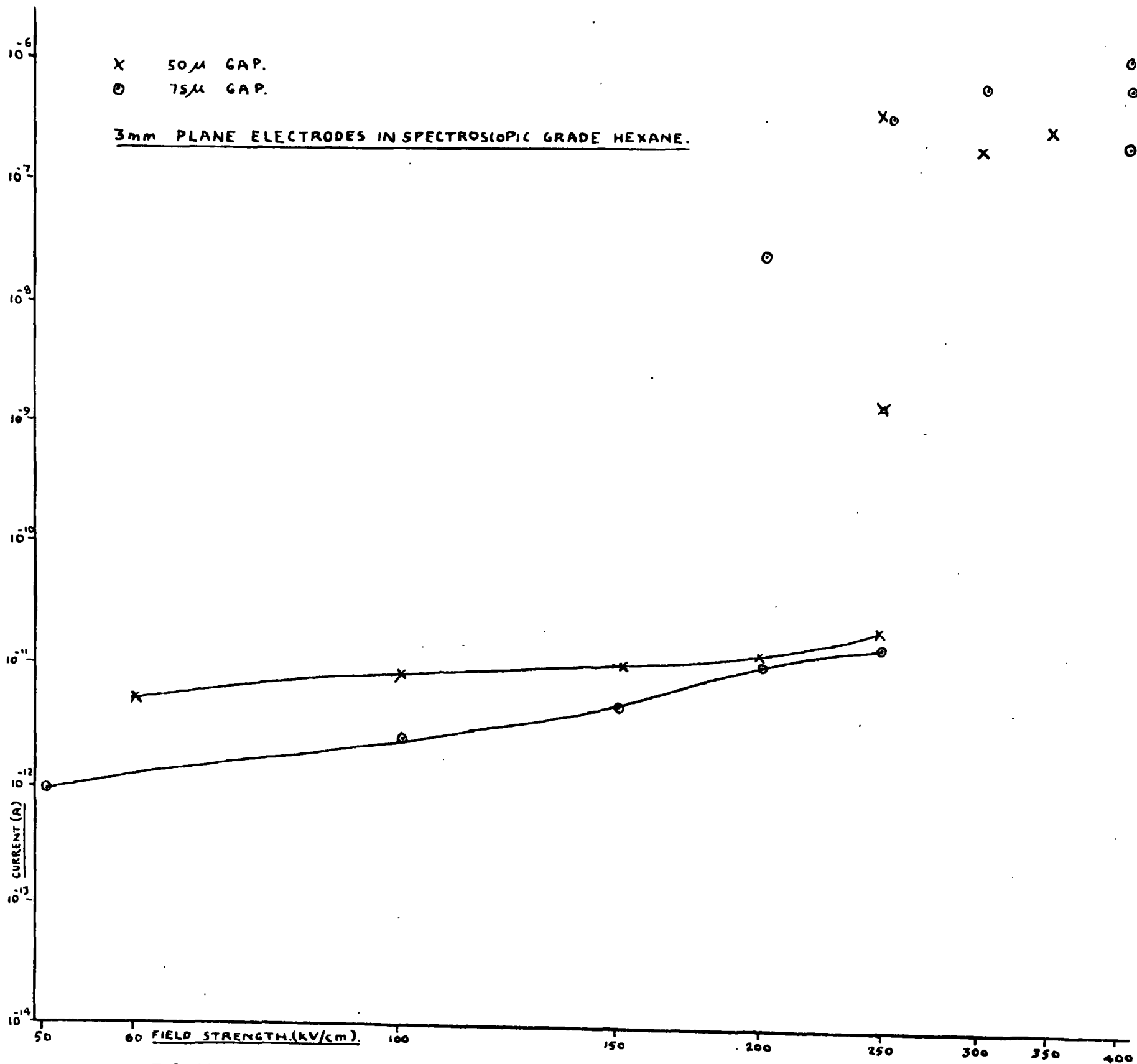

FIG. 41. DEPENDENCE OF THE (I,V) CHARACTERISTIC ON GAP LENGTH.

### 3.11. Particles.

Although a great amount of precaution was taken in the design of the distillation apparatus to prevent solid particles from reaching the test cell, a certain number were always seen adhering to the electrodes, and were most probably minute dust particles from the atmosphere, which settled on the electrodes when the cell was opened for electrode polishing. They were too small to be seen by direct illumination and because of this, their size could not be estimated easily. However, when viewed by means of scattered light they appeared as small bright specks against a darker background and in this way their behaviour could be observed.

#### 3.11.1. Particle movement with spherical electrodes.

On first applying the voltage the particles aligned themselves in the direction of the electric field, and remained in that position as long as the field was maintained. Movement did not occur until the field strength was in the region of 150kV/cm and could then take a number of forms. At times the particle would remain on one electrode for a period of seconds or more, and then suddenly appear on the other electrode, the particle not being visible during its very rapid movement. A little later it would reappear on the first electrode and the process would repeat itself. At other times the particle would oscillate rapidly between the electrodes, the oscillations being so fast the movement could only be detected by the scintillation of the particle.

Although there were always several particles

visible in the gap, movement was always confined to only one or two at a time. There could in fact be several particles very close to each other and only one of these would move. On the other hand, two particles close together were often seen to move but in different modes. Thus, one could move quite slowly while the other could perform the rapid oscillations mentioned above.

There were occasions when the particles remained firmly attached to the electrodes through a whole test even though in the previous test in the same series there had been very active particle movement. When particle movement did take place, it was never seen at field strengths below about 150kV/cm and only rarely above 350kV/cm.

### 3.11.2. Dependence of particle movement on electrode geometry.

The general behaviour of the particle movement with plane electrodes was exactly as described above for spherical electrodes with only one difference. With spherical electrodes particle movement was never observed at very high fields, whereas with plane electrodes once movement had started it continued throughout the whole test, even upto fields just below breakdown. The onset of particle movement was at approximately 150kV/cm as with spherical electrodes.

### 3.11.3. Dependence on liquid.

No change in the particle behaviour was noticed on changing the test liquid from hexane to any of the other liquids used, provided these were degassed. There was, however, some indication of increased

particle activity when air-saturated hexane and cyclopentane were used, although this might have been due to the addition of extra particles when the cell was opened to admit air.

#### 3.11.4. Dependence of the current, stability and pulses on particles.

No relationship whatsoever was found between particle activity and the value of the current. Similarly, there was no connection between the stability of the current and particle movement. On one occasion there was, however, an exception to this. The current was in the region of  $10^{-14}$ A and there was some indication that peaks of the order of  $10^{-13}$ A, superimposed on the steady current level, could be associated with the movement of a particle.

It could not be ascertained if particle movement had any effect on the fast pulses described in Sec. 3. 13. as the microscope and the oscilloscope could not be observed at the same time. Thus, an individual pulse could not be associated with the transfer of a particle from one electrode to another. It would however seem, from the fact that no difference in the general pattern of the pulse behaviour was observed between times when there was much particle activity and times when particle movement was absent, that the two are unrelated.

#### 3.11.5. Particles and breakdown.

Occasionally either a large particle or a series of particles would bridge the gap, but as far as could be ascertained, they had no influence on the breakdown strength of the degassed liquid, even though they

caused high currents at field strengths as low as 100kV/cm. In air-saturated spectroscopic grade hexane, in one of the two breakdown tests carried out, a particle bridged the gap and this resulted in a breakdown strength of 800kV/cm compared with 1MV/cm for the particle free test. However, in view of the large spread in the results of the breakdown values in the degassed liquid, conclusive evidence cannot be drawn from only two observations.

The work done here on particles confirms the general conclusions arrived at by Sletten(1) who worked in degassed, spectroscopic grade hexane using spherical electrodes, and later work by Morant (2) who used conditions similar to those of Sletten but considerably refined the degassing technique.

### 3.12. Stability of the current level.

#### 3.12.1. Introduction.

The current in the liquid measured at a given voltage was often highly unstable. This instability could be roughly classified into three types.

- (1) A fairly slow variation in the current level which extended over a period of several minutes.
- (2) Small upward kicks, or peaks, of several seconds duration superimposed on the steady component.
- (3) Peaks, or upward kicks, similar to those in category (2) but very much larger and often at least two orders of magnitude greater than the steady component of current.

These three types of instability, which are shown sketched in Figs. 54A, 54B and 54C could appear either together or separately, but that shown in Fig. 54A was usually only seen at fairly low fields.

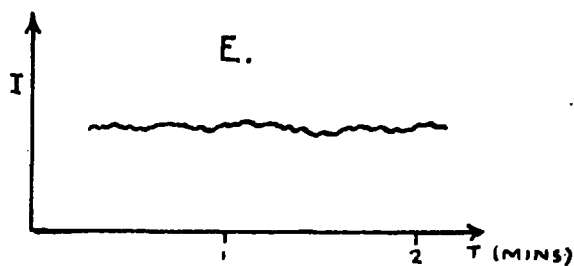
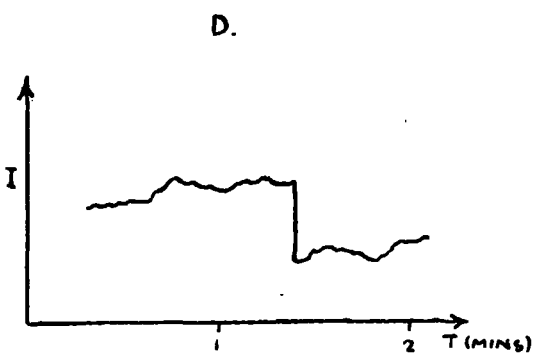
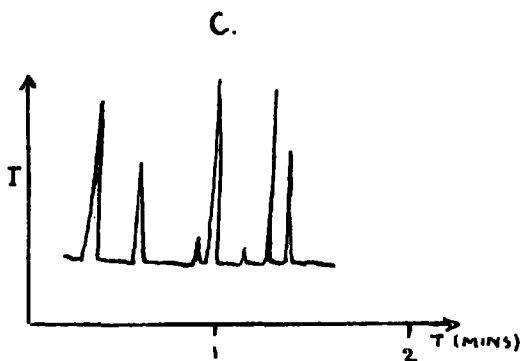
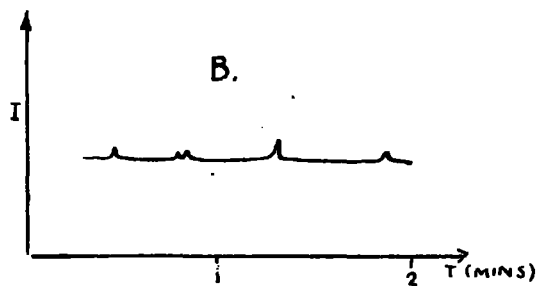
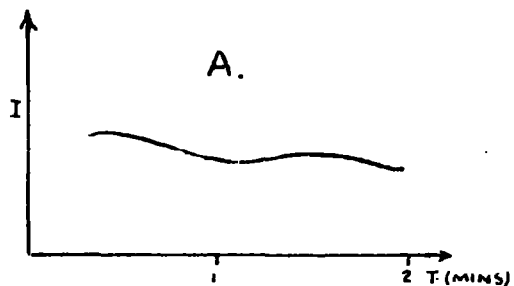

FIG. 54. IMPRESSION OF THE DIFFERENT FORMS OF FLUCTUATIONS SEEN IN THE CONDUCTION CURRENT.

All the types of instability were completely random in the sense that the peaks, or waves, did not repeat themselves in any sort of cycle. A marked feature of the instability was that the peaks were always in an upwards direction and gave the appearance of being additional bursts of current superimposed on the steady component. Thus, in spite of quite considerable instability, the steady value of the current could be estimated with reasonable accuracy.

### 3.12.2. Dependence of the instability on field strength.

At the lower end of the (I,V) characteristic the current usually appeared to be smooth on the scale used. There was however a tendency for the long time variations of the type shown in Fig. 54A to occur, especially when the liquid was not allowed to settle in the cell after filling it. The field strength upto which the current remained smooth showed some dependence on electrode geometry. Thus, with plane electrodes the current was smooth upto approximately 250kV/cm whereas with spheres, smooth current was only obtained at 150kV/cm and below.

The instability first showed itself as upward kicks superimposed on the steady component of current as shown in Fig. 54B. At the lower field strengths these kicks were usually few in number and separated from each other by periods as large as several minutes. As the field was increased further, the separation between the peaks became increasingly smaller, until at the field strength just below which the high currents occurred, they were so close together that the current became too unstable to determine the steady component with any degree of accuracy. The field



strength at which this high instability occurred was higher with the spherical electrodes than with the planes, corresponding to the higher field for the onset of high currents with these electrodes.

### 3.12.3. Dependence of the instability on the purity of the liquid.

With the spectroscopic grade hexane there were many tests in which high currents were not present, and in these, although the instability as a whole followed the general pattern described above, the very high instability found at field strengths just before the start of the high currents was absent. Except in the high current region, no change in the general pattern of the instability was observed when changing from the spectroscopic grade of liquid to the pure liquid, even though the continuity of the (I,V) characteristic was considerably improved. The high currents were almost invariably unsteady in the spectroscopic grade hexane, having the general appearance shown in Fig. 54D. Thus in this grade of liquid, besides the sudden transitions from the high to the low current levels described in Sec. 3.3.2., the current varied slowly between levels which differed by a factor of two or more, with the occasional occurrence of large peaks.

In contrast, the high currents in the pure hexane were usually steady. Large peaks were absent and the general appearance of the high currents in this grade of liquid was that shown in Fig. 54E. It is worth noting that except for the large peaks which occurred in the spectroscopic grade hexane, the instability in the high current region did not have the appearance of being superimposed on the steady component of current

but gave the impression that there was no steady component of current at all.

#### 3.12.4. Dependence of the instability on the current level.

Although the actual form of the instability depended on the field, its magnitude was directly linked with the magnitude of the steady component of current. Thus, in the low current region where the magnitude of the current could vary by as much as 3 orders from one series of tests to another, the magnitude of the instability varied accordingly. Similarly, when the current changed abruptly from one level to another as described in Sec. 3.3.2., the instability changed by the same order of magnitude.

On the whole, the value of the steady current was much greater than the instability, the ratio between the two being about 10 - 1 in the low current region. In the high current region this ratio was even greater, particularly in the pure liquid. However, the exception to this was at the field strength just before the onset of high currents where the instability was actually greater than the steady component of current, as already mentioned in Sec. 3.12.2.

#### 3.12.5. Dependence of the instability on various parameters

##### 3.12.5.1. Age of the liquid.

No dependence of the general pattern of the instability on the time after which the liquid was degassed was found.

##### 3.12.5.2. Gap length.

Similarly, no change was found on changing the gap length from a minimum of 40 $\mu$  to a maximum of 100 $\mu$ .

### 3.12.5.3. Prestressing the liquid.

Prestressing the liquid had no effect on either the general pattern of the instability or on its magnitude, even though it did have the effect of improving the continuity of the (I,V) characteristic in spectroscopic grade hexane.

### 3.12.5.4. Hydrostatic pressure.

When the pressure above the liquid was changed from the vapour pressure of hexane to atmospheric pressure (see Sec. 3.16.1.) the pattern of the instability was again unaffected.

### 3.12.5.5. Settling the liquid.

Settling the liquid had the effect of reducing the type of instability shown in Fig. 54A which was often found in the low field region i.e. upto about 150kV/cm. This effect was more pronounced with spherical electrodes and corresponds to the effect settling had on the (I,V) characteristic (see Sec. 3.4.7.). It is therefore thought that the type of instability found in the low current region is due to the redistribution of static charge and that settling simply allows it to neutralize (see also the remarks in Sec. 3.3.6.).

### 3.12.5.6. Electrode material and surface finish.

Changing either the cathode or the anode from stainless steel to gold or varying the surface finish had no effect on the instability.

### 3.12.5.7. Length of application of the applied voltage.

There was no tendency for the instability to either

increase or decrease with the length of time for which the field was applied, even when this was for several hours.

### 3.12.6. Stability of the current in air-saturated hexane.

When spectroscopic grade hexane was allowed to become air-saturated the current was extremely steady and free from instability at field strengths below 350kV/cm, even though in the degassed liquid the current was always unstable at fields well below this value. At higher fields the current started to become unstable, until, at approximately 600kV/cm, the current was so unstable that a reliable estimate of its value was difficult. The current was then in the region of  $10^{-9}$ A with peaks as large as  $10^{-6}$ A superimposed. The form of the instability at these fields was in fact very similar to that in the degassed liquid just before the onset of high current.

### 3.12.7. Stability of the current in cyclohexane.

As mentioned in Sec. 3.7.1. these results are of doubtful validity. However, the currents obtained in this liquid were comparatively smooth. It is worth noting that no high currents were obtained in this test.

### 3.12.8. Stability of the current in cyclopentane.

The dependence of the instability on field strength, current etc. was exactly the same as in hexane except that it commenced at field strengths of about 100-150kV/cm compared to 150-200kV/cm in hexane. This corresponds to the difference in field

strengths at which high currents first appeared in these liquids.

#### 3.12.9. Stability of the current in air-saturated cyclopentane.

In air-saturated cyclopentane the current was stable upto 200kV/cm. Above this field strength a small degree of instability was present at first, and increased rapidly as a field strength of 400kV/cm was approached. At 500kV/cm high currents were obtained.

#### 3.12.10. Stability of the current in 3-methyl pentane.

The general pattern of the instability in 3-methyl pentane followed that of the instability in hexane and cyclopentane with one marked difference. In this case instability was present even at the lowest fields used i.e. 60kV/cm. It is worth noting that this liquid also showed the highest maximum current.

### 3.13. Pulses.

#### 3.13.1. Introduction.

In addition to the slow instability of the current described in Sec. 3.12. fast current pulses were also observed. These were measured by passing the current through a  $3.3 \times 10^5$  ohm resistor and feeding the voltage developed into an oscilloscope via a cathode follower. By this means the form of the current could be observed at the same time as its average value, and depending on the field strength, pulses of varying lengths and magnitudes were seen. A straightforward account of these pulses is given below, a more detailed analysis of the information contained in their

shape is given in the discussion, Sec. 5.4.4.

### 3.13.2. Dependence of the pulses on the current and voltage.

The lowest d.c. current at which pulses were seen was of the order of  $10^{-8}$  A, the pulses at that level of current being of such magnitude that they could just be detected. (The maximum sensitivity of the oscilloscope was 0.005V/cm so that the smallest pulse which could be seen was roughly 1/10th of this i.e. 0.0005V. When used in conjunction with a  $3.3 \times 10^5$  ohm resistor, and providing the pulse is long compared with the time constant of the circuit, (see Appendix B) so that the maximum height of the pulse can be reached, this corresponds to a current of the order of  $10^{-9}$  A. ). On one occasion when a preamplifier was used with a gain of 100, pulses were observed when the current was as low as  $10^{-9}$  A. In general the height of the pulses increased with increasing d.c. current until at the maximum current values,  $10^{-7}$  -  $10^{-6}$  A, single pulses were observed of the order of  $5 \times 10^{-3}$  V, this corresponds to an instantaneous current of approximately  $1.5 \times 10^{-8}$  A ( $I = V/R = 5 \times 10^{-3} / 3.3 \times 10^5 = 1.5 \times 10^{-8}$  A).

At the lower field strengths, approximately 200kV/cm with plane electrodes, the pulses usually occurred singly. The shape of the single pulses at a given field strength varied from the small and short pulses shown in Fig. 55A to the flat topped long pulses shown in Fig. 55B, depending on the ratio of the pulse length to the time constant of the circuit, see Appendix B. As the field strength was increased the frequency of the pulses increased until each pulse

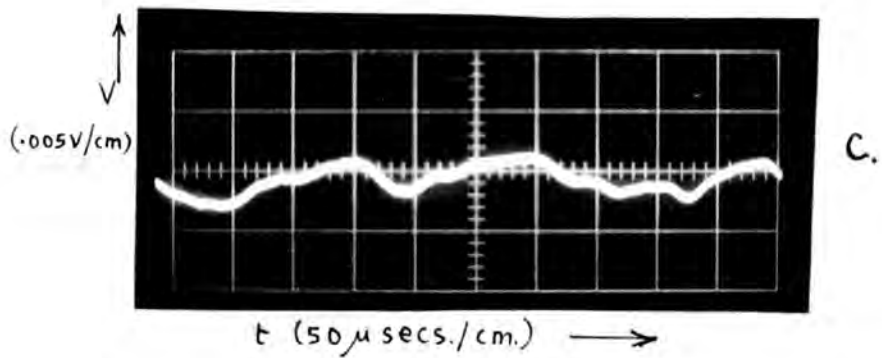
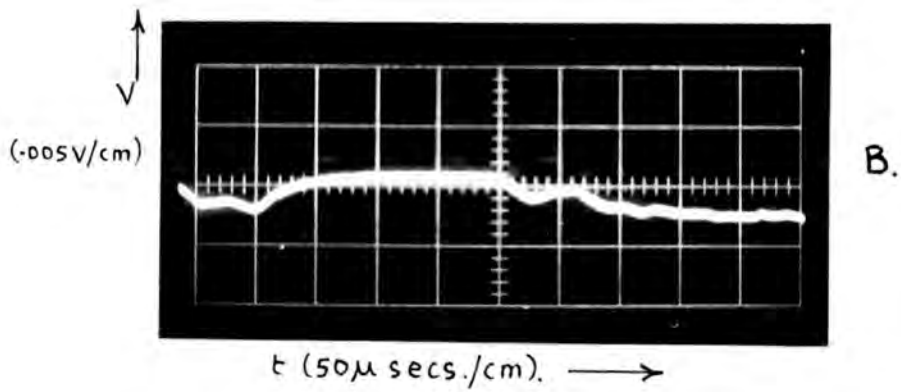
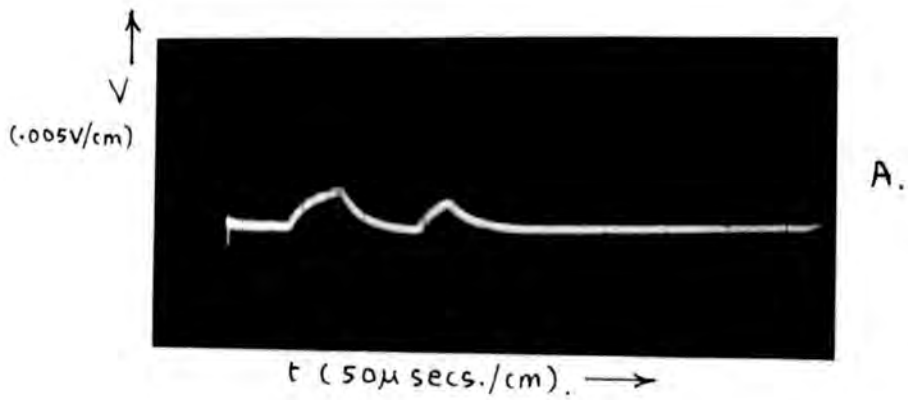

FIG. 55. OSCILLOGRAPHS OF TYPICAL PULSES (300 kV/cm, 75 μ GAP).

appeared as several pulses superimposed, and at approximately 300-350kV/cm the individual pulses were so close together that no clear pattern could be seen in their shape. They then appeared as shown in Fig. 55C.

### 3.13.3. Pulse length and field strength.

It was found that when the field strength was increased it was often necessary to increase the length of sweep of the oscilloscope trace from 20μsecs/cm to 50μsecs/cm, in order to obtain the whole length of the pulse in the width of the screen. Two series of photographs of the pulses were taken, one at 200kV/cm and the other at 300kV/cm, in order to confirm this observation. An exact statistical analysis of the pulses could not be made because not all of them could be measured. Some were as shown in Fig. 55C and others were longer than the maximum pulse length measureable on the oscilloscope with the time scale used. A histogram of the lengths of all the pulses which could be measured was drawn and this showed a slight tendency for the pulses to be longer at the higher field strength. This histogram has not been reproduced here because it is not strictly valid since all the pulses photographed could not be measured.

### 3.13.4. Pulse length and mobility.

If the pulses are due to a layer of charge crossing the gap from one electrode to the other, and the pulse length is the time of transit, then the mobility can be calculated from the expression  $u = d/txE$  where  $u$  = mobility,  $d$  = the gap length and  $E$  is the electric field strength, which is assumed



constant. However, the result of this calculation for the mobility is too low when compared with the results found experimentally by other workers, see Sec. 4.2. For example with  $d = 75\mu$  and  $E = 300\text{kV/cm}$ , it was sometimes found that  $t$  was greater than 500usecs.

$$\therefore u < 75 \times 10^{-4} / 5 \times 10^{-4} \cdot 3 \times 10^5 \text{ i.e. } < 2.5 \times 10^{-4} \text{ cm}^2 \text{ volt}^{-1} \text{ sec}^{-1}.$$

This is approximately a factor of 5 smaller than the accepted value of mobility in hexane.

#### 3.13.5. Pulse length and gap width.

An attempt was made to see if there was any relationship between the length of the pulses and the gap width but no conclusions could be drawn from the comparatively small number of results taken.

#### 3.13.6. Pulses and instability.

The pulse activity was found to depend on the current and voltage only and to be independent of the stability of the current. Thus, pulses were seen even when the instability of the current was less than the minimum observable on the measuring range used at the time. Conversely, high instability did not produce pulses if the current level was too low. However, as mentioned above, the fact that pulses could not be seen did not rule out the possibility of their presence, since there could have been pulses smaller than the limit of the sensitivity of the oscilloscope.

### 3.13.7. Pulses and particle movement.

Whether or not the arrival of an individual particle at an electrode gave rise to a pulse could not be ascertained, because the microscope with which the gap was viewed, and the oscilloscope screen, could not be viewed simultaneously. There was, however, no change in the pulse behaviour between times when the particle movement was extremely active and times when there was no particle movement at all.

### 3.13.8. Pulses and the electrode material and the surface finish.

Here again, no variation in the pulse activity was observed when either the cathode or anode was changed from stainless steel to gold. Similarly, no change was found when the electrode surface finish was changed from the normal optical finish to the relatively rough surface produced by the 6 $\mu$  grade of diamond polish. However, if the pulses are in fact influenced by emission from asperities, these might well be of atomic dimensions, so that their effect would be independent of the degree of polish obtainable by conventional means.

### 3.13.9. Pulses and the purity of the liquid.

No change was observed in the pulse activity when the liquid was changed from spectroscopic grade hexane to the pure hexane.

## 3.14. Breakdown.

### 3.14.1. Introduction.

This project was primarily concerned with conduction and once a breakdown had occurred in the gap

the initial conditions were considered to have changed and the series of tests was concluded. A number of breakdown measurements was nevertheless taken and it was considered worthwhile to record the results obtained here because of the unique conditions under which these tests were carried out i.e. the high degree of degassing and the attainment of high currents. The results are given in table 1, the values quoted being those for the first breakdown which occurred with a fresh pair of electrodes. (In this work breakdown was considered to have taken place when a flash of visible light occurred between the electrodes.) Subsequent breakdowns usually occurred at a slightly higher value of field strength. However, the first breakdown changes the conditions prevailing in the gap and only the value of field strength at which the first breakdown occurs can reasonably be considered to be the intrinsic breakdown strength of the gap. It should be noted that the spread in the results is quite considerable and the average values of the breakdown strengths of the different liquids listed in the table are based on too few results to be accurate. They are nevertheless sufficiently reliable to give a reasonable idea of the sort of value to expect under the conditions stated.

#### 3.14.2. Breakdown strength and electrode geometry.

From the table it can be seen that the breakdown of spectroscopic grade hexane fell from an average of 570kV/cm when using 1cm diameter chromium plated spheres at a spacing of 50 $\mu$ , to an average of 410kV/cm when 3mm diameter stainless steel plane electrodes with the same spacing was used.

Liquid	Electrodes	Test No.	B.D. Strength	Average
Spectroscopic grade hexane (degassed)	Spherical 1cm dia., chromium	1	480kV/cm	570kV/cm
		2	640kV/cm	
		3	600kV/cm	
	Plane, 3mm dia., stainless steel	1	350kV/cm	410kV/cm
		2	500kV/cm	
		3	350kV/cm	
		4	500kV/cm	
	Both 6u polish	5	350kV/cm	
	Cathode 6u polish	6	400kV/cm	
Air-saturated spectroscopic grade hexane	Plane	1	1MV/cm	
	..particle bridging gap	2	840kV/cm	
99% pure hexane (degassed)	Plane	1	525kV/cm	430kV/cm
		2	330kV/cm	
Cyclohexane (degassed)	Plane	1	400kV/cm	
Cyclopentane (degassed)	Plane	1	460kV/cm	

Table 1.

Electric strengths of the liquids used in this work.

This could be due to a combination of the following three causes.

- (1) Geometry dependence of the intrinsic electric strength.
- (2) Dependence on the electrode material: the spherical electrodes were chromium plated whereas the plane electrodes were stainless steel.
- (3) Difference of areas. (The ratio of the effective areas of the planes to the spheres was about 10 - 1.)

No attempt was made to distinguish between these three possible effects.

#### 3.14.3. Breakdown strength and liquid composition.

No apparent difference was found between the breakdown strength of spectroscopic grade hexane and the pure liquid. Similarly no difference was observed when the liquid was changed from hexane to cyclohexane or cyclopentane. This result is rather important since the boiling point of cyclohexane is approximately  $80^{\circ}\text{C}$  while that of cyclopentane is only  $49.5^{\circ}\text{C}$ , a difference of  $30.5^{\circ}\text{C}$ . On the theory of thermal mechanism of breakdown it would certainly be expected that the liquid with the higher boiling point would have a correspondingly higher breakdown strength.

#### 3.14.4. Air-saturated liquid.

The value found for the breakdown strength of air-saturated spectroscopic grade hexane using plane electrodes was  $1\text{MV/cm}$ . This is in agreement with the value quoted by previous investigators (1), (3.), and

serves as a comparison to show the remarkable change in the electric strength when the liquid is degassed. Although a conduction test was done in air-saturated cyclopentane, a breakdown measurement was not taken because it was not known at the time if air-saturated cyclopentane was an explosive mixture or not. However, although the field was not brought up to the expected breakdown value, it was increased to a value far in excess of that which caused breakdown in the degassed liquid without breakdown occurring. It could be thus stated with certainty that dissolved air increased the electric strength of cyclopentane.

#### 3.14.5. The effect of pre-breakdown current on breakdown.

Although the current just before breakdown in the degassed spectroscopic grade hexane often differed by as much as 5 orders of magnitude, no difference was noticed in the breakdown strength. Thus the breakdown strength obtained at the end of a series of tests in which high currents always occurred was no different from that found in tests where there was no high current at all. Similarly the electric strength of cyclohexane, in which there were no high currents, was virtually the same as that of pure hexane in which high currents were always present. This, of course, does not exclude the possibility that the instantaneous current before breakdown was in fact in the high current region, or even higher.

#### 3.14.6. Dependence on the degree of polish of the electrode surfaces.

Two different types of test were carried out to find the effect of the degree of polish on the electric

strength of the gap. In one, both electrodes were finished with 6 $\mu$  diamond paste instead of the usual lu grade, and in the other test, one electrode was finished with the 6 $\mu$  grade polish while the other was given the usual highly polished, scratch free surface, using the lu grade compound. In each case the breakdown strength was approximately the same as in tests where both electrodes were highly polished.

#### 3.14.7. Particles and breakdown.

Although high erratic currents were noticed in highly degassed hexane when solid particles bridged the gap, no effect on the breakdown strength was ever observed. With air-saturated hexane two breakdown measurements were taken, in one of which particles bridged the gap. The particle free gap had a breakdown strength of 1MV/cm whereas for the other, the value was 840kV/cm. Thus, though particles had no effect on the electric strength of degassed hexane, they might have influenced that of the air-saturated liquid.

#### 3.14.8. Damage to the electrodes.

Damage to the anode took the form of one or two comparatively large and deep pits which took a considerable amount of polishing to remove. That to the cathode consisted of many small, shallow pits, scattered over a wide area and were easily polished out. Examination of the electrode damage gave the impression that a large piece of metal had been torn off the anode during breakdown, broken up into fragments as it crossed the gap, and the large number of pits in the cathode marked the spot where these fragments had impinged upon it.

### 3.15. Viscosity tests.

#### 3.15.1. Introduction.

As mentioned previously in Sec. 3.1., an explanation of the high currents based on the molecular construction and configuration was suspected. It is well known (see Sec. 5.3.) that the viscosity of a liquid is also dependent on the molecular construction and configuration, and it was thought that a viscosity test might give further insight into the basic processes involved in conduction. A viscometer was constructed as described in Sec. 2.7. to test for a difference in the viscosity of degassed and air-saturated hexane. This was attached to a suitable part of the high vacuum side of the degassing apparatus, Fig. 7, filled with degassed hexane and sealed off under high vacuum.

All the measurements were taken with the viscometer immersed in a mixture of melting ice and water which was stirred mechanically throughout the experiment. The stability of the temperature was such that no movement was observed in a mercury thermometer graduated in  $1/10^{\circ}\text{C}$ .

To measure the viscosity of air-saturated hexane the seal on the viscometer was broken, the contents emptied out, and liquid from the same bottle from which the degassed liquid was obtained was poured in. Although it was intended to use pure hexane in this test, it was subsequently found upon chromatographic analysis that the bottle had been wrongly labeled by the suppliers, and the liquid was in fact almost identical to the spectroscopic grade hexane. The liquid used in this test is therefore referred to here as spectroscopic grade hexane.



### 3.15.2. Results.

The results of 10 measurements, 5 each in the degassed and air-saturated liquids, are shown in table 2. Two of the measurements in the air-saturated liquid have been marked with an asterisk because they are not strictly valid for the following reason. With air-saturated liquid it took several minutes to refill bulbs A and B from bulb C, Fig. 13, because of air locks. The viscometer had therefore to be immersed in the constant temperature bath for a period of approximately 20 minutes before the commencement of the actual test to allow it to reach equilibrium with its surroundings. However, in these two measurements only a short period of immersion was allowed before the start of the test so that the temperature of the liquid in the viscometer was slightly higher than that in the bath. This is borne out by the fact that the times of flow were smaller in this two tests, and this agrees with the temperature dependence of viscosity shown in Fig. 56.

The average time recorded for the degassed liquid to flow between the two marks shown in Fig. 13 is 10 mins. 29 secs., with 6 secs. spread in the results. The average time found for the air-saturated liquid to pass between the same two marks is 10 mins. 19.1 secs. if the two doubtful results are not included, and 10 mins. 18.6 secs. if they are. The spread in results if the doubtful results are ignored is only 0.2 secs., the accuracy with which the stopwatch could be read, and even if all the results are taken into account the spread is only 2 secs. The difference in the absolute value of the comparative viscosities of

Liquid	Test No.	Time of flow in secs.
Degassed spectroscopic grade hexane	1	621.8
	2	626.0
	3	619.8
	4	621.0
	5	615.8
Air-saturated spectroscopic grade hexane	6	619.2
	7	619.0
	8	618.4*
	9	617.6*
	10	619.0

Table 2.

NOTE: THE VALUES FOR VISCOSITY SHOWN IN THIS FIGURE HAVE BEEN TAKEN FROM "THE HANDBOOK OF CHEMISTRY AND PHYSICS." THE POINTS MARKED WITH AN ASTERISK REFER TO VALUES OBTAINED BY THE SAME INVESTIGATOR.

FROM THE SLOPE OF THE BROKEN LINE IT CAN BE SEEN THAT THE RATE OF CHANGE OF VISCOSITY WITH TEMPERATURE IS APPROXIMATELY 1.06% PER °C. AT 0°C.

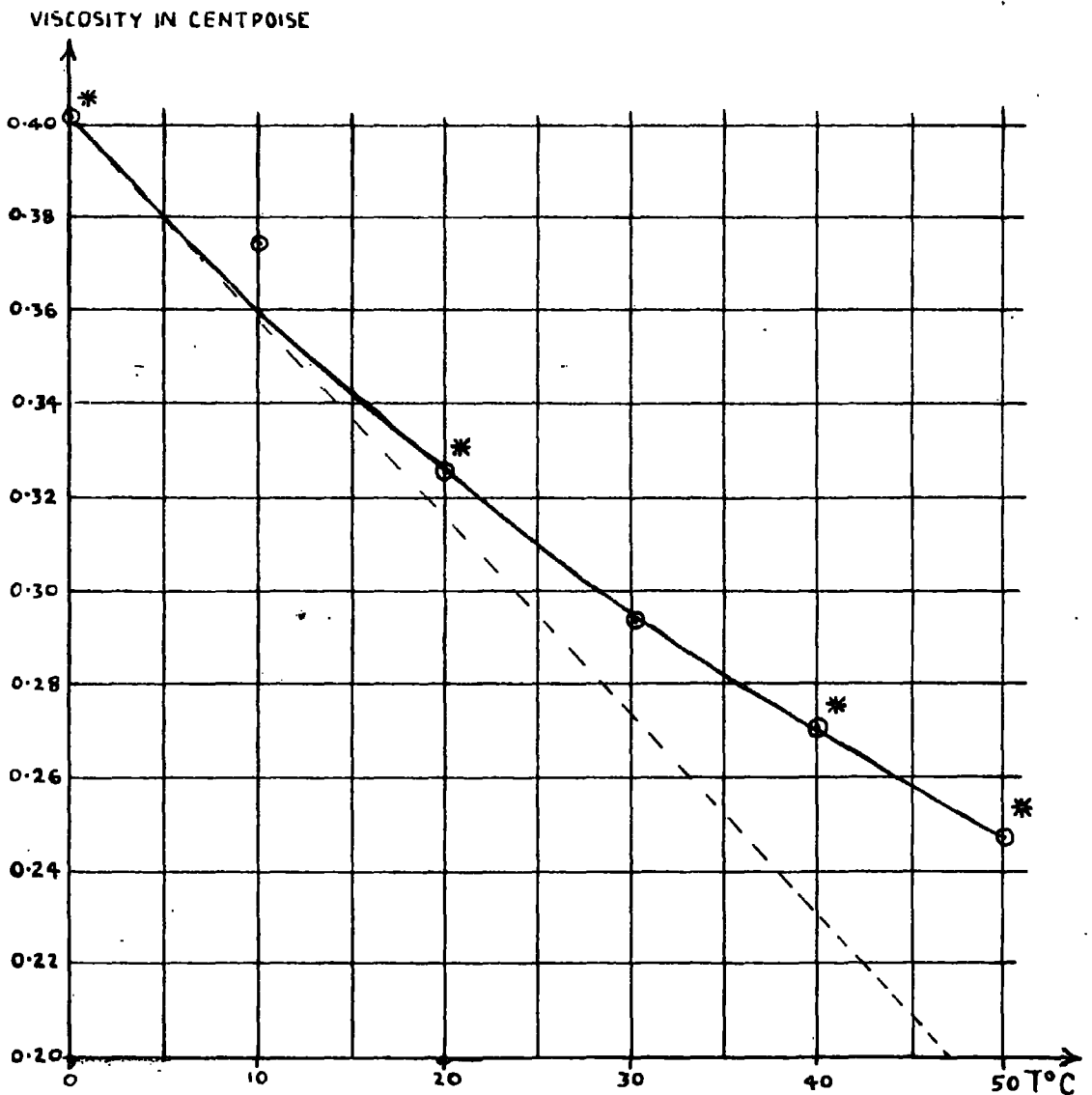

FIG. 56. THE TEMPERATURE DEPENDENCE OF THE VISCOSITY OF HEXANE.

the two liquids might not be significant in view of the spread in results of the degassed liquid but the difference in the spread of the two sets of results certainly seems to be significant. The dependence of the reproducibility on the air content is remarkably similar to that obtained in the conduction tests, where reproducibility could not be obtained in the degassed liquid but was good in the air-saturated liquid.

The only possible external cause of the variation observed in the degassed liquid could be a change in viscosity due to a change of the temperature in the surroundings of the viscometer. From Fig. 56, the rate of change of viscosity of hexane with temperature at  $0^{\circ}\text{C}$  is approximately 1.06%. The variation in the temperature of the bath was less than  $1/10^{\circ}\text{C}$  so that the maximum change in the viscosity of the liquid due to temperature fluctuations could not have been greater than approximately 0.1% i.e. a factor of 10 smaller than that observed in the degassed liquid. The spread in the results must therefore have been due to some process taking place in the liquid itself. The possible reasons for the difference in the results obtained in the air-saturated and degassed liquids, and the bearing these measurements have on electrical conductivity is discussed in Sec. 5.4.7.

### 3.16. Miscellaneous tests and observations.

#### 3.16.1. Pressure dependence of the high currents.

All the tests, except those in which air-saturated liquid was used, were conducted under vacuum, so that the hydrostatic pressure in the liquid was that due to the head of liquid in the cell (approximately 4cm of hexane)

plus the vapour pressure of hexane at room temperature (approximately 100 torr). It is known that many of the results quoted in the literature refer to work done at atmospheric pressure, and it was therefore thought desirable to show that the high currents obtained in the present work were not the result of working at low pressure.

For this test a springham greaseless tap with a "Viton A" insert was placed at point Q, Fig. 7, instead of the usual sealing-off restriction, and after the test cell system had been filled with degassed liquid, the tap was closed with the gas pressure in the system being at  $10^{-6}$  torr. Several tests were first carried out in the usual manner and then dry nitrogen was admitted in the following way. (Nitrogen was chosen because it is known to have no effect on the electrical conduction and breakdown of hexane (1) ).

A cylinder of oxygen free nitrogen was connected to the inlet of the degassing apparatus, Fig. 7, and the spiral and filter A and B cooled by means of a mixture of solid carbon dioxide and methylated spirit. Tap C was opened and nitrogen admitted until the previously evacuated system was brought up to atmospheric pressure, any moisture present in the gas being frozen out in the spiral and filter. Tap C was closed, the system evacuated and a further charge of nitrogen admitted. This procedure was repeated several times in order to ensure that all traces of air were removed from the tubing connecting the cylinder to the degassing apparatus. The tap at Q was then opened and dry nitrogen at atmospheric pressure admitted to the testing system.

Measurements were made immediately atmospheric pressure had been established over the liquid, and steady high currents<sup>were</sup> found at the same field strength as in the previous tests at reduced pressure. The magnitude of the current also appeared to be unchanged, so confirming that the high currents were not caused by working at reduced pressure.

### 3.16.2. Time dependence of the high currents.

In the spectroscopic grade hexane the high currents were not constant with time but could vary by as much as several orders of magnitude over a period of minutes. The change was sometimes extremely rapid and at other times quite gradual as mentioned in Sec. 3.3.2. However, there was no tendency for the average current to vary, even over periods of an hour or more. In pure hexane the variation was considerably less than in the spectroscopic grade liquid, and the current was often constant for periods of 30 mins. or more.

### 3.16.3. Discharge currents.

Zaky (12) found that when the applied voltage was removed, a discharge current of similar magnitude as the forward current, flowed in the reverse direction. In this work no detectable discharge current was ever obtained, either in the low or high current region, and confirms the work carried out by Morant (2) in the present cell, using spherical electrodes and spectroscopic grade liquid. It must be pointed out that in this work the electrodes were surrounded by an earthed screen whereas in Zaky's cell no screening was used. It is therefore probable that the discharge currents found by Zaky were the effects of static charge on the glass walls of the test cell.

3.16.4. Elimination of spurious discharges as a  
cause of high currents.

Because of the high voltages used ( up to 3,300V) it is necessary to show that the high currents were not caused by spurious corona discharges from the cell itself. This was ruled out by the following measurements.

- (1) When the hexane was air-saturated no high currents were obtained even when the maximum voltage of the powerpack was used. It is therefore certain that corona discharges were not generating the high currents.
- (2) Upon reversing the polarity of the electrodes the (I,V) characteristic was unchanged (see Sec.3.6.3.) Had the high currents been due to corona discharges a different characteristic might have been expected.
- (3) The characteristic did not change when the gap length was increased from 50 to 100 $\mu$ . Again, if discharges were the cause of the high currents they would have occurred at the same applied voltage with the 100 $\mu$  gap i.e. at half the field strength.

### 3.17. Summary of the experimental results.

A summary of the results obtained in this project is given below in order to give an overall view of the work carried out. These are the most important results and will be used in the discussion which follows.

(1) Chromatography. All the liquids used in this project have been analysed chromatographically and in particular, the spectroscopic grade hexane, which is known to have been extensively used in the past, and which has often been referred to as n-hexane, was found to be only approximately 80% pure, the impurities being isomers of hexane and other hydrocarbons. Important differences were found between this impure hexane and 99% pure hexane.

(2) The (I,V) characteristic. The general form of the (I,V) characteristic in pure hexane was as follows. At low field strengths i.e. 60 - 150kV/cm, the current was in the region of  $10^{-13}$  -  $10^{-12}$  A. At about 150kV/cm the characteristic curved sharply upwards until at about 300kV/cm it flattened off at a current value between  $10^{-7}$  and  $10^{-6}$  A. It was found, in agreement with the work done by Morant (2) using spheres, that with spectroscopic grade hexane the current in the high current region was extremely erratic and would change by as much as three orders of magnitude for no apparent reason. There were also occasions when it was impossible to obtain high currents in this liquid even though they appeared in other tests on the same liquid sample. This erratic behaviour has been established here as an inherent property of the impure liquid.



(3) Dependence of the high currents on time and hydrostatic pressure. There was no tendency for the high currents to change with time at a given voltage. Similarly no change was noticed when the hydrostatic pressure was changed from the vapour pressure of hexane at room temperature, to atmospheric pressure.

(4) Prestressing. Prestressing the gap with a high voltage resulted in a smooth current voltage-curve, even when spectroscopic grade hexane was used. This prestressing appears to be a liquid rather than an electrode effect.

(5) Electrode geometry. There was no noticeable difference between the results obtained with plane and spherical electrodes, except for the single fact that the high currents were obtained at a somewhat lower field strength with the former.

(6) Electrode surface. No variation in any of the electrical properties of the gap was noticed when the surface of either or both of the electrodes was changed from the usual optical finish to a comparatively rough state. Similarly there was no change on reversing the polarity when electrodes of gold and stainless steel were used.

(7) Current decay. In agreement with earlier work by Morant (2), there was no flow of current in the reverse direction of the type found by Zaky (12) when the voltage source was replaced with, what was in effect, a short circuit. Also, the current decay when the voltage was first applied was only approximately one order of magnitude, and this was further reduced when the liquid was allowed to settle in the cell after it

was filled. The smallness of the current decay is undoubtedly due to the electrostatic shielding of the screen.

(8) Instability. At approximately 100kV/cm the current started to become unstable. This instability took the form of apparently random fluctuations superimposed on the steady current, and these were often at least two orders of magnitude greater than the steady component of the current. The instability was most marked just before the onset of a high current. It was independent of the age of the liquid, the gap length, the length of time the voltage was applied, the electrode material or surface finish and hydrostatic pressure. However, some dependence on the liquid used was found.

(9) Pulses. In the high current region pulses of microsecond duration were observed, their shape and length being determined by the applied voltage. There appeared to be no relationship between these pulses and the instability mentioned above or the particle movement.

(10) Particles. Particles were always visible in the gap, in spite of the most stringent precautions to exclude them. At about 100kV/cm they started to oscillate between the electrodes but had no apparent effect on any of the properties of the gap. However, on one occasion, when the current was in the region of  $10^{-14}$  A, there seemed to be some relationship between the low level of instability present, and particle movement. Occasionally particles would attract each other and thus bridge the gap, and although they caused

high erratic currents, there was no apparent lowering of the breakdown strength in degassed liquid.

(11) Air-saturated hexane. When spectroscopic grade hexane was allowed to become saturated with air the current remained in the low current region even at field strengths where the degassed liquid would have normally broken down. At about 600kV/cm the current became highly unstable and the form of the current, as shown by the pen recorder, was then very similar to that in the degassed liquid just before the onset of high current. With air-saturated cyclopentane high currents were in fact obtained at very high fields.

(12) Results obtained in different liquids. Changing the liquid from hexane to one of the other hydrocarbons used produced the following results.

- a.) There was a marked dependence of the maximum value of the current on the liquid used.
- b.) The field strength at which the high currents first appeared was different.
- c.) A small change in the pattern of the instability was also found.

(13) Breakdown strength. The breakdown strength of the degassed liquid was in the region of 450kV/cm when 3mm diameter plane electrodes were used, without any apparent liquid or electrode surface dependence. Saturating hexane with air produced an approximate twofold increase of the breakdown strength.

(14) Viscosity experiments. Highly reproducible results could be obtained when measuring the viscosity of air-saturated spectroscopic grade hexane. However, when using the same apparatus and the degassed liquid the scatter in the results was increased to the point where reliable measurements could not be obtained. This followed very closely the pattern of reproducibility of the electrical measurements taken in these liquids.

#### 4. Review of previous work.

Several comprehensive reviews (13,14,15) covering the work in the field of electrical conduction and breakdown in dielectric liquids up to 1961 have already appeared in the literature, so that only work that is highly relevant to the present project has been included in this review. It must be pointed out, however, that in view of the important effect of impurities found in the present work, there is some question of the validity of any comparison between the work of different investigators.

##### 4.1. High field conduction.

The present theories of high field conduction can be classified under the following headings.

- (1) Schottky type field aided thermionic emission and Fowler-Nordheim high field cold emission.
- (2) Field assisted dissociation of the liquid itself or of impurities.
- (3) Ionisation by collision at very high fields.

Of the earlier workers, Edler and Zeis (16) and Baker and Boltz (17) favoured Schottky emission because they found that the conductivity of toluene obeyed a Richardson type plot ( $\log. I \propto T^{-1}$ ). They both found a large reduction in the current when the electrodes were heated in either oxygen or hydrogen and it was assumed that this was due to the change of work function caused by absorbed layers on the electrodes. Dornste (18) suggested Fowler-Nordheim emission because he found no

dependence of the current on the temperature of the liquid. LePage and Dubridge (19) measured the current in toluene as a function of the electric field and temperature, (0 - 250kV/cm and -15 to 70°C) and showed that the current followed a Richardson type plot although the slope was too small, and the emitting area found from the intercept made by the straight line plot with the axes was also too small by a factor of  $10^{-13}$  -  $10^{-11}$ . Also, the slope of the line obtained by plotting  $\log. I$  against  $E$  was found to be a factor of 2 greater than that predicted by Schottky theory. They therefore suggested that the current was due to a combination of both thermionic and cold cathode field emission.

More recently House (3) has also suggested a combination of Schottky and Fowler-Nordheim emission. Watson and Sharbaugh (9) have proposed Fowler-Nordheim emission through a barrier whose thickness is reduced by a layer of positive charge at the cathode. A similar theory has been put forward by Green (20).

Some very careful work was done by Plumley (21) on pure heptane which he further purified by distilling it over metallic sodium in order to dry it, and then passed it over silica gel to remove polar impurities, through sintered glass discs to remove dust particles and finally purified it by means of electrical purification. He rejected both thermal and cold field emission mechanisms of conduction because he found no dependence on polarity when using a point-plane electrode system. He therefore proposed a mechanism in which the carriers are formed by dissociation of the liquid molecules in the high field ; this does not depend on the electrode geometry but simply on the highest field present in the gap.

The suggested reaction in heptane was

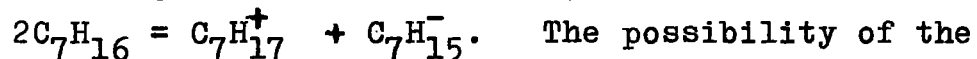

dissociation of the impurities present was discarded because the conduction was found to be independent of the purification. Macfadyen (22) has pointed out that this process is unlikely because the energy of dissociation of the proposed reaction is in the region of 10eV. It is worth noting that Plumley obtained currents of the order of  $10^{-6}$  A at a field strength of about 350kV/cm. Although he does not mention the pressure at which he degassed his liquid, it would seem from the apparatus sketched in his paper that the pressure was in fact very low, as he used a diffusion pump and wide bore tubing. He also took the precaution of degassing his electrodes by heating them under vacuum by means of eddy currents. Although currents as high as this had not been previously reported in liquids of this type he did not remark on them. Dissociation theories have also been forward by Reiss (23) and Pao (24) and more recently by Coelho and Bono (25).

House (3), working in hexane with a relatively high air content, succeeded in measuring the conduction current up to field strengths just below breakdown (approximately 1MV/cm) by means of conditioning. This consisted of waiting for the decline of pulses at each voltage level. ~~the damage caused by breakdowns at these voltages being minimized by the use of a thyatron divertor.~~ Stable currents were obtained by this technique. House interpreted his results on the basis of electron emission from the electrodes with the effective work function of the electrode metal

reduced by the presence of the dielectric, and the field strength greatly increased at the electrodes because of asperities. From his work on changing the gap length he concluded that there might possibly be an electron multiplication process. However, a rigorous interpretation of his results on the variation of the gap width is extremely difficult because spherical electrodes were used.

Sletten (1) was the first to realize the importance of oxygen in solution in hexane, when he found that the breakdown strength fell from the accepted value of around 1MV/cm to approximately 0.8MV/cm and the level of the conduction current increased by a factor of 2 or 3 when the oxygen was removed. Nitrogen was found to have no effect on either conduction or breakdown. Zaky (12) found that when the voltage supply was replaced by a short circuit, a current flowed in the reverse direction and the quantity of this reverse charge was approximately the same as that which flowed in the forward direction. However, his electrodes were unscreened. It is quite certain from the work carried out by Morant (2) in which he found that discharge currents only occurred when the electrodes were not screened, that the discharge currents found by Zaky were in fact due to electrical charging of the glass wall of the cell, and had nothing whatsoever to do with basic processes occurring in electrical conduction in dielectric liquids. This was confirmed by the present work in which, using screened electrodes, no discharge currents were ever obtained under a variety of conditions.

Objections to electrode emission theories on the



grounds of lack of dependence of the current on electrode material have been removed by Morant (26) who reasoned that a space charge must exist at the electrode-liquid interface, in the same manner as at a metal-dielectric contact. Morant succeeded in demonstrating this experimentally and estimated the potential due to this space charge to be in the region of 1eV. Thus it is probable that this potential masks any effect due to the different work functions of the different metals.

Forster (27) plotted the potential distribution between a pair of parallel plate electrodes in benzene by means of probes and found the field near the electrodes to be much greater than that in the bulk of the liquid, thus showing directly the existence of space charge. The conduction of various related liquids was also measured and it was found that the conductivity was related to the number of  $\pi$  electrons available in the molecule. He therefore postulated that the carriers in these types of liquids are  $\pi$  electrons which remain attached to the parent molecule until a collision of the correct type for the transfer of this electron from one molecule to another occurs. Zein Eldine, Zaki, Gullingford and Hawley (28) carried out probe measurements in transformer oil at field strengths up to 60kV/cm and a similar field distribution was found.

Helliwell and Macfadyen (29) and Watson and Sharbaugh (9) have carried out conduction experiments under microsecond pulse conditions and found currents many orders higher than that normally obtained under d.c. conditions. Indeed, the former obtained a current of 80 $\mu$ A at a field strength of 400kV/cm. It must be mentioned that Watson and Sharbaugh reported a decay in

the d.c. current of approximately three orders of magnitude during the first few minutes after first applying the voltage, and reverse currents when the voltage was removed. This indicates the use of unscreened electrodes in their case at least, and this might well be the cause of the high currents found. Because of some dependence on cathode material and none on the liquid sample, Macfadyen and Helliwell ruled out the possibility of ionic conduction. Watson and Sharbaugh found no evidence for an electron multiplication process at field strengths up to 1.2MV/cm but reported marginal evidence for such a process at about 1.3MV/cm. Their use of plane electrodes makes their results more easy to interpret than that of House.

#### 4.2. Mobility.

In contrast with measurements on conduction, there is good agreement between the different investigators on the value of the carrier mobility in the saturated hydrocarbon liquids. The method used up to date has been to form carriers in the liquid by means of X-rays or to inject electrons into the liquid by photo emission from the cathode. There is thus always the possibility that the carriers in these experiments are not those which take part in natural conductivity.

A great deal of work on mobility in the saturated hydrocarbons by Adamczewski and his group using air-saturated liquid which was dried over metallic sodium and electrolytically cleaned. It is known (30) that his group used commercial grade hexane so that besides the inherent difficulty of not knowing if the carriers produced by external stimulation are the same as those

taking part in conduction, there is the additional uncertainty that the carriers might in fact be impurity ions.

Adamczewski (31) measured the mobility of ions produced by X-rays in saturated hydrocarbon liquids over a temperature range of 8 - 50°C and has given an empirical formula connecting the mobility with the number of carbon atoms in the molecular chain and the temperature. The mobilities of the positive and negative carriers in cyclohexane were found to be  $0.9 \times 10^{-4}$  and  $3.6 \times 10^{-4} \text{ cm}^2 \text{ volt}^{-1} \text{ sec}^{-1}$  respectively. The activation energies of mobility and current were found to be very similar in magnitude. Jachym (32) found that the relationship between carrier mobility and viscosity could be expressed  $u = An^{-x}$  where A is a constant and  $x = E_u/E_n$ ,  $E_u$  and  $E_n$  are the activation energies of mobility and viscosity respectively. For negative quantities this quantity is unity so that this relationship is in fact Stokes law,  $u = An^{-1}$ . For positive ions x is 3/2 and this relationship obeys the law previously found by Adamczewski,  $u = An^{-3/2}$ .

Terlecki (33) measured the mobility of negative ions in hexane, octane and decane at field strengths up to approximately 120, 200 and 300kV/cm respectively, and found the respective mobilities to be  $9.8 \times 10^{-4}$ ,  $7 \times 10^{-4}$  and  $3 \times 10^{-4} \text{ cm}^2 \text{ volt}^{-1} \text{ sec}^{-1}$ . Gzowski (34) found exactly the same relationship between u and n as Jachym, using X-rays to produce the carriers, in hexane, heptane, octane and decane. A diffuse spectrum of positive carrier velocities was found showing the existence of different types of positive carriers.

LeBlanc (35) working at fields up to 2kV/cm found the mobility of negative carriers in hexane and pentane to be in the region of  $1.4 \times 10^{-3} \text{ cm}^2 \text{ volt}^{-1} \text{ sec}^{-1}$  and the activation energy in hexane to be 0.14eV. The product of viscosity and mobility was not constant with temperature so that the carriers did not obey Walden's rule. It was therefore concluded that the carrier could not be ionic in nature and because of this he proposed a mechanism in which the electrons travelled partly in the free state and partly as a negative ion. It must be noted, however, that Walden's rule is purely empirical and only holds strictly for the single substance tetraethyl-amonium picrate in a variety of solutions (36), so that no deductions can validly be drawn from it as far as the carriers in liquids such as hexane are concerned.

Inuishi and Chong (37) using photo injected electrons in air-saturated hexane found the mobility of their carriers to be  $1 - 1.2 \times 10^{-3} \text{ cm}^2 \text{ volt}^{-1} \text{ sec}^{-1}$  and independent of the field up to 0.5MV/cm. The activation energy was found to be 0.16eV, this being different from the activation energy of the viscosity of the liquid. The viscosity was varied by adding silicone oil and when  $\eta$  was plotted against  $n$  Stoke's law was not obeyed. A small amount of added alcohol decreased the mobility and increased the breakdown strength even though the conduction current increased. When the mobility of the carriers in hexane gas was extrapolated to the temperature and density of the liquid, it was found that the value obtained was approximately 4 orders too high. This of course is not surprising in view of the fact that the physical structure of gases is very different from that of liquids. This is discussed in greater detail in Sec. 5.2.

Davis, Rice and Meyer (38),(39) have produced a quantitative theory for the mobility of carriers in argon, krypton and xenon, based on the interaction potential of the carriers with their surroundings and the radial distribution function for the liquid itself. Agreement is obtained between theory and experiment if the negative carriers in these liquids are  $O_2^-$  ions, and  $Ar_2^+$ ,  $Kr_2^+$  and  $Xe_2^+$  the positive carriers.

There is little doubt that this direct theoretical approach to the study of liquids is correct as it does not invoke the use of any sort of model nor does it call on gas or solid state theory to aid it.

The values obtained for both positive and negative carriers lie in the region of  $10^{-4} - 10^{-3} \text{cm}^2 \text{volt}^{-1} \text{sec}^{-1}$  depending on the temperature and pressure. Long gaps were used with field strengths not exceeding 250V/cm. Swan (40), who also worked in argon and used high fields in conjunction with a narrow gap, found the mobility of the negative carriers to be in the region of  $100 \text{cm}^2 \text{volt}^{-1} \text{sec}^{-1}$  i.e. about 4 orders of magnitude higher than the value obtained by Rice. He explains this discrepancy by saying that with the high fields and narrow gap used by him the electrons do not have sufficient time in their transit across the gap to attach themselves to a molecule, and therefore travel as free electrons. At the low fields and long gaps used by Rice there is sufficient time for the electrons to attach themselves to molecules so that these experiments in fact measure the mobility of ions.

### 4.3. Breakdown.

As mentioned previously, the main concern of this work was with conduction, and there are not sufficient breakdown results to contribute anything new to the discussion of possible mechanisms of breakdown. However, the ideas postulated up to date have been listed below and in Sec. 5.8. those which seem most relevant to the present results will be discussed.

(1) Space charge theories. In space charge theories the local field near one or both of the electrodes is enhanced until at sufficiently high applied fields breakdown occurs. Bragg, Sharbaugh and Crowe (41) have put forward such a theory. In this the anode field is enhanced by negative space charge produced by Schottky emission at the cathode. On the other hand, Goodwin and Macfadyen (42) contend that it is the local cathode field which is increased by positive charge which is generated by ionisation by collision. Swan (43) has proposed a similar theory based largely on equations derived from gas theory and depends on the assumption that at high field strengths the electrons are free. Their mobility is thus much greater than that of the positive carriers so that the electrons produced at the cathode are swept away to leave a net positive space charged for field enhancement at the cathode.

#### (2) Bubble theories.

Kao and Higham (44) found a strong pressure dependence of breakdown strength and consequently Kao (45) proposed a theory in which bubbles, formed either by a thermal or a degassing process, initiates

breakdown. In this theory the bubbles are elongated in the electric field, and at fields approaching the breakdown strength of the liquid, electrons travelling along their length gain sufficient energy from the field to be able to ionize or rupture the liquid molecules. It must be pointed out in this connection that Maksiejewski and Tropper (46) found no dependence of the breakdown strength on pressure when this was subatmospheric if the electrodes were degassed, although there was a marked change when they were not degassed. Watson and Sharbaugh (47) have also proposed a thermal mechanism for breakdown under pulse conditions in which very high currents are obtained. In this, the high power input at asperities on the electrodes is sufficient to cause local vaporisation of the liquid and these vapour bubbles subsequently cause breakdown.

### (3) Particle theory.

It is well known that particles bridging the gap can sometimes cause breakdown. Kok and Corbey (48) have developed a theory based on this model of particles bridging the gap and have extended it to particles of molecular size i.e. when the bridge is formed by the molecules of the liquid itself. For d.c. conditions their theory predicts that the breakdown strength should be proportional to  $r^{-\frac{3}{2}}$  where  $r$  is the radius of the bridging particles. On this basis liquids with short molecules should show a higher breakdown strength than those with long molecules.

Adamczewski (49) and Lewis (50) have attempted to explain the dependence of the breakdown strength of the paraffins on the molecular chain length by assuming

that breakdown is initiated by high energy electrons which are capable of producing ionisation by collision. The energy of the electrons is limited by inelastic collision with the liquid molecules in which their energy is given up to increase the vibrational energy of the molecules. Adamczewski has postulated the C - C bond to be the major energy sink while Lewis favours the C - H bond.

#### 4.4. Relevant experimental results.

Sletten (1) was the first to realise the important role played by dissolved gas on the electric strength of insulating liquids when he found that the electric strength of air-saturated hexane fell from 1.33MV/cm to 0.88MV/cm when the liquid was degassed. It was found that dry nitrogen, carbon dioxide and hydrogen did not influence the electric strength of the liquid whereas dry oxygen did. He therefore concluded that it was the oxygen in the air which produced <sup>the</sup> increase in the electric strength. On the other hand, oxygen was found to have no effect when microsecond pulse voltages were used. This was later confirmed by Lewis and Ward (51).

Gallagher and Lewis (52) found that when oxygen was present in argon in the ratio of 20ppm the surface conditions of both the anode and the cathode influenced the static electric strength. When oxygen was removed only the anode effect remained. However, under pulse conditions, no anode effect was found unless 10% of oxygen was present. Ward and Lewis (8) found that with air-saturated hexane the pulse strength was increased with either positive or negative prestressing, but with degassed liquid either increased or decreased



depending on whether the prestressing was negative or positive.

Zaky, Zein Eldine and Hawley (54) found that the breakdown strength of transformer oil was increased by a factor of approximately three if either the cathode or anode was coated with a layer of plastic material. Coating both electrodes produced no further increase in the electric strength.

#### 4.5. Instability.

The increase of instability when the liquid is degassed has been noted by several observers. Sletten (1) noticed that the increase in conduction current when hexane was degassed was accompanied by a corresponding increase in instability. This was also found by Nossier (55) in transformer oil when it was degassed at  $8 \times 10^{-3}$  torr.

A rather quantitative study of the effect of dissolved gas on the instability in transformer oil and liquid paraffin using different electrode geometries has been carried out by Hug and Tropper (56). Their results are listed below.

- (a) No relationship was found between noise and particle movement at high fields.
- (b) Although in general increasing the oxygen content of the liquid decreased the noise level, an exception to this was when the partial pressure of the dissolved oxygen was 14 torr, when a slight increase in the noise was noticed.
- (c) Increasing the gap length from 81 $\mu$  to 125 $\mu$  resulted in a slight increase in the noise level.
- (d) Nitrogen had no effect on transformer oil but

increased the noise level in liquid paraffin.

- (e) The effect of changing the electrode geometry from spherical to point and sphere was to increase the noise level when oxygen was present, the noise level being higher when the point was negative. Another surprising result was that with the non-uniform field it was found that the presence of nitrogen produced an increase in the noise level, in contrast with the uniform-field case in which there was no nitrogen effect.
- (f) Oxygen had no significant effect on the noise level in liquid paraffin.
- (g) The addition of anthraquinone to transformer oil produced the same quenching effect as oxygen.

These effects are explained by assuming that high energy electrons are present which are capable of breaking the C - H bonds. The hydrogen released forms pockets of gas in which electrons are further accelerated to produce a breakdown. The pulses seen are thus the onset of a breakdown and the effect of oxygen is to capture the fast electrons and reduce their abundance. With non-uniform fields the effect of the large quantity of liberated gas is assumed to mask the quenching effect of oxygen. Similarly the lack of an effect of oxygen on liquid paraffin is explained as being due to the fact that it does not readily absorb hydrogen so that here again the gassing effect masks the quenching effect of oxygen.

It was noticed that high pulse activity corresponded to a low breakdown strength and this is thought to support the proposed explanation of the noise. However, it is not recorded if the increase in the pulse activity

caused by nitrogen in liquid paraffin corresponded to a lower breakdown strength in that liquid.

#### 4.6. Miscellaneous relevant observations.

Darveniza (57) found that light was emitted from transformer oil when it was subjected to a high electric field. The light was analysed spectroscopically and it was deduced from its wavelength that electrons with energy of at least 2.5eV must be present in the liquid. He later found the same effect when anthracene was added to hexane (58). At fields of about 600 - 950kV/cm, luminous streamers completely bridged the gap while at still higher field strengths the glow became diffuse.

Goodwin (59) using the Kerr effect has shown that in monochlorobenzene the field is greatly enhanced near the cathode at fields above 0.5MV/cm and there is evidence that conduction occurs in filamentary channels. Hart (60) has found a change in the viscosity amounting to as much as 400% when a liquid is subjected to an electric field. Coelho (61) found an increase in the viscosity of heptane in a direction perpendicular to the electric field.

## 5. Discussion.

### 5.1. Introduction.

The most important result obtained in the present project is the production of stable high currents in well degassed pure liquids. Although high currents were found previously by Morant (2) in spectroscopic grade hexane, they were highly erratic and no firm relationship between these high currents and the field strength could be discerned. The stable high currents and the reproducible current-voltage curves obtained here in pure liquid, and using plane electrodes, are therefore considered to be in important advance. Several possible mechanisms of this phenomenon will be considered, and it will be shown that a mechanism based on the reorientation of the liquid molecules when they are subjected to high electrical stress, appears to fit the facts well. The results obtained by other workers will be discussed in the light of the proposed model. In particular, it will be shown that results which have been previously considered to be conclusive evidence of the existence of free electrons in dielectric liquids, could be adequately explained by means of ionic conduction.

It must be emphasized at the very outset that without additional experimental and theoretical verification, the proposed mechanism can by no means be considered as irrefutable fact. It has been put forward because, in the opinion of the author, it appears to fit the results obtained in this project better than any other possible mechanism and is also physically plausible. Further, if the proposed mechanism were in fact correct,

it could lead to a new experimental approach to the study of conduction in dielectric liquids (see Sec. 6), and from this point of view it certainly seems worthy of further consideration.

## 5.2. The structure of liquids.

It is very tempting to regard a liquid as a very high pressure gas, or a solid in which there is only short range order. In fact a liquid is neither, and results deduced by extrapolation from either phase are likely to be erroneous. Even if apparently good agreement is obtained between a theory based on extrapolation and experiment it can only mean that either the particular property is not strongly dependant on the structure of the material, or that agreement is purely coincidental (62).

The difference between a rarified gas and a solid is obvious. In a solid even though some migration of molecules does occur, on the whole the molecules are held rigidly in a mean position by interaction with their nearest neighbours, their only movement being oscillations about the mean positions. In a rarified gas the molecules spend the majority of their time in the free state, well outside the influence of any other molecule, and are only able to alter their kinetic energy by means of collisions. The properties of a gas are therefore determined by the kinetic energy of its components only.

As the gas is compressed, the molecules are brought closer together so that the potential energy due to their mutual interaction becomes increasingly important. The molecules are then able to form short-lived clusters of

two or more molecules. As the pressure is increased still further, large stable clusters are formed, this being the process of condensation. The process is discontinuous, and at this point the interaction between the molecules becomes the dominant factor in determining the properties of the material, the kinetic energy being of minor importance. This is perhaps best shown by the fact that a gas, even at densities comparable with that of the liquid state, exerts an outward pressure on the walls of its container, whereas a liquid tends to confine itself to the smallest possible volume compatible with the forces exerted on it. For instance a drop of oil suspended in water will be almost spherical. This shows quite clearly that the molecules of a liquid attract each other whereas those of a gas are free. Thus all the properties of a gas can in principle be calculated by considering the kinetic energy of its molecules, their mutual potential energy need only be considered as a correction factor. On the other hand to predict the properties of a liquid only the form of the interaction forces between the molecules need be known. In the light of these considerations it is not in the least surprising that Inuishi's extrapolation from the mobility of the carriers in hexane vapour to liquid hexane, for example, gave a result which was too high by four orders of magnitude.

If the distribution of the nearest neighbours surrounding a molecule in a liquid is plotted as a function of the radial distance, there is an apparent state of order close to the molecule. However, this must not be confused with ordering in the solid state in which the molecules are fixed in a mean position, as

mentioned above. In a liquid this ordering, or radial distribution as it is called, is of a purely statistical nature and is simply a measure of the probability that a second molecule is present at a given distance from the first. Thus, if it were possible to make a series of instantaneous measurements of the number of molecules in a spherical shell at a given distance from an individual molecule, the result of each measurement would probably differ. Their average, however, would be very close to the value given by the radial distribution function, if sufficient measurements were taken.

### 5.3. Transport phenomena in liquids.

As might be expected from their radically different structures, transport phenomena in liquids and gases are also radically different. If a molecule in a gas could be continuously accelerated by some means, it would rapidly gain velocity until it struck a second molecule. It would then either undergo an elastic collision with no net loss of energy, or an inelastic collision, in which some or all of the energy is lost to excitation of one or both of the molecules. The molecule would continue to absorb energy from the accelerating force until a balance was reached between the energy gained and that lost to other molecules on impact. In a liquid each molecule is at all times in the attractive field of its nearest neighbours and if it were subjected to an accelerating field it would attempt to drag its neighbours with it. It would thus readily share with them any energy it gained from its movement along the direction of the force, this energy being converted to heat.



For example, let us consider the mechanism of viscosity in the two media. It is well known that when a velocity gradient is set up in a fluid, the slower-moving layers exert a viscous drag on the faster ones, and tend to reduce the velocity gradient so that the whole of the fluid is moving with a uniform velocity. Consider two adjacent layers in the fluid, A and B, A being the faster-moving and B the slower-moving layer. In a gas the viscous drag is explained thus; the molecules in the two layers are virtually free and can readily cross from one layer to another. The faster molecules from A which cross into B collide with the slower molecules there and give up some of their momentum to them. Similarly molecules from B, which cross into A, will absorb momentum from the faster molecules, and this will serve to even out the molecular velocities in the two regions. In a liquid, however, the transport of matter is slow compared to that which takes place in the gaseous state, and one must look for a different mechanism for the viscous drag. It is in fact accounted for by the attractive forces between the molecules. The faster moving molecules are retarded by the forces exerted on them by the neighbouring slower molecules and a viscous drag is produced with very little transfer of mass. Transfer of mass obviously does occur in a liquid also, for otherwise phenomena such as diffusion would be absent. However, in a liquid this is a very slow process and transfer of energy is still almost entirely due to intermolecular forces.

It is with these considerations in mind that one must look for an explanation for the high mobility of ions in a gas and their low mobility in a liquid. The



gaseous ion is virtually free and can be accelerated to very high velocities in a sufficiently high electric field, the limiting mobility being reached when the energy loss due to collisions balances the energy input from the electric field. In a liquid an ion is always in the field of influence of its nearest neighbours. It will also polarize its surroundings so that the density in its immediate neighbourhood is further increased (38). Its mobility is therefore very low because the majority of the energy of the energy ion receives from the electric field is soon given up to the surroundings and is converted to heat. From the above considerations it is seen that the mobility of an ion in a liquid is completely controlled by its interaction forces with its surroundings.

Exactly the same reasoning applies to an electron. The fact that an electron is very small is of no significance, since it is the interaction potential between it and its surroundings which determines its final velocity, and not its collision cross-section. Even though an electron can exist in the free state in a solid because of the high degree of order of the molecules of the solid, this is unlikely in a liquid. As mentioned previously, even the short range order in a liquid far removed from its boiling point is only of a statistical nature, so that electrons are unable to travel in a liquid in the same manner as in a solid, except, perhaps, for very short distances indeed, when the molecular distribution is favourable.

#### 5.4. A possible mechanism for the explanation of several high field phenomena in dielectric liquids.

Because the mechanism which is to be proposed for conduction in highly degassed liquid follows naturally on to the previous sections, it will be discussed first. Other possible mechanisms will then be discussed later.

Conduction in any medium consists of two parts, (a) the production of carriers and (b) their mode of transport. The high currents found in this project could therefore be due to an increase of either (a) the number of carriers, or (b) their mobility, or a simultaneous increase in both. It will be shown in the following sections that mechanism (b) is a plausible explanation of the high currents obtained in this project and their dependence on various parameters.

##### 5.4.1. Explanation of the high currents.

From Sec. 5.2. and 5.3. it is quite clear that the mobility of a carrier in a liquid, whether it is an electron or an ion, is determined by the form of the interaction field between it and its neighbours. It is possible that at high fields, the hexane molecules align themselves, either across the whole or part of the gap, in such a manner that the interaction forces with a carrier are reduced. This may then allow the mobility of a carrier to increase by a factor of between two and three orders of magnitude. The evidence for such an alignment and increased mobility will be discussed below.

When a hexane molecule is situated in an electric field its electrons are reorientated from their equilibrium configuration so as to form a weak dipole.

and this naturally accounts for the non-unity permittivity. It would be expected that the molecule would follow its electron cloud to place itself in a position of minimum potential energy. However, the liquid molecule is situated in a potential well and the polarisation forces are normally too weak to significantly influence its position, and in any case, even if there were a small degree of reorientation it would be masked by the effect of thermal agitation. It is possible that at the very high field strengths used ( up to  $5 \times 10^5 \text{V/cm}$ ) the electronic dipole moment of the molecules at the electrode surfaces is just sufficient to allow the necessary degree of alignment. This is because asperities at the electrodes are capable of enhancing the field by a factor as great as 100 (63). Space charge could further increase the field by a factor of between 10 and 100 so that the electric field at the electrode surfaces could possibly be in the region of  $10^8 - 10^9 \text{V/cm}$ . At this field strength the polarizability of hydrocarbon molecules is no longer constant but strongly field dependent (64). It is shown in Appendix C that at these field strengths the assumption that the molecules will tend to reorientate themselves into a position of maximum polarizability is very reasonable indeed.

It is proposed that this alignment does not occur across the whole area of the gap but in filamentary channels, probably initiated at asperities on the electrodes. These aligned channels are in all probability unstable, being soon broken up by thermal agitation,<sup>so</sup> that they are very short lived. While the molecules are in the aligned position it is possible that the carriers are able to travel the length of the channels at mobilities

of between two and three orders of magnitude greater than when the liquid is unaligned, depending on the degree of alignment. This could produce a further increase in the current since an increase in mobility would remove space charge from the electrode surfaces and allow increased emission from the cathode. This could adequately explain the high currents.

There is no necessity for the channels to bridge the gap completely, for even if the gap is only partly bridged the movement of charge in it will make itself felt in the external circuit. The reason for this is that when the charge approaches an electrode it will produce induced charges on it, attracting charge of opposite sign to it, whilst charge of the same polarity is conducted away in the closed circuit.

Now since the mechanism proposed for the high currents depends entirely on the realignment of the molecules in the electric field, it is necessary to ask if the forces on the induced dipole are in fact sufficient to overcome the binding forces on the molecule and cause rotation. To this question it is possible to answer in the affirmative. Since the binding forces on the molecule are of the same nature as these experienced by the carrier, and since the field is capable of overcoming these forces with respect to the carrier, it is a reasonable assumption that the field will also be capable of inducing some degree of reorientation of the induced dipole.

#### 5.4.2. Explanation of the (I,V) characteristic in pure hexane.

An explanation of the current-voltage curve is given in this section based on the foregoing considerations

without any attempt to deduce the origin of the carriers. The characteristic can be divided into three regions, (1) the low current region at field strengths of up to about 100 - 150kV/cm in which the curve has a slowly increasing slope, (2) the region between 150 - 250kV/cm in which the curve rises sharply upwards, (3) the high current region, with currents in the region of  $10^{-7}$  -  $10^{-6}$ A. In this region the slope of the curve decreases with increasing voltage, tending to become asymptotic to the voltage axis.

Region (1) is the part of the curve in which lining up is insignificant, and therefore follows the normal pattern found by other workers in gassy liquid. At somewhat higher fields ligning up starts to become significant and part (2) of the curve is reached. Now if the energy of the molecules follows the normal Boltzman distribution, the probability of obtaining an aligned channel will vary exponentially, in such a manner, that at infinitely high fields the molecules will be fully aligned. This could explain the flattening off of the curve in region (3). This is of course an oversimplified picture. The actual process is very complicated indeed, for as the field strength is increased the dipole moment is increased, and as the molecule rotates, its potential energy in the field of the other molecules will also change. Further, the relationship between the carrier mobility and the degree of alignment is probably quite complicated. Nevertheless, the sharp rise of the curve at fairly high field strengths, and its asymptotic approach to parallelism with the voltage axis, appears to be reasonably well explained by the proposed model.

### 5.4.3. Instability.

At low field strengths the current is perfectly steady. At about 100kV/cm instability sets in, and increases in magnitude and frequency until, just before the onset of high current, the instability is very high indeed. On the basis of the alignment model the explanation of this follows quite naturally. According to this model the fluctuations in the current are in fact due to very short lived aligned channels. At low fields the probability of the occurrence of an aligned channel of sufficient duration to have an effect on the external circuit is small. At very high field strengths the channels have a comparatively long life and the frequency of their occurrence is high, so that the overall effect is an average current which is fairly smooth. However, at field strengths between these two extremes individual or groups of short-lived aligned channels can occur, and these are the cause of the fluctuations. On increasing the voltage the duration of the alignment of these channels and their frequency increase, with a corresponding increase in the magnitude and frequency in the current. fluctuations, until at the point where high current is about to commence the instability reaches its peak.

### 5.4.4. Pulses.

From the discussion of pulse shapes in Appendix B it can be seen that the long pulses shown in Fig. 55B, Sec. 3.13.2. correspond to a process taking place which is very much longer than the time constant  $RC$ , whilst Fig. 55A shows a pulse which has not reached its maximum height because the event taking place is comparable with

the time given by RC. Fig. 55C obviously corresponds to many pulses superimposed on each other.

The picture of the single pulses could correspond to either a single layer of charge travelling in the gap from one electrode to the other, or a continuous process in which new charge is continuously being provided. However, it has been shown in Sec. 3.13.4. that the model of a single layer of charge would imply a mobility in the region of  $2.5 \times 10^{-4} \text{ cm}^2 \text{ volt}^{-1} \text{ sec}^{-1}$  and this is approximately a factor of 5 lower than the value accepted for the mobility of carriers in hexane by many investigators working in different laboratories, and presumably under different experimental conditions. It would therefore appear that the model of a continuous supply of charge is best able to explain the shape of the pulses obtained.

On the basis of the lining up model the pulses are a measure of the lifetime of an aligned channel. It would be expected on the basis of this proposition that at higher voltages the pulses would be more frequent and of longer duration because of the increased probability of alignment. The former of these two phenomena is in fact well borne out by experiment. As the voltage is increased the pulses become much more frequent, and when it is sufficiently high, the pulses often follow each other so rapidly that they become superimposed and have the appearance shown in Fig. 55C. There also appears to be marginal evidence for the second process i.e. an increase in the length of the pulses as the voltage is increased, as has been mentioned in Sec. 3.13.3.

At first sight it would appear that increasing the gap length would diminish the probability of obtaining an

aligned channel bridging the gap, so that the result of increasing the gap length should produce a decrease in the pulse activity. However, it is not necessary for charge to traverse the entire gap length to produce current in the measuring circuit. Any moving charge in the gap will induce charge on the electrodes, and these will appear in the external circuit as current. Thus, an aligned channel which only extends over part of the gap length, would be capable of producing a pulse because of the increased mobility of the carriers in its path. The fact that no difference was noticed in the pulse activity when the gap length was changed does not therefore disprove the mechanism proposed for the pulses.

No deviation from the pulse shape shown in Fig. 66, Appendix B was found so that it appears from the pulses that there is no carrier multiplication process occurring at the field strengths used i.e. up to about 500kV/cm.

#### 5.4.5. Effect of the purity of the liquid.

The fact that it is impossible to obtain reproducible results in spectroscopic grade hexane is extremely surprising, particularly since reproducible results could not even be obtained in the same sample of liquid. This lack of reproducibility has been shown quite conclusively to be the effect of liquid impurity and not an electrode effect, by the fact that reasonably reproducible results were obtained in pure hexane, even when different samples were used. On the lining up model it is possible to explain the lack of reproducibility as follows.

It is known from the chromatographic analysis that the main impurities in the spectroscopic grade hexane



are isomers of hexane and other paraffins. These are chemically similar and it would be expected that their chemical potentials would be almost identical, since the chemical potential is a measure of the interaction potential between the molecules. This is supported by the fact that their boiling points are very close. Thus, the work, necessary to remove a molecule from the liquid state is very similar for all the isomers. In the mixture of the liquids the molecules of each individual component are surrounded, on the average, by molecules of the other species in the liquid in the same ratio as in the macroscopic mixture. This would serve to further equate the chemical potentials of the molecules of the individual species of the mixture, and, in fact, seems to be borne out by the extreme difficulty found in attempting to separate out the different components by means of distillation.

Now if one considers a small volume A, situated in a larger volume B, both of which are filled with liquid of composition R, the probability that at some time the liquid in A will have a relative composition  $R_A$  say, and the composition in B will be  $R_B$ , where  $R_A$  and  $R_B$  are both different from the normal composition R, will depend entirely on the chemical potentials of the components of the mixture and the relative sizes of the two volumes. Thus, if the chemical potentials are practically identical, and the ratio of A to B is small, the probability that molecules of one type will diffuse from B into A, and molecules of another type diffuse out of A into B, in such numbers as to appreciably change the relative composition in the small volume A,

will be quite high if the chemical potentials of the components are virtually identical, (65). An example of this is in the region of the critical point where the chemical potentials of the molecules in the liquid and vapour state are identical so that the molecules can pass freely from one phase to another. This causes large fluctuations in the density of the vapour near the critical region.

The reason for the inherent lack of reproducibility of the results in the impure hexane can now be explained on the basis of density fluctuations. It is assumed that the lining up does not occur over the whole area of the gap but in filamentary channels, and these are most probably initiated by the very high fields in the region of electrode asperities. The ease with which the molecules can be lined up by the field will depend on the instantaneous composition of the liquid in this small volume. When the composition of the liquid in this high field region is that of the average, the molecules interact to form a stable matrix which the field cannot break up, for a length of time sufficient for its effect to be seen in the external circuit as a high current. When the composition is favourable, alignment can occur, and high currents are observed. However, any deviation from the equilibrium composition is unstable and there will be a tendency for this small volume to return to the equilibrium composition. This can happen either quite abruptly or over a period lasting several seconds. This could explain the fluctuations observed in the high currents between different levels as seen in spectroscopic grade hexane.

The existence of these density fluctuations seems

to be further confirmed by the viscosity experiment described in Sec. 3.15. In this carefully controlled experiment there was no reason why the same very high factor of reproducibility should not have been observed in the degassed spectroscopic grade hexane as in the air-saturated liquid. It seems difficult to explain the low factor of reproducibility of the viscosity measurements in the degassed liquid on anything but composition fluctuations.

It must be pointed out that the proposed mechanism is incapable of satisfactorily explaining why smooth reproducible curves were obtained in the spectroscopic grade hexane after it had been prestressed, see Sec. 3.3.5. It has been shown in that section that this is a liquid and not an electrode effect. A possible explanation could be that when the field is maintained for a sufficient length of time, the field distributes the space charge in such a manner that the composition at an asperity, which is capable of producing a high current is preserved by the space charge. It must be admitted, however, that such an explanation is forced. In any case it would be difficult to obtain a mechanism which satisfactorily explains the fluctuations in this liquid which are present even when the field is maintained for a considerable period, and at the same time is able to explain the smooth curves obtained in the prestressed liquid. It is rather tempting to regard the fact that smooth curves were obtained after prestressing as having no significance because there was only a small number of these measurements, especially since on one occasion prestressing did not produce a smooth current-voltage curve. Also, there were occasions when smooth curves were obtained without any prestressing whatsoever.

#### 5.4.6. The effect of air on the electrical conductivity of hexane.

The current in air-saturated hexane at high fields is in the region of  $10^{-9}$  A compared with  $10^{-7}$  -  $10^{-6}$  A in the degassed liquid at the same field strength. Also the current remains steady even at field strengths where violent fluctuations would have occurred in the degassed liquid. Sletten (1) has shown that this effect is probably due to the oxygen content of the air. Now oxygen is an extremely active element and it will readily attach itself to metal and other substances either chemically or by absorption. It is therefore extremely probable that even though oxygen will not react chemically with hexane, it will be strongly attracted to it by intermolecular forces. These forces are of the same nature as those which bind identical molecules, such as those of hexane, to form a liquid, and must obviously exist even though there is no chemical action.

From these considerations it would be reasonable to expect that oxygen will increase the bonding between the molecules, and there would therefore be less tendency for the formation of aligned channels at high fields which are sufficiently long-lived to cause an increase in the current. However, at very high fields the probability of short-lived aligned channels may be quite high, and these would show as fluctuations in the current. On this assumption, if the field could be raised to a high enough level without breakdown occurring, it should be able to overcome the binding effect of the oxygen and to produce aligned channels which would in

turn allow high mobility and the passage of high currents. When the pattern of the fluctuations in air-saturated and degassed hexane are compared, it is seen that the fluctuations occurring just before breakdown in the former are very similar to those which appear in the latter just below the onset of the high current. This does in fact give the impression that high currents would be found in the air-saturated liquid if sufficiently high fields could be supported. This is further supported by the results obtained in cyclopentane. Here, even though air had the same quenching effect as in hexane, high currents were nevertheless obtained at very high fields (400kV/cm compared with 150kV/cm in the degassed liquid).

It is perhaps significant that in both hexane and cyclopentane dissolved air had no effect on the low current part of the (I,V) characteristic, where in any case the liquid is assumed to be in the unaligned state. Also, in spectroscopic grade hexane when the current fluctuated between two levels, the current at the lower level was approximately the same as that in the air-saturated liquid. Here again the liquid is assumed to be in the unaligned state in both cases.

#### 5.4.7. The effect of dissolved air on the viscosity of spectroscopic grade hexane.

The viscosity experiments showed the same marked effect of oxygen on the reproducibility of the results as was found in conduction experiments. However, the averages of the two sets of results showed a higher viscosity for the degassed liquid and this, at first thought, would appear to disprove the postulated binding

effect of oxygen. Nevertheless, the number of experiments carried out was insufficient to form a conclusive determination of the relative viscosities of the two liquids in view of the large scatter in the results for the degassed liquid, and particularly since one of the measurements did give a lower relative viscosity for the degassed liquid.

There is the further possibility that the binding could have opposite effects on viscosity and mobility in this particular case. This is because in the process of conduction, it is the potential between isolated carriers and the rest of the liquid which determines the mobility. However, as far as viscosity is concerned, each molecule takes part in the process, so that the average binding effect on all the molecules must be considered. Thus, if the effect of the oxygen was to bind the hexane molecules into closed groups of molecules, it is possible that the interaction between the groups would be reduced so that the viscosity would decrease. Since electrical carriers must travel through these groups, and their mobility is determined by the potential between them and their immediate neighbours inside the group, the fact that the interaction between the groups was reduced would be immaterial.

The lack of reproducibility of the viscosity measurements in the degassed liquid could also be explained in the same manner as the lack of reproducibility of the high currents in the degassed spectroscopic grade hexane, Sec. 5.4.5., i.e. on composition fluctuations. In fact the lack of reproducibility obtained in the viscosity experiments can be looked upon as verification of the composition fluctuations proposed in that section.

#### 5.4.8. Dependence of the high currents on molecular structure.

On the basis of the remarks made in Secs. 5.4.1. and 5.4.2. it would be expected that the high currents should be strongly dependant on the molecular shape. Tests were therefore carried out in cyclohexane because its chemical properties are similar to those of hexane yet its molecular structure is considerably different. However, as mentioned in Sec. 3.7.1. the results were inconclusive because of the difficulty in degassing the liquid with any degree of certainty. Cyclopentane was then considered to be the next most suitable liquid. However, high currents were found in this. It was then thought that if the true cause of the lack of reproducibility of the results in spectroscopic grade hexane is, in fact, the non-uniform composition of the liquid, and low currents are produced by the interlocking of the different species, then one of the species should be tested. For this 3-methyl pentane was chosen because its boiling point is very close to that of hexane, so that its chemical potential is also quite likely to be very close, (see Sec. 5.4.5. ). 3-methyl pentane was therefore thought to be the most probable cause of the lack of reproducibility. This was tested and again high currents were found.

At first sight these results seem to disprove the lining up process and need explaining. It must be pointed out that even the molecules of cyclohexane (66) and cyclopentane do show some tendency to orientate themselves in a particular direction in the liquid, and it is therefore still probable that a high field will reorientate even these molecules in such a manner that

the interaction forces between them and the carriers are reduced.

With regard to the test on 3-methyl pentane it is only fair to mention that this compound is only one of the 6 impurities detected by the chromatography, and it is possible that it is one of the other impurities which causes the bonding of the molecules. It is also plausible that each liquid on its own is capable of sustaining high currents whereas the mixture is not. Although direct comparison between solids and liquids cannot be made it is possible to quote an example from the solid state where the mobility in each of two elements is comparatively high, yet when one is added to the other as an impurity, the scattering due to the impurity reduces the mobility. Such an example is any metal alloy (67). For example when zinc and copper are mixed to produce brass, the mobility in the resulting alloy, and also the conductivity, is less than that of either the two pure metals. As mentioned above, this merely serves as an illustration, since the mechanisms of conduction in a solid and that in a liquid are entirely different. The only conclusive test would be to test each impurity separately for high currents, and then mix these pure liquids together in the same ratio as in the spectroscopic grade hexane, and see if erratic high currents result.

Even though there was no spectacular difference in the high currents when the liquids were changed, the results obtained in the different liquids used did nevertheless differ quite considerably. Thus the high currents in cyclopentane were in the region of  $10^{-7}$  A, whilst those in 3-methyl pentane were nearer the  $10^{-5}$  A



region. The low currents were the same within the factor of reproducibility. The high currents in hexane were in between these two values, being in the region of  $10^{-7}$  -  $10^{-6}$  A. There was also a marked difference in the pattern of the fluctuations. The 3-methyl pentane, which showed the highest currents, also showed the largest degree of instability, being unstable at the lowest field strengths used in the tests i.e. about 60kV/cm.

#### 5.4.9. Explanation of the difference between plane and spherical electrodes.

On the whole the results obtained with spherical and plane electrodes were similar except for the single fact that there was a tendency for the high currents to appear at a lower field strength with the plane electrodes. There are several factors which could have caused this. Firstly, the materials of the two electrode systems were different, the spherical electrodes being chromium and the plane electrodes stainless steel. There were also differences in the geometries and the effective areas of the two electrode systems.

It seems likely that conduction currents in dielectric liquids are almost independent of the electrode material. This was found in the present work and that of others (3),(10). This leaves the difference in the geometries and the effective areas of the two electrode systems. On the basis of the lining up mechanism the difference would appear to be best explained as an area dependence. If lining up does occur, it will most probably be initiated in the region of the highest field i.e. near an asperity as mentioned previously. It is

reasonable to assume that the number of such asperities is proportional to the area, so that the probability of an aligned channel occurring at a given field will be proportional to the area. Since this is statistical in nature it explains why occasionally, even with spherical electrodes, high currents were occasionally obtained at the lower fields. There will, of course, be a lower limit of field strength below which the probability of alignment is negligibly small, and a higher value of field strength above which the probability of alignment is almost unity. Outside these limits there will be very little area dependence. It is quite obvious that further work on accurately parallel plane electrodes of different areas would be useful.

#### 5.5. Other possible mechanisms of the high currents.

Although the present work suggests that the high currents may be explained by alignment, several other mechanisms are given below. Any proposed mechanism must be able to explain the dependence of the high currents on the oxygen content and the inherent lack of reproducibility of these high currents in spectroscopic grade hexane. It must also explain the factor of 100 difference between the maximum currents found in cyclopentane and 3-methyl pentane.

##### 5.5.1. Space charge mechanism.

There have been several theories of breakdown proposed based on unstable space charge in the gap. By substituting the appropriate boundary conditions in solving Poisson's equation it is possible to produce

equations showing such instability (43) and obtain a figure for the breakdown strength. It should, in principle, also be possible to explain the high currents on the rearrangement of space charge, the mechanism of the fluctuations and pulses would then follow on quite simply. An unstable arrangement of space charge would satisfactorily explain the transitions between the different current levels in spectroscopic grade hexane but it is difficult to see why such instability does not exist in the pure liquid. It would appear to be even more difficult to explain the factor of 100 between the high currents in 3-methyl pentane and cyclopentane.

Even though the dependence of high currents in hexane on air content could possibly be explained by the effect of oxygen ions on the space charge distribution, it is reasonable to assume that the same dependence would be seen in cyclopentane. In fact, high currents were found in air-saturated cyclopentane but not in air saturated hexane. Also, the potential distribution between parallel electrodes at fields upto 1.2kV/cm has been examined by Forster (68) in a variety of hydrocarbon liquids, and the addition of oxygen was found to have no effect. This of course, does not exclude the possibility that at the field strengths used in this project oxygen might influence the space charge distribution.

It would certainly be possible in principle to put forward various complicated processes to explain all the observed phenomena by means of space charge theory. However, it is one of the basic principles of physics that when a theory becomes involved and forced, it is rejected in favour of a theory which still adequately

fits the facts and at the same time is more straightforward.

### 5.5.2. Bubble theory.

The formation of bubbles by various processes has been proposed as a mechanism of breakdown (44), (45) and more recently by Huq and Tropper (56) as an explanation of the current fluctuations (instability) seen at high fields. It is likely that any mechanism which can be used for breakdown, where the current is limited only by the external circuit, could also explain the high currents.

It would be expected on the basis of the bubble theory that the high currents would show a dependence on hydrostatic pressure; no such dependence was found. Further, 3-methyl pentane, whose boiling point is  $64^{\circ}\text{C}$ , showed currents almost 2 orders of magnitude higher than in cyclopentane which has a boiling point of  $49^{\circ}\text{C}$ . Also, the fact that the (I,V) characteristic approaches a plateau value at fields just below breakdown seems to rule out any sort of incipient breakdown mechanism as an explanation of the high currents, unless it were of a discontinuous nature.

### 5.5.3. Ionisation by collision.

There has been no evidence so far of ionization by collision at the field strengths used in this work, i.e. 500kV/cm, although, admittedly, previous work has been in liquids with a relatively high gas content. Further, the (I,V) characteristic is flat topped in the high current region and it would be expected that ionization by collision would produce a characteristic

curving sharply upwards since it is a runaway process. Also, as mentioned in Sec. 5.4.4. the pulse shape is inconsistent with an avalanche process.

#### 5.5.4. High field dissociation of the molecules.

The dissociation of the molecules under the influence of the high field does not seem to be able to explain the origin of the high currents because of the lack of reproducibility of the results obtained for the impure grade of hexane. The bonding energy of a molecule is only negligibly influenced by its surroundings since the bonding is due to very strong internal molecular forces and the intermolecular interaction forces are comparatively weak. This is shown by the fact that the spectrum of the bonding vibrations is negligibly changed in passing from the vapour to the liquid state (69). The fluctuations in composition would have even less effect, and if high currents were due to high field dissociation it would take place in any composition.

#### 5.5.5. Electron hopping process.

In the electron hopping process the electron remains attached to a molecule until a suitable molecular configuration occurs for its release, and it is then capable of travelling freely until it is again captured by another molecule. Using this process the high currents could be explained by postulating that the high field considerably increases the probability of the release of an electron from its trap. This would adequately explain the dependence of the high currents in hexane on oxygen, as oxygen is an electron attaching

gas, and it would be expected that it could form fairly deep traps for the electrons from which the field cannot easily extract them.

However, this process can reasonably be rejected for several reasons. Firstly, the probability of an electron being released from a trap by the influence of the field would be expected to be exponentially dependant on the field. This should give a sharply rising characteristic instead of the flat topped curve. Also, the lack of reproducibility of the high currents in the impure liquid would be more difficult to explain on this model. Further, it is difficult to see why oxygen should act as a very efficient electron trap in hexane but not in cyclopentane, in which high currents were obtained even when it was air-saturated.

#### 5.6. Discussion of the results of other workers having a direct bearing on the present work.

It would seem from the emission of light in transformer oil (57) and in hexane doped with anthracene (58) that high velocity free electrons must be present, for the emission of this light infers the existance of particles having kinetic energy of at least 2.5eV. However, this need not necessarily be true. If it is assumed that the carrier is an electron attached to a hexane molecule or an impurity molecule such as  $O_2$ , and not in fact a free electron, the mobility which corresponds to an average kinetic energy of 2.5eV agrees very closely with that inferred from the high currents i.e. 2 to 3 orders higher than the accepted value in air-saturated hexane. This can be seen quite simply as follows. Let  $U$  be the velocity of the carrier which

corresponds to an energy of 2.5eV.

Then  $\frac{1}{2}MU^2 = 2.5 \times 1.6 \times 10^{-12}$  ergs where M is the mass of the carrier, since 1eV =  $1.6 \times 10^{-12}$  ergs.

Now if the carrier is a hexane molecule  $M = 1.44 \times 10^{-22}$  gms. From which  $U = 1.18 \times 10^5$  cms/sec.

Now  $u = E/U$  where u is the mobility and E is the electric field. At a field strength of about 250kV/cm i.e. the field at which high currents were found in hexane when plane electrodes were used, u would be of the order of  $5 \times 10^{-1} \text{ cm}^2 \text{ volt}^{-1} \text{ sec}^{-1}$  in order to have a kinetic energy of 2.5eV. This agrees with the value of mobility inferred from the high current measurements. The actual mobility can, of course, be much less than this in order to produce fluorescence, since mobility is only a measure of the average velocity of the carriers, individual carriers can reach much higher velocities. These values have been calculated assuming the carrier to be a hexane molecule, but the reasoning is still valid even if the carrier is, say, an oxygen ion since its mass is only a factor of about 2.5 less than that of the hexane molecule. Also the fact that the glow started at the electrodes and then spread to the bulk of the gap at high fields is explained quite naturally on the basis of the lining up model, since it is assumed that the lining up of the channels is initiated at asperities on the electrodes, and only starts to bridge the gap at higher fields.

Similarly, the fluctuation measurements of Huq and Tropper (56) appear to be well explained by the lining up mechanism, in which it is proposed that fluctuations are caused by short-lived aligned channels, (see Sec. 5.4.3.). Their finding that oxygen quenched the

fluctuations is in agreement with the findings of the present work and the binding mechanism proposed for oxygen, Sec.5.4.6. When the liquid was subjected to a non-uniform field, these authors found that the fluctuations increased with the presence of oxygen. This also agrees with the findings of the present project in which fluctuations in air-saturated hexane were so large at very high fields that reliable current readings could not be obtained. The reason for this is that because of binding effect of oxygen, fluctuations do not occur until a very high field is reached, therefore when an aligned channel is formed, the current is extremely high for the very short time of alignment. With the point-plane configuration used by the above workers, the electric field strength near the point is much greater than the average field so that the momentary high currents in the short-lived aligned channels give rise to large fluctuations.

Further support for the lining up theory might come from the viscosity experiments of Hart (60) and Coelho (61). The latter, using pure heptane supplied by Philips Petroleum Co., U.S.A. found an increase in the viscosity of the liquid in the direction perpendicular to the electric field. This could point to some rearrangement of the average configuration of the molecules, for viscosity, like mobility, is solely dependant on the interaction potential between the constituent molecules, and this in turn is dependent on the radial distribution function. However, this increase of viscosity produced by the application of the electric field might be due to some other cause such as electrostriction. This would also alter the radial



distribution function and could produce a change in the viscosity.

Goodwin (59) has reported evidence that in polar liquids at least, conduction occurs in filamentary channels. Although the liquids used in the present work are non-polar, it is possible, that at the very high fields at the electrode surfaces, the dipole moment of the induced dipoles is comparable to that of the permanent dipoles in polar liquids, (see Appendix C).

Lastly, Inuishi (70) has found evidence of high mobility carriers in hexane. Using the rate of charge method for measuring mobility, there were occasions when the initial rate of charging indicated the presence of carriers with a value of mobility approximately 100 times greater than the accepted value of  $\sim 10^{-3} \text{cm}^2 \text{volt}^{-1} \text{sec}^{-1}$ . These results have not been published as Inuishi felt unable to accept them as being valid, and ascribed them to some unknown factor in the experimental technique. However, from the good agreement with the value of mobility inferred from the high current measurements in this project it would seem that they were in fact perfectly valid, and correspond to the bursts of high mobility carriers due to the short-lived aligned channels which are postulated to be present in air-saturated hexane at high fields.

#### 5.7. The source of the carriers.

Three possible sources of carrier production at high fields are listed in Sec. 4.1. Process (3), ionization by collision, can be ruled out with a reasonable amount of confidence because all the available evidence shows no sign of such a process occurring in

liquids at the field strengths used in this project. Process (1), field aided thermionic emission and cold cathode emission, are exponentially dependant on the work function of the cathode, and this in turn is very sensitive to the exact condition of the cathode surface. For instance, an absorbed layer of positive ions will reduce the work function while an absorbed layer of negative ions will increase it. To a lesser extent, the work function also depends on the crystal plane presented to the field, very close packed crystal planes having higher work functions than atomically rough ones. A further difficulty is the fact that the exact value of the field at the surface of the cathode is unknown. It is therefore difficult to prove or disprove these processes.

The fact that particles are able to move with and against the direction of the field shows that there must be positive charge in the gap, so that besides cathode emission processes there must be another which produces this positive charge, both thermionic and cold cathode emission being only capable of producing negative charge. In any case, the current is almost certainly space charge limited since there is little or no dependence on the cathode material. Attempts to prove or disprove cathode emission processes by the production of field-current relationships with a certain slope are in all probability completely fallacious.

Process (2), high field dissociation of the molecules, is of course independant of the cathode material and can also explain the existance of positive charge. A modified version of this, field ionization, might also take place, and could explain the motion of the particles

at high fields. This process is easily understood from the diagrams shown in Figs. 54A and B. In these diagrams, which are shown for the 1s electron of the hydrogen atom, the dotted lines show the potential well seen by this electron in the absence of an electric field. It is of infinite width and the probability of the electron tunnelling through this barrier is therefore negligibly small. In a strong electric field the shape of the well is changed to that shown by the full line in Fig. 54A. The electron then sees a well of finite width and the probability of tunnelling through it is finite. Fig. 54B shows the situation when the atom is near an electrode. Here the image potential of the electron in the metal further reduces the already diminished barrier width. Thus at very high fields the electrons are able to tunnel out of the atom or molecule into the conduction band of the metal, in fact, Fowler-Nordheim emission in reverse. The diagrams shown are for the hydrogen atom, but for molecules of hydrocarbons somewhat lower fields would probably be necessary since they have a lower ionization potential.

The mechanism of particle movement is then this. Consider a particle situated at the cathode. Electrons emitted from the cathode charge the particles negatively and it is then repelled towards the anode. There the particle is first discharged and then becomes positively charged by field emission. It then moves towards the cathode, this process repeating itself continuously so that the particle performs continuous oscillations between the electrodes.

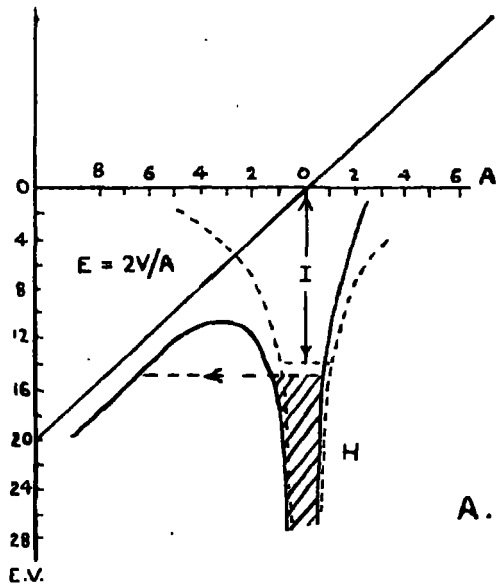

**FIG. 57.** A. POTENTIAL-ENERGY DIAGRAM FOR A 1S ELECTRON OF AN H ATOM IN A FIELD OF  $2V/A$ . BROKEN LINES SHOW THE COULOMB POTENTIAL IN THE ABSENCE OF AN EXTERNAL FIELD.  
 B. SAME ATOM AT A DISTANCE OF  $5.5A$  FROM A TUNGSTEN SURFACE:  $\mu$ , FERMI ENERGY;  $\phi$ , WORK FUNCTION;  $P_M$  ATOM POTENTIAL;  $P_W$ , SUPERPOSITION OF APPLIED AND PSEUDO-IMAGE POTENTIAL.

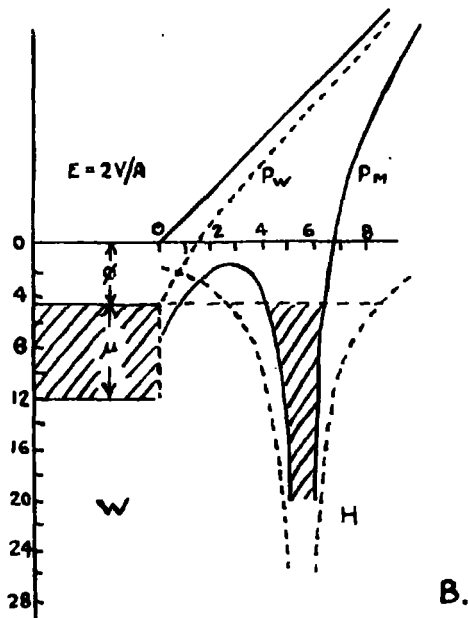

TAKEN FROM "FIELD EMISSION AND FIELD IONISATION" BY R. GOMER. FIG. 44.

### 5.8. Breakdown.

It has already been pointed out in Sec. 3.14.1. that this project was mainly concerned with conduction, and conclusions about breakdown cannot be drawn from the insufficient experimental results obtained. However, a few negative conclusions are made in this section and a further possible model for breakdown is suggested.

According to the particle mechanism of Kok, the electric strength is limited by particles bridging the gap, and in pure liquids the molecules of the liquid itself form the bridge. No significant difference was found between the breakdown strength of cyclopentane and cyclohexane which have ring structure molecules, and hexane, which has straight chain molecules. Further, the breakdown strength was unaffected by particles of several microns in diameter bridging the gap. It would thus seem, that under the present experimental conditions at least, Kok's theory is incapable of explaining the experimental facts.

It would also appear that the thermal mechanism of breakdown can be discarded as far as the experimental conditions in this project are concerned, since no difference was found in the breakdown strength of liquids whose boiling points differed by as much as  $31^{\circ}\text{C}$ . Also there was no apparent dependence on energy input, as the current could vary by as much as three orders of magnitude at high fields in spectroscopic grade hexane without any noticeable difference in the breakdown strength. This, of course, is not entirely conclusive because at the instant before breakdown the current might be in the same region in both cases.

A mechanism which might occur is the transport of electrode material from one electrode to the other under the high stress of the electric field. It has been suggested in Sec. 5.4.1. that at the electrode surfaces local fields of  $10^8 - 10^9$  V/cm exist. Now the outward force on the surface of an electrical conductor situated in a medium of dielectric constant  $\epsilon$  is given by  $F = \frac{\epsilon X^2}{8\pi(300)^2}$  dynes/cm<sup>2</sup> where X is in volts/cm.

If the local field, X, is  $10^8$  V/cm, and  $\epsilon$  for hexane is taken to be 1.9,  $F = 8.4 \times 10^9$  dynes/cm.

Now the tensile strength of steel is  $4 - 8 \times 10^9$  dynes/cm, so it can be seen that a local field strength of  $10^8$  V/cm would be sufficient to breakdown the electrode in the region of this high field.

When the electrodes were examined under a microscope after a single breakdown, the cathode was found to have a single deep pit of comparatively large diameter and the anode many small, shallow pits, and did indeed give the impression that a piece of metal had been torn from the cathode, and the small pits on the anode were the result of bombardment by fragments from this piece of material.

This process could explain the lack of dependence of breakdown strength on the liquid boiling point and the current level, as it is purely a field effect, and depends only on the maximum field strength at the electrodes. On this model the higher strength obtained with the spherical electrodes would be due to the fact that chromium is mechanically stronger than stainless steel (the spherical electrodes were chromium and the

planes were stainless steel). It would, however, be difficult to account for the increase in the breakdown strength with oxygen content, unless, in some manner or other, the mechanical strength of the electrode surfaces is influenced by oxygen which they absorb from the liquid. While evidence of this process is very scant, it must nevertheless be taken into consideration until evidence is available to discard it.

## 6. Conclusions and suggestions for further work.

In the preceeding chapter a mechanism for the high currents was proposed based on the realignment of the liquid molecules which allows an increase in the mobility of the carriers by a factor of two or three orders of magnitude. Evidence for this process can be summarised as follows.

- (a) The inherent non-reproducibility of the results in spectroscopic grade hexane can be satisfactorily explained on the basis of this model.
- (b) A factor of approximately 100 was found between the high currents in 3-methyl pentane and cyclopentane. This would seem to indicate dependance on molecular shape.
- (c) The flourescence found by Darveniza and others is adequately explained by this model without having to postulate the existance of free electrons.
- (d) An increase in the viscosity of pentane in a direction perpendicular to the electric field was found by Coelho and could possibly indicate realignment of the molecules.
- (e) There is some evidence that in polar liquids the current does in fact flow in filamentary channels.
- (f) Inuishi has found carriers at high fields whose mobility was approximately 100 times greater than that of the low field carriers.
- (g) The values of high mobility deduced from the high currents obtained in the present project and those from (c) and (f) are of the same order of magnitude.



However, the evidence, although strong, is far from conclusive. Mobility measurements at very high fields in highly degassed hexane would be extremely desirable, both from the point of view of the present work and the fact that as far as is known, all mobility measurements have been made in liquids with a comparatively high gas content, and they might not in fact give the intrinsic mobility of the natural carriers in hexane.

If it could be established that at high fields carriers with a mobility of the order of  $1\text{cm}^2\text{volt}^{-1}\text{sec}^{-1}$  are present, it could mean a new tool in the study of conduction in these liquids. It might then just be possible to carry out experiments of the Hall effect type, which could give the mass and sign of the charge carriers.

The lining up process might be a more difficult process to detect directly since it is presumed that the alignment only occurs in filamentary channels of microsecond duration. Any method designed to detect it would therefore have to be extremely sensitive, as the ratio of the aligned liquid to that of the bulk of the liquid is very small. This would seem to rule out X-ray techniques, because at the present time, X-ray techniques for measuring the radial distribution function in liquids are not very accurate (71). An accurate determination of the dielectric constant of the liquid at very high fields might detect a field dependence of the polarizability of the molecules, but whether or not the realignment of molecules to follow the displaced electron cloud as proposed in Sec. 5.4.1. would influence the dielectric constant needs much further thought.

A mechanism for breakdown has been proposed as an additional possibility to be considered. This is based on the transport of metal from one electrode to the other. This could possibly be proved by accurate weighing of the electrodes after a large number of unidirectional breakdowns, and might prove a useful experiment to perform.

## Appendix A.

### Effective area of 1 cm dia. spherical electrodes.

Without any exact knowledge of the space charge density in the gap it is impossible to make an accurate mathematical analysis of the field distribution between two spherical electrodes. As a working rule, providing that the current is not saturated, it is not unreasonable to assume that at a point where the gap length is twice that at the centre, the field strength is reduced sufficiently to assume that the majority of the current flows through the area inside a circle, having the axis of the electrode system as its centre and the above mentioned point lying on its circumference.

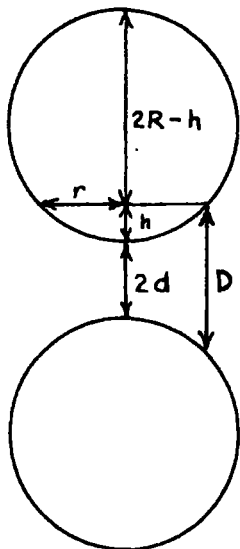

FIG. 58.

Consider the electrode arrangement shown in Fig. 58.

$$\text{Then } (2R - h)h = r^2$$

$$\therefore 2Rh - h^2 = r^2$$

Now  $h$  is very small compared to the other quantities in the expression.

$$\therefore h = \frac{r^2}{2R}$$

$$2d = \text{the gap length} = 50\mu.$$

$\therefore$  when  $h = 25\mu$ , then the distance  $D$ , will be twice the gap length  $2d$ .

$$\therefore .0025 = \frac{r^2}{1} \text{ since } R = 0.5 \text{ cms.}$$

$$r^2 = .0025 \text{ sq. cms.}$$

and the effective area  $= \pi r^2 = 0.0079 \text{ sq. cms}$   
approx. which is approximately  $\frac{3}{4}$  sq. mm.

When the gap length is  $100\mu$  then  $r^2 = .0050 \text{ sq. cms.}$   
and then the effective area is approximately 1.5 sq. mm.

Appendix B.

Pulse observation of charge movement between electrodes.

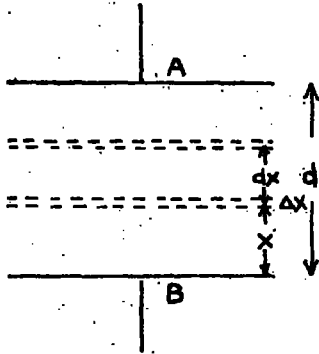

FIG. 59.

In Fig. 59, A and B are electrodes of unit cross-sectional area. Consider a layer of charge of thickness  $\Delta x$  at a distance  $x$  from B and moving with velocity  $v$ . The work done in moving this layer a distance  $dx = n(x)e\Delta x \cdot E dx$  where  $n(x)$  is the charge density at  $x$ ,  $e$  is the charge on each carrier and  $E$  is the electric field.

Now this energy is supplied by the applied voltage and is equal to  $\int Vi(t)dt$  where  $i(t)$  is the instantaneous current in the circuit.  $\therefore n(x)e\Delta x \cdot E dx = \int Vi(t)dt$

$$\therefore i(t) = \frac{eV}{d} \cdot n(x)\Delta x \dots\dots\dots (1)$$

since it is assumed  $E = \frac{V}{d}$  and  $\frac{dx}{dt} = v =$  velocity of the charge layer.

Now consider the circuit shown in Fig. 60. which is the

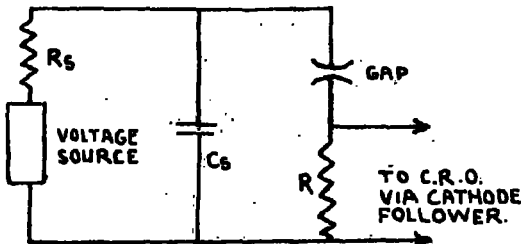

FIG. 60.

circuit used in this project. In this  $R_s$  and  $C_s$  are the resistance and capacitance of the voltage source respectively.  $R$  is the measuring resistor. For pulses in the microsecond region  $C_s$  can be regarded as an effective short circuit (the input capacitance of source was at least  $.002\mu F$ ) so that the effective circuit is that shown in fig. 61. Here  $C$  is

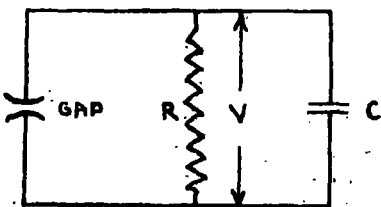

FIG. 61.

given by  $C = C_{\text{gap}} + C$  across  $R +$  (input capacitance of cathode follower: etc..

The equation connecting the instantaneous current and the voltage  $V$  is given by  $C \frac{dV}{dt} + \frac{V}{R} = i(t)$  (2)

The solution of (2) is given by

$$V = \frac{1}{C} e^{-\frac{t}{CR}} \left\{ \int_0^t e^{\frac{t}{CR}} i(t) dt \right\} \dots \dots \dots (3) \text{ when } V \text{ is the}$$

additional voltage due to the pulse i.e. excluding the standing voltage of the source.

If the current is due to a charge layer, then from (1)

$$i(t) = \frac{eV}{d} \cdot n(x) \cdot \Delta x = \frac{eV}{d} \cdot N \quad \text{where } N \text{ is the total number of carriers.}$$

$$\therefore i(t) = \frac{NeV}{d} = \text{const.} \quad \text{for } 0 < t < \tau \text{ where } \tau \text{ is the time of transit.}$$

When this is substituted in (3) the solution is then

$$V = \frac{NeV}{d} R (1 - e^{-\frac{t}{CR}}) \quad \text{for } 0 < t < \tau \dots \dots \dots (4)$$

$V$  is the voltage across  $R$ .

When the time constant of the circuit  $RC \ll \tau$  the pulse can attain full height during the transit time of the charge layer, and the pulse shape is then as shown in Fig. 62.

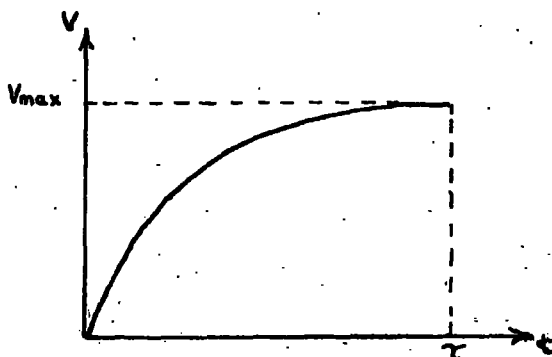

FIG. 62.

$$\text{In this } V_{\text{max}} = \frac{NeV}{d} R.$$

When  $RC \gg \tau$  the quantity contained in the bracket in expression (4) can be expanded to give

$$V = \frac{NeV}{d} R \left( 1 - 1 + \frac{t}{CR} \right) = \frac{NeV}{d} R \frac{t}{CR} = \frac{NeV}{Cd} t \dots \dots \dots (5)$$

since  $\frac{t}{CR}$  is small and terms of 2nd order and greater can be neglected.

Thus  $V$  is a linear function of  $t$  for  $0 < t < \tau$  and the form of the pulse is then as shown in Fig. 63.

When  $t = \tau$ ,  $V = \frac{Ne}{C} \cdot \frac{1}{\tau} \cdot \tau = \frac{Ne}{C}$

since  $\frac{V}{d} = \frac{1}{\tau}$ .

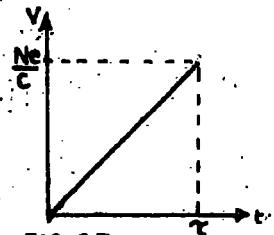

FIG. 63.

When  $RC$  lies between these two extremes the pulse shape is as shown in Fig. 64.

In this, the current does not decrease instantly for  $t = \tau$  but there is an exponential decay because of the time constant of the circuit.

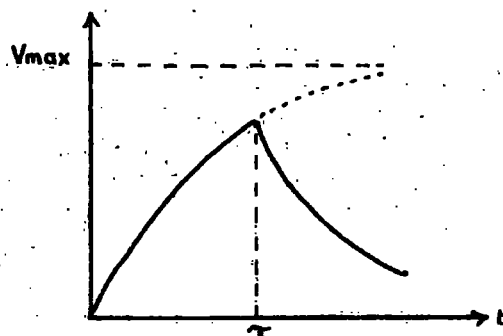

FIG. 64.

### Continuous charge production at an electrode.

In this case, from (1),  $i(t) = \frac{eNt}{\tau}$  where  $t < \tau$ ,

using  $\frac{V}{d} = \frac{1}{\tau}$ , and  $N$  is the number of carriers produced in unit time,

and  $i(t) = eN$   
for  $t \geq \tau$

The solution of (3) for these two conditions is then

$$V(t) = \frac{eNR}{\tau} [t - RC(1 - e^{-\frac{t}{RC}})] \quad \text{for } t < \tau$$

$$V(t) = NeR \left[ 1 - \frac{RC}{\tau} \left( 1 - \frac{\tau}{RC} \right) e^{-\frac{(t-\tau)}{RC}} \right] \quad \text{for } t \geq \tau.$$

This again can be divided into two extreme cases,  $RC \gg \tau$  and  $RC \ll \tau$ , these are shown in Figs. 65 and 66 respectively.

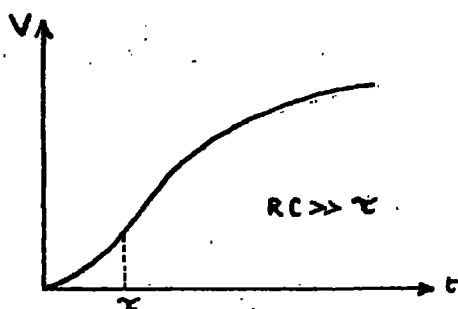

FIG. 65.

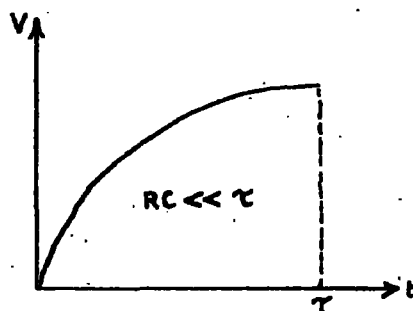

FIG. 66.

The signal is then much larger than previously because there is far more charge in the gap.

When the charge production is suddenly stopped the current will decay as shown in either Fig. 67 or 68 depending on whether  $RC \gg \tau$  or  $RC \ll \tau$ .

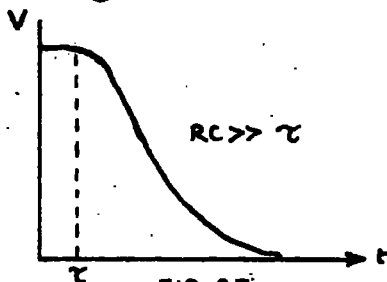

FIG. 67.

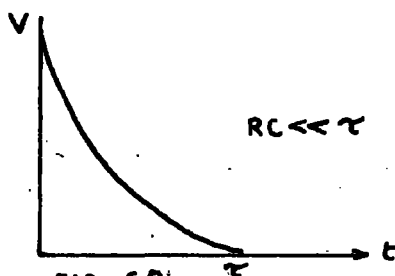

FIG. 68.

Therefore, if the flow of charge is suddenly halted, the current does not stop instantly, but decays gradually, the rate of decay of the voltage depending on the time constant. Thus, if many pulses follow each other rapidly the wave shape would resemble the form shown in Fig. 69.

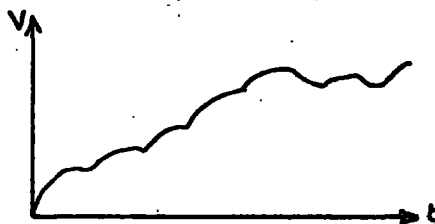

FIG. 69.

### Secondary processes and space charge.

Equation (2) can also be used where secondary processes occur, such as electron multiplication, by putting in the correct form of  $i(t)$ . It is found that when secondary processes are present, the wave shape is

considerably changed from the forms given above.

When space charge is present, the field will not be given by  $\frac{V}{d}$  and equation (1) will then not be valid. However, in liquids there is good reason both experimentally (27), (28) and theoretically (26) to believe that the space charge is very close to the electrodes, so that over the greater part of the gap  $E$  is constant. The small time the carriers spend in the non-uniform field near the electrodes would not show on the oscillograms taken in this project.



Appendix C.The effect of very high electric fields on the realignment of non-polar molecules

It has been proposed in Sec. 5.4. that many of the phenomena which occur in dielectric liquids when they are subjected to a high electric field could possibly be explained in terms of realignment of the molecules. It is therefore necessary to examine the possibility of such a process occurring in a more quantitative manner. Without an exact knowledge of the interaction forces between the molecules it is impossible to produce a rigorous quantitative theory for an alignment process. However, a few simple arguments will be put forward to show that such a process is physically plausible.

Since a liquid is an isotropic medium the Clausius-Mosotti equation will hold, i.e.

$$\alpha = \frac{3}{4\pi} \frac{M}{N\rho} \left( \frac{\epsilon - 1}{\epsilon + 2} \right) \quad \text{where,}$$

$\alpha$  = polarisability,

M = molecular weight of the molecule = 86 for hexane,

N = Avogadro's number =  $6.023 \times 10^{23}$

$\rho$  = density of the liquid = 0.67 for hexane.

$\epsilon$  = dielectric constant = 1.9 for hexane.

From which  $\alpha = 1.65 \times 10^{-23}$  e.s.u.

Now W, the energy of a polarisable molecule in an electric field is given by  $W = \frac{1}{2} \alpha E^2$  so that when  $E = 300 \text{ kV/cm} = 10^3$  e.s.u.,  $W = 8.2 \times 10^{-18}$  ergs.

If the field multiplication factor M due to the combined effect of field enhancement at asperities and space charge is 20, say, then  $W = 1.65 \times 10^{-15}$  ergs, and if M = 200 then  $W = 1.65 \times 10^{-13}$  ergs.

Now the polarisability of two atoms chemically bonded is given by  $\alpha_{\theta} = \alpha_{\parallel} \cos^2 \theta + \alpha_{\perp} \sin^2 \theta$  (72) where  $\alpha_{\theta}$  is the polarisability in a direction inclined at an angle  $\theta$  to the electric field.  $\alpha_{\parallel}$  and  $\alpha_{\perp}$  are the polarisabilities in the directions parallel and perpendicular to the direction of the bonds respectively. Averaging over all orientations gives  $\alpha_{AV} = \frac{1}{3}(\alpha_{\parallel} + 2\alpha_{\perp})$ .

To a first approximation the polarisability of a molecule is given by the sum of the polarisabilities of the separate bonds. For the hexane molecule  $\alpha_{\parallel}$  and  $\alpha_{\perp}$  for the C - C bond are 18.8 and  $0.2 \times 10^{-25} \text{ cm}^3$  respectively while for the C - H bond the values are 7.9 and 5.8.

Thus the proportion of  $\alpha$  due to the five C - C bonds is

$$\frac{\frac{1}{3} \times 5 \times (18.8 + 2 \times 0.2)}{\frac{1}{3} \times 5 \times (18.8 + 2 \times 0.2) + \frac{1}{3} \times 14 \times (7.9 + 2 \times 5.8)} = 0.26$$

It is easily seen that the main dependence of  $\alpha$  upon  $\theta$  is due to the C - C bond, as follows.

$$\begin{aligned} \text{For the C - C bond } \alpha_{\theta} &= \{18.8 \cos^2 \theta + 0.2 \sin^2 \theta\} \times 10^{-25} \text{ cm}^3 \\ &= \{18.6 \cos^2 \theta + 0.2 (\cos^2 \theta + \sin^2 \theta)\} \times 10^{-25} \text{ cm}^3 \\ &= \{18.6 \cos^2 \theta + 0.2\} \times 10^{-25} \text{ cm}^3. \end{aligned}$$

$$\begin{aligned} \text{For the C - H bond } \alpha_{\theta} &= \{7.9 \cos^2 \theta + 5.9 \sin^2 \theta\} \times 10^{-25} \text{ cm}^3 \\ &= \{2.1 \cos^2 \theta + 5.9 (\cos^2 \theta + \sin^2 \theta)\} \times 10^{-25} \text{ cm}^3 \\ &= \{2.1 \cos^2 \theta + 5.9\} \times 10^{-25} \text{ cm}^3. \end{aligned}$$

Thus, as a rough approximation only the orientation<sup>energy</sup> of the C - C bonds need be considered, and for  $M = 200$  this is approximately  $0.26 \times 1.65 \times 10^{-13} = 4.3 \times 10^{-14}$  ergs.

If  $\phi$  is the potential energy of the molecule in the field of its neighbours and  $f(\theta)$  is the angle dependence of  $\phi$ , then the potential energy of the molecule at an angle  $\theta$  to the electric field is  $W_{\theta} = (\phi f(\theta) - 4.3 \times 10^{-14} \cos^2 \theta)$  ergs.  $f(\theta)$  will, of course, be different for each molecule since the equilibrium orientation of the molecules is random.

Now the ratio of the probabilities of the molecule being at angles  $\theta_1$ , and  $\theta_2$  is  $e^{-\frac{W_{\theta_1}}{kT}} / e^{-\frac{W_{\theta_2}}{kT}}$ .

$\therefore$  if  $\theta_1 = 0^\circ$  and  $\theta_2 = 90^\circ$  the ratio will be

$$e^{-\{(\phi f(\theta_1) - \phi f(\theta_2)) - 4.3 \times 10^{-14}\} / kT}; \text{ at } 300^\circ\text{C } kT = 4.1 \times 10^{-14} \text{ ergs.}$$

From experiments on the activation energy of the viscosity of hydrocarbon liquids (68) the potential energy of a molecule in the field of its neighbouring molecules is in the region of 0.1eV, i.e.  $16 \times 10^{-14}$  ergs. Thus  $\phi, kT$  and the change in energy due to orientation are all of the same order of magnitude, and whether or not the molecules will tend to line up will be strongly dependent on the form of  $f(\theta)$ . In the case where  $f(\theta)$  is not a strong function of  $\theta$ , the ratio of the probabilities of finding the particle at  $0^\circ$  and  $90^\circ$  will be  $e^{\frac{4.3}{4.1}} = 2.86$  if  $M = 200$  and  $e^{\frac{4.3 \times 10^{-2}}{4.1}} = 1.01$  if  $M = 20$ .

Thus, if  $M = 20$  there will be a small tendency for the molecules to rotate in the direction of the field while if  $M = 200$ , the degree of rotation will be very high indeed.

In view of the fact that the degree of alignment is very sensitive to the form  $f(\theta)$  it might be expected that the degree of reorientation would be different for different liquids. This would explain the variation of the maximum current found in the different liquids used (see Sec. 5.4.8.).

The above argument has been based on the assumption that the polarisability of a molecule is constant. In fact it has been proposed on theoretical grounds that at fields of  $10^8$  V/cm it is strongly field dependent (64).

This would have the effect of further increasing the energy of the molecules in the electric field and the probability of alignment.

References.

- (1) Sletten, M. A. Ph.D. Thesis, London University  
(1960)
- (2) Morant, M. J. Private communication.
- (3) House, H. Ph.D. Thesis, London University  
(1955)
- (4) Halasz, I. and Schreyer, G. Chemie-Ing-Techn. 32,  
675, (1960)
- (5) Lovelock, J. E. J. Chromatography, 1, 35, (1958)
- (6) Lovelock, J. E. Anal. Chem. 33, 162, (1961)
- (7) Sharbaugh, A. H. and Watson, P. K. Nature, 184,  
2,006, (1959)
- (8) Ward, B. W. and Lewis, T. J. Br. J. Appl. Phys.,  
14, 368, (1963)
- (9) Watson, P. K. and Sharbaugh, A. H. J. Electrochem.  
Soc., 107, 516,  
(1960)
- (10) Plumley, H. J. Phys. Rev., 52, 140, (1937)
- (11) Read, J. Introduction to Organic Chemistry, (G.Bell  
and Sons Ltd., London 1958), P.201.
- (12) Zaky, A. A. Ph.D. Thesis, London University, (1959)
- (13) Lewis, T. J. Progress in Dielectrics, Vol.1,  
(Heywood and Co. Ltd., 1959).
- (14) Sharbaugh, A. H. and Watson, P. K. Progress in  
Dielectrics, Vol.4, (Heywood and Co. Ltd.,)  
(1962)
- (15) Swan, D. W. Br. J. Appl. Phys., 13, 208, (1962).
- (16) Edler, H. and Zeis, O. Z. Phys., 84, 356 (1933)
- (17) Baker, E. B. and Boltz, H. A. Phys. Rev., 51, 275,  
(1937)
- (18) Dornte, R. W. Industr. Engrg. Chem., 32, 1,529,  
(1940).

- (19) LePage, W. R. and DuBridge, L. A. Phys. Rev., 58,  
61, (1940)
- (20) Green, W. B. J. Appl. Phys., 27, 921, (1956)
- (21) Plumley, H. J. Phys. Rev., 59, 200, (1941)
- (22) Macfadyen, K. A. Brit. J. Appl. Phys., 6, 1, (1955).
- (23) Reiss, K. Ann. Phys. 28, 325, (1926).
- (24) Pao, C. Phys. Rev., 64, 60, (1943).
- (25) Coelho, R. and Bono, M. J. Electrochem. Soc., 107,  
94, (1960).
- (26) Morant, M. J. J. Electrochem. Soc., 107, 671,  
(1960).
- (27) Forster, O. E. J. Chem. Phys., 37, 1,021, (1962)
- (28) Zein Eldine, M. E., Zaky, A. A., Hawley, R. and  
Cullingford, M. C. Nature, 201, 1,309, (1964).
- (29) Macfadyen, K. A., and Helliwell, J. C. J. Electro-  
chem. Soc., 106, 1,022, (1959).
- (30) Gzowski, O. Private communication.
- (31) Adamczewski, I. and Gzowski, O. and Jachym, B.  
Conference paper, 1.1, Electronics  
Group, Inst. of Phys. and the Phys.  
Soc., Durham, April, (1963).
- (32) Jachym, B. Conference paper 1.4, Electronics  
Group, Inst. of Phys. and the Phys. Soc.,  
Durham, April, (1963).
- (33) Terlecki, J. Nature, 194, 172, (1962).
- (34) Gzowski, O. Nature, 194, 173, (1962).
- (35) LeBlanc, O. H. J. Chem. Phys. 30, 1,443, (1959).
- (36) Stokes, R. H. and Robertson, R. A. Electrolyte  
Solutions, (Butterworth, 1959), P.130.
- (37) Chong, P. and Inuishi, Y. J.I.E.E. (Japan),  
P.1,112, July, (1962).

- (38) Davis, H. T., Rice, S. A., and Meyer, L. J. Chem. Phys. 37, 947, (1962).
- (39) Davis, H. T., Rice, S. A., and Meyer, L. J. Chem. Phys. 37, 2,470, (1962).
- (40) Swan, D. W. Proc. Phys. Soc., 83, 659, (1964).
- (41) Bragg, J. K., Sharbaugh, A. H. and Crowe, R. W. J. Appl. Phys. 25, 382, (1954).
- (42) Goodwin, D. W. and Macfadyen, K. A. Proc. Phys. Soc., B66, 85 and 815, (1953).
- (43) Swan, D. W. Proc. Phys. Soc., 78, 423, (1961).
- (44) Kao, K. C. and Higham, J. B. J. Electrochem. Soc., 108, 522, (1951).
- (45) Kao, K. C. Conference paper 60-84, Winter meeting, American Institute of Electrical Engineers, (1960).
- (46) Maksiejewski, L. J. and Tropper, H. Proc. Inst. Elec. Engrs., 101, Pt.2, 183, (1954)†
- (47) Watson, P. K. and Sharbaugh, A. H. Progress in Dielectrics, Vol.4, (Heywood and Co. Ltd., 1962), P.244.
- (48) Kok, I. A. and Corbey, M. M. G. Appl. Sci. Res., Hague. B6, 285, (1957).
- (49) Adamczewski, I. Zestyty Naukowe Politechniki Gdanskiej, 3, 3, (1957).
- (50) Lewis, T. J. J. Electrochem. Soc., 107, 185, (1960).
- (51) Lewis, T. J. and Ward, B. W. Proc. Roy. Soc. A, 269, 233, (1962).
- (52) Gallagher, T. J. and Lewis, T. J. Br. J. Appl. Phys., 15, 491, (1964).
- (54) Zaky, A. A., Zein Eldine, M. E. and Hawley, R. Nature; 202, 687, (1964).
- (55) Nossier, A. Nature, 198, 1,295, (1963).

- (56) Huq, A. Z. and Tropper, H. Br. J. Appl. Phys., 15,  
481, (1964).
- (57) Darveniza, M. Nature, 183, 743, (1959).
- (58) Darveniza, M. Nature, 200, 558, (1963).
- (59) Goodwin, D. W. Proc. Phys. Soc., B69, 61, (1956).
- (60) Hart, J. Conference paper 2.4, Electronics group,  
Institute of Physics and the Physical  
Society, Durham, April, (1963).
- (61) Coelho, R. Paper presented before the Société Française des Électriciens  
11 April 1961
- (62) Green, H. S. The Molecular Theory of Fluids,  
(North Holland Publishing Co.,  
Amsterdam, 1952), P.65 and P.117.
- (63) Little, R. P. and Whitney, W. J. Appl. Phys., 34,  
2,430, (1963)
- (64) Coulson, C. A., Maccoll, A. and Sutton, L.  
Trans. Farad. Soc., 48, 106, (1952).
- (65) Green, H. S. The Molecular Theory of Fluids,  
(North Holland Publishing Co.,  
Amsterdam, 1952), P.55 and P.67.
- (66) Ward, H. K. J. Chem. Phys. 2, 153, (1934).
- (67) Nordheim, L. Anal. Phys. 9, 607, (1931).
- (68) Forster, O. E. J. Chem. Phys. 40, 91, (1964).
- (69) Herzberg, G. Infra Red and Roman Spectra, (D. Van  
Nostrand and Co. ), P.534.
- (70) Inuishi, I. Private communication.
- (71) Temperley, H. N. V. Br. J. Appl. Phys. I , 835,  
(1963).
- (72) Hirschfelder, J. O., Curtis, F. C. and Bird, R. B.  
Molecular Theory of Gases and Fluids,  
(John Wiley and Sons, Inc., New York,  
1954), P.948.

