

Durham E-Theses

The application of radioactive tracer techniques in the elucidation of the mechanism of chemical reactions

Walton, Alan

How to cite:

Walton, Alan (1956) *The application of radioactive tracer techniques in the elucidation of the mechanism of chemical reactions*, Durham theses, Durham University. Available at Durham E-Theses Online: <http://etheses.dur.ac.uk/9533/>

Use policy

The full-text may be used and/or reproduced, and given to third parties in any format or medium, without prior permission or charge, for personal research or study, educational, or not-for-profit purposes provided that:

- a full bibliographic reference is made to the original source
- a [link](#) is made to the metadata record in Durham E-Theses
- the full-text is not changed in any way

The full-text must not be sold in any format or medium without the formal permission of the copyright holders.

Please consult the [full Durham E-Theses policy](#) for further details.

THE APPLICATION OF RADIOACTIVE TRACER
TECHNIQUES IN THE ELUCIDATION OF THE
MECHANISM OF CHEMICAL REACTIONS

T H E S I S

submitted for the degree of

D O C T O R O F P H I L O S O P H Y

of the University of Durham

by

Alan Walton B.Sc., A.R.I.C.

July 1956.



ACKNOWLEDGEMENTS.

I wish to record my sincere thanks to my supervisor Dr. S.J. Thomson for suggesting the problem, for the sustained interest which he has shown in this work, and for the sound advice and encouragement which he gave at all times.

I am very grateful to Mr. G.R.Martin for many valuable discussions and in particular for the advice which he has given me on the radiochemical aspects of the problem.

This work is being prepared for publication in collaboration with Dr. S.J. Thomson.

Finally I should like to thank Durham County Council Education Committee, St. Cuthbert's Society, and the Durham Colleges for maintenance grants held during the period of this research.

Alan Walton.

Alan Walton.

CONTENTS

	<u>Page</u>
<u>SUMMARY.</u>	1
<u>INTRODUCTION.</u>	4
<u>CHAPTER I. - Method of solution of the problem of exchange.</u>	9
<u>Part I. - The introduction of tritium into cyclohexene.</u>	9
(a) Exchange reaction and tritium determination.	14
(b) Distribution of tritium in cyclohexene.	15
(c) Results of tritium distribution experiments.	17
<u>Part II. - Investigation of double bond movement in cyclohexene - HTO exchange reaction.</u>	21
(a) Synthesis of C ¹⁴ labelled cyclohexene.	22
(b) The purity and carbon activity of the synthesised cyclohexene.	24
(c) The distribution of the carbon activity in the synthesised cyclohexene.	26
(d) Exchange experiments using C ¹⁴ active cyclohexene.	30
<u>Part III. - Disproportionation of cyclohexene.</u>	46
(a) Effect of added substances on the disproportionation reaction.	47
(b) "Peroxide" Effect.	50
<u>CHAPTER II. - Isotope Effects.</u>	54
(a) Isotope Effects in the exchange reaction.	54
(b) Isotope Effects in the degradation reactions.	63
<u>CHAPTER III. - Discussion of Results.</u>	67
(a) Discussion of the mechanism of the exchange reaction.	69
(b) Discussion of the disproportionation reaction.	76

<u>CHAPTER IV.</u> - <u>Experimental Details.</u>	82
(a) Combustion techniques.	82
(b) Determination of tritium in organic compounds.	97
(c) Determination of C ¹⁴ in C ¹⁴ active organic compounds.	107
(d) Experimental procedures carried out during the exchange reaction investigations.	118
(e) Synthesis of C ¹⁴ labelled cyclohexene.	133
<u>APPENDIX</u> - Calculations.	143
<u>BIBLIOGRAPHY</u>	

SUMMARY

Isotopic Exchange reactions may be broadly classified into two main types, homogeneous and heterogeneous (1).

In the homogeneous-exchange reaction the reactants are uniformly distributed in the same phase and the only change taking place in the system, during the reaction, is the distribution of the different isotopes. In heterogeneous exchange reactions, on the other hand, the reactants exist in different phases.

In this thesis, attention has been confined to an exchange reaction of the latter type, the exchanging atoms being the hydrogen atoms in a hydrocarbon and those in tritiated water.

In the case of exchange between hydrogen isotopes (2) the reactions may be divided into four classes according to the state of the bonding of the hydrogen atoms.

1. Ionisable hydrogen atoms which exchange very rapidly.
2. Labile hydrogen atoms which exchange rapidly at a measurable rate. These are found in molecules which can undergo tautomeric changes.
3. Incipiently ionised hydrogen atoms which are liberated under the influence of electron attracting groups and exchange slowly.
4. Hydrogen atoms which are covalently bound and exchange at a much slower rate than the other types, e.g. those of the paraffins and aromatic hydrocarbons.



The work, which is to be described, concerns a reaction in which the type of bonding falls into the last class.

During the past twenty years many investigations have been carried out to determine the mechanisms for this type of exchange reaction (3,4,5,6), and to illustrate these investigations two examples will be described briefly. In these, the authors concerned, have described their attempts to determine the basic reaction which is responsible for the exchange of the hydrogen atoms in their respective examples.

The first author, J. Turkevich (3), was investigating the exchange of hydrogen between butenes and tritiated water in the presence of various catalysts, and he found that every exchange of hydrogen was accompanied by an isomerisation of the carbon-carbon double bond.

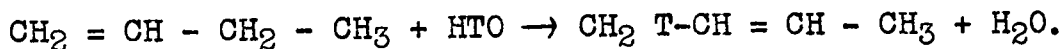

This result suggested that the mechanism was the same for both exchange and isomerisation, and from his observations Turkevich developed his "hydrogen switch" mechanism. Dobeler and Taylor (4) confirmed the deductions made by Turkevich.

The second example of an investigation into the mechanism of an exchange reaction of hydrogen isotopes is taken from a paper by J. Bell and his co-workers (5). They were interested in the deuteration of optically active lactic acid and they observed that the substitution of deuterium for hydrogen in the α position of the acid was accompanied by

optical inversion. It was therefore suggested by these authors that the mechanism for the exchange involved the formation of a transition state, produced when deuterium approaches the α carbon atom. Expulsion of hydrogen from the other side of the α carbon atom led simultaneously to inversion and to exchange with the hydrogens of HDO.

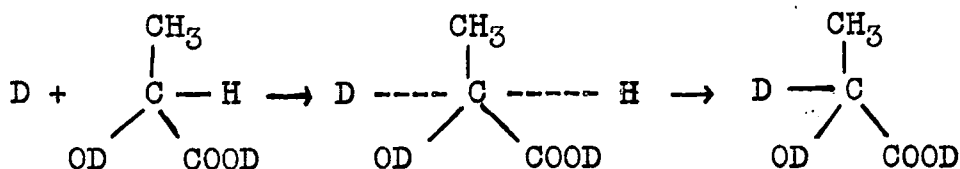

In this thesis an investigation into the mechanism of the exchange of hydrogen atoms between cyclohexene and tritiated water will be described. The exchange reaction between cyclohexene and deuterated water has been observed by Bell and Thomson (7) but the mechanism of the process was not elucidated. In order to obtain information about the mechanism of the exchange process it was decided to determine

(a) the distribution of the tritium atoms in the cyclohexene molecule after the hydrocarbon has undergone an exchange reaction with tritiated water,

(b) the extent of double bond migration which has occurred in the cyclohexene ring during the exchange reaction.

From the results of these experiments it may be possible to postulate whether a type of "hydrogen switch" mechanism is operating, if migration does occur, or whether the exchange of hydrogens takes place by a mechanism which does not necessitate double bond migration.

INTRODUCTION.

Exchange reactions involving olefinic compounds have, in general, been found to require the presence of a catalyst and the mechanism of the reaction has been explained in most cases by a process which included an adsorption on the catalyst. A typical example of such a reaction is the case of the butene exchange which has been mentioned previously. During the investigations into this reaction the catalysts which were used were varied, and it was observed that some of them led to exchange of hydrogen, and at the same time, isomerisation of the carbon-carbon double bond. The two reactions were interdependent. Under the same experimental conditions propylene exchanged very slowly and ethylene did not exchange at all.

It was therefore postulated, on the basis of the results of these experiments, that for a substance to act as a satisfactory catalyst it had to possess a hydrogen donor and a hydrogen acceptor separated by a distance of 3.5\AA . The mechanism of the process was explained by a "hydrogen switch" mechanism and it can be demonstrated by the following example.

(a) Double bond migration and exchange with tritium

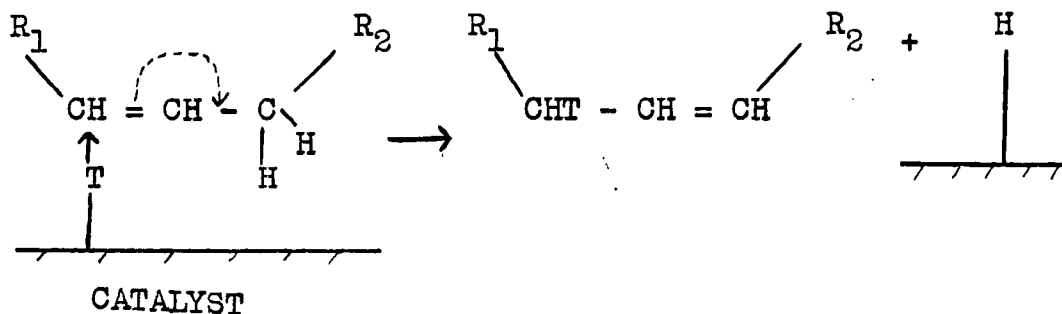

It can be seen that the "hydrogen switch" mechanism does not involve an adsorption of the carbon-carbon double bond on the catalyst.

It was thought that the olefinic hydrocarbon cyclohexene, might undergo double bond migration in a manner similar to that pictured by the "hydrogen switch" mechanism, since it had already been shown to exchange its hydrogens with deuterated water (7) in the presence of a catalyst.

This exchange reaction of cyclohexene might also be compared with the classic example of the ethylene-hydrogen exchange (6), a reaction which has been investigated and discussed by many workers. In most cases, the explanations to account for the exchange reaction of ethylene have involved the adsorption of the C = C by a catalyst. One of the mechanisms, suggested originally by Horiuti and Polanyi, could also account for a possible double bond shift if the theory was applied to cyclohexene. It was known as the "associative mechanism".

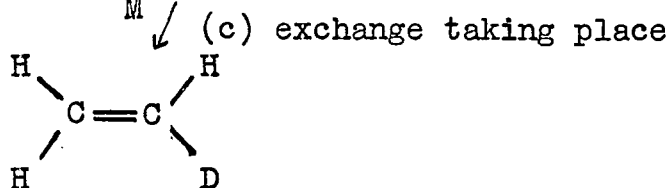
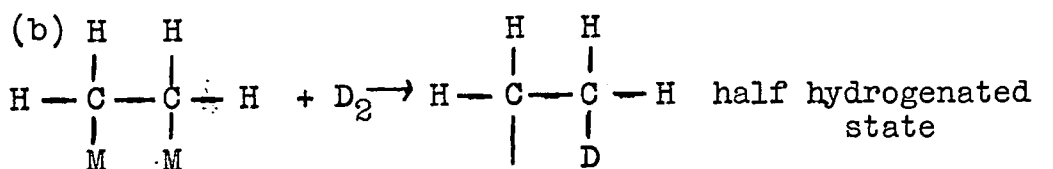
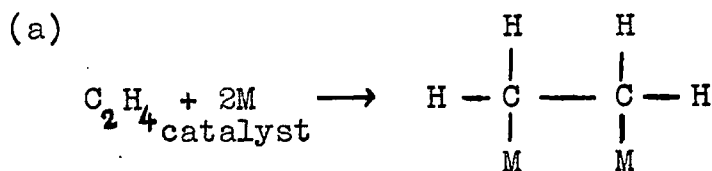

Double bond migration in a cyclohexene molecule could occur at reaction (c) as follows

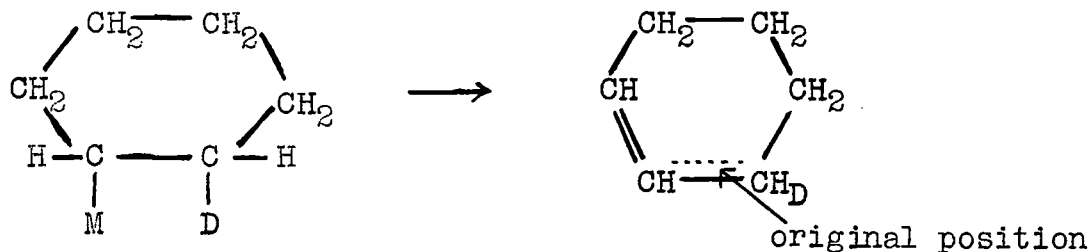

These brief examples demonstrate the possible occurrence of double bond migration during an exchange reaction involving an olefinic hydrocarbon, and the important part played by the catalysts in such reactions.

In the experiments to be described in this thesis the catalyst which was chosen for the exchange reaction between cyclohexene and tritiated water, was platinum black supported on asbestos. This catalyst was similar to that employed in the deuterium work, discussed by Bell and Thomson (7). The transition metal platinum possesses vacant 'd' band orbitals and the influence of this electronic factor on adsorption mechanisms, particularly in the ethylene example outlined above, has been stressed by Beeck (11) and other workers (34). It is likely that this factor may play some part in the cyclohexene exchange reaction. Furthermore, platinum possesses good geometrical properties (12) for the two point adsorption process suggested in the Horiuti-Polanyi mechanism.

Since cyclohexene was found to exchange its hydrogens for deuterium it is highly probable that it will also exchange with tritium (9), the radioactive isotope of

hydrogen mass 3. It is likely that the exchange rate with tritium will be slower than with deuterium under comparable conditions, because of the "isotope effect". (10).

It would be expected that freshly distilled cyclohexene would be used in this work. It has been found, however, under the conditions employed in the experiments to be discussed, that freshly distilled cyclohexene undergoes a disproportionation reaction to yield cyclohexane and benzene according to the following equation:- (8)

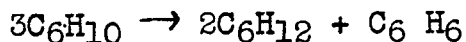

This reaction was first discovered by Zelinsky and Pawlow (13) when cyclohexene was passed over a palladium catalyst at temperatures between 92°C and 230°C. If, however, the cyclohexene was allowed to 'age', in a stoppered reagent bottle, for a number of days, then it was discovered that this type of reaction was inhibited in the presence of a platinum catalyst.

Investigations have therefore been made to try and discover the reason for the prevention of this disproportionation reaction.

The thesis has been divided accordingly into the following sections:-

Chapter 1 - Method of solution of the problem of exchange.

Part (1) The introduction of tritium into cyclohexene and its location within the cyclohexene molecule.

Part (2) Investigation of double bond movement in cyclohexene.

Part (3) Investigation of the disproportionation reaction.

Chapter II.

Isotope "Effects"

Chapter III.

Discussion of Results.

Chapter IV.

Experimental Details.

Appendix.

Calculations.

CHAPTER I.

METHOD OF SOLUTION OF THE PROBLEM OF EXCHANGE

From the introduction it can be seen that the main point of interest is to determine whether any double bond movement occurs when cyclohexene undergoes a hydrogen exchange reaction with tritiated water in the presence of a platinum catalyst. Before this can be done, however, it is necessary first of all to show that the exchange reaction does occur, and secondly, it may be possible from the results of the tritium exchange alone, to obtain some evidence as to the method of introduction of tritium into the molecule.

Four possible mechanisms have been suggested which may explain the introduction of tritium into a cyclohexene molecule and these will be described briefly, (Two of these mechanisms have already been mentioned)

1. Hydrogen "switch" mechanism.

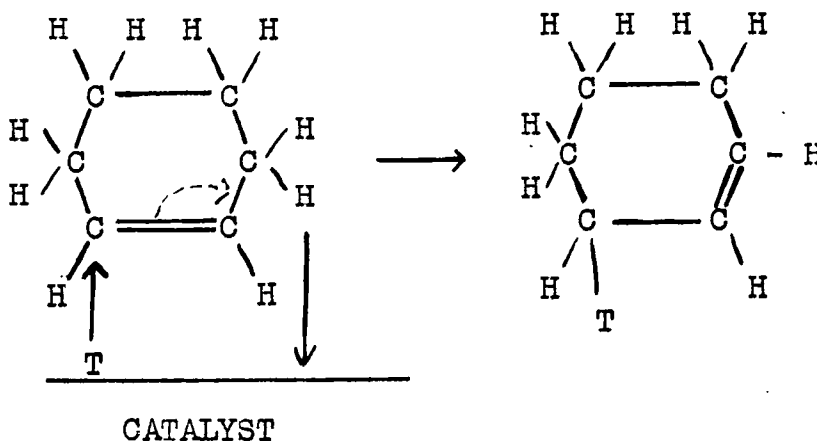

This mechanism explains double bond migration and

exchange of hydrogen in one movement. Further reaction of this product can lead to tritium in all positions in the ring, but if the number of subsequent reactions is small then most of the tritium activity will be in the α positions to the double bond.

2. Associative mechanism.

This was first applied to the ethylene-hydrogen exchange reaction but if cyclohexene can be treated in a similar manner then the reaction would take place as follows:-

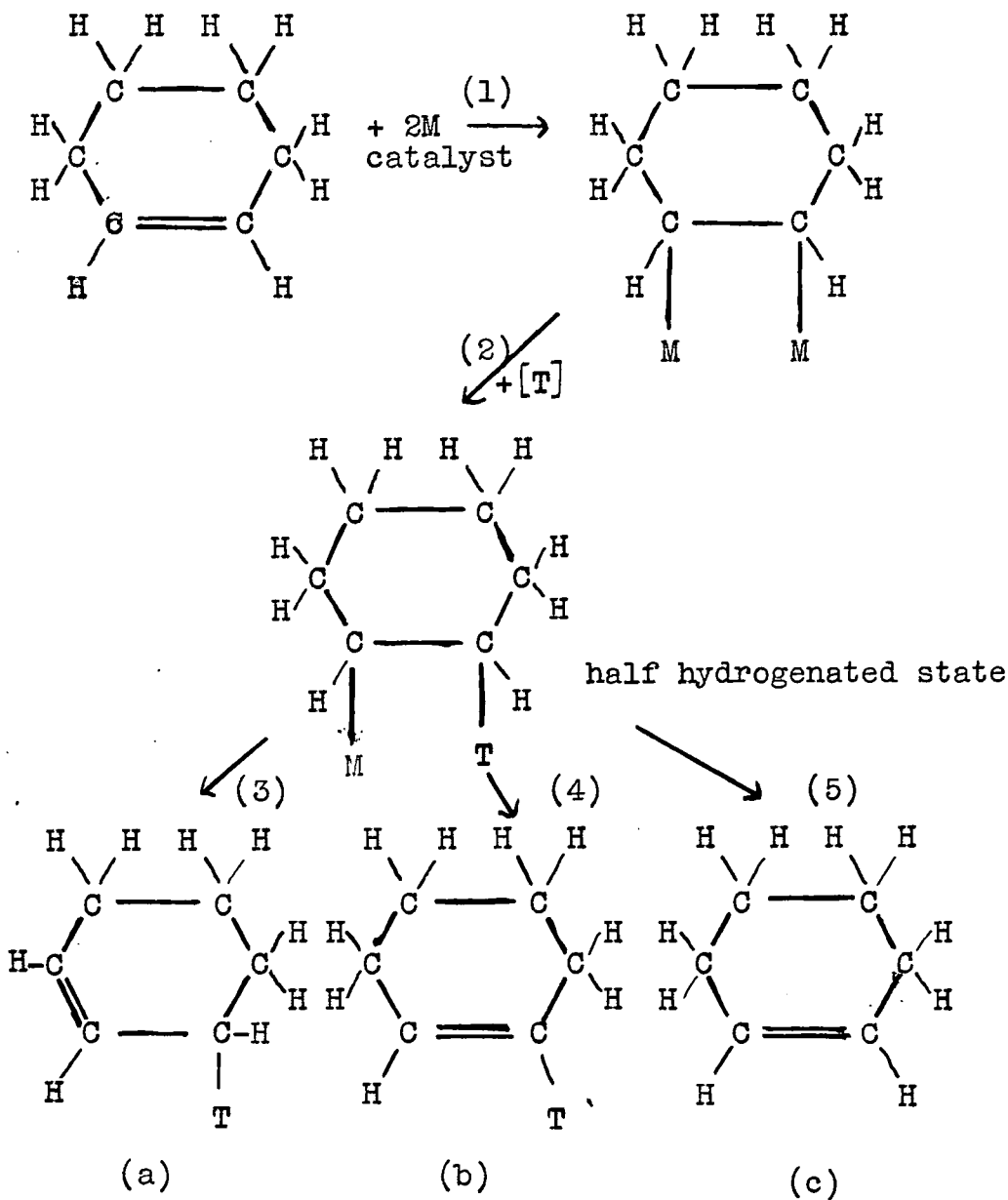

After the formation of a half hydrogenated state of cyclohexene in reaction (2) there are three possible products.

(a) Reaction (3) has led to double bond migration and also to an exchange with tritium appearing in the α position.

(b) Reaction (4) has led to exchange, with tritium on the double bond carbon atoms but no double bond migration.

(c) Reaction (5) yields no exchange and no migration.

Further reaction of the products can yield cyclohexene molecules with tritium in all positions. If, as in the first mechanism, the number of these is small, then by this mechanism there should be approximately twice as much tritium activity on the α carbon atoms as on the double bond carbon atoms. The assumption is made here that the isotope effect which may govern reactions (4) and (5) is small. Furthermore, the distribution of tritium in the cyclohexene ring, as a result of this mechanism serves to distinguish the mechanism from the "hydrogen switch" process. The "hydrogen switch" mechanism would lead to nearly all of the tritium being in the α positions and no 2:1 ratio should be observed in this case.

3. Dissociative mechanisms.

This mechanism was first suggested by Farkas (15) for the ethylene exchange and it involves the rupture of a carbon hydrogen bond as opposed to the partial disruption of the carbon carbon double bond in the associative mechanism.

If it is applied to cyclohexene as before, exchange can be explained but no double bond migration can occur.

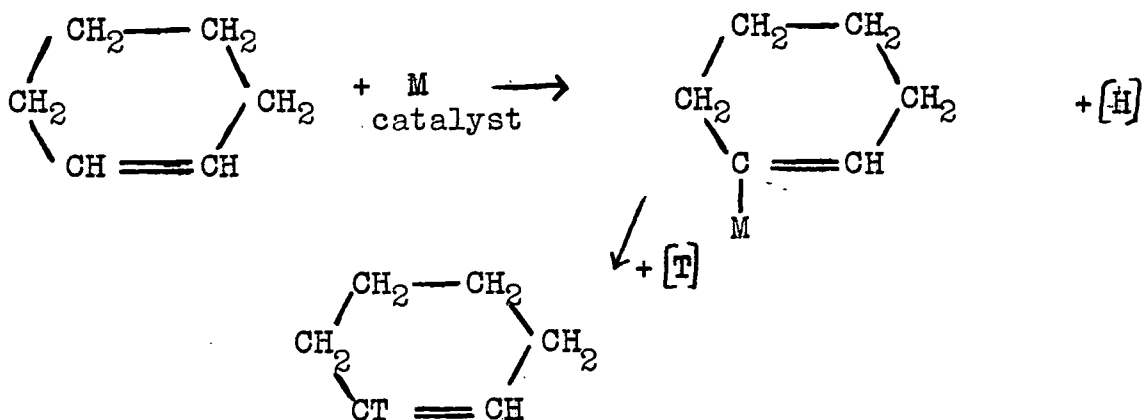

It has been suggested that this mechanism can be applied to saturated hydrocarbons (16) and it may therefore be possible for dissociation to occur at the CH₂ positions, thus allowing tritium to enter all positions in the cyclohexene molecule.

4. Carbonium Ion mechanism.

This mechanism has been applied fairly successfully to explain processes occurring in catalytic cracking reactions (17) and Whitmore (18)(19) has applied it to account for a number of organic reactions. If, as in the other examples, the theory is applied to cyclohexene, it may be demonstrated diagrammatically as follows:-

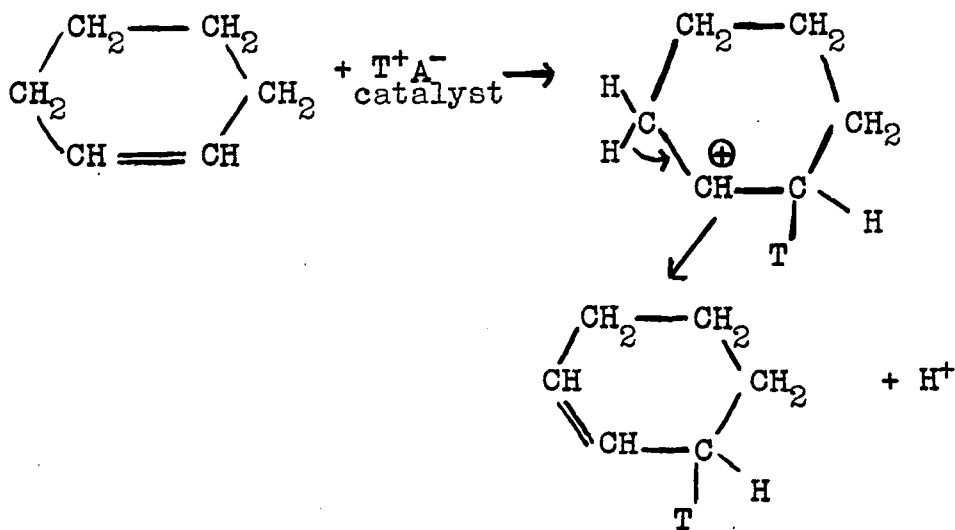

This mechanism can explain both double bond migration and exchange, and yields the same products with the same tritium distribution as in the "hydrogen switch" mechanism. A medium is required which can both supply and remove protons, (or tritons) i.e. an acid catalyst. The acidity of a typical cracking catalyst - silica- alumina, has been demonstrated by C.L. Thomas (31).

If one of these explanations for exchange applies to the exchange reaction of cyclohexene and tritiated water in the presence of a catalyst, then on examination of the hydrocarbon after the reaction, for tritium distribution, and double bond migration, it may be possible to come to a decision about the mechanism of the process.

The first section which follows deals with the introduction of tritium into the molecule of cyclohexene, and the method for determining the distribution throughout the ring. Full experimental details appear in Chapter IV.

PART 1. (a) Exchange reaction and tritium determination.

Cyclohexene was tritiated in a manner similar to that used in the deuteration experiments of Bell and Thomson (7).

The hydrocarbon was weighed into a 'Pyrex' brand tube together with the platinum black catalyst, tritiated water, and glacial acetic acid, the latter being present to maintain uniformity with previous deuteration experiments of this type (20). The function of the acid is not known. After these weighings the tube was frozen in liquid nitrogen or solid carbon dioxide, evacuated by means of an oil 'Hyvac' pump, sealed, and shaken in a thermostatically controlled oven at 130°C for three days. The tube was then cooled, and opened, the cyclohexene layer was isolated, washed with sodium carbonate solution, and then distilled water, dried over calcium chloride, and finally distilled.

Samples of the hydrocarbon were characterised, both before, and after the exchange reaction, by determining the following properties:-

1. Boiling range;
2. Double Bond Content, obtained by bromination;
3. Refractive Index.

A sample of the purified cyclohexene 0.03-0.04 g. was then examined for its tritium content after the exchange. This was done by weighing the sample into a glass capillary tube and then burning the cyclohexene in a stream of oxygen in the

usual Pregl type combustion tube.(21). The water, which was trapped out in a cold bath, was then converted into hydrogen by passing it over magnesium turnings which were heated to 500°C. Aliquots of the hydrogen were then introduced into a Geiger counter for activity determinations, using ethyl alcohol vapour as a 'quenching agent'.

This experiment will yield the total tritium content of the cyclohexene, and the distribution of the tritium may be determined by the following methods.

(b) Distribution of tritium in cyclohexene.

The first step employed in these experiments was to convert a sample of tritiated cyclohexene into adipic acid and to crystallise the acid from a large volume of water .

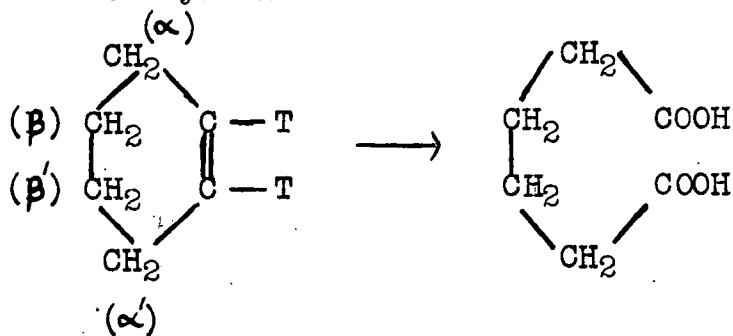

All the tritium atoms on the positions shown would thus be removed, and tritium determinations before, and after the reaction, would yield the number of tritium atoms in these positions.

The second step was to convert a sample of tritiated adipic acid to the $\alpha\alpha'$ dibromo adipic acid and compare the tritium contents of both acids. If it is assumed that

bromine replaces tritium as easily as protium then calculation will reveal the number of tritium atoms in the α and β positions to the double bond in cyclohexene

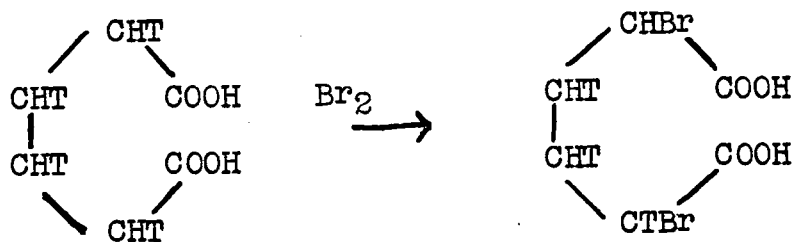

The calculations for these experiments are described in the Appendix.

Oxidation of the cyclohexene was carried out under very mild conditions using osmium tetroxide and hydrogen peroxide in tertiary butyl alcohol solution, so as to reduce the possibility of rearrangements. Osmium tetroxide is an additive reagent and is a specific reagent for the attack of double bonds in olefinic substances (32). By using this reagent it is fairly certain that oxidation takes place at the C = C bond.

The cyclohexane-diol, thus produced, was further oxidised to adipic acid by potassium permanganate solution. The solution was acidified and the adipic acid isolated by extracting with ether. The ethereal solution was then evaporated to dryness and the adipic acid recrystallised from water.

Treatment of the adipic acid with bromine was performed in thionyl (22) chloride solution and the solid $\alpha\alpha'$ dibromo

adipic acid was recrystallised from formic acid. Both acids were burnt in the combustion tube in the usual manner, the water being converted to hydrogen and the tritium contents determined by the gas counting technique in a Geiger counter.

(c) Results of tritium distribution experiments.

A pilot experiment was carried out to confirm that cyclohexene would exchange with tritiated water and produce tritiated cyclohexene with an activity which could be determined accurately. An exchange reaction was then performed on a larger scale to yield sufficient cyclohexene to allow the degradation experiments to be performed in duplicate. The activity of the exchange solution was determined and the cyclohexene employed in all experiments was 'aged' material. Experiments were also carried out with no catalyst present to determine whether the catalyst was necessary for the exchange reaction to take place.

Tables of the results which were obtained from these experiments are shown on the following pages.

RESULTS.

TABLE 1.

REACTION MIXTURES.

Tube Number	Wt. of Catalyst (g).	Wt. of Tritium Solution (g).	Acetic Acid (g).	Cyclohexene (g)	Specific Activity of H ₂ . (counts/min/cm. H ₂ at 20°C.)
1.	0.0812	0.6212	1.6832	2.9915	255.1 ± 2.6
2.	1.6247	12.4562	33.6291	59.8560	{ 102.3 ± 1.0 102.5 ± 1.0
{ 3.	0.0810	0.6486	1.6892	2.9942	50.67 ± 0.63
{ 4.	nil	0.6487	1.6470	2.9976	1.96 ± 0.019

TABLE 2.

PHYSICAL PROPERTIES OF CYCLOHEXENE.

Property	Before Exchange	After Exchange.
Boiling Range	83 -83.5°C.	82.5-83.5°C.
Refractive Index 20°C.	1.4470	1.4474
Double Bond Content/ Molecule.	1.00	0.98

TABLE 3.

DEGRADATION RESULTS. From Tube No.2.
Specific Activity expressed as Counts/min/cm.of H₂ at 200C.

Substance	Hydrogen Yield	Specific Activity
Cyclohexene	1 97.52%	102.5 ± 1.0
	2 90.40%	102.3 ± 1.0
Adipic Acid M.pt.148-151°C	1 98.49%	77.67 ± 0.68
	2 { 99.38% 98.53%	{ 77.32 ± 0.71 77.20 ± 0.90
αα'dibromo adipic acid M.Pt.192-193°C	1 { 100.00% 99.98%	{ 61.81 ± 0.66 60.39 ± 0.75
	2 98.04%	61.32 ± 0.50
Exchange Solution Tritiated H ₂ O	1 98.13%	(629.6 ± 6.0) x25
	2 97.10%	(637.8 ± 6.0)

TABLE 4.

TYPICAL TRITIUM DISTRIBUTION IN CYCLOHEXENE.
(Calculated from results in Table 3).

The results are expressed as the number of tritium atoms/g. mol. cyclohexene.

Cyclohexene	CH = CH	Total in 4α positions	Total in 4β positions
2.68 x 10 ¹⁴	0.65 x 10 ¹⁴	1.50 x 10 ¹⁴	0.53 x 10 ¹⁴

(d) Comments on Results.

Cyclohexene, under the conditions of the experiments, has been found to exchange all of its hydrogens with the

hydrogens of a tritiated water sample in the presence of a platinum catalyst.

The results of experiments 3 and 4 in Table 1 indicate that a small amount of exchange takes place in the absence of the catalyst and that it is approximately 4% of the amount occurring in the presence of a catalyst under the same experimental conditions.

Table 3 indicates that the major part of the tritium activity in cyclohexene is in the α positions. In this calculation no correction has been applied for a possible isotope effect in the bromine-adipic acid reaction.

The results of Table 4 show that the ratio of the tritium activities in the α positions and on the double bond carbon atoms is $\frac{1.50 \times 10^{14}}{0.65 \times 10^{14}}$ i.e. approximately 2:1. This distribution of tritium appears to be good evidence in favour of the 'associative' type of mechanism for exchange which was discussed at the beginning of this chapter. Further discussion of these results will appear in Chapter III.

PART II. Investigation of double bond movement in cyclohexene - HTO exchange reaction.

It can be seen from the brief introduction to the possible mechanisms for exchange that it is impossible to determine whether any double bond migration has occurred during the exchange reaction unless the position of the double bond can be located in some way.

To solve this problem it was decided to label the cyclohexene molecule, on the double bond position, with the radioactive isotope of carbon (23), (C^{14} $t_{1/2} = 4500$ years) and subject the hydrocarbon to an exchange reaction in the usual way. The effects of this labelling can be seen if the associative mechanism is considered.

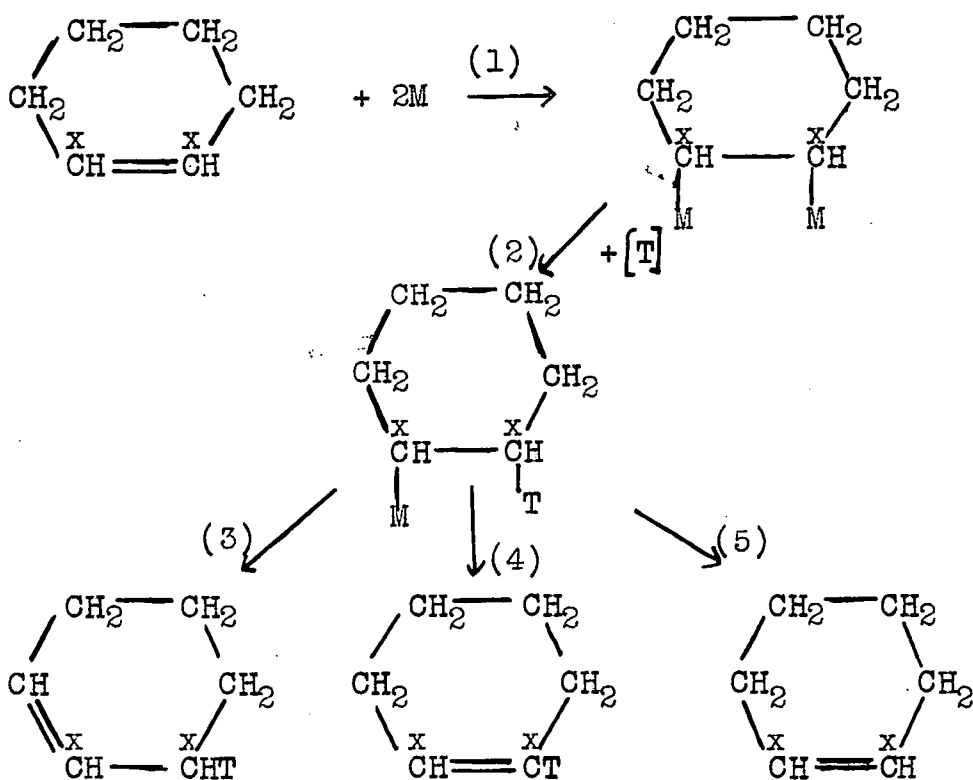

Reaction (3) has led to a decrease of C^{14} activity on the

double bond carbon atoms after migration of the ethylenic linkage. Double bond movement will always lead to a decrease in carbon activity on the double bond position if the exchange with tritium occurs by this procedure.

In order to detect this change in activity cyclohexene was degraded before and after the exchange reaction in such a manner that any change in carbon activity, on the double bond carbon atoms, could be detected.

The synthesis of C^{14} labelled cyclohexene is briefly described first and this is followed by a description of the degradations reactions which were used to investigate double bond migration.

(a) Synthesis of C^{14} labelled cyclohexene.

The synthesis of simple olefinic compounds labelled at the double bond has been described by Calvin (24). He found that all of the methods tried led to products in which the activity was not all present on the double bond.

To come to a decision concerning double bond migration it is not necessary, however, for all the activity to be concentrated on the double bond carbon atoms. Provided that the activity is not symmetrically distributed between the double bond positions, and the α positions, in the cyclohexene molecule, then the degradation procedures to be described should still detect a change in activity on the double bond carbon atoms.

The method adopted for the synthesis of labelled

cyclohexene involved a six stage process starting with pentamethylene dibromide and active potassium cyanide. The first part of the synthesis was based on a procedure suggested by Loftfield (25) for the preparation of cyclohexanone. After this the cyclohexanone was reduced to cyclohexanol using aluminium isopropoxide ~~in~~ isopropyl alcohol. Dehydration of cyclohexanol to cyclohexene was then carried out using concentrated sulphuric acid.

The full synthesis is shown in the following scheme of reactions:-

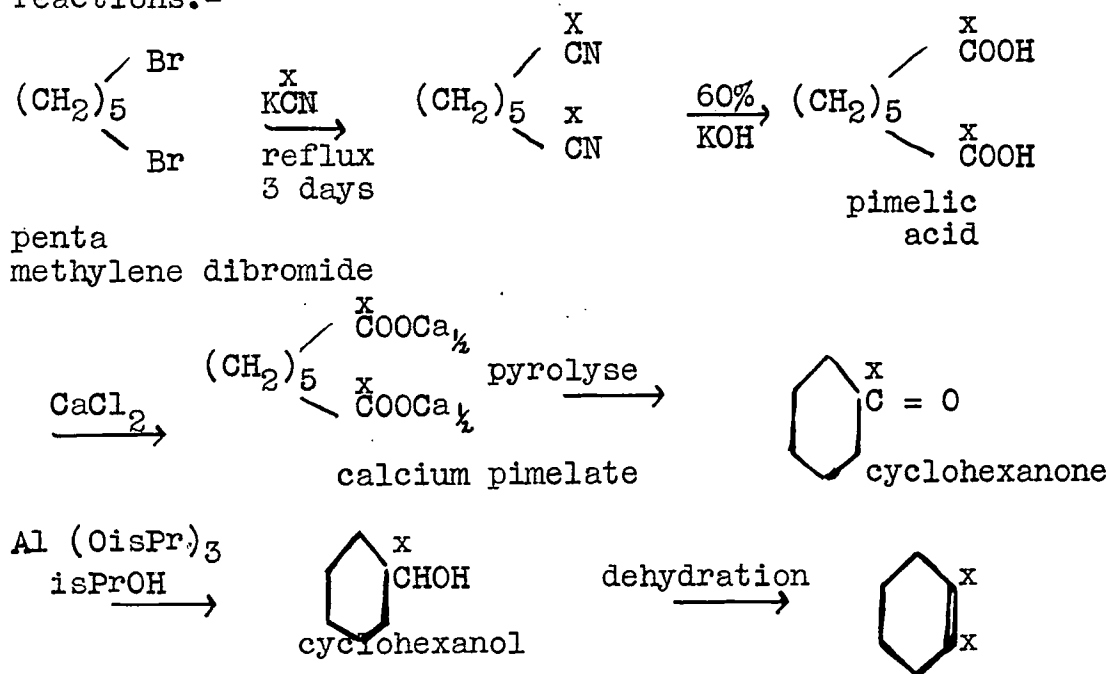

After the active cyclohexene was isolated at the end of this procedure it was examined with a view to determining

1. The purity, and carbon activity, of the hydrocarbon.
2. The distribution of the carbon¹⁴ in the cyclohexene.

The methods used in these investigations will be described in the two sections which follow, and the full description of the synthesis of active cyclohexene will be described in

Chapter IV.

(b) The purity and carbon activity of the synthesised cyclohexene.

The purity of the synthesised cyclohexene was estimated by measuring

- (a) Boiling Range.
- (b) Double Bond Content.
- (c) Refractive Index.

and comparing the results with the values obtained from pure, inactive, freshly distilled cyclohexene.

A further experiment was designed to estimate the purity of the synthesised material and at the same time to determine the carbon¹⁴ content of the hydrocarbon. It will also establish whether all of the carbon activity is present in the cyclohexene.

Cyclohexene was first oxidised to cyclohexane 1-2 diol using the same procedure as that described in the tritium distribution experiments i.e. employing osmium tetroxide and hydrogen peroxide in tertiary butyl alcohol. This ensures that oxidation will take place at the double bond carbon atoms because of the specific manner in which the osmium tetroxide attacks olefinic structures to form an additive compound. The diol was then further oxidised to adipic acid using aqueous potassium permanganate solution.

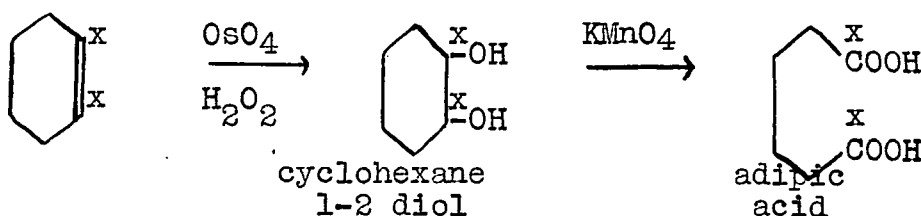

The carbon activities of the cyclohexene and the adipic acid were then determined. A comparison of these two activities should reveal no change if the original cyclohexene was pure since no carbon atoms have been removed in the degradation experiments.

Outline of Experimental Procedures.

Double bond contents of cyclohexene were obtained in the usual way. A measured volume of a solution of dry bromine in carbon tetrachloride was added to a known weight of cyclohexene. Excess bromine was then titrated with standard sodium thiosulphate solution.

Oxidation of cyclohexene was carried out with osmium tetroxide and hydrogen peroxide, and then aqueous potassium permanganate. The acidified solution was extracted with ether and the ethereal solution evaporated to dryness. The adipic acid was then recrystallised from water.

Carbon activities of cyclohexene and adipic acid were obtained after burning the substances in a combustion tube and condensing out the carbon dioxide and water in liquid oxygen. Carbon dioxide was removed from the condensate by distillation at an acetone 'Drikold' bath temperature. The activity of the carbon dioxide gas was then determined by introducing a known pressure of the gas into a Geiger-Muller counter. Carbon disulphide vapour was added to the carbon dioxide as a quenching agent.

The results of these experiments are shown in the

following tables whilst full experimental details for the procedures may be found in Chapter IV.

TABLE 5.

PROPERTIES OF CYCLOHEXENE.

	Boiling Range	Refractive Index @ 20°C.	Double Bonds per molecule.
Synthesised Cyclohexene	83-84.5°C.	1.4467	1.01
Pure Cyclohexene	83°C.	1.4463	1.00

TABLE 6.

CARBON ACTIVITY DETERMINATIONS ON CYCLOHEXENE AND ADIPIC ACID (M.P.T. = 148 - 151°C.)

Substance	Carbon Dioxide Yield	Specific Activity (Counts/Min/cmCO ₂ at 20°C)	No. of C ¹⁴ Atoms per g. mol. of substance
Cyclohexene	95.00%	20.14 ± 0.15	2.25 x 10 ¹⁶
Adipic Acid	101.0%	19.10 ± 0.16	2.13 x 10 ¹⁶

Comments on the Results of Tables 5 and 6.

The results of Table 5 indicated that the synthesised cyclohexene was reasonably pure 95 ± 1.2%. The physical properties of the active material were in good agreement with the properties of pure freshly distilled material.

(c) The distribution of carbon activity in the synthesised cyclohexene.

The work of Calvin (24) established that C¹⁴ active

olefinic compounds, synthesised in a manner similar to the procedure which has been described, did not possess all of the activity on the double bond carbon atoms. It was decided therefore, to determine the carbon activity distribution in the synthesised cyclohexene. A series of degradation reactions were devised which would enable calculations to be made to determine the amount of Carbon¹⁴ activity on the double bond carbon atoms and the amount of activity in the remainder of the ring.

The first reaction involved the oxidation of cyclohexene to adipic acid via the methods which have been described previously. In order to represent the scheme of reactions it is assumed that all of the activity is on the C = C carbon atoms.

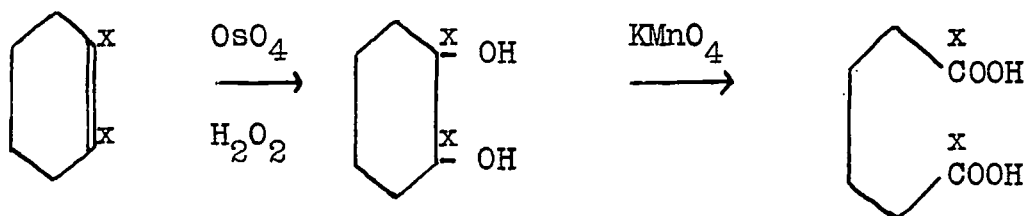

No loss of active carbon atoms should be sustained in this reaction.

The second reaction was to remove one of the carboxyl C atoms from the adipic acid. From the reaction scheme, this is seen to be equivalent to removing one of the C = C carbon atoms. Half of the carbon activity on the double bond atoms was therefore lost in this reaction. The degradation reaction involved the preparation of the calcium salt of adipic acid which was then pyrolysed to produce cyclopentanone.

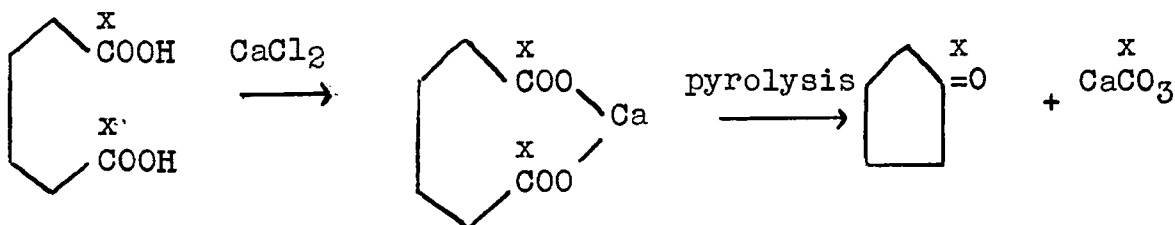

The difference in activity determinations of the adipic acid and the cyclopentanone therefore yielded the amount of carbon activity on one of the $\text{C} = \text{C}$ carbon atoms.

Outline of Experimental Procedures.

Adipic acid was prepared from the active cyclohexene using osmium tetroxide and hydrogen peroxide followed by aqueous potassium permanganate solution. The acid was recrystallised from water. A slightly alkaline solution of sodium adipate was then treated with the required amount of calcium chloride and the calcium adipate filtered off from the hot solution. The dried calcium salt was then pyrolysed at $350\text{-}400^\circ\text{C}$ to yield the cyclopentanone, which was purified via the bisulphate compound.

Activity determinations were carried out in the usual manner. The substances were burnt in a stream of oxygen in the combustion tube and the carbon dioxide produced was introduced into the Geiger counter. Carbon disulphide vapour was used as a quenching agent.

The experimental results are shown in the following tables and the details of the degradation procedures appear in Chapter IV.

TABLE 7.

C¹⁴ ACTIVITY RESULTS.

Substance	Specific Activity (Counts/Min/cm.CO ₂ at 20°C.	No. of C ¹⁴ atoms per G.Mol.of substance.
Cyclohexene	20.14 ± 0.15	2.249 x 10 ¹⁶
Adipic Acid	19.10 ± 0.16	2.133 x 10 ¹⁶
Cyclopentanone	11.46 ± 0.16	1.066 x 10 ¹⁶

TABLE 8.

DISTRIBUTION OF C¹⁴ ACTIVITY.

% age of total activity in cyclohexene = 100%

" " " " " adipic acid = 95.13%

" " " " " cyclopentanone = 50.00% ± 1.6%

" " " " " off C=C in  = 100.0% (From adipic acid activity)

" " " " " in remainder of  ring = 0% "

Comments on the results of Tables 7 and 8.

The results from Table 7 have demonstrated that when the active adipic acid was degraded to cyclopentanone 50% of the C¹⁴ atoms were removed. Hence all of the activity appears to be on the double bond carbon atoms in cyclohexene as shown in Table 8. The error on the cyclopentanone was approximately 1.6% and hence the amount of activity on double bond carbon atoms could vary between 98.4 and 100%. The adipic acid activity figure was taken as the most reliable estimate for the total activity in the cyclohexene. The distribution of C¹⁴ activity within the cyclohexene ring is not symmetrical

and hence any movement of the double bond during the exchange reaction will lead to a fresh distribution of C^{14} in the ring. This new distribution of C^{14} activity can be detected, and differentiated from the original distribution, by degrading the cyclohexene before, and after the exchange reaction to cyclopentanone. Further explanation of this procedure will be given in the following section.

(d) Exchange Experiments using C^{14} active cyclohexene.

The results of the experiments which have just been described have established two main points:-

- (a) that the C^{14} synthesised cyclohexene was reasonably pure.
- (b) that the C^{14} in cyclohexene was not symmetrically distributed, between the $C = C$ and the remainder of the cyclohexene ring, so allowing double bond movement in cyclohexene, during exchange, to be detected.

It was decided therefore to subject the active cyclohexene to an exchange reaction with tritiated water, in the presence of a platinum catalyst, to determine whether any double bond migration occurs. If movement does occur then some of the cyclohexene after exchange would have a C^{14} distribution as follows:-

Before Exchange.

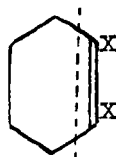

After Exchange.

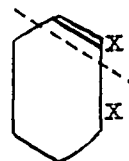

This change could be detected if a reaction scheme was devised which would remove the carbon atoms forming the double bond. Such a scheme would result in an increase of carbon activity in the residual part of the cyclohexene molecule after the exchange as shown above.

The degradation reactions which were employed have already been described in connection with previous work. The first reaction was to oxidise the cyclohexene to adipic acid in the usual manner:-

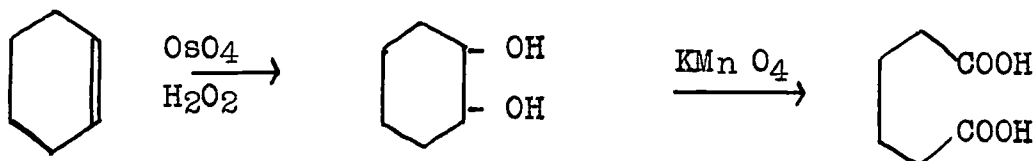

Calcium adipate was then pyrolysed to yield cyclopentanone

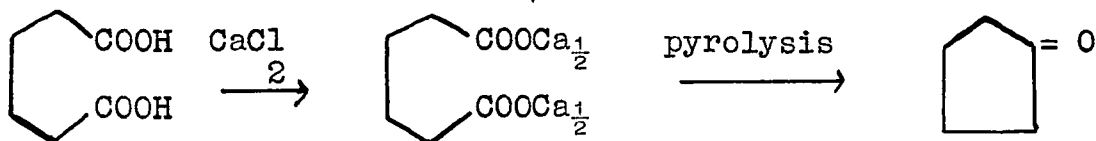

If double bond migration has occurred during the exchange reaction then an increase in the activity of the cyclopentanone after the exchange should be revealed. The following reactions demonstrate how this can occur:-

1. No migration during exchange:-

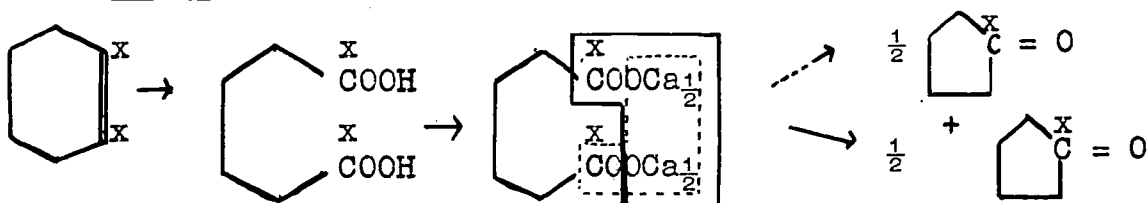

2. Migration occurring during exchange.

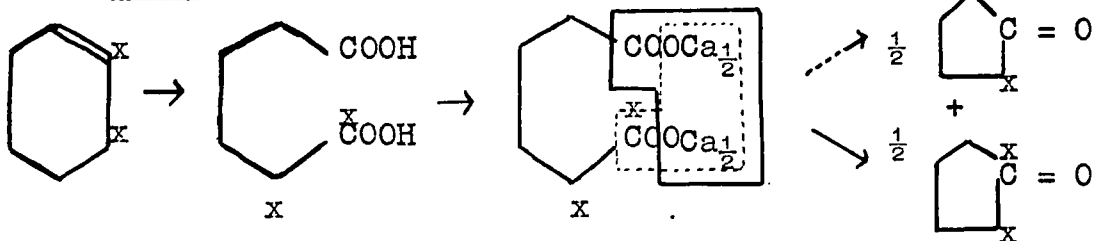

If C^{14} activity determinations on the cyclopentanone, before and after the exchange are performed, then an increase in the activity of the cyclopentanone after the exchange will demonstrate that migration of the double bond has occurred.

Outline of Experimental Procedures.

Experiment 1.

The first experiment performed was designed to establish that the active cyclohexene would exchange its hydrogens with those of tritiated water. Furthermore, it is possible, from the tritium activity of the cyclohexene, to perform a calculation to predict the amount of double bond movement occurring in the exchange reaction. This calculation appears in the Appendix and it is based on the 'associative' theory for exchange.

C^{14} active cyclohexene was subjected to an exchange reaction with tritiated water in the presence of the platinum catalyst. This was carried out in the usual manner. Catalyst, tritiated water, acetic acid and platinum catalyst were weighed into a 'Py rex' tube. The tube and its contents were then frozen in liquid nitrogen, evacuated, sealed, and shaken at $130^{\circ}C$ for three days. After the exchange the cyclohexene layer was isolated, washed with sodium carbonate and distilled water, dried over calcium chloride, and finally distilled.

Samples of the cyclohexene were characterised both before, and after the exchange reaction by determining

1. Boiling Range.
2. Double bond content, obtained by the bromination method.
3. Refractive Index.

The tritium content of the purified cyclohexene was then determined after the exchange reaction. A sample of cyclohexene was burnt in the combustion tube, and the water converted to hydrogen by passing it over magnesium at 500°C. The activity of the hydrogen was then estimated in a Geiger counter. Results from this experiment are shown in the following tables.

Experiment 1 - Tube 5.

TRITIUM DETERMINATION IN CYCLOHEXENE.

TABLE 9. - Tube Filling.

Catalyst	Tritiated Water	Acetic Acid	Active Cyclohexene
0.0545g	0.4196g.	1.1358g.	2.0044g.

TABLE 10 - Characterisation of Cyclohexene - Before and After Exchange.

Boiling Range.		Refractive Index at 20°C.		Double Bonds per Molecule	
Before	After	Before	After	Before	After
83-84°C	83-84.5°C	1.4465	1.4462	0.99	1.00

TABLE 11 - Tritium Content and Calculated Amount of Double Bond Movement.

Cyclohexene Wt.	Hydrogen Yield	Specific Activity (counts/min./cm. of H ₂ @ 20°C.)	Prbbable Double Bond Movement
0.0419g.	95.01%	139.25 ± 0.95	8.2%

The value for the probable double bond movement shown in Table 11 was calculated from the tritium specific activity shown in this table. The distribution of the tritium within the cyclohexene ring was required in this calculation, and it was obtained by assuming that it was distributed in the same ratios as shown in Table 4.

Experiment 2.

It has now been established that the active cyclohexene would exchange its hydrogens for those of tritiated water. From the amount of tritium exchange occurring, it has been calculated, using certain assumptions, that the probable amount of double bond movement was 8.2%. Experiment 2 was therefore devised to measure the amount of double bond movement which had actually occurred in the active cyclohexene during exchange under the same conditions as Experiment 1. To obtain this result it was necessary to degrade the active cyclohexene to cyclopentanone before, and after the exchange reaction. C¹⁴ activity results from the cyclopentanone in the two cases will yield the amount of double bond shift which has occurred during the exchange reaction.

C^{14} active cyclohexene, the same as in Experiment 1, was subjected to an exchange reaction in the same way as in Experiment 1 except that inactive water was used. The precaution of leaving out the tritium was taken so as to eliminate the possibility of tritium contamination of the carbon dioxide, (30) since any contamination may mask any difference in cyclopentanone activity values before, and after the exchange reaction.

After the exchange reaction was performed as described in Experiment 1, the cyclohexene layer was isolated, purified, and the hydrocarbon characterised.

Approximately 5g. of the cyclohexene was oxidised to adipic acid using osmium tetroxide and hydrogen peroxide, and then aqueous permanganate. A slightly alkaline solution of sodium adipate was then converted to the calcium salt by addition of calcium chloride. The calcium adipate was then pyrolysed at 350-400°C to yield cyclopentanone which was purified via the bisulphite compound.

C^{14} activity results on the cyclopentanone, obtained from the C^{14} cyclohexene before, and after the exchange reaction, were obtained after burning the sample in oxygen in the combustion tube, and condensing the carbon dioxide in a spiral surrounded by a liquid oxygen bath. The carbon dioxide gas was introduced into a Geiger counter together with carbon disulphide vapour to act as quenching agent.

The results of Experiment 2 are shown in the following tables and the experimental details for the procedures which have been described can be found in Chapter IV.

Experiment 2 - Carbon Activity Results - Tube 6.

TABLE 12 - Tube Filling.

Catalyst	Water	Acetic Acid	Active Cyclohexene
0.1904g.	1.4584g.	3.9362g.	7.0232g.

TABLE 13 - Characterisation of Cyclohexene - Before and After Exchange.

Boiling Range		Refractive Index at 20°C.		Double Bonds per Molecule.	
Before	After	Before	After	Before	After
83-84°C.	83-85°C.	1.4465	1.4463	0.99	1.00

TABLE 14 - Cyclohexene and Adipic Acid - C14 Activity Results.

	Cyclohexene Specific Activity	Adipic Acid Specific Activity	Counts/min/cm. CO ₂ at 20°C.
Before Exchange	20.14 ± 0.15	19.10 ± 0.16	
After Exchange	20.01 ± 0.18	19.07 ± 0.14	

TABLE 15(a) - Cyclopentanone C14 Activity Results.

Cyclopentanone Wt.		Carbon Dioxide Yield	Specific Activity (Counts/Min/cm. CO ₂ at 20°C.
Before 1.	0.0369g.	100.0%	11.48±0.17
Exchange 2.	0.0286g.	100.3%	11.43±0.14
			11.46 ± 0.16
After 1.	0.0349g.	100.2%	12.00±0.17
Exchange 2.	0.0349g.	99.68%	12.04±0.12
			12.02 ± 0.17

The errors expressed in the last column of this table are the standard deviations obtained from eight separate activity determinations on each sample.

This large number of specific activity determinations were performed on the cyclopentanone so that the final result could be expressed with a good degree of accuracy. A full list of the results obtained in these experiments is shown in Tables 15(b) and 15(c).

TABLE 15(b) - Specific Activities of Cyclopentanone - before exchange. All results are expressed as counts min/10cm of CO₂ in the counter at 20°C.

Cyclopentanone 1.	Cyclopentanone 2.	Background.
1. (149.4 ± 1.49	5. (148.4 ± 1.48	1. 35.29 ± 0.60
(148.6 ± 1.49	(150.3 ± 1.50	2. 34.57 ± 0.59
2. (149.4 ± 1.49	6. (151.6 ± 1.52	3. 33.10 ± 0.58
(148.7 ± 1.49	(149.1 ± 1.49	4. 32.60 ± 0.64
3. (147.5 ± 1.47	7. (148.5 ± 1.48	5. 35.67 ± 0.55
(149.8 ± 1.50		6. 35.22 ± 0.60
4. (149.1 ± 1.49	8. (147.5 ± 1.47	7. 35.39 ± 0.60
(147.5 ± 1.47	(149.6 ± 1.50	

TABLE 15(c) - Specific Activities of cyclopentanone - after exchange. All results are expressed as counts/min./10cm. of CO₂ in the counter at 20°C.

Cyclopentanone 1.		Cyclopentanone 2.	Background.		
1.	(155.2 ± 1.55 155.0 ± 1.54)	5.	(155.1 ± 1.55 154.7 ± 1.55)	1.	36.84 ± 0.65
2.	(153.8 ± 1.54 152.8 ± 1.53)	6.	(154.0 ± 1.54)	2.	33.72 ± 0.58
3.	(154.5 ± 1.54 154.0 ± 1.54)	7.	(154.9 ± 1.55 156.9 ± 1.57)	3.	33.35 ± 0.58
4.	(155.9 ± 1.56 157.1 ± 1.57)	8.	(154.5 ± 1.54 156.3 ± 1.56)	4.	34.11 ± 0.59
				5.	36.14 ± 0.55
				6.	34.82 ± 0.59

The standard deviations shown in Table 15(a) were calculated according to the method shown in the Appendix.

Comments on the Results of Experiments 1 and 2

The results in Table 15(a) have shown that the C¹⁴ activity of the cyclopentanone has increased after the exchange reaction by approximately 5%. This is in agreement with the postulated double bond movement occurring in cyclohexene during the exchange reaction with tritiated water.

Calculation of the amount of double bond migration from the figures in Table 15(a) show that the movement was 10.01% whilst the amount of movement predicted from the tritium figures in Table 11 yielded a value of 8.2%. The value of 10.01% was calculated, assuming that all of the carbon activity was present on the double bonds. These two values of 8.2% and 10.01% for the amount of double bond movement in

cyclohexene are in quite good agreement.

This result, confirming that double bond migration has occurred in cyclohexene during an exchange reaction with tritiated water, together with the results of tritium exchange in Part 1, suggest that the "associative" mechanism could explain the exchange procedure. Further discussion of these results will appear in Chapter III.

(e) Further exchange reactions using C¹⁴ active cyclohexene

A second pair of experiments were carried out in the same manner as Experiments 1 and 2 but with a different sample of active cyclohexene. The active cyclohexene used in this work had been 'ageing' in a flask for a period of approximately two months and gave a strong peroxide test. It was also observed that on distilling a sample of the hydrocarbon, a vigorous effervescence occurred towards the end of the distillation. This seemed to indicate the presence of a large amount of peroxide in the cyclohexene.

The purity of the cyclohexene and distribution of the C¹⁴ in the molecule were determined according to the procedures which have been described in previous sections. These procedures involved

1. Measurement of physical properties i.e. boiling range, refractive index and double bond content.
2. C¹⁴ activity determination in cyclohexene and in the degradation products, adipic acid and cyclopentanone.

The results are tabulated below:-



TABLE 16. PROPERTIES OF CYCLOHEXENE.

	Boiling Range.	Refractive Index @ 20%	Double Bond per molecule
Synthesised Cyclohexene	83-84.5°C.	1.4467	1.01.
Pure Cyclohexene	83°C	1.4463	1.00

TABLE 17. CARBON ACTIVITY DETERMINATIONS ON CYCLOHEXENE ADIPIC ACID AND CYCLOPENTANONE.

Substance	Carbon Dioxide Yield.	Specific Activity (Counts/min/cm. CO ₂ at 20°C.	No. of C ¹⁴ atoms per G.Mol. of substance.
Cyclohexene	99.13%	68.04 ± 0.70	7.60 x 10 ¹⁶
Adipic Acid	101.6%	66.07 ± 0.68	7.38 x 10 ¹⁶
Cyclopentanone	102.0%	42.83 ± 0.45	3.98 x 10 ¹⁶

TABLE 18. DISTRIBUTION OF C¹⁴ ACTIVITY.

% age of total activity in cyclohexene = 100%
 " " " " " " adipic acid = 97.16%
 " " " " " " cyclopentanone = 53.93%
 " " " " " on C = C in  = 92.14%
 " " " " " in remainder of  ring = 7.86%

Comments on the Results.

The results of these tables confirmed that the cyclohexene was approximately 97% pure. 92.0% of the C¹⁴ activity in the cyclohexene was on the double bond carbon atoms and the remainder of the activity was distributed

throughout the remainder of the ring. With such a carbon activity distribution it is possible to detect any double bond migration which may occur during the exchange reaction of cyclohexene with tritiated water.

With these results in mind, two exchange experiments were conducted in the same manner as Experiments 1 and 2 i.e.,

- (a) Active cyclohexene and tritiated water.
- (b) Active cyclohexene and pure distilled water.

The experiments to be described were performed in the same order as Experiments 1 and 2, the first one to determine the amount of tritium exchange and to calculate the probable double bond movement.

Experiment 3.

Active cyclohexene was shaken with tritiated water, acetic acid, and catalyst for three days at 130°C. The hydrocarbon layer was then isolated, and purified, and the tritium content of the cyclohexene was measured in the usual way. Samples of the cyclohexene were also characterised before, and after the exchange reaction by determining (a) boiling range (b) double bond content and (c) refractive index. The results of this experiment are shown in the following tables.

Experiment 3 - Tube 7. TRITIUM DETERMINATION IN CYCLOHEXENE.

TABLE 19 Tube Filling.

Catalyst	Tritiated Water	Acetic Acid.	Active Cyclohexene.
0.2162g.	1.6700g.	4.2802g.	8.0421g.

TABLE 20 CHARACTERISATION OF CYCLOHEXENE - BEFORE AND AFTER EXCHANGE.

Boiling Range		Refractive Index at 20°C		Double Bonds per Molecule.	
Before	After	Before	After	Before	After
84-84.5°C	83-84.5°C	1.4461	1.4468	6.98	1.00

TABLE 21. TRITIUM CONTENT AND CALCULATED AMOUNT OF DOUBLE BOND MOVEMENT.

Specific Activity expressed as Counts/min/cm. of H₂ at 20°C.

Cyclohexene Wt.	Hydrogen Yield.	Specific Activity.	Probable Double Bond Movement.
0.0370g.	98.00%	33.40 ± 0.34	1.10%

Comments on the Results of Experiment 3.

The results of this experiment showed that the amount of tritium exchange occurring was considerably lower than the amount of exchange occurring in Experiment 1 (Specific Activity = 139.25 counts/min/cm H₂ at 20°C.)

As a result of this figure the probable amount of double bond movement expected from the calculation (Table 20) was also much lower(1.10%). It would also be expected therefore

that the change in C^{14} activity of the cyclopentanone, before, and after the exchange reaction, would be small. This was, in fact, confirmed by the results of Experiment 4 which will now be described.

Experiment 4.

In this experiment the amount of double bond migration taking place during the exchange reaction was determined according to the procedures described in Experiment 2.

C^{14} active cyclohexene, the same as that used in Experiment 3 containing a large amount of peroxide, was shaken with pure distilled water, acetic acid, and catalyst, for three days at $130^{\circ}C$. The cyclohexene layer was then isolated, purified, and characterised.

Approximately 5g. of the cyclohexene was then oxidised to adipic acid and the calcium adipate pyrolysed to yield cyclopentanone. The ketone was purified by preparing the bisulphite compound, and the cyclopentanone was then regenerated and vacuum distilled.

C^{14} activity results on the cyclopentanone, before, and after the exchange reaction were obtained after burning the samples to carbon dioxide in the combustion tube. The carbon dioxide activity was measured in the Geiger counter as before.

The results obtained from this experiment are shown in the following tables.

Experiment 4 - CARBON ACTIVITY RESULTS - Tube 8.

TABLE 22 - Tube Filling.

Catalyst.	Water.	Acetic Acid	Active Cyclohexene
0.2162g.	1.6608g.	4.2706g.	8.0427g.

TABLE 23 - CHARACTERISATION OF CYCLOHEXENE - BEFORE AND AFTER EXCHANGE.

Boiling Range		Refractive Index at 20°C.		Double Bonds per molecule	
Before	After	Before	After	Before	After
84-84.5°C	83-84°C	1.4461	1.4470	0.98	1.01

TABLE 24 - CYCLOHEXENE AND ADIPIC ACID - C¹⁴ ACTIVITY RESULTS

	Cyclohexene Specific Activity	Adipic Acid Specific Activity.	
Before Exchange	68.04 ± 0.70	66.07 ± 0.68	Counts/min/cm. of CO ₂ at 20°C.
After Exchange	68.65 ± 0.69	66.47 ± 0.37	

TABLE - 25 - CYCLOPENTANONE C¹⁴ ACTIVITY RESULTS.

	Cyclopentanone Wt.	Carbon Dioxide Yield.	Specific Activity (Counts/min/cm. Co ₂ at 20°C.
Before Exchange	0.0274g.	101.6%	42.83 ± 0.45
After Exchange	0.0325g.	102.0%	42.56 ± 0.45

Comments on the Results of Experiment 4.

The results of Table 23 appear to have borne out the predictions made from the results of Experiment 3 i.e. that the amount of double bond migration occurring would be small. In fact the cyclopentanone activity results, before, and after the exchange reaction, are within experimental error.

It is also established, as a result of this experiment, that it is possible to carry out the degradation reactions on cyclohexene, before and after the exchange reaction, with no loss of carbon activity in the processes.

Discussion, in greater detail, of the results of Experiments 1,2,3 and 4 will be given in Chapter III.

PART III - Disproportionation of Cyclohexene.

Zelinsky and Pawlow (13) discovered in 1924 that freshly distilled cyclohexene, in the presence of a palladium catalyst, disproportionated at a rapid rate to yield cyclohexane and benzene according to the following equation

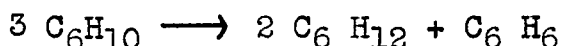

The reaction was followed by the uptake of a dry solution of bromine in chloroform, before, and after the reaction. The products in the above equation do not absorb bromine under the conditions of the bromination, and hence the double bond content fell to zero after reaction on the catalyst.

Corson and Ipatieff (33) demonstrated that the reaction occurred on a nickel catalyst, and Bell and Thomson, in work on the exchange reaction between cyclohexene and deuterium oxide, observed that it also occurred in the presence of a platinum catalyst at temperatures between 120-130°C.

The last two workers also discovered that 'aged' cyclohexene, under the same conditions as in their original experiments, did not undergo this disproportionation. Boiling point, refractive index, and bromine value results both before, and after the exchange reaction on the platinum catalyst, indicated that cyclohexene, was still the major constituent of the hydrocarbon layer.

It was therefore decided to investigate the reasons for the prevention of the disproportionation reaction under similar conditions to those employed by Bell and Thomson

in the exchange investigations and the work to be described falls into two sections.

1. This section describes experiments carried out with the addition to freshly distilled cyclohexene, of various substances which may develop in fresh cyclohexene when the hydrocarbon is allowed to "age".
2. The second section describes experiments designed to investigate whether any cyclohexene "peroxide" developed when freshly distilled cyclohexene was allowed to 'age'. These were performed because of the known existence of the peroxide in the hydrocarbon (26) after oxygen has been passed into it.

SECTION 1.

EXperiments were carried out on a platinum on asbestos catalyst using freshly distilled cyclohexene to which had been added 5% by weight of substances which may be present as impurities in aged cyclohexene. The substances added were

1. Cyclohexane 1-2 dione
2. Cyclohexane 1-4 diol
3. Cyclohexane 1-3 dione
4. Cyclohexane 1-2 dione

The reactions were performed in the same manner as the exchange reactions i.e., catalyst, acetic acid, water, freshly distilled, cyclohexene and added substance were shaken for 3 days in "Pyrex" tubes at 130°C. The cyclohexene layer was then isolated and purified.

Two other experiments were also performed in this series.

(a) An experiment with the usual tube contents with the exception of the acetic acid. The results of this experiment may indicate whether the acetic acid is concerned in any prevention of the disproportionation.

(b) An experiment with the usual tube contents with the exception of the platinum catalyst. If the freshly distilled cyclohexene disproportionates when the catalyst is present, but no reaction occurs when it is absent, then this would suggest that the catalyst is playing a major part in the disproportionation.

The disproportionation reaction was followed by a method similar to that used in the original work by Zelinsky and Pawlow. An excess of a standard solution of dry bromine in carbon tetrachloride was added to a known weight of the cyclohexene in a stoppered flask. After allowing the flask to stand in the dark for fifteen minutes, excess 10% potassium iodide solution was added to the mixture, and the solution titrated with standard sodium thiosulphate solution. The results were expressed as number of double bonds per molecule of cyclohexene, and are shown in the following tables.

TABLE 26 - TUBE CONTENTS.







Tube Number	Wt. of Catalyst (g).	Wt. of Water (g).	Wt. of Acetic Acid(g).	Wt. of Cyclohexene. (g)	Added Substance.	Wt. of Added Substance (g)
9	0.0810	0.6300	1.6864	2.9300	N O N E	
10a	0.0807	0.6743	1.6812	2.9861		0.1600
11	0.0812	0.6550	1.6824	2.9806		0.1500
12.	0.0807	0.6881	1.6877	2.9606		0.1600
10b	0.0810	0.6459	1.6488	2.9851		0.1600
13	-	0.6444	1.6499	2.9753	N O N E	
14	0.0810	0.6415	-	2.9711	N O N E	

TABLE 27 - RESULTS OF DOUBLE BOND DETERMINATIONS ON THE CYCLOHEXENE BEFORE? AND AFTER REACTION ON THE CATALYST.

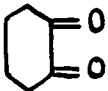
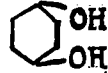
Tube Number	Added Substance	Double Bond Content/ Molecule	
		Before	After
9	Pure 1	1.01	0.00
10a		1.01	0.14
11		1.01	0.00
12		1.01	0.00
10b		1.02	0.01
13	No catalyst	1.02	0.99
14	No acetic acid	1.02	0.01

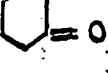
* No.10a repeated.

Comments on the Results.

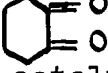
None of the added substances had any effect on the disproportionation reaction as shown in the results in Table 27. Cyclohexane 1 - 2 dione, appeared to inhibit the reaction slightly (see Tube Number 10a) but a second experiment with the same substance added, showed that the cyclohexene had disproportionated completely. The results from Tube 13 demonstrated that the catalyst was necessary for the disproportionation reaction to occur whereas the results from Tube 14 indicated that the acetic acid was not playing a major part in any prevention of the disproportionation reaction.

SECTION 2.

"Peroxide" Effect on the Disproportionation of Cyclohexene

Cyclohexene is known to absorb oxygen to form a peroxide but the structure of the peroxide was not determined until a number of years after the original investigations. Zelinsky and Borissow (27) observed the uptake of oxygen by cyclohexene over a period of one hundred and fifty days and they suggested that a peroxide had been formed with the formula $C_6 H_{10}O_2$.

Stephens, (28) in some later work, suggested that Zelinsky and Borissow had not isolated the pure material. He also put forward a suggestion that the formula for the peroxide was

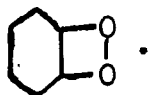

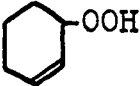
Farmer and Sundralingham (26), after isolating and studying the reactions of the peroxide, finally concluded that the structure was that of a hydroperoxide . In this formula, unlike that suggested by Stephens, the double bond is retained in the structure of the cyclohexene molecule. No change therefore, in the double bond content of cyclohexene should be detected when the hydroperoxide is produced in cyclohexene.

Since the development of this substance in 'aged' cyclohexene might be responsible for the inhibition of the disproportionation reaction, experiments were conducted on a qualitative basis to investigate this possibility.

The first step in these experiments was to try and detect the presence of this cyclohexene hydroperoxide. This was carried out by shaking a small sample of the 'aged' material with an equal volume of 2% potassium iodide solution and a few drops of dilute hydrochloric acid. Liberation of iodine indicated the presence of peroxide. In all cases, listed in the results which follow, inhibition of the disproportionation reaction was accompanied by a positive peroxide result from the cyclohexene, before reaction on the catalyst. Freshly distilled cyclohexene gave no reaction in this test.

The second step in these investigations was to try and remove the peroxide, without distillation, from aged cyclohexene and observe the effect on the disproportionation reaction. The removal of peroxides from organic substances can be

performed by shaking them with a freshly prepared solution of ferrous sulphate (29) .

Aged cyclohexene was therefore shaken with ferrous sulphate solution in an attempt to remove the hydroperoxide. The hydrocarbon layer was separated, washed with water, and dried over CaCl_2 . Tubes were then made up with catalyst, water, acetic acid, and cyclohexene, and shaken for three days at 130°C . The cyclohexene layer was then isolated and purified. A standard bromine solution was used to follow the disproportionation reaction in the same manner as in Section 1.

The results of these experiments are shown in the following tables.

TABLE 28 - TUBE CONTENTS.

Tube Number	Catalyst (g)	Water (g)	Acetic Acid(g)	Cyclohexene (g)
15	0.0812	0.6212	1.6832	2.9915
16	0.0807	0.6567	1.6258	3.0027
17	0.0805	0.6821	1.6442	2.9299
18	0.0810	0.6798	1.6558	2.9894

TABLE 29. RESULTS OF DOUBLE BOND CONTENTS AND PEROXIDE TESTS.

1 Tube Number	2 Cyclohexene (Aged) Treatment.	3 Double Bond Content. Before and After Reaction on catalyst.		4 Peroxide Test Before and After Treatment in Column 2.	
		Before	After		
15	No treatment (aged)	1.00	0.98	Positive	Positive
16	Freshly distilled	1.00	0.00	Nil	Nil
17	Shaken with FeSO ₄	0.99	0.00	Positive	Nil.
18	Shaken with FeSO ₄	0.99	0.00	Positive	Nil.

Comments on the Results.

After removal of the peroxide from 'aged' cyclohexene with ferrous sulphate solution, it was observed that the disproportionation of the hydrocarbon occurred in the same manner as with freshly distilled cyclohexene.

The experiments have shown that cyclohexene hydroperoxide is probably responsible for the prevention of the disproportionation reaction, although the mechanism of the reaction has not been examined.

Full discussion of the results in this section will appear in the following chapters.

CHAPTER II.

Isotope Effects .

In the exchange reaction which has been investigated there are a number of reactions which have been carried out in which an isotope effect may occur, due to the differences in zero point energy of the various isotopes concerned.

These reactions may be divided into two sections.

- (1) Isotope effects in the exchange reaction.
- (2) Isotope effects in the degradation reactions, and they will be described in turn.

(1) Isotope Effects in the exchange reaction.

During the exchange of the hydrogens of cyclohexene with the hydrogen and tritium atoms in a tritiated water solution it is possible that isotopic discrimination may occur, i.e., statistical replacement of the hydrogen in cyclohexene with hydrogen and tritium from the solvent may not take place. This effect may manifest itself in one or more possible reactions. The first of these is in the actual exchange reaction. If the associative mechanism is considered, it can be seen that the formation of a half hydrogenated state may involve an isotope effect.

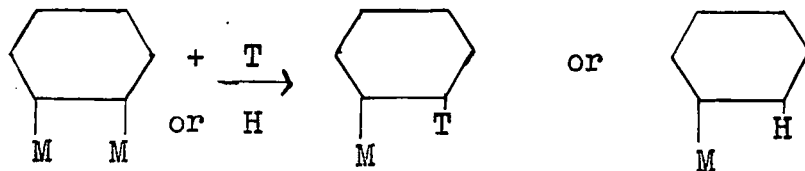

A second possibility for an isotope effect occurs in the following reaction

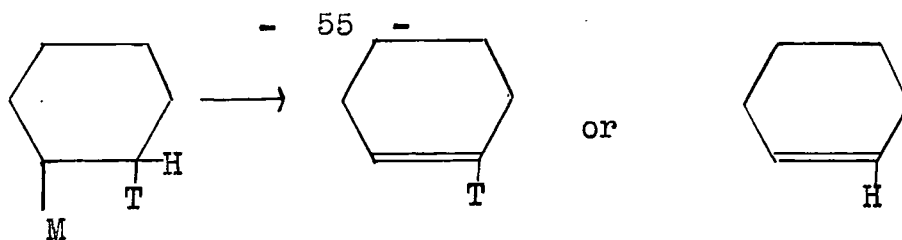

Other isotope effects may occur in the breaking of O-H and O-T bonds in HTO. Acetic acid has been found to exchange its hydrogens with those in a deuterated water solution, under the conditions used in the exchange reactions of cyclohexene, and it is also possible for isotopic discrimination to occur in this acetic acid exchange.

To investigate the overall amount of isotopic discrimination occurring during a typical cyclohexene exchange reaction, the exchange experiment was carried out using a water sample containing both deuterium and tritium. An estimate of the extent of the isotopic effect can be obtained by measuring the D/T ratio in the solvent before the exchange and D/T ratio in the cyclohexene after the exchange. Before an isotope effect can be measured in this exchange reaction it is necessary to use a water sample containing the three isotopes H, D, and T. A simple experiment carried out in the usual way but using two isotopes in the water, eg., H and T, would not show an isotope effect because the H/T ratio in cyclohexene is continuously changing during exchange. This is due to the large number of hydrogen atoms present in cyclohexene which do not exchange, and therefore their presence masks any isotope effect which may occur. The presence of the three isotopes H, D, and T in the water

enables the isotope effect to be measured (D/T) because the presence of the other hydrogens does not interfere with the D/T ratio. An isotope effect will immediately show itself in a difference in the relative rates of introduction of deuterium and tritium into the cyclohexene.

Furthermore, it is not possible to measure the different rates of introduction of deuterium and tritium into cyclohexene in separate experiments with these isotopes. The results from such experiments would be most difficult to interpret because of a change in solvent from say $HTO + H_2O$ to D_2O and the solvent may have different properties in each case: a difference in the amounts of exchange occurring with the two isotopes might not be due to a simple isotope effect. If the exchange is performed with H, D and T in one solvent medium then this difficulty does not arise.

Experimental Details.

A water sample was prepared from a mixture of D_2O - 99.76% by weight, and a tritiated water sample. The amount of deuterium present in the mixture was obtained by calculation and checked by the Gradient Tube method (81), and the tritium content determined by converting a sample of the water to hydrogen with magnesium, and measuring the activity of the hydrogen in a Geiger-Muller gas counter. Both deuterium and tritium contents of the above mixture were obtained after a sample of the mixture had been diluted with pure distilled water 100x. Purification of all water samples for deuterium

assays was carried out in a purification train similar to that used in the work described in reference (8), except that the apparatus was converted to a high vacuum system.

The exchange experiments with the doubly labelled solvent, were performed in a similar manner to those described in Chapter 1.

After the exchange reaction a sample of the purified cyclohexene ~ 0.15g. was then examined for its deuterium and tritium contents. These were obtained after first oxidising the cyclohexene to carbon dioxide and water in the combustion tube, and trapping the water sample. Part of the water was converted to hydrogen by passing it over magnesium, which was maintained at 500°C, and part of the remaining fraction of water was purified and the deuterium content was measured by the gradient tube method. Care was taken to ensure that the degradation reactions which were performed on the cyclohexene were quantitative, to eliminate the possibility of isotope effects in that part of the experiment.

The chemicals used in the deuterium purification train i.e., chromium trioxide, potassium permanganate, and sodium carbonate were all dry materials. Chromium trioxide was obtained by subliming a sample under vacuum. Bromobenzene and xylene were the organic liquids used in the gradient tube and they were previously washed three times with distilled water, dried with calcium chloride, and finally distilled.

The gradient tube was calibrated during deuterium assays with water solutions of known deuterium contents, and a graph of atom % deuterium against cathetometer reading was drawn. This is shown in Graph 12, and the results of the remaining experiments described above are shown in the following tables.

TABLE 47.

Reaction Mixture.

Tube No.	Wt. of catalyst(g).	Wt. of D ₂ O-HTO solvent (g).	Wt. of acetic acid (g).	Wt. of Cyclohexene (g)
19	0.3242	2.4998	6.4120	12.0670

TABLE 48.

Physical Properties of Cyclohexene.

Property	Before Exchange.	After Exchange.
Boiling Range	83-83.5°C.	83.5-84.5°C.
Refractive Index at 20°C.	1.4471	1.4470
Double Bond content per molecule.	0.98	0.99

GRAPH 12

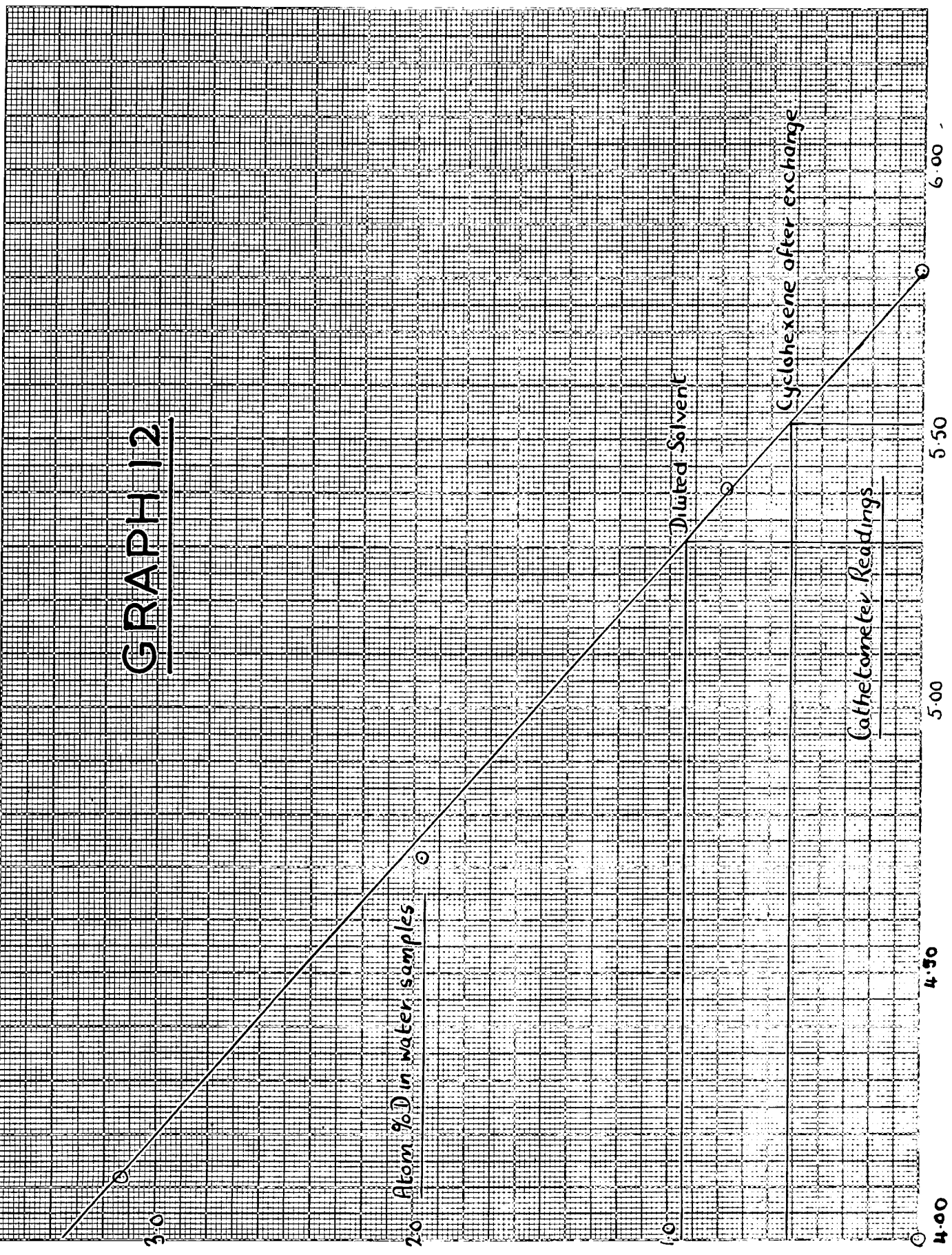

TABLE 49.

Tritium and Deuterium Contents of the solvent.

(a) Total number of deuterium atoms in 2.4998g. of solvent mixture = 1.42×10^{23}

(b) Tritium determinations.

Conversion of water to hydrogen(Exchange mixture diluted 100x)

Wt. of water. (g)	% age yield of hydrogen.	Specific Activity (counts/min. of hydrogen. cm. H ₂ at 20°C.)
0.0492	99.93%	923.2 ± 4.1
0.0456	99.82%	945.4 ± 4.0

Total number of tritium atoms in 2.4998g. of solvent mixture (calculated from average value of specific activity)= 6.15×10^{15}

$$\therefore D/T \text{ in solvent} = \frac{1.42 \times 10^{23}}{6.15 \times 10^{15}}$$

TABLE 50.

Combustion and Reduction of Cyclohexene samples.

Sample No.	Wt. of cyclohexene (g).	% age yield of water.	Wt. of water(g).	% age yield of hydrogen.
1.	0.1460	99.17%	0.0392	99.10%
2.	0.1528	99.59	0.0498	99.95%

TABLE 51.

Tritium and Deuterium Contents of cyclohexene.

(a) Total number of deuterium atoms in lg. mol. of cyclohexene

$$= \underline{\underline{3.12 \times 10^{22}}}$$

(b) Tritium determinations.

Conversion of water to hydrogen.

Wt. of Water (g)	% age yield of hydrogen.	Specific Activity (Counts/min./cm. of H ₂ at 20°C.
0.0392	99.10%	473.1 ± 2.3
0.0498	99.95%	481.6 ± 2.3

Total number of tritium atoms/lg. mol. of cyclohexene =

$$\underline{\underline{1.25 \times 10^{15}}}$$

$$\therefore D/T \text{ in cyclohexene} = \frac{3.12 \times 10^{22}}{\underline{\underline{1.25 \times 10^{15}}}}$$

Discussion of the Results of these experiments.

A measure of the isotope effect in the exchange reaction may be given by

$$\alpha = \frac{D/T \text{ solvent}}{D/T \text{ cyclohexene}} = \underline{\underline{1.077}}$$

Since this value for α diverges from unity there must be an isotope effect in the exchange reaction. It is not possible, at this stage, to state the exact reaction or reactions in which there is an isotope effect, and it is proposed to investigate later the D/T ratio produced in the acetic acid after exchange to obtain more information on this point.

Before the isotopic ratio α can be of any use in interpretations

for the tritium hydrogen case it is necessary to make the best estimate for the value of α for the H/T ratio from the observed value of α for the D/T ratio. It will be seen later; in the discussion of the results in Chapter III, that the magnitude of the isotope effect in the H/T case is of great importance in the elucidation of the mechanism of the exchange reaction.

The calculation of the value of α for H/T from α for D/T will now be described.

The method for determining the magnitude of the hydrogen-deuterium isotope effect has been described by Wiberg (83), and the expression relating the equilibrium constants of the respective reactions involving hydrogen and deuterium is

$$\frac{k_{\text{H}}}{k_{\text{D}}} = \left(\frac{M_{\text{D}}^{\ddagger}}{M_{\text{H}}^{\ddagger}} \right)^{\frac{1}{2}} \frac{h\nu_{\text{D}}}{h\nu_{\text{H}}} \cdot e^{(h\nu_{\text{H}} - h\nu_{\text{D}})/2RT} \cdot \frac{1 - e^{-h\nu_{\text{H}}/RT}}{1 - e^{-h\nu_{\text{D}}/RT}}$$

At temperatures up to 400-500°C the last term is unity and the first two terms cancel and hence the expression simplifies to

$$\frac{k_{\text{H}}}{k_{\text{D}}} = e^{(h\nu_{\text{H}} - h\nu_{\text{D}})/2RT}$$

where $\nu = \frac{K}{\sqrt{\mu}}$ and μ = reduced mass.

In the case of deuterium and tritium

$$\frac{k_{\text{D}}}{k_{\text{T}}} = e^{(h\nu_{\text{D}} - h\nu_{\text{T}})/2RT}$$

and substituting for ν

$$\therefore \frac{k_{\text{D}}}{k_{\text{T}}} = e^{(h K / \sqrt{2} - h K / \sqrt{3}) / 2RT}$$

$$\frac{k_D}{k_T} = e^{K^1 \left(\frac{1}{\sqrt{2}} - \frac{1}{\sqrt{3}} \right)}$$

$$\frac{k_D}{k_T} = e^{0.1299K^1}$$

From the results of the experiments $\frac{k_D}{k_T}$ for the overall reaction was 1.077

$$\therefore 1.077 = e^{0.1299K^1}$$

$$\therefore \log_e 1.077 = 0.1299K^1$$

$$\therefore K^1 = \frac{0.0744}{0.1299} = \underline{\underline{0.5727}}$$

Substituting this value in the $\frac{k_H}{k_T}$ case

$$\frac{k_H}{k_T} = e^{K^1 \left(\frac{1}{\sqrt{1}} - \frac{1}{\sqrt{3}} \right)}$$

$$\frac{k_H}{k_T} = e^{K^1 \cdot 0.4226}$$

$$\therefore \log_e \frac{k_H}{k_T} = 0.4226 \times 0.5727 = 0.2419$$

$$\therefore \frac{k_H}{k_T} = \underline{\underline{1.274}}$$

In this calculation various assumptions have been made. It has been assumed that the reduced masses in the values of the frequency $\nu = \frac{K}{\sqrt{\mu}}$ are governed by the values of the hydrogen, deuterium, and tritium reduced masses, and that the contribution from the remainder of the isotopic complex is small. If it is a C - H bond which is being broken then in this case $\mu = 0.93$ as compared with the value of 1 which was used. The value of 0.93 is probably a minimum value since it

is likely that a cyclohexene molecule should be involved in this calculation of the reduced mass and the value would be much closer to 1.

Isotope Effects in the degradation reactions.

In the degradation reactions described in Chapter 1 for determining tritium and carbon¹⁴ distributions in cyclohexene, after the exchange reaction, there are two cases in which isotope effects may occur. If large isotopic fractionation occurs in either of these two reactions then the conclusions from the results of the experiments will be invalidated.

The first of the two reactions to be discussed is the step, in the determination of the tritium distribution in cyclohexene, which involves the bromination of adipic acid.

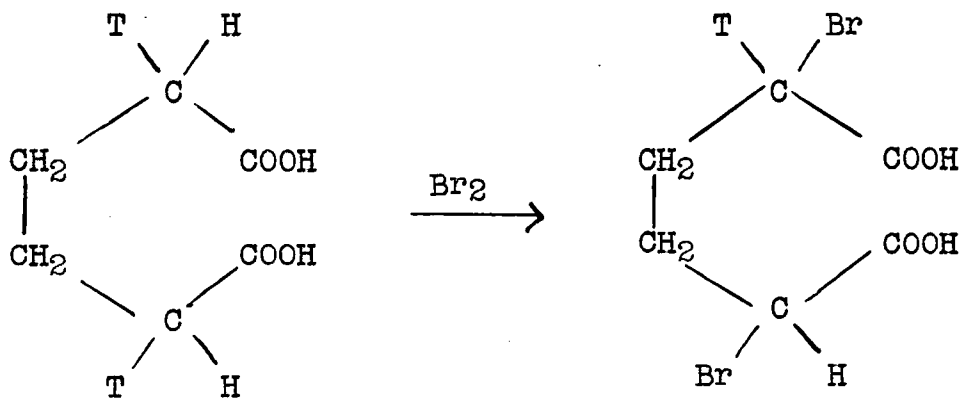

From the results of the tritium contents of the adipic acid and the $\alpha\alpha'$ -dibromoadipic acid it is possible to calculate the amount of tritium in the 4 α and 4 β positions of the original cyclohexene which had been oxidised to adipic acid. It is assumed in this calculation that exactly 50% of the α tritium atoms are removed by bromine, i.e. there is no

isotope effect. If, however, the bromine replaces the hydrogen atoms in the α positions of the adipic acid at a faster rate than the tritium atoms, then less than 50% of the tritium atoms will be removed in this reaction.

No direct information about the mechanism of this reaction was available but it is possible to obtain information about the extent of this possible isotope effect by comparing the relative amounts of bromine replacement of deuterium in deuterated adipic acid, and tritium in tritiated adipic acid. If these values are identical then there is no isotope effect. A table is shown below which contains comparable figures obtained in deuterium and tritium degradation reactions. The deuterium figures are those obtained by Thomson (8).

TABLE 52.

Deuterium and Tritium Distribution Results.

(a) Tritium - Results expressed as tritium atoms/g.mol. of cyclohexene.

Total in $4\alpha + 4\beta$	Total in $2\alpha + 4\beta$	$\frac{2\alpha + 4\beta}{4\alpha + 4\beta}$
2.03×10^{14}	1.28×10^{14}	0.63

(b) Deuterium - Results expressed as deuterium atoms in 1 molecule of cyclohexane.

Total in $4\alpha + 4\beta$	Total in $2\alpha + 4\beta$	$\frac{2\alpha + 4\beta}{4\alpha + 4\beta}$
0.059	0.044	0.74
0.124	0.083	0.67
0.151	0.109	0.72

In this table the figures shown represent the amounts of tritium and deuterium in adipic acid ($4\alpha + 4\beta$) and the amounts in α' -dibromoadipic acid ($2\alpha + 4\beta$). Hence the ratio $\frac{2\alpha + 4\beta}{4\alpha + 4\beta}$ represents the fraction of the amount of the isotopes which remains after the adipic has been brominated. If there is a difference in the value of this ratio between the deuterium and the tritium cases then there is an isotope effect in the bromination reaction.

From the closeness of the values of these ratios, shown in the table, it is therefore highly probable that any isotope effect in the bromination reaction is very small.

If the deuterium in deuterated adipic acid is replaced more easily by bromine than tritium in tritiated adipic acid, then the ratio, $\frac{2\alpha + 4\beta}{4\alpha + 4\beta}$ should be higher in the tritium case than in the deuterium example. In fact, as the final column shows, the deuterium ratio is slightly higher than the tritium value.

From the results of this examination it is therefore concluded that the deductions which were made concerning the distribution of deuterium and tritium in cyclohexene after exchange were valid.

The second reaction in the degradation scheme which may involve an isotope effect is the pyrolysis of calcium adipate to produce cyclopentanone.

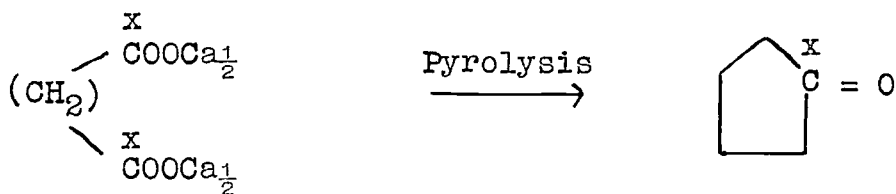

In this reaction it is possible that fractionation may occur between molecules of calcium adipate containing C^{12} in the carboxyl carbons and calcium adipate with C^{14} in these positions. There are two pieces of evidence which seem to show, however, that no such effect takes place in this reaction.

Bigeleisen (82) has investigated the formation of cyclopentanone by the pyrolysis at $350^{\circ}C$ of barium adipate labelled with C^{14} and he concluded that the fractionation factor was less than a few tenths of a per cent. It is therefore unlikely that the isotope effect will be large when calcium adipate is pyrolysed.

The occurrence of an isotope effect in this particular reaction would not lead to a serious error because the C^{14} activities of the cyclopentanone samples were measured before and after the exchange reaction. If double bond migration had occurred in cyclohexene during exchange and an isotope effect did take place during the pyrolysis of calcium adipate then the double bond migration would still be detectable in a change in C^{14} activity of the cyclopentanone.

CHAPTER III

DISCUSSION OF RESULTS.

Summary of Results obtained.

In Chapter 1 the investigations, which were made to determine the mechanism of the exchange reaction between cyclohexene and tritiated water in the presence of a platinum catalyst, have been described. The results of these experiments have shown, that under the conditions employed in the work, hydrogen atoms in all positions of the cyclohexene molecule have exchanged with the hydrogens in a tritiated water sample.

Any theory which may be suggested for the mechanism of the exchange reaction has to be able to explain adequately the following facts which have been observed:-

- (a) the tritium introduced into the cyclohexene ring is unevenly distributed throughout the ring in all positions;
- (b) the majority of the tritium activity is in the 4 α positions,
- (c) double bond migration in cyclohexene accompanies the exchange of the hydrogens in the hydrocarbon with the hydrogens in tritiated water.

Furthermore, the theory will also have to take into account the results obtained by Thomson (8) during the investigations into the exchange reaction of cyclohexene and deuterated water; these latter investigations were carried out under similar conditions to those employed in the tritium work.

The results obtained for the distribution of deuterium and tritium produced in cyclohexene after exchange is shown below. It can be seen, that in both cases, the majority of the exchanged atoms are to be found in the α positions, but considerable exchange does occur in the remaining positions.

TABLE 53.

(a) Tritium Distribution in Cyclohexene.

Tritium atoms/g.mol. of cyclohexene.

Cyclohexene	CH= CH	Total in 4 α positions.	Total in 4 β positions.
2.68×10^{14}	0.65×10^{14}	1.50×10^{14}	0.53×10^{14}

(b) Deuterium Distribution in Cyclohexene.

Atom % D in one molecule of cyclohexene.

Cyclohexene	CH= CH	Total in 4 α positions.	Total in 4 β positions.
0.069	0.010	0.029	0.030
0.142	0.018	0.082	0.042
0.167	0.016	0.083	0.068

It can be seen, from this table, that the deuterium results are not consistent, whereas the tritium results, which were obtained from two series of degradation reactions on cyclohexene after exchange, have been shown to give reproducible values (Table 3, Chapter 1). The tritium figures were therefore taken to represent a better estimate for the distribution of the exchanged atoms in cyclohexene.

For the exchange reaction to proceed under the conditions employed, it has also been shown that the platinum catalyst was necessary. The part played by the catalyst in the mechanism of the reaction must therefore be very important.

In Chapter II experiments have been described in which attempts were made to determine the extent of the isotope effect in the exchange reaction. The results of this work have shown that the value of the isotope effect was 1.077 for the D/T case, and calculation revealed that the best estimate which could be made for the H/T value was 1.274. This result meant that cyclohexene exchanged its hydrogens for protium at a faster rate than it did for tritium.

A small number of experiments have also been carried out to determine the reasons which may explain the disproportionation reaction of freshly distilled cyclohexene, under the conditions used in the exchange reactions. It has been found that the presence of a "peroxide" in aged cyclohexene was one of the factors which influenced this reaction.

On the basis of these results the discussion which follows has been divided into two main sections:-

- (a) Discussion of the mechanism of the exchange reaction.
- (b) Discussion of the disproportionation reaction of cyclohexene.
- (a) Discussion of the mechanism of the exchange reaction.

Four possible mechanisms which could explain the exchange of hydrogens in olefinic compounds with the hydrogens in water

have been explained at the beginning of Chapter 1. These were

- (i) Hydrogen Switch Mechanism.
- (ii) Associative Mechanism.
- (iii) Dissociative Mechanism.
- (iv) Carbonium Ion Mechanism.

It is proposed to examine the possible applications of these theories to the cyclohexene exchange, bearing in mind the results which have just been outlined at the beginning of this chapter.

Carbonium Ion Mechanism.

In this type of mechanism the catalysts which are operative are the acid-type catalysts. It is usually found that these substances are oxides, e.g., silica-alumina, which are associated with water molecules and are capable of donating hydrogen ions. The chemical properties of these substances have been discussed by Oblad, Milliken and Mills (75), and they are found to be quite different in character from the properties of the catalyst which has been used in the investigations described in this thesis.

The platinum catalyst, used in this work, is generally grouped alongside other metal type catalysts. In this class, the property which appears to be the main factor influencing their activities is the 'd' band factor. Platinum, together with other transition metals e.g., palladium, nickel, rhodium etc.

possess vacancies in their 'd' band of electrons (76) which allow a sharing of electrons with another substance to form a type of covalent linkage. Eley (77) has suggested that the participation of an ionic mechanism, such as the carbonium ion mechanism, is therefore extremely unlikely with the metal type catalyst which has been used in this exchange reaction. For these reasons it was considered that the mechanism of the exchange reaction investigated could probably be explained more adequately on the basis of the remaining theories which did not involve ionic mechanisms.

(2) Dissociative Mechanism.

It is proposed that this mechanism is responsible for the exchange which occurs in the β positions of the cyclohexene molecule in this manner

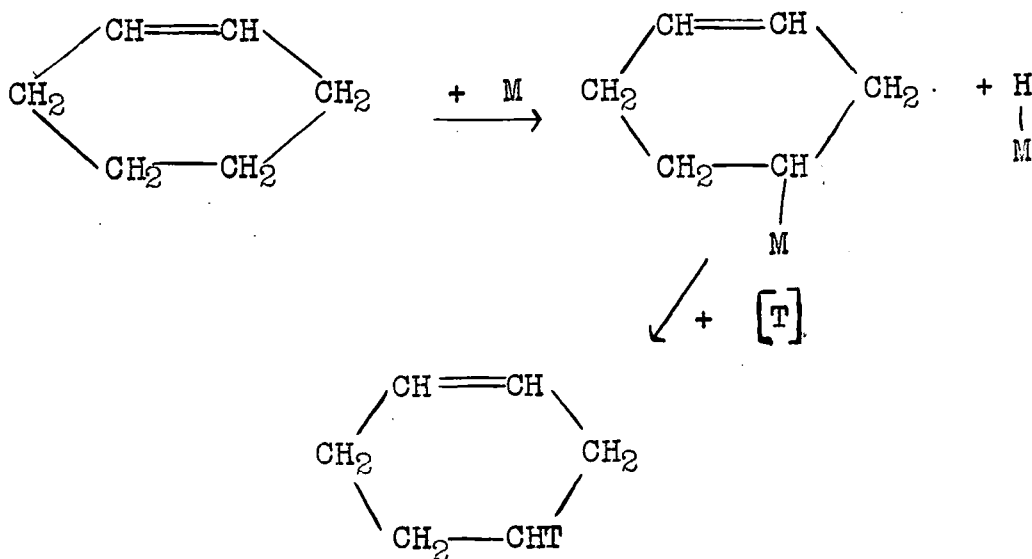

This method of exchange has already been successfully applied to account for the exchange of hydrogens which occurs

in saturated hydrocarbons (8) e.g. hexane and cyclohexane, under similar conditions to those employed in the experiments described in this thesis. In the case of cyclohexene, however, the dissociative mechanism can be applied only to the β positions, because it will be shown later that the exchange taking place in the α and CH = CH positions can be explained fully by another type of mechanism, namely, the associative mechanism.

It is therefore suggested that the mechanism which operates during a particular exchange reaction depends upon the manner in which the cyclohexene approaches the catalyst. If the β positions in the cyclohexene molecule are nearest to the catalyst, then exchange will take place by a dissociative mechanism. When the α or CH = CH positions are nearer to the catalyst then the exchange will occur predominantly by an associative mechanism. This latter postulate will be justified later on the basis of the tritium which appears on the α carbon atoms and on the CH = CH positions during exchange.

(3) Associative Mechanism.

This mechanism for exchange can be successfully applied to the cyclohexene exchange to account for all of the exchange occurring in the α and CH = CH positions, and also for the occurrence of double bond migration during exchange. When the cyclohexene approaches the catalyst so that the CH = CH

or α positions are nearest to the catalyst then reaction will take place as follows:-

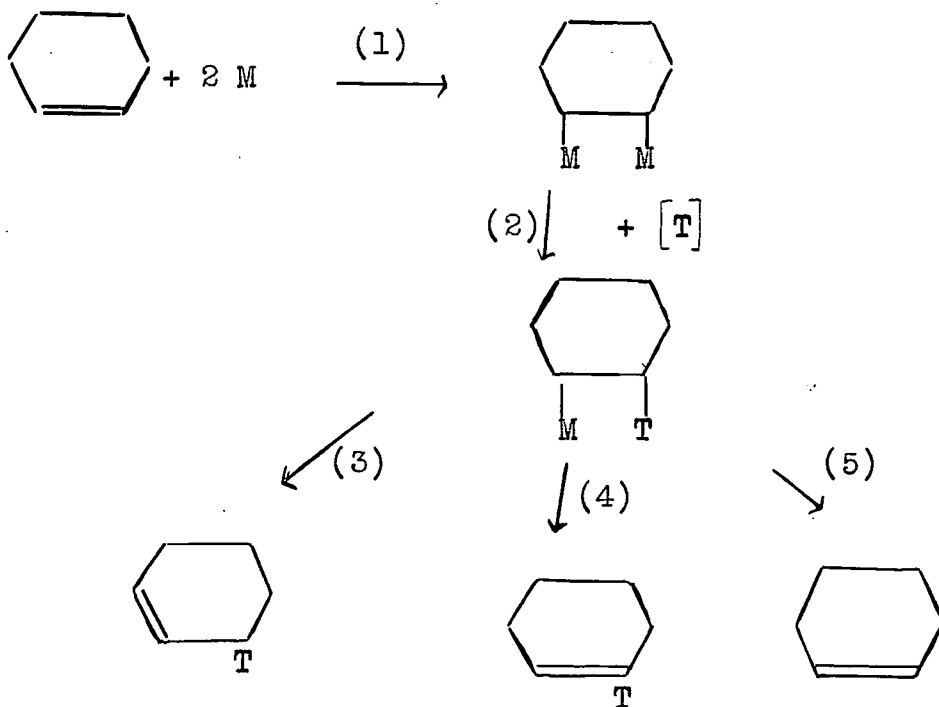

In this mechanism double bond migration during exchange is explained by reaction (3) and the ratio of tritium activities in the α and CH = CH positions of $2/1$ is also explained by the combination of reactions (3) (4) and (5).

Further justification for this mechanism being predominant when the CH = CH or α positions in cyclohexene approach closer to the catalyst than the β positions, can be obtained from the following calculation.

From the observed value of 10.01% double bond movement (Table 15a) it is possible to calculate the number of tritium atoms in the α positions of cyclohexene which have been introduced by the associative mechanism. If it is assumed

that the movement which has occurred is due to exchanges of both hydrogens and tritiums, and knowing the isotope effect in this reaction, the number of tritium atoms which should appear in the α positions can then be determined.

If this calculated value is equal to the observed number of tritium atoms in the α positions, then it can be said that the associative mechanism is responsible for all of the exchange occurring in these positions and also on the CH = CH.

From Chapter II $\frac{k_H}{k_T} = 1.274$

i.e. $\left(\frac{H}{T}\right)_{\text{solv.}} = \frac{1}{1.274} \left(\frac{H}{T}\right)_{\text{cyclohexene}}$

if the isotope effects for the dissociative and the double bond migration mechanisms are the same,

From calculation 7 (Appendix)

$$\left(\frac{H}{T}\right)_{\text{solv.}} = \frac{3.94 \times 10^{22}}{1.78 \times 10^{14}} \quad \text{Tritium value is taken as the average tritium content of the solvent before and after exchange.}$$

For a 10.01% movement of the double bond

∴ In 1g. mol. of cyclohexene

$$\frac{10.01}{100} \times 6 \times 10^{23} \quad \text{Hydrogen atoms are involved in exchange.}$$

After exchange in α positions ∴ $H_{\text{cyclohexene}} + T_{\text{cyclohexene}} = \frac{10.01}{100} \times 6 \times 10^{23} = 6 \times 10^{22}$

∴ Substituting relationships above

$$T_{\text{cyclohexene}} + (1.274) \times T_{\text{cyclohexene}} \times \frac{3.94 \times 10^{22}}{1.78 \times 10^{14}} = 6 \times 10^{22}$$

$$\begin{aligned} \therefore T_{\text{cyclohexene}} &= \frac{6 \times 10^{22} \times 1.78 \times 10^{14}}{1.274 \times 3.94 \times 10^{22}} \quad / \text{g.mol. of cyclohexene} \\ &= \frac{2.12 \times 10^{14}}{\times 10^{14}} \text{ tritium atoms/g.mol. of cyclohexene} \end{aligned}$$

Observed value was $\frac{2.06 \times 10^{14}}{\times 10^{14}}$ tritium atoms/g.mol. of cyclohexene.

The observed and calculated values differ by only 3% and hence it is postulated that the associative mechanism is responsible for all of the exchange in the α and CH = CH positions in cyclohexene.

(4) Hydrogen Switch Mechanism.

In Chapter 1 it was suggested that this mechanism could explain tritium activity in the α positions and also double bond migration. It can be seen from the following diagrams however, that it would not explain the tritium in the CH=CH positions.

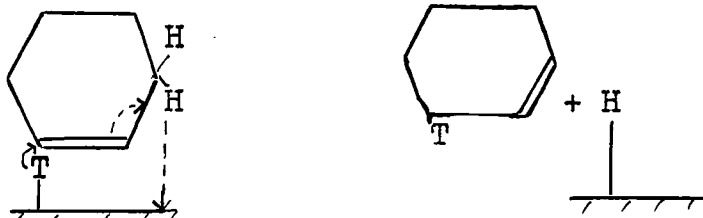

The hydrogen switch mechanism is therefore ruled out because tritium activity on the CH = CH positions was observed.

There is a possibility, however, that a combination of the hydrogen switch mechanism, to explain double bond migration and tritium in the α positions, and the dissociative mechanism to explain the tritium on the CH = CH and CH₂ positions, would give tritium in all positions in the cyclohexene ring. Such a state of affairs can be dismissed on the grounds of the following reasons

(a) No $2/1$ ratio of tritium in the α positions to tritium in the CH = CH positions would be observed.

(b) If the dissociative mechanism is operating together with the hydrogen switch mechanism then a much higher tritium content in the α positions should be observed.

Note on the Amounts of Exchange occurring.

It can be seen from calculation 7 in the Appendix, also from Table 15(a), that about 10% of the cyclohexene molecules present in an exchange mixture, undergo exchange. If any molecule undergoes a second exchange on the catalyst then tritium activity would be produced in the β positions of the cyclohexene molecule by an associative mechanism. The amount of exchange which has been observed in the β positions is, however, too large to be accounted for by such secondary reactions, since it would be expected that only a further tenth of those molecules which have reacted once, would react a second time.

The discussion in this section may therefore be summarised by saying that the exchange of hydrogens in cyclohexene with the hydrogens in tritiated water takes place by two mechanisms

1. A dissociative mechanism which operates at the β positions in the cyclohexene ring.
2. An associative mechanism which can account for all of the exchange occurring in the α and CH = CH positions of the cyclohexene ring.

(b) Discussion of the Disproportionation Reaction.

The disproportionation of cyclohexene to form

cyclohexane and benzene in the presence of palladium according to the equation

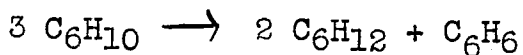

has been explained by Balandin in terms of his multiplet theory. This theory explains the reaction by assuming that the cyclohexene ring is adsorbed at six points on the catalyst and interaction of three adjacent rings occurs, as shown in the following diagram.

Fig. 8

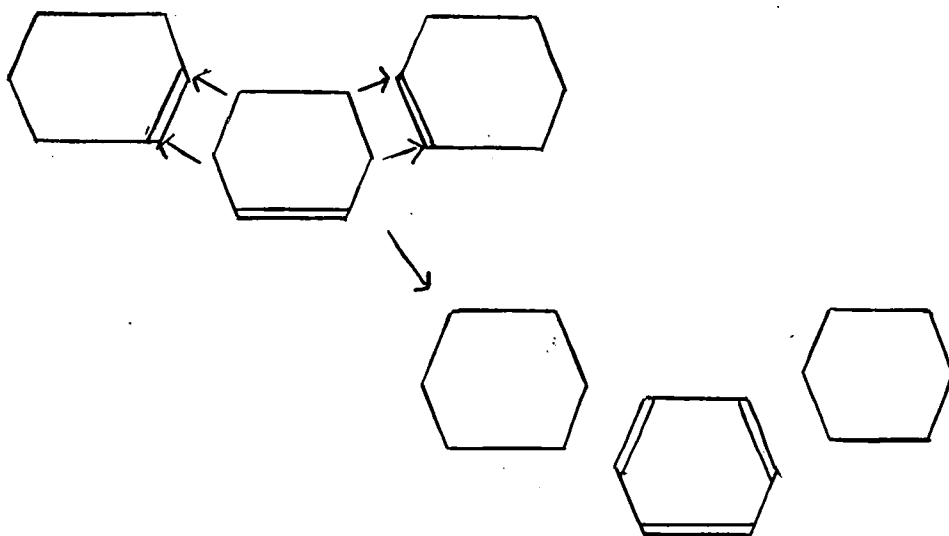

When this reaction takes place in the presence of deuterium oxide and the deuterium contents of the cyclohexane and benzene are determined afterwards (7), it is found that the deuterium values for the cyclohexane correspond to the cyclohexane having received its hydrogens from the solvent first, and not from cyclohexene as in the diagram. The theory

outlined above would result in the products of the reaction containing smaller amounts of deuterium than the values which were observed, because the cyclohexane has received its hydrogen atoms from the cyclohexene molecule and not from the hydrogens in the deuterium mixture. It is on these grounds that the Balandin mechanism is considered to be untenable for the disproportionation reaction of cyclohexene, under the conditions which were employed in the exchange experiments. The mechanism is acceptable in the absence of a solvent.

The results of Table 29 in Chapter 1 have indicated that the presence of the hydroperoxide in cyclohexene, which probably develops when the hydrocarbon is allowed to age, has a large effect on the disproportionation reaction. Oxygen is a substance which is well known to have a poisoning effect on various catalysts (79), and in the case of a platinum black catalyst, differing effects of the presence of oxygen on the hydrogenation of benzene have been observed (80). Sulphur is also a renowned poison and the electronic structure of the two elements is very similar. It is possible therefore that oxygen may be able to form oxygen-catalyst bonds in a similar manner to the sulphur bonds with the catalyst, and consequently poison the catalyst for the reaction which has been investigated in this work.

The presence of the peroxide in cyclohexene also appears

to inhibit the exchange reaction. It was observed that the longer a particular sample of cyclohexene was allowed to age, the less was the amount of exchange which occurred in the presence of the platinum catalyst. (This qualitative result could, however, be masked by a fall in the activity of the sample of catalyst which was used.) Comparison of the amount of tritium exchange occurring in Tubes 1 and 2 in Table 1 demonstrated this effect. In these examples the only change in the contents were that in Tube 2 the cyclohexene, which was used, had aged for a longer period of time, than the hydrocarbon used in Tube 1. The fall in tritium activity in Tube 2 was not due to the ageing of the catalyst because in later experiments, using different cyclohexene, higher activities were obtained with the same catalyst.

Final summary of results.

To summarise this discussion, the conclusions which have been drawn from this work are therefore:

1. The process of the platinum catalysed exchange of the hydrogens in cyclohexene and those in tritiated water probably occurs by two mechanisms.
 - (a) An associative mechanism which can account for double bond migration, and exchange in the α and CH=CH positions of the ring.
 - (b) A dissociative mechanism which can explain the exchange of hydrogens which takes place on the β positions.

2. The disproportionation reaction of cyclohexene, in the presence of a platinum catalyst, is inhibited to a large extent by the presence in aged cyclohexene of a peroxidic substance, probably cyclohexene hydroperoxide.

Further insight into the mechanism of this latter reaction may be obtained by conducting similar experiments to those which have been performed using freshly distilled cyclohexene in the presence of other peroxidic substances e.g. benzoyl peroxide.

As far as the exchange reaction is concerned, the picture is complicated to some extent by the occurrence of the disproportionation reaction and it may be possible to perform the experiments in the presence of other similar catalysts which do not cause the hydrocarbon to disproportionate, but which allow the hydrogen exchange to take place.

The exchange mixture could also be simplified by removing the acetic acid from the mixture, because under the conditions of the experiment this substance also exchanges its hydrogens with those of the water (8). If the exchange experiments were performed in the gas phase using the hydrocarbon and hydrogen gas in the presence of a catalyst, then the possibility of ionic mechanisms in the exchange reaction would be reduced. No complicating factors, such as the breaking of O - H and O - T bonds in the water would then be involved in the exchange mechanism.

It would also be interesting to find out whether one cyclohexene molecule undergoes exchange in all positions of the ring or whether the results which have been obtained represent the statistical picture which arises when the cyclohexene molecules react in one way only i.e., associative or dissociative. Some information about this fact could be obtained from a mass spectrometric investigation of cyclohexene which had undergone exchange with deuterium.

CHAPTER IV.

EXPERIMENTAL.

The majority of the experimental work which is to be described in this chapter is concerned with the development of an apparatus which was designed to determine carbon¹⁴ and tritium activities in organic compounds on the semi-micro scale. Use was made of high vacuum techniques in the design of the apparatus which may be divided into three sections.

(a) A combustion section which was used for oxidising the organic materials to carbon dioxide and water. To remove the possible occurrence of isotope effects in the oxidation procedure when radioactive materials were used, it was necessary for the organic substances to be oxidised completely in this section. A number of experiments were therefore carried out to check that the oxidation procedure was quantitative.

(b) A conversion section for reducing water to hydrogen gas quantitatively. This part of the apparatus was included so that the tritium activities of the organic substances could be estimated in the form of hydrogen gas. Estimation of the tritium in hydrogen gas form was preferred rather than in water vapour because it has been suggested that water vapour possesses poor counting properties (66). The reduction of water to hydrogen had to be quantitative to eliminate the possibility of isotope effects and therefore experiments were carried out to develop a system which would give quantitative reduction.

(c) A counting section for determining the activities of radioactive carbon dioxide and tritium.

Diagrams of the apparatus are shown in Fig.1,2 and 3.

The experimental procedure during a complete determination was briefly as follows. The organic compounds were burnt in a stream of purified oxygen in the silica combustion tube at atmospheric pressure, the products $^{14}\text{CO}_2$ and $^3\text{H}_2\text{O}$ being condensed out in the U tube and spiral (Fig.1). After evacuation of the combustion tube, the carbon dioxide was distilled into, and stored in the bulb (B4). The water vapour was collected in the conversion section and reduced to hydrogen by distillation over magnesium at 500°C . (Fig.2). Yields of both products were then determined individually by toeplering the gases into the calibrated counting section. (Fig.3.)

The specific activities of the gases could then be obtained by toeplering known volumes at known pressures into the counting tube (C), with the addition of suitable quenching agents, - carbon disulphide with carbon dioxide and ethyl alcohol with hydrogen. Inactive gases were introduced into the counter for background determinations.

Preliminary Investigations.

A number of investigations were carried out to determine the efficiency of the apparatus. Benzoic acid (micro analytical reagent standard) and distilled water (distilled

FIG. 1.

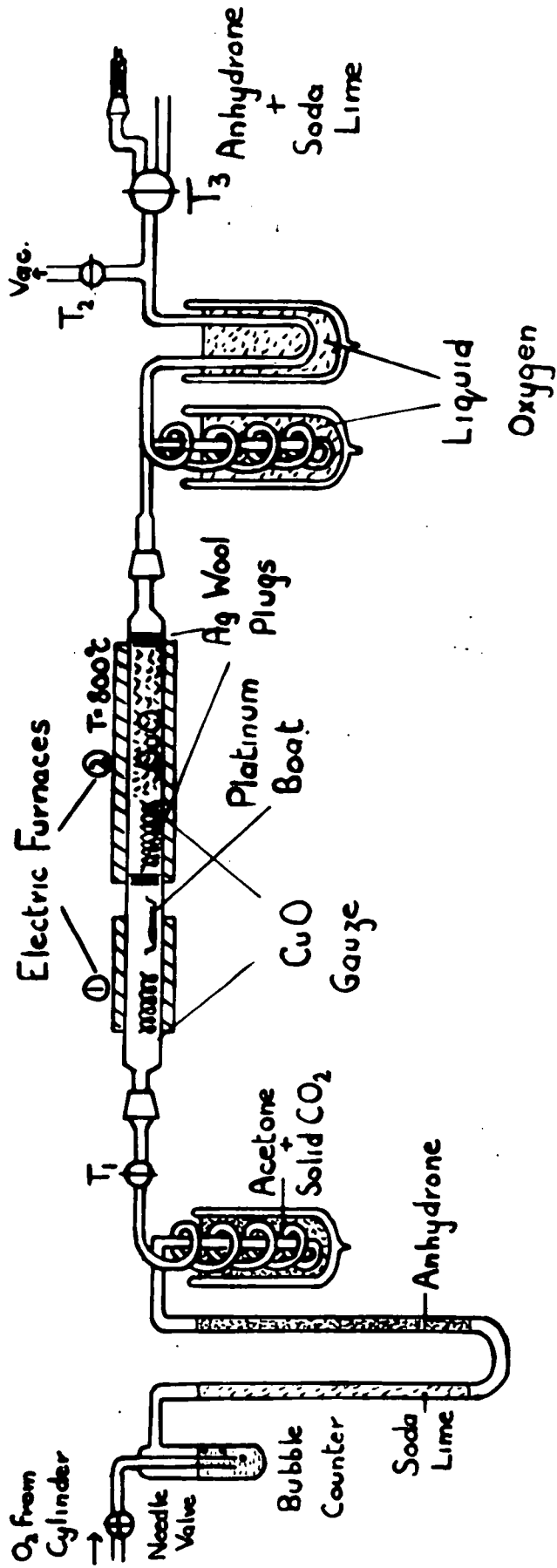
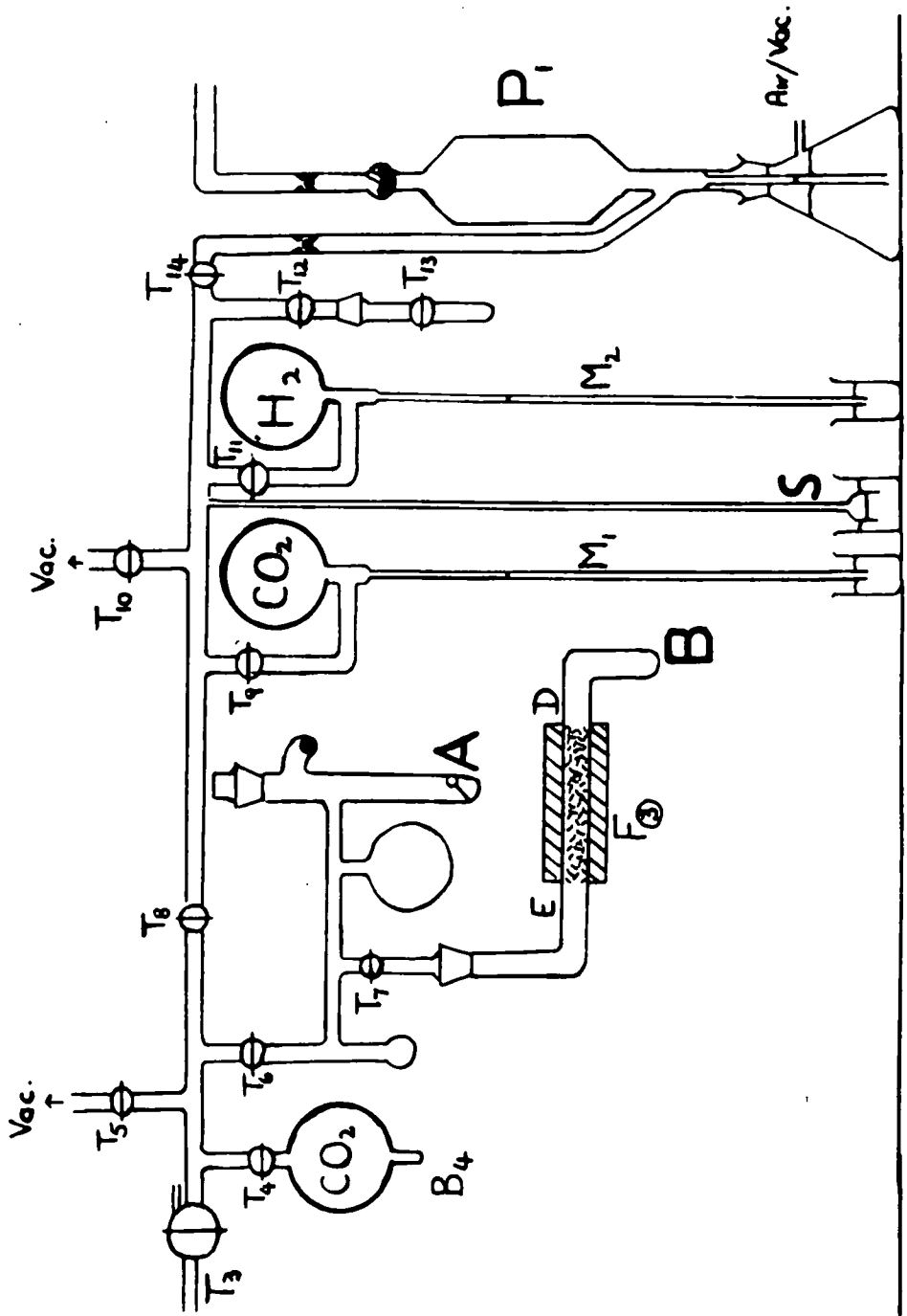

FIG. 2.



twice from alkaline potassium permanganate) were used as standard reference substances to determine the efficiency of combustion and reduction reactions.

The first part of the descriptions which follow is concerned with the method which was finally adopted for the reduction of water to hydrogen. The second part describes the experiments which were carried out during the development of the combustion apparatus.

H₂O → H₂ reduction method.

During the investigations described in Chapter 1, the tritium activities of various organic substances were required. To determine these activities it was decided to estimate the tritium in the form of hydrogen gas produced from the substances after they had been oxidised to carbon dioxide and water, and the water reduced with magnesium turnings. The reasons for the choice of hydrogen gas as the counter filling have been outlined at the beginning of this chapter.

Many methods for the reduction of water to hydrogen have been discussed in the literature (35-37) and the method which was finally developed and which will now be described, employed magnesium turnings at a temperature of 500°C.

The apparatus which was used for the reduction reaction is shown in Fig.2. Magnesium turnings (B.D.H. Grignard Reagent) were packed into a "Pyrex" tube-diameter 20 mm., over a length of ~ 120 mm. The metal was first of all baked

out at 350°C under vacuum in this tube for a period of one hour and then allowed to cool.

After the organic substances were burnt in the combustion tube, the water which was produced, was condensed through the magnesium metal into B. During the trial investigations into this reduction procedure, weighed water samples were introduced directly in sealed glass bulbs, into this section(A). The bulbs were broken with a small steel ball before the water was condensed into B. surrounded by a liquid N₂ trap.

Furnace F₃, which was constructed from a silica core, on which was wound "Nichrome" resistance wire on asbestos, was then heated up to 500°C. During the heating of this furnace the tap T₇ remained open to vacuum. When the magnesium metal had reached the required temperature of 500°C, T₇ was closed and the liquid nitrogen trap was removed from B. The water was then allowed to distil over the hot magnesium turnings and the hydrogen gas, which was produced, was pumped by the Toepler pump P₁ into the calibrated bulbs B1 B2 or B3 shown in Fig.3. A small amount of magnesium hydroxide, produced near D by the reaction of the water vapour with a mirror of magnesium metal, was decomposed by heating with a bunsen flame. This mirror was produced when the magnesium was being heated to 500°C.

The results of a number of experiments carried out in this way, using water samples introduced into A, are shown in the following table.

TABLE 30 - CONVERSION OF H₂O → H₂

Number of Experiment	Wt. of H ₂ O (g)	CC. of H ₂ (at N.T.P)obtained	% age conversion.
1	0.0354	43.63	99.08
2	0.0345	42.85	99.82
3	0.0362	44.83	99.54
4.	0.0354	43.22	98.13
5	0.0352	43.41	99.13

Blank runs on this procedure were also carried out and the results of these determinations are shown in Table 31.

TABLE 31 - BLANK RUNS H₂O → H₂ PROCEDURE.

Number of Experiment	CC. of H ₂ at N.T.P obtained.
6	0.04
7	0.03

The results of this method for producing hydrogen from water showed that the procedure gave quantitative conversion. Yields of hydrogen, in most cases, lay between 99 and 100%. Blank runs on the method gave yields of hydrogen which were less than 0.5% of the hydrogen yield from the usual quantities of water which were reduced.

Discussion of the methods available for the reduction of water to hydrogen.

The method which has been described was developed after other attempts to quantitatively convert water to hydrogen had been carried out.

1. Reduction of water with granulated zinc at 400°C in an apparatus similar to that used in the magnesium method was tried. Unsatisfactory results were obtained with this method and the hydrogen yields varied from 85 to 104%. Furthermore, very careful temperature control was required to prevent the zinc from distilling outside the region of the tube surrounded by the furnace (Zn - M.P. 419°C). When this distillation had occurred, condensation of water through the zinc was very slow, and the reduction reaction required from three to six hours before it was complete.

2. Using magnesium for the reduction of water, the procedure which has been described above required a period of just over one hour to complete the reaction. This period excludes the time which was required for the baking of the magnesium at 350°C . The baking procedure which has been described (for the metal) was found to yield the lowest results for the blank determinations. Modifications of this baking procedure were tried but gave unsatisfactory results as are shown below.

(a) Baking the magnesium at 500°C led to the production of a metallic mirror on the "Pyrex" tube at C and D. The condensation of water vapour through the metal, which had been cooled to room temperature, was very slow. Reaction of the water occurred with the magnesium mirror during this procedure and reduced the final yield of hydrogen.

(b) The pretreatment of the magnesium at lower temperatures was tried to prevent the production of this very reactive form

of the metal. Baking the metal at 250°C yielded blank values of ~ 7cc. of gas at N.T.P. and this was unsatisfactory.

(c) Since $\text{Mg}(\text{OH})_2$ dissociates at 350°C according to the equation

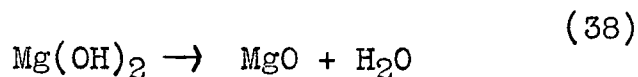

it was decided to de-gas the metal at 350°C. No mirror was produced but further baking at 500°C was required to completely de-gas the metal. The initial baking was sufficient to remove any water which may be present but the treatment at 500°C was necessary to remove some permanent gas which was probably occluded in the metal. This gas could not be condensed in liquid nitrogen.

The procedure which was used for the reduction reaction was different from that suggested by Kennedy and Ruben (68). No baking of the magnesium metal before reaction with water vapour was performed by these workers. A similar method, employed by Norris, Ruben and Allen (69), employed magnesium turnings at a higher temperature 625°C. In agreement with some of the observations mentioned in this chapter, these authors have also found that the reaction of the water with magnesium was much quicker than with hot zinc. M. Viallard and his co-workers (40) who used magnesium at 480°C found that degassing of the metal was required but like the other authors no mention was made of the production of the magnesium mirror at any stage during their procedures.

Determination of Total Blanks for oxidation and reduction processes.

Having standardised the reduction procedure the next step carried out was to investigate the combustion procedure. The experiments performed were designed to obtain a method for burning organic materials, which would yield carbon dioxide and water quantitatively. The blanks in this technique would have to be consistently low to be certain that the oxidation was quantitative.

Blanks for the total procedure employing both combustion and reduction reactions were carried out at an arbitrary oxygen flow rate of three bubbles per second as recorded by a concentrated sulphuric acid bubbler as shown in Fig.1.

In the initial experiments the purification train was not present. The oxygen came from a cylinder, and the flow rate was regulated by means of a needle valve, and then the gas finally passed through a bubbler. The width of the central tube of the bubbler was ~ 5 mm.

The blank runs were performed in the same manner as in a normal oxidation procedure when only hydrogen contents were being measured. An empty platinum boat was placed in position in the combustion tube and any water which was produced was condensed in the spiral and U-tube, which were surrounded with acetone - "Drikold" baths. The water was reduced to hydrogen by passing it over magnesium which was maintained at 500°C .

Table 32 shows the results of the experiments which were performed and this is followed by a brief discussion of the results.

TABLE 32. - BLANK DETERMINATIONS ON COMBUSTION AND REDUCTION METHODS.

Experiment Number	CC. of H ₂ collected (at N.T.P.)
8	2.54
9	7.17
10	1.49
11	0.26
12	0.83
13	0.20
14	0.18

It was observed immediately after Experiment 8, that a considerable amount of water was condensing out in the spiral, and a purification train for the oxygen supply, similar to that shown in Fig.1. was introduced. This alteration, however, did not reduce the amount of water being produced, as is shown in the results from Experiments 9 and 10. Two possible sources for the gas then existed:-

- (a) vapours from the oxygen cylinder.
- (b) vapours from the rubber tubing used in connecting together the various pieces of the apparatus.

The former possibility was not considered as giving rise to such large quantities of gases particularly in view of

the fact that the purification train would take up any water or carbon dioxide present in the oxygen. Therefore the second possibility was investigated more fully.

The rubber tubing, as suggested by Pregl (21), was heated to $\sim 90^{\circ}\text{C}$ in a stream of air, and then replaced on the apparatus, and a blank run performed. The result is shown in Experiment 11. Considerable reduction in the amount of water being produced was observed and the blank yield was diminished to a reasonable level. A second determination, Experiment 12, did not confirm the results of the first observation. It was therefore decided to construct an all-glass purification train for the oxygen supply, using very small lengths of rubber connections only where it was absolutely necessary. The results of the two further blank determinations using this modified apparatus are given in Experiments 13 and 14.

From the results of these last two experiments it may be seen that the amount of gas being finally obtained represented $< 0.5\%$ of the total yield of hydrogen obtained when a sample of benzoic acid of the order of 0.1g. was burned and the water converted to hydrogen.

Determinations of Correct Oxygen Flow Rate.

In order to determine the correct oxygen flow rate a number of samples of benzoic acid were burnt, and the water collected and converted to hydrogen using the apparatus as in Fig.1.

A different oxygen flow rate was used for each sample. The results of these experiments are shown in Table 33. Flow rates are given in terms of bubbles/sec. as recorded by the concentrated sulphuric acid bubbler.

TABLE 33..

Experiment Number	Wt. of acid in g.	Flow rate.	% Yield of H ₂ .
15	0.0891	0.5	79.02%
16	0.0934	1.0	86.28%
17	0.0946	1.5	92.20%
18	0.0813	2.0	94.25%
19	0.0811	3.0	98.83%

At the oxygen flow rate of approximately three bubbles per second the yield of hydrogen determined lay between 98 and 100% for a number of experiments, including those results shown in Chapter 1. Further work on carbon dioxide and hydrogen determinations on cyclohexene, adipic acid, and cyclopentanone revealed very good results as has been already shown in Chapter 1.

The oxygen flow rate mentioned above was used as a guide for the combustion procedure since it was sometimes observed that when the substance burnt rather quickly in the combustion tube, low yields of products were obtained. On such occasions the rapid burning was indicated in the bubbler

as a back pressure and the low yields could be eliminated by increasing the oxygen flow rate slightly until the burning was completed. In the case of volatile liquids, particularly cyclohexene, this rapid burning sometimes occurred but careful observation of the oxygen flow rate and slow heating of furnace (1) gave good carbon dioxide and hydrogen yields.

Combustion of substances with simultaneous measurement of carbon dioxide and hydrogen.

Taking all the precautions mentioned in previous sections, solids and liquids have been burnt in the combustion tube and given satisfactory results.

In the case of solids these have been weighed directly into a platinum boat but for liquids a slight modification was applied (67). These were weighed into a small "Pyrex" capillary tube sealed at one end as shown in the diagram

Fig.7

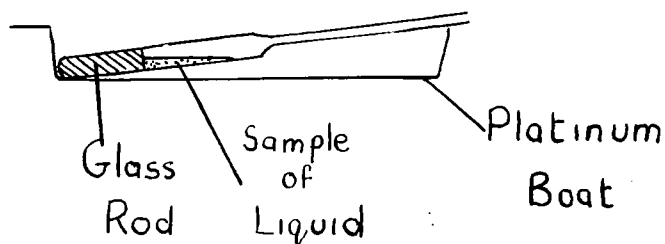





and the tube was then placed in the platinum boat before going into the combustion tube. Careful burning was necessary for liquids to prevent incomplete combustion.

When the carbon dioxide was being collected, together with water, liquid oxygen traps were placed round the spiral

and U tube as shown in Fig.1. but when only the water was required an acetone - "Drikold" bath was sufficient to condense all the water.

Yields of carbon dioxide and hydrogen for a number of different organic compounds are shown in the following table.

TABLE 34.

Substance	Weight	CO ₂ Yield	H ₂ Yield.
 COOH	0.0574g.	101.7%	98.80%
 COOH	0.0573g.	100.2%	99.22%
 COOH	0.0476g.	101.0%	99.98%
 COOH	0.0398g.	99.13%	101.0%

These results, on simultaneous determinations of carbon dioxide and water, were almost quantitative, and the combustion and conversion methods were considered to be satisfactory. Further confirmation of the techniques was provided when the substances, described in Chapter 1, were oxidised. In most of these examples only one product was required for further determinations i.e., either CO₂ or H₂O, but the yields in most cases lay between 98% and 100%.

Total Blanks on the Combustion and reduction procedures.

In order to establish that the carbon dioxide and hydrogen results, from the experimental procedures which have been described, were correct, blank runs were performed and

the carbon dioxide and hydrogen produced were collected. The experimental procedure used was exactly the same as that used in a normal 'run' with the empty platinum boat in position. Results are shown in the following table.

TABLE 35.

Experiment Number.	Ccs. of CO ₂ at N.T.P.	Ccs. of H ₂ at N.T.P.
20	0.19	0.38
21	0.10	0.20
22	0.20	0.25

These 'blank' results represent less than 0.5% of the total yields of carbon dioxide and hydrogen collected in a normal experimental determination (i.e., between 40-50 ccs. gas at N.T.P.).

A blank run was performed when a new oxygen cylinder was attached to the apparatus (Expt.22), and little change in the amounts of gases collected was observed.

Final Conclusions on the Combustion and Reduction Procedures.

Using the procedures which have been described, quantitative conversion of various organic substances to carbon dioxide and water have been performed. Further reaction of the water with magnesium turnings at 500°C has led to the quantitative production of hydrogen.

The combustion reaction was carried out at atmospheric pressure and this is in contrast with the method recommended

by Glascock (70) in which the procedure is carried out under reduced pressure. Glascock found that with his apparatus it was not possible to condense the carbon dioxide quantitatively at atmospheric pressure, in traps surrounded by liquid oxygen. In the apparatus which has been described in the previous sections the spiral tube possessed larger dimensions than Glascock's (1.5 metres of 9 mm. tubing compared with Glascock's 1 metre x 3 mm) and this may increase the efficiency of condensation. Furthermore it has been found that many other conditions e.g., oxygen flow rate, rapidity of oxidation etc. do affect the efficiency of the combustion reaction and much attention to these factors was needed to ensure quantitative oxidation.

DETERMINATION OF TRITIUM IN ORGANIC COMPOUNDS.

SUMMARY.

Methods for the quantitative determination of radioactive hydrogen (tritium) have already been described fully in the literature (39-42) and the method which has been developed here makes use of many of the established facts.

Because of its low β ray energy $E_{\max} = 0.014$ Mev. tritium is invariably determined in its gaseous form and in the experiments which are to be described it was decided to employ the Geiger-Muller tube method.

The tritium sample, in the form of water, was reduced to hydrogen with magnesium turnings and a sample of the active hydrogen gas was introduced into a Geiger-Muller counting tube together with alcohol vapour which acts as a good quenching agent. An external electronic quenching circuit (Dead time = 500 μ sec) was also used. A potential of

1300 v. was applied to the anode of the counter and the pulses were registered by a scale of 100 and a recorder. The active hydrogen could also be diluted with inactive gas and another specific activity determined with this decreased concentration of tritium.

APPARATUS.

The apparatus is illustrated in Fig.3.

Hydrogen prepared in the apparatus shown in Fig.2 was stored in the bulbs B_1 B_2 and B_3 and this section could be

evacuated through T₂₀ . The volumes of each section shown in the diagram had been calibrated by means of the air pipette P. Pressures in this section were measured by the mercury manometer M₃. M₄ is another manometer used for measuring the pressure of alcohol introduced into the counter C. The toepler pump P₂ was used to pump the gases, measured on manometer M₃, into the Counter C.

The Geiger Muller tube C was constructed from a copper cylinder 10.3 cm length 2.0 cm in diameter, which acted as the cathode and this was surrounded by a glass sheath. Through the centre of the tube ran a fine tungsten wire (100M) which served as the anode and this wire was connected to a preamplifier, scaler, and a high voltage supply. This section of the apparatus containing this counting tube could be evacuated through T₂₅.

PROCEDURE FOR TRITIUM COUNTING OF ACTIVE WATER SAMPLES.

A sample, 30-40 mg., of active water was converted to hydrogen by magnesium turnings at 500°C, and the gas pumped into B₁. A sample of this product corresponding to ~ 8 cm. in the counting tube was then measured out on the manometer M₃. 2 cm. of ethyl alcohol (distilled from quicklime and then vacuum distilled) measured on M₄ were introduced into the counter via T₂₂T₂₃ and T₂₄ and then T₂₂ was closed. The hydrogen was then mixed with the alcohol in the counting tube by means of the toepler pump P₂ and the non return valve.

The sinter S served to prevent mercury from entering the counter and giving rise to sparking and hence spurious counts.

The voltage was then applied to the anode and a plateau determined, from which the activity of the sample could be obtained by observing the value of the count on the flattest portion of the curve.

Background rate was determined with inactive hydrogen before and after a series of active samples. If the sample was too active it was diluted with inactive hydrogen to 8 cm. All active samples were counted to within 1% accuracy.

After the activity measurement the counting tube was evacuated for about 15 min. when it was again ready for another determination.

Performance of the Counter.

1. Characteristic Curves.

To determine the counter plateau the counter was first filled according to the above procedure, the high voltage supply was switched on at the starting voltage, and the voltage was allowed to settle down for a period of approximately 15 minutes. Readings of counts were then observed over 20 or 40 volt intervals to an accuracy of 1% until the plateau ended or the counter 'raced'.

Some typical characteristic curves using this method are shown in Graphs 1 - 3. Background counts were taken with inactive hydrogen and alcohol on each occasion.

GRAPH 1

4600

4500

4400

4300

4200

4100

4000

1200

Counts/min / 8 cm of H₂ at 20°C

Anode Voltage

1250

1300

1350

1400

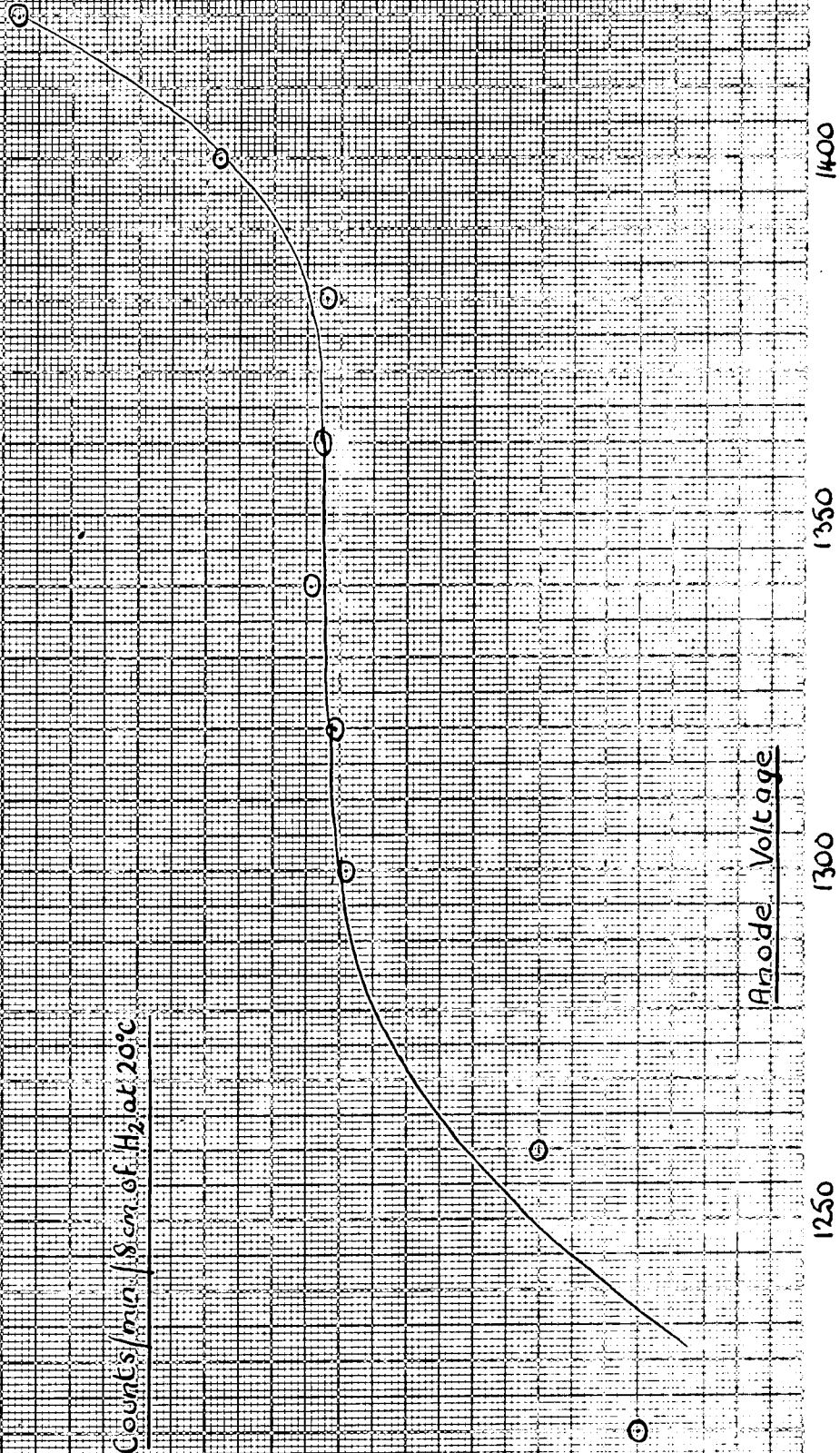

GRAPH 2

4600

4500

4400 Counts/min / 8cm. H₂O at 20°C

4300

4200

4100

4000

3900

1250

1300

1350

1400

Anode Voltage

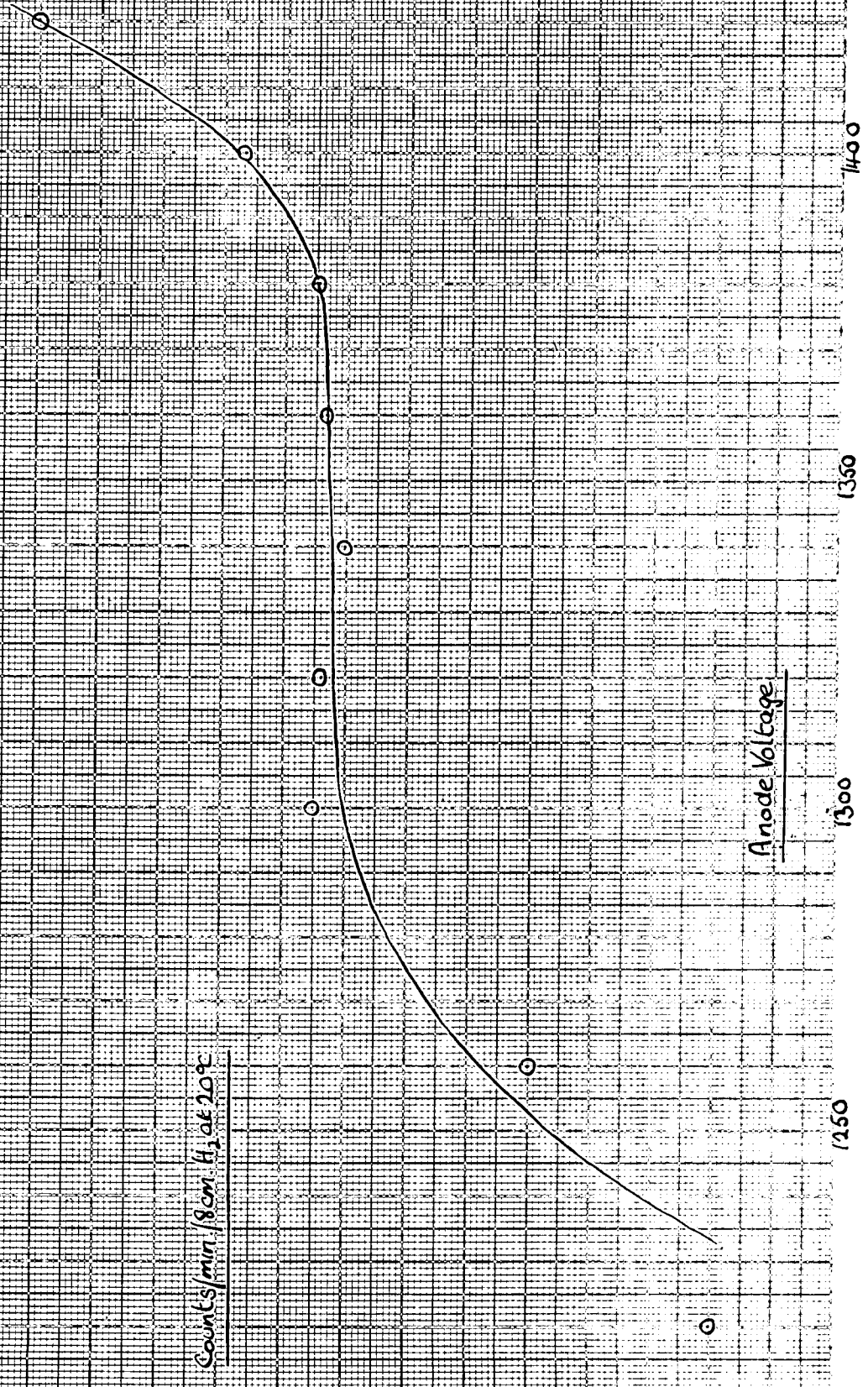

GRAPH 3

COUNTS/min./Pcm of H_2 at 20°C

Anode Voltage

4200

4100

4000

3900

3800

3700

3600

3500

3400

1200

1250

1300

1350

1400

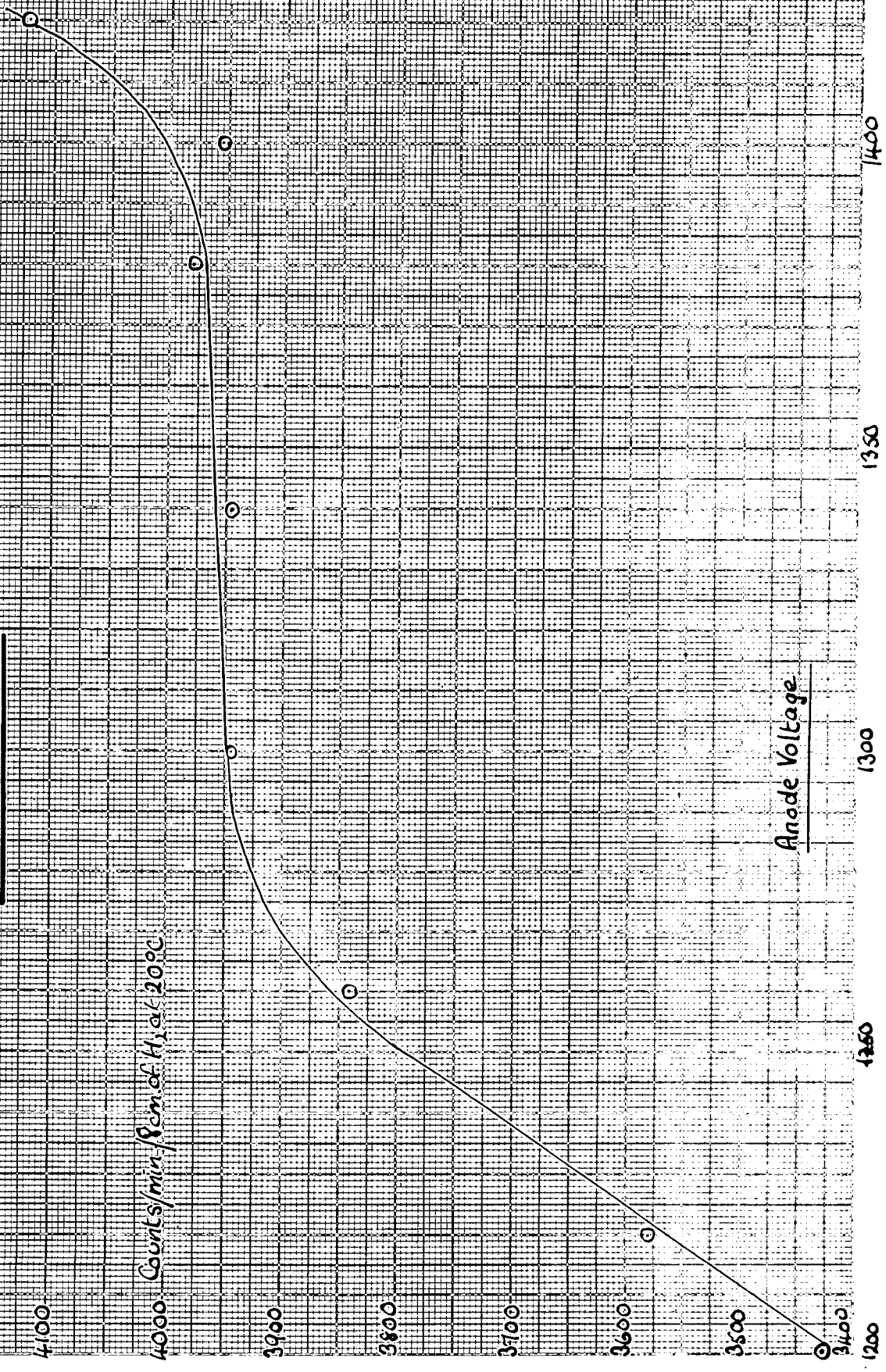

From these graphs it was observed that with this filling mixture a good plateau of about 80 - 100 volts in length with a slope of 1 - 2% per 100 volts was obtainable. Moreover the plateau was reproducible and the centre was about 120 volts above the starting voltage. The plateau had well defined limits with a rapid rise to the beginning and a similar rise after the end.

In all cases the counter 'raced' at approximately 40 volts after the end of the plateau.

The background was determined with inactive hydrogen and alcohol to the same pressures as with active material. With an unshielded tube the count remained steady with this inactive filling at ~ 100 counts/min/8cm. H₂ at 20°C.

With 8 cm. H₂ plus 2 cm. alcohol the working voltage was thus 1340 volts, the external quenching circuit having a dead time of 500 μ sec. The scaler employed was a Type 200.

2. Different Filling Pressures.

To establish that the Geiger-Muller tube yielded activities which were proportional to the partial pressure of the active gas in the counter activity measurements were obtained for varying pressures of active hydrogen from three different sources

- (1) Water containing tritium (Exchange solution diluted x25)
- (2) Tritiated cyclohexene obtained in the exchange reaction.
- (3) Adipic acid obtained on oxidation of the above cyclohexene.

In each case graphs were plotted of counts/min. against the partial pressure of active hydrogen introduced into the counting tube (Graphs 4 - 6). The total pressure of hydrogen in the counter was always made up to approximately 8 cm. with inactive hydrogen, and 2 cm. of alcohol were added as quenching agent. External quenching and scaler were as before.

In all the experiments performed it was found that the counts/min. varied in a linear manner with the partial pressure of active hydrogen introduced into the counter after background and dead time corrections had been applied to the activity results.

3. Reproducibility of Specific Activities.

A number of specific activity determinations were made on samples of the following substances with a view to finding out whether the results obtained for each substance were reproducible.

- (1) Active water used in exchange reaction (Diluted x 25)
- (2) Active cyclohexene produced after exchange with (1).
- (3) Adipic acid obtained on oxidation of the active cyclohexene in (2).
- (4) $\alpha\alpha'$ Dibromo adipic acid obtained by bromination of active adipic acid.

Tables of the specific activities calculated for the different samples are shown in Tables 36, 37, 38 and 39. In each case the specific activity was expressed as counts/min/cm. of H_2 at $20^\circ C$.



GRAPH 4

Exchange Solution (1-25)

Counts/min

Partial Pressure of Active Hydrogen in Counter (cm.) 20°C

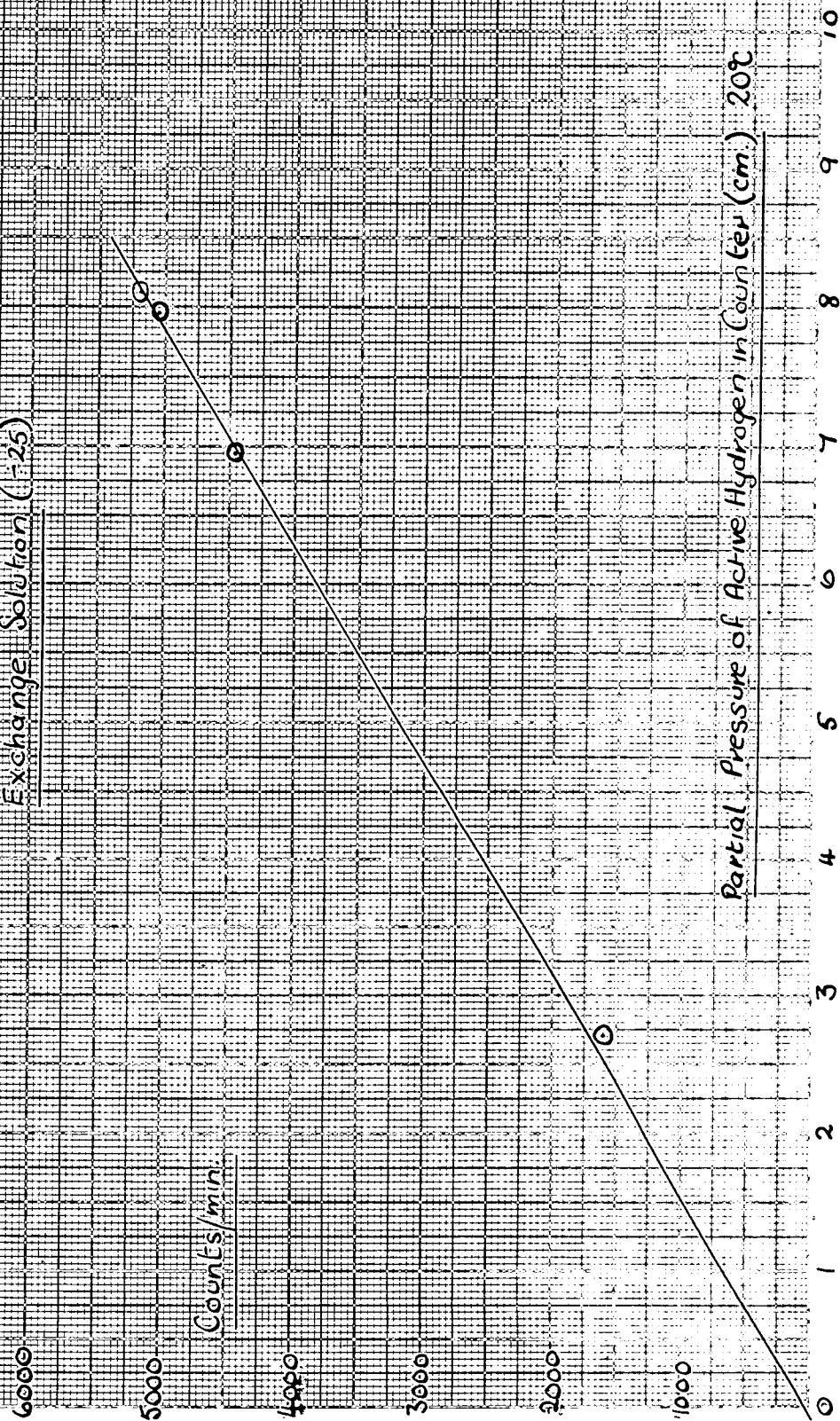

GRAPH 5

Cyclohexene after Exchange

Counts/min

Partial Pressure of Active Hydrogen in Counter (cm) 20°C

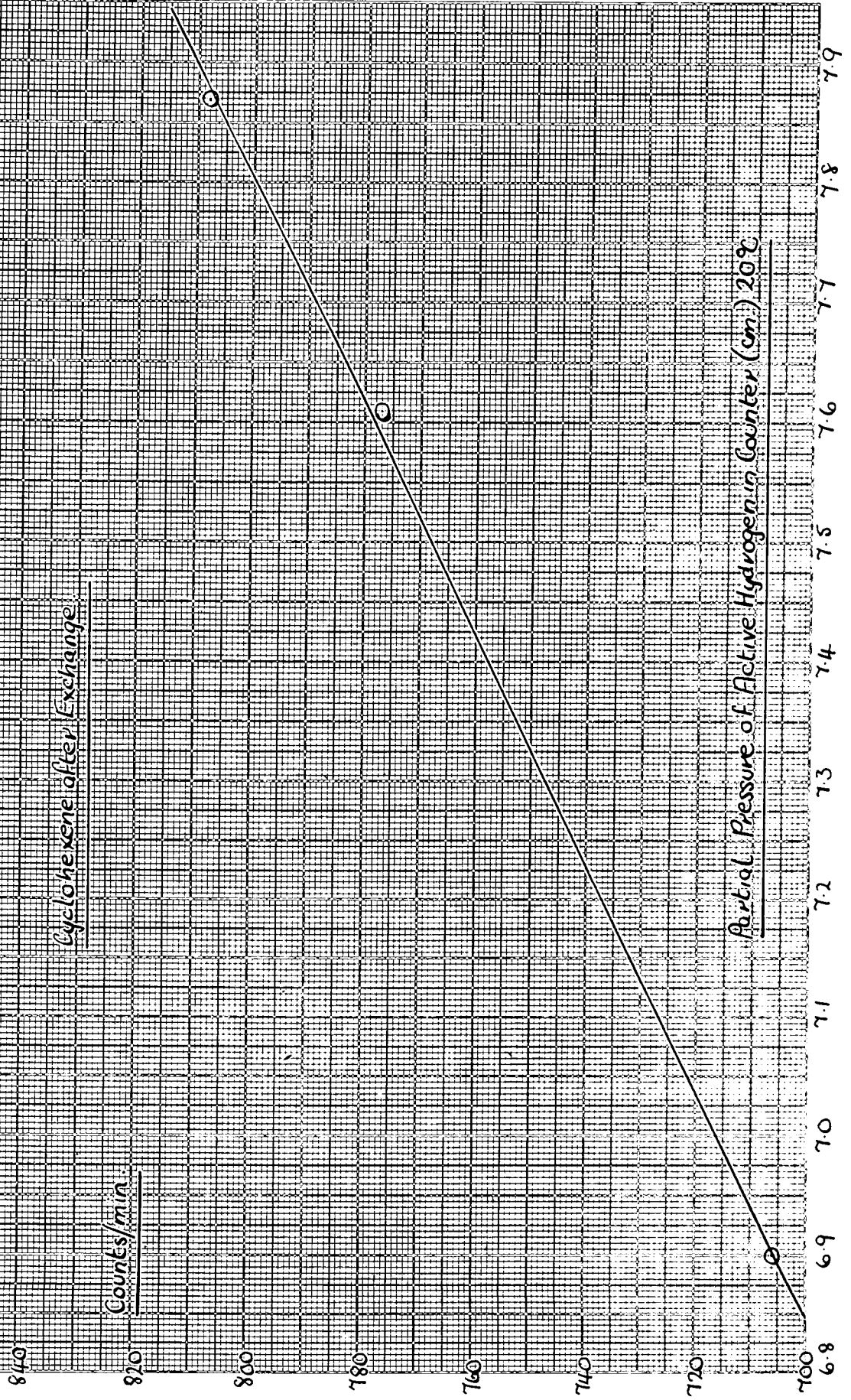

GRAPH 6

Adipic Acid

Counts/min

Partial Pressure of Active Hydrogen in Counter (cm) 20°C

640
630
620
610
600
590
580
570

7.3 7.4 7.5 7.6 7.7 7.8 7.9 8.0 8.1 8.2 8.3



Water samples were converted directly to hydrogen by reduction with magnesium at 500°C, the other substances being first of all oxidised to water and carbon dioxide in the combustion tube. The water was then reduced, as above, with magnesium.

Background and resolving time corrections were applied to the original count obtained, and the specific activity was then calculated after allowing for temperature variation from 20°C.

TABLE 36.

Specific Activity of diluted exchange solution.

TABLE 37.

Specific Activity of cyclohexene

Counts/min/cm. of H₂ at 20°C.

640.4 ± 6.0	102.2 ± 1.0
629.6 ± 6.0	102.3 ± 1.0
651.0 ± 6.0	102.5 ± 1.0
637.8 ± 6.0	

TABLE 38.

Specific Activity of Adipic Acid.

TABLE 39.

Specific Activity of αα'dibromo adipic acid.

Counts/min/cm. of H₂ at 20°C.

77.67 ± 0.68	60.39 ± 0.75
77.32 ± 0.71	61.81 ± 0.66
77.20 ± 0.90	61.32 ± 0.50

The results from these experiments confirmed that the measured specific activities, from sample to sample of each substance, were reproducible to within an error of 2%.

In fact in most cases the error was nearer 1%. When greater accuracy of the results was required, e.g. in the C^{14} work on cyclopentanone, this could be obtained by increasing the number of counter fillings and determining their activities.

Each individual sample shown in the tables required two days before a count could be determined and in the case of the exchange solution it required a period of greater than one week before all the results were accumulated. The counter was, therefore, not only stable over the period of counting, which varied from 4 min. to 2 hr. but also reproduced the results over much longer times, up to two weeks.

4. Retention of Tritium in the counter and the apparatus.

An experiment was carried out in which a sample of water (inactive) was passed through the combustion train, according to the normal procedure, reduced to hydrogen with magnesium and then counted, after a similar experiment had been carried out with a sample of active water having a count of 1300 counts/min.

In this way it is possible to show whether there is any retention of tritium in the combustion train or the magnesium furnace or in both. A background count was also needed for both experiments as a check.

<u>ACTIVE SAMPLE</u>	<u>INACTIVE SAMPLE</u>
Activity-1300 counts/min/8cm. H_2O	Activity-103 counts/min/8cm. H_2O
Background-106 " " " "	Background-102 " " " "
	at 20°C.

The results of this experiment demonstrated that tritium

had been retained in the apparatus after a sample of the activity shown had passed through it. Since this was about 1.5 times as strong as most of the other samples which were burnt, and the water reduced, it was assumed that no retention of activity occurred in the latter cases.

It was also found that after determining activities in the counter there was no retention if the counter tube was pumped down to a 'sticking' vacuum for 15 minutes-30minutes.

5. Backgrounds.

In all activity measurements background counts were observed. The inactive gas used for these determinations was cylinder hydrogen, admitted by means of the sinter S (in Fig.2). The hydrogen was purified by allowing it to flow through a trap containing activated charcoal. This was maintained at 195°C by surrounding it with a trap of liquid nitrogen.

With an unshielded counter the background count was of the order of 100 counts/min. but since the activities of substances being determined were in the region 1000 counts/min. no shielding was necessary at that stage.

It was observed that pumping on the counter tube for about 15 min. was sufficient to remove all the tritium after an activity determination, and reduce the counts to background level.

Slight variations in the background count over a period

of time are to be expected and in fact this has been the case over a period of about six months although the amount of variation was no more than $\pm 5\%$ on a background rate of 100 counts/min. in most observations. A table of results is shown in Table 40.

TABLE 40 - H₂ BACKGROUND RESULTS.

Number of Filling	Counts/Min/8 cm. of H ₂ in counter at 20°C.
1	100 \pm 1.01
2	95 \pm 1.80
3	97 \pm 1.70
4	98 \pm 2.01
5	97 \pm 1.68
6	100 \pm 1.67
7	106 \pm 1.10

These results are from seven different determinations of the hydrogen background over a period of 2½ months.

FINAL CONCLUSIONS ON TRITIUM COUNTING PROCEDURES.

With a counter filling of 8 cm. H₂ and 2 cm. of ethyl alcohol, good plateaux of about 100 volts in length and a slope of ~2% per 100 volts have been obtained with a Geiger-Muller counter. It has been shown that the measured specific activity is proportional to the amount of tritium in the counter tube. This is in agreement with the

determinations carried out by L. Melander (71). No contamination of the counter was observed if the tube was evacuated for \sim 30 min. after each determination. Specific Activity determinations were also found to be reproducible over periods of time which varied up to two weeks. It is possible that the counter contamination by tritium-hydrogen, observed by Arrol and Wilson (73), could be due to the differences in counter construction. These workers used graphite cathode glass counters whereas in the work which has been described in this thesis the cathode was a copper cylinder.

DETERMINATION OF C¹⁴ IN C¹⁴ ACTIVE ORGANIC COMPOUNDS.

SUMMARY.

As in the case of tritium there are also many methods which have been described in the literature for the counting of substances containing carbon - 14 (43-46).

Carbon¹⁴ is a β emitter with a half life of 4500 years and the β ray energy $E_{\max} = 0.15$ M.e.v.(47). The β particles are more energetic than those from tritium and it is possible to count C¹⁴ in the solid form e.g. Ba C¹⁴O₃. In solid counting, however, numerous losses are encountered due to self absorption, back scattering etc. and in the case of low energy betas these losses are quite large, and difficult to estimate.

It was therefore decided to count C¹⁴ in the gaseous form as carbon dioxide, since this was most conveniently prepared from the organic compounds by burning them in the combustion tube. The carbon dioxide and water, produced on combustion at atmospheric pressure, were condensed in the spiral and U tube surrounded by liquid oxygen traps. After evacuating the combustion tube section, and allowing the carbon dioxide to distil over into the storage bulbs by replacing the liquid oxygen traps with acetone-"Drikold" traps, the carbon dioxide was introduced into a Geiger-Muller tube, with some carbon disulphide vapour to act as a charge transfer gas. An external electronic quenching circuit (Dead time) 1000 μ sec. was also employed and the pulses

were registered by a scale of 100 and a recorder.

Active carbon dioxide could also be diluted with the inactive gas and further specific activities obtained from the diluted mixtures.

APPARATUS.

The counting section for carbon dioxide is illustrated in Fig.3.

Carbon dioxide, prepared in the combustion section of Fig.1 was distilled into the calibrated section and stored in one of the bulbs B_1 B_2 or B_3 . All volumes in this section had been calibrated by the air pipette P. This section of the apparatus was the same as that used in tritium determinations with the detachable Geiger-Muller counter C being the same as in the previous experiments.

PROCEDURE FOR CO_2 COUNTING FROM C^{14} ACTIVE ORGANIC COMPOUNDS.

A sample of the organic compound about $\sim 0.04g - 0.10g$. was burnt in the combustion tube according to the methods which have been fully described in a previous section of this chapter. The carbon dioxide was stored in the bulbs B_1 B_2 or B_3 until required for activity determinations.

2 cm. pressure of carbon disulphide vapour were measured into the counter via taps T_{22} T_{23} and T_{24} and recorded on the manometer M_4 . A sample of the carbon dioxide, amounting to 10 cm. pressure in the counter, was measured out on manometer M_3 and toepled into the counter by means of the pump P_2 . It could also be introduced into the counter

by surrounding F with liquid nitrogen and opening T₂₁ and T₂₂, after the carbon disulphide had been removed from the section between T₂₁ and T₂₂ by pumping through T₂₀.

In carbon dioxide counting the counter was removed from the apparatus and placed in a lead castle. This was done because the activities being determined were lower than in tritium samples and a low background figure was required. Furthermore a new high voltage system was required because the counting voltage for carbon dioxide was near to 2,200v.

The voltage was then applied to the anode and a plateau determined, from which the value of the activity of the sample may be obtained by observing the count on the flattest portion of the curve.

After evacuation of the tube for 15 min. it was again ready for a new determination.

Background count rates were observed using inactive carbon dioxide. This was obtained by allowing carbon dioxide to distil in vacuo from a piece of "Drikold" maintained at its own temperature by a "Drikold" bath. The carbon dioxide was stored in the bulb shown in Fig.2. All samples were counted to within 1% accuracy.

Note on electronics:-

The counting region for the mixture of carbon dioxide and carbon disulphide used, was approximately 2200v. A power-pack giving voltages up to 4 K.V. was therefore employed.

The dead time set for the external quenching circuit (1000 μ sec). was greater than for tritium counting. This was found to be necessary to allow the positive sheath to diffuse away after the discharge produced by the β particles. Unfortunately, even after allowing such a long period, it was observed by Brown (48), that a good plateau was not obtainable. This was overcome by "reducing" the voltage on the anode by a further 120 v. during the dead time, using a high tension battery (Fig.4). With this apparatus good plateaux up to 100 v. long with a slope of $\sim 2\%$ were obtained.

Fig. 4

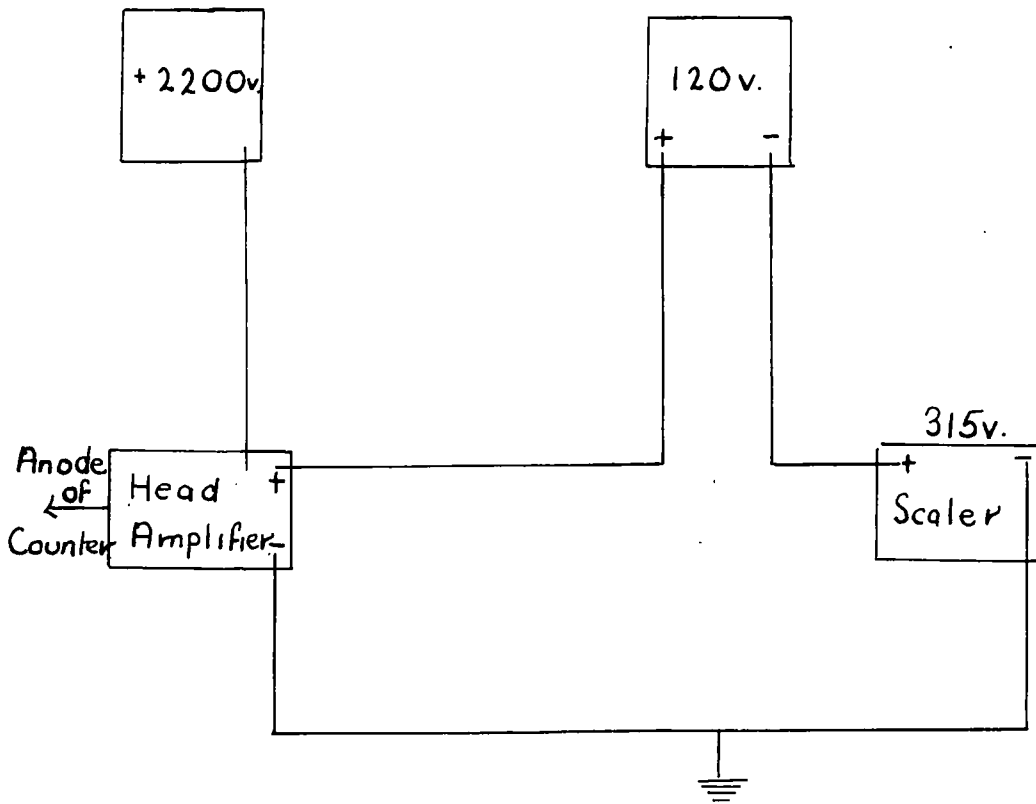

PERFORMANCE OF THE COUNTER.

1. Characteristic Curves.

The counter plateau was determined as follows. The counter was filled according to the procedure described previously and the voltage switched on at the anode and allowed to settle down for 15 mins. Readings of counts were then observed to an accuracy of 1% over intervals of 20 - 40 volts, until the plateau ended.

Background counts were observed, using the same procedure as above, with inactive carbon dioxide and carbon disulphide vapour. Graphs were then drawn of counts/min. against applied voltage and the results of some of these characteristic curves are shown in Graphs 7 - 9.

It was observed, that with the standard counter filling, plateaux of about 80 - 100 volts in length with a slope of approximately 2% per 100 volts were obtainable. The plateaux were very similar to those obtained with the tritium filling, with well defined limits, and rapid rises at both the beginning and the end of the flat portion.

The counter 'raced' in most determinations at about 40 volts after the end of the plateau, but on the occasions when it failed to race the counting rate was increasing very steeply.

Background counting rates were between 32 and 35 counts/min. for the same pressures of gases. These lower values

GRAPH 7

4800

Counts/min / 10cm. of CO_2 at $20^\circ C$

4600

4400

4200

4000

3800

3600

3400

2020

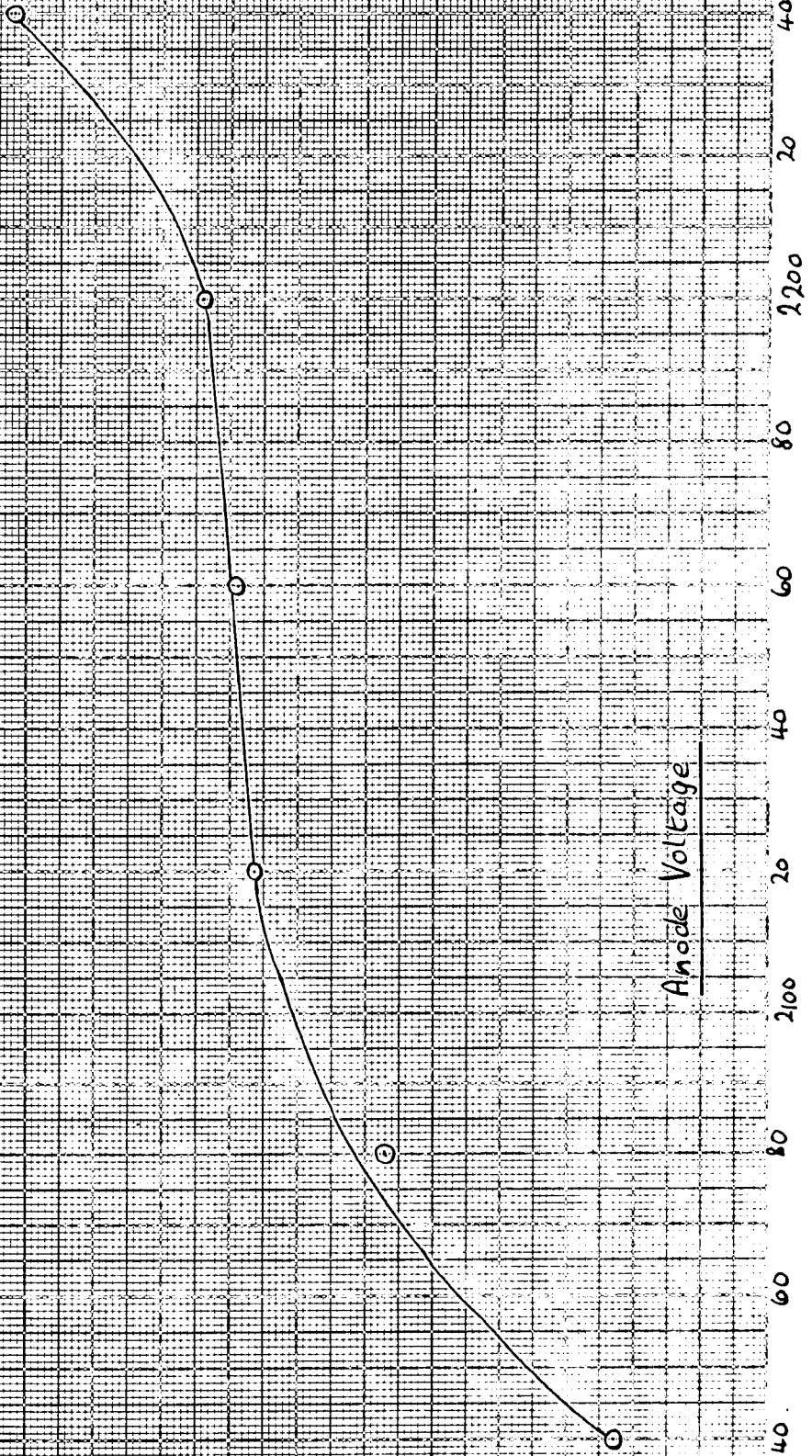

GRAPH 8

Counts/min / 10cm of CO_2 at $20^\circ C$

Anode Voltage

6400

6200

6000

5800

5600

5400

5200

5000

2000

60

80

2100

20

40

60

80

2200

20

40

60

60

60

60

60

60

60

GRAPH 9

Counts/min / 10 cm of CO_2 at $20^\circ C$

Anode Voltage

6200
6000
5800
5600
5400
5200
5000
4800
2040

60
40
20
2100
80
60
40
20
2100
80
60
2100
80
60

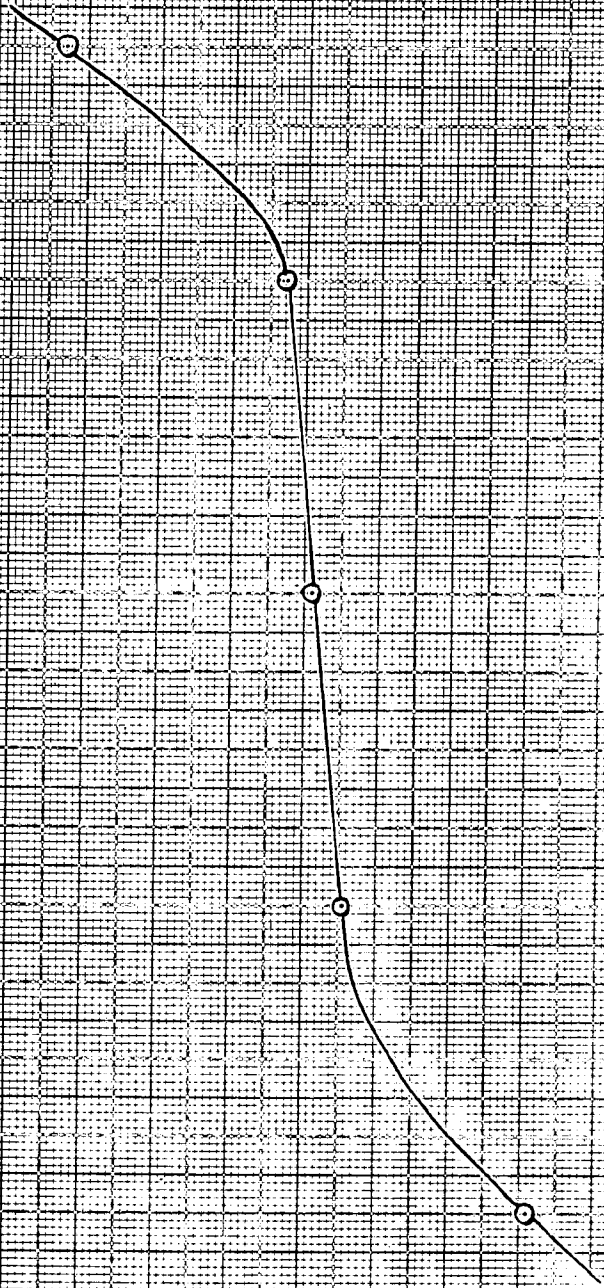

were obtained because the tube was suspended inside a lead castle as opposed to the unshielded tube in the tritium experiments.

With 10 cm. pressure of CO_2 and 2 cm. pressure of CS_2 the working voltage was $\sim 2180\text{v}$.

2. Different Filling Pressures.

In the same way as in the tritium measurements, it was decided to examine the counter to establish that it possessed linear counting characteristics for varying pressures of active carbon dioxide. In each case the active gas was made up to 10 cm. pressure in the counter with inactive carbon dioxide from the reservoir, and 2 cm. of carbon disulphide were added as quenching gas. A graph was then plotted of counts/min. against the partial pressure of active carbon dioxide in the counter. The electronic equipment was the same as that employed in all other carbon dioxide counting measurements.

At the same time as this experiment was performed, an extra experiment was carried out with an active tritium sample so as to obtain more points on the graph than those shown in Graphs 4 - 6. The results of these two experiments are shown in Graphs 10 and 11.

In both examples it was found that the C^{14} or tritium activity, expressed as counts/min., varied in a linear manner with the partial pressure of the active gas introduced into the counter. Background and dead time corrections were

GRAPH 10

Counts/min

Counts/min

Partial Pressure of Active CO₂ in counter (cm.) 20°C

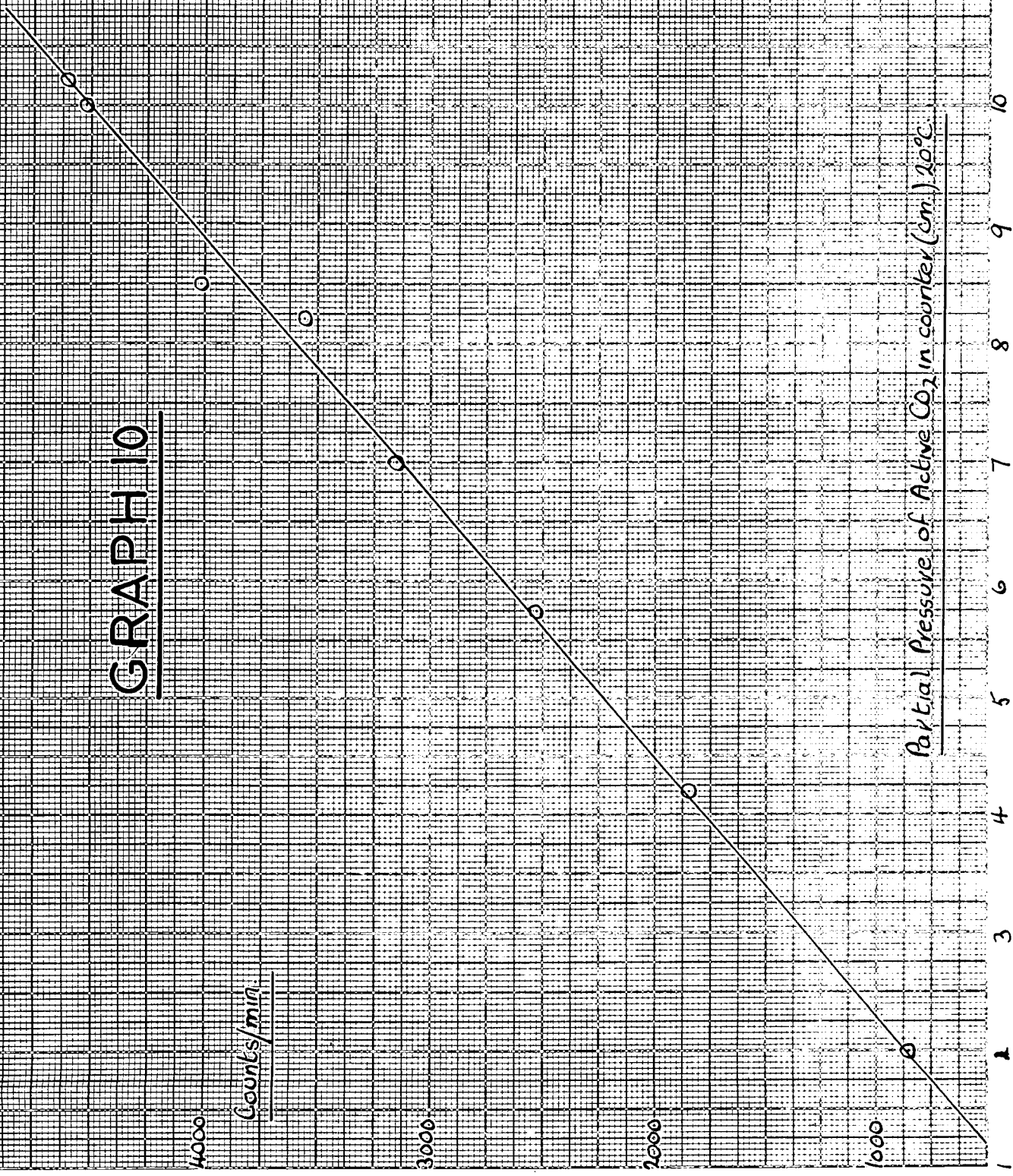

GRAPH II

Counts/min.

Partial Pressure of Active Hydrogen in Counter (cm.) 20°C

1600

1400

1200

1000

800

600

400

200

2

3

4

5

6

7

8

9

10

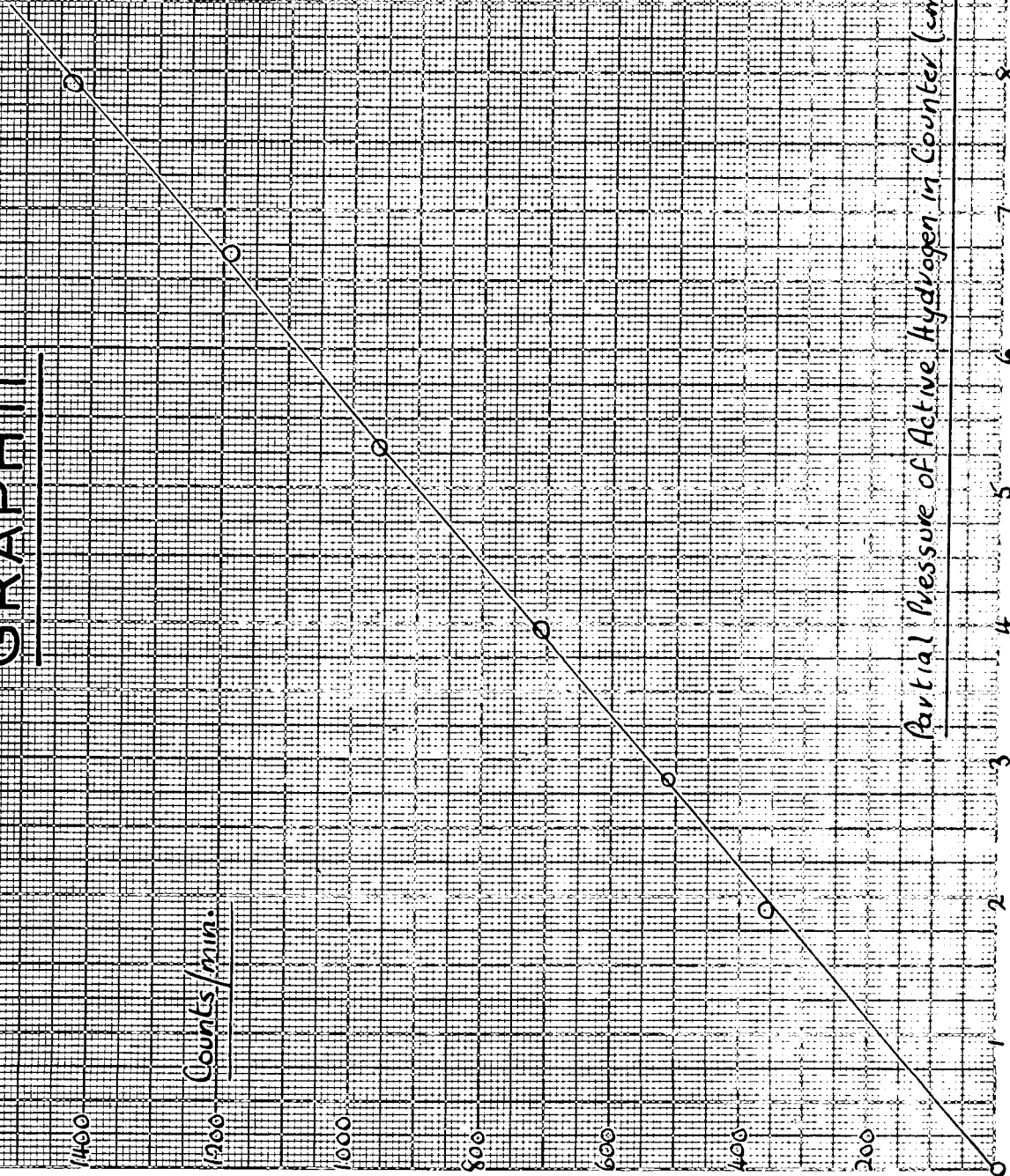

applied in both cases.

3. Reproducibility of Specific Activities.

During the course of the investigations which have been described in previous sections, specific activity determinations were carried out on two samples of the C^{14} active organic compound, to ensure that the results were reproducible.

The organic samples were burnt in the combustion tube in the normal manner, and the carbon dioxide collected was introduced into the Geiger counter, together with carbon disulphide vapour to act as quenching agent. The results of these investigations are shown in the following tables. Background and resolving time corrections were applied in all cases.

The figures shown for each cyclopentanone sample represent the results which were obtained for four counter fillings on each sample. In the adipic acid, two counter fillings were estimated for each sample which had been oxidised. The normal procedure in counting work was to determine the activity of two counter fillings from each sample of material which had been burnt. When greater accuracy of the results was required then the activities of a greater number of counter fillings were determined.

TABLE 41.

Substance		Specific Activity counts/min./cm. CO ₂ at 20°C.
(a) Cyclopentanone	1.	11.48 ± 0.17
	2.	11.43 ± 0.14
(b) Cyclopentanone	1.	12.00 ± 0.17
	2.	12.02 ± 0.12
(c) Adipic Acid	1.	65.97 ± 0.68
	2.	66.17 ± 0.66

The results from these experiments confirmed that the measured specific activities of the various substances shown, were reproducible, within the experimental error incurred in counting. Since the individual samples were not always counted on the same day e.g. each cyclopentanone figure required eight days counting, it may be said that the counter reproduced the results over periods up to two weeks.

4. Retention of carbon¹⁴ in the apparatus.

The cyclopentanone figures obtained in the above table were obtained when the two samples of each cyclopentanone batch were burnt on consecutive days. No change in the activities of the two samples indicated that there had been no retention of the carbon¹⁴ in the combustion apparatus.

It was also found that after determining the activities

of the samples in the counter there was no retention of the active carbon in the counter tube if the tube was pumped down to a 'sticking' vacuum for thirty minutes. This is demonstrated in the following table for four counting fillings of carbon dioxide obtained from one sample of cyclopentanone which had been oxidised.

TABLE 42. - CYCLOPENTANONE - SPECIFIC ACTIVITY RESULTS.

Number of Filling	Counts/min/cm. of CO ₂ at 20°C.
1.	149.4 ± 1.49
	148.6 ± 1.49
2.	148.7 ± 1.49
	149.4 ± 1.49
3.	149.8 ± 1.50
	147.5 ± 1.47
4.	149.1 ± 1.49
	147.5 ± 1.48

5. Backgrounds.

Background counts were determined for every specific activity determination. The carbon dioxide used for these observations was obtained by distillation in vacuo from a piece of "Drikold" which was maintained at solid carbon dioxide temperature.

In the carbon dioxide specific activity determinations

the counter was surrounded by a lead castle which reduced the background count to approximately 34 counts/min. for 10 cm. of CO₂ at 20°C. Slight variations in this value were observed over a period of time as shown by the results in the following table. These figures are values of the background count observed over a period of three weeks, for the number of counter fillings shown.

TABLE 43. - CO₂ BACKGROUND RESULTS.

Number of Filling	Counts/min/10cm. of CO ₂ at 20°C.
1.	35.29 ± 0.60
2.	34.57 ± 0.59
3.	33.10 ± 0.58
4.	32.60 ± 0.64
5.	35.67 ± 0.55
6.	35.22 ± 0.60
7.	35.39 ± 0.60
8.	36.84 ± 0.65
9.	33.72 ± 0.58
10.	33.35 ± 0.58
11.	34.11 ± 0.59
12.	36.14 ± 0.55
13.	34.82 ± 0.59.

These figures have indicated that the background count did vary slightly over a period of time although no major

increase has been observed, indicating that there is no retention of carbon¹⁴ on the walls of the counter.

FINAL CONCLUSIONS ON THE C¹⁴ COUNTING PROCEDURES.

Gas counting of carbon dioxide in a Geiger-Muller counter has been found to be satisfactory with a counter filling of 10 cm. of CO₂ and 2 cm. CS₂. Plateaux of about 80 volts in length, with a slope of 2.3% per 100 volts have been observed. These counter characteristics are not as good as in the tritium results but the specific activities of the various organic substances which have been investigated, have been found to be reproducible over periods up to two weeks. No contamination of the counter has been observed if the tube was evacuated for 30 min. between each determination. Higher counting voltages are necessary for carbon dioxide counting and this is in agreement with the work carried out by Brown and Miller (44):

In agreement with the observations of Glascock (72) it has been observed that no contamination of the combustion apparatus with C¹⁴ was ever detected. Furthermore no contamination with tritium in this section of the apparatus was observed. The possibility of this trouble occurring was reduced by flushing the combustion tube with oxygen between runs and also by passing oxygen through the tube for 45 min. before every determination.

THE TRITIATION OF CYCLOHEXENE AND C¹⁴ ACTIVE CYCLOHEXENE
BY A PLATINUM CATALYSED EXCHANGE REACTION.

Method.

The substances used in these experiments were prepared by the methods to be described later.

Platinum catalyst, water, acetic acid, and cyclohexene were weighed into "Pyrex" brand reaction tubes. The tubes were then cooled in a liquid nitrogen bath and after the contents had frozen the tubes were evacuated with a "Hyvac" oil pump and sealed. After being shaken for three days at $130 \pm 2^{\circ}\text{C}$ the tubes were allowed to cool, and then opened. The cyclohexene layer was pipetted into a small separating funnel and washed with 2% sodium carbonate solution until it was free from acid. Washing with water was then continued until the cyclohexene was free from alkali. The hydrocarbon was then dried with calcium chloride overnight and finally distilled.

This procedure was used in all the exchange experiments described in Chapter 1 and also in the disproportionation investigations in Chapter 1, Part 3. The chief variations in these experiments were in the materials employed. Some experiments involved tritiated water and C¹⁴ active cyclohexene as opposed to the materials used in the above description.

Preparation of the Components of the Reaction Tubes.

(a) Platinum Black Catalyst.

This catalyst was prepared according to the method described in Vogel (49). The platinum was supported on purified Gooch asbestos and the metal was obtained by reducing an aqueous solution of a platinum salt with formalin. Thorough washing of the catalyst was carried out with hot water, and the material was dried and stored in a desiccator.

(b) Acetic Acid.

"Analar" acetic acid was refluxed for three hours with "Analar" chromium trioxide (1g. of solid CrO_3 /100g. acid). A further 0.5g. of chromium trioxide per 100g. of acetic acid were added and the mixture was refluxed for another three hours. The acid was distilled until colourless and the fraction distilling between 116-118°C was collected. The liquid was cooled to 11- 12°C and the supernatant liquid decanted. After two crystallisations the melting point was 16.7°C.

(c) Water.

1. Tritiated water (\sim 30 millicuries) was obtained from Harwell and diluted to the required strength with pure distilled water.

2. Pure distilled water.

This was obtained from ordinary distilled water by further distillation twice from "Analar" potassium permanganate in an all glass apparatus. The product was then distilled twice alone in the same glass apparatus and finally stored in an 'aged' Winchester bottle.

(d) 1. Cyclohexene. supplied by Messrs. Lights was used in the titiation experiments in Chapter 1, Part 1, The hydrocarbon was distilled B.P. 83°C and allowed to "age" in a stoppered reagent bottle.

2. C¹⁴ Active Cyclohexene. was obtained by the synthetic procedure to be described later.

DEGRADATION EXPERIMENTS EMPLOYED IN THE DETERMINATION OF THE TRITIUM DISTRIBUTION IN CYCLOHEXENE.

Tritiated cyclohexene was prepared by the exchange reaction of cyclohexene with tritiated water according to the procedures which have been described.

1. Oxidation of tritiated cyclohexene to adipic acid.

(a) 5g. of tritiated cyclohexene were placed in a 250 ml. flask and a solution of 16.8 ml. of hydrogen peroxide (30%) in 74.6 ml. tertiary butyl alcohol was added and mixed.

1.1 ml. of 2% osmium tetroxide (32) in tertiary butyl alcohol was added to the mixture. A vigorous reaction occurred at room temperature and it was sometimes necessary to cool the flask with cold water to prevent the contents from boiling. The colour of the solution varied from colourless to red, to pale yellow and then, after standing overnight at room temperature, back to colourless again. A boiling water bath was then used to remove the solvent, and the residue was taken to be cyclohexane 1-2 diol (50,51).

Water was added to the diol and a solution of 19g. "Analar" potassium permanganate in 315 ml. water was then added to the mixture. The contents of the flask became warm, and after allowing the mixture to stand overnight, the manganese dioxide was filtered off at the pump and the filtrate acidified with hydrochloric acid. Ferrous sulphate solution was used to decolourise the filtrate after acidification before it was extracted with ether. The

ethereal extracts were evaporated to dryness and the yellowish solid was recrystallised twice from distilled water to yield white crystals of adipic acid.

These were dried in a vacuum dessicator over concentrated sulphuric acid before tritium assay. Yield = 2.60g.

M.P. = 148.5 - 151°C (151-152°C).

(b) The method described above gave yields of approximately 30% of adipic acid from cyclohexene and therefore it was decided to investigate another possible process for the oxidation reaction. It involved the application of the method for the oxidation of cyclohexane to adipic acid, as described by Hoot and Kobe. (52).

Experiment (1)







Addition of 50% by volume of liquid NO_2 to cyclohexene in a "Pyrex" tube at room temperature was accompanied by a vigorous reaction and liberation of heat. The tube was sealed and allowed to stand at room temperature for one hour, after which, the excess of liquid NO_2 was decomposed by boiling with water. The residue separated into two layers, an aqueous layer, and a yellow oil which could not be crystallised and possessed an aldehydic odour. Concentration of the aqueous layer yielded no crystals.

Experiment (2)

Further experiments on NO_2 oxidations were carried out using cyclohexane to dilute the cyclohexene to avoid the initial vigorous reaction. A control experiment with

cyclohexane alone was performed at the same time. The sealed tubes, with 50% by volume of liquid NO₂, were allowed to stand overnight. Excess liquid NO₂ was decomposed by boiling with water and the aqueous layer was concentrated and the solid filtered off and recrystallised from water.

Results - TABLE 44.

Tube No.	Contents.	Yield of Product.	M.P. of Product.
1	0.4g  + 1.6g 	0.0460g.	130-135°C.
2	2.0g 	nil.	-
3	0.4g  + 3.6g 	0.1049g.	136-140°C.
4	4.0g. 	Trace	-

The yields of the crystalline solid were very poor and the substance appeared to be impure. It was decided to use the original method of oxidation of cyclohexene with hydrogen peroxide, and potassium permanganate, in view of the unsatisfactory nature of the last results.

2. Bromination of Tritiated Adipic Acid.

The Hell-Volhard method was used for the bromination of adipic acid, using a solution of dry bromine in thionyl chloride (53,54).

0.5g. of adipic acid were weighed into a 50 ml. B.14 conical flask and 10 ml. thionyl chloride were added. The mixture was refluxed on a water bath until a homogeneous

solution was obtained and then further refluxed for thirty minutes. To the cooled solution was added 0.43 ml. dry bromine and the whole mixture refluxed for about four hours. After cooling the mixture it was poured into 3 ml. formic acid and after an initial vigorous reaction a yellowish brown oil separated from the solution. The mixture was heated on a water bath for a few minutes, and then cooled. A yellowish brown solid was precipitated.

This solid was recrystallised from the minimum amount of formic acid on a water bath, and then decolourised by boiling with "Norit" charcoal. Two recrystallisations were sufficient to bring the melting point up to 192-193°C. Further recrystallisations of the white solid failed to raise the melting point.

Yield 0.30 g... after two recrystallisations M.P. = 191-193°C (193°C).

Determination of the Double Bond Content of Cyclohexene.

A measured quantity of a standard bromine solution in carbon tetrachloride was added to a weighed quantity of cyclohexene (0.1g.) until a red coloration was produced. The solution was allowed to stand in a stoppered flask for fifteen minutes, extra bromine being added if the colour had disappeared. Aqueous potassium iodide solution was then added and the liberated iodine was titrated with standard sodium thiosulphate solution. Standardisation of the bromine solution was performed by running a known volume

into potassium iodide solution and titrating the iodine with thiosulphate as before.

The results were expressed as number of double bonds per molecule of cyclohexene.

DEGRADATION EXPERIMENTS EMPLOYED IN THE DETERMINATION OF THE CARBON-¹⁴ DISTRIBUTION IN C-¹⁴ CYCLOHEXENE.

In these experiments cyclohexene was degraded to adipic acid and the acid was then converted to cyclopentanone. The preparation of the adipic acid has been described in the previous section. A second method to determine the C¹⁴ distribution was also tried in this scheme, and it is described in the second section.

1. Preparation of cyclopentanone from adipic acid(25,55)

2g. of adipic acid were dissolved in water and titrated with sodium hydroxide solution until the solution was slightly alkaline to phenolphthalein. 3g. of "Analar" calcium chloride were added, and the volume of the solution was reduced on a steam bath to approximately 15 ml. The calcium adipate was filtered off under suction whilst it was still hot, and then dried in a vacuum desiccator over phosphorus pentoxide. (Yield of Ca salt = 2.90g. Theory for anhydrous salt = 2.51g.)

The salt was packed into a clean dry Pyrex tube 8 x 100 mm. fitted with a 6 mm. delivery tube, and heated slowly in an oven up to ~400°C. Cyclopentanone distilled into a test tube immersed in ice and after three hours the pyrolysis was stopped. A solution of 4g. of sodium bisulphite in 6 ml. of water was added to the distillate and the crystalline solid, produced on shaking, was cooled in ice overnight, and then filtered, and dried. Yield of bisulphite compound = 1.1734g. (52.5%).

To regenerate the ketone for C¹⁴ activity determinations, the bisulphite compound was shaken with a solution of 2.5g. "Analar" potassium carbonate in 10 ml. water and extracted with 4 x 4 ml. ether. The ethereal solution was dried with a small amount of magnesium sulphate. The ether was removed by distillation and the cyclopentanone was vacuum distilled in a microdistillation apparatus (56). A portion of the cyclopentanone was characterised by preparing the semi-carbazone compound and also by burning a sample in the combustion tube and determining the carbon content. M.P. of cyclopentanone semi-carbazone = 210°C - 212°C. (210°C.) CO₂ yield = 100.0% of cyclopentanone.

2. Preparation of Dibromobutane from Adipic Acid.

A second method was tried for the removal of the carboxyl carbon atoms in adipic acid, based on the procedure suggested by H. Schmid (57).

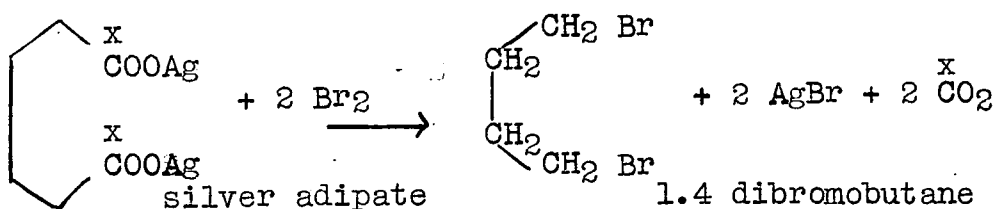

It has been explained previously in Chapter 1, Part 2 that the removal of one or two of the carboxyl carbon atoms of adipic acid, obtained from C¹⁴cyclohexene, before, and after the exchange reaction, would make it possible for any double bond migration in cyclohexene, during the exchange reaction, to be detected. This method, to be explained,

involved the removal of both carboxyl atoms of adipic acid, by the reaction of dry bromine on silver adipate, to produce 1.4 dibromobutane which was collected and purified. The carbon dioxide liberated according to the equation was also collected.

2g. of adipic acid were converted to the silver salt according to the method of Hoot and Kobe (52).

5g. of dry silver adipate were then treated with dry bromine in "Analar" carbon tetrachloride under anhydrous conditions according to the method suggested by Schmid. The carbon dioxide produced in this reaction was carried into a carbonate free solution of barium hydroxide (58) by a stream of purified nitrogen in the apparatus illustrated below. The precipitated barium carbonate was collected, and washed with carbonate free distilled water, and then finally dried at 140°C.

Fig. 5

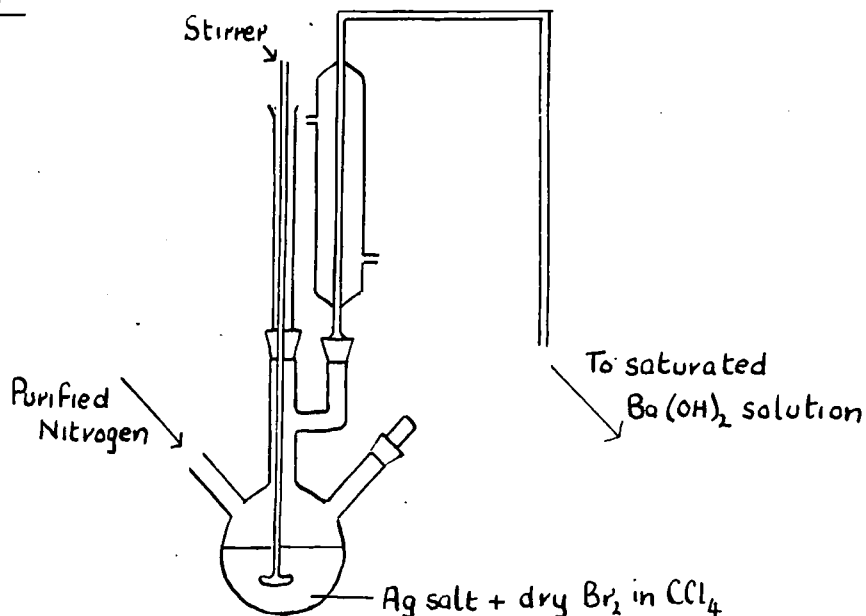

By collecting the barium carbonate, and determining its specific activity, and by determining the specific activity of the dibromobutane, the sum of these two activities should be equal to the activity of the original adipic acid.

The barium carbonate C^{14} activity was determined by measuring the activity of the carbon dioxide produced when the barium carbonate was decomposed with concentrated sulphuric acid. The apparatus used for this purpose (59) was attached to one end of the combustion train and the carbon dioxide collected in traps surrounded by liquid oxygen.

Dibromobutane was burnt in the combustion apparatus in the usual way and the activity of the carbon dioxide collected was estimated by the gas counting method.

The results of these experiments are shown in the following tables.

TABLE 45. Yields from 2g. adipic acid.

Substance	Wt. of substance.	% age of theoretical yield.
Silver adipate.	4.8002g.	99.6%
1.4 Dibromobutane.	0.2102g.	7.0%
Barium carbonate.	1.0071g.	18.5%

Br_2 content of 1.4 Dibromobutane - Stepanow Method (74) = 72.7% (74.0%).

TABLE 46. C¹⁴ Analysis of Dibromobutane, Barium Carbonate and Adipic Acid.

Substance	CO ₂ Yield.	No. of C ¹⁴ atoms per g. Mol. of substance.
Adipic Acid	101.6%	738 x 10 ¹⁶
1.4 Dibromo Butane	106.9%	1.02 x 10 ¹⁶
Barium Carbonate	96.61%	2.84 x 10 ¹⁶

Since 1 molecule of adipic acid yields 2 mols. of BaCO₃, then from the results of Table 46 the adipic acid should have 6.60 x 10¹⁶ C¹⁴ atoms per g. mol. This figure was not in agreement with the value determined of 7.38 x 10¹⁶ C¹⁴ /g.mol. of adipic acid.

The low yields of the substances, 1.4 dibromobutane and barium carbonate, together with the inconsistency of the activity results, led to this method being abandoned in favour of the cyclopentanone method.

It is also possible for the bromine to react with the silver adipate to produce a five membered ring lactone - (δ-valero-lactone) (60). Slight contamination of the 1.4 dibromobutane with this substance would seriously affect the results.

Thermostatic Controller for the oven used in the exchange experiments.

A temperature controller was required to maintain the

temperature of the tubes used in the exchange experiments at 130°C. The method which was chosen for this task, involved the use of an energy regulator and a thermostat, so arranged within a circuit so that both the basic input, and the increment to the load could be separately adjusted. The use of this technique enabled the temperature to be maintained within $\pm 2^\circ\text{C}$ of 130°C. The system used was circuit F 102/3M to be found in "Sunvic" publication R.12b. A diagram of the circuit is shown below.

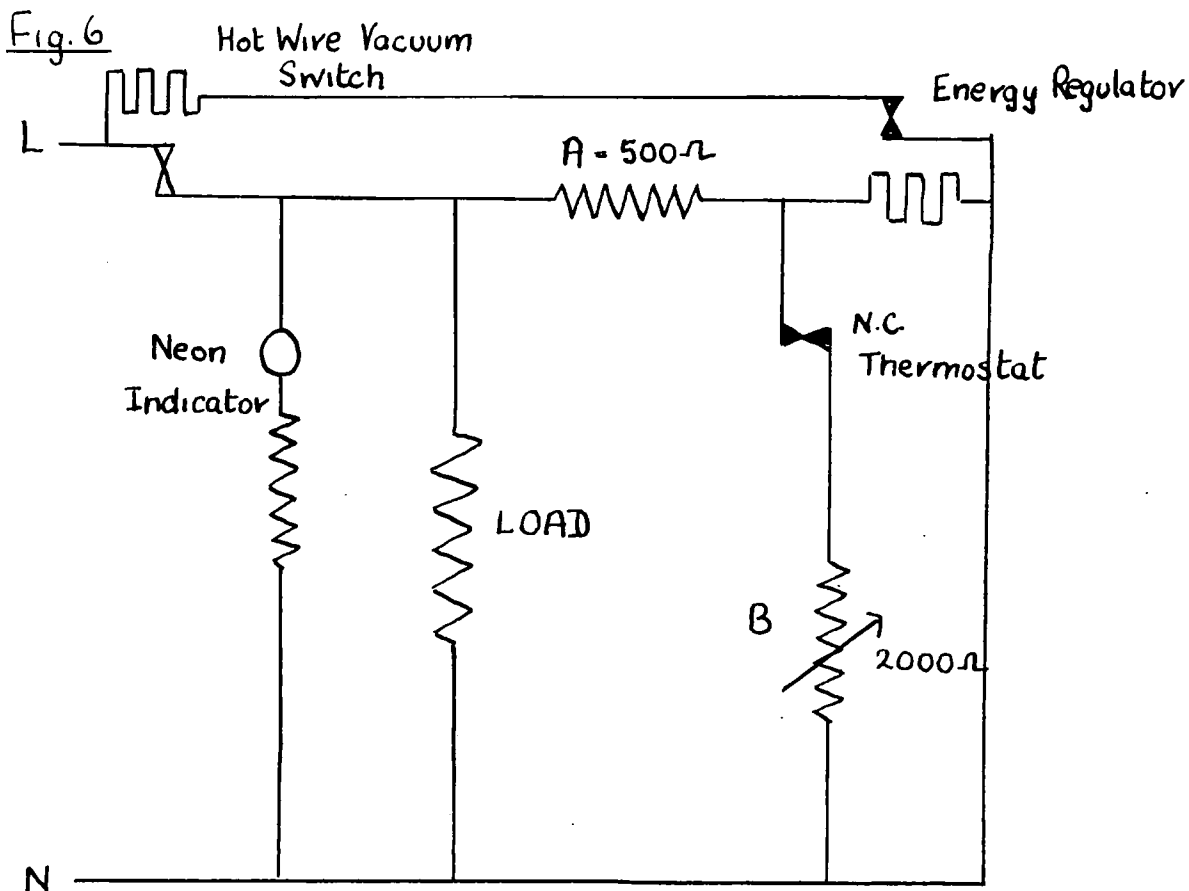

In this system the basic input to the load is controlled by the setting of the energy regulator and the variable resistance controls the increase or decrease in input when

the thermostat operates. The values of the resistances used to control the furnace winding of 125 Ω were

$$A = 500 \Omega \text{ } 10 \text{ W}$$

$$B = 2000 \Omega \text{ (variable).}$$

A neon indicator was placed in parallel across the load so that adjustment of the combined regulator could be made by timing the on/off ratio of the power supply to the load. The system was adjusted so that when the thermostat called for power the input increased by 20%.

SYNTHESIS OF C¹⁴ LABELLED CYCLOHEXENE.

The synthesis of C¹⁴ labelled cyclohexene was based, in the first part, on a procedure suggested by Loftfield for the preparation of 1-cyclohexanone-1C¹⁴. The second part of the synthesis involved the reduction of cyclohexanone to cyclohexanol which was then dehydrated to yield cyclohexene.

Before the synthesis was attempted using C¹⁴ active materials, the yields and purity of the products, at each stage in the procedure, were determined by using inactive substances. Attention was also paid to the dilution of the active substances at certain stages during, and at the end of the synthesis. In the first part, the yields were made up at each step, where necessary, to those observed by Loftfield. At the end of the synthesis the active cyclohexene was diluted with "aged" inactive cyclohexene to ensure that the disproportionation reaction would not occur, in the presence of the platinum catalyst, during the exchange reaction investigations.

The description of the synthesis is divided into three parts.

1. The preparation of Pimelic Acid- 1 - C¹⁴₂.
2. The preparation of 1-Cyclohexanone 1 - C¹⁴.
3. The preparation of Cyclohexene - C¹⁴.

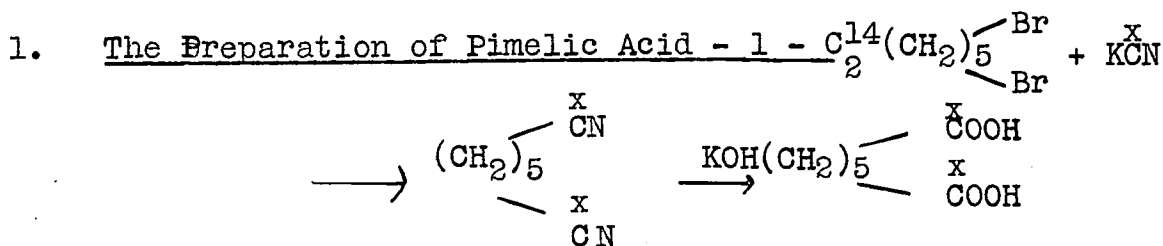

Penta methylene dibromide as supplied by Messrs. Light and Co.Ltd., was distilled and the fraction boiling between 220 and 222°C was collected. 0.1g of C¹⁴ active KCN was supplied by Harwell and a solution of the active potassium cyanide after diluting it with 2.50g. of inactive "Analar" potassium cyanide, was made up in 8ml. of distilled water.

4.60g. of pentamethylene dibromide were weighed into a 40 ml. flask and the active solution of potassium cyanide (0.5 millicurie), as prepared above, was added, together with 2 ml. methyl alcohol. The mixture was then refluxed for two days with stirring to prevent bumping. It was observed that the halide layer disappeared and a brownish oil separated out and floated on the aqueous layer. After two days refluxing a further 1.5g. of inactive potassium cyanide was added to the mixture and the reaction was continued for one more day. (This second addition of potassium cyanide caused the mixture to turn dark brown in colour, after about thirty minutes stirring). The methyl alcohol was then removed by distillation. As in the Loftfield procedure the pimelic nitrile was not isolated at this stage. A solution of 3g. of potassium hydroxide in 6 ml. water was added to the mixture which was then refluxed for a further eight hours. The potassium salts were then brought into solution by the addition of 80 ml. of distilled water. The aqueous solution was extracted with 3 x 30 ml. of ether and afterwards acidified with hydrochloric acid, and finally

continuously extracted with ether for 12 hours. The ethereal layer was evaporated cautiously to dryness and the residue was recrystallised from water to yield a white solid m.p. 98 - 102°C, (103°C) weight = 1.4640g.

Loftfield quoted a yield of 100% for the above reaction but this was never obtained. It was found necessary to add excess of hydrochloric acid before the continuous ether extraction because hydrochloric acid is slightly soluble in ether.

2. The Preparation of 1 - Cyclohexanone - 1 - C¹⁴.

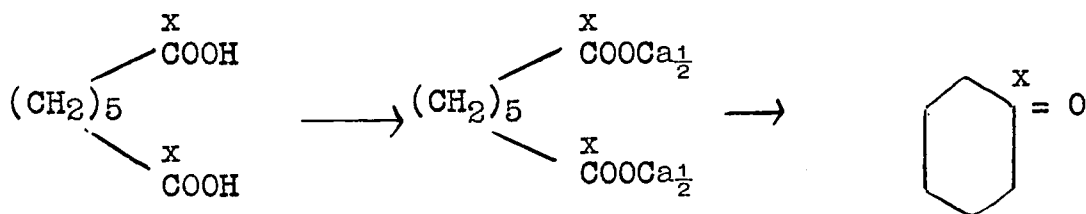

1.74g. of inactive pimelic acid, prepared by the same procedure as above except that inactive KCN was used, were added to the active acid from 1 and the mixture dissolved in 60 ml. water. The solution was made slightly alkaline to phenolphthalein by titrating with sodium hydroxide solution. 10g. of "Analar" hydrated calcium chloride were added to the sodium pimelate solution and the mixture concentrated on a steam bath to 30 ml. The white solid precipitate of calcium pimelate was filtered off under suction whilst it was still hot and dried over phosphorus pentoxide in a vacuum dessicator.

Wt. of Ca salt = 4.52g. (Theory for anhydrous salt 3.96g)

The calcium pimelate was packed into a "Pyrex" tube

10 x 200 mm. fitted with a 6 mm. delivery tube. The tube was then heated gradually up to a temperature of 500°C, over a period of about three hours, and the distillate was collected in a test tube which was cooled in ice. A solution of 4.0g. of sodium bisulphite in 6 ml. of distilled water was added to the distillate and the pale yellow crystalline derivative was cooled in ice overnight, filtered, and washed with ether.

The crystalline bisulphite compound was then shaken with a solution of 8g. of potassium carbonate, 30 ml. of water and 5g. of ordinary cyclohexanone, and the upper layer extracted with ether and dried with a little magnesium sulphate. After the ether was evaporated off the resultant cyclohexanone was vacuum distilled and diluted with inactive cyclohexanone to about 10g.

B.P. (atmospheric pressure) = 156 - 158°C (156.7°C).

3. The Preparation of C¹⁴ labelled cyclohexanol and cyclohexene

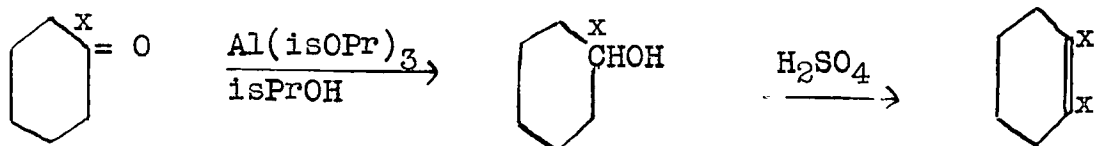

(a) Cyclohexanol.

The reduction of the cyclohexanone to cyclohexanol was carried out by a method similar to the method suggested in references 61,62,63 and known as the Meerwein-Ponndorf reduction. Purified cyclohexanol was then dehydrated to cyclohexene using the procedure described in "Organic Synthesis" (64).

9.62g. cyclohexanone were weighed into a 250 ml. round bottomed flask together with 20g. aluminium isopropoxide and 100 ml. of dry isopropyl alcohol. The isopropyl alcohol was dried by refluxing it with small pieces of lime for four hours and then distilling it. B.P. 82-83°C. (82.3°C).

The flask containing the mixture was fitted with a short vertical air condenser (25 cm. in length) and a water condenser was attached to the top of the air condenser at an angle of 45° to the vertical. Careful refluxing of the mixture on a water bath was then carried out for a short while with water running in the vertical condenser, and then the distillate was collected at a rate of 5 - 10 drops per minute after removing the water from the vertical condenser. Distillation was continued until the distillate no longer gave a yellow precipitate when one drop was added to about 5 ml. of a 0.1% solution of 2,4 dinitrophenylhydrazine in 21 ml. concentrated hydrochloric acid and 104 ml. distilled water. Refluxing was again carried out for about five minutes after which the distillate was tested once more as described above. When this test gave a negative result the solvents were removed by vacuum distillation. A white syrupy residue remained in the flask.

To this residue was added a mixture of 15 ml. concentrated hydrochloric acid in 100g. of cracked ice to decompose the aluminium derivative of cyclohexanol. The cyclohexanol, liberated by this process was extracted from

the residue with 4 x 40 ml. of ether. The ethereal solution was washed with a small volume of a saturated solution of sodium chloride and dried with some magnesium sulphate. After distilling off the ether, the product was vacuum distilled.

Yield of cyclohexanol = 5.35g. B.P.(atmospheric pressure) = 160 - 162°C (161.5°C). $M^{20} = 1.4650$ (1.4656).

(b) Cyclohexene.

About 6g. of inactive cyclohexanol were added to the active material prepared in (a) and distilled.

10.4g. of this cyclohexanol were weighed into a 50 ml. Claisen flask together with 0.30 ml. concentrated sulphuric acid. The mixture was distilled very slowly and the receiver was surrounded by a bath of ice to prevent loss of the cyclohexene. The temperature of the oil bath was maintained at about 130 - 140°C.

The distillate was saturated with salt and the cyclohexene layer separated from the water layer. Calcium chloride was used to dry the cyclohexene which was then distilled carefully, and the fraction boiling between 82-84.5°C (83°C) was collected.

$M^{21} = 1.4455$ ($M^{22} = 1.4451$) Double bond content = 0.99.

Yield = 5.82g.

10g. of inactive freshly distilled cyclohexene were added to the product and the mixture distilled again. The final product was diluted to about 30g. with inactive 'aged' cyclohexene.

To establish that the product was pure cyclohexene further experiments were carried out on this diluted active material. A sample of the substance was burnt in the combustion tube and the carbon content and the specific activity determined. About 5g. of the material was oxidised to adipic acid by the methods described in Chapter 1 and the C^{14} activity of the carbon dioxide produced was determined. The results from these experiments (Table 17) established that the cyclohexene could be oxidised to adipic acid with almost identical C^{14} content.



- 99.13% CO_2 yield. Specific Activity = 68.04 ± 0.70
of CO_2 counts/min./cm.
 CO_2 at $20^\circ C$.



- 101.6% CO_2 yield. Specific activity = 66.07 ± 0.68
of CO_2 counts/min./cm.
 CO_2 at $20^\circ C$.

Second method for the preparation of cyclohexanone.

A second method was tried for the preparation of cyclohexanone, based on a synthesis suggested by Grignard and Vignon (65). The reaction involved the preparation of the di-Grignard compound of pentamethylene dibromide which was then reacted upon by carbon dioxide to produce cyclohexanone.

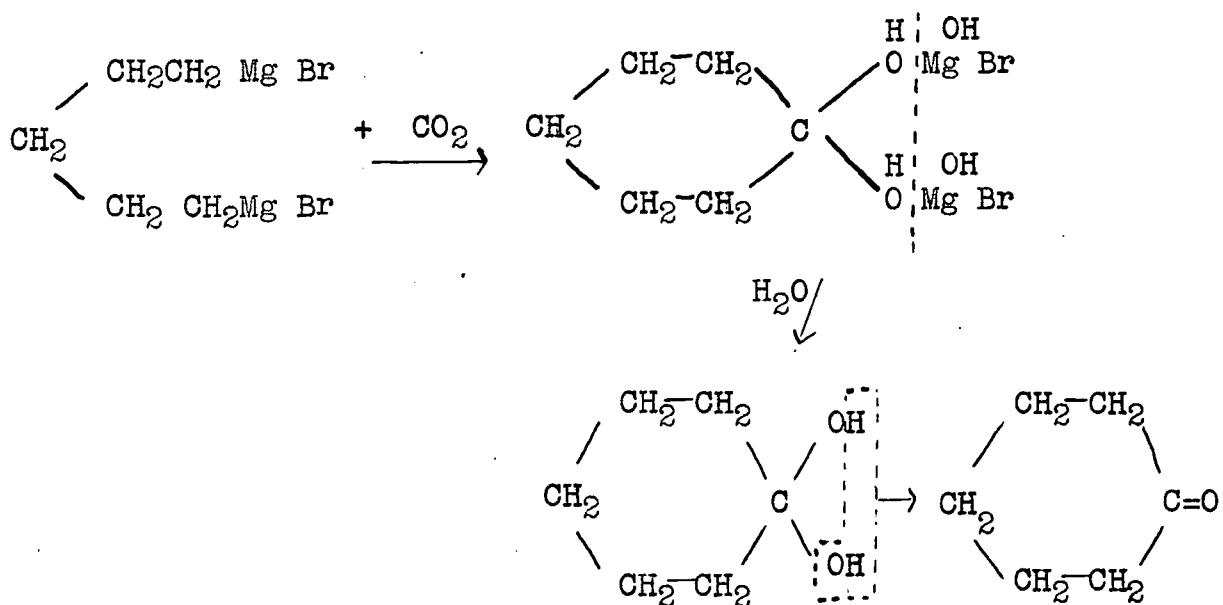

5g. of dry magnesium and 100 ml. dry ether were placed in a dry flask fitted with a reflux condenser, stirrer, and dropping funnel. Inside the dropping funnel were placed 20g. of pentamethylene dibromide, which was then added slowly to the mixture in the flask. The temperature of the flask was raised to 40-50°C and the mixture kept well stirred. A crystal of iodine was added to start the reactions and the addition of the alkyl halide was spread over a period of 3 hours. After this the mixture was then boiled for one hour and allowed to cool.

An amount of barium carbonate equivalent to about 10g. of CO₂ was decomposed with concentrated sulphuric acid and the carbon dioxide produced was carried into the mixture in the flask in a stream of nitrogen. The flask was surrounded by an ice bath during this addition. 75g. of ice were then added to the flask to hydrolyse the products. The mixture

was made slightly acid with hydrochloric acid and then slightly alkaline with sodium hydroxide solution before extracting with ether. Any cyclohexanone which has been produced should be in the ethereal layer.

The cyclohexanone was extracted from the ether with sodium bisulphite solution. To this solution was added potassium carbonate to decompose the bisulphite compound and it was finally extracted with ether. The ether was distilled off and the product was taken to be cyclohexanone.

Yield of product was 0.72g.

The low yield obtained in this reaction was probably due to the secondary reactions which can occur when the di-Grignard compound of pentamethylene dibromide is treated with carbon dioxide.

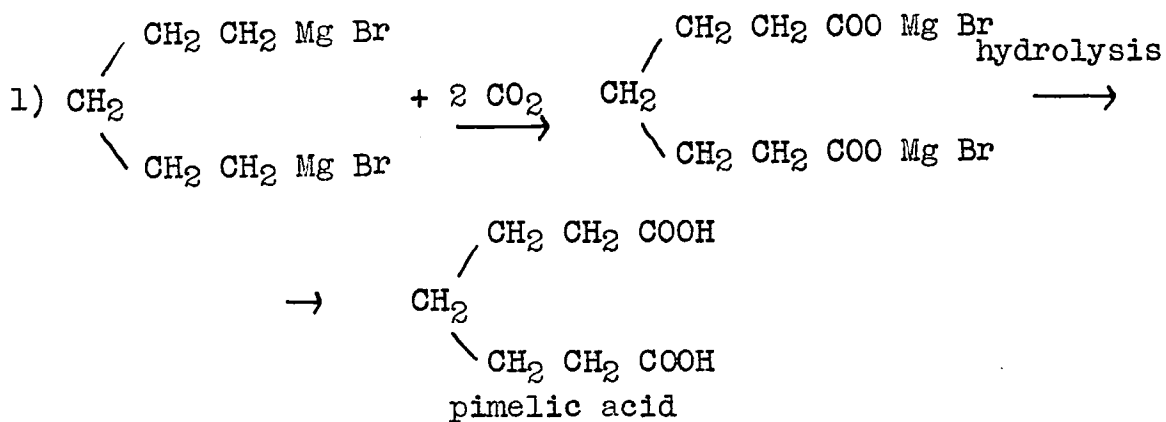

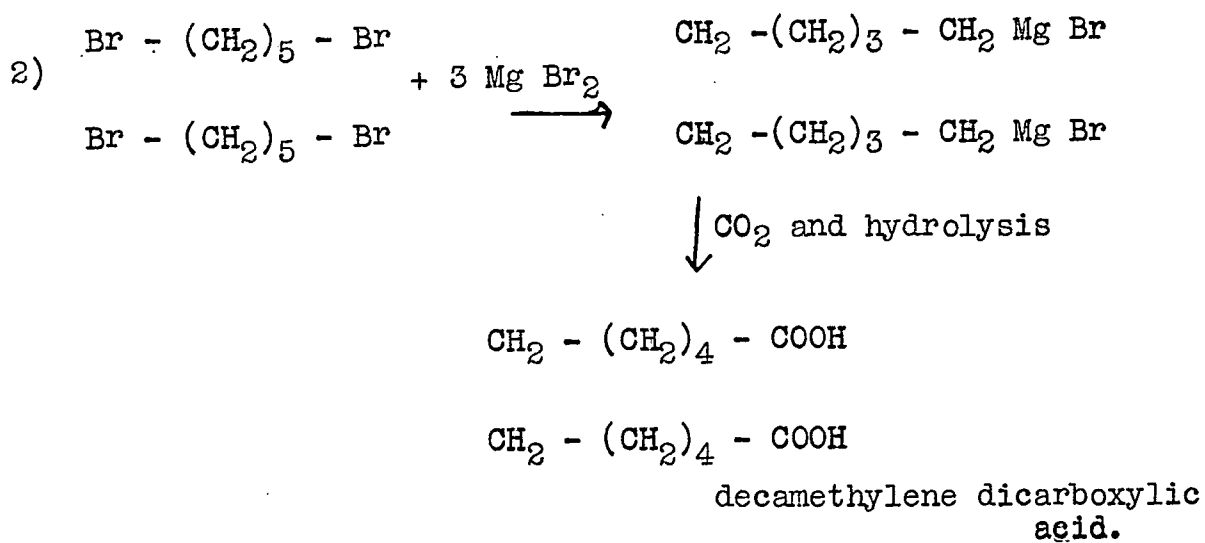

It was decided, in view of these drawbacks to this method, to use the method of Loftfield for the synthesis of cyclohexanone.

APPENDIX.

Calculations

1. Calculation of the double bond content of a sample of cyclohexene.

Table 2 - Double Bond Content of cyclohexene after the exchange reaction.

Weight of cyclohexene = 0.1907g.

Volume of bromine added to the cyclohexene = 34.11 ml.

Volume of sodium thiosulphate required for the titration of the excess bromine remaining = 18.32 ml.

Strength of sodium thiosulphate soln. = 0.02002N.

Standardisation of the bromine.

5.03 ml. of Br₂ soln. required 36.25 ml. of 0.02002N Na₂ S₂ O₃ soln.
∴ Strength of Br₂ solution = $\frac{36.25 \times 0.02002}{5.03}$
= 0.1442N.

Amount of bromine solution remaining = $\frac{18.32 \times 0.02002}{0.1442}$
after reaction with cyclohexene
= 2.54 ml.

∴ Amount of bromine absorbed by the cyclohexene = (34.11 - 2.54) ml.
= 31.57 ml.

lg.mol. of cyclohexene would require lg.mol. of bromine to saturate the double bond.

i.e., 82g. would require 2 litres N. bromine solution.

∴ Number of double bonds per molecule of cyclohexene in the above sample
= $\frac{31.57 \times 0.1442}{2000} \times \frac{82}{0.1907}$
= 0.98.

2. Calculation of the total number of tritium atoms transferred into lg. mol. of cyclohexene during the exchange reaction.

Table 3 - Tritium content of cyclohexene - sample 1.

Pressure of hydrogen in the counter = 7.92 cm. at 21.5°C.

Counts observed = 13,413 counts in 15 min.

$$\begin{aligned} \text{Error on the counts} &= \sqrt{\text{No. of counts}} \approx \sqrt{13,413} \\ &= 116 \end{aligned}$$

∴ True count = 13,413 ± 116 in 15 min.

$$\text{i.e.} = \underline{894.2 \pm 7.7 \text{ counts/min.}}$$

Dead Time = 500 μsec.

$$\begin{aligned} \text{Corrected Rate of Counting } R_1 &= \frac{R}{1 - R\tau} & R &= \text{Observed Rate} \\ & & \tau &= \text{Dead Time.} \end{aligned}$$

$$\begin{aligned} &\approx \frac{894.2}{1 - 894.2 \times \frac{500}{10^6 \times 60}} \\ &= \frac{894.2}{0.9925} = \underline{901.0 \pm 7.8 \text{ counts/min.}} \end{aligned}$$

Background Counting Rate.

4620 counts in 50 min. for 8.00 cm. at 24°C in counter.

4620 ± 58 counts in 50 min. " " " " " "

i.e. 92.4 ± 1.4 counts/min " " " " " "

$$= 92.4 \times \frac{7.92 \times 297}{8.00 \times 294.5}$$

= 92.3 ± 1.4 counts/min for 7.92 cm. at 21.5°C in the counter.

True Rate of counting after correcting for background and dead time.

$$= 901.0 - 92.3 \pm \sqrt{7.8^2 + 1.4^2}$$

= 808.7 ± 7.93 counts/min for 7.92 cm. at 21.5°C.

Counting rate for 1 cm. H₂ at 20°C.

$$= \frac{808.7}{7.92} \times \frac{1.00}{293.0} \times \frac{294.5}{293.0}$$

$$= \underline{\underline{102.5 \pm 1.0 \text{ counts/min/cm. H}_2 \text{ at } 20^\circ\text{C} \text{ in the counter.}}$$

Total number of tritium atoms in lg.mol. of cyclohexene.

Counter dimensions = 10.34 x 2.02 cm.

$$\text{Volume of counter} = \pi r^2 h = \pi \times (1.01)^2 \times 10.34 = \underline{\underline{33.13 \text{cc.}}}$$

Since lg.mol. of H₂ occupies 22,400 ccs. at 76 cm. pressure and 273°C.

∴ Number of g.mol. in 33.13 cc. at 1 cm. and 293°C

$$= \frac{1}{76} \times \frac{33.13}{22,400} \times \frac{273}{293}$$

Furthermore lg. mol. of H₂ contains 6 x 2 x 10²³ atoms of H at N.T.P.

∴ No. of atoms of H in 33.13 cc. at 1 cm. pressure and 293°C

$$= \frac{33.13}{22,400} \times \frac{1}{76} \times \frac{273}{293} \times 6 \times 2 \times 10^{23}$$

$$= \underline{\underline{2.18 \times 10^{19}}}$$

- $\frac{dN}{dt} = N\lambda$ i.e. Sp. Activity = No. of active atoms x disintegration constant

$$\lambda = \frac{0.693}{t_{\frac{1}{2}}} \quad t_{\frac{1}{2}} = \text{half life of the isotope.}$$

(For tritium $t_{\frac{1}{2}} = 12.5$ years).

∴ Number of active atoms in the counter

$$N = \frac{-dN}{dt} \times \frac{t_{\frac{1}{2}}}{0.693}$$

$$N = \frac{12.5 \times 365 \times 24 \times 60}{0.693} \times \text{Activity}$$

For cyclohexene above

$$N = \frac{12.5 \times 365 \times 24 \times 60}{0.693} \times 102.5$$

$$(1 \text{ cm. at } 293^\circ\text{C}) = 9.48 \times 10^6 \times 102.5$$

$$= \underline{\underline{9.72 \times 10^8}}$$

∴ Fraction of H atoms which is active in counter (and hence in cyclohexene)

$$= \frac{9.72 \times 10^8}{2.18 \times 10^{19}}$$

Since 1g. mol of cyclohexene yields 5g. mol. of H₂ or
5 x 2 x 6 x 10²³ atoms of H

∴ the number of active H atoms in 1g. mol. of cyclohexene

$$= \frac{9.72 \times 10^8 \times 5 \times 2 \times 6 \times 10^{23}}{2.18 \times 10^{19}}$$
$$= \underline{\underline{2.68 \times 10^{14}}}$$

3. Calculation of the distribution of tritium atoms in tritiated cyclohexene produced during the exchange reaction (Table 4)

(a) Number of tritium atoms in 1g. mol. of cyclohexene = 2.68 x 10¹⁴

(b) Calculation of No. of tritium atoms in 1g. mol. of adipic acid.

(Table 3) Specific activity of adipic acid = 77.67 counts/min./cm. of H₂ at 20°C in the counter.

No. of active H atoms in the counter = 9.48 x 10⁶ x 77.67

Total no. of H atoms in the counter = 2.18 x 10¹⁹

∴ Fraction of atoms (from adipic acid) which is active

$$= \frac{9.48 \times 10^6 \times 77.67}{2.18 \times 10^{19}}$$

1g. mol. of adipic acid yields 5g. mol. of H₂ i.e.

5 x 2 x 6 x 10²³ atoms of H

∴ No. of active H atoms in 1g. mol. of adipic acid

$$= \frac{9.48 \times 10^6 \times 77.67 \times 5 \times 2 \times 6 \times 10^{23}}{2.18 \times 10^{19}}$$
$$= \underline{\underline{2.03 \times 10^{14}}}$$

(c) Calculation of the no. of tritium atoms in lg. mol. of $\alpha\alpha'$ dibromo adipic acid.

(Table 3) Specific Activity of this acid = 61.20 counts/min./cm. of H_2 at 20°C in the counter.

∴ No. of active H atoms in the counter = $9.48 \times 10^6 \times 61.20$

Total no. of H. atoms in the counter = 2.18×10^{19}

∴ Fraction of atoms from $\alpha\alpha'$ dibromo adipic acid which are active

$$= \frac{9.48 \times 10^6 \times 61.20}{2.18 \times 10^{19}}$$

1 g. mol. of $\alpha\alpha'$ dibromo adipic acid yields 4g. mol. of H_2
i.e., $4 \times 2 \times 6 \times 10^{23}$ atoms of H

∴ No. of active H atoms in lg. mol. of $\alpha\alpha'$ dibromoadipic acid

$$= \frac{9.48 \times 10^6 \times 61.20 \times 4 \times 2 \times 6 \times 10^{23}}{2.18 \times 10^{19}}$$

$$= \underline{\underline{1.28 \times 10^{14}}}$$

The series of degradation reactions were

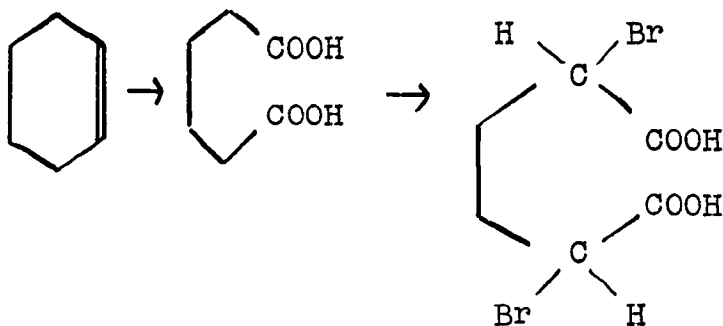

i.e. lg. mol. of cyclohexene yields lg. mol. of adipic acid
which in turn would yield lg. mol. of $\alpha\alpha'$ dibromoadipic acid.

Number of Tritium atoms in CH = CH positions in cyclohexene.

$$= (2.68 - 2.03) \times 10^{14}$$

$$= \underline{\underline{0.65 \times 10^{14}}}$$

Number of Tritium atoms in 4 α and 4 β positions in cyclohexene ring.

Let the number of T atoms in each β position = b

\therefore total T atoms in 4 β positions = $4b$.

\therefore the no of tritium atoms in the 4 α positions = $2.03 \times 10^{14} - 4b$
 half of these are removed in the bromination of adipic acid

$$\therefore 4b + \frac{1}{2} (2.03 \times 10^{14} - 4b) = 1.28 \times 10^{14}$$

$$4b + 1.015 \times 10^{14} - 2b = 1.28 \times 10^{14}$$

$$\therefore \underline{4b = 0.53 \times 10^{14}}$$

Hence no. of Tritium atoms in 4 α positions = $(2.03 - 0.53) \times 10^{14}$
 $= \underline{\underline{1.50 \times 10^{14}}}$

\therefore Distribution of tritium in cyclohexene ring for 1g.mol. is

CH = CH posns.	Total in 4 α posns.	Total in 4 β posns.
0.65×10^{14} atoms	1.50×10^{14} atoms.	0.53×10^{14} atoms of tritium.

4. Calculation of the total number of C¹⁴ atoms in 1g.mol. of synthesised C¹⁴ cyclohexene.

Table 7. C¹⁴ Specific Activity of Cyclohexene = 20.14 ± 0.15 counts/min/cm. of CO₂ at 20°C in the counter.

$$-\frac{dN}{dt} = N \lambda$$

$$\therefore N = \frac{dN}{dt} \frac{1}{\lambda} = \frac{dN}{dt} \frac{t_{\frac{1}{2}}}{0.693} \quad t_{\frac{1}{2}} \text{ for C}^{14} = 4500 \text{ years} \\ = 4500 \times 365 \times 24 \times 60 \text{ min.}$$

$$\frac{dN}{dt} = 20.14$$

\therefore Number of C¹⁴ atoms in the counter

$$= \frac{4500 \times 365 \times 24 \times 60}{0.693} \times 20.14$$

$$= \underline{3.414 \times 10^9} \times 20.14$$

$$= \underline{\underline{6.87 \times 10^{10}}}$$

Volume of counter = 33.13cc.

1g.mol. CO₂ occupies 22,400 cc. at N.T.P.

∴ No. of g.mol. of CO₂ in 33.13cc. at 1 cm. pressure and 20°C.

$$= \frac{33.13}{22,400} \times \frac{1}{76} \times \frac{273}{293}$$

Furthermore 1g.mol. of CO₂ contains 6×10^{23} atoms of C at N.T.P.

∴ No. of atoms of C in 33.13cc. at 1 cm. pressure and 20°C.

$$= \frac{33.13}{22,400} \times \frac{1}{76} \times \frac{273}{293} \times 6 \times 10^{23}$$

$$= 1.10 \times 10^{19}$$

∴ Fraction of C atoms which are active = $\frac{6.87 \times 10^{10}}{1.10 \times 10^{19}}$

Since 1g.mol. of cyclohexene yields $6 \times 22,400$ cc. CO₂ at N.T.P

i.e. $6 \times 6 \times 10^{23}$ atoms of carbon

∴ the number of active carbon¹⁴ atoms in 1g. mol. of cyclohexene

$$= \frac{6.87 \times 10^{10}}{1.10 \times 10^{19}} \times 6 \times 6 \times 10^{23}$$

$$= \underline{\underline{2.25 \times 10^{16}}}$$

5. Calculation of the distribution of carbon¹⁴ atoms in synthesised C¹⁴cyclohexene.

(a) Number of tritium atoms in 1g. mol. of cyclohexene = $\frac{2.25 \times 10^{16}}{16}$

(b) Calculation of the no. of C¹⁴ atoms in 1g.mol. of adipic acid.

(Table 6) Specific Activity of Adipic Acid = 19.10 counts/min./
cm. of CO₂ at 20°C in
the counter.

$$-\frac{dN}{dt} = N\lambda \quad N = \frac{dN}{dt} \frac{t}{0.693}$$

Number of C¹⁴ atoms in the counter

$$= \frac{19.10 \times 4500 \times 365 \times 24 \times 60}{0.693}$$

$$= \underline{\underline{6.52 \times 10^{10}}}$$

Total number of carbon atoms in the counter containing 1cm.
pressure of CO_2 at 20°C = 1.10×10^{19}

$$\begin{aligned} \therefore \text{Fraction of atoms in the counter which are active } \text{C}^{14} \text{ atoms} \\ = \frac{6.52 \times 10^{10}}{1.10 \times 10^{19}} \end{aligned}$$

Since 1g. mol. of adipic acid yields $6 \times 22,400$ cc. CO_2 at
N.T.P. i.e. $6 \times 6 \times 10^{23}$ atoms of carbon

$$\begin{aligned} \therefore \text{the number of active carbon}^{14} \text{ atoms in 1g. mol. of} \\ \text{adipic acid} \\ = \frac{6.52 \times 10^{10}}{1.10 \times 10^{19}} \times 6 \times 6 \times 10^{23} \\ = \underline{2.13 \times 10^{16}} \end{aligned}$$

(c) Calculation of the no. of C^{14} atoms in 1g. mol. of
cyclopentanone

(Table 7) Specific Activity of cyclopentanone = 11.46 counts/
min./cm. of CO_2 at 20°C in the counter.

Number of C^{14} atoms in the counter

$$\begin{aligned} = 11.46 \times \frac{4500 \times 365 \times 24 \times 60}{0.693} \\ = 3.91 \times 10^{10} \end{aligned}$$

Total number of carbon atoms in the counter containing 1cm.
pressure of CO_2 at 20°C . = 1.10×10^{19}

$$\begin{aligned} \therefore \text{Fraction of atoms in the counter which are active } \text{C}^{14} \text{ atoms} \\ = \frac{3.91 \times 10^{10}}{1.10 \times 10^{19}} \end{aligned}$$

Since 1g. mol. of cyclopentanone yields $5 \times 22,400$ cc. CO_2 at
N.T.P. i.e. $5 \times 6 \times 10^{23}$ atoms of carbon

∴ the number of active carbon¹⁴ atoms in lg. mol. of cyclopentanone

$$= \frac{3.91 \times 10^{10}}{1.10 \times 10^{19}} \times 5 \times 6 \times 10^{23}$$

$$= \underline{1.07 \times 10^{16}}$$

∴ In lg.mol. of cyclohexene	2.25 × 10 ¹⁶	C ¹⁴ atoms	}	-Table 7.
lg.mol. adipic acid	2.13 × 10 ¹⁶	C ¹⁴ atoms		
lg.mol. cyclopentanone	1.07 × 10 ¹⁶	C ¹⁴ atoms.		

6. Calculation of the standard deviations on the cyclopentanone activity results.- Table 15 - Chapter 1.

In the determination of the specific activities of the cyclopentanone produced from C¹⁴ cyclohexene before and after the exchange reaction, the probable change of specific activity of the cyclopentanone calculated from the results shown in Table 11 was about 4%. Because of this low figure it was decided to determine the specific activity of the cyclopentanone as many times as possible so as to reduce the error on the determination.

The standard deviation, which is a measure of the reliability of a result, is given by $\sigma^2 = \frac{\sum(\bar{x} - x_i)^2}{n}$

where σ = standard deviation

\bar{x} = arithmetic mean of a series of measurements of x_i ;

n = number of results taken into the mean.

The following tables and calculations demonstrate the calculation of one of these results. All of the other results shown in the Table 15 were calculated in a similar manner.

Calculation of the standard deviation on the cyclopentanone results before the exchange reaction sample 1 and sample 2.

Specific Activity of the Cyclopentanone (Counts/min/10cm. of CO ₂ at 20°C)			
Number of counter filling.	Counts/min. observed (Corrected).	$\bar{x} - x_i$	$(\bar{x} - x_i)^2$
1.	149.4	-0.4	0.16
	148.6	+0.4	0.16
2.	149.4	-0.4	0.16
	148.7	+0.3	0.09
3.	149.8	-0.8	0.64
	147.5	+1.5	2.25
4.	149.1	-0.1	0.01
	147.5	+1.5	2.25
5.	148.4	+0.6	0.36
	150.3	-1.3	1.69
6.	151.6	-2.6	6.76
	149.1	-0.1	0.01
7.	148.5	+0.5	0.25
8.	147.5	+1.5	2.25
	149.6	-0.6	0.36

66

$$\bar{x} = 2235.0 \div 15 = 149.0 \quad \sum = 17.40$$

$$\frac{\sum (\bar{x} - x_i)^2}{n} = \frac{17.40}{15} = 1.16 = \sigma^2$$

$$\therefore \sigma = \underline{\underline{1.08}}$$

∴ Standard deviation on this determination =

$$1.08 \quad \therefore \text{result is } \underline{\underline{149.0 \pm 1.08.}}$$

Specific Activity of Background Determinations (Counts/min/10cm. of CO ₂ at 20°C.			
Number of counter filling.	Counts/min. observed. (Corrected)	$\bar{x} - x_i$	$(\bar{x} - x_i)^2$
1.	35.29	-0.74	0.55
2.	34.57	-0.02	0.00
3.	33.10	+1.45	2.10
4.	32.60	+1.95	3.80
5.	35.67	-1.12	1.25
6.	35.22	-0.67	0.45
7.	35.39	-0.84	0.71

$$\bar{x} = 241.84 \div 7$$

$$= 34.55$$

$$\sum = 8.86$$

$$\sum \left(\frac{\bar{x} - x_i}{n} \right)^2 = \frac{8.86}{7} = 1.27 = \sigma^2$$

$$\therefore \sigma = \underline{1.13}$$

∴ Correct result is 34.55 ± 1.13

∴ Resultant error on the cyclopentanone result after subtraction of the background count

$$= 149.0 - 34.55 \pm \sqrt{1.08^2 + 1.13^2}$$

$$= 114.45 \pm \sqrt{2.43}$$

$$= 114.45 \pm 1.56$$

This result is for 10 cm. of CO₂ at 20°C in the counter

∴ Specific Activity for 1 cm.

$$= \underline{11.45 \pm 0.16 \text{ counts/min/cm. of CO}_2 \text{ at } 20^\circ\text{C in the counter.}}$$

7. Calculation, from the tritium activity figures, of the probable amount of double bond movement occurring during the exchange reaction.

In Table 11. Specific Activity of hydrogen from cyclohexene
 = 139.25 ± 0.95 counts/min./cm. of H₂ at 20°C in the counter.

Contents of the tube in this experiment were

- Catalyst 0.0545g.
- Tritiated Water 0.4196g.
- Acetic Acid 1.1358g.
- Active Cyclohexene 2.0044g.

- (1) Calculation of the tritium distribution in cyclohexene.

$$-\frac{dN}{dt} = N\lambda \quad N = \frac{dN}{dt} \frac{t}{0.693}$$

Number of tritium atoms in the counter

$$= \frac{139.25 \times 12.5 \times 365 \times 24 \times 60}{0.693}$$

$$= 1.32 \times 10^9$$

Total number of H atoms in the counter (Calculation 2)

$$= 2.18 \times 10^{19}$$

∴ Fraction of atoms in the counter which is active

$$= \frac{1.32 \times 10^9}{2.18 \times 10^{19}}$$

∴ Number of tritium atoms in 1g.mol. of cyclohexene

$$= \frac{1.32 \times 10^9}{2.18 \times 10^{19}} \times 60 \times 10^{23}$$

$$= 3.63 \times 10^{14}$$

From calculation 3 the fraction of these tritium atoms which

will be in the 4 α positions (assuming the same distribution of the tritium in the cyclohexene ring) is

$$\frac{1.50 \times 10^{14}}{2.68 \times 10^{14}} = \underline{\underline{0.5598}}$$

(2) Calculation of the number of hydrogen atoms in cyclohexene which have exchanged. (Isotope effect neglected in this particular calculation).

Before the exchange the mixture is

- a)  with no tritium
 b) HTO, H₂O,
 c) CH₃ COOH, CH₃ COOT

After the exchange the mixture is

- a)  with tritium
 b) depleted tritium in HTO, H₂O
 c) depleted tritium in CH₃ COOH,
 CH₃ COOT
 d) tritium in CH₂T.COOH, CH₃ COOH

During the exchange reaction it is assumed that 1. a atoms come from cyclohexene and exchange.

2. hydrogen atoms come from HTO. H₂O mixture into the mixture
3. hydrogen atoms come from H in COOH of CH₃ COOH
4. 2a atoms come from the methyl group in acetic acid.

The last postulate is taken from the deuterium work described in reference 8.

∴ the total number of hydrogen atoms in the exchanging mixture is

$$\begin{aligned} & a + f_{\text{H}_2\text{O}} + f_{\text{HAc}} + 2a \\ & = 3a + f_{\text{H}_2\text{O}} + f_{\text{HAc}} \end{aligned}$$

f_{H₂O} In exchange mixture 0.4196g. of HTO, H₂O were in the tube

$$\begin{aligned} \therefore \text{ number of H atoms} &= \frac{0.4196}{18} \times 12 \times 10^{23} \\ &= \underline{\underline{2.80 \times 10^{22}}} \end{aligned}$$

f_{HAc} In exchange mixture 1.1388g. of acetic acid were in the tube

$$\begin{aligned} \therefore \text{ number of H atoms from COOH in acetic acid} &= \frac{1.1388}{60} \times 6 \times 10^{23} \\ &= \underline{1.14 \times 10^{22}} \end{aligned}$$

$$\begin{aligned} \therefore \text{ total number of hydrogen atoms in the exchanging mixture} \\ &= \underline{3a + 3.94 \times 10^{22}} \end{aligned}$$

The tritium atoms which are present in this exchange mixture have come originally from the tritiated water solution which had an activity of 633.7 x 25 counts/min./cm. of H₂ in the counter at 20°C (Table 3)

$$-\frac{dN}{dt} = N\lambda \quad N = -\frac{dN}{dt} \lambda$$

∴ Number of tritium atoms in the counter from this tritiated water solution

$$\begin{aligned} &= \frac{633.7 \times 25 \times 12.5 \times 365 \times 24 \times 60}{0.693} \\ &= \underline{1.50 \times 10^{11}} \end{aligned}$$

Total number of hydrogen atoms in the counter

$$= 2.18 \times 10^{19}$$

∴ Fraction of atoms which is active tritium

$$= \frac{1.50 \times 10^{11}}{2.18 \times 10^{19}}$$

∴ total number of hydrogen atoms in 0.4196g. water which are tritium

$$\begin{aligned} &= \frac{1.50 \times 10^{11}}{2.18 \times 10^{19}} \times \frac{0.4196}{18} \times 12 \times 10^{23} \\ &= \underline{1.92 \times 10^{14}} \end{aligned}$$

Hence the fraction of tritium atoms in the exchanging mixture

$$= \frac{1.92 \times 10^{14}}{3a + 3.94 \times 10^{22}}$$

The number of tritium atoms which go into the cyclohexene

$$= a \times \left(\frac{1.92 \times 10^{14}}{3a + 3.94 \times 10^{22}} \right)$$

It was observed, as the results in Table 11 show, that 1g.mol. of cyclohexene contained 3.63×10^{14} atoms of tritium

∴ in 2.0044g. there are

$$\frac{2.0044}{82} \times 3.63 \times 10^{14} \text{ atoms of tritium}$$

$$= \frac{8.89 \times 10^{12} \text{ atoms of tritium}}{\left(\frac{1.92 \times 10^{14}}{3a + 3.94 \times 10^{22}} \right)}$$

$$= a \times \left(\frac{1.92 \times 10^{14}}{3a + 3.94 \times 10^{22}} \right)$$

$$\therefore 1.92 \times 10^{14} a = (8.87 \times 10^{12})(3a + 3.94 \times 10^{22})$$

$$1.92 \times 10^{14} a = 26.61 \times 10^{12} a + 3.49 \times 10^{35}$$

$$1.65 \times 10^{14} a = 3.49 \times 10^{35}$$

$$\therefore a = \underline{\underline{2.12 \times 10^{21}}}$$

(3) Calculation of the amount of double bond movement.

In this calculation it is assumed that the tritium atoms which appear in the 4α positions of the cyclohexene molecule have been introduced by the double bond movement mechanism outlined in the associative mechanism and described in Chapter 1. Again, in this particular calculation, the isotope effect is neglected.

e.g. in the half hydrogenated state.

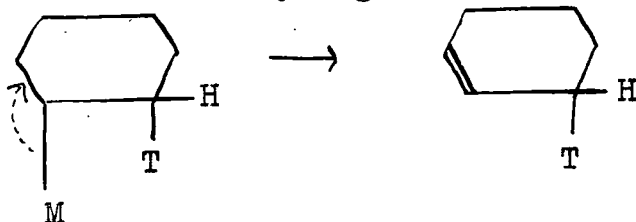

It is also assumed that 1 tritium atom in the α position appears there as a result of 1 molecule of cyclohexene exchanging. In the first part of this calculation it has been shown that the fraction of the total number of tritium atoms in cyclohexene in the α positions = 0.56.

. . the number of hydrogen atoms which have exchanged and given activity in α positions

$$\begin{aligned} &= \frac{0.56 \times 2.12 \times 10^{21}}{1} \\ &= \underline{1.19 \times 10^{21}} \end{aligned}$$

This figure also represents the number of molecules which have exchanged and produced tritium in the α positions i.e. the number of molecules in which double bond movement has occurred.

Total number of molecules which are present in the exchange solution

$$\begin{aligned} &= \frac{2.0044}{82} \times 6 \times 10^{23} \\ &= \underline{1.47 \times 10^{22}} \end{aligned}$$

. . Fraction of molecules in which double bond movement occurs

$$= \frac{1.19 \times 10^{21}}{1.47 \times 10^{22}} = 0.0816.$$

. . percentage of molecules in which double bond movement occurs

$$= \underline{8.2\%}$$

Calculation to determine the number of molecules of cyclohexene decomposed by the β radiation from C^{14} .

C^{14} $E_{\max.}$ for β rays = 0.15 Mev.

\therefore Average energy will be ~ 0.08 Mev.

Average energy of a C - H bond is 80 K cal./mole.

$$= \frac{80 \times 1000 \times 4.18 \times 10^7}{6 \times 10^{23}} \text{ ergs/C - H bond.}$$

$$= \frac{33.44}{6} \times 10^{-12}$$

$$= \underline{\underline{5.57 \times 10^{-12}}} \text{ ergs/C - H bond.}$$

If the activity of the sample is 1 millicurie

i.e., 3.7×10^7 disintegrations/sec. are occurring

Average energy of β ray is 0.08 Mev.

1 ev. = 1.6×10^{-12} ergs.

\therefore energy of β rays = $0.08 \times 10^6 \times 1.6 \times 10^{-12}$ ergs.

$$= \underline{\underline{0.13 \times 10^{-6}}} \text{ ergs.}$$

\therefore In sample which is 1 millicurie the number of bonds which could be ruptured/sec.

$$= 3.7 \times 10^7 \times \frac{0.13 \times 10^{-6}}{5.6 \times 10^{-12}}$$

$$= \underline{\underline{8.6 \times 10^{11}}} \text{ bonds/sec.}$$

It is highly likely that in order to break a C - H bond something like 1.5 times as much energy as the bond energy will be required.

i.e. in 1 mole. 120 K cal.

∴ the number of C - H bonds broken with an activity of 1 millicurie will be

$$8.6 \times 10^{11} \times \frac{80}{120} = \underline{\underline{5.7 \times 10^{11} / \text{sec.}}}$$

If there is 1 mole of active cyclohexene

i.e., 6×10^{23} mol.

∴ No. of seconds required to break a C - H bond in every molecule will be

$$\frac{6 \times 10^{23}}{5.7 \times 10^{11}} = \underline{\underline{1.05 \times 10^{12} \text{ sec.}}}$$

∴ Time required in years

$$\begin{aligned} &= \frac{1.05 \times 10^{12}}{365 \times 24 \times 60 \times 60} \\ &= \frac{1.05}{3.15} \times \frac{10^{12}}{10^7} \\ &= \underline{\underline{3.3 \times 10^4 \text{ years.}}} \end{aligned}$$

BIBLIOGRAPHY

1. Wahl and Bonner, "Radioactivity applied to Chemistry", J. Wiley and Sons Inc., New York, 1951. p.7.
2. Kamen, "Radioactive Tracers in Biology", Academic Press Inc., New York, 1947.
3. Turkevich and Smith, J. Chem. Phys., 1948, 16, 466.
4. Bell, Macdonald, and Reed, J.C.S., 1953, 3459-63.
5. Dobeler and Taylor, J.Chem.Phys., 1948, 16, 4008.
6. Horiuti and Polanyi, Trans. Faraday Soc., 1934, 30, 1164.
Twigg and Rideal, Proc. Roy. Soc., 1939, A171, 55.
Jenkins and Rideal, J.C.S. 1955, 2490.
7. Bell and Thomson, J.C.S. 1952, 572.
8. S.J. Thomson, Ph.D. Thesis, Glasgow, 1951.
9. Kamen, "Radioactive Tracers in Biology, " Academic Press Inc., New York, 1947.
10. Wahl and Bonner, "Radioactivity applied to Chemistry," J. Wiley and Sons Inc., New York, 1951, p.2-5.
11. Beeck, Discuss. Faraday Soc., 1950, 8, 118.
12. idem, Rev.Mod.Physics, 1945, 17, 61.
13. Zelinsky and Pawlow, Ber., 1924, I, 1066.
Zelinsky ibid., 1925, I, 185.
Zelinsky and Pawlow, ibid., 1933, II, 1420.
14. Jones, Phys. Review, 1951, 83, 537.
Jenks, Ghormley and Sweeton, ibid., 1949, 75, 701.
idem, ibid., 1950, 80, 990.
15. Farkas, Trans. Faraday Soc., 1939, 35, 906.
16. Eley, Quart. Reviews, 1949, 111, No.3, 209.
17. "Advances in Catalysis," Academic Press Inc., New York, Volumes 1 - VII.

18. Whitmore, J. Amer. Chem. Soc., 1932, 54, 3274.
19. idem. Chem. and Eng. News, 1948, 26, 668.
20. Bloch and Rittenberg, J. Biol. Chem., 1943, 149, 505.
21. Pregl, "Quantitative Organic Microanalysis," J. and A. Churchill, London, 1924.
22. Le Sueur, J.C.S. 1908, 93, 716.
Ingold, *ibid.*, 1921, 119, 951.
23. Kamen and Ruben, Phys. Review, 1940, 58, 194.
idem, *ibid.*, 1941, 59, 349.
24. Fries and Calvin, J. Amer. Chem. Soc., 1948, 70, 2235.
25. Loftfield, *ibid.*, 1951, 73, 4707.
26. Farmer and Sundralingham, J.C.S. 1942, 121.
27. Zelinsky and Borissow, Ber., 1930, II, 2362.
28. Stephens, *ibid.*, 1931, I, 637.
idem, J. Amer. Chem. Soc., 1928, 50, 568.
29. S.J. Thomson - Private Communication.
30. Glascock, "Isotopic Gas Analysis for Biochemists," Academic Press Inc., New York, 1954, p.129.
31. Thomas, Chem. and Eng. News, 1949, 41, 2564.
32. Annual Reports for 1943, 40, 107.
ibid., 1945, 42, 146.
33. Corson and Ipatieff, J. Amer. Chem. Soc., 1939, 61, 1056.
34. Dilke, Maxted, and Eley, Nature, 1948, 161, 804.
Trapnell, Proc. Roy. Soc., 1953, A, 218, 566.
35. Kamen, "Radioactive Tracers in Biology," Academic Press Inc., New York, 1947.
36. Graff and Rittenberg, Analyt. Chem., 1952, 24, 878.
37. Gurin and Delluva, J. Biol. Chem., 1947, 170, 545.
38. Mellor, "A Comprehensive Treatise on Inorganic and Theoretical Chemistry," Longmans, 1923, IV, p.291.

39. Glascock, *Nucleonics*, 1951, 9, No.5, 28.
40. Viillard, Corval, Grenon, Hermann, and Dreyfus-Alain, *Chimie Analytique*, 1954, 36, 102.
41. Eidinoff and Knoll, *Science*, 1950, 112, 250.
42. Payne and Done, *Nature*, 1954, 174, 27.
43. Röhringer and Broda, *Z. Naturforsch.*, 1953, 86, 159.
44. Brown and Miller, *Rev. Sci. Instr.*, 1947, 18, 496.
45. Wilzbach and Sykes, *Science*, 1954, 120, 494.
46. Audric and Long, *Nature*, 1954, 173, 992.
47. Calvin, "Isotopic Carbon," J. Wiley and Sons, Inc., New York, p.7.
48. J. Brown - Private Communication.
49. Vogel, "Text Book of Practical Organic Chemistry," Longmans, 1948, p.824, Method A.
50. Milas and Sussman. *J. Amer.Chem.Soc.*, 1936, 58, 1302.
idem, *ibid.*, 1937, 59, 2345.
51. Mugdan and Young, *J.C.S.* 1949, 2988.
52. Hoot and Kobe, *Ind.Eng.Chem.*, 1955, 47, 782.
53. Le Sueur, *J.C.S.*, 1908, 93, 716.
idem, *ibid.*, 1910, 97, 181.
54. Ingold, *ibid.*, 1921, 119, 951.
55. Ruzicka, Brugger, Pfeiffer, Schinz, and Stoll, *Helv. Chim. Acta*, 1926, 9, 515.
56. Weissberger, "Techniques of Organic Chemistry," Interscience Publishers, 1954, V1 p.79.
57. Schmid, *Hel. Chim.Acta*, 1944, 27, 127.
58. Lindenbaum, *Analyt.Chem.*, 1948, 20, 1120.
59. Brownell and Lockhart, *Nucleonics*, 1952, 10, 2, 26.
60. Kleinberg, *Chem.Reviews*, 1947, 40, 381.

61. Lundt, Ber., 1937, 70, 1520.
62. Ferrier, Compt. rend., 1945, 220, 460.
63. "Organic Reactions," J. Wiley and Sons, Inc., New York. Volume 2, p.178.
64. Gilman, "Organic Syntheses," Collective Volume 1, J. Wiley and Sons, Inc., New York, 1932, p.177.
65. Grignard and Vignon, Compt. rend., 1907, 144, 1359.
66. Pace, Kline, Schachman, and Harfenist, J. Biol.Chem., 1947, 168, 459.
67. Lescher, Analyt. Chem., 1949, 21, 1247.
68. Kamen, "Radioactive Tracers in Biology," Academic Press Inc., New York, 1947.
69. Norris, Ruben, and Allen, Ind. Eng.Chem.Anal.1946, 18, 420.
70. Glascock, "Isotopic Gas Analysis for Biochemists," Academic Press Inc., New York, 1954.
71. Melander, Acta Chem. Scand., 1948, 2, 440.
72. Glascock, "Isotopic Gas Analysis for Biochemists," Academic Press Inc., New York, 1954, p.132.
73. Arrol and Wilson, Private communication to Glascock, loc.cit.
74. Stepanow, Ber., 1906, 39, 4056.
75. Oblad, Milliken, and Mills, "Advances in Catalysis," Academic Press Inc., New York, Volume 111 p.199.
76. Trapnell, Quart. Reviews, 1952, 8, No.4, 404.
77. D.D. Eley, - Private Communication.
78. "Advances in Catalysis," Academic Press Inc., New York, Volume 111, p.9.
79. Eley and Rideal, Proc.Roy.Soc., 1941, A178, 429.
80. Willstätter, and Jacquet, Ber., 1918, 51, 767.
Willstätter, Waldschmidt and Leitz *ibid.*, 1921, 54, 113.
Skita, *ibid.*, 1922, 55, 139.
Hess, *ibid.*, 1913, 46, 4104.

81. Johansen, Linderstøm-Lang and Jacobsen, Compt.rend.
Trav.Lab. Carlsberg, 1938, 23, 17.
Linderstøm-Lang and Lanz, ibid., 1938, 21, 315.
82. Bigeleisen, J.Amer.Chem.Soc., 1953, 75, 2908.
83. Wiberg, Chem. Reviews, 1955, 55, 717.

