



## Durham E-Theses

---

### *A study of the settlements to the north of the vale of Pickering*

Musto, Naomi Muriel

#### How to cite:

---

Musto, Naomi Muriel (1962) *A study of the settlements to the north of the vale of Pickering*, Durham theses, Durham University. Available at Durham E-Theses Online: <http://etheses.dur.ac.uk/9356/>

#### Use policy

---

The full-text may be used and/or reproduced, and given to third parties in any format or medium, without prior permission or charge, for personal research or study, educational, or not-for-profit purposes provided that:

- a full bibliographic reference is made to the original source
- a [link](#) is made to the metadata record in Durham E-Theses
- the full-text is not changed in any way

The full-text must not be sold in any format or medium without the formal permission of the copyright holders.

Please consult the [full Durham E-Theses policy](#) for further details.

A STUDY OF THE SETTLEMENTS TO THE NORTH OF THE VALE OF PICKERING

VOLUME TWO: MAPS AND DIAGRAMS

BY

N. M. MUSTO B.A. (BRISTOL)

THESIS SUBMITTED FOR THE DEGREE OF MASTER OF LETTERS,

THE UNIVERSITY OF DURHAM, NOVEMBER, 1962

# CONTENTS

Figure		Page	Figure		Page
1	RELIEF	1	36	MONASTIC HOUSES AND HOLDINGS	22
" 2	GEOLOGICAL STRUCTURE	2	" 37	CASTLES	22
" 3	THE GLACIERS AND GLACIAL LAKES OF CLEVELAND AREA	3	" 38	DESERTED MEDIAEVAL VILLAGES	23
" 4	LAKE PICKERING: IMMEDIATE POST-GLACIAL TIMES, 7,500 B.C. 2,000 B.C.	3	" 39	OPEN FIELDS & ANCIENT ENCLOSURES OF SNAINTON & BROMPTON	24
" 5	PHOTOGRAPHS OF GRAVEL DEPOSIT WHICH EXTENDS FROM AYTON TO WYKEHAM	4	" 40	SNAINTON AND BROMPTON AFTER ENCLOSURE	24
" 6	GENERALISED CONTOURS	5	" 41	ENCLOSURE OF PICKERING 1790	25
" 7	DRAINAGE PATTERN	6	" 42	PROPORTION OF ARABLE LAND IN 1801	26
" 8	SOIL & CROP TRANSECTS; KEY AND POSITION OF TRANSECTS	7	" 43	MAIN CROPS IN 1801	26
" 9	SPIKERS HILL TO DARRELL'S LOW FARM, WEST AYTON	8	" 44	CROP REGIONS FROM 1801 CROP RETURNS	27
" 10	GREAT MOOR ROAD TO INGS FARM, HUTTON BUSHEL	8	" 45	FIRST RANKING CROP IN 1801	27
" 11	HIGH BROW, WYKEHAM TO NEW INGS, HUTTON BUSHEL	9	" 46	SECOND RANKING CROP IN 1801	27
" 12	GRANARY FARM, SAWDON TO BROMPTON BRIDGE	9	" 47	THIRD RANKING CROP IN 1801	27
" 13	COCKMOOR HALL TO FOULBRIDGE FARM, SNAINTON	10	" 48	LAND UTILISATION FROM THE TITHE AWARD MAPS	28
" 14	HIGH SCAMRIDGE FARM, EBBERSTON TO YEDINGHAM	10	" 49	KIRBY MISPERTON & PART OF RYTON - LAND USE 1845	29
" 15	WARREN HOUSE, ALLERSTON TO YEDINGHAM	11	" 50	APPLETON LE MOORS - LAND USE 1847	29
" 16	WILTON	11	" 51	GREAT AND LITTLE HABTON - LAND USE 1847	29
" 17	FOX & RABBIT, LOCKTON TO SUMMERTREE BRIDGE, THORNTON DALE	12	" 52	PICKERING - LAND USE 1847	30
" 18	YATT'S ROAD, NEWTON TO HOWE BRIDGE, PICKERING MARISHES	12	" 53	MANOR OF HUTTON BUSHEL DRAWN FOR SALE IN 1838	31
" 19	JENNY BRADLEY TO WESTGATE CARR, PICKERING	13	" 54	LAND USE PROPORTIONS IN 1867	32
" 20	CAWTHORNE TO WRELTON AND AISLABY CARR LANE	13	" 55	MAIN CROPS IN 1867	32
" 21	SINNINGTON TO NEWSHAM BRIDGE, LITTLE HABTON	14	" 56	LAND USE PROPORTIONS IN 1877	33
" 22	OLDFIELD LANE, SPAUNTON TO LITTLE EDSTONE	14	" 57	MAIN CROPS IN 1877	33
" 23	HUTTON LE HOLE TO GREAT BARUGH	15	" 58	LAND USE PROPORTIONS IN 1887	34
" 24	KIRK HOWE, GILLAMOOR TO SOUTH INGS FARM, KIRBY MOORSIDE	15	" 59	MAIN CROPS IN 1887	34
" 25	FADMOOR BY STARFITTS LANE TO MUSCOATES	16	" 60	LAND USE PROPORTIONS IN 1897	35
" 26	WETHERCOTE FARM, SKIPLAM TO RIVER RYE	16	" 61	MAIN CROPS IN 1897	35
" 27	PASTURE HOUSE, NAWTON TO COMMON LANE, HAROME	17	" 62	LAND USE PROPORTIONS IN 1907	36
" 28	NORTH OF OX CLOSE FARM, POCKLEY TO HAROME SIDING	17	" 63	MAIN CROPS IN 1907	36
" 29	COW HOUSE BANK TOP, CARLTON TO HAROME	18	" 64	LAND USE PROPORTIONS IN 1917	37
" 30	FOUR LANE ENDS, PICKERING TO GREAT HABTON	18	" 65	MAIN CROPS IN 1917	37
" 31	SOIL MAP	19	" 66	LAND USE PROPORTIONS IN 1927	38
" 32	SETTLEMENT PATTERN	20	" 67	MAIN CROPS IN 1927	38
" 33	ALTITUDINAL EXTENT OF NUCLEATED SETTLEMENT	20	" 68	LAND USE PROPORTIONS IN 1937	39
" 34	TOWNSHIP BOUNDARIES IN THE NINETEENTH CENTURY	21	" 69	MAIN CROPS IN 1937	39
" 35	EARLIEST PARISH BOUNDARIES	21	" 70	LAND USE PROPORTIONS IN 1947	40
			" 71	MAIN CROPS IN 1947	40

	Page
Figure 72 GRAPHS OF LAND USE PROPORTIONS 1867 - 1947	41 & 42
" 73 GRAPHS OF PROPORTION OF ARABLE UNDER THE MAIN CROPS 1867-1947	43 & 44
" 74 CATTLE PER 100 ACRES 1867 - 1917	45
" 75 CATTLE PER 100 ACRES 1927 - 1947	46
" 76 SHEEP PER 100 ACRES 1867 - 1917	47
" 77 SHEEP PER 100 ACRES 1927 - 1947	48
" 78 CROP REGIONS FROM JUNE AGRICULTURAL RETURNS 1867 - 1917	49
" 79 CROP REGIONS FROM JUNE AGRICULTURAL RETURNS 1927 - 1947	50
" 80 GRAPHS OF POPULATION 1801 - 1951	51 & 52
" 81 LAND UTILISATION 1961 FOR NORMANBY AND HUTTON BUSHEL	53
" 82 SUBDIVISIONS OF THE VALE OF PICKERING	54
" 83 NORTH YORK MOORS NATIONAL PARK	54

NORTH OF THE VALE OF PICKERING : RELIEF



# NORTH OF THE VALE OF PICKERING : GEOLOGY

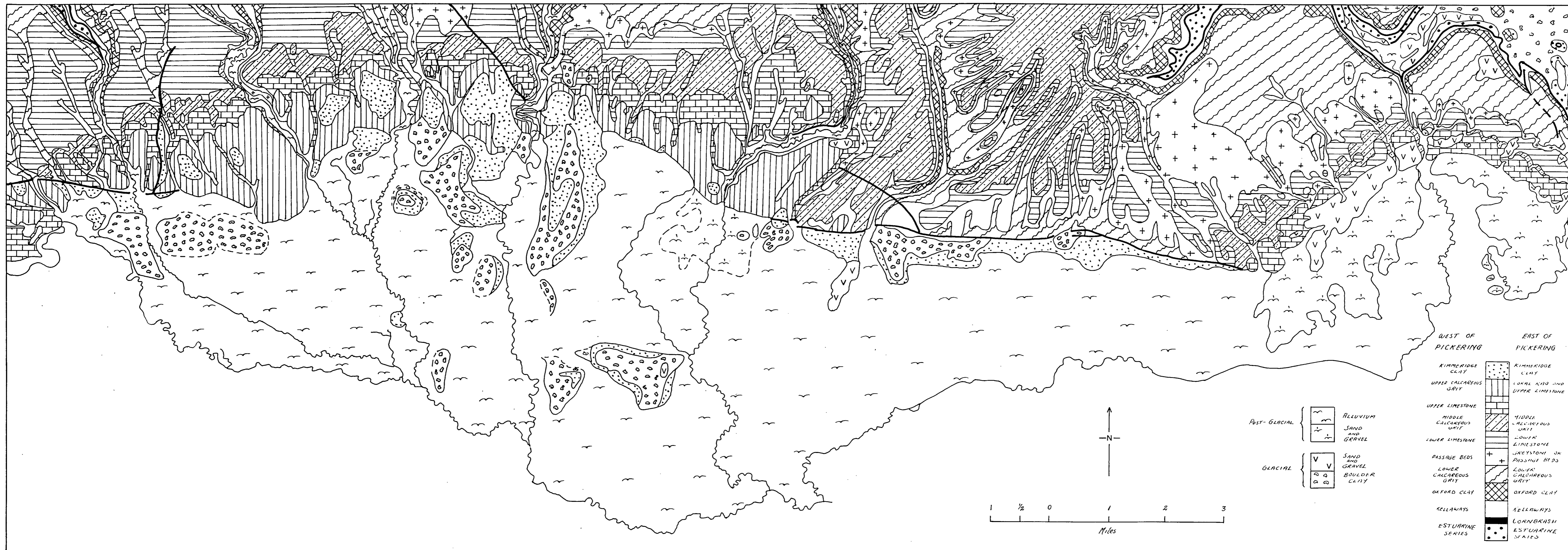

# THE GLACIERS AND GLACIAL LAKES

OF CLEVELAND AREA P. F. KENDAL

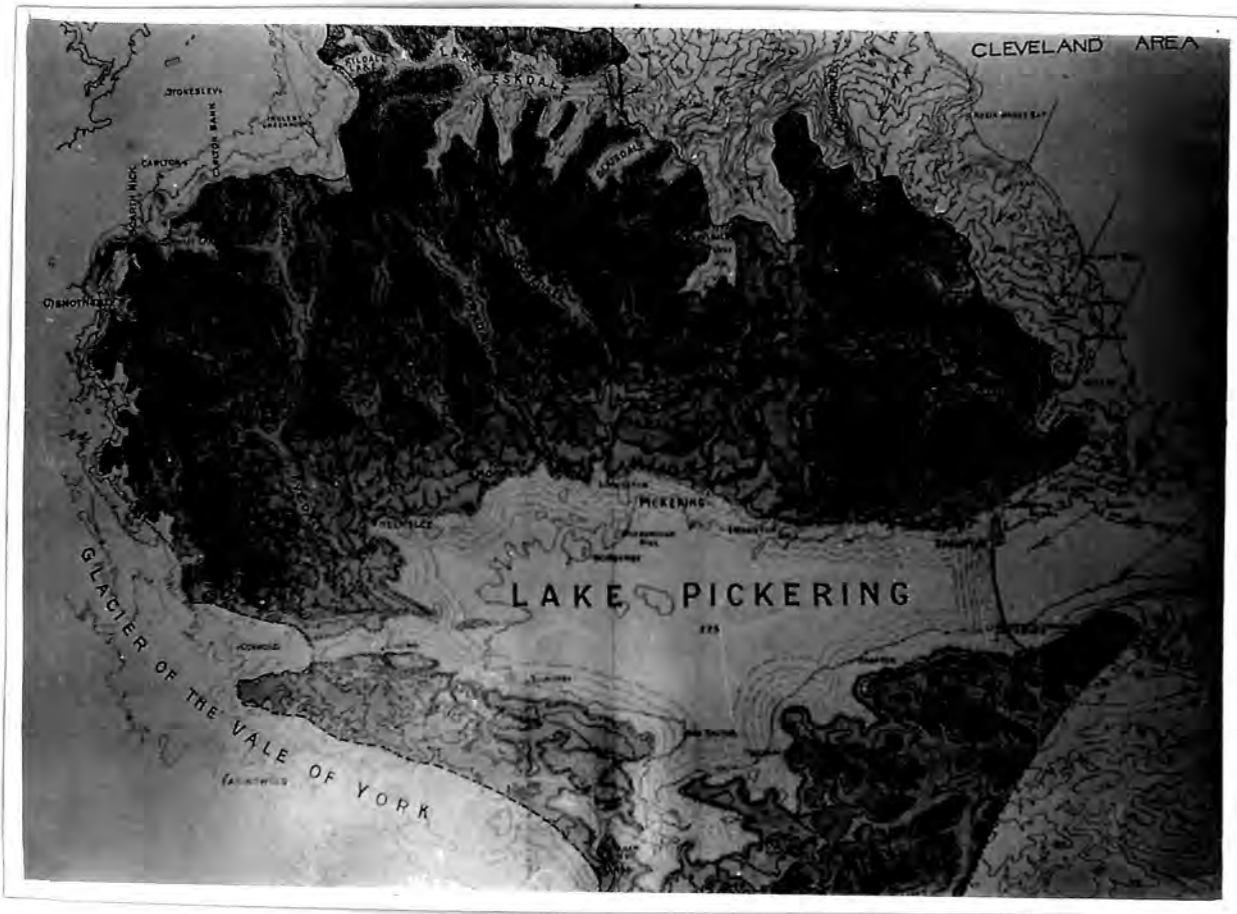

## LAKE PICKERING AFTER J. SHEPPARD

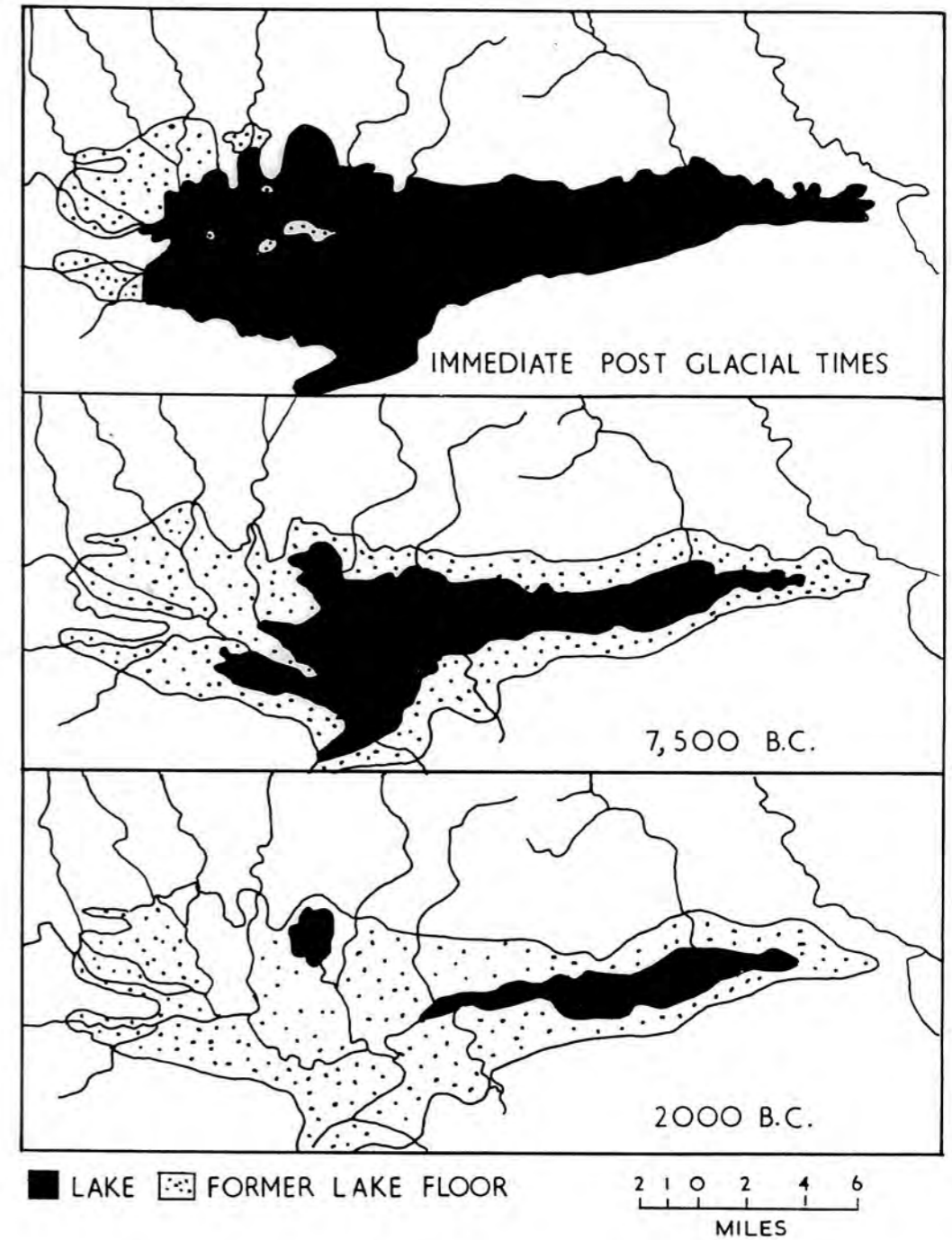

## PHOTOGRAPHS OF GRAVEL DEPOSIT WHICH EXTEND FROM AYTON TO WYKEHAM

TOULSON'S QUARRY LOOKING NORTH



TOULSON'S QUARRY LOOKING SOUTH



VIEW N.N.E. TO YEDMANDALE



TOULSON'S QUARRY LOOKING NORTH

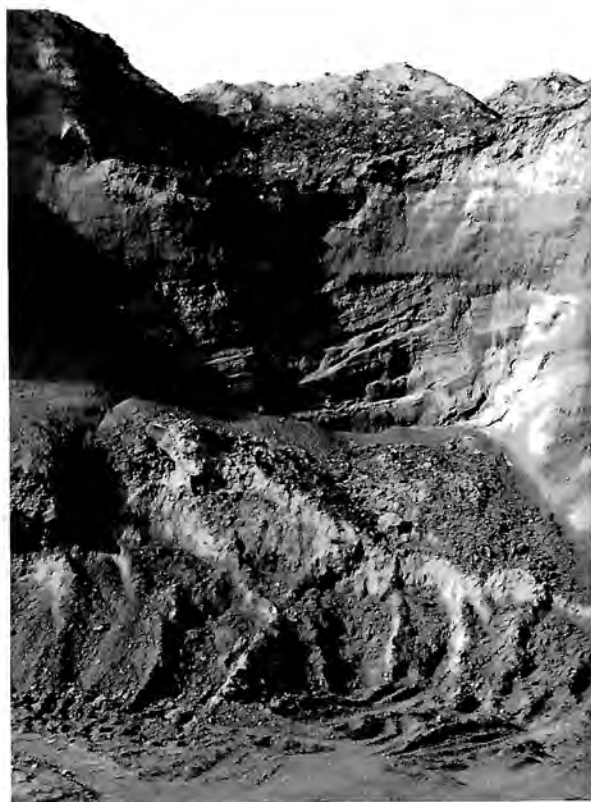

TOULSON'S QUARRY LOOKING EAST



TOULSON'S QUARRY LOOKING EAST



ICE SHATTERED ERRATICS NEAR THE SURFACE TO THE NORTH





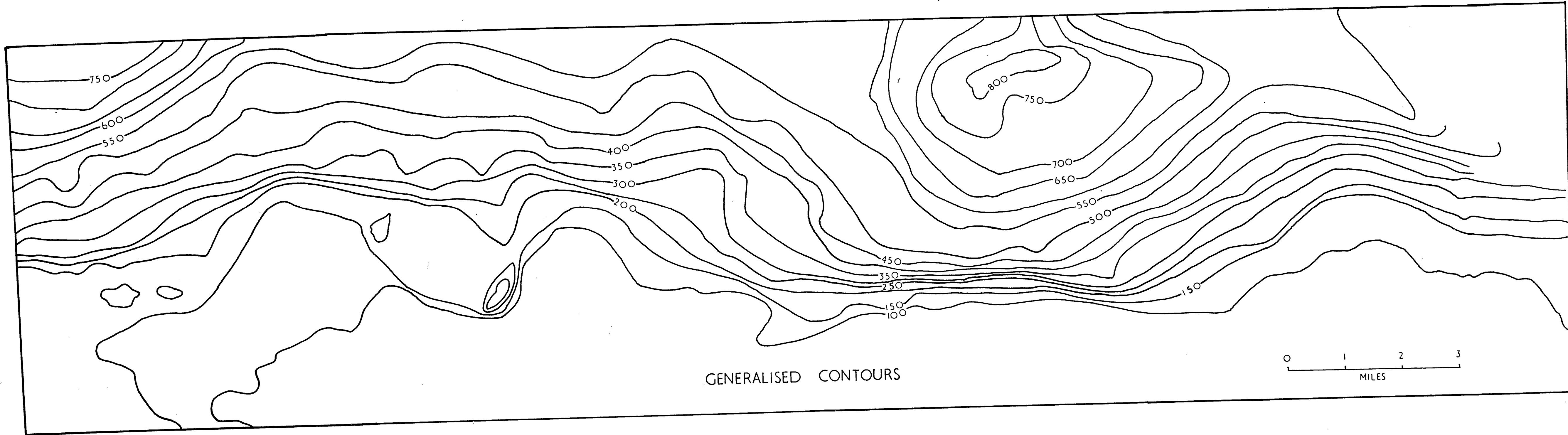





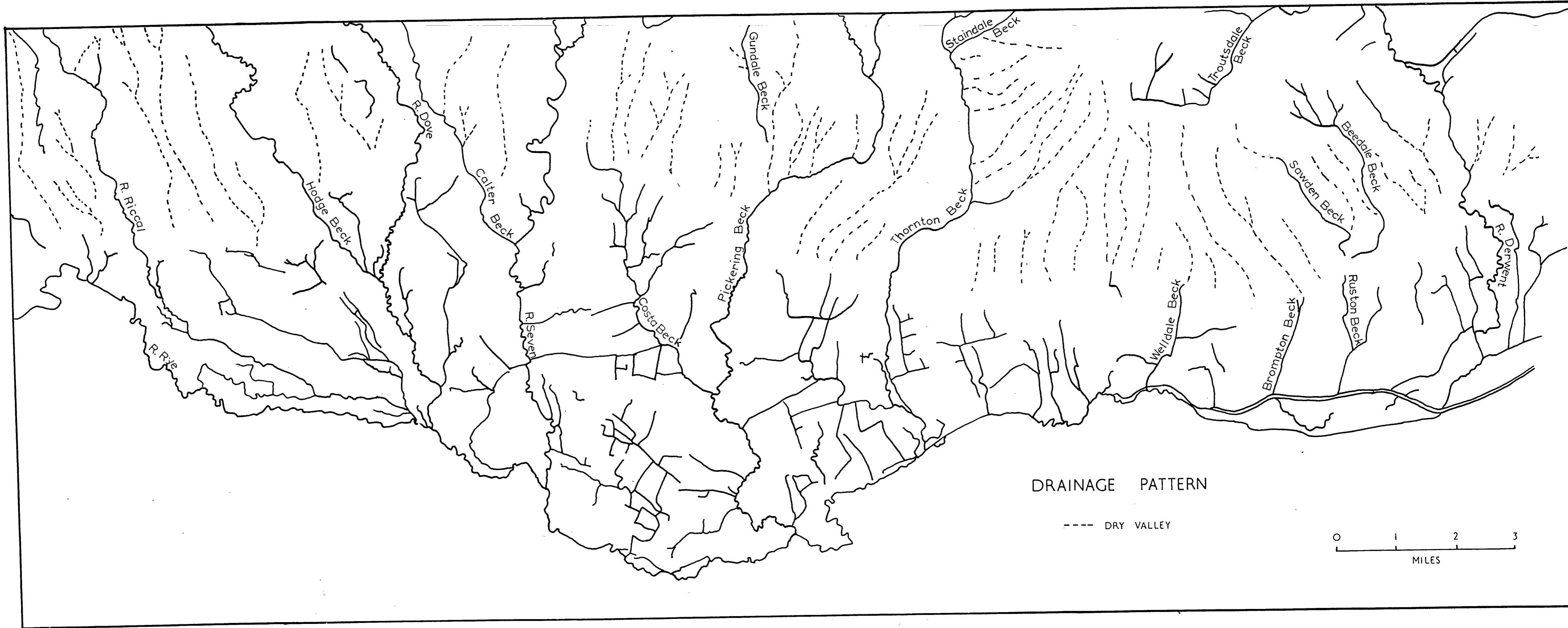



GENERALISED CONTOURS

















# SOIL AND CROP TRANSECTS APRIL - JULY 1959















## LAND UTILISATION

-  GRAIN
-  FODDER CROPS
-  GRASS
-  MARKET GARDEN
-  WOODLAND
-  MOOR OR PASTURE WITH BRACKEN
-  WASTE & QUARRIES
-  BUILDINGS

## GEOLOGY

-  ALLUVIUM
-  SAND & GRAVEL
-  SAND AND GRAVEL } GLACIAL
-  BOULDER CLAY } GLACIAL
-  KIMMERIDGE CLAY
-  UPPER CALCAREOUS GRIT
-  UPPER LIMESTONE
-  MIDDLE CALCAREOUS GRIT
-  LOWER LIMESTONE
-  PASSAGE BEDS
-  LOWER CALCAREOUS GRIT
-  OXFORD CLAY

## SOIL

-  GREY
  -  DARK ALLUVIAL
  -  BROWN
  -  RED BROWN
  -  DARK
  -  BLACKISH BROWN
- } CLAY LOAMS
-  REDDISH LIMEY
  -  REDDISH BROWN
  -  CHOCOLATE BROWN
  -  SANDY ALLUVIAL
  -  BROWN
  -  BROWN RED
- } SANDY LOAMS
-  GREY PODSOL
  -  PEATY
- \* SAMPLES SHOWING GLEYING  
+ SAMPLES CONTAINING STONES FROM OTHER AREAS

HORIZONTAL SCALE 1:25,000

VERTICAL SCALE 1 INCH TO 1,000 FEET

POSITION OF TRANSECTS

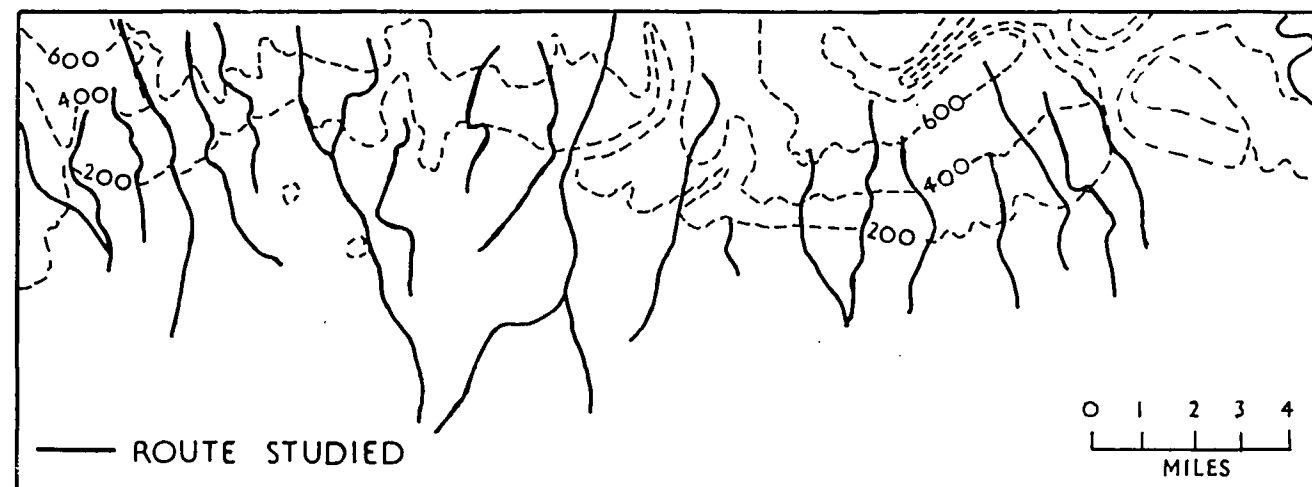

SPIKER'S HILL TO DARRELL'S LOW FARM WEST AYTON

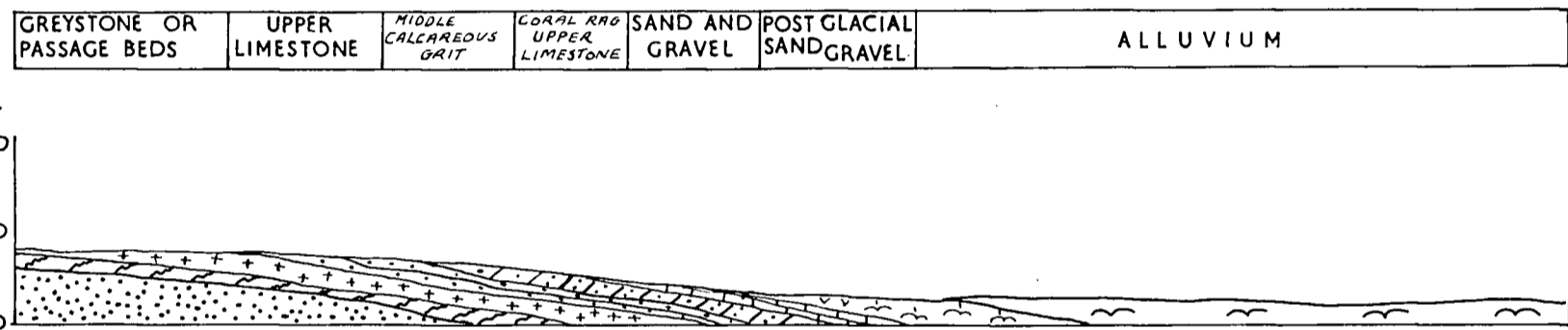
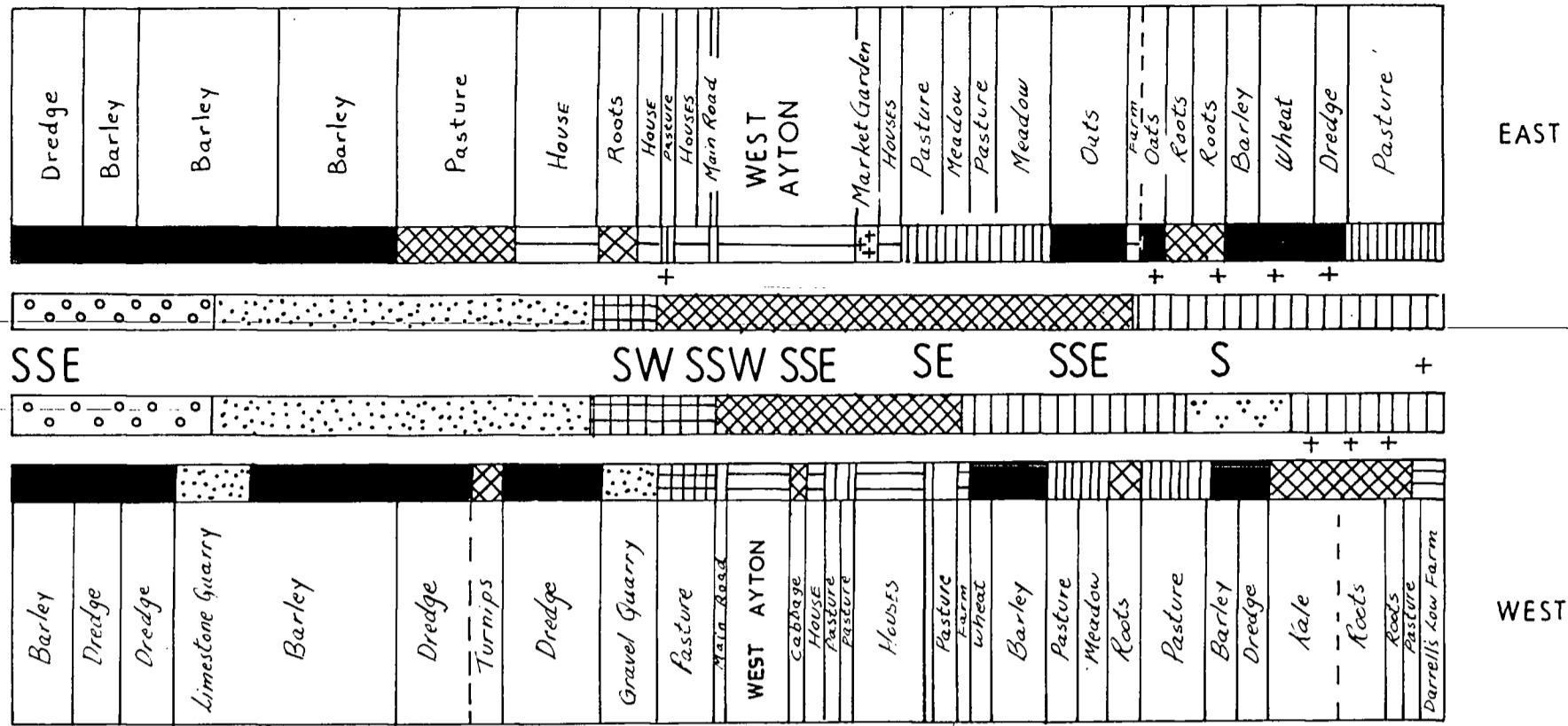

GREAT MOOR ROAD TO INGS FARM HUTTON BUSHEL

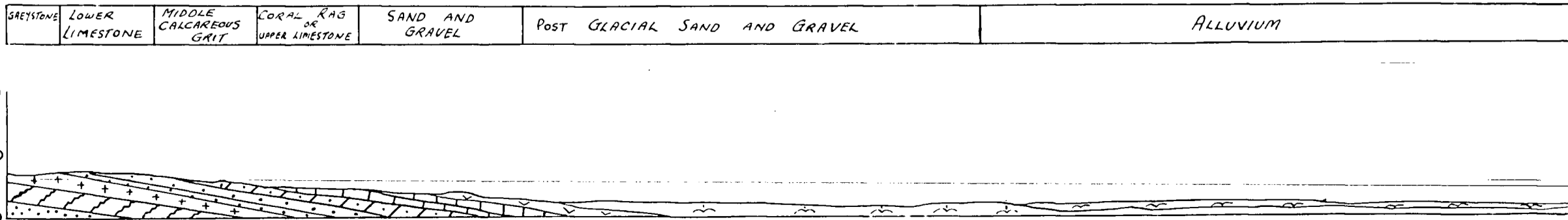
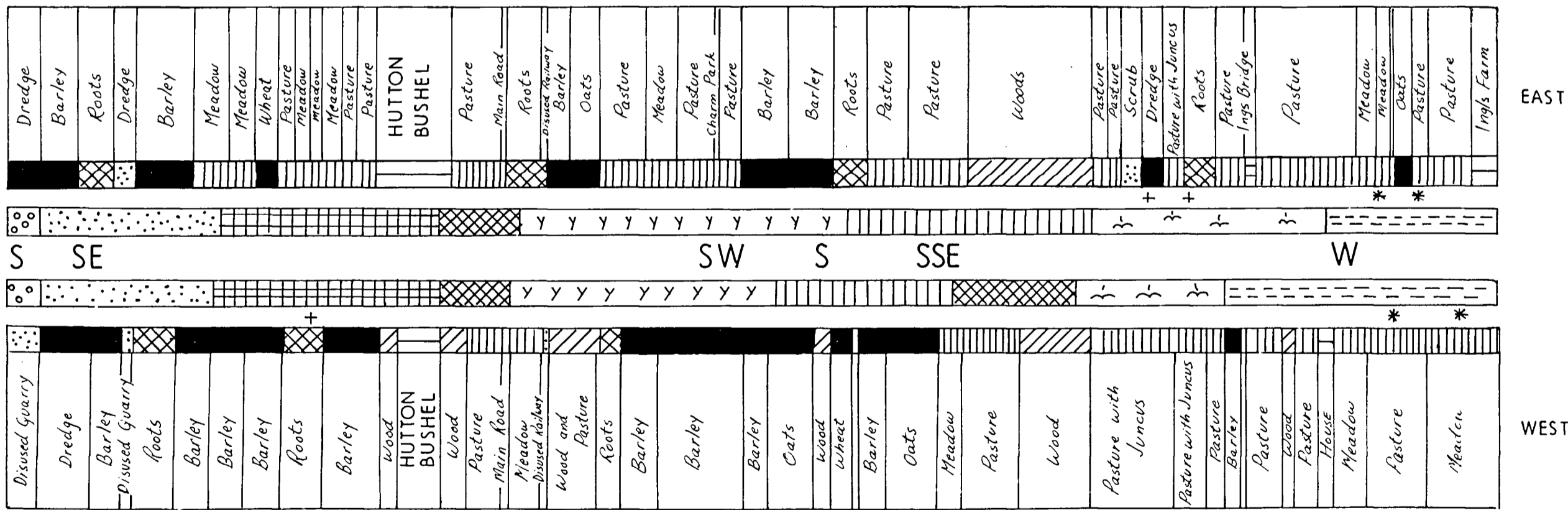



COCKMOOR HALL TO FOULBRIDGE FARM, SNAINTON

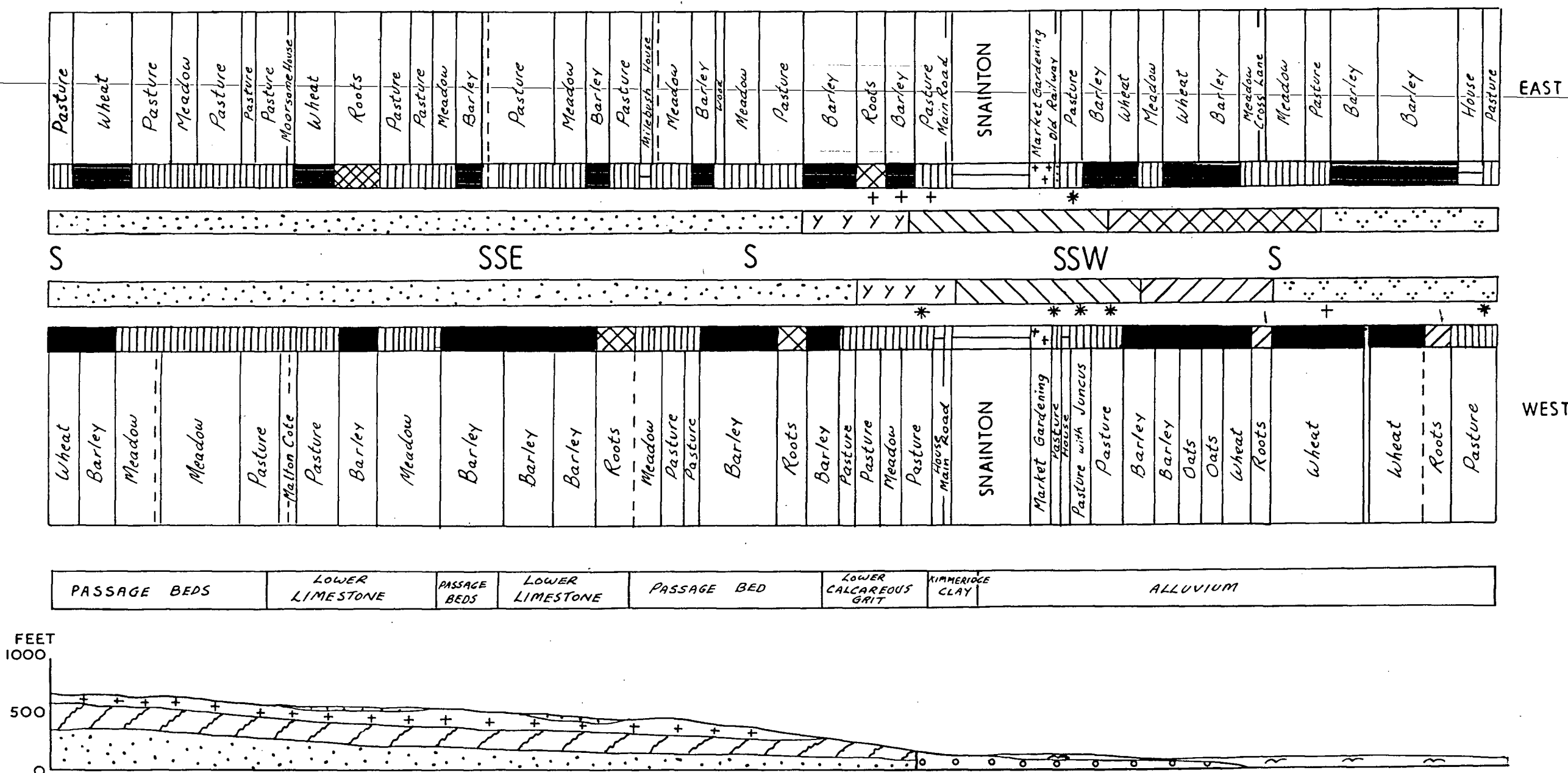

HIGH SCAMRIDGE FARM, EBBERSTON TO YEDINGHAM

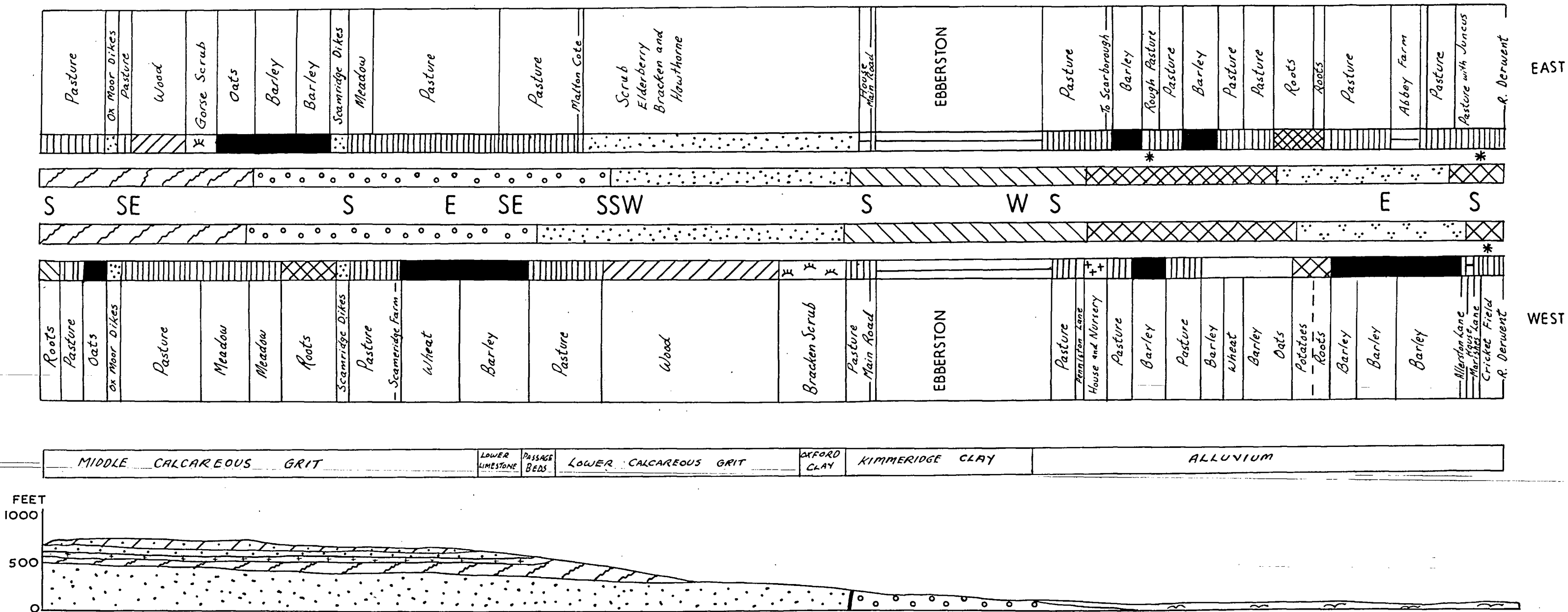

# !! WARREN HOUSE, ALLERSTON TO YEDINGHAM

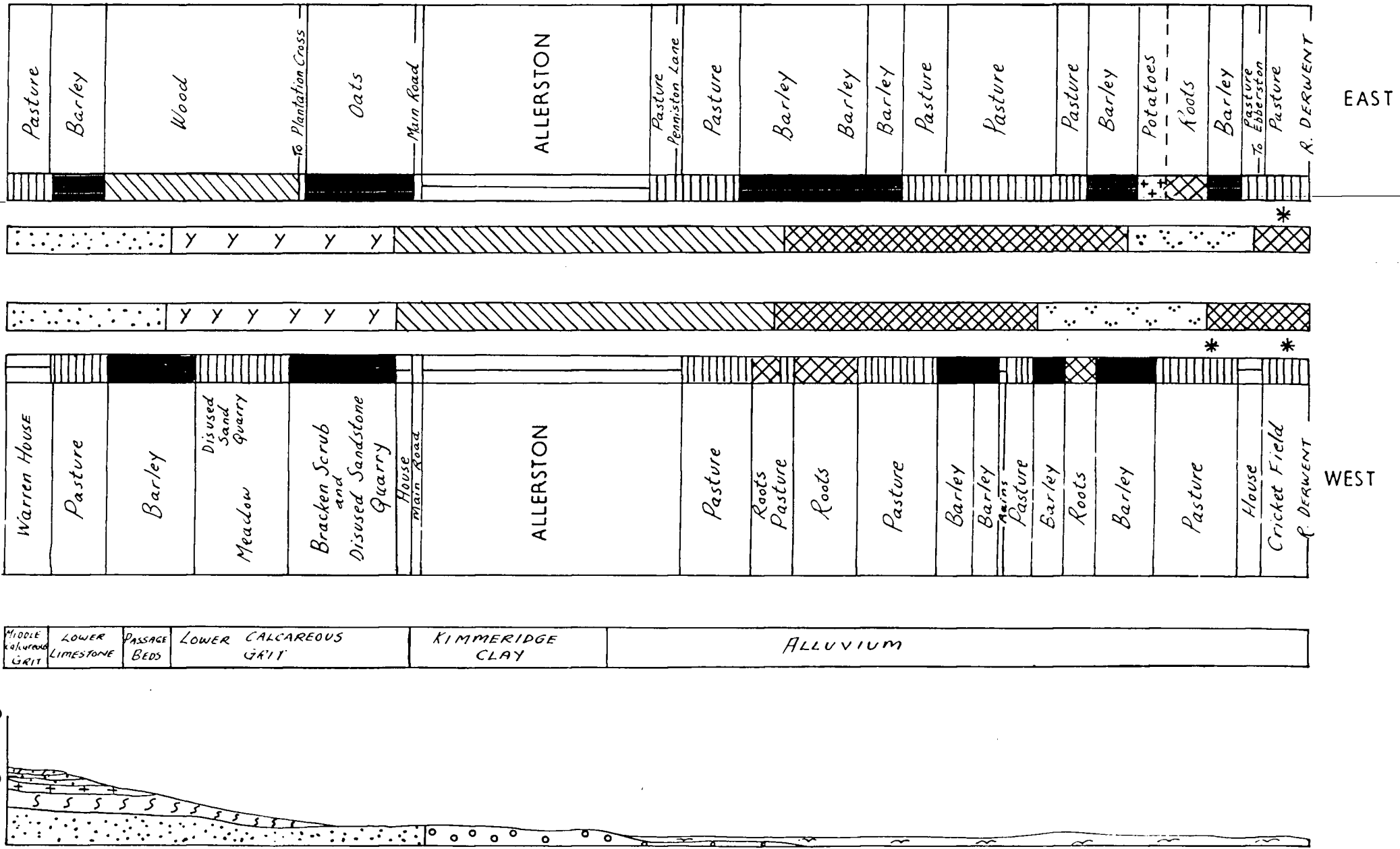

## WILTON

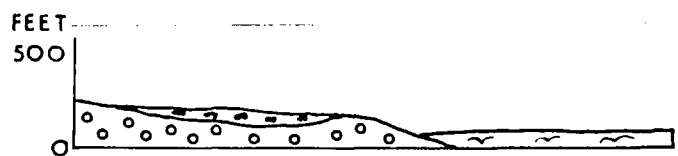
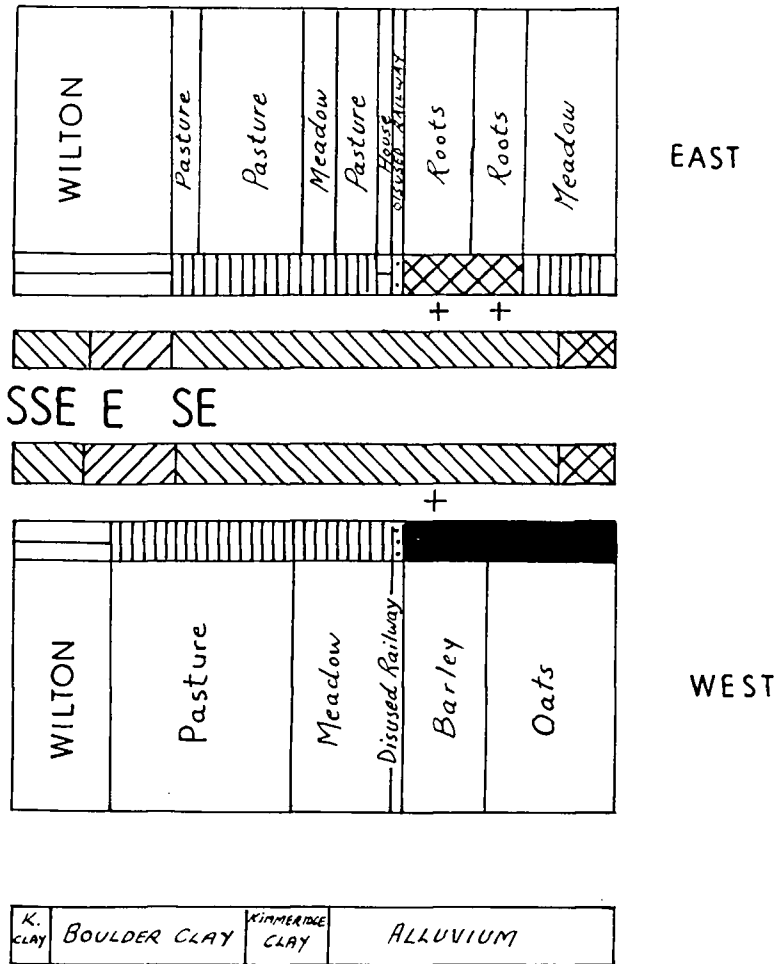

FOX AND RABBIT, LOCKTON TO SUMMERTREE BRIDGE, THORNTON DALE

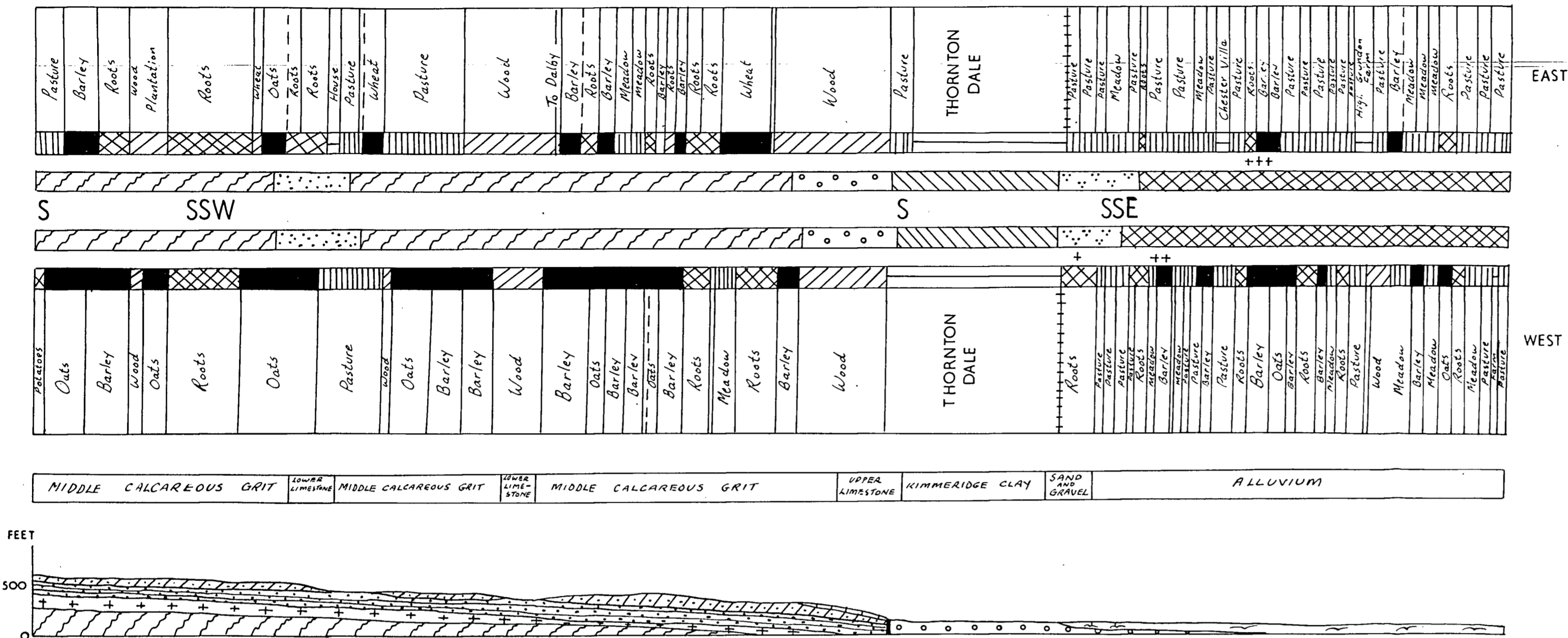

YATT'S ROAD NEWTON TO HOWE BRIDGE, PICKERING MARISHES

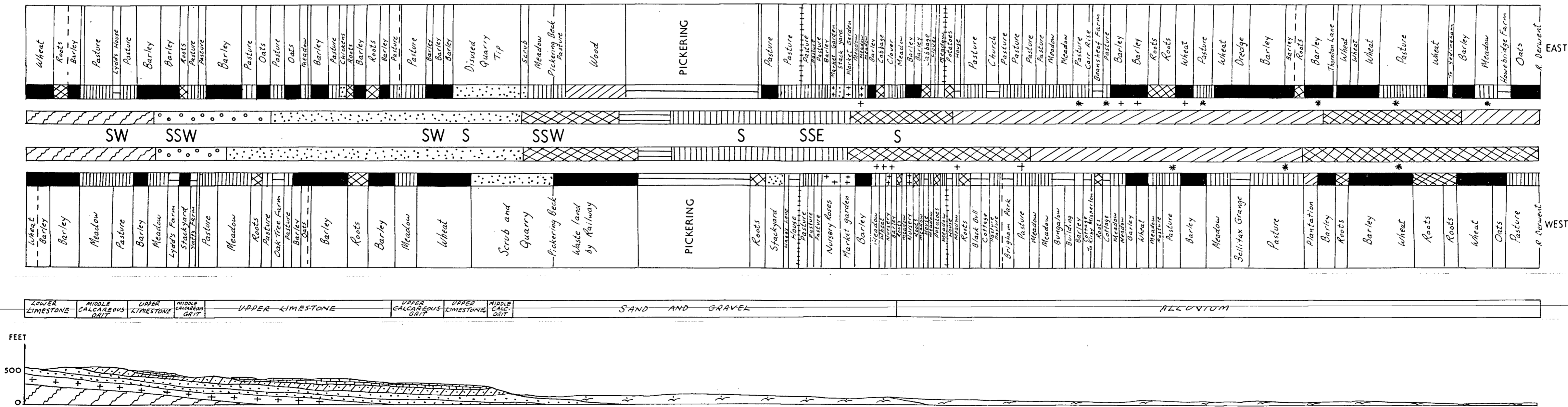



JENNY BRADLEY TO WESTGATE CARR, PICKERING

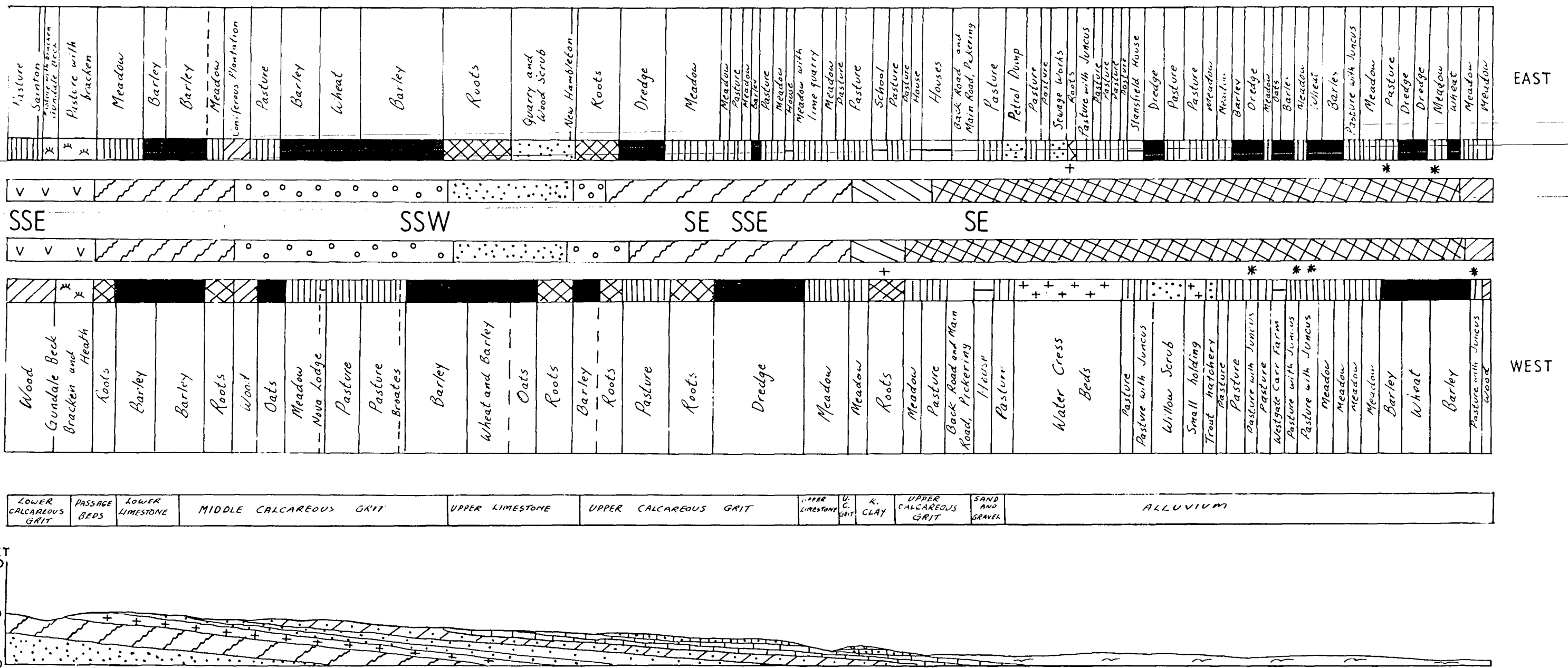

CAWTHORNE TO WRELTON AND AISLABY CARR LANE

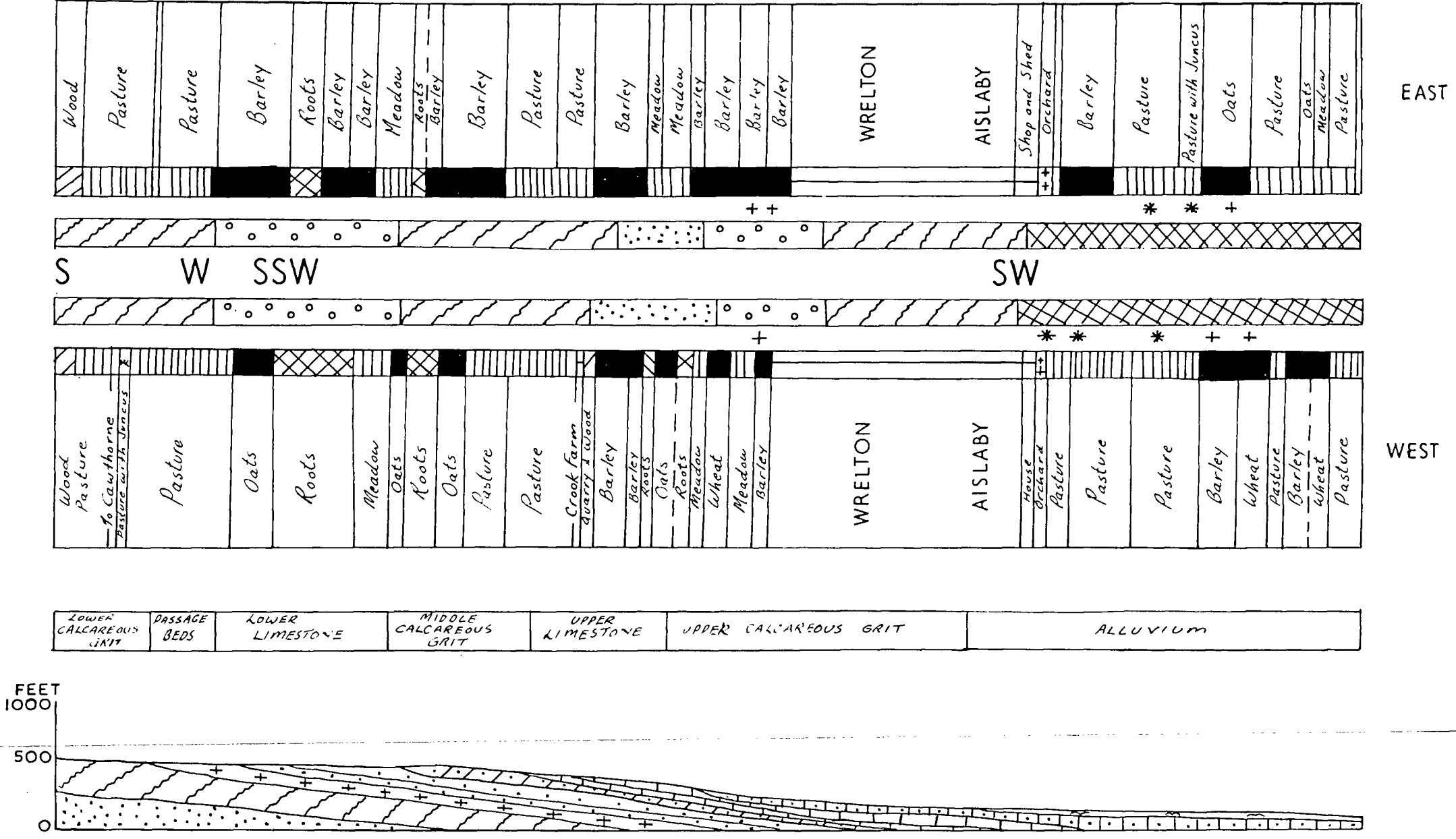

14  
SINNINGTON TO NEWSHAM BRIDGE, LITTLE HABTON

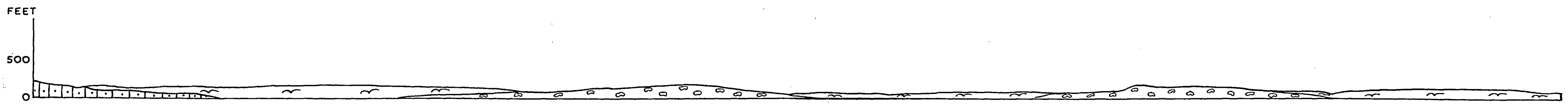
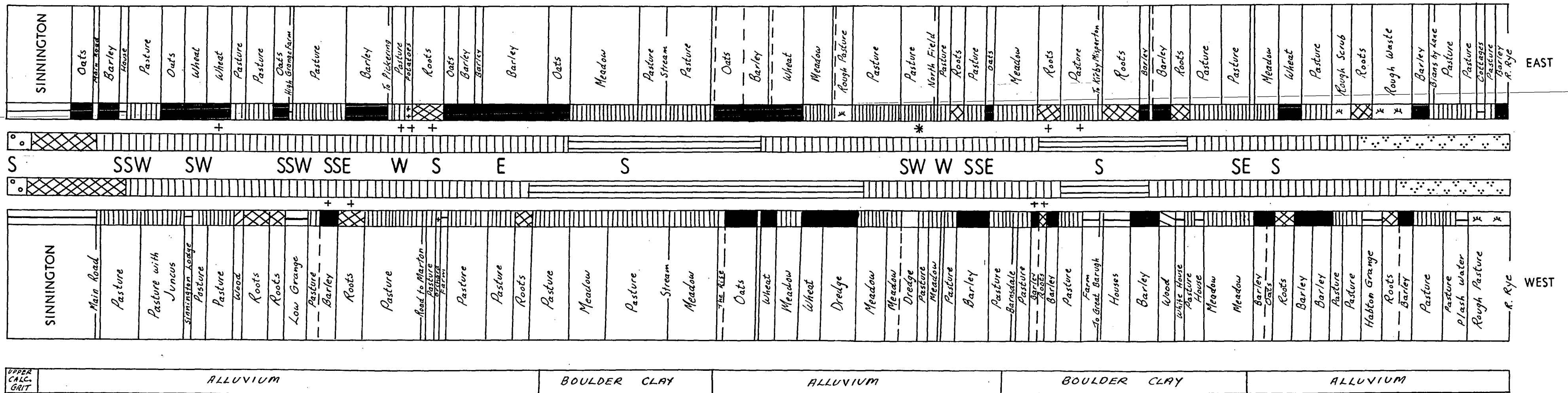

OLDFIELD LANE, SPAUNTON TO LITTLE EDSTONE

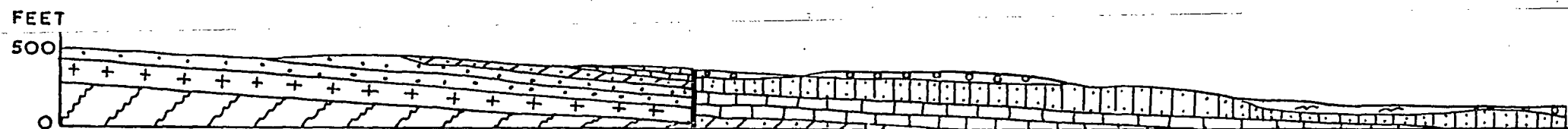
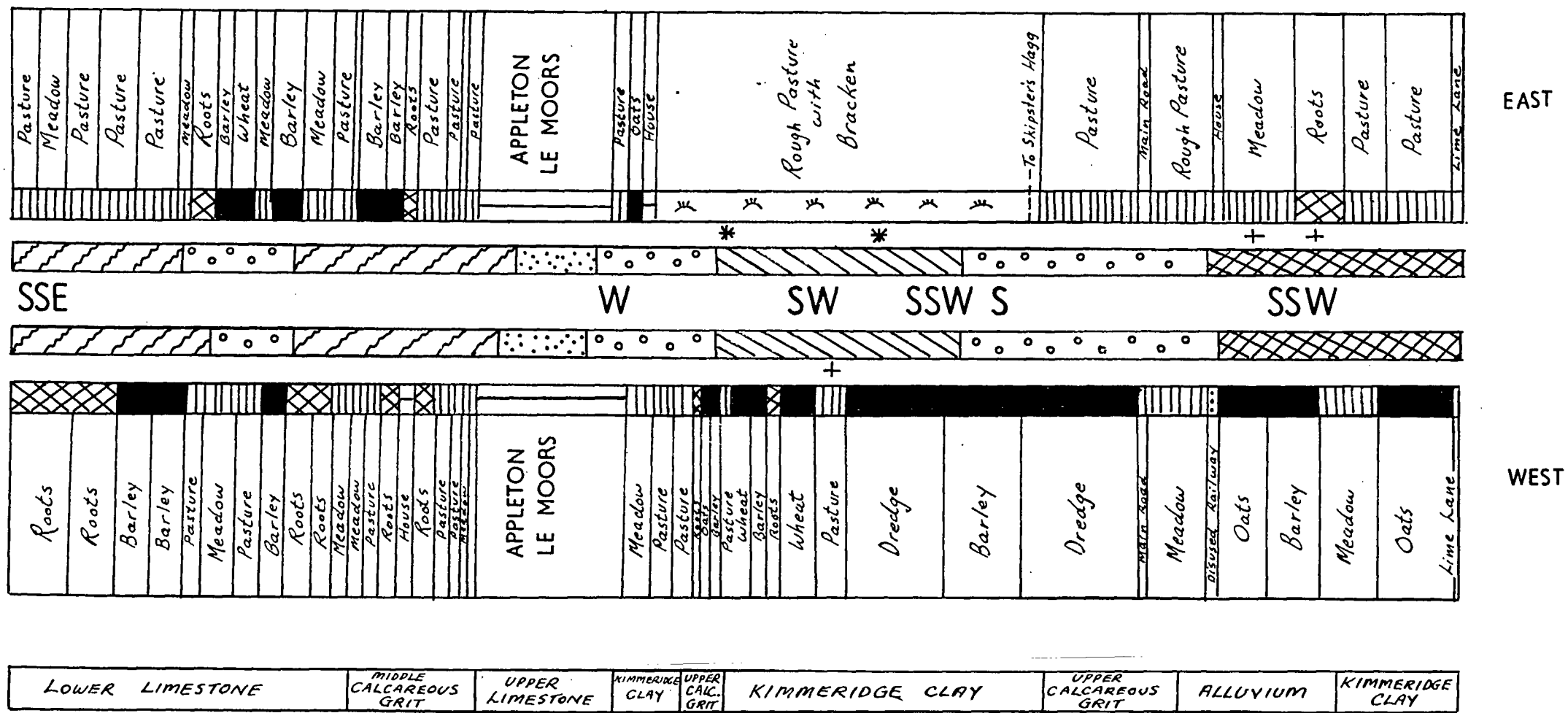

HUTTON LE HOLE TO GREAT BARUGH

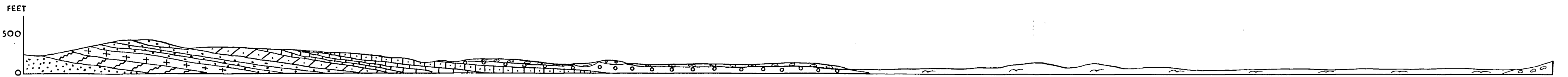
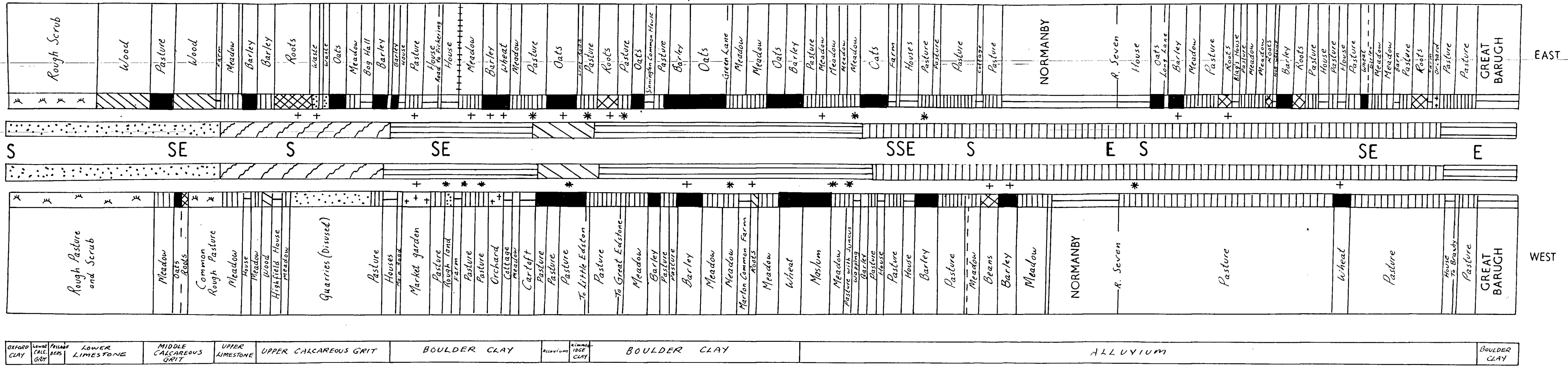

KIRK HOWE, GILLAMOOR TO SOUTH INGS FARM, KIRBY MOORSIDE

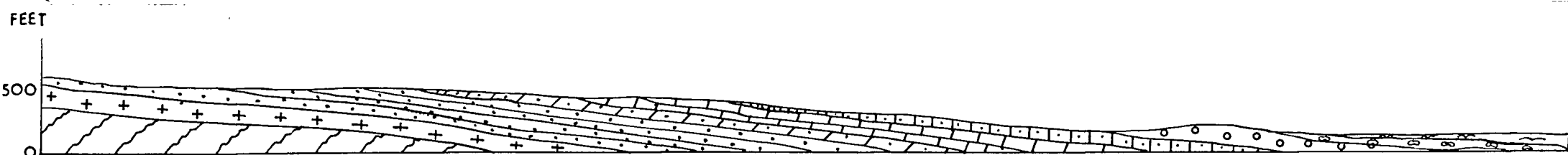
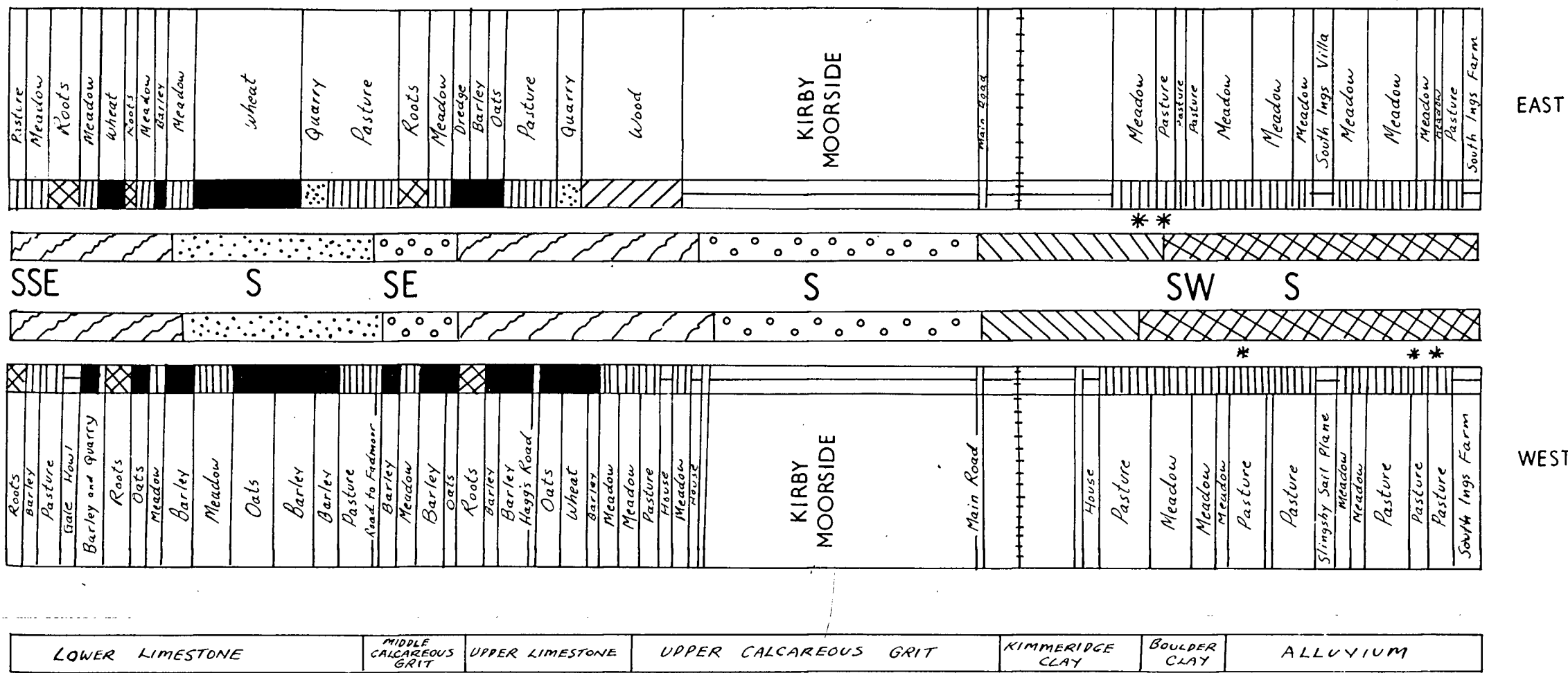

16  
FADMOOR BY STARFITS LANE TO MUSCOATES

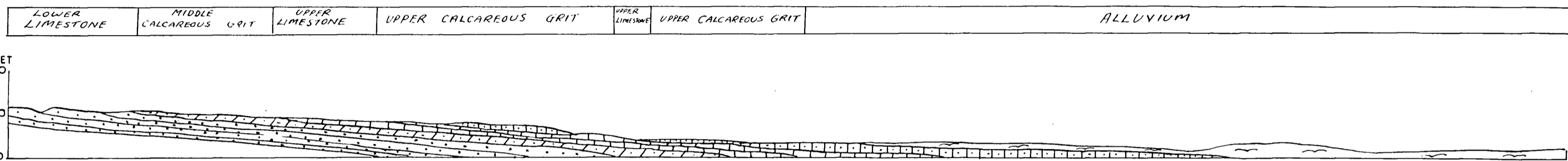
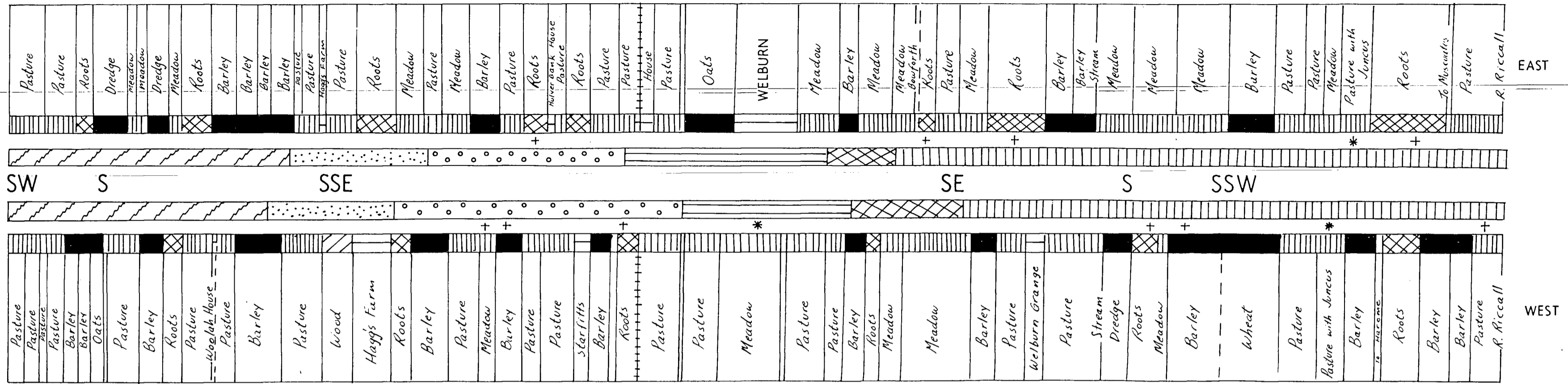

WETHERCOTE FARM, SKIPLAM TO RIVER RYE

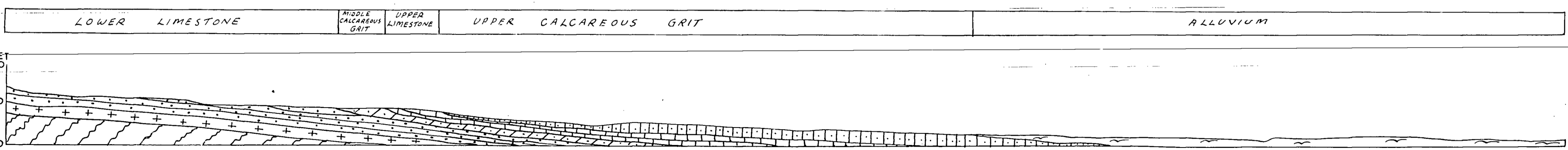
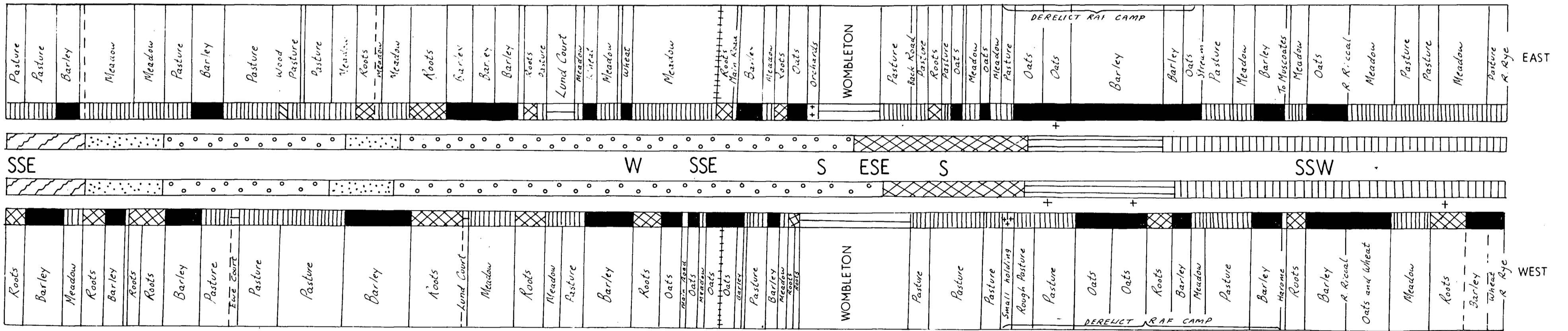

PASTURE HOUSE, NAWTON TO COMMON LANE, HAROME

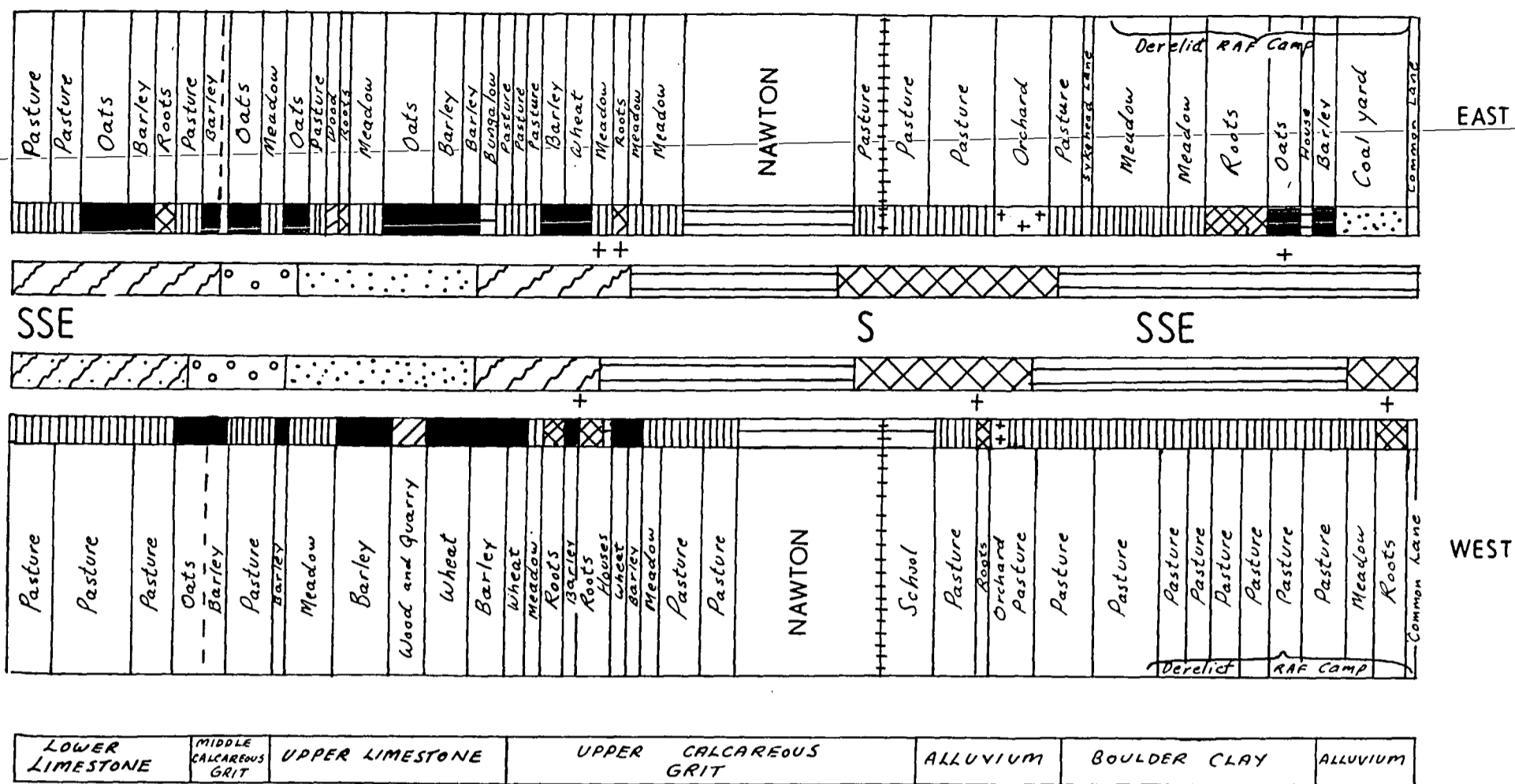

NORTH OF OX CLOSE FARM, POCKLEY TO HAROME SIDINGS

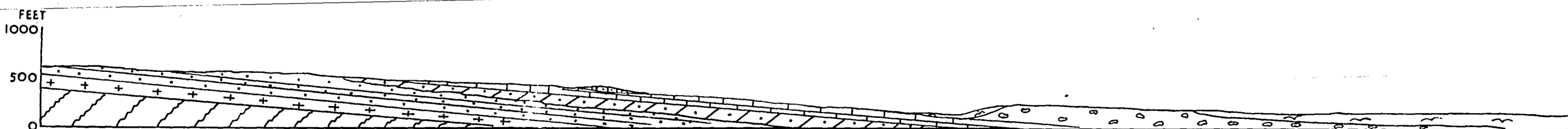
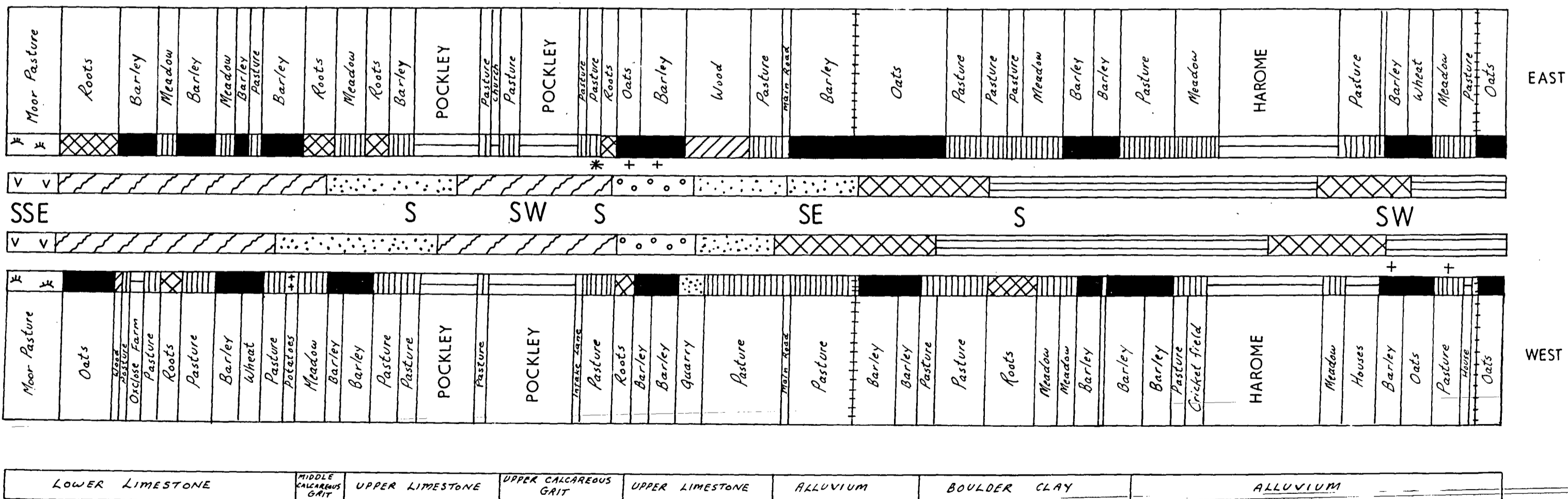

COWHOUSE BANK TOP, CARLTON TO HAROME

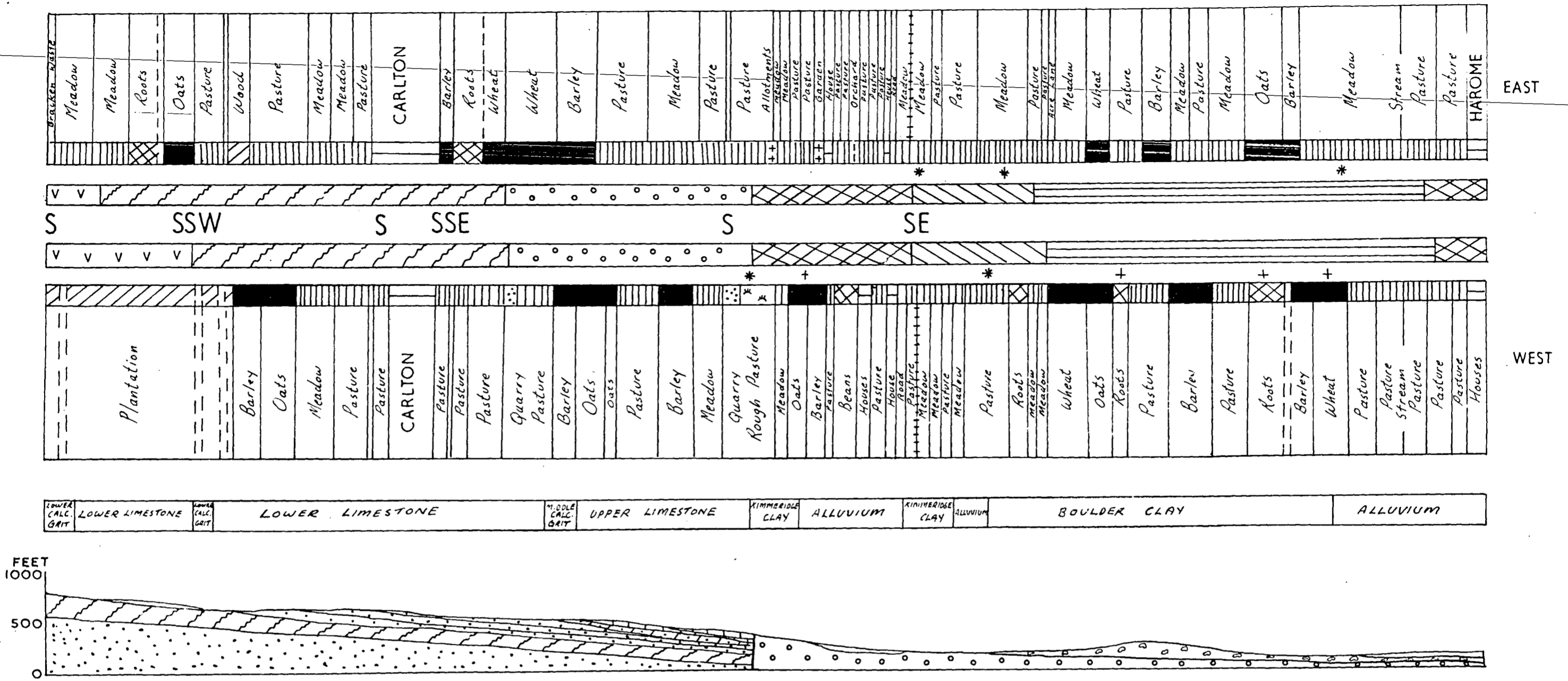

FOUR LANE ENDS, PICKERING TO GREAT HABTON

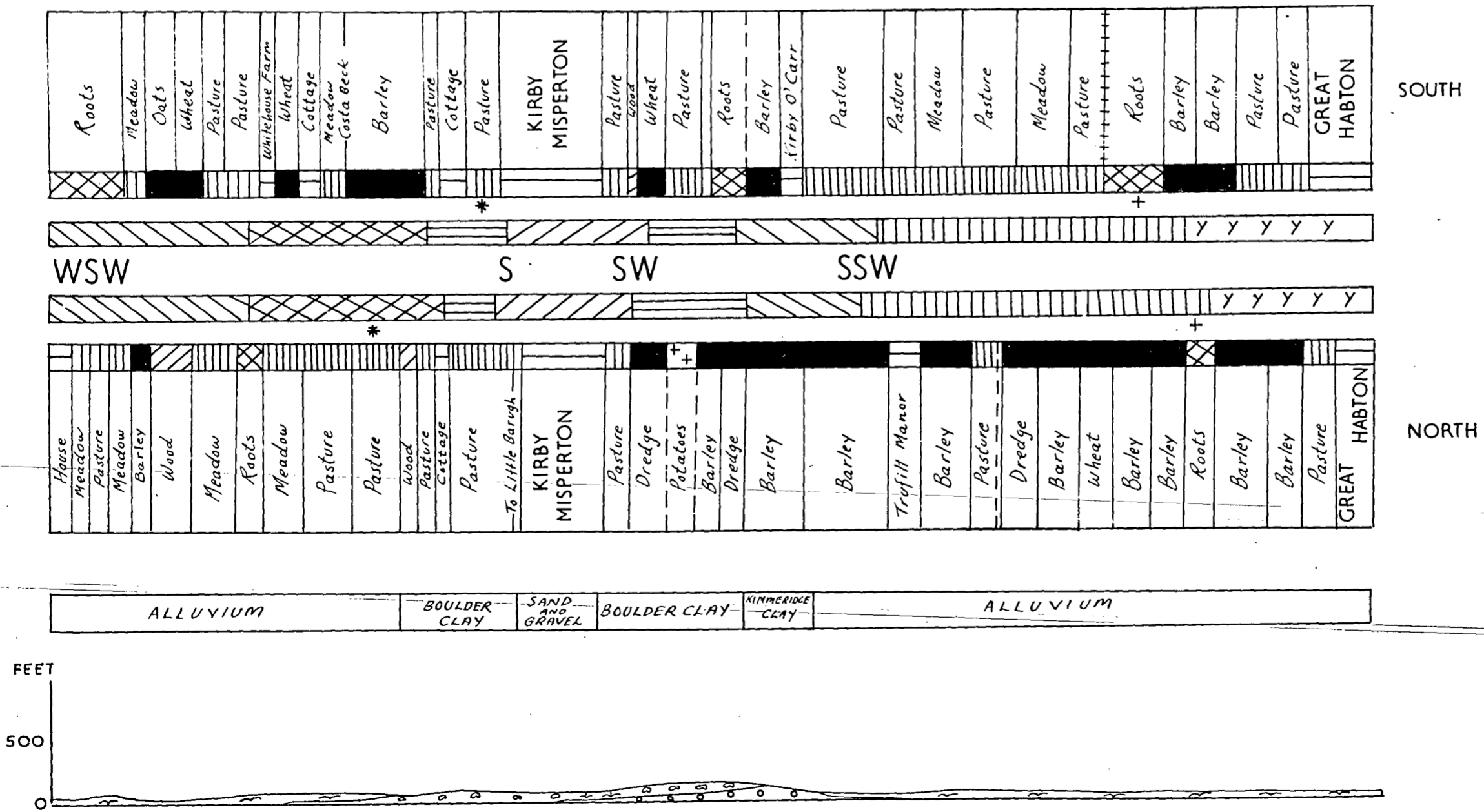

SOIL

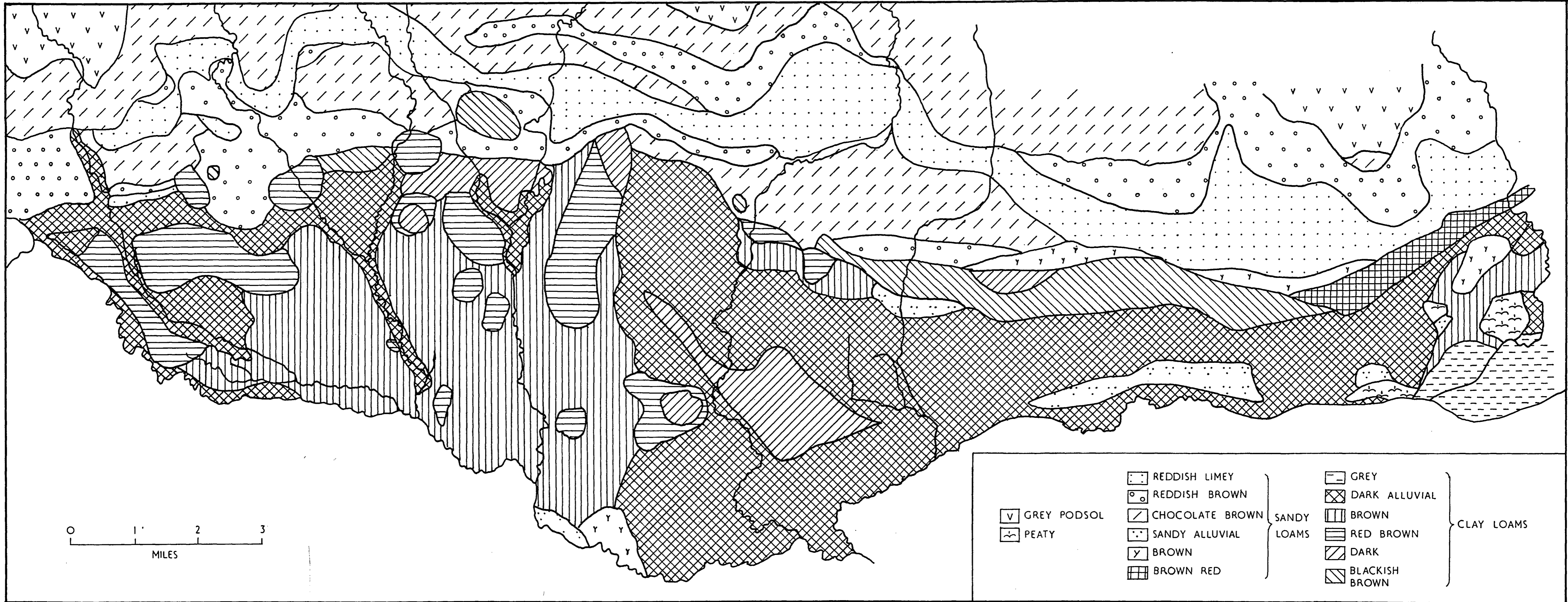

# SETTLEMENT PATTERN

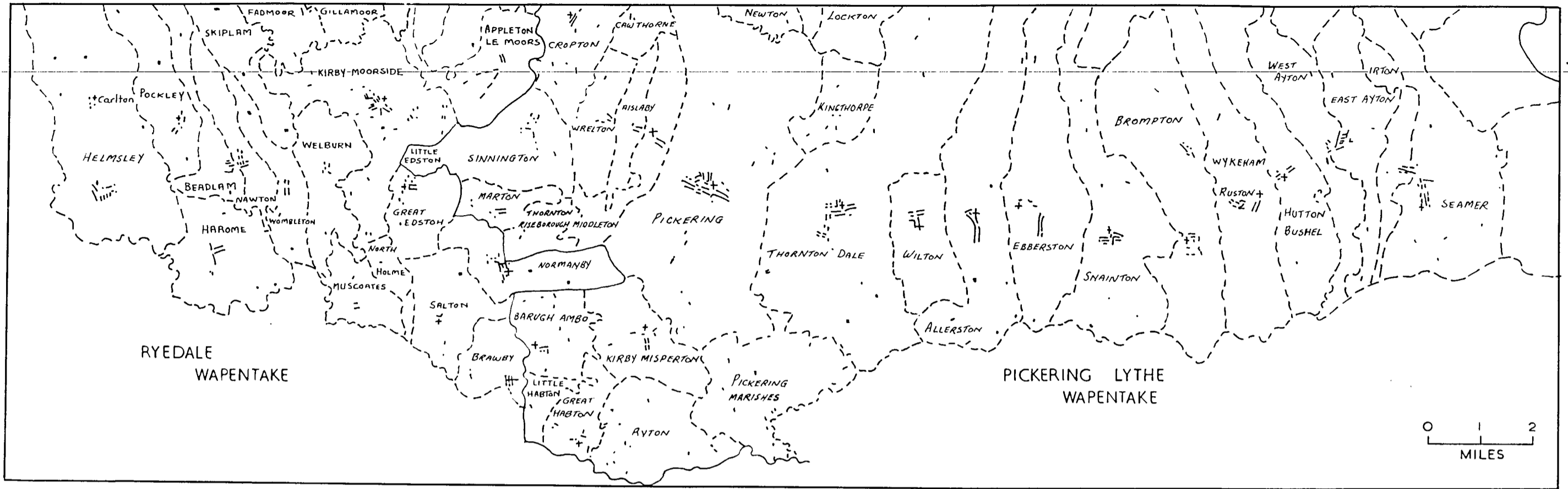

## ALTITUDINAL EXTENT OF NUCLEATED SETTLEMENTS

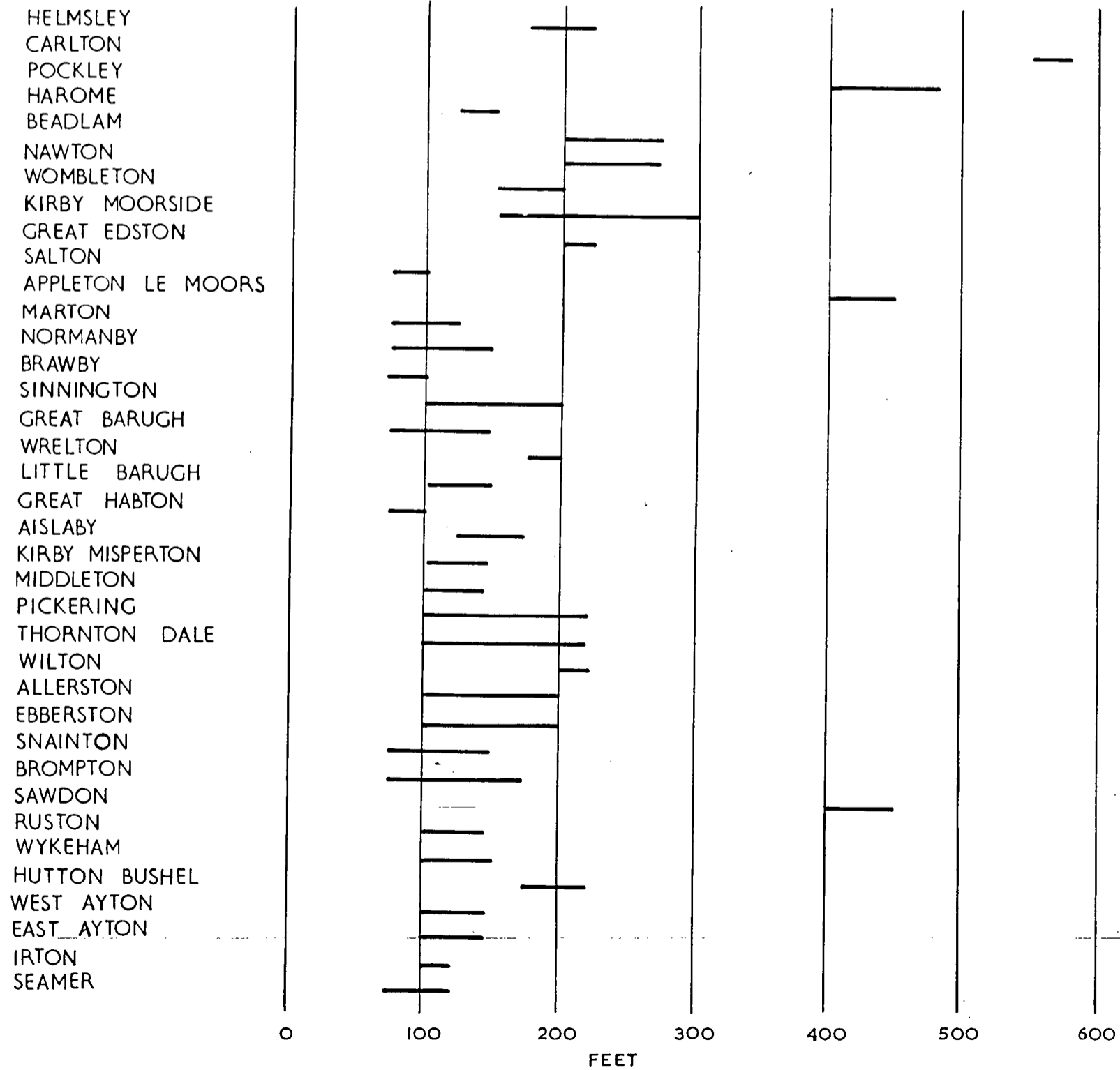



### TOWNSHIP BOUNDARIES IN THE NINETEENTH CENTURY

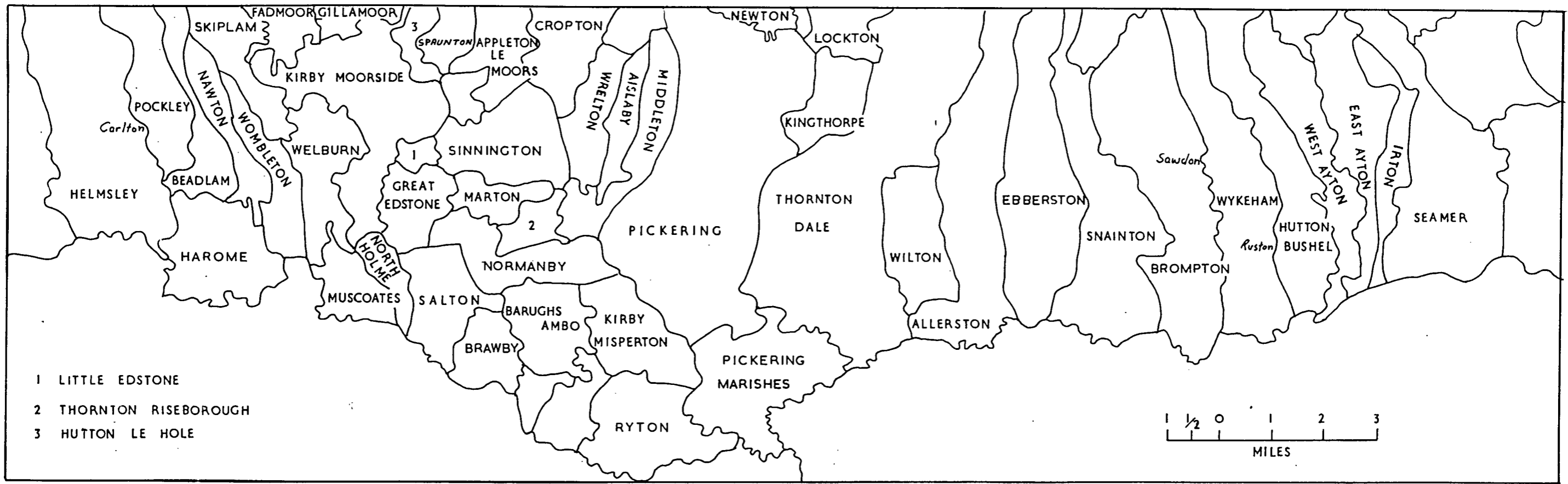

### EARLIEST PARISH BOUNDARIES AFTER VICTORIA HISTORY OF NORTH RIDING

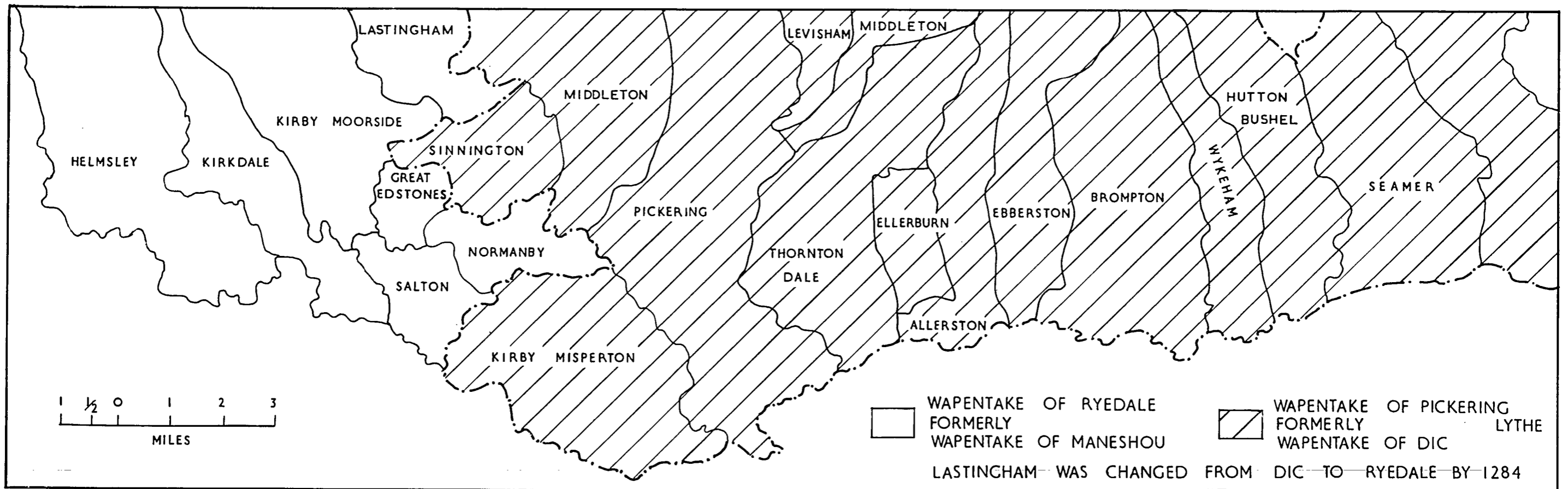

## MONASTIC HOUSES AND HOLDINGS

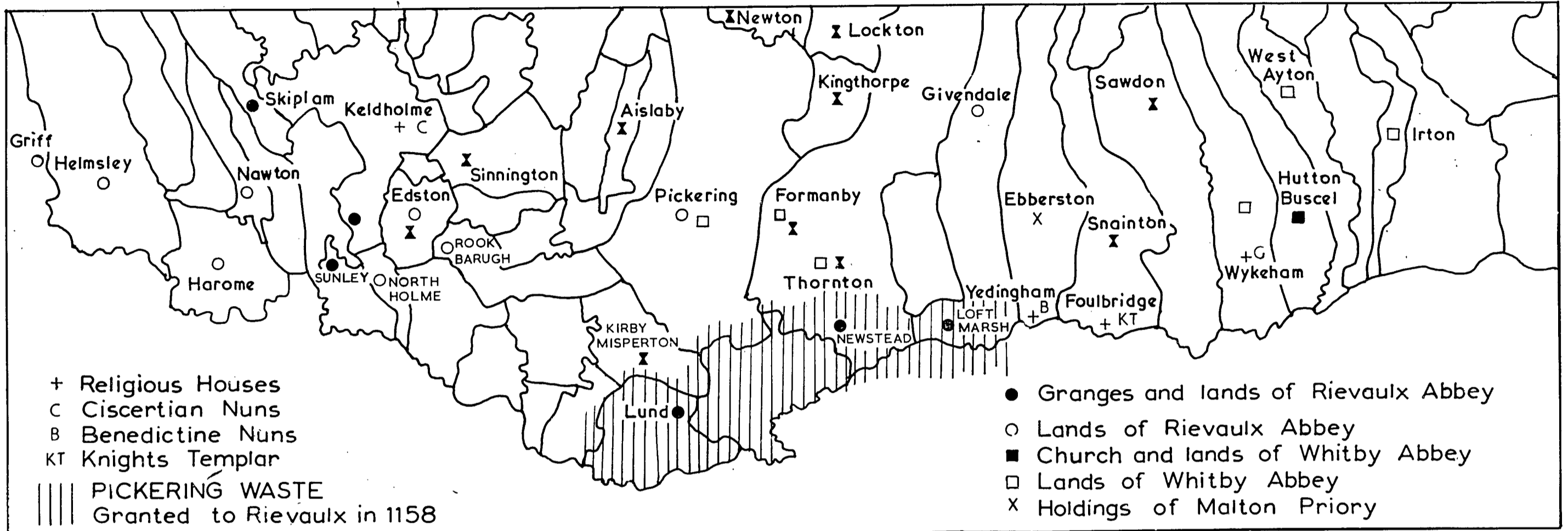

## CASTLES

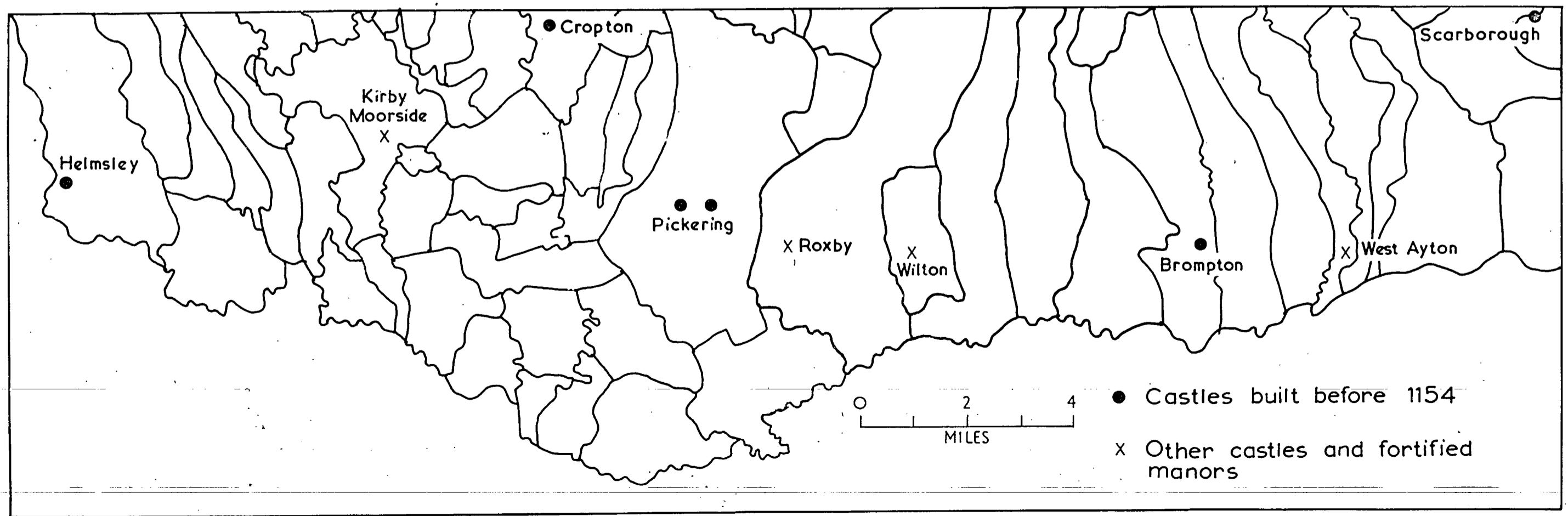

# DESERTED MEDIAEVAL VILLAGES

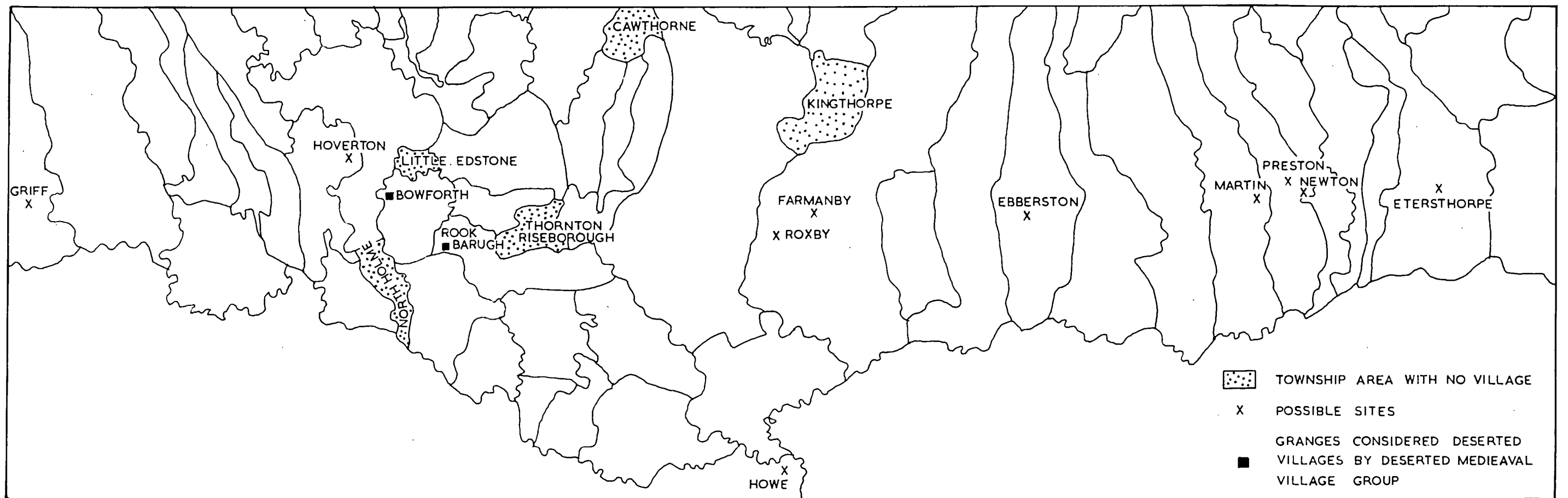

OPEN FIELDS & ANCIENT INCLOSURES of SNAINTON & BROMPTON

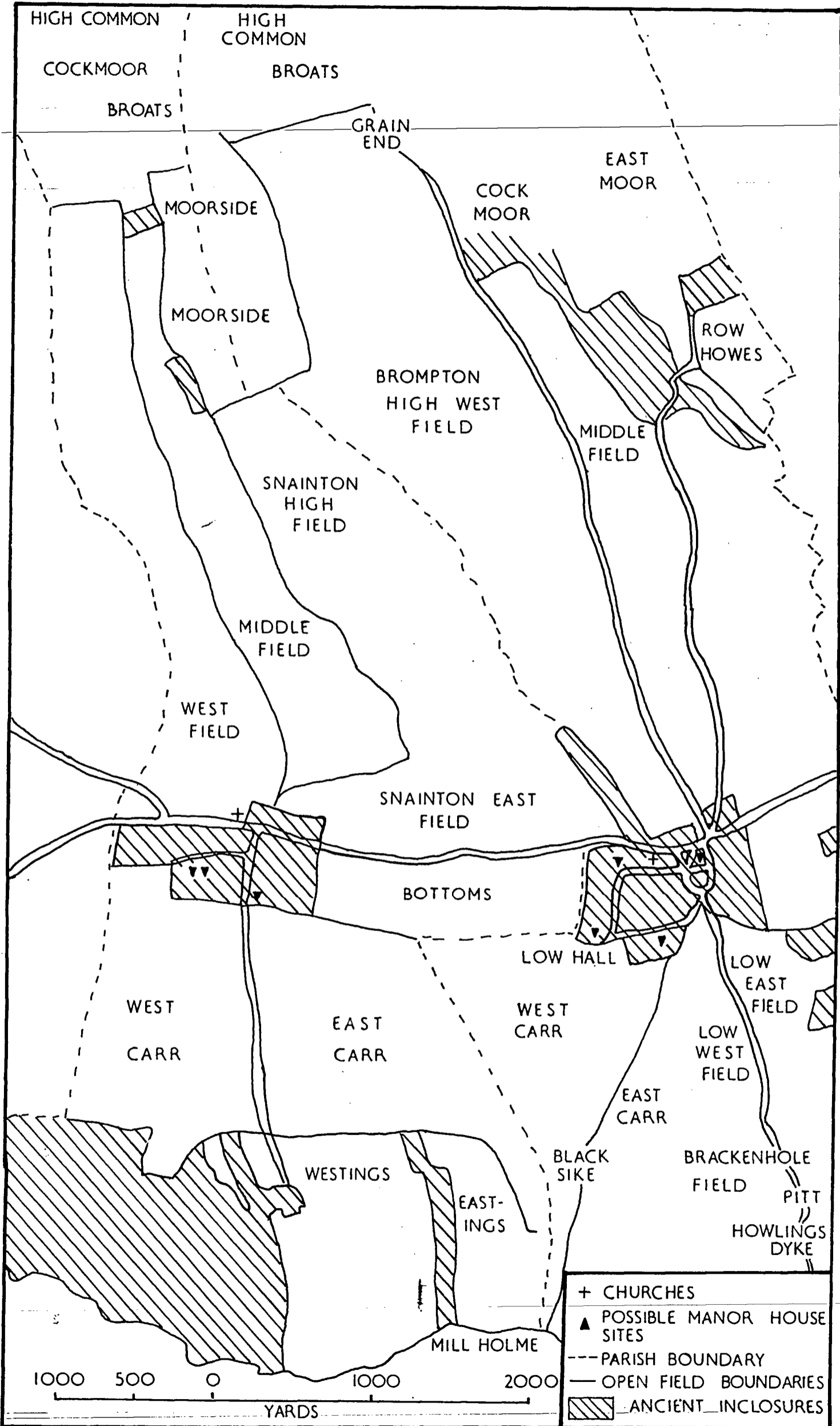

SNAINTON AND BROMPTON AFTER INCLOSURE

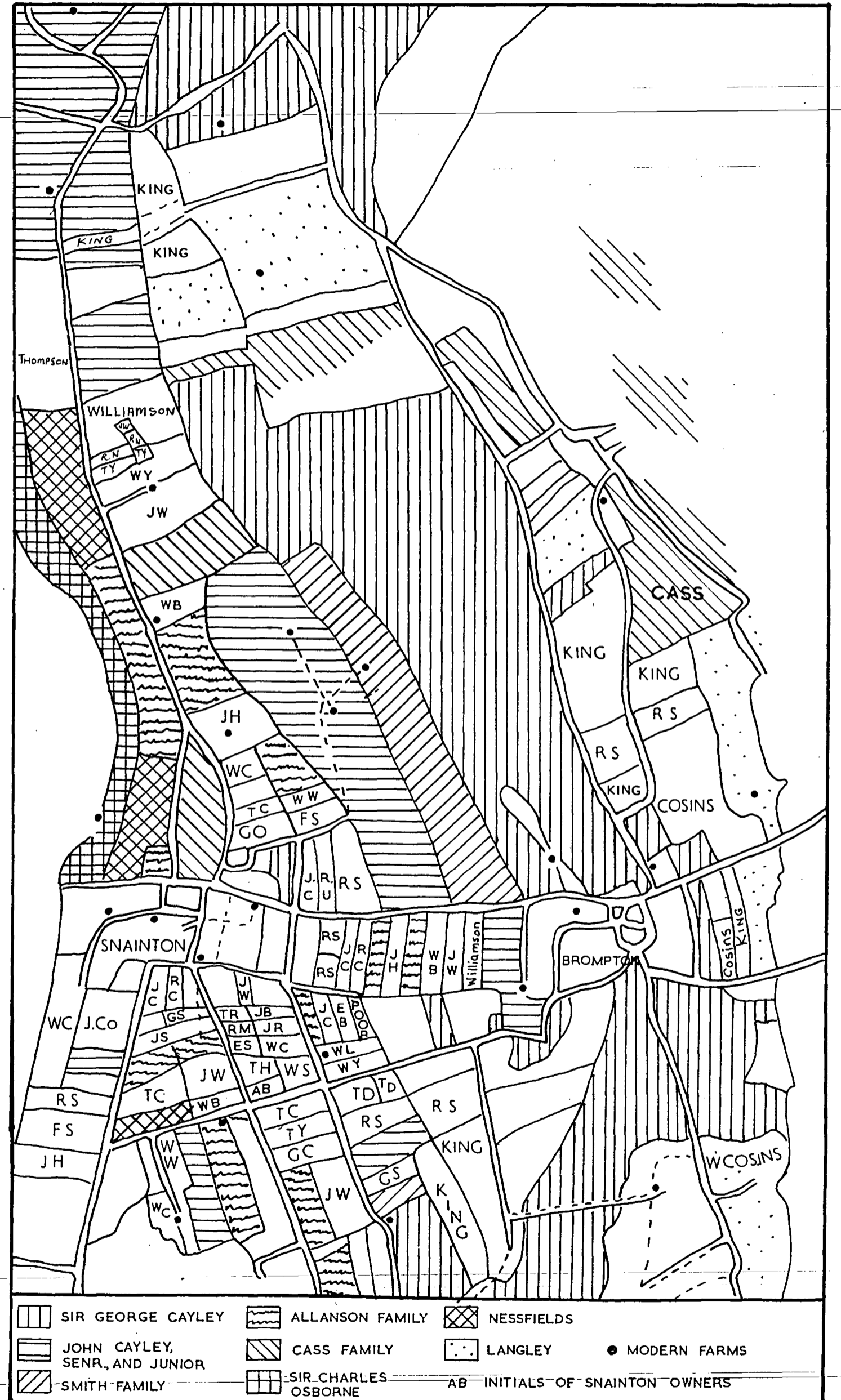

ENCLOSURE OF PICKERING  
1790

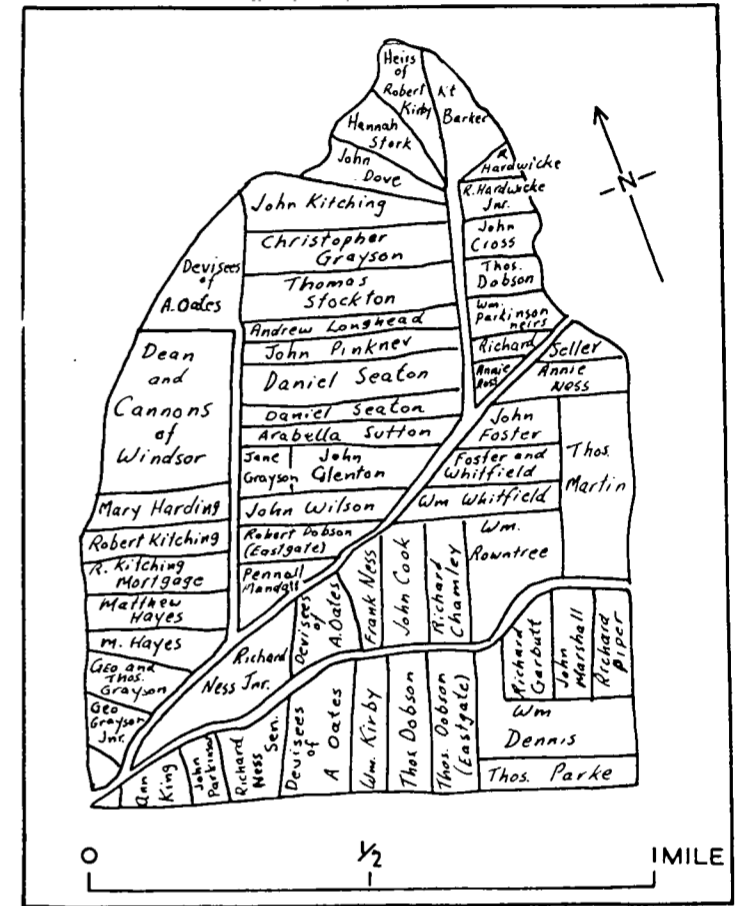
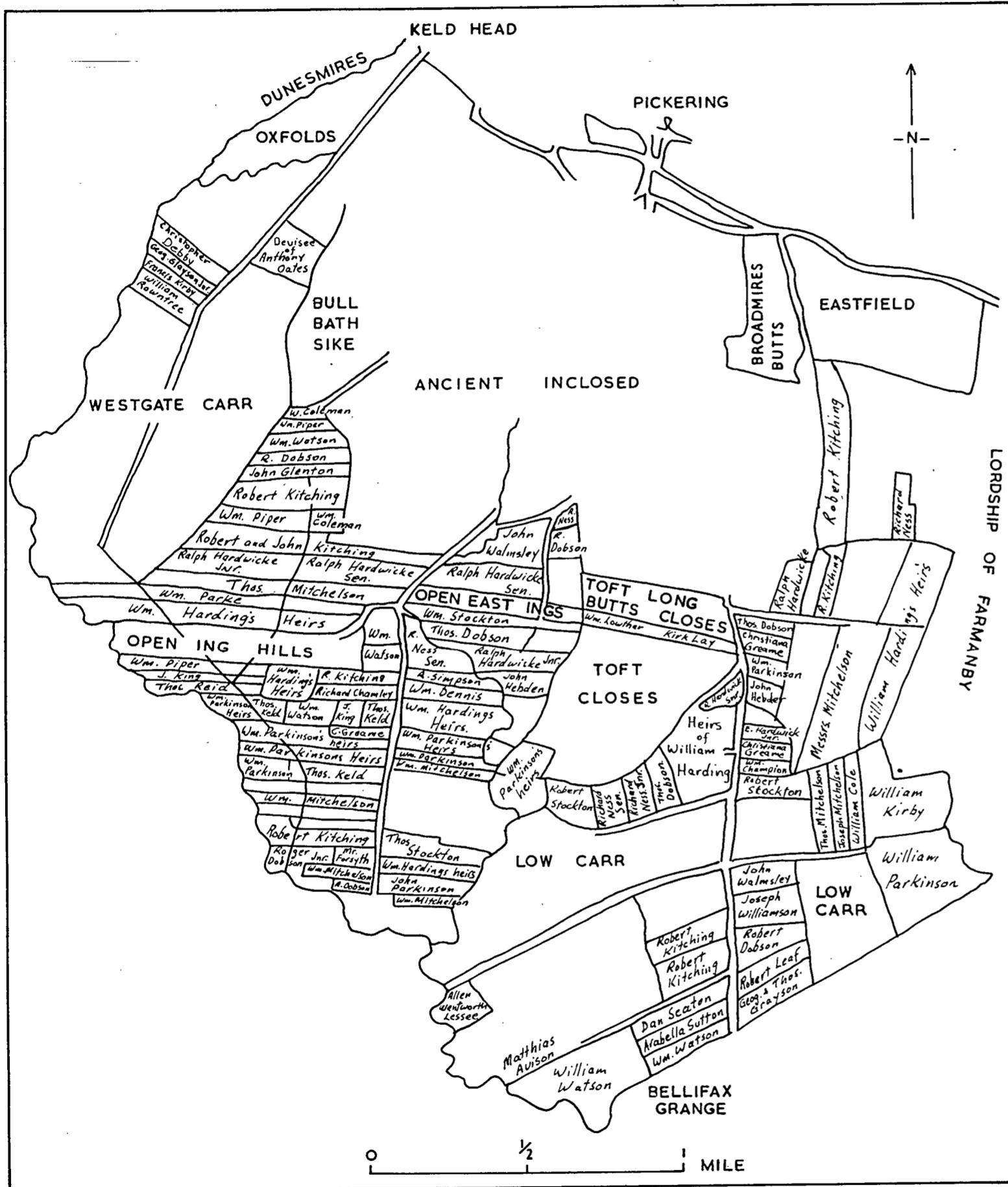

PART OF THE ALLOTMENT OF THE HIGH COMMONS OF PICKERING AND NEWTON

THIS PLAN COMPRISES THE LOW COMMONS OF PICKERING WITH THE PUBLIC AND PRIVATE ROAD AND ALLOTMENTS OF HIS MAJESTY IN RIGHT OF HIS CROWN SET OUT THERE ON WITH COMMON DRAINS OR WATER SEWERS ON THE SAME

### PROPORTION OF ARABLE LAND IN 1801

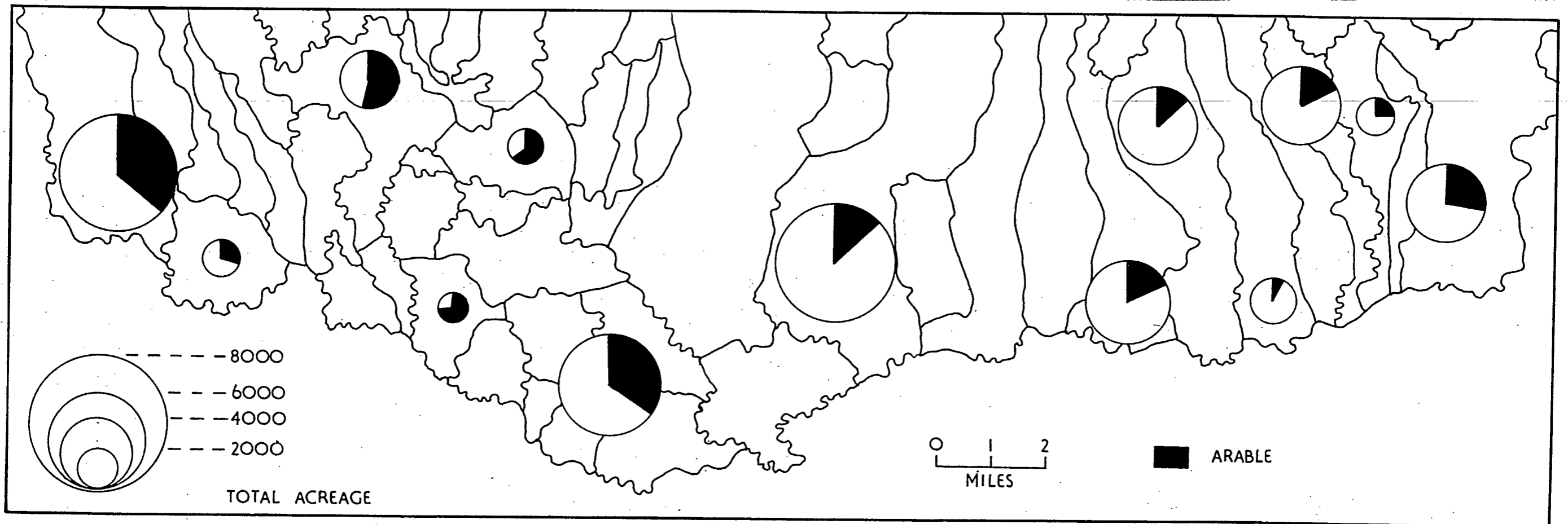

### MAIN CROPS IN 1801

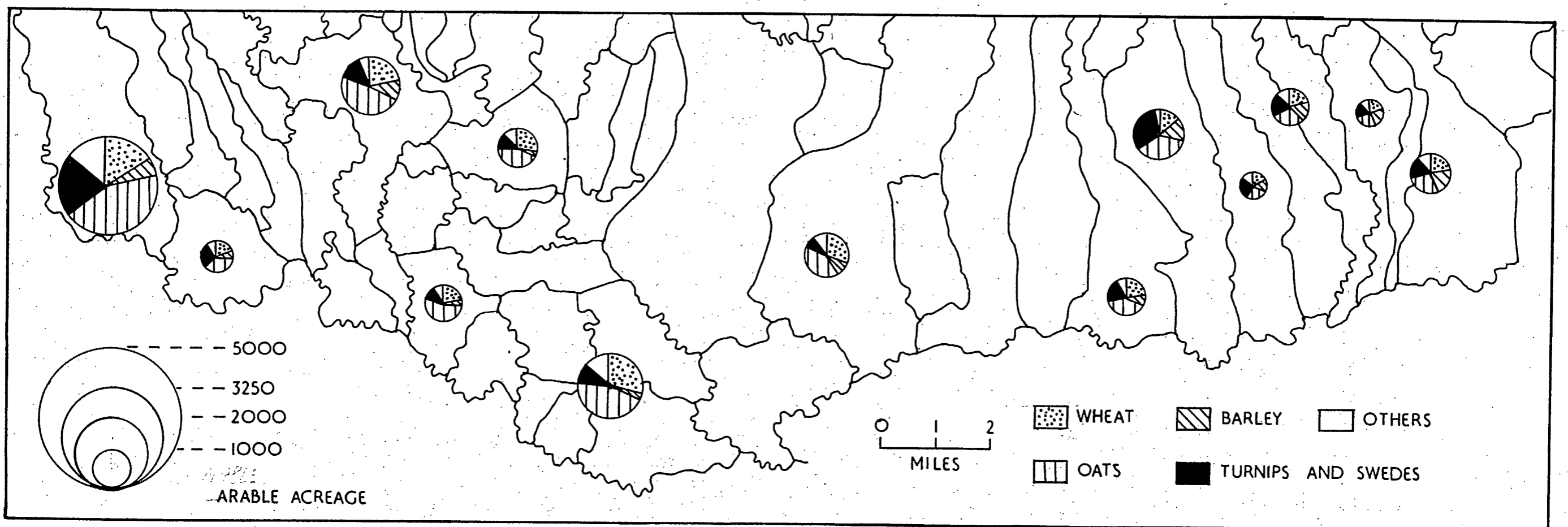

### CROP REGIONS FROM 1801 CROP RETURNS

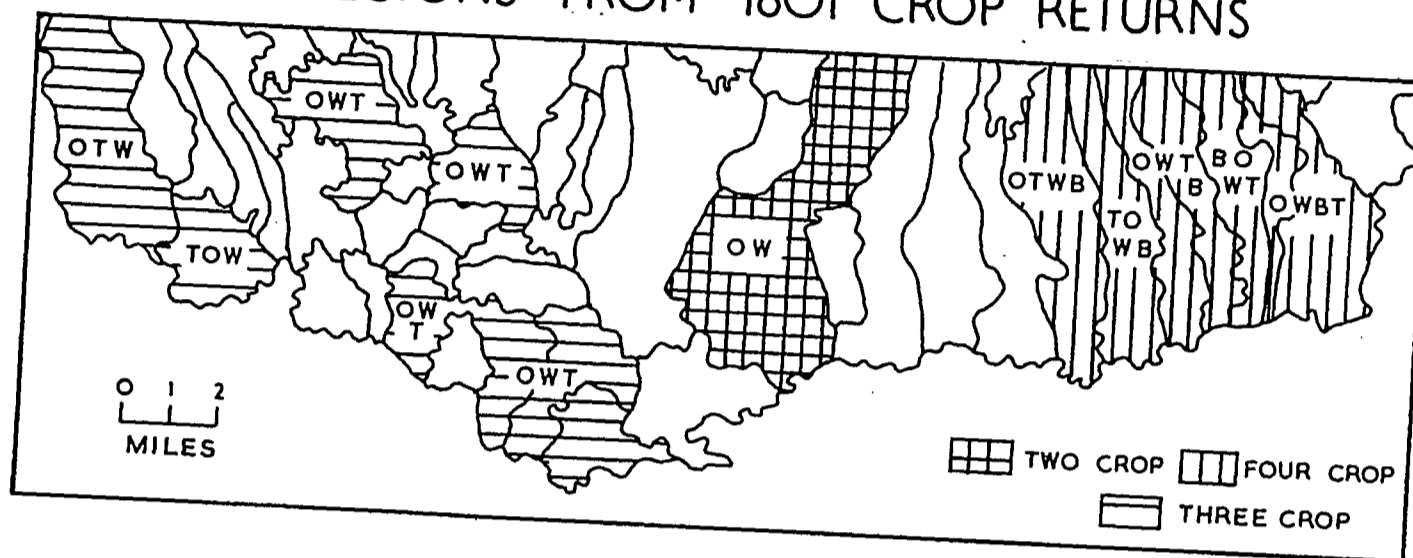

### FIRST RANKING CROP IN 1801

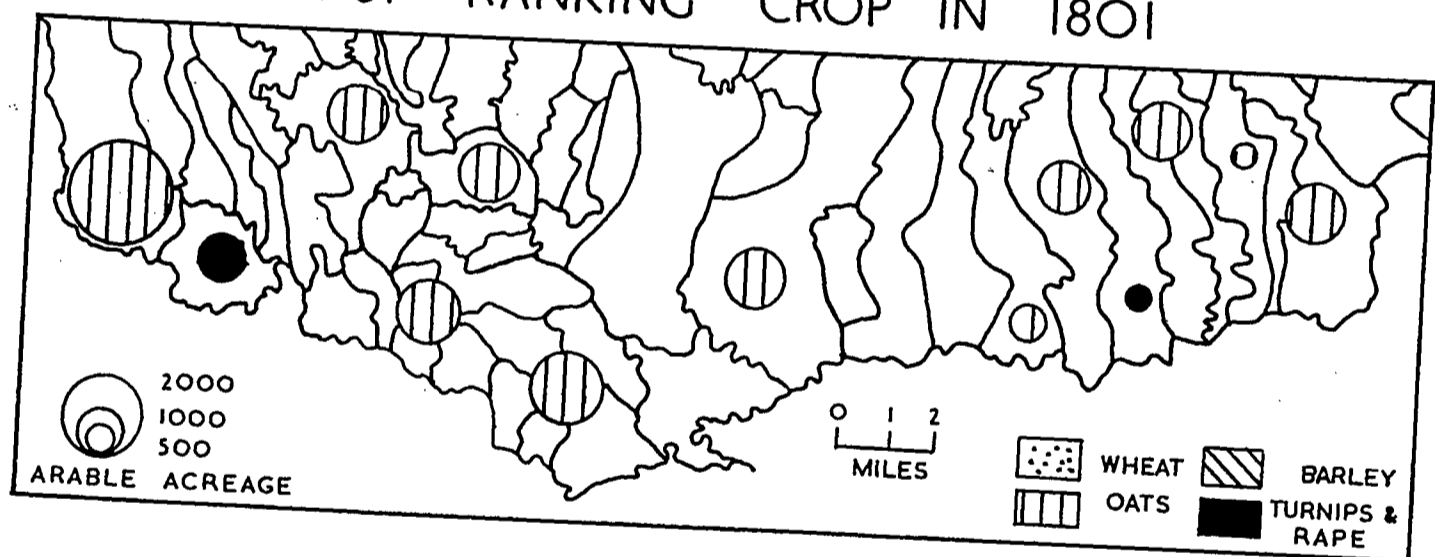

### SECOND RANKING CROP IN 1801

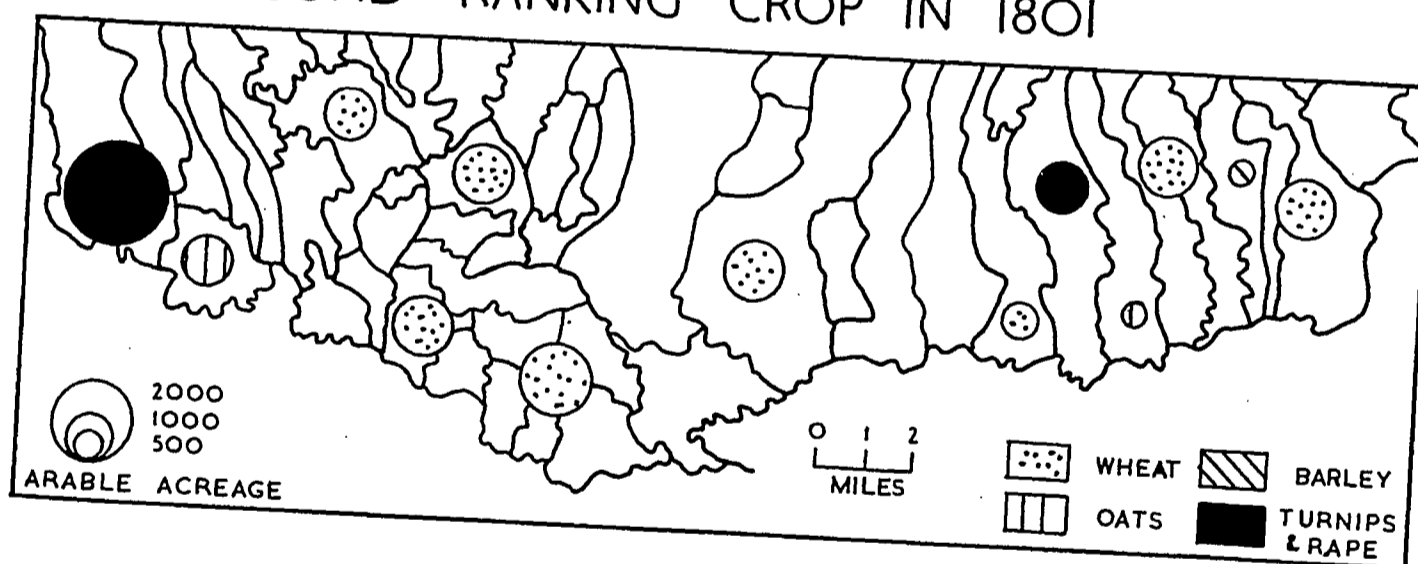

### THIRD RANKING CROP IN 1801

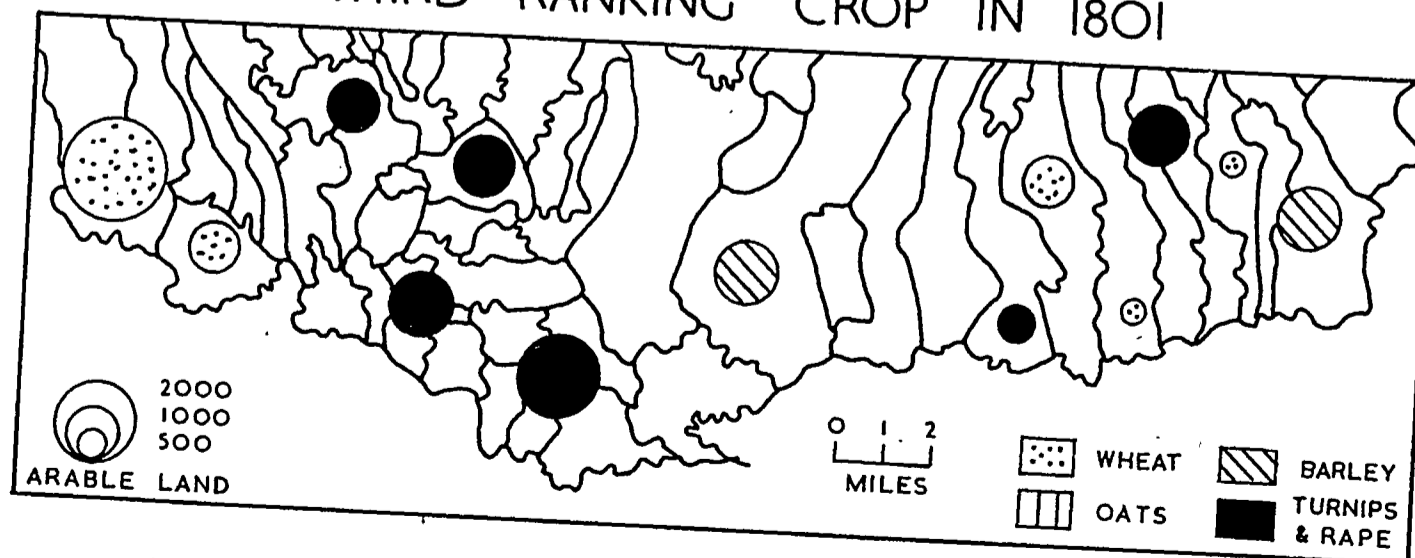

### LAND UTILISATION FROM THE TITHE AWARD MAPS

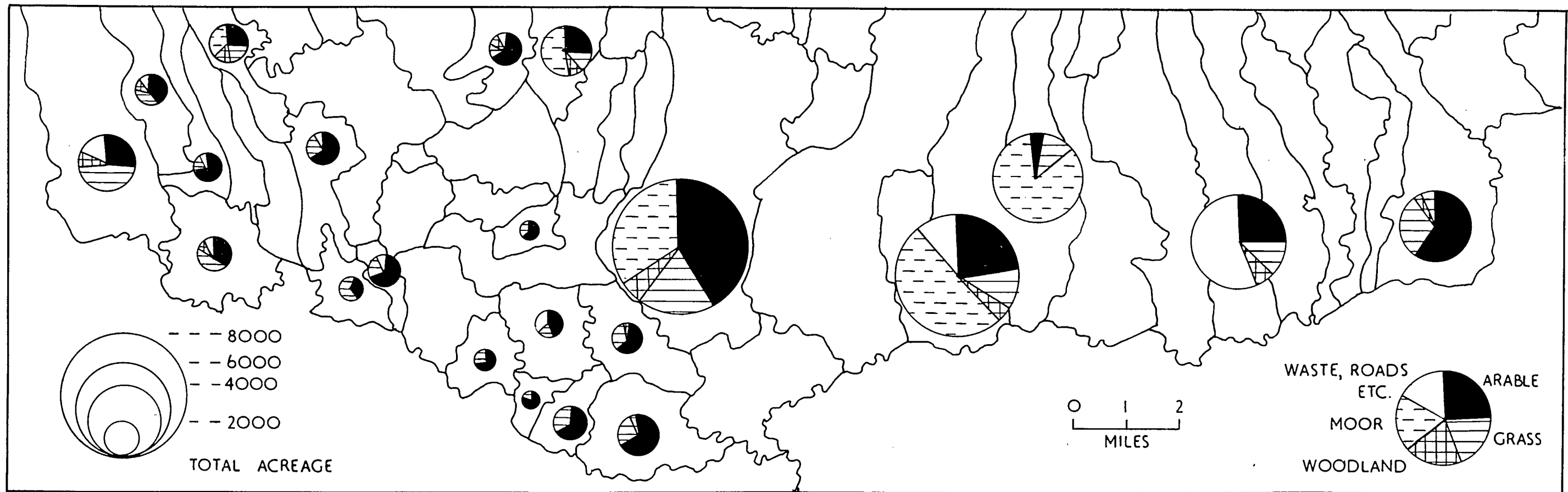



APPLETON LE MOORS - LAND USE 1847

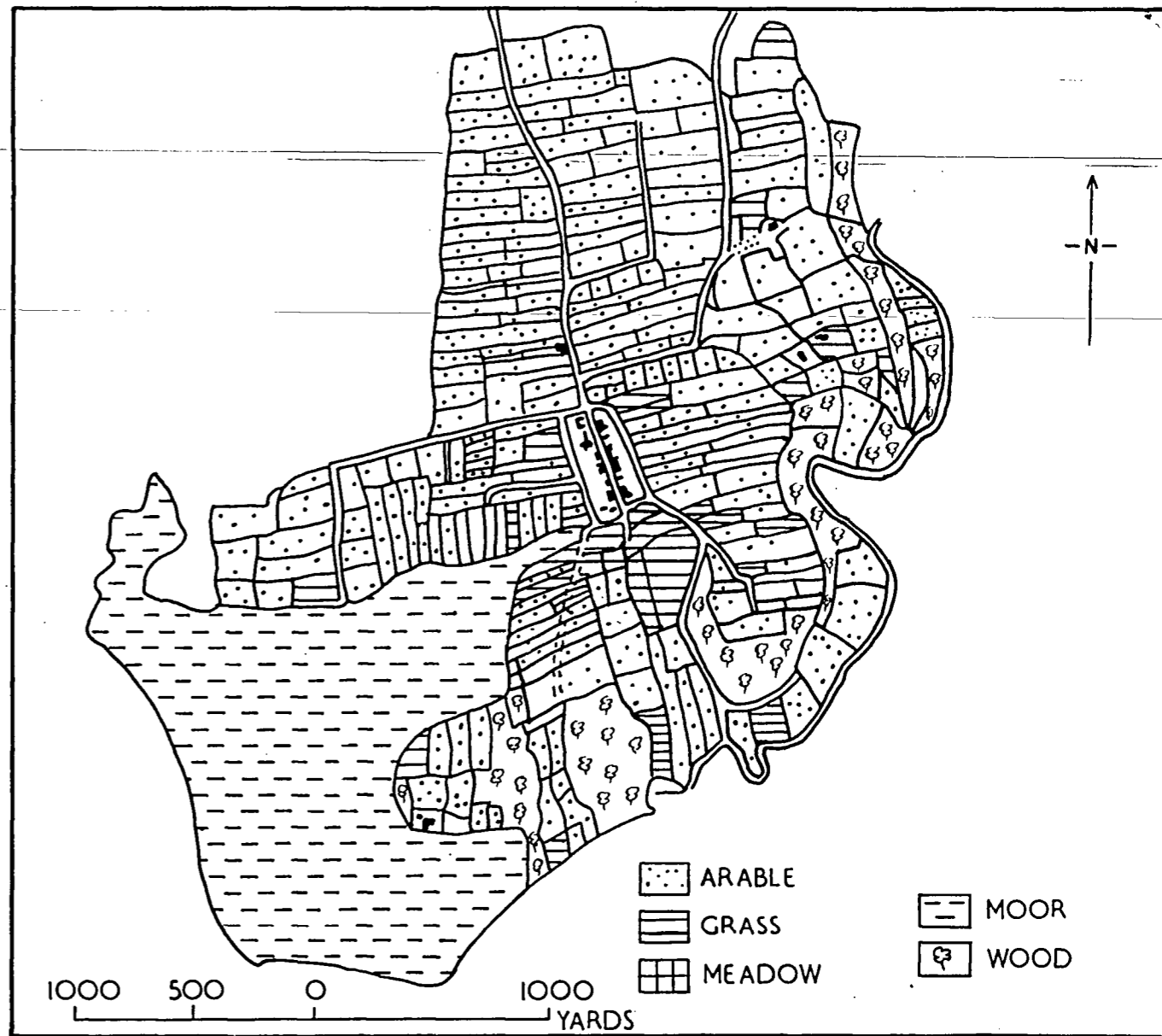

KIRBY MISPERTON AND PART OF RYTON - LAND USE 1845

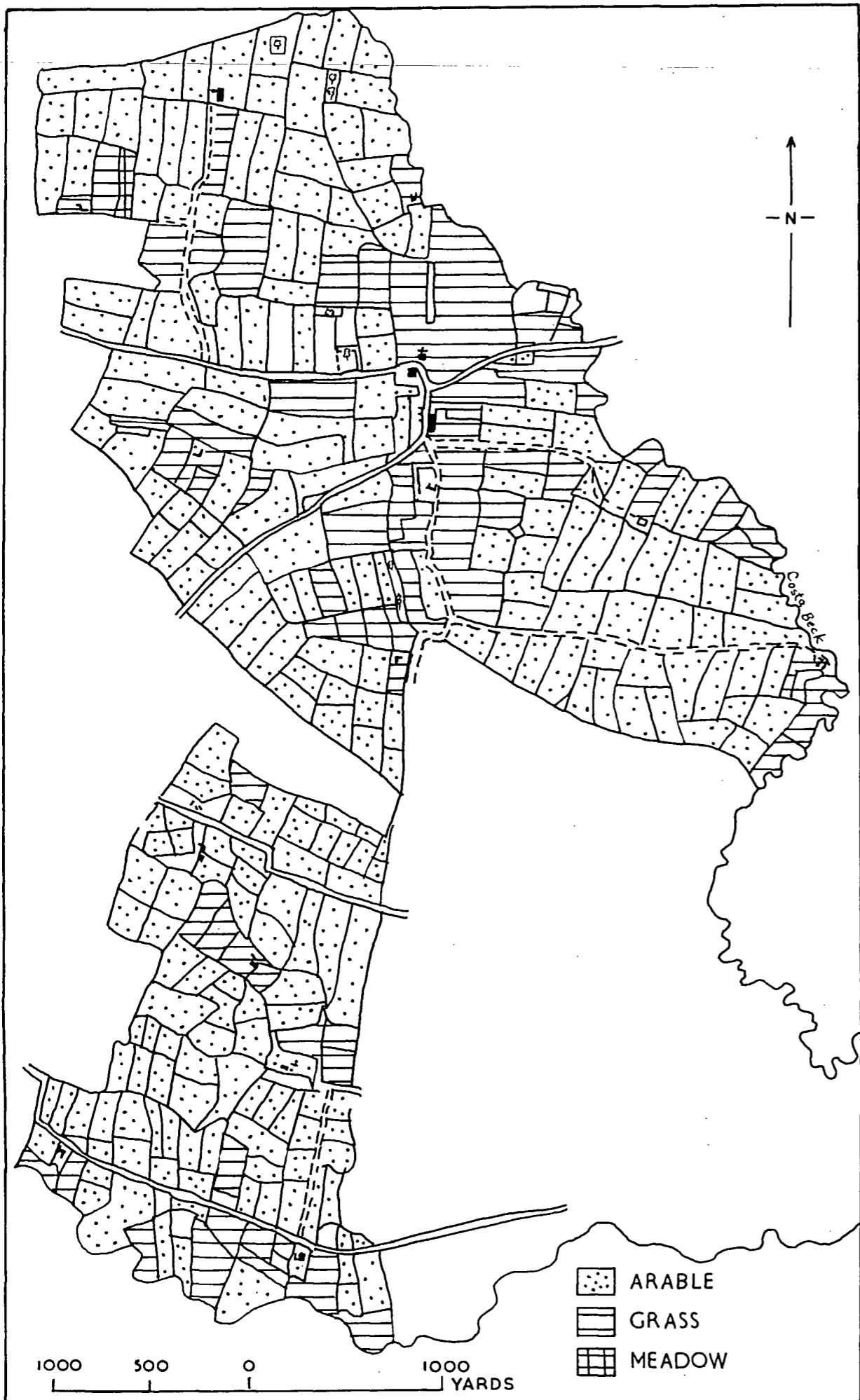

GREAT AND LITTLE HABTON : LAND USE 1847

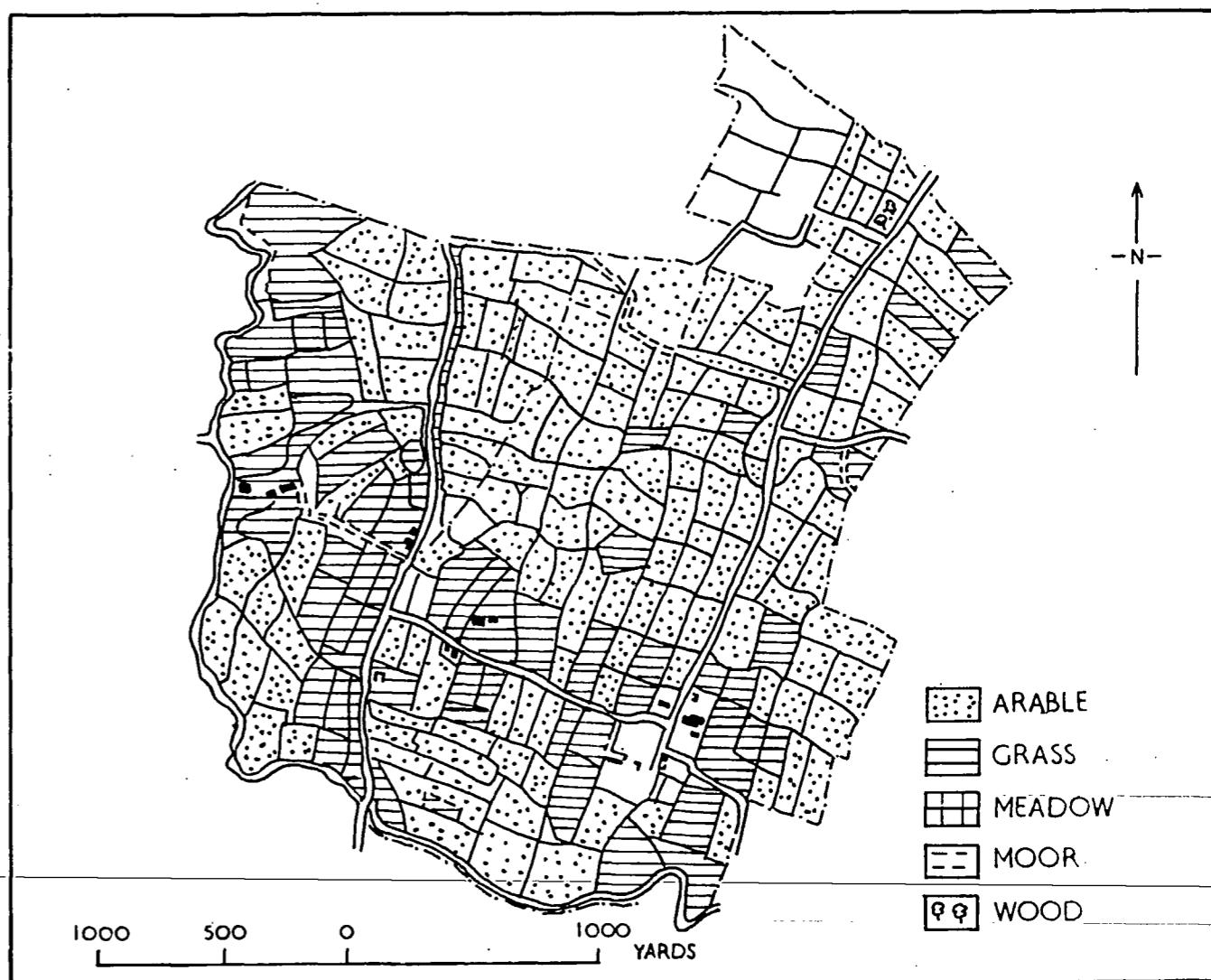

# PICKERING

LAND USE FROM THE TITHE AWARD 1847

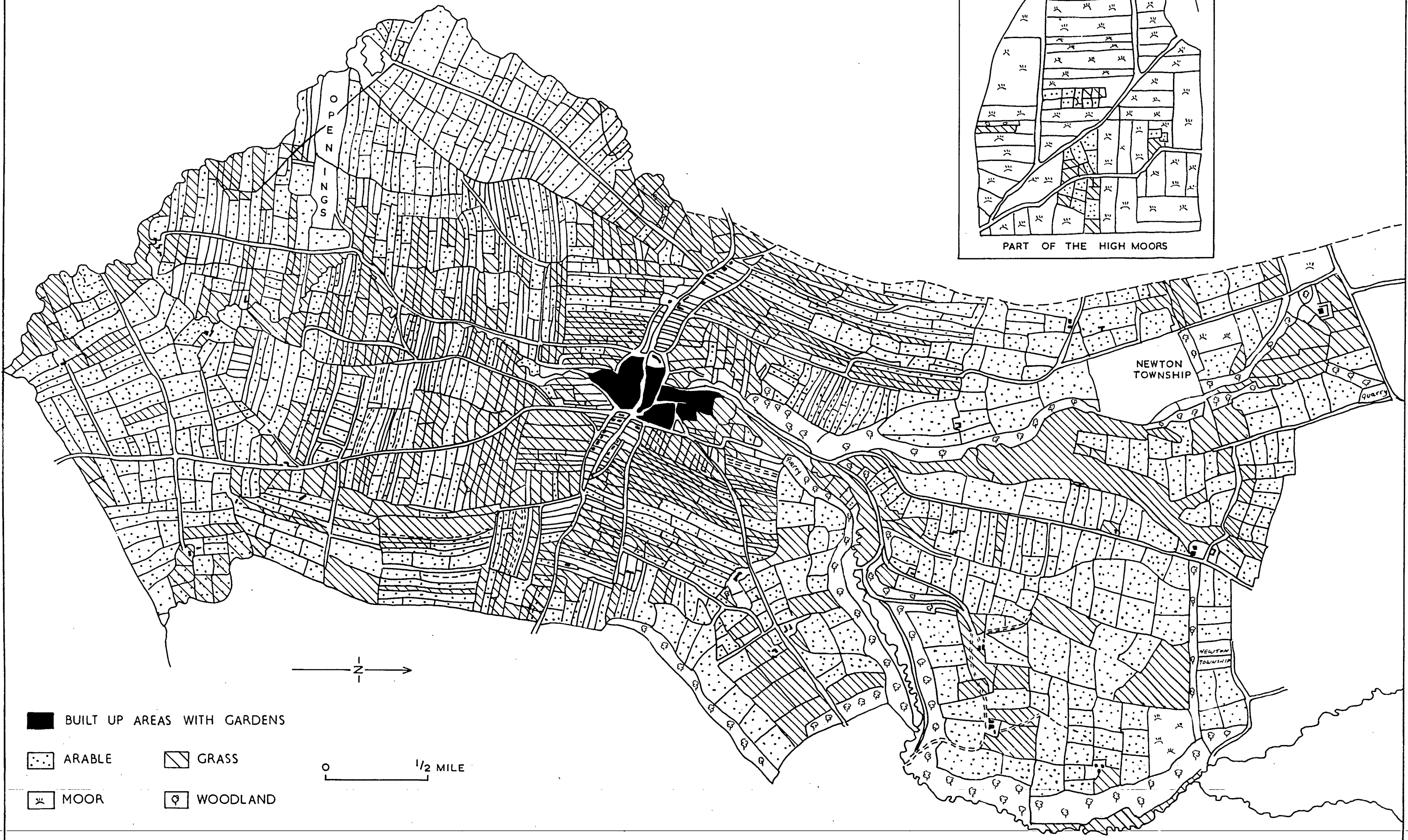
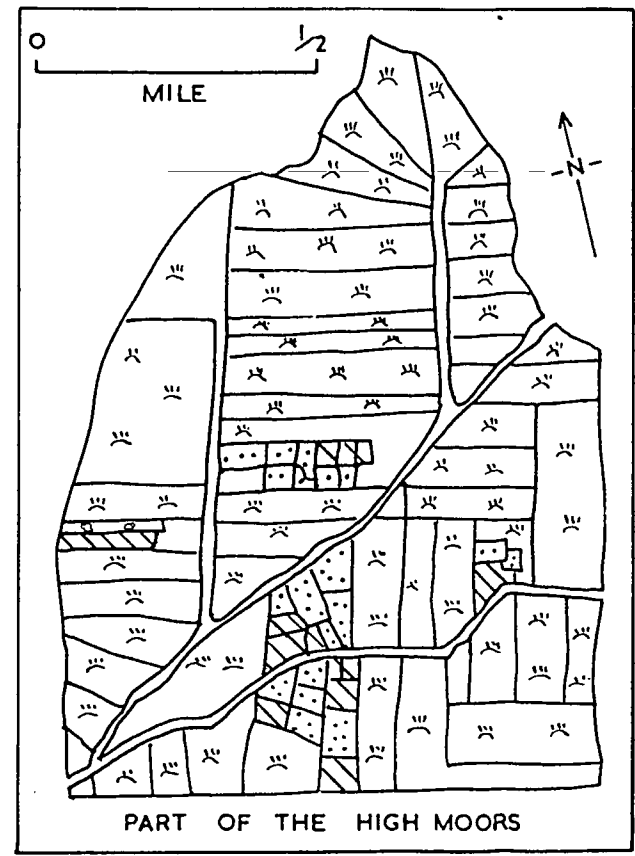

- BUILT UP AREAS WITH GARDENS
- ▤ ARABLE
- ▨ GRASS
- ☒ MOOR
- ⊙ WOODLAND

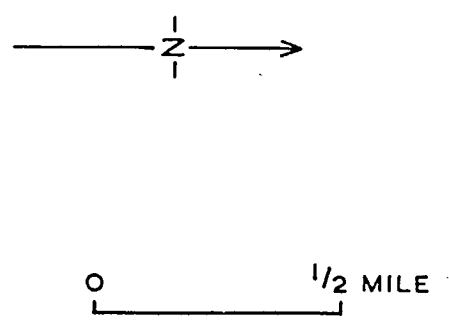



### LAND USE PROPORTIONS IN 1867

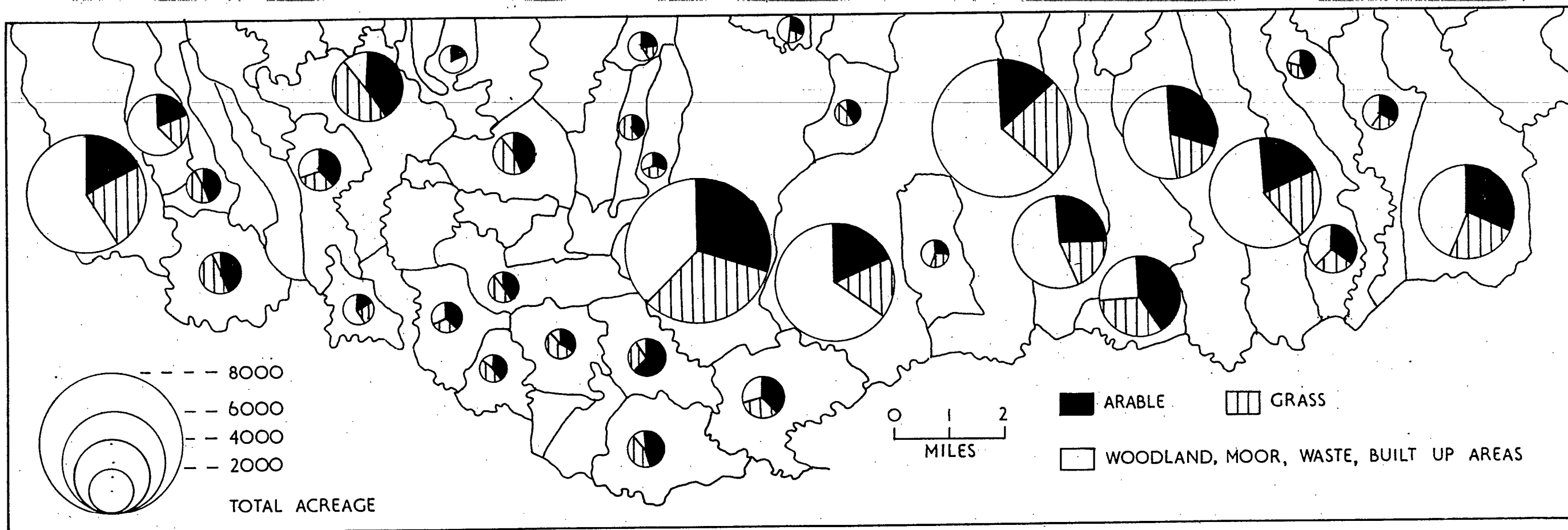

### MAIN CROPS IN 1867

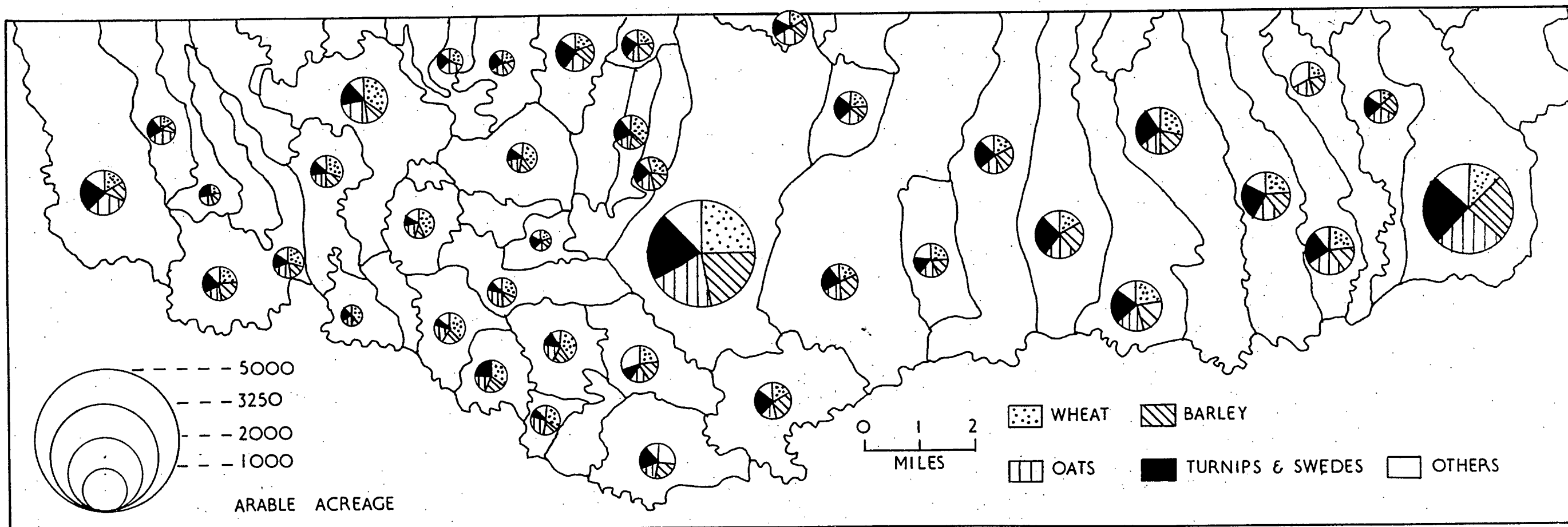

LAND USE PROPORTIONS IN 1877

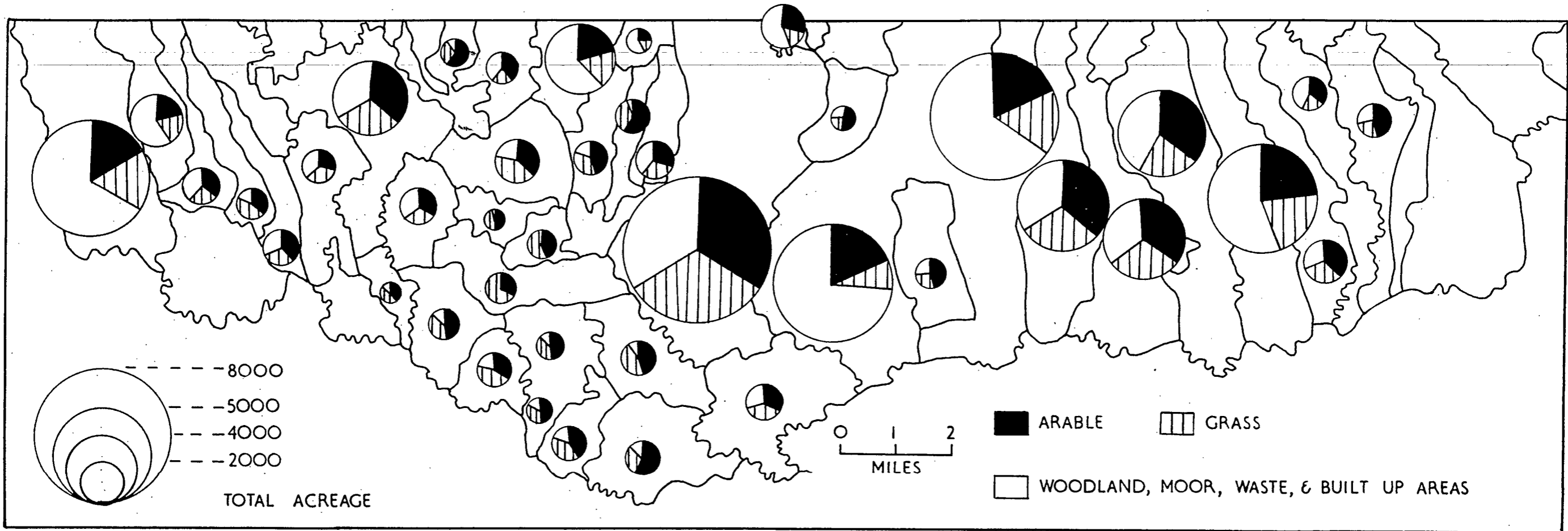

MAIN CROPS IN 1877

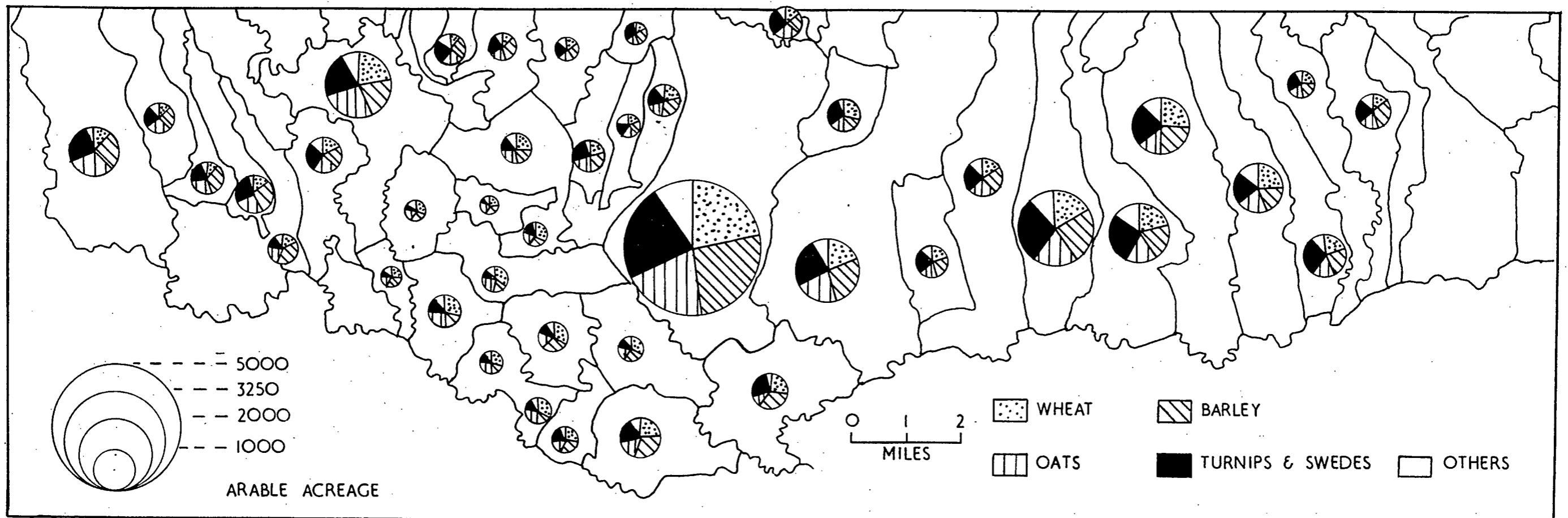

### LAND USE PROPORTIONS IN 1887

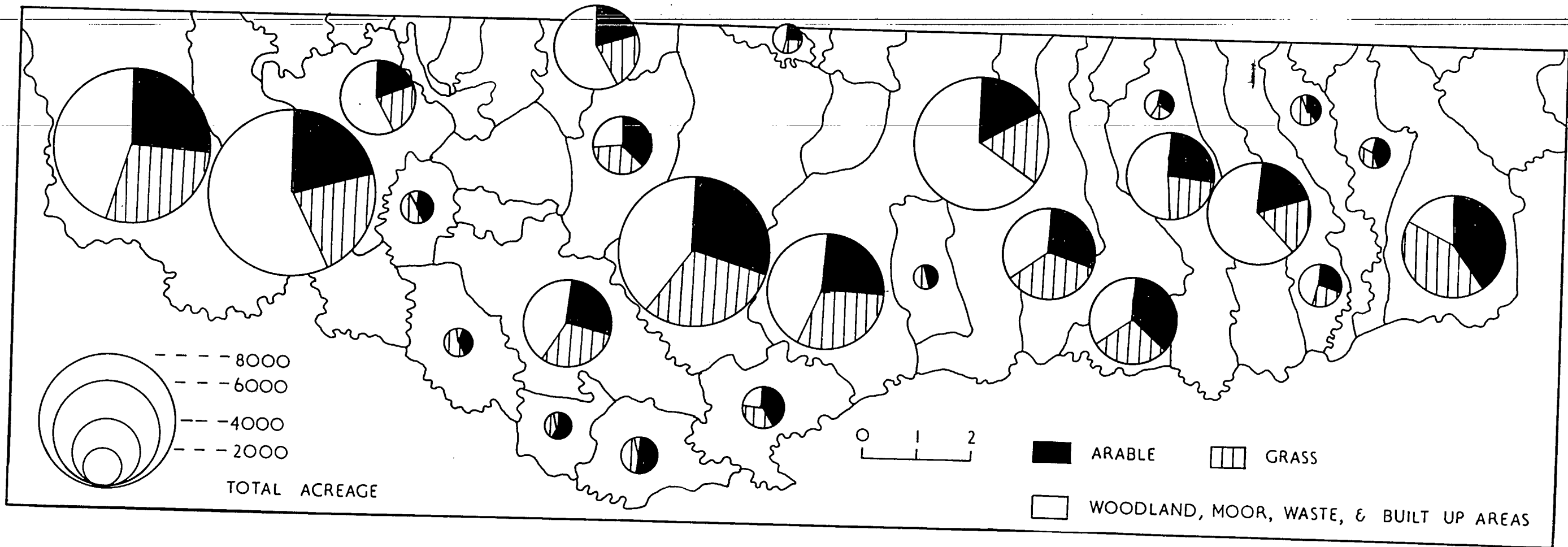

### MAIN CROPS IN 1887

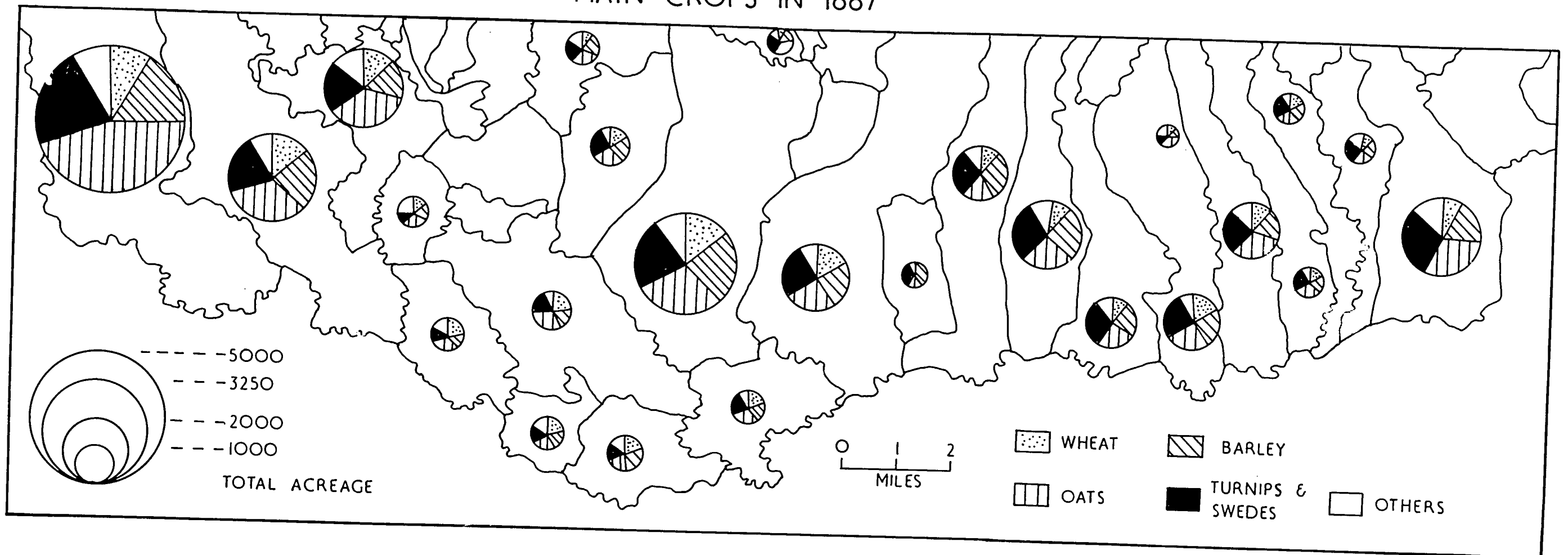

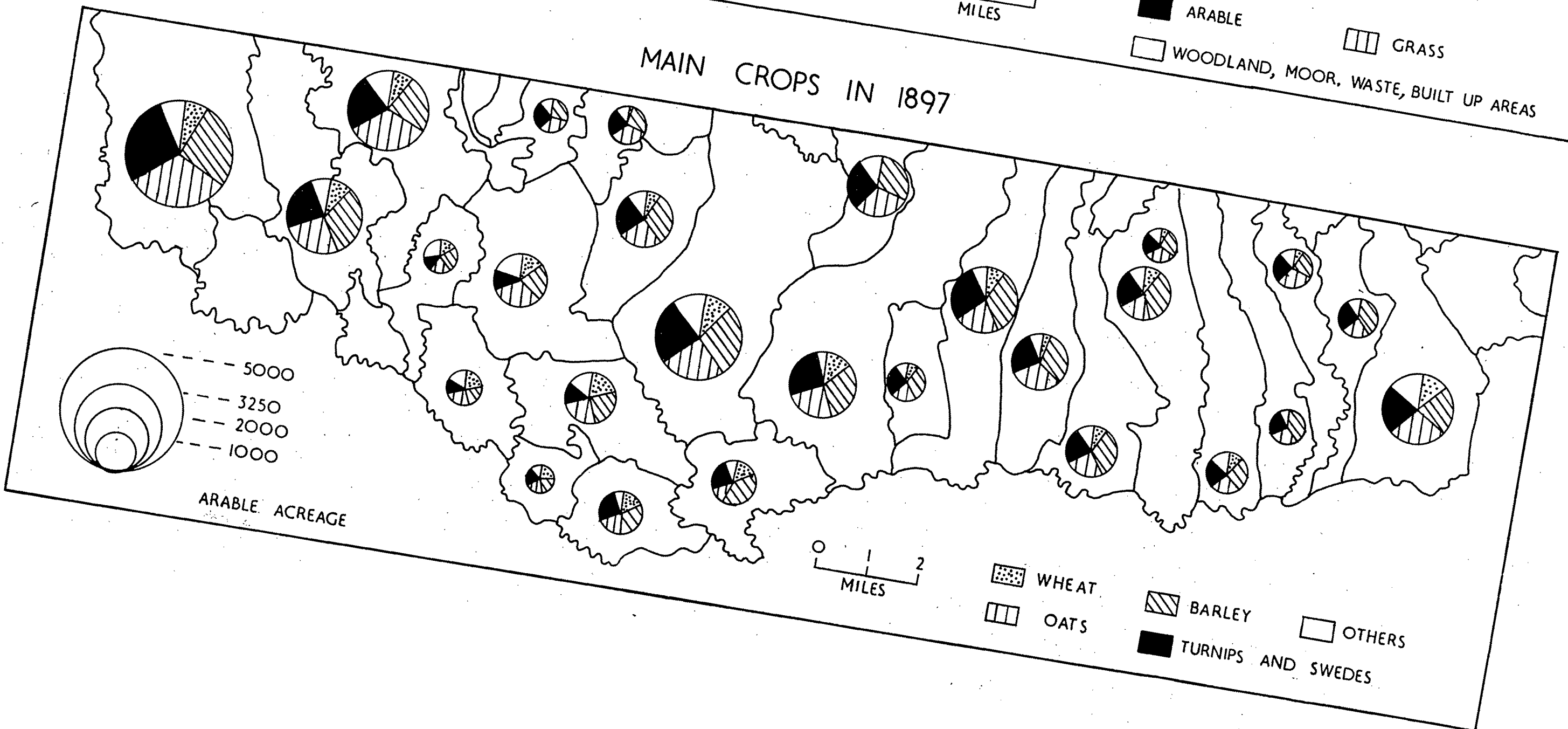
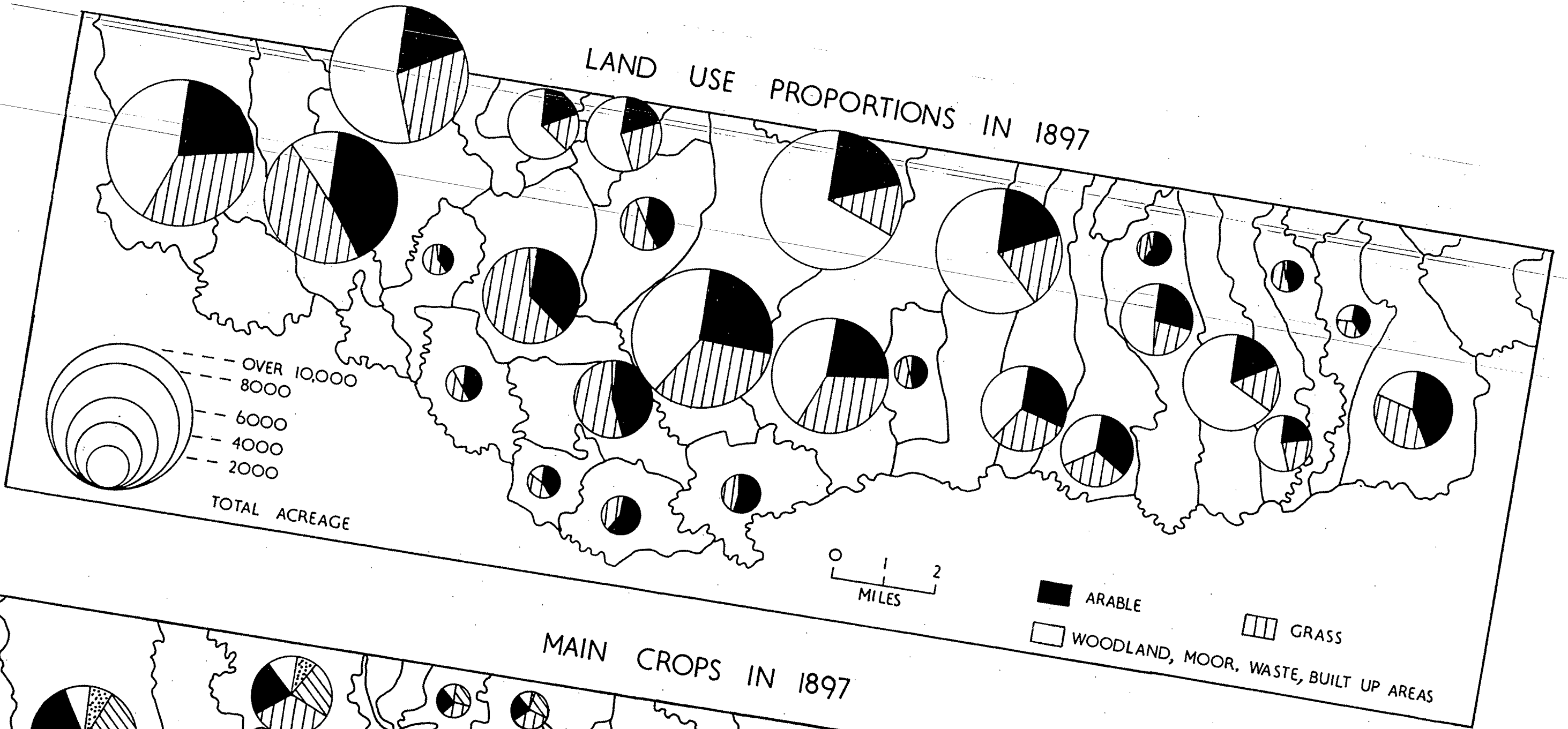

### LAND USE PROPORTIONS IN 1907

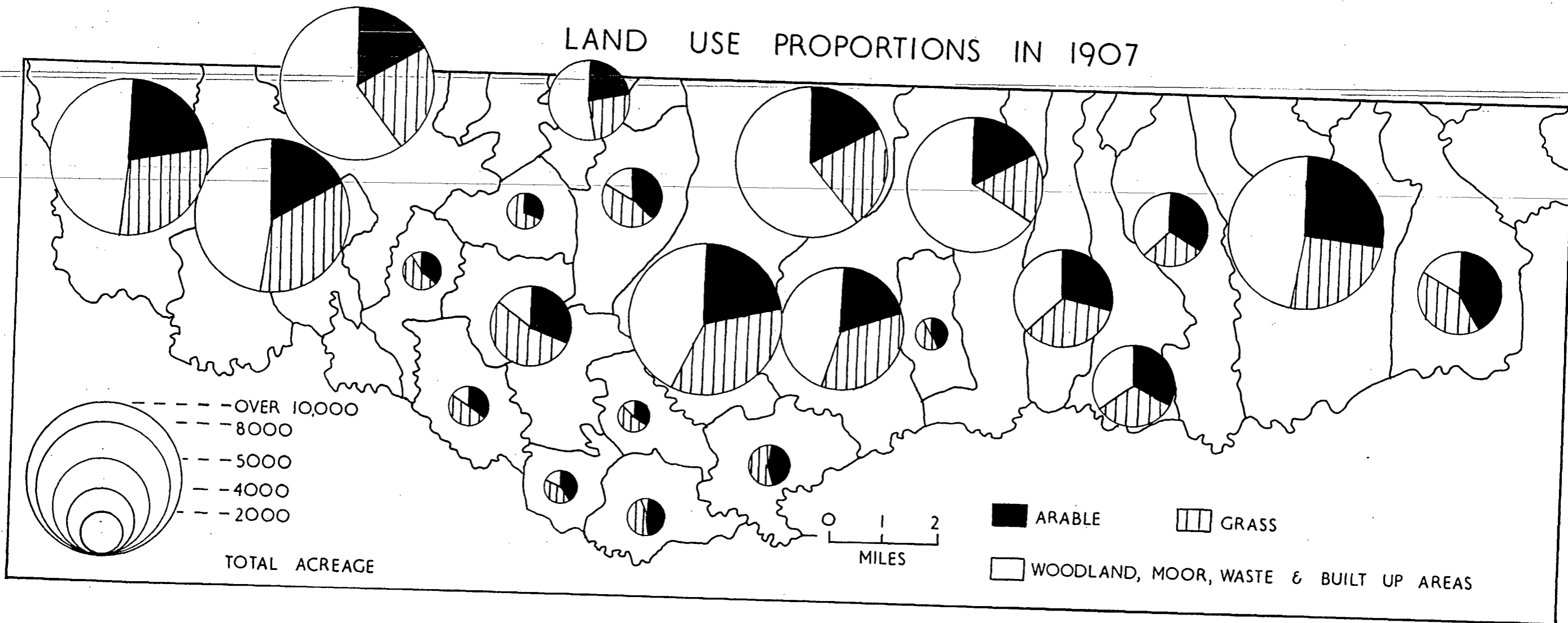

### MAIN CROPS IN 1907

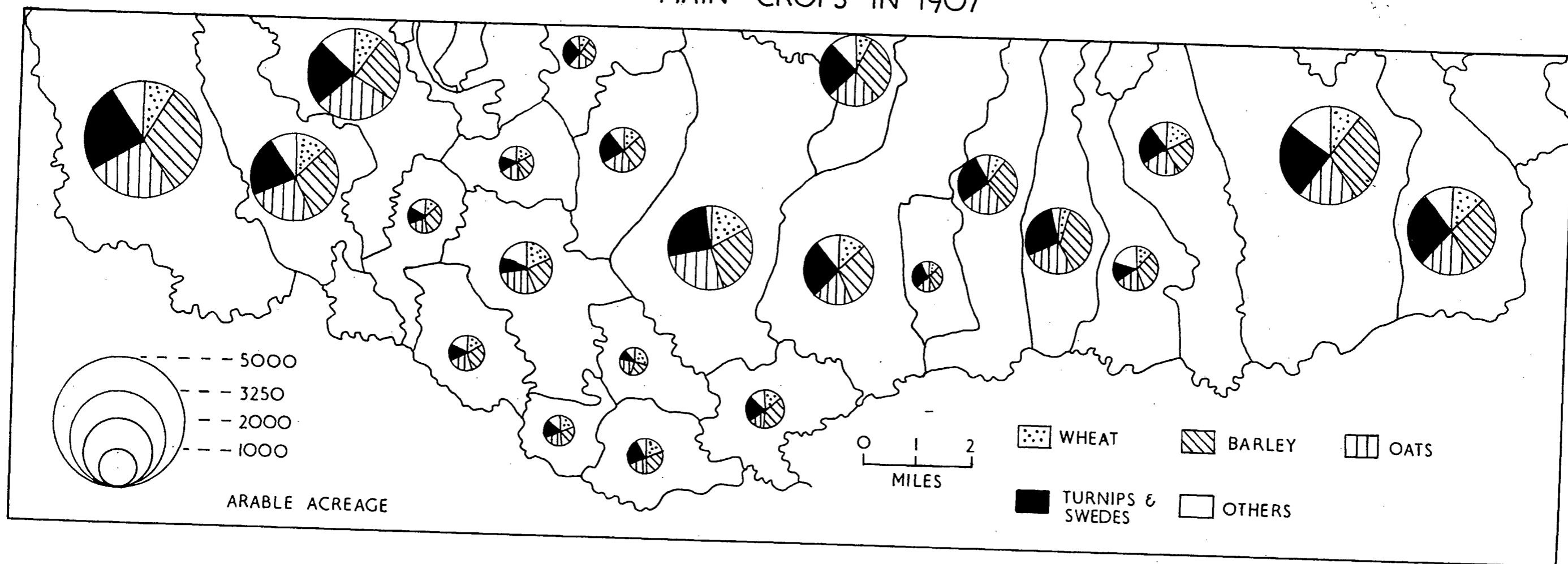



LAND USE PROPORTIONS IN 1937

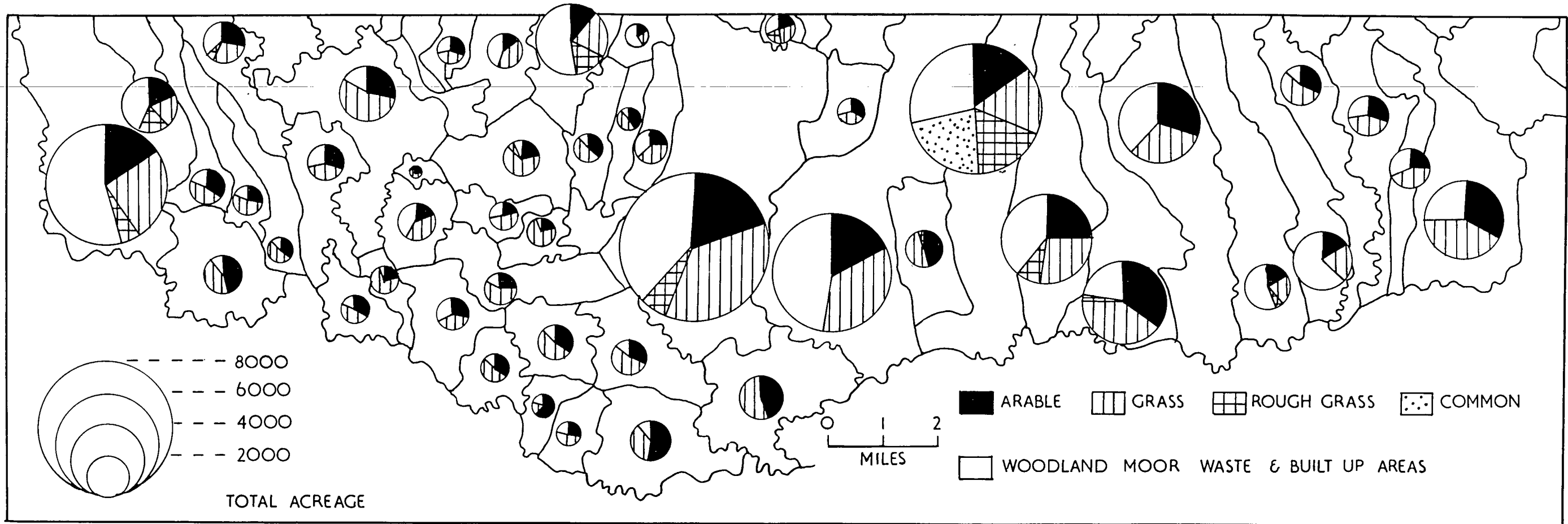

MAIN CROPS IN 1937

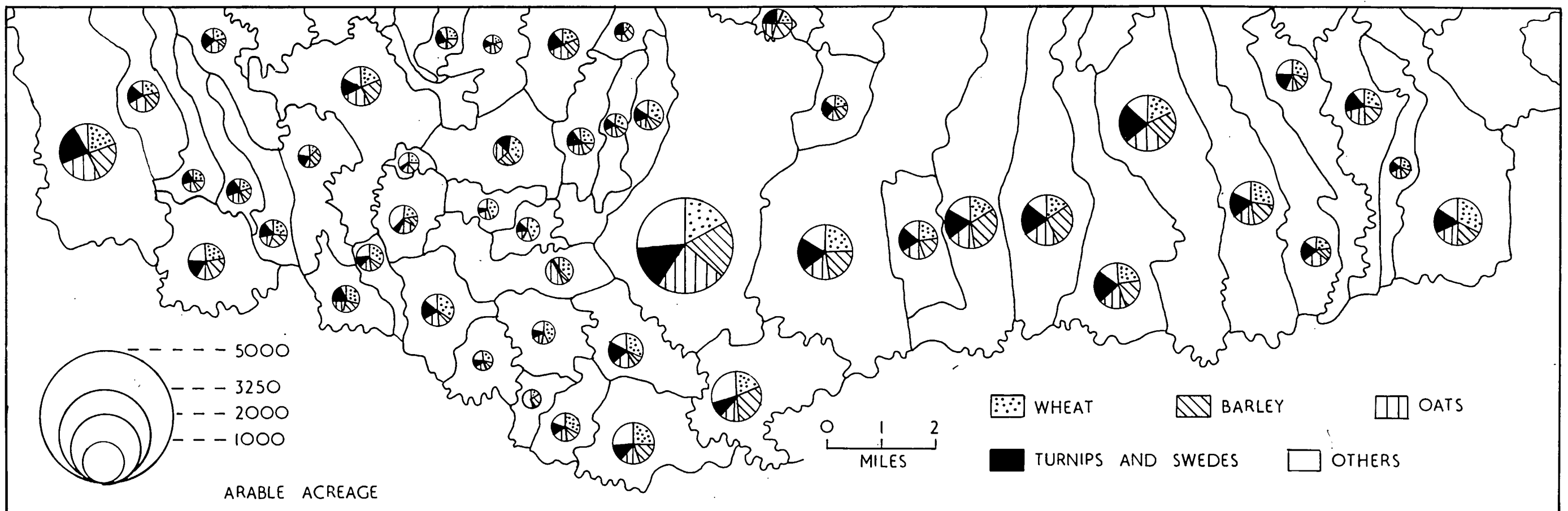

LAND USE PROPORTIONS IN 1927

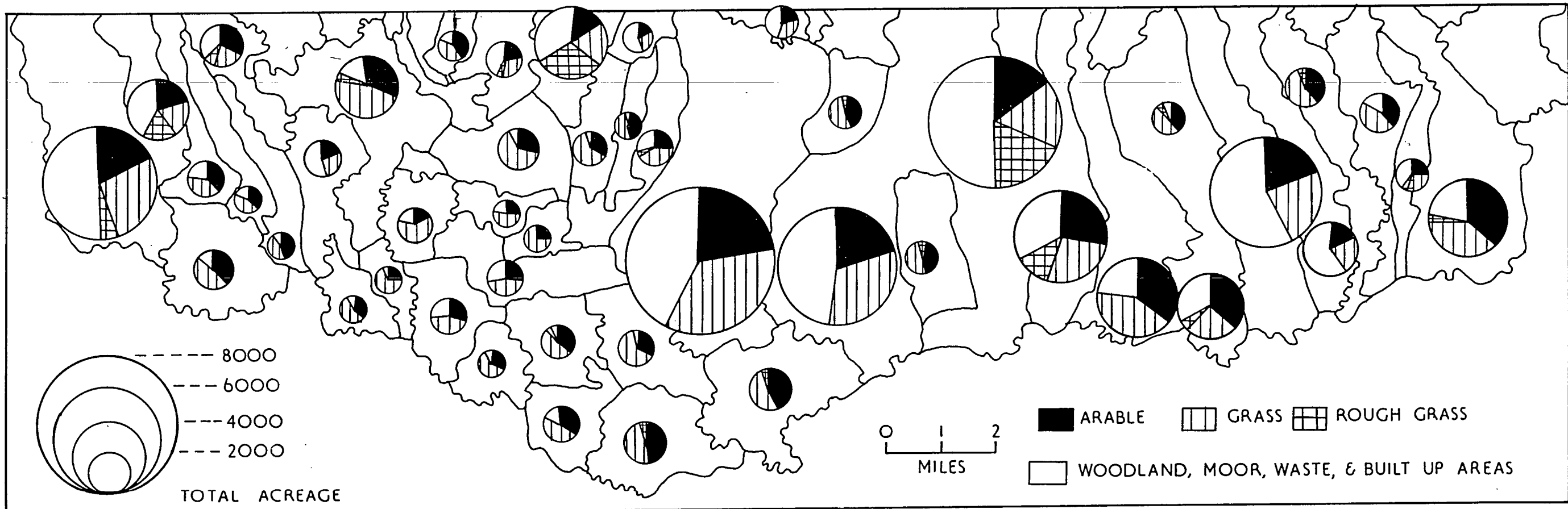

MAIN CROPS IN 1927

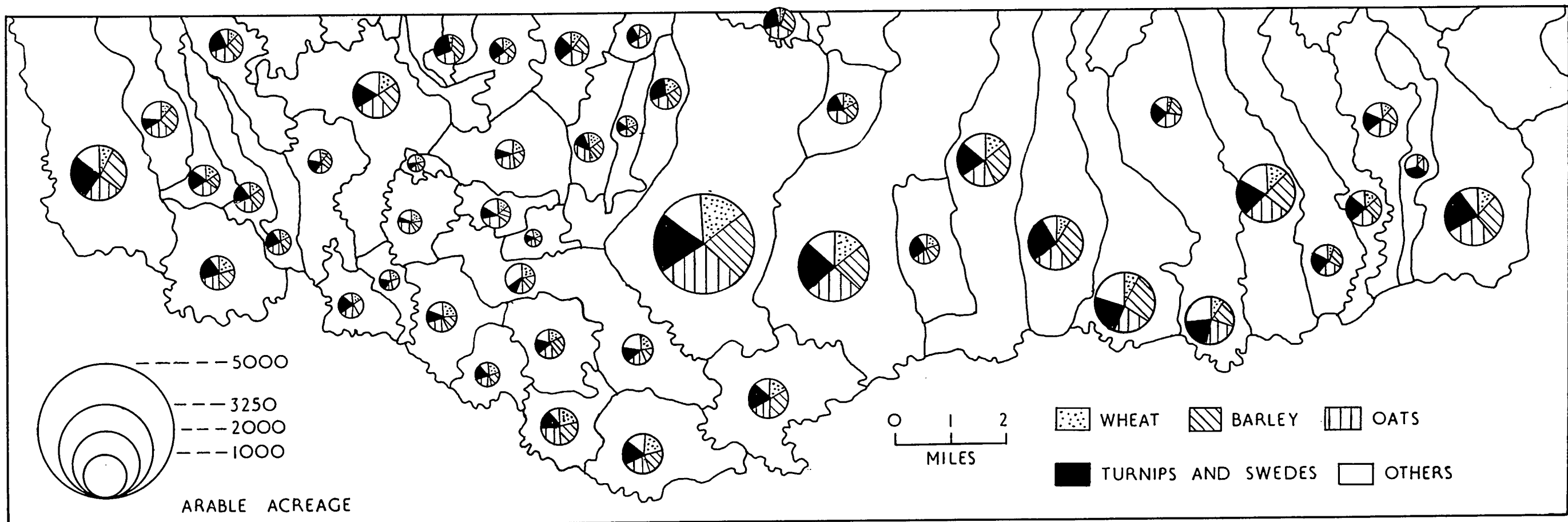

LAND USE PROPORTIONS IN 1927

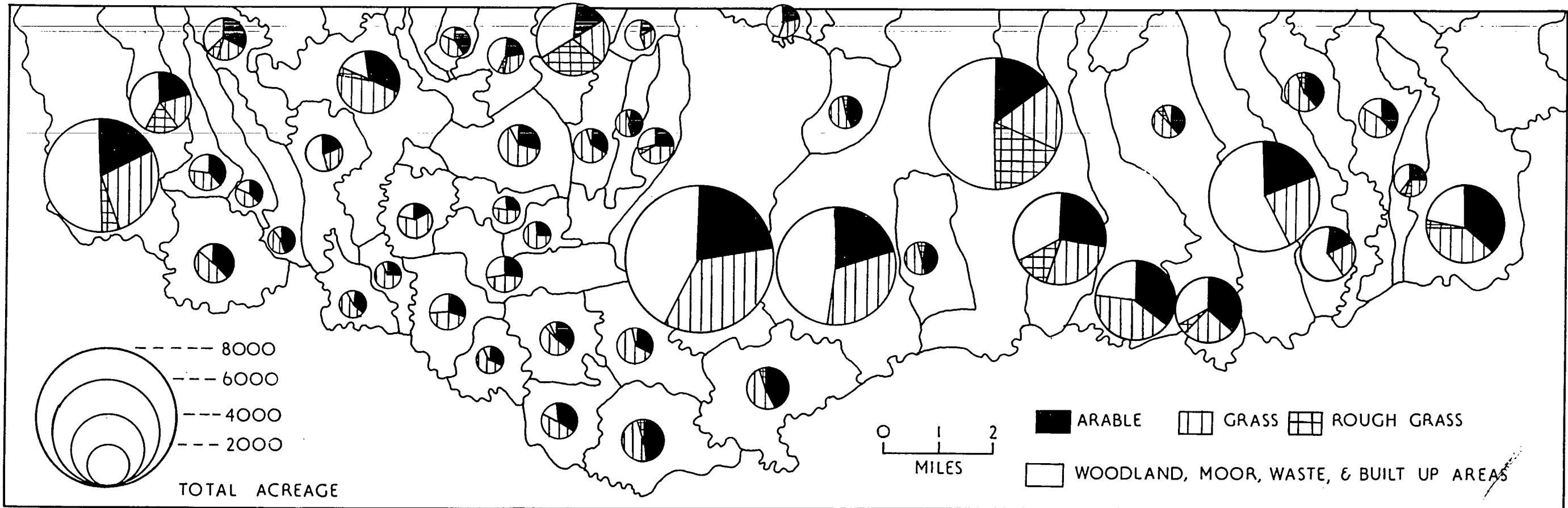

MAIN CROPS IN 1927

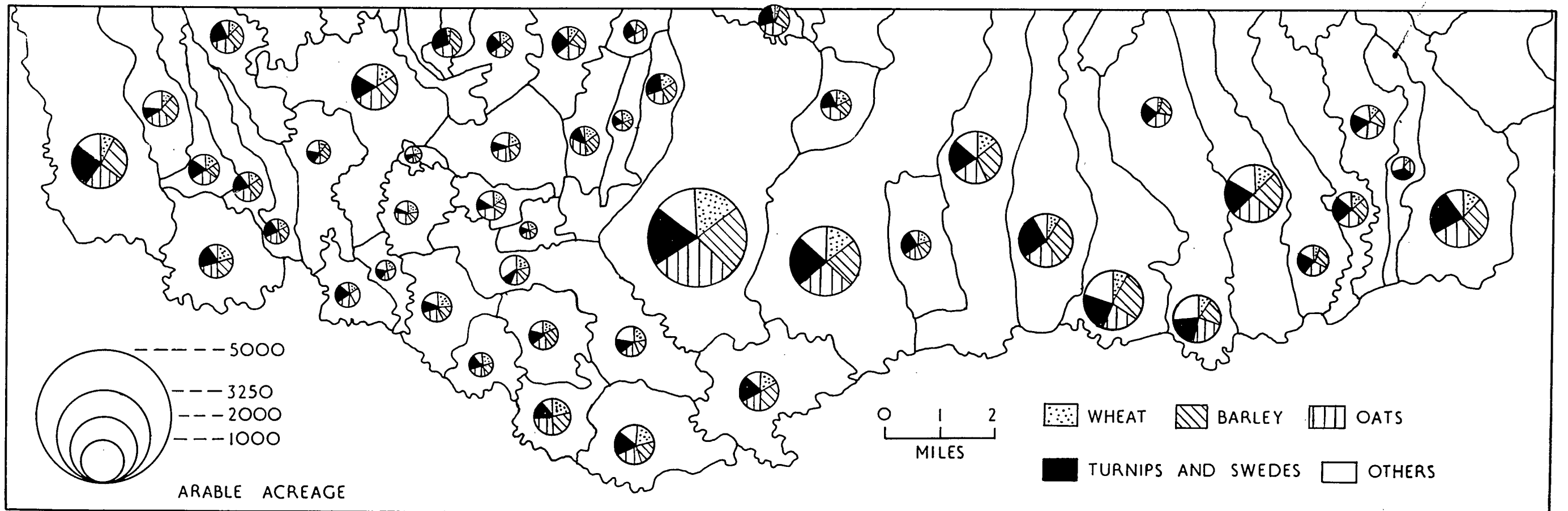

### LAND USE PROPORTIONS IN 1947

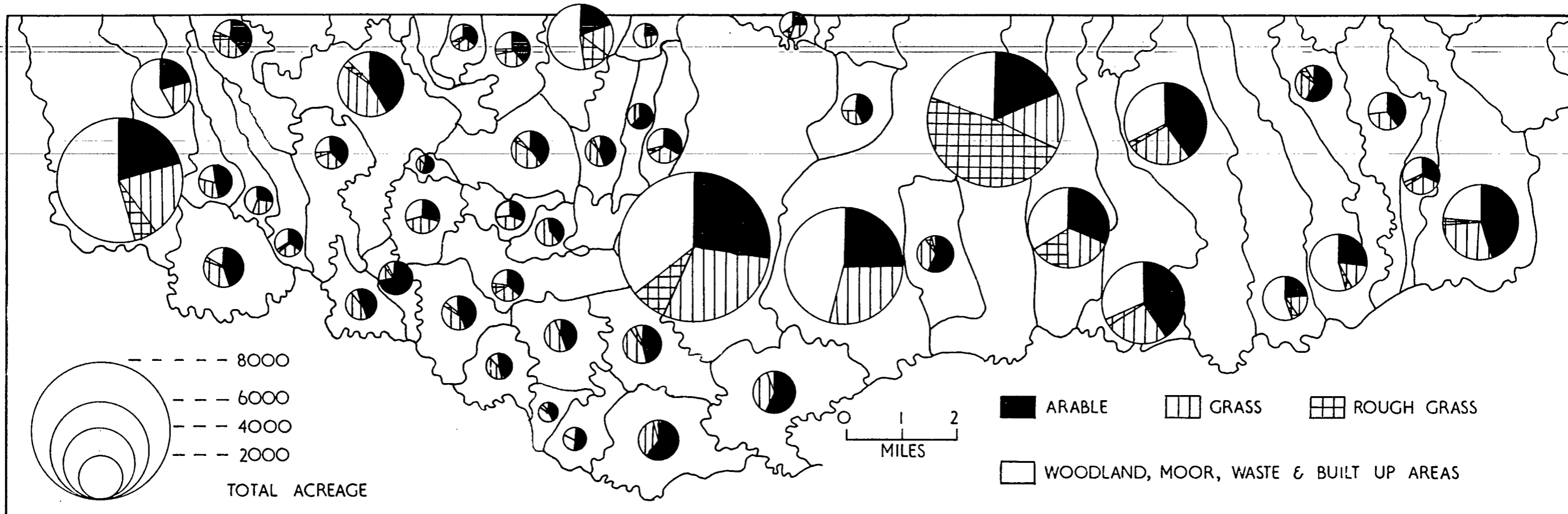

### MAIN CROPS IN 1947

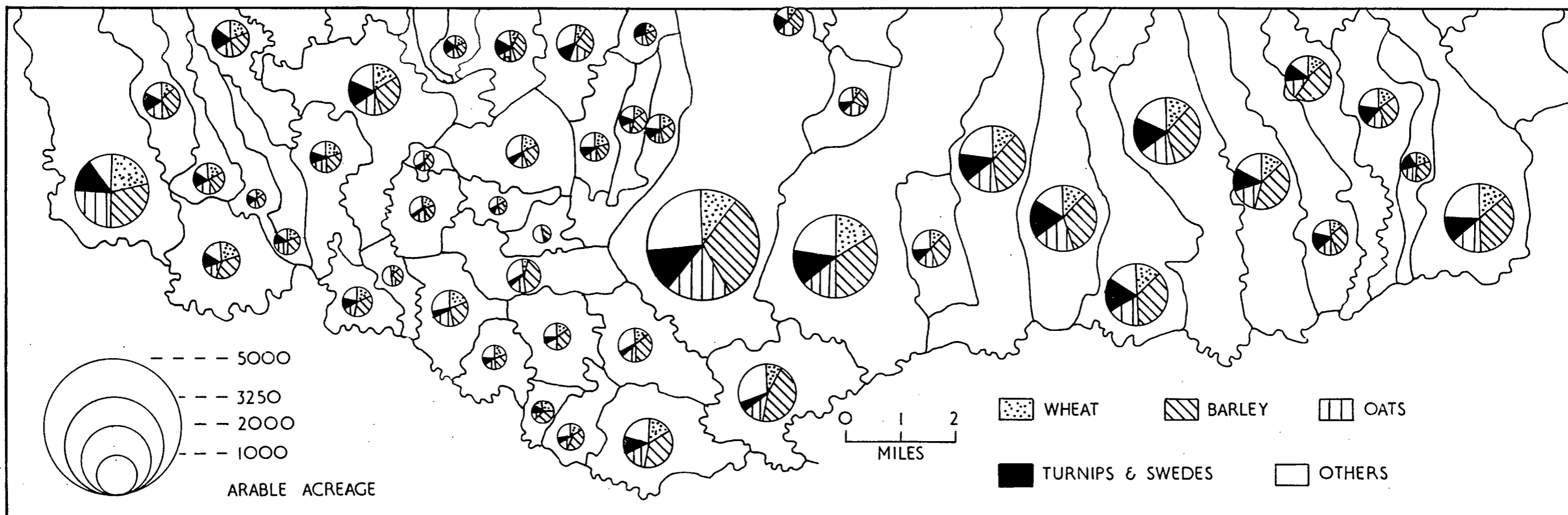

LAND USE PROPORTIONS

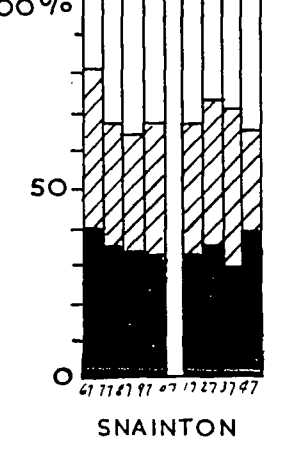
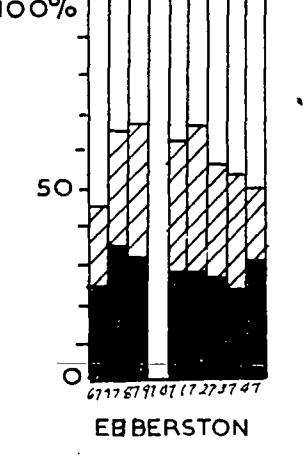
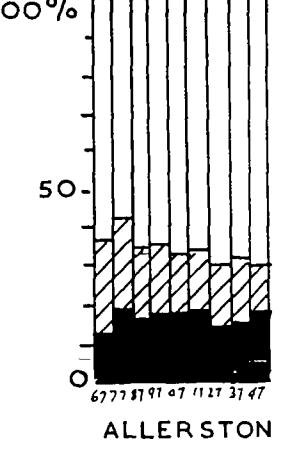
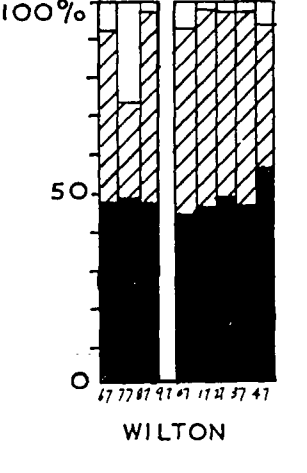
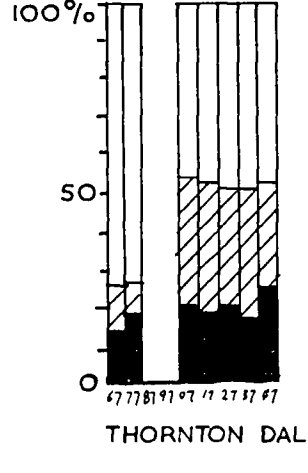
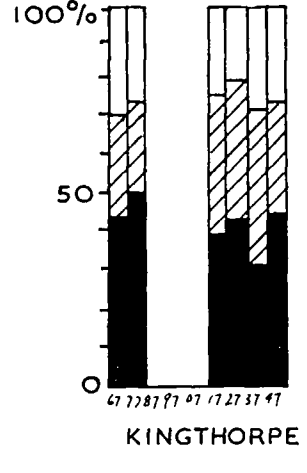
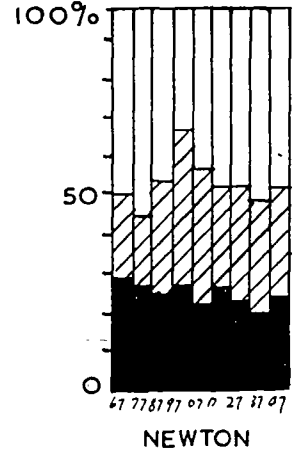
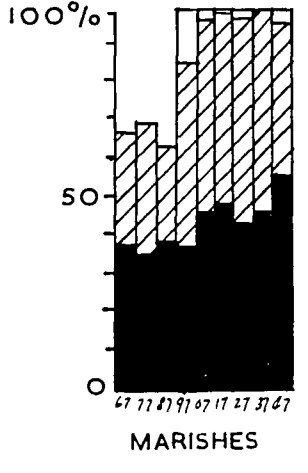
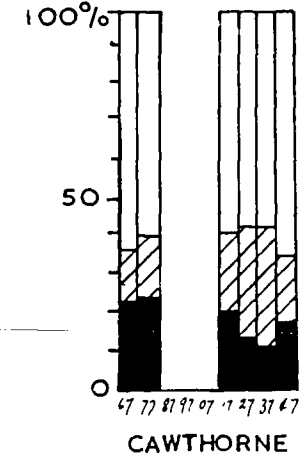
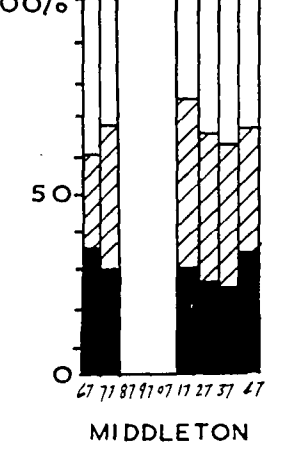
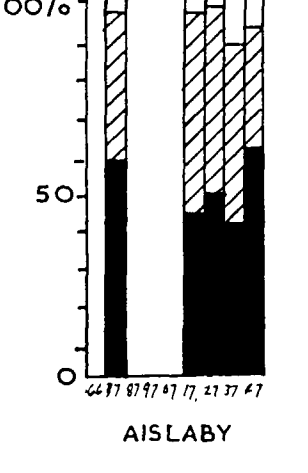
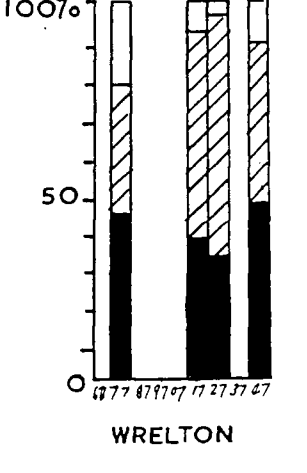
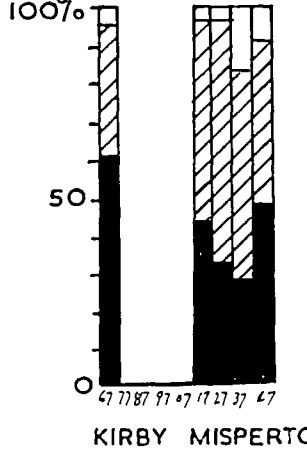
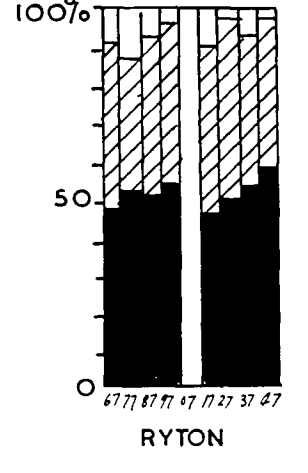
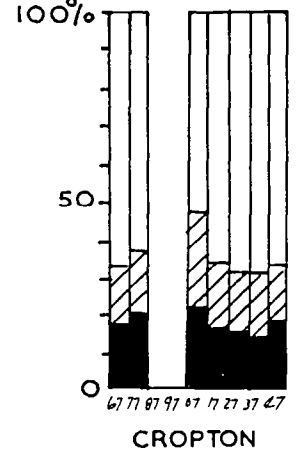
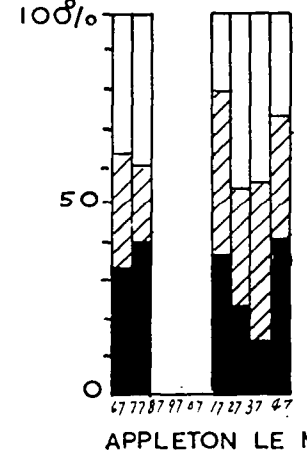
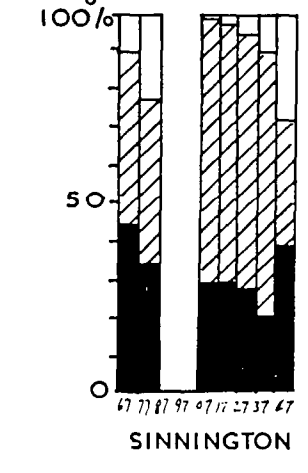
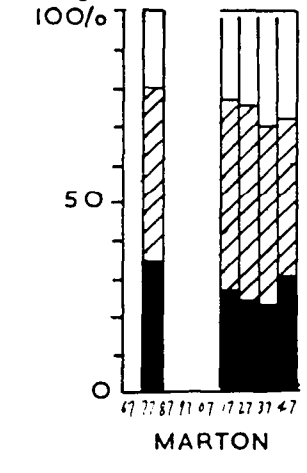
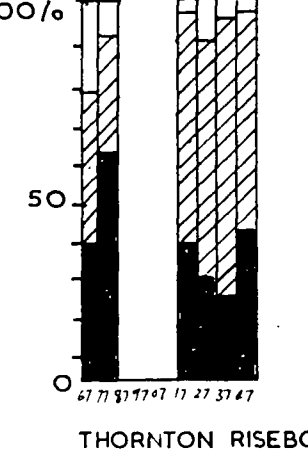
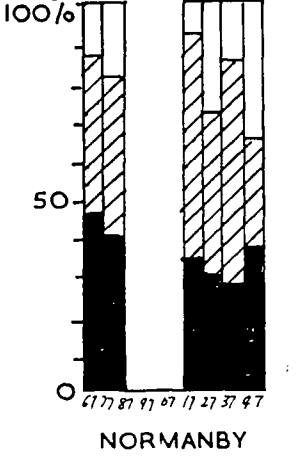
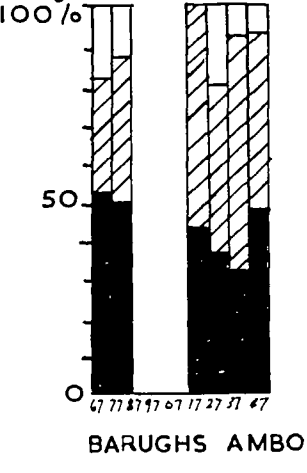
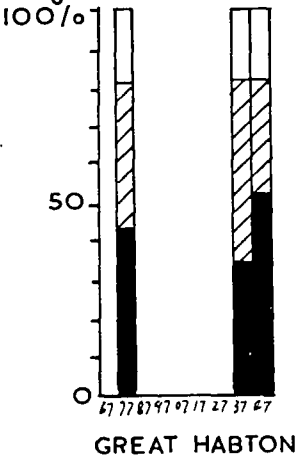
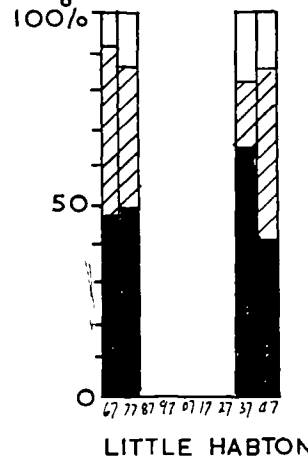
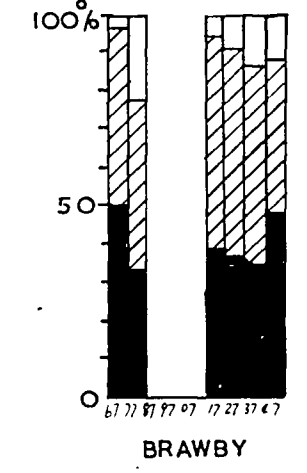
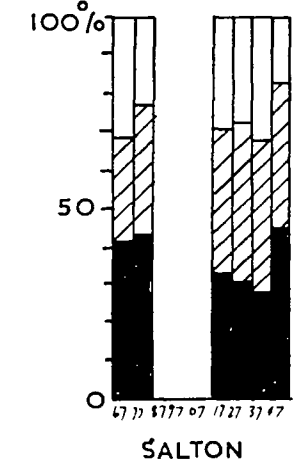
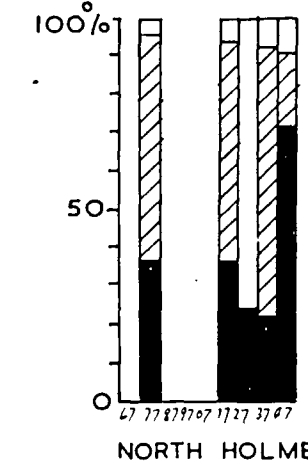
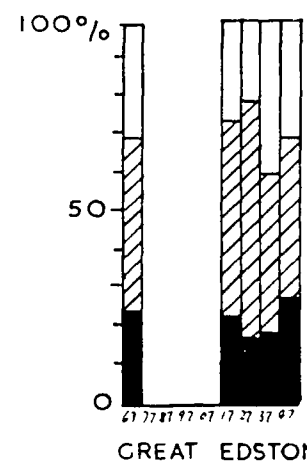
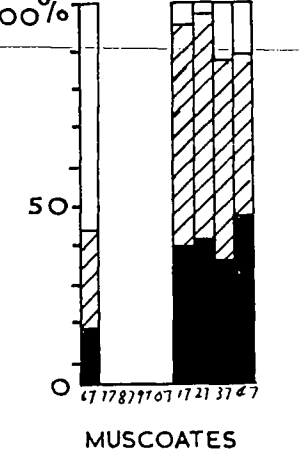
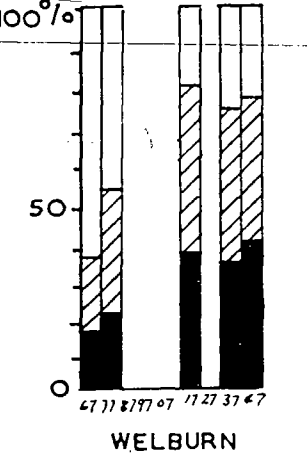
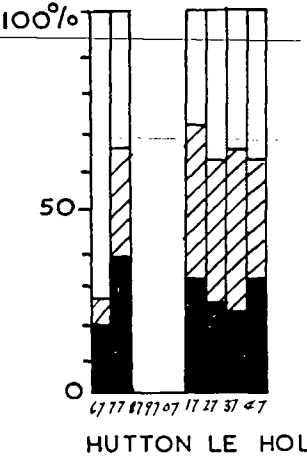
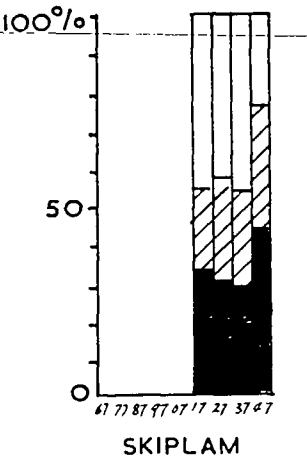
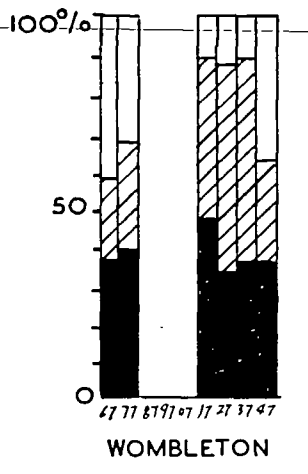
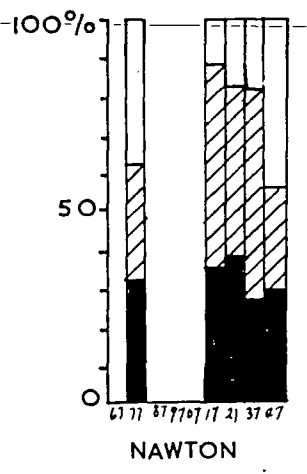
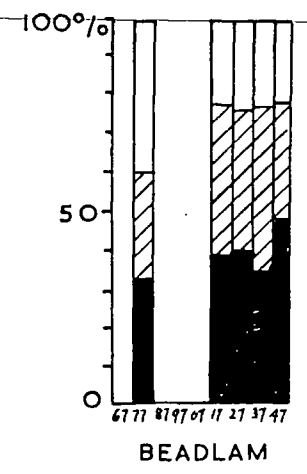
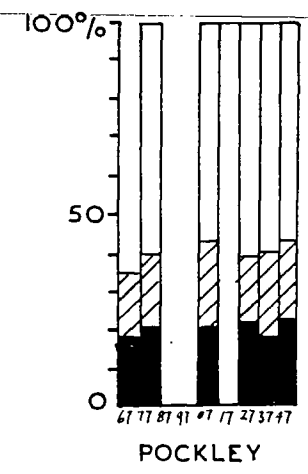
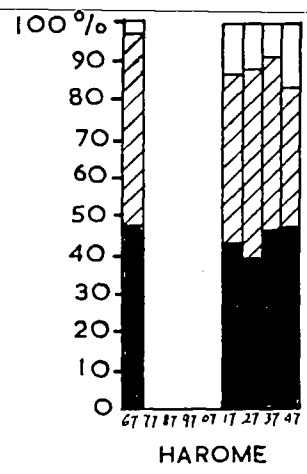

ARABLE

GRASS

WASTE, MOOR, WOODLAND, & BUILT UP AREAS

LAND USE PROPORTIONS

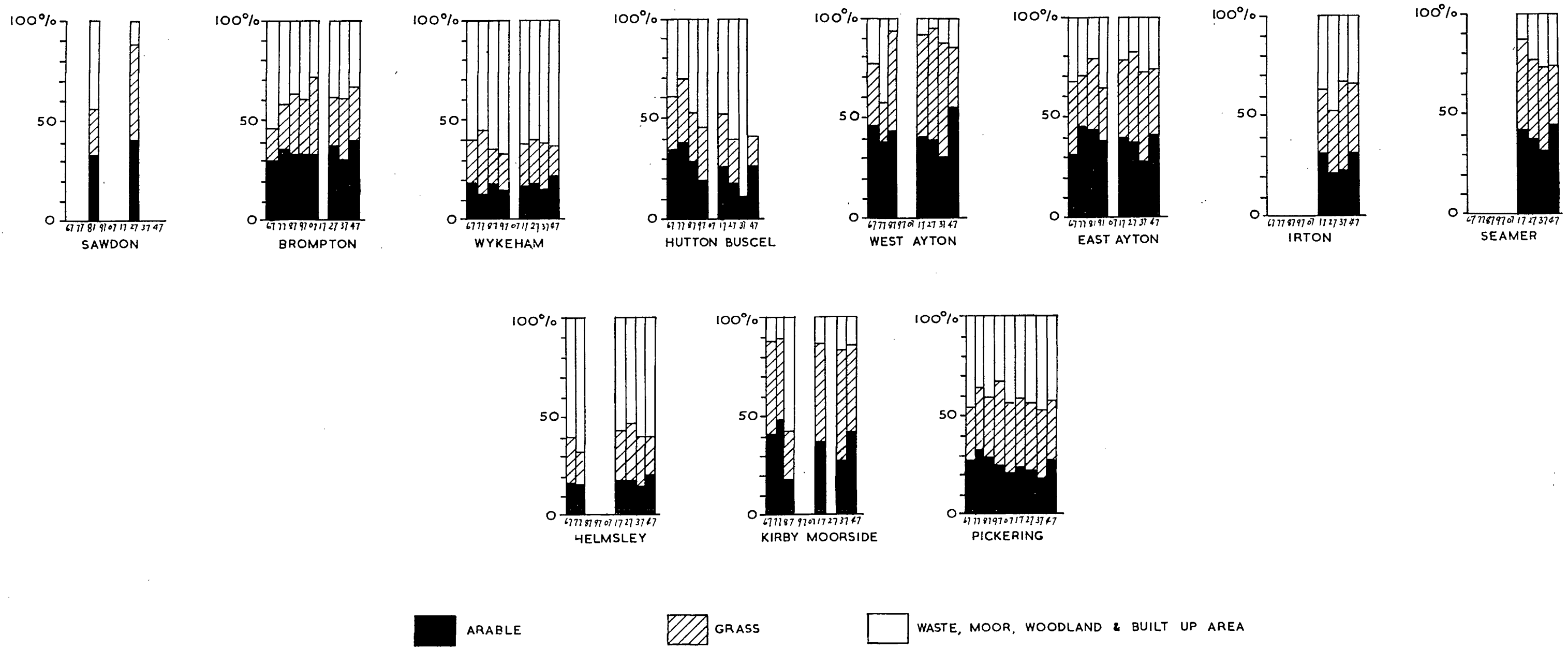

GRAPHS OF PROPORTION OF ARABLE UNDER THE MAIN CROPS

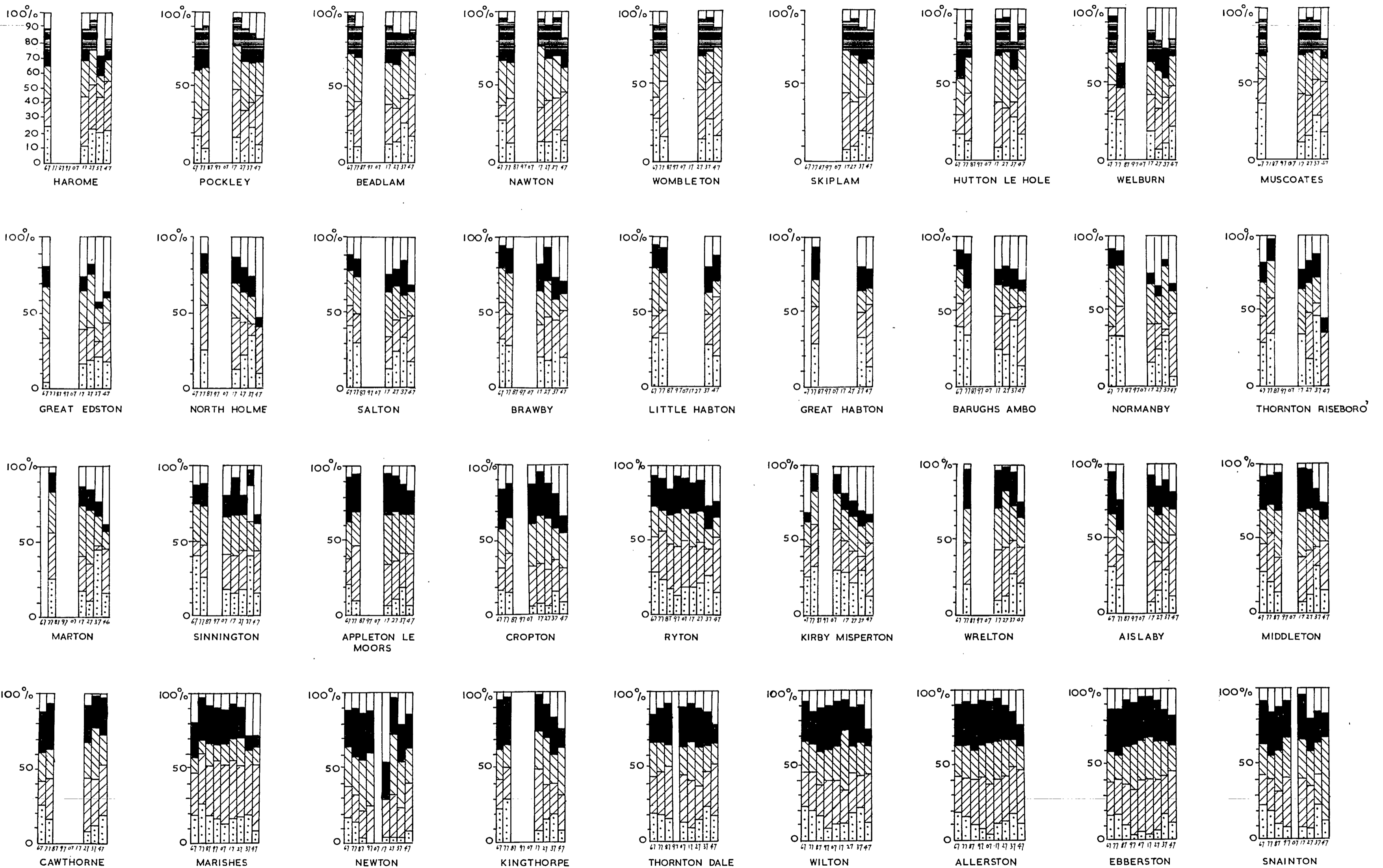

WHEAT

BARLEY





OATS

TURNIPS & SWEDES

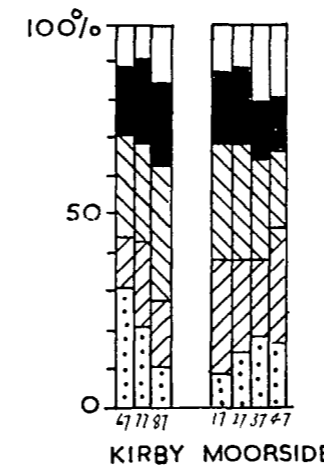
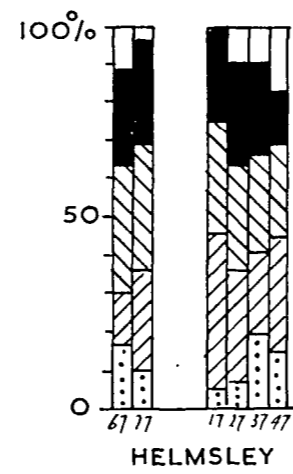
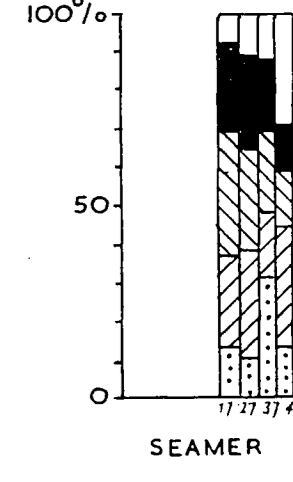
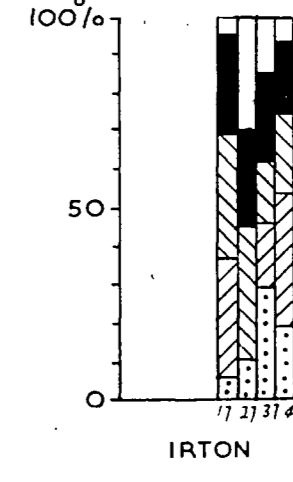
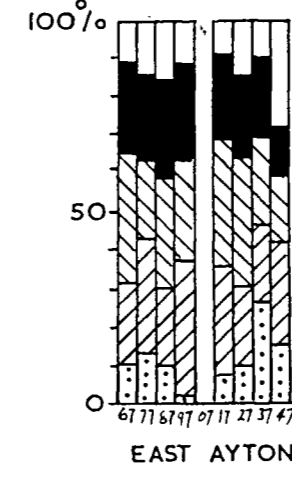
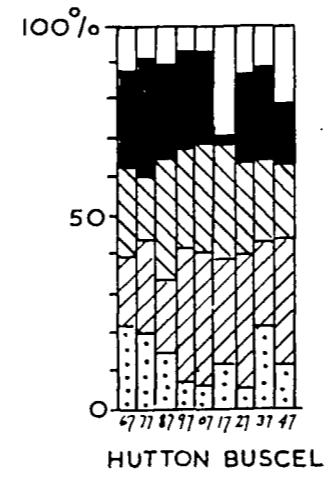
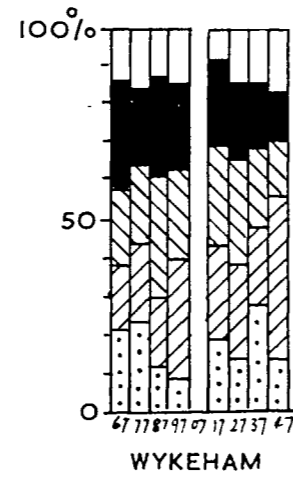
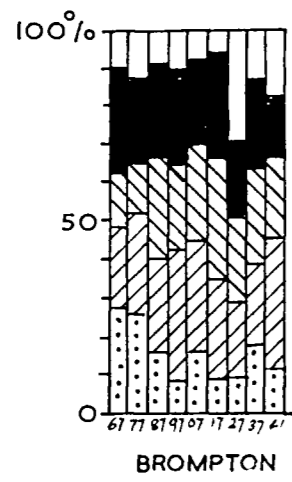
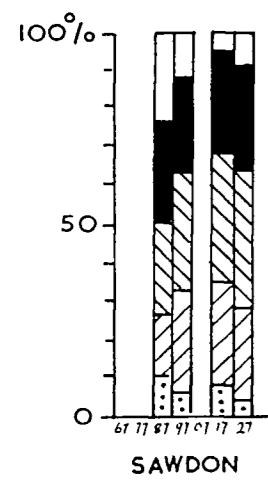
OTHER CROPS & FALLOW

GRAPHS OF PROPORTION OF ARABLE UNDER THE MAIN CROPS



-  WHEAT
-  BARLEY
-  OATS
-  TURNIPS AND SWEDES
-  OTHER CROPS AND FALLOW



CATTLE 1867

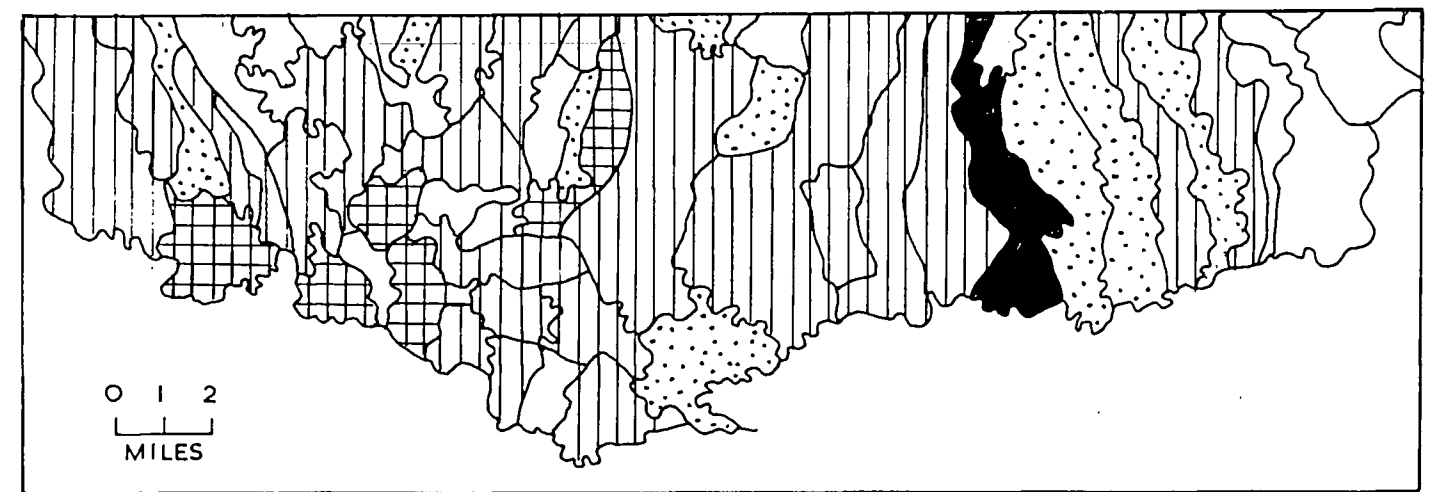

CATTLE 1877

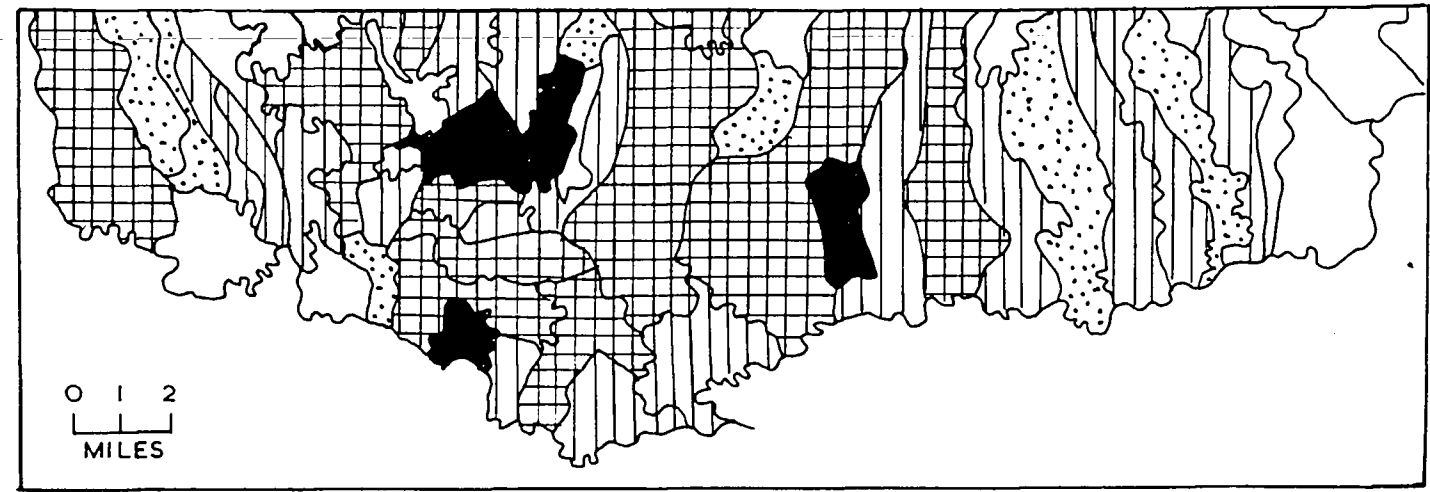

CATTLE 1887

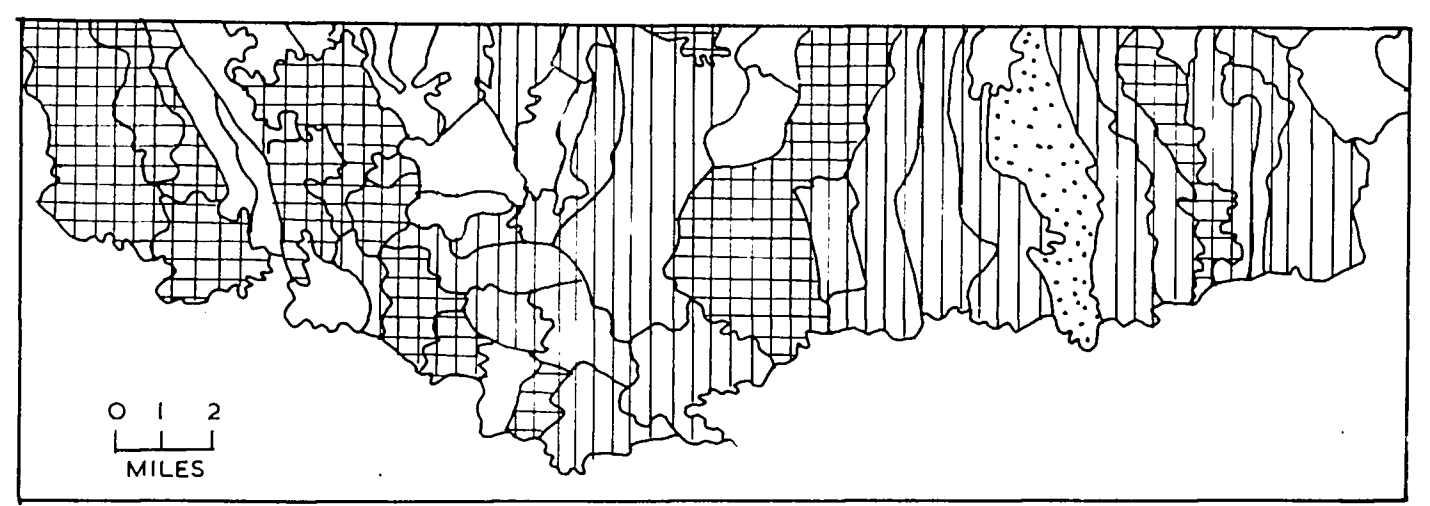

CATTLE 1897

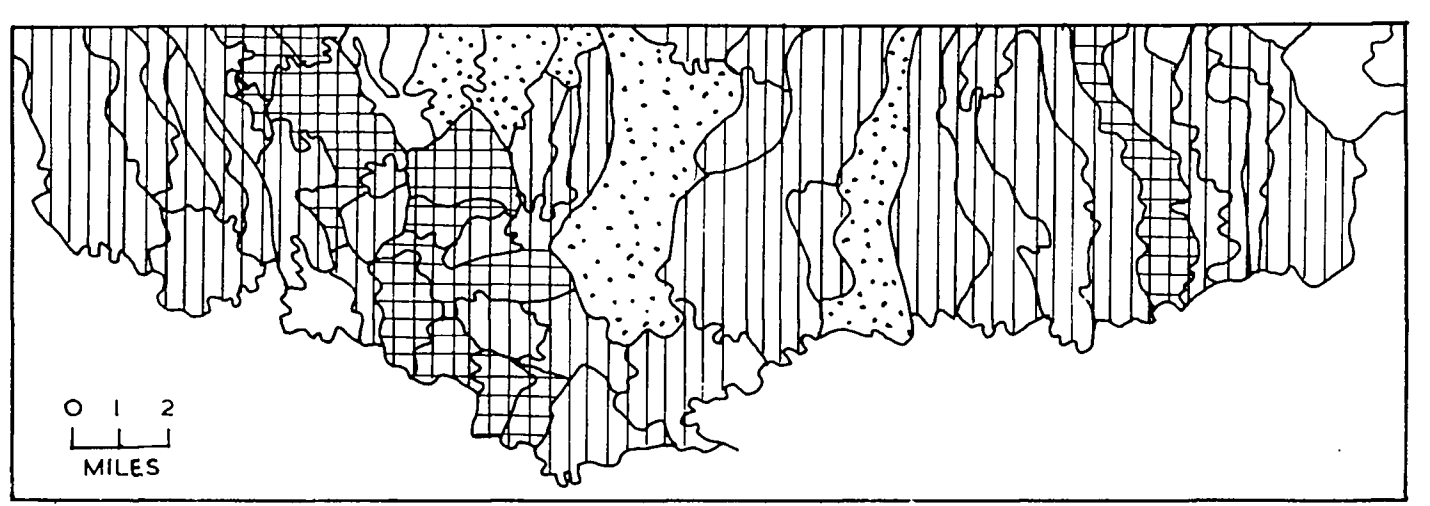

CATTLE 1907

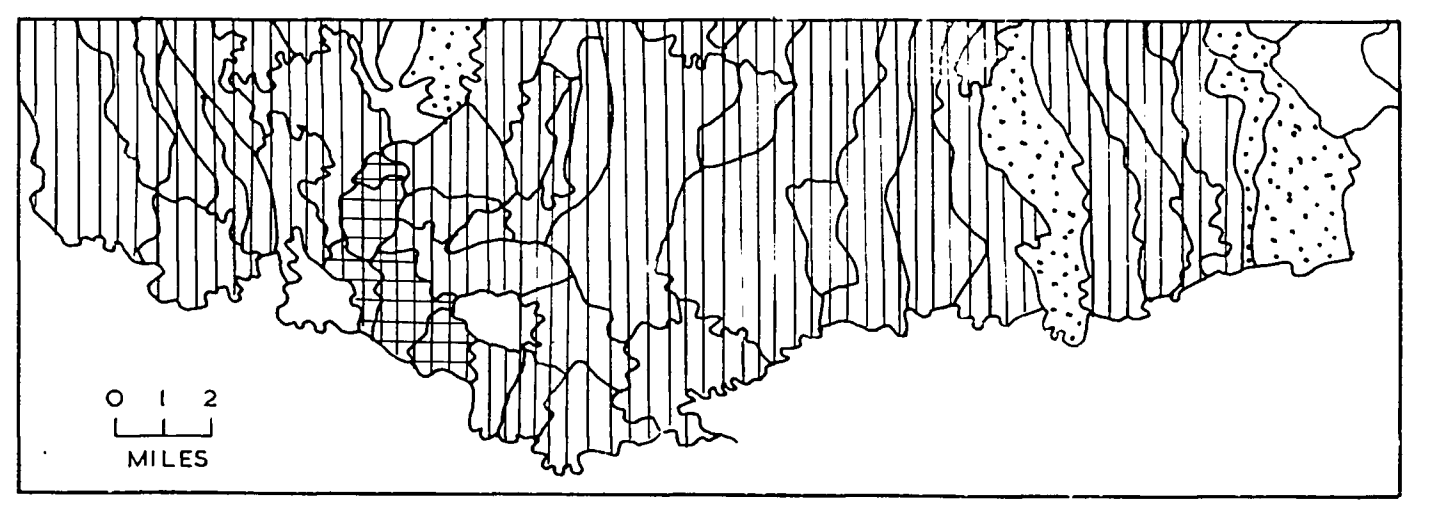

CATTLE 1917

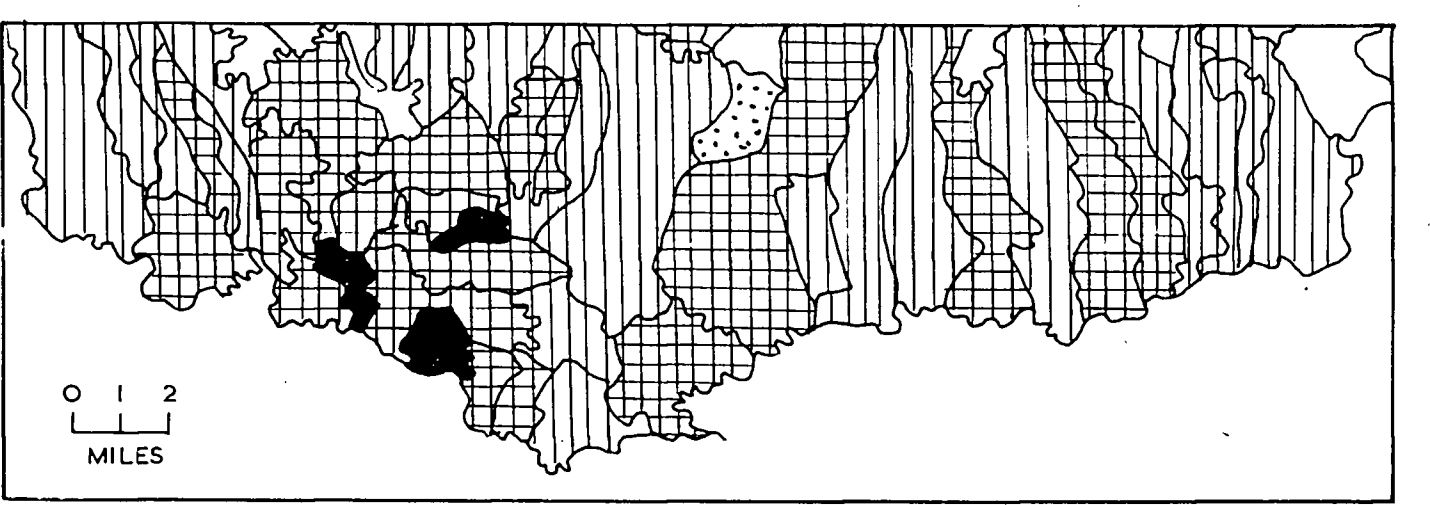

CATTLE PER 100 ACRES OF ARABLE AND GRASSLAND

••• UNDER 12

|||| 12-18

||||| 18-24

■ OVER 24

CATTLE 1927

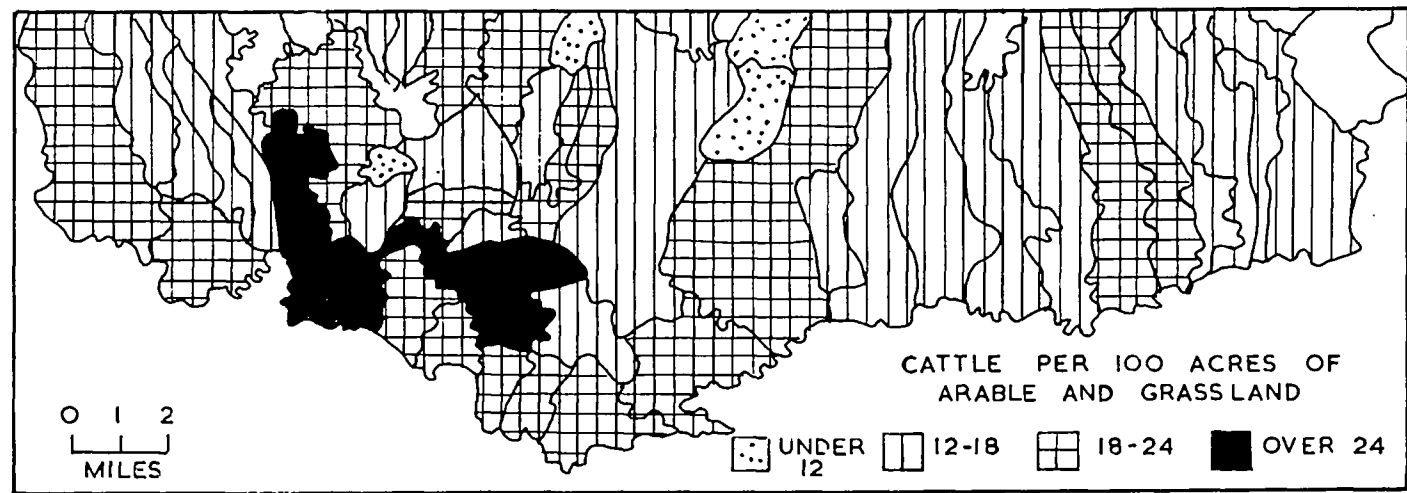

CATTLE 1937

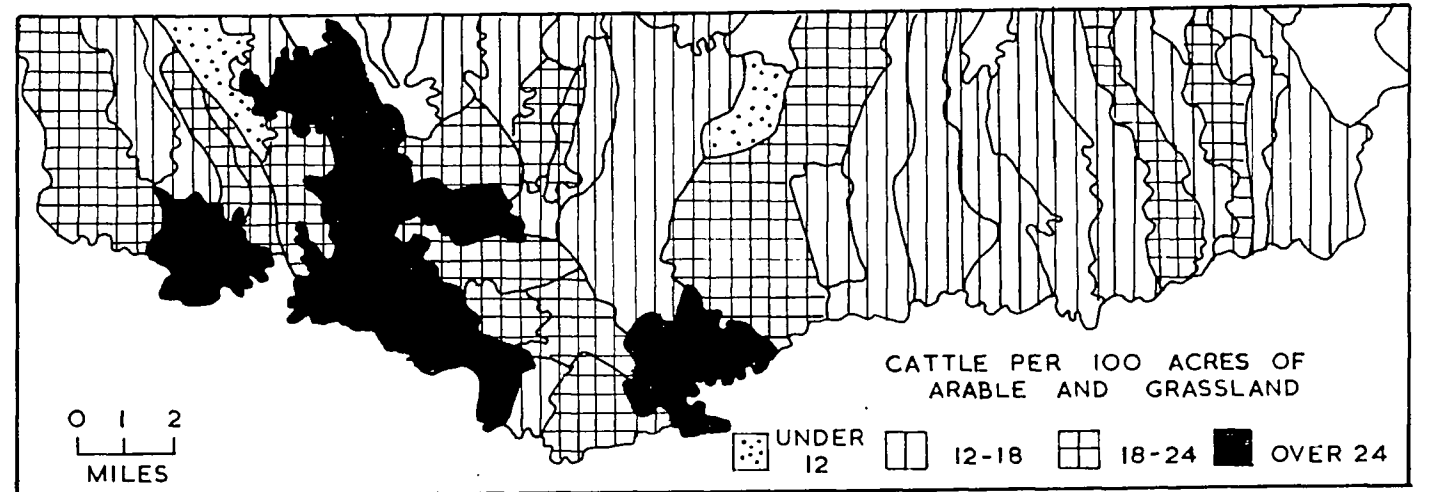

CATTLE 1947

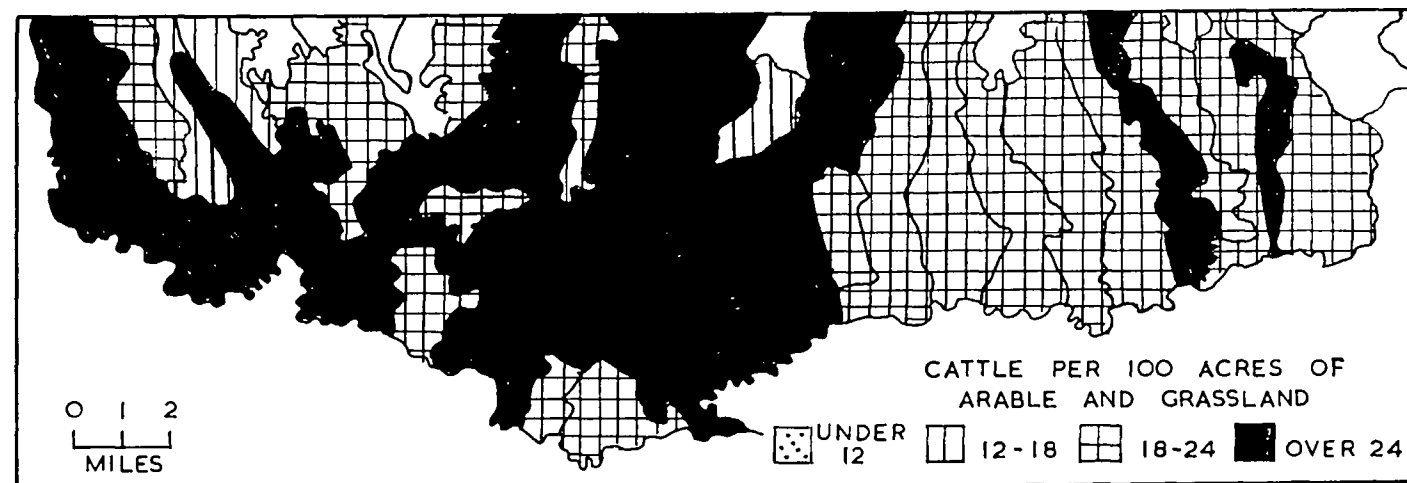

SHEEP 1867

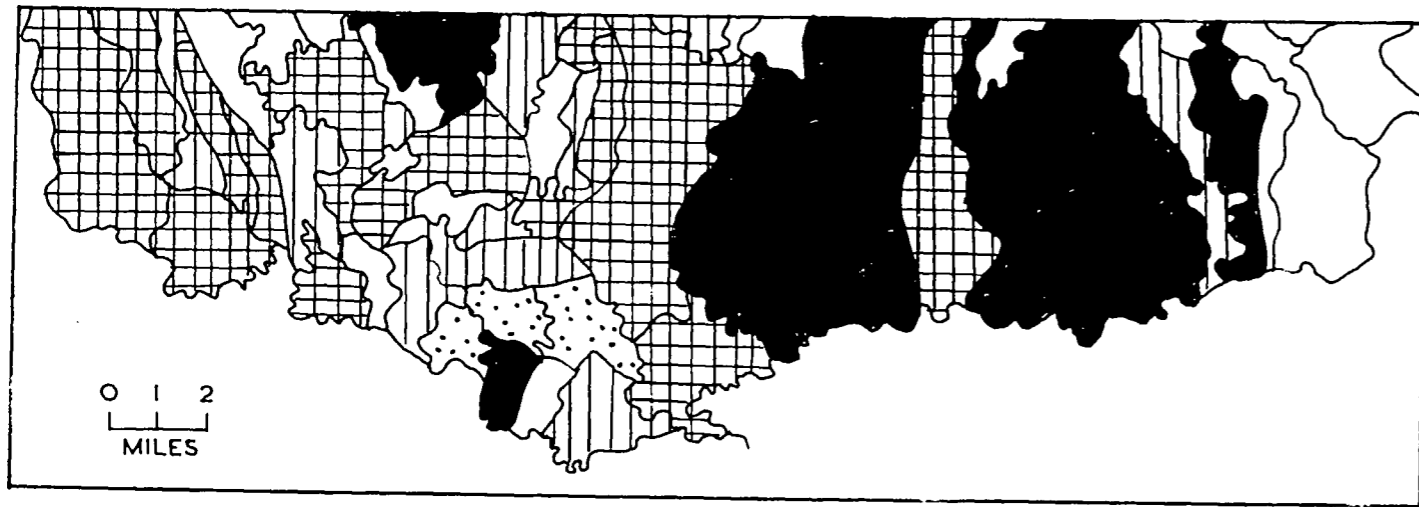

SHEEP 1877

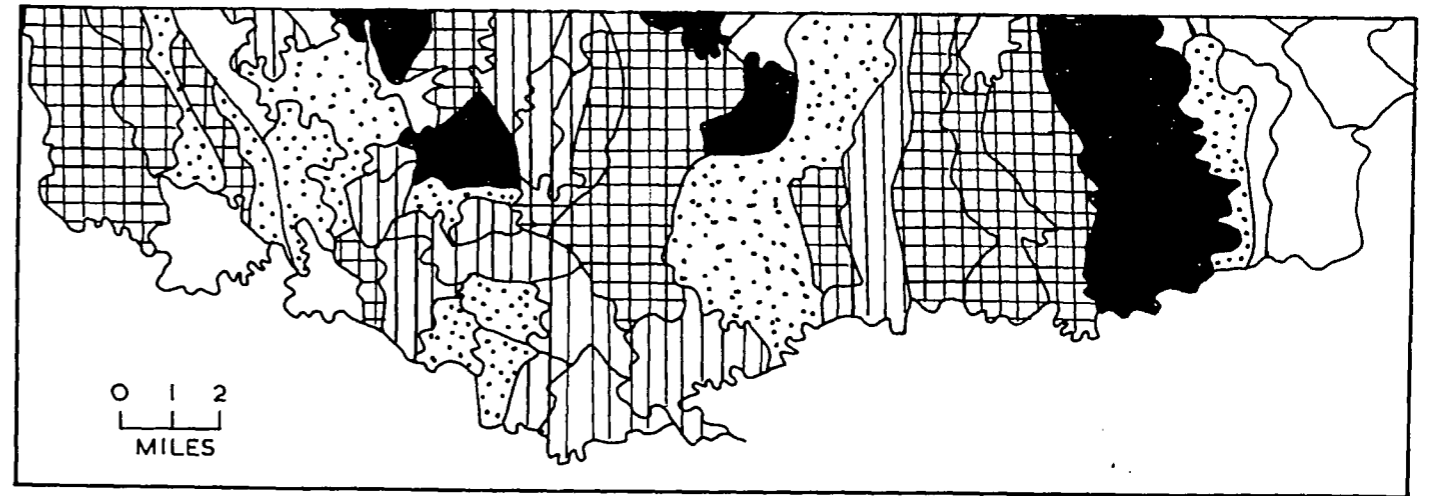

SHEEP 1887



SHEEP 1897

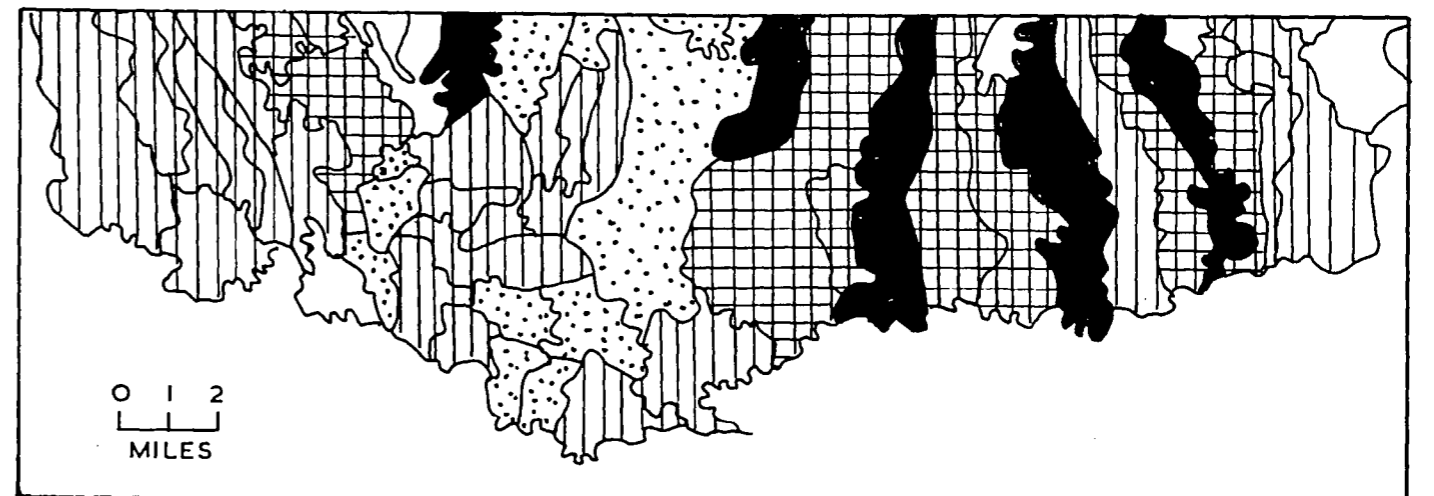

SHEEP 1907

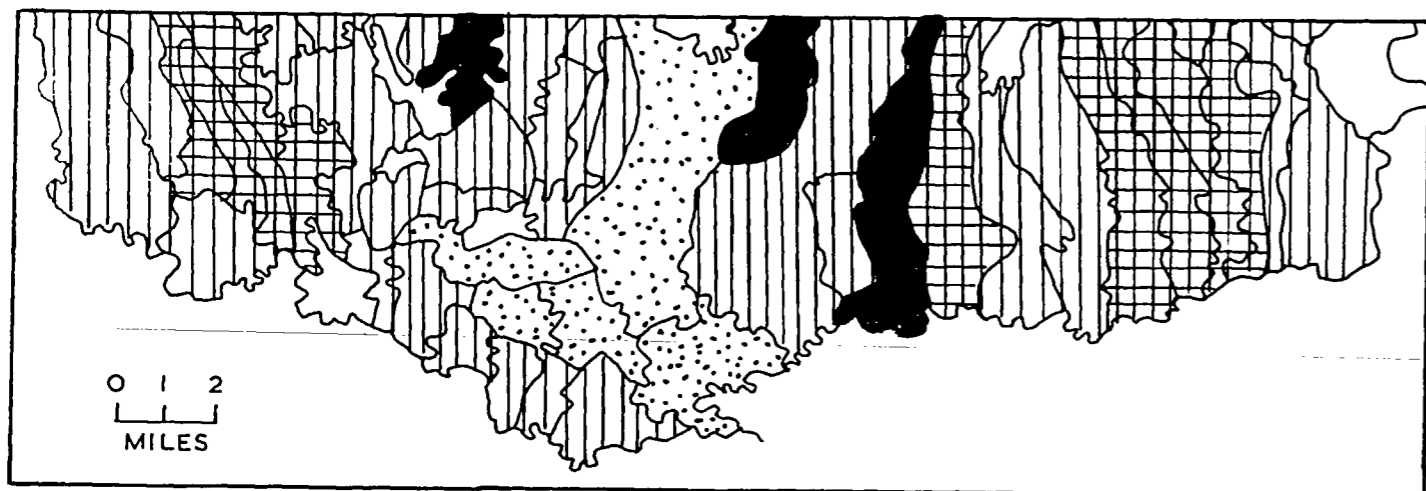

SHEEP 1917



SHEEP PER 100 ACRES OF ARABLE AND GRASSLAND

 UNDER 70   
  70-90   
  90-110   
  OVER 110

SHEEP 1927

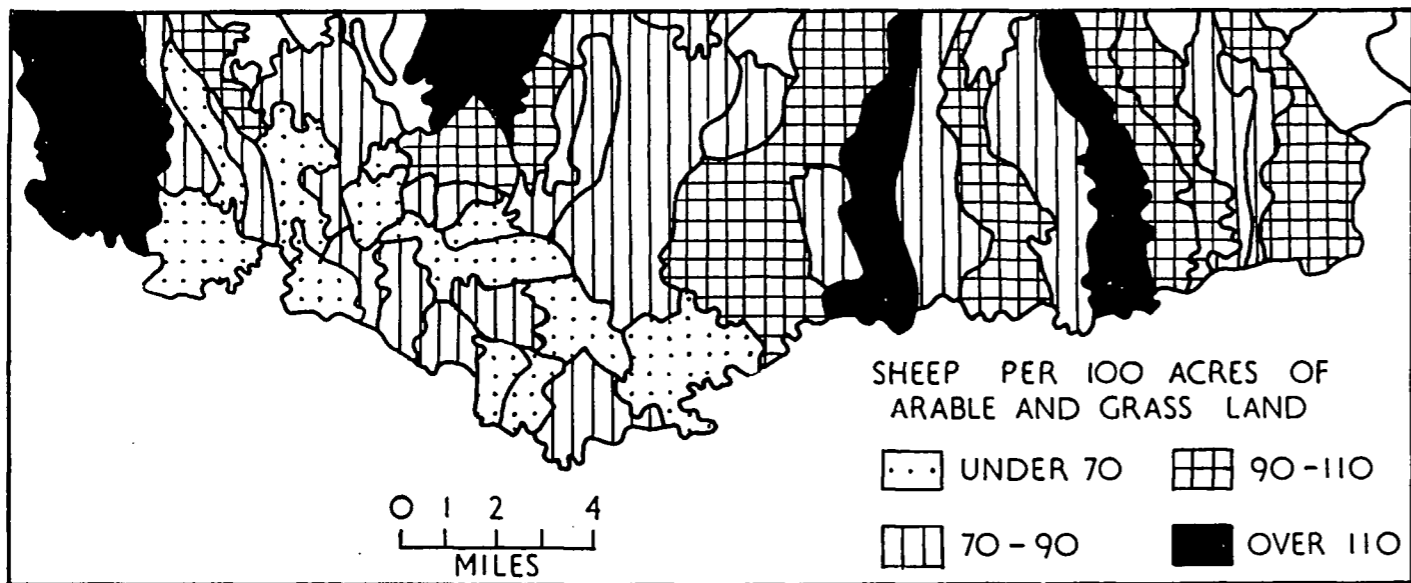

SHEEP 1937

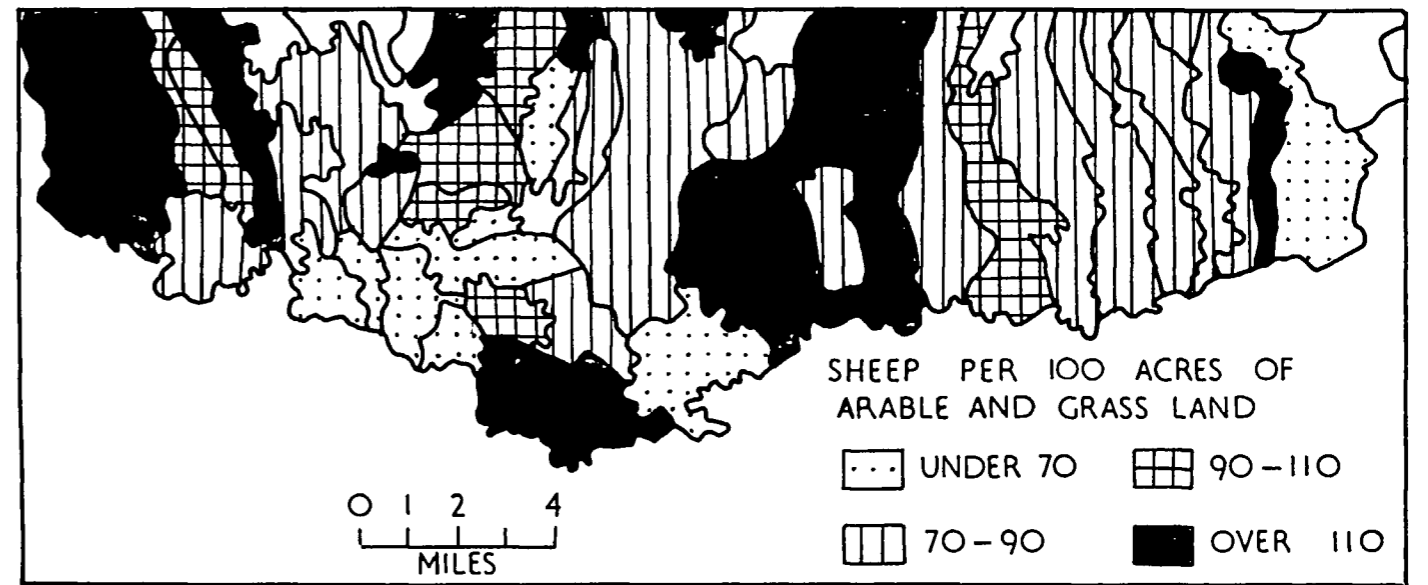

SHEEP 1947

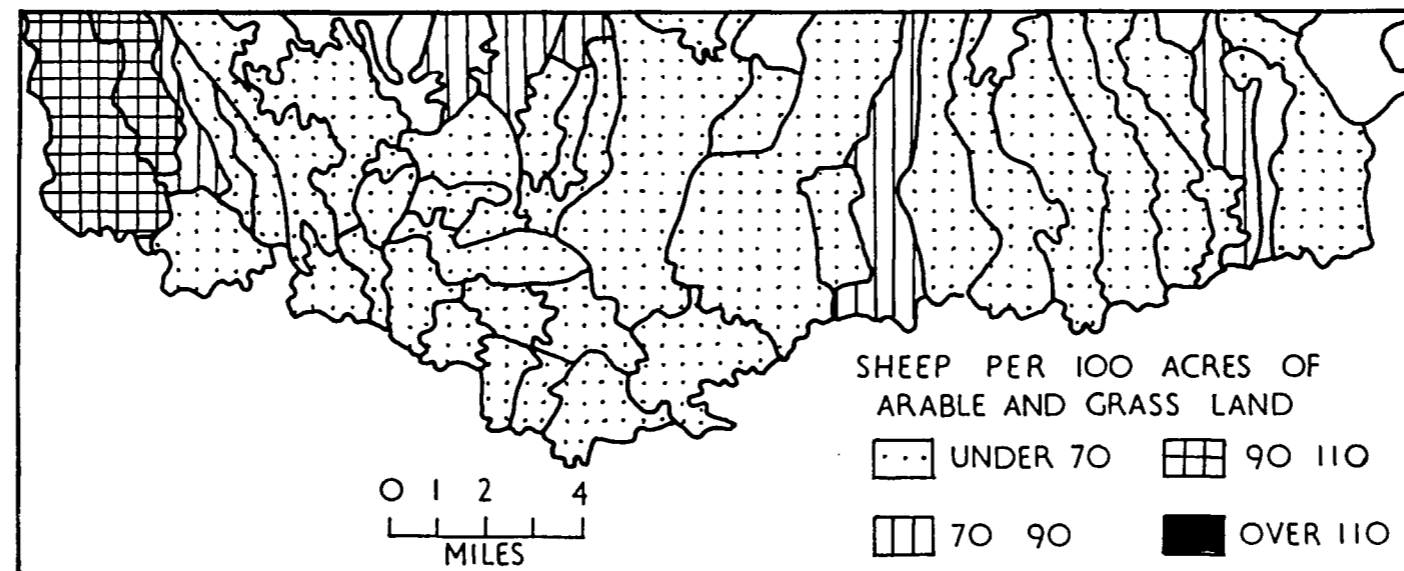

# CROP REGIONS FROM JUNE AGRICULTURAL RETURNS

1867

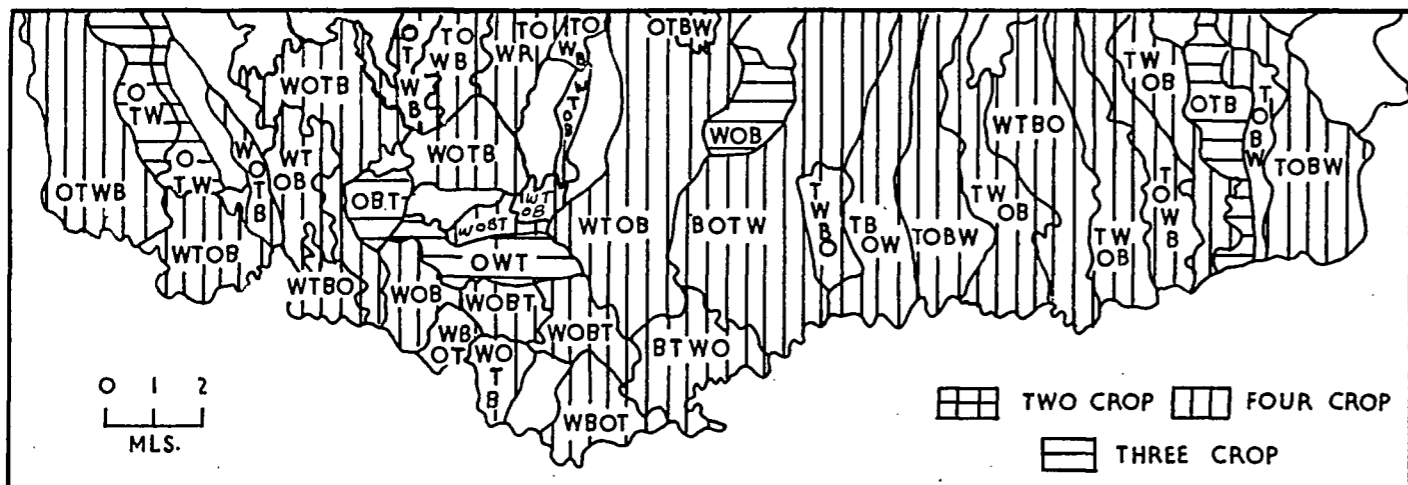

1877

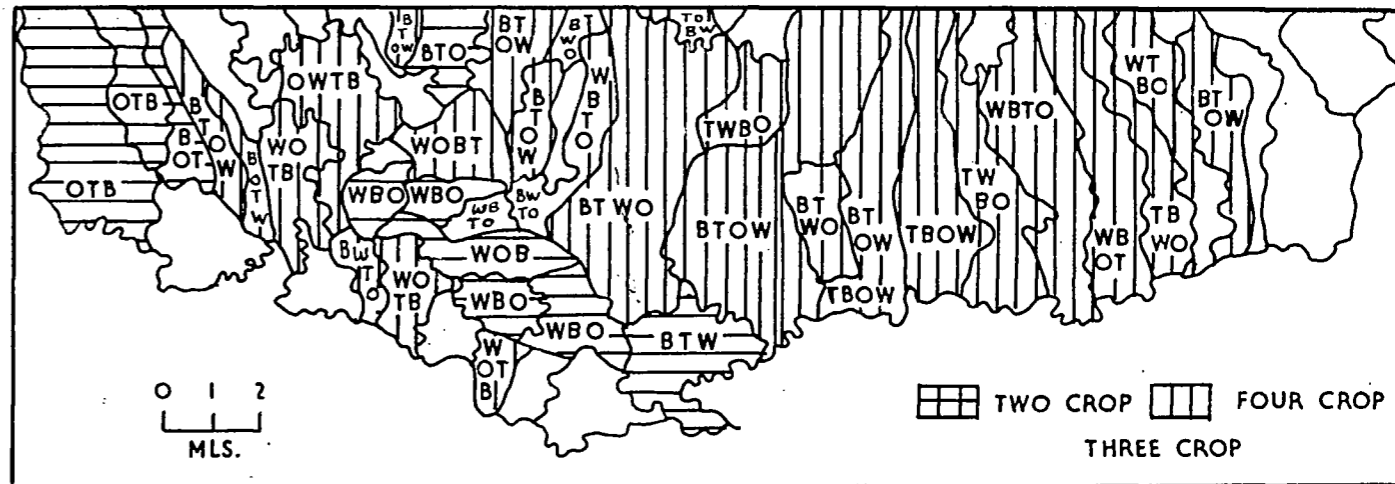

1887

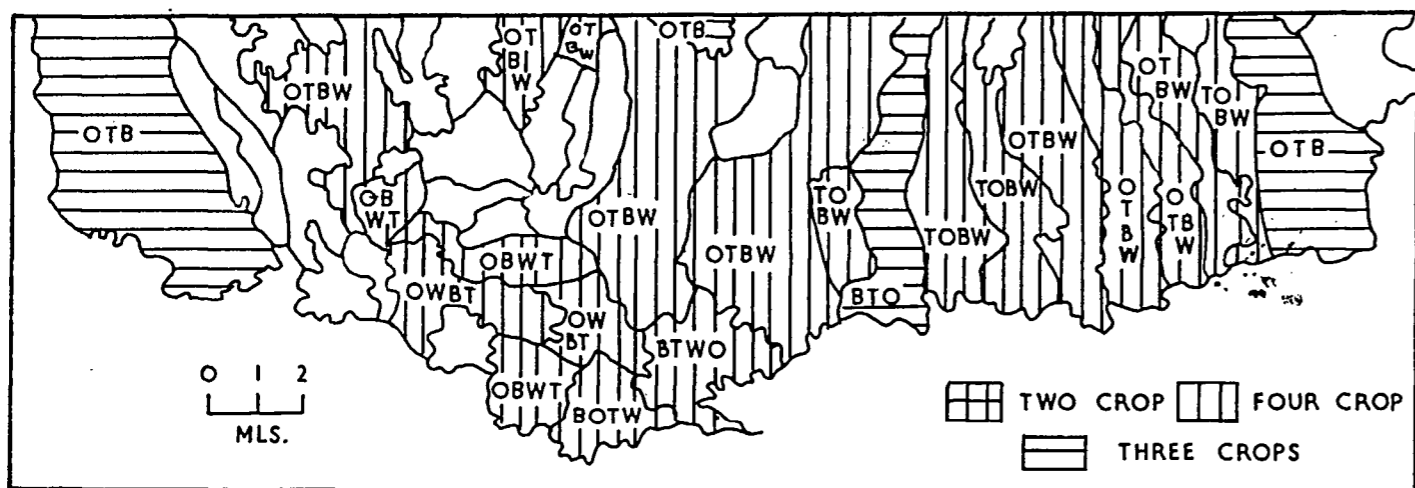

1897

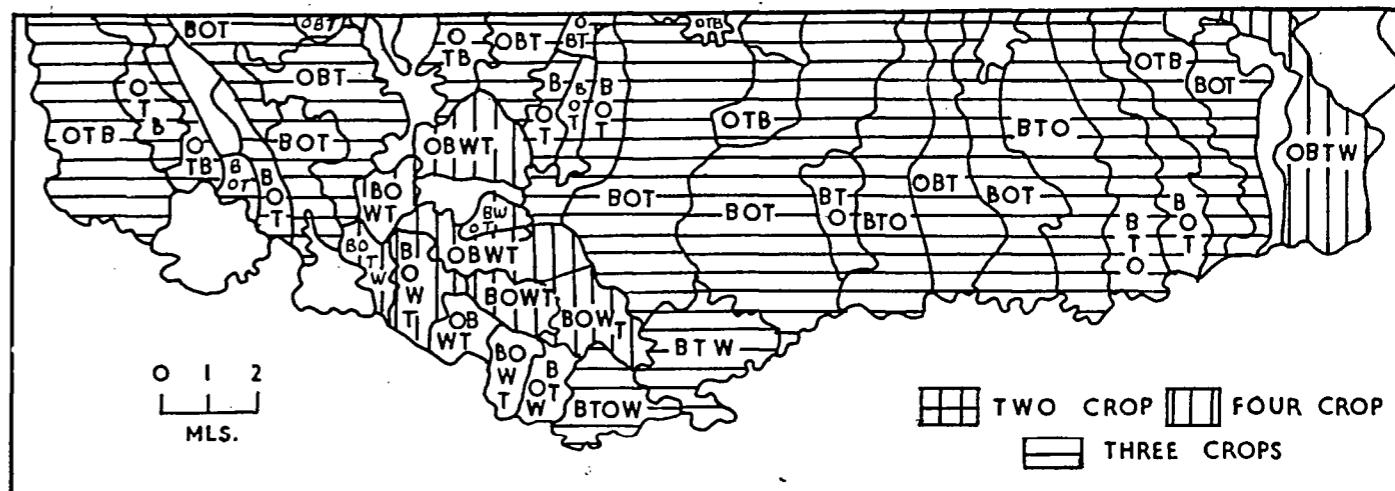

1907

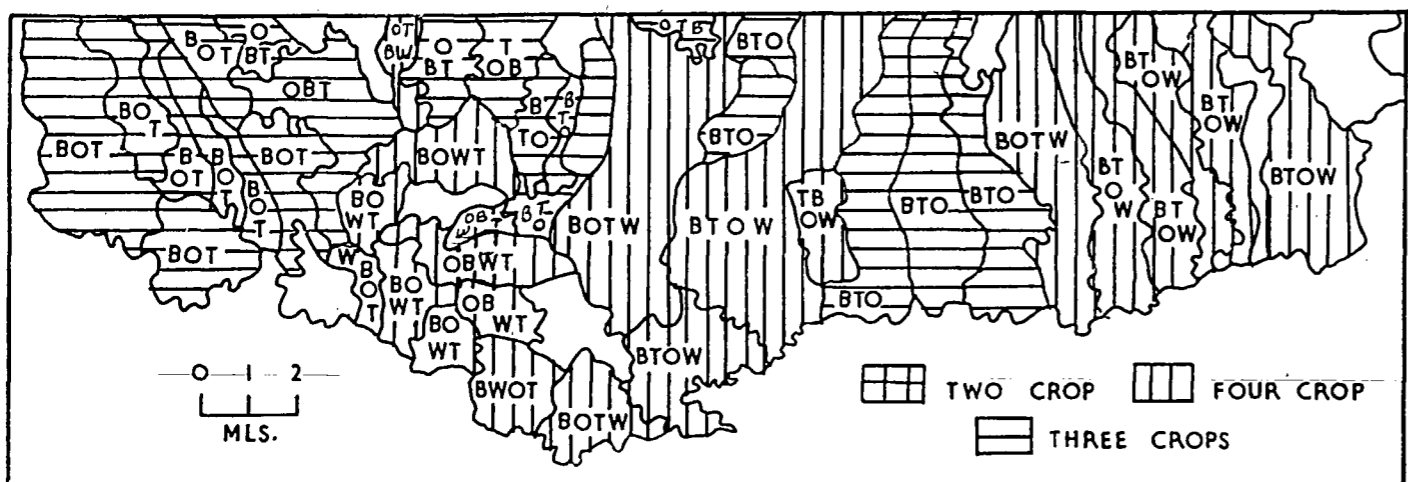

1917

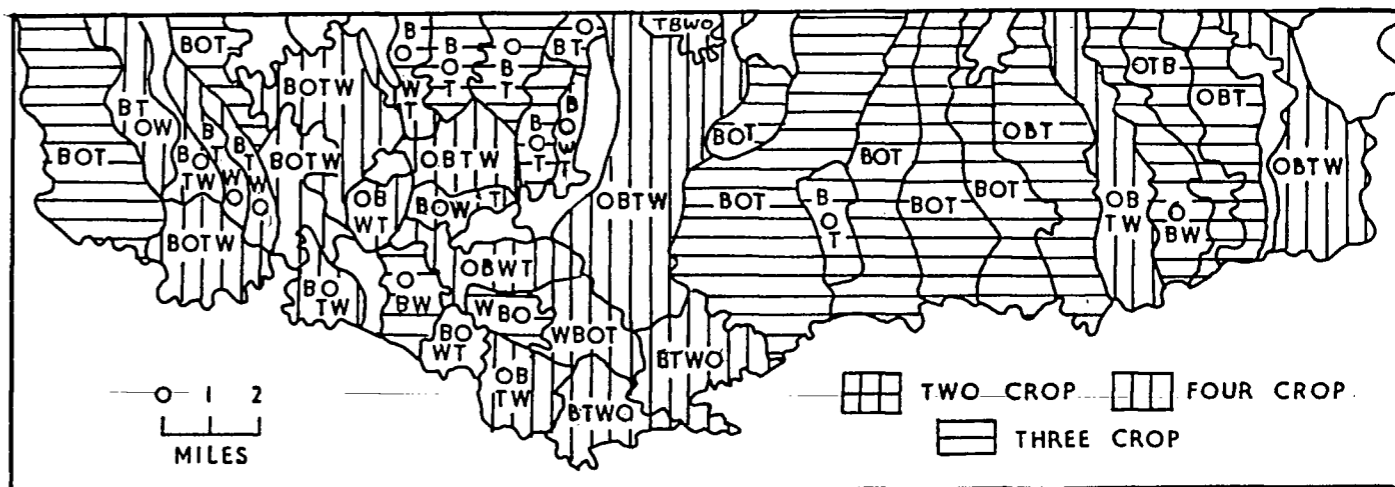

### CROP REGIONS FROM JUNE AGRICULTURAL RETURNS

1927

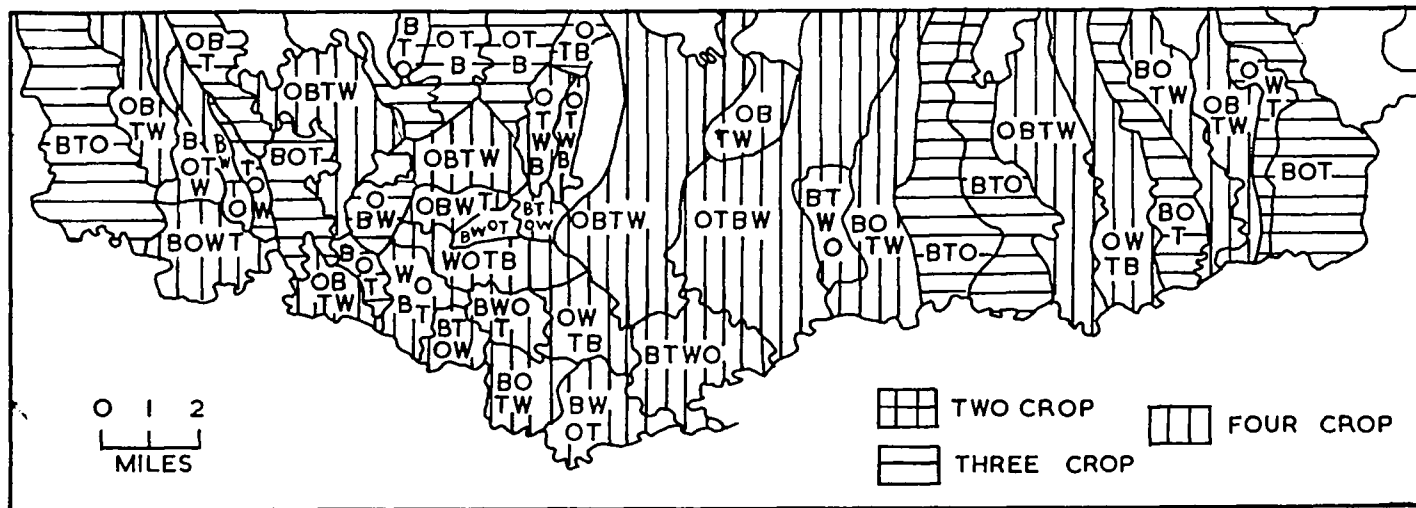

1937

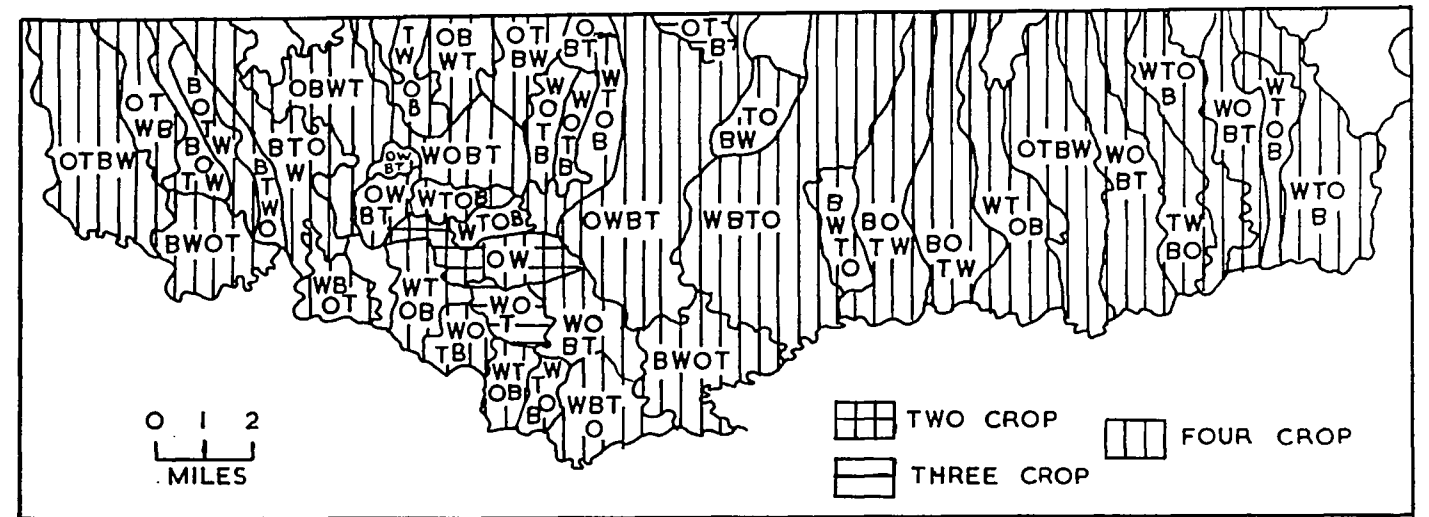

1947

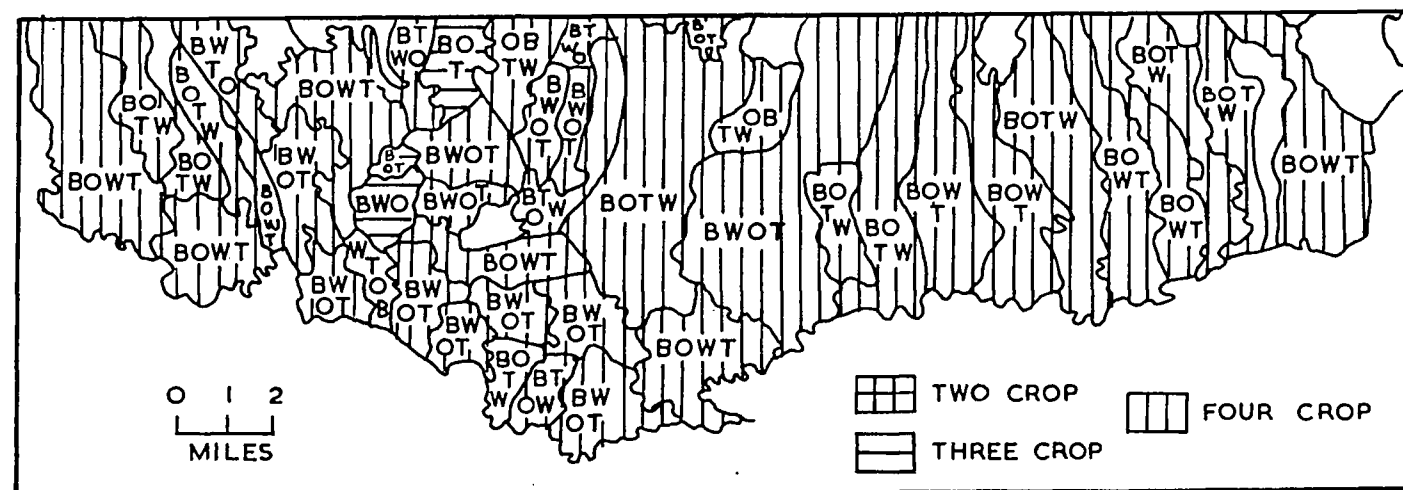

POPULATION GRAPHS

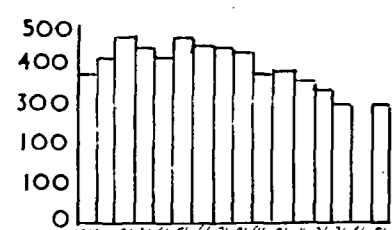

HAROME

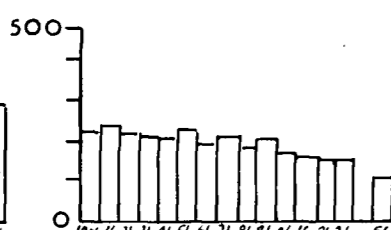

POCKLEY

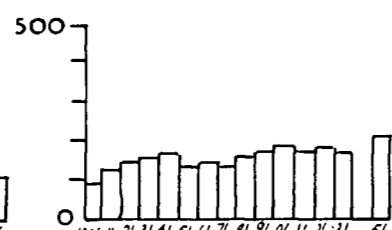

BEADLAM

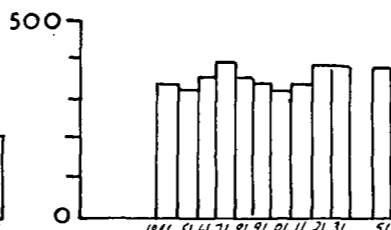

NAWTON

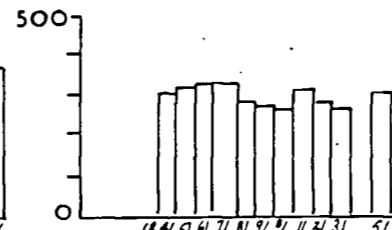

WOMBLETON

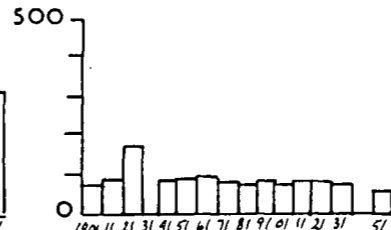

SKIPLAM

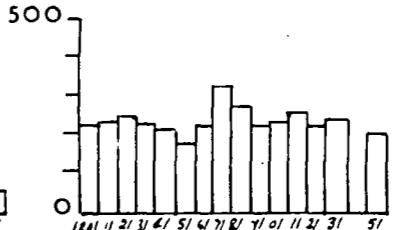

HUTTON LE HOLE

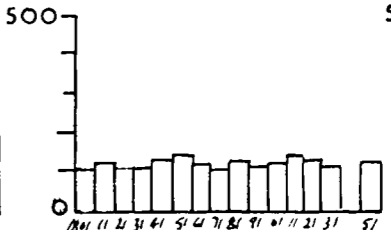

WELBURN

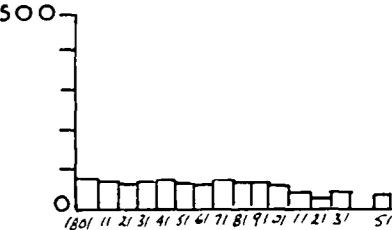

MUSCOATES

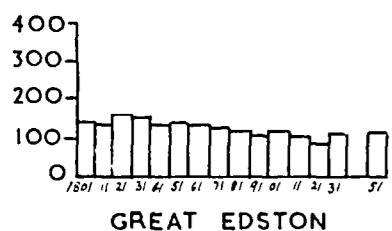

GREAT EDSTON

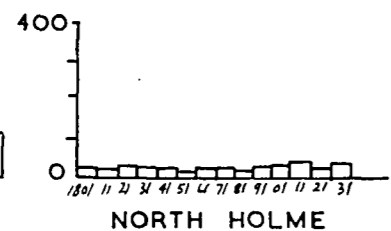

NORTH HOLME

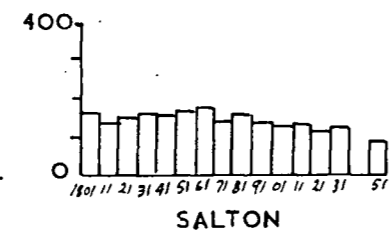

SALTON

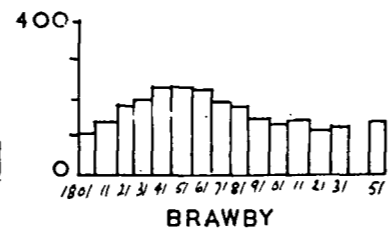

BRAWBY

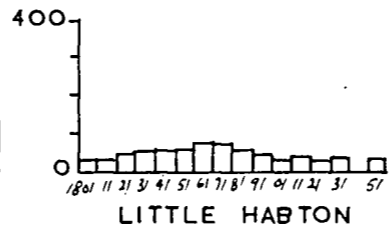

LITTLE HABTON

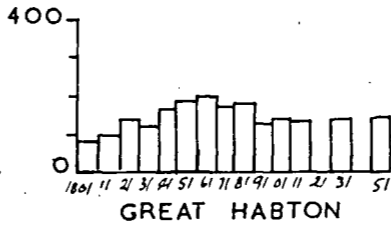

GREAT HABTON

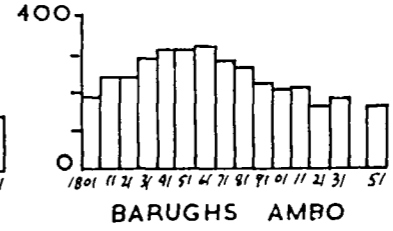

BARUGHS AMBO

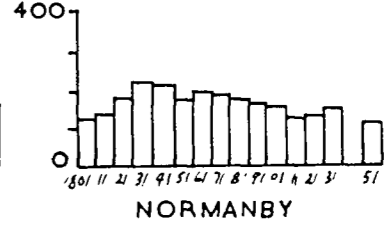

NORMANBY



THORNTON RISEBROUGH

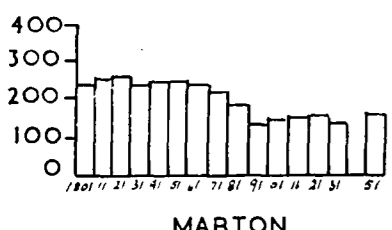

MARTON

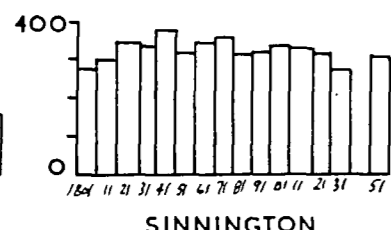

SINNINGTON

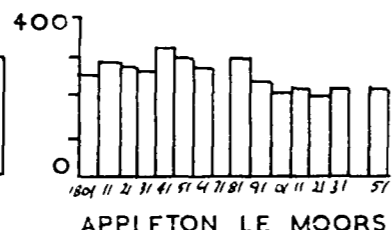

APPLETON LE MOORS

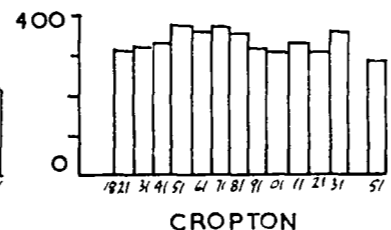

CROPTON

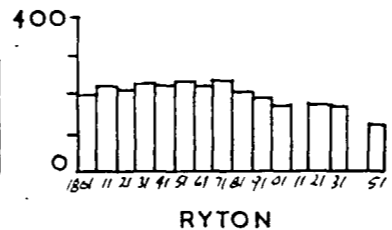

RYTON

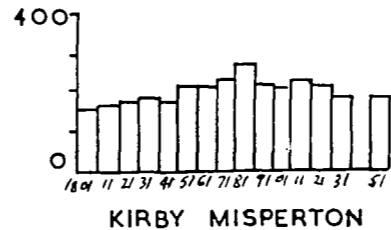

KIRBY MISPERTON

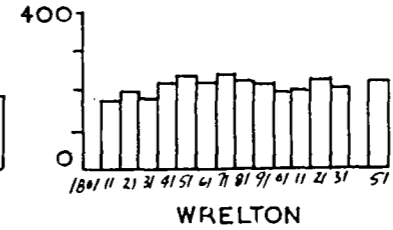

WRELTON

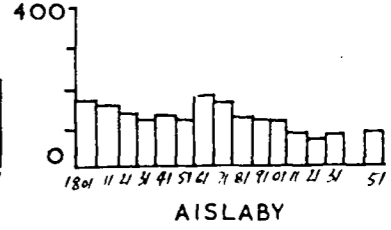

AISLABY



MIDDLETON



CAWTHORNE

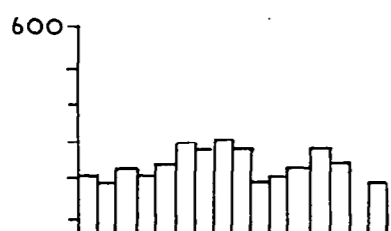

PICKERING MARISHES

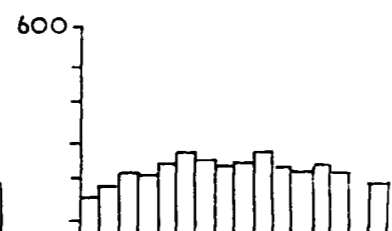

NEWTON



KINGTHORPE

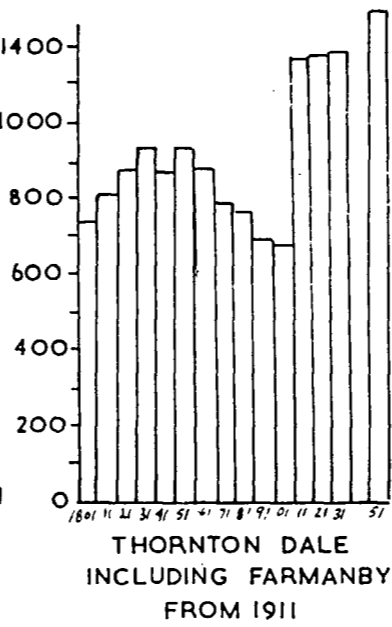

THORNTON DALE INCLUDING FARNABY FROM 1911

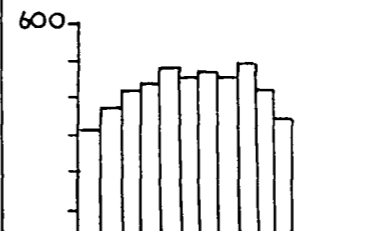

FARNABY & ELLERBURN

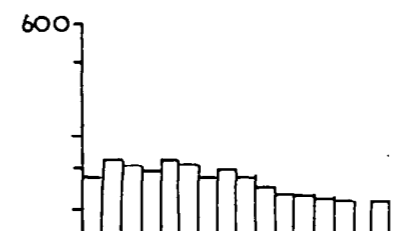

WILTON

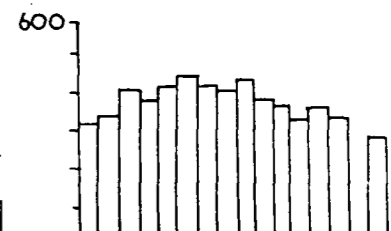

ALLERSTON

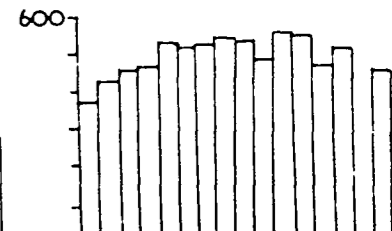

EBBERSTON



SNAINTON



SAWDON

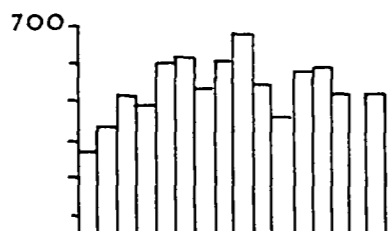

BROMPTON INCLUDING SAWDON FROM 1911

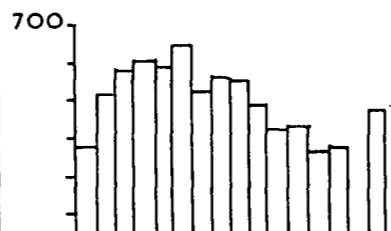

WYKEHAM

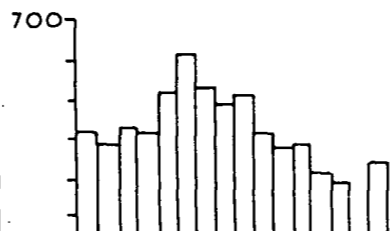

HUTTON BUSHEL

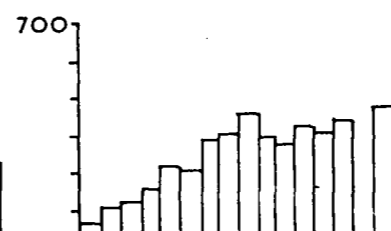

WEST AYTON

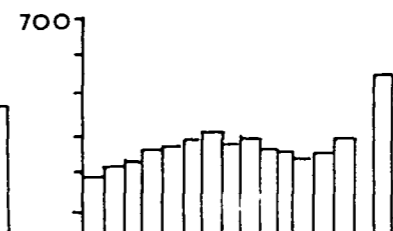

EAST AYTON

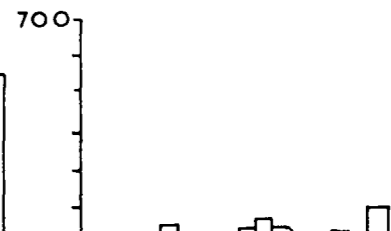

IRTON

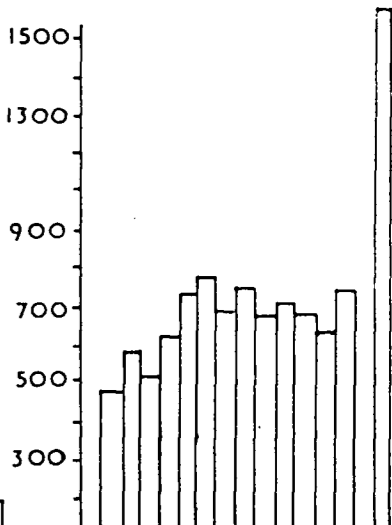

SEAMER

POPULATION GRAPHS

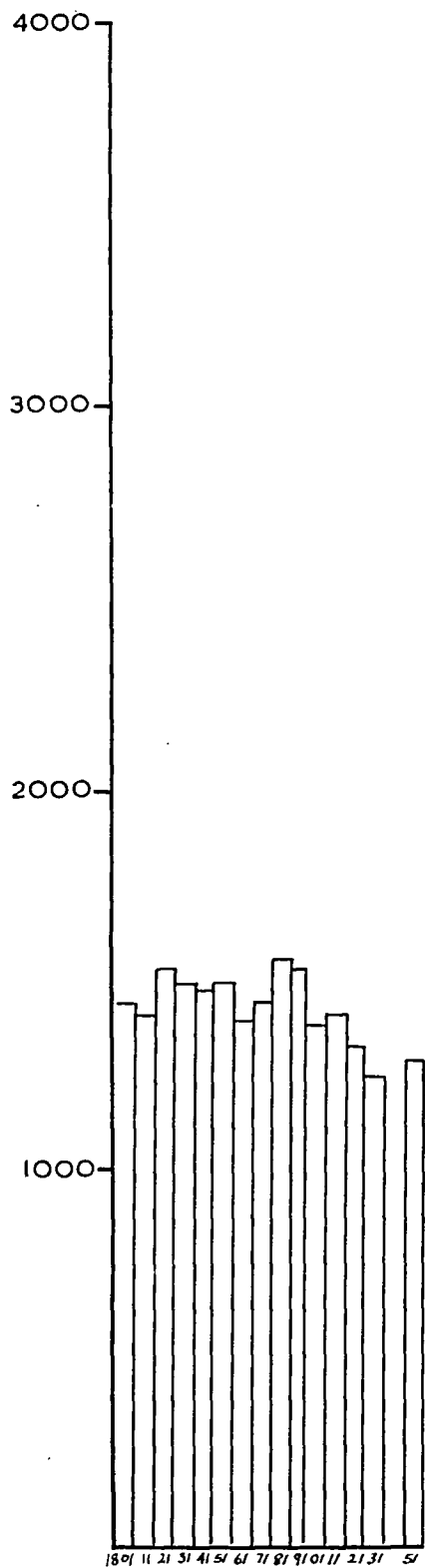

HELM斯LEY

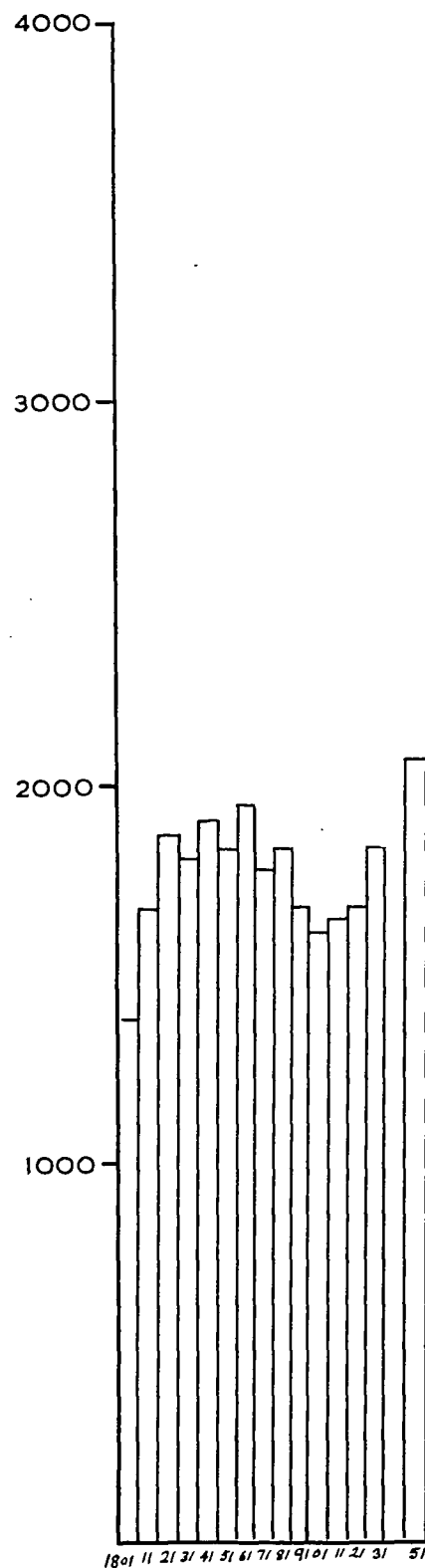

KIRBY MOORSIDE

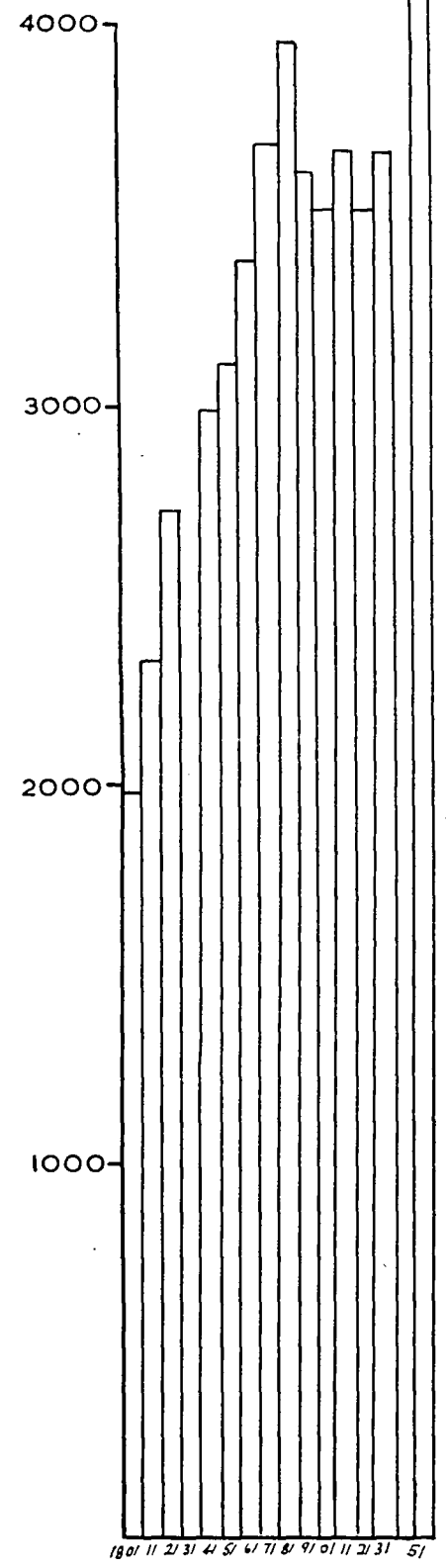

PICKERING



LAND UTILISATION 1961

HUTTON BUSHEL

NORMANBY

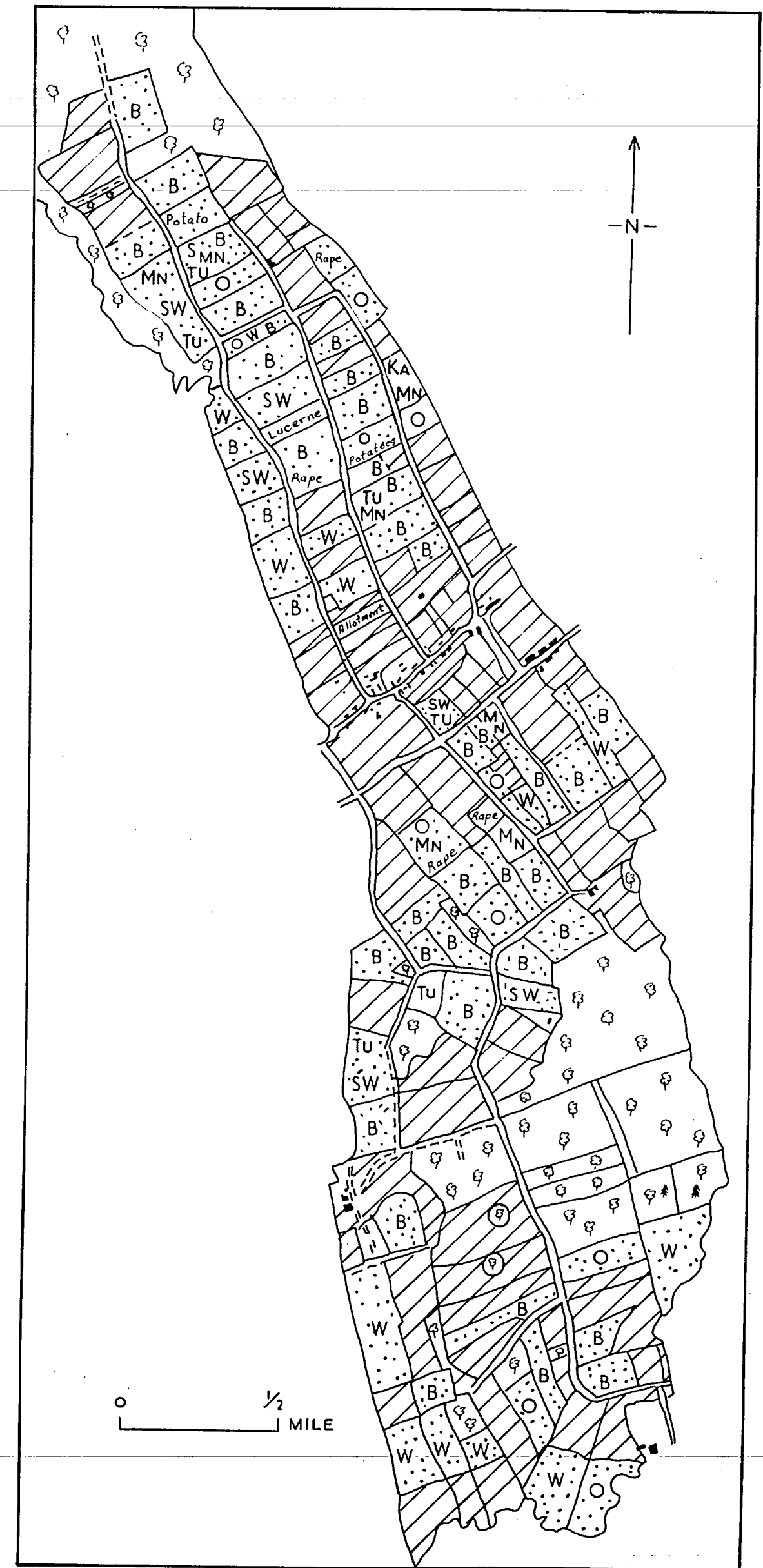

KEY



ARABLE

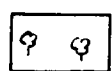

WOODLAND

W WHEAT



GRASSLAND

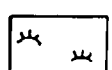

MOOR

B BARLEY

O OATS

MN MANGOLDS

TU TURNIPS

# PHYSICAL SUBDIVISIONS OF THE NORTH OF THE VALE OF PICKERING

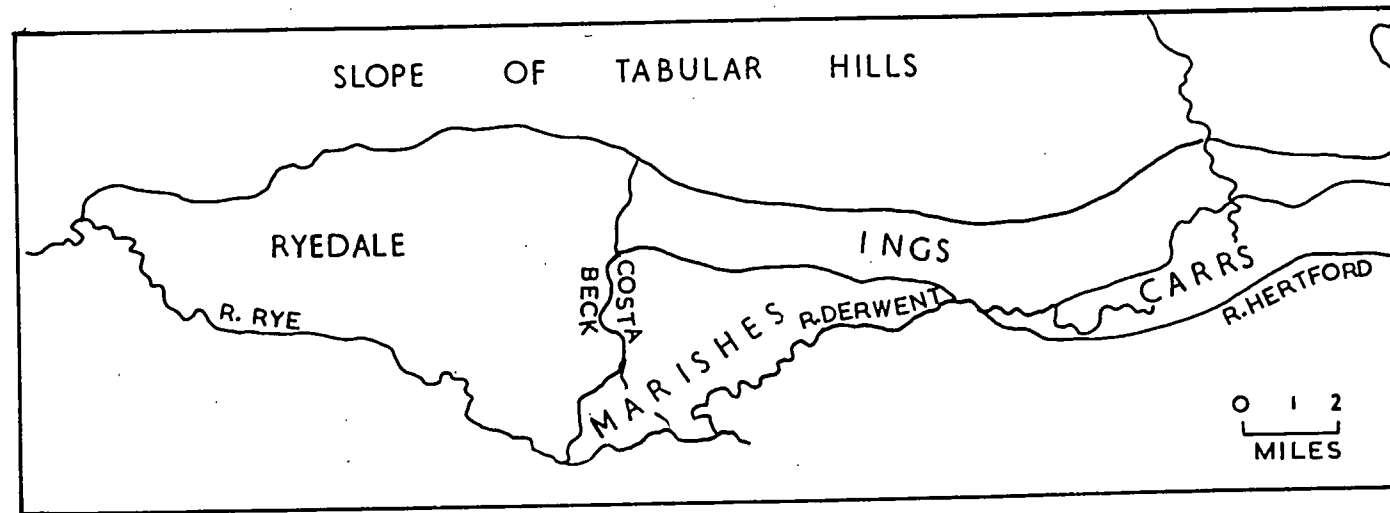

# NORTH YORK MOORS NATIONAL PARK

