



Durham E-Theses

The Irish harp in art music c1550 - c1650

Robson, Tristram Newton Fatkin

How to cite:

Robson, Tristram Newton Fatkin (1997) *The Irish harp in art music c1550 - c1650*, Durham theses, Durham University. Available at Durham E-Theses Online: <http://etheses.dur.ac.uk/9354/>

Use policy

The full-text may be used and/or reproduced, and given to third parties in any format or medium, without prior permission or charge, for personal research or study, educational, or not-for-profit purposes provided that:

- a full bibliographic reference is made to the original source
- a [link](#) is made to the metadata record in Durham E-Theses
- the full-text is not changed in any way

The full-text must not be sold in any format or medium without the formal permission of the copyright holders.

Please consult the [full Durham E-Theses policy](#) for further details.

**The Irish Harp in Art Music
c.1550 - c.1650**

Two Volumes

Volume I

Tristram Newton Fatkin Robson

Ph.D.

University of Durham

Department of Music

1997

The copyright of this thesis rests with the author. No quotation from it should be published without the written consent of the author and information derived from it should be acknowledged.



21 MAY 1998

Tristram Robson

The Irish Harp in Art Music c.1550 - c.1650

Ph.D.

1997

The sixteenth century brought increased English military occupation and settlement to Ireland. Members of the invading nobility, who consequently came into contact with the native culture, were seduced by the sound of the Irish harp and took the instrument from its roots in Gaelic society and placed it in the setting of European courtly music. My aim is to examine this process, the resulting developments which took place in the evolution of the Irish harp, and compositions associated with its usage in the 'art' music of England and the Continent. Particular reference is made to the 'Harpe' Consorts of William Lawes together with their sources and resulting implications when considering the capabilities of the instrument employed. The harp's role within this music is also analysed and a complete set of transcriptions of Lawes' consorts is included.

Works by other musicians associated with the Irish harp during the period 1550-1650 are also discussed with specific reference to the compasses and accidentals of the instruments required by the composers where appropriate. Transcriptions of works attributed to Cormack MacDermott and the anonymous harp parts located at the back of Ch Ch Mus MS 5 are included. Martin Peerson's 'Mottects or Grave Chamber Music' and a collection of works for 'Treble Bass Viol and Harp', included in the back of the 1687 edition of Christopher Simpson's *A Compendium of Practical Music* are also discussed.

A major part of the research involved the reconstruction of an Irish chromatic harp (presented as part of this thesis) capable of playing the music examined. An account of this is given in a report which looks at the decisions and processes involved, difficulties encountered, as well as some recommendations for future experimental directions.

The Irish Harp in Art Music
c.1550 - c.1650

Volume I

Contents

Acknowledgements	1
1. Retrospective of Scholarship on the Irish Harp	3
2. Irish Harpers and Patrons	7
3. The Development of the Irish Harp and the Evidence for a Chromatic Instrument	60
4. William Lawes' 'Harpe' Consorts	132
5. The Role of the Irish Harp in Lawes' 'Harpe' Consorts	186
6. Other Examples of Music Written for the Irish Harp, and Music Related to This Genre	207
7. A Report on the Reconstruction of an Irish Chromatic Harp	261
8. Bibliography	286

Volume II

Appendices

Contents

Editorial Method	1
A. William Lawes' 'Harpe' Consorts	3
B. Works Attributed to Cormack MacDermott	238
C. Anonymous Harp Parts (Och Mus MS 5)	270
D. 'Man dreame no more' Martin Peerson, <i>Mottects or Grave Chamber Music</i> (1630)	306
E. 'Lessons by Sundry Authors for the Treble Bass Viol and Harp' <i>A Compendium of Practical Music</i> (1687)	313

List of Tables

Chapter 2

1. References to harps and clarsachs in the accounts of the Lord High Treasurer of Scotland (1491-1513) 18

Chapter 4

1. The 'Harpe' Consorts of William Lawes (sources) 138
2. David Pinto's suggested dates for the composition of Lawes' Consorts during the 1630s 142
3. The numbers of bars within each dance movement of Consorts I-IV 149
4. The possible intended arrangement of movements in the 'Harpe' Consorts 166
5. Accidentals occurring in the harp parts of Lawes' 'Harpe' Consorts other than those given by Peter Holman 176
6. Instrumental combinations featured in Lawes' Consorts 182

Chapter 6

1. Sources for works attributed to Cormack MacDermott 206
2. Anonymous Harp Parts [Mus. MS 5] 227
3. Incidents of wide (harp) intervals [Mus. MS 5] 228
4. Identical notes required simultaneously by both hands [Mus. MS 5] 229
5. Examples of a build up of texture within the harp part [Mus. MS 5] 239
6. Examples of sustained notes in the harp part [Mus. MS 5] 239
7. Examples of a lively bass part [Mus. MS 5] 240
8. 'Lessons by Sundry Authors for the Treble Bass Viol and Harp' (1687 edition of Simpson's *Compendium of Practical Music*) 252
9. 'The Consort' (musicians performing at the funeral of King James I) 259

List of Examples

Chapter 2

1. Payments made to harpers at the Scottish Court during the year 1501 17
2. Transcription of a corant or saraband probably played by Jean la Fuelle in *The Temple of Love* (1635) 43

Chapter 3

1. String positions for the Dalway harp as suggested by Michael Billinge and Bonnie Shaljean 91
2. Possible tunings for the Dalway harp as suggested by Michael Billinge and Bonnie Shaljean 93
3. Duplicated strings in the possible tunings for the Dalway harp as suggested by Billinge and Shaljean 95
4. My proposed string positions for the Dalway harp in which lower tuning pins are also used as hitch pins 96
5. The route which Praetorius may have used when recording the tuning of an Irish harp (as suggested by Billinge and Shaljean) 115
6. The tuning of an Irish harp as recorded by Bunting in 1792 122

Chapter 4

1. The diatonic range of notes and accidentals required for each movement of Lawes' 'Harpe' Consorts 169-173
2. The scale of notes necessary for the harp parts in Lawes' 'Harpe' Consorts based on the findings of Peter Holman and myself, and the possible string patterns of instruments required to play these 174-175

Chapter 6

1. A reconstruction (by Peter Holman) of the opening of Sir John Peyton's Pavan 215
2. A reconstruction (by Peter Holman) of the opening of Sir Thomas Brook's Pavan in the manner of a Lawes' style harp consort 220

3. The range of notes required to play the anonymous harp parts of Mus. MS 5	233-235
4. The possible string pattern of an instrument required to play the anonymous harp parts of Mus. MS 5	237
5. The range of notes required to play the organ parts of Peerson's <i>Mottects</i>	248
6. The possible string pattern of a harp required to play the organ parts of Peerson's <i>Mottects</i>	250
7. The range of notes required to play the harp parts in the 1687 edition of Simpson's <i>Compendium of Practical Music</i>	254-255
8. The possible string patterns of an instrument required to play the harp parts in the 1687 edition of Simpson's <i>Compendium of Practical Music</i>	256

List of Illustrations

Chapter 2

1. Figure with harp, a plaque on the shrine of St. Mogue: eleventh century. National Museum of Ireland 8
2. King Henry VIII playing the harp, an illustration from the King's psalter c1540. British Library Royal MS 2A. 21
3. Reciter and harper performing before an Irish chieftain. Woodcut. John Derricke, *Image of Ireland* (London, 1581) 24
4. Autograph bill for the repair to Robert Cecil's harp by Cormack MacDermott, dated 20th May 1607. Hatfield House, Cecil family and Estate Papers, bills 14/20 34
5. Illustration of a Triple harp from Mersenne's *Harmonie universelle* (Paris, 1636) 42
6. Inigo Jones, sketches of Orpheus in *The Temple of Love*. Chatsworth, collection of the Duke of Devonshire 45
7. Known as *The Cabal* by J.B.Medina. *Members of the King's Private Music* c1661-3. Nostell Priory, The National Trust 54

Chapter 3

1. The principal Characteristics of an Organological Irish Harp c.1550 61
2. *The Trinity College Harp* (14th century) Trinity College Dublin 64
3. *The Lamont Harp* (15th Century), National Museum of Antiquities of Scotland 70
4. *The Queen Mary Harp* (c.1500), National Museum of Antiquities of Scotland 75
5. *The Ballinderry Fragments* (16th century), National Museum of Ireland 80
6. *The Otway Harp* (17th century), National Museum of Ireland 83
7. The neck of the *Dalway Harp* (1621), National Museum of Ireland 86
8. An artist's reconstruction of the *Dalway Harp* fragments taken from Edward Bunting, *A General Collection of the Ancient Music of Ireland...* (London, 1809) 88

9. A reconstruction of the <i>Dalway Harp</i> fragments demonstrating the string system proposed by Michael Billinge and Bonnie Shaljean	92
10. A reconstruction of the <i>Dalway Harp</i> fragments demonstrating how some of the lower tuning pins may also have been used as hitch pins	97
11. <i>The Kildare Harp</i> (17th century), National Museum of Ireland	100
12. <i>The O'Ffogerty Harp</i> (17th century), Castle Ffogerty, Thurles, Co. Tipperary	103
13. <i>The SIRR Harp</i> (18th century), National Museum of Ireland	105
14. The stringing system for a chromatic double harp, Vicentio Galilei, <i>Dialogo...della musica antica e della moderna</i> (Florence, 1581), 14.	109
15. A list of instruments making use of wire strings including the Irish harp; Michael Praetorius, <i>Syntagma Musicum</i> , II, 5	110
16. A table showing the comparative compasses and use of semitones in three different types of harp (including an Irish harp), Michael Praetorius, <i>Syntagma Musicum</i> , II, 30	112
17. Descriptions and comparative stringing scales of three different types of harp (including an Irish harp), Michael Praetorius, <i>Syntagma Musicum</i> , II, 54; A transcription of Praetorius' stringing scale for an Irish harp by Harold Blumenfeld, <i>Michael Praetorius, Syntagma Musicum</i> (New York, 1980)	114
18. An illustration of an Irish harp, Michael Praetorius, <i>Syntagma Musicum</i> , II, Plate XVIII	118
19. Reinhold Timm, <i>A group portrait of of musicians at the court of King Christian IV of Denmark</i> (c.1622-25)	126

Chapter 4

1. William Lawes' 'Harpe' Consorts, movements 1 and 2, autograph harp parts [Ob. MS Mus. Sch. D 229]	133
2. William Lawes' 'Harpe' Consorts, movements 28 and 29, theorbo part giving Lawes' attribution to Cormacke and Coprario [Ob. MS Mus. Sch. D238]	134
3. William Lawes' 'Harpe' Consorts, first page of movement 30, 'Paven on a theme of Cormacke' showing the layout of the score [Ob. MS Mus. Sch. B3]	135

4. William Lawes' 'Harpe' Consorts, movement 1, harp part in the hand of Francis Withy [Och. MS 5] 136
5. William Lawes' 'Harpe' Consorts, *Court Ayres*, ed. John Playford (London, 1665), preface [BL. Mus. K.4.a.4.] 139
6. William Lawes' 'Harpe' Consorts, movement 16, *Court Ayres*, ed. John Playford (London, 1665) [BL. Mus. K.4.a.4., no 95] 140

Chapter 6

- 1.(a) 'The Lor: Sheffelds Pauin Mr: Cormake' (treble) [Filmer MS 4], Yale Music Library 209
- 1.(b) 'The Lor: Sheffeld's Pavin Mr: Cormake:' (alto) [Filmer MS 4], Yale Music Library 210
- 1.(c) 'The Lor Sheffelds pauin Mr: Cormake.' (bass) [Filmer MS 4], Yale Music Library 211
- 2.(a) 'Sr John Paitons pauan: by mr Cormake' (treble) [Och. MS 379] 212
- 2.(b) 'Sr John Paitons pauan by mr Cormake' (alto) [Och. MS 380] 213
- 2.(c) 'Sr John Paitons pauan: by mr Cormake' (bass) [Och. MS 381] 214
3. 'Almaine. Mr Cormack.' (bass) [Och. Mus. MS 1022, no 84] 217
4. 'Cormacks Almain by Daniel Nercum' (bass viol divisions) [Ob. MS Mus. Sch. D 246] 219
5. William Lawes, Harp Consort no 9 (theorbo part) attribution to Cormack in Lawes' hand [Ob. MS Mus. Sch 238] 222
6. Ayre no 7 (anonymous harp part) [Och. Mus. MS 5] 226
- 7.(a) Martin Peerson, *Mottects or Grave Chamber Musique* (London, 1630) [BL. Mus. K.d.2.13.], title page 242
- 7.(b) Martin Peerson, *Mottects or Grave Chamber Musique* (London, 1630) [BL. Mus. K.d.2.13.], table page 244
- 7.(c) Martin Peerson, *Mottects or Grave Chamber Musique* (London, 1630) [BL. Mus. K.d.2.13.], no 15 (organ part) 245

Chapter 7

1. End elevation and soundboard plan of my first reconstruction of an Irish chromatic harp showing the disposition of the tuning pins and strings 266

2. Isometric projection of my first reconstruction of an Irish chromatic harp showing the general layout and stringing pattern	268
3. Isometric projection showing the interior construction of the soundbox of my first reconstruction of an Irish chromatic harp	269
4. Photographs of the neck, pillar and soundbox of my first reconstruction of an Irish chromatic harp	272
5. Photographs of my first reconstruction of an Irish chromatic harp showing the major components in position and an experiment taking place to calculate the distances between the strings	273
6. Photographs showing the brass strips used to reinforce the split soundboard	275
7. Isometric projection of the second reconstruction of a soundbox for an Irish chromatic harp	276
8. The finished harp featuring the second reconstruction of a soundbox	278
9. Photographs showing close up views of the head of a wolf hound and the new soundboard, string holes and shoes	280

ACKNOWLEDGEMENTS

During the course of my research for this thesis I have received invaluable help and support from a number of people and organisations without whom the task would have been impossible. I am therefore very pleased to express my grateful thanks for the roles which they have played in assisting me in this venture.

Firstly I would like to mention Layton Ring for his constant friendship and help over many years, and for bringing the 'Harpe' Consorts of William Lawes to my attention in the first place. I would also like to thank my supervisor, Prof. David Greer, who has guided my studies throughout this period, as well as providing direction and order to my frequently chaotic thoughts.

I am indebted to the Goldsmiths Company of London for their award of a Travel Study Grant to enable me to visit Denmark, Ireland and London to examine source material essential to this research.

I am grateful to David Pinto for helping me with facts concerning the historical context of this work as well as for his thoughts concerning Lawes' Royal Consorts and other works. Dr. Robert Ford has been most helpful in replying to my letters requesting information about the Filmer Manuscripts and Sean Donnelly has been very generous in sharing his thoughts regarding Irish harpers in the service of English and European households.

I have received valuable aid from the staff of the British Library, London; the Bodleian Library, Oxford; Christ Church Library, Oxford; Rigsarkivet, Copenhagen; the City Library, Cork; the National Library of Ireland, Dublin; the National Museum, Dublin; Trinity College Library,

Dublin; the University Library, Palace Green, Durham; the Public Library, Manchester; the Central Library, Newcastle upon Tyne; the Public Record Office, London; I am most grateful for the help given by their staff and governing bodies. My special thanks are due to Kendall Crilly of Yale University Library and Yens Egberg of The Royal Danish Library for the individual attention which they gave me.

For technical advice and help with the reconstruction of Irish harps many thanks are due to my late father in law, Bob Gillon, to Jimmy Gillon and Alan Macmillan. I am grateful to my colleagues at Gosforth Central Middle School for their interest and to my Head Teacher Diane Darwin for her understanding as I attempted to balance the demands of a full time teacher with those of a part time research student.

My appreciation is due to my examiners, Ian Woodfield, who provided me with many welcome comments and additional citations, and Robert C. Provine, who encouraged me to complete the minor alterations needed to successfully submit my thesis.

Finally I wish to express the greatest debt to my wife Jane for putting up with me during the course of this work and for her invaluable service as a proof reader.

CHAPTER 1

Retrospective of Scholarship on the Irish Harp

In the course of writing this thesis I have made frequent reference to the work of other scholars. Early research into the historical context of the Irish harp had previously been undertaken by the historian Gratton Flood (*A History of Irish Music* [Dublin, 1905], *An Introductory Sketch of Irish Musical History* [London, n.d.], *The Story of the Harp* [Dublin, 1905]). Unfortunately the author rarely cited specific references to substantiate his statements and the depth of research remained embryonic. Gratton Flood was significant in establishing the history of the Irish harp as a field of study however.

Robert Bruce Armstrong's book *The Irish and Highland Harps* (Edinburgh, 1904) was the first major survey of known ancient Irish and Scottish harps. It is a substantial work and examines the subject very thoroughly, particularly with regards to the construction of the instruments, though many contextual references and two eighteenth century instruments have since come to light.

More recently, Joan Rimmer's articles concerning the evolution of the harp published in the *Royal Musical Association Research Chronicle* (1964) and the *Galpin Society Journal* (1963 and 1964) provided a very welcome update to Armstrong's work. This is in particular respect to methodical and accurate measurement of instruments, as well as the publication of notes made by James Talbot on the Irish harp during the late seventeenth and early eighteenth centuries.

Research into the context of the Irish harp owes a great deal to the recent work of Sean Donnelly in *Cheol* (1984 and 1986). He has done

much to present references to the Irish harp from the time of the Norman Conquest to the end of the seventeenth century. Sean Donnelly has frequently retraced the steps of Gratton Flood, making discoveries first explored by the historian, accurately available to scholars today.

A major figure in the composition of music for the Irish harp in art music is the English court composer William Lawes. Murray Lefkowitz's biography *William Lawes* (London, 1960) remains the most comprehensive account of the composer's life and works, and in particular includes a chapter devoted to the 'Harpe Consorts.' An important contribution by Lefkowitz in this book is his complete catalogue of Lawes' work together with a transcription of the saraband 'Oh my Clarissa' from Consort IV. William Lawes' *Select Consort Music*, *Musica Britannica*, XXI, ed. Murray Lefkowitz (London, 1960) is important insofar as several of the 'Harpe' Consorts were published here for the first time, together with other works by the composer.

The earliest champion of the theory that the Irish harp was the instrument intended by Lawes for the 'Harpe' Consorts was Layton Ring. He informed me that it was in 1956 that he first came to the conclusion that the Irish harp was the instrument intended by Lawes for the 'Harpe' Consorts. This was due to the reference to the combination of the Irish harp and bass viol made by Francis Bacon in *Sylva Sylvarum*: 'As the Irish Harpe and Base Viall agree well.'¹ The proposition was convincing enough for Thurston Dart to repeat the theory in the footnotes of the fourth edition of Francis Galpin's *Old English Instruments of Music* (London, 1965) 13. This was the first published reference to the *Irish*

¹ Francis Bacon, *Sylva Sylvarum* (London, 1627), century iii, 72, no.278.

harp (as opposed to any other type) being the instrument which Lawes wrote for.

In 1981, Layton Ring gave an illustrated lecture at Newcastle University on the Lawes' 'Harpe' Consorts with particular reference to the employment of a succession of Irish harpers in the 'Private Music', the chromatic potential of the Dalway harp and the eccentric requirement of accidentals in the harp part. He repeated this lecture at a meeting of the Lute Society held during 1986, at the Arts and Crafts Guild in London. During this second lecture, the audience was given the opportunity to compare the employment of an Italian double harp with an Irish harp. On both occasions the wire strung Irish harp was played by myself.

Peter Holman's article, 'The harp in Stuart England', *Early Music*, XV (1987) 188-203, was the first comprehensive account of the Irish harp in art music, and did much to reinforce the view that Lawes wrote for the Irish harp. Holman looks at the employment of Irish harpers at the English Court during the reigns of the Stuart kings, and in particular for the 'Private Music'. In this article, lists are also made of manuscript sources, suggestions are made as to the evolution of harp consorts, and a table is given of possible notes required to perform Lawes' 'Harpe' Consorts. Though I disagree with some of Holman's findings, I used this work as a constant source of reference in my chapters concerned with music written for the Irish harp.

Finally, Michael Billinge and Bonnie Shaljean's article 'The Dalway or Fitzgerald harp [1621]', *Early Music*, XV (1987) 175-187, was important as, in proposing a partially chromatic string layout, it offered the first published practical solution to the puzzle of the

stringing of the Dalway harp. I found some aspects of this article under-researched, particularly where the authors refer to Praetorius, but nevertheless believe it offered further weight to propositions by Clayton Ring, Thurston Dart and Peter Holman that the Irish harp was the instrument intended by William Lawes in his 'Harpe' Consorts.

CHAPTER 2

Irish Harpers and Patrons

The first images of musicians playing harps appear in Ireland in the form of stone carvings as early as the ninth century. The stones have eroded over the years however, and sculpted details of stringing and construction are very difficult to ascertain. It is not until the eleventh century that a clear and detailed portrait of a man playing an Irish form of harp is found. In this case the illustration is on a metal plaque attached to the shrine of St. Mogue which is displayed in the National Museum of Ireland (see Illustration 1). It depicts a robed figure with a triangular shaped harp placed upon his knees. The instrument consists of a slender, decorated sound box, a curved forepillar which shows signs of having a characteristic 'T' formation, and a gently curved neck. There is a row of ten or eleven tuning pins, below which are stretched eight or nine strings that are not in proper alignment. It is placed upon the player's left shoulder and his right hand plays the longer bass strings, while his left is seen playing the short treble strings.¹ This harp and the method of playing it, were typically Irish and exponents carried on the traditions of construction and performance into the late eighteenth century.

After the eleventh century, visual representations and written accounts of Irish harpers become more frequent and the latter are generally full of praise. In 1566, John Good, a Catholic priest who was educated at Oxford and worked in Limerick as a teacher for many years, wrote: "They love music mightily and of all instruments are particularly

¹ Joan Rimmer, *The Irish Harp* (Cork 1969, 3rd edn., 1984), 26.

Illustration 1



1 Figure with harp. A plaque on the Shrine of St. Mogue; eleventh century. National Museum of Ireland.

taken with the harp, which being strung up with brass wire, and beaten with crooked nails, is very melodious. They use the bagpipe in their war instead of a trumpet".² The sound produced by plucking brass strings with long finger nails is very clear and bell-like in quality, and its tone enchanted visitors and natives of Ireland alike.

Giraldus Cambrensis

An earlier and more significant description is that given by the Welsh-born Norman, Giraldus Cambrensis, who studied Latin poets, law, philosophy and theology in Paris between 1167 and 1172. His family were heavily involved in the Norman conquest of Ireland and he visited that country in 1183. In 1185 he returned to Ireland with Prince John of England to whom he became a tutor. Much of the importance attached to the writings of Giraldus is due to the experience which he must have gained in the capital cities of Paris and London. We must assume that having studied theology, he was well acquainted with the music employed in the church of the day, and he was probably also well acquainted with the secular music sung and played in feudal households. Giraldus was a cultivated ecclesiastic and not an uneducated Norman-Welshman.³ In his *Topographica Hiberniae* he describes many of the attitudes and customs of the Irish as 'barbarian'.⁴ From his description however, he found the music he heard in Ireland far from barbarian and he goes on to compare it very favourably with that 'generally' heard in England. It is worth quoting in full:

2 Robert Bruce Armstrong, *The Irish and The Highland Harps* (Edinburgh, 1904, repr., Shannon, 1969), 19.

3 Joan Rimmer, *The Irish Harp*, 28-30.

4 Giraldus Cambrensis, *Topographiae Hiberniae*, Rolls Series, V; Joan Rimmer, *The Irish Harp*, 28-29, including translation; Robert Bruce Armstrong, *The Irish and The Highland Harps*, 11-12.

I find among these people commendable diligence only on musical instruments, on which they are incomparably more skilled than any nation I have seen. Their style is not, as on the British instruments to which we are accustomed, deliberate and solemn but quick and lively; nevertheless the sound is smooth and pleasant.

It is remarkable that, with such rapid finger work, the musical rhythm is maintained and that, by unfailingly disciplined art, the integrity of the tune is fully preserved throughout the ornate rhythms and the profusely intricate polyphony - and with such smooth rapidity, such 'unequal equality', such 'discordant concord'. Whether the strings strike together a fourth or a fifth, [the players] nevertheless always start from B flat and return to the same, so that everything is rounded off in a pleasant general sonority. They introduce and leave rhythmic motifs so subtly, they play the tinkling sounds on the thinner strings above the sustained sound of the thicker strings so freely, they take such a secret delight and caress [the strings] so sensuously, that the greatest part of their art seems to lie in veiling it, as if 'That which is concealed is bettered - art revealed is art shamed.'

Thus it happens that those things which bring private and ineffable delight to the people of subtle appreciation and sharp discernment, burden rather than delight the ears of those who, in spite of looking do not see and in spite of hearing do not understand; to unwilling listeners, fastidious things appear tedious and have a confused and disordered sound.

One must note that in both Scotland and Wales, the latter by virtue of extension, the former by affinity and intercourse, depend on teaching to imitate and rival Ireland in musical practice. Ireland uses and delights in two instruments only, the cithara and the tympanum. Scotland uses three, the cithara, the tympanum and the chorus. Wales uses the cithara, tibiae and chorus. Also they use strings made of brass not of leather. However, in the opinion of many, Scotland today not only equals Ireland, her mistress, but also by far outdoes and surpasses her in musical skill. Hence many people already look there as though to the source of the art.

In this description, the cithara is almost certainly a harp, while it is probable that the tympanum was a beaten lyre. Tibiae were a form of pipes, though the description does not give enough detail to determine the exact type. From the work of Giraldus it is possible to determine that many harpers in Ireland were highly skilled in their art. They belonged to a sophisticated oral tradition which may, judging from the phrase 'unfailingly disciplined art', have involved a long and well taught apprenticeship in order to reach the heights of performance described. As the music was handed down orally from musician to

musician, it is impossible to know exactly what form it took. Another description of the performance of a native Irish harper made in the eighteenth century does make an interesting comparison however. The observations on Denis Hempson, a harper born in the year 1695, were made by Edward Bunting, a collector of ancient Irish music and songs.⁵ It should be noted that, unfortunately, Bunting arranged all the music he collected for the pianoforte, and in doing so, lost a valuable chance to record past playing traditions. His account of Hempson is as follows:

The pieces which he delighted to perform were unmixed with modern refinements, which he seemed studiously to avoid; confining himself chiefly to the most antiquated of those strains which have long survived the memory of their composers, and even a knowledge of the ages that produced them. Hempson was the only one of the harpers at the Belfast Meeting, in 1792, who literally played the harp with long crooked nails, as described by the old writers. In playing he caught the string between the flesh and the nail; not like the other harpers of his day, who pulled it by the fleshy part alone. He had an admirable method of playing staccato and legato, in which he could run through rapid divisions in an astonishing style. His fingers lay over the strings in such a manner, that when he struck them with one finger, the other was instantly ready to stop the vibration, so that the staccato passages were heard in full perfection. When asked the reason of his playing certain parts of the tune or lesson in that style, his reply was, 'That is the way I learned it', or 'I cannot play it in any other.' The intricacy and peculiarity of his playing often amazed the editor, who could not avoid perceiving in it vestiges of a noble system of practice, that had existed for many centuries; strengthening the opinion, that the Irish were, at a very earlier period, superior to the other nations of Europe, both in the composition and performance of music. In fact, Hempson's staccato and legato passages, double slurs, shakes, turns, graces, &c. &c., comprised as great a range of execution as has ever been devised by the most modern improvers.

The impression given by Bunting is that Hempson was the last of an unbroken line of Irish harpers to play in a style which appears to be very similar to that recorded by Giraldus in 1185, six hundred years

⁵ Edward Bunting, 'The Irish Harp and Harpers', *The Ancient Music of Ireland* (Dublin, 1840, repr., 1969), 73.

previously. Comparisons made between the fourteenth-century harp in the library of Trinity College, Dublin, and the Downhill harp owned by Hempson (now in the possession of Messrs. Arthur Guinness, Son and Co., Dublin) show that the latter instrument had thirty-two strings while the former had thirty. Other than noticing that the bass strings of the Downhill Harp are longer, there is little difference in the musical potential of the two instruments.

The Historical Context of the English Appreciation of the Irish Harp

In order to understand the patronage of the Irish harp it is necessary to refer to the history of Ireland. From 1185 until 1792, all references to the wire strung Irish harp (clarsach) are associated with the aristocracy or gentry, either in their role as patrons or performers. The clarsach was not what might be described today as a 'folk instrument', despite the fact that it was part of an oral tradition and that no system of musical notation was used by Irish harpers. There are no references to the clarsach being played by the peasant classes, or of harpers being hired for their entertainment. Harps were very expensive items and only wealthy people could afford to purchase one or pay maintenance to a skilled harper.⁶ Ireland was largely a feudal and agricultural society until the early years of the eighteenth century and the changes that took place in England between the Black Death and the reign of King James I had very little effect upon this. As a result there was no significant growth in the size of its towns or cities. This is in contrast to the development of industry

⁶ Joan Rimmer, *The Irish Harp*, 37-38.

and enclosures which took place in England, resulting in a new middle class of merchants and manufacturers. These people could afford to be involved in the arts, purchase expensive musical instruments for their own pleasure and employ musicians as tutors.

Until the sixteenth century, patrons of Irish harpers were members of the Gaelic-Irish aristocracy, the Norman-Irish and later on, the Anglo-Irish. It should be noted that by this period, the Norman families which had invaded Ireland during the twelfth and thirteenth centuries, had become fully integrated with Irish society, adopting the language and culture of the Gaelic Irish. The principal area of English influence was a strip of land surrounding Dublin known as the Pale in which chieftains owed direct fealty to the English Crown. Outside the Pale, the language and culture of the aristocracy was predominantly Irish.

English involvement in Ireland increased gradually from the twelfth to the sixteenth century with little effect upon Irish culture other than disruption. This process changed during the sixteenth and seventeenth centuries however, when successive English monarchs began the process of subjugating the whole of Ireland. This involved attempts to convert the Irish into law-abiding Englishmen by banning many aspects of Irish culture, including the playing of harps. The process became increasingly more violent throughout the reign of Elizabeth I and the Commonwealth of Oliver Cromwell. Finally a climax was brought about by the invasion of William of Orange and the siege of Aughran in 1691. This resulted in the Protestantisation of the country and the destruction of the Gaelic society.⁷ The Irish aristocracy and gentry had largely fled

⁷ Constantine FitzGibbon, *The Irish in Ireland* (London, 1983), 165.

or been Anglicised, leaving few harps or harpers behind to continue the ancient traditions. Any vestiges of the old culture and language which remained were left in the hands of peasants living in the wilder countryside of the West of Ireland.

With this historical background it is an ironic fact that most information regarding Irish harps and harpers during the sixteenth and seventeenth centuries comes from English sources, and indeed, many of these references occur as a result of laws and statutes passed with an aim of suppressing the influences of Irish culture. In 1367, the fortieth year of Edward III, a parliament was held in Kilkenny by Lionel, Duke of Clarence, during which he passed the act c.15, which was as follows:⁸

Also whereas the Irish Agents who come amongst the English, spy out the secrets, plans, and policies of the English, whereby great evils have often resulted; it is agreed and forbidden that any Irish Agents, that is to say, minstrels, story tellers, babblers, rimers, mowers, nor any other Irish Agent shall come amongst the English, and that no English shall receive or make gift to such; and that he that shall do so, and be attainted, shall be taken, and imprisoned, as well the Irish Agents as the English, who receive or give them anything, and after that they shall make fine at the King's will; and the instruments of their agency shall forfeit to our Lord the King.

It is apparent that this law was not always strictly enforced as there are records of its subsequent revival. These occur in 1402 when Lord Thomas Lancaster, second son of King Henry IV was appointed Lieutenant of Ireland and held a parliament, and later on in 1495, when the statutes of Kilkenny were revived and confirmed during the tenth year of Henry VII.⁹ With the threats offered by the statutes of Kilkenny it is a

⁸ James Hardiman, 'The Statute of Kilkenny... with translation and notes', *The Irish Archaeological Society*, II (Dublin, 1841), 55, 58; Robert Bruce Armstrong, *The Irish and Highland Harps*, 15.

⁹ Robert Bruce Armstrong, *The Irish and Highland Harps*, 15.

wonder that any Englishmen ever listened to the Irish harp during their visits to Ireland. The fact that they did so must testify to the enchanting qualities of music played upon the clarsach. From letters patent dated the 25th October 1376 however, it can be seen that exceptions could be made:¹⁰

Downald O'Moghane, an Irish minstrel residing among the English, had constantly remained in the fealty, peace and obedience of the King; and that he had inflicted divers injuries on the Irish enemies, for which reason he durst not approach them; it was concluded that he might continually reside among the English, and that they might receive and entertain him notwithstanding the statute.

In 1395, King Richard II spent a great deal of time in Ireland, and during his stay in Dublin he met four native chieftains who swore fealty to him. A translator named Henry Castide was present at the meeting and subsequent entertainment, and he described the occasion to the writer Froissart. Froissart describes the attempts of Henry Castide to make the chieftains' minstrels and servants sit at a lower table, because they were accustomed to sitting behind their lords and eating off the same plates.¹¹ It would appear that even King Richard would prefer to have Irish harpers in his presence if the occasion suited him. In 1435, a patent roll of the thirtieth year of Henry VI describes how some Englishmen, who chose to ignore the statute of Kilkenny, came to regret their patronage of Irish minstrels.¹²

¹⁰ Robert Bruce Armstrong, *The Irish and Highland Harps*, 15.

¹¹ Jean Froissart, *Froissart's Chronycles*, trans., Sir John Bouchier, (Oxford, 1927), II [part iv], Cap, ccii, 1046; Robert Bruce Armstrong, *The Irish and Highland Harps*, 16-17.

¹² James Hardiman, *Irish Minstrelsy or Bardic Remains of Ireland* (London, 1831, repr., 1971), I, xviii, xix; Robert Bruce Armstrong, *The Irish and Highland Harps*, 17.

The Irish Mimi, Clarsaghours [harpers], Tympanours, Crowthores, Keraghers, Rymours, Skelaghes, Bards, and others, contrary to the statute of Kilkenny, went among the English and exercised their arts and minstrelsies [minstrelsias et artes suas], and that they afterwards proceeded to the Irish enemies, and led them upon the King's liege subjects.

Scotland

Scotland was another state where the Irish harp could be heard. In 1316, Edward Bruce landed in the North of Ireland and declared himself to be King of Ireland. His forces took over a great deal of the country including most of the territory which is called Ulster today. In 1318, having reached the walls of Dublin, Edward was killed in battle leaving his forces to retreat slowly northwards. Despite having the effect of unifying the Gaelic Irish with the Norman Irish, the invasion did begin strong links between Scotland and the north of Ireland.¹³ Many Irish musicians travelled to Scotland taking their harps and music with them. The harp in the National Museum of Antiquities of Scotland known as the Queen Mary harp is so similar to the fourteenth-century instrument housed in the Library of Trinity College, Dublin, that they look as if they could have been made in the same workshop.¹⁴

The *Accounts of the Lord High Treasurer of Scotland* contain many records of payments made to harpers. Example 1 lists the payments made during the year 1501 and gives us a picture of the use of the harp and clarsach (Irish harp) at the Scottish Court.¹⁵

13 Constantine FitzGibbon, *The Irish in Ireland*, 113.

14 Keith Sanger & Alison Kinnaird, *Tree of Strings* (Temple, 1992), 80-92; Robert Bruce Armstrong, *The Irish and Highland Harps*, 142-154.

15 *Accounts of the Lord High Treasurer of Scotland*, ed., Sir James Balfour Paul (Edinburgh, 1900), II, 55, 102, 109, 110, 119, 120, 125, 126; Robert Bruce Armstrong, *The Irish and Highland Harps*, 142-154.

Example 1

Payments made to harpers at the Scottish Court during the year 1501
extracted from the *Accounts of the Lord High Treasurer of Scotland*

December, clothes for Pate Harpar, clarscha.....
April 13th, Pate Harpar on the harp, Pate harper on the
clarscha, James Mylson harpar, the Ireland clarschar,
and an English harper each received,.....xiiij s
May 22nd, be the Kingis command, to Pate harpar,.....xiiij s
May 25th, to James Mylson, harpar, be the Kingis command,.....xiiij s
June 1st, to Pate harpair,.....xiiij s
September 14th [Balquidder], to ane clarschaar thare,.....ij s
September 16th [Balquidder], to tua men that playit on the
clarscha and sang to the King, be the Kingis command,.....xxviiij s
November 11th, be the Kingis command, to the lard of
Balnagownis harpare,.....xiiij s
November 15th, to Alexander Harper be [the Kingis command] to
help him to by ane hors,.....xxviiij s
November 18th, to the Thayn of Caldoris harpar, be the Kingis
command,.....xiiij s

The accounts give a very clear indication of the frequency with which the harp was heard at the Scottish court. Some names such as Pate Harpar appear often throughout the Treasurer's accounts and it is clear that they were musicians who served King James IV on a regular basis. This view is backed up by extra payments made for livery or clothing. Others appear in isolation, frequently in places such as Balquidder, which the King was visiting. This in turn gives a picture of the distribution of harpers throughout the kingdom. It is interesting to note that a clear distinction is drawn between the clarscha (wire-strung Irish harp or clarsach) and the harp (European style gut-strung harp). Between the years 1491 and 1513, a number of references are made to harps and clarsachs and these are listed in Table 1. ¹⁶

On the frequent excursions of the King, reports of harps are made at Linlithgow, Fowlis, Duchal, Elgin, Eliotstown and Dingwall. Reports

¹⁶ *Accounts of the Lord High Treasurer of Scotland*, I, II, III, IV; Robert Bruce Armstrong, *The Irish and Highland Harps*, 144-154.

Table 1

The number of references to harps and clarsachs between the years 1491 and 1513.

1490	-1	2 clareschaw	
1491		3 clareschaw	1 harp
1494			1 harp
1496			3 harps
1496	-7	1 clarscha	2 harps
1497			10 harps
1497	-8	1 clarscha	4 harps
1501		5 clarscha	9 harps
1501	-2	1 clarscha	4 harps
1502			1 harp
1502	-3		5 harps
1503		5 clarscha	8 harps
1503	-4	1 clarscha	4 harps
1504			4 harps
1504	-5	2 clarscha	3 harps
1505		5 clarscha	11 harps
1506		8 clarscha	9 harps
1506	-7	5 clarscha	1 harp
1507		7 clarscha	2 harps
1507	-8		3 harps
1508		1 clarscha	3 harps
1511			1 harp
1512-13			1 harp
1513			1 harp

of clarsachs are made at Perth, Dumbarton, Balquidder, Glenluce, Lochmaben, Stirling, Wigtown, Inchmahome and Ayr. As in Ireland, the accounts reveal that the musicians were in the employment of the aristocracy and the names of the patrons are usually listed instead of those of their harp players. The lists of payments to players of the harp should not be viewed entirely in isolation and it is significant that frequent mention is also made of drums, organs, trumpets, pipes, shawms, fiddles, lutes, monochords and clavichords. Evidently the King was very fond of music and had a taste for instruments of diverse tone colour. A complete list of known references to harpers in Scotland (from c.1200 - 1778) is given in Keith Sanger and Alison Kinnaird's book *Tree*

of Strings.¹⁷

Throughout the period 1491 to 1513 there is only one reference which suggests that the clarsach was used in any other way than as a solo instrument.¹⁸ This is the entry for September 1501 which mentions two men who played upon the clarsach and sang to the king. Sadly, the entry is ambiguous, and though it is probable that the musicians accompanied themselves on the clarsach, it is also possible that they sang without instrumental accompaniment.

There is evidence to suggest that several Irish harpers visited Scotland between 1490 and the early years of the eighteenth century but sadly, much of this was initially handed down in the oral tradition. Among the list of harpers believed to have visited Scotland during the seventeenth century was Ruairi Dall (Blind Rory) O'Cathain who is said to have changed his name to Morrison. He is credited with the composition of the tune *Da mihi manum* (*Give me your hand*).¹⁹

16th-Century England

By the mid-sixteenth century, documentation recording English appreciation of the Irish harp begins to appear. In 1549 a large force of soldiers from the Pale (a defended area of a few hundred square miles surrounding Dublin) led by Walter Sherlock were campaigning in Scotland under the command of the Earl of Rutland. The Earl is recorded as paying 3s. 4d. to two Irish minstrels who provided him with entertainment on

¹⁷ Keith Sanger & Alison Kinnaird, *Tree of Strings* (Temple, 1992), 222-225.

¹⁸ *Accounts of the Lord High Treasurer of Scotland*, II, 120.

¹⁹ Keith Sanger & Alison Kinnaird, *Tree of Strings*, 101-110.

9th July, 1549.²⁰ It is possible that the musicians were in the employment of Walter Sherlock and had journeyed to Scotland from the east coast of Ireland. Political events by this time had changed however, and the relationship between England and Ireland had taken a dramatic turn. The future of the two countries was determined by King Henry VIII who was obsessed with the notion of continuing the Tudor dynasty with a male heir. Despite his problems with both State and Church, Henry was still a great patron of the arts and his patronage of painters, musicians and instrument makers is well recorded. The inventory of musical instruments in his possession at his death in 1547 is vast indeed.²¹

An illumination from King Henry VIII's psalter c1540 clearly demonstrates the affection with which the King held the harp. He is portrayed in the presence of his jester playing a small instrument which has a curved pillar, a characteristic of the Irish form of harp. The soundbox is very slender however, and resembles a European style of instrument. It is interesting that the King is playing the harp in the European manner, the instrument resting on his right shoulder with the right hand playing the treble strings, instead of the Irish technique of resting it on the left shoulder, using the left hand to play the treble strings (see Illustration 2).

The principal harper employed at King Henry VIII's court was the blind musician, William More, one of a long line who held this position.

20 Royal Commission on Historical Manuscripts [HMC], Rutland MSS, IV (1905), 354; Sean Donnelly, 'The Irish Harp in England', *Ceol*, VII (1986), 55.

21 *Inventory of the Guarderoberes, etc., 1547* (British Library, Harl. 1419); Raymond Russell, *The Harpsichord and Clavichord* (2nd edn., Glasgow, 1973), 155-160.

Illustration 2



2 King Henry VIII playing the harp. Illustration from the king's psalter c1540. British Library. Royal MS 2A. xxi. f63v.

The surviving work of More is discussed in Chapter 6. His skill and artistry were apparently sufficient to keep him employed at the court throughout the reigns of Edward VI, Mary, and even into that of Elizabeth I, until his death in 1565.²² Indeed, More was so highly regarded by Henry VIII that he received a pardon for his part as a courier in a Catholic intrigue during the English Reformation and was even later awarded the title of Master More.²³ His ability to compose was significant enough for a musician of standing (Thomas Whythorne) to take the trouble of copying out manuscripts of his work, and for other copies to be held in the possession of such a notable literary figure as John Heywood.²⁴ It is apparent that William More must have been a very remarkable musician. He stood on the threshold of significant developments in the history of English instrumental music, as well as being one of the last remnants of the court minstrel tradition. His nearly complete surviving work, a fantasia entitled *Levavi Oculos Meos* is proof that he was experimenting with new styles of composition and consort groupings.²⁵ More was not replaced at court when he died, indicating that changes in courtly-musical fashion had moved away from the medieval-diatonic harp.

In 1533, Anne Boleyn and King Henry travelled into London with 'all pomp and ceremony' to celebrate High Mass on Easter Saturday. King Henry thus proclaimed her as his wife 'in all but name' and in so doing

22 Richard Rastall, 'More, William', *The New Grove Dictionary of Music and Musicians* (London, 1980), XII, 565.

23 Cardinal Francis Aidan Gasquet, *Henry VIII and the English monasteries* (London, 1988), II, 361, 364-366.

24 James M. Osborne, ed., *The Autobiography of Thomas Whythorne* (Oxford, 1971), 14.

25 Gerald Hayes, *Kings Music* (Oxford, 1937), 26-27, 52, 81.

began the rift with Rome and the English Reformation.²⁶ One of Anne's relatives, her uncle, the Earl of Kildare (and governor of Ireland) was visiting London at the time of the celebrations and in his absence, anarchy swept throughout the Pale. During the Earl's visit to London, his son, the Earl of Offaly (known as Silken Thomas) rejected the advice of the Council of Ireland and led an army into Dublin to defend his family's governorship. Offaly failed to take Dublin Castle but set fire to the wooden buildings of the medieval city. In response to the insurrection, King Henry sent the largest English army ever sent to Ireland at which Offaly's army dispersed and vanished. This in turn resulted in the capture and execution of Offaly and his uncles as the King of England and Ireland proceeded to assume total supremacy in all matters spiritual and temporal. This was the beginning of nearly four hundred years of conquest and settlement in Ireland.²⁷

During the last quarter of the sixteenth century, English references to the Irish harp became more frequent and it is evident that even the most trusted of the Crown's servants succumbed to the sound of this instrument (see Illustration 3). When travelling north to Ulster in 1574, Walter Devereux, 1st Earl of Essex, rewarded a harper at the house of Sir John Bellew in Bellewstown.²⁸ By 1589 there is evidence of an Irish harper being employed by an Englishman. Due to storms at sea in December 1589, The Earl of Cumberland who was sailing in the Azores, was

26 *Calendar of the State Papers and Manuscripts relating to English Affairs in the Archives and Collections of Venice* (London, 1871), 12 April 1533, Carlo Capello to the Signory, 393, quoted by Richard Foster & Pamela Tudor Craig, *The Secret Life of Paintings* (Woodbridge, 1986), 84-87.

27 Constantine FitzGibbon, *The Irish in Ireland*, 146-147.

28 Herbert F. Hore, 'The Old Bards of Ulster', *Ulster Journal of Archaeology*, Series 2, IX (1861-2), 92; Sean Donnelly, 'The Irish Harp in England', 55.

Illustration 3



3 Woodcut. Reciter and harper performing before an Irish chieftain. John Derricke, *Image of Ireland* (London, 1581).

forced to take shelter at Dingle in Kerry. During his stay he was refreshed and entertained by Captain Edward Denny, a local settler. The narrator of the Earl's voyage wrote, "There we well refreshed ourselves, while the Irish harp sounded sweetly in our ears."²⁹

The patronage continued and further significant members of the English contingent in Ireland began to obtain harps for themselves, as well as employ their own harpers. Sir John Perrot kept an Irish harp at Carew Castle (his Welsh home near Tenby in Pembrokeshire) during the 1580s³⁰ and Sir William Fitzwilliam's household accounts show that he both owned Irish harps and employed Irish harpers. In 1591, 10s. was paid to Plunkett, his Lordship's harper and in the same year, 12s. 2d. was paid for making a case for his two harps. A half pound of wire was also purchased that year for 2s, and a further 18d. was paid for drawing the wire into the necessary gauges for harp strings.³¹ The fact that Sir William was not just collecting harps for souvenirs is suggested by the purchase of harp strings, a very necessary consideration if the instruments were to be played on a regular basis. It should be noted that brass and bronze wire breaks frequently, particularly in the narrow gauges of the treble section.

An interesting letter written by Sir Arthur Basset to his friend Sir Edward Stradling in 1583, possibly suggesting the presence of a performer upon the Irish harp is quoted by Walter Woodfill in *Musicians in English Society*:³²

²⁹ Hakluyt's *Voyages* (Everyman ed., 1907-9), IV, 377: Sean Donnelly, 'The Irish Harp in England', 55.

³⁰ Geraint Dyfualt Owen, *Elizabethan Wales* (University of Wales Press, 1962), 38-39.

³¹ Sean Donnelly, 'The Irish Harp in England', 55.

³² Walter Woodfill, *Musicians in English Society* (Princeton, New Jersey, 1953), 235; Samuel Butler, *Sidneiana* (London, 1837), 81.

...I am hereby to request you to send unto me at any of my houses in Devonshire your servant Thomas Richards by the last day of this instant month, and to cause him to bring with him both his instruments, as well as that which is stringed with wire strings, as his harp, both those that he had when he was last in Devon. I have given some commendations of the man and his instrument knowledge, but chiefly for the rareness of his instrument with wires, unto sundry of my good friends, namely my cousin Sir Philip Sidney who doth expect to have your man at Salisbury before the seventh of March next, where there will be an honourable assembly and receipt of many gentlemen of good calling. So hoping you will herein accomplish my request, do most heartily commend you to God's good keeping. From London this sixth of February, 1583. Your very loving friend Arthur Basset.

In 1596 an inventory was made of Lord Lumley's estate and this included two Irish harps among the instruments listed.³³

By 1597, English officers were adopting the custom of Irish chieftains by being accompanied by a harper during campaigns. In August of that year, an English soldier named Conyers Clifford was employing an Irish harper while serving at Ballyshannon, County Donegal.³⁴ In 1598, Thomas Lee, an infantry commander, was obviously desperate to obtain an Irish harp. He was denied one by Murchadh Mac Tadhg Og, a Wicklow man who was loyal to the crown, whom he proceeded to prosecute with great malice "making no difference between him and the rebels, for no other cause than for denying him a harp, which he desired."³⁵ One can only speculate as to his reasons for his desire: were they the result of musical appreciation or a need for a status symbol? Fortunately for some English nobles, there were people in Ireland who understood the need to own an Irish harp. In 1597 the Countess of Desmond made a gift of such

33 C.W.Warren, 'Music at Nonesuch', *The Musical Quarterly*, LIV (1968), 50.

34 *Calendar of State papers [Ireland], 1596-7*, ed. R.P.Mahaffey (London, 1912), 375; Sean Donnelly, 'The Irish Harp in England', 55.

35 *Cal. SP IRE, 1598-9*, 103; Sean Donnelly, 'The Irish Harp in England', 55.

an instrument to Robert Cecil, Queen Elizabeth's Secretary of State, and the future Earl of Salisbury.³⁶

The Seventeenth Century

During the early seventeenth century examples of the English nobility acquiring Irish harps continue to occur. Sir Michael Hicke the former secretary to William Cecil (father of Robert Cecil), was presented with an Irish harp in 1604 by Sir Francis Shaen, a settler from Ardircath, County Westmeath.³⁷ In March 1607, Sir John Egerton, who was later to become the Earl of Bridgewater, was looking for an Irish harp.³⁸ His patronage bore a very significant role in seventeenth-century English music and links have been established between the Egertons, Coperario and Henry and William Lawes.³⁹ An entry in the Accounts of the Earls of Huntington informs us of the employment of another Irish harper in an English household; "1610 31 March Given to Daniell the Irish harper, 30s."⁴⁰ In 1615, during a period of imprisonment, an inventory was made of the possessions of Robert Kerr (King James' favourite) at his mansion in Whitehall, and this included a

36 HMC Salisbury MSS, 7 (1899), 372; Sean Donnelly, 'The Irish Harp in England', 55.

37 British Library MS Lansdowne 92, f119r; A.G.R. Smith, *The Life of Sir Michael Hicke* (London, 1977), 167; Sean Donnelly, 'The Irish Harp in England', 55.

38 Cal. SP IRE, 1606-8, 228; Sean Donnelly, 'The Irish Harp in England', 55.

39 Murray Lefkowitz, *William Lawes* (London, 1960), 13. Henry Lawes is known to have taught Egerton's children and Coperario's manuscript treatise 'Rules How to Compose' was in the possession of John Egerton as he signed the document twice in 1617. The Manuscript is now in the Henry E. Huntington Library, San Marino, California.

40 HMC Hastings MSS, 1, 368; Walter Woodfill, *Musicians in English Society*, 263.

theorbo and two Irish harps.⁴¹ By 1611, Sir Michael Hickes was looking for a new harp and he asked an English official in Dublin called Thomas Bellott to help him obtain one. In 1612, Bellott wrote to Hickes:⁴²

Sir...I am not unmindful of you for an Irish harp, and to that end a sennight past, I entreated Sir Josias Bodley, my ancient acquaintance, that if he could understand of any such that were excellent (being skilful himself in music), that he would make me know it. To which he answered that if he could hear of a special good one, he would bestow and send it you from himself. Therefore in this I will not omit my best endeavour....

Yours assured, always to be commanded,
Thomas Bellott,
In Dublin the 16th of January 1612

Hickes did eventually obtain an Irish harp, though not through the services of Bellott. Instead he obtained one through John Denham who had one made for him in 1612. The correspondence from Denham is quoted in Chapter 3 (The Harps) as it also contains information about the stringing process involved (the raising of the strings).⁴³ Another reference to this procedure occurs in the Lismore Papers where in February 1616 Richard Boyle, 1st Earl of Cork states 'I lent my harp to William Barry the blind harper to raise.'⁴⁴

At the end of April 1612, Robert Cecil, Lord High Treasurer of England travelled to Bath in the hope that the waters there would cure him of a grave illness. In his company were Sir Michael Hickes and King James 1's Irish harper, Cormack MacDermott, who retrospectively received

41 Alfred John Kempe, ed., *The Losely Manuscripts* (London, 1835), 238-239; Keith Sanger and Alison Kinnaird, *Tree of Strings*, 89; Sean Donnelly, 'The Irish Harp in England', 55-56.

42 BL MS Lansdowne 92, f83r; Sean Donnelly, 'The Irish Harp in England', 56.

43 BL MS Lansdowne 92, f92r; Sean Donnelly, 'The Irish Harp in England', 56-57.

44 Alexander Grosart, ed., *The Lismore Papers*, I (London, 1882-8), 241; Sean Donnelly, 'The Irish Harp in England', 57.

£10 on 19th June 1612 "for his pains in attending his Lordship to Bath". Cecil died on 24th May 1612 and Sir Michael Hickes on 15th August, 1612.⁴⁵

An interesting comment which serves as a warning to Englishmen who wished to play the Irish harp appeared in the Custom Book of St. Omers College (*Constitutiones Collegii Anglorum*). The book was compiled by the Rector of the English College of St. Omers, Pas de Calais, Giles Schondonch between 1600 and 1617. Sadly this book, which included details about the provision made for the study of music at the college, was destroyed during World War II. Fortunately a copy had been made in 1904 by Fr. L. Willaert, who presented it to Stonyhurst College (formerly St. Omers) in Lancashire. The passage concerning the Irish harp is as follows:⁴⁶

6 Also to be recommended are the instruments with metal strings, to be plucked, not with the plectrum as the cittern, but with the fingers and fingernails; such as

The orpharion; and psal-mallett, recently invented in England and given to us by the inventor.

Lastly, the Irish harp, if there is anyone who knows how to use it.

Also the Italian Theorbo, which has strings of gut.

We can only assume that no adequate instruction on how to play the Irish harp was available at St. Omers college during the early years of the seventeenth century.

In the early years of the seventeenth century, Englishmen who maintained strong links with Ireland continued to show an interest in

45 HMC Salisbury MSS, 24 (1973), 203; Sean Donnelly, 'The Irish Harp in England', 57-58;

46 Louvain University Library, D.321 (160) [Destroyed]; William H. McCabe, 'Music and Dance on a 17th-Century College Stage', *The Musical Quarterly*, XXIV, 313-322; John M. Ward, 'Sprightly and Cheerful Musick', *Lute Society Journal*, XXI (1979-81), 104-106.

the Irish harp. During Sir William Monson's voyage to Ireland in 1614, reference is made to "a harper who played merrily, to make his welcome the greater...."⁴⁷ The former Lord Deputy of Ireland, Sir Arthur Chichester, retained an Irish harper named Ned Scott. A payment was given to Scott by the Earl of Cork in July, 1620⁴⁸ and in October 1632, The Earl of Cork gave his powerful English patron, The Earl of Coventry 'a fair new Irish harp'.⁴⁹ Robert Carew, who served in the household of the Earl of Coventry as servant and tutor to the Earl's sons, was paid expenses in October 1638 which included £1 to the 'man that brought over his harp' (probably from Ireland.⁵⁰) There is also at least one reference to the need for performers of the Irish harp outside court circles to be able to read and play from written parts. In 1638, in a letter from his home on the Welsh border, Lord Herbert of Chirbury, wrote to the steward of his Irish estates at Castleisland, County Kerry stating "Your Irish harper shall be welcome if he can play by the book after the English manner and speak good English." Clearly Lord Herbert believed that he had part books suitable for the Irish harp in his possession, and that the instrument would make a welcome addition to his domestic entertainment.⁵¹

Cormack MacDermott

Unfortunately many of the sources concerning the Irish harp in the

47 Awmsham Churchill & John Churchill, *A Collection of Voyages* (London, 1704), III, 219-220.

48 Alexander Grosart, ed., *The Lismore Papers*, II, 20; Sean Donnelly, 'The Irish Harp in England', 59.

49 Alexander Grosart, ed., *The Lismore Papers*, III, 162; Sean Donnelly, 'The Irish Harp in England', 59.

50 Sean Donnelly, 'The Irish Harp in England', 59.

51 *Herbert Correspondence*, ed., N.J. Smith, Irish Manuscripts Commission (University of Wales Press, 1963), 145; Sean Donnelly, 'The Irish Harp in England', 58.

sixteenth and seventeenth centuries are proof of little more than ownership, as existing records are usually account books. Evidence of the use of the instrument in England is particularly rare in the sixteenth century. By 1600 however, references start to appear concerning the career of the previously referred to harper, Cormack MacDermott. In December 1600, the Spencers of Althorp gave 5s to 'The Queen's Man a harper', a reference that suggests the employment of the first harper at the English Court since the death of William More.⁵² In a list of payments made near the end of Elizabeth's reign (late 1602 or early 1603), £46. 10s. 0d. was paid to 'Gormock [sic] M'Dermott' a musician.⁵³ It is interesting to note that his appearance at court coincides with a letter concerning the popularity of Irish tunes, written by the Earl of Worcester on 17th September, 1602, and addressed to the Earl of Salisbury:⁵⁴

We are frolic here in court; much dancing in the Privy Chamber of country dances before the Queen's Majesty who is exceedingly pleased therewith; Irish tunes are at this time most pleasing but in Winter, Lullaby, an old song of Mr. Bird's will be more in request I think.
E. Worcester.

It is evident that MacDermott was also in the service of Robert Cecil, Earl of Salisbury, in whose household accounts he also appears. On the 4th December 1602, one Cormack MacDermott made a petition for 'the Wardship of the heir of John Bysse in the county of Somerset, yeoman, being a man of value.'⁵⁵ As Cecil was Master of the Court of Wards he was able to grant the request but it seems that the income was less than

52 Walter Woodfill, *Musicians in English Society*, 273.

53 Walter Woodfill, *Musicians in English Society*, 310.

54 Edmund Lodge, *Illustrations of British Biography and Manners*, II (London, 1838), 577.

55 HMC Salisbury MSS 10 (1904), 406 [Cecil Papers, Petitions 666], Sean Donnelly, 'An Irish Harper and Composer, Cormac MacDermott [?-1618]', *Ceol*, VIII (1986), 40.

MacDermott might have expected, he applied for another means of income before 20th August 1604. This time he was granted the bailiwick of a small town.⁵⁶

The humble petition of Cormack, your Lordship's servant. Most humbly beseech your Lordship to bestow on him the bailiwick of Cranfield on the county of Bedford, or the bailiwick of Northbourne in the county of Kent, both which are now in your Honour's disposition as [sic] I suppose not yet granted, being of small value...the rather he is emboldened in this suit for that he hath not a long time received any benefit by wardships, his charge being great. And for this, your Lordship's favour, he will ever pray for your Lordship.

Endorsed in Cecil's hand: Cranfield granted.

It is worth noting that Coperario was also in the service of Cecil during MacDermott's period of employment.⁵⁷

Cormack MacDermott was obviously no ordinary musician of the period. It appears that he served two of the greatest patrons in the land as well as possibly being involved in land deals himself, for in all probability he was employing a substitute to act as a bailiff, as his own services were required elsewhere. His other role would appear to be that of courier between Cecil and the English forces in Ireland as there are several references to his travels. He is recorded as 'bringinge lettres for her majesties specyall serveyce from Corke in Ireland' on 14th February 1603, when he was paid £8 by Robert Cecil.⁵⁸ Cecil sent MacDermott on four other such journeys between 1603 and 1611, and that of the Autumn of 1604 proved to be of special interest, as he received letters from Richard Burke, fourth Earl of Clanrickarde who presumably heard the harper perform.⁵⁹ On 25th February 1605,

⁵⁶ HMC Salisbury MSS 23 (1973), 168 [Cecil Papers, Petitions 1570]; Sean Donnelly, 'An Irish Harper and Composer', 40-41.

⁵⁷ Christopher D.S. Field, 'Coprario, John', *The New Grove Dictionary of Music and Musicians* (London, 1980), IV, 727.

⁵⁸ PRO, E351/543, f136; Peter Holman, 'The harp in Stuart England', *Early Music*, XV (1987), 189.

⁵⁹ Cal. SP IRE, 1603-6, 263; Sean Donnelly, 'An Irish Harper and Composer', 41.

Clanrickarde wrote to Cecil asking if he could have a licence to return to England as he wished to hear Cormack's harp again: 'Good my Lord, hasten my leave, for there is a great difference between the sound of Cormack's harp and the tune and harsh sound of a cow or garran [a small horse], so there is no other music.'

In 1606, MacDermott appears in a list of King James's musicians made before 18th March.⁶⁰ In this entry, £11. 12s. 8½d. was paid to 'Cormocke M'Dermott' while Dr. John Bull received only £10. It is tempting to suggest that the difference in their quarterly salaries reflects the relative regard in which they were held but lack of information must preclude this. MacDermott was paid a further year's salary of £46. 10s. 0d. in 1604.⁶¹

On 2nd July 1605 John Lanier, a flautist in the King's Musick, wrote to Cecil requesting him to grant a place in the Royal Musick for his son Nicholas, also described as a flautist at this stage. Lanier entreats that 'Mr Cormack, your Lordship's servant' should listen to his son's playing and report on 'his sufficiency for the flute.'⁶² Sadly the request was unsuccessful and Nicholas Lanier was not appointed to the Royal Musick until 1616, when he was sworn in as a lutenist.

Another skill associated with Cormack MacDermott would seem to be that of repairer of harps (see Illustration 4). A bill, quoted below, was submitted by the harper to Cecil for the repair of his Lordship's harp on 20th May, 1607.⁶³ This may well have been the instrument given

60 HMC Salisbury MSS 24 [Addenda 1605] (1973), 63.

61 Walter Woodfill, *Musicians in English Society*, 310.

62 HMC Salisbury MSS 17 (1938), 279; Richard Charteris, 'Jacobean Musicians at Hatfield House, 1605-1613', *Royal Musical Association Research Chronicle*, XII (1974), 116.

63 Richard Charteris, 'Jacobean Musicians at Hatfield House', 116; Peter Holman, 'The harp in Stuart England', 190.

Illustration 4

Item for putting of a newe balke to yo^r lo^{ds} harpe
and mending of it in the plate where it was broken } 20j⁶
and cutting ^{the} newe sharter _____
for a leather case wth a chine and lynde wth _____ } 20j⁶
Cotton for yo^r lo^{ds} harpe _____

Received by me Cormack MacDermott

4 Autograph bill for the repair to Robert Cecil's harp by Cormack MacDermott, dated 20th May 1607. Hatfield House, Cecil family and Estate Papers, bills 14/20.

to Cecil by the Countess of Desmond.⁶⁴

Item; for putting of a new back to your Lordship's
harp and mending of it with plate where it was broken
and cutting the neck shorter.....16s.
For a leather case with a chine and lined with
cotton for your Lordship.....30s.

Received by me Cormacke Dermode

Endorsed on the back: Item: 46s., Cormacke, bill of the 20th May,
1607.

The last reference to Cormack MacDermott in the Cecil papers refers to
his receiving £10 for a harp some time before 22nd April, 1613.⁶⁵

In addition to repairing and performing upon the harp there is
evidence to suggest that MacDermott was also active as a composer.
Collections of music manuscripts at Yale University Music Library
(Filmer 4) and also William Brade's *Neue Ausserlesene leibliche Branden*
(Hamburg, 1617) include attributions to MacDermott which are discussed
in Chapter 6. William Lawes also gives an attribution to MacDermott in
an autograph theorbo part to 'Harpe' Consort IX (Ob Mus.Sch. D 238,
F42v) and this is discussed in Chapter 4. In all, eight works attributed
to Cormack MacDermott are in existence.⁶⁶

MacDermott lived in the Westminster parish of St. Martin in the
Field from 1605/6 until his death in 1618, he paid rates on a property
in the Waterside district of the parish until 1614.⁶⁷ It appears that he
was a Protestant, married and had children, as the parish registers
record the baptism and burial of several children bearing the surname
MacDermott and two of the entries record the father's name as being

⁶⁴ Sean Donnelly, 'An Irish Harper and Composer', 41.

⁶⁵ Richard Charteris, 'Jacobean Musicians at Hatfield House', 135.

⁶⁶ Peter Holman, 'The harp in Stuart England', 190.

⁶⁷ Victoria Library, London, PRO, F332/40.

Cormack.⁶⁸ The entries are as follows:

Baptism,	29 October	1605:	'Joannes Macdurmucke'
Baptism,	9 November	1607:	'Anna MacDurmuck'
Burial,	15 January	1608:	'Jana MacDurmuck'
Baptism,	15 January	1609:	'Anna MacDirmoot fil, Corn'
Baptism,	1 March	1610:	'Marg...& Jana m't D'mot'
Burial,	13 March	1613:	'John MacDirmac'

Cormack MacDermott died on 26th February 1618 and was buried on the 28th of that month.⁶⁹

Other Irish Harpers employed at the Stuart Court

Other harpers were also employed by the Stuart Court during the time of MacDermott. In 1590, When Queen Anne of Denmark entered Edinburgh, 'Thair was Hautbois and the Harp playing maist sweit and pleasant springs'.⁷⁰ Unfortunately we do not know whether the instruments were playing together or not, there is insufficient information to determine any performance practice from this extract. Recent research by Sean Donnelly has revealed that after James' accession to the English throne, Queen Anne herself retained an Irish harper from about 1607 until her death in 1619. Daniel Cahill, the Queen's harper had previously served David FitzJames Barry, Viscount Buttevant, usually called Lord Barry or Barrymore. He returned to County Cork after the Queen's death and lived within twenty miles of Cloyne

68 Thomas Mason ed., *A Register of the Baptisms, Marriages and Deaths in the Parish of St. Martin-in-the-Fields in the county of Middlesex from 1550 to 1619* (London, 1898), 35, 37, 38, 44, 158, 167; Sean Donnelly, 'An Irish Harper and Composer', 43; Peter Holman, 'The harp in Stuart England', 190.

69 PRO, E403/1724.

70 Sir John Graham Dalyell, *Musical Memoirs of Scotland, With Historical Annotations* (Edinburgh and London, 1849), 236-237.

near the City of Cork. He was living in Cork City in 1621 as there are deeds signed by him in that year. It is a coincidental fact that within a year or two of his return to the area of Cloyne, a very sophisticated wire strung harp (the Dalway harp) should be built there of a type not extant elsewhere in Ireland. The instrument may display the very latest techniques of harp design as practised at the English Court. Another coincidence is that its owner, Sir John FitzGerald of Cloyne, married Lord Barrymore's daughter and that her initials 'E.B' are inscribed on the harp.⁷¹ Further references to Daniel Cahill occur in the *Lismore Papers*: 3 January 1614, 'I paid to donnell duff o cahell her majestys harper in London xxxvij¹ⁱ ster:...' and 14 May 1629: 'donnell duff cahill, the harper, this day delivered W^m Barber 40¹ⁱ to be paid by his wife by exchange in Ireland....'⁷² The name Daniel Cahill is also listed in the account books of Queen Henrietta Maria during the financial years of 1629/30 and 1634/5.⁷³ He is not named in the accounts of 1640 and so it can be assumed that he had either left her service or died between 1635 and 1640. The Daniel Cahill who served Henrietta Maria used the mark of a triangle (perhaps a symbol for a harp) to sign for his wages and was therefore probably illiterate. It is also likely that he did not read music either, and may well have played the harp in the traditional Irish manner rather than in the fashion of the English Court.

If the Daniel Cahill who served Queen Anne did own a chromatic harp which served as a model for the Dalway Harp, it is probable that he could read the music written for such a sophisticated instrument. It is

⁷¹ Sean Donnelly, 'The Queen's Harper' (to be published).

⁷² Alexander Grosart ed., *The Lismore Papers*, I, 36, II, 321.

⁷³ PRO, E101 438/4, 7, 11, 13-15. E101 439/3. E101 674/11; BL, Egerton MS 1048, f186;

therefore possible that there were two harpers named Daniel Cahill. Without further information however, this must remain a matter for speculation

Sir John FitzGerald of Cloyne

The inscriptions in Latin and Irish on the Dalway harp are especially interesting as they also record information regarding the household, instrument maker and musicians of Sir John FitzEdmund FitzGerald. A translation is as follows:⁷⁴

Latin: Bravery flourishes by wounds. Press Forward. [mottoes of the coats of arms].

I.G.E. and E.B. caused me to be made. I am the queen of harps. I sound, I conquer. I rule...[animals] men. Music consoles the troubled mind just as the sound...Thus passes worldly pomp. Truth conquers. Donatus son of Thade made me. My hope [is] in God.

Irish: The following were the members of the household staff of John Fitzedmond Fitzgerald at Cloyne at the time that I was made: James Fitzjohn was Wine Butler, John Ruane was Beer Butler, and Philip MacDonnell was Cook, in the year 1621. Thade O'Rourke was Chamberlain and James Russell was Major Domo, and there were also Maurice Fitzthomas and Maurice Fitzedmund; these were all trusted retainers. Philip the son of Thade McGrath was Tailor. Donough sone of Thade was Carpenter [and the craftsman] who made me. My Musician and Minstrel was Giollaphadraig Mac Criodain, and none better could I have had, together with Diarmaid Mac Criodain - two masters [of music] who [fostered and] trained me. And on each and every one of these may God have mercy.

No further information regarding the harp maker, Donnchadh FitzTeigh or the musicians Giollaphadraig and Dermott Mac Criodain, remains. The description giving the title of the maker as a carpenter is interesting however, as it suggests that the household carpenter was instructed to build a harp at his master and mistress's command. Clearly Sir John was convinced that his servant was capable of undertaking the task, but it is also very probable that FitzTeigh had not served his time as an

⁷⁴ Joan Rimmer, *The Irish Harp*, 75.

apprentice and journeyman to a harp maker, and therefore was very likely to have had another instrument or accurate drawings and templates to serve as a model. It should be noted that though no contemporary templates or drawings for the construction of ancient Irish harps exist, accurate stringing and tuning pin placing would be extremely difficult to achieve without such aids. The possibility of the Dalway harp being a copy of another chromatic instrument is made more likely by the previously mentioned research of Sean Donnelly regarding the movements of Daniel Cahill in this area during the period when it was built.

The house in which the FitzGeralds of Cloyne lived was once the palace of the Bishops of Cloyne, and its ownership was the subject of fierce argument between the family and the church over many years. This matter came to a head in 1641, when many of the records of the family and church were destroyed by the FitzGeralds.⁷⁵ Those records which survived were sent to Dublin Castle for safekeeping during the nineteenth century, only to be destroyed by fire during the civil war of 1922. These two destructive events have made any further research into the background of the family and the harp very difficult.⁷⁶

The Stuart Masque

Under the patronage of James I and Queen Anne, lavish masques flourished at court and the popularity of the Irish harp was reflected in some of these. In Jonson's text for the *Irish Masque at Court* (performed at Whitehall on 29th December 1613 and 3rd January 1614) a

75 Horace T. Fleming [Dean of Cloyne], 'Some of the History of the Castell and See Demesne of Cloyne', *Journal of the Cork Historical and Archaeological Society*, IX (1903), 209-223.

76 Paul MacCotter & Kenneth Nichols, *The Pipe Roll of Cloyne* (Cloyne, 1996), x.

song is sung by a bard to two harps and a dance of gentlemen performed in Irish mantles, to a solomne musique of harpes'.⁷⁷ In the anonymous 'Masque of Flowers' (performed on the 6th January 1614) a blind harper and his boy were included in the consort of musicians in an antimasque.⁷⁸ Peter Holman suggests that one of the harpers on these occasions may have been Cormack MacDermott, though he would have to have been pretending to be blind as his autograph signature on the bill for repairing Cecil's harp on 20th May 1607 demonstrates.⁷⁹

One of the most elaborate and expensive court masques to be produced during the Stuart period was James Shirley's *Triumph of Peace*. It cost more than £21,000, and was presented to King Charles I at the Four Inns of Court in 1634. Bulstrode Whitelock, a parliamentarian who was responsible for the organisation of the music in the production, produced plans for the various acts showing the exact positions of singers and instrumentalists.⁸⁰ The consort of musicians on the occasion included six lutes, a bass lute, a harp, a violin and three viols. The name of the harper on the plan is Thomas Bedoes, of whom nothing else is known. There is no information to suggest what type of harp he was using. Simon Ives and William Lawes both received £100 for providing music for the entertainment.

The harper who was originally intended to play in *The Triumph of*

77 *The Works of Benjamin Jonson* (London, 1616, repr., 1976), 1000-1004.

78 Terence J.B. Spencer & S. Wells, eds., *A Book of Masques* (Cambridge, 1976), 164.

79 Peter Holman, 'The harp in Stuart England', 194.

80 Longleat House Warminster, *The Longleat Papers of Bulstrode Whitelock*, f28v; A.J. Sabol, 'New Documents on Shirley's Masque *The Triumph of Peace*', *Music and Letters*, XLVII (1966), 18, 22; Peter Walls, *Music in the English Courtly Masque 1604-1640* (Oxford, 1996), 150, 173, 175; Murray Lefkowitz 'Masque', *New Grove Dictionary of Music and Musicians*, XI (London, 1980), 764.

Peace was the Frenchman Jean La Fuelle, but he was replaced by Bedoes at a very early stage in the arrangements. La Fuelle was not an Irish harper but a very influential performer on the triple-strung gut harp, who arrived in England and was sworn 'his Majesty's servaint and a musition for the harp in ordinary' on 11th October, 1629.⁸¹ Mention is made of La Fuelle in Mersenne's *Harmonie universelle* (Paris, 1636-7) where he is described as playing the triple harp 'en perfection'. Mersenne goes on to state that the triple harp was invented in Italy by the Neopolitan Luc Anthoine Eustache, a member of the household of Pope Paul V (see Illustration 5).⁸² In the account books of the household of Queen Henrietta Maria for the year 1640, La Fuelle appears as a member of the Queen's group of French musicians who included the singers Antoine Robert and Nicholas Duval and the lutenist, Jacques Gaultier.⁸³ At no time does La Fuelle appear in the 'lutes and voices', the principal group of court musicians (who included a succession of Irish harpers).

The highlight of William Davenant's masque *The Temple of Love*, presented by the Queen and her Ladies-in-waiting at the Banqueting House on 10 February 1635, was the arrival on stage of Orpheus, who calmed tempestuous waters with the sound of his harp.⁸⁴

Out of a creek came waving forth a Barque of Antique design, adorned with Sculpture finishing in Scrowles that on the Poop had for Ornament a great masque head of a Sea-God; and all the rest enrich'd with embossed work touch'd with silver and gold. In the midst of this Barque sat Orpheus with his Harp, he wore a white Robe girt, on

81 H.C.Lafontaine, ed., *The Kings Musick* (London, 1909, repr., 1973), 58;

82 Marin Mersenne, *Harmonie universelle*, III (Paris, 1636, repr., 1963), 216.

83 PRO, E101 438/4, 7, 11, 13-15. E101 439/3. E101 647/11; BL, Egerton MS 1048, f186; Peter Holman, 'The harp in Stuart England', 198.

84 William Davenant, *Works*, II (London, 1673, repr., 1968), 382-394;

Illustration 5

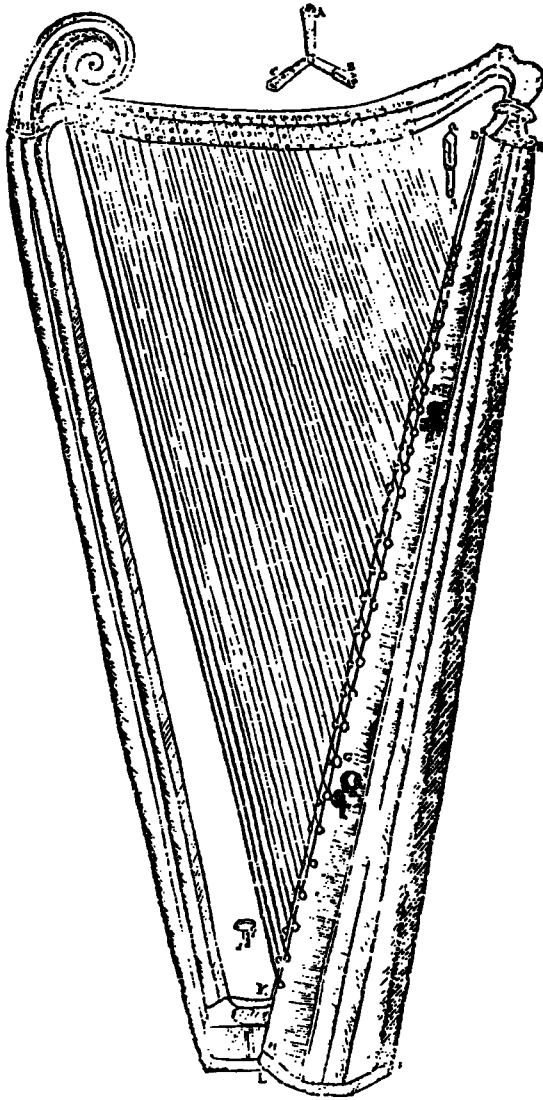

5 Illustration of a triple harp from Mersenne, *Harmonie universelle* (Paris, 1636-7, repr., 1963)

his shoulders [was tyed with a Knot] a Mantle of Carnation, and his head was crown'd with a Laurel Garland: with him, other persons in habits of Seamen, as Pilots and Guiders of the Barque, he played on one strain, and was answered by the voices and instruments of the Brachmani joy'nd with the Priests of the Temple of Love, in extravagant habits sorting to their titles: Whilst this Barque moved gently on the Sea, heaving and setting, and sometimes rowling, arrived near to the farther shore, it turn'd and return'd to the port from whence it came.

Evidence that the part of Orpheus was played by La Felle is borne out by an inscription in the *Reymes Lute Manuscript* which states that 'Monsieur la flale played these tunes [a set of short pieces consisting of a courant or saraband and three almans or airs] in the Queen's maske on his harpe'.⁸⁵ Peter Holman presents a transcription of one of these pieces (a corant or saraband) in his article 'The harp in Stuart England' (see Example 2). *The Temple of Love* is the only masque of the period which requires a solo harp, making La Felle a prime candidate for the role of Orpheus. A payment made on 11th June, 1635 'to Mons.

Example 2
Peter Holman, 'The harp in Stuart England', 198,
Transcription of a corant or saraband probably played by
Jean la Felle in *The Temple of Love* (1635)

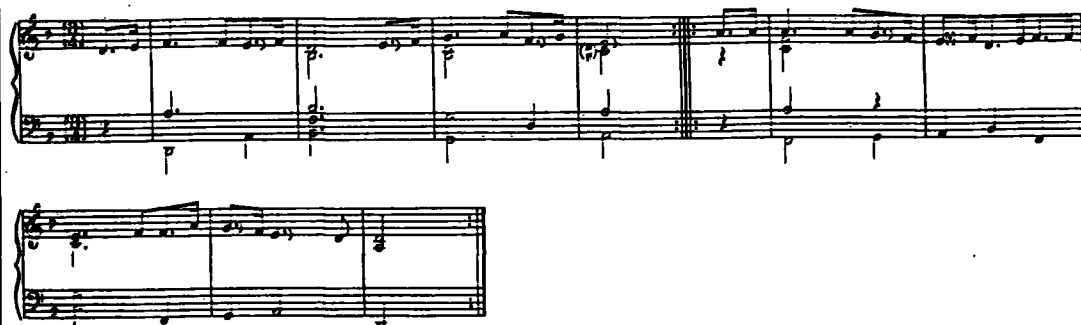

85 Centre Nationale de la Recherche Scientifique, Paris, *Reymes Lute Manuscript*, f59v-60, quoted by Peter Holman, 'The harp in Stuart England', 198.

Nicholas Du Val, for a lute provided by him, to play in the consort of Mons. le Felle' is suggested by Peter Holman as evidence that Du Val was being paid for taking part in the masque. The date would fit the theory as the payment was made four months after the performance, but there is no further information regarding Du Val's participation and his payment must remain a piece of circumstantial evidence.⁸⁶

On the 20th May, 1630, at the Church of St. Antholin, Budge Row, 'John Laffell' married Hester Maior, the widow of the Royal Musician, 'Roger Maior'.⁸⁷ Roger Maior was a viol player who became a Royal musician in 1618. He was made a member of the 'consort' in 1625 and died in 1626.⁸⁸ It is probable that La Felle returned to France with Queen Henrietta Maria and other members of her household in the spring of 1642.⁸⁹

A series of sketches by Inigo Jones portraying Orpheus in 'The Triumph of Peace' may give us an impression of the appearance of La Felle, though he may well have been 'made up' for his role (see Illustration 6). Peter Holman draws attention to the harps displayed and makes the suggestion that they are single strung instruments.⁹⁰ While that possibility cannot be ruled out, it must be borne in mind that these are very 'free' sketches which are impressionistic rather than accurate representations. The strings on the harp portrayed are at the wrong angle as the lowest string is not capable of reaching the table (soundboard). Instead, this string would have to be attached to the

86 Peter Holman, 'The harp in Stuart England', 198.

87 Joseph L. Chester & G.J. Armytage, eds., *The Parish Registers of St. Antholin, Budge Row* (London, 1883), 64.

88 PRO, E403/ 1724, entries for May and July 1618. E403/1737, entries for 23rd June 1626; H.C. Lafontaine, ed., *The Kings Musick*, 58.

89 J. Bennett and P. Willetts, 'Richard Mico', *Chelys*, VII (1977), 39;

90 Peter Holman, 'The harp in Stuart England', 198.

Illustration 6



6 Inigo Jones, sketches of Orpheus in *The Temple of Love*.
Chatsworth, collection of the Duke of Devonshire.

bass of the pillar. Jones has only given the harp seven strings anyway, making it difficult to deduce any significant pattern, especially as they are drawn in such a way as to miss the table completely and attach themselves to the side of the soundbox. The argument that La Fuelle may have played other types of harp is still valid however, though it is unlikely that a professional gut-strung harper could play the Irish harp effectively. The long nails which are required to play the Irish harp would cut and destroy the gut strings in a relatively short space of time. The importance of La Fuelle and Thomas Bedoes is that they were both possible rival performers of any music requiring harps which was written during their floruit.

Peter Walls reminds us in *Music in the English Courtly Masque* that this form of entertainment was not confined to Royal circles, and that other spectacular performances took place in such settings as Chirk Castle. Of particular interest is a reference to a masque entitled *Raguaillo D'Oceano* written by the second Earl of Westmoreland, Mildmay Fane, for the entertainment of his household at Apethorpe in 1640. Walls states that "The two harpists carry the main burden of the entertainment. It is they who 'Play ye Mayn Masking Daunce wch ye Six Yong Princes & Six Ladies attired in Starres performe in a New composed figure...'"⁹¹ Unfortunately, other than an 'idiosyncratic' description of the effects he wished to achieve, Fane gives no specific information regarding the music, the type of harps or who the performers were.

A Succession of Irish Harpers at the Stuart Court

On the 28th August 1618, Cormack MacDermott was succeeded at court

⁹¹ Peter Walls, *Music in the English Courtly Masque 1604-1640*, 288-289.

by another Irish harper, Philip Squire. His ability to play the Irish harp is supported by a salary of £30 made to him for teaching 'Lewis Evans a child of great dexterity in music to play on the Irish harp and other musical instruments'. His teaching continued until at least 1628 when he was paid £210 for 7 years arrears 'for his charge and paines in mainteyning and teaching of Lewys Evans to play upon the Irish harpe'.⁹² Peter Holman suggests that Philip Squire may have been taught to play the Irish harp by Cormack MacDermott and that they played the roles of Irish harpers in *The Irish Masque at Court* and *The Masque of Flowers*.⁹³ There are no documents to prove these particular theories however. Philip Squire's name appears in the list of musicians provided with livery at the funeral of James I in 1625.⁹⁴ He signed his name 'Phillip Squier' in an exchequer acquittance book for receipt of wages in July 1628 and had died or retired before 1660, the date when his place in the 'Private Music' was taken by Charles Evans.⁹⁵

Lewis Evans, who also appears in documents as Lewis Williams, was appointed to the 'Lutes and Voices' in the place of the lutenist Robert Johnson, who died in the autumn of 1633.⁹⁶ Lewis Evans played the harp for the king prior to this appointment as he is mentioned in the *Acts of the Privy Council* (19th February, 1621): 'Another to pay unto Lewis Williams, a younge youth that playeth upon the harpe to his Majesty and the Prince, the summe of twentie pounds, which his Majestie was graciously pleased to bestowe upon him in regard that hee had ben lately

92 CSPD, 1611-1618, 559.

93 Peter Holman, 'The harp in Stuart England', 194.

94 H.C. Lafontaine, ed., *The King's Musick*, 58.

95 PRO, E405/543, f101v.

96 PRO, LC5/132, 346; H.C.Lafontaine, ed., *The King's Musick*, 86.

visited with sickness etc. My Lord Digbie gave order for this warrent.⁹⁷ He served in this position up to the Civil War, and from the Restoration until his death in 1666. Some of the circumstances surrounding his death were recorded by the diarist Samuel Pepys on 19th December 1666:⁹⁸

Then to talk of the King's family [The Royal Household]; he [John Hingeston] says many of the Musique are ready to starve, they being five years behindhand for their wages. Nay, Evans, the most famous man upon the Harp, having not his equal in the world, did the other day die for mere want, and was fain to be burried at the almes of the parish - and carried to his grave in the dark at night, without one Linke, but that Mr. Hingeston met it by chance, and gave 12d. to buy two or three linkes. He says all must come to ruin at this rate, and I believe him.

The court accounts referring to payments due to Lewis Evans bear out the fact that his wages were several years in arrears.⁹⁹

Harp Music

Apart from the masques, other music exists from the first half of the seventeenth century in which a harp part is mentioned. On the title page of Martin Peerson's *Mottects or Grave Chamber Music* (London, 1630), the composer states that the pieces are 'fit for Voices and Vials, with an Organ Part; which for the want of Organs, may be performed on Virginals, Bass Lute, Bandora, or Irish Harpe' (to be discussed in Chapter 6). It is probable that sometime between his appointment to the Private Music on 30th April 1635, and the outbreak of the Civil War in

⁹⁷ Acts of the Privy Council of England 1619-1621 (H.M.S.O., 1930), 346.

⁹⁸ Samuel Pepys, *The Diary of Samuel Pepys*, Robert Latham & William Matthews, eds., VII (London, 1972), 414.

⁹⁹ Andrew Ashbee, ed., *Lists of Payments of the King's Music in the Reign of Charles II [1660-1685]* (Snodland, 1981), 49, 52, 56, 64, 66.

1642, William Lawes wrote his 'Harpe Consorts'.¹⁰⁰ The 'Harpe Consorts' are to be found in several part books including a book of harp parts.¹⁰¹ The Lawes' 'Harpe Consorts' are to be discussed in Chapters 4 and 5. Lawes does not specify the use of an Irish harp in these works but the exclusive appointment of Irish harpers to the Lutes and Voices and Private Music together with the attribution to Cormack in the theorbo part of Consort IX in D suggests their use.¹⁰² The harp part book, Och. Mus. MS 5 contains another set of unattributed harp parts at the back. Peter Holman has suggested that as the music stops for several beats in places and is less melodic than one might expect for solo music, these must be parts for consort pieces.¹⁰³ The anonymous parts at the back of Och. Mus. MS 5 are discussed in Chapter 6.

In 1641, William Lawes wrote music for three plays: James Shirley's *The Cardinal*, Richard Brome's *A Jovial Crew* and Sir John Denham's *The Sophy*. During 1642, Parliament ordered the closure of the theatres thus depriving musicians such as William Lawes of a possible source of patronage and in March 1643 Civil War drew near and King Charles ordered his household to report to the Court at Oxford. Lawes was given the post of a commissary at the King's headquarters. There is little evidence to suggest that Lawes wrote any music while at Oxford and it is possible that the music for the three plays mentioned above was the last that he wrote.¹⁰⁴ An account of the circumstances which led up to the death of William Lawes at the siege of Chester on 24th

100 H.C. Lafontaine, ed., *The King's Music*, 91.

101 Ob MS Mus.Sch. D 229; Och Mus. MS 5, a book containing harp parts to Lawes' 'Harpe Consorts' in the hand of Francis Withy; Ob MS Mus.Sch. B3 (autograph score).

102 Ob MS Mus.Sch. D 238, f42v.

103 Peter Holman, 'The harp in Stuart England', 202.

104 Murray Lefkowitz, *William Lawes* (London, 1960), 203.

September 1645 was related in a paper given by Layton Ring at the William Lawes Conference held at Hertford College, Oxford, September 23-24 1995.¹⁰⁵ In his talk, Layton Ring informed the gathering that during the siege of Chester (in the hours which followed the battle of Rowton Heath) several sorties took place outside the city walls. It was thought that during one of these, William Lawes rode from the north of the city in the presence of Lord Bernard Stewart and General Gerrard together with a company of Lifeguards. Both William Lawes and Lord Bernard Stuart were fatally wounded. Writing in 1662, Thomas Fuller explains the event thus:¹⁰⁶

In these *distracted times* his [William's] Loyalty ingaged him in the War for his *Lord and Master* and though he was by *General Gerrard* made a *Commissary* on designe to secure him [such *Officers* being commonly shot-free by their place, as not Exposed to danger,] yet such the *activity of his Spirit*, he disclaimed the *Covert* of his *Office*, and betrayed thereunto by his own adventurousness was casually shot at the *Siege of Chester*, the same time when the *Lord Bernard Stuart* lost his life.

Nor was the *Kings soul* so ingrossed with *grief* for the death of so near a *Kinsman*, and *Noble a Lord*, but that hearing of the death of his deare servant William Lawes, he had a particular Mourning for him when *dead*, whom he loved when living, and commonly called the *Father of Musick*.

The Civil War, the death of William Lawes and the disbanding of the 'Lutes and Voices' and 'Private Musick' appears to have put an end to the composition of music for the Irish harp in English consort music. In Ireland the destruction of the upper strata of Gaelic and Royalist society had a disastrous effect upon the ancient patronage of the Irish harp. In England, without the court and theatres, musicians had to find

105 Layton Ring, 'The Death of William Lawes at the Battle of Rowton Heath', *Proceedings of the William Lawes Conference, Hertford College, Oxford [23rd-24th September, 1995]* (To be published by Ashgate Publishing Ltd. Aldershot, 1997).

106 Thomas Fuller, *The History of the Worthies of England* (London, 1662), 157; Murray Lefkowitz, *William Lawes*, 20.

employment with those people who still cared, frequently in households and taverns. A description of the employment of musicians in taverns is given by the Dutch traveller Lodewijk Huygens in January, 1651/2:¹⁰⁷

They served us with four good courses, apples for dessert with a little saucer of anise sugar for each person. Six fiddlers ['Ses violons'] came to offer their services and played for the whole afternoon some very good pieces of Will. Lawes, [Charles] Colemans, [Robert?] Taylor, and some compositions of their own. Three of them had theorboes, two of them had ordinary violins ['hand violen'], and one had a bass with four strings.

Seventeenth-Century Descriptions of Irish Harps

A clearer picture of the use of the Irish harp in the seventeenth century is given in the writings of Michael Praetorius, Francis Bacon and John Evelyn. In 1619 Praetorius states: "The Irish harp has rough thick brass strings, forty three in number, and is beyond measure sweet in tone."¹⁰⁸ He goes on to give classification, details about the stringing of the instrument and an illustration. In *Sylva Sylvarum* published posthumously in 1627, Francis Bacon wrote one of the most frequently-quoted descriptions of the Irish harp. He refers to the instrument which he states: "maketh a more resounding sound than a pandora, orpharion, or cittern, which have likewise wire strings, and no instrument hath the sound so melting and prolonged as the Irish harp."¹⁰⁹ He continues to describe the construction of the Irish harp and makes comments upon its use in 'broken music' or consort music. The

¹⁰⁷ Lodewijk Huygens, *The English Journal 1651-1652*, eds., A.G.H. Bachrach & R.G. Collmer (Leiden and London, 1982), 62; Peter Holman, *The Four and Twenty Fiddlers* (Oxford, 1993), 143.

¹⁰⁸ Michael Praetorius, *Syntagma Musicum*, II (Wolfenbüttel, 1619, repr., 1980), 56.

¹⁰⁹ Francis Bacon, *Sylva Sylvarum* (London, 1627), 61, ed., James Spedding, Robert L. Ellis & Douglas D. Heath, *The Works of Francis Bacon* (London, 1876), 420.

writings of Praetorius and Bacon are discussed in greater detail in Chapter 3. The importance of these references to this chapter is the fact that the tonal qualities of the Irish harp had been brought to the attention of men who, if not patrons of the instrument themselves, were among the most significant commentators on the musical practices of their time.

John Evelyn had taken lessons upon the theorbo and lute and was very competent to give opinions about musical matters. On the 20th January 1654, he wrote:¹¹⁰

Come to see my old acquaintance and the most incomparable player on the Irish harp, Mr. Clark, after his travels. He was an excellent musician, born in Devonshire (as I remember). Such music before or since did I never hear, that any instrument being neglected for its extraordinary difficulty; but in my judgement far superior to the lute itself, or whatever speaks with strings.

On the 17th November, 1688, he wrote:¹¹¹

When dining at the Groom Porters, I heard Sir Edward Sutton play excellently upon the Irish harp; he performs genteelly, but not approaching my friend, Mr. Clark, a gentleman of Northumberland, who makes it exceede lute, viol, and all the harmony an instrument is capable of: pity is that it is not more in use; but indeed to play well takes up the whole man, as Mr. Clark has assured me, who, though a gentleman of quality and parts, was yet brought up to that instrument from five years old, as I remember he told me.

John Evelyn writes about the Irish harp in glowing terms and it would appear from his observations that the instrument was very suitable for an English gentleman to play. It can be assumed that the Irish harp was in use outside court circles and, as in the case of Philip Squire and Lewis Evans, was being played by musicians who did not necessarily hail from Ireland.

¹¹⁰ John Evelyn, *Diary*, I, 300, ed., E.S. de Beer (Oxford, 1955), III, 92.

¹¹¹ John Evelyn, *Diary*, II, 39, ed., E.S. de Beer, III, 518.

The Restoration

The Restoration of 1660 brought with it new requirements as regards music in court, and these did not include the use of the Irish harp. On 17th June, 1660, Charles Evans was appointed 'his Majesty's harper for the Italian harp' in succession to Philip Squire.¹¹² Charles Evans, possibly a relative of Lewis Evans, remained in the 'Private Music' until at least February 1684 when he was paid for the strings of his harp for the last time.¹¹³ On the 25th November, 1663 he was paid £15 for 'a harp bought by him for his majesties service'.¹¹⁴ Peter Holman has suggested that the harper portrayed in a painting of 'Stuart' musicians (hung in Nostell Priory, near Wakefield) is Charles Evans. Holman asks the question, is this the harp purchased in 1663?¹¹⁵ The instrument is clearly not an Irish harp (see Illustration 7).

Towards the closing years of the seventeenth century, references to the use of the Irish harp become more scarce in England and it becomes apparent that the instrument was giving way to new fashions as old performers died. On 21st November, 1682, the diplomat Robert Southwell, a close friend of King Charles II, wrote from his home in King's Weston near Bristol to Sir John Percival, his brother-in-law at Kinsale in County Cork: "My children are all in perfect health, and dancing every night with Dick Barry's harp." Sadly, three months later his son, Edward wrote to his aunt, Lady Percival, telling her of the death of the harper: "We are mightly troubled for the loss of poor Dick

¹¹² PRO, E405/543, f101v.

¹¹³ PRO, E403/2460, f37v; Andrew Ashbee, ed., *Records of English Court Music, I [1660-1685]* (Snodland, 1986), 51, 219;

¹¹⁴ Andrew Ashbee, *Records of English Court Music*, 51.

¹¹⁵ Peter Holman, 'The harp in Stuart England', 195.

Illustration 7



7 Known as *The Cabal* by J.B.Medina. *Members of the King's Private Music c1661-3*. Nostell Priory, The National Trust.

Barry, he leaving a sad heart in the nursery. But to repair his loss all we can do is that Miss Helena must play her old tune upon the harpsichord seven times a day till we go up to London, we are to learn all manner of things which Mr. Desirer with his one eye can teach us in that time. So you see in what manner we are to repair his loss."¹¹⁶

Another reference to the harp giving way to keyboard instruments is found in the household of the Duke and Duchess of Hamilton at Brodick Castle in Perthshire. In February, 1682 the Duke and Duchess sent their harper Jago McFlahertie south to Edinburgh to purchase music wire for the virginals on which their daughters were being taught to play.¹¹⁷

The manuscripts of James Talbot, Regius Professor of Hebrew at Cambridge from 1689 to 1704 (to be discussed in Chapter 3), provide another source of information regarding the Irish harp in England during the closing years of the seventeenth century. Talbot measured and made notes about many musical instruments in use in his time, including two Irish harps. The examples he describes were made in England and had necks and forepillars made of walnut while the soundboxes were still made of traditional willow.¹¹⁸ This information is important as it opens up the possibility of the Irish harp being developed in England in such a way as would make it capable of performing sophisticated and chromatic music. There is no evidence that any chromatic harps were made and imported from Ireland for the English market. Other than the Dalway

¹¹⁶ HMC, Edmont MSS, 2 (1909), 123, 127; Sean Donnelly, 'The Irish Harp in England', 60-61.

¹¹⁷ Rosalind K. Marshall, *The Days of Duchess Anne: Life in the Household of the Duchess of Hamilton 1656-1715* (Edinburgh, 1973), 73; Sean Donnelly, 'The Irish Harp in England', 61.

¹¹⁸ Joan Rimmer, 'James Talbot's Manuscripts, VI, Harps', *Galpin Society Journal*, XVI (1957), 66-67, 70-71.

harp, the native Irish harps which have survived are not capable of performing the works of William Lawes.

In 1697, William Turner states that: "the harp is increased in repute, and though the Welsh Gut-String formerly gave place to the Irish Wire-String, now the Spanish Gut-String now comes up with it."¹¹⁹

The Continent

The Irish harp gained popularity on the Continent as well as in England. Michael Praetorius's descriptions in *Syntagma Musicum* (1619) display a familiarity with the instrument, and the work of his illustrator demonstrates that an Irish harp must have been at hand to serve as a model.¹²⁰ This is despite the fact that the engraving may be in reverse due to the printing process. A familiar instrument such as the German Clavichord illustrated on plate XV is also clearly in reverse.

In 1637, an inventory of the Hofkapelle of the Landgrave of Hesse at Kassel includes an Irish harp.¹²¹ It is also not inconceivable that as members of the Irish aristocracy left Ireland in successive outbreaks of rebellion and suppression, they took their harps and harpers with them. In 1607 the Earls of Tyrone and Tyrconnell left their native land taking with them nearly one hundred of the prominent Irishmen of Ulster (The Flight of the Earls).¹²²

English musicians were no strangers to the court at Kassel. John Dowland was in the service of the Landgrave from 1594-1596, after being

¹¹⁹ Michael Turner, 'Some Improvements in Music Noted by William Turner in 1697', *Galpin Society Journal*, XX (1957), 59.

¹²⁰ Michael Praetorius, *Syntagma Musicum*, II, 56, Plate xviii.

¹²¹ Joan Rimmer, *The Irish Harp*, 47.

¹²² Joan Rimmer, *The Irish Harp*, 47.

rejected by Queen Elizabeth I following the vacancy in the Queen's Music caused by the death of John Johnson.¹²³ After a brief return to England, John Dowland was appointed court lutenist to King Christian IV of Denmark at the princely salary of 500 daler a year, more than most members of the royal household, no matter in what capacity they served.¹²⁴ The King was a great patron of the arts and encouraged music, architecture, painting and astronomy with great enthusiasm. His wealth was founded on the guns of Helsingor Castle (the Kronberg) which dominated the Baltic Straits and demanded vast tolls from shipping. Not content with the great English lutenist, Christian developed a taste for English consort music and sent Dowland to England to obtain the best musicians available.¹²⁵ An entry in the Danish court records reveals that one of the musicians hired by Dowland was a harper. Henning Gioe the Knight Marshal received the following orders:¹²⁶

As we desire that the English Harpist and the dancer be discharged because their time is up, we likewise beg of you that you discharge them and please them by granting them an allowance which Dulante of England has promised and pledged, still you will have to keep the harp because we paid for it.

As we have learnt that the English musicians who ran away have left an instrument and a viola da gamba at Hermandt Rosse in Elsinore we ask you to appropriate them if they are still there, so that we may have some compensation for the money they ran away with.

Actum den 24 Septembris anno 1602.

In *Musiken ved Christian Fjerdes Hof* (Copenhagen, 1892), Hammerich Elling suggests that the two performers discharged because their contract had ended, were the harper Carolus Oralli and the dancing

¹²³ Diana Poulton, *John Dowland* (London, 1972, repr., 1982), 30-48.

¹²⁴ Diana Poulton, *John Dowland*, 52.

¹²⁵ *Rentemesterregnskaber* (Danish Court Records 1599-1600, f326v, quoted and translated in: Diana Poulton, *John Dowland*, 57.

¹²⁶ *Rentemesterregnskaber*, f379, trans., Diana Poulton, *John Dowland*, 58.

master Henrick Sandon.¹²⁷ A proposal that the name Carolus Oralli is a corruption of Charles O'Reilly was made by John M. Ward in an article entitled 'A Dowland Miscellany'.¹²⁸ O'Reilly would certainly be a suitable name for an Irish harp player. Oralli ('Harpeslager' trans. harp beater) was employed at the Danish court from 6th November 1601 until the 9th October 1602. He was paid a salary of 200 Daler.¹²⁹ The two musicians who ran away were John Maynard (singer and composer) and Daniel Norcombe (bass viol and composer). They fled to Venice through Germany and Hungary.¹³⁰

A group portrait of some of King Christian IV's musicians by his court painter, Reinhold Timm, illustrates a broken consort consisting of a flute, bass viol, lute and Irish harp.¹³¹ The painting is of the highest quality and very detailed indeed. Sadly Timm has opted to display the harp in a frontal manner, thus obscuring details of stringing, fingering and tuning pin disposition. The origins of the instrument are unmistakable however, as is the position of the hands on the strings. The left hand is clearly playing the treble strings while those of the bass are plucked by the right hand. Mette Muller and Ole Kongsted have suggested the identities of the musicians in the Nineteenth Council of Europe Catalogue. The harper is probably Derby Scott, and William Brade is suggested as the candidate for the role of bass viol player. Jorgen Rasch is the probable lutenist, while the flûte

²⁷ Angul Hamerich-Elling, *Musiken ved Christian den Fjerds Hof* (Copenhagen, 1892), 24, 211; Diana Poulton, *John Dowland*, 58.

²⁸ John M. Ward, 'A Dowland Miscellany', *Journal of the Lute Society of America*, X (1977), 103, note 188.

²⁹ Angul Hamerich-Elling, *Musiken ved Christian den Fjerds Hof*, 211, note 32.

³⁰ Diana Poulton, *John Dowland*, 58.

³¹ Reinhold Timm, *Group of Musicians* [c1620], Provenance: Otto Thott's auction 1787, no 562; Gavno 169, Christies 9.7.1976.

player remains unknown.¹³² This painting is examined in further detail in Chapter 3.

In 1622 an envoy from the court of Gottorp, called Gosche Wensin, sent a diplomatic report which tells of an exquisite banquet at Rosenberg (a palace built in Copenhagen by Christian IV) at which was heard solo music by an Irish harp with brass strings.¹³³ Darby Scott ('Harpslager') was appointed by Christian IV on the 25th September 1621 and he remained in that employment until his death on 19th December, 1634. His annual salary was 150 Daler.¹³⁴ Two other harpers were employed by King Christian. Their instruments were not of the Irish type and they were given the title 'Harpenist'. These were Magnus Maxi, employed from 1627 until his death in 1633 and Edvard Adam, employed from 1641 until he departed in 1643.¹³⁵

On the Continent, King Christian became heavily involved in the Thirty Years War at a great financial cost. As a result, his musical patronage was greatly reduced. In Denmark too fashions were changing and the employment of Heinrich Schutz to the post of Kapellmeister in 1642 marked a change in the King's musical tastes. The heyday of the popularity of the Irish harp in Europe was over. The instrument was once again mainly to be heard in its native land, where it was used to perform Irish airs and dances, and occasionally new works in praise of members of the nobility and gentry.

¹³² Mette Muller & Ole Kongsted, 'Christian IV and Music', *19th Council of Europe Exhibition Catalogue* (Herning, 1988), 120-121.

¹³³ Mette Muller & Ole Kongsted, 'Christian IV and Music', 121.

¹³⁴ Angul Hamerich-Elling, *Musiken ved Christian den Fjerds Hof*, 214.

¹³⁵ Angul Hamerich-Elling, *Musiken ved Christian den Fjerds Hof*, 215, 216.

CHAPTER 3

The Development of the Irish Harp and the Evidence for a Chromatic Instrument

The Organological Context of the Chromatic Irish Harp

The surviving music for the Irish harp employed in the courts of the European nobility, as opposed to its native Irish or Scottish setting, is examined in Chapters 4, 5 and 6. These manuscript and printed sources indicate that a chromatic development of the instrument took place during the last decades of the sixteenth century and first few decades of the seventeenth. It is therefore important to examine significant surviving instruments in order to understand the context in which developments in harp construction occurred, and the problems which beset instrument makers and harpers alike. It is not my aim to present a comprehensive survey of these instruments as this has already been done, and is featured in publications by Robert Bruce Armstrong, Joan Rimmer, Michael Billinge and Bonnie Shaljean, and Keith Sanger and Alison Kinnaird. Instead, aspects of extant historic instruments are examined with a view to understanding factors which may have influenced the design and construction of Irish chromatic harps. There is currently some debate over the national origins of the Irish harp, Scotland now being suggested as the cradle of the instrument in Sanger and Kinnaird's book, *Tree of Strings* (Temple, 1992). History has determined the generic name however, and such arguments do not form part of this thesis. The principal features of the Irish harp were well established centuries before the time scale defined by the title of this work, and these are shown in Illustration 1.

Illustration 1

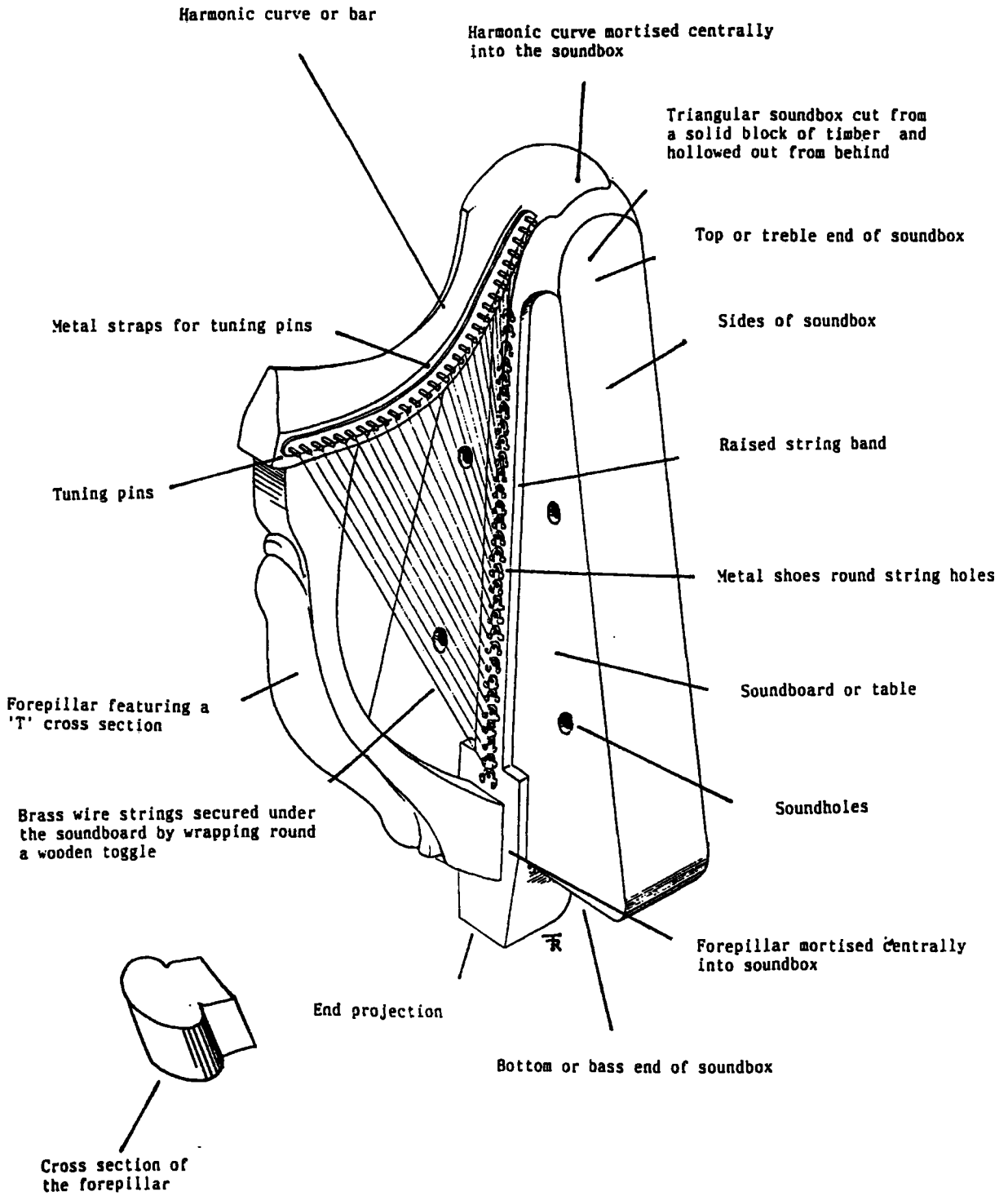

1 The Principal Characteristics of an Organological Irish Harp c1550.

The number of early Irish harps in existence today is small and this may be due to several factors such as their inability to adapt to changes in musical fashion, fabric decay, positive destruction in times of occupation and war and perhaps the very nature of the mechanical construction of the instruments. Years of tension caused by the taut wire strings has caused the soundboards to lift and split, and this has also had the effect of twisting and bending forepillars. Those harps which have survived frequently show signs of these defects having occurred. Almost without exception, those ancient Irish harps which are extant today are of great value for reasons such as association with noble families and musicians, or as significant examples of excellent craftsmanship and decoration.

As well as surviving ancient harps, several contemporary descriptions of Irish harps were drafted during the sixteenth and seventeenth centuries and these can provide evidence of technical developments which may have taken place. Notable sources include writings by Galilei, Bacon, Praetorius and Talbot. Visual representation of the Irish harp is plentiful but almost invariably allegorical and decorative. Most of the resulting images are far too fanciful to be relied upon as faithful sources of information. The group portrait of musicians employed at the Danish Court painted during the seventeenth century by Reinhold Timm, discussed later in this chapter, is perhaps the only serious attempt to provide an accurate and contemporary portrayal of an Irish harper of this period to have survived.

The Trinity College Harp (see Illustration 2)

The earliest surviving Irish harp is the fourteenth-century instrument preserved in the library of Trinity College, Dublin. It is significant that even at this early date, this instrument had attained its near final form. This small harp originally had twenty nine strings and is about 70cm high. If the instrument was tuned diatonically it would have a compass of four octaves which was an extensive range for the period. It should be noted that only organs had a greater compass at that time.¹

The structure consists of three carved pieces of willow held together in a triangular form by a combination of mortice joints and string tension. These three wooden components are known as the soundbox, forepillar and neck. The relatively short length of the bass strings means that the forepillar is correspondingly short and this produces a format described as being 'low headed'. The forepillar is extensively worm eaten at the point where it meets the soundbox, and as a result has had to be reconstructed at various periods in its history, with differing results. The most recent restoration of the harp took place in 1961 under the supervision of Joan Rimmer who aimed to return it as closely as possible to its original form.

The soundbox is typically Irish as it has been carved out of a solid block of wood (other harpmaking traditions frequently used glue and nails in order to fabricate a resonator out of several components which may have included such materials as wood, ivory, gourds and skin). The exterior surfaces were originally flat but years of string tension

¹ Joan Rimmer, *The Irish Harp* (Dublin, 1969, 2nd edn, 1984), 33.

Illustration 2

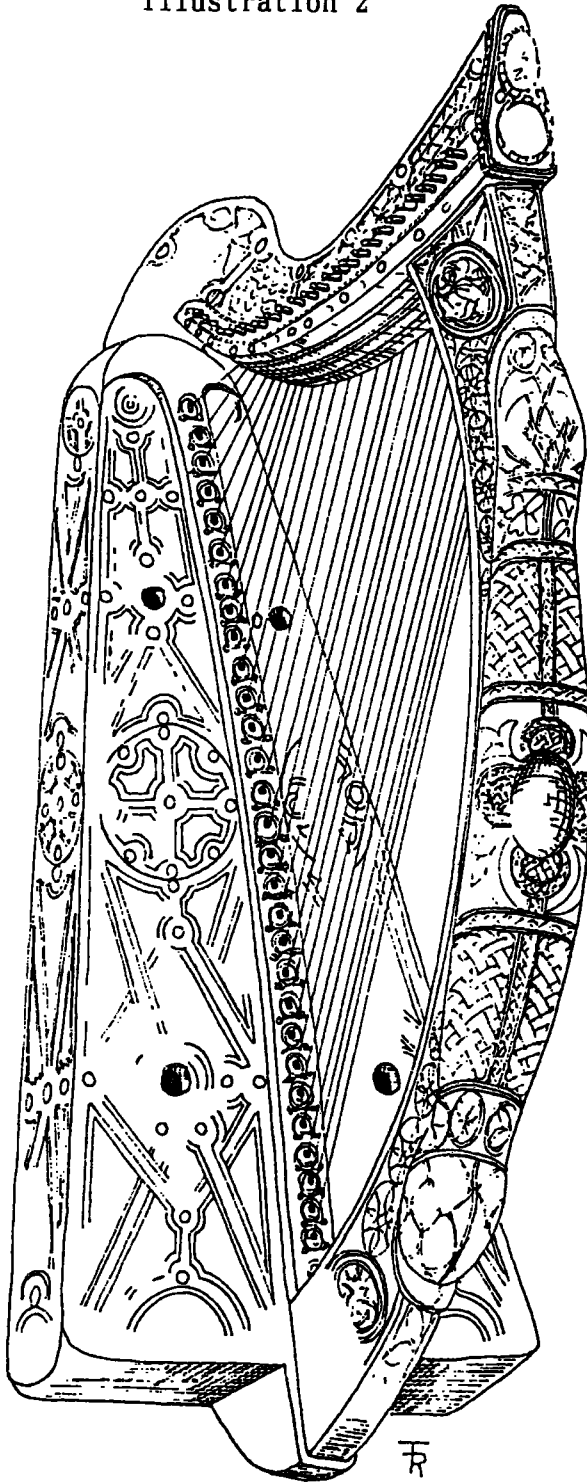

2 *The Trinity College Harp* (14th century), Trinity College, Dublin.

have resulted in a convex soundboard. A bridge or raised 'string band' is carved on the surface of the soundboard to a height of 3mm, giving a total depth of 9mm in order to increase the strength of the instrument at this most vulnerable point. Elsewhere the thickness of the soundboard is 6mm. After hollowing out the soundbox the maker recessed a wooden panel into the back of the harp.

The width of the lower (bass) end of the soundbox is 31.75cm and 12.1cm at the top (treble), resulting in a characteristic triangular shape. The sides of the soundbox become slightly deeper towards the bass. In the bass they are 9.2cm deep while in the treble they are 8.6 cm deep. The sides are carved to a thickness of 1.6cm at the opening in the back where a board is fastened to complete the structure. Four soundholes pierce the soundboard and it is interesting to note that the two lower holes are not placed in a symmetrical position. The degree to which these two holes are unmatched however, is insufficient to suggest that there was any reason other than accident for their eccentric location.

The holes on the string band, through which the strings pass are reinforced on their upper surface with small metal shoes attached to the string band with pins. The shoes help to prevent the wire strings cutting into the wood, while the pins help to transmit vibrations into the soundbox. Three of the shoes now seen on the harp are not original and belong to the recent restoration. There are two other designs of shoe in the treble which have not been replaced in the recent restoration, and which may be original or replacements for shoes lost at an earlier date.

The soundboard and the sides of of the box are decorated with a

series of burned designs based upon lines, curves and circles. There does not appear to have been much concern by the decorator to achieve perfect symmetry as the ornaments on the sides of the box are very different from each other. The workmanship throughout is very elaborate and varied.

The neck (harmonic bar) of the Trinity College harp is made of very similar wood to the soundbox. It is comparatively heavy, triangular in cross section and projects over the upper end of the forepillar which is mortised into it. Two metal strips run along the sides of the harmonic bar into which are drilled thirty holes to house the metal tuning pins. Both the pins and holes are tapered in such a manner that the widest end is on the player's right side. The strings are attached to the left end of the pins and a tuning key operates the right. The pins are circular in cross section except at the right end where they are forged into a square section to ensure that a tuning key can function effectively. The square ends are decorated with a simple cross.

Unlike a modern clarsach or concert harp, the neck of the Trinity College harp is mortised into the soundbox centrally, which results in strings which cannot run vertically from the soundboard. Instead, they come away at an angle towards the player's left and are even splayed in the treble. This peculiar arrangement is perfectly playable if performers use their left hand to operate the top strings, but is very difficult if they attempt to use their right hand.

The decoration of the harmonic bar has many similarities to that of the soundbox. Once again the decorator has created a pattern out of finely burned lines, curves and circles. Silver bosses were incorporated into the design and some of these may still be seen. The surface under

the harmonic bar is moulded and the metal reinforcement straps are decorated with a finely engraved border of diagonal lines. The neck of the harp is terminated in an extremely fine piece of metal work which incorporated two large stones of which only a cut crystal cabachon remains. A variety of decorative borders are engraved into the design.

The forepillar of the Trinity College harp is made of a slightly darker wood than the neck and soundbox. The lower part is missing and has been replaced during the recent restoration. Like most Irish harps, the curve is very deep and is strengthened with a 'T' cross section, of which the broad part is across the front, while the stem is on the inside. Fishes' heads are carved on the upper and lower terminations of the 'T' section and the body is engraved with interlaced knotwork and a Celtic cross. There is a great deal of engraving on the sides of the forepillar and this includes geometric patterns and circular medallions containing the images of grotesque, wild beasts.

The wood engraving on the forepillar is a lot finer than the patterns burnt into the neck and soundbox of the harp, and there is good reason to suppose that it was done at a later date. As the wood is slightly different in quality to the rest of the harp, it is also possible that the pillar is not contemporary with the rest of the instrument.²

The twenty nine strings of the harp belong to the recent restoration and are made of brass. Originally it would have had thirty wire strings but these may have been made of other metals such as bronze while some of steel may have been used in the treble. The harp was

² Joan Rimmer, *The Irish Harp*, 40.

strung by wrapping one end of the string round a wooden toggle inside the soundbox and passing it through the soundhole, over the metal shoe and up to the tuning pin to which it was secured. When a harp was strung for the first time, the tension of the strings caused the soundboard of the box to lift so forming the characteristic curved profile. As the soundboard lifted, the tension of the strings was reduced, causing the pitch of the harp to fall. The tension of the strings had to be continually increased until a stable equilibrium was established between the forces involved. This process of tuning the instrument for the first time was termed the 'raising of the harp'. The following interesting letter mentions the raising of a harp and suggests that it took about four months to achieve stability, from Michaelmas (29th September) to early February of the following year. It is addressed to Sir Michael Hicke, secretary to William Cecil for twenty five years.³

Honoured Sir,

Understanding from Sir James Ley, His Majesty's Attorney for Wards, my worthy friend, that you were desirous of a good Irish harp, I made trial for the obtaining of an old one - for that they report the oldest best - but finding none to my liking, caused a new one to be made, which, if it proves as good in sound as it is fair in show, I shall commend it to your kind acceptance. The masters of the art give hopes of the well-proving thereof, and if the ceremony of the raising thereof had not been observed, it had been presented unto [you] before Michaelmas. I caused the same to be put into a stout case to preserve it from breaking. And so, recommending my due observance unto Your Lordship, rest now and ever,

Yours truly assured

John Denham

From Dublin the 7th February 1612

During its recent restoration, The Trinity College harp was

³ Sean Donnelly, 'The Irish Harp in England 1550-1690', *Ceol*, VII (1985), 40.

restrung with brass wire and made partially playable. It was recorded by the B.B.C. for a radio programme entitled 'Ancestral Voices' which was presented by Madeau Stewart in conjunction with Joan Rimmer. The harper on the occasion was Mary O'Hara who used long finger nails in the ancient Irish manner. When played, Joan Rimmer described the sound of the Trinity College harp as being "extraordinarily sweet and clear, with a quality which is somewhat bell-like but with an added richness akin to that of a guitar".⁴

The Trinity College harp is a remarkable survivor from the medieval period and its form conforms perfectly, to the organological definition of an Irish harp. There is little doubt that its survival owes much to its value as a musical instrument in its early years, as well as being a revered object of great craftsmanship in later centuries.

The Lamont Harp (see Illustration 3)

The Lamont harp is the next oldest harp after the Trinity College instrument. It belongs to the fifteenth century and is kept in the Scottish National Museum of Antiquities in Edinburgh.⁵ Though the harp has a Scottish background during its recorded past, it is Irish in organological terms. It is a small low headed instrument and is constructed in a similar manner to the Trinity College harp. One very significant fact is that it is constructed out of hornbeam, a tree native to the Continent and the South East of England. This may indicate the importing of tone-wood (timber with qualities suitable for the

⁴ Joan Rimmer, *The Irish Harp*, 33.

⁵ Joan Rimmer, *The Irish Harp*, 76.

Illustration 3

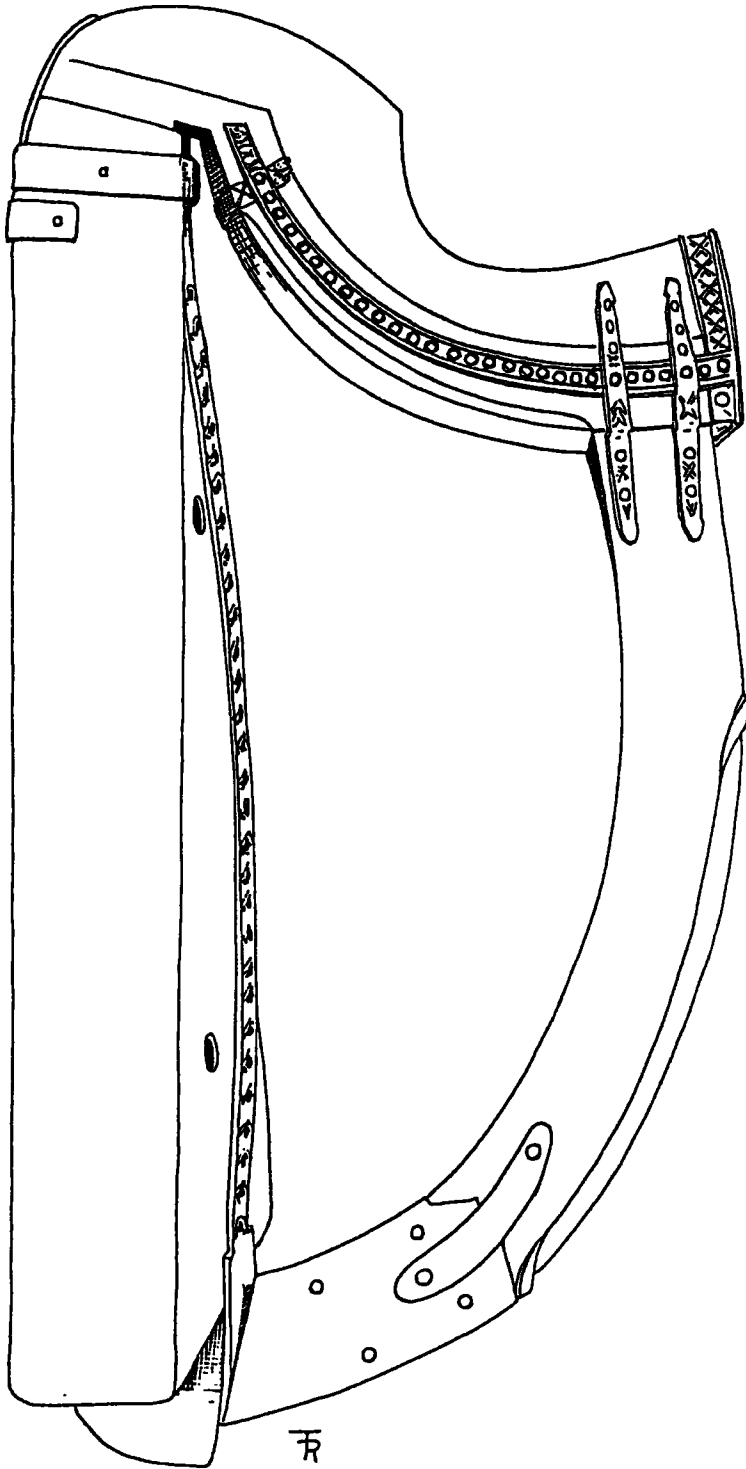

3 *The Lamont Harp* (15th century), National Museum of Antiquities of Scotland.

manufacture of musical instruments) to parts of Scotland or Ireland. The compass of the Lamont harp is slightly larger than that of its predecessor insofar as it has thirty two strings, giving it a diatonic compass of over four octaves.

The soundbox is carved out of a single piece of wood and is 73cm long. It is triangular in form and is 11.5cm wide at the top and 43.2cm wide at the base. The sides are approximately the same height all round: 10.1cm at the top, 9.9cm in the middle and 9.9cm at the bottom. They are carved to a thickness of 1cm all round. The only bracing on the box is an external metal strap round the top which was added to reinforce a crack which occurred. The soundboard is pierced with four holes, each 2.6cm in diameter. The soundbox is terminated at the top with a carved collar and at the base with a projecting block which is 10.11cm long and 6.7cm wide. Mortises are cut in both the collar and projecting block to house tenons on the neck and forepillar.

Running the length of the soundboard is a raised stringband which opens out into semicircular curves at the top and steps at the bottom. It is carved to a depth of 3mm, and a width of 4.2cm and has two parallel lines burned in with a hot iron throughout its length as decoration. This simple design is continued round the outside edges of the soundbox and soundholes. The string band is pierced with thirty two holes, each 5mm in diameter. They are reinforced on their upper surface with metal string shoes consisting of two different patterns. The top three and bottom two are not as sophisticated as the remaining twenty six (one is missing), but it appears that all are original as there are no signs of alteration. The top five holes gradually approach the player's left side of the string band in an attempt to make those

strings more vertical. In its original form the soundboard was probably level but the strain of the string tension has raised the stringband by 1.6cm in the centre. There are no signs of the soundboard splitting as a result, however.

The harmonic bar is comparatively heavy, having a depth of 10.7cm for much of its length and a width of 4.3 cm. After leaving the collar of the soundbox, the top of the bar is relatively flat. It gradually assumes a curved surface until it reaches the summit of the hump when it becomes sharp. It remains sharp until it meets the bass termination. The harmonic bar has no carved or burned ornamentation. Decoration is restricted to applied metalwork.

A curved brass strip pierced for thirty two tuning pins, 1.3cm wide and 3cm thick is fixed to each side of the harmonic bar with small pins. The bands are decorated with a series of engraved oval shapes and lines parallel with the outside edges. Another small metal strip has been added to the treble to reinforce two pin holes damaged by a split in the wood. Thirty tuning pins remain in position. Most of these are old and display two types of decoration while several are believed to be replacements.⁶

The bass end of the harmonic bar is decorated with well designed and executed brass work. The borders and edges feature ropework, foliage and interlaced patterns and these encapsulate a replica in brass of a crystal cabachon. Two brass straps were added to the bass end as a means of reinforcing the joint between the harmonic bar and the top of the forepillar. They are 18.8cm long, 1.5cm broad in the centre tapering to

6 Joan Rimmer, *The Irish Harp*, 76.

approximately 1cm at the extremities. The upper terminations of the straps are leaf shaped while the lower appear to have dragon-like heads. Each strap is pierced for four large nails and one tuning pin and they are both decorated with foliaceous designs.

A heavy iron strap was sunk into the underside of the harmonic curve at a period subsequent to the small split, in an attempt to strengthen the structure. Despite the reinforcement of the curve with metal straps it appears to have warped under the tension of the strings.

The forepillar of the harp has quite a pronounced curve and features the characteristic 'T' section of an Irish harp. Unfortunately this structural element did not run the full length of the pillar and this resulted in a split at the lower termination of the reinforcement. A subsequent repair with metal straps was also unsatisfactory, resulting in a further fracture with the straps acting as hinges instead of extra strength. Metal plates would have been far more effective.

The interior height of the forepillar is 59.7cm and the width is 2.55cm. The 'T' starts 23cm from the base of the pillar, is 11.1cm wide at its widest point and terminates 19.2cm from the top. Other than fashioning the 'T' in the form of a fish there appears to be no evidence of original decoration on the forepillar. Two circles are engraved into the wood and as these are not burned in the manner of the soundbox decoration, it can be assumed that this work belongs to a later date than the original construction. The fractures and stress caused by string tension and faulty design have had the effect of reducing the height of the forepillar and increasing its curvature. This makes accurate reconstruction of the instrument very difficult. The number of repairs and the determination of subsequent craftsmen to put the harp in

playing order testifies to the value of the instrument and its musical capability.

It is extraordinary that repairers of the Lamont harp did not decide to rectify the problems of the forepillar by replacement. The fact that they did not suggests that the instrument was repaired by a metal worker rather than a harp maker. We are reminded of questions surrounding the origins of the forepillar of the Trinity College harp and whether or not it was a replacement for a structural failure in its past. If it were a replacement it is evident that the work in this case was sympathetic and undertaken by a craftsman who was fully acquainted with harp making skills and traditions. We are therefore left with assumptions regarding the repair of the Lamont harp which include a lack of willingness on the owner's part to pay for a decent repair, the unavailability of a reputable maker and repairer in the vicinity or the ignorance of either owners or repairers, who did not understand how best to put the harp in good playing order.

The Queen Mary Harp (see Illustration 4)

The Queen Mary harp, c.1500, is a well-preserved instrument and is kept at the National Museum of Antiquities of Scotland.⁷ At this point it is worth quoting Alison Kinnaird and Keith Sanger who, when discussing the Trinity College, Lamont and Queen Mary instruments, state that "all three harps are thought to date from the mid to late 15th

⁷ Joan Rimmer, *The Irish Harp*, 77.

Illustration 4

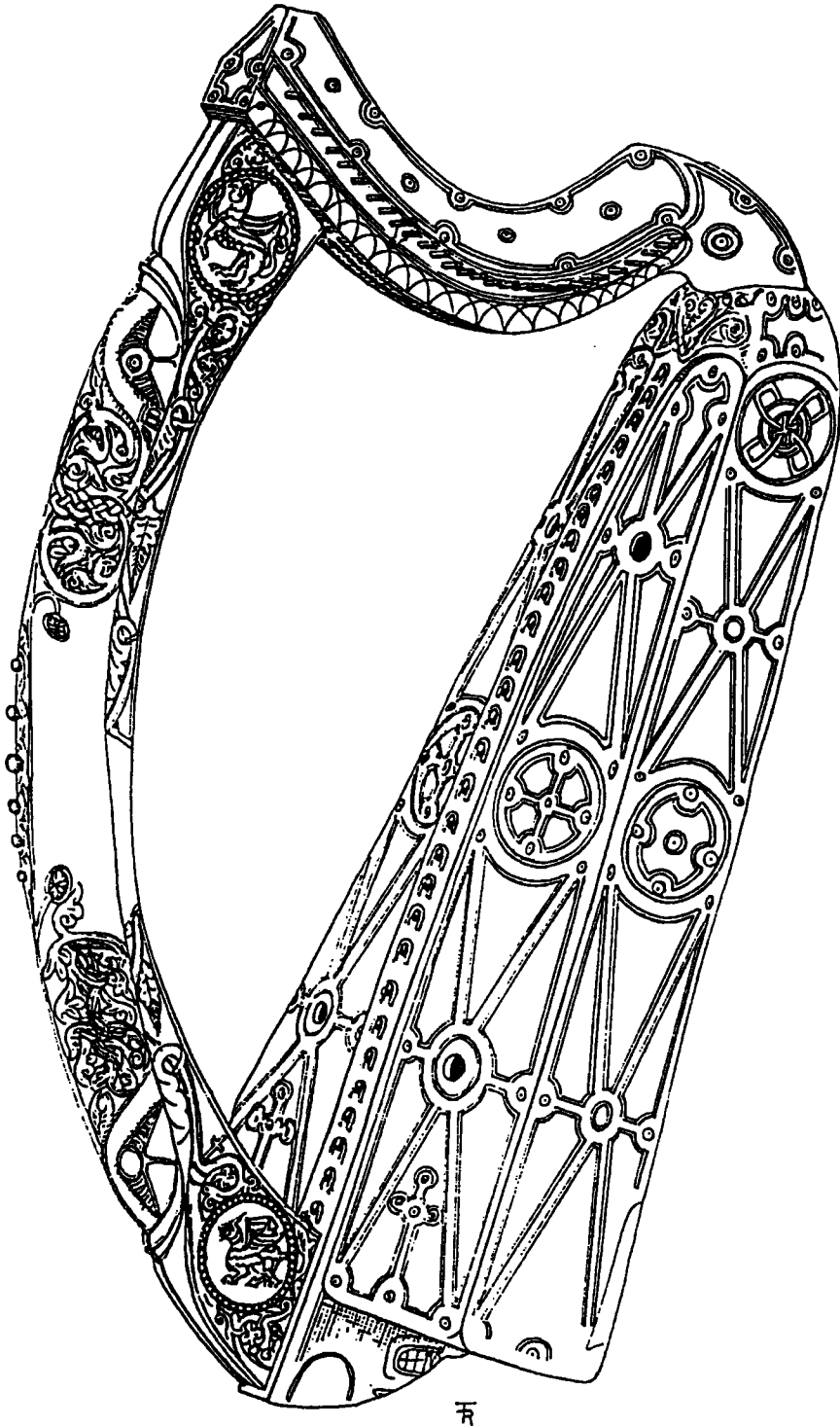

4 *The Queen Mary Harp* (c.1500), National Museum of Antiquities of Scotland.

century."⁸ Kinnaird and Sanger offer no point of reference for this statement but by making it, remind us that there are no records or inscriptions on the instruments to make accurate dating possible. Considering the importance of these early harps it would be helpful if Trinity College and the National Museum of Antiquities of Scotland adopted a more scientific approach towards dating such as the measurement of timber rings. Like the Trinity College and Lamont harps it is of the small 'low-headed' type. It originally had twenty nine strings though there are signs of another being added in the bass at a later date. The harp is constructed throughout with hornbeam, the same non-native wood as the Lamont harp which suggests an instrument-making tradition founded upon imported timber. All the major parts of the harp are decorated to a very high standard indeed.

The soundbox is hollowed from a single block of wood and is 68.5cm long, 30cm wide at the base and 12.3cm wide at the top string position. The depth of the sides of the box are 10.2cm cm for the greater part and they are carved to a thickness of 1cm. The thickness of the bottom side is far greater at 2.8cm. The top of the soundbox ends in carved semicircular shoulders which have a recess to accept the harmonic bar. The raised string band is 4.2cm wide at the bottom of the box and this increases to a width of 4.9cm where it opens out into a semicircular shoulder. The soundboard has four circular holes and these are 1.6cm in diameter. At the position of the highest holes, the soundboard is 6mm thick and at the lowest, 8mm thick.

The string band is pierced for twenty nine strings and each hole had a brass shoe (two of which are missing), 'horse shoe' shaped in

⁸ Keith Sanger and Alison Kinnaird, *Tree of Strings* (Temple, 1992), 53.

form. Some of these are pierced for pins and others have had their terminations bent back and sharpened like staples in order to fasten them directly into the band. It should be noted that an extra iron loop, without a hole, was added in an attempt to increase the number of strings to thirty. There are three types of shoe in evidence.

The harp was strung with brass wire in 1807 by the Highland Society of Scotland when it was played with finger pads. As finger nails were not used, the sound was found to be disappointingly weak. The harp was then restrung with gut strings by a performer upon the pedal harp called Joseph Elouis, a native of Switzerland who was then living in Edinburgh.⁹ During this process, the string holes may have been enlarged to take the large wooden pegs which are now to be found in the string band.

Small horizontal metal straps 2.2cm long have been added under each string hole and it is assumed that these were added when a crack appeared along five of the holes in the string band. The tension of the strings has raised the string band by 2.5cm in the centre of the soundboard. The back of the harp is enclosed by a board 6mm thick which was let into the sides of the soundbox. This board received as much care and attention to finish from its maker as the rest of the harp, and it is secured to the box with nails or pegs.

The soundbox is decorated with a design consisting of circles and straight lines burned into the wood. At the top of the string band the design becomes very foliaceous in character. The projecting block at the bass of the harp is carved to resemble a dog's head. All of this

⁹ Keith Sanger and Alison Kinnaird, *Tree of Strings*, 58.

decoration was done to a very high standard indeed. A lot of the designs have been worn with constant handling and there are signs of damage by fire and worms.

The harmonic bar leaves the soundbox with an oval cross section and this gradually changes as the top becomes sharp. The bar has been attached to the soundbox with a crude iron strap in an attempt to strengthen the instrument. The intention of the original instrument maker was that the tension of the strings alone would hold the three main components of the harp together.

The underside of the harmonic bar has decorative mouldings incised. The sides of the bar have patterns consisting of concentric curves and circles burned in with a hot iron. This decoration is identical on both sides apart from the space below the tuning pins, where an arcaded motif is featured on the player's left side. Brass bands pierced for twenty nine tuning pins are attached to the sides of the harmonic bar with an unusually large number of small pins, sixteen above and seventeen and eighteen below. These bands are reinforced round two pin holes with a plate and a strap in an attempt to halt splits that began to appear during the course of the life of the harp. The bass end of the harmonic curve is decorated with burned lines and circles.

The brass tuning pins of the Queen Mary harp are unusually slender, being 3mm in diameter at the round end and 6mm across at the square end and 7.6cm long. The original pins have a single cross inscribed on the square ends while the replacements have a double cross. At a much later stage, when a thirtieth string was required in the bass, a hole was drilled below the brass straps for a thicker and shorter iron tuning pin. The string end of this extra pin is split in the manner of tuning

pins found on Welsh or French instruments.¹⁰

The forepillar of this harp is remarkably well decorated. It measures 76.2cm along the outside of the curve, is 4.1cm thick on the outside and 3.5cm thick on the inside. The 'T' section extends for the greater part of its length and this has provided much greater strength over the years than that on the Lamont harp. It is carved in such a way that it resembles a double headed salmon. The rest of the pillar features carving and patterns burned in with a hot iron. Some of the motifs featured include interlaced knotwork, mythical beasts, foliaceous patterns and geometric borders. Pin holes and carved hollows serve as a reminder that the instrument once had decorative metal bosses attached to the forepillar. String tension has caused the pillar to become slightly twisted and somewhat shorter than its original state.

The minor repairs on the harp are proof that the instrument was valued and used over a great number of years. The fact that there are no major repairs serves as a testimony to the design and craftsmanship of the harp's creator.

The Ballinderry Fragments (see Illustration 5)

The Ballinderry fragments consist of the bronze fittings from the harmonic bar of a large 'low headed' harp. They are believed to belong to the sixteenth century and are now housed in the National Museum of Ireland.¹¹ The mountings are so called because they were found at Ballinderry near Moat, Co. Westmeath. No evidence of any wooden

¹⁰ Robert Bruce Armstrong, *The Irish And The Highland Harps* (Edinburgh, 1904, repr., Shannon, 1969), 71.

¹¹ Joan Rimmer, *The Irish Harp*, 75.

Illustration 5

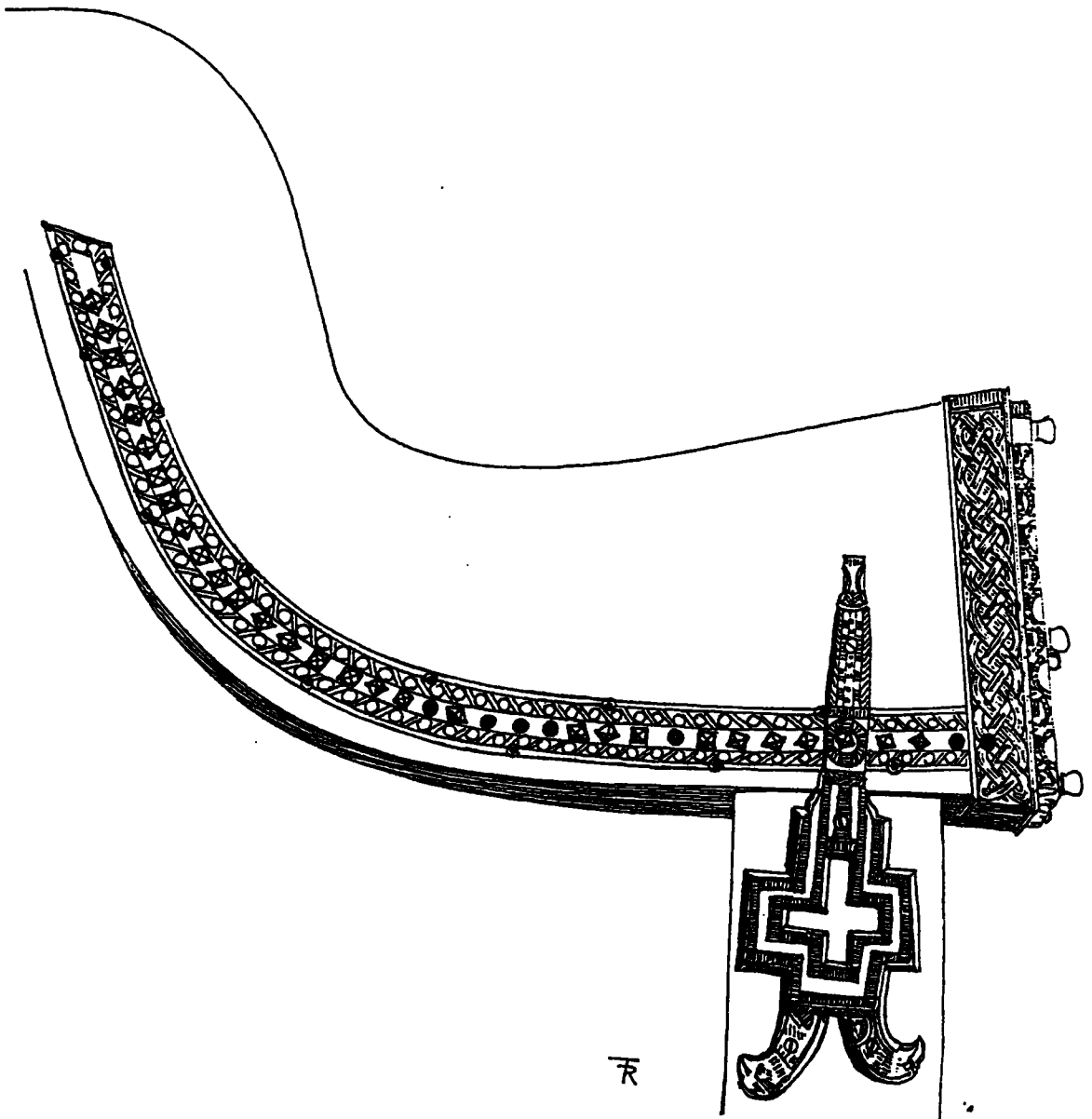

5 The Ballinderry Fragments (16th century), National Museum of Ireland.

components for the harp are now in existence and indeed Keith Sanger and Alison Kinnaird have suggested that, as the metalwork is so fine "they appear never to have been used".¹²

The bronze fittings include two neck straps with 36 pin holes for reinforcing the harmonic bar, a decorative triangular plate and neck finial, a brace for strengthening the joint between the harmonic bar and forepillar, nineteen forged tuning pins and a further twelve which are cast. If the thirty six strings, suggested by the number of holes in the straps, were tuned diatonically, then the harp would have a compass of five octaves. This range was large for the sixteenth century, even by the standard of keyboard instruments of that time.

The neck straps are 48.2cm long and the subject of very fine decorative engraving, consisting of a design made up of diagonal lines and circles. They are attached to the harmonic bar by thirteen visible pins. The strengthening brace is 21cm long and made in the form of a cross constructed in the 'leather strapwork' style of the period. The top strap is fashioned in the form of a dragon head while the lowest terminations are made to look like birds' heads. The entire piece is finely chased with a design consisting of borders, horizontal, vertical and herringbone lines and feather effects for the birds' necks.

The finial is unusual insofar as the design on the right hand side differs from that on the left. The motif on the player's right consists of a Celtic style border while that on the left consists of a foliaceous border. Decoration on the underside of the finial is limited to a much

¹² Keith Sanger and Alison Kinnaird, *Tree of Strings*, 57.

simpler pattern based upon stripes with engraved vertical, horizontal and diagonal lines.

The front of the harmonic bar consists of a triangular plate held in place with five decorated nails. The lowest part of the plate consists of a circular cross with the monogram I.H.S. surmounted by a cross. The triangle is completed with a foliaceous pattern above the cross and a scalloped border. All the motifs on the triangular plate are decorated with finely engraved lines. The quality of the metalwork on the Ballinderry fragments surpasses that of any other existing instruments.¹³

The Otway Harp (see Illustration 6)

The Otway harp is believed to belong to the early seventeenth century and now forms part of the collection of the National Museum of Ireland.¹⁴ It has provision for thirty five strings and is of the large 'low headed' type.

The triangular soundbox which is cut from a solid block of willow has four soundholes. Each of these consists of a pierced hexafoil and is surrounded with concentric circles. The soundboard is unusually thick and measures 1.4cm in the treble and 1.9cm in the bass. The sides of the box are 90.08cm long, the width at the treble is 9.5cm and the width in the bass is 30.17cm. An important development in soundbox design is demonstrated by the fact that on this harp, the depth of the soundbox is reduced from the treble where it is 12.7cm, to the bass where it is

13 Robert Bruce Armstrong, *The Irish And The Highland Harps*, 73-74

14 Joan Rimmer, *The Irish Harp*, 77.

Illustration 6

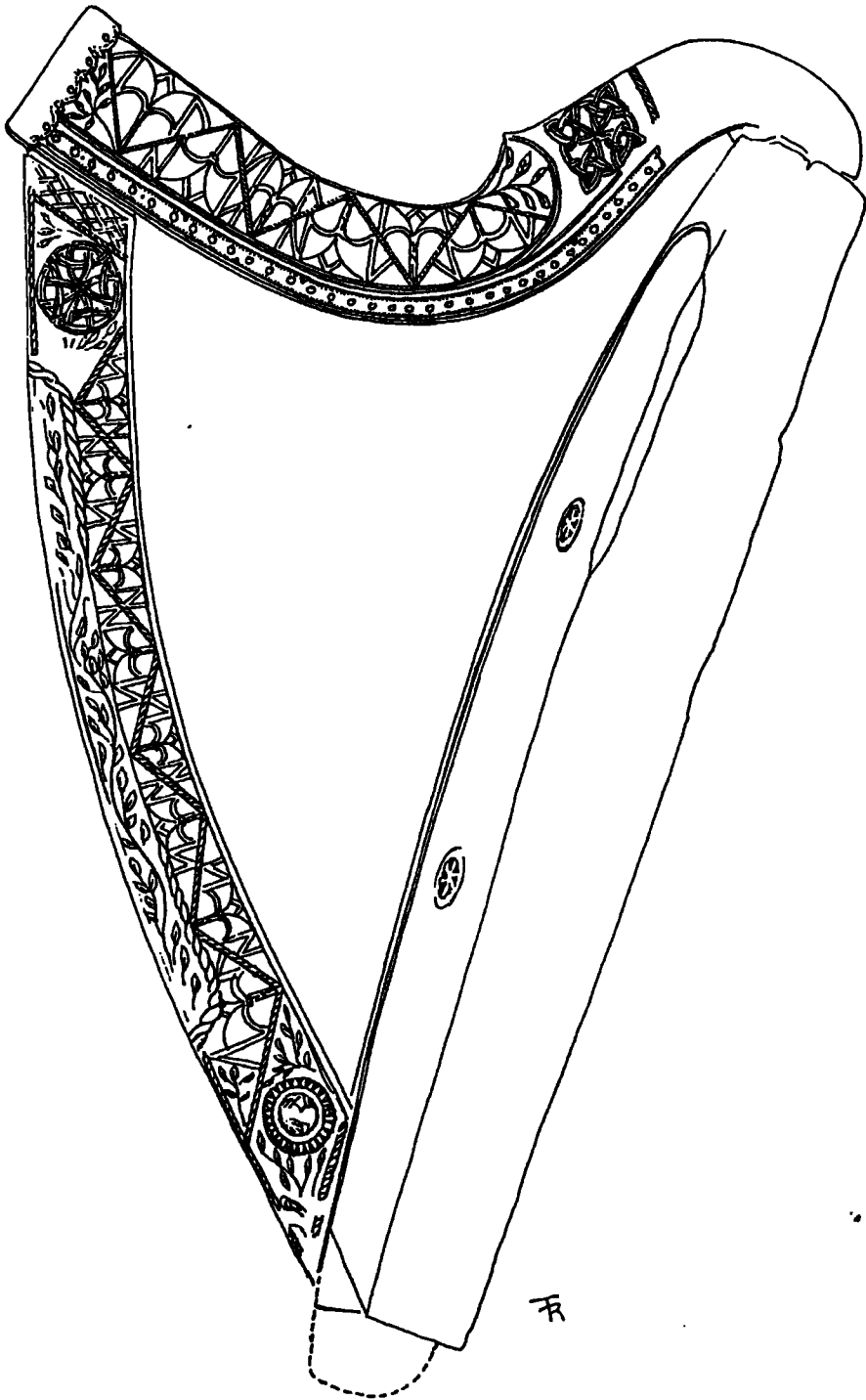

6 *The Otway Harp* (17th century), National Museum of Ireland.

8.9cm. Joan Rimmer suggests that the increase in the size of the chamber under the top and middle register strings may be due to some loss in resonance, as harps in the early baroque period were used as bass instruments.¹⁵ This is an interesting observation as it infers that this is evidence that the harp could have been used to provide a bass accompaniment to another instrument, instruments or voice within the context of music making in Ireland.

The raised string band terminates in steps at the bass and semicircular curves in the treble. It is 4.1cm wide and, instead of being supplied with string shoes, has thin strips of brass applied to it. The strips are pierced for strings and fixing pins, and are decorated with a series of scallops on the edges. The soundbox was probably originally formed with a curve along the length of the string band as the height to which it rises in the centre is 4.1cm.¹⁶ If it was originally flat, the tension required to raise the string band by this distance would have probably destroyed the box completely. There is some evidence of a semicircular pattern on the edges of the soundbox but this has largely disappeared.

The harmonic bar is very elegant and well decorated. It is 67cm long and 5.1cm thick at its lowest surface. The upper surface is decorated with large 'rope like' chevrons into which have been placed patterns based upon arcading, while the hump of the bar is decorated with a knotwork motif. There are two brass neck bands to reinforce the string holes, and as there are small portions missing, it would appear

15 Joan Rimmer, *The Irish Harp*, 46.

16 Robert Bruce Armstrong, *The Irish And The Highland Harps*, 73-4.

that they were not strong enough for their intended purpose. The neck bands are decorated with saw-tooth edges. The bass end of the harmonic bar was enriched with a brass cap decorated with five ornamental nails. The sides of this finial are finished with a series of curves, chevrons and pierced holes. Of the original brass tuning pins, only nine now survive.

The forepillar is as well decorated as the harmonic bar. It is 90.02cm long along the outside of the curve and 3.3cm wide. The 'T' is particularly broad, 7cm wide at the top and 8cm wide at the bottom. The strength of the forepillar has resulted in an instrument which shows no sign of structural failure. A variety of ornaments are featured on the surface and these include knotwork, arcading, foliaceous patterns, wolfhound medallions and carved ropework. The name of the eighteenth century harpmaker and restorer, Cormack O'Kelly, is carved into the back of the pillar. As there are signs of repairs having been made to the upper string band of the soundbox, it is likely that the harp was sent to O'Kelly for this work to be undertaken.¹⁷ It should be noted that the only resemblance between this harp and the genuine work of O'Kelly is the hexafoil decoration of the soundboard holes which he may have copied.

The Dalway Fragments (see Illustration 7)

The Dalway fragments consist of the forepillar and harmonic bar of a large 'low-headed' harp with provision for fifty two tuning pins. Although the instrument is called the Dalway harp after the Antrim

¹⁷ Robert Bruce Armstrong, *The Irish And The Highland Harps*, 78.

Illustration 7

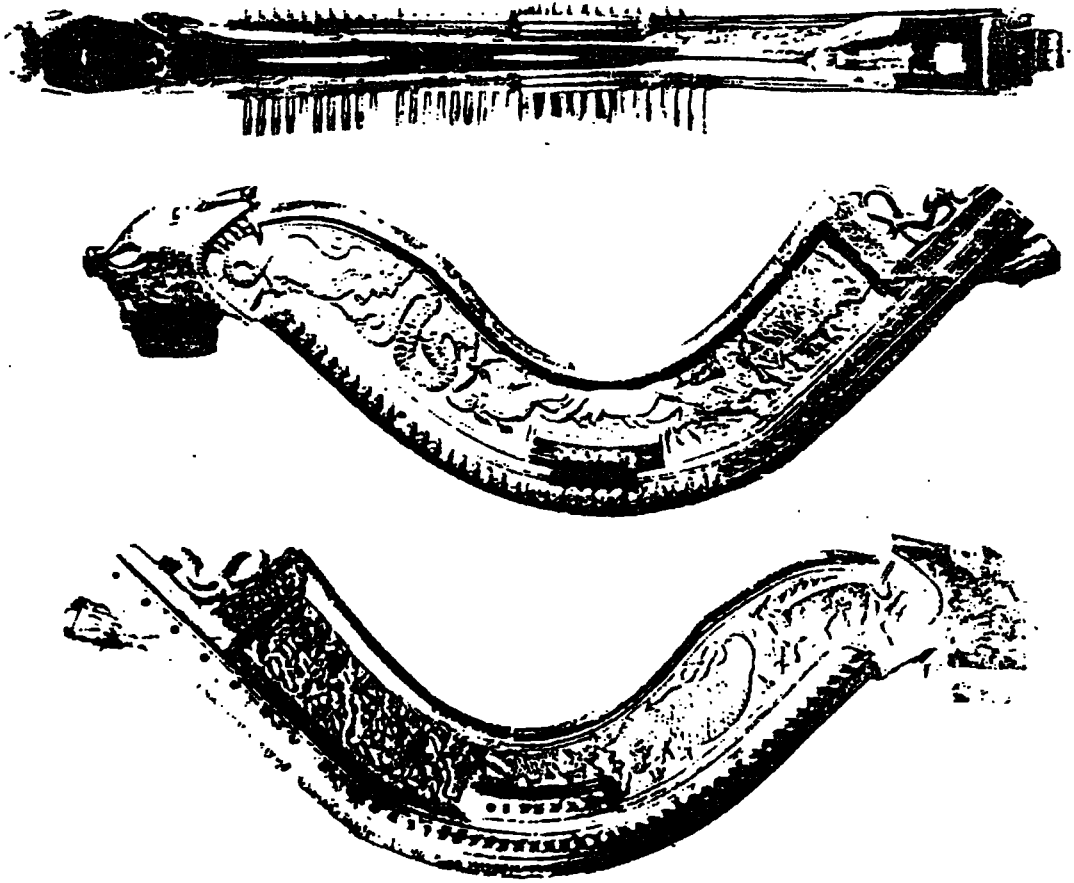

7 The neck of the Dalway harp (1621), National Museum of Ireland.

family in whose possession it was kept for a great number of years, it was in fact made for Sir John FitzEdmund Fitzgerald of Cloyne, Co. Cork, and the inscription naming the household of Sir John is quoted in Chapter 2. The fragments of this harp are now housed in the National Museum of Ireland in Dublin. The remains of the harp are very highly decorated and the large number of tuning pins indicates that the harp was tuned in some other way than is usual. A diatonic harp of fifty two strings would have a compass of over seven octaves.

The soundbox of the harp has been missing since before 1809, when the harp was depicted in an artist's reconstruction (see Illustration 8) which made no provision for strings leading from the extra row of seven pins.¹⁸ As the forepillar was shown in a badly worm-eaten state, even at this date, we can assume that it was destroyed either by worms or the tension of fifty two strings. When the forepillar and harmonic bar are fitted together, the length of the soundboard can be estimated as being 96cm long.

The harmonic bar of the Dalway harp is comparatively heavy and profusely decorated with carvings. That part of the neck which springs from the soundbox is fashioned in the form of a wolf's head, the sides of the bar are covered in mythical beasts set within a border of mouldings, and the finial includes a further pair of beasts and the bust of a queen with a crown, orb and sceptre. The beasts on the side of the harmonic bar bear a remarkable resemblance to illustrations in Edward Topsell's *Historie of Foure-Footed Beasts, and Histories of Serpents* (London, 1658), and it is possible that Topsell's illustrator had either

¹⁸ Edward Bunting, *A General Collection Of The Ancient Music of Ireland* (Dublin, 1809, repr., Dublin, 1969), frontplate.

Illustration 8

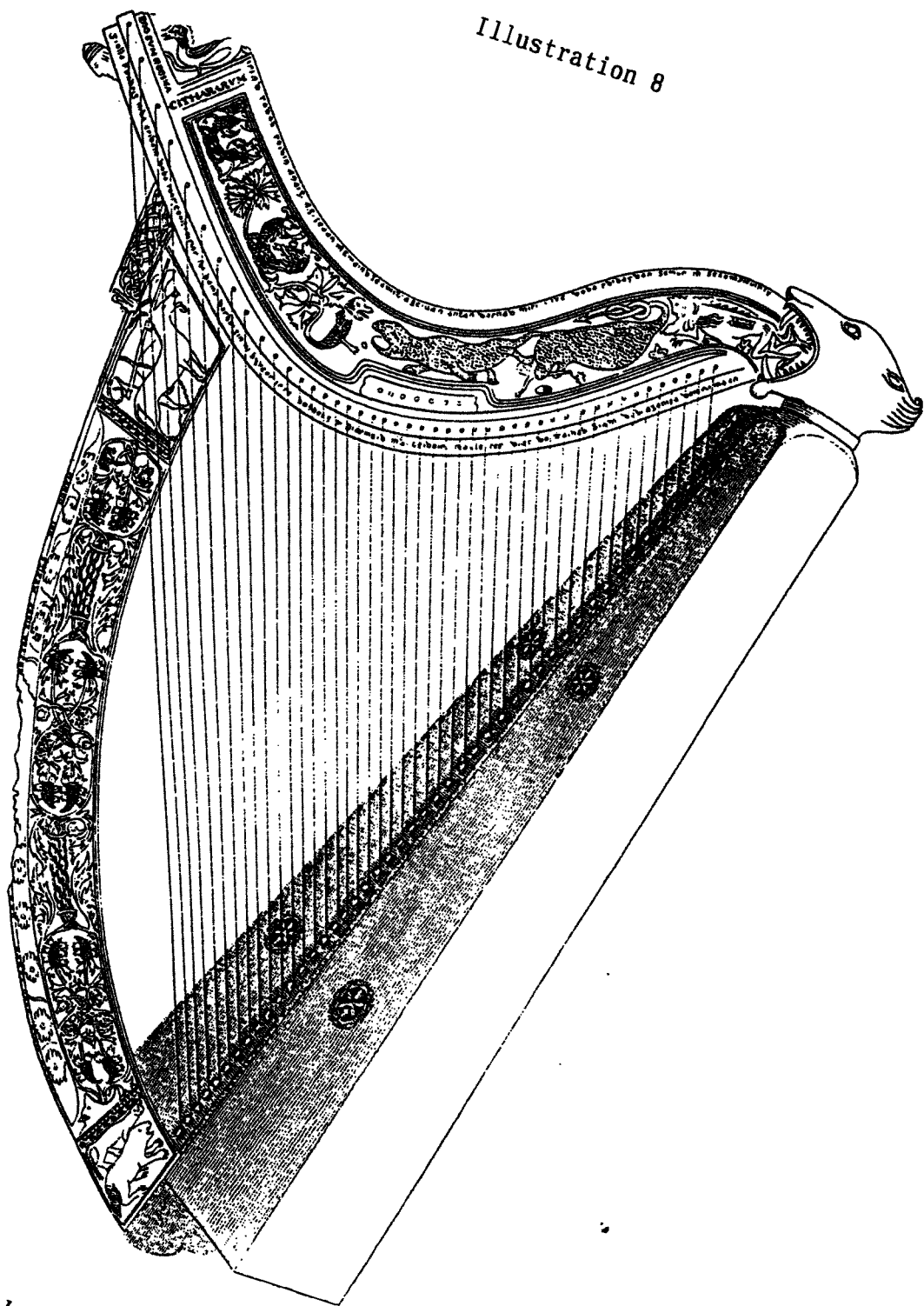

8 Edward Bunting, *A General Collection of the Ancient Music of Ireland arranged for the pianoforte* (London, 1809). An artist's reconstruction of the Dalway Harp fragments.

seen the Dalway harp or that both the illustrations in the book and the carvings on the harp are derived from some other earlier source.¹⁹ Inscriptions in Irish and Latin surround the bar. The extreme length of the harmonic curve is 90.05cm and it is 15.9cm deep between the third and fourth tuning pins in the bass.

There are two metal straps on each side of the harmonic bar. The lower straps have a simple engraved border and are pierced for forty five tuning pins. The upper straps are very short, pierced for seven tuning pins and are placed centrally above the lower straps. The Dalway harp is the only surviving Irish harp to have this arrangement of tuning pins. Of the fifty two original decorated tuning pins, forty two now survive.

The forepillar is very badly worm-eaten and the central edges of the 'T' section in particular have suffered. The extreme length of this section is 83.8cm and its width at the front is 4.3cm. The 'T' has been very substantial and is 67cm long and 11.4cm broad at its greatest width. Carvings on the front of the pillar include the Royal Arms, and those of Sir John Fitzgerald of Cloyne impaled with those of his wife, Ellen Barry, daughter of Viscount Buttevant. The mottoes "Virescit vulnere virtus, and Boutez en avant," are carved underneath. It is worth noting that the title Buttevant is a derivation of "Boutez en avant". The rest of the carving on the forepillar consists of heraldic and mythical beasts, foliaceous designs and Latin inscriptions which are now partially lost.²⁰

19 Michael Billinge and Bonnie Shaljean, 'The Dalway or Fitzgerald harp', *Early Music*, XV (1987), 175.

20 Robert Bruce Armstrong, *The Irish And The Highland Harps*, 67.

Michael Billinge and Bonnie Shaljean wrote a pioneering article suggesting that the tuning of the Dalway harp was "chromatic in the upper section and diatonic in the lower, with an overlapping duplication of some strings making it similar to a triple harp in the middle of its range".²¹

Basing their argument upon the number and length of the strings, the article is most convincing. Example 1 shows Billinge and Shaljean's suggested string dispositions for the Dalway harp taking into account the placing of the additional upper row of tuning pins (see Illustration 9). The authors go on to give two possible tunings for the Dalway harp and these are shown in Example 2. In referring to the duplication of notes in the suggested tunings, Billinge and Shaljean go on to state the following:

Notice that at the overlap there is a separate chromatic string for each hand, even though this means having two strings per note in the centre row. This may seem extravagant when compared with the arrangement of strings of a normal triple harp (that is, one chromatic string common to both hands, positioned between two outer diatonic strings of the same pitch), but this duplication of chromatic notes becomes necessary with this type of pin distribution. The reason for this lies with the fact that the main rank of strings originates from a single row of pins. Therefore, in the area of overlap with the seven extra strings the main row of pins has to provide the diatonic strings for both hands.

When examining the suggested tunings (Example 2) it is apparent that duplication of notes in adjacent positions is an important feature of this string disposition. If we consider that the makers of Irish harps were struggling to prevent their instruments from splitting apart by

²¹ Michael Billinge and Bonnie Shaljean, 'The Dalway or Fitzgerald harp', 176.

Example 1

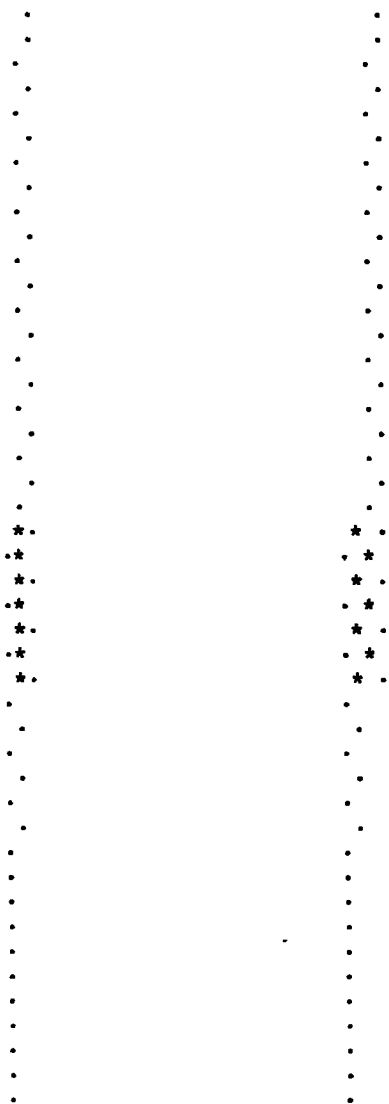

String positions for the Dalway harp as suggested by Michael Billinge and Bonnie Shaljean (assuming that the strings are open). The strings coming from the upper row of pins are shown thus: *.

Illustration 9

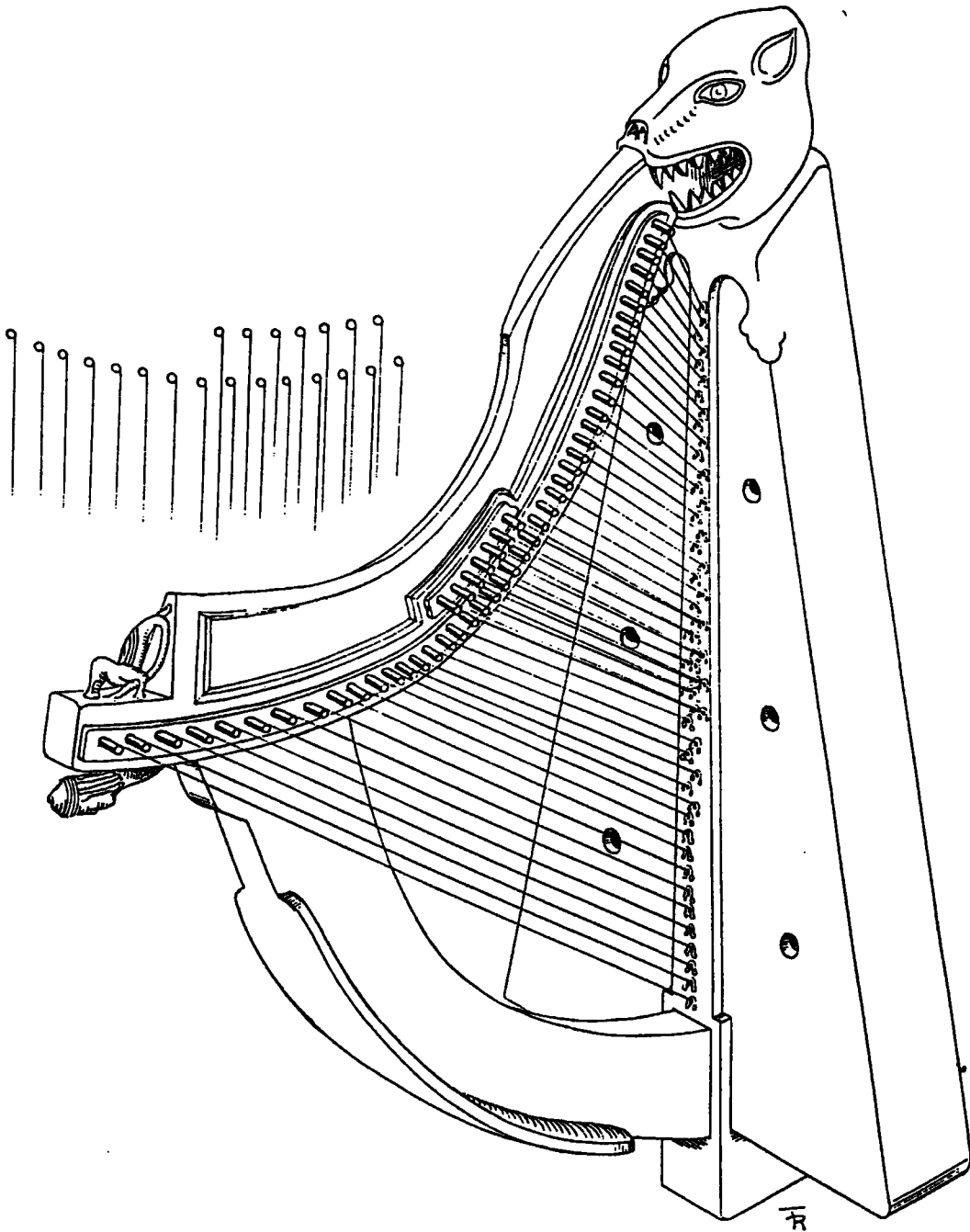

The Dalway Harp fragments (1621), National Museum of Ireland. A reconstruction of the instrument which demonstrates a stringing system using open strings proposed by Michael Billinge and Bonnie Shaljean.

Example 2

c''	.		d''	.
b''	.		c''	.
b ^b ''	.		b''	.
a''	.		b ^b ''	.
g#''	.		a''	.
g''	.		g#''	.
f#''	.		g''	.
f''	.		f#''	.
e''	.		f''	.
e ^b ''	.		e''	.
d''	.		e ^b ''	.
c#''	.		d''	.
c''	.		c#''	.
b'	.		c''	.
b'	.		b'	.
b ^b '	.		b'	.
a'	.		b ^b '	.
g#'	.		a'	.
g'	.		g#'	.
f#'	.		f#'	*
e'	*	f'	f'	**
e'	*	e'	e'	*
e ^b '	*	e ^b '	e ^b '	*
d'	*	e ^b '	d'	*
c#'	*	d'	c#'	*
c'	*	c#'	c'	.
b	.	c'	b	.
b	.		b	.
b ^b	.		b ^b	.
a	.		a	.
g#	.		g#	.
g	.		g	.
f#	.		f	.
f	.		f	.
e	.		e	.
d	.		d	.
c	.		c	.
B	.		B	.
A	.		A	.
G	.		G	.
F	.		F	.
E	.		E	.
D	.		D	.
C	.			.

Two possible tunings for the Dalway harp suggested by Michael Billinge and Bonnie Shaljean (assuming that the strings are open). The strings coming from the upper row of pins are shown thus: *.

using metal reinforcement strips, it is difficult to imagine that they would include unnecessary duplicated strings in their designs. Instances of such duplication of strings are demonstrated in Example 3.

Another way of approaching the problem of stringing the Dalway harp would be to accept the principle of a diatonic bass, overlapping mid range and chromatic treble, and draw the plan of an ideal string pattern (from a player's point of view) without considering the exact disposition of the upper row of tuning pins. The solution I propose, based partly upon my knowledge of musical requirements of works to be discussed in Chapters 4, 5 and 6, is shown in Example 4. This plan consists of a diatonic bass from D to e, chromatic capability from f to e''' with an overlapping section from f to f#' and no d#'''. If we accept that the main row of tuning pins are evenly spaced from f - e''', and the seven extra strings are placed in ideal positions to retain this positioning (every third string from f to f') then we can begin to produce another possible solution. I have marked the extra strings in Example 4 thus: *. The difficulty then remains as to how the strings travel from their tuning pins on the upper row and arrive at the pattern suggested in Example 4. I believe that this could be achieved by using every second pin (within the overlapping range) on the lower row as both a tuning pin and hitch pin. This effect is shown in Illustration 10. It should be noted that Billinge and Shaljean's solution is based upon the premise that the strings from the upper row of tuning pins were open and not hitched. Clearly a solution utilising hitched strings would result in an instrument which would be more useful from both the musical potential it could offer in terms of compass, the removal of unnecessary duplicated strings and the practicality with which the harp could be

Example 3

c''	.		
b''	.		
bb''	.		
a''	.		
g#''	.		
q''	.		
f#''	.		
e''	⊙		
e''	.		
eb''	.		
d''	.		
c#''	.		
c''	.		
b'	⊙		
b'	.		
bb'	.		
a'	.		
g#'	.		
g'	.		
f#'	.		
e'	⊙*	f'	
e'	⊙*	e'	
eb'	*	eb'	
d'	*	d'	
c#'	*	c#'	
c'	⊙*	c'	
b	.		
bb	.		
a	.		
g#	.		
g	.		
f#	.		
f	.		
e	.		
d	.		
c	.		
B	.		
A	.		
G	.		
F	.		
E	.		
D	.		
C	.		

d''	.		
c''	.		
b''	⊙		
b''	.		
bb''	.		
a''	.		
g#''	.		
q''	.		
f#''	.		
f#''	.		
e''	⊙		
e''	.		
eb''	.		
d''	.		
c#''	.		
c''	.		
b'	⊙		
b'	.		
bb'	.		
a'	.		
g#'	.		
f#'	*		
f#'	*		
e'	⊙*	f'	
e'	⊙*	e'	
eb'	*	eb'	
d'	*	d'	
c#'	*	c#'	
c'	.		
b	⊙		
bb	.		
a	.		
g#	.		
g	.		
f#	.		
f	.		
e	.		
d	.		
c	.		
B	.		
A	.		
G	.		
F	.		
E	.		
D	.		

The possible tunings suggested for the Dalway harp by Michael Billinge and Bonnie Shaljean with unnecessarily duplicated strings highlighted with circles. The strings coming from the upper row of pins are shown thus: *.

Example 4

e''	.
d''	.
c#''	.
c''	.
b''	.
bb''	.
a''	.
g#''	.
g''	.
f#''	.
f''	.
e''	.
d#''/eb''	.
d''	.
c#''	.
c''	.
b'	.
bb'	.
a'	.
g#'	.
g'	.
f#'	.
f'	* .
e'	* .
d#'/eb'	.
d'	* .
c#'	.
c'	* .
b	. .
bb	* .
a	. .
g#	* .
g	. .
f#	* .
f	. .
e	.
d	.
c	.
B	.
A	.
G	.
F	.
E	.
D	.

My proposed string positions and tuning for the Dalway harp assuming that those strings coming from the upper row of seven tuning pins (demonstrated thus: *) use seven lower pins as hitch pins.

Illustration 10

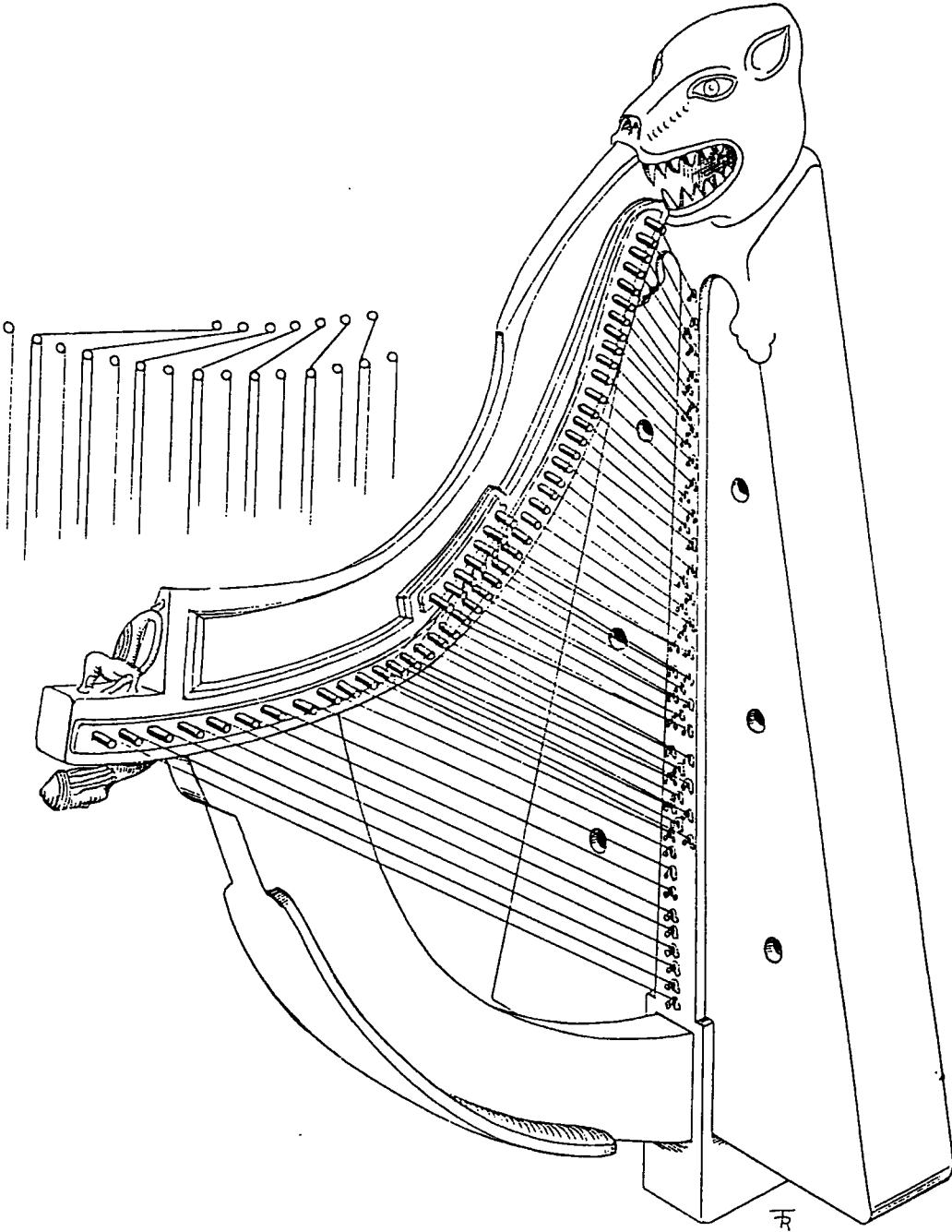

10 *The Dalway Harp fragments (1621), National Museum of Ireland. My proposed reconstruction which demonstrates how the instrument may have been strung using some of the lower tuning pins as hitch pins.*

played. Another result of this approach is that the sounding length of the strings would belong to the same scale and not include seven of another length and scale. I therefore believe that there is scope here for another attempted reconstruction of the Dalway harp.

As recently as 1984, the date of the reprint of Joan Rimmer's *The Irish Harp*, the author maintained that the extra row of strings "were probably sympathetic, not struck strings, added at a point where the sonority of the harp was weak."²² Unfortunately Rimmer offers no suggestion as to how this solution might work and how the strings might be arranged on the soundboard. The date of the Dalway harp does coincide with experimental sympathetic strings added to the baryton in England however.²³

If the Dalway harp were chromatic (that it had the capability of being so has already been demonstrated), then this would suggest that music making in the household of Sir John Fitzgerald of Cloyne differed from the norm for the Gaelic aristocracy in Ireland. Unlike English notables who visited Ireland and became entranced by the sound of the native Irish harp and its repertoire, here we have an Irish lord who has become interested in the music of the European court tradition and who has commissioned a special form of Irish harp to indulge in this passion. We are reminded of part of the previously quoted inscription (Chapter 2) on the harp "My Musician and Minstrel was Giollaphadraig MacCriodain, and none better could I have had, together with Diarmaid MacCriodain - two masters [of music] who [fostered] and trained me." If Giollaphadraig were a harper, could it be that Diarmaid played the bass

²² Joan Rimmer, *The Irish Harp*, 49.

²³ Robert Donnington 'Baryton', *New Grove Dictionary of Music and Musicians*, II (London, 1980), 233.

viol?

The Kildare Harp (see Illustration 11)

The Kildare harp is of the large low-headed type and is kept at the National Museum of Ireland. Its craftsmanship is unusually fine and it bears the inscription "R.F.G. fecit Anno 1275". The second figure of this date is not clear but this harp was probably made in 1675 for Robert, second son of George, the sixteenth Earl of Kildare, as it bears his arms.²⁴

The soundbox of the Kildare harp is more elegant than earlier examples insofar as it is longer, relatively more slender and having a bottom cut with two semicircular ends, a common feature of surviving seventeenth-century harps. It is cut from a solid block of willow and its depth varies from 11.5cm in the treble to 14.3cm in the centre and 9.4cm in the bass. The box is carved to a thickness of 0.9cm and is unusual in that there are four internal braces 1.3cm deep.²⁵ Externally three metal straps have been added to counteract the effect of string tension upon the soundboard which is 1.1cm thick. There are six soundholes and these consist of two finely ornamented central holes, 7cm in diameter, and designs in the treble and bass which are barely pierced and are enclosed in circles. The raised string band is pierced for thirty nine strings and has a hollow depression in its centre to house the shoes which are horse-shoe in form and of finely wrought brass. The extremities of the shoes are turned outwards and represent birds' heads.

24 Joan Rimmer, *The Irish Harp*, 76.

25 Joan Rimmer, 'The Morphology of the Irish Harp', *Galpin Society Journal*, XVII (1964), 49.

Illustration 11

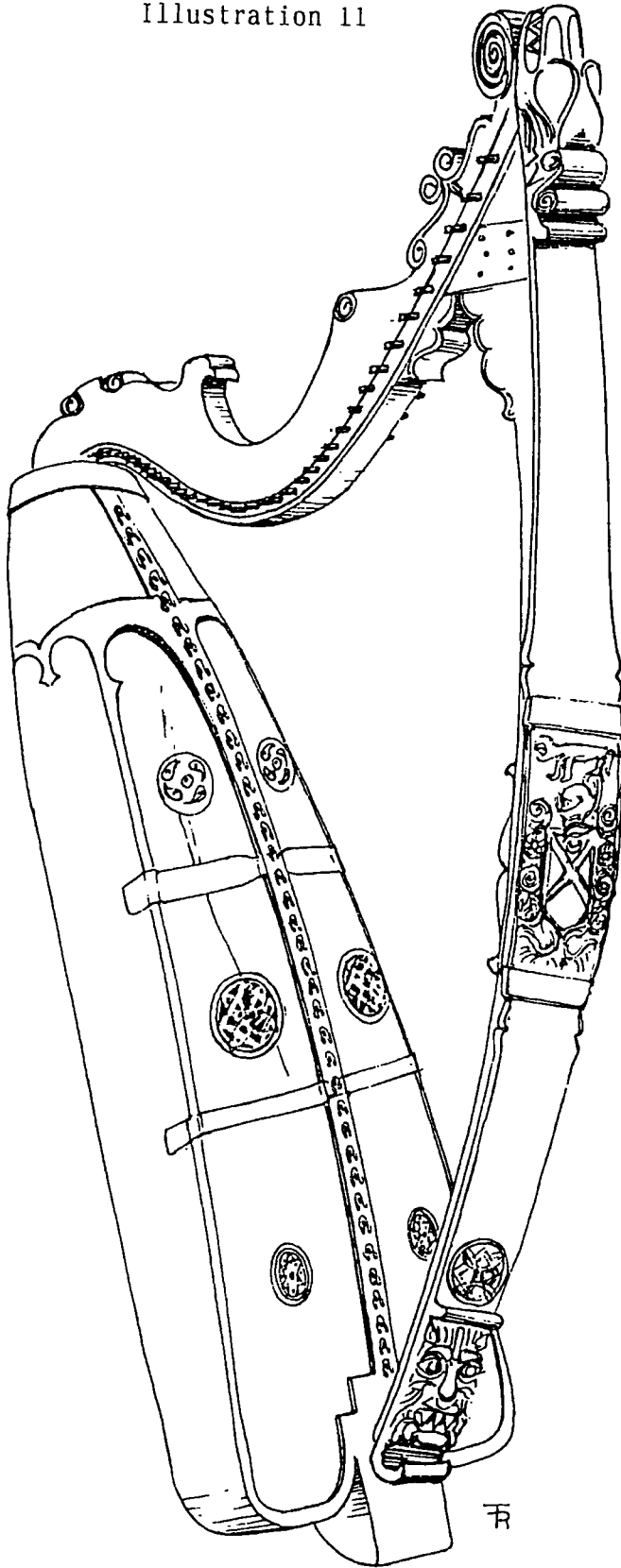

11 *The Kildare Harp* (17th century), National Museum of Ireland.

The soundbox features decoration consisting of raised arcading which coincides with the tenth string. This continues round the sides of the harp.

The harmonic bar of the Kildare harp is comparatively long, decorated with carved scrolls and a grotesque head and is made from pear or whitebeam or mountain ash.²⁶ The external length is 75.5cm, and its depth varies between 6.4 and 9cm and its width varies between 4.5 and 5.4 cm. The metal neck bands are pierced for thirty six decorated pins and there are signs of provision being made for four other pins (one of the holes is plugged) in the bass at a later date. The upper surface of the bar consists of a rounded off rectangular section in contrast to the triangular one of earlier harps.

The forepillar, made of birch, is attached to the harmonic bar with the aid of two metal plates and meets the harmonic bar in the manner of a Renaissance harp instead of being mortised from below like earlier Irish harps. Its internal height is 92.7cm and it has a pronounced curve. The pillar is greatly strengthened by a 'T' which is 11.4cm broad at its greatest width and runs its entire length. The decoration includes the arms of George Fitzgerald, geometric patterns and further grotesque heads. There are signs of paint being applied to the ornamental details of the instrument.

The Kildare harp exhibits features which demonstrate that the Irish harp was departing from its medieval origins. These include an increased number of strings, a more fashionable soundbox and pillar and different construction techniques employed in joining the pillar and neck. Despite these advances, the Kildare harp does not show any signs of having been

²⁶ Joan Rimmer, 'The Morphology of the Irish Harp, 49.

influenced by the radical thinking with regards to tuning, implicit in the design of the Dalway harp.

The O'Ffoggerty Harp (see Illustration 12)

The O'Ffoggerty harp is a large low-headed instrument which belongs to the seventeenth century.²⁷ It is in the possession of the Ryan family of Castle Ffoggerty, near Thurles in Co. Tipperary, where it has been kept since it belonged to Cornelius O'Ffoggerty, a notable musician who died in 1730. It has thirty six stringholes which gives it a diatonic compass of five octaves. The harp retains its original light colour and shows no signs of having been painted or varnished during its history.

The soundbox is cut from a solid piece of willow in the triangular fashion with two large semicircular curves in the bass and its length to the end of the projecting block is 94cm. The soundboard is pierced for six soundholes and the lowest of the four of these are each decorated with a pattern of ten concentric circles. The slightly raised string band terminates at the treble end with an elaborately carved foliage design and semicircular arches. Crude metal straps have been added at an apparently later date in order to provide additional strength to the soundbox. Part of the carved foliage work is cut away to allow one of the straps to pass over it. The soundbox has thirty six string holes and the majority of these still have their original brass shoes in the shape of horse shoes with upturned ends, terminating in birds' heads in a manner similar to those on the Kildare harp.

The harmonic bar, also made of willow, is fashioned in the ancient manner but is unusual in that it terminates at the bass end in a

27 Joan Rimmer, *The Irish Harp*, 77.

Illustration 12

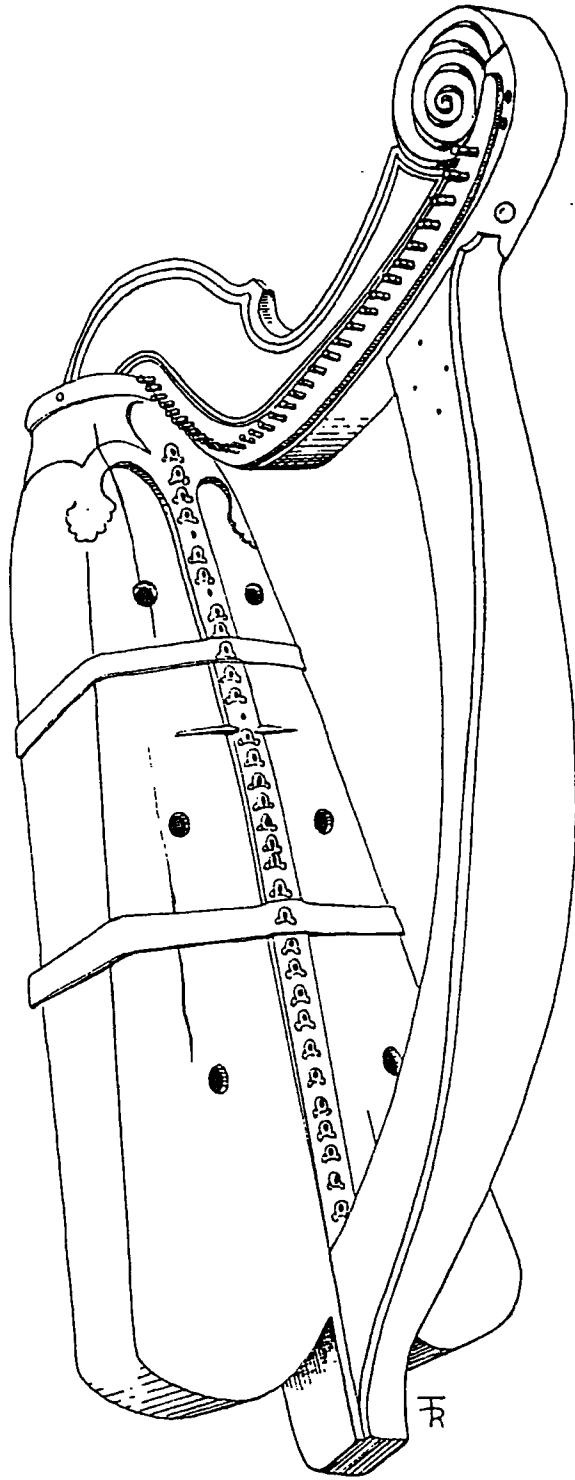

12 *The O'Ffogerty Harp* (17th century), Castle Ffogerty, Thurles, Co. Tipperary.

magnificent carved scroll. The two neck straps on either side of the bar form simple curves and are pierced for thirty six brass tuning pins. Thirty five of these are still in position.

The willow forepillar has a deep curve and a 'T' section which runs along its entire length. This has enabled the pillar to withstand the tension of the strings and resist the twisting and shortening which is so common in Irish harps. At its widest point the 'T' is 10.5cm across and at its most narrow it is 3.2cm across. Four holes at the top of the pillar mark the position of retaining pins which once held a gold plate inscribed with the legend "This is the harp of Cornelius Ffoggerty" in Irish.²⁸ The total height of the O'Ffoggerty harp is 112.5cm.

As in the case of the Kildare harp, the maker of this instrument shows no signs of having been influenced by the tuning developments which took place on the Dalway harp.

The SIRR Harp (see Illustration 13)

The SIRR harp, named after a previous owner called Major SIRR, belongs to the eighteenth century and represents the Irish harp in its fully developed form.²⁹ It is a large high-headed instrument with pin holes for thirty six strings and it is now housed in the National Museum of Ireland. The extreme height of the harp taken from the bottom of the projecting block to the highest point on the forepillar is 157.5cm.

The soundbox is carved from a solid block of willow to a thickness of 1.3cm, and is 11.5cm deep at the top, 12.1cm at the middle and 8.9cm

28 Robert Bruce Armstrong, *The Irish And The Highland Harps*, 79.

29 Joan Rimmer, *The Irish Harp*, 77.

Illustration 13

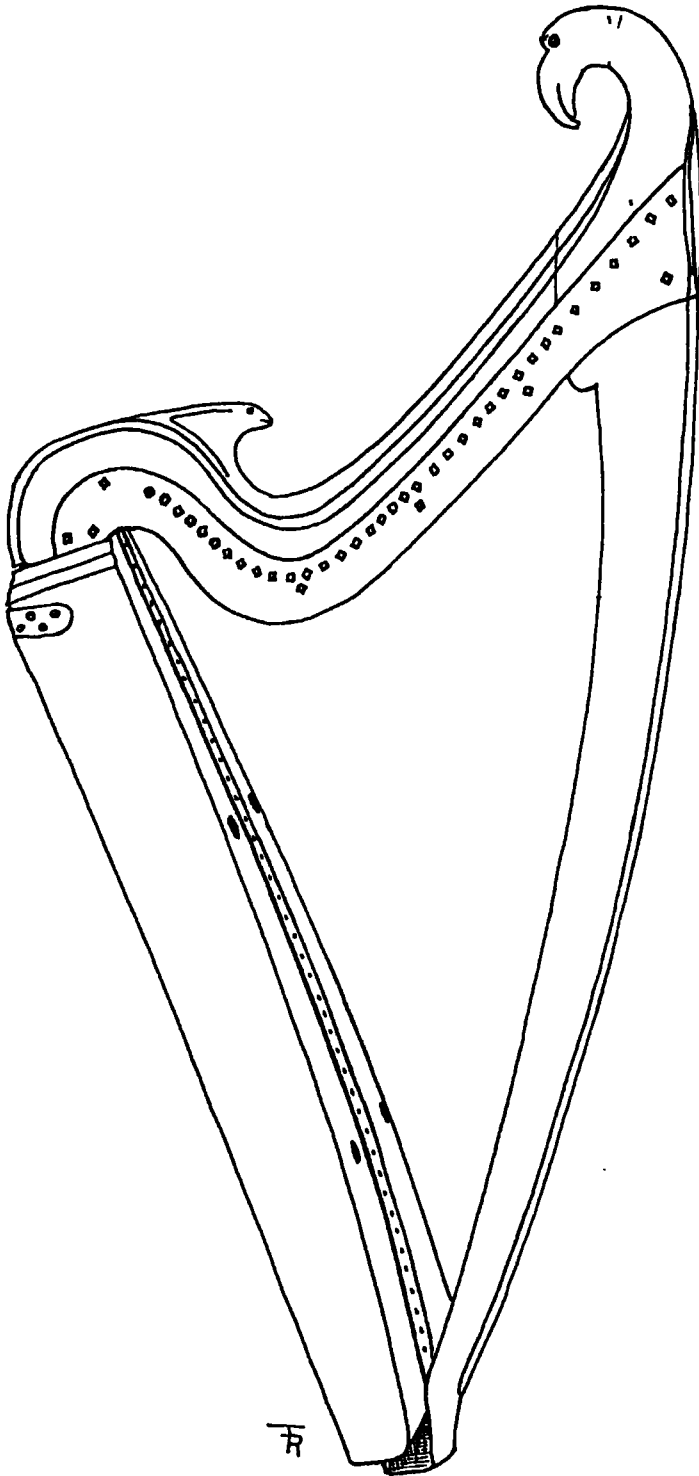

13 *The SIRR Harp* (18th century), National Museum of Ireland.

at the bottom. It is interesting to note the significant reduction in depth at the bass of the box. The soundboard is curved, 8.9cm wide at the top and 34.3cm wide at the bottom where it terminates in a straight edge, unlike some of the surviving examples from the seventeenth century. Four plain soundholes are cut into the soundboard and these are 2.2cm in diameter. The string band has been altered at some stage in the harp's history as it now consists of a brass strip pierced for forty two strings. There is no evidence of a carved, raised band. As there are only thirty six string holes on the soundboard, four holes in the bass and two in the treble of the brass strap are placed over solid wood and are therefore of no use. The only bracing associated with the soundbox is an external brass strap attached to the back near the top. The back panel of the box is made from spruce.

The harmonic bar is also cut from a solid piece of willow and it terminates at its peak, in a carving of a goshawk. The depth varies between 11.4cm in the treble and 10.2cm in the bass and its thickness is 5.1cm. The cross section of the bar is rectangular. The metal plates attached to either side of the bar for strength are considerably broader than those found on many earlier harps and another unusual feature is the addition of thirty six bridge pins, sited below the tuning pins which were consequently set at a higher position than the norm. This appears to be the influence of European design upon the native Irish school of harp making.³⁰ Thirty undecorated tuning pins remain in their original positions.

The forepillar, made of alder, is 111.8cm long, gently curved and

30 Joan Rimmer, 'The Morphology of the Irish Harp', 45.

has a 'T' section which runs its entire length. Its width varies between 2.4 and 2.9cm at the bottom and 5.1cm at the top while the 'T' is 8.3cm wide at its greatest breadth. The result of the great length of the pillar is a lowest string which is 101.6cm long. That of the Lamont harp was only 61cm. The shortest string of the SIRR harp is 7.6cm long.

Documentary Evidence and Pictorial Representations

Vicentio Galilei's Descriptions of the Irish Harp

Vicentio Galilei's *Dialogo... della musica antica e della moderna*, produced as a folio edition in Florence in 1581, provides a possible description of an Irish harp of that period. A translation is as follows:

...The harps used by these [Irish] people are greater than ordinary [harps]. They generally have strings of brass, with a few of steel for the highest notes, as in the harpsichord. The musicians keep their fingernails long, carefully shaping them in the manner of the quills with which the strings of the spinet are struck. The number of these is 54, 56 and even 60. However among the Hebrews we do find that the cithera or psaltery of the prophet passed the number of ten. A few months ago I carefully examined the distribution of the strings of this harp (with the assistance of a gentleman of Ireland) and I found it to be the same as that which a few years ago, with double the strings, was introduced in Italy, though some people (against every good reason) claim that they have newly invented it, and try to persuade the ignorant that only they know how to play and tune it.³¹

³¹ Vicentio Galilei, *Dialogo... della musica antica e della moderna* (Florence, 1951, repr., Rome, 1934), 143; Michael Billinge and Bonnie Shaljean, 'The Dalway or Fitzgerald harp', 180.

It would appear from this description that Galilei had examined a simple single-strung Irish harp which may well have conformed to the usual pattern of having approximately thirty strings. He refers in his writing to larger Irish harps being imported into Italy, but as he makes no specific reference to having examined one of these as well, we might assume that his information was at best, second hand. If the information about the number of strings was correct however, it is possible that these instruments were at least partly double strung and therefore had a chromatic capability.

Galilei gives an illustration (see Illustration 14) for the stringing of a double harp which places the accidentals on the player's left in the treble and on the right in the bass. This suggests the opposite practice to the Irish custom of playing the harp with the left hand in the treble position and it is therefore probable that the scale belongs to an Italian, gut-strung double harp.³²

Michael Praetorius' Description of the Irish Harp

In his *Syntagma Musicum*, Praetorius makes several references to the Irish harp. The first occurs in a section listing instruments which make use of wire strings (Section XV, 1. p.5), when discussing the manner in which they are played he states "Just with fingers alone: Pandora, Penorcon, Orpheoreon, Harpa Irlandica, Irlandische Harffe".³³ (See Illustration 15)

32 Michael Billinge and Bonnie Shaljean, 'The Dalway or Fitzgerald harp', 181.

33 Michael Praetorius, *Syntagma Musicum*, II (Wolfenbüttel, 1619, repr., Kassel, 1976), 5; translation and editorial, David Z. Crookes, Oxford, 1986), 5.

Illustration 14

Temperamento dell' Harpa.
Acuto.

parte destra	Ac.	parte sinistra
Ddd. 1		
Ccc. 2		1. X Ccc.
Bbb. 4		5. hhh.
Aaa. 6		7. Aaa.
Gg. 8		9. X. Gg.
Ff. 10		11. X. Ff.
Ee. 12		13. b. E.
E.d. 14		15. Dd.
Cc. 16		17. X. Cc.
Bb. 18		19. h h.
Aa. 10		21. Aa.
G. 21		23. X. G.
f. 24		25. X. f.
E. 16		27. b. c.
d. 28		29. d.
X. c. 30		31. c
h. 32		33. b.
a. 34		35. a.
X. G. 36		37. G.
X. F. 38		39. F.
b. E. 40		41. E.
D. 42		43. D.
X. C. 44		45. C.
h. 46		47. B.
A. 48		49. A.
X. r. 50		51. r.
X. FF. 52		53. FF.
b. EE. 54		55. EE.
DD. 56		57. DD.
		58. CC.

Cr. acc.

14 Vicentio Galilei, *Dialogo...della musica antica e della moderna* (Florence, 1581) p.146. The stringing system for a chromatic double harp.

DE ORGANOGRAPHIA.

5

Chorus seu Tympanischiza, ein Trumfscheide.

Dies ist ein Instrument ziemlich lenge / fast wie ein Balcke / auff welchen die vier Saiten mit einem Bogen werden angestimmt / vnd gibe einen Resonanz / gleich als wenns vier Trommeln wehren / vnd Clarien mit eingeblasen würde. Davon auch im 2. Theil.

3. Ist noch ein Instrument / an welchem zugleich die Clavier geschlagen / vnd die Saiten mit einem Rade / an statt des Bogens / erregt werden / Nemlich /

Lyra Rustica, seu pagana, ein gemeine Lyra.

XV.

Dies Instrumenta / welche jetzt erzehlet haben (wie gesaget) Drumsaiten. Nun folgen welche mit Ersaiten (auß Silber / Eysen / Stahl oder Messing gezogen) bezogen werden. Vnd werden dieselbige klingend gemacht oder geschlagen ;

1. Nur mit den blossen Fingern / als /

Pandora, Penorcon, Orpheoreon, Harpa Irlandica, Irli-
dische Harffe.

2. Ersliche aber mit einem Federkleschen / als da ist:

Cithara, die Cither.

3. In Irlichen werden die Saiten mit Waben Feddern / so in die hölzernerne Tangen-
ten eingefügt / angeschlagen / als da seyn:

Instrumentum specialiter sic dictum, Virginal, Spinetta,

Clavicymbalum, Clavicytherium, ein Instrument ;

Arpichordium, Clavichordium.

4. Ersliche aber mit hölzen Klöppeln intoniret, als:

Sambuca, Barbyrus, ein Hackebret.

XVI.

Vnd alle diese bisher erzehlete Instrumenta können prima genennet werden / zum Unterscheid der nachfolgenden / welche als à primis orta aus den vorhergehenden gleichsam zusammen gesetzt seyn / als da ist. 1. Claviorganum, welches ein Instrument ist / da nicht allein die Pfeiffen durch die Blasebälge / sondern auch die Saiten durch die Federkleschen / mit anschlagen / der Clavierstimmen / klingend gemacht werden / vnd also einen lieblichen schall von sich geben.

2. Crembalum, ein Drumsaiten / zu welchem / wenn es sol Thönend gemacht werden / der Menschliche Athem / gleich wie in den andern blasenden Instrumenten / auch helfen / vnd zugleich mit dem Finger geschlagen werden muß. Vnd auff solche Weise / sind diese Instrumenten / Mixta oder vermischet genennet werden.

X VI

XVII. Bud

15 Michael Praetorius, *Syntagma Musicum II*, p.5. A list of instruments making use of wire strings including the Irish harp.

The reference to the performance of the Irish harp with fingers alone is interesting as it could suggest a move from the use of long finger nails as practised in Ireland at that time. It is also possible that techniques of playing the instrument varied from country to country, and that by 1619, there was no international consensus on using nails or fingers to pluck the strings. The major consideration is whether the observation made was accurate in the first place. In the same section Praetorius describes the strings of a clavichord as being "struck with raven feathers inserted into wooden tangents" in the manner of a harpsichord. This is clearly inaccurate, and though it is quite possible that Praetorius may never have seen an Irish harp being played, it is very probable that he was well acquainted with the clavichord. Inaccuracies in *Syntagma Musicum* are also reflected in the illustrations at the end of this particular volume, both the Irish harp featured on Plate XVII, and the clavichord illustrated on Plate XV are printed back to front.

The second reference to the Irish harp in *Syntagma Musicum* is in the short table which compares the range of the instrument with that of the double and single strung harps.³⁴ (See Illustration 16.) The compass given for the Irish harp is four and a half octaves from C to e''' "with semitones". As the comparative compass given for the double harp is four octaves from C to c''' with "all semitones", we can assume that the Irish harp he described was not fully chromatic.

The third description of an Irish harp appears on a page which examines three types of harp as well as giving lists of their

34 Michael Praetorius, *Syntagma Musicum*, 30.

Illustration 16

30.

Signa.	S:ffen.		
aa	♯	♯	♯
bb	♭		
g			
f			
d			
f	♯		
c		♯	♯
f			
c			
	Einfa: che Sarff.	Mit allen Semitonis.	Mit den Semitonis.
		Woppe: Sarff.	Irish: ische Sarff.

Was ferner die rektirende Instrumenta, sub numeris subsequentibus 33-34. 35-36. &c. belangen thut, ist vnrnuechten dieselbe alhier in diese Tabell mit einzu-
bringen; Sineernahl in nachfolgender deroeselen eigendliche Erckdhrung
hntzen an gungfamer Bericht darvon zu finden.

Das V. Capittel.

Derweill Ich aber am Ende des Ersten Theils dieses Tomi Se-
cundi, die Instrumenta in Inflatilia & Fidicina, in Blasende vnd
Besaitete abgetheilet:

So folget nun alhier

Erstlich

Von Blasenden Instrumenten/

Itali,

INSTRUMENTA DA FIATO.

Als da seynd:

Trombo.

16 Michael Praetorius, *Syntagma Musicum II*, p.30. A table showing the comparative compasses and use of semitones in three different types of harp (including an Irish harp).

stringing.³⁵ Praetorius states that "The Irish harp, or Harpa Irlandica, has forty three very heavy-gauge brass strings which produce a sweet, gentle sound, as we would expect." The description, together with the stringing scale and a transcription of the scale by the translator and editor Harold Blumenfeld, *Michael Praetorius, Syntagma Musicum* (New York, 1980) are featured in Illustration 17. It is apparent from the scale that the harp was diatonic from C to a, and chromatic from b^b to c#'''. In some cases, the order in which the strings are given on the list makes no logical sense. Having ascended up the scale from C, the notes start to go down and up the scale in the chromatic section. Interestingly, neither of the first two references to the Irish harp by Praetorius are mentioned by Michael Billinge and Bonnie Shaljean who state (when referring to the third reference) that "...these few lines (his entire writings on the Irish harp) are only part of a large work...."³⁶ Billinge and Shaljean do however give a possible interpretation of the tuning method of Praetorius' Irish harp and this is given in Example 5. It is worth noting that Praetorius (like Galilei) specifies a B^b in the bass strings suggesting that the harp was tuned to a diatonic scale in the key of F with the addition of accidentals in the mid and upper range. This may be the reason why Billinge and Shaljean, in their "possible interpretation" of the Praetorius scale, have placed b, b' and b'' in the row of strings which would otherwise all be accidentals.

Even applying the system of ascending or descending according to the use of the left or right hand, as used in Praetorius' description of

³⁵ Michael Praetorius, *Syntagma Musicum*, 54.

³⁶ Michael Billinge and Bonnie Shaljean, 'The Dalway or Fitzgerald harp', 181.

Example 5

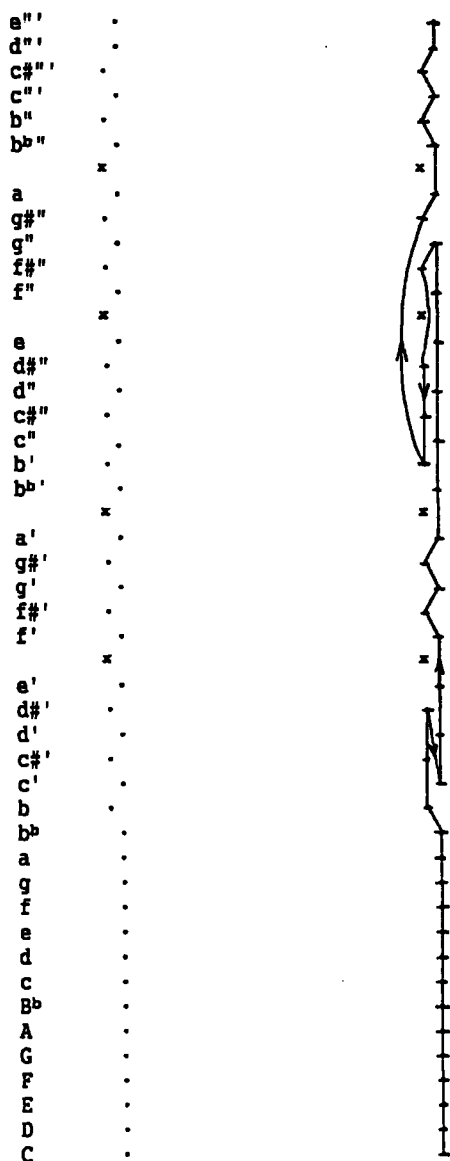

A route which Praetorius may have used to record the tuning of an Irish harp (as suggested by Michael Billinge and Bonnie Shaljean). Billinge and Shaljean give no explanation for those string positions marked thus: x, we must assume that the strings in these positions are unnecessary.

the large double harp, fails to produce a workable solution. Another factor which may be taken into account is the fact that the scale, as printed for Praetorius, includes a few strings placed below the rest in a central position, similar to the extra set of tuning pins to be found on the harmonic bar of the Dalway harp. Unfortunately the pitch and resulting relatively short length of these strings (g'' to d'''), suggests that they belong to the top of the harp and not to their central position in the diagram. We must therefore conclude that a printing error occurred and that the book was not properly proof-read.

Assuming that the number and pitch of the notes described by Praetorius are correct, despite their unexpected order, it is surprising that the chromatic section starts as high up the scale as it does. One of the advantages of a chromatic section would have been the greater ability to modulate. During the earlier decades of the seventeenth century, most keyboards with short octave tuning, or lutes with diapason strings, were chromatic from a much lower point in their compass.³⁷ It appears that the Irish harp observed by Praetorius displayed a compromise in this respect.

Another point worthy of note is the fact that no strings are duplicated as one would expect of a chromatic harp with an overlapping section. It is therefore possible to assume that the harp was single strung up to a, and double strung from there up to the top of the treble. The usual practice for stringing double harps was to place the accidentals behind the naturals (or diatonic scale) and, as performers of the Irish harp used their left hand to play the treble strings, we

³⁷ Diana Poulton, *John Dowland* (London, 1972, 2nd edn., London, 1982), 457.

can assume that the accidental strings were placed on the harper's right hand side.

The fourth reference to the Irish harp by Praetorius is the previously-mentioned illustration of the instrument to be found, back to front, on Plate XVIII (see Illustration 18). This illustration depicts an Irish harp with a convex sound box, tapered towards the bass. As in the manner of more ancient examples such as the Lamont harp, the harmonic bar has only one metal brass strap on each side (presumably due to contemporary practice), unlike the Dalway harp. The metal strapwork uniting the forepillar and neck is very reminiscent of the Ballinderry fragments, while the 'T' section of the pillar is very like those carved on the Trinity College and Queen Mary harps. The Praetorius engraving has forty three strings as described in the text. The metal strap round the treble of the harp is interesting and it may suggest that attempts were made to strengthen the soundbox of this harp at an early stage in its existence, possibly even from the beginning.

Writing in 1964, Joan Rimmer says of Praetorius' writings:

I think that there must have been some abortive attempts at the beginning of the seventeenth century to make the Irish harp at least partly chromatic. Praetorius said that the Irish harp had forty-three strings - an unlikely number for a diatonically-tuned instrument which would have come out at six octaves. He also gave an inconsistent and improbable partly-chromatic tuning.³⁸

Though not giving any practical suggestion how this view might be applied, Rimmer does go on to draw a comparison between this description and the remains of the Dalway harp. This is in contrast with

38 Joan Rimmer, 'Harps in the Baroque Era', *Royal Musical Association Research Chronicle* (1964), 62-3.

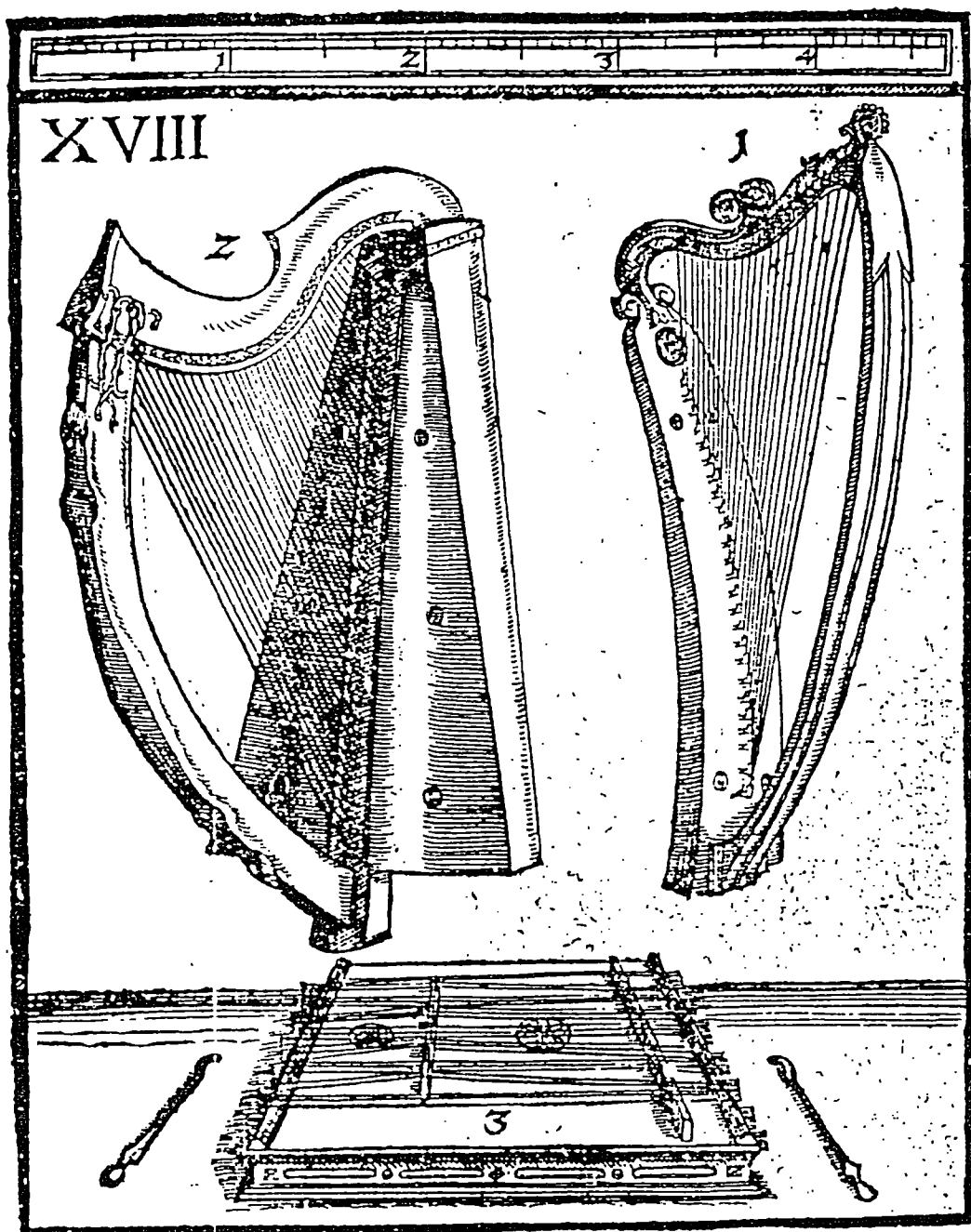

1. Gemeine Harff. 2. Irlandisch Harff mit Messingenen Saiten 3. Harfeneck.

18 Michael Praetorius. *Syntagma Musicum II*, Plate XVIII. An illustration of an Irish harp is featured at the top left hand side.

her earlier suggestion (quoted in the section concerning the Dalway harp) that the extra row of strings was probably sympathetic.

Francis Bacon

Descriptions of the Irish harp appear in Francis Bacon's *Sylva Sylvarum*.³⁹ The passages are not in any great detail however and they offer no clues as to the stringing scales or patterns used on instruments seen and heard by the writer. His accounts are as follows:

The *Harpe* hath the *Concaue* not along the *Strings*, but across the *Strings*, and no *Instrument* hath the *Sound* so *Melting* and *Prolonged*, as the *Irish Harpe*. So as I suppose, that if a *Virginall* were made with a double *Concaue*; the one all the length as the *Virginall* hath; the other at the End of the *Strings* as the *Harpe* hath; It must needs make the *Sound* perfecter, and not so *Shallow* and *Iarring*. You may trie it, without any *Sound-Board* along but only *Harpe-wise*, at one end of the *Strings*; Or lastly with a double *Concaue*, at Each end of the *Strings* one.

Trial may also be made of an Irish harp, with a *concaue* on both sides; whereas it useth to have it but on one side. The doubt may be, lest it should make too much *resounding*, whereby one note would overtake another.

An *Irish Harpe* hath *Open Aire* on both sides of the *Strings*: And it hath the *Concaue* or *Belly*, not along the *Strings*, but at the end of the *Strings*. It maketh a more *Resounding Sound*, than a *Bandora*, *Opharion*, or *Citterne*, which haue likewise *Wire-strings*. I judge the *Cause* to be, for that *Open Aire* on both Sides helpeth, so that there be a *Concaue*; which is best placed at the end.

Other than demonstrating his enthusiasm for the Irish harp and making suggestions for developing the virginal in a similar manner, Bacon adds little to our technical knowledge of the instrument.

³⁹ Francis Bacon, *Sylva Sylvarum* (London, 1627, ed. James Spedding, Robert Ellis & Douglas Heath, London, 1876), 420, 422, 399-400.

James Talbot's Manuscript (Och.Ch. Mus.MS 1187)

The notes made by James Talbot, Regius Professor of Hebrew at Cambridge from 1689 to 1704, include descriptions of specific Irish harps as well as making passing reference to their manufacture in England during that period.⁴⁰ His references to stringing are particularly interesting as one of the instruments which he describes has forty three strings, the same number as that quoted by Praetorius. His notes are worth quoting in full.⁴¹

Irish Harp (1)

Carries 42 single brass strings, some 40. Suppose for CC (some 36 at least)

Body of Willow (Belly and sides of one piece). Back Oak. Bow and Head ditto. in England Body, Bow and Head Wallnut back Oak.

On the Belly a number of Brass loops and in the Head Brass Cheeks of each side to prevent pins turning by draught of strings.

In the upper cheek 27 Pins in some only one cheek.

Instrument tuned gradually from the highest treble to half in 43 tune 21 gradually afterwards the 22nd is a unison (these two called a Wolf) from them bring the rest up gradually by octaves Bow crooked outwards. Soundholes.

Body 3f.6'. Breadth below 1f.7' above 5'.

Bow's sweep outward 4f. short of head to whose end from Bow 1f.2'. Depth 4'. Body very thick near 4".

Irish Harp (2)

It carries from 40 to 43 single strings (some lately made in England usually 35) Its Body is of Willow (whose Belly and sides are of one piece) its BackBow and Head of Irish Oak. In England Body Bow and Head Wallnut. Back Oak. This instrument being tun'd with Brass strings which draw hard by hand must be strengthened by Brass cheeks on each side to which the Pins are fitted to prevent their turning round by the draught of the strings.

Answerable to the number of Pins in the head are the Brass loops in the Belly through which strings pass from the head and are fastened on the inside by a Noose drawn over a bit of wood.

The instrument tun'd gradually from the highest Treble to the middle insert then a Unison those two call'd a Wolf the rest

⁴⁰ Joan Rimmer, 'James Talbot's Manuscript IV -Harps' [Oxford, Christ Church. Mus. MS 1187], *Galpin Society Journal*, XVI (1963), 66-7.

⁴¹ Michael Praetorius, *Syntagma Musicum*, 54.

arrived gradually thus supposing that in 36 strings the first is ggg the last GG which includes 5 octaves the Wolf should be about C (if not g).

The Bow of the Instrument is crooked sweeping outwards and coming short of the drop of the head 1f.2".

The Body is very thick not less than 4" to bear the draught of strings. The Depth is but 4' the back flat.

The first description of a harp appears to encompass several instruments, as the numbers of strings vary between 42, 40 and 36. This is developed further when Talbot goes on to describe the harmonic bar and forepillar of the instruments as being manufactured in oak as well as providing an alternative (walnut) for instruments made in England. This is a very important reference as it infers that there was another, 'Anglo Irish' school of harp making. It is tempting to suppose that an Anglo Irish tradition of manufacture could provide instruments capable of performing sophisticated English 'Art Music' of the period.

Talbot also refers to an upper cheek, possibly suggesting more than one brass cheek on each side of the harmonic bar, similar to the Dalway harp. This could infer some form of double stringing, or even chromatic tuning. An instrument with 42 strings would have had a compass of almost six octaves if it were tuned diatonically, and even strung in brass, it would have had to be far larger than five feet if it were going to do justice to the increased bass register.

It should be remembered that the most sophisticated harpsichords of the late-seventeenth century had a compass of five octaves, and even this was frequently achieved with the aid of a short octave in the bass. If the harp had a compass of approximately four octaves, which would be probable considering its size and string lengths, there would be several 'spare' strings left over for chromatic purposes. Suppose the harp had a

range of just over four octaves, C to d''' for example, thirty strings could be diatonic leaving twelve available for accidentals or duplication.

Talbot does refer to tuning in his notes, but not in enough detail to determine the relative pitch of each string. One interesting reference is to the 'Wolf', two strings tuned in unison at some mid point in the compass. This feature is referred to by Edward Bunting in his description of the practice of tuning the instrument (by musicians in 1792) where he calls the two strings in question 'The Sisters'.⁴² (See Example 6) It is difficult to understand why the harps were tuned in this manner as it would appear to be a waste of a valuable string or note, particularly when one other, (F) was missing in the bass. Joan Rimmer describes the function of the duplication of these two notes as being "obscure".⁴³

Example 6

The tuning of an Irish harp as recorded by Edward Bunting in 1792.



⁴² Edward Bunting, *The Ancient Music of Ireland* (Dublin, 1840, repr., Dublin, 1969), 23.

⁴³ Joan Rimmer, 'James Talbot's Manuscript VI - Harps', 71.

The remainder of Talbot's description conforms to that of a large low-headed Irish harp. The dimensions and information concerning details, such as appearance and the presence of soundholes, offer no other surprises.

Talbot's second description of an Irish harp differs slightly from his first. Once again he appears to be making observations about several instruments, as different numbers of strings are given as well as passing reference to Irish harps being made in England. In this set of notes, he describes an Irish harp as having 40 to 43 strings, while some examples recently made in England had 35. The reduced number of strings for those instruments manufactured in England, suggests that an 'Anglo Irish school' was producing harps for less sophisticated music than those being made in Ireland. This rather contradicts some of the conclusions which may be drawn from the first description.

The remainder of the second description is very similar to the first and the harp described also conforms to that which one might expect from a large low-headed harp. Talbot does give a suggestion as to the pitch of the harp (assuming it had a compass of five octaves and a top note of g'''). If this is an 'Anglo Irish' harp (it has 36 notes as opposed to 40 or 43), it should be noted that it has a similar compass to the Thomas Hitchcock harpsichord in the Victoria and Albert Museum, which belongs to the first three decades of the eighteenth century.⁴⁴ Earlier English harpsichords and virginals rarely had a compass which extended beyond d'''.

⁴⁴ Raymond Russell, *The Harpsichord and Clavichord* (London, 1959, repr., Glasgow, 1973), 74.

Joan Rimmer expresses surprise that no mention is made of a difference in the depth of the soundbox between the treble and the bass, as might be expected at this period.⁴⁵ This possible lack of detail is a feature of both descriptions.

Other Possible References to Irish Chromatic Harps

Some other references to harps which could have held a significant place in the development of the Irish chromatic harp do occur, but these are frequently ambiguous in their description. Bunting refers to the writings of titular archdeacon Lynch of Tuam who stated that in the fifteenth century: 'Robert Nugent, a jesuit, who resided some time in this country, then improved it by enclosing an open space between the trunk and upper arm, covering with a lattice work of wood the sound holes on the right side, and placing a double row of chords on each side.'⁴⁶ It is difficult to imagine what this instrument may have looked like but the concept of a double row of chords is interesting.

Gratton Flood states that 'About the year 1584, Wiliam Bothe a young Dublin student at Oxford... presented Queen Elizabeth with a harp of new device.'⁴⁷ While the temptation to link references to Ireland with a new form of harp and arrive at the conclusion that Bothe was the inventor of the Irish chromatic harp are great, there is insufficient evidence to form this interpretation. Another quotation refers to a highly esteemed harper Nicholas dall [blind] Pierse (1561-1653) for:

45 Joan Rimmer, 'James Talbot's Manuscript VI - Harps', 71.

46 Edward Bunting, *A General Collection of the Ancient Music of Ireland* (London, 1809, repr. Dublin, 1969), 24; Robert Bruce Armstrong, *The Irish and the Highland Harps*, 33.

47 W.H. Gratton Flood, *The Story of the Harp* (Dublin, 1905), 75; Michael Billinge and Bonnie Shaljean, 'The Dalway or Fitzgerald harp', 183.

'completing [the] said instrument [harp] with more wires than ever before his time were used.'⁴⁸ Once again, without further information regarding such important facts as string disposition and compass, we cannot form an accurate impression of the role which Pierse and his instrument might take in the history of the Irish chromatic harp.

Finally, another reference is quoted by Brendan Jennings in his book *Wild Geese in Spanish Flanders*. Juan de Neocalde [Ambassador to England] writes in a letter to Martin de Arpe, dated 16 March 1635: 'An Irish Catholic Gentleman, Earl of Westmeath has arrived [in London]. He came to see me upon his return from Italy. Will visit Flanders and His Highness. He has an unusual kind of harp to present to his Highness, as he has heard that he likes music. He left instructions that it should be given to me after it had been put in order and tuned; so when they deliver it to me, I will send it.'⁴⁹ Here too there is the possibility of linking Irish connections with what is regarded as an extraordinary type of harp. Again, the description of the instrument is too vague to draw any conclusions as to its being an Irish chromatic harp.

A Portrait by Reinhold Timm (See Illustration 19)

The portrait of a group of musicians from the court of King Christian IV of Denmark, by Reinhold Timm (now in private hands in the Netherlands), is a unique documentation of the use of an Irish harp in consort music during the seventeenth century. Timm, a painter influenced

48 Michael Billinge and Bonnie Shaljean, 'The Dalway or Fitzgerald harp', 184; J.H. Pierse, 'Nicholas dall Pierse', *Journal of the Kerry Archaeological and Historical Society*, VI (1973), 40, 67.

49 Brendan Jennings, *Wild Geese in Spanish Flanders [1582-1700]* (Dublin, 1964), p281.

Illustration 19



19 Reinhold Timm, *A group portrait of musicians at the court of King Christian IV of Denmark* (c1622-25)

Some Conclusions Regarding the Development of the Irish Harp

The basic construction of the Irish harp remained fairly constant from the fourteenth to the seventeenth centuries. The bass strings in the earlier instruments are relatively short and this resulted in the triangular instrument referred to as the small low-headed harp. By the late-sixteenth century, Irish harps became larger with the addition of a few more strings, but despite this, they retained their basic proportions. These larger instruments, typified by the Otway and Kildare harps, fall into the category of large low-headed harps. By the end of the seventeenth century, the harps had become taller with comparatively longer bass strings and consequently a long forepillar. These later instruments are known as high-headed harps.

The design of the sound box did not change a great deal from the fourteenth to the beginning of the seventeenth century. It always consisted of a hollowed out block of wood which was broader in the bass than in the treble. A carved, raised string band was pierced for string holes and a series of metal shoes were added to act as bridges and to help transmit the sound, as well as protecting the wood surrounding the hole. At a later stage this system was simplified by the employment of pierced brass strips instead of the employment of individual shoes. On the earliest examples, the depth of the soundbox was approximately the same from top to bottom, but by the mid-seventeenth century, the bass end was considerably more shallow than the treble.

Similarly, the design of the forepillar did not change a great deal either. The basic form of a curved piece of timber reinforced by a wide 'T' section remained constant, though the length of this component did gradually increase together with the length of the bass strings. It

remains a matter of conjecture as to whether the increase in the length of the bass strings was linked in some way to the reduction in the depth of the soundbox at the bottom of the harps. Longer strings may have been more sonorous and as a result, louder in comparison with those of the treble. A shallow bass end to the soundbox may have been an attempt to redress this imbalance.

The neck shape and details of Irish harps also remained basically the same from the fourteenth to the seventeenth century, apart from the increase in the number of string holes from about thirty to thirty six. The most significant difference which we find in a surviving harp is the great change in the number and disposition of string holes which occurs on the Dalway harp. The 52 strings which this instrument had are more similar in number to Irish harps described by Galilei (54, 56 and 60), Praetorius (43) and Talbot (35, 36 and 40 to 43), than to any other surviving Irish harp. It is apparent that if the Dalway harp were to be tuned diatonically, it would have a compass of well over six octaves and that the bass strings would not be long enough to provide the notes required for such a range. Even towards the end of the eighteenth century, the most sophisticated harpsichords were not provided with such an extended compass.⁵³

Clearly the extra strings of the Dalway harp (and those described by Talbot and Galilei) were intended for some other purpose, such as the chromatic capability which was then available to the performers of Continental double harps. We have seen that Praetorius in particular, mentions the chromatic capability of the Irish harp. Many instruments of the early-seventeenth century did not require chromaticism throughout

⁵³ Raymond Russell, *The Harpsichord and Clavichord*, 17.

their compass and diatonic basses were common on lutes, virginals and organs. A result of this was the proliferation of 'short octave' basses in keyboard instruments before the period known as the 'ravalement'. The relatively wide spaces provided between the bottom eleven tuning pins of the Dalway harp suggest that this section of the instrument was also diatonic. It is the close nature of the higher strings, and in particular, the extra row of seven in the centre, which suggest a more complicated arrangement in the treble. The suggestions for stringing and tuning the Dalway harp, by Michael Billinge and Bonnie Shaljean in *Early Music* (Examples I and 2 in this Chapter) are conjectural and one might question the duplication of notes in both accidental and natural rows of strings. Nevertheless, their scales do present a good argument for an Irish harp which was diatonic in the bass and chromatic from mid compass upwards, using a combination of triple and double stringing.

The painting, by Reinhold Timm, of an Irish harp being played in a consort of music also suggests that there is a good case for proposing the existence of an Irish harp of chromatic capability. English consort music of the late-sixteenth and early-seventeenth centuries became very sophisticated and an instrument with a chromatic mid and upper range would have been essential to cope with the increased use of modulation which took place during this period. If the Dalway harp was chromatic as suggested, it represents a high point in the development of the Irish harp. No other Irish harp has survived which has the capability of such chromaticism. What is apparent, is that by the mid-eighteenth century, the Irish harp had returned to its less complex form, despite having grown in size. The SIRR harp has none of the sophisticated possibilities suggested by the remains of the Dalway harp.

Other than the household of Sir John Fitzgerald of Cloyne, there is little evidence to suggest that the native school of Irish harpers and patrons experimented with chromaticism in their music or instruments throughout the seventeenth and eighteenth centuries. Even Turlough Carolan, the highly renowned Irish harper of the early-eighteenth century, worked within the limitations of a diatonic compass, despite being influenced by such European masters as Geminiani and Corelli. The evidence examined in this chapter suggests that the Dalway harp was possibly an example of an 'Anglo Irish' style of harp being 'bought back' to its country of generic origin. The probability that its maker, Donnchade Fitz Teigh, was Irish suggests that the instrument was copied from another example, possibly hailing from England. Whether Fitz Teigh saw the original on a visit to England or at another Irish household remains a matter of conjecture.

CHAPTER 4

William Lawes' 'Harpe' Consorts

Sources - See Appendix A

The Harp Consorts of William Lawes are written for violin, bass viol, theorbo and harp, thus constituting a broken consort. They consist of thirty movements, most of which are dances, and are arranged by key into eleven 'setts'. There are three principal sources for these pieces. These are: bound sets of autograph parts in the Bodleian Library, Oxford, Ob. MS Mus.Sch.D 229 and D 238-40; an autograph score also in the Bodleian Library, Ob. MS Mus.Sch. B3; and a partbook for harp (not autograph) in the hand of Oxford musician, Francis Withy (Withie), in the library of Christ Church, Oxford, Och. Mus.MS 5.¹

The bound parts Ob. Mus.Sch.D 229 and D 238-40 (Illustrations 1 and 2) include a complete set of parts for all thirty movements for the violin, bass viol and theorbo. Harp parts in this source exist only for the first eight movements but these display Lawes' probable intention for the treble and bass lines only, as no inner harmonisation is included. The score Ob. MS Mus.Sch. B3 (Illustration 3) includes complete parts for the last five movements of the 'Harpe' Consorts. The harp parts in this source are fully worked and include inner lines. They represent the only complete autograph harp parts by Lawes known to exist.

The harp part book Och. Mus.MS 5 (Illustration 4) includes harp

¹ Norman Josephs, 'John Withy', *The New Grove Dictionary Of Music and Musicians* (London, 1980), XX, 464-5; Peter Holman, 'The harp in Stuart England', *Early Music*, XV (1987), 201.

Illustration 1

The image displays two pages of handwritten musical notation for harp. The top page, labeled '1', contains two staves of music. The first staff is marked 'Allegretto' and the second 'Allegro'. The bottom page, labeled '2', contains two staves of music. The first staff is marked 'Cavat' and the second 'Cavat'. The notation is dense and characteristic of 18th-century manuscript notation, with many notes and ornaments. There are some ink blots and corrections throughout the score.

1. William Lawes' 'Harpe' Consorts, movements 1 and 2, autograph harp parts.

Ob. MS Mus. Sch. D 229, f. 34v, the Bodleian Library, Oxford.

Illustration 2

Handwritten musical notation for movement 28. The page is numbered '28' in the top left. It features seven staves of music. The first staff is a lute tablature with letters 'a', 'b', 'c', 'd', 'e', 'f', 'g' and a sharp sign. The second staff is a theorbos part, marked with a sharp sign and the name 'Paum'. The remaining five staves continue the theorbos part with various rhythmic and melodic patterns.

Handwritten musical notation for movement 29. The page is numbered '29' in the top left. It features seven staves of music. The first staff is a lute tablature with letters 'a', 'b', 'c', 'd', 'e', 'f', 'g' and a sharp sign. The second staff is a theorbos part, marked with a sharp sign and the name 'Paum'. The remaining five staves continue the theorbos part with various rhythmic and melodic patterns.

2. William Lawes' 'Harpe' Consorts, movements 28 and 29, theorbos part giving Lawes' attribution to Cormacke and Coprario. Ob. MS Mus. Sch. D 238, ff.42v and 43r, the Bodleian library, Oxford.

Illustration 3

The image displays a handwritten musical score for a piece titled 'Paven'. The score is written on ten staves, arranged in two systems of five staves each. The notation is dense and characteristic of early modern manuscript notation, featuring various rhythmic values, accidentals, and clefs. The first staff begins with a treble clef and a common time signature. The word 'Paven' is written in a decorative, calligraphic hand below the first staff. The score includes numerous slurs, ornaments, and dynamic markings, typical of the style of William Lawes. The manuscript is well-preserved, showing clear ink and distinct staff lines.

3. William Lawes' 'Harpe' Consorts, first page of movement 30, Paven on a theme by Cormacke showing layout of the score, autograph. Ob. MS Mus. Sch. B3, p.39, the Bodleian Library, Oxford.

Illustration 4

The image displays a handwritten musical score for a harp part, organized into five systems. Each system consists of two staves: the upper staff is in treble clef and the lower staff is in bass clef. The notation is dense and includes various rhythmic values, accidentals, and dynamic markings. The first system is marked with a '1.' and a common time signature. The second system is marked with a '2.' and a common time signature. The third system is marked with a '3.' and a common time signature. The fourth system is marked with a '4.' and a common time signature. The fifth system is marked with a '5.' and a common time signature. The score concludes with a double bar line and repeat signs.

4. William Lawes' 'Harpe' Consorts, movement 1, harp part in the hand of Francis Withy.
Och. Mus. MS 5, f.1r, the Library of Christ Church, Oxford.

parts for the first twenty movements and no 26 (Aire) of Lawes' 'Harpe' Consorts at the beginning of the volume. In addition there is another movement, numbered 21 in this source, which bears no relation to any parts in Ob. Mus.Sch.D 229. Furthermore, harp parts for a collection of unattributed consorts are included at the back of Och. Mus.MS 5 and these will be discussed later.

The sources for William Lawes' 'Harpe' Consorts are shown in Table 1. It should be noted that Lefkowitz was the first person to catalogue these works and that the consort numbers are therefore his.² The movement numbers correspond to those in Lawes' own hand in the part books for violin, theorbo and bass viol.

In addition to these sources, a selection of the shorter dance movements (1-16) were published by John Playford and are to be found in his *Courtly Masking Ayres* (London, 1662), and *A Musical Banquet* (London, 1651). Playford was clearly publishing for as wide a market as possible and so presented the music in a form which made it available to many potential customers (see Illustrations 5 and 6). He therefore omitted the complicated divisions, which demanded a great deal of skill from the bass viol and violin players, as well as the harp part. In their published form, the movements consisted of only a treble and unfigured bass, thus stripping Lawes' work of its conceived complexities of structure, harmony and texture. From the simplifications made, we can deduce that the amateur music makers who bought the printed music from Playford were not as skilled as the court musicians of King Charles I, and that they had no great desire (or had the opportunity taken away

² Murray Lefkowitz, *William Lawes* (London, 1960), 268-9.

Table 1
'Harpe Consorts' of William Lawes

	P	H	H	V	B	T	F
	A	A	A	I	A	H	U
	R	R	R	O	S	E	L
	T	P	P	L	S	O	L
				I		R	
				N	V	B	S
	O.				I	O	C
					O		O
					L		R
Consort							E
No I in G Minor						D 238 &	
Almane	1	D 229	Mus.MS 5	D 240	D 229	D 239	B3
Corant	2	"	"	"	"	"	
Corant	3	"	"	"	"	"	
Saraband	4	"	"	"	"	"	
No II in G Minor							
Aire	5	"	"	"	"	"	
Corant	6	"	"	"	"	"	
Corant	7	"	"	"	"	"	
Saraband	8	"	"	"	"	"	
No III in G Major							
Almane	9		"	"	"	"	
Corant	10		"	"	"	"	
Corant	11		"	"	"	"	
Saraband	12		"	"	"	"	
No IV in D Minor							
Aire	13		"	"	"	"	
Aire	14		"	"	"	"	
Corant	15		"	"	"	"	
Saraband	16		"	"	"	"	
No V in D Major							
Almane	17		"	"	"	"	
Corant	18		"	"	"	"	
Corant	19		"	"	"	"	
Saraband	20		"	"	"	"	
No VI in D Major							
Almane	21			"	"	"	
Almane	22			"	"	"	
Corant	23			"	"	"	
Corant	24			"	"	"	
Saraband	25			"	"	"	
No VII in G Major							
Aire	26		"	"	"	"	"
No VIII in G Major							
Paven	27			"	"	"	"
No IX in G Dorian							
Paven	28			"	"	"	"
(Theme by Cormacke)							
No X in G Minor							
Paven	29			"	"	"	"
(Theme by Coperario)							
No XI in D Minor							
Fantazy	30			"	"	"	"

COURT-AYRES:

OR,
Pavins, Almains, Corants, and Sarabands, of two parts,

TREBLE & BASSE, for VIOLS or VIOLINS.

Which may be performed in Confort to the *Theorbo Lute, or Virginals.*



TREBLE.

LONDON, Printed for *John Playford*, at his Shop in the Temple, 1655.

- 5. William Lawes' 'Harpe' Consorts, Court Ayres, ed. John Playford (London, 1665)
K4 a4. preface, the British Library.

Mr. William Lawes.

Treble.

14 4:2

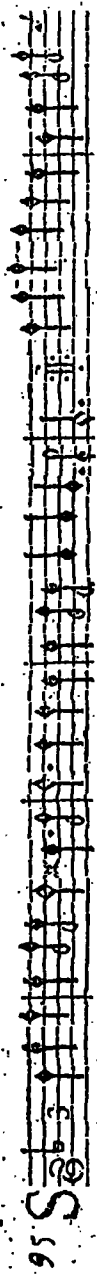
95 S  Araband.

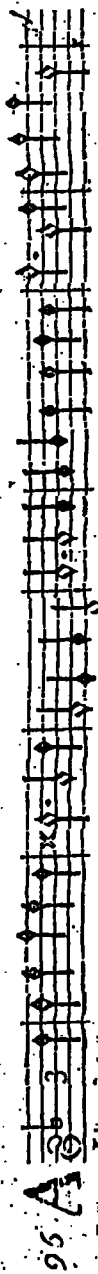
96 A  Jiggc.

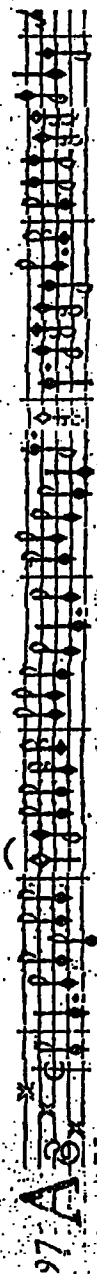
97 A  Yrc.

6. William Lawes' 'Harpe' Consorts, movement 16, *Court Ayres*, ed. John Playford (London, 1655)
K4 a4. p44, no 95, the British Library.

from them) to attempt the challenges presented by the divisions of the composer. The exclusion of the harp part may be explained by a lack of instruments and harpers among the amateur music makers of the period. Playford was running a profitable business and was unlikely to allow respect for a dead composer's original intentions to interfere with his source of income.

Curiously, the omission also suggests that Playford failed to value the concertante interplay between the violin and the treble register of the harp, a feature to be discussed later. Perhaps he felt that the violin part was able to stand on its own regardless of the composer's concept. Certainly, manuscripts of this body of work were made available to Playford and it is a tantalising thought that these may have included the missing Lawes' harp parts from the first six 'Harpe' Consorts, even if these were rejected for publication. Of course it is equally possible that the omission of the harp parts was due to them not being available to Playford. Could it be that they were already lost and separated from the parts for violin, bass viol and theorbo?

From the point of view of seventeenth-century music marketing, this is very different to the approach of Martin Peerson, who in the preface to his *Mottects or Grave Chamber Musique* (London, 1630) presents the purchaser with "five parts of severall sorts, some full, and some verse and chorus, but all fit for voyces and viols", including a figured bass which he suggests may be played upon "Organs, virginals, base-lute, bandora or Irish harpe". Here the music was composed with a view to publishing and the composer took great pains to point out that the work could be played upon almost any combination of voices and instruments to

hand. Virtuoso divisions were not expected of the performers, though an ability to work from a figured bass was an advantage.

Historical Context

In order to assess the significance of Lawes' 'Harpe' Consorts in the development of the suite, it is necessary to look at the date they were written, and various ways in which dance forms were being combined at that time. Like much of Lawes' consort writing, the manuscript sources of the 'Harpe' Consorts are not dated. David Pinto gives the following tentative list:³

Table 2
David Pinto's suggested dates for the composition
of Lawes' Consorts during the 1630s

1628-30:	early four-part aires
1630-4:	'old' Royall Consort (<i>d-D ordres</i>)
1635:	early fantasy and 'playnsong' a5 in g
1634-6:	violin setts
1637-8:	five part viol setts
1638:	'new' Royall Consort <i>d-D aires</i>
1639-40:	six-part viol setts, and remainder of Royall Consort in symphyseal old-new versions.

Pinto goes on to state, "It seems, merely from their adjacent position in Lawes' own playing part books, that the harp pieces followed shortly in time the setts for violins." This would suggest that the 'Harpe' Consorts were written during or shortly after 1636.

Throughout the sixteenth century, dances grouped together by intention into the same key were dominated by the pavan-galliard pair.

³ David Pinto, *For Ye Viols* (Richmond, 1995), 153.

In England, Coprario extended this paired grouping during the early 1620s with the addition of a fantasia at the start of his three movement fantasia setts.⁴ There is also an experimental eight-movement keyboard work in the Fitzwilliam Virginal Book entitled 'A Medley' which is doubtfully attributed to William Byrd.⁵ This piece exploits changes in tempo and rhythm in a manner similar to examples of 'variations' included in the same collection. It is likely that it was the composer's intention that the performer should treat the structure as if it were a set of variations rather than separate movements of a suite. Peter Holman suggests that "the extended consort suite was established in Germany" in books published between 1609 and 1617 by William Brade, Thomas Simpson and Johann Hermann Schein.⁶ He credits Brade with such combinations as canzona-galliard-canzona-galliard, Simpson with a nine movement pattern consisting of pavan-intrada-ricercar-canzona-corant-corant-volta-corant-alman and Schein with a standard pavan-galliard-corant-alman-tripla.

David Fuller states that the "most important single milestone in the history of the suite" is the *Tablature de mandore de la composition du Sieur Chancy* (Paris, 1629). Fuller gives no attribution for the authorship of this book and suggests that it is unlikely that the new kind of suite included was invented for the mandora. In this book the usual form of suite consists of a recherche (a type of unmeasured prelude) followed by an allemande, two or three courantes and a

⁴ Peter Holman, *Four and Twenty Fiddlers* (Oxford, 1993), 259.

⁵ Fuller Maitland, J.A. & Barclay Squire, W.[eds.]: *The Fitzwilliam Virginal Book* (1899; re. New York, 1963), II, 220-225; Joseph Kerman, 'William Byrd', *The New Grove Dictionary of Music and Musicians* (London, 1980), III, 552.

⁶ Holman, *Four and Twenty Fiddlers*, 259.

saraband.⁷ Indeed we can see in Table 1 that apart from the omission of the *recherches*, four of Lawes' 'Harpe' Consorts follow exactly the pattern of the suites in the *Tablature de mandore*.... As the date of the first version of the 'old' Royall Consorts appears in the early 1630s it is apparent that Lawes' work occupies a very important place in the history of the development of the suite. As a result, the inclusion of divisions for bass viol and sometimes the violin in most of the movements of the 'Harpe' Consorts (to be discussed later), represents a significant advance in the development of the consort suite, by exploring further means of extending the material and length of a combination of dance forms.

The Structure of the 'Harpe' Consorts

In the following discussion I make frequent reference to points of interest which may be found in my transcription of Lawes' 'Harpe' Consorts (Vol II, Appendices). The sections of a movement are indicated by letters thus: A//B//C. Repeats are shown by the conventional dots, //: ://. First- and second-time statements are distinguished A', A'', etc. The consorts are numbered I-XI and the movements are numbered 1-30. Although no figures are provided for the theorbo part it may be presumed that the performer was expected to produce an improvised harmonised accompaniment. The theorbo frequently duplicates the bass of the harp part. In Consorts I, II and VII, Withy's harp part duplicates that of Lawes, except for his own later additions and departures which are cited in the tables and text.

⁷ David Fuller, 'Suite', *The New Grove Dictionary of Music and Musicians* (London, 1980), XVII, 339.

As shown in Table 1, the harp consorts are grouped according to key. These keys consist of G minor, G major, D minor, D major and in the case of Consort IX an example of G Dorian which features frequent use of c#s and cadences in D major. One other piece appears in Withy's harp parts for the Lawes' consorts which does not coincide with any known matching parts by Lawes himself. This is placed in numerical order in Mus. MS 5. as no 21 in the key of D minor. It should also be noted that Withy has two pieces numbered as 14, one of which relates to Lawes' no 14 and the other to Lawes' no 26. Withy's no 21 does not relate to the violin, theorbo and bass viol parts of that number in Lawes' autograph. When discussing Mus. MS 5, Peter Holman states that "for Consort V and the first movement of Consort VI (the rest is missing), there is merely a score of the violin and bass parts."⁸ This would suggest that a harp part by Withy for the first movement of Consort VI does exist. It is possible that Holman based his statement upon another by Lefkowitz which states that "The significance of Ch.Ch. MS 5 is that it supplies the new treble parts for the harp scores to numbers nine through twenty one. There remain but four dances, the major portion of the sixth suite, of which no trace of the harp music has as yet been uncovered."⁹

As the parts for no 21 do not match (the part in Mus. MS 5 is in D major and that of D 229 is in D minor), Withy's no 21 must instead belong to some other unattributed work which we must consider to be anonymous, perhaps a consort, which features a harp part resembling those of the Lawes 'Harpe' Consorts, and perhaps another work by Lawes

⁸ Peter Holman, 'The harp in Stuart England', 201.

⁹ Murray Lefkowitz, *William Lawes*, 90.

himself. I must however disagree with Lefkowitz and Holman, and conclude that there is no known harp part for the first movement of Consort VI. In my transcriptions I have placed this anonymous harp part at the end of the 'Harpe' Consorts of William Lawes.

Like Lawes' 'Royall Consorts', the 'Harpe' Consorts are significant in part, because of their length and number of dance movements - the 'Fantazy Setts' for violin use only three movements compared to at least four in the 'Harpe' Consorts. This becomes increasingly significant if the later 'Harpe' Consorts are added to the first in the manner of the 'Royall' Consorts, a subject to be discussed later in this chapter.

As shown in Table 1 the movements of the 'Harpe' Consorts are grouped primarily by key. The first six are subdivided into four or five dance movements making up a suite or 'sett'. The remaining five are larger single movement works related to the first six by key. Lefkowitz suggests that these may have been intended as first movements to the first six consorts.¹⁰ Each of the earlier consort setts ends with a courante followed by a sarabande, which at this period was one of the fastest triple time dances in use. The first two dances of each consort sett begin with either an allemande or an air followed by either an allemande, air or courante.

Each dance in the first six consorts is divided into sections or strains according to the practice of the time, featuring repeats. The allemandes are all bipartite in form and follow a variety of patterns which include:

¹⁰ Murray Lefkowitz, *William Lawes*, 90.

//:A://:B:// (movements 22 and 26), //A'//A"//B'//B"// (movements 1, 9, 14 and 17) and //:A://:B://A'//A"//B'//B"// (movement 21).

The courantes are also bipartite and these feature patterns including:

//:A://:B:// (movements 6 and 11) , //A'//A"//B'//B"// (movements 3 and 19) and //:A://:B://A'//A"//B'//B"// (movements 2, 15, 18, 23 and 24).

It is interesting that sarabandes are to be found in both bipartite and tripartite form in this collection. The patterns found in bipartite sarabandes include:

//:A://:B://A'//A"//B'//B"// (movements 12 and 25) and
//:A://:B://A'//A"//B'//B"//A''//A'''//B''//B'''// (movement 16).

The patterns to be found in tripartite form are:

//A'//A"//B'//B"//C'//C"// (movements 4 and 8) and
//A'//A"//B'//B"//C'//C"//A''//A'''//B''//B'''//C''//C'''// (movement 20).

In addition to the allemandes, courantes and sarabandes, there are three airs (5, 13 and 26) which are bipartite in form and follow the patterns:

//:A://:B:// (movement 26), //:A://:B://:A'://:B':// (movement 5) and
//A'//A"//B'//B"// (movement 13).

The three pavans (27, 28 and 29) are all of the same pattern:

//:A://:B://:C://A'//A"//B'//B"//C'//C"//, while by its very nature, the fantasia (30) is not structured in the manner of a dance and has no repeated sections.

Divisions

As we have seen, Lawes makes use of the repeats and frequently presents the entire dance again with repeats to explore different

opportunities for writing divisions for bass viol and subsequently, the violin. The way in which he approaches this exploration is almost like change ringing as he tries out different orders in an almost mathematical pattern. One can only imagine the delight which players presented with this music would experience as they set about exploring the pages before them, never knowing when a division would occur next. In the light of no other information it must be assumed that players not involved in playing divisions proceed to repeat their parts.

The last five consorts appear only after Lawes seems to have exploited every possibility of division. Perhaps after all the spectacular displays of virtuosity by the bass viol and later the violin in the first six consorts, the harp and theorbo players wished to share some of the activity. It is noticeable that the last five consorts, in particular no VII and no XI, display far greater equality in part writing, to the advantage of the harp and theorbo, despite continuing to be vehicles for spectacular bass viol and violin writing.

The divisions featured in the 'Harpe' Consorts were also a means of extending the length of the material which constituted the dance movements. In the case of the sarabande (no 20), we see as many as five repeats of each basic dance section. Lefkowitz states that "The length of the movements alternate between long and short", and goes on to inform us that "this concept of the dance suite appears purely English in character, since continental models concentrate upon the alternation of slow and fast movements."¹¹ Unfortunately he gives no examples to substantiate this claim. The alternation of lengths of movements of the

¹¹ Murray Lefkowitz, *William Lawes*, 101.

'Harpe' Consorts may be best shown by looking at Table 3, which lists the numbers of bars in each dance of the first six consort setts.

Table 3

The numbers of bars within each dance movement of
Consorts I-VI.

Consort no	Nos of bars
I	32 / 64 / 24 / 54
II	88 / 24 / 64 / 48
III	34 / 48 / 28 / 80
IV	44 / 38 / 52 / 96
V	36 / 64 / 30 / 96
VI	72 / 24 / 52 / 44 / 64

This scheme of alternating lengths of movements has been made to work through the employment of divisions. It is significant therefore that divisions for bass viol occur in twenty five out of the thirty (83.3%) movements which make up this body of work. Only numbers 6, 11, 22, 26 and 30 do not feature divisions for bass viol. It should perhaps be noted that the dance type does not necessarily have a bearing upon its relative length in this scheme of things. While most of the last movements (sarabandes) tend to be larger than their preceding movement this is not always so, as in the case of that concluding Consort II, in which the sarabande has 48 bars compared to 64 in the previous courante.

Lawes' 'Harpe' Consorts are also significant in the development of writing for the violin in England, particularly with respect to the inclusion of divisions for the instrument. Peter Holman states that "In most of the collection divisions are confined to the bass viol, but in Consorts nos 9 and 10 they are extended to the violin as well. This was something new, at least in serious consort music."¹² When I examined the 'Harpe' Consorts I found that divisions for violin occur in several other consorts as well as those mentioned by Holman. These extra divisions are to be found in movements 16, 20, 23, 24 and 25.

These five, probably earlier, examples of divisions for violin not mentioned by Holman, contribute towards a total of seven dance movements featuring divisions for this instrument. Out of a total of thirty movements this makes up a statistically significant 23.3% or nearly a quarter. It is therefore evident that the Lawes' 'Harpe' Consorts were an important vehicle for the early writing of divisions for violin in England. We must therefore conclude that divisions for violin also have a substantial bearing upon the lengthening of the dances in order to achieve the effect of alternate long and short movements.

A Comparison of the Characteristics of the Harp Parts in D 229, Mus. MS 5 and MS B3.

In seeking to determine the nature of harp required to perform the 'Harpe' Consorts it is important to look at the various characteristics exhibited in the different parts for the instrument. References to bar

¹² Peter Holman, *Four and Twenty Fiddlers*, 262.

numbers refer to those in my transcriptions to be found in the appendices (Vol II).

The movements located in these manuscripts are listed in Table 1. MS D 229 (autograph) and represent a very early example of a harp part. It is written by Lawes almost entirely for two voices (treble and bass). In contrast to this, MS B3, also written by Lawes (autograph), features many different musical devices which result in a great deal of fully worked harp music utilising up to four voices. Clearly there is a significant difference between these two autograph sources. Mus. MS 5 (not autograph) appears to be an attempt by Francis Withy to realise some playable harp parts at a later date, probably in post Restoration Oxford, and this part book features the frequent employment of three voices.¹³ We therefore have three manuscript sources which display three different stages or styles in writing for the harp.

Comparison of sources is fortunately aided by the fact that movements 1-8 are featured in both MS D 229 and Mus. MS 5 and movement 26 is to be found in both MS B3 and Mus. MS 5. We are therefore able to compare the work of Francis Withy with both the two-line and fully-worked writing of William Lawes.

MS D 229

The harp treble in MS D 229 (movements 1-8) is largely melodic and independent of the violin part, while the harp bass is predominantly doubled by the theorbo and bass viol. The exception to this pattern occurs during the divisions for bass viol when in the absence of any

¹³ Peter Holman, 'The harp in Stuart England', 201.

other material for harp, violin or theorbo, it has to be assumed that these parts continue to be repeated. Occasionally the harp bass does differ from that of the bass viol or theorbo at a time when divisions are not being played. It should be noted however that these differences in the bass line are usually very minor and consist of such features as the harp doubling the theorbo at an octave below as in movement 1, bars 1 and 2, or the harp sustaining a note against the theorbo's division of it, as in the case of bar 5 of movement 1, when the theorbo and bass viol play a dotted crotchet (c) followed by a quaver to the harp's sustained minim (also c). A variant of this occurs in bar 1 of movement 5 when the harp bass plays g followed by G to the bass viol and theorbo's G followed by g. Here Lawes has created a point of exchange between the instruments using octave doubling.

The harp treble in this manuscript source has to be viewed in the context of the violin part, and in this respect we are faced with two rather conflicting statements by Lefkowitz when writing about the first twenty five movements.¹⁴ These are as follows:

That they are not merely reductions of the other instrumental parts for thorough-bass, however, is proved by the fact that the treble line is not a duplicate of the violin part, but a new and vital component of the score.

But one of the salient features of the *Royall Consort*, the *concertante* interplay between the parts, is not present in the *'Harpe' Consorts*.

That the material in the treble of the harp part does not duplicate the violin in MS D 229 can be illustrated by the maxim that the

¹⁴ Murray Lefkowitz, *William Lawes*, 90, 94.

exception proves the rule. I found an example of doubling at pitch in movement 2, bar 16 and an example of the harp doubling at an octave below in movement 8, bar 18. Other than isolated instances, or at the end of a cadential sequence (e.g. the end of bar 16 in movement 2), these must be considered to be at the most, very rare occurrences. In contrast to this there are several instances of points of exchange between the harp treble and violin (e.g. movement 1, bars 5-6), examples of the parts in contrary motion (e.g. movement 1, bar 13) and several other examples of the harp treble being placed either above or below the violin (e.g. movement 3, bars 1 and 21).

While it can be seen that examples of the use of 4ths between the harp treble and violin seem to be comparatively rare, the use of thirds is more common (e.g. movement 3, bar 15). Consecutive 5ths, notably those featured in movements 2 (bars 1-2) and 4 (bars 13) are very rare but remind us of the comment by Anthony Wood who said that Lawes' music "broke sometimes ye rules of mathematicall composition".¹⁵ We can only guess what surprises have been lost due to the missing harp parts in MS D 229.

On the evidence examined I can only agree with Lefkowitz's statement regarding a "new and vital component of the score." Clearly the bass voice of the harp part does, together with the theorbo, provide an accompaniment to the rest of the consort. However, the treble voice of the harp, as has been demonstrated, offers more than just an accompaniment to the violin in MS D 229. In the first eight movements of

¹⁵ Bodleian Library, Oxford, *Anthony Wood, manuscript notes on the lives of English Musicians* (Wood. D. 19 4). no 106, f83r; Murray Lefkowitz, *William Lawes*, 6.

Lawes' 'Harpe' consorts we do see a concertante interplay between the violin and the harp treble.

Mus. MS 5 (Movements 1-8)

In looking at the first eight movements in Mus. MS 5 we are able to begin comparing the work of Lawes directly with that of Francis Withy. For the greater part of these eight dances Withy appears to have had direct access to MS D 229 or a similar two voice sketch by the composer. It is clear that movements 1 to 8 in Mus. MS 5 are an attempt to fill out these parts to produce a fuller and more complete harp part, perhaps with a view to some attempt at performance. In making an addition to Lawes' written intentions, Withy has either seen fit to alter the original in several places or had access to an alternative source. These departures from Lawes' autograph intentions frequently involve such simple devices as the transposition of the treble down an octave, perhaps to add some other material in the top end of the harp's register. In the first bar of movement 3 for instance, we see the treble of the harp part transposed down an octave, while the violin part is doubled at pitch in its place. The transposed original treble and doubled violin part, combined with the original harp bass line therefore make up a three voice harp part.

A similar simple departure from Lawes occurs in the bass of the harp part in bar 25 of movement 4, when Withy transposes the violin part down an octave resulting in a c' on the second beat of the bar. This makes the following original c' on the third beat of the harp part superfluous, and it is therefore omitted. Other devices used by Withy to achieve a fuller harp part include doubling the violin at pitch or an

octave below, doubling the bass line at one or two octaves above (though instances of the latter are relatively rare) and using chords to fill in the harmony. An example of the use of a five-note chord filling out the harmony in this manner is to be found in bar 11 of the movement 1. Considering the capability of the harp for filling out harmony with chords of five notes or more, Withy is very sparing of their use.

Mus. MS 5 (Movements 9-20)

In looking at these movements we have no Lawes' autograph harp parts available for comparison (with the exception of a harp part relating to movement 26). Lefkowitz tells us that "The real significance of Ch.Ch. MS. 5 is that it supplies the new treble parts for the harp scores to numbers nine through twenty one".¹⁶ Of the same manuscript source, Holman states that "For the first four consorts the part consists of a treble and bass, as in Mus. Sch. D.229, but with fragments of the violin part added, sometimes transposed down an octave to serve as a makeshift tenor. For consort no. 5 and the first movement of consort no. 6 (the rest is missing), there is merely a score of the violin and bass parts".¹⁷ Holman goes on to say, "Perhaps Withy lacked even these 'skeletons'" (the sort found in Mus.Sch.D 229.) "for consorts nos. 5 and 6 and was reduced to making the harp double the violin and bass parts".

An examination of movements 9-20 therefore, must look at the material which is derived from the violin or theorbo parts for use in the treble and subtract this from the total. In this manner it might be

¹⁶ Murray Lefkowitz, *William Lawes*, 90.

¹⁷ Peter Holman, 'The harp in Stuart England', 201.

seen that what remains is independent of the other consort parts, and it might therefore represent the survival of an original harp part, whether by William Lawes or another, in the hand of Francis Withy. This should in turn give us something which may be compared with Lawes' autograph parts in MS D 229. The issue to be addressed is posed by Lefkowitz when he states that "the real significance of Ch.Ch. MS 5 is that it supplies the new treble parts for the harp scores to numbers nine through twenty one". It needs to be established whether these 'new' parts represent the creativity of William Lawes or the work of another writer such as Francis Withy.

An examination of the relationship between the violin and original material in the harp treble of movements 9-20, appears to display three styles of writing. Movements 9-11 demonstrate a variety of techniques, possibly vertically written on a bar to bar basis rather than a linear fashion, strain by strain. This is frequently unlike the concept of the first eight movements. Movements 12-16 return to an inventive, overall linear style and finally, movements 17-20 largely consist of doubling at pitch with little or no original material at all.

The Three Styles

In movements 9-11 the first style in writing a harp treble which presents itself is simply doubling each other at pitch. These are particularly evident in bar 2, movement 9, and in bars 1-2 and 8 and 13 in movement 11. These instances are a lot less inventive than the nearest example in Lawes' own hand, that of bar 16 in movement 2, which also includes some original material as well. Though it may be possible that the composer was exploring contrasts of texture (unison with

harmony) this does not appear to be the case as the instances cited lack consistency in their occurrence within the structure. One is reminded of Lawes' ability to explore such an idea, demonstrating great organisational skill, when thinking of the deliberate contrasts of instrumental resources deployed in the 'Echo' of 'The Royall Consorts', Sett No 6, 5th movement.¹⁸

The second style in evidence in movements 9-11 involves a heavy reliance upon the use of 3rds between the violin and harp treble. This style is frequently extended through the use of 10ths or even 17ths above the theorbo or bass viol parts as in bars 1, 3 and 5 of movement 9.

The third style is the employment of simple stylised cadences such as those occurring throughout movement 12.

In the quest for original material in the harp treble parts, if the third technique of using simple stylised cadences is discounted together with harmonisation based upon excessive use of thirds, and the doubling of the parts at pitch, then what remains is material which should reflect at best, the inventiveness of William Lawes. In this respect, the first eight bars of movement 14 display such a variety of consecutive intervals, including the use of contrary motion, that there is no doubt that a great deal of invention has gone into the creation of this part.

Movement 26 - The possibility of two harp parts by Lawes

The appearance of a harp part (unnumbered) for movement 26 is to be

¹⁸ William Lawes, *Royal Consort [New Version]*, ed. David Pinto (London, 1995), 40.

found surprisingly (out of sequence), between nos 14 and 15 in Mus. MS 5. When looking at the transcription of this movement in which the Mus. MS 5 part is compared with the harp part in Lawes' own hand (Mus. MS B3) it is clear that Withy had access (directly or indirectly) to a part by the composer. That this harp part is either lost or undiscovered is borne out by the fact that the part in Lawes' own hand (Mus. MS B3) is fully worked and that, if examined by Withy, the inner harmonies could have been copied. In this movement Lawes writes in part in an imitative style and as such, the harp treble and the violin interact in a concertante manner, equally important and without resorting to the exceptionally heavy use of such techniques as consecutive thirds. This is also demonstrated by Lawes' exploration of silences in the violin part as in bars 14-15, when clearly the harp treble has to be independent. This is further emphasised by differences between the harp bass and the theorbo which is silent for the first time in bars 18-21. Though there are differences between the two harp parts, as in bar 8, these are very minor and the parts are far too similar in totality to have been conceived independently by two different persons.

The fact that Lawes may have produced two different types of harp part for movement 26 is fascinating, especially when considering what form the filling in of his two-line harp parts should take. Peter Holman suggests that "this apparently confusing state of affairs is best explained by supposing that Lawes, without first hand knowledge of the harp, initially wrote a part consisting only of the essential melodic and harmonic material: the treble and the bass parts as in Mus.Sch. D 229. Later, after consultation with a harper, he produced the fully-worked versions that are given in Mus.Sch. B3. Mus. MS 5 may record an

attempt by someone without access to Lawes' later versions - perhaps by Withy himself - to create some sort of usable harp part from the sort of skeletal versions to be found in Mus.Sch. D 229."¹⁹

In this respect it is worth looking at his system of writing down the harp part, as shown in Illustration No 3, the first page of his Paven on a theme of Cormacke. Here we see Lawes writing notes with their tails down in the bass and alto registers, and with their tails up in the treble and tenor registers. This system is consistent throughout MS B3 and is also to be seen in my transcriptions where I have retained the original directions of the tails. Of particular interest are the first three bars of the bass line in movement 30 (Fantazy) in which the tails of the notes are placed downward despite the fact that there is no tenor line to prevent them being placed in an upward direction. Lawes has made no attempt to rationalise the tails of his notes for the sake of economic use of space.

In MS D 229 however, we see that he is capable of rationalising the tails of his notes, as shown in Illustration 1, where during the first strain of movement 1 (Almane) he has placed all of the bass line notes upward. As this line duplicates the theorbo, there is no reason to suppose that the composer intended to place a bass line below this, making it a tenor. I therefore believe that Lawes intended to write a two line part only, and that he had no intention of writing any inner lines at a later stage. One can only assume that the harper was expected to improvise the 'filling in' (continuo style) in a manner similar to the theorbo player.

¹⁹ Peter Holman, 'The harp in Stuart England', 201.

In returning to movement 26, the bass lines of the two sources must be examined for a comparison of the direction of the tails of notes. Sure enough, when looking at the first four bars in Mus. MS 5 for example, Withy has a rationalised system of notation, perhaps copied from an earlier two voice part by Lawes, while MS B3, in Lawes' own hand, places the tails of the bass voice downwards.

It would appear that the composer originally wrote a two voice harp part for movement 26 and that at a later date, due to its increased complexity (as compared to the first twenty five movements) wrote out the part completely, allowing nothing to chance. The composer has changed styles of writing for the harp at this point and has taken over complete control of the performance of his music. The harper, it would appear, had to be a musician who was able to improvise and fill in his part as well as follow a fully worked part. His instrument no longer maintained the continuo role which it held throughout the first twenty movements of the 'Harpe' Consorts as Lawes was employing the harp in a new manner.

Mus. MS 5 (Movements 9-21) - Are Lawes' intentions present in the treble of these harp parts?

To return to Mus. MS 5 and the writing by Withy, the treble of movement 16 may also reflect the original intentions of the composer as the violin divides against the theme provided by the treble of the harp part. The theme of this particular movement is 'O My Clarissa', a ballad by William Lawes with which Withy may well have been familiar.²⁰

²⁰ British Library, Add. 11,608 and Add. 29,291; Murray Lefkowitz, *William Lawes*, 167, 287-293.

That a two part sketch of Lawes' own harp part for movement 26 occurs out of sequence between nos 14 and 15 tends to confirm the possibility that the harp parts in and around these movements of Mus MS 5 could represent, at least in part, the original intentions of the composer. Possibly the whole of Consort IV, movements 13-16, may have harp treble voices derived from Lawes' originals.

It is difficult to sort out what is the work of Lawes and what could be the work of another, however, because by their very nature, any additions are based upon the work of the composer in the form of the parts for violin, bass viol and theorbo and therefore knit into the structure of the compositions. Any final judgement, due to the lack of autographs, must remain subjective and unproven. Some bars of the harp parts in Mus. MS 5 are very inventive, some lack invention, while others simply duplicate an existing part at pitch, demonstrating perhaps a lack of inspiration or the desire to include a contrasting unison section. It must be remembered however that the doubling of parts at pitch is sometimes used by the composer as a springboard for violin divisions. In such circumstances the harp may be left playing the theme that both parts had been playing previously, while the violin divides upon it. Just such an instance occurs during bars 87-118 in movement 29 (Paven on a theme by Coperario), when cleverly, the violin plays the divisions first before doubling the harp part.

If a musician such as Withy was familiar with the work of Lawes and was capable of producing some inventive material as well as following a formula based on thirds and doubling, then the harp parts for movements 9-12 may have been produced by such a person. In movements 9-12 as featured in Mus. MS 5, if the work of William Lawes is present,

then it lacks the consistent flow of inventiveness and overall conception featured in his earlier autograph parts. Too often these parts appear to be created in either manageable small sections or use doubling of the violin part as though the task were becoming unmanageable. If these harp parts are by Lawes, then to some extent they represent a change in writing style from movements 1-8.

By movement 17 any attempt at inventiveness runs out. The harp part as written by Withy doubles the violin in its entirety. There is no original material here. Movements 18-20 contain very little which does not consist of doubling the violin part. The apparent increase in originality which occurs after bar 24 of movement 20 is due to the nature of the violin dividing against the harp part. Movements 21-25 have no harp parts of any type ascribed to them in Mus. MS 5. It can only be guessed why this might be the case.

Withy has made no attempt to write any harp parts for Consort VI, movements 21-25. There is an irony here as movements 23-25 feature divisions for violin and Lawes frequently doubles the harp treble and violin at some point to enable the violin to divide against its theme, as in bars 49 to 99 in movement 27, bars 52-69 in movement 28, and bars 70 to 86 in movement 29. This therefore means there is a good chance that the original harp treble is featured in the violin parts of these movements at some point. Withy could have made an educated guess as to a reconstruction of Lawes' original treble and bass voices in the harp parts of movements 23-25 but he seems to have ceased work upon his reconstruction before reaching these. Withy could have created the harp trebles for movements 16 and 20, which could well reflect the original intentions of the composer due to the employment of divisions for

violin.

As mentioned previously, an anonymous harp part appears at the end of the Lawes' parts in Mus. MS 5 and is numbered 21, though it does not match the parts for violin, theorbo and bass viol of that number. It is therefore difficult to ascertain, whether the part is an original harp part or a copy of some other treble and bass parts, as elsewhere in this set of parts. It is written in the style of an allemande. Bars 2, 3, 6 and 7 feature a dialogue between the treble and bass voices and it would not be surprising if these were taken from a dialogue between a violin and bass viol. If this was an original harp part, the effect of the dialogue would be lost if the harp was doubling a violin and bass viol, and so it could be possible that the harp would be solo or playing with only one other voice at this point. Incidents of imitation are featured when both the treble and bass in bars 2 and 3 are repeated at an octave above during bars 6 and 7. The only attempt at adding extra harmony to the two voices occurs in bar 9 when a semiquaver g' is added to a semiquaver b^b'. The bass line in bars 14-16 are rather lively for a Lawes' harp part, though this in itself should not rule out the composer as its author. Finally, it should be stated that the treble and bass voices appear to make up a complete entity, contrary to what one might expect from a consort part. Other than some inner harmony, which is not necessary, this could pass for a piece written for solo harp. We must remember that this is also the case in such movements as no 17 when Lawes' violin and theorbo parts have been copied to produce a harp part.

Some Conclusions regarding Mus. MS 5

Other than giving the performer a third inner voice, Withy rarely

exploits the chordal potential of the harp. It would therefore appear that despite all the trouble Withy had gone to to make the harp parts full, the harper was still expected to fill in harmony, especially during the cadences at the end of strains. In this respect the parts in Mus. MS 5 are similar to those in Lawes' own hand, Mus. Sch. D 229.

When looking at Mus. MS 5 there is a great temptation to look upon this source as one which supplies us with missing harp trebles and harmonies by the composer, assuming that the bass line doubles the theorbo at pitch. However, the value of much of this manuscript in this respect remains unproven. Only parts of movements 1-8 and no 26 which correlate with parts in the composer's own hand, can be valued as the composer's intention, and of course these only partly duplicate Lawes' autograph part books. Perhaps the real value of Mus. MS 5 is that it is a late-seventeenth century attempt at the performance of William Lawes' 'Harpe' Consorts rather than an accurate reconstruction of the original parts.

Ob MS Mus.Sch. B3

Movements 26 to 30 of the Lawes' 'Harpe' Consorts are to be found in this manuscript source and are written in the form of a full score for violin, bass viol, theorbo and harp. The harp parts in this source are fully worked, with up to four voices and chords of up to seven notes. The movements, consisting of an air, three pavans and a fantasia are written on a far larger scale than the first twenty five movements. There is a significant difference between the layout of the air (no 26) and the other movements in this manuscript. The staves of the air are presented in descending order thus: violin, harp, bass viol and theorbo.

In the later pavans and fantasia they are presented as: violin, bass viol, theorbo and harp. The first layout demonstrates logic in its descending order of pitch of instruments, while the second may demonstrate a more hierarchical approach.

Another point of note is that the order of the movements is different in this manuscript from that of the part books for violin, bass viol and theorbo. In MS B3 the Fantasy is placed between the Aire (no 26) and the Paven (no 27) whereas the part books designate it as no 30. In cataloguing the works of Lawes, Lefkowitz followed the order of the part books dividing the works into Consorts (I-XI) as key changes occurred within the order.²¹.

While the order of the movements is perfectly correct it may be unfortunate that Lefkowitz gives the titles of Consorts VII to X, for movements 26-30. After all, it is conceivable that Lawes intended these larger movements as the first movements for the previous consort setts as was his practice with other of his consort groupings. In Table 4, I have displayed the key signatures of the first six consorts alongside those of MS B3 to see where possible matches may be made. I have used the numbering from the part books rather than that of MS B3.

If it was Lawes' intention to group the pieces in a manner similar to this, it is apparent that some larger movements may be missing, perhaps one in G Minor to precede Consorts I or II and another in D Major to precede Consorts V or VI. I have placed movements 26 and 27 together in the same consort because they are related by key but it

21 Murray Lefkowitz, *William Lawes*, 268.

Table 4
The possible intended arrangement of movements
in the 'Harpe' Consorts

Movements 1-25.

Consort I in G Minor
 " II in G Minor
 " III in G Major
 " IV in D Minor
 " V in D Major
 " VI in D Major

Movements 26-30

Movement 26 in G Major
 Movement 27 in G Major
 Movement 28 in G Dorian
 Movement 29 in G Minor
 Movement 30 in D Minor

These could be presented thus, making for larger Setts:

Movement 29 in G Minor	Consort I in G Minor
" " " " "	Consort II in G Minor
Movement 27 in G Major	Consort III in G Major
Movement 26 in G Major	" " " " "
Movement 30 in D Minor	Consort IV in D Minor
Movement 28 in G Dorian	Consort V in D Major
" " " " "	Consort VI in D Major

should also be noted that they are related by the material used in their opening bars. This would make Consort III in G Major six movements long,

though it should also be stated that an additional first movement for Consort VI in D Major would make this a similar length. It has to be remembered that Withy placed the Aire (movement 26) between movements 14 and 15 in Mus MS 5. As has been discussed, these movements are incompatible, being written in a different key, but it may demonstrate that Withy could consider placing the Aire in the context of one of the earlier consort setts.

Without further information or the discovery of lost movements, such discussion can only remain as conjecture. It is possible after all, that the 'Harpe' Consorts were unfinished and that the missing parts never existed.

Accidentals and Compasses of the Harp Parts

The purpose of examining the accidentals and compasses of the harp parts is to determine the specifications of the instrument required by Lawes to perform his 'Harpe' Consorts.

Example 1 shows the diatonic compass of the harp part employed in each of the movements of the 'Harpe' Consorts by William Lawes. I have shown accidentals to the given key signature to the right of the compass and an x denotes a note in the diatonic compass not employed. If an x coincides or is adjacent to an accidental it would be possible for a harper to retune this note at the start of the piece to make the playing of the accidental feasible. It therefore follows that where accidentals occur and there is no free note available for retuning, then the harps for which Lawes and Withy were writing must have had some chromatic capability at this point. As Withy was copying and filling out his harp part at a later date than the original composition, I have displayed his

compasses and accidentals separately for comparison, in case the harp parts were written for instruments of differing specifications. I have placed the compasses and accidentals of the miscellaneous piece in Withy's hand at the end of Example 1.

Example 2 illustrates the scale of notes required to play all of William Lawes' 'Harpe' Consorts together with layouts of possible string patterns for a harp needed for this music. A similar scale is given by Peter Holman, who uses it to state that a harp of 40 notes must have been used to play Lawes' 'Harpe' Consorts "assuming that the player never retuned accidentals between pieces in different keys, which is unlikely."²² On my own findings I have added six extra notes to Holman's list and have set down instances of their occurrence in Table 5. The E⁴ illustrated is found only in Lawes' autograph; Withy omits the accidental and I have added it editorially in my transcription, basing my decision upon the Lawes' autograph and the fact that the note coincides with e^{hs} in both the bass viol and theorbo parts. It should be noted that Withy's part for Lawes no 26 features the passage containing c''' and d''' at an octave below and so is not listed as a source. It can only be guessed as to whether the part he was copying omitted these notes or whether the harp for which he was writing did not possess them.

The significance of these top two notes is that they affect the extreme compass of the instrument required to play this music. The compass of the harp required to play the Lawes' 'Harpe' Consorts is therefore either 44 or 46 notes, depending upon the original source used for Lawes' no 26. The apparent avoidance of accidentals does occur,

²² Peter Holman, 'The harp in Stuart England', 201-2.

Example 1

The diatonic range of notes + accidentals required for each movement of the Lawes Harp Consorts.

Nb. x denotes a string not required.

Ob. MS Mus.Sch.D 229

Och. Mus. MS 5

1

1

2

2

3

3

4

4

5

5

6

6

Example 1 Continued

Ob. MS Mus.Sch. D 229

Och. Mus. MS 5

7

7

8

8

9

10

11

12

Example 1 Continued

Och. Mus. MS 5

The image shows six systems of handwritten musical notation, numbered 13 through 18. Each system is written on a grand staff consisting of a treble clef and a bass clef. The notation includes various notes, rests, and markings. System 13: Treble clef has a whole note with a flat (Bb) and a 'p' dynamic marking. Bass clef has a whole note with a flat (Bb) and a 'p' dynamic marking. System 14: Treble clef has a whole note with a flat (Bb) and a 'p' dynamic marking. Bass clef has a whole note with a flat (Bb) and a 'p' dynamic marking. System 15: Treble clef has a whole note with a flat (Bb) and a 'p' dynamic marking. Bass clef has a whole note with a flat (Bb) and a 'p' dynamic marking. System 16: Treble clef has a whole note with a flat (Bb) and a 'p' dynamic marking. Bass clef has a whole note with a flat (Bb) and a 'p' dynamic marking. System 17: Treble clef has a whole note with a sharp (B#) and a 'p' dynamic marking. Bass clef has a whole note with a sharp (B#) and a 'p' dynamic marking. System 18: Treble clef has a whole note with a sharp (B#) and a 'p' dynamic marking. Bass clef has a whole note with a sharp (B#) and a 'p' dynamic marking. There are also some 'x' marks and 'no' markings scattered throughout the systems.

Example 1 Continued

Ob. MS Mus.Sch. B3

Och. Mus. MS 5

Handwritten musical score for Ob. (MS Mus.Sch. B3) and Och. (Mus. MS 5) parts, measures 19-29. The score is written on two staves per measure, with a brace on the left indicating the measure number. The key signature is one sharp (F#) and the time signature is 2/4. The notation includes notes, rests, and dynamic markings such as *ff*, *mf*, and *ff*. Measure 19 shows a half note G4 in the treble and a half note G3 in the bass. Measure 20 shows a half note G4 in the treble and a half note G3 in the bass. Measure 26 shows a half note G4 in the treble and a half note G3 in the bass. Measure 27 shows a half note G4 in the treble and a half note G3 in the bass. Measure 28 shows a half note G4 in the treble and a half note G3 in the bass. Measure 29 shows a half note G4 in the treble and a half note G3 in the bass.

Example 1 Continued

Ob. MS Mus.Sch. B3

Och. Mus. MS 5

30

Musical notation for measures 30-31. Measure 30 shows a treble clef with a key signature of one flat (Bb) and a common time signature (C). The note is a half note G4. The bass clef has a key signature of one flat (Bb) and a common time signature (C). The note is a half note G3. Measure 31 shows a treble clef with a key signature of one flat (Bb) and a common time signature (C). The note is a half note A4. The bass clef has a key signature of one flat (Bb) and a common time signature (C). The note is a half note A3. Handwritten annotations 'b0#0' are present above the treble clef notes and below the bass clef notes.

21

Musical notation for measures 32-33. Measure 32 shows a treble clef with a key signature of one flat (Bb) and a common time signature (C). The note is a half note G4. The bass clef has a key signature of one flat (Bb) and a common time signature (C). The note is a half note G3. Measure 33 shows a treble clef with a key signature of one flat (Bb) and a common time signature (C). The note is a half note A4. The bass clef has a key signature of one flat (Bb) and a common time signature (C). The note is a half note A3. Handwritten annotations 'b0#0' are present above the treble clef notes and below the bass clef notes.

Eight sets of empty musical staves, each consisting of a treble clef staff and a bass clef staff, arranged vertically.

Example 2

The scale of notes necessary for the harp parts in William Lawes' 'Harpe' Consorts as stated by Peter Holman in 'The harp in Stuart England', *Early Music*, XV (1987), 201.



The scale of notes necessary for the harp parts in William Lawes' 'Harpe' Consorts based upon my own findings.



Example 2 continued

The possible string pattern of a harp required to perform the harp parts of William Lawes' 'Harpe' Consorts assuming that the harper changed the tuning between movements and played in the 'left-handed' Irish manner.

d''	.	The possible string pattern of a harp required to perform the harp parts of William Lawes' 'Harpe' Consorts assuming that the harper did not change the tuning between movements but did play in the 'left-handed' Irish manner.	d''	.
c''	.		c''	.
b''	.		b''	.
a''	.		b ^b ''	.
g''	.		a''	.
f''	.		g''	.
e''	.		f [#] ''	.
d''	.		f''	.
c [#] ''	.		e''	.
c''	.		d [#] ''/e ^b ''	.
b'	.		d''	.
a'	.		c [#] ''	.
g'	.		c''	.
f'	..		b'	.
e'	..	b ^b '	.	
d [#] '/e ^b '	..	a'	.	
d'	..	g [#] '	.	
c [#] '	..	g'	.	
c'	..	f [#] '	.	
b	..	f'	..	
b ^b	..	e'	..	
a	..	d [#] '/e ^b '	..	
g [#]	..	d'	..	
g	..	c [#] '	..	
f [#]	..	c'	..	
f	..	b	..	
e	.	b ^b	..	
d	.	a	..	
c [#]	.	g [#]	..	
c	.	g	..	
B	.	f [#]	..	
A	.	f	..	
G	.	e	.	
F	.	d [#] /e ^b	.	
E	.	d	.	
D	.	c [#]	.	
		c	.	
		B	.	
		B ^b	.	
		A	.	
		G	.	
		F [#]	.	
		F	.	
		E	.	
		D	.	

sometimes highlighting possible differences between the instruments available to Lawes and Withy. It is of course equally possible that one is reading too much into differences which may occur by chance. When looking at the two harp parts in the second movement of Consort I for example, it is noticeable that Lawes avoids the use of an accidental e^b

Table 5

Accidentals occurring in the harp parts of Lawes' 'Harpe' Consorts other than those given by Peter Holman.

SOURCE

- | | | |
|-----------------|--|------------------|
| 1. E^{\sharp} | Lawes no 4 (Consort I, 4th movement) bar 4. | D 229 |
| 2. c^{\sharp} | Lawes no 7 (Consort II, 3rd movement) bar 7. | D 229 & Mus.MS 5 |
| 3. $e^{b''}$ | Lawes no 1 (Consort I, 1st movement) bar 1. | Mus.MS 5 |
| 4. $b^{b''}$ | Lawes no 7 (Consort II, 3rd movement) bar 1. | D 229 & Mus.MS 5 |
| 5. c''' | Lawes no 26 (Consort VII) | bar 22. B3 |
| 6. d''' | Lawes no 26 (Consort VII) | bar 23. B3 |

and $e^{b''}$ whereas Withy makes much use of them when transposing or copying the violin part as in bars 2 and 7.

A rare accidental appearing in Consort I is E^{\sharp} , due to its relatively low position in the instrument's compass. It must be noted that as no E^b is required in this consort the accidental could have been achieved by retuning that string. Consort I is the only one of the set which requires both a B and a B^b , and also an F and an F^{\sharp} . The appearance of an $f^{\sharp''}$ in bar 9 of Withy's harp part in the first movement of Consort II is based upon an editorial transposition I made

to match this phrase with the violin part. There was clearly an error in Mus. MS 5 as this source placed an even more unlikely a#' in the harp part against an f#' in the violin part. As Withy makes use of an f⁴' in bar 7 of this Aire it is possible that he was writing for a harp which was chromatic at this point. Lawes' autographs only make use of an accidental at this point in the compass of the harp in bar 41 of Consort VIII (Paven), and as he makes no use of f⁴' this note could be playable by retuning the string. The e⁴' featured in bar 2 of movement 6 (Corant) is also as a result of an editorial decision based upon the fact that Withy is doubling the violin at pitch at this point and the violin plays an e⁴'.

Interestingly the issue of an e⁴' occurs in bar 3 of movement 7 where both Lawes and Withy avoid its use against the e⁴' in the violin part. Perhaps Lawes felt that as a passing note, the problem was not significant and perhaps even added a touch of 'spice' to the harmony. If Withy did have the opportunity of using an e⁴' here he either chose not to use it or made an oversight. An F# occurs in bar 9 of this movement and as an F⁴ occurs in bar 8 of the first movement (Aire) the question arises: was there was enough time allowed in performance between movements to allow retuning? Or did the harp have to be chromatic at this point to allow speedy transition between them?

In bar 10 of movement 8 (Saraband) both Lawes and Withy make use of an e⁴. Lawes makes no use of an e^b in this movement but Withy does, in bar 11. Lawes does however use an e^b in bar 2 of the first movement of this consort (Aire). Once again questions are presented about the possible use of instruments with different chromatic capabilities or the time available for a musician to change tuning between movements in

performance.

There is no Lawes' autograph harp part for Consorts III, IV, V and VI, and the parts to which I refer are from Mus. MS 5, written in the hand of Withy. Consort III is written in the key of G major. The slight departure in the harp bass line from the theorbo part in bar 11 of movement 9 (Almane), which results in the omission of an F \sharp , could be because this note was not available on the harp for which Withy was writing. He had already used an F \sharp in bar 5 perhaps making it impossible to use the same string for both notes. No F is required in movement 10 (Corant) but an F \sharp is required in movement 11 (Corant) in bar 11. No F \sharp is demanded during this movement and it is possible that the harper could retune this note on his instrument between movements. This would make it necessary to have a break between movements to facilitate tuning. An F \sharp also occurs in bar 12 of the movement 12 (Saraband) but again no F \sharp is needed. An incidence of the possible avoidance of accidentals in the lower register of the harp occurs in bar 23 of movement 13 (Aire) where the chromatic descent of the bass viol and theorbo is doubled at an octave above by the harp. Of course it could also be due to reasons of texture, but this seems unlikely.

In bar 7 of movement 18 (Corant) Withy avoids an accidental g \sharp '', perhaps because g \sharp ' is also required in bars 1,5 and 6. The use of a g'' in bar 7 of this movement is as a result of an editorial decision based upon the use of that note in the violin part. A problem certainly exists at this point and as no c \sharp is used in this consort this note could be retuned by the harper. Was Withy copying a Lawes autograph part, or did he overlook this clash? I feel that the latter is the most likely in this case. As Consort V is not fully worked, no further

difficulties regarding the use of accidentals occur.

No harp parts exist for Consort VI and the remaining five feature fully worked autograph parts by Lawes himself. The issues concerning accidentals raised in the previous consorts appear to have been resolved and problems may only present themselves if we try linking these with the smaller movements of the first six consorts in an attempt to produce larger works in the manner of the 'Royall Consorts', which begin with a more substantial movement such as the pavan featured in Sett No 2 in D minor.²³

From this examination it would appear that Lawes was writing for a harp with a compass from D to d''', fully chromatic from f to f' with the addition of extra chromatic strings at c and c''. Any other changes in accidentals could be achieved between movements. It is not inconceivable that makers were capable of producing an instrument which had increased chromatic facilities, and additional strings would make possible the playing of the extra accidentals previously mentioned, without retuning between movements. It is also possible that Lawes and Withy were writing for instruments with different specifications, as Withy frequently requires extra strings, especially if the editorial suggestions regarding the use of accidentals reflect his desired intentions. Of course it is also possible that Withy was producing parts that would be performed on a gut strung double harp, as the heyday of the Irish harp in art music was past when he was active in Oxford.

²³ *William Lawes, Select Consort Music*, Musica Britannica, XXI, ed. Murray Lefkowitz (London, 1963), 127.

Temperament

No contemporary sources have been discovered which discuss the temperament used in the tuning of an Irish chromatic harp. Lawes 'Harpe' Consorts feature a combination of the Irish harp with the theorbo, viol and violin, instruments which were usually tuned to an approximate 'equal' temperament thus avoiding the problem of 'wolf' intervals. It has to be noted that the pitch of these instruments could be altered while playing, by the manner in which the fingers pressed down the strings.²⁴ It is possible therefore that the harp was tuned to the other instruments in performance. This is in contrast to works by Lawes which feature an organ part where it may be assumed that the string instruments had to be tuned to the organ and its 'meantone' temperament.

Unlike the organ, the Irish harp is capable of being retuned with relative ease and it would be possible to tune it to either an 'equal' or 'meantone' temperament. Of course the harpsichord and virginals are also capable of being tuned to different temperaments but idealism and the capability of being tuned accurately resulted in their being tuned with unequal semitones in a form of regular mean-tone temperament.²⁵ The result of this method of tuning is that an E^b is higher than a D[#] and an A^b is higher than a G[#]. Wolf 5th intervals therefore occur at C[#]-A^b, G[#]-E^b or D[#]-B^b.²⁶

To some extent the issue is avoided by Lawes not using an A^b in the

24 Mark Lindley, 'Temperaments', *The New Grove Dictionary of Music and Musicians* (London, 1980), XVIII, 672.

25 Mark Lindley, 'Temperaments', 672; Mark Lindley, 'Tuning Systems for 12-note Keyboard Instruments', *The English Harpsichord Magazine*, II (1977), 13-15.

26 Mark Lindley, 'Meantone', *The New Grove Dictionary of Music and Musicians* (London, 1980), XI, 875.

'Harpe' Consorts. Though Lawes does use both a D# (bar 4) and a Bb (bar 46) in movement 28 these notes do not coincide and wolf 5ths are avoided. Was Lawes was avoiding wolf intervals because his harp was tuned to a meantone temperament or because he was used to writing for an organ?

Another factor to be considered is one of personalities within the 'Private Music'. Would the performers on the violin, bass viol and theorbo wish to tune to the temperament of the Irish harp or not? Clearly there may well have been some hierarchical relationships which could affect attitudes towards tuning as well as performance. Without further information, and bearing in mind the avoidance of wolf intervals, I am of the opinion that the Irish harp was tuned with a 'meantone' temperament in the 'Private Music'.

Signs of Development

If the order of movements given in the violin, theorbo and bass viol parts demonstrate the order in which Lawes conceived the 'Harpe' consorts there might be some signs of the works having developed during their creation. Certainly bass viol divisions occur throughout the works and it is not surprising to see these continue in movements 27, 28, and 29 (the three large pavans). After the appearance of divisions for violin in movements 16, 20, 23, 24, and 25, these might be expected to be featured in the later movements of MS B3. While they do occur in movements 28 and 29, it is interesting that Lawes chooses to make the violin double the harp treble during the bass viol divisions of movement 27, thus giving the impression that the violin part in the first strains is not indispensable to the whole, whereas the harp part is. This is

interesting remembering Playford's practice of only publishing the violin and theorbo parts of some earlier movements.

The instrumental writing of movements 26 (Aire) and 30 (Fantazy) is very different from the earlier movements as Lawes writes in a fantasia style, and parts enter and depart in textures featuring imitative, contrapuntal and homophonic effects. It is possible that Lawes was trying out different instrumental combinations in Mus. B3. Examples of these different instrumental combinations are shown in Table 6. There is

Table 6

Instrumental combinations featured in Lawes' 'Harpe' Consorts.

Harp Solo	movement 30. bars 1-3
Harp + Violin	movement 30. bars 71-72
Harp + Bass Viol	movement 26. bars 20-21
Harp + Theorbo	movement 29. bars 43-44
Harp + Theorbo + Violin	movement 30. bars 83-84
Harp + Theorbo + Bass Viol	movement 26. bars 14-15
Harp + Violin + Bass Viol	movement 30. bars 19-20
Harp + Violin + Bass Viol + Theorbo	movement 26. bars 2- 3
Theorbo + Violin	movement 30. bar 10
Violin + Bass Viol	movement 30. bar 43
Violin + Bass Viol + Theorbo	movement 30. bar 11

No evidence that Lawes intended to experiment in such a way with the previous twenty five movements, though without autograph harp parts for movements 9-25, it cannot be certain that he did not intend to include

bars of silence in the harp parts. This is unlikely however, and indeed, the only examples in MS B3 occur in bars 10, 11 and 43 of movement 30.

Four possibilities are not to be found in Table 6 and these are solos for violin, bass viol, theorbo and the combination of bass viol and theorbo. It appears that for the most part, and with the exception of the three bars mentioned in movement 30 (Fantazy), the harp is ever present in The 'Harpe' Consorts. Additional means of varying the sound of the consort are achieved by altering the texture of the harp part itself and this will be examined in the section concerned with the role of the harp in Lawes' 'Harpe' Consorts. It is a feature of Lawes' autograph parts for movements 1-8 that all instruments are playing virtually all of the time. This state is continued for those instruments other than the harp during movements 9-25 in their part books. There is no reason to suppose that Lawes intended any departure from this practise in his harp parts for these movements.

In bars 22-25 of movement 26 (Aire) Lawes gives the theorbo a part which departs from doubling the harp bass line. This freedom from previous practice is repeated in bars 9-11, 21-24, 29-30, 49-55 and 61-63 of movement 30 (Fantazy). As this feature is not to be found in the earlier movements (nos 1-25) it must be regarded as a development.

The three large pavans (movements 27-28) are written in a very complex manner. Aided by their relatively slow measure, some very sophisticated part writing is able to take place. This is in contrast to the earlier movements (nos 1-25) which are of a quicker and simpler form, heavily influenced by the then current modes of dancing within the Caroline Court. In considering the shorter dance forms Seldon states:

The court of England has much altered. Att a Solemne dancing, first you have the grave measures, then the Corantoes and the Galliards, and all this is kept upp with ceremony. Att length they fall to Trenchmore, and so to the Cushion Dance, and then all the company dance, Lord and Groome, Lady and Kitchen Maid, no distinction. So in our Court in Queen Elizabeth's time Gravitie and State was kept upp. In King James' time things were pretty well. But in King Charles' time there has binn nothing but Trenchmore and the Cushion dance, Omnium gatherum tolly polly, hoyte come toyte.²⁷

In fact Lawes doesn't resort to Trenchmore and the Cushion Dance in the 'Harpe' Consorts, but this is perhaps in contrast to the inclusion of Echos and even a Morris Dance in the 'Royall' Consorts.

The opening bars of the three pavans all start with a falling figure in the harp or bass viol parts reminiscent of the start of Dowland's *Lachrimae 'Pavens'*. They then proceed to develop a complex web of inventive imitation and counter melody. The harp parts in nos 27 and 28, and the violin in no 29, feature syncopated entries evoking a vocal part preceded by sighs, a characteristic of the violin, bass viol and harp parts throughout the pavans. Sections of a more homophonic nature also occur in these pavans, as in bars 128-136 of movement 29, though it has to be recognised that imitation is also taking place here. When divisions do take place in these pieces, the slow nature of the pavan lends itself to many different types of variation including the use of demisemiquavers and tripla dialogues between the violin and bass viol. In short, many of the features of a fantasia are taking place

27 *Table Talk of John Selden*, ed. Sir F. Pollock (London, 1926), 64-5; Robert Mullally, 'More about the measures', *Early Music*, XXII (1994), 419, 435; John Playford, *The Complete Country Dance Tunes from Playford's Dancing Master [1651-ca. 1728]*, ed., Jeremy Barlow (London, 1985), 38, 64.

within the tight structure of the pavan form, and one of the few features of a Lawes' 'Fantazy' which is excluded by the dance origin of the movements is the slow chromatic drag that often occurs at the end of these pieces, as in movement 30 (bars 70-105). Although these movements cannot be compared to any earlier pavans in the 'Harpe' Consorts, their inventive exploration of material represents a development within the concept of a dance form.

The airs (movements 5, 13 and 14) also reflect the simpler dance types featured in movements 1-25 though Lawes was later to make this particular form of measure the subject of more sophisticated settings, as in movement 26. As a change in the setting of the airs have taken place between the earlier movements and those of MS B3, another development can be deemed as having occurred.

Finally, it was Lawes' practice to precede most of his setts for a variety of consort groupings with a larger movement such as a pavan or fantasia and there is no reason to believe that his intention for the 'Harpe' Consorts was any different.

CHAPTER 5

The Role of the Irish Harp in Lawes' 'Harpe' Consorts

Sound quality - See Appendix A

The primary element to be considered must be that of sound quality. The surviving chamber works by William Lawes are almost exclusively written for combinations of bowed strings (violins or viols), plucked theorbos or lutes, or chamber organ. Some transcriptions of his work were made by Playford for keyboard instruments such as virginals or harpsichord, but there is no reason to suppose that the composer intended to write for these instruments. The appearance of the Irish harp in a group of consort setts must therefore be viewed as being very exotic indeed, though there is evidence for precedents which will be discussed later. The interest and appreciation of the Irish harp during this period was discussed in Chapter 2 (Harpers and Patrons) and of course this would provide Lawes with a very good reason for the instrument's inclusion in some of his consort setts. The instrumental grouping of the 'Harpe' Consorts is nevertheless very interesting. Other than using two theorbos (as in the Royal Consorts) Lawes doesn't use a theorbo in consort setts in combination with an instrument of similar role, except for the Irish harp. He doesn't, for example, combine a theorbo with the chamber organ. This may be due to the fact that organs were tuned with a meantone temperament while the harp could have been tuned with an equal temperament, or it could have been due to contemporary practice or fashion, or because the composer did not personally like the combination.

In putting together the combination of instruments which make up the

'Harpe' Consorts, Lawes uses the bright, bowed string sound of the violin, the rich and mellow, bowed string sound of the bass viol, the plucked gut sound of a theorbo with its relatively rapid decay, together with the clear metallic bell-like sound of the plucked Irish harp with its ability to sustain notes. Clearly the Irish harp contrasts with the bowed strings and perhaps it offers something more to the bass of the theorbo than a second theorbo could (as used in the Royal Consorts). Perhaps the Irish harp had inherited the position the orpharion, bandora and cittern had occupied in broken consorts in providing a plucked metallic-sounding contrast to the gut strings of the lute in earlier consort groupings. Using its frequently independent treble line, it can be assumed that the Irish harp was able to carry through the sound of the bowed strings, while providing a sustaining quality, which went some way to approaching that of the chamber organ in its role as a consort instrument. While considering the contrasts which this consort grouping affords one must remain mindful of the fact that Lawes never departed from tasteful subtlety. His consort groupings do not include such obvious contrasting sounds to the strings as recorders or flutes, and indeed the chamber organ has a wonderful tendency to blend with the strings rather than compete with them. In the combination of sounds in the 'Harpe' Consorts there is a coming together of traditions, that of the bass division viol in England, the violin and theorbo from Italy and the harp from Ireland. The 'Harpe' Consorts are indeed written for a 'broken consort'. Combinations of wire with gut strung instruments gained popularity in England towards the close of the sixteenth century and are epitomised by Thomas Morley's *First Booke of Consort Lessons* (London, 1599) which features music arranged for treble lute, pandora,

cittern, bass viol, flute and treble viol. Lawes' 'Harpe' Consorts may well represent the last flowering of this type of combination in English consort music.

Exploitation of the Sustaining Qualities of the Irish Harp

The sustaining quality of the sound produced by the Irish harp was mentioned in the previous section. It is such an important characteristic of the Irish harp that one would expect a composer writing for the instrument to exploit this feature. As the first twenty five movements consist of relatively fast dance forms it is unfair to expect that Lawes would be able to make great use of this quality. Any sustained notes would be lost against the drive of the other parts, remembering that all of the instruments in these movements are playing for most of the time. In these earlier movements the harp is playing similar rhythms to the other instruments in the consort, utilising similar note values. Instead an examination of the slower, more substantial movements (nos 26-30) is necessary to see if the composer makes use of the sustaining qualities of the Irish harp.

The most obvious examples of this feature to seek are pedal points in the bass of the harp part and in this respect pedal notes are found in bars 22-24 of the Aire (movement 26) in Mus.Sch. B3. This is actually as opposed to an alternative in the hand of Withy in Mus. MS 5. In this case Lawes' pedal note (D) is held against movement in all other parts including the theorbo. It has to be noted that, despite the harp's ability to sustain, the composer has had to break the pedal up into three semibreves. He would not have to do this with a chamber organ

which does not have to cope with the problem of decay. Other examples of the use of a harp pedal are to be found as follows:

Paven (movement 27) (d) bars 45-47

" " " (d) bars 95-97

Paven (movement 29) (d) bars 6- 7

" " " (d) bars 14-16

In all of these examples the pedal is divided into semibreves in the same manner as featured in the Aire (movement 26).

Interestingly, this broken pedal is sometimes doubled with a tied example on the theorbo, as in bars 77-78 in movement 27 (Paven). This is unusual as one would expect the tone of the theorbo to decay far more rapidly than that of the Irish harp. This must therefore reflect some accepted practice in the notation of the theorbo part and the probability that its performer was able to improvise upon the pedal.

Another example of the exploitation of the sustaining quality of the Irish harp is the use of the tied semibreves featured during extended bars at the end of strains in divisions (division cadences). Very good examples of these occur during the division sequences of the Paven (movement 29). In these circumstances the harp and theorbo parts are notated as static chords while movement occurs in the violin and/or bass viol parts.

In bars 72-91 of the Fantazy, Lawes uses suspended notes tied across the measure in all parts including the harp. The sustained 10ths which are held against moving tenths of bars 64-68 are to be discussed further in the section concerning the use of tenths in the harp part.

The Irish harp is also to be found sustaining notes in different instrumental combinations, including movement in its own treble register. These include:

1. Harp bass, bass viol and theorbo sustaining against movement in the violin as in the Paven (movement 29) during bars 51, 55-57 and 67-68.
2. Harp bass doubling theorbo, sustaining against movement in the harp treble, bass viol and violin as in the Paven (movement 27) during bars 2-6.
3. Harp bass doubling theorbo and bass viol, sustaining against movement in the violin as in the Paven (movement 28) during bars 70-79.
4. Harp sustaining at an octave above the theorbo and bass viol, sustaining against movement in the harp treble and the violin as in the Paven (movement 28) during bars 81-84.
5. Harp octave in bass together with the theorbo sustaining against movement in the harp treble, bass viol and violin as in the Paven (movement 28) during bars 4-5.
6. Harp chord with bass viol sustained against movement in violin and theorbo as in the Fantazy (movement 30) during bar 69.

7. Harp chord with theorbo and bass viol sustaining against movement in the violin as in the Fantazy (movement 30) during bars 31-42.

With the exception of cadential chords, Lawes has a tendency to exploit the bass register of the harp when sustaining notes. There are many examples of bass semibreves being held against movement in other parts throughout movements 26-30. The examples cited in this section do demonstrate that Lawes was exploiting the sustaining potential of the Irish harp, though there is no evidence to suggest that he was exploring the instrumental combinations of movement against sustained notes in a systematic way. The examples of repeated semibreves in the bass line suggest that the instrument could not compete with the organ in this respect however, and that allowances for this had to be made by the composer.

Filling in Harmony

One of the characteristic advantages of a harp is its ability to play chords and so, like the theorbo or organ, fill in harmony. When looking for examples of this the difficulty of the autograph parts (or the lack of these) for movements 9-25 becomes apparent. If the Lawes' manuscript parts for nos 1-8 are in their final form, i.e. treble and bass line only, then it is inconceivable that the harper would not be expected to improvise on his part by filling in the harmony. If the parts are incomplete, then it must be assumed that Lawes intended to return to the manuscript to more fully work the material. After all, Lawes would not have neglected such an idiomatic quality of the instrument, particularly when he wrote such full parts in Mus MS B3. It

is important to remember the quotation by Henry Lawes about his brother, "Neither was there any Instrument then in use, but he compos'd to it so aptly, as if he had only studied that."¹

In considering this quotation it is worth remarking that in the Harp parts of Mus MS 5 in the hand of Withy, the writer was producing an impractical part by creating distances between the fingers that really are impossible to play without some kind of leap. Two examples of these are to be found in movement 13, bar 5 (F, c' and f'') and in movement 16, bar 13 (F, c' and g''). In his quest to create a tenor line in the harp part by transposing the violin down an octave, the author has created a physical impossibility. Such aberrations are not to be found in Lawes' own hand.

When the fully worked harp parts in Mus MS B3 are examined it is evident that Lawes was capable of exploiting the ability of the harp to fill in harmony to the full. It can be seen from the first eight movements and nos 27-28 in Lawes' own hand, that he largely made the bass of the harp part a reduction of that of the theorbo, and in strains before divisions, frequently the bass viol too. If the harp parts of nos 1-8 are considered to be complete then the harp is being employed in a similar manner to the theorbo, improvising on an unfigured bass with the exception that the harp parts also included a treble line. In Mus MS B3 however, something different occurs. Here the theorbo continues to improvise upon its unfigured bass line, but the harp now has a fully worked part with little room for any improvisation, even if its bass line still doubles the theorbo in the pavens, and to a lesser extent in

¹ Henry Lawes, *Choice Psalms* (London, 1648), preface.

the air and fantasia.

In these later works Lawes does not simply use the harp as an instrument for filling in harmony or as a means of doubling the other parts by producing a part which is merely a reduction. After all, the 'Harpe' Consorts are very different from the composer's Five- and Six-Part Fantazy Setts as the violin and bass viol make up only two voices. A reduction of these in the manner of the organ parts to the five- and six-part works would be very dull indeed and would use very little of the potential of the Irish harp. Instead, in his later movements for the 'Harpe' Consorts the composer gives the harp itself extra parts, up to four, an example of which can be seen clearly in bars 12 and 13 of movement 27 (Paven).

It is interesting to compare this feature of the harp parts with The Royal Consorts which are scored for two violins, two bass viols and two theorbos. Here, the composer is able to achieve a similar number of parts or voices in his work, but has an extra violin and bass viol compared to the resources deployed in the 'Harpe' Consorts. Lawes is using the harp as both an accompanying instrument, as in the case of doubling the theorbo in the bass, and as up to three other voices in the consort, as in the case of the second violin and bass viol of the Royal Consorts. The harp also has, in the theorbo, an accompanying instrument to support its role. As has been remarked before, there are no examples by Lawes of the chamber organ being supported by the theorbo.

The duality of roles displayed by the harp in the later movements of the harp consorts is not unique to that instrument in the work of William Lawes. The parts for chamber organ in the setts for one or two violins, bass viol and organ feature a similar double role. In the first

15 bars of Sett No I in G Minor the organ doubles violin 1 at pitch, providing a bass line in the tacet section of the bass viol, and in bar 11, providing four parts around the single voice of the violin.² This movement ends with a six note chord in the organ part which is clearly an example of filling in harmony. The harp parts of the 'Harpe' Consorts are therefore closely related to the organ parts of the Fantazy Setts for one or two violins, bass viol and organ.

The instrumentation of the Harp consorts is also particularly closely related to the Fantazy setts for one violin, bass viol and organ, in this case with the harp and theorbo taking over the role of the organ. A significant difference is therefore in the number of movements. The Violin Setts follow a three movement Fantazy / Aire / Galliard structure whereas the Harp Consorts, if they include larger first movements from Mus MS B3, consist of up to five or six movements. Once again the nature of Lawes' parts for nos 1-8 must be considered because if the harp part was expected to be improvised, and these movements were preceded by a fully worked part from the later movements in MS B3, then the harper would be working within two performing traditions in the same sett.

The role of the harp in Mus MS 5 in the hand of Withy is more clearly defined than in the Lawes' autograph parts for movements 1-8. In nos 1-8, the harp part performs Lawes' treble and doubling of the theorbo bass line but also includes doubling of the other parts either at pitch or by transposition, usually at an octave above the bass or below the violin. Whatever Lawes' intentions were regarding his two

² *William Lawes - Select Consort Music*, ed. Murray Lefkowitz, *Musica Britannica*, XXI (London, 1963), 107.

voice harp parts for movements 1-8, Withy did not expect his harp player to have to improvise and fill in the harmony to such an extent. This is interesting because if Lawes' harper was present at the Oxford Restoration gatherings of musicians which Withy attended, then he would also presumably have had the skill to improvise from the two voice autographs, assuming that these were all that were available to him in Lawes' own lifetime. Holman has suggested that "it is not impossible that Charles Evans (appointed 'his Majesties harper for the Italian harp' in succession to Squire on 17th June 1660), probably the son of Lewis Evans who taught Squire to play the Irish harp and other instruments, visited the Oxford Music School and took part in performances of them [the 'Harpe' Consorts] there".³

If Charles Evans was the harper for whom Withy was reconstructing harp parts, then the character of the parts may reflect later seventeenth-century writing and performance styles and the use of the Italian instead of the Irish harp. The reversion to a simple reduction of the theorbo and violin parts for movement 17-20 for example is indeed close in concept to the works for bass viol, violin and harp by Francis Forcer, included in the 1667 edition of Christopher Simpson's *A Compendium of Practical Music*, to be discussed later. Once again, without further insight into Lawes' early parts it is difficult to come to any conclusions regarding those by Withy. It is difficult to decide whether the variety of types of harp writing to be found in Mus MS 5 reflect a respect towards the composer when possible (i.e. when the composer has left us with a two-voice part), and a late seventeenth-

³ Peter Holman, 'The harp in Stuart England', *Early Music*, XV (1987), 201.

century performance practice when Withy had no Lawes harp parts to guide him. Certainly the role of Withy's harp in movements 17-20 as straightforward reductions of the theorbo and violin parts, is different from those of a more independent manner seen in Lawes parts for movement 1-8 or 26-30. It can only be a matter of conjecture to consider whether Withy was occasionally producing a simple reduction of the violin and theorbo parts out of respect for Lawes, because he felt unable to produce something in a style akin to Lawes' harp parts, or because he was writing in the fashion of the late-seventeenth century. One is reminded of the changes in style illustrated by the simple accompaniments to a single voice treble found in such collections of mid-seventeenth century keyboard music as that of Elizabeth Rogers⁴ and the far more complicated part writing frequently found in the Fitzwilliam Virginal book of c.1619 (the date of the death of Francis Tregian).⁵

Texture

Another aspect of the role of the harp in the 'Harpe' consorts to be considered is that of texture. It has already been demonstrated that, apart from three bars in the Fantasy (movement 30), the harp is ever present, even in the arrangements in the hand of Francis Withy (Mus MS 5 movements 1-20). It has to be remembered that Withy made no provision for harp parts in nos 21-25. It is therefore evident that the harp part must contribute to the overall texture of sound produced by the consort

⁴ *Elizabeth Rogers Hir Virginall Booke*, ed. Charles Cofone (New York, 1982), ix.

⁵ *The Fitzwilliam Virginal Book, Vol I*, ed. J.A. Fuller Maitland and W.Barclay Squire, (New York, 1963), ix.

grouping of instruments. This does not vary to any significant extent during the earlier movements as all instruments are playing for virtually all of the time. The only way in which the texture could be altered under these circumstances therefore would be for the texture of the harp part itself to change. Of course this is one of the important features of movements 26-30 but in these cases the texture of the consort is also altered with the inclusion of tacet sections for various instruments.

In the earlier works (nos 1-25) the problems caused by not having any fully worked harp parts by the composer are again illustrated. Certainly it was Lawes' intention that for the first eight movements, the harp would be playing with the other instruments all of the time. What is harder to assess is the extent to which the harp could alter the texture of the consort as a whole by reducing or increasing the number of voices in its part against the violin, bass viol and theorbo. Lawes' autograph parts only give us a consistent employment of two voices, one of which doubles the theorbo. There is however, an extremely rare example of the harp filling in harmony in bar 16 of movement 1. When considering the parts in Mus MS 5, changes in texture do occur and perhaps this is for a variety of reasons.

In Mus MS 5, Withy mostly presents a three-voice harp part making use of Lawes' two-voice part with additions, largely in the tenor register, as discussed previously. Occasionally he introduces a four- or five-note chord, frequently at the end of a strain, to fill in the harmony, so affecting the texture of the consort as a whole through the harp. On other occasions, such as in bar 5 of the first movement, he fails to add to Lawes' two-voice part and so reduces the harp's

contribution to the overall texture of the consort group. In movements 1-8 there is no apparent scheme to alter the texture of the consort, through the build-up of voices using imitative entries for example.

Lawes creates a variety of textures in the 'Harpe' Consorts by giving instruments tacet sections. As mentioned previously these varied groupings occur in the movements of MS B3. Interestingly the harper is the only musician who is given a solo role and who is given the opportunity of playing with the other musicians in the consort in every possible combination. The only combination of instruments which does not occur is that of bass viol and violin. The harp also has tacet sections, but these are very few. It is also important to recognise the fact that the variety of sound combinations produced by giving instruments tacet sections do not make up the greater part of the music. Instead the dominant combination of instruments remains the full consort, and the harp's textural role is hence largely within this context.

The Fantasy (movement 30) provides interesting examples of the texture of the consort being altered by changes within the harp part itself. In bar 1, the solo harp provides a bass entry which is joined by an imitative treble entry in bar 2. Bar 4 features the entry of a third voice and it is only after a minim rest into this bar that the harp is joined by another instrument, in this case the violin. In these first four bars the harp has begun the consort with a gradual build-up of texture through the addition of voices in its registers. The build-up is taken up by the rest of the consort after this, with the arrival of the bass viol in bar 5, and the theorbo in bar 6. In bars 11-13 the process is repeated, but this time the build up within the harp part takes place while all three other instruments in the consort are playing. Bars 14-15

feature four voices in the harp part, while the bass viol followed by the violin stop playing, thus making for two different textures.

Bar 22 features a variant as a two-voice harp part, this time in the treble register, accompanies the bass viol and theorbo. The harp starts bar 23 with an additional three-note chord in the bass, beginning the entry of a third voice in the lower register. The increase of texture is achieved in the opposite manner to that which opened the movement, this time from the treble downward instead of the bass upward.

An upward increase in texture from one voice to four is achieved again through bars 32-34. This occurs during a period when the bass viol is silent. That the harp is not being used as an accompanying instrument is demonstrated by the imitative nature of the voice parts. The harp's voices have an equality with that of the violin.

Bars 58-61 feature another downward build-up of texture within the harp part. This time it is made interesting by the rapid passage work featuring the single treble voice of the harp combined with the bass viol. This is surprising as one might expect the delicate rapid treble of the harp to be lost against the rapid but more robust tones of the bass viol in such a quick succession of notes.

Another way in which the texture of the consort could be altered would be for the harp treble or bass to be doubled by the violin or bass viol during divisions, thus making it thinner. In this respect the harp continues to play the same part as previously but the violin or bass viol part changes to affect the role of the harp. As already discussed, an example of this feature occurs during the divisions of movement 28, Paven on a theme of Cormacke (bars 52-86).

A texture featuring a thinner harp part relative to those of the

violin, bass viol and theorbo could also be achieved if the harp was to provide slow sustained notes against more rapid movement in those other parts. Once again this is frequently achieved by changes in other parts, as in division writing, rather than in the harp part itself. Such an example occurs during movement 29, Paven on a theme by Coprario (bars 142-144).

The use of 10ths in the Harp part

The clear metallic bell-like sound of the Irish harp has already been remarked upon on this chapter and the characteristic sound of a bell is made up of harmonics which are dominated by the fundamental, an interval of a tenth above and, on larger bells, an octave below. If a composer really wanted to exploit the bell-like sound of the harp he might feature intervals of a tenth in the harp part. One would expect such an interval to occur perhaps within a part which featured at least three voices, as a two-voice part featuring bass and treble would be rather monotonous if it followed a long sequence of intervals of a tenth. It is therefore unlikely to be found in Lawes' autograph harp parts for movements 1-8 (MS D 229) which give us treble and bass lines only. Instead, an examination of Mus MS 5 and Mus MS B3 has to take place in order to find examples of such intervals.

In Mus MS 5 Withy uses intervals of a tenth in the harp part frequently, as in bars 1, 3, 5, 7 and 14 of movement 2. The difficulty with the first eight movements is that it is probable that Withy produced these intervals, not from a desire to create a bell-like effect, but from transposing the violin part down an octave to fill in the harp part. It is possible therefore that Withy's intervals of a

tenth reflect instead, the fact that the violin might be occasionally operating at intervals of one third above the harp treble. As has been discussed earlier, it is also more than probable that Withy was writing for an instrument other than the Irish harp and so would not be trying to exploit the bell-like sound of this instrument.

As the styles of writing change in Mus MS 5 from movements 9-25 so must the frequency of occurrence of intervals of one tenth. In movement 9 (Almane) bar 5, there is a succession of tenths in the harp part. In no 10 however the writing of the harp part is so near to being limited to two voices that intervals of a tenth are very scarce. There are examples of limited use of tenths in bars eight and nine in movement 11 and a few isolated instances of their use in no 12, certainly nothing to suggest they are being used to exploit a bell-like sound. This state continues throughout movements 13-16, despite the parts demonstrating a higher degree of creativity. The return to the practice of duplicating the violin and theorbo in movements 17-20, and the non-existence of a harp part to nos 21-15, greatly reduces the possibility of this feature occurring at all.

An examination of Mus MS B3 and Lawes' fully worked harp parts is necessary to see if the composer had any intention of exploiting the bell-like sound of the harp, by bestowing on it the characteristic harmonic interval of one tenth. This feature occurs straight away in bars 14-15 of movement 26 (Aire), but it is in the Fantasy (movement 30) that the best example is to be found, during bars 63-68. Here Lawes produces an effect akin to the ringing of bells with successive rising tenths and answering phrases using quavers heightened by playing these against a background of slowly rising held tenths. There can be little

doubt that in doing this, he is writing specifically for the Irish harp and exploiting its unique, bell-like sound.

Other Aspects of the Role of the Irish Harp in the 'Harpe' Consorts of William Lawes

Several aspects of the role of the Irish harp within this body of work have been discussed earlier in this chapter in different contexts. The continuo manner in which the harp bass in particular, works together with the theorbo is very important. Indeed the two instruments are almost inseparable in this respect, apart from movements 26 and 30 (Aire and Fantasy). In these two movements, the use of imitation and part writing is explored and new or different roles for the Irish harp established. At times, as has been demonstrated, lines within the compass of the harp are even given equality with the single lines of the other instruments in the consort.

Another important element to be examined is that of the interplay between the harp treble and the violin. This is demonstrated by the frequent use of such devices as the harp treble being written either above or below the violin using a variety of intervals, points of exchange and examples of contrary motion. This independence of polyphonic line is to be found throughout those manuscripts in the hand of Lawes. Those in the hand of Withy, for movements 9 to 20, demonstrate this to a more varied or even lesser degree, and may even have been written for another type of harp.

The two-line parts in Lawes' hand for movements 1-8 are open for the interpretation or ability of the the harper. The only appearance in the 'Harpe' Consorts of anything resembling a written ornament is the

curious sign which occurs during bar 70 of the Fantazy (movement 30). Its presence is perhaps surprising as, if this was to be treated as an ornament, many other chords in the consort setts could be considered more worthy of decoration. As with dynamics, the harper was probably expected to improvise ornamentation if and where appropriate.

Divisions are not included as part of the role of the Irish harp in these works. It can be assumed that the continuo role of the bass, and the significant role of the treble of the harp parts were so fundamental to Lawes' overall concept that it was inconceivable that the instrument should be given divisions. The rapid style of division which frequently occurs in the bass viol or the violin, if transferred to the Irish harp, would actually create a conflict between its sustaining tonal qualities and the clarity of the variations. Undamped, due to otherwise occupied fingers, the wire strings would cause a clash of sound which would blur the effect of the rapid sequence of notes, particularly during more chromatic passages. The sustaining tone of the instrument was better suited to providing a foil for divisions by other instruments in the consort. The very strength of the Irish harp was therefore its limitation and, William Lawes in the experimental part writing for harp in the Aire, (movement 26) and the Fantazy, (movement 30) tested the role of the instrument in a consort to its very limits.

CHAPTER 6

Other Examples of Music Written for the Irish Harp, and Music Related to This Genre

Scope

This chapter is concerned with music relating to the Irish harp other than the William Lawes' 'Harpe' Consorts, and, as such, makes for a varied anthology. Works by several musicians are discussed and these include William More, Cormacke MacDermott, Martin Peerson, Francis Forcer and other anonymous figures. In particular, the music will be examined to see what might be gleaned concerning the chromatic development of the Irish harp and its repertoire.

William More

The four-part textless piece entitled *Levavi Oculos* is the only nearly complete composition attributed to More known to have survived.¹ Of another five-voice work by him, *Ad Dominum Contribularum*, only one part is now known to be in existence.² The source for *Levavi Oculos* (written in four parts) is a set of five partbooks which originally belonged to the Hamond family of Hawkedon now held in the British Library (Add. 30480-4).³ Included in the manuscripts are settings of canticles, instrumental pieces, motets, part-songs and anthems, for cantus, contratenor, tenor, bassus, and quintus.⁴

1 British Library, Add. 30480-4; Gerald Hayes, *Kings Music* (Oxford, 1937), 26-7.

2 British Library, Harl. 7578.

3 Craig Monson, *Voices and Viols in England, 1600-1650* (Michigan, 1982), 77-108.

4 Peter Le Huray, *Music and the Reformation in England 1549-1660* (London, 1967), 98.

Levavi Oculos, an abbreviation for *Ad Te Levavi Oculos Meos*, is a very ironic title for a work conceived by More. Translated, it means 'To Thee I Lift Up Mine Eyes' and William More was blind. If this work is by More (there is only the evidence of a non-autograph attribution) he must have had assistance in notating the parts. The title of *Levavi Oculos* appears to be a reference to a motet and it could therefore be a reworking of a vocal composition. This practice was common in the sixteenth century and several examples appear in the collection to which More's piece belongs. No instrumentation is specified.

Levavi Oculus tells us little about the employment of the harp in English court music during the sixteenth century except perhaps, that harpers were restricted by the mainly diatonic nature of their instruments and that more creative musicians were welcoming the new chromatic possibilities presented by other instrumental and vocal combinations.

Cormacke MacDermott (See Appendix B)

The surviving works of Cormacke MacDermott are identified by attribution rather than by autograph. Their authorship therefore remains unproven. These compositions, though written by a harper, do not feature the harp, and their instrumentation is unspecified except in the case of divisions for bass viol by Daniel Norcombe and the theorbo part of a paven set by William Lawes.

Eight works (all dance movements) attributed to MacDermott survive, and the sources for these are listed in Table 1. The Filmer Manuscripts 4 (part-books for a collection of popular dance and vocal music of the late-sixteenth and early-seventeenth centuries) are a major source for

Table 1
Sources for works attributed to Cormack MacDermott

Code	Sources
F4	Yale Music Library, Filmer MS 4, ff34, 35, 37, 39, 40, 41, 43
MS 379-81	Christ Church Library, Oxford, Mus.MSS 379-81, nos 40, 41
MS 1022	Christ Church Library, Oxford, Mus.MS 1022, no 84
D 246	Bodleian Library, Oxford, MS Mus.Sch.D 246, pp. 251-252f
B3	Bodleian Library, Oxford, Mus. Sch. B.3, pp. 39 -43
D 238-40	Bodleian Library, Oxford, Mus. Sch. D 238-40, ff.42v, 522v-54, 30v-32
WB	William Brade, <i>Neue Ausserlesene liebliche Branden</i> (Hamburg, 1617), nos 40 & 48
1	'S ^r : Joh: Packintons Pauin M ^r : Cormake' (a3) F4, ff34v, 39v, 40v 'S ^r John Paitons pauan by m ^r Cormake' (a3) MS379-81, no 40
2	'Allmane M ^r : Cormake' (a3) F4, ff. 34v, 39v, 40v 'Almaine a 3 WD' MS 379-81, no 41
3	'M ^r : Cormakes pauin' (a3) F4, ff. 35, 40, 41 'S ^r Thomas Brooks pauin' [bass viol divisions] D246, pp. 252f
4	'M ^r : Cormake Allman' (a3) F4, ff. 35v, 40v, 41v 'M ^r Cormack' [bass part] MS1022, no 84 'Cormacks Almane by Daniell Nercum' [bass viol divisions] D246, pp. 251f
5	'The Lor: Sheffelds pauin M ^r : Cormake' (a3) F4, ff. 37, 42, 43
6	'Schoch.a.torum Cormacke' (a5) WB, no 40
7	'Cormacke' (a5) WB, no 48
8	'Paven' / Division on the Paven for Violin and Base Viol', 'Wi Lawes' B3, pp. 39-43 D238-40, ff.42v, 52v-54, 30v-32

these works and they were possibly copied out by one Francis Block, and probably date from the mid 1630s to the late 1660s.⁵ The attribution to Block remains inconclusive. Dr Robert Ford of Yale University is of the opinion that the copying of the treble lines is generally accurate when compared to sources for many of the works which Block copied. However it appears that (in the case of works apart from those attributed to MacDermott) many of the bass and inner lines differ greatly from other surviving versions. These may well have been created by the copyist, and therefore it is possible that only the treble lines represent the work of the attributed composers. In a personal communication to myself, Robert Ford states that:

...our scribe's copying is generally accurate: In days past I checked it against a great number of other sources for various of the works he copied. However, he was no gem of a composer or arranger, and it is clear that for many of the two-part and three-part pieces, he has composed the bass and/or the middle part, so different are these from other surviving versions. This is in keeping with the image that FB was a professional "gigging" musician, who did whatever needed to be done to put on a good show. Trebles to other "composed" pieces are generally pretty close, so he probably had access to somebody else's tune book; it is harder to say whether he did the pop tunes by ear or from a written source. One would be well not to assume a priori that anything but the tune of the Cormacke pieces is by Cormacke.

It is worth noting however that bass and treble lines from the two sources of *Sr: Joh: Packintons Pauin (Sr John Paitons pauin)* and *Allmane Mr: Cormake (Almaine a 3 WD)* are almost identical. This suggests that in the case of these two works there is perhaps a common source, despite the differing attribution ('WD') to the *Allmane*.

The works attributed to MacDermott in the Filmer Manuscripts survive

⁵ Robert Ford, 'The Filmer MSS - A Handlist', *Notes*, XXXIV (1978) 814-25.

in three partbooks: for treble, tenor and bass which has been figured, frequently with crossings out, suggesting that the figures were added by the copyist in an attempt to aid performance, perhaps by employing different instrumentation to that intended in the original source. Examples of the parts from Filmer 4 are shown in Illustration 1 (a-c). Peter Holman suggests that the figures added to the bass line are to compensate for missing quintus and altus lines, and that the work was perhaps originally written in five parts.⁶

The alternative sources for *Sr: Joh: Packintons Pauin* and *Allmane Mr: Cormake* are to be found in another set of three partbooks (Och Mus. MSS 379-81) (see Illustration 2 [a-c]), which originally belonged to the library of John Browne (1608-1691).⁷ As previously stated, the treble and bass parts are almost identical with those of Filmer 4. The inner lines in MSS 379-81 are written for altus however. Holman produces a speculative (five-part) reconstruction of *Sr: Joh: Packintons Pauin* by adding his realisation of the 'lost' quintus to the treble and bass lines together with the tenor and altus from each of the sources.⁸ The result appears to be most convincing though one has to ask what the original sources of these five-part settings were (See Example 1).

Interestingly, two other dances attributed to MacDermott also survive in five-part settings. These are to be found in a collection of popular tunes and dances of mainly English origin called *Neue Ausserlesene liebliche Branden* printed in Hamburg in 1617 by William

6 Peter Holman, 'The harp in Stuart England', *Early Music*, XV (1987), 190.

7 Ibid., 190.

8 Ibid., 192

Illustration 1.(a)

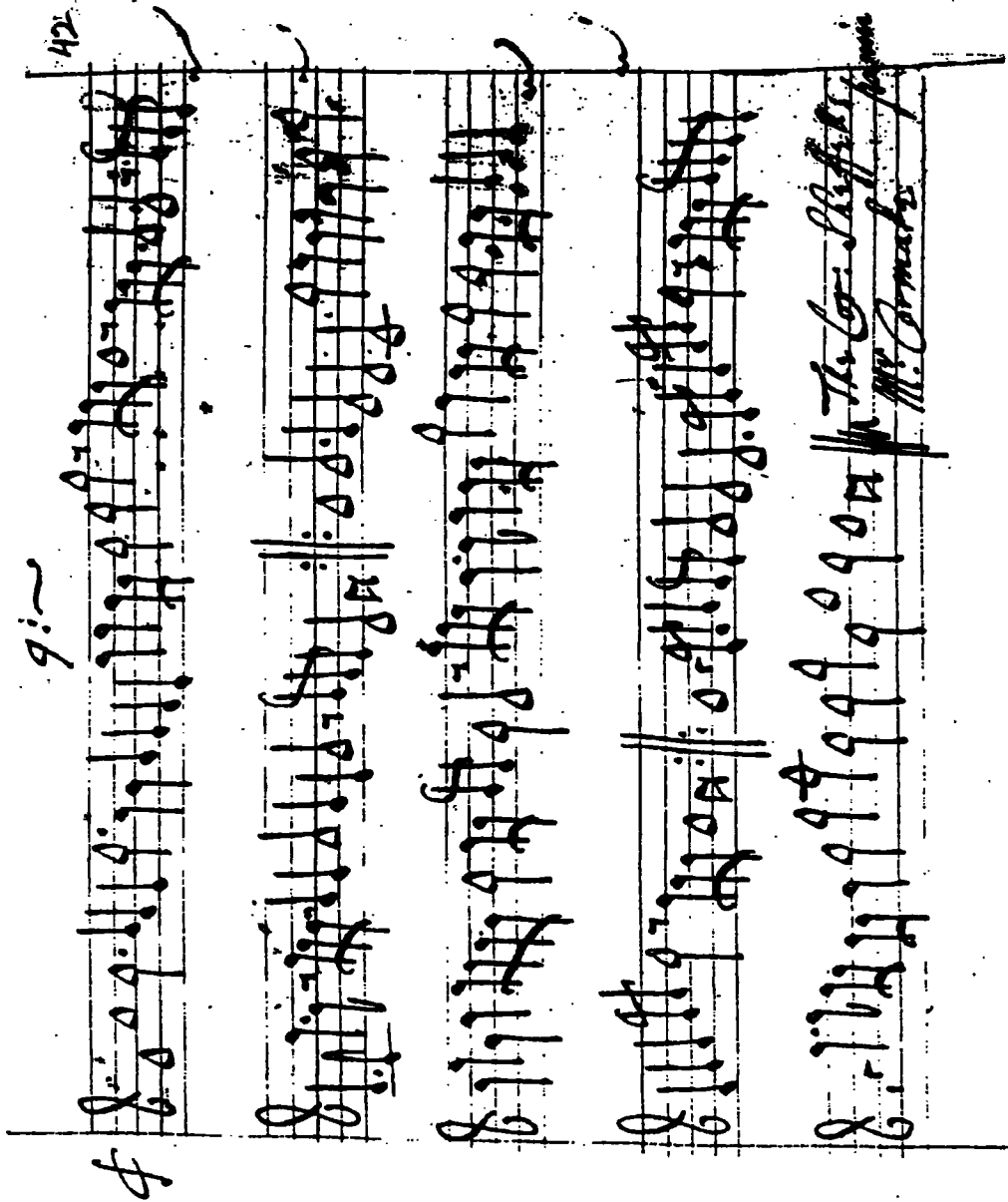

1.(a) 'The Lor: Sheffelds Pain Mr: Cormake' (treble)
Filmer Manuscript 4. f.42r, Yale Music Library.

Illustration 1.(b)

17

9:6

The Lor: Sheffield's Pavin
Mr: Cormake:

1.(b) 'The Lor: Sheffield's Pavin Mr: Cormake:' (alto)
Filmer Manuscript 4. f.37r, Yale Music Library.

Illustration 1.(c)

Handwritten musical score for bass, featuring four staves of music with various notes, rests, and fingerings. The score includes a treble clef and a key signature of one flat. The music is written in a style typical of early 20th-century manuscript notation. The first staff begins with a treble clef and a key signature of one flat. The notation includes eighth and sixteenth notes, rests, and various fingerings. The second staff continues the melody with similar notation. The third staff shows a change in rhythm with some dotted notes. The fourth staff concludes the piece with a double bar line. Below the staves, there is a signature 'The Lor: Sheffield's pain' and 'Mr: Cormake.' followed by a circled number '8'.

1.(c) 'The Lor: Sheffield's pain Mr:Cormake.' (bass)
Filmer Manuscript 4. f.43r, Yale Music Library.

Illustration 2.(a)

Sr John Paitons pauan: by mr Cormake

40.

41.

Almaine a 3

2.(a) 'Sr John Paitons pauan: by mr Cormake' (treble)
Och.MS 379, f.19v, the Library of Christ Church, Oxford.

Illustration 2.(b)

The image displays two systems of handwritten musical notation on five-line staves. The first system, labeled '40.' at the bottom left, contains two staves of music. The title 'Sr John Paitons Pauan by mr Cormake.' is written in cursive above the first staff. The second system, labeled '41.' at the bottom left, also contains two staves of music. The title 'Almaine a 3. C.W.D.' is written in cursive above the first staff. Both systems feature rhythmic notation with stems and flags, and include repeat signs with first and second endings. The notation is characteristic of early printed music manuscripts.

2.(b) 'Sr John Paitons pauan by mr Cormake' (alto)
Och.MS 380, f.19v, the Library of Christ Church, Oxford.

Illustration 2.(c)

Sr. John Paitons pauan: by mr. Cormack

40.

41.

Almanico a 3

2.(c) 'Sr John Paitons pauan: by mr Cormack' (bass)
Och.MS 381, f.19v, the Library of Christ Church, Oxford.

Example 1

A reconstruction of the opening of Sir John Packinton's Pavan/Sir John Peyton's Pavan by Peter Holman, 'The harp in Stuart England', *Early Music*, XV (1987), 192.

Ex 1 C MacDermott, Sir John Packingham's Pavan/Sir John Peyton's Pavan, opening

The musical score is presented in two systems. The first system includes vocal parts and a harp reconstruction. The vocal parts are labeled as follows: Cantus (Filmer 4, Ork 1-9), Altus (Ork 100), Tenor (Filmer 4), Quartus (Reconstruction), and Bassus (Filmer 4, Ork 101). The harp reconstruction is labeled 'Reconstruction'. The second system shows a harp reconstruction of the opening. The score is written in a single system with five staves. The first staff is the Cantus part, the second is the Altus part, the third is the Tenor part, the fourth is the Quartus part, and the fifth is the Bassus part. The harp reconstruction is shown in a separate system below the vocal parts. The harp reconstruction is written in a single system with five staves. The first staff is the Cantus part, the second is the Altus part, the third is the Tenor part, the fourth is the Quartus part, and the fifth is the Bassus part. The harp reconstruction is written in a single system with five staves. The first staff is the Cantus part, the second is the Altus part, the third is the Tenor part, the fourth is the Quartus part, and the fifth is the Bassus part. The harp reconstruction is written in a single system with five staves. The first staff is the Cantus part, the second is the Altus part, the third is the Tenor part, the fourth is the Quartus part, and the fifth is the Bassus part.

Brade. They are identified in this work as number 40, *Schoch.a.torum Cormacke* and number 48, *Cormacke*. Holman suggests that these dances are possibly evidence of MacDermott providing music for masques, as several of the other dances collected by Brade can be identified as having been written for such occasions.⁹ Despite tantalising reminders by Holman that music for two harps is "mentioned in Ben Jonson's *The Irish Masque at Court*, performed at Whitehall on 29th December 1613 and 3 January 1613/14", it must be remembered that there is a lack of substantial evidence to connect *Schoch.a.torum Cormacke* and *Cormacke* with these performances. Equally difficult to substantiate is Holman's suggestion that *The Irish Dance* featured as "the third item in *Parthenia In-Violata* (London, c1614), set for keyboard and bass viol" is also probably from this masque. A more significant feature of the works attributed to MacDermott in Brade's collection is perhaps their being written for five parts in the manner suggested by Holman for *Sr: Joh: Packintons Pauin Mr: Cormake* and *Allmane Mr: Cormake*.

Another two dances attributed to MacDermott in the Filmer Manuscript (*Mr: Cormakes pauin* and *Mr Cormake Allman*) also have divisions for bass viol and these are to found in MS D 246. Another bass part for Mr: Cormake Allman is to be found in MS 1022 (see Illustration 3). The divisions for *Mr Cormake Allman (Cormacks Almane* in D 246) are attributed to Daniel Norcombe ('Daniell Nercum') and because of similarities in style and adjacent proximity in the manuscript, there is a strong possibility that the divisions upon *Mr: Cormakes pauin (Sr Thomas Brooks pauin* in D 246) are also by the same composer. The

⁹ Peter Holman, 'The harp in Stuart England', 194.

Illustration 3.

Handwritten musical score for two pieces. The first piece, 'Almaine', is marked with a circled '84' at the beginning and a circled '37' at the end. It consists of three staves of music. The second piece, 'Corrante', is marked with a circled '85' at the beginning and consists of three staves of music. The names 'Mr Cormack' and 'Charles Coleman' are written in the right margin of the second and third staves, respectively. The notation includes treble and bass clefs, a key signature of one flat, and various rhythmic values such as quarter, eighth, and sixteenth notes, as well as rests and bar lines.

3. 'Almaine. Mr Cormack.' (bass)
Och.Mus.MS 1022, no.84, the Library of Christ Church, Oxford.

divisions attributed to Daniel Norcombe are shown in Illustration 4. It is interesting that here there are examples of dance music written for a consort which features divisions for bass viol in much the same manner as those featured in Lawes' 'Harpe' Consorts. This similarity was sufficient to inspire Peter Holman to produce an example of a conjectural harp consort, scored in Lawes' manner, for violin, bass viol, theorbo and harp based upon the two sources for *Mr: Cormakes pauin* (*Sr Thomas Brooks pauin*).¹⁰ Here, the violin has been given the cantus part, the bass viol the Norcombe divisions, the theorbo the bass part, and the harp part consists of a reduction of the cantus, tenor and bass parts (See Example 2).

Once again Peter Holman's reconstruction looks most convincing and it is certainly possible to see how Lawes' Harp consorts may have developed from such origins as the works attributed to Cormack MacDermott. The difficulty in accepting this however, is once again due to lack of proof. In fact evidence such as the painting by Reinholdt Timm discussed in Chapter 2 (*Harpers and Patrons*) suggests that other combinations of instruments may have been used in a consort featuring the Irish harp. In the painting, the harp is shown being used with a bass viol, lute and flute and this suggests that Lawes may not have inherited the grouping of instruments which are featured in his consorts, and that previous harp consorts may have consisted of many varied combinations. One cannot help thinking that such conjectural harp consorts could be reconstructed from a great variety of material composed during this period and Holman is imposing a later model (Lawes) upon earlier material.

¹⁰ Peter Holman, 'The harp in Stuart England', 193.

Illustration 4.

The image displays a handwritten musical score for the piece 'Cormacks Almain' by Daniel Nercum. The score is written on ten staves. The top staff begins with the title 'Cormacks Almain' and the composer's name 'by Daniel Nercum' written in cursive. The music is written in a style characteristic of early modern manuscript notation, featuring various rhythmic values, accidentals, and complex melodic lines. The notation includes many beamed notes and rests, typical of the 'Almain' dance form. There are some markings above the first staff, possibly indicating a key signature or time signature. The score is densely packed with musical notation, showing intricate patterns and textures.

4. 'Cormacks Almain by Daniel Nercum' (bass viol divisions)
Bodleian MS Mus.Sch.D 246, pp.251f, the Bodleian Library, Oxford.

Example 2

A reconstruction of the opening of Sir Thomas Brook's Pavan arranged in the manner of a Lawes' style harp consort by Peter Holman, 'The harp in Stuart England', *Early Music*, XV (1987), 193.

Ex. 2a C MacDermott, Sir Thomas Brook's Pavan, opening the three surviving parts

Musical score for three parts: Violin, Tenor, and Bassoon. The score shows the opening of Sir Thomas Brook's Pavan. The Violin part is in the treble clef, the Tenor part is in the alto clef, and the Bassoon part is in the bass clef. The music is in a 3/4 time signature. The Bassoon part includes a sequence of fingerings: 0, 2, 3, 4, 5, 10, 8, 10, 8, 10, 12, 8, 10, 3.

Ex. 2b A possible version of the above as a harp consort, using Norcombe's divisions

Musical score for a harp consort arrangement. The score includes four parts: Violin, Bass viol, Theorbis, and Harp. The Violin part is in the treble clef, the Bass viol part is in the alto clef, the Theorbis part is in the bass clef, and the Harp part is in the bass clef. The music is in a 3/4 time signature. The Harp part includes a sequence of fingerings: 2.

Musical score for a harp consort arrangement, showing a different version of the opening. The score includes four parts: Violin, Bass viol, Theorbis, and Harp. The Violin part is in the treble clef, the Bass viol part is in the alto clef, the Theorbis part is in the bass clef, and the Harp part is in the bass clef. The music is in a 3/4 time signature.

Holman extends this concept when examining Lawes' 'Harpe' Consort 9 (B3, D 238-40) which features a theorbo part with an attribution to 'Cormack' (shown in Illustration 5). Using his well researched maxim that "when bass viol divisions were written on consort dances, the accompaniment was normally a reduction for keyboard of some or all of the parts of the original", he suggests that the harp part of Consort IX may be "a unique survival, an original solo harp piece by a 17th-century Irish harper." His argument is convincing, though one has to ask why Lawes went to the trouble of giving the attribution to Cormack in the theorbo part and not in the harp, especially if such a significant proportion of the composition was not his own work. Another factor which must be considered is that of accidentals in the harp part. If the assumption that the harp parts of consorts (perhaps by Cormack MacDermott) featuring bass viol divisions consist of reductions of the other parts then the accidentals which occur in these must be examined.

Of the dances in Filmer 4 attributed to Cormack MacDermott which have additional divisions for bass viol, *Mr: Cormakes pauin* features one example of an accidental f#' while the parts for *Mr: Cormake Allman* make no use of any accidentals. This is in contrast to the use of accidentals featured in the harp part of Lawes' 'Harpe' Consort IX, which makes use of the following accidentals: c#, b^b, c#, d# and c#'. It would appear from this comparison that Lawes was writing for, and making use of, an instrument with a greater chromatic capability than that of MacDermott. It would therefore be unlikely that the harp part of Consort IX was an original harp piece by MacDermott. Of course this view is unfair, as other of the works attributed to MacDermott, particularly those collected by Brade in his *Neue Ausserlesene*, feature greater use of

Illustration 5.

28

Paurm

Cormack

5. William Lawes, Harp Consort no 9 (theorbo part) attribution to Cormack in Lawes' hand.
Bodleian MS Mus.Sch.D 238, f.42v, the Bodleian Library, Oxford.

accidentals, albeit not so great as Lawes in the instance of the harp part to Consort IX. It would also be possible to argue that this harp part represented a major break-through for MacDermott, featuring increased chromaticism. But really, without greater evidence, I am of the opinion that Lawes' integrity and attributions, should be respected and his theorbo part must be regarded as the work of MacDermott and the remainder of the composition as the work of Lawes himself. After all, Lawes was working within an English tradition in which a theme such as *In nomine* could appear within the bass parts of a consort as well as the treble.

The one remaining work with an attribution to MacDermott is *The Lor: Sheffelds pauin Mr: Cormake* which is located in Filmer 4. Other than the use of accidentals c#' and f#', there is little of interest with regard to implications for the Irish harp. As with the other works attributed to MacDermott, there is nothing in the manuscript source to connect this dance movement with the Irish harp, and the links with this harper/composer are also tenuous without other evidence. It may be significant that there is an alternative attribution to that of MacDermott to found in MS 379-81, no 41, *Almaine a 3 WD*.

The existence of the music attributed to MacDermott is tantalising indeed. Its very presence suggests it to be the 'missing link' we wish it to be in the development of the history of the consort and in particular, the harp consort. Perhaps in producing a possible reconstruction of a MacDermott harp consort, and in suggesting that the harp part of Lawes' 'Harpe' Consort IX may be an original seventeenth-century solo harp piece (also by MacDermott), Holman is going some way towards fulfilling our wishes. He has produced that which we would like

to hear, but admittedly, has used such words as 'speculative', 'circumstantial evidence' and 'possible version' in its presentation.

There are further questions which have to be asked with regards to the origins of these works. Are the possible five-voice and three-voice settings of these dances the work of Cormack MacDermott or some other hand? Do they originate from a common source? Are they arrangements of original works by MacDermott, perhaps for solo harp or a consort featuring the harp? Peter Holman's theory that the harp parts may have evolved from the practice of giving an organ or keyboard reductions of the other parts is almost certainly correct. A significant feature of the 'Harpe' Consorts however, is the frequent difference between the violin part and harp treble. Indeed, this difference is further emphasised by the fact that Lawes wrote more divisions for violin in the 'Harpe' Consorts than Peter Holman credits him with. Without further information and answers to some of these questions we are not in a sound position to understand the position which MacDermott may deserve in the history of the development of the harp consort, or even in the field of writing for the solo harp.

Anonymous Harp Parts (Och Mus MS 5)(See Appendix C)

The anonymous harp parts to 16 works (Och Mus MS 5) are to be found in the back folios of this manuscript, which features the previously-described harp parts to William Lawes' 'Harpe' Consorts located in the front. The folio numbers are therefore independent from those used in identifying the works by William Lawes, and are numbered in reverse from the back. The pieces are arranged into four groups according to key, though this is complicated by idiosyncrasies of notation and numbering.

The first two pieces, a fantasia and an air, are unnumbered and written in Lydian F: I have numbered these A1 and A2. The following three pieces, titled Fantazia, Pavan and Almayne, numbered 1-3, are in Mixolydian G. The next seven pieces, Fantazia and 6 Ayres numbered 4-10 (Illustration 6) are in A minor, while the last four, Fantazia and three Ayres (unnumbered) are in C. The grouping of these pieces is shown in Table 2.

The assumption that these parts are written for harp is based upon the frequent occurrence of wide intervals, impossible to manage even on a short octave keyboard, and the fact that the front of the manuscript consists of parts for a recognised collection of harp consorts. A list of wide intervals is given in Table 3. Also of possible interest in the attribution of these parts to a harp with triple capability, is the number of incidents of the same note being played by both the right and left hands simulataneously. This is a very practical possibility on such an instrument, as the two outer rows of strings consist of the same notes and these could be plucked together. A list of the occurrence of identical notes being required simultaneously is given in Table 4. Interestingly, with the exception of an occurence of a double c'' in bar 71 of the Fantazia (no 1), f20v-21r, all the instances of double notes fall within the range of f-a', part of the triple compass of a projected Irish chromatic harp.

An interesting illustration of the problems associated with such parts is presented by David Pinto, when discussing the organ part to the first fantasy of Lawes' Six-Part Consort Sett (No IX) in B^b.

For a start, Lawes for once did not write his own organ part to the first fantasy and the start of the second (bars 1-23). The hand which helped him out was unwilling to take on the responsibility of

Illustration 6.

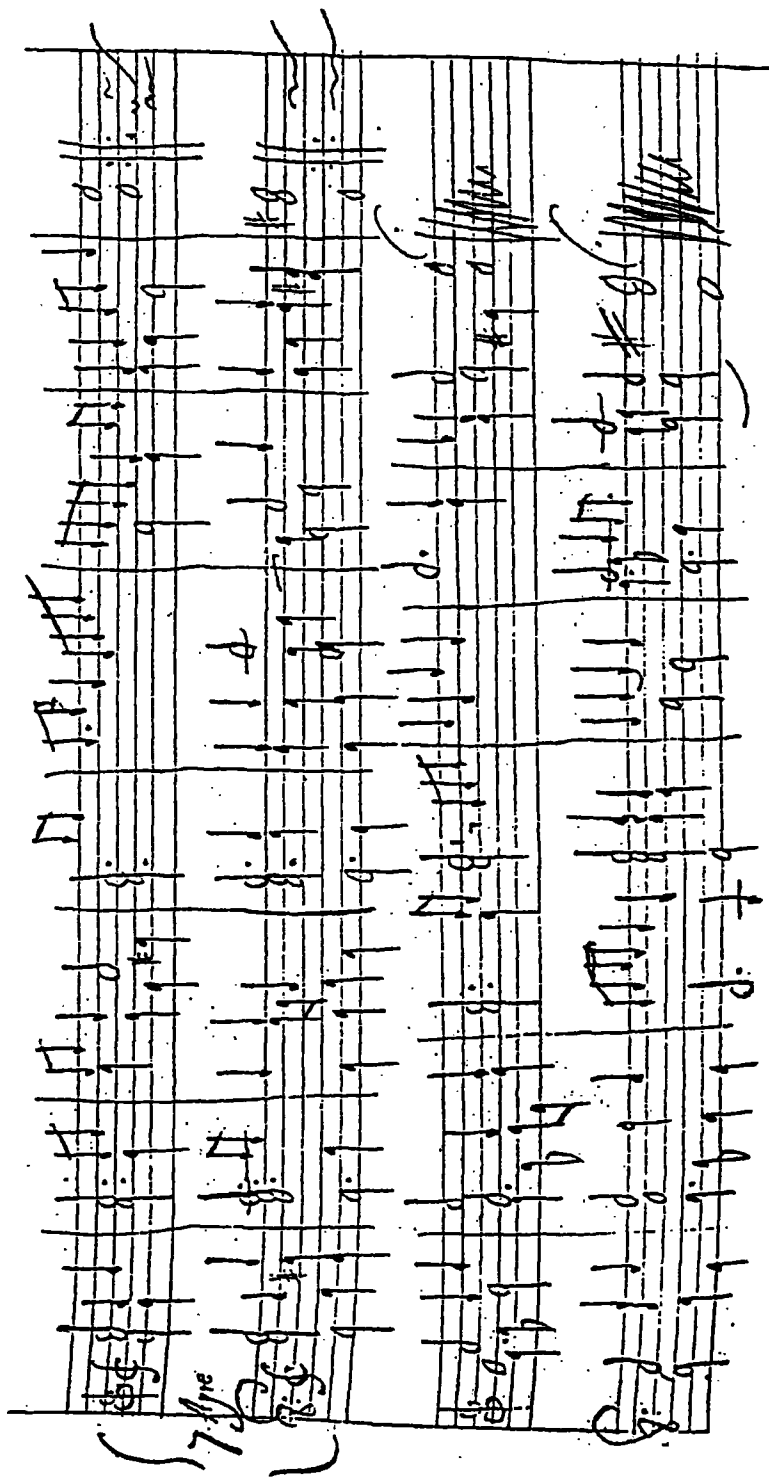

6. Ayre no 7 (anonymous harp part)
Och.Mus.MS 5, f.23v, the Library of Christ Church, Oxford.

Table 2

Anonymous Harp Parts (Och Mus MS 5)

numbers in brackets are in addition to those already used in the manuscript.

(A1) Untitled (Fantazia)	ff. 6v - 7r	F major
(A2) Untitled (Ayre)	f. 7v	" "
1 Untitled (Fantazia)	ff.20v - 21r	G major
2 Pavan	ff.21v - 22r	" "
3 Almayne	f.22r	" "
4 Fantazia	ff.22v - 22r	A minor
5 Ayre	f.23v	" "
6 Ayre	f.23v	" "
7 Ayre	f.23v	" "
8 Ayre	f.24r	" "
9 Ayre	f.24r	" "
10 Ayre	f.24r	" "
(11) Fantazia	ff.24v - 25r	C major
(12) Ayre	f.25r	" "
(13) Ayre	f.25v	" "
(14) Ayre (unfinished)	f.26r	" "

Table 3
Incidents of wide (harp) intervals of a 10th or greater.

Bar Numbers

(A1) Fantazia	14, 21, 55, 56, 57, 78, 94, 95, 104
(A2) Ayre	1, 2, 4, 6, 12, 15, 17
1 Fantazia	1, 20, 22
2 Pavan	20, 70
3 Almayne	18, 24
4 Fantazia	43, 56, 65, 66, 67, 71, 92
5 Ayre	4, 9, 12, 14, 18, 21
6 Ayre	3, 4
7 Ayre	3, 4, 5, 11, 12
8 Ayre	15, 17
9 Ayre	1, 11, 20
10 Ayre	17
(11) Fantazia	8, 9, 18, 24, 29, 38, 42, 61, 62, 63
(12) Ayre	9, 14, 15, 16
(13) Ayre	2, 3, 15
(14) Ayre	12, 18

Table 4
Identical notes required simultaneously by both hands.

Bar Numbers

(A1) Fantazia	6, 29, 49, 62
(A2) Ayre	10, 11, 20
1 Fantazia	11, 68, 71, 75, 81
2 Pavan	47, 54, 55
3 Almayne	11
4 Fantazia	47, 87, 95
5 Ayre	
6 Ayre	
7 Ayre	
8 Ayre	
9 Ayre	
10 Ayre	7, 10
(11) Fantazia	27, 36, 37, 39
(12) Ayre	
(13) Ayre	2, 23
(14) Ayre	7, 18

creating a semi-independent part after Lawes' inimitable practice, or else unused to the idea. As a result these parts do nothing further than make a short-score intabulation of the pre-existing strings, and indulge in some unusually cumbersome stretches and note clusters, that exceed the unmanageability of the composer's own lumpy but very effective way with chamber-organ texture.¹¹

The significance of this observation is that the same reasoning may be applied to the anonymous harp parts of Mus. MS 5. The work of Francis Withy in the front of this manuscript must be remembered when attempting to produce workable harp parts for Lawes' 'Harpe' Consorts. Without the presence of string parts to these anonymous consort sets it is difficult to state what is an independent harp part and what might be a reduction of other consort voices. As Pinto observed, reductions of string parts might well result in clumsy part writing featuring such devices as unusually wide stretches and note clusters, the very evidence which might be used to define this body of work as harp music. Interestingly, Holman bases his evidence that these are consort parts on the observation that the music in all of them is "less melodic than one would expect from a solo piece", and that "several of the fantasias have passages where the music stops for several beats."¹² The only example I found of several beats silence is during bar 25 of the Fantazia in A minor (no 4). Though this clearly demonstrates that this particular piece was intended to be performed with at least one other instrument, I do not find such conclusive evidence for the other movements, as suggested by Holman. Instead, I am persuaded that these are harp

11 David Pinto, *For Ye Viols* (Surrey, 1995), 132-133.

12 Peter Holman, 'The harp in Stuart England', 202.

parts, by their being included in a Harp part book, as demonstrated by the inclusion of parts for William Lawes' 'Harpe' Consorts, by the occurrence of wide stretches and notes being played simultaneously by both hands (frequently 10ths) as well as the apparently deliberate exclusion of accidentals outside the range of f#-g#, a feature which will be explored when looking at the compass and accidentals used in this body of work. Even the simplest keyboard instruments of this period had a greater chromatic capability, and if accidentals were available, it is probable that composers would have used them to melodic and harmonic advantage.

Holman has pointed out the fact that each group begins with a fantasia suggesting some form of consort sett, despite the fact that the combination of dance movements does not conform to any known order by William Lawes.¹³ The fantasias are relatively short, and as such, do not display a great deal of inventive material. It should be noted that when writing this, Holman was of the opinion that this body of work may have been written by that composer. The group of pieces in A minor is particularly unusual in this respect as it consists of a fantasia and six airs. With the exception of the 'Pavan' and 'Almayne', all the movements are either defined as 'Fantazias' or 'Ayres', and as such are not named dances, despite the similarity to an allemande in the case of many of the airs. It is therefore probable that this music was intended for listening to, rather than dancing, and would have been performed in a concert format or as private music.

13 Peter Holman, 'The harp in Stuart England', 202.

The parts are not autographed and do not correlate with any other known parts. Holman has recently quoted Layton Ring in suggesting that these parts are by Coperario ¹⁴. Layton Ring states that "their harmonies and general range of melodic invention even in this 'full-but-incomplete' scoring are less technically adventurous than one would expect from Lawes, but seem just right for Coperario."

The Compass and Accidentals

The compass and accidentals required to perform the anonymous harp parts of Och. Mus MS 5 are shown in Example 3. The diatonic range required is D-a'' (26 notes) while the majority of accidentals occur within the centre of the compass (f#-g#'). Other accidentals are required but, as in the case of the F# needed in the Pavan (no 2) no F^b is necessary, so it would be possible to tune this string to an F# before performance. If this practice of tuning accidentals, where an unused string is available, is adopted throughout this collection of pieces then the only problematic accidental is a quaver in bar 18 of the Almayne (no 3). If the f'' string of the harp were tuned to f#'' then the string would be capable of playing the 4 sharps specified in the movement. I think that it is probable that the natural in bar 18 is an oversight and that it was intended to be a sharp. After all, the avoidance of accidentals outside the range of f#-g#' is such a well

14 Layton Ring, 'The harp for Lawes', *Early Music*, XV (1987), 589-90; Peter Holman, *Four and Twenty Fiddlers* (Oxford, 1993), 262.

Example 3

The diatonic range of notes + accidentals required to play the anonymous harp parts of Och. Mus MS 5. Nb. x denotes a diatonic string not required.

Fantazia ff.6v - 7r (no A1)

Ayre f.7v (no A2)

Fantazia ff.20v - 21r (no 1)

Pavan ff.21v - 22r (no 2)

Almayne f.22r (no 3)

Fantazia ff.22v - 23r (no 4)

Example 3 Continued

Ayre f.23v (no 5)

Musical notation for Ayre f.23v (no 5). The system consists of two staves. The upper staff is in treble clef and contains a single note, G4, with a sharp sign (#) to its right. The lower staff is in bass clef and contains two notes: G3 and A3, both with sharp signs (#) to their right. A vertical line connects the G4 note in the upper staff to the G3 note in the lower staff.

Ayre f.23v (no 6)

Musical notation for Ayre f.23v (no 6). The system consists of two staves. The upper staff is in treble clef and contains two notes: G4 and A4, both with sharp signs (#) to their right. The lower staff is in bass clef and contains one note, G3, with a sharp sign (#) to its right. A vertical line connects the G4 note in the upper staff to the G3 note in the lower staff.

Ayre f.23v (no 7)

Musical notation for Ayre f.23v (no 7). The system consists of two staves. The upper staff is in treble clef and contains two notes: G4 and A4, both with sharp signs (#) to their right. The lower staff is in bass clef and contains two notes: G3 and A3, both with sharp signs (#) to their right. A vertical line connects the G4 note in the upper staff to the G3 note in the lower staff.

Ayre f.24r (no 8)

Musical notation for Ayre f.24r (no 8). The system consists of two staves. The upper staff is in treble clef and contains two notes: G4 and A4, both with sharp signs (#) to their right. The lower staff is in bass clef and contains three notes: G3, A3, and B3, all with sharp signs (#) to their right. A vertical line connects the G4 note in the upper staff to the G3 note in the lower staff.

Ayre f.24r (no 9)

Musical notation for Ayre f.24r (no 9). The system consists of two staves. The upper staff is in treble clef and contains one note, G4, with a sharp sign (#) to its right. The lower staff is in bass clef and contains two notes: G3 and A3, both with sharp signs (#) to their right. A vertical line connects the G4 note in the upper staff to the G3 note in the lower staff.

Ayre f.24r (no 10)

Musical notation for Ayre f.24r (no 10). The system consists of two staves. The upper staff is in treble clef and contains one note, G4, with a sharp sign (#) to its right. The lower staff is in bass clef and contains two notes: G3 and A3, both with sharp signs (#) to their right. A vertical line connects the G4 note in the upper staff to the G3 note in the lower staff.

Example 3 Continued

Fantazia ff.24v - 25r (no 11)

Musical notation for Fantazia ff.24v - 25r (no 11). The score consists of two staves. The upper staff is in treble clef and contains a whole note chord with a sharp sign (#) above it. The lower staff is in bass clef and contains a whole note chord with a sharp sign (#) above it and the word "basso" written above the staff.

Ayre f.25r (no 12)

Musical notation for Ayre f.25r (no 12). The score consists of two staves. The upper staff is in treble clef and contains a whole note chord with a sharp sign (#) above it. The lower staff is in bass clef and contains a whole note chord with a sharp sign (#) above it.

Ayre f.25v (no 13)

Musical notation for Ayre f.25v (no 13). The score consists of two staves. The upper staff is in treble clef and contains a whole note chord with a sharp sign (#) above it. The lower staff is in bass clef and contains a whole note chord with a sharp sign (#) above it.

Ayre (unfinished) f.26r (no 14)

Musical notation for Ayre (unfinished) f.26r (no 14). The score consists of two staves. The upper staff is in treble clef and contains a whole note chord with a sharp sign (#) above it. The lower staff is in bass clef and contains a whole note chord with a sharp sign (#) above it.

Four sets of empty musical staves, each consisting of a treble clef staff and a bass clef staff, arranged vertically.

adhered to handicap, that it is almost unthinkable that a composer would succumb to the temptation of a sharp for a single quaver, when the facility of an extra string at this point in the harp's compass would have been so useful elsewhere in the collection.

Assuming that the natural in bar 18 is an oversight, then the anonymous harp parts of Och. Mus MS 5 could have been played on a single (for the most part, diatonically tuned) harp, with a triple section (f#-g#') in the centre of its compass (D-a''). The possible string layout of such a harp is illustrated in Example 4. This reconstructed harp would utilise 36 diatonic strings (10 doubled in mid range) and 7 central accidentals, making a total of 43. It should be noted that the total compass is rather short in Irish terms, having a diatonic compass of only 26 notes. A single strung harp would normally have at least 30 diatonic strings giving a typical compass of C-d'''. This would suggest that the top a'' used in this body of work is relatively low and that perhaps the compass of the harp was sacrificed in order to gain increased chromaticism.

The lack of a chromatic capability at the extremes of the harp's compass helps to explain the somewhat limited melodic and harmonic qualities commented upon by Layton Ring and Peter Holman, and indeed, goes some distance towards explaining some of the eccentricities in the writing of the part. It is significant that the music suggests a simple form of partially chromatic harp. Such an instrument may well represent an early stage in the evolution of the chromatic Irish harp and therefore provide further evidence that these anonymous compositions belong to a period earlier than that of William Lawes. Without the discovery of the missing consort parts however, it is difficult to

Example 4

the possible string patterns of an instrument required to play the anonymous harp parts of Och. Mus MS 5. (Assuming that the player performed the Irish [left handed] fashion)

a ^{''}	.
g ^{''}	.
f ^{''}	.
e ^{''}	.
d ^{''}	.
c ^{''}	.
b [']	.
a [']	.
g ^{#'}	.
g [']	.
f ^{#'}	.
f [']	..
e [']	..
d ^{#'} /e ^b	.
d [']	..
c ^{#'}	.
c [']	..
b	..
b ^b	.
a	..
g [#]	.
g	..
f [#]	.
f	..
e	.
d	.
c	.
B	.
A	.
G	.
F	.
E	.
D	.

assess just how representative the harp parts are of the composer's writing in general.

Some General Observations about the Anonymous Parts at the Back of Och.

Mus MS 5.

These parts are predominantly fully worked and written in four voices. This is occasionally augmented with the addition of extra notes in bars where chords predominate, as in bar 8 of Fantazia (no A1, ff.6v-7r), where the composer uses a six-note chord to complete a cadence. Bar 25 of Fantazia (no 4, ff.22v-22r) has already been referred to, as the silence of the harp part has been used as evidence of another instrumental part or parts performing at this point. When the harp does enter in the treble of bar 26, it is at the start of an imitative build-up, from one to four voices, which takes place over five bars. One can assume that another instrument provides the material to be imitated in bar 25. Although there are no further examples of the harp being silent while other instruments play in this body of work, there are instances of the harp part increasing its texture, as voices are added over a number of bars. These invariably occur as a feature of a fantasia and examples are shown in Table 5.

When looking for evidence that this music may be written for an Irish harp, as opposed to any other instrument, signs of idiomatic writing must be sought after. The eccentric compass and accidentals have already been examined but one might expect to find use of tied notes of long value such as semibreves, which would exploit the instrument's sustaining qualities, as well as the use of 10ths, which would make use

of the bell-like sound the Irish harp is capable of producing. Examples of the sustained notes are surprisingly rare but are listed in Table 6.

Table 5

Examples of a build up of texture within the harp part.

Fantazia no A1 [ff.6v-7r] (bars 1, 39-41) treble exposition
Fantazia no 1 [ff.20v-21r] (bars 49-52) treble exposition
Fantazia no 4 [ff.22v-23r] (bars 26-30) treble exposition
(bars 57-58) bass accompaniment
Fantazia no 11 [ff.24v-25r] (bars 1-3, 30) treble exposition

Table 6

Examples of sustained notes in the harp part.

Fantazia no A1 [ff.6v-7r] bars 63-64
Pavan no 2 [ff.21v-22r] bars 11-12, 36-37
Fantazia no 4 [ff.22v-23r] bars 120-121
Ayre no 12 [f.25r] bars 4-5

The use of 10ths is widespread throughout these movements however, and bar 3 of the Ayre (no 12, f.25r) is typical in demonstrating their use in the bass, when keyboard music would probably have employed octaves. The chromatic capability of the centre of the compass of the harp is exploited fully in bars 11 and 12 of the Ayre (no 8, f.24r), but this is the only occasion in this collection of music in which this

feature is really explored. Also of interest is the occasional employment of a lively bass part, demonstrating dexterity of the performer in this portion of the register. It is known that the traditional Irish harpers, unlike their European contemporaries, used their right hands to play the bass strings and their left to play the treble. An illustration of this technique is demonstrated in the painting of *King Christian IV's musicians* by Reinholt Timm, illustrated in Chapter 3. No evidence has come to light to demonstrate whether this practice was continued by successive Irish harpers in the service of the English court, but the possibility that this dexterous part is evidence of a right handed musician performing in the Irish manner, a left handed player performing in the European manner, or even someone with great skill in both hands must be considered. Examples of the use of a lively bass part are illustrated in Table 7. Of course it should be noted that the few examples illustrated make this a rare feature indeed in this body of work.

Table 7

Examples of a lively bass part.

Fantazia no A1 [ff.6v-7r] bars 42, 46-52.

Fantazia no 1 [ff.20v-21r] bars 37, 53-54, 56-57, 59-60.

Finally, mention ought to be made concerning changes in the pattern of writing airs which take place in this set of pieces. The first eight airs are written in an almane-like fashion, but in the last two,

something different occurs. In bars 26-45 of Ayre (no 13, f.25v) this is a rhythm change to triple time, and in the first 21 bars of the unfinished Ayre (no 14, f.26r), there is an extensive use of a simple rhythm largely employing minims as opposed to the variety of crotchets and quavers featured in the earlier examples. It is possible that the composer was beginning to experiment with the concept of an air in these movements.

Mottects or Grave Chamber Music (1630)(see Appendix D)

The *Mottects or Grave Chamber Music* by Martin Peerson, printed by William Stansby in 1630, was the second collection of the composer to be published. It consists of 25 verse anthems and the publication is prefaced with the following statement: (see Illustration 7a)

...Containing songs of five parts of severall sorts, some full, and some verse and chorus. But all fit for voyces and vials, with an organ part; which for want of organs, may be performed on virginals, base-lute, bandora, or Irish harpe. ¹⁵

Our interest in Peerson's *Mottects* stems from the reference to the Irish harp on the title page. Holman has suggested that as the works were dedicated to Peerson's friend, patron and poet, the Right Honourable Sir Fulke Greville (d. 1628), there was a possibility that Greville may also have employed an Irish harper.¹⁶ As there is no evidence to support this view, I would suggest that as the Irish harp is mentioned at the very bottom of the list of possible instruments, its presence represents

¹⁵ Martin Peerson, *Mottects or Grave Chamber Music* (London, 1630).

¹⁶ Peter Holman, 'The harp in Stuart England', 200.

Illustration 7.(a)

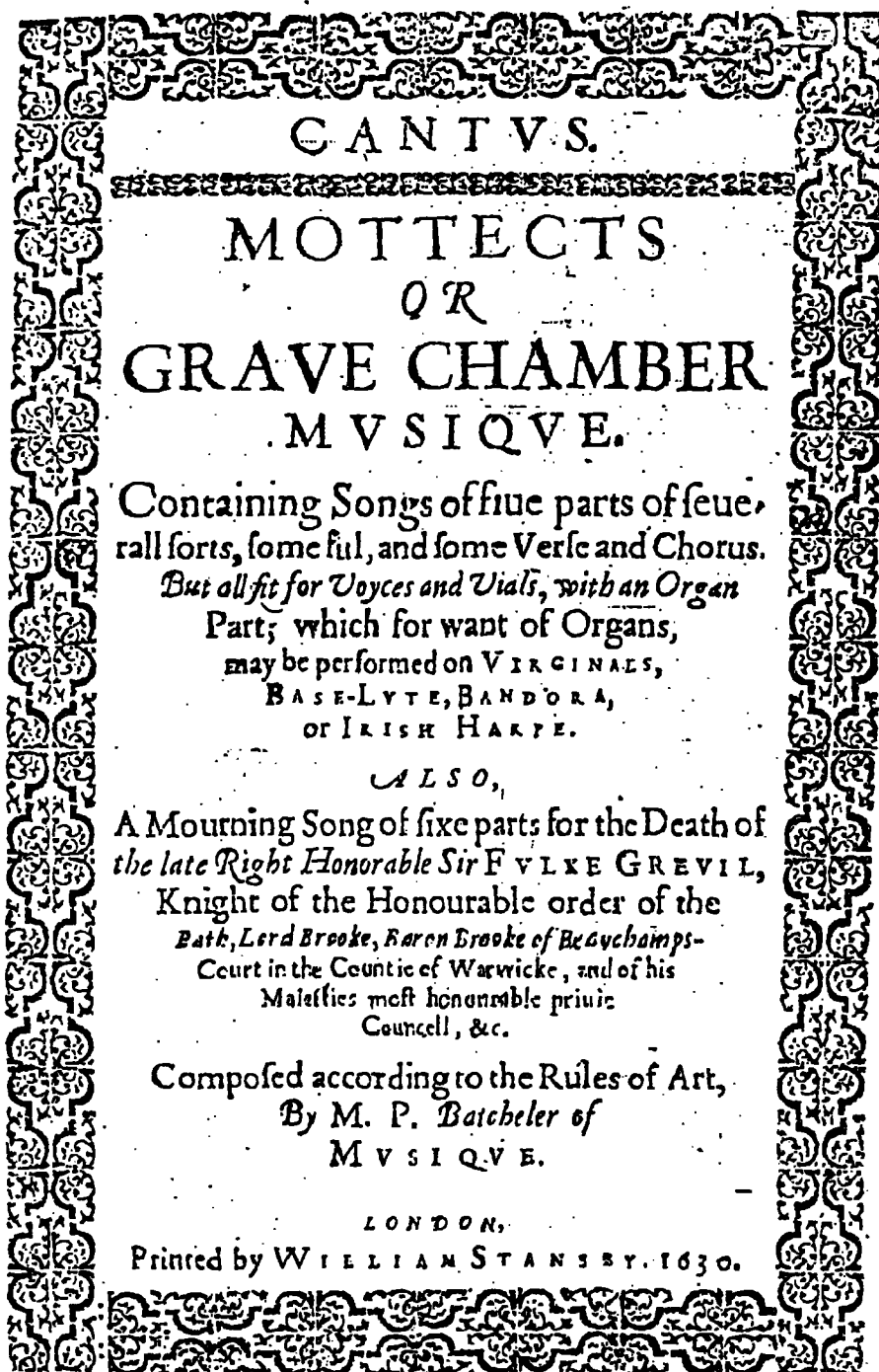

7.(a) Title page of Martin Peerson, *Motects or Grave Chamber Musique* (London, 1630) (cantus part)
B.L.Mus. K.d.2.13. by permission of the British Library.

commercial interest rather than instrumental preference. What is perhaps of greater importance is the claim by the composer that the organ part could be played on an Irish harp. It is interesting that Peerson regarded an organ, virginal, bass lute, bandora or Irish harp as being interchangeable in this respect. It raises the possibility that the Irish harp may have been used to perform such parts as those written for organ in other consort settings, perhaps by other composers, and in so doing gives the practice a legitimacy. Of equal interest is the inclusion of the Irish harp in this list for commercial reasons, as it would suggest that the instrument was common enough outside of exclusive court circles to warrant a mention.

The collection consists of 25 secular motets which employ a limited number of key signatures: C major, F major, B^b major, and their relative minors (see illustration 7b). The anthems appear to have been conceived as five- or six-part works for viol with voices doubling the strings for appropriate passages. The organ part (see Illustration 7c) is written in two voices which largely double the treble and bass viols. An illustration of this style of writing is the transcription of *Man dreame no more*, no 19 (see Appendix D). The result of this doubling is that the part which is specified as being able to be played upon an Irish harp, has no independent role which might exploit the idiomatic characteristics of any of those alternative instruments, other than perhaps the organ itself. Robert Baxter regards the organ part as one of the strengths of Peerson's work and expresses it thus:¹⁷

¹⁷ Robert Baxter, *Martin Peerson's 'Mottects or Grave Chamber Music' [1630]*, (diss., Catholic University, Washington, DC, 1970), 103-4.

Illustration 7.(b)

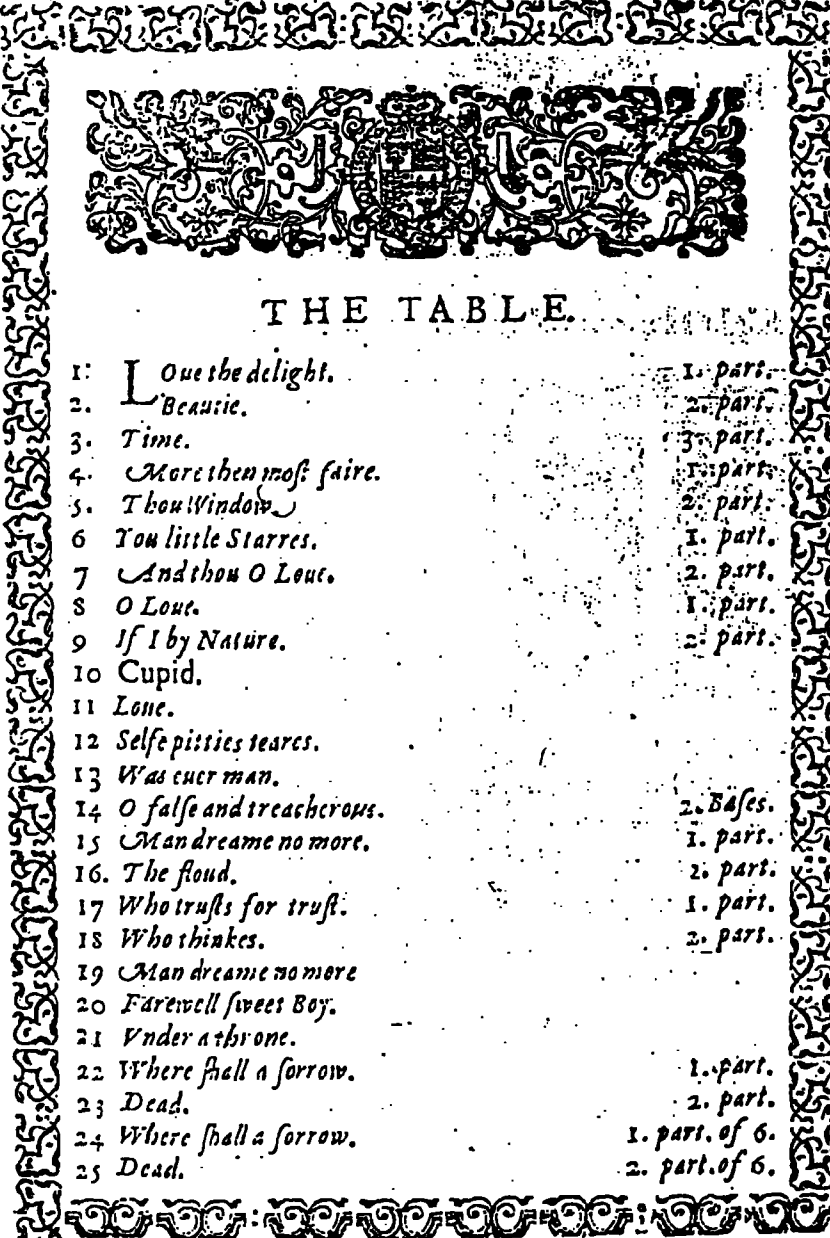

THE TABLE.

1:	<i>L</i> oue the delight.	1. part.
2.	<i>B</i> eautie.	2. part.
3.	<i>T</i> ime.	3. part.
4.	<i>M</i> ore then most faire.	1. part.
5.	<i>T</i> hou Window.	2. part.
6	<i>T</i> ou little Starres.	1. part.
7	<i>A</i> nd thou O Loue.	2. part.
8	<i>O</i> Loue.	1. part.
9	<i>I</i> f I by Nature.	2. part.
10	<i>C</i> upid.	
11	<i>L</i> one.	
12	<i>S</i> elfe pitties teares.	
13	<i>W</i> as euer man.	
14	<i>O</i> false and treacherous.	2. Bases.
15	<i>M</i> an dreame no more.	1. part.
16.	<i>T</i> he flood.	2. part.
17	<i>W</i> ho trusts for trust.	1. part.
18	<i>W</i> ho thinkes.	2. part.
19	<i>M</i> an dreame no more	
20	<i>F</i> arewell sweet Boy.	
21	<i>V</i> nder a throne.	
22	<i>W</i> here shall a sorrow.	1. part.
23	<i>D</i> ead.	2. part.
24	<i>W</i> here shall a sorrow.	1. part. of 6.
25	<i>D</i> ead.	2. part. of 6.

7.(b) Table page of Martin Peerson, *Motets or Grave Chamber Musique* (London, 1630) (cantus part)

B.L.Mus. K.d.2.13. by permission of the British Library.

Illustration 7.(c)

Of 5. first Part. 15. *Organ Part.*

Man dreame no more, V 43. Vers. 43.

56 56 765

Cho. 56 765

Of 5. Third part. *Organ Part.*

When thou, Vers. 654

663 Cho.

7.(c) Martin Peerson, *Motects or Grave Chamber Musique* (London, 1630)
 (organ part)
 B.L.Mus. K.d.2.13. no.15. by permission of the British Library.

...a web of contrapuntal lines centered around a solid melodic and harmonic two part organ continuo. This continuo supplies the underlying strength and support for each composition.

Those harp parts which may have existed as accompaniments to the voice in the masques of the Stuart Court are now lost, and Peerson's *Mottects* are, therefore, the only extant works demonstrating this role. Also of note is the manner in which a harp may be combined with up to five viols or violins in the manner of the lute part in Dowland's *Lachrimae or Seaven Teares* collection of 1604. In Dowland's compositions, the lute doubles four of the five bowed string parts.¹⁸ The fact that a harp is being used in conjunction with five bowed strings is a departure from the balance of the harp consort, as illustrated by the works of William Lawes or Francis Forcer (to be discussed at a later stage in this chapter). He has moved away from the formula of working with two bowed strings (violin and bass viol) in conjunction with a theorbo. If Peerson is being genuine in his combination of the Irish harp with five bowed strings and voices, then he may well be creating a new role for the instrument. In this respect, a description of the festivities accompanying the baptism of Prince Henry in Scotland in 1594 states that: 'Arion played upon the harp and was accompanied by viols and voices which chanted Latin hexameters'¹⁹ Unfortunately the account gives no information as to how literally Arion played the harp or indeed what type of instrument he held. Although Peerson offers the choice of a variety of instruments as an alternative to the organ, he is precise in naming them.

¹⁸ Diana Poulton, *John Dowland* (2nd edn., London, 1982), 345.

¹⁹ E.M.Tenison, *Elizabethan England*, IX (Royal Leamington Spa, 1933), 305.

Of particular interest is the fact that the organ part is the earliest dated example of a figured bass in England.²⁰ This view is put into another context by Peter Le Huray who when referring to Peerson's *Mottects*, states that "there is, indeed, nothing in his music which is not to be found in the early seventeenth-century English madrigal, nor even is the basso continuo anything more than a normal English organ score, in which the outer parts (top and bottom) are supplied, the inner parts only being improvised by the performer."²¹

In matching the organ part to the layout of an Irish harp to establish the disposition of the instrument required for performance, one is hampered by the lack of detail in the inner parts, despite the presence of the figures in the bass. The nature of this style of writing is that a great deal of information is available concerning notes required at the extreme ends of the compass, but not in the middle. Example 5 shows the diatonic compass and accidentals required to play the organ parts of Peerson's *Mottects* and it can be seen that the instrument had to be fully chromatic from E^b to f#['] apart from e^b' which is omitted in the centre of the range. The reason for the omission of the e^b' is probably due to the nature of writing for two voices with figured bass. It is inconceivable that Peerson was writing for an organ which did not have this note in the middle of its compass. It therefore appears that if this part were to be suitable for performance upon an Irish harp, then this instrument would also have to be chromatic in order to play the treble and bass lines which Robert Baxter regards as

²⁰ Marilyn Wailes, 'Some Notes on Martin Peerson', *The Score*, IX (1954), 21; Marilyn Wailes, 'Martin Peerson', *P.R.M.A.*, LXXX (1953-54), 59.

²¹ Peter Le Huray, *Music and the Reformation in England*, 333.

Example 5

The diatonic range of notes + accidentals required to play the organ parts of Peerson's *Moffects*. Nb. c', d', e^b' and e are not specified. It is unlikely, that in the light of such chromatic requirements elsewhere in the compass, an instrument meeting these demands would not have these notes available. The omission probably has more to do with the nature of writing the organ part in two voices with figured bass.

The image shows a grand staff with two staves. The top staff is a treble clef and the bottom staff is a bass clef. The notation is handwritten and consists of a single note on the top staff and a series of accidentals on the bottom staff. The accidentals on the bottom staff are: b, b, #, #, #, #, b, #, #, #, b, #, #. The accidentals on the top staff are: #, #, #, b, #, #, b, #, #. The notation is arranged in a way that suggests a chromatic scale or a specific sequence of notes and accidentals.

being so crucial to the 'strength and support' of each composition. If Peerson is serious about his organ part being playable upon an Irish harp, the harp he had in mind must have been more sophisticated than that which Lawes was writing for. Example 6 shows the probable stringing of an Irish harp needed to perform Peerson's *Mottects*, assuming that the player performed in the Irish manner of left hand to the treble, and right to the bass.

The only conclusions that can be arrived at with regard to the playing of the organ part upon the Irish harp are, either Peerson was being so commercially-minded that his suggestion was totally impractical and unplayable on instruments of the day, or that very sophisticated, fully chromatic Irish harps were available. If such instruments were to hand, and in such numbers as to make their inclusion a viable suggestion in a publication, the question must be considered, why Lawes was not writing for one at court? The truth may lie somewhere between the two possibilities and it is probable that one or two fully chromatic harps were built for experimental purposes, and it may have been one of these instruments which Peerson had in mind. The composer may have been looking towards a future for the instrument which was not to be realised, due to changes of fashion and taste. It is equally probable that Peerson's suggestion that the organ parts could be played upon an Irish harp was an exaggeration on his part, and that most Irish harps of the period did not have the chromatic capability required for their performance. It is unlikely that Lawes did not have the most sophisticated instruments and musicians available at court.

Example 6

The possible stringing pattern of an instrument required to play the organ parts of Peerson's *Mottects* (assuming that the player performed in the Irish [left handed] fashion.

f#"	.
f"	.
e"	.
d#"/eb"	.
d"	.
c#"	.
c"	.
b'	.
bb'	.
a'	.
g#'/ab'	.
g	.
f#'	.
f'	.
e'	.
d#'/eb'	.
d'	.
c#'	.
c'	.
b	.
bb	.
a	.
g#/ab	.
g	.
f#	.
f	.
e	.
d#/eb	.
d	.
c#	.
c	.
B	.
Bb	.
A	.
G#/Ab	.
G	.
F#	.
F	.
E	.
D#/Eb	.

A Compendium of Practical Music (1667)(see Appendix E)

The collection of ten *Lessons by Sundry Authors for the Treble Bass Viol and Harp*, included in the 1667 edition of Christopher Simpson's *A Compendium of Practical Music* is of interest in that it serves as a pointer to the direction in which harp music in the seventeenth century was moving.²² These pieces were not included in Simpson's original 1659 volume and it must be assumed that their inclusion in this later edition was to increase sales. The date is too late to fall within the boundaries of this thesis and there is no evidence to suggest that the music was written for the Irish (as opposed to a European) type of harp. Peter Holman has stated that, with the addition of a theorbo and harp part however, these pieces could have been performed by the same harp consort favoured by William Lawes.²³ The airs are not named and the first of these is unnumbered. The following four are numbered 1-4 and utilise three different key signatures, demonstrating that a sett is not intended. The next four airs are also numbered 1-4 and these are all written in the key of A minor while the last air is unnumbered and written with a single flat as its key signature. The key of G minor may well be more appropriate to this last air and I have suggested this in Table 8. The only named composer for any of these pieces is Francis Forcer, though Peter Holman has suggested that the first (unnumbered) air is a setting of the song by Simon Ives called *See That Building*. Ian Spink tells us that "there is little to say about Francis Forcer, whose songs are among the feeblest written by any composer of the

²² Christopher Simpson, *A Compendium of Practical Music* (London, 1667) ed., P.Lord (Oxford, 1970), 114-19.

²³ Peter Holman, 'The harp in Stuart England', 201.

period."²⁴ Table 8 sets out the pieces in this collection giving details about attribution and key.

The airs are written in two separate voices, treble and bass, and other than the first and last examples, are set out with the parts on opposite pages. As there are only two voices per piece, it can be

Table 8

"Lessons by Sundry Authors for the Treble Bass Viol and Harp"

(1687 edition of Simpson's *Compendium of Practical Music*)

Number	Page Numbers	Key	Attribution
Unnumbered	p.183	D minor	Francis Forcer (Ives)
1	pp.184 - 185	G minor	Francis Forcer
2	pp.184 - 185	D minor	Francis Forcer
3	pp.186 - 187	G major	Francis Forcer
4	pp.186 - 187	D minor	Francis Forcer
1	pp.188 - 189	A minor	
2	pp.188 - 189	A minor	
3	pp.190 - 191	A minor	Francis Forcer
4	pp.190 - 191	A minor	Francis Forcer
Unnumbered	p.120	G minor?	

²⁴ Ian Spink, *English Song, Dowland to Purcell* (London, 1974), 178.

assumed that the harp doubled these. There is no inner harmonisation and so writing for the harp is thin in the middle of its compass. One can only guess as to whether the harper was expected to add chordal harmony to these pieces as the texture of seventeenth-century keyboard music was frequently just as thin. An example of this style of writing for keyboard is an air by John Blow, no 16 in Howard Ferguson, *Early English Keyboard Music*, (Oxford, 1971) p46.²⁵ If the accidentals required to perform the *Lessons by Sundry Authors* are examined we discover that they fall into a different pattern to those used by Lawes, or which are needed in the anonymous parts at the back of Och. Mus MS 5. The diatonic range and accidentals required to play these works is given in Example 7. The *Lessons* make use of accidentals at the extremes of the compass while c#' and d#' are not used at all. This is in contrast to the earlier parts, such as those by Lawes in MS B3, which make great use of the central accidentals, but relatively little of those at the top and bottom of the instrument's compass. It is clear that Francis Forcer and his contemporaries were writing for an instrument which had increased chromatic capability. The possible string pattern for a harp capable of performing these pieces is illustrated in Example 8. As there is no evidence that these pieces were intended for performance on an Irish harp, I have arranged the strings in the (right handed) European manner.

Lost Music Featuring the Irish Harp

The presence of Dowland at the Danish Court and his resulting role in the employment of an Irish harper there have already been discussed

²⁵ British Library, Add. 22,099, f5.

Example 7

The diatonic range of notes + accidentals required for each movement of the harp parts in the 1687 edition of Simpson's *Compendium of Practical Music*
 Nb. x denotes a diatonic string not required.

(Unnumbered) p.183

Francis Forcer (Ives?)

1 pp.184 - 185

Francis Forcer

2 pp.184 - 185

Francis Forcer

3 pp.186 - 187

Francis Forcer

4 pp.186 - 187

Francis Forcer

1 pp.188 - 189

Example 7 Continued

2 pp.188 - 189

Musical notation for Example 2, measures 188-189. The system consists of two staves. The upper staff is in treble clef with a sharp sign above the first measure. The lower staff is in bass clef. Handwritten notes and symbols include a sharp sign, a circled 'o', and 'x' marks.

3 pp.190 - 191

Francis Forcer

Musical notation for Example 3, measures 190-191. The system consists of two staves. The upper staff is in treble clef with a sharp sign above the first measure. The lower staff is in bass clef. Handwritten notes and symbols include a sharp sign, a circled 'o', and 'x' marks.

4 pp.190 - 191

Francis Forcer

Musical notation for Example 4, measures 190-191. The system consists of two staves. The upper staff is in treble clef with a sharp sign above the first measure. The lower staff is in bass clef. Handwritten notes and symbols include a sharp sign, a circled 'o', and 'x' marks.

(Unnumbered) p.120

Musical notation for an unnumbered example on page 120. The system consists of two staves. The upper staff is in treble clef with a sharp sign above the first measure. The lower staff is in bass clef. Handwritten notes and symbols include a sharp sign, a circled 'o', and 'x' marks.

Four sets of empty musical staves, each consisting of a treble clef staff and a bass clef staff, arranged vertically.

Example 8

The possible string pattern of an instrument required to play the harp parts in the 1687 edition of Simpson's *Compendium of Practical Music* (assuming that the player performed in the European [right handed] fashion.)

c''	.
b''	.
b ^b ''	.
a''	.
g [#] ''	.
g''	.
f [#] ''	.
f''	.
e''	.
e ^b ''	.
d''	.
c [#] ''	.
c''	.
b'	.
b ^b '	.
a'	.
g [#] '	.
g'	.
f [#] '	.
f'	.
e'	.
e ^b '	.
d'	.
c [#] '	.
c'	.
b	.
b ^b	.
a	.
g [#]	.
g	.
f [#]	.
f	.
e	.
e ^b	.
d	.
c [#]	.
c	.
B	.
B ^b	.
A	.
G [#]	.
G	.
F [#]	.
F	.
E	.
D	.

in Chapter 2 (Harpers and Patrons). The arrival of a group of musicians hailing from England and Ireland working in the service of the Danish king, as illustrated in the painting by Reinhold Timm, suggests that a repertoire of consort music incorporating the Irish harp was available.²⁶ It is probable that the instrument was used in a mixed consort similar to that portrayed in the painting, and that Dowland provided music for such a grouping. One can only assume that the *Lachrimae or Seaven Teares Figured in Seaven Passionate Pauans, with divers other Pauans, Galliards and Almands* by Dowland published in 1604 points towards the nature of consort music being performed in Denmark.²⁷ The text of the title page describes the music as being "set forth for the Lute, Viols or Violins, in fiue parts...", and it is interesting to compare this with Peerson's combination of instruments. Dowland is expressing his desired instrumental grouping without going to the lengths of recommending alternatives to the lute, including the bandora or Irish harp. In contrast to Peerson however, Dowland offers violins as an alternative to viols, an option not stipulated by Peerson. In retrospect, Dowland's instrumentation predicts more accurately the future rise in popularity of the violin while Peerson fails to foresee the decline of the bandora and Irish harp.

As has been previously discussed in Chapter 2 (Harpers and Patrons), harps were employed in masques of the Stuart Court. All too frequently, references are too vague to indicate whether an Irish harp was the

26 Reinhold Timm, 'King Christian IV's Musicians', *19th Council of Europe Exhibition, Denmark [1988], Catalogue* (Herning, Denmark, (1988), 104, 567.

27 John Dowland, *Lachrimae or Seaven Teares Figured in Seaven Passionate Pauans...* (London, 1604); Diana Poulton, *John Dowland*, 342.

intended instrument or indeed who the harper was. One is reminded of Ben Jonson's text for *The Irish Masque at Court*, performed at Whitehall on 29th December, 1613, which includes a song sung by a bard to two harps, and a dance of gentlemen 'in Irish mantles, to a solemne musique of harpes.'²⁸ The inclusion of Thomas Bedoes (an otherwise unknown harper) in the plan of musicians performing in James Shirley's masque *The Triumph of Peace* adds to the tantalising list of lost harp parts from masques performed at the Stuart Court.²⁹ The funeral of King James I also brought with it a performance by musicians of 'The Chamber of our late Sovereign Lord King James' called 'The Consorte' which included the Irish harper Philip Squire, see Table 9.³⁰ The roles of the musicians of 'The Consorte' are taken from Peter Holman's *Four and Twenty Fiddlers*, (Oxford, 1993), pp.229-9.

Conclusions

The works attributed to William More and Cormacke MacDermott were examined because they may represent the thinking of composers, and suggest directions in which they may have been moving, with regard to composition for the harp during this period. Sadly no autograph parts for harp by these two harper-composers have survived, and indeed, of those works attributed to them, none are specified for harp. If the attributions are correct however, and the form in which these works have come down to us is genuine, then it can be assumed that More and

28 *The Workes of Benjamin Jonson* (London, 1616, repr., 1976), 1,000-4; Peter Holman, 'The harp in Stuart England', 194.

29 Andrew. J. Sabol, 'New Documents on Shirley's Masque *The Triumph of Peace*', *Music and Letters*, XLVII (1966), 18; *Longleat Papers of, Bulstrode Whitelock*, F.28v, Longleat House, Warminster.

30 Diana Poulton, *John Dowland*, 88.

Table 9
'The Consorte'

Charles Coleman	Counter Tenor/Lute
Francis Cozens	Unknown
Maurice Webster	Lute
Philip Squire	Harp
Robert Johnson	Lute
Robert Major	Viol
John Dowland	Lute
Daniel Farrant	Viol
Timothy Collins	Lute
John Friende	Viol
Nicholas Lanier	Tenor/Lute

cDermott were involved in the creation of consort music and not just
rks for solo harp. It is also apparent that these musicians were using
cidentals in their music and thus departing from the diatonic nature
music suitable for earlier forms of harp, whether from Irish or
ropean traditions.

The anonymous harp parts of Och Mus MS 5 are fascinating in that
ey suggest they were written for an early form of sophisticated Irish
arp, in which only just over the middle octave (f#-g#') is chromatic.
e rest of the compass of the instrument (D-a'') is still diatonic in
e manner of its native Irish cousins. The suggestion by Layton Ring,
nd the further reference by Peter Holman, that Och Mus MS 5 could be
e work of Coperario is given some substance by the fact that a later
omposer working in the genre, such as William Lawes, had a more

sophisticated harp available to him. It has been demonstrated in Chapter 4, that Lawes was writing for an instrument which had (at the very least) a compass from D to d''', fully chromatic from f to f' with the addition of extra strings at c# and c#''. This indicates an increase in chromaticism between the Irish harps available to the two composers. In fact, if Lawes' instrument was not retuned between movements, its chromatic capability would have to be far greater, as shown in Example 2 (Chapter 4).

The greatly increased chromaticism of the organ parts, 'which for want of organs, may be performed on Irish harp' in Peerson's *Mottects* certainly suggests that a well established composer believed that his music-purchasing public could be convinced that their Irish harps were capable of playing his compositions. It is possible that fully chromatic Irish harps were in existence, albeit on an experimental basis, or that Peerson believed that such instruments would soon be available due to the increasing popularity of the Irish harp and its developing sophistication. It does not appear that Peerson could foresee the rapid decline of the Irish harp in favour of such instruments as the spinet and harpsichord.

The other works examined in this chapter (Simpson, *Compendium of Practical Music*, [1687]) belong to a period outside the boundaries of this thesis. Like the reconstructions of William Lawes' 'Harpe' Consorts by Francis Withey, there is no evidence that this music was written for an Irish harp. Indeed it is highly probable that a European style of double harp (such as those from Italy) was the intended instrument.

CHAPTER 7

A Report on the Reconstruction of an Irish Chromatic Harp

The Need for a Reconstruction

At present, too, we can only imagine the effect of a Lawes harp consort played by an Irish harper in the proper manner using quill-shaped fingernails; its sound, so 'melting and prolonged' as Bacon put it, sustaining Lawes's frequently slow-moving lines and its wire strings contrasting delightfully with the gut-strung theorbo. I hope that we will not have to wait too long before imagination becomes reality.¹

These are the closing words of Peter Holman's article 'The harp in Stuart England' published in 1987, and they are a clear signpost towards the reconstruction of a chromatic Irish harp to facilitate the exploration of the repertoire of that instrument. I had an early opportunity of exploring Lawes' 'Harpe' consorts using a diatonic Irish harp played in this manner, at a joint meeting of the Viola da Gamba Society and Lute Society on 23rd November 1985.² Together with Doug Wooton (theorbo), Peter Salem (violin), Ian Gammie (division viol), Andrew Lawrence King (Italian double harp) and Layton Ring (guest speaker), we contrasted the different sonorities and textures resulting from the employment of the two types of harp available. When comparing instruments in the 'Pavan', Lawes' 'Harpe' Consort VIII, performance on the diatonic Irish harp was made possible by the omission of an accidental c# - a total of five altogether - which was an annoying loss to the Irish harper, but this was not commented upon by other musicians

¹ Peter Holman, 'The harp in Stuart England', *Early Music*, XV (1987), 202

² Viola da Gamba Society, Newsletter No 52 (1986), 5-8.

or members of the audience. Discussion on this occasion was centred on the contrasting sonority of the wire strings of the Irish harp with the gut strings of the theorbo, and the blending of the gut strings of the Italian harp with those of the theorbo. The debate remained inconclusive with the realisation that Mr. Wooton's theorbo was strung with modern wire wound strings as opposed to gut, making the assessment of contrasting sonority very difficult.

Establishing the specifications of the reconstruction

My attempts at reconstructing a chromatic Irish harp began with this performance in 1985, as it was apparent that an instrument capable of playing the missing accidental c#, and any others in Lawes' consorts, was necessary. The first decision to be made was the scope of the repertoire for which the instrument was to be built. A chromatic Irish harp is such a specialised and rare instrument that I decided to design an instrument capable of exploring the entire existing repertoire (those works described in Chapters 4-6). I realised that this was to be the first compromise of many, but the thought of constructing a different harp for each collection of harp parts when, as in the case of the anonymous harp parts of Och Mus MS 5, other consort parts were missing, appeared to be daunting and uneconomic. Interestingly, the first modern harpsichords were designed to explore the entire repertoire for that instrument, and copies of Italian single manual instruments for example, came a good deal later.

The complete repertoire suggested a compass of C-e''', and the temptation to make the harp fully chromatic to explore all possibilities was too great to reject. This required employing a total of fifty nine

strings in two rows (double strung) with a triple (overlapping) section in the middle of the compass. I therefore used these factors as my basic musical specifications. The remains of the Dalway harp (described in Chapter 3) provided the nearest surviving elements of an Irish harp similar in capability to my objective. I therefore chose these vestiges as the basis for my own design, using the string lengths in particular, as a starting point for the scaling of my reconstruction. This determined the dimensions and shape of the pillar and neck of the reconstruction but the soundbox remained a mystery as that of the Dalway harp was long since lost. I turned to the soundbox of the Kildare harp (also described in Chapter 3) as a source of inspiration for a reconstruction, but altered the dimensions to suit the remains of the Dalway harp, simplified the top of the structure and imposed a different string hole pattern to accommodate the addition of nearly double the number of strings.

Another compromise introduced at an early stage was the disposition of the strings in a right-handed manner. The technique of playing in the left-handed style of the ancient Irish harpers was lost by the close of the eighteenth century, and as a reversal of the possible string pattern on the soundboard could have no appreciable affect upon the quality of sound produced, and a right-handed pattern would make the instrument accessible to all harpers, I opted for this compromise. In fact, as no soundbox from an Irish chromatic harp of this period has survived, and the instrument was frequently played by people not from Ireland, there is no reason to suppose that only left-handed string patterns were employed in the past. From a practical point of view, this harp has to be played by contemporary musicians who, like myself, have been

influenced by centuries of mainstream European tradition, and who would not wish to adopt such a different technique for what is a small proportion of the harpers' repertoire.

The design of a harp revolves around its string pattern and spacing, and it was not until these constants had been fixed that plans of a reconstruction could be drawn up. Fortunately, as the remains of the Dalway harp provided me with the dimensions of two sides of the triangle which makes up the harp, it was an easy matter to establish the length of the third. This having been achieved and a drawing produced, it was possible to calculate approximate string lengths. If the original instrument had been constructed using an externally convex soundboard, strings (particularly in the centre of the compass) would be relatively shorter than those rising from a flat surface. I chose to base my drawing upon the option of a flat soundboard knowing that, as in the case of harps in the past, string tension may lift the centre of the soundbox giving the instrument a convex form over a period of time.

The next decisions to be made were therefore concerning the distances between the strings, both longitudinally up the soundboard and transversely across the soundboard. Establishing the distance between the strings longitudinally was achieved by drawing in the bottom and top strings and dividing the space between equally according to the number of strings required. The transverse distance between the strings (across the soundboard) was established by experimenting with different measurements to see if it were possible to pluck between two diatonic strings to catch the accidental easily and without striking other strings. The experiment was achieved by creating an artificial soundboard as a test bed and trying out a succession of different

measurements. A distance of 1cm between each row of strings appeared to be the most effective and I used this as the basis of my design. Having made the decisions regarding the string measurements I transferred these to the drawing which I then went on to complete (see Illustration 1).

Further factors affecting the design of the harp

In deciding upon the compass and number of accidentals for the reconstruction, I had already departed from the specifications of the Dalway harp and it became apparent that further differences would occur. The metal bands on the neck of the Dalway harp, through which the tuning pins pass, house the pins in a single row with another band housing seven extra pins above. As my reconstruction was to include yet a further eight, I decided to arrange the tuning pins in two rows, with a third row consisting of six pins in the centre - on a single brass band. This was to make the precise placing of all the chromatic strings easier and more accurate. The result of this decision was that some strings were approximately 1cm longer than the others, but as the Dalway harp may have had seven strings longer than the rest, I felt that principles had not been entirely broken.

The pillar of my harp was made in the same manner as the Kildare harp, a solid piece of timber for the curve with an additional, bent panel added on to form the front of the 'T' section. This departure from the constructional practise of the Dalway harp meant that I did not have to carve down into such a large piece of timber as the original, saving a great deal of timber and effort in the process and achieving the same effect. I also decided not to copy all of the carved decoration of the Dalway harp either, as I was not making an exact copy of that

Illustration 1

End elevation of my first reconstruction of an Irish chromatic harp showing the disposition of the strings and tuning pins.

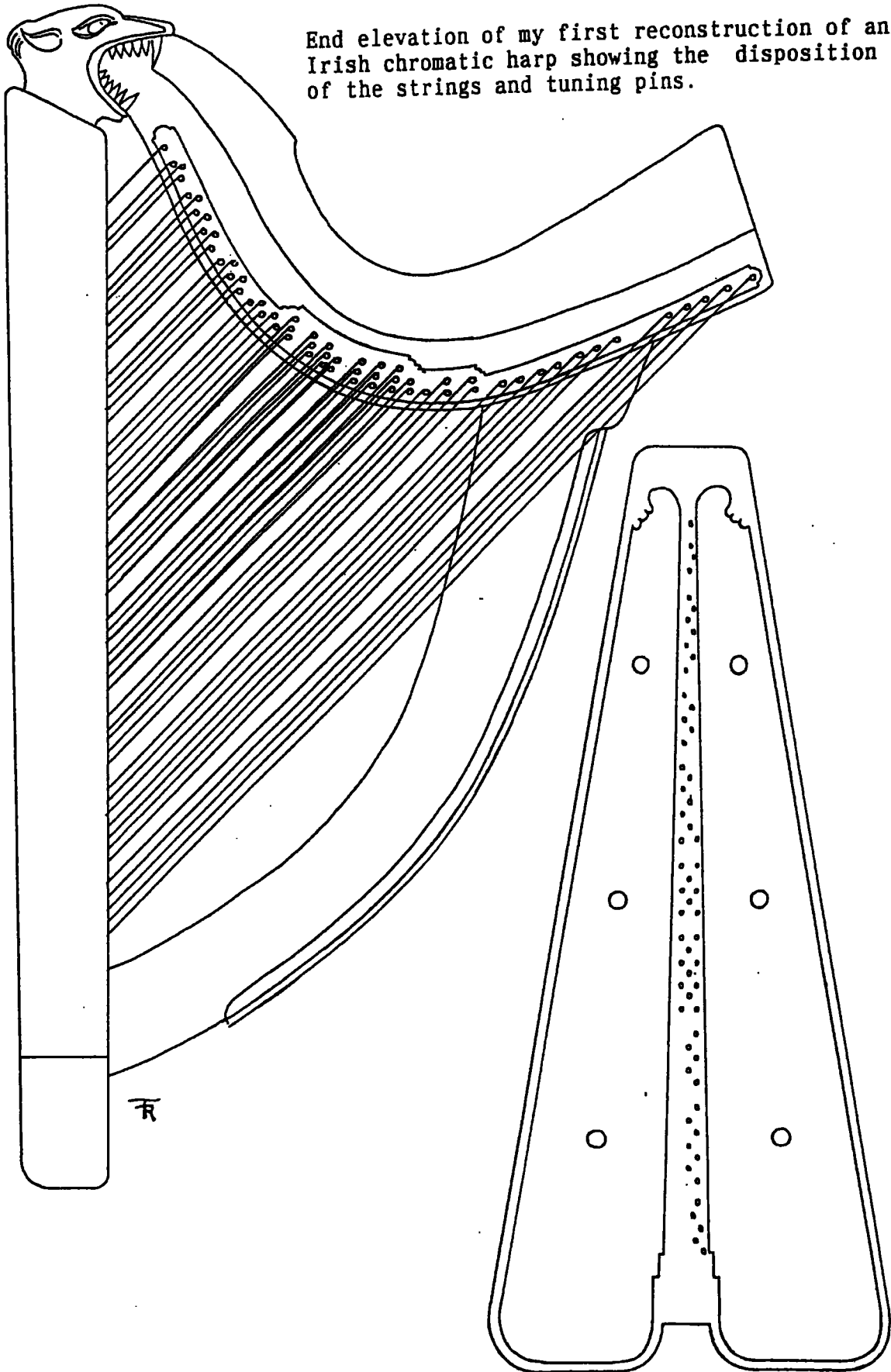

Plan of the soundbox of my first reconstruction of an Irish chromatic harp showing the pattern of string holes on the soundboard.

instrument. Instead, I limited reference to the original decoration with a carving of the head of a wolf hound on the shoulder, as a homage to the origins of my reconstruction (see Illustration 2).

The design of the soundbox however, was the result of a series of decisions which were very influenced by modern woodworking techniques. Firstly, knowing that the soundboxes of ancient Irish harps were carved out of solid pieces of willow I attempted to find some similar timber for this purpose. This was to no avail. No timber merchants that I contacted dealt with willow, let alone timber of the large dimensions (110cm x 41cm x 12cm) which I required. Knowing that most contemporary makers reconstructing Irish harps use sycamore in a slab construction, I decided to follow that course, aware that I could replace the soundbox if the right timber became available in the future. My decision to model the shape of the soundbox on that of the Kildare harp using a construction process instead of hollowing method led to the fashioning of some complicated components in order to achieve the desired form and these are shown in Illustration 3.

The purpose of the design was to end up with a structure which was the same as an ancient Irish soundbox with the exception that it was made up of several pieces of timber instead of one hollowed out trunk. Of course this necessitated the use of glue (not a requisite of ancient Irish harps), and I opted for a modern hard and brittle resin adhesive which I believed would combine strength with the ability to transmit tonal vibrations. A final refinement to the design of the sound box involved the siting of the string holes which I placed in a slight curve in the treble in order to reduce the angle at which the strings met the soundboard. This was to help make the instrument easier to play and

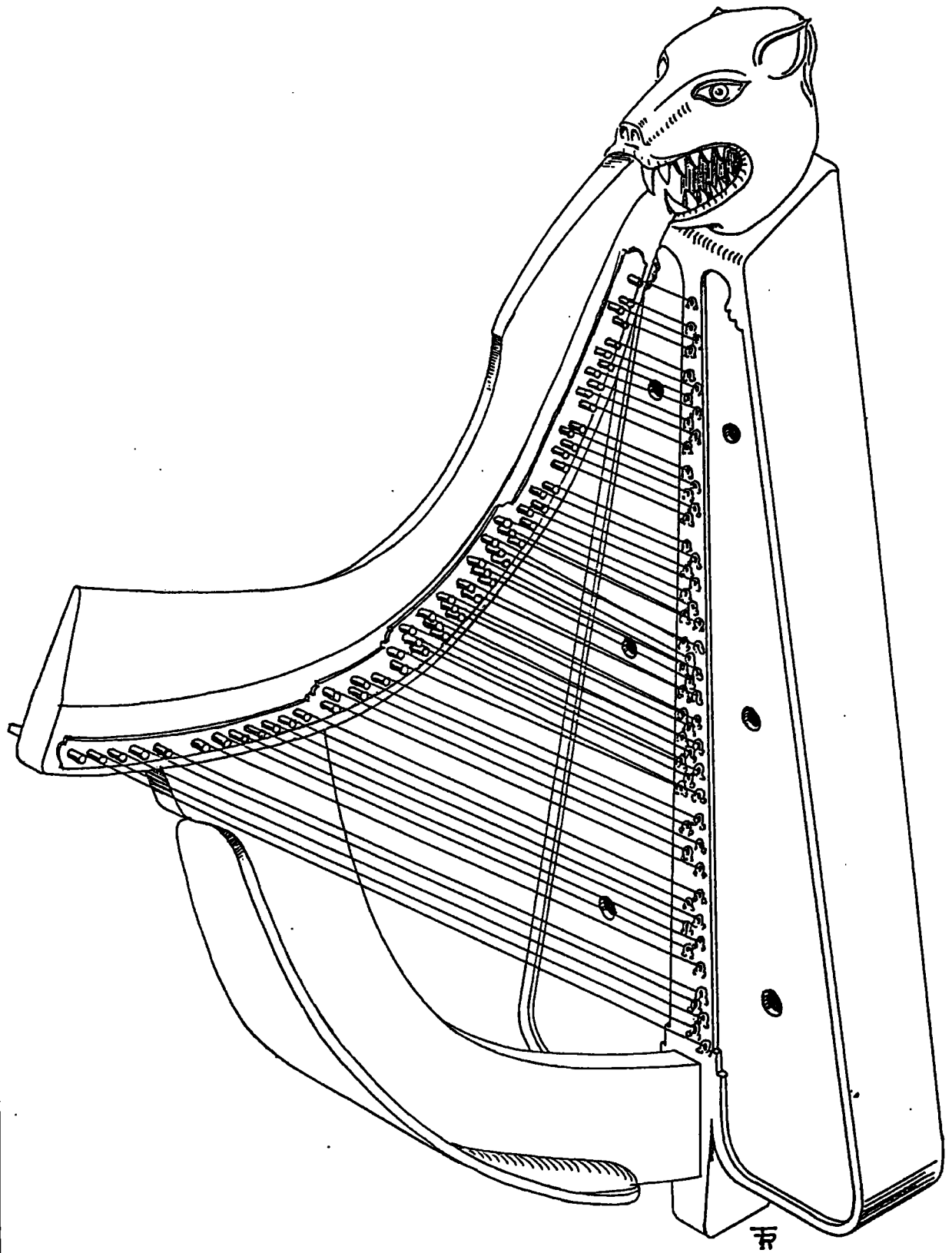

Isometric projection of my first reconstruction of an Irish chromatic harp showing the general layout and stringing of the instrument as well as the tapered depth of the soundbox.

Illustration 3

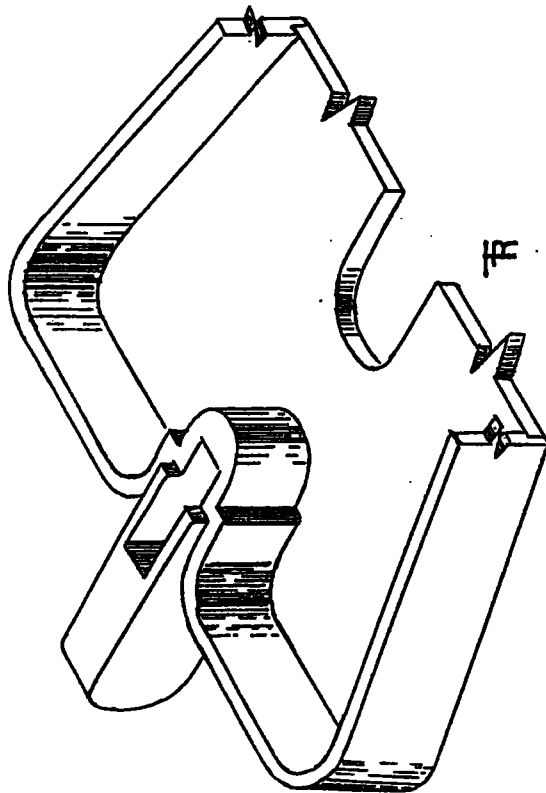

Isometric projection showing the interior construction of the foot and bottom of the harp. The form was created by joining together different shapes according to the direction of the grain of the wood.

ollowed an example of this feature used on the Lamont harp, described in Chapter 3. Having made these decisions about structure and design, I continued to develop the working drawing. The sides of the soundbox were to be approximately 12.5mm thick while the soundboard itself was to be about 7mm thick. These dimensions were based upon measurements taken from existing historical Irish harps realising that as none of these were chromatic, they may not represent the thicknesses used in the original soundbox of the Dalway harp. Despite this, I decided that as the thicknesses of timber could affect the tonal qualities of the instrument it would be a good idea to follow the practice employed on surviving ancient examples of the Irish harp.

Construction

Having obtained the timber for the harp, several months lapsed before I began construction. This was a period for checking over drawings and reconsidering compromises and decisions made with regards to the design. There is a daunting finality about cutting into a length of timber or a brass plate - once done, it cannot be undone. The craftsman is committed to a course of action which, during construction, gives ever decreasing opportunities for changes in direction. Interestingly, when cutting the curves of the pillar and neck, the use of modern circular saws and bandsaws became restricted as the machines struggled to cope with the resistance which the thickness of hardwood presented them. Instead, I had to resort to an axe to rough out the forms first, before finishing with a spokeshave. The brass bands were next screwed to the neck and pilot holes for the tuning pins drilled from either side. That having been achieved, a full diameter drill was

used before reaming out the holes for the tuning pins (see Illustrations 4 and 5).

Having cut and shaped the timber, I glued the soundbox components together and drilled the pattern of string holes on the soundboard of the harp. After assembling the entire structure, I stained and varnished it and then pinned the metal shoes onto the string band. The harp was ready for stringing. Most of the strings were of brass from the bass up, but the top eight were of steel. The ends of the strings inside the soundbox were wound round wooden toggles before being passed through the string holes. Traditional accounts of stringing an Irish harp refer to 'the raising of the harp', a procedure which took place over a number of months and which is described in Chapter 3.³ I followed this procedure and raised the tension of the strings gradually, a process which was made complicated by the fact that in raising the tension of a string, one is reducing the tension of the adjacent strings. This problem was dramatically increased by the double and triple stringing of this harp. Finally, while raising the tension of the strings by a semitone to the desired pitch, a very loud bang indicated that something drastic had occurred. In fact, the soundboard had split from top to bottom indicating that it was not substantial enough to resist the tension of fifty nine chromatically tuned strings. Of course this number of strings was approximately twice the number associated with a diatonic Irish harp of the period.

My first attempts at addressing this problem followed the practice of repairs made to ancient Irish harps in previous centuries. I screwed

³ Sean Donnelly, 'The Irish harp in England', *Ceol*, VII (1985), 57.

Illustration 4

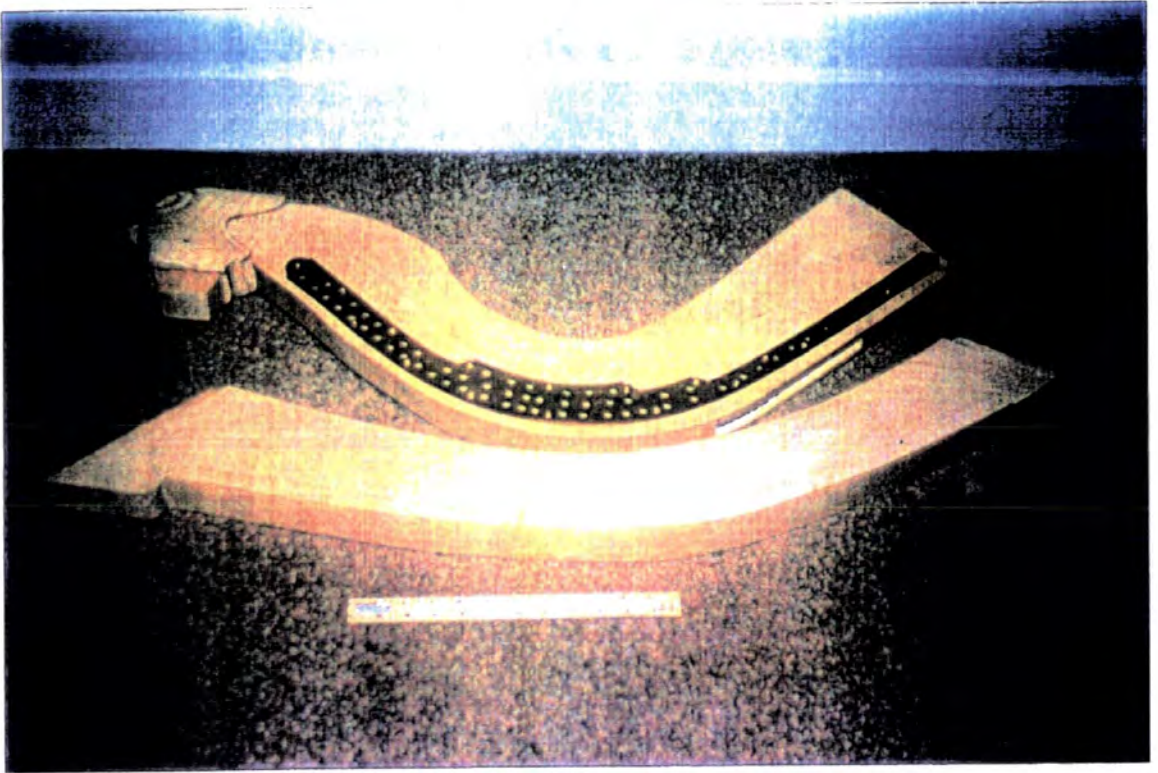

Photograph of the first reconstruction showing the neck and pillar.

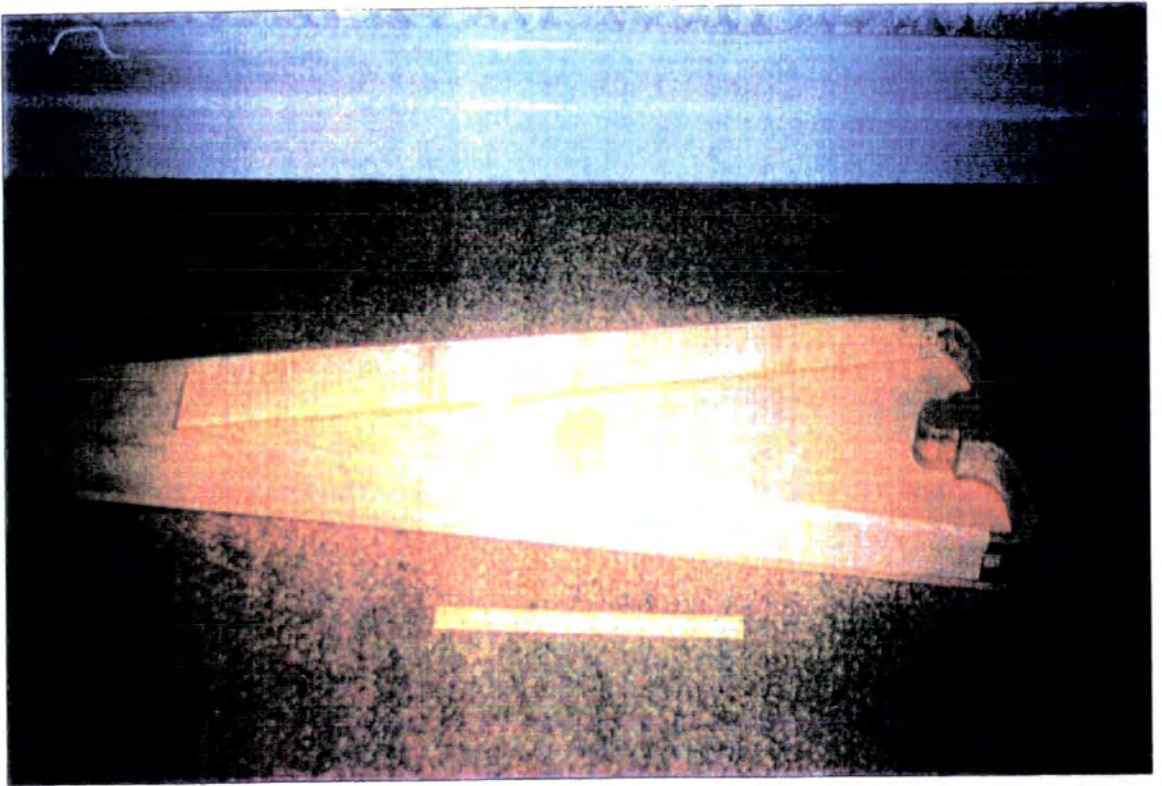

Photograph of the first reconstruction showing the back of the soundbox.

Photograph of the first reconstruction showing the major components in position. The soundboard has yet to be carved and the 'T' section added to the pillar.

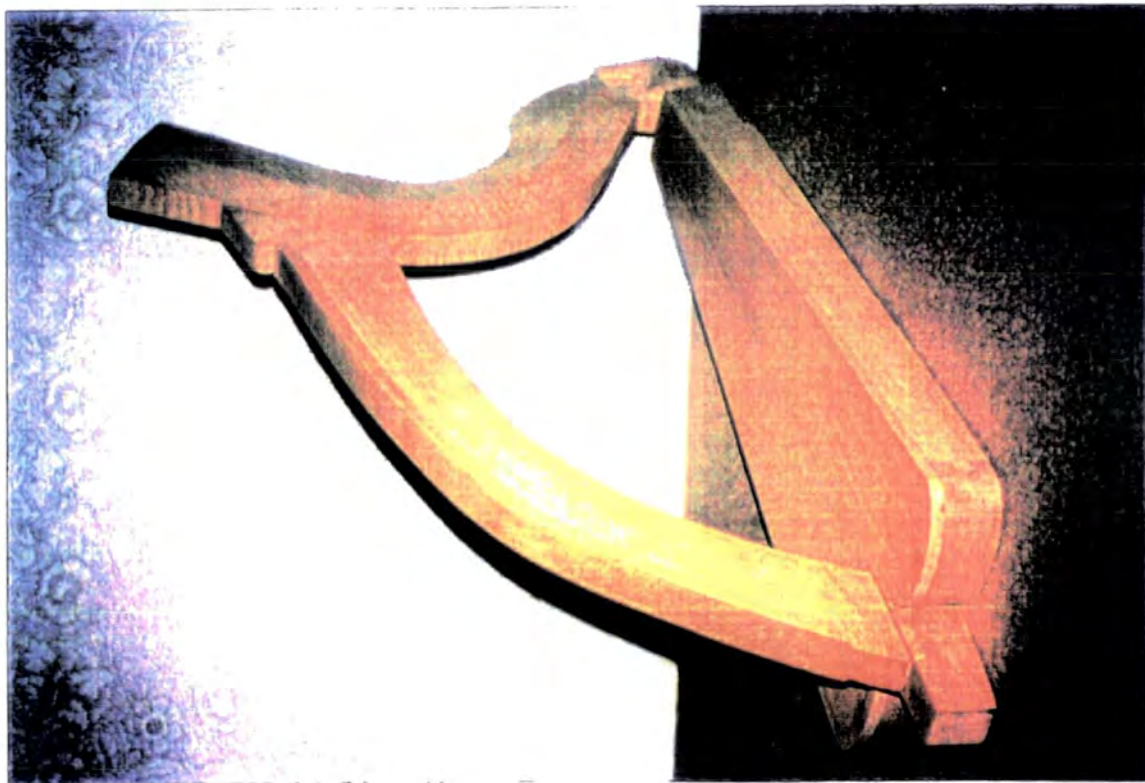

Photograph of the first reconstruction showing the experiment taking place to calculate the distances between strings using thread and pins.



Illustration 5

brass straps round the soundbox as a means of adding strength and reinforcement to the structure (see Illustration 6). Unfortunately, after the re-introduction of the string tension it became apparent that the harp was too unstable to maintain an accurate pitch on any note, particularly in the middle register. The instrument had failed musically even if I had managed to patch up the structure following traditional processes. I was now convinced that the soundboxes of Irish chromatic harps must have been more robustly constructed than those of their diatonic cousins, and that the soundboards in particular must have been considerably thicker. It was time to consider re-designing the soundbox and depart from the existing dimensions of diatonic harps by increasing the thickness of the soundboard. I opted for 13mm in my new design, realising that this might be an over-compensation, but not wishing to have to build yet another soundbox in the near future. Having achieved success in the form of stability, it would always be possible to construct another (lighter soundbox) at some distant point in the future, knowing that I could always return to a well tested, structurally sound formula if this should collapse as well. At this stage I produced a new set of drawings for a soundbox - following the form of the Kildare harp even more closely than before, and purchased the timber for my second attempt at building a soundbox for a chromatic Irish harp (see Illustration 7).

A New Soundbox for the Harp

Taking off the strings and removing the soundbox of my reconstruction was a daunting prospect. After months of planning and making I was faced with going back to the beginning again. A long period

Illustration 6

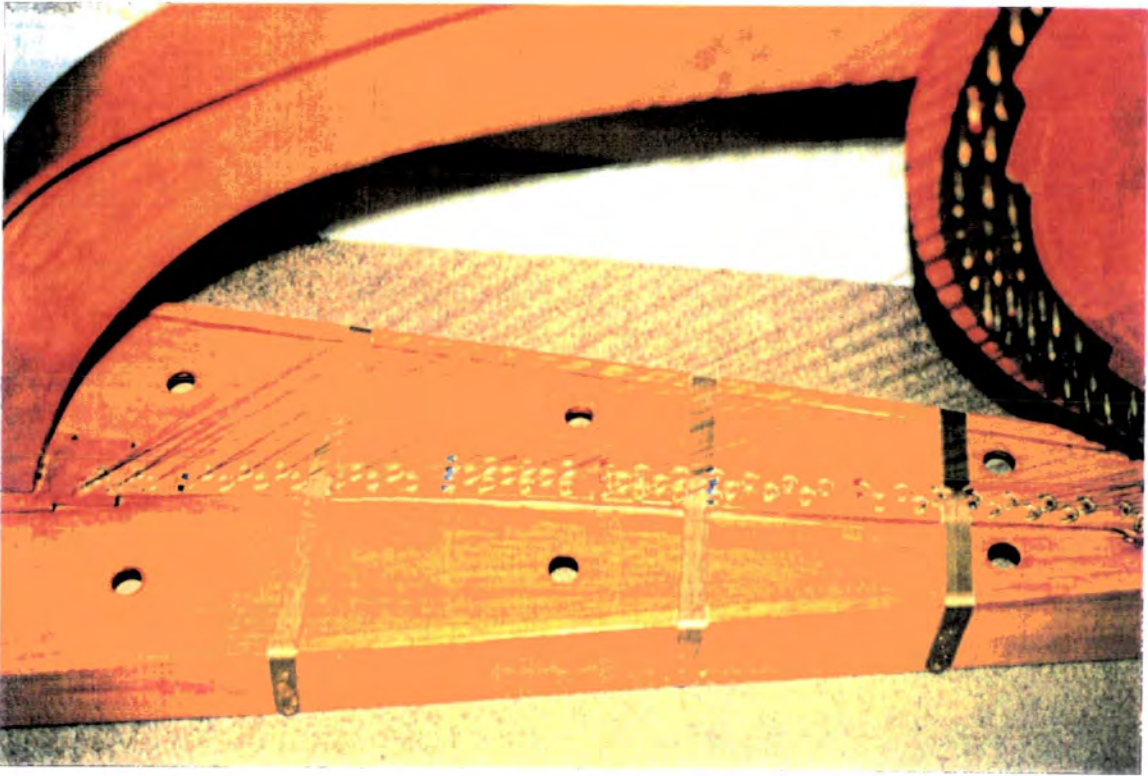

Photograph of the first reconstruction showing the split in the soundboard (the white line next to the raised string band) and the brass reinforcement strips.

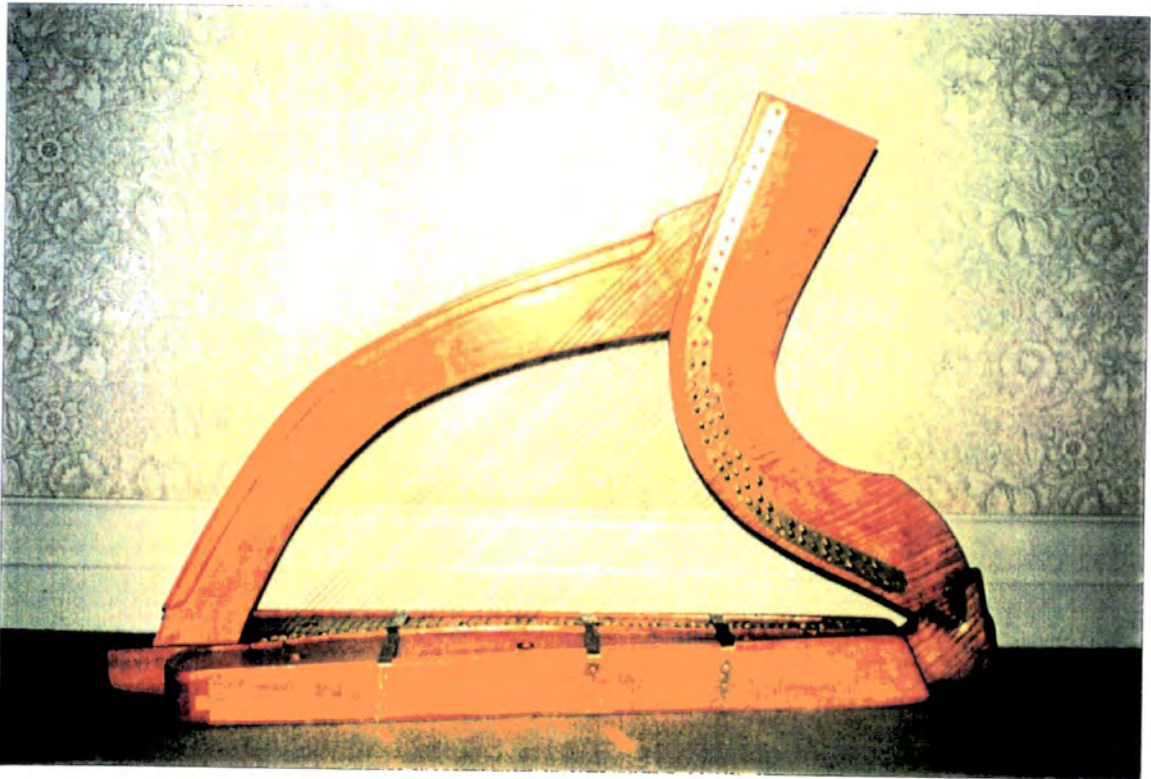

Photograph of the completed first reconstruction showing the brass strips used to reinforce the split soundboard.

Illustration 7

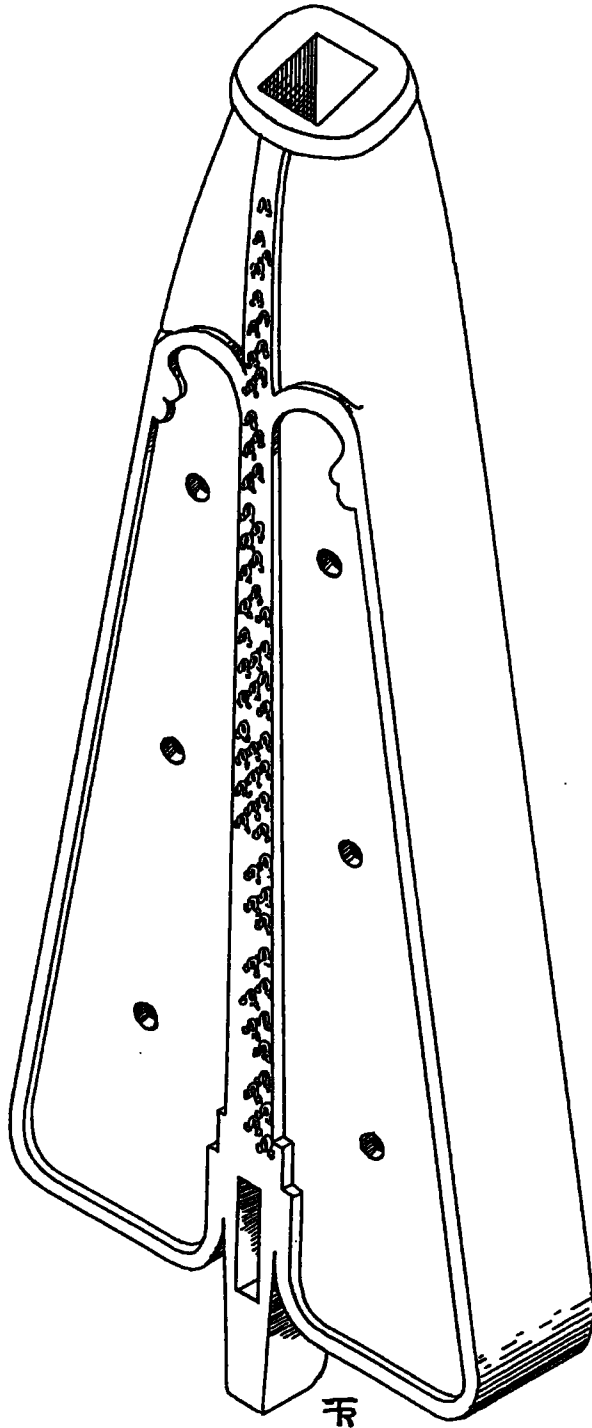

Isometric projection of my second reconstruction of a soundbox for an Irish chromatic harp showing the rounded treble section as well as the even depth of the sides.

reflection had to be followed by a brief outburst of brutality, the
ral of the strings and destruction of the soundbox. The dilemma that
me was that more demonstrable evidence of my labours existed in my
an harp than in no instrument at all.

The depth of the new soundbox does not become shallow towards the
as in the case of the first attempt. Instead, it remains constant
ughout its length except at the treble where, as the soundboard
mes thinner, it becomes less thick towards the head of the wolf
d. The treble section also follows the Kildare harp in being more
ded in section, making access to the strings more accessible at the
of the register. Much of the soundboard of my first reconstruction
been crafted using chisels, a very laborious if authentic process.
making of the new soundbox was made easier by the use of a router
ch removed unnecessary timber quickly, accurately and effortlessly.
result was a speedy replacement which rapidly dismissed my long
templation of dismantling the harp and I wondered why I had spent so
y pondering over the removal of the original soundbox and strings.
e again I stained and varnished the instrument to make the components
ch (see Illustration 8).

Stringing the harp was much easier than the first time. Many
ings were re-used, albeit at a higher pitch due to wire being lost,
it snapped from being unwound from the tuning pins. This meant that
hin each gauge, only the lower (longer) strings had to have loops
ound and fitted to wooden toggles. Raising the tension of the strings
also much easier, as the new soundbox was remarkably more stable
m the first. The strings were able to hold their pitch more
fectively and there were no signs of structural failure as they neared

Illustration 8

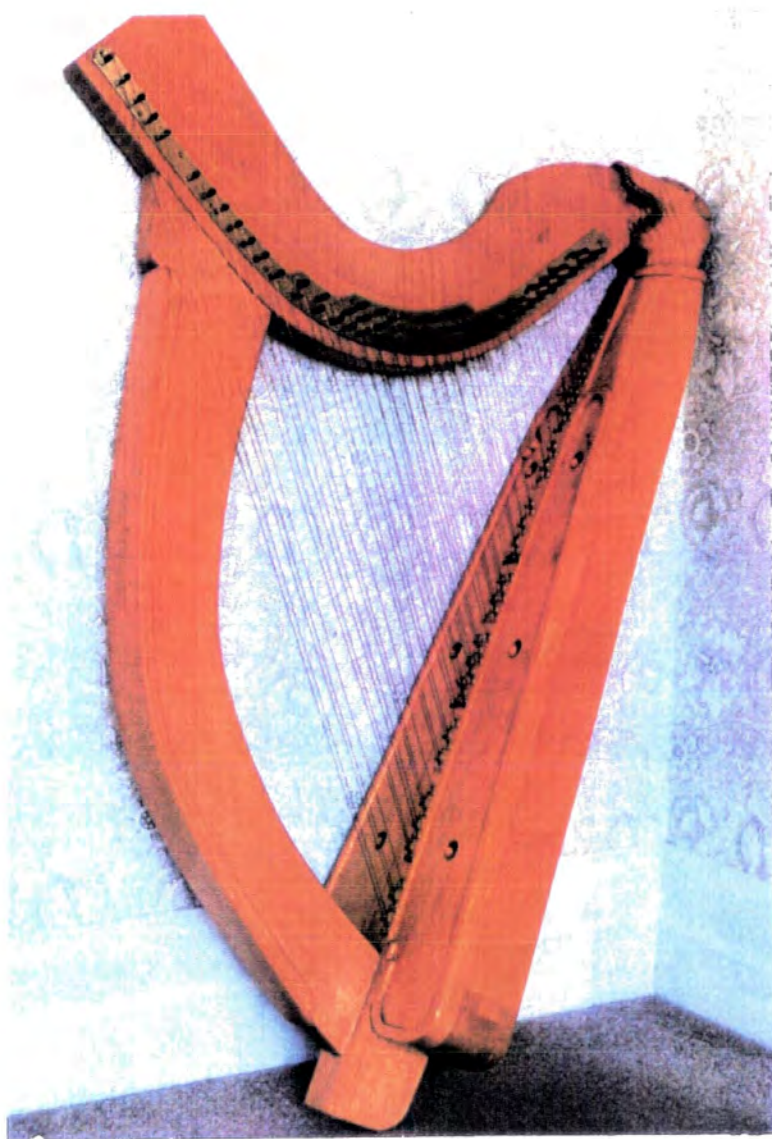

The finished harp featuring the second reconstruction of a soundbox for an Irish chromatic harp.

their final tension. It appeared as if I had solved the mechanical problems of building a reconstruction of a chromatic Irish harp.

Appraisal

The reconstruction of the harp is successful in a number of ways. Firstly it looks like a large Irish low-headed harp, and is mechanically sound - after resolving the problems of a thin soundboard. Secondly it sounds well, it is clear, bell-like and very sonorous. The conjectural pattern of string holes and shoes on the soundboard, and the resulting layout of strings are very accessible and playable, offering a practical solution to the problem presented by missing evidence of such soundboxes from the past (see Illustration 9).

Limited verbal descriptions are the only record we have of the sound of the Irish chromatic harp and in this light, it is difficult to assess the extent to which the reconstruction mirrors the sound of its predecessors. Though the neck and pillar of my instrument are based upon an original I cannot be absolutely sure that the sound board and string layout of a seventeenth century Irish chromatic harp were similar. The use of glue and modern tools are clear departures from ancient construction techniques and one can only guess at the effect this may have upon the sound of the reconstruction. Similarly, the choice of music wire for the strings is guesswork and we do not know the exact proportions and components of metals used in the alloy described in Ireland as brass, or the gauges used, without surviving examples or detailed reference material. Sadly no music wire associated with the Dalway harp or any other early examples of Irish harps has survived. The pattern of tuning pins on the neck of the harp is also different from

Illustration 9



Close up view of the head of a wolf hound.

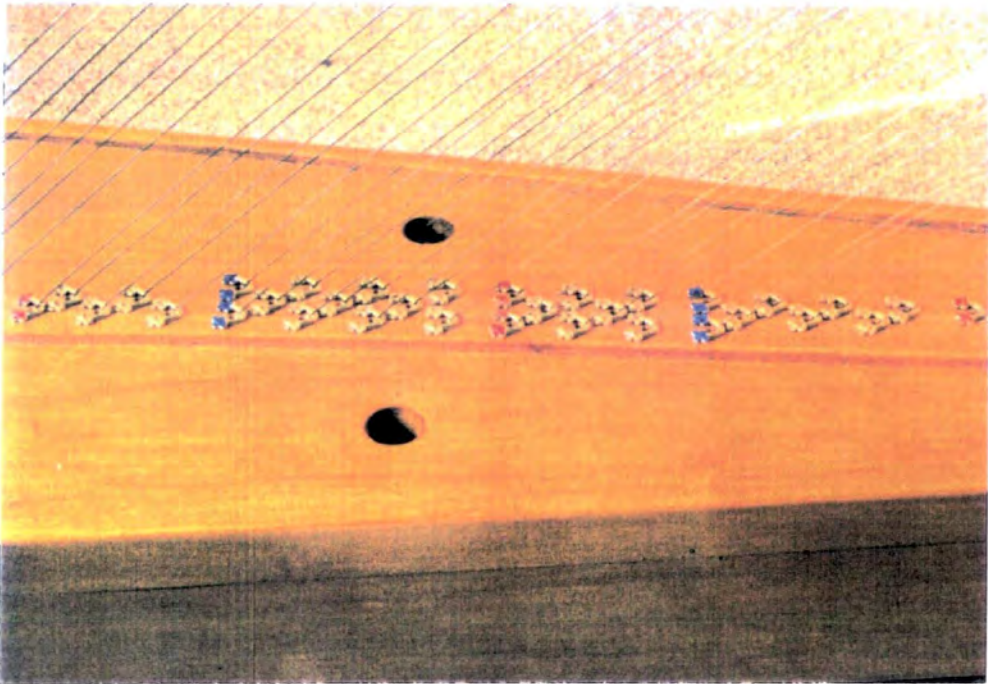

Close up view of the soundboard showing the string disposition, string holes and shoes.

that suggested by the Dalway harp inasmuch as a single row of pins has been split into two making some strings longer in the process.

However, an important aspect of a reconstruction is the information it can give us about instruments of the past, and we must look at the experience of building it in this light. From a design point of view it would appear inconceivable that the original Irish chromatic harps were built without the employment of full size drawings, templates or possibly experimental prototypes. Indeed, Michael Billinge and Bonnie Shaljean mention the need for prototypes when discussing the Dalway harp.⁴ The complexity of the string pattern and the possibility of strings vibrating against other strings or tuning pegs, makes accuracy critical. I am full of admiration for the craftsman who drilled the holes for the tuning pins of the Dalway harp - so close together, so accurate and true without the benefits of a modern pedestal drill.

When holding the reconstruction in its playing position one becomes very conscious of the weight and resulting momentum presented by the heavy neck and pillar. One cannot simply rest the instrument against the shoulder as it would tend to fall to the side with great force. Instead the player has to grip the harp very firmly between the legs in order to hold it steady, leaving the hands and arms free to move over the strings. It actually requires some strength to lift and move the reconstruction into a playing and tuning position and one is aware that the Irish chromatic harp must have been regarded to some extent as a solid piece of furniture. It could not have been as easily transportable

⁴ Michael Billinge & Bonnie Shaljean, 'The Dalway or Fitzgerald harp [1621]', *Early Music*, XV (1987), 179.

as many of its diatonic relations and it therefore seems probable that once installed in a building, the music came to it, and that the room to which it belonged became the venue for its repertoire. This weight factor makes it unlikely that such harps were ever played by female members of wealthy households who were expressing femininity (in the manner of the day), by playing instruments such as virginals or lutes in an altogether more genteel fashion.

Interestingly, when one holds the reconstruction in its playing position and looks down upon the strings the player is faced with a visual forest of wire. I am of the opinion that a possible suggestion by Billinge and Shaljean that there may have been four parallel rows of strings at the mid range of the Dalway harp is unlikely.⁵ I am sure that all of that music wire, unidentified by colour as in the gut strings of modern harps, would have been an awesome sight, even to one familiar with the instrument. Instead, I prefer to think that harp makers and players opted for the most practical and easy method of solving the problem of chromaticism in Irish harps. Three rows of strings would have provided a simpler and more accessible answer to the difficulty.

The inadequacy of the thin soundboard (7mm) suggests that the seventeenth-century prototypes must have been somewhat thicker to resist the tension of the strings. The failure of the metal reinforcement straps on the reconstruction also makes it appear unlikely that this solution was used in Irish chromatic harps in the past with any great success. It would also point to the possibility that such straps were used on diatonic harps in the past with only limited

⁵ Michael Billinge & Bonnie Shaljean, 'The Dalway or Fitzgerald harp', 177.

effectiveness. The problems associated with the soundbox and split soundboard may also be an indication of the fate of the original box of the Dalway harp. Nevertheless, the mechanical success of the second attempt at reconstructing a soundbox does demonstrate that the construction of an instrument of such specifications was a real possibility in the seventeenth century.

Pointers for Future Reconstructions

The analyses of different manuscript and printed sources of parts for the Irish chromatic harp in Chapters 4, 5 and 6, has revealed that composers of the late-sixteenth and early-seventeenth centuries were almost certainly writing for instruments of different specifications. The examples of possible stringing scales required for these sources (shown in Chapters 4, 5 and 6), demonstrate the development from a basically diatonic instrument using a compass of four octaves from D to d''' with a chromatic range from f to f', to a fully chromatic instrument with a compass of at least E^b to f#'. While my reconstruction of a chromatic harp was designed with the intention of exploring the complete repertoire, there is a need for the construction of several instruments of differing specifications which would match the different sources of music. Such a range of instruments would enable a performer to explore the capabilities of partially chromatic Irish harps, and aid those interested in the structural behavioural of ancient harps to witness their mechanical performance under the stress of different stringing patterns.

Ideally, the reconstructions should feature hollowed-out soundboxes made of willow and my experience of trying to obtain timber for this

purpose would suggest that this may involve obtaining a tree or trees and instructing a timber merchant to prepare the wood especially. As the timber would be at least 12cm thick and prone to splitting if kiln dried, several years may have to be allowed for seasoning. As previously mentioned, my own reconstruction should have its soundbox replaced in the future with a hollowed-out willow example. The production of several chromatic Irish harps of differing specification would also give an opportunity for experimenting with different gauges of brass wire throughout the compass, together with the possibilities of steel gauges in the top octave. A particularly interesting reconstruction would be of the Dalway harp fragments, using the string patterns and hitch/tuning pin arrangement demonstrated in Example 4 and Illustration 7 of Chapter 3.

The availability of reconstructions of Irish chromatic harps would make possible the performance of much of the music examined in Chapters 4, 5 and 6 (using the instruments for which it was written). Peter Holman's "hope that we will not have to wait too long before imagination becomes reality", when speaking about the possibility of performing William Lawes' 'Harpe' Consorts upon an Irish chromatic harp is now a very real possibility.⁶ Performance of this music upon instruments of varying specifications would help us to understand more about the development of the Irish chromatic harp as well as the performing practises associated with these instruments. Sadly the anonymous harp parts of Mus. MS 5 no longer have their corresponding consort parts and so this music cannot be explored within its conceived context.

⁶ Peter Holman, 'The harp in Stuart England', 202.

Appropriate harps would however, enable this music to be examined in the light of performance practise and related harp part-writing of the period. Peerson's *Mottects* provide us with the opportunity of comparing different instrumental combinations which could include the Irish chromatic harp as one of the alternatives. It would be interesting to explore the relative advantages and disadvantages of the different instruments (organ, virginal, theorbo, bandora or Irish harp) which Peerson lists as alternatives in accompanying viols and voices on his title page.⁷ John Dowland's *Lachrimae or Seaven Teares* also provides an opportunity for experimentation by including an Irish chromatic harp in the consort. This could help us discover what sounds the musicians at the court of King Christian IV of Denmark were capable of producing.⁸

Clearly much has still to be done, both in the field of reconstructing Irish chromatic harps and also in establishing and exploring a repertoire for the instrument.

7 Martin Peerson, *Mottects or Grave Chamber Musique* (London, 1630), title page.

8 John Dowland, *Lachrimae, or Seaven Tears Figured in Seaven Passionate Pauans...* (London, 1604).

BIBLIOGRAPHY

- Armstrong, Robert Bruce: *The Irish and The Highland Harps* (Edinburgh, 1904, repr. Shannon, 1969), 11-12, 15-17, 19, 67, 71, 73-74, 78-79 142-154.
- Ashbee, Andrew [ed.]: *Lists of Payments of the Kings Music in the Reign of Charles II [1660-1685]* (Snodland, 1981), 49, 52, 56, 64, 66.
- : *Records of English Court Music* (Snodland, 1986-91, Aldershot, 1991-), 51.
- Bacon, Francis: *The Complete Works*, ed. James Spedding, Robert Ellis & Douglas Heath (London, 1876), II, 399-400, 420, 422, 433.
- Baxter, Robert: *Martin Peerson's 'Mottects or Grave Chamber Musique' [1630]* (diss., Catholic University, Washington, DC., 1970), 103-104.
- Bennett, J. & Willetts: 'Richard Mico', *Chelys*, VII (1977), 39.
- Billinge, Michael & Shaljean, Bonnie: 'The Dalway or Fitzgerald harp [1621]', *Early Music*, XV (1987), 175-187.
- Brade, William: *Neue Ausserlesene liebliche Branden* (Hamburg, 1617, ed. Bernard Thomas, London, 1972), nos 40 & 48.
- Bunting, Edward: *The Ancient Music of Ireland* (Dublin, 1840, repr. Dublin, 1969), 23, 73.
- : *A General Collection of The Ancient Irish Music* (Dublin, 1796, repr. Dublin, 1969), preface.
- : *A General Collection of The Ancient Music of Ireland* (Dublin, 1809, repr. Dublin, 1969), frontplate, 1-8, 18, 23-28.
- Butler, Samuel: *Sidneiana* (London, 1837), 81.
- Carew, Sir George [governor of the province of Munster]: *Pacata Hibernia* (London, 1633), 502-503.
- Carolan, Nicholas: 'Two Irish Harps in Co. Dublin', *Ceol*, VII (1985), 40-45.
- Catch, John: 'The Harp Consorts of William Lawes', *Viola da Gamba Society Newsletter*, LII (1986), 5-8.
- Charteris, Richard: 'Jacobean Musicians at Hatfield House, 1605-1613', *Royal Musical Association Research Chronicle*, XII (1974), 116, 135.
- Chester, Joseph L & Armytage, G.J. [eds.]: *The Parish Registers of St. Antholin, Budge Row* (London, 1883), 64.

- Churchill, Awnsham & Churchill, John [eds.]: *A Collection of Voyages*, III, 219-220.
- Cofone, Charles, [ed.]: *Elizabeth Rogers Hir Virginal Booke* (New York, 1982), ix.
- Coprario, John: *John Coprario, Fantasia-Suites*, Musica Britannica, XLVI Richard Charteris, ed., (London, 1980)
- : *Rules How to Compose*, Manfred. F. Bukofzer ed. (Los Angeles, 1952), 8-9.
- Crookes, David Z. [trans. & ed.]: *Michael Praetorius, Syntagma Musicum* (Oxford, 1986), 5.
- Dalyell, Sir John Graham: *Musical Memoirs of Scotland, With Historical Annotations* (Edinburgh and London, 1849), 236-7.
- Dart, Thurston & Coates, William [eds.]: *Jacobean Consort Music*, Musica Britannica, IX (London, 1955)
- Davenant, William: *Works*, II (London, 1673, repr. 1968), 382-394.
- Donnelly, Sean: 'An Irish Harper in the Royal Musick', *Ceol*, VI (1984), 34-36.
- : 'An Irish Harper and Composer - Cormac MacDermott [? - 1618]', *Ceol*, VIII (1986), 40-49.
- : 'The Irish Harp in England', *Ceol*, VII (1986), 54-62.
- Donington, Robert: 'Baryton', *The New Grove Dictionary of Music and Musicians* (London, 1980), II, 233.
- Evelyn, John: *Diary*, E.S. de Beer, ed. (Oxford, 1955), III, 92, 518.
- Field, Christopher D.S. : 'Coprario, John', *The New Grove Dictionary of Music and Musicians*, IV (London, 1980), 727.
- FitzGibbon, Constantine: *The Irish in Ireland* (London & New York, 1983), 113, 146-147, 165.
- Flemming, Horace: 'Some of the History of the Castell and See Demesne of Cloyne', *Journal of the Cork Historical and Archaeological Society*, IX (1903), 209-223.
- Ford, Robert: 'The Filmer MSS - A Handlist', *Notes*, XXXIV (1987), 814-825.
- Foster, Richard & Craig, Pamela Tudor: *The Secret Life of Paintings* (Woodbridge, 1986), 84-87.
- Froissart, Jean: *Froissart's Chronycles*, II, trans. Sir John Bouchier (Oxford, 1927), part 4, Cap, ccii, 1046.

- Fuller Maitland, J.A. & Barclay Squire, W. [eds.]: *The Fitzwilliam Virginal Book*, (New York, 1963), ix.
- Fuller, David, 'Suite', *The New Grove Dictionary of Music and Musicians* (London, 1980), XVIII, 339.
- Fuller, Thomas: *The Historie of the Worthies of England* (London, 1662), 157.
- Fulton, Cheryl A.: 'For the Harpe, Base Violl, Violin and Theorbo', *American Harp Journal* (Winter 1985), 15-20.
- Galilei, Vicentio: *Dialogo... della musica antica e della moderna* (Florence, 1581, repr. Rome, 1934), 143.
- Galpin, Francis: *Old English Instruments of Music* (4th edn., with footnotes by Thurston Dart, London, 1965), 13.
- Gasquet, Cardinal Francis Aidan: *Henry VIII and the English Monestaries* (London, 1888), II, 361, 364-366.
- Grossart, Alexander [ed.]: *The Lismore Papers* (London, 1882-8), I, 21, 36, 52, 59, 74, 95, 100, 119, 120, 124, 241; II, 321, 347; III, 162.
- Hakluyt, Richard: 'The voyage of the right honourable the Earl of Cumberland to the Azores', *The Principal Navigations, Voyages, Traffiques and Discoveries of the English Nation...* (Everyman Library, 1907-1909), IV, 377.
- Hammerich-Elling, Angul: *Music ved Christien den Fferds Hof* (Copenhagen, 1892), 24, 210-211, 213-216 .
- Hardiman, James: *Irish Minstrelsy or Bardic Remains of Ireland* (London, 1831, repr. 1971), I, xviii, xix.
- : 'The Statute of Kilkenny... with translation and notes', *The Irish Archaeological Society*, II (Dublin, 1841), 55, 58.
- Hayes, Gerald: *Kings Music* (Oxford, 1937), 26-27, 52, 81.
- Heideberg, Steffen [ed.]: *Christian IV and Europe* [Catalogue of the 19th Art Exhibition of the Council of Europe] (Denmark, 1988), 104, 120-121, 567.
- Holman, Peter: *Four and Twenty Fiddlers* (Oxford, 1993), 143, 262.
- : 'The harp in Stuart England', *Early Music*, XV (1987), 188-203.
- Hore, Herbert F.: 'The Old Bards of Ulster', *Ulster Journal of Archaeology*, Series 2, IX (1861-2), 55.
- Houghton, Raymond & Berman, David & Lapan, Maureen: *Images of Berkeley* (Dublin, 1986), 84, 97.

- Hurray, Peter Le: *Music and the Reformation in England 1549-1660* (London, 1967), 98, 333, 395-396.
- Huygens, Lodewijk: *The English Journal*, eds. G.H. Bachrach and R.G. Collmer (Leiden & London, 1982), 62.
- Jennings, Brendan, [ed.]: *Wild Geese in Spanish Flanders, 1582-1700* (Stationary Office for the Irish Manuscripts Commission, 1964), 281.
- Jonson, Benjamin: *The Works of Benjamin Jonson* (London, 1616, repr. 1976), 1000-1004.
- Josephs, Norman: 'Withy, John', *The New Grove Dictionary of Music and Musicians* (London, 1980), XX, 464-465.
- Kempe, Alfred John [ed.]: *The Losely Manuscripts* (London, 1835), 238-9.
- Kerman, Joseph: 'William Byrd', *The New Grove Dictionary of Music and Musicians* (London, 1980), III, 552.
- Kingston, William: *The Story of West Carbery* (Waterford, 1985), 33-45.
- Lafontaine, H.C. De [ed.]: *The Kings Musick* (London, 1909, rep. 1973), 58, 86, 91.
- Lawes, Henry: *Choice Psalms* (London, 1648), preface.
- Lawes, William: *Royal Consort [New Version]*, ed., David Pinto (London, 1995), 40.
- : *Select Consort Music*, *Musica Britannica*, XXI, ed. Murray Lefkowitz (London, 1963), xix, xxv, 64-89, 107, 138.
- Lefkowitz, Murray: 'Masque', *The New Grove Dictionary of Music and Musicians* (London, 1980), XI, 764.
- : *William Lawes* (London, 1960), 13, 20, 88-105, 167, 203, 268-269, 287-292.
- Lindley, Mark: 'Meantone', *The New Grove Dictionary of Music and Musicians* (London, 1980), XI, 875.
- : 'Temperaments', *The New Grove Dictionary of Music and Musicians* (London, 1980), XVIII, 672.
- : 'Tuning Systems for 12-note Keyboard Instruments', *The English Harpsichord Magazine*, II (1977), 13-15.
- Lodge, Edmund: *Illustrations of British Biography and Manners* (London, 1983), II, 577.
- Lyle, J.V. [ed.]: *Acts of the Privy Council of England* (P.R.O., 1931), XXVII, 346.

- McCabe, William H.: *Music and Dance on a 17th-Century College Stage*, *The Musical Quarterly*, XXIV (1938), 313-322.
- MacCotter, Paul & Nichols, Kenneth: *The Pipe Roll of Cloyne* (Cloyne, 1996), x.
- MacLysaght, Edward: *Irish Life in the Seventeenth Century* (Dublin, 1939, 2nd edn. repr. Dublin, 1979), 22, 33, 35, 111, 158.
- Mahaffey, R.P. [ed.]: *Calendar of State Papers [Ireland]* (London, 1912), (1596-7) 375, (1598-9) 103, (1603-6) 263, (1606-8) 228, (1615-36) 674.
- Marshall, Rosalind K.: *The Days of Duchess Anne: Life in the Household of the Duchess of Hamilton 1656-1715* (Edinburgh, 1973), 73.
- Mason, Thomas [ed.]: *A Register of the Baptisms, Marriages and Deaths in the Parish of St. Martin-in-the-Fields in the County of Middlesex from 1550 to 1619* (London, 1898), 35, 37, 37, 44, 158, 167.
- Mayer, Ernst H.: *English Chamber Music* (London, 1946, repr. 1951), 83, 132, 179-187, 210, 271-276.
- Mersenne, Marin: *Harmonie universelle*, III (Paris, 1636, repr. 1963), 216.
- Monson, Craig: *Voices and Viols in England, 1600-1650* (Michigan, 1982), 77-108.
- Morley, Thomas: *A Plain and Easie Introduction to Practicall Musicke* (London, 1597, ed. Alec Harman, London, 1952), 296.
- Mullally, Robert: 'More about the measures', *Early Music*, XXII (1984), 419, 435.
- Muller, Mette & Kongsted, Ole: 'Christian IV and Music', *19th Council of Europe Exhibition Catalogue* (Herning, 1988), 121.
- North, Roger: *Roger North on Music*, ed. John Wilson (London, 1959), 337.
- Osborne, James M. [ed.]: *The Autobiography of Thomas Whythorne* (Oxford, 1971), 14.
- O'Sullivan, Donal: *Carolan: The Life, Times and Music of an Irish Harper* (1958, repr. Louth, 1983), I, 3-19.
- Owen, Geraint Dyfuallt: *Elizabethan Wales* (University of Wales Press, 1962), 38-39.
- Paul, Sir James Balfour [ed.]: *Accounts of the Lord High Treasurer of Scotland* (Edinburgh, 1900), II, 55, 102, 109, 110, 119, 120, 125, 126.

- Pepys, Samuel: *The Diary of Samuel Pepys*, Robert Latham & William Matthews eds., VII (London, 1972), 414.
- Pinto, David: *For Ye Viols* (Surrey, 1995), 132-133, 153.
- Playford, John: *The Complete Country Dance Tunes from Playford's Dancing Master [1651-ca, 1728]* ed. Jeremy Barlow (London, 1985), 38, 64.
- Pollock, Sir F.: *The Table Talk of John Seldon* (London, 1926), 64-65.
- Poulton, Diana: *John Dowland* (London, 1972, repr. 1982), 30-48, 52, 57-58, 342, 345, 457.
- Power, Rev.P.: 'Place-Names and Antiquities of Imokilly', *Journal of the Cork Historical and Archaeological Society*, Vol XLV (1940), 15.
- Praetorius, Michael: *Syntagma Musicum, II* (Wolfenbüttel, 1619, repr. Barenreiter Kassel, 1976), 5, 30, 54, 56, Plate xviii.
- Price, David C.: *Patrons and Musicians of the English Renaissance* (Cambridge, 1981), 35, 128.
- Rastall, Richard: 'More, William', *The New Grove Dictionary of Music and Musicians*, XII (London, 1980), 565.
- Rimmer, Joan: 'Harps in the Baroque Era', *Royal Musical Association Research Chronicle* (1964), 62-63.
- : 'James Talbot's Manuscript VI-Harps', *Galpin Society Journal*, XVI (1963), 66-67, 70-71.
- : *The Irish Harp* (Dublin and Cork, 1969, 2nd edn. 1984), 26, 28-30, 33, 37-38, 40, 46-47, 49, 75-77.
- : 'The Morphology of the Irish Harp', *Galpin Society Journal*, XVII (1964), 45, 49.
- Ring, Layton: *A Preliminary Enquiry into the Continuo Parts of William Lawes for Organ, Harp and Theorbo*, (M.A. Thesis, Nottingham, 1972)
- : 'The Harp for Lawes', *Early Music*, XV (1987), 589-590.
- Rosenzweig, Heidrun [ed.]: *Historische Harfen* (Dornach/Switzerland 1991), 46, 60-79, 145-176
- Russell, Raymond: *The Harpsichord and Clavichord* (London, 1959, repr. Glasgow, 1973), 17, 74, 155-160.
- Sabol, Andrew J.: 'New Documents on Shirley's Masque The Triumph of Peace', *Music and Letters*, XLVII (1966), 18, 22.
- Sanger, Keith & Kinnaird, Alison: *Tree of Strings* (Temple, 1992), 53, 57, 58, 80-92, 222-225.

- Simpson, Christopher: *A Compendium of Practical Music* [London, 1667], ed. P. Lord (Oxford, 1970), 114-19.
- Smith, A.G.R.: *The Life of Sir Michael Hicke* (London, 1977), 167.
- Smith, N.J. [ed.]: *Herbert Correspondence*, Irish Manuscripts Commission (University of Wales Press, 1963), 145.
- Spedding, J. & Ellis, R. & Heath, D.: *The Works of Francis Bacon* (London, 1871), century ii, 146, century iii, 223.
- Spencer, Terence J.B. & Wells S. [eds.]: *A Book of Masques* (Cambridge, 1976), 164.
- Spink, Ian: *English Song, Dowland to Purcell* (London, 1974), 178.
- : 'Forcer, Francis', *The New Grove Dictionary of Music and Musicians* (London, 1980), VI, 704.
- Stompe, M.J.T.: 'Reinhold Timm', *The Dictionary of Art* (London, 1996), XXX, 734.
- Tenison, E.M.: *Elizabethan England* (Royal Leamington Spa, 1933), IX, 305.
- Turner, Michael: 'Some Improvements in Music Noted by William Turner in 1697', *Galpin Society Journal*, XX (1957), 59.
- Van Schaik, Martin: *Aspects of the Historical Harp* (Utrecht, 1992), 41, 99-104.
- Wailles, Marylin: 'Martin Peerson', *Proceedings of The Royal Musical Association*, LXXX (1953-54), 59.
- : 'Some Notes on Martin Peerson', *The Score*, IX, (1954), 21.
- Walls, Peter: *Music in the English Courtly Masque* (Oxford, 1996), 150, 173, 175, 288-289.
- Ward, John M.: 'A Dowland Miscellany', *Journal of the Lute Society of America*, X (1977), 103.
- : 'Sprightly and Cheerful Musick', *Lute Society Journal*, XXI (1979-81), 104-106.
- Warren, C.W.: 'Music at Nonesuch', *The Musical Quarterly*, LIV (1968), 50.
- Woodfill, Walter: *Musicians in English Society - Elizabeth to Charles I* (New Jersey, 1953), 235, 273, 310.

MANUSCRIPT SOURCES

GREAT BRITAIN

London

British Library

(Music)

Add. 11,608

Add. 22,099 f5.

Add. 29,291

Add. 30,480-4

Harl. 7578

Mus. K.4.a.4.

Mus. K.2.d.13

(Household)

Egerton MS 1048, f186

Harl. 1419

Lansdowne. 92, f83r, f92r, f119r

Public Record Office

E 101/438, 4, 7, 11, 13-15; /439, 3 /674/11

E 351/543, f94, f136.

E 403/1724; /1737 (23rd June 1626); /2460, f37v

E 405/543, f101v

F 332/40

LC5/132, 346

State Papers Domestic (1611-1640), 553, 559.

Royal Commission on Historical Manuscripts (HMC)

Egmont MSS 1 (1905), 453-454.

Egmont MSS 2 (1909), 123, 127.

Hastings MSS 1, (1928), 368

Rutland MSS 4 (1905), 354

Salisbury MSS 7 (1899), 372, 378.

Salisbury MSS 10 (1904), 406

Salisbury MSS 16 (1933), 409.

Salisbury MSS 17 (1938), 297

Salisbury MSS 23 (1973), 168

Salisbury MSS 24 (1973), 63, 203

Oxford

Bodleian Library

MS Mus.Sch.D 229

MS Mus.Sch.D 238-40

MS Mus.Sch.D 246

MS Mus.Sch.B3

Wood. D.19 4, no 106, f83r.

Douce. HH 203 (10).

Christ Church Library

Mus.MS 5
Mus.MSS 379-81
Mus.MS 1022

Warminster
Longleat House

Longleat Papers of Bulstrode Whitelock, f28v.

IRELAND

Dublin
Library of Trinity College

MS 1209

UNITED STATES OF AMERICA

New Haven, Connecticut
Yale University Music Library

Filmer MS 4, ff34v- 35r, 37, 39v-43r

