



Durham E-Theses

Studies on the olfactory responses of certain calliphorine flies

Cole, Patricia

How to cite:

Cole, Patricia (1955) *Studies on the olfactory responses of certain calliphorine flies*, Durham theses, Durham University. Available at Durham E-Theses Online: <http://etheses.dur.ac.uk/9268/>

Use policy

The full-text may be used and/or reproduced, and given to third parties in any format or medium, without prior permission or charge, for personal research or study, educational, or not-for-profit purposes provided that:

- a full bibliographic reference is made to the original source
- a [link](#) is made to the metadata record in Durham E-Theses
- the full-text is not changed in any way

The full-text must not be sold in any format or medium without the formal permission of the copyright holders.

Please consult the [full Durham E-Theses policy](#) for further details.

STUDIES ON THE OLFACTORY RESPONSES OF
CERTAIN CALLIPHORINE FLIES

by

PATRICIA COLE

- being a thesis presented in candidature
for the degree of Doctor of Philosophy in
the University of Durham, 1955.

The work in this thesis was carried out
under the supervision of Professor J.B.Cragg,
at the Science Laboratories of the Durham
Colleges in the University of Durham.



The author wishes to acknowledge the ready help and constant encouragement given by Professor J.B. Cragg. Thanks are also due to Mr. T. Spence, M.R.C.V.S., of the Research Laboratories, Weybridge whose willing co-operation made possible those experiments which involved the breeding of larvae on living sheep.

C O N T E N T S

INTRODUCTION.....	page. 1.
-------------------	-------------

P A R T 1

AN INVESTIGATION AND CRITICISM OF THE Y-TUBE TECHNIQUE.....	4.
1. <u>THE Y-TUBE OLFACTOMETER.</u>	5.
Apparatus	
Calibration of flowmeters.	
The air-flow within the apparatus.	
Experimental Method.	
2. <u>EXPERIMENTS USING THE Y-TUBE OLFACTOMETER.</u>	15.
Trial runs testing the apparatus for bias.	
A meat bait incorporated in the apparatus.	
The repellent effect of menthol.	
Modification of the olfactory response.	
SUMMARY.....	31.

P A R T 2

THE CHARCOAL CHOICE-CHAMBER.....	32.
1. <u>THE DEVELOPMENT OF A NEW TECHNIQUE.</u>	33.
Apparatus.	
Method.	
2. <u>THE RESPONSES OF BLOWFLIES TO MEAT.</u>	41.
3. <u>MENTHOL EXPERIMENTS WITH <i>L. sericata</i>.</u>	44.
Sex-Difference in the response to menthol.	
A statistical method for comparing 2 groups.	
Modification of the olfactory response.	
4. <u>CHEMICAL ATTRACTANTS IN THE LABORATORY.</u>	56.
5. <u>THE RESPONSES OF BRITISH <i>L. sericata</i> TO SAMPLES OF FLEECE.</u>	61.

6.	<u>THE PHYSIOLOGICAL STATE OF L. sericata AND ITS EFFECT ON THE RESPONSE TO SAMPLES OF FLEECE.</u>	66.
	(a) In the period from emergence to 7 days later.	
	(b) In the period from oviposition to a time 4 weeks later.	
7.	<u>CONDITIONING EXPERIMENTS.</u>	75.
8.	<u>THE COMPARATIVE RESPONSES OF DIFFERENT SPECIES OF BLOWFLY TO SAMPLES OF FLEECE.</u>	84.
	Introductory Notes on the species studied.	
	Experimental work in the laboratory.	
	SUMMARY.	95.

P A R T 3.

	<u>THE BLOWFLY ANTENNAE.</u>	99.
1.	HISTORICAL SURVEY.	99.
2.	THE EXPERIMENTS OF McINDOO.	101.
3.	THE PHYSIOLOGY OF THE CHEMORECEPTORS.	104.
4.	THE MORPHOLOGY OF THE BLOWFLY ANTENNA.	106.
5.	MUTILATION EXPERIMENTS.	110.
6.	HISTOLOGY OF THE ANTENNA.	116.
7.	THE TEXT-FIGURES.	126.
	SUMMARY.	138.

	GENERAL DISCUSSION	139.
	REFERENCES	152.
	APPENDIX.	158.

I N T R O D U C T I O N

Insect repellents were discovered early among primitive peoples. Many plant products such as vegetable oils, and irritants like pitch and smoke were used by primitive man in an effort to protect himself from noxious insects. This is described by Dethier (1947), who also records the fact that the Greeks found a practical application for the use of insect attractants. Yet in spite of these well established facts which were accepted and used, and in spite of the interest which developed in the subject in the eighteenth century (see Marshall, 1935) and which has continued unabated to the present day, it was as late as 1895 before a simple practical piece of apparatus appeared, designed to measure an olfactory response. This particular olfactometer, the work of Zwaardemaker, was designed to measure human olfaction, and was unsuitable for use with insects. However, it was an important advance into olfactory studies in general.

Barrows (1907) working on the pomace fly, Drosophila ampelophila introduced the principle of the Y-tube olfactometer. This apparatus consisted of a simple Y-tube, down one arm of which odourless air ~~diffused~~, and, down the other, air which had been in contact with some test substance. Insects entering the tube were presented with a simple choice, and on their selection of one side or the other, the attractive or repellent effect of the substance was established.

In 1926, McIndoo adapted the Y-tube olfactometer with



some improvements and demonstrated that insects are attracted to plant odours. This was an important step in olfactory studies in insects, and from it developed still further interest in the subject.

More recently Thorpe and Jones (1937) and Thorpe (1938) used the Y-tube principle to study olfactory conditioning in a parasitic insect and its relation to the selection of the host. Crombie (1943) adapted it for the Blowflies Calliphora erythrocephala and Lucilia sericata.

About this time, the problem of sheep blowfly behaviour had been taken into the field, and a considerable amount of information has since accumulated, bearing on various aspects of these flies. All the relevant work and literature cannot be cited here, but a brief outline will give some idea of its extent. Hobson (1934, et seq) undertook a series of investigations, and among other problems, he considered what was then described as chemotropism in L. sericata, and also substances which induced the fly to oviposit on sheep. Holdaway (1933) observed the comparative behaviour of L. sericata and L. caesar in their natural environments, and MacLeod (1937) studied the nature and control of strike in Britain. At the same time, in Australia, where the blowfly problem had become acute, more field work was forthcoming, concerned, first with a general survey from Tillyard and Seddon (1933) and later from Freney (1937) on the chemotropic behaviour of the flies. A few years later, in this country, Cragg and Ramage (1945) undertook behaviour studies on

L. sericata and L. caesar in the field. This was followed by Cragg and Thurston (1950) with observations on the reactions of the flies to organic sulphur compounds used in traps - i.e. this work did not involve the living sheep as part of the mechanism of attraction. Cragg (1950) considered the reactions of L. sericata to various substances placed on sheep. In 1943, MacLeod, in a survey of British sheep blowflies, attempted to establish the relationship of strike to host and edaphic factors. In Australia, Mackerras and Mackerras (1944) published work on the attractiveness of sheep for L. cuprina.

There has been, therefore, a tremendous piling up of data concerned with several aspects of sheep blowfly behaviour in the field, and at the same time laboratory studies on the flies have been few. For this reason it seems necessary now, to pursue the problem of blowfly behaviour and to study the flies and their reactions in the controlled conditions of the laboratory.

P A R T 1

AN INVESTIGATION AND CRITICISM OF THE

Y-TUBE TECHNIQUE

1. THE Y-TUBE OLFACTOMETER.

Work was begun in Durham to construct a simple Y-tube olfactometer of the type described by Thorpe and Jones (1937) Thorpe (1938) and Crombie (1943), in which it would be possible to measure simple reactions to attractants and repellants.

APPARATUS: The apparatus as it was first used is shown in Fig.1. The actual Y-piece had an internal diameter of 4 cm; two arms each 16 cm. long joined a stem 20 cm. long. This had an outlet tube some 13 cm. along the stem from the junction of the arms. This central Y-piece was firmly screwed to the bench by the metal clips, C. From each arm a phosphor-bronze cone, X, led into the trap of each side, T₁ and T₂, each 2 cm. in diameter and 15 cm. long. Insects which made a choice^{of} one side or the other were retained^{at} there, unable to wander out again through the cone at the entrance. Each trap connected with a flowmeter, F₁, and F₂, across which the air-streams passed to enter the apparatus. The stem of the Y led through a rubber connection to a loading tube where the flies were allowed to settle before entering the apparatus. This tube was cut off from the light source, L, by a cardboard screen, S.

CALIBRATION OF FLOWMETERS: This was carried out as described by Crombie, and using an aspirator. Readings of the time taken for a known volume of water to run out of the aspirator

Y-TUBE OLFACTOMETER.

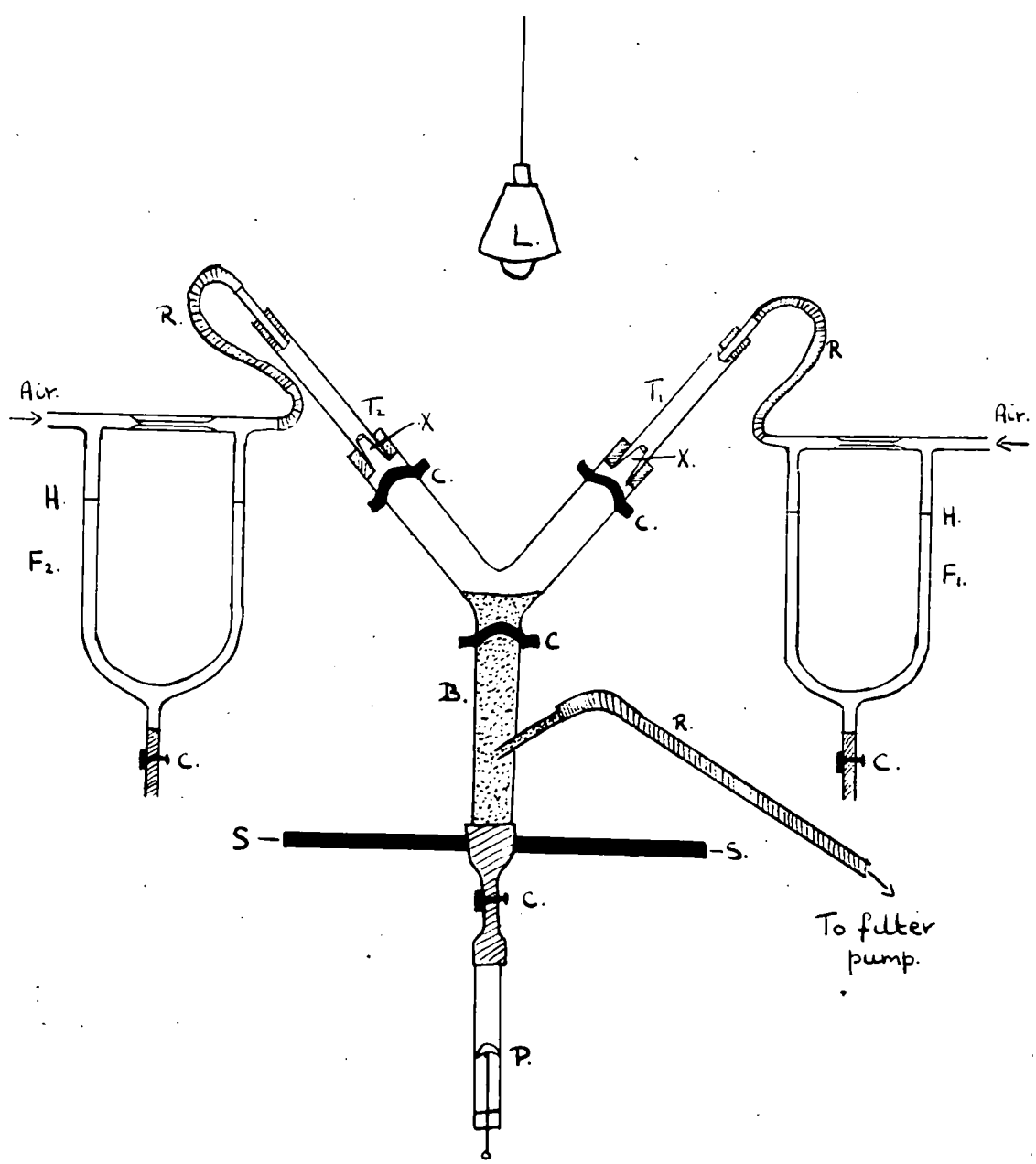

- L - Light Source.
- C - Clips.
- P - Plunger of loading tube.
- S - Position of screen.
- R - Rubber tube connections.
- F₁ + F₂ - Flow meters.
- T₁ + T₂ - Traps.
- B - Blacked-out stem of Y-tube.
- X - Phosphor-Bronze cone leading to trap.
- H - Liquid Level.

were taken, and the pressure difference in the attached flowmeter was adjusted to each point in turn by a screw on one of the rubber leads. By the same means the meniscus of the liquid in the capillary was kept at the point concerned as the water ran out of the aspirator. The flowmeter readings were plotted against the rate of flow of air in ccs per second and a curve was drawn for each flowmeter. From the graphs, the rate of flow of air corresponding to any reading of the flowmeter could be read, and therefore the number of ccs of air entering the arms of the Y-tube per second could be obtained directly from the readings of the flowmeter. An extra flowmeter was calibrated for use with menthol crystals. The stream which passed across this was menthol-saturated, but could be diluted to a known degree by mixing with a plain airstream passing across another flowmeter. The sum of the readings of the flowmeter on this side equalled the reading of the single flowmeter on the 'blank' side.

THE AIR-FLOW: To investigate the course of the 2 air streams entering the Y-piece, Crombie had used fumes of ammonium chloride. The fumes were drawn in through one limb and plain air through the other, so that the flow, when the two streams met at the junction of the arms, was easily visible. He described it thus "..... At the junction of the arms there was some turbulence, but the streams from each arm remained distinct all the way down to the outlet...." For similar

tests in the Durham apparatus, the same arrangement of ammonium hydroxide and hydrochloric acid was set up, and air was bubbled through to produce the dense white fumes. There was a steady, slow stream of the gas down one side of the apparatus to the angle of the Y. Here, some of it trickled round the bend and occupied a small area at the lower end of the 'air' arm. There was also turbulence at the junction and definite mixing with the air stream. In the stem, the ammonium chloride became less dense but filled the entire tube. There were not two distinct streams but rather a uniform dilution of the chloride with air. Certain small hollows and crevices existed at the angle of the Y where the inside of the tube was roughly finished and it was thought that this uneven inner surface was a possible cause of the turbulence observed. For this reason another Y-tube was procured. The finish on the inside was improved but some unevenness was still clearly visible, and the flow of ammonium chloride and air through the tube remained much the same as in the original.

A U-tube modification as in Fig. 2 was tried. The dimensions were similar to those of the Y but because of the piece of straight tubing across the junction it was an easier piece of apparatus to construct and still retain a smooth inner surface. However, fumes of the ammonium chloride continued to pass directly across the junction of the arms with the stem, no matter how the rate of flow was timed, and they filled the entire stem.

It seemed possible that because the densities of air and

U-TUBE OLFACTOMETER.

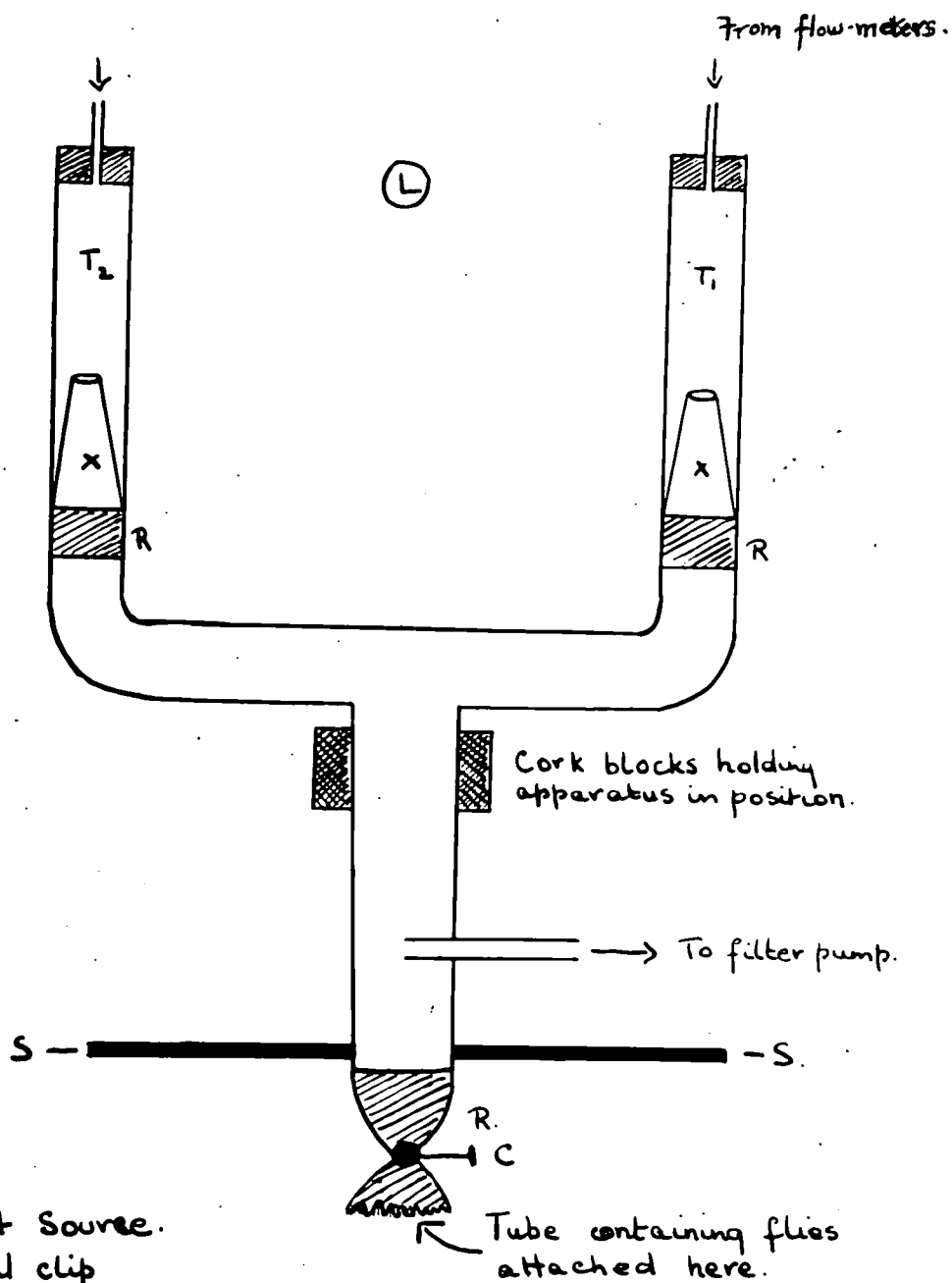

- L - Light Source.
- C - Metal clip
- S - Position of screen.
- R - Rubber connections.
- X - Phosphor-Bronze cone.
- T₁ + T₂ - Traps.

ammonium chloride are so different, the flow within the Y piece might be explained by the fact that the heavier fumes were sinking and spreading on the floor of the apparatus. To overcome this, the easily recognisable but much lighter nitrogen dioxide was substituted for the chloride. At a rate of flow of 7 cc per sec. and less, the brown gas fumes filled the entire interior of the Y-tube, although they were considerably less dense on the 'air' side. In the U-tube, at the same rate of flow, the 'air' side remained clear but a mixture of gas and air occupied the cross-piece at the junction of the stem. There was, therefore, no central area when flies had crawled up the stem where a clear-cut choice was presented to them.

Some attempts were made to aid the separation of the two streams by fixing a cardboard partition at the junction of the arms, (Fig.3, A & B). The cardboard was held in place by a small pad of plasticene, attached to the inner angle of the Y in one case, and in the middle of the cross-piece tube in the other. The flow of gas was not altered by this obstruction and the two streams still mixed freely in the stem.

A further attempted variation was the provision of a new outlet tube, (Fig.3,C). The original outlet had run off the stem at right angles to it and it was possible that this caused disturbance to the flow by drawing it away from the centre of the stem. In its place, a long straight glass tube, held in a cork was inserted in the stem to occupy a completely median position. No improvement in separation of the gas

ATTEMPTED VARIATIONS.

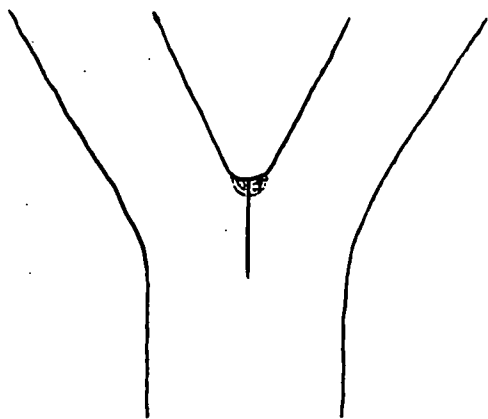

A:

Cardboard disc to aid separation of 2 streams.

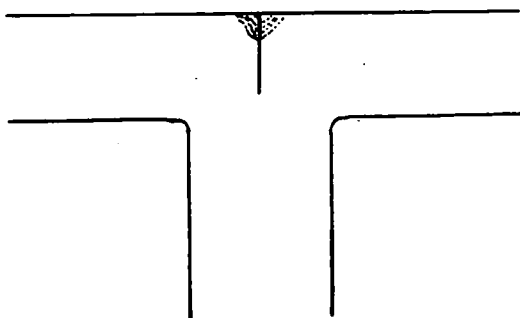

B:

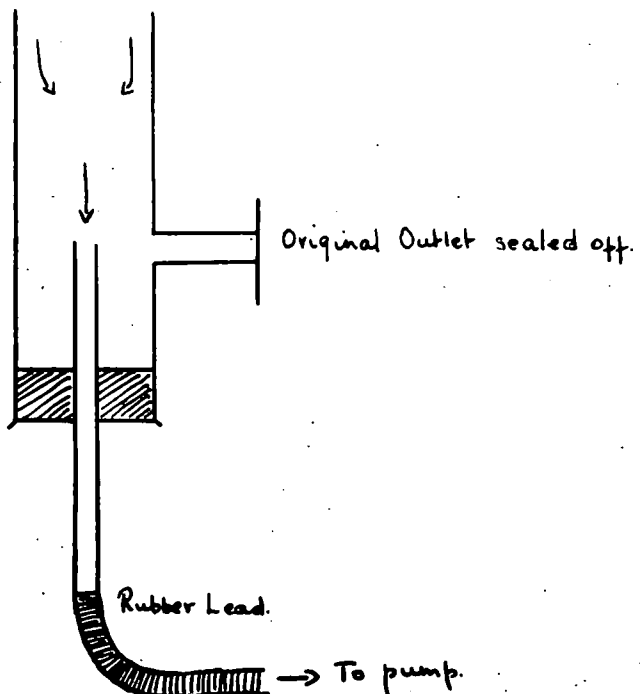

C:

streams resulted. In spite of the doubts about the functioning of the apparatus, it was decided to put some flies through the olfactometer to observe their behaviour.

EXPERIMENTAL METHOD:

The light was switched on, and the pump started which drew the air across the flowmeters into the limbs of the Y, down the stem and out through the exit tube. Meantime, some 50 or 60 flies were collected in the loading tube, and allowed to settle down, concealed from the lamp by a screen. When a smooth flow was established, the screw-clip on the rubber connection between the loading tube and the stem of the olfactometer was undone and the flies crawled up into the apparatus towards the light. Some of them would select one side or the other, and continue to crawl along the chosen side until they entered the trap, where they remained until the end of the experiment. When the apparatus was run with a test substance, this was placed beyond the flowmeter on one side. Air was then drawn across it and then across the flowmeter while a plain air stream entered the apparatus on the opposite side. When all the flies had been coaxed out of the loading tube by gentle pressure from the plunger, the screw-clip was closed. The blacked-out stem was an adaptation, found necessary because the illumination here was so good that many of the flies settled down immediately after entering the apparatus, and refused to move further.

The light source was for most purposes a 25 Watt lamp, arranged so that both limbs and traps of the olfactometer had equal illumination.

The running time for a single experiment varied considerably. At first there was a tendency to extend the time limit up to 15 or 20 minutes in order that the largest possible number of insects might make a definite response, for large numbers persisted in settling in the lower parts of the apparatus, so that only about half of the sample responded during the first few minutes of the experiment. As the work proceeded, however, and particularly during the menthol tests, the time allowed for each experimental run was never more than 5 minutes. This was to safeguard against possible fatigue of the sense organs in a menthol atmosphere, which might result in a random rather than a selected distribution.

For purposes of counting, the entire traps were removed and placed in a refrigerator running at about 5°C. for 10 minutes. Counting and sexing was then quick and simple, and there was considerably less risk of injury from rough handling. It soon became apparent that after a single run through the olfactometer and the subsequent chilling for counting purposes, the flies were dull and slow in behaviour. Succeeding experiments showed increasing numbers which tended to remain in the stem of the apparatus, without making a choice of sides. It was reasonable to suppose that the experimental technique was severe and likely therefore, that the sensory responses were being affected. Subsequently

it was decided to put the insects through the apparatus only once each day. After an experiment, the flies were put into a fresh cage supplied with sugar and water, and given some chance of recovery before being used again.

2. EXPERIMENTS USING THE Y-TUBE OLFACTOMETER.

All readings were made in a constant temperature room, running at 25°C. The only source of illumination was the 25 Watt lamp, held in position above the centre of the olfactometer. The insects used were adult L. sericata.

Group 1: Trial runs to test the apparatus for bias.

In these tests, the olfactometer was run 'blank'. A plain air stream entered each limb and travelled downwards to be withdrawn at the outlet in the stem. Illumination was equal on both limbs.

TABLE 1.

Number of Expt.	No. in Left Trap.	No. in Right Trap.	No. not making choice	Total No. Flies used.
1.	29 14♂ 15♀	21 5♂ 16♀	12 4♂ 8♀	62 28♂ 34♀
2.	39 14♂ 25♀	53 23♂ 3♀	26 7♂ 19♀	118 44♂ 74♀
3.	32 13♂ 19♀	33 11♂ 22♀	48 19♂ 29♀	113 43♂ 70♀
4.	30 9♂ 21♀	30 6♂ 24♀	30 14♂ 16♀	90 29♂ 61♀
5.	20 9♂ 11♀	37 9♂ 28♀	25 10♂ 15♀	82 28♂ 54♀
6.	27 8♂ 19♀	29 10♂ 19♀	58 23♂ 35♀	114 41♂ 73♀
7.	22 4♂ 18♀	18 5♂ 13♀	55 25♂ 30♀	95 34♂ 61♀
Total.	199.	221	254	674

There is no significant deviation from the expected ratio in the above counts ($C = 1.07$ and therefore $P = > 0.3$ approx). It was assumed that the apparatus was uniform in its effect on the insects. An interesting point emerges from the Table in that only 62% of the sample made a choice. There was rather more than one third of the flies which remained in the stem throughout the experiments.

Group 2: A meat bait incorporated in the apparatus.

There existed the possibility that an attractant included in the circuit would increase the numbers of insects responding. A wash-bottle containing raw chopped meat was attached to one side of the apparatus, air being drawn through it and then across the flowmeter of that side. The insects were one week old at the time of the tests and had been meat-starved for the 48 hours preceeding the tests.

The results in Table 2 show that more flies do react when meat is present in the apparatus. There still remains, however, some 25% of the sample which fails to select one side or the other. The Table also shows clearly that although the baited trap attracted more flies than the blank one, the deviation in favour of the bait is not significant. Under the conditions described, therefore, *L. sericata* was not attracted to a meat bait.

TABLE 2.

Expt. No.	Number in Baited Trap		Number in "Blank" Trap		No Choice.		Total number of flies used.	
1.	34	14♂ 20♀	26	15♂ 11♀	9	3♂ 6♀	69	32♂ 37♀
2.	34	11♂ 23♀	30	13♂ 17♀	24	12♂ 12♀	88	36♂ 52♀
3.	36	14♂ 22♀	28	13♂ 15♀	28	16♂ 12♀	92	43♂ 49♀
Total	104		84		61		249	

The olfactometer was cleaned out and rearranged. A series of control runs showed the expected 50:50 ratio in each trap, so the meat experiment was repeated. Counts were taken and the results are recorded in Table 3. They show that the flies were definitely repelled from the meat-baited trap, P for the result = < 0.001 .

TABLE 3.

Expt. No.	Number in Baited Trap.		Number in "Blank" Trap	
1.	14	5♂ 9♀	32	16♂ 16♀
2.	15	4♂ 11♀	29	13♂ 16♀
3.	23	15♂ 8♀	29	18♂ 11♀
4.	25	18♂ 7♀	32	16♂ 16♀
5.	23	9♂ 14♀	51	25♂ 26♀
6.	18	4♂ 14♀	26	11♂ 15♀
7.	14	5♂ 9♀	22	7♂ 15♀
Total.	132		221	

Possible sources of error were considered, the entire apparatus was reversed and the position of the light source readjusted. The flowmeters were changed. The position of the meat in the series was altered. Later, it was finely chopped and spread along the bottom of a long glass tube through which the air stream passed; this to ensure that the 'bait' stream was thoroughly saturated with the attractant odour. Another trial incorporated the meat actually inside the trap of the 'bait' side, as in Crombie's arrangement. After each of these changes a control test was made and the insects never failed to respond with the expected 50:50 ratio on each side, although they continued, equally steadily, to avoid the meat when it was included in the apparatus. One factor remained unbalanced within the olfactometer, and that was the relative humidity. The plain air stream was drawn in from the general atmosphere of the constant temperature room where the relative humidity as measured by a paper hygrometer was about 55%. The air-stream which had passed over the meat bait was probably considerably more. A trial run, which balanced a tube containing damp cotton wool on the one side against the meat bait on the other, showed that the insects made a clear-cut and significant choice in favour of the 'bait' side, see Table 4. Cobalt thiocyanate papers placed in each trap for 15 minutes showed the humidity on both sides to be approximately the same.

TABLE 4.

No. of Expt.	Number in Baited Trap.		Number in Blank Trap.	
1.	48	21♂ ⁷ 27♀	9	6♂ ⁷ 3♀
2.	34	8♂ ⁷ 26♀	13	10♂ ⁷ 3♀
3.	23	12♂ ⁷ 11♀	26	13♂ ⁷ 13♀
4.	33	18♂ ⁷ 15♀	21	9♂ ⁷ 12♀
Total	138		69	

This reaction is one which was firmly established later, using a completely different principle. Namely that under laboratory conditions, L. sericata presented with a choice between two relative humidities always chooses the lesser and continues to do so, even when attractants such as meat or chemical compounds are associated with the higher humidity.

It was now established that the insects would respond to an attractant presented in the Y-tube apparatus, under suitable conditions, and some of the earlier unsatisfactory results were explained away. There still remained, however, a lot of variation between the different readings. For example, if in Table 4, the first 2 counts are compared with the last 2, it is apparent that there is a significant difference between them. This type of fluctuation appeared quite often, even in control runs. Distances from the light source were constantly re-measured, and the entire set-up of the apparatus checked. The cause of the variations

remained obscure, except in so far as they might be explained by the peculiarities of the airflow inside the tube.

Group 3: The repellent effect of menthol.

An attempt was made to repeat the menthol experiments described by Crombie (1943), in order to achieve, if possible, greater certainty about the reliability of the apparatus. In these experiments, a varying concentration of menthol had been balanced against a fixed intensity of illumination, the lamp favouring the limb containing the menthol flow. In this manner attraction to the light source was opposed by the repellent effect of the menthol.

In the repeat experiments, menthol crystals were loosely packed in two small U-tubes arranged in series, through which the air stream was passed to ensure saturation. This was diluted later, as occasion required, to any given strength by mixing it with a stream of air, both flows being controlled by flowmeters.

Two test runs were made first. In one, the light source lay along the axis of the olfactometer, and in the other, the lamp was placed at an angle of 45° to the axis, so that the light favoured one limb. The menthol concentration was 100% in the first case; in the second, the apparatus was run 'blank'. The results obtained are recorded in Tables 5 and 6 and agree with those published by Crombie.

TABLE 5

No. of Expt.	Number in Menthol Trap	Number in Blank Trap	% in Blank
1.	3	41	87%
2.	7	51	
3.	16	46	
4.	16	49	
5.	9	60	
6.	2	58	
7.	3	55	
8.	6	69	
Total	62	429	

TABLE 6

No. of Expt.	Illuminated Blank Trap.	Dull Blank Trap.	% in Illuminated.
1.	72	2	92%
2.	54	9	
Total	126	11	

In the repetition of Crombie's later experiments, the light source used in Durham was a 15 Watt lamp placed so as to make an angle of 45° with the axis of the Y-tube, and illuminating the limb down which the menthol stream flowed.

This remained unchanged throughout the experiments. The menthol concentration was varied as already described. Two groups of experiments were done, using one intensity of illumination with six concentrations of menthol. The responses obtained are given in Table 7. The figures in the last column are the percentage responses obtained by Crombie in similar experiments.

TABLE 7

Light	% Menthol in stream.	I			II			% obtained by Crombie
		Number of flies in menthol trap.	Number of flies in blank trap.	% in blank.	Number of flies in menthol trap.	Number of flies in blank trap.	% in blank.	
15 Watt	0%	54	10	17%	57	15	16.6%	9%
		43	10		35	7		
	10%	52	13	22%	59	15	21%	23%
		49	15		69	14		
	25%	82	26	24%	64	24	25%	31%
		74	23		73	22		
	50%	75	22	27%	56	32	35%	45%
		52	17		50	26		
		34	20		50	26		
		59	18		50	26		
	75%	47	21	31%	52	24	38%	65%
		45	20		54	33		
100%	—	—	—	58	27	38.8%	73%	
	—	—		44	28			

As Table 7 indicates, the attraction towards light far exceeds the repellance of menthol. The percentages recorded in the 'blank trap' columns (none of which is significant) show that in fact the flies were not repelled, even at 100% menthol concentration. Crombie had found that attraction to the light held as far as about 50% menthol concentration, and that around this point, a balance was reached between attraction and repellance. At 75% concentration, however, repellance was much stronger than attraction.

A possible explanation of the Durham results is that the menthol stream was not fully saturated. Yet, in the trial run using pure menthol to oppose a plain air stream, (Table 5) the percentage repellance agreed closely with that obtained by Crombie. Another and more likely explanation, in view of the peculiarities of the flow within the olfactometer, is that the menthol stream was mixing thoroughly with air from the opposite limb, so that menthol (in rather dilute form) was available across the entire area of choice. It is therefore quite probable that the insects were surrounded by menthol fumes and made a simple response in favour of the illuminated limb.

In an attempt to arrange a series of lights of a fixed intensity of illumination, to correspond with those used by Crombie, 4 lamps were calibrated using a photocell. Three concentrations of menthol were balanced against each of the

four available illuminations in turn. The lamp was placed so as to illuminate the 'menthol' limb. The intensity of illumination was measured at the divergence of the limbs.

Crombie writes that a difference in the intensity of illumination had no effect on the responses of the flies for corresponding concentrations of menthol. This is quite clear from his results which are quoted in the last column of Table 8. The Durham data is also given in this table. This shows that under the conditions available in the Durham olfactometer, illumination intensity did affect the behaviour of the insects towards menthol. At 0.095 and 0.6 metre-candles, the results show that the flies appeared to be aware of the repellence of menthol rather than the attraction of the light. At the two higher intensities, however, there is a sharp falling off in the apparent repellence, so that the insect response again appears to be a simple one of attraction towards the light. This is, of course, based on the assumption that the courses of both the menthol and the air streams within the apparatus remained distinct and separate - an assumption which is scarcely justified in view of the earlier evidence.

TABLE 8.

Illumination at divergence of limbs.	% Menthhol in stream.	Number of flies in menthol trap.	Number of flies in 'blank' trap.	% in 'blank'.	% obtained by Crombie.
0.095 mc.	0%	43	23	34%	8%
		38	19		
	50%	36 22	39 24	52%	60%
	100%	13 18	36 57	75%	79%
	0.6 mc.	0%	49	14	32%
53			33		
50%		31 25	57 45	63%	56%
	100%	9 14	52 40	80%	74%
	2.4 mc.	0%	53	9	16%
58			12		
50%		44 47 40	21 18 24	32%	45%
	100%	28 21	40 30	59%	73%
	9.2 mc.	0%	62	8	13%
64			10		
50%		58 67	13 17	19%	33%
	100%	57 73	28 23	28%	69%

Group 4: Modification of the olfactory response.

Crombie concluded that the adults of C. erythrocephala and L. sericata are normally repelled by menthol, but that the degree of repellence was modified if the insects had first experienced menthol at some time during their development. He was satisfied that the modified response resulted from the 'memory' of a larval experience, and that it was not because of the persistence of larval gut contents in the newly emerging adult fly. This conclusion was reached after repetition of an experiment first devised by Thorpe (1939). Some larvae were fed on minced meat which had been treated with carmine. After finishing feeding, they were washed in distilled water and put in clean sawdust to pupate. A few days before emergence, the pupae were dissected out and examined for traces of carmine. None was found, either between the pupa and the puparium or (in the case of pupae left intact) inside the empty pupa cases after emergence. It was concluded that the fate of menthol crystals incorporated in the larval food was probably the same. If so, the adult fly could not experience the smell just before emergence. Any modification of the olfactory response would therefore result, either from the memory of a larval experience, or the toxic action of menthol on the sense organs of the new fly; the latter possibility does not seem to have been considered by Crombie.

Batches of sterile larvae were raised on a sterile synthetic medium based on that described by Lennox (1939). The development of the breeding medium is described in the

Appendix, together with the breeding technique, and the method used to obtain menthol-fed larvae.

After the feeding period, both types of larvae were hand-sorted from the medium flasks, and 50 from each group killed by immersion in 20 ml. absolute alcohol. These were then ground down in a mortar and the mixtures centrifuged to bring down the solid. Menthol is optically active, with an angle of rotation of -50.1 at 18°C . so that its presence can be detected using a polarimeter. The extracts from larvae fed on plain blood medium, and from larvae fed on the menthol medium both showed a negative rotation in the polarimeter. However, the rotation from the extract of menthol -fed larvae was twice that obtained from the controls, and this was taken as an indication that menthol was present in fully fed larvae which had been reared on a menthol medium.

The Responses of Menthol Flies.

Pupa cases from newly emerged flies were collected for tests in the Y-tube olfactometer. One batch of flies had passed its larval life on a menthol blood medium, and the other (control) batch had been reared on a plain blood medium. The tests were made very soon after emergence, and the readings obtained are recorded in Table 9. A few days later, the pupa cases were washed under running water, and dried, between filter papers, in an oven at 28°C . They were once again placed in the olfactometer and a series of flies put through the apparatus. The results are given in Table 10.

TABLE 9

Larval Food.	Pupa cases tested. Unwashed.	Number of flies in 'bait' trap.	Number of flies in 'blank' trap.	% in 'blank'
Menthol Medium	Menthol	36 33	48 45	57%
Blood Medium	Menthol	20 32	55 47	66%
Menthol Medium	Control	28 45	48 63	60%
Blood Medium	Control	27 37	56 55	63%

TABLE 10

Larval Food.	Pupa cases tested. Washed.	Number of flies in 'bait' trap.	Number of flies in 'blank' trap.	% in 'blank'
Menthol Medium	Menthol	49 41	45 53	52%
Blood Medium.	Menthol	44 46	47 38	49%
Menthol Medium	Control	49 49	56 62	55%
Blood Medium.	Control	46 45	47 42	49%

Both Tables indicate (i) that newly emerged flies are repelled from their own and other pupa cases and (ii) that the subsequent washing and drying removes the repellent factor from the pupa cases. Later experiments (see Part 11) however did not confirm these results, and so, although they

suggest a factor of biological importance, it would be unwise at this stage to place much reliance on them.

In another attempt to observe a modification in the menthol response, the olfactometer was run with a 50% menthol concentration entering one limb, and a plain air stream, the other. The illumination was reduced to 0.6 m.c. and favoured the menthol limb - these were the conditions which produced an increased response to menthol in some of the earlier experiments. Three groups of flies, each one of which had passed its larval life in a different medium, were tested, and the responses obtained are given in Table 11.

TABLE 11

Larval Food.	% Menthol in stream.	Number of flies in menthol trap.	Number of flies in 'blank' dull trap.	% in 'blank' dull trap.
Raw Meat	50%	15	38	71%
Blood Medium	50%	22 28 21	34 44 43	63%
Menthol Medium.	50%	17 19 25	46 44 49	69%

From the Table, all the groups were definitely, if not equally repelled from the menthol air-stream. There is no suggestion that a modification of the olfactory response occurred in the flies which passed their larval life on a menthol medium.

In concluding the tests on specially bred larvae and adults, the only information obtainable from the experimental results was the suggestion of the repellent factor associated with the pupal cases. If any modification of the olfactory response occurred, it was not apparent and not detected by the apparatus in use.

SUMMARY.

1. The setting up of a Y-tube olfactometer, similar to that used by other workers, is described.
 2. Conditions within the Y-tube were observed using ammonium chloride and nitrogen dioxide. It was concluded that inside the apparatus the 2 air-streams were greatly confused, and that no clear-cut choice was available to the flies.
 3. An attempt is described to repeat experiments carried out on the blowflies L. sericata and C. erythrocephala by Crombie (1943), in a similar apparatus, based on the repellent effect of menthol.
 4. Experiments are quoted in which an effort was made to modify the response of adult L. sericata by breeding the larvae on a menthol medium. No suggestion of modification having occurred is apparent from the results.
 5. The responses of newly-emerged flies to their own and other pupa-cases are investigated. An apparent repellence exists in the results, but these are of doubtful value because of the uncertainty attaching to the reliability of the olfactometer.
-

P A R T 2

THE CHARCOAL CHOICE- CHAMBER.

1. THE DEVELOPMENT OF A NEW TECHNIQUE.

An apparatus which would present a clear-cut choice to insects was the first necessity in a new approach to olfactory studies. This, together with the requirements of an olfactometer outlined by Hoskins and Craig (1934) were the factors considered in devising the choice-chamber which was eventually used.

The technique was developed from a suggestion made by Dr.D.L. Gunn (in conversation), who recommended that a method devised by D.P. Pielou should be used. This method made use of the extremely adsorbent properties of activated charcoal for organic odours. The velocity of adsorption for gases is very high, and for the purposes described in this work may be regarded as instantaneous (Stewart 1922, and Thorpe and Whiteley 1938).

When the suggestion was first adopted in Durham, several methods of incorporating the charcoal in an apparatus were considered. It was placed in dishes of varying size within a circular glass tank. Odourous material was placed in a similar container adjacent to it, so that an olfactory gradient was set up within the apparatus. Difficulties arose because of the large space which lay between the test dish and the charcoal dish. Willis and Roth (1950) faced a similar problem in olfactory and humidity studies, where the apparatus used was a modification of the Venturi-type olfactometer described

by Dethier (1947). Part of the modification consisted in reducing the size and altering the shape of the insect cage to conform closely to the shape of the two ports through which test air-streams entered to reach the insects. This reduced the 'neutral area' and meant that a larger proportion of the insects responded to one port or the other. There remained, however, three possible choices, and the intermediate 'neutral' area had to be allowed for in calculating the insect response. Elimination of the central area thereby providing a simple choice was achieved in the Durham apparatus by replacing the separate dishes by a circular tray, divided across its diameter into two compartments, (see description of the apparatus). This arrangement provided a very simple choice-chamber containing two distinct areas across which an olfactory gradient could be set up, under the glass roof.

APPARATUS The charcoal choice-chamber (see Fig.1) consisted of a circular glass tank (T), 29 cm. in diameter and 12 cm. deep. A perspex tray (P), 28.5 cm. in diameter and 2 cm. deep, fitted within the glass tank and rested on wooden blocks so that it was 1 cm. below the top of the tank. The tray was divided across its diameter by a thin strip of perspex into two shallow compartments. A known quantity of test-material was spread over one half of the tray (Sb) and the other half (C) was filled with activated charcoal. Over the tray, and fitting tightly within the glass tank, rested a muslin floor (M) held taut by a pair of thin metal hoops,

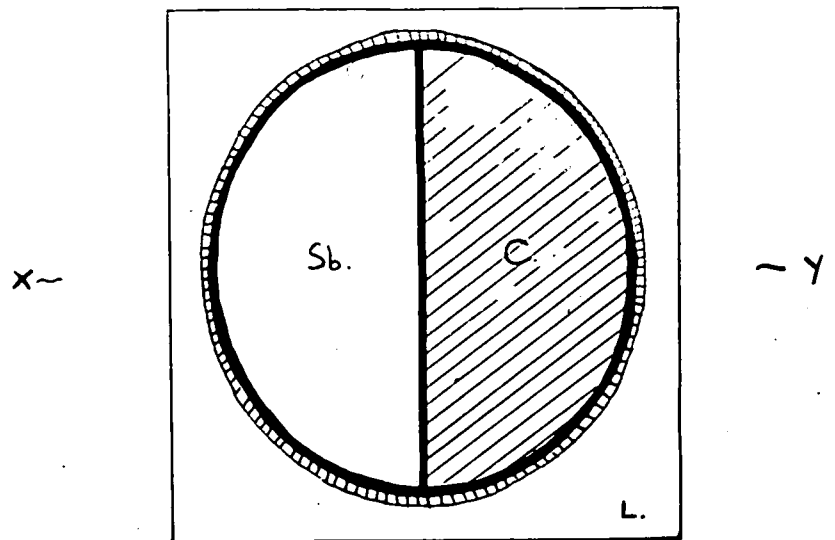
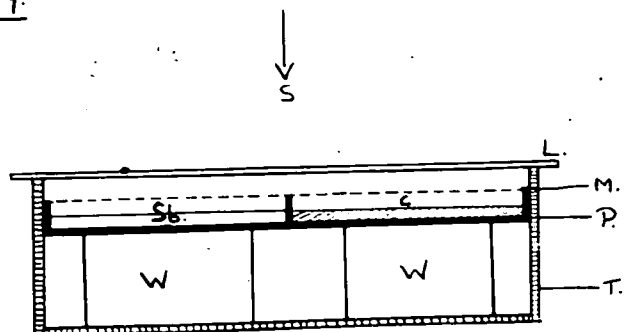
(i) SURFACE VIEW.(ii) ELEVATION X-Y.

T: Glass Tank.

W: Blocks supporting perspex tray.

P: Perspex tray.

M: Muslin floor held by aluminium hoops.

L: Glass roof.

C: Activated charcoal.

Sb: Test substance.

S: Light source.

FIG. 1.

similar to those used by Wigglesworth (1941). The whole was covered by a plate of glass (L). A space of 2 cm. existed between the muslin and the glass top - sufficient to permit a fly to move about freely and even make short flights. The light source (S) was a 40 Watt Argenta-type lamp, unshaded and plugged in position exactly over the centre of the apparatus. Argenta bulbs were used because they provided more uniform light than ordinary bulbs whose filaments may be asymmetrical.

METHOD. The apparatus was used in a constant temperature room which provided, unless otherwise stated, a temperature of 25°C, and usually 55% - 60% relative humidity. During experiments the only form of illumination was the light source already described. All the flies used in the work were bred and maintained in another, similar, constant temperature room.

In the early trial runs, batches of ten insects were introduced into the apparatus and their positions recorded at 1 or 2 minute intervals over a given period. But with an attractant in the choice-chamber, many of the flies became excited and jostled one another violently, so that some uncertainty attached to the results. The recorded positions were often a matter of chance upset and not of deliberate choice. Eventually the method suggested by Hafez (1950) of observing an individual in the arena was adopted. The response was obtained by timing with a stop-watch the periods passed

in one half of the apparatus. This method brought out clearly the variations in behaviour which exist between individuals of the same, supposedly homogeneous, population.

The apparatus was set up for one minute before the introduction of the fly. This was achieved by sliding the glass roof aside to allow the insertion of a small glass tube containing the insect. The tube was withdrawn immediately and the roof moved back into position. One minute elapsed before readings began, and during this time the fly moved about the chamber. Then two minutes after setting up the olfactory gradient, readings were begun and lasted for ten minutes. At the end of this time the fly was removed, and the apparatus reset for the next one.

Readings taken from the responses of ten individual flies made up a single experiment. Table 1. reproduces a typical score-sheet on which the readings were recorded alongside the apparatus. The position of the insect was recorded at half-minute intervals by a plus sign in the column of the sheet which corresponded to the half of the arena occupied by the fly. The actual number of seconds passed in the charcoal half of the apparatus was recorded in the column marked 'T'. The sum of these readings for each individual, by subtraction from the total time of 600 seconds, gave an expression of the attractiveness of the odourous half of the chamber. The sum of the positions on the two sides gave an approximation of the behaviour response, but, as can be seen from the table, more

L. sericata - British strain:

In lay March 10.
Expts. March 12.
Meat-fed daily.

Choice : 5g Raw Meat | Charcoal.

														Time in Secs.		
L	R	R	L	R	R	L	R	R	L	R	L	L	R	L	Chare.	Meat.
M	Ch	T	M	Ch	T	M	Ch	T	Ch	M	T	Ch	M	T		
+	-	22	+	-		+	-	4	+	-	16	-	+	8	1.164	436
+	-	3	-	+	8	+	-	1	-	+	3	+	-	17	2.168	432
-	+	2	+	-	17	-	+	13	-	+	4	-	+	29	3.139	461
-	+	23	-	+	29	+	-	6	-	+	24	+	-	18	4.196	404
+	-	3	+	-	6	+	-	3	-	+	2	-	+	9	5.143	457
+	-	1	+	-		+	-	14	+	-	4	+	-	9	6.149	451
+	-	1	+	-		+	-	4	-	+	7	-	+	9	7.210	390
-	+	7	+	-		-	+	8	-	+	3	-	+	6	8.125	475
-	+	6	-	+	2	-	+	14	+	-	14	-	+	4	9.176	424
+	-	7	+	-	10	-	+	17	-	+	12	-	+	17	10.192	408
+	-		+	-	1	+	-	3	-	+	4	-	+	6		
+	-		+	-	3	+	-	2	-	+	3	-	+	4		
-	+	7	+	-		+	-	2	+	-	9	-	+	8		
-	+	13	+	-	2	+	-	13	+	-	30	-	+	15		
-	+	9	+	-	2	-	+	20	-	+	12	-	+			
+	-	14	+	-	4	+	-	3	+	-	6	-	+			
+	-	3	+	-	11	+	-	9	-	+	23	+		3	1662	4998s
-	+	9	-	+	17	-	+	6	-	+	20	-	+	3		
+	-	15	-	+	23	+	-	6	-	+	14	-	+	11		
+	-	19	+	-	5	+	-	1	-	+		-	+			
12	8	164	15	5	139	14	6	143	6	14	210	4	16	176		
True Mean = 433.8s S.E. = 18.6.																
L	R	R	L	R	R	L	R	L	L	R	L	L	R	L	Key:	
M	Ch	T	M	Ch	T	Ch	M	T	Ch	M	T	Ch	M	T.		
+	-	2	+	-		-	+		-	+	1	-	+	6	L: Left side of Chamber.	
-	+	20	-	+	15	-	+	1	-	+		+	-	6	R: Right side.	
+	-	4	+	-	26	-	+		-	+	7	+	-	30	+: Position of fly at 1/2 min. intervals.	
-	+	9	+	-	1	-	+	2	-	+		-	+	7	T: Time (in secs) spent over charcoal.	
+	-	16	-	+	3	-	+		+	-	10	+	-	26		
+	-		+	-	30	-	+	1	-	+	11	+	-	6		
+	-	3	+	-	13	-	+		-	+	10	+	-	12		
+	-	2	+	-	1	+	-	15	-	+	8	-	+	8		
+	-		+	-		-	+	10	-	+	1	-	+			
+	-		+	-	15	+	-	14	-	+		-	+			
-	+	23	+	-	15	+	-	24	+	-	23	-	+			
+	-	24	+	-		-	+	13	-	+	12	-	+	23		
+	-	9	+	-		-	+	3	+	-	9	-	+			
+	-	2	-	+	18	-	+		+	-	13	+	-	27		
-	+	12	-	+	26	+	-	14	-	+	2	-	+			
+	-	11	-	+	9	-	+	14	-	+		+	-	12		
+	-		+	-	24	+	-	1	-	+	18	-	+	17		
+	-	12	+	-		-	+	22	-	+		+	-	8		
+	-	8	+	-		+	-	10	-	+		-	+	3		
-	+	11	+	-		-	+	5	-	+		-	+	7		
15	5	168	13	7	196	6	14	149	4	16	225	7	13	192		

TABLE I.

accurate results were obtained from readings of the actual times. These brought out the variations between the individuals mentioned above.

From the score-sheets, the mean response of a group of ten flies to the test material was calculated, together with its standard error. On the advice of Mr. D.J. Finney, Lecturer in the Design and Analysis of Scientific Experiment, Oxford, the responses of any two groups were compared statistically by a 't' test, which is available for samples of as small a number as ten. The 't' test used was that described by Garrett (1951) for testing the reliability of the difference between the means in small independent samples.

When it became necessary or desirable to raise the humidity within the apparatus, a damp muslin floor replaced the usual dry one. This was washed with soap and warm water and rinsed thoroughly between tests.

To eliminate bias the apparatus was reversed after five readings from each sample had been taken. A series of responses observed when the apparatus was run with charcoal on both sides, showed that the flies divided their time equally between the two. It was therefore assumed that the apparatus was uniform in its effect on the insects.

Since the experiments done in the charcoal choice-chamber, an olfactometer has been devised by Varley and Edwards, (1953). It is very similar in providing a gradient across which the insect is free to move while its behaviour is timed. There

also appears to be an advantage in that a moving air-current is available, in which the insect may orientate itself. It is possible, however, that if the glass chamber were adapted for blowfly studies, the increase in size might create difficulties in maintaining a smooth air-flow, as it did in the case of the Y-tube olfactometer. The requirements of the experimental animals, appear to be met by the charcoal choice-chamber and no immediate advantage is apparent in the Varley-Edwards olfactometer.

2. RESPONSES TO MEAT.

The attractiveness of a standard quantity of raw meat was measured in the choice-chamber.

Flies of seven types were tested and are listed below. They were taken from cultures which had been in lay about 3-7 days. Meat, sugar and water were available daily. The meat used in the tests was 5g. raw 'lights'. A uniform humidity was maintained by a damp muslin floor. Conditions were therefore standardised as far as possible, so that any variations arising could be attributed to essential differences between the flies.

The insects tested were:

- (i) *Lucilia sericata* (Mg). British.
- (ii) *Lucilia illustris* (Mg). "
- (iii) *Calliphora erythrocephala* (L)."
- (iv) *Lucilia cuprina* (Wied). Australian.
- (v) *Lucilia sericata* (Mg). "
- (vi) *Lucilia sericata* (a) (Mg). Danish countryside flies.
- (vii) *Lucilia sericata* (b) (Mg). Danish city flies.

The responses obtained are recorded in Table 2.

TABLE 2.

Species.	Mean response to raw meat and its S.E.	% attraction.
<i>L. sericata</i> (British).	437.8 sec. ± 10.5	73.0%
<i>L. cuprina</i> (Australian).	430.3 sec. ± 13.2	71.7%
<i>L. sericata</i> (Danish-country).	413.2 sec. ± 9.2	68.8%
<i>L. illustris</i> (British).	398.7 sec. ± 8.9	66.5%
<i>L. sericata</i> (Danish-city).	398.3 sec. ± 14.3	66.4%
<i>C. erythrocephala</i> (British).	396.4 sec. ± 7.5	66.0%
<i>L. sericata</i> (Australian).	393.0 sec. ± 9.0	65.5%

All the samples show a positive response to the meat despite the fact that it had been available daily.

The British *L. sericata* and Australian *L. cuprina* are most strongly attracted. The response shown by these two species, while not significantly different from the others, shows a marked divergence. In the field, all the Calliphorine species are attracted to, and feed, on meat or carcasses. Yet a selection of these species, reared under identical laboratory conditions and presented with a standard quantity of raw meat,

does not respond in a completely uniform manner. There appears to be a natural division into two groups, and the one which shows the higher response comprises the two species of blowfly which are the acknowledged sheep-pests of their respective countries. The other species appear to be much less specific in their habits and feed and breed on small carcasses.

Liebermann (1925), in correlating olfactory organs with biology in the Muscids, attempted to show that flies which have highly specific feeding or breeding habits possess more numerous and more complex sensory pits in the antennae, than species whose habits are not so clearly defined. Again, Hobson (1938) commented on the 'keen scent' possessed by female L. sericata, relating it to the speed with which they find their way to attractive sheep. It is possible, therefore that British L. sericata and Australian L. cuprina possess more efficient olfactory apparatus than the other species studied—more efficient, not necessarily in numbers of sensory pits, but in their sensitivity.

These early experiments are of interest chiefly because they serve to establish the fact that an apparatus had been devised in which fly behaviour could be observed and recorded, as the fly moved freely about the arena. Having found a satisfactory technique, further attempts were made to check the conclusions of Crombie (1944).

3. MENTHOL EXPERIMENTS.

The first attempts to obtain menthol responses were made using 1 or 2 g. pure menthol crystals in the test-half of the choice-chamber. Most of the flies tested became totally inactive after the first few minutes in the arena, settling over the charcoal and remaining there without further movement until taken out of the apparatus. It was obvious that a high concentration of menthol or of any similar substance was unsuitable for use, especially within an apparatus which contained only a small free air-space. Eventually it was found that as little as 0.2 g. menthol crystals worked very well in the choice-chamber, producing clear-cut avoidance responses and yet not inhibiting the activity of the flies. For this reason, a repetition of Crombie's first group of experiments, namely those in which he balanced a varying concentration of menthol against a fixed intensity of illumination, was impossible. But since there existed the consideration, as many other workers have pointed out, that high concentrations of irritants must of necessity produce questionable results in behaviour studies, a repetition seemed hardly necessary. There was an advantage in the use of the low (0.2%) concentration from the point of view of the conditioning experiments already attempted (see Part 1). 0.2 g. menthol was the concentration used in the breeding flasks. It would now be possible to test flies for a possible modification of the olfactory response in the

conditions under which the attempt at modification was made. This had not been possible using the Y-tube, since a 0.2% menthol flow could not be achieved with any accuracy by manipulation of the flow-meters.

0.2 g menthol crystals make up a very small volume so that it was difficult to arrange them uniformly in the apparatus. A simple experiment balancing powdered chalk against activated charcoal showed that the fly response to these materials remained unbiased. It was therefore possible to use chalk in the 'test' half of the choice-chamber as a neutral base for the menthol crystals. The latter were ground in a mortar and mixed thoroughly into three or four grams of chalk. This mixture was then spread out to cover one half of the tray within the apparatus.

Sex-Difference in Response to Menthol. In the course of experiments with the normal laboratory cultures, it became apparent that the males of L. sericata are more sensitive to menthol than the females of the species. The large difference in the mean response of the two sexes was consistent through 6 groups of insects which were tested to observe it. The individual responses of a group of 10 males and 9 females are recorded in Table 3.

TABLE 3.

♂ avoidance of 0.2% Menthol.

Time	F	FD	FD ²
40	1	26	676
46	1	20	400
50	1	16	256
61	1	5	25
66	1	-67	
67	1	1	1
68	1	2	4
78	1	12	144
87	1	21	441
94	1	28	781
	10	+64	2731

Correction for mean —

$$\frac{-67+64}{10} = \frac{-3}{10} = -0.3$$

True Mean = 65.7

Correction for FD² —

$$\frac{3 \times 3}{10} = \frac{9}{10} = 0.9$$

True FD² =
$$\begin{array}{r} 2731.0 \\ \underline{0.9} \\ 2730.1 \end{array}$$

Estimate of variance

$$= \frac{2730.1}{9}$$

$$= 303.34.$$

S.D. =
$$\sqrt{303.34}$$

$$= \pm 17.38.$$

S.E. =
$$\frac{17.38}{\sqrt{10}} = \pm 5.4.$$

True mean and S.E = 65.7 ± 5.4.

♀ avoidance of 0.2% Menthol.

Time	F	FD	FD ²
62	1	67	4489
72	1	57	3249
90	1	39	1521
129	1	-163	
131	1	2	4
132	1	3	9
133	1	4	16
141	1	12	144
178	1	49	2401
	9	+70	11833

Correction for mean —

$$\frac{-163+70}{9} = \frac{-93}{9} = -10.33.$$

True Mean = 118.7

Correction for FD² —

$$\frac{93 \times 93}{9} = \frac{8649}{9} = 961.0.$$

True FD² =
$$\begin{array}{r} 11833.0 \\ \underline{961.0} \\ 10872.0 \end{array}$$

Estimate of variance

$$= \frac{10872.0}{8}$$

$$= 1359.0$$

S.D. =
$$\sqrt{1359.0}$$

$$= \pm 36.86.$$

S.E. =
$$\frac{36.86}{\sqrt{9}} = \pm 12.3.$$

True mean and S.E = 118.7 ± 12.3

The 't' test applied to the results obtained from both sexes is shown below.

$$\begin{aligned} \left(\begin{array}{l} N_{\sigma^7} - 1 \\ N_{\text{♀}} - 1 \end{array} \right) &= \begin{array}{l} 9 \\ 8 \end{array} \\ &= \underline{17} \text{ degrees of freedom.} \end{aligned}$$

Pooling the sums of the squares of the 2 groups:

$$\begin{aligned} \text{S.D.} &= \sqrt{\frac{\sum (X_{\sigma^7} - M_{\sigma^7})^2 + \sum (X_{\text{♀}} - M_{\text{♀}})^2}{(N_{\sigma^7} - 1) + (N_{\text{♀}} - 1)}} \\ &= \sqrt{\frac{2731 + 11833}{9 + 8}} = 29.2 \end{aligned}$$

The standard error of the difference between the means = S.E_D

$$\begin{aligned} \text{S.E.}_D &= \text{S.D.} \sqrt{\frac{N_{\sigma^7} + N_{\text{♀}}}{N_{\sigma^7} N_{\text{♀}}}} \\ &= 29.2 \sqrt{\frac{19}{90}} \\ &= 29.2 \times 0.46 \\ &= 13.4 \end{aligned}$$

$$\begin{aligned} 't' &= \frac{\text{Difference between the 2 means}}{\text{S.E. of the difference between the means.}} \\ &= \frac{118.7 - 65.7}{13.4} = 4.0 \end{aligned}$$

For 17 degrees of freedom, the 0.01 level for 't' is 2.90. The critical ratio obtained (4.0) is much greater, indicating that the difference of 53.0 seconds between the mean responses of the 2 groups is significant. It is therefore concluded that male L. sericata are more strongly repelled by the odour of menthol than the females.

The standard errors of the 2 means shown in Table 3

indicate that the male sample behaved with greater uniformity than the females. This difference between the sexes was not apparent in the earlier experiments where the Y-tube apparatus was used; Crombie did not comment on it.

Modification of the olfactory response:

Some alterations were made in the breeding technique described in Part 1. The feeding medium remained the same as that described in the Appendix except for the fact that the menthol was added after autoclaving. 0.2 g. menthol crystals were ground to powder in a mortar and sprinkled on the surface of the medium in the flasks, when it had cooled after autoclaving. At this stage it was still light and spongy and could be readily broken up, so that the powdered menthol could be easily mixed into it. A further change was that the eggs were hatched on meat and the maggots not put into the breeding flasks until just after the change into second instar, when the mortality risk due to the menthol would be reduced. Eggs destined to form control batches received the same treatment the second instars being put into flasks containing plain blood medium.

In a test to compare the mortality of control and menthol-fed larvae, a known number of second instars was put in each of a series of breeding flasks and the number of prepupae coming off the medium, after the feeding period, was counted. The mortality observed was 16% in control, and 15% in menthol-fed larvae.

Using this method it was no longer practical to sterilise

the egg batches before hatching, but the practice of rearing on a medium was continued because of its convenience and the complete uniformity it provided.

The conditioning treatment used in Durham was not exactly the same as that described by Crombie. It involved the exposure of larvae for progressively longer times, as well as at different stages in their development.

Batches of larvae fed on the menthol medium were divided into four separate groups which received the following treatment.

Group 1. After menthol feeding, these larvae were put into clean sawdust and left to pupate at 25°C.

Group 2. The prepupae were removed from the breeding flasks and put into sawdust containing 0.2 g. menthol crystals to pupate. The pupae were later removed to await emergence in plain sawdust.

Group 3. The prepupae were put into clean sawdust to pupate. The pupae were later transferred to sawdust containing 0.2g. menthol crystals, to await emergence into a mentholated atmosphere.

Group 4. These prepupae pupated in and emerged into a 0.2% menthol atmosphere.

Separate control batches corresponding to all the experimental groups were reared on plain blood medium at 25°C.

On emergence, readings were taken in the choice-chamber of the response to 0.2g. menthol crystals in a chalk base. The

groups involved equal numbers of males and females as far as it was possible. It is interesting to note here that no difference was apparent between the sexes after menthol treatment, so that the fact that the sexes were not exactly balanced was unimportant. The numbers of males and females were always balanced in the experimental group and its corresponding control.

TABLE 4.

Extent of menthol treatment.	MENTHOL FLIES		CONTROL FLIES.		Difference between the means.	Deg. of F.	Value of 't'	Value of 't' when $P=0.01$.
	Mean response to 0.2g. menthol in secs. + its S.E.		Mean response to 0.2g. menthol in secs. + its S.E.					
A:	160.7	± 12.5	103.0	± 12.6	57.7	20	3.04	2.84
Feeding period only.	186.1	± 16.0	129.4	± 12.7	56.7	18	2.72	2.88
B:	202.2	± 8.7	124.0	± 13.7	78.2	14	4.76	2.98
Feeding and pupation periods.	237.6	± 17.0	124.9	± 13.1	112.7	18	4.98	2.88.
C:	244.8	± 11.9	107.2	± 11.6	137.6	18	8.1	2.88
Feeding and emergence periods.								
D: Feeding, pupation + emergence periods.	230.0		161.0		69	/	/	/
	(4 flies only)							

Table 4 summarises the experiments and records the results obtained. Modification of the normal response to menthol occurred in all 4 groups increasing with the duration of the

treatment and the stage at which it was experienced, as shown by the increase in the value of 't'. The results suggest that adults emerging into a mentholated atmosphere show the most marked modification. Experimental difficulties, in the form of the lethal effect of menthol on newly-emerged adults, resulted in the survival of only one out of 4 batches of flies thus treated. However, the results from this single batch show such a marked divergence from the control responses that it seems reasonable to explain the change in behaviour as mainly caused by the emergence into a menthol atmosphere.

Crombie in testing his conditioned flies used a 2% menthol air flow and a very dim light. All the flies which had encountered menthol either during feeding or pupation, or emergence developed a tolerance of it. By 'tolerance' is meant an approximately even distribution of flies in each arm of the Y-tube.

In Durham the conditioned flies did not show a chance distribution between the 2 halves of the apparatus. They continued to be positively repelled by 0.2% menthol, but the degree of repellence was significantly less than that shown by non-conditioned flies.

The apparatus and method used made it possible to observe the behaviour of individuals in addition to that of the whole sample, and from the former it was clear that some flies actually did become tolerant of the 0.2% menthol atmosphere, dividing their time fairly equally between the 2

halves of the choice-chamber. In Group A, a single fly in each sample showed this modification to tolerance; 4 such flies existed in Group B and 3 in Group C. There was not a single example of tolerance among the control flies. The standard errors of the means of the menthol samples would, under other circumstances, make this clear, because they are in effect a measure of the diversity of the sample - a wide divergence in behaviour being indicated by a correspondingly large standard error. But because of the difference between the sexes with regard to menthol (see Table 3) the standard errors of the means of the control batches are large too, so that the 2 groups cancel each other out but for different reasons. It is of interest to refer back to Crombie on this point. From his experiments he retained those flies which selected the menthol side and those which chose the blank, and tested the 2 groups separately afterwards. There was a marked difference in behaviour between the two, the menthol sample still selecting the menthol limb (but not 100% selection) and the 'blank' sample continuing to avoid it. This showed that although the population in the olfactometer had appeared tolerant, each individual fly was not necessarily so. The menthol treatment had, therefore, divided the population into 2 groups, and the writer uses this fact as evidence of the possibility that similar circumstances may lead to the formation of 'biological races' (Thorpe 1930).

The modification of response was rapidly lost by the

Durham flies, in a matter of 3 or 4 days. Crombie writes that "..... the modification of response to the odour of menthol had in almost all cases disappeared by the end of the pre-oviposition period, (approximately 6 days for Lucilia)".

A batch of newly emerged menthol flies was kept overnight in a cage provided with water and mentholated sugar. A sample of the population tested the following morning showed a mean response of 263.8 secs. \pm 14.3 to 0.2% menthol in the choice-chamber. The flies were then transferred to a fresh cage and given plain sugar and water. Four days later the menthol response had decreased to 105.6 secs. \pm 9.5. A 't' test applied to the 2 groups, gives a value of 9.1 for 't', which is highly significant at the 0.01 level.

It was concluded that it is possible to modify the olfactory responses of L. sericata to menthol by feeding the larvae on a menthol medium. There still remains, however, the question of how the modification occurs. Possible explanations include Crombie's conclusion that the memory of a larval experience survives metamorphosis; or that mentholated material from the larval gut persists inside the pupa cases to be experienced by the adult just before emergence. A third possibility is that substances like menthol produce a toxic effect in the developing sense organs. This explanation does not seem to have been considered by Crombie, although he recorded that more than 2% menthol

probably produced an irritant effect, thereby tending to obscure the olfactory responses. Thorpe's experiment with carmine tends to remove the second possibility, if it is assumed, as Crombie assumed, that the fate of menthol will be the same as that of carmine.

To investigate this, a further attempt was made to obtain a response from the flies to empty mentholpupa cases. A large batch of larvae was fed on menthol blood medium and washed under running water before being put in clean sawdust to pupate. The empty pupa cases were collected after two day's emergence had taken place, and about 400 of them put in the charcoal choice-chamber. Responses were obtained from newly emerged, unfed, flies. The behaviour of both types of fly to the alleged menthol pupa cases was unbiased; the mean response in the case of the menthol-fed insects was 316.9 ± 12.0 secs. and 309.2 ± 10.3 secs for the controls. The response of both types of fly to empty control pupa cases was similarly unbiased. A repetition of the experiments produced the same results. Since control flies are repelled by as little as 0.02% menthol in the choice-chamber, it seems reasonable to assume that menthol was not persisting in the pupa cases. It appears therefore that the modification of the adult response is directly associated with conditions experienced during development. A change is produced in the organism which can be measured in the adult stage. But, partly because of the irritant properties of menthol, and partly because the modification of response to it is so transient, it seems

highly probable that the altered response may result from a temporary toxic effect which disappears very soon after removal from contact with the irritant.

4. CHEMICAL ATTRACTANTS IN THE LABORATORY.

The method of testing attractant solutions in the choice-chamber was by absorbing a known quantity of a solution of known strength on a circle of filter-paper. This was then placed in the 'test' half of the plastic tray. This method was suggested by Wigglesworth (1941), and Hafez (1950). A damp muslin floor was necessary to ensure symmetry within the apparatus. In testing for bias, a filter-paper saturated with distilled water was used. L. sericata showed a random distribution in the arena under these conditions.

These experiments with chemical attractants formed part of a very general preliminary survey of laboratory behaviour. They were not pursued in any detail. The first chemical tests were made observing the responses of gravid female L. sericata to a 0.002% indole solution. Once again, the relatively small, free, air-space had to be allowed for, because what was apparently alcoholic anaesthesia affected the flies within a few minutes of their being put in the arena. A second 0.002% indole solution, made up with a minimum amount of alcohol, stimulated activity in the insects. As other workers have observed, the best responses were obtained from flies which had been meat-starved for twenty four hours or more before the tests. Both male and female flies were observed. Males were not attracted to the indole, and showed a random distribution in the apparatus; gravid females all gave a positive response, the mean attraction being 55%

Hobson (1936 and 1937) found that indole in conjunction with ammonium carbonate is an active stimulant to oviposition when it is placed on sheep. Cragg (1950), extended Hobson's studies by showing that indole by itself can stimulate both attraction and oviposition. Its role, however, is essentially that of enhancing the already attractive properties of other materials, and in these circumstances its own activity is increased. In behaviour studies, it has always been associated with the induction of oviposition. It is therefore interesting that in the experiments in the choice-chamber, male flies made no response to the indole side of the apparatus.

A dilute ammonium hydroxide solution (1 ml. concentrated ammonia (s.g. = .880) in 1000 ml distilled water) attracted both male and female flies in the choice-chamber - male L. sericata 58% and gravid females 61%.

Ammonium hydroxide has proved an efficient attractant when used on sheep in the field. Hobson (1935) succeeded in getting flies to oviposit on pads saturated with 5% ammonium hydroxide. Later work, however, has not supported the presence of an oviposition stimulus with this chemical by itself, although Cragg (1950), found it a powerful attractant which in conjunction with other compounds would induce oviposition. In the laboratory, as in the field, it acted as an attractant for both sexes.

Neither oviposition nor attempts to oviposit were recorded during these tests in the choice-chamber. The damp

floor produced periodic extensions of the proboscis as it usually does, even when the apparatus is run 'blank' but the oviposition^{or} was not extruded.

Some further attempts were made to induce attraction and oviposition by exposing chemical compounds inside a cage of L. sericata in the constant temperature room. Pads of cotton wool saturated with 25 ml. of an attractant mixture were placed in small flasks in the cage. On some occasions, the flasks were placed in an electrical heating device, thermostatically controlled, so as to raise the temperature of the flask and its contents to 37°C - the temperature encountered on the fleece under summer conditions when blowflies are attracted to sheep. Attractants arranged thus were exposed either heated or unheated for varying periods and the fly activity within the cage observed.

A mixture of 1.0% ammonium carbonate and 0.02% indole heated to 37°C was exposed in a cage containing gravid females for 2 hours. It attracted both sexes and many of the flies alighted and walked about on the cotton wool pad. There was no oviposition. Fresh meat put in the cage immediately after the removal of the attractant was oviposited on freely within 60 min. A mixture of 2.0% ammonium carbonate and 0.04% indole exposed at 37°C produced the same effect; there was a great deal of activity, but no oviposition.

A further mixture, 1.0% ammonium carbonate, .02% indole, .002% ethyl mercaptan, also proved attractive to the flies.

Fourteen trials were made exposing it in the cage at 37°C and five at 24°C, the normal temperature of the C.T. room. Only on 5 occasions was oviposition induced, 4 of them on the heated attractant. All were single, isolated batches. When meat was put in the cage between experiments, the flies laid large numbers of egg batches on it within comparatively short spaces of time. And on the days when it was put in for feeding purposes only, it could not be left for more than 20 min. without eggs being deposited on it. Eggs were never laid on an attractant pad in less than 1½, usually 2 hours.

It is apparent that under laboratory conditions, as in the field a distinction exists between the attraction and oviposition stimuli. This separation of the 2 was made first by Hobson (1938) and emphasized by Cragg (1950). As already described, the flies were definitely attracted to chemical compounds exposed inside the cages, but only rarely was oviposition induced, despite the fact that the females were gravid and would oviposit readily on meat when it was provided. The essential oviposition factor, or, what is more likely, combination of factors was absent.

Cragg and Thurston (1950) studied the reactions of blowflies to chemical attractants exposed in the field but not associated with sheep. The materials used were known to induce oviposition when they were used on sheep, and the tests, for the most part, were carried out on days when climatic conditions favoured blowfly activity. Oviposition

was recorded in only 19 out of 156 tests - always associated with indole, and on both cotton wool and sheep wool pads. The numbers of eggs laid were small. The writers put forward the view that the failure to stimulate oviposition was related to the low temperature at which the materials were exposed, a view also suggested by Mackerras and Mackerras (1944) in similar experiments with L.cuprina. The present experiments, using a heated attractant, were undertaken to investigate the importance of temperature. Cragg (unpublished data) has proved that temperature is important under field conditions. That it plays some part, in the laboratory as in the field, is indicated by the fact that the percentage oviposition recorded on the heated attractant (28.5%) considerably exceeds that recorded by Cragg and Thurston using unheated attractants in the field (12%). But from the results, it could not be claimed that a heated attractant by itself induces oviposition. It therefore seems probable that the oviposition stimulus depends on the interaction of several factors, including possibly a tactile response, (Hobson 1938) and/or a humidity response as well as the response to temperature. The cotton wool pads used in the experiments described, were usually saturated, with free liquid on the exposed surface. And while 95% - 100% relative humidity is suitable for hatching the eggs, and although female L.sericata are said to occasionally oviposit around the edge of their drinking vessel, they do not appear to lay eggs on a wet surface. It is therefore suggested that the oviposition response could be inhibited by an unsuitable humidity factor.

5. THE RESPONSES OF BRITISH *L. sericata* TO SAMPLES OF FLEECE.

It has been shown that under field conditions, a moist clipped fleece treated with chemical attractants will attract flies and induce them to oviposit (Cragg and Ramage 1945). This is proof that the attraction of flies to sheep in the field, is not necessarily dependant on a live sheep factor, as was suggested by Hobson (1935).

Some experiments with females of *L. sericata* were carried out, to observe whether flies from the laboratory cultures would respond to different samples of fleece without the addition of chemical attractants and under laboratory conditions.

Part of the work was done in January, so that samples of winter fleece from half-breed sheep at Houghall Farm, Co. Durham, were available at the time of the experiments. Samples of a similar summer fleece had been obtained from the same source. Merino and Oxford Down fleece, both raw and scoured, were supplied by the Wool Research Institute at Leeds. The effect of relative humidity on the response was observed using a damp muslin floor inside the arena.

TABLE 5.

FLEECE	QUANTITY	FLOOR	Mean response to sample of fleece + its attraction. S.E.	%
Winter Half-breed.	5.0g	dry	500.6 sec. \pm 10.6	85.2%
Summer Half-breed.	5.0g.	dry	466.2 sec. \pm 24.0	81.7%
Merino.	3.5g	dry	454.3 sec. \pm 12.9.	77.8%
Merino.	3.5g.	damp	451.5 sec. \pm 10.9.	77.1%
Oxford Down.	3.5g.	dry	458.7 sec. \pm 14.9.	78.9%
Oxford Down.	2.5g.	dry	394.9 sec. \pm 11.9	67.8%
Oxford Down.	2.5g.	damp	402.0 sec. \pm 11.7	69.1%
Winter Half-breed.	2.5g.	dry	457.1 sec \pm 10.6	77.9%.

Table 5 records the mean responses of groups of 10 individual flies to the different samples under different conditions. It is clearly seen that samples of fleece

presented to females of L. sericata in the laboratory behave as an attractant to the insects. This is of further interest when it is remembered that the samples of Merino and Oxford Down type fleece were not freshly clipped from sheep and had probably been in store for a considerable time. The samples obtained locally had been recently removed from living sheep. A quantity of fleece which had lain in a cupboard in the laboratory for about 2 years was tested in the choice-chamber and found to be still attractive to L. sericata. Samples of scoured wool of both Merino and Oxford Down types also proved attractive but to a considerably lesser extent. An average attraction of 59% (which is statistically significant) was obtained for the scoured fleece. But the standard error of the means was large in every case (of the order of 22 or 23) and this indicates a wide variation in the individual responses obtained.

Some samples of the Houghall Farm fleece were washed in water, soap and water, and ether. The mean response of a group of 10 females to the water-washed fleece was 376.8 sec. \pm 14.2; to the soap and water washed sample it was 376.5 sec. \pm 14.5, i.e. about 63% attraction. Even washing in ether did not wholly remove the attractiveness of the sample of fleece. It seems reasonable to conclude from these results that the essential attractive quality of fleece, which has now been established under laboratory conditions, is not dependent on the presence of the living sheep. This is confirmed by the

work of Cragg and Ramage, already quoted, in the field. Nor, it appears, is the attractant power destroyed by storage, nor by washing with soap and water which removes soiling and other possibly attractive elements from the surface of the wool fibres. Suint is defined by Freney (1934) as 'those substances in raw wool which are soluble in warm water....' and, as stated above, removal of this material does not greatly reduce the responses of blowflies to a sample of fleece. Other materials exist in the wool apart from suint, and it is apparently in these that the basic attractiveness of the fleece is found. Cragg and Ramage (1945) using unwashed and washed fleece also found that washing and storing does not permanently remove the wool factor. These field experiments, however, depended on the presence of an attractant, and so are not strictly comparable with the Durham laboratory experiments. But the washed fleece was active with regard to blowflies when the attractant added to it contained only half of the normal amount of indole. The present experiments show that under laboratory conditions, washed fleece, without the addition of chemical attractants, produces an olfactory response in L. sericata.

The responses recorded in Table 5 show that where equal quantities of fleece are used, its attractiveness to L. sericata is not significantly affected by variation of the relative humidity within the choice-chamber. It is also apparent that the different types of fleece available do not affect

the insects and that they continue to respond uniformly, so long as the quantity being tested remains uniform. The exceptional result obtained for the sample of half-breed winter fleece might have been caused by contamination of the wool with faeces or urine. A further sample of winter fleece, obtained in the following November, produced a mean response of $418.7 \text{ sec.} \pm 13.3$ to a 2.5 g. sample.

6. THE PHYSIOLOGICAL STATE OF *L. sericata* AND ITS EFFECT ON THE RESPONSES TO SAMPLES OF FLEECE.

(a) The period from emergence to 7 days later.

The following experiments were planned to investigate a possible variation in response of insects to samples of fleece, which might result from physiological differences in the adult female *L. sericata*. The physiological differences involved depended on fertilisation or non-fertilisation, the degree of development of the gonads, and the presence or absence of a meat diet after oviposition had taken place.

Two experiments were arranged, each involving 4 groups of 10 females each. The type and quantity of the fleece tested, differed in the 2 series but was constant within each one. A set of readings was obtained from each of the groups of flies on the day of their emergence as adults - these will be referred to as the 'emergence' responses. Further readings were taken, usually seven days later, when, under normal conditions female *L. sericata* would be gravid and ovipositing freely. These later readings will be referred to as the 'post-emergence' responses. After obtaining the 'emergence' responses, the flies were separated into four groups of ten flies each, which received the treatments described below.

Group 1. 30 male *L. sericata* were introduced to the cage containing the females. This culture was fed with meat, sugar and water daily, in order to produce fertilised females with fully developed ovaries.

Group 2. 30 male *L. sericata* were introduced and the culture

fed only on daily sugar and water, in order to produce fertilised females with undeveloped ovaries.

Group.3. No males were introduced to the cage. The females which comprised the culture were fed with meat sugar and water daily, to produce unfertilised females with fully developed ovaries.

Group.4. No males were introduced. The females were fed on sugar and water only to produce unfertilised females with undeveloped ovaries.

After seven days the groups were tested for their 'post-emergence' responses. After the readings had been obtained, all the females were dissected to determine the state of the ovaries.

Tables 6(a) and 6(b) record the responses obtained. 't' values for comparisons made between the groups of the 'post-emergence' means are also given.

TABLE 6(a): Series A: 5.0g.
Winter Fleece.

GROUP NUMBER.	FOOD	Mean 'emergence' response in secs. + its S.E.	Mean 'post-emergence' response in secs + its S.E.	Difference between means	State of development of ovaries.
1. ♂ + ♀	Meat.	475.0 sec. ± 12.6	500.6 sec. ± 10.6	+25.6	2 vestigial; others developed.
2. ♂ + ♀	No meat.	468.0 sec ± 12.3	488.0 sec ± 11.3	+20.0	All vestigial.
3. ♀ ^s only	Meat	470.8 sec. ± 11.3	467.4 sec. ± 12.7	-3.4	All developed.
4. ♀ ^s only	No meat	476.3 sec. ± 8.8	449.6 sec. ± 14.0	-26.7	All vestigial.

Groups compared.	Deg. of F.	Value of 't'	P.	Value of 't' when P=0.01.
1 + 2	16	0.755	< 0.5	2.92
3 + 4	18	0.923	< 0.5	2.88
1 + 4	17	2.72	> 0.01	2.90
2 + 4	17	2.05	> 0.05	2.90.

TABLE 6(b): Series B: 2.5g. Winter Fleece.

GROUP NUMBER.	FOOD.	Mean 'emergence' response in secs. and its S.E.	Mean 'post-emergence' response in secs. and its S.E.	Difference between means.	State of development of ovaries
1. ♂ + ♀	Meat	409.6 sec. ± 8.9	441.5 sec. ± 14.8	+ 31.9	All developed.
2. ♂ + ♀	No meat	424.4 sec. ± 8.4	451.0 sec ± 7.9	+ 26.4	All vestigeal.
3. ♀ ^s only	Meat	411.8 sec ± 12.7	399.2 sec. ± 11.2	- 12.6	2 vestigeal; others developed.
4. ♀ ^s only	No meat	421.9 sec. ± 5.7	401.7 sec. ± 6.3	- 20.6.	All vestigeal.

GROUPS COMPARED.	Deg. of F.	Value of 't'	P.	Value of 't' when P = 0.01.
1 and 2.	18	0.57.	> 0.5	2.88
3 and 4.	17	0.20.	> 0.5	2.90
1 and 3.	17	2.20.	> 0.05	2.90
2 and 4.	17	4.84.	< 0.01.	2.90.

From the Tables, Group 1 in both series shows an increased response to the fleece in the 'post-emergence' tests. An increase also occurred in Group 2 in the females which were reared without meat. Groups 3 and 4 show a falling-off in the mean 'post-emergence' responses. 't' tests applied to the 'emergence' responses indicate that at the outset of the experimental period, all the groups were behaving similarly, i.e. the 't' value is approximately < 0.60.

The same statistical treatment applied to the 'post-emergence' responses of the different groups shows that the absence of male flies from the cultures results in a trend towards a significant difference, as in groups 1 and 3 and groups 2 and 4; the absence of meat does not, at least at this stage, (c.f. Groups 1 and 2; 3 and 4.)

The results of dissections, to observe the state of development of the ovaries, are recorded in the last column of Tables 6(a) and 6(b). The individual 'post-emergence' responses to the sample of fleece made by the flies with vestigeal ovaries were 462 sec. and 521 sec. (Series A, group 1) and 408 sec. and 450 sec. (Series B, group 3). This indicates that failure of the ovaries to develop does not necessarily, by itself, result in a blowfly which is not attracted to fleece.

Summarising the responses recorded in the Tables, it can be said that the differences within each group between the 'emergence' and the 'post-emergence' behaviour are not significant. But differences between the 'post-emergence' responses of groups 1 or 2 and 3 or 4 show a tendency towards significance as seen by the increased value of 't'. The condition of vestigeal ovaries in itself does not appear to be an important factor influencing the female response to fleece, at least during the early adult period. But a trend towards a significant difference exists which suggests that fertilisation increases the response of female L. sericata to fleece.

6. THE PHYSIOLOGICAL STATE OF L. sericata AND ITS EFFECT ON THE RESPONSES TO SAMPLES OF FLEECE.

(b) The period from oviposition to a time 4 weeks later.

For these experiments, flies were selected from a standard laboratory culture which was newly in lay, i.e. about 6 days after their emergence as adults. The culture had been fed daily on raw meat. The selected flies were divided into three groups, including both males and females; ten females in each group were marked with spots of aluminium paint, so that identification for the successive experiments would be possible. The paint-marking was finished a few hours before the first readings were taken to allow for recovery from the possible effects of handling the insects. The three groups each received the same treatment before the experiments began and a comparison of the responses statistically showed that all were behaving similarly. The subsequent treatment of each group was as follows.

1. The flies were maintained, after the first experiment, on daily sugar and water with a meat meal given once each week.
2. Sugar, water and meat were available daily.
3. Sugar and water only were available daily. No meat was available after the first set of readings was obtained.

Readings were taken at regular intervals until the flies were five weeks old. In group 1, two additional sets of readings were obtained on the days following those on which the weekly meat was supplied. In all the groups, only 8 of the original 10 marked females survived to the last experiment.

Table 7 records the mean responses of the groups to 5g. of fleece in the choice-chamber.

TABLE 7.

AGE	MEAN RESPONSE TO FLEECE IN SECS. AND ITS S.E.					
	GROUP 1. MEAT WEEKLY.		GROUP 2. MEAT DAILY.		GROUP 3. NO MEAT.	
(i) 7 days.	466.2	± 24.0	481.9	± 23.8	452.1	± 25.6.
(ii) 14 days- after meat meal.	396.6	± 12.4	460.2	± 18.9	438.2	± 19.9
	432.3	± 23.5				
(iii) 21 days. after meat meal.	380.2	± 15.4	459.1	± 9.1	402.2	± 23.0
	395.4	± 23.4				
(iv) 28 days.	389.8	± 23.3	461.5	± 13.3	391.9	± 25.6.

The fluctuation in the response of females of Group 1 is clearly seen in Table 7. It is accompanied by a steady and gradual falling off, which is interrupted by the effects of the two meat meals which punctuated the four weeks experiment. These produced some recovery in the flies' behaviour towards the sample of fleece, particularly in the first instance, when the insects were younger. After a further eight days without meat, however, a full recovery in the response appeared to be impossible and it remained at a low level. The difference between the means of Group 1,

(i) and (iv) is 76.4 sec. which is significant at the 0.05 level.

Group 2 behaviour is the most uniform of the series. A small falling-off in response occurred during the second week and thereafter the behaviour did not vary throughout the series of experiments. An important point which emerged was that the flies of this group were the most active of the whole series and remained so to the last experiment.

Group 3 behaviour paralleled that of group 1 without the fluctuations which had resulted from the extra meat meals supplied to the latter group. The same steady falling off in response took place, so that readings taken at the end of four weeks showed a decrease of 60.2 sec. The final readings obtained from the 3 groups are compared in Table 7(a) and the values derived for 't' are shown.

TABLE 7(a).

GROUPS COMPARED	DEG. OF F.	VALUE OF 't'	P.	VALUE OF 't' WHEN P=0.01
1 and 2.	13	2.8	> 0.01	3.01.
2 and 3.	14	2.4	> 0.02	2.98.
1 and 3.	13	0.06	> 0.5	3.01.

On the evidence of these experiments, the provision of daily meat produces and maintains in female L. sericata a high level of response to samples of fleece. Correlated with this is the greatly increased uniformity of behaviour towards

fleece, within the population - this can be appreciated by comparing the standard errors of the means in all 3 groups, particularly at the end of the 4-week period. And, finally, also the result of the daily meat diet, it was obvious that Group 2 possessed considerably more vitality than the others.

As a result of the above experiments it was decided to further standardise the treatment of cultures reared for work in the choice-chamber. Fresh meat was provided daily, and readings of the attraction to samples of fleece were obtained during the five or six days following the first signs of oviposition.

7. CONDITIONING EXPERIMENTS.

A further attempt was made to modify the olfactory responses of adult blowflies, by conditioning the larvae on living sheep. Any modification of the response which might result from a larval life passed under such specialised but natural conditions would be of considerably greater interest than an altered olfactory reaction produced by contact with menthol. It was possible, for example, that larvae reared on living sheep would develop into adults with an increased affinity for sheep. Something of this idea originated with Froggatt and is quoted by Tillyard and Seddon (1933). Froggatt's theory of the development of the blowfly problem in Australia, according to the above source, was that during a severe drought, blowflies acquired the habit of feeding on sheep carcasses and of ovipositing there. From this association with dead wool, developed the attraction to soiled wool on living sheep. This suggests that a conditioning effect was active. It should be added that Froggatt's theory is largely discounted nowadays, as an explanation of the blowfly problem.

Working in conjunction with the Research Laboratories at Weybridge, some batches of British L. sericata and Australian L. Cuprina larvae were reared on living sheep. When the maggots had finished feeding, they were removed from the sheep and placed in peat moss. At this stage, they were sent to Durham where they were kept until the emergence of the adult insects. They were then maintained as cultures

until the females were gravid, when they were put through the choice-chamber in order to obtain responses to a sample of fleece. The control flies were from two sources. Some were reared at Weybridge on raw liver and sent to Durham together with the sheep-bred prepupae. Other controls were provided by the laboratory cultures in Durham, and were raised either on 'lights' or on the fresh-blood medium described in the Appendix.

The material used in the choice-chamber was, in each case, 3.5g. Oxford Down fleece.

Altogether three batches of sheep-bred L.cuprina and one batch of L.sericata emerged in Durham at different times. Controls were available for each batch, either from Weybridge or the Durham cultures. There was no significant difference in behaviour between any of the control batches, whether they had been fed on raw liver, or 'lights' or on the blood medium.

All the cultures received daily meat meals. The first readings were taken from each group within three or four days after the first fertile eggs were laid, since this is the time at which response to the fleece has been shown to be most active. The results obtained are shown in Table 8.

TABLE 8.

SPECIES	SHEEP-BRED. Mean response to fleece and its S.E.	CONTROL. Mean response to fleece + its S.E.	DEG. OF F.	VALUE OF 't'	P.	VALUE OF 't' WHEN P=0.01.
<i>L. cuprina</i>	479.2 sec. \pm 13.3	441.2 sec. \pm 11.6	18	2.11	<0.05	2.88.
	462.3 sec. \pm 12.0	432.2 sec. \pm 16.7	18	1.39	>0.1	2.88.
	472.9 sec. \pm 15.4	425.8 sec. \pm 19.8	18	1.82	>0.05	2.88
<i>L. sericata</i> (British).	450.0 sec. \pm 14.4	430.3 sec. \pm 10.5	18	1.10	>0.1	2.88.

Of the four 'conditioned' cultures, one of *L. cuprina* was then maintained on daily meat meals until it was four weeks old. Two further sets of readings were obtained from this culture, the first after it was three weeks old and the second at four weeks. Readings were also obtained from a control culture which had received identical treatment. Both sets of results are recorded in Table. 9.

TABLE 9.

AGE	SHEEP - BRED S. Mean response to fleece and its S.E.	CONTROLS C. Mean response to fleece and its S.E.	Difference between the means.
1. 10 days	479.2 sec. \pm 13.2	441.2 sec. \pm 11.6	38.0
2. 21 days	448.7 sec. \pm 16.9	414.8 sec. \pm 9.7	33.9.
3. 28 days	427.4 sec. \pm 12.1	425.8 sec. \pm 19.8	1.6.

GROUPS COMPARED.	DEG. OF F.	VALUE OF 't'	P.	VALUE OF 't' WHEN P = 0.01.
1. Sand C	18	2.1	= 0.05	2.88.
2. Sand C	18	1.7	= 0.10	2.88
3. Sand C	18	0.06	> 0.5	2.88
S. 1 and 3	18	2.81	> 0.01	2.88
C. 1 and 3	18	0.65	> 0.5	2.88.

The two remaining sheep-bred L. Cuprina cultures and the single L. sericata sheep-bred culture were discarded after a fertile batch of eggs was obtained from each. These eggs were hatched and the maggots reared on the standard blood medium to produce groups of first generation offspring. These, when the adults emerged, were meat-fed until oviposition occurred. A sample from each of these cultures was put through the choice-chamber. Batches of eggs produced by the first generation offspring were bred out, again on the blood medium, to produce groups of second generation offspring. When these had completed the cycle from egg to gravid female adult, samples of them were also put through the choice-chamber. As in the previous experiments, control cultures were available which had received treatment identical with that of the experimental cultures. The readings obtained are shown in Table 10.

TABLE 10

SPECIES.	GENERATION.	SHEEP-BRED.		CONTROLS.	
		Mean response to fleece and its S.E.		Mean response to fleece and its S.E.	
I <i>L. cuprina</i>	Parents.	(i) 479.2 sec. ± 13.3	(i) 441.2 sec. ± 11.6		
	1 st offspring	(ii) 460.5 sec. ± 12.3	(ii) 432.2 sec. ± 6.6.		
	2 nd generation	(iii) 448.8 sec. ± 13.4	(iii) 439.7 sec. ± 13.1		
	Parents.	(a) 462.3 sec. ± 12.0	(a) 432.2 sec. ± 16.7.		
	1 st offspring	(b) 455.1 sec. ± 16.5	(b) 414.8 sec. ± 9.7		
	2 nd generation	(c) 433.2 sec. ± 10.9	(c) 427.0 sec. ± 14.7.		
II <i>L. sericata</i> (British).	Parents.	(i) 450.0 sec. ± 14.4	(i) 430.3 sec. ± 10.5		
	1 st offspring	(ii) 463.5 sec. ± 12.7	(ii) 424.2 sec. ± 15.6		
	2 nd generation	(iii) 430.2 sec. ± 13.7	(iii) 440.1 sec. ± 12.1.		

TABLE 10(a).

GROUPS COMPARED.	DEG. OF F.	VALUE OF 't'	P.	VALUE OF 't' WHEN P = 0.01.	
I	(i) and (i)	18	2.10	0.05	2.88
	(ii) and (ii)	18	0.99	> 0.05	2.88
	(iii) and (iii)	18	0.478	> 0.50	2.88.
I	(a) and (a)	18	1.39	> 0.10	2.88
	(b) and (b)	18	2.05	> 0.05	2.88
	(c) and (c)	18	0.290	> 0.50	2.88.
II	(i) and (i)	18	1.10	> 0.10	2.88
	(ii) and (ii)	18	1.91	> 0.05	2.88
	(iii) and (iii)	18	0.482	> 0.50	2.88.

In considering the results contained in Table 8, it can be seen that the responses of the sheep-bred flies are not significantly different from those of the controls. Nevertheless the values of 't' obtained from comparisons of the controls by themselves are of the order of 0.688 or less. This is the level for 't' when $P = 0.5$. When this is taken in conjunction with the results in Tables 9 and 10, it would appear that the breeding of blowfly larvae on sheep tends to produce an increased response to samples of fleece in the adult flies. It has been suggested (Prof. J.B. Cragg) that feeding on fresh sheep meat might produce a similar effect, and this possibly important factor of food quality has not been investigated. But even if this proved true, it simply serves to indicate the plastic quality of the flies and the fact that favourable larval feeding conditions may tend to 'condition' the adult.

Tables 9 and 9(a) in which the behaviour of groups of flies from two ageing cultures is recorded, show that the value of 't' decreases as the age of the flies increases, slowly reverting to a level where it can be compared with 't' values obtainable from control cultures. If the first and last readings from the 'conditioned' flies are compared (see Table 9(a)) the value derived for 't' is 2.81, which is very near the 0.01 level of significance. That this is not simply resulting from the effect of increased age is shown by comparing the corresponding groups of control flies where the value of 't' equals 0.65. This argues the presence of a

factor which affects the sheep-fed insects when they are young, and which disappears as they approach old age. A similar pattern is evident in the three cultures which were bred out to produce second generation offspring, see Table 10. In these, the parent generation and the first succeeding generation in each case cannot be compared exactly, either with their respective controls or with the second generation offspring. The values of 't' obtained from the comparisons of these groups are given in Table 10(a), and once again they show a marked decrease towards the control level in the second generation offspring.

Clearly, no definite conclusions can yet be drawn concerning the effects on adult flies of a larval life passed feeding on living sheep. In the first place more experiments are necessary, and a greater number of 'conditioned' cultures than were available. The one immediate possibility of obtaining a statistically significant difference in behaviour from sheep-fed flies might well be a culture bred continually on sheep through three or four generations. What can be said, however, as a result of the present work is that in sheep-bred flies, there exists a marked tendency to exhibit a higher response towards fleece than is shown by the standard meat-fed cultures, under the conditions available in the choice-chamber. This tendency towards different behaviour can only be the result of contact with different larval food material and/or environment since in every other detail, the breeding and

experimental methods were identical. It can also be said that the trend towards a higher response does not remain fixed; it appears to fade out both with increasing age and after its passage through a succeeding generation. The fact that this influence, resulting from 'conditioned' larvae, is still visible among the offspring of the first generation which had passed their larval existence on a blood-medium immediately suggests that a marked divergence in behaviour might well result if these larvae had been fed on sheep as were their parents.

The question of a possible toxic effect, which arises when modification of the olfactory response is produced by contact with menthol, does not exist in the experiments described. If, therefore, a form of conditioning is at work when blowfly larvae are reared on living sheep - a fact which cannot be positively determined without further work, but which the present results at least indicate - then it can be assumed that the adult flies retain a positive link with their larval existence. A possible explanation of how this occurs has been suggested by Professor J.B. Cragg, to the effect that the larval tissues, during feeding, become 'saturated' with substances which, after metamorphosis, modify the responses of the adult fly.

8. THE COMPARATIVE RESPONSES OF DIFFERENT SPECIES OF BLOWFLIES TO SAMPLES OF FLEECE.

Introductory Notes on the different species:

The genus *Lucilia* is represented all over the world. Among its species *L. sericata* (Mg), which is cosmopolitan, and *L. cuprina* (Wied) which is widespread in the tropics and subtropics, both owe their wide distribution to the agency of man and to their connection with sheep-farming. It is an established fact that *L. sericata* is a virulent sheep-pest in Great Britain, and that strikes in this country, according to MacLeod (1943), are due almost entirely to the activity of this one species. From the same survey comes the information that together with *Protophormie terraenovae* (R-D) females of the *L. caesar* group can act as alternative striking species. This depends on geographical factors and also, possibly those of vegetation. *L. caesar* in particular, may occur in strikes in sufficiently high frequency to be of economic importance in Scotland, North Wales and Northern England. *L. illustris* is described as being more frequent in lowland strikes than in the hills. Heather or bracken-type grazing, where they are available, appear to be associated with the conditions which result in MacLeod's 'alternative species' striking. Cragg, in a private communication, reported that *L. caesar* in N. Wales is not generally associated with sheep myiasis, and that strikes from this species occurred only on a single isolated farm, not investigated by Maldwyn Davies in his survey of 1934.

Two strains of L. sericata were collected in Denmark by Professor Cragg. One of them was trapped in the countryside; the other in a garden on the outskirts of Copenhagen. In contrast to the behaviour of this species in Great Britain, strikes produced by it in the countries of the Western European mainland rarely reach a level of economic importance. In spite of this, however, Cragg (1950) found that the reactions of Danish L. sericata to attractive materials placed on sheep were similar to those shown by the species in this country.

The Australian blowfly problem involves a larger number of economically important flies than the British. Two of the species concerned were made available by the Research Laboratories at Weybridge, L. cuprina, and a strain of Australian L. sericata. L. cuprina is the most important sheep-pest in Australia; L. sericata is economically unimportant by itself, and although it occurs in strikes it appears to do so wholly, as a secondary species, i.e. after a primary attack by another fly, usually L. cuprina. Morphologically, the Australian L. sericata is similar to the British species. It is described by Waterhouse and Paramonov (1950) as a more "domesticated" fly, occurring for the most part in populated areas and frequenting the garden dumps and garbage of urban communities. It is not found in open country. The above writers draw a tentative comparison between the habits of the Australian L. sericata and those of L. caesar in N. Wales, based on unpublished work by Cragg.

Calliphora species in Great Britain occur generally in

lowland areas of the East and South. They occasionally appear in attacks of myiasis, but do so in very small numbers and are unimportant economically.

Experimental work in the laboratory:

The blowfly species available in Durham and tested in the choice-chamber for their responses to samples of fleece were the following:-

- (i) British strain of *L. sericata* (Mg).
- (ii) Australian strain of *L. sericata* (Mg).
- (iii) Danish country strain of *L. sericata* (Mg).
- (iv) Danish city strain of *L. sericata* (Mg.)
- (v) *L. illustris* (Mg).
- * (vi) *L. caesar* (L).
- (vii) *L. cuprina* (Wied).
- (viii) *C. vomitoria* (L).

The purpose of the experiments was to find whether or not the responses of the different species under laboratory conditions could be correlated with what is known of their behaviour in the field. The series of experiments and the results obtained are tabulated below.

TABLE 11

SPECIES	1. 2.5g. Ox. Down. Dry.	2. 2.5g. Ox. Down Damp.	3. 3.5g. Ox. Down. Dry.	4. 3.5g. Ox. Down Damp.	5. 3.5g. Merino Dry	6. 3.5g. Merino Damp.	7. 5.0g. Houghall Fleece. Damp.
<i>L. sericata</i> (British).	394.9 ± 11.9	409.0 ± 11.7	458.7 ± 14.9	430.7 ± 13.3	455.3 ± 12.9	451.5 ± 10.9	482.1 ± 23.8
<i>L. euprina.</i>	325.4 ± 11.3	412.5 ± 8.7	/	439.7 ± 13.1	300.4 ± 10.6	445.5 ± 14.8	482.6 ± 9.4
<i>L. sericata</i> (Australian)	/	/	396.7 ± 13.0	/	391.0 ± 7.2	393.1 ± 9.6	383.0 ± 6.1
<i>L. caesar.</i>	/	/	^x 301.1 ± 10.0 310.4 ± 11.7	^x 312.6 ± 10.4 296.8 ± 5.4	/	/	/
<i>L. illustris</i>	/	/	302.2 ± 5.7	307.6 ± 8.3	/	/	311.0 ± 9.0
<i>C. vomitoria</i>	/	/	/	/	/	/	302.0 ± 14.0
<i>L. sericata</i> (Danish-city)	/	/	379.6 ± 13.1	372.2 ± 16.3	389.9 ± 9.9	354.7 ± 12.3	370.4 ± 18.7
<i>L. sericata.</i> (Danish-country)	382.4 ± 15.4	409.6 ± 12.1	444.4 ± 14.2	436.9 ± 14.0	378.1 ± 15.9	415.3 ± 11.1	412.7 ± 13.6
			441.8 ± 11.8				

Statistical comparisons of the different species are contained in Tables 11(a) - 11(f).

TABLE 11(a)

SPECIES COMPARED.	Columns compared.	Deg. of F.	Value of 't'	Value of 't' when $P=0.01$.
British L. sericata and L. cuprina.	1.	18	4.08	2.88
	2.	18	0.64	2.88
	4.	18	0.47	2.88
	5.	18	9.0	2.88
	6.	18	0.32	2.88
	7.	18	0.02	2.88

TABLE 11(b)

SPECIES COMPARED	Columns compared.	Deg. of F.	Value of 't'	Value of 't' when $P=0.01$.
British L. sericata and Australian L. sericata.	3	18	3.1	2.88
	5	18	4.2	2.88
	6	18	3.9	2.88
	7	18	3.9	2.88

TABLE 11(c)

SPECIES COMPARED.	COLUMNS COMPARED.	DEG. OF F.	VALUE OF 't'	VALUE OF 't' WHEN $P = 0.01$.
BRITISH <i>L. sericata</i>	3	18	^x 8.6	2.88
AND <i>L. caesar.</i>	4	18	^x 8.9	2.88
BRITISH <i>L. sericata</i> AND <i>L. illustris</i>	7	18	6.5	2.88
BRITISH <i>L. sericata</i> AND <i>C. vomitoria.</i>	7	16	6.0	2.92.

TABLE 11(d)

SPECIES COMPARED	COLUMNS COMPARED.	DEG. OF F.	VALUE OF 't'	VALUE OF 't' WHEN $P = 0.01$.
BRITISH <i>L. sericata</i>	3	18	3.9	2.88
AND DANISH CITY <i>L. sericata.</i>	4	18	2.7	2.88
	5	18	6.9	2.88
	6	18	5.7	2.88
	7	18	3.6	2.88.

TABLE 11(e)

SPECIES COMPARED)	COLUMNS COMPARED)	DEG. OF F.	VALUE OF 't'	VALUE OF 't' WHEN P=0.01.
BRITISH L. sericata AND DANISH COUNTRY L. sericata.	1	18	0.62	2.88
	2	18	0.38	2.88
	3	18	0.87	2.88
	4	18	0.31	2.88
	5	18	3.7	2.88
	6	18	2.3	2.88
	7	18	2.5	2.88

TABLE 11(f)

SPECIES COMPARED)	COLUMNS COMPARED)	DEG. OF F.	VALUE OF 't'	VALUE OF 't' WHEN P=0.01.
AUSTRALIAN L. sericata AND L. caesar.	3	18	5.7	2.88
AUSTRALIAN L. sericata AND L. illustris	7	18	6.0	2.88
AUSTRALIAN L. sericata AND C. vomitoria	7	16	5.6	2.92.

Summarising Tables 11 - 11(f), it can be said that L. cuprina showed no significant response to a sample of fleece unless the relative humidity within the choice-chamber was

artificially raised. On the substitution of a damp floor, however, the responses of L.cuprina to samples of fleece became statistically the same as those shown by British L.sericata, see Table 11(a). L.cuprina, in its natural habitat, experiences semi-arid conditions, where L.sericata prefers regions of relatively high humidity. But Mackerras and Mackerras (1944) have shown, with respect to L.cuprina, that in the field, sheep with a clean dry fleece are not attractive. Nor is a fleece which is soiled but dry attractive, and flies are seldom observed on such. A sheep whose fleece has been treated with water is very attractive and oviposition by L.cuprina takes place rapidly on such animals. Samples of wet fleece exposed under insectary conditions also attracted L.cuprina and stimulated oviposition, although to a very slight degree. It appears to remain true, that in the laboratory as in the field, and under the conditions available in the choice-chamber, L.cuprina never made a significant response to a dry sample of fleece. As soon as the humidity over the fleece was raised, however, this species reacted strongly. The responses obtained from all the L.sericata strains did not appear to be influenced by either 'damp' or 'dry' conditions in the choice-chamber.

It was found that in general, individuals of L.cuprina were more sluggish in the apparatus than those from L.sericata strains. They had a strong tendency to settle in the arena, and moved only with sudden short flights. They appeared

too, to prefer the periphery of the arena, where the light was less intense than in the centre. Because of this, some readings were made with a reduced intensity of illumination. A 15 Watt lamp, dimmed by a paper shade was used to light the apparatus in the constant temperature room. Under these conditions, the behaviour of L.cuprina was more active than formerly. The mean response made by a group of the flies to 3.5g. fleece was $434.8 \text{ sec.} \pm 11.4$ - a result very similar to that obtained with the original bright illumination. Dimming of the light made no difference in the behaviour of L.cuprina to a sample of fleece exposed under the 'dry' conditions, and they continued to show a chance distribution in the arena. British L.sericata observed with the paper-shaded 15 Watt lamp showed a clear-cut change in behaviour. The mean response of a group of these flies to a 3.5 g sample of fleece was $315.0 \pm 15.9 \text{ sec}$, which is not significantly selective for the fleece. This result can probably be explained by the fact that the insects were reacting towards the amount of available light rather than to the fleece. The illumination was not quite uniformly distributed, and the two halves of the experiment show a bias towards the right hand side of the arena.

The strain of Australian L.sericata compared with the British strain of the same species (see Table 11(b)) is significantly different in behaviour. The two sets of responses are similar in that the Australian strain reacts

to fleece whether it is exposed under a wet or dry floor, and in that there is definite selection of the fleece. But the 't' values in Table 11(b) indicate that the degree of response in the two strains is distinctly different.

Groups of flies of the species L.caesar, L.illustris and C.vomitoria are not attracted to samples of fleece exposed in the choice-chamber. The mean responses obtained for the groups do not diverge significantly from the expected 50:50: ratio. These three species are compared statistically with British L.sericata in Table 11(c), where the increased value of 't' is noticeable as compared with the values obtained in Table 11(b).

The responses of British L.sericata are compared with those of Danish city L.sericata in Table 11(d). Statistical treatment indicates that the attractiveness of samples of fleece for the two strains is not the same. The 't' values obtained for a similar comparison involving the Danish country L.sericata show that a greater similarity exists between the latter and the British strain, (see Table 11(e)). That they are not strictly comparable is seen from the large variation in 't'.

Table 11(f) compares the Australian L.sericata with L.caesar, L.illustris and C.vomitoria. A clear-cut significant difference exists between the two groups in their behaviour towards samples of fleece. The Table shows that at least in this respect, the Australian L.sericata and

L.caesar cannot be regarded as similar in behaviour.

In general, information obtained from a study of the eight available species in the choice-chamber indicates that their behaviour, under laboratory conditions, is very similar to that in the field. In some respects, the above experiments both explain and extend what is known of their behaviour under natural conditions. The implications arising out of this work will be dealt with in the general discussion.

SUMMARY.

1. A simple choice-chamber, based on the adsorptive properties of activated charcoal is described, together with a technique for studying the olfactory responses of blowflies.
2. The olfactory responses of 7 species of blowfly are investigated, partly as a means of checking the reliability of the apparatus. The different species are not uniform in their responses to meat, L.cuprina and the British strain of L.sericata being the most active.
3. A further attempt to modify the olfactory response to menthol is described. It is possible to alter the adult reactions to dilute quantities of this substance if it has been experienced during the larval life of the individual. The modified response is rapidly replaced by the normal degree of repellence. It is suggested that modification achieved by menthol is not desirable because of the possibility of the toxic action involved.
4. Indications are apparent that male L.sericata are repelled by menthol to a greater extent than the females.
5. The statistical method of comparing the responses of two groups is described.
6. A method is given for testing attractant solutions in the choice-chamber. Under the conditions available, male L.sericata were not attracted to a weak indole solution, but both sexes responded to weak ammonium hydroxide.

No oviposition was recorded during the tests.

7. An attempt to induce oviposition in the constant temperature room using heated chemical attractants on cotton wool is described. The temperature effect, in itself, does not appear to be sufficient to stimulate egg-laying.
8. L. sericata is shown to be attracted to samples of different types of fleece presented in the choice-chamber. The attractiveness of the fleece is not removed by washing or storing, and apparently does not vary from one type of fleece to another, provided that the quantity remains constant.
9. In experiments on young adult L. sericata, the results suggest that non-fertilisation of the female produces a decrease in response to samples of fleece.
10. In adult female L. sericata the attractiveness of fleece for the fly decreases with increased age. The decrease in response becomes more marked if the insects are wholly or partially meat-starved. Daily meat meals are necessary for the maintenance of L. sericata population which is active and uniform in its response to fleece.
11. There is some indication that conditioning occurs in L. sericata and L. cuprina adults whose larval existence has been passed on living sheep. This results in a trend towards greater attraction to samples of fleece, which fades out both with increased age and passage through a succeeding generation.

12. The comparative behaviour of 8 species of blowfly to samples of fleece is observed under laboratory conditions. The results obtained agree for the most part with what is known of the behaviour of these insects in the field.

P A R T 3.

STUDIES ON THE BLOWFLY ANTENNAE.

THE BLOWFLY ANTENNAE1. HISTORICAL SURVEY.

Studies on insect olfaction began at the end of the eighteenth century and rapidly gave rise to the theory that the olfactory organs were located in the stigmata or tracheae. A little later, almost every part of the insect body in turn was suggested as bearing the olfactory organs. Lefebvre (1838) was the first to establish the fact that the sense of smell was located chiefly on the antennae and as more work was done evidence accumulated in favour of the antennal theory, until it was widely supported. The first investigator to find the sensory pits in the antennae was Leydig (1860) who described them in detail and demonstrated their connection with the antennal nerve. He claimed that their function was olfactory. At the same time, however, there were large numbers of workers opposing the antennal theory of olfaction, all of them influenced by the fact that many insects continued to respond to chemicals after the elimination of their antennae. This persistence of response has now come to be accepted, not necessarily as the result of an olfactory stimulus, but rather as a response made by receptors of the insects' general chemical sense, to what were often fairly high concentrations of irritants. This aspect of olfactory studies is dealt with by Marshall (1935) in a survey of the work related to the location of olfactory receptors in insects.

Recent work on the whole tends to accept and confirm the

antennae as the site of the olfactory organs. Barrows (1907) working with Drosophila ampelophila concluded that the antennae possessed all or nearly all the olfactory powers. It was significant that a fly with one antenna amputated, orientated itself to an odour by 'circus movements' towards the intact side. However, among modern workers, McIndoo remained convinced that the sense of smell was not centred in the antennae and in 1933 attempted to close the controversy, at least as far as it concerned the blowflies.

2. THE EXPERIMENTS OF MCINDOO.

In the early experiments of 1914 and thereabouts, McIndoo strongly objected to amputation or elimination of the antennae, on the grounds that flies thus treated were subsequently abnormal and as a consequence gave unreliable experimental results. This is not in accord with the findings of other workers including von Frisch (1919) Abbot (1927) and Hartung (1935) all of whom carried out similar operations. They found the post-operation insects abnormal only in so far as the loss of their olfactory powers made them abnormal. However, at this time, McIndoo looked elsewhere than on the antennae for the olfactory receptors, and came to the conclusion that the olfactory pores, which have a wide distribution over the insect body, were responsible for receiving odour stimuli. He demonstrated anatomically that these pores existed on the wing bases and legs and claimed to have shown that they lacked an external chitinous membrane; this rendered them capable of receiving olfactory stimuli. Similar pores on the antennae bore a chitinous covering and therefore failed to serve olfaction. But some years later, Eidmann (1922) was able to show that chitin was not impermeable and therefore not necessarily a barrier to olfactory stimuli. When, in 1933, McIndoo came to work on blowflies, he amputated the antennae and used as test materials a variety of natural products including sugar solutions, milk, putrid steak, putrid eggs and ammonium hydroxide. The responses obtained from the mutilated flies



did not differ significantly from those given by intact insects, so that it was concluded again that the olfactory receptors were not borne on the antennae. A study of the antennae themselves, using caustic soda preparations the sections revealed the so-called olfactory hairs in the pits of the third segment, but because of the results obtained in the olfactometer McIndoo could not accept the pits as being associated with olfaction. His work of 1934 described olfactory pores on the legs, wings and halteres and repeated the conviction that blowflies do not smell with their antennae. These conclusions have not been confirmed by contemporary or later workers, and because they bear directly on the present investigation, a consideration of the circumstances in which they were arrived at seems necessary.

The wooden olfactometer has been described in the paper published in 1933. The general method of using it seems open to criticism on several counts. In the first place, a batch of 200-300 flies maintained for two or three weeks in a box of the described dimensions (12" x 12" x 3") indicates serious overcrowding. It is unlikely that pairing of males and females could take place under these conditions. In addition, there is no mention, in the text, of the insects being provided with protein food. It is almost certain, therefore, that the populations of experimental flies with which McIndoo was working, were abnormal in that the females must have remained mostly unfertilised and probably with

vestigial ovaries. From the published results, single counts i.e. the mean of 10 counts at 15 sec. intervals which made up a single test, were of the order of 30-40 insects. This was a very small percentage (about 15% - 20%) of the total population, and a population which was closely confined and therefore dense. There is no indication that McIndoo considered that this small percentage response might affect the validity of the results. It is recorded too, that the flies soon ceased to respond to the test air-currents and to the odours carried by them - hence the brevity of the complete experiment (10 x 15 sec. = $2\frac{1}{2}$ min.). It is possible, therefore, that the test materials used by McIndoo were of a concentration high enough to produce rapid fatiguing of the olfactory receptors under the conditions of the experiments. Wigglesworth (1950) has described the pit organs of the Muscoid antennae as probable long-distance chemo-receptors, that is, organs capable of stimulation by extremely dilute substances and sensitive enough to respond to minute traces of odourous material. If then, the antennal receptors were fatigued in McIndoo's experiments, not only would the behaviour of intact flies be concealed but responses could be obtained from mutilated flies by stimulation of the body chemo-receptors mentioned earlier. The final criticism of McIndoo's blowfly studies is concerned with the fact that control and antennaless flies were not tested consecutively. It is unfortunate that in an apparatus which was liable to sharp fluctuations, there was a lapse of 12 months between the two sets of experiments.

3. THE PHYSIOLOGY OF THE CHEMORECEPTORS.

All insect sensilla are covered by a continuous sheet of cuticle (Wigglesworth 1950). On some, the covering layer is extremely delicate and these are usually held to be responsible for the perception of taste and odour stimuli. The cuticular parts of the sensilla vary enormously in shape, and may take the form of hairs and bristles or may be reduced cones or pegs arising from the body surface or from pits as they do in the Muscid antennae. Nerve endings of many kinds are sensitive to chemical irritants and between the two senses of taste and smell there appears to be no absolute distinction, except that sensitivity in the case of smells is usually much greater. Dethier (1947) notes that the one outstanding feature of the mechanism of stimulation by chemicals is that it is accomplished by relatively small material particles which emanate from a source and then impinge on the insect receptors. Stimuli emanating from a distance are said to be smelled; those in close physical contact with the insect are said to be tasted. Taste substances usually stimulate one set of receptors, and smells a different set; but where high concentrations are involved a general response may be produced. It is believed that without some form of moving air currents or convection currents, insects would be unable to orientate to odours.

Natural sources of odours and taste substances are diffusing particles or molecules of organic substances.

The normal odours to which an insect responds assist it to find its food, its mate, and often also, a site for oviposition. Liebermann (1925) has published a survey of Muscid flies in which it has been suggested that the number of olfactory organs on the antennae of these insects is proportionate to the difficulty they have in finding food.

The most frequent site for the taste chemoreceptors in the Muscid flies is the tarsus. The existence of the tarsal organs has been demonstrated for *Calliphora* by Minnich (1929) and Crow (1932). The oral lobes of the proboscis in *Calliphora* also bear gustatory hairs along their margins, (Minnich, 1931). Eltringham (1933) was the first to describe the tarsal organs, in studies made on the Lepidoptera. The visible response made by insects to tarsal stimulation, is the extension of the proboscis.

4. THE MORPHOLOGY OF THE BLOWFLY ANTENNA

The antennae arise as a pair of appendages on the head of the insect, in the space between the compound eyes. The single appendage consists of three segments (see Fig.1.), the first segment being that which is attached to the insect head and the third segment being the terminal one. The third segment is supplied by a large sensory antennal nerve, and bears both on its surface and within its tissues a very large number of sense organs. It is probable that, collectively, these receptors are capable of responses to a variety of stimuli, including possibly temperature and humidity, as well as those of smell. It is the purpose of this part of the investigation to correlate, if possible, the olfactory responses of blowflies with the sensory apparatus on the antennae.

Conspicuous along the outer surface of the third segment is a line of apertures, leading into a series of pits provided with numerous peg-shaped sensilla. Normally, when a fly has settled or is resting, the antennae are folded down and lie in two shallow grooves on the anterior surface of the head. If a needle bearing odourous material is brought near the resting insect, the antennae are immediately extended into a horizontal and slightly diverging position, and the insect will then move towards or away from the source of the smell, depending on whether it is attractive or repellent. Fig.2 illustrates the position of the blowfly antennae, as it was

Calliphorine Antenna.

Right Antenna.

Fig. 1.

The antenna of *Lucilia sericata* (Mg). The site of the apertures to the compound pits, on the lower, outer surface of the 3rd segment, is indicated.

HEAD OF LUCILIA sp.

A: Resting position of antennae. "

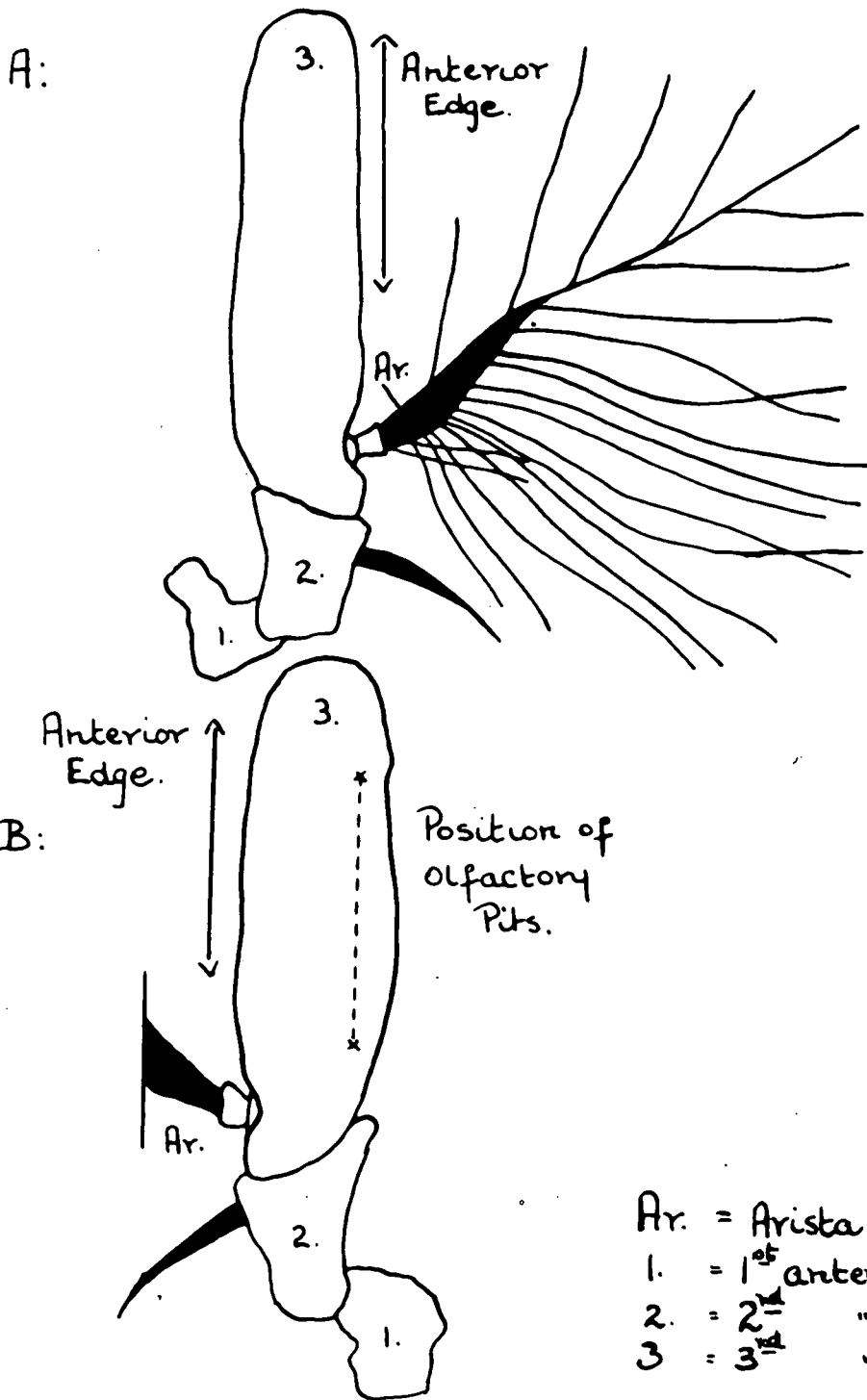
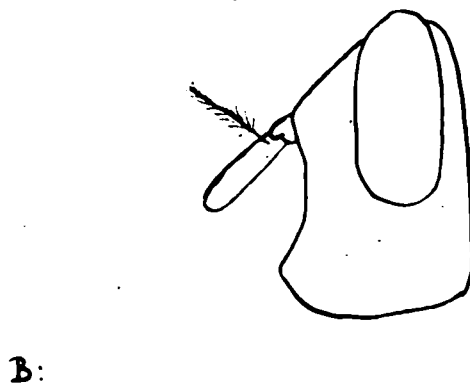
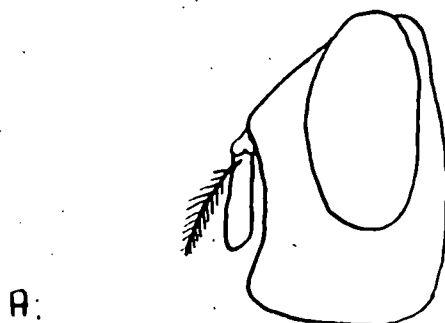
B: Position of antennae on an insect in the olfactometer.

Fig. 2.

The antennae erected in response to an olfactory stimulus.

observed during tests in the charcoal choice-chamber. During flight, the insect appears to erect the antennae. This has been described by Liebermann, who suggested the horizontal position as the one in which the sensory pits are most effectively exposed to an on-coming air-stream. He has also commented on the oblique position of the pits which ensures full exposure of the sense pegs to the air, when the antennae are erect. The pegs or cones in the pits have been widely acknowledged as sensory, and as already described, generally held to be responsible for the perception of odours.

5. MUTILATION EXPERIMENTS.

Both antennae were removed from two species of sheep blowfly, L.cuprina and the British strain of L.sericata, in order to find out whether or not the operation affected their response to samples of fleece in the choice-chamber.

The flies were meat-fed daily and brought into lay in the usual way. Females were put through the apparatus, and on being taken from it, their antennae were removed with a pair of fine forceps, and without the use of an anaesthetic. These mutilated insects were then placed in a special cage, where meat, sugar and water were available. A period of 24 hours was allowed for recovery before any further readings were taken in the choice-chamber.

The behaviour of the insects in the cage after the removal of the antennae appeared quite normal. They cleaned and rubbed the surface of the head vigorously using the first pair of legs; they also ran about, and were, on the whole, fairly active. They did not feed on meat as readily as intact flies, and oviposition was rare. All these observations on the behaviour of antennaless flies agree with those made by Hartung (1935) about similarly mutilated *Calliphora*.

No attempt was made to remove the arista separately, because the evidence is fairly conclusive that it is not concerned with olfactory perception, Liebermann (1925) and Hartung (1935).

In some of the Durham mutilation experiments, both pairs

of second and third tarsi were cut off with a pair of sharp scissors. This operation, when coupled with antennal amputation was severe, and resulted often in rendering the insects completely useless. Results obtained from these inert and obviously abnormal flies were ignored in the final estimate.

Experiments on the two species are not exactly comparable because of the fact mentioned in Part 11, that L.cuprina never responds to fleece in a dry arena. Consequently, a damp floor was always necessary to produce responses from this fly - a practise not used with L.sericata and which introduced the complication of tarsal stimulation.

The fleece sample in all tests was 3.5g. of Oxford Down.

Three groups of experiments were carried out on each species. They are described below.

Group 1. A set of normal responses was obtained, after which the antennae were removed. Further readings were taken on the following day.

Group 2. As in Group 1. After obtaining readings from antennaless flies on a dry floor, a damp floor was substituted. At the end of these readings, both pairs of second and third tarsi were removed, and the flies tested again on the day following this final operation.

Group 3. Intact flies of both species were tested on a damp floor, and after the normal responses were obtained both pairs of second and third tarsi were removed. Final readings were taken on the following day.

TABLE 1. BRITISH *L. SERICATA*.

No. of Expt.	State of the insects.	Floor.	Mean time spent over fleece in secs. + its S.E.	% attraction
1.	a. Intact	Dry	431.5 sec. \pm 12.0	72.0%
	b. Antennae removed.	"	297.1 sec. \pm 9.6	49.5%
2.	a. Intact.	Dry	430.7 sec. \pm 13.3	71.8%
	b. Antennae removed.	"	296.7 sec. \pm 10.3	49.5%
	c. "	Damp	351.7 sec. \pm 12.9	58.7%
	d. Antennae and Tarsi removed.	"	334.8 sec. \pm 9.1	55.8%
3.	a. Intact	Damp	431.5 sec. \pm 12.0	72.0%
	b. Tarsi removed.	"	425.2 sec. \pm 12.2	70.8%

TABLE 1a.
't' values.

Groups compared.	Deg. of F.	Value of 't'	Value of 't' where P=0.01
1. a+b	18	8.3	2.88
2. a+b	18	7.8	2.88
a+c	16	4.1	2.92
b+c	16	3.3	2.92
c+d	13	2.0	3.01
3 a+b	16	0.346	2.92

TABLE 2. *L. CUPRINA*.

No. of Expt.	State of the insects	Floor	Mean time spent over fleece in secs. + its S.E.	% attraction
1.	a. Intact.	Damp	432.2 sec. \pm 6.6	72.0%
	b. Antennae removed.	"	342.8 sec. \pm 11.0	57.2%
2.	a. Intact.	Damp	439.7 sec \pm 13.1	73.3%
	b. Antennae removed.	"	341.8 sec \pm 18.4	57.0%
	*c. Antennae and Tarsi removed.	"	329 sec.	54.8%
3.	a. Intact	Damp	420.0 sec. \pm 14.7	71.2%
	^o b. Tarsi removed.	"	417 sec.	69.5%

* Results from only 2 flies.

^o Results from only 3 flies.TABLE 2a.
't' values.

Groups compared.	Deg. of F.	Value of 't'	Value of 't' where P=0.01.
1. a+b	18	6.7	2.88
2. a+b	14	8.2	2.98

Tables 1 and 2 indicate the separate experimental treatments and the results obtained from them. It is obvious that L.cuprina suffered badly as a result of the operations, and the number of flies giving reliable results afterwards is greatly reduced in this species. However, it should be emphasized that those results which are recorded here were provided by active and apparently normal specimens. The use of the 't' test was limited because of the small number of survivors. The results indicate the following conclusions.

1. Removal of the antennal results in L.sericata being totally unable to orientate towards a sample of fleece in the choice-chamber. It can be assumed that the olfactory organs have been removed with the antennae.

2. Where a damp floor replaced the usual dry one antennaless L.sericata were attracted to the fleece, but to a significantly lesser extent than normal flies on a damp floor. This indicates that another but less efficient set of receptors has been called into use by the damp floor. It is thought that this attractant stimulus was received by contact chemoreceptors on the tarsi and probably also on the proboscis and mouth parts, because antennaless flies on a damp floor continually extend and withdraw the proboscis as if in response to a tarsal stimulation. Further mutilation in the form of removal of the tarsi produced little alteration in the existing results. There was a further lowering of the response but the difference is not significant. This would seem to

indicate the existence of chemoreceptors elsewhere than on the tarsi.

3. Removal of the tarsi, leaving the insect with both antennae intact produces a very small decrease in the original normal response. This tends to confirm that the receptors on the antennae are by far the most sensitive and are therefore olfactory in function.

4. L.cuprina loses most of its ability to orientate towards the fleece when the antennae are removed. But because this species never responds to a dry sample it was impossible to cut out completely the attractant stimulus which was presumably received through the contact chemo-receptors in the same way as in L.sericata under similar conditions.

5. Removal of the tarsi made very little difference to the response of L.cuprina, provided that the antennae remained intact.

It was finally concluded that in both species, the antennae are unquestionably the site of the olfactory organs. Loss of these appendages greatly reduces (and can remove altogether in L.sericata) the ability to orientate towards a natural attractant. Some indication that humidity receptors are also borne on the antennae was given by placing small groups of antennaless insects in a humidity gradient of 20% range. Normal flies, under these conditions, selected and remained in the drier side of the arena; those with the antennae amputated moved restlessly from one side of the chamber to

the other throughout the experiments and failed to settle for long in either of the relative humidities available. The final tables indicated a random selection of sides. These experiments were not followed out in detail and are only worth a brief mention at this point.

6. HISTOLOGY OF THE ANTENNAE.

The antennae of females of five species were examined to obtain details of their organisation.

Methods and Materials: The five species used were

1. British *Lucilia sericata* (Mg).
2. Australian *Lucilia sericata* (Mg).
3. *Lucilia cuprina* (Wied).
4. *Lucilia caesar* (L).
5. *Lucilia illustris* (Mg).

Attention was concentrated on the third antennal segment. A variety of methods was used in making preparations. The Sporal (chlorine dioxide) treatment, highly recommended by Liebermann, was not attempted because of practical difficulties. Instead, whole antennae were treated with potassium hydroxide and stained afterwards with basic fuchsin as in Roth and Willis (1951). Information obtained from the study of these specimens was very limited because the internal structure of the pits remained invisible. But the line of apertures leading from the antennal surface down into the pits was clear (Fig.3).

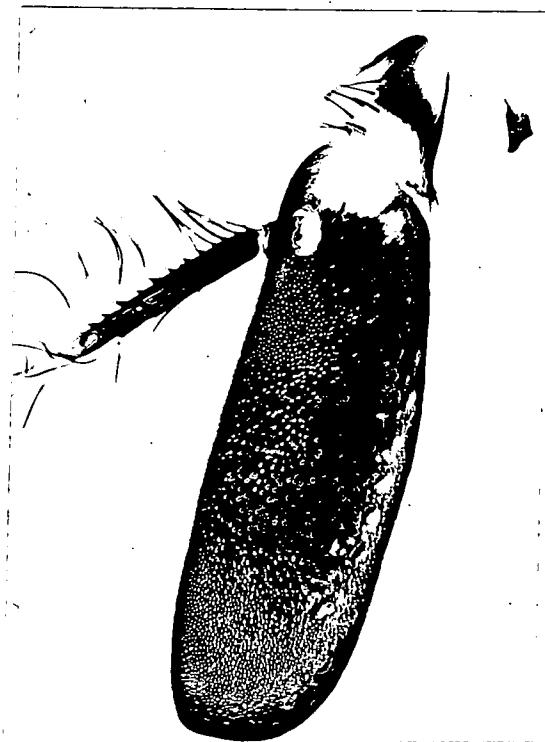
Fig.3

Whole mount boiled in potassium hydroxide and stained with basic fuchsin x 90. Apertures to the pits visible along the lower edge of the outer surface of the 3rd segment.

No constant differences in the numbers of apertures exhibited by antennae of the different species was apparent.

Serial longitudinal and transverse sections were cut from mounts embedded in Celloidin - Paraffin and in ester wax (Steedman 1947). Ester wax blocks were the more satisfactory and a general staining with Ehrlich's haematoxylin and eosin gave good all-round results. Some sections were treated with silver nitrate to stain nerve tissue, and one or two methods of identifying chitin were tried out. For the most part, longitudinal sections illustrated the organisation of the pits more clearly than transverse sections, although the

latter were of use in another respect. Sections were cut at a thickness of 10μ . Attempts at thinner sections were unsuccessful.

Structure: The histology of the third segment and its sense organs in the Calliphorine species studied is very similar to that described by Liebermann in his work on the Muscids. Among the blowflies he had dealt only with L.caesar and Calliphora species.

The cuticle covering the segment has a dense covering of hairs and bristles, many of which appear to be sensory. Scattered in the hairy covering there exist isolated sense pegs, but, perhaps because it was impossible to obtain really thin sections, these were seen with difficulty, and they did not appear to be as numerous as Liebermann's counts of them would suggest. Shallow saucer-like depressions were observed in the cuticle, and these contained either solitary or small numbers (2 or 3 or 4) of sensory pegs.

The structures which were given greatest attention were the large pits sunk in the tissues of the third segment whose apertures are visible externally. These extend in a line for approximately two thirds of the length of the segment along its outer, lower surface, see Figs 1 and 3. Each separate aperture leads down to a whole series of compartments which branch off from each other, see Figs. 11,13,14 and 15. Stout cuticular ridges bearing bristles of varying sizes separate the compartments. Liebermann believed that these

pits were the result of the inward growth of whole areas of the outer antennal surface complete with its bristles and small simple pits. Each group of compartments comprises a compound pit. Each compartment within the group is equipped with sensory pegs and protected by bristle-bearing ridges, and in the main entrance, leading down from the exterior are rows of densely packed bristles arranged in concentric rings. It is assumed that the purpose of these bristles is protective and that they serve to prevent the penetration of dust particles and similar material to the sense organs below. The number of compartments per pit, and their size, and the number of sensory pegs, is very variable within the species and sometimes even within the two antennae which make up a pair. The amount of equipment, as estimated from the number of sense-pegs in a single antenna remains uncertain, because although the pit-structure was clearly visible and some counts of pegs were made for each species, accurate counting from the material available was very doubtful.

The sensory pegs, whether they occur on the surface or in pits, do not vary in form. They appear in sections as thin-walled processes. Each arises from the surface of a small dome-like or convex base, similarly thin-walled. Immediately beneath each of these rounded supports is found a large sense-cell from which a nerve fibre passes to join with those from neighbouring sense-cells to form a branch which eventually connects with the main antennal nerve.

The position of the large compound pits on the 3rd segment

of the antenna is constant in all five species examined, and is confined to the central part of the lower, outer surface. The terminal third of the segment and a small area at the proximal end did not appear to bear pit structures.

The compound pits appear to function only during flight. At this time the antennae are extended outwards and forwards from the front of the head, so that the pit-apertures and the pits themselves as a result of their oblique position are directly exposed to an on-coming air-stream. It is thus that olfactory stimuli in the field appear to be intercepted by the flying insect. In the down-turned, resting position of the antennae, the pits appear to be cut off from stimuli and this would indicate that the sensory pegs of the antennal surface are involved in the perception of odours by stationary insects. Liebermann argued that the surface pegs were exclusively for this purpose but it seems more likely that some of them, at least, are concerned with receiving stimuli from other than olfactory sources.

From the experimental results quoted earlier in the text, which deal with responses to raw meat and to fleece, it appears that the British L. sericata and L. cuprina possess more efficient olfactory organs than the other species. It is certainly true that both these species are most highly responsive to the attractiveness of fleece. A fairly large variation in size exists between the antennae of the five species studied. Those of L. caesar and L. illustris are the largest, while those of L. cuprina are the smallest; yet the

olfactory powers of the latter, at least in so far as the present investigation shows, are quite as good as the larger British *L. sericata* and appear to be more keen than those of the other two species mentioned. It follows, therefore, that within the Calliphorine species, as in the Muscids generally, efficiency in olfactory perception is not necessarily correlated with antennal size. Liebermann wrote that the size of the antenna is in no way related to the number of olfactory organs it bears, and that often among Muscids, a large antenna can show greatly reduced numbers of olfactory organs. Olfactory efficiency, however, on the strength of Liebermann's work, is proportionate to the number of sense pegs borne on the antenna. Yet within the species studied in the present work, this did not appear to be the case. Table 3 gives a summary of the antennal dimensions and the sensory equipment in four of the species studied.

TABLE 3.

Species	<i>L. illustris</i> .	<i>L. sericata</i> (British).	<i>L. cuprina</i>	<i>L. sericata</i> (Australian).
Length of 3 rd segment.	829 μ	930 μ	572 μ	701 μ
Width of 3 rd segment.	157 μ	215 μ	143 μ	157 μ
Length of segment occupied by pits.	0.673 of total length	0.555 of total length	0.451 of total length	0.633 of total length
Number of compound pits.	13	12	7	9
Number of pegs in compound pits.	576	480	206	300.

The approximate length of the sensory pegs is about 28 μ in all four species.

The information given in Table 3 was obtained from studies of only two or three antennae from each species, made using a micrometer slide. It does not pretend in any way to be a final or even accurate summing up, and is only intended to give a comparative idea of the material dealt with. Measurements of the width of the antennae are of doubtful significance, because this is a factory subject to variation. It will be referred to later in the text.

Because the information recorded in the table contradicts some of the conclusions at which Liebermann arrived, after an extremely detailed survey, it is necessary to emphasize certain points. In the first place, the figures given were obtained from a very limited number of specimens and it is impossible to compare them with those of Liebermann since he gave no figures for the numbers of each individual species he studied. Secondly, the sections used were 10 μ thick, and while these gave a fairly good comparative idea of the pit organs, it was not possible to obtain from them any accurate counts of the other sensory processes which the antennae bear. At the same time, it must be remembered that Liebermann did not find sections necessary to his survey and made only a small number of them. Most of his counts were made on whole mounts which had been bleached in Sporal.

The Internal Cuticle of the Third Segment:

It appears that the walls of the third antennal segment

are not rigidly fixed, so that the segment as a whole is capable of variation in width or girth. In other words, the outer wall can collapse to a limited extent, or remain smooth and firm. Whether this flexibility provides for an automatic adjustment to conditions encountered is not certain, but it does appear that it might be correlated with the presence of a cuticular structure within the third antennal segment. Reference to this second cuticle has not been encountered in the literature, but its presence is obvious in most of the sections, and particularly in those left unstained or treated by silver impregnation; it can be seen in the text figures.

It is possible that the function of this inner wall is purely mechanical, providing additional support for a firm but flexible appendage, and/or affording a certain extra protection to the compound pits with their senseorgans and the antennal nerve, all of which are placed internal to it.

Various histological techniques were applied to the sections in order to identify the structure as being of a cuticular nature. No kind of cell structure has ever been visible within it. Since chitin is the best known constituent of the cuticle specific tests for this substance were sought. Chlor-azol black (Cannon 1941) which usually stains chitin greenish-grey, gave unsatisfactory results. Periodic acid treatment (Gurr 1951) which is diagnostic for fungine (a substance which has been proved to be identical with chitin) with a reddish-pink colour gave a clearer indication that the layer is chitinous. Finally, the 'chitosan' test of

van Wisselingh quoted by Wigglesworth (1950) was applied. Unfortunately boiling with potassium hydroxide removed all the internal structure and left only the outer cuticle to provide the characteristic violet colour, specific for chitin.

Attempts to follow the position of the suspected inner cuticle were made by drawings of both transverse and longitudinal sections in series. Fig.4 illustrates its appearance through a transverse series. It first appears near the terminal end of the third antennal segment, occupying the middle of the section as a finely-branched structure. Gradually, as the sections move towards the proximal end of the segment, it comes to surround the space in which are accommodated the nerve and the groups of sensory cells which surround the pits with their sense pegs.

Surface views, obtained by sectioning off the outer layers of the segment, show the inner cuticle as a network or reticulum. This arrangement, while it provides support would also allow for the passage of nerve fibres from the sense organs on the antennal surface to the trunk of the main antennal nerve.

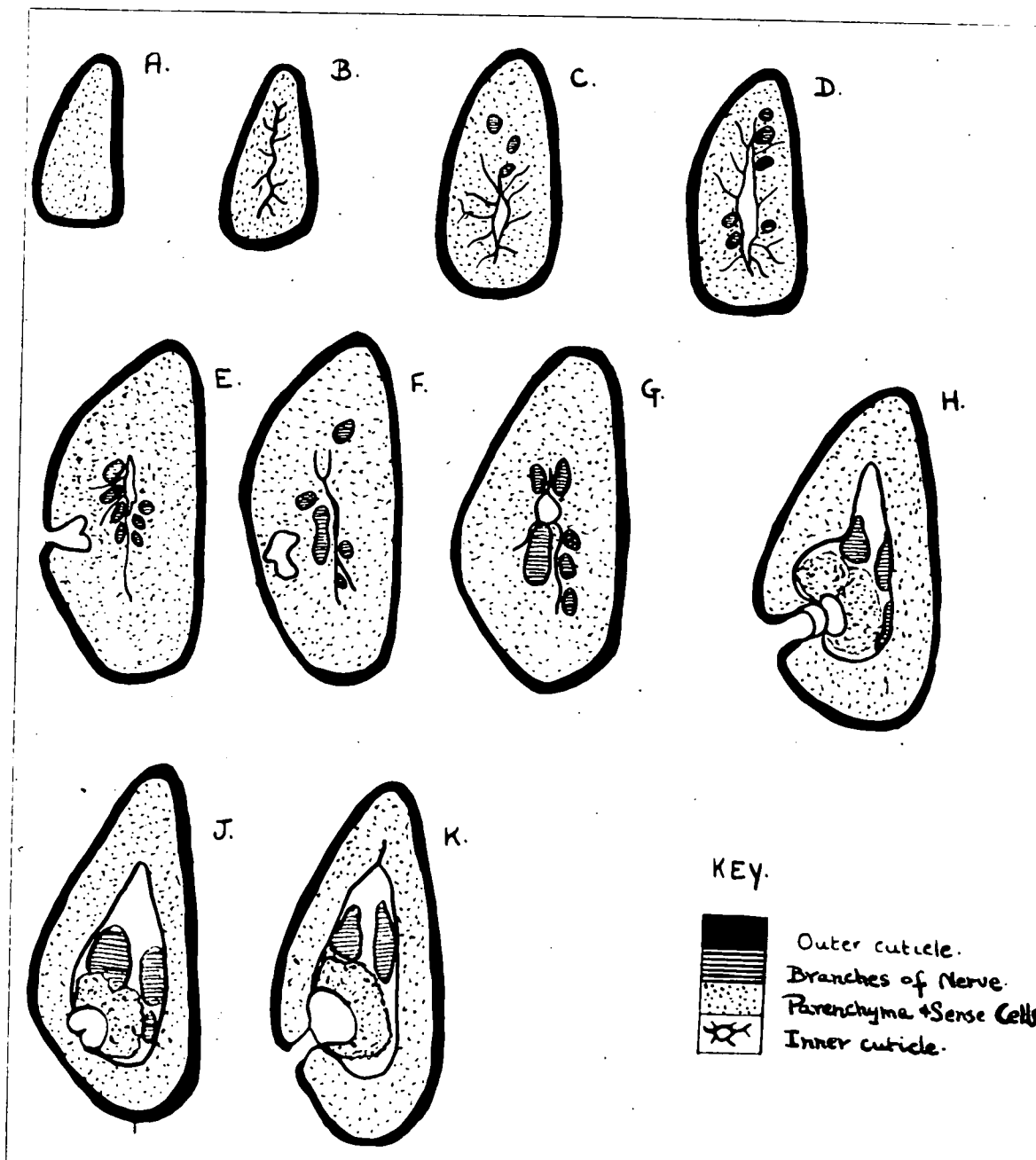

FIG 4.

Serial transverse sections (X120) of the 3rd antennal segment from the Australian type *L-sericata*. Sectioning began at the distal end of the segment.

A:	Sections	1-5.	F:	Sections	21-23
B:	"	6-9	G:	"	24-30
C:	"	10-12	H:	"	31-33
D:	"	13-19	J:	"	34-37
E:	"	20	K:	"	38-41.

7. THE TEXT FIGURES.

Figs. 5 - 9: These were prepared from Camera lucida drawings of a series of longitudinal sections of the third antennal joint, 10μ thick. Only those sections which bear pits or pit apertures are included. The variation in size of the segment between the different species is immediately obvious. In both L.illustris and L.caesar numerous simple superficial pits can be seen on the surface opposite that which bears the apertures to the compound pits. These simple pits appear to occur on the inner surface of the antennae, i.e. the surface which faces the antennae of the other side.

The space within each section is that which accomodates the several branches of the antennal nerve and the trachea, but the details of the structure of this region have been omitted in order to keep the drawings simple and focus attention on the nature and position of the pits.

The numbers included on the drawings were an attempt to follow individual pits through the series so as to obtain some idea of their extent. Numbering was carried out on the principle that the entire complex of a compound pit possesses a single aperture to the external surface.

A point clearly illustrated by the figures is the oblique angle of the entrance and of the pit base to the vertical axis of the segment. The aperture is thus directed forwards when the antennae are erect. This point which was mentioned earlier also holds for the simple pits of L.caesar and L.illustris.

Fig.10: This is a section (x90) through the antenna of British L.sericata. It illustrates that region of the third segment which bears the apertures to the compound pits.

Fig.11: The same section at higher magnification (x350) shows the density of the protective bristles and sensory hairs which cover the antennal surface. Bristles packing the entrances to the pits are also visible, as is the inner cuticle.

Fig.12: A silver impregnated section (x260) showing the path of the antennal nerve together with some of its branches. In the upper right hand corner is a dense mass of sense cells surrounding two pits. The dark broken line parallel with the outer wall is the inner cuticle.

Figs. 13 and 14: Silver impregnated sections (x350) showing the sensory apparatus of the pits. No apertures to the exterior are visible. Fig.13 shows the sensory pegs distinctly, together with the compound nature of the pits. Each compartment is separated from its fellows by stout ridges topped with bristles. The darkly stained bodies beneath the pegs are the nuclei of the sensory cells, one of which is associated with each peg. An alteration in focus brings out, in Fig.14 the elongated nuclei of the antennal nerve trunk on the right-hand side. A single nerve fibre can be seen passing from each of the sense cells.

Fig.15: The above section (x800) shows very little extra detail. Each peg is distinctly seen to be associated with an individual nerve cell. The small mounds on which the individual pegs stand are also visible.

Fig.16: This reproduces a drawing made from a silver-impregnated section under an oil-immersion lens. It was possible to relate only a small number of fibres and to follow them to the point where they join and eventually meet the main nerve trunk. Most of the fibres, however, disappeared out of the section and so were visible for a very short part of their course.

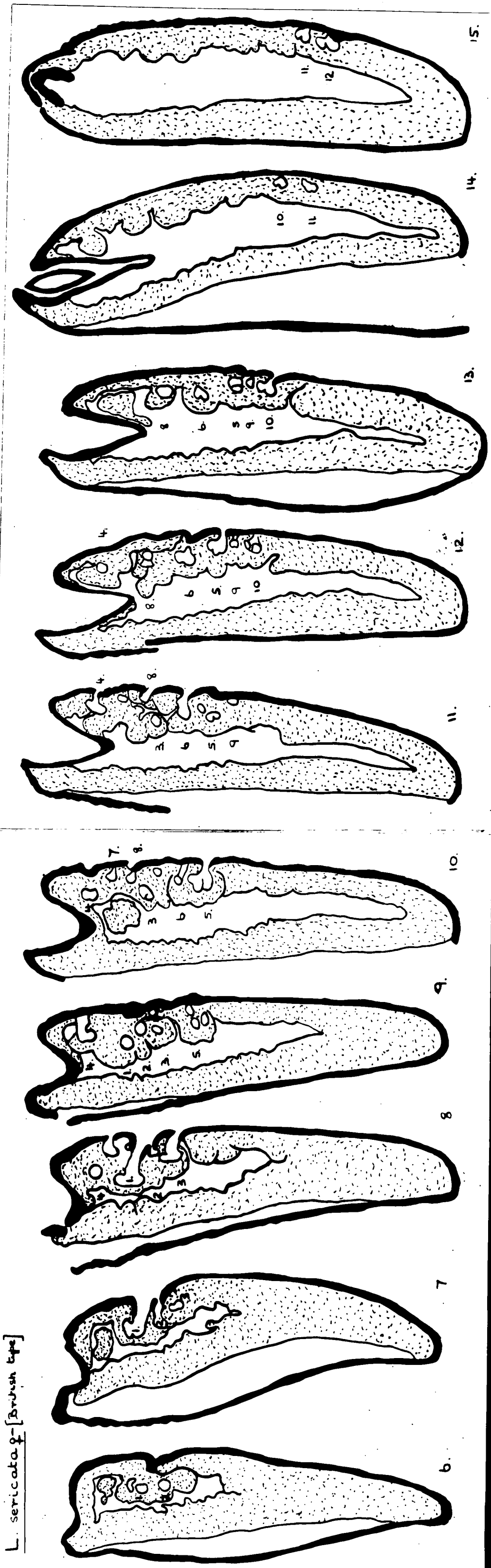

L. sericata ♀ - [British type]

FIG. 5.

L. sericata ♀ [Australian type.]

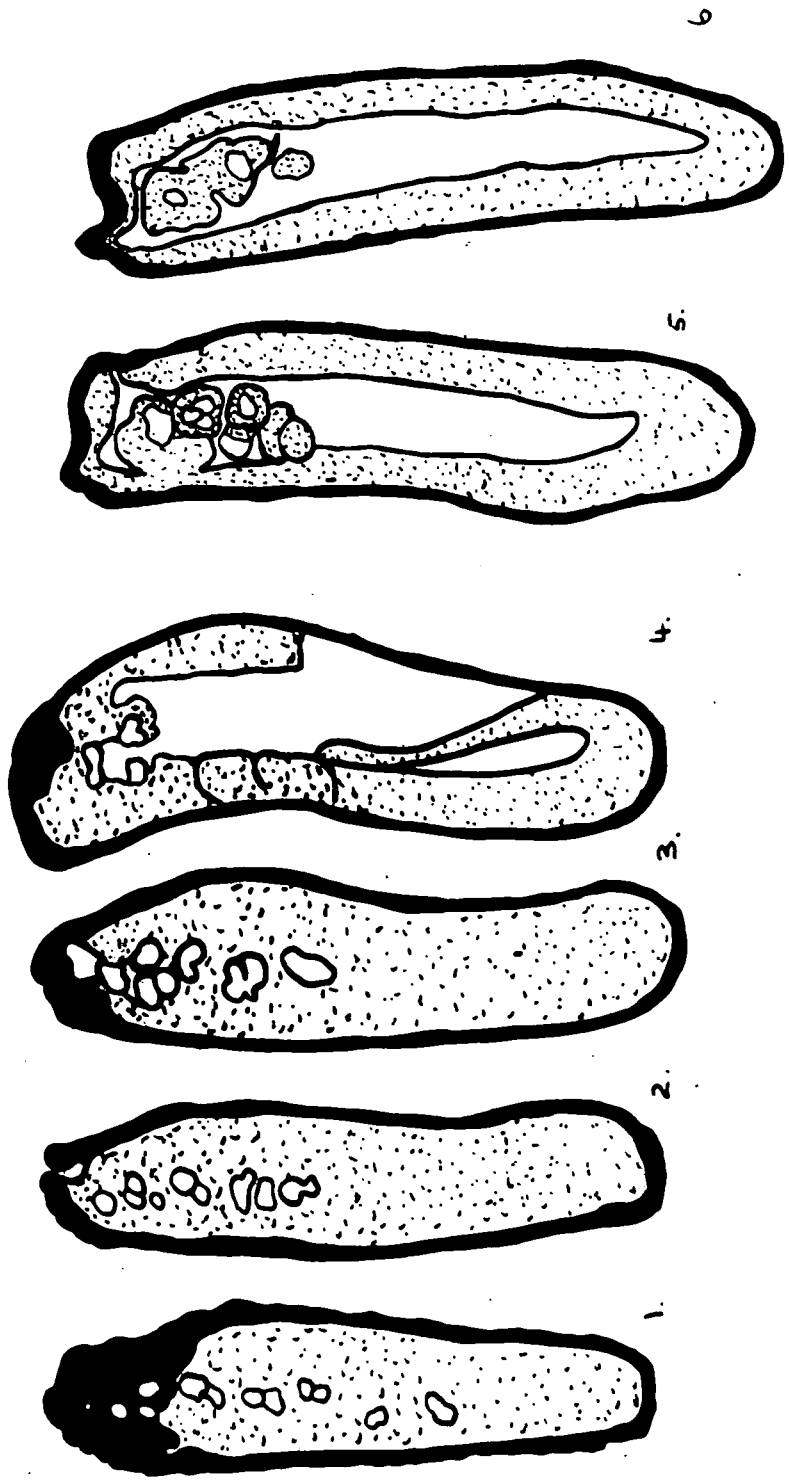

FIG. 6.

L. cuprina. ♀

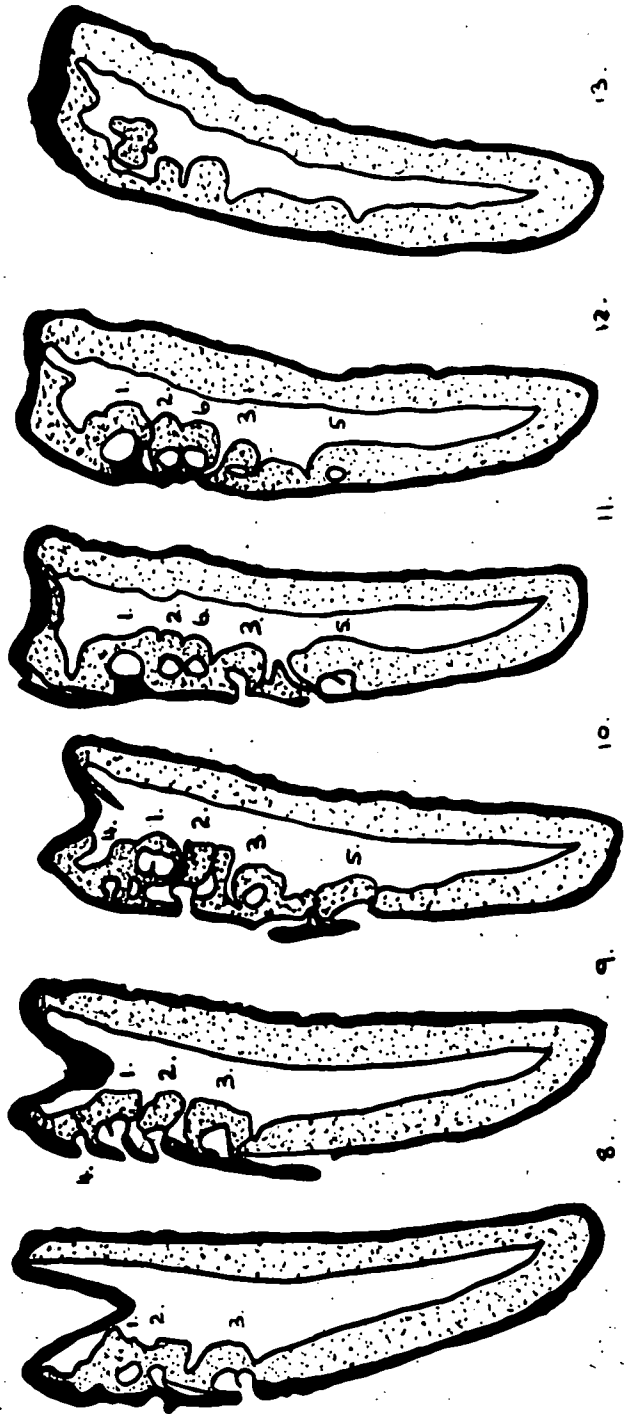
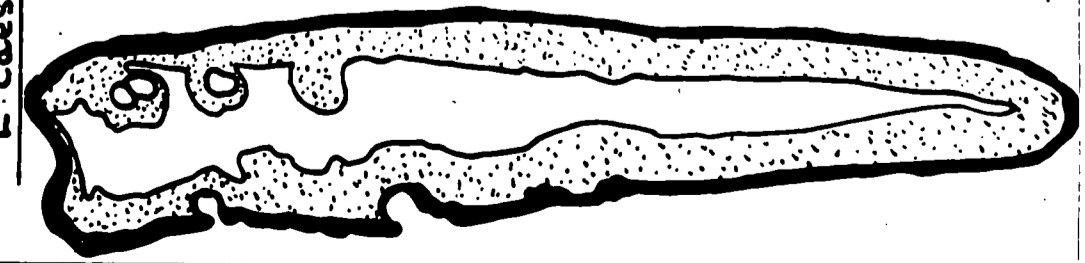
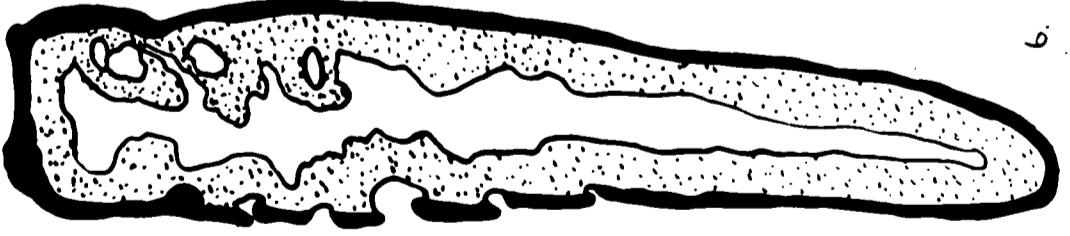

FIG 7.

L. caesar ♀



5.



6.

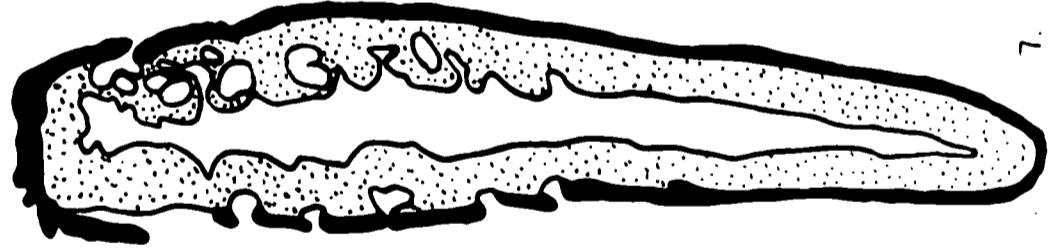

7.

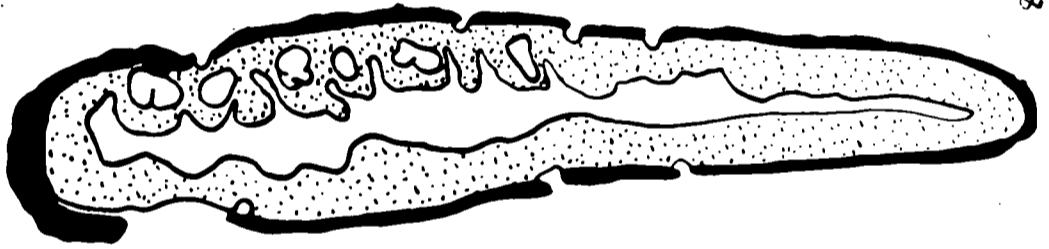

8.

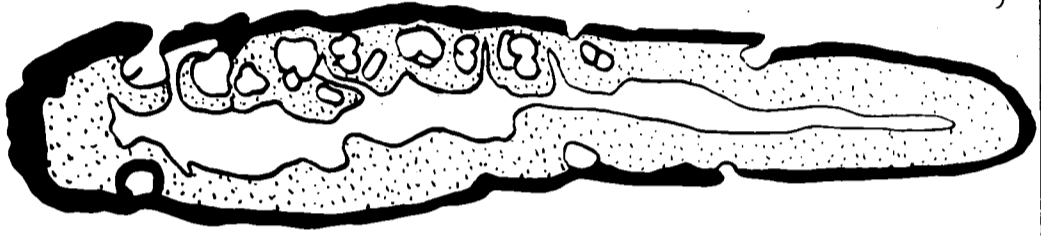

9.

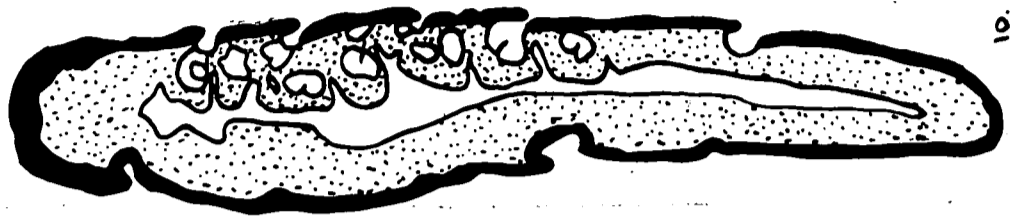

10.



11.

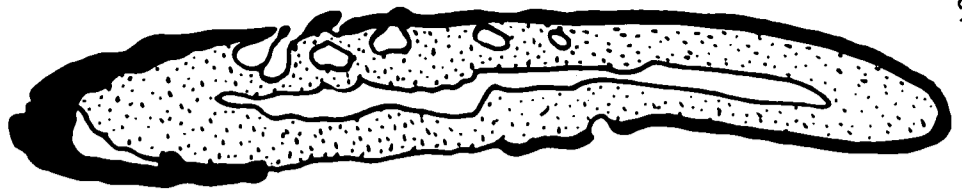

12.

FIG. 8.

L. illustris. ♀

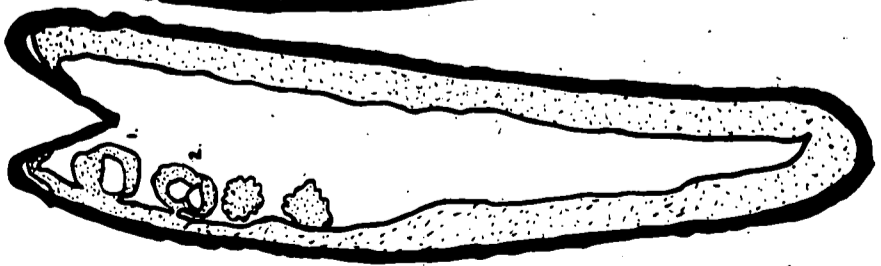

13.

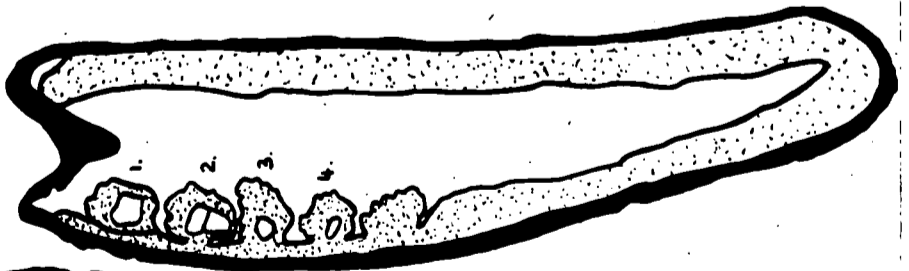

14.

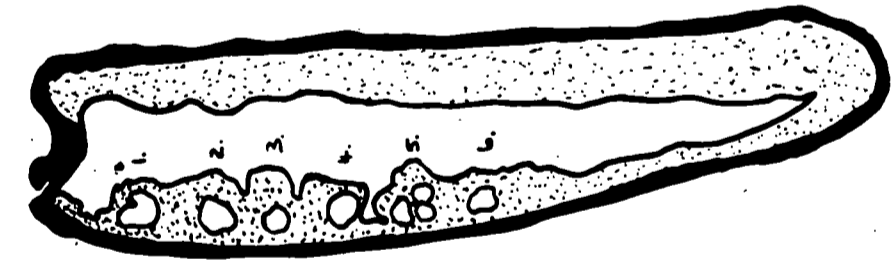

15.

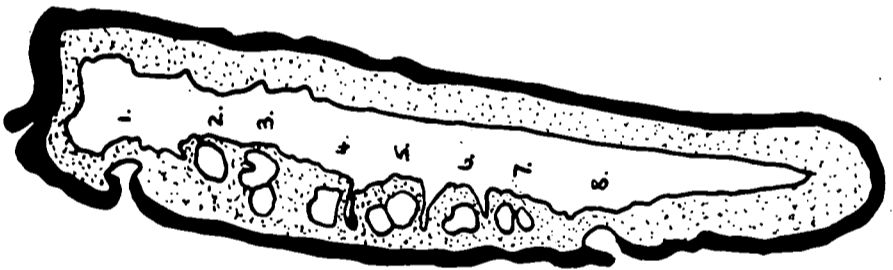

16.

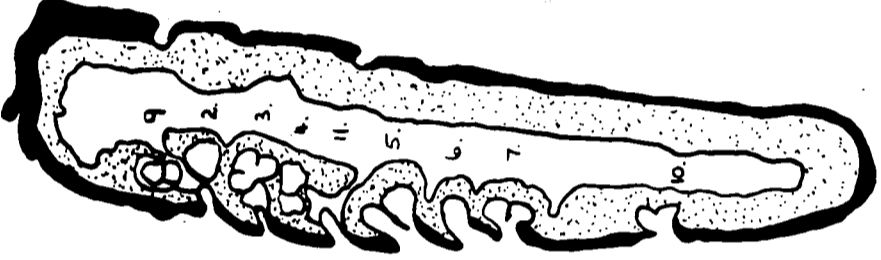

17.



18.



19.

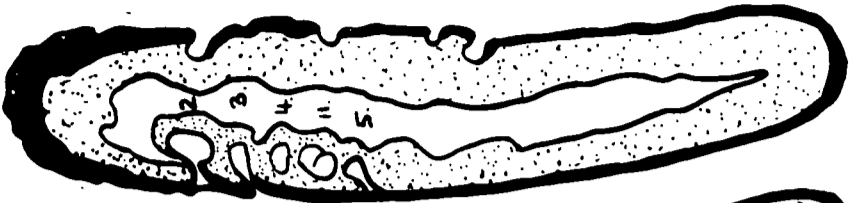

20.

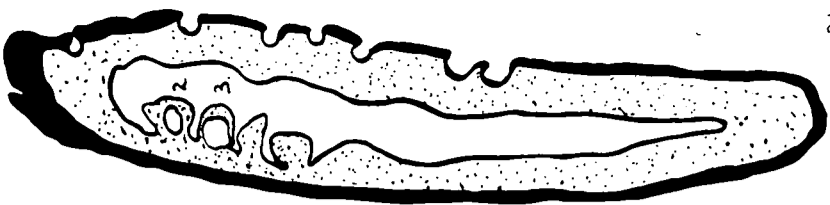

21.

FIG. 10.

L.S. (x90) showing the entrances from the exterior to the compound pits. The inner cuticle is also visible.

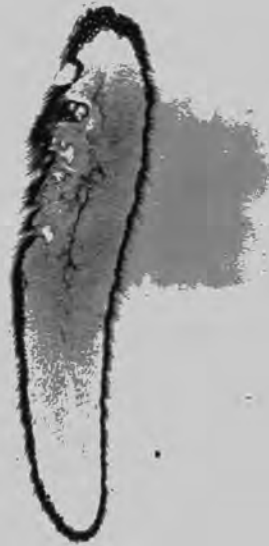
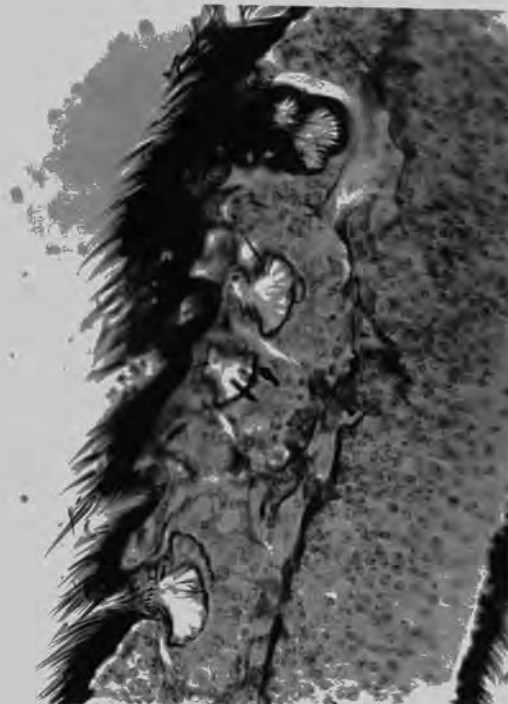

FIG. 11.

L.S. (x350) to show the hairy covering of the outer cuticle, and the bristles which protect the pits.



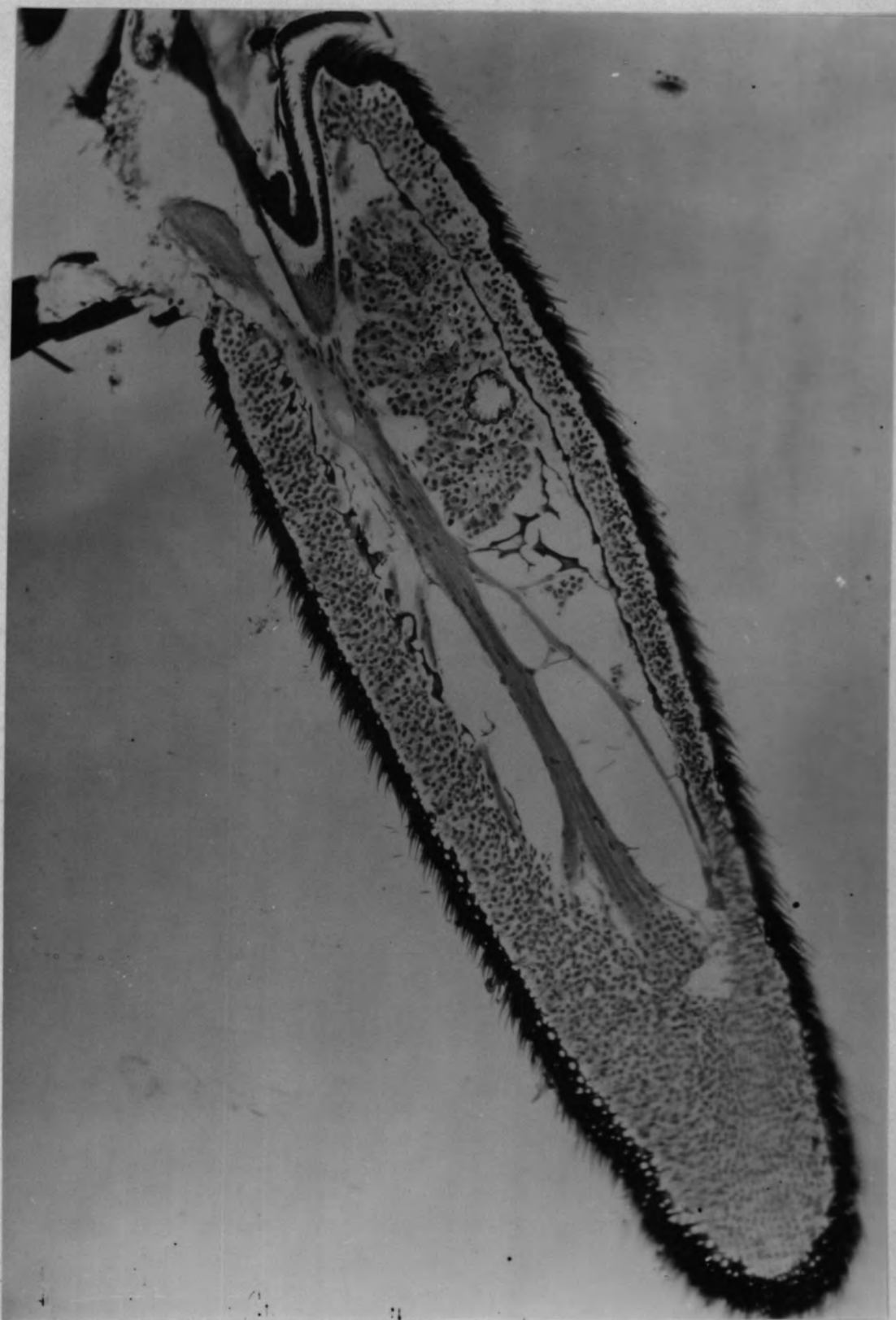

FIG. 12.

L.S. (X260), silver-impregnated to show the antennal nerve, together with some of its branches. A sensory pit surrounded by sense cells is visible, top right.



FIG. 13. (X350)

L.S. showing sensory processes inside the pits. The ridges separating the pit compartments + their associated bristles also visible.



FIG. 14. (X350)

L.S. to show nuclei of the antennal nerve, the inner cuticle, + the nerve fibres passing from the sense cell beneath each sensory peg.



FIG. 15. (X800)

Taken from L.S. to show the arrangement of the sensory pegs within the pits + the association of a sensory cell with each peg.

BRITISH *LUCILIA sericata*.

H.P. Drawing of section of
3rd antennal joint showing
detail of an olfactory pit.

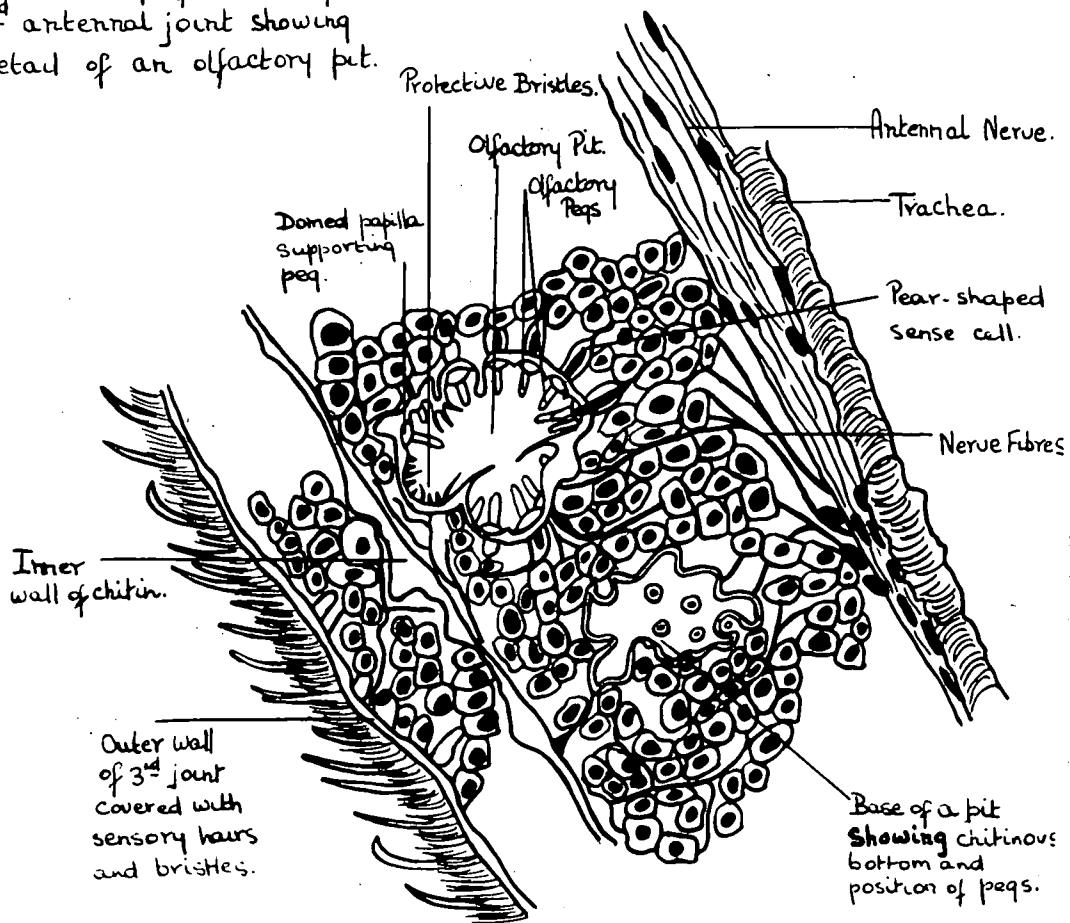

FIG. 16.

SUMMARY.

1. The divergence of opinion on the location of olfactory receptors in insects, which existed until recently, is summarised.
 2. McIndoo's studies on blowfly olfaction are criticised, from the point of view of both method and apparatus.
 3. Experiments involving antennal loss in L.cuprina and L.sericata are described. The results obtained indicate that removal of the antennae results in both species being unable to orientate towards a natural odour.
 4. Some evidence is obtained which indicates that after antennal loss, under certain conditions, the tarsal contact receptors provide a means of orientating towards fleece in the choice-chamber.
 5. The morphology and histology of the antennae of 5 *Lucilia* species is described. The structure of the compound pits in the third segment is dealt with in detail. Attention is drawn to an apparently chitinous structure within this segment, not hitherto described. Its function is suggested as one of support or protection for the sensory pits and their nerve supply, both of which lie internal to it.
 6. A relationship between the amount of sensory apparatus and the habits of particular species of the genus *Lucilia* is not apparent from the histological studies.
-

GENERAL DISCUSSION

The apparatus originally set up in Durham for use in observing olfactory responses was the Y-tube olfactometer, which has been described. As the experiments which made use of it show, it proved wholly unsatisfactory for obtaining dependable results. The chief failure of the apparatus, as observations on the course of the two air-streams inside it indicated, was that the insects were seldom, if ever, presented with a clear-cut choice. The presentation of such a choice is the whole purpose of an olfactometer of this type and since it failed in this respect, it was useless. Aside from this, other considerations were that the technique involved in using the apparatus was severe on the insects; and also, that the response obtained was of a low order, because large numbers failed to select either of the two traps.

It has been generally agreed since 1934 when Hoskins and Craig studied the requirements of an insect olfactometer, that the apparatus must be of a type which produces a response of a high order. Even when the stem was blacked-out (a modification not recorded by Crombie, 1943) the Durham Y-tube did not meet this essential, and large numbers of insects continued to wander and settle there.

Because of the severity of experimental conditions, all the Durham flies were allowed recovery time after being put through the apparatus. Yet they never again appeared as

active as in the first run through the olfactometer. Crombie realised this difficulty and noted that most of his insects died in less than half their normal span of life. But he continued to put most of his flies through the apparatus four times, and in the later experiments with menthol, anything between two and ten times. There is no mention of a recovery period being allowed, and it must be assumed that the tests were made consecutively. It is therefore reasonable to suppose that many of the insects were abnormal, particularly as the tests involved the use of concentrated menthol.

Criticisms of technique, however, may be often only a matter of opinion; but it was established beyond doubt that the experimental conditions within the Durham Y-tube were completely unsatisfactory. The fact that this is not necessarily always so with a Y-tube olfactometer has been demonstrated by Thorpe and Jones (1937) and Thorpe (1938 and 1939). This immediately suggests that the turbulence and other disturbances observed in the Durham apparatus might have resulted from an uneven internal surface, and this, most probably, the result of increasing the bore of the tube to accommodate large insects. Whatever the cause of the disturbances, however, an apparatus which would either avoid or overcome the difficulties encountered in the Y-tube was necessary before olfactory studies could begin.

A solution to much of the problem was found in the charcoal choice-chamber. This provided for the flies an area on which test substances could be exposed alongside a neutral area, with an olfactory gradient passing from one to the other. Using this apparatus, it was possible to observe the experimental flies as individuals. This fact soon made it clear that attractants possess varying degrees of attractiveness for separate individuals of the same population, in spite of the uniformity of breeding and experimental conditions. The nature of the apparatus made it necessary to use relatively small quantities of test materials in order to avoid saturation of the air in the arena. This was an advantage in that it reduced the risk of obtaining results from insects rendered abnormal by over-exposure to the olfactory stimuli being tested. When a natural substance such as fleece was used, or dilute concentrations of other materials, the charcoal adsorbed efficiently and was not rapidly exhausted. Some tests with fleece, designed to observe possible diffusion in the arena, indicated that even after sixty minutes, a gradient still existed. The insects continued to respond to the fleece as readily at the end of this time as at the outset of the readings.

One failure attached to the choice-chamber, and this was its inability to test the responses of insects in a moving air-current. But apart from this limitation, the

apparatus, and the experimental technique which developed with it, provided most of the conditions which have come to be regarded as necessary in olfactory studies. And, perhaps not least important, the insects emerged from the apparatus after testing without showing any signs of injury or abnormality.

With a suitable apparatus established, some mutilation experiments were performed on blowflies of the species L. sericata and L. cuprina. These indicated that for the two species named, olfactory perception is centred in the antennae. Later histological studies showed that the antennae are richly supplied with sense organs.

It is now realised that in insects in general, the antennae, although primarily concerned with olfaction, are also provided with sensilla capable of response to other stimuli. Examples include the tactile hairs and temperature receptors on the antennae of Rhodnius, described by Wigglesworth and Gillett (1934), and the hygrometers on the antennae of Coleoptera, described by R6th and Willis (1951). Some experiments on L. sericata in the course of the present work showed that antennal-loss rendered these insects incapable of orientating themselves in a humidity gradient. Steiner (1942) has shown that in the blowfly Phormia regina, the antennae act as both olfactory and humidity receptors; without the antennae this insect responds to gustatory and visual stimuli only.

It is probable, therefore, that in the insects studied during the work described here, the receptors observed on the third antennal segment are not all concerned with olfactory perception. It is not yet possible to be definite about the exact location of this sense, although the pegs of the compound pits with their thin and permeable composition immediately suggest themselves as olfactory organs.

Liebermann's survey of the antennae of the Muscids is based on the assumption that all the sensory pegs on the third antennal segment are concerned with olfactory perception. On this basis, the results of his work suggest that a relationship exists between the number of pegs and the mode of life of particular insects. No correlation of this kind has emerged during the present work, although the species involved are rather closely related in their oviposition habits. If the ability to perceive relatively faint odours is based on a numerical advantage in sensory equipment, as Liebermann's thesis suggests, it is impossible to explain the differences in behaviour between the sheep blowflies, and the less specific blowflies like L.caesar and L.illustris. The two latter are as well equipped in the sensory apparatus of the third antennal segment as L.sericata and L.cuprina. An alternative explanation, based on the present work, suggests that the perception of olfactory stimuli has a qualitative rather than a quantitative basis. As described

earlier, the olfactory organs are recognised as chemoreceptors of extreme sensitivity, capable of stimulation by very dilute concentrations of odourous material. It is therefore suggested that insects with definite and specific habits have become highly sensitized to the odours associated with their particular mode of life, and are responsive to them, even when they are extremely dilute. Consequently, their behaviour is determined, not so much by the number of olfactory receptors that they possess, as by the sensitization of the insect to specific odours.

There exists evidence that the olfactory responses of insects are not static, and that they can be modified, with the result that certain individuals may be induced to tolerate or even select an odour which originally was repellent to them. Crombie (1943) reported that 'tolerance' of menthol odour developed in some of his experimental insects. Thorpe (1939) using 0.5% peppermint essence succeeded in producing a positive conditioning in Drosophila melanogaster adults, so that the olfactory responses which they made showed a small but marked attraction towards the test odour. Certain experiments carried out during the present work involved the breeding of blowfly larvae on a menthol medium. Subsequent tests showed that the olfactory responses of the adults to this substance had been modified slightly. A very dilute quantity of menthol (0.2%) was used. There were some

indications that 'tolerance' of the new odour was achieved by a few individuals. But the responses of the conditioned samples, as a whole, continued to show a marked repulsion from the menthol odour, although not so marked as in the control samples.

Examples of divergence of habit within a species occur naturally and are well known. The fact that a similar effect can be induced experimentally, offers some explanation of the origin of biological races as described by Thorpe (1930 and later). In olfactory conditioning resulting from larval association with a natural odour, the experiments described in the present work cannot be compared exactly with those of Thorpe. In the conditioning of Nemeritis to the odour of Meliphora which he describes, Thorpe induced a response to a hitherto unknown odour, by breeding the larvae on an abnormal host. The experimental insects showed signs of, to quote Thorpe, "becoming accustomed to" an odour which they associated with satisfactory environmental conditions. In the larvae of L. sericata and L. cuprina which were bred on sheep for the Durham experiments, the host odour was already familiar to the adult insects, and is one which is specifically attractive to them under certain conditions in the field. But it was possible that the initial attractant response would be increased as a result of a larval existence passed on a living sheep. Before pursuing discussion of this

aspect of the olfactory work, it must be emphasized that the Durham conditioning experiments were not carried beyond the preliminary phase, and so comparatively few results are available. At the very least, however, those results indicate that larval conditioning on a living sheep cannot be definitely ruled out as a possible influence on the olfactory responses of the adult blowfly. They suggest, rather, that there may be a tendency for blowflies which are bred on living sheep to be more strongly attracted to samples of fleece. There is also a suggestion that a modified response is apparent in their offspring. This indicates the possible importance of attempting to condition several succeeding generations.

The blowfly problem in Australia is of particular interest in this context, since it is of comparatively recent development. One explanation has been put forward by Froggatt who attributed the sudden development of the problem there to the large numbers of sheep carcasses which were available after a severe drought. This hypothesis admits the existence of a conditioning effect. But it seems an over-simplification of the problem to attribute its origin entirely to the presence of sheep carcasses; and in any case, Tillyard and Seddon (1933) have stated that during droughts, the carcasses become rapidly unsuitable for Blowflies. The

same writers, in discussing the development of sheep-breeding for wool, point out that breeders have unwittingly increased the attractiveness of such sheep. This has been achieved by selecting animals with a dense fleece, and also by producing a breed whose skin is thrown into folds, thereby increasing its wool-carrying capacity. The fleeces of such sheep tend to hold moisture, and in the breech, the products of excretion retained there result in persistent dampness and soiling.

Mention should be made here of the work of Cragg (1950) on *Lucilia* species under Danish conditions. He observed that, while *L. sericata* was attracted to sheep whose attractiveness had been enhanced by chemical methods, at no time was either the blowfly activity, or the number of egg batches recorded, equal to those observed with British *L. sericata*. And, as is well known, sheep myiasis is of very infrequent occurrence in Denmark.

It is suggested that some explanation of both the development and non-existence of the blowfly problem respectively may be found in the conditions prevailing in the two countries. In Australia, large populations of particularly attractive and susceptible sheep were available. This, in conjunction with what is known of experimentally produced divergence of habit, appears to offer some explanation of the association which has developed between

blowflies and living sheep. In Denmark, on the other hand, flocks of sheep tend to be small. Under natural conditions, they seldom become attractive to blowflies. This seems to be, in part, associated with the dry warm climate which prevails there, and also with the microclimate of the fleece. In such circumstances a L. sericata population has very little stimulus to visit sheep unless their attractiveness is artificially enhanced. This means that the blowfly population is not normally reared on sheep and there is a tendency to produce succeeding generations of insects which complete their cycle on available carrion more readily than on the living sheep.

The bulk of the present work involved a laboratory study of a variety of blowfly species and their responses to samples of fleece. It was found that the laboratory behaviour of these insects agreed with, and in some measure explained, what is known of them in the field.

The British strain of L. sericata and L. cuprina are the two species for which the attractiveness of fleece is most marked. This is consistent with their behaviour in the field in Great Britain and Australia respectively, where they are responsible for a problem of economic importance.

L. caesar, L. illustris and C. vomitoria, none of which is acknowledged as a sheep-pest in this country, are marked off by their behaviour in the laboratory as a distinct group.

The behaviour of L.caesar in the laboratory, at least in part, fits in with what is known of its activity in those localised areas where it strikes sheep in Great Britain. It was apparent, during the experiments, that a very small number of individuals in each sample was active towards samples of fleece. MacLeod (1943) lists L.caesar as an 'alternative' striking species, occurring with sufficiently high frequency to be of economic importance in certain regions, such as the north and north-west of Scotland, and northern England. Bracken and heather-type grazings appear to be associated with the special conditions which result in L.caesar causing strike. It has been suggested that bracken fronds often become tangled in the neck wool. If these decay, they may render the sheep abnormally attractive. Secondary strikes by L.caesar, on sheep already struck by L.sericata, are also quite common. This type of behaviour may be explained by the fact that certain L.caesar individuals do exist which appear to respond to the attractiveness of fleece. Where these coincide with a sheep of heightened attractiveness, and with the climatic factors which enhance it, the conditions required for attraction and oviposition to occur are provided.

The Australian L.sericata occupies an intermediate position. It is significantly different, in its behaviour to fleece, from the British strain, and also from the caesar-illustris group to which it has been likened. In the field

this fly is not known to initiate an attack on living sheep, but it oviposits on sheep already suffering from myiasis when they are consequently more than normally attractive. A comparison of the two Australian species studied illustrates a situation in which, under natural conditions, L.cuprina has a biological advantage. Being an insect of hot and arid regions, for which L.sericata is unsuited, it populates those areas to which the pure Merino breed is most suited. Sheep are excluded from the coastal regions because the humidity factor which would favour L.sericata also makes these areas ideal for agriculture and dairy farming. In the few regions where the two species exist side by side, L.sericata is recognised as secondary in importance to L.cuprina. Although described as morphologically similar to the British L.sericata, the Australian strain responds to the attractiveness of sheep (in the field) and fleece (in the laboratory) at a level low enough to mark it off as different in behaviour from the species as it exists in western Europe.

The two Danish strains of L.sericata differed from each other consistently through the series of experiments, although the difference is not significant. The 'city strain' is markedly different from the British one, although those trapped in the Mols area can be induced to oviposit on sheep under certain conditions. The fact that the Danish 'city strain' is less responsive to samples of fleece may be

correlated with the fact that they come from an area where sheep are not available. What would be of interest in this connection, and what has not yet been possible, would be the opportunity to compare the behaviour of city-trapped British L. sericata with that of a strain from a sheep-farming area.

Summarising the conclusions drawn from this work, it can be said that although the activity of a blowfly population with regard to sheep is related to many factors, among the most important of these are climatic conditions. In the effects they produce these may act so as to favour the insect concerned biologically; or they may, together with ecological factors, aid in producing more than normally attractive sheep, or sheep which are remarkable for their lack of natural attractiveness. In the uniformity of the laboratory, both in the conditions of breeding and of the experimental apparatus, the divergence in behaviour of the species continued to be apparent, and to reflect the diversity of blowfly behaviour as it is known from field studies in the regions represented by the flies. And there remains the possibility, which on the strength of the evidence it is possible neither to accept nor dismiss, that a conditioning effect is at work. If so, it must operate alongside the ecological factors in those regions where sheep myiasis is common, tending to promote its incidence.

REFERENCES.

- Abbot C.E. 1927(a): Experimental data on the olfactory sense of Coleoptera.
Ann. ent. Soc. Amer; 20. p.207.
- Barrows W.M. 1907 : The reactions of the pomace fly *Drosophila ampelophila* Loew, to odourous substances.
J. exp. Zool; 4. p.515.
- Cannon H.G. 1941 : On Chlorazol Black as a stain for 'Chitin'.
J.Roy. Micr.Soc. 61. p.88.
- Cragg J.B. and Ramage G.R. 1945 : Chemotropic studies on *L. sericata* (Mg) and *L. Caesar* (L).
Parasitology 36. p.168.
- Cragg J.B. and Thurston B.A. 1950 : Reactions of blowflies to organic sulphur compounds and other materials used in traps.
Parasitology 40. p.187.
- Cragg J.B. 1950 : Reactions of *L. sericata* (Mg) to various substances placed on sheep.
Parasitology 40. p.179.
- Cragg J.B. and Cole P. 1952 : Diapause in *L. sericata* (Mg) Diptera.
J.exp. Biol. 29. p.600.
- Crombie A.C. 1943 : On the measurement and modification of the olfactory response in blowflies.
J.exp. Biol. 20. p.159.
- Crow S. 1932 : The sensitivity of tarsi to sucrose in the Calliphoridae.
Physiol. Zool. 5. p.16.
- Dethier V.G. 1947 : "Chemical Insect Attractants and Repellents".
London.

Eidmann H. 1922 : Die Durchlässigkeit des Chitins bei osmotischen Vorgängen.

Biol. CBl., 42. p.429.

Eltringham H. 1933 : On the tarsal sense organs of the Lepidoptera.

Trans. Roy. Ent.Soc., 81. p.33.

Frenay M.R. 1934 : Studies on the Merino Fleece.

1. The Chemistry of Suint.

J.Soc. of Chem,Industry. Vol.53,No.18,p.131

Frenay M.R. 1937 : Studies on the chemotropic behaviour of sheep blowflies.

Pamphl.Coun.Sci.Industr.Res.,Aust.,
74. pp. 1-24.

Frisch K.von. 1919 : "Über den Geruchssinn der Bienen und seine blutenbiologische Bedeutung.

Zool. Jahrb.(Physiol) 37. p.1.

Garrett H.E. 1951 : "Statistics in Education and Psychology".

New York.

Gunn D.L. and Pielou D.P. 1940 : Humidity reactions of the meal worm beetle *Tenebrio molitor* (L.).

1. Reactions to differences in relative humidity.

J.exp. Biol. 17. p.286.

Gurr G.T. 1952 : "Biological Staining Methods".

London.

Hafez M. 1950 : Behaviour and sensory physiology of the house-fly larva, *Musca domestica* (L.)

Parasitology 40 p.215.

Hartung E. 1935 : On the orientation by smell in the *Calliphora* Dipt.

Z. vergl. Physiol. 22. p.119.

Hobson R.P. 1935 : Substances which induce *L. sericata* (Mg.) to oviposit on sheep.
Ann. Appl. Biol., 22. p.294.

Hobson R.P. 1936 : Observations on the chemotropism of *L. sericata* (Mg.)
Ann. Appl. Biol., 23. p.845.

Hobson R.P. 1937 : Chemotropic tests carried on in 1936.
Ann. Appl. Biol., 24. p.627.

Hobson R.P. 1938 : Observations on the development of eggs and oviposition in the sheep blowfly *L. sericata* (Mg.)
Ann. Appl. Biol., 25. p.573.

Holdaway F.G. 1933 : Differential behaviour of *L. sericata* (Mg.) and *L. caesar* (L.) in their natural environments.
J. Anim. Ecol., 2. p.263.

Hoskins W.M. and Craig R. 1934 : Olfactory responses of flies in a new type of insect olfactometer.
J. Econ. Ent., 27. p.1029.

Lefebvre A. 1938 : Note sur le sentiment olfactif des antennes.
Ann. Soc. ent. Fr., 7. p.395.

Lennox F.G. 1939 : The development of a synthetic medium for the aseptic culture of *L. cuprina* larvae.
Pamphl. Coun. Sci. Industr. Res., Aust., No. 90

Leydig F. 1860 : Geruchs - und Gehörorgane der Krebse und Insekten.
Arch. f. Anat. u. Physiol., p.265.

Liebermann A. 1925 : Correlation zwischen den antennalen Geruchsorganen und der Biologie der Musciden.
Z. Morph. Ökol. Tiere. 5. p.1 - 97.

Mackerras I.M. and Mackerras M.J. 1944 : The attractiveness of sheep for *L. cuprina*.
Bull. Coun. Sci. Industr. Res., Aust. 181
p. 1-44.

- Maldwyn Davies W. 1934 : The sheep blowfly problem in N.Wales.
Ann.Appl. Biol., 21. p.267.
- Marshall J. 1935 : The location of olfactory receptors in insects.
Trans. R. ent.Soc.Lond., 83. p.49.
- Minnich D.E. 1929 : Chemical sensitivity of the legs of the blowfly *Calliphora vomitoria* Linn; to various sugars.
Z. vergl. Physiol., 11. p.1.
- Minnich D.E. 1931 : The sensitivity of the oral lobes of the blowfly *C. vomitoria* Linn. to various sugars.
J. exp. Zool., 60. p.121.
- McIndoo N.E. 1928 : Responses of insects to smell and taste and their value in control.
J.Econ.Ent. 21. p.903.
- McIndoo N.E. 1933 : Olfactory responses of blowflies with and without antennae in a wooden olfactometer.
Amer. J. Agr.Res., 46. p.607.
- MacLeod J. 1937 : The nature, epidemiology and control of sheep myiasis in Britain.
J. comp. Path., 50. p.10.
- MacLeod J. 1943: Survey of British sheep blowflies.
1. Relation of strike to host and edaphic factors.
Bull. ent. Res., 34. p.95.
- Roth L.M. and Willis E.R. 1951 : Hygroreceptors in adults of *Tribolium* (Coleoptera, Tenebrionidae).
J. Exp. Zool., Vol.116, No.3. p.527.
- Steedman H.F. 1947 : Ester wax as an embedding medium.
Quart.J. Microsc.Sci., 88. p.23.
- Steiner G. 1942 : Methodische Untersuchungen über die Geruchsorientierung von Fleischfliegen.
Z. f. vergl. Physiologie 30. p.1.

Stewart A.W. 1922 : "Some Physico - Chemical Themes."
Adsorption Phenomena.
London.

Thorpe W.H. 1930 : Biological races in insects and allied
groups.
Biological Reviews. 5. p.177.

Thorpe W.H. and Jones F.G.W. 1937 : Olfactory conditioning
in a parasitic insect and its relation to host selection.
Proc. Roy. Soc. B. 124. p.56.

Thorpe W.H. 1938 : Further experiments on olfactory
conditioning in a parasitic insect.
Proc. Roy. Soc. B. 126. p.370.

Thorpe W.H. 1939 : Further studies on pre-imaginal
olfactory conditioning in insects.
Proc. Roy. Soc. B. 127. p.424.

Thorpe J.F. and Whiteley M.A. 1938 : "Dictionary of
Applied Chemistry." Active Charcoal and its properties.
Vol.11 p.315.

Tillyard R.J. and Seddon H.R. 1933 : The sheep blowfly
problem in Australia.
Rept. No.1. Pamphl. Coun.Sci.Industr.
Res., Aust., 37 pp. 1 - 136.

Varley G.C. and Edwards R.L. 1953 : An olfactometer for
observing the behaviour of small animals.
Nature. Vol. 171. p.789.

Waterhouse D.F. and Paramonov S.J. 1950 : The status of
the two species of *Lucilia* (Diptera, Calliphoridae)
attacking sheep in Australia.

Aust. J.Sci. Res., Series B., Vol.3 p.310

Wigglesworth V.B. and Gillett J.D. 1934 : Temperature
receptors in *Rhodnius*.

J.exp. Biol., 11. p.120.

Wigglesworth V.B. 1941 : Sensory Physiology of the human louse.
Parasitology 33. p.67.

Wigglesworth V.B. 1950 : "Principles of Insect Physiology".
London.

Willis E.R. and Roth L.M. 1950 : The humidity reactions of *Tribolium castaneum* (Herbst.)
J.exp. Zool., 115. p.561.

A P P E N D I XTHE DEVELOPMENT OF A BREEDING MEDIUM AND TECHNIQUE.

The sterile synthetic medium described by Lennox (1939) was developed for rearing L.cuprina larvae, and the technique adopted in Durham was based on this, see Cragg and Cole (1952).

The first batches of larvae were fed on Lennox's enriched medium, which contained 93% blood serum dissolved in distilled water, 6.7% dry yeast and a trace of sodium chloride. This medium proved very suitable for rearing larvae of L.sericata and produced maggots which compared favourably in weight with those reared, in the normal way, on meat. It was, however, an unwieldy mixture to make up, and after several trials, a medium of the following type was evolved.

Fresh Blood Medium

100 ml. fresh slaughter-house blood
7 ml. distilled water
6.7 g. dry brewer's yeast
0.5 g. agar-agar
0.3 g. sodium chloride
0.3 g. potassium phosphate

Method:

All the dry materials were put in a 250 ml. flask and shaken up together. The blood and distilled water were then poured in. The flask was rotated gently, until all the dry materials were dissolved or in a fine suspension in the blood. A close fitting cotton wool plug was inserted in the neck of the flask which was then put in an autoclave for 15 minutes sterilisation at 15 lb. pressure. It was

very simple to make up a batch of flasks containing this mixture and autoclave them together. After 'cooking' the mixture was spongy and homogeneous in appearance.

Eggs were collected from meat in the breeding cages some 4 - 5 hours before being sterilised for the medium. At the end of this time they were separated in a solution of 1½% aqueous sodium sulphide for 15 minutes. The sulphide was drained off and the eggs washed in sterile distilled water and poured into a sterile filter in a suction flask, the filter being covered with a lid. When the water drained away, the eggs were covered with 3% Lysol for 2 minutes. After removal of the Lysol, the eggs were washed several times with sterile distilled water and finally transferred on a sterile platinum loop to the flasks containing the blood medium. The neck of the flask was flamed before the plug was replaced.

A Menthol Medium:

A menthol medium was prepared in which 0.2 g. menthol crystals dissolved in 7 ml. absolute alcohol was added to the original mixture and autoclaved.

In order to find out how much, if any, of the menthol survived the sterilisation, 0.2g menthol crystals were dissolved in absolute alcohol in a flask which was then plugged and autoclaved. Another, similar, solution was made up and used immediately to obtain rotations in the polarimeter - it showed a mean rotation of - 0.32. The

menthol solution which had been autoclaved evaporated entirely, but the flask was rinsed out with absolute alcohol and this solution put into the polarimeter -aamean rotation of - 0.06 was obtained. A clean flask was rinsed with absolute alcohol and the resulting solution gave a positive rotation of 0.12. Obviously, a large percentage of the menthol was lost during the autoclaving but sufficient remained to be detected by the polarimeter and therefore sufficient to affect the larvae during subsequent feeding on an autoclaved menthol medium.

