

Durham E-Theses

Tracer studies of reaction mechanisms -: the photolysis of acetone labelled with (14)c.

Brown, John.

How to cite:

Brown, John. (1956) *Tracer studies of reaction mechanisms -: the photolysis of acetone labelled with (14)c.*, Durham theses, Durham University. Available at Durham E-Theses Online:
<http://etheses.dur.ac.uk/9206/>

Use policy

The full-text may be used and/or reproduced, and given to third parties in any format or medium, without prior permission or charge, for personal research or study, educational, or not-for-profit purposes provided that:

- a full bibliographic reference is made to the original source
- a [link](#) is made to the metadata record in Durham E-Theses
- the full-text is not changed in any way

The full-text must not be sold in any format or medium without the formal permission of the copyright holders.

Please consult the [full Durham E-Theses policy](#) for further details.

THESIS

presented in candidature for the degree of

DOCTOR OF PHILOSOPHY

by

John Brown, B.Sc.(Dun.), A.R.I.C.

Being an account of work carried out at the Londonderry Laboratory for Radiochemistry, Durham University, (Durham Division), during the period OCTOBER 1952 - SEPTEMBER 1955, under the supervision of Mr. G.R. Martin.



P. 59

TRACER STUDIES OF REACTION MECHANISMS -

THE PHOTOLYSIS OF ACETONE LABELLED WITH ^{14}C .

Investigations of the primary process and the reaction of the radicals formed in the presence of added iodine and oxygen.

CONTENTS.

<u>Chapter</u>		<u>Page</u>
I	Introduction	1
II (a)	The Primary Process	3
	(b) The Photo-oxidation of Acetone	31
III	Aims of the Present Investigation	50
IV	Experimental Techniques	
	(1) Filling the Reaction Vessel	53
	(2) Irradiation	70
	(3) Analysis	75
	(4) Counting	96
V	Some Counting Problems	
	(1) Specific Activity of Acetone Used	106
	(2) Counter Memory	112
VI	The Photolysis of Acetone in the Presence of Added Oxygen	114
VII	The Photolysis of Acetone in the Presence of Added Oxygen and Iodine	124
	Appendix to Chap. VII - Determination of Formaldehyde	127
VIII	Discussion of Results	
	(1) Acetone-Oxygen	130
	(2) Acetone-Oxygen-Iodine	144
IX	Summary.	156
	Bibliography.	
	Equation Key.	
	Acknowledgments.	

I. INTRODUCTION.

The ultra-violet photolysis of acetone has figured prominently among the chemical researches of the past thirty years, along with similar studies on other, more complex, ketones. The inherent interest of these compounds is augmented, in the case of the lower members, (acetone - methylpropylketone), by the appearance in the reaction of organic free radicals which are intermediates in the formation of the final products.

Since these photodecompositions are known to be free from chain characteristics, (for a review of early work see Davis¹ and Noyes and Dorfmann²), they provide useful reproducible sources of such radicals and find application in the study of their properties. In particular, above about 100°C., the photodecomposition of pure acetone vapour gives one radical pair, (methyl + acetyl), for each quantum absorbed, i.e. the quantum yield of acetone decomposition is unity. However, before applying photolyses in this way it is prudent to investigate the conditions under which these radicals arise. Fairly recent investigations, by Martin and Sutton³ and Pitts and Blacet,⁴ have illustrated the fallacy of assuming that



the primary radical yield in the photolysis of pure acetone is necessarily maintained in the presence of other agents. Those of Martin and Sutton, which were performed in this laboratory, have shown that, in the presence of iodine, the quantum yield of acetone decomposition, Φ_d , falls well below unity at 100°C. To have assumed that unit quantum yield of each radical was made available, initially, for reaction with iodine would, in this case, have led to a misunderstanding of the true significance of the results. To be able to predict the radical quantum yield under any given conditions would require a more comprehensive knowledge of the mechanism of the primary process than has hitherto been available. The present work has therefore been directed towards extending the information available, in this context, on the photochemistry of the simplest ketone, acetone. Acetone was chosen because it was already well investigated in other directions and because of its simplicity, only one radical pair being possible regardless of which bond is broken.

II(a) THE PRIMARY PROCESS: A REVIEW.

Before defining more precisely the aims of the present work it is expedient to present the collected evidence, from a number of sources, on which the scheme was based. Since the voluminous nature of past publications on the photochemistry of acetone prohibits a comprehensive survey, an attempt has been made to present only that information which is strictly relevant, (a), to an understanding of the primary process and, (b), in providing a background to the experimental work envisaged.

PURE ACETONE.

The great weight of evidence now available on the ultra-violet photolysis of pure acetone vapour indicates, reasonably conclusively,^{1,2} that all the observed data can be explained on the basis of a single primary reaction

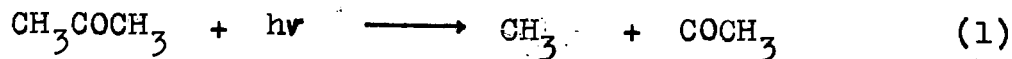

Two other reactions suggested in the past

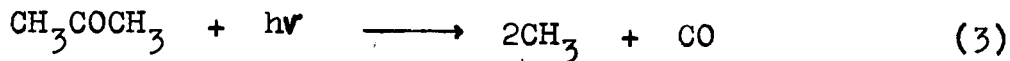
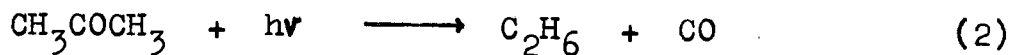

may be regarded as making a negligible contribution, if any, to the photodecomposition since, in the presence of

iodine,^{3,4} the quantum yield of carbon monoxide, Φ_{CO} , falls to a very low figure (≤ 0.01).

The reaction (1) certainly occurs at 2537 \AA and 3130 \AA , the two principal wavelengths used in past researches. Variations in the amounts of major products formed under changing conditions of temperature, pressure, and wavelength are explained by secondary reactions of the radicals in (1) computed on the basis of the experimental evidence. The validity of such deduced reactions is usually supported by predictions, from their kinetics, of values of quantum yields and rate constants which can be verified by experiment. Two such reactions are worthy of note here:

(a) At high temperatures, ($> 100^{\circ}\text{C.}$), the quantum yield of carbon monoxide, Φ_{CO} , is very nearly unity, and pressure independent, at either wavelength. In the absence of chain characteristics this leads to the assumption that the acetyl radical becomes increasingly unstable as the temperature rises and decomposes according to the equation

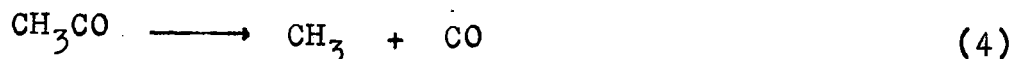

or alternatively

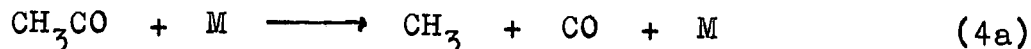

to the extent of almost 100% above 100°C. It follows that Φ_d , the quantum yield of acetone decomposition, is also virtually unity and that the reactions

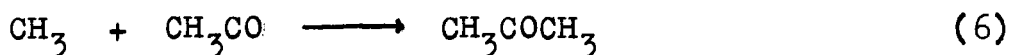

compete most unfavourably above this temperature.

(b) At low temperature, ($\sim 25^\circ\text{C}.$), the quantum yield of acetone decomposition is considerably reduced: at 3130\AA , at 100 mm. acetone pressure, it is approximately 0.3,¹ but appears to tend to unity as the acetone pressure tends to zero.

This has been explained in the past in terms of increasing efficiency of (6) with fall in temperature and increase in pressure rather than by a reaction which might reasonably inhibit the primary decomposition (such as the formation of a fairly long-lived intermediate excited state of acetone which could be increasingly subject to collisional deactivation by 'normal' molecules as the temperature falls). However, recent work,^{3,7,8} reviewed below, required mechanisms based on at least two excited species to explain the observed phenomena in two independent investigations with different added materials. Thus the presence of such excited modifications

has been reasonably established and the possibility has arisen that a comprehensive evaluation of their properties might well allow the explanation, on a single basic scheme, of the trend of results in the photolysis under any conditions of temperature, pressure, wavelength, and added materials. In particular, in the photo-oxidation of acetone, to be discussed at length later, no satisfactory explanation of the results at room temperature has been previously advanced although tentative reaction schemes have been advanced for results obtained above 120°C.

PHOTOLYSIS OF ACETONE-IODINE MIXTURES.

The principal investigations into the photolysis of acetone in the presence of iodine have been carried out by Gorin,⁵ Benson and Forbes,⁶ Martin and Sutton,³ and Pitts and Blacet.⁴

The experiments of Gorin, and Benson and Forbes, were carried out using techniques inferior to those of the later workers, especially in the analytical departments of the work. A reassessment of Gorin's work, after correcting the calibration figure used in the original paper, showed his results to be improbably high and lacking agreement with those in (3) and (4). Similarly the results

of Benson and Forbes, after weighing carefully against the later results, can only be counted of limited qualitative importance. In the subsequent discussion, therefore, only the work of Pitts and Blacet, and Martin and Sutton, is referred to. Their results, obtained independently and by different techniques, show excellent agreement and, coincidentally, are complementary in presenting a fairly complete picture of the wavelength, temperature, and pressure dependence of the reaction yields.

The following is a summary of the main points arising from these results:-

- (a) No ethane was found at 100°C. at 3130Å, and 2654Å*, at the lowest pressure of iodine employed.
- (b) The overall quantum yield of methyl iodide, $\Phi_{\text{CH}_3\text{I}}$, was temperature dependent at 3130Å and constant (120 mm.) acetone pressure, rising from 0.12 at 80°C., to 0.28 at 177°C. Since the carbon monoxide quantum yields were very small, $\Phi_{\text{CH}_3\text{I}}$ was approximately the same as $\Phi_{\text{acetone decomposition}}$.
- (c) The methyl iodide quantum yield was wavelength dependent. At 100°C., at constant acetone pressure, (120 mm.) it rose from 0.17 at 3130Å to 0.50 at 2654Å.

* The wavelength 2654Å was presumably employed to obviate mercury resonance effects which are so troublesome at 2537Å.

- (d) The methyl iodide quantum yield at 100°C. was pressure dependent, decreasing with increase in the pressures of both acetone and iodine. The pressure of iodine required to reduce the quantum yield of acetone decomposition drastically below the value of unity was very small.
- (e) Small amounts of carbon monoxide were found at 3130Å, and at 2654Å, the amount increasing with decrease in wavelength, and pressure, and increase in temperature. However, even at 2654Å ϕ_{CO} did not rise above 0.06 at 100°C., and at 3130Å did not rise above about 0.020 even at low acetone and iodine pressures.
- (f) Traces of methane were recorded at the higher temperatures and shorter wavelength.

The analyses used to obtain these results differed in the two investigations but gave similar results where direct comparison was possible. The analytical methods were also rigorously checked with synthetic samples (of known strength) of the materials to be analysed. Neither set of workers was able to produce consistent acetyl iodide results yet the appearance of this compound would be expected in the near-absence of carbon monoxide. Pitts

and Blacet, however, were able to demonstrate that the apparent yields of acetyl iodide obtained from their photolyses gave no indication of the true yields. Analysis of synthetic samples, containing known amounts of acetyl iodide, showed that it decomposed very quickly in the presence of daylight and mercury, making accurate analysis impossible with the techniques available.

The main products of the reaction were, therefore, methyl iodide, acetyl iodide (by deduction), and small amounts of carbon monoxide, and, in the absence of ethane and methane,

$$\Phi_d = \Phi_{\text{CH}_3\text{I}} - \Phi_{\text{CO}}$$

This is true if the reasonable assumption is made that the acetyl radical cannot produce methyl iodide except by dissociation into carbon monoxide and a methyl radical.

Although much of the work covered in both cases overlapped, the experiments of Pitts and Blacet were organised in such a way that very little variation in acetone or iodine pressure occurred. Consequently it was left to Martin and Sutton to derive a mechanism which would explain the most difficult, but interesting, point (d) which was demonstrated in the course of their

work. It was of considerable significance that Φ_d , which in the absence of iodine was pressure and temperature independent above about 100°C ., became dependent not only on the added iodine pressure but on that of the acetone too.

MECHANISM.

In the straightforward photolysis of pure acetone vapour the absorption of a quantum of radiation at 3130\AA is followed by the formation of an electronically excited state of the acetone molecule which is unstable. To explain the observed results in the direct photolysis this state must dissociate, above 100°C ., to the extent of almost 100% into radicals, which give rise to the final products.

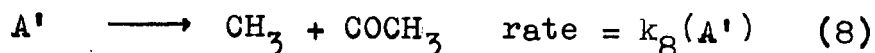

In the presence of iodine, however, the state A' can be converted into a second state which, though still excited, has different properties from A'

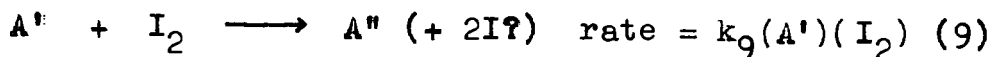

This state, A'' , which is identified with that sensitive to deactivation by iodine and acetone, presumably differs from its partner A' in being longer-lived, allowing the

following possibilities:

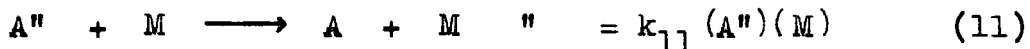
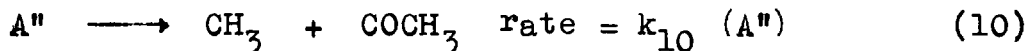

In the deactivation process, (11), M represents iodine or acetone and, if the deactivating efficiencies are assumed equal, then M can be equated to the total pressure in the system in kinetic calculations.

Secondary reactions postulated are:

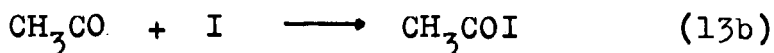
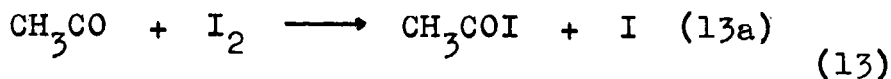
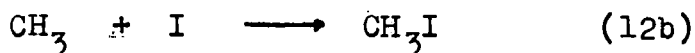
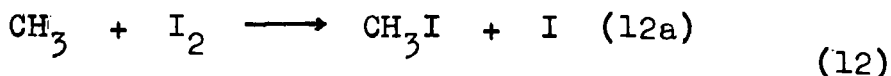

Small yields of carbon monoxide are attributed to reaction (4) rather than to any direct dissociation of the acetone molecules as in (2). Reactions (12) and (13) are assumed fast enough to quench effectively other secondary reactions of the radicals, even at low pressures of iodine, appreciable competition coming only from (4). Some sources (2, 4, 6,) have suggested that CO probably arises from a small proportion of "hot" acetyl radicals,

formed, in the initial dissociation, with sufficient energy to split immediately i.e. before being caught in the iodine "trap". Martin and Sutton, however, extrapolated the $\Phi_{\text{CO}} / \Phi_{\text{CH}_3\text{I}}$ ratio to infinite acetone pressure at 3130\AA and arrived at a value of not more than 0.01, and possibly zero, inferring that such hot acetyl radicals are not essential to the process and, in fact, are doubtful entities. A similar trend was observed at 2537\AA but the results were less accurate owing to mercury resonance troubles.

Note. - the value of $\Phi_{\text{CH}_3\text{I}}$ used is that arising from A' only

$$= \frac{1}{1 + (k_9/k_8)I_2}$$

Further comments of importance are:

- (i) The photolysis of acetone in the presence of added CO_2 (194 mm.) caused a reduction in the value of Φ_{CO} , but only a very slight one ($\Phi_{\text{CO}} = 0.93 \pm 0.03$). No other polyatomic molecules were used as potential deactivating bodies in this series of experiments and this information is therefore not as valuable as it might have been in providing details of the efficiencies of various substances in this context.

(ii) The fact that the system was so sensitive to iodine prompted Martin and Sutton to consider the possibility that the state A" could be a complex of iodine and acetone (A'I₂) rather than another electronically excited state. Since, however, such an assumption does not alter the relevant kinetic treatment, no decision between the two possibilities can be made. It is equally feasible that the iodine molecule could have a particularly favourable 'resonance' level for deactivation of A' to A".

(iii) By usual kinetic methods an equation for Φ_d , independent of the acetyl mechanism, was obtained.

$$\Phi_{\text{CH}_3\text{I}} - \Phi_{\text{CO}} = \Phi_d = 1 - \left\{ 1 + \frac{k_8}{k_9(\text{I}_2)} \right\}^{-1} \left\{ 1 + \frac{k_{10}}{k_{11}(\text{M})} \right\}^{-1} \quad (15)$$

When this function was plotted against p_{I_2} at various acetone pressures, (after calculation of the appropriate constants from two results at constant acetone pressure), the resultant curves were in reasonably close agreement with the other experimental results obtained under varying conditions of pressure.

- (iv) Making reasonable assumptions regarding collision diameters and efficiencies, the half-life for the spontaneous decomposition of A' must be approximately 4×10^{-7} secs.
- (v) Experiments on the effect of added visible light in the acetone-iodine photolyses were not entirely conclusive, but showed what might have been a significant increase in $\Phi_{\text{CH}_3\text{I}}$ when mixed light was employed. If the increase was due to reaction of iodine atoms with one of the intermediates then, to account for the magnitude of the effect, a half-life of about 10^{-5} sec. or more had to be assigned to the intermediate and might represent a minimum lifetime of A".

ALTERNATIVE MECHANISM.

In postulating the above mechanism Martin and Sutton added the reservation that, even though it explained the results, it might not be unique and that other mechanisms might reduce to the same kinetic expression. This is, indeed, the case and a more plausible mechanism is now advanced which does reduce to the same expression, differing only in the significance of the reaction rate constants.

The first scheme, already described, may be

summarised thus:-

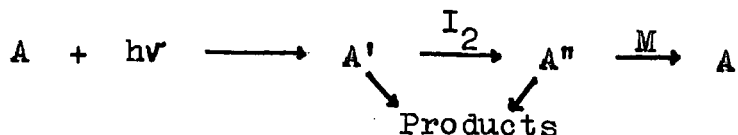

The alternative mechanism merely interchanges the deactivating functions of the iodine and acetone molecules:-

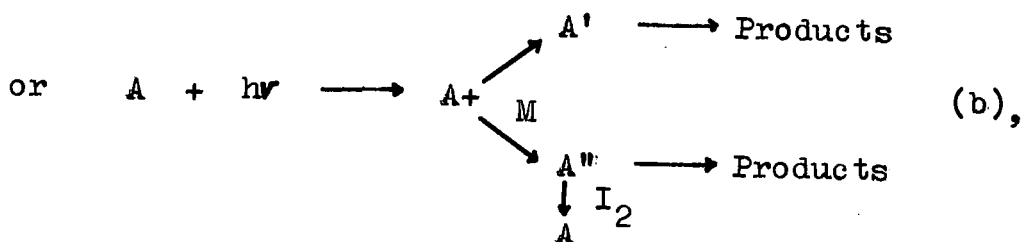

which is essentially a more complete statement of the same thing,

and follows with:-

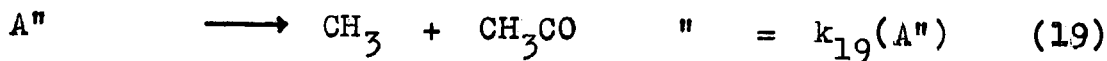
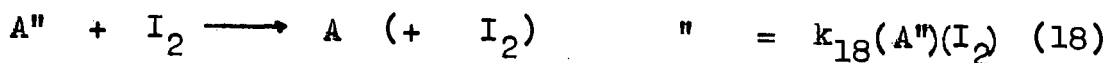
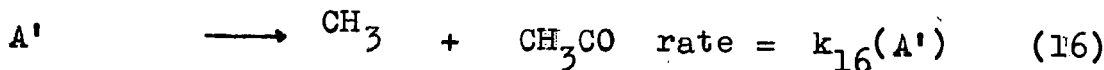

Making the same assumptions about secondary reactions,

$$\Phi_{CH_3I} \approx \Phi_d = 1 - \left\{ 1 + \frac{k_{19}}{k_{18}(I_2)} \right\}^{-1} \left\{ 1 + \frac{k_{16}}{k_{17}(M)} \right\}^{-1} \quad (20)$$

which will be seen to be of the same form as equation (15).

The attractive features of this mechanism are,

- (a) The two states A', A'', are both present initially and there is no need to invoke the exceptional formation of A'' from A' by collision with iodine. This point is important in correlating the iodine work with the fluorescence studies reviewed later.
- (b) If the reaction



is assumed possible, but with considerably reduced efficiency in competition with (19) as the temperature rises, then the reduction in Φ_d in the photolysis of pure acetone at lower temperatures than 100°C. can be reasonably explained. (This seems consistent with the view that A'' is long-lived and, therefore, temperature sensitive.)

FLUORESCENT STUDIES.

Sutton noted³ that his iodine mechanism was similar, in certain respects, to the scheme advanced⁷ to explain certain fluorescent phenomena resulting from the action of U.V. light, of 3130Å wavelength, on acetone vapour. However, more recently, Groh, Luckey and Noyes⁸ have made available further data on the fluorescence and in the

light of this work a more detailed comparison of the two fields of investigation can be made. The following is a summary of the present position on the fluorescent work abstracted from the investigations of Luckey and Noyes,⁷ and Groh, Luckey, and Noyes,⁸ these being the only accounts of major importance.

A study was made of the effect of, (a), rise in temperature, and, (b), addition of oxygen, nitrogen and nitric oxide, on the lifetime of the blue fluorescence in acetone vapour irradiated with light of 3130\AA wavelength. The green fluorescence was not considered since it had been shown to be almost certainly due to biacetyl sensitized by collision.^{9,10} The main findings were as follows.

- (a) The fluorescence was complex. Following a flash excitation the fluorescence at room temperature showed a rapid decay followed by a slower exponential decay. The lifetime of the shorter-lived part was estimated at $\sim 8 \times 10^{-8}$ sec., and of the longer lived part at 2×10^{-4} sec. at 25°C . The latter had a demonstrable structure.
- (b) Structure was not evident if the temperature was raised to 120 to 150°C . or if oxygen was added in

sufficient quantity at room temperature. Nitrogen did not have the same effect as that of oxygen but nitric oxide did.

- (c) The short-lived fluorescence persisted even at high temperatures and high oxygen pressures. Thus, quenching of the fluorescence by oxygen above 120°C. was small.
- (d) The quantity $1/Q$, the inverse fluorescent efficiency, rose sharply with oxygen pressure and levelled out at a value dependent on acetone pressure. (An increase in acetone pressure resulted in an increase in $1/Q$).
- (e) The intensity of the short-lived fluorescence was independent of the rate at which the long-lived fluorescence was removed, indicating that the former did not form the latter reversibly.

MECHANISM.

The mechanism advanced by Noyes, Luckey, and Groh in the most recent paper⁸ is as follows:

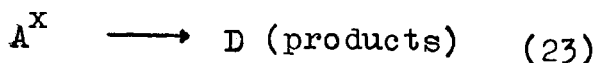

Two reactions, (23) and the additional $A^x + O_2 \longrightarrow ?$ (26), are not really necessary to fit the observed facts but must be considered as possible. If (23) is ignored then dissociation must follow from A^* or A^{**} to the extent of nearly 100% above $100^\circ C$. since the fluorescent efficiencies are small.

The following equations are also cited as necessary to explain the results

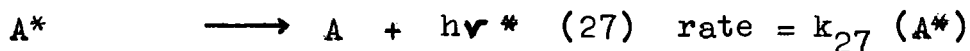

and, for A^{**} ,

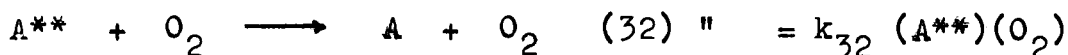
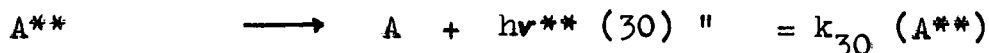

The reaction



is neglected since Noyes supposes the amount of A^{**} to be small in any case. The only evidence for this appears to lie in the fact that, although oxygen quenches the fluorescence attributed to A^{**} , it does not appear to influence the quantum yield of acetone decomposition.¹¹

Further work on the acetone-oxygen system^{12,13,14} makes it more doubtful whether so simple a conclusion can be drawn, with any certainty, in view of the fact that Φ_c (the quantum yield of carbon atoms in all the products of the photooxidation) rises substantially above the value of 3 which would correspond to $\Phi_d = 1.0$. In any event, even if this reaction is not significant from the photochemical point of view, it is wrong to ignore its possible influence on the fluorescence mechanism without specific justification. In addition to the reactions postulated another can be added,

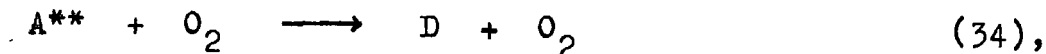

since there is no evidence that the fluorescence disappears by deactivation rather than by dissociation. If (34) were, in fact, correct then the need to infer a small concentration of A^{**} would be eliminated.

A critical examination of the mechanism presented in equations (22)-(32), in the light of the results on which it is based, is not reassuring when agreement with other photochemical work is sought, and, although the various reactions may be correct, they do not present a complete statement of the process as is shown below.

In the Noyes, Luckey, and Groh paper⁸ results and

values of reaction constants are given which have been abstracted from various investigations covering this field as well as from the authors' own researches, - notably from the work of Kaskan and Duncan.¹⁵

In particular

$$k_{27} = 3.4 \times 10^5 \text{ sec}^{-1} \text{ and from ratios}$$

$$\frac{k_{28}(A)}{k_{27}} \quad \text{and} \quad \frac{k_{29}}{k_{27}}$$

it is found that $k_{28} = 5 \times 10^{13}$ ccm/mole sec. and $k_{29} = 6 \times 10^8 \text{ sec}^{-1}$. (It is not clear, however, on looking at the derivation of k_{27} in Kaskan and Duncan's paper¹⁵ whether the lifetime can justifiably be assigned to A^* rather than to A^x). If these values are assumed to be correct, and (A) can assume values of 1.2×10^{-6} to 6×10^{-6} mole/ccm. (corresponding to pressures of 20 and 100 mm. respectively referred to 0°C.) then it will be seen that $k_{28}(A)$ and k_{29} are comparable and large compared with k_{27} which can be ignored in considering the photochemistry - a point already evident from a practical knowledge of overall fluorescent efficiency. If it is also assumed, for the moment, that only A^* contributes significantly to the photochemistry, (which is one of Noyes suppositions), then

$$\Phi_d = \frac{k_{29}(A^*)}{I_a} \quad \text{where } (A^*) = \frac{I_a}{k_{27} + k_{28}(A) + k_{29}}$$

since $\alpha \approx 1$. (where α is the fraction transferred to A^*).

Neglecting k_{27} , $A^* = \frac{I_a}{k_{28}(A) + k_{29}}$ and

$$\Phi_d = \frac{k_{29}}{k_{28}(A) + k_{29}} = \frac{1}{1 + \frac{k_{28}(A)}{k_{29}}}$$

Now, if values for the ratio $\frac{k_{28}(A)}{k_{29}}$ obtained from observations on the fluorescent efficiencies at 50°C . and 300°C ., respectively, are substituted in the expression obtained it is found that

$$\Phi_{d_{50^\circ}} = \frac{1}{1 + 0.83} = \frac{1}{1.83} = \underline{0.55}.$$

$$\Phi_{d_{300^\circ}} = \frac{1}{1.3} = \underline{0.77}. \quad (\text{both at } 100 \text{ mm. of acetone}).$$

(Noyes quotes values of 0.7 and 0.99 respectively without setting out the method of calculation). The values calculated above do not agree with photochemical observations of Φ_d at 300°C . where the value should be 1.0 and the mechanism as quoted must, therefore, be considered deficient. It also follows from the expression

deduced above for Φ_d that (29) could not be second order, since the term would become $\frac{k_{28}(A)}{k_{29}(A)}$, and Φ_d would be pressure independent at all temperatures which is contrary to observation at room temperature.¹ In fact to explain the photochemical data on the basis of a mechanism as simple as that from which the above calculations were made, the rate of increase in k_{29} relative to $k_{28}(A)$ would have to be much larger than the fluorescent data provided indicates.

ALTERNATIVE MECHANISMS.

At least two possible alternatives to the above mechanism are immediately apparent which do not involve the rejection of the above reactions, but do require rather different assumptions. For instance, reactions (24)-(32) may all be correct as far as the fluorescence is concerned but dissociation may occur via (23) to a marked extent. Such an explanation would require small concentrations of both A^* and A^{**} and implies that the effect of oxygen on the fluorescence would not be obviously associated with its effect on the photochemistry, since the contributions of the fluorescing states to the latter process would be small. The idea is not objectionable but has the disadvantage of making the picture

more complex than does the alternative discussed below, especially when comparison with the acetone-iodine photolysis is made (see p.26). This is not, however, sufficient reason for its rejection.

A further alternative to be considered possible, in addition to the other reactions presented, is



or

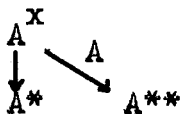

which would yield the same kinetic expression as that obtained by considering (28a). This would involve the same suppositions regarding the primary process as the second of the mechanisms presented to explain the acetone-iodine work and, therefore, possesses certain advantages which will be considered in the next section of this review. It would also involve accepting the principle that the concentration of A^{**} , and its subsequent contribution to the photochemistry via reaction (33), could be quite large. Also if $\Phi_d = 1.0$ for the acetone-oxygen photolysis then the reaction (34) must be incorporated into the mechanism too. Here, of course, Φ_d represents decomposition of acetone molecules by light quanta, and not by subsequent radical chain "abstraction" reactions. Such a mechanism would,

in principle, be fairly desirable since, even at saturation oxygen pressures, the residual fluorescence is dependent on acetone pressure. This could be explained by (28a) in that the acetone pressure would determine the amount of A^{**} formed at the expense of A^* for subsequent deactivation by the oxygen. If (28a) were assumed irreversible Noyes observation on the mode of formation of A^{**} would not then be violated. Moreover, since two gases with similar magnetic properties, (O_2 and NO), both quench the fluorescence, whereas nitrogen does not, it is not unreasonable to suppose that A^{**} may be a triplet state and that the interaction of this state with a paramagnetic molecule might result in decomposition according to (34) rather than simple deactivation (32). A question which is not immediately answered by any of these mechanisms is the mode of quenching by merely raising the temperature, unless the relative values of the rate constants alter rapidly to favour (29) instead of (28a) or, alternatively, (33) or (31) instead of (30).

Once a reaction like (28a) is introduced into the mechanism, however, the kinetics of the process do not involve two well-defined separate treatments for A^*

and A^{**} respectively. Instead the expression for Φ_d , for instance, becomes quite complex, involving all the rate constants for reactions determining the fates of A^* and A^{**} , and more than one term containing the acetone concentration. It is of the right form but it is virtually impossible to derive from it, in conjunction with the available experimental data, values of the important quantities required for testing the accuracy of the mechanism (as Noyes was able to do using the simpler, incorrect, mechanism which allowed independent consideration of A^* and A^{**}).

COMPARISON OF ACETONE-IODINE AND FLUORESCENT STUDIES.

It would appear logical, at this point, to consider the photochemistry of acetone-oxygen mixtures and its relation to the fluorescent work with oxygen, especially with a view to extending the conclusions which can be drawn from the two regarding the nature of the primary process. Unfortunately the photochemistry is complex and the picture of it presented by recent investigations¹¹⁻¹⁴ is incomplete in several respects and, confused to a certain extent. More important, no reliable conclusions can yet be drawn from this work regarding the primary process itself. At this juncture, therefore, much is to

be gained by first comparing the information from the fluorescence and iodine studies and postponing the oxygen discussion, which is still essential in providing a background to the work envisaged, till later.

The studies of both Martin and Sutton,³ with iodine, and Noyes et al.,^{7,8} on fluorescence, require the postulation, for their explanation, of at least two intermediate excited states of the acetone molecule. Each mechanism also requires that one state be long-lived and one short-lived and the lifetimes advanced in each case, for these modifications, are remarkably similar. The possibility arises that A' of Sutton's mechanism and A* in the fluorescent work are the same and, likewise, that A" is the same as A**. This implies, in fact, that the results from both investigations can be explained on the basis of two states only. To prove such a point it would be necessary to predict, from the evidence outlined above, what the effect of such a coincidence would be on a complex photolysis involving mixtures of acetone, iodine, and oxygen and to see to what extent it was followed in practice. This would not be easy because the necessary background knowledge to such a course of action is not well enough defined. Results from both the iodine and fluorescence studies are ambiguous,

the former by virtue of two possible reaction mechanisms each of which is satisfactory in explaining the observed kinetics, and the latter because the mechanism previously proposed is considered deficient and there is insufficient evidence to confirm either of the two proposed, in its place, in this account. The uncertainty could probably be considerably reduced if the acetone-oxygen photochemistry were better understood.

In spite of the equivocal nature of arguments which may be advanced at this stage, it is interesting to consider the major possibilities. The alternative mechanism proposed for the acetone-iodine photolysis seems the more plausible, as is the second alternative proposed for the fluorescence, and it is interesting that the initial processes are almost identical. If, in fact, A' and A^* (and A'' and A^{**}) are the same, the key equations (17) and (28a) are the same for both mechanisms, and, in addition, could probably form a basis for the explanation of the phenomena observed in the straightforward photolysis of acetone, as has been already suggested. Such an approach would involve accepting the existence of comparable concentrations of A' (A^*) and A'' (A^{**}). A'' (A^{**}) would have the following properties,

- (a) it would be susceptible to deactivation by acetone at low temperatures, this effect becoming negligible at about 100°C. to explain the primary yield of unity at this temperature in the direct photolysis.
- (b) it would be susceptible to deactivation by iodine at all temperatures studied but, again, with decreasing efficiency as the temperature rises.
- (c) its response to oxygen, on present limited evidence that $\Phi_d = 1.0$ in the presence of oxygen above 120°C., would appear to be a dissociation (34).

From (b) and (c) it becomes apparent that, if the efficiencies for reaction of the long-lived state of acetone with iodine and oxygen are comparable, then the addition of iodine to an acetone-oxygen photolysis should result in deactivation and a fall in Φ_d . Similarly, the addition of oxygen to an acetone-iodine photolysis should, from (c), result in an increase in Φ_d . If point (c) is incorrect, however, then it is possible that this would not be observed and, in fact, that oxygen itself might further enhance the deactivation process.

The arguments advanced above are merely those which appear most probable from what is already known. It must be pointed out that they do not represent the only

point of view to be considered. The process might be complicated rather than simple and it is not impossible that the scheme may be of the following form,

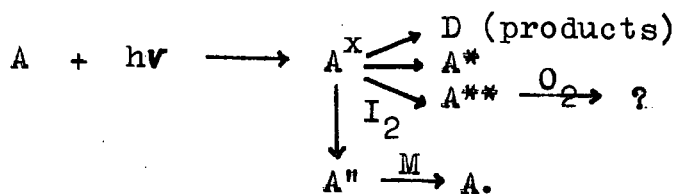

which is essentially a combination of the original iodine mechanism and the first alternative fluorescent mechanism, in which the amounts of A^* and A^{**} are supposed small and dissociation follows directly from A^x (now identified with A'). Such a hypothesis renders it impossible to predict (for experimental verification) the effect of oxygen, which quenches A^{**} , on A'' or, alternatively, the function which oxygen might fulfil if added to an acetone-iodine photolysis. The reaction scheme is also undesirable in that it does not allow such a ready explanation of the direct photolysis studies if A'' is not formed by acetone deactivation of A' , but only by the action of iodine.

The above suggestions are merely the outcome of a great deal of speculation, but they do indicate that an investigation of the characteristics of acetone-iodine-oxygen photolyses would be worthwhile and might, possibly, provide a more definite experimental basis for adopting one or other of the mechanisms put forward.

II(b) THE PHOTO-OXIDATION OF ACETONE

Before a useful study of the photochemistry of acetone-iodine-oxygen mixtures can be made it is necessary to have a good working knowledge of the two contributing systems, acetone-iodine and acetone-oxygen. The former has been discussed. It remains, therefore, to consider the position regarding the latter, and whether useful information can be added to it by further experimentation. This is also important from the point of view of correlating the photochemical and fluorescent phenomena if they are, indeed, related.

Since 1951, a succession of papers¹¹⁻¹⁴ has appeared, each of which has shed further light on the acetone photo-oxidation and, at the same time, invalidated some of the conclusions previously drawn. They have not, however, been compared to obtain maximum information. In 1951, Noyes and Marcotte published the first¹¹ of two papers on this subject and suggested that the mechanism of the photo-oxidation was very simple at temperatures above 120°C. and up to 200°C. The experimental details on which the mechanism was based were, briefly:-

- (a) No ethane was formed even at oxygen pressures as low as 0.01 mm.

- (b) Methane was formed only at low oxygen pressures, the oxygen pressure required to prevent its formation rising with increase in temperature.
- (c) the quantum yield of oxygen consumption was ~ 4.0 and varied remarkably little with experimental conditions.
- (d) Φ_{CO} was a function of oxygen pressure, passing through a maximum of ~ 3.0 . This maximum was determined by inference since, at the lowest oxygen pressure used, the value was still rising. At high oxygen pressures it could fall below unity.
- (e) Φ_{CO_2} varied such that $\Phi_{\text{CO}} + \Phi_{\text{CO}_2} \approx 3.0$.

With CO and CO₂ apparently the only products, and the total quantum yield almost constant at 3.0, the results seemed very straightforward and consistent with the idea that Φ_d , the primary quantum yield of acetone decomposition, was unity and that subsequent radical reactions gave rise to three molecules of products, each with a single carbon atom. The fact that, at low oxygen pressures, $\Phi_{\text{CO}} + \Phi_{\text{CO}_2} + \Phi_{\text{CH}_4} > 3.0$ proved no stumbling block to such an interpretation since the proposed mechanism allowed the probable appearance of a molecule of carbon monoxide as a consequence of the formation of a molecule of methane.

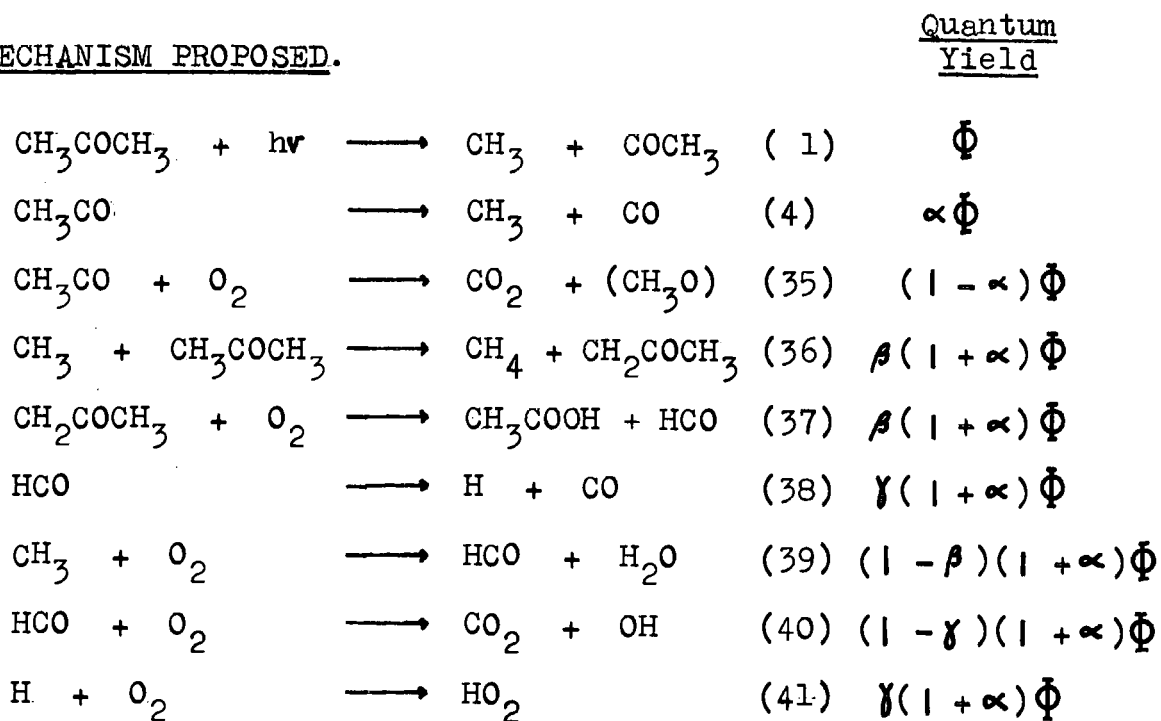
MECHANISM PROPOSED.

The fates of OH , HO_2 , and CH_3O were not specified. Kinetic treatment of the results indicated that

$$E(36) - E(39) = 9.6 \pm 0.5 \text{ Kcal.}$$

Since $E(36) - \frac{1}{2}E(42) = 9.7 \text{ Kcal.}^{16}$,

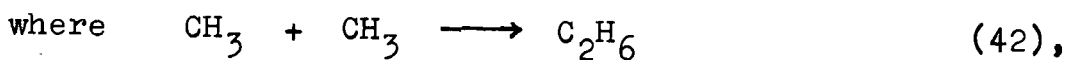

then $E(39) - \frac{1}{2}E(42) \sim 0$ (both probably small).

Also the steric factor p_{39} , (by comparison with $p_{36}/p_{42}^{\frac{1}{2}}^{16}$), must be as low as 2×10^{-4} .

Small reservations were made in this paper,¹¹ namely that the quantum yields at very high oxygen pressures, or at temperatures as low as 120°C. , were not entirely satisfactory but these points were ignored in the discussion. This was most unfortunate because an extension

of the range of the results, which was subsequently made and presented in a second paper,¹² showed that, although points (a), (b) and (c) were true, the conditions outlined in (d) and (e) were only fulfilled under idealized conditions, at high temperature (200°C.) and medium oxygen pressures. Presumably the first investigations were centred mainly in this ideal range and presented a falsely simple picture of the results. The new investigations produced the following amendments to the results already stated:-

(f) $\frac{\Phi_{\text{CO}} + \Phi_{\text{CO}_2}}{\quad}$ does not always approximate to 3.0. Above 225°C. it may be more, making reasonable assessments from graphs presented by the authors, (approx. 3.5 at 225°C. at 1.2 mm. oxygen pressure), and, at lower temperatures, the value of 3.0 is certainly not realised at high oxygen pressures. In fact, at 120°C., 150°C., and 175°C., Φ_{CO_2} shows a maximum when plotted against oxygen pressure. To the high pressure side of this maximum both CO and CO₂ yields are falling together and a relationship of the type $\Phi_{\text{CO}} + \Phi_{\text{CO}_2} = k.$ is therefore impossible.

(g) $\Phi_{\text{CO}} \rightarrow 3.0$ at very low pressures at all temperatures but must, of course, pass through a maximum since

Φ_{CO} = 1.0 at zero oxygen pressure. At high oxygen pressures (i.e. up to 2 mm.) it tends to a limit which depends on the temperature ($120^{\circ}\text{C.} \rightarrow 0.3$ approx. and $200^{\circ}\text{C.} \rightarrow 1.0$ approx.).

(h) Φ_{CO_2} , in the low pressure range, rises as Φ_{CO} falls but eventually achieves a maximum at a pressure dependent on the temperature. At 200°C. , however, even at 2.4 mm. of oxygen, this maximum has still not been achieved, although the carbon dioxide quantum yield is levelling out. After the maximum the yield falls and eventually levels out as for Φ_{CO} (at 120°C. $\Phi_{\text{CO}_2} \rightarrow 0.8$ approx., $200^{\circ}\text{C.} \rightarrow 2.0$ approx.)

(i) Φ_{CH_4} may be quite significant. At 120°C. , at 50 microns pressure of oxygen, $\Phi_{\text{CH}_4} = 0$ but at 10 microns = 0.45. At 175°C. , $\Phi_{\text{CH}_4} = 0$ at 130 microns but at 30 microns = 0.85. At 200°C. it is till appreciable (0.2) at pressures in excess of 200 microns of oxygen.

To account for the observed results Noyes and Marcotte considered that only one equation in the mechanism already proposed needed alteration. This was equation (35) which became

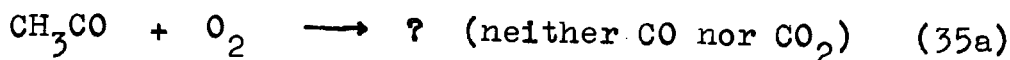

This reaction, in competition with (4) and subsequent methyl radical reactions, was held to account for simultaneous reductions in both CO and CO₂ yields with rising oxygen pressure beyond the CO₂ maximum. A further alteration was also included. The reaction (35a) was thought to consume two molecules of oxygen since the oxygen consumption then alters from $(3 + \alpha)\phi$ to 4ϕ (i.e. becomes α independent which is essential to explain the non-variance of the oxygen consumption). The products of reaction (35a), which must be major products, were not identified. A consequence of this reaction is that all the CO₂ must arise from reaction (40), and, originally, from methyls.

Further points which were made about the photochemistry, which should be noted are:

- (i) At low pressures of oxygen $\phi_{CO} \longrightarrow 3.0$ and $\phi_{CO_2} \longrightarrow 0$.

It, therefore, seemed reasonable to infer that the acetyl radical, in this range, dissociates according to equation (4) to the extent of almost 100% and that each CH₃ radical produced in the reactions (1) and (4) gives 1 molecule of carbon monoxide. This suggests, at first sight, that $\phi_a = 1.0$ and that oxygen does not interfere with the primary decomposition, as iodine does.

- (ii) it was considered significant, in support of the above statement, that at 120°C., where the primary quantum yield in the direct photolysis is unity, the effect of oxygen on the fluorescence is small.
- (iii) Radical reactions included, as speculations on the mechanisms of reactions (35), (37), (39), and (40), were of the types:

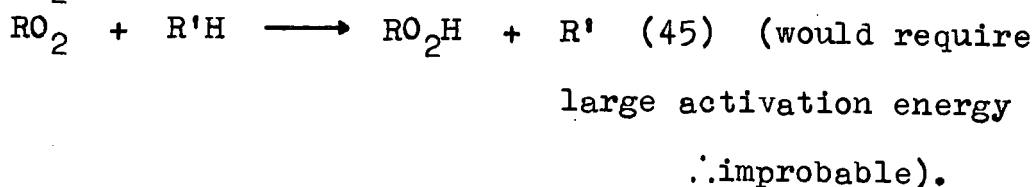
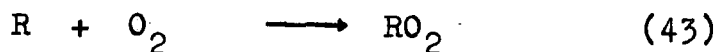

- (iv) Reactions of OH and HO₂, although unspecified, could not lead to hydrogen abstraction as this would lead to chains via reaction (37).

HOARE'S INVESTIGATIONS.

The position, at this stage, was still relatively simple, although the unspecified course of (35a) was unsatisfactory. However, in 1953, Hoare¹³ reported the results of studies on acetone photo-oxidation and, also, of photolyses of acetone-oxygen-formaldehyde mixtures. His analytical techniques included the use of the mass spectrometer and

he identified by this means, as products in the acetone-oxygen photolyses, carbon monoxide, carbon dioxide, methane, formaldehyde, acetaldehyde, acetic acid, methanol, water, and perhaps a little methyl formate. No formic acid was reported and the actual importance of these products was not elaborated on except in the case of formaldehyde. In addition to obtaining carbon monoxide and dioxide yields, (between 120°C . and 200°C .), in substantial agreement with those of Noyes and Marcotte, Hoare claimed that formaldehyde was formed in quantities approaching, or exceeding unit quantum yield. This immediately cast doubts on the merits of the argument advanced in subsection (i) above, but, in the absence of actual values for the formaldehyde yields at low oxygen pressures, did not provide evidence for rejecting it. The method of analyzing for formaldehyde was not entirely satisfactory owing to loss in cold traps and some contamination with CO_2 . Acetaldehyde was cited as an impurity in the formaldehyde - a point not borne out in later work.

Hoare's work, however, was primarily directed towards deciding whether or not, the formyl radical (HCO) could, in fact, be an intermediate in the photo-oxidation and to this end he photolysed acetone-oxygen, acetone-formaldehyde, formaldehyde-oxygen and, finally, acetone-oxygen-formaldehyde

mixtures. His results were somewhat complex and partly obscured by the fact that formaldehyde, too, is sensitive to ultra-violet photodecomposition. However, if Noyes and Marcotte's mechanism is expanded slightly, as follows:

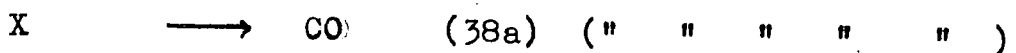
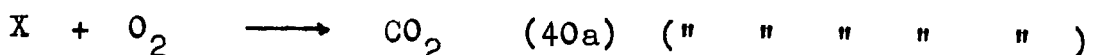
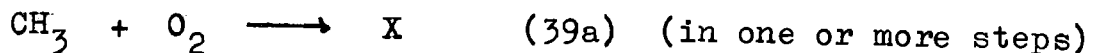

then Hoare was able to state with some confidence that X is not HCO in (40a). This decision was arrived at by comparing the ratio CO_2/CO , in the presence of oxygen, for both formaldehyde and acetone. The variation of this quantity with oxygen pressure did not show any similarity in the two cases, yet in the formaldehyde photolysis the formyl radical is almost certainly an intermediate^{17,18} in the formation of the CO and CO_2 .

It is important at this stage that too much should not be inferred from this evidence. The fact that the formyl radical does not react markedly with oxygen to produce carbon dioxide does not mean that X cannot be formyl in (39a). It may be that (40a) should be amended to



i.e. X and Y are different species altogether and (38)

and (40) are not competitive for the same radical. A point which is significant in support of this is that other sources of methyl radicals, when photolysed with oxygen, gave CO_2/CO ratios which were nearly independent of oxygen pressure.¹⁹ A further point of great importance is that when formaldehyde was added to an acetone-oxygen photolysis, so that the formaldehyde was considerably in excess of the oxygen (say tenfold), the quantum yield of oxygen consumption was reduced to 2.0 and the CO_2 yield to very low values. (At 120°C . this was certainly true but at 200°C ., although similar effects were obtained, the results were less valuable because of the greater corrections necessary to allow for formaldehyde photooxidation and some chain oxidation of the acetone). Furthermore, as the CO_2 yield dropped with increasing formaldehyde concentration (relative to oxygen), the carbon monoxide yield rose to unity. This effect was considered to be due to a competition between

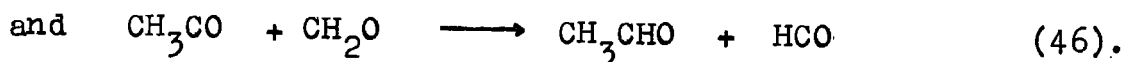

Reaction (46) had already been proposed to explain results in the photolysis of acetone-formaldehyde mixtures. Since this result (increase in CO) was observed to occur with a simultaneous decrease in the yield of CO_2 it seems

reasonable to suggest that the original equation (35) does represent the fate of the acetyl radical rather than (35a). If the course of (35) is complex, involving 2 molecules of oxygen, as suggested by Noyes for (35a), then reaction (46) would explain the fall in oxygen consumption to 2.0 from 4.0.

CHRISTIE'S INVESTIGATION.

Following Hoare's work a further paper appeared¹⁴ setting out the results of work done on the photoxidation of acetone by Christie under the auspices of Professor Noyes. The work presented two interesting innovations, the determination of formaldehyde colorimetrically, by two methods, and the photolysis of acetone labelled in the 1.3 positions with radiocarbon ($^{14}\text{CH}_4\text{CO}^{14}\text{CH}_3$).

The following is a summary of the results obtained:-

- (a) At 120°C ., $\Phi_{\text{CH}_2\text{O}}$ increased with increasing oxygen pressure from 1.6 at 17 microns of oxygen to 2.3 at 262 microns and then decreased to 1.2 at 2240 microns. These figures checked to within $\pm 0.1 - 0.2$ of those obtained by the second colorimetric method. Virtually no acetaldehyde was reported.
- (b) At 175°C ., $\Phi_{\text{CH}_2\text{O}}$ increased from 1.0 at 20 microns to 2.5 at 400 microns O_2 and then decreased to 1.6 at about 5000 microns (2.0 at 2230). Little

acetaldehyde was reported except at the lowest pressure of 20 microns, where the yield was 0.3.

(c) Runs with radioactive acetone were held to show that (i) All, or most, of the CO_2 came from the end carbons

(ii) An acid, assumed to be acetic was estimated by condensing products not volatile at -100°C . into $\text{Ba}(\text{OH})_2$ and removing acetone by ignition at 450°C . The quantum yield of this acid was at least unity. The reservation was made that these results were uncertain since an unidentified impurity in the labelled acetone caused CO_2 yields obtained with the radioactive material to be higher than those from pure acetone. No tables of results from these experiments were included.

ALTERNATIVE MECHANISM.

The mechanism was now amended to the following:

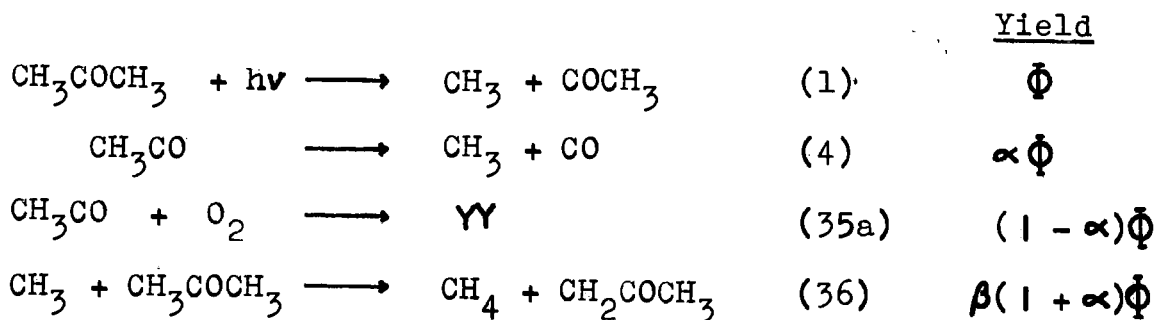

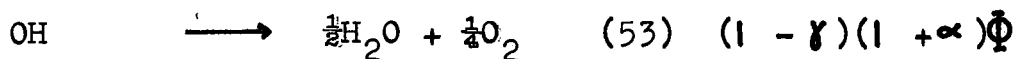
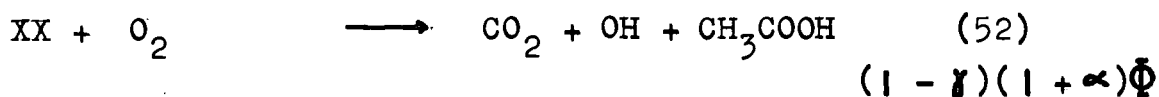
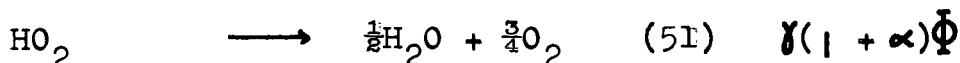
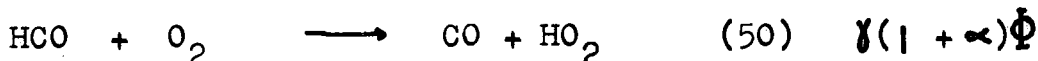
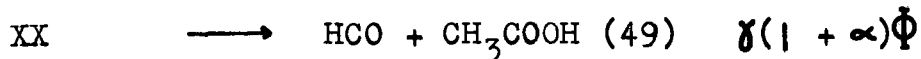
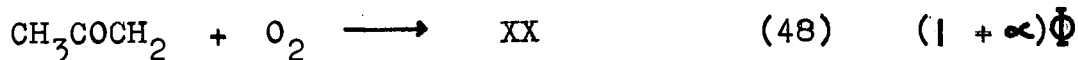
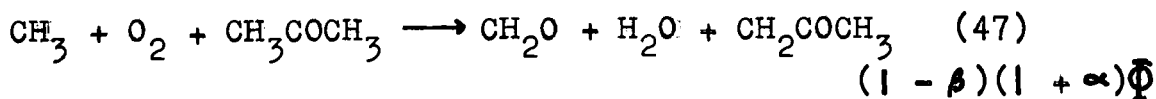

(51), and (53), were merely speculations based on the fact that no peroxides were detected. With appropriate limiting values of α , β , and γ , the above mechanism gave an apparently satisfactory explanation of the maxima and minima observed in quantum yields of CO , CO_2 , and CH_4 . The reaction (47) was thought to be a complex one and the following steps were proposed as most likely

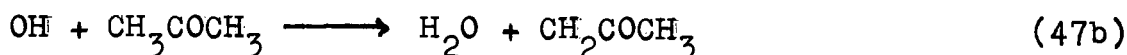
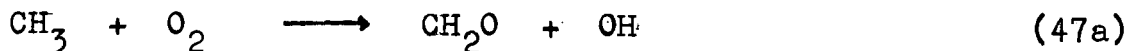

or alternatively,

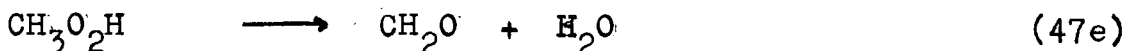
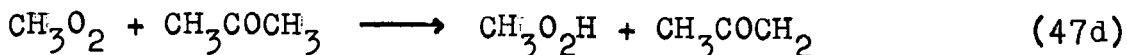

(47a) has been proposed many times before²⁰⁻²² as a

likely reaction but (47d) may have some foundation since methyl hydroperoxide has been isolated in the mercury photosensitized methane oxidation²³ at low temperatures. A suggestion that XX might be methyl glyoxal (+ OH) was made on the basis of another suggestion that it is an intermediate in the oxidation of acetyl in the liquid acetone-oxygen system.²⁴ No reaction was postulated to explain satisfactorily the fate of the acetyl radical.

The following criticism is offered of the above mechanism. If the primary equation (1) is realised in unit quantum yield and $\alpha = 1.0$, as is probable at very low oxygen pressures, then $\Phi_{CO} + \Phi_{CO_2}$ should be equal to three, (or less if the various radical reactions leading to their formation were inefficient), $\Phi_{CH_2O} + \Phi_{CH_4}$ should have a maximum value of 2.0 and Φ_{CH_3COOH} should be equal to about 2.0. It seems significant, therefore, that Hoare did not mention acetic acid as a major product, along with formaldehyde, unless he did not follow up his mass spectrometric detection of the acid with quantitative analyses. Moreover, the formaldehyde quantum yield, in Christie's results, showed a maximum of ~ 2.5 at both 120° and $175^\circ C$. This would

seem impossible on the basis of the above mechanism unless the acetyl radical, not previously considered in this respect, were capable of producing more than one molecule of formaldehyde by reaction with oxygen. The ignorance existing regarding the course of (35a) is rather unsatisfactory, and, in the absence of a complete analytical scheme which would allow all the products to be determined, speculation is of relatively little value. However, it is strange that the known major products of the reaction have been explained away on the basis of methyl radical reactions only. As long as $\alpha = 1.0$ this is reasonable but at higher oxygen pressures, where acetyl radicals would be expected to react with oxygen, either acetyl radicals give one or more of the products already mentioned, or some other product is still to be identified. Another peculiar feature of the results presented is that above about 0.3 mm. of oxygen at 120°C., and 0.9 mm. at 175°C., all three quantum yields (CO , CO_2 , CH_2O) appear to be falling together. Is this the result of an overall deactivation or is it a consequence of a reaction of the acetyl radical to give an unidentified product? Before a mechanism can be written with more confidence these are points

which must be resolved.

PHOTO-OXIDATION AT ROOM TEMPERATURE.

At this point it should also be recalled that no mechanism has been proposed to explain the acetone-oxygen photolysis at room temperature. The results, obtained by Noyes and Marcotte,¹¹ in their first series of investigations, were, briefly, as follows:-

- (a) No methane or ethane were formed at all above 0.02 mm. O_2 (the lowest pressure studied).
- (b) Φ_{CO} was lower in the presence than in the absence of oxygen but was almost constant as the oxygen pressure varied.
- (c) The carbon dioxide yield was greater than that of Φ_{CO} .
- (d) Φ_{O_2} was less than unity and approximately constant and independent of oxygen pressure.

However, these statements represent an over-simplification of the results obtained. The four sets of values presented varied in a peculiar manner. As the oxygen pressure varied through 20.4, 50.4, 123 and 245 microns, at constant acetone pressure,

$$\Phi_{CO} = 0.044, 0.048, 0.040, 0.032$$

$$\Phi_{CO_2} = 0.20, 0.18, 0.26, 0.16,$$

and $\Phi_{O_2} = 0.56, 0.48, 0.58, 0.40.$

Calculations from these results of α in equation (4) gave negative values, if the mechanism already cited for higher temperatures was held to apply at 25°C. In Noyes original paper¹¹ the CO₂ yield was thought to arise from acetyl radicals by reaction with oxygen, a point of view later abandoned. It is interesting, however, that, by making further reasonable assumptions, Noyes and Marcotte were, then, able to explain the results of the process at 25°C. with a fair degree of accuracy. If it is assumed that all the CO arises from acetyl dissociation at this temperature, and that all the CO₂ does arise from (35) rather than (40), then

$$\Phi_d = \Phi_{CO} + \Phi_{CO_2} \approx 0.24 \text{ which is remarkably near to the accepted value for this temperature and pressure in the photolysis of pure acetone.}^1$$

Also, the number of methyls = 2CO + CO₂ = 0.28 and, if each methyl and acetyl consumes one oxygen molecule, then

$\Phi_{O_2} = 0.28 + 0.20 = 0.48$ which is in the range of values found. Reactions advanced to explain the fate of the methyl radical at this temperature were taken from

previous work, and were remarkable in anticipating some of the later high-temperature findings:

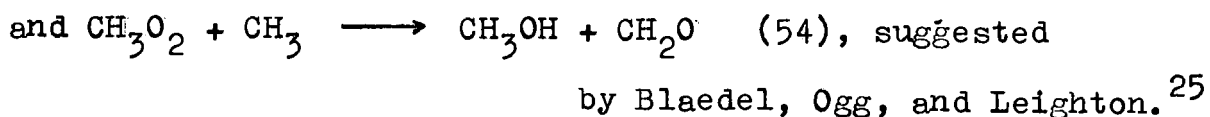
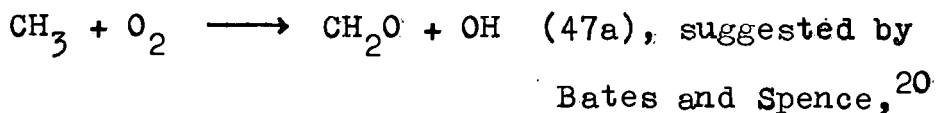

The latter, however, would require two methyls to one oxygen which is not strictly compatible with the results on the basis of the assumptions made.

The significant point arising from this work, in relation to the high temperature work, is that, at a low temperature, where the acetyl radical is known to be more stable, the CO_2 yield is considerably in excess of the CO yield. This, coupled with Hoare's observation that the CO_2 yield in the photoxidation falls under conditions where the acetyl radical is removed by formaldehyde rather than oxygen, suggests quite strongly that CO_2 is, in fact, formed from acetyl radicals to a marked extent, even though Christie's work with radioactive acetone seems to contradict this.

In conclusion, it may be said that, although several uncertainties exist in the interpretation of results at all temperatures, (and in the preceding discussion no

inference has been made from the photoxidation regarding the primary process for that reason), the evidence points to the fact that, even though Φ acetone decomposition is greater than 1.0 at high temperatures, the actual decomposition by light quanta, as opposed to radical chains, is still unity in the presence of oxygen.

III AIMS OF THE PRESENT INVESTIGATION.

When the present work was started the aims in view seemed reasonably simple, since only one acetone-iodine mechanism had been put forward, and only two papers^{11,12} had appeared regarding the oxygen-acetone photochemistry. The appearance of results of additional oxygen-acetone studies and the realization of a second, equally valid, acetone-iodine mechanism caused appreciable changes. However, one of the original intentions was to photolyse 1.3.¹⁴C-labelled acetone in the presence of oxygen to establish the actual sites in the molecule from which the products, carbon monoxide and dioxide, arose. Consequently, when Christie's work was published, results in this direction were already available and in direct opposition to the trend reported. In view of the uncertainties regarding the purity of the labelled acetone used in Christie's experiments, it was decided to proceed further with this work, and more so, since a private communication²⁶ of results from studies on the photoxidation with ¹⁸O indicated that Christie's conclusions were wrong.

The following, then, represent the modified aims of the work which is described in the subsequent chapters of

this thesis.

1. To extend the investigations of the acetone-iodine system. It was realised that acetone-oxygen-iodine photolyses might be expedient under conditions of acetone and iodine pressures, and temperatures, not previously studied. In such cases the relevant acetone-iodine result would be essential for comparison with the more complex case to ascertain the effect of added oxygen.
2. To photolyse acetone-oxygen mixtures using acetone labelled in the 1,3 carbons with ^{14}C as described above, (this to enable the determination of the proportions of CO and CO_2 arising from the methyl and carbonyl groups, and, thereby, to provide more valuable information than was hitherto available). It was also intended to attempt analyses for acetic acid. The formaldehyde results quoted by Christie were felt to be reliable since they were determined with unlabelled acetone and double checked.
3. To photolyse acetone-oxygen-iodine mixtures in an attempt to solve some of the problems posed in the comparison of the iodine and fluorescent work.

4. To collect the information so obtained and to use it, in conjunction with that already presented, to clarify the conception of the primary process in the U.V. photolysis of acetone at 3130 μ .

IV EXPERIMENTAL TECHNIQUES(1) FILLING THE REACTION VESSEL

The filling system adopted was essentially that described by Sutton³ but with several modifications peculiar to the requirements of the present investigations. These modifications are described below, followed by an account of the filling procedure.

(a) Source of Iodine. Sutton, in his work, used ^{131}I as tracer to follow the reactions of the radicals, from acetone, with iodine. This provided him with a convenient method of producing iodine sources of known strength for his photolyses.

The radioactive iodide, supplied as KI, was diluted with carrier KI and the iodine precipitated as palladous iodide with slightly acid palladous chloride. The palladous iodide formed was then decomposed to elementary iodine, under vacuum conditions, and the iodine condensed in a long capillary, which was subsequently sealed off and subdivided into shorter lengths. The strength of each iodine capillary was then determined by counting in a standard position relative to an end window β counter and, finally, by breaking one or two

capillaries under potassium iodide and titrating them with thiosulphate, the relationship between counting strength and iodine content was established.

The first iodine sources for the present work were prepared in this way, but some time before they were needed, to allow the iodine activity to decay to a negligible level. In the preparation of the capillaries, however, it was observed, in assessing the total counts for the capillaries prepared, that the iodine obtained by the precipitation and vacuum decomposition procedure amounted to at least 95% of the carrier iodide added, initially, to the active sample. During sublimation of the iodine the capillary was kept open to the pumps to prevent clogging, some loss of iodine almost certainly occurring, and, in reality, a figure for iodine recovery greater than 95% should be quoted. The inference from this result is that palladous iodide can be decomposed under vacuum conditions to give up all of its iodine and, therefore, if the palladous iodide used is weighed, its iodine "strength" is immediately known without further determinations. The molecular weight of palladous iodide is also quite high and amounts equivalent to fairly low iodine

pressures in the reaction vessel considered for this work, could be weighed fairly accurately (0.5 mm. I_2 at $120^\circ C. \pm .0050$ gm. PdI_2).

This method of preparing iodine sources was adopted since it has two immediate advantages. It obviates the need for radioactive iodine, which constitutes an unnecessarily expensive method of preparation, and also permits accurate reproduction of the same iodine pressure, if required. Sutton's method was less commendable in this latter respect since it was somewhat difficult to subdivide a long capillary into sources of equal strength with rough counting measurements as the only guide.

For trial experiments on acetone and iodine the palladous iodide was merely weighed into a short glass tube, which was attached to the filling apparatus directly at some convenient point. This was heated when required, the iodine liberated being condensed in the reaction vessel ($-195^\circ C.$) These trial experiments did not, however, yield reproducible results for runs in which the conditions of temperature, pressures of reactants, etc. were the same. Since it was necessary to include a porous plug above the palladous iodide, to retain flying palladium flakes liberated in the

reaction, it was thought that the nature of the plug employed might be responsible. The first material used for this purpose was glass wool, which could have contained air and presented the possibility of liberation of indeterminable amounts of permanent gases during the heating process. Substitution of a platinum plug in a constriction did not alleviate the problem however and a red deposit of mercuric iodide was observed on heating the palladous iodide in both cases. It was difficult to see how this arose since the equilibrium pressure (vapour pressure) of mercury in the system at room temperature represented an infinitesimal amount of mercury and, before decomposition, the mercury reservoirs were sealed off from the palladous iodide.

The following added precautions were then taken. A trap was inserted between the iodide and the mercury reservoirs in the system. Acetone was condensed into this, after measurement, and distilled into the reaction vessel at $-60^{\circ}\text{C}.$, thus eliminating the possibility of distillation of mercury into the eventual iodine containing part of the assembly during this procedure. These precautions did not, however, stop the formation of appreciable amounts of mercuric

iodide and the consequent indeterminate depletion of available iodine. If two days elapsed between preparation of the apparatus and actual operation, as at week-ends, the mercuric iodide formation was particularly heavy and in one case amounted to 0.116 gm. of HgI_2 from a palladous iodide source of 0.238 gm. - a quite considerable loss. The evidence pointed conclusively, after this finding, to the fact that palladous iodide, left in an atmosphere saturated with mercury vapour at room temperature, reacted with the mercury present to give either mercuric iodide or a palladium - mercury iodide complex which decomposed preferentially into mercuric iodide on heating. The obvious solution to this problem was to pre-decompose the iodide into a container which could be sealed off but with provision made for breaking later to liberate the iodine when needed. The apparatus used suffered various minor alterations in the course of the work and finally assumed the form illustrated in Fig. 1.

Procedure in Preparing a Source

The apparatus was pumped down to sticking vacuum with liquid nitrogen around the trap U. This prevented contamination of the palladous iodide (in A)

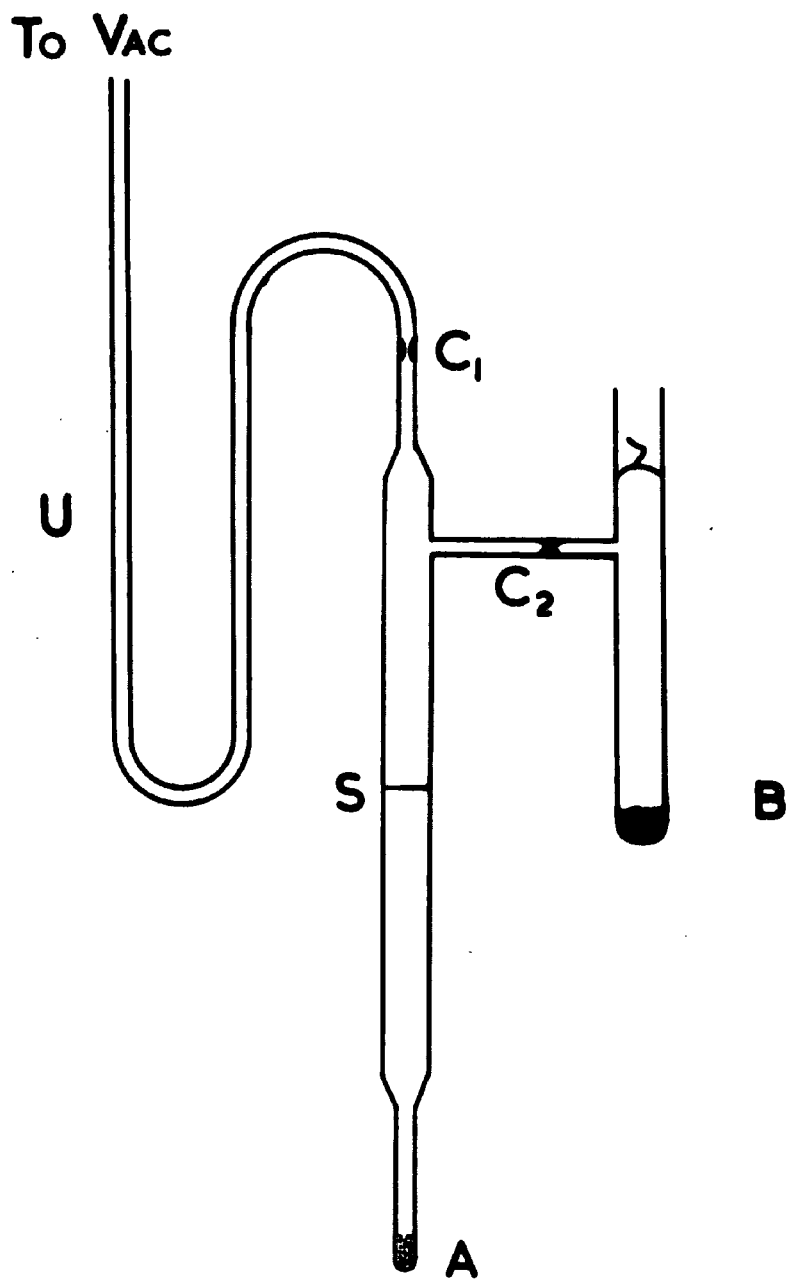

FIG. 1.

with mercury from the McLeod gauge attached to the main vacuum line. When a sticking vacuum had been obtained the constriction, C_1 , was sealed off, isolating the iodide decomposition section from the rest of the apparatus, including mercury reservoirs. The iodide in A was then decomposed at a temperature just below the softening point of the glass and the iodine condensed in B, mobile palladium flakes being retained by a coarse sinter S. C_2 was then sealed and drawn off, and the tube B, (sealed at its upper end by a weak glass septum), removed to the filling apparatus where it was attached by glassblowing. A tube of the form of B was preferred to a capillary since it was less fragile in general construction and much more easily filled with the required amount of iodine.

- (b) Source of Oxygen. Noyes and his collaborators,^{7,8,11,12} working on acetone-oxygen mixtures only, i.e. without iodine, produced their oxygen in gross quantities from potassium permanganate and purified it by passage through liquid nitrogen. It was introduced into the reaction system, from a calibrated tube, by means of a permanently attached Toepler pump which could also be used to replenish oxygen at low pressures where the danger of depletion was greatest. This method could

not be adapted to the present work on account of the presence of iodine, which precluded the use of a mercury containing pump. In this case it was necessary to introduce a fixed amount of oxygen during the filling procedure and to avoid low pressures where possible. Since the most interesting part of the problem was centred in the high-medium oxygen pressure range this did not constitute a serious limitation of the usefulness of the technique for its immediate purpose. Methods were therefore investigated for introducing oxygen to the reaction system by heating suitable solid materials.

(i) Potassium Permanganate. To introduce the small quantities of oxygen required it was decided to evaporate dilute solutions of oxidizing agents and to decompose the residues. (1 mg. of KMnO_4 was equivalent to approximately 0.1 mm. pressure of oxygen in the reaction vessel at 120°C .). Potassium permanganate was tried for this purpose but gave most unsatisfactory and inconsistent oxygen yields, probably due to the instability of dilute solutions of this material, especially under the small compressed air jet used to facilitate evaporation of solvent.

(ii) Potassium Chlorate seemed stable under the evaporation procedure employed but its subsequent decomposition, without catalyst, left much to be desired. In the presence of manganese dioxide as catalyst it is reputed²⁷ to give up all of its available oxygen. However, decomposition, under vacuum conditions, of chlorate-manganese dioxide mixture, yielded more than the theoretical amount of oxygen. Investigation of the dissociation pressure of oxygen over manganese dioxide showed that it was as high as 0.03 atmospheres at 372°C.²⁸ and, under the conditions obtaining, it would decompose, in contrast to its behaviour when the oxygen pressure over the mixture is greater than the dissociation pressure.

(iii) Potassium Chlorate + Ferric Oxide. Other catalysts mentioned by Mellor as being active in promoting the decomposition of potassium chlorate included ferric oxide, which seemed eminently suitable for the present purpose, the reaction starting at 110°C. and ferric oxide having a dissociation pressure as low as 0.0066 atmospheres at 1100°C. Measured volumes (~ 1 ml.) of dilute potassium chlorate solutions were evaporated in an oven, at

about 100°C. , with a stream of compressed air continuously removing water vapour about two inches above the liquid surface. Without the air stream the process was very slow, since the solution was contained in a thimble of pyrex glass up to 10 cm. long and 1 cm. in diameter. The residual chlorate, which adhered reasonably well to the pyrex after evaporation of the solution, was dusted with ferric oxide catalyst, sealed onto the necessary gas measuring assembly, and heated to just below the softening point of the glass to liberate oxygen. The oxygen liberated was collected and measured after passage through a trap at the temperature of liquid nitrogen. Consistent yields, proportional to the amount of chlorate taken and independent of the amount of catalyst, were obtained but, within the experimental error, only $66\frac{2}{3}\%$ of the theoretical oxygen was obtained

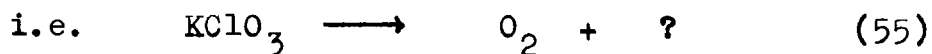

as opposed to the expected



Some idea of the reason for this departure from the

normal decomposition was provided by the appearance, in the liquid nitrogen trap, of a yellow ring which quickly dispersed on warming up the trap. This could have been chlorine, or a chlorine oxide. It is a well-known fact that $\text{KClO}_3 - \text{MnO}_2$ mixtures, after decomposition under normal atmospheric conditions, are altered physically and contain traces of KMnO_4 . This points to some intermediate formation and it is conceivable that under vacuum conditions a volatile intermediate could be removed continuously, altering the course of the reaction. This phenomenon was not further investigated since the immediate need for a reproducible source of oxygen had been satisfied and such an investigation was beyond the scope of the work.

(c) The Filling System and Method of Filling the Reaction Vessel.

The main requirements of the filling system, in addition to those already outlined, were:

- (i) that it should be tapless, to prevent absorption of radioactive acetone in tap grease and the risk of subsequent error from this source.
- (ii) that provision should be made to isolate the

iodine source from any source of mercury prior to its release into the reaction vessel.

(iii) that it should be possible to prevent condensation of appreciable amounts of mercury in the reaction system during filling operations.

(iv) that, for convenience, the reaction vessel should be detachable since it was inconvenient to arrange the irradiating system in situ, nor had such an arrangement any practical advantages, owing to the design of the rest of the section.

These requirements could only be satisfied by constructing a system involving glass constrictions as potential seals, and make-and-break components generally. These elements of construction had to be renewed before each experiment - a time consuming process but an essential one in view of the reactive nature of the reaction mixtures envisaged. The system evolved is illustrated in Fig. 2.

Acetone was contained in two reservoirs R_1 and R_2 isolated behind mercury seals at C_1 and C_2 . The acetone in R_2 was inactive but that in R_1 contained 0.2 millicurie of acetone labelled in the 1,3 carbon atoms with ^{14}C ($^{14}\text{CH}_3\text{COCH}_3$).

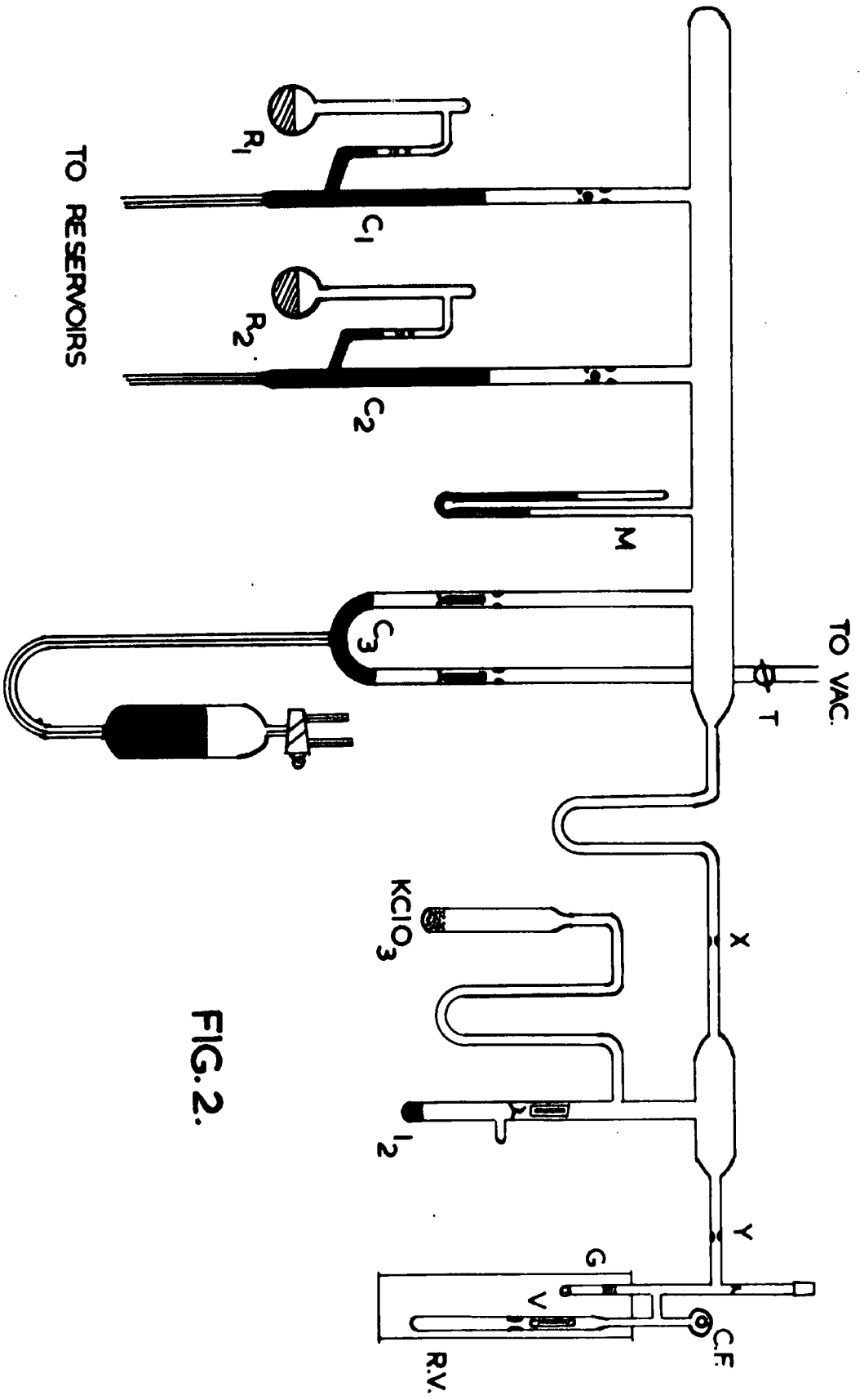

FIG. 2.

The activity, originally in a few milligrams of material, was diluted to about 6 cc., with acetone from R₂, to give a suitable level of activity for eventual analytical measurements. The inactive acetone in R₂ was used for calibration runs which merely involved gas-volumetric measurements and did not require measurements of radioactivity. These calibration figures themselves, however, were only used when it had been demonstrated that active and inactive samples gave the same calibration results under the same conditions of temperature, pressure and absorbed quanta. This procedure was followed to conserve radioactive material for those experiments in which its use was essential.

The inactive acetone was obtained by distillation of 'AnalaR' grade acetone in a concentric tube column of several theoretical plates, the first and last thirds of the distillate being rejected. It gave no reaction with dilute potassium permanganate solution at room temperature nor did it reveal any biacetyl when attempts were made to detect this compound (by formation of dimethylglyoxime with hydroxylamine and subsequent formation of the nickel complex). It must be conceded however that this test, at the level of sensitivity employed, really demonstrated that the biacetyl concentration did not exceed 1 part

in 10,000 parts of acetone, since at lower concentrations the test was not sensitive enough to allow definite conclusions to be drawn, even though the colours of the test solutions compared very favourably with blanks carried out under the same conditions. "AnalaR" acetone which had not been distilled at all was shown to be equally insensitive when tested for unsaturated compounds and biacetyl so, when later it was desired to replace the acetone in R_2 , this was done with "AnalaR" acetone, which was vacuum distilled from magnesium sulphate direct to the storage bulb. Presumably the quality of commercially available acetone has improved considerably since the time when Rice²⁹ found his material to contain cyclic compounds. It is notable that Trotman-Dickenson and Steacie³⁰ observed that the behaviour of acetone in the direct photolysis was relatively independent of its purification, some samples merely being distilled and others distilled from permanganate.

The reaction vessel, R.V., was in quartz and cylindrical, being 24 cm. long and 6 cm. in diameter (vol. ~ 664 cc.). The ends were plane polished quartz discs containing virtually no distortion which could interfere with the path of the light beam. The vessel

was attached to the rest of the apparatus, in pyrex, via a quartz-pyrex graded seal G. Since the diameter of the vessel was large, being approx. three times most employed by other workers, it was thought that fairly low pressures could be studied safely without serious interference from wall effects. The side tube containing C.F. and V was a permanent appendage in pyrex glass, C.F. being a cold finger on which condensable matter could be frozen out during irradiation, if required, and V a greaseless valve with ground glass seating under which acetone could be isolated, by freezing out, while the vessel was still attached to the system in a vertical position. The reaction vessel was closed by a weak glass seal surmounted by a B.14 Quickfit cone to provide a means of attaching the vessel to the analytical system following irradiation.

The section bounded by the constrictions X and Y contained the oxygen and iodine sources. The iodine was present behind a seal either in the form of a capillary or in a tube with a weakened seal as already described (Fig. 1). The seal, in either case, could be broken, magnetically, by raising and releasing a glass weight with an iron core. The oxygen was present as KClO_3 in the auxiliary thimble shown. The U-tube between the KClO_3 and iodine limbs served to remove less volatile products from the $\text{KClO}_3 - \text{Fe}_2\text{O}_3$

reaction. Since the iodine and oxygen sources, R.V.B14 and seal, and constrictions X and Y could only be used once (being consumed, broken, or sealed up) the system to the right of X had to be reconstructed each time a full run was performed.

C₃ was a mercury cut-off by means of which the system could be isolated from the vac. line and the tap T, the only one involved. M was a manometer for registering acetone pressure.

Procedure. After pumping down to high vacuum and raising the mercury in C₃, to isolate the system from the pumps, acetone was admitted, from the appropriate reservoir, to the desired pressure, registered on M. A knowledge of the volumes of various parts of the system allowed the estimation of the eventual pressure to be realised in the reaction vessel after sealing off. After closing off the reservoir used (using C₁, or C₂) the acetone was condensed in the reaction vessel sidearm below V at -140°C. and pumped on to remove any gases in the acetone volatile at this temperature. It was then isolated, by dropping the valve V into place, (again magnetically), and kept at -195°C. until required. For runs involving iodine, where the presence of mercury vapour constituted an undesirable source of error, precautions had to be taken to prevent condensation

of mercury onto the frozen acetone before V was dropped into place. This was done by cooling the U-tube to the left of X, immediately after the acetone was condensed in the tube V. Distillation of acetone at -140°C . was negligible.

In calibration runs, using the photolysis of pure acetone as actinometer, the constriction Y was sealed immediately the acetone had been condensed in V, and the vessel removed for irradiation. In other runs with iodine and/or oxygen the constriction X was sealed at this juncture, isolating the right hand side of the system from mercury vapour. The capillary or tube containing the iodine was then broken and the iodine liberated condensed at the base of the reaction vessel away from V and the acetone. Finally oxygen was liberated by heating the chlorate-ferric oxide mixture and allowing the oxygen to diffuse to the reaction vessel through the liquid nitrogen trap mentioned previously. The oxygen was not condensable at the low pressures used but did not interfere with subsequent sealing off of Y. The reaction vessel, now detached, was polished at its ends and the contents allowed to warm up, care being taken not to allow iodine to vapourise so quickly that it could come into contact with acetone as

liquid and give rise to liquid phase reactions. The vessel was then removed to the irradiation oven.

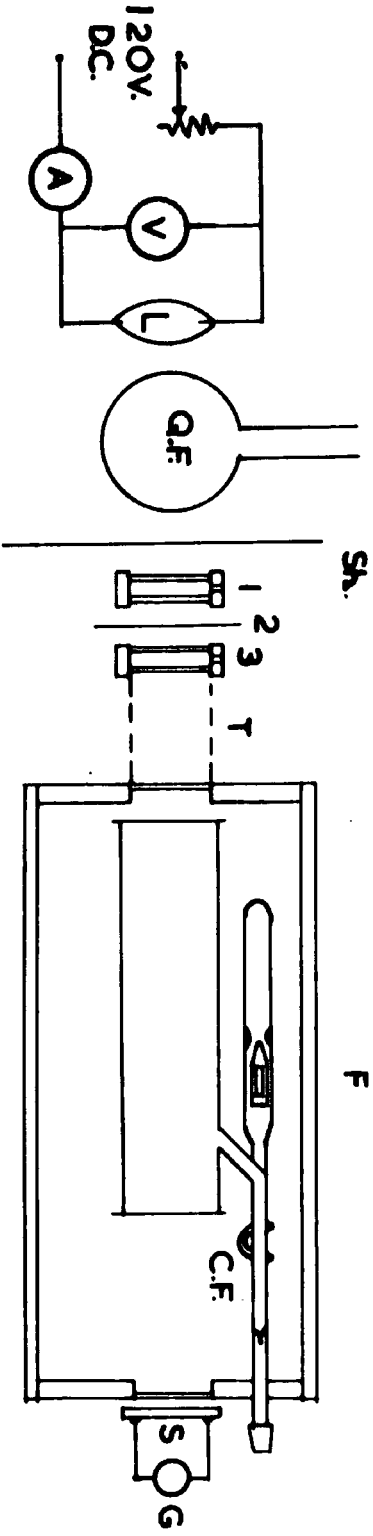

FIG. 3.

EXPERIMENTAL TECHNIQUES: (2) IRRADIATION.

The irradiation system was quite straightforward and is illustrated in fig. 3. Radiation was supplied from a 250 watt, medium pressure, mercury burner, L, which was struck and run from a 120 V D.C. supply through a variable resistance in series with the lamp. The lamp was operated without its protective envelope.

Q.F. was a spherical quartz collimating flask, furnishing an approximately parallel beam of light, and containing the first of a series of filters in the form of a 50 gm./litre solution of nickel sulphate ($\text{NiSO}_4 \cdot 7\text{H}_2\text{O}$). Cell 1 was in silica, having a diameter of 6 cm. and contained 10 mm. of potassium chromate solution (0.48 gm./litre) with sufficient NaOH added to prevent the formation of dichromate, which has different transmission characteristics. 2 was a Chance OX7 glass window, 2 mm. thick, and 3 contained a silica window and another thickness of Chance OX7 glass enclosing 10 mm. of potassium biphthalate solution (5 gm./litre). This system, which was similar to those used by previous investigators, was intended to filter out all but 3130\AA radiation. The transmissions of the various components were checked using a Unicam spectrophotometer and are shown below.

Table I

Transmission Characteristics of Filter System Components (in 10 mm. silica cell relative to H ₂ O = 100%).					
Biphthalate		Chromate		2 thicknesses Chance Glass (OX7)	
Wave- length	% trans- mission	Wave- length	% trans- mission	Wave- length	% trans- mission
				2600Å	17.5
3000Å	0.0			2700Å	29.0
3030Å	0.7	2900Å	0.2	2800Å	40.0
3050Å	12.5	3100Å	29.6	2900Å	49.0
3130Å	89.4	3130Å	32.2	3130Å	61.0
		3150Å	30.5	3500Å	67.0
		3200Å	19.2	3800Å	42.5
				3900Å	17.0
		3342Å	0.5	4000Å	2.5

Both solutions deteriorated with time and were changed fairly frequently. However the deterioration did not cause serious changes in the relative transmission characteristics of the solutions for various wavelengths, the main effect being merely to increase the optical density of the system and cut down the transmitted intensity. Light emerging from this system was always essentially 3130Å radiation, considering the available lines in the mercury arc and the

characteristics of the filter system.

S was a shutter, removal and re-insertion of which provided a means of starting and stopping the process of photolysis. T was a cylindrical tube (~ 6 cm. diameter) with colloidal graphite painted on its inner surface and served to prevent stray light from entering the reaction vessel along with the direct beam. The lamp and filter system up to the end of the cylindrical tube T were shrouded so that light could not reach the photocell S except by the direct path through the reaction vessel. The reaction furnace, F, was heated by a nichrome spiral and was constructed to give temperatures up to about $220-250^{\circ}\text{C.}$, if required. Temperature control within this maximum was adequately effected by using a simple Sunvic energy regulator.

The direct beam, after traversing the reaction vessel, was measured by means of the selenium photocell S, in conjunction with a Unipivot galvanometer G, resistance 111 ohms. The photocell current response to increase in intensity was linear providing the load resistance was not more than 200 ohms. This was checked for the system under consideration by interposing calibrated screens between the light beam and the photocell. The linearity provided a

convenient method for estimating quantum yields. Some actinometric standard was required for this purpose and it was decided to use the acetone photolysis itself, measuring the CO yield and making the assumption that $\Phi_{\text{CO}} = 1.0$, which has been adequately demonstrated for temperatures above 100°C . by previous workers. Since iodine and oxygen do not absorb at this wavelength, the absorption of 3130\AA light is solely a function of acetone pressure and, by performing a calibration run, and the run proper, under the same conditions of temperature and acetone pressure, the amount of a product equivalent to a quantum yield of unity could be deduced from the relative photocell deflections and the carbon monoxide yield in the calibration and, of course, the period of irradiation.

Procedure.

After removal from the filling line, the reaction vessel was placed in position in the furnace F, as shown in fig. 3. The furnace was already at approximately the required temperature and, after closing in the reaction vessel, the assembly was allowed to come to this temperature and left, at least, a further half-hour to allow the contents to mix and reach equilibrium. During this period the mercury arc was struck with the shutter in position and allowed to settle down to steady running conditions at the same time

as the reaction vessel and its contents were coming to thermal equilibrium with their surroundings. When both had achieved their respective "steady states" the system was ready for irradiation. The shutter was then removed for the required time and the value of the photocell current plotted at half-minute intervals. The lamp output was found to vary slightly over the 5-15 minutes usually required and the values obtained were averaged to give one intensity figure operating over the whole of the period of irradiation. The photocell was mounted in a stiff frame which was bolted to the furnace, ensuring accurate reproduction of its position relative to the fixed parts of the system. Its output decreased somewhat with rise in temperature so, to give reproducible conditions, it was placed in position immediately the reaction vessel was introduced into the furnace (and the end replaced) so that it, too, could achieve a steady temperature along with the furnace and its contents.

After irradiation the vessel was allowed to cool before passing to the analytical system.

EXPERIMENTAL TECHNIQUES: (3) ANALYSIS.

Initially it was desired to analyse for carbon monoxide, carbon dioxide, and methyl iodide, where applicable. Further analyses, for acetic acid and formaldehyde, required techniques which could not conveniently be incorporated in the procedure evolved to deal with the first-mentioned products, and determination of these compounds involved separate experiments with special analytical techniques. These techniques are discussed later.

No difficulty was anticipated in effecting separation of carbon monoxide and/or dioxide from unreacted acetone and other less volatile products. The main problem presented was that of separating micromole quantities of methyl iodide from millimole quantities of acetone and establishing a suitable method of determining their radiocarbon contents. Since methyl iodide could only arise from the radioactively labelled methyl groups within the acetone molecule the radioactivity of the sample could be used for direct estimation of the total yield, providing the specific activity of the methyls was known. The procedure involved extracting the active product-methyl iodide with a known amount of inactive carrier methyl iodide

and observing the reduction in specific activity resulting from this dilution (technique of isotopic dilution). This technique had the virtue that, once dilution had been effected, only a portion of the iodide had to be recovered and counted to provide the necessary information i.e. 100% recovery was not essential providing the sample separated was pure and free from contaminating acetone. In Sutton's work, using radioactively labelled ^{131}I as tracer, contamination of methyl iodide with materials not containing iodine was relatively unimportant, since the iodide content was precipitated. In the present work, however, the activity of the iodide and the parent acetone was carbon-14 in both cases, and the presence of even trace quantities of strongly radioactive acetone in relatively weak, diluted, methyl iodide could have led to appreciable errors so that, even though quantitative recovery of iodide was not essential, the highest possible degree of separation from the acetone was.

To this end attention was first directed to a method of rendering the acetone involatile, and complexes with sodium iodide, sodium bisulphite, and dinitrophenylhydrazine were tried. Synthetic acetone-methyl iodide mixtures were treated with the above reagents, volatile products distilled

at about -80°C . and the distillate tested for acetone colorimetrically. The spot test employed was that given in Feigl's "Spot Tests". To the solution suspected of containing acetone were added the appropriate quantities of ethyl alcohol, sodium nitroprusside, sodium hydroxide and glacial acetic acid, till acid. The presence of acetone was indicated by a violet coloration and the test was made semi-quantitative by comparison of the colour with a range of colours developed in acetone solutions of known concentrations. The results of these tests showed that sodium iodide was of no value and that, although sodium bisulphite and dinitrophenylhydrazine, under suitable conditions, retained much of the acetone, the reactions were not quantitative enough to prevent prohibitive amounts of acetone from distilling. Furthermore the reproducibility of this type of derivative formation was uncertain and the need for other reagents (e.g. H_2O , CH_3COOH , and EtOH) in the reaction mixtures led to further undesirable separation problems. Also, looking ahead, it was apparent that there existed the possibility of producing other volatile compounds, in the photolyses, which would not separate from the iodide by such simple treatment. It was therefore decided to abandon this approach.

On turning to the chemistry of methyl iodide for a possible method of attack a fairly elegant method presented itself involving the reduction of methyl iodide to methane with zinc-copper couple in alcohol. It was hoped that such a procedure would not affect the acetone at all and experiments were performed to confirm this. Such a method had two obvious virtues,

- (a) methane so formed could easily be freed from acetone, and most other imaginable volatile products except permanent gases, by passing the gas formed in the reduction through a liquid nitrogen cooled trap. (V.P. methane at $-195^{\circ}\text{C.} = 9.5 \text{ mm.}$). Since permanent gases could be dealt with before this reduction stage, the method seemed ideal.
- (b) it was intended to convert ^{14}CO to $^{14}\text{CO}_2$ for gas counting, and also to gas count $^{14}\text{CO}_2$ from acetone-oxygen photolyses. The logical extension of this was to convert $^{14}\text{CH}_4$ to $^{14}\text{CO}_2$, thus standardizing the radioactivity determinations. Such a procedure was to hand, and fairly simple.³¹

Reduction of methyl iodide to methane

Zinc copper couple was prepared by the action of granulated zinc on 2% copper sulphate solution. Test solutions of

of approximately 0.03 ccm. of methyl iodide in 0.5 ccm. of methyl alcohol were made up and vacuum distilled onto Zn/Cu couple and allowed to warm up to room temperature. Reaction soon commenced and methane was extracted for gas volumetric measurement after about 2 hours and also after leaving overnight. Without following excessive precautions against loss of methyl iodide vapour in the initial manipulations, methane was recovered, after two hours, equivalent to about 75% of that theoretically possible, and, after overnight, about 85% yield was obtained. After checking that acetone-alcohol-Zn/Cu mixtures gave no permanent gases under the same conditions the procedure was repeated for methyl iodide (0.03 ccm.), acetone (0.2 ccm.), methyl alcohol (0.5 ccm.-1.0 ccm.), Zn/Cu mixtures and the results confirmed. 0.03 ccm. of methyl iodide yielded, approximately, after allowing for oxidation losses and counting efficiencies, the amount of gas required to fill the gas counter to be used, and 0.2 ccm. of acetone was enough to fill the reaction vessel at the pressure orders envisaged, so these experiments represented a close approximation to actual running conditions. The identity of the gas produced in these reductions was checked by lowering the temperature of part of the measuring apparatus to $-195^{\circ}\text{C}.$, when the vapour

pressure registered was 0.95 cm. i.e. the vapour pressure of methane at this temperature. It was assumed that acetyl iodide, under these conditions, could not produce methane.

Possibility of Exchange

It was thought desirable to check that the mechanism of reduction of methyl iodide in methyl alcohol did not lead to exchange of radiocarbon between the active iodide and the inactive alcohol. Some ^{14}C labelled methyl alcohol was procured and a portion burned to give CO_2 , the activity of which was determined. Part of the same alcohol sample was then converted to methyl iodide by the action of iodine and red phosphorus, and the iodide obtained reduced to methane and then oxidised to CO_2 . The CO_2 so obtained had, within the experimental error, the same specific activity as that from the original alcohol, demonstrating the absence of exchange.

RESULTS OF EXCHANGE EXPTS. TABLE II.

Source of CO_2	p_{CO_2} (Active)	Sp. Act. (c.p.m./cm. CO_2)
Active $^{14}\text{CH}_3\text{OH}$	3.90 cm.	809 \pm 13
Active $^{14}\text{CH}_3\text{I}$	1.92 cm.	787 \pm 20

Errors in specific activities included about 1% due to

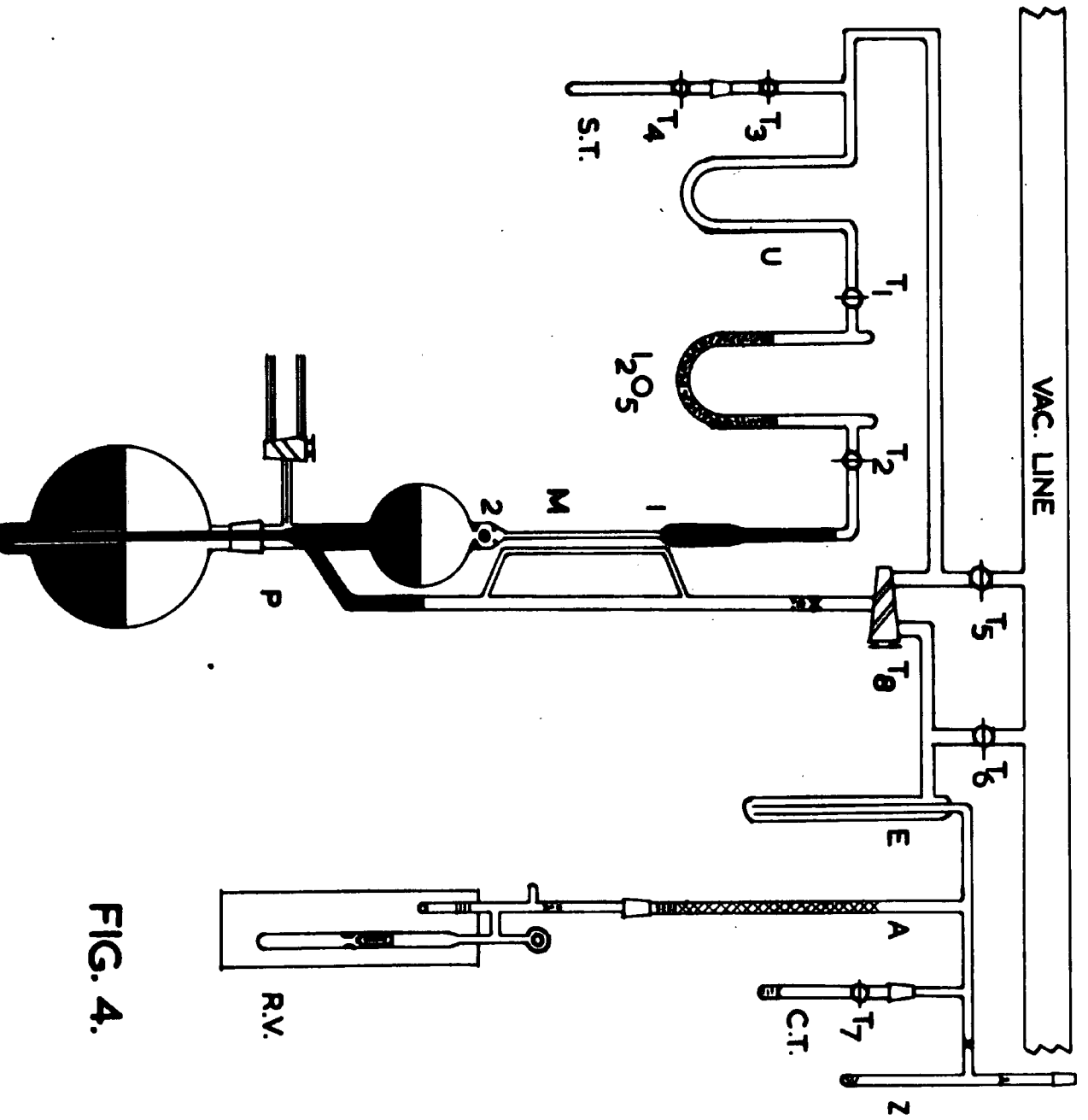

FIG. 4.

counting in each case and also a rather larger error (approximately 2½% in the second result) due to the small pressures of active gas realised, which were measured on a simple millimetre scale. However, the experiment served its purpose in showing that no troublesome exchange occurred in the reduction process.

Analytical Procedure, with Commentary

The analytical system devised to meet the requirements stated i.e. analysis of micromole quantities of CO, CO₂, and CH₃I is illustrated, diagrammatically, in Figs. 4, and 6.

(a) extraction of products. The reaction vessel, after removal from the irradiation oven and cooling, was transferred to the analytical system A, (see Fig. 4), where it was attached by means of the B14 joint with which it was initially provided. It contained excess reactants and photolysis products (e.g. ¹⁴(CH₃)₂CO, O₂, I₂, ¹⁴CH₃I, CO, ¹⁴CO, CO₂, ¹⁴CO₂, and ¹⁴CH₂O). The system was evacuated via taps T₅ and T₆. Methyl iodide carrier, present in methyl alcoholic solution, was kept frozen out in the carrier tube C.T., behind T₇, during the evacuation process.

When a hard vacuum had been obtained, the taps

T₅, T₆, and T₈ were closed and the weak glass septum sealing the reaction vessel was broken magnetically, by means of a steel ball, with the trap E immersed in liquid nitrogen. The contents of the reaction vessel passed through the tube A, packed with silver powder on glass wool to retain unused iodine, and non-permanent gases condensed in E. (It was deemed essential, especially in runs with oxygen, to have E cooled before breaking the seal, since acetone could not be condensed efficiently against the residual oxygen pressure after passing through E, and neglect in this respect could have led to acetone being collected as permanent gas yield). T₈ was then opened in the appropriate direction and permanent gases volatile at -195°C . were pumped into M by means of the Toepler pump, P, using the valve 2 (steel ball on ground seat) as a non-return valve. When the permanent gases had all been transferred by this procedure, T₈ was closed and T₇ opened, allowing the carrier solution in C.T. (brought to room temperature) to distil onto the frozen photolysis products. The contents of E were then allowed to warm up to mix the carrier iodide/alcohol mixture with the active iodide products and, also, to liberate any occluded permanent gases. These permanent gases were added to the gas already in M after

refreezing volatile matter into E with liquid nitrogen.

- (b) measurement of permanent gases. The gas measuring device M was rather a special one and merits a detailed explanation. The narrow gauge, constant bore, tube M, and P, constituted a combined McLeod gauge and Toepler pump. The calibrated section M was equipped with two valves, 1 and 2, each consisting of a steel ball on a ground glass seating. The capacity of M was about 1 ccm. of gas at a pressure of 12 cm. Hg. and, to measure gas, the tube was closed at its top end by the ball 1, sealed by a suitable head of mercury (>12 cm.), and the gas pumped in using 2 as a non return valve in the usual way. With tap T_8 reversed to form a closed circuit, and with the valve 1 open, the device was used as a normal Toepler pump to circulate gas through the tube containing iodine pentoxide and the trap U.
- (c) estimation of CO by oxidation. This procedure varied, somewhat, under different conditions. In runs which did not involve oxygen, the time of irradiation was adjusted so that the capacity of the measuring device, M, was greater than the permanent gas yield and the gases were measured before, and after, cycling through iodine pentoxide at a temperature of $150^{\circ}\text{C}.$, a process which was specific in converting carbon monoxide to carbon dioxide.

The carbon dioxide formed in this way was condensed out in U, the course of the oxidation being followed by the decreasing quantity of residual permanent gases measured in M at intervals during the cycling procedure. The process was taken to be complete when consecutive readings of the McLeod were the same and the residue was assumed to be methane. The residual gas was then pumped away and the CO₂ in U allowed to warm up for recollection in M. Thus the total permanent gas yield and its two constituent members, CO and CH₄, could all be measured.

When the Apiezon grease (N) on the taps T₁ to T₄ and T₈, was newly applied it was found that the condensable gas in the closed system increased, i.e. condensable + permanent residue > initial permanent gases. It was suspected that this was due to continued removal of dissolved condensable matter from the tap grease, especially when U was at -195°C., since such evolved gas was continuously condensed under these conditions. Reasonable confirmation of this point was obtained by leaving the system closed overnight and observing the increase, (1), for a run with newly applied grease and, (2), for the run immediately after (1). The results are shown in (Table III).

The discrepancies between the sums of the components and the original totals decreased with age of the grease. In view of the constancy of the residue, it was felt that the most accurate figure for the carbon monoxide yield was that obtained by subtracting the residue from the total, which, in itself, was reliable since it was extracted, initially, via the trap E at -195°C . In all runs, to minimize this trouble with condensable gas, the trap U was not kept permanently at -195°C . during the cycling procedure, but only during collection of the residual permanent gases into the McLeod. The foreign gas liberated from the grease was probably CO_2 since an attempt to retain it in U, while collecting the CO_2 from the oxidation process at -135°C ., failed.

In runs which involved oxygen, the excess oxygen collected in the extraction of permanent gases made it impossible to measure these gases in M before oxidation of the carbon monoxide content. In such a case the gas from E was pumped, via ball 2, direct to the iodine pentoxide tube with tap T_1 closed. T_8 was then reversed, T_1 opened, and the gas cycled through the oxidising tube, as before, for approximately the same time as had been observed previously to give

complete reaction of the order of carbon monoxide yield obtained in these experiments. At the end of this time the CO_2 produced was condensed out in U, using two or three strokes of the pump, and the excess oxygen and any residues were collected, with T_1 closed, between T_1 and mercury suspended, above the ball 1, for this purpose (and subsequent CO_2 measurement). The CO_2 in U was then allowed to warm up and was collected in M. This procedure was repeated until the CO_2 reading in M was constant and was noted. Trouble was expected in this context from evolution of condensable gas from tap grease, which would tend to make the CO_2 figure high, and no "subtraction check" was possible. However, from the reproducibility of results obtained using this technique, little trouble was encountered and this was attributed to the relatively high permanent gas pressure which presumably prevented the elimination of condensable matter from the tap grease to a marked extent.

CO_2 obtained from oxidation of CO in runs with oxygen was partially radioactive and, after dilution with a sample of inactive carrier CO_2 , (introduced via the sample tube, S.T., after pumping away oxygen

and residues), to facilitate extraction, it was condensed in S.T. and removed to the counting assembly (see IV, (4).).

- (d) extraction and measurement of CO₂ from E. This product was found only in photolyses involving oxygen. For its extraction E was warmed up to -150°C. and CO₂ which volatilized at this temperature, was pumped into M. Since CO₂ is very soluble in acetone, which itself is solid at -150°C., the contents of E had to be thawed and refrozen several times (usually about 5) before the reading in M became constant. After measurement the CO₂ was diluted with inactive carrier, as described above in (c), and removed for counting. Care had to be exercised in interpretation of results at this stage since Hoare¹³ was of the opinion that formaldehyde was not completely involatile at this temperature and distilled, in small amounts, with the CO₂ (up to 10% quoted).

In experiments involving the photolysis of acetone with both iodine and oxygen, slight deterioration of the methyl iodide carrier (introduced in the course of the initial extraction of products from the reaction vessel) produced prohibitive quantities of a gas which appeared in the CO₂ fraction (C₂H₆ ?) and rendered

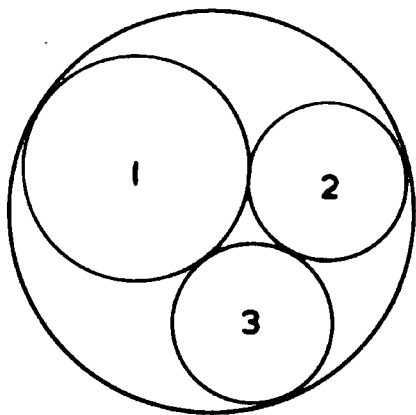

(a) PLAN

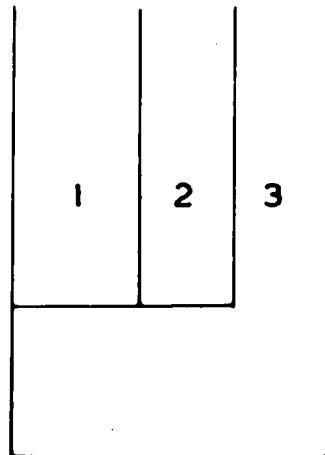

(b) SECTION

COPPER BLOCK

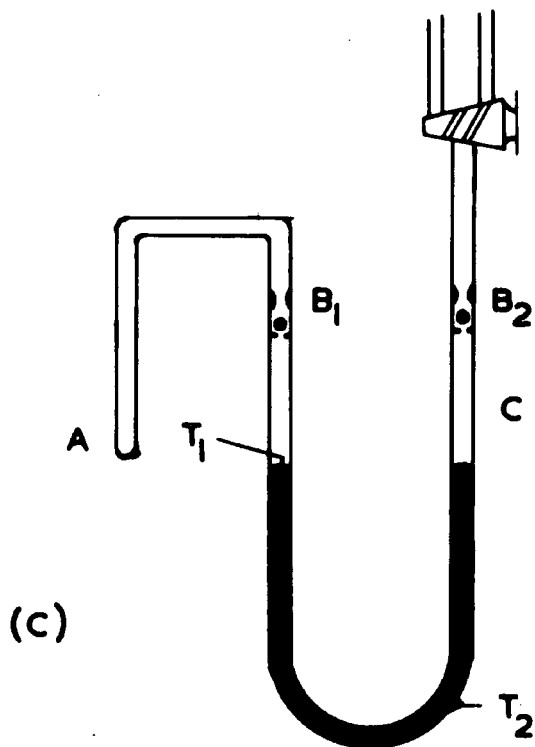

(c)

FIG.5.

quantitative volume estimates useless, although the radioactivity could still be estimated without error. For this reason the experiments had to be repeated, without iodide carrier, for the purpose of obtaining the CO_2 yield and, incidentally, checking the CO figure.

The device used to produce a temperature of -150°C . in the trap E is illustrated in fig. 5. It was found to be more satisfactory than the use of slush baths at this temperature. Figs. 5(a) and 5(b) represent a vertical plan and a section, respectively, of a copper cylinder, hollow and without top, which contained three subsidiary cylinders, also in copper (1, 2, and 3). Of these, 1 and 2 were short, extending only $\frac{2}{3}$ of the way down the container, and closed at the bottom, while 3 was not closed but opened directly into the hollow chamber under the other two. Compartment 1 housed the trap to be cooled i.e. E. The second, 2, enclosed the thimble, A, of a vapour pressure thermometer shown in Fig. 5(c). 3 served as an inlet whereby liquid nitrogen could be introduced into the hollow chamber. To ensure good thermal contact between the parts, and a good evaporating surface for the liquid nitrogen, the gaps between the cylinders, and the hollow chamber itself,

were packed with copper turnings. Contact between the copper tubes and the glass of the thermometer and trap was effected with 40-60°C. petroleum ether. The thermometer bulb was filled with a material with a suitable vapour pressure, in this case krypton which has a vapour pressure of 1 atmosphere at about -152°C.

If the bulb A was above -152°C. the mercury in the U of the thermometer was held, by the pressure of the krypton, so that there was no circuit between the tungsten terminals T_1 and T_2 . While this state of affairs persisted, liquid nitrogen was blown into 3, from a Dewar flask closed by a rubber bung (with inlet and outlet tubes), using compressed air. This air, in transit to the Dewar, had to pass through a port, in a brass block, which was kept open by activating a solenoid to depress the necessary plunger magnetically. The solenoid was fed from the mains through a Sunvic "currentless" relay. When the temperature of A had reached the required value the pressure in the thermometer had dropped to one atmosphere and contact between T_1 and T_2 was established via the manometer mercury. This completed a second circuit, also fed from the Sunvic, and tripped the relay, cutting off the

solenoid and, thus, the air and liquid nitrogen supplies. The trap and thermometer then began to warm up again until the circuit was broken at T_1 and the flow of coolant resumed.

The device was slightly more versatile than is indicated by the above procedure. The right hand limb, C, ended in a three-way tap. If this was open to the atmosphere then the temperature at which the bulb settled was -152°C . and, for most runs, this was the temperature employed. If, however, the tap was connected to a source of vacuum the thermometer could be used to produce and control temperatures below -152°C . depending on the residual pressure employed. Thus, if a temperature of -159°C . were required, the pressure in the limb C was adjusted to 400 mm. of mercury since the vapour pressure of krypton achieves this value at -159°C . and the mercury could again make contact at T_1 . Since the vapour pressure changes by 36 cm. over a mere seven degrees of temperature it will be seen that the instrument was quite sensitive in this range. In practice it was used so that the distance the mercury travelled between breaking and making contact at T_1 was as small as possible. Since there was an appreciable time lag between introduction of liquid nitrogen and fall in

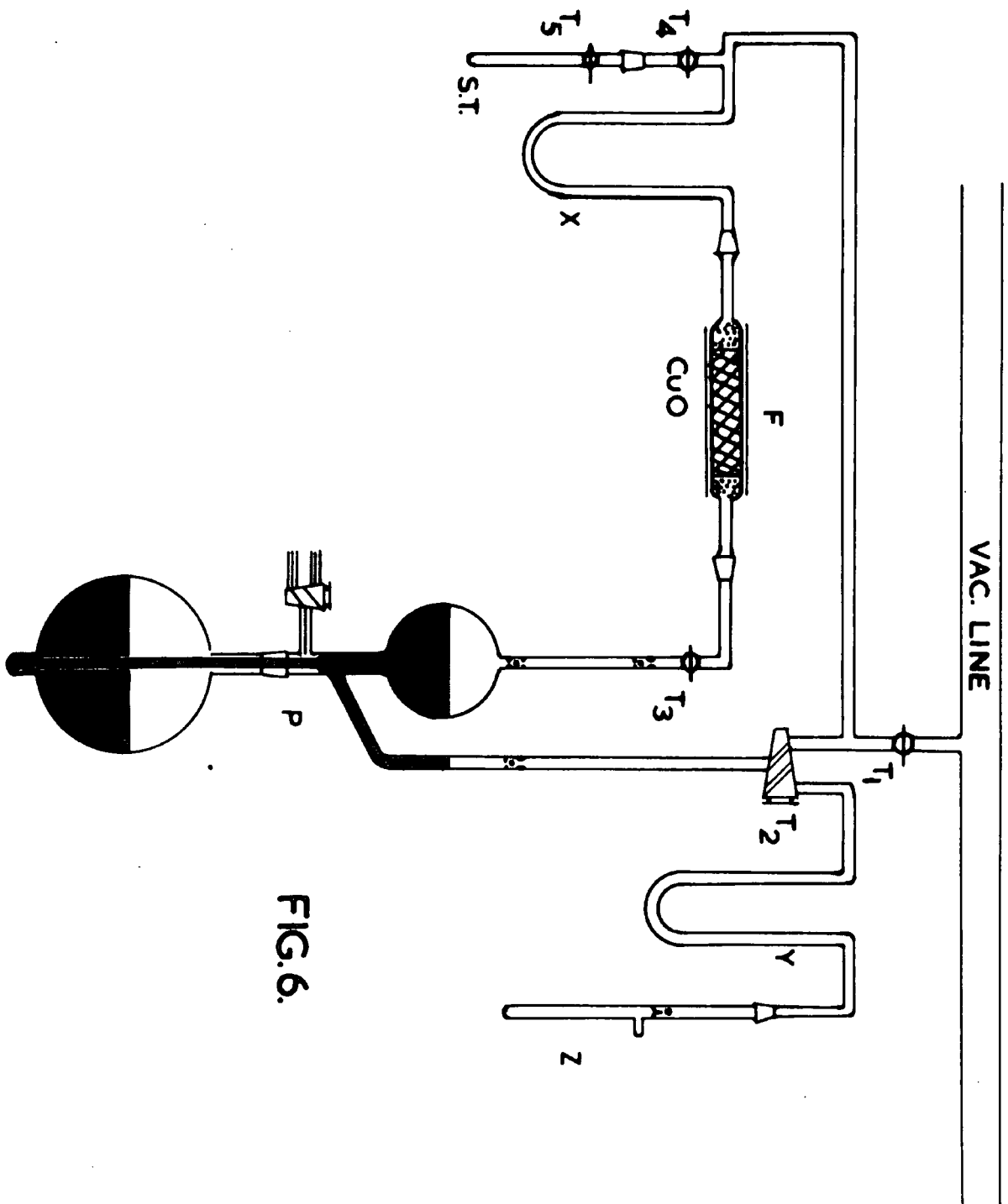

FIG. 6.

temperature in 1 and 2, it was realised that a further controlling device was necessary to make the instrument really accurate which would give an intermittent nitrogen delivery, with suitable on-off times, even while the solenoid was live. The balls B_1 and B_2 served to prevent motion of the mercury beyond the obvious limits.

- (e) measurement of methyl iodide. After extraction of CO_2 from E, at $-150^\circ C.$, the remaining contents of the trap were distilled into the tube Z and sealed by means of the constriction in the side arm. The tube Z contained zinc copper couple which, along with the alcohol in the methyl iodide carrier solution, reduced the methyl iodide to methane, a process which was allowed to proceed conveniently overnight.

When reduction was complete Z was attached to the second part of the analytical system illustrated in fig. 6. After pumping down to vacuum all the taps were closed and the weak glass septum sealing Z below the B.14 cone was broken, magnetically, with Y immersed in liquid nitrogen. Acetone and other condensable matter were thus retained in Y while the methane liberated was pumped, via T_2 , P, and T_3 to the oxidation tube in the furnace F. The oxidant was

specially prepared copper oxide³¹ (containing 1% Fe₂O₃) contained in a silica tube and maintained at 750-800°C., although 700°C. was reputed³¹ to be high enough. After reversing the 3-way tap T₂ to form a closed circuit, the Toepler pump P was used to cycle the methane through the hot copper oxide. The products of the oxidation, carbon dioxide and water, were condensed in the U-trap X and, after pumping away permanent residues, the CO₂ was distilled from X at -120 to -130°C. and condensed in S.T., water being retained in X. The tube S.T. was then removed to the counting apparatus.

In circulating gas through the oxidizing mixture in some early experiments, (e.g. those for demonstrating that no exchange occurred in methyl iodide reduction - see p. 80), it was observed that the rate of oxidation was very slow and the yields realised were disappointing. Some investigation was, therefore, deemed advisable on the effect of various items of procedure on the efficiency of the oxidation process. The following points were observed.

- (i) If CO₂ and H₂O were progressively condensed in X as they were formed, by keeping a liquid nitrogen bath around X during the whole of the cycling procedure,

the oxidation was slow. The reason was fairly obvious: although methane is reasonably volatile at -195°C . its vapour pressure is only 9.5 mm. The total pressure of methane developed during an average run, measured with the mercury filling the whole of the Toepler bulb, was approximately 10-15 cm. Thus, with X at -195°C . throughout the experiment only a small fraction ($<10\%$) of the methane was available for oxidation at any one time and the methane concentration was much lower than it need have been. By circulating the gas without the cold trap the reaction efficiency was improved.

- (ii) If the mercury in the Toepler pump was left in the raised position near to T_3 for some time during each stroke, (instead of raising and lowering immediately afterwards for recycling), then the efficiency of each stroke increased. Presumably this action was twofold - the gas concentration was at its maximum attainable value and the gas could have longer contact with the reaction zone. When time was available this process was extended further, the gas being left in this compressed state for 2 to 3 hours and this effected most of the oxidation, only a few cycles being

employed at the end of this time to condense out CO_2 and H_2O . The reaction could be followed by the appearance of water droplets at the ends of the combustion tube.

(iii) Since each methane determination consumed a large proportion of the copper oxide content of the combustion tube, it was reoxidized, after every run in which methane determination was involved, by admitting air to the hot tube.

The specific activity of the $^{14}\text{CO}_2$ obtained from the methane was used to estimate, directly, the yield of methyl iodide, since the specific activity of the acetone methyls and also the weight of carrier iodide added were known. Since methyl iodide could only have arisen from the methyl groups in the acetone molecule,

$$\frac{\text{Yield } \text{CH}_3\text{I}}{\text{Wt. of carrier iodide}} = \frac{\text{Sp. Act. of } \text{CO}_2 \text{ from } \text{CH}_4 \text{ oxidation}}{\text{Sp. Act. of } \text{CH}_3\text{S in orig. acetone}}$$

or, more correctly,

$$\frac{^{14}\text{CH}_3\text{I}}{^{14}\text{CH}_3\text{I} + \text{carrier } \text{CH}_3\text{I}} = \frac{\text{Sp. Act. of } \text{CO}_2 \text{ from } \text{CH}_4 \text{ oxidation}}{\text{Sp. Act. of acetone methyls}}$$

However, $^{14}\text{CH}_3\text{I}$ was usually less than 1% of the added

carrier and the use of the original statement of
the above equation did not introduce serious error.

EXPERIMENTAL TECHNIQUES: (4) RADIOACTIVE COUNTING.

(a) Merits of Gas Counting. The estimation of carbon-14 can be effected by the counting of external (solid) sources, (e.g. $\text{Ba}^{14}\text{CO}_3$), or by internal gas counting, in which the counter is filled with the gaseous material, (e.g. $^{14}\text{CO}_2$ or $^{14}\text{CH}_4$), to be counted. The former, while convenient, had two distinct drawbacks from the point of view of the present work. Exchange of CO_2 with the atmosphere was liable to occur, introducing indeterminate errors, and, more important, high specific activities of acetone would have been required to render the method sensitive, on account of the low counting efficiency of this method for the low energy (0.15 MeV) ^{14}C - β particles. High specific activities had to be avoided to reduce the possibility of complications which might have arisen due to radiation decomposition of the acetone (under its own radiation).

The second method, that of internal gas counting, was capable of providing almost 100% counting efficiencies for these β particles within the sensitive volume of the counter used. Furthermore the counting characteristics of $^{14}\text{CO}_2$ had been fairly widely investi-

gated, and since it was fairly convenient to estimate each of the products mentioned above (^{14}CO , $^{14}\text{CO}_2$, and $^{14}\text{CH}_3\text{I}$) as $^{14}\text{CO}_2$, after simple conversions where necessary, this method seemed almost ideal for the problem in hand, especially since the manipulations of these compounds in a closed (vacuum) system reduced considerably the chances of losing, or contaminating, very small yields.

- (b) Considerations influencing procedure. Numerous methods exist for the counting of carbon dioxide in the manner indicated above, each differing from the others in some aspect of procedure or technique reputed to give more satisfactory results. Consequently it was decided to investigate some of these points before selecting a specific procedure for the estimations required in the course of this work.

Rohringer and Broda³² have claimed that it is possible to count $^{14}\text{CO}_2$ in the Geiger region without any added charge transfer gas, by using a suitable electronic quenching arrangement. Attempts here to reproduce their results failed and it was found that satisfactory plateaux could only be obtained after the addition of a suitable chemical quenching agent, an observation also made by other authors.^{33,34} It cannot be

inferred from the present work that Rohringer and Broda were wrong because they stressed that the CO_2 should be very pure, and free especially from traces of air and moisture, and also that the Neher-Pickering quenching circuit should be employed. In this work carrier CO_2 was stored in a 2 litre flask after distillation of "Drikold" at -80°C . and, although air free, may well have contained traces of moisture in excess of the level at which the CO_2 could have been counted alone. Also the quench units used were a type 1014A and a Neher-Harper since it was thought that they should be satisfactory. The reason that the CO_2 was not further purified, in an attempt to make this method a success, was that reasonable plateaux could be obtained with added carbon disulphide and, in the present work, it was more convenient to have a reasonably sensitive, robust, system, in which the CO_2 purity was not so critical, than a particularly refined one in which it was (and which, in the present context, could not justify the added precautions necessary to its success because added accuracy was not required).

Use of CS_2 as charge transfer gas. $^{14}\text{CO}_2$ is difficult to count alone because the CO_2^+ ions formed

in the cascade process will form CO_2^- ions at the cathode³³ rather than neutral molecules. Such negative ions are able to re-initiate the discharge giving spurious counts which are reflected in poor counting characteristics. The addition of even a small amount of carbon disulphide to the carbon dioxide gives a counting mixture with reasonable properties^{33,34} i.e. a reproducible plateau of reasonable length and slope. It is generally assumed that the function of the CS_2 is to give CS_2^+ ions by charge transfer and that these ions do not give negative ions at the cathode.

Further points, affecting fine details of counter performance, were investigated with a view to obtaining the longest plateau with the least slope from a $\text{CS}_2\text{-CO}_2$ filling. The form of counter used was usually one containing a cylindrical cathode inside a glass case with a tungsten wire anode running along the axis of the cylinder and sealed through the case at the ends (see fig. 7.). Some tests were also made on counters in which the cathode also constituted the wall, i.e. end window counters used as internal counters, and these were also satisfactory. Their sensitive volume was, however, small and they were not adopted for this reason. The following are some of the

variations tested within the above general outline.

- (i) Cathodes. Cylinders in brass, stainless steel and copper were tried, the counters being fabricated in the laboratory. The choice of cathode did not affect the counter characteristics appreciably. Backgrounds varied with the volume of the cathode cylinders but were similar for all three materials. The cathodes employed in the three counters used for subsequent determinations were brass (approx. 2 cm. diameter and 8 cm. long), stainless steel (2.5 cm. diameter and 11 cm. long), and copper (1.9 cm. in diameter and 10 cm. long). The backgrounds of the last two counters were initially 31 and 24 c.p.m. respectively.
- (ii) Anodes were always of 50 μ or 100 μ tungsten wire, the change in diameter merely affecting the working voltage.
- (iii) Quenching Time. Since the positive ions formed in an ionising cascade required a finite time to clear to the cathode it was necessary to prevent the counter from becoming operative again until these ions had dispersed and, to this end, an external electronic quenching device was used to suppress the voltage on the anode for a finite period following

each event. The "dead-time" necessary was, fairly obviously, dependent on the diameter of the cathode cylinder and it was found that, for a counter with a cathode cylinder of 2 cm. diameter, the plateau length was improved from about 40 V, at 300 μ sec. dead-time, to 80 V, at somewhere between 500 and 1000 μ sec. dead-time, with a simultaneous marked decrease in the plateau slope.

The magnitude of the quenching pulse was increased by putting an extra 120 volts on the anode of the quenching valve in the 1014A head amplifier employed. This innovation, recommended by A.F. Henson³⁵, led to a further increase in plateau length of 40 V and a further decrease in the slope.

The counter finally adopted had a plateau 120 volts long with a slope of 3%-5%/100 volts. The filling consisted of 2 cm. pressure of carbon disulphide and 10 cm. pressure of carbon dioxide. The cathode was a copper cylinder, diameter 1.9 cm. and the anode was of tungsten wire, diameter 100 μ , and the operating voltage was 2280 volts. While these characteristics were not as good as those reported by various other workers,^{32,33,34} who had carried out more extensive research into the con-



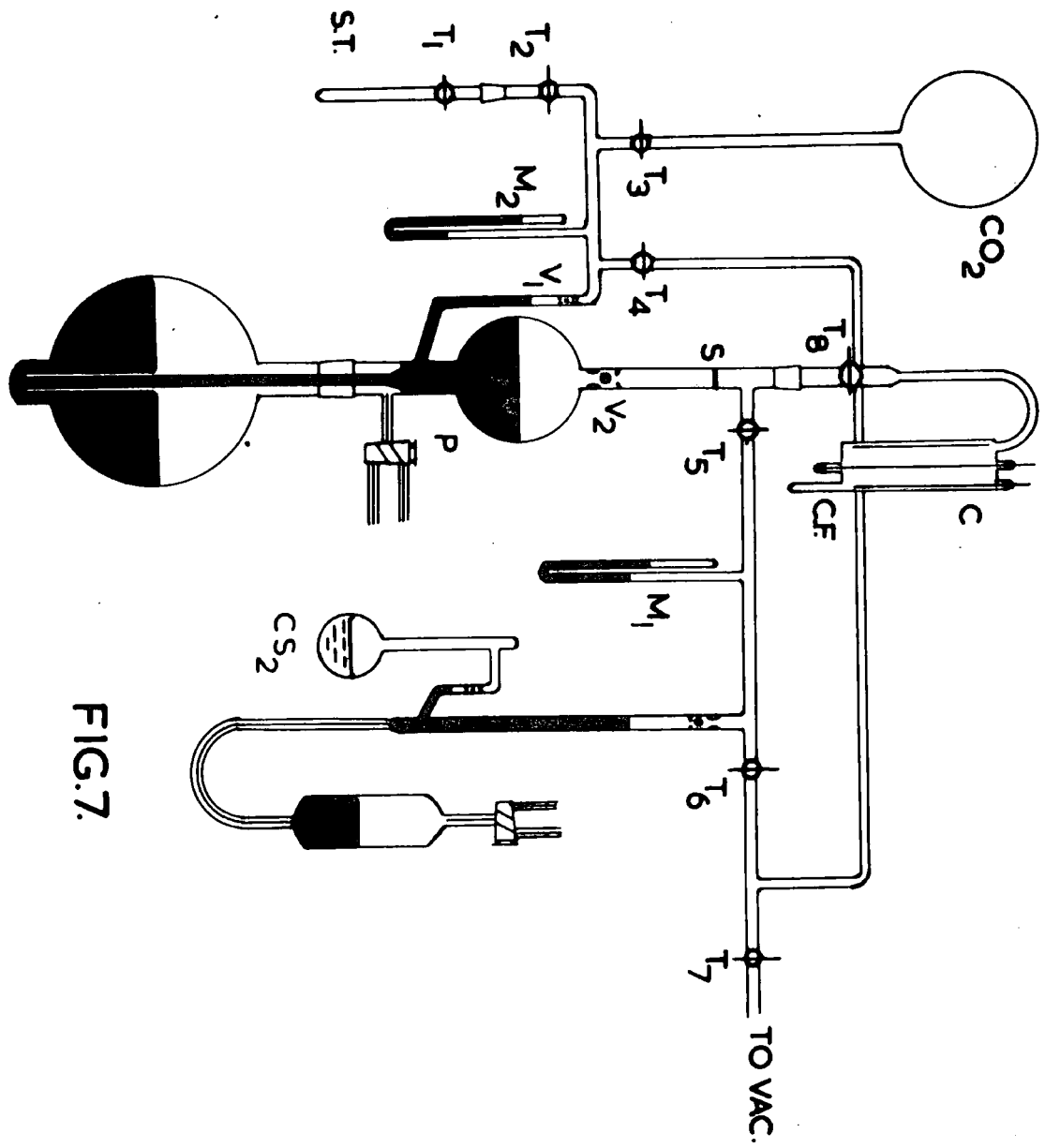

FIG. 7.

struction and operation of gas counting systems, they were comparable with those of Audric and Long,³⁶ and enabled accurate and reproducible measurements of active samples to be made within the limits required by the work. It was shown that counting rates accurately proportional to the partial pressures of $^{14}\text{CO}_2$ used were obtained. The counter pulses were quenched by a 1014A probe unit (with the above mentioned modifications) and registered on a 1009A scaler.

(c) Counting procedure (details). The counter filling system is illustrated in fig. 7. The sample tube, S.T., contained the active sample of CO_2 to be counted and was attached to the assembly, as shown, by a B.12 cone. The system was pumped down to vacuum with the carbon dioxide frozen at -195°C . behind T_1 . When a sticking vacuum had been obtained the mercury in the Toepler pump was raised to the ventille V_1 in the side arm and to the sinter S in the main arm of the pumping system. The volume of the inlet side to V_1 , (with T_1 and T_2 open, and T_3 and T_4 closed), was known, as was also the variation in this volume with the reading of the manometer M_2 . Likewise the volume of the counter itself, bounded by S and T_5 , was known so that the

pressure developed in the counter, after transfer of a given pressure of gas from the inlet side, could be calculated. With the mercury in the "raised" position, T_6 was closed and carbon disulphide vapour was admitted to the counter from the storage bulb by dropping the mercury in the cut-off until the required pressure of 2 cm. was registered on M_1 . T_5 was then closed. The radioactive carbon dioxide in S.T. was allowed to warm up to room temperature with T_3 and T_4 closed and the pressure registered on M_2 observed. The gas was then pumped to the counter using V_2 as a non-return valve and, subsequently, enough inactive CO_2 was added (via T_3 and the inlet measuring and pumping systems) to bring the total pressure in the counter to 10 cm. The partial pressure of active material was, of course, known from the reading of M_2 and the relative volumes of the inlet and counter compartments, as mentioned above.

Initially samples were counted with the counter permanently attached to the system, a practice which was discontinued owing to difficulties in providing adequate shielding. For the major part of the work the counter was fitted with a B.10 cone and small tap so that

it could be detached from the filling apparatus and removed to a lead castle to provide good shielding and minimum background. Also the main counter tube case was equipped with a two inch cold finger, C.F., in 4 mm. pyrex glass tubing, into which the counter contents could be frozen down at -195°C . and allowed to warm up again to facilitate mixing of the disulphide and carbon dioxide. This innovation was made when it was discovered that, without it, the counter required up to an hour to settle down and give consistent counting rates. The inconsistency over the first hour took the form of a steady decrease in the counting rate for a given filling and was presumed to be due to inefficient mixing of the charge transfer gas with the main filling of CO_2 , since it was also observed on testing the characteristics of inactive $\text{CO}_2\text{-CS}_2$ fillings with externally mounted γ sources. Presumably the "extra counts" over the settled value represented spurious counts from negative ions. After eliminating this fault the only time lag between the introduction of the counter to the castle and actual counting, was the fifteen minutes required to allow the high tension supply to settle down. Although the counter was always filled to the same pressure it was deemed advisable,

where time permitted, to take a plateau each time, to establish the optimum counting voltage.

V. SOME COUNTING PROBLEMS: (1) SPECIFIC ACTIVITY
OF ACETONE USED.

Three reasonably convenient methods were available for measuring the specific activity of the 1.3 ^{14}C -labelled acetone. The method adopted here involved complete combustion of a specimen of the acetone to carbon dioxide and water, followed by distillation of the CO_2 and determination of its specific activity, allowance being made for the inactive carbon atom;

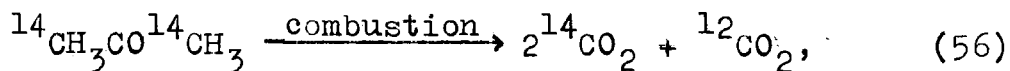

The other methods, used by Christie,¹⁴ consisted of combustion, to carbon dioxide, of samples of methane and ethane from the photolysis of pure acetone. They were employed in this work only as a convenient check on the preferred method, since they were felt to be subject to sources of error of an unreasonable magnitude. For instance, at normal absorbed intensity levels of about 10^{12} to 10^{13} quanta/cc/sec. the system was only capable of producing a micromole of gas per unit quantum yield (actually 3×10^{12} quanta/cc/sec. $\equiv 10^{-6}$ mole/5 mins) in five minutes of irradiation. It was felt that long periods of irradiation were, in principle, undesirable, on account of uncertainties which could arise in the course of the

process due to building up of products to fairly high concentrations and, here, the time required to produce large amounts of gas was held to be prohibitive. Although it seemed quite practical to pursue the method using 10^{-5} - 10^{-6} mole quantities, with an accurate measuring system, it was found, in practice, that the manipulation of such small amounts of gas from measuring system to oxidizing tube and back again, with attendant condensations in liquid nitrogen in apparatus containing exposed new stopcock grease, resulted in contamination with appreciable quantities of condensable matter from the grease (of order 5% on one sample of $\sim 3 \times 10^{-6}$ gm. mol. of ethane). This method could, of course, have been refined but in view of the availability of the other, in which gross acetone samples could be combusted to give two counter fillings of CO_2 (approximately 2.7×10^{-4} - 5×10^{-4} moles), it was deemed unnecessary. With these quantities of gas available contamination at the level mentioned was unimportant and ordinary manometers could be read to an accuracy of at least 1%.

Experimental Details

The active acetone originally obtained from Amersham had already been diluted once to provide a material of suitable activity for photolytic runs. It was, however, too concentrated, even in this form, for direct combustion

and measurement in the manner envisaged. A further dilution of the acetone was therefore made (about 100 times) to bring the activity down to the required value. The dilution was effected in the following manner: a B.14 cone was drawn down to a 1 mm. capillary at its smooth end and the whole weighed. Subsequently a small amount of acetone was transferred to this capillary (~ 0.05 gm.) by vacuum distillation and, as soon as condensation of the acetone was complete, the capillary was sealed across. The B.14 cone was then rigorously cleaned with benzene, to remove any Apiezon grease, and the cone + capillary weighed to ascertain the weight of acetone taken. The benzene cleaning technique was quite satisfactory since trials had shown that a tube could be weighed, greased, cleaned and reweighed to within 0.0002 gm. In condensing the acetone care had to be taken that no mercury condensed in the capillary at the same time and, to this end, the acetone was usually condensed quickly in an auxiliary limb (adjacent to the capillary) and the section immediately sealed off from any source of mercury. The acetone was then transferred to the capillary at leisure, which was desirable in view of the relatively lengthy procedure involved in capillary condensations. The capillary was then broken under a

weighed amount of inactive acetone (~ 5 gm.) and shaken immediately to complete mixing.

Small aliquots of the diluted acetone were pumped through the copper oxide combustion train, (Fig. 6), and there oxidized to carbon dioxide and water. The carbon dioxide was separated, for counting, by distillation from X, at -135°C ., to S.T., at -195°C . Large yields of CO_2 , sufficient to more than fill the counter to a pressure of 10 cm., were obtained and, providing care was taken in determining the dilution ratio of the acetone itself, quite accurate determinations of the specific activity could be made in this way. It was necessary to ensure complete oxidation had occurred and this was best achieved by not overloading the oxidizing agent with too much acetone. If this precaution were not observed pyrolysis occurred, as opposed to oxidation, with resultant higher activities due to the appearance of fragments or products containing more than one carbon atom.

One further possible source of error was also discovered and eliminated. It was found that freshly prepared radioactive acetone, obtained from the Radiochemical Centre at Amersham, contained, as impurity, a volatile compound which appeared, in actual photolyses, in the carbon dioxide fraction (collected from the products at -150°C .).

This compound was, of course, not isotopically diluted on addition of inactive acetone to the original active material and consequently retained a very high specific activity such that only extremely small amounts were necessary to cause havoc in estimating the radioactivity of the carbon dioxide fraction. Before attempting determination of the specific activity of the acetone this impurity had to be removed. This was not easy. An attempt to remove it by distilling the acetone onto carbosorb was unsuccessful, but it ought to be observed that the carbosorb was perfectly dry and might not have taken up carbon dioxide under these conditions. Alternatively the impurity might have been not, carbon dioxide, but a gas with similar volatility at -150°C . The activity was significantly reduced by pumping on the acetone at about -80°C . for a considerable time when the impurity distilled out preferentially. However, the time required to reduce the residual activity of the -150°C . fraction from a blank run, i.e. no photolysis, was considerable and the technique eventually adopted here, to conserve acetone, was to leave the acetone at room temperature overnight and to pump away evolved gases for a short time, at -80°C ., the next day and this process was repeated until a reasonable blank was obtained. The process of allowing

the vapour over the acetone to achieve an equilibrium concentration of impurity overnight, followed by a short period of pumping, was less wasteful on radioactive acetone supplies than the method of continual depletion of vapour by continuous pumping, since acetone is itself lost by this process at -80°C .

If this impurity was not removed from the acetone, and a small sample of acetone was withdrawn to a separate reservoir for specific activity combustions, then each successive aliquot of acetone taken from this reservoir to the combustion tube was less rich in impurity than its predecessor and consequently had a smaller activity. Thus each successive activity approached nearer to the true value for the uncontaminated acetone. The effect is illustrated below by comparison of specific activities (a) from a contaminated sample and (b) from a "well-aged" one. The results themselves are not comparable for (a) and (b) since the dilutions used were different.

(a) contaminated acetone	(1) 464.0 ± 3.3 (2) 422.4 ± 3.1 (3) 415.1 ± 3.0 (4) 409.2 ± 4.2
(b) "well-aged" acetone	(1) 213.8 ± 2.2 (2) 211.0 ± 2.6 (3) 211.3 ± 2.1

Table IV. Successive activities of different types of acetone

Note The specific activity of the acetone methyls (which was required for calculation of that portion of any yield which had arisen from the methyls) was one and a half times the activity observed for the carbon dioxide from complete combustion of the acetone.

Activity of Carbon Monoxide in Calibration Runs.

The activity of CO from calibration runs, with active acetone fillings, was found to be zero proving that the acetone was labelled as indicated i.e. in the methyl groups only.

(2) CONTAMINATION OF COUNTER : MEMORY EFFECT.

It was found, by experience from many determinations, that none of the cathodes used in counters was susceptible to memory effects with $^{14}\text{CO}_2$. Usually evacuation of the counter for about fifteen minutes was sufficient to remove the active filling and reduce the counter background to its normal value. However, when attempts were made to count the carbon dioxide fraction from acetone-oxygen runs, extracted at -150°C ., it was observed that the background increased subsequent to each determination, and that this was true for any of the cathodes employed. Moreover, the acquired background was permanent and did not decrease significantly even when the counter was flushed several times with inactive carbon dioxide.

The material responsible was obviously not carbon dioxide and, in view of Hoare's experience¹³ of formaldehyde contamination in this fraction of the photolysis products, it was thought that formaldehyde was being polymerized by the counter discharge and leaving traces of involatile active material in the counter. It proved extremely inconvenient since the background rapidly became embarrassingly high and the counter had to be discarded and time consumed in construction and calibration of a new one.

To prevent this undesirable effect the analytical procedure was modified slightly. After extraction and measurement of the carbon dioxide containing fraction, and dilution with carrier CO_2 to facilitate manipulation, the diluted material was circulated through the copper oxide combustion train and then recollected for counting. This procedure converted any organic material to CO_2 and the acquisition of memory in the above manner was then rendered impossible. It should be noted however that the procedure was only valid if the contaminating compound contained one radioactive carbon atom in its molecule. The only products of the acetone-oxygen photolysis volatile at this temperature were CO , CO_2 , CH_2O , and perhaps CH_4 , so that in this case it was correct.

RUN NO.	TEMP. t°C.	ACETONE PRESSURE (mm. at t°C.)	IRRAD- IATION TIME (MIN.)	TRANS- MITTED IN- TENSITY I _t (ARBITRARY UNITS)	CO x 10 ⁷ gm.mol.	I _{abs.} x 10 ⁻¹² quanta/ cc./sec.	CO/I _t x time
A1	120°C.	62.0	5 min.	27.0	10.53	3.20	0.078
A2	"	61.0	"	32.0	11.55	3.52	0.072
A3	"	62.0	"	27.5	9.87	3.00	0.072
A4	"	63.0	"	24.0	9.11	2.77	0.076
D1	"	62.0	"	24.5	13.48	4.10	0.110
D2	"	62.5	"	29.0	16.02	4.88	0.111
D3 (Radioact.)	"	62.5	"	27.0	14.92	4.54	0.111
D12	122°C.	63.0	"	33.0	18.33	5.57	0.111
E2	121°C.	128.0	"	18.5	24.84	7.55	0.269
E3	120°C.	129.0	"	22.5	29.15	8.86	0.260
G1	175°C.	37.2	10 min.	23.0	15.95	2.43	0.0692
G4	176°C.	37.0	10 min.	15.5	10.47	1.59	0.0675
K1	120°C.	32.0	10 min.	45.0	20.78	3.25	0.0462
K12	120°C.	32.0	10 min.	51.5	23.08	3.51	0.0450
K21 (Radioact.)	120°C.	32.0	10 min.	40.5	17.93	2.73	0.0443

Table V.

Calibration runs from various series.
(rest inactive).

Radioactive D3, K21,

VI. THE PHOTOLYSIS OF ACETONE IN THE PRESENCE OF ADDED OXYGEN

After the problems presented in the construction and operation of the filling, irradiation, analytical, and counting apparatus had been resolved, experiments were performed to confirm that the combination of these techniques was capable of providing reproducible results for calibration runs performed under identical conditions of acetone pressure and temperature. Calibration runs merely involved photolysing pure acetone vapour with 3130\AA radiation and the only analysis necessary was that for carbon monoxide. The ratio of carbon monoxide yield to transmitted intensity, in such runs, gave the amount of gas per unit of transmitted intensity equivalent to unit quantum yield over the period of irradiation, at the particular acetone pressure and temperature employed, (providing the temperature was above 120°C .). The results are illustrated in table V. It was also demonstrated that the calibration yields, under identical conditions of temperature and pressure, were the same for both radioactive and inactive acetone. This was essential since some photolyses were known to be sensitive to even extremely small amounts of impurities and it was realised that the radioactive acetone used could have contained radiation decomposition products. It was also confirmed, briefly, that the methods outlined gave comparable values to those

RUN NO.	TEMP. $t^{\circ}\text{C.}$	ACETONE $\text{pm}^m \cdot \text{at } t^{\circ}\text{C.}$	OXYGEN $\text{pm}^m \cdot \text{at } t^{\circ}\text{C.}$	IRRADIATION (MINUTES)	I_t (Arbitrary U_s)	I_{abs} ($\times 10^{-12}$)
F2	120 $^{\circ}\text{C}$	32.5	0.42	10	36.5	2.52
D11	120 $^{\circ}\text{C}$	63.0	0.42	5	31.5	5.30
D13	120 $^{\circ}\text{C}$	63.0	0.42	5	28.0	4.71
E4	120 $^{\circ}\text{C}$	128.5	0.42	4	24.0	9.62
F3	120 $^{\circ}\text{C}$	32.0	0.84	10	50.0	3.45
D14	120 $^{\circ}\text{C}$	63.5	0.84	5	37.0	6.22
E1	120 $^{\circ}\text{C}$	129.0	0.84	5	29.5	11.80
F6	120 $^{\circ}\text{C}$	32.5	1.68	10	35.5	2.53
D15	120 $^{\circ}\text{C}$	63.0	1.68	5	24.5	4.12
E5	120 $^{\circ}\text{C}$	129.0	1.68	5	20.0	8.02
G2	175 $^{\circ}\text{C}$	37.0	0.48	10	19.3	2.05
H2	175 $^{\circ}\text{C}$	72.0	0.48	5	30.3	7.47
G3	175 $^{\circ}\text{C}$	37.0	0.96	10	23.3	2.48
H3	175 $^{\circ}\text{C}$	72.0	0.96	5	15.5	3.84
G5	175 $^{\circ}\text{C}$	37.0	1.92	10	19.0	2.02
H5	175 $^{\circ}\text{C}$	72.0	1.92	5	12.0	2.97

TABLE VI. ACETONE-OXYGEN PHOTOLYSES (12

of Sutton³ for acetone-iodine photolyses.

At this stage, for reasons already given in Chap. III, it was decided to re-investigate some of the work carried out by Noyes and co-workers, on the photo-oxidation of acetone, but using the 1.3. ¹⁴C-labelled acetone to establish the origin of the photolytic fragments. By irradiating acetone-oxygen mixtures with 3130Å at two temperatures, namely 120°C. and 175°C., and analysing for ¹⁴CO, ¹²CO, ¹⁴CO₂ and ¹²CO₂, results were obtained which were in good agreement with the results of Noyes and Marcotte, i.e. for total CO and total CO₂, but did not agree in distribution of radioactivity with those of Christie and were incompatible with some aspects of the mechanism proposed in the last paper of the series.¹⁴ The results are given in table VI. The main points may be summarized as follows,

- (i) The majority of the carbon monoxide yield was radioactive although a certain amount was still obtained from the carbonyl group by acetyl dissociation.
- (ii) The amount of active carbon monoxide decreased with increase in oxygen pressure under otherwise identical conditions but was relatively unaffected by acetone pressure. For this reason the results have been grouped according to oxygen pressure rather than acetone pressure. Although the figures for the inactive carbon monoxide quantum yield varied from 0.02 to 0.10

the pattern was irregular and probably represents a measure of the inaccuracy of the measuring system rather than a genuine variation of that magnitude. It would seem that the results are probably subject to an error of about ± 0.03 .

(iii) Most of the carbon dioxide was inactive. The portion which has been represented in the table as radioactive was probably largely formaldehyde rather than CO_2 , since it contaminated the counter, giving rise to the memory effects mentioned in Chap. V, if suitable precautions were not taken. For this reason no significance has been attached to these figures except that they represent an upper limit for radioactive CO_2 and that this limit is always small compared to the inactive figure. It is, however, noteworthy that this yield is quite irregular and is the only yield which does not increase markedly with rise in temperature, which seems compatible with partial withdrawal of formaldehyde at -150°C ., as found by Hoare, and also inferring that there is very little, if any, active CO_2 formed at all. Two carbon dioxide yields, those in F2 and D15 were rather low and it was suspected that this was due to incomplete extraction of the CO_2 from the acetone rather than a deviation in the trend of the results.

(iv) The overall inactive quantum yield, $\Phi_{\text{CO}} + \Phi_{\text{CO}_2}$, was

interesting in that it assumed values greater than 1.0 both at 120°C., at low oxygen pressure, and at 175°C. over the whole range studied. This is by far the most significant result since it points to generation of further acetyl radicals by a different process to (1), a factor which was certainly not apparent from Noyes results.

- (v) The effect of rise in temperature on the yields mentioned above was to increase all the yields without appreciably altering the pressure dependence, except that for Φ_{CO} (carbonyl) which also showed a decrease with increasing oxygen pressure.

It must be stressed at this point that these results do not represent the whole picture but do provide a considerable improvement in the detailed knowledge of results on the high oxygen pressure side of the maximum which Noyes observed to occur in the carbon dioxide yield curve. Result (iii) is a direct contradiction of Christie's findings that all the CO_2 was active and some justification should perhaps be presented here for accepting the results of this work in preference to the others.

The major justification is provided by the fact that Kutschke, performing the photolysis with $^{18}O,^{26}$ has obtained results substantially the same as those quoted in (iii). Secondly, in the section dealing with

radioactive counting problems, (Chap. V), it has been shown that new radioactive acetone as supplied from the Radiochemical Centre at Amersham contained an impurity which, if not removed, appeared undiluted in the CO₂ fraction and presented the illusion that the CO₂ itself was highly active. It was even possible that the contaminant was ¹⁴C₂O, and, if Christie's acetone had been so contaminated, she would have observed the same effect even though her method of analysis first involved absorption in KOH. This was felt to be likely since Christie observed in her paper that some unidentified impurity was present in her acetone. Also no results were actually quoted and, presumably, few experiments were performed with active material. In the present work, the presence of the foreign activity was not detected until several runs had been performed and it was observed that the activity of the CO₂ fraction had fallen unaccountably (due to preferential removal of the impurity from the acetone in the reservoir in the earlier runs).

Christie's formaldehyde yields were obtained by two different methods, each checking against the other, and both colorimetric. They were, therefore, felt to be reliable and no attempt was made to reproduce them here.

ACETIC ACID

Christie's experiments with 1.3. ¹⁴C-labelled acetone also

led her to the conclusion that acetic acid was a major product in the photo-oxidation although, again, no results were given except a statement to the effect that the quantum yield was at least unity assuming no other acid was formed. The method of estimation of the $^{14}\text{CH}_3\text{COOH}$ was not clearly stated but involved, initially, condensation of the photolysis products not volatile at -100°C . into barium hydroxide solution, and removal of acetone by subsequent evaporation to dryness and ignition at 450°C . In view of the lack of detailed information on these points it was decided to attempt estimation of acetic acid as part of this work.

The method adopted was one which followed fairly closely the available steps in Christie's method. Products from the photolysis were condensed as usual and any permanent gases which could have interfered later were pumped off at -195°C . Carrier acetic acid, in water, was then introduced, i.e. condensed onto the photolysis products, and the whole mixture was distilled back into the reaction vessel, since it was possible that a product like acetic acid might have been adsorbed onto the walls of the vessel. This mixture of carrier acid and products was then distilled into a solution saturated with barium hydroxide, and, in fact, actually standing over solid barium hydroxide octahydrate. The contents of the tube containing the baryta were allowed

to warm up and the acetic acid reacted with the hydroxide leaving a weak solution of barium acetate over an excess of $\text{Ba}(\text{OH})_2$. All volatile matter, including acetone and water, was then pumped off leaving a solid mixture of barium acetate with excess barium hydroxide. When such a mixture was heated to about 500°C . the methyl carbon atoms of the acetic acid were evolved as methane and were separated from any source of impurity (other than permanent gases) by collection from a trap at -195°C . Any radioactive acetic acid from the photo-oxidation was thus converted to $^{14}\text{CH}_4$. This was oxidized to carbon dioxide in the usual way and the specific activity of the carbon dioxide determined. From a knowledge of this specific activity, the specific activity of the original acetone, and the amount of carrier acetic acid added, the yield of active acetic acid from the photolysis was deduced (isotopic dilution). It was felt that such a method could distinguish acetic acid from most other products. A precaution which had to be observed was that the silver powder normally used for trapping out excess iodine was removed from the system, since it was capable of reacting with the acetic acid, presumably due to traces of oxide and, perhaps, of iodide. In spite of this, however, the experiments were a failure.

The first photo-oxidation performed for the purpose of estimating acetic acid gave a counting rate in the CO_2

obtained which was equivalent to a quantum yield of about 0.78, which seemed to bear out Christie's observations. However, this was soon shown to be fallacious. A calibration run, performed with acetone only, i.e. no added oxygen, gave an apparent quantum yield of acetic acid of approximately 0.52, and a blank on acetone only, i.e. no photolysis, gave a counting rate equivalent, on a similar calibration figure, to 0.34. The most reasonable conclusion which could be drawn from this was that the acetone itself yielded small amounts of acetic acid in the presence of alkali. To counter this an attempt was made to perform the reaction under dry conditions.

A sample of potassium hydroxide was melted under vacuum to eliminate traces of water vapour. A blank run was then performed in which the usual amount of radioactive acetone was diluted with carrier acetic acid in acetone solution and distilled onto the hydroxide, and allowed to react. The volatile matter was then pumped away. The colour of the hydroxide had become yellow presumably due to some reaction. Methane was liberated and oxidized and counted. The counting rate corresponded to a yield of approximately 17.9×10^{-7} gm. molecules of acetic acid which, on the calibration figure used initially, represented a quantum yield of about 0.89. A further experiment in which barium hydroxide was used in place of KOH (on account of its milder alkaline

action) gave a poor methane yield which was thought to be due to the modified physical state of the baryta after melting. Nevertheless the specific activity of the methane obtained was equivalent to a yield of 12.5×10^{-7} gm. mole. of acetic acid and a quantum yield, based on the previous calibration figure, of 0.62.

This high blank level, coupled with the inconsistent variation in the blank, was considered sufficient reason for abandoning the method. No other method was sought in view of the lack of time available and the necessity for proceeding with acetone-iodine-oxygen photolyses at this stage. However, one or two comments, can be made. Firstly, the highest blank obtained was with potassium hydroxide, a stronger base than barium hydroxide, and indicated that some reaction to give acetic acid was taking place. The matter was not quite so simple, however, since in the experiments with acetic acid carrier in acetone, a further dilution of the radioactive acetone species occurred and, if the cause of the high blanks was supposed to be reaction of the alkali with acetone, then one might have expected these blanks to be much lower than the others.

In conclusion it must be pointed out that the above results place considerable uncertainty on the reliability of Christie's results obtained with a similar technique, and indicate that the presence of acetic acid in the photo-oxidation has not yet been proved, although it would be

foolish to claim that they disprove it. A rather more reliable technique for acetic acid determination would be necessary to settle this point and provide an extension of the knowledge of the process of photo-oxidation.

VII. THE PHOTOLYSIS OF ACETONE IN THE PRESENCE OF ADDED OXYGEN AND IODINE

Initially it could not be predicted with any certainty whether or not oxygen could compete favourably with iodine, (or vica versa), as a radical remover, or as an agent affecting the fates of the various excited species formed in the primary process, in the photolysis of acetone. Using the experimental techniques already described, an experiment was performed in which the iodine and oxygen pressures used were comparable, and it was found that the yields of oxygenated products were very much reduced, whereas the yield of methyl iodide was relatively undisturbed, i.e. was approximately the same as that for acetone-iodine only under the same conditions of temperature and pressure. Subsequent experiments were performed at constant, fairly high, oxygen pressure and the iodine pressure was progressively reduced until the oxygen-iodine ratio was as high as 22.2:1. The results are presented in table VII but before considering them some comment is necessary on the way in which they were obtained.

For reasons already mentioned in the experimental sections it was impossible to determine all the required quantities simultaneously. For instance, total carbon dioxide could not be determined at the same time as methyl iodide on account of the evolution of gases, volatile at

-150°C., from the iodide carrier solution after only slight deterioration. Also formaldehyde could not be determined with any of the other quantities, ideally, since it was undesirable that it should be given the opportunity of polymerizing in cold traps to any marked extent. It was estimated by a colorimetric method which is described later. Thus the acquisition of a reasonably comprehensive set of results for even one acetone-iodine-oxygen experiment was somewhat arduous, since it involved the following programme.

- (a) a calibration figure for the particular acetone pressure employed. If a series of experiments were performed at the same acetone pressure, as in this case, calibration runs were carried out every five or six runs to check that the optical system had not been accidentally, and imperceptibly, moved giving different irradiation characteristics.
- (b) for each iodine pressure to be used in conjunction with given acetone and oxygen pressures, it was necessary to perform a control run with acetone and iodine only, at the same pressures as those required for the full run. This was to ensure that the observed effects in any particular run were a function of iodine and oxygen pressures and not merely due to alteration in the former.
- (c) Each determination required, ideally, three separate

RUN NO.	TEMP. t °C.	ACETONE pmm. at t °C.	OXYGEN pmm. at t °C.	IRRADIATION (MINUTES)	I _t (Arbitrary U _S)	I _{abs} (x 10 ⁻¹²)	Φ _{CO} (methyl)	Φ _{CO} (carbonyl)	Φ _{CO₂} (methyl)	Φ _{CO₂} (carbonyl)	Φ _{CO₂} (methyl)	Φ _{CO₂} (carbonyl)
F2	120°C	32.5	0.42	10	36.5	2.52	0.33	0.06	0.10	1.06	0.43	1.12
D11	120°C	63.0	0.42	5	31.5	5.30	0.28	0.08	0.11	1.24	0.39	1.32
	120°C	63.0	0.42	5	28.0	4.71	0.28	0.07	0.16	1.18	0.44	1.25
E4	120°C	128.5	0.42	4	24.0	9.62	0.31	0.05	0.17	1.20	0.48	1.25
F3	120°C	32.0	0.84	10	50.0	3.45	0.23	0.04	0.07	0.77	0.30	0.81
D14	120°C	63.5	0.84	5	37.0	6.22	0.18	0.07	0.08	0.81	0.26	0.88
E1	120°C	129.0	0.84	5	29.5	11.80	0.18	0.02	0.11	0.73	0.29	0.75
F6	120°C	32.5	1.68	10	35.5	2.53	0.17	0.10	0.11	0.74	0.28	0.84
D15	120°C	63.0	1.68	5	24.5	4.12	0.12	0.10	0.12	0.58	0.24	0.68
E5	120°C	129.0	1.68	5	20.0	8.02	0.16	0.04	0.18	0.70	0.34	0.74
G2	175°C	37.0	0.48	10	19.3	2.05	0.61	0.31	0.14	1.75	0.75	2.06
H2	175°C	72.0	0.48	5	30.3	7.47	0.55	0.43	0.13	1.48	0.68	1.91
G3	175°C	37.0	0.96	10	23.3	2.48	0.42	0.15	0.13	1.54 [*]	0.55	1.69
H3	175°C	72.0	0.96	5	15.5	3.84	0.44	0.15	0.24	1.59	0.68	1.74
G5	175°C	37.0	1.92	10	19.0	2.02	0.25	0.17	0.13	1.15	0.38	1.32
H5	175°C	72.0	1.92	5	12.0	2.97	0.35	0.13	0.34	1.19	0.69	1.32

TABLE VI. ACETONE-OXYGEN PHOTOLYSES (120 AND 175°C)

experiments, one for active and inactive CO and CO₂ yields, another for methyl iodide, during which the CO yields could be checked, and one for formaldehyde determination.

The process was also rendered more time consuming by the make-and-break seal reconstructions necessary after each experiment and, in the time available after a rather extended investigation of the acetone-oxygen problem, the more complex investigation could not be investigated more thoroughly than is shown in the table of results. However, sufficient information was obtained to draw some interesting conclusions and to make it worth while continuing the work. A further, more comprehensive, programme of work on this topic is now in progress in this laboratory but in different hands.

The results obtained, all at 120°C. and 32.0 mm. of acetone, and mainly at 3.36 mm. pressure of oxygen were as follows.

- (i) The total CO and CO₂ yields were much reduced in the presence of iodine and were of approximately the same magnitude in the few runs in which they were available. The majority of the CO was, again, radioactive, and virtually all the CO₂ was inactive. This might indicate formation of these two products from the acetyl radical, the methyl radical being almost

entirely quenched by iodine even at 3.36 mm. of oxygen and 0.50 mm. of iodine. The number of results did not permit any generalization on the pressure dependence of these yields, the pattern of the few available being somewhat irregular.

- (ii) The yields of methyl iodide at comparable oxygen-iodine pressures were almost identical with those in the absence of oxygen at the same acetone and iodine pressures. At low iodine pressures, where oxygen competition might have been expected, the iodide yield, somewhat surprisingly, rose and, indeed, more rapidly than in the corresponding iodine-acetone series, but levelled out at iodine pressures, of 0.31 mm. and 0.15 mm., the lowest studied.
- (iii) The formaldehyde yield, probably the primary indicator of the efficiency of oxygen as a methyl radical quencher, was almost negligible, even at an iodine pressure of 0.30 mm. where the oxygen-iodine ratio was 11:1.

APPENDIX TO CHAP. VII - THE DETERMINATION OF FORMALDEHYDE

Christie's colorimetric methods for estimating formaldehyde were those employed by Gomer and Noyes³⁷ in earlier photochemical work. Reference to this latter paper did not yield a great deal of information beyond the fact that the methods were essentially slightly modified versions of those

of Matsukawa³⁸ and Stotz.³⁹ The modifications were not described, however, and, since the initial methods were rather tedious, (Matsukawa's employing solutions of phenylhydrazine, sodium chloride, potassium ferricyanide, hydrochloric acid and also ethyl alcohol), it was decided to use, here, the much simpler method described by Bricker and Johnson.⁴⁰ This method merely involved the use of the solution to be tested, chromotropic acid solution, and concentrated sulphuric acid. The process of colour development was quite simple and did not require rigid control to produce consistent results. The main amendment here to the procedure outlined in their paper was to develop the colour at 60-65°C., since this was found to be preferable to 100°C. in the presence of excess acetone. Tests with prepared solutions of formaldehyde showed that the extinction observed after a certain standard procedure was proportional to the formaldehyde concentration, and the sensitivity was good since an extinction of 0.15, on the sensitive portion of the log. scale of the spectrophotometer, was obtained with 6.54×10^{-8} gm. mole. of formaldehyde in 0.2 ml. of test solution made up to 5 ccm. At the irradiation levels used this corresponded to a quantum yield of about 0.03 so the method was sensitive to about 0.01, which was considered adequate. The strength of the prepared formaldehyde solutions was determined by formation of the bisulphite compound and titration with iodine.⁴¹

Procedure

A photolysis was performed in the usual way and, after attachment of the reaction vessel to the analytical apparatus and pumping down, the seal on the vessel was broken with liquid nitrogen around E. Excess oxygen was pumped off and then the contents of E were allowed to warm up to room temperature and distilled back into 0.5 ccm. of a degassed solution of chromotropic acid in water (2.5 gm./25 ccm.), contained in a tube replacing C.T. This was detached from the apparatus and the volume quickly made up to 4.5 ccm. with concentrated sulphuric acid. The total volume of the acetone from the photolysis was approximately 0.2 ccm., so a blank of 0.2 ccm. of AnalaR acetone was also treated with 0.5 ccm. of chromotropic acid solution and the requisite amount of H_2SO_4 . These two samples along with a further blank of 0.5 ccm. of chromotropic acid solution and sulphuric acid as before, were left for thirty minutes at 60-65°C. At the end of this time the solutions were allowed to cool to room temperature and then made up to 5 ccm. with more conc. H_2SO_4 . The extinctions of the samples were then measured in a 10 mm. cell, in a Unicam Spectrophotometer, at a wavelength of 570 m μ . The acetone blank. was usually negligible and thus the formaldehyde yield from the photolysis could be read off directly from the extinction versus formaldehyde calibration curve.

VIII. DISCUSSION OF RESULTS(1) ACETONE-OXYGEN

A background of existing ideas on the process of photo-oxidation, together with a critical assessment of their validity, has already been provided in the introduction to this work. At this point, with the results quoted in Chapter VI to hand, it is proposed to consider, in more detailed terms, the amount of information which can be deduced from the work of Noyes and Marcotte, and Christie, and the present work, regarding the mechanism. Throughout the present discussion, to facilitate recognition of the origin of a product, the carbon atoms originally present in the acetone molecule as methyls are denoted ^{14}C .

(a) Origin of Formaldehyde

The opinion has been expressed, by Christie,¹⁴ that formaldehyde is the primary product of the reaction of a methyl radical with oxygen, and that carbon monoxide, contrary to the initial ideas of Noyes and Marcotte, is formed in the subsequent reaction chain. This idea is probably correct but a close examination of the yields of carbon dioxide and formaldehyde shows that it cannot account satisfactorily for all formaldehyde formation. The reasons are as follows:

- (i) if formaldehyde were formed solely from free methyl radicals, (which are formed by reactions (1) and (4) at low oxygen pressures), and carbon dioxide were formed by

reaction of acetyl radicals with oxygen, (a point demonstrated in this work), then, as the carbon dioxide yield rises, the formaldehyde yield should fall, due to the reduction in available methyl radicals from acetyl dissociation. This is not borne out in practice since the formaldehyde and carbon dioxide yields achieve their respective maxima together, at both 120°C. and 175°C. Thus formaldehyde must arise by some process other than methyl-oxygen reaction, and perhaps from the acetyl reaction sequence.

(ii) if formaldehyde were formed solely from methyls, then, in the absence of a methyl producing chain, the maximum yield should be 2.0. In actual fact the maxima at both 120°C. and 175°C. are substantially in excess of this figure, being 2.3 and 2.5 respectively. It has already been shown in the present work that the generation of acetyl radicals in the overall process can exceed unit quantum yield owing to the contribution of a reaction other than (1), and it is possible that these apparently anomalous formaldehyde yields are partially realised either in this process or in subsequent acetyl reactions.

(b) The Fate of the Methyl Radical : Production of $^{14}\text{CH}_2\text{O}$, $^{14}\text{CH}_4$, and ^{14}CO .

Methane is only formed at very low oxygen pressures, although the amount realised at a particular pressure increases

with increased temperature. These two points are to be expected since the reaction (36), by which the methane is formed, involves hydrogen abstraction from an acetone molecule, a process requiring a fair activation energy. However, it should be noted that, in the region where methane is formed, the formaldehyde yield and the methane yield together are roughly constant and

$$\Phi_{\text{CH}_2\text{O}} + \Phi_{\text{CH}_4} \approx 2.0$$

If the temperature is raised, so that the methane realised at a particular pressure is increased, then the formaldehyde yield falls and the above relationship is preserved. The carbon monoxide yield, however, increases as this increase in temperature occurs at constant concentrations of acetone and oxygen molecules. This series of events, occurring simultaneously, suggests that

- (i) The reason the combined yields of methane and formaldehyde are constant at 2.0, under conditions where the yield of CO_2 is still relatively small, is that all the acetyls dissociate according to (4), and that the two methyls, formed by the combination of (1) and (4), then react to form, as primary products, either formaldehyde or methane, depending on conditions of temperature and pressure,

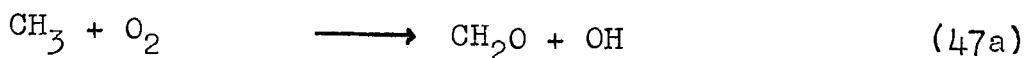
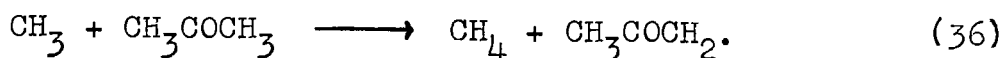

followed presumably by

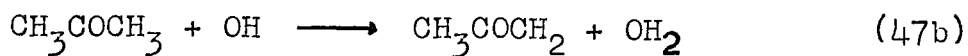

It will be observed that both (36) and (47b) produce acetylonyl and that both involve hydrogen abstraction. If the acetylonyl radical is, indeed, the intermediate responsible for the production of ^{14}CO then each methyl, regardless of its initial reaction, can produce, further, under favourable conditions, a molecule of ^{14}CO . This would explain why, at very low oxygen pressures, the CO yield tends to a value of 3.0 ($^{12}\text{CO} + 2\ ^{14}\text{CO}$). The fact that the ^{14}CO yield rises with temperature at a given pressure over the whole oxygen pressure range indicates that the process is not necessarily 100% efficient, and the fall in this yield below 1.0 with increasing oxygen pressure suggests that oxygen is capable of reducing the efficiency of ^{14}CO production at some point in the reaction chain which cannot, at this point, be specified.

(c) The Fate of the Acetyl Radical : Production of $^{12}\text{CO}_2$ and ^{12}CO

Small amounts of ^{12}CO are produced in the photo-oxidation at the temperatures studied, the amount increasing with rise in temperature. This indicates that a small fraction of acetyls always dissociates before reaction with oxygen can occur. It is interesting to note, in this context, that the residual ^{12}CO yield in the presence of oxygen is much greater than the low

figures obtained, at equivalent pressures of iodine, in acetone-iodine photolyses - a further indication of the inefficiency of radical-oxygen reactions compared with radical-iodine reactions.

Most of the carbon dioxide formed is $^{12}\text{CO}_2$. Owing to experimental difficulties it was impossible to deduce what proportion of the active residue from the second analytical fraction, if any at all, was $^{14}\text{CO}_2$, rather than $^{14}\text{CH}_2\text{O}$ extracted at the same time as $^{12}\text{CO}_2$. Since, at 175°C ., $\Phi_{^{12}\text{CO}_2}$ reached a value of 1.75 under conditions near the maximum yield, (see Noyes curves for maxima), and $\Phi_{^{12}\text{CO}} + \Phi_{^{12}\text{CO}_2}$ was 2.06 in the same experiment, it would seem that the formation of acetyl radicals is more complex than indicated in (1), unless the acetyl radical can also react with oxygen to give ^{12}CO or $^{12}\text{CO}_2$. A further discussion of this point is made later.

(d) High Pressures

At 120°C . and 175°C ., at high oxygen pressures, the ^{14}CO , $^{14}\text{CH}_2\text{O}$, and $^{12}\text{CO}_2$, yields all fall together on the high pressure side of the $^{12}\text{CO}_2$ and $^{14}\text{CH}_2\text{O}$ maxima. This may be explicable in terms of an alternative reaction of the acetyl radical to account for the reduction in yield of the second and third quantities, and variations in the yield of ^{14}CO can be explained under all conditions. However, the possibility should be noted that since all the yields are falling, the excited acetone

molecules may be suffering deactivation, although such a point of view conflicts with ideas arising from the results of the acetone-iodine-oxygen work (see later discussion). One major difficulty in the way of a decision on this point lies in the failure of any analytical scheme devised to date to reveal the nature of an alternative product from the acetyl radical.

REVIEW OF MECHANISM

It is obvious that many of the findings mentioned in (a) - (d) cannot be satisfactorily explained on the basis of reactions in existing mechanisms^{12,14} and, indeed, a considerably revised mechanism is required to account for all the observed phenomena. However, after consideration of the available information, it is apparent that, even with the extended investigations of the present work, there still exists a paucity of evidence and the formulation of a satisfactory mechanism is impossible at this stage. It is, nevertheless, possible to comment fairly accurately on the implications of the above observations and to suggest where existing mechanisms require drastic amendments.

Whether or not any deactivation of acetone molecules occurs, the radical producing reaction can still be conveniently represented by

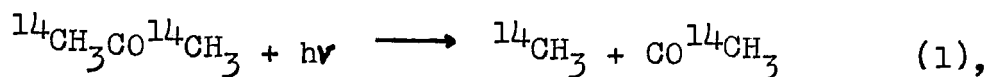

unless excited acetone molecules are capable of forming oxygen complexes and decomposing directly to products, a process for which there is no supporting evidence. Also, it is fairly reasonable to assume that any ^{12}CO appearing in the photolysis arises from reaction (4)

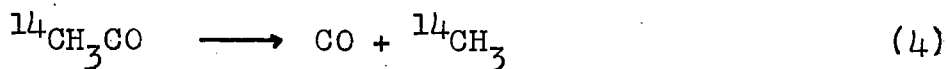

For reasons already cited in (b) above, the reactions available to the methyl radical are

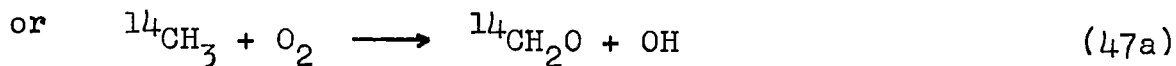
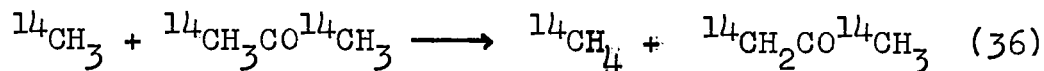

The former is only important at very low oxygen pressures and/or high temperatures. The course of reaction (47a) is not necessarily that written. Reactions (47c)-(47e) show that although the intermediate CH_3O_2 is a potential source of formaldehyde it cannot be said with certainty that the formaldehyde appears spontaneously, along with a hydroxyl radical, rather than after reaction of the CH_3O_2 radical with acetone. If, in actual fact, the hydroxyl radical never appears, the postulate that the inefficiency of reaction 47b can explain the variation in the ^{14}CO yield is wrong. However, if for the moment, the reaction (47a) is accepted as the probable one, then the formation of ^{14}CO may well occur by the reaction sequence 47b-48-49-38

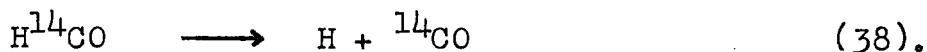
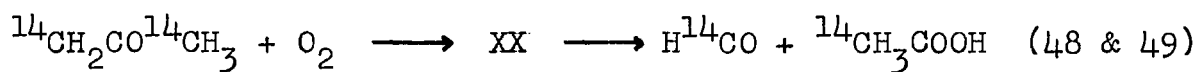
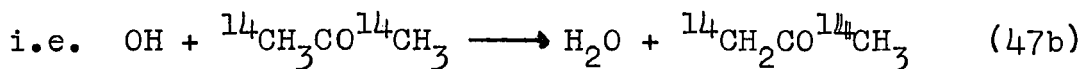

This is a compendium of reactions suggested by Noyes and Marcotte and by Christie and requires some further explanation. The reaction (38) is preferred to the alternative



advanced by Christie, since this latter involves consumption of a third molecule of oxygen in the reaction chain initiated by the methyl-oxygen reaction. As long as the carbon dioxide yield was thought to arise by a similar process,

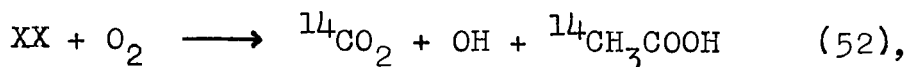

this was satisfactory, since the total oxygen consumption for ${}^{14}\text{CO}$, ${}^{14}\text{CO}_2$, and ${}^{14}\text{CH}_2\text{O}$ formation was still only 3.0, and the acetyl was thought to take up the fourth molecule to give some unidentified product. Now, however, it has been demonstrated, in the present work, that the CO_2 is ${}^{12}\text{CO}_2$ and arises, in part at least, from the acetyl radical, and, also, Hoare's work has demonstrated that the acetyl radical must be held to account for two molecules of oxygen, leaving only two to the methyl radical. The whole of Christie's carbon dioxide-formation mechanism must be declared invalid, as is, also, Noyes second attempt involving reaction (40)

which also requires the formation of radioactive $^{14}\text{CO}_2$, instead of $^{12}\text{CO}_2$, from the 1.3. ^{14}C -labelled acetone.

NEW REACTIONS

The difficulty in proceeding with the construction of a reasonable mechanism arises when an attempt is made to find reactions which will account for the production of $^{12}\text{CO}_2$ in more than unit quantum yield, with attendant formation of some formaldehyde. A simple reaction like (35),

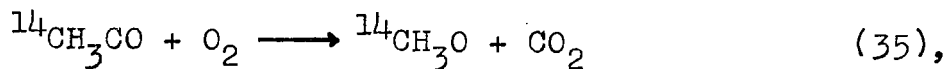

could possibly further yield formaldehyde from CH_3O by a reaction like (57),

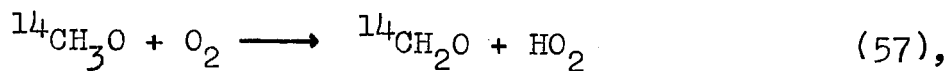

but this does not hold out hope of acetyl regeneration to supply more CO_2 , and the second molecule of oxygen has already been consumed without producing a further CO_2 molecule. Moreover there seems to be no obvious method by which the acetyl radical might conveniently regenerate itself.

It seems likely, therefore, that $^{12}\text{CO}_2$ is produced from an alternative source to that represented in equation (35), or that acetyl is produced other than by (1), but not by a chain involving the acetyl radical, and the only radical formed in the system which appears reasonably suited to such a function is acetonyl. In the absence of information on the properties of this radical, it is proposed to consider,

at this point, the types of reaction it might plausibly undergo since it seems to offer the only hope of a solution to this aspect of the problem. A point in favour of the acetyl radical as a source of $^{12}\text{CO}_2$ is that the carbon monoxide yield falls rapidly as the carbon dioxide and formaldehyde rise rapidly, suggesting a dual competition for the same radical, and it is significant that the acetyl radical has already been nominated as the probable intermediate in carbon monoxide formation. For the same reason, however, the following fairly obvious reaction must be discounted

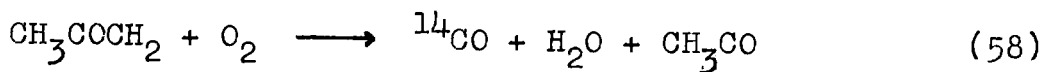

It is conceivable that the acetyl radical might undergo a spontaneous dissociation according to (59), or even (60),

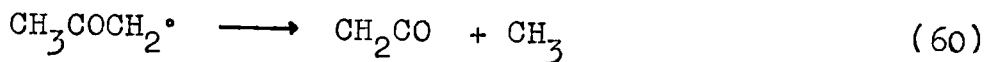
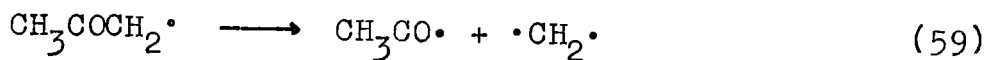

but such reactions should be favoured at low oxygen pressures, and (48) at high pressures, whereas the pressure dependences of the carbon monoxide and carbon dioxide yields indicate that the reverse is true. Moreover, the acetyl radical is probably more stable than any of the products of (59) or (60), so such reactions would be highly improbable. It is interesting to note, regarding the stability of the acetyl radical, that two resonance forms can be written,

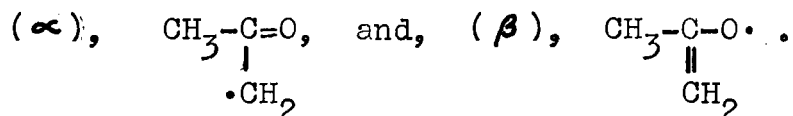

If the acetyl radical is actually a hybrid of these two forms then it would be expected to be relatively stable and, also, its reaction with oxygen might well be complex, although it is not apparent, from this argument, why the reaction should be influenced by the pressure of oxygen in the reaction mixture. The conventional method of representing the acetyl radical is that above, (α), but it might equally well assume either of the forms shown below, namely,

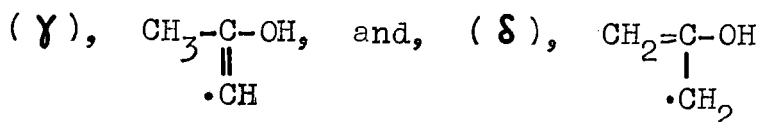

α , γ , and δ are merely forms of a prototropic tautomerism and, therefore, not impossible. It is not suggested here that there is any evidence for this, but some justification for a duplicity of reactions with oxygen could well be provided on structural grounds, although again the influence of oxygen pressure on the relative efficiencies of the alternative reactions is not immediately explained. It is interesting that the structure γ looks the most likely of the three to give formyl and acetic acid as postulated in reactions 48 and 49. The others, α and δ , also seem to be conveniently arranged for reactions (61) and (62), which, after the elimination of (58)-(60), are virtually the only reactions left

which might solve the problem.

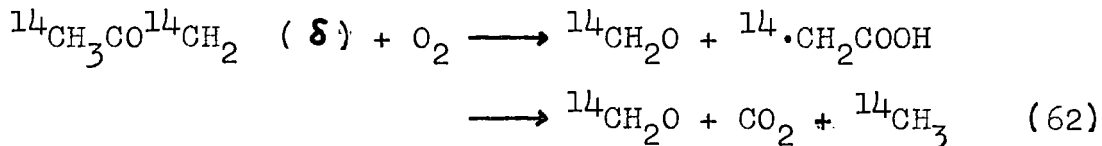
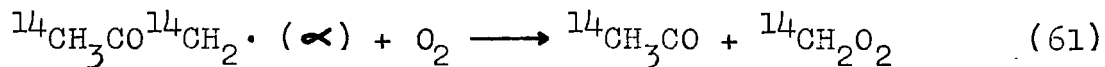

Reaction (61) is the least favourable of the two since CH_2O_2 would be almost certain to rearrange to HCOOH and Hoare has reported that no formic acid was found in mass spectrometer analyses of the photo-oxidation products. The objection to (62) is that it regenerates methyl and starts the process all over again. However, if a reaction like (47b) were quite inefficient and only a fraction of the hydroxyls, depending on temperature, gave rise to acetylonyls, then the additional number of methyls produced, would be

$\beta + \beta^2 + \beta^3 \dots$, where β is the fraction of hydroxyls reacting to give acetylonyls. If $\beta < 1$ this is a converging series and can be written

$$\beta \left(\sum_{n=0}^{\infty} \beta^n \right) = \frac{\beta}{1-\beta}$$

This is only true if all the acetylonyls produced react according to (62), which, at low pressures, is far from true but it does demonstrate that methyl regeneration does not involve discarding the reaction, since if $\beta = \frac{1}{2}$, the additional methyl value is only 1.0 and, if it is less, the value drops

rapidly. Such a mechanism, with a potential chain and a temperature dependent β , could explain why formaldehyde figures in excess of two can be noted, if these results are really significant. What it has not explained is why the acetyl should prefer to give carbon monoxide at low oxygen pressures and carbon dioxide and formaldehyde at high ones, and why all the yields apparently fall together at 120°C. and 175°C. in the high oxygen pressure region.

REVIEW

The photo-oxidation of acetone, which seemed in 1952 to be such a simple process, is now known to be fairly complex. Although it is still not possible to give a clear cut mechanism, the present work has made it possible for the yields of CO and CO₂ to be assigned to specific origins in the acetone molecule and has thus exposed some fallacies in previous work on the topic. The more controversial remaining points have been listed and indications made as to which suppositions are unlikely, and which may prove reasonably near the truth, when more evidence is available. To acquire such evidence several arduous investigations would probably prove necessary, namely,

- (a) an extended investigation of the process over a wide temperature and pressure range using the radioactive technique.
- (b) an investigation of the reactions of the various postulated

radicals with oxygen under unambiguous conditions, For instance, if acetyl radicals could be manufactured in the presence of oxygen by some other process than the present photo-oxidation much of what is at present speculation could be tested. The prospects of producing this radical under ideal conditions are remote since the obvious source, $\text{CH}_3\text{COCH}_2\cdot\text{CH}_2\text{COCH}_3$, could probably not be made to split in the correct place to produce two acetyls. However work could probably be done on the methyl and acetyl radicals.

It must be stressed that any series of investigations envisaged would be enhanced in its usefulness if a more comprehensive analytical system could be devised, especially with respect to the analysis of acetic acid.

In connection with (b) it should be noted that the fates of various radicals e.g. H, OH, and HO_2 remain unspecified and this is unsatisfactory. Further information on these radicals would be reassuring.

(2) ACETONE-OXYGEN-IODINE.

The possible reactions of methyl and acetyl radicals with iodine and oxygen together should be those already written for the separate acetone-iodine and acetone-oxygen mixtures. The experimental evidence does not indicate that any complex reactions are introduced by using a mixture of the two added radical removers. The yields of various products, and their variations with pressure, provide information on the relative efficiencies of certain radical reactions and also indicate some of the consequences, for the primary process, of the addition to the reaction mixture of these "radical catchers".

REACTION EFFICIENCIES

The methyl radical. Consider first the possible reactions of the methyl radical, namely,

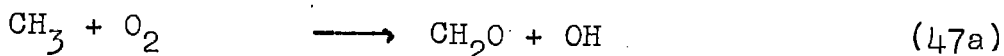
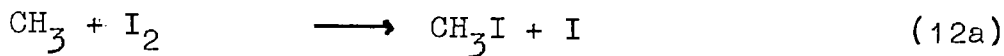
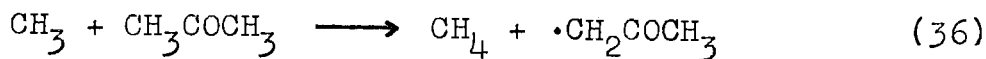

Studies on the direct photolysis of acetone, without added agents, have shown that reactions (42) and (36) are the main reactions of the methyl radical. Comparison of the yields of methane and ethane have demonstrated that (42) is an

extremely efficient reaction with a small (undefined) activation energy. Relative to (42), reaction (36) has a steric factor^{16,30} of 9.5×10^{-4} , and $E_{(36)} - \frac{1}{2} E_{(42)} = 9.7\text{K cal.}$

Noyes and Marcotte, in the first of their papers,¹¹ estimated that (39)



had an activation energy such that $E_{(36)} - E_{(39)} = 9.6\text{ K cal.}$, (i.e. $E_{(39)}$ was low and comparable with $\frac{1}{2} E_{(42)}$), and that the ratio of the steric factors $p_{(36)}/p_{(39)} = 4.5$. (39) has now been abandoned in favour of (47a) but calculations based on the formaldehyde yields of Christie¹⁴ and the methane yields of Noyes and Marcotte¹² show that these values are also substantially correct for $E_{(36)} - E_{(47a)}$ and $p_{(36)}/p_{(47a)}$ respectively. Thus $E_{(47a)} \sim \frac{1}{2} E_{(42)}$ and $p_{(47a)} = 2 \times 10^{-4}$. In the absence of an appreciable activation energy it is difficult to see why the methyl-oxygen reaction should have such a poor efficiency in view of the simplicity of the radical involved.

In the present work the inefficiency of the methyl-oxygen reaction has been confirmed by allowing it to compete with a more efficient reaction, (12a). With comparable iodine and oxygen pressures in the reaction mixture, representing equal probabilities of collision of a radical with either of the added materials, the formaldehyde yield

dropped to a fraction of its former value whereas the methyl iodide yield remained virtually unchanged from its value in the equivalent acetone-iodine experiment. If it is assumed that the reactions (47a) and (12a) have very small, and similar, activation energies then reaction (47a) must have quite a low steric factor relative to (12a). If the only reactions available to the methyl radical at moderate pressures of oxygen and iodine are (47a) and (12a) then this part of the mechanism can be written quite simply

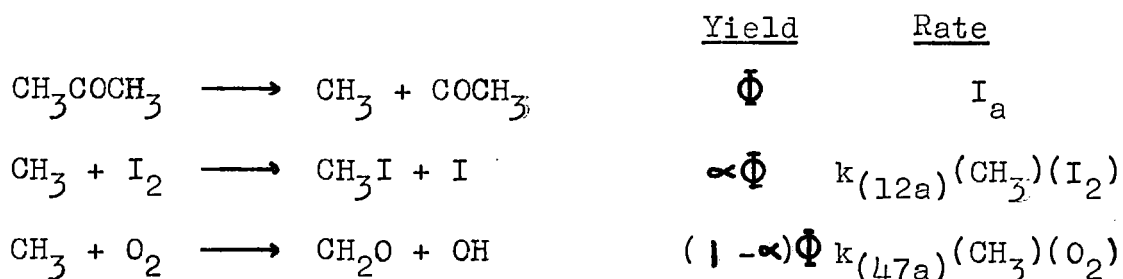

and

$$\frac{\Phi_{\text{CH}_2\text{O}}}{\Phi_{\text{CH}_3\text{I}}} = \frac{k_{(47a)}}{k_{(12a)}} \frac{(\text{O}_2)}{(\text{I}_2)} \quad \text{and} \quad \frac{k_{(47a)}}{k_{(12a)}} = \frac{\Phi_{\text{CH}_2\text{O}}}{\Phi_{\text{CH}_3\text{I}}} \frac{(\text{I}_2)}{(\text{O}_2)}$$

Unfortunately only two formaldehyde determinations were made and in a region where the yields were low so that the accuracies of the figures, 0.015 and 0.03, are in some doubt. Certainly substitution of these values, and the appropriate values of the other quantities, in the equation for k_{47a}/k_{12a} does not give good agreement. If the higher of the two formaldehyde figures is assumed to be the more reasonable

$$\text{then } \frac{k_{(47a)}}{k_{(12a)}} = \frac{0.03}{0.47} \times \frac{0.31}{3.36} = 5.9 \times 10^{-3}$$

If, as has been mentioned, the activation energies are similar and the collision numbers assumed approximately the same, this ratio gives an approximate indication of the ratio of the steric factors, and indicates that (12a) itself is not extremely efficient (steric factor $\sim 3 \times 10^{-2}$). It must be remembered that these figures are all based on the assumption that the steric factor for (42) is unity. Further speculation, at this point, in the absence of further formaldehyde yields under more favourable conditions, where the yields are more accurately determinable, is not particularly valuable. A question which is far from answered is: why do these two similar reactions, (47a) and (12a) have such different steric factors? In this respect it would be interesting to know whether, in fact, reaction (47a) proceeds via a peroxy-radical stage and whether, or not, the complex radical is subject to steric hindrance in its subsequent reaction. It is even possible that CH_3O_2 formed by (47a) is too energy-rich and dissociates easily into methyl and oxygen again so that only a small proportion of collisions leads to further reaction to give formaldehyde.

The acetyl radical. Although the acetone-oxygen-iodine runs were few in number, enough methyl iodide and formaldehyde

results were obtained to give a good idea of what was happening to the methyl radicals, even if the quantitative calculations possible were limited. With the acetyl radical, however, the situation is much less satisfactory. No analyses for acetyl iodide were made since two pairs of workers^{3,4} had already failed in this respect and had given good reasons for their non-success, and indicated that the isolation of the compound was virtually impossible. No reaction scheme for this radical can, therefore, be written down. In runs K2, K7 and K8, (Table VII) enough information is provided to indicate that ^{14}CO and $^{12}\text{CO}_2$ are formed in small, and almost equal, amounts and, therefore, possibly together from the acetyl radical. It is highly unlikely that the ^{14}CO arises from the methyl reaction sequence since its yield is greater than that of formaldehyde. At this point, therefore, the original comment, that the results did not require the postulation of any new reactions (in addition to those already described in the separate mechanisms), must be revised since it seems from the above that a reaction like

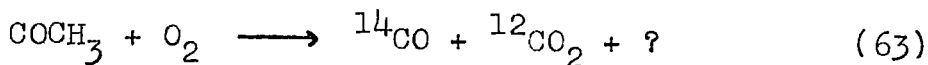

may occur. It is even conceivable, since formaldehyde may arise, too, from the acetyl radical, that the formaldehyde yields observed are not from methyls at all, as supposed, but formed after the $^{12}\text{CO}_2$, (which is the larger yield),

and, therefore, are not valid for substitution in the kinetic equations written above for the estimation of steric factors.

The argument advanced above, however, must be treated with caution since only two completed results are available to support it. K5, which could have confirmed it further was subject to an accident which resulted in the loss of the CO collected before its activity could be determined, and K8 and K9 are merely inactive repeats of K5 and K7 to obtain the CO₂ yields which could not be obtained in the originals owing to determinations of methyl iodide.

The experiments K11-K15 were performed with a new batch of radioactive acetone which, owing to lack of time, could not be subjected to the necessary radio-contamination purification procedure, and was therefore unsuitable for CO₂ determinations. The methyl iodide figures in K11 and K13 seemed consistent with previous estimates and are probably reliable. The mysterious feature of this new acetone was that it failed to give similar CO activity distributions to the previous "aged" material. It is probable that the further investigations at present under way in this laboratory, will be able to clarify this point and show that ageing of the new acetone will reproduce the yields of the older experiments.

If, for the moment, the radioactive experiments are disregarded and the inactive ones only considered, (K8, K9), it is still apparent that the yields of CO and CO₂ are comparable and larger than the formaldehyde figures. If

$\Phi_d = \Phi_{\text{CH}_3\text{I}} + \Phi_{\text{CH}_2\text{O}}$, and the acetyl radical has virtually the same value, then the attribution of the yields of CO and CO₂ to the acetyl radical can be supported only if it is assumed that the acetyl-oxygen reaction, (35), fares better in competition with the acetyl-iodine reaction, (13), than the methyl-oxygen reaction, (47a), does with the methyl-iodine reaction, (12). This, however, does not seem to be entirely consistent with previous remarks on the efficiencies of (35) and (13), made when considering the residual ¹²CO yields in the individual acetone-iodine and acetone-oxygen photolyses. Here, in view of the lack of information, it is not proposed to say more than that.

THE PRIMARY PROCESS

Although the previous discussion has indicated that formaldehyde is probably formed in other reactions besides (47a), in the experiments under consideration the yields of formaldehyde are very low and may well, in fact, arise solely from methyl radicals. In any case the yields are so low that little significant error is introduced into the following discussion by writing

$$\Phi_{\text{acetone decomposition}} = \Phi_{\text{CH}_2\text{O}} + \Phi_{\text{CH}_3\text{I}},$$

providing $\Phi_{^{12}\text{CO}} = 0.$

If this relationship is then investigated in the light of the results presented in table VII, some rather curious features are observed. As the iodine pressure dropped at constant oxygen pressure, it might have been expected that the yields of the oxygen-containing compounds would have risen at the expense of those containing iodine, and also that Φ_d would have increased at the same rate as it does in the acetone-iodine photolysis when the iodine pressure is progressively reduced. Observation showed, however, that both the methyl iodide and formaldehyde yields increase, and, therefore, so does Φ_d , but not at the rate of the equivalent acetone-iodine photolysis. The increase in Φ_d was actually greater in the presence of oxygen and iodine together than in the case of iodine alone.

Consider in particular K13, K14, and K16. In the absence of oxygen at an iodine pressure of 0.31,

$$\Phi_{\text{CH}_3\text{I}} = 0.404, \quad \Phi_{\text{CO}} = 0.020, \quad \text{and} \quad \Phi_d = 0.384$$

With oxygen, at a pressure of 3.36 mm., and the same iodine pressure,

$$\Phi_{\text{CH}_3\text{I}} = 0.474, \quad \Phi_{\text{CH}_2\text{O}} = 0.030, \quad \text{and} \quad \Phi_d = 0.504$$

This, again, is only true so long as $\Phi_{^{12}\text{CO}} = 0$, a point which has already been discussed. Inspection of K3, K5, and K17 gives, for an iodine pressure of 2.46 mm.

$$\Phi_{\text{CH}_3\text{I}} = 0.363, \quad \Phi_{\text{CO}} = 0.016, \quad \text{and} \quad \Phi_d = 0.347,$$

whereas, with the addition of 3.36 mm. O_2 ,

$$\Phi_{CH_3I} = 0.374, \quad \Phi_{CH_2O} = 0.015, \quad \text{and} \quad \Phi_d = 0.389.$$

Thus, for a given oxygen pressure, Φ_d rises as the iodine pressure falls but by an amount greater than can be accounted for by the reduction in iodine pressure. The implication of this is that oxygen is competing with iodine for the second activated state of the acetone molecule, but that its function is one leading to dissociation rather than deactivation i.e. a competition between reactions (18) and (34). Since, at an iodine pressure as high as 2.4 mm., the quantum yield of acetone decomposition, Φ_d , rises appreciably on the addition of 3.36 mm. of oxygen, the process must be relatively efficient. This implies that oxygen molecules cause radical formation in their own vicinity, by collision, and it is a striking example of the inefficiency of (47a) that the radicals do not give oxygenated products as a result of these collisions, but live long enough to be preferentially removed as iodides, since it is the iodide yield which rises. It is unfortunate that formaldehyde results were not obtained at the lowest iodine pressure studied (0.15 mm.) because, from 0.50 mm. down to 0.15 mm., the methyl iodide yields have levelled out and it is essential to know, in confirmation of the above argument, whether the formaldehyde yield is rising rapidly over this range to maintain the predicted rise in Φ_d . In the absence of such evidence the following speculative

reaction scheme, which incorporates existing ideas on acetone-iodine and acetone-oxygen photochemistry, is suggested

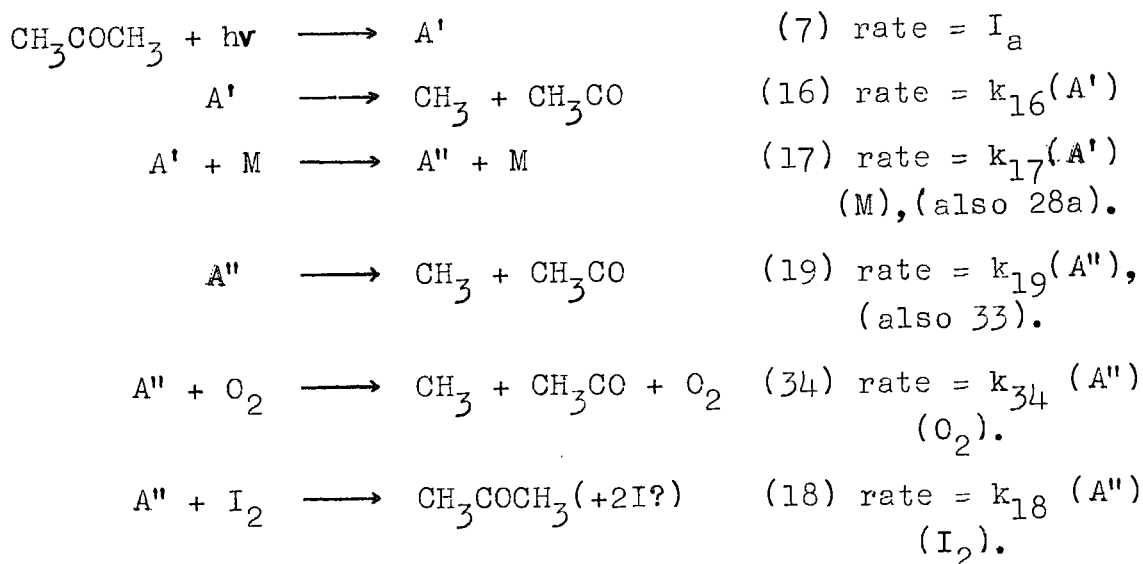

Applying the steady state concept to A' , A'' ,

$$I_a = k_{16}(\text{A}') + k_{17}(\text{A}')(\text{M}), \text{ i.e. } (\text{A}') = \frac{I_a}{k_{16} + k_{17}(\text{M})},$$

$$\text{and } k_{17}(\text{A}')(\text{M}) = k_{19}(\text{A}'') + k_{34}(\text{A}'')(\text{O}_2) + k_{18}(\text{A}'')(\text{I}_2),$$

$$\text{i.e. } (\text{A}'') = \frac{k_{17}(\text{M})I_a}{k_{16} + k_{17}(\text{M})} \cdot \frac{1}{k_{19} + k_{34}(\text{O}_2) + k_{18}(\text{I}_2)}$$

$$\text{Finally, } \Phi_d = \frac{k_{16}(\text{A}') + k_{19}(\text{A}'') + k_{34}(\text{A}'')(\text{O}_2)}{I_a}$$

$$= \frac{k_{16}}{k_{16} + k_{17}(\text{M})} + \left(\frac{k_{19}k_{17}(\text{M})}{k_{16} + k_{17}(\text{M})} + \frac{k_{34}(\text{O}_2)k_{17}(\text{M})}{k_{16} + k_{17}(\text{M})} \right) \left(\frac{1}{k_{19} + k_{34}(\text{O}_2) + k_{18}(\text{I}_2)} \right)$$

$$= \frac{1}{1 + \frac{k_{17}(M)}{k_{16}}} + \left\{ \frac{1}{1 + \frac{k_{16}}{k_{17}(M)}} \right\} \left\{ \frac{1}{1 + \frac{k_{18}(I_2)}{k_{19} + k_{34}(O_2)}} \right\}$$

This may appear an unusually complex equation but it should be pointed out that values of k_{17}/k_{16} and k_{18}/k_{19} can be obtained from the acetone-iodine work, leaving only the ratio k_{34}/k_{18} unknown. Only four acetone-iodine results at 120°C. are available for this purpose, namely K3, K6, and K13, all at 32.0 mm. pressure of acetone and a further result, K4, at 63.0 mm. of acetone. The values of the rate constants mentioned which best fit these results are $\frac{k_{16}}{k_{17}} = 17.0$ mm., and $\frac{k_{19}}{k_{18}} = 0.0254$ mm., compared with Sutton's values of 11.2 mm. and 0.059 mm., respectively, obtained at 100°C. The values mentioned above are not extremely accurate since they are based on a small number of results and the agreement with the result obtained at 63.0 mm. acetone pressure is poor. Substitution of these values in the equation above, however, yields values of $\frac{k_{34}}{k_{18}}$ of 0.0261 mm. from K14 and 0.085 mm. from K5. This disagreement is disappointing but more results are required before the mechanism can be regarded as entirely inadequate. Some idea of the disagreement is given if a reduction of Φ_d by 0.01 (approximate error) is considered in each case. $\frac{k_{34}}{k_{18}}$ becomes 0.0235 mm. from K14 and 0.0722 mm. from K5.

REVIEW

The photolysis of acetone in the presence of oxygen and

iodine has been investigated, briefly owing to lack of time, but sufficiently fully to indicate that an exhaustive investigation will be necessary to allow a full elucidation of the various processes involved. In the light of the evidence available some tentative suggestions have been made which, it is hoped, will shortly be confirmed or rejected on the basis of further work being carried on in this laboratory.

Surveying the evidence already accumulated, it is recommended that a great number of experiments of the type already described should be performed, using the tracer technique, and that more attention should be directed to the very low iodine pressure range (0.00-0.3 mm.) where the formaldehyde yield may become rapidly larger and permit more accurate observations of reaction rates. The number of variations which may be applied to the experimental conditions is large and, in view of the rather arduous experimental procedure involved, the full investigation of these variations will be no easy task. The most obvious variables are the pressures of the reactants which present a formidable programme. Temperature effects will probably also provide much useful information, especially on the activation energies of the various reactions postulated. Finally these investigations will only realise their maximum usefulness if the maximum analytical data are obtained from each experiment, especially those results relating to the distribution of radioactive material in the CO and CO₂ yields.

SUMMARY

This work has been directed towards the elucidation of the mechanism of reaction, with iodine and oxygen mixtures, of the radicals formed in the photolysis of acetone (3130Å radiation), and towards the further elucidation of the process of photo-oxidation of acetone in the absence of iodine. It was hoped that the pressure dependence of the quantum yields of acetone decomposition in the acetone-iodine-oxygen photolyses would provide valuable information on the nature of the primary process in the photolysis. The term "primary process" signifies the events taking place between the absorption of a quantum of radiation by a molecule and the production of radicals. To ensure certain identification of the origin within the acetone molecule of various products, (e.g. CO and CO₂), and to provide a convenient and sensitive analytical technique, 1,3-¹⁴C-labelled acetone was employed in the various determinations.

The time employed in developing experimental techniques limited the time available for new determinations but sufficient results have been obtained to demonstrate that existing ideas on the photo-oxidation require considerable revision, and suggestions have been made as to the probable sequence of events, although no absolute confirmation of the suggested steps could be provided. The acetone-iodine-oxygen work has received only a brief preliminary investiga-

tion but it seems apparent from the results that the function of oxygen in the primary process is a positive one leading to dissociation of one of the activated species of the acetone molecule into radicals by collision. However, the reservation must be made that some of the acetone-oxygen results have led to the suspicion that deactivation may occur in the high oxygen pressure range. This conclusion can only be thoroughly tested when a comprehensive analytical system becomes available to enable a mass-balance of the products in the photo-oxidation to be made and further comment must wait till then.

In the introductory section a certain amount of further information has been obtained by critically comparing the various scattered works in this field, some amendments to existing mechanisms have been made, and it is hoped that this assessment of existing ideas plus the further comment and conclusions of the discussion in Chap. VIII represent the latest information on the work under review. A survey of the work done to date produces the impression that it is not improbable that, with additional experimental results, a mechanism could be advanced based on two electronically-excited states of the acetone molecule which would account satisfactorily for all aspects of the photolysis of acetone including,

- (i), the direct photolysis and its pressure dependence
(a re-evaluation of early work would be required here),
 - (ii), the acetone-iodine photochemistry,
 - (iii), the acetone-oxygen photochemistry,
 - (iv), the acetone-iodine-oxygen photochemistry
- and (v), the fluorescence of irradiated acetone, either pure, or with added oxygen.

This impression first arose after the formulation of a more plausible acetone-iodine photolysis mechanism, coupled with the removal from the fluorescent mechanism of the necessity of having a small concentration of one of the activated species.

BIBLIOGRAPHY (NUMERICAL INDEX)

1. DAVIS CHEM. REVIEWS 1947, 40, 201.
2. NOYES AND DORFMAN J. CHEM. PHYSICS 1948, 16, 788.
3. MARTIN AND SUTTON TRANS. FARAD. SOC. 1952, 48, 812.
4. PITTS AND BLACET J. AMER. CHEM. SOC. 1952, 74, 455.
5. GORIN J. CHEM. PHYSICS 1939, 7, 256.
6. BENSON AND FORBES J. AMER. CHEM. SOC. 1943, 65, 1399.
7. LUCKEY AND NOYES J. CHEM. PHYSICS 1951, 19, 227.
8. GROH, LUCKEY, AND
NOYES J. CHEM. PHYSICS 1953, 21, 115.
9. MATHESON AND ZABOR J. CHEM. PHYSICS 1939, 7, 536.
10. ALMY AND ANDERSON J. CHEM. PHYSICS 1940, 8, 805.
11. NOYES AND MARCOTTE DISC. FARAD. SOC. 1951, 10, 236.
12. NOYES AND MARCOTTE J. AMER. CHEM. SOC. 1952, 74, 783.
13. HOARE TRANS. FARAD. SOC. 1953, 49, 1292.
14. CHRISTIE J. AMER. CHEM. SOC. 1954, 76, 1979.
15. KASKAN AND DUNCAN J. CHEM. PHYSICS 1948, 16, 223.
16. TROTMAN-DICKENSON
AND STEACIE J. AMER. CHEM. SOC. 1950, 72, 2310.
17. CALVERT AND STEACIE J. CHEM. PHYSICS 1951, 19, 176.
18. STYLE AND SUMMERS TRANS. FARAD. SOC. 1946, 42, 388.
19. MARTIN AND NOYES J. AMER. CHEM. SOC. 1953, 75, 4183.
20. BATES AND SPENCE J. AMER. CHEM. SOC. 1931, 53, 381,
1689.

21. VAN TIGGELEN ANN. MINES BELG. 1942, 43, 117.
22. WALSH TRANS. FARAD. SOC. 1947, 43, 297.
23. GRAY J. CHEM. SOC. 1952, 3150.
24. FRANKENBERG AND
NOYES J. AMER. CHEM. SOC. 1953, 75, 2847.
25. BLAEDEL, OGG, AND
LEIGHTON J. AMER. CHEM. SOC. 1942, 64, 2499.
26. KUTSCHKE NAT. RES. COUNCIL, Private comm-
OTTAWA unication.
27. MELLOR A Comprehensive Treatise of
Inorganic and Theoretical Chemistry
Vol. 1, p. 350.
28. INTERNATIONAL CRITICAL TABLES
29. RICE PROC. ROY. SOC. 1915, 91(A),
76.
30. TROTMAN-DICKENSON
AND STEACIE J. CHEM. PHYSICS 1950, 18, 1097.
31. MURDOCH, BROOKS,
AND ZAHN ANAL. CHEM. 1948, 20, 65.
32. ROHRINGER AND
BRODA Z. fur. Naturforsch. 1953, 8b, 159.
33. BROWN AND MILLER REV. SCI. INSTR. 1947, 18, 496.
34. EIDENOFF ANAL. CHEM. 1950, 22, 529.
35. HENSON BRIT. JOURNAL APP.
PHYSICS 1953, 4, 217.

36. AUDRIC AND LONG CRL Report/A.E.51
37. GOMER AND NOYES J. AMER. CHEM. SOC. 1950, 72, 101.
38. MATSUKAWA J. BIOCHEM. (TOKYO) 1939, 30, 386.
39. STOTZ J. BIOL. CHEM. 1943, 148, 585.
40. BRICKER AND
JOHNSON ANAL. CHEM. 1945, 17, 400.
41. DONNALLY ANAL. CHEM. 1933, 5, 91.

AUTHOR INDEX (REFERENCE NUMBERS)

ALMY AND ANDERSON	10	GORIN	5
AUDRIC AND LONG	36	GRAY	23
		GROH, LUCKEY AND	
BATES AND SPENCE	20	NOYES	8
BENSON AND FORBES	6		
BLAEDDEL, OGG AND		HENSON	35
LEIGHTON	25	HOARE	13
BRICKER AND			
JOHNSON	40	KASKAN AND DUNCAN	15
BROWN AND MILLER	33	KUTSCHKE	26
CALVERT AND STEACIE	17	LUCKEY AND NOYES	7
CHRISTIE	14		
		MARTIN AND NOYES	19
DAVIS	1	MARTIN AND SUTTON	3
DONNALLY	41	MATHESON AND ZABOR	9
		MATSUKAWA	38
EIDENOFF	34	MELLOR	27
		MURDOCH, BROOKS AND	
FRANKENBERG AND NOYES	24	ZAHN	31
GOMER AND NOYES	37	NOYES AND DORFMANN	2

NOYES AND MARCOTTE	11,12
PITTS AND BLACET	4
RICE	29
ROHRINGER AND BRODA	32
STOTZ	39
STYLE AND SUMMERS	18
TROTMAN-DICKENSON AND STEACIE	16
TROTMAN-DICKENSON AND STEACIE	30
VAN TIGGELEN	21
WALSH	22

EQUATION KEY

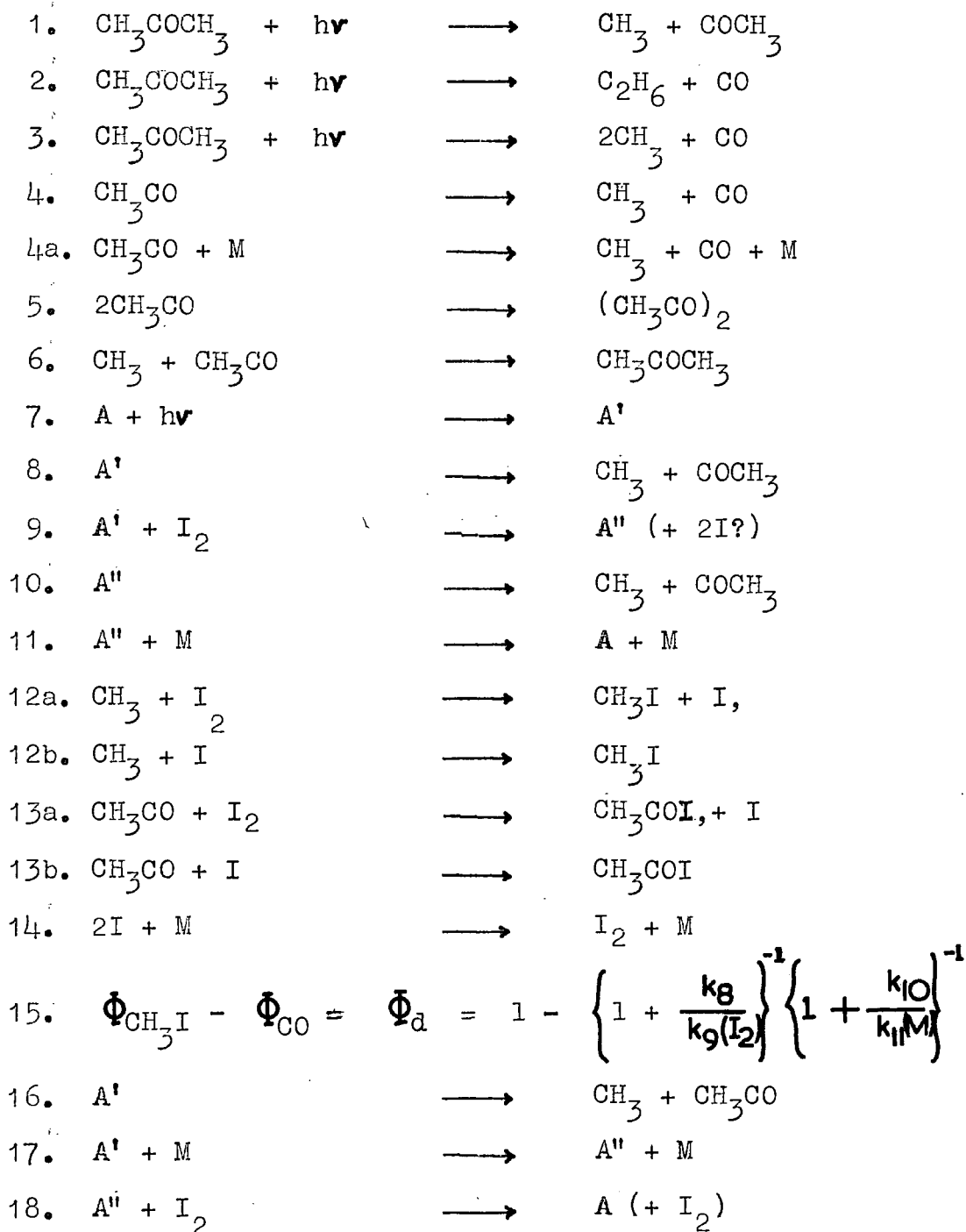

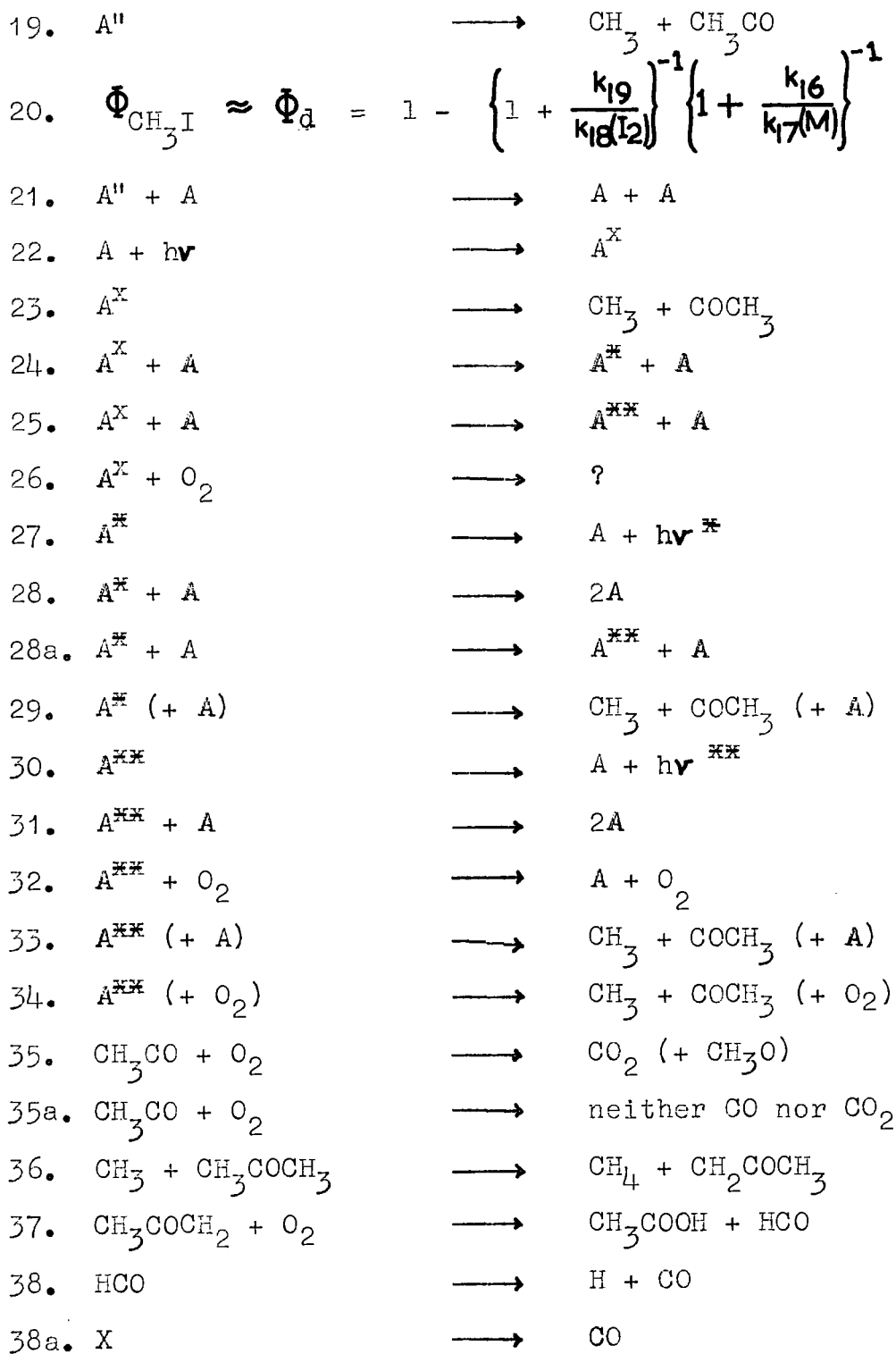

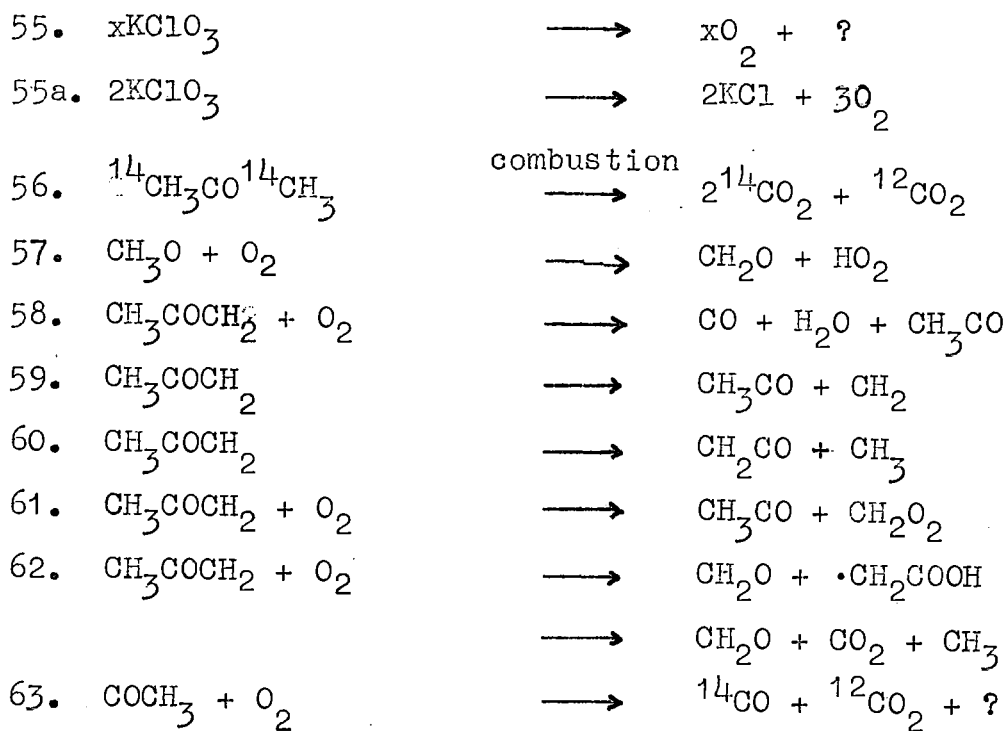

ACKNOWLEDGMENTS

I wish to record my sincere thanks to Mr. G.R. Martin, B.Sc., F.R.I.C., for suggesting the problem, and for his continued interest and encouragement throughout the work.

I am also indebted to the Department of Scientific and Industrial Research for a grant towards the cost of radioactive materials and for the maintenance grant without which this work could not have been carried out.

John Brown.

