



## Durham E-Theses

---

### *The preparation and investigation of the chloro-fluorocyclohexanes*

Mobbs, R. H.

#### How to cite:

---

Mobbs, R. H. (1961) *The preparation and investigation of the chloro-fluorocyclohexanes*, Durham theses, Durham University. Available at Durham E-Theses Online: <http://etheses.dur.ac.uk/9130/>

#### Use policy

---

The full-text may be used and/or reproduced, and given to third parties in any format or medium, without prior permission or charge, for personal research or study, educational, or not-for-profit purposes provided that:

- a full bibliographic reference is made to the original source
- a [link](#) is made to the metadata record in Durham E-Theses
- the full-text is not changed in any way

The full-text must not be sold in any format or medium without the formal permission of the copyright holders.

Please consult the [full Durham E-Theses policy](#) for further details.

## SUMMARY

### The Preparation and Investigation of the Chloro-fluorocyclohexanes

#### PART I      Bromo-, Chloro-, Bromochloro-, and Other Derivatives of Cyclohexane as Sources of Lightly Fluorinated Cyclohexanes

Attempts have been made to prepare lightly fluorinated cyclohexanes by the action of anhydrous hydrofluoric acid, alone and with catalysts, upon cyclohexane derivatives containing small numbers of halogen atoms. From 1-chloro-1,2-dibromocyclohexane a bromo-fluoro-compound was produced but its identity could not be established, while with 1,2-dibromocyclohexane rearrangement occurred and no fluorine containing material was obtained.

The use of newer fluorinating agents, potassium fluoride in dimethylformamide, caesium fluoride, perchloryl fluoride, and sulphur tetrafluoride, upon suitable intermediates did not yield significant amounts of fluorine containing compounds.

A gas chromatography unit able to operate, both analytically and preparatively, at column temperatures up to 200° was devised and used in this work, while a method of bromine analysis was introduced which enabled bromine, chlorine, and fluorine to be estimated in one compound.

PART II      High Temperature Dehalogenation Reactions  
of Perchlorofluorocyclohexanes and Chloro-  
fluorocyclohexanes

Passage of perchlorofluorocyclohexanes of the general formula  $C_6F_{12-n}Cl_n$  ( $n = 1$  to  $5$ ) over iron gauze at  $430^\circ$  yielded mainly perfluorobenzene and some perfluorocyclohexene, negligible amounts of chlorine containing product being obtained.

The product from a vapour phase reaction between benzene and a large excess of chlorine trifluoride was examined and shown to contain compounds of the general formula  $C_6F_{12-n}Cl_n$  ( $n = 1$  to  $4$ ) together with large amounts of hydrogen containing chlorofluorocyclohexanes.

Similar dehalogenation of this material at  $500^\circ$  yielded perfluorobenzene, pentafluorobenzene, and material not easily separable by gas chromatography, which appeared to be tetrafluoro- and trifluoro-benzenes.

At lower dehalogenation temperatures complex mixtures were obtained which consisted largely of dienes. In some cases considerable yields of a diene,  $C_6F_7Cl$ , almost certainly a 1:3-diene, were obtained.

THE PREPARATION AND INVESTIGATION OF THE CHLORO-  
FLUOROCYCLOHEXANES

PART I BROMO-, CHLORO-, BROMOCHLORO-, AND OTHER  
DERIVATIVES OF CYCLOHEXANE AS SOURCES OF  
LIGHTLY FLUORINATED CYCLOHEXANES.

PART II HIGH TEMPERATURE DEHALOGENATION REACTIONS  
OF PERCHLOROFUOROCYCLOHEXANES AND CHLORO-  
FLUOROCYCLOHEXANES.

A thesis submitted by R.H. Mobbs B.Sc. (University  
College) in candidature for the degree of Doctor of  
Philosophy.

Durham Colleges in the University of Durham 1960.

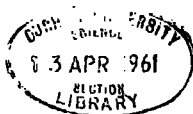

### ACKNOWLEDGEMENTS

I should like to record my indebtedness to Professor W.K.R. Musgrave, who supervised this work, for his continual help and encouragement, to Dr. L.H. Sutcliffe of Liverpool University for some nuclear magnetic resonance determinations, and to the Imperial Smelting Corporation for supplying samples of fluorinated cyclic dienes and aromatic fluorocarbons used in this work.

I should also like to thank the Department of Scientific and Industrial Research for the award of a Research Studentship held during the period of this research.

SUMMARYThe Preparation and Investigation of the Chloro-fluorocyclohexanesPART I      Bromo-, Chloro-, Bromochloro- and Other Derivatives of Cyclohexane as Sources of Lightly Fluorinated Cyclohexanes

Attempts have been made to prepare lightly fluorinated cyclohexanes by the action of anhydrous hydrofluoric acid, alone and with catalysts, upon cyclohexane derivatives containing small numbers of halogen atoms. From 1-chloro-1,2-dibromocyclohexane a bromo-fluoro-compound was produced but its identity could not be established, while with 1,2-dibromocyclohexane rearrangement occurred and no fluorine containing material was obtained.

The use of newer fluorinating agents, potassium fluoride in dimethylformamide, caesium fluoride, perchloryl fluoride, and sulphur tetrafluoride, upon suitable intermediates did not yield significant amounts of fluorine containing compounds.

A gas chromatography unit able to operate, both analytically and preparatively, at column temperatures up to 200° was devised and used in this work, while a method of bromine analysis was introduced which enabled bromine, chlorine, and fluorine to be estimated in one compound.

PART II      High Temperature Dehalogenation Reactions  
of Perchlorofluorocyclohexanes and  
Chlorofluorocyclohexanes

Passage of perchlorofluorocyclohexanes of the general formula  $C_6F_{12-n}Cl_n$  ( $n = 1$  to  $5$ ) over iron gauze at  $430^\circ$  yielded mainly perfluorobenzene and some perfluorocyclohexene, negligible amounts of chlorine containing product being obtained.

The product from a vapour phase reaction between benzene and a large excess of chlorine trifluoride was examined and shown to contain compounds of the general formula  $C_6F_{12-n}Cl_n$  ( $n = 1$  to  $4$ ) together with large amounts of hydrogen containing chlorofluorocyclohexanes.

Similar dehalogenation of this material at  $500^\circ$  yielded perfluorobenzene, pentafluorobenzene, and material not easily separable by gas chromatography, which appeared to be tetrafluoro- and trifluoro-benzenes.

At lower dehalogenation temperatures complex mixtures were obtained which consisted largely of dienes. In some cases considerable yields of a diene,  $C_6F_7Cl$ , almost certainly a 1:3-diene, were obtained.

CONTENTS

	Page No.
<u>PART I</u>	1
<u>CHAPTER I INTRODUCTION</u>	2
References 1-57	17
<u>CHAPTER II DISCUSSION OF EXPERIMENTAL WORK</u>	21
Preparation of 1-Chlorocyclohexene and dehydrochlorination of 1,1-dichloro- cyclohexane	23
Chlorination of 1-chlorocyclohexene	23
Bromination of 1-chlorocyclohexane	24
The action of anhydrous hydrofluoric acid upon 1-chloro-1,2-dibromocyclohexane	25
Attempts to determine nature of product by:-	
Oxidation	27
Catalytic hydrogenation	27
Infra-red data	27
Vapour phase chromatography	28
Reduction with lithium aluminium hydride	28
N.M.R. measurements	29
The action of anhydrous hydrofluoric acid upon trans-1,2-dibromocyclohexane with catalysts:-	
SnCl <sub>4</sub>	31
SnBr <sub>4</sub>	32



The action of potassium fluoride upon 1,2-dibromocyclohexane in dimethyl- formamide	34
The action of caesium fluoride upon 1,2- dichlorocyclohexane	36
The action of perchloryl fluoride:-	
upon cyclohexanone piperidyl enamine	38
upon cyclohexanone pyrrolidyl enamine	39
Reactions with sulphur tetrafluoride	41
<u>CHAPTER III</u> <u>EXPERIMENTAL WORK</u>	42
Preparation of 1-chlorocyclohexene	43
Dehydrochlorination of 1,1-dichlorocyclo- hexane	44
Chlorination of 1-chlorocyclohexene	52
Bromination of 1-chlorocyclohexene	53
Action of anhydrous hydrofluoric acid upon 1-chloro-1,2-dibromocyclohexane:-	
without catalysts	57
with catalysts	60
Attempted oxidation of reaction product	69
Attempted catalytic hydrogenation of reaction product	71
Reduction of product with $\text{LiAlH}_4$ in tetrahydrofuran and ether solution	72
The action of anhydrous hydrofluoric acid upon 1,2-dibromocyclohexane:-	
with stannic chloride as catalyst	75
with stannic bromide as catalyst	83

The action of potassium fluoride in dimethylformamide upon 1,2-dichlorocyclohexane	88
The preparation of caesium fluoride	90
The action of caesium fluoride upon 1,2-dichlorocyclohexane	91
The preparation of perchloryl fluoride	92
The preparation of cyclohexanone piperidyl enamine	95
The reaction between perchloryl fluoride and cyclohexanone piperidyl enamine	96
The preparation of cyclohexanone pyrrolidyl enamine	98
The reaction between perchloryl fluoride and cyclohexanone pyrrolidyl enamine	100
References 58-83	105
<u>CHAPTER IV</u> <u>ANALYSIS OF COMPOUNDS CONTAINING CHLORINE, BROMINE AND FLUORINE</u>	107
References 84-90	118
<u>CHAPTER V</u> <u>GAS CHROMATOGRAPHY</u>	119
References 91-96	133

	Page No.
<u>PART II</u>	134
<u>CHAPTER I</u> <u>INTRODUCTION</u>	135
References 1-9	140
<u>CHAPTER II</u> <u>DISCUSSION OF THE EXPERIMENTAL WORK</u> <u>AND THE RESULTS</u>	141
I.    Dehalogenations of cyclic $C_6F_{12-n}Cl_n$ (n = 1 to 5) compounds.	142
II.   Dehalogenations of materials produced by the action of chlorine trifluoride upon benzene in the vapour phase.	152
Preliminary investigation of starting material composition	153
Results of dehalogenations	160
<u>CHAPTER III</u> <u>EXPERIMENTAL WORK</u>	168
Dehalogenations by heated reduced iron <sub>2</sub>	
Apparatus	169
Experimental procedure	172
Dehalogenations of cyclic $C_6F_{12-n}Cl_n$ (n = 1 to 5) materials:	177
cyclic $C_6F_{11}Cl$	178
cyclic $C_6F_{10}Cl_2$	178
cyclic $C_6F_9Cl_3$	181
cyclic $C_6F_8Cl_4$	184
cyclic $C_6F_7Cl_5$	185
Distillation of the material obtained by the action of chlorine trifluoride upon benzene in the vapour phase	188

Analytical V.P.C. of distillation fractions	191
Preparative V.P.C. separation of some distillation fractions	195
Dehalogenation of the distillation fractions from chlorine trifluoride-benzene reaction:-	
I At ca. 400°	205
II At ca. 500°	210
Attempted defluorination of mixed cyclic $C_6F_{10}H_2$ isomers at 500° and 630°	215
Preparation of chloropentafluorobenzene	216
References 10-18	218

PART I BROMO-, CHLORO-, BROMOCHLORO-, AND  
OTHER DERIVATIVES OF CYCLOHEXANE AS  
SOURCES OF LIGHTLY FLUORINATED CYCLOHEXANES.



CHAPTER I

INTRODUCTION

## INTRODUCTION

Although many perhalo- and polyhalo-cyclohexane derivatives have been prepared only three are known in which a small number of hydrogen atoms have been replaced by fluorine alone, or by fluorine and other halogens. These are cyclohexyl fluoride,<sup>1</sup> 1,1-difluorocyclohexane,<sup>2a,b,3</sup> and 1-chloro-1-fluorocyclohexane.<sup>2a,b</sup>

Attempts have been made to prepare others, for example Henne et al.<sup>4</sup> reacted mercuric fluoride with trans-1,2-dibromocyclohexane but in the working up of the product hydrofluoric acid was lost to give cyclohexa-1,3-diene.

Swarts<sup>1</sup> treated cyclohexyl fluoride with bromine in acetic acid and isolated a 1,2-dibromocyclohexane and claimed that a trace of a bromo-fluorocyclohexane was formed, but gave very little detail.

In general, interest has centred mainly on the perhalo- and polyhalo- cyclohexane derivatives because of their great stability and possible industrial importance.

In the chlorofluorinations of benzene by chlorine trifluoride which have been carried out in this laboratory by other workers,<sup>5a,b,6</sup> a very complex mixture of chlorofluoro-cyclohexanes and possibly -cyclohexadienes and -cyclohexenes resulted, and at the time it was thought interesting to

attempt the preparation of some of these compounds by unambiguous routes and to investigate their properties.

To this end Cuthbertson<sup>2a,b</sup> prepared 1,1-difluorocyclohexane, and 1-chloro-1-fluoro-cyclohexane, but attempts to prepare other derivatives met with no success, one of the main reasons for this being the great ease with which hydrofluoric acid is lost from the molecule autocatalytically, leading to rapid decomposition and formation of polymeric material. Moreover it appears that the choice of reaction conditions is critical in many cases.

Although it became obvious that it would not be possible to introduce step-wise enough halogens to make molecules comparable to those, such as cyclic  $C_6F_9Cl_2H$ , produced in the afore mentioned chlorofluorination process, in view of the small number of the lesser halogenated compounds known it was thought worthwhile to continue the attempts to make them.

Also present in the benzene chlorofluorination product were small quantities of the aromatic derivatives chlorobenzene, p-chlorofluorobenzene and just possibly o- and m-chlorofluorobenzenes. It was thought that these compounds might perhaps arise from the dehydrohalogenation, in the product bicarbonate washing stage, of an addition product such as cyclic  $C_6H_6F_3Cl$ . If this compound could have been synthesised the idea could be tested.



There is also the possibility that these aromatic compounds might arise from the 1,4 addition and elimination sequence as suggested by Tatlow<sup>7</sup> to explain the cobalt trifluoride-benzene reaction products. The fact that chlorobenzene and p-chlorofluorobenzene were isolated while o- and m- chlorofluorobenzenes were not suggests a similarity in the mechanism.

#### Preparation of fluorine containing compounds

The following methods are well established for the preparation of straight and branched chain compounds but few have been applied to cyclic compounds.

##### (a) The addition of anhydrous hydrofluoric acid to a simple or substituted olefine

In this way cyclohexyl fluoride has been made from cyclohexene<sup>8</sup> and 1-chloro-1-fluorocyclohexane from 1-chloro-cyclohexene.<sup>2a,b</sup> Very many other examples could be quoted.<sup>9,10,11</sup>

Zinc chloride, boron trifluoride, aluminium chloride titanium tetrachloride, stannic chloride, antimony pentachloride and ferric chloride are among the various inorganic halides that have been used to catalyse this process.<sup>12</sup>

For example Grosse and Linn<sup>13</sup> found that the addition of anhydrous hydrofluoric acid to ethylene, propylene and cyclohexene would give good yields of the corresponding

fluorides. Metallic fluorides of zinc, aluminium, manganese, copper and iron as catalysts enable higher reaction temperatures to be used without polymerisation occurring.<sup>14</sup>

(b) The replacement of a halogen by fluorine using anhydrous hydrofluoric acid

This occurs in some cases when anhydrous hydrofluoric acid is used alone, but with catalytic amounts of various inorganic halides and certain other inert materials many more replacements can be effected. For example 1,1-dichloroethane with 2.5% w/w stannic chloride as catalyst yielded 1-chloro-1-fluorethane and 1,1-difluoroethane.<sup>12</sup>

With inorganic halides as catalysts the general mode of action is thought to be:-

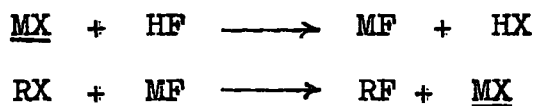

The effective fluorinating agent is thus the metallic fluoride.

Probably the most widely used halides in this process are those of antimony in its tri- and pentavalent states.

(c) The reaction between anhydrous hydrofluoric acid and various hydroxy compounds

<sup>15,16</sup>  
Klatt examined the solution of various hydroxy compounds

in anhydrous hydrofluoric acid and found that in many cases traces of the corresponding fluoro-derivatives were present.

The reaction has been of occasional preparative value, for example ethyl and propyl fluoride have been made from the corresponding alcohols in this way.<sup>17,a,b</sup>

(d) Replacement of halogens by fluorine using metallic fluorides alone

Metallic fluorides in all groups from one to five of the periodic table have been used to replace halogens in alkyl and olefinic halides and in some cases certain other groups as well. For an extensive account of the literature on this subject 'Aliphatic Fluorine Compounds' by A.M. Lovelace, D.A. Rausch, and W. Postelnek (Reinhold Corp. N.Y. 1957) can be consulted, the more important applications and some recent developments will however be discussed here.

In group Ia potassium fluoride in a solvent such as ethylene glycol or anhydrous glycerol has long been used to replace chlorine and less often bromine. Hoffmann<sup>18</sup> has prepared w,w-difluoroalkanes containing three to six carbon atoms by this method in good yield.

Pattison<sup>19</sup> noted that best yields were obtained in the production of w-fluoroalcohols and w-fluoroacetates from

w-chloroalcohols and w-chloroacetates when the reagents were very pure and moisture was rigidly excluded. He also suggested that if the reaction products were unstable in polyhydroxylic solvents the reactions could be carried out without a solvent in an autoclave, vigorous stirring being required.

Vorozhts<sup>20</sup>ov has recently prepared 2,4-dinitrofluorobenzene from the corresponding chloro- compound using potassium fluoride without a solvent.

The use of potassium fluoride in basic solvents viz, acetamide, formamide, and dimethyl formamide has been introduced by Miller,<sup>21a,b</sup> the advantage of the process being partly due to the increased solubility of potassium fluoride in these solvents.

Caesium fluoride<sup>22</sup> has recently been introduced for the fluorination of aromatic compounds and is found to be far more effective than potassium fluoride in some cases. No solvent is used, with a solvent the reaction does not occur.<sup>23</sup>

Pattison et al.<sup>24</sup> have shown that methane sulphonates of primary alcohols react with potassium fluoride to yield the corresponding fluoride, diethylene glycol being used as a solvent, while Bergmann et al.<sup>25</sup> showed recently that the use of the more easily prepared toluene p-sulphonates

led to better yields.

In group Ib both argentous and argentic fluorides have been used to replace halogens, usually in the absence of a solvent, the divalent compound will also replace hydrogen and is generally more reactive.

Argentous fluoride has been used to replace fully the gem dibromo-group in 1,1-dibromomethyl phenyl ketone,<sup>26</sup> this is usually not very easily accomplished. Argentic fluoride suffers from the disadvantage that it is difficult to prepare it anhydrous, but it can be used in the nascent state, hydrofluoric acid being added to silver carbonate in the presence of the organic halide. There still remains the further disadvantage that the double salt  $\text{AgCl} \cdot \text{AgF}$  is formed, only half the fluorine being then available for the replacement reaction.<sup>27</sup>

In group IIb mercurous fluoride has been used with some success with bromides and iodides containing one halogen only<sup>28</sup> and does not lead to coupling or olefine formation as the silver fluorides often do. Far more important, however, is the divalent compound introduced by Henne<sup>29</sup>. In many cases where argentous and mercurous fluorides give small yields in lengthy reactions, mercuric fluoride will react swiftly to give good yields. Polychlorides seem to be little affected by this reagent, except when heated under

pressure, and can be used as solvents if required. Mercuric fluoride can be prepared by the action of elemental fluorine on mercuric chloride in 75% yield and is a fluffy powder extremely sensitive to moisture. It is generally simpler to generate the compound in situ by the action of anhydrous hydrofluoric acid on mercuric oxide, as in the preparation of 1,1-difluoroheptane from the corresponding dichloride.<sup>30</sup>

In group IV a lead tetrafluoride has been used, in effect to add fluorine across the double bond, the material being generated in situ by the addition of anhydrous hydrofluoric acid to lead dioxide.<sup>31</sup>

In group Vb occur the most important fluorinating agents, the halides of antimony which can be used separately, together in various combinations or in the presence of free halogens. The following list details the principal ways in which they have been used.

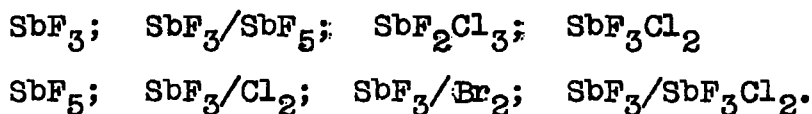

Some examples are given:-

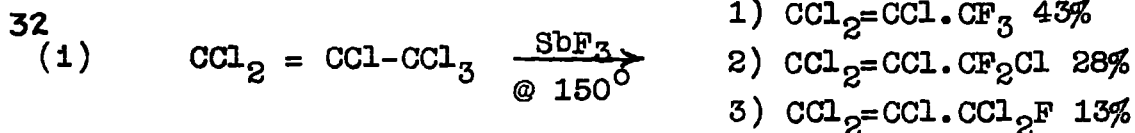

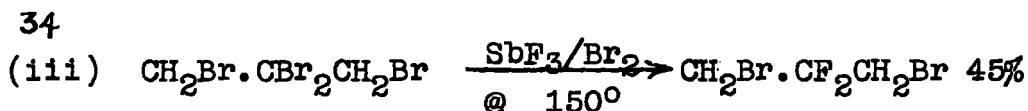

(e) Reactions between sulphur tetrafluoride and oxygen containing compounds

Very recently a fluoride of a group VI element, sulphur, has become important as a fluorinating agent for carbonyl groups. Sulphur tetrafluoride can be made by the action of sodium fluoride on sulphur dichloride in refluxing acetonitrile, or by the action of iodine pentafluoride upon sulphur.<sup>35</sup> It is a yellow poisonous gas b.p.  $-40.1^\circ$ .

In many cases this reagent will replace oxygen by two fluorine atoms in acids, esters, acid halides, amides, quinones, aldehydes, ketones and acid anhydrides. Carbon to carbon double and triple bonds are not affected.

Typical examples are:-<sup>3</sup>

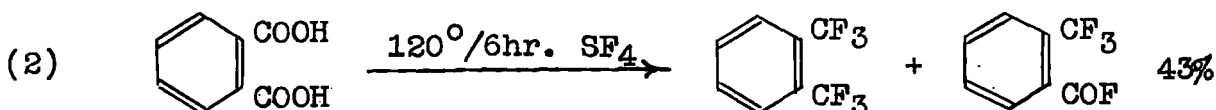
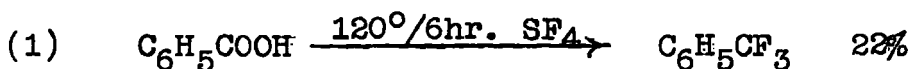

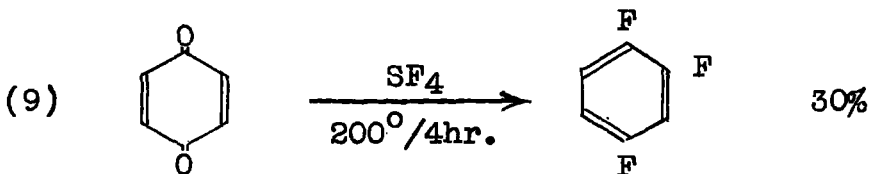
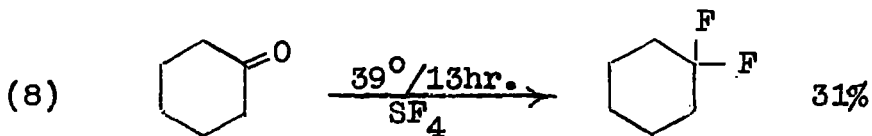
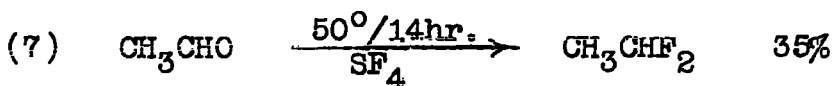
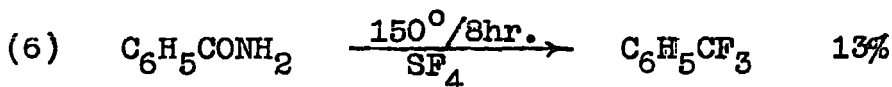
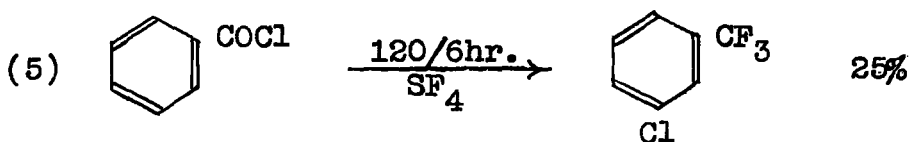
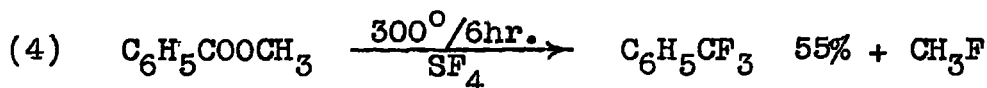
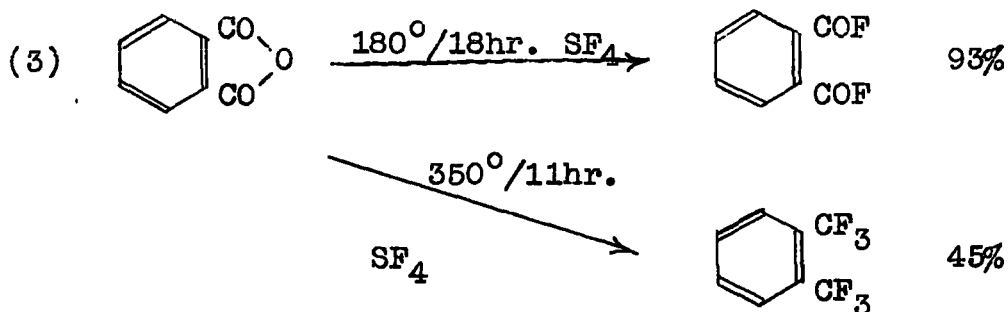

The reaction is catalysed by hydrogen fluoride but other fluorides viz. boron trifluoride, arsenic trifluoride, phosphorus pentafluoride, and titanium tetrafluoride are even more potent catalysts.



(f) Reactions of perchloryl fluoride with enamines, enol-ethers and sodio-derivatives of active methylene groups

Another new fluorinating agent for which a simple method of preparation has been discovered is perchloryl fluoride.

This can easily be made by heating potassium perchlorate in a large excess of fluosulphonic acid at  $80^{\circ}$ .<sup>36</sup> Perchloryl fluoride is evolved as a colourless stable gas, b.p.  $-46.8^{\circ}$  which can conveniently be stored in a cylinder.

With the monosodio- derivatives of active methylene groups perchloryl fluoride will react to yield gem -difluoro groups. In this way diethyl difluoromalonate, ethyl 2,2-difluoroacetate and 3,3-difluoro-2,4-pentanedione have been made from the corresponding monosodio-derivatives.<sup>37</sup>

This reagent has been more widely used in the field of steroid chemistry, the pyrrolidyl enamines of keto-steroids reacting to yield, after hydrolysis, mono fluorosteroids the fluorine substituting  $\alpha$ - to the carbonyl group.<sup>38,40</sup>

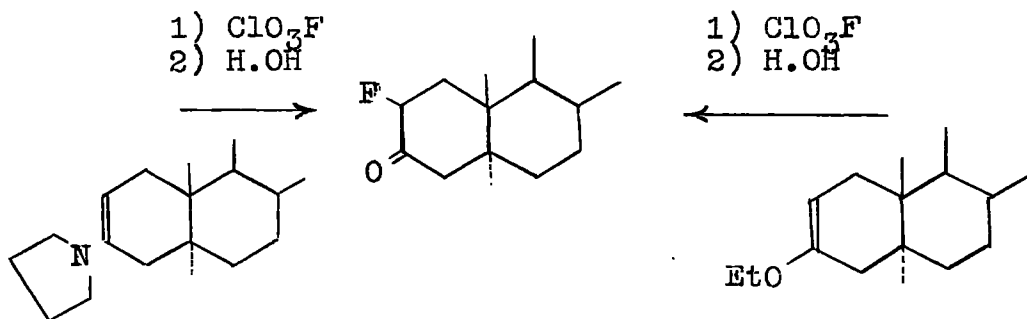

The enolic ether derivative of the steroid can also be used and reacts in the same manner.<sup>38</sup>

One case of the reaction being applied to a simple cyclohexane derivative has been reported, 2-fluorocyclohexanone has been made from ethoxy-cyclohexene.<sup>39</sup>

(g) Reaction between N-bromoacetamide and an olefine in anhydrous hydrofluoric acid

This is another reaction which has been developed by workers in the steroid field.

Bowers et al.<sup>41</sup> converted  $\Delta^5$ -pregnene-3 $\beta$ ,17 $\alpha$ -diol-20-one 17-acetate into 5 $\alpha$ -bromo-6 $\beta$  fluoropregnane-3 $\beta$ ,17 $\alpha$ -diol-20-one 17-acetate by treating the starting material in methylene chloride or tetrahydrofuran, with a molar equivalent of N-bromoacetamide, a 25-100 molar excess of anhydrous hydrofluoric acid being present.

A wide variety of unsaturated steroids have been treated in this way.<sup>42</sup>

(h) Addition of the elements of bromine monofluoride to a double bond using bromine/bromine trifluoride mixtures

In this laboratory the effective addition of the elements of bromine monofluoride across a double bond by means of equimolar mixtures of bromine and bromine trifluoride has been carried out for a number of simple fluorinated or chlorofluorinated olefines, good yields being obtained in

some cases.

For example monobromofluoroethane was obtained from tetrafluoroethylene in 80% yield and perfluorocyclohexyl bromide from perfluorocyclohexene in 77% yield.<sup>43</sup>

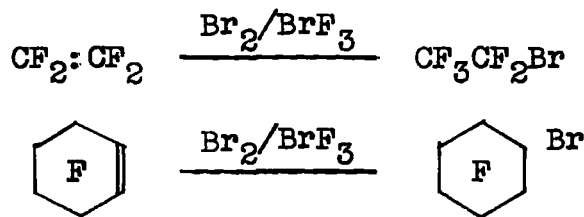

Application of the above processes to the present problem

As suitable starting materials for methods (a), (b) (d), (g) and (h) various halogenated cyclohexanes, cyclohexenes and cyclohexadienes are available. 1-chlorocyclohexene can be prepared from cyclohexanone and phosphorus pentachloride,<sup>44</sup> 3-bromo-1-chlorocyclohexene by the action of N-bromosuccinimide on 1-chlorocyclohexene and 2-bromocyclohex-1-ene from the action of N-bromosuccinimide upon cyclohexene.<sup>45</sup><sup>46</sup>

Addition of chlorine to 1-chlorocyclohexene is reported to yield 1,1,2-trichlorocyclohexane<sup>47</sup> from which hydrogen chloride can be removed to give a mono- or di- olefine.

Addition of bromine to 1-chlorocyclohexene yields 1-chloro-1,2-dibromocyclohexane,<sup>48</sup> and elimination of hydrogen chloride is reported to yield 1,2-dibromocyclohexene.<sup>48</sup>

49 50

1,2-dibromocyclohexane and 1,2-dichlorocyclohexane are readily obtainable or easily made.

The action of quinoline hydrobromide dibromide upon cyclohexa-1,3-diene is supposed to yield 1,2,3,4-tetrabromocyclohexane at 120°-145°, and dibromocyclohexene at 0°. <sup>51</sup> The latter compound would be useful but it appears from the details available that the reaction product is probably an isomeric mixture of dibromocyclohexenes.

For method (c) 1-chloro-2-hydroxycyclohexane can be made by the addition of hypochlorous acid to cyclohexene. <sup>52</sup>

2-chlorocyclohexanone can be prepared by chlorinating cyclohexanone and this, together with 1-chloro-2-hydroxycyclohexane would be useful starting materials for method (e). <sup>53</sup>

54,55 56,57

For method (f) enamines, and enolic ethers of cyclohexanone and substituted cyclohexanones could be prepared by standard methods.

REFERENCES

1. F. Swarts, Bull. sci. acad. roy. Belge 1936, 22, 105-21.
- 2.(a) F. Cuthbertson, Ph.D. Thesis, Durham 1957.
- (b) F. Cuthbertson, & W.K.R. Musgrave, J. App. Chem., 1957, 7, 99.
3. W.R. Hasek et al., J.A.C.S., 1960, 82, 543.
4. A.L. Henne et al., ibid., 1936, 58, 884.
- 5.(a) J.F. Ellis, Ph.D. Thesis, Durham 1952.
- (b) J.F. Ellis and W.K.R. Musgrave, J.C.S., 1950, 3608.
6. R.E. Banks, Ph.D. Thesis, Durham, 1956.
7. J.C. Tatlow, Advances in Fluorine Chemistry, Vol. I, p. 184 et seq. Butterworths Scientific Publications, London 1960.
8. S.M. McElvain et al., J.A.C.S., 1944, 66, 1759.
9. M.W. Renoll, ibid., 1942, 64, 1115.
10. A.L. Henne et al., ibid., 1943, 65, 1271.
11. A.L. Henne et al., ibid., 1941, 63, 2692.
12. W.B. Whalley, C.A., 43, 2217i.
13. A.V. Grosse and C.B. Linn, J. Org. Chem., 1938, 3, 26.
14. E.I. du Pont de Nemours, B.P. 406, 284.
15. W. Klatt, Z. anorg. Allgem. Chem., 1935, 222, 225.
16. Idem, ibid., p. 289.

- 17.(a) M. Meslans, Compt. rend., 1892, 115, 1080.
- 17.(b) idem, ibid., 1894, 117, 853.
18. F.H. Hofmann, J. Org. Chem., 1949, 14, 105.
19. F.L.M. Pattison, ibid., 1956, 21, 739.
20. N. Vorozhtzov, International symposium on fluorine chemistry Birmingham, July 1959.
- 21.(a) W.T. Miller, ibid.
- 21.(b) idem, J.A.C.S., 1960, 82, 3091.
22. N. Vorozhtzov, International symposium on fluorine chemistry, Birmingham July, 1959.
23. A.L. Henne, ibid.
24. F.L.M. Pattison, and J.E. Millington, Can. J. Chem. 1956, 34, 757.
25. E.D. Bergmann et al., Chem. and Ind., 1947, 39, 353.
26. J.H. Simons and D.F. Hermann, J.A.C.S., 1943, 65, 2064.
27. A.L. Henne, Organic Reactions, Vol. II, p. 57, John Wiley and Sons, New York.
28. A.L. Henne and M.W. Renoll, J.A.C.S., 1938, 60, 1060.
29. A.L. Henne, ibid., 1936, 58, 884.
30. idem, ibid., 1938, 60, 1569.
31. A.L. Henne et al., ibid., 1945, 67, 1639.
32. A.L. Henne, ibid., 1941, 63, 3478.

33. E.T. McBee et al., Ind. and Eng. Chem., 1947, 39, 415.
34. E.T. McBee et al., J.A.C.S., 1947, 69, 946.
35. C.W. Tullock et al., ibid., 1960, 82, 539.
36. G. Barth Wehrenhalp, J. Inorg. and Nuc. Chem. 1956, 2, 266.
37. C.E. Inman et al., J.A.C.S., 1958, 80, 6533.
38. S. Nakamshi et al., 136th Meeting, A.C.S., Atlantic City, N.J., Sept., 1959 Abstracts 55 p.
39. idem, J.A.C.S. 1959, 81, 5259.
40. R.B. Gabbard and E.V. Jensen, J. Org. Chem., 1958, 23, 1406.
41. A. Bowers et al., J.A.C.S., 1959, 81, 4107.
42. C.H. Robinson et al., ibid., p. 2191.
43. W.K.R. Musgrave and J. Savory, B.P. Appln. 5646/1959.
44. E.A. Braude et al., J.C.S. 1950, 2014.
45. M. Mousseron and R. Jacquier, Bull. Soc. Chim. France, 1951, 106-114.
46. K. Ziegler et al., Ann., 1942, 551, 80.
47. D.V. Tischenko, C.A. 33, 4190.<sup>7</sup>
48. A. Faworski and W. Boshowski, Ann., 1912, 390, 123.
49. H.R. Snyder et al., Org. Syntheses, Coll. Vol. II p. 171, John Wiley and Sons Inc. New York.
50. M.S. Kharasch and H.C. Brown, J.A.C.S., 1939, 61, 3432.
51. N.A. Domnin and V.A. Cherkasova, C.A., 48, 13644b.

52. G.H. Coleman and H.F. Johnstone, Org. Syntheses, Coll. Vol. I p. 151, John Wiley and Sons Inc., New York.
53. M. Newman et al., op. cit., Vol. III, p. 188.
54. C. Mannich and H. Davidsen, Ber 1936, 2106.
55. F.W. Heyl and M.E. Herr, J.A.C.S., 1953, 75, 1918.
56. N.A. Domnin and A.S. Beletskaya, C.A., 49, 11572h.
57. A. Gerecs and J. Kollonitsch, ibid., p. 2470d.



CHAPTER II

DISCUSSION OF THE EXPERIMENTAL WORK  
AND THE RESULTS

### DISCUSSION OF EXPERIMENTAL WORK

At the beginning of this work it was decided to investigate more thoroughly the possibility of addition of anhydrous hydrofluoric acid to 1,2-dichlorocyclohex-1-ene. Cuthbertson<sup>58</sup> had attempted to fluorinate this compound with lead tetrafluoride, a reagent which is used to add fluorine across the double bond, but had obtained only a polymeric product. His starting material which he records as having a wide boiling range,  $b_{35-10} (62^{\circ}-96^{\circ})$ , and which contained chlorocyclohexadienes and probably other unsaturated material also, was probably too impure for there to have been much chance of success. If appreciable amounts of cyclohexadienes were present unstable difluorocompounds would be formed and their decomposition would probably initiate the decomposition of the rest of the product.

It was thought that if a chromatography unit were developed capable of operating both analytically and preparatively up to  $200^{\circ}$  and that if these techniques were combined with efficient fractionation then pure starting materials might be obtained.

Considerable time, therefore, was spent in the construction of a gas chromatographic unit which fulfilled

these conditions. This work is described in chapter **V**. At the same time apparatus was constructed for controlled reduced pressure fractionation. This was similar to that of Banks.<sup>59</sup>

#### Preparation of 1-Chlorocyclohexene

This was carried out according to the method of Braude and Coles<sup>44</sup> and pure 1-chlorocyclohexene and pure 1,1-dichlorocyclohexane obtained by fractionation at reduced pressure.

#### Dehydrochlorination of 1,1-dichlorocyclohexane

It was anticipated that large quantities of 1-chlorocyclohexene would be required and it was considered worthwhile to dehydrochlorinate the dichloride obtained in the 1-chlorocyclohexene preparation. Various methods, some standard and some unpublished, were employed in an attempt to avoid using quinoline, which suffered from the drawback of the tedious recovery process necessary. Eventually a continuous vapour phase process was devised, the dichloride vapour being catalytically dehydrochlorinated by passage over kieselguhr at 250°. The product contained 91-98% of the olefine representing an overall yield of ca. 95%.

Chlorine was then added to 1-chlorocyclohexene in the manner described by Cuthbertson,<sup>60</sup> but analytical V.P.C.

showed that the product was a complex mixture which repeated fractionation failed to purify. From the acid nature of the crude product and distillates it seemed that hydrogen chloride was splitting out of the molecule to give chloro-cyclohexenes and -cyclohexadienes. The projected next stage was the dehydrochlorination of this material with quinoline and since this was known to give rise to unwanted chlorocyclohexadienes as well,<sup>47</sup> further complicated mixtures would arise. For this reason no further work was carried out on these lines and instead it was decided to add bromine since this was known to give a solid product which could be purified by recrystallisation if necessary.

#### Preparation of 1-chloro-1,2-dibromocyclohexane

This followed essentially the method of Faworski and Boshowski<sup>48</sup> although lower yields (35-45%) were obtained than by the authors (ca. 60%). Some attempts to improve the yield e.g. by using dioxan dibromide, increasing the reaction temperature and the use of different solvents, were not successful.

Having obtained this material pure it was thought interesting to investigate the action of anhydrous hydrofluoric acid upon it.

The action of anhydrous hydrofluoric acid upon 1-chloro-1,2-dibromocyclohexane

(a) Estimation of reaction conditions

The only comparable reaction in the cyclic series which could be found was the action of anhydrous hydrofluoric acid upon 1,1,2-trichlorocyclohexane carried out by Cuthbertson. With anhydrous hydrofluoric acid and 1,1,2-trichlorocyclohexane at  $100^{\circ}$  only polymeric material was obtained while with anhydrous hydrofluoric acid and stannic chloride at  $-78^{\circ}$  to  $20^{\circ}$  no reaction occurred. Since bromine is quite often more easily replaced than chlorine it was thought advisable to start with mild conditions, and increase the temperature, reaction time, and use of catalysts as was necessary.

(b) Results

Without a catalyst and under a variety of conditions, temperature, from  $-78^{\circ}$  to  $80^{\circ}$ , pressure, from atmospheric to autogenous at the temperature employed, and with varying excesses of anhydrous hydrofluoric acid only starting material was recovered, generally in good yield.

With stannic chloride as catalyst a reaction at atmospheric pressure gave no product but autogenous pressure at  $100^{\circ}$  gave a small quantity of fluorine containing material. When the reaction temperature was increased to  $130^{\circ}$  only

tar resulted. At 80° and autogenous pressure, aluminium chloride as catalyst caused no reaction.

At 80° and autogenous pressure, anhydrous hydrofluoric acid and antimony trifluoride dichloride yielded a fluorine containing product qualitatively similar to that produced with stannic chloride, but mercuric oxide under similar conditions yielded a more complex product, which was not further investigated.

Analytical V.P.C. showed that the products from the stannic chloride and antimony trifluoride dichloride catalysed reactions were qualitatively similar, and larger scale reactions to produce more of the material employed stannic chloride (for simplicity and ready accessibility) under slighter milder reaction conditions, final temperature 80°.

The reaction products contained one component which predominated and this was separated out by preparative gas chromatography, and in 98% purity (analysis by V.P.C.) by semi-micro fractionation using a specially constructed column. Unfortunately the identity of this product has not yet been established, and has presented a perplexing problem. Elemental halogen analyses on this product separated by V.P.C., and distillation, from a number of reactions indicated a bromine/fluorine atom ratio of unity,

but the actual analytical figures were never correct for the only possible compound, a bromofluorocyclohexene containing one bromine and one fluorine, which could be produced from the starting material. It was thought that one way in which the material might arise was as follows:-

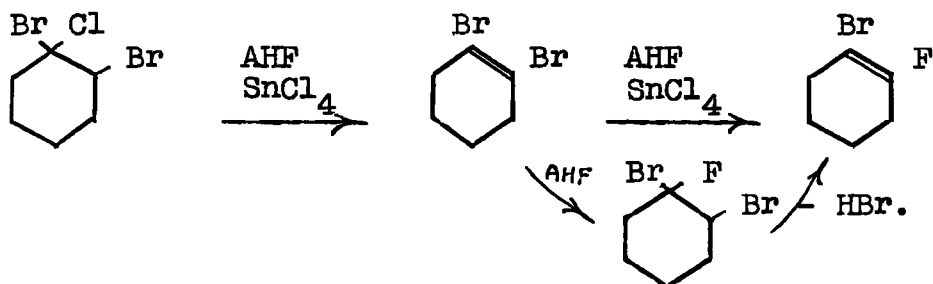

Both hydrogen chloride and/or hydrogen bromide could be lost from other positions to give the corresponding isomers of bromofluorocyclohexene.

The existence of the double bond could never be conclusively proven. Oxidations with permanganate gave no isolatable products, neither was any starting material recovered. The material took up no hydrogen at atmospheric pressure using a palladised charcoal catalyst.

An infra-red spectrum of the material gave a very weak absorption at  $1681 \text{ cm}^{-1}$  which is in the  $\text{>C=C<}$  stretching range.<sup>61</sup> However in non-conjugated compounds the absorption due to the stretching vibration is very weak and in certain symmetrical non-conjugated compounds does not appear at all. More useful in detecting double bonds is the C-H stretching

absorption in the structural element  $= \text{C}^{\text{H}}$  which appears in the region (3040 - 3010  $\text{cm}^{-1}$ ). In chlorocyclohexene the corresponding absorption appears at 3040  $\text{cm}^{-1}$  for example. In the compound studied bands in this region were not observed at all.

All of this evidence could be interpreted as indicating that bromine and fluorine occupy positions at the end of the double bond.

If we consider that no double bond is present then it is impossible to explain the halogen analysis unless there is present a second component. This possibility was tested by running chromatograms of the material on all the column packings available i.e. kieselguhr-silicone high vacuum grease, -tricresyl phosphate, -dinonyl phthalate, -Reoplex 400 plasticizer, - silicone trimer, -Apiezon L, -hydrocarbon high vacuum oil. At a variety of temperatures no resolution of the peak due to this material was ever observed.

Reduction of the material with lithium aluminium hydride in ether gave a small yield of a material which was, from fluorine analysis, qualitative unsaturation tests and infra-red evidence, a fluorocyclohexene. This would tend to support the bromofluorocyclohexene structure, although cases are known where hydrogen halide has been removed by



lithium aluminium hydride to give a double bond.<sup>62</sup>

A very strong absorption at  $1698 \text{ cm.}^{-1}$  indicated that fluorine was bound to the double bonded carbon atom with a consequent increase in the  $>C=C<$  stretching frequency.<sup>61</sup> (In cyclohexene the corresponding value is  $1646 \text{ cm.}^{-1}$ ). A  $=C-H$  stretching frequency at  $3035 \text{ cm.}^{-1}$  was however weak. The remainder of the spectrum bore remarkable similarities to that of 1,1-difluorocyclohexane.

Dr. L.H. Sutcliffe at Liverpool University carried out a nuclear magnetic resonance study on the material and from the  $^{19}\text{F}$  spectrum concluded that a gem difluoro-grouping was definitely present, and that the main fluorine containing component was 2-bromo-1,1-difluorocyclohexane. Other compounds containing fluorine could only be present to the extent of 5-10%. He found no evidence for unsaturation. The  $^1\text{H}$  spectrum was difficult to determine unequivocally but it was thought that cyclohexyl bromide was present also.

Analytical V.P.C. showed that authentic cyclohexyl bromide had a smaller retention time on kieselguhr-tricresyl phosphate at  $163^\circ$  than the bromofluoro compound, and that it separated from it when mixed. Also the infra-red spectrum showed the absence of cyclohexyl bromide in the material. There is also the difficulty of explaining how this compound could arise from the starting material.

Molecular weight determinations by the Victor Meyer method gave  $M=198$  ( $M$  for  $C_6H_9BrF_2 = 199.1$  and for  $C_6H_8BrF = 179.1$ ). There is some doubt about the value obtained because of possible decomposition of the material.

It is considered that the material is a mixture, the N.M.R. evidence seems indisputably to indicate that a bromo-difluoro-compound is present, as would be expected from a simple replacement reaction. Fluorocyclohexene which was only isolated in small quantity from the lithium aluminium hydride reduction product, could have arisen by bromine reduction and removal of hydrogen fluoride. The nature of the other component or components is not known.

Lack of time prevented any further investigation of this subject, however later work on the action of anhydrous hydrofluoric acid upon trans-1,2-dibromocyclohexane showed that with stannic chloride as catalyst, replacement of bromine by chlorine and rearrangement, both of the starting material and rearranged product, can occur. Although this does not make clearer the course of the reaction discussed above it does show that as a method of producing fluorinated cyclohexanes of known structure the method is limited, because of the uncertainty in position of the replaced halogen atoms.

The reaction between anhydrous hydrofluoric acid and trans-1,2-dibromocyclohexane using stannic chloride and stannic bromide as catalyst

Since the action of anhydrous hydrofluoric acid upon 1-chloro-1,2-dibromocyclohexane had produced isolatable fluorine containing product attention was turned to the possibility of reaction with trans-1,2-dibromocyclohexane. Cuthbertson<sup>63</sup> had tried one reaction with anhydrous hydrofluoric acid alone at 100° and autogenous pressure and obtained only a solid polymer, other reactions with mercuric fluoride and argentic fluoride had yielded polymeric products and small amounts of unsaturated liquids containing small amounts of fluorine only. However with the experience gained in previous reactions with 1-chloro-1,2-dibromocyclohexane it was thought that there might be a good chance of isolating a bromofluoro- compound when stannic chloride was employed as a catalyst under mild conditions. Taking into consideration the reaction conditions used by Cuthbertson also, it was decided to keep the temperature below 100° and in the absence of other data to retain a similar molar ratio of A.H.F./compound/catalyst as was used with the chlorodibromo-compound. To minimise possible loss of hydrogen fluoride from the reaction product it was decided to neutralise the ethereal solution of the product with solid anhydrous sodium carbonate. In later reactions sodium fluoride was used.

In two reactions carried out under these conditions a tar-free reaction product was obtained which contained no starting material but which also contained negligible amounts of fluorinated material. Some further work was done on the product to find out what had happened since it might have thrown some light on the previous problem.

It was found that a simple replacement reaction had occurred between the catalyst and dibromo-compound to give dichlorocyclohexanes and bromochlorocyclohexanes. Under the influence of the catalyst rearrangement had also occurred, no 1,2-dichloro- compounds being present as indicated by infra-red spectroscopy. Probably some 1,2-bromochloro- compounds were present but the full investigation of these products was not pursued. A crystalline solid was isolated which was believed to be a 1:1 molecular compound of a dichlorocyclohexane and a bromochlorocyclohexane. Elemental analysis, molecular weight determinations and analytical V.P.C. data were consistent with this.

To avoid the complicating factor of a third halogen, chlorine, a reaction was carried out using stannic bromide as catalyst under slightly more vigorous conditions. Again a rearrangement was observed trans-1,4-dibromocyclohexane being isolated from the reaction product. A small quantity of a fluorine containing compound was produced but not in significant yield and it was not isolated.

Starting material was also present and analytical V.P.C. showed that two other components were present. This conflicted with the infra-red data which suggested that, in the particular fraction being considered, mainly trans-1,2-dibromo-, and trans-1,4-dibromocyclohexane were present, although there was some indication of unsaturation. Qualitatively, unsaturation was detected and it is thought that the other materials present were dehydrobromination products such as bromocyclohexene, and cyclohexadienes.

A similar rearrangement to the above has been observed by Goering and Sims<sup>64</sup> who found that the ionic addition of hydrogen bromide to 1-chlorocyclohexene proceeded rapidly when the olefin and catalytic amounts of ferric chloride were added to liquid hydrobromic acid at low temperature. Replacement of the chlorine by bromine followed and, by varying the amounts of ferric chloride present, 1,2-, 1,3- and 1,4- dibromocyclohexanes were formed by rearrangement in the following sequence.

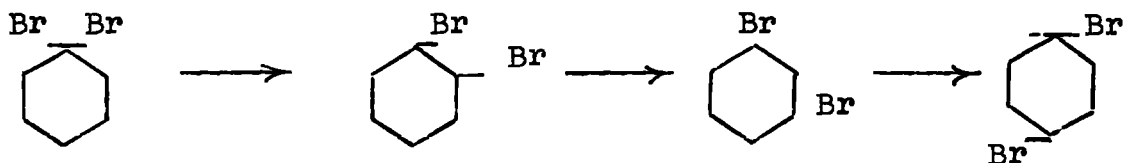

The configuration of the 1,3-isomer was not established and it is of interest to note that the trans-1,2-dibromo-

cyclohexane was never detected, whereas it is the starting material in the reaction described previously.

Analysis of compounds containing bromine, chlorine and fluorine

To analyse compounds containing bromine, chlorine and fluorine, the method of determining bromine by hypochlorite oxidation to bromate was applied on a semi-micro scale. In conjunction with previous methods used for determining total halogens, and total halogens minus fluorine,<sup>67</sup> it enabled bromine, chlorine and fluorine to be determined in one compound if required. The method was also used for the estimation of bromine in bromochloro- and bromofluoro- compounds.

This work is fully described in Chapter IV.

The action of potassium fluoride upon trans-1,2-dichloro-cyclohexane in N,N-dimethylformamide

Potassium fluoride has usually been employed as a fluorinating agent for alkyl halides, in an aliphatic di- or poly- hydroxylic solvent. A series of w,w- difluoroalkanes has been prepared in this way in good yield.<sup>18</sup>

Recently 2,4- dinitrofluorobenzene has been prepared from the corresponding chloro- compound without the use of a solvent.<sup>20</sup>

<sup>65</sup>

Cuthbertson unsuccessfully attempted to replace the

the chlorine atoms in 1,1,2-trichlorocyclohexane using potassium fluoride alone and in glycerol.

It has recently been found that anhydrous potassium fluoride in basic solvents such as acetamide, formamide, and dimethyl formamide sometimes will replace vinyl chlorine in good yield. <sup>21a,b</sup> For example 1,2-dichlorotetrafluoropropene gave a 55% yield of 2-chloro-1,1,1,3,3,3 hexafluoropropane when heated with potassium fluoride in formamide at 60° for twenty-seven hours. The reaction is supposed to occur in two steps, the first involving replacement of vinylic chlorine.

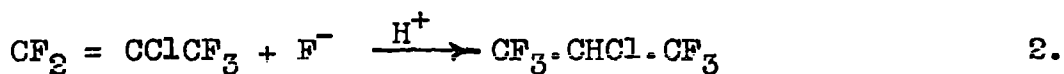
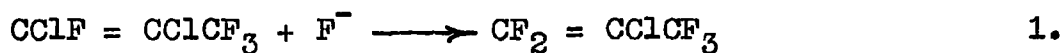

The success of reactions of this sort is partly due to the relatively large solubility of potassium fluoride in the carboxamide solvents, and hence it was thought worthwhile to attempt to fluorinate 1,2-dichlorocyclohexane with potassium fluoride in N,N-dimethylformamide, the latter material being readily available at the time.

Heating the materials at 160°-70° for eight hours with vigorous stirring caused no significant reaction and more vigorous conditions, 190°-200° for four hours gave a small

quantity of fluorine containing product which was not isolated as the yield was not significant. Not surprisingly at these temperatures some loss of hydrogen chloride occurred.

The action of caesium fluoride on trans-1,2-dichlorocyclohexane in the absence of a solvent

Recently caesium fluoride has been introduced as a fluorinating agent and has been found more effective than potassium fluoride in some cases.<sup>20,22</sup> Thus o- and p-chloronitrobenzenes gave o- and p-fluoronitrobenzenes when heated with caesium fluoride whereas potassium fluoride would not bring about this reaction.

When caesium fluoride and trans-1,2-dichlorocyclohexane were heated together for sixteen hours at 190°-220° the product was largely unreacted starting material containing some unsaturated material arising by dehydrochlorination.

The action of perchloryl fluoride upon the piperidyl and pyrrolidyl enamines of cyclohexanone

Perchloryl fluoride is of very recent development as a fluorinating agent, the first practical laboratory preparation was described by G. Barth Wehrenhalp in 1956.<sup>36</sup>

In 1958 Inman<sup>37</sup> reported the replacement of active hydrogen by fluorine in compounds such as sodio malonic ester, to give the corresponding difluoro compound. Steroid chemists



then carried out numerous reactions with the reagent and steroid enamines replacing hydrogen alpha to the original keto-group.

Nakanishi<sup>38</sup> showed that similar results could be obtained by using enol ether derivatives of steroidal ketones, the fluorine atom of perchloryl fluoride in the absence of acids, was supposed to be electrophilic, and the reaction sequence to be as follows.

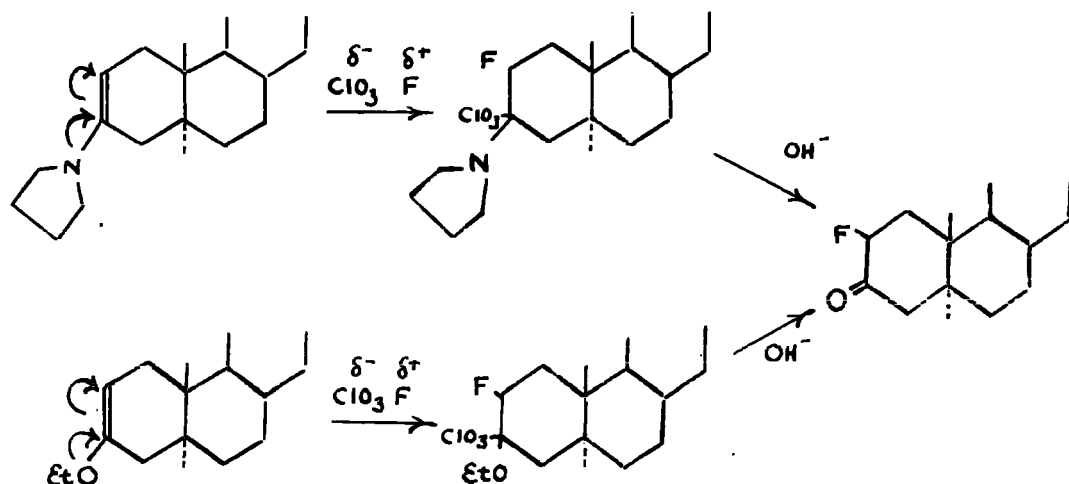

2-Fluorocyclohexane was reported to have been made from 1-ethoxycyclohexene by reaction with perchloryl fluoride in this way.<sup>39</sup>

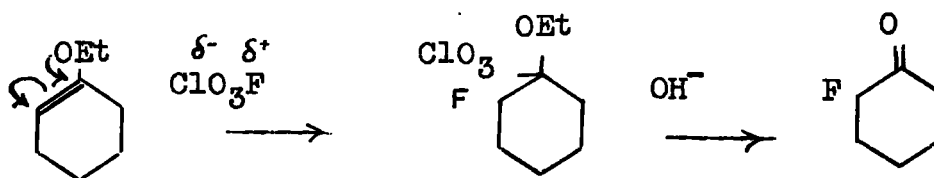

It seemed that the enamine derivatives of cyclohexanone

could be prepared more easily and quickly than the alkoxy ethers and as piperidine was available cyclohexyl piperidyl enamine was made by the method of Mannich and Davidsen.<sup>54</sup>

A reaction between the enamine and perchloryl fluoride was carried out using conditions similar to those used in the fluorination of cholestan-3-one to give 2 fluoro-cholestan-3-one.<sup>40</sup>

Reaction between cyclohexanone piperidyl enamine and perchloryl fluoride

Cyclohexanone piperidyl enamine in benzene was treated with perchloryl fluoride under mild conditions and the hydrolysed product, after benzene removal, examined by V.P.C. Only cyclohexanone and some unchanged enamine appeared to be present. Qualitative analysis showed the presence of chlorine, nitrogen and fluorine while quantitative analysis (on a fraction after distillation) gave total acid 32.7% (calculated as fluoride ion). An infra-red spectrum showed that material other than cyclohexanone and unchanged enamine was present.

The method of fluorine analysis employed in this laboratory<sup>67</sup> can be applied to determine fluorine uniquely only when other groups are absent which can form acids on passage through a cation exchange column. Here the possible presence of the  $-\text{ClO}_3$  group could give rise to  $\text{NaClO}_3$  (or

NaCl) in the decomposition process, both of which give the corresponding acid quantitatively on passage through a cation exchange column.

However even if we suppose the whole fraction under consideration to be the unhydrolysed intermediate,

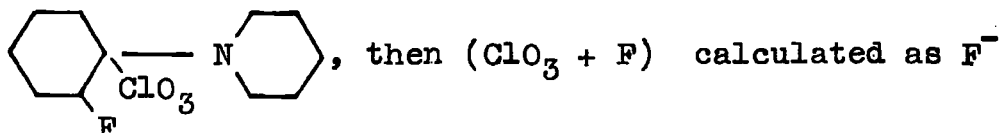

is still only 14.2% so further reaction must have occurred.

The absence of peaks, other than cyclohexanone and enamine peaks in the V.P.C. Chromatogram can only mean that the other material has been retained on the column under the conditions used.

The reaction between cyclohexanone pyrrolidyl enamine and perchloryl fluoride

Since the reaction with the piperidyl enamine was not straightforward, attention was turned to the use of the pyrrolidyl enamine, pyrrolidine now being available. The preparation of cyclohexanone pyrrolidyl enamine had not been described; the method of Heyl and Herr,<sup>55</sup> previously applied to solid steroidal ketone enamine preparation, was therefore adapted to this purpose and the enamine obtained in 70% yield. Elemental analysis and infra red analysis were consistent with the expected structure.

Treatment of this material in pyridine solution (re-

ported to promote the reaction) with a 35% excess of perchloryl fluoride and subsequent hydrochloric acid hydrolysis yielded product again apparently containing mainly cyclohexanone, a little unchanged enamine, and small quantities of two unidentified materials.

In case 2-fluorocyclohexanone had a similar retention time to cyclohexanone (cf benzene and fluorobenzene) the cyclohexanone was isolated by preparative vapour phase chromatography but elemental analysis and an infra-red spectrum showed it to be pure.

From the amount of cyclohexanone present it seemed that ca. 20% of the original enamine had not reacted.

A second reaction using 150% excess of perchloryl fluoride gave a product which largely decomposed on distillation to give a fluorine containing tar. A small semi-solid fraction contained some cyclohexanone. From this fraction sharply melting silky white crystals were obtained by recrystallisations. After further purification by sublimation these were analysed and shown to contain Cl, 5.7%; F, 23.6%. Unfortunately these figures do not fit any likely compound which could arise. The material was water soluble and did not contain ionically bound chlorine.

It is thought that in both these reactions the addition

product was formed and either was not hydrolysed sufficiently, or else underwent further reactions of an unknown nature. Presumably the intermediate was retained on the V.P.C. column under the conditions used. The fact that the crystalline product formed when 150% excess of perchloryl fluoride was used was water soluble probably accounts for the poor recovery observed in both reactions.

#### Reactions with sulphur tetrafluoride

Sulphur tetrafluoride was prepared as described by Tullock et al.<sup>35</sup> but several attempts to fluorinate cyclohexanone gave only tarry products and the idea of reacting it with 2-chlorocyclohexanone, which had been prepared by the action of chlorine upon cyclohexanone,<sup>53</sup> was abandoned.

#### Preparation of 3-bromo-1-chlorocyclohexene

This material was prepared from 1-chlorocyclohexene and N-bromosuccinimide but the 30% yield claimed by Mousseron<sup>45</sup> was not obtained, and the addition of anhydrous hydrofluoric acid was not proceeded with, production of enough starting material being too lengthy a process. It was hoped that the addition of anhydrous hydrofluoric acid would give 3-bromo-1-chloro-1-fluorocyclohexane, 3-bromo-1,1-difluorocyclohexane and possibly in the presence of catalysts 1,1,3-trifluorohexane.

CHAPTER III

EXPERIMENTAL WORK

### Preparation of 1-chlorocyclohexene

In this laboratory it has been found that the most convenient and satisfactory method of preparing 1-chlorocyclohexene is that of Braude and Coles,<sup>44</sup> and accordingly this method was used.

The preparation has been carried out many times with yields of ca. 50-60% and the following is an account of a typical preparation.

Reagents:    Cyclohexanone - Towers, redistilled b.r. 151-152°.

Phosphorus pentachloride - Albright and Wilson Ltd.

Cyclohexanone (250 mls., 238 g., 2.43 moles) was added drop-wise through an air condenser to phosphorus pentachloride (500 g., 2.43 moles) contained in a 1 litre flask cooled in an ice bath, the flask being vigorously swirled after each addition.

The red brown product was then added drop-wise to water (2 litres) which was mechanically stirred. The yellow oil which was at the bottom after the addition was run off.

Solid anhydrous sodium carbonate was added to neutralise partially the aqueous solution remaining, which was extracted three times with ether (3 x 350 mls.). The

extracts were added to the separated organic layer and after drying (calcium chloride) the ether was distilled off.

The product was either distilled through a Claisen flask with a Vigreux side arm, or fractionated through a glass helices column (62 x 1.9 cms.) at 160 mm. Hg. In the former case the distillate obtained (b.r. 150 90°-100°) contained ca. 25% 1,1-dichlorocyclohexane while in the latter negligible amounts of the dichloride were present. In both cases analysis was by vapour phase chromatography, kieselguhr-silicone high vacuum grease at 160°, p.d. 69 cms. Hg, nitrogen flow rate 25 mls./minute.

The distillation column and ancillary apparatus used are shown in diagrams I to IV. Diagram II shows an internal still pot heater used to prevent 'bumping' and diagram III a Cartesian-diver type manostat (see R.E. Banks, Ph.D. Thesis Durham 1956 p. 83 et seq. for further details).

#### Dehydrochlorination of 1,1-dichlorocyclohexane

A series of exploratory experiments were carried out to find the best method of dehydrochlorinating the 1,1-dichlorocyclohexane obtained in the preparation of the 1-chlorocyclohexene.



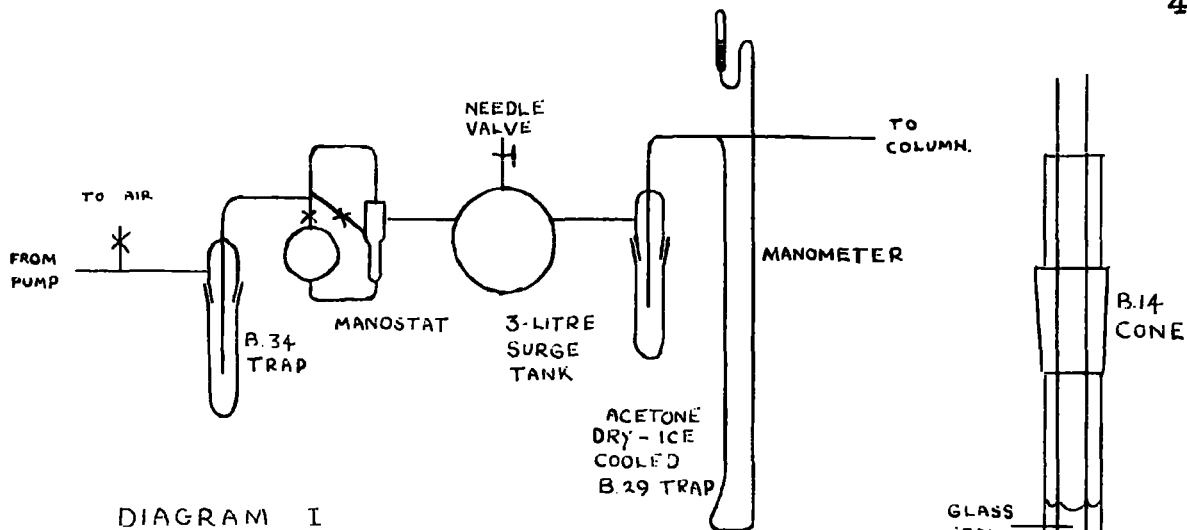

DIAGRAM I

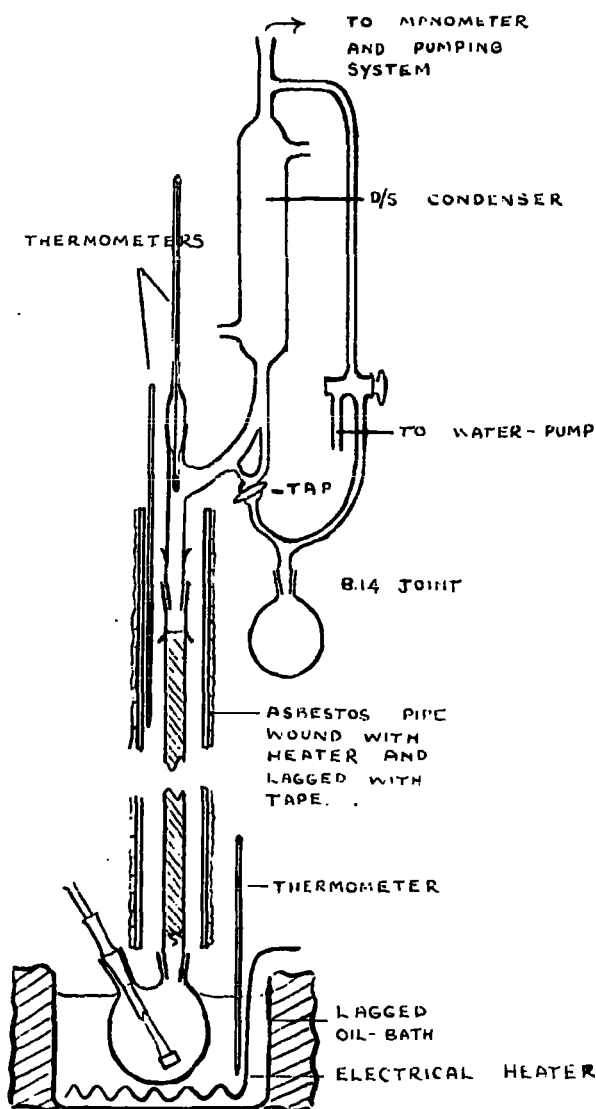

DIAGRAM IV

DIAGRAM II

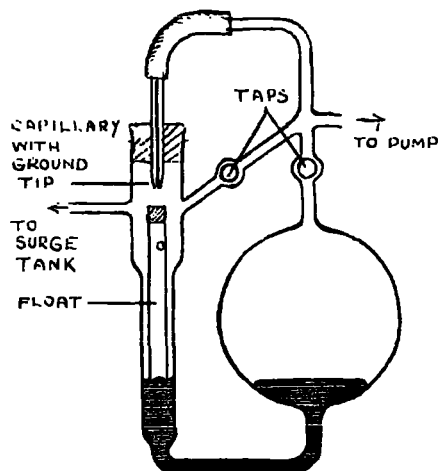

DIAGRAM III

Vapour phase chromatography was used to estimate the amount of olefine produced, correction being made for the different response of the two materials, by carrying out a calibration run with a mixture of known composition.

The conditions used were, column, kieselguhr-silicone high vacuum grease at  $190^{\circ}$ , p.d. 70 cms. Hg, nitrogen flow rate 20 mls./minute.

(i) Catalytic action of Amberlite IRA 400 (OH) resin

(a) At  $180^{\circ}$

1,1-dichlorocyclohexane (22.4 g.) containing 11% 1-chlorocyclohexene was heated with dry Amberlite IRA 400 (OH) resin (1 g.) for  $2\frac{1}{2}$  hrs. at  $180^{\circ}$  with occasional shaking. Some hydrogen chloride was evolved and the product (15.5 g.) was filtered from the resin.

6% conversion of the dichloride to the olefine had occurred.

(b) At  $210^{\circ}$

1,1-dichlorocyclohexane (11.2 g.) containing 11% of the olefine was refluxed at  $210^{\circ}$  for 11 hrs. with resin as before (0.5 g.), the material being occasionally shaken. The product (7.5 g.) was filtered from the resin.

39% conversion of the dichloride to the olefine had occurred.

(ii) Action of sodium hydroxide

1,1-dichlorocyclohexane (28 g.) containing 11% 1-chlorocyclohexene was heated at refluxing temperature with 25% aqueous sodium hydroxide (40 mls.) for 1 hour. The organic layer was run off, the aqueous layer extracted with ether, and the combined materials dried (calcium chloride). The ether was distilled off to give product (26.5 g.).

No conversion to the olefine had occurred.

(iii) Alcoholic potassium hydroxide

1,1-dichlorocyclohexane (25 g.) containing 11% 1-chlorocyclohexene was heated at refluxing temperature with ethanolic potassium hydroxide (5%) for one hour. The product was poured into water, separated off and dried (calcium chloride) weight 24 g.

No conversion to the olefine had occurred.

(iv) Action of quinoline

1,1-dichlorocyclohexane (105 g.) containing 11% of 1-chlorocyclohexene was added to quinoline (250 g.) contained in a 500 mls. two-necked flask fitted with two double surface condensers in series the remaining neck carrying a thermowell.

The temperature was raised quickly to 180° when a very vigorous reaction set in, the temperature rapidly rising to 200°. This phase lasted ca. ten minutes, the mixture was then kept at 180° for another hour. After the material had cooled it was poured into 5N hydrochloric acid,

the organic layer run off and the acid layer ether extracted. The extracts were combined with the separated organic layer, washed with water until neutral and dried (calcium chloride).

The ether was distilled off on a water bath and the crude product distilled at 160 mm. Hg through a helices column distillate being collected, b.r. 160,  $88^{\circ}$ - $94^{\circ}$  (46 g.).

This material contained 95% 1-chlorocyclohexene representing a yield of 48% from the available 1,1-dichlorocyclohexane.

(v) Catalytic action of heated inert materials

It had been noted that 1,1,2-trichlorocyclohexane lost hydrogen chloride on passage through a preparative scale gas chromatography column when kieselguhr was used as an inert support (p. 53) and experiments were carried out to develop this as a preparative method for dehydrochlorinating 1,1-dichlorocyclohexane.

A pyrex U-tube column was contained in an asbestos pipe wound with a resistance wire heater controlled by a Variac auto-transformer. A pressure drop of about one atmosphere was maintained across the column by means of an oil pump and nitrogen was passed in through the inlet (see diagram V). The organic material was added dropwise from a calibrated tube and passed through a vaporizer before going onto the column packing.

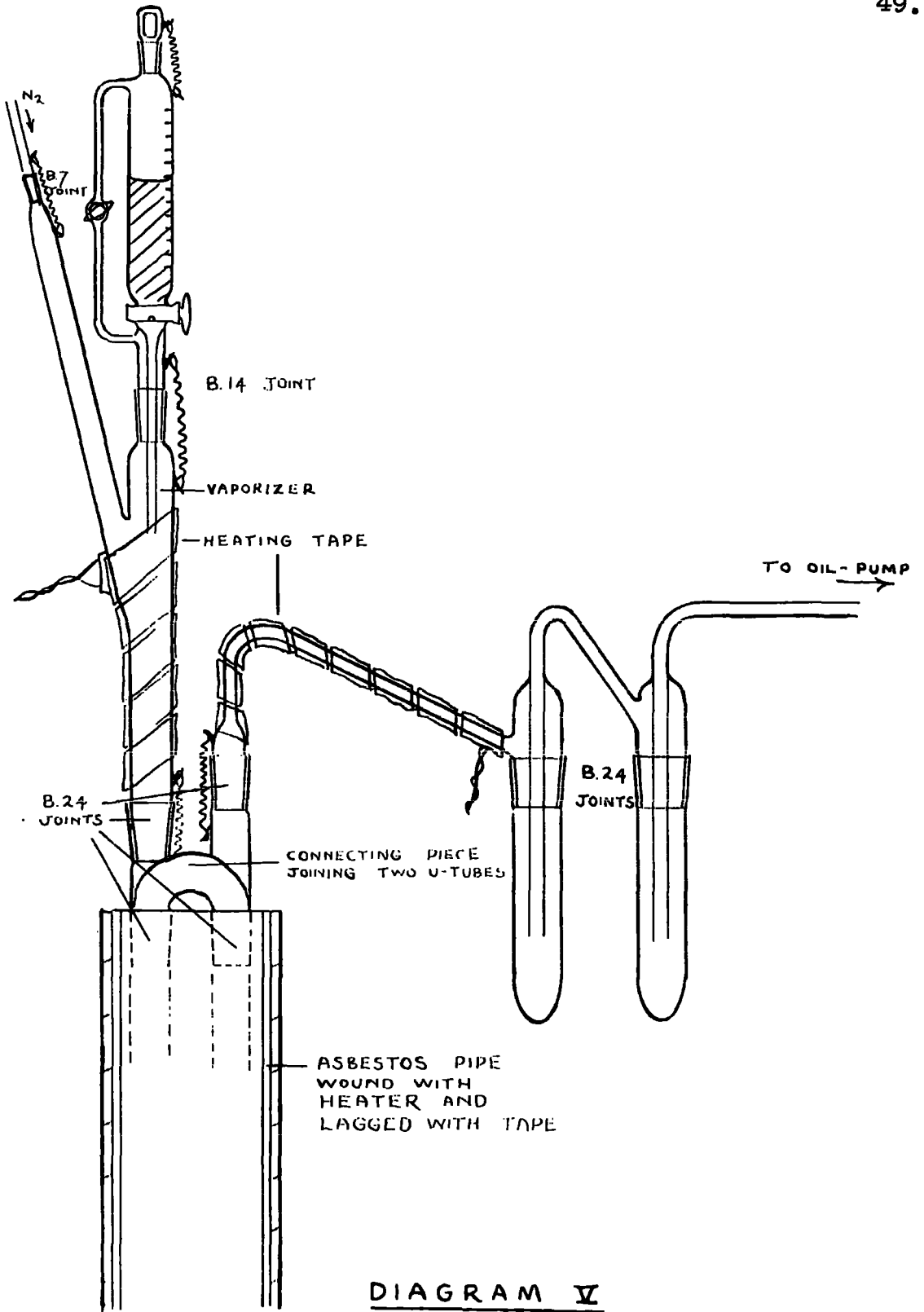

DIAGRAM V

The product was trapped out at the outlet in two traps, the first which collected the bulk of the product, cooled with ice, and the second cooled in an acetone-dry ice bath.

Initial experiments with a kieselguhr packed tube did not give sufficient conversion to the olefine and the effect of passing the material through an unpacked tube, and a tube packed with graded sodium chloride, was tried, since here a longer tube in each case would enable a greater flow rate to be maintained than in one packed with kieselguhr. No conversion to the olefine, however, occurred and eventually it was found that a longer tube packed with kieselguhr allowed a reasonable flow rate and gave a good conversion.

The results of these experiments are summarised in the table below:

TABLE I

Dimen- sions of tube Length x diam.	Packing	Tempera- ture of pack- ing	Flow rate <u>cc./min.</u>	Inlet press- ure	Outlet press- ure <u>mm.Hg</u>	% 1- chloro- cyclo hex- 1-ene in product
a 8' x <sup>10</sup> / <sub>16</sub> "	kiesel- guhr	220°	50	Atmos- pheric	2	39
b " " "	"	245°	150	" + 10cm.Hg	"	65
c " " "	none	245°	50	Atmos- pheric	"	11
d " " "	graded NaCl	245°	70	" - 2cm.Hg.	"	11
e 16' x <sup>10</sup> / <sub>16</sub> "	kiesel- guhr	250	25	" + 5cm.Hg.	"	91

The conditions of 'e' above were adopted for all subsequent work and it was found that about 40 mls./day of 1,1-dichlorocyclohexane could be dehydrochlorinated, the product containing 90-98% of the olefin.

The product was obtained as an acid red liquid which changed to pale yellow on neutralisation in the cold, with sodium bicarbonate. The combined material from several runs was then distilled at reduced pressure to give practically pure 1-chlorocyclohexene.

The advantages of the method over that involving quinoline were that working up stages and the tedious recovery of the quinoline were absent, and that once set

up the apparatus required only occasional attention while running.

#### Addition of Chlorine to 1-chlorocyclohexene

A modification of a method previously used in this laboratory was employed, in which chlorine was bubbled through 1-chlorocyclohexene until the theoretical increase in weight was observed.<sup>60</sup>

1-chlorocyclohexene (101 g. 0.86 mole) was contained in a cylindrical vessel fitted with a gas inlet tube reaching to the bottom and ending in a sintered disc. The vessel was kept cool in a Dewar filled with crushed ice, and light was excluded as far as possible while chlorine was passed in until approximately the theoretical amount had been added (61 g., 0.86 mole).

The product (158 g.), a yellow oil, was poured onto crushed ice and stirred vigorously. Sodium hydroxide and sodium sulphite were added to take up the hydrochloric acid and dissolved chlorine. The heavy yellow oil which sank to the bottom was separated off and the aqueous layer ether extracted, the extracts being added to the main bulk, which was then dried (calcium chloride).

This preparation, using similar quantities of olefine was repeated several times and after distilling off the



ether the combined products were fractionated. However, repeated distillations at reduced pressure would not yield chromatographically pure 1,1,2-trichlorocyclohexane.

When separation of the material by vapour phase chromatography was attempted extensive loss of hydrogen chloride occurred, apparently catalytic dehydrochlorination was occurring on the column. The acid fumes affected the thermistor detector causing it to behave erratically and leading to its early failure. It seems that it is possible to obtain results analytically because of the much shorter contact time which is involved.

#### Addition of bromine to 1-chlorocyclohexene

This has been reported<sup>48</sup> by Faworski and Boshowski and initial brominations were carried out according to their procedure.

1-chlorocyclohexene (50 g., 0.43 mole) together with redistilled dry chloroform (50 mls.) were placed in a 500 mls. three necked flask fitted with dropping funnel, stirrer and thermowell, the flask being cooled in an ice-salt bath.

From the dropping funnel was added, over a period of seven hours, bromine (70 g. 0.44 mole) in chloroform (25 mls.), a red colour becoming apparent in the reaction vessel

after little more than half the bromine solution had been added.

At the end of the addition the dark red-brown solution which fumed to air was washed with alkaline sodium bisulphite solution, the colour fading almost completely, then water washed until neutral, and dried (calcium chloride).

Chloroform was removed at reduced pressure to minimise heating of the crude product, and the dark brown product obtained (129 g.) was distilled at a pressure of 12 mm. Hg through a simple Claisen head, the following fractions being taken.

Fraction (1)	b.r.	20°-80°	32.7 g., colourless liquid.
Fraction (2)	b.r.	80°-115°	36.0 g., violet semi-solid.
Fraction (3)	b.r.	115°-130°	51.0 g., violet semi-solid.
	Residue		4.3 g., black tar.

The solid material from fractions (2) and (3) was filtered off at the pump yielding pale violet crystals (47.5 g.). A portion of this material was recrystallised from aqueous ethanol to yield white crystals, m.p. 43°-44° (quoted for 1-chloro-1,2-dibromocyclohexane, 43.5<sup>48</sup>°).

As it was suspected that more of the 1-chloro-1,2-dibromocyclohexane was present in the filtrate from the

fractions (2) and (3) these were combined and cooled in acetone/dry-ice mixture and the pasty mass then filtered through a dry-ice jacketed funnel. After two such operations a further 6 g. of crystals were recovered.

#### Vapour phase chromatography of products

Using a kieselguhr-silicone high vacuum grease column at  $192^{\circ}$ , p.d. 69 cms. Hg, nitrogen flow-rate 24 mls./min., the fractions were chromatographed with the following results:- fraction (1), mainly chloroform; filtrate from fractions (2) and (3) about 70% 1-chloro-1,2-dibromocyclohexane with unreacted 1-chlorocyclohexene and other materials; crystalline product, pure 1-chloro-1,2-dibromocyclohexane.

Yield Since fraction (1) is chloroform real crude yield is (129-32.7) g. = 96.3 g. which is 81.5%.

The total amount of crystalline material is 53.5 g. representing a yield of 45%.

In view of the amount of product present in the liquid distillate some means was sought to remove it.

Although the material has a large retention time and could therefore probably be separated in large amounts by grossly overloading the vapour phase chromatography column, it would almost certainly decompose on the preparative scale column at the temperature required, and so this idea was

discarded.

Low temperature crystallisation from 40°-60° petroleum ether was attempted, this solvent proving to be the most suitable of several tried but the process was considered too lengthy and was not continued with.

Eventually the described method of filtering several times through a dry-ice jacketed funnel was adopted as being a reasonable compromise between recovery and speed of operation.

Brominations carried out in this way afforded yields of between 35 - 45%.

#### Modified brominations of 1-chlorocyclohexene

In an attempt to improve the yield, brominations with dioxan dibromide<sup>68,69</sup> were carried out but poor yields were obtained.

Also several brominations were carried out using methylene chloride as solvent the idea being that the easier and more complete removal of this solvent, due to its lower boiling point, would facilitate the sharp separation into liquid and solid fractions. Very similar or slightly smaller yields to those found with chloroform as solvent were obtained.

The results of these attempts are summarised in the following table.

TABLE II

Solvent	Wt. of 1-chloro- cyclohex- 1-ene	Crude Yield	Wt. solid dibromo compound obtained	% yield on weight increase	Actual yield %
Dioxan	10 g.	15.7 g.	2.8 g.	67.6	11.7
Dioxan	5 g.	10.6 g.	0.6 g.	89	5.0
Dioxan	5 g.	8.5 g.	2.5 g.	71.3	21.1
Chloro- form	5 g.	9.0 g.	3.9 g.	75.5	33
Chloro- form	50 g.	87.0 g.	53.5 g.	73.3	45
Chloro- form	50 g.	87.5 g.	41.5 g.	73.4	35
Methylene Chloride	5 g.	10.7 g.	4.0 g.	90	33.6 <sup>a</sup>
Methylene Chloride	100 g.	170 g.	76.0 g.	76.5	31.8
Methylene Chloride	100 g.	194 g.	73.5 g.	81.7	30.8

<sup>a</sup> reaction carried out at 10°C., remainder at 0°C

The action of anhydrous hydrofluoric acid upon  
1-chloro-1,2-dibromocyclohexane

I. Without Catalysts

(i) Atmospheric Pressure

1-Chloro-1,2-dibromocyclohexane (20 g., 0.07 mole)

was contained in a brass vessel, fitted with a calcium chloride packed drying tube and cooled in a dry-ice/acetone bath (see diagram VII). Anhydrous hydrofluoric acid (3.0 g., 0.15 mole) was added, the lid sealed on, and the vessel allowed to reach room temperature in eighteen hours.

The contents, a small quantity of fuming red-violet liquid and much dark solid were dissolved in ether and the solution poured into water (200 mls.). The ethereal solution was separated, washed with dilute sodium bicarbonate solution and water until neutral, and then dried (calcium chloride).

The ether was removed at reduced pressure to leave a solid mass of violet crystals (19 g.) a portion of which were recrystallised to give white crystals, m.p.  $43-4^{\circ}$ , mixed m.p. with authentic 1-chloro-1,2-dibromocyclohexane  $43-5^{\circ}$ .

Analytical V.P.C., kieselguhr-silicone high vacuum grease at  $190^{\circ}$ , p.d. 43 cm. Hg, nitrogen flow-rate 17 mls./min., confirmed that the compound was starting material.

(ii) Autogenous Pressure

(a) With moderate excess of anhydrous hydrogen fluoride  
1-chloro-1,2-dibromocyclohexane (20 g. 0.07 mole)

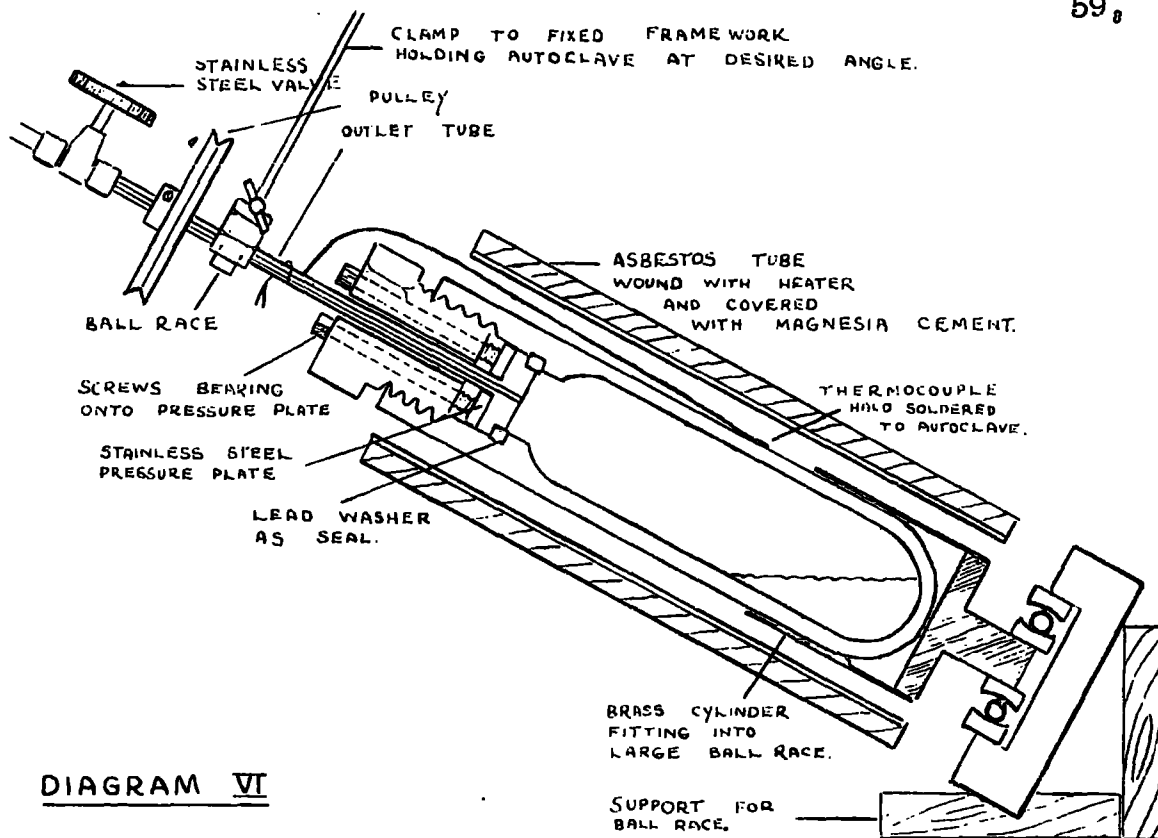

DIAGRAM VI

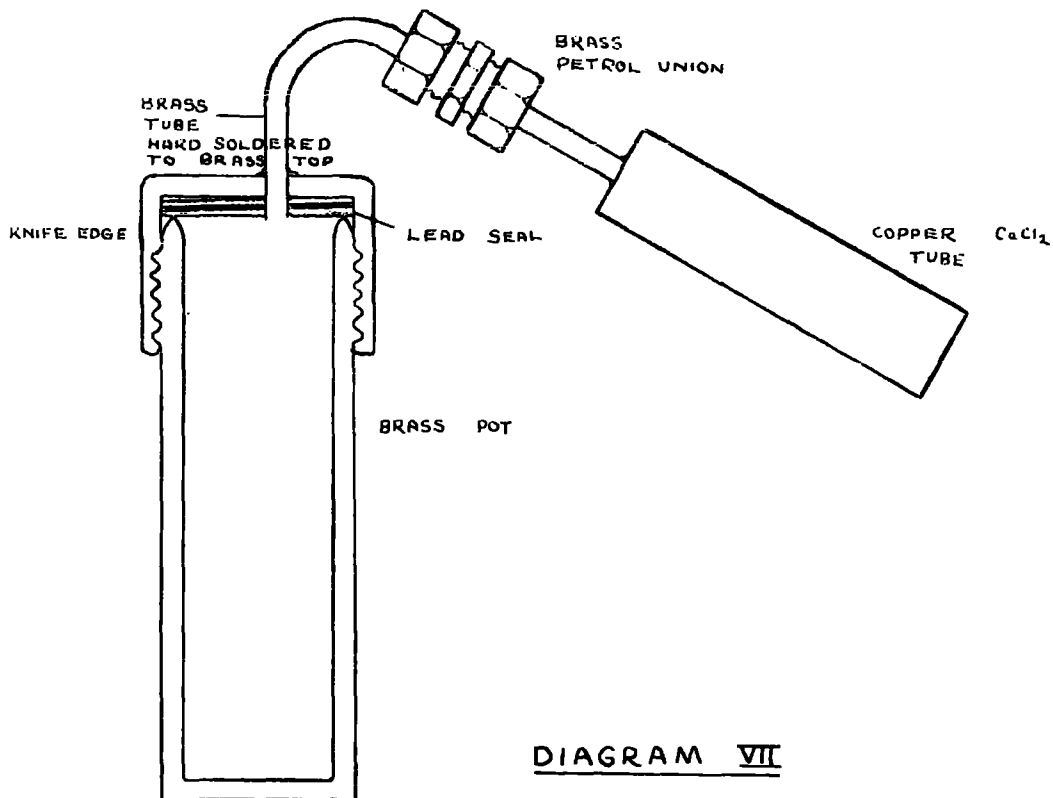

DIAGRAM VII

was contained in a stainless steel autoclave, capacity 500 mls., which was cooled in a dry-ice/acetone bath (see diagram VI).

Anhydrous hydrofluoric acid (8.9 g., 0.44 mole) was added, the top sealed on, the whole heated to  $70^{\circ}$  in 30 minutes and kept at this temperature for a further 30 minutes. After quenching in ice-water the vessel was vented and the contents, violet liquid and solid, taken up in ether. The ethereal solution was treated as in (i) above and again yielded a solid mass of crystals (17 g.).

These were shown by the previously described methods to be starting material.

(b) With large excess of anhydrous hydrogen fluoride

1-chloro-1,2-dibromocyclohexane (20 g., 0.07 mole) and anhydrous hydrofluoric acid (17.4 g., 0.87 mole) were contained in the previously described autoclave (see diagram VI) which was rotated and heated for  $5\frac{1}{2}$  hours until the temperature had reached  $80^{\circ}$ .

On working up as before 19.0 g. crude starting material were obtained.

II. With Catalysts

(a) At Atmospheric Pressure

1-chloro-1,2-dibromocyclohexane (20 g., 0.07 mole).



was dissolved in diethyl ether (20 mls.) and placed in the brass reaction vessel cooled in a dry-ice/acetone bath. Stannic chloride (11.2 g., 0.04 mole) and anhydrous hydrofluoric acid (8.9 g., 0.44 mole) were added, the vessel sealed and allowed to warm up to room temperature in 18 hours.

The violet coloured contents were washed with ether into 2N hydrochloric acid (200 mls.) and the ether layer was separated, washed with water, dilute sodium bicarbonate solution, and water until neutral, and then dried (calcium chloride).

On working up as before 19 g. crude starting material were obtained.

(b) Autogenous Pressure

(i) Stannic chloride as catalyst

1-chloro-1,2-dibromocyclohexane (20 g., 0.07 mole) together with stannic chloride (11.2 g., 0.04 mole) and anhydrous hydrofluoric acid (8.9 g., 0.44 mole) were contained in the 500 mls. autoclave heated to 100° in an hour and kept at this temperature for a further 1½ hours.

After quenching in ice water the autoclave was vented and the dark liquid and solid present washed with ether into 2N hydrochloric acid (200 mls.) The ether layer was

washed as before and dried (calcium chloride).

The ether was distilled off at reduced pressure, the crude product rapidly distilled at 8 mm. Hg, material being collected b.r. 50<sup>o</sup>-120<sup>o</sup> (3.5 g.). Much decomposition and tar formation occurred.

Analytical V.P.C. This was carried out on kieselguhr-Reoplex 400 at 162<sup>o</sup>, p.d. 40 cms. Hg, nitrogen flow-rate 17 mls./min., see diagram 2. (p.66).

The material was quite complex but one component predominated (A run carried out at 190<sup>o</sup> established that no starting material was present).

#### Qualitative Analysis

Br', Cl' and F' present.

#### Quantitative F' Analysis

4.8% F' present.

#### Preparative V.P.C.

Using the semi-micro column (see chapter V p.128) kieselguhr-silicone high vacuum grease at 160<sup>o</sup>, p.d. 43 cms. Hg, nitrogen flow-rate 25 mls./min., 0.60 g. was separated in four runs to give 0.24 g. of the main peak material. Analytical V.P.C. indicated that this was pure and qualita-

tive analysis showed that bromine and fluorine were present.

Quantitative analysis, after distilling the material from phosphorus pentoxide to ensure complete dryness gave:- Br, 41.0%; F, 9.5% (calculated for a bromofluorocyclohexene Br, 44.6%, F, 10.6%).

(ii) Stannic chloride as catalyst - larger excess of anhydrous hydrofluoric acid

1-chloro-1,2-dibromocyclohexane (35 g., 0.13 mole) stannic chloride (17.9 g., 0.07 mole) and anhydrous hydrofluoric acid (31.7 g., 1.58 mole) were contained in the 500 mls. autoclave and heated with rotation to 80° in the course of 5½ hours.

After quenching in ice water the autoclave was vented, opened and the contents treated as in (i). Rapid distillation of the crude product at 2 mm. Hg. gave tar (4.5 g.) and liquid b.r. 40°-95° (12.5 g.). Some decomposition occurred.

Using a semi-micro fractionating column based on a design by Cooper and Fasce<sup>81</sup> (see diagram VIII) the liquid distillate was fractionated at 17 mm. Hg to give fractions as follows:- Fraction (1) b.r. 25°-50°, (0.58 g.), (2) b.r. 50°-60° (2.36 g.); (3) b.r. 60°-65° (1.09 g.); (4) b.r. 65°-70° (1.67 g.); (5) b.r. 70°-80° (1.38 g.);

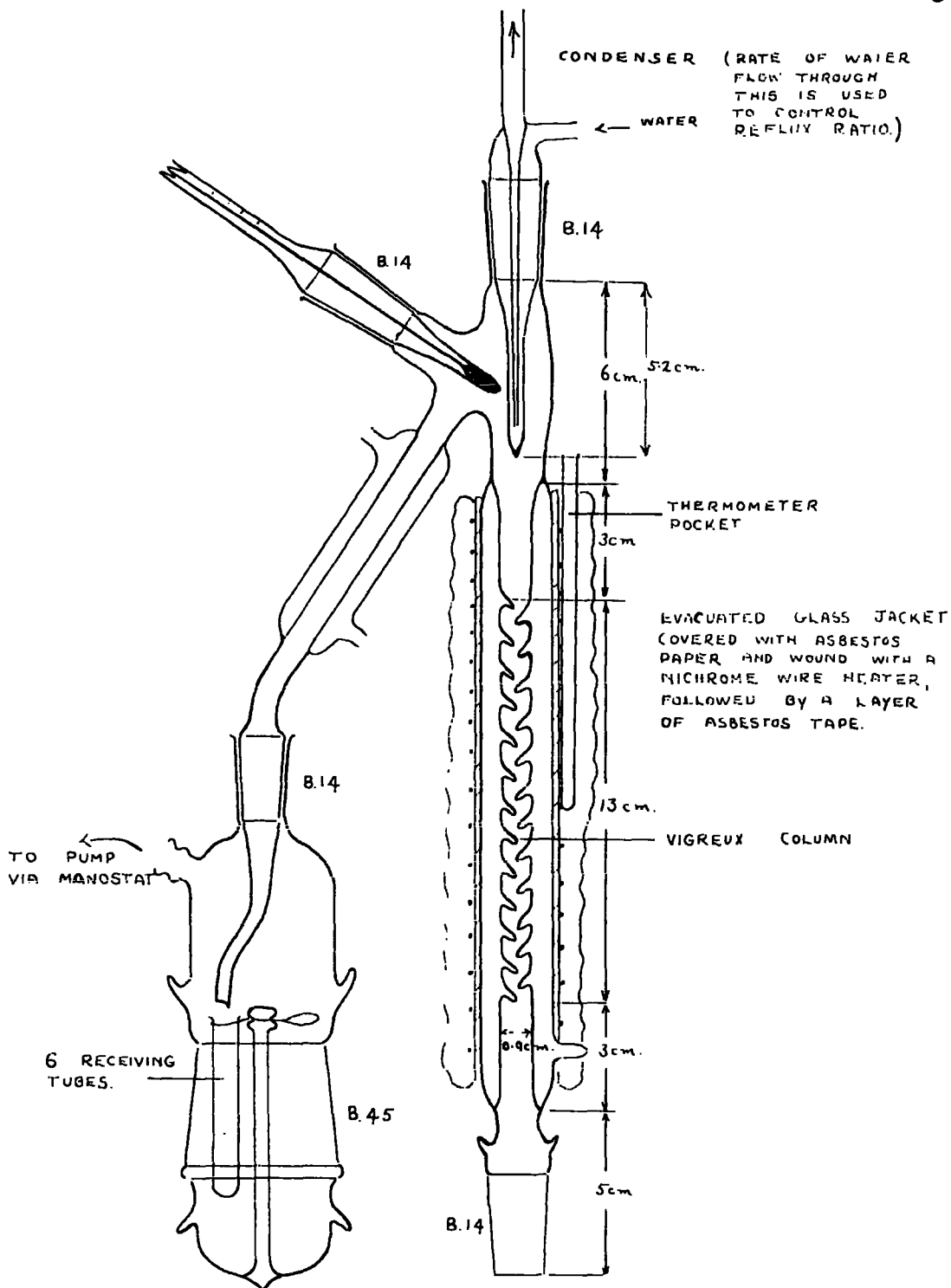

SEMI-MICRO COLUMN (TO SCALE).

DIAGRAM VIII

(6) b.r.  $80^{\circ}$ - $95^{\circ}$  (3.29 g.); black residue, (0.50 g.).

Analytical V.P.C., on kieselguhr-silicone high vacuum grease at  $153^{\circ}$ , p.d. 40 cms. Hg, nitrogen flow-rate 28 mls./min.

The crude product, diagram (I) has a similar qualitative composition to that produced in (1) above, one main component being present.

Fractions (2), (3), and (4) contain only small amounts of material other than the main component and were therefore combined (5.1 g.).

#### Preparative V.P.C.

Using the semi-micro preparative column kieselguhr-apiezon L at  $140^{\circ}$ , p.d. 22 cms. Hg, nitrogen flow-rate 27 mls./min. 0.30 g. of the combined fractions (2), (3) and (4), was separated in three runs to give 0.25 g. material giving a single peak by analytical V.P.C. and analysing, after distillation from phosphorus pentoxide to, Br, 41.8%; F, 8.9%. A bromofluorocyclohexene requires Br, 44.6%; F, 10.6%.

(iii) Stannic chloride as catalyst - larger excess of anhydrous hydrofluoric acid at a higher temperature.

1-chloro-1,2-dibromocyclohexane (35 g., 0.13 mole)

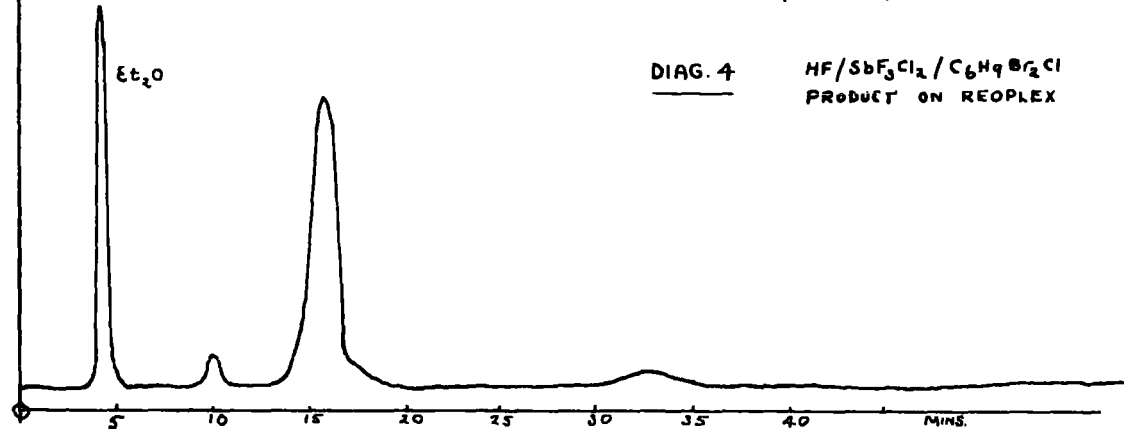
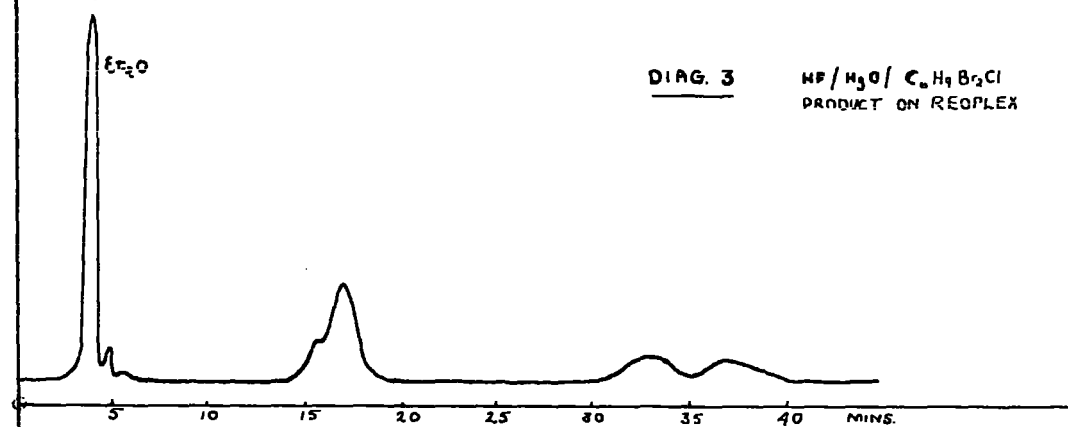
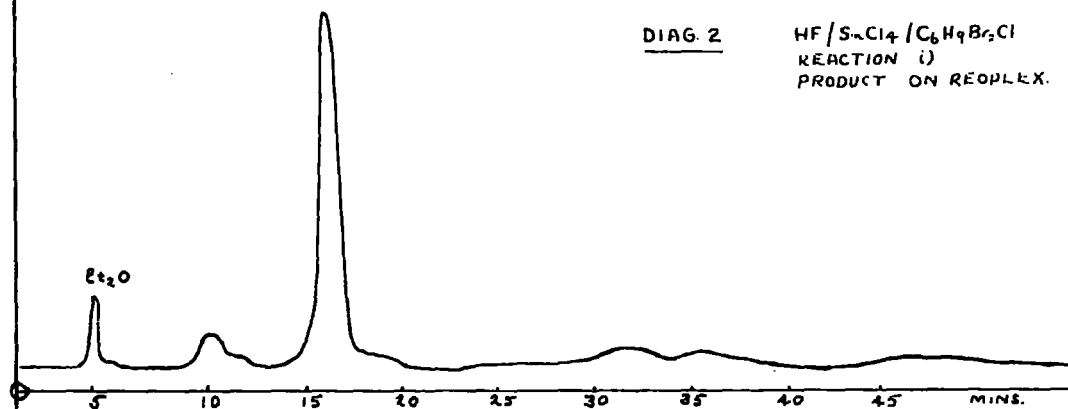
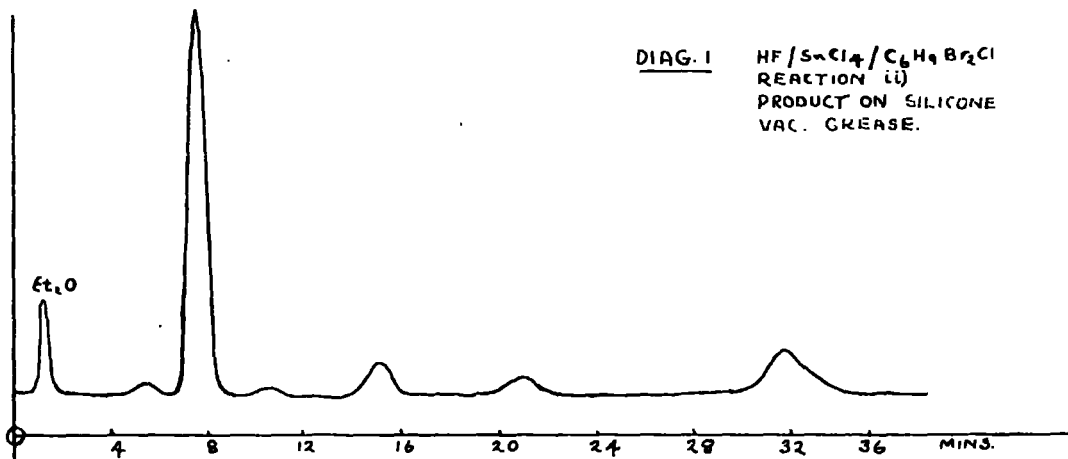

stannic chloride (17.9 g., 0.07 mole) and anhydrous hydrofluoric acid (31.7 g., 1.58 mole) were contained in the autoclave as before and heated to 130° in 5½ hours.

On venting and opening only black tar was obtained.

(iv) Anhydrous aluminium chloride as catalyst

1-chloro-1,2-dibromocyclohexane (20 g., 0.07 mole) anhydrous aluminium chloride (4.9 g., 0.04 mole) and anhydrous hydrofluoric acid (17.4 g., 0.87 mole) were reacted together as in (ii) above.

Some tar and 16.0 g. crude liquid product were obtained which deposited crystals (12.5 g.) on cooling. These proved to be starting material. The mother liquor was shown to be mainly ether by analytical vapour phase chromatography.

(v) Mercuric oxide as catalyst

1-chloro-1,2-dibromocyclohexane (20 g., 0.07 mole) and anhydrous hydrofluoric acid (17.4 g., 0.87 mole) were contained in the autoclave as before, cooled in dry-ice/acetone mixture, and red mercuric oxide (31 g., 0.14 mole) previously dried for 1 hour at 110°, added portion wise with stirring. After sealing the autoclave it was heated and rotated as in (ii).

The product was worked up to yield crude material (5 g.).

Analytical V.P.C., semi-micro column, kieselguhr-Reoplex 400 at  $162^{\circ}$ , p.d. 40 cms. Hg, nitrogen flow-rate 17 mls./min. showed that the product had a different qualitative composition to that produced in (ii) and (iii) above (see diagram 3), and no one component appeared to predominate. No further work was therefore done on this material.

(vi) Antimony trifluoride dichloride as catalyst

Preparation of  $SbF_3Cl_2$

The trifluoride dichloride was prepared from the trifluoride, itself made from the oxide as follows.

Antimony trioxide was dissolved in 40% aqueous hydrofluoric acid and evaporated down to dryness. The pale brown material was ground to a fine powder and continuously extracted with anhydrous methanol. On cooling, the methanol deposited white crystals of the trifluoride.

Chlorine was bubbled into the molten trifluoride until the theoretical increase in weight had been obtained, the product, a greyish pasty mass, was not purified further.

Use as a catalyst

1-chloro-1,2-dibromocyclohexane (20 g., 0.07 mole) antimony trifluoride dichloride (20 g., 0.08 mole) and anhydrous hydrofluoric acid (17.4 g., 0.87 mole), were heated



in the rotating autoclave from room temperature to 80° in 2 hours. After quenching the contents were worked up as before to yield 7.5 g. crude product.

Fractionation through the semi-micro column at 15 mm. Hg yielded fractions as follows:- (1) b.r. 40°-54° (1.1 g.); (2) b.r. 54°-59° (1.6 g.); (3) b.r. 25°-30° (0.3 g.); residual tar 0.7 g. The poor recovery is due to residual ether pumped away.

Analytical V.P.C. kieselguhr-Reoplex 400 at 162°, p.d. 40 cms. Hg, nitrogen flow-rate 17 mls./min., showed the crude product to have a very similar qualitative composition to that produced in the stannic chloride catalysed reaction (see diagram 4). Fraction (1) consisted of two components while fraction (2) contained only the main component. Qualitative analysis on this fraction showed the presence of bromine and fluorine and a quantitative analysis gave:- Br, 41.9%; F, 8.9%.

Calculated for a bromofluorocyclohexene Br, 44.6%; F, 10.6%.

Attempted oxidations of the suspected bromofluorocyclohexene 70, 71, 72

Reagents      A.R. acetone refluxed with, and distilled from, potassium permanganate and dried with magnesium sulphate.  
AR potassium permanganate.

(i) Oxidation at room temperature

The supposed olefine (0.93 g.) and a solution of potassium permanganate (0.93 g.) in acetone (185 mls.) were placed in a 500 mls. flask. The flask was shaken vigorously for twenty hours, at the end of which time a brown precipitate was present the purple colour remaining. Water (200 mls.) was added the flask heated to 40° and the acetone removed under reduced pressure.

The solution was acidified with concentrated sulphuric acid (5 mls.) and sulphur dioxide passed in until the solution was decolourised.

Continuous ether extraction for 48 hours yielded a pale yellow ether extract which was distilled to small volume and cooled. No crystals appeared, and evaporation to dryness yielded a few viscous brown drops with an acetic acid type odour.

The remaining aqueous acid solution was made just alkaline with sodium bicarbonate and evaporated to dryness. The brownish crystals obtained (mainly potassium and manganese sulphates ) were continuously extracted with ethanol for 6 hours. Evaporation of this extract yielded some pale brown crystals which only showed slight charring when heated on a Pt foil. Negligible organic material was therefore present.

(ii) At elevated temperatures with large excess of permanganate

The suspected olefine (1.09 g.), was dissolved in acetone (10 mls.) in a 250 mls. two-necked flask fitted with a condenser terminating in a calcium chloride tube, and a dropping funnel.

The flask was heated to 70° on a water bath and from the dropping funnel was added slowly a solution of potassium permanganate (1.24 g.) in acetone (200 mls.). The colour faded rapidly until 10 mls. had been added but then persisted. Addition was then stopped until the colour faded again. In this way the whole of the permanganate was added in 24 hours.

The material was then worked up as in (i) and again no organic product was isolated.

Attempted hydrogenations of the suspected olefin

Using the Tower's 'General Purpose Hydrogenator' and a 5% palladised charcoal catalyst (prepared according to Vogel, 'A Textbook of Practical Organic Chemistry', Longmans Green and Co., London, 1948, p. 989) hydrogenations of standard materials, cyclohexene and 1-chlorohexene were carried out as described by Banks (Ph.D. Thesis Durham 1956 p. 145 et. seq.) with similar results.

The suspected olefine, when subjected to the same

procedure did not take up any hydrogen.

Reduction of the suspected bromofluorocyclohexene  
lithium aluminium hydride 73,74

(i) Using tetrahydrofuran as solvent

Reagents

Tetrahydrofuran, distilled from potassium and stored over sodium, the approximate quantity required for immediate use was left over lithium aluminium hydride and then distilled.

Lithium aluminium hydride B.D.H.

Lithium aluminium hydride (0.50 g.) was put in a three necked flask, fitted with a stirrer, dropping funnel, and a double surface condenser terminating in a dry-ice/acetone reflux condenser. Dry tetrahydrofuran (5 mls.) was added and stirring commenced, the suspected olefine (0.95 g.) in tetrahydrofuran (6 mls.) was added over one hour, no reaction being observed. The reaction mixture was stirred at 80°-85° for 22 hours. After cooling 50/50 v.v. tetrahydrofuran/water mixture (10 mls.) was added followed by water (10 mls.), and the mixture poured onto crushed ice. The solid material was dissolved by the addition of concentrated sulphuric acid and the clear solution extracted with ether (3 x 30 mls.). The combined extracts were water washed and dried (MgSO<sub>4</sub>).

Using the semi-micro column the bulk of the ether was distilled off leaving ca. 4 mls. residue.

Analytical V.P.C. of product, kieselguhr-silicone high vacuum grease at  $90^{\circ}$ , p.d. 40 cms. Hg, nitrogen flow-rate 25 mls./min. showed complete removal of starting material and a small peak, retention time just greater than that of tetrahydrofuran, was present with the tetrahydrofuran peak. It was clear that the product material was mainly tetrahydrofuran and further distillation of the material resulted in rapid decomposition, as the remaining tetrahydrofuran was removed, to give a gummy residue.

(ii) Diethyl ether as solvent

Reagents

Diethyl ether; distilled over phenyl magnesium bromide and stored over sodium wire.

Lithium aluminium hydride as before.

The apparatus was as in (i) but modified to enable an oxygen free nitrogen atmosphere to be used.

The suspected olefine (40 g.) was dissolved in ether (20 mls.) and added over 5 minutes to lithium aluminium hydride (2 g.) in ether (10 mls.) some heat being generated.

Vigorous stirring was then continued for 16 hours at  $45^{\circ}$ - $50^{\circ}$ . After cooling, moist ether followed by water was used to destroy the excess lithium aluminium hydride and the solution was filtered, the solid on the filter ether washed, and the ethereal solution dried ( $\text{MgSO}_4$ ). The material was distilled through the semi-micro column until only ca. 1 ml. of residual material remained.

Analytical V.P.C. on kieselguhr-silicone high vacuum grease at  $135^{\circ}$ , p.d. 35 cms. Hg, nitrogen flow-rate 25 mls./min. showed complete removal of starting material and the appearance of a new peak just after the ether peak.

Preparative V.P.C. on the semi-micro preparative column, kieselguhr-silicone high vacuum grease at  $60^{\circ}$ , p.d. 35 cms Hg, nitrogen flow-rate 42 mls./min.

The residual material was separated in two runs yielding 0.22 g. of the reduction product, pure by analytical V.P.C.

Quantitative analysis gave Br, nil; F, 18.33%.  
cyclic  $\text{C}_6\text{H}_9\text{F}$  requires F, 18.96%.

Qualitative unsaturation test

5 mg. of reduction product were dissolved in 0.5 ml. methanol free acetone and one drop 0.5% aqueous potassium permanganate added. In  $2\frac{1}{2}$  mins. the colour had faded

to pale pink, a brown precipitate being formed. Overnight the colour faded completely and the solution was acid to litmus.

In a blank run carried out at the same time no fading at all was observed.

#### Infra-red spectroscopy

A strong absorption at  $1698\text{ cm.}^{-1}$  and a weak absorption at  $3035\text{ cm.}^{-1}$  were evidence for unsaturation.<sup>61</sup>

#### The action of anhydrous hydrofluoric acid on trans-1,2-dibromocyclohexane

#### Reagents

Trans-1,2-dibromocyclohexane Lights redistilled,  
b.r.<sub>5</sub>  $79^{\circ}$ - $81^{\circ}$ .

Anhydrous hydrogen fluoride Imperial Smelting  
Corporation Ltd.,

Stannic chloride B.D.H. redistilled b.r.  $112^{\circ}$ -  
 $114^{\circ}$ .

Stannic bromide B.D.H.

#### I(a) Using stannic chloride as catalyst

Trans-1,2-dibromocyclohexane (24.2 g., 0.10 mole) was

placed in a dry-ice cooled 500 mls. stainless steel autoclave, together with anhydrous hydrofluoric acid (24.0 g., 1.2 moles), and stannic chloride (13.0 g., 0.05 mole).

The vessel was sealed and allowed to rotate while reaching room temperature (2 hours) and then heated with rotation for a further 2 hours, a final temperature of 70° being reached. After quenching in ice-water the vessel was vented. The contents, a tar-free purple liquid, were washed with ether into a dry-ice cooled polythene beaker and neutralised with solid anhydrous sodium carbonate, the colour changing through yellow to pale green.

The resultant slurry was filtered (Super-Cel) to yield clear yellow liquid which was dried ( $\text{MgSO}_4$ ).

The ether was distilled off to give crude dark brown product (17.5 g.) which was fractionated through the semi-micro column at 17 mm. Hg to yield fractions as follows:-  
(1) b.r. 20°-48°; (2) b.r. 48°-55°; (3) b.r. 55°-80°;  
(4) b.r. 80°-86°; tar residue 1.6 g.

The weights of the distillates were not recorded since a manostat failure caused losses by 'bumping', and the later fractions solidified on the condenser walls preventing complete recovery.

Analytical vapour phase chromatography was carried out



on the semi-micro preparative column, kieselguhr-Apiezon L at  $158^{\circ}$ , p.d. 28 cms Hg, nitrogen flow-rate 28 mls./min. Diagram (5) shows the chromatogram of the crude product before fractionation, no starting material is present and four new materials, giving peaks A, B, C and D, have appeared. The chromatograms for the various fractions (2) to (4) are not shown since they consist merely of the same four peaks in different proportions, a partial separation having been effected. Fraction (1) is ether.

#### Quantitative analysis

	Fraction (2)	Fraction (3)	Fraction (4)
%Br	7.9	11.1	17.9
%Cl	42.0	38.4	27.9
%F	2.3	2.7	0.5

These analyses were carried out by the method described in Chapter IV.

#### Further fractionation

1.56 g. of fraction (3) was refractionated through the semi-micro column at 16 mm. Hg to give fractions:-  
 (1) b.r. ( $60^{\circ}$ - $70^{\circ}$ ), 0.16 g.; (2) b.r. ( $70^{\circ}$ - $74^{\circ}$ ), 0.27 g.;  
 (3) b.r. ( $74^{\circ}$ - $78^{\circ}$ ), 0.16 g.; (4) b.r. ( $78^{\circ}$ - $100^{\circ}$ ), 0.44 g.  
 (solid); still pot residue 0.25 g.

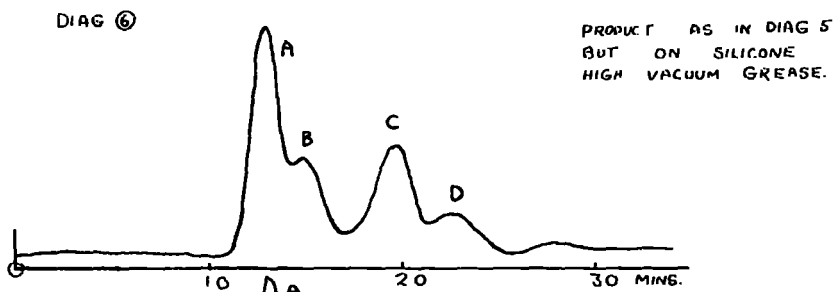
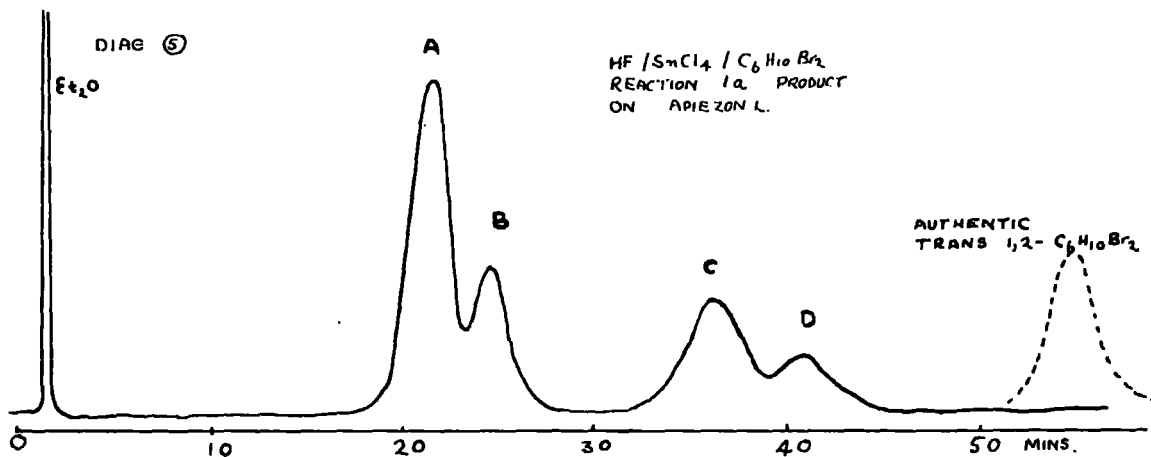

DIAG ⑦  
FN. ① ON  
S.H.V. GREASE

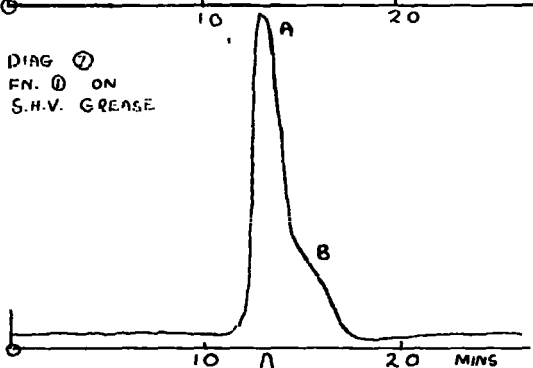

DIAG ⑧  
FN. ③ ON  
S.H.V. GREASE

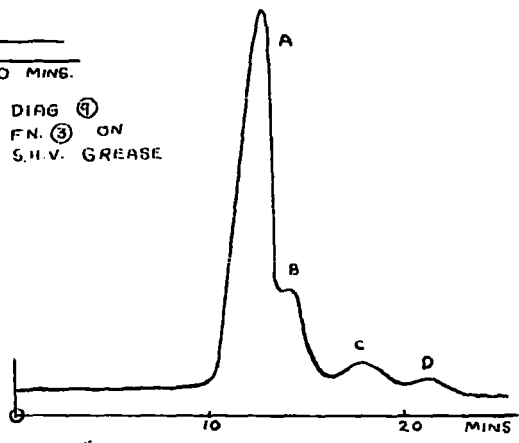

DIAG ⑨  
FN. ② ON  
SHV GREASE

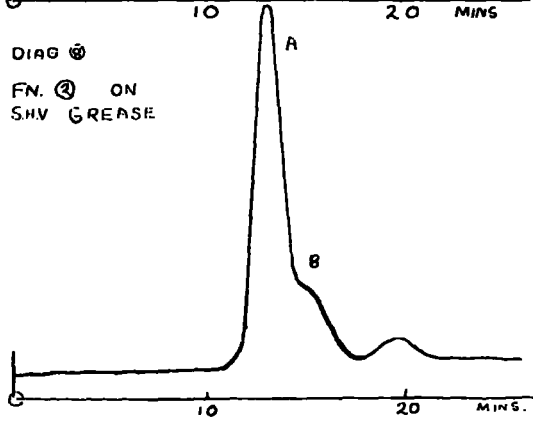

DIAG ⑩  
FN. ④ ON  
S.H.V GREASE

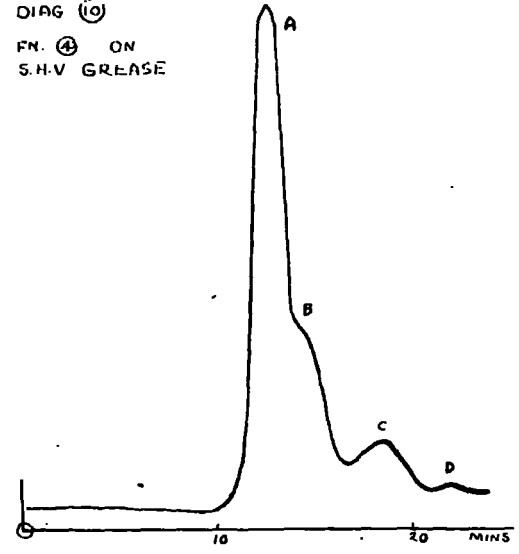

Analytical V.P.C. on kieselguhr-silicone high vacuum grease at  $158^{\circ}$ , p.d. 24 cms. Hg, nitrogen flow-rate 24 mls./min., gave the results shown in diagrams (7), (8), (9), and (10); diagram (6) is the crude product under the same conditions. It is clear that fractions (1) and (2) consist mainly of the first two combined peaks.

Quantitative analysis gave results as follows:-

	Fraction (1)	Fraction (2)	Fraction (3)
%Br	2.1	2.4	2.9
%Cl	45.4	47.0	47.0
%F	-	-	-

Cyclic  $C_6H_{10}Cl_2$  requires Cl, 46.3%.

Infra-red spectroscopy on fraction (1)

The material does not correspond to cis- or trans-1,2-dichlorocyclohexane and is probably a mixture of the 1,3- and 1,4- dichloro- isomers a rearrangement having occurred.

No further work was done on any of this material since it seemed quite obvious that a simple exchange reaction between catalyst and dibromo- compound had occurred together with rearrangement.

(b) Stannic chloride as catalyst under more vigorous conditions

Trans-1,2-dibromocyclohexane (69 g. 0.29 mole) with

anhydrous hydrofluoric acid (69.2 g., 3.46 moles) and stannic chloride (35.8 g., 0.14 mole) were charged into the autoclave as before which was rotated until it reached room temperature (2 hours), and was then rotated with heating for four hours more, a final temperature of  $75^{\circ}$  being reached.

The autoclave was vented and the contents treated as in (a) above, the crude product being distilled rapidly at 5-2 mm. Hg to give distillate (38 g.) b.r. ( $50^{\circ}$ - $70^{\circ}$ ) and tar (6.5 g.). Occasional blocking of the condenser occurred and the distillate consisted of a blue liquid overlying a white crystalline solid.

The solid was filtered from the distillate (6.0 g.) and the remaining material distilled at 18 mm. Hg through a 6" Vigreux column to give fractions:- (1) b.r. ( $84$ - $86^{\circ}$ ), 4.5 g.; (2) b.r. ( $89$ - $91^{\circ}$ ), 11.5 g.; (3) b.r. ( $91^{\circ}$ - $100^{\circ}$ ), 10.5 g. residue, 2.5 g.

The solid (6.0 g.) was recrystallised from ( $40^{\circ}$ - $60^{\circ}$ ) petroleum ether twice, and afforded brilliant white crystals with a faint odour (3.5 g.) m.p.  $99.5^{\circ}$ - $100^{\circ}$ . Elemental analysis showed the presence of bromine and chlorine and the absence of fluorine and tin, no residue being obtained when the material was burnt on a Pt foil.

Quantitative analyses were carried out, bromine and

chlorine were determined by the described method (see Chapter IV) and carbon and hydrogen as usual. Found: C, 40.4; H, 5.6; Br, 22.6; Cl, 30.71%.  $C_{12}H_{18}Cl_3Br$  requires, C, 41.3; H, 5.2; Br, 22.9; Cl, 30.5%. M by Rast,  $205 \pm 20$ ; M for  $C_{12}H_{18}Cl_3Br$ , 348.6.

Analytical V.P.C. of liquid fractions and crystalline solid

Column, kieselguhr-silicone high vacuum grease at  $186^\circ$ , p.d. 10.6 cms. Hg, nitrogen flow rate 12 mls./min.

The crude product had the same qualitative composition as that obtained in reaction (a), peaks A and B (see diagrams (11) to (13)) are thus isomeric dichlorocyclohexanes while C and D are almost certainly isomeric monobromomonochlorocyclohexanes since their retention time is less than that of trans-1,2-dibromocyclohexane and the 1,3- and 1,4- dibromo-isomers probably have higher boiling points than the trans-1,2-compound, (trans-1,4- $C_6H_{10}Br_2$  has m.p.  $113^\circ$ <sup>75</sup>; cis-1,3- $C_6H_{10}Br_2$  has m.p.  $112^\circ$ <sup>76</sup>; trans-1,3- $C_6H_{10}Br_2$  has  $b_{16} = 116^\circ$ ; cis-1,2- $C_6H_{10}Br_2$  has  $b_9 = 104^\circ$ <sup>64</sup> and trans-1,2- $C_6H_{10}Br_2$  has  $b_{13} = 99^\circ$ <sup>77</sup>).

The crystalline solid gave a chromatogram, diag. (14), with two peaks having identical retention times to A and C. Since the melting point of the material is sharp we probably have a 1:1 molecular compound of a dichlorocyclo-

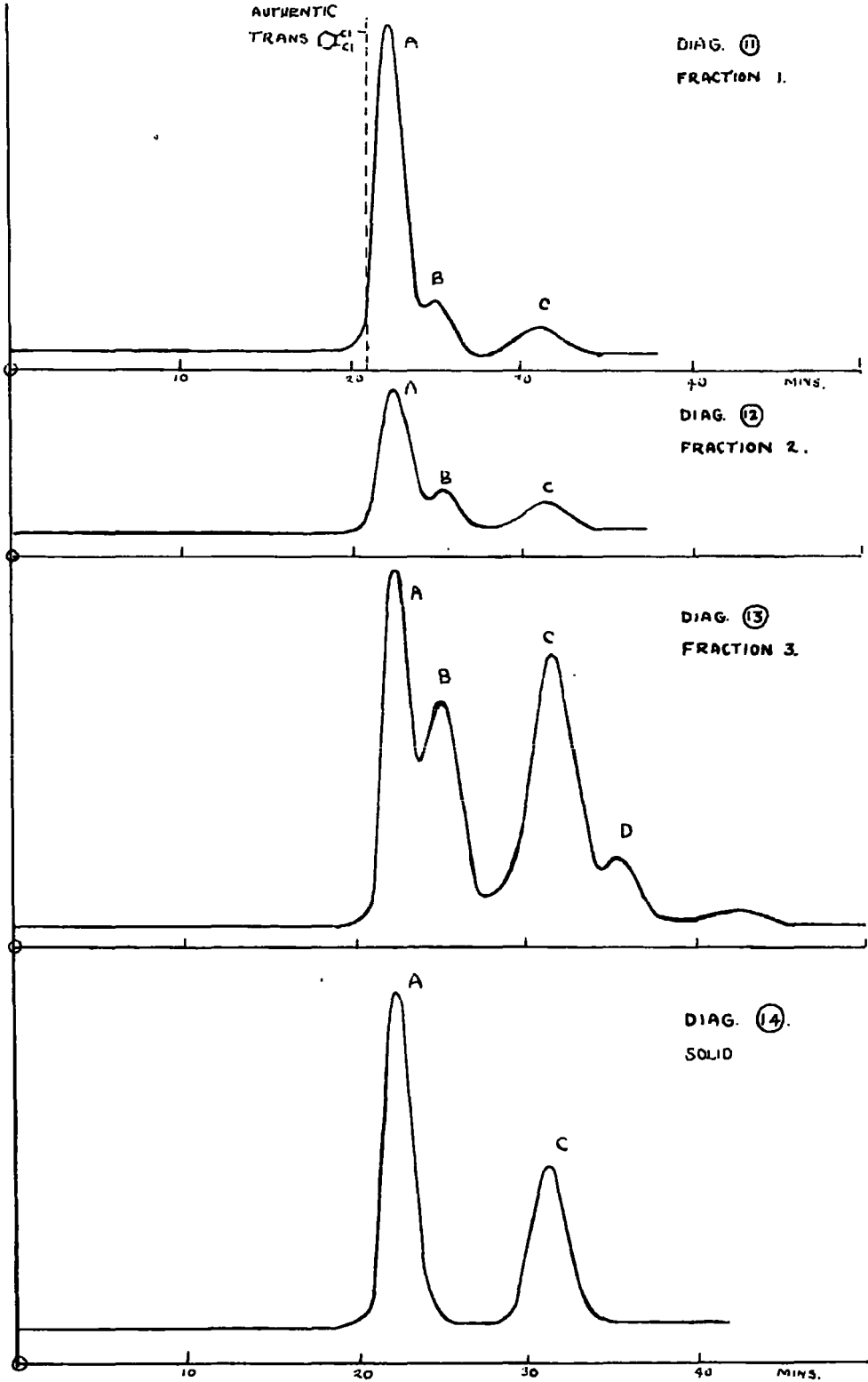

hexane and a bromochlorocyclohexane, which is consistent with the analytical results.

Found: C, 40.4; H, 5.6; Br, 22.6; Cl, 30.71%

$C_6H_{10}Cl_2$ :  $C_6H_{10}BrCl$  requires: C, 41.1; H, 5.7; Br, 22.8; Cl, 30.4%. Found M,  $205 \pm 20$ ; average M for molecular compound when dissociated is 175.2. (m.p. trans-1,4- $C_6H_{10}Cl_2$ ,  $102^{\circ}$ <sup>78</sup>; m.p. trans-1,4- $C_6H_{10}ClBr$ ,  $102^{\circ}$ <sup>79</sup>).

## II(a) Using stannic bromide as catalyst

Trans-1,2-dibromocyclohexane (24.2 g., 0.1 mole) together with anhydrous hydrofluoric acid (24.0 g., 1.2 moles) and stannic bromide (22.0 g, 0.05 mole) were sealed inside the 500 mls. autoclave as before.

The vessel was rotated until room temperature was reached (2 hrs.) and then heated with rotation to  $80^{\circ}$  in  $3\frac{1}{2}$  hours. The contents, a dark brown liquid were worked up as in I(a) and (b) above, except that sodium fluoride was used to remove the excess of anhydrous hydrofluoric acid.

Rapid distillation of the crude product at 1 mm. Hg gave fractions:- (1) b.r. ( $20^{\circ}$ - $35^{\circ}$ ), 30 g. yellow fuming liquid; (2) b.r. ( $35^{\circ}$ - $75^{\circ}$ ), 25 g., brown fuming liquid plus solid; residue, tar (8.0 g.).

In the later stages of the distillation the distillate solidified in the condenser, and this material was washed out with ether and subsequently evaporated to give

violet crystals (4.1 g.).

(a) Treatment of solid

This appeared to be differentially soluble in methylated spirits and was separated into three portions by means of this property.

(i) Very soluble portion was recrystallised to give white crystals (0.4 g.), m.p.  $112.5-113^{\circ}$ , containing no fluorine. Found: C, 30.1; H, 4.4; Br, 69.3%.

(ii) A less soluble portion was dissolved in excess methylated spirit and recrystallised twice from ( $40^{\circ}-60^{\circ}$ ) petroleum ether affording white crystals (0.5 g.) m.p.  $113^{\circ}-113.5^{\circ}$  (d). Found: C, 30.5; H, 5.3; Br, 68.8%.

(iii) A much less soluble portion recrystallised from ( $40^{\circ}-60^{\circ}$ ) petroleum ether/chloroform afforded white crystals (1.4 g.) m.p.  $112^{\circ}-113^{\circ}$ . Found: C, 30.8; H, 4.3; Br, 66.6%. These materials appeared to be mixtures of the two solid dibromo -isomers.  $C_6H_{10}Br_2$  requires C, 29.8; H, 4.17; Br, 66.1%. Cis-1,3-dibromocyclohexane has m.p.  $112^{\circ}$ <sup>76</sup>, and trans-1,4-dibromocyclohexane has m.p.  $113^{\circ}$ <sup>75</sup>.

An infra-red spectrum of the material from portion (iii) confirmed that it was mainly trans-1,4-dibromocyclohexane, with some cis-1,3-dibromocyclohexane also present.



(b) Treatment of the liquid material

(i) (20°-35°) fraction

Analytical V.P.C. indicated that this fraction was ether, but it was possible that a small quantity of a low boiling fluoro- compound was present, which would be masked by the ether peak when the column was overloaded sufficiently to show it up. Freezing in methylene chloride/dry-ice mixture afforded a white solid portion (5.0 g.) which was added to the (35°-75°) fraction, while the remaining ether was distilled through a 6" helices packed column to leave liquid residue (ca. 60 mg.). Found: Br, 36.0; F, 5.8%. This material gave a strongly positive unsaturation test, and it is suggested that it consists of bromocyclohexenes and a fluoro-compound, possibly also containing bromine.

(ii) (35°-75°) fraction

This material (with the 5.0 g. from fraction (i)) was distilled through a 6" Vigreux column at 5 mm. Hg to give the following fractions:- (1) b.r. (20°-50°), 6.5 g.; (2) b.r. (50°-74°), 4.1 g.; (3) b.r. (78°-84°), 14.5 g.; Residue, 4.5 g.

Analytical V.P.C.

Column, kieselguhr-silicone high vacuum grease at 184°, p.d. 10 cms Hg, nitrogen flow-rate 13 mls./min.

Diagram (15) is the chromatogram of the 60 mg. residue referred to in b(i) above, diagrams (16) to (18) are chromatograms of the fractions obtained in b(ii) above while diagrams (19) and (20) are chromatograms of authentic trans-1,2-dibromocyclohexane, and the solid trans-1,4-dibromide in (a)(iii) above.

Quantitative analyses, and unsaturation tests

Material	%Br	%F	Unsaturation, KMnO <sub>4</sub> in acetone
60 mg. residue	36.0	5.8	strongly positive
fraction (1)	(obviously ether		not analysed).
fraction (2)	59.4	0.8	positive
fraction (3)	69.9	-	positive

Infra-red spectra

An infra-red spectrum of fraction (3) br<sub>5</sub> (78°-84°) gave absorptions due to trans-1,2-dibromocyclohexane and trans-1,4-dibromocyclohexane, an absorption at 1603 cm<sup>-1</sup>,\* together with the positive unsaturation test suggests that probably bromocyclohexenes and perhaps cyclohexadienes are present. These materials presumably give rise to peak B (see diagram (18)).

6/

\* -C=C- stretching absorption occurs in the region 1680-1620 cm<sup>-1</sup>.

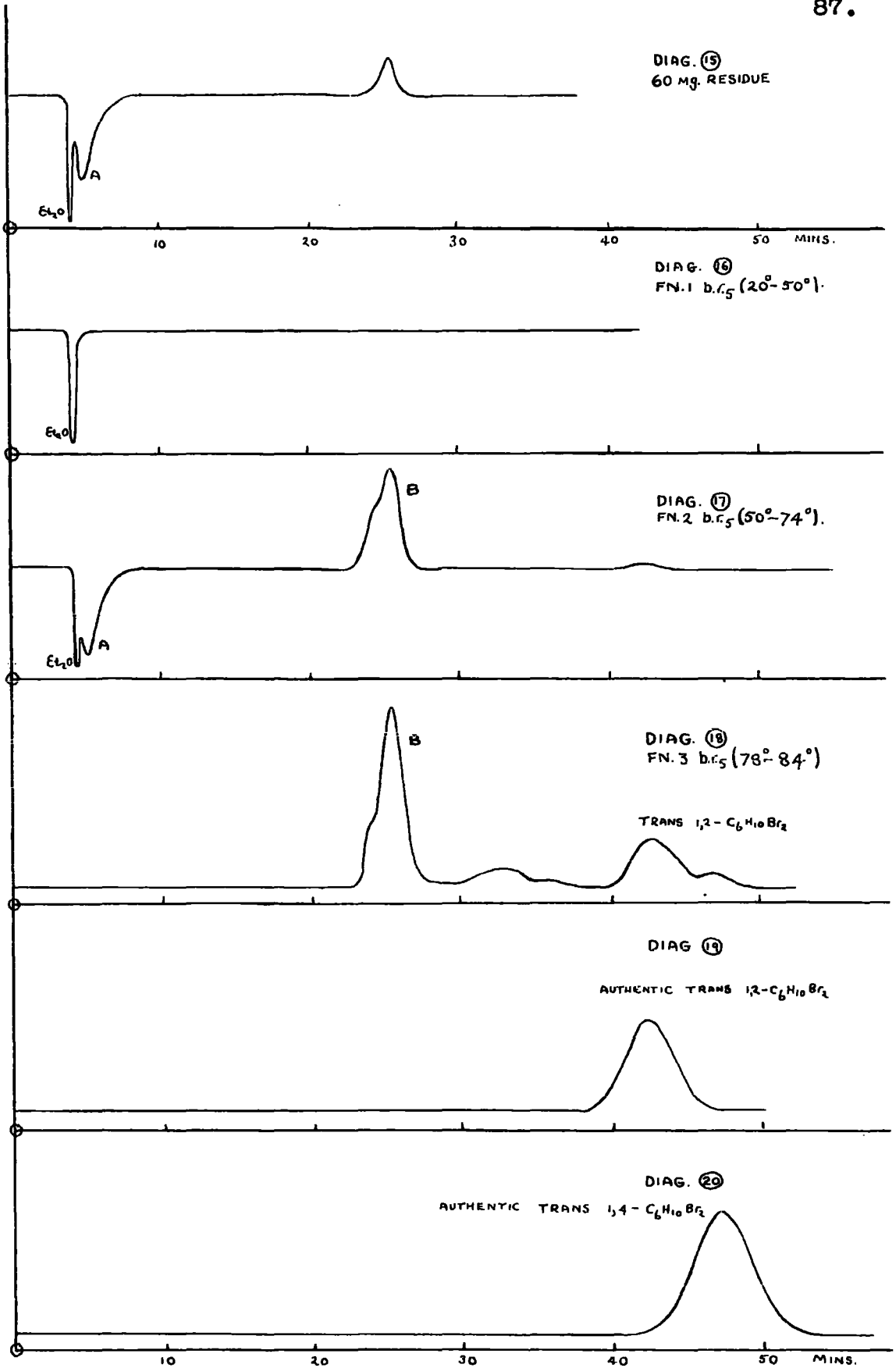

The analysis on the 60 mg. residue and on the fraction b.r.<sub>5</sub> (50°-74°) together with their analytical chromatograms (diagrams (15) and (17) respectively) suggest that a small quantity of a fluorine containing compound is present, presumably giving rise to peak 'A'. This material has not, however, been produced in significant amounts and was not isolated.

The action of potassium fluoride on trans-1,2-dichloro-cyclohexane using N,N-dimethylformamide as solvent 21a,b

### Reagents

Potassium fluoride B.D.H., dried at 350° in a muffle.

N,N-dimethylformamide, Lights' redistilled b.r. 152.5-53°.

Trans-1,2-dichlorocyclohexane, prepared according to the method of Kharasch and Brown,<sup>50</sup> b.r.<sub>20</sub> 80°-84°, pure by analytical V.P.C.

#### (1) At 170° with excess potassium fluoride

Anhydrous potassium fluoride (16.5 g., 0.28 mole) with 20 mls. of N,N-dimethylformamide were contained in a 50 mls. three-necked flask fitted with a dry-ice/acetone cold finger and P<sub>2</sub>O<sub>5</sub> drying tube, dropping funnel, and a nichrome Hershberg mercury-seal stirrer.

The mixture was heated to  $170^{\circ}$  and trans-1,2-dichloro-cyclohexane (6.5 g., 0.04 mole) added dropwise with stirring over 15 minutes. No vigorous reaction was observed. The mixture was kept at  $160^{\circ}$ - $170^{\circ}$  for 8 hours with stirring and then cooled and filtered at the pump, yielding solid (15.5 g.).

Water (400 mls.) was added to the filtrate to take up the N,N-dimethylformamide and the organic material was separated and dried ( $\text{MgSO}_4$ ), weight 15.8 g.

Analytical V.P.C. on kieselguhr-silicone high vacuum grease at  $180^{\circ}$ , p.d. 32 cms Hg, nitrogen flowrate 18mls./min. showed product was starting material plus trace of solvent. Found: Cl, 44.5%, F, 0.8%.  $\text{C}_6\text{H}_{10}\text{Cl}_2$  requires, Cl, 46.3%.

No significant reaction had occurred, the recovered potassium fluoride gave a positive chloride test, this could however be due to exchange between the potassium fluoride and the hydrogen chloride liberated by some decomposition of the starting material.

(ii) At ( $190^{\circ}$ - $200^{\circ}$ ) with smaller excess of potassium fluoride

### Reagents

As before, except potassium fluoride dried at  $600^{\circ}$  in a muffle.

Potassium fluoride (15 g., 0.26 mole) with N,N-dimethylformamide (30 mls.) were placed in a flask equipped as in (i) above and heated to 170°. 1,2-dichlorocyclohexane (15 g., 0.09 mole) was added drop-wise over 30 minutes. No heat was evolved, the flask was then kept at ca. 200° for 4 hours.

The product was worked up as before, solid (16.8 g.) and liquid (12.9 g.) being recovered.

Analytical V.P.C., kieselguhr-silicone high vacuum grease at 150°, p.d. 29 cms. Hg., nitrogen flowrate 21 mls./min. showed that product was mainly starting material although a small earlier peak was present. Found: Cl, 38.1%, F, 3.6%.  $C_6H_{10}Cl_2$  requires Cl, 46.3%.

The potassium fluoride recovered gave a positive chloride test probably due to exchange as before, since the liquid product was unsaturated to some extent.

The action of caesium fluoride on trans-1,2-dichlorocyclohexane.

(a) Preparation of caesium fluoride <sup>82</sup>

Caesium carbonate (100 g.) was dissolved in excess 60% aqueous hydrofluoric acid and the solution evaporated to dryness, a solid glass of the CsF.HF salt being produced.

In a nickel basin this was heated to red heat and acid

fumes were evolved, small quantities of ammonium fluoride being added occasionally to catalyse this process. The melt began to solidify indicating that caesium fluoride had been formed (m.p. CsF,  $684^{\circ}$ ; m.p. CsF.HF.,  $160^{\circ}$ ).

The vessel was transferred to a muffle and kept at  $800^{\circ}$  for 20 minutes. On cooling a hygroscopic pale yellow solid was obtained, which was continuously extracted with dry methanol to give, on evaporating off the solvent, white crystals (84 g.). Found: F, 12.4%, CsF requires F, 12.5%. The material was stored in a dessicator.

b) Reaction with trans-1,2-dichlorocyclohexane

Trans-1,2-dichlorocyclohexane (15 g., 0.09 mole) and anhydrous caesium fluoride (30 g. 0.20 mole) were contained in a 25 mls. two necked flask fitted with a nichrome wire mercury-seal Hershberg stirrer, and a short air condenser leading to an acetone/dry-ice cooled trap, terminating in a phosphorus pentoxide drying tube.

The flask was maintained at ( $190^{\circ}$ - $210^{\circ}$ ) for six hours and then raised to  $200$ - $220^{\circ}$  for a further ten hours, 6.2 g. of material having by then distilled into the cold trap.

After allowing to cool the solid was filtered off and ether washed, the washings being added to the filtrate.

The ether was distilled from the filtrate to give liquid product (8.0 g.).

Analytical V.P.C., kieselguhr-silicone high vacuum grease at 150<sup>o</sup>, p.d. 29 cms Hg., nitrogen flowrate 21 mls./min. showed that the distillate in the trap and the material remaining in the flask were both mainly starting material, with traces of other materials giving earlier peaks. The materials were combined and analysed. Found Cl 38.2%, F, 2.6%  $C_6H_{10}Cl_2$  requires Cl, 46.3%.

It is considered that some reaction has occurred but again no significant yield of product has been obtained.

#### Preparation of perchloryl fluoride

The method of Barth Wehrenhalp<sup>36</sup> was used.

#### Reagents

Potassium perchlorate, technical grade  
Fluorosulphonic acid, Imperial Smelting Corporation, technical grade.

An apparatus was constructed so that 50 g. batches of material could be made in one run (see diag. IX). All joints were greased with fluorocarbon grease, since there is a possibility of explosion with hydrocarbon or silicone greases,<sup>83</sup> and Teflon sleeves were used on each joint of the three-necked flask. A typical preparation is described.

Crude potassium perchlorate (120 g., 0.87 mole) and fluorsulphonic acid (1200 g., 12.0 moles) were placed in



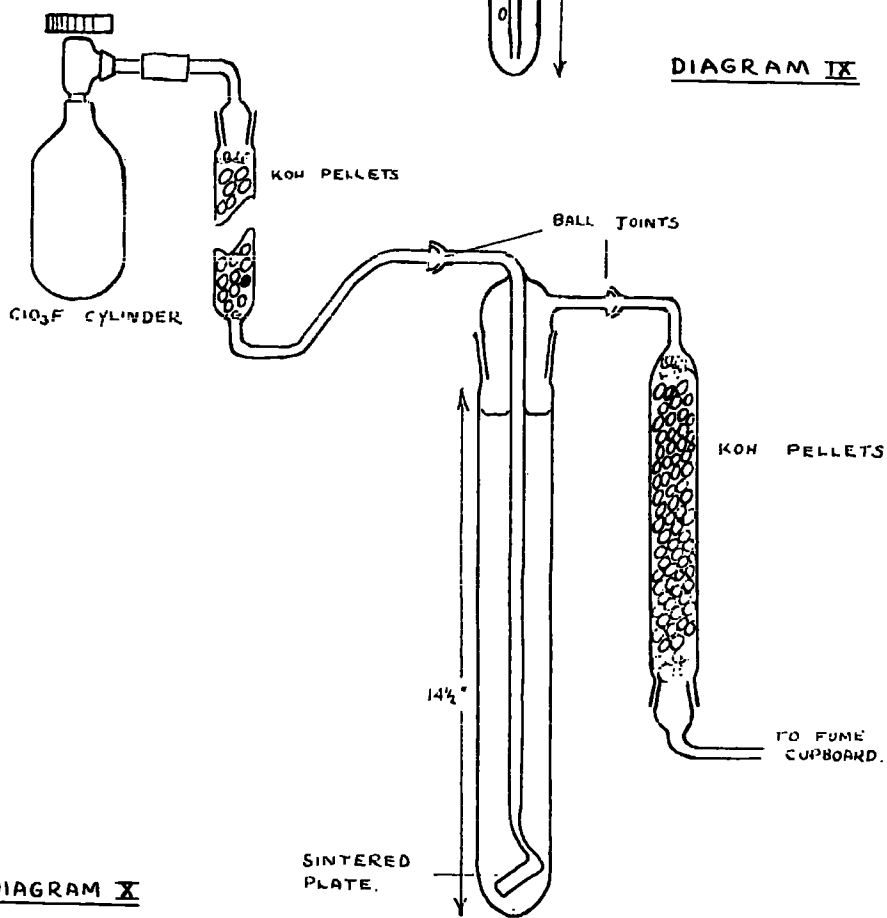
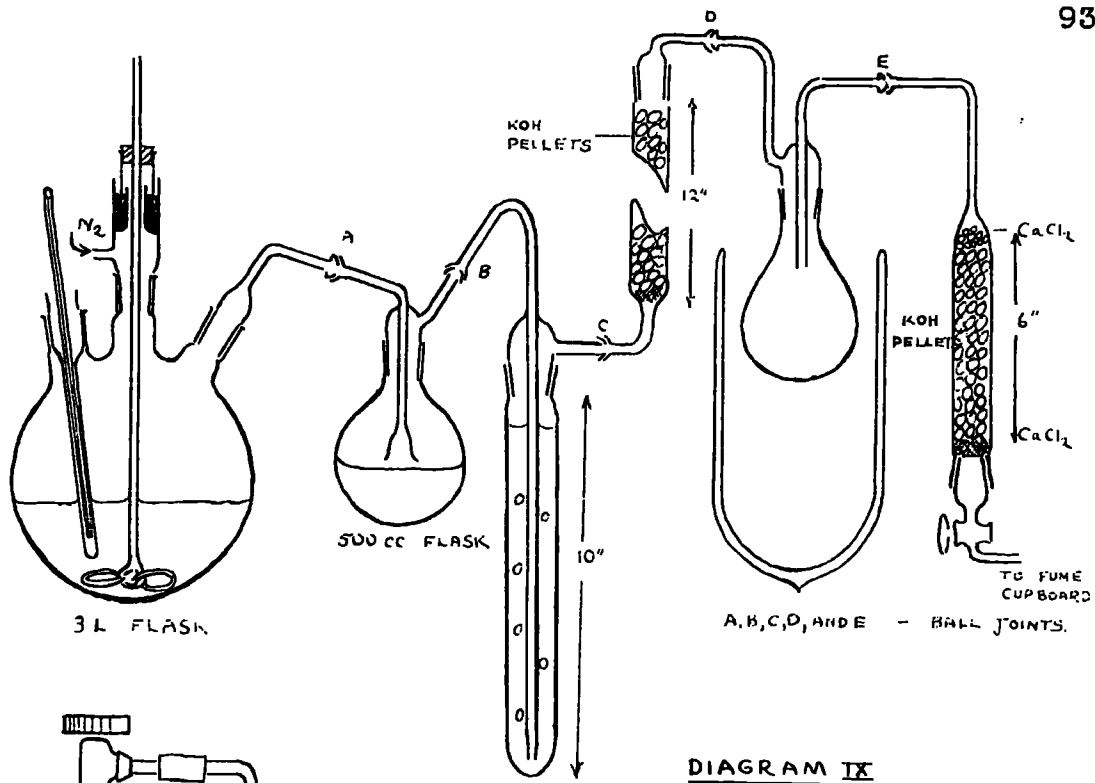

the three litre flask and stirred slowly, the perchlorate dissolving completely to give a colourless solution. The flask was slowly heated in an oil bath, and gas was evolved, the evolution becoming rapid at 75°-80°. The gas was passed over a solution 10% in sodium hydroxide and 5% in sodium thiosulphate and bubbled through such a solution. The scrubbed gases were then passed over solid potassium hydroxide pellets, and condensed in a Florentine flask cooled in liquid air. Heating was continued for six hours, the product being finally swept out of the system by nitrogen.

The flask containing the product was transferred to a small vacuum line and the perchloryl fluoride condensed into a steel pressure vessel, fitted with a greaseless bellows type valve, and cooled in a dry ice-acetone bath.

The product was contaminated with liquid oxygen also produced in the reaction, and it was necessary to pump for some time before a sticking vacuum could be achieved and the condensation begun. Unfortunately a stainless steel pressure vessel was not available and so a dry-ice acetone coolant had to be used. At this temperature (ca. -78°) perchloryl fluoride had a vapour pressure of 147 mm. Hg and<sup>83</sup> so condensation was not very rapid.

The yield of available material was 47 g., an infra-red spectrum in a gas cell at 20 mm. Hg showed that the material

was practically pure.<sup>83</sup>

The colour changes in the reactant mixture during the course of the reaction, described by Barth Wehrenhalp, did not occur when pure recrystallised potassium perchlorate was used. This indicates that it may not be the coloured  $(\text{ClO}_2)_2\text{S}_3\text{O}_{10}$  which is formed in the reaction as suggested by Barth Wehrenhalp.

#### Preparation of cyclohexanone piperidyl enamine

This was prepared by the method of Mannich and Davidsen.<sup>54</sup>

#### Reagents

<u>Piperidine</u>	Lights, dried over solid KOH and redistilled b.p. 105°.
<u>Cyclohexanone</u>	Towers, dried ( $\text{MgSO}_4$ ) and redistilled b.r. 151°-153°.
<u>Calcium oxide</u>	B.D.H. technical grade, dried at 110°.

Piperidine (75 g., 0.88 mole), cyclohexanone (45 g., 0.46 mole) and calcium oxide (90 g.) were heated and stirred together for fifty hours at 90°-100°, moisture being excluded from the flask.

After cooling and filtering off the solid, the pale yellow liquid was distilled at 100 mm. Hg through a 6" helices packed column. Up to 45° excess piperidine

distilled, the pressure was lowered to 6 mm, the column replaced by a 6" Vigreux and a repulsive smelling fraction, b.r.<sub>6</sub> 95°-100° (30 g.) collected. Residue remained, (2 g.).

Analytical V.P.C. on kieselguhr- Apiezon L at 150° p.d. 35 cms. Hg, nitrogen flowrate 30 mls./min., gave a small peak coincident with authentic cyclohexanone and a large later peak. Assuming equal response material is 95% pure.

An infra-red spectrum gave the  $\begin{array}{l} \diagup \\ \text{C}=\text{C} \\ \diagdown \end{array}$  stretching absorption at 1637 cm.<sup>-1</sup>, and the  $\begin{array}{l} \diagup \\ \text{C}=\text{H} \\ \diagdown \end{array}$  stretching absorption at 3049 cm.<sup>-1</sup>.<sup>61</sup>

The reaction between perchloryl fluoride and cyclohexanone piperidyl enamine

Reagents

perchloryl fluoride prepared as described.

cyclohexanone piperidyl enamine prepared as described.

benzene AR, dried over sodium wire.

The enamine (8 g., 0.05 mole) in benzene (100 mls.) was contained in a long trap (see diag. X) and perchloryl fluoride was bubbled into the solution, at ambient temperature, (a previous exploratory experiment had shown that little absorption occurred at 0°). After 50 minutes, during which time little absorption appeared to occur, the

temperature was raised to  $35^{\circ}$  and very quickly the solution darkened, long transparent crystals being precipitated. At this point the reaction was stopped 4.5 g. (0.04 mole) having been added. Theory requires 5 g. (0.05 mole).

The dark brown solution was washed with saturated bicarbonate solution and water until neutral, then dried ( $\text{CaCl}_2$ ).

The bulk of the benzene was removed at 10 cms. Hg leaving 6.0 g. dark brown liquid, which was distilled at 2 mm. Hg to give fractions as follows:- (1) b.r. ( $18^{\circ}$ - $30^{\circ}$ ), 1.9 g.; (2) b.r. ( $30^{\circ}$ - $65^{\circ}$ ), 2.6 g.; residue black tar, 1.1 g.

Analytical V.P.C., kieselguhr-silicone high vacuum grease at  $177^{\circ}$ , p.d. 30 cms. Hg nitrogen flowrate 15 mls./min. Peaks for benzene and cyclohexanone only were obtained when the crude product was analysed. The column temperature was reduced to  $155^{\circ}$  and fns (1) and (2) analysed, and shown to be benzene, cyclohexanone and a trace of enamine respectively.

An infra-red spectrum of fraction (2) gave absorptions additional to those of cyclohexanone and its piperidyl enamine at, 1183 (s)\*, 1086(s), 943(s), 800(w) and 680 (m)  $\text{cm.}^{-1}$

---

\* These letters refer to relative intensities, and this will be assumed in future.

Qualitative fluorine analyses were negative for fn. (1), faintly positive for fn. (2) and strongly positive for the residue.

After the usual sodium fusion fn. (2) was shown to contain nitrogen and chlorine.

Quantitative analysis

$$[\text{ClO}_3^- \text{ (or } \text{Cl}^-) + \text{F}^-] = 32.7\%. \text{ (calculated as } \text{F}^-).$$

Further working up of fraction (2)

On standing for one week this pale yellow fraction became deep red and deposited colourless crystals, soluble in water and containing ionic chlorine. These were filtered off (150 mg.) and recrystallised twice from alcohol/ether. m.p. 249-50°, admixed with authentic piperidine hydrochloride, 249-50°.

Preparation of Cyclohexanone pyrrolidyl enamine

Reagents

Pyrrolidine Lights, dried KOH and redistilled  
b.r. 88-89°

Cyclohexanone Towers, redistilled b.r. 151-153°

Benzene AR stored over sodium wire.

The preparation of this material could not be found in the literature, however Heyl and Herr<sup>55</sup> describe the preparation of steroidal ketone pyrrolidyl enamines by heating the

reactants in refluxing benzene, the latter azeotroping out the water which is collected in a moisture trap. The same method was simply applied to cyclohexanone.

Cyclohexanone (24.5 g., 0.25 mole), pyrrolidine (21.3 g. 0.30 mole) and benzene (50 mls.) were contained in a flask fitted with a Bidwell Stirling moisture trap surmounted by a reflux condenser .

The mixture was refluxed for  $1\frac{1}{2}$  hrs. the theoretical amount of water, (4.4 g., 0.25 mole) based on the cyclohexanone used, being collected.

Excess pyrrolidine was distilled from the product at 10 cms. Hg pressure and the residual yellow oil distilled through a 4" Vigreux column at 10 mm. Hg to give fractions:-  
(1) b.r. ( $20^{\circ}$ - $40^{\circ}$ ), 1.8 g.; (2) b.r. ( $40^{\circ}$ - $100^{\circ}$ ), 8.5 g.;  
(3) b.r. ( $100^{\circ}$ - $105^{\circ}$ ), 28.0 g.; residue 1.5 g.

Fraction (3) was redistilled at 3 mm. Hg to give distillate b.r.<sub>3</sub> ( $93^{\circ}$ - $94^{\circ}$ ), 26.5 g. (70% yield). This material was initially colourless but became pale yellow after  $\frac{1}{2}$  hour although stored under nitrogen.

Analytical V.P.C. on kieselguhr-silicone high vacuum grease at  $150^{\circ}$ , p.d. 30 cms. Hg, nitrogen flowrate 15 mls./min. gave for this material a single peak, retention time greater than either cyclohexanone or pyrrolidine.

Quantitative analysis Found: C, 78.3%; H, 12.1%.

$C_{10}H_{17}N$  requires C, 79.4%; H, 11.33%.

An infra-red spectrum gave absorptions at  $1639\text{ cm}^{-1}$ (s) due to  $\text{>C=C<}$  stretching, and at  $3050\text{ cm}^{-1}$ (m) due to the  $\text{=C-H}$  stretching mode.<sup>61</sup>

The reaction between perchloryl fluoride and cyclohexanone pyrrolidyl enamine

Reagents

Perchloryl fluoride:- as described.

Cyclohexanone pyrrolidyl enamine:- as described.

Pyridine:- dried over solid potassium hydroxide and distilled b.r.  $113^{\circ}$ - $14^{\circ}$ .

(a) At  $0^{\circ}$  and with 35% of perchloryl fluoride

Cyclohexanone pyrrolidyl enamine (15 g., 0.1 mole) and pyridine (200 mls.) were placed in a long trap, surrounded by an ice-filled Dewar. (See diagram X).

Passage of perchloryl fluoride was commenced and after 15 minutes the solution had become orange red deepening in colour on further passage of the gas, which was continued for  $13/4$  hours, a 35% excess (14 g., 0.14 mole) having been added.

The solution was hydrolysed by gradual addition of 7N hydrochloric acid (300 mls.) at  $40^{\circ}$ - $50^{\circ}$ , and allowed to stand, excess acid being present. Ether extraction



(5 x 100 mls.) was carried out and the extracts water washed and dried ( $\text{CaCl}_2$ ).

Removal of the ether gave crude product (7.5 g.) which was distilled at 15 mm. Hg through a 3" Vigreux column fractions being collected as follows:- (1) b.r. ( $40^\circ$ - $75^\circ$ ), 3.25 g.; (2) b.r. ( $75^\circ$ - $80^\circ$ ), 0.50 g.; residue red-brown tar, 1.30 g.

Fraction (2) partially solidified in the still head and on the condenser walls.

Analytical V.P.C. on kieselguhr-silicone high vacuum grease at  $150^\circ$ , p.d. 30 cms. Hg, nitrogen flowrate 15 mls./min. showed that fraction (1) was pyridine, cyclohexanone, and a little unchanged enamine while fraction (2) was pyridine, cyclohexanone and two later peak materials (see diagrams (21) and (22)).

To confirm that any 2-fluorocyclohexanone formed was not coming over with the cyclohexanone a preparative separation of part of fraction (1) was carried out, kieselguhr-silicone high vacuum grease at  $145^\circ$ , p.d. 46 cms. Hg, nitrogen flowrate 25 mls./min. 0.75 g. in two runs gave; cut 1 Found: F, ml, an infra-red was identical with one of authentic pyridine; cut 2, found F, 1.0%, an infra-red spectrum was identical to one of authentic cyclohexanone.

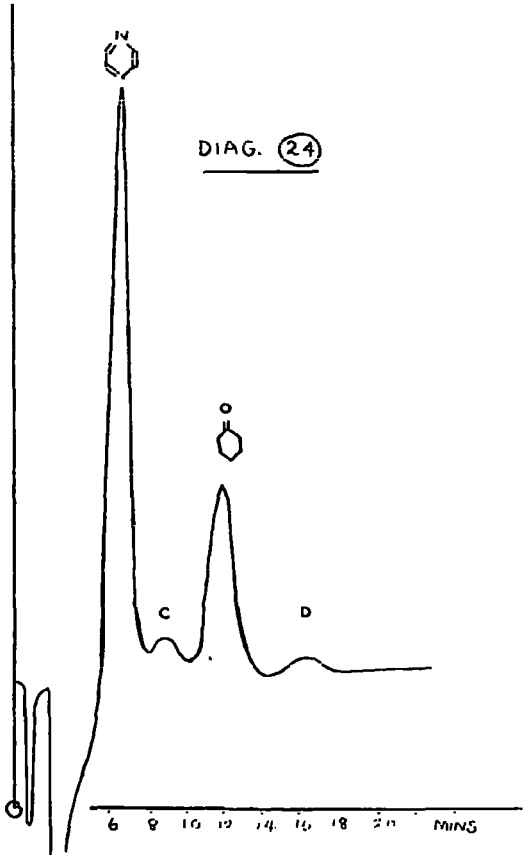
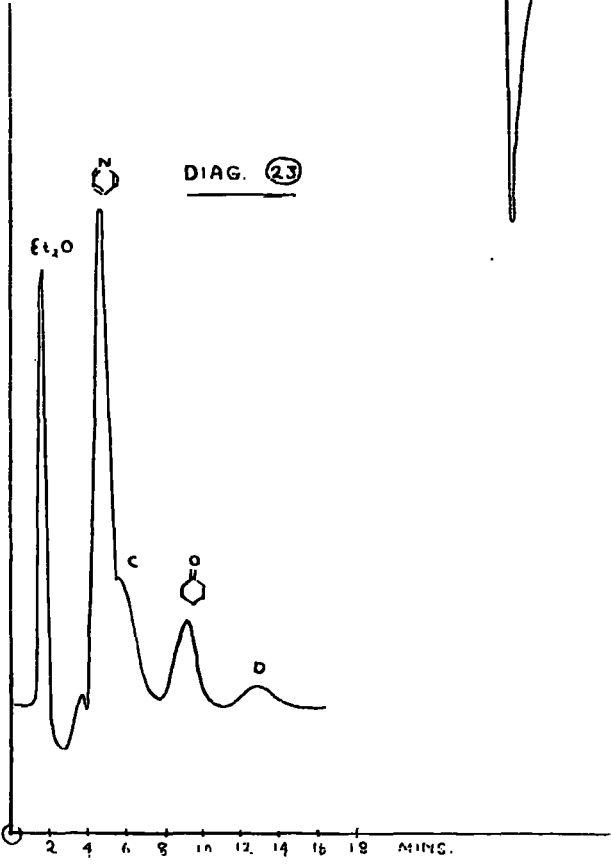
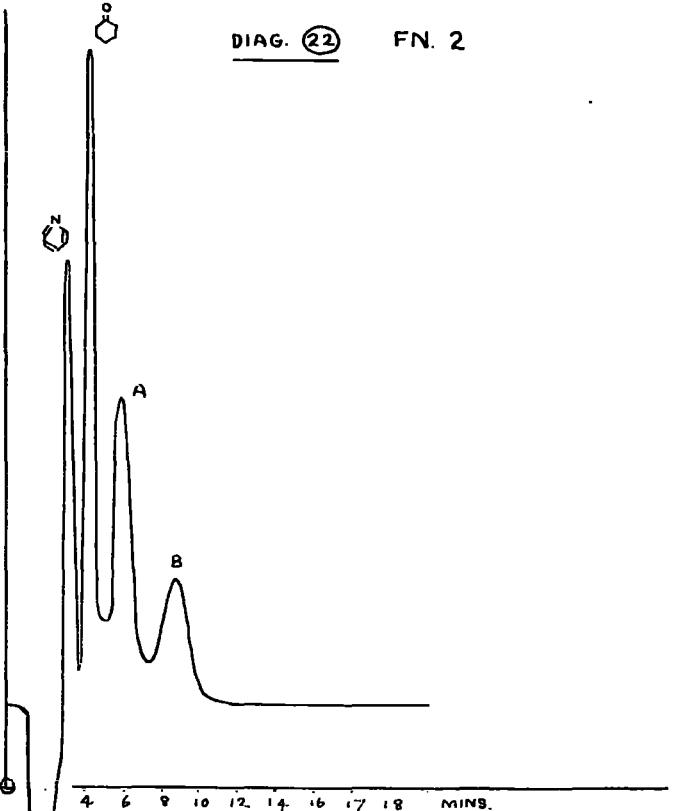
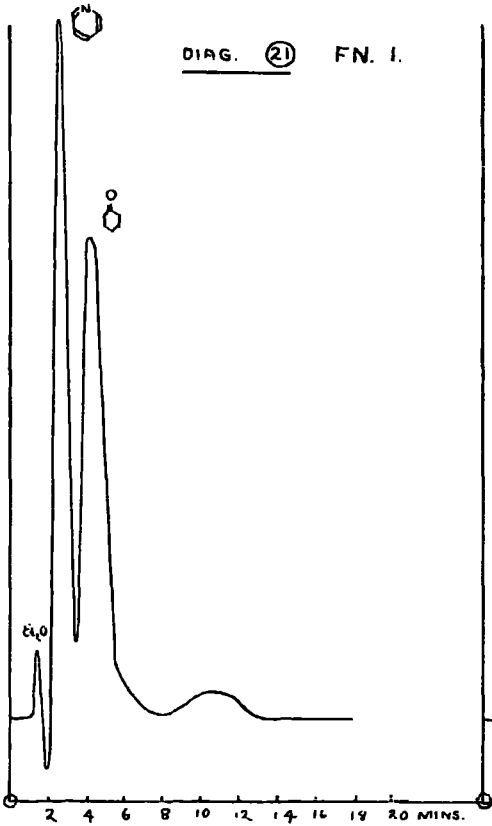

(b) At 0° , with 150% excess perchloryl fluoride

Cyclohexanone pyrrolidyl enamine (6 g., 0.04 mole) and pyridine (50 mls.) were treated with a 150% excess of perchloryl fluoride (10.5 g., 0.1 mole) for six hours as before. To the resultant dark red-brown solution were added water (50 mls.) and 10N hydrochloric acid (100 mls.) in portions. Pieces of brown tar were observed but no separate organic layer appeared. The solution was ether extracted (5 x 50 mls.) the extracts washed twice and dried ( $\text{MgSO}_4$ ). Removal of ether by distillation left brown liquid (3.8 g.) which was distilled at 10 mm. Hg in a simple still to give material b.r. ( $50^\circ$ - $60^\circ$ ), 0.7 g. and tarry residue (1 g.).

Analytical V.P.C. on kieselguhr-silicone high vacuum grease at  $140^\circ$ , p.d. 27 cms. Hg, nitrogen flowrate 25 mls./min. gave for crude product peaks for ether, pyridine, unknown material 'C' (as shoulder on pyridine peak), cyclohexanone, and unknown material 'D' (see diagram (23)). The column temperature was lowered to  $135^\circ$ , p.d. 27 cms. Hg, nitrogen flowrate 20 mls./min. and the semi-solid fraction, b.r. ( $50^\circ$ - $60^\circ$ ) analysed (see diagram (24)). The amounts of 'C' and 'D' have been reduced relative to the pyridine and cyclohexanone peaks.

Qualitative fluoride tests gave a strongly positive result for both the (50°-60°) fraction and the tar.

Further treatment of b.r. (50°-60°) fraction

The pasty mass (0.7 g.) was filtered at the pump to give crude crystalline product (0.41 g.) recrystallised from (40°-60°) petroleum ether/ether to give silky white crystals, (0.24 g.) m.p. 110°-112° (sub.). A quantity of insoluble red crystals remained (0.1 g.).

This material was soluble in water, but did not contain ionically bound chlorine, a test for chlorate was inconclusive while that for fluorine was positive.

The material was further purified by sublimation and the sublimate analysed, Found: F, 23.6%; Cl, 5.7%.

REFERENCES

58. F. Cuthbertson, Ph.D. Thesis, Durham 1957, p. 28.
59. R.E. Banks, Ph.D. Thesis Durham 1956, p. 83 et seq.
60. F. Cuthbertson, op. cit., p. 57-8.
61. L.J. Bellamy, Infra-red Spectra of Complex Molecules, Methuen 2nd ed. London 1958 p. 34 et seq.
62. W.G. Brown, Organic Reactions Vol. IV John Wiley and Sons Inc. New York p. 507.
63. F. Cuthbertson, op. cit., p. 64 et seq.
64. H. Goering and L. Sims, J.A.C.S., 1957, 79, 6270.
65. F. Cuthbertson, op. cit., p. 25.
66. R.E. Banks et al., Anal. Chim. Acta, 1955, 13, 442.
67. P. Johncock et al., Analyst, 1959, 84, 245.
68. G.M. Kosolapoff, J.A.C.S., 1953, 75, 3596.
69. A.V. Dombrovski, C.A., 49, 5484c.
70. J. Burdon and J. Tatlow, J. App. Chem., 1958, 8, 293.
71. F.D. Gunstone, J.C.S., 1952, 1274.
72. E.F. Armstrong and T.P. Hilditch, J. Soc. Chem. Ind., 1925, 44, 43T.
73. J.E. Johnson et al., J.A.C.S., 1948, 70, 3664.
74. W.G. Brown, Organic Reactions, Vol. VI, John Wiley and Sons, Inc. New York, p. 469 et seq.

75. A. von Baeyer, Ann., 1894, 278, 94.
76. H. Lindemann and H. Baumann, Ann., 477, 83, 87 and 88.
77. J.S. Winstein, J.A.C.S., 1942, 64, 2792.
78. L. Palfrey and B. Rothstein, Compt. rend., 1929, 189, 701.
79. O. Hassel and K. Lunde, C.A., 47, 8024h.
80. B. Carrol et al., J.A.C.S., 1951, 73, 5382.
81. C.M. Cooper and E.V. Fasce, Ind. and Eng. Chem., 1928, 20, 420.
82. M.C. Chabrie, Compt. rend., 1901, 132, 678.
83. Technical Bulletin DC-1819, Pennsalt Chemicals Corporation, U.S.A.

CHAPTER IV

ANALYSIS OF COMPOUNDS CONTAINING  
BROMINE, CHLORINE AND FLUORINE

ANALYSIS OF COMPOUNDS CONTAINING CHLORINE BROMINE  
AND FLUORINE

In this laboratory chlorine and fluorine in organic compounds are determined by a method involving decomposition to the sodium salts, determination of total halogen acids by alkalimetry, after passage through a cation exchange column, and determination of the chloride by the method of Vieböck. Fluoride is then obtained by difference.<sup>66, 67</sup>

The method can be used when the halogen other than fluorine is bromine or iodine, but the unfavourable equivalents of these halogens can lead to errors.

If the compound contains two other halogens and fluorine then of course only the fluorine can be determined uniquely in this way.

Since it was possible that compounds containing bromine, chlorine, and fluorine could be produced by the action of anhydrous hydrofluoric acid upon bromochloro- compounds it was desirable to have a separate method of determining bromine and then, by the usual procedure, combined bromine plus chlorine, and fluorine. Chlorine could then be found by difference.

Of the available methods for determining bromine the hypochlorite oxidation method first suggested by van der



<sup>84</sup> Meulen seemed to be the best. On a macro-scale the method has been used in modified forms by various authors <sup>85,86,87</sup> while Belcher et al. have successfully applied it on a micro-scale. <sup>88</sup> It was thought that for semi-micro work a suitable scaling up of this latter method would be applicable.

In this method a solution of the bromide buffered by sodium dihydrogen phosphate is oxidised to bromate by an excess of sodium hypochlorite solution at 95°-100°. The excess of hypochlorite is destroyed by sodium formate solution. The bromate formed liberates iodine from potassium iodide added in the presence of acid. The iodine is then determined by thiosulphate.

The reactions involved are:-

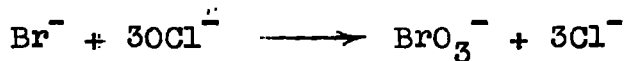

A very favourable factor here is the liberation of 3I<sub>2</sub> for every bromide ion, giving a six-fold amplified titre, in comparison with the direct alkalimetric method via the cation exchange column.

A survey of the literature showed that different opinions were held as to the amounts of reagents required, and the conditions necessary at each stage, to ensure the

quantitative nature of the whole process.

In practice some difficulty was experienced in obtaining acceptable results, and it is interesting to compare the quantities of reagents used at each stage of the process by various workers, with the quantities finally decided upon by the present worker (see TABLE I).

According to Haslam and Moses<sup>86</sup> for quantitative hypochlorite oxidation the pH of the buffered bromide solution must be in the range 4.12-7.35 and the bromide concentration must be less than 0.421 g./litre unless chloride ion is present, when it can be rather higher (van der Meulen<sup>84</sup> in fact advocated the addition of chloride ion to a bromide solution for this reason). The concentration was thus arranged to lie below the limit.

The amount of sodium hypochlorite required was found after some trial, Kolthoff and Yutzy<sup>85</sup> state that 5 mls. of 7.5% (i.e. N w.r.t.  $\text{OCl}^-$ ) is sufficient to oxidise 10 mls. of neutral 0.01 M  $\text{Br}^-$  (i.e. 7.99 mg.  $\text{Br}^-$ ). It will be seen that Belcher<sup>88</sup> prefers a much greater excess but the present worker found 4 mls. 7.5% to be sufficient for a sample containing 3 mg. bromide ion.

The amount of sodium formate used is important since too great an excess inhibits the liberation of iodine upon acidification in the final stages of the analysis.<sup>89</sup>

Again, after some investigation 5 mls. of a 50% solution was found suitable.

The phosphate buffer concentration did not appear to be critical.

The inhibiting effect of the sodium formate solution has caused some workers to suggest that after acidification the solution should be allowed to stand until the full amount of iodine is liberated.<sup>87</sup> However, this is objectionable since ariel oxidation can give rise to more iodine by the following reaction,



and some loss of iodine can occur by volatilization.

A more usual practice is to add a catalytic quantity of ammonium molybdate which speeds up the liberation of iodine by an unknown process.<sup>85,86,88</sup> It was found that a sample of technical grade ammonium molybdate was far more effective than AnalaR material for this purpose.

When the procedure had been worked out for standard bromide solutions attempts were made to determine bromide produced by the decomposition of organic bromides by the sodium biphenyl method.

Low and inconsistent results were obtained. It was found that traces of di-isopropyl alcohol, present in

TABLE I

Author	Aliquot (mls.)*	Mg. Br <sup>-</sup> in Aliquot	Wt. of NaH <sub>2</sub> PO <sub>4</sub> (g)	Vol. of NaOCl (mls)	Vol. on Heating (mls.)	Wt. of sodium formate (g)	Vol. on Acidifying (mls) (Approx.)	Wt. of KI (g)	Acid N. in Final Soln.
Belcher	20 10	1 0.5	1.2 KH <sub>2</sub> PO <sub>4</sub> 0.6	5(5%) 2.5	30 15	2.5 1.3	40 20	0.5 0.25	N
Haslam	100 10	85 8.5	4 0.4	20(7.5%)	120 12	10 2	620 62	4 0.4	6/7N
Kolthoff and Yutzy	25 10	2.0 0.8	1.0 0.4	5(7.5%)	30 12	2.5 1.0	150 60	1.0 0.4	6/7N
D'ans and Hofer	35 10	4 1.1	3 0.8	10(2.3%)	45 13	1 0.3	47 13	0.3 0.1	2/3N
Mobbs	10	3	1.4	4(7.5%)	30	2.5	35	0.5	N

\* Figures in the lower halves are calculated for a 10 mls. aliquot for comparison purposes.

the aliquot from the extraction process were the cause.  
<sup>86</sup> Haslam and other workers have noted that traces of  
<sup>85</sup> organic material affect the amount of iodine liberated.

The problem was overcome by simply evaporating  
 the 10 mls. aliquot down almost to dryness before commencing  
 the oxidation.

The main advantage of the method lies in the increased  
 accuracy of determining bromine, and to a greater extent  
 iodine because of the increased titre. White and Kilpatrick<sup>90</sup>  
 confirm that iodide is converted quantitatively to iodate  
 by the hypochlorite oxidation.

When as well as chlorine and fluorine, bromine or  
 iodine are present an aliquot of the halide solution allows  
 bromine, or iodine to be determined and then (bromide +  
 chloride) or (iodine + chloride) by the Vieböck method  
 modified as described by Belcher et al.<sup>88</sup>

<sup>88</sup> Belcher has shown that the reaction,

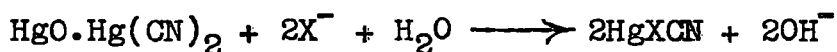

is stoichiometric for X = Br<sup>-</sup>, Cl<sup>-</sup> and I<sup>-</sup>.

However the accuracy of the process could be improved  
 by taking a neutralised aliquot from the ion exchange column  
 containing only sodium halide salts, evaporating down to a  
 suitable concentration and determining fluoride uniquely

by one of the standard methods, interfering ions having been removed.

At the time, however, it was decided to retain as much of the standard procedure as possible and no further work was done on this point.

Used in conjunction with the cation exchange column this method enables analysis of compounds containing chlorine and either bromine or iodine, and the method was in fact used for this also.

#### Preparation of reagents

In making up the solutions distilled water which had been passed through a 'Deminrolit' column was always used.

#### Methyl red solution

Methyl red was dissolved in distilled water to give a saturated solution.

#### Sodium hypochlorite solution (N w.r.t. $\text{OCl}^-$ ).

AR sodium hydroxide (44 g.) was dissolved in 750 mls. distilled water and bromine free chlorine (35.5 g.) passed in. The resultant acid solution was made alkaline by the addition of solid AR sodium hydroxide until a  $\text{pH} \approx 12$  was attained. (It was possible to use B.D.H. indicator paper which registered a colour before being bleached). The solution

was stored in a brown glass bottle at 0° and standardised with sodium arsenite solution.

When prepared and stored as above the strength of the solution changed by only 0.25% over a period of two months.

#### Sodium dihydrogen phosphate solution

AR sodium dihydrogen phosphate (69.0 g.) was dissolved in distilled water and made up to 250 mls.

#### Sodium formate solution

AR sodium hydroxide pellets (30 g.) were dissolved in distilled water, the solution cooled in ice and 90% formic acid solution (32 mls.) added slowly with stirring. The solution was diluted to 100 mls. with distilled water.

#### Ammonium molybdate solution

Technical grade B.D.H. ammonium molybdate (5 g.) was dissolved in 100 mls. distilled water.

Sodium thiosulphate solution 0.02 N

Starch solution 0.5 %

#### Procedure

Sufficient of the organic bromide is weighed out to give about 30 mg. bromide ion when decomposed.

After decomposition of the sample by the sodium biphenyl -

67

dimethoxy ethane method as described elsewhere, a 10 mls. aliquot of the solution is taken and evaporated almost to dryness. 10 mls. of distilled water are added and two drops of methyl red solution. 0.5 N hydrochloric acid is added drop-wise until the solution is just acid, and then 5 mls. of sodium dihydrogen phosphate solution.

10 mls. distilled water and 4 mls. 7.5% sodium hypochlorite are added and after covering the conical with a watch glass, the solution is heated just to boiling in the course of 10-15 minutes.

The watch glass and conical sides are carefully washed down with a fine jet of distilled water and 5 mls. sodium formate solution are added. The solution is then allowed to cool to room temperature with frequent swirling.

Lingering amounts of gaseous chlorine which may be present are swept out of the flask by a stream of nitrogen, and 0.5 g. of AR potassium iodide added followed by 5 mls. 9N sulphuric acid and 2 drops 0.5% ammonium molybdate solution.

The solution is then allowed to stand for 15 mins. and titrated with standard sodium thiosulphate in the usual way. Bromine found is calculated from:-

1 ml. 0.02N  $\text{Na}_2\text{S}_2\text{O}_3$  = 0.2664 mg. bromine.

At the same time a blank is run using 10 mls. of



distilled water in place of the halide solution. The resultant sodium thiosulphate titre is subtracted

### Bromine and fluorine present

Bromine is determined as above, total halogens by alkalimetry after passage through the cation exchange column, and fluorine by difference.

### Bromine and chlorine present

As above, chlorine found by difference.

### Bromine, chlorine, and fluorine

Bromine is determined as above, total halogens by passage through an ion exchange column and alkalimetry, and (bromide plus chloride) by the Vieböck procedure. Hence chlorine and fluorine are found by difference.

### Results:

Compound	Found			Calculated		
	Br <sup>-</sup>	Cl <sup>-</sup>	F <sup>-</sup>	Br <sup>-</sup>	Cl <sup>-</sup>	F <sup>-</sup>
KBr solution	0.00284			0.00279		
Bromobenzene	50.8			50.9		
1,2-dibromocyclohexane	64.9			66.0		
p-bromotoluene	45.6			45.1		
(bromobenzene + fluorobenzene)	50.4		19.8	50.9		19.8
(bromobenzene + cyclic C <sub>6</sub> F <sub>8</sub> Cl <sub>4</sub> )	50.0	39.4	42.4	50.9	38.8	41.6
dichlorocyclohexane + bromochlorocyclohexane	22.6	30.7		22.8	30.4	

REFERENCES

84. Meulen, J.H. van der, Chem. Weekblad., 1931, 28, 82, 238 and 1934, 31, 558.
85. I.M. Kolthoff and H. Yutzy, Ind. and Eng. Chem., Anal. Ed., 1937, 9, 75.
86. J.H. Haslam and G. Moses, Analyst 1950, 75, 343.
87. J. D'Ans and P. Höfer, Z. angew. Chem. 1934, 47, 73.
88. R. Belcher et al., Mikrochem. Acta. 1954, 4, 104.
89. W.P. Ford et al., J. Soc. Chem. Ind. (Trans.) 1940, 59, 177.
90. L.M. White and M.D. Kilpatrick, Analyst. Chem. 1950, 22, 1049.

CHAPTER V

GAS CHROMATOGRAPHY

## GAS CHROMATOGRAPHY

Gas-liquid partition chromatography has been used extensively in both parts I and II of this work for analytical and preparative separations. The high vapour pressures of chlorofluorocyclohexanes and fluorocyclohexanes coupled with the fact that these very similar compounds often form azeotropic mixtures inseparable by distillation, makes the application particularly suitable.

As far as the work on cyclohexanes containing few halogen atoms is concerned the analytical technique was used principally to control fractionation, the preparative technique in general not being applicable, because of possible dehydrohalogenations occurring on the much longer column.

The general arrangement of the system used is given in diagram I.

Nitrogen was used as the carrier gas, and the pressure drop across the column, which controls the nitrogen flow rate, was set by means of the two needle valves 1 and 2, at the inlet and outlet sides of the column. An oil-pump was used as the source of reduced pressure.

Initially as a detector a glass thermal conductivity cell containing platinum wire resistances was used, similar to that

described by Cuthbertson and Musgrave.<sup>2b</sup> However the stability of this system was not good at elevated temperatures and the thermistor detector, a modified form of that described by Musgrave,<sup>91</sup> was used for the greater part of the work.

This type of detector has a high sensitivity since the thermistors have a large temperature coefficient of resistance and being small in size can be enclosed in a small volume, so that the concentration of the organic vapour, when being eluted from the column and passing through the detector, is high.

Other workers<sup>92,93,94</sup> have described similar detectors and the Perkin-Elmer Corporation of the United States of America use one in their commercial apparatus.

The thermistors (Type A, Stantel Ltd.) were sealed into holes drilled in a brass or aluminium block by means of a cold curing silicone rubber (Midland Silicones Ltd.), which has shown itself capable of withstanding temperatures up to 200°C for the two years that the apparatus has been used, and which still shows no signs of deterioration, (see diagram II).

The practice of passing a stream of pure nitrogen over a reference thermistor was discontinued when it was found to add nothing to the stability, and the thermistor

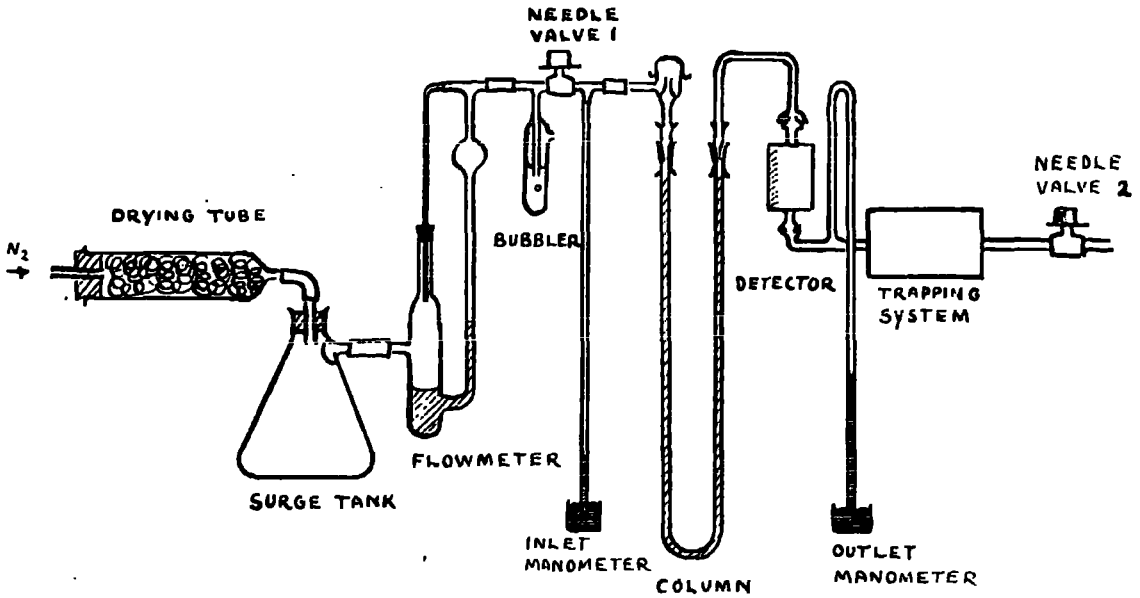

DIAGRAM I

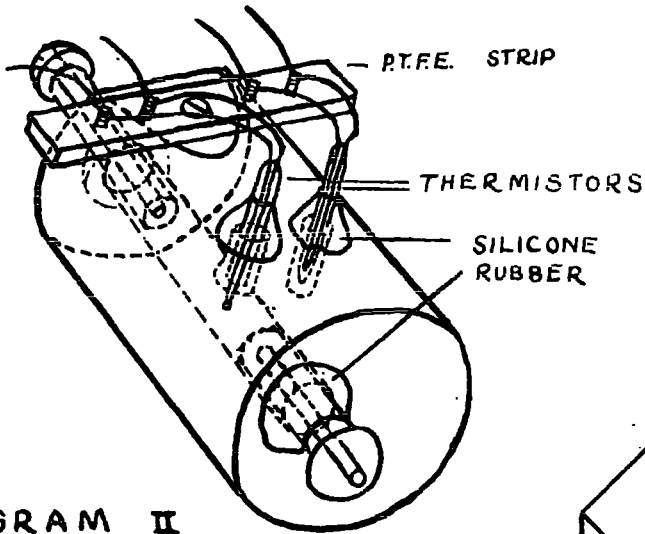

DIAGRAM II

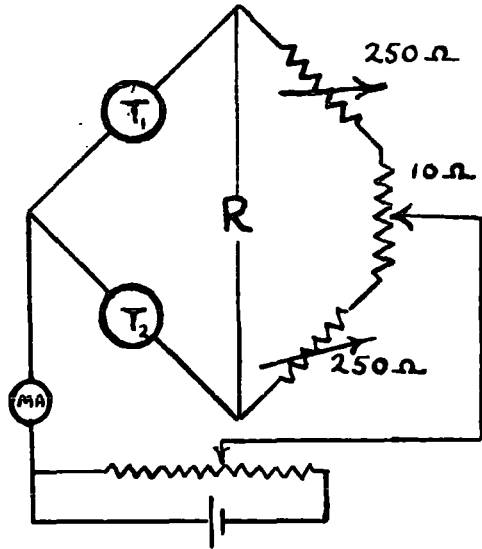

DIAGRAM III

was merely sealed into a hole in the block. The other thermistor, after cutting off the glass sheathing, was sited directly in the stream of effluent gas from the column.

At first, two 500,000  $\Omega$  thermistors were employed for work in the temperature range 150°-200°, and were perfectly satisfactory when a galvanometer was being used to record the out of balance potential. When a Sunvic automatic recorder became available the impedance of the bridge circuit proved to be too great for satisfactory working and two 2,000  $\Omega$  thermistors were subsequently used at all temperatures, although the sensitivity fell off with increase of temperature.

The resistance of each thermistor, initially 2,000  $\Omega$  at room temperature, was not completely reversible with temperature, and moreover each thermistor resistance tended to change by a different amount with the passage of time. To prevent the need for continually changing fixed compensating resistances two variable helical wire-wound resistances of value 250 ohms, were placed in each other bridge arm, and connected via a 10 ohm helical potentiometer for fine adjustment. The bridge was driven by a 2 volt accumulator connected in parallel with a 2,000 ohm resistance, so that the voltage could be varied to maintain approximately

the same sensitivity at various temperatures. (see diagram III).

In early versions of the apparatus the column and detector were heated in separate heaters but to minimise dead-space and condensation troubles they were later both incorporated in a single heating cabinet.

The design of this heating cabinet is evident from diagram IV. A fan was used to blow air over two 1 kw. heaters to which a variable voltage could be supplied by means of a 'Variac' auto-transformer. The hot air passed through the perforated floor of the cabinet and heated the interior. This arrangement was found to be satisfactory at temperatures from  $20^{\circ}$ - $200^{\circ}$  although at the higher temperatures the bottom of the oven could be as much as  $10^{\circ}$  higher than the top. Since a steady temperature gradient was obtained the stability of the detector was unaffected by this.

When the detector was placed in the cabinet unshielded and unlagged an unsteady base line was obtained on the recorder, and this was attributed to air blowing past the detector. The trouble was easily rectified by enclosing the detector in an asbestos box, or lagging it thoroughly with asbestos rope (see diagram IV).

To further minimise dead-space and condensation



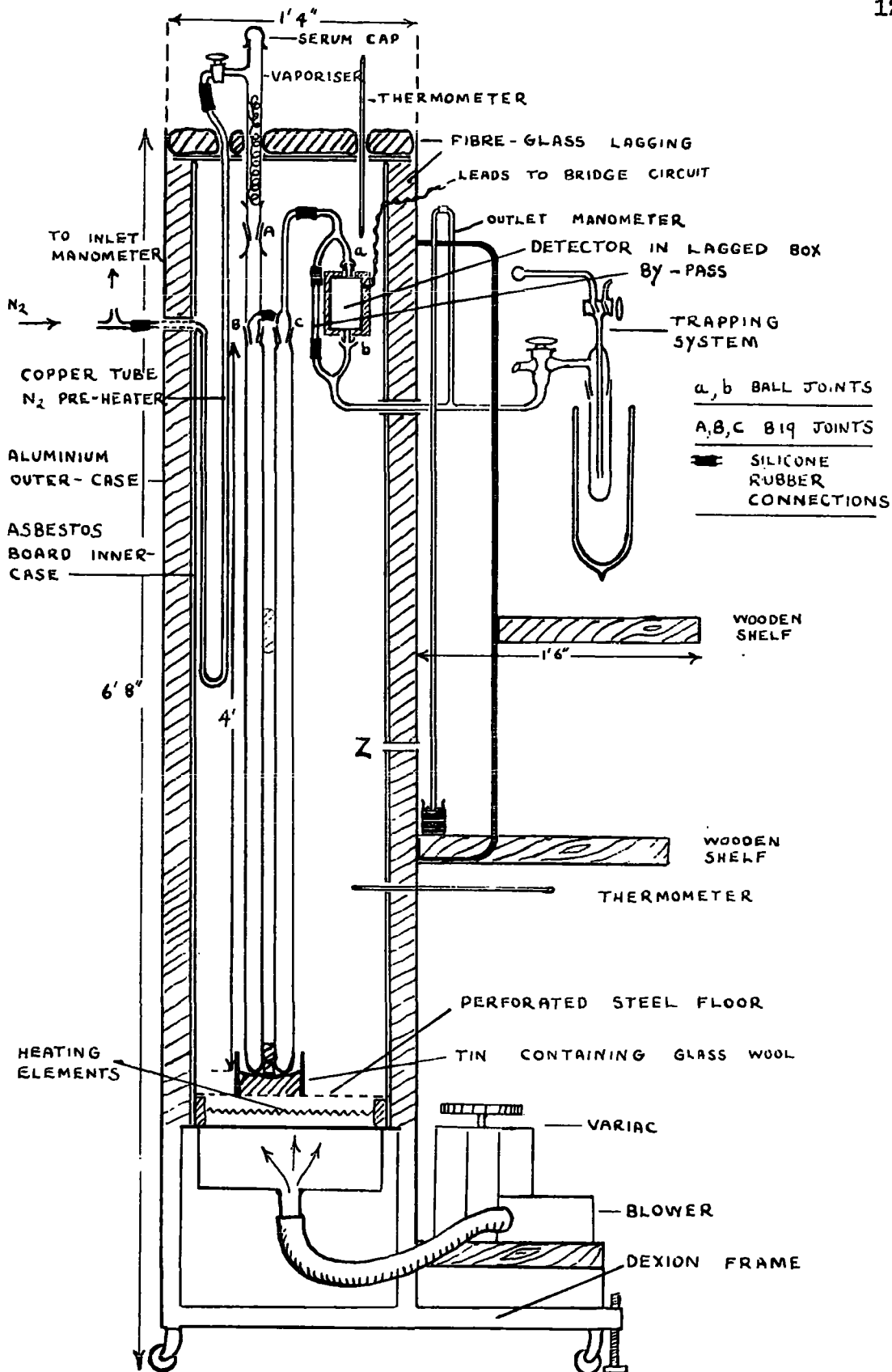
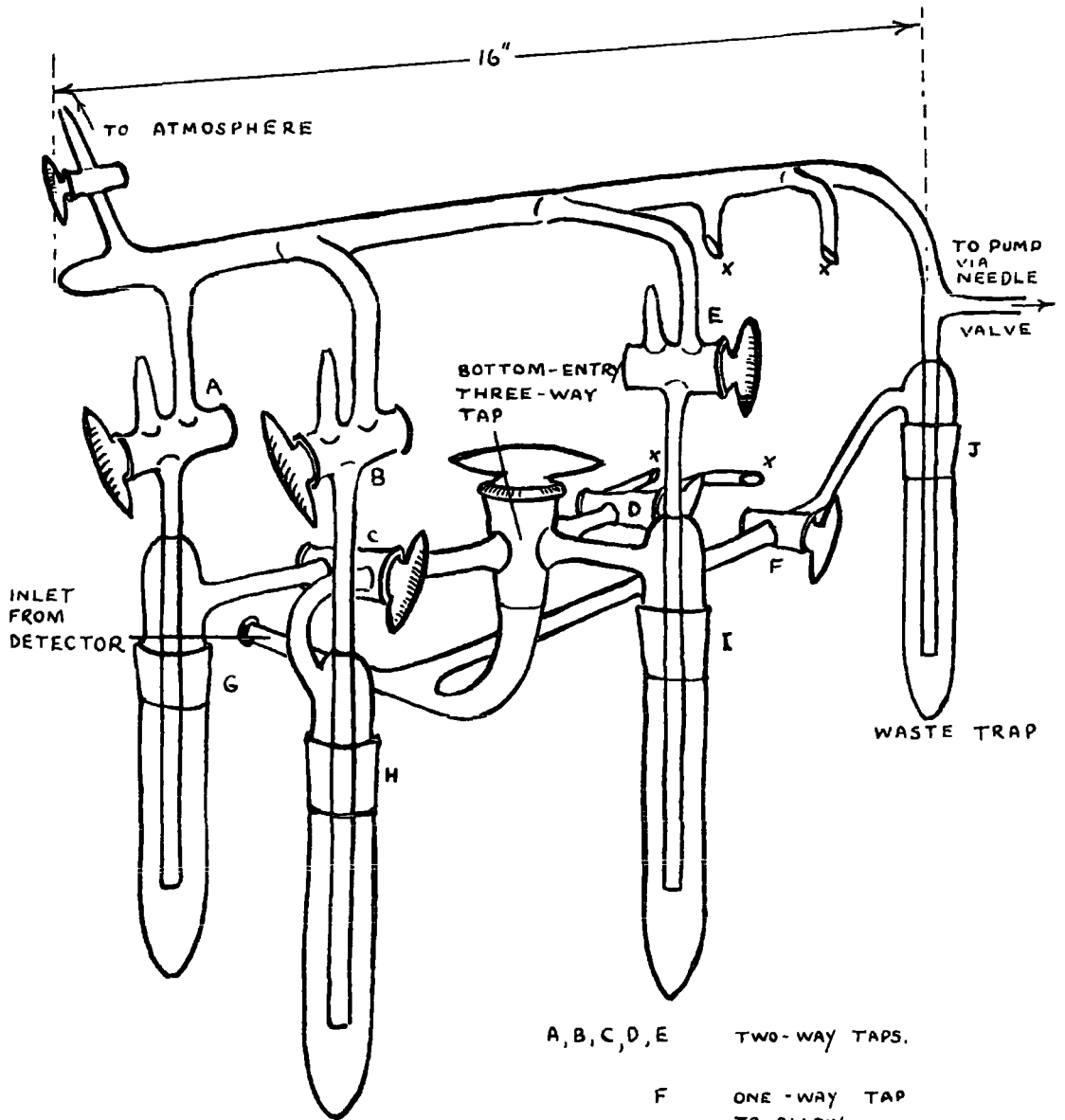

DIAGRAM IV



- A, B, C, D, E      TWO-WAY TAPS.
- F                    ONE-WAY TAP TO ALLOW BY-PASSING OF TRAPPING SYSTEM.
- G, H, I, J          B.24 TRAPS.
- X                    AT THESE POINTS TWO MORE B.24 TRAP UNITS ARE FITTED.

DIAGRAM V

troubles the trapping system described by Cuthbertson<sup>95</sup> was abandoned and a more compact one incorporating a three-way tap and two two-way taps used. The lay-out of this system is clear from diagram V, and its position in relation to the oven from diagram IV.

The connecting tubes leading to the traps were conveniently heated with Simmerstat controlled heating tapes to prevent condensation.

When a preparative column is used, in order to obtain results comparable to those obtained analytically the flow/unit area through the columns should be of the same order. This however means that the flow through the detector is very much greater with a preparative column and this causes instability. Quite often it was found satisfactory to operate the preparative columns at a low flow/unit area, and in some cases better resolution was obtained. At other times a by-pass system was used, the design being apparent from diagram IV.

It was possible, in some cases, with this system to duplicate corresponding analytical chromatograms exactly and much less broadening of the peaks was observed. The

sensitivity of the system was also much greater although only a portion of the organic vapour was flowing through the detector. Presumably the increased vapour concentration due to the 'sharpened' peaks more than offset this factor. The ratio of the cross-sectional areas of the by-pass tube, and detector channel was 2:1 and the sensitivity could be altered by substituting by-pass tubes of different diameters.

When small quantities of material (ca. 0.5 ml.) were required to be separated, a semi-micro preparative column was used which was also enclosed in the oven and which led via a separate detector to a smaller compact trapping system, similar to the larger one described, but having only three B.10 traps connected directly to a bottom-entry three-way tap. For the sake of clarity this apparatus is not shown in position in diagram IV, but the detector was mounted about half-way down the oven, the outlet passing through the wall at **Z** to the trapping system, mounted above the lower wooden shelf. The column head came through the oven top as with the larger apparatus.

In the later stages of the work a Griffin and George Mk II B. apparatus became available and was then used for analytical work and for small-scale separations.

The sizes of the columns and the packings used are indicated at appropriate points in the text, further data

is given below.

Columns (see diagram VI)

(1) Analytical

(a) 5' x  $\frac{3}{16}$ " int. diam. pyrex U-tubes containing ca. 17 g. packing.

(b) Griffin and George analytical columns:-  
two U-tubes, 3' x  $\frac{1}{4}$ ", joined by a flexible metal capillary, and containing ca. 50 g. packing.

(ii) Semi-micro preparative

Twin U-tubes joined by a capillary, total length 9'7", int. diam.  $\frac{5}{16}$ " containing ca. 80 g. packing.

(iii) Preparative columns

U-tubes 8' x  $\frac{7}{8}$ ", each containing ca. 375 g. packing, used separately, or joined together as double U-tubes to form 16' lengths.

An attempt was made to use three such U-tubes connected together, but the increased spread of the peaks offset the larger peak separation obtained, and no advantage was gained.

Stationary phases

Analytical, Silicone high vacuum grease, Apiezon L

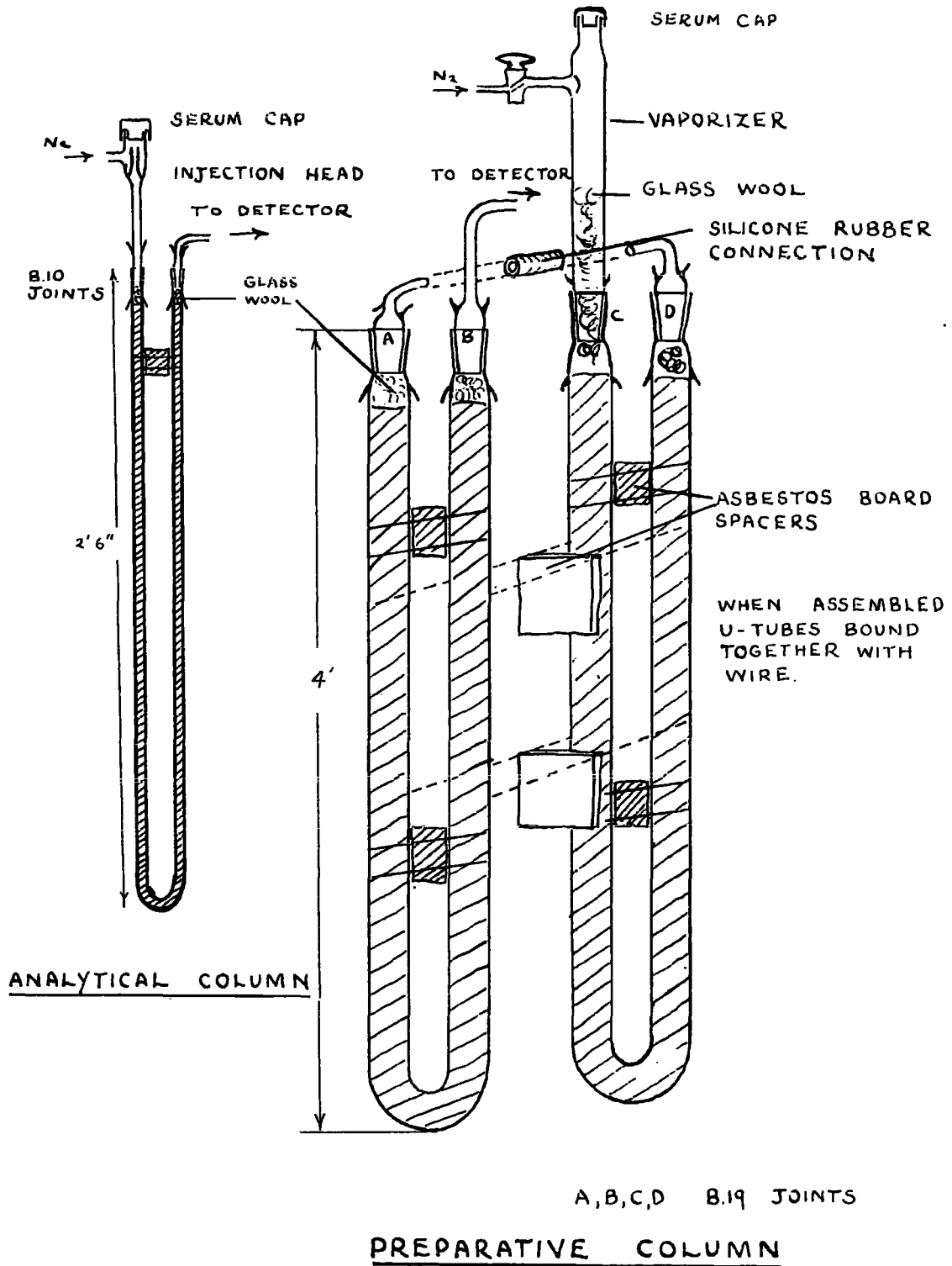

DIAGRAM VI

grease, tricresyl phosphate, dinonyl phthalate, silicone trimer Reoplex 400 plasticiser, and Edwards 8A high vacuum oil.

Preparative Silicone high vacuum grease, tricresyl phosphate, dinonyl phthalate.

### Preparation of the packing

Following the experience of previous workers it seemed that a ratio of 10:4 parts w/w inert support to stationary phase was satisfactory and this was always used.

The stationary phase was dissolved or suspended in a suitable solvent and the support added gradually with continuous stirring as far as possible. After drying the packing in the oven final traces of solvent were removed by actually operating the column.

The packing was introduced into the column which was tapped by a piece of pressure tubing until no further settling was observed. A fairly uniform packing was obtained in this manner .

### Introduction of samples

(i) Analytical samples 1-4 drops 0.02 mls. were injected through the serum cap using a 1 ml. Summit syringe.

(ii) Preparative samples When the preparative column

was being used the preferred method was to keep a reduced pressure of a few centimetres at the inlet side of the column, and to shut off the nitrogen stream by means of the tap attached to the vaporizer (see diagram IV). The sample was then injected into the vaporizer (pre-heated simply by a gas flame) and went onto the column as a 'plug' under its own vapour pressure. Recent work has indicated that this is in fact the best method of injecting a large sample.<sup>96</sup> The sample size varied according to the difference in retention times of the components to be separated. In favourable cases where the peaks were widely separated as much as 10 g. could be injected at one time in this way.



REFERENCES

91. W.K.R. Musgrave, Chem. and Ind., 1959, 46.
92. D. Ambrose and R. Collerson, J. Sci. Inst. 1955, 32, 323.
93. A.D. Davis and G.A. Howard, J. App. Chem. 1958, 8, 183.
94. L.C. Browning and J.O. Watts, Anal. Chem. 1957, 29, 24.
95. F. Cuthbertson, Ph.D. Thesis, Durham 1957, p. 41.
96. W.J. de Wet and V. Pretorius, Anal. Chem., 1960, 32, 169.

PART II      HIGH TEMPERATURE DEHALOGENATION REACTIONS  
OF PERCHLOROFLUOROCYCLOHEXANES AND CHLORO-  
FLUOROCYCLOHEXANES.

CHAPTER I

INTRODUCTION

## INTRODUCTION

The reaction between chlorine trifluoride and benzene<sup>1,2</sup> carried out under various conditions has yielded saturated chlorofluorocyclohexanes of the general formula  $C_6F_{12-n}Cl_n$  ( $n = 1$  to  $4$ ) and various hydrogen containing chlorofluorocyclohexanes.

Cobalt trifluoride upon hexachlorobenzene in the vapour phase<sup>3</sup> gave better yields of saturated chlorofluorocyclohexanes of general formula  $C_6F_{12-n}Cl_n$  ( $n = 1$  to  $5$ ).

In the past compounds of this type have generally been dehalogenated by the action of zinc dust in a solvent, usually ethanol.

McBee and co-workers,<sup>4,5</sup> after fluorinating hexachlorobenzene with bromine trifluoride followed by antimony pentafluoride to give a product of average composition  $C_6Cl_4F_7Br$ , dehalogenated the material with zinc dust and ethanol. The perfluorocyclic compounds  $C_6F_6$ ,  $C_6F_8$  and a number of unsaturated chlorofluorocyclic compounds  $C_6F_7Cl$ ,  $C_6F_6Cl_2$ ,  $C_6F_7Cl_3$ , and  $C_6F_5Cl_3$  were isolated but no attempt was made to realise their configurations.

Johncock<sup>6</sup> used zinc and butyl alcohol to dehalogenate cyclic  $C_6F_8Cl_4$  and cyclic  $C_6F_7Cl_5$ . From cyclic  $C_6F_8Cl_4$  he obtained cyclic  $C_6F_6$  and octafluorocyclohexa-1,4-diene in 20% yield, cyclic  $C_6F_7Cl$  in 10% yield, cyclic 1H- $C_6F_7$

1:4-diene, and a cyclic  $C_6F_7H$ , both in approximately 6% yield.

Cyclic  $C_6F_7Cl_5$  with the same reagents yielded 65% cyclic  $C_6F_6$ , 7% cyclic  $C_6F_5Cl$  and 4% of a cyclic  $C_6F_5H$ .

Johncock<sup>7</sup> also investigated the action of potassium graphite upon cyclic  $C_6F_9Cl_3$ . Using a solvent, methylcyclohexane, he found that very little halogen was extracted, even with a molar ratio of  $KC_8$ :cyclic  $C_6F_9Cl_3$  of 26:1 only traces of perfluorobenzene were obtained. Considerable reaction with the solvent occurred.

When no solvent was used a vigorous reaction with flame ensued, and only 3 and 4% of perfluorobenzene and octafluorocyclohexa-1:4-diene respectively, were obtained.

Johncock<sup>8</sup> also investigated the possibility of removing halogen from this type of compound by using organo-lithium and organo-sodium reagents.

With phenyl lithium and cyclic  $C_6F_{11}Cl$  at room temperature 40% starting material was recovered and 12% of the coupled product  $C_6H_5.C_6F_9$ . None of the anticipated cyclic  $C_6F_{10}$  was found, and no other fluorine containing compounds were isolated.

With phenyl sodium, under the same conditions 35% start-

ing material was recovered, 6% cyclic  $C_6F_{10}$  and 8%  $C_6H_5.C_6F_9$ , again no other fluorine containing materials were recovered. In both these reactions about 30-40% of the starting material was unaccounted for and this was thought to be due to the instability of the cyclic  $C_6F_{11}M$  (M = Li, or Na) formed by:-

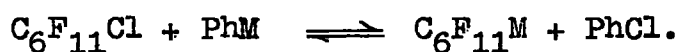

However it is difficult to see why more cyclic  $C_6F_{10}$  was not isolated if this is the case since the normal reaction of a lithium fluoroalkyl is the elimination of lithium fluoride to give a fluoro-olefine.

Recently Gething, Patrick, Stacey and Tatlow<sup>9</sup> have reported the defluorination of perfluoro-cyclohexane and -cyclohexane derivatives, to perfluorobenzene and the corresponding perfluorobenzenes, by passing them over a clean metal surface (iron or nickel) at 400°-600°.

Perfluoromethylcyclohexane was defluorinated at 500° over iron gauze to give a 25% yield of perfluorotoluene. Similarly perfluoroethylcyclohexane at 490° gave a 23% yield of perfluoroethylbenzene while perfluoro-p-dimethylcyclohexane at 660° gave a 45% yield of perfluoro-p-xylene.

It was anticipated that chlorofluorocyclohexanes

would be more susceptible to this process because of the weaker C-Cl bond present, and a programme of dehalogenations was decided upon, using as starting materials the products from the fluorination of hexachlorobenzene with cobalt trifluoride, and the products from the vapour phase chlorofluorination of benzene.

REFERENCES

1. J.F. Ellis and W.K.R. Musgrave, J.C.S., 1950, 3608.
2. R.E. Banks, Ph.D. Thesis, Durham 1956.
3. P. Johncock, Ph.D. Thesis, Durham 1959.
4. E.T. McBee et al., Ind. Eng. Chem., 1947, 39, 378.
5. E.T. McBee et al., C.A., 1952, 46, 8675.  
U.S.P., 2,586,364.
6. P. Johncock, op. cit., p. 122.
7. idem, ibid p. 127 et seq.
8. idem, ibid p. 133 et seq.
9. B. Gething, C.R. Patrick, M. Stacey and J.C. Tatlow, Nature, 1959, 183, 588.



CHAPTER II

DISCUSSION OF THE EXPERIMENTAL WORK

AND THE RESULTS

DEHALOGENATIONS - DISCUSSION OF RESULTS

I. Cyclic  $C_6F_{12-n}Cl_n$  ( $n = 1$  to  $5$ ) compounds

When hexachlorobenzene was fluorinated with cobalt trifluoride and cyclic compounds of general formula  $C_6F_{12-n}Cl_n$  ( $n = 1$  to  $5$ ) obtained it was assumed that all isomers of each molecular formula were present. Other workers<sup>10,11,12</sup> have shown that the isomers have very similar properties distilling over as one unit and being inseparable by vapour phase chromatography on packings so far used. As yet no method has been found of separating them.

It is known that in fluorinations of this sort chlorine can be removed from, and then re-enter, the organic molecule in a different position. Tatlow and Worthington<sup>11</sup> fluorinated o-dichlorobenzene with cobalt trifluoride and obtained some cyclic  $C_6F_9Cl_3$ . However from steric considerations we should not expect that the chlorine atom would attach itself to a carbon already bearing one. Also in the lithium aluminium hydride reduction of the cyclic  $C_6F_{10}Cl_2$  isomers obtained by Johncock, no 1,1-dihydrodecafluorocyclohexane was obtained, although the cis- and trans- forms of the 1,2-, 1,3- and the cis form of the 1,4- dihydro- isomers were shown to be present

(Johncock, *op. cit.* p. 45 et seq.).

We can therefore fairly safely assume that no gem-dichloro-groupings are present in these materials and hence produce a reaction scheme, showing how possible dehalogenation products could arise, which considers the remaining isomers only. (see SCHEME I).

In constructing this reaction scheme it is assumed that the isomerisation and disproportionation reactions which occurred with the cyclic perfluorodienes, and the isomerisation reaction which occurred with the cyclic hydrofluorodienes<sup>13</sup> also occur with chlorinated cyclic fluorodienes. In the reaction scheme shown only the dehalogenations of cyclic  $C_6F_{10}Cl_2$  and  $C_6F_9Cl_3$  are outlined, since these two compounds gave significant amounts of chlorine containing product under the conditions used, whereas the others did not. If all chlorine (together with the requisite amount of fluorine) is eliminated from the molecule the products, from all the compounds dehalogenated, can only be cyclic  $C_6F_{10}$ , the two isomeric cyclic perfluorodienes and cyclic  $C_6F_6$ . (This is of course ignoring possible products where fission of the ring occurs.)

Inclusion of a detailed dehalogenation scheme for the

# REACTION SCHEME I

**KEY**

<u>df</u>	DEFLUORINATION.	<u>NB</u>	FLUORINE ATOMS ARE
<u>dc</u>	DECHLORINATION		PRESENT AT VACANT
<u>dcf</u>	DECHLOROFLUORINATION.		VALENCIES
<u>dp</u>	DISPROPORTIONATION.		

①  $C_6F_{10}Cl_2$

a) BOTH CHLORINES ELIMINATED

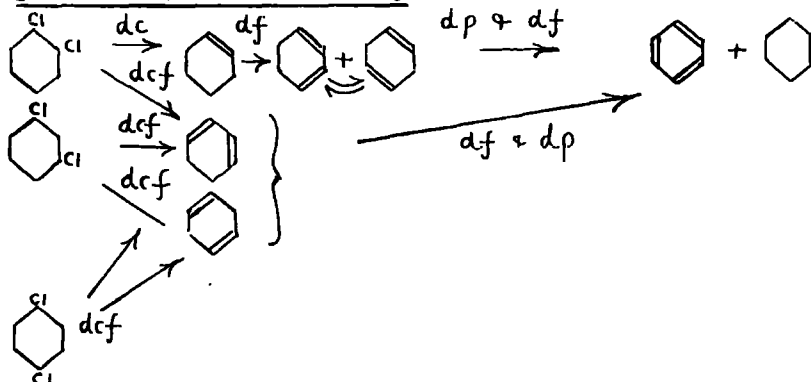

b) ONE CHLORINE RETAINED

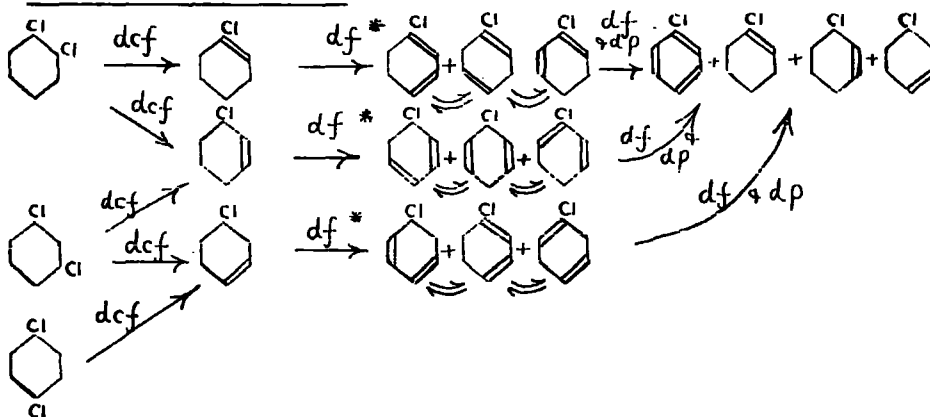

c) BOTH CHLORINES RETAINED

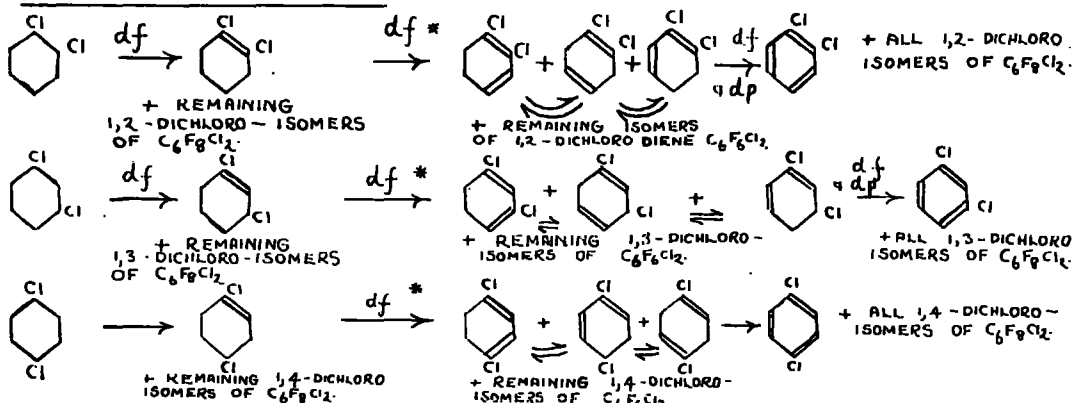

\* ONLY DIENES ARISING FROM THE MONO-OLEFIN BY DIRECT DEFLUORINATION ARE SHOWN, ISOMERISATION CAN LEAD TO ADDITIONAL STRUCTURES.

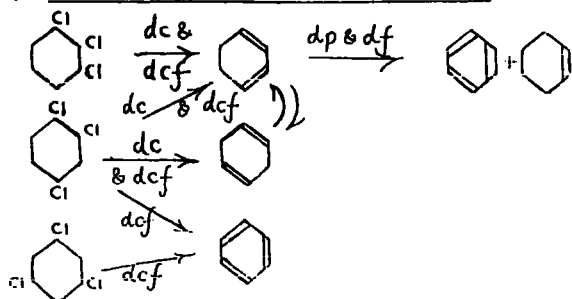
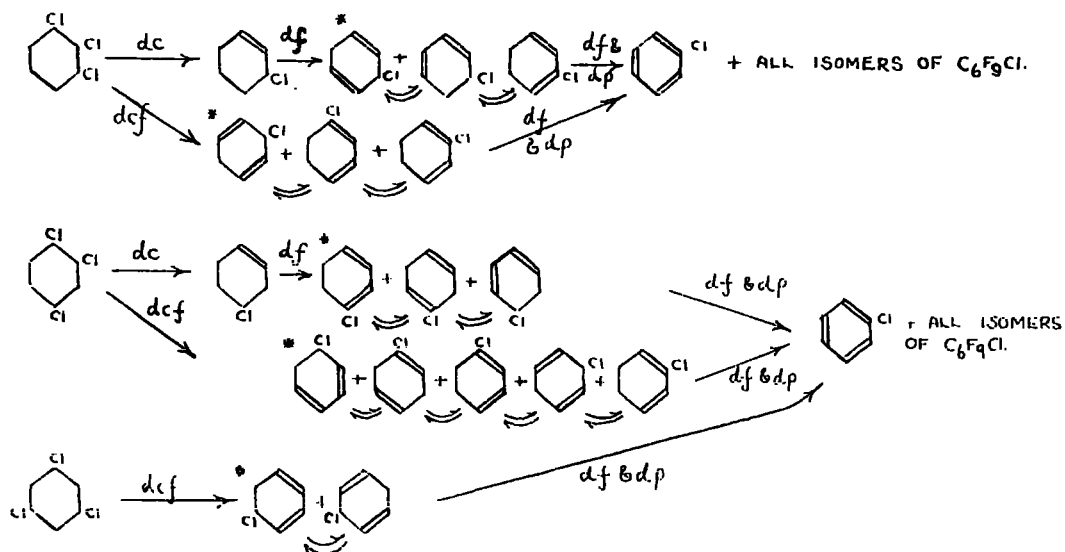
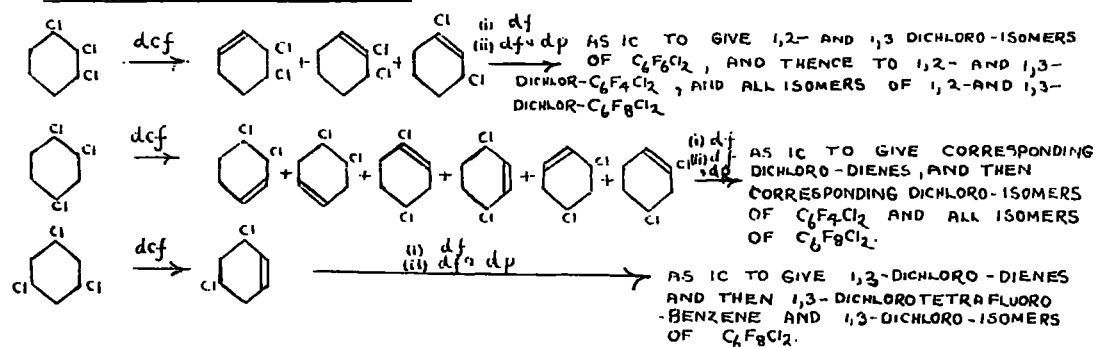
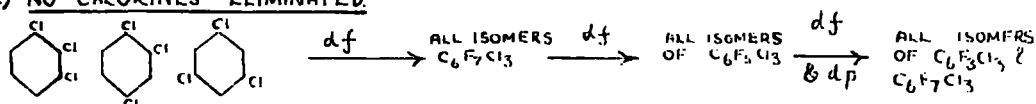
②  $C_6F_9Cl_3$ a) THREE CHLORINES ELIMINATEDb) TWO CHLORINES ELIMINATEDc) ONE CHLORINE ELIMINATEDd) NO CHLORINES ELIMINATED

\* ONLY DIENES ARISING BY DIRECT DEHALOGENATION OF THE MONO-OLEFINE ARE SHOWN. ISOMERISATION CAN LEAD TO ADDITIONAL STRUCTURES

remaining cyclic  $C_6F_{12-n}Cl_n$  compounds is not therefore really necessary since application of the principles illustrated enables the possible products to be derived. A few remarks can however be made about the remaining compounds.

Retention of the chlorine atom in cyclic  $C_6F_{11}Cl$  leads to all isomers of cyclic  $C_6F_9Cl$   $C_6F_7Cl$ , and to chloropentafluorobenzene.

Retention of varying amounts of chlorine in both cyclic  $C_6F_8Cl_4$  and  $C_6F_7Cl_5$  leads to chlorofluorocyclohexenes, chlorofluorocyclohexadienes and chlorofluorobenzenes. It is worth noting that complete removal of chlorine from cyclic  $C_6F_7Cl_5$  must give solely perfluorobenzene, this is not so for certain isomers of cyclic  $C_6F_9Cl_4$ .

These dehalogenations almost certainly do not occur in the step-wise manner shown but some simplification had to be made to prevent the whole scheme from becoming too unwieldy. However even if several processes proceed together there can be no products other than those shown in the scheme.

The results of the dehalogenations carried out are given in TABLE I and show that under these particular conditions only a few of the theoretically possible products are obtained. As was expected, chlorine is

TABLE I

Starting Material	Reactor temp. °C	Products and % yield from Starting Material					Starting Material
		Cyclic C <sub>6</sub> F <sub>10</sub>	Cyclic 1:4-C <sub>6</sub> F <sub>8</sub>	Cyclic 1:3-C <sub>6</sub> F <sub>8</sub>	Cyclic C <sub>6</sub> F <sub>7</sub> Cl	Cyclic C <sub>6</sub> F <sub>6</sub>	
Cyclic C <sub>6</sub> F <sub>11</sub> Cl	625 350 430	COMPLETE	DECOMPOSITION			15.2	69
Cyclic C <sub>6</sub> F <sub>10</sub> Cl <sub>2</sub>	430 375	15.4 25.7		2.2	5.6	10.9	30 10.2
Cyclic C <sub>6</sub> F <sub>9</sub> Cl <sub>3</sub>	430 340		10.9	4.6	26.6	11.0	22.5
		0.5	5.7	60*		6.8	
Cyclic C <sub>6</sub> F <sub>8</sub> Cl <sub>4</sub>	430					70.0	
Cyclic C <sub>6</sub> F <sub>7</sub> Cl <sub>5</sub>	430					43.5	

\* This yield has been calculated using an average molecular weight.

preferentially removed from the molecule, and in runs carried out at  $430^{\circ}$  the products from each compound were mainly perfluorocyclohexene and/or perfluorobenzene. At this temperature only cyclic  $C_6F_9Cl_3$  gave any significant yield of chlorine containing product. Even so this compound is probably not anomalous since the time of introduction of the material into the reactor for this run was shorter than usual (see Table VI p 187). It was an extremely difficult task to distil these materials into the reactor at a steady predetermined rate. We should in this case expect less conversion to perfluorobenzene and there is little doubt that a run carried out with a more normal time of introduction would give mainly perfluorobenzene as a reaction product.

Very small amounts of some chlorine containing material appeared in the vapour phase chromatograms of the dehalogenated products from cyclic  $C_6F_{12-n}Cl_n$  ( $n = 2$  to  $5$ ) as a small peak having a retention time somewhat greater than that of perfluorobenzene. Infra-red and analytical V.P.C. evidence indicated that this was the same material in each case but its identity was not discovered.

At first it was thought that it might be chloropentafluorobenzene, but the authentic material was synthesised



(see p. 216) and proved to have a much greater retention time and different infra-red spectrum. Since the material arises from, inter alia cyclic  $C_6F_{10}Cl_2$  it cannot contain more than two chlorine atoms (unless chlorine can re-enter the organic molecule when ferric fluoride and ferric fluoride are present, c.f. fluorinations with cobalt trifluoride).

If chloropentafluorobenzene was formed in these dehalogenations it can only have been in very small amounts since it was never detected by analytical V.P.C.

In order to obtain more products containing chlorine cyclic  $C_6F_{10}Cl_2$  and cyclic  $C_6F_9Cl_3$  were dehalogenated at lower temperatures of  $375^\circ$  and  $340^\circ$  respectively. Unfortunately there was not enough of the tetrachloro- and pentachloro- compounds to dehalogenate similarly but these would have certainly given interesting results.

Both cyclic  $C_6F_{10}Cl_2$  and cyclic  $C_6F_9Cl_3$  gave rise to a chloroheptafluorocyclohexadiene which had a retention time on kieselguhr-tricresyl phosphate just less than that of octafluorocyclohexa-1:3-diene and which could not be completely separated from it even at room temperature. Thus the material was not obtained pure and its configuration could not be established. There

are five possible structures for the molecule:-

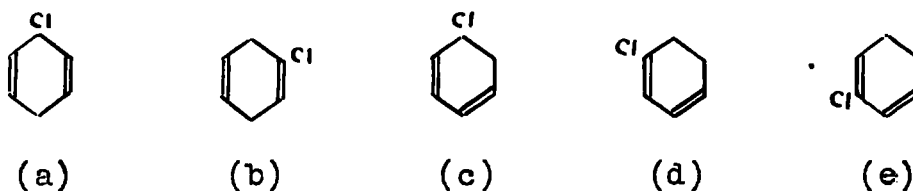

It is considered that the conjugated 1:3-diene would be more stable than the non conjugated 1:4-diene, structure (c) is not considered likely because of the great ease with which chlorine and fluorine could be lost to yield cyclic  $C_6F_6$ . The most likely structures are those of (d) and (e). Infra-red analysis supported a conjugated structure.

The presence of substantial amounts of a material with this structure does not necessarily mean that chloropentafluorobenzene should also be present, arising from the defluorination of the diene. It could be that under the milder reaction conditions used further removal of fluorine would not occur to aromatise the molecule. This is not invalidated by the presence of an 11% yield of perfluorobenzene since this could quite easily have arisen from the dechlorofluorination of the 1,2,4- and 1,3,5-trichloro- isomers (see reaction scheme I 2(a)).

What is more likely is that isomerisation of (d) and

(e) takes place to give (c) and hence perfluorobenzene as previously explained. In view of the greater ease with which chlorine is removed this is to be expected.

Isomerisation of the octafluorocyclohexadienes has been reported and also an isomerisation of a cyclic heptafluorodiene which has some bearing on this point.<sup>13</sup> 1H-heptafluorocyclohexa-1:3-diene on defluorination over steel Dixon gauzes at 570° gave pentafluorobenzene and a small quantity of hexafluorobenzene which was probably formed by dehydrofluorination of the isomeric 6H-heptafluorocyclohexa-1:3-diene with a >CHF group.

As will be seen from an inspection of the reaction scheme, perfluorocyclohexene can arise by direct dehalogenation or by disproportionation of an intermediate fluorodiene. This latter process does not take place to any great extent (Gething et al. loc. cit.) but will account for the formation of the small amount of perfluorocyclohexene from cyclic  $C_6F_9Cl_3$ , since this cannot arise by direct dehalogenation.

Perfluorocyclohexene was not detected in the cyclic  $C_6F_8Cl_4$  reaction product although it could arise by the dechlorination of the 1,2,3,4- and 1,2,4,5- tetrachloroisomers and disproportionation of the cyclic diene formed.

There are obvious lines along which further work could proceed, the dehalogenation of cyclic  $C_6F_8Cl_4$  and cyclic  $C_6F_7Cl_5$  at a lower temperature would probably give rise to interesting products, although it seems unlikely that chloropentafluorobenzene would be produced in this way. It is clear that reactor temperature, nitrogen flow-rate, and through-put rate, greatly affect the nature and yield of products, and this aspect could be looked into with a view to improving the yields.

II. Materials produced by the action of chlorine trifluoride on benzene in the vapour phase

After dehalogenating the pure chlorofluorocyclohexanes it was an obvious step to dehalogenate the material produced by the action of chlorine trifluoride upon benzene in the vapour phase, since other workers<sup>2,3</sup> in this laboratory had shown that this material, produced in reactions with a variety of chlorine trifluoride-benzene ratios, contained chlorofluorocyclohexanes of general formula  $C_6F_{12-n}Cl_n$  ( $n = 1$  to  $4$ ) and cyclic material of general formula  $C_6F_xCl_yH_z$  ( $x + y + z = 12$ ).

There was, however, also the possibility that if good yields of perfluoro- and pentafluoro- benzenes were obtained, then there would be available a two stage route to these useful aromatic compounds, starting with readily

available benzene and chlorine trifluoride. There would possibly be some advantage in this process over that using cobalt trifluoride where discontinuity is introduced by the regeneration of the fluorinating agent.

A further advantage would be the possibility of obtaining some chlorofluoroaromatics especially if the chlorofluorination product contained some gem dichloro-groups, a point which has never been resolved.

Reaction product was available from a run where a very large chlorine trifluoride- benzene ratio was used and it was argued that this should contain very little hydrogen containing material and consist mainly of cyclic chlorofluorocarbons.

Exploratory dehalogenations at 380°-400°, however, yielded products which gave complex vapour phase chromatograms whereas if the materials present had been mainly cyclic  $C_6F_{12-n}Cl_n$  ( $n = 1$  to 4) compounds simple products, as described earlier, should have been obtained. It was therefore decided to look more closely into the composition of this reaction product, and the results obtained must be discussed with some reference to previous chlorofluorinations.

R.E. Banks (op. cit., p. 64 et seq.) carried out two large scale chlorofluorinations of benzene. Chlorine

trifluoride and benzene separately diluted with nitrogen were passed through a concentric tube burner and allowed to react within an iron tube packed with copper clippings, the products being collected in cold traps.

Dr. W.K.R. Musgrave used the same apparatus to carry out a further run. The reactant ratios and other relevant data are summarised in TABLE II.

TABLE II

Worker	Run No.	$C_6H_6$ Feed rate Moles/hr.	$ClF_3$ Feed rate Moles/hr.	$ClF_3/$ $C_6H_6$ mole Ratio	$N_2(1)$ L./Hr.	$N_2(2)$ L./Hr.
BANKS	1	0.248	0.460	1.85:1	4.0	24.0
	2	0.109	0.714	6.53:1	4.0	24.0
MUSGRAVE	1	0.236	0.476	2.01:1	4.7	10.9

$N_2(1)$  Nitrogen flow rate through the benzene vaporiser.

$N_2(2)$  Nitrogen flow rate through the centre annular space of the concentric tube burner.

The material obtained from Bank's first run, a complex product containing about 20% unreacted benzene was distilled through a 60 plate concentric tube column into a number of azeotropes, no pure compounds being obtained (op. cit. p. 104 et seq.).

The advent of vapour phase chromatography allowed a partial separation of the fractions with b.p.  $130^{\circ}$  and some pure materials were isolated. Cyclic  $C_6F_{10}Cl_2$ , cyclic  $C_6F_9Cl_3$ , chlorofluorocyclohexanes containing hydrogen, and the aromatic derivatives chlorobenzene and a mixture of the isomers of chlorofluorobenzene were obtained in this way.

The efficient fractionation used by Banks only served to distribute the components between a large number of azeotropes and Johncock (op. cit. p. 27 et seq.) realising this then examined the material from Dr. Musgrave's chlorofluorination run, by roughly fractionating it through a 20 plate concentric tube column, and separating the first two fractions, b.r. ( $55^{\circ}$ - $85^{\circ}$ ) and ( $85^{\circ}$ - $135^{\circ}$ ) by vapour phase chromatography.

The first fraction consisted of only three components, cyclic  $C_6F_{11}Cl$ , cyclic  $C_6F_{10}Cl_2$  and benzene, the latter being about 30% of that initially reacted.

The second fraction was more complex but consisted predominately of three components which were isolated and characterised as cyclic  $C_6F_9Cl_3$ , chlorobenzene, and cyclic  $C_6F_8Cl_4$ .

Direct comparison of the amounts of each compound isolated by Banks and Johncock is impossible because of

the different boiling fractions taken and the different recoveries obtainable on the respective chromatography units used in their separation. However if we take Bank's combined fractions b.r. ( $79.5^{\circ}$ - $130^{\circ}$ ) to correspond roughly to Johncock's b.r. ( $55^{\circ}$ - $135^{\circ}$ ) material we can find the amounts of each compound obtained per 100 g. of unseparated material. This has been done in TABLE III.

TABLE III

	BANKS	JOHNCOCK
b.r. $^{\circ}$ C	79.5-129.5	55-135
Wt. (g.)	100	100
$C_6H_6$ (g.)	55.6	38.6
$C_6F_{11}Cl$ (g.)		2.98
$C_6F_{10}Cl_2$ (g.)	1.71	14.40
$C_6F_9Cl_3$ (g.)	3.58	18.70
$C_6F_8Cl_4$ (g.)		7.09
$C_6H_4ClF$ (g.)	7.72	
$C_6H_5Cl$ (g.)	0.86	6.35*
Other hydrogen containing materials	30.53	11.88*

\* These contain an unspecified amount of p-chloro-fluorobenzene.

It is clear that the lower nitrogen dilution and the



slightly increased chlorine trifluoride benzene ratio has caused greater conversion to chlorofluorinated products.

From the foregoing results one would expect that Bank's second run material, produced using a six-fold excess of chlorine trifluoride should contain mainly saturated chlorofluorocarbons and less hydrogen containing material.

The reaction product from the second run was distilled through a 14-plate helices packed column (see distillation curve on p.189) and each fraction was vapour phase chromatographed under standard conditions. It was hoped that by running a calibration curve of a mixture of known weights of the cyclic  $C_6F_{12-n}Cl_n$  ( $n = 1$  to  $5$ ) materials it would be possible to get a quantitative estimate of the components present. When it was shown later that much hydrogen containing material was present this idea was abandoned, and it was decided to apply preparative scale vapour phase chromatography to the separation of some fractions. The materials separated were, where possible, identified by halogen analysis and analytical V.P.C. In this way the quantitative compositions of some fractions were obtained; the compositions of the fractions not separated in this way were calculated from chromatographic peak areas.

If we, as before, assume a rough correspondence between the 66°-130° combined fractions and those similar boiling range materials from the other two chlorofluorination runs described, then in 100 g. of this material there are present 2.05 g. cyclic  $C_6F_{11}Cl$ , 34.2 g. cyclic  $C_6F_{10}Cl_2$  and 63.75 g. hydrogen containing material (containing no unchanged benzene).

It is remarkable that so much hydrogen containing material is present but this, judging from the other results, could almost certainly be reduced by using a smaller nitrogen dilution in the outer concentric tube during the halogenation. There seems to be no explanation for the absence of cyclic  $C_6F_9Cl_3$  since it was detected in the similar boiling range material by the previous two workers. The isolation of cyclic  $C_6F_8Cl_4$  by Johncock is rather surprising even allowing for the higher upper limit of the boiling range of his material. There is of course complex azeotrope formation with these materials, and possibly the distribution of components may be appreciably different in each case.

The main point to note is that the overall analysis figures for each fraction (see p. 188) are rather misleading when it is realised that the substitution of one or two

fluorines and in some cases chlorine by hydrogen in chlorofluorocyclohexanes has relatively little effect on the halogen figures, as shown in TABLE IV.

TABLE IV

COMPOUND	%Cl	%F
$C_6F_{10}Cl_2$	21.3	57.1
$C_6F_9Cl_2H$	22.5	54.3
$C_6F_8Cl_2H_2$	23.8	51.2
$C_6F_9Cl_3$	30.5	49.0
$C_6F_8Cl_3H$	32.1	46.0
$C_6F_7Cl_3H_2$	33.9	42.5
$C_6F_8Cl_4$	38.8	41.5
$C_6F_7Cl_4H$	40.8	38.2
$C_6F_7Cl_3H_2$	33.9	42.4

Knowing the identity and amount of the cyclic chlorofluorocarbons present in a particular fraction and the halogen analysis figures for the whole fraction the figures for the remaining material can be calculated. When this was done the resultant figures were not incompatible with the presence of trihydro- compounds in even the highest boiling fractions.

We are now in a position to discuss the actual dehalogenation results.

### Results of dehalogenations

The product obtained by dehalogenating each fraction at 500° had always a simple composition, perfluorobenzene, pentafluorobenzene, and fluorobenzenes containing more hydrogen being present in each case. The results are summarised in TABLE V below, where the weight percentage composition of each dehalogenated product is given. (For the actual experimental results see TABLE VII p.212).

TABLE V

Fraction b.r. °C	% C <sub>6</sub> F <sub>6</sub> in product	% C <sub>6</sub> F <sub>5</sub> H in product	% C <sub>6</sub> F <sub>6-x</sub> H <sub>x</sub> in product
100-110	36	26	38
110-120	48	34	18
120-130	15	52	33
130-150	24	31	45
150-165	20	32	48
Combined first two fractions of residues distillation.	28	28	44

Note: calculated assuming complete gas chromatographic recovery.

There is no real point in trying to correlate the

amounts of perfluorobenzene and pentafluorobenzene formed with the amounts of chlorofluorocyclohexanes and hydrochlorofluorocyclohexanes present in the starting materials, because of the possibility that loss of hydrogen fluoride occurs from the hydrogen containing compounds to give perfluorobenzene. A case of this has already been noted in connection with the defluorination of 1H-heptafluorocyclohexa-1:3-diene.<sup>13</sup> In the case of products containing chlorine there is also the additional possibility that hydrogen chloride might also be lost.

Despite this there seems to be reasonable agreement between the composition of the starting materials and the dehalogenated products. For example there is a high proportion of perfluorobenzene in the product from the (110°-120°) fraction known to be about 70% cyclic  $C_6F_{10}Cl_2$  by weight. Also the (120°-130°) fraction containing about 90% by weight of hydrogen containing compounds gave a smaller yield of perfluorobenzene and correspondingly more pentafluorobenzene.

The rather small amount of perfluorobenzene in the product from the (150°-165°) and residues material can perhaps be explained by noting that a reactor temperature of 430° was sufficient to convert the pure cyclic  $C_6F_8Cl_4$  almost completely to perfluorobenzene whereas here a

temperature of  $500^{\circ}$  was used on materials estimated to contain ca. 35% and 60% by weight of the tetrachloro-compound. It is significant that after the completion of the dehalogenation runs on the pure cyclic  $C_6F_{12-n}Cl_n$  ( $n = 1$  to  $5$ ) compounds, the gauze reactor packing was quite clean, whereas after the dehalogenation runs on the chlorine trifluoride-benzene products the meshes were largely encrusted with deposits of carbon.

Some of the fluorine analyses on the pentafluorobenzene cuts were low and it was thought that perhaps the material was contaminated with an isomer of tetrafluorobenzene which was inseparable from it on the column packing used (kieselguhr-tricresyl phosphate). The infra-red spectra of all samples of pentafluorobenzene isolated from these dehalogenations however were almost identical with that of an authentic sample.

After separating the perfluorobenzene and pentafluorobenzene there remained material which gave three overlapping peaks and which was in each case separated as one cut. Analytical V.P.C. showed that the peaks corresponded to each other in each separate cut and the infra-red spectra of all cuts were virtually the same. Halogen analyses carried out on cuts from dehalogenated fractions 2, (b.r.  $100^{\circ}$ - $110^{\circ}$ ) and 5, (b.r.  $130^{\circ}$ - $150^{\circ}$ ) showed the absence

of chlorine which must therefore be absent in all cuts.

The infra-red spectrum had a strong absorption at  $1515 \text{ cm.}^{-1}$  which was characteristic of an aromatic ring, and a C-H band at  $3086 \text{ cm.}^{-1}$

This evidence, together with the fluorine analyses, suggest that these later cuts consist of mixtures of isomers of tetrafluoro- and trifluoro- benzenes. Unfortunately authentic samples were not available for analytical vapour phase chromatography and infra-red calibration, and an attempted defluorination of cyclic  $\text{C}_6\text{F}_{10}\text{H}_2$  at  $600^\circ$  yielded a small quantity of material giving an inexplicably low fluorine analysis. Lack of time prevented any further investigation of this point.

On the packings which were available at the time these later peaks could not be resolved completely. It would probably be possible if enough material was available, to isolate a sample of each peak by tedious recycling processes. Apart from the fact that time did not permit this, contamination of the product with column packing usually occurs in this process, and it would be preferable to search for a more efficient stationary phase.

Only in the case of the ( $100^\circ$ - $110^\circ$ ) fraction was product from a dehalogenation at a lower temperature,  $380^\circ$ , examined closely. This fraction before dehalogenation

contained about 75% by weight of cyclic  $C_6F_{10}Cl_2$  and the products isolated and identified, were those expected from this compound at this temperature, i.e. cyclic  $C_6F_{10}$ ,  $C_6F_7Cl$ , 1:4- and 1:3-  $C_6F_8$ ,  $C_6F_{10}Cl_2$  and  $C_6F_6$ . About 20% by weight of the product was present as material giving unidentified peaks, and these were presumably hydrogen containing compounds.

Fraction (5), b.r. (130-150) and fraction (6) b.r. (150°-165°) when dehalogenated at about the same temperature gave complex products which were not investigated further.

Possible use as a method for preparing perfluoro- and pentafluorobenzene

The amounts of cyclic  $C_6F_6$  and  $C_6F_5H$  obtainable from each distillation fraction, and hence from the whole of the chlorofluorination product have been calculated. (The 66°-100° fraction was not dehalogenated but no serious error is introduced, considering the general accuracy of the calculation, if we assume it would give the same amounts of cyclic  $C_6F_6$  and  $C_6F_5H$  as fraction (2)).

From 464 g. benzene, 54 g. cyclic  $C_6F_6$ , 67 g. cyclic  $C_6F_5H$  and 78 g. cyclic  $C_6F_{6-x}H_x$  could be obtained. These represent overall yields of 5 and 7% of cyclic  $C_6F_6$  and  $C_6F_5H$  respectively. Since these figures are based on



amounts obtained from single dehalogenations, and single chromatographic separations they could be subject to rather wide variations. No doubt by suitably adjusting the dehalogenation temperature these yields could be increased, but not greatly.

The pure cyclic  $C_6F_{12-n}Cl_n$  ( $n = 1$  to  $5$ ) materials gave better yields of perfluorobenzene especially the tetrachloro- and pentachloro- compounds (see TABLE I p 147). Unfortunately we cannot obtain the potential yield of perfluorobenzene from the fractions which contain these materials, because the presence of hydrochlorofluorocyclohexanes compels one to use a higher reactor temperature to give a separable product. It would seem to be extremely difficult to substitute all the hydrogen during the chlorofluorination process, probably the chlorine and fluorine atoms already added shield the remaining hydrogen atoms from further attack. Nevertheless the effect of all variables on the chlorofluorination process have not been fully explored, and it is certain that improved yields of chlorofluorocyclohexanes containing less hydrogen could be obtained. For example the slightly increased chlorine trifluoride-benzene ratio, and the halving of the nitrogen dilution greatly simplified the chlorofluorination product separated by Johncock as compared to that of Bank's.

It would be advantageous to dehalogenate the chlorofluorination product without prior distillation, and it is clear that this could be done. However it is quite likely that for optimum yields of perfluorobenzene from cyclic  $C_6F_{12-n}Cl_n$  ( $n = 1$  to  $5$ ) compounds a temperature decrease is required as  $n$  goes from  $1$  to  $5$ . If a mixture of chlorofluorocyclohexanes containing little hydrogen containing compounds was made by the chlorofluorination process dehalogenation in one step would not give the optimum yield of perfluorobenzene.

Figures are not available for the yield of perfluorobenzene from cyclic  $C_6F_{12}$  but yields of perfluorotoluene, perfluoroethylbenzene, and perfluoro-*p*-xylene from the corresponding perfluoro- alycyclic compounds range from 23-45%, and yields of perfluorobenzene from a one stage dehalogenation of a mixture of chlorofluorocyclohexanes would certainly compare favourably with these.

#### Future work

The nature of future work follows naturally from the discussion above; an improvement in the chlorofluorination process and detailed investigation to find the optimum dehalogenating conditions for the product. Also a new stationary phase is required which will enable vapour

phase chromatographic separation of the cyclic  $C_6F_{12-x}H_x$  materials while still separating cyclic  $C_6F_6$  and  $C_6F_5H$ .

If chlorine trifluoride and hexachlorobenzene reacted to give good yields of chlorofluorocyclohexanes then reasonable yields of perfluorobenzene would be obtained from the dehalogenated product, since the complications arising from hydrogen containing materials would be avoided. Especially interesting would be the possibility that gem dichloro-groups could be present and might give rise to chlorofluorobenzenes. As an example we could imagine a compound, produced by addition of chlorine trifluoride followed by some fluorine substitution, dehalogenating as follows:-

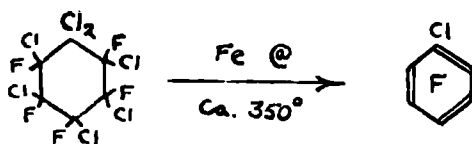

Although hexachlorobenzene is more expensive than benzene, in the actual chlorofluorination process no fluorine would be lost as hydrogen fluoride. Since fluorine, in this case in the form of chlorine trifluoride, is the most expensive item this tends to outweigh the initial expense of the hexachlorobenzene.

CHAPTER III

EXPERIMENTAL WORK

## DEHALOGENATIONS BY HEATED REDUCED IRON

### Apparatus

The general arrangement of the dehalogenator is given in diagram I.

A mild steel tube, 44" long and 2" in diameter, was packed with 1,260 g. of iron gauze in the form of a tightly wound roll. At the outlet end of the tube was hard soldered a disc bearing a  $\frac{5}{16}$ " diam. copper outlet tube.

The inlet end of the reactor tube was sharpened to a knife-edge, after a mild steel annulus had been hard soldered a short distance down the tube. A steel disc, bearing a  $\frac{5}{16}$ " diam. copper inlet tube and carrying an inlaid aluminium washer into which the knife edge bedded, was bolted to the annulus to form the seal (see diagram II).

The reactor tube was heated by three 1 kw. rod-type electrical heating elements placed longitudinally around the lower half (see diagram II- end view). These elements were individually controlled by Simmerstats. The tube and heaters were surrounded by firebricks encased in an open topped aluminium box, the slotted ends of which supported the tube. Additional support for the tube was

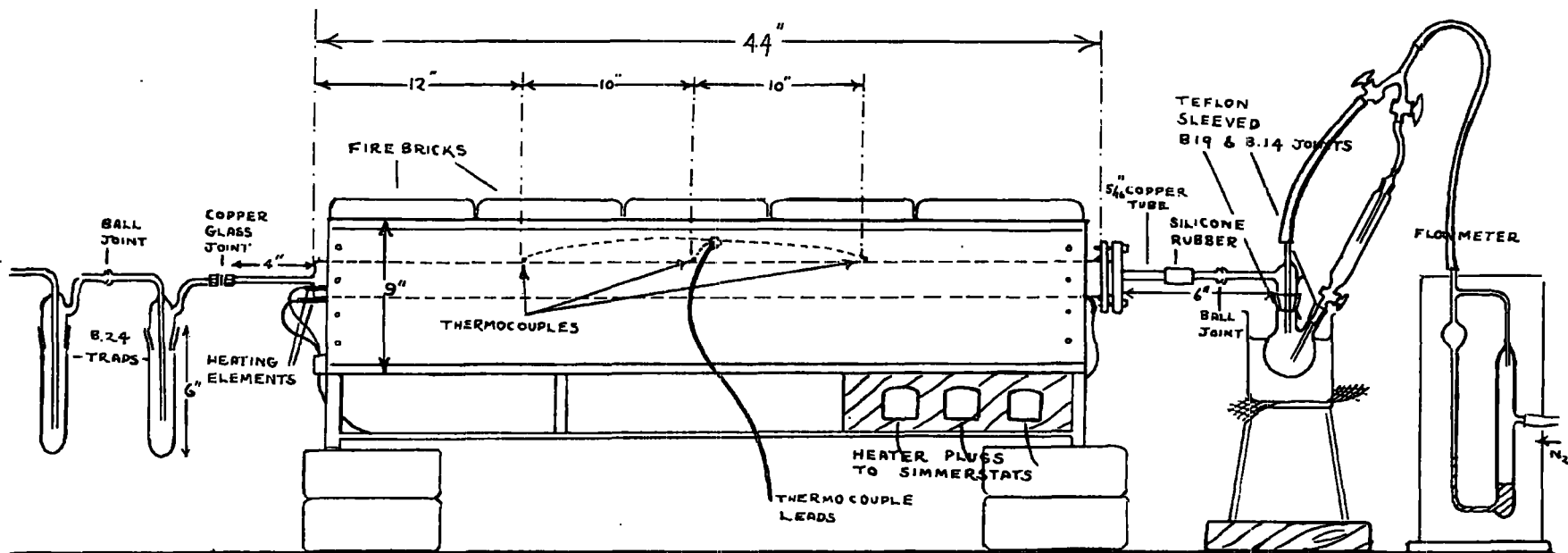
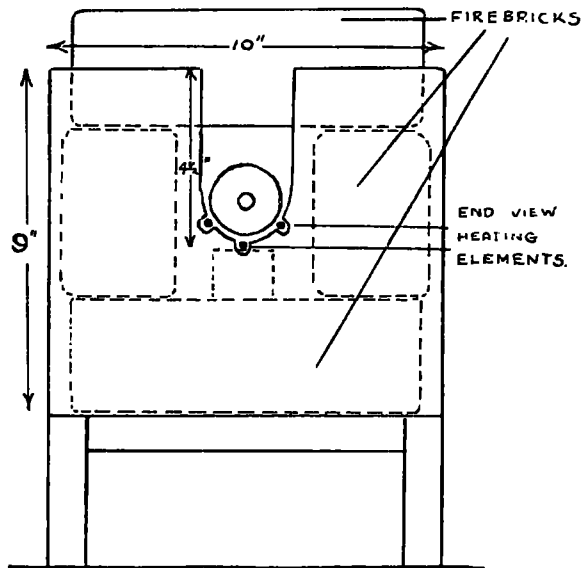
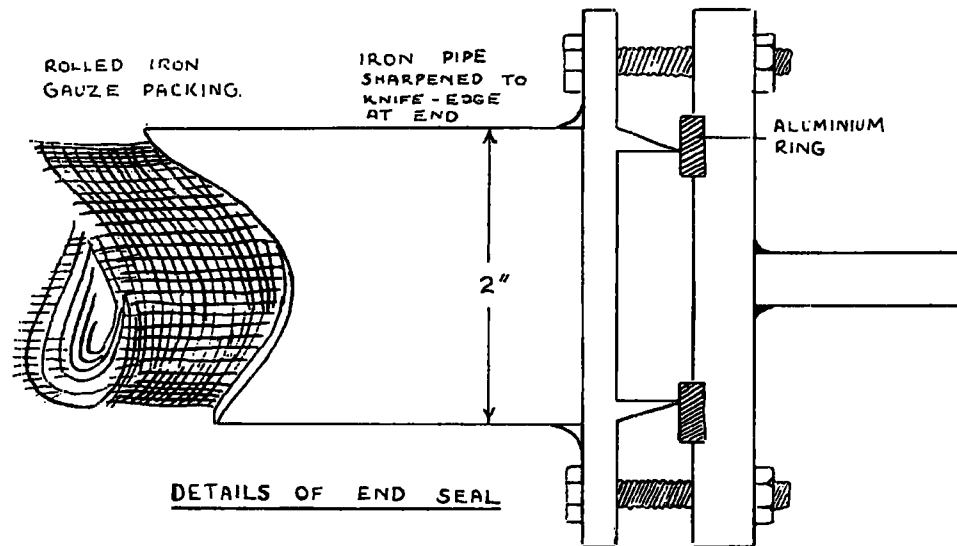

DIAGRAM I



END VIEW OF OVEN



DETAILS OF END SEAL

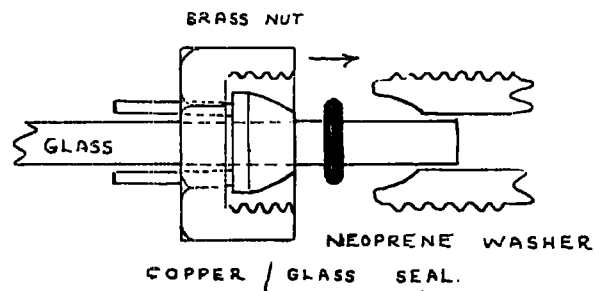

DIAGRAM II

provided by small pieces of firebrick placed underneath it at intervals.

The temperature at points along the tube was measured by three chromel-alumel thermocouples cemented into position by fireclay cement.

Attached to the copper inlet tube by a short length of silicone rubber tubing was the system used for introducing the organic material into the reactor. This is discussed in more detail later.

At the outlet end two liquid air cooled traps were used to condense the product, the first being attached to the outlet tube by a copper glass seal.

### Experimental procedure

#### (a) Introduction of sample

Two methods were used, depending upon whether the material to be dehalogenated was a liquid or solid at room temperature.

##### (i) Liquids

For liquids the system was set up as in diagram I. Oxygen free nitrogen was passed through the apparatus at ca. 4 litres/hr. for about 90 mins., and the two outlet traps then cooled in liquid air. A weighed



quantity of the material to be dehalogenated was placed in the dropping funnel which was then purged with nitrogen at an increased flow rate for a few minutes. The nitrogen flow rate was set, and the oil bath heated rapidly to the desired temperature, and maintained there while the liquid was dropped into the vaporising flask at a rate such that little liquid collected there at any time.

When high boiling liquids were used a Simmerstat controlled heating tape was wound round the reactor inlet tube.

After all the liquid had distilled in the nitrogen flow was continued for a further two hours to sweep out all remaining organic material. The traps were then allowed to warm up, and the product removed.

(ii) Solids

For the introduction of solid materials the system in diagram I was altered slightly, a single necked R/B flask replacing the two necked one, and having a single nitrogen lead in.

A stream of oxygen free nitrogen (ca. 4 l./hr.) was allowed to flow through the apparatus for about 90 mins.

The flask in position was then replaced by one containing a weighed amount of organic sample which was then cooled in liquid air. Nitrogen was then allowed to flow through the apparatus for about 90 mins. to remove all traces of introduced air.

The flask was allowed to warm up and the nitrogen flow set. An oil bath preheated to a temperature above the boiling point of the sample was placed round the flask and the material distilled in, the oil bath being maintained at the same temperature. Again, if the material was high boiling a heating tape was wound round the inlet tube.

(b) Nitrogen flow control

An oil filled flow meter, which had been calibrated in position in the system by collecting emergent nitrogen from the final trap over water, was placed before the vaporising flask.

The calibration was repeated before each run as an additional check.

(c) Temperature control

The temperature along the 20" between the two outer thermocouples varied along the length by a maximum of 15<sup>o</sup>,

but was constant throughout any run. Outside this length the temperature fell off towards the reactor ends. The reactor temperature quoted in subsequent discussion is the temperature of this middle section.

The thermocouples were insensitive to temperature changes due to reaction inside the tube although this effect was looked for.

(d) Contact time

A measure of the contact time can be obtained as follows:-

tube length 110 cms., internal diam. 4.4 cms.

wt. of gauze 1260 g., density 7.7 g./cc.

$$\text{Empty volume of tube is } \pi (2.2)^2 \cdot 110 - \frac{1260}{7.7}$$

or  $\approx$  1500 ccs. and contact time is

1500/30 or 50 mins.

Observation during a run however, showed that white fumes appeared on the outlet side in less time than this and determination of the flow at this period by water displacement showed a greatly increased rate. It appears that the vapour expands through the reactor under its own vapour pressure, and for this reason a contact time will not be quoted.

After the organic vapour had passed through the

reactor the flow always returned to the initial set rate.

(e) Regeneration of a clean iron surface by passage of hydrogen

After each dehalogenation the iron gauze was regenerated by passing hydrogen over it at a rate of ca. 20 litres/hr. until fumes of hydrogen fluoride were no longer visible. This took from three to twelve hours depending on the amount of material which had been dehalogenated.

The regeneration was carried out at temperatures between 400° and 600°.

Towards the end of the series of dehalogenations carried out on the chlorine trifluoride-benzene reaction products it became apparent that the reactor was blocking up. On removing the gauze thick deposits of carbon were noted, and these were removed, after unrolling the gauze, by wire brushing, followed by steeping in strong sodium hydroxide solution.

DEHALOGENATION OF CYCLIC  $C_6F_{12-n}Cl_n$   
MATERIALS (n = 1 to 5)

Chlorofluorocyclohexanes of general formula  $C_6F_{12-n}Cl_n$  (n = 1 to 5) obtained by the action of cobalt trifluoride upon hexachlorobenzene, were dehalogenated by passing them over a clean heated iron surface. The general method of sample introduction, and operation of the apparatus has been described earlier, each run used the standard procedure.

The dehalogenated material was in each case analysed by analytical V.P.C. and then separated wholly, or in part, on a preparative vapour phase chromatography column. The separated materials were analysed for chlorine and fluorine and their identity confirmed by vapour phase chromatography and by infra-red spectra, in comparison with standard samples.

Exploratory runs

Using cyclic  $C_6F_{11}Cl$  as the test material dehalogenations were carried out at various temperatures. At  $600^\circ$  almost complete decomposition occurred while at  $350^\circ$  mainly starting material was recovered. At  $430^\circ$  a reasonable conversion of material was obtained and this

reactor temperature was used in all subsequent experiments, unless stated to the contrary.

### Monochloroundecafluorocyclohexane

10.4 g. cyclic  $C_6F_{11}Cl$  gave 3.7 g. product. Analytical V.P.C., kieselguhr-dinonyl phthalate at  $90^\circ$  showed that peaks due to cyclic  $C_6F_{10}$  and cyclic  $C_6F_6$  were present, and negligible starting material. 3.0 g. were separated by preparative V.P.C., kieselguhr-dinonyl phthalate (16' column) at  $90^\circ$ , p.d. 15 cms. Hg, nitrogen flowrate 175 mls./min., giving:-

cut (1) 1.05 g. Analytical V.P.C., kieselguhr-dinonyl phthalate at  $60^\circ$  gave a single peak coincident with that of cyclic  $C_6F_{10}$ . Found: F, 71.1%. Calculated for cyclic  $C_6F_{10}$ : F, 72.6%. The identity was confirmed by an infra-red spectrum.

cut (2) 0.75 g. Analytical V.P.C. kieselguhr-dinonyl phthalate at  $60^\circ$  gave a single peak, coincident with that due to authentic cyclic  $C_6F_6$ . Found: F, 61.4%;  $C_6F_6$  requires F, 61.2%. Identity was confirmed by an infra-red spectrum.

### Dichlorodecafluorocyclohexanes

(a) At  $430^\circ$

9.8 g. yielded 3.81 g. product. Analytical V.P.C.,

kieselguhr-dinonyl phthalate at  $95^{\circ}$  gave peaks for cyclic  $C_6F_{10}$ , cyclic  $C_6F_6$  and a small later peak, in order of retention times. 3.81 g. were separated on a 16' kieselguhr-dinonyl phthalate column at  $110^{\circ}$ , p.d. 26 cms. Hg, nitrogen flowrate 200 mls./min., giving:-

cut (1) 1.21 g. Analytical V.P.C., conditions as before, gave a single peak coincident with that due to authentic cyclic  $C_6F_{10}$ . Found: F, 71.2%;  $C_6F_{10}$  requires; F, 72.6%. Identity was confirmed by an infra-red spectrum.

cut (2) 1.70 g. Analytical V.P.C. indicated that the small later peak was still present, and the material was recycled on 16' kieselguhr-tricresyl phosphate at  $94^{\circ}$ , but 'tailing' of the main peak occurred as before and no separation was obtained. An initial cut was therefore taken. Found: F, 61.3%; cyclic  $C_6F_6$  requires; F, 61.2%.

Assuming equal response for the two components calculation of peak areas showed that the original cut was 97% cyclic  $C_6F_6$ , while an infra-red spectrum showed peaks additional to those of perfluorobenzene at 1179, 1073, 968, 943, and 719  $cm.^{-1}$

(b) At  $375^{\circ}$

22.7 g. of cyclic  $C_6F_{10}Cl_2$  gave 16.5 g. product.

Analytical V.P.C., kieselguhr-tricresyl phosphate showed that peaks due to, cyclic  $C_6F_{10}$ , unknown material and cyclic  $C_6F_{10}Cl_2$  were present, in order of retention times. At this reactor temperature no cyclic  $C_6F_6$  and the following later peak material were produced.

5 g. were separated by preparative V.P.C., kieselguhr-tricresyl phosphate at  $85^\circ$  p.d. 18 cms. Hg, nitrogen flow-rate 160 mls./min. to give:-

cut (1) 1.39 g. Analytical V.P.C. kieselguhr-tricresyl phosphate at  $60^\circ$  gave a single peak coincident with that due to authentic cyclic  $C_6F_{10}$ . Found: F, 70.1%;  $C_6F_{10}$  requires F, 72.6%. An infra-red spectrum showed that some absorptions due to octafluorocyclohexa-1:4-diene were present.

cut (2) 0.90 g., unknown material. Found: F, 67.9%; Cl, 10.3%, corresponding to no definite compound. An infra-red spectrum showed that some octafluorocyclohexa-1:4-diene, octafluorocyclohexa-1:3-diene and a small quantity of cyclic  $C_6F_{10}$  were present, together with material giving the additional absorptions at:- 1290, 1188, 1111, 1078, 1044, 961, 877, and 862  $cm.^{-1}$

These are characteristic of a monochloroheptafluorocyclohexadiene isolated later on from the dehalogenation of the b.r. ( $100^\circ$ - $110^\circ$ ) fraction from the benzene-chloro-fluorination product (see p.207).



Analytical V.P.C., kieselguhr-tricresyl phosphate at  $19^{\circ}$ , p.d. 6 cms. Hg, nitrogen flowrate 16 mls./min. resolved this material into three components, in order of retention time, cyclic-1:4-diene, a chloroheptafluorocyclohexadiene, and cyclic-1:3-diene. The identity of the 1:4- and 1:3- cyclic dienes was confirmed by coincident retention times with authentic materials.

Assuming equal response and calculating from peak areas there were present 0.1 g. cyclic-1:4- $C_6F_8$ , 0.54 g. cyclic  $C_6F_7Cl$  and 0.26 g. cyclic-1:3- $C_6F_8$ .

Cut (3) 0.70 g. Analytical V.P.C. kieselguhr-tricresyl phosphate at  $19^{\circ}$  gave a peak coincident with that for cyclic  $C_6F_{10}Cl_2$  and the identity of the material was confirmed by an infra-red spectrum.

### Trichlorononafluorocyclohexanes

(a) At  $430^{\circ}$

12.3 g. cyclic  $C_6F_9Cl_3$  gave 6.2 g. product. Analytical V.P.C., kieselguhr-dinonyl phthalate at  $70^{\circ}$  showed peaks due to the cyclic-1:4-diene, unidentified material, cyclic  $C_6F_6$  and starting material, in order of retention times.

6.19 g. in four runs were separated by preparative V.P.C. on 16' kieselguhr-dinonyl phthalate at  $80^{\circ}$ , p.d. 34 cms. Hg, nitrogen flowrate, 200 mls./min., to give:—

cut (1) 0.85 g. Analytical V.P.C. kieselguhr-tricresyl phosphate at  $68^{\circ}$  gave a single peak coincident with that due to the cyclic 1:4-diene. Found: F, 65.2; Cl, 2.2%.  $C_6F_8$  requires: F, 67.9%. An infra spectrum gave additional absorptions at 1290 and  $862\text{ cm.}^{-1}$  characteristic of a chloroheptafluorocyclohexadiene.

cut (2) 2.60 g. Analytical V.P.C., kieselguhr-dinonyl phthalate at  $69^{\circ}$ , gave a single peak. Found: Cl, 12.7; F, 61.2%, not corresponding to a definite compound. An infra-red spectrum showed that cyclic 1:3- $C_6F_8$  was present together with a cyclic  $C_6F_7Cl$ , characteristic absorptions for the latter being present at 1290, 962 and  $862\text{ cm.}^{-1}$ . From the analytical figures the material contained 2.24 g. cyclic  $C_6F_7Cl$  and 0.36 g. cyclic 1:3- $C_6F_8$ .

cut (3) 0.72 g. Analytical V.P.C. kieselguhr-tricresyl phosphate at  $68^{\circ}$  gave a single peak coincident with that due to cyclic  $C_6F_6$ . Found: Cl, 2.5; F, 59.4%.  $C_6F_6$  requires: F, 61.2%. An infra-red spectrum showed additional absorptions at 1250, 1235, 1212, 1190, 1145, 1109, 943, 926, 900, 813, and  $800\text{ cm.}^{-1}$ . This material was recycled on a 16' kieselguhr-tricresyl phosphate column at  $60^{\circ}$  and an initial cut taken. Found: F, 58.2%.  $C_6F_6$  requires F, 61.2%. An infra-red spectrum showed, however, that the material was substantially pure cyclic  $C_6F_6$ .

In an attempt to produce more chlorine containing material the reactor temperature was lowered to 340°, and a further dehalogenation carried out.

(b) At 340°

30 g. gave 21.8 g. product. Analytical V.P.C., kieselguhr-tricresyl phosphate at 94° gave peaks due to, a trace of cyclic C<sub>6</sub>F<sub>10</sub>, cyclic 1:4-diene, unknown material, trace cyclic C<sub>6</sub>F<sub>6</sub>, unknown material 'z' and starting material (in order of retention times).

The product was distilled through a 30-plate concentric tube column to give fractions as follows: (1) b.r. (48-65°), 0.44 g.; (2) b.r. (65°-77°), 0.60 g.; (3) b.r. (77-79°), 5.15 g.; b.p. >79°, not distilled, 15.30 g.

Analytical V.P.C., kieselguhr-tricresyl phosphate at 94°, showed the qualitative and quantitative composition of the fractions to be as follows:—

Fraction No.	Compound and Wt. (g.)					
	C <sub>6</sub> F <sub>10</sub>	1:4-C <sub>6</sub> F <sub>8</sub>	*(1:3-C <sub>6</sub> F <sub>8</sub> + C <sub>6</sub> F <sub>7</sub> Cl) <sup>8</sup>	C <sub>6</sub> F <sub>6</sub>	'z'	C <sub>6</sub> F <sub>9</sub> Cl <sub>3</sub>
(1)	0.04	0.20	0.20			
(2)	0.03	0.21	0.36			
(3)		0.36	4.11	0.16	0.52	
Residue			7.40	0.31	1.50	6.10

\* These materials do not separate on kieselguhr-T.C.P. at 94°, and it was not until later that the material was shown to have this composition.

Tetrachloro-octafluorocyclohexanes

11.04 g. gave 4.1 g. product. Analytical V.P.C., kieselguhr-tricresyl phosphate at  $139^{\circ}$ , showed that perfluorobenzene was the only component, no unchanged starting material being present. At  $91^{\circ}$  a small later peak separated, just after the perfluorobenzene.

4.1 g. were separated on a 16' kieselguhr-dinonyl phthalate column at  $88^{\circ}$ , p.d. 32 cms. Hg, nitrogen flowrate, 175 mls./min. to give:-

cut (1), 3.95 g. Analytical V.P.C. kieselguhr-dinonyl phthalate at  $91^{\circ}$  gave a single peak. Found: Cl, 2.9%; F, 58.0%.  $C_6F_6$  requires: F, 61.2%. An infra-red spectrum gave weak absorptions additional to those of perfluorobenzene at 1181, 1074, 962, 943 and 840  $cm.^{-1}$ . Part of this cut was recycled on kieselguhr-tricresyl phosphate at  $70^{\circ}$ , p.d. 30 cms. Hg, nitrogen flowrate 160 mls./min., to yield material; found Cl, nil; F, 60.3%.  $C_6F_6$  requires F, 61.2%. An infra-red spectrum indicated that the material was pure.

Assuming equal response for the perfluorobenzene and the unknown component the original dehalogenated product contained 95%, or 3.90 g. perfluorobenzene.

cut (2), ca. 30 mg. Analytical V.P.C. kieselguhr-

dinonyl phthalate at  $91^{\circ}$  showed that this material was mainly the second component. Unfortunately it evaporated when an attempt was made to take the infra-red spectrum.

Pentachloroheptafluorocyclohexane

10.0 g. gave 2.22 g. product (0.4 g. residual black tar remained in the vaporising flask). Analytical V.P.C. kieselguhr-tricresyl phosphate at  $160^{\circ}$  and  $92^{\circ}$ , showed that no starting material remained and that perfluorobenzene and a small later peak were present.

1.2 g. were separated in two runs by preparative V.P.C., 16' kieselguhr-dinonyl phthalate column at  $86^{\circ}$ , p.d. 33 cms. Hg, nitrogen flowrate 175 mls./min. to give:-

cut (1) 0.75 g. Analytical V.P.C., kieselguhr-tricresyl phosphate at  $90^{\circ}$ , gave a single peak. Found: F, 60.2%.  $C_6F_6$  requires F, 61.2%. An infra-red spectrum confirmed the identity of the material. Assuming equal response the original product contained 95% perfluorobenzene, or 2.11 g.

cut (2) ca. 50 mg. Analytical V.P.C. on kieselguhr-tricresyl phosphate at  $90^{\circ}$  showed the material was almost all the second component. However on attempting to take the infra-red spectrum the material evaporated.

An infra-red spectrum of the original reaction product, before separation, had shown weak absorptions

additional to those of perfluorobenzene at 1179, 1075, 952, 943 and 840  $\text{cm.}^{-1}$

### Results

The results of the dehalogenations, together with additional information on experimental conditions, are summarised in TABLE VI.

Starting Material	N <sub>2</sub> flow mls./min.
----------------------	----------------------------------

C <sub>6</sub> F <sub>11</sub> Cl	25
-----------------------------------	----

C <sub>6</sub> F <sub>11</sub> Cl	25
-----------------------------------	----

C <sub>6</sub> F <sub>11</sub> Cl	30
-----------------------------------	----

C <sub>6</sub> F <sub>10</sub> Cl <sub>2</sub>	25
--	----

C <sub>6</sub> F <sub>10</sub> Cl <sub>2</sub>	30
--	----

C <sub>6</sub> F <sub>9</sub> Cl <sub>3</sub>	25
---	----

C <sub>6</sub> F <sub>9</sub> Cl <sub>3</sub>	30
---	----

C <sub>6</sub> F <sub>8</sub> Cl <sub>4</sub>	25
---	----

C <sub>6</sub> F <sub>7</sub> Cl <sub>5</sub>	30
---	----

DISTILLATION OF THE MATERIAL OBTAINED BY THE ACTION OF  
A LARGE EXCESS OF CHLORINE TRIFLUORIDE UPON BENZENE  
IN THE VAPOUR PHASE

R.E. Bank's second large scale benzene chlorofluorination run using a chlorine trifluoride/benzene molar ratio of 6.53:1 produced 1,625.4 g. of product from 464 g. benzene (Banks Ph.D. Thesis, Durham 1956, p. 82).

This product was distilled through a 14-plate column packed with  $\frac{1}{8}$ " single turn Fenske glass helices and yielded the fractions shown in TABLE I (op. cit. p. 104). The halogen analyses were obtained later by the present worker.

TABLE I

Fraction No.	Boiling Range °C	Vol. (mls.)	Wt.(g.)	Analyses	
				% Cl	% F
(1)	66-100	44	76.5	15.4	60.1
(2)	100-110	45	78.8	17.1	57.2
(3)	110-120	66	117.0	21.3	55.3
(4)	120-130	78	137.2	23.4	52.3
(5)	130-150	220	391.1	29.3	48.4
(6)	150-165	140	251.1	33.2	42.3
Residue	> 165	222	412.5	-	-

The poor recovery 1,464 g., was due to two accidents, occurring when the column flooded violently.

The distillation curve is given in diagram III and it is clear that a number of azeotropes have been produced.

Further distillation of the residues material

The residues were not analysed initially since they were



DISTILLATION CURVE FOR 440 MLS. REACTION PRODUCT  
FROM R.E. BANK'S CHLOROFLUORINATION RUN NO. TWO

COLUMN : 14-PLATE  
PRESSURE : ATMOSPHERIC  
TAKE-OFF RATIO : 1:14

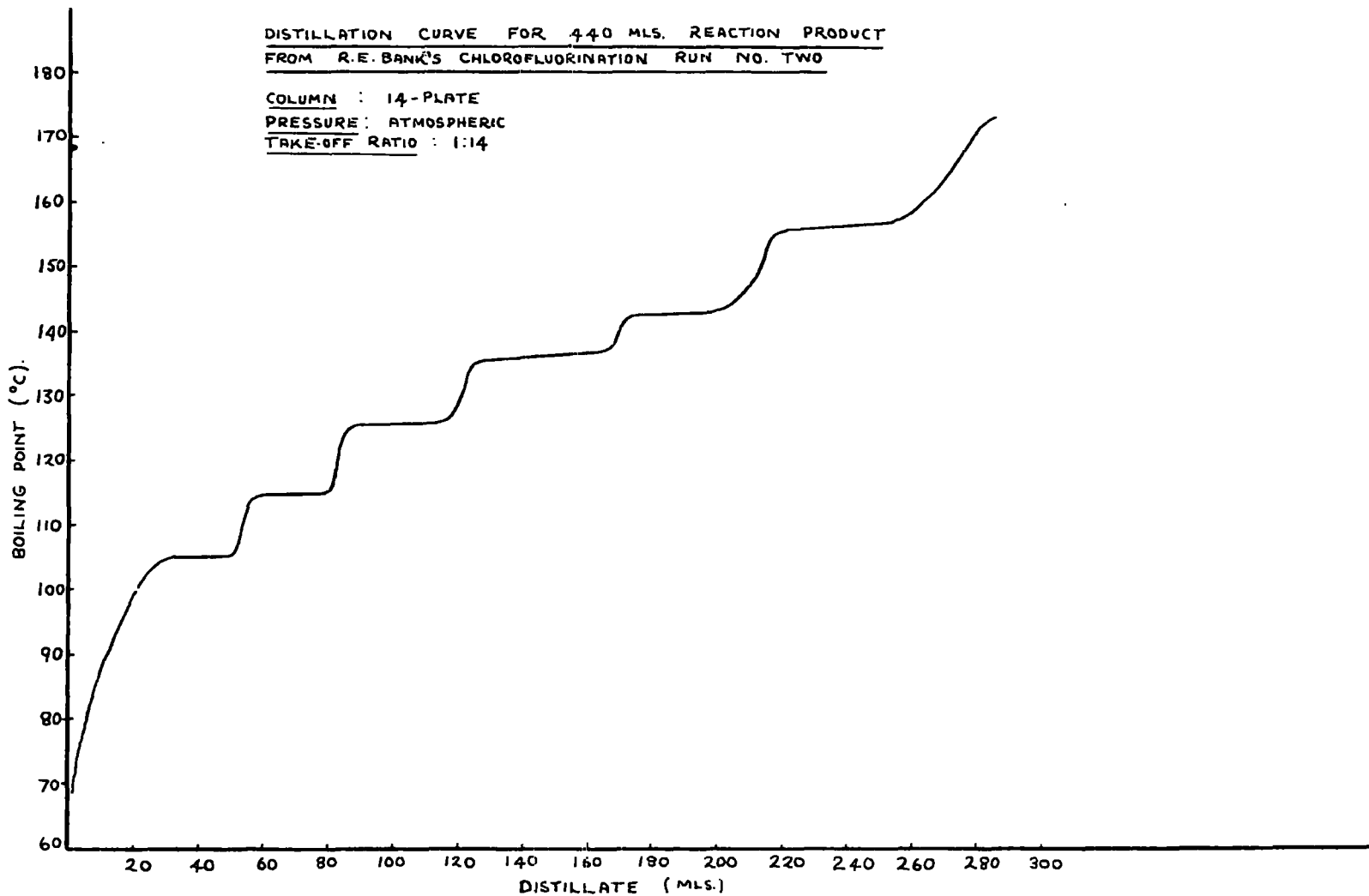

DIAG. III

not homogeneous, being very dark in colour and containing solid material. Using an ordinary Claisen flask they were distilled in two batches at reduced pressure. Details are given in the tables below.

Batch I 70 g. still pot charge.

TABLE II

No. Fraction	Boiling range °C	Pressure mm. Hg.	Wt. (g.)	Analysis	
				% Cl	% F
1	30-47	3	18.0	37.7	37.9
2	42-46	1	22.0		
3	46-56	1	9.0	-	-
4	56-90	1	10.4	34.7	40.5
Residue	> 90	1	6.5	-	-

Batch II 289 g. still pot charge.

TABLE III

No. Fraction	Boiling range °C	Pressure mm. Hg.	Wt. (g.)
1	20-50	3	90.5
2	50-60	3	107.5
3	60-70	3	32.0
4	70-115	3	45.5
Residues	> 115	3	7.5

Notes

\* These fractions were combined because of their similarity as indicated by analytical V.P.C. (see later, p.194) and are in future discussions described as the 'residues initial distillate'.

§ These fractions were not analysed since analytical V.P.C. showed that they had the same qualitative composition as the corresponding ones in TABLE II.

Analytical V.P.C. of each fraction

Using a 6' kieselguhr-tricresyl phosphate column at 162°, p.d. 8 cm. Hg, nitrogen flowrate 16 mls./min. each fraction in TABLE I and TABLE II was analysed. At the same time a mixture of known weights of authentic chlorofluorocyclohexanes of general formula  $C_6F_{12-n}Cl_n$  ( $n = 1$  to  $5$ ) were chromatographed under identical conditions. The complete results are given in diagrams (1) to (12).

Taken in conjunction with the analytical figures these results were at first taken to indicate that three major components were present, cyclic  $C_6F_{10}Cl_2$ , cyclic  $C_6F_9Cl_3$  and cyclic  $C_6F_8Cl_4$ .

The calculated analytical figures for the cyclic Compounds of general formula  $C_6F_{12-n}Cl_n$  ( $n = 1$  to  $5$ ) are given in the table below.

DIAG. ① AUTHENTIC MIXTURE

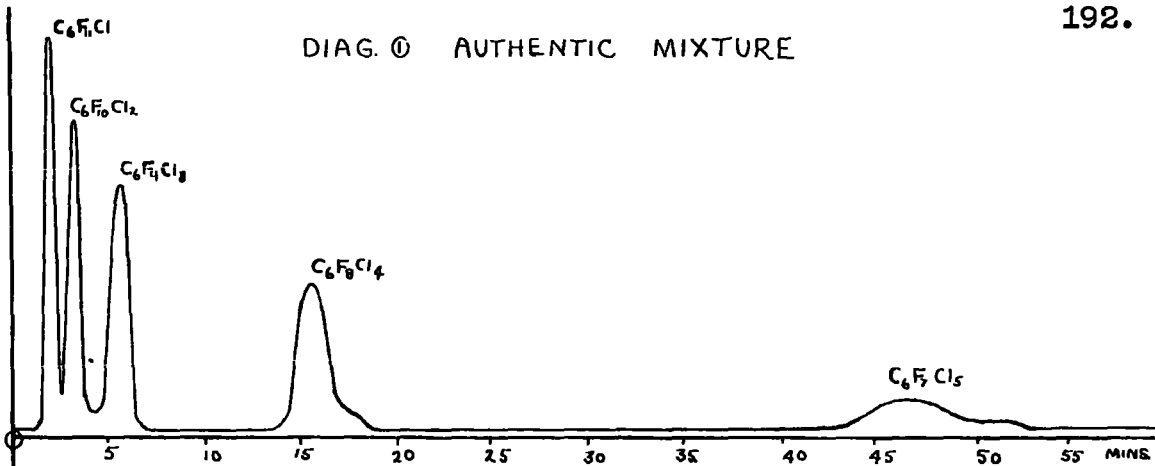

FN. 1 (66°-100°) DIAG. ②

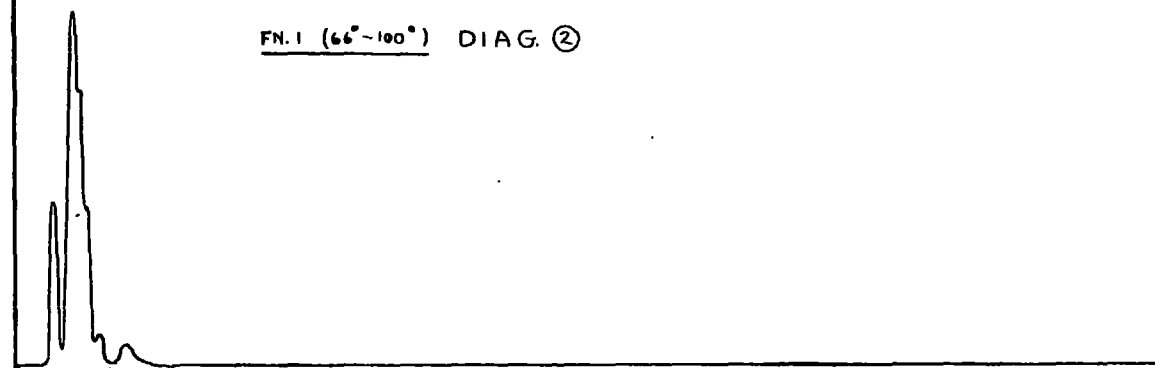

FN. 2 (100°-110°) DIAG. ③

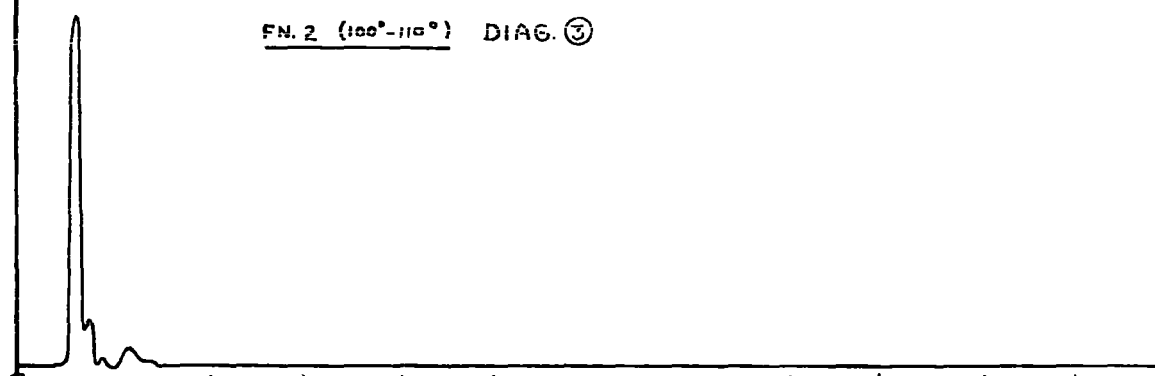

FN. 3 (110°-120°) DIAG. ④

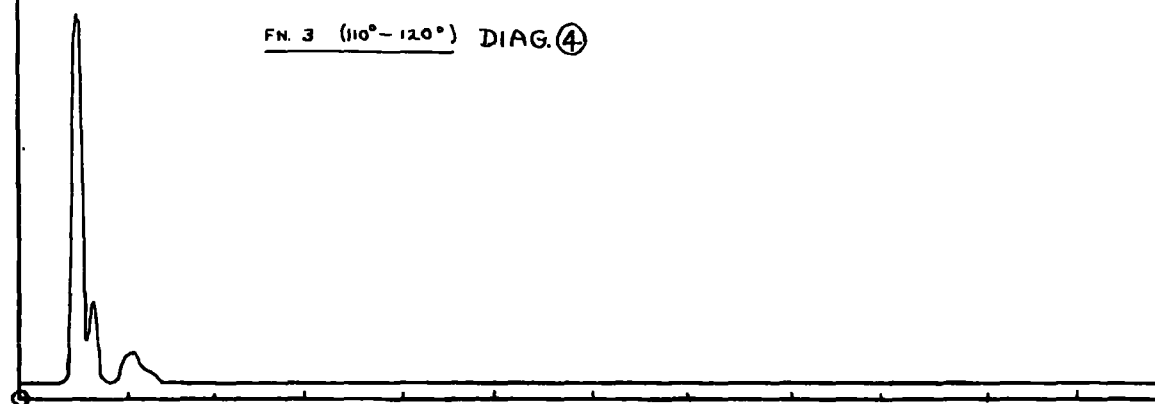

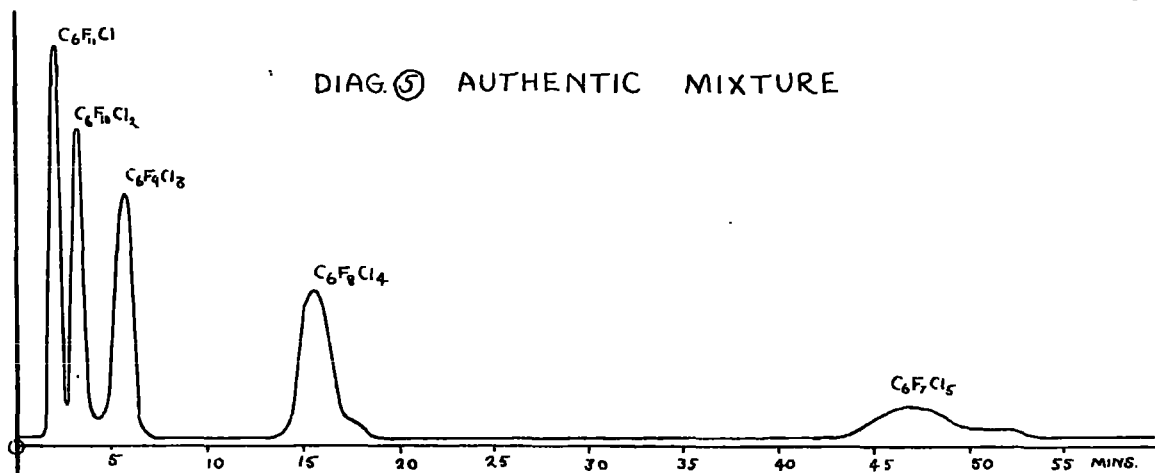

FN. 4 b.r.  $120^\circ-130^\circ$  DIAG. ⑥

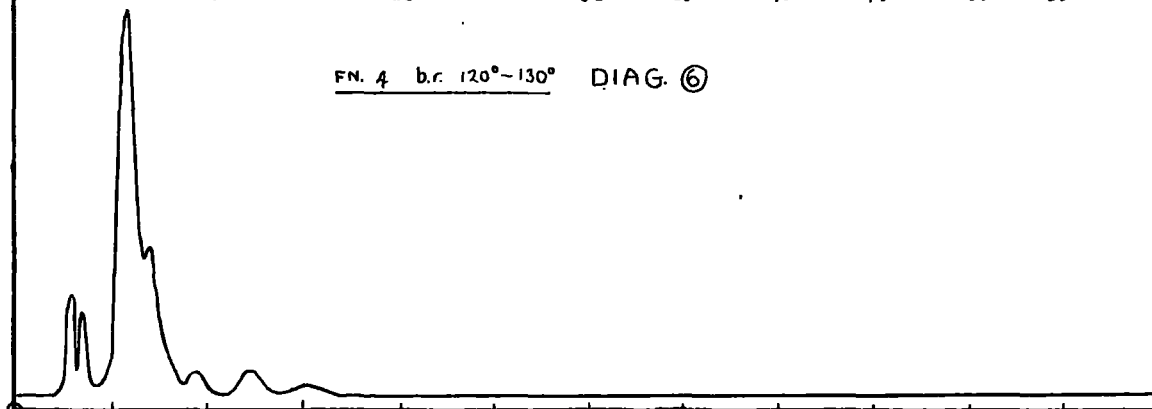

FN. 5  $130^\circ-150^\circ$  DIAG. ⑦

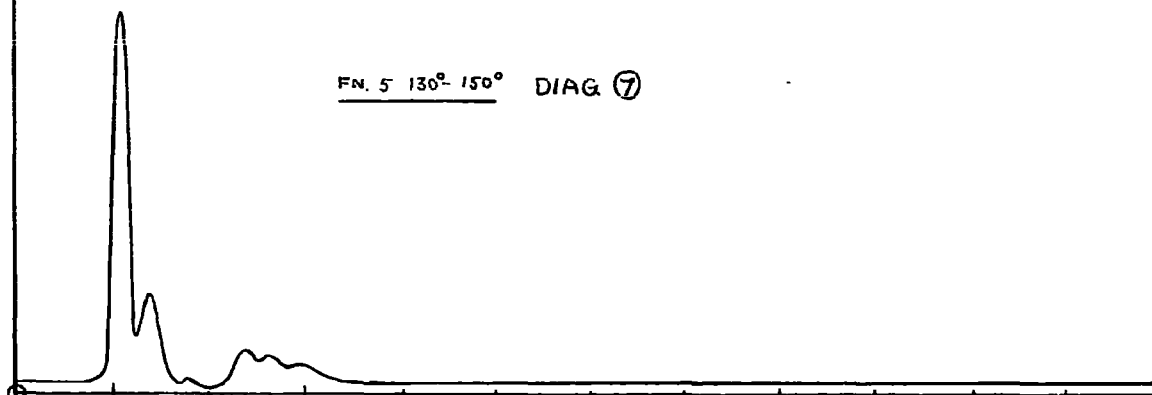

FN. 6 b.r.  $150^\circ-165^\circ$  DIAG. ⑧

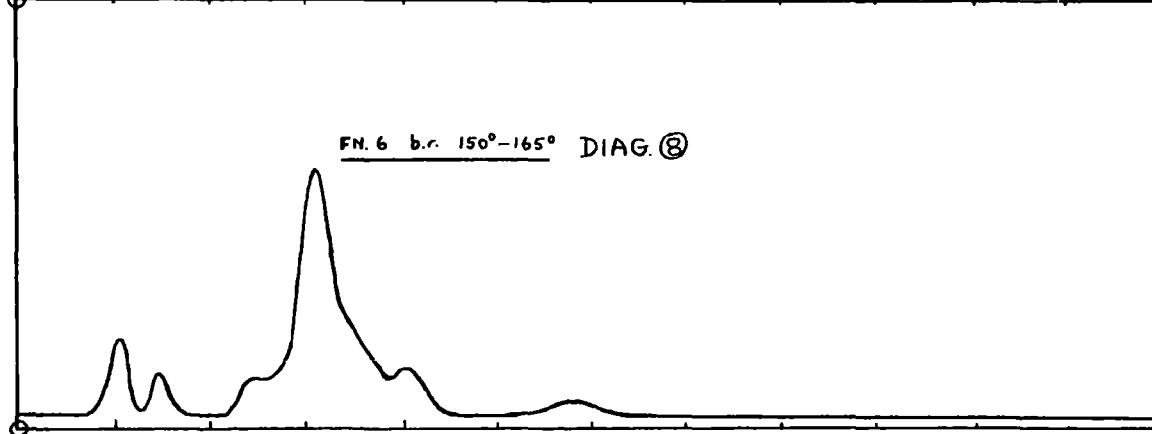

DIAG. ⑨ AUTHENTIC MIXTURE

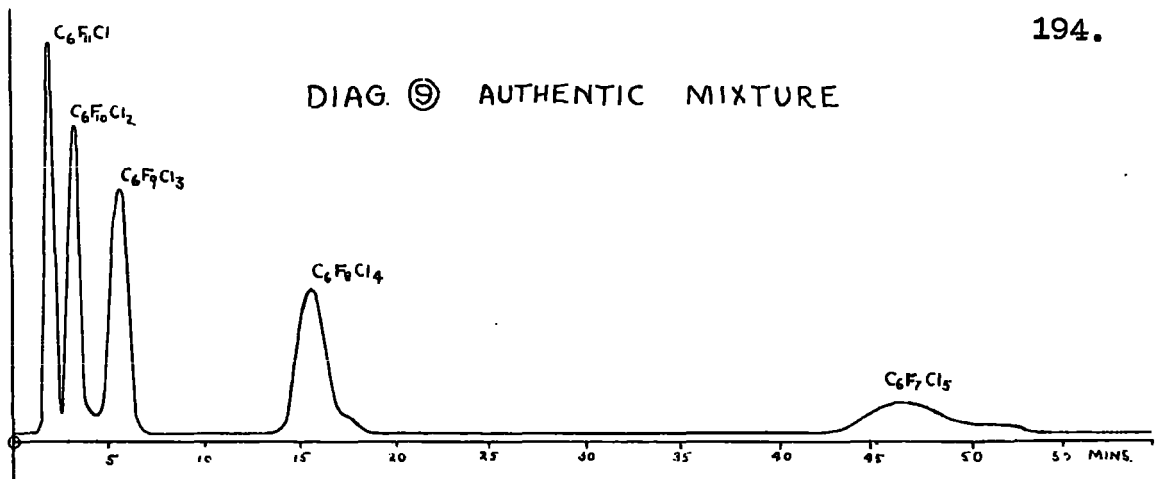

RESIDUES  
FN. 1 b.r.<sub>3</sub> 30°-47° DIAG. ⑩

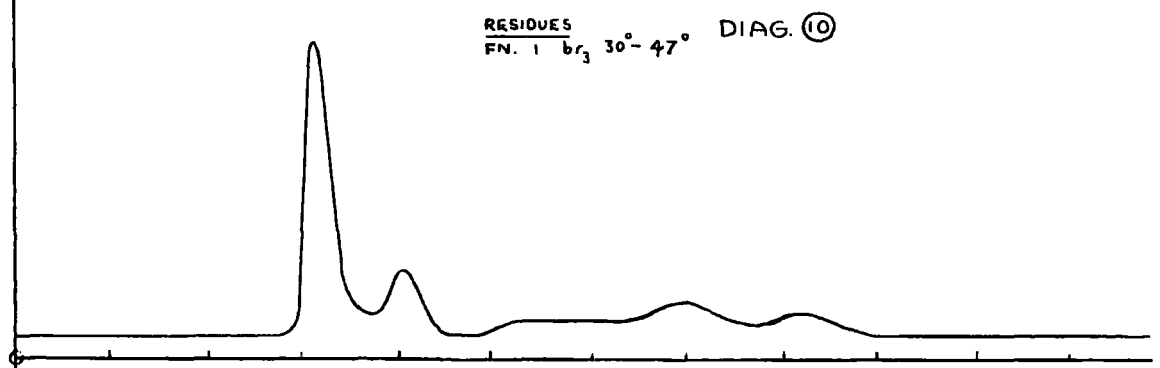

RESIDUES  
FN. 2 b.r.<sub>1</sub> 42°-46° DIAG. ⑪

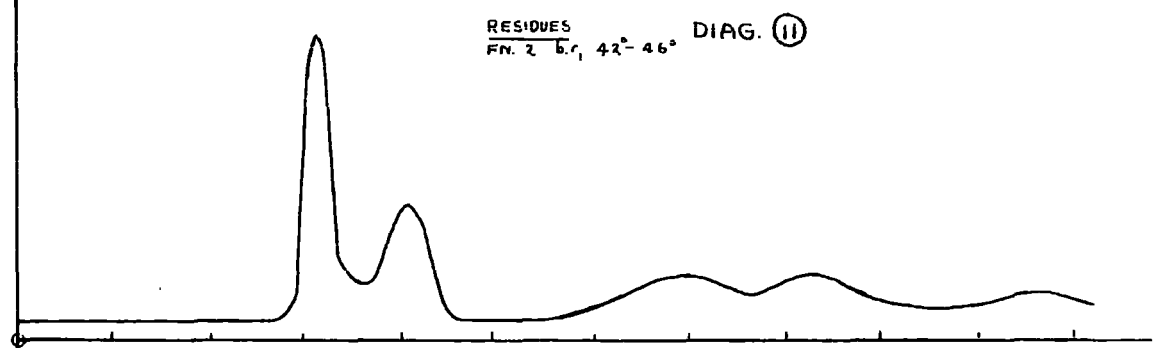

RESIDUES  
FN. 4 b.r.<sub>1</sub> 56°-90° DIAG. ⑫

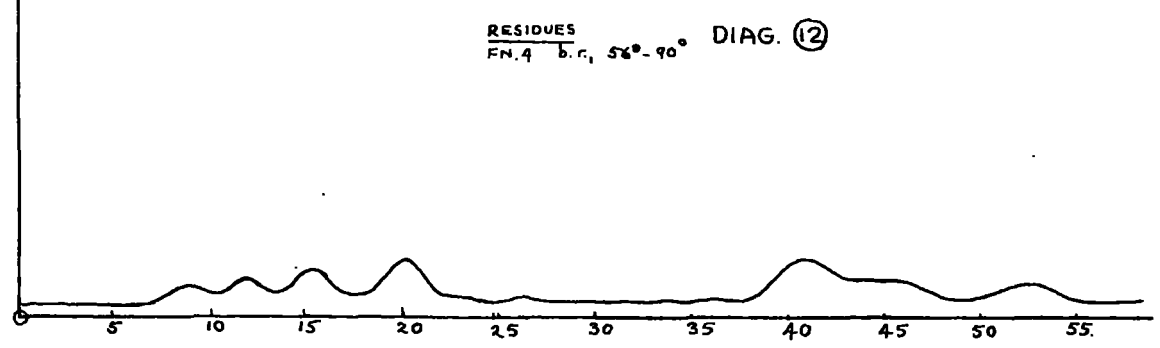

TABLE IV

Compound	Analysis	
	% Cl	% F
$C_6F_{11}Cl$	11.2	66.0
$C_6F_{10}Cl_2$	21.4	57.0
$C_6F_9Cl_3$	30.4	48.9
$C_6F_8Cl_4$	38.8	41.2
$C_6F_7Cl_5$	46.4	34.8

The separation of some distillation fractions by preparative vapour phase chromatography

Fraction 3 (b.r.  $110^{\circ}$ - $120^{\circ}$ )

Analytical V.P.C., kieselguhr-tricresyl phosphate at  $94^{\circ}$  gave the chromatogram in diagram (13).

In four runs 5 g. were separated on a 16' kieselguhr-tricresyl phosphate column at  $130^{\circ}$ , p.d. 38 cms. Hg  $N_2$  flowrate 190 mls./min. to give:-

cut (1) 1.50 g. Analytical V.P.C., kieselguhr-tricresyl phosphate at  $94^{\circ}$ , gave a single peak coincident with that due to authentic cyclic  $C_6F_{10}Cl_2$ . The material was a white waxy solid at room temperature and analysis gave; Cl, 21.5; F 57.1%. Calculated for cyclic  $C_6F_{10}Cl_2$ ; Cl, 21.4; F, 57.0%.

FN. 3 (110°-120°) @ 94° ON KIESELGUHR - T.C.P. DIAG. (13)

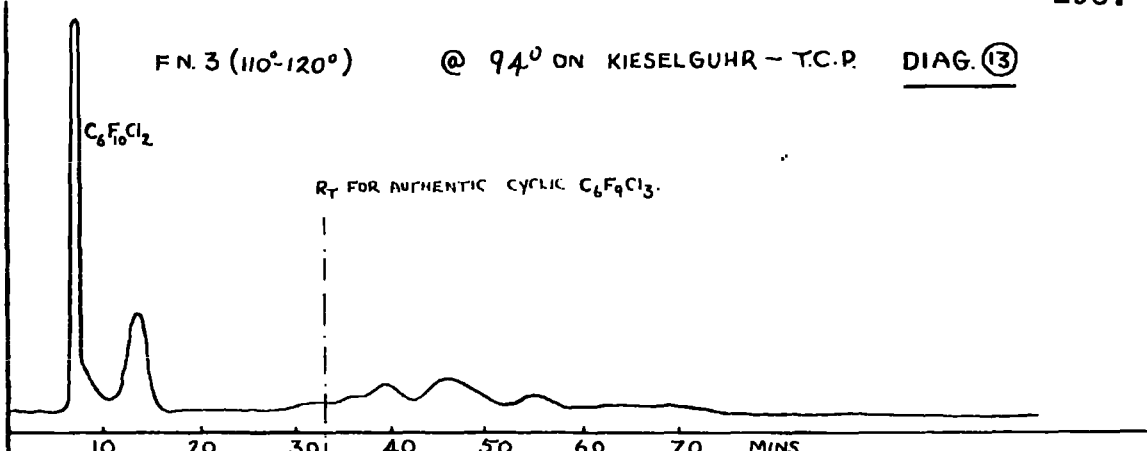

FN. 4 (120°-130°) @ 94° ON KIESELGUHR - T.C.P. DIAG. (14)

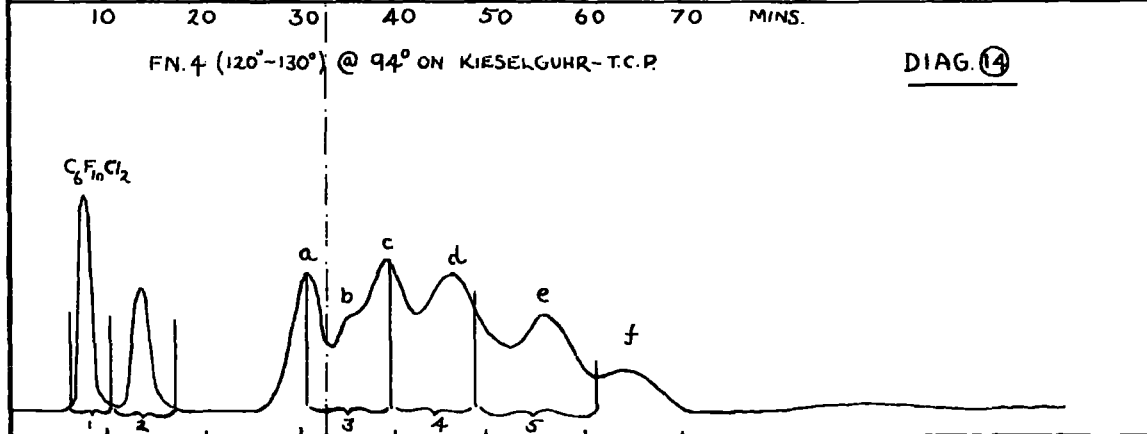

DIAG. (15)  
CUT 3. OF FN. 4 ON K/T.C.P @ 94°

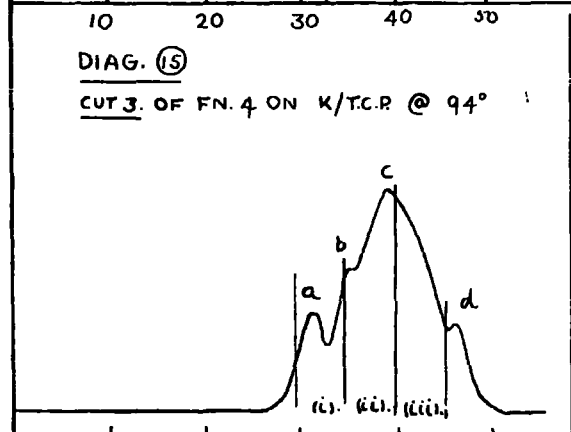

DIAG. (16)  
CUT (i) OF CUT 3.

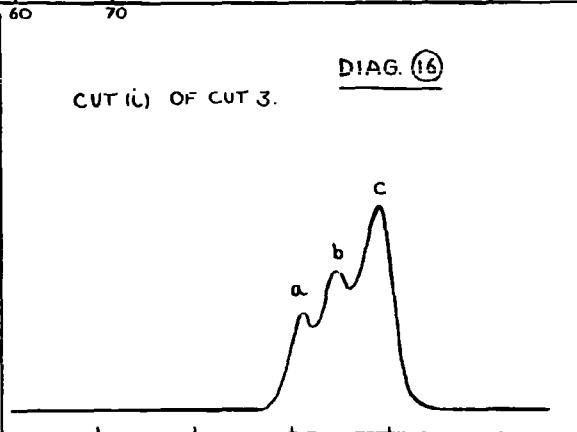

DIAG. (17)  
CUT (ii) OF CUT 3.

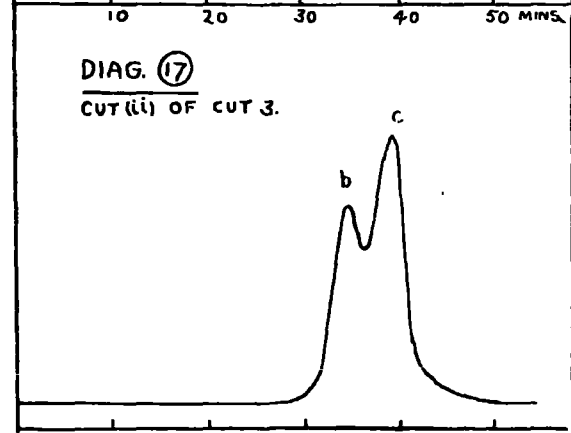

DIAG. (18)  
CUT (iii) OF CUT 3

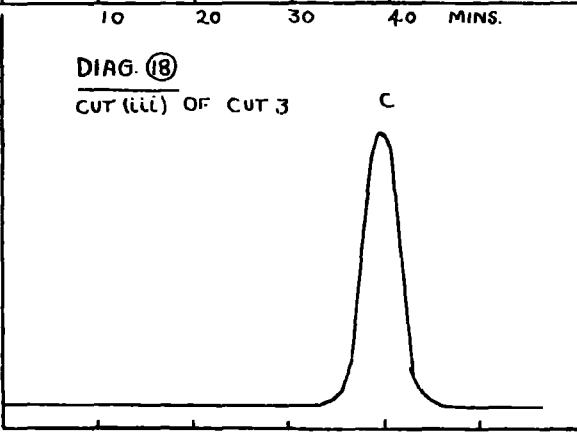



Cut (2) 0.60 g. Analytical V.P.C. kieselguhr-tricresyl phosphate at  $94^{\circ}$  showed that a trace of cut (1) material was present and the material was recycled under the same conditions to yield material giving a single peak. Found: Cl, 22.7; F, 52.3% Calculated values for possible compounds are given below:

Compound	% Cl	% F
$C_6F_9Cl_2H$	22.5	54.3
$C_6F_8Cl_2H_2$	23.8	51.3
$C_6F_7Cl_2H_3$	25.4	47.8

Cut (3) 1.40 g. This material was obviously a mixture and was not investigated further. However, since on the analytical chromatogram the overlapping peaks had retention times greater than those for both cyclic  $C_6F_{10}Cl_2$  and cyclic  $C_6F_9Cl_3$  but less than that of cyclic  $C_6F_8Cl_4$  the material was almost certainly hydrogen containing (The possibility that the materials might be chlorofluorocyclohexenes or chlorofluorocyclohexadienes is remote, since these materials were not present in Bank's first chlorofluorination product where a much smaller chlorine trifluoride/benzene ratio was employed.

Fraction 4 (b.r.  $120^{\circ}$ - $130^{\circ}$ )

Analytical V.P.C., kieselguhr-tricresyl phosphate at

94° showed that the material was quite complex (see diagram (14)). In six runs 12.0 g. were separated on a 16' kieselguhr-tricresyl phosphate column at 123°, p.d. 34 cms. Hg nitrogen flowrate 180 mls./min, and cuts were taken as shown in diagram (14)). (The preparative chromatogram was very similar to the analytical one and hence the approximate positions of the cuts taken can be shown).

Cut (1) 0.40 g. White solid. Analytical V.P.C., kieselguhr-tricresyl phosphate at 94°, gave a single peak coincident with that due to authentic cyclic  $C_6F_{10}Cl_2$ , and no separation was noted when authentic cyclic  $C_6F_{10}Cl_2$  was added.

Cut (2) 0.25 g. Liquid. Analytical V.P.C. kieselguhr-tricresyl phosphate at 94° gave a single peak coincident with that due to cut (2) in the b.r. (110°-120°) fraction. This material was therefore a hydrochlorofluorocyclohexane.

Cut (3), 4.0 g.; cut (4), 1.9 g.; cut (5), 1.82 g.  
cut (6) later peaks, 1.0 g. Analytical V.P.C., kieselguhr-tricresyl phosphate at 94°, showed that each cut was a mixture of two or more components with overlapping peaks. Cut (3) (see diagram (15)) was recycled on kieselguhr-tricresyl phosphate at 120°, p.d. 34 cms. Hg, nitrogen flow-

rate 175 mls./min. and further subdivided into three further cuts in an effort to get a pure component out.

Weights and analyses of the cuts were:-

No Cut	Wt.(g.)	Analysis		V.P.C. on Kieselguhr-T.C.P. at 94°
		%Cl	% F	
(i)	1.20	23.9	52.4	diagram (16)
(ii)	1.15	21.5	53.1	diagram (17))
(iii)	0.94	22.0	53.6	diagram (18)

Calculated values for possible compounds are, cyclic  $C_6F_9Cl_2H$ ; Cl, 22.5; F, 54.3: cyclic  $C_6F_8Cl_2H_2$ ; Cl, 23.8; F, 51.3.

An infra-red spectrum of each cut gave an absorption at  $2976\text{ cm}^{-1}$  in each case (Whiffen<sup>16</sup> states that the  $-C-H$  stretching absorption in saturated fluorocyclohexanes occurs in the region  $2968-2984\text{ cm}^{-1}$ ), while no absorptions attributable to unsaturation were present.

We can therefore conclude that this whole fraction consists mainly of hydrogen containing chlorofluorocyclohexanes since from the chromatogram on kieselguhr-tricresyl phosphate at  $162^\circ$  no cyclic  $C_6F_8Cl_4$  can be present.

#### Fraction 5 (b.r. $130^\circ-150^\circ$ )

Analytical V.P.C., kieselguhr-tricresyl phosphate at  $162^\circ$  gave the chromatogram in diagram (19).

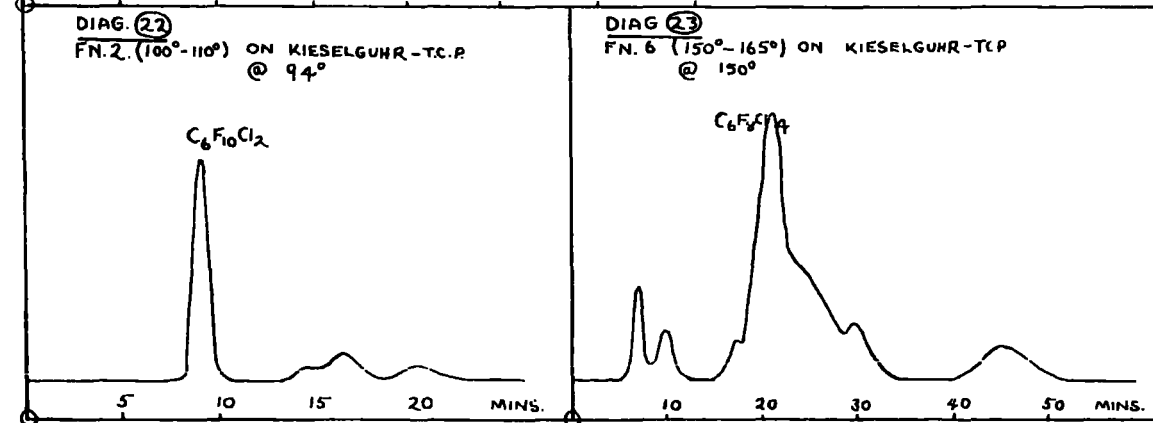
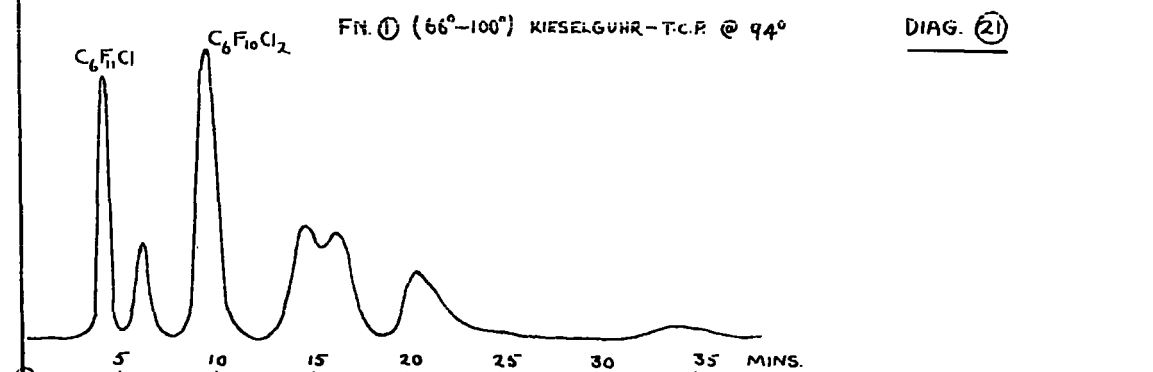
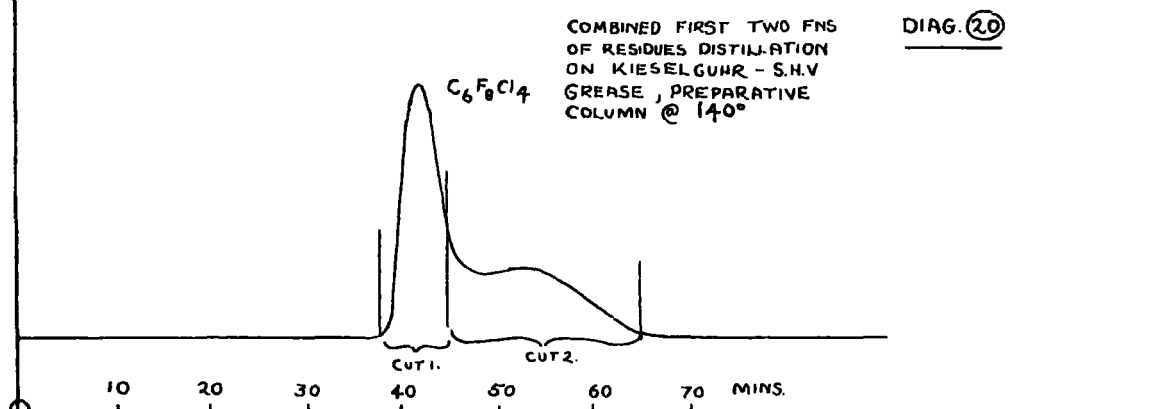
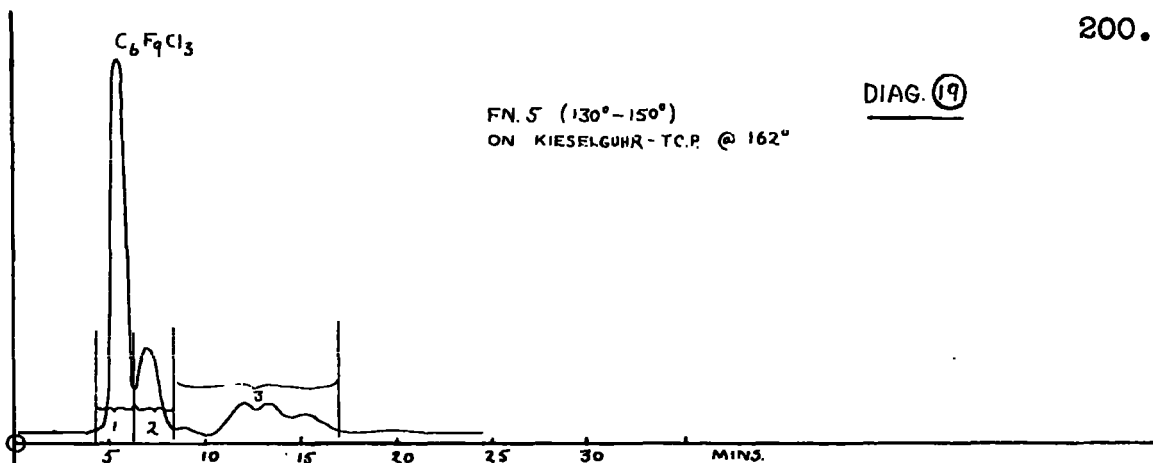

10 g. were separated in four runs on 16' kieselguhr-tricresyl phosphate at  $125^{\circ}$ , p.d. 34 cms. Hg, nitrogen flowrate 180 mls./min. and cuts taken as follows:-

Cut (1) 4.31 g., white waxy solid. Analytical V.P.C. on kieselguhr-tricresyl phosphate at  $94^{\circ}$  gave a single peak coincident with that due to authentic cyclic  $C_6F_9Cl_3$ . Found: Cl, 30.0%; F, 48.6%. Calculated for  $C_6F_9Cl_3$ : Cl, 30.4; F, 48.9%. No separation was observed when chromatographed with authentic cyclic  $C_6F_9Cl_3$ .

Cut (2) 1.10 g. Analytical V.P.C., kieselguhr-tricresyl phosphate at  $94^{\circ}$  gave two overlapping peaks. Found: Cl, 17.0; F, 50.8%. Since the retention time for both is greater than that due to cyclic  $C_6F_9Cl_3$  and less than that due to cyclic  $C_6F_8Cl_4$  the materials are hydrogen containing chlorofluorocyclohexanes.

Cut (3) 4.01 g. This is a mixture and no analyses were carried out, but again, since the retention times of all peaks present are less than that due to cyclic  $C_6F_8Cl_4$  the materials are hydrogen containing.

Residues: initial distillate (see p.191)

As described earlier this material consists of the combined first two fractions of the residues distillation. A preparative column, packed with kieselguhr-tricresyl

phosphate could not be operated at a high enough temperature to effect a separation in a reasonable time, because of 'bleeding', and so attempts were made to separate the material on an 8' kieselguhr-silicone high vacuum grease column at 140° p.d. 14 cms. Hg, nitrogen flowrate 300 mls./min.

Resolution was very poor on this packing (see diagram (20)) and two recyclings were necessary, an initial cut being taken each time, before a quantity of white waxy solid was obtained giving a single peak by analytical V.P.C., kieselguhr-tricresyl phosphate at 160°. The peak was coincident with that due to authentic cyclic  $C_6F_8Cl_4$ , and did not resolve when mixed with authentic material. Found: Cl, 39.5; F, 39.7.  $C_6F_8Cl_4$  requires: Cl, 38.8; F, 41.5.

The later peak (see diagram (20)) could not be obtained pure but is presumably hydrogen containing, the retention time for cyclic  $C_6F_7Cl_5$  being much greater.

Analytical vapour phase chromatography of the remaining fractions:

Using a kieselguhr-tricresyl phosphate column and adjusting the temperature to give the best resolution in each particular case, chromatograms were obtained for the fractions which had not been separated on a preparative scale (see diagrams (21)-(23)). From the peak areas:

of the components an estimate of the amount of each present was obtained. These results cannot be very accurate since equal thermal conductivities were assumed and poor resolution of the peaks in some cases meant that some areas measured were indefinite.

From these results, together with those from the actual preparative separations (complete recovery being assumed) the composition of each fraction was estimated and is given in TABLE V.

Fraction b.p. °C.	Wt. of Fraction (g.)
66-110	76.5
100-110	78.8
110-120	117.0
120-130	137.2
130-150	391.0
150-165	251.1
Res. Initial	238.0
Distill- ate	

\* The absence of an  
was shown by infra-



DEHALOGENATION OF THE DISTILLATION FRACTIONS FROM THE,  
CHLORINE TRIFLUORIDE-BENZENE VAPOUR PHASE REACTION,  
PRODUCT

I. Dehalogenations at ca. 400°

(a) Fraction (2) b.r. (100°-110°)

10 g. dehalogenated at 380° yielded 5.8 g. product, having an analytical vapour phase chromatogram, on kieselguhr-tricresyl phosphate at 94°, showing several overlapping peaks. It was decided to dehalogenate more material before attempting separation.

20 g. yielded 11.6 g. product having a similar chromatogram to that first obtained (see diagram 24).

11.0 g. were separated in six runs (see diagram 24 for cuts), on a 16' kieselguhr-tricresyl phosphate column, at 65°, p.d. 25 cms. Hg, nitrogen flowrate 200 mls./min., to give cuts as follows:-

cut (1), 1.36 g. Analytical V.P.C., kieselguhr-tricresyl phosphate at 94°, gave a single peak coincident with that of cyclic  $C_6F_{10}$ . Found: F, 71.5%.  $C_6F_{10}$  requires: F, 72.6%. An infra-red spectrum was identical with that of authentic cyclic  $C_6F_{10}$ .

Cut (2), 2.42 g. Analytical V.P.C., kieselguhr-tricresyl phosphate at 94°, gave a peak with a slight shoulder. A part of this material was recycled on

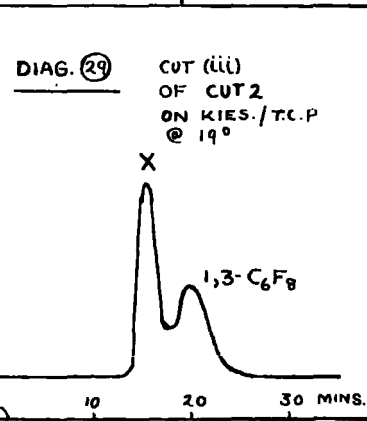
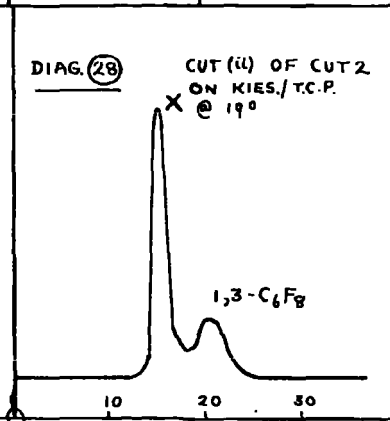
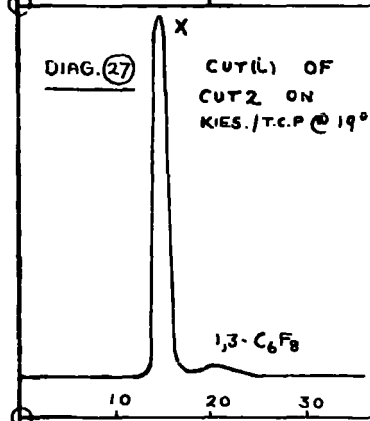
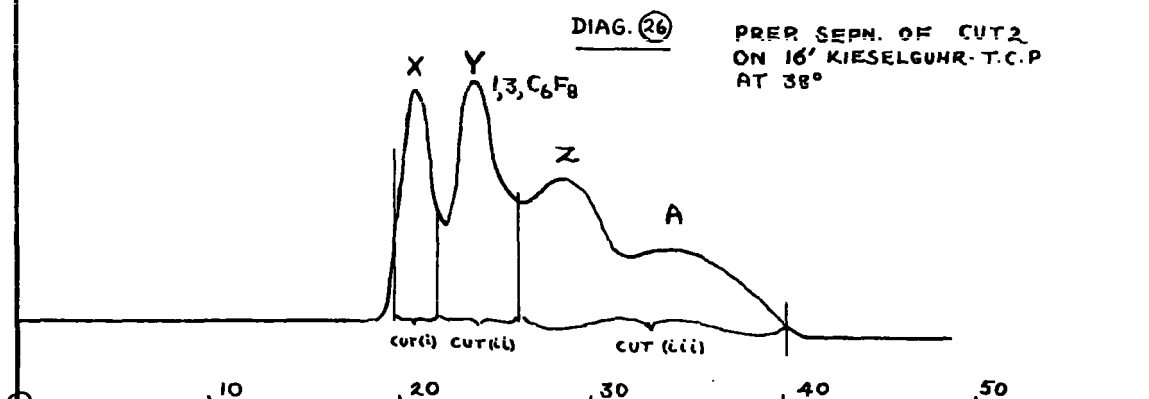
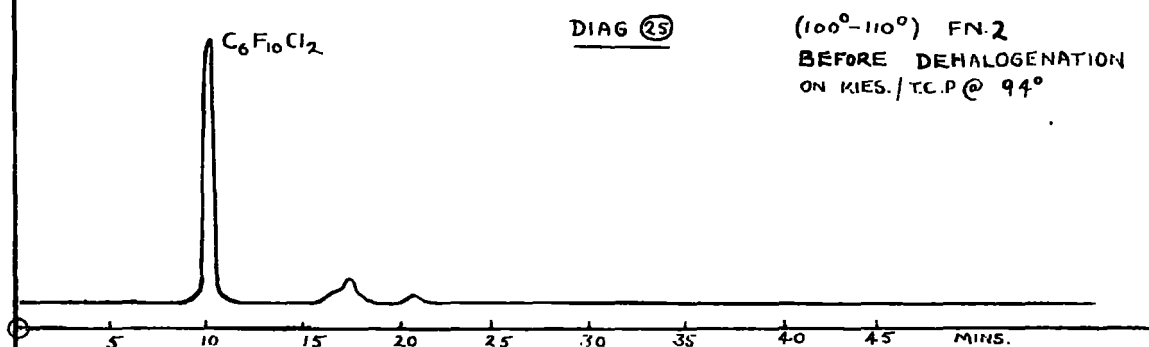
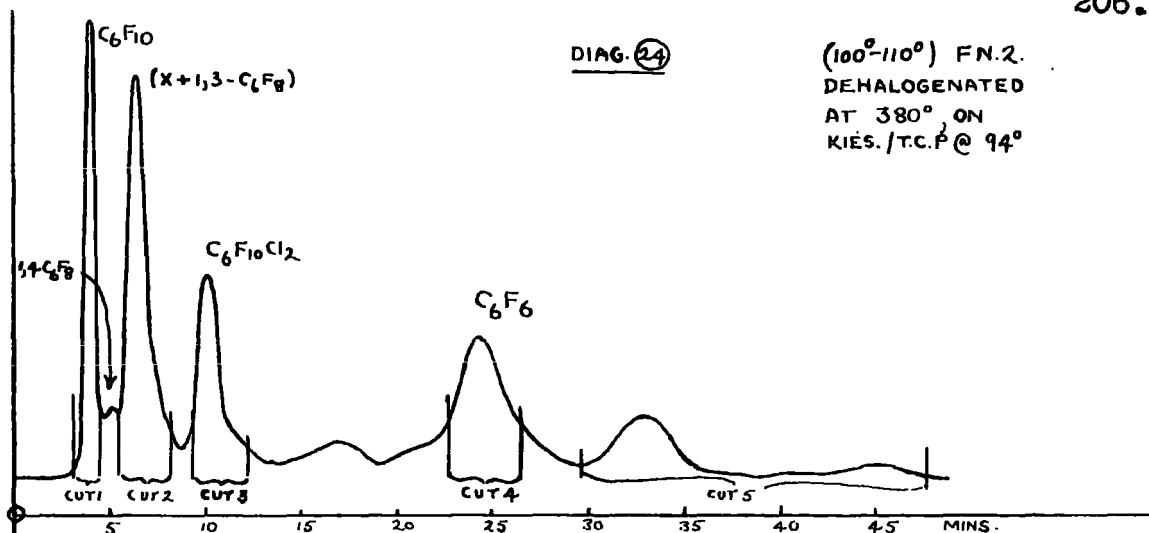

kieselguhr-tricresyl phosphate at  $55^{\circ}$ , and began to resolve into two more peaks. The temperature was lowered successively through  $48^{\circ}$  to  $38^{\circ}$  until no further improvement in separation could be obtained. At the latter temperature, p.d. 29 cms. Hg, nitrogen flowrate 175 mls./min., a separation of the remaining material was attempted. Cuts were made at the points indicated (see diagram 26):- cut (i) 0.51 g., cut (ii), 0.07 g., cut (iii), 0.30 g. Analytical V.P.C., kieselguhr-tricresyl phosphate at  $19^{\circ}$ , gave chromatograms as in diagrams 27 to 29. At this temperature peaks 'A' and 'Z' did not show up. Peak 'Y' was identified as octafluorocyclohexa-1:4-diene, the nature of peaks 'Z', 'A', and 'X', was not known.

cut (i) was separated in five runs through a 6' analytical kieselguhr-tricresyl phosphate column at  $19^{\circ}$ , p.d., 5 cms. Hg, nitrogen flowrate 20 mls./min. An initial cut was taken each time and ca. 50 mg. of a colourless liquid obtained. Found: Cl, 13.3; F, 58.1%. Cyclic  $C_6F_7Cl$  requires: Cl, 14.75; F, 55.4%. Analytical V.P.C., kieselguhr-tricresyl phosphate gave a single peak but an infra-red spectrum showed very weak absorptions due to octafluorocyclohexa-1:4-diene and additional ones at 1290(s), 1188(s), 1111(s), 1078(m), 1044(s), 961(vs), 877(s), 862(vs), 679(w)  $cm.^{-1}$ . The absorption in the diene double bond region

occurred at 1742(m) and 1684(w)  $\text{cm.}^{-1}$  (The diene doublet absorption in octafluorocyclohexa-1:3-diene occurs at 1748 and 1706  $\text{cm.}^{-1}$ ). The analytical figures and infra-red evidence suggest that this material is a chloroheptafluorocyclohexadiene. No absorptions due to -C-H bonds were present.

cut (3), 1.30 g., waxy white solid. Analytical V.P.C., kieselguhr-tricresyl phosphate at  $94^{\circ}$  gave a single peak coincident with that of authentic cyclic  $\text{C}_6\text{F}_{10}\text{Cl}_2$ . No peak separation occurred when the material was mixed with authentic cyclic  $\text{C}_6\text{F}_{10}\text{Cl}_2$ .

cut (4), 2.45 g. Analytical V.P.C., kieselguhr-tricresyl phosphate at  $94^{\circ}$  gave a single peak coincident with that due to authentic perfluorobenzene. Found: F, 61.5%. Cyclic  $\text{C}_6\text{F}_6$  requires: F, 61.2%. An infra-red spectrum confirmed the identity of this material.

cut (5), 1.60 g. This material, obviously a mixture, was not investigated further.

(b) Fraction 5 b.r. ( $130^{\circ}$ - $150^{\circ}$ )

20 g. of material dehalogenated at  $400^{\circ}$  gave 15 g. of dehalogenated product. An analytical vapour phase chromatogram kieselguhr-tricresyl phosphate at  $162^{\circ}$  showed the mixture to be quite complex (see diagrams 30 and 31), and no further work was done on it.

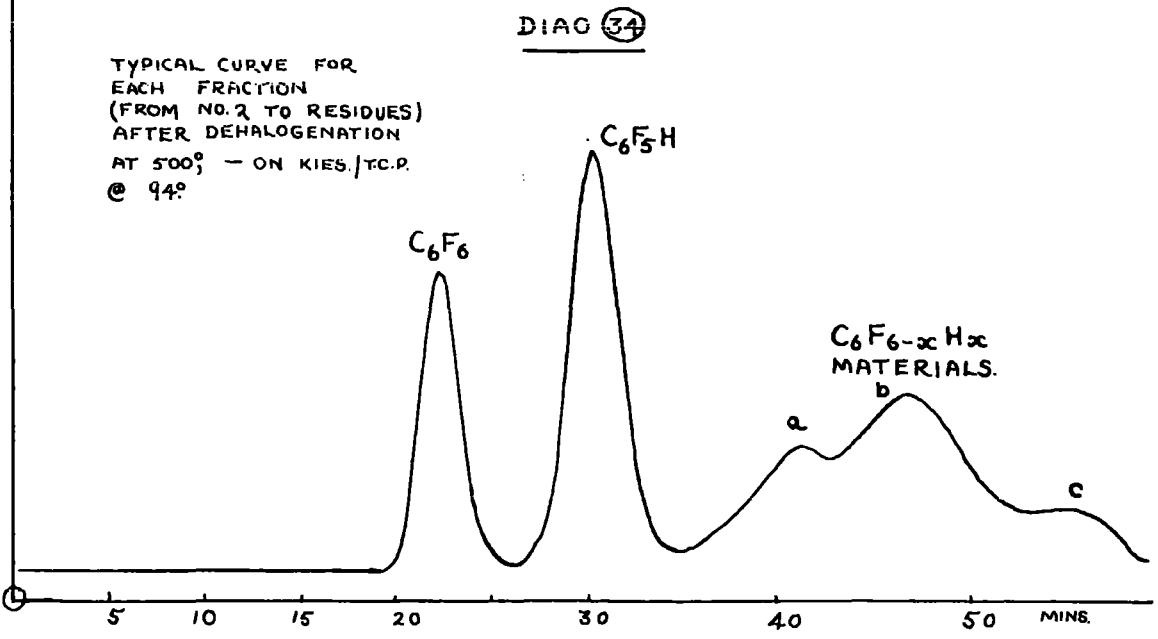
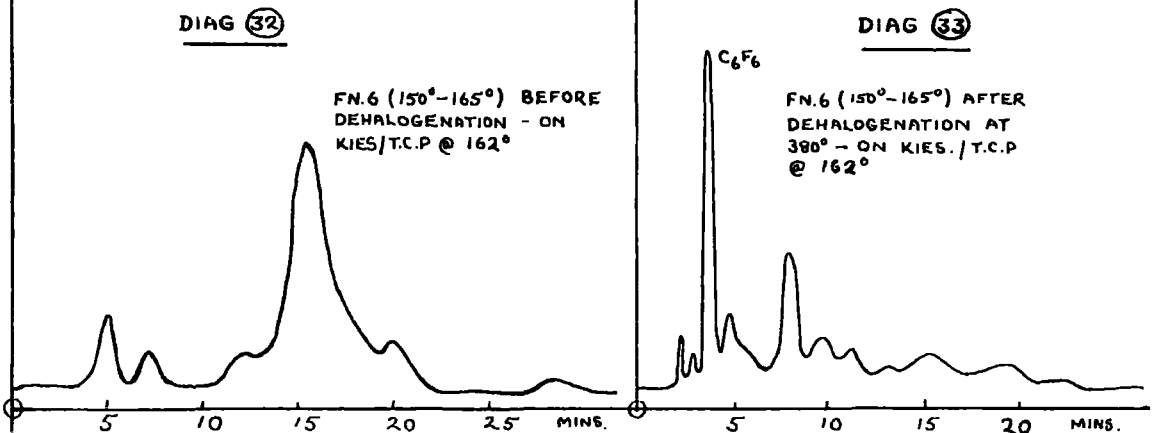
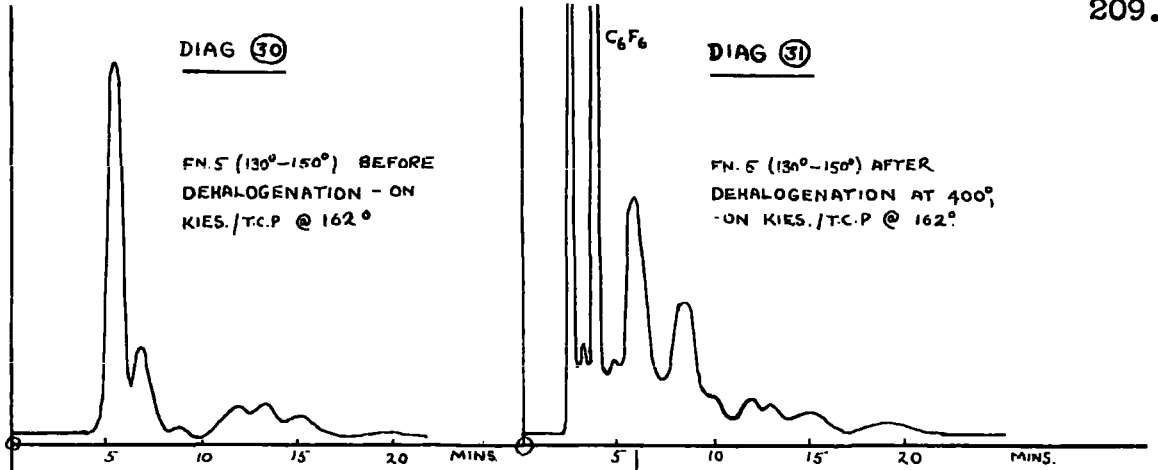

(c) Fraction 6 b.r. (150-165°)

50 g. were dehalogenated at 380° to yield 31.5 g. product. Analytical vapour phase chromatography kieselguhr-tricresyl phosphate at 162° showed that the product was a complex mixture (see diagrams 32 and 33). However the material was distilled through a 25-plate concentric tube column but very little separation of the components was effected, and vapour phase chromatography of the initial fractions at a lower column temperature of 94°, on kieselguhr-tricresyl phosphate, showed further resolution of the mixture into more components. No further work was therefore carried out on this material.

II. Dehalogenations at 500°

In the dehalogenations carried out at this temperature, analytical V.P.C. showed that the product had always the same qualitative composition, showing peaks for cyclic  $C_6F_6$  and  $C_6F_5H$ , followed by three overlapping peaks (see diagram 34 for a preparative scale vapour phase chromatogram of a typical product). For this reason a separate account of each dehalogenation and the working up of the products is not given.

The following techniques were used in every case to separate and characterise the products.

(1) Analytical vapour phase chromatography

Column, 6' kieselguhr-tricresyl phosphate at  $94^{\circ}$ , p.d. 6 cms. Hg, nitrogen flowrate 15 mls./min. Used before and after separation of products to establish their identity and purity.

(2) Preparative vapour phase chromatography

Column, 16' kieselguhr-tricresyl phosphate at  $80^{\circ}$ - $90^{\circ}$ , p.d. ca. 25 cms. Hg, nitrogen flowrate, 175-200 mls./min.

(3) Halogen analysis

This was carried out by the standard method used in this laboratory, that of Johncock, Musgrave and Wiper.<sup>18</sup>

(4) Infra-red spectroscopy

An infra-red spectrum was taken for each separated component, or mixture of components and, except where stated otherwise, confirmed its identity.

Results

The full conditions used for the dehalogenations and the results obtained are summarised in TABLE VII.

Theoretical values for the fluorine content of the products, and some possible, (although in many cases unlikely) products are given below:-

TABLE VII

Starting Material	Nitrogen flow ccs./min.	Reactor Temp. °C.	Time of Introduction of sample (mins.)	Wt. Starting Material (g.)	Wt. Product (g.)	Nature, weight and analysis of products after separation by preparative V.P.C.					
						Cyclic C <sub>6</sub> F <sub>6</sub> (g.)	Found % F	Cyclic C <sub>6</sub> F <sub>5</sub> H (g.)	Found % F	Combined Later Peaks (g.)	Found % F
Fn. 2 b.r. (100-110°)	30	500	45	12.0	2.62	0.82	61.0	0.60	55.3	0.88	*44.1(1) (2)46.6
Fn. 3 b.r. (110-120°)	30	500	120	30.0	7.05	3.06	61.1	2.18	53.4	1.11	-
Fn. 4 b.r. (120°-130°)	30	500	125	30.0	6.53	0.90	61.2	3.01	55.7	1.93	-
Fn. 5 b.r. (130°-150°)	30	500	120	30.0	5.92	0.99	60.5	1.26	53.0	1.81	42.2
Fn. 6 b.r. (150°-165°)	30	500	120	30.0	6.20	1.08	60.5	1.70	56.7	2.50	46.1
Residues initial distillate	30	500	75	35.0	4.55	0.87	59.9	0.87	54.6	1.35	-

\* The combined later peaks in this product were chromatographed preparatively on a 16' kieselguhr-tricresyl phosphate column at 74° and two arbitrary cuts made, (1), and (2). The analyses of these cuts are given.



Compound	% F	Compound	% F
$C_6F_6$	61.2	$C_6F_9H$	70.1
$C_6F_5H$	56.5	$C_6F_8H_2$	67.3
$C_6F_4H_2$	50.6	$C_6F_7H_3$	63.9
$C_6F_3H_3$	43.2	$C_6F_6H_4$	60.7
$C_6F_2H_4$	33.3	$C_6F_5H_3$	55.8

It will be seen from TABLE VII that fraction (1), b.r. ( $66^{\circ}$ - $100^{\circ}$ ), was not dehalogenated. This was because at the start of these dehalogenation reactions it was thought that this material was quite complex and possibly contained some benzene. Its dehalogenation therefore was shelved. Later work showed it to contain no benzene and it seems very likely from its composition (see TABLE V p. 204) that its dehalogenation would lead to products similar to those of the other fractions.

Some further work was carried out to find more about the 'combined later peaks' material.

#### Analytical vapour phase V.P.C. of the later peaks

Under standard conditions, 6' kieselguhr-tricresyl phosphate column at  $96^{\circ}$ , p.d. 8.3 cms. Hg, nitrogen flow-rate 17 mls./min. each 'combined later peaks' cut was chromatographed. Peaks a, b, and c, (see diagram 34 p. 209), corresponded exactly to each other in every case.

Unfortunately no samples of tetra-, and tri-fluorobenzenes and hydrogen containing fluoro-dienes were available for direct comparison. Cyclic  $C_6F_5Cl$  had a greater retention time than any of the peaks a, b, and c.

#### Infra-red analysis of the combined later peaks'

An infra-red spectrum was taken for each cut and again the spectra were almost identical. An absorption at  $3086\text{ cm.}^{-1}$  showed the material was hydrogen containing, while very strong absorptions at  $1527$  and  $1508\text{ cm.}^{-1}$  suggested the presence of an aromatic nucleus. The corresponding absorptions in perfluorobenzene occur as very strong bands at  $1543$  and  $1511\text{ cm.}^{-1}$ , and in pentafluorobenzene at  $1535$  and  $1512\text{ cm.}^{-1}$ . For pentafluorobenzene Steele and Whiffen<sup>16</sup> report the carbon-hydrogen frequency at  $3102\text{ cm.}^{-1}$  while for mono-olefines, and polyenes it can occur in the regions  $(2968-2984)\text{ cm.}^{-1}$  and  $(3087-3113)\text{ cm.}^{-1}$  respectively.

#### Partial separation of 'combined later peak' from the b.r. (130-150) dehalogenated material

The later peak material from the fn. 5 b.r. (130-150) dehalogenated material was separated preparatively on a 16' kieselguhr-tricresyl phosphate column at  $80^{\circ}$ , p.d.

30 cms. Hg, nitrogen flowrate 170 mls./min. and two arbitrary cuts were taken. These analysed to:- cut (1); F, 43.6: cut (2); F, 43.0%.

Attempted defluorination of mixed cyclic  $C_6F_{10}H_2$  isomers

(a) At 500°

10.15 g. of cyclic  $C_6F_{10}H_2$ , b.r. (86°-92°), were distilled into the reactor over 10 mins. in a nitrogen flow of 30 mls./min. 6.0 g. of product were obtained, which was shown to be mainly starting material by analytical V.P.C. on kieselguhr-tricresyl phosphate at 94°.

(b) At 630°

20 g. of cyclic  $C_6F_{10}H_2$  were distilled into the reactor over 45 mins. in a nitrogen flow of 30 mls./min. 0.69 g. of liquid, containing some carbon, was obtained. Analytical V.P.C., 6' kieselguhr-tricresyl phosphate column at 75°, p.d. 8 cms. Hg, nitrogen flowrate 15 mls./min. showed that the product consisted mainly of two large overlapping peaks. This combined material was separated from the rest in six runs on the analytical column under the conditions referred to and analysed. Found: F, 27.2, and F, 27.7% in two analyses.

Lack of time prevented further investigation of this reaction.

### Preparation of chloropentafluorobenzene

Tatlow et al.<sup>15</sup> brominated and iodinated cyclic  $C_6F_5H$  using bromine and iodine in oleum and an aluminium bromide catalyst, but did not mention the production of the monochloro- compound in this way.

It was decided to apply their technique, suitably modified for the gaseous halogen, in an attempt to make cyclic  $C_6F_5Cl$ .

### Method

A 100 ml. three necked flask was equipped with a gas lead tube extending almost to the paddle of a mercury seal stirrer, and a D/S condenser terminating in a dry-ice-acetone cooled cold finger, and calcium chloride tube.

Fresh anhydrous aluminium chloride (0.2 g.) and oleum (15 mls.) containing 20% sulphur trioxide, were placed in the flask, and pentafluorobenzene (5 g., 0.03 mole) added. The flask was heated in an oil bath at 45-50° for six hours while chlorine was passed in with the stirrer running slowly. Chlorine was bubbled in at such a rate that the theoretical amount (2.13 g., 0.03 mole) would have been added in four hours if it was all absorbed.

After allowing the dark red-brown product to cool it was poured onto crushed ice (100 g.) contained in a

separating funnel, and the small lower layer run off. Washing twice with sodium carbonate solution, once with metabisulphite solution, and once with water gave product (1.3 g.) which was dried over  $P_2O_5$ .

Analytical V.P.C., on kieselguhr-tricresyl phosphate at  $95^\circ$  showed two peaks, the first, coincident with authentic cyclic  $C_6F_5H$ , being present to the extent of ca. 30%. A run at a higher column temperature,  $180^\circ$ , showed that more highly chlorinated addition products were absent.

Preparative V.P.C., on a 16' kieselguhr-tricresyl phosphate column at  $105^\circ$ , p.d. 26 cms. Hg, nitrogen flow-rate 180 mls./min, was carried out on 1.1 g. product. A clean separation of both peaks was obtained and 0.7 g. of the main product collected, which was pure by analytical V.P.C.

Found: Cl, 17.4; F, 46.4%, B.pt.  $122^\circ$ ,  $n_D^{20} = 1.4258$   
 $C_6F_5Cl$  requires; Cl, 17.5; F, 46.9%. McBee et al.<sup>5</sup> gave  
 b.pt.  $122-123^\circ$   $n_D^{20}$  1.4256 for this compound.

REFERENCES

10. P. Johncock, Ph.D. Thesis, Durham 1959, p. 99 et seq.
11. J.C. Tatlow and R.E. Worthington, J.C.S. 1952, 1251.
12. J. Roylance, J.C. Tatlow and R.E. Worthington, J.C.S. 1954, 4426.
13. B. Gething, C.R. Patrick, Nature 1959, 183, 586.  
J.C. Tatlow, R.E. Banks, A.K. Barbour, and A.E. Tipping,
14. A.K. Barbour, H.D. Mackenzie, M. Stacey and J.C. Tatlow, J. App. Chem. 1954, 4, 341.
15. E. Nield, R. Stephens and J.C. Tatlow, J.C.S., 1959, 166.
16. D. Steele and D.H. Whiffen, Tetrahedron 1958, 3, 181.
17. J. Burdon and D.H. Whiffen, Spectrochim Acta 1958, 12, 139.
18. P. Johncock, W.K.R. Musgrave and A. Wiper, Analyst, 1959, 84, 245.