



Durham E-Theses

The iodous sulphates

Argument, Cyril

How to cite:

Argument, Cyril (1944) *The iodous sulphates*, Durham theses, Durham University. Available at Durham E-Theses Online: <http://etheses.dur.ac.uk/9113/>

Use policy

The full-text may be used and/or reproduced, and given to third parties in any format or medium, without prior permission or charge, for personal research or study, educational, or not-for-profit purposes provided that:

- a full bibliographic reference is made to the original source
- a [link](#) is made to the metadata record in Durham E-Theses
- the full-text is not changed in any way

The full-text must not be sold in any format or medium without the formal permission of the copyright holders.

Please consult the [full Durham E-Theses policy](#) for further details.

Part I. The Iodous Sulphates.

Part II. Adsorption at the Interface between two fluids,
(with special reference to the adsorption of five
dyes at a mercury-water interface).

By Cyril Argument, B.Sc.,

of The College of the Venerable Bede,

for the degree of Ph.D.

Part I.

The formula and general properties of the yellow iodous sulphate have been investigated, with special reference to previous work. Two main methods of investigation have been applied, viz:-

1. An adaption of the wet residue method.
2. A direct determination of wetting H_2SO_4 in samples of solid by the use of dissolved $BaSO_4$ as an indicator in the acid medium.

Both methods have given good results, confirmatory of the conclusion that the formula is simply $I_2O_3 \cdot SO_3$, or $(IO)_2SO_4$, and contained no water.

A new, white, crystalline compound has been discovered and found to be much more unstable than the yellow solid, and consequently more difficult to handle. It is formed from the yellow solid in acids stronger than 100%. The methods used in studying its formula were those used in work on the yellow solid; modified by extra precautions against atmospheric influences. Results are not so decisive as for the yellow sulphate, but it is concluded that:-

1. The ratio of I_2O_3 to SO_3 in the molecule is 1 : 4.
2. The great activity of the compound makes the determination of

the water-content (if any) impracticable without the development of a new technique, for which there is no opportunity at the present time.

A new method of preparation of the yellow iodous sulphate has been used which is very convenient, clean, and dispenses with the application of heat.

The inter-relationship and inter-conversion of the two iodous sulphates has been studied and a novel type of change noted; involving complete decomposition of the white solid in acids below 100% H_2SO_4 into I_2 and I_2O_5 ; before the transition to the yellow form takes place. The transition seems to be confirmed by microphotographic observation.

Part II.

The adsorption of Methylene Blue, Congo Red, Bordeaux Extra, Indigo Carmine X and Solway Ultra-blue B, from aqueous solutions of each has been measured at the mercury-water interface at 17°C. The interface was provided by a stream of droplets falling through the dyestuff solution. The adsorbed material was estimated colorimetrically in a Bausch and Lomb tintometer. Interfacial tensions of the same systems have been measured and from these theoretical adsorptions calculated by way of the Gibbs' adsorption equation.

$$\Gamma = - \frac{c}{RT} \cdot \frac{d\sigma}{dc}$$

In all five dyes studied the measured adsorption passes through a maximum with increasing concentration which is in agreement with several examples previously published by other workers although the experimental technique and materials under consideration differed widely.

Exact agreement between measured adsorptions and those calculated from the Gibbs' equation was not expected in view of the latitude in evaluating $\frac{d\sigma}{dc}$ from σ/c curves, the use of concentrations instead of activities, and of factors such as the influence of electrical double layers of which Gibbs' equation takes no account. The discrepancies between the two sets of values are nevertheless striking.

In the case of Methylene Blue, Solway Ultra-blue B, and Indigo Carmine X the form of the "theoretical" adsorption curve is the same as that of the measured curve though of different dimensions. In the case of Congo Red and Bordeaux Extra however the interfacial tension/concentration curve has two inflexions which lead to "theoretical" values for the adsorptions which change from positive to negative and then back to positive as the concentration increases. Such a change is independent of the use of concentrations instead of activities in calculating adsorptions from Gibbs' equation and of errors in assessing $\frac{d\sigma}{dc}$. In none of the cases investigated do the curves for theoretical and measured adsorptions coincide at low concentrations as would be the case if the only reason for the discrepancies were to be found in the omission of the activity coefficients.

THE IODOUS SULPHATES.

The results described have been published in the October 1938
issue of the Journal of the Chemical Society.

THESIS.

Part I.

Presented in candidature for the degree of

Doctor of Philosophy

of the University of Durham

by

Cyril Argument

B.Sc.

entitled

The Iodous Sulphates.

Being an account of the work carried out
during the Session 1937 - 8 at the Science
Laboratories, Durham University, (Durham
Division), under the direction of
Dr. Irvine Masson M.B.E., D.Sc., F.I.C., F.R.S.

Contents.

	Page.
<u>Publication.</u>	-
<u>Introduction.</u>	-
<u>Chapter I.</u> Historical	1.
<u>Chapter II.</u> Preliminary Investigation	28.
Preparation of Yellow Iodous Sulphate in this work.	29.
Preparation of Yellow Iodous Sulphate as carried out by P. Chretien & others.	30.
Preliminary analyses for determination of "R"	32.
Analytical Procedure of other workers.	35.
Attempted Direct Analysis in this work.	37.
Survey of Analytical Methods adopted.	40.
Full scale preparation of Yellow Iodous Sulphate.	42.
Range of Stability of Yellow Sulphate.	43.
Final series of tubes for wet residue analysis	45.
Sensitivity of Yellow Sulphate to light.	47.
<u>Chapter III.</u> Preparation of starting materials.	48.
<u>Chapter IV.</u> Details of Analysis of a typical tube of yellow Iodous Sulphate.	57.
(a) Wet Residue Method.	
(b) $BaSO_4$ = Indicator Method.	
<u>Chapter V.</u> Theoretical Considerations.	71.

	Page.
(a) The Yellow Iodous Sulphate.	
(b) The White Iodous Sulphate.	
<u>Chapter VI.</u> Details of Analysis of White Iodous Sulphate.	82.
<u>Chapter VII.</u> Complete Summary of Results of all analyses.	89.

Illustrations.

	Page.
Figure I. All glass filtration apparatus.	32.
Figure II. Vacuum drying desiccator.	38.
Figure III. Tie-lines required by the Chretien and by the Bahl and Partington formulae.	41.
Figure IV. Graph showing solubility of BaSO_4 in concentrated H_2SO_4 solutions.	55.
Figure V. Typical Plot of experimental results from analyses of tube IV.	63.
Figure VI. Apparatus for distilling of liberated iodine in a current of air.	68.
Figure VII. Microphotographs.	79.
Figure VIII. Apparatus for dilution of Oleum.	86.
Figure IX. Plot of analyses for series of 9 preliminary tubes of yellow iodous sulphate.	90.
Figure X. Plot of final series of 6 tubes of yellow iodous sulphate.	91.
Figure XI. Plot of preliminary series of wet residue analyses on white solid.	94.

THE IODOUS SULPHATES

BY
IRVINE MASSON
AND
CYRIL ARGUMENT

Reprinted from the *Journal of the Chemical Society*,
October, 1933.

321. *The Iodous Sulphates.*

By IRVINE MASSON and CYRIL ARGUMENT.

The preparation of Chrétien's yellow crystalline iodous sulphate by decomposing iodic acid by heat in concentrated sulphuric acid is shown to be a mingling of three or more reactions, one thermal and the others isothermal at room temperature. The thermal reaction $I_2O_5 \rightarrow I_2O_3 + O_2$ occurs quantitatively in fuming sulphuric acid at 215–220°, the product being there stabilised as an iodous sulphate. In the cold, the reaction $2I_2 + 3I_2O_5 \rightarrow 5I_2O_3$ occurs, with a 100% yield of Chrétien's sulphate, when the reagents are shaken in concentrated sulphuric acid.

By two methods, Chrétien's sulphate is proved to be $I_2O_3 \cdot SO_3$, not hydrated as its discoverer and others represented it. In acid more dilute than $H_2SO_4 \cdot H_2O$ it decomposes, reversing its own synthesis. In fuming sulphuric acid it undergoes transition into a white crystalline iodous sulphate, determined as $I_2O_3 \cdot 4SO_3 \cdot xH_2O$, where probably $x = 1$. The converse (isothermal) transition, on dilution of the fuming acid to below 100% H_2SO_4 by addition of concentrated sulphuric acid, leads to the yellow crystals again, but does so through the remarkable *intermediate* step of precipitating iodine and pentoxide, which disappear again. This is discussed, and it is concluded that the "white" solutions in fuming acid contain their tervalent iodine in a complex ion (possibly negative), while the "yellow" solutions in concentrated acid contain the cations of an equilibrium $IO^+ + 2H^+ \rightleftharpoons I^{+++} + H_2O$; the bare ion I^{+++} is considered to be the agent responsible both for the curious features of the transition and, in general, for the organic reactions of iodous salts, elsewhere treated.

It was well recognised by Fichter and his associates at Basel that tervalent iodine is essentially base-forming, yielding with suitable acids salts which are either normal ("Jodi-") or basic ("Jodyl"). All these are rapidly decomposed by water into iodic acid, iodine, and the acid whose radical they contain.

Such compounds (other than iodine trichloride) have, in general, been prepared by methods of two types. One is the oxidation of elementary iodine at the ordinary temperature by such agents as ozone or chlorine monoxide, in the presence of the acid—as far as possible anhydrous—whose iodous compound is desired. By such means Schützenberger (*Compt. rend.*, 1861, 52, 135; 1862, 54, 1026) obtained the white crystalline iodine triacetate, doubtless a covalent compound; Fichter, Kappeler, and Krummenacher (*Z. anorg. Chem.*, 1915, 91, 134) obtained an unstable perchlorate represented as $I(ClO_4)_3 \cdot 2H_2O$; Kappeler (*Ber.*, 1911, 44, 3496) made a nitrate of uncertain composition; Beger (*Chem. Z.*, 1906, 33, 1232) and Fichter and Rohner (*Ber.*, 1909, 42, 4092) oxidised iodine with ozone in chloroform to I_4O_9 , which the latter authors regard as $I(IO_3)_3$.

The other method, derived from old experiments by Millon, has involved the partial decomposition of iodic acid by heat in the presence of concentrated sulphuric acid. By this process Chrétien (*Compt. rend.*, 1896, 123, 814; *Ann. Chim. Phys.*, 1898, 15, 358) obtained a yellow crystalline compound represented by him as $I_2O_3 \cdot SO_3 \cdot \frac{1}{2}H_2O$; and Pattison Muir (J., 1909, 95, 656) made and studied a lemon-yellow solid of analytical composition IO_2 , which chemists follow Fichter in regarding as a basic iodous iodate $I_2O_3 \cdot I_2O_5$, or $IO \cdot IO_3$ iodyl iodate, rather than as an oxide of quadrivalent iodine. Beger's "normal" iodate above mentioned was also got by Fichter and Kappeler (*loc. cit.*) by the thermal method from iodic acid, in a medium of metaphosphoric acid.

Besides these compounds, others have been reported whose reality Fichter and his associates have disproved or questioned. With Kappeler and Helfer (1915, *loc. cit.*) he made a further iodous substance, by heating Chrétien's sulphate with sulphur trioxide in a sealed tube, which was represented as "Neutrales Jodisulfat," $I_2(SO_4)_3$, in approximate accord with the analytical data; and the authors remarked "Durch diese neue Untersuchung ist einstweilen die Chemie der Sulfate des dreiwertigen Jods abgeschlossen." However, Bahl and Partington (J., 1935, 1258), in repeating the experiments of Muir and of Chrétien (*loc. cit.*), were unable to confirm Chrétien's formula for his sulphate, assigning it (by analytical difference) $1H_2O$ per $I_2O_3 \cdot SO_3$ instead of $0.5H_2O$; thereupon Fichter and Dinger (*Helv. Chim. Acta*, 1936, 19, 607) adversely criticised Bahl and Parting-

ton's data and adduced their own analyses of the solid in support of Chrétien's original formula. It will be shown (p. 1704) that all three sets of authors have been misled, and that the composition of Chrétien's yellow sulphate is simply anhydrous $I_2O_3 \cdot SO_3$, that is $(IO)_2SO_4$; and that it can be turned into another iodous sulphate, a white compound, with interesting properties.

Our work, prompted by the need to prepare properly an iodous sulphate as a reagent with which to attack aromatic compounds (Masson and Race, J., 1937, 1718; Masson and Hanby, preceding paper), has enabled us to obtain light upon the general equilibria between the elementary, the iodic, the hypoiodous, and two, perhaps three, iodous conditions of iodine. These equilibria have two aspects: one is the effect of high temperature; the other is the effects of changes in composition at room temperature; and in both aspects, a powerful factor proves to be the composition of the acidic medium in which the equilibria must be studied if they are to be made distinct.

As is well known, if iodine pentoxide is heated by itself it dissociates into its elements irreversibly; the process begins to be noticeable towards 350° , and at this temperature some of the iodine is retained by the residual solid in a complex of uncertain nature. Heated in concentrated sulphuric acid, however, the pentoxide dissociates more easily, as Chrétien showed (using iodic acid), oxygen being gradually evolved at $250\text{--}260^\circ$; the yellowish liquid, when cooled, deposits mixtures of iodous and iodic compounds. At slightly higher temperatures, iodine as well as oxygen is strongly evolved, and the liquid turns deep brown. This is the condition used by Chrétien and subsequent authors in order to obtain his sulphate: the brown liquor (to which more iodine may with advantage have been added during the heating, according to Chrétien and to Fichter) is cooled and allowed to stand in a desiccator for 1—2 days or longer, whereupon it turns yellow in depositing yellow crusts of the material. Consideration shows, however, not only that this process is inconvenient and far from quantitative, but also that it confuses in uncertain proportions at least three distinct reactions; and experiment proves that these can readily be separated, studied, and made to proceed quantitatively.

The primary thermal decomposition of iodine pentoxide



is, in the absence of an acidic medium, indistinguishable from the further decomposition



Iodine sesquioxide is itself unknown; but in a suitably powerful acid, its basic quality comes into play to stabilise it as a salt, and to lessen the temperature at which, owing to reaction (1) alone, an evolution of oxygen from heated iodine pentoxide begins. Nevertheless, ordinary concentrated sulphuric acid (used by the several authors named) is scarcely of powerful enough acidity usefully to protect the iodous product against the thermal decomposition represented in (2). We find, however, that fuming sulphuric acid will do so; it also lowers still further the temperature needed to bring reaction (1) to rapid completion. By heating iodine pentoxide in fuming sulphuric acid (20% SO_3) at $215\text{--}220^\circ$ in connexion with a gas burette, one obtains a brisk evolution of oxygen which ceases sharply when 1.00 mol. of measured oxygen per mol. of I_2O_5 has been released, the white solid finally disappearing into solution at the same time; no iodine whatever is produced, the liquid formed is of a very pale yellow tint, and its analysis corresponds to a sulphate of an oxide $I_2O_{3.00}$ as the solute. This, then, affords one easy way quantitatively to prepare a crystallisable iodous sulphate; the other way depends upon reactions at room temperature, as follows.

In Chrétien's method the thermal decomposition of iodic acid must be carried so far as to give copious fumes of iodine and a deep brown liquor; and it is this liquor which, when kept at the ordinary temperature, becomes the source of the desired product. But we find that the same liquor can be got by merely mixing iodine and iodine pentoxide in concentrated sulphuric acid without any application of heat: so that Chrétien's and Fichter's thermal method may be said to be mainly a crude way of producing some free

FIG. 2.

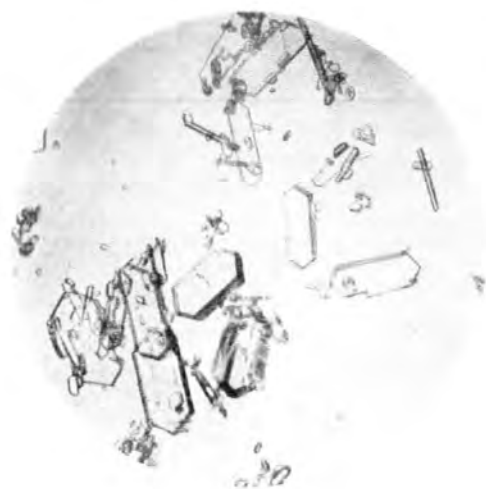

(a) $I_2O_3 \cdot 4SO_3 \cdot xH_2O$; white iodous sulphate.

(b) Transition: showing iodine as a metastable intermediate, and developing crystals of



(c) $I_2O_3 \cdot SO_3$; yellow iodyl sulphate.

showed the same colours and behaviour as solutions of sulphur in these acids, wherein various other authors have recognised a coloured substance S_2O_3 .

The Transition between the Two Sulphates.—The transition yellow \rightarrow white in media exceeding 100% H_2SO_4 proceeds normally, like that from a crystalline sulphate to the corresponding hydrogen sulphate; but the reverse change, induced by adding the white compound in fuming acid to concentrated (96%) acid until the medium is a little less than 100% H_2SO_4 , takes a path which is of a type quite new to us in any reversible transition among inorganic salts; and its interpretation throws light upon the natures of iodous compounds. The very pale yellow liquid at first remains clear, then it grows turbid and grey with a suspension of solid iodine and (if the proportions are suitable) a white solid, apparently pentoxide; as one watches, the grey turns to dusky greenish and then yellow, and in a short time the temporarily precipitated iodine (and any white suspension) has vanished again and is wholly replaced by pure crystals of the yellow $I_2O_3 \cdot SO_3$, the stable phase in the new concentration of acid. In the later stages, the brown colour is seen which iodine gives when put into sulphuric acid solutions of the pentoxide or of the yellow sulphate; but it is weak and transient. Temperature changes are not concerned in the series of events. Fig. 2 shows microphotographs of (a) the white sulphate in fuming acid, (b) the dusky greenish stage of transition during slight dilution, the large irregular needles of iodine being interspersed with small crystals of the yellow product which is superseding them, (c) the yellow $I_2O_3 \cdot SO_3$ (somewhat rounded by stirring) in concentrated acid.

The interest of this perfectly reversible transition between the white and the yellow compound lies in the fact that, although the iodine begins and ends in the tervalent state, it spontaneously undergoes valency-bifurcation and reassembly, *en route* from one to the other. Thus:

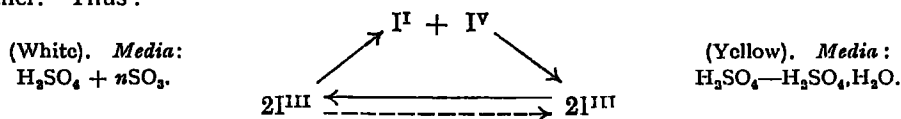

That an atomic change so extreme as valency partition occurs, only to be spontaneously followed by valency reintegration to the original value, must mean that the tervalent iodine of the white sulphate is in a radical different from that in which the tervalent iodine exists in the yellow sulphate. The two compounds cannot be related in the same way as interconvertible sulphates and hydrogen sulphates, which have one and the same cation in common; and our view of the matter is as follows.

The ion in the yellow crystals $(IO)_2SO_4$ is, we do not doubt, the iodyl cation IO^+ ; and their solution in concentrated sulphuric acid behaves towards aromatic compounds (as we show elsewhere) so as to suggest that it contains some proportion, not necessarily more than quite small, of iodous cations I^{+++} , produced in an equilibrium



The monohydrate formula for the white crystals, $I_2O_3 \cdot 4SO_3 \cdot H_2O$, or $HI(SO_4)_2$, might suggest the possibility that their ion is a negative one, $[I(SO_4)_2]^-$; without, however, entering into detailed speculation on this point, we are at all events entitled to regard their solution in fuming acid as containing the tervalent iodine in the form of a complex ion containing sulphur trioxide and kept in stable equilibrium by the excess of sulphur trioxide in the medium. On removal of this excess by dilution to slightly below 100% H_2SO_4 , the complex dissociates; and we conceive that its tervalent iodine is thus all momentarily released as simple I^{+++} , not a stable entity in so high a concentration. At such a concentration, therefore, it is able to produce, by the electron partition $2I^{III} \rightarrow I^I + IV$, free iodine and the pentoxide faster than these can undergo their normal reassembly to give yellow iodyl sulphate, which later visibly proceeds in the liquor; and faster also than the establishment of the equilibrium

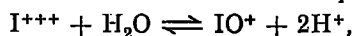

the progress of which also constitutes yellow iodyl sulphate. Although this hypothesis may be mistaken in naming I^{+++} as the immediate precursor of the observed iodine and

pentoxide, yet the dynamics of the whole train of processes, coupled with our other work, are clarified by invoking it; and, on the grounds of electronic structure, it appears improbable that this ion could exist *per se* except in minute equilibrium concentration or as a transitory product intermediate between one complex, that of the white compound, and another, that of the yellow. The same instability of I^{+++} is held to account for the swift organic reactions of tervalent iodine which we have elsewhere described.

EXPERIMENTAL.

In syntheses of the yellow iodyl sulphate by the method described, at a late stage of the process the product should be ground under its own liquor, to release traces of enclosed solid reagents. Precautions against the access of water vapour must be strict in handling the yellow compound, and are difficult to make strict enough for the white compound. Our sintered-glass filtering apparatus was specially designed to further these precautions and to simplify sampling with a minimum of exposure. For each analysis of a solid or of a solution, duplicate samples were used. In dilutions of samples with water, appropriate vessels and care are needed to prevent loss of vapour, especially in systems involving the white sulphate and fuming acid.

Determination of the Degree of Oxidation of Iodine.—Given that, in warm water,

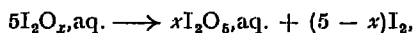

we warm the well-diluted material under reflux, adding pure carbon tetrachloride; the iodine is extracted with this solvent, and the extract, after the addition of water, potassium iodide solution, and a few drops of dilute acid, is titrated with thiosulphate; to the acid aqueous layer, freed from iodine by the extraction, is added a bare excess of potassium iodide solution, and the liberated iodine is extracted with tetrachloride and is similarly titrated. If the numerical ratio of the second titre to the first is R , we have $x = 5R/(6 + R)$; hence for $x = 1, 2, 3, 4, 5$, R is respectively 1.5, 4, 9, 24, ∞ , which gives a very sensitive measure of the degree of oxidation, as others have noted who have used some form of this method. All the preparations and samples analysed for the work of this paper gave values of R lying between 9.019 and 9.004, corresponding with $I_2O_{3.003}$ to $I_2O_{3.000}$.

Sulphur trioxide was always determined gravimetrically as barium sulphate in the aqueous solution from the foregoing extractions. In the indicator method, separate samples were required for determining the indicator content; in them, after dilution, the liberated iodine was removed by distillation at reduced pressure before collecting the precipitated indicator on a filter; and the comparability of these samples with those taken for the remaining constituents was tested and proved by their giving identical figures for the content of iodic acid.

Analytical Results.—A. Yellow solid.

(i) "Barium sulphate indicator" method. One experiment. Temp. 14.5—17°.

	Rel. wts. in filtrate.		Rel. wts. in wet solid.		Rel. mols. in pure solid.	
	(a).	(b).	(a).	(b).	(a).	(b).
BaSO ₄	1.0000	1.0000	0.0161	0.0161	—	—
I ₂ O ₃	0.0798	0.0800	0.5452	0.5456	1.000	1.000
SO ₃	14.507	14.502	0.3781	0.3784	1.000	1.001
H ₂ O (diff.)	3.548	3.553	0.0606	0.0599	0.065	0.043
Total	19.135	19.135	1.0000	1.0000	—	—

(ii) "Wet residues" method. A preliminary set of 9 solids and their liquids having virtually confirmed the results just given, the following definitive data were obtained; these these are the data used for Fig. 1, and (excepting col. 1) are expressed in *molecular* percentages, those for H₂O (diff.) being for brevity omitted in each half of the table.

Temp. 15.5—18°.

Solvent acid : H ₂ SO ₄ , wt. %.	Wet solids.				Solutions.			
	I ₂ O ₃ .		SO ₃ .		I ₂ O ₃ .		SO ₃ .	
86.3	28.00, 28.48	43.05, 43.63	0.170, 0.167	36.06, 35.67				
88.6	24.36, 24.33	43.90, 43.93	0.143, 0.143	37.72, 37.93				
94.2	21.73, 21.70	46.42, 46.40	0.084, 0.084	43.34, 43.29				
95.8	30.86, 30.72	48.43, 48.20	0.065, 0.065	45.24, 45.02				
97.5	24.74, 24.68	48.76, 48.73	0.066, 0.067	46.97, 47.35				
99.8	30.33, 29.39	49.95, 49.82	0.121, 0.121	49.74, 49.76				

B. *White solid.*

(i) "Barium sulphate indicator" method. Two experiments. Weights:—

	Experiment 1: 16.5—18.5°.				Experiment 2: 16.0—19.0°.			
	Filtrate.		Wet solid.		Filtrate.		Wet solid.	
BaSO ₄	1.0000	1.000	0.0447	0.0444	1.0000	1.0000	0.0463	0.0468
I ₂ O ₃	0.0754	0.0749	0.2785	0.2794	0.1092	0.1099	0.2763	0.2635
SO ₃	6.866	6.868	0.6067	0.6059	7.369	7.347	0.6213	0.6266
H ₂ O (diff.) ...	1.076	1.078	0.0701	0.0703	1.235	1.247	0.0561	0.0631
Total ...	9.017	9.021	1.0000	1.0000	9.713	9.704	1.0000	1.0000

These yield formulæ: Expt. 1, I₂O₃.4.11SO₃.1.34H₂O;
Expt. 2, I₂O₃.4.08SO₃.0.41H₂O.

(ii) "Wet residues" method. Molecular percentages (except col. 1); H₂O (diff.) omitted from table. Temp. 16.5—18.5°.

Solvent acid: free SO ₃ , wt. %.	Wet solids.		Solutions.	
	I ₂ O ₃ .	SO ₃ .	I ₂ O ₃ .	SO ₃ .
17.4	7.42, —	60.07, —	0.115, 0.115	55.95, 55.80
18.7	6.99, —	59.35, —	0.111, 0.111	56.35, 55.13
25.8	7.44, 7.47	61.13, 61.08	0.172, 0.171	58.85, 58.81
32.6	10.91, 10.55	65.38, 63.84	0.181, 0.182	61.16, 61.76
33.7	8.34, 8.30	64.41, 64.11	0.188, 0.188	61.79, 62.04

UNIVERSITY OF DURHAM (DURHAM DIVISION).

[Received, September 5th, 1938.]

Introduction.

It has long been recognised that iodine can exist in a tervalent state, and that in such a state it is essentially base forming; yielding with suitable acids, salts which are either normal or basic.

The investigation described in this thesis was prompted by the necessity for preparing an iodous sulphate of the type reported by Chretien, of which the composition could be stated with certainty and which could be used to attack aromatic compounds, (Masson and Race, J.C.S. 1937, 1718.); (Masson and Hanby, J.C.S. 1938, 1699.). As a result it has been possible to throw light upon the general equilibria between the elementary, the iodic, the hypoidous, and two, perhaps three iodous conditions of iodine. These equilibria have two aspects: one is the effect of high temperature; the other the effects of changes in composition at room temperature. In both aspects a powerful factor proves to be the composition of the acidic medium in which the equilibria must be studied if they are to be made distinct.

By two methods Chretien's yellow iodous sulphate was proved to be $I_2O_3 \cdot SO_3$, not hydrated, as its discoverer and others had represented it. In the course of the investigation of the influence of acid media on the formation of Chretien's iodous sulphate, a transition of the compound in fuming sulphuric acid into a white, beautifully crystalline iodous sulphate was discovered; the new compound being determined as $I_2O_3 \cdot 4SO_3 \cdot xH_2O$ where x is probably equal to 1.

The converse (isothermal) transition took place on diluting the fuming acid to below 100% sulphuric acid by adding concentrated sulphuric acid, and led to the yellow crystals again; but it did so through the remarkable intermediate step of precipitating iodine and pentoxide, which apparently re-combine to give the yellow compound. This reaction will be discussed in a later section of this thesis and grounds will be given for inferring that the "white" solutions in fuming acid contain their tervalent iodine in the form of a complex ion (possibly negative), whilst the "yellow" solutions in concentrated acid contain the cations of an equilibrium

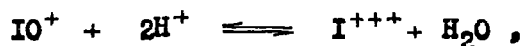

and that the bare ion I^{+++} should be considered as the agent responsible both for the curious features of the transition and, in general, for the organic reactions of iodous salts. (Masson and Race, loc. cit.) and (Masson and Hanby, loc. cit.).

Chapter 1.

Historical.

This section deals mainly with previous experimental work relevant to the present research. It describes the substances and methods employed and the results obtained.

References are quoted in the bibliography.

A historical review of the actual details of apparatus and calculations used in determinations of degrees of oxidation of iodine etc., have been omitted from this outline and are dealt with, where necessary, in their appropriate section.

Previous work on the lower oxides of iodine has been prosecuted along three main lines :-

- (a) the formation of lower oxides, their degree of oxidation and their base forming capacity,
- (b) the extent of combination of the lower oxides with the acid medium in which they are formed,
- and (c) the particular study of iodic sulphate as regards the molecular formula.

In view of these different aspects it has been thought advisable to deal with the various works as they occur in chronological order.

The reactions of iodic acid in the presence of other acids were studied first by Davy (1) in 1814, who claimed that a combination

took place between the iodic acid and the reaction medium. Davy's results were partly contradicted in 1832 by Serullas who showed that iodic acid could form several acid salts, the bi- and tri-iodates - peculiar properties which one finds rarely in the metalloids acids.

In 1843 and 1844 Millon (2) published two memoirs on iodic acid in the second of which he studied more particularly the action of sulphuric acid on iodic acid. In all these papers, as with that of M. Ditte in 1870, the combination of iodic acid with other acids was not stressed. The only exception was Millon's second paper of 1844.

Millon claimed to have obtained combinations of iodic acid and sulphuric acid in the cold. Continuing the work further, Millon heated the solution of iodic acid in sulphuric acid and found that the iodic acid was soon reduced, first with the sole evolution of oxygen, and then a mixture of oxygen and iodine vapour; the mixture meanwhile turning yellow, and finally brown. On cooling, the liquor deposited a more or less yellow substance - sometimes crystalline but more often amorphous. Millon attempted to separate and characterise a great number of these products whose preparation was altered by the time allowed for the evolution of oxygen. He described two crystalline substances, the first obtained after allowing the evolution of oxygen to continue for a very short while and then stopping the reduction. The hot sulphuric acid deposited abundant yellow crystals to which Millon ascribed the composition

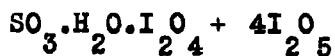

If the evolution of oxygen was prolonged for seven to eight minutes, crystals were formed of the composition

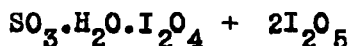

which were of a deeper yellow colour.

On pushing the reduction further, allowing the oxygen to escape for a long time and become mingled with iodine vapours, Millon obtained a further series of compounds to which he attributed most complicated formulae. Thus he distinguished three phases in the reduction of iodic acid in sulphuric acid which can best be summed up in his own table :-

First Phase.

Sulphuric acid and 1 equiv. of H ₂ O.	{	1. 3(SO ₃ ·H ₂ O.) + I ₂ O ₅ ·H ₂ O.
		2. Combination of SO ₃ ·H ₂ O and I ₂ O ₅ with less acid than above.
Sulphuric acid and 3 equivs. of H ₂ O.	{	3. 3(SO ₃ ·3H ₂ O) + I ₂ O ₅ ·H ₂ O.
		4. Compounds of SO ₃ ·3H ₂ O and of I ₂ O ₅ ·H ₂ O containing less H ₂ SO ₄ than above.
Sulphuric acid and 5 equivs. of H ₂ O.	{	5. 3I ₂ O ₅ ·H ₂ O.

Second Phase.

Sulphuric acid and 1 equiv. of H ₂ O.	{	1. 4I ₂ O ₅ + I ₂ O ₄ + SO ₃ ·H ₂ O.
		2. 2I ₂ O ₅ + I ₂ O ₄ + SO ₃ ·H ₂ O.

Third Phase.

- Sulphuric acid
 and 1 equiv. H₂O
- | | | |
|---|----|--|
| { | 1. | $I_2O_4 \cdot + 2SO_3 \cdot H_2O$ |
| { | 2. | Compounds of I_2O_4 and $SO_3 \cdot H_2O$. with less H_2SO_4 than above. |
| { | 3. | $I_5O_{19} + 10(SO_3 \cdot H_2O)$ |
| { | 4. | Compounds of $SO_3 \cdot H_2O$ and I_5O_{19} with less H_2SO_4 than above. |

These products, according to Millon, were not the only ones which could be produced by the reduction. There could be added the compounds formed by the combination of two of the preceding products, eg. a body of the composition, $(2I_2O_5 + I_2O_4 + SO_3 \cdot H_2O) : (I_2O_4 + 2SO_3 \cdot H_2O)$

Thus, Millon appears to have left the problem of this reducing action of sulphuric acid indeterminately solved, and today it might well be said that some, at least, of his compounds were simply the result of arresting the reducing action by chance at very arbitrary points. The suggested formulae he gives probably reflect only the analyses of aggregates of compounds accumulated at these points and therefore do not clearly indicate the products of the reactions which he had investigated. Further, throughout his second and third phases the progress of the reduction can be traced in terms of an increasing proportion of I_2O_4 to the unreduced I_2O_5 content.

It was not until 1896 and 1898 that Chretien (7) and (8) continued work on this aspect of the iodous condition of iodine; but in the interval that elapsed M.P. Schutzenberger (3) and (4) reported work

on a new approach to the investigation of iodous conditions and the existence of iodine in combined state as a trivalent radicle.

In 1861 Schutzenberger (3) attempted to carry out syntheses such that the action of monochlorides of iodine, bromine, sulphur, cyanogen, etc. on metallic oxy - salts in which the metal is electro - positive, could take place by a simple double decomposition represented by the general equations :-



In such reaction products, the first of which was an isomer of iodo-acetic acid, the iodine etc., instead of being substituted for one equivalent of hydrogen of the acetyl radicle, appeared to be substituted for one equivalent of basic hydrogen. He foresaw that if these compounds existed they would exhibit very special properties, and above all, a very great instability.

He prepared the compound $\text{C}_2\text{H}_3\text{ClO}_2$, isomeric with monochloroacetic acid, by mixing equivalent proportions of ClO and acetic anhydride at low temperatures. The red liquor, the colour of which was said to be due to the presence of free ClO , decolourised spontaneously after about a quarter of an hour. Analysis of the liquors led to the formula $\text{C}_2\text{H}_3\text{ClO}_2$, which is the formula of monochloroacetic acid; but, said Schutzenberger, "the character of the product does not permit us

to confuse it with the latter. The method of preparation and the properties enable us to consider this compound as an acetate of chlorine." As forecast, it was highly unstable both physically and chemically. Decomposition under the influence of light and at ordinary temperatures was spontaneous and metals attacked it, liberating chlorine and forming ordinary metallic acetates.

Iodine dissolved in it instantaneously, causing the evolution of chlorine only and forming a crystalline solid which the author claimed to be isomeric with iodoacetic acid. The nature of the product was again entirely different from iodoacetic acid, and it was to be regarded as an acetate of iodine.

A similar reaction took place with bromine and the acetate of chlorine, yielding a liquid product which was apt to explode spontaneously.

Also in this paper the existence of an analogous reaction with sodium benzoate and monochloride of iodine was suggested according to the equation :-

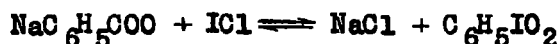

the product being benzoate of iodine; and finally, the formation of acetate of cyanogen was claimed according to the equation :-

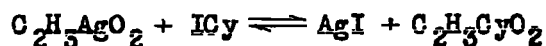

Although the author pointed out that his investigation was not completed, he stated that he had studied carefully a sufficient

number of compounds to enable him to predict with certainty that it was possible to prepare oxy - salts of iodine, chlorine, bromine, and cyanogen, just as it is possible to obtain the corresponding salts of potassium, lead, and mercury etc.

In the following year (1862) Schutzenberger (4) recalled his previous work and pointed out the difficulties of preparing compounds such as iodine acetate, owing to the ease with which they explode. His method of preparation, (by which he isolated the compound) was by passing a current of HClO into anhydrous acetic acid containing a suspension of iodine. This reaction was more easily controlled than the direct action of iodine on chlorine acetate, but amounted in effect, to the same thing.

He stressed the sensitivity of the compound to light and moisture, pointing out that the formation of iodine was a sure indication of such decomposition.

He was able to state that analysis of the compound which he claimed to be iodine acetate, showed that :-

(a) The crystals contained no chlorine,
and (b) that all of their iodine was in a state other than that of an iodine substitution product. In fact, he says, "One finds the same quantity of iodine if one decomposes the crystals by heat, as in the ordinary determination of iodine in organic substances; or if one

decomposes them by water and precipitates the iodine by silver nitrate after addition of a sufficient quantity of sulphurous acid."

Analyses indicated the formula $C_6H_9IO_6$ for the crystals, and this formula may be written in the form $3(C_2H_3O)_3$, and therefore considered as an iodine tri-acetate. I^{+++}

Thus, to quote the author again, "in substituting for the chlorine in chlorine acetate, or for the sodium in sodium acetate, the iodine, instead of functioning as a monatomic radicle, behaves as a triatomic radicle. The equations for the reaction are therefore :-

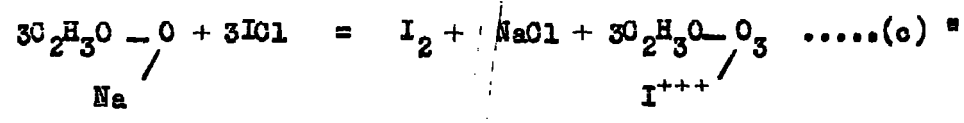
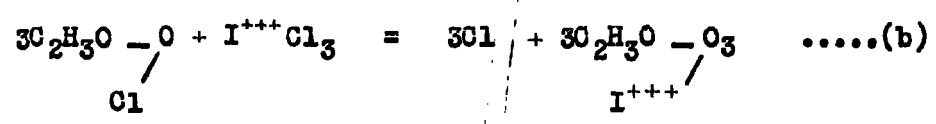
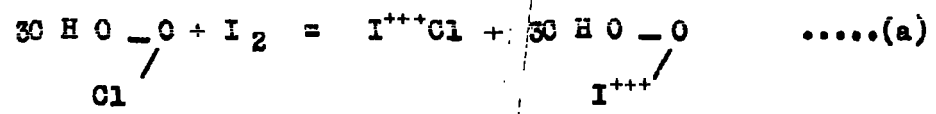

Thus, there appears in this author's second paper a definite development of a theory that iodine may exist as a triatomic electropositive radicle. When the date of this work is considered, it is surprising that so many years should have elapsed before any appreciable development of this view point was renewed.

Once again, in 1896, Chretien () took up the study of the action of sulphuric acid on iodic acid, stating that at 200° C. sulphuric acid, (of which the strength was not specified), dissolved about one

fifth of its weight of iodic acid. The dissolution never took place without the evolution of some bubbles of oxygen - indicating the beginning of some reaction of the iodic acid. On cooling, the liquid deposited pale yellow crystals.

This reaction could be prevented or reversed by the action of a little fuming nitric acid, which quite naturally re-oxidised any lower oxide of iodine to the pentoxide. The crystals then deposited were found to be pure iodic anhydride which, though wet with sulphuric acid, showed no tendency to combine with the latter. This statement on the part of Chretien seems to contradict the findings of Millon (2), who described several combinations of this type and studied the reduction of iodic acid in sulphuric acid.

If the temperature of the solution of iodic acid in sulphuric acid was raised to 250° - 260° C., the former decomposed with abundant evolution of oxygen and the liquid took on a fairly strong yellow colour. On cooling, the evolution of oxygen ceased and soon a yellow amorphous deposit began to form. The composition of the powder was variable, but it always had the property of decomposing in contact with water - yielding iodic and sulphuric acids.

If the reduction was carried as far as the evolution of copious iodine vapours, the liquor became progressively browner and finally black, depositing nothing on cooling. At the end of a few days however, yellow crystals began to form slowly. This deposition lasted

for some months, and was accompanied by loss of colour in the liquid.

The solubility of iodine in sulphuric acid was very slight although it dissolved readily in the presence of iodic acid. When excess of iodine was added to a hot sulphuric acid solution of the latter acid, the solution turned black and deposited crystals which were identical in composition with those just described. Chretien claimed to have been able to free the crystals from mechanically held sulphuric acid and to have analysed them by direct methods.

The compound was decomposed by water instantaneously to give iodine, iodic acid, and sulphuric acid. The "free" iodine, as we have called it, was distilled off in a current of hydrogen and collected for estimation in a set of KI-bubblers. The iodic acid in the colourless residual liquor was reduced by zinc and excess phosphoric acid. The iodine produced was distilled off and estimated as above. The sulphuric acid was determined as barium sulphate. Water in the compound, which must have been a very small proportion by weight, was estimated by heating to complete decomposition with litharge. A column of copper retained the iodine, and the water was collected in an absorption tube and weighed.

This method of analysis gave the percentage composition, the ratio of the weight of iodine set free by the water ("free" iodine) to that as iodic acid ("iodate" iodine), and the ratio of total iodine to oxygen. The figures which Chretien obtained for his analyses of this

compound, corresponding to the formula :- $I_2O_3 \cdot SO_3 \cdot \frac{1}{2}H_2O$.

Calculations of decomposition ratios were made on the assumption that iodous anhydride gave in cold water an analogous reaction to that given by chlorous anhydride, or better still, the chlorites on boiling. The decomposition should in fact be :-



but iodic acid and hydriodic acid cannot exist together, and give the reaction :-

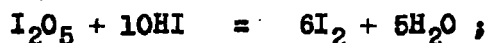

which finally means :-

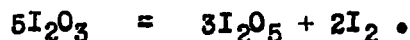

This equation indicates that the weight of iodine as iodic acid and that liberated as "free" iodine are in the ratio of 1.5 : 1 . Chretien's experimental value was 1.506 : 1 .

Chretien referred to the already known reaction between ozonised oxygen and iodine vapour which had been studied by M. Ogier (5) and (6), and which yielded a yellow powder decomposed by water in an identical manner with Chretien's compound above. Ogier's compound corresponded to iodous anhydride contaminated with a little iodic anhydride.

In this paper Chretien did not mention in what particular range of sulphuric acid strengths he was able to obtain the iodous anhydride, and he claimed to have satisfactorily dried his product free from mechanically adhering sulphuric acid. We found it practically impossible to accomplish this last, and in consequence very

unsatisfactory to use direct analysis for the water content of the compound. Again, Chretien did not record any tendency of the "dried" solid to pick up atmospheric moisture. That it does is evidenced by the rapid darkening of specimens exposed for only short periods to ordinary air.

In 1898, Chretien (8) published a second and longer paper in which he reviewed his previous publication and elaborated its contents. He dealt at length with Millon's work (2) and attempted to furnish complete analyses of Millon's compounds as reported in each of his phases for the reactions of iodic and sulphuric acids. He said, particularly of Millon's second phase; "one may prepare crystalline substances for which the properties are such that one can picture them as compounds of sulphuric acid and iodine peroxide, but the presence of iodic acid in variable proportions does not allow conclusions of a certain nature as to the number of such compounds which one can prepare."

Thus it would appear that the first stage in the reduction of iodic acid up to the evolution of oxygen and preceding the liberation of iodine vapours, is to the stage of I_2O_4 , a compound which is basic in nature and can combine with sulphuric acid.

Chretien continued with the simpler course of reduction indicated in Millon's "third phase". He attributed the black colour of the solute which formed when iodine vapours were evolved, to the presence of excess iodine, and inferred that it was this iodine which combined with

the remaining iodic anhydride to give the yellow crystalline compound which deposited after some days.

In brief, the action of sulphuric acid on iodic acid gave at first iodic anhydride. This was then reduced, with the evolution of oxygen but without the evolution of iodine vapours giving crystalline compounds which, by their composition and their properties corresponded to combinations of iodine peroxide with sulphuric acid. The third stage was, in reality, very simple, consisting only of the reducing action of iodine on iodic acid to give iodous anhydride, which then combined with the sulphuric acid medium to form a crystalline compound.

Beger in 1906 (9) followed up Ogier's work (5) and (6) on the action of ozone on iodine and showed that, from the vapours obtained by the action of well dried ozone on completely dried solid iodine at 40° - 60° C., a yellowish white powder could be condensed. This was very sensitive to moisture, turning red-brown and decomposing into free iodine and iodic acid. A series of analyses gave good agreement with the formula I_4O_9 , so that this compound was identical with that obtained by Fichter (10) on oxidising iodine by ozone in chloroform solution.

He then proceeded to describe a lemon-yellow crystalline product deposited on passing ozone into a solution of iodine in concentrated sulphuric acid whereby the small solubility of iodine in the liquid was greatly increased. This product too, is very sensitive to

moisture, and "could be prepared for analysis by treatment in dry air, anhydrous ether and drying in vacuum." Analysed by aqueous decomposition, this product proved to be a compound of I_2O_3 with SO_3 in proportions corresponding to Chretien's $I_2O_3 \cdot SO_3 \cdot \frac{1}{2}H_2O$, (which he obtained by the action of iodine on warm solutions of iodic acid in concentrated sulphuric acid).

A white crystalline body, to which Beger attributed the formula $3(CH_3CO)_2O \cdot I_2O_3$, was obtained when ozone was passed into a solution of iodine in acetic anhydride. This latter compound seems to fit into the system of properties of iodic anhydride in the same manner as does the sulphate, in that the weakly basic, unstable oxide is partially stabilised by combination with the acidic medium in which it was formed. On the other hand, it seems difficult to formulate the above compound of I_2O_3 and acetic anhydride along similar lines to the iodic sulphate of Chretien; which might well be written as $(IO)_2SO_4$, neglecting its degree of hydration claimed by its discoverer but shown by us to be lacking. It may be however, that this compound is related to Schutzenberger's iodine triacetate and may be co-valent in nature.

Further studies on the oxidation of iodine by ozone were reported in 1909 by Fichter and Rohner (10), who pointed out the difficulty of preventing the formation of additional oxidation products in Ogier's method of vapourising iodine in ozonised oxygen. This necessarily meant a constant excess of ozone and favoured the formation of higher

oxidation products. The authors described a method of oxidation in which ozonised oxygen was bubbled through an ice cold, saturated solution of iodine in chloroform. The product was pale yellow in colour, amorphous in nature and very sensitive to moisture. It decomposed into iodine and iodic acid. They noted difficulty in freeing the oxide from a solvent even so volatile as chloroform, and this in a vacuum desiccator.

Studying the aqueous decomposition and the ratio of "free" iodine to iodine as iodic acid (or "iodate" iodine); they concluded that the compound could not be I_2O_3 as claimed by Ogier (5) and (6). The composition lay between I_4O_9 and I_3O_7 , and it was pointed out that this could be explained if the compound was considered as I_4O_9 contaminated with I_2O_5 . Fichter and Rohner agree that the criticism may be offered that their compound need not necessarily be the same as that of Ogier (who did not use a solvent) - in spite of the agreement between the properties of the two compounds. They therefore repeated Ogier's work and found that the composition of the product lay between I_2O_4 and I_4O_9 , and yet the properties were not in agreement with Millon's I_2O_4 . The decomposition of the Fichter and Rohner compound under the action of heat, and the action of it on phenol were considered as characteristics of the compound I_4O_9 .

Continuing further with the properties of this oxide I_4O_9 , the authors studied its solubility in concentrated sulphuric acid and noted

the deposition of crystals from the solution. Reference was made to the work of Chretien (7) and (8), and to the theory that Millon's compounds were mixtures of Chretien's yellow sulphate with I_2O_5 .

It was pointed out that the possibility of transformation of I_4O_9 into a sulphate of trivalent iodine must be considered with caution; since, if the yellow salt could be obtained by heating iodine and iodic acid in concentrated sulphuric acid, then there might also be a preliminary decomposition of I_4O_9 into iodine and iodic acid.

A strong claim for similarity between I_4O_9 and the iodine acetate of M.P. Schutzenberger (3) and (4) was made in that it is very sensitive to moisture, decomposing into iodine and iodic acid. It is also readily decomposed by the action of light, with a liberation of iodine.

As a result of this work the authors designated the compound I_4O_9 as iodine iodate, i.e. as iodate of trivalent iodine $I(IO_3)_3$. Beside this neutral, sensitive body, the authors went on to say, "Millon's sparingly soluble and almost inert body arranges itself as basic iodine iodate, $O : I(IO_3)$." This paper was concluded by discounting the abundant oxides postulated by Millon and others, and reaffirming that the existence of trivalent iodine as a cation can be seen in such compounds as phenyl iodochloride, iodosobenzene acetate, iodosobenzoic acid, and diphenyl iodonium hydroxide.

Pattison Muir (11) in 1909, recalled Millon's (2) work on I_2O_4 and repeated the latter's preparation as for the "second phase". Muir studied its properties very carefully, concluding that the oxide was quite stable for an oxide of iodine and that no evidence of salt-formation with sulphuric acid could be obtained.

A compound was, however, obtained of sulphur trioxide and I_2O_4 when the two were heated together at $85^\circ - 90^\circ C$. The formula $I_2O_4 \cdot 3SO_3$ was given as that of the main, if not the only product of such an interaction. A compound was also recorded of the formula $I_2O_5 \cdot 2SO_3$, resulting from the interaction of SO_3 and I_2O_5 in circumstances similar to the above.

Muir follows Fichter in regarding the oxide I_2O_4 as a basic iodous iodate, $I_2O_3 \cdot I_2O_5$ or $IO \cdot IO_3$, iodyl iodate, rather than as an oxide of quadrivalent iodine.

The oxides $I_{10}O_{19}$, described by Millon (2) and I_6O_{13} , described later by Kammerer in 1861, were the subject of a paper in 1911 by Hans Kappeler (12). In his introductory remarks, the author classified the salts of trivalent iodine into normal and basic; and into the first of these classes he put I_4O_9 or $I(IO_3)_3$ of Beger (9) and Fichter and Rohner (10); together with the iodine acetate of Schutzenberger (3) and (4). In the basic class he assigned the iodous sulphate $(IO)_2 \cdot SO_4 \cdot \frac{1}{2}H_2O$ of Chretien (7) and (8) and others; along with

the oxide I_2O_4 which was considered as $(IO)IO_3$.

The formulae of Millon and Kammerer ($I_{10}O_{19}$ and I_8O_{13} respectively) were based on oxygen determinations in the oxides. In this paper the author claimed the determination of the ratio of "free" iodine to "iodate" iodine to be a much more suitable method of approach. Millon's oxide, prepared by the same method as gave I_2O_4 , and Kammerer's oxide, prepared by reduction of iodic acid with dry SO_2 at $100^\circ C.$, were both claimed to be the basic iodous iodate $IO(IO_3)$ or I_2O_4 . It would seem that this conclusion was quite justified, since, in the present work the method of analysis involving the ratio of "free" iodine to "iodate" iodine in aqueous decompositions was found to be very precise indeed; whereas there seemed to be considerable latitude in the determination of the oxygen content by direct analysis.

Kappeler also described the preparation of an iodous nitrate which, though he did not class it as normal or basic, he claimed to resemble Chretien's sulphate very closely and therefore, by analogy, suggested the formula $IO(NO_3)$.

In summarising, the author concluded that when the oxidation of iodine or the reduction of iodic acid took place in the absence of moisture, the reaction ceased as soon as the iodous stage of I_2O_3 was reached; whilst the final product depended on the nature of the reaction medium. Dealing with the aqueous decomposition in moist air, Kappeler suggested that this proceeded according to the equation :-

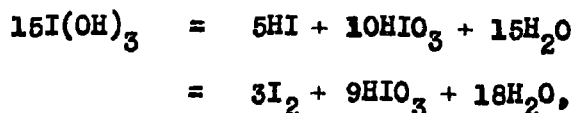

and that in the case of the sulphate, the nitrate, and the product of reduction of HIO_3 with SO_2 , the decomposition took place so slowly that the resulting iodic acid had time to combine with part of the still undecomposed salt to form the insoluble basic iodine iodate while the free iodine volatilised. That is :-



In 1915 a collection of works was published by Fichter, Kappeler, Krummenacher and Helfer (13) which dealt at length with previous studies of the tervalent state of iodine. In this paper it was pointed out that, as a general rule, the normal compounds of trivalent iodine of the general formula IX_3 were decomposed more readily than the basic compounds of the type IOX .

The authors studied a red powder, formed by the action of perchloric acid on iodine in a sealed tube, and reported by A. Michael, and W.T. Conn (Amer. Chem. Jour. 25. 1900. 89.). This compound decomposed in moist air with the release of iodine. The discoverers assigned to it the formula HI_7O_3 , by which they implied that a large, multi-atomed molecule of combined iodine was oxidised to only one thing, and that was iodic acid. According to Fichter the formula may be reduced to I_6HIO_3 , i.e. a compound of iodine with iodic acid.

Fichter, Kappeler and Krummenacher oxidised iodine with ozone in

perchloric acid solution in ice cold condition, thereby increasing the solubility of the iodine and resulting in loss of colour from the solution. A yellowish-green crystalline substance separated and was handled so as to reduce the action of atmospheric moisture to a minimum. It was found that this crystalline iodine perchlorate was extraordinarily sensitive in two ways :-

(1) It could not exist in contact with moisture since it visibly decomposed according to the equation,

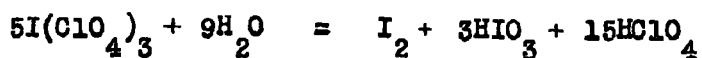

and (2) It was unstable at ordinary temperatures, being converted by oxidation to iodine, with evolution of chlorine.

The authors stated that the substance must not be kept for longer than one hour in a desiccator, otherwise too low a value for the "direct" or "free" iodine was obtained. After a still longer time than this it lost its property of aqueous decomposition entirely, and remained as yellowish, but almost pure iodic anhydride. So that, in this respect, the iodine perchlorate resembled iodine iodate $\text{I}(\text{IO}_3)_3$.

Fichter and his associates carried out their analyses very rapidly and with considerable precautions against access of atmospheric moisture and the influence of rise of temperature. They laid great stress on the importance of the establishment of the proportions of "free" iodine (direct iodine) to "iodate" iodine, formed by aqueous decomposition; since this proved the degree of oxidation or the valency state of the iodine.

Like Chretien, the authors of this paper claimed that it was possible by drainage to obtain the salt independent of the free applied acid medium. Their "free" iodine values were slightly low and this was attributed to :-

- (1) Slight decomposition and consequent loss of iodine during drainage;
- (2) The vigour of aqueous decomposition causing volatilisation of some of the liberated iodine.

The analytical data corresponded to neutral iodine perchlorate, $I(ClO_4)_3$, and the authors claimed that there should be two molecules of water of crystallisation. They justified this on the grounds that, although all initial reagents were strictly anhydrous, water must have been formed in the preparation according to the equation :-

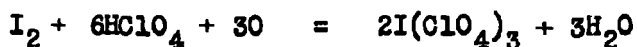

To quote the authors, "the acceptance of water of crystallisation in a compound so easily decomposed by water is not absurd, in so far as the basic iodine sulphate of P. Chretien contains water of crystallisation."

In this description of work undertaken by the writer it will be shown that there is no real basis for such a statement, since Chretien's basic sulphate has been shown to contain no water in its molecule. Attempts by Fichter and his co-workers to obtain iodine perchlorate from iodine nitrate, or from the basic iodine sulphate, were unsuccessful.

With L. Helfer, Fichter and Kappeler studied the oxide I_2O_4 with special reference to Muir's (11) compound $I_2O_4 \cdot 3SO_3$, which, they said

showed an unusual proportion of base to acid for a salt of a quadri-valent cation. The conclusion was reached that Muir succeeded in preparing the neutral sulphate of trivalent iodine and that the preparation was contaminated with iodic acid.

With reference to Chretien's basic yellow sulphate, the authors suggested that it should be possible to convert it into a neutral iodine sulphate by simple addition of SO_3 to the molecule, according to the equation :-

$$(\text{IO})_2\text{SO}_4 + 2\text{SO}_3 = \text{I}_2(\text{SO}_4)_3$$

Chretien's sulphate was heated in a sealed tube at $100^\circ - 120^\circ \text{C.}$ with SO_3 . After some time the separation of deep yellow crystals began and continued for about 140 hours. On the removal of excess SO_3 in a vacuum desiccator over sulphuric acid, the yellow crystals could be isolated. They showed properties typical of a neutral iodine salt, being specially sensitive to moisture. Analysis showed that the compound was mainly neutral iodine sulphate $\text{I}_2(\text{SO}_4)_3$, that it was contaminated with a little adhering SO_3 , that the total iodine was low and that the sulphate content was raised a corresponding amount. Muir's formula $\text{I}_2\text{O}_4 \cdot 3\text{SO}_3$ required total iodine and sulphate contents very little different from those required for $\text{I}_2(\text{SO}_4)_3$. However, the ratio of "direct" to "iodate" iodine is much different, and these proportions (not found by Muir) were nearly 1 : 1.5.

Continuing further with the study of neutral salts of iodine, Fichter, Kappeler and Helfer obtained iodine iodate by a new method. They stated that it was immaterial whether, in the preparation of iodine salts, one

oxidised iodine in the presence of a suitable anhydrous acid or reduced iodic acid by heat in similar circumstances. Iodine iodate $I(IO_3)_3$ had previously been prepared by the action of ozone on iodine and the authors of this paper succeeded in obtaining it by reduction of iodic acid in anhydrous phosphoric acid medium on heating. It was claimed that the phosphoric acid was not concerned in the composition of the compound, and the analyses showed that the ratio of "direct" to "iodate" iodine corresponded to the theoretical value of 1 : 9, calculated for $I(IO_3)_3$ according to the equation :-



In comparing the salts $(IO)_2SO_4 \cdot \frac{1}{2}H_2O$ and $I_2(SO_4)_3$, as with $IO \cdot IO_3$ and $I(IO_3)_3$, it is found that the neutral salts have a much lighter yellow colour than the basic iodine salts and that the former possess a greater solubility in organic liquids and a greater sensitivity to water.

Twenty years later, Rama K. Bahl and James R. Partington (14) published an extensive work on lower oxides and sulphates of iodine. They repeated Muir's work and confirmed the production of I_2O_4 . This compound they described as a yellow granular powder that did not absorb moisture, was only slightly soluble in cold water, but dissolved in hot water forming iodine and iodic acid. They found that I_2O_4 was sensitive to heat, decomposing at $85^\circ C.$ and more rapidly towards $100^\circ C.$, liberating iodine and leaving iodic anhydride. This was not the course of decomposition stated by Muir, who claimed to have obtained iodine and oxygen. Bahl and Partington estimated the percentage loss of iodine

and found it corresponded to the equation :-

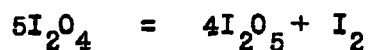

Passing next to the sulphates of iodine, the authors claimed that on heating iodic acid with concentrated sulphuric acid, a mixture of equimolecular quantities of $\text{I}_2\text{O}_4 \cdot \text{H}_2\text{SO}_4$ and $\text{I}_2\text{O}_3 \cdot \text{H}_2\text{SO}_4$ was obtained. By dissolving iodine in a hot solution of iodic acid in concentrated sulphuric acid, and also by heating a mixture of iodic acid and concentrated sulphuric acid until iodine was evolved, a sulphate of the composition $\text{I}_2\text{O}_3 \cdot \text{H}_2\text{SO}_4$ was obtained, contaminated by a small amount of $\text{I}_2\text{O}_4 \cdot \text{H}_2\text{SO}_4$. Chretien's sulphate $\text{I}_2\text{O}_3 \cdot \text{SO}_3 \cdot \frac{1}{2}\text{H}_2\text{O}$ could not be obtained.

It appears that in an analysis of such a compound as this, there can not be great certainty in stating the water content of the molecule. In Chretien's formula as in that of Bahl and Partington, the water content was obtained by difference between the I_2O_3 and SO_3 in any given sample and the weight of the initial sample before analysis. It is therefore obvious that such a determination is subject to great experimental error, since the water content of the sample must always be subject to the effect of the combined experimental errors in the I_2O_3 and the SO_3 determinations. This latter criticism has been strongly substantiated throughout our analyses. Again, throughout the history of the lower oxides of iodine, considerable attention has been given to the slight sensitivity of the basic salts as compared with that of the normal salts, while less attention has been given to the equally important fact that the former salts themselves are quite sensitive to moisture during even careful handling.

Bahl and Partington continued with a study of the action of ozone on iodine, dealing with this question historically from the time when Andrews and Tait (Proc. Roy. Soc. 1859. 606; Phil. Trans. 1860. 150. 113.) discovered that ozone reacted with iodine at room temperature. They reviewed Ogier's work (5) and (6), noting his products I_2O_4 , I_2O_5 , and periodic anhydride I_2O_7 , and then passed on to a consideration of the compound I_4O_9 described by Beger (9) and Fichter and Rohner (10) and on which they considered the data somewhat inadequate. The method of preparation used by Fichter and Rohner, of bubbling ozonised oxygen through a concentrated solution of iodine in chloroform or carbon tetrachloride, was considered neither convenient nor rapid. The authors stated that the reaction did not occur in the solution itself, but at the surface, where iodine vapour reacted with ozone to give a yellow solid which slowly fell into the solution: so that it might be supposed that the solid was deposited from the solution itself.

Ogier's first method was found more suitable if slightly modified. Ozonised oxygen was passed through a warmed U-tube with bulbs containing iodine. The iodine vapours reacted with ozone producing yellow vapours, which were passed through a tube packed with glass wool. The yellow product collected on the glass wool and was analysed. The results of analysis showed the compound to be I_4O_9 , a light yellow powder which, unlike I_2O_4 , was extremely hygroscopic and decomposed into iodine and iodic acid. Its thermal decomposition began at $75^\circ C.$, and continued up to $120^\circ C.$, according to the equation :-

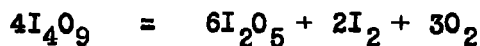

In order to eliminate the possibility that traces of oxides of nitrogen present in the ozonised oxygen (produced from the small amounts of nitrogen in the cylinder oxygen) might play some part in the oxidation of iodine, an experiment was made with ozonised electrolytic oxygen (free from nitrogen). The same yellow product was obtained.

Finally in 1936, Fr. Fichter and Alfred Dinger (15) reviewed previous work on iodine sulphates noting the discrepancy between the formulae of Chretien on the one hand and Bahl and Partington on the other. Very rightly the authors state, "Of greater interest is the appearance of iodine compounds with iodine as the trivalent cation, with great matter of factness; without any mention of such a method of treatment. In comparison with this peculiar role of the iodine, the water content of the compound is a very minor question."

It was claimed that the analyses of Bahl and Partington were not sufficient to shake the formula of Chretien; and a very illuminating table was given showing the theoretical results required by both formulae when analysed for total iodine, iodate oxygen, $\text{SO}_3, \text{H}_2\text{O}$, and the ratio of "free" iodine to "iodate" iodine. From this table it was obvious that the difference between the two sets of theoretical values were very small, and also that they were either equal to or less than the differences between the calculated and experimental values. Further, Fichter and Dinger pointed out that the yellow sulphate was highly

sensitive and that traces of moisture raised the "iodate" content in proportion to the "free" iodine content, which is reduced by volatilisation. They were also of the opinion that the existence of a sulphate $I_2O_4 \cdot H_2SO_4$ was not adequately proved, and that preparations corresponding in formula to the Bahl and Partington compound $I_2O_4 \cdot H_2SO_4$, $I_2O_3 \cdot H_2SO_4$, were probably the sulphate of Chretien partially decomposed by moisture. Though the authors stressed the supreme importance of the trivalent iodine cation in such compounds as these, they did not elaborate further; being content to prepare the sulphate by Chretien's original method in a rather more precise form and to claim, as the result of their analyses, that their compound had Chretien's formula $I_2O_3 \cdot SO_3 \cdot \frac{1}{2}H_2O$.

Chapter 2.

(a) Preliminary Investigation.

In all previous work on the lower oxides of iodine, evidence for the nature of any particular oxide has largely been obtained from aqueous decomposition and subsequent determination of the ratio of "iodate iodine" titre to "free iodine" titre. We found this method very convenient and capable of yielding extremely accurate results. Briefly, the theoretical basis for the factor "R" is as follows :-

If "R" is the ratio $\frac{\text{"iodate iodine" titre}}{\text{"free iodine" titre}}$, obtained after aqueous decomposition of a lower oxide of iodine I_2O_x , then :-

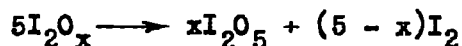

i.e. in the "iodate iodine" estimation, by adding excess iodide, one molecule of I_2O_5 liberates six molecules of I_2 , or :-

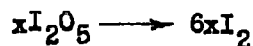

So that $\frac{\text{"iodate iodine" titre}}{\text{"free iodine" titre}} = R = \frac{6x}{5 - x}$

$$5R - Rx = 6x$$

$$5R = 6x + Rx$$

$$= x(6 + R)$$

$$x = \frac{5R}{6 + R}$$

Hence it can be seen at once that not only is the nature of the oxide determinable by a simple consideration of this ratio of the two titres, but that passage from one value of x to another involves a large change in the value of R.

For example :- if $x = 3$ then $R = 9$

but if $x = 4$ then $R = 24$, so that it should be very easy to distinguish one oxide from another, given reasonable purity.

By means of this method of approach it was first necessary to ascertain whether or not the yellow iodous sulphate with which we were working was identical with that considered by Chretien, Fichter and Dinger, and others. The chief reason for this will be apparent from an outline consideration of our method of preparation as compared with the methods of previous workers.

Outline of Preparations of Yellow Iodous Sulphate :-

(1) As used in this work.

Finely ground "Analar" iodine and iodine pentoxide, details of the purity of which will be given later, were weighed out accurately in the proportions demanded by the equation :-



the preparation being on a twenty millimol scale. Weighing was done rapidly into a reaction tube of 50 ccs. capacity fitted with a ground glass stopper, which latter was inserted immediately the operation was completed.

100 ccs. of "Winchester" sulphuric acid, approximately $3.5 \text{H}_2\text{SO}_4 \cdot \text{H}_2\text{O}$, was enriched by adding 10 ccs. of 20% "Nordhausen" and the resulting acid, found by analysis to be 97.92% H_2SO_4 , was used as the acid medium for the preparation. 40 ccs. of this acid was added to the

iodine and the pentoxide in the reaction tube, the ground glass stopper was firmly secured, and the tube given a vigorous shaking by hand for some minutes. It was then covered with black paper so as to exclude light and strapped radially on to the spokes of a bicycle wheel which was rotated in a vertical plane at the rate of some 30 revs./minute; thus causing a thorough mixing of the tube contents at each revolution of the wheel.

At first the contents of the tube were very dark brown in colour but after having been on the wheel for two or three hours the colour had lightened considerably, and after about thirty hours a minimum lemon yellow colour was reached by the clear supernatant liquor, and a bright yellow crystalline solid settled on stopping the wheel. This was the solid investigated, all visible trace of solid iodine and pentoxide having disappeared. The whole process was carried out cleanly and at room temperature.

(2) Initial method of preparation due to Chretien.

In papers of 1896 and 1898 (See Ch. I) Chretien described two methods of preparation of yellow iodous sulphate, in both of which heating was apparently considered essential. The first method described was his "Third Phase" in the reduction of iodic anhydride when heated in concentrated sulphuric acid solution:- that in which heating was continued until evolution of copious iodine vapours took place and the liquor turned a progressively darker brown and finally black.

No deposit was noted on cooling, but after several days yellow crystals began to form slowly. This process of crystallisation was very slow and often lasted for months, being accompanied by a reduction in, or even complete loss of the dark colour.

Chretien's second method was that of adding excess of iodine to a hot solution of iodic acid in sulphuric acid. The liquor at once became darker and finally black and on cooling deposited the yellow crystals already noted. Such crystals, prepared by these two methods, were the subject of Chretien's analyses.

Bahl and Partington in 1935, though in doubt as to the precise nature of the yellow iodous sulphate, repeated the above two methods of preparation and obtained the same product.

The most detailed account of such a preparation was given by Fichter and Dinger who dissolved 2.8 grams of iodic acid in 14 grams of warm sulphuric acid ($d = 1.84$) and added 2 grams of iodine. Heating was continued for three to four minutes until evolution of iodine vapours commenced. The solution was then placed in a crystallising dish over fresh sulphuric acid in a desiccator. After one to two days a yellow crystalline crust formed which was dried on a porcelain tile in a sulphuric acid desiccator for one and a half hours and then immediately analysed.

FIGURE 1 □

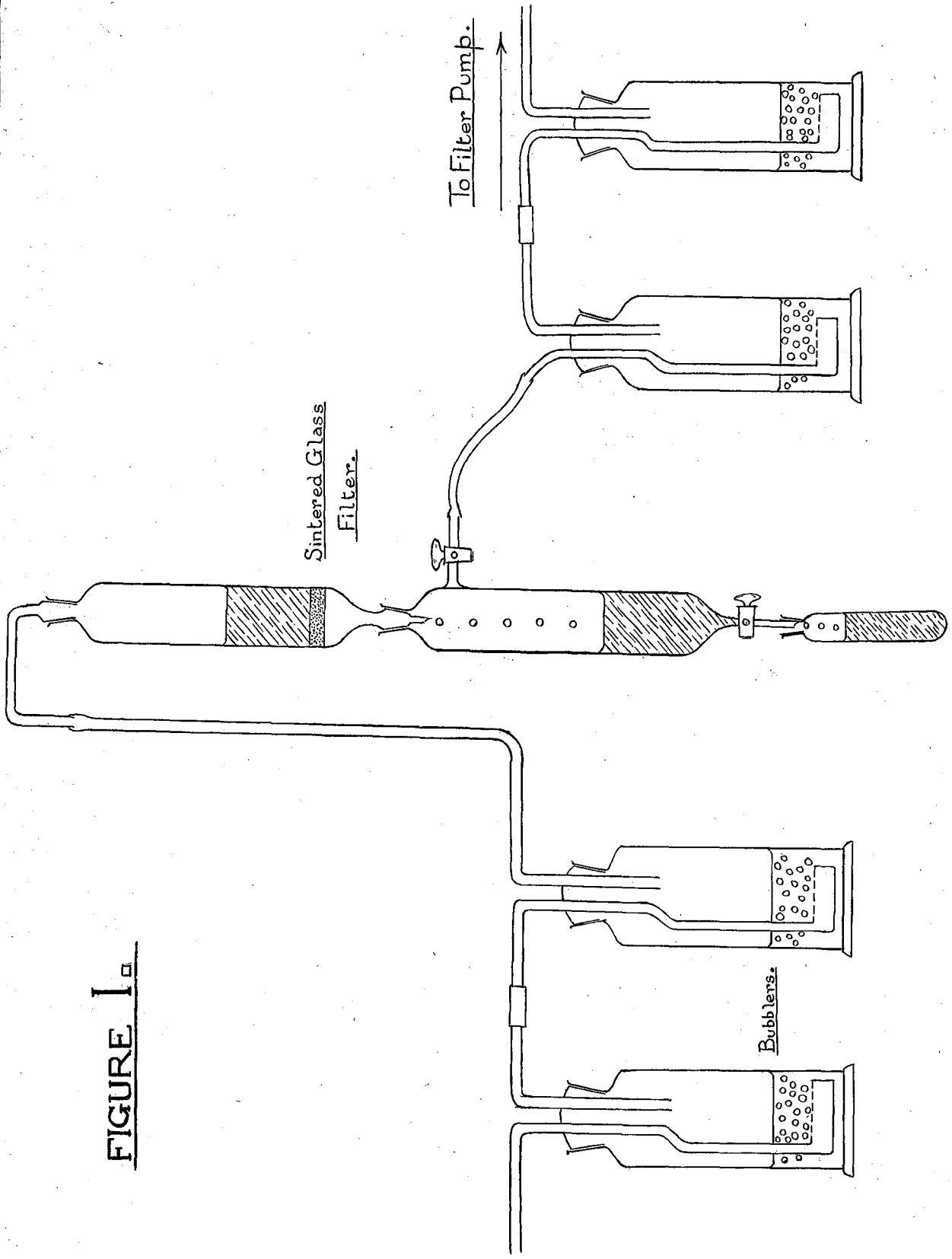

Preliminary Analysis for determining the value of "R".

The yellow iodous sulphate, prepared as stated earlier in the chapter, was filtered on a No. 3 Jena sintered glass filter which was protected at both ends by sulphuric acid moisture traps. All air which passed through the filter was dried by passage through sulphuric acid in sintered glass bubblers. The apparatus was made entirely of glass and all joints were ground and of standard pattern. Taps were only slightly lubricated at the edges with "Apiezon" tap grease. Having drained the yellow solid as thoroughly as possible on the filter, samples were removed from the bulk by pressing a glass tube of $\frac{1}{2}$ cm. bore into the solid and then withdrawing it. The plugs so obtained were ejected rapidly into weighing bottles (with ground lids) by means of a piston of glass rod. The samples, which were usually of about 1 gm. weight, were at once weighed and placed in a vacuum desiccator till required. In this manner samples of yellow sulphate could be collected which were reasonably freed from wetting sulphuric acid without showing any trace of atmospheric effects.

Sampling of the lemon coloured filtrate from the above crystals was carried out straight-forwardly by running 5 ccs. samples into specimen tubes fitted with ground glass stoppers, which, after immediate weighing, were stored in a vacuum desiccator till required.

In preliminary analyses with the object of determining the values of "R" and "x", it was not necessary to weigh the samples. Duplicate

samples of the solid were "drowned" by dropping the plugs into round-bottomed flasks each of 500 ccs. capacity containing about 150 ccs. of distilled water, and carefully rinsing the weighing bottles of small fragments. The solid was at once decomposed by the water with the liberation of the "free iodine", but this decomposition was apparently incomplete and when 30 ccs. of carbon tetrachloride was added for extraction of the "free iodine", a dirty greyish yellow scum was formed which persisted despite prolonged shaking and standing in the cold. In order to avoid this scum, the nature of which was uncertain, the samples after drowning, were heated gently under reflux with 30 ccs. of carbon tetrachloride for 15 to 20 minutes. At the end of this period scum had disappeared and clear violet carbon tetrachloride and almost colourless aqueous layers remained. Thus it would seem probable that the aqueous decomposition failed to be complete because of the formation of a protective coating of iodine around the inner undecomposed sulphate. On addition of carbon tetrachloride this iodine was removed but the inner solid became wet with carbon tetrachloride which protected it from anything but very slow aqueous action.

The contents of each flask were allowed to cool, the reflux tube rinsed down with distilled water and the entire contents of the flask carefully washed into a separating funnel. The carbon tetrachloride/iodine layer was separated and the aqueous layer progressively extracted with further 30 ccs. portions of carbon tetrachloride until

the latter remained colourless after prolonged shaking. To the combined carbon tetrachloride extracts about 50 ccs. of water were added and the whole titrated against $\frac{N}{10}$ thiosulphate the carbon tetrachloride itself serving as the indicator and giving a sharp end point to half a drop of thiosulphate.

The aqueous layer after the above extraction of "free" iodine contained the "iodate" iodine and this was determined by acidifying with slight excess of hydrochloric acid (c.a. 10 ccs. of concentrated acid) and then adding potassium iodide in the form of an $\frac{N}{2}$ solution. After the first addition of potassium iodide, which was of itself insufficient for reaction with all the iodate present, the liberated iodine was extracted with carbon tetrachloride and then more potassium iodide added drop by drop with repeated extractions until further addition produced no formation of brown colour in the solution due to liberation of iodine. A further drop of potassium iodide was then added and the carbon tetrachloride extraction carried to completion. The combined extracts were titrated as before against $\frac{N}{10}$ thiosulphate. The ratio of these two titres - $\frac{\text{"free" iodine titre}}{\text{"iodate" iodine titre}} = R$ was found in these preliminary investigations to be 8.96, 9.06, and 9.07 for three separate experiments; corresponding to values of 2.977, 3.007, and 3.009 for "x".

This closeness to the value of 3.00 for x was maintained throughout all later analyses and it would therefore seem that the oxidation stage of the iodine in the yellow sulphate was that of I_2O_3 and that

the compound which was under investigation was identical with that studied by Chretien, Bahl and Partington, Fichter and Dinger, and others.

Analytical methods of earlier workers :-

(1) Chretien :-

Samples of yellow sulphate, carefully freed from mechanically held sulphuric acid, were dropped into water and decomposed instantly to give iodine, iodic acid, and sulphuric acid. The liquid was boiled and a current of hydrogen passed through it; causing the iodine to distil over and be collected in a potassium iodide solution. Zinc and excess phosphoric acid were added to the residual colourless liquid to reduce the iodic acid. The resulting iodine was distilled off and estimated as before. The sulphuric acid remained in the liquid and was determined as barium sulphate.

Finally, the water which the crystals contained was determined separately by heating samples of solid to complete decomposition with litharge in a glass tube. A column of copper retained the iodine and the water was collected in an absorption tube and weighed.

Despite the fact that criticism may be offered with regard to the presence of mechanically held sulphuric acid and its ultimate effect on the results of analyses, it must be acknowledged that Chretien's numerical results were in very close agreement with his theoretical values.

Chretien also analysed 10 ccs. portions of the brown liquor which had deposited crystals over a period of two months. The iodine liberated was distilled off and determined; the iodic acid being then reduced and estimated as in the solid analysis. He found that 1 litre of the liquor contained 67 grams of iodine and 10.2 grams of iodic acid, and noted that the brown colour of the solution was removed by oxidation of the excess iodine with resulting deposition of a fresh crop of yellow crystals.

(2) Fichter and Krummenacher, in their work on iodine perchlorate - $I(ClO_4)_3$ - adopted similar analytical methods; distilling off the "free" iodine and collecting it in potassium iodide solution. The residual solution was analysed for iodic acid content either by addition of excess potassium iodide and volumetric estimation of liberated iodine, or by reduction with sulphur dioxide and gravimetric estimation of the iodate iodine as silver iodide.

(3) Bahl and Partington.

In this work the yellow crystalline powder or crust was added to warm water containing sulphurous acid and the iodide so formed precipitated as silver iodide. Sulphate radical was determined by dissolving the solid in hot water and treating the solution containing iodine, iodic acid and sulphuric acid, with zinc dust and a small quantity of hydrochloric acid so as to reduce the iodine and iodic acid to iodide. The sulphate in the filtrate was then precipitated as barium sulphate.

(4) Fichter and Dinger, on decomposing the yellow solid with water distilled off the iodine in a carbon dioxide stream and collected it in a potassium iodide solution. For estimation of the iodic acid excess potassium iodide and H_2SO_4 were added and the iodine estimated volumetrically again. Sulphate was determined separately as $BaSO_4$.

Our initial attempts at Direct Analyses.

Yellow iodous sulphate was prepared as already described, the charge of the preparation tube being :-

2.032 grams iodine

4.052 grams of iodic anhydride (98.9% pure)

40 ccs. of sulphuric acid (100 ccs. "Winchester" acid to
10 ccs. "20% Nordhausen")

Samples of acid medium were diluted for titration against standard $\frac{N}{2}$ alkali and by this means were found to be 97.92% H_2SO_4 . The preparation resulted in a dark brown solution and a canary-yellow crystalline product of uniformly fine texture.

The method of analysis of this solid for "R" and "x" has already been described but it is interesting to note that on washing with fresh acid medium the first washings of 5 ccs. were only a pale lemon yellow whilst the second and third washings were practically colourless.

The brown filtrate on analysis for "R" and "x" showed values considerably less than 3.00 for x - viz. 2.68 and 2.78 for two different brown liquors, thus bearing out Chretien's observations

FIGURE II.

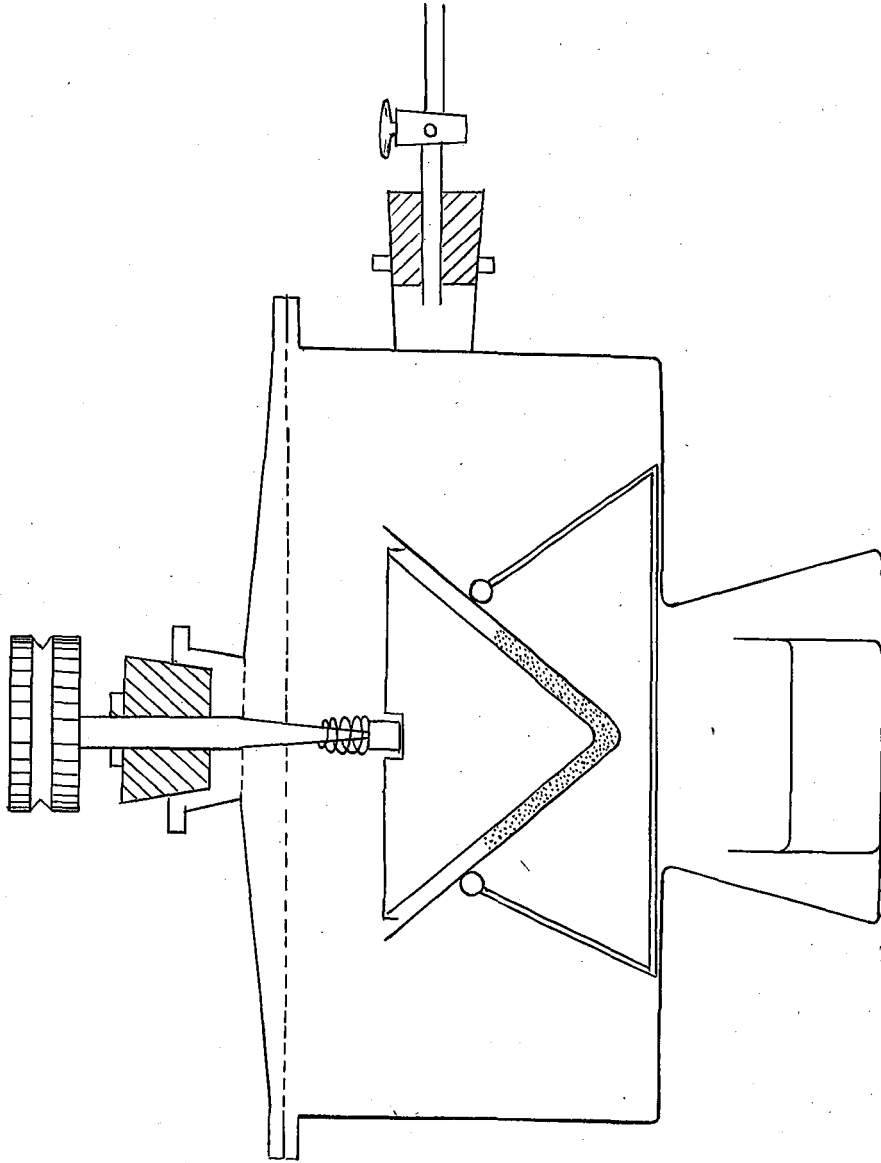

on this subject and suggesting that the deep colour is due to excess I_2 .

Having drained the yellow solid on the sintered glass filter for half an hour, after which time maximum "dryness" was reached, it was transferred rapidly to a bottle by means of a glass spatula. The bottle was securely stoppered and stored in a vacuum desiccator, small losses in transfer being sacrificed to speed of operation.

In an attempt to absorb still further quantities of mechanically wetting sulphuric acid, a special desiccator was prepared as follows :- In the lid a hole of one inch diameter was ground to take a brass cone through which ran a bearing. The bearing faces were all tight enough to allow the desiccator to be evacuated. At the upper end of the central spindle a milled disc was fitted for turning, whilst at the lower end was a spring-loaded extension which connected centrally with a metal disc which clipped over the mouth of the inner of the two concentric cones. This arrangement enabled the inner cone to be turned independently of the outer cone. The two cones fitted, as shown in figure II, into a cradle, and the whole was supported in a frame over 100% sulphuric acid. The desiccator was capable of holding a good vacuum for at least 24 hours. The metal bearing in the desiccator lid was lubricated with a little "Apiezon" tap grease.

These porcelain cones were removed, filled with concentrated nitric acid and allowed to stand overnight in order to remove any organic matter. They were then washed with distilled water several times and finally subjected to boiling with water twice. Finally they were allowed to drain thoroughly, placed in an oven at $95^{\circ} - 100^{\circ}\text{C}$. for about eight hours, allowed to cool slightly and replaced in the desiccator over 100% sulphuric acid.

When the cones were cool the yellow solid was placed in the bottom of the outer cone, stroked up the side so as to form a uniform layer, and the inner cone then replaced. The lid was placed on the desiccator, the spring-loaded spindle was connected and the joints secured so that grinding could be carried out easily and frequently; whilst maintaining the maximum vacuum in the desiccator. Such grinding was carried out for several days at intervals of an hour or so during the day and the vacuum was revived from time to time on a "Hyvac" pump.

Samples of the resulting yellow solid, which had become so dry as to shake loosely in the cones, were weighed out (about 1.5 grams each), "drowned" and analysed in exactly the same manner as described before for "free" iodine and "iodate" iodine. Values of "x" obtained were 3.007 and 3.009 for duplicate samples. Sulphate analysis was carried out on the hot residual liquors by addition of excess of hot $\frac{\text{N}}{2}$ "Analar" barium chloride solution. The mixture was shaken well, boiled for about five minutes to coagulate the precipitate and then allowed to cool and settle. The bulk of the supernatant liquid was

decanted and the precipitate filtered through a clean, weighed, No.4 Jena sintered-glass filter by suction. There was no leakage of barium sulphate through the filter and the precipitate was washed repeatedly with warm distilled water until the washings were free from chloride and showed no action to litmus. Having drained as dry as possible on the pump the filter was dried in a hot air oven at $90^{\circ} - 100^{\circ} \text{C.}$ to constant weight; this often occupying the better part of a day.

From these sulphate analyses it became immediately evident that the ratio of the I_2O_3 -content of the solid to the sulphato-content was by no means constant; and also that the water-content, which was found "by difference" in the final balance, was subject to even greater variations. Hence, it was concluded that it had been impossible to free the yellow solid from mechanically held sulphuric acid despite the increased precautions. The results also showed that the determination of water by difference, in samples which were apparently quite dry, was much too sensitive to experimental error to be of any real value. Thus, from the point of view of verification or otherwise of Chretien's formula, direct analysis seemed to be impracticable and new methods of approach had to be sought.

As the yellow solid could be handled in the wet condition with reasonable ease it was firstly decided to attempt to employ the wet residue method of analysis for a three component system, often known as Schreinemaker's method. The problem as seen from this angle was

H_2O

H_2O

Liquidous Phase.

Solidous Phase.

Chretien.

Bahl and
Partington.

SO_2

FIGURE III.

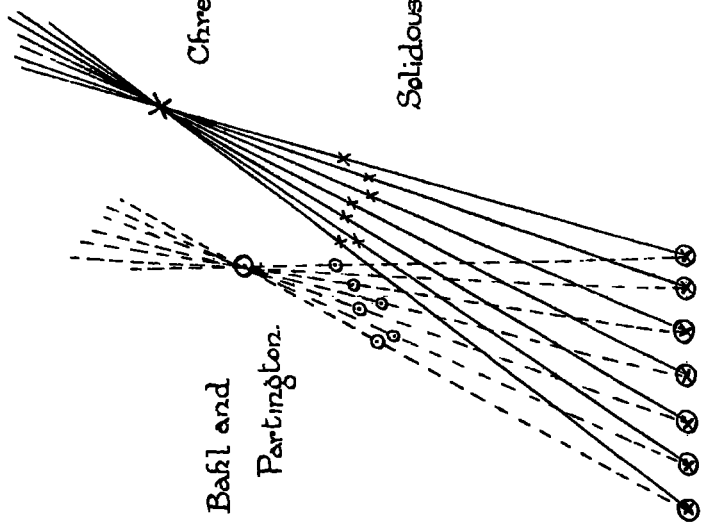

briefly as follows. If the compound is $I_2O_3 \cdot xSO_3 \cdot yH_2O$, what are the values of x and y . It had always been that $x = 1$ but y had been given as $\frac{1}{2}$ by Chretien's school and as 1 by Bahl and Partington. If the yellow solid could be prepared in acid media of strengths varying over a wide enough range, and the complete analyses of really wet solidous samples and corresponding solution phases for I_2O_3 , SO_3 and H_2O could be plotted on a triangular diagram, then it should be possible to show the composition of the dry solid. The formulae claimed by Chretien on the one hand and Bahl and Partington on the other fall well apart on such a triangular diagram and there should be no difficulty in distinguishing which, if either, corresponded to the formula of our yellow solid. Figure III shows hypothetical tie lines corresponding to both formulae.

Secondly, from the more direct analytical approach, if the wetting acid could not be avoided the only alternative would be to determine it. Barium sulphate was found to be appreciably soluble in concentrated sulphuric acid, but, practically speaking, was completely thrown out of solution under conditions of dilution corresponding to our "drowning" of samples. Thus, being chemically inert, barium sulphate was selected as the "indicator". Its concentration in the initial acid medium being known and the quantity recovered on drowning any given sample of yellow solid being determinable, this should lead directly to the amount of wetting acid phase and thence to the composition of the dry solid.

Yellow sulphate preparation in a range of acid strengths.

Large Scale Preparation of Yellow Solid.

Prior to commencing on the two methods of analysis just outlined an adequate reserve of yellow sulphate was prepared. Four tubes were set up as already described. In this case however, the charge of each was as set out below :-

Iodine..... 4.0640 gms. i.e. 16 millimols.

Iodine pentoxide (98.9% pure)... 8.1040 gms. i.e. 24 millimols.

Winchester Sulphuric acid

96.32% by weight or 4.805 $\text{H}_2\text{SO}_4 \cdot \text{H}_2\text{O}$... 70 ccs.

The pentoxide was 98.9% pure, so that 8.1040 gms. of reagent as weighed out contained 8.0149 gms. or 24 millimols of I_2O_5 . The prospective yield from each tube was therefore 12.08 gms. or 40 millimols. Each tube was wrapped in black paper, shaken vigorously by hand and secured to the wheel. Because of the increased scale of the preparation, incompleteness of reaction was feared, due to the formation of the yellow sulphate around small lumps of unreacted pentoxide. This would have become very evident during analysis in discrepancies in the values of R and x. Hence, after 24 hours, during which time reaction had proceeded almost to completion, the contents of each tube, in turn, were transferred to a glass mortar and ground carefully under the acid medium with a glass pestle to break down any lumps. An almost immediate effect of this was to lighten the colour of the acid medium; in other words to liberate I_2O_5 from the lumps which was available for reaction with

the iodine causing the dark colour. The slight absorption of atmospheric moisture was not sufficient to have any effect on the equilibrium of the reaction. The reaction mixture was then returned to the tube, together with a few additional ccs. of acid used in washing the pestle and mortar, given another handshaking and replaced on the wheel till required. A precautionary analysis of two samples from different tubes gave 3.006 and 3.007 as values of x.

The Range of Stability of the Yellow Solid.

By diluting "Winchester" sulphuric acid with a "stock" of $\text{H}_2\text{SO}_4 \cdot \text{H}_2\text{O}$ acids were prepared whose compositions ranged between these two limits. Above "Winchester" strength was obtained by addition of 20% "Nordhausen" acid; so that strengths up to almost 100% were obtained. Such acids were analysed by dilution to about $\frac{N}{2}$ and titrated against $\frac{N}{2}$ alkali using phenol phthalcin as indicator. Eight such acids were made up in this series between 86% and 100% H_2SO_4 by weight, and were used in the setting up of trial tubes.

One of the "stock" preparations was filtered in a current of dry air as already described, drained as dry as possible, washed with one of the above acid media and drained once more on the filter. This washing process was repeated and the drained solid sampled into a 25 ccs. ground glass stoppered tube to which about 15 ccs.-20 ccs. of the particular acid media was added. The tube was stoppered, wrapped in black paper and placed on the wheel. The process was repeated for each of the acids and after vigorous handshaking the tubes

were allowed to stay on the wheel for at least a week to reach equilibrium. At the end of this time they were removed and their condition noted.

(a) The Lower Limit.

In the weakest acid media used, 85.4% H_2SO_4 by weight, or 1.075 $H_2SO_4 \cdot H_2O$, the solid product was tinged brown-green in colour and the solution was a greenish brown. In an acid of 86.3% H_2SO_4 , the solution was not so dark, nor was the solid much more than "off yellow" in colour. In all other acids the solution was a pale lemon yellow and the finely divided solid was a clean canary yellow.

On diluting the weakest medium still further by addition of a few drops of bench dilute sulphuric acid, the solution became a very dark brown indeed and it was at once obvious that the equilibrium :-

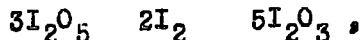

passed over to the left in acids below about $H_2SO_4 \cdot H_2O$, and that the boundary between stability and instability was not sharp at the lower end. This was proved by the fact that the yellow solid which was obtained from tubes in which the acid medium was a dark brown, was still very pure I_2O_3 ; giving values for x of this order of 3.01 to 3.02.

(b) Upper Limit of Stability of the Yellow Solid.

In an acid which was found volumetrically to be 99.8% H_2SO_4 by weight, the colour of the solid was slightly paler. On addition of 5 cos. of 20% "Nordhausen" acid to the reaction tube and after a

further wheeling for several hours, the colour progressively lightened and the yellow solid could be seen in decreasing quantities, mixed with a new and practically colourless crystalline solid. This new solid was of a different crystalline form, as will be seen from the microphotographs included later, and the glistening platelets appeared a very pale primrose colour in a pale solution of the same colour. On filtering, the solid was seen to be virtually white. Continuing further, a sample of drained yellow sulphate was "wheeled" in undiluted 20% "Nordhausen" and the transition took place much more rapidly. Only a few lumps of yellow solid remained after half an hour and these were quickly removed by breaking up the lumps with a glass rod. Thus it seemed that the presence of excess SO_3 in the acid medium was the factor which set the upper limit to the stability of the yellow iodous sulphate, and in fact brought about a complete transition in the solid phase.

The investigation of this white solid was postponed till a later date and attention confined to the consideration of the yellow solid in acid media between the limits of $\text{H}_2\text{SO}_4 \cdot \text{H}_2\text{O}$ and H_2SO_4 . For the final analytical work on the wet residue method tubes were set up; each containing about 4 to 5 grams of yellow solid which had been twice washed and drained with its own specific acid. The acids used were made up as follows :-

- Tube I :- 15 ccs. "Winchester" acid / 100 ccs. of $\text{H}_2\text{SO}_4 \cdot \text{H}_2\text{O}$ "stock"
- Tube II :- 35 ccs. "Winchester" acid / 100 ccs. of $\text{H}_2\text{SO}_4 \cdot \text{H}_2\text{O}$ "stock"
- Tube III :- 25 ccs. "Winchester" acid / 100 ccs. of $2\text{H}_2\text{SO}_4 \cdot \text{H}_2\text{O}$ "stock"

Tube IV :- "Winchester" acid alone

Tube V :- 20 ccs. of 20% "Nordhausen" / 100 ccs. "Winchester" acid

Tube VI :- 40 ccs. of 20% "Nordhausen" / 100 ccs. "Winchester" acid

The making up of the tubes was carried out as previously described and they were left on the wheel for a clear week before commencing analyses.

The tube for the barium sulphate indicator method was also set up. The acid medium was prepared by adding 10 ccs. of 20% "Nordhausen" to 100 ccs. of "Winchester" acid. In this acid, which was found to be 97.98% sulphuric acid by weight, 10 grams of specially prepared barium sulphate was dissolved. The detailed investigation of such a solution will be considered in the following chapter. Iodine and pentoxide were weighed into the reaction tube as already described for a 20 millimol preparation, and 40 ccs. of the above acid solution added. The tube was stoppered, given a vigorous shaking, wrapped in black paper and put on the wheel as for an ordinary preparation. After 48 hours it looked just like an ordinary preparation; with canary yellow solid and pale lemon coloured solution. There was no evidence of any barium sulphate being precipitated from the acid and this was verified by observing samples from the tube under the microscope. Only crystals of yellow solid were seen in a clear matrix and after half an hour, during which time atmospheric moisture had been absorbed, there was quite a sudden deposition of colourless needle-shaped crystals of barium acid sulphate. This seemed to indicate that there would be little practical difficulty with the indicator method and the tube was replaced on the wheel till required.

Sensitivity of the Yellow Solid to Light.

During all initial preparations the tubes were wrapped in black paper to exclude light, and for the same reason all samples in storage were kept in the dark whenever possible. The reason for this was the reference in various historical accounts to the possibility of related iodine compounds showing such sensitivity. It was found in practice that no apparent change in the yellow solid took place, either as regards appearance or composition as shown by analysis. However, it was suspected that the white solid was not so insensitive, for although all tubes contained almost dead white solid at first in equilibrium with colourless solutions, they all became pale primrose coloured in the solid phase and the palest yellow in solution after 2 or 3 days in the sunlight. It was therefore necessary to retain wrappings on the white solid tubes.

Chapter 3.

Preparation of Starting Materials.

(a) Iodine.

This was of standard "Analar" quality which had been slowly sublimed in all-glass apparatus. The sublimate was carefully ground in a glass mortar till very fine, dried in a vacuum desiccator over anhydrous calcium chloride for several days. The fineness of the product allowed accurate weighing in preparation of the iodous sulphate and it was taken as the standard of purity against which the thiosulphate and the potassium iodide was standardised.

(b) Potassium Iodide.

This was also of "Analar" quality and was used without further treatment.

(c) Sodium Thiosulphate, of the same quality was used directly from stock.

(d) Iodine Pentoxide.

Although of B.D.H. quality, it was suspected that slight absorption of atmospheric moisture may have taken place and it was deemed necessary to check the purity against the iodine. A standard solution of iodine was made up, containing 3.2073 grams in 250 ccs. of potassium iodide solution; giving a normality of 0.10108. This solution was used to standardise a thiosulphate solution of normality 0.1003. 0.7432 grams of "B.D.H." iodine pentoxide was dissolved in 100 ccs.

of distilled water. To 10 ccs. of this solution 15 ccs. of normal potassium iodide and 5 ccs. of 2N sulphuric acid were added. 2 ccs. of "analar" carbon tetrachloride were then added as an indicator, and not for "shaking out" the liberated iodine, which was titrated against the standard thiosulphate solution. An average titre of 26.32 ccs. of thiosulphate gave the purity of the pentoxide as 98.87%.

(e) Carbon Tetrachloride.

This reagent was used extensively in extraction of iodine which was liberated when the yellow and white solids were decomposed in water. In initial work fresh "Analar" reagent was used, but the cost of this and the quantity used made it necessary to work with a total of some 4 litres and recover the used reagent as described below. When residues of CCl_4 were left standing in contact with iodide solutions in the sunlight, some liberation of iodine took place and this was taken up in the organic layer, so that CCl_4 layers from residues were always slightly coloured, and in recovery were shaken vigorously in a separating funnel with thiosulphate solution. This removal of free iodine was ensured by a second such treatment and the organic layer was then washed thoroughly by four vigorous and prolonged shakings with distilled water. It was noted that the first few ccs. of any distillate from recovered CCl_4 had a strong odour of CS_2 and so, after shaking with water and separating, the CCl_4 was shaken vigorously with mercury. A considerable quantity of black scum was formed (mercury sulphide) and after removal by filtration the shaking was repeated till the mercury remained clean. The tetrachloride was

separated, filtered, and dried over anhydrous calcium chloride. It was finally distilled and the first few ccs. were rejected since they were still slightly contaminated with CS_2 . The remainder of the distillate came over within half a degree of 77°C .

(f) Sulphuric Acid.

The "Winchester" stock was fresh and of good quality by Brady and Martin, and was quite colourless. The "Winchester" was always kept carefully stoppered when not required and by volumetric analysis against $\frac{N}{2}$ NaOH it was found to be 96.32% by weight H_2SO_4 . The stocks of $\text{H}_2\text{SO}_4 \cdot \text{H}_2\text{O}$ and $2\text{H}_2\text{SO}_4 \cdot \text{H}_2\text{O}$ were made up by dilution of "Winchester" acid to the respective densities determined on a Westphal balance.

(g) Oleum Solutions.

The 20% "Nordhausen" acid was a Brady and Martin product and the 65% acid used later was a very fresh B.D.H. supply. Handling of 20% oleum presented little difficulty though considerable exercise of care was essential. In the case of the 65% oleum it was almost impossible to see the mouth of the bottle during pouring, due to SO_3 fumes, and this at once indicated that extra precautions would have to be taken if the same kind of loss was to be avoided in the actual analytical work. Special care had to be taken in storage of this latter acid because of its tendency to "creep" past ground joints. Care had to be taken to see that the oleum solutions never came into contact with any grease or other organic matter since charring at

once took place.

Before considering wet residue analysis with the white solid a review of the physical state of oleums of various strengths was made. It may be summed up in the following table of R. Krietsch which was taken from Mellor's Comprehensive Treatise on Inorganic Chemistry Vol.X p. 352. Table VI.

<u>Free SO₃ by weight.</u>	<u>Melting Pt. °C,</u>	<u>Physical State at Room Temp. i.e. 15°C.</u>
0	10.0	
5	3.5	
10	-4.8	
15	-11.2	<u>LIQUID</u>
20	-11.0	
25	-0.6	
30	15.2	
35	26.0	
40	33.8	
45	34.8	<u>SOLID</u>
50	28.5	
55	18.4	
60	0.7	
65	0.8	
70	9.0	<u>LIQUID</u>
75	17.2	
80		<u>SOLID</u>

It will thus be seen that the range of oleum solutions available for the preparation of white solid is limited to the following strengths :-

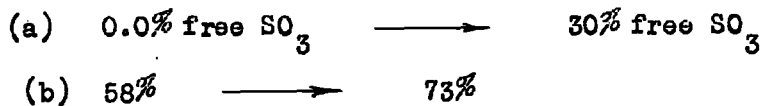

When these percentages were converted into molecules % of SO₃ the apparent preponderance of SO₃ over the water content was not so great as might have been imagined; and a greater variation would have been

desirable between the available working limits from the point of view of a triangular diagram.

The great tendency of these acids to absorb the moisture from the air will be indicated in the next section where the effect of such absorption on the dissolved iodous sulphate will be discussed.

(h) Yellow and White Solids.

The large scale preparation of the yellow iodous sulphate has already been described. For conversion into a "stock" of white solid, a 40 millimol scale preparation of yellow solid was first carried out. Glass beads were added to the tube so that grinding took place in situ, and this was supplemented by grinding in a mortar as already described. The product was very finely divided and bright canary yellow in a pale lemon yellow coloured solution. The solid was filtered in the "protected" apparatus, washed twice with "Winchester" acid, drained as dry as possible, and transferred with clean beads to a new tube. 50 ccs. of 20% "Nordhausen" acid were added, the tube shaken vigorously and put on the wheel. Within half an hour the whitest preparation we had obtained was present in the tube and this was attributed to the very fine state of the initial yellow solid. A small sample was taken for microphotography and the rest replaced on the wheel for the weekend.

In white solid tubes great care had to be taken to avoid any of the contents becoming lodged in the neck of the tube. When this took

place a deep blue colouration was soon noticed locally and on shaking the tube the colour spread throughout the tube. The explanation of this may be found in the sensitivity of the white solid to atmospheric moisture. To about 5 ccs. of such a blue solution, formed in a 25% oleum tube, $\frac{1}{2}$ cc. of "Winchester" acid was added. The only change was a movement towards a more definite but lighter green in preference to the deeper blue. A further addition of 1.5 ccs. of $H_2SO_4 \cdot H_2O$ brought about a complete dissolution of the white crystals initially present and also a change to brown in the colour of the solution. Thus it seems that a progressive change took place as the strength of the acid medium was lowered, resulting in a complete decomposition of the white solid. It was also noted that the colour of such a solution varied from a green below about 20% oleum to a deep blue above that strength.

A crystal of iodine added to 2 ccs. of 25% oleum gave a greenish-brown colour which changed slowly to a deep blue-green on dissolution of the iodine; the change being accelerated by heating gently. Addition to this solution of a little I_2O_5 caused the colour to become an even deeper and more definite blue. Dilution of this solution with $H_2SO_4 \cdot H_2O$ gave the same results as the first experiment recorded above.

It therefore seems likely that the initial decomposition of white solid around the mouth of the tube liberated iodine which at once attacked the oleum, reducing the free sulphur trioxide to sulphur

sesquioxide. This compound is reported as unstable in water and would therefore decompose on dilution below 100% H_2SO_4 . It is said to be "made as malachite green coloured mass by direct reduction of molten sulphur trioxide at $15^{\circ}C$. with sulphur, or as a blue solution by the action of flowers of sulphur on "Nordhausen" sulphuric acid". It seems equally possible that liberated iodine could fill the role of sulphur as reducing agent. In actual analytical work on the white solid this blue compound formation was not found to be any inconvenience. Finally, in preliminary investigations on the working range for white solid tubes, it was found that there was a very great increase in the solubility of the white solid in acids over 60% oleum strength. This increase would mean that in wet residue analyses of such tubes, the solidous and liquidous compositions would be much closer together and hence any experimental errors, which would almost certainly be greatest in these acids, would produce much greater uncertainty as to the direction of the tie-lines. Because of this it was considered advisable to disregard the acids above 60% oleum in making up wet residue tubes for the white solid.

(i) Barium Sulphate.

In the preparation of barium sulphate for use as indicator in the direct determination of wetting acid medium, 250 ccs. of a normal solution of "A.R." barium sulphate were added to 250 ccs. of 2N sulphuric acid in the cold. This use of concentrated reagents and cold conditions should assist in the formation of a finely divided precipitate. However, since the solutions were so concentrated,

SOLUBILITY OF BaSO_4 IN CONC. AQUEOUS
 H_2SO_4
AT
 $20^\circ\text{C}_.$

(SEIDELL'S DICT. OF SOLUBILITIES) ○

FIGURE IV.

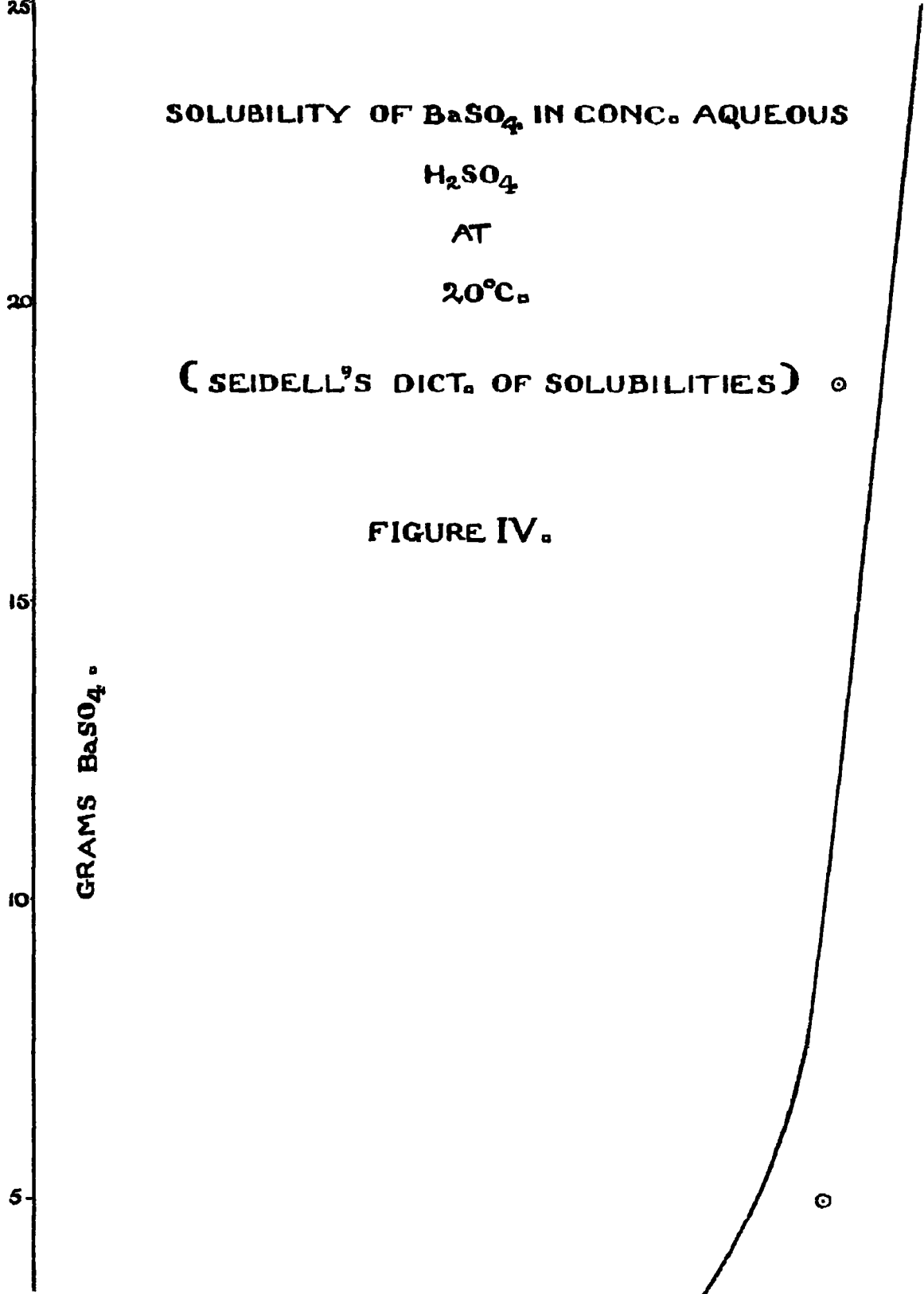

there would be a greater tendency towards adsorption of chloride, and hence great care would have to be exercised in washing the precipitate free from this. The precipitate was allowed to settle, as much as possible of the liquid was poured off and the remainder filtered through No. 50 Whatman papers. (these being least likely to give any filter fluff.) The precipitate was then washed repeatedly and finally turned out into a large conical flask and heated gently for half an hour on a water-bath, allowed to settle and filtered as before. The filtrate was tested for chloride with silver nitrate and gave positive results. The barium sulphate was then heated up again with 500 ccs. of distilled water for two hours before cooling and filtering. This process was repeated eight times before all trace of chloride had disappeared. Filtering was a very slow process but finally the thick pasty mass was transferred to a large watch-glass and put into a vacuum desiccator over sulphuric acid. The vacuum was renewed every two hours during the day. When the mass had dried to a cake it was broken up to assist drying. When dry enough to powder it was crushed in a mortar and sieved through a No. 120 sieve before being put back into the vacuum desiccator till required.

Figure IV shows the known solubilities of barium sulphate in sulphuric acids and it can be seen at once that a big increase in solubility takes place above 96% sulphuric acid by weight. An acid was made up by adding 12 ccs. of 20% "Nordhausen" acid to 100 ccs. of "Winchester" acid and the strength found volumetrically to be 97.98% by weight. In such an acid it should be possible to dissolve some

13 gms. of barium sulphate in 100 ccs. of acid without supersaturating the solution. Actually 10 gms. were added to 100 ccs. of acid, the tube shaken vigorously and put on the wheel for a few hours. At the end of this time a clear solution showed no trace of solid undissolved. To test the extent of dilution possible before precipitation of the dissolved barium sulphate took place, 2 ccs. of the above solution were diluted with 2 ccs. of $H_2SO_4 \cdot H_2O$ and this failed to produce any precipitation. Next, water was carefully added drop by drop, and 5 drops were added before the slight precipitate of barium sulphate which formed with the addition of each drop, failed to redissolve. Thus it will be seen that such a solution is capable of withstanding greater dilution than it is likely to receive from atmospheric moisture. This solution was used to make up a 20 millimol preparation of the yellow solid as described later.

In making up oleum tubes for "indicator" analyses it was found that barium sulphate was very readily soluble in such acids; much more so than in solutions weaker than 100% sulphuric acid. However in these latter acids it seemed certain that the solubility was much greater than indicated by the figures available, and the investigation of this should prove profitable.

Finally, microscopic observation showed that the solutions of barium sulphate in these strong acids were completely homogeneous.

Chapter 4.

Details of analysis of a typical tube of Yellow Sulphate.

(a) Wet Residue Method.

Complete analysis of tube IV was carried out as set out below. The tube, which contained finely divided, bright yellow solid and pale lemon colour solution, was removed from the wheel eight days after the initial setting up. The contents were shaken up and poured rapidly into the filtering apparatus already described and shown in figure I. Gentle suction was applied through two sulphuric acid bubblers, the stream of air being dried by passage through two more such bubblers. The solid was drained as thoroughly as possible since "dry" samples are advantageous in fixing the direction of the tie-line with the greatest accuracy. Suction was stopped and the apparatus allowed to stand till air had ceased to be drawn through the preliminary bubblers. The top of the solid-reservoir was removed and two plugs of solid removed into weighed bottles which were at once stoppered. The tap in the side tube of the filtrate reservoir was opened and two samples of the pale lemon coloured liquor run off into small weighed tubes into which ground-glass stoppers were immediately inserted. In these operations the time during which the samples were in contact with undried air was never more than half a minute for either solids or solutions. As soon as taken the samples were stored in a desiccator as a further precaution and taken at once for rapid weighing on a "chainomatic" balance of good accuracy.

Weights of Samples :-

Solidous	A = 1.1719 gms.
	B = 1.2369 gms.
Liquidous	A = 13.0695 gms.
	B = 14.1667 gms.

Analysis of Solidous Samples.(I) Iodous Content :-

The duplicate samples were each dropped into about 100 ccs. of distilled water in 500 ccs. round-bottomed, ground-glass jointed flasks; the sampling bottles rinsed out thoroughly and the washings added to the respective flasks. 40 ccs. of "Analar" CCl_4 were added to each flask and the contents refluxed for 20 minutes until all trace of the usual scum (already described) had disappeared. When the contents of the flasks had cooled the reflux tube was rinsed into the flasks and the contents then transferred to separating funnels where the extraction of the "free" iodine was completed, using 30 ccs. portions of carbon tetrachloride. The combined extracts for each sample, after addition of 10 ccs. of $\frac{N}{2}$ KI and a drop of sulphuric acid, were titrated against 0.0988 N thiosulphate.

"Free Iodine" Titres :-

Sample A	=	21.45 ccs.	0.0988 N	thiosulphate
Sample B	=	22.65 ccs.	" "	" "

The colourless residual liquors in each separating funnel contained iodic and sulphuric acids and the iodate iodine was next estimated. 5 ccs. of concentrated hydrochloric acid were added to

each, together with several ccs. of $\frac{N}{2}$ KI solution. Iodine was deposited and extracted with CCl_4 . This addition of KI solution and extraction of the liberated iodine was continued until a final addition of iodide produced no brown colouration of liberated iodine and the CCl_4 used in extraction remained colourless. As in the determination of the "free iodine" the extracts were combined, and after addition of 10 ccs. of $\frac{N}{2}$ KI solution and a drop of sulphuric acid, titrated against thiosulphate.

"Iodate Iodine" Titres.

Sample A = 195.15 ccs. 0.0988 N thiosulphate

Sample B = 205.70 ccs. " " "

Hence, in Sample A :-

$$\text{"R"} = \frac{\text{"Iodate Iodine"}}{\text{"Free Iodine"}} = \frac{195.15}{21.45} = 9.098$$

$$\text{So that "x"} = \frac{5R}{6+R} = 3.013$$

$$\begin{aligned} \text{Total I}_2 \text{ as I}_2\text{O}_3 &= 21.45 + \frac{195.15}{6} \text{ ccs. 0.0988 N.} \\ &= 2.6661 \text{ millimols / 1.1719 gms. of sample} \\ &= 2.2750 \text{ millimols / gm. of sample} \\ &\text{or .6867 gm. / gm. of sample} \end{aligned}$$

Similarly in Sample B :-

$$\text{"R"} = 9.082 \text{ and } x = 3.011$$

$$\begin{aligned} \text{Total I}_2 \text{ as I}_2\text{O}_3 &= 22.65 + 34.28 \text{ ccs. 0.988 N} \\ &= 2.8123 \text{ millimols / 1.2369 gms. of sample} \\ &= 2.2737 \text{ millimols / gm. of sample} \\ &\text{or .6863 gm. / gm. of sample.} \end{aligned}$$

(II) Sulphate Determination :-

The aqueous layers, after extraction of "iodate iodine", were heated to boiling in a 750 cc. conical flask and 10 ccs. of boiling, normal "A.R." barium chloride solution added. The flask was heated and shaken vigorously for some time to coarsen the precipitate, allowed to cool, and its contents then filtered by suction through a No. 4 sintered glass filter previously dried to constant weight. The precipitate was washed by sucking warm water through it until the washings were free from chloride, and then dried to constant weight in an oven at 90° - 100° C. It should be noted that filters used for such filtrations as above were cleaned by sucking concentrated sulphuric acid through them till the pores were once more open. They had then to be washed free from sulphuric acid of course.

SO₃ Content.

Sample A	BaSO ₄ to constant weight	= 0.8332 gm./gm. of sample
	So that SO ₃	= 0.2858 gm./gm. of sample
		= 3.5672 millimols/gm. of sample.
Sample B	BaSO ₄ to constant weight	= 0.8327 gm./gm. of sample
	So that SO ₃	= 0.2856 gm./gm. of sample
		= 3.5672 millimols/gm. of sample.

(III) Water Content of Solidous Samples.

This had to be found by difference from the data above :-

Sample A	= 0.0275 gms. / gm. of sample
	= 1.5264 millimols / gm. of sample

Sample B = 0.0281 gm. / gm. of sample
 = 1.5597 millimols / gm. of sample

From the above results it will be seen that direct analyses of samples in which the water-content was so small by weight would be very susceptible to large errors due to atmospheric moisture effects.

The percentage composition by molecules of the two samples can be summarised as :-

	<u>Sample A.</u>	<u>Sample B.</u>
I_2O_3	30.86%	30.72%
SO_3	48.43%	48.20%
H_2O	20.71%	21.08%

Analysis of Liquidous Samples.

(I) Iodous Content:-

The samples were each "drowned" in 200 ccs. of distilled water in a 500 ccs. flask, the washings added and the flasks stoppered and shaken under the tap to cool the contents. No iodine was thrown out of solution in this dilution as was the case with solidous samples, only a brown solution being formed. There was no need to reflux. 40 ccs. of CCl_4 were added to each flask for extraction of the "free iodine" and this was usually almost sufficient to complete the process. Further extractions were carried out till the CCl_4 layer was colourless, and the combined extracts were then titrated against thiosulphate as for the solidous samples. The free iodine was so small in quantity that 0.00988 N thiosulphate was used in its

estimation.

"Free Iodine" Titres.

Sample A = 14.8 ccs. of 0.00988 thiosulphate

Sample B = 16.07 ccs. of 0.00988 thiosulphate

The "iodate iodine" was liberated and extracted as in the solidous determination and gave results as below.

"Iodate Iodine" Titres.

Sample A = 13.35 ccs. 0.0988 N thiosulphate

Sample B = 14.55 ccs. 0.0988 N. thiosulphate

Hence in Sample A :-

"R" = 9.020 and x = 3.003

Total I_2 as I_2O_3 3.003 = 1.48 + 2.225 ccs. 0.0988 N
 = 0.1830 millimols / 13.0695 gms. of sample
 = 0.0140 millimols / gm. of sample
 = 0.0042 gms. / gm. of sample

And in Sample B :-

"R" = 9.054 and x = 3.007

Total I_2 as I_2O_3 3.007 = 1.607 + 2.425 ccs. 0.0988 N
 = 0.1992 millimols / 14.1667 gms. of sample
 = 0.0141 millimols / gm. of sample
 = 0.0043 gms./ gm. of sample.

(II) Sulphate Content.

The acid residues above were much stronger than in the case of solid phase analyses, and so, to avoid excessive precipitates of barium sulphate the residues were each made up to 1 litre and 100 ccs.



FIGURE V.

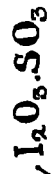

Cfaretien.
⊙

Bahl and
Partington.
⊙

B Ⓟ A

B Ⓟ A

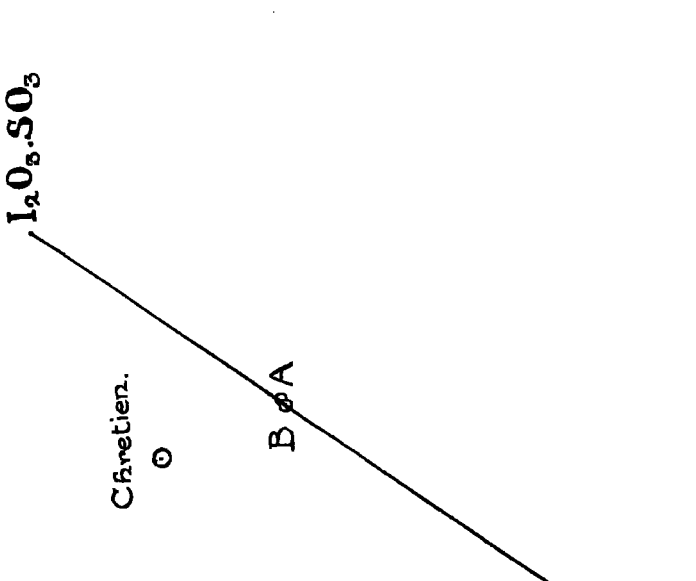

portions taken from each. As in the case of solidous analysis, normal barium chloride solution was added, the precipitate filtered, washed chloride free and dried to constant weight.

SO₃ Content.

Sample A BaSO₄ = 2.2824 gms. / gm. of sample
 So that SO₃ = 9.776 millimols / gm. of sample
 = 0.7828 gm. / gm. of sample

Sample B BaSO₄ = 2.2779 gms. / gm. of sample
 So that SO₃ = 9.7583 millimols / gm. of sample
 = 0.7812 gm. / gm. of sample.

(III) Water Content, was again determined by difference.

Sample A = 0.2130 gms. / gm. of sample
 = 11.8228 millimols / gm. of sample
 Sample B = 0.2144 gms. / gm. of sample
 = 11.9033 millimols / gm. of sample.

Hence the percentage composition by molecules can be summarised as below :-

	<u>Sample A</u>	<u>Sample B.</u>
I ₂ O ₃	0.065 %	0.065 %
SO ₃	45.24 %	45.02 %
H ₂ O	54.70 %	54.92 %

With these two series of data for the solidous and liquidous phases, the composition of tube IV was plottable on a triangular diagram as in figure V opposite.

Where the solutions were lemon yellow and the solid bright canary yellow, the values of R were within experimental accuracy of 9.0 but where the acid medium was close to $\text{H}_2\text{SO}_4 \cdot \text{H}_2\text{O}$, the liquors became brown and the solid appeared yellowish-green through the solution. In these cases the analyses gave values of R for the solution much greater than 9, whilst the solid phase gave somewhat less than 9. This discrepancy increased as the amount of decomposition, as shown by the physical nature of the tube, increased. It thus became possible to predict the purity of a given preparation by its appearance.

The data supplied by the six tubes, and which was used in the construction of the published figure, was not the sole evidence for the formula $\text{I}_2\text{O}_3 \cdot \text{SO}_3$ of the yellow solid from wet residue consideration. An initial series of nine tubes had provided data which virtually confirmed this formula and the six tubes set up as repeat experiment were analysed in such a manner as to embody all improvements in technique arising out of the initial series of analyses. The results for both series will be tabulated in the appropriate appendix.

(b) Barium Sulphate Indicator Method :-

The preliminary investigation of the solubility of barium sulphate in concentrated sulphuric acid has already been described in the previous chapter, as has the setting up of a 20 millimol. preparation of yellow sulphate in acid dosed with 10 grams of barium sulphate. A preliminary analysis of the acid medium used in making up this tube was carried out by "drowning" two samples of about 13 grams each in

200 ccs. of distilled water and boiling each gently for a few minutes with shaking to coagulate the precipitated barium sulphate. After cooling, the precipitate was filtered through No. 4 sintered glass filters and dried to constant weight in a hot air oven. It was then found that the two samples gave 5.208 and 5.201 grams of BaSO_4 per 100 grams of original solution. Taking the average of these two figures, this means that :-

5.204 gms. indicator BaSO_4 were associated with 75.820 gms. SO_3
 1.00 gm. " " was " " 14.570 " "

or 181.99 millimols. SO_3 .

In actual analyses of the contents of the dosed tube, account had to be taken of the yellow iodous sulphate dissolved in the equilibrium acid medium.

After having been on the wheel for six weeks the solid phase was bright yellow and finely divided whilst the solution was just tinged faintly brown. The contents of the tube were filtered as already described for other tubes. Samples taken as below, it being most advantageous to have the solidous samples as wet as practicable.

Solidous Samples.

A.	1.8899 grams.
B.	3.2283 "
C.	3.0437 "

Solution Samples.

A. 13.2497 grams.

B. 13.2489 "

The solid was all used up in the sampling but the residue of solution was retained in a stoppered tube for future reference.

Analysis of Solution Samples :-

A third sample of solution was first drowned, as described earlier, and analysed for "free" and "iodate" iodine with the sole object of determining the values of R and x for the solution and the I_2O_3 content. When the two other samples were drowned the liberated barium sulphate was allowed to settle out from the brown solution and then the whole was filtered through No. 4 filters. When the filtrate and washings were analysed for "free" and "iodate" iodine it was found that the former was considerably below the value commensurate with the values of 8.983 for R and 2.998 for x which were obtained from the analysis of the first solution sample. In this first analysis the liberated indicator $BaSO_4$ was neglected in preference to obtaining the two iodine titres. This discrepancy noted above was attributed to the loss of iodine from the solution by suction during filtration and it was considered feasible to use the above value of R to back-calculate the "free" iodine and so obtain the I_2O_3 content of all the samples of solution. This assumption was upheld by the fact that the I_2O_3 content per gram of solution sample found in all three samples was in good agreement.

The residual solutions from the "iodate" iodine determinations were each made up to 1 litre and 100 ccs. portions taken for estimation of SO_3 content as BaSO_4 , exactly as in wet residue analyses.

Thus, from the analyses of the solution phase the strength of BaSO_4 / acid medium solution was obtained, together with the amounts of I_2O_3 , SO_3 , and H_2O , corresponding to any given quantity of dissolved BaSO_4 indicator.

Analysis of Solid Samples :-

As in the case of the solution phase, sample A was drowned, the liberated BaSO_4 neglected and the values of 9.048 and 3.006 obtained for R and x respectively, together with the I_2O_3 content per gram of sample. Sample B was refluxed as usual with 40 ccs. of CCl_4 to complete the aqueous decomposition, but it was found that the presence of the CCl_4 / iodine layer made filtering of the flask contents when cool, a difficult process; the CCl_4 freezing and clogging the filter when suction was applied. Filtering without suction was impracticable. On final completion of the filtration the iodine and the CCl_4 layer had both practically disappeared and after careful washing of the indicator BaSO_4 and drying to constant weight, the residual filtrate was analysed as below. The slight remaining "free" iodine was extracted with CCl_4 and then the estimation of "iodate" iodine carried to completion. This was followed by sulphate estimation in the residue. On applying the value of R already found for this particular yellow solid preparation, the calculated "free" iodine and determined "iodate"

Apparatus for distilling off

Iodine

in a current of air.

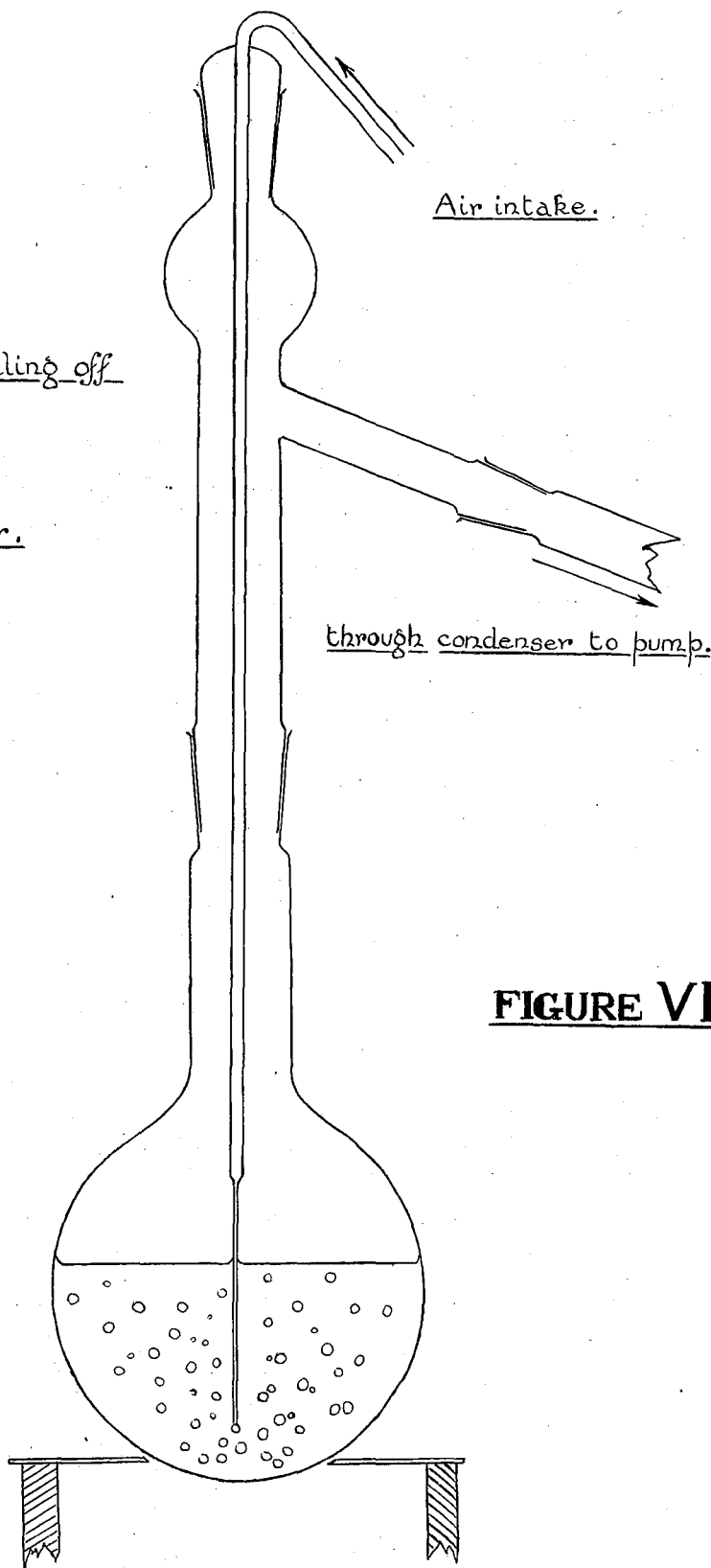

Air intake.

through condenser to pump.

FIGURE VI.

iodine gave an I_2O_3 content for sample B which agreed with that of sample A.

In analysis of sample C, the iodine liberated by refluxing without CCl_4 (for a longer period) was removed by distillation in a current of air which was drawn through a fine jet immersed in the liquor as shown in figure VI. After distillation of all the iodine the residual solution was colourless and the indicator $BaSO_4$ was quite white. Filtering of the cooled contents of the flask was then quite straightforward and the analyses for "iodate" iodine, and afterwards for sulphate were both carried to completion as in any wet residue analysis. The total I_2O_3 content resulting from back-calculation of the free iodine corresponded as before with the value obtained by analysis of sample A and again justified the calculation method.

Therefore, from analyses of solid sample the quantity of indicator barium sulphate, the total I_2O_3 content and total sulphate content were obtained and from the quantity of indicator, the actual amount of wetting acid was directly available. The summarised numerical evidence for supporting the formula $I_2O_3 \cdot SO_3$ for the dry yellow solid will be given in Chapter VII but it is interesting to note some implications of the results obtained from the analyses before proceeding further.

In sample C indicator $BaSO_4$ = 0.049 gms.

Corresponding to wetting
Solution = 0.9416 gms.

Subtracting the I_2O_3 and the SO_3 in the wetting solution from the total content of the sample we have :-

SO_3 in dry cpd.	=	0.4381 gms.
I_2O_3 " " "	=	1.6650 gms.
Hence total weight of sample	=	3.0447 gms.
Now sample C weighed		3.0437 gms.

So that there was a discrepancy of - 0.0010 gms.

In the same way, in sample B there was a discrepancy of - 0.0041 gms. and the fact one was - ve and the duplicate analysis was - ve seemed to indicate that the discrepancies were due to experimental error and not to water content of the dry compound. For a half a molecule of water in the pure compound there would have to be a discrepancy in the above balance sheet equivalent to 2.758 millimols of water in sample C; or 0.0497 gms. of water in the 3.0437 gms. of sample. This is much in excess of experimental data and fuller consideration of the complete results further substantiated the view that the compound, in its pure condition, could contain no water.

The amount of indicator barium sulphate obtained from any sample was very small and it is possible that a little remained in solution. Barium sulphate has a slight solubility in water ranging from 0.0024 gms/l. at 20° C. to 0.0034 gms/l. at 50° C. and 0.0039 gms/l. at 100° C. Although the solutions were always filtered warm for speed it is doubtful whether sufficient time was allowed for the equilibrium solubility to be attained. Again, the solution in contact with the barium sulphate was about 0.3 N. sulphuric acid, and although there was no data

available on the solubility of the barium sulphate in dilute sulphuric acids, it would seem that the sulphuric acid would tend to reduce this solubility below that in pure water. With this uncertainty of the slight effect which this solubility would have on the results of the "indicator" method, all that can be said is that the possible effect is in the direction of reducing and - ve discrepancies in the balance sheet already referred to.

Chapter 5.

Theoretical Considerations.

(a) The Yellow Sulphate.

It is well known that iodine pentoxide, when heated by itself, dissociates into its elements irreversibly; the process beginning to be noticeable at about 350° C. At this temperature some of the iodine is retained in the residual solid in a complex of uncertain nature. Heated in concentrated sulphuric acid, however, the pentoxide dissociates more easily. The course of the reactions involved at various temperatures has already been recorded in the historical section under Chretien's three phases. The first dissociation, in which oxygen is evolved, takes place between 250° and 260° C.; the yellowish liquid, on cooling, depositing mixtures of iodous and iodic compounds. In the final stage, at slightly higher temperatures iodine as well as oxygen is strongly evolved and the liquors become dark brown and finally black. On cooling the liquor in a desiccator, nothing deposits for several days after which time yellow crystals were deposit from a liquor which becomes progressively lighter. This condition was used by Chretien and subsequent authors to obtain their supplies of yellow iodous sulphate. Consideration shows, however, not only that this process is inconvenient and far from quantitative, but also that it confuses in uncertain proportions at least three distinct reactions; and experiment proves that these can be separated, studied, and made to proceed quantitatively.

The primary thermal decomposition of iodine pentoxide



is, in the absence of an acid medium, indistinguishable from the further decomposition



Iodine sesquioxide is itself unknown; but in suitably powerful acid, its basic quality comes into play to stabilise it as a salt, and to lessen the temperature at which, owing to reaction (1) alone, an evolution of oxygen from heated iodine pentoxide begins. Nevertheless, ordinary concentrated sulphuric acid (as used by the several authors already named) is scarcely of powerful enough acidity usefully to protect the iodous product against the thermal decomposition represented by (2). It was found in this work, however, that fuming sulphuric acid will do so, it also lowers still further the temperature needed to bring reaction (1) to rapid completion. By heating iodine pentoxide in fuming sulphuric acid (20% oleum) at 215° - 220° C. in connection with a gas burette, a brisk evolution of oxygen was obtained which ceases sharply when 1.00 mol. of measured oxygen per mol. of I_2O_5 had been released, the white solid finally disappearing into solution at the same time. No iodine whatever was produced, the liquid formed was of a very pale primrose tint, and its analysis corresponded to a sulphate of an oxide $\text{I}_2\text{O}_{3.00}$ as the solute. This, then, afforded one easy way to prepare quantitatively a crystallisable iodous sulphate; the second method depending on the reaction at room temperature as already described.

In Chretien's method of preparation the thermal decomposition of iodic acid must be carried so far as to give copious fumes of iodine and deep brown

"In concentrated sulphuric acid, the yellow iodous sulphate $I_2O_3 \cdot SO_3$ takes up elementary iodine to form a deep brown solute. Saturation with excess of iodine gives solute whose compositions (expressed as oxides) range from $I_{2.8}O$ to $I_{8.5}O$ according as the acid medium is near $H_2SO_4 \cdot H_2O$ or neared absolute H_2SO_4 . The brown liquids react upon chlorobenzene instantly, but quite quietly; and it is shown that, of an initial "oxide" solute I_xO , exactly I_2O is thus consumed, the remaining $(x - 2)$ atoms of iodine being precipitated as element. The organic product is a quantitative yield of chlorotriiodobenzene (not, in the main, the symmetrical isomer, and including one which is new).

Thus the active iodine in the brown solute is univalent, and the effective absence of trivalent iodine is confirmed by the non-formation of iodonium in the organic reaction (cf. Masson and Hanby, this vol., p. 1699).

The facts are explained by the inorganic equilibria

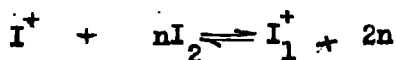
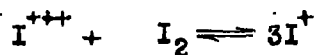
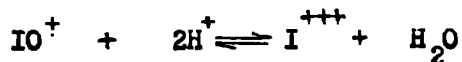

the values of n in the last being 1 and 2; thus, corresponding with familiar negative ions of univalent iodine I^- , I_3^- , I_5^- , we have here cations I , I_3 , I_5 . The organic reaction is in accordance with the equation



Successively repeated to complete the observed tri-iodination; and these ionic exchanges are to be compared with those assigned to iodous cations (preceeding papers). Other aspects are reviewed".

It is clear, however, that essentially the process consists in a quantitative reversal, by means of concentrated sulphuric acid at the ordinary temperature, of the familiar aqueous decomposition which converts the lower oxy-compounds of iodine into iodic acid and the element.

Composition of the Yellow Sulphate :-

In the work of previous authors on Chretien's sulphate, one difficulty inherent in the method of preparation, was to stop the heating at the right stoichiometrical point. The ensuing purification of the solid product for analysis, as performed by all these workers consisted in spreading it out on porous tiles in a desiccator. Fichter and Dinger left it thus for 1 - $1\frac{1}{2}$ hours only, stating that a longer time affected the purity. As already pointed out, it is obvious that a finely grained material such as this yellow sulphate, cannot be expected easily to give up all its adherent mother-liquor to a porous porcelain, and that in the necessary grinding, some exposure to moist air could scarcely have been avoided without special apparatus which seems not to have been used. Such sources of error can readily affect the apparent composition of a very hygroscopic solid, in which the difference between a mono - and a hemi - hydrate of $I_2O_3 \cdot SO_3$ amounted only to 2.3% by weight and the water content was assessed by difference; this was pointed out by Fichter and Dinger in criticising Bahl and Partington, and the same criticism is applicable to the difficulty of

or black liquor, and it is this liquor which, when kept at room temperature, becomes the source of the desired product. It was found in this work that the same liquor can be got by merely mixing iodine and iodine pentoxide in concentrated sulphuric acid without any application of heat: so that Chretien's and Fichter's thermal method may be said to be mainly a crude way of producing some free iodine, which shall eventually react in the cold with some undecomposed iodine pentoxide. In our preparation, which has already been described, the initial brown liquor and temporary excess of solid pentoxide quickly gave place to the very pale lemon liquor and finely crystalline, brilliantly yellow precipitate of Chretien's sulphate. The yield was quantitative, including a small measured solubility, viz, 0.024 molecules as I_2O_3 per litre of 96% sulphuric acid. Heating the mixture did not facilitate but rather tended to reverse the reaction.

The nature of the several equilibria involved in the preparative reaction summarised in the equation :-



is bound up in the nature of the brown solute formed in the early stages. The brown solute may first be formed from the iodine and pentoxide and the yellow sulphate then arises as the result of reaction between the brown solute and excess iodine pentoxide. In this connection it has been thought advisable to quote from the paper by Dr. I. Masson on "Hypoiodous Cations, and their Action upon an Organic Reagent". J.C.S. Oct. 1938. 1708.

He says :-

distinguishing between a hemi-hydrate and an anhydrous compound by this method. This seemed to be conclusively proved by the preliminary investigations already described. In any case using the new quantitative methods described herein for making Chretien's compound on any scale, it was further possible to avoid these risks of under-purification or of exposure to moisture, by resorting to the two independent principles of analysis just described in chapter IV. In the "wet residues" method it was possible to vary the composition of the solvent through the whole range of stability of the yellow sulphate at ordinary temperature. The results of both methods, described in detail in the preceding chapter, agreed conclusively with the composition $I_2O_3 \cdot SO_3$, and forbade either the hemi-hydrate of Chretien and of Fichter and Dinger, or the monohydrate of Bahl and Partington.

Effect of Water upon the Yellow Sulphate.

In a medium of $H_2SO_4 \cdot \frac{1}{2} H_2O$, the synthetic reaction, by which the substance was prepared in a more concentrated acid, already begins to be slightly reversed, liberating a little iodic acid and iodine, the latter partaking in a secondary reaction which forms visible traces of the brown solute. The complete triangular diagram in chapter VII shows imperfect convergence of the line belonging to this particular medium due to this cause. In very slightly more aqueous media the reversal is almost complete (and can be made finally so by dilution, warmth and extraction of iodine); almost the whole iodous salt is decomposed, with valency-bifurcation, in the sense of the schematic equation :-

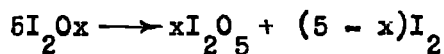

which governs the aqueous behaviour of derivatives of all lower oxides of iodine and is the basis of their quantitative analysis.

White Iodous Sulphate :-

In more anhydrous media, Chretien's sulphate ceased to be stable in sulphuric acid of concentration exceeding 100% H_2SO_4 ; the bright yellow crystals, put into such an acid, turned into another crystalline sulphate as previously described. This new solid was practically white with a faintly yellow solution and was increasingly soluble in the medium as its SO_3 content was raised. In this solid the iodine is still wholly tervalent, but the proportion of sulphur trioxide much higher than in the yellow solid. As described in detail in the next chapter, the composition was sought by the same two methods that were successful with the yellow form; but despite care, it proved difficult to define it completely with confidence. In the "wet residues" method, five pairs of duplicate analyses gave a diagram with so narrow a parallax (owing mainly to the limited range of fuming acids available as liquid solvents see chapter III) that this group of data merely set approximate limits of $\text{I}_2\text{O}_3 \cdot 4\text{SO}_3 \cdot \text{H}_2\text{O}$ and $\text{I}_2\text{O}_3 \cdot 3\text{SO}_3$ to the possible formula. The use of the BaSO_4 -indicator method, however, was more satisfactory, except in the difficult point of deciding the degree of hydration (if any). One experiment gave $\text{I}_2\text{O}_3 \cdot 4.11\text{SO}_3 \cdot 1.3\text{H}_2\text{O}$, and a second gave $\text{I}_2\text{O}_3 \cdot 4.08\text{SO}_3 \cdot 0.4\text{H}_2\text{O}$ (the respective water-contents are only 3.7% and 1.1% by weight). It was concluded that the white solid is $\text{I}_2\text{O}_3 \cdot 4\text{SO}_3 \cdot x\text{H}_2\text{O}$, adding that probably

$x = 1$, and if so the substance is $\text{H}_2\text{SO}_4 \cdot \text{I}_2(\text{SO}_4)_3$, a complex containing the $\text{I}_2(\text{SO}_4)_3$ of Fichter, Kappeler and Helfer.

Local wetting with water of the white solid in fuming acid, so long as the general composition of the medium did not fall below 100% H_2SO_4 , turned it to a deep manganate green or intense blue colour, which remained permanent in a sealed specimen. This occurrence has already been described in chapter III as being due to local liberation of elementary iodine, which at once reduced fuming sulphuric acid to sulphur sesquioxide in being reoxidised to the iodous state. The evidence given for this was qualitative: direct experiments with iodine and fuming sulphuric acids gave solutions of the same colours, which evolved sulphur dioxide, and which showed the same colours and behaviour as solutions of sulphur in these acids, wherein various other authors have recognised a coloured substance S_2O_3 .

The Transition between the Two Sulphates :-

The transition yellow white in media exceeding 100% H_2SO_4 proceeds normally, like that from a crystalline sulphate to the corresponding hydrogen sulphate; but the reverse change, induced by adding the white compound in fuming acid to concentrated (96%) acid until the medium is a little less than 100% H_2SO_4 , takes a path which was of a type new to us in any reversible transition among inorganic salts; and its interpretation throws light upon the natures of iodous compounds. The white solid rapidly went into solution forming a pale yellow liquid which at first remained clear, then grew turbid and grey with a suspension

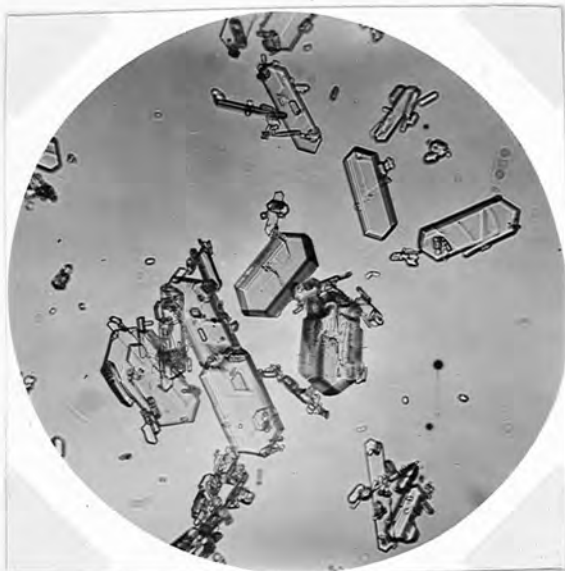

(a) $I_2O_3 \cdot 4SO_3 \cdot xH_2O$;
white iodous sulphate.

(b) Transition: showing iodine as
a metastable intermediate,
and developing crystals of

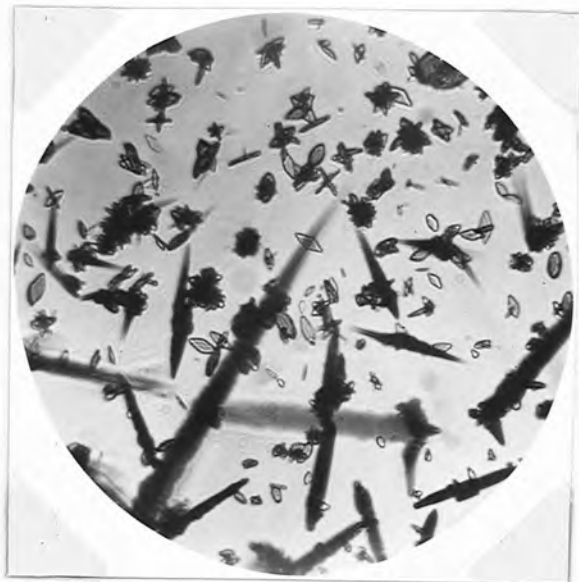

(c) $I_2O_3 \cdot SO_3$;
yellow iodous sulphate.

of solid iodine and (if the proportions were suitable) a white solid, apparently pentoxide. As it was watched, the grey turned to a dusky greenish and then yellow, and in a short time the temporarily precipitated iodine (and any white suspension) had vanished again and was wholly replaced by an increasing deposit of pure crystals of the yellow $I_2O_3 \cdot SO_3$, the stable phase in the new concentration of acid. In the later stages, the brown colour was seen which iodine gave when put into sulphuric acid solutions of the pentoxide or of the yellow sulphate; but it was weak and transient. Temperature changes were not concerned in the series of events. Figure VII shows microphotographs of (a) the white sulphate in fuming acid, (b) the dusky greenish stage of transition during slight dilution, the large irregular needles of iodine being interspersed with small crystals of the yellow product which is superseding them, (c) the yellow $I_2O_3 \cdot SO_3$ (somewhat rounded by stirring) in concentrated acid.

The interest of this perfectly reversible transition between the white and the yellow compound lies in the fact that, although the iodine begins and ends in the trivalent state, it spontaneously undergoes valency-bifurcation and reassembly, en route from one to the other. Thus:

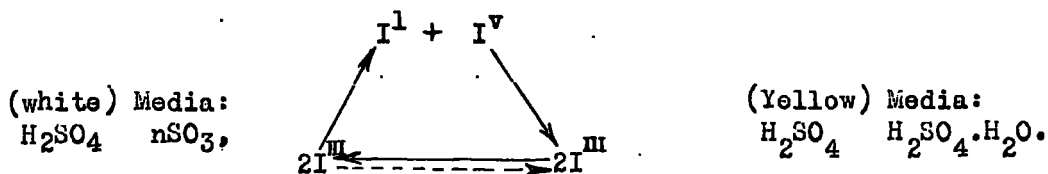

That an atomic change so extreme as valency partition occurs, only to be spontaneously followed by valency reintegration to the original

value, must mean that the tervalent iodine of the white sulphate is in a radicle different from that in which the tervalent iodine exists in the yellow sulphate. The two compounds cannot be related in the same way as inconvertible sulphates and hydrogen sulphates, which have one and the same cation in common; and our view of the matter is as follows.

The ion in the yellow crystals $I_2O_3 \cdot SO_3$ is, we do not doubt, the iodyl cation IO^+ ; and their solution in concentrated sulphuric acid behaves towards aromatic compounds (Masson and Race J.C.S. 1937, 1718; Masson and Hanby, J.C.S. 1938, 1699.) so as to suggest that it contains some proportion, not necessarily more than quite small, of iodous cations I^{+++} produced in an equilibrium

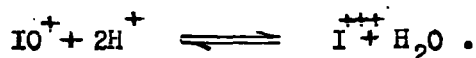

The monohydrate formula for the white crystals, $I_2O_3 \cdot 4SO_3 \cdot H_2O$, or $HI(SO_4)_2$, might suggest the possibility that their ion is a negative one, $[I(SO_4)_2]^-$; without, however, entering into detailed speculation on this point, we are at all events entitled to regard their solution in fuming acid as containing the tervalent iodine in the form of a complex ion containing sulphur trioxide and kept in stable equilibrium by the excess of sulphur trioxide in the medium. On removal of this excess by dilution to slightly below 100% H_2SO_4 the complex dissociates and we conceive that its tervalent iodine is thus all momentarily released as simple I^{+++} , not a stable entity in so high a concentration. At such a concentration, therefore, it is able to produce, by the electron partition $2I^{III} \longrightarrow I^I + I^V$, free iodine and the pentoxide faster than these can undergo their normal reassembly to

give yellow iodyl sulphate, which later visibly proceeds in the liquor; and faster also than the establishment of the equilibrium



the progress of which also constitutes yellow iodyl sulphate. Although this hypothesis may be mistaken in naming I^{+++} as the immediate precursor of the observed iodine and pentoxide, yet the dynamics of the whole train of processes, coupled with other work of Dr. Masson, are clarified by invoking it; and, on the grounds of electronic structure, it appears improbable that this ion could exist per se except in minute equilibrium concentration or as a transitory product intermediate between one complex, that of the white compound, and another, that of the yellow. The same instability of I^{+++} is held to account for the swift organic reactions of tervalent iodine which have been described by Drs. Masson and Race, and by Dr. Masson and W.E. Hanby.

Chapter VI

Details of analysis of White Sulphate :-

(a) Wet Residue Method:-

Both methods used in the analysis were essentially the same as for the yellow iodous sulphate, with modifications necessitated by the increased sensitivity of the white solid and its solutions to atmospheric moisture.

Setting up of Tubes :-

A 40 millimol scale preparation was set up in "Winchester" acid and this, after grinding as described earlier, yielded the usual finely crystalline and clean product. After a week on the wheel it was filtered, drained nearly dry, and the solid washed with fresh Winchester acid. The whole of the solid, together with a few glass beads, was transferred to another tube, 50 ccs. of 20% oleum added, the whole shaken vigorously by hand for 10 minutes and then placed on the wheel. The conversion to the white solid in this particular case took place very rapidly and this was attributed to the fineness of the initial yellow solid which seemed to be the main controlling factor.

As already indicated in chapter III the physical state of the oleum forbids the use of 30% - 50% oleum solutions at room temperatures and 65% oleum was found to be very difficult to handle in the undiluted condition, there being a very great tendency to lose SO_3 on slightest contact with the air. This loss would have become excessive when suction was applied for filtration. The preparation

was filtered with very slight suction, the air passing through bubblers containing about 5% - 10% oleum in place of ordinary concentrated acid. There was no formation of SO_3 fumes in the bubblers and no apparent danger of transfer to the filter chamber. Drainage of the solid was not carried so far as for the yellow solid so as to avoid SO_3 losses by suction, and the solidous product then sampled as usual into clean, dry tubes to which 20% oleum was at once added, before any visible decomposition could take place. The contents of one tube were diluted well with ordinary Winchester acid so that the medium would finally contain only slight excess of SO_3 . In a second case, a few ccs. of 65% oleum were added to increase the strength of the medium towards 30% oleum. Other tubes were made up of intermediate strengths.

Finally, one tube was made up in which 5 - 6 gms. of white solid were added with 15 ccs. of 65% oleum. On shaking, the whole of the solid dissolved, yielding a faintly yellow solution. Thus, a great increase of solubility of the white compound must occur as the strength of the oleum solution increases, as was predicted by Dr. Masson from the beginning. Also, since the solubility was so much greater the compositions of solutions and equilibrium wet solid samples would approach one another. This would mean that sensitivity to experimental errors, which are almost certain to be greatest in this region, would produce more evident deviations in the direction of tie-lines. Hence this tube was diluted with 100% acid to bring it below 30% oleum and highly concentrated media were abandoned for the

time being at least.

Tubes set up as described above were wheeled for at least a week before removal for analysis. The apparatus used for sampling was carefully dried in the oven and kept in a vacuum desiccator till required. When set up, great care was taken that smearing of rubber tap grease was put on all joints only at their extremities and a plug was inserted over the delivery tube for the filtrate to prevent access of moisture. Samples of solid were taken as for the yellow solid with added care but the filtrate was run off and sampled later as will be described. Solid samples were not stored in weighing bottles but in longer, stoppered tubes, for reasons given later.

Analysis of Solidous Samples :-

Samples being wetter than in the case of the yellow solid, they could not be tipped out so easily for drowning. This was the reason for the use of larger tubes. 10 ccs. of water were added to each tube and the stopper inserted. Considerable heat was at once produced and the tube carefully cooled under the tap. Decomposition was much more rapid than that of the yellow solid and was complete. Refluxing was dispensed with but otherwise the method of analysis was exactly as for the yellow solid.

Analysis of Solution Samples :-

Considerable difficulty was experienced in finding a method of drowning oleum samples in such a way as to avoid loss of SO_3 and of iodine vapours liberated by local heating.

Preliminary experiments on dilution of oleum.

About 5 ccs. portions of 30% oleum were taken in sampling tubes and lowered on a length of platinum wire into 150 ccs. of water in a 250 ccs. flask, care being taken that the tubes did not fall over. The water was allowed to enter the sampling tube slowly and the dilution proved so vigorous that liquid was splashed out of the neck of the flask (a good 8" long), despite the presence of a funnel in the neck of the flask as a protective measure. The dilution was then attempted in the outer jacket of a Victor Meyer apparatus, the length of neck being about 2 feet. Water was filled in to a few inches up the neck and the tube of oleum lowered down gently on a platinum wire threaded through the stem of a protective funnel. The entry of water was slow and dilution was vigorous and suddenly became violent and uncontrollable. It therefore seemed that mass dilutions in this way could not be controlled easily or kept quantitative.

The next possibility explored was that of dilution with a known quantity of $\text{H}_2\text{SO}_4 \cdot \text{H}_2\text{O}$. The experimental aspect of this would have been satisfactory but the disadvantage of adding SO_3 to the solution samples in such quantity would be in the great decrease in the accuracy of the oleum- SO_3 estimation, and in the greater possibility of experimental errors.

Finally, the Lunge pipette was employed. The reservoir of the pipette was filled and the pipette filled in turn from it by gentle suction, great care being taken to avoid any grease whatever on the

FIGURE VIII.

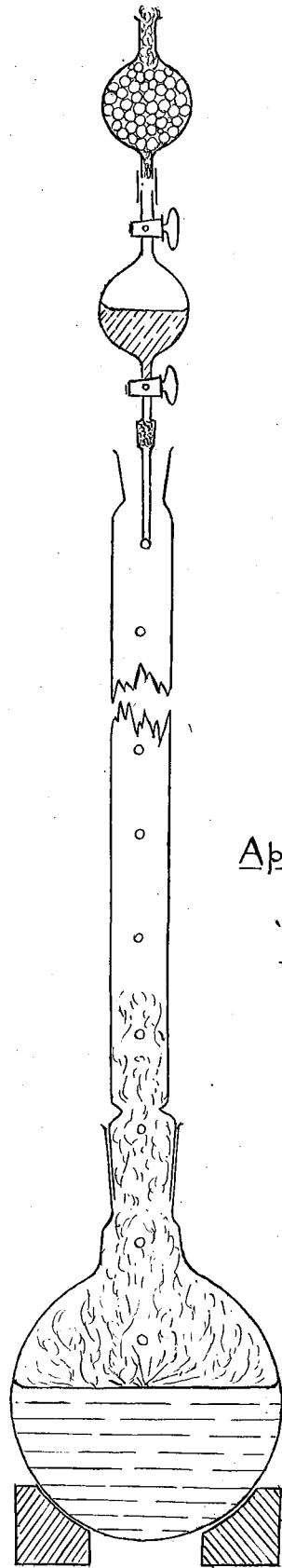

Apparatus for dilution of
'Oleum' samples.

taps and joints. The pipette was then removed and clamped with its delivery tube inside a tall refluxing tower which surmounted a litre flask containing water. The top of the tower could be stoppered immediately after addition of the oleum. Tested on blank oleum samples, duplication of results was found satisfactory and the method adopted. Little loss of SO_3 took place from the narrow delivery tube of the Lunge pipette which was replaced in its reservoir and reweighed immediately after the addition. The dilution took place quietly and fumes only rose half way up the tower. After addition of the sample the flask and tower were stoppered and shaken till all trace of fumes had disappeared, the tower was then carefully rinsed and removed, and the solution in the flask analysed in exactly the same manner as for the yellow solid solution samples.

Due to the greater possibility of experimental error and the ease with which both iodine and SO_3 could be lost from samples on drowning, and to the very great tendency to absorb atmospheric moisture; accuracy in analysis of the order found in the yellow solid analysis was not expected.

(b) Barium Sulphate Indicator Method :-

The setting up of the two tubes used in this method was essentially the same as in the yellow solid work. There were, of course, all the added precautions applied to wet residue work with oleum tubes. The indicator BaSO_4 added was more readily soluble than in the ordinary concentrated sulphuric acids but the strength of solution was kept

approximately the same, i.e. 4 gms. per 20 ccs. of 20% oleum. A sample of the tube's contents observed under the microscope showed no trace of the indicator BaSO_4 . The course of absorption of atmospheric moisture could be clearly followed. It resulted first in the deposition of BaSO_4 , after some minutes, as crystalline acid sulphate; at the outer edges of the specimen. This was accompanied by liberation of large crystals of free iodine, and finally by the formation of minute yellow sulphate crystals as reported in chapter V.

Analysis of Solidous Samples.

The same methods of drowning as for the wet residue samples were adopted. Refluxing was again unnecessary and, as in the corresponding yellow solid analyses, the "free" iodine/"iodate" iodine ratio was obtained from a separate sample and applied to back calculation of "free" iodine content of further samples analysed for indicator content and for "iodate" iodine and sulphate contents. The I_2O_3 content of all samples, per gram of sample, was carefully checked and found to agree as before; thus justifying the method of procedure. Analysis for sulphate content was by the method common to all analyses carried out.

Analysis of Solution Samples.

The Lunge pipette was used as in the wet residue method for weighing and diluting samples which were otherwise analysed in exactly the same manner as the corresponding solution phases for the yellow solid. The following chapter will give the results of two separate

experiments and the temperature range quoted in these, as in all other experiments, was obtained on a maximum and minimum thermometer set before each experiment.

It will be seen in the following chapter that this method of analysis was more successful with the white solid than was the wet residues method and it is also safe to say that, if direct analysis on the yellow solid had been unsatisfactory, it would have been impossible on the white solid.

Chapter VII.

Complete Summary of Results of all analyses in the following order:-

- (I) Series of 9 preliminary analyses for yellow iodous sulphate by the Wet Residue method.
 - (II) Final series of 6 analyses of yellow iodous sulphate by the Wet Residue method.
 - (III) Barium Sulphate Indicator Method on yellow iodous sulphate.
 - (IV) Series of 5 analyses of White iodous sulphate by the Wet residues method.
 - (V) Barium sulphate indicator method on the white iodous sulphate Results of two analyses.
-



FIGURE IX.

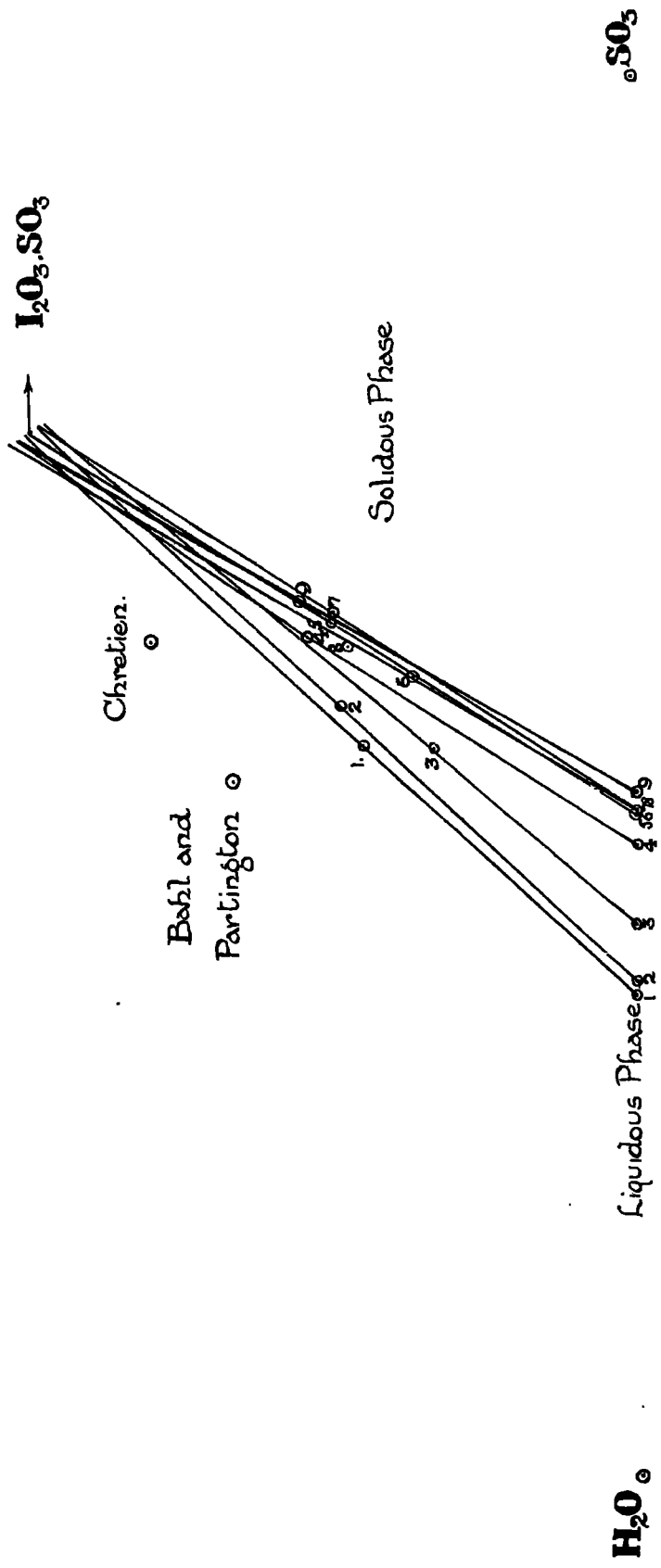

Wet - Residue Method of analysis applied to the Yellow Solid.

(Summary of first series of results, in order of increasing acid strengths.)

Tube.	Sample.	A or B.	% Composition by molecules.			Acid strength- % H ₂ SO ₄ by weight.
			I ₂ O ₃ .	SO ₃ .	H ₂ O.	
1.	Solid.	A.	22.82	41.81	35.37	
		B.	22.74	41.39	35.87	
	Solution.		0.165	34.56	65.27	85.93
2.	Solid.	A.	24.40	43.02	32.58	
		B.	24.44	43.09	32.47	
	Solution.		0.127	35.58	64.29	87.09
3.	Solid.	A.	16.90	43.88	39.22	
		B.		-----		
	Solution.		0.085	39.56	60.56	91.19
4.	Solid.	A.	27.07	46.92	26.01	
		B.	27.48	48.06	24.45	
	Solution.		0.061	45.26	54.68	96.32
5.	Solid.	A.	25.04	48.73	26.24	
		B.	25.82	49.52	24.65	
	Solution.		0.062	47.26	52.68	97.92

This is the BaSO₄ - Indicator Method result considered purely as
a Wet Residue tube.

6.	Solid.	A.	18.41	48.03	33.56	
		B.	18.53	48.35	33.15	
	Solution.		0.068	47.32	52.62	97.99
7.	Solid.	A.	25.08	49.56	25.36	
		B.	23.79	47.98	28.23	
	Solution.		0.075	47.73	52.24	98.29
8.	Solid.	A.	23.94	47.75	28.30	
		B.	23.71	47.82	28.47	
	Solution.		0.067	47.70	52.23	98.29
9.	Solid.	A.	27.96	48.86	23.18	
		B.	27.64	48.33	24.03	
	Solution.		0.058	49.02	50.92	99.29

FIGURE X.

I_2O_3

$I_2O_3 \cdot 5SO_3$

H_2O

Liquidous Phase

SO_3

Chretien

Bahl and
Pantington

Solidous Phase

1.0

2.5

5.0

10.0

20.0

30.0

40.0

50.0

60.0

70.0

80.0

90.0

100.0

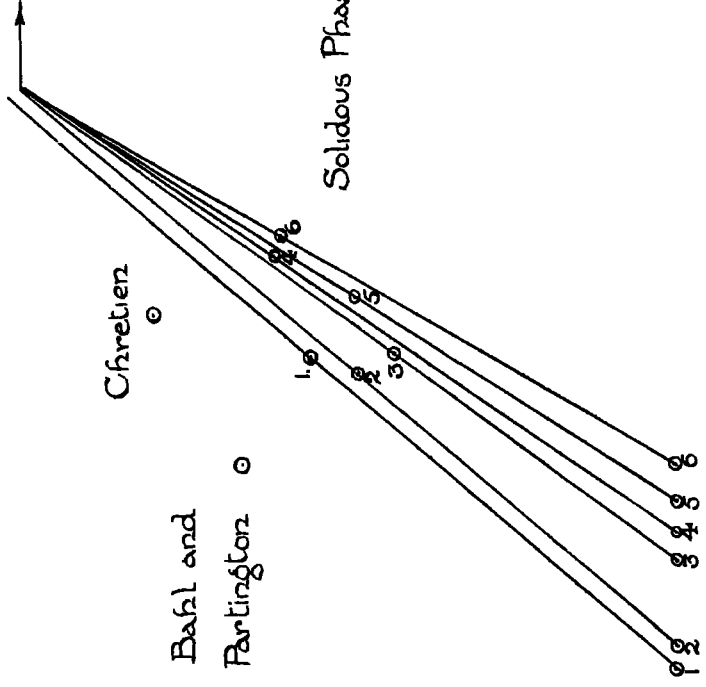

Wet Residue Method of Analysis as applied to the Yellow Solid.

(Summary of second series of results, in order of increasing acid strength.)
 (Acids determined gravimetrically throughout.)

Tube.	Sample.	A or B.	% Composition by molecules.			Acid strength- % H ₂ SO ₄ by weight.
			I ₂ O ₃ .	SO ₃ .	H ₂ O.	
1.	Solid.	A.	28.00	43.05	28.95	
		B.	28.48	43.63	27.89	
	Solution.	A.	0.17	36.03	63.77	86.54
		B.	0.17	36.67	64.16	86.14
2.	Solid.	A.	24.36	43.90	31.74	
		B.	24.33	43.93	31.73	
	Solution.	A.	0.14	37.72	62.14	88.45
		B.	0.14	37.93	61.93	88.67
3.	Solid.	A.	21.73	46.42	31.85	
		B.	21.70	46.40	31.90	
	Solution.	A.	0.084	43.34	56.57	94.23
		B.	0.084	43.29	56.63	94.19
4.	Solid.	A.	30.86	48.43	20.71	
		B.	30.72	48.20	21.08	
	Solution.	A.	0.065	45.24	54.70	95.90
		B.	0.065	45.02	54.15	95.72
5.	Solid.	A.	24.74	48.76	26.50	
		B.	24.68	48.73	26.59	
	Solution.	A.	0.066	46.97	52.95	97.31
		B.	0.067	47.35	52.58	97.61
6.	Solid.	A.	29.33	49.95	19.72	
		B.	29.39	49.82	20.79	
	Solution.	A.	0.121	49.74	50.135	99.84
		B.	0.121	49.76	50.12	99.84

The above figures are those obtained when the whole range of acid strengths was repeated and, instead of calculating the compositions of the solutions from the initial acid strength (determined volumetrically); the complete analysis of the solution samples was performed for I₂O₃ (volumetrically) & then for the SO₃ (gravimetrically); after the attainment of the equilibrium in the tube on the wheel.

Summary of analyses of filtrate samples in the BaSO₄ Indicator
method on the Yellow Solid.

1 gram of Indicator BaSO₄ represents :-

Component.	Sample 1.	Sample 2.	Average.
Wt. of wetting Solution.	19.135 gms.	19.135 gms.	19.135 gms.
Wt. of I ₂ O ₃ in gms.	0.0798 gms.	0.0800 gms.	0.0799 gms.
Millimols I ₂ O ₃ .	0.2642	0.2651	0.2646
Wt. of SO ₃ in gms.	14.5070 gms.	14.5025 gms.	14.5045 gms.
Millimols SO ₃ .	181.20	181.15	181.17
Wt. of H ₂ O in gms.	-----	3.550 gms.	-----
Millimols H ₂ O.	-----	197.1	-----

Summary of analysis of the BaSO₄ Indicator Method on the Yellow Solid.

All figures are per gram of sample for correlation purposes.
(Acid medium = Winchester acid).

Component.	Sample 1.	Sample 2.
Value of "R"	9.048 from an independently analysed sample.	
Value of "x"	3.0064	----- ditto -----
Total I ₂ O ₃ in gms.	0.5465 gms.	0.5469 gms.
Ditto in Millimols	1.8106	1.8119
Total SO ₃ in gms.	0.3781	0.3784 gms.
Ditto in Millimols	4.7222	4.7261
Indicator BaSO ₄ Wt. in gms.	0.0161 gms.	0.0161 gms.
Wetting Soln. in gms.	0.3081 gms.	0.3081 gms.
I ₂ O ₃ in wetting solution in gms.	0.0013 gms.	0.0013 gms.
Ditto in Millimols	0.0043	0.0043
SO ₃ in wetting solution in gms.	0.2335 gms.	0.2335 gms.
Ditto in Millimols.	2.9168	2.9168
I ₂ O ₃ in dry solid in Millimols	1.8063	1.8076
SO ₃ in dry solid wt. in gms.	0.1446 gms.	0.1449 gms.
SO ₃ in dry solid in millimols.	1.8054	1.8093
Possible H ₂ O by difference in gms.	0.0021 gms.	0.0014 gms.
Ditto in millimols.	0.1166	0.0777

Hence by direct analysis the compound is :-

Sample 1. I₂O₃.SO₃: H₂O = 1 : 0.9995 : 0.0645

Sample 2. --- ditto -- = 1 : 1.0009 : 0.0430

FIGURE XI.

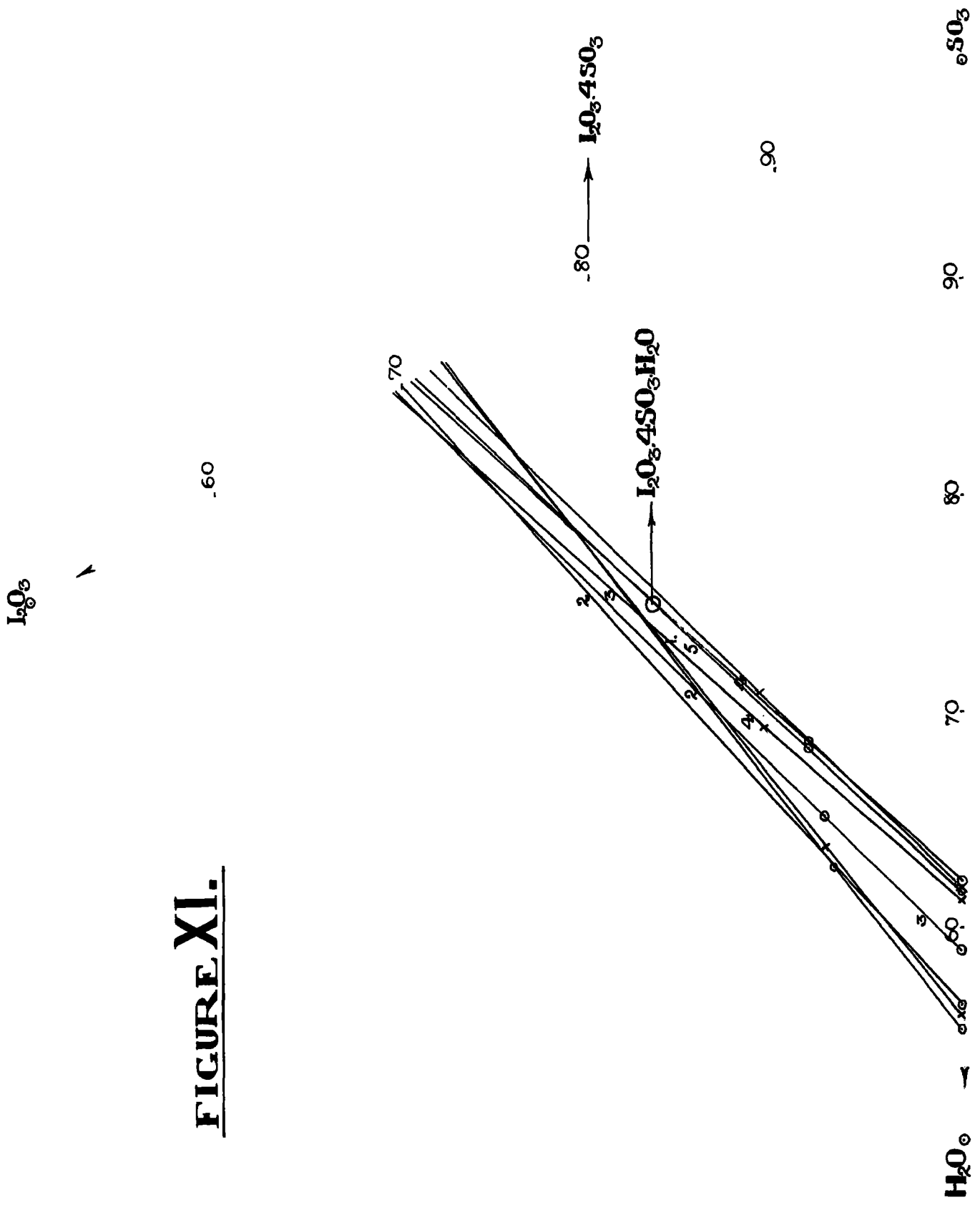

Summary of results for the Wet Residue Method as applied to the White Solid.

Order of increasing acid strengths. %age composition by molecules.

Tube.	Sample.	I ₂ O ₃	SO ₃	H ₂ O
1.	Solid.	7.42	60.07	32.51
		(Duplicate not completed).		
	Solution.	0.115	55.95	43.94
		0.155	55.30	44.09
2.	Solid.	6.99	59.35	33.66
		(Duplicate not done -- insufficient solid).		
	Solution.	0.111	56.35	43.54
		0.110	55.13	44.76
This is the first analysis of the white solid by "indicator method" neglecting BaSO ₄ .				
3.	Solid.	7.50	61.44	31.11
	Average-Solution.	0.170	58.84	40.99
	Average-			
4.	Solid.	10.91	55.38	23.71
		10.55	63.84	25.61
	Solution.	0.181	61.16	38.66
		0.182	61.76	38.06
5.	Solid.	8.344	64.41	27.24
		8.30	64.11	27.59
	Solution.	0.188	61.79	38.02
		0.188	62.04	37.77

In reviewing the full results of all analyses of the white solid, it would seem that in the second sample of solid (more particularly than in solutions); there is a greater H₂O content and a correspondingly smaller SO₃ content. Thus in this short space of time (never greater than ca. 1½ minutes) there have been changes in the composition of the wet solids which might be explained by the following :-

1. Irregularity in the composition of the "plugs" due to the effect of suction in the filtration. (this however, was reduced to a minimum by the use of No.3 filter and by cutting off the suction at the moment the filtering began - so keeping the system closed as much as possible.
2. Rapid absorption of atmospheric moisture by the main bulk of the white solid (the actual course of this can be observed by the formation of yellow solid in the filter after only 2 or 3 minutes; this being accentuated by suction, even though the incoming air had been dried in sintered glass H_2SO_4 bubblers).
3. Loss of SO_3 due to fuming. This however would be supposed to be quite small as there is no visible loss and in the " $BaSO_4$ indicator method" there is no great evidence of any loss of SO_3 .
4. The lunge pipette is apparently the best apparatus to use, but still permits the access of atmospheric moisture during the period when the pipette is dismantled for drowning of the filtrate samples. During this, the lower reservoir is kept covered with a small watch-glass; care being taken to see that no solution ever came into contact with latter.
5. Drowning of samples :-

This was carried out in 25ccs. tubes used for sampling. These tubes were much larger than used for the yellow solid samples, and this was found necessary because the white solid samples were much wetter and could not be tipped out into the "drowning" flask. On adding water rapidly to the sample in the 25ccs. tubes considerable heat was evolved causing copious vapours of iodine and no doubt aiding the loss of SO_3 . Thus a little water was added and

the tube at once stoppered. It was then cooled under the tap, otherwise it became too hot to hold. After the dilution the contents of the tube could be transferred to the "drowning" flask without further risk. Any loss of "free iodine" could be detected by a corresponding discrepancy in the ratio of the "iodate iodine"/"Free iodine" titrations; and, if as was never necessary, a correction could have been applied.

6. In the drowning of the filtrate samples by dripping from the lunge pipette down a long tower into the flask containing the water (some 300ccs) it was found that there was no visible loss of SO_3 fumes although the height to which they rose could be clearly seen some distance below the mouth of the tower.

After removal of the pipette from the mouth of the tower, the latter was closed by a ground glass stopper and the closed system subjected to a very vigorous shaking until some time after all the fumes appear to have dissolved.

Summary.

The formula and general properties of the yellow iodous sulphate have been investigated, with special reference to previous work. Two main methods of investigation have been applied, viz :-

1. An adaption of the wet residue method

2. A direct determination of wetting H_2SO_4 in samples of solid by the use of dissolved $BaSO_4$ as an indicator in the acid medium.

Both methods have given good results, confirmatory of the conclusion that the formula is simply $I_2O_3 \cdot SO_3$ or $(IO)_2SO_4$, and contained no water.

A new, white, crystalline compound has been discovered and found to be much more unstable than the yellow solid, and consequently more difficult to handle. It is formed from the yellow solid in acids stronger than 100%. The methods used in studying its formula were those used in work on the yellow solid; modified by extra precautions against atmospheric influences. Results are not so decisive as for the yellow sulphate, but it is concluded that :-

1. The ratio of I_2O_3 to SO_3 in the molecule is 1 : 4 .

2. The great activity of the compound makes the determination of the water content (if any) impracticable without the development of a new technique, for which there is no opportunity at the present time.

A new method of preparation of the yellow iodous sulphate has been used which is very convenient, clean, and dispenses with the application of heat.

The inter-relationship and inter-conversion of the two iodous sulphates has been studied and a novel type of change noted; involving complete decomposition of the white solid in acids below 100% H_2SO_4 into I_2 and

and I_2O_5 ; before the transition to the yellow form takes place. The transition seems to be confirmed by microphotographic observation.

Bibliography.

- (1) Davy Ann. Chim. Phys. t. XCVI, 1814.
 - (2) Millon " " " 1843. & 1844. t. XII, 336.
 - (3) M.P. Schutzenberger Compt. rendus. 1861, 52, 135.
 - (4) " " " " 1862, 54, 1026.
 - (5) Ogier Compt. rendus. 1877, 85, 957.
 - (6) " " " " 1878, 86, 722.
 - (7) P. Chretien Compt. rendus. 1896, 123, 814.
 - (8) " " " " 1898, 15, 358.
 - (9) Beger, Chem. Zeit. 1906, 33, 1232.
 - (10) Fichter & Rohner, Ber. 1909, 42, 4092.
 - (11) Pattison Muir, Trans. Chem. Soc. 1909, 95, 656.
 - (12) Kappeler, Ber. 1911, 44, 3496.
 - (13) Fichter, Kappeler, Krummenacher, & Helfer, Z. Anorg. Chem. 1915, 91, 134 - 144.
 - (14) Bahl & Partington, J.C.S. 1935, 1258.
 - (15) Fichter & Dinger, Helv. Chim. Acta. 1936, 19, 607.
-

Acknowledgements.

I wish to express my very sincere and grateful thanks to Dr. Irvine Masson, M.B.E., D.Sc., F.I.C., F.R.S., who suggested this line of investigation, and under whose supervision this work has been carried out. I am happy to have been his collaborator, and his guidance and constant encouragement have been directly responsible for what success this work may have obtained. I am grateful to him for his kind permission to make use of the full facilities of the Science Department of the Durham Division of the University at all times, and to the Staff of the laboratories for their helpful co-operation.

I should like to express to the various members of the Laboratory Lecturing Staff, and in particular to Dr. C.W. Gibby, M.Sc., Ph.D., my appreciation of their keen interest and constructive criticism, which have always been apparent and which have been invaluable in the progress of this work.

Again, I would record my deep appreciation of the friendly assistance and cheerful encouragement of W.E. Hanby Esq. B.Sc., A.I.C., whose aid in checking the numerous figures and calculations, was quite indispensable.

Finally, I am greatly indebted to the Principal, Rev. Canon E.F. Braley, M.A., L.L.D., and the Governors of The College of the Venerable Bede, whose assistance has done much to make this work possible.

Cyril Argument.