



Durham E-Theses

Measurement of space charge if the lower atmosphere

Smiddy, M.

How to cite:

Smiddy, M. (1958) *Measurement of space charge if the lower atmosphere*, Durham theses, Durham University. Available at Durham E-Theses Online: <http://etheses.dur.ac.uk/9109/>

Use policy

The full-text may be used and/or reproduced, and given to third parties in any format or medium, without prior permission or charge, for personal research or study, educational, or not-for-profit purposes provided that:

- a full bibliographic reference is made to the original source
- a [link](#) is made to the metadata record in Durham E-Theses
- the full-text is not changed in any way

The full-text must not be sold in any format or medium without the formal permission of the copyright holders.

Please consult the [full Durham E-Theses policy](#) for further details.

MEASUREMENT OF SPACE CHARGE IN THE LOWER ATMOSPHERE

BY

M. SMIDDY B.Sc.

PRESENTED IN CANDIDATURE FOR THE DEGREE OF DOCTOR
OF PHILOSOPHY

SEPTEMBER 1958

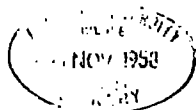

ABSTRACT

A double field mill is described which, when placed at a point above the earth's surface, is automatically brought to the potential of that point and registers the potential gradient. Two such instruments are employed to study space charge values in the first five metres of the atmosphere.

Comparison is made between results obtained using the double mills and an Obolensky-type air filter, which lead to the conclusion that the latter instrument gives incorrect readings in the presence of large small-ion concentrations. Space charge studies in fair weather conditions indicate the presence of a negative charge close to the ground of approximately $-50 \mu\mu\text{C}/\text{m}^3$, decreasing in the first two metres to zero and having an average value between one and three metres of $+3 \mu\mu\text{C}/\text{m}^3$. The average height to which this charge extends is shown to be proportional to the potential gradient, and has its origin in ionization produced by radioactive substances in the earth, close to the surface.

In disturbed conditions, heavy rain is found to generate a negative space charge of the order of $-1000 \mu\mu\text{C}/\text{m}^3$ arising from a splashing effect at the earth's surface. In snowfalls charges of $\pm 500 \mu\mu\text{C}/\text{m}^3$ originate from the charge on the individual snowflakes and a positive charge left in the air due to rubbing or shattering of the snow as it is falling.

The fair weather results in the first metre show a good agreement with those of Norinder, but higher up show the usual positive charge found by Kähler, Dauderer, Scrase, Obolensky and Brown.

FOREWORD

In this work the rationalized M.K.S. system of units is used throughout. References to original papers are made in the usual way except with regard to the book by Chalmers (1957), where page numbers are given directly in the text.

Cross references are given in a shortened form e.g. "S.3.2." refers to Chapter III, section 2, and not written out in full. To avoid the large numbers which would be reached if equations were numbered consecutively throughout, these are grouped in chapters. Thus in discussion of an equation in the same chapter reference will merely be made to the equation number, if however in a subsequent chapter the equation is referred to, the chapter and section are quoted.

When values of resistors are given above 1000 ohms, to avoid constant repetition of the word "ohm" or use of the Greek letter Ω , 10^3 ohms will be expressed as "K" and 10^6 ohms as "M".

CONTENTS

Page

CHAPTER I

INTRODUCTION

- 1.1. General ----- 1
- 1.2. Methods of Measurement ----- 6

CHAPTER II

SPACE CHARGE DETERMINATION

- 2.1. Summary of Results Previously
Obtained ----- 10
- 2.2. Diurnal Variation of Potential
Gradient ----- 14
- 2.3. Space Charge Measurement ----- 15
- 2.4. Principle of the Double Field
Machine ----- 19
- 2.5. Choice of Field Machine ----- 21

CHAPTER III

THE DOUBLE FIELD MILL

- 3.1. Design Considerations ----- 23
- 3.2. Mounting and Driving of the Mill ----- 27
- 3.3. Operation as a Collector ----- 32
- 3.4. Time Constant of the Collector
System ----- 33

CHAPTER IV

APPARATUS AND EXPERIMENTAL

PERFORMANCE

- 4.1. Field Mill ----- 39
- 4.2. Cathode Followers, Amplifiers and
Power Supply ----- 42
 - 4.2.1 Cathode Followers and Addition
Amplifier ----- 42
 - 4.2.2 Potential Gradient Amplifiers and
Power Supply ----- 48
- 4.3. Potential Balancing Servo-Mechanism ----- 59
- 4.4. Recording Galvanometers and Time
Synchronisation ----- 63

CHAPTER V

OPERATION AND BEHAVIOUR OF THE

COLLECTORS

- 5.1. The Site and Erection of the Apparatus ----- 67
- 5.2. Field Operation ----- 69
- 5.3. Recording Procedure and Record
Analysis ----- 78

CONTENTS (continued)

CHAPTER VI

APPARATUS FOR THE DIRECT

MEASUREMENT OF SPACE CHARGE

6.1.	The Apparatus	82
6.2.	Calibration and Testing	84

CHAPTER VII

RESULTS OBTAINED IN FAIR

WEATHER CONDITIONS

7.1.	Introduction	87
7.2.	Effects of Wind Speed and Direction	89
7.3.	Variation with Potential Gradient	92
7.4.	Comparison of Results with the Air Filter	101

CHAPTER VIII

RESULTS OBTAINED IN DISTURBED

WEATHER CONDITIONS

8.1.	Rain	104
8.2.	Snow	109
8.3.	Mist	112

CHAPTER IX

CONCLUSIONS

9.1.	Summary of Results	115
9.2.	Further Work	117

CHAPTER I
INTRODUCTION

1.1. General

The part of the atmosphere which has been of prime concern in the study of atmospheric electricity up to the present day, is that part existing between the earth and ionosphere. 'Ionosphere' is used to denote the layer of ionized gas surrounding the earth, with a relaxation time (the time needed for the charge on an exposed conductor to leak away to $\frac{1}{e}$ of it's initial value) of less than 10^{-8} secs., thus to all intents and purposes constituting a conducting medium. The height above the earth's surface of this layer is approximately 10 Km., but is very indefinite because of the conception of a 'good' conductor; it has been defined here as one which has a relaxation time of less than 10^{-8} secs., but one could easily use the criterion of 10^{-6} secs. or even longer, thus bringing the ionosphere down to a height of 50 Km.

The potential of the ionosphere has been calculated in various ways and values ranging from 270 to 400 Kv. positive with respect to the earth have been obtained. This potential appears to vary diurnally and shows also an annual variation, these have been extensively studied and related to world wide thunderstorm activity, which is held to be the chief mechanism maintaining the positive charge on the ionosphere.

The potential difference between the ionosphere and earth gives rise to a vertical electric field and, the air not being a perfect insulator, a vertical conduction current. The value of the fair' weather electric field is approximately 100 v/m. ('Fair' being used to denote

conditions which do not involve precipitations, charge separating clouds such as thunderclouds, etc.)

In atmospheric electric work it is convenient to give this value a positive sign and call it 'potential gradient', as opposed to the electrostatic field which, being in a downward sense, has a negative sign.

If the potential gradient existing at the earth's surface extended uniformly upwards, the ionospheric voltage would be reached at a height of 3 to 4 Km., thus the potential gradient must decrease in some way with an increase in height. Fair weather conditions can be treated as being in a quasi-static state, that is the formulae of current electricity can be applied so long as any change in conditions of a section of the atmosphere take place in a time which is long compared with the relaxation time of that section.

Now applying Ohm's law over unit height of a column of air of unit cross-section:-

$$i = \frac{E}{r} \\ \text{or } i = E\lambda \text{ --- -- -- -- } l.$$

where i = downward current in
amps/m²

E = average potential gradient
over metre height.

r = resistance of air (m³).

λ = conductivity of air (m³).

i must necessarily be constant over each section of air between earth and ionosphere in the quasi-static state stipulated, hence:-

$$E_1\lambda_1 = E_2\lambda_2 = E_3\lambda_3 = \text{--- -- --} = E_n\lambda_n \text{ for each successive } m. \text{ height.}$$

So if E decreases vertically, then λ must increase with increasing height, which increase is confirmed by measurement.

Now Poisson's equation gives:-

$$\rho = -\epsilon_0 \frac{dE}{dx} \quad \text{2.}$$

ϵ_0 = permittivity of free space = $8.854 \cdot 10^{-12}$ Farads/m.

in M.K.S. units.

So a decrease in potential gradient vertically gives rise to a positive space charge. This conclusion is easy to see if one considers lines of force, the number per unit area must decrease on ascending, and so must end on positive charges in the air.

Looking at some typical fair weather conductivity measurements, such as those carried out by Sagalyn and Foucher (1954), the conductivity increase is very slight up to one Km., then progressively more and more up to 3 Km. where it abruptly changes in slope to a lesser value, continuing uniformly up to the limit of measurement (5 Km.). The abrupt change in gradient at 3 Km. was identified by Mrs. Sagalyn, using temperature measurements, with the upper boundary of the 'Austausch', or mixing region, and so by the previous deductions concerning the quasi-static state the upper part of the Austausch region must contain a high positive charge. Results from balloon flights and aeroplane soundings by other observers e.g. Vonnegut and Moore (1958), confirm this result, leading to the conclusion that free space charge in fair weather exists mainly in the Austausch region i.e. below 3 Km.

Measurements of potential gradient on balloon and aircraft flights give results in fair weather confirming the expected relation $E\lambda = \text{constant}$, but near the earth, within approximately 100 m. of the surface, results are anomalous. All observers seem to agree that over the sea the potential gradient decreases over the first 100 m. thus giving a positive space charge, but over land on some occasions

increases are found, on other occasions, decreases.

To interpret these results two phenomena must be considered, the 'electrode effect' and the effect of radioactive sources in the earth. The electrode effect arises because in say, fair weather conditions, considering unit volume of air at the earth's surface: positive ions are moving into the volume from above and leaving it to earth, negative ions are travelling upwards out of the volume but none are entering from the earth. However in a similar volume at a point vertically above this in the atmosphere, assuming a uniform ionizing process, equal numbers of ions of both sign are moving into, and out of, this volume. Thus a positive charge should be present at the earth's surface giving a calculated (Chalmers 1957, p148) reduction in potential gradient between the earth and one metre, of 30%.

The effect of radioactivity in the surface of the earth is to increase the conductivity of the air just above the surface, thus giving rise to a negative space charge close to the earth. It is thus possible that the one effect might cancel out the other, because both depend on still air conditions to give any detectable effect, any air disturbances would eliminate both. This is probably an explanation of why no successful measurements have been carried out to detect the electrode effect in fair weather values of potential gradient.

Adkins (1958) measuring potential gradient simultaneously with space charge using an Obolensky type air filter (S.I.2.) reasons that the electrode effect cannot be detected at a height of 2 m. with potential gradient values less than 500 v/m. Above this value good correlation of potential gradient and space charge were obtained in fine weather,

seeming to indicate the appearance of the electrode effect. That this was indeed the case was shown by a time lag occurring between potential gradient fluctuations and the resulting space charge changes. If the space charge fluctuations were bringing about changes in potential gradient, then the two would occur simultaneously.

Another space charge effect due to conductivity changes, is that produced in a non-precipitating cloud by virtue of the cloud having a lower conductivity than the surrounding air (as much as 20 times lower, according to Vonnegut and Moore (1958)), this change produces a negative charge on the lower cloud-air interface and a positive charge on the upper.

In addition to the variation of space charge with height, an observer at, or near, the ground would note short period variations with time. These are due to two main causes in fair weather; air of different conductivity passing over the observer; man-made charges carried by surface winds. Mühleisen (1953), and Whitlock and Chalmers (1956) studied carefully this latter phenomenon by observing the potential gradient variations at the ground, and identified passage of positive charge with smoke or steam from locomotives. These 'pockets' of charge could also be identified with convective cells beneath small cumulus clouds and the rate of passing agreed with wind speed measurements.

Without going into more detail of the charges associated with different meteorological conditions such as mist, rain, snow etc. it is clear that the most difficult part of the atmosphere in which to study space charge magnitudes, distribution and causes - excepting perhaps clouds - is the first few tens of metres of the atmosphere, it being however the most accessible part. has been in the past the most

extensively studied.

1.2. Methods of Measurement.

A method of measurement of electric charges present in the atmosphere just above the surface of the earth, was first suggested by Lord Kelvin (1859, 60 and 62). He describes the use of a spirit lamp whose flame acts as a 'collector', bringing the metal lamp to the potential of its surroundings; then measuring the potential of the lamp by means of a sensitive electrometer, he was able to trace the presence of charged smoke, emitted from a similar lamp connected to a Wimshurst machine, from one room in a building to another.

Kelvin observed the earth's vertical potential gradient and deduced that variations were due to movement of space charge in the air. The apparatus used by him, called a "water dropper", removed excess charge by spraying water from an insulated metal nozzle, thus bringing its potential to that of the surrounding air, and measuring this with an electrostatic voltmeter. However his interpretation of a change in sign of the field was at fault, because he assumed that the earth was a negatively charged body losing charge to the air in contact with it. He suggested for further investigation; measurement of potential simultaneously at the earth and from a balloon to gain knowledge of space charge between the two; also the use of an earthed wire cage enclosing a water dropper placed at the centre, the potential on which, will indicate the magnitude of charge within the cage.

This suggested method was used by Chauveau (1902), Mache (1903) and much more carefully by Kähler (1927), who

made observations over a year at Potsdam.

Two other methods of measuring space charge were evolved in the early 20th century. Dauderer (1907 and 1909) at Bad Aibling carefully selected a flat meadow, and mounted three well insulated spirit lamps; at the earth surface and on poles at one metre and two metres above the earth's surface, these he connected to two double gold leaf electroscopes isolated from earth. He thus obtained the potential differences, one electroscope showing earth to 1 m., and the other, earth to 2 m., and by using Poisson's equation was able to get a measure of average space charge distribution up to a height of 2 m.

Norinder (1921) at Uppsala also measured the potential at fixed heights of one, two and three metres above the ground, but he used for his collectors water droppers spraying water horizontally. These were fixed at the centre of horizontal wires, insulated at the ends and provided with an automatic tensioning device to keep the collectors at a fixed height. In addition to this fixed system he had a similar movable system of two collectors, one mounted 1 m. vertically above the other and adjustable, as a whole, up to a height of $9\frac{1}{2}$ m.

He made very careful calibrations of both systems, suspending them in an artificial field between two horizontal plates; also comparing one system with the other in operating conditions. Comparison was also made between the efficiencies of his water droppers and specially prepared polonium collectors, but at the start of his measurements the water dropper was the more satisfactory of the two because of the weakness of the radioactive source. Later measurements with stronger sources compared more favourably with the water dropper.

Obolensky (1925) at Leningrad used a more direct method than any used previously by drawing air through an insulated cylinder containing cotton wool, the cylinder was connected to a Dolezalek type electrometer. The cotton wool cylinder was carefully screened from potential gradient changes, no variations in electrometer reading being observed with the sucking motor turned off. The efficiency of collection by the cotton wool was deemed satisfactory because; a large pressure drop (60 mms. mercury) was observed across the cylinder; a change in air flow above a minimum of 1.5 ft / min. produced no change in electrometer reading; mounting a second similar tube in series with the first, between it and the pump, and connecting this second cylinder to an electrometer gave a continuous zero reading.

The whole apparatus was mounted in a room with the intake extending through a window at a height of one metre above the ground, in front of ^A which was a flat meadow.

More recent work has been done by Mühlisen and Holl (1952) using a modified form of Kähler's apparatus, where the drops are allowed to fall from an earthed needle inside an earthed cage ("Faraday cage"), thus receiving a charge by induction from the space charge present inside the cage. The drops are then allowed to fall through a hole in the base, collected, and their charge measured. Scrase (1935) working at Kew used Norinder's type of movable apparatus with polonium collectors adjustable up to a height of 10 m., and Brown (1930) at Stanford University, San Francisco, used an Obolensky type apparatus filled with steel wool and mounted at a height of $7\frac{1}{2}$ m. above the ground.

Vonnegut and Moore (1958) have recently published a review of instruments and techniques used in space charge determination, in which the instruments already mentioned

are examined. In addition they describe ion counters of the type first used by Ebert (1901), and developed by Swann, Langevin, Gockel and Pollock, a difference in the positive and negative counts giving the mean space charge over the recording time. This type of instrument will not be discussed further apart from quoting two typical results given in the following chapter, because to get a reliable space charge estimate four instruments have to be used simultaneously namely, two for positive and negative large ions, and two of a different sort for small positive and negative ions.

Table I

METHOD	OBSERVER	HEIGHT RANGE	LOCATION	TIME	VALUE ESU/M	MEAN ANNUAL	YEAR
WATER DROPPER IN FARADAY CAGE	KÄHLER		POTSDAM	NOV, JAN, FEB. JUNE, JULY, AUG	+0.67 +0.36	+0.58	1922 1YA.
FLAME COLLECTOR	DAUNDERER	0-3m	BAD AIBLING	MARCH - JUNE JAN - MARCH JULY - NOV	+0.616 -0.577 +0.630	+0.115	1906 1YA
WATER DROPPER & RADIOACTIVE COLLECTOR	NOBINDER	0-3m fixed SYSTEM	UPSALA	SUMMER WINTER SPRING - AUTUMN	-0.07 -0.20 -0.11	-0.12	1918 1919 2YA
RADIOACTIVE COLLECTOR	SCARBE	1-10m	KEW	TURBULENT AIR STILL AIR	+0.02 +0.04	+0.03	1924 1YA
FILTRATION METHOD	OBOL- ENSKY	1m	PAVLOSK	DEC - FEB JULY - SEPT	+0.051 -0.095	0.003	1924 1YA
FILTRATION METHOD	BROWN	7.5m	SAN - FRANCISCO	SEPT - FEB MARCH - AUG	+0.098 +0.072	+0.083	1929 1YA
ION COUNTER	EBERT	/	/	/	/	+0.09	
ION COUNTER	GOCKEL	/	/	/	$E^+ = 0.32$ $E^- = 0.33$	-0.01	1917 1YA

CHAPTER II

SPACE CHARGE DETERMINATION

2.1. Summary of Results previously obtained.

Table I shows summer, winter and mean values of space charge found by various observers. It would appear from these results that, with the exception of Norinder, all observers found a positive mean annual value of charge of approx $0.1 \text{ E s u} / \text{m}^3$ ($3.33 \cdot 10^{-12}$ coulombs/ m^3) over the first 3 m. of the atmosphere. Considering the variations between summer and winter values; Daunderer and Norinder obtain negative values in winter and higher values in summer, Daunderer's results becoming positive but Norinder's remaining small negative; Kähler, Obolensky and Brown get positive results in the winter months and lower values in summer months, Obolensky's results becoming negative.

It seems reasonable to assume, as several observers have pointed out, that the lower positive or negative results obtained in summer are due to negatively charged dust particles raised up at the surface of the earth. Clark (1958) observed this phenomena to a very marked degree in New Mexico, U.S.A., where the dust raised up by a person walking could be detected by an Obolensky type apparatus, as much as 100 yards down wind from the source, and in dust storms negative charges greater than $1000 \text{ E s u} / \text{m}^3$ have been recorded.

Norinder attributed his high negative winter values to a layering of air near the ground, and observed an immediate increase in potential gradient from 0 to 1 m. as the temperature increased, thus creating convection cells and producing a mixing of the air.

All the differences could possibly be explained by the different locations of the observing stations, one of the

main factors being the position with respect to near large towns and prevailing wind directions. Thus in the day time at least, a station down wind of a town would record a higher than normal average of positive space charge.

It is also noticable that Kähler and Daunderer, using the wire cage and flame collector methods respectively, obtain results which are about a factor of ten higher than those given by the stretched wire or air filter methods. It is of interest to examine these results more closely, especially Daunderer's, because his results are widely quoted when referring to space charge magnitudes.

Daunderer notes that he had to keep the wires connecting his collectors to the electroscopes tightly stretched. If they were allowed to become slack, then the electroscope gave a variation of as much as 3%. This seems to indicate that the lamps, instead of taking up a potential, as supposed, of the air at the height of the collector, took up a slightly lower one, due to the connecting wire running down into a lower potential. This is the case of the lamps being above the electroscopes, but the opposite holds, for lamps below the electroscopes.

Using Daunderer's mean value of $\rho = 0.616 \text{ E S U/m}^3$, for March-June then using his formula giving ρ average for height 0 - 2 m.:-

$$\rho = \frac{1}{6\pi} (V_1 - \frac{1}{2} V_2)$$

where $V_1 = \text{P.D. between one metre and ground}$

$V_2 = \text{P.D. between two metres and ground}$,

it can be seen that this value of space charge gives:-

$$V_1 - \frac{1}{2} V_2 = 11.6 \text{ volts.}$$

Now over this period March-June, the average value of V_2 is approximately 270 v., so an error of 9% in the value

of V_2 would reduce the space charge to zero. Hence the combination of the ground level collector giving a high reading and the two metre collector giving a low reading, result in a value of V_2 which is too low, hence a high space charge value.

The use of the wire cage requires care, a free flow of air is essential otherwise the field set up between the water dropper and the cage will be sufficiently high to remove some of the small ions, Mühleisen and Holl's modification removes this difficulty. Another requirement is that the collector should not be influenced by the potential gradient external to the cage, this can happen in two ways:

1). High values of potential gradient may cause the wire mesh of the cage to 'leak', hence fine mesh is needed to prevent this, but will impede the air flow to a certain extent.

2). A bound charge on the cage created by the earth's field may lead to a selective filtering of charges entering the cage, e.g. a fair weather potential gradient would induce a negative charge on the cage, thus allowing more positive charge to enter, than negative.

Both these effects lead to a high space charge measurement and so may account for the high values found by Kähler.

The air filter, as used by Obolensky and Brown, also has the disadvantage of induced charges producing a probable selective filtering effect. In addition it is not unlikely that large ions or uncharged particles will produce some impaction effect within the filter. A further effect giving erroneous space charge readings, may be produced by the field set up at the air inlet arising from the potential present on the filter.

Most of the difficulties associated with the measurement.

of space charge; by methods not involving potential or potential gradient measurements; arise from effects due to the potential gradient. These effects are eliminated by artificial screening, situating the apparatus inside buildings or mounting the instruments under natural objects such as trees. But these shielding devices must distort the earth's field thus altering the normal distribution of electric charges and, as pointed out by Chalmers (1957 pl17) make it most unlikely that such phenomena as the electrode effect will be detected.

As regards the ion counting methods to determine space charge, no satisfactory measurements have been carried out, principally due to the difficulty of collecting the ions of low mobility by electrostatic precipitation. A very extensive examination of this type of instrument has been carried out by Vonnegut and Moore (1958).

Two observers, Norinder (1921) and Scrase (1935), both using the stretched wire method, have carried out measurements up to 10 m. Norinder plotted out on a graph the average potential gradients for summer, spring-autumn and winter, found at various heights. For the winter and spring-autumn results, an increase in potential gradient (all averages gave positive values) up to 5 m., and a decrease above this height up to $9\frac{1}{2}$ m. The summer results however show a steady increase over the measured range of heights.

Scrase, also plotting average values, for still air and turbulent air, found for still air, an increase up to 5m. and then a very pronounced decrease above this height, whereas for turbulent air, a continuous decrease was found. The plots for still air, although based on an average of only 5 or 6 readings per point, agree very closely with Norinder's winter and spring-autumn results when calm air

can be expected to produce this layering effect. The origin of the negative charge may be due to radioactive material as discussed in Chapter I, section 1.

2.2. Diurnal Variation of Potential Gradient.

Synoptic investigations of the magnitude of potential gradient over oceans and land stations where no sources of pollution exist, have shown a marked agreement, when all results are plotted on the same time scale i.e. Greenwich Mean Time. They show a minimum occurring at 3 a.m., then a steady increase until 7 a.m. remaining constant until 10 a.m. Values rise quite sharply through the day reaching a maximum at 6 p.m. then falling through the night to the 3 a.m. minimum. Although the terms night and day are used in respect of Greenwich time, the ^Pposite applies to places 180 W. of Greenwich, thus these variations can have nothing to do with an effect of the sun. Whipple (1929) assuming no change in conductivity, relates the evening maximum with the time of greatest world wide thunderstorm activity.

Observers at land stations where air pollution is possible, usually obtain values of potential gradient with a double maximum occurring at 8 a.m. and 6 p.m., local time. Several different reasons are given for local effects, but all attribute the variations to changes in space charge above the observing station.

Brown (1930) relates magnitude of space charge with temperature, heating of the earth producing convective effects in the lower 5 Km. of the atmosphere, he admits the effect of water vapour and smoke but only as "secondary factors". Mühleisen, on the other hand, proposes the presence of water vapour in the air, together with purely

local effects of smoke from towns, to account for the diurnal variation. Israël (1953) maintains that change in the total columnar resistance¹ brought about by local conditions cause the diurnal variation, and explains Brown's results on this basis.

It is difficult to assess the contribution of space charge produced from smoke, or other pollution on the one hand, and changes in local conductivity resulting from pollution giving rise to space charge on the other, thus both concepts play a part in the resulting diurnal variation.

¹Total resistance of a column of air, cross-section one metre square, between earth and ionosphere.

2.3. Space Charge Measurement

From consideration of the previously used apparatus, described in the Introduction, it is clear that to avoid disturbance of the natural space charge distribution near to the ground, the only suitable method is that of Norinder and Scrase, where the collector and supporting wires are brought to the potential of the surrounding air. The supporting wires are kept as near parallel to the ground as possible and hence will lie in equipotential planes.

The main difficulty however, lies in the 'strength' of the collector, which must be sufficient to follow changes in potential gradient with a time lag of the order of a few seconds, coupled with strict precautions to keep the insulators clean and dry. That this is a problem in itself can be seen by taking a value of conductivity near the ground (Chalmers 1957, Appendix II) for land stations of $1.8 \cdot 10^{-14} \text{ ohm}^{-1}$, which is a resistance of

$5.6 \cdot 10^{13}$ ohm/m. Hence any insulators used must have a resistance greater than 10^{14} ohms at least, so as not to 'short circuit' the air between earth and collector.

The relative efficiencies of the water dropper and radioactive collectors have been discussed at length by Chalmers (1957 p 82-90). He deduces that the water dropper, although an efficient collector in many ways, has the serious disadvantage that its speed of response cannot be lower than 30 secs., thus is not of use in measuring potential gradient changes of the order of a few minutes. However, the radioactive collector has a response time of the order of seconds, but has two objectionable features to offset this advantage:

- 1). The ions produced by a strong source must modify the potential gradient to an extent dependent on wind speed.
- 2). The effective resistance² tends to vary with potential gradient.

The difficulties involving the use of a flame or fuse collector, would be comparable with the radioactive collector, with the added difficulty of maintaining these at a constant temperature with respect to the surrounding air.

A common objection to the use of all instruments which measure the potential at a given height above the earth's surface, as opposed to measuring the potential gradient at

²If the collector is at a potential V , and the surrounding air V_0 , then a current i will flow from, or to, the collector. $R = \frac{V - V_0}{i}$ is termed the effective resistance assuming $V - V_0$ is constant. This gives a measure of the efficiency of a collector, the lower R being, the more efficient collector. For a new radioactive source this is approx. $10^{10} \Omega$ (Serase 1934).

this height, is that the measurement of potential can only give the average potential gradient over the height measured. That this will give erroneous space charge measurements can be seen from the following considerations:-

Let the conductivity of the air up to a height $x = \lambda_0$
and conductivity of the air above this height $= \lambda_1$.

With a positive potential gradient F_0 below x

and F above x , then downward current $i = F_0 \lambda_0 = F \lambda_1$

$$\therefore F = F_0 \frac{\lambda_0}{\lambda_1} \text{ --- 1.}$$

Assuming all space charge present to be due only to this change in conductivity.

Potential at height $x = V_1 = F_0 x$

Potential at height $h > x = V = F(h-x) + V_1 = F(h-x) + F_0 x$.

and substituting the value of F from 1. gives:-

$$V = F_0 \frac{\lambda_0}{\lambda_1} (h-x) + F_0 x \text{ --- 2.}$$

From Poisson's eqⁿ; $\rho = - \epsilon_0 \frac{dF}{dx}$; then the average space

charge over height h ,

$$\rho_F = \frac{\epsilon_0}{h} (F_0 - F)$$

again substituting the value of F from 1. :-

$$\rho_F = \frac{\epsilon_0}{h} F_0 \left(1 - \frac{\lambda_0}{\lambda_1} \right) \text{ --- 3.}$$

Now calculating the potential gradient over height h , using the value of V given by eqⁿ 2.

$$F_V = \frac{V}{h} = \frac{F_0}{h} \left[\frac{\lambda_0}{\lambda_1} (h-x) + x \right]$$

hence the average space charge, calculated using F_V is:-

$$\rho_V = \frac{\epsilon_0}{h} (F_0 - F_V) = \frac{\epsilon_0}{h} F_0 \left[1 - \left(1 - \frac{x}{h} \right) \frac{\lambda_0}{\lambda_1} - \frac{x}{h} \right] \text{ --- 4.}$$

From equations 3 and 4.

$$e_F - e_V = \frac{\epsilon_0}{h} E_0 \left[\left(1 - \frac{\lambda_0}{\lambda_1}\right) - \left(1 - \frac{\lambda_0}{\lambda_1} + \frac{\lambda_0}{\lambda_1} \frac{x}{h} - \frac{x}{h}\right) \right]$$

$$\therefore e_F - e_V = \frac{\epsilon_0}{h} E_0 \frac{x}{h} \left(1 - \frac{\lambda_0}{\lambda_1}\right) \text{ --- --- --- 5.}$$

Now examining equations 3. and 5. it is seen that

$$e_F - e_V = \frac{x}{h} e_F$$

hence if x is small compared with h , then $(e_F - e_V) \rightarrow 0$. If the change in conductivity takes place within 50 cms. of the earth's surface, then measuring potential at 5 m., would give a result which would not differ by more than 10% from a result given by measuring the potential gradient at the earth's surface and at 5m. But as $x \rightarrow h$, then $(e_F - e_V) \rightarrow e_F$, or $e_V \rightarrow 0$, so measuring the potential at 1 m. in the previous case, would give a value of e which is only half the actual value.

This treatment, although based on an idealized state, assuming an abrupt change in conductivity, and that all space charge arises from this conductivity change, does show that space charge values based on potential measurements depend on how and where conductivity changes take place. Basing results on potential gradient measurements give results which solely depend on the values of conductivity at the heights where readings are taken, and not on what happens between these heights.

Hence some form of instrument must be sought which will, not only adjust it's potential to that of the surrounding air, but will then also register the potential gradient at this height. The only suitable instrument for this purpose is, as suggested by Chalmers (1957 p 104),

some form of double field machine.

At this stage it is convenient to consider what order of potential gradient changes will have to be measured, to give a required degree of accuracy to space charge determinations.

Taking the value of 0.1 ESU's/m^3 , as an average value of charge to be expected, then Poisson's eqⁿ, taking the permittivity of free space to be $8.854 \cdot 10^{-12}$ farads/m, gives:-

$$1 \text{ ESU} = 3.33 \cdot 10^{-10} \text{ coulombs}$$

$$0.1 \text{ ESU} = 3.33 \cdot 10^{-11} \text{ c.}$$

$$\frac{dF}{dx} = \frac{-\rho}{\epsilon_0} = - \frac{3.33 \cdot 10^{-11}}{8.854 \cdot 10^{-12}} = -3.76 \text{ volts/m/m.}$$

So over a metre change in height, a potential gradient change of $3\frac{3}{4}$ v/m must be measured, that is in fair weather, the potential gradient should be measured with an accuracy better than 3%.

2.4. Principle of the Double Field Machine.

Consider a thin conducting disc of area A placed horizontally in a uniform vertical potential gradient F, then if the disc carries zero charge:

The upper surface has an induced charge $-Q = -\epsilon_0 FA$,

and the lower surface a charge $+Q = \epsilon_0 FA$,

Assuming positive potential gradient. If, however, the disc be placed in zero field, then a charge of $2q$ on the disc will result in a charge of $+q$ on each surface.

Combining the two conditions where the disc is situated in a field F, and carries a self charge $2q$ then:-

Charge on upper surface $X = -Q + q = q - \epsilon_0 FA$

Charge on lower surface $Y = +Q + q = q + \epsilon_0 FA$.

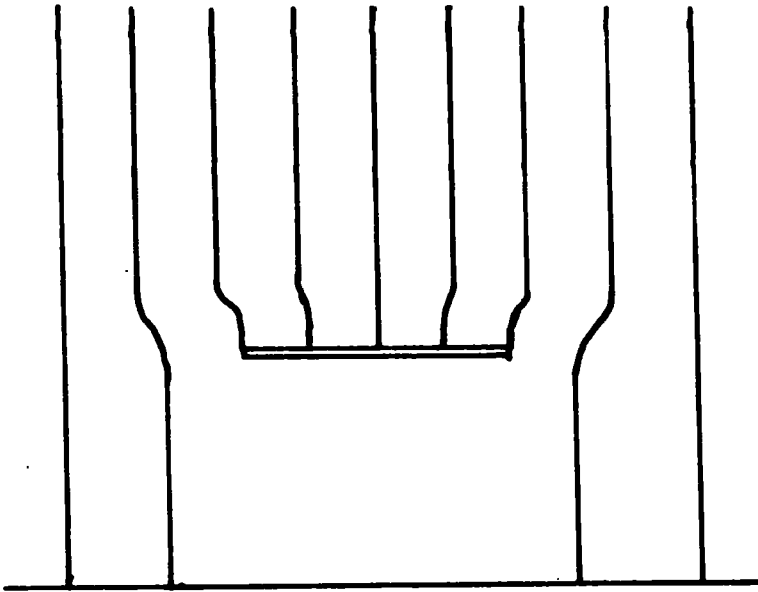

Fig 1a

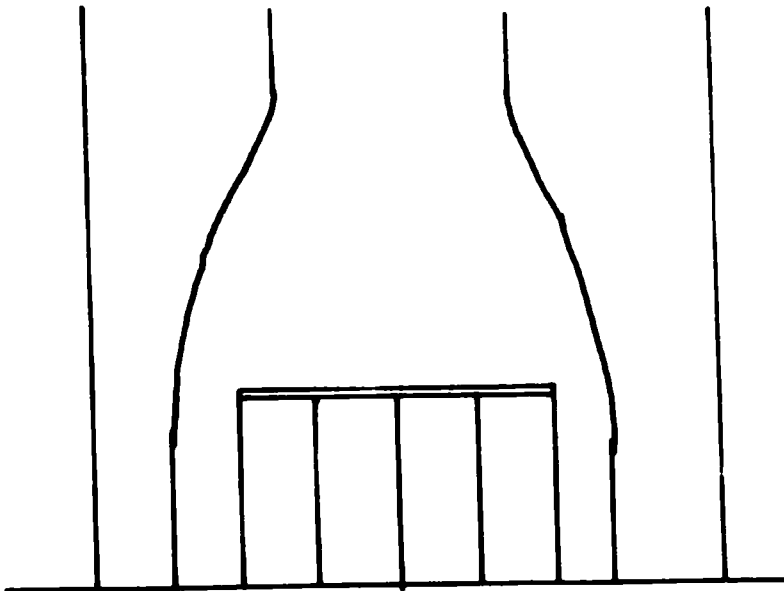

Fig 1b

The measurement of $\mathcal{Y}-\mathcal{X}$ thus gives $2 \epsilon_0 EA$, irrespective of the value of q , and so will give a measure of potential gradient above the earth's surface. Methods based on this principle have been used in aircraft, Gunn (1948), Gish and Wait (1950) and others, using symmetrically placed field mills. Demon (1953) has used a double field mill close to the ground.

As shown in s.2.3., in order to measure space charge successfully, the effect due to the charge q on the conductor has to be zero i.e. $q = 0$. Fig. 1.a. shows the distortion produced on a uniform field when $q = -Q$, in this case $\mathcal{X} = -2Q$ and $\mathcal{Y} = 0$. Fig. 1.b. shows the opposite effect when $q = Q$, when $\mathcal{X} = 0$ and $\mathcal{Y} = 2Q$.

Considering now how the relative values of \mathcal{X} and \mathcal{Y} can be used to regulate the potential of the disc, let the applied potential gradient be positive. When q is positive

$|\mathcal{X}| < |\mathcal{Y}|$, irrespective of whether q is greater or less than Q . On the other hand, when q is negative then $|\mathcal{X}| > |\mathcal{Y}|$. Thus a mechanism controlling disc potential would operate on the magnitude of $|\mathcal{X}| - |\mathcal{Y}|$. Moreover, since $\mathcal{X} + \mathcal{Y} = 2q$, it is clear that when $\mathcal{X} + \mathcal{Y}$ is positive the potential of the disc must be decreased relative to earth, and increased when $\mathcal{X} + \mathcal{Y}$ is negative.

In the case of a negative potential gradient when q is positive $|\mathcal{X}| > |\mathcal{Y}|$, and with q negative $|\mathcal{X}| < |\mathcal{Y}|$, irrespective of whether q is greater or less than Q . So when $\mathcal{X} + \mathcal{Y}$ is positive the potential of the disc again has to be decreased with respect to earth, and increased when $\mathcal{X} + \mathcal{Y}$ is negative. Thus when the field changes sign then the regulating potential must change also.

2.5. Choice of Field Machine.

Field machines can be divided into two main groups, the 'Electrostatic Fluxmeter' type and the 'Field Mill' type. In the former an insulated test plate moves alternately into, and out of, the field to be measured, whereas in the latter type the test plate is fixed and is alternately shielded and exposed to the ambient field.

Of the numerous variations of each type the 'Agrimeter' described by Chalmers (1957 p 100-104) is typical of the fluxmeter type, and a field mill of the sector type is described by Mapleson and Whitlock (1955). In both instruments the test plate gives an alternating current output which, in the rather specialized case of the Agrimeter, is rectified by utilising a commutator mounted on the machine, which earths the test plate in its exposed position, and connects the plate to earth through a measuring instrument in the shielded position.

Considering which type of instrument will be most suitable for use as a double machine, nothing can be found which will make one eminently more suitable than the other. Both have the same outputs for corresponding plate areas, and both require the same form of construction. Bearing in mind the important consideration that the machine, when constructed, will have to be supported in some way, such that its height can be varied without too much trouble, the machine will not have to be too heavy nor too bulky.

In the fluxmeter machine, because the output has to be taken from a moving part, then the use of a brush-slip ring system is necessary to this type of machine. It was thought that construction of a system like this, to ensure a sufficiently good contact with a high speed of revolution, would entail a too bulky system compared with the direct

contact needed in the field mill type of instrument.

For this reason, and also having the advantage that all previous workers in this department at Durham have used field mills, it was decided to use this instrument.

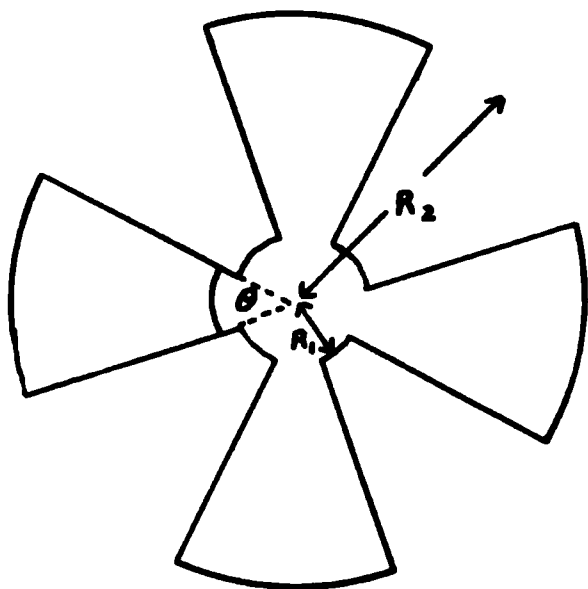

$$\theta = \frac{\pi}{N}$$

Fig 2a

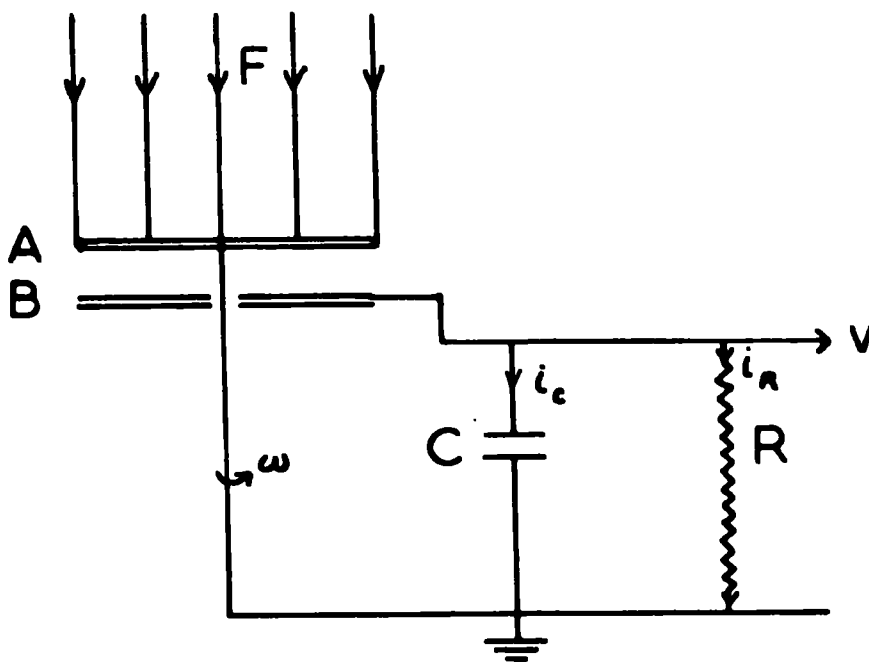

Fig 2b

CHAPTER III

THE DOUBLE FIELD MILL

3.1. Design Considerations.

It was decided to construct a sector-type field mill, the theory of which has been worked out by Mapleson and Whitlock (1955). Their mill had an accuracy of measurement of potential gradient to ± 1 V/m over a range -75 to +75 V/m, with a background noise equivalent to $\frac{1}{2}$ V/m within a frequency range 0.1 to 10 c/s, so the machine as used by them seems eminently suitable for obtaining the desired accuracy of 3% in fair weather conditions.

Fig. 2.a. shows the shape of the rotating and fixed vanes, shown at A and B in Fig. 2.b. giving the fundamental output circuit of the mill. The following theory is worked out on the same lines as that used by Whitlock (1955), and eq.1. is that worked out by him for the sector type field mill.

Theory gives that the mill output v has a triangular waveform superimposed on an exponentially decaying D.C. voltage, applying a field E at time $t = 0$. By considering the current i_c through the stator fixed capacitance C , and i_R through the resistance to earth R , the D.C. component has a time constant of $R.C.$ secs, and the output after an infinite time, V is given by:-

$$V = \frac{E_0 FN \omega R}{2} (r_2^2 - r_1^2) \left[\frac{1 - e^{-\frac{\pi}{N\omega RC}}}{1 + e^{-\frac{\pi}{N\omega RC}}} \right] \text{----- 1.}$$

where F = applied field in V/m

ω = rate of revolution of roter in radians / sec

r_2 and r_1 = external and internal plate radii (Fig. 2.a.)
in m.

N = number of vanes.

Hence both variations in ω and R will influence V. To minimise the effect of changes in rotor speed it is necessary that:-

$$\frac{\pi}{N\omega RC} \ll 1 \quad \text{---} \quad 2.$$

Assuming that this is the case, and expanding the exponential terms in 1. gives:-

$$V = \frac{\epsilon_0 F \pi (r_2^2 - r_1^2)}{4 C} \left[1 - \frac{\pi^2}{12(N\omega RC)^2} + \text{--- higher terms} \right] \quad \text{---} \quad 3.$$

so neglecting $\frac{\pi^2}{12(N\omega RC)^2}$ and higher terms will make V independent of ω and R. The value of V is now in such a form that approximate sizes of components can now be decided.

Taking $r_2 = 7.65$ cms. and $r_1 = 2.6$ cms., the smallest field to be measured is 1V/m, and the smallest value of V which can be measured is 0.1 m v. then 3. gives:-

$$C \ll \frac{\epsilon_0 F \pi (r_2^2 - r_1^2)}{4 V} = 3.6 \cdot 10^{-10} \text{ farads} \quad \text{---} \quad 4.$$

the dimensions of the vanes given above are considered to be of convenient size for the machine.

In arriving at a value for R, the prime factor to be considered is the method of feeding the mill output into the amplifier circuit, this must be done through a device to match the high output impedance of the mill circuit, to the low impedance presented by the length of cable needed to transmit the signal to the amplifier, this is done through a cathode follower (e.g. Parker 1950).

If the grid current of the valve used as a cathode follower is I_g , then the D.C. voltage developed across the input resistor R is $R I_g$.

The valve used was a Mullard EF 37a run at reduced

heater and anode potentials, this is a voltage amplifying pentode used as a triode, and had a measured grid current of $10 \cdot 10^{-11}$ amps.¹ This value was found to vary considerably from valve to valve reaching as high a value as $3 \cdot 10^{-9}$ amps., so a selection was made of those with the lowest grid current for use as cathode followers.

The capacitance of stator-rator assembly and connecting cables, was measured on an 'AVO' bridge giving $C = 60 \mu\mu F$, and the variation from exposed to screened position of the vanes $\Delta C = 4 \mu\mu F$. The A.C. component generated by this variation in vane capacitance V_c has the same frequency as the signal generated by the field and is given by:-

$$V_c = \frac{\Delta C}{C} R I_g \text{ ----- } 5.$$

Thus the smaller ΔC can be made compared with C , then the smaller V_c becomes. Bearing in mind the maximum value of C given by eq. 4. i.e. $360 \mu\mu F$, a capacitor can be placed across R to increase the value of C . In this case it was decided to insert $200 \mu\mu F$, thus increasing C to $260 \mu\mu F$.

$$\therefore \text{From 5. } V_c = 1.54 \cdot 10^{-12} R.$$

For an applied field of 1 V/m, From 3. $V = 1.38 \cdot 10^{-4}$ volts.

¹. This measurement was performed by placing a 10^8 ohm resistor from the grid to earth of the constructed cathode follower unit, the potential drop across this resistor being measured by an 'E K C O' vibrating reed electrometer, giving a grid current sensitivity of 10^{-11} amps.

In order that V_c be small compared with V , let $\frac{V}{V_c} = 10$.

$$\therefore V_c = 1.38 \cdot 10^{-5} \text{ volts.}$$

$$\therefore R \ll 0.9 \cdot 10^7 \text{ ohms} \text{ ----- 6.}$$

Considering now the condition stipulated in 2. viz.

$N \omega \gg \frac{\pi}{RC}$, substituting for R and C gives:-

$$N \omega \gg 11,540 \text{ r.p.m.}$$

A convenient value for N is four, the greater the number of vanes, the lower the value of ω need be, but the output voltage will be reduced because of the smaller exposed vane surface.

$$\therefore \omega \gg 2,900 \text{ r.p.m.} \text{ ----- 7.}$$

This is rather a high value to attempt to attain. To avoid large variations in ω a synchronous motor, running from the mains can be used. A large pulley on the motor driving a smaller pulley on the mill will give a step-up ratio of $\frac{R_1}{R_2}$ where:-

$$R_1 = \text{radius of motor pulley} = 7.2''$$

$$\text{and } R_2 = \text{radius of mill pulley} = 3.42''.$$

With a motor speed of 1,425 r.p.m. a mill speed of 3,000 r.p.m. is attained, which just satisfies equation 7.

To see what effect variations in motor speed will have on the mill output, return to 3. where inserting final values gives:-

$$V = 1.4 \cdot 10^{-4} F [1 - 7.7 \cdot 10^{-2}] \text{ volts} \text{ ----- 8.}$$

Thus allowing for a 1% change in mains frequency, producing a 1% change in ω , hence a 2% change in the second term in the brackets, giving an error in V of 0.17% which is negligible.

3.2. Mounting and Driving of the mill.

Before dealing with the structural details of the mill itself, it is essential to consider how the mill is to be supported to fulfil its function as a collector. Obviously, owing to its weight and size the mill will require more rigid supports than the wires used by Norinder to support his water droppers. In deciding what form the supports must take, it must be born in mind that a too massive structure, although rigidly supporting the mill, will probably influence the earth's field unduly and so destroy the whole purpose of constructing the mill in the first place, which is to measure values of potential gradient without introducing distortion!

Two effects are likely to arise from the supports:

- 1). Any conducting parts which are not at the potential of their surroundings will distort the earth's field.
- 2). Any insulating parts are likely to acquire charge, and must therefore be placed at such a distance from the mill so as not to influence the field there.

The effect of any object, natural or artificial, near a potential measuring device can be expressed as a 'reduction factor' for that particular location, and is given by:-

$$R.F. = \frac{\text{measured value of the potential gradient}}{\text{value at the centre of a large conducting plane placed at the same site.}}$$

In actual practice the large "horizontal conducting plane" is rather difficult of attainment, and a small reasonably flat meadow has to suffice and the effect of trees or buildings in the vicinity have to be estimated. It can be seen that unless a flat meadow exists within 50 metres or so of the site chosen and the potential gradient remains

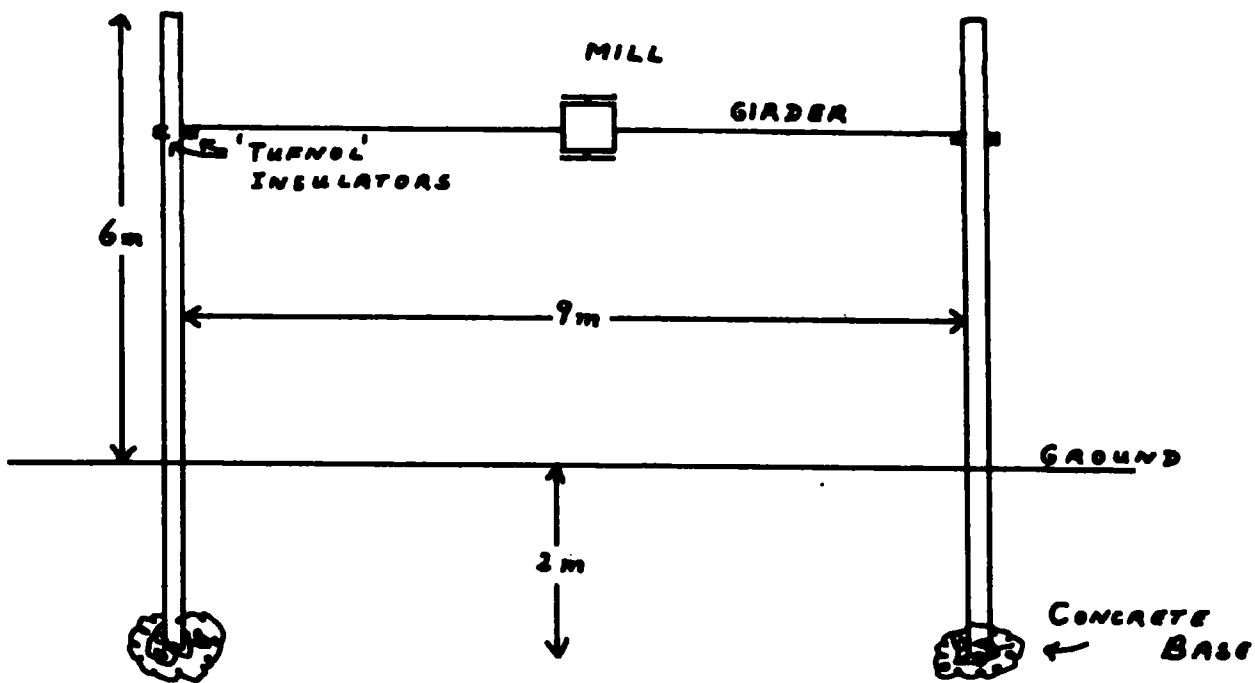

Fig 3a

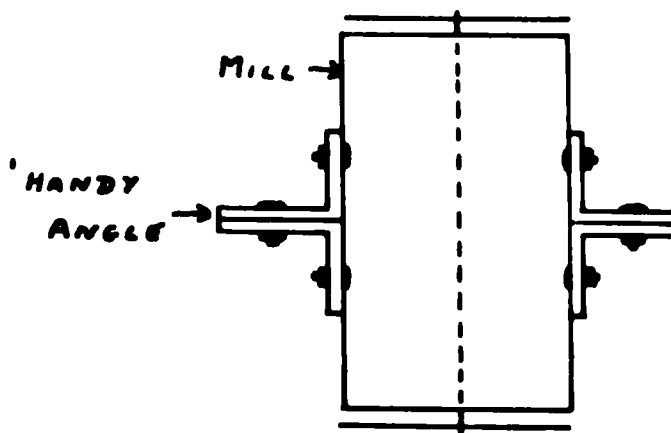

Fig 3b

uniform over a few hours, no rigorous estimate of the exposure factor can be obtained.

Benndorf (1906) considered reduction factors of various objects and found that a vertical conducting post one metre in height, has less than 1% influence on the potential measured one metre above the ground three metres away from the post. This gives an estimate of what effect to expect if conducting supports are used.

In view of this, it was thought that the use of wood in constructing the supports would combine rigidity, with insulating properties comparable with that of the air, the wood being painted to prevent it from becoming conducting in wet weather. By sinking the posts deeply into the ground, the use of guy ropes could be avoided, but this will restrict the height to which one can work.

The supporting system erected is shown in Fig. 3a. The girder carrying the mill is made of aluminium 'Handy Angle', consisting of four lengths bolted together to form two T-sections securing the mill between them as shown in 3b. The method of joining the girders to the posts is shown in Fig. 4.

This system proved highly satisfactory, only in strong winds did the mill sway with a frequency of almost exactly one cycle per sec., which did not appear on the record because of the longer time constant of the recording apparatus. The sag on the girder was only 15 cms. from the horizontal measured at the centre.

The girder supporting the mill is parallel to the ground thus being situated in an equipotential plane, in order not to influence the earth's electric field it must be at the same potential as the field mill, i.e. at the potential of the surrounding air. At 6 m, which is the maximum height

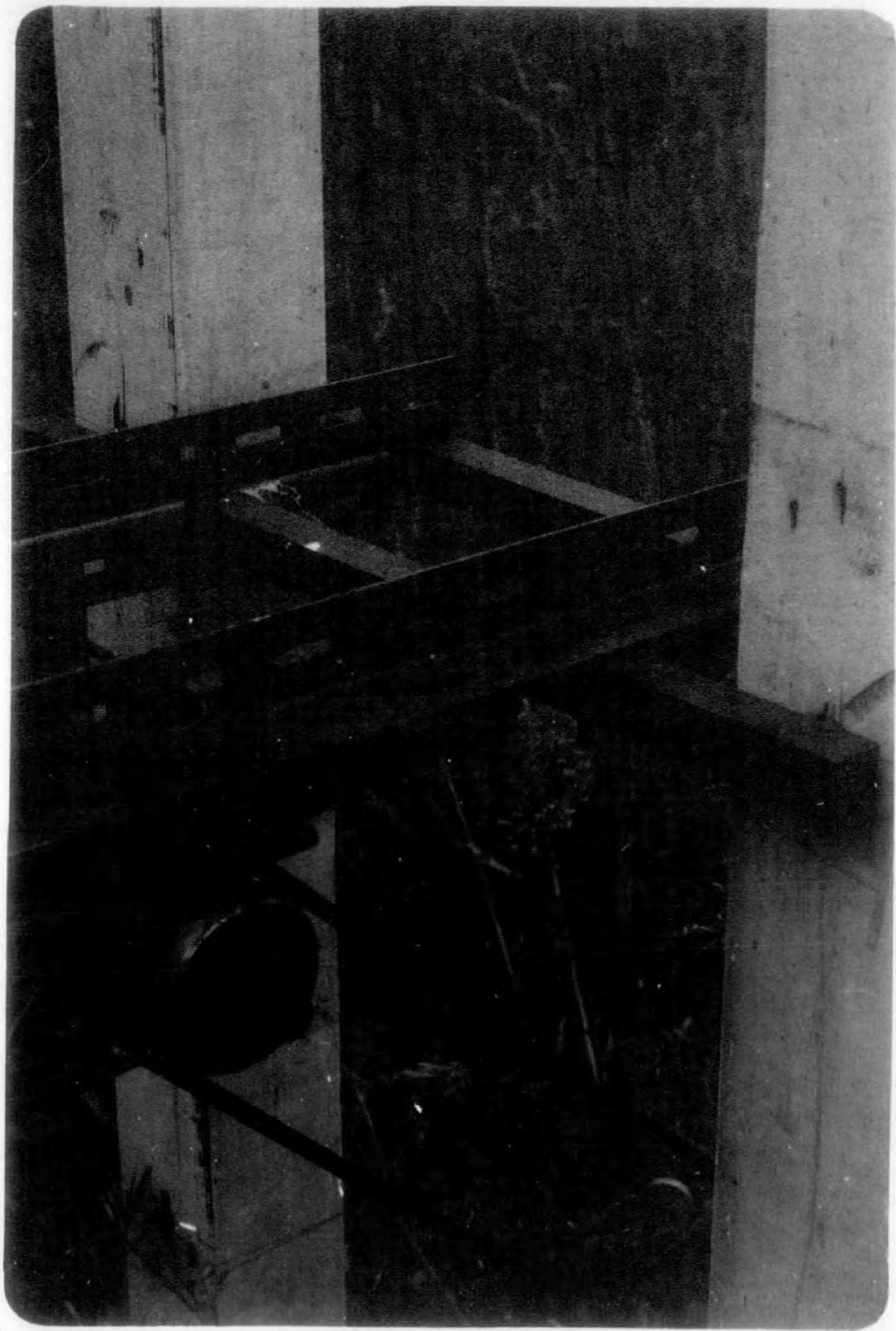

Fig 4

to which the system can be raised, in fair weather conditions the potential applied to the mill-girder assembly will be of the order of 600 volts. This high potential creates two problems associated with the operation of the mill as a collector, viz:

- 1). Method of sign determination of the potential gradient.
- 2). Mechanism to be used to drive the mill.

If the sign of the potential gradient is to be determined, then the phase of one of the outputs, either from the upper collecting plate or the lower one, being of the same magnitude but of opposite phase, will have to be determined. This can be done, either by generating a constant voltage reference signal either from the mill direct or using the voltage fed to the driving motor, and comparing the phase of this voltage with that of the mill output, or by means of a mechanical system within the mill and feeding the amplified mill output back to this system.

Utilizing the power supply fed to the driving motor is not possible in this case because a constant phase relation between motor and mill cannot be maintained. This arises from the method of transmitting the drive to the mill which, as described on the following page, involves a belt running over pulleys where a certain amount of slip is inevitable.

Both reference generator and mechanical systems involve making connections back to the mill with all its attendant problems, effect of sudden potential gradient changes, insulation of the leads, etc. The choice of which system to use will depend on the relative characteristics of the systems.

Whitlock (1955) and Maund (1958) both used a reference generator fixed onto the driving shaft of their mills,

the output voltage from which has a phase difference with the mill output of zero or π radians depending upon the sign of potential gradient. Thus by using a modified Schuster circuit (phase sensitive rectifier) a positive or negative D.C. output is obtained. Both Whitlock and Maund had great difficulty in maintaining a constant voltage from the reference generator, which is essential for the satisfactory operation of this type of rectifier, also frequent electronic troubles occurred making the use of this system a matter of constant 'trouble shooting'.

The mechanical system on the other hand, as used by Adamson (1958) proved extremely reliable and in two years constant use the only trouble encountered has resulted from wear in the carbon brushes. In view of this it was decided to use the mechanical system, which involves feeding the amplified mill output back to a commutator mounted on the mill driving shaft. The commutator arranged with respect to the rotating vanes such that with a positive potential gradient, the negative half cycles of the mill output are cut off, thus giving a positive D.C. output. Fig. 5a illustrates this case, and 5b the case with a negative potential gradient.

Considering the problem of driving the mill, the usual way of mounting the motor inside the field mill, if done in this case would involve, either insulating the driving shaft from the vanes and motor casing, thus isolating the motor whose field and armature windings are at earth potential, or isolating the motor power supply from earth and using 'mill earth' (potential of the mill-girder assembly) for this supply. In either case the insulation difficulties will be considerable, involving screening for the supply leads, which must be at earth potential up to

the end of the mill girder, and then changed to mill potential for connection to the mill so as not to affect the earth's field. In addition, the power for the motor could not be obtained from the mains necessitating a constant voltage supply to maintain ω constant within the proposed limits (§.3.1.).

In view of these difficulties an external method of driving the mill was adopted. The error introduced by the upper collecting plate being below the air potential at that height, and similarly the lower plate being above it's correct potential- assuming that the mid point of the two is correct- is minimised by reducing the upper-lower plate separation. Hence a further advantage arises from this distance no longer being restricted by the size of the motor used.

Situating the motor on the ground, means that the belt used to transmit the drive to the mill will have to be made of an insulating material so as not to short circuit it to earth. However, the use of an insulator will mean that charges may be picked up by the belt e.g. friction over the pulleys, and carried to the vicinity of the mill thus modifying the potential gradient values, or even producing a ' van der Graaf generator' effect.

It was hoped that; having one driving belt running from the motor to a metal double pulley, situated at one end of the mill girder, see Fig.4; then a second belt in the plane of the girder; this charge carrying effect would be reduced.

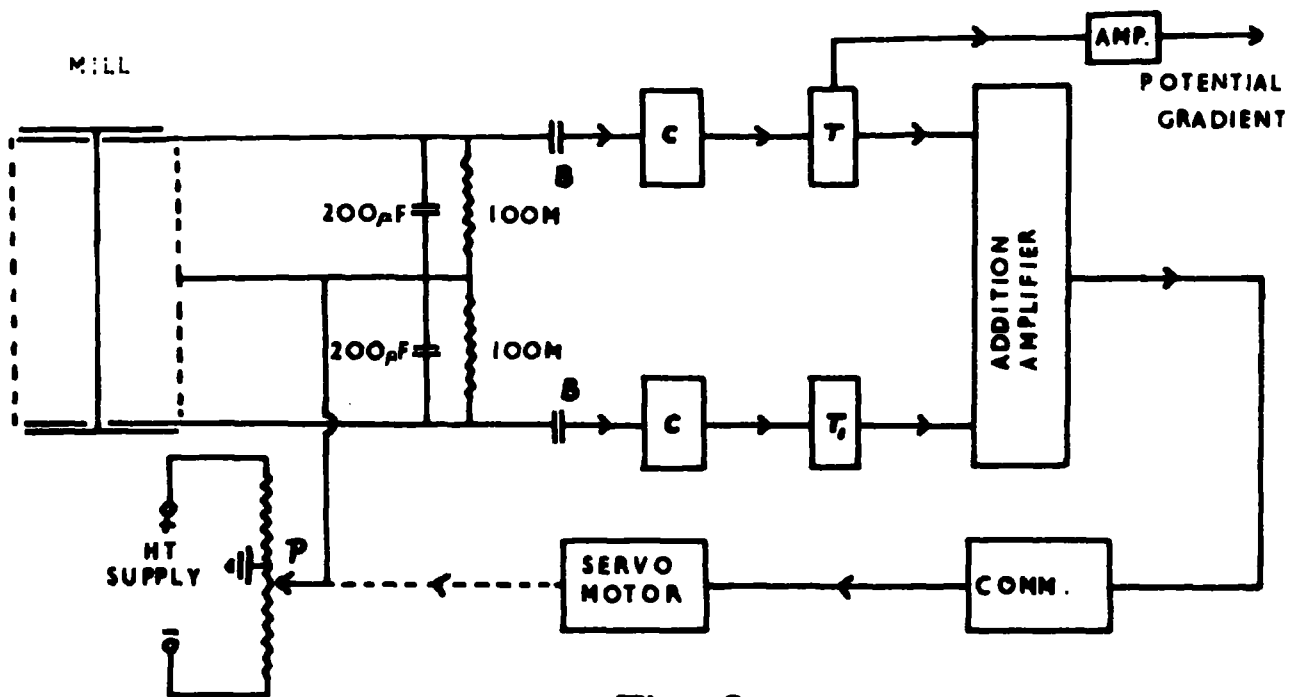

Fig 6

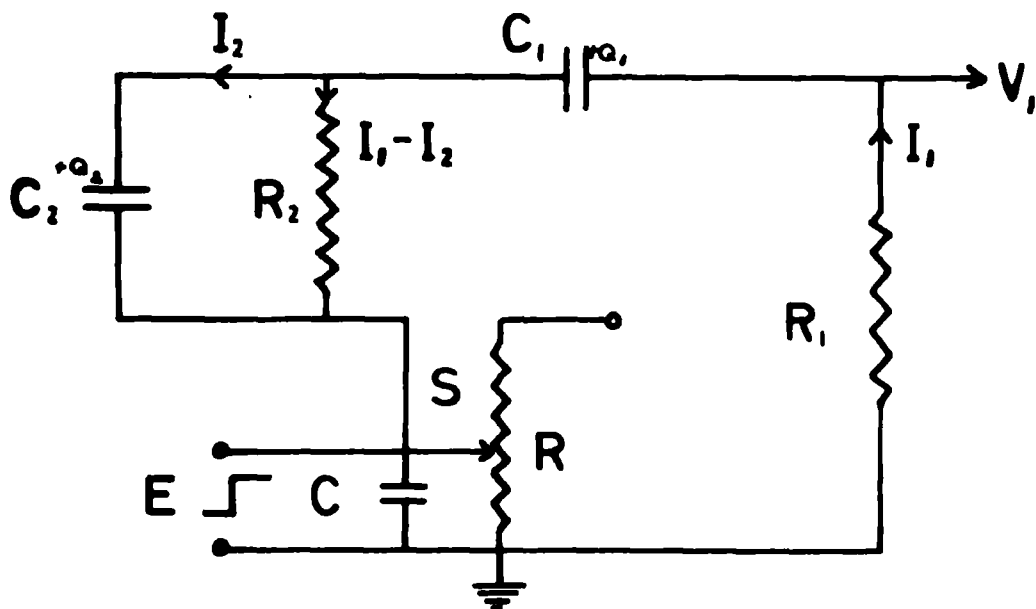

Fig 7

3.3. Operation as a Collector.

Fig. 6. shows the proposed 'flow diagram' for the double mill. The outputs from the upper and lower collecting plates are fed to cathode followers C through blocking condensers B, thus isolating 'mill earth' from actual earth. The outputs are fed from the outdoor apparatus through coaxial cable to the amplifier through transformers T, T_1 . The purpose of T is to tap off a fixed ratio of the output from the upper collecting plate, to be fed through an amplifier giving a measure of potential gradient. T_1 is a dummy transformer with an impedance across it's secondary winding equivalent to the input impedance of the potential gradient amplifier, thus matching up the two mill outputs.

By aligning the upper and lower rotating vanes on the mill correctly with respect to the collecting plates, i.e. both shielding at the same time, the upper and lower plate outputs are arranged to be exactly out of phase with one another, hence when the two outputs are equal their resultant is zero.

Feeding the outputs then onto an addition amplifier, will give an output of magnitude depending upon the difference in size of the upper and lower plate outputs, but having a phase relation with one of the plate outputs of zero or π radians depending on which is the larger.

This added output is then fed back to a commutator on the mill, producing a D.C. output of sign dependant on $1X1-1Y1$ (see §.2.4.) Allowing this D.C. to drive a servomotor a slide is moved along a potentiometer wire, across which is placed a constant H.T. voltage, the slide being connected back to the mill as shown.

Referring back to §.2.4 it is seen that for positive values of potential gradient when q is negative, i.e. the mill

below the potential of the surrounding air, then $|X_1| > |V_1|$. If the commutator is arranged to give a positive D.C. output in this condition, and the motor to drive the slide to a higher potential, then the mill is brought up to the correct potential. However if q is positive, $|X_1| < |V_1|$, then the rectified output will be negative and the slide driven to a lower potential.

Taking the case of a negative potential gradient, it is obvious that if q is negative in this case, the mill is at a higher negative potential than the surrounding air, then $|X_1| < |V_1|$, giving a positive rectified output this time, the change in field reversing the commutation; and driving the slide up the wire. This change in direction of drive can be corrected by reversing the H.T. voltage on the potentiometer or, as shown in Fig.6, by earthing the centre of the slide wire. This is the conclusion arrived at in S.2.4. but it is useful to see how the balancing system operates in conjunction with the commutator.

3.4. Time Constant of the Collector System.

It is important to find the response time of the servo-motor to a sudden potential gradient change, because the size of this value compared with the response time of the mill and amplifier circuit, is the criterion as to whether the servo-motor will follow changes in potential gradient steadily or will 'hunt' and become unstable.

Let τ_1 = time constant of servo-motor

τ_2 = time constant of mill output circuit

then $\tau_1 > \tau_2$ is the condition for no hunting.

The relevant components of the mill output circuit are shown in Fig. 7.

C_2 and R_2 are the mill output capacitor and resistor respectively.

C_1 = blocking capacitor (Fig.6)

R_1 = input resistor of cathode follower C.

S = potentiometer slide of resistance R ohms.

The case to be considered is the behavior of the circuit when subject to a sudden change in potential gradient, but this may equally well be taken as the situation when a step-voltage is applied to the mill. That this is in actual fact what happens will be shown later (S.4.3.)

Assuming zero initial conditions i.e. zero potential on the mill, and at a time $t=0$, apply a potential E to the system as shown. Hence when $t > 0$, let $E = V$, and the charges on capacitors C_1 and C_2 be respectively Q_1 and Q_2 with currents I_1 and I_2 flowing as shown.

Since initial conditions are zero, when $t < 0$, $\dot{V} = \dot{Q}_1 = \dot{Q}_2 = \dot{I}_1 = \dot{I}_2 = 0$.

Applying Kirchoff's second law at a time t :

$$R_1 I_1 + \frac{Q_1}{C_1} + R_2 (I_1 - I_2) = V \text{ ----- } 9a.$$

and

$$R_2 (I_1 - I_2) - \frac{Q_2}{C_2} = 0 \text{ ----- } 10a.$$

but also:

$$I_1 = \frac{dQ_1}{dt} \text{ ----- } 11a.$$

and

$$I_2 = \frac{dQ_2}{dt} \text{ ----- } 12a.$$

Performing Laplace transformations on these equations, and using the same notation as given in Jaegar (1946) where a bar over the symbol denotes the transform:

$$R_1 \bar{I}_1 + \frac{\bar{Q}_1}{C_1} + R_2 (\bar{I}_1 - \bar{I}_2) = \bar{V} \text{ ----- } 9.$$

$$R_2 (\bar{I}_1 - \bar{I}_2) = \frac{\bar{Q}_2}{C_2} \text{ ----- } 10.$$

$$p \bar{Q}_1 = \bar{I}_1 \text{ ----- } 11.$$

$$p \bar{Q}_2 = \bar{I}_2 \text{ ----- } 12.$$

substituting for 11. in 9. and for 12. in 10. gives:-

$$\bar{I}_1 (R_1 + R_2) - \bar{I}_2 R_2 + \frac{\bar{I}_1}{pC_1} = \bar{V} \text{ ----- } 13.$$

and

$$R_2 \bar{I}_1 - R_2 \bar{I}_2 = \frac{\bar{I}_2}{pC_2} \text{ ----- } 14.$$

from 14.

$$\bar{I}_2 = \frac{\bar{I}_1 R_2}{R_2 + \frac{1}{pC_2}}$$

substituting for \bar{I}_2 in 13.

$$\bar{I}_1 (R_1 + R_2) + \bar{I}_1 \left(\frac{1}{pC_1} - \frac{R_2^2}{R_2 + \frac{1}{pC_2}} \right) = \bar{V}$$

or simplifying:-

$$\bar{I}_1 \left(R_1 + \frac{1}{pC_1} + \frac{R_2}{1 + pR_2C_2} \right) = \bar{V}$$

now $\bar{V} = \frac{E}{p}$, because initially $V = 0$ when $t = 0$,

$$\begin{aligned} \therefore \bar{I}_1 &= \frac{E}{p} \left[\frac{pC_1 (1 + pR_2C_2)}{pR_1C_1 + p^2R_1R_2C_1C_2 + 1 + pR_2C_2 + pR_2C_1} \right] \\ &= E \left[\frac{C_1 (1 + pR_2C_2)}{1 + p(R_1C_1 + R_2C_1 + R_2C_2) + p^2R_1R_2C_1C_2} \right] \end{aligned}$$

or

$$\bar{I}_1 = \frac{E}{R_1 R_2 C_1 C_2} \left[\frac{C_1 (1 + p R_2 C_2)}{p + p \frac{(R_1 C_1 + R_2 C_1 + R_2 C_2)}{R_1 R_2 C_1 C_2} + \frac{1}{R_1 R_2 C_1 C_2}} \right]$$

In order to de-transform this equation it must be expressed in a standard form, so making the substitution:-

$$2a = \frac{R_1 C_1 + R_2 C_1 + R_2 C_2}{R_1 R_2 C_1 C_2} \quad \text{and} \quad a^2 + n^2 = \frac{1}{R_1 R_2 C_1 C_2} \quad \text{gives:-}$$

$$\bar{I}_1 = \frac{E}{R_1 R_2 C_1 C_2} \left[\frac{C_1 (1 + p R_2 C_2)}{(p + a)^2 + n^2} \right]$$

splitting this into partial fractions:-

$$\bar{I}_1 = \frac{E}{R_1 R_2 C_1 C_2} \cdot R_2 C_1 C_2 \left[\frac{p + 2a}{(p + a)^2 + n^2} - \frac{\frac{1}{R_1 C_2} + \frac{1}{R_1 C_1}}{(p + a)^2 + n^2} \right]$$

and now transforming back:-

$$I_1 = \frac{E}{R_1} e^{-at} \left[\cos nt + \frac{a}{n} \sin nt - \frac{1}{n} \sin nt \left(\frac{1}{R_1 C_1} + \frac{1}{R_2 C_2} \right) \right]$$

or simplifying gives:-

$$I_1 = \frac{E}{R_1} e^{-at} \left[\cos nt + \frac{1}{2n} \sin nt \left(\frac{1}{R_2 C_2} - \frac{1}{R_1 C_1} - \frac{1}{R_1 C_2} \right) \right]$$

the potential across $R_1 = I_1 R_1 = V_1$

$$\therefore V_1 = E e^{-at} \left[\cos nt + \frac{1}{2n} \sin nt \left(\frac{1}{R_2 C_2} - \frac{1}{R_1 C_1} - \frac{1}{R_1 C_2} \right) \right] \quad \text{--- 15.}$$

This waveform possesses a D.C. exponentially decaying component of time constant $\tau_2 = \frac{1}{a}$

$$\therefore \tau_2 = \frac{2 R_1 R_2 C_1 C_2}{R_1 C_1 + R_2 C_1 + R_2 C_2} \quad \text{secs.}$$

The time constant of the servo-motor is given by the resistance of the slide S , assuming the slide is at it's full-scale position, and the capacitance of the mill-girder

assembly to earth. This value, being only of the order of micro-farads, was increased by placing a $20 \mu F$ high voltage capacitor between slide and earth, shown at C in Fig. 6. Then

$$\tau_1 = R C \text{ secs.}$$

So the condition for no hunting can now be expressed by:-

$$R C > \frac{2R_1 R_2 C_1 C_2}{R_1 C_1 + R_2 C_1 + R_2 C_2}$$

Let the slide have a resistance of a megohm, then taking the worst possible case when the potential at one metre above the earth's surface is 1 volt. Then with 600 volts across the potentiometer wire, the resistance of the slide to earth = $\frac{10^6}{600}$ ohms.

$$\therefore \tau_1 = \frac{20}{600} \text{ secs.}$$

$$\therefore \frac{2R_1 R_2 C_1 C_2}{R_1 C_1 + R_2 C_1 + R_2 C_2} < \frac{1}{30}, \text{ or}$$

$$\frac{1}{R_2 C_2} + \frac{1}{R_1 C_2} + \frac{1}{R_1 C_1} > 60$$

Taking $C_2 = 260 \mu\mu F$ and $R_2 = 10^8$ ohm then this condition becomes:-

$$38.46 + \frac{10^{12}}{260R_1} + \frac{1}{R_1 C_1} > 60$$

so if $R_1 < 10^8$ ohms then this condition is satisfied, independent of the value of C_1 , a suitable value for R_1 is seen to be 10^6 ohm. (S.3.1.)

In arriving at a suitable value for C_1 the only consideration is that it should have a small impedance at the mill frequency compared with R_2 . Mill output frequency = 200 c.p.s. (S.3.1.)

hence:

hence:- $\frac{1}{400 \pi C_1} < 10^8$

$\therefore C_1 > \frac{10^{-8}}{400 \pi} = 7.956 \cdot 10^{-12}$ farads.

taking a value of $C_1 = 10^{-9}$ F easily satisfies this condition.

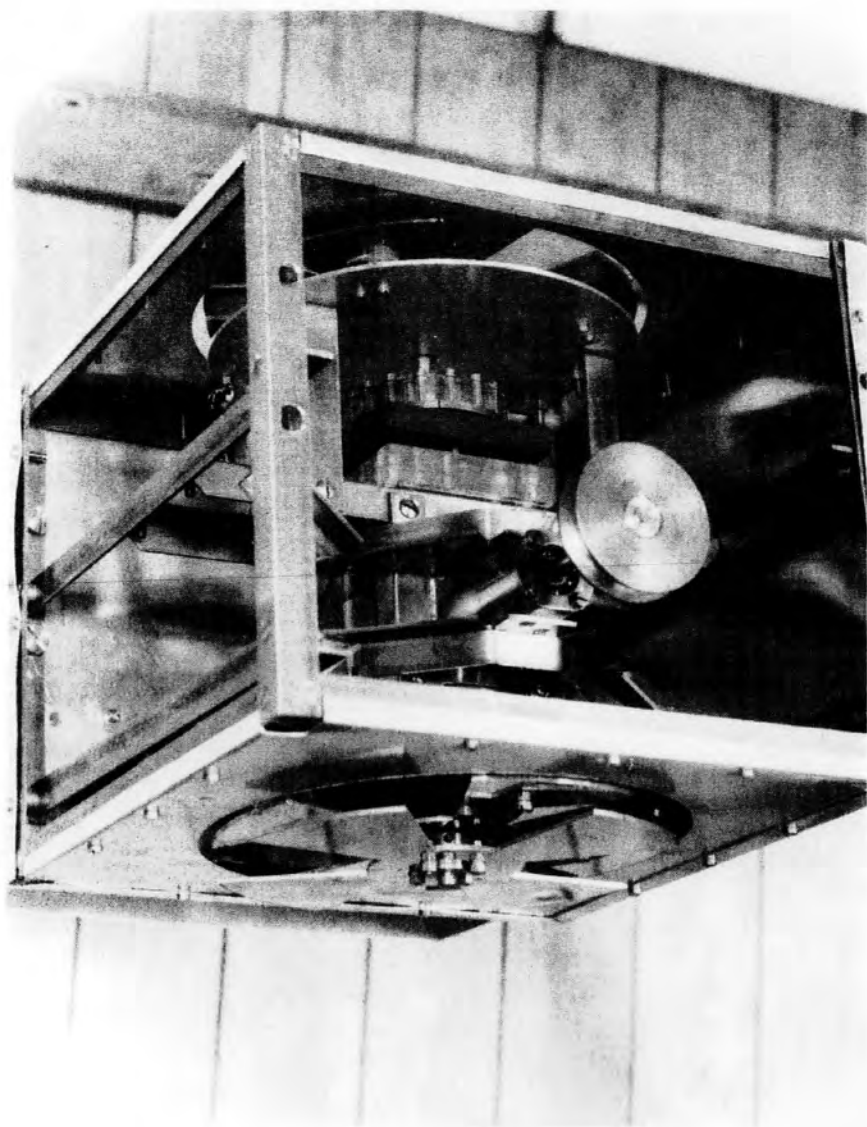

FIG 8

CHAPTER IV
APPARATUS AND EXPERIMENTAL PERFORMANCE

4.1. Field Mill.

The construction of the mill was based on an old steel motor casing shown in Fig. 8, which, when the ball races were renewed served admirably for this purpose. The rotary vanes were cut out of 1/16" stainless steel sheet, polished on both surfaces and mounted at the ends of a 1/4" diameter silver steel shaft, mounted in the motor casing. The drive is transmitted to this shaft by a similar shaft housed in a brass tube securely bolted at right angles to the centre of the motor casing. This shaft has at one end a steel pulley of diameter 6.84" and at the other, a bevel gear engaging a similar gear on the vane shaft, giving a 1 : 1 drive.

The collecting plates are identical to the rotors, mounted on four, 3/4" diameter polystyrene insulators, 1/2" long. The insulating property of polystyrene is solely dependant on the nature of the surface finish of the material, great care being taken with this work¹, and was rewarded by the insulators behaving perfectly in all conditions, needing no protection, and only occasional cleaning with tissue. The stators were mounted flush with the case of the

¹In working polystyrene, the tools were kept very sharp and soapy water used as a lubricant. After 'skimming' down in the lathe, the insulators were polished successively with "Vim", "Brasso" and finally very carefully with 'French chalk'.

mill, 6 mms below the rotors and secured through the insulators to circular aluminium plates. These are in turn bolted to brass angle-girder extensions fixed to the motor housing.

The commutator system has to be insulated from the rest of the mill (see S.3.2.), so the brushes are seated in a perspex ^{block} bolted onto one end of the vane shaft housing. To this block is fixed a second Tufnol block which acts as a brush guide, also keeping the brushes insulated from one another and from the rest of the mill. The brushes are in two diametrically opposite pairs, only two brushes are necessary, but were duplicated to increase reliability. These bear onto a segmented brass disc let into the face of a perspex cylinder, this being easily visible in Fig. 8. The commutator has eight segments of which four are connected together, leaving the other alternate four unconnected.

The whole structure is bolted rigidly to a brass frame, covered with aluminium sheet, and centred within this frame by judiciously inserted washers on the securing bolts. When assembled the mill has horizontal dimensions of 22 by 22 cms., with 20 cms. separating the rotating vanes.

Co-axial cable is used to connect the two brushes and the collecting plate outputs, to Pye co-axial plugs mounted on the mill case. The sheath of the cable is at mill potential, so in the case of the brush leads will have to withstand a potential difference of the order of 600 volts between core and sheath. The cable used for this purpose is Uniradio "Telcon", low capacitance P.V.C. insulated cable, this was tested with a Megger generating 1000 volts and no leak between core and sheath could be detected.

Similar cable is used to make the connections from the mill to a 'junction box' situated at the end of the girder. This is deemed to be a suitable place to terminate the mill potential on the cable sheath, and to situate the blocking condensers in the mill output leads. The box consists of a Tufnol base onto which is fixed a metal plate, where the output and brush leads are terminated. The mill condenser C_2 and resistor R_2 (see Fig.7), are inserted at this point and the mill outputs then pass through the blocking condensers C_1 . These latter are T.C.C. "Cathodray" 'visconol' condensers having a D.C. working voltage of 6 Kv., and a capacity of $0.001 \mu F$. The cover for this box is at earth potential, and the connections are made to 'Belling-Lee' coaxial plugs fixed onto the side of this cover, thus the sheaths of all leads will now be at earth potential. A further lead, in addition to the two brush and two output leads, was connected direct to the base-plate of the box, for the purpose of supplying the mill potential.

Across each $200 \mu F$ (C_2) condenser a small $20 \mu F$ trimming capacitor was connected, for the purpose of matching up the upper and lower plate outputs. This is necessary for two reasons:

- 1). It is essential that the girder be brought to the potential of it's surrounds, so any ~~asymmetry~~ asymmetry existing in the position of the collecting plates about a horizontal plane through the girder, will cause the two outputs to differ.
- 2). Although the nominal value of the condensers C_2 is $200 \mu F$ there may be as much as 5% error in this value, also the connecting cables will differ slightly in capacitance.

It may be noted here that another reason for the outputs

differing from one another at the correct girder potential, is that the surface of the collecting plates and rotors may be different for one pair than the other, this giving a difference in output with zero applied field, due to a differing contact potential. Making the vanes of polished stainless steel reduces this contact potential, but remains, as Whitlock (1955) found, equivalent to a field of ± 10 V/m.

A surprising result arose from his measurement of this zero output, in that measurements from two identical mills indicated slow changes over a year which were the same for each mill! This could be due to the nature of the test plate which was used for both mills, hence a change in it's surface would affect both mills equally. Whitlock thinks however, that it is more likely that the surface of the mill vanes 'aged' in a comparable manner for each mill. If the latter is the case then it may be assumed that both sets of vanes on the double mill will give the same spurious zero output, and so the size of this output will not matter as regards the balancing property of the mill. However, it will have to be taken into account for potential gradient measurements.

4.2. Cathode Followers Amplifiers and Power Supply.

4.2.1. Cathode Followers and Addition Amplifier.

The cable used to transmit the signals from the outside site to the amplifiers indoors, has to be approximately 100 ft. long. The cable used for this purpose was Radiospares "Hygrade" co-axial cable, having a capacitance of $22 \mu\mu\text{F} / \text{ft}$, presenting a reactance of 362 K at the

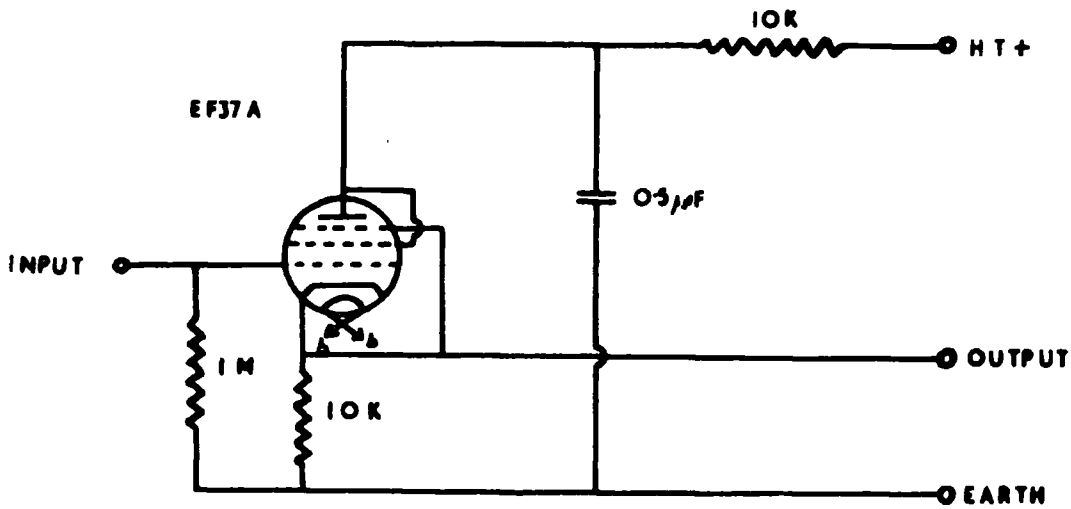

Fig 9

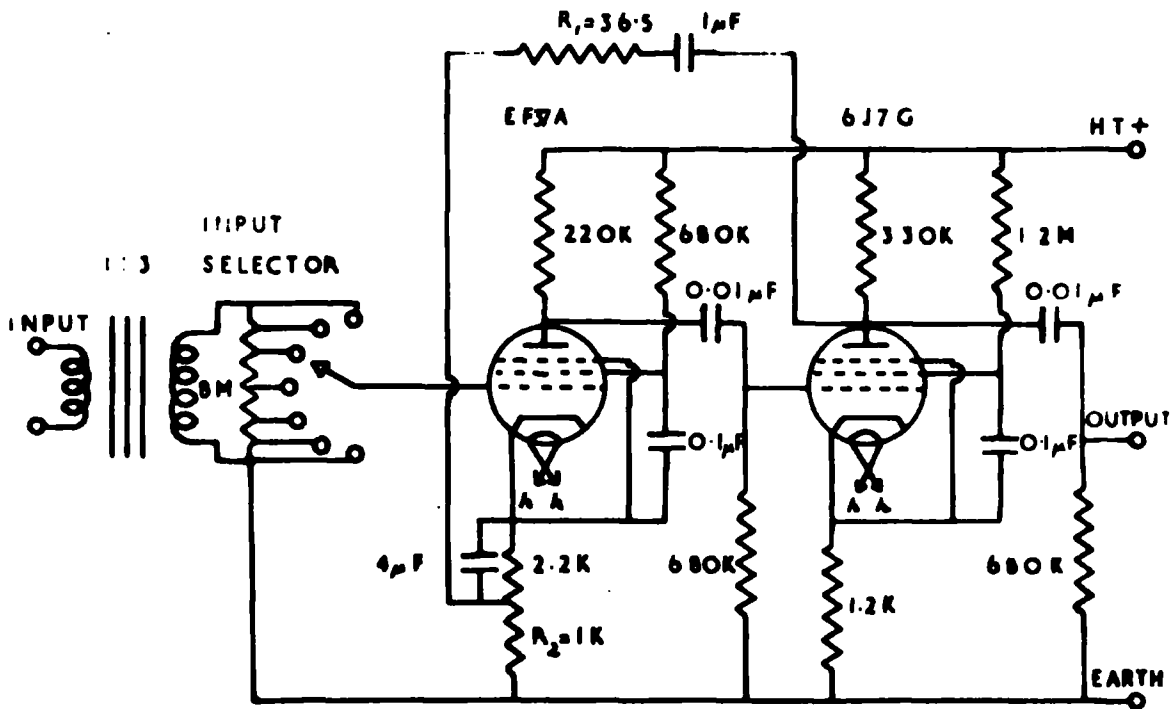

Fig 11

mill frequency, to the mill output if attached directly to the mill. Thus the 10^8 ohm resistor in the mill would be practically shorted out, and no output could be obtained from the mill. In addition to this, the capacitance of this length of cable is 2,200 $\mu\mu$ F. This would be in parallel with the 200 $\mu\mu$ F stator capacitance, and so the condition given in equation 4 (S.3.1.) would not be satisfied.

The method of matching the low cable impedance to the high stator impedance, and also isolating the cable from the stator capacitance, is to use a cathode follower. The advantage of running the valve at reduced heater and anode potentials, has already been discussed in S.3.1. Fig. 9 shows the circuit diagram, the output resistance now being 10 K which is small compared with the cable reactance.

An identical pair of cathode followers were constructed, and mounted in waterproof aluminium boxes measuring 3" x 3" x 7". The working position of these were half-way up the mill supporting posts, this position giving a minimum possible length to the cables connecting the cathode followers to the junction box, keeping the capacitance involved therein as low as possible (see Fig.19).

To ensure that both cathode followers had identical characteristics, they were connected to the power supply, giving an H.T. voltage of 95 v. The heater supply (b-b Fig. 12), because it will eventually have to supply four cathode followers, had another two valves connected in parallel in order to test the cathode followers in working conditions. An input of 10 volts at 200 c.p.s. was obtained from a "Beat Frequency Oscillator" (B.F.O.), fractions of this voltage down to 1 m V, were obtained using resistance boxes. The outputs being measured on a Cossor "Cathode Ray

Oscilloscope" (C.R.O.)

Testing both with a voltage range 0 - 10 volts, no difference in output between the two could be detected within the range of accuracy of the C.R.O., namely 1%. The output begins to distort at 4 V input, which is to be expected since under these conditions the anode current is approximately 0.5 m A, thus giving a grid bias through the 10 K cathode resistor of -5 volts. The stage gain worked out to be 0.77, with an input impedance of the test set of 20 K.

The addition amplifier will not be dealt with in detail, because the use of this was abandoned after preliminary testing (see later this section). The mill outputs were fed onto the grids of a double triode, both the cathodes and the two anodes were strapped together, and the output taken through two stages of conventional resistance-capacity coupled A.F. amplifier. Since the only condition of interest is when the resultant of the two inputs is zero, this amplifier was not required to have a linear response, and the overall gain need not be constant, hence no precautions were taken to these ends.

To test the equality of response of each side of the double triode, each grid in turn was connected to earth, and a variable potential of 200 c.p.s. was applied to the other grid. Measuring the output with the C.R.O. it was found that the amplifier saturated at an input potential of 10 m V, and each side responded equally to within 1%.

To determine the overall gain of the amplifier, one grid was supplied with a known fixed input (0, 25, 50 and 100 m V) at 200 c.p.s., and a variable input fed onto the other grid with a phase difference of π radians to the other input. The output versus input difference, for each

of the four fixed inputs were then plotted on a graph, and the gain was found to be $7,000 \pm 500$ in each case. The response being linear over the range -10 to $+10$ mV difference in inputs.

In order to test the operating characteristics of the mill and amplifier, two horizontal insulated metal plates were erected, one 56 cms. vertically above the other, each plate being one metre square. The mill was supported on two short lengths of 'Handy Angle' girder, centrally between the plates with the girder 26 cms. above the bottom plate. Because of the small size of the room available for this test, it was impossible to remove the driving motor to any great distance away from the mill. It was hoped that positioning the motor below the level of the lower plate, would reduce any distorting effects the motor may have on the electric field between the plates. This arrangement necessitated the driving belt running up to the mill at an angle, and not, as it should be, in the plane of the supporting girder.

Since this was only a test of the mill and amplifier, it was decided not to simulate working conditions completely by having the lower plate earthed, and bringing the mill to the potential of its surroundings. Instead, the arrangement adopted was to earth the mill, so not requiring blocking condensers in the output leads, and enabling the outputs to be fed through short leads, direct to the amplifier. A high resistance potentiometer (500 K) was connected across the upper and lower test plates, having its slide connected to the mill. Thus on applying a potential difference to the plates, movement of the slide will vary the surrounding potential with respect to the mill. This potential was registered by a voltmeter connected

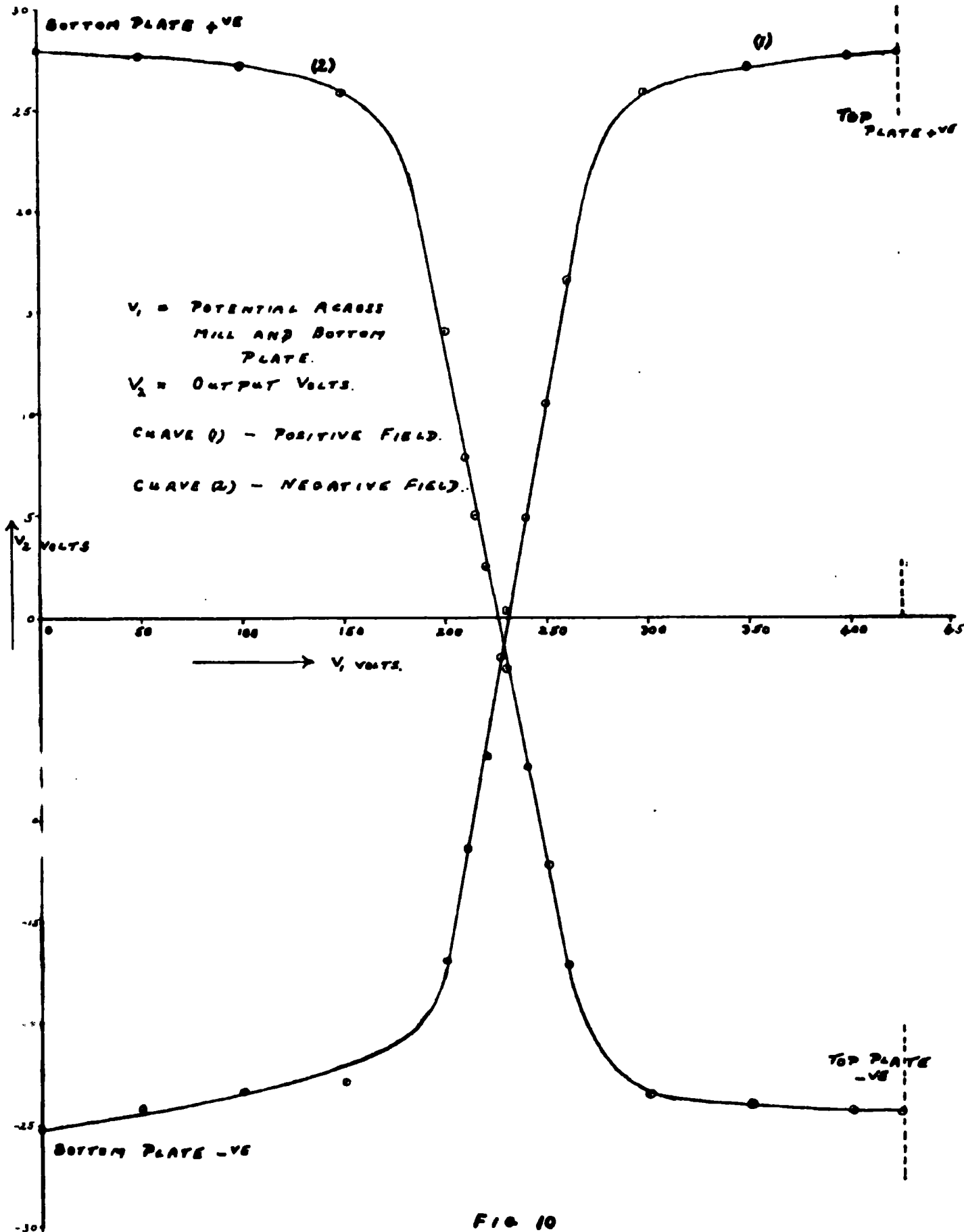

FIG 10

between bottom test plate and mill.

The amplifier output was taken through the commutator and connected through a 330 K resistor to earth. Initially for the purpose of aligning the rotating vanes correctly with respect to the commutator, the C.R.O. was connected across this resistor and adjustment made so that the negative half-cycles were exactly chopped out in a positive potential gradient, when the mill was below it's correct potential.

For the purpose of measurement, H.T. batteries were connected across the test plates giving a potential of 425 volts., which with the stated plate separation (56 cms.) corresponded to a field of 760 V/m. The C.R.O. was replaced by an AVO meter, model 8 having a resistance of 2 M on the 100 volt range.

The rectified output voltage is plotted against mill potential with respect to the lower test plate, for both negative and positive potential gradient values. Fig. 10 shows the results obtained. It is seen that when the mill potential differs by more than 50 volts from it's surroundings, the amplifier reaches a saturation value, but between these limits it responds linearly with a sensitivity given by:-

$$\frac{\text{P.D. between mill and surrounds}}{\text{output voltage}} = \frac{1}{1.9}$$

This means that to adjust the mill to within 1 volt of it's surrounding potential, the servo motor must respond to a change in output of 2 volts, which condition should not be difficult to satisfy.

As regards accuracy of balancing, it can be seen that the intercept on the X-axis for a positive potential gradient is 226 volts, and for a negative value is -231 volts. The calculated values, assuming a uniform field,

are 198 volts and -227 volts respectively. That this discrepancy is not serious, can be seen by calculating the vertical distance h , corresponding to the potential difference from the theoretical value, e.g. for positive potential gradients:-

$$h = \frac{226 - 198}{7.60} = 3.7 \text{ cms.}$$

This is very probably due to distortion of the field by charges picked up on the driving belt, but also could be due to assymetrical distortion by the mill.

The operation of mill and amplifier as a collector is quite satisfactory, the only disturbing feature being the behavior of the commutator. The output measured on the voltmeter would remain quite steady for a few seconds, enabling an accurate reading to be taken, and then vary alarmingly for a further few seconds before settling back to it's former value, and so on.

The use of the C.R.O. enabled this spurious output to be traced down to the commutator, the 'noise' being due to brush jumping. No matter what was done, this undesirable noise could not be eliminated or even reduced! The commutator was carefully tested for uneven running, brushes replaced, brush springs lengthened to increase brush pressure, and even running the mill continuously through the day, wore flats on the brushes at the point of contact, but all to no avail. It was decided that the only thing to do was to construct a new, more robust brush and commutator system, or to convert the method of rectification into a phase sensitive type. Since this would mean a drastic alteration of mill design and probably having to increase the mill dimensions, the whole question of rectification of the output was reconsidered with a view to disregarding the phase of the outputs altogether.

TABLE II

POSITIVE POTENTIAL GRADIENTS

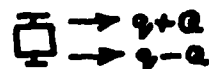

MILL POTENTIAL HIGHER THAN SURROUNDS $\psi +ve$				MILL POTENTIAL LOWER THAN SURROUNDS $\psi -ve$			
CONDITION	PLATE OUTPUTS	1. MINUS 2.	DIRECTION OF SERVO-DRIVE	CONDITION	PLATE OUTPUTS	1. MINUS 2.	DIRECTION OF SERVO-DRIVE
$ Q > \psi $	1. $Q + \psi$ 2. $Q - \psi$	$+2\psi$	\downarrow	$ Q > \psi $	1. $Q - \psi$ 2. $Q + \psi$	-2ψ	\uparrow
$ Q = \psi $	1. 2ψ 2. 0	$+2\psi$	\downarrow	$ Q = \psi $	1. 0 2. 2ψ	-2ψ	\uparrow
$ Q < \psi $	1. $Q + \psi$ 2. $\psi - Q$	$+2Q$	\downarrow	$ Q < \psi $	1. $\psi - Q$ 2. $Q + \psi$	$-2Q$	\uparrow

NEGATIVE POTENTIAL GRADIENTS



MILL POTENTIAL HIGHER THAN SURROUNDS $\psi +ve$				MILL POTENTIAL LOWER THAN SURROUNDS $\psi -ve$			
CONDITION	PLATE OUTPUTS	1. MINUS 2.	DIRECTION OF SERVO-DRIVE	CONDITION	PLATE OUTPUTS	1. MINUS 2.	DIRECTION OF SERVO-DRIVE
$ Q > \psi $	1. $Q - \psi$ 2. $Q + \psi$	-2ψ	\uparrow	$ Q > \psi $	1. $Q + \psi$ 2. $Q - \psi$	$+2\psi$	\downarrow
$ Q = \psi $	1. 0 2. 2ψ	-2ψ	\uparrow	$ Q = \psi $	1. 2ψ 2. 0	$+2\psi$	\downarrow
$ Q < \psi $	1. $\psi - Q$ 2. $Q + \psi$	$-2Q$	\uparrow	$ Q < \psi $	1. $\psi + Q$ 2. $\psi - Q$	$+2Q$	\downarrow

4.2.2. Potential Gradient Amplifiers and Power Supply.

If the two mill outputs are amplified equally and then rectified, both the same way, then a difference in outputs from upper and lower collecting plates is proportional to the divergence in mill potential from that of its surroundings, except in one case; when the self charge on the mill q (S.2.4.), is greater than the induced charge Q due to the field; the difference in outputs is then proportional to the field, and if this is zero or very small, then the mill may take up any potential. These peculiar circumstances can be avoided by ensuring that the mill always starts off at zero potential.

Another characteristic of having a servo-motor not recognising the sign of potential gradient, is that a centre-earthed slide wire (Fig.6) cannot now be employed. Consulting Table II it can be seen that if the direction of drive is correct for positive values of potential gradient, then negative values give a drive in the opposite sense, the output being no longer reversed by the commutator (S.3.3.). In this case then, one end of the slide wire must remain earthed, and the polarity of the other end reversed when the potential gradient changes sign.

An advantage now gained over the system employing a commutator, is that for a given potential across the slide wire, the range of balancing potentials is now doubled by virtue of having a one-ended zero. The disadvantages are; that continuous notes have to be made of the polarity of the slide wire, to obtain the sign of potential gradient; also recordings are impracticable in disturbed conditions when the polarity may have to be changed every few minutes.

Table II shows all possible combinations of potential gradient and mill potential values, using the same notation

as in S.2.4., with the resulting servo-drive in a 'commutatorless' system. From this it is seen that the proposed system, working on the magnitude of the mill outputs alone, will serve the required purpose. Thus the addition amplifier is no longer necessary, the output for the servo-motor being taken from two matched 'potential gradient amplifiers'.

Fig.11 shows the circuit diagram of a two stage amplifier, utilizing negative feedback over the two stages. The input transformer is no longer essential for the operation of this amplifier, but was retained to safeguard the amplifier, in the event of a breakdown of the blocking condenser. An input selector is placed across the secondary of the transformer giving fractions of the input of $1, \frac{1}{2}, 1/5, 1/10, 1/50$ and $1/100$.

Feedback is effected from the anode of the second valve (Brimar 6J7G) through a $1 \mu F$ capacitor; this value introducing negligible reactance or phase shift at the mill frequency; and a resistor R_1 . The feedback voltage is developed across R_2 , which being in the cathode lead of the first valve (Mullard E F 37 A), feeds the voltage back in opposite phase to the incoming signal on the grid.

The fraction of the output voltage fed back β is given by:-

$$\beta = \frac{R_2}{R_1 + R_2},$$

since this voltage just divides itself across R_1 and R_2 . If A = amplification without feedback, then the voltage amplification with feedback

$$A_F = \frac{A}{1 - A\beta} = -\frac{1}{\beta} \frac{1}{1 - \frac{1}{A\beta}},$$

thus if the feedback factor $A\beta \gg 1$, then

$$A_F = -\frac{1}{\beta}$$

and is independent of any amplifier characteristics.

In the present case, for the first valve stage $\frac{V_{out}}{V_{in}} = 176$

and for the second stage $\frac{V_{out}}{V_{in}} = 140$

$$R_1 = 36.5K \quad \text{and} \quad R_2 = 1K$$

$$A = 24,640 \quad \text{and} \quad \beta = \frac{1}{37.5}$$

$$\therefore A\beta = \frac{24,640}{37.5} \gg 1,$$

hence

$$A_F = 37.5.$$

When a plot was made of output against input voltage, using a value of the input selector = 1,

$$A_F = 86.3$$

hence the transformer must have a step-up ratio of 1:2.3. The amplifier proved to be stable within the tested range 0 - 10 volts input, and gave a perfectly linear output for inputs up to 1 volt. These measurements were performed measuring the peak to peak output with the C.R.O., and using a B.F.O. at 200 c.p.s. for the input.

A second similar amplifier was built on the same chassis as the first, care being taken to match-up the resistors in the input selector, and feedback resistors R_1 and R_2 . The input selector switches were 'ganged' on the two amplifiers, to enable them to be operated by the same control knob. This second amplifier was tested similarly to the first one, and it was found necessary to adjust the value of R_1 slightly, presumably due to a slightly different transformer ratio, to produce identical results. The amplifiers were built on a standard size, 10" x 17",

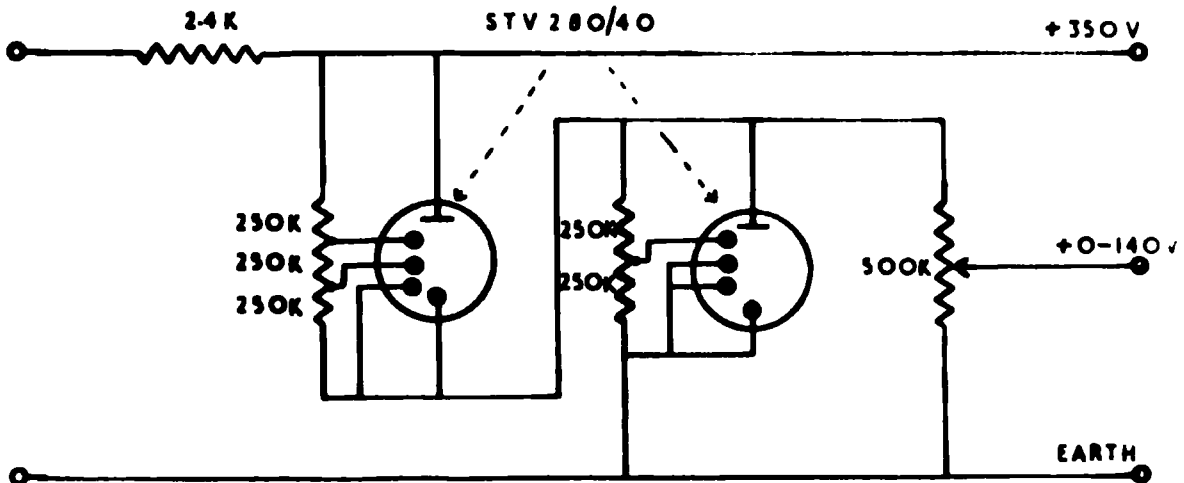
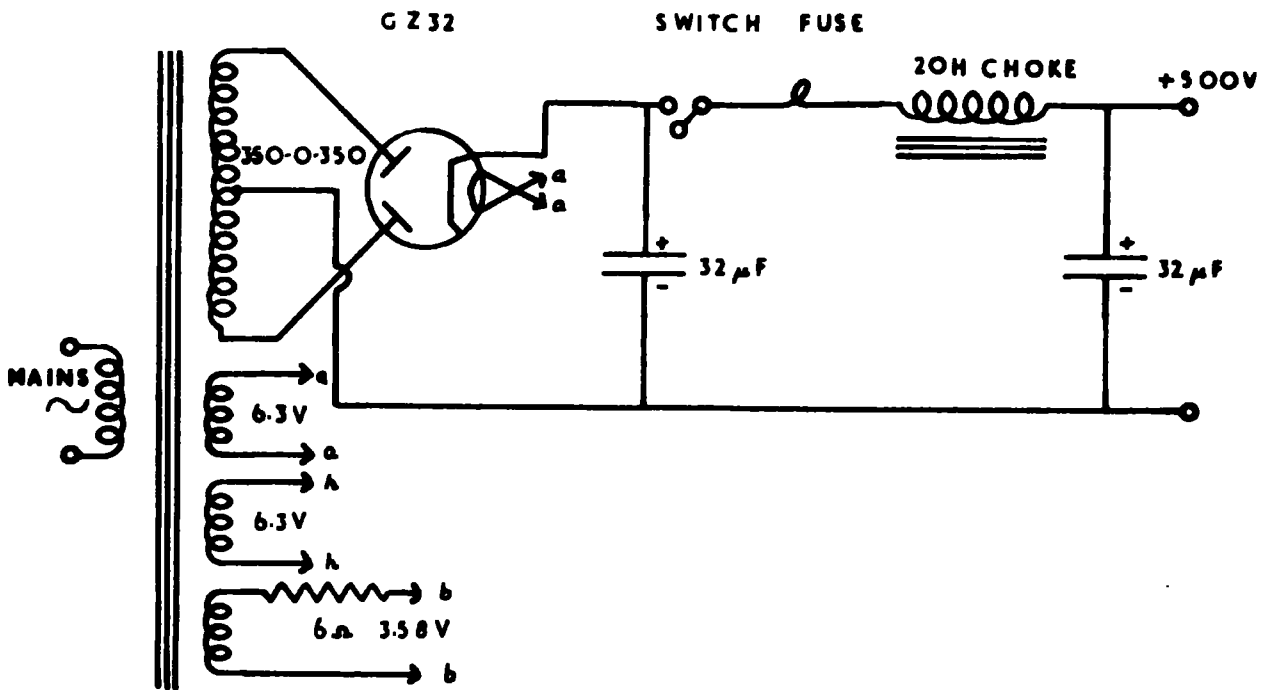

Fig 12

duralumin panel, so that when completed all the electronic gear could be mounted in a single rack thus being readily accessible.

The power supply for the amplifiers and cathode followers is shown in Fig. 12. This is a full wave rectifier using a Mullard GZ32 double diode valve, giving a maximum current of 33 m A at 350 volts. The stabilizing circuit employed is shown in the lower part of the diagram, and comprises of two Osram STV280/40 "Stabilovolt" tubes. These are multi-contact neon tubes, giving 70 volts potential drop across each section, each tube having 4 cathodes. To provide the cathode followers with approximately 95 volts H.T., three cathodes were utilized on the first tube and two on the second, short circuiting the remaining cathodes as shown in Fig. 12. This arrangement will give 140 volts between earth and the anode of the second tube, which is placed across a potentiometer, which is then set to the required cathode follower voltage.

The stabilizing property of the neon tubes, is due to them maintaining a constant P.D. across their electrodes independent of the current flowing. The sum of the currents flowing through these tubes, and round through the external circuit will thus always be the same, and provided the external circuit current does not exceed the tube current when the rest of the circuit is open (33 m A), then the voltage supply will be constant. The 250 K resistors^S are placed across the electrodes to facilitate 'firing' of the tubes when switching on, all four parts can then fire individually. If these resistors were not included, then all would have to fire simultaneously, requiring an initial P.D. across the tube of 80 volts in excess of the stabilized value. Individual firing however, only requires an excess

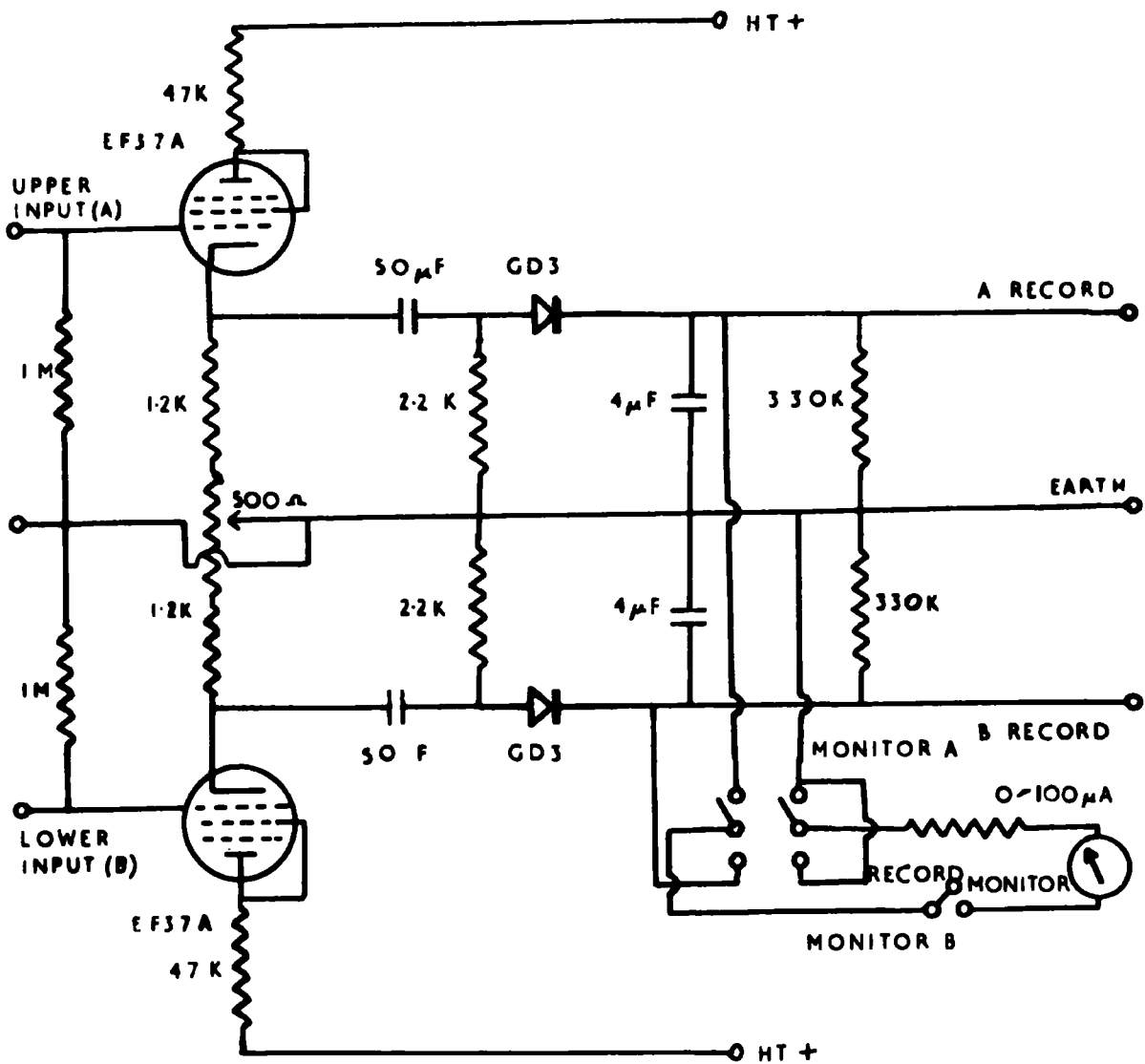

Fig 13

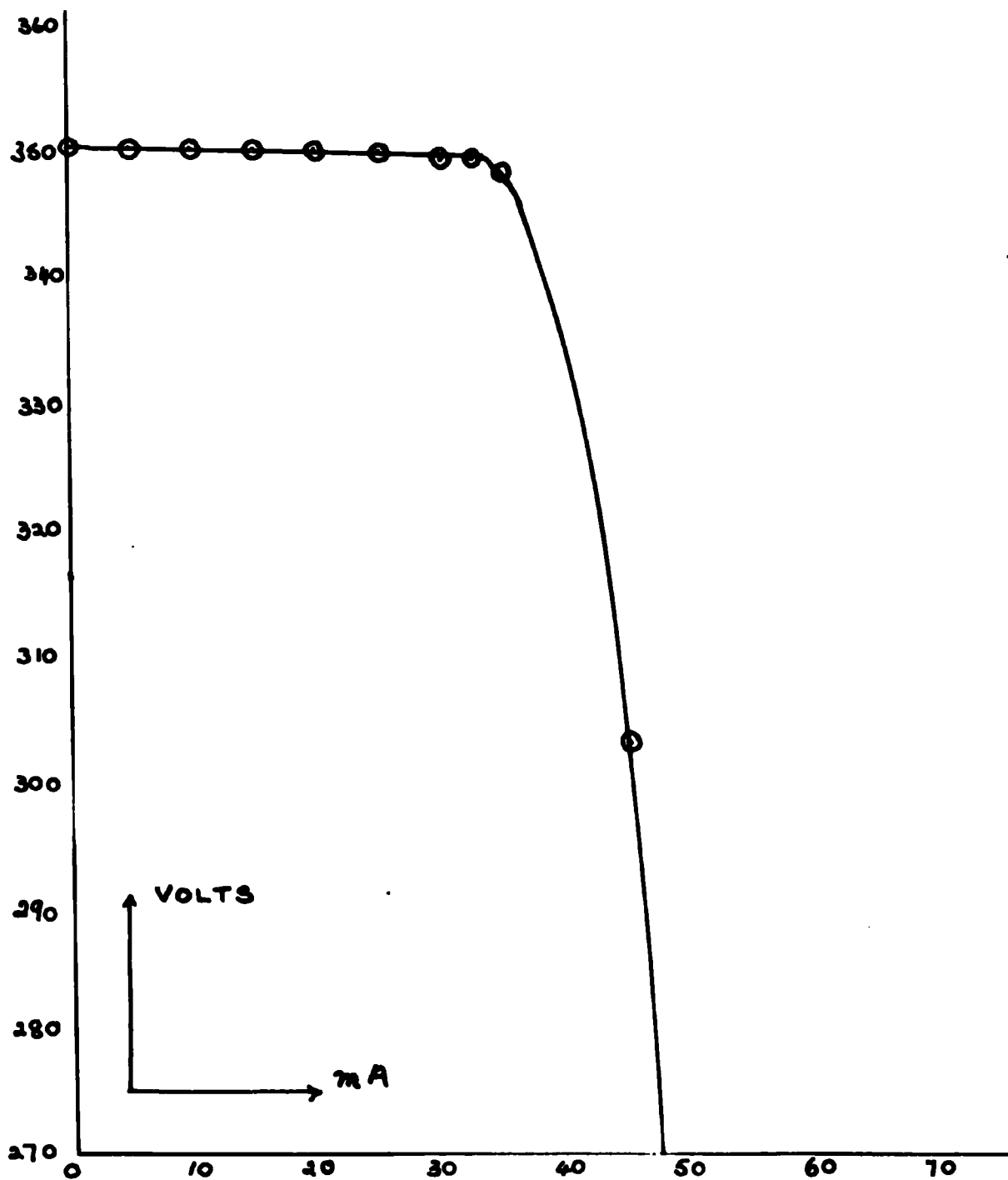

Fig 14

of 20 volts.

The rectified current output from the power pack is shown plotted against the voltage in Fig.14, where it is seen that up to 33 m A the voltage drops from 350 volts to 349.2 volts, giving a variation in output of 0.23%. The actual H.T. current flowing in recording conditions is given below, with bracketed figures indicating the number of units to be finally connected to the power supply:

1). Cathode followers (4) = 1 m. A.

2). Potential gradient amplifiers (4) = 6 m. A.

Making a total current of 28 m A, hence a voltage from Fig. 14 of 349.4 volts, this value was checked every month for 1½ years and remained steady at this figure throughout.

Because of the high output impedance of the amplifiers (see Fig.11), it was thought necessary to couple the instruments following, to the amplifier through cathode follower stages. This is not necessary for the recording galvanometers, which may be obtained with a sufficiently high impedance, but the servo devices were being obtained from the U.S.A., and at this stage in the work no details of these instruments were available. The circuit diagram is shown in Fig.13, the valves used are again Mullard E F 37A's but in this case normal voltages are used on H.T. and heaters.

It was mentioned in S.4.1. that a small trimmer condenser was placed between stator and rotor of the mill, to balance up any assymetry existing between the upper and lower collecting plates or pairs of components. For this same purpose the 500 ohm potentiometer is placed in the cathode leads of the output cathode followers, Fig.13. This provided a very useful adjustment of the balance point of

the mill and in practice, after the initial setting of the trimmers had been carried out, all subsequent adjustments were made by means of this control. The output is then rectified through a Brimar G.D.3. Germanium diode, the 50μ F condenser is inserted in series with this to block the cathode bias voltage which otherwise, being positive with respect to earth, would also be recorded. Assuming that this steady voltage is equal for both upper and lower halves of the cathode follower stage, no effect would be produced on the servo-motor balance point. However taking off one output to record the potential gradient, would give an inconvenient zero output to this value.

In order to monitor the outputs, a subsidiary monitoring circuit was incorporated in the cathode follower stage, this consisted of a sensitive meter which could be switched into either upper or lower output and when recording, removed from the circuit so as not to upset the balance point. The series meter resistance R_m was provisionarily given a value of $7.2K$, this giving a full scale deflection of 830 m V on the meter (meter resistance = $1.1 K$). It was later intended to alter this resistor if necessary, to give a meter reading directly equivalent to potential gradient values.

In order to check the properties of the upper (A) potential gradient amplifier against the lower one (B), an input from the B.F.O. was fed onto both amplifiers of 30 m V r.m.s. . With both input selectors on 1, the 500 ohm potentiometer was set so that the monitor meter gave an equal reading on A and B, the input was varied to give F.S.D. on the meter giving maximum sensitivity of adjustment to this control. The meter reading for each amplifier was then plotted against input, using each valve of the input selector

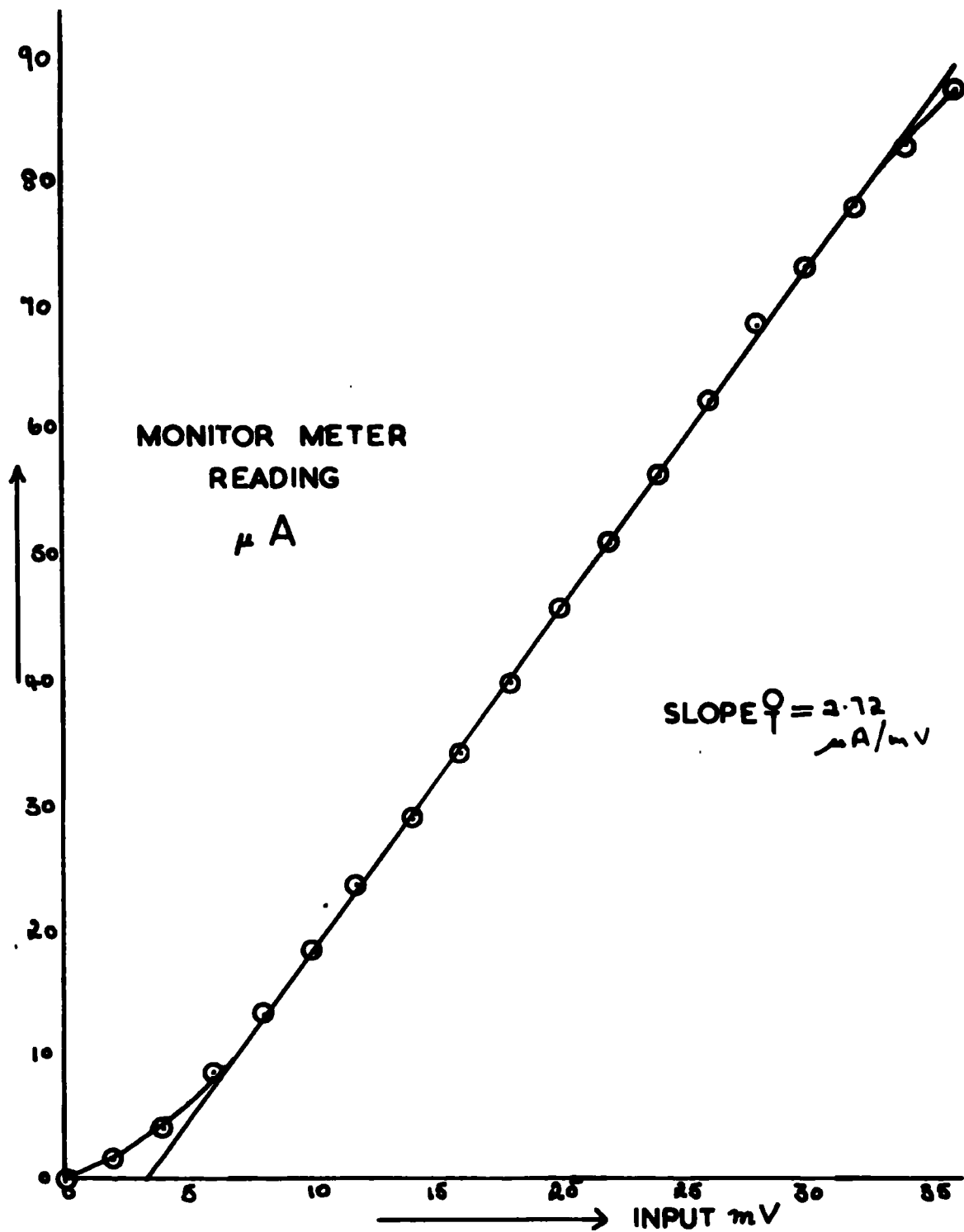

Fig 15

in turn, for inputs from 0 to 5 volts.

The graphs obtained for upper and lower amplifiers were identical to within 1% on all input selector values. Although the resistor values in the input selectors were calculated to give values of $\frac{1}{2}$, $1/5$, $1/10$, $1/50$ and $1/100$ of the input, the graphs showed slight variations from these values, the actual values being $1/2.01$, $1/4.5$, $1/9$, $1/60$ and $1/135$. Fig.15, using an input selector value of unity, is typical of all these plots. The 'tail off' which occurs for small inputs is due to the non-linearity of the Germanium rectifier on small voltages, i.e. below 100 m V. The flattening of the curve at the upper end, is due to the resistance of the monitor meter not being sufficiently high compared with the output resistance of the rectifier circuit. An increase in the former however, would make the meter too insensitive. The slope of the graph is 2.72 A/m V, which corresponds to an overall amplification of 22.6. Comparing this with the value for the amplifier alone 86.3, a considerable loss has been sustained through the cathode follower and rectifier stages.

It is convenient at this point to see what the magnitude of the rectified output is going to be approximately, for a given potential gradient:-

$$\text{From 8, S.3.1.} \quad V = 1.4 \cdot 10^{-4} \text{ F} [1 - 7.7 \cdot 10^{-2}] \text{ volts,}$$

$$\text{stage gain of mill cathode followers} = 0.71$$

$$\text{and amplifier gain} = 22.6.$$

Hence assuming that the loss through the mill blocking condenser and all connecting cables is zero, then the final output

$$V_o = 2.07 \cdot 10^{-3} \text{ F volts} \text{ ----- 1.}$$

thus a potential gradient of 1 v/m gives an output of 2 m V, which corresponds to a monitor meter deflection of $0.24 \mu A$. In choosing a value of 7.2 K for R_m , it was estimated that unit field would give a deflection of $0.5 \mu A$, this bringing a fair weather potential gradient deflection to approximately half scale. Rather than halve the value of R_m , which would decrease the point where the monitor meter becomes non-linear from $80 \mu A$ to $65 \mu A^2$, it was decided to leave R_m at its present value.

It was found from the previous mill test, using the addition amplifier (S.4.2.1.), that a potential difference of one volt between mill and surrounds, produced an amplified difference in A and B outputs of 2 volts. The addition amplifier had an overall gain of 7,000 hence:-

$$V_A \sim V_B = \frac{2}{7000} = 0.29 \text{ m V.}$$

Proceeding in the same way as for one output, and again assume no loss in output through the blocking condenser and connecting cables, a difference in the final outputs of

$$V_{OA} \sim V_{OB} = 4.6 \text{ m V} \text{ ----- } 2.$$

is obtained for a 1 volt difference from the surroundings. Comparing this result with 1., and bearing in mind the fact that when the mill potential differs from its surroundings, V_{OA} changes in one direction and V_{OB} equally in the other, it is seen that a unit change in potential gradient gives almost the same effect on the output, as a unit divergence of the mill potential from its surrounds.

To test the balancing properties of the mill, the test plates previously employed were again set up, this time

²This is an experimental result, found by decreasing R_m to 3 K.

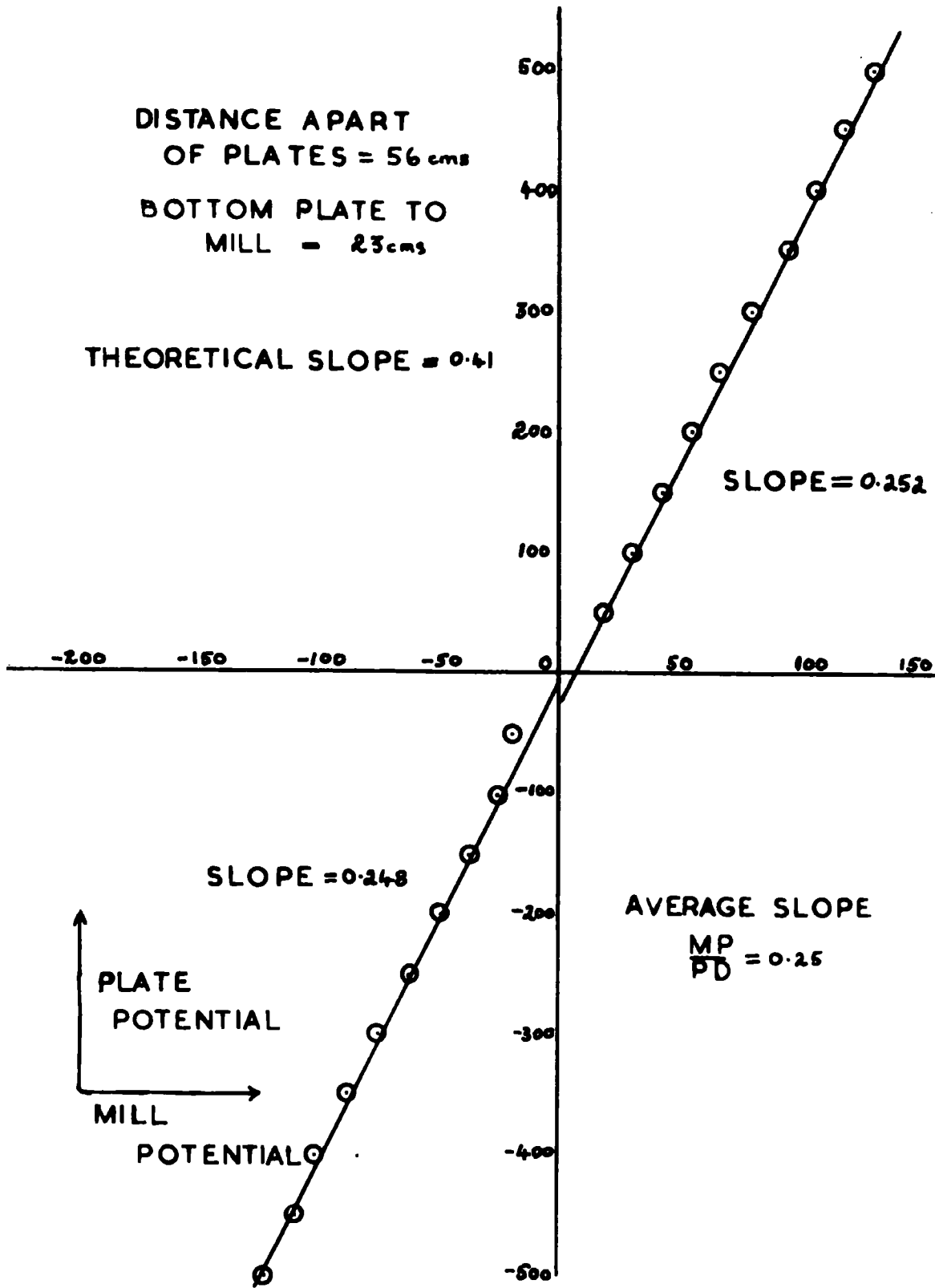

Fig 16

however the potentiometer connecting the two test plates was used to apply a variable potential to the top plate, the lower plate being earth connected. The $0.001 \mu F$ blocking condensers and mill cathode followers were included in the mill output circuit, and a 1 M potentiometer used to apply a variable potential to the mill. This arrangement, apart from the length of cables employed, simulates the conditions under which the mill will be finally operated. For each plate potential value between -500 and +500 volts, the mill potential was adjusted until the monitor meter reading was the same for both A and B outputs, this output was noted and the mill potential measured. Initially the 500 ohm ratio control was adjusted until the monitored outputs A and B were equal, this was done with a potential of -50 volts on the test plate, so that with a mill potential of $-50 \cdot \frac{23}{56} = -20.5$ volts the mill is at it's surrounding potential. That this adjustment was incorrect may be seen from the resulting graph Fig.16, where this point is the only strongly deviating value, due very probably to field distortion produced by the charged belt, as noted in the previous test. This misadjustment thus gave the two amplifier outputs the wrong ratio, producing a straight line of slope 0.25 instead of the theoretical value of 0.41. Apart from this, the linearity shown by the graph indicates the satisfactory functioning of the double mill as a collector.

The range of potential gradients covered by this test were ± 890 V/m. Taking care to switch down the input selector when the monitor meter deflection approached $80 \mu A$, and plotting the meter reading against potential gradient gave a sensivity of exactly 2 m V per V/m.

The fact that this is almost exactly equal to the estimated value given in 1. is extremely fortuitous, and cannot be ascribed to the exactness of the calculations, considering the approximations involved therein!

As previously mentioned, the divergence from linearity in meter readings below $13\mu A$ is due to the rectifying diode characteristics, and is identical for both A and B outputs. The effect of this on the servo-motor will thus be cancelled out, but when measuring potential gradient values this non-linearity will have to be taken into account by means of a calibration of the mill, at values below $108 V/m$ when using the unity position of the input selector switch. At other positions of the switch the 'minimum linear potential gradient' will be correspondingly higher, but the same calibration will serve because the operating voltage range of the rectifier circuit remains the same as the calibrated range.

All was now ready for incorporating the servo-mechanism in the mill circuit, but as these instruments had not yet arrived, work went ahead in the building of a second double field mill and its attendant apparatus. As explained in S.2.3., for space charge measurements to be made between two heights in the atmosphere, it is required that the potential gradient at these two heights be measured simultaneously, so a second mill is required.

The equipment constructed was identical to that of the first mill with the exception of the mill itself, which was designed without allowance being made for a commutator system, thus enabling the vertical height of the mill to be considerably reduced. The vane shaft and driving shaft were mounted in a duralumin rectangular block, cast specially for this purpose and making a much neater job

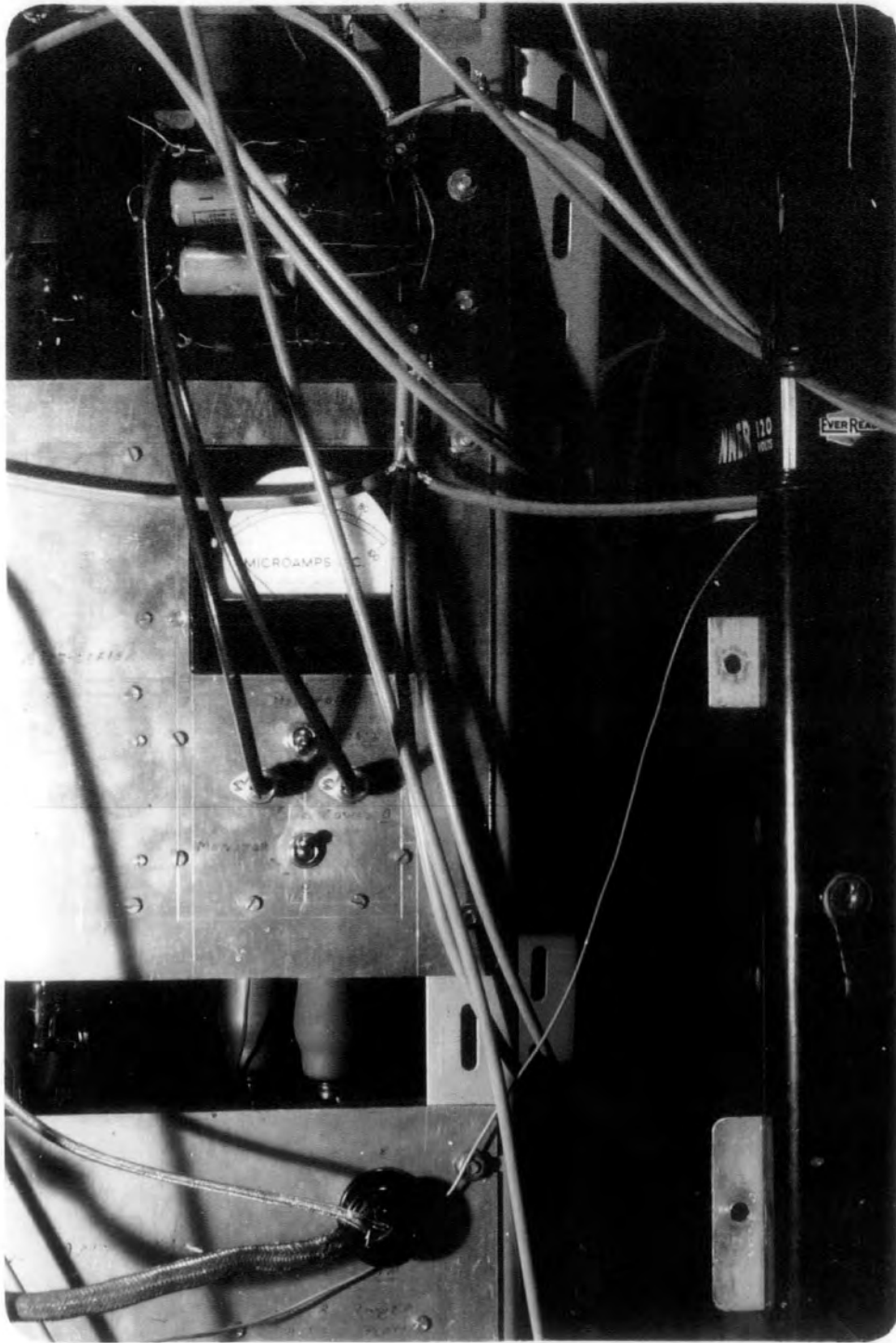

Fig 17

than the motor casing employed for the first mill. When assembled the second mill had the same horizontal dimensions as the first i.e. 22 x 22 cms., the vertical height however being reduced to 14 cms. between rotating vanes, with the stators again 6 mms below the rotors.

For convenience in maintaining the electronic apparatus, the upper and lower potential gradient amplifiers were built on the same chassis, and the input selectors were 'ganged' together so as to be operatable by the same rotary switch. They were constructed on an $\frac{1}{8}$ " Dwalumin panel, measuring 18" x 10", and fitting into a rack constructed from "Handy-Angle" girder for this purpose. This may be seen in Fig. 17, which clearly shows the two mill amplifier panels. The power pack was fitted onto a shelf below the amplifiers, the H.T. and heater leads plugging into the front of their respective panels.

All earth connections were taken to a common earth line consisting of an $\frac{1}{8}$ " diameter copper lead, this being 'earthed' through a piece of copper sheet buried firmly outside several feet below ground level. This method of earthing, ensures that the currents flowing to earth from the various parts of the apparatus i.e. amplifiers, cathode followers etc., all have the same resistance to earth. If this were not the case, then spurious D.C. voltages would appear on the various components and upset any attempt to take accurate readings.

4.3. Potential Balancing Servo-Mechanism.

The instruments used for this purpose are Honeywell-Brown Electronik "Continuous Balance" chart recorders, the original purpose of the instruments was to balance an input voltage from a thermocouple of the order 0 to 25 m V, against a standard voltage supplied by the instrument. Briefly this is accomplished by a potentiometer method, placing the unknown voltage on the slide of a resistance wire across which a battery creates a known drop in potential. The voltage difference between potentiometer slide and input is amplified through a two stage vibrating reed D.C. amplifier, and then actuates a servo-motor driving the slide to the correct potential. The slide is attached to a pen which thus records the input voltage on a strip chart, the chart speed being variable from 30 to 120 inches/hour.

The sensitivity of the amplifier may be varied, the motor responding to a minimum change in input of 0.03 m V at maximum sensitivity. The time of travel of the slide from zero to full scale position is 12 secs. So by modifying the slide wire circuit, this instrument should easily fulfil the requirements for balancing the mill potential.

The most convenient way of adapting the existing potentiometer would be simply to remove the low resistance wire and replace it with one of higher resistance. The deciding factor in the choice of slide wire resistance is the current which may be drawn from the H.T. supply. It was originally decided to use a 2 KV power pack supplying a maximum current of 4.5 m. A, this would mean a wire resistance of 1 M in order to supply two instruments from this power pack. Unfortunately no wire is obtainable

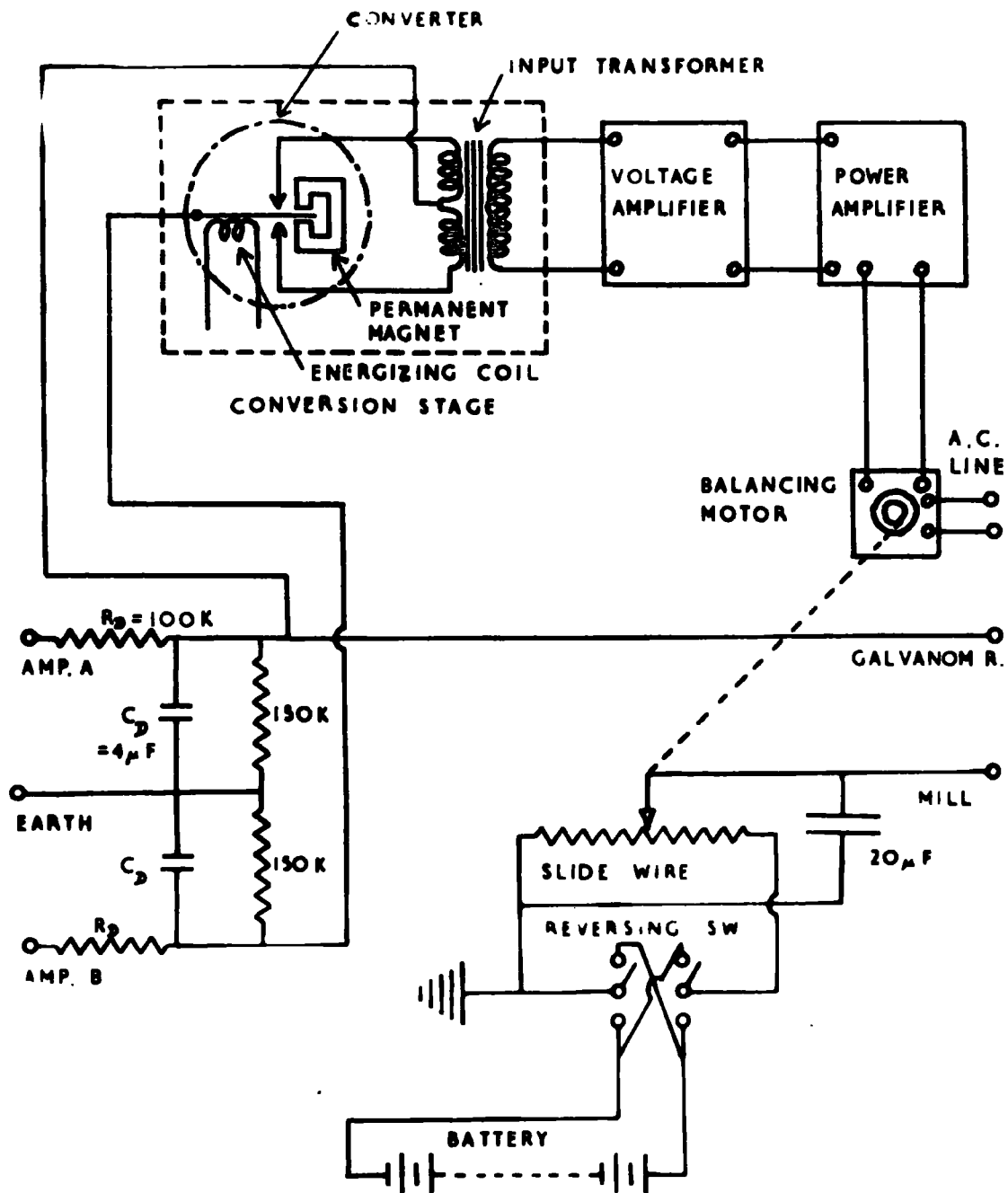

Fig 18

having this resistance and of the desired length, so a composite resistance was constructed on a Tufnol strip fitting in the Brown Recorder in place of the old wire.

The slide wire constructed, consisted of 101, 8 B.A. bolts screwed into the Tufnol strip. In order to ensure smooth running of the slide over the heads of the bolts a gap of only $1/32$ " was left between each bolt head, this meant that nuts could not be used to secure them in place, so the holes for the bolts had to be accurately drilled and tapped, a task requiring endless patience and ten new taps. To the reverse side of the bolts one hundred 10K resistors were soldered, thus giving a wire of 1 M resistance. In operation it was found necessary to short out 3 of the contacts at one end and 4 at the other, to bring the pen zero and full scale positions into coincidence with zero and maximum voltage, resulting in a final resistance of 930 K. The two completed slides will thus have a resistance of 465 K, drawing from the power supply at 2 K V a current of 4.3 m A.

The slide contacts are insulated from the rest of the instrument, one sliding along the bolt heads and the other along a 'collector' wire, placed parallel to the resistance contacts. Fig. 18 shows a schematic diagram of the balancing system. The R C circuit across the input is the circuit recommended by the manufacturers to render the instrument slightly overdamped, without the components R_D and C_D the motor oscillated about the balance point with an amplitude of approximately 4% F.S.D. The purpose of the 150 K resistor across each input, is to eliminate the unbalancing which would result from a change in the resistance of the potential gradient recording galvanometer circuit (which resistance is high

compared with 150 K).

Because the slide wire has not a uniform variation of resistance along it's length i.e. is composed of 10 K steps, the voltage supplied to the mill will vary in steps as the slide progresses from one bolt head to the next. This is the reason why the theory in S.3.4. was worked out for a step voltage applied to the mill, and not for a sudden potential gradient change.

Another effect produced by this discontinuity in the slide wire is to reduce the accuracy with which the voltage is fed to the mill. For an estimate of what error is introduced by this, let the mill be at a height of 1 m, with a potential gradient F V/m. If the voltage across the slide wire is V volts, then the error in the voltage applied to the mill E is given by

$$E = \frac{100}{93} \frac{V}{F} ,$$

thus for a permissible error of 1.08% then $V = F$, which situation would result in the slide deflection being always near full scale. This only assumes a position of the sliding contact either on one stud or the next, whereas in fact it may be midway between the two, bridging the gap between them. Coupled with the fact that the potential gradient very rarely remains constant, the slide voltage may be increased considerably above F . Taking a slow potential gradient change to occur at the rate of 1 V/m per min., and $V = 600$ volts, then initially the Brown Recorder will indicate at 100 V/m a potential of 100 volts (midway between two contacts). The table overleaf indicates the positions at each minute interval up to 10 mins.

TIME mins	0	1	2	3	4	5	6	7	8	9	10
POTENTIAL GRADIENT V/m	100	101	102	103	104	105	106	107	108	109	110
POTENTIAL ON B.R. volts	100	100	103	103	103	106.5	106.5	106.5	106.5	109.7	109.7

If readings are taken from the record produced at minute intervals, it is clear that the largest divergence is 1.5 volts with this rate of change, that is an error of 1.4%. This value will be correspondingly higher for less rapid fluctuations and lower, for more rapid ones. Thus a slide potential of 600 volts is quite satisfactory for fair weather conditions, with the mill at 1 m, or higher.

As previously stated, it was intended to use a 2 K V power pack to supply the slide potential, it was not finally used because preliminary tests using this gave an output from the mill due to mains ripple on the H.T. supply. This output was approximately ten times larger than the output due to the ambient field, and could not possibly be eliminated. In addition to this defect, the output from the supply was found to wander by as much as ± 50 volts per day from a mean value, so the use of this was abandoned and recourse made to H.T. batteries.

The switches for reversing the slide wire potential were mounted at the bottom of the amplifier rack Fig. 17, on an ebonite board behind which, in the base of the rack, were fixed the H.T. batteries. The two $20 \mu F$ smoothing condensers (Fig. 18 and S.3.4.) are positioned in front of the switch panel. The connections from the slides and the H.T. supply to the slide wires, were unscreened Radiospares "E.H.T." leads, and run up the back of the amplifier rack to the Brown recorders seen in the upper right hand corner of Fig. 17.

4.4. Recording Galvanometers and Time Synchronisation.

As seen in the previous section, the Brown Recorders give the potential of the two mills and register this value on their respective charts. For the purpose of recording the potential gradient, the output from the upper (A) side of the amplifier is taken in each case to its own galvanometer. Because the input impedance of the Brown Recorders is 1.4 K, the galvanometers must have a high resistance compared with this so as not to upset the balancing. This entails either using a high resistance galvanometer or a very sensitive one with a high resistance in series with it. The latter method was employed because a galvanometer of the high resistance, in the region of 100 K, required by the former were not readily available.

The galvanometers used were Tinsley, suspension type 4500/10 f, having a periodic time of 2 secs. and a sensitivity of 1500 mms/ μ A. The coil resistance is 45 ohms and requires a shunt resistance of 12 K to give critical damping. It was decided to have a choice of three series resistors to give different galvanometer sensitivities, the values being chosen to give suitable sensitivities on the unit position of the amplifier input selector.

Trial measurements showed that including the Brown Recorders in the circuit, reduced the estimated output (§ S.4.2.) from 2 mV to 1 mV per V/m. The width of photographic paper used was 240 mms and the full width can be used because the output is always positive with respect to earth, so a current of 0.16 μ A is needed to give full scale deflection. Using resistor values of 1.5, 0.68 and 0.22 M give F.S.D. on the galvanometer trace of 240, 109 and 35 V/m corresponding to sensitivities of 1, 2.3 and 6.8 mms per V/m respectively, these sensitivities

will be known as 'Low', 'Medium' and 'High' in all subsequent references.

From the sensitivities just calculated, the range of potential gradients covered by the recording circuit, utilizing the input selector is $\pm 24,000$ V/m with a maximum sensitivity of 6.8 mms per V/m. The limits of the measured range however, are set by the maximum slide wire voltage obtainable in combination with the height of the mill. Using 600 volts on the slide wire will give a range of $\pm 1,200$ V/m with the mill at a height of $\frac{1}{2}$ m, but only ± 100 V/m at a height of 6 m.

The camera used for the potential gradient recordings was made in the laboratory workshops. It was equipped to take a 100 ft roll of 240 mms width recording paper, driven by a geared down motor powered from the mains, giving a paper speed of 30"/hour. The galvanometer lamps were focussed to give a parallel beam of light through a vertical slit, this is reflected from a plane mirror fixed to the galvanometer suspensions onto the camera lens which, being a cylindrical horizontal lens, focussed the vertical slit image to give a spot on the recording paper.

In addition to the two Tinsley potential gradient recording galvanometers, a third galvanometer was inherited from a previous worker. This was connected to the Agrimeter (Chalmers 1953), and gave a useful check on potential gradient values at the earth's surface. From November 1957 to June 1958, when the double field mills were in an operatable condition, the Agrimeter was carefully tended by another worker, Mr. J. W. Milner B.Sc., who required this instrument for his own measurements.

Since recording was being done on photographic paper,

some zeroing check of the galvanometers was needed, and also time marks must be recorded both in the camera and on the two Brown Recorder charts. For this purpose a $\frac{1}{2}$ minute pulse on the laboratory clock was made to operate a Post Office 'Uniselector', this was connected to a 50 volt D.C. supply in such a way that it supplied a $\frac{1}{2}$ minute 'pulse' every five minutes, and also by driving a second Uniselector with this five minute pulse, a half hourly pulse was made available. This was a standard supply and wired into all the laboratory recording rooms.

The five minute pulse was made to operate a Post Office 5,000 type relay, with it's contacts arranged so that the A output from each amplifier was earthed for $\frac{1}{2}$ minute every 5 minutes, this zeroed the potential gradient recording galvanometers, thus giving a zero line on the photographic paper. In addition to this, the Brown Recorders see this earthing of the upper outputs as a decrease in potential gradient which they attempt to follow, and consequently move the slide down to zero mill potential, and thus provide time marks on the recording charts. This incidentally fulfils the condition noted in S.4.2.2., where the mill must start off from zero potential if potential gradient values are very small.

The Brown Recorder charts were graduated laterally with $\frac{1}{3}$ " divisions, thus enabling readings to be made at 40 sec. intervals, and divided longitudinally into 100 divisions, a slide wire potential of 600 volts enabling a reading to be made easily to within 0.6 volts. For ease of reading off values from the photographic paper a mm scale was enscribed on the camera lens, it's 'shadow' being recorded on the paper by means of a fogging lamp placed as near as possible to the galvanometers. This lamp

was connected to it's supply through a second relay worked again by the 5 minute pulse, being switched off at the same time as the galvanometers are zeroed, thus leaving a white line across the recording paper every 5 minutes. A celluloid scale was made with $\frac{1}{2}$ " divisions ruled along it, enabling one minute readings to be taken from the record, which has a speed identical to that of the Brown Recorder charts i.e. 30"/hour.

Later a subsidiary timing circuit was constructed which interrupted the fogging lamp supply for two seconds, every $\frac{1}{2}$ minute still leaving the $\frac{1}{2}$ minute line every 5 minutes, this dispensed with the use of the celluloid scale altogether, and made the analysis of recordings much quicker.

The Agrimeter galvanometer, having both positive and negative indications was zeroed at approximately the centre of the camera scale. It was also earthed at 5 minute intervals by means of an earthed plate covering the instrument. Every half-hour a known voltage was put on this plate automatically, giving a calibration deflection of the galvanometer. This instrument had also three sensitivity values, high, medium and low, having the values 0.125, 0.0305 and 0.00585 mms per V/m respectively. These values give corresponding full scale deflections (120 mms) of 960, 4,000 and 20,000 V/m. The calibration voltage on the shielding plate was ± 12 volts, which gave a corresponding potential gradient of ± 165 V/m.

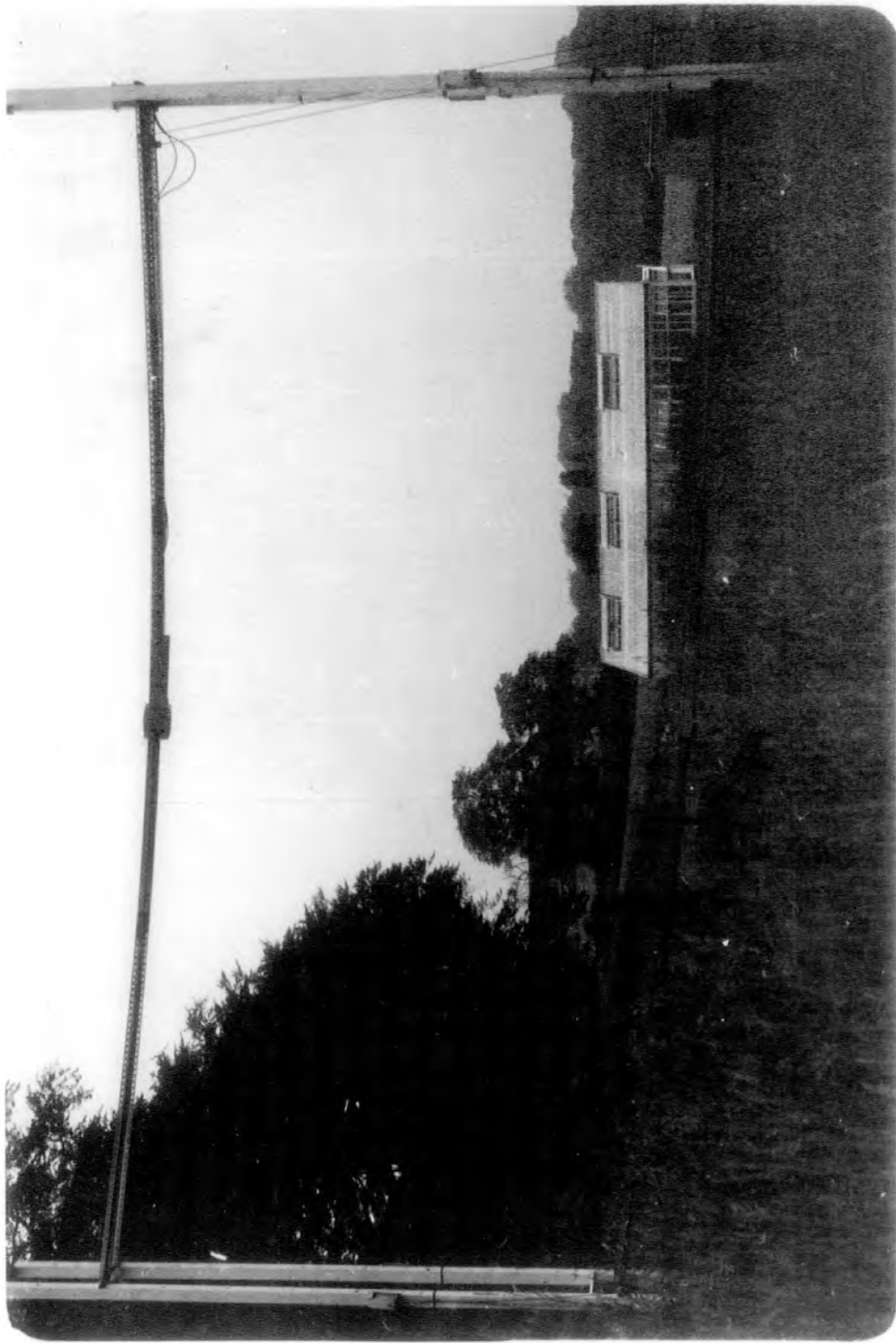
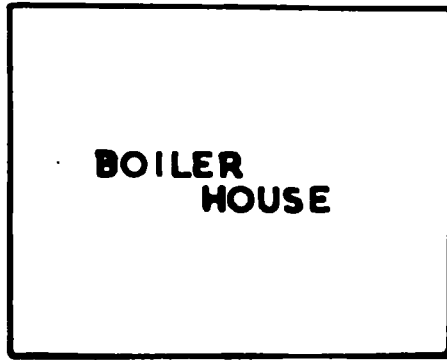

Fig 19

TREES



TREES

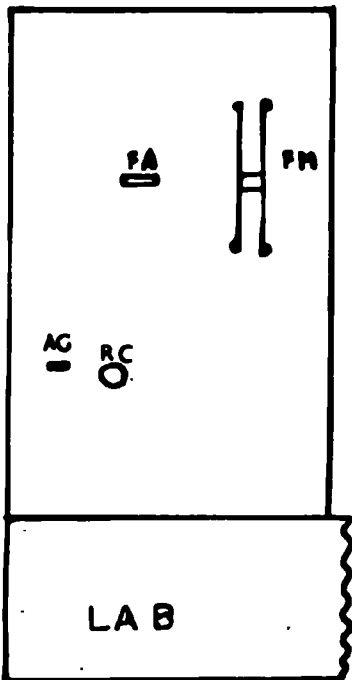

FIG 20

CHAPTER V
OPERATION AND BEHAVIOUR OF THE COLLECTORS.

5.1. The Site and Erection of the Apparatus.

Unfortunately no choice could be exercised in siting the apparatus, the only one available being that shown in Fig.20. As can be seen from this diagram the site is screened on the eastern side by a single line of trees, on the north by laboratory buildings and on the southern side by a boiler house behind which is a large wood. The ground slopes quite steeply upwards beyond the southern fence and because of this, no direct southerly winds could reach the plot of ground where the apparatus is installed. To the West and East of the site the landscape consists, in the main, of open meadows and on the North lies the major part of Durham city.

The plot itself slopes gently downwards from South to North, as may be seen from Fig.19. The mill supporting posts were erected vertically, and the method employed to fix the Tufnol bars (supporting the mill girders) to these posts, necessitated drilling holes through the posts to take metal pins securing the bars in position; this arrangement can be seen in Fig.4. The positioning of these holes were such that the mill girders when fixed, were as nearly parallel to the ground as possible. Sets of holes were drilled at half-metre intervals from the ground, giving possible mill heights from $\frac{1}{2}$ to $5\frac{1}{2}$ metres.

In order to decrease the sag on the girders as much as possible, the pin holes in the posts were not drilled parallel to the ground, but sloping upwards towards the mill at an angle of approximately 5° . This 'offset' applied a couple at each end of the girder tending to turn the mill in an upward direction, and reduced the sag from 45 cms

in a natural hanging position, to 15 cms. This distance being measured vertically at the mill from a line joining the ends of the girders.

This 'counter-couple' acting on the girders put the metal securing pins under a considerable strain and rendered an alteration in the height of the mills a difficult operation. In order to withdraw the pins, the mill had to be supported, which support was ably tended by the author's fellow research workers without whom, the operation of raising the mills would have been impossible, especially to the higher positions!

The space charge effects that may be obtained due to the location of the measuring site can be assessed according to wind direction and potential gradient values, but the disturbances caused by precipitation will not be considered at this juncture. With westerly winds short bursts of charge will pass over the site from passing locomotives, the railway being approximately $1\frac{1}{4}$ miles away, this effect being noticed by Whitlock in his potential gradient measurements (1955). Also vehicles passing along a road 400 yards away may be near enough to give space charge effects, but will be bursts of very short duration and may not be detected. With northerly winds the observed space charge will again be artificial, this time due to smoke coming from domestic fires and will probably be sufficient to blanket out any effects due to traffic passing along a road approximately 300 yards away to the North.

With winds from the East and South no peculiarities should be detected except in circumstances when the potential gradient is such a value as to produce point discharge from the surrounding trees. The easterly line of trees when discharging, although affecting the potential gradient at

the ground downwind, will probably not give a space charge at as low a level as 6 m unless wind conditions are extremely turbulent, the height at which point discharge ions are produced being approximately 18 m. The onset potential gradient for a metal point mounted 2 m above one of these trees is in the region of 450 V/m (Kirkman 1956); for point discharge to occur at lower trees in the neighbourhood such as to produce ions detectable with the double field mills, the potential gradient will have to exceed some ten times this value at which recording is impossible anyway. On the other hand, in point discharge conditions the mass of trees to the south should give appreciable space charge within the detectable height, so with a S E or S W wind this effect is to be expected.

In Fig.20 are also shown the positions of the Agrimeter at a horizontal distance of 14 m, and two other items of equipment to which reference will be made later, namely a rain current measuring instrument (R.C.) at a distance of 13 m and an Obolensky type filter (F.A.) at 5 m, from the double mills.

5.2. Field Operation.

For the purpose of calibrating the mills, an aluminium calibrating plate was constructed to fit closely over the top or bottom of each double mill in such a way that it remained parallel to the mill vanes at a distance of 3 cms from the stator. The voltage for this plate was supplied from batteries fixed onto it's upper surface, of such a value that a potential gradient of ± 600 V/m, in 50 V/m steps, could be applied to the mill.

Only one detailed calibration of both field mills was

RECORD VII NOV 6 TH.

A OUTPUT FROM
UPPER MILL

I.S. $\frac{1}{2}$

GALVO. LOW SENS.

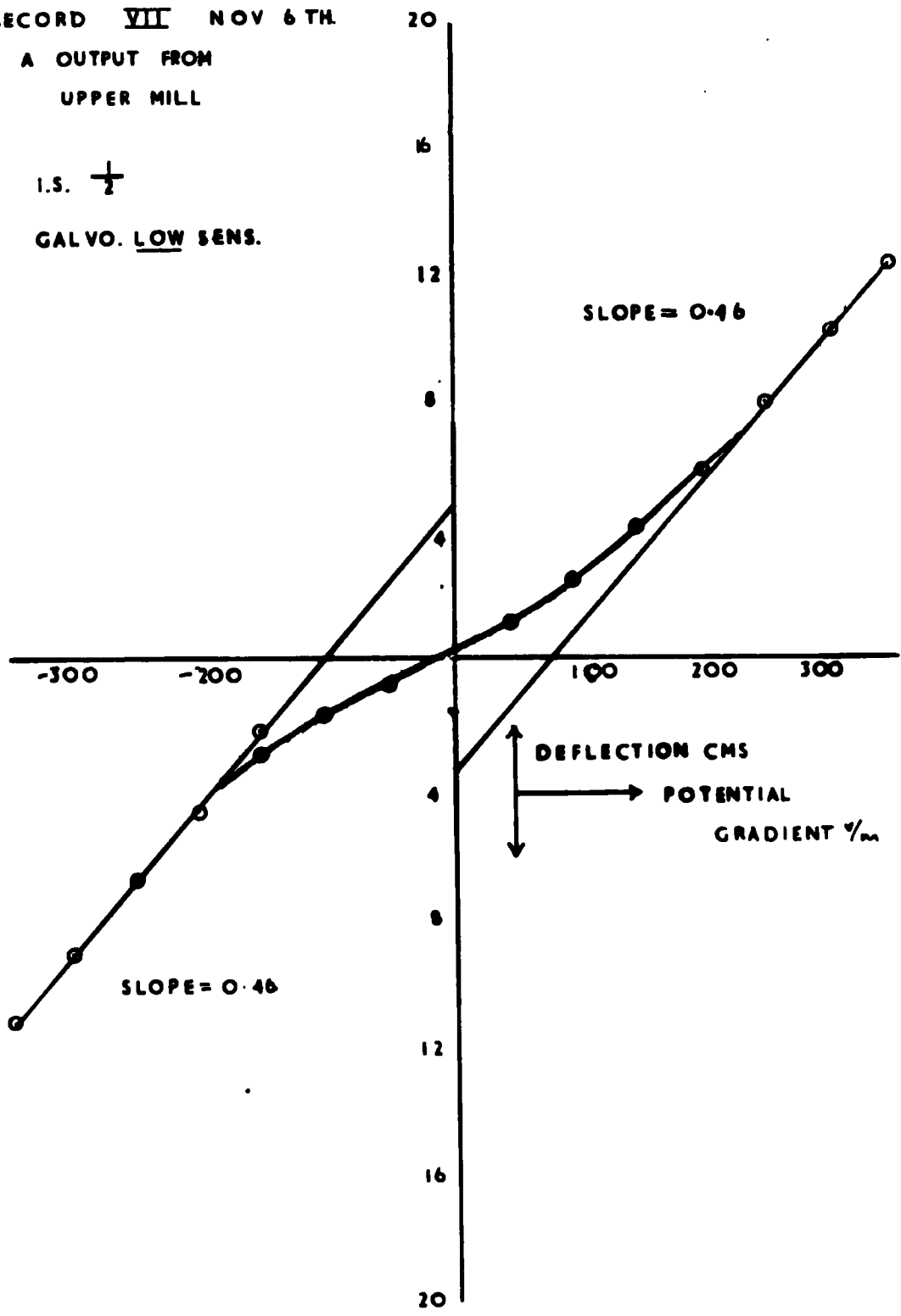
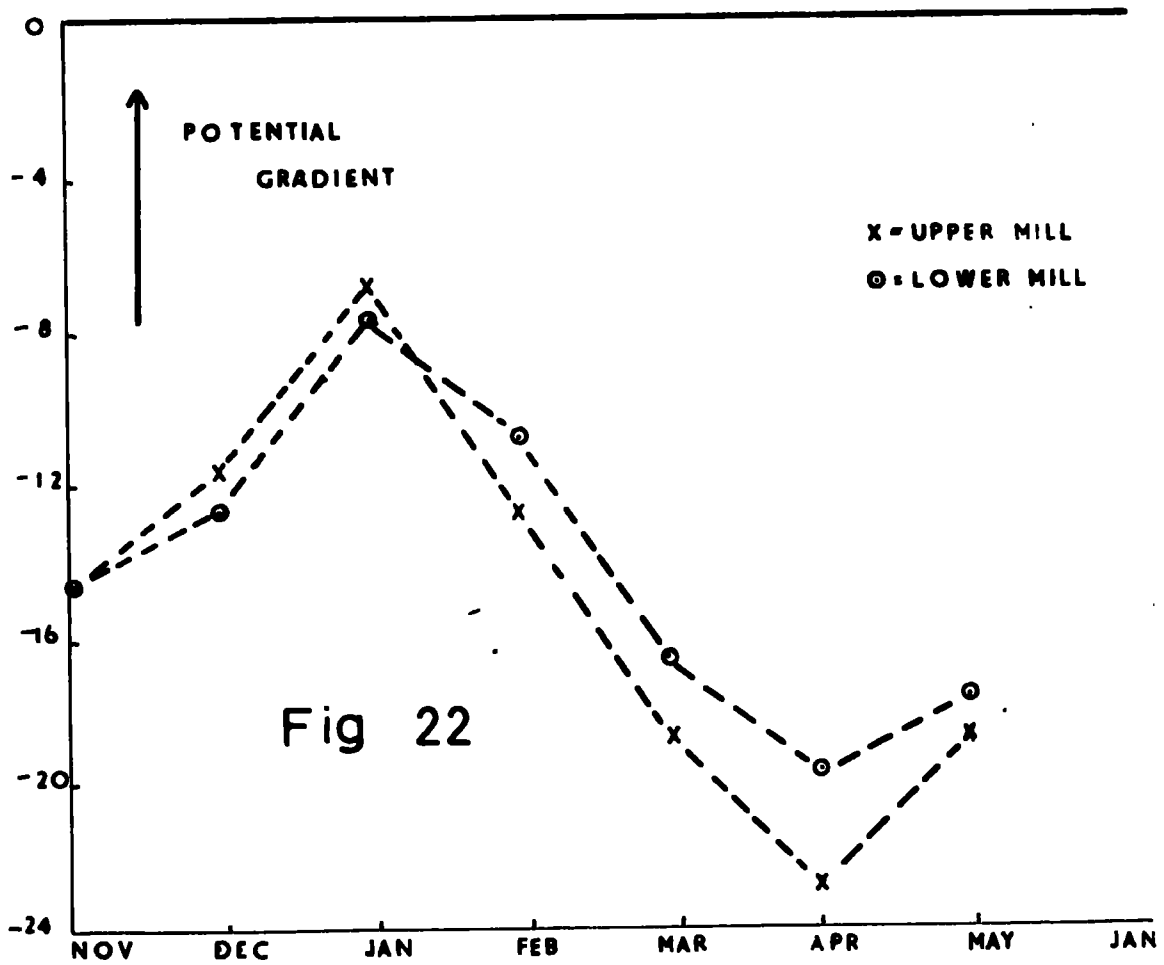

Fig 21

carried out, all subsequent checks consisted of placing the calibrating plate over each side of each mill in turn, and measuring the deflections produced on the recording galvanometers with potential gradients of 0, ± 200 , ± 400 and ± 600 V/m., This check was carried out at monthly intervals from Nov. 1957 to May 1958, and deflections obtained only varied by ± 3 mms from the initial calibration plot. On investigation, this variation proved to be systematic in a way which will be discussed in the following paragraphs.

Since the recording galvanometers are normally connected to the upper collecting plates of the mills, in order to calibrate the lower plates these connections were temporarily changed. To cover the necessary potential gradient range used in calibration, the galvanometer sensitivity was set at Low and the input selector at $\frac{1}{2}$. Reading off the deflections taking 'galvanometer earthed' as zero, from the record produced to the nearest mm, gave the calibration plots for the upper and lower collecting plates of each mill, one of which (for the upper plate output of the 'upper' mill) is reproduced in Fig. 21.

From the graphs produced two main points arise, namely that below 220 V/m the galvanometer sensitivity decreases appreciably, and there appears to be a negative zero output from the mill. The 'tail off' in sensitivity occurs at a deflection of 60 mms., corresponding (S.4.4.) to an output of 60 m V. Bearing in mind the fact that the Brown Recorder damping circuit loses half the output from the amplifier (S.4.4.), this tail off will commence at an amplifier output of 120 m V. The resistance of the monitor meter is 8.3 K, so 120 m V will give a deflection of 14.5μ A. on this meter. Comparing this with the value found in



S.4.2.2. of $13 \mu A$, it is seen that this tail off occurs at the expected value. The intercepts of the straight line portions of the graph on the potential gradient axis are $75 V/m$ and $-105 V/m$, corresponding to a lateral displacement of $15 m V$ to the left of the origin i.e. a zero mill output of $15 V/m$. As stated in S.4.1. this zero output may be a property of the mill or of the calibrating plate, and the question was settled simply by substituting a second similar plate made of steel in place of the aluminium one, and performing a recalibration of one mill. This new calibration proved to be identical to the first, only this time displaced $2 V/m$ to the right of the origin thus indicating a large zero output from the aluminium plate and possibly a smaller one from the mill.

The calibration of the other side of the upper mill, and also the two from the lower mill gave identical graphs to Fig.21, so at this stage all zero outputs were equal. A graph of subsequent measurements of the potential gradient needed to reduce the respective mill outputs to zero, is shown in Fig.22. Because the zero output from the two halves of the same mill remained identical throughout this period, it is difficult to see why a difference should occur between the upper and lower mills. The mill referred to as 'upper' mill was placed in it's outside location in June 1957, and the 'lower' one in September, both were kept covered up when not in use until just after the November calibration, a gale then removed the covers which were not replaced. The fact that the upper mill had been in use longer than the lower for a matter of 11 weeks, may have affected the matter, but does not explain why they should give equal results in November, and follow the same sort of subsequent variation. From these results it is clear

that, the large fluctuations of the order of ± 8 V/m which both mills follow is caused by a change in the surface of the calibrating plate, and the smaller divergence of ± 2 V/m is due to the change in relative zero outputs of the two mills.

A further check of the November calibration was made by supporting one of the large test plates used previously, at a height of 70 cms above the ground. The second earthed plate was placed on the ground underneath the first, care being taken that they were both parallel to the mill which was supported in its $\frac{1}{2}$ m position centrally between the plates i.e. at a height of 35 cms. A variable potential was applied to the test plates and the mill allowed to balance automatically at a series of known potentials, with the input selector setting at $\frac{1}{2}$ and using the Low galvanometer sensitivity.

When the outdoor tests on the mill were commenced in June, no reasonable balance point could be obtained on the Brown Recorder. Upon investigation this was found to be due to excessive charges picked up by the plastic driving belt and carried towards the mill. The effect of this charge was eliminated by completely enclosing the belt, for a distance of a metre from the mill, in an aluminium case. The belt was prevented from rubbing against this and also from hitting against the girder, by fitting small guides mid-way between mill and the end of the girders.

To avoid the difficulty experienced in the indoor tests (S.4.2.2.) where the 500 ohm ratio control was wrongly set, the maximum potential was applied to the test plates and the ratio control adjusted to give equal monitor meter readings when the Brown Recorder was set at half the test plate potential. On switching the Recorder balancing motor

into the circuit, the slide oscillated slightly about this potential and was brought to rest by decreasing the sensitivity of the B.R. amplifier. Reversing the polarity of the test plate voltage had the effect of driving the slide down to zero which, when the slide potential was reversed, drove up again to it's former reading. Hence it can be safely assumed that the ratio control had been set correctly.

Recording mill potential and potential gradient for various test plate voltages between -480 and +480 volts in 60 volts steps, equivalent to a potential gradient range of ± 685 V/m, the potential readings took up their theoretical value on the B.R. within ± 3 volts. As expected with zero potential gradient the slide could be made to assume any desired value, but to obtain a zero potential gradient reading it was set on zero.

In order to find the 'dead zone' of the B.R. i.e. the minimum potential gradient required to give a correct potential setting, the potential of the test plate was raised from zero in steps equivalent to 5 V/m. At a potential gradient of 15 V/m the Recorder moved off zero but only very weakly, and it was not until 25 V/m had been reached that the Recorder registered it's correct potential of 9 volts, resetting at this value when deflected to either side by turning the balancing motor by hand. This test was repeated using negative potentials and the same result obtained giving a dead zone of the instrument to be ± 25 V/m. This large value can be ascribed to two causes; firstly that the sensitivity of the B.R. amplifier was reduced below it's maximum value to eliminate oscillation at high potential gradients; secondly the slope of the graph in Fig. 21 at the point of inflection is only 0.1625 mms per

V/m, thus a potential gradient of 25 V/m will correspond to a deflection of 4 mms on Low sensitivity, or 4 m V output. At higher values of potential gradient e.g. above 100 V/m, the slope of the graph approaches the value 0.46 mms per V/m. Hence at these higher values the dead zone is reduced to 8.7 V/m, using an input selector of $\frac{1}{2}$, this being equal to the observed accuracy of setting on the B.R. of ± 3 volts.

These tests showed that the Brown Recorder balanced the mill potential at the correct value, but had a rather larger error than was expected, this was due mainly to reducing the amplifier sensitivity too much. In actual operation frequent adjustments of sensitivity were made to a point just below that of slide oscillation, thus maintaining the balancing error at a value given by the test adjustment of 0.6%. However a mean has to be chosen between, accepting a higher balancing error at low potential gradients, and an undue oscillation of the slide at high values as it is impracticable to follow varying potential gradients with B.R. sensitivity adjustments.

The calibration curve obtained from the potential gradient recording was identical to the one obtained from the small calibrating plate to within ± 1 mm, or within an accuracy of ± 2 V/m at potential gradients above 100 V/m.

Because both upper and lower test plates were made of the same material, and were equidistant from the mill, they would give approximately the same zero output on each side which, if it is assumed to be the same as for the calibrating plate, will be of the order of ± 2 V/m. As near as could be seen from the resulting calibration curve, it passed through the origin and the straight line portions had intercepts of 90 ± 1 V/m. Hence for comparison with the

calibrating plate graphs, 3 mms deflection was subtracted from the latter to compensate for the zero output difference.

Between 25 and 100 V/m, three additional readings were taken at 25, 50 and 75 V/m and these were found to be within ± 2.5 mms of the corrected previous calibration results. This corresponds to an error in potential gradient of ± 3 V/m which is the expected value calculated from the slope of the graph at zero potential gradient, and also equal to the predicted error in equation 2, S.4.2.2. with a balancing potential uncertainty of ± 3 volts. From this test, and also the evidence presented from Fig.22, it is now verified that the zero output obtained using the calibrating plate is a property of this plate and not of the mill, so hereafter was treated as such.

Only one mill was tested in this way, it being assumed that the other mill, because of it's identical calibration curve, would behave in the same fashion under balancing conditions. In operation it was found that this mill had also a dead zone of 25 V/m, so it may be concluded from this that the assumption is valid. However, in order to set the ratio control on this mill, the test plates were erected as before.

As mentioned, the upper mill was placed outside in June 1957, in it's 1 m position i.e. at a height of 85 cms, and the lower one in September. During the time that the single mill was operating, the potential gradient recording galvanometers were not yet installed, but on several occasions short recordings were taken and values compared with a conventional type mill situated in the plane of the earth's surface at R.C. (Fig 20), the Agrimeter not being in operation at this time.

A typical fine weather recording is reproduced in Fig 23,

RECORD I 3 JUNE 1957

X BR RECORD
O CONVENTIONAL MILL

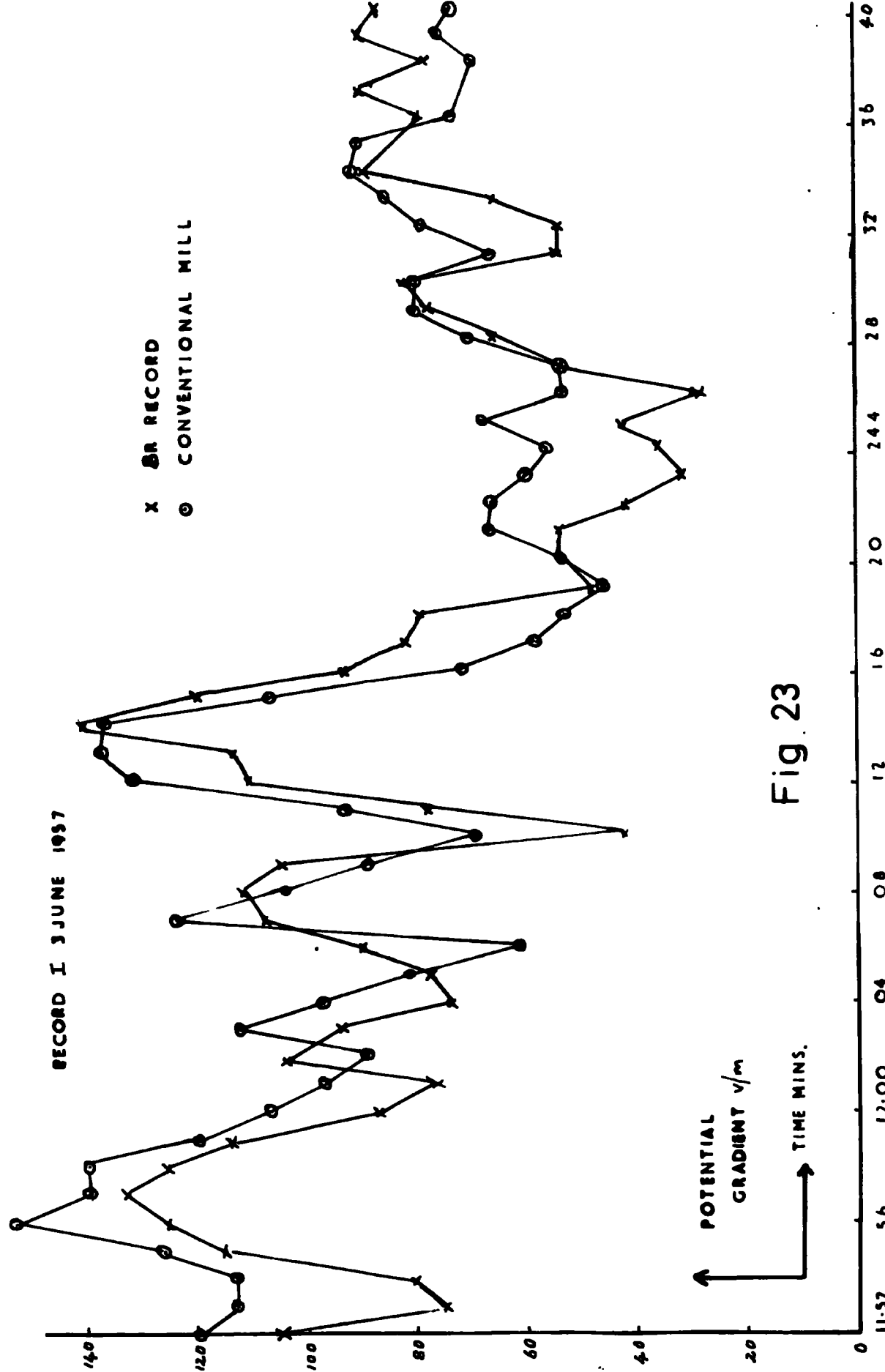

Fig. 23

POTENTIAL GRADIENT v/m
↑
TIME MINS. →

0 20 40 60 80 100 120 140 160 180 200 220 240 260 280 300 320 340 360 380 400

RECORD II 20 JUNE 1957

X = B R RECORD
O = CONVENTIONAL MILL

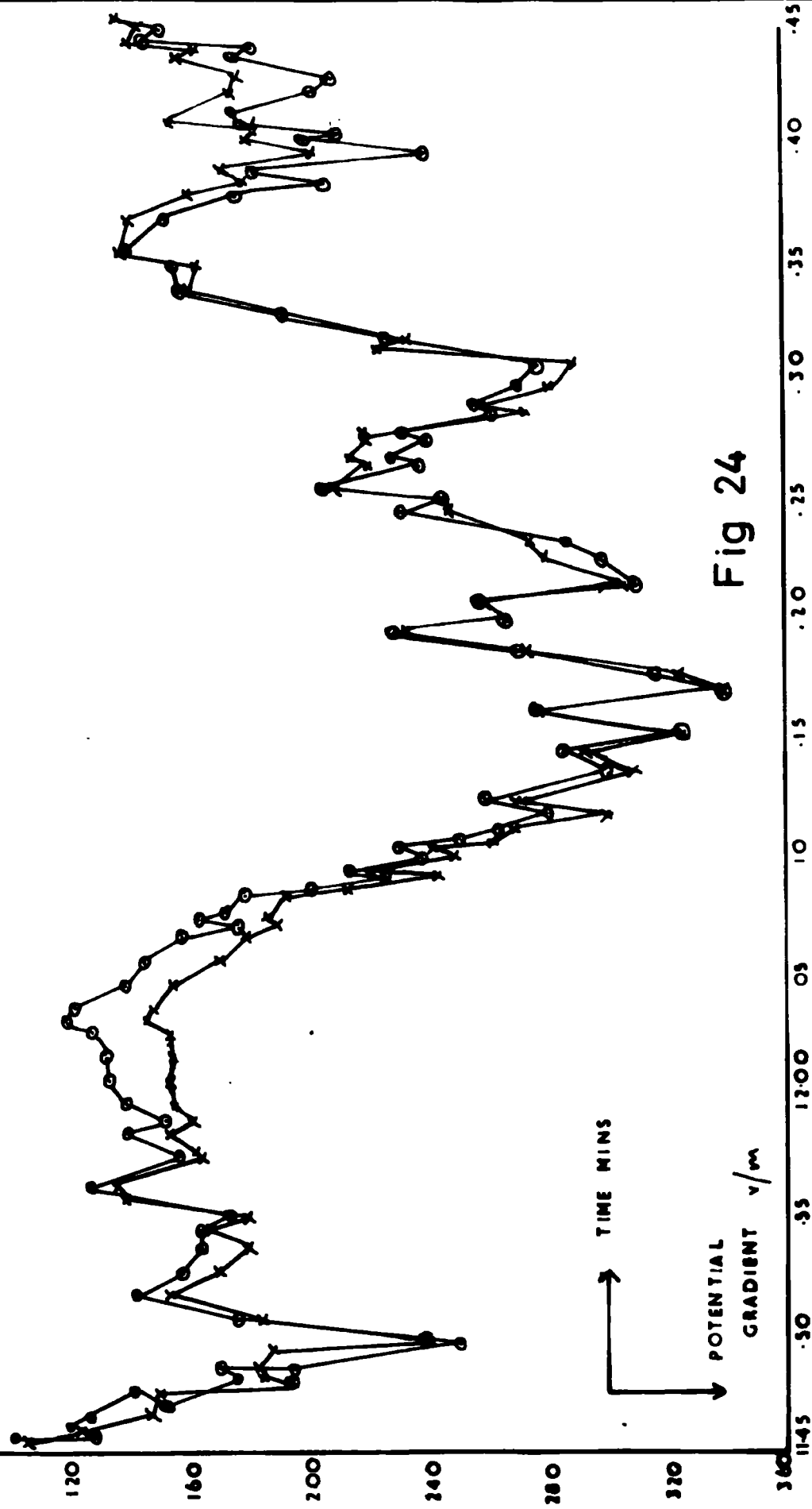

Fig 24

where the agreement between the potential gradient at the ground and that calculated from the potential at 85 cms is quite good. As expected, the potential gradient is lower on the average at a height of 85 cms, than at the ground. No advantage is to be gained by a discussion of the charge values which can be obtained from this recording, other than stating it has an average positive value of $110 \mu\mu C/m^3$ over the recording time with an average potential gradient at the ground of $+91.6 V/m$.

A recording made in light steady rain is shown in Fig. 24, where the potential gradient was negative and very much higher than in the last case. Here it is seen that the average potential gradient at the mill is more negative than at the ground, again giving a positive space charge but of a value $50 \mu\mu C/m^3$. During this recording measurements of the rain current were made at R.C. showing an average positive rain current, with maximum values between 11.57 a.m. and 12.08 p.m., becoming negative at 12.35. These values agree with the times of maximum space charge and the time of change of sign, as can be seen by the upper potential gradient becoming appreciably less than the value at the ground after 12.35, and clearly show, even at this preliminary stage, the value of space charge measurements in the study of precipitation currents.

The troubles experienced in these preliminary tests; apart from the difficulties of a charge being picked up by the belt, which has already been discussed; mainly arose from the starting and stopping of the driving motor. This is mounted on two horizontal rails fixed firmly to the ground, and laying along the line of the mill girder from the foot of two mill supporting posts, to a distance of 2 m outside them. This arrangement enabled the mill

height to be altered without having to replace the motor driving belt, the motor simply being moved along it's rails until the belt was again sufficiently tight.

The motor used, being a synchronous motor, did not gradually gain speed when switched on but immediately reached it's running speed. Due to the inertia of the mill rotors, they could not achieve maximum speed as quickly as the motor, consequently the driving belt tended to slip considerably over the pulleys. In addition to this slipping, the belts also stretched and would quite often fly off the pulleys altogether. This situation was dealt with by including a "Variac" in the motor supply, slowly turning it up to maximum voltage. This had the effect of starting the motor slowly, thus not placing the driving belt under such a strain and being kinder to the gearing in the mill itself, which had to be renewed after a month of 'sudden' starting.

The only other trouble experienced was occasional snapping of the driving belt running along the girder, this belt being quite elastic was tightly stretched to prevent the non-driving side from oscillating unduly and running off the pulleys. Weak spots developed and as soon as a tear started the belt soon snapped, fortunately it was easily joined again by melting the two ends together, which process did not entail too much hardship at the stage when the mill was in an easily accessible position. However, when the mill was raised to a higher level, replacing the belt became more arduous and not infrequently, recording runs were completed with only one mill operating. The occasion of both belts snapping together occurred only once but needless to say, at a period when space charge values were in an interesting condition!

5.3. Recording Procedure and Record Analysis.

At the commencement of a recording session after switching on the camera motor and field mills, the camera was allowed to run for five minutes with the amplifier inputs earthed. This warming up period gave the recording paper in the camera chance to tighten and so take up a uniform speed. Also by this means, a check was obtained that the galvanometer trace with the amplifier inputs earthed, had the same value as that when the amplifier output is earthed by the automatic timing circuit. The power supplies to the potential gradient amplifiers and B.R. amplifiers were left on permanently so these components needed no time allowed for settling down.

During this period the insulators supporting the mill girders were cleaned and their insulation checked by connecting an AVO meter from each girder in turn to earth. The H.T. batteries providing the mill potential were connected, and the corresponding Brown Recorder slide turned rapidly by hand to full scale position. Observing the subsequent rise in potential on the AVO meter indicated the effectiveness, or otherwise, of the insulation by the time taken to reach maximum potential which was usually of the order of 30 to 40 secs. If the time was appreciably less than this, steps were taken to locate the leak before proceeding further. The cleaning of the insulators prior to testing was not at first carried out, and was only done if the test indicated the necessity of this. On one occasion a workman engaged on repairing a nearby fence, left a coil of wire looped over one end of the lower mill girder effectively shorting it to earth, a fact which was not discovered until 600 volts had been applied to the girder. The upper section of the resistance slide was

replaced, and in future greater care was given to examining the insulators before testing.

The sign of the potential gradient was established; either by referring to the Agrimeter, or by switching on the B.R. and noting the direction of drive, if it stayed on zero and attempted to drive downwards the H.T. supply to the slide was reversed. However, if it showed no tendency to drive and could be set in any desired position then the potential gradient had a value less than 25 V/m (or 12 V/m with the input selector at unity) and recording was abandoned.

When the two B.R.'s were balancing the sensitivity of each was adjusted as described in S.5.2. The potential gradient recording galvanometers were now observed and their respective input selectors were changed until they were recording on the camera, using the highest possible selector value to obtain a reasonable deflection. The galvanometer sensitivity adjustment was very seldom used, it remaining set on Low for the majority of recordings. Because the operation of the input selector switch, if changed from its previous setting, will have altered the B.R. sensitivity, this control has to be reset at each change.

After completion of these checks, the time of the next $\frac{1}{2}$ minute extinction of the fogging lamp was noted together with the sign of the potential gradient on each B.R. chart, and the record counted as beginning at this point. Throughout the recording session note was taken of wind direction and approximate strength, time of potential gradient changes, precipitation details, and the state of overhead cloud. In fact any occurrence which may have a bearing on space charge or potential gradient values.

With regard to analysis of the records obtained from the camera and Brown Recorders, it has already been mentioned in S.4.4. how timing marks and zeroes are indicated on the records. Readings are taken to the nearest mm on the photographic paper, the thickness of the trace being approximately $\frac{1}{2}$ mm, and to the nearest tenth of a division on the Recorder charts. This gives an accuracy of reading potential gradients to ± 1 V/m and of mill potentials to ± 1 volt, with an input selector of 1 and Low galvanometer sensitivity. To distinguish between upper and lower mill traces on the photographic recording, the galvanometer zeroes were set approximately 1 cm apart and in addition, the upper mill galvanometer lamp was slightly offset to give a fainter trace, thus no error could possibly occur by reading off the wrong trace.

A choice of three methods of reading off values from the records are possible:

- 1). Taking values at 'major features' e.g. maximum and minimum values.
- 2). Taking average values over minute intervals.
- 3). Instantaneous readings at minute intervals.

The first method has the advantage over the other two that a true picture of the order of changes is obtained, but has a big disadvantage that not enough readings will be obtained to make accurate statistical deductions from the results. The second method still gives quite a reasonable picture of events, but in rapid fluctuations (> 5 V/m per minute) it will become difficult to judge by eye the correct mean value. The third method, although missing the main features of a short potential gradient change entirely, gives results which are more accurate than the second and statistical analysis can be applied more easily than

to the first, so for these reasons this method was chosen.

From the result of analysis of a record, the potential at each of the two mills was calculated, the potential gradients were read off from the calibration curve, multiplying by the appropriate input selector value, and the potential gradient at the ground calculated from the Agrimeter galvanometer deflection. From these readings the average space charge between the two field mills at minute intervals may be obtained by using potential or potential gradient differences. These two results were usually identical to within $\pm 10 \mu\mu \text{ C/m}^3$. Average space charge may also be calculated in the region between ground and lower mill, by using the Agrimeter readings or by finding the difference between the potential gradient at the lower mill, and the calculated average potential gradient over the first metre using mill potentials. These last mentioned methods will not in general agree because:

- 1). The effective 'sampling' height differs in the two cases.
- 2). The Agrimeter is at a horizontal distance of 14 m from the mills, and a small variation in potential gradient can be expected over this distance.
- 3). The response time of the Agrimeter galvanometer is very long (20 secs) compared with the response time of the mills, hence short period variations will show less amplitude on the Agrimeter than the mills.

CHAPTER VI

APPARATUS FOR THE DIRECT MEASUREMENT OF SPACE CHARGE

6.1. The Apparatus.

Having constructed and brought into operation an apparatus for the indirect measurement of space charge, it was thought that an instrument taking direct readings, would be useful for comparison of results obtained by these two methods. In addition to this, the two methods could be used in conjunction for investigation of precipitation currents.

An Obolensky type filter was constructed along the same lines as that made by Kinman (1954). This consisted of an insulated brass cylinder packed tightly with fine steel wool and effectively screened from any effects of potential gradient changes by enclosing the cylinder in a brass box. The air inlet was shielded to prevent any possibility of precipitation entering the inlet or splashing in the near vicinity giving spurious effects due to the splashing or Lenard effect (Adkins 1958).

Air was drawn through the filter by a motor driving an old "Hoover" fan unit, this motor was driven by the mains through a 'Variac' enabling the air speed to be varied up to 0.6 L/s. The 'suction motor' was connected to the air filter by 6 m of flexible rubber hose and a reservoir interposed between the two to smooth out small changes in the rate of air flow, due to short period variations in mains voltage. The purpose of using the long length of hose was to enable the suction motor to be moved down-wind of the filter, ensuring that the air expelled from the motor would not re-enter the filter or the latter pick up any charges which may be generated at the motor brushes. To eliminate variations in air flow

which may arise from changes in wind speed, the motor outlet and filter inlet were made to face in the same direction.

To measure the charge collected by the filter an EKCO Vibrating Reed Electrometer (VRE) Type N 572 was employed. The 'Head Unit' of this instrument was bolted onto the screening case of the filter and a direct rigid connection made from the collecting cylinder to the input terminal of this unit, thus eliminating any trouble due to the piezo-electric effect produced in a connecting cable. An input selector switch on the Head Unit gives a choice of 10^{12} , 10^{10} or 10^8 ohms for the input resistor, and the output from the V.R.E. is read off from a meter, mounted on the Indicator Unit, in m V having choice of 4 ranges i.e. 0-30, 0-100, 0-300 and 0-1000 m V.

In it's most sensitive condition, the instrument gives a full scale reading for a current of $0.03 \cdot 10^{-12}$ amps. The day to day stability is given by the manufacturers as ± 1 m V with a short term stability "considerably better than this".

The precautions to be observed with the use of the V.R.E. were quite straight forward. A 24 hour stabilising period was allowed after switching on the instrument, and no readings were taken for an hour after having turned the selector switch on the Indicator Unit to it's 'Set Zero' position, for the purpose of adjusting the instrument zero output. In this position a relay is operated in the Head Unit which shorts out the input resistor, this operation gives a mechanical shock to the insulators in this unit which must be given time to recover. The hour recovery time also applies to operation of the selector switch on the head unit, but as this was set permanently

on the 10^{12} ohm position the condition was not applicable.

The filter, when calibration and testing had been carried out in the laboratory, was mounted at F.A. (Fig.20), at a distance of 5 m horizontally from the double field mills. The air inlet was set facing west at a height of 65 cms above the ground, bringing the height of the top of the instrument to 80 cms. In this position Benndorf's criterion (S.3.2.) is satisfied, so the effect on potential gradient values at the double mill will be less than 1% when the mill is at 1 m or higher.

6.2 Calibration and Testing.

For the purpose of recording the V.R.E. output, a Nivoc suspension type galvanometer was set up to give a photographic trace on the camera. It was positioned to zero approximately in the centre of the recording paper, offset by a cm from the Agrimeter zero so as not to confuse the two, and when calibrated in conjunction with the V.R.E., had a sensitivity of 4.21 mms/m V using the 0-30 m V range. This gives a full scale deflection of 12 cms corresponding to 29.5 m V, which was intentionally made slightly smaller than the meter range because the V.R.E. is not intended for use in measuring negative inputs and an overload device operates slightly below meter full scale deflection (at a meter reading of -29.8 m V on the 0-30 m V range), this rendering the full scale reading of -30 m V to be inaccurate.

The filter was set up in a small room in the laboratory with the sucker motor situated outside, connected by it's rubber hose to the filter, and mounted in such a way that precluded the possibility of any 'feed-back' of filtered air.

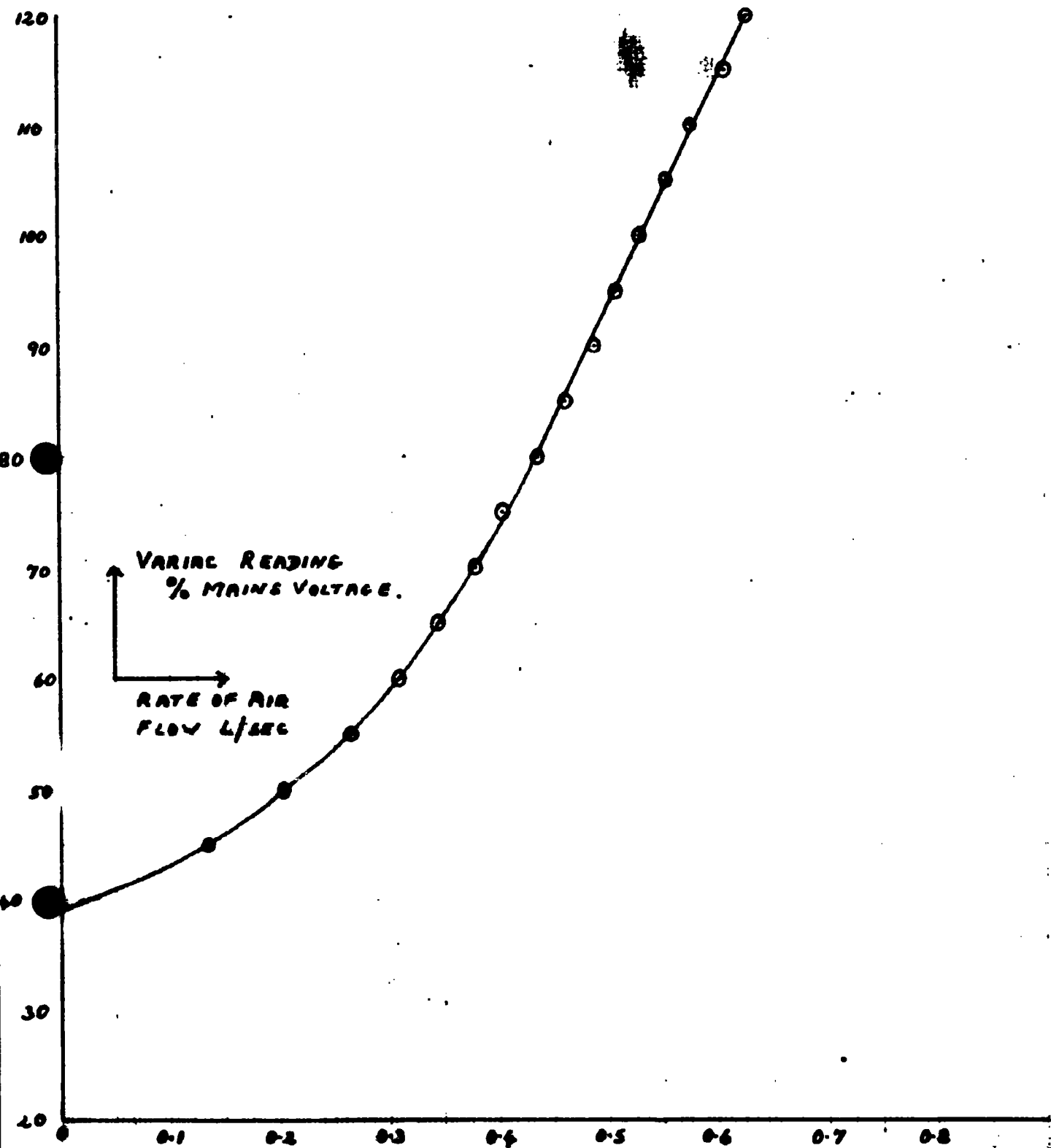

FIG 25.

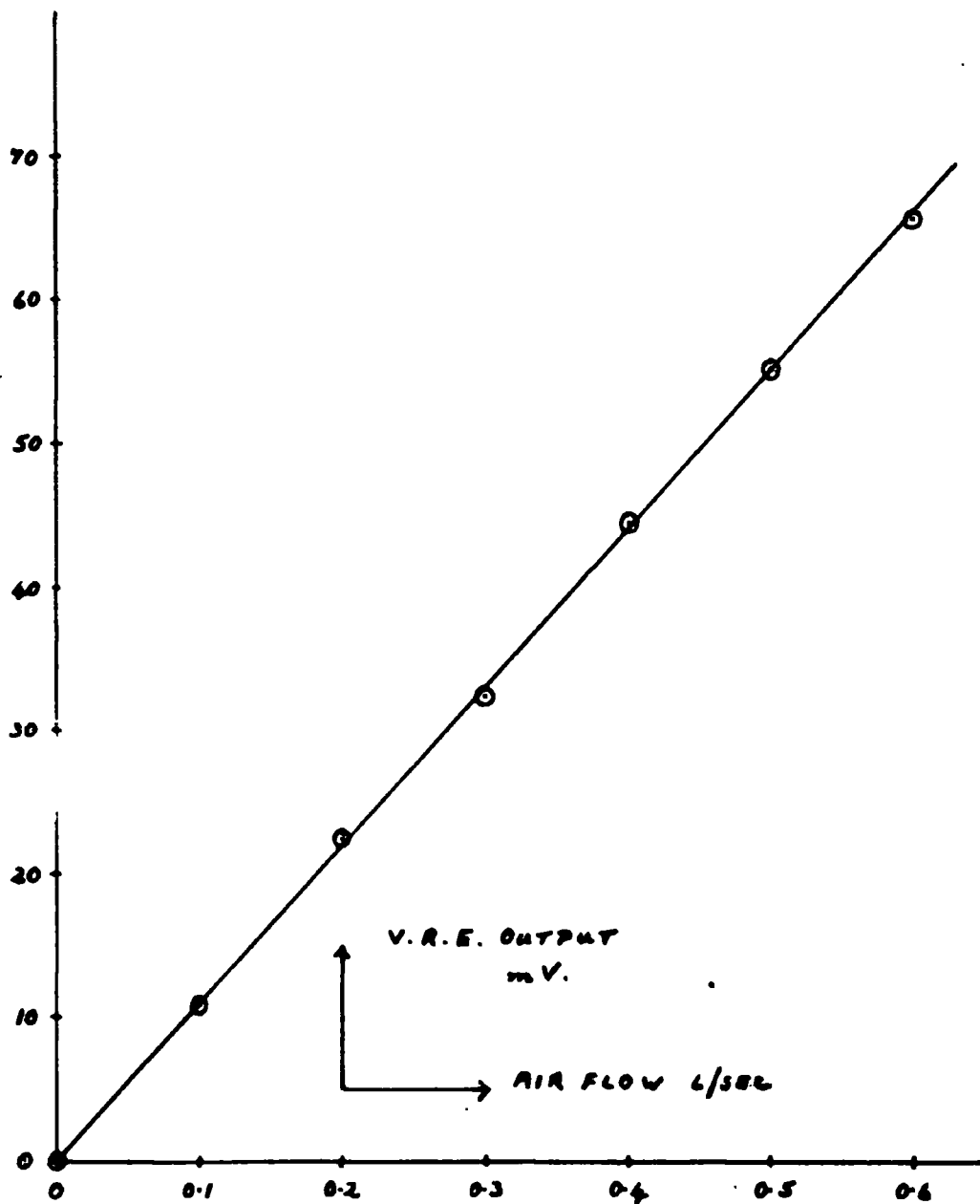

FIG 26.

A 4" anemometer was mounted close to the filter inlet and a calibration made of the air flow through the filter, against the setting of the Variac controlling the voltage, and hence the speed, of the suction motor. The resulting calibration, verified on three successive days is shown in Fig.25, the setting on the Variac was then marked corresponding to rates of flow from 0-0.6 L/sec. in steps of 0.1 L/sec.

After removing the anemometer, a test was then made to see if a linear relation existed between air flow and V.R.E. output. This was performed by placing a fan in the room in such a position that the air stream was not directed at the filter inlet, and suspending a smouldering piece of string in front of the fan thus producing a uniformly distributed smoke cloud in the room. The door was left open slightly so that the smoke concentration would not increase with time. After allowing the recording to proceed for 5 minutes with an air flow of 0.5 L/sec; during which time the V.R.E. output was observed, to verify that no alteration occurred in the reading; the rate of flow was altered, two minutes being allowed on each setting. At the conclusion of the measurements the reading for 0.5 L/sec. was repeated, checking for any alteration during the recording time. The graph produced is shown in Fig.26, and as can be seen the relation is linear within the measured range, the slope of the line is 110 m V per L/sec., corresponding to a space charge of $+1.1 \cdot 10^{-10}$ C/m³, with a V.R.E. input resistor of 10^{12} ohms. This space charge corresponds to a concentration of approximately 600 elementary electronic charges/cm³, which is of the same order as found by Kinman who tested his apparatus using cigarette smoke.

Using an air flow of 0.5 L/sec and the 10^{12} ohms input resistor, the relation between space charge measured ρ , and the V.R.E. output v is:

$$2 \rho = v 10^{-15} \text{ C/m}^3$$

or expressing the output in mV will give the space charge in 10^{-12} C/m^3 . In S.2.3² it was shown that if the potential gradient can be measured to an accuracy of 3% in fair weather conditions, then a measure of space charge to within $\pm 3 \cdot 10^{-11} \text{ C/m}^3$ is obtainable. However using the filtration method and taking the stability of the V.R.E. to be 1 mV, an accuracy of more than ten times this value is obtained, but subject to the objections stated in S.2.1.

Because of the circuit employed in the V.R.E.; where the input resistor has it's lower end connected, not to earth, but to a feedback line; a zero for the galvanometer cannot be obtained by simply earthing the filter output. For this purpose the suction motor was switched off for approximately 5 mins. every half hour, giving a zero for no air flow. To check that this coincided with the zero input reading, the range selector switch was turned to it's 'Set Zero' position five minutes before the recording camera was turned off in each recording session.

Since the filtration apparatus was not installed and working until 14 March 1958, it was not possible to compare results obtained before this date, for the two methods.

CHAPTER VII

RESULTS OBTAINED IN FAIR WEATHER CONDITIONS

7.1. Introduction.

Since only 7 months remained available for recording after the apparatus had been erected ready for operation, it was decided to make a general study of space charge in various weather conditions, rather than to concentrate on a few selected aspects. This meant that for any given meteorological condition only a few recordings would be available for study. The average length of a recording session was from two to three hours giving approximately 150 readings from each record.

The records are classified according to the prevailing conditions of potential gradient and weather. Fair weather recordings are those where no precipitation fell at any time in the recording period, no mist was present and the potential gradient remained within the range 0 - +400 V/m. These last two conditions were really synonymous and the recordings were classed as fair weather unless mist or fog was sufficient to cause the potential gradient to become negative.

In a large number of cases the potential gradient traces showed variations of the order of 10 to 20 mms., corresponding to changes of 10 to 20 V/m in a matter of 2 secs. Because of the difficulty of reading off the exact value at the appropriate minute interval, the mean of these changes was estimated introducing a reading error of not more than ± 2 V/m. This error will be random and will not introduce a serious inaccuracy when a statistical average is obtained from a number of readings.

Space charge values are calculated from Poisson's equation:-

$$\epsilon_0 \frac{dF}{dx} = - \rho$$

where F = change in potential gradient
over height change dx , in V/m .

$$\epsilon_0 = 8.854 \cdot 10^{-12} \text{ Farads /m.}$$

giving the mean space charge in Coulombs/ m^3 over a height dx . In the majority of cases this equation becomes:-

$$\rho = \epsilon_0 \frac{(F_L - F_U)}{h}$$

where F_U and F_L are potential gradients registered by upper and lower mills respectively, and h is the vertical height between the mills. This value will be referred to as ρ_{1-3m} or ρ_{1-5m} , even though the actual heights of the mills are 15 cms below these values.

In a few cases the space charge between ground and lower mill was calculated using the potential gradient difference between Agrimeter and lower mill, also using the difference between lower mill potential gradient and that calculated from it's potential i.e. the average potential gradient over 0 - 1 m. These values are both referred to as " ρ_{0-1m} ", but the source of the information is indicated to avoid confusion, where this is not obvious.

In discussing the results obtained, the actual records will not, in the main, be referred to because of the difficulty of interpreting from potential gradient changes what is the character of space charge variation. This will also be complicated by the two traces not necessarily showing the same sensitivity nor having the same zero point. For analysis therefore plots are shown of space charge values against time, with also the potential gradient shown which is, unless stated otherwise, the mean value over the height 0 - 85 cms calculated from the

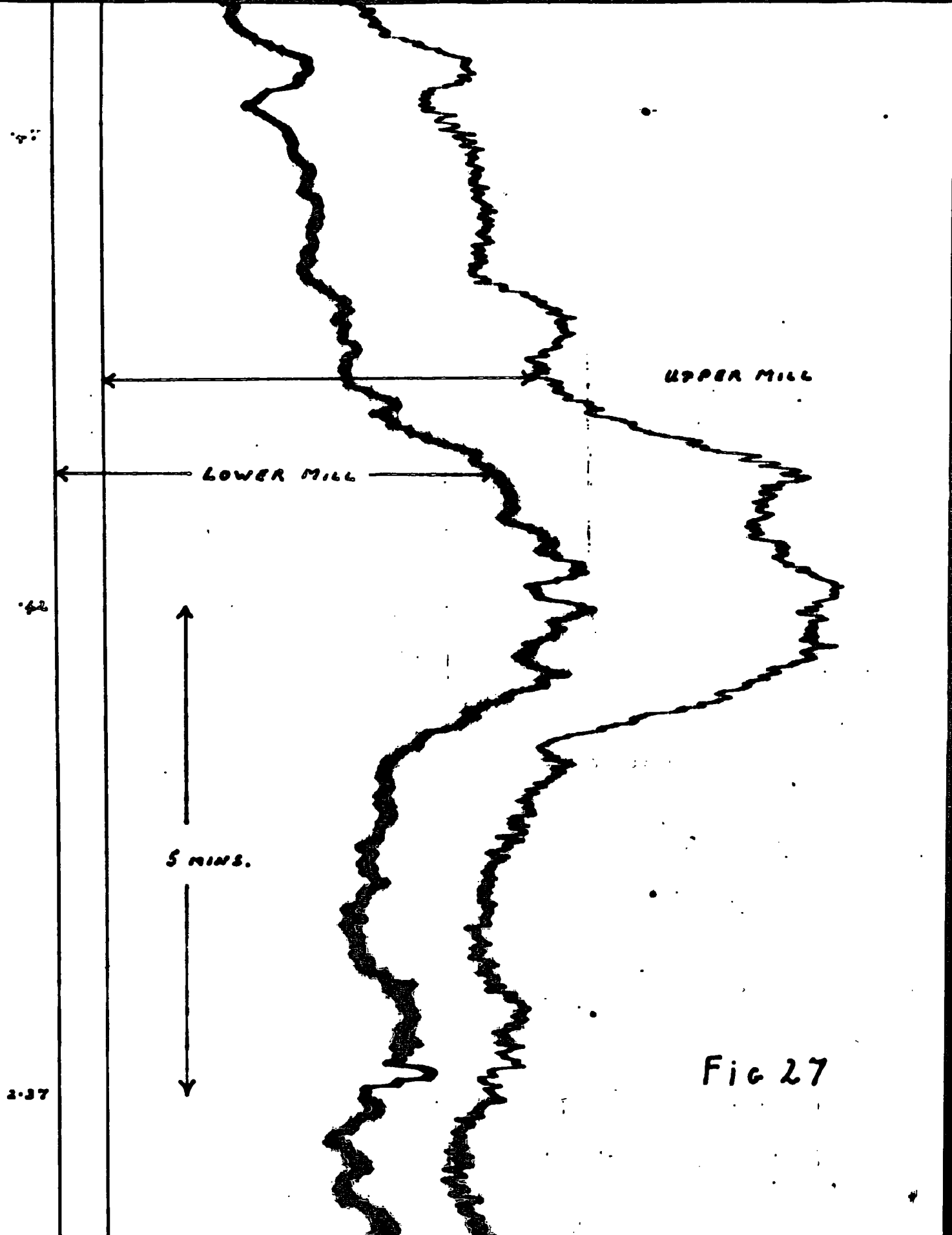

UPPER MILL

LOWER MILL

5 MINS.

Fig 27

42

42

2-37

5 MINS.

CHANGE OF INPUT
SELECTOR
ON UPPER MILL

ACCELERATOR

UPPER MILL

LOWER MILL

Fig 28

AIR FILTER

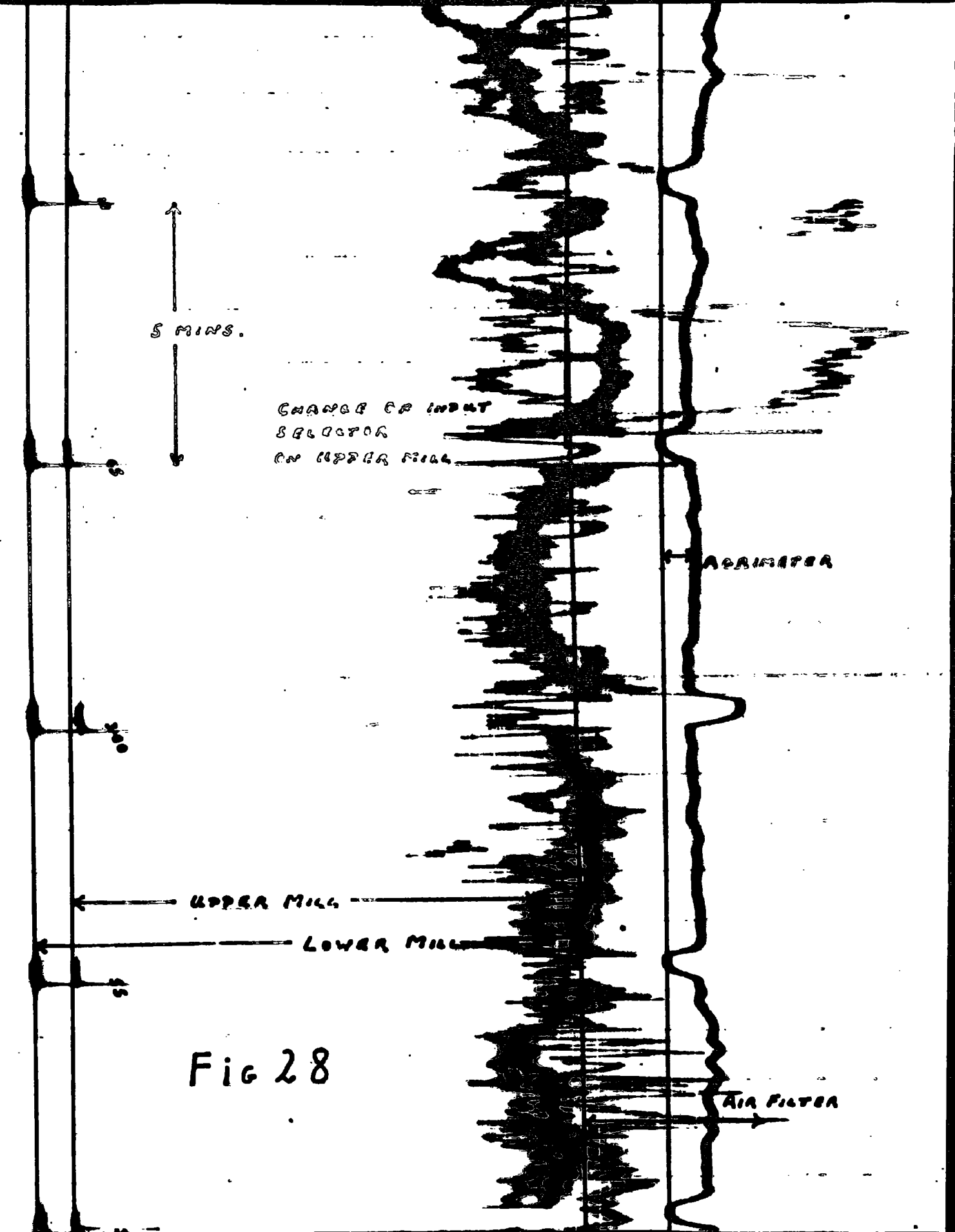

potential of the lower field mill, which remained at a height of 85 cms throughout. These plots will be referred to by their original record number and not given a figure number.

7.2. Effects of Wind Speed and Direction.

In fair weather conditions it is reasonable to assume that most of the space charge existing in the air close to the ground resides on large ions i.e. ions of mobility in the order 10^{-3} C.G.S. units, since the only natural sources of small ions, mobility approximately 1 C.G.S. units, are ionization of the air due to cosmic radiation and possibly radioactivity in the earth's crust. This being so, then it is to be expected that charge will pass overhead with approximately surface wind velocity, and the variations will increase in frequency and consequently amplitude with increasing wind speed.

This effect can be clearly seen by comparing Fig.27 with 28, which are actual records of the two potential gradient traces. Fig.27 is a record taken in fine sunny conditions, clear sky and a very slight westerly wind of not more than two or three ft/sec velocity. Compared with this, Fig.28 was taken when a certain amount of Cumulus cloud was evident, the wind was again westerly but this time much stronger with a speed of approximately 15 ft/sec. The short period fluctuations are much larger on the upper mill trace where the B.R. sensitivity is the same as in Fig. 27. The lower mill is operating on a reduced sensitivity and shows approximately the same degree of fluctuation. On the latter record the air filter trace can also be seen to possess quite large fluctuations, even

though the V.R.E. was set at it's lowest sensitivity.

The automatic earthing of the galvanometers by the timing circuit, was not in operation on Fig. 27 and the zeroes had to be drawn in from their position at the end of the recording. Comparing this with the zeroes obtained in Fig.28, it is seen that alterations of ± 1 mm can easily occur within the recording time, leading to a systematic error if the timing circuit were not employed.

On examining the size of space charge variations to which these short period fluctuations of potential gradient correspond, it was found that the average value in Fig.27 was $10 \mu\mu\text{C}/\text{m}^3$ compared with $40 \mu\mu\text{C}/\text{m}^3$ from Fig. 28, which is a ratio of 1 : 4 compared with a wind speed ratio of 1 : 5 approximately. These values are quite good in agreement considering the difficulty of estimating average wind speed, and also that the amplitude of the fluctuations was taken to represent the frequency. Taking the values from Fig.28, and the period of oscillation to be 2 secs., then in a volume of air 30 ft long an alteration in space charge of $40 \mu\mu\text{C}/\text{m}^3$ may take place during the passage of this volume overhead. This means that in a horizontal distance of one metre, considering the air at rest, a variation of approximately $4 \mu\mu\text{C}/\text{m}^3$ can be expected.

Considering how this effect will influence the comparison of recordings made with the other instruments erected on the site (see Fig.20), and taking the unfavourable condition when the wind direction is along a line from the double mills to the instrument concerned in each case then:

- 1). The Filtration Apparatus may register $\pm 20 \mu\mu\text{C}/\text{m}^3$ difference in space charge to the field mills.
- 2). The conventional field mill at R.C., with which a

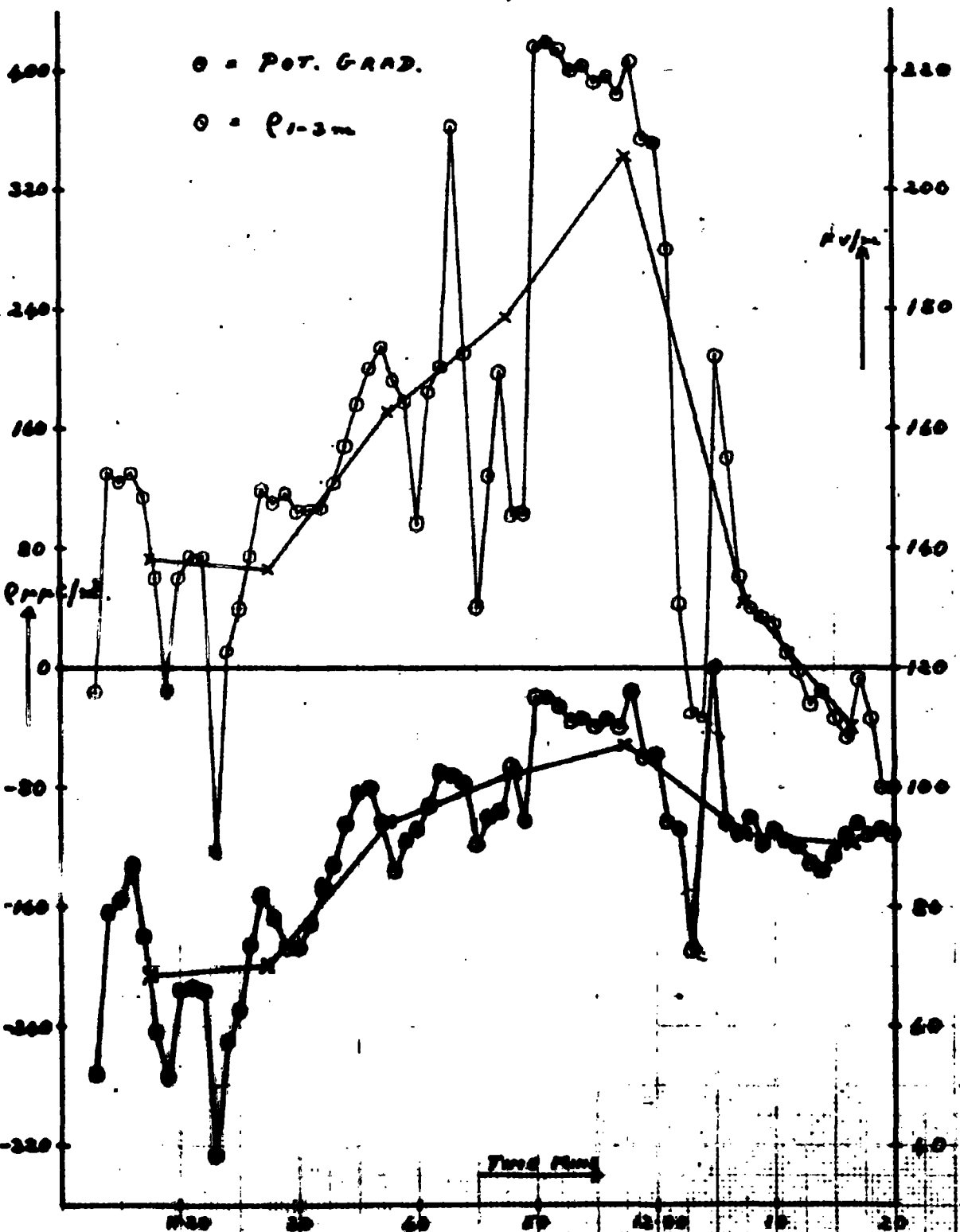
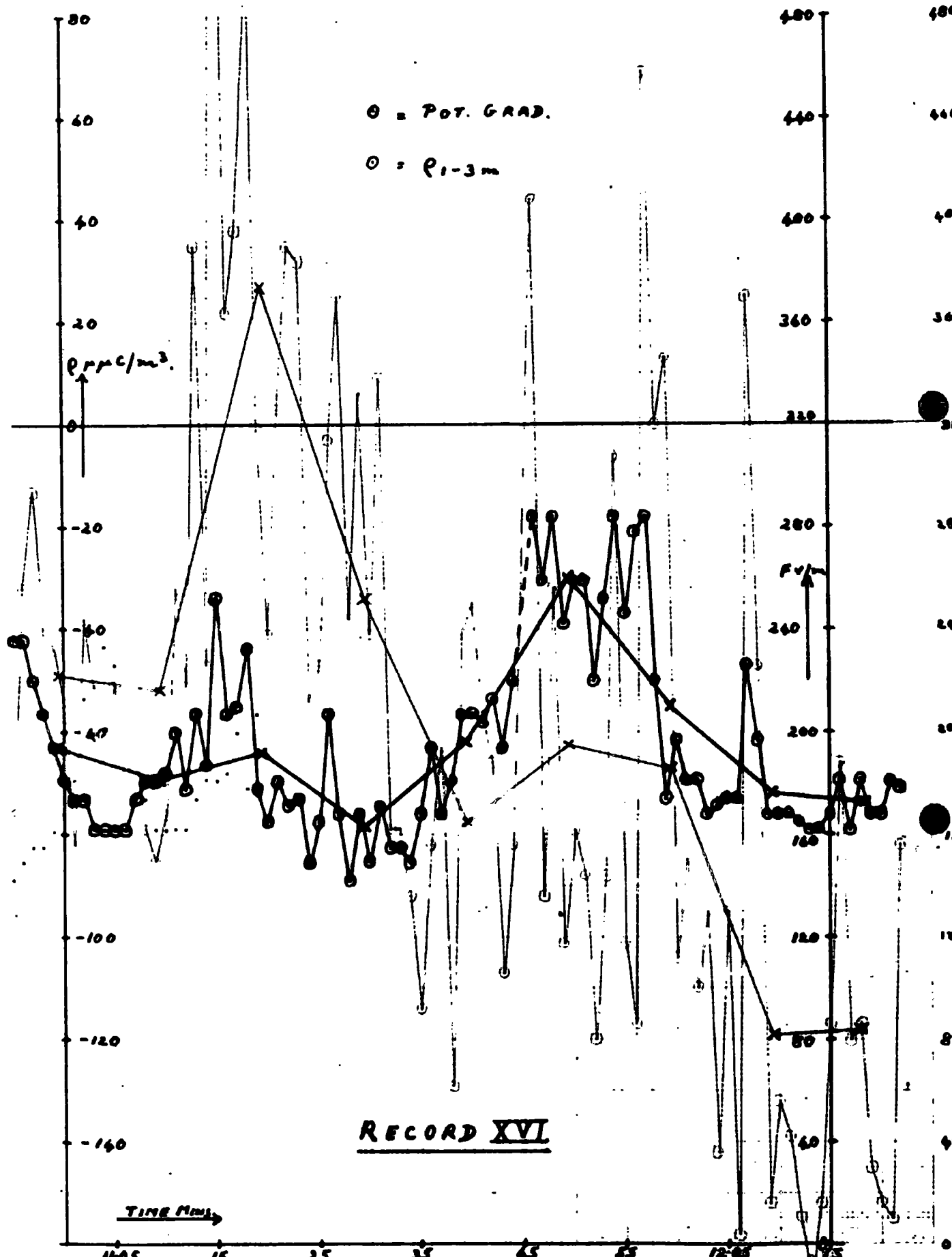

Figure 1



trial potential gradient comparison was made in Fig. 23, may register a difference of as much as 5.9 V/m.

3). The Agrimeter; a difference of ± 6.3 V/m.

It is assumed in cases 2) and 3) that the space charge difference between the two points exist only for one metre in height, which is not necessarily the case.

A total of six fair weather recordings were made, five with westerly wind directions and one with a wind from the North. For comparison purposes a part of record V (with a northerly wind) is shown together with a portion of a typical westerly wind record. In addition to the individual points indicated by circles, averages over 10 minute periods are indicated by crosses.

The two records cover roughly the same time of the day and on both occasions the sky was cloudless. Record V was taken in November and it can be seen that the potential gradient is of a much lower value than record XVI taken in January, but the space charge values in the former are much higher than in the latter. A possible explanation of this will be proposed in the next section, but the significant point is that, although the order of fluctuations occurring in a time of 2 or 3 minutes are comparable for the two recordings, the average value of charge found from the whole of the recording in each case, is $+ 66.9 \mu\mu\text{C/m}^3$ for the former and $- 58.7 \mu\mu\text{C/m}^3$ for the latter. The explanation of this phenomenon comes from the fact, mentioned in S.5.1., that to the north of the site is Durham City and the source of the high positive charge is the smoke originating mainly from domestic fires. There are, of course, sources of smoke to the west of the site also, but not in sufficient quantity or near enough

to give the same concentration as from the northerly sources.

7.3. Variation with Potential Gradient.

In all the records taken no sign of the 'Electrode effect', as defined in S.I.1., could be detected.

Adkins (1958) showed that in normal values of potential gradient the naturally occurring fluctuations in small ion density, will obscure this effect and it can only be detected up to a height of 2 m in potential gradients exceeding 500 V/m, or at greater heights with correspondingly higher potential gradients. Since the lower mill was set at 85 cms, it was possible in the highest values of potential gradient encountered i.e. 280 V/m, that the effect would just be apparent between the two mills, but since this value was not sustained for more than one or two minutes no aggregate increase in space charge could be expected to occur.

It is seen in the portion of record XVI shown, and also occurring less frequently in record V, that fluctuations in space charge taking place over one or two minutes produce corresponding fluctuations in potential gradient at the ground. In longer times, of the order of 10 or 20 mins., no agreement seems to exist. Record XVI for instance, indicates a general decrease in space charge values with the potential gradient remaining generally in the region of 180 V/m when it might be expected to decrease correspondingly.

Considering the vertical potential gradient at a point, height h above the earth's surface, at a horizontal distance S from a vertical line of charge q / unit length,

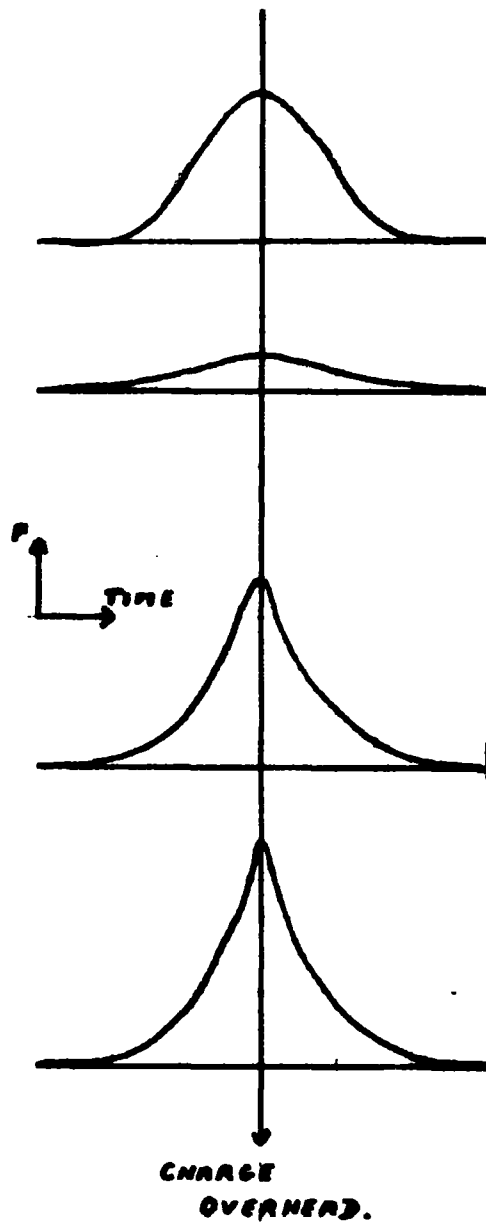
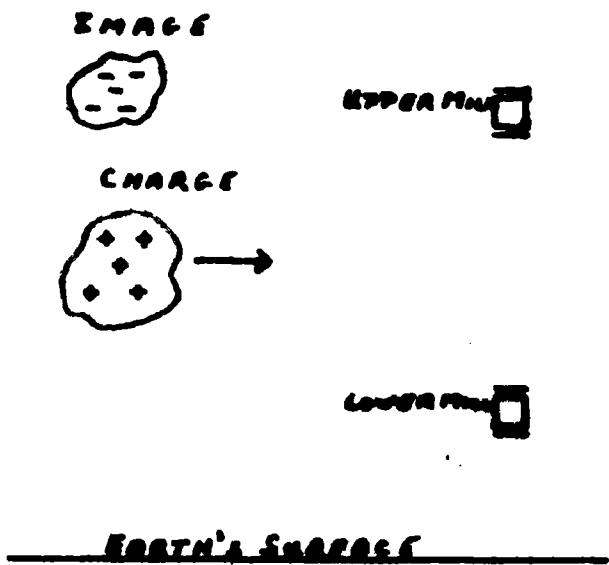
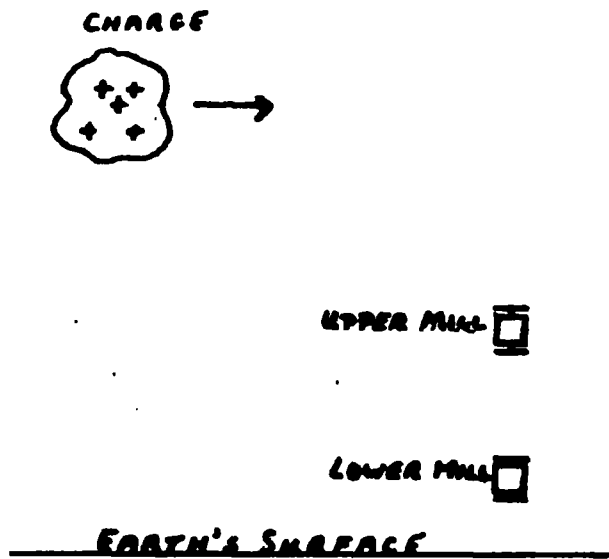

Fig 29.

of length $2l$ with its centre at a height y above the earth's surface, it can be shown by simple electrostatic theory that:-

$$F_y = \frac{q}{\epsilon_0} \left\{ \frac{l}{[s^2 + (y-h-l)^2]^{\frac{3}{2}}} - \frac{l}{[s^2 + (y-h+l)^2]^{\frac{3}{2}}} + \frac{l}{[s^2 + (y+h-l)^2]^{\frac{3}{2}}} - \frac{l}{[s^2 + (y+h+l)^2]^{\frac{3}{2}}} \right\}$$

Comparing the effect at field mills placed at heights of one and three metres, produced by a charge of $+1 \mu\mu\text{C}$ of length 1 m at a height of 10 m , substituting these values in the formula give the vertical potential gradients at the lower and upper mills respectively of:-

$$F_L = 1.10^{-4} \text{ V/m}$$

$$F_U = 9.5.10^{-5} \text{ V/m} \quad \text{when } S = 20 \text{ m}$$

but when $S = 0$, $F_L = 1.7.10^{-4} \text{ V/m}$

$$F_U = 1.7.10^{-3} \text{ V/m.}$$

With the charge at a height of 2 m however,

when $S = 20$ $F_L = F_U = 0.$

and $S = 0$ $F_L = .0817 \text{ V/m}$

$$F_U = .0776 \text{ V/m.}$$

No advantage is achieved in working out further values, because the concept of a space charge cloud as a line of charge is extremely tenuous. This consideration however is sufficient to give an idea of the nature of the changes in potential gradient as a cloud of charge approaches the apparatus. If the charge passes over the mills, then the rise (considering positive charge) in potential gradients at the two mills is a gradual one, see Fig.29. When the cloud is directly overhead, the upper mill will show a larger value than the lower mill, indicating an apparent negative charge passing between the two. This apparent negative charge will decrease with increasing height of

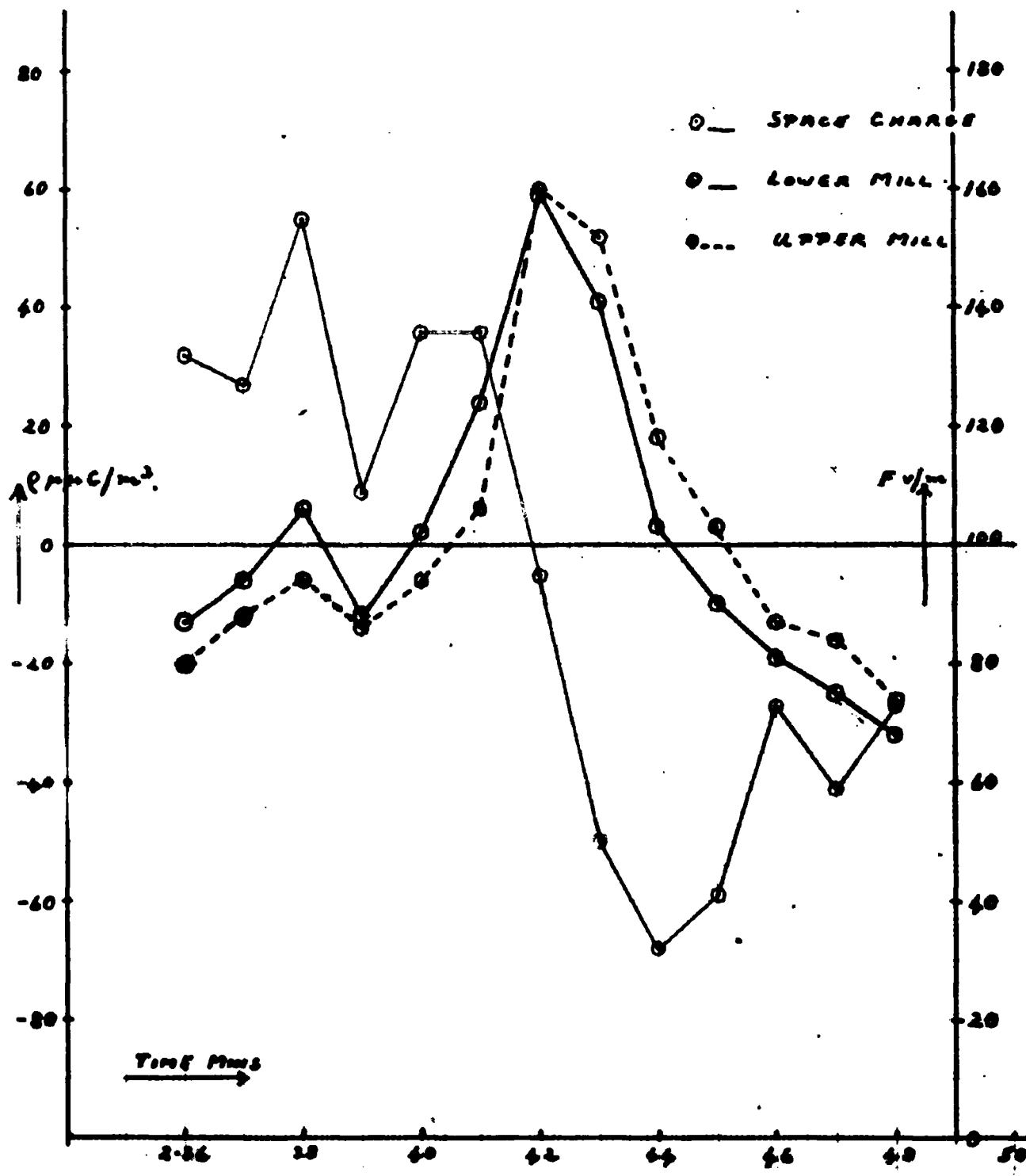

FIG 30.

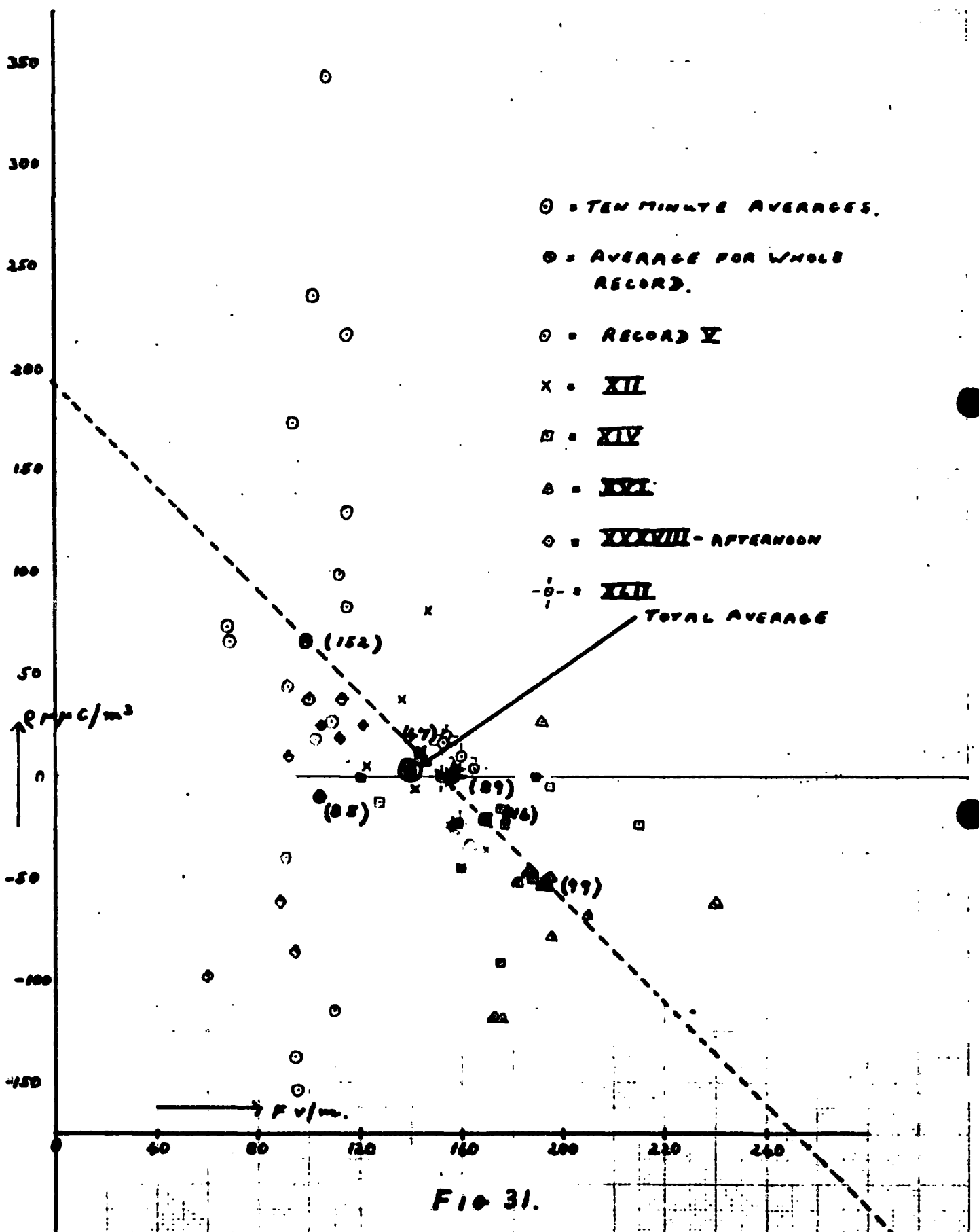

Fig 31.

the cloud.

The results of analysis of the portion of record shown in Fig.27, are plotted in Fig.30. This illustrates the effects produced in the passage of a fair weather cumulus cloud overhead, the charge associated with this type of cloud can be attributed (Whitlock and Chalmers 1956) to the convective cell produced beneath the cloud, containing positive charge. The analysis shows a very marked agreement with the predicted result from Fig.29. Other explanations are of course possible to account for this 'mirror image' effect shown in fluctuations occurring in times of the order of 10 mins., and will be discussed in the following paragraphs. From Fig.29 it is now obvious that the 1-2 min. fluctuations shown in records XVI and V, where the space charge produces the correct change in potential gradient, result from charge passing between the two mills.

To investigate further the mirror image effect produced in long period potential gradient changes; and also to arrive at a possible explanation of the number of records which shown an average negative space charge, when, as pointed out in S.1.1., a net positive charge should exist in the air close to the ground, a plot was made of average space charge against average potential gradient for the six records taken. This plot is shown in Fig.31, the figures on the record average points give the number of one minute readings which contribute to the average. It is perhaps a coincidence that five of the six record averages lie exactly on a straight line, but the plot indicates anyway the tendency to give a line of negative slope. Neglecting the results from record V, where the positive charge arises from smoke as explained in S.7.2., the mean

charge given by the other five records is $-19.15 \mu\mu\text{C}/\text{m}^3$

This negative value of charge in the region 1-3 m may have its origin in the Reduction Factor (S.3.2.) for the lower mill being larger than that for the upper mill, thus in a fair weather potential gradient indicate a negative space charge.

Let $\frac{1}{R}$ = ratio of lower mill to upper mill reduction factors, or R = ratio of 'exposure factors'.

F_U and F_L be potential gradients indicated by upper and lower mills respectively, and an average space charge between the mills of $\rho \mu\mu\text{C}/\text{m}^3$.

Then Poisson's equation gives:-

$$R \cdot F_L - F_U = \rho \cdot \frac{2}{8.854} \text{ --- --- --- --- --- (1)}$$

where the mills are 2 m apart. This indicates a straight line similar to the one obtained in Fig. 31 if ρ is assumed constant. The average space charge from all the recordings is $+2.97 \mu\mu\text{C}/\text{m}^3$, and the average potential gradient $F_L = 140 \text{ V/m}$, hence:-

$$F_L - F_U = \frac{2 \cdot 2.97}{8.854} = 0.771 \text{ V/m} \text{ --- --- --- --- (2)}$$

assuming R to be unity.

Solving equations (1) and (2) for R gives a value of 1.011, if an actual space charge of $+10 \mu\mu\text{C}/\text{m}^3$ is taken to be correct. Such an exposure factor is not at all improbable due to the shielding effect of the posts and would, if present, render the argument put forward for a radioactivity effect less probable.

Investigation of the relative reduction factors for the two mills would not be difficult if they could be raised and lowered quickly, enabling a relation to be obtained between measured potential gradient and height, in settled

weather conditions. For the apparatus in use, this procedure would not be possible in a time short enough compared with the time taken for conditions to alter appreciably, however 'settled', thus invalidating the results obtained.

It was shown in S.5.2. that the B.R. balancing error in potential gradients greater than 100 V/m was ± 3 volts, for an input selector value of 1, and the mill at 1 m height. So to investigate the presence, or otherwise, of a shielding effect by the supporting posts, an occasion was chosen when the potential gradient was in the region of 400 V/m. The lower mill was set in operation and the Brown Recorder observed whilst an earthed metal post 6 m long was alternately raised and lowered, with its base initially 6 m from the mill and moved towards the mill in half metre steps. No movement in the B.R. slide could be detected to coincide with a raising or lowering of the post, until it approached within a distance of 5 m from the mill. This test then giving a result, that for a metal post at 5 m, the exposure factor is less than 1.008.

How far a metal post at 5 m, can be held to be equivalent to four wooden posts of an equal height at $4\frac{1}{2}$ m is not certain, but it is a safe assumption that the screening effect of the wooden posts will be less than the single metal post, so the exposure factor will be less than 1.005. This brings the error introduced by screening, in the measured potential gradient to $-\frac{1}{2}\%$ on a single mill, and the effect on the relative exposure factor of the lower to the upper mill will be less than this value.

Although the screening effect of the posts introduces an error which is quite low compared with the accuracy of balancing the mill potential, it must be remembered that

the latter is a random error which is reducible by performing a large number of readings, whereas the former is a systematic error giving an apparent space charge opposite in sign to that of the potential gradient, and of a size proportional to the potential gradient and inversely proportional to the measured space charge. Thus allowing for a maximum relative exposure factor of 1.005, the average space charge found could be as high as $+6.51 \mu\mu\text{C/m}^3$ i.e. more than double the determined value of $+2.97 \mu\mu\text{C/m}^3$.

Examining the graph produced in Fig.31 of measured space charge against potential gradient, to determine the effect on the slope of different values of R. Poisson's equation gives:-

$$\frac{\rho_A}{F_L} = \frac{\epsilon_0(R-1)}{h} + \frac{\rho_M}{F_L} \quad "$$

where ρ_A and ρ_M are the actual and measured (assuming $R=1$) space charge values. The slope $\frac{\rho_M}{F_L} = -1.25 \mu\mu\text{C/m}^3$ per V/m,

so a value of $R = 1.28$ would be necessary to reduce $\frac{\rho_A}{F_L}$ to zero.

In other words, to account for the mirror image effect by a difference in exposure factors of the field mills alone, the ratio of lower to upper must be at least 1.28, which would require a shielding effect of the posts 50 times larger than the estimated one and so it is most improbable that the whole of the effect can be accounted for in this way.

An explanation of the negative charge found between one and three metres arises from the effect of radio-

active materials in the earth's crust. Ionization of the air in contact with the earth's surface takes place by a combined action of ionized air diffusing from the earth, and probably direct ionization of the air. By this process small ions of both signs are produced and under the influence of the field at the earth's surface, positive ions pass into the ground and negative ions move upwards. Taking a value of mobility of a negative small ion to be $1 \cdot 10^{-4}$ m/sec. for a potential gradient of 1 V/m (Chalmers 1957, p.55), and the average life to be 40 secs.-- assuming an average degree of air pollution. If all the negative ions are destroyed by capture with large ions or uncharged nuclei, i.e. no recombination of small ions, then all the negative small ions will be destroyed at an average height of 40 cms with a potential gradient of 100 V/m. Hence a layer of both large and small ions will be formed, extending to a height of 40 cms. Because of spurious effects due to diffusion and eddy currents present in the air, and also the small ion mobilities being distributed about the mean of 10^{-4} m/sec per V/m, the upper boundary of this layer can only be approximated in this way.

An explanation of the graph obtained in Fig.31 is now possible on this basis because the height of the negative charge layer will vary directly with potential gradient. From this graph the potential gradient required to give zero mean charge between 1 and 3 m is 150 V/m. Now this value will give a height of 0.60 m to the negative charge layer, and will not extend up to the height of the lower mill. It is obvious that the average value of mobility taken is too low, and $2 \cdot 10^{-4}$ m/sec per V/m is a much more likely value, bringing the negative charge up to 1.20 m. The amount of this layer above the lower mill will then

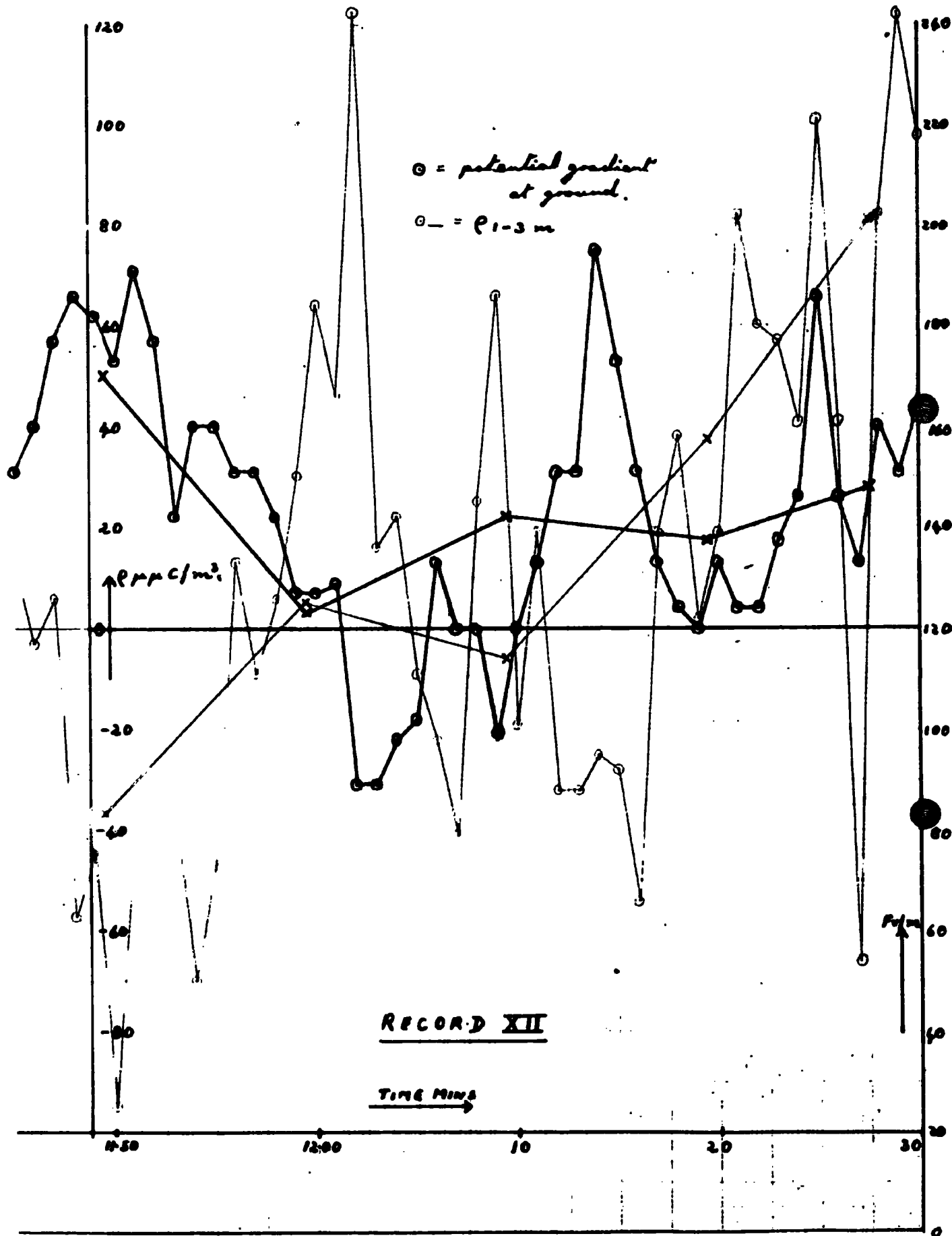

just balance the 'normally existing' positive charge, giving zero average charge between the mills.

To gain an estimate of what rate of ion pair production is necessary to produce the negative charge layer, assume that the 'normally existing' positive charge has a concentration of $+ 10 \mu\mu C/m^3$. Thus within a vertical column 1 m square between the mills, there exists a charge of $+ 20 \mu\mu C$. To give zero net charge within this column a charge of $- 20 \mu\mu C$ will have to be concentrated into a height $(1.20 - 0.85)$ m, taking the higher mobility value, giving a negative charge concentration of $- 57 \mu\mu C/m^3$. It may be safely assumed that this charge is uniformly distributed over 1.2 m height (whether on large or small ions), and corresponds to a charge of $-350 \cdot 10^6$ elementary electronic charges $/m^3$. If the small ions are singly charged then the rate of pair production is 350 per cc/sec. This is rather a high value to expect, but it may well be that the average value of positive charge is ten times smaller than the assumed one, reducing the necessary rate to 35 ion pairs per cc/sec.

Looking again at Fig.30, a time lag of 2 minutes is apparent between potential gradient maximum and space charge minimum, which fact favours the production of the negative charge by the radioactivity effect rather than the postulated apparent negative charge due to the passage of a cloud over the field mills. Record XII also shows the operation of the radioactivity effect in the first part quite nicely, but towards the end of the record an increase in positive space charge causes a corresponding potential gradient increase and obscures the effect. The divergence of the average results obtained from record XXXVIII, which show a negative space charge in potential

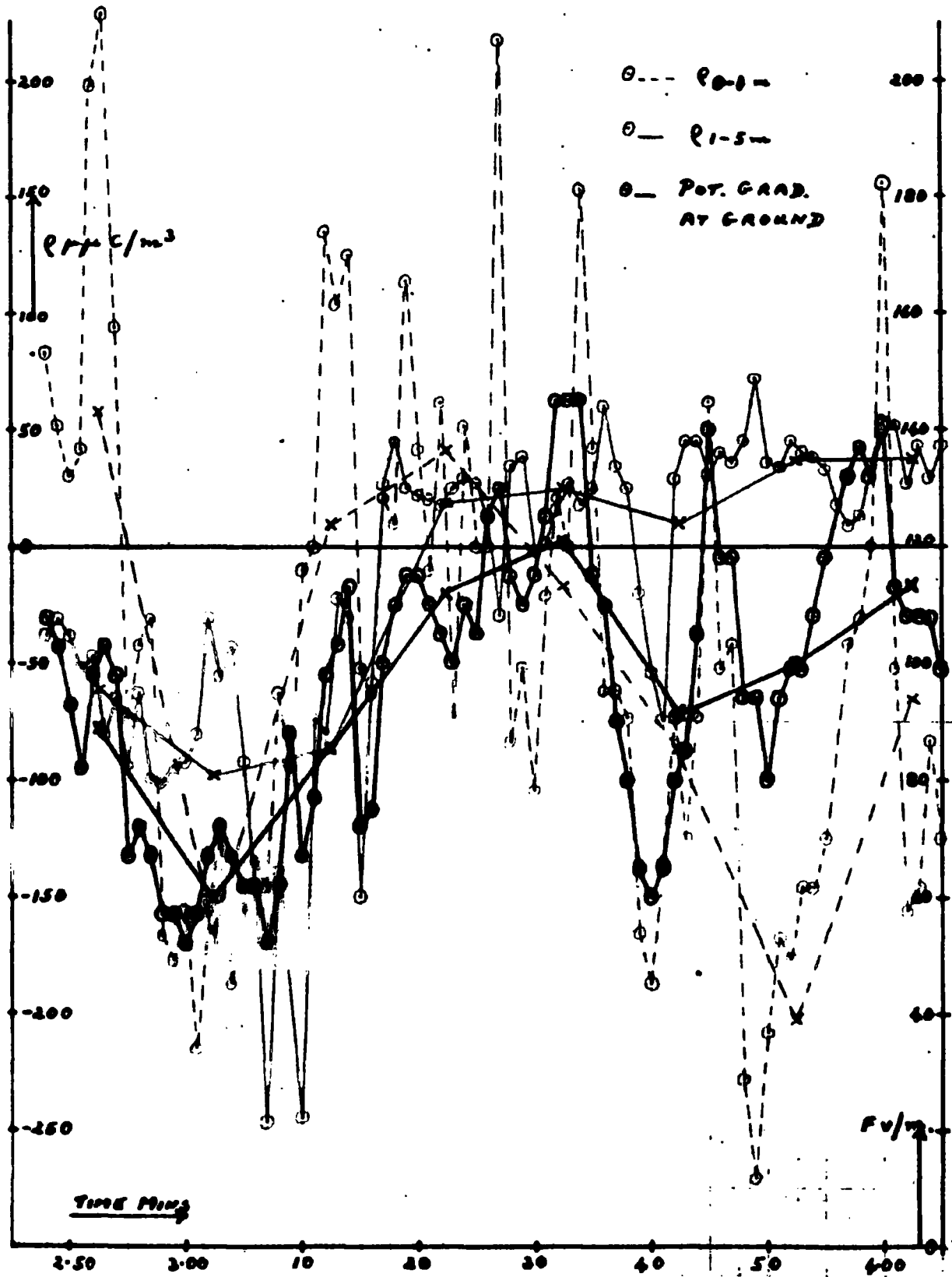

RECORD XXXVIII - AFTERNOON A.

gradients much lower than is expected, is probably due to very heavy rain which fell prior to this recording. The effect of the rain was to wash out most large ions and uncharged nuclei, in the absence of which, the negative small ions will travel a much greater vertical distance before being captured, thus raising the negative charge layer to a much higher level than normally is the case.

Because the 'mirror image' effect is dependant on the upper boundary of the negative charge layer being lifted above, or depressed below, the lower mill by variations in potential gradient, then studies of space charge density between the lower mill and earth should reveal the opposite effect i.e. an agreement between potential gradient and space charge fluctuations. In an attempt to investigate this, the space charge between the lower mill and earth was calculated using the potential gradient difference between the lower mill and the Agrimeter. As pointed out in §.5.3., because of the horizontal distance between the two instruments and the difference in time constants, fluctuations of the order 1 - 2 min may not give true space charge values but in times long compared with this, the error involved in this measurement should not be too serious.

A part of record XXXVIII (afternoon A) is given showing this space charge plotted against the potential gradient shown by the Agrimeter. In this recording the upper mill was in it's 5 m position and the space charge between the two mills is also plotted. A very good agreement is seen to exist between potential gradient and space charge from ground to one metre, as expected from the previous argument, but the 'mirror image' effect is not at all as clearly

R. 254 4 June 58

x = av. 5 min points ○-○ = P₁
 ● = ind. points ○-○-○ = (P₁ + P₂)
 ○-○-○ = P₂

RECORD XLII

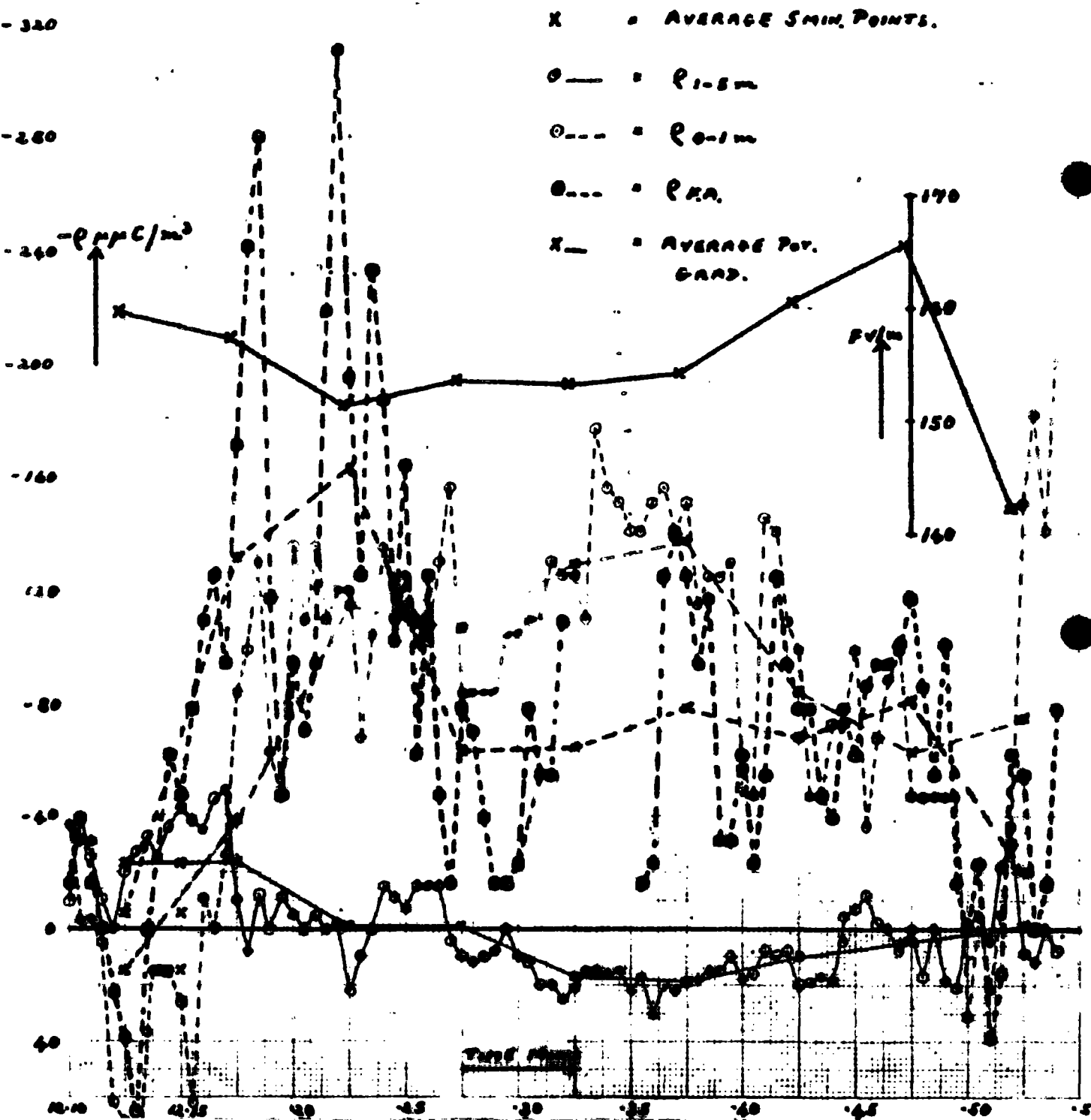

shown as expected in the absence of large ions and uncharged nuclei.

7.4. Comparison of Results with the Air Filter.

Because the height of the air intake of the filter is at 65 cms, then in view of the results obtained in S.7.3., the space charge values obtained from potential gradient measurements will, for comparison purposes, have to give an indication of the charge at approximately this height. To this end therefore, the space charge was calculated from the difference in potential gradient between the value given by the lower mill, and the value calculated from the potential of the lower mill. Assuming a uniform change in potential gradient between ground and 85 cms, the value calculated in the latter case will be that at 42.5 cms. Thus the space charge determined will be the mean value between 42.5 and 85 cms i.e. at approximately 65 cms, which should agree with the filter measurements.

Record XLII shows the result of a recording obtaining space charge values in this way, to avoid complicating the plot too much, the potential gradient is only shown as average values and is that calculated from the potential of the lower mill. The agreement between space charge measured by the two different methods is quite well marked, except between 12.13 and 12.36 where the filter shows much larger fluctuations than the corresponding field mill variations. From the average results it would seem that the filter measurements give space charge sampling from a slightly higher level than the lower mill potential results, indicating the incorrectness of the assumption that the potential gradient between the lower mill and ground varies

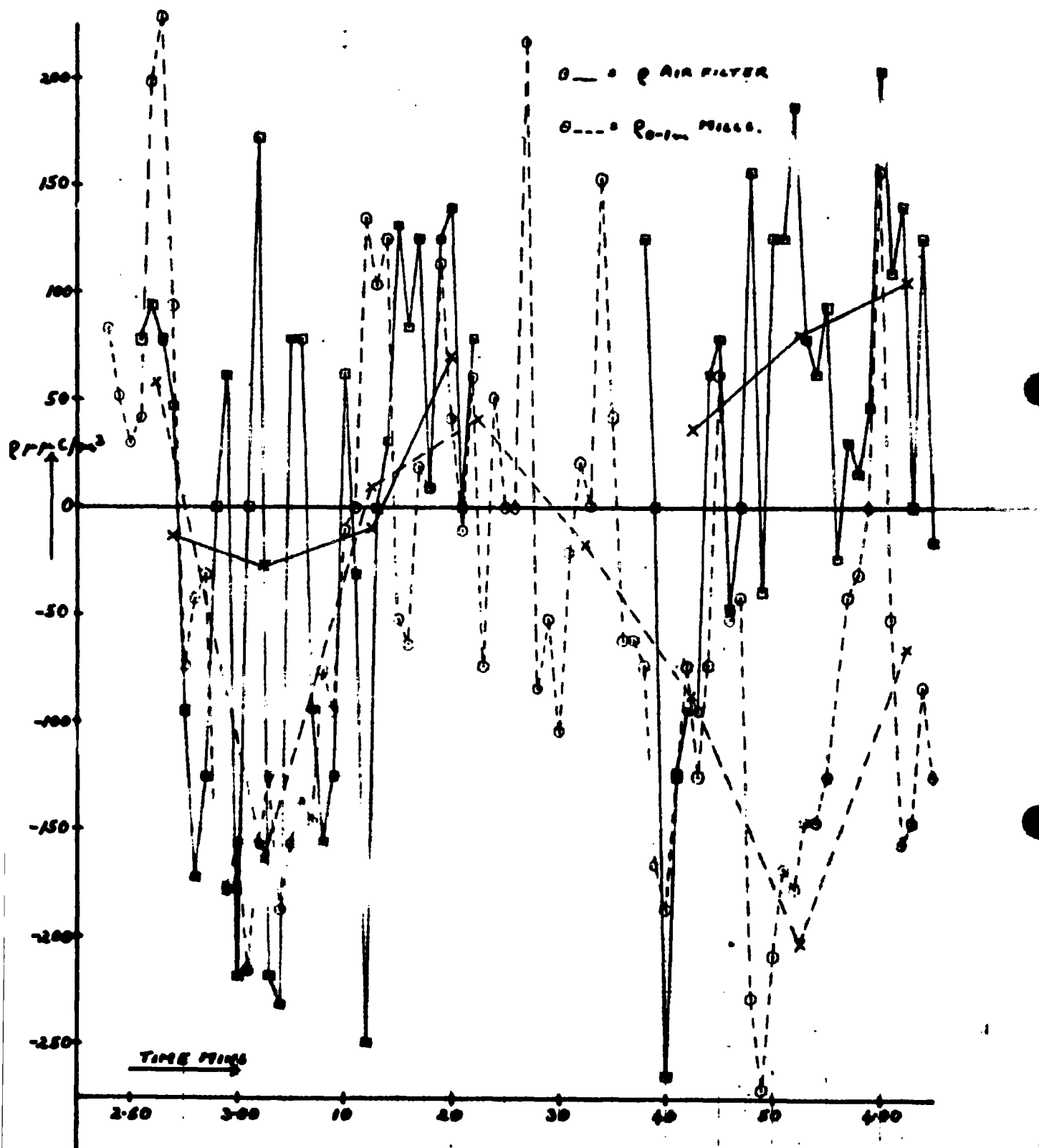

RECORD XXXVII - AFTERNOON 5.

uniformly with height. This has been shown in S.7.3. not to be the case anyway, so the filter results in this recording appear to confirm the results of this last section.

A further comparison with the filter is shown in record XXXVIII (afternoon B) where the space charge obtained from mill and Agrimeter readings is again shown over the same times as in XXXVIII (afternoon A), together with the air filter results. Although the agreement is reasonable for short period fluctuations, the average results show no such agreement. Comparing the A and B records it appears that as far as average results are concerned, the airfilter curve lies much closer to the space charge curve between one and five metres.

One of the major disadvantages inherent in the use of the Obolensky-type air filter (S.2.1.), is the probable selective filtering due to the bound charge on the earthed case of the instrument. This will lead to a higher value of space charge than actually exists in a positive potential gradient, and this effect will take place to a much greater degree for small ions than for large ones. The results obtained in this recording, where small ions constituted the main part of space charge values, confirm that this is in fact happening.

The average value given by the air filter for the whole recording is $+84.1 \mu\mu\text{C/m}^3$ and for $\rho_0 - 1m = -54.9 \mu\mu\text{C/m}^3$, showing a very large discrepancy between the results given by the two methods. The actual divergence will be less than this amount because at the height at which the filter samples the charge, the space charge concentration will be less than $-54.9 \mu\mu\text{C/m}^3$ which is an average value between ground and 85 cms.

In conclusion then, the filter gives space charge

readings which are in good agreement with those obtained from potential gradient measurements, but in conditions where small ions are present in any number, a difference between the results is to be expected of an amount depending upon the size of the potential gradient.

CHAPTER VIII

RESULTS OBTAINED IN DISTURBED WEATHER CONDITIONS.

8.1. Rain.

As previously mentioned (S.4.1.), the field mill itself behaved perfectly even in the strongest rain, and the mill output, although becoming a little 'grassy' due to splashing on the vanes, did nothing abnormal, indicating the efficiency of the collecting plate insulators. However two effects did become apparent namely:

- 1). The Tufnal insulating bars for the mill girder collected sufficient water on their surfaces to short out the girders to earth through the junction box covers, which are mounted on these insulators. This effect became immediately apparent by the Brown Recorders becoming suddenly unstable, due to the girder time constant being reduced. The situation was restored to normal by simply wiping off the surface moisture from the insulators.
- 2). Large charged drops of water falling from the upper mill impinged directly on the upper vanes of the lower mill, giving such a shock to the Brown Recorder that it required up to 10 secs. to return to it's balance point. This effect was not apparent in medium or strong winds because the drops were blown clear, but with light winds and heavy rain a balance point was impossible for the lower mill. A temporary cure could be effected by pushing the upper mill to one side, but it would soon work back to it's normal position and splashing would resume. If the heavy rain persisted then ultimately recording would be abandoned.

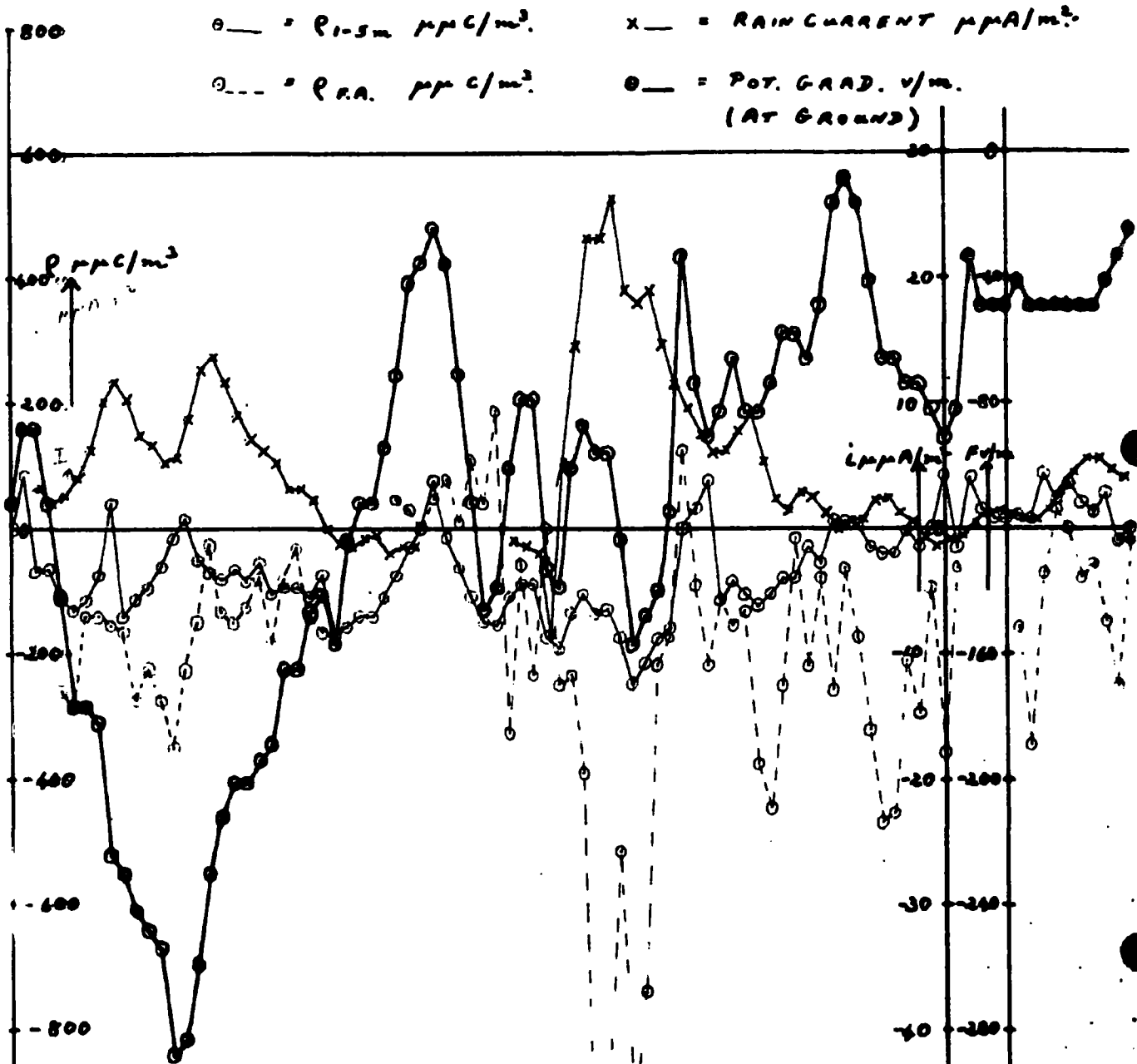

RECORD XXXVIII - MORNING A.

RATE OF RAINFALL
mm/min

TIME MIN

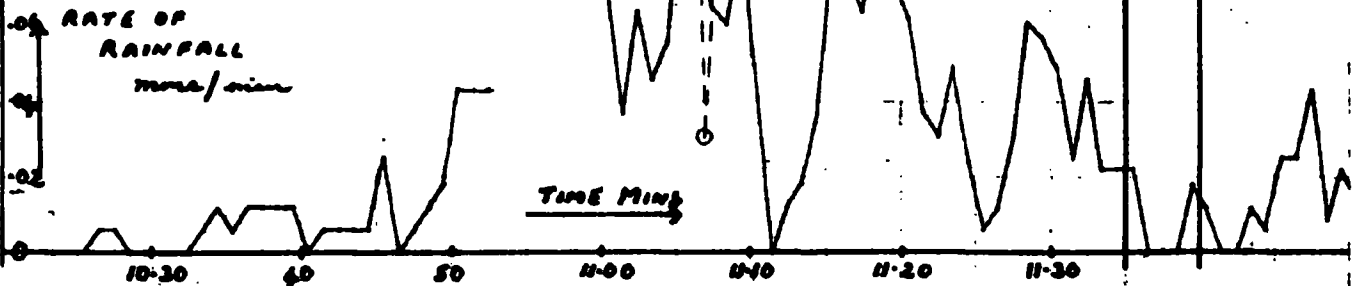

By shielding the air filter to prevent rain splashing directly on the air inlet and producing probable undesirable results, it was hoped to measure the 'background' space charge. The double field mills would give the total space charge, the difference between the two giving the charge on the rain whilst descending. By comparing this result with the rain current obtained at R.C. (Fig.20), valuable information would be obtained on any electrical effects due to splashing at the ground. However, according to Adkins (1958) the action of splashing in heavy rain is to produce small ions of opposite sign to that of the potential gradient.

As shown in S.7.4. in the presence of these small ions a 'background' charge measured by the air filter would be biased towards a space charge of the same sign as the potential gradient at the filter. This must be taken into account when an attempt is made to deduce rain charge from these measurements.

A portion of record XXXVIII (morning A) is shown where the rain current may be compared with the space charge measured by the two different methods with relation to rate of rainfall and potential gradient values. The first point to be noted from this record is that the space charge between 1 and 5 m shows no abnormally high values compared with fair weather conditions, indicating that even when the rate of rainfall is of the order 0.08 mms/min, no space charge due to splashing is detectable between these heights.

The indications given by the air filter however, seem to point to a negative charge of the order $1000 \mu\mu \text{ C/m}^3$ being generated at the highest rates of rainfall i.e. at a time of 11.08 a.m. on the record. At this time the potential

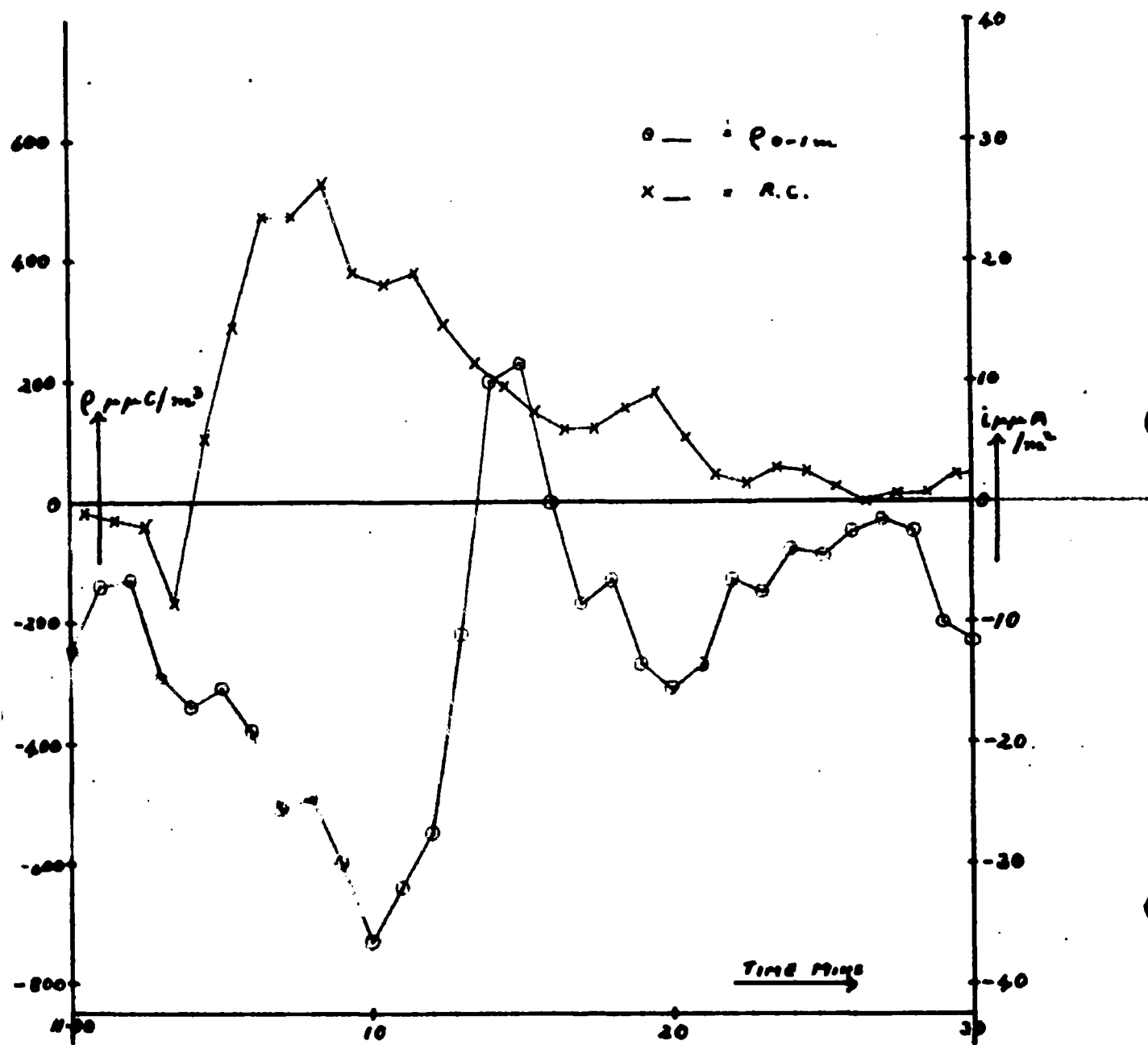

RECORD XXXVIII - MORNING B.

gradient at the ground is seen to be approximately -100 V/m which, if production of small ions arises from an Adkins splashing effect, would give a positive space charge and a negative current passing into the ground. To account for this opposition in sign of the space charge produced, it might be supposed that it is not the potential gradient at the ground which determines the sign, but that measured higher up (e.g. Adkins measured this value at 2 m height). In this case, a space charge within the first metre of $-1000 \mu\mu \text{ C/m}^3$ would give a potential gradient at 1 m of $+13$ V/m.

The plot of this record would become too confused if the potential gradient at the lower mill was also indicated, or the equivalent space charge between ground and lower mill, so a second plot - XXXVIII morning B - is shown between the times of 11.00 and 11.30 a.m. giving the calculated space charge from 0 - 1 m and the rain current. From this plot it may be seen that the form of the space charge curve follows more closely that of e_{1-5m} than e_{FA} but the order of changes shown are a little over a half e_{FA} at the time of heaviest rain. Taking a value of space charge at this point to be $-700 \mu\mu \text{ C/m}^3$ gives a potential gradient at 1 m of -11 V/m, still not bringing the potential gradient to the required positive value. At this point the value at 5 m is -22 V/m, showing a positive mean space charge between 1 and 5 m.

If it is assumed that the space charge is due entirely to small ions, then at 11.10 a.m. the current due to small ions entering the earth is $+7 \mu\mu \text{ A/m}^2$, where the potential gradient is 100 V/m, disregarding for the moment the discrepancy in sign. At this time the measured rain current is $+20 \mu\mu \text{ A/m}^2$, thus although part of the rain current can

be attributed to splashing, the greater part is carried on the rain itself.

During the heavy rain and afterwards this space charge (indicated by the air filter) was in general, more than that calculated from the potential gradient. As can be seen from the record up to 11.50 a.m., where the potential gradient remained negative, a lower value is obtained. However, at 11.52 the potential gradient changed sign and stayed positive for the remainder of the day, when the air filter registered a more positive space charge than the field mills. This, as already mentioned, prohibits the use of the filter readings in estimating rain charge after a rate of rainfall exceeding 0.06 mms/min, depending upon the nature of the ground which in this case was grass. A harder surface will probably require less heavy rain to produce the splashing effect.

In the earlier part of the recording, the rate of rainfall hardly exceeded 0.02 mms/min, so taking average values from 10.20 - 10.50 gives:-

$$\begin{aligned} \rho_{FA} &= -170 \mu\mu \text{ C/m}^3 & i &= +5.667 \mu\mu \text{ A/m}^2 \\ \rho_{0-1m} &= -109 \mu\mu \text{ C/m}^3 & r &= 0.006 \text{ mms/min} \\ E_g &= -182 \text{ V/m} & &= 0.36 \text{ mms/hr.} \end{aligned}$$

Best (1950) found a relation between drop size and rate of rainfall which can be expressed:-

$$W = C \cdot I^r \quad \text{where } W = \text{amount of liquid water in unit vol. of air, in } \text{mm}^3/\text{m}^3.$$

$$C = 67 \quad r = 0.846 \quad I = \text{rate of rainfall, in mms/hr}$$

manipulating this equation gives a relation between space charge due to rain and rain current:-

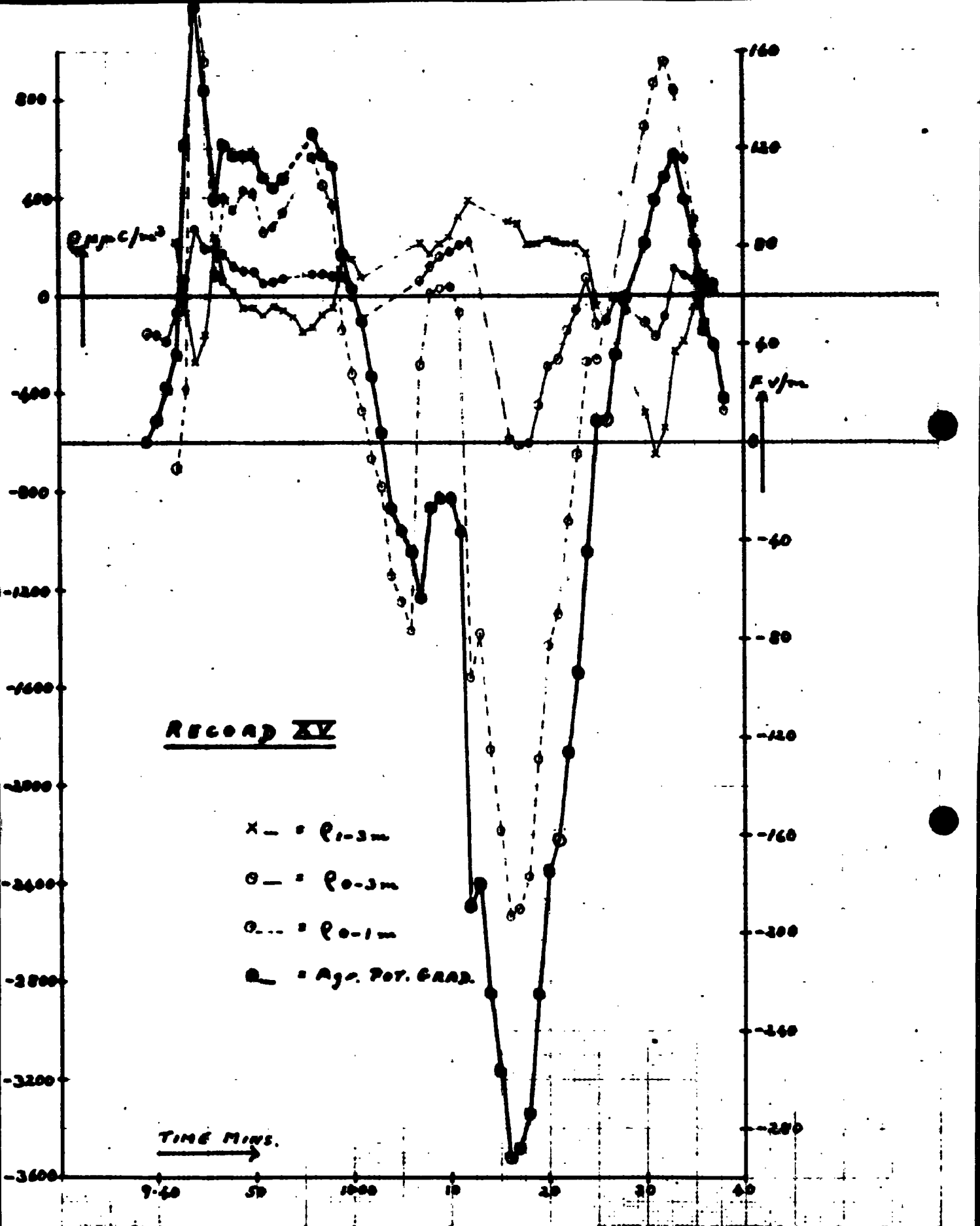

$$e = \frac{0.2412 i}{I^{0.154}} \text{-----} 3.$$

expressing i in $\mu\mu\text{A}/\text{m}^2$ gives a value of e in $\mu\mu\text{C}/\text{m}^3$.
Substituting the average values of i and I in equation 3 gives

$$e = +1.6 \mu\mu\text{C}/\text{m}^3$$

and comparing this value with

$$e_{0-1m} - e_{FA} = +61 \mu\mu\text{C}/\text{m}^3$$

it is seen that the space charge arising from the rain is negligible compared with the inaccuracy introduced by assuming that the field mills and air filter sample space charge at the same height.

Record XV shows the occurrence of a very heavy shower, unfortunately no rain current or rate of rainfall measurements were available on this occasion, but at the point of heaviest rain the rate of rainfall was estimated to be 0.2 - 0.3 mms/min. The rain commenced at 9.58 a.m. but did not become really heavy until 10.10, at 10.12 it became perceptibly less, finishing altogether by 10.21.

Relating these events to space charge variations, it is seen that immediately following the heaviest part of the shower the space charge between ground and 1 m decreased, reaching a very high negative value approximately six minutes after the heaviest rain. Here again the large negative charge produces a depression of potential gradient at the ground, the value at 1 m remaining in the region of -30 V/m, but the space charge produced, as in the previous record, being of the same sign as the potential gradient. The space charge recovers its original value 10 mins after the negative maximum, presumably by the small negative ions ascending above the level of the lower mill, and being captured by larger nuclei.

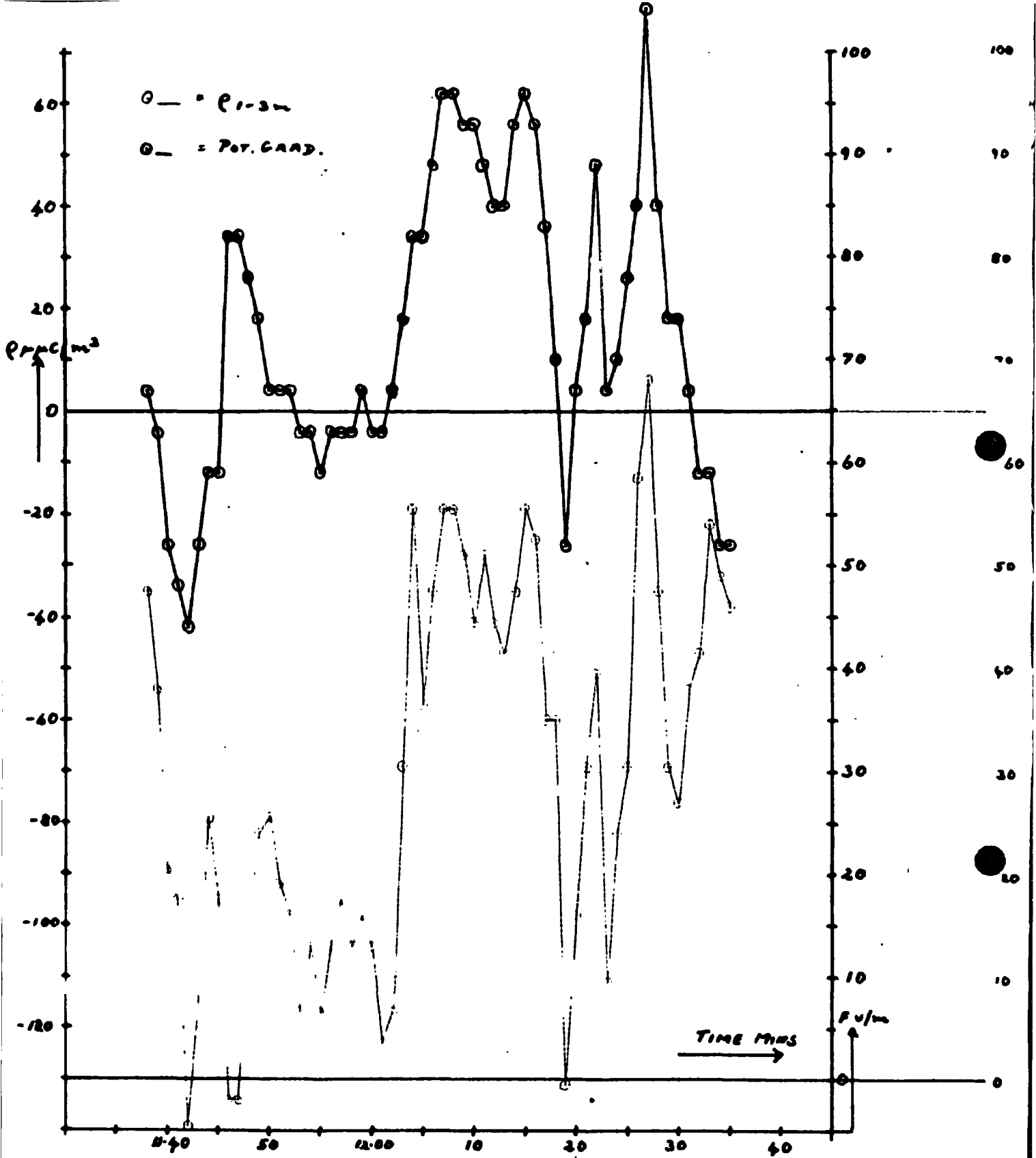

RECORD XXII

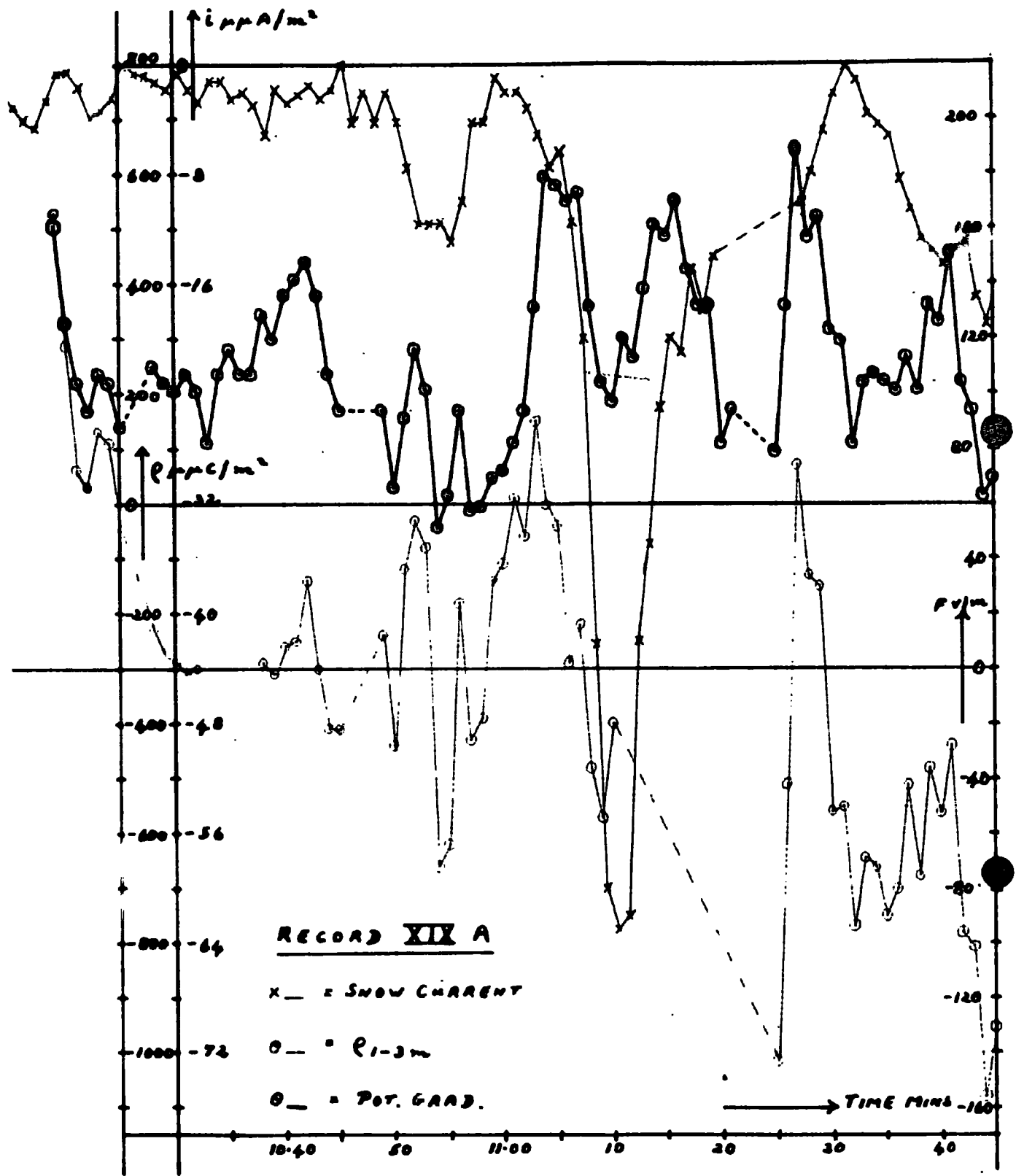

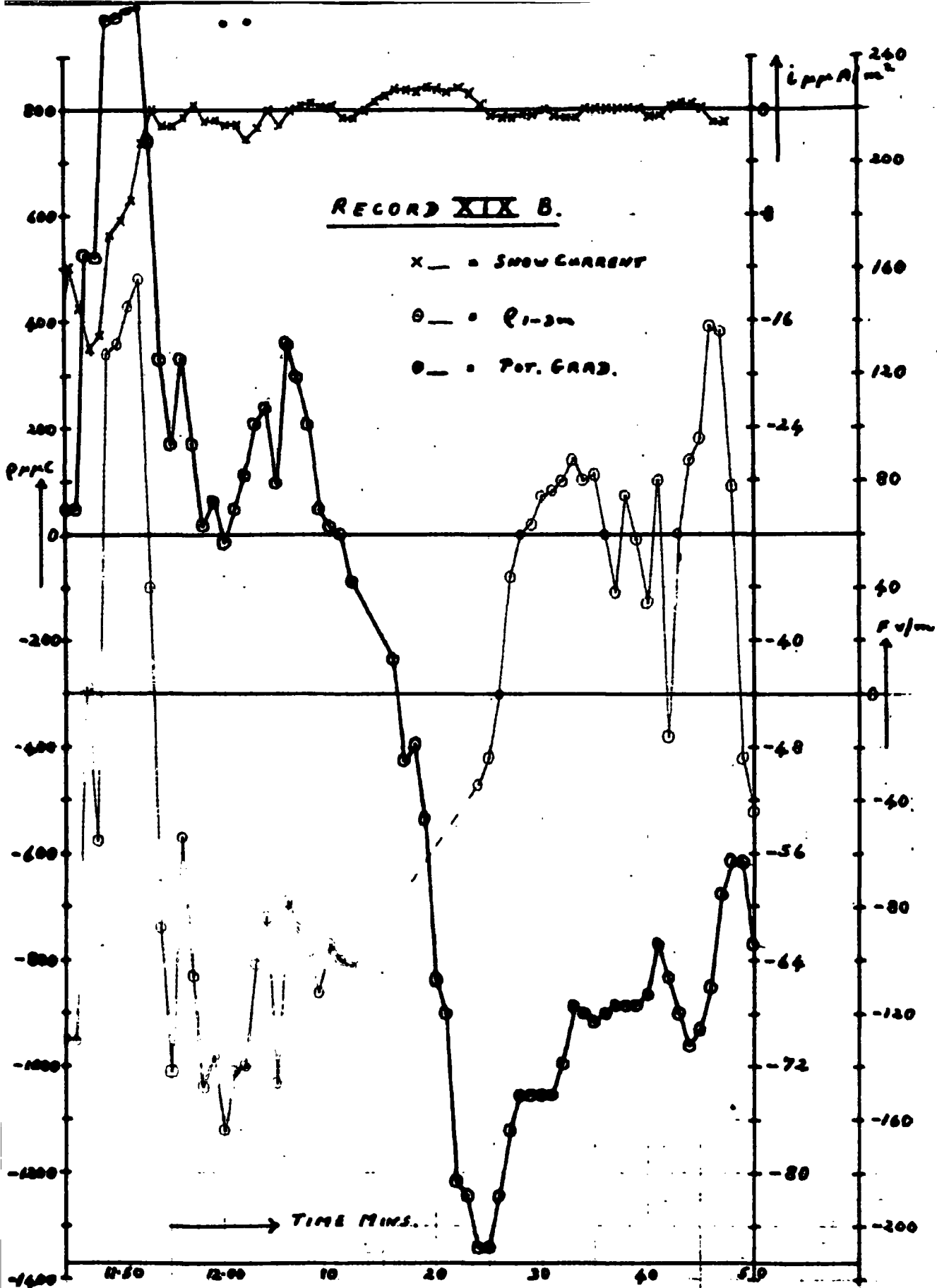

The variations in space charge in the region 1 - 3 m are not at all so marked, remaining in the region $+200 \mu\mu\text{C}/\text{m}^3$ until the rain had ceased. However as the lower space charge recovers, a fall occurs in the upper value reaching a minimum value of $-600 \mu\mu\text{C}/\text{m}^3$. This charge is present in the second and third metres above the ground, and so will account for roughly a half of the charge existing originally in the first metre.

This record was taken in December compared with record XXXVIII (morning) which was taken in April. An explanation for the much greater charges found on this occasion, in addition to a greater rate of rainfall, may arise from the state of the ground. In December the grass will present a much harder surface than in April, and so enhance the shattering of a raindrop when it strikes the ground.

Part of record XXII is shown merely to show the magnitudes of space charge in medium rain compared with the previous records in heavy rain. In this case the space charge does not exceed $-130 \mu\mu\text{C}/\text{m}^3$, which value is comparable with fine weather magnitudes.

8.2. Snow

A typical snow recording is shown in record XIX A and B, where the space charge is compared with potential gradient at the lower mill and with the current brought down by the snow at R.C. (Fig.20). Snow was falling continuously through the recording quite heavily up to approximately 12.00 noon when the snow decreased, and had ceased altogether by 12.10. The negative peaks in space charge could be identified closely with visual increases in rate of snowfall, and agree with negative peaks in snow current e.g. at 10.55,

11.44. By far the heaviest snow occurred at 11.10, with one almost as heavy at 11.24. Unfortunately at this latter point the upper mill driving belt was under repair, and the camera recording the current was being reloaded.

The space charge present during the snowfall is mainly negative and of a size comparable with that produced in heavy rain, the origin of this charge is due to the charge on the snow itself, and charge produced by shattering or rubbing of the snow-flakes either in the air or at the ground. This latter will be mainly carried by small ions. Since quite a thick layer of snow (4 - 6") lay on the ground during this recording, it is very unlikely that the radioactivity effect (S.7.3.) contributed towards the measured space charge.

Measurements made by Chalmers (1956) show that this recording shows conditions which prevail in snow in the greater number of cases i.e. a positive potential gradient and negative snow current. He also investigated the effect of shattering, or rubbing together of snow particles (1952a), and found that a positive space charge is produced, leaving a negative charge on the snow. These positive small ions would travel to the ground in the prevailing positive potential gradient, and may explain the difference in order of snow current and space charge found in this recording. For example, the negative peak shown at 10.55 for snow current is $-13 \mu\mu A/m^2$ and for space charge is $-650 \mu\mu C/m^3$, but at 11.10 when the snow was at it's heaviest, the snow current descends to $-63 \mu\mu A/m^2$ whereas the space charge only reaches $-550 \mu\mu C/m^3$. This latter point is not definite because of the break in the recording, but similar discrepancies occur particularly at 12.00 when the snow current is only $-1 \mu\mu A/m^2$, yet a space charge of

RECORD XVIII

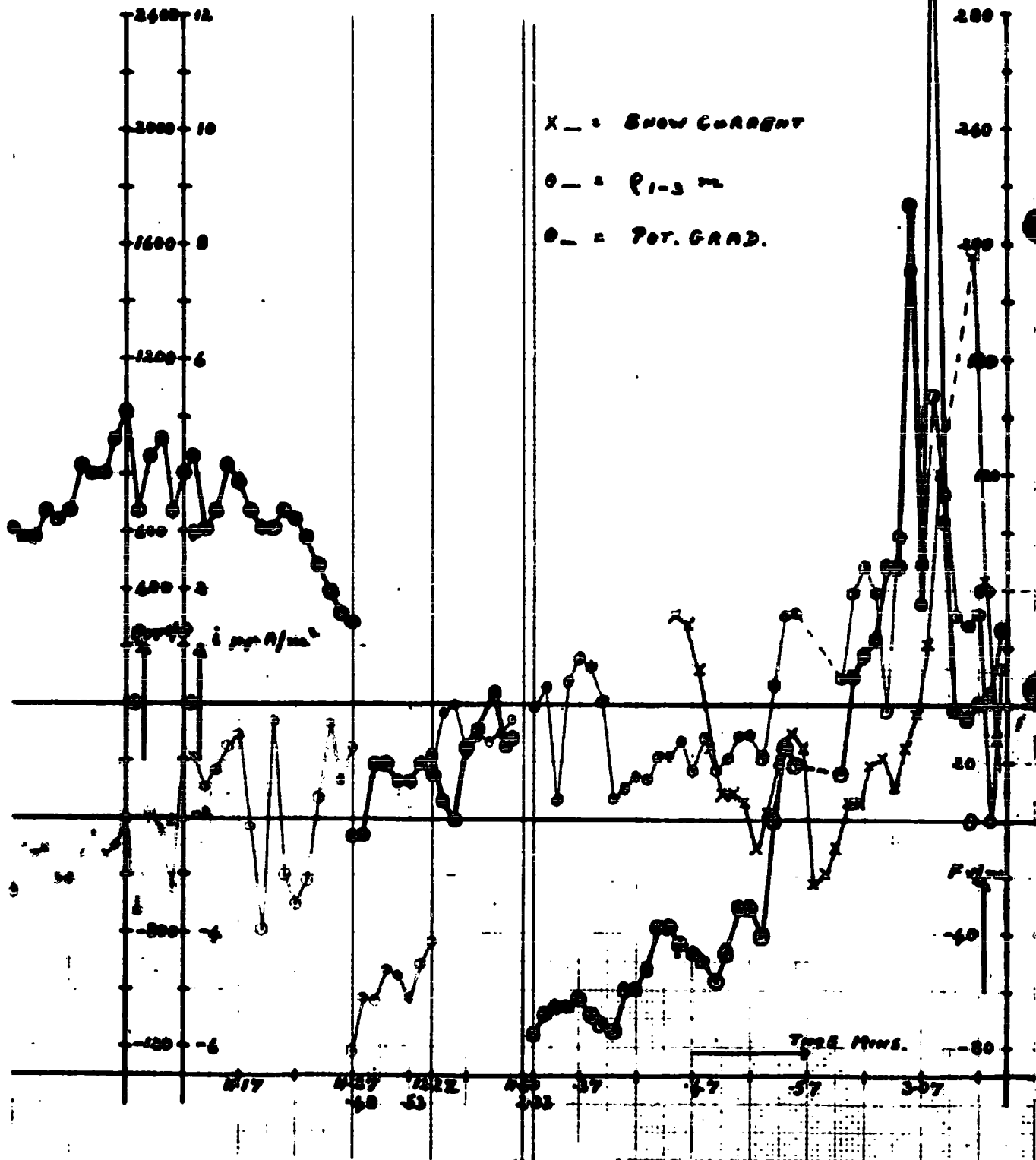

$-1100 \mu\mu \text{ C/m}^3$ is recorded. This seems to indicate that when the snow is at it's heaviest, a greater amount of shattering or rubbing takes place, producing a positive space charge which neutralizes to a certain extent the charge due to the snow itself. Unfortunately this phenomenon can only be discussed in a very general aspect because it is impossible to form even a rough estimate of the magnitude of the charge carried by the snow when it is falling, from the resulting snow current. This theory of positive ions being produced in the heaviest falls seems to be substantiated by the space charge undergoing a considerable rise after each rate of snowfall maximum i.e. at 11.03 and 11.50 after the maxima of 10.55 and 11.44, caused by the positive small ions being brought downwards into the region covered by the field mills.

Record XVIII shows another recording taken in snow, the morning fall (broken at two points by mill repairs) is of the same type as the previous record showing a positive potential gradient and negative space charge. In contrast, the afternoon fall is of a much steadier and quieter nature, commencing with a negative potential gradient, positive snow current and negative space charge. The snow current changes to a negative value at 2.48 p.m. changing back to positive at 3.07, attaining a maximum value at 3.10. The space charge on the other hand, changes in sign at 2.54 and reaches it's maximum at 3.06, no visible alteration in snowfall accompanying these changes.

Initially conditions are as expected if little or no positive charge is liberated by the rubbing or shattering process. When the conditions change and the snow charge becomes negative, a positive charge is liberated by friction and asserts itself after 5 minutes, as shown by the previous

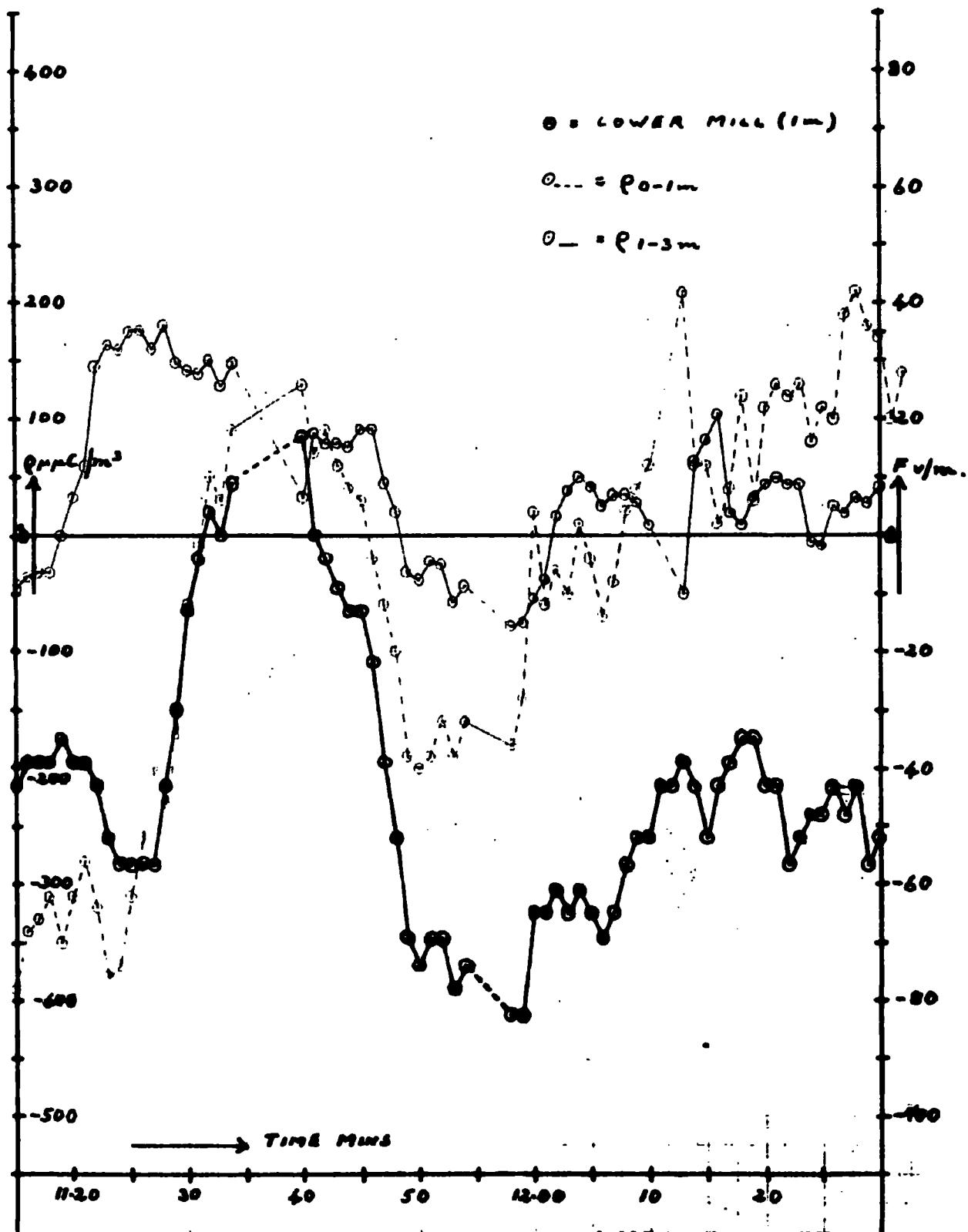

RECORD XIII

record, giving a positive space charge. After the potential gradient change at 2.54, the positive ions will end to move upwards, thus reducing the space charge once more to zero at 3.04. From this point the predominating charge is contributed by the charge on the snow itself, reaching a current of $+8 \mu\mu \text{ A/m}^2$. It seems evident that the large increase in potential gradient produces a corresponding positive charge on the snow because of the time lag of approximately 5 minutes, but why this should happen is not very clear. A possible explanation is that the effect of rubbing of the snow particles produce a negative charge in the high potential gradient existing at this time, the negative ions will move upwards and not be detected as a space charge, but a high positive charge will be left on the snow and registered as a snow current when the snow later reaches the ground.

8.3. Mist.

No fog or very thick mist occurred in Durham during the time recording was possible, however record XIII shows the space charge and potential gradient when a wet mist was present reducing visibility to approximately 20 yards. Initially where the potential gradient shows a large variation, the lower space charge is more negative than the upper, later the potential gradient becomes much more steady at -50 V/m and the lower space charge becomes approximately $+100$ and the upper $+50 \mu\mu \text{ C/m}^3$.

In a mist of this sort, small ions are captured more easily than in fair weather conditions, rendering the conductivity lower than in clear air. As discussed in S.1.1. this change in conductivity will give rise to a negative

charge at the upper boundary of the mist layer, assuming a negative value of potential gradient at the ground. The change in conductivity is not of course sufficient to produce a positive potential gradient above the mist layer, and if this is the case then a much higher negative charge must be associated with the mist. In the case of a negative potential gradient, the radioactivity effect will produce a positive space charge near the ground but because of the early capture of the positive ions, this charge will reside mainly on water droplets which have a much lower mobility.

This effect can clearly be seen at 11.32 a.m. when the potential gradient becomes positive for 9 minutes. The space charge in the first metre does not undergo a corresponding sign change until 11.46, and then remains negative for 19 minutes. The space charge in the next two metres assumes a negative value at 11.49, but changes again to positive after only 14 minutes due to only a small amount of negative charge travelling above the lower mill in the time available before the effect of positive charge becomes again pronounced.

These results show that an approximate time taken for the charge to travel from earth to 1 m is 14 mins, but this assumes the potential gradient remaining positive over this time. Actually it only remains positive for 9 mins after which presumably, the negative ions tend to return to the ground. Reducing this time then to 11 mins and assuming a constant potential gradient of 10 V/m, gives a value of mobility for the negative ions of $1.5 \cdot 10^{-4}$ m/sec per V/m, which corresponds quite well with small ion mobility values.

During the recording period the wind was very light and westerly, so the negative potential gradient at the ground is difficult to account for in terms of the mist having a negative charge. No power lines or transformer stations exist in this direction close enough to give the effect observed by Chalmers (1952b) and Adkins (1958). It must be assumed that although the mist may possess a net negative charge, the potential gradient above the mist layer must have been very small positive, or negative.

The average space charge from 1 to 3 m is $+50 \mu\mu\text{C}/\text{m}^3$, and the average potential gradient, $-40 \text{ V}/\text{m}$. This space charge may be compared with a typical fair weather recording e.g. XVI, giving a space charge of $-58.7 \mu\mu\text{C}/\text{m}^3$ with an average potential gradient of $192.8 \text{ V}/\text{m}$. Comparing these two recordings, it can also be seen that the recording in mist shows much steadier space charge values, even allowing for a difference in scale of the two plots.

CHAPTER IX
CONCLUSIONS

9.1. Summary of Results.

In fair weather the average space charge in the region 1 to 3 m is $+2.97 \mu\mu\text{C/m}^3$ in an average potential gradient of 140 V/m. This value is taken from a total recording time of 10 hours, and indicates a rate of ion pair production of approximately 35 per cc/sec at the earth's surface giving a conduction current downwards of the order of $5 \cdot 10^{-12} \text{ A/m}^2$. This value assumes that all ionizing processes take place within 10 cms of the surface and all positive ions produced re-enter the earth's surface, which in actual fact is not so, because of capture occurring by large ions or uncharged nuclei, leading to a value less than $5 \cdot 10^{-12} \text{ A/m}^2$. This figure compares favorably with the usual values obtained in fair weather, and adds support to the accuracy of the results quoted in S.7.3. Thus an upper limit of $3 \cdot 6 \cdot 10^{-14} \text{ ohms}^{-1}/\text{m}$ is arrived at for the conductivity of the air in the lowest cm, being approximately double the value deduced by Gish and Wait (1950) from aircraft measurements for positive ions.

In the lowest metre an average charge of $-68.2 \mu\mu\text{C/m}^3$ was found, but is only the result from 3 hours recording, and may have an error as great as $\pm 20 \mu\mu\text{C/m}^3$, due to the horizontal separation of the double mills and the Agrimeter with which potential gradient comparisons were made.

The variations in space charge arise from changes in potential gradient altering the small ion density between the mills, superimposed on normal fluctuations in large ion density. The rapidity of changes in this latter value

were found to depend on wind speed and evidence was found for artificial space charge of a positive sign being produced by smoke.

No definite indication was obtained of effects produced from the exhaust gases of passing vehicles, because of lack of sufficient data.

Comparing these results, with those obtained by previous workers in this field S.2.1., it is seen that the negative charge found in the first metre agrees quite well with Norinder's measurements. Above this height, the negative charge can be considered to be 'diluted' successively more and more with the 'normally' present positive space charge. Performing a rough extrapolation with the aid of Fig.31, from which the space charge which should be present between one and three metres, in a potential gradient of 140 V/m, is $+15 \mu\mu\text{C}/\text{m}^3$; gives a value of space charge of $+40 \mu\mu\text{C}/\text{m}^3$ in higher regions. This value agrees with the average results of Kähler, Daunderer, etc. which, stated in M.K.S. units, is $+54 \mu\mu\text{C}/\text{m}^3$.

Comparison of the results obtained from the apparatus with those from the air filter method were in reasonably good agreement, except in conditions where small ions contribute appreciably to space charge densities e.g. in or after heavy rain, of similar sign to the potential gradient and of a degree dependant on the magnitude of the potential gradient.

In heavy rain large negative space charges of the order of $1000 \mu\mu\text{C}/\text{m}^3$ are recorded, and since the potential gradient is also negative at these times, the splashing of the rain producing this charge seems to be of a Lenard (1892) type, rather than an Adkins (1958) type. In normal rain, below 0.08 mms/min, no abnormal charges were

detected in the lowest metre of the air, which were of a magnitude and sign to be expected in fair weather conditions, showing the absence of any splashing effects. No consistent relation was found between rain current and space charge in normal rain, and calculations show that the space charge due to the rain is only of the order $1 \mu\mu\text{C}/\text{m}^3$, which small value is obscured by normal fluctuations.

Results obtained in snowfalls show charges of the order $1000 \mu\mu\text{C}/\text{m}^3$. The charge on the snow itself and a positive charge produced in the form of small ions, by a rubbing or shattering process, contribute equally to the net space charge.

9.2. Further Work.

All of the topics discussed in Chapters 7 and 8, obviously require the evidence of more recordings to verify, or contradict, the conclusions drawn from the available records.

To investigate further the radioactivity effect, a systematic study with the present apparatus of the distribution of space charge with height should show the effects diminishing appreciably in the region 1 to 2 metres. Above this height the numbers of positive and negative small ions should become more equal, the rate of ion production in this region due to cosmic radiation is approximately 10 per cc/sec. At 2 m height and above the large ion content will predominate, showing the 'normal' expected positive value in average fair weather potential gradients.

Vertical distribution of space charge in mist and fog would also repay investigation to determine the net sign of charge. Especially with easterly winds, because two Grid

lines running approximately North - South pass three Km to the East of the recording site, and it is of interest to investigate the extent of the negative charges produced by these lines.

To investigate charges produced by exhaust gases from passing vehicles, a note of traffic density will have to be made in conjunction with wind speed, wind direction and space charge values, with regard to time of day. This will give an indication of any resultant effects, but care will be necessary not to confuse resulting variations in space charge with other phenomena also fluctuating with time which may affect space charge distributions e.g. time of lighting domestic fires.

In using the apparatus several disadvantages have become apparent:

- 1). The driving belt of one or other mill snapped on the average every two hours. The use of a leather instead of plastic material will remedy this defect, but disadvantages may be encountered due to stretching, and the conductivity may become inconveniently high in wet weather.
- 2). The alteration of mill heights is extremely difficult. The adoption of some sort of pulley arrangement should not be too complicated, and would give the apparatus a much wider application.
- 3). The mill potential had to be manually reversed each time a sign change occurred in potential gradient. An automatic device could quite easily be fitted to the Brown Recorder such that, each time the slide was driven down to zero and stayed there for a period exceeding 30 secs, a switch would be operated causing the slide voltage to be reversed.

The advantages of having 2). modified have already been stated. As regards 1). and 3)., recordings could be made to extend over much longer times than have been accomplished, and effects less 'microscopic' recorded e.g. diurnal variations, recording over a complete rainstorm, etc.

Apart from these limitations, the apparatus functioned successfully and gave an overall accuracy to individual readings of $\pm 10 \mu\mu\text{C}/\text{m}^3$. The absolute accuracy cannot be found owing to the uncertain reduction factor for the surrounding trees and buildings, this will be the same for both mills and should not cause the space charge values to be low by more than 2%.

AKNOWLEDGEMENTS

With great sincerety the author wishes to thank Dr.J.A.Chalmers for his continual help and guidance at all stages of the project.

Thanks are also given to Professor G.D.Rochester for the facilities granted, and to the Physics Department workshop staff for their assistance.

The writer is indebted to his fellow research students, Mr.M.W. Ramsay for precipitation current and potential gradient records made available, Mr. J.W. Milner for the use of the Agrimeter, and others who gave invaluable assistance in raising the field mills.

The author is especially indebted to his wife for her help in the translation of papers into English, and typing this work into it's final form.

Further thanks are due to the Air Research and Development Command, United States Air Force, for a maintenance and equipment award from 1955 to 1958.

REFERENCES

- ADAMSON J. 1958. The compensation of the effects of potential gradient variations in the measurement of the atmospheric air-earth current. Ph.D. Thesis. Durham. Unpublished.
- ADKINS. 1958. Some measurements in atmospheric electricity. Ph.D. Thesis. Cambridge. Unpublished.
- BENNDORF H. 1906. Über gewisse Störungen der Erdfeldes mit Rücksicht auf die Praxis luftelectrischer Messungen. S.B. Akad. Wiss., Wien. 115. pp. 425 - 456.
- BEST A.C. The size distribution of raindrops. Quart. J. R. Met. Soc. 76. pp. 16 - 36.
- BROWN J.G. 1930. The relation of space charge and potential gradient to the diurnal system of convection in the lower atmosphere. Terr. Magn. Atmos. Elect. 35. pp. 1 - 35.
- CHALMERS J.A. 1952a. Electric charges from ice friction. J. Atmosph. Terr. Phys. 2. pp. 337 - 339.
- CHALMERS J.A. 1952b. Negative electric fields in mist and fog. J. Atmosph. Terr. Phys. 2. pp. 155 - 159.
- CHALMERS J.A. 1953. The agrimeter for continuous recording of the atmospheric electric field. J. Atmosph. Terr. Phys. 4. pp. 124 - 128.
- CHALMERS J.A. 1956. The vertical electric current during continuous rain and snow. J. Atmosph. Terr. Phys. 9. pp. 311 - 321.
- CHALMERS J.A. 1957. Atmospheric Electricity. Pergamon Press, London.
- CHAUVEAU B. 1902. Recherches sur l'electricité atmospherique. Mem. II. p. 103.
- CLARK J.F. 1958. Private correspondence. Unpublished.
- DEMON L. 1953. Premiers résultats obtenus au cours du printemps 1953. J. Res. C.N.R.S. 24. pp. 126 - 127.
- DAUNDERER A. 1907. Luftelectrische Messungen. Phys. Z. 8. pp. 281 - 286.

REFERENCES (continued)

- DAUNDERER A. 1909. Über die in den unteren Schichten der Atmosphäre vorhandenen freie elektrische Raumladung. Phys. Z. 10. pp. 113 - 118.
- EBERT H. 1901. Aspirationsapparat zur Bestimmung des Ionengehaltes der Atmosphäre. Phys. Z. 2. pp. 662 - 666.
- GISH O.H. and WAIT G.R. 1950. Thunderstorms and the earth's general electrification. J. Geophys. Res. 55. pp. 473 - 484.
- GUNN R. 1948. Electric field intensity inside of natural clouds. J. Appl. Phys. 19. pp. 481 - 484.
- ISRAËL H. 1953. The atmospheric electric field and its meteorological causes. Thunderstorm Electricity. pp. 4 - 23.
- JAEGER J.C. 1946. Introduction to the Laplace Transformation with engineering applications. Reproduced by C.S.I.R., Melbourne.
- KÄHLER K. 1927. Die elektrische Raumladung der Atmosphäre in Potsdam. Met. Z. 44. pp. 1 - 5.
- KELVIN; LORD. 1859, 1862. Observations on atmospheric electricity. Proc. Lit. Phil. Soc., Manchester. (Papers on electrostatics and magnetism), pp. 200 - 203, 230 - 235.
- KELVIN, LORD. 1860. Atmospheric electricity. R. Inst. Lecture. Papers on electrostatics and magnetism. pp. 208 - 226.
- KINMAN T.D. 1954. The measurement of atmospheric space charges. Admiralty Research Laboratory, Teddington, Middlesex. Unpublished, (classified information).
- KIRKMAN J.R. 1956. Point discharge in atmospheric electricity. Ph.D. Thesis. Durham. Unpublished.
- LENARD P. 1892. Über der Electricität der Wasserfälle. Ann. Phys., Lpz.
- MACHE. 1903. Phys. Z. 4. pp. 587 - 588.
- MAPLESON W.W. and WHITLOCK W.S. 1955. Apparatus for the accurate and continuous measurement of the earth's electric field. J. Atmosph. Terr. Phys. 7. pp. 61 - 72.

REFERENCES (continued)

- MAUND J.E. 1958. Point discharge in atmospheric electricity. Ph.D. Thesis. Durham. Unpublished.
- MÜHLEISEN R. and HOLL W. 1952. Eine neue Methode zur Messung die elektrische Raumladungsdichte der Luft. Geophys. pur. appl. 22. pp. 3 - 8.
- MÜHLEISEN R. 1953. Die luftelectrischen Elemente im Gross-tadhereich. Z. Geophys. 29. pp. 142 - 160.
- NORINDER H. 1921. Researches on the height variation of the atmospheric electric potential gradient in the lowest layers of the air. Geogr. Ann. Stockholm. pp. 1 - 96.
- OBOLENSKY W.N. 1925. Über elektrische Ladungen in der Atmosphäre. Ann. Phys., Lpz. 77. pp. 644 - 666.
- PARKER. 1950. Electronics. Edward Arnold and Co., London. p. 272.
- SAGALYN R.C. and FOUCHER G.A. 1954. Aircraft investigation of the large ion content and conductivity of the atmosphere and their relation to meteorological factors. J. Atmosph. Terr. Phys. 5. pp. 253 - 272.
- SCRASE F.J. 1935. Some measurements of the variation of potential gradient with height near the ground at Kew Observatory. Geophys. Mem. Lond. 67.
- VONNEGUT B. and MOORE C.B. 1958. A study of techniques for measuring the concentration of space charge in the lower atmosphere. Final report to the Geophysics Research Directorate, Air Force Cambridge Research Center, Bedford, Mass. U.S.A.
- WHIPPLE F.J.W. 1953. On the association of the diurnal variation of electric potential gradient in fine weather with the distribution of thunderstorms over the globe. Quart. J. R. Met. Soc. 55. pp. 1 - 17.
- WHITLOCK W.S. 1955. Variations in the earths electric field. Ph.D. Thesis. Durham. Unpublished.

REFERENCES (continued)

- SCRASE F.J. 1934. Observations of atmospheric electricity at Kew. A survey of results obtained from 1843 to 1931. Geophys. Mem., Lond. 60.
- WHITLOCK W.S. and CHALMERS J.A. 1956. Short period variations in the atmospheric electric potential gradient. Quart. J.R. Met. Soc. 82. pp. 325 - 336.