



Durham E-Theses

*The effects of refinery effluent on the invertebrate
intertidal fauna and flora of Little Wick Bay, Milford
Haven*

Archer-Thomson, John Henry Stuart

How to cite:

Archer-Thomson, John Henry Stuart (1979) *The effects of refinery effluent on the invertebrate intertidal fauna and flora of Little Wick Bay, Milford Haven*, Durham theses, Durham University. Available at Durham E-Theses Online: <http://etheses.dur.ac.uk/9021/>

Use policy

The full-text may be used and/or reproduced, and given to third parties in any format or medium, without prior permission or charge, for personal research or study, educational, or not-for-profit purposes provided that:

- a full bibliographic reference is made to the original source
- a [link](#) is made to the metadata record in Durham E-Theses
- the full-text is not changed in any way

The full-text must not be sold in any format or medium without the formal permission of the copyright holders.

Please consult the [full Durham E-Theses policy](#) for further details.

The Effects of Refinery Effluent on the Invertebrate Intertidal Fauna and Flora
of Little Wick Bay, Milford Haven

by JOHN HENRY STUART ARCHER-THOMSON

The copyright of this thesis rests with the author.
No quotation from it should be published without
his prior written consent and information derived
from it should be acknowledged.

Submitted for the Degree of Master of Science

(Advanced course in Ecology)

University of Durham

Department of Zoology

1979



The Effects of Refinery Effluent on the Invertebrate Intertidal Fauna and Flora
of Little Wick Bay, Milford Haven

by ARCHER-THOMSON J.H.S.

ABSTRACT

The effects of continuous low level oil pollution from a refinery effluent, on intertidal fauna and flora in Little Wick Bay are investigated.

A shore survey of the intertidal species on six transects at varying distances from the effluent discharge point, is carried out and the results compared with past surveys of the same transects. Any differences or similarities in the findings are related to the environmental agencies in operation since the first survey.

A detailed investigation of the size classes and abundance of the Limpet Patella vulgata at each of the six transects and a quantitative analysis of Petroleum Oil Pollutants in P. vulgata by Infra red Spectrophotometry is carried out in an attempt to relate findings to the effluent discharge.

ACKNOWLEDGEMENTS

I would like to express my sincere gratitude to all those people at O.P.R.U. who were so helpful with both advice and equipment, and say a special thank you to Saran Petpiroon for his help, and for allowing me to use his unpublished results from his Ph.D. thesis.

I would also like to thank the Chemistry Department of the University College of Swansea for their exceptional generosity with time, help and equipment without which the whole project would have been impossible. A special thank you is due to Professor H Purnell, Dr J Ballantine and especially to Jean Pierre Aubertin.

Finally, I would like to thank Dr P R Evans of Durham University for his help and advice throughout the project and especially with the preparation of the manuscript.

Dedicated to Maggie, with thanks.

TABLE OF CONTENTS

	page
Abstract	
Title Page	
Acknowledgements	
List of Tables and Illustrations	
<u>Introduction</u>	1
<u>Methods</u>	10
I The Shore Survey	10
II Studies of <u>Patella vulgata</u> at the six Little Wick Transects	14
(i) Investigation of the sizes of <u>P. vulgata</u> in Little Wick Bay	15
(ii) Quantitative analysis of Petroleum oil Pollutants in <u>P. vulgata</u> by Infra red Spectrophotometry	15
(a) Sampling and Sample preparation	16
(b) Extraction and Analysis	17
<u>Discussion</u>	24
I The Shore Survey	24
(i) The distribution of Littoral Animals and Plants in 1979 in relation to the refinery effluent discharge point	24
(ii) Possible Explanations of the observed Species Distributions	28
(iii) Comparisons of the present Survey with those of Past Surveys	33
Summary of the Shore Survey	35
II Studies of <u>Patella vulgata</u> at the six Little Wick Transects	36
(i) Comparisons of the Size-frequency distributions of <u>P. vulgata</u> at the six Little Wick Transects	36

	Page
(ii) Quantitative Analysis of Petroleum Oil Pollutants in <u>P. vulgata</u> by infra red Spectrophotometry	44
Summary of the studies of <u>P. vulgata</u>	49
 <u>Appendix</u>	 52
A (1) Results for the 1979 Shore Survey (Archer-Thomson)	53
A (2) Results for the 1978 Shore Survey (Petpiroon)	60
A (3) Results for the 1970 Shore Survey (Crapp)	67
A (4) Criteria of Abundance	74
A (5) Exposure score sheet (Ballentine 1961)	77
A (6) Raw Limpet Data	79
A (7) Mean Effluent quality	83
 <u>References</u>	 94

List of Tables and Illustrations

	Page
Figure One	2
South West Wales, showing Milford Haven and the surrounding area	
Figure Two	6
Showing the Position of Little Wick Bay near the town of Milford Haven	
Figure Three	6
The Little Wick Transects in relation to the Outflow Pipe and Esso Jetty	
Figure Four	12
Showing the Present model of the "Crosstaff" after modification by Crapp in 1970 (Taken from Crapps (1970) Ph.D. thesis, University College of Swansea	
Figure Five	12
The sample area investigated at each station along the Transect Tape	
Figure Six	18
Showing sample points from the six Little Wick Transects	
Figure Seven	18
Detail of a single Sample Area for any given Transect	
Figure Eight	18
An idealised trace from a Spectrophotometer readout	
Figure Ten	39
Approximate Shore Cross sections for the six Little Wick Transects	
Figure Nine	25
Distributions of six common species at the six Little Wick Transects	
Figure Eleven	40
Size Frequency Distributions of <u>P. vulgata</u> at the six Little Wick Transects	
Figure Twelve	19
Standard "Beer Bouguer Law" Plot of Absorbance vs. Concentration of oil in Solvent	
Figure Thirteen	48
Calculated Regression Lines of Body Burden on Dry Weight for each Transect and for all the data pooled irrespective of Transect Origin	

List of Tables and Illustrations (continued)

	Page
Table I Results for the Statistical Analysis on the Limpet Volume Index Data	37
Table II Spectrophotometry Data for <u>Patella vulgata</u>	21
Table III Results from the Statistical analysis of the Spectrophotometry data given in Table II for <u>P. vulgata</u> soft tissue	45
KEY: To the Symbols used in Tables I, II and III	38

INTRODUCTION

After the end of the Second World War, a search for ports capable of accommodating bulk carriers and tanker's of up to 100,000 ton's capacity revealed that Milford Haven was one of the very few suitable sites in Britain. Consequently the remote natural harbour at the south-western extremity of Wales (see figure one) used by fishing vessels, coastal freighter's and small naval craft became Britains largest oil port, a development greatly accelerated by the closing of the Suez Canal in 1956.

Milford Haven is situated where the ranges of Arctic and Southern Marine invertebrates overlap and it supports one of the most varied fauna and flora in the British Isles. The great depth of the water channel, so imperative to its functioning as a Modern Oil Port, also means that this variety extends far into the estuary.

A preliminary report by Arnold (1959) and a major account of the estuary by Nelson-Smith (1964) provide the foundations of the pre-industrial monitoring of Milford Haven's Marine Biology. Since the early 1960's, when industrial development saw the establishment of three refineries (Esso in 1960, Texaco in 1964 and Gulf in 1968), the monitoring has continued. Paper's on the Physical structure of the estuary and its Marine Biology were prepared by Nelson-Smith (1965, 1967 respectively) and a more detailed study of the Dale peninsular was carried out by Moyse and Nelson-Smith in 1963. Although changes in the intertidal fauna and flora were apparent, these were attributed

l.c. l.c.

l.c.

l.c.

l.c.

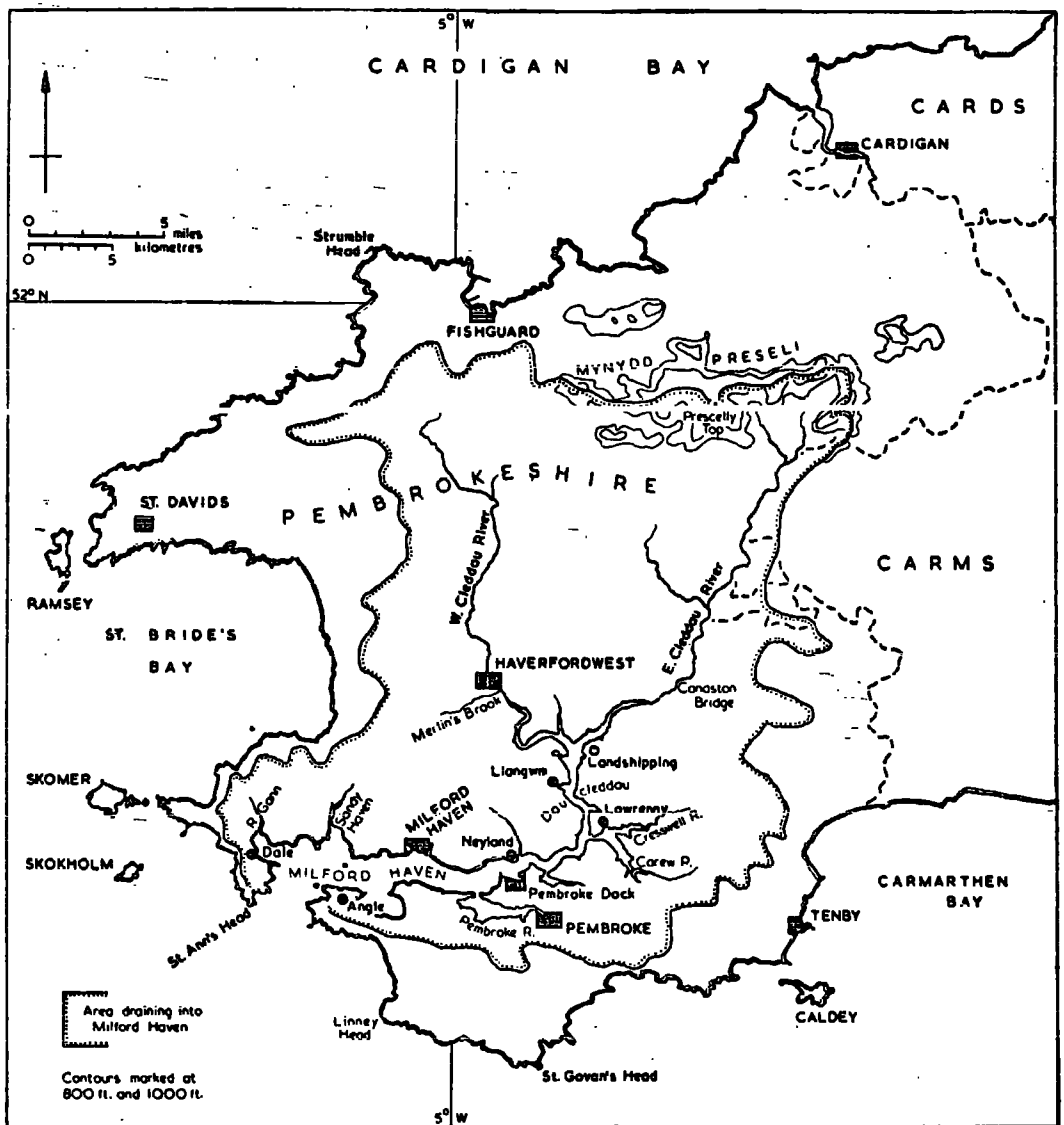

Figure One: South West Wales, showing Milford Haven and the surrounding area

to a general climatic deterioration. Furthermore, there was no evidence to suggest that a general impoverishment of the fauna and flora had taken place, and it was suggested that the establishment of an oil port had not caused any major ecological damage to the estuary.

A major re-surveying of all the Milford Haven transects is being carried out at present by the Oil Pollution Research Unit (O.P.R.U.) at Orierton. Their results, when compared with the pollution histories of the various areas, should prove extremely interesting and useful in assessing the impact of extension of industrial operations in the estuary since 1967.

Pollution associated with oil developments can take one of three forms:-

1. Spillage of oil in the sea. Depending on the type of oil involved, this may lead to deaths of marine organisms, particularly if large percentages of volatile hydrocarbons are present. However, by the time the oil drifts onshore the toxic light fraction's may have evaporated.

2. Spillage of oil directly on intertidal areas. Here stranded oil may kill intertidal animals either by poisoning or smothering. Again the toxic fraction's of oil disappear rapidly through evaporation and solution, in this way spilt oil will soon lose its toxic properties.

Oil is rarely stranded in quantities sufficient to kill intertidal species by smothering, though applications of emulsifier prove far more toxic to, for example Patella vulgata than does the original oil spill (Crapp, 1970).

3. Discharge of oil/water mixtures from refinery, or stabilizing tanks, onto intertidal areas.

The first and second categories are examples of 'Acute pollution', the third, of 'Chronic pollution'. The effects of Acute pollution are well documented, (e.g. Dudley, 1968; George, 1961; Nelson-Smith, 1968 (a) and (b), 1970:) but there is much less information on the effects of continuous low level pollution as may be seen around discharge points, where although a very low concentration of oil in water is released, the toxic fractions of the oil may be continually present. l c

In the case of the above-mentioned refineries, the effluent is derived from three separate sources.

1. Process Effluent - water condensed from the steam injected into the refinery process
2. Fresh Water runoff - from rain falling into the refinery area
3. Ballast water from tankers

Before it is discharged, the effluent passes through skimming pools and separators. Even so, contaminants such as sulphides, copper, cyanides, Phenols and Ammonia are discharged, though below the limits set by the South West Wales River Board, and normally amount to a fraction of a mg/litre of the effluent. Oil, the principal contaminant, is limited to 50 mg/litre though normally the actual amount released varies from 20 — 25 mg/litre.

A total of 1×10^9 gallons of effluent may be discharged during a year which may contain up to 20,000 gallons of oil, at a concentration of 20 mg/litre.

The major stimulus for the present investigation came from work carried out by Crapp in the three years prior to 1970. A summary of his findings is given below.

Crapp's work showed that continuous low level pollution, outlined above, was having a significant ecological effect at the Esso discharge point in Little Wick Bay, near the town of Milford Haven (figure two). Crapp visited the bay in 1969, after about ten years of discharging and discovered that Fucus vesiculosus was the dominant intertidal species. If the bay was sufficiently sheltered to be Algal dominated then the main weed should have been Ascophyllum nodosum, however the position the bay occupied within the Haven, as regards exposure to wave action, indicated that it should be a Barnacle/Limpet dominated shore. Indeed photographs taken before industrialisation started in 1960 show this to be the case (see Milford Haven Conservancy Board Booklet 1968).

Crapp investigated why this should be and the details of his experimental work and findings are discussed fully in later sections. Briefly, Crapp investigated the six transects shown in figure three and recorded the relative abundance of the species present at each. The pattern revealed by the survey indicated that the pre-industrial species distribution of the shore had been disturbed, and the disturbance centred on the outfall adjacent to transect three. It was concluded that the fauna of the shore had been severely depleted and this had allowed invasion by Fucoid algae.

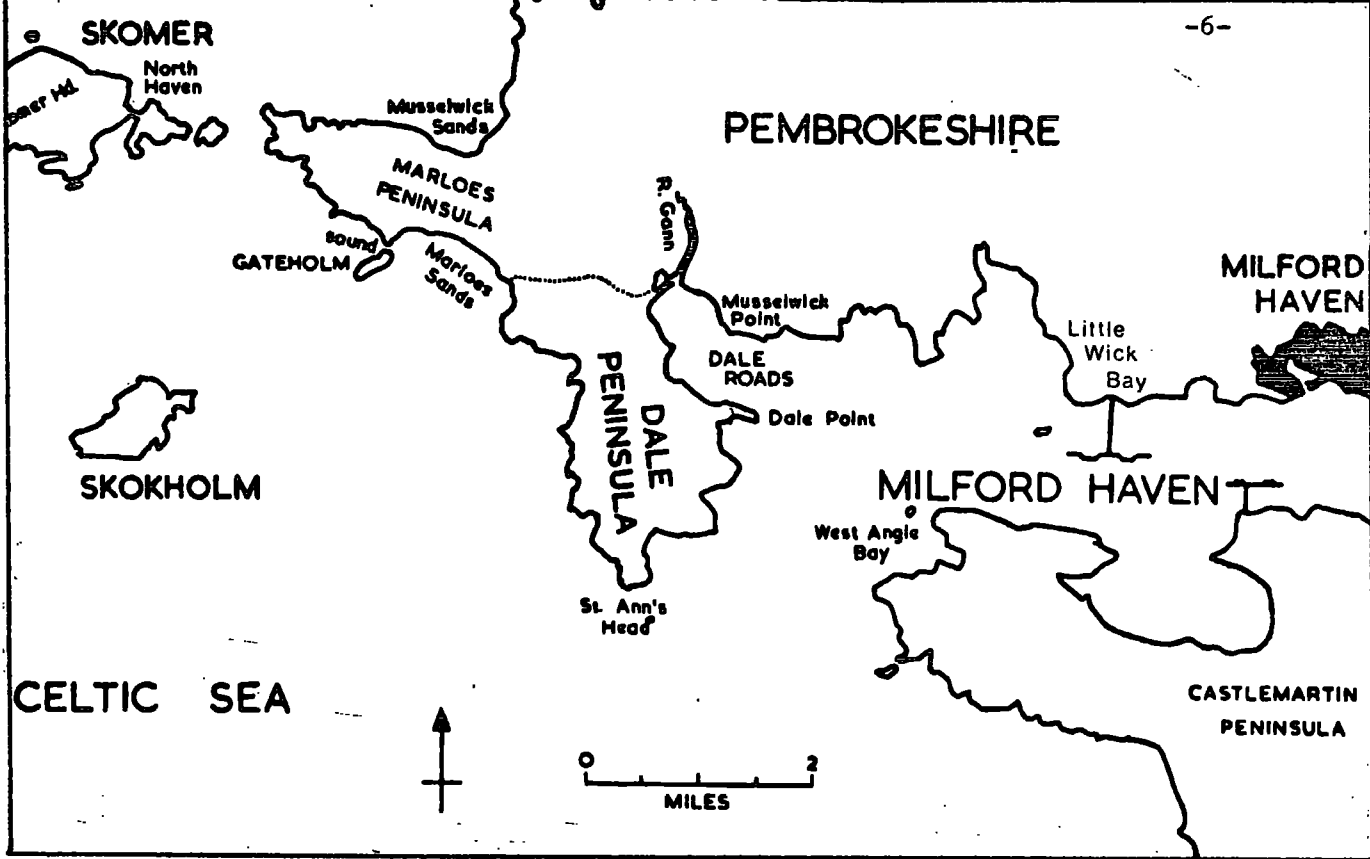

Figure Two: Showing the position of Little Wick Bay near the town of Milford Haven

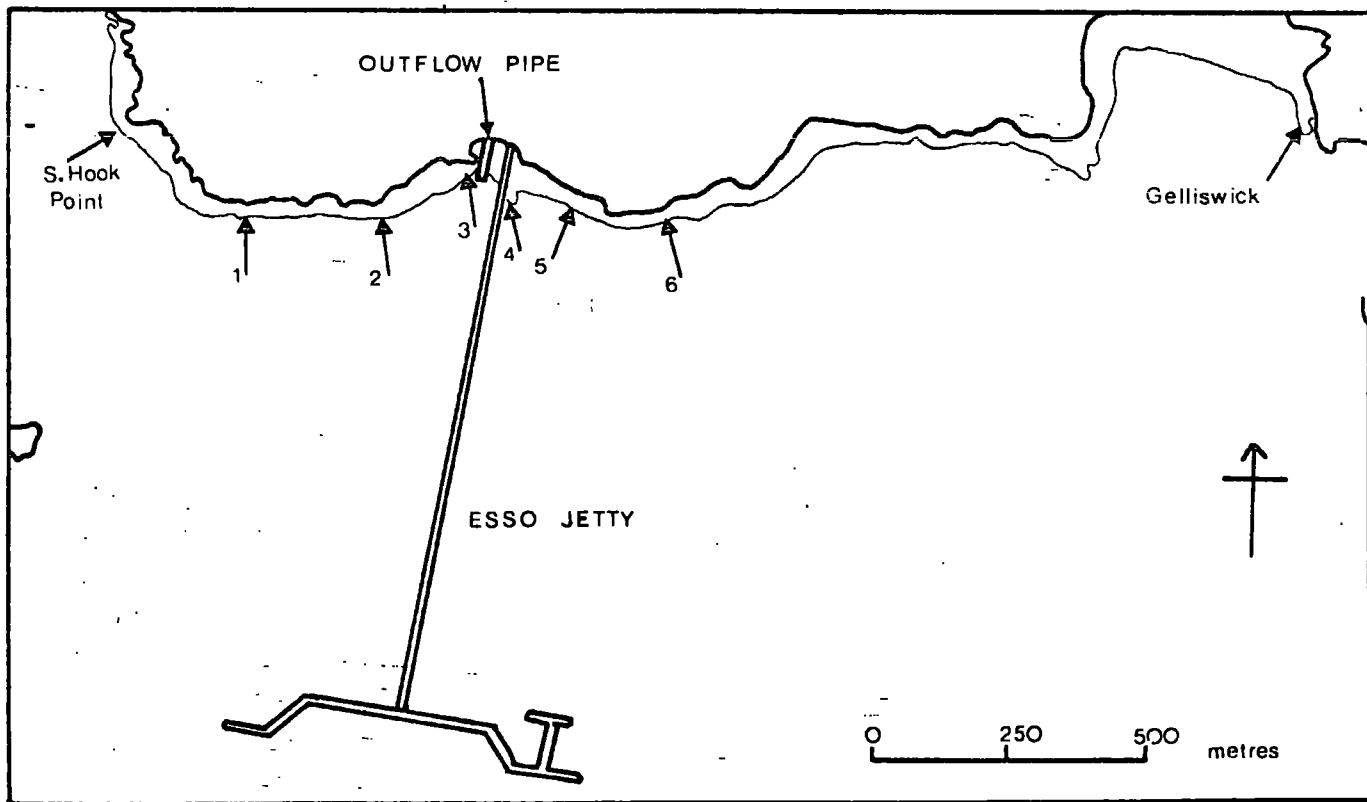

Figure Three: The Little Wick transects in relation to the Outflow Pipe and Esso Jetty

Given that any differences in Topography, Climate and Exposure (Ballantine's scale 1961) between the transects were insufficient to explain the ecological differences noted, Crapp concentrated on unnatural factors for an explanation. (Again a more detailed breakdown of these factors is given later).

The use of emulsifiers to clean Little Wick Bay could have produced the observed distribution of intertidal species but Crapp's enquiries showed that no such cleaning procedure had been used within the few years ^{prior?} subsequent to his investigation. Even if such a cleaning operation had taken place it is difficult to reconcile such findings with a general cleaning of the Bay, as the species changes so intimately related to the outflow itself, and Crapp subsequently concentrated on the outflow and its contents.

The use of emulsifiers in the skimming pools and separation plants are a possible cause of the changes observed but Crapp considered this to be unlikely as the usage was reported as highly infrequent (the last known occasion being seven years before Crapp's investigation was undertaken).

Salinity changes due to the effluent are not great enough to explain the Biological differences recorded, no salinity figures below 27‰ were recorded and the average reading approximated to 30‰. It is possible however that reduced salinities may impose an additional stress upon many species. l.c.

The possibility therefore remained that it was oil itself, discharged in the effluent, that was causing the changes in species composition observed at transects three (and four to a lesser extent). It seemed unlikely that the other chemical constituents were responsible as the concentrations released were considered low enough to be ineffectual (see Appendix one). For the oil to be implicated it had to be established that continuous oil pollution could have such a toxic effect at such low concentrations. Laboratory experiments undertaken by Crapp, on Asterias rubens and Carcinus maenas, showed that the extent to which different species might be affected varied considerably. However field studies into some of the dominant intertidal organisms^{ms} revealed firstly, that first year age class Patella vulgata (taken to be those with a longest shell diameter of less than 5 mm), were reduced in abundance near the outfall (transect three), and secondly, that Barnacle spats were less abundant at transect three. Knight-Jones (1953b) has shown that Balanus balanoides, B. crenatus and Elminius modestus all exhibit a gregarious settling behaviour i.e. the spat is less likely to settle in an area devoid of, or lacking in barnacles of the same species, other factors being equal. Therefore this might be a contributory factor to the low abundances recorded. However Crapp has shown that mortality rates amongst those spats that do settle are higher at transect three than at any other transect in Little Wick Bay.

Crapp concluded that some deleterious influence was affecting the young limpets and barnacle spats, settling near the outfall, and the normal refinery effluent was implicated.

The aim of the present investigation, some ten years later, was to compare results of repeated surveys of the six transects, firstly with Crapp's 1970 results and secondly, with Petpiroon's unpublished 1978 results (Taken from his Ph.D. thesis, to which he has kindly allowed me access), and to relate differences or similarities in the findings to the environmental agencies (natural and otherwise) that have operated since that time. I also carried out a quantitative analysis of Petroleum Oil pollutants on the Limpet l.c., Patella vulgata by infra red spectrophotometry along with a detailed description of the size classes and abundance of the species at each of the six transects, in an attempt to relate this to the Esso refinery effluent discharge in Little Wick Bay.

METHODS

I. The Shore Survey

This survey, the third of its kind at Little Wick, was undertaken to ascertain if any changes in the intertidal fauna and flora had occurred since Crapp's original work in 1970, and again since Petpiroon's more recent work in 1978, and if so to try to relate this to known environmental agencies in operation in that period.

The Little Wick transects (figure three) are situated as follows, with respect to the Esso refinery discharge point.

Transect	1	-	400 m	West of the outfall				
"	2	-	200 m	" " " "				
"	3	-	9 m	" " " "				
"	4	-	27 m	East " " "				
"	5	-	160 m	" " " "				
"	6	-	360 m	" " " "				

All three survey's were based on station's established at constant vertical interval's along a transect lying roughly at right angles to the line of high or low water. The methods used correspond exactly to those used by Petpiroon and Crapp unless stated otherwise.

Each transect extends from low water of Spring tides to the first few flowering plants at the top of the shore. The zero level, (or Chart Datum), is usually established by the level of low water on the day of the survey, taken from data in the Admiralty Tide Tables. However, in the present survey the uppermost station of each transect was known exactly having been marked by Petpiroon in the previous year, and I decided to start there and work toward's low water mark to ensure that the position's of sampling station's used in the two survey's coincided exactly.

To ensure accurate resurveying, a seaward compass bearing was taken, in this case from the paint mark, though usually this would be from a map reference point, and a tape laid along the bearing line. In accordance with the past survey's the transect was divided into equally spaced vertical interval's of 60 cm from the top marker, which in the Milford Haven estuary ensured at least ten intertidal station's, the average tidal range being 6.3 metres. This was achieved by a "Crosstaff".

The instrument consists of a stsiting bar fixed at a standard distance up a vertical pole and levelled by a bubble in spirit. The original instrument was modified by Crapp in 1970 to include a mirror, (figure four), so that the previous station could be stsited and the instrument kept level from the same view point. This allowed shore surveying to be carried out by a single worker instead of the pair needed, prior to the modification.

All stations once established were marked off on the bearing tape enabling an approximate shore cross-section to be drawn at a later date (see figure ten). Notes were kept at each station of the nature of the substratum and any other points of interest.

When considering the distribution of the intertidal fauna and flora, an area of one square metre was investigated as displayed in figure five. This was in exact accordance with Petpiroon's method and any species "present" but outside the sample area were noted as such on the results sheet. The size of Crapp's sample area differed slightly, (for comparison see Moyse and Nelson-Smith (1963), who outline the procedure Crapp followed). Organisms in gullies, on the landward side of pinnacles or occupying crevices were scored merely as "present in gullies" unless that was their only habitat (e.g. Littorina neritoides). Similarly organisms in rock pools were ignored, though this habitat proved to be rare at Little Wick.

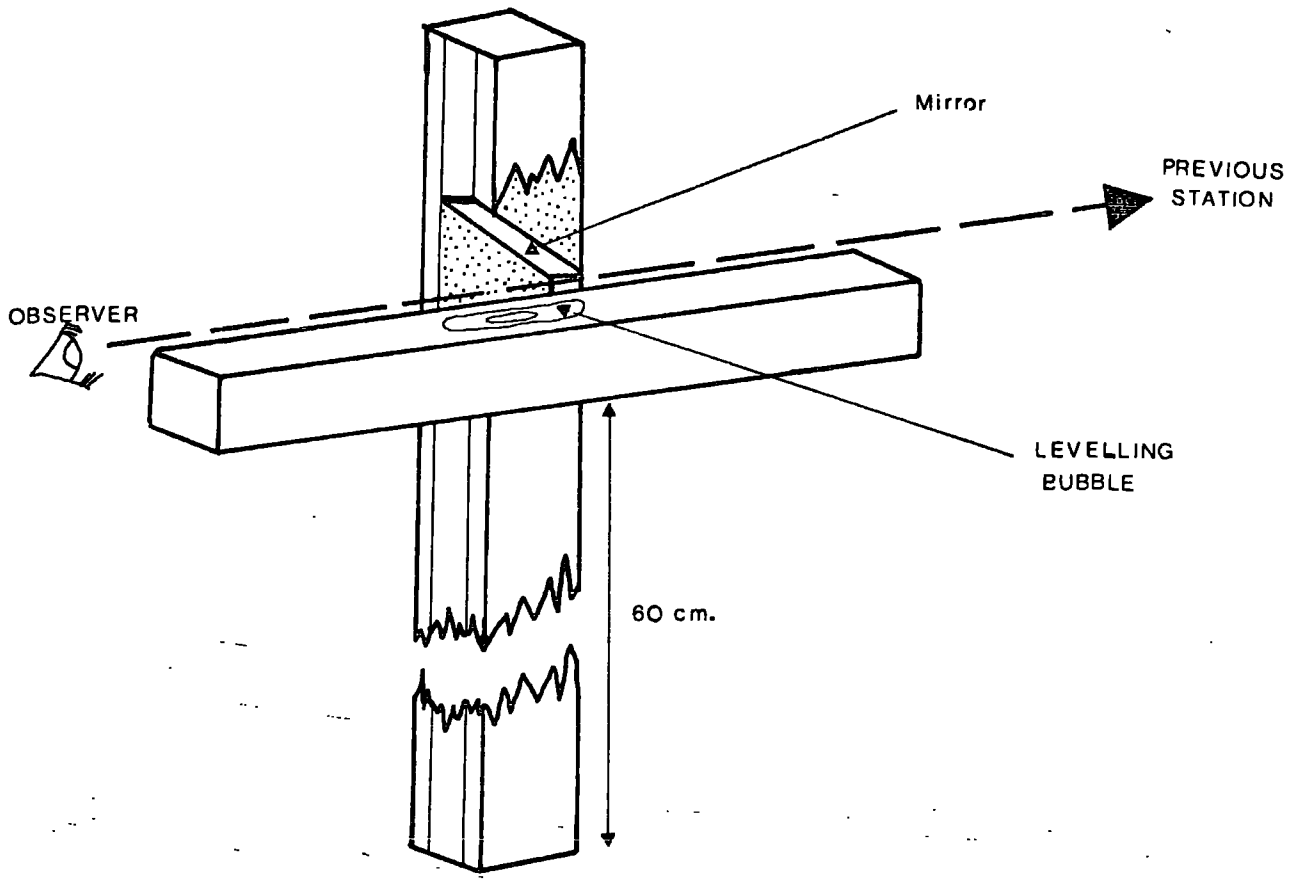

Figure Four: Showing the present Model of the "Crosstaff" after modification by Crapp in 1970 (Taken from Crapps Ph.D. Thesis, University College of Swansea)

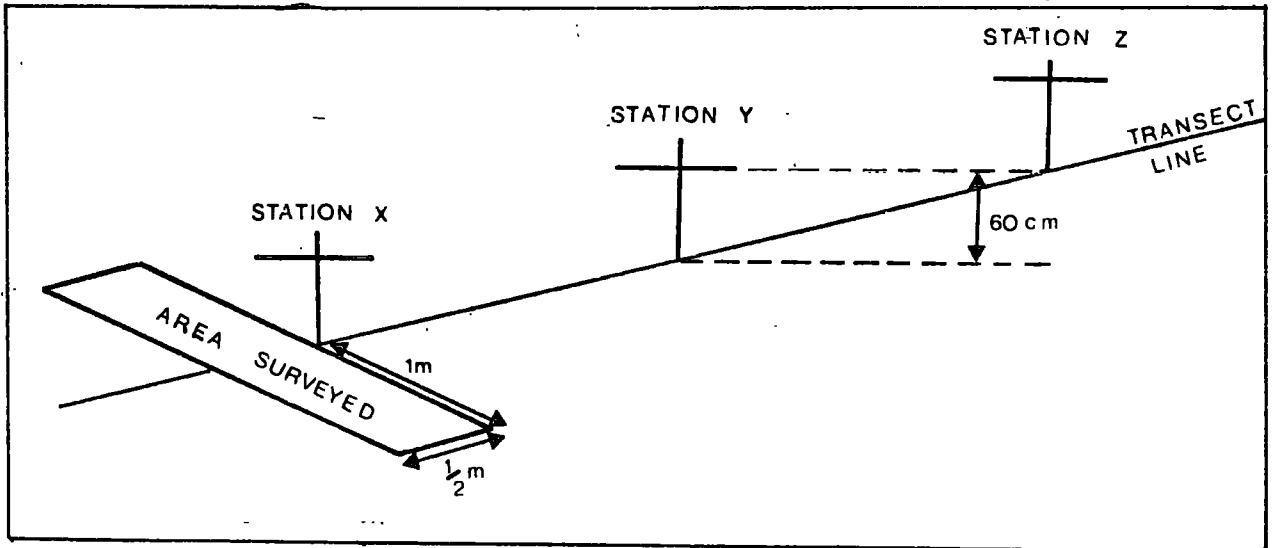

Figure Five: The Sample area investigated at each station along the Transect Line

The criteria of abundance used, displayed in full in the Appendix, were those developed by Ballantine, Moyse and Nelson-Smith from the original proposals of Crisp and Southward (1958). Crapp (1970) considered that the criteria for "Abundant" were set too low for several groups and thus added the grades "Super Abundant" (S) and "Extremely Abundant" (Ex), but did not modify the original grades except by setting an upper limit to "Abundant". In brief the categories used were Extremely Abundant (7), Super Abundant (6), Abundant (5), Common (4), Frequent (3), Occasional (2) and Rare (1).

Such criteria of abundance were used rather than any absolute number or densities, because after practice they are easier to estimate quickly in the field and because actual numbers per unit area must differ between organisms according to their size. Most recognizable changes involve orders of magnitude and are thus demonstratable by such criteria.

The checklist of species used was that assembled by Petpiroon, slightly modified from Crapp (1970), consisting of 48 locally occurring species of rocky shores. It was considered unnecessary to take Spirorbis specimens further than genus level due to difficulties of identification and rarity of occurrence. Likewise Limpets were left at genus level as Crapp's study had shown Patella aspera and P. depressa to be rare at Little Wick and identification involved the removal of the specimens which was considered undue disturbance of the habitat for the extra information gained.

For identification purposes Collins Pocket Guide to the Sea Shore (Barrett and Younge, 1973) proved sufficient in most cases with additional notes from O.P.R.U. and Petpiroon (pers. comms.) where necessary.

Previous estimates of the exposure grade of the shore using Ballantine's (1961) scale were accepted as accurate. However as an exercise in familiarization with the species involved, transect five was surveyed to ascertain if the exposure score thus obtained would agree with the literature. The technique involved,

for every organism listed, the circling of every grade whose criteria of abundance corresponded with the maximum found on the shore (see Appendix). The number of 'rings' for each exposure grade were then summed and the exposure grade with the most rings was classed as the grade for that shore or part of the shore. Checking every listed species is important in such a survey as the technique relies on the presence, or absence, of certain indicator species common to the eight grades of exposure observed.

Emphasis has been placed in my study on the exact location of each transect and its subsequent stations. This should enable future survey's to relocate the exact sample points studied previously, and enable comparison's of changes in species composition, with time (and any changes in environmental variables) to proceed relatively free from locational sampling errors. The results of the shore survey are given in full in the Appendix.

II. Studies of *Patella vulgata* at the Six Little Wick Transects

During the period in which survey's of the six Little Wick transects were carried out, it was noticed that Limpets varied considerably in size from transect to transect. Transect three, and to a certain extent transect four, appeared to support Limpet populations of greater average size (estimated visually) than did transects one, two, five and six.

I therefore decided to investigate firstly, whether the differences in average Limpet size were statistically significant, and secondly, whether any differences in body burdens and/or concentrations of Hydrocarbon could be detected in P. vulgata.

Patella vulgata was considered a suitable subject for investigation for two reasons:-

1. It was recorded in significant numbers on all six transects
2. Limpets as a group vary in size under different environmental

regimes (Lewis and Bowman, 1975). This being the case, further insight into possible effects of the Esso refinery effluent may be gained from a study of the genus.

(i) Investigation of the sizes of *Patella vulgata* in Little Wick Bay

From the initial shore survey it was discovered that *P. vulgata* reached its greatest abundance around station four of each transect studied. It was decided that this would be an appropriate station to adopt for the study of the size variation outlined above.

Sampling proceeded by counting every Limpet specimen within two 50 cm quadrats either side of the bearing tape. In this way half of a square metre was sampled for each transect unless this did not provide adequate numbers of results for subsequent statistical analysis. If this was the case subsequently larger areas were sampled as appropriate. The results are given in figure eleven.

Measurements of the longest diameter, shortest diameter and height of the shell were taken and a shell volume index calculated (see Appendix). For the calculation the Limpet shell was assumed to approximate to a cone.

(ii) Quantitative analysis of Petroleum Oil Pollutants by Infra red Spectrophotometry

The method employed for the determination of Hydrocarbon body burden in *Patella vulgata* is a relatively new approach to the problem and one which has not been previously used on this particular genus as far as is known. For this reason the methods are outlined in somewhat greater detail than would normally be appropriate.

The use of Spectroscopic, as opposed to Gravimetric methods in the quantitative analysis of water dispersed oils, is advantageous for a number of reasons.

Both methods employ solvent extraction to isolate and concentrate water

dispersed oils for quantitative measurement. Solvent evaporation, or "stripping", which precedes weighing in Gravimetric methods has the drawback that some of the volatile petroleum fractions are lost (Gruenfeld, 1975). Also, questionable sensitivity and accuracy are achieved by weighing minute oil residues in comparatively large (125 ml) distillation flasks in another gravimetric method (American Public Health Association 1971). Harra and Somersalo (1958) conclude that the Spectroscopic methods are far more sensitive and accurate. D.C.

(a) Sampling and Sample Preparation

Sampling was carried out on the 5th June, 1979 at Low Water Mark (figure six), and transects were relocated as described in the previous sections. Once the bearing tape was in position, a quadrat was placed with one side along the tape and its base just above the water line as shown in figure seven. Conditions were calm and the tide was on the ebb side of 'on the turn' i.e. no allowances had to be made for water movement in between the sampling stations.

Sampling proceeded in the top left, or right, division of the quadrat, and from the top left corner of that division, as indicated in figure seven, until three Limpets from three sample points (a, b and c) had been obtained at all six of the transects. Thus any subjective error due to variation in specimen size was reduced to a minimum. The samples were collected in labelled plastic bags and transported to the laboratory where they were removed from their shells and washed in clean sea water. This precaution ensured that no exogenous source of Petrogenic Hydrocarbon (namely oil residue on the body or shell of the Limpet, or on weed attached to the shell), was included in the analysis. The samples were then air dried for up to 78 hours allowing the largest of the specimens to dessicate completely. Once fully dried the specimens were weighed and wrapped individually in filter paper for extraction. E.C. U.C.
E.C.

(b) Extraction and Analysis

(i) Apparatus

Extractions were performed using standard Soxhlet apparatus, and the Hydrocarbons determined quantitatively with a Pye Unicam SP 1050 Infrared Spectrophotometer. Solution absorbances were all measured in matched 10 mm quartz cells.

(ii) Procedure

Firstly a "Beer-Bouguer Law" plot had to be prepared. Quantitative determination by a "single point analysis" (Gruenfeld, 1975) requires a linear plot that passes through the origin. To obtain such a plot, five standard solutions of accurately known concentrations of oil in Carbon Tetrachloride were prepared. The oil solution concentrations were adjusted to yield absorbances that were within the ordinate scale range of the Infrared Chart Paper.

Zero ordinate scale expansion and 10 mm quartz cells required 5 solutions of concentrations ranging between 0.5 and 40 mg/100 ml CCl₄ and these were prepared accordingly. The solutions were then put through the spectrophotometer (with a "blank" of CCl₄ from the same bottle) and the readings converted into absorbance values. These absorbance values were plotted against the known concentrations of oil in solvent and the standard plot prepared (see figure twelve). The absorbance band maxima of the oil mixture used was 2750/cm.

The calculation of absorbance values proceeds as follows: A typical trace from the spectrophotometer is shown in the figure eight.

A base-line (p, q) is drawn, then the values A and B are read from the infra red paper. The values A and B are then summed to give the transmission value (T%) which is substituted into the formula given below to obtain the absorbance value.

$$\text{Absorbance} = \text{Log}_{10} \frac{(100)}{(T\%)}$$

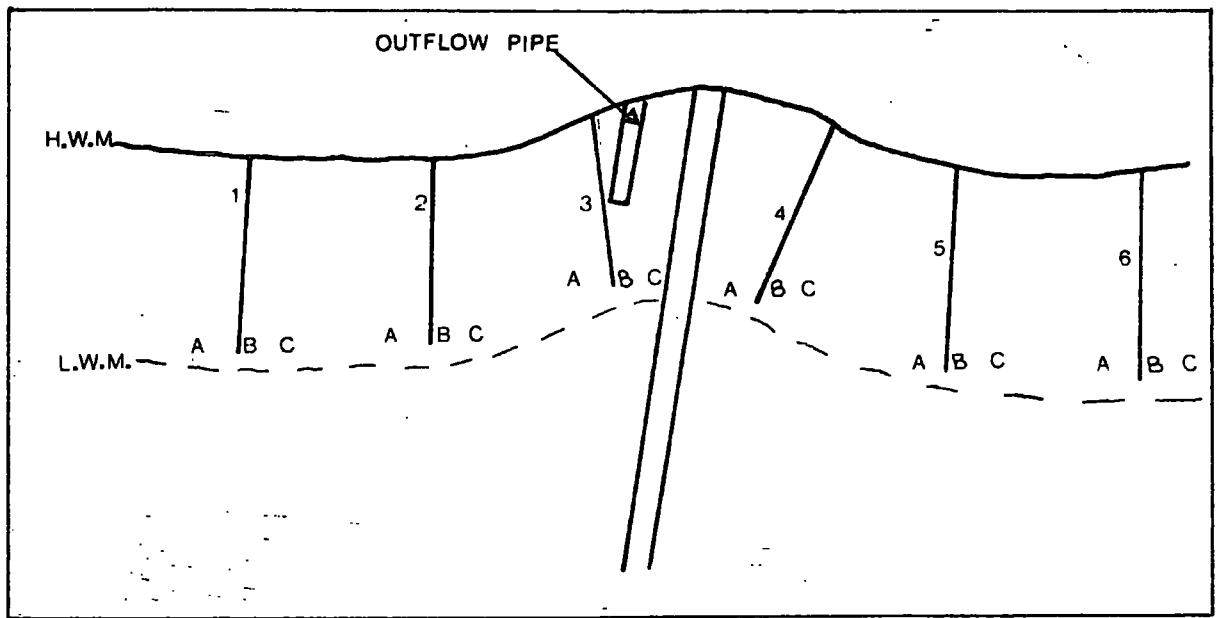

Figure Six: Showing sample Points from the six Little Wick Transects)
(H.W.M. = High water mark)

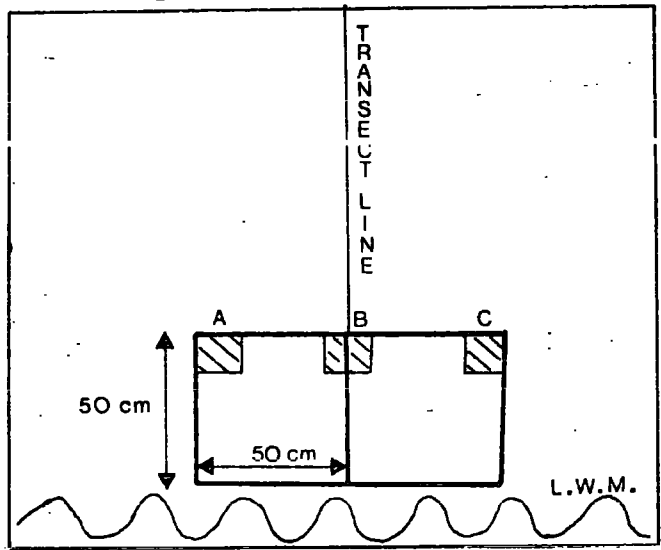

Figure Seven: Detail of a Sample area for any given transect
(L.W.M. = Low water mark)

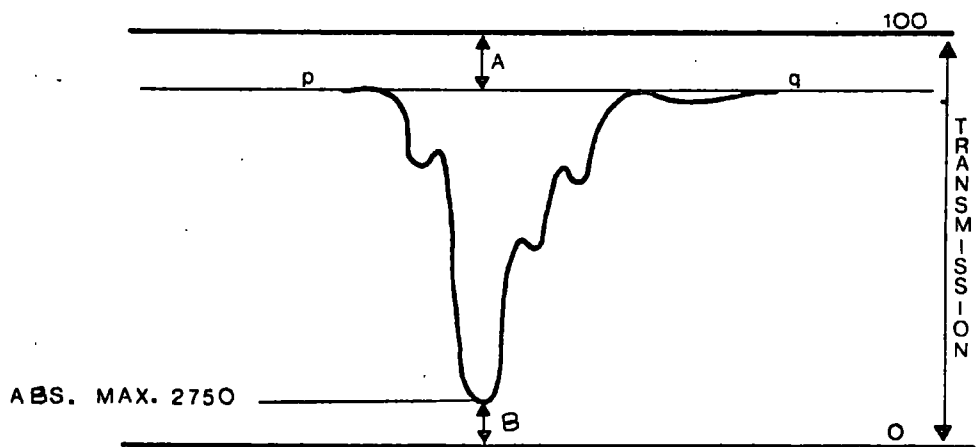

Figure Eight: An idealised trace from a Spectrophotometer readout

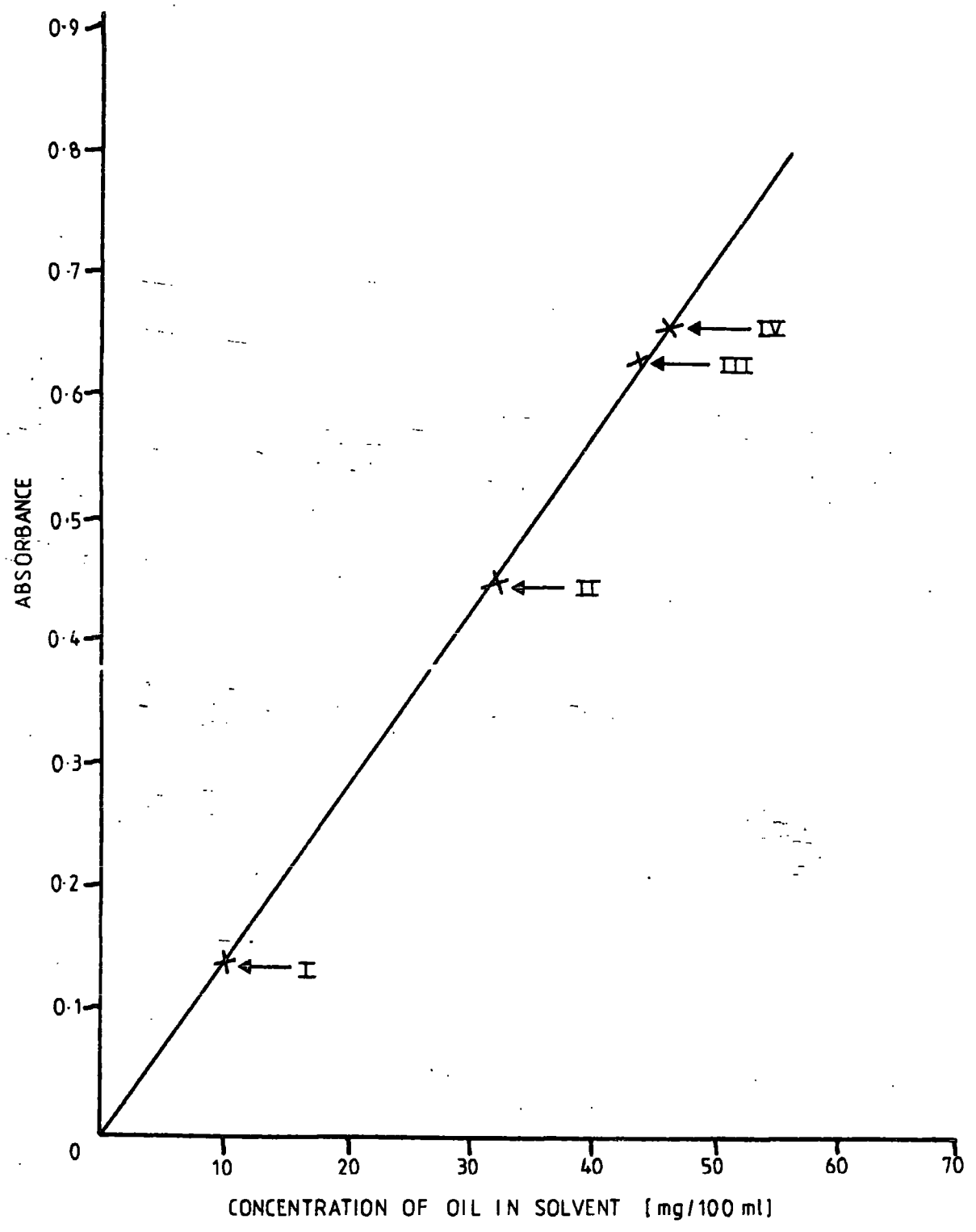

Figure Twelve: A standard "Beer Bouguer Law" Plot (Solution V was contaminated and was not plotted)

Once the transect samples have been processed and absorbance values obtained either a body burden may be read off the standard plot or, more accurately, an arbitrary value is read from the plot and this plus the sample absorbance reading are substituted into the following formulae used for single point analysis.

$$C_x = C_s \cdot \frac{A_x}{A_s}$$

Where C_x = the unknown oil concentration of the sample extract used for infra red measurement (= Limpet body burden)

A_x and A_s = The absorbances of the sample extract and standard solution respectively.

C_s = The Standard solution concentration used for I.R. measurement

The results are given in Table II.

A single point analysis as opposed to a full Infra red scan offers considerable time saving which is invaluable in such work requiring over fifty samples to be processed. Before sample absorbances could be put through the above procedure each sample was extracted in 200 ml of Carbon Tetrachloride (B.P. 72°C) for six hours. The resultant solutions were allowed to come off the boil before being decanted into flasks and put through the spectrophotometer. Once again a 'blank' of CCl_4 was used taken from the same bottle as that used for the extraction.

Table II Spectrophotometry Data for *Patella vulgata*

Sample Number	T%	Ax	Cx	Dry Weight	[]
1A(i)	54	0.268	18.48	0.494	37.41
1A(ii)	65	0.187	12.89	0.380	33.92
1A(iii)	86	0.066	4.55	0.278	16.37
1B(i)	43	0.366	25.24	1.389	18.17
1B(ii)	89	0.051	3.52	0.148	23.78
1B(iii)	70	0.155	10.68	0.530	20.15
1C(i)	51	0.292	20.14	1.057	19.05
1C(ii)	77	0.114	7.86	0.299	26.29
1C(iii)	76	0.119	8.20	0.454	18.06
2A(i)	50	0.301	20.75	0.624	33.25
2A(ii)	58	0.236	16.28	0.546	29.82
2A(iii)	63	0.201	13.86	0.413	33.56
2B(i)	31	0.509	35.10	0.758	46.31
2B(ii)	67	0.174	12.0	0.450	26.67
2B(iii)	77	0.114	7.86	0.193	40.73
2C(i)	55	0.259	17.86	0.627	28.48
2C(ii)	56	0.252	17.38	0.446	38.97
2C(iii)	61	0.215	14.83	0.482	30.77

Table II (continued)

Sample Number	T%	Ax	Cx	Dry Weight	[]
3A(i)	26	0.585	40.34	1.059	38.09
3A(ii)	29	0.409	28.21	1.441	19.58
3A(iii)	32	0.495	34.14	1.285	26.57
3B(i)	54	0.268	18.48	1.029	17.96
3B(ii)	29	0.538	37.10	2.697	13.76
3B(iii)	34	0.468	32.28	1.448	22.29
3C(i)	43	0.366	25.24	1.314	19.21
3C(ii)	37	0.432	29.79	1.720	17.32
3C(iii)	34	0.468	32.28	1.171	27.57
4A(i)	44	0.356	24.55	0.825	29.76
4A(ii)	65	0.187	12.89	0.445	28.97
4A(iii)	65	0.187	12.89	1.209	10.66
4B(i)	52	0.284	19.59	1.019	19.22
4B(ii)	44	0.356	24.55	1.165	21.07
4B(iii)	69	0.161	11.10	0.950	11.68
4C(i)	43	0.366	25.24	1.078	23.41
4C(ii)	67	0.174	12.0	0.465	25.81
4C(iii)	29	0.538	37.10	1.880	19.73
5A(i)	62	0.208	14.34	0.496	28.91
5A(ii)	82	0.086	5.93	0.200	29.65
5A(iii)	75	0.125	8.62	0.349	24.01

Table II (Continued)

Sample Number	T%	Ax	Cx	Dry Weight	[]
5B(i)	66	0.180	12.41	0.823	15.08
5B(ii)	81	0.092	6.34	0.325	19.51
5B(iii)	33	0.481	33.17	1.756	18.89
5C(i)	69	0.161	11.10	0.661	16.79
5C(ii)	48	0.319	22.0	0.672	32.74
5C(iii)	71	0.149	10.28	0.428	24.02
6A(i)	61	0.215	14.83	0.454	31.67
6A(ii)	72	0.143	9.86	0.329	29.97
6A(iii)	60	0.222	15.31	0.284	53.91
6B(i)	73	0.137	9.45	0.337	28.04
6B(ii)	68	0.167	11.15	0.409	27.26
6B(iii)	68	0.167	11.15	0.290	38.45
6C(i)	58	0.236	16.28	1.198	13.59
6C(ii)	62	0.208	14.34	0.438	32.74
6C(iii)	70	0.155	10.69	0.184	58.09

DISCUSSION

1. The Shore Survey

- (i) The distribution of Littoral Animals and Plants in 1979 in relation to the refinery effluent discharge point (see appendix)

Flowering Plants and Lichens

The presence or absence of flowering plants has been recorded for completeness, but they are considered to be of little relevance to the present investigation. Similarly some of the more characteristic lichens of the "supra littoral" zone, (Lewis, 1964) have been noted. Any distributional differences between the transects (of which there seem to be none of distinction) are considered to be for reasons other than those attributable to the outfall. However the greenish littoral *Verrucaria* group, referred to as "Verrucaria mucosa", show a reduction in relative abundance and a reduction in the width of the zone of occurrence at transects three, four and, to a lesser degree, two, (the three transects nearest to the outfall pipe.)

The Brown Algae (Phaeophyceae)

A pronounced increase in the relative abundance of *Pelvetia canaliculata* was observed at transects three and four. *P. canaliculata* was absent at transects one and two, and present in reduced amounts at transects five and six (figure nine).

Both *Fucus spiralis* and *Ascophyllum nodosum* were absent from transects one, two, five and six, which contrasts with the situation on transects three and four (figure nine). *A. nodosum* shows an increased relative abundance and zone of occurrence at transect three whereas *F. spiralis* shows this at transect four.

Laminaria digitata was present at all six transects. The reduction in relative abundance observed at transects three and four may be attributed to the instability of the substratum^{um} which is mainly sand and boulders at the lowest stations investigated.

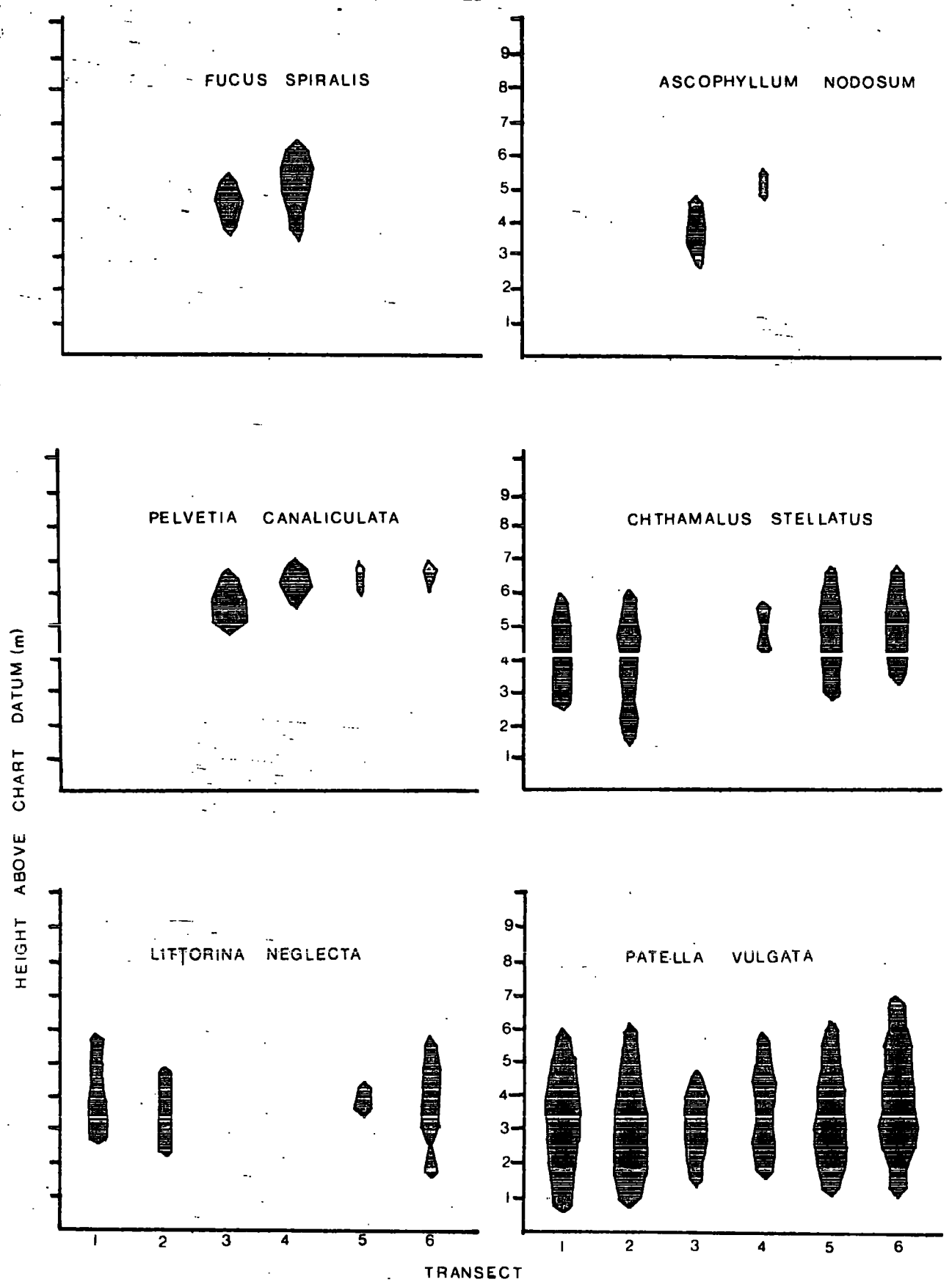
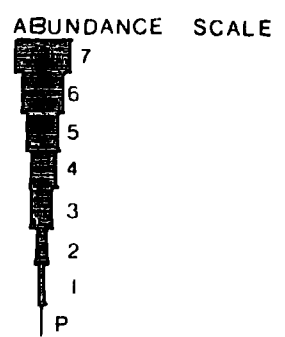

Figure Nine: Distributions of six common species at the six Little Wick transects. (The abundance scale follows the format outlined in the methods section)



Fucus serratus showed a maximum relative abundance at transect three and a greatly increased zone of occurrence, the same was true for transect four but to a lesser degree. At transect five the relative abundance was similar to transect four but with a slightly narrower zone of occurrence whilst at transects one, two, and six the relative abundances and zones of occurrence were markedly reduced. F. vesiculosus exhibited the same trend but was less abundant than F. serratus and absent at transects one and six.

The Green Algae (Chlorophyceae)

Species of Ulva were rarely found at any of the Little Wick transects, outside the rock pools, though a small increase in relative abundance was noted at transect three. Enteromorpha species were found at all transects and the zone of occurrence widened at transects three and four. However the relative abundances were similar throughout.

The Red Algae (Rhodophyceae)

Gigartina stellata showed a slight increase in relative abundance at transect three though the distribution among transects was variable. The reduction of Gigartina stellata and the Rhodophyceae as a whole at transect four may be explained by the somewhat unstable nature of the substratum between stations three and five consisting of sand and boulder's. No other general trends were apparent with the exception of a reduction in the relative abundance of Porphyra at transect three.

Barnacles (Cirripedia)

In contrast to the situation at transects one, two, five and six, Chthamalus stellatus was noticeably reduced in relative abundance, and had a much narrower zone of occurrence, at transect four, and was unrecorded at transect three (figure nine). Elminius modestus however showed no reduction in its zone of occurrence at any of the transects, and only a slight reduction in abundance at transect three.

Balanus balanoides showed a marked reduction in relative abundance and a restricted zone of occurrence at transects one, two and three. The situation was alleviated slightly at transects four and five, and a maximum relative abundance, and zone of occurrence were seen at transect six.

Balanus crenatus occurred only in small numbers at any of the transects (excepting transect six) and is noted as rarely extending above the infra littoral fringe (Lewis, 1964).

Winkles (Littorinidae)

All species of winkle recorded at Little Wick showed marked reductions in both abundance and zone of occurrence at transects three and four,

Littorina neglecta being totally absent there (figure nine).

Topshells (Trochidae)

The Topshells reflected the same distributional changes as the Littorinid's, but more drastically. All species of Topshells were completely absent at transects three and four. Maximum abundances for Gibbula umbilicalis and Monodonta lineata were recorded at transects six though the zone of occurrence remained fairly constant.

Limpets (Patellidae)

Limpets were separated only to genus level (for reasons' given above). Both reduced relative abundance and zone of occurrence were observed at transects three and four (figure nine). The other four transects supported more abundant populations. (The next section deals with Patella vulgata in more detail).

The remaining Fauna

Mytilus edulis was recorded in small numbers at transect six only. Nucella lapillus the dog whelk was recorded at transects one and six only, again in small numbers.

The Serpulid Pomatoceros triqueter was rarely recorded as it is confined to the infra littoral fringe. The coelenterate Actinia equina was absent at transect three

← (7)

though present in varying abundances at all other transects.

(ii) Possible Explanations of the observed Species Distributions

In general the central transects at Little Wick (transects three and four), differ from the other four transects firstly, by supporting a greater number of species of Brown Algae and a greater percentage cover of the majority of those species, and secondly, by supporting a depleted number of faunal species and a lesser abundance of the majority of those species.

The Fauna

With the exception of ^aBalanus balanoides the species of barnacle found at Little Wick reach their lowest abundance at the central transects. (B. balanoides is actually less abundant at transect one and this remains essentially unexplained). Crapp (1970) implicated the refinery effluent as the main cause of such reduced abundances and noted reduced numbers of barnacle spats plus an increased spat mortality rate near the outflow. Knight-Jones (1953b) has shown that B. balanoides, B. crenatus and Elminius modestus spats show a gregarious settling behaviour. Thus less spats settle in areas of low barnacle density, all other factors being equal. The reaction was shown to be species specific. More recent work by Dick's (1975b) in Little Wick Bay has shown that fewer B. balanoides spats settle near the outfall (none having settled on the end of the pipe), and that the numbers increase with distance from the outflow. To establish why this might be, Dick's carried out laboratory tests on the nauplii of B. balanoides and concluded that the Little Wick effluent had a dual influence on barnacle larvae, firstly because of its reduced salinity, and secondly because of "other effluent constituents which were not measured". The barnacle nauplii are positively phototactic and thus swim to the surface of the sea; the effluent also forms a thin layer on the surface of the water. When the nauplii encounter the effluent, an immediate cessation of swimming occurs and the nauplii drop below the effluent layer. This observation explains

the observed pattern of spat settlement as follows - As the surface film of effluent moves up and down the shore with the tide, so spat settlement is prevented in the area the effluent covers. (NB Although it is the cyprid stage that settles and not the planktonic nauplii larvae, it is assumed, not unreasonably, that it reacts to the effluent in the same way.) However, there are long periods at high tide when the effluent has no effect on the middle shore during which time some cyprids will have a chance to settle. Hence Dick's concluded that settlement could only be seriously influenced where the effluent occurred continuously, very close to the outflow pipe, with a lessening effect as distance from the outfall pipe increases, produced by dispersion of the effluent. It seems reasonable to conclude from Dick's work that the effluent effects spat settlement, but that once settled this barnacle may continue growth and development normally.

The settlement of Chthamalus stellatus may also be affected in the manner suggested above. However, the complete absence of C. stellatus at transect three suggests the effect might be even more acute. As well as the nauplii and cyprid showing aversive reactions to the effluent, there might be mortality among both the young stages and adults. 87

The results for Elminius modestus require another explanation. Compared to the other barnacle species present at Little Wick, E. modestus is comparatively abundant at transects three and four, and it is possible that Elminius' settling stage is less sensitive to the effluent. It has also been established that Elminius grows well underneath a covering of Fucaceae (Nelson-Smith, 1967), therefore once established it may be in a position to outcompete other barnacle species less well adapted to growth under a fucoid canopy, such as B. balanoides and Chthamalus stellatus (Lewis, 1964).

In short, the observed reduction in barnacle densities near the outflow pipe (transects three and four) may be caused directly by the effluent itself,

and indirectly by the cover of furoid algae which have invaded the area.

The winkle population at Little Wick showed an extremely marked change at transects three and four. As early as 1968 L. littorea and L. littoralis were recorded as being very sensitive to oil pollution (Nelson-Smith). Parsons, (1972a) noted that L. saxatilis ceased activity and retracted into its shell when exposed to effluent and Baker (1975b) has shown that 50% of a population of L. saxatilis in a rock pool, crawled up and out of the water when effluent was added.

A mark and recapture experiment was carried out by Baker (1975b) in which she released one hundred L. littorea near the Kent refinery outlet. No winkles were recaptured near the effluent pipe, and those observed just after release were in a "sick flaccid" condition and presumed to have been subsequently washed away. This confirms Parson's observations, as retraction into the shell was often followed by the winkle being washed out of the area. Recovery did not ensue until the water was free from effluent or the animal was carried out of the contaminated area (Parsons 1972a; Baker, 1975b).

Nelson-Smith (1968) observed that when L. neritoides lives in dead barnacle cases, the oil pollutants tended to wash harmlessly past, thus protecting an otherwise very vulnerable species. This observation was unlikely to be of importance at Little Wick as no winkles were recorded in dead barnacle shells in the central transects.

Although L. littorea is rare at Little Wick Bay (Nelson-Smith, 1967) it is interesting to note that the free swimming larval stage avoids surface waters of low salinity (Brattegard, 1966). Referring to the observations for B. balanoides nauplii larvae, reviewed above, this may explain the reduced relative abundance of L. littorea at transects three and four compared to transects five, six and one.

The effects of refinery effluent on the topshells Gibbula umbilicalis

and Monodonta lineata have not been studied. However as the refinery effluent has a direct effect on Barnacles and mollusc species closely related to topshells, namely Littorinids, it is likely that the complete absence of either of the above two topshells is due to the effects of the refinery effluent. Nelson-Smith (1968) cites M. lineata as another sensitive species to oil pollution. Crapp (1970) has found that both topshell's and winkles retract into their shells when under the influence of pollutants and thus are washed into the sublittoral zone, eventually crawling back onto the littoral zone in a non-polluted area to become reestablished. f.c.
e.c.

Lewis (1964) notes that dense shading, encountered for example under a dense cover of fucoid algae, favours Gibbula umbilicalis, Monodonta lineata and Actinia equina. Neither of these three species showed any increase on the central transects (all being absent from transect three). Thus, presumably, sensitivity to the effluent negates any beneficial effects of the fucoid cover. h

Mytilus edulis, Nucella lapillus and Pomatoreros triqueter are so rare at Little Wick that any attempts to relate their distribution to the effluent would be dubious. N. lapillus might be expected to be reduced or absent from the central transects due to reduced densities of its prey species (barnacles), regardless of any direct effect of the effluent.

The possible explanations for the reduced Limpet densities are dealt with fully in the following section. e. e

Another trend observed from the Little Wick transects was the increased abundance of Nucella lapillus, Monodonta lineata and Gibbula umbilicalis at the eastern transects five and six. As noted in Crapp's study these transects are marginally more sheltered than transects one and two. The above mollusc's are reported to be better adapted to sheltered areas within Milford Haven (Nelson-Smith 1967) and this may explain the observed distribution.

The Flora

With the exception of Laminaria digitata (whose main abundance was outside the sampling area), all of the Phaeophyceae increased in abundance and showed an increased zone of occurrence at the central transects. Algae are reported to be unusually resistant to effluent because they are protected by a mucilage covering. The abundance of Brown Algae within the immediate area of the refinery discharge shows them to be resistant (Baker, 1975). However resistance to effluent toxicity is not enough on its own to explain the increases in abundance observed. The main factor responsible for the observed increase in brown algae must be reduced grazing pressure from Limpets, (Crapp, 1970; Baker, 1975). Reduced grazing pressure allows the establishment of the young algal stages and once the algae have reached maturity they are extremely resistant to grazing damage, except by very large limpets. l.c.

Enteromorpha shows an increased abundance and zone of occurrence at the central transects. An abundant growth of these green seaweeds was reported by Baker (1975a), followed by a growth of furoid algae following Limpet detachment, shortly after an oil spill in the Milford Haven estuary. This particular green algae is noted for its great resistance to effluent discharge (Baker, 1975), and Nelson-Smith (1967) has reported Enteromorpha to be abundant at all levels where fresh water drains across the shore. As exposure to effluent also coincides with exposure to waters of reduced salinity, the ability of Enteromorpha to tolerate salinity changes may in part explain its resistance to effluent discharge.

Van Gelder-Ottway (1975) has looked at the effect of a floating oil film on algal Photosynthesis and concludes that for Enteromorpha neither gas exchange l.c. temperature or light reduction effects are significant in the marine environment. (Some effects were observed in the Rockpool habitat though).

The increase in relative abundance of Gigartina stellata at transect three is probably due to the dense furoid cover which encourages many red

algae to extend their range further upshore. The furoid cover prevents dessication, a condition to which the Rhodophyceae are particularly susceptible.

Porphyra actually decreases in abundance at transect three. Since Porphyra is a weed of the more exposed areas of the Pembrokeshire coast (Evans, 1947) it is possible that the furoid cover offers too sheltered an environment for the successful establishment of this algae. Such observations are supported by the fact that Porphyra attains its greatest relative abundance at transect one, the most exposed of the six at Little Wick, having an exposure grade of four (Ballentine, 1961).

(iii) Comparisons of the present Survey with the Survey's of Crapp (1970) and Petpiroon (1978)

Not surprisingly the differences between Petpiroon's results and my own, (taken one year apart and at the same time of year), are negligible.

Before comparing the differences between Crapps results and my own (taken nearly ten years apart and at the same time of year), it will be useful to summarise Crapp's conclusions (full results of both Surveys are given in the Appendix).

1. There is a change in exposure from South Hook Point (Grade three, Ballentine, 1961) to Gelliswick (Grade six). The Little Wick transects vary between grades four and five. The Bay itself (transects three and four) is probably more sheltered (Grade five) as is transect six, while transect's one, two and five may be assigned to Grade four. Changes in exposure are not sufficient to explain the variations found in flora and fauna.
2. Several species of gastropod molluscs were absent or reduced in numbers on the central transects. This could not be explained in terms of natural environmental factors. Littorina saxatilis and Littorina littoralis appear to be unaffected this way.
3. Limpets (Patella vulgata) and barnacles (Chthamalus stellatus, Balanus balanoides and Elminus modestus) were considerably reduced in numbers on transects

three and four.

4. The Seaweed's Fucus serratus, F. vesiculosus and F. spiralis were particularly abundant on the central transects. Pelvetia canaliculata and supralittoral lichens did not appear to be affected.

Crapp's hydrographic studies showed that surface currents away from the outfall are slow, except on the early stages of the ebb and the flood. It is possible that the siting of the outflow leads to some retention of effluent in the Bay.

Crapp's survey and my own are in close agreement in general but there are one or two differences apparent.

Patella vulgata has been further reduced at transects three and four since 1970, as has Chthamalus stellatus at transect three. If the effluent is reducing recruitment, which is strongly indicated by the evidence given above, and that in the next section, then it is not surprising that numbers of Patella and Chthamalus are falling even if the mortality rate has remained constant, though this is only likely to apply if both species are very long lived and longevity is discussed later.

Since the earlier survey, Balanus balanoides has been reduced in relative abundance at all six transects, the greatest effect being shown at transects one, two and three. The relative abundance of Chthamalus stellatus is also reduced at transect one. Elminius modestus has an extended breeding season, a higher growth rate, a high desiccation tolerance, and adaptability to variations in temperature and salinity (Tait 1968). It is likely that Elminius is outcompeting B. balanoides for space at all transects, B. balanoides is better adapted to more sheltered conditions so it is possible that any competitive effects might be greater at more exposed areas thus explaining the above distributional changes. However no subsequent increase in Elminius has occurred since 1970 so this rather weakens the hypothesis.

The ability of Elminius modestus to tolerate variations in temperature

and salinity might explain why it is less affected by the effluent than the other barnacles species. The observed Elminius mortalities probably result only from the toxic chemicals in the effluent (Crapp's data implicates the oil fraction of the discharge). B. balanoides was affected both by the toxic chemicals in, and the reduced salinity of the effluent (Dick 1975b).

Contrary to Crapp's findings, both Littorina saxatilis and L. littoralis were reduced at transects three and four in the present survey for reasons which have been suggested above. L. littoralis numbers have also decreased since 1970 at transects five and six, this correlates well with a reduction of Fucus vesiculosus and F. spiralis at the same transects, (L. littoralis is a grazer on furoid algae). The Fucus decrease, however, is less easy to explain as it does not correlate with increases of Limpets or other grazing molluscs. Possibly at the time of the earlier survey the Fucoids were abundant following a localised oil spill (Baker, 1975). Since then, if young Limpets have reestablished, they would check the growth of new Fucus plants. The overall abundance of the algae would decrease as the older plants died.

The final difference between the two survey's is that Crapp maintained Pelvetia canaliculata was essentially unaffected by the effluent. My observations indicate that it has increased its relative abundance at transects three and four, and decreased its relative abundance at transects one, two, five and six, since the 1970 survey. The reasons for these changes may be similar to those for the other brown Algae.

Conclusions from the Shore Survey

Crapp implicated the continuous input of low levels of crude oil into Little Wick Bay, as being the major factor influencing the observed biological differences apparent between the transects investigated. In doing so he rejected the possibility that ephemeral discharges of emulsifier in the effluent were responsible.

The fact that the three surveys of the Little Wick transects give essentially the same results suggests two important conclusions.

1. The mean Effluent quality has not changed significantly since 1970, except l.c.
for the fact that oil content has been reduced from a mean of 25mg/litre to
one of 15mg/litre (Esso 1979, pers. comm.). The survey's show that the
situation at Little Wick is essentially an Equilibrium one. Thus a relatively l.c.
constant effluent is producing a relatively ^scontant Biological effect and s l.c.
this supports Crapps early conclusions that continuous low level pollutants h
are the main vectors in bringing about the observed changes.

The implication is that the oil is the actively toxic constituent of the
effluent (Crapp, 1970). The effect of reduced salinity is shown to be
important for some species.

2. The area affected by Esso's discharge into Little Wick Bay has not increased
over a period of ten years since industrial operations started, and the effects
are localised to the immediate vicinity of the outflow pipe.

2. Investigations concerning the Limpet Patella vulgata l.c.

(i) Comparisons of the Size-frequency distributions of P. vulgata at the
six Little Wick Transects

There was sufficient doubt as to whether the data in this section met
the assumptions of analysis of variance, to make the use of non-parametric
methods necessary. Here the null hypothesis is not concerned with specific
parameters (such as the mean in analysis of variance) but only with the
distribution of the variates.

A Kruskal-Wallis test showed that the limpet samples differed in
'location' significantly (Sokal and Rohlf, 1969). Once this had been
established, fifteen Wilcoxon two-sample tests, comparing each transect with
every other transect, were carried out. These tests established whether, for
instance transect one had the same distribution of Limpet sizes (volumes) as l.c.
transect three or not, and the results are as given in Table I.

If we look firstly at the results differing at the $P = 0.01$ level of
significance, the Limpet distributions at both central transects were

Table I Results for the Statistical analysis on the Limpet Volume index data (for the raw data see Appendix)

TECHNIQUE: Kruskal-Wallis Test			
H = 245.85		$H/D = 245.86$	P = 0.01
TECHNIQUE: Wilcoxon Two-sample test			
Transect Comparison	t_s	Significance at	
		P = 0.01	P = 0.05
1 vs 2	0.488	N.S.	N.S.
1 " 3	7.745	S.	S.
1 " 4	6.683	S.	S.
1 " 5	0.556	N.S.	N.S.
1 " 6	1.328	N.S.	N.S.
2 " 3	8.475	S.	S.
2 " 4	7.504	S.	S.
2 " 5	2.054	N.S.	S.
2 " 6	2.355	N.S.	S.
3 " 4	2.595	S.	S.
3 " 5	9.095	S.	S.
3 " 6	8.544	S.	S.
4 " 5	7.958	S.	S.
4 " 6	6.934	S.	S.
5 " 6	2.019	N.S.	S.

Reference: Sokal, R.R. and Rohlf, F.J. (1969). Biometry pp 387-395

Key to the Symbols used in Tables I, II, III

Symbol	Meaning
H	Kruska-Wallis H statistic
H/D	Corrected value for tied ranks
P	Probability Level
t_s	Sample statistic of t distribution
S	Significant
N.S.	Not Significant
T%	Transmission
Ax	Absorbance value
Cx	Hydrocarbon Body Burden (200 ml. CCl_4)
[]	Hydrocarbon Concentration $Cx/Dry\ Wt.$
$F_{x,y}$	Fishers ratio with x indexing Transects of Fishers ratio with y indexing error of
T_n	Transect number (1 \rightarrow 6)
μ	Mean
γ_i	Treatment ie. Transect origin
e_{ij}	Error
df	Degrees of Freedom

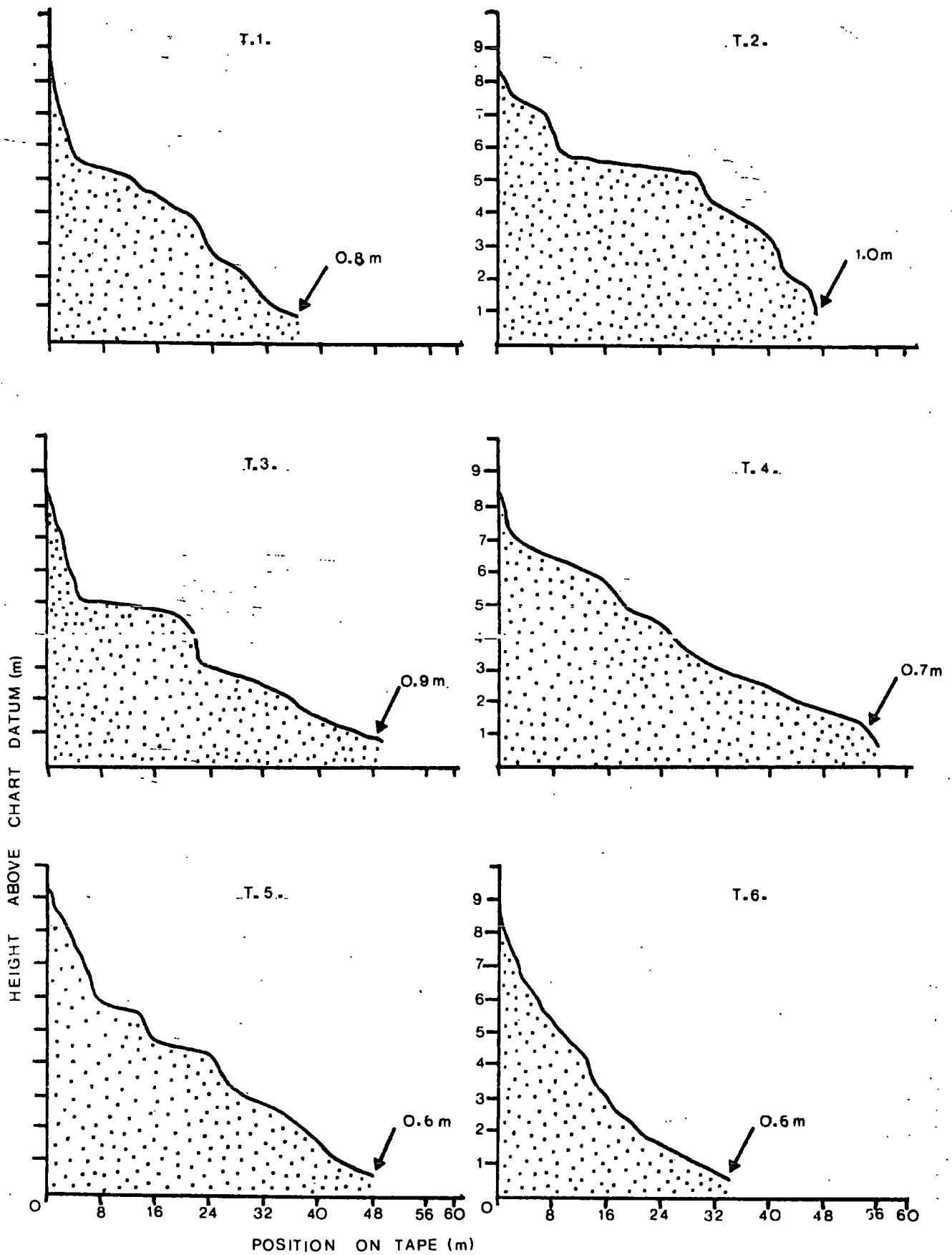

Figure Ten : Approximate Shore Cross-sections for the six Little Wick Transects. (The height of station one above chart datum is indicated by the arrows)

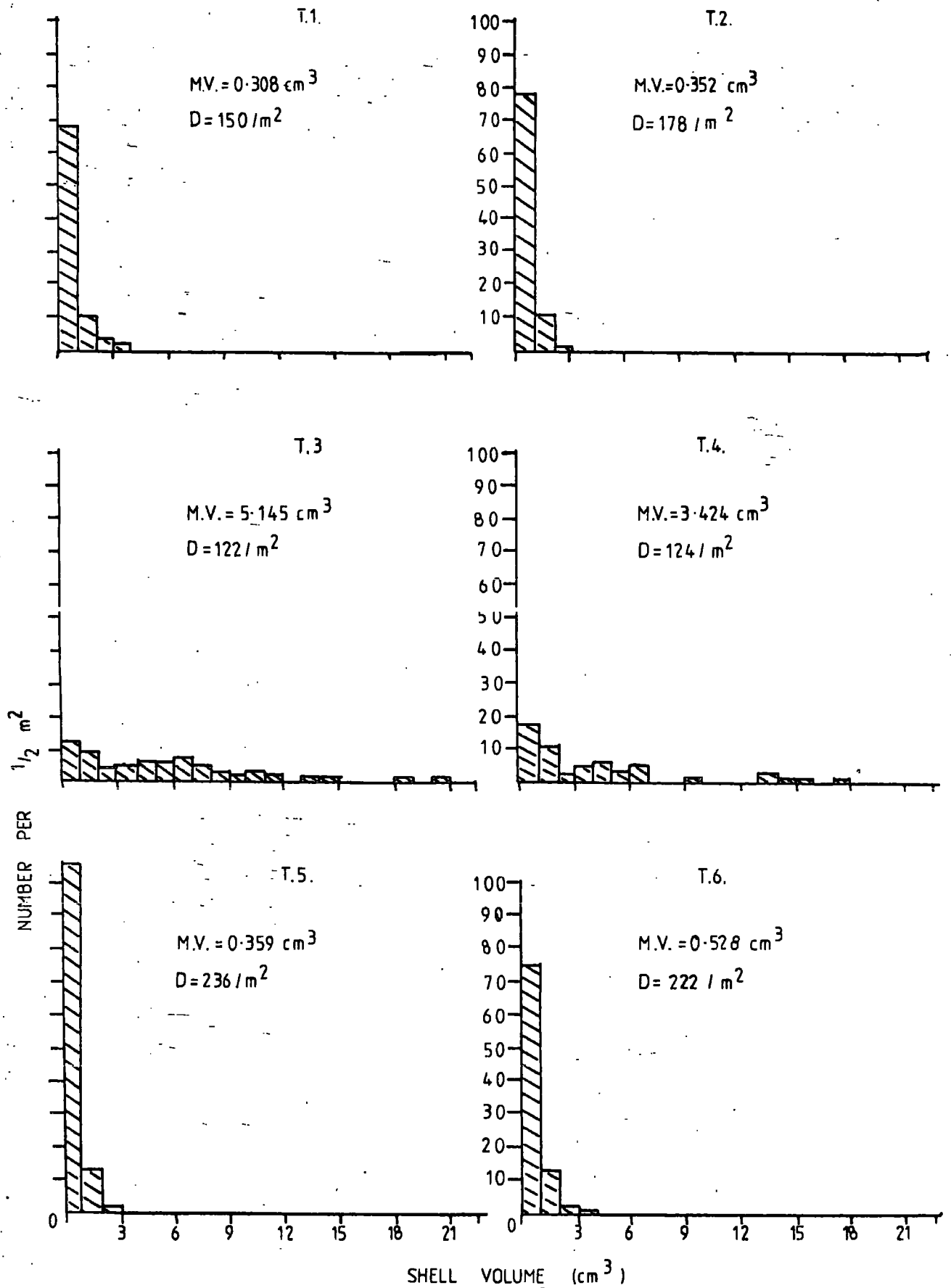

Figure Eleven: Size-Frequency distributions for *P. vulgata* at the six Little Wick Transects. (M.V. = Median volume, D = Density)

significantly different from those of any other transect.

Crapp (1970) and Baker (1975) observed:-

1. Limpet densities per m² measured at mid tide level show that densities are lowest near the effluent in Little Wick Bay, and that the largest limpets occur where the density is lowest.
2. The youngest limpet classes were missing from these areas characterised by low density and large size. Ovary weights indicated that the large limpets near the effluent were healthy.

These findings correspond exactly with the results of the present survey and once again show the situation to be essentially unchanged over a ten year period. Of relevance here is Lewis and Bowman's (1975) observation that relative densities of P. vulgata from different habitats remain fairly steady as long as the biological condition have remained similar.

The evidence from the shore surveys strongly suggests that any biological differences observed at the Central Little Wick transects are as a result of effluent discharge into that area. Although no direct evidence is available from experiments with Patella vulgata and refinery effluent, once again the inference is that variations in limpet size/frequency distribution are due to the effluent. In support of this Dick's (1975b) has shown P. vulgata to be very sensitive to both crude oil and dispersants.

Baker (1975b) transplanted limpets (in the size range 20 - 40mm longest diameter) onto the end of the Little Wick effluent pipe and to control areas, to find if there was an effect of effluent on adult animals. She concluded that there was not such effect. It therefore seems likely that as for B. balanoides (Dick, 1975b) the effluent affects limpet settlement or young stages and the absence of young age classes on the central transects supports this hypothesis.

The release of Emulsifiers through the effluent output is rare (Crapp, 1970).^{l.c.}
However the occasional release might kill a few of the adult population as

Dick's (1975b) has shown that P. vulgata exposed to emulsifier will drop off the rock and are then more easily subject to predation at the next low tide. Experiments to confirm this, (Baker 1975b) showed that when individuals were marked and oiled they dropped off the rock's and were no longer present in the area on the second low tide after the oiling. Dick's (1973) has also shown that P. vulgata is more susceptible to pollutants at certain times of day. The limpet exhibits a diurnal pattern of activity, being most active at midnight and least active during the day (superimposed on this is the tidal rhythm). Activity, feeding or otherwise, involves the limpet leaving its home scar and Dick's work showed that 60 - 64% of a population of limpets detached from a rock when oiled while feeding, whereas only 15 - 24% detached from home scars when oiled, then it is unlikely that the normal effluent will affect the adult limpet populations in this way but the effluent quality varies and a pulse of high oil content or a release of Emulsified, however, rare may be ^{ec.} a contributory factor.

There are a number of reasons why limpets might attain a larger size near the effluent outflow. Lewis and Bowman (1975) have found an inverse relationship between density and mean size in P. vulgata. Reduced intra-specific competition and an abundant food supply found at transects three and four might well contribute to a faster growth rate and hence to a larger size.

Alternatively the limpets at the central transects may be older than those at transects one, two, five and six. Very little is known about the age attained by shore organisms but sixteen years is considered feasible (Lewis and Bowman, 1975). Baker (1975) suggested that the limpets at the central transects became established before industrialisation in 1960 and had attained their large size from the availability of an abundant food supply for many years. This explanation is unlikely for all but a few individuals as nineteen years have passed since industrialisation began, and the survival of a large number of individuals for that time span must be improbable. It is more

likely that some limpets having settled further away from the effluent pipe, will subsequently be able to move into the area and establish themselves near the outflow. Once established, the abundant food supply and reduced intraspecific competition will allow a large size to be attained.

Interspecific interactions may also contribute to the large size obtained by P. vulgata near the outflow. Lewis and Bowman (1975) have found the highest growth rate and maximum length obtained when barnacle density is lowest (as is the case here). This is also the case near a dense Fucus canopy as suggested above and also under a Fucus canopy due to increased shelter and reduced barnacle density. Lewis et al. have also correlated a high survival rate and elongated life span amongst P. vulgata where annual recruitment is low, so Baker's point about greater longevity at transects three and four may again contribute to this rather complex situation.

To Summarise, the effluent is implicated as the major vector leading to reduced limpet density near the discharge point. It is suggested that the effluent has the greatest affect on young age classes of limpet and establishment, through factors such as variation in effluent quality and rare inputs of emulsifier are possible contributory factors in removing some of the adult population.

The large size attained by the limpets near the outflow is mainly due to reduced intra and inter-specific competition accompanied by an abundant food supply though other factors contribute and are discussed.

The observed distributions at the central transects also differ from each other. The best explanation for this is offered by a recent hydrographic survey (Addy 1978) in which the effluent is seen to be retained around the effluent pipe itself (transect three) due to embayment of the discharge pipe. Thus, exposure to effluent material is even greater at transect three than at transect four. The survey also shows the effluent to be restricted to the

area around transects three and four at all stages of the tide.

If we also look at the results for the $P = 0.05$ level of significance there are other differences that become apparent. The limpet distributions at transects two, five and six are significantly different from each other, though this is only border line significance, it is suggested that these observations are due to natural habitat variation to which P. vulgata is extremely sensitive (Blackmore 1969; Lewis and Bowman 1975). Transect six is one grade (Ballentine 1961) more sheltered than transects two and five, and this might explain the greater median volume obtained. Transects five and six have suffered reductions in Balanus balanoides abundance since Crapp's 1970 survey, and Lewis and Bowman (1975) have shown a reduction in barnacle density to lead to increased growth rate and maximum attainable size in P. vulgata. This might also explain the greater limpet density found at transects five and six.

(ii) Quantitative Analysis of Petroleum Oil Pollutants in P. vulgata by
infra red spectrophotometry

The results summarised in Table III show that the variation in both hydrocarbon Body Burden and Dry weight of limpet soft tissue, is greater between transects than within them. Transect three has a significantly higher hydrocarbon Body Burden than any other transect whereas transect four only differs significantly from transect one.

Dry weight determination also gave a higher mean value at transect three than at any other transect, with transect four differing from transects one, two, three and six but not transect five. Both the dry weight determination and the earlier size frequency investigation for P. vulgata, show limpets at transects three to be significantly larger than at any other transect and for the trend to be repeated for transect four but to a lesser degree. This is explained by differences in effluent retention between the two central transects. The mean dry weight at transect five was not significantly different from that at transect four, and the reasons for this may be due to

Table III Results from the Statistical Analysis of the Spectrophotometry
data given in Table II for *P. vulgata* Soft Tissue

TECHNIQUE: Analysis of Variance (Model one ANCOVAR)			
$Y_{ij} = \mu + \gamma_i + e_{ij}$			
Data Source	Significance of Difference between means		Significantly different transect means (P = 0.05)
Cx (Cx)	$F_{5,48} = 8.54$	P = 0.01	T ₃ from all other transects T ₄ from T ₁
Dry weight	$F_{5,48} = 8.97$	P = 0.01	T ₃ from all other transects T ₄ from T _{1,2,3,6}
[]	$F_{5,48} = 4.9$	P = 0.01	T ₂ from T _{1,3,4,5} T ₆ from T _{1,3,4,5}
TECHNIQUE: Regression of Cx (Y) on Dry Wt. (X) of <i>P. vulgata</i> Soft Tissue			
Transect	Slope of Regression t		Significance of Regression
All transects	1.477		$F_{1,52} = 106.8$ P = 0.01
1	1.658		$F_{1,7} = 28.91$ P = 0.01
2	4.109		$F_{1,7} = 21.54$ P = 0.01
3	0.425		$F_{1,7} = 0.88$ N.S.
4	1.529		$F_{1,7} = 9.28$ P = 0.05
5	1.715		$F_{1,7} = 34.9$ P = 0.01
6	0.534		$F_{1,7} = 4.21$ N.S.

Table III (continued)

TECHNIQUE: Comparison of the Slopes of the Significant Regressions ($T_{1,2,4,5}$) with that of a slope of one		
Transects	Slope	Significance of Difference between Regressions
All Significant		
ones	1.587	P = 0.01
1	1.658	P = 0.01
2	4.109	P = 0.01
4	1.529	P = 0.01
5	1.715	P = 0.01

natural habitat variation effecting limpet size (Lewis and Bowman, 1975). One possible cause for the increased mean dry weight at transect five may be reduced interspecific competition, as Balanus balanoides has shown a decline in abundance since Crapp's survey in 1970. Although this may be a contributory factor it is insufficient to provide the sole explanation, since at transect six (subject to the same depletion in B. balanoides) a lower mean dry weight was found than at transect five over the population sampled.

When dry weight of a specimen was related to its body burden of hydrocarbon (hence providing an estimation of concentration (in an individual) no difference between the central transects and transects one and five were found. Rather surprisingly transects two and six held animals with a significantly higher mean concentration than the other transects. There appears to be no obvious explanation for such a result and the result for transect two must be viewed with some caution because the relation between Body Burden and Dry weight (see below) has a negative intercept which is rather suspect.

Since the limpets near the effluent discharge did not show higher mean hydrocarbon concentrations than those further away it was decided to investigate the relationship between Dry weight and Body Burden more fully. When the data ^{were} pooled irrespective of transect of origin, Body Burden was strongly dependant on Dry Weight (thus as Dry weight increased so did Body Burden) (figure thirteen). This relationship also held true for the individual transects (excluding transects three and six). The non significant result for these two transects may have arisen because the samples collected did not span a wide enough range of weights for a linear relationship to be detected.

Of rather more importance than the establishment of such a relationship, however, was the fact that the pooled data, and that for each individually significant regression, had slopes significantly greater than one. This indicates that as the weight of the limpets increased, so did the concentration of hydrocarbon in their soft tissue, irrespective of the transect of origin.

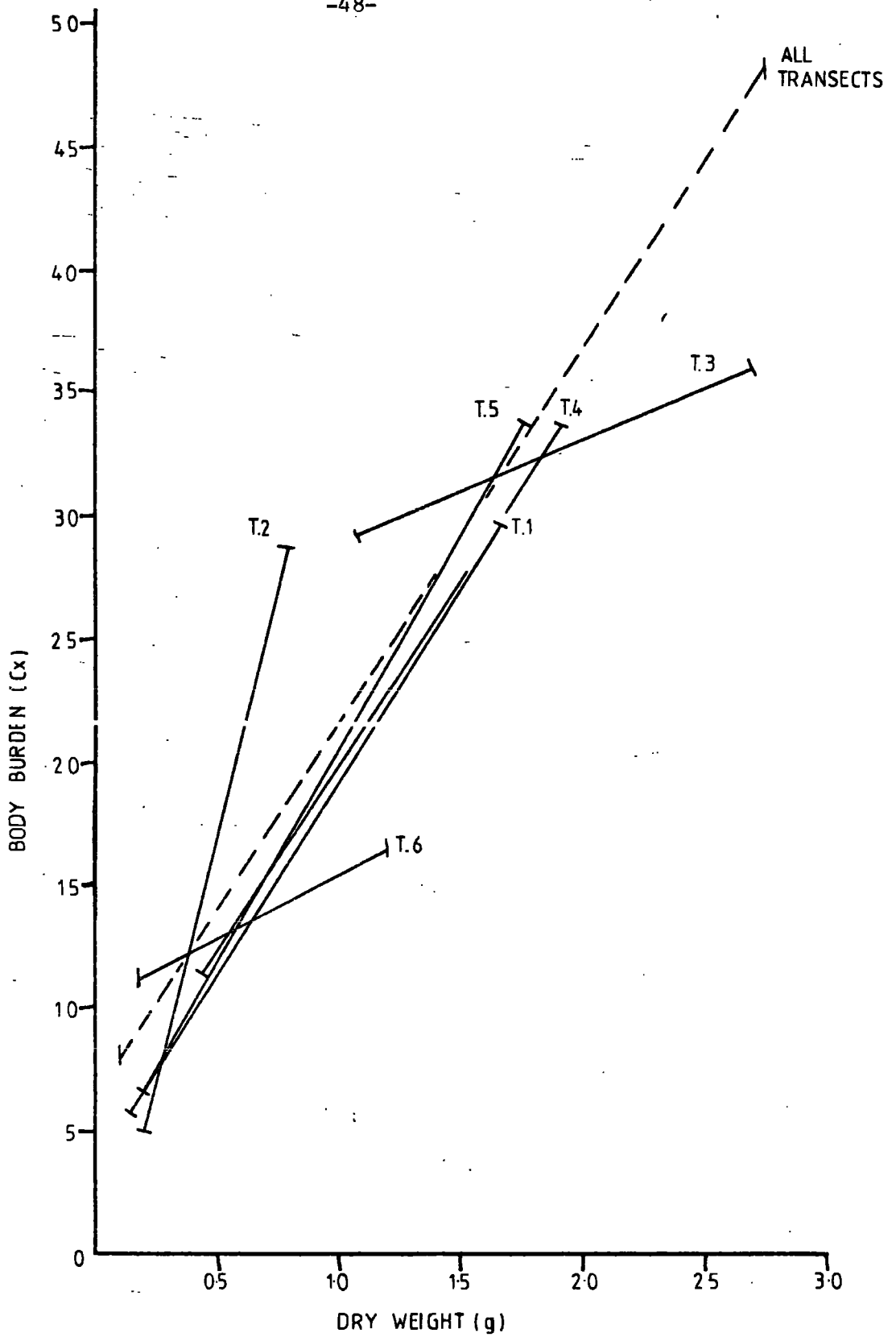

Figure Thirteen: Calculated Regression Lines of Body Burden vs. Dry Weight, for each transect and for all the data, pooled irrespective of Transect origin.

To summarise, two points of interest emerge from the spectrophotometry data:

1. That mean hydrocarbon concentration in P. vulgata is not greater near the effluent discharge.
2. That hydrocarbon concentration increases with increased Dry weight for transects one, two, four and five.

The first of these findings is open to a number of interpretations. Infra red spectrometry does not distinguish between hydrocarbons of Biogenic and Petrogenic origin and virtually all the hydrocarbon types found in crude oil occur naturally (Abus 1979, pers. comm.) Therefore, even with a "single point" analysis at the oil mixtures absorption maxima, Biogenic hydrocarbons will be present. The results might indicate firstly that all six transects are equally contaminated or secondly that there is differential contamination between the transects. Since the majority of the evidence here shows that contamination is far from evenly spread between the six transects, the first option must be extremely unlikely.

If the second alternative is accepted, there are a number of important deductions.

1. Infra red spectrometry has shown equal concentrations of hydrocarbons at the Little Wick Transects, these therefore are likely to be of Biogenic origin. It is not clear at present whether or not the marine invertebrates are synthesising their own hydrocarbons or whether their hydrocarbon content simply reflects the hydrocarbon content of their food source (Zsolnay et al, 1977). Lee et al (1977) have discovered that animals from areas of low, but constant petroleum input do not always show a markedly higher total hydrocarbon content relative to animals from cleaned areas and this leads on to the second deduction.
2. If Petrogenic hydrocarbons near the effluent outflow were ingested and accumulated by P. vulgata then this would show, over and above the Biogenic

concentrations found at all six transects. This is not the case and suggests that P. vulgata is either not taking the Petrogenic hydrocarbons into its system or that it has a mechanism for removing the Petrogenic hydrocarbons from its system once ingested. The first alternative is unlikely as an oil film was observed on the algae near the outflow and this is the limpets main food source. Also Teal (1976) has stated that it is clear from the chemistry of hydrocarbons that they should be absorbed through the guts of animals along with lipids in the diet. With the extra Petrogenic hydrocarbon present in the ambient water at certain stages of the tide, P. vulgata would almost inevitably absorb some oil into its system. Since ingestion of oil into the limpet system seems highly probable then it is likely that P. vulgata has some depuration mechanism. This is not unlikely, various species of shrimp, crab's and lobster's rapidly take up petroleum by hydrocarbons from either the water or their food, (Anderson 1973; Cox et al. 1975; Sanborn and Malins 1976). Most of the hydrocarbons in the food were not assimilated by the tissues of the blue crab Callinectes sapidus but instead were immediately eliminated from the animal (Lee et al, 1976). Polychaetes, particularly Capitella capitata, are associated with areas of high oil input (Reish, 1971; Sanders et al, 1972). As a consequence, the polychaetes and quite possibly worms belonging to other phyla have evolved enzyme systems which metabolise Petroleum hydrocarbons (Lee 1976, Lee et al. 1977). Presumably hydrocarbon metabolism facilitates the rapid discharge of hydrocarbons observed for various species of Polychaetes.

The shore survey not only indicates that the limpet P. vulgata is in a contaminated environment at transects three and four, but it is likely that individuals live longer in this region of reduced recruitment and reduced intra and inter specific competition (Lewis and Bowman, 1975), thus they are subject to contamination for long periods of time. The fact that oil concentrations in their soft tissues are not significantly greater than of those limpets in

cleaner water makes the existance^e of an efficient depuration mechanism highly likely. L

The Second inference from this work, that hydrocarbon concentration increases with increased body weight, suggests that the larger limpets in any given area retain more hydrocarbon in their systems than do smaller ones, and Boyden (1977) has discovered a similar relationship for P. vulgata with Cadmium. Work on the landsnail Cepaea hortensis sampled at a suburban roadside showed that both total Cadmium and Cadmium concentrations increased with age for soft tissues, but at a given age larger animals had lower Cadmium concentrations than smaller ones (Williamson 1979). Lewis and Bowman (1975) have shown that the accurate age determination of limpets is extremely uncertain (especially if comparisons are to be made between different sites) so to investigate the differential effects of size and age without observing a cohort of P. vulgata from settlement to maturity would be unreliable, but as an idea for a future investigation it is very promising. l.c

Another important topic for future study would be to differentiate between Biogenic and Petrogenic hydrocarbons in limpet tissue from the six Little Wick transects. This could best be achieved by Gas Liquid Chromatography (Zsolnay, 1977), comparing traces for extraction solutions from limpet samples (as obtained by the above method) with a sample of the effluent itself. The analysis of some fresh limpet material from a known unpolluted site would be a valuable addition to the study as well.

APPENDIX

<u>Contents</u>	<u>Page</u>
A (1) Shore Survey Data for 1979 Survey Archer-Thomson, J.H.S.	53
A (2) Shore Survey Data for 1978 Survey Petpiroon, S.	60
A (3) Shore Survey Data for 1970 Survey Crapp, G.B.	67
A (4) Criteria of Abundance for Common Plants and Animals of Rocky Sea Shores	74
A (5) Biological exposure score sheet (Ballantine 1961) for Little Wick Transect Five	77
A (6) Raw Data for Limpet Volume Index	79
A (7) Details of the mean effluent quality discharged in Little Wick Bay from the Esso Refinery	93

A (1) Shore Survey Data. Archer-Thomson, J.H.S. (1979)

Key (for all Shore Survey Data)

- 1 - Rare (R)
- 2 - Occasional (O)
- 3 - Frequent (F)
- 4 - Common (C)
- 5 - Abundant (A)
- 6 - Super Abundant (S)
- 7 - Extremely Abundant (Ex)

- D - In dead barnacles
- C - In crevices
- P - Present but outside survey area
- S - On seaweed
- U - Understones
- * - In Rock Pool

STATION NUMBER

Date 29/5/79

LITTLE WICK 1
136° 410 m WEST

WORKER J.A-T.

SPECIES ↓ 1 2 3 4 5 6 7 8 9 10 11 12 13 14 15 16 17

GA Enteromorpha spp	2	5	4	4	3	3													
RL Ulva spp																			
EG Cladophora spp																			
EA																			
NE																			
B A. esculenta																			
RR L. digitata	4	2	2																
O Fucus serratus	4	3																	
WA F. vesiculosus																			
NL F.v. var. linearis																			
G Ascophyllum nod.																			
A Fucus spiralis																			
E P. canaliculata																			
RED Corallina offic.	4	3																	
D Gigartina stellata	2	2																	
A Chondrus crispus																			
L Laurencia pinnat.	2	2																	
AG Lithothamnien spp.	2	2																	
L Lomeleturia art.	3	2																	
GA Rhodymenia pal.	4	3																	
EA Porphyra spp.		3	3	3	3														
E Catenella repens																			
L V. mucosa	2	2	1	2	3	4	4	5	4										
L V. maura										5	3	3							
L Lichina pygmaea																			
L L. confinis											3	3	3						
L K. parietina										1	1	2	3	3					
L Caloplacca spp											2	2	2	3	3				
L Lecanora spp										2	2	2	2	4	4				
L Ramalina spp										1	1	2	2	4	4				
L Flowering Plants											✓	✓	✓	✓					

Sea Anemones																			
Actinia equina	2	2	2	2															
Annelid worms																			
Spirorbis spp																			
Panatoceros triid	3	2																	
Barnacles																			
B. perforatus																			
B. crenatus	4	2	2																
B. balanoides																			
Elminus modestus	3	2	2	3	4	3	3	3	2										
Gutharealus stellatus																			
Limpets																			
Patella sp	3	4	5	6	6	6	5	4	2										
Topshells																			
Gibbula umbilicalis			2	3	3														
Gibbula cineraria																			
Morodonta lineata					3	3													
Winkles																			
L. neritoides							2	3	2										
L. saxatilis			5	4	4	4	2	3	2										
L. littoralis			2				4	4	5										
L. littorea																			
L. neglecta							3	3	2	2									
Dog Whelks																			
Nucella lapillus							2												
Mussels																			
Mytilus edulis																			

STATION NUMBER

Date 14/5/79

LITTLE WICK 3
186° 9m WEST

WORKER J.A-T.

SPECIES ↓ 1 2 3 4 5 6 7 8 9 10 11 12 13 14 15 16 17

1 2 3 4 5 6 7 8 9 10 11 12 13 14

GA	Euteromorpha spp	2																	
RL	Ulva spp	2	3																
EG	Cladophora spp																		
EA																			
NE																			
B	A. esulenta																		
R	L. digitata	2																	
O	Fucus serratus	4	5	6	4	3	4	2											
VA	F. vesiculosus				3	3	2	2											
NL	F.v. var. linearis																		
AG	Ascophyllum nod.				1	3	3	2											
AA	Fucus spiralis						2	5	3										
EA	P. canaliculata							6	6	3									
B	Corallina offic.																		
ED	Gigartina stellata	5	4	4	3	2													
A	Chondrus crispus	2	2																
L	Laurencia pinnat.																		
AG	Lithothamnion spp.	1	4																
L	Lomentaria art.	4	4																
AA	Rhodomenia pal.	4	1																
EA	Porphyra spp.																		
E	Catenella repens						1	2											
L	V. mucosa																		
I	V. maura				1	1	1	1	4										
C	Lichina pygmaea								4										
H	L. confinis									4									
E	X. parietina									1	1								
N	Caloplacca spp									4	4								
S	Lecanora spp									4	4								
S	Remalina spp									2	4								
	Flowering Plants																		

Sea Anemones																			
Actinia equina																			
Annelid worms																			
Spirorbis spp																			
Paratoceros trid	2																		
Barnacles																			
B. perforatus																			
B. crenatus										1									
B. balanoides										2	3	2							
Elminus modestus										3	2	3	4	3	2	2	2		
Githaralus stellatus																			
Limpets																			
Patella sp										2	3	4	4	4	2				
Topsnelis																			
Gibbula umbilicalis																			
Gibbula cineraria																			
Monodonta lineata																			
Winkles																			
L. neritoides																			
L. saxatilis															2	2			
L. littoralis																			
L. littorea																			
L. neglecta																			
Dog Whelks																			
Nucella lapillus																			
Mussels																			
Mytilus edulis																			

STATION NUMBER

Date 1/6/79

LITTLE WICK 6
178° 30.0m EAST

WORKER J.A-T.

SPECIES 1 2 3 4 5 6 7 8 9 10 11 12 13 14 15 16 17 1 2 3 4 5 6 7 8 9 10 11 12 13 14

GA	Enteromorpha spp	2	4	4	2	1	1													
RL	Ulva spp	2																		
EG	Cladophora spp																			
EA																				
NE																				
B	A. esculenta																			
R	L. digitata	3																		
O	Fucus serratus	4	3	3																
V	F. vesiculosus																			
A	F.v. var. linearis																			
N	Ascophyllum nod.																			
L	Fucus spiralis																			
G	P. canaliculata																			
A	Corallina offic.																			
A	Gigartina stellata	3	2	2																
E	Chondrus crispus	1																		
D	Laurencia pinnat.	3																		
A	Lithothamnion spp.	3																		
L	Lomentaria art.	3																		
G	Rhodomenia pal.	3																		
A	Porphyra spp.	4																		
E	Catenella repens	2	1																	
L	V. mucosa	2	2	1	1	3	3	4	4	3	4	4	1							
I	V. maura																			
C	Lichina pygmaea																			
H	L. confinis																			
I	X. parietina																			
C	Caloplacca spp																			
H	Lecanora spp																			
I	Lecanora spp																			
N	Remalina spp																			
S	Flowering Plants																			

Sea Anemones	Actinia equina	2	4	3	3	3	3													
Annelid worms	Spirobrhis spp																			
Panatoceros triid		3	3	3																
Barnacles	B. perforatus																			
	B. crenatus	5	4	2	2	4	4	4	4	3	2									
	B. balanoides	4	4	4	4	4	4	4	4	4	4	3								
	Elminus modestus	3	5	5	4	4	4	4	4	4	4	3								
	Chthamalus stellatus																			
Limpets	Patella sp	3	3	6	7	6	6	5	5	3	3									
Topshells	Gibbula urbilicalis					3	4	4												
	Gibbula cineraria																			
	Monodonta lineata						4	4	4											
Winkles	L. neritoides					2	2	2	2	2	2	3	3	2						
	L. saxatilis					3	5	5	5	6	5	4	4							
	L. littoralis					3	3	3	3	3	2									
	L. littorea					2	3	3	3	3	2									
	L. neglecta																			
Dog Whelks	Nucella lapillus						2	2	3											
Mussels	Mytilus edulis						2	2	2	2	2	2	2							

A (2) Shore Survey Data. Petpiroon, S. (1978)

STATION NUMBER

Date 25/5/78

LITTLE WICK 1

WORKER S.P.

SPECIES 1 2 3 4 5 6 7 8 9 10 11 12 13 14 15 16 17

GA	Enteromorpha spp	2	5	4	4	4	3													
RL	Ulva spp																			
BG	Cladophora spp																			
EA																				
NE																				
B	A. esculenta																			
R	L. digitata		4	2																
O	Fucus serratus		4	3																
WA	F. vesiculosus																			
NL	F.v. var. linearis																			
AG	Ascophyllum nod.																			
AE	Fucus spiralis																			
E	P. canaliculata																			
B	Corallina offic.																			
DE	Gigartina stellata	4	3																	
D	Chondrus crispus	2	2																	
A	Laurencia pinnat.	2	2																	
L	Lithothamnium spp.	2	2																	
GL	Lomentaria art.	3	2																	
L	Rhodomenia pal.	3	2																	
AA	Porphyra spp.	4	2																	
AE	Catenella repens		2	3	3															
L	V. mucosa	2	1	1	4	4	4	5	5	5										
TI	V. maura																			
C	Lichina pygmaea																			
H	L. confinis																			
E	X. parietina																			
N	Caloplacca spp																			
S	Lectonora spp																			
S	Ramalina spp																			
	Flowing Plants																			

1 2 3 4 5 6 7 8 9 10 11 12 13 14

Sea Anemones	Actinia equina																			
Actinia equina		2		2	2															
Annelid worms	Spirorbis spp																			
Spirorbis spp																				
Pematoceros trid		3	1																	
Pematoceros trid																				
Barnacles	B. perforatus																			
B. perforatus																				
B. crenatus		4	2	3																
B. crenatus																				
B. balanoides																				
B. balanoides																				
Elminus modestus		3	2	3	3	4	3	3	3	2										
Elminus modestus																				
Chthamalus stellatus																				
Chthamalus stellatus																				
Limpets	Patella sp																			
Patella sp		3	5	6	6	6	5	5	5	5										
Topshells	Gibbula umbilicalis																			
Gibbula umbilicalis																				
Gibbula cineraria																				
Gibbula cineraria																				
Monodonta lineata																				
Monodonta lineata																				
Winkles	L. neritoides																			
L. neritoides																				
L. saxatilis		3	7	2	4	5	7	2	2	2										
L. saxatilis																				
L. littoralis		3	3																	
L. littoralis																				
L. littorea																				
L. littorea																				
L. neglecta																				
L. neglecta																				
Dog Whelks	Nucella lapillus																			
Nucella lapillus																				
Mussels	Mytilus edulis																			
Mytilus edulis																				

STATION NUMBER

Date 26/5/78

LITTLE WICK 2

WORKER S.P.

SPECIES 1 2 3 4 5 6 7 8 9 10 11 12 13 14 15 16 17

1 2 3 4 5 6 7 8 9 10 11 12 13 14

GA	Enteromorpha spp	4	2	2	2															
RL	Ulva spp																			
EG	Cladophora spp																			
EA																				
NE																				
B	A. esculenta																			
R	L. digitata	3																		
O	Fucus serratus	4																		
VA	F. vesiculosus																			
NA	F.v. var. linearis																			
NL	Ascophyllum nod.																			
GL	Fucus spiralis																			
AA	P. canaliculata																			
EE																				
RD	Corallina offic.																			
ED	Gigartina stellata	3	3	1 ^r																
AD	Chondrus crispus																			
AL	Laurencia pinnat.	1	2																	
GL	Lithothamnien spp.	2																		
AL	Lomentaria art.	3	2																	
GA	Rhodoglossum pel.	2	2																	
AA	Rorippa spp.																			
EE	Catenella repens																			
LI	V. mucosa	3	1	1 ^r	2	4	4	4	1											
TI	V. maura								3	5	4									
CC	Lichina pygmaea																			
CH	L. confinis																			
HE	X. parietina																			
EN	Caloplacca spp									2	4	4	4	3 ^r	4	1				
NS	Lecanora spp									4	4	4	4	3 ^r	5					
SS	Ramalina spp									1	3									
	Flowering Plants																			

Sea Anemones																				
Actinia equina	3																			
Annelid worms																				
Spirorbis spp																				
Panatoceros triq	2																			
Barnacles																				
B. perforatus		2																		
B. crenatus		3	3	3	3	4	2	2												
B. balanoides		3	3	3	4	2	2													
Elminus modestus		3	3	3	4	2	2													
Chthamalus stellatus		2	2	3	3	3	2	2												
Limpets																				
Patella sp	3	6	6	6	6	6	4	3	2											
Topshells																				
Gibbula urbillicalis						2														
Gibbula cineraria																				
Monodonta lineata		2																		
Winkles																				
L. neritoides																				
L. saxatilis		4 ^r	6 ^r	2	2	2	3	2	3											
L. littoralis		4 ^r	6 ^r	6 ^r	5 ^r	6 ^r	4 ^r	4 ^r	4 ^r											
L. littorea		3 ^r	4 ^r	4 ^r	3															
L. neglecta																				
Dog Whelks																				
Nucella lapillus																				
Mussels																				
Mytilus edulis																				

STATION NUMBER

Date 25/5/78

LITTLE WIK 3

WORKER S.P.

SPECIES 1 2 3 4 5 6 7 8 9 10 11 12 13 14 15 16 17

G A	Euteromorpha spp	2	3	4	3	2	2	2	1								
R L	Ulva spp	1	3														
E G	Cladophora spp																
E A A																	
N E																	
B	A. esculenta																
R	L. digitata	1	4	6	3	2	3	3									
O	Fucus serratus	4			3	3	4	5	3								
V A A	F. vesiculosus																
N L	F.v. var. linearis				2	3	3	3									
G	Ascophyllum nod.																
A A E	Fucus spiralis								3								
E	P. canaliculata								6	5	2						
R	Corallina offic.																
E E D	Gigartina stellata	5	2	4	2												
A	Chondrus crispus	2	2														
L A	Laurencia pinnat.		1	1													
G L	Lithothamnion spp.																
A A E	Lomentaria art.	3	2														
	Rhodomenia pal.	4															
	Porphyra spp.																
	Catenella repens								2								
L	V. mucosa	2	1	1	1	3	2	1	2								
I	V. maura									5	4						
C	Idchima pygmaea																
H	L. confinis									1	1	1	1	1	1	1	1
B	X. parietina										4	4	4	4	4	4	4
E	Caloplacca spp											5	3	3	3	3	3
N	Lecumora spp																
S	Ramalina spp																
	Flowering Plants																

1 2 3 4 5 6 7 8 9 10 11 12 13 14

<u>Sea Anemones</u>	Actinia eouina																
<u>Annelid worms</u>	Spirorbis spp																
<u>Paratoceros triq</u>		3															
<u>Barnacles</u>	B. perforatus																
	B. crenatus	3	2														
	B. balanoides				2	2											
	Elminus modestus	3	3	4	3	2	2										
	Chthamalus stellatus																
<u>Limpets</u>	Patella sp		2	3	4	4	3										
<u>Topshells</u>	Gibbula umbilicalis																
	Gibbula cisteraria																
	Monodonta lineata																
<u>Winkles</u>	L. neritoides																
	L. saxatilis									5	3	3	3				
	L. littoralis																
	L. littorea																
	L. neglecta																
<u>Dog Whelks</u>	Nucella lapillus																
<u>Mussels</u>	Mytilus edulis																

STATION NUMBER

Date 24/5/78

LITTLE WICK 4

WORKER S.P.

SPECIES 1 2 3 4 5 6 7 8 9 10 11 12 13 14 15 16 17

1 2 3 4 5 6 7 8 9 10 11 12 13 14

GA	Euteromorpha spp	1	1	3	3	1	2	5	3								
RL	Ulva spp																
EG	Cladophora spp																
EA																	
NE																	
B	A. esculenta																
R	L. digitata		1	1													
O	Fucus serratus		1	3	2	4	4										
V	F. vesiculosus						1	3	3								
A	F.V. var. linearis																
N	Ascophyllum nod.																
L	Fucus spiralis							3	5	3							
A	P. canaliculata								6	1							
E																	
R	Corallina offic.																
E	Gigartina stellata		1	2	1	2											
D	Chondrus crispus																
A	Laurencia pinnat.																
L	Lithothamnien spp.																
A	Lomentaria art.																
G	Rhodomyria pal.																
A	Porphyra spp.																
E	Catenella repens							2	2	2							

Sea Anemones	Actinia equina																
Annelid worms	Spirorbis spp																
Panatoceros triq																	
Barnacles	B. perforatus																
	B. crenatus																
	B. balanoides																
	Elminus modestus																
	Chthamalus stellatus																
Limpets	Patella sp																
Topshells	Gibbula umbilicalis																
	Gibbula cineraria																
	Monodonta lineata																
Winkles	L. neritoides																
	L. saxatilis																
	L. littoralis																
	L. littorea																
	L. neglecta																
Dog Whelks	Nucella lapillus																
Mussels	Mytilus edulis																

STATION NUMBER

Date 24/5/78

LITTLE WICK

5

WORKER S.P.

SPECIES 1 2 3 4 5 6 7 8 9 10 11 12 13 14 15 16 17

1 2 3 4 5 6 7 8 9 10 11 12 13 14

GA	Enteromorpha spp	3	5	2	2	2													
RL	Ulva spp	1																	
EG	Cladophora spp																		
EA																			
NE																			
B	A. esculenta		4																
R	L. digitata		4																
O	Fucus serratus	3	4	4	2														
WA	F. vesiculosus				3	2	2												
N	F.v. var. linearis																		
L	Ascophyllum nod.																		
G	Fucus spiralis																		
A	P. canaliculata								1c	1c									
E																			
R	Corallina offic.																		
E	Gigartina stellata	4	3	4															
D	Chondrus crispus																		
A	Laurencia pinnat.	2	2																
L	Lithothamnien spp.						1												
A	Tomostericia art.	4	3	1	1														
G	Rhodomenia pal.		2	1	1														
A	Forpura spp.																		
E	Catemelia repens								1c										
L	V. tucosa	3	1	4	2	4	4	4	4	1									
T	V. maura									4									
C	Lichina pygmaea									6									
H	L. confinis									4									
E	X. parietina									3									
B	Caloplacca spp									4									
E	Lecanora spp									4									
N	Lecanora spp									4									
S	Ramalina spp									4									
	Flowering Plants																		

Sea Anemones	Actinia equina		2																
Annelid worms	Spirorbis spp																		
Penatoceros triq		3	3	2															
Barnacles	B. perforatus																		
	B. crenatus	2	2																
	B. balanoides		4	4	3	3	3	4	4	4	4	4	4	4	4	4	4	4	4
	Elminus modestus	2	4	4	4	4	4	4	4	4	4	4	4	4	4	4	4	4	4
	Gnathaxalus stellatus																		
Limpets	Patella sp		3	5	6	6	6	5	5	4	3	3							
Topshells	Gibbula umbilicalis						4												
	Gibbula cineraria																		
	Monodonta lineata						4	3											
Winkles	L. neritoides						2		2	2	2	3	3						
	L. saxatilis		4	5	5	5	5	5	5	5	5	5	5	5	5	5	5	5	5
	L. littoralis		2	6	6	5	5	5	5	5	5	5	5	5	5	5	5	5	5
	L. littorea						2												
	L. neglecta						3												
Dog Whelks	Nucella lapillus																		
Mussels	Mytilus edulis						2												

STATION NUMBER

Date 23/5/78

LITTLE WICK 6

WORKER S.P.

SPECIES ↓ 1 2 3 4 5 6 7 8 9 10 11 12 13 14 15 16 17

GA	Enteromorpha spp	2	4	4	1	1	1											
RL	Ulva spp	2																
EG	Cladophora spp																	
DE																		
AE																		
BN																		
B	A. esculenta																	
R	L. digitata	3	4	3														
O	Fucus serratus	4	4															
WA	F. vesiculosus																	
NL	F.v. var. linearis																	
AG	Ascophyllum nod.																	
AE	Fucus spiralis																	
AE	P. canaliculata								1 st	2 nd	2							
RD	Corallina offic.																	
AE	Gigartina stellata	3	2	2														
AE	Chondrus crispus	1																
AE	Laurencia pinnat.	3	3															
AE	Lithothamnium spp.	3	3															
AE	Lomentaria art.	4	4															
AE	Rhodomenia pal.																	
AE	Porphyra spp.	2	1															
AE	Catenella repens																	
AE	V. mucosa	2	2	1	1	3	3	5	4	4	5	5	1					
AE	V. maura								4	4	5	5	1					
AE	Lichina pygmaea																	
AE	L. confinis																	
AE	X. parietina																	
AE	Caloplaca spp																	
AE	Lecanora spp																	
AE	Ramalina spp																	
AE	Flowering Plants																	

1 2 3 4 5 6 7 8 9 10 11 12 13 14

Sea Anemones																		
Actinia equina	2																	
Annelid worms																		
Spirorbis spp																		
Panatoceros tria	3	3	3															
Barnacles																		
B. perforatus																		
B. crenatus	5	4	2															
B. balanoides	4	4	4	4	4	4	4	4	4	4	4	4	4	4	4	4	4	4
Elminus modestus	3	5																
Ontharalus stellatus									2	4	4	4	4	4	4	4	4	4
Limpets																		
Patella sp	3	3	6	7	6	6	5	4	3	3								
Topshells																		
Gibbula umbilicalis																		
Gibbula sinuata																		
Monodonta lineata																		
Winkles																		
L. neritoides	2	2	2	2	2	2	2	2	2	2	2	2	2	2	2	2	2	2
L. saxatilis	3	3	5	5	6	6	5	4	4	5	5	6						
L. littoralis	3	3	3	3	3	3	3	3	3	3	3	3	3	3	3	3	3	3
L. littorea																		
L. neglecta	2	3	3	3	3	3	3	3	3	3	3	3	3	3	3	3	3	3
Dog Whelks																		
Nucella lapillus	2	3																
Mussels																		
Mytilus edulis	2	2	2	2	2	2	2	2	2	2	2	2	2	2	2	2	2	2

A (3) Shore Survey Data. Crapp, G.B. (1970)

STATION NUMBER

Date 21/6/70

LITTLE WICK 1

WORKER G.B.C.

A = Paspere
1 = Pintermedia
V = P. vulgaris

SPECIES 1 2 3 4 5 6 7 8 9 10 11 12 13 14 15 16 17

GA	Enteromorpha spp	2	3	2	2														
RL	Ulva spp																		
EG	Cladophora spp																		
TE																			
NE																			
B	A. esolenta																		
R	L. digitata	5																	
O	Fucus serratus	3	2	1	1														
WA	F. vesiculosus																		
NL	F.V. var. linearis																		
G	Ascophyllum nod.																		
A	Fucus spiralis																		
E	P. canaliculata								2										
D	Corallina offic.	2	2	2	1 ^P														
E	Gigartina stellata	3	2																
D	Chondrus crispus	2	2																
A	Laurencia pinnat.	2	2	2	1 ^P	1 ^P													
L	Lithothamnion spp.	4	4	2	1 ^P	1 ^P													
G	Lomentaria art.	3	3																
A	Rhodomenia pal.	4	2	1															
E	Porphyra spp.	2	2	1															
	Catenella repens																		
L	V. mucosa	4	3	3	4	4	4	4	3										
T	V. maure								2	5	5								
I	Lichina pygmaea								3	2	3								
C	L. confinis								2	3	3								
H	X. parietina								2	2	2								
E	Caloplacca spp								2	2	2								
N	Lecanora spp								2	2	2								
S	Ramalina spp								2	3	3								
	Flowering Plants																		

Sea Anemones	Actinia equina	4	3	3	2	1	2	2											
Annellid worms	Spirorbis spp																		
Penatoceros triq																			
Barnacles	B. perforatus								2										
	B. crenatus	3	4	4	3	3	3	3	3	3	3								
	B. balanoides	3	4	4	4	4	4	4	4	4	4								
	Elminus modestus																		
	Chthamalus stellatus	3	4	4	4	4	4	4	4	4	4								
Limpets		2	2	2	1 ^P														
	Patella sp	4	7	7	6	7	7	7	6	6	4								
Topshells																			
	Gibbula umbilicalis	3	4	4															
	Gibbula cineraria																		
	Monodonta lineata	1	4	4	2														
Winkles																			
	L. neritoides																		
	L. saxatilis																		
	L. littoralis	1	1																
	L. littorea																		
	L. neglecta	2	4	3	4	4	5	3	3										
Dog Whelks																			
	Nucella lapillus	1																	
Mussels																			
	Mytilus edulis																		

STATION NUMBER

Date 28/3/70

LITTLE WICK 3

WORKER G.B.C.

SPECIES 1 2 3 4 5 6 7 8 9 10 11 12 13 14 15 16 17

GA	Enteromorpha spp																		
RL	Ulva spp	3	2	2	2	3	3	4											
EG	Cladophora spp																		
EA																			
NE																			
B	A. esculenta																		
R	L. digitata	5	2																
O	Fucus serratus	3	5	6	6	5	2												
WA	F. vesiculosus					4	6	6	2										
NL	F.v. var. linearis																		
GL	Ascophyllum nod.																		
AG	Fucus spiralis							5	6	5									
AE	P. canaliculata							2	5	2									
RE	Corallina offic.		2																
ED	Gigartina stellata	3	3	5	4	3													
DA	Chondrus crispus	2	3																
LA	Laurencia pinnat.	4	2	4	4	P													
LL	Lithothamnium spp.	3	3																
LG	Lomentaria art.	3	3																
LA	Rhodomenia pal.	3	3																
AE	Porphyra spp.																		
EA	Catenella repens					2	2	2		3	1								
LI	V. mucosa	3	2	2	3	3													
TI	V. maura									5	5								
IC	Ulva pinnata									4	4								
CH	L. confinis									4	4								
HE	X. parvifolia									2	2								
FE	Galoplacea spp									4	4								
EN	Lecanora spp									5	5								
NS	Ramalina spp									5	5								
	Flowering Plants																		

Sea Anemones	Actinia equina				1														
Annellid worms	Spirorbis spp		2																
Panatoceros tria				1															
Barnacles	B. perforatus		2	2	1														
	B. crenatus				2	3	3	2	2	2									
	B. balanoides				2	3	3	3	3	3	1								
	Elminus modestus																		
	Chthamalus stellatus								2	2	1								
Limpets	Patella sp	1		3	3	3	4	3	3	2									A I V
Topshells	Gibbula umbilicalis																		
	Gibbula cineraria																		
	Monodonta lineata																		
Winkles	L. neritoides																		
	L. saxatilis									1	2	3							
	L. littoralis				3	3	2												
	L. littorea																		
	L. neglecta																		
Dog Whelks	Nucella lapillus																		
Mussels	Mytilus edulis																		

STATION NUMBER

Date 9/3/70

LITTLE WICK

4

WORKER

G.B.C.

SPECIES ↓ 1 2 3 4 5 6 7 8 9 10 11 12 13 14 15 16 17

G A R L E G E A N E	Enteromorpha spp																			
	Ulva spp	2																		
B O V A N L G A E	A. esculenta																			
	L. digitata	4	1	P	5	5	4													
V A N L G A E	Fucus serratus	5	5	6	2	5	6	6												
	F. vesiculosus																			
V A N L G A E	F.v. var. linearis																			
	Ascophyllum nod.																			
V A N L G A E	Fucus spiralis							3	3											
	F. canaliculata							6	5											
R E D	Corallina offic.	1				P														
	Gigartina stellata	3	2																	
R E D	Chondrus crispus																			
	Laurencia pinnat.	3	3	2	P															
L A G A E	Lithothamnien spp.	2	2	2																
	Lomentaria art.	2	2	2																
L A G A E	Rhodomenia pal.	2	3	3	2															
	Porphyra spp.																			
L I C H E N S	Catenella repens							3	3											
	V. mucosa	3	2	2	3	3	3	4	4	5	5	4	3	2	2					
L I C H E N S	V. maura							4	4	5	5	4	3	2	2					
	Lichina pygmaea																			
L I C H E N S	L. confinis																			
	X. parietina																			
L I C H E N S	Caloplacca spp																			
	Lecanora spp																			
L I C H E N S	Ramalina spp																			
	Flowering Plants																			

1 2 3 4 5 6 7 8 9 10 11 12 13 14

Sea Anemones

Actinia equina

2 2 2 2

Annelid worms

Spirorbis spp

2

Panatoceros triq

2 2

Barnacles

B. perforatus

3

B. crenatus

4

B. balanoides

3

Elminus modestus

3 3 3 3 3 4 3 2 2 2 2 1

Chthamalus stellatus

2 2 2 2 1

Limpets

Patella sp

3 4 5 6 4 4 4 3 2 2 P

Topshells

Gibbula umbilicalis

Gibbula cineraria

Monodonta lineata

Winkles

L. neritoides

L. saxatilis

L. littoralis

2 2 2 2 2

L. littorea

L. neglecta

Dog whelks

Nucella lapillus

Mussels

Mytilus edulis

A I V

STATION NUMBER

Date 8/3/70

LITTLE WICK

5

WORKER G.B.C.

SPECIES 1 2 3 4 5 6 7 8 9 10 11 12 13 14 15 16 17

GA	Enteromorpha spp	1	2	2	1	2	2	1										
RL	Ulva spp																	
EG	Cladophora spp	1																
EAE																		
BN																		
B	A. esculenta																	
R	L. digitata	3	3	P														
O	Fucus serratus	4	6	5	2													
WA	F. vesiculosus			3	5	5	5	4	2									
NL	F.v. var. linearis																	
AG	Ascophyllum nod.																	
GA	Fucus spiralis								2									
AE	P. canaliculata								2	4								
R	Corallina offic.		2	2	P													
ED	Gigartina stellata	4	4	2														
D	Chondrus crispus																	
A	Laurencia pinnat.	4	4	3	2	2												
L	Lithothamnium spp.	4	4	3	2	2	P											
AG	Forseteria art.	2	2	2	2													
GA	Rhodomenia pal.	3	2	3	2	2												
AE	Porphyra spp.																	
	Catenella repens									2								
L	V. mucosa	4	4	3	3	4	5	5	5	5	4	5	5	2	2	2	2	2
TI	V. natra																	
IC	Lichina pyramea									2								
CH	L. confinis																	
HE	X. parietina									2	2	3	4	4	4	4		
EN	Caloplacca spp																	
NS	Lecanora spp																	
S	Ramalina spp																	
	Flowering Plants																	

1 2 3 4 5 6 7 8 9 10 11 12 13 14

Sea Anemones	Actinia equina	1	2	2	3	2	2											
Annelid worms	Spirorbis spp																	
Panatoceros tria		2																
Barnacles	B. perforatus																	
	B. crenatus	2	4	4	4	4	2	2	2	2	2	2	2	2	2	2	2	2
	B. balanoides	2	3	4	4	4	4	4	3	2	2	2	2	2	2	2	2	2
	Elminus modestus																	
	Onthalius stellatus								4	4	4	4	4	3	3			
Limpets	Patella sp.	3	4	5	6	7	6	6	4	4	4	2						
Topshells	Gibbula umbilicalis																	
	Gibbula cineraria																	
	Monodonta lineata						2	3	3									
Winkles	L. neritoides																	
	L. saxatilis						3	3	3	4	4	3	4	3	2			
	L. littoralis						3	2	2									
	L. littorea																	
	L. neglecta						2	3	3	3	3	3						
Dog Whelks	Nucella lapillus																	
Mussels	Mytilus edulis																	

A I V

A (4) Criteria of Abundance for Common Plants + Animals of Rocky Sea Shores

Live barnacles (except B. perforatus)
(record adults, spat, cyprides sep'tly)

1. Littorina neritoides

Littorina neglecta

Ex 500 or more per $0.01m^2$ -5+/cm²

S 300-499 per $0.01m^2$ 3-4/cm²

A 100-299 per $0.01m^2$ 1-2/cm²

C 10-99 per $0.01m^2$

F 1-9 per 0.01

O 1-99 per m²

2. Balanus perforatus

Ex 300 or more per $0.01m^2$

S 100-299 per $0.01m^2$

A 10-99 per $0.01m^2$

C 1-9 per $0.01m^2$

F 1-9 per $0.1m^2$

O 1-9 per m²

R Less than 1 per m²

3. Patella spp. 10mm+

Littorina littorea (juvs & ads)

Littorina littoralis (adults)

juv. Nucella lapillus (3mm)

Ex 20 or more per $0.1m^2$

S 10-19 per $0.1m^2$

A 5-9 per $0.1m^2$

C 1-4 per $0.1m^2$

3. continued

F 5-9 per m²

O 1-4 per m²

R Less than 1 per m²

4. Littorina 'saxatilis'

Patella smaller than 10mm

Anurida maritima

Hyale nilssoni & other amphipods

juvenile L. littoralis

Ex 50 or more per $0.1m^2$

S 20-49 per $0.1m^2$

A 10-19 per $0.1m^2$

C 5-9 per $0.1m^2$

F 1-4 per $0.1m^2$

O 1-9 per m²

F Less than 1 per m²

5. Nucella lapillus (3mm)

Gibbula spp., Monodonta lineata

Actinea equina

Idotea granulosa

Juv. & recent sett. Carcinus

Ligea oceanica

Ex 10 or more per $0.1m^2$

S 5-9 per $0.1m^2$

A 1-4 per $0.1m^2$

5. continued

- C 5-9 per m² locally sometimes more
- F 1-4 per m² locally sometimes more
- O less than 1 per m² locally sometimes more
- R Always less than 1 per m²

6. Mytilus edulis

- Ex 80% or more cover
- S 50-79% cover
- A 20-49% cover
- C 5-19% cover
- F Small patches 5% ., 10+ sm. inds. per 0.1m², 1 or more lg. per 0.1m²
- O 1-9 sm. per 0.1m², 1-9 lg. per m²
No patches except sm. in crevices
- R Less than 1 per m²

7. Fomatoceros triqueter

- A 50 or more tubes per 0.01m²
- C 1-49 tubes per 0.01m²
- F 1-9 tubes per 0.1m²
- O 1-9 tubes per m²
- R Less than 1 tube per m²

8. Spirobis spp.

- A 5 or more per cm² on approp. substs.
More than 100 per 0.01m² generally
- C Patches of 5 or more per cm²
1-100 per 0.01m² generally
- F Widely scattered small groups
1-9 per 0.1m² generally

8. continued

- O Widely scattered small groups
Less than 1 per 0.1m² generally
- R Less than 1 per m²

9. Sponges

Hydroids

Bryozoa

- A Present on 20% or more suit. surf.
- C Present on 5-19% of suit. surf.
- F Scattered patches, less than 5% cover
- O Small patch or single Sprig in 0.1m²
- R Less than one patch over strip, one small patch or sprig per 0.1m²

10. Flowering Plants, lichens &

lithothamnia

- Ex More than 80% cover
- S 50-79% cover
- A 20-49% cover
- C 1-19% cover
- F Large scattered patches
- O Widely scattered patches, all small
- R Only 1 or 2 patches

11. Algae

Ex More than 90% cover

S 60-89% cover

A 30-59% cover

C 5-29% cover

F Less than 5% cover, zone still apparent

O Scattered plants, zone indistinct

R Only 1 or 2 plants

Other animal species

Record as % cover or approx. average

numbers within 0.01, 0.1 or $1m^2$

A (5) Biological Exposure Score Sheet (Ballantine, 1961) for Little Wick

Transect 5

Exposure Grade	Exposed			:	Sheltered		
	1	2	3	4	5	6	7
<i>Alaria esculenta</i>	A	N-A	N-A	N-A	N	N	N
<i>Porphyra umbilicalis</i> (hlf)	A	C-A	N-A	N	N	N	N
<i>Laminaria hyperborea</i>	N-D	O-A	R-C	N	N	N	N
<i>Lichina pygmaea</i>	N-C	C-A	C-A	R-A	N	N	N
<i>Mytilus edulis</i>	R-A	R-A	R-A	R-F	R-F	N-O	N
<i>Corallina officinalis</i>	A	F-A	F-A	O-C	O-C	N-F	N
<i>Patella depressa</i>	O-C	O-A	O-A	O-A	O-A	N-C	N
<i>Patella aspera</i>	F-A	F-A	F-A	R-A	R-A	N-A	N
<i>Littorina neritoides</i>	C-A	C-A	C-A	C-A	C-A	R-C	N
<i>Laurencia</i> spp.	O-F	O-A	O-A	O-A	O-A	R-A	N
<i>Chthamalus stellatus</i>	A	A	A	C-A	C-A	C-A	R-F
<i>Fucus serratus</i>	N	R-A	R-A	R-A	R-A	A	A
<i>Balanus perforatus</i>	N	N-F	O-A	O-A	O-A	O-A	O-A
<i>Pelvetia canaliculata</i>	N	N	R-F	R-F	F-C	A	A
<i>Nucella lapillus</i>	N	N	R-A	C-A	C-A	C-A	C
<i>Spirobis rupestris</i>	N	N	N-O	O-F	C-A	C-A	C-A
<i>Gibbula umbilicalis</i>	N	N-A	N-A	C-A	A	A	A
<i>Littorina obtusata</i>	N	N	N	R-F	R-F	F-A	A
<i>Littorina littorea</i>	N	N	N	N-C	R-C	R-C	A

<i>Fucus vesiculosus</i>	N	N	N	N	R-C	O-C	C-A
<i>Catenella repens</i>	N	N	N	N-O	N-O	F-A	F-A
<i>Fucus spiralis</i>	N	N	N	N	N	R-A	C-A
<i>Spirorlis spirorbis</i>	N	N	N	N	N	N-F	C-A
<i>Ascophyllum nodosum</i>	N	N	N	N	N	N-A	A
<i>Laminaria saccharina</i>	N	N	N	N-A	N-A	N-A	N-A

Scoring Totals 6 6 6 14 13 9 8

Shore/Transect. Littlewick/5

Exposure Grade 4

Date surveyed: 12.5.79

A (6) Raw Data for P. vulgata Volume - Index

Key

- \longleftrightarrow = Longest Diameter (mm)
 \updownarrow = Shortest Diameter (mm)
 \triangle = Weight of Shell (mm)
 \vee = Volume (cm³)

Transect One: 28.6.79

\longleftrightarrow	\updownarrow	\triangle	\vee
27	22	13	2.042
23	20	12	1.458
24	18	6	0.691
10	6	4	0.067
20	14	6	0.452
20	18	12	1.131
21	16	9	0.811
20	15	9	0.726
5	4	2	0.010
12	10	6	0.188
13	11	6	0.226
21	14	11	0.889
12	8	4	0.105
13	8	4	0.117
13	10	5	0.173
12	10	4	0.126
12	9	4	0.117
12	8	6	0.157
19	12	9	0.565
12	8	7	0.183
13	10	6	0.207
12	10	5	0.157
16	11	4	0.193
20	15	10	0.806
5	4	3	0.016
15	10	5	0.204
20	18	12	1.131
14	10	6	0.226
20	16	9	0.263
26	22	14	2.111
25	20	11	1.463
14	11	7	0.286
10	8	4	0.084
10	8	5	0.105

Sample Point : Station 4

Low water = 15.32

Height 1.3 m

Area Sampled = $\frac{1}{2}$ a square
metre

Transect One (continued)

↔	↕	△	√
14	12	6	0.264
12	10	5	0.157
13	11	5	0.188
10	9	4	0.096
12	10	4	0.126
12	8	4	0.105
17	12	9	0.499
26	20	12	1.659
10	7	4	0.075
24	20	10	1.267
23	20	10	1.215
14	10	5	0.916
18	12	8	0.469
18	14	6	0.402
14	12	7	0.308
10	8	4	0.084
12	9	4	0.117
21	19	3	1.361
12	9	7	0.205
14	10	6	0.226
13	10	5	0.173
16	12	5	0.257
15	10	4	0.163
16	12	6	0.308
18	16	7	0.528
16	12	7	0.359
20	16	10	0.848
30	22	17	3.009
21	16	10	0.901
18	16	10	0.890
30	20	12	1.960
20	15	9	0.726
30	26	15	3.079
18	14	7	0.469
26	12	20	1.885
26	22	14	2.111
12	10	4	0.126
24	16	15	1.571
25	16	14	1.579
14	12	9	0.396
16	15	9	0.565

n = 75

Transect Two: 29.6.79

↔	↕	△	∇
20	13	8	0.570
9	6	4	0.059
20	16	9	0.763
16	10	7	0.308
15	10	7	0.286
22	16	8	0.754
16	10	9	0.396
20	14	7	0.528
25	18	14	1.701
14	12	6	0.264
18	15	10	0.712
14	10	6	0.226
19	14	10	0.712
20	16	8	0.679
23	19	14	1.466
20	16	9	0.763
16	14	6	1.097
20	14	9	0.679
10	8	5	0.105
19	13	8	0.536
10	7	4	0.075
16	14	6	0.352
14	10	5	0.183
13	10	5	0.356
14	10	4	0.151
15	11	6	0.264
16	12	5	0.257
17	14	5	0.314
20	15	9	0.726
12	10	4	0.126
22	14	11	0.933
20	15	10	0.806
16	13	6	0.320
18	14	10	0.670
18	11	8	0.444
18	13	10	0.628
14	11	6	0.245
11	6	3	0.057
10	6	3	0.050
17	12	10	0.555
26	22	14	2.111
21	18	11	1.094
15	12	5	0.241
6	4	3	0.019
26	20	14	1.935
14	11	5	0.204
20	14	6	0.452
5	4	3	0.016

Sample Point : Station 4

Low water = 4.04

Height = 1.5m

Area sampled = $\frac{1}{2}$ square
metre

Transect Two (continued)

\longleftrightarrow	\updownarrow	\triangle	\vee
10	8	4	0.084
8	6	4	0.050
16	10	6	0.264
24	20	14	1.774
16	10	6	0.264
14	10	5	0.188
18	14	6	0.402
17	14	6	0.377
20	15	6	0.484
17	13	10	0.586
18	13	10	0.670
16	12	9	0.462
16	14	6	0.352
21	18	14	1.393
18	14	6	0.402
18	13	10	0.628
18	16	6	0.452
9	6	3	0.044
15	12	8	0.385
19	17	12	1.018
10	6	5	0.084
14	12	8	0.352
15	12	9	0.434
10	7	6	0.113
19	14	8	0.569
22	18	14	1.466
15	10	5	0.204
16	10	6	0.264
16	12	6	0.308
10	7	3	0.057
14	10	6	0.226
20	14	7	0.528
10	6	4	0.067
9	6	3	0.044
20	15	9	0.726
17	10	6	0.289
16	12	9	0.462
14	12	6	0.264
15	12	7	0.337
14	10	6	0.226
24	18	10	1.152

n = 89

Transect Three : 29.6.79

↔	↕	△	∇
43	34	25	9.713
24	20	9	1.140
43	35	19	7.561
25	19	11	1.394
52	40	18	9.971
48	32	25	10.472
43	36	17	6.943
41	32	15	5.231
46	41	23	11.392
42	33	18	6.635
48	36	18	8.313
26	18	9	1.140
40	33	23	8.020
49	36	31	14.674
28	23	18	3.072
22	15	7	0.630
18	15	9	0.641
40	29	20	6.241
32	28	14	3.299
20	14	9	0.679
19	14	8	0.569
53	46	32	20.542
26	20	13	1.797
9	4	2	0.023
22	18	7	0.733
48	38	31	14.998
41	30	15	4.948
49	28	22	8.547
39	31	19	6.088
38	30	17	5.145
39	28	16	4.708
20	15	9	0.726
42	39	17	7.299
40	32	18	6.107
39	28	17	5.002
42	32	19	6.805
41	32	15	5.231
41	34	19	7.004
40	31	14	4.618
24	20	9	1.140
22	18	7	0.733
26	22	9	1.357
24	20	10	1.267
38	24	13	3.267
51	41	25	13.849
40	31	12	3.958

Sample Point : Station 4

Low Water = 4.04

Height = 1.5 m

Area Sampled = $\frac{1}{2}$ square meter

Transect Three (continued)

↔	↕	△	∇
25	17	9	1.037
18	16	7	0.528
16	13	5	0.278
60	51	35	28.222
38	30	19	5.750
15	12	4	0.193
38	32	19	6.088
40	36	20	7.561
41	37	20	7.77
36	31	16	4.708
38	32	17	5.448
42	38	21	8.796
46	37	25	11.284
52	43	31	18.309
34	28	16	4.021

n = 61

Transect Four : 29.6.79

↔	↑↓	△	∇
37	30	21	6.179
40	36	18	6.805
34	28	18	4.524
38	36	19	6.805
51	40	25	13.561
36	26	15	3.769
28	21	12	1.885
21	18	9	0.896
34	29	17	4.415
33	28	15	3.659
36	30	16	4.557
49	37	27	13.063
30	25	13	2.573
44	35	17	6.943
47	34	21	9.016
48	38	20	9.676
53	47	27	17.671
18	14	7	0.469
37	26	20	5.194
25	21	14	1.935
32	23	20	3.958
16	14	5	0.293
60	49	35	27.232
30	22	15	2.655
17	13	7	0.411
16	13	5	0.278
13	10	4	0.138
16	12	5	0.257
23	17	10	1.047
18	14	9	0.603
19	14	10	0.712
22	20	9	1.037
20	16	11	0.933
39	32	18	5.938
28	34	13	3.267
17	14	9	0.565
25	23	13	1.960
40	30	21	6.729
15	11	7	0.308
20	16	17	1.442
36	30	16	4.557
27	22	12	1.885
23	22	11	1.463
36	30	18	5.127
35	28	20	5.194
16	12	5	0.257
32	28	15	3.534
25	20	11	1.463

Sample Point : Station 4

Low water = 4.04

Height = 1.5 m

Area sampled = $\frac{1}{2}$ square metre

Transect Four (continued)

↔	↕	△	√
35	30	15	4.147
20	14	9	0.679
34	30	15	4.021
20	13	28	0.641
30	23	7	2.765
50	42	10	15.511
16	13	6	0.389
25	23	9	1.508
18	13	8	0.377
27	20	9	1.301
16	13	8	0.444
39	31	21	6.729
30	29	15	3.424
47	40	29	14.364

n = 62

Transect Five

↔	↕	△	∇
15	13	8	0.411
13	10	5	0.173
23	18	12	1.319
17	13	6	0.352
18	13	7	0.440
10	8	5	0.105
13	10	4	0.138
11	9	5	0.131
10	8	4	0.084
26	20	10	1.382
13	8	4	0.117
13	10	5	0.173
25	19	10	1.267
14	10	6	0.226
13	9	6	0.188
15	10	7	0.286
17	15	9	0.528
13	9	7	0.220
18	13	10	0.293
16	12	6	0.308
16	13	9	0.499
15	12	9	0.434
17	14	10	0.628
13	11	7	0.264
13	10	7	0.242
10	8	4	0.084
8	7	3	0.044
14	13	8	0.385
18	15	9	0.641
16	13	7	0.389
20	16	10	0.848
22	19	12	1.319
10	6	5	0.084
13	11	8	0.302
6	4	3	0.019
15	11	5	0.220
10	5	4	0.059
16	11	6	0.289
16	13	6	0.333
13	9	7	0.220
21	16	10	0.901
23	19	12	1.382
20	16	9	0.763
20	15	9	0.763
19	15	7	0.528

Sample Point: Station 4

Low water = 18.11

Height = 2.2 m

Area sampled = $\frac{1}{2}$ square metre

Transect Five (continued)

↔	↑↓	△	√
9	8	4	0.075
11	8	5	0.120
15	10	7	0.286
20	15	9	0.726
11	8	4	0.096
20	16	10	0.848
20	16	10	0.848
17	11	9	0.462
21	16	9	0.811
14	10	6	0.226
21	15	10	0.440
17	13	7	0.411
16	12	7	0.359
16	14	10	0.586
17	12	10	0.555
6	4	3	0.019
8	7	4	0.059
13	8	6	0.176
18	13	5	0.314
13	9	4	0.126
12	8	5	0.131
20	16	10	0.848
18	12	5	0.293
18	13	7	0.440
17	14	9	0.565
11	8	7	0.169
9	6	4	0.059
15	12	7	0.357
13	11	7	0.264
20	14	10	0.754
24	20	9	1.140
25	22	15	2.168
19	18	10	0.901
22	16	9	0.848
18	10	9	0.462
10	7	4	0.075
11	8	5	0.120
18	12	8	0.469
14	11	7	0.264
14	10	5	0.188
16	15	7	0.440
16	14	10	0.586
16	12	7	0.359
17	15	8	0.536
23	19	11	1.267
15	11	6	0.264
14	10	4	0.151
16	12	8	0.411
19	15	10	0.754
12	9	4	0.117
15	8	5	0.173

Transect Five (continued)

↔	↑	△	∇
16	12	5	0.257
20	14	11	0.829
22	18	10	1.047
24	20	13	1.647
18	14	9	0.603
23	20	10	1.215
23	20	13	1.579
18	12	6	0.352
20	16	11	0.933
15	10	7	0.264
24	20	12	0.452
11	9	4	0.105
20	15	10	0.806
24	18	10	1.152
18	14	11	0.737
15	10	6	0.245
12	9	5	0.247
17	13	8	0.469
11	7	4	0.084
12	10	7	0.220
15	11	6	0.264
18	16	11	0.829

n = 118

Transect Six : 2.7.79

↔	↕	△	∇
19	13	9	0.603
20	16	14	1.188
10	6	4	0.067
18	14	9	0.603
26	18	15	1.901
22	16	11	1.037
16	13	8	0.444
14	10	7	0.264
15	12	9	0.434
20	17	12	1.081
19	16	11	0.887
16	14	13	0.762
20	16	9	0.763
22	19	13	1.429
24	18	15	1.728
17	12	9	0.499
21	14	11	0.887
22	13	11	0.887
10	8	4	0.084
16	13	9	0.499
12	9	5	0.147
12	8	5	0.131
18	14	7	0.469
26	23	15	0.833
10	6	4	0.067
12	10	8	0.251
21	19	14	1.466
12	9	5	0.147
18	13	6	0.377
16	12	4	0.205
6	4	3	0.019
16	11	9	0.434
14	10	8	0.302
13	9	7	0.219
15	12	10	0.482
14	12	7	0.308
26	22	17	2.564
22	16	12	1.131
10	8	5	0.105
12	10	6	0.188
17	14	9	0.565
14	12	7	0.308
13	11	5	0.188
12	10	6	0.188
15	11	7	0.308
30	26	15	3.079
22	16	14	1.319
20	15	11	0.887

Sample Point : Station 4

Low Tide = 18.11

Height = 2.2 m

Area sampled = $\frac{1}{2}$ square metre

Transect Six (continued)

↔	↑	△	√
10	8	3	0.063
11	9	3	0.079
14	10	6	0.226
10	6	2	0.034
14	12	8	0.352
19	14	9	0.641
16	11	5	0.241
16	12	9	0.462
23	18	15	1.649
17	11	9	0.462
17	13	9	0.528
22	18	8	0.838
16	13	10	0.555
23	18	13	1.429
16	12	6	0.308
16	14	10	0.586
24	18	15	1.728
14	11	8	0.327
20	14	11	0.829
20	16	10	0.848
21	15	12	1.018
14	11	5	0.204
18	14	10	0.670
16	12	9	0.462
25	20	15	1.995
10	15	10	0.754
22	18	15	1.571
29	21	12	1.898
24	18	15	1.728
14	16	9	0.528
8	6	2	0.025
10	8	5	0.105
8	6	2	0.025
10	8	4	0.084
13	12	6	0.245
18	14	10	0.670
12	10	4	0.126
23	16	14	1.393
13	8	7	0.205
12	9	3	0.088
17	14	8	0.503
19	15	10	0.754
19	12	10	0.628
21	16	11	0.991
18	13	11	0.691
19	16	9	0.726
20	16	13	1.103
21	17	15	1.414
15	12	9	0.433

Transect Six (continued)

\longleftrightarrow	\updownarrow	\triangle	\surd
11	9	6	0.157
20	15	13	1.048
13	10	9	0.311
16	12	9	0.462
20	15	12	0.967
20	17	15	1.351
12	9	7	0.205
17	14	9	0.763
10	8	6	0.126
17	15	8	0.536
19	16	9	0.726
26	20	16	2.212
19	16	10	0.806
18	14	8	0.536

n = 111

A (7) Details of the mean Effluent Quality discharged in Little Wick Bay
from the Esso Refinery

Mean Effluent Quality in 1970

Oil content	-	25 mg/l
pH	-	8.0
Temperature	-	80°F
Phenols	-	0.3mg/l
Suspended Solids	-	50 mg/l
Oxygen absorbed from acid permanganate	-	10.2 mg/l
H ₂ S	-	Not detectable
NH ₃	-	1.5 mg/l

Effluent quality has not changed significantly since 1970 except for the fact that oil content has reduced from a mean of 25 mg/l to one of 15 mg/l.

Information supplied by the Esso Petroleum Company, Limited, Milford Haven, 1979.

REFERENCES

1. ADDY, J.M. (1978) Biological and hydrographic survey off Little Wick Bay, Milford Haven, O.P.R.U. Annual Report 1977/1978.
2. ADMIRALTY HYDROGRAPHIC DEPARTMENT. The Admiralty Tide Tables (1) European Waters, H.M.S.O. London.
3. ANDERSON, J.W. (1975) Laboratory Studies on the effects of oil on marine organisms: an overview, American Petroleum Institute Publication, No. 4349, American Petroleum Institute, Washington, D.C., 1975
4. BAKER, J.M. (1975) Investigation of refinery effluent effects through field surveys, in Marine Ecology and Oil Pollution (ed. J.M. Baker), Applied Science Publishers, for Institute of Petroleum, Essex, England, 201-225
5. BAKER, J.M. (1975a) Biological monitoring - principles, methods and difficulties, in Marine Ecology and Oil Pollution (ed. J.M. Baker).
6. BAKER, J.M. (1975b) Experimental investigation of refinery effluents, in Marine Ecology and Oil Pollution (ed. J.M. Baker).
7. BALLANTINE, W.J. (1961). A Biologically-defined exposure scale for the comparative description of rocky shores. Field Studies, 1 (3), 1-19
8. BARRETT, J. and YOUNGE, C.M. (1958). Collins Pocket Guide to the sea shore, Collins, London.
9. BLACKMORE, D.T. (1969) Studies of Patella vulgata L.1. Growth, reproduction and zonal distribution. J. exp. mar. Biol. Ecol., Vol. 3, pp 200-213
10. BOYDEN, P. (1977) Effect of size upon metal content of shellfish. J. mar. biol. Ass. U.K. 57, 675-714
11. BRATTEGARD, T. (1966) The natural history of the Wardangerfjord. 7. Horizontal distribution of the fauna of rocky shores, Sarsia, 22, 1-54

12. COX, B.A., ANDERSON, J.W. and PARKER, J.C. (1975). An experimental oil spill: The distribution of aromatic hydrocarbons in the water, sediment, and animal tissues within a shrimp pond. pp 607-612.
In: Proceedings of the Conference on Prevention and Control of Oil Pollution, American Petroleum Institute, Washington, D.C., 1975.
13. CRAPP, G.B. (1970). The Biological effects of Marine Oil Pollution and Shore Cleansing, Ph.D. Thesis. University of Wales, Swansea.
14. CRISP, D.J. and SOUTHWARD, A.J. (1958). The distribution of intertidal organisms along the coasts of the English Channel. J. mar. biol. Ass. U.K. 37, 157-208
15. DICKS, B. (1973). Some effects of Kuwait crude oil on the limpet, Patella vulgata. Environ. Pollut. 2, 219-229
16. DICKS, B. (1975b) The importance of behavioural patterns in toxicity testing and ecological prediction in Marine Ecology and Oil Pollution (ed. J.M. Baker).
17. DUDLEY, M. (1968). Oil Pollution in Milford Haven, Field Studies, 2 (Suppl), 21-29.
18. EVANS, R.G. (1947). The intertidal ecology of rocky shores in the Plymouth neighbourhood. J. mar. biol. Ass. U.K., 27, 173-218
19. GEORGE, M. (1961). Oil pollution of marine organisms. Nature, Lond. 192, 1209
20. GRUENFELD, M. (1975) "Quantitative analysis of Petroleum Oil Pollutants by Infrared spectrophotometry" Water Quality Parameters, ASTM STP 573, American society for testing and materials, pp 290-308
21. HARVA, O. and SOMERSALD, A. (1958). Suomen Kemistilehti, 31 (b) pp 384-387: Cited in Gruenfeld (1975).
22. KNIGHT-JONES, E.W. (1953b). Laboratory experiments on gregariousness during setting in Balanus balanoides and other barnacles. J. exp. biol. 30, 584-598

23. LEE, R.F. (1976). Metabolism of petroleum hydrocarbons in marine sediments, pp 334-344. In: Sources, Effects and Sinks of Petroleum in the Aquatic Environment, American Institute of Biological Sciences, Washington, D.C.
24. LEE, R.F., RYAN, C. and NEUHAUSER, M.L. (1976). Fate of petroleum hydrocarbons taken up from food and water by the blue crab, Callinectes sapidus, Mar. Biol. 37, 363-370
25. LEE, R.F., FURLONG, E. and SINGER, S. (1977). Metabolism of hydrocarbons hydroxylase from the tissues of the blue crab, Callinectes sapidus, and the Polychaete worm, Neries spp. In: C.S. Giam (ed) Pollutant Effects of Marine Organisms, D.C. Heath, Lexington, Massachusetts.
26. LEWIS, J.R. (1964). The Ecology of Rocky Shores
27. LEWIS, J.R. and BOWMAN, R.S. (1975). Local Habit-induced variations in the population dynamics of Patella vulgata L. J. exp. mar. Biol. Ecol., 17 pp 165-203.
28. MILFORD HAVEN CONSERVANCY BOARD (1968). The Port of Milford Haven, Milford Haven Conservancy Board, pp. 32.
29. MOYSE, J. and NELSON-SMITH, S. (1963). Zonation of animals and plants on rocky shores around Dale, Pembrokeshire. Field Studies, 1, (5) 1-31
30. NELSON-SMITH, A (1964) "Some aspects of the Marine Ecology of Milford Haven; Pembrokeshire" Ph.D. thesis, University College of Swansea.
31. NELSON-SMITH, A. (1965). Marine Biology of Milford Haven: the physical environment, Field Studies, 2, 155-188.
32. NELSON-SMITH, A. (1967). Marine Biology of Milford Haven: The distribution of Littoral Plants and Animals. Field Studies, 2 (4), 407-434.
33. NELSON-SMITH, A. (1968a) "The effects of Oil pollution and Emulsifier cleansing on marine life in South West Britain, J. Applied Ecol. 5, 97-107

34. NELSON-SMITH, A. (1968b) The Biological consequences of oil pollution and shore cleansing, *Field Studies*, 2 (suppl) 73-80.
35. NELSON-SMITH, A. (1970) The Problem of Oil Pollution of the Sea. *Adv. Mar. Biol.* 8
36. PARSON, R. (1972a) Some sub-lethal effects of refinery effluent upon the winkle *Littorina sarscatilis*, O.P.R.U. Annual Report 1972, pp 21-3
37. PETPIROON, S. (Unpublished) Ph.D. thesis, University of Wales, Swansea.
38. REISH, D.J. (1971) Effect of pollution abatement in Los Angeles harbours, *Mar. Pollut. Bull.* 2, 71-74
39. SANBORN, H. and MALINS, D.C. (1977). Toxicity and metabolism of naphthalene: a study with marine larval invertebrates. *Proc. Soc. Exp. Biol. Med.*
40. SANDERS, H.L, GRASSLE, J.F. and HAMPSON, G.R. (1972) The West Falmouth oil spill, I. Biology, Reference No. 72-70, Woods Hole Oceanographic Institution, Woods Hole, Massachusetts.
41. SOKAL, R.R. and ROHLF, F.J. (1969) *Biometry: The principles and practice of statistics in biological research.*
42. STANDARD METHODS FOR THE EXAMINATION OF WATER AND WASTE WATER (1971) 13th Ed. American Public Health Association, New York. 254-256
43. TAIT, R.V. (1968) *Elements of marine ecology.* Butterworths
44. TEAL, J.M. (1976) Hydrocarbon uptake by deep sea benthos. pp 358-371 In *Sources, Effects and Sinks of Hydrocarbons in the Aquatic Environment.* Allis Washington, D.C.
45. VAN GELDER-OTTLAY, S. (1975) Some Physical and Biological Effects of Oil films floating on water, in *Marine Ecology and Oil Pollution* (ed. J.M. Baker)
46. WILLIAMSON, P. (1979) Opposite effects of age and weight in Cadmium concentrations of a gastropod mollusc. *Ambio.* 8 pp 30-31.

47. ZSOLNAY, A., MAYNARD, N.G. and GEBELEIN, C.D. (1977). Biogenic hydrocarbons in Intertidal communities: in Monitoring, and Enforcement: 1977 Oil Spill Conference, American Petroleum Institute.

