



Durham E-Theses

Externally pressurised stern - gear

Rose, Albert

How to cite:

Rose, Albert (1975) *Externally pressurised stern - gear*, Durham theses, Durham University. Available at Durham E-Theses Online: <http://etheses.dur.ac.uk/8955/>

Use policy

The full-text may be used and/or reproduced, and given to third parties in any format or medium, without prior permission or charge, for personal research or study, educational, or not-for-profit purposes provided that:

- a full bibliographic reference is made to the original source
- a [link](#) is made to the metadata record in Durham E-Theses
- the full-text is not changed in any way

The full-text must not be sold in any format or medium without the formal permission of the copyright holders.

Please consult the [full Durham E-Theses policy](#) for further details.

EXTERNALLY PRESSURISED STEIN - GEAR

BY

ALBERT ROSE B.Sc.

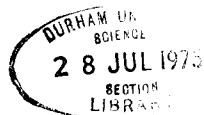

Submitted for the degree
of Master of Science in
The University of Durham
1975

ABSTRACT

Figures presented periodically by classification societies show a major cause of ship casualty to be stern bearing failure. This is particularly the case for large full bodied bulk carriers and tankers. Non-uniform wake distribution around the stern of vessels causes uneven and constantly varying loads upon the bearing. These loads are examined and it is concluded that they may cause lubricant film breakdown and seal failures. Examination of stern bearing failures generally confirms this view and several bearing case histories are presented. Present designs of stern bearings are appraised with the conclusion that all recent advances in stern bearing design have been for the purpose of improving maintainability rather than reliability.

Examination of the loading pattern and the basic design requirements of stern gear indicate that the provision of jacking oil would considerably improve stern gear reliability. This is particularly aimed at reducing the frequency of failure caused by turning gear operation. Experimental work in which oil film thickness measurements were taken on the aftermost bearing of a container ship is presented. This clearly demonstrates the problem of turning gear damage. Furthermore the shaft movements recorded at this plunger bearing show that considerable tailshaft lift (the full stern bearing clearance is taken up) occurs and that the tailshaft probably executes a closed loop under the action of the propeller. Design curves are given to show the lubricating oil pressures and quantities required. It is further postulated that, within the framework of existing classification society rules full hydrostatic lubrication would have even greater advantages. Design curves to a basis of shaft diameter are presented to enable clearance, pressure, lubricant flow, stiffness and basic dimensions to be derived by simple calculation.

Experimental data on suitable materials are given and an overall material specification produced. Designs are given for three typical ship types and based upon these, cost comparisons made. Costs are such that an economic as well as technical case can be advanced for the use of hydrostatic stern bearings.

CONTENTS

| <u>SECTION</u> | <u>TITLE</u> | <u>PAGE NO.</u> |
|----------------|---|-----------------|
| 1 | INTRODUCTION | 1 |
| 2 | LOADING OF STERN BEARINGS | 8 |
| 3 | EXISTING DESIGNS OF STERN BEARING | 40 |
| 4 | SEALING | 65 |
| 5 | COMPARISON OF PRESENT STERN GEARS | 70 |
| 6 | STERN BEARING FAILURES | 71 |
| 7 | APPRAISAL OF PRESENT DESIGNS | 77 |
| 8 | STERN BEARING REQUIREMENTS | 79 |
| 9 | HYDROSTATIC PRINCIPLES | 85 |
| 10 | LUBRICANTS | 88 |
| 11 | BEARING MATERIALS | 91 |
| 12 | LUBRICANT SUPPLY | 109 |
| 13 | DESIGN DATA FOR FULL HYDROSTATIC BEARINGS | 115 |
| 14 | DESIGN DATA FOR JACKING SYSTEMS | 127 |
| 15 | TYPICAL DESIGNS | 130 |
| 16 | POWER REQUIREMENTS | 138 |
| 17 | ECONOMIC APPRAISAL | 139 |
| 18 | CONCLUSION | 141 |
| | REFERENCES | 142 |
| | APPENDICES | 145 |

| | | |
|--------|---|----|
| Fig. 1 | Paddle Wheel and bearing | 3 |
| " 2 | Typical water lubricated stern bearing | 6 |
| " 3 | Stern bearing wear down | 7 |
| " 4 | Hull deformation | 10 |
| " 5 | Effect of wear down | 10 |
| " 6 | Shaft loads and deflexions 250,000 dwt. tanker | 14 |
| " 7 | Shaft loads and deflexions twin screw liner | 15 |
| " 8 | Shipbuilders alignment instructions | 16 |
| " 9 | Stern bearing load distribution | 18 |
| " 10 | Shipbuilders load distribution | 19 |
| " 11 | Wake components | 22 |
| " 12 | Wake analysis | 24 |
| " 13 | Propeller forces | 25 |
| " 14 | Effect of hull forms upon thrust eccentricity | 26 |
| " 15 | Variation in resultant bending moments | 28 |
| " 16 | Propeller induced bending moment single screw liner | 29 |
| " 17 | Bending moments according to Mott & Fleetings | 32 |
| " 18 | Bearing load for fast tanker | 34 |
| " 19 | Shaft position for fast tanker | 34 |
| " 20 | Bearing load and film thickness bulk carrier | 36 |
| " 21 | Approximation of tail shaft resonant speed | 41 |
| " 22 | Conventional oil lubricated bush | 45 |
| " 23 | Lubrication oil system | 46 |
| " 24 | Glacier Herbert bearing | 48 |
| " 25 | Furnbull Mark I bearing | 51 |
| " 26 | Furnbull Mark IV bearing | 51 |

| | | |
|---------|---|-----|
| Fig. 27 | Tilting Pad Stern Bearing | 55 |
| " 28 | Effect of number of Pads on film thickness | 57 |
| " 29 | Film thickness of oil lubricated tail shaft bearings | 58 |
| " 30 | Film thickness and clearance ratio for plain and tilting Pad Bearings | 59 |
| " 31 | Camella Bearing | 60 |
| " 32 | Algonquin Stern - Gear | 64 |
| " 33 | Crane Split Seal | 67 |
| " 34 | Cavitation Damage | 74 |
| " 35 | Whitemetal Fatigue in Stern Bush | 76 |
| " 36 | Film stiffness @ 100 r.p.m. | 82 |
| " 37 | Partial Hydrostatic Bearing | 86 |
| " 38 | Full Hydrostatic Bearing | 86 |
| " 39 | Leakage Path in "D.U." Material | 104 |
| " 40 | Feed Pocket in Resin Bush | 104 |
| " 41 | Effect of control upon stiffness | 112 |
| " 42 | Effect of pocket shape upon stiffness | 114 |
| " 43 | Suggested clearances | 116 |
| " 44 | Supply Pressure | 117 |
| " 45 | Flow Factor and Shaft Diameter | 120 |
| " 46 | Water flow per 100 p.s.i. load (L/D = 1) | 122 |
| " 47 | " " " " " " (L/D = 2) | 123 |
| " 48 | Oil Flow per 100 p.s.i. load (L/D = 1) | 124 |
| " 49 | " " " " " " (L/D = 2) | 125 |
| " 50 | Jacking System proposed by Hill | 128 |
| " 51 | Dimensions of Two Slot Jacking System | 128 |
| " 52 | Guide to Jacking Oil Flow | 129 |
| " 53 | Water Lubricated Hydrostatic Stern Bearing (1) | 132 |
| " 54 | " " " " " " (2) | 133 |
| " 55 | Oil Lubricated Split Hydrostatic Stern Bearing (1) | 136 |
| " 56 | " " " " " " (2) | 137 |

LIST OF SYMBOLS

| <u>SYMBOL</u> | <u>SECTION 2</u> | <u>SECTION 3</u> |
|---------------|--|------------------------------|
| A | | Bearing Equivalent Area |
| a | | area of orifice (Section 15) |
| a | | axial land length |
| b | distance between CG. of propeller and centre of pressure of stern bush | |
| c | | radial clearance |
| D | | shaft diameter |
| d | | diametral clearance |
| e | thrust eccentricity | |
| E | Young's Modulus | |
| g | | acceleration due to gravity |
| K | | arbitrary constant |
| L | Distance centre pressure of stern bush to aft end of Aftermost bearing | Bearing length |
| M | Bending moment | |
| M_{FT} | " " due to transverse thrust | |
| M_W | " " due to propeller weight | |
| M_R | Resultant Bending moment | |
| M_T | Bending moment due to eccentric thrust | |
| n | number of blades | |
| P | | Pressure |
| Q | Torque | Flow |
| R | Blade Tip Radius | Shaft Radius |
| T | Propeller Thrust | |
| Va | Speed of advance | |
| Wa | Axial Wake Component | |
| W_T | Tangential Wake Component | |
| x | | misalignment |

SYMBOL

SECTION 2

SECTION 3 - 17

| | | | |
|-----------|-----------------|-------|---|
| α | angle of attack | | |
| β | | Ratio | $\frac{\text{Recess Pressure}}{\text{supply Pressure}}$ |
| γ | | Ratio | $\frac{\text{axial flow resistance}}{\text{circumferential flow resistance}}$ |
| δ | a constant | | |
| λ | | | Stiffness Parameter |
| μ | | | absolute viscosity |
| θ | blade angle | | |
| ω | shaft speed | | |

1. INTRODUCTION

Figures presented periodically by Lloyds (15) and other (3) classification societies show that a major cause of ship casualty is stern bearing failure. This is particularly the case for large, full bodied bulk carriers and tankers. Non-uniform wake distribution round the stern of vessels causes uneven and constantly varying loads (20) upon the bearing and can induce serious vibration problems. Ultimate bearing failure caused by material breakdown, lubricant film breakdown and seal failure has been attributed to these load variations and induced vibrations (5). Limited qualitative data on the amount of tail shaft movement derived from measurement on aftermost plummer bearings will be given.

An additional cause of bearing failure has been excessive wear during the non-hydrodynamic mode of operation which occurs at slow speeds during manoeuvring and when the ship's shaft is on turning gear (for the entire period in port for steam turbine ships). Experimental substantiation of the susceptability of large bearings to turning gear failure is given.

This latter situation will be prevented if high pressure jacking oil is supplied to the bearing below a certain shaft speed.

It will be further argued that within the existing framework of classification society rules the use of full hydrostatic bearings will overcome the problems posed by the constantly varying wake forces and induced vibrations. Design parameters will be presented. Experimental data upon suitable materials will be compared and material recommendations made.

It is proposed too, that the bearing will be appraised from an economic standpoint as well as a technical one.

1.1. Background

Prior to investigating novel stern gear it is well to examine the background leading to the present situation.

Early steam ships were, generally speaking, paddle steamers and the shafts supporting the paddles were clear of the water and did not have to perform a major sealing problem. Undoubtedly in a seaway the paddle wheel bearings (fig. 1) would have to support fluctuating loads but these would be of a fairly low magnitude.

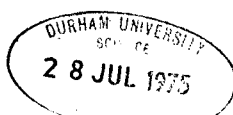

With the advent of the screw propeller which, for most applications, quickly ousted the paddle, the naval architect was faced with the problem of preventing ingress of water to his ship while at the same time having a shaft pass through his hull at a position well below the water line. Some earlier screw propellers had an outboard bearing, but, in the interests of screw efficiency this soon disappeared.

The solution to this problem was to use a water lubricated bearing with an inboard sealing gland which, while preventing the wholesale inflow of water to the ship, did allow sufficient water to lubricate the bearing. Lignum vitae was found to be an ideal lining material under these conditions and stern bearing design remained (satisfactorily) static until rapid increases in ship size (in the 1950's) rendered water lubricated bearings unsuitable. At the present time many merchant ship shafts are water lubricated, (Fig. 2) being a typical modern (1968) design. In this design it can be seen that the bush is in two parts, separated by an annular space. Although leakage is possible, filtered sea water is pumped to this space, and flowing for'd and aft, guarantees lubrication with clean water, rather than relying upon leakage of (possibly) silted water. It will also be noted that the bearing surface is of tufnol, a modern asbestos reinforced phenolic material rather than the traditional lignum vitae. However the "staved" construction essential for manufacture from wooden staves has been retained. This aspect of the design may be open to criticism in that the numerous short bearing surfaces are not conducive to a build up of a lubricating film. On the other hand the numerous grooves allow free passage of water for cooling purposes and allow silt and bearing detritus to be continually flushed out.

Even with light loads it seems unlikely that hydrodynamic lubrication will be maintained over the full operating range on a water lubricated stern bearing. This is shown by wear down figures (Fig. 3) supplied to the writer for the particular bearing shown in Fig. 2. The ship in question is incidentally a 26,000 ton dwt bulk carrier of reasonably fine lines for the type of vessel. Because of the difficulty in maintaining full hydrodynamic lubrication with water, oil lubricated stern bearings became necessary for the larger vessels built from the 1950's onwards. Oil lubricated bearings had been used earlier on merchant ships although the exact date of their introduction is not known to the writer.

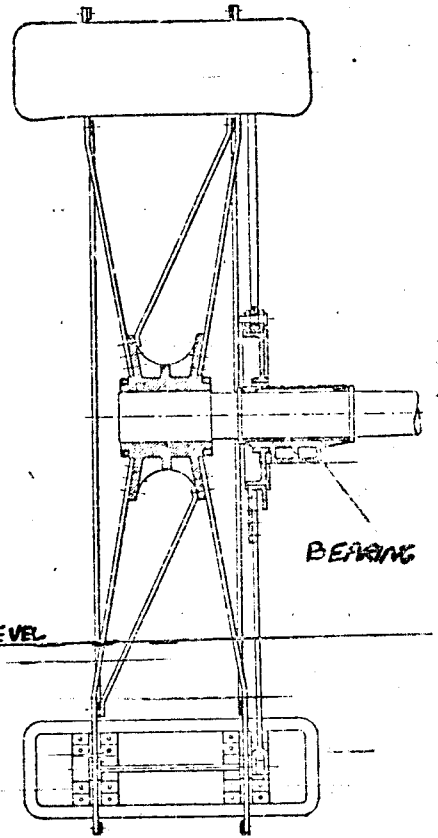
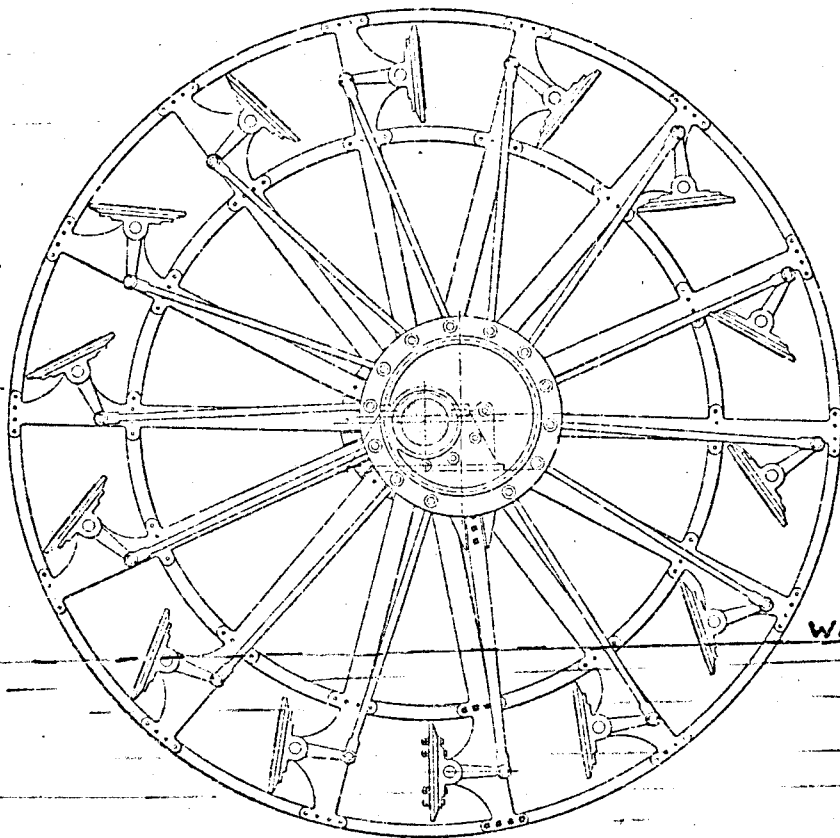

PADDLE-WHEEL & BEARING FIG 1

a major stumbling block to the wholesale introduction of oil lubricated stern bearing was, and still is, the difficulty in producing a reliable stern seal. Numerically, oil lubricated stern bushes were only a minor part of the stern bearing market for some years after their introduction. This point can be verified from the records of specialised bearing manufacturers. One of these (Michell Bearings) made its first whitmetal lined stern bush in 1965.

In tonnage terms it is difficult to be precise as to where the necessity for change from water to oil lubricated stern gear occurs. Below a deadweight of 50,000 tons seems to be the province of the water lubricated bearing while the stern bearings of ships above 100,000 tons dwt are oil lubricated. Specialist vessels such as cross channel ferries are exceptions to this very generalised rule, many of them having small bore oil lubricated stern bushes.

However, since size is a criterion for the decision to fit oil lubricated stern bearings in place of water lubricated bearings, the majority of future tonnage will, by present standards, use oil lubricated bearings. The advantages and disadvantages of these designs are examined in the light of operating condition at a later stage of this report.

Manufacture of large whitmetalled stern bushes present considerable problems. In the period 1969 - 71 the reject rate, during manufacture, was about 50% in one factory. Although attention to detail and considerable expenditure on new plant has reduced this considerably, the mere question of size leads to manufacturing difficulties, particularly when it is remembered that the basic process initially takes place at 230°C.

Appendix 1 has been prepared to describe the manufacturing process and the major problems associated with it.

Summarising this appendix shows that, for a variety of reasons, the main effects of the manufacturing process difficulties are lack of bond at the whitmetal/ bush interface and segregation of the constituents of the whitmetal.

Because of the difficulties met in service various types and designs of stern gear have been produced over the last few years. It seems a feature of these that they are not designed for any greater reliability in service than the plain (oil lubricated) bush but have features which enable servicing, repair or replacement to be carried out.

The tilting pad bearing proposed by Wankesha Bearing Corporation has been an attempt to improve service reliability but, as pointed out by Rose, (23) (24) suffers from reduced operating film thickness.

Seals fitted to stern gear are a major source of trouble in service; failure of this component frequently causing complete bearing failure. The seal manufacturers have carried out considerable research into the sealing problems and, in general, have produced seals which are satisfactory for fine lined vessels where more uniform flow to the propeller results in less tail-shaft movement. However, it is debatable whether seals have yet reached the desirable degree of reliability for use in full bodied vessels whose wake patterns are such that considerable lateral and vertical movement is induced into the tail-shaft.

This thesis will examine the loading pattern and port operation of stern bearings. Jacking oil is recommended to overcome turning gear problems but after examining current designs and failures, will argue that a full hydrostatic bearing will improve the reliability of stern gear to a greater extent. Furthermore, provided water is used as the lubricant, aftermost sealing will cease to become a problem.

It is also intended to show that such a system will, in overall economic terms, be a viable proposition although it may be conceded that the apparent first cost is higher.

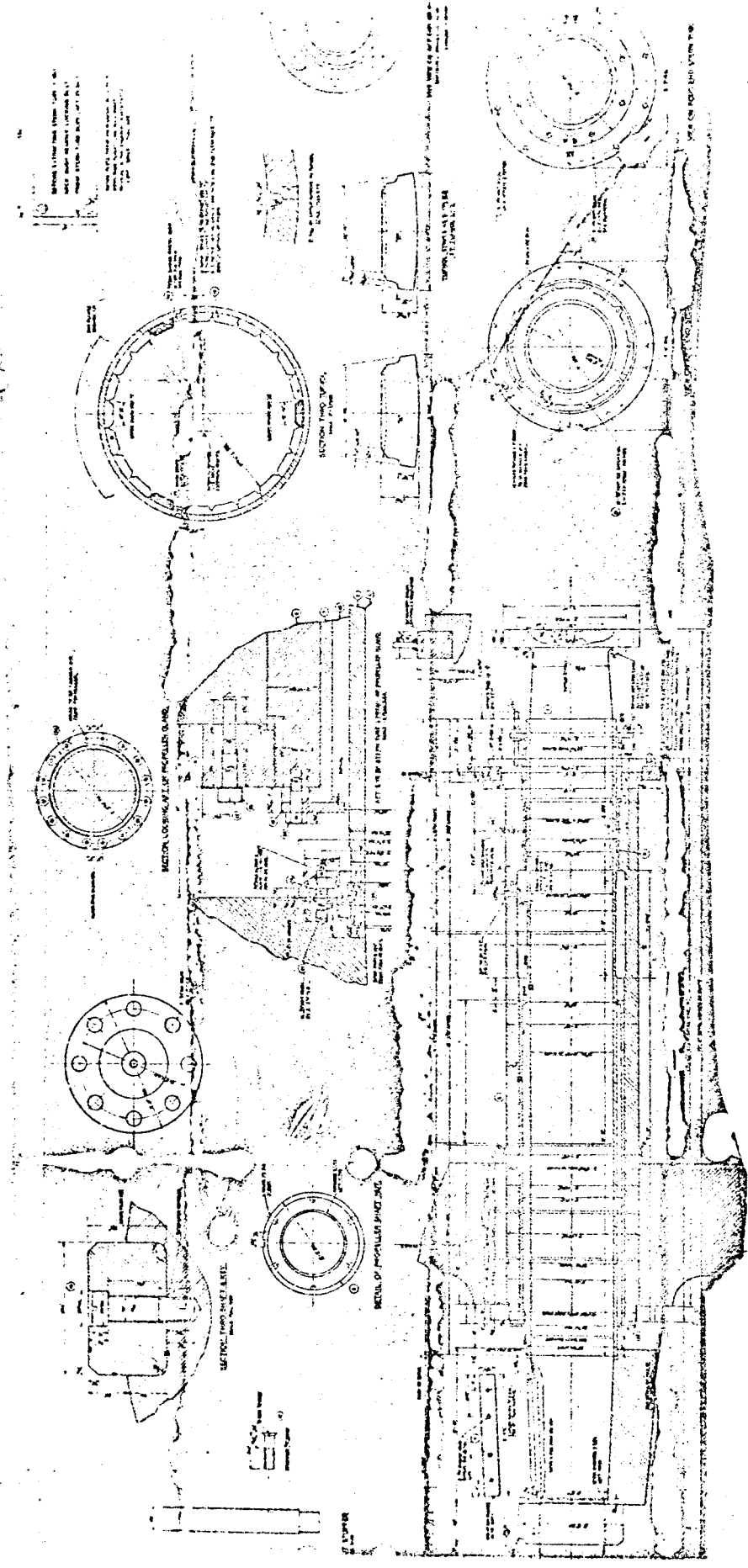

WATER-LUBRICATED STERN BEARING FIG. 2

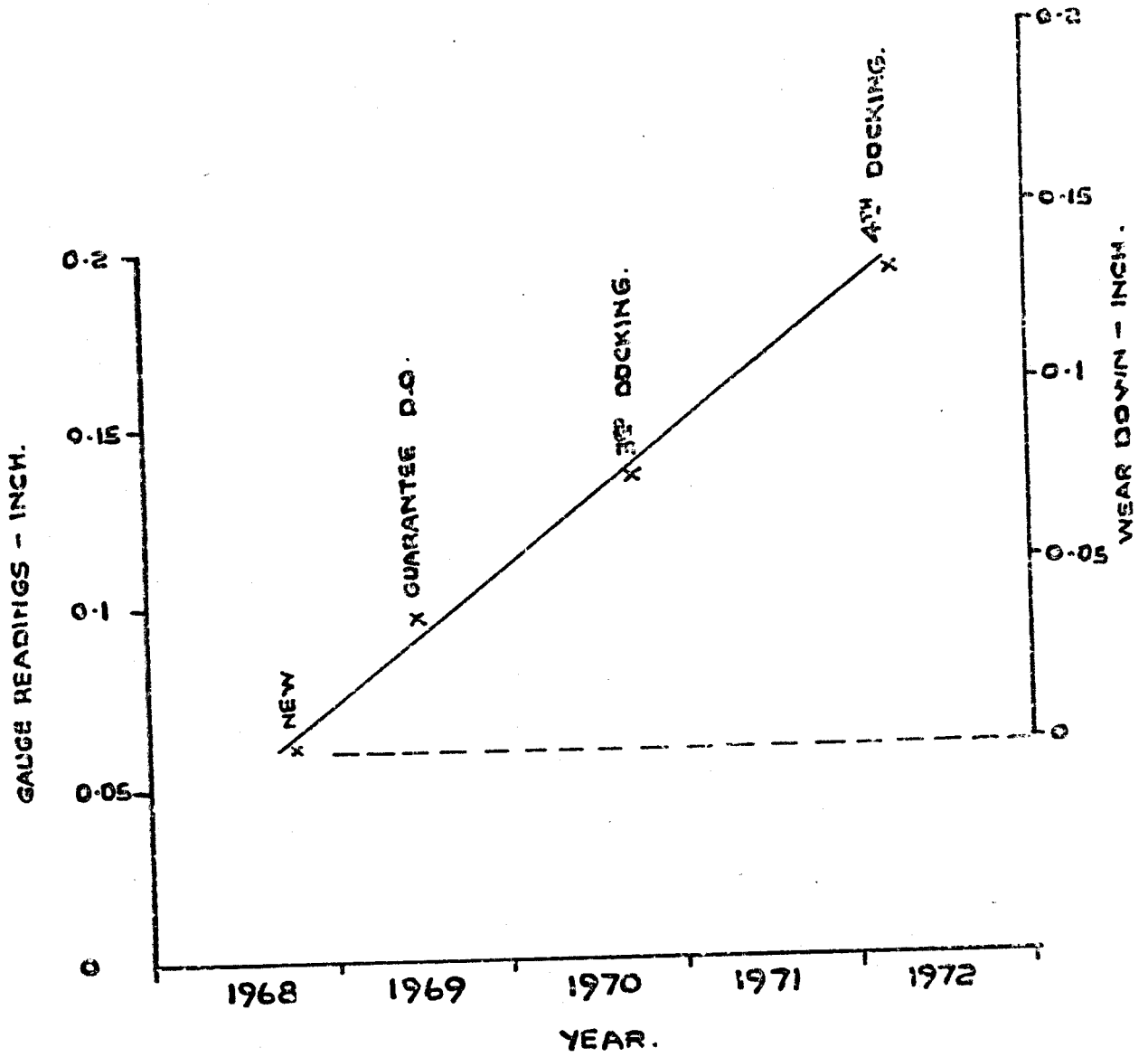

STERN BEARING WEAR DOWN FIG. 3

2. LOADING OF STERN BEARINGS

2.1 Static Loads

2.1.1 General

To calculate the loads on the stern bearing and, indeed, all the shaft bearings, the shaft is treated as a continuous beam with the component loads regarded as point or uniformly distributed loads as appropriate.

If possible, the bearings will be placed at the optimum positions along the shaft but such items as length of individual sections of shafting, bulkhead position and general ship structure may have greater influence on bearing position than the need for optimum positioning. However the design of the shafting system must be such that:-

- (i) Stresses within the system are within acceptable limits.
- (ii) Loads on individual bearings are acceptable.
- (iii) Stern tube loading limits are even and acceptable.
- (iv) The shafting system is maintained as flexible as possible so that the effect of bearing wear and hull distortion are minimal.
- (v) Vibration is within an acceptable limit.

Throughout these design criteria the word acceptable is used and in the marine industry the classification societies have tended to be the bodies which specify acceptable limits. Their views may, by some, be considered conservative in the extreme but the necessity to provide a safe ship must be the overriding condition. It must be remembered that not only the ship and her machinery operate in a hostile environment (salt water and salt laden air) but that she must withstand storm and tempest to guarantee the safety of her crew and cargo.

2.1.2 Permissible loads

Generally, classification societies do not specify maximum acceptable stresses on shafting but specify the minimum tensile strength and diameter of shafting based upon (presumably) factors of safety which are not shown in the rule books. Lloyds Register of Shipping specify that the intermediate shafting shall be manufactured from steel having a minimum tensile strength of 44 kg/mm^2 and that the diameter "d" shall not be less than:

$$d = 25.4 \times C \times \sqrt[3]{\frac{H}{R} \left(\frac{60}{T + 16} \right)} \text{ mm}$$

where C = coefficient based on engine type and number of cylinders. It varies between 4.50 and 3.55 for oil engines and is 3.5 for turbine engines.

H = Maximum continuous horse power

R = r.p.m.

T = minimum tensile strength of material

The diameter of the tail-shaft is derived from this by multiplying by a factor based upon propeller size. Lloyds insist that torsional vibration characteristics of the shaft system are submitted to them for approval but do not specify that axial or transverse vibration calculations be submitted. Nor do Lloyds dictate the loading, spacing or alignment of the intermediate shaft bearings but they will sell to builders the necessary computer programmes to calculate these.

European practice tends to limit intermediate bearing loads to about 100 p.s.i. while U.S. practice is to employ larger bearings (L/D = 2) which result in lower loadings of about 50 p.s.i. The greater length of the American type makes them more prone to misalignment problems. Rose (22) and Couchman (3) have expressed the opinion that bearing loads could, with safety, be increased. Stern bearing loading must not exceed 6.3 kg/mm^2 (90 ps.i) according to Lloyds and furthermore, the bearing length must not be less than twice the minimum allowable shaft diameter.

Shorter bearing lengths would assist the builder in that alignment becomes less critical. In private correspondence (Swan Hunter and Michell Bearings in 1970) ratios of 1 : 1 have been discussed but Rose (24) in discussions of sterngear for supertankers showed L/D ratios of 1.5:1 to be preferable.

In all cases, however, where discussing higher loading of marine bearings the performance at reduced r.p.m. or on turning gear must be considered. One criteria has been that a minimum film of .002" should be maintained at half ahead.

The shafting system must be as flexible as possible since the hull of a ship continually flexes in a seaway and also deflects different amounts under different loadings. The effect upon static bearing load of ship movement is considerable. Bearing manufacturers have indicated that actual load in service may be twice the static calculated load.

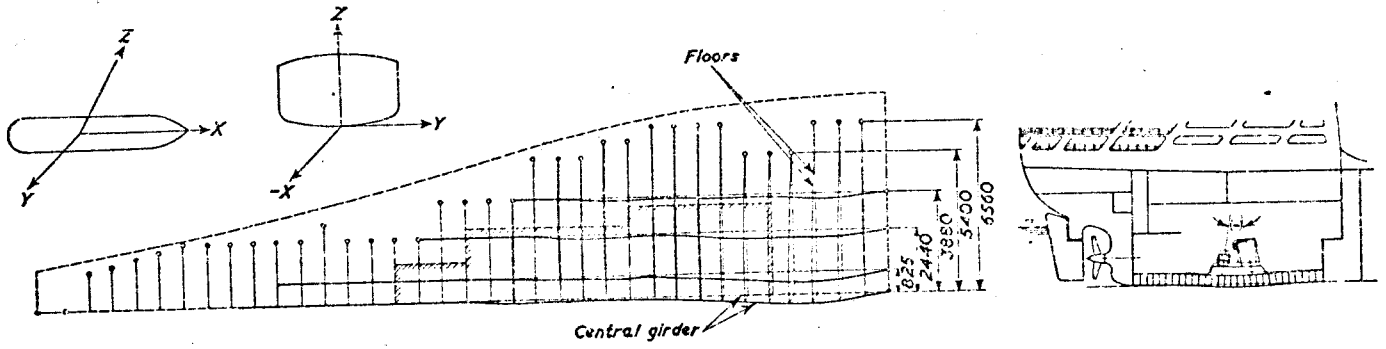

a) LIGHT SHIP

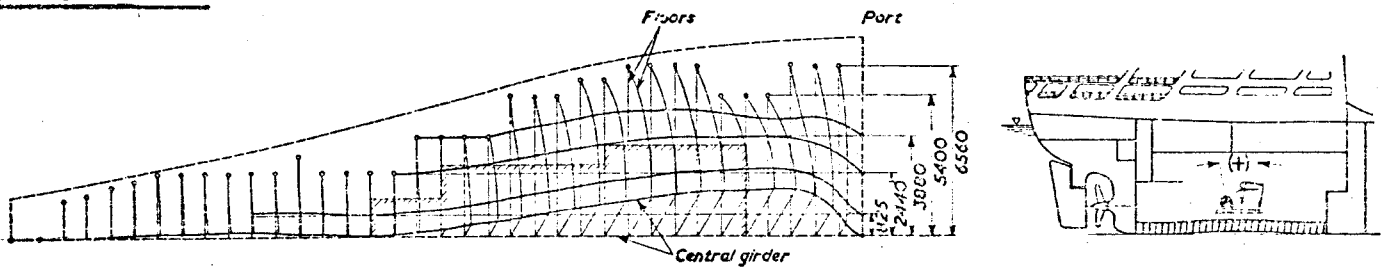

b) FULLY LOADED (70,000 t dwt)

HULL DEFORMATION (Vale) FIG 4

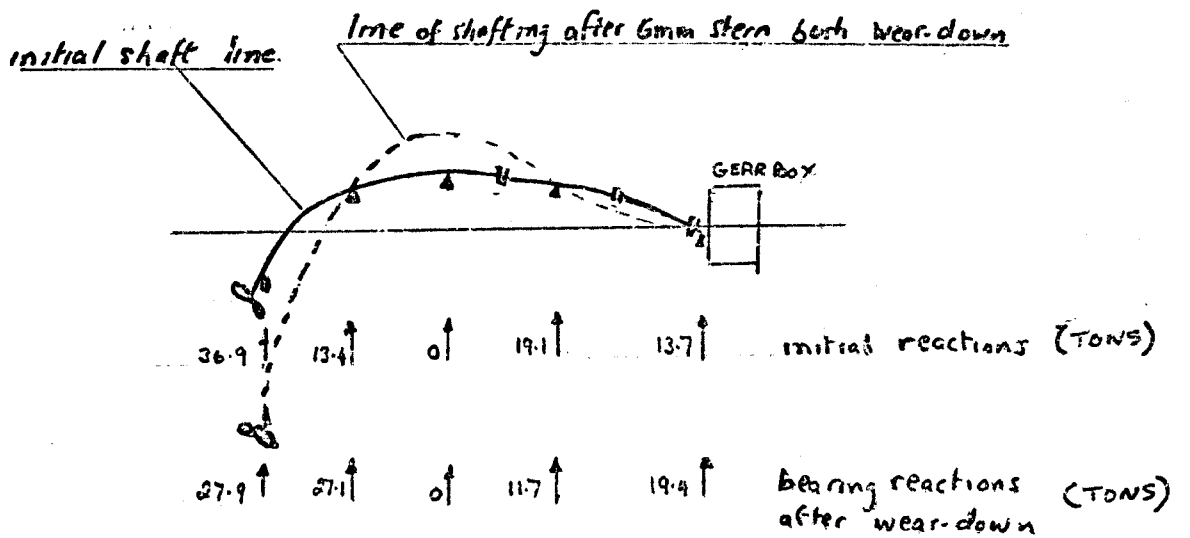

EFFECT OF WEAR DOWN

FIG 4
FIG 5

Fig. 4 shows typical engine room deflexions due to loading while Fig. 5 shows the effect on bearing loads of stern bearing wear down. Both these diagrams are derived from Bureau Veritas records (29)

It can be seen that as wear proceeds the load at the aft end of the stern bearing has reduced by almost ten tons but this is accompanied by an increase in load of 14 tons at the forward bush. Wear is a function of load and it is reasonable to assume that rate of wear will decrease with time. This assumption however is not borne out by the wear down figures presented in Fig. 3 In this case wear rate has been directly proportional to time in service.

One explanation of the continuation of wear after considerable reduction loading has taken place may lie in the fact that the process of wear down is accompanied by deterioration in bearing surface so that whereas bearing contact will take place at, say, slow ahead engine speed when the bearing is first installed contact will take place at higher speeds once the surface is roughened, hence wear is taking place for a much greater operating period. Also, it must be pointed out that judging by the absolute values of wear presented, the bearing will be excessively damaged and unfit for service before wear rate has dropped to an acceptably low value. The paper from which these figures are derived clearly emphasises the effect, over the last few years, of changing ship dimensions upon the loading of stern and other line shaft bearings. It points out that over the last 20 years shaft sizes have increased almost twofold and hence shafting stiffness has increased by 16 times. At the same time as shaft stiffness has increased the floor stiffness has decreased 16 times. This considerably increases the magnitude of loading that ships bearings must withstand due to hull deflexion and increases the significance of shaft alignment (or misalignment).

2.1.3 Magnitude of Loads

The static loads on shaft bearings are calculated by considering the shaft as a continuous beam and generally making the following assumptions.

- (a) The shaft is continuously loaded but supports a point load at its extremity representing the propeller weight in sea water (i.e. propeller weight less up-thrust due to water displaced.)
- (b) The shaft is considered to be point supported at the plummer blocks but has uniform support on the stern bearing.

This latter assumption is, in the writers opinion, somewhat far reaching in that it assumes the bearing bush to remain properly aligned to the shaft. As has already been pointed out the shafting of a large vessel is stiff in comparison to the hull. Even if the alignment calculation is correctly carried out and the shaft bored to this alignment any change in loading will radically change both the alignment and static load.

When commencing the load calculations of a line of shafting, modern procedure is to assume that wherever possible there is one bearing per shaft length. This represents a considerable change in attitude over the last twenty years from the principle that each shaft length required two bearings, if only for installation and alignment considerations. On merchant ships the bearing spacing tends to be between 6 and 12 diameters. Ideally maximum distance between bearings should be the object, consistent with the necessity to suppress shaft whirl.

Both the correct spacing of bearings and the necessary alignment are calculated by an iterative process. For (Ship) structural reasons the axial position of the bearings is often fixed to fairly close limits and at the start of the calculation it is usual to assume straight line alignment. Loads and influence values (influence value = change of bearing load per .001" change in bearing height) are calculated for each bearing. If influence values are reasonably similar it will merely be necessary to adjust the bearing heights relative to the centre line in order to achieve a reasonably uniform load. If there is too great a variation in influence coefficients then it may be necessary to re-locate bearings or in some cases remove a bearing altogether. Probably the most convenient method of carrying out such a calculation is by a conversational mode operator interactive computer programme such as has been developed by N.E.L.

Ref (32) describes alignment theory and practice in considerable depth. The result of such a calculation is shown in Fig. 6 and it can be seen that the shaft itself follows a fair curve.

This shafting is that for a 250,000 tanker and by way of comparison Fig. 7 has been drawn for the shafting of a twin screw passenger liner. These diagrams have been supplied by the shipbuilder. Both stern tubes being in fact, oil lubricated.

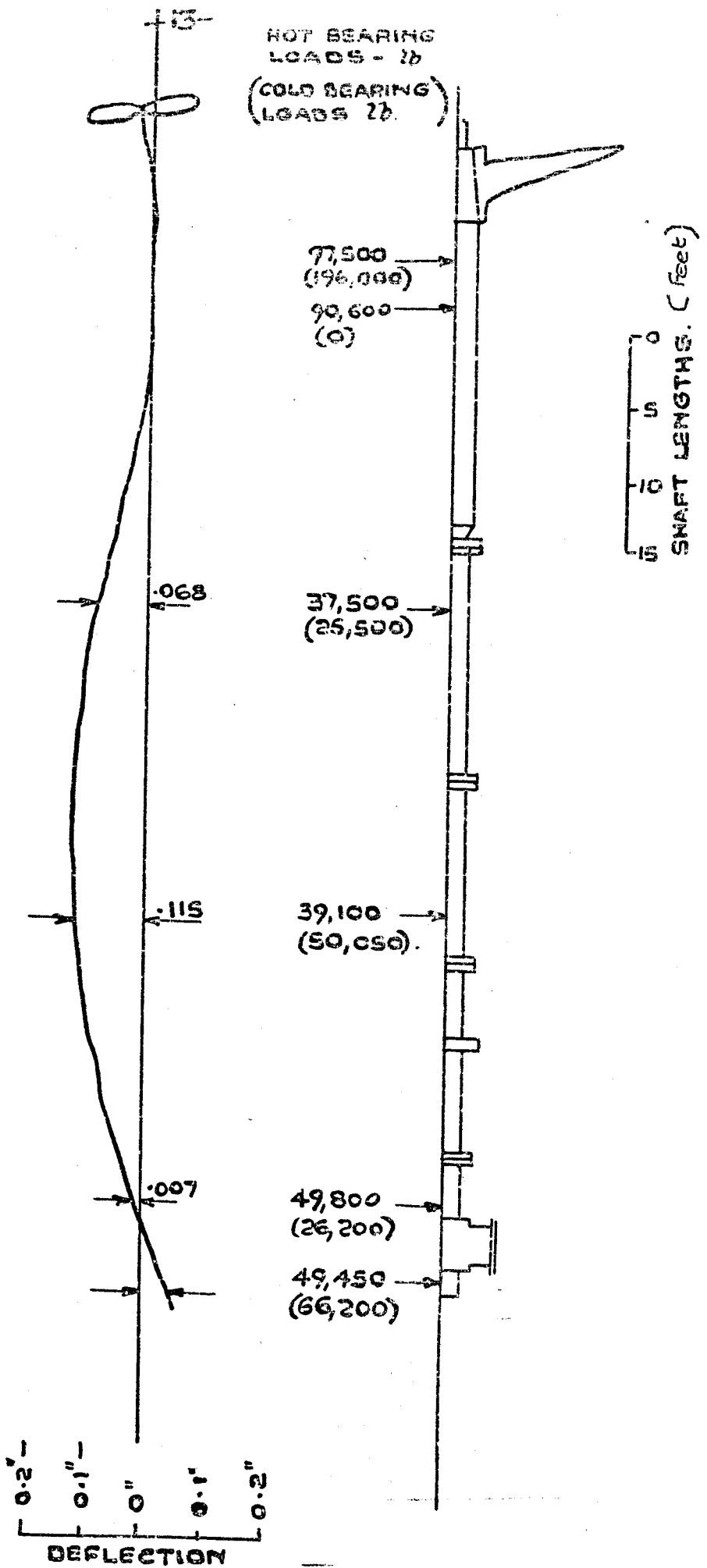

SHAFT LOADS & DEFLECTIONS.
250,000 d.w.t. TANKER.

FIG. 6.

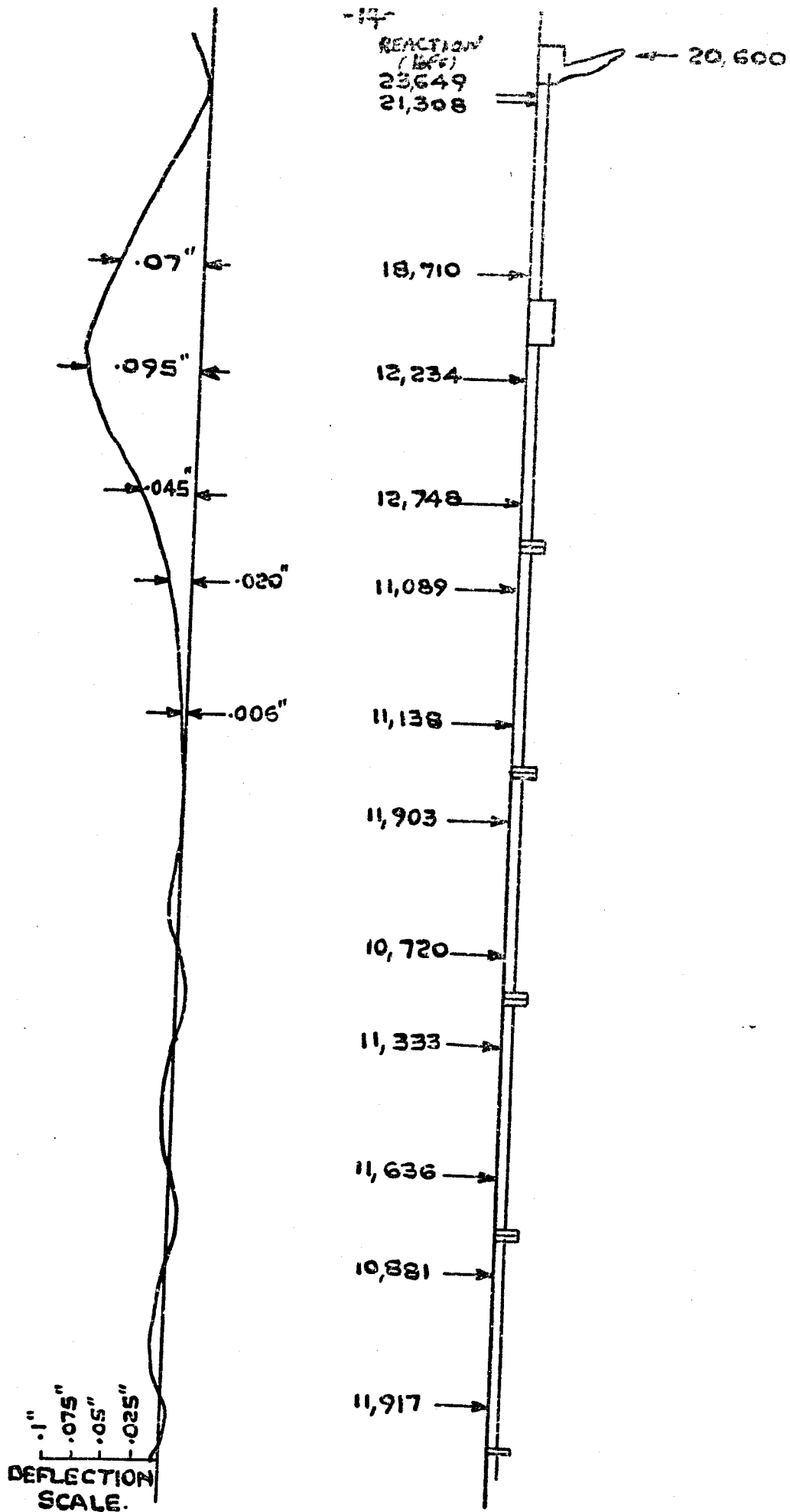

LOADS & DEFLECTIONS, TWIN SCREW LINER.

FIG. 7.

In practice - achieving the calculated alignment is probably difficult. The diagrams show a fair curve for the entire shafting but it must be remembered that the shafting consists of a number of shorter (and stiffer) shaft sections. It is usual to calculate the spacial positions of these sections so that, when bolted up, they will form a fair curve. The individual sections are supported both on the installed bearings and on temporary jacks set to predetermined heights using a stretched piano wire or an alignment telescope. The shafting and bearings are adjusted to give a previously calculated series of "gaps" with the unbolted shaft. Bolting the shafting then gives the overall correct alignment. Fig. 8, a shipbuilders instruction sheet, illustrates the principle involved. The installation and alignment of shaft takes place while the vessel is completely light and the engines cold. Needless to say the deflexions to the hull which occur when the vessel is loaded or ballasted considerably affect both the alignment and the individual loading.

This is particularly so on large bulk carriers where the shafting is stiff in comparison to the hull.

It is clear too that the alignment of the stern bearing relative to the shafting will change between installation and commissioning.

The stern bearing is long in comparison to other bearings and hence, in absolute terms, the misalignment of this bearing relative to the shaft will be greatest.

Because of the length of the stern bush it is usual to "slope bore" the stern frame to accommodate the stern bearing. The natural shape of the shaft is such at this point that this is necessary to evenly distribute the load. However when the change in alignment after launching is taken into account considerable doubt must be cast on the final alignment and load distribution. Volcy (29) who, if only for his position in the classification societies, must be considered authoritative, claims that fair curves alignment of stern bushes does give good results provided the stern bearing assembly is of the single bearing type and not the type with a for'd and an after bush (Figs. 2 and 22 show examples of each type). Hill disagreed with Volcy on this point and has produced diagrams which show the effect of ship loading on the pressure distribution within a stern bearing and also the consequent change in the point of support of the shaft within the bearing.

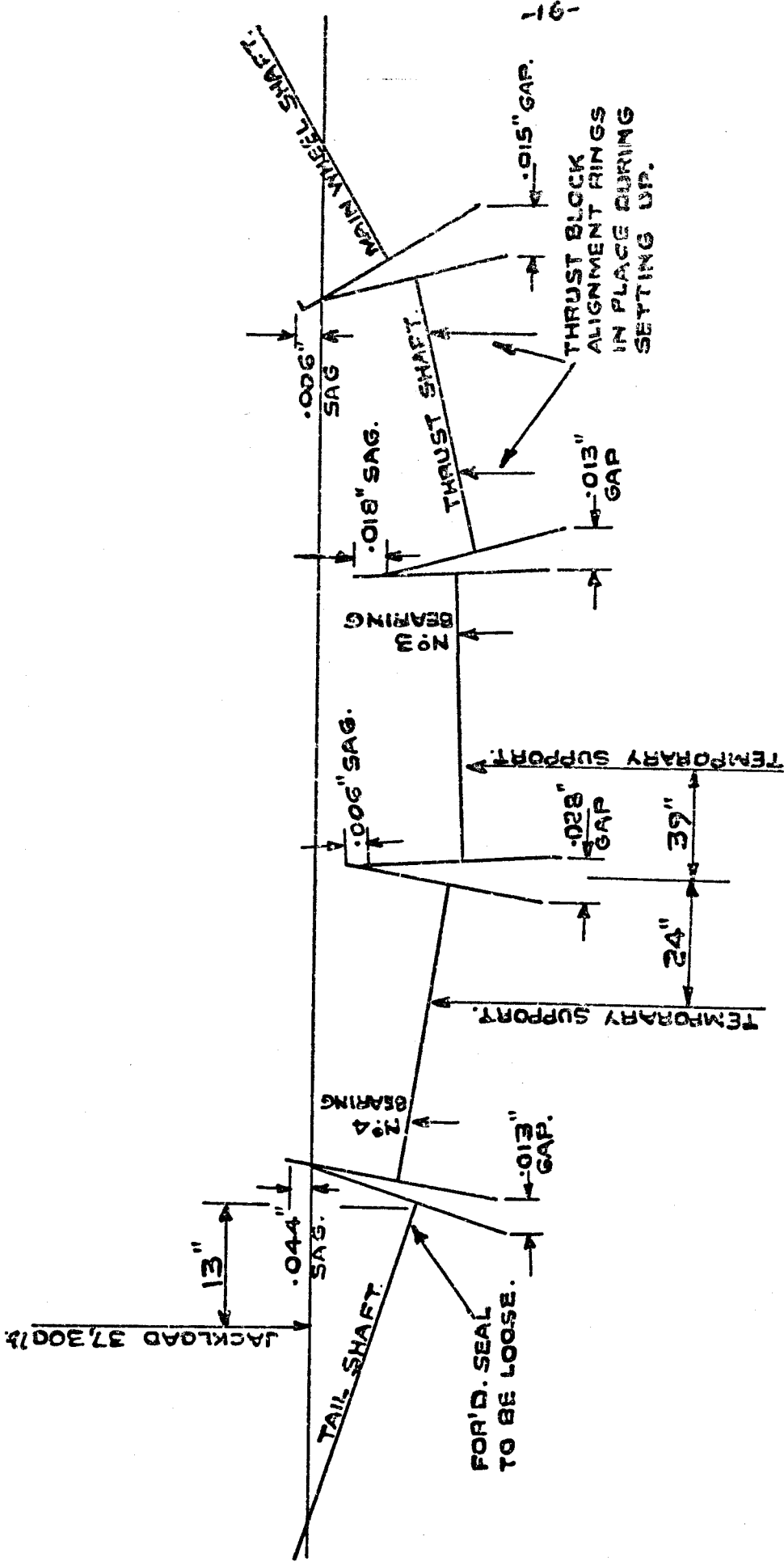

SHIP-BUILDERS ALIGNMENT INSTRUCTIONS.

FIG. 8.

Hill does not give a scale of pressure on his diagram but assuming a typical load of 80 p.s.i. Fig. 9 has been prepared. It has further been assumed that the bush in question is 66 inches long so that the movement of the point of theoretical support may be seen in absolute terms. The diagram assumes hydrodynamic lubrication. Superimposed upon this is a pressure distribution calculated by the writer for a 250,000 ton ship. The graphs of Raimondi & Boyd (21) were used to calculate this pressure distribution in which a series of minimum film thicknesses were assumed for a shaft bent into a parabola and corresponding pressures calculated at intervals along the shaft. Integrating these individual pressures gave the total load carried for the series of minimum film thickness. Plotting these loads against film thickness permitted the pressure distribution at the normal load to be derived. The steps in the calculation were

- (1) Calculate attitude angle for a straight shaft at the load and speed required.
- (2) Assume the shaft to be bent into a parabola equally distributed about the mid-point of the bearing.
- (3) Project the shape of the shaft onto a plane located by the attitude angle.
- (4) Divide the bearing into 16 equal lengths,
- (5) Assume a series of minimum film thicknesses at the outer ends of the bearing.
- (6) For each of these minimum films derive the minimum film thickness at the centre of each of the 16 sections.
- (7) For each of these films calculate the mean bearing pressure in each section.
- (8) Integrate the pressures along the length of the bearing to obtain the "no end-leakage" load carrying capacity.
- (9) Correct load carrying capacity for end leakage.
- (10) Plot load carried against assumed film thickness and equate to total bearing load.
- (11) Derive pressure distribution for result of (10).

Fig. 10 shows the shipbuilders calculations of pressure distribution for the same ship when fully loaded and when light ship.

The shipbuilders graphs have used a simple iso-viscous calculation for film thickness but are valuable to this thesis as they show:-

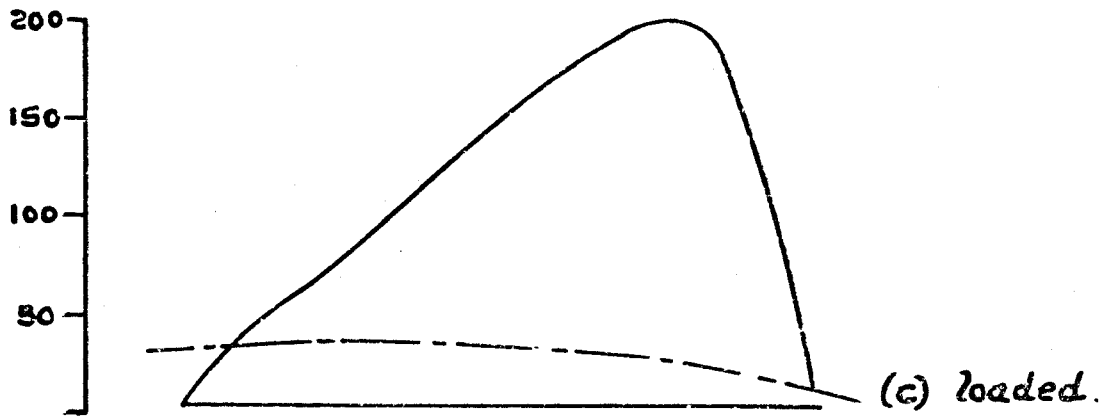
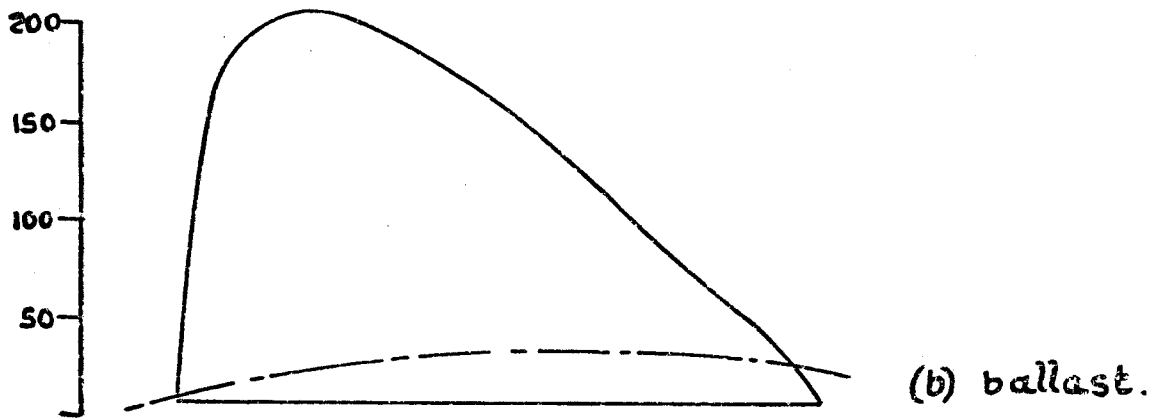
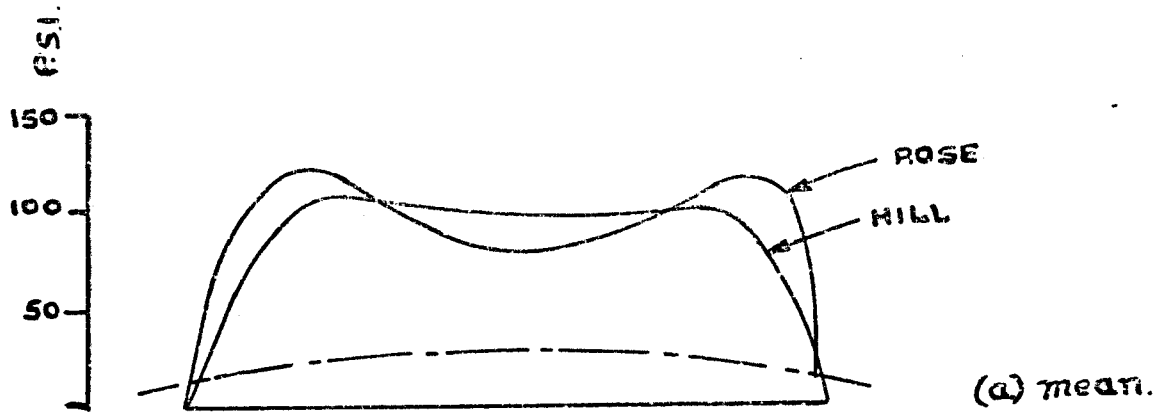

→ FOR'd.

0 20 40 60 inches

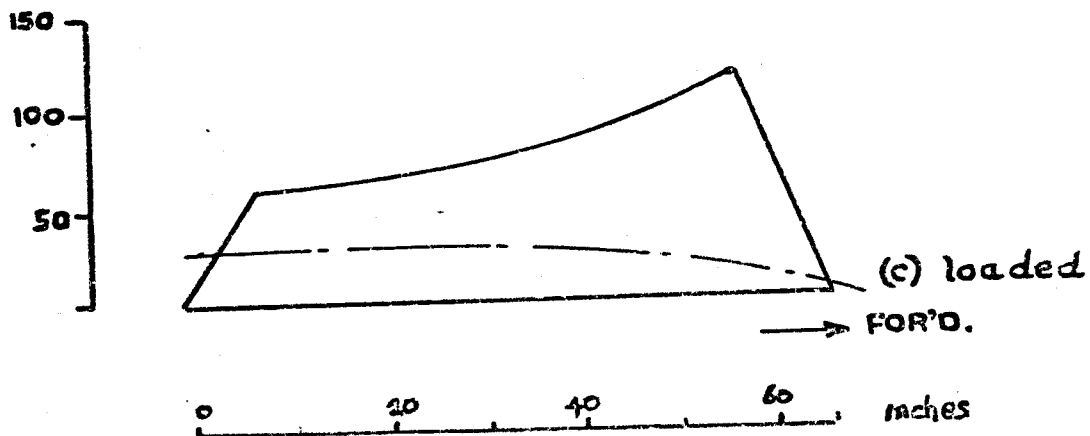
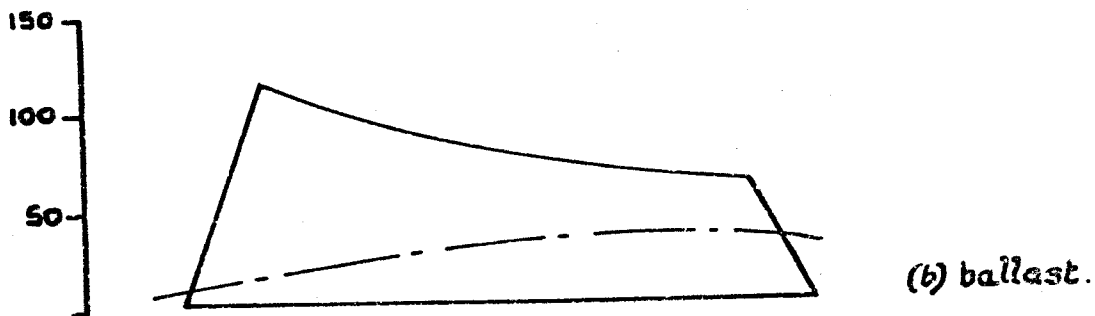

SHIP-BUILDERS LOAD DISTRIBUTION FIG. 10

2.2.1 Loads due to Hull movement in a seaway

These loads are caused by the flexing of the hull as the vessel moves in a seaway. They are similar to the variations in forces caused by ship flexure due to different loading conditions. It seems unlikely that in normal seas these seaway force variations will be as high as those caused by loading patterns but it is possible that during storm conditions such variations occur. It seems reasonable to assume that the load on a stern bearing is likely to vary about $\pm 5\%$ due to hull movement. Frequency of such load changes will be a function of wave length and ship speed. With a wave length of 100 ft. tanker speeds would result in a frequency of .3 to .4 Hz or 2.5 seconds per cycle. Since the length of a modern bulk carrier is several wavelengths the loading cycle is probably not such a simple one. Since, however, the frequency of the seaway induced load is low in comparison to blade frequency (7-10 Hz) it is felt to be acceptable to treat it as a steady average load and to merely increase the average loading of the stern tube to account for it.

2.2.2 Loads due to eccentric thrust and transverse thrust on the propeller

A propeller acting behind a ship does so in an unsymmetrical wake field i.e. the flow of water into the propeller disc is neither parallel to the axis of rotation nor does its flow remain constant in magnitude and direction relative to the propeller blades.

A typical blade element acting in a wake is shown in Fig. 11. The wake flowing round the stern of the vessel has both axial and transverse components W_a and W_t . An increase in axial wake will increase the angle of attack (α) of the propeller blade which will result in larger thrust and transverse forces. The tangential wake components will be directed towards the centre plane of the vessel. This results in an increased angle of attack on one side (starboard for clockwise rotating propellers) and a reduced angle of attack on the other side. Because of this the propeller develops an unbalanced transverse force. Any rotating propeller blade will develop maximum thrust at a point of maximum wake. The literature shows (13) that normally the wake is highest relative to the propeller blades in the upper half of the propeller disc and on the starboard side for a clockwise turning propeller. Since the wake is varying at all points around the disc and, at any one propeller position, along the radial line of the propeller the resultant hydrodynamic thrust on the propeller will act, not through the centre of the propeller boss, but at some point eccentric to it.

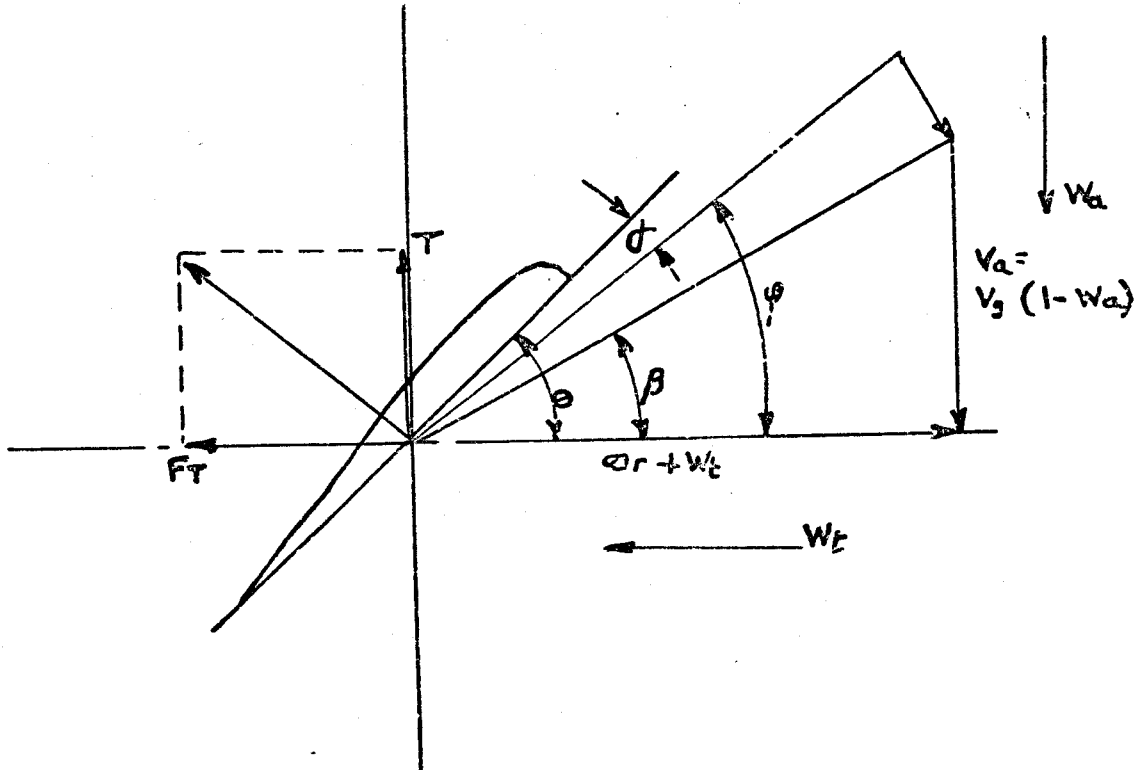

W_a = AXIAL WAKE COMPONENT.

W_t = TANGENTIAL WAKE COMPONENT.

V_a = SPEED OF ADVANCE OF PROPELLER.

V_s = SHIP SPEED

α = ANGLE OF ATTACK.

θ = BLADE ANGLE

T = THRUST.

F_T = TRANSVERSE FORCE.

Fig. 12 attributable to Sinclair & Emerson (27) shows a typical wake distribution for a single screw vessel. This clearly shows the variation in wake that a single blade will experience.

The forces generated by a propeller have been summarised in a diagram presented by Wereldsma (13) and used by several other writers on the subject. This diagram is reproduced as Fig. 13 in this thesis.

In this diagram, T represents the axial (i.e. propulsive) thrust which, as has been indicated, varies in magnitude. It also varies in position the centre of thrust being a closed loop the thrust centre being in the same position whenever the blades occupy the same position. That is to say the thrust varies cyclically at blade frequency both in magnitude and position.

The transverse force F varies in a similar manner.

The wake flow is obviously dependent upon the form of the ships hull. Fine lined vessels will have a more uniform flow into the propeller and hence smaller load variations.

Wake flow is also dependent upon draught. The effect of after body shape upon thrust eccentricity is shown in Fig. 14. Unfortunately this reference does not attach figures of thrust values to the various patterns shown.

Changing draught also affects the general position of thrust centre.

According to Vedeler (29) the centre of thrust is generally higher (relative to the boss) for a fully loaded ship than for a ship in the ballast condition.

Obviously the combination of varying eccentric thrust and varying transverse load impresses a bending moment on the shaft. As can be seen from Fig. 14 this moment may be positive (tending to load the shaft down into the stern bearing) or negative (tending to lift the shaft in the stern bearing).

Vedeler points out that the propeller induced bending moments are of sufficient magnitude to load the upper rather than the lower half of the bearing.

Cambell and Laskey (7) show vertical load oscillations in which the tail-shaft moves the full bearing clearance during service operation.

2.2 Magnitudes of Propeller Induced Bending Moments and Loads

Several references are available as to the relative values of bending moments from which loads may be estimated. Unfortunately, however, many investigations have failed to give sufficient data to enable absolute figures to be calculated. Vedeler shows graphs of thrust variation and transverse force expressed as percentage of average thrust.

WAKE FRACTION = WAKE VELOCITY \div SHIP SPEED

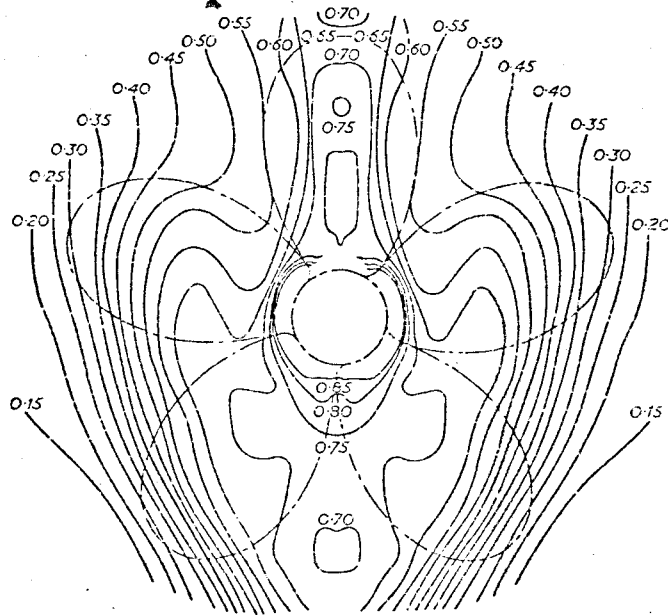

WAKE DISTRIBUTION FIG. 12

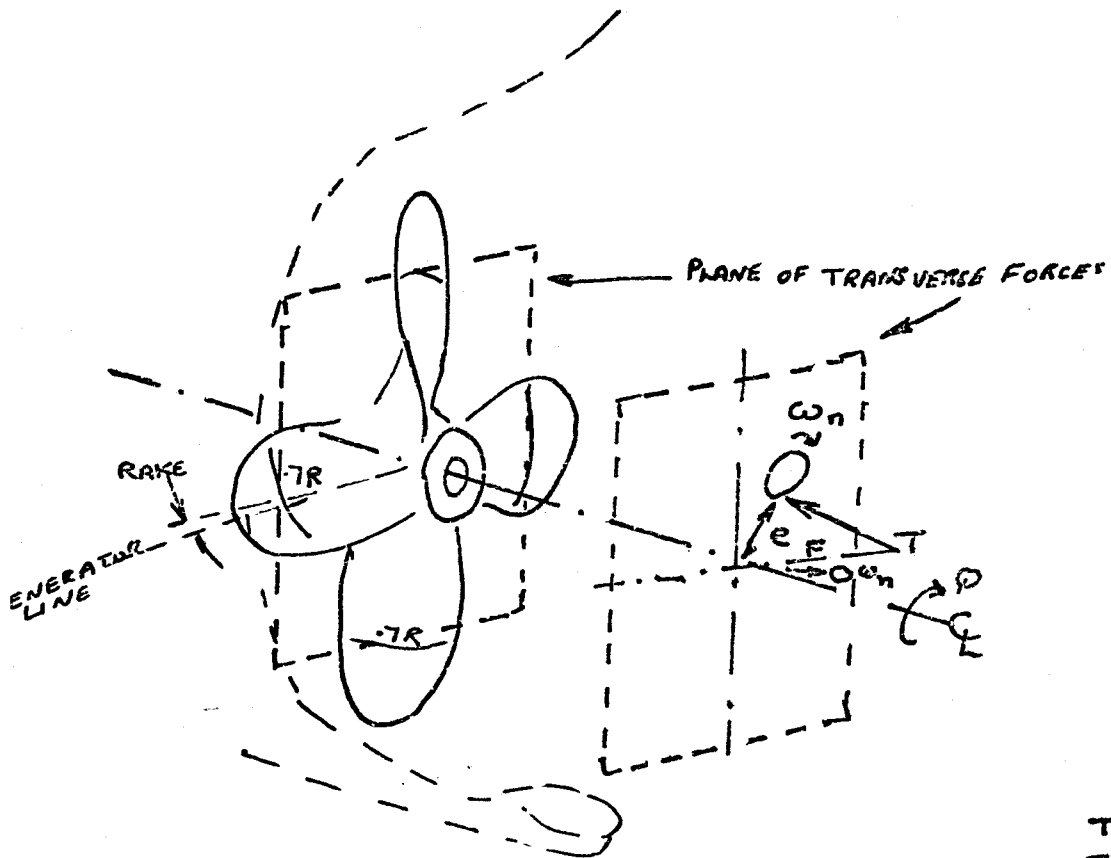

- T - THRUST
- F - TRANSVERSE FORCE
- Q - TORQUE
- e - THRUST ECCENTRICITY
- n - NUMBER OF BLADES

PROPELLER FORCES FIG. 13

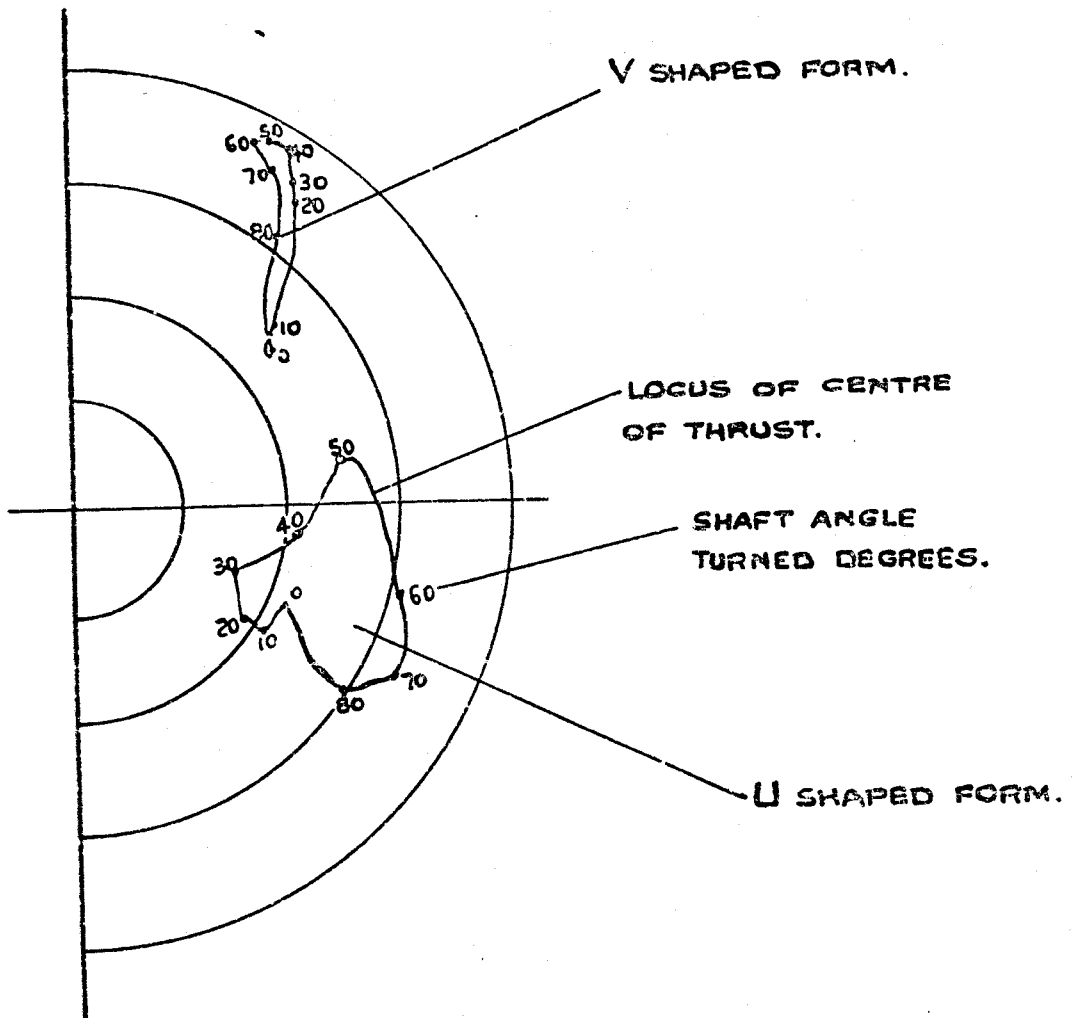

EFFECT OF HULL FORM UPON THRUST ECCENTRICITY FIG.14

He also gives position of thrust centre expressed as a percentage of propeller radius. Fig. 15 has been prepared from Vedeler's information to show the variation in relative thrust and eccentricity. Vedeler has measured these figures on the shaft of a self propelled model of a dry cargo vessel. Assuming that these figures are reasonably representative of dry cargo vessels put into service at the time of Vedeler's paper the following figures have been calculated for MV Lobito Palm - (Commissioned 1961) whose tail-shaft arrangement is shown in Fig. 22.

| | | |
|------------------|---|----------|
| Propeller radius | - | 8.25 ft. |
| Propeller weight | - | 13 tons |
| Shaft diameter | - | 20 tons |
| R.P.M. | - | 118 |
| S.H.P. | - | 7500 Bhp |
| Speed | - | 14 Knots |

Estimated thrust using approximate formula

$$\text{Thrust} = \frac{\text{H P} \times 326}{\text{Speed}} \times .9 = 150,000 \text{ lb.}$$

The propeller weighs 13 tons in air and the density of bronze is 520 lb per cubic foot from which the weight of the propeller when submerged in water is 11.4 tons.

Table I has been prepared using a mean thrust of 150,000 lb to show the vertical, propeller-induced bending moment on the tail-shaft.

TABLE I
PROPELLER INDUCED VERTICAL BENDING MOMENTS
MV LOBITO PALM

| <u>BLADE ANGLE</u> | <u>BENDING MOMENT</u> | |
|--------------------|-----------------------|---|
| 0 | 46 |) |
| 11.25 | 46.2 |) |
| 22.5 | 48.5 |) |
| 33.75 | 50.5 |) |
| 45 | 54 |) |
| 56.25 | 51.5 |) |
| 67.5 | 48.5 |) |
| 78.75 | 46.2 |) |
| 90 | 46 |) |

Tons ft acting
upwards

As a general rule it is assumed that the bearing reaction acts at a point 1/3 bearing length from the aft end of the stern bush.

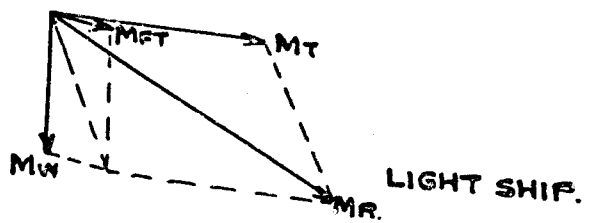
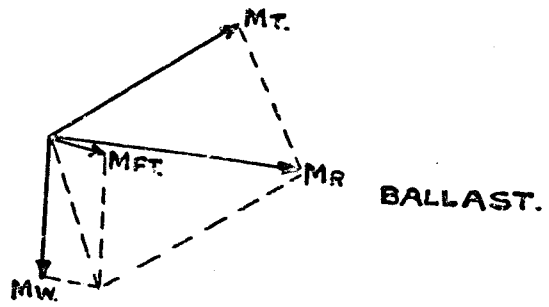
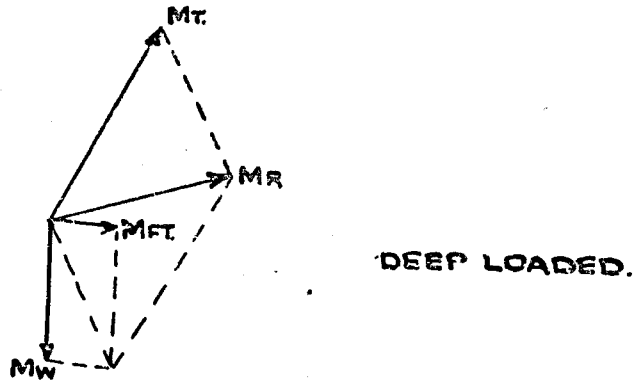

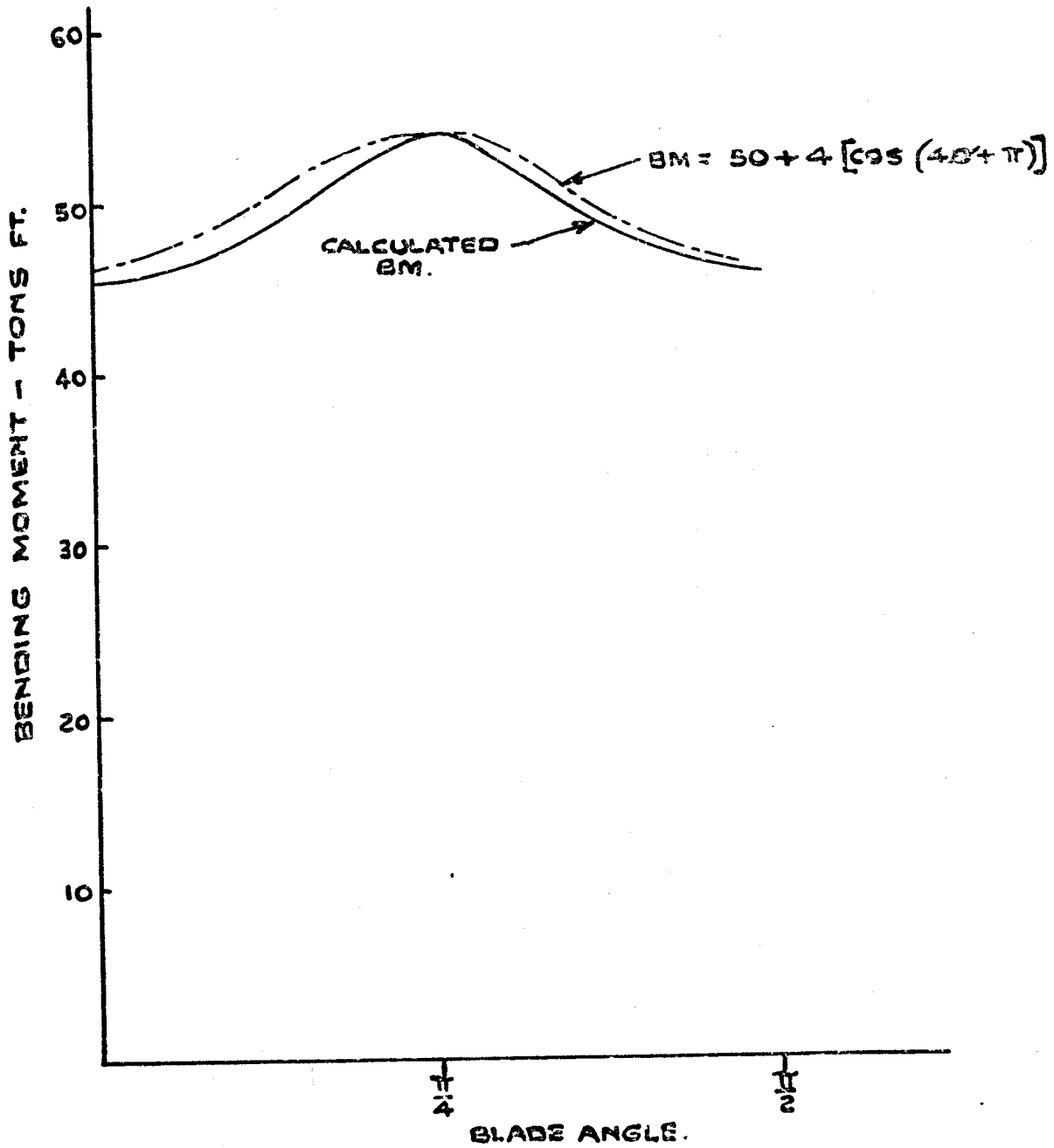

PROPELLER INDUCED BENDING MOMENT SINGLE SCREW CARGO LINER FIG. 16

Lobito Palm drawings show this point to be 3.625 ft. from the centre of gravity of the propeller. With a propeller weight (in water) of 11.4 tons the downward bending moment is 41.5 tons ft. Hence under all conditions of loading the tendency is for the propeller induced bending moment to unload the tail-shaft bearing. As this happens the point of support in the bush moves forward from the "1/3" position until the BM due to propeller weight is in equilibrium with the propeller thrust induced B.M. As this occurs the aftermost plumper block or, if fitted, the for's bush, becomes more heavily loaded. The net result is a barely loaded stern bearing and a long cantilivered shaft which is unstable and liable to very high vibration amplitudes.

It is interesting to note that this particular vessel suffered extremely heavy cavitation damage to her tail-shaft liner which, on examination by the writer, was attributed to shaft vibration.

Vedeler's graphs show for this type of vessel, with a four bladed propeller, horizontal transverse force is fairly consistent at 5% of mean thrust and that the horizontal thrust eccentricity is small. This results in a near constant horizontal bending moment of 12 tons ft. acting to starboard. Fig. 16 has been prepared to show the variation on propeller induced bending moments for Lobito Palm.

It can be seen that the plot approximates to a sine wave. For comparison the equation $BM = 4 \cos \left(4\theta - \frac{\pi}{2} \right)$ has been plotted. This may suggest a

bending moment equation of the general form

$$BM = A + B \cos \left(n\theta + \frac{\pi}{2} \right) \quad \text{where } n = \text{number of blades.}$$

Mott & Fleeting (18) dispute the analysis of propeller induced forces in general terms without detailed wake analysis. The work of Tsakonas, Bresten & Miller (28) tends to confirm this. Their detailed paper requires that a wake analysis be carried out for each ship considered before propeller forces may be derived.

Mott does however give calculated bending moments for a single screw tanker and a twin screw passenger vessel. Fig. 17 shows these figures. The tanker is a fleet auxilliary and so will have fine lines for a tanker. Both ships have four bladed propellers so blade frequency will be about 7 Hz.

For the twin screw vessel the bending moment at all times tends to lift the shaft.

By inference the net weight of each propeller is 16.4 tons with a centre of gravity 4 feet from the theoretical point of support in the stern tube. At this point of support the propeller weight gives a bending moment of 65 tons ft. which is considerably less than the induced bending moment, hence the shaft will be lifted in the bearing. Neglecting shaft elasticity, equating moments leads to a point of support about 10 ft. for'd of the aft end of the bearing, i.e. in the neck ring.

Horizontal bending moments vary from 100 tons ft. acting to starboard to 55 tons feet acting to port. Clearly such an unloaded shaft may be expected to oscillate in a transverse direction in the bearing.

In the case of the single screw tanker the vertical bending moment acts to relieve the load in the bottom half bearing except for about 10° of arc as each blade passes the horizontal position.

Scaling the small drawings in the paper gives a propeller weight moment of 215 tons ft. Upward bending moments induced by propeller action never exceed this but at 190 tons ft. come close to unloading the lower half bearing.

In order to assess the loads on the bearing moments have been taken about the for'd bush with the shaft weight calculated at 10 tons.

Table II shows the result of this calculation.

TABLE II

| Blade Angle | Load on stern bush | | Resultant | Load line angle measured from vertical |
|-------------|--------------------|----------------|-----------|--|
| | Vertical | Horizontal | | |
| 0 | 63 psi | 49 psi (port) | 80 psi | 38° (S) |
| 20 | 59 psi | 49 " " | 77 psi | 40° (P) |
| 40 | 46.5 psi | 0 " | 46 psi | 0 |
| 60 | 49.5 psi | 117 " (star'd) | 126 psi | 13° (S) |
| 80 | 70 psi | 107 " (star'd) | 128 psi | 19° (S) |

Using these loadings the locus of the shaft centre may be calculated. In view of the relatively low speed of shaft rotation and of load variation it has been felt justifiable to use a quasi-static method of calculation of film thickness.

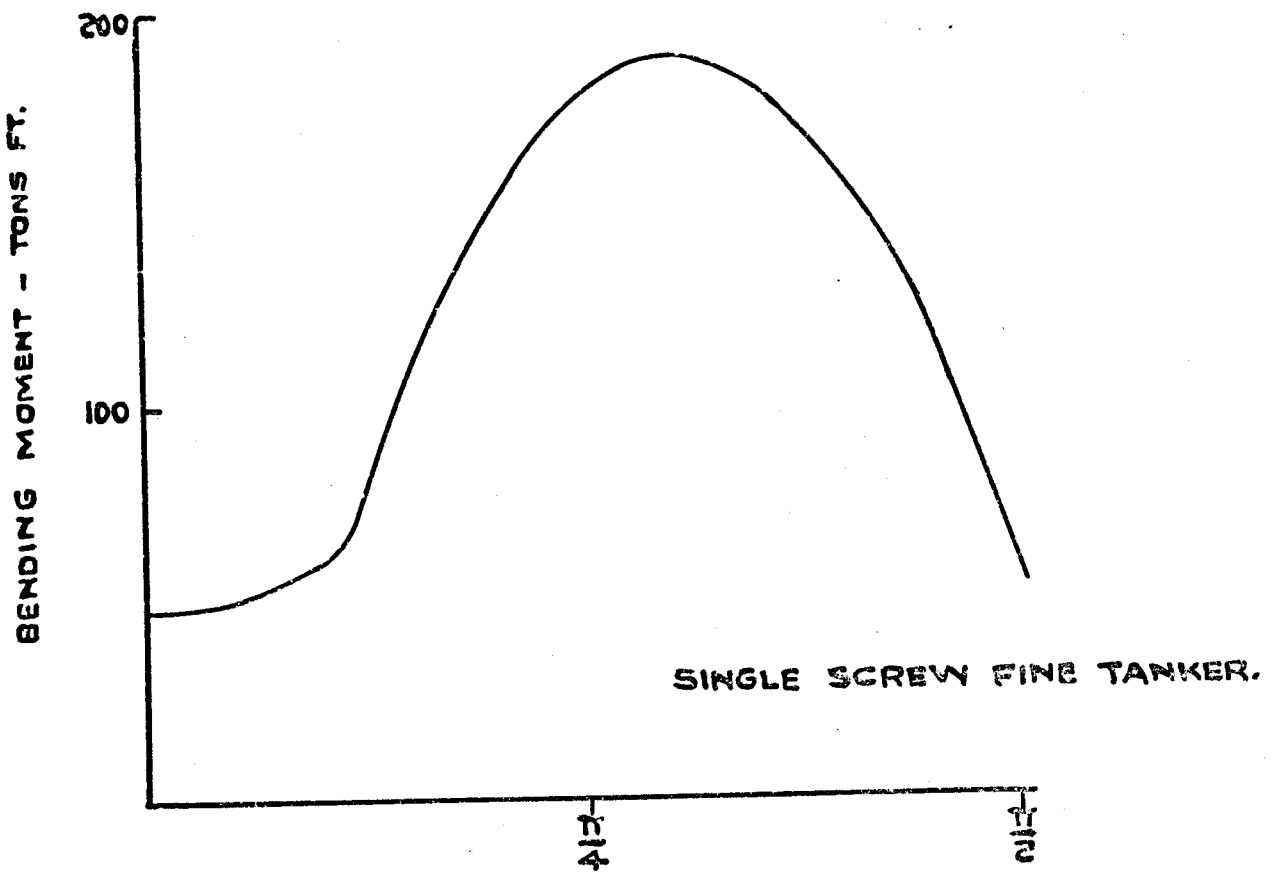
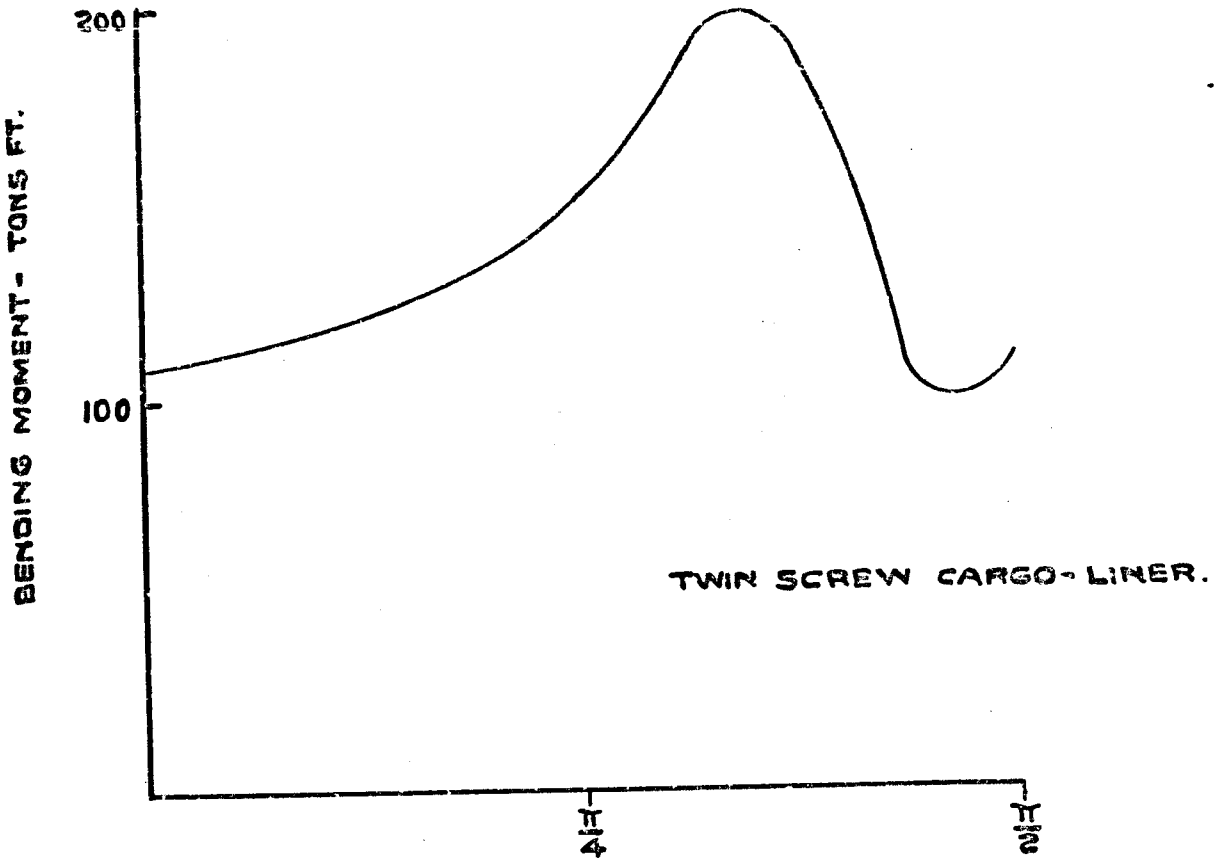

This omits any squeeze film terms and is probably least accurate in the region where the load changes almost unidirectionally from 50 to about 130 psi. The result of the calculation in which a typical stern bearing lubricant of 12×10^{-6} Reyn viscosity at 110° F has been used is given in Table III. Fig.18 shows the plot of the shaft movement in terms of film thickness.

TABLE III
FILM THICKNESS AND POSITION
FINE LINED TANKER

| Blade Angle | Resultant Load psi | Film Thicknesses inch | Relative position of min film. |
|-------------|--------------------|-----------------------|--------------------------------|
| 0 | 80 | .0164 | 58°) |
| 20 | 77 | .0164 | 58°) in |
| 40 | 46 | .018 | 68°) advance |
| 60 | 126 | .014 | 50°) of load |
| 80 | 128 | .014 | 50°) line |

The centre of the shaft at the axial midpoint of the bearing is shown as performing a "figure eight" movement of small amplitude. The eccentricity ratio varies between 0.1 and 0.3, this small variation again seeming to justify a simplified calculation. Intuitively it would be expected that the use of a more rigorous calculation would result in a simpler closed loop locus of slightly reduced amplitude.

Because of the bent shape of the shaft, however, the movement of the ends of the shaft is likely to be considerably greater and there seems reason to suspect that film thickness will be reduced to the extent that metal to metal contact is likely at the ends of the stern bush. The plot of film thickness at the ends of the bearing is also shown in Fig. 19. In deriving this, hysteresis in the shaft material has been neglected. The general shape of the arc over about 90° is confirmed by the form of wear pattern observed by the Writer. Fig. 35 reproduced later (14) shows an arc of contact generally heavier over the arc from the bottom of the bearing to about 90° on the port side.

Appendix V shows the results of an investigation into plummer bearing failure and contains measurement of bearing film thickness. Graph IV of that appendix shows the misalignment of the shaft across the length of the bearing plotted to a basis of shaft speed. As speed increases the propeller tends to lift the tail-shaft within the stern bearing which misaligns the shaft relative to the plummer bearing.

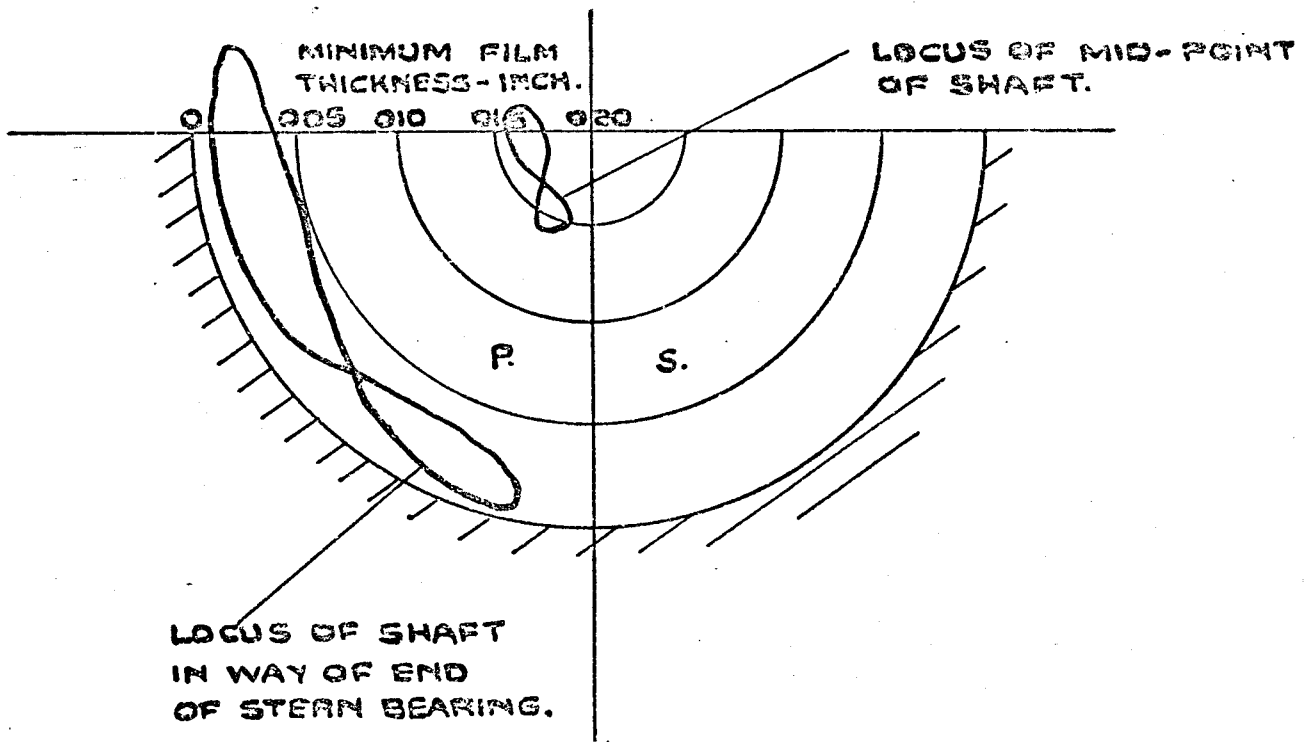
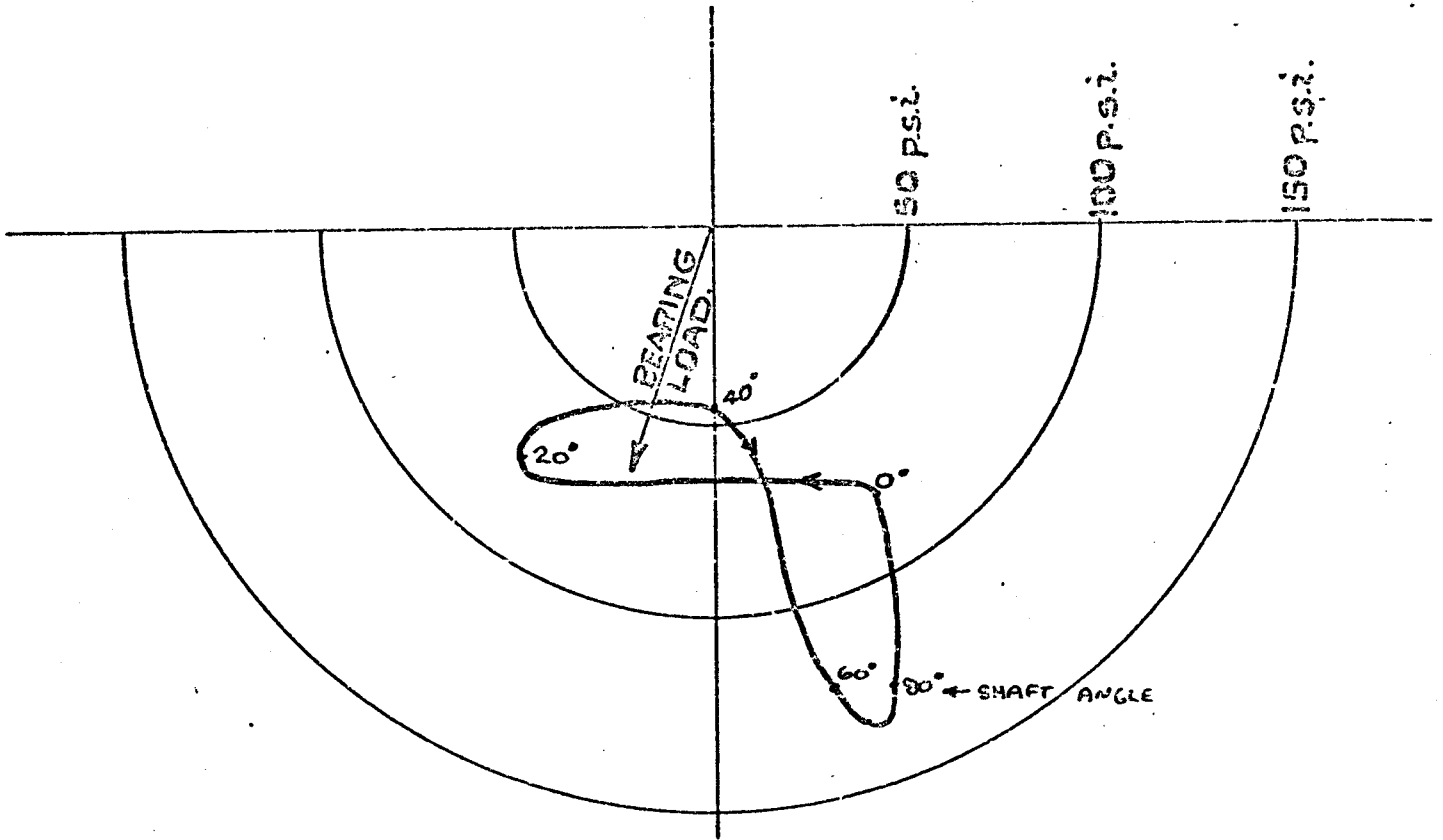

BEARING LOAD & SHAFT POSITION FIG. 18

FILM THICKNESS FAST TANKER FIG. 19

Above 70 rpm this misalignment is relatively constant at 0.0035 inches. The stern bearing dimensions and distance from the aftermost bearing to the stern tube indicate that from 70 rpm upwards the tail-shaft is loaded into the upper half of the stern bearing.

Also indicated is an elliptical shaft movement at the aftermost plunger bearing. If this reading is reliable (being small, less than 001", factors other than shaft movement influence it) a movement of about .005" could be taking place in the stern bearing. Although to put on absolute quantitative interpretation on these readings may be unwise, they do however clearly demonstrate if only on a qualitative basis that considerable tail-shaft movement takes place in service.

Hoshino and Kume (11) carried out an analysis of the wake of a 56,000 ton bulk carrier of full form (Block Co-efficient 0.83) and compared this with measured values on board ship. Using a similar approach as that used to prepare Fig. 19, Fig. 20 has been prepared to show the loading diagram and likely shaft excursions in the stern bearing of a bulk carrier.

In qualitative terms the general motion of the shaft in way of the end of the bearing as shown by Fig. 20 is correct. Again a more rigorous analysis may be expected to show slight quantitative differences.

In view of the agreement between prediction of shaft movement using simplified hand analysis and the observed wear patterns it seems reasonable to use such methods until such time as the real values of load can be derived with any greater accuracy.

As a result of their measurements Hoshino and Kume did succeed in deriving a general equation for the bending moments induced by propeller loading for a series of loading conditions. They give the following equations for vertical BM (Mv) and horizontal BM (MH) deep loaded condition:

$$MV = -80.7 \left(\frac{\text{rpm}}{100} \right)^3 + 19.4 \left(\frac{\text{rpm}}{100} \right)^6 \sin (50 - \delta)$$

$$MH = 42.0 \left(\frac{\text{rpm}}{100} \right)^3$$

where + ve sign indicates downward and port load, " δ " varies with speed over a fairly wide range.

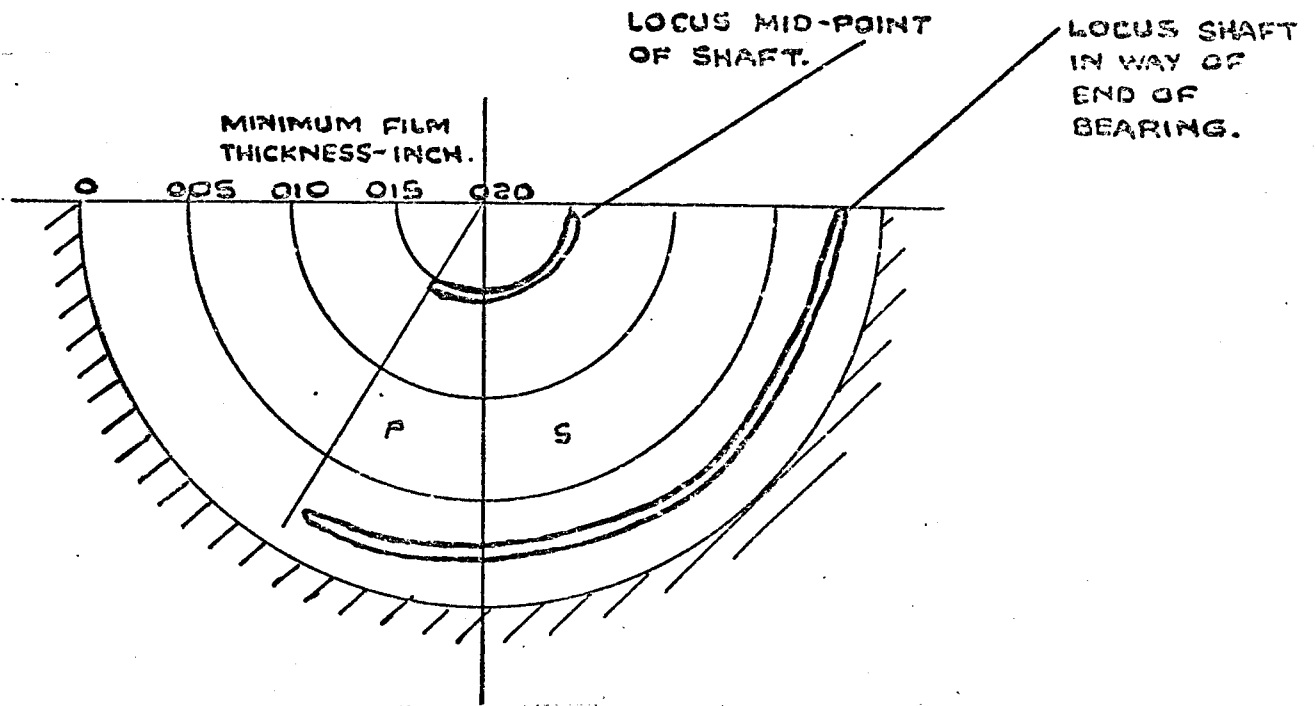
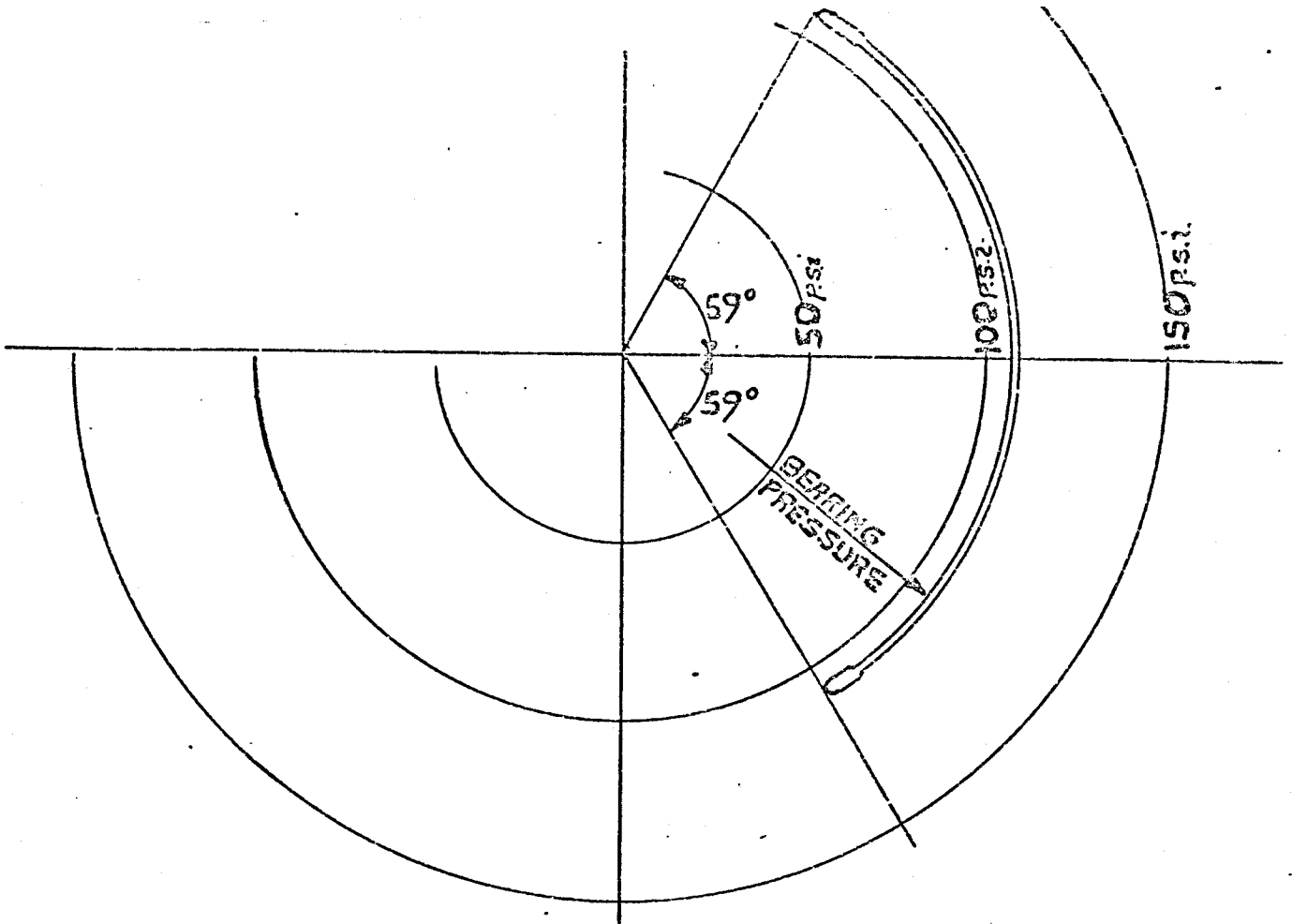

BEARING LOADS & FILM THICKNESS
56,000 D.W.T. FULL BODIED BULK CARRIER FIG.20

Equations of a similar form express M_v and M_H for the ballast condition and it is shown that the vertical bending moment increases with stern draught. Horizontal bending moment increases to a draught between ballast and deep draught and then decreases with increase in draught.

Hoshino and Kume have taken bending moment measurements in both calm and rough sea conditions. In calm seas the tendency of the propeller induced moments acts to relieve stern tube load but rough seas will increase stern tube loading.

The figures of bending moment given for the rough sea condition would indicate a variation in load from about 100 p.s.i. upwards to 200 p.s.i. downwards. From the few cases examined in this section the following broad conclusions have been reached.

Propeller induced bending moments are cyclic in nature.

The vertical bending moment may be represented by an equation of the form:-

$$A (\text{r.p.m.})^3 + B (\text{r.p.m.})^6 (\sin n \theta + x)$$

where A, B, x are constants for any ship and load conditions, n = number of propeller blades and θ = angle of propeller rotation.

As presented, the equation probably gives too simple an impression of the situation. At the present time it has been impossible to derive the constants A, B, x in mathematical terms. Each is apparently a complex function of draught, ship form, ship speed and possible sea state. Hoshino and Kume give only a limited number of the "constants" for certain conditions. They derived A, B, x from measured bending moments and an assumed form of the equation.

More work is necessary on the subject of propeller induced bending moments but it seems unlikely that a general equation holding good for the life of the ship can be derived. The induced bending moments and their variation have been attributed to the variations of lift and drag on the propeller blade elements as they pass through the wake field. Presumably if an equation could be obtained to describe the wake field (whose complexity is shown in Fig.12) it could be used to derive the equation of the bending moments. Once ship form is defined it ought to be a function of draught but in a practical situation draught is constantly varying. At any instant in a ships life speed through the water is a function of shaft speed but as hull fouling and roughening take place the relationship between r.p.m. and ship speed will vary.

Also varying with age and roughening is the thickness of the boundary layer which also has considerable influence on the wake flow into the propeller disc.

The cyclic bending moments cause considerable variation in loading and also result in actual loads in excess of those calculated.

Considerable shaft movement will take place under these load conditions, particularly in the horizontal directions where full bearing clearance may be taken up.

If P = classified society permitted pressures the following variations in bearings loads seems likely in average sea conditions:-

| | | | | |
|---------------------------|---|--------|----|----------|
| Medium lined cargo vessel | + | .5 | to | .56 P |
| Fine lined fast tanker | + | 0.5 | to | 1.3 P |
| Full bodied bulk carrier | - | 1.25 P | to | + .125 P |

Whether such a generalisation is valid on so few figures may be questioned but failure rates on tankers and bulk carrier suggest that the figures of load and hence, movement, for these ships is representative.

Calculated film thicknesses show adequate films in the bearing centre but questionable films towards the ends of the bush. Also it must be considered that bearing film stiffness for centrally running shafts are low hence the bearings studied will have little resistance to induced vibration.

2. 2.2 Loads due to tail-shaft vibration

It has been shown in the last section that the action of a propeller in a wake produces a cyclic bending moment on the tail-shaft. Obviously if the frequency of excitation is close to the natural frequency of the shafting in its bearing then resonance will occur. Such a condition can cause considerable damage to the shafting, bearing and seals of the vessel involved.

In 1950 Panagopulus (20) laid down a set of rules for the calculation of torsional, axial and lateral vibrations of tail-shaft in a paper which has since become a classic. He differentiates between general lateral vibration of the entire shafting system and the "local" vibration of the tail-shaft and propeller.

One of the results of the Panagopulus analysis was the identification of the cause of tail-shaft failures between 1940 - 1950.

It was shown that the "epidemic" (Panagopulus' word) of tail-shaft failures was due to fatigue induced by the constantly changing bending stress in the shaft.

He demonstrated that whereas normal stress reversal levels were of an acceptable order (1-2000 p.s.i.) the whirling of the shaft caused by local resonance introduced a magnification factor of 10 into the stress. Bearing failure however was not a problem on these ships. This was not the case, however, for the series of stern bearing failures investigated by Canadian consultants in 1963 (7). The failures had all occurred to large tankers and bulk carriers of full bodied form. The largest of the vessels was 61,300 ton displacement. At the time of the investigation these would be considered very large vessels.

The investigation showed that the Jasper (13) formula gave better correlation with measured frequencies than the Panagopolus formula. Since that time Couchman (8) has given a graph for the rapid assessment of shaft resonant frequency.

One of the tail-shafts examined after regular failure by Campbell & Lasky (7) was a 46,000 ton dwt. OBO. Examination showed that the upper half of the aftermost plummer block had wiped and it was agreed that the stern bearing was virtually unloaded. In this condition the resonant vibration of the tail-shaft and propeller (effectively cantilevered about the aftermost plummer) would be close to running speed multiplied by number of blades. Investigations of constant trouble with a 38,000 ton dwt. ore carrier again pointed to the possibility of resonant vibration.

Whether the findings of Campbell & Lasky may be applied to larger vessels may be questioned. However it is pointed out that the bulk coefficients are similar and hence similar wake perturbations will be experienced.

Also the loading diagrams of the last section show that shafts tend to run central in the tail-shaft bearing and hence the oil film stiffness is very low and also the cyclic upthrust reverses the loading in the bearing. If the graphs of Couchman (Fig. 21) are used to calculate the resonant vibration of the 250,000 ton dwt. tanker (Page 9) then shaft resonance occurs below 20 r.p.m. and can therefore be discounted. This graph assumes a fully effective stern bearing acting as a solid support for the shaft but the previous section shows that the stern bearing is likely to be unloaded throughout part of its operating cycle and throughout its entire cycle has a low oil film stiffness.

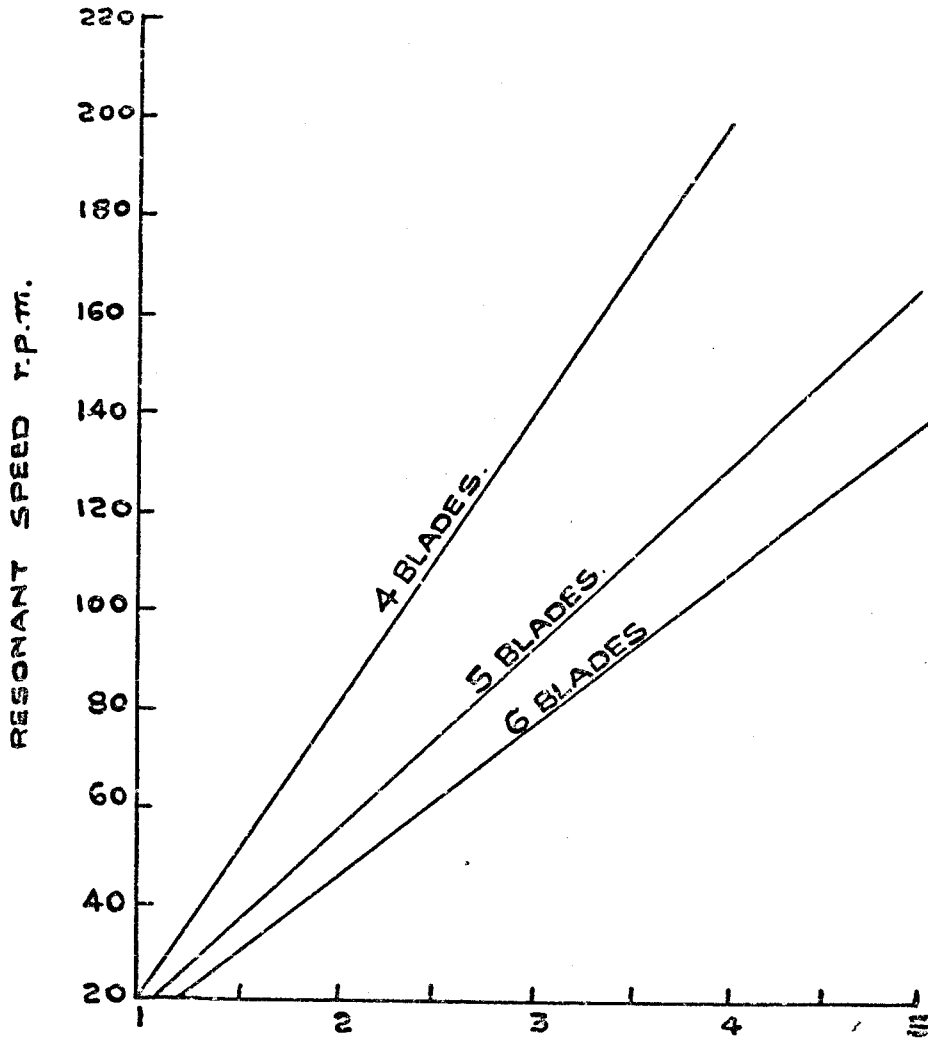

$$\text{FACTOR} = \sqrt{\frac{\frac{\pi D^4}{64} \times 10^6}{M(b+L)b^2}}$$

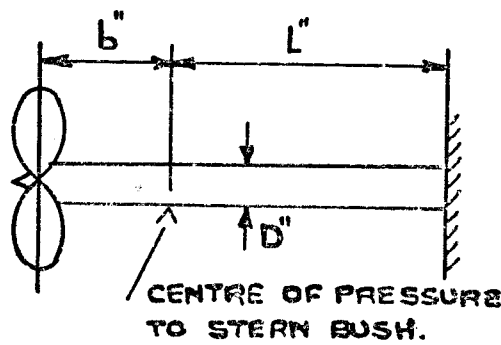

$M = (\text{wt propeller} + 10\%)$
 $+ 0.38 \text{ wt of shaft}$
 to encastre position.

APPROXIMATION OF TAIL SHAFT RESONANT SPEED FIG. 21

If the stern bearing is considered non-effective and the system taken as a weight suspended at the end of a beam, encastre at the aftermost plunger bearing (i.e. a 26000 lb. mass at the end of a 33" diameter 355" long circular steel beam) the natural frequency is about 400 cycles per min. The vessel has a five bladed propeller which rotates at 80 r.p.m. Presumably the actual resonant speed lies between these two extremes but based upon this evidence it seems reasonable to suppose that the Campbell & Lasky findings for bulk carrier stern gear are pertinent for large modern tankers of similar block coefficients. It is therefore essential that the stern bearing is an effective, stiff bearing if trouble free running is to be achieved. It also seems reasonable to assume that many of the stern bearing failures may be attributed to shaft oscillation at blade frequency.

3. EXISTING DESIGNS OF STERN BEARINGS

3.1 Water Lubricated Staves

Fig. 2 shows a typical design of water lubricated bearing which at a nominal 24 inch bore is at the larger end of the size range of water lubricated stern bearings. As can be seen the bearing is in two parts. A long after bush and a shorter forward bush. The two sections are contained in a single cast iron tube which pierces the after-peak bulkhead and the stern frame. A flange on the tube locates against a suitably thickened portion of the after-peak bulkhead to which it is fixed by studs and nuts. It is attached to the stern frame by means of a nut (screw thread 2' 9 $\frac{1}{2}$ " diameter) which draws a spigott on the tube against the for'd side of the stern frame.

Each bush consists of a series of staves, manufactured from a phenolic impregnated cloth material, which are held in a gunmetal cage.

A water supply is led to the central space between the for'd and after bushes. Sea water from main engine or other pump is supplied to this space.

Although the particular bearing assembly shown has plastic staves more traditional construction uses lignum vitae staves. This material is a hard wood which is not only suited for water lubrication but which seems to have self lubricating properties enabling it to run under surface to surface conditions. It has been found that lignum vitae has better wearing properties when cut so that the end of the grain is the bearing surface. Unfortunately this is a wasteful method of cutting wood.

Past practice has often been therefore to line the lower half of the bush with end cut wood and to use lengthwise grained wood in the upper half of the bush. This practice has grown up from the belief (shown to be falacious in section 2) that the lower half bush is loaded while the upper half is unloaded. The use of plastic staves as shown in Fig. 2 is a development of the wooden staved bearing and uses a material whose quality can be more accurately controlled and which has been shown to have excellent boundary lubricated running properties.

In the United States similar bearings are manufactured using hard rubber (Cutlas Rubber) staves.

In all cases it will be noted that a staved construction is used with large "Vee" shaped spaces on the bearing surface. The object of these spaces is to distribute the water over the length of the bearing and also to trap silt and bearing detritus, allowing it to be washed out of the bearing without causing too much damage to the bearing surfaces. It is the latter function which is the more important design criteria in this case.

There is no seal to prevent ingress of water on the after end of the stern tube but a simple gland is fitted to the forward end to prevent (too much) leakage into the engine room.

It is usual for this gland to be adjusted so that there is a steady stream of water entering the ship which collects in the aft bilge well and is regularly pumped out. In this way a supply of lubricant to the for'd bush is ensured and the gland maintained cool.

The correct method of supplying the lubricating water is to the central annular space at about 5 p.s.i. Many Chief Engineers, however, dispense with this supply and depend upon sea water leakage from the after end to the bilge well. In many cases this is adequate but in many more insufficient water, either to lubricate or to cool, is supplied. Damage to the for'd bush in particular is a consequence of this practice.

Cavitation damage too, often occurs when a pressure of water is not maintained in the central space.

With water as a lubricant hydrodynamic lubrication is obtained only at fairly high shaft speeds (say half ahead and above). The ability to generate films is also hampered by the very short bearing lengths caused by the necessity of providing debris slots in the surface of the bearing. If it were possible to provide a silt free supply of water to the bush a better bearing (hydrodynamically speaking) could be made by using a full bush.

Even so because of the low film thicknesses and the fairly high speed at which the surfaces touch considerable wear would take place necessitating debris slots, causing rather a vicious circle of events.

3.2 Oil Lubricated Stern Bearings

For large vessels oil lubricated bearings are in almost exclusive use and more and more smaller vessels use them. There are several patented designs on the market and some of these can boast of extensive sales. The patented systems sometimes incorporate special sealing systems. Obviously it is most necessary that an oil lubricant stern bearing is supplied with adequate oil seals, one of which will be described later, to prevent ingress of water or egress of oil. Provided that adequate oil supplies are carried on board ship it is preferable that oil leaks from the ship rather than water leaks into the oil. Oil lubricated bearings, by virtue of the greater viscosity of their lubricant generate greater film thicknesses than water lubricated bearings but even so it is likely that metal to metal contact takes place many times during the life of the bearing. Without considering the effect of dynamic loads at full speed, metal contact will occur during manoeuvring. In a recent paper Asanabe et al (24) showed that in 200,000 dwt. tanker no oil film was generated in the stern bush below 23 r.p.m. By 40 r.p.m. a film of .004" was measured but the paper points out vibration amplitude increased with speed.

The bearings described here will be the conventional oil lubricated bush, the Glacier Herbert system, the Turbull system, the Tilting Pad Bearing, the Camella bearing and the Algonquin system.

3.2.1 Conventional Oil Lubricated Bush

The conventional oil lubricated stern arrangement consists of a steel tube passing through the after peak welded to the stern frame and to the after-peak bulkhead. The after-peak bulkhead is itself a specially strengthened bulkhead. The stern frame of the ship is bored and a plain whitemetalled cast iron bush fitted. The arrangement is shown in Fig. 22. The tail-shaft of the ship which supports the propeller passes through the tube, which is about five inches clear of the shaft, and is supported by the whitemetalled bush.

At the after end of the bush, between the propeller boss and the bearing is a seal, usually supplied by a specialised seal manufacturer. At the for'd end of the entire tube is another seal mounted on the bulkhead.

It is usual for this seal also to be of specialist supply although because of its less onerous duties it is a simpler seal than that of the seaward end of the tube.

Oil is fed to the bearing surfaces by a series of holes supplying two axial grooves in the whitemetal. In the particular case drawn each groove is supplied by three oil holes. The grooves are diametrically opposite and are displaced from the horizontal plane by 15° in an attempt to ensure the line of action of the impressed load is along a point midway between the oil grooves. Oil is fed to the grooves by a $1\frac{1}{4}$ " bore pipe which runs through the stern tube. Oil from the bearing spills into the for'd stern tube and into the oil space of the after seal. The oil in the stern tube is forced to a header tank by the pressure of incoming oil while that from the after seal flows to a sump tank which allows any water to separate out and so provides a check on the efficacy of the seal. Excessive water collection in this tank would indicate a faulty seal. The lubricating oil system is shown in Fig. 23. The header tanks shown maintain a head of oil in the system greater than the head of water outside the stern seal preventing massive ingress of water in the event of failure.

Oil is normally supplied to the bearing by pumps drawing from the sump tank (topped up from the header tanks). Prior to entering the bearings the oil passes through coolers and filters.

Not only are header tanks connected to the sump but they are connected via a non return line to the discharge side of the lubricating oil pump.

Thus in the event of pump failure positive lubrication is obtained for a period sufficiently long to stop the main machinery.

It is a feature of many stern tube lubrication systems that, at reduced speed, sufficient heat will be dissipated into the after peak to allow the bearing to continue in service. In this situation there will be a small amount of circulation in the entire system caused by natural convection.

As is now common practice a thermocouple is embedded in the whitemetal of the bush.

3. 2.2 Glacier Herbert System

The bearing housing is a flanged S.G. iron tube in two halves lined with whitemetal. They are firmly bolted together and supported at the aft end by a spherical carrier ring to which is bolted the outboard seal housing, and at the forward end by a circular diaphragm to which is bolted the inboard seal housing.

The bearing halves are completely symmetrical and thus reversible and invertible within the sub assembly.

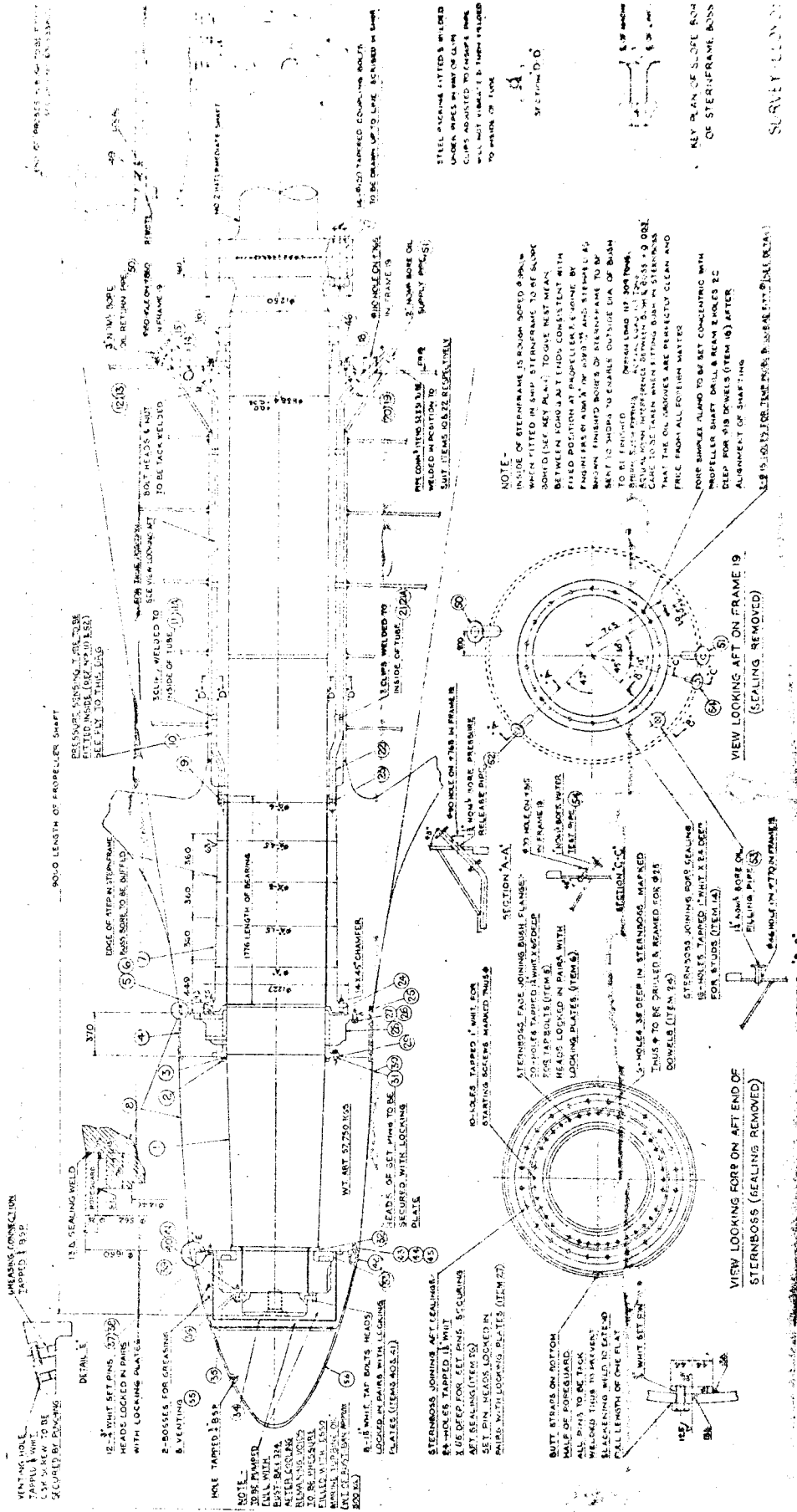

VENTING HOLE... TAPPED 1/8" DIA. TO BE SECURED BY BRASS CAP

DETAIL 1
12.3" WHIT ST PINS (27730) HEADS LOCKED IN PAIRS WITH LOCKING PLATES (ITEM 27)

12.3" WHIT ST PINS (27730) HEADS LOCKED IN PAIRS WITH LOCKING PLATES (ITEM 27)

NOTE: STERNBOSS JOINTS ACT LEAKING. 84 HOLES TAPPED IN WHIT ST PINS DEEP FOR SET PIN. SECURING AFT SEALING (ITEM 20) SET PIN HEADS LOCKED IN PAIRS WITH LOCKING PLATES (ITEM 27)

NOTE: BUTT BRATS ON AFT END OF HALF OF FOREHEAD. ALL PINS TO BE TACK WELDED TO IN PREVENT SLACKENING WELD IN EXPOSED FULL LENGTH OF ONE PLAT

NO. 0 LENGTH OF PROPELLER SHAFT

PRESSURE SENSING I RELIEVE FITTED INSIDE (REF. 1010 & 152) DEL. BY 10 THIS LEG

EDGE OF STEEL STERNBOSS (6) PINS ARE TO BE BUFILED

17/16" LENGTH OF BEARING

2.3" IN DIA. HOPE ON RETURN PIPE (50)

14.000" NAMED CORNER JOINTS TO BE GRIND UP TO LINE. SEAMLESS IN LINE

3.2" IN DIA. HOPE ON SUPPLY PIPE (5)

3.2" IN DIA. HOPE ON SUPPLY PIPE (5)

STEEL JOINTS LIMITED WELDED UNDER PRESSURE IN ORDER TO BE GRIND UP TO LINE. SEAMLESS IN LINE

STEEL JOINTS LIMITED WELDED UNDER PRESSURE IN ORDER TO BE GRIND UP TO LINE. SEAMLESS IN LINE

STEEL JOINTS LIMITED WELDED UNDER PRESSURE IN ORDER TO BE GRIND UP TO LINE. SEAMLESS IN LINE

KEY PLAN OF SLOPE FOR OF STERNFRAME BOSS

KEY PLAN OF SLOPE FOR OF STERNFRAME BOSS

KEY PLAN OF SLOPE FOR OF STERNFRAME BOSS

KEY PLAN OF SLOPE FOR OF STERNFRAME BOSS

KEY PLAN OF SLOPE FOR OF STERNFRAME BOSS

KEY PLAN OF SLOPE FOR OF STERNFRAME BOSS

KEY PLAN OF SLOPE FOR OF STERNFRAME BOSS

KEY PLAN OF SLOPE FOR OF STERNFRAME BOSS

KEY PLAN OF SLOPE FOR OF STERNFRAME BOSS

SURVEY PLAN

SURVEY PLAN

SURVEY PLAN

SURVEY PLAN

SURVEY PLAN

SURVEY PLAN

SURVEY PLAN

SURVEY PLAN

SURVEY PLAN

CONVENTIONAL OIL-LUBRICATED STERN BEARING FIG. 22

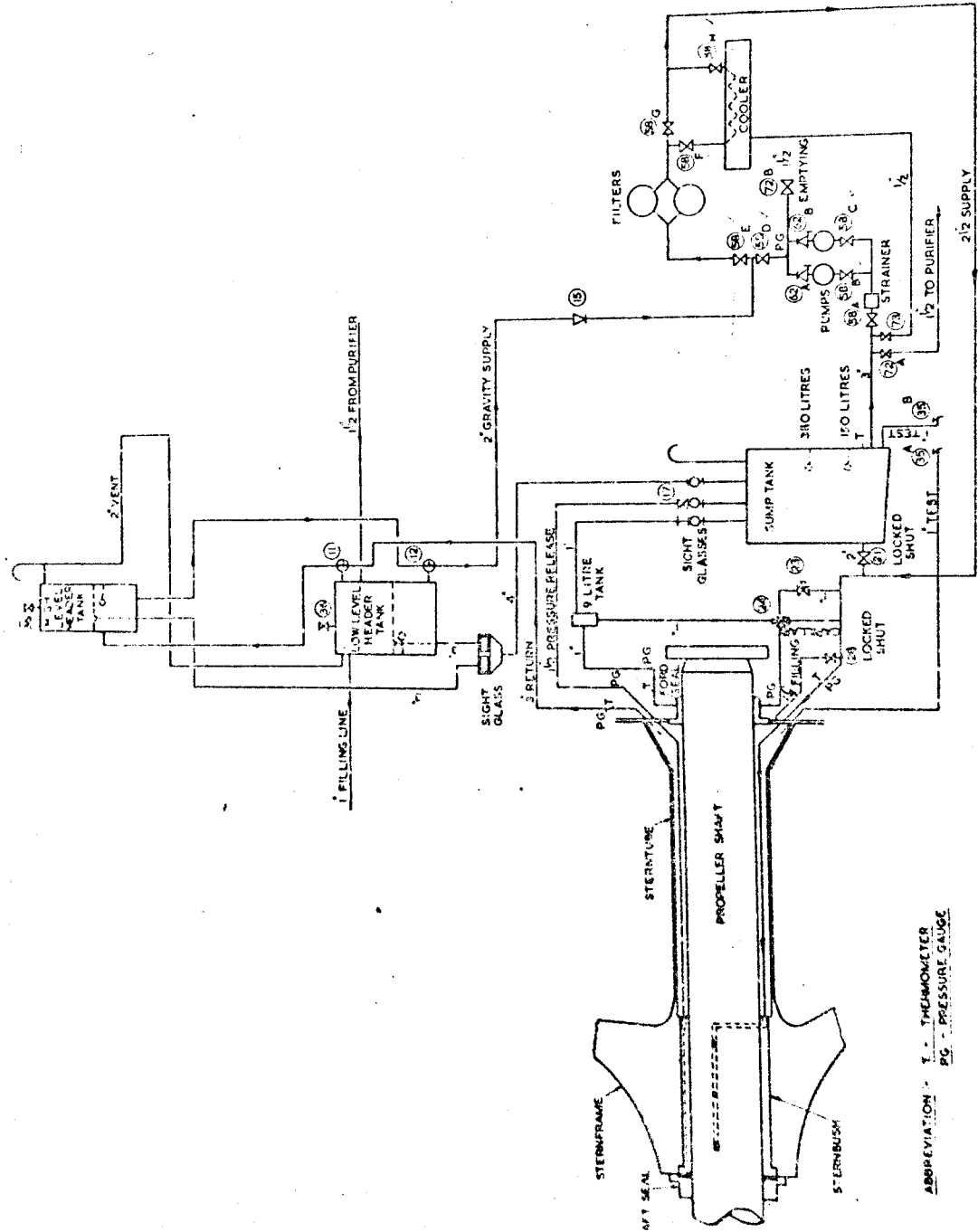

LUBRICATING OIL SYSTEM FIG. 23

A full assembly of the complete sterngear is shown in Fig. 24. The bearing assembly, consisting of the bearing (1), the spherical carrier ring (2) and the diaphragm (5) with outboard and inboard seal housings respectively attached, is housed entirely within the sternframe. The sternframe casting is shaped to accommodate a short outer bore within which the spherical seating ring (3) is fitted and secured with substantial bolts. This ring in turn receives the spherical carrier ring (2), the whole forming an all round supporting annulus around the aft end of the bearing. At its inboard end the casting is provided with a bulkhead which stiffens the frame itself and in which is formed a short stepped bore backed by two partial flanges.

The diaphragm is received loosely within the smaller diameter of the stepped bore, the larger diameter of which forms a seating ring for the blocks (7) and (8) which locate and support the forward end of the bearing.

The whole assembly is secured in position by the axial bolts (9) which are anchored to the frame casting.

'O' ring seals are provided on the periphery of the spherical carrier ring and the forward diaphragm to form an oiltight space surrounding the bearing which is filled with lubricating oil. The 'O' rings used at the forward diaphragm are of large diameter (25-30 mm). This allows a working clearance between the diaphragm and its mating bore within which the diaphragm may be eccentrically displaced to achieve final alignment of the bearing relative to the shaft line.

The chosen location of the diaphragm is determined by adjustment of the distance pieces (7) fitted in way of the lower supporting chocks (6).

The upper wedge chocks (8) hold the diaphragm firmly in this position with radial pressure determined by the axial bolt loading.

This arrangement allows for the fact that the bearing will expand when warming up at a greater rate than its housing and permits this to take place without detracting from the rigidity of support at the forward end of the bearing. The Belleville washer packs (10) fitted to each axial bolt ensure virtually constant loading of these bolts and those securing the spherical seating ring. The initial controlled load is applied by hydraulic nuts.

The spigot arranged on the after side of the spherical seating ring (3) runs concentric with the flange carrier ring (4) with a nominal radial clearance of 3 to 4 mm. This latter ring and the rotating element of the outboard seal, is bolted to the forward face of the propeller shaft flange.

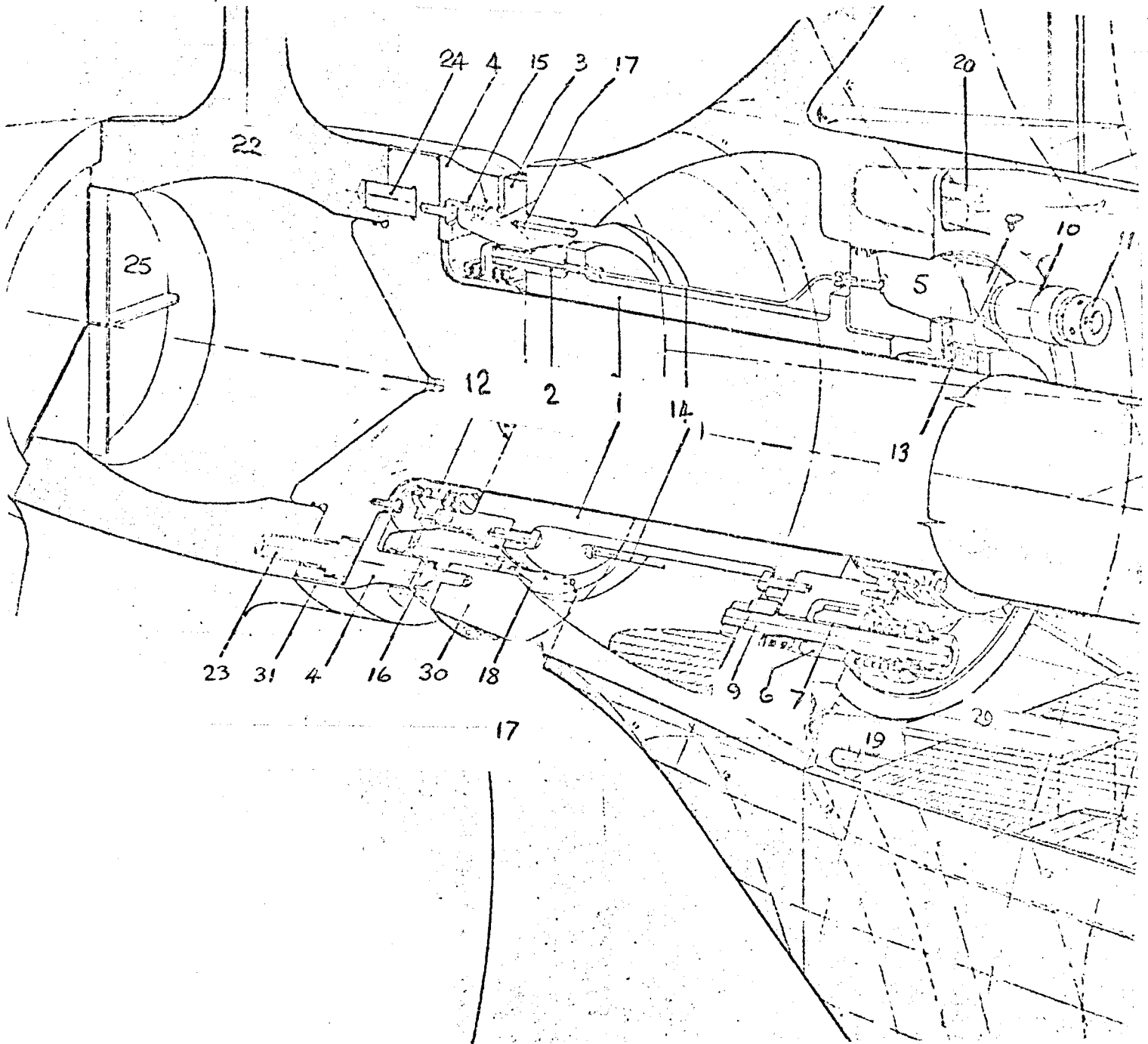

GLACIER HERBERT SYSTEM FIG. 24

Alternatively, the ring may be formed by appropriate shaping of the forward end of the propeller boss. Two inflatable seals (15) each with independent air supply, are housed within recesses in the spherical seating ring spigot and seal against the inner wall of the shaft carrier ring when brought into action for under-water withdrawal. The outer diameters of the two rings are machined parallel to receive an external bandage which can be fitted by a skin-diver as alternative to using the inflatable seals or to seal off the gland space from the sea if the ship is laid up.

The sea water spaces between propeller boss and stern frame are coated to avoid corrosion and the resulting accumulation of circulating abrasive debris in the space surrounding the seal. Additionally the labyrinth form of the assembly and rotation of the enclosed water by entrainment discourages the penetration of suspended abrasive in shoal conditions. There are arranged top and bottom pipes connecting the space between working and inflatable seals to within the vessel. The prime function of these is to test the effectiveness of the withdrawal of the bearing and seal assembly. These lines terminate as drilled passages in the spherical seating ring. By inclining the radial drilling in the direction of ahead rotation and connecting the internal pipes to a suitable service line during normal operation, the natural rotational flow within the enclosed area is converted into a positive cleansing action and the water is constantly changed.

It is claimed that the high velocities of entrainment produced in the outer regions of restricted clearance discourage marine growth. The manufacturers suggest that in ships which produce a surplus of fresh water, a nominal flow of this would produce virtually fresh water conditions in the interior. In applications with stainless steel propellers the spherical seating ring, spherical carrier ring and gland housing are made of "Ni-Resist" iron and the shaft carrier ring of stainless steel to the propeller specification. With bronze alloy propellers, compatible bronze alloys are used for these parts. The bearing runs fully submerged in a cooled oil bath, positive circulation of the oil through the bearing being achieved without the forced lubrication. The bearing is provided with side grooves connected by holes to the surrounding oil. A system of grooves in the bearing end spigots likewise connect the ends of the bearing to the oil bath. With this arrangement a pumping action, stimulated by shaft rotation, draws oil into the bearing through the side ports along its length and discharges it from the ends of the bearing to return to the oil bath via the end channels referred to. This system ensures a balanced oil distribution and thermocouples embedded in the lower half at each end of the bearing measures the temperature of the whitemetal in the loaded area.

It is claimed that the arrangement is self cleaning since entrained dirt or debris has ample opportunity to settle out rather than be recirculated. Water which may pass the outboard seal in event of chronic seal leakage, gravitates directly to the undisturbed area at the bottom of the oil bath from which it can be drained.

Water can accumulate in the lower part of the oil bath in significant quantity without being drawn into the circulating system.

Monitoring devices are available to give alarm before the presence of water introduces a hazard. The system thus permits the use of normal lubricating oil with safety.

In the design of this stern gear the bearing company recommend that the propeller is fitted to a spigot and flange rather than the more usual taper, nut and key. The inboard junction between tail-shaft and main shafting will be a muff coupling. The tail-shaft is drawn outboard. Some designs incorporate a buoyancy cone on the propeller. However it is perhaps significant that the description of the bearing Hill (12) states "The ultimate capability of any sterngear design limits to be determined by the skill of the naval architect in producing a reasonable wake pattern".

3. 2.3 Turnbull Split Stern Bearings

The Turnbull design of bearing is again split but, instead of the halves being clamped together in the conventional manner by centre line flange studs and nuts they are clamped by jacks acting against the stern frame.

Fig. 25 shows an early version of this stern gear. The cast iron whitened lined bush is split along the horizontal centre line which allows the top half bearing to be lifted and moved forward into the ship for the shaft to be examined.

The seals at the for'd and after ends are split. The earlier version of this bearing had a bore of Camella design which is described later.

It is claimed in a paper by Crombie & Clay (9) that it is a feature of the Camella design that the bearing itself can pump oil to a header tank and hence circulation can be achieved without a pump.

This is achieved by positioning the lobes so that oil from the high pressure zone of one lobe discharges into the low pressure zone of the adjacent lobe. The final leakage pressure, it is claimed, is sufficient to lift oil in sufficient volume to the coolers and header tank.

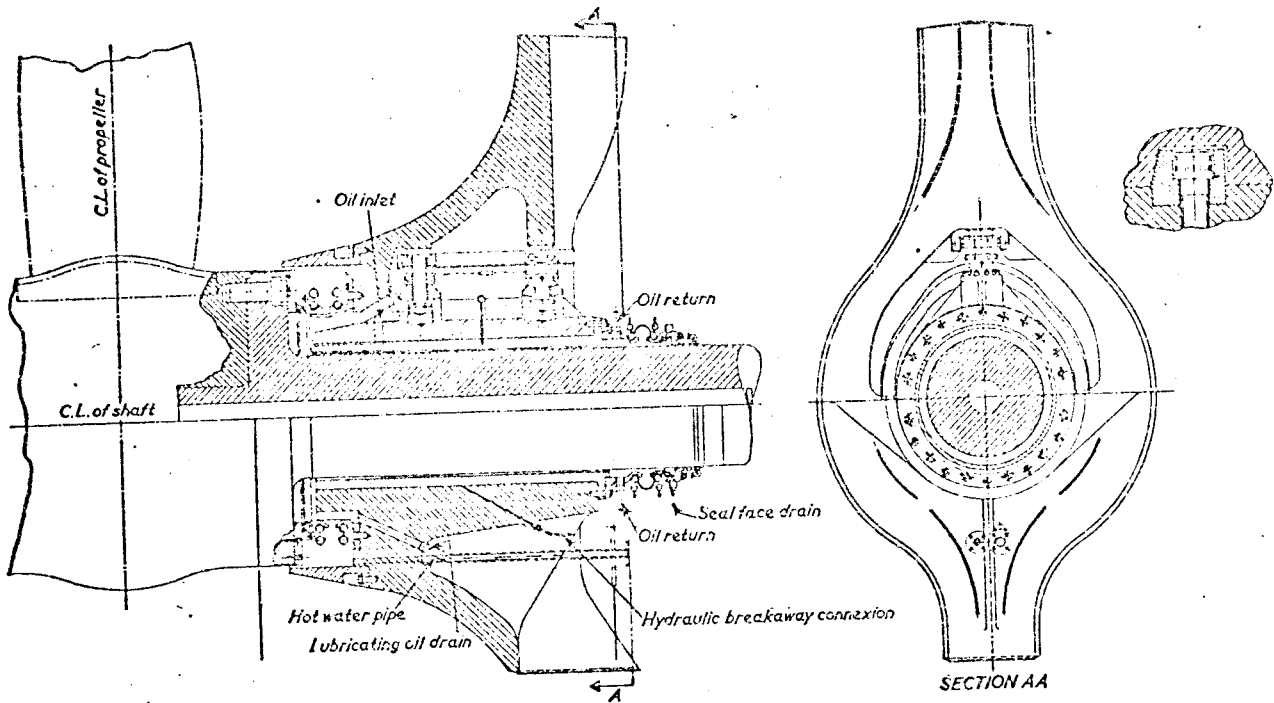

TURNBULL MK I BEARING

FIG 25

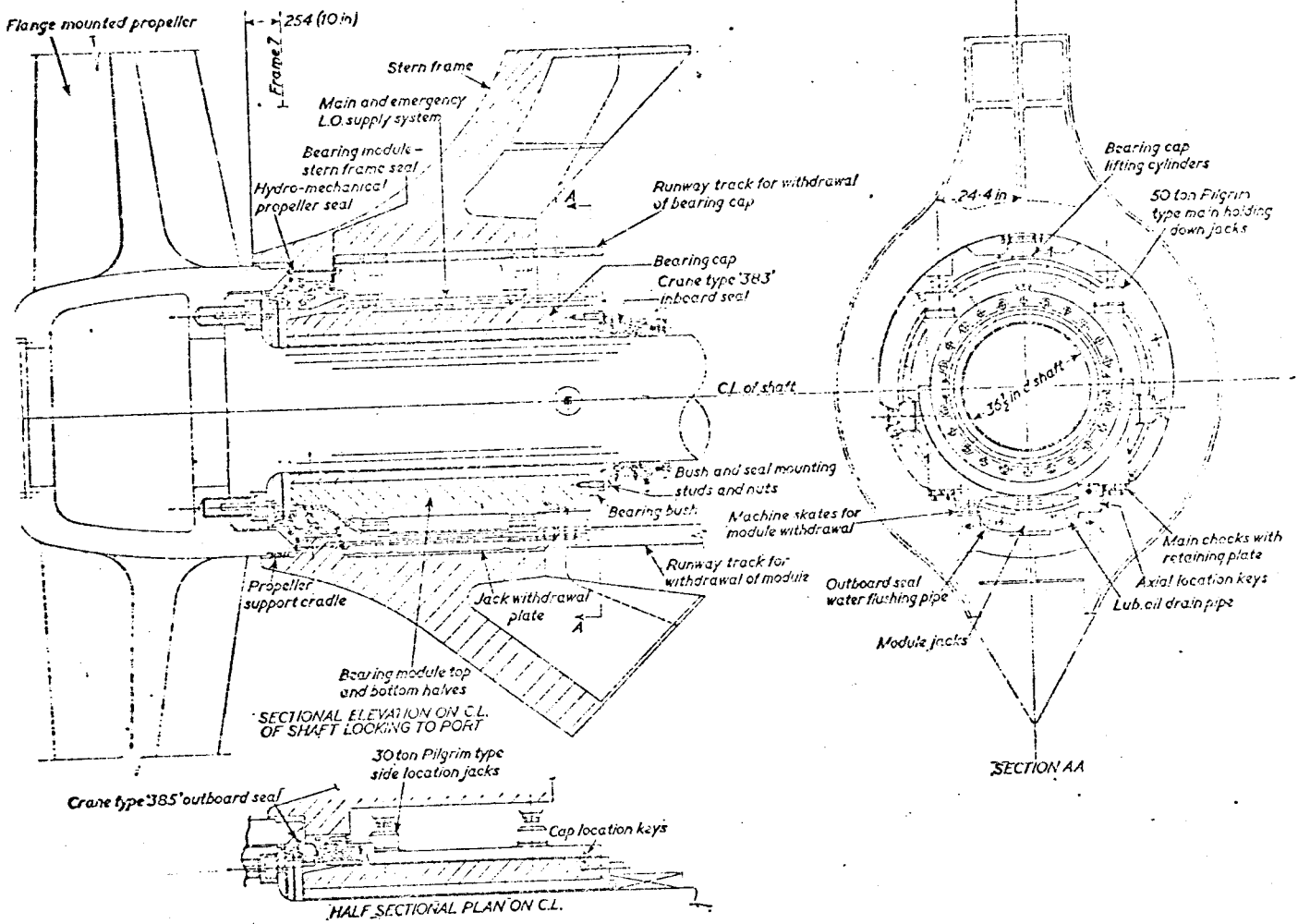

TURNBULL MK IV BEARING

FIG. 25
FIG. 26

Such an arrangement is unlikely to be effective when running astern. Presumably sufficient heat is dissipated via the adjacent ships structure when running astern to maintain service temperatures at a reasonable level. Milne (36) has indicated that sufficient heat is normally dissipated in this manner even when running ahead. It has also been the policy of Milne's company to use thermal cycling as a means of circulating oil through coolers.

The Turnbull system is manufactured complete with a special design of stern frame and it is necessary for this specially shaped stern frame to be welded into the existing ship structure while the vessel is on the stocks. This type of construction did not appeal to shipbuilders and a later design which was in effect two concentric cylinders was manufactured. The outer cylinder fitted into a conventional, albeit large, stern frame in the manner of a normal stern tube while the inner cylinder was in fact the Turnbull bearing. Fig. 26 shows the latest design of Turnbull bearing designated the Mk IV bearing which again incorporates a section of stern frame which the builder must incorporate into the ship. The accurate welding of such a section is likely to present some difficulties.

It will be seen that there is an hydraulic/mechanical sealing ring outboard of the outboard working seal. This seal is brought into operation before removing the lower half module into the ship where the outboard seal can be completely removed from its working position and replaced by an entirely new seal if necessary. The hydraulic/mechanical seal is positioned so that the propeller tap bolts can be removed from inside the vessel at survey time. The lubricating oil system proposed for use with the Mk IV bearing installation is similar to that of conventional stern gear.

The Mark IV version uses whitemetal bearing bushes and lubricating oil pumps are therefore necessary since plain bushes do not have the pumping action which is claimed for the Camella bearing. A three-way pressure control valve is fitted to control the bearing oil inlet pressure. The pipe runs are kept as short as possible since there is no header tank in the system. The oil return from the bearing is taken from the top of the seal space so that in the event of pump failure an oil bath system will be maintained while the shaft is brought to a stand-still.

The bottom half of the internal module is chocked on to two horizontal fore and aft machined surfaces within the stern frame. A detachable arch fastened to the lower half of the module is fitted with an adjustable sealing unit which seals inside the circular portion of the stern frame.

This arch, together with the bottom half of the module, carried the outboard seal, the face of which comes into contact with the seal seat attached to the tail-shaft flange. The top half bearing of the module is of very similar design to the Mark I and makes an axial seal on the face of the arch and a seal along the horizontal joint of the bottom half module. A support extending 45° either side of the vertical centre line of the tail-shaft is built into the stern frame in the lower rope guard area to enable the propeller to seat when the chocks are removed from the lower half module so that it can be moved into the vessel.

The sequence of operations from a shipbuilder's point of view, therefore, is that a portion of the stern frame, including the internal module which is chocked in position within the frame, is aligned by telescope and welded in as for the Mark I. The top half of the bearing is then removed and the tail-shaft introduced. Because of the large aperture present when the top half bearing is removed it is possible to use a tail-shaft with an integral forward flange thus eliminating the need for a muff coupling. The propeller is fitted, the shaft moved into its correct axial position and the top half bearing locked down. With the ship at the draught specified by the owner and builder the top half bearing is removed and feeler gauge readings are taken between the shaft and the bottom half bearing to ascertain the position of the bearing relative to the shaft. The spare chocks can then be machined to bring the complete length of the bearing into alignment with the tail-shaft.

Two hydraulic jacks which have to be carried in the ship's stores are placed underneath the bottom half module and the shaft, propeller and module lifted to allow withdrawal of the original chocks. The new chocks are then fitted, the module lowered and the hydraulic jacks removed from underneath the module. The top half bearing is replaced after readings have been taken on the wear-down gauge and the owners and builders are satisfied that, at this draught, the shaft is correctly supported. If trouble is experienced with the outboard seal, provided that the vessel can be put into a safe position, the oil is drained from the bearing and seal space opened. If it is found that water continues to run then the outboard seal is known to be faulty. The hydraulic/mechanical seal is then actuated to make a seal on the forward face of the propeller. The movement of the sealing ring is normally due to hydraulic pressure but can also be accomplished mechanically. The seal is then locked mechanically in position. The space can be drained of sea water and the seal checked by opening a drain on the inside of the hydraulic mechanical seal.

The top half bearing can then be removed and jacks and roller-race skids placed underneath the module. The jacks are used to lift the module, shaft and propeller to enable the module chocks to be removed after which the jacks are lowered until the propeller is resting in the support cradle built into the stern frame. Further lowering of the jacks brings the module away from the tail-shaft until it is resting on the roller-race skids. The module, complete with outboard seal, can be removed into the vessel for examination of the seal. The split running face attached to the outboard flange of the tail-shaft can be examined and removed if necessary. The seal can be repaired or replaced and the whole of the module returned to its working position by a reversal of the above sequence.

It is, therefore, not necessary to dry dock or trim the vessel to carry out full maintenance of the outboard bearing and oil seal.

3. 2,4 Tilting Pad Stern Bearings

Two bearing manufacturers have proposed tilting pad stern bearings for large ships. However, only one such unit has been installed. The advantages claimed for this particular unit have been (primarily) its self aligning properties and ease of handling of the pads.

In order to provide self alignment within the limited space available in the stern frame each pad has been provided with a hardened spherical button upon which it pivots. This button sits upon a hardened insert in the stern tube. In shore based installations these hardened buttons and seats have given trouble in service mainly because of surface cracking. Experience has shown that the degree and depth of the surface hardening is critical and exceptional quality control over the heat treatment is necessary.

The proposals of the other manufacturers have not included hardened buttons but allow the pads to pivot on a cylindrical back. Fig. 27 shows one proposal made for the incorporation of tilting pad units in a Turnbull stern bearing module. No self alignment properties have been built into these pads except for a small degree of end relief.

Two rows of pads are shown and it is likely that some degree of differential slope boring would be necessary in the stern module and bearing cap to allow the two rows of pads to align themselves to the curvature of the shaft. The radius of curvature of the back face of the pads is so dimensioned as to reduce the contact stress to an acceptable amount without the necessity of hardening. An apparent drawback of cylindrical pivoting of this kind is that as the pad pivots, the point about which it pivots moves "forward" relative to the shaft rotation, thus tending to reduce the load carrying capacity.

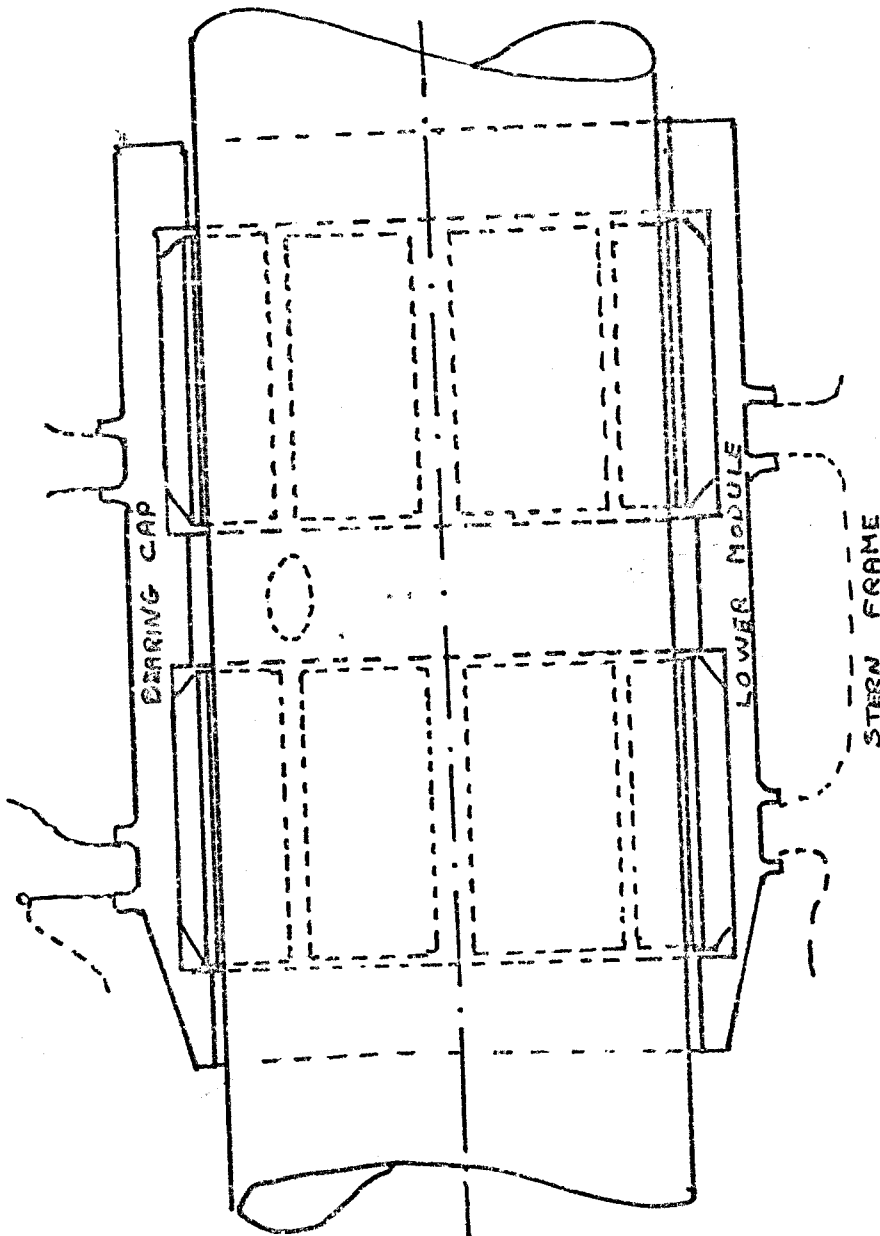
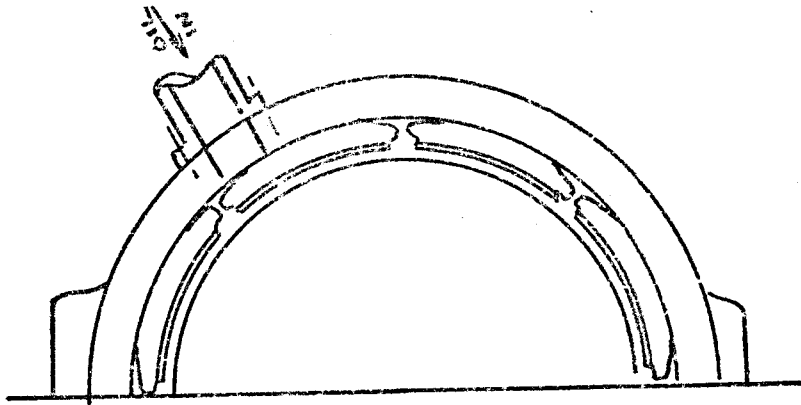

TIMING PAD STERN BEARING FIG. 27

According to Elwell and Findlay (10) however, variations in pivot position of up to $\pm 20\%$ will have little effect on the load carrying capacity of tilting pad journal bearings using a high viscosity lubricant such as oil. (In the case of low viscosity, compressible lubricants such as air, this is not the case).

For reasons of handling specified by the customer, eight pads per row have been used. The effect of this has been to reduce the minimum film thickness to about one third of that of the plain bush ($L/D = 2$) previously used in this stern gear.

Since two rows have been used (and properly aligned) a reduction to about half of that for the long bush would have been acceptable since the deflexion of the shaft over the bearing length is reduced. For reasons of enhanced film thickness a reduced number of pads would be preferable. This is shown in Fig. 28 which has been reproduced from the A.S.M.E. Standard Handbook of Lubrication Engineering.

However, to compare bearings of similar dimensions Fig. 29 has been prepared. Minimum oil film thickness has been plotted to a base of shaft diameter assuming a full away speed of 100 r.p.m. and a load equivalent to 90 p.s.i. This indicates the tilting pad bearing to be at a disadvantage to the plain bush in respect of film thickness when the clearance ratio is 0.0015 but at a ratio of 0.002 the position is reversed. This is explored a little further in Fig. 30 which has been drawn to show film ratio against clearance ratio for an $L/D = 2$ bearing. End leakage has been taken into account but the iso-viscous case has been used. ($U = 4.5 \times 10^{-6}$ Reyns)

A more rigorous determination of film clearance ratio would be expected to reduce the ratio at the smaller clearance end of the graph.

The graph also shows that in the range of clearances normally adopted for industrial bearings the bush has a considerably thicker lubricant film than pads taking up a similar space.

In the case of stern bearings the classification societies insist on fairly high clearances and in the range 0.0015 to .002 generally used, the advantage of the bush is not so marked.

However, it must be noted that for any number of pads greater than four, no advantage in respect of load carrying capacity can be claimed for the pad bearing. The assumption has also been made in preparing this graph that the pads occupy a space equivalent to 0.8 of the shaft periphery.

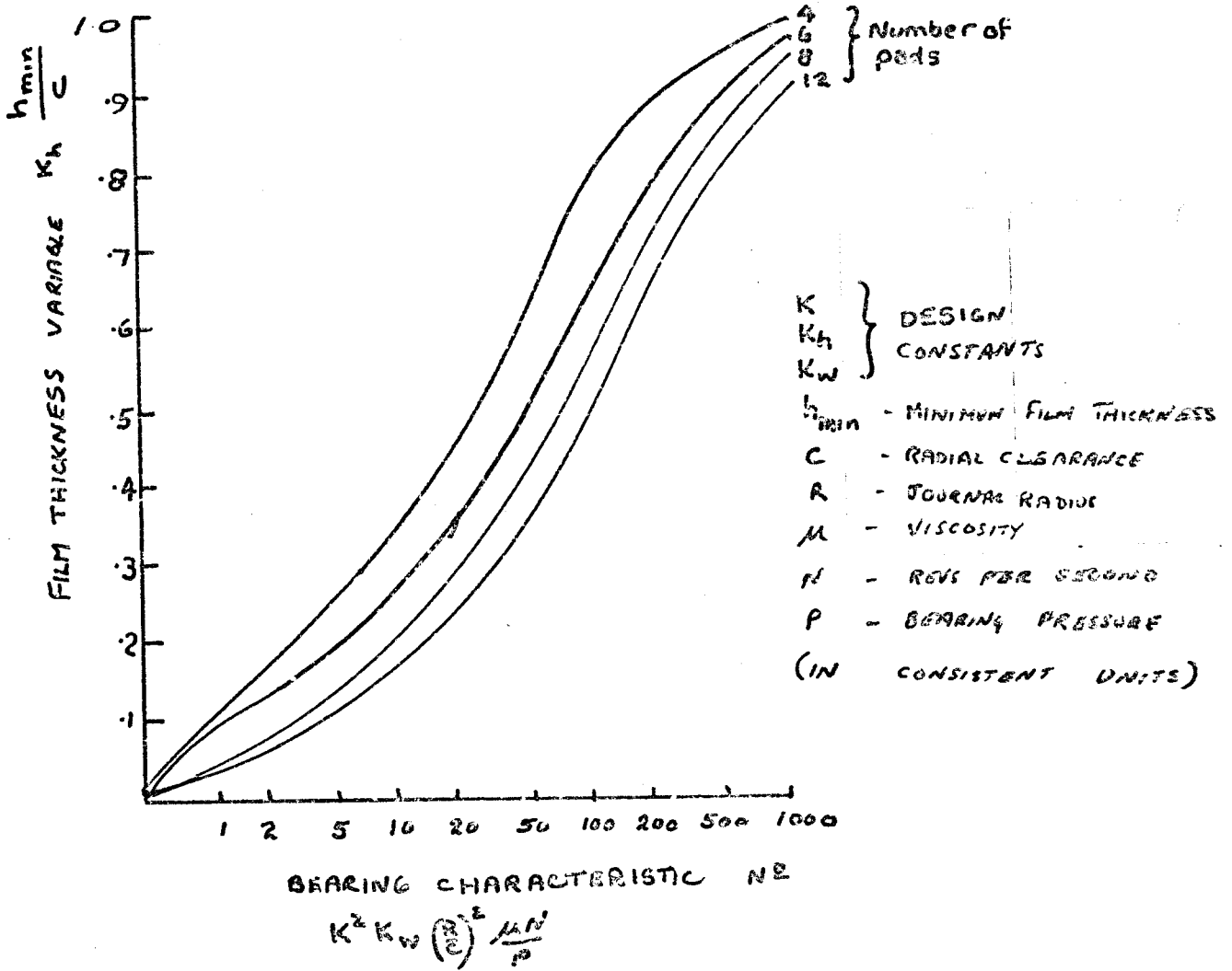

EFFECT OF NUMBER OF PADS ON FILM THICKNESS

FIG. 28

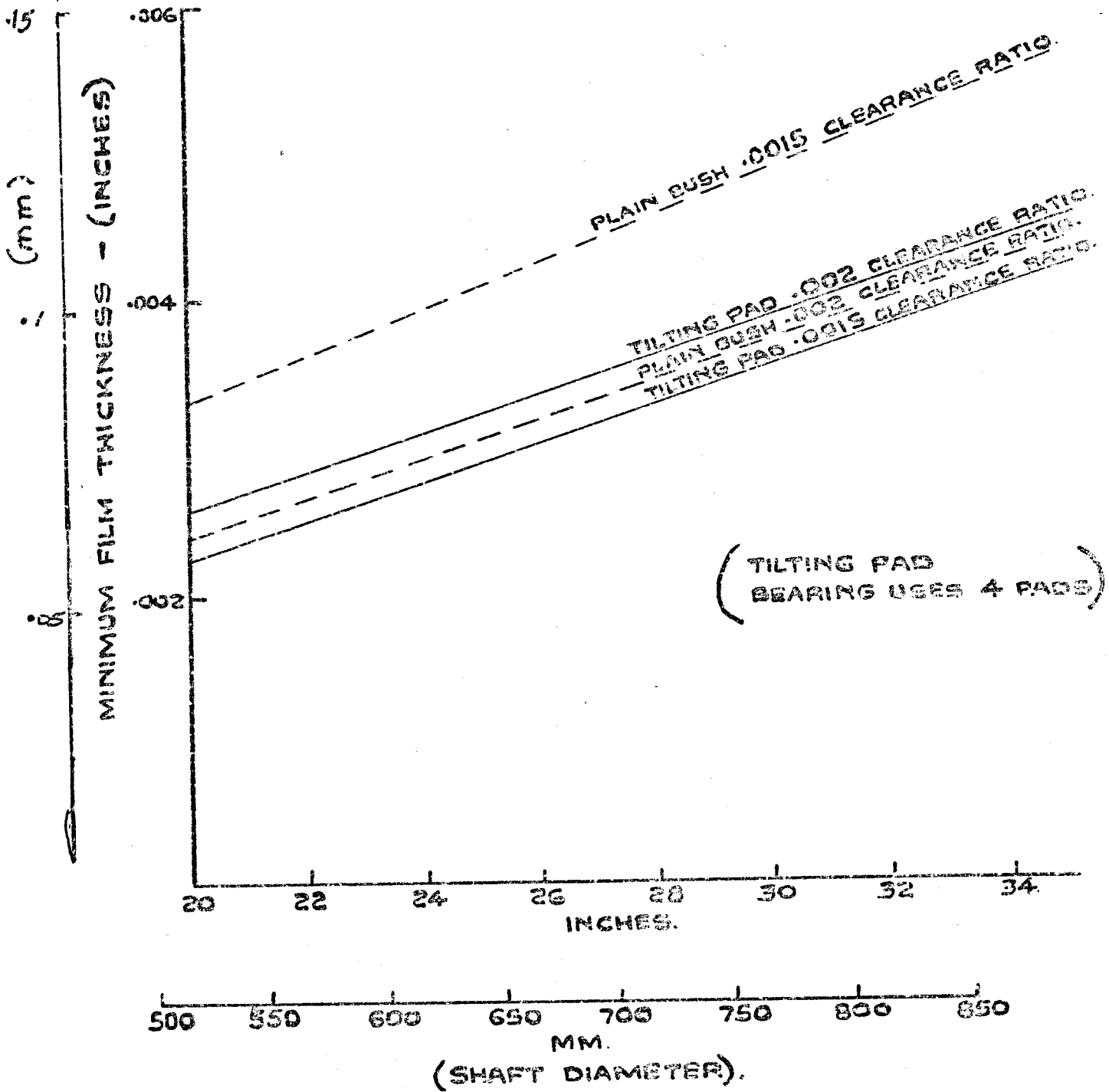

FILM THICKNESS OIL-LUBRICATED.

TAIL SHAFT BEARINGS @ 100 rpm & 90 psi.

FIG 29

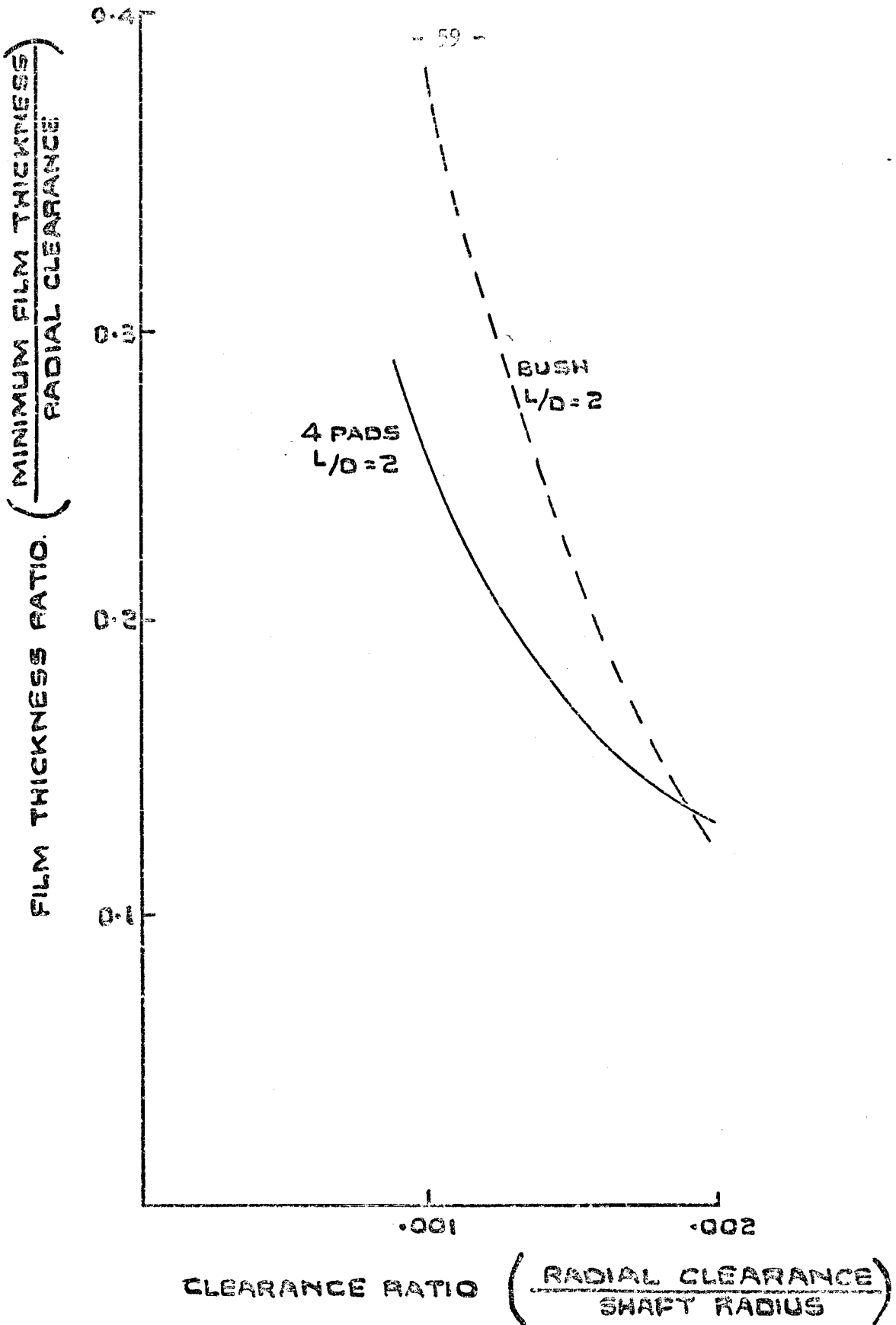

MINIMUM FILM THICKNESS AND
CLEARANCE RATIO FOR PLAIN
AND TILTING PAD STERN BEARINGS.

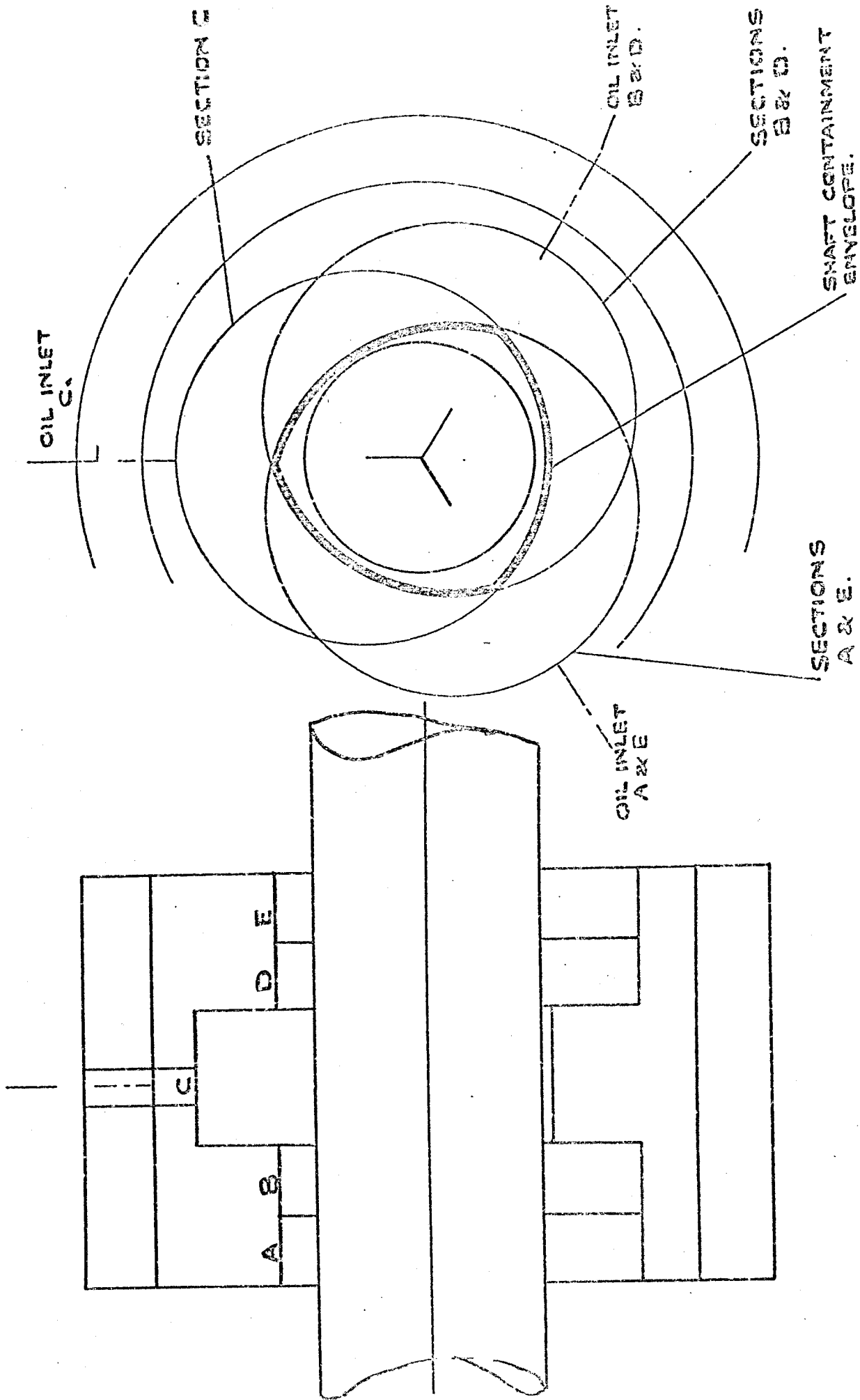

CAMELLA BEARING

FIG. 31

This is about the highest ratio that can be achieved and any reduction in this ratio will reduce the film ratio. 0.7 is perhaps a more common ratio of total pad length to shaft circumference and this would give a film ratio of .11 at the .002 clearance ratio. Hence, it would appear that over the entire likely clearance range of the stern bearing the tilting pad unit is at a disadvantage to the plain bush.

3. 2.5 Camella Stern Gear

The Camella type of stern gear is not a complete design but a type of bush fitted to a conventional system. A series of circular bores is situated along the bearing. Each bore is oversize by normal standards but its centre is displaced from the central axis. The centre of each bore is also displaced from its neighbour's centre by 120° . If the lines of each bore are projected onto one end the shape obtained is a three lobe bearing. This is shown diagrammatically in Fig. 31.

By the selection of bore sizes and suitable eccentricities a bearing which restricts the movement of a shaft to close limits but which at the same time has large oil flow clearances can be manufactured. In order that there will be no turning moment induced, five bores are required in the bearing. Generally the central lobe is twice the length of the other four.

Relative to each of the bores the shaft runs eccentrically and, therefore, a wedge shaped oil film is generated in each bore. This in turn results in a force being generated in each of the bores. Obviously the vectorial summation of the forces in each of the sections must be equal to the total load on the bearing. Reference to Fig. 31 in which the centre section (C) is considered to be the load carrying part shows that if section C is considered to generate an upward load then sections A and E will generate a force displaced by 120° clockwise to the force from C while sections B and D generate a force displaced by 120° anticlockwise.

The forces generated by Sections A, E, B and D are essentially stabilising forces. In order that no net turning moment be impressed on the shaft the sections are arranged as shown.

An example of a bearing which does not require five lobes to prevent turning is a turbine bearing where bearings are paired. In this case three sections only are needed.

Oil supply systems are conventional.

3. 2.6 Other Stern Gear

3. 2.6.1 Algonquin Stern Gear

The Algonquin system is one of the few radical approaches to stern gear design. Described by Campbell and Laskey (7) the purpose of this bearing system is to reduce the level of vibration in the tail shafting. It is this vibration which they claim has been responsible for much stern bearing trouble. The object of their design is to stabilise the rotation of the shaft and at the same time reduce the loading on the stern bearing. The main feature of the system shown in Fig. 32 is a comparatively short water lubricated stern bearing which penetrates the stern frame only. The after peak bulkhead has been cut away in its normal position and a space made within the after peak. Into the space a roller bearing has been installed close to the stern bearing. The conventional stern tube penetrating the after peak has been dispensed with. By situating a tight clearance bearing close to the stern bearing a nodal point has been established close to the propeller and the stern bearing has been effectively unloaded, serving more as a sea water seal than an effective bearing. Close to the aftermost roller bearing another roller bearing has been installed effectively making the shaft encastre from the aftermost plummer. The system is designed so that during installation the loads on the stern bearing and on the roller bearings can be controlled using hydraulic jacks one of which is specially designed for and fitted into, in the stern frame, the other is mounted between the two aftermost plummer blocks. In order to control the loads on the various bearing components the following assembly and alignment procedure is followed:-

- (1) The spherical roller races and bearing houses are assembled on the shaft.
- (2) The tail-shaft is inserted into the stern bearing and positioned axially. The jacks are pressurised to support the shaft and its lay adjusted to that calculated in the earlier design stages (Section 2. 1.3) by use of the jacks.
- (3) The propeller is now fitted complete with nut and cone.
- (4) The pressure in the two jacks is now adjusted to a previously calculated value to impress the correct load on the stern bearing, the alignment checked and the plummer bearings checked.

The Algonquin stern gear uses "Cutlas" rubber on the stern bearing which is water lubricated. This tends to be a first choice material in U.S.A. and Canada for water lubricated bearings but the inventors of the system point out that any suitable bearing material may be used.

There are other proprietary types of stern gear but all seem to be variations of those previously described.

One manufacturer (Railko) proposed an oil lubricated bearing which instead of using a whitemetalled bush uses a plastic material which can run under conditions of boundary lubrication with water as the lubricant. In the event of aft seal failure the bearing will continue operating satisfactorily until dry docking can be carried out.

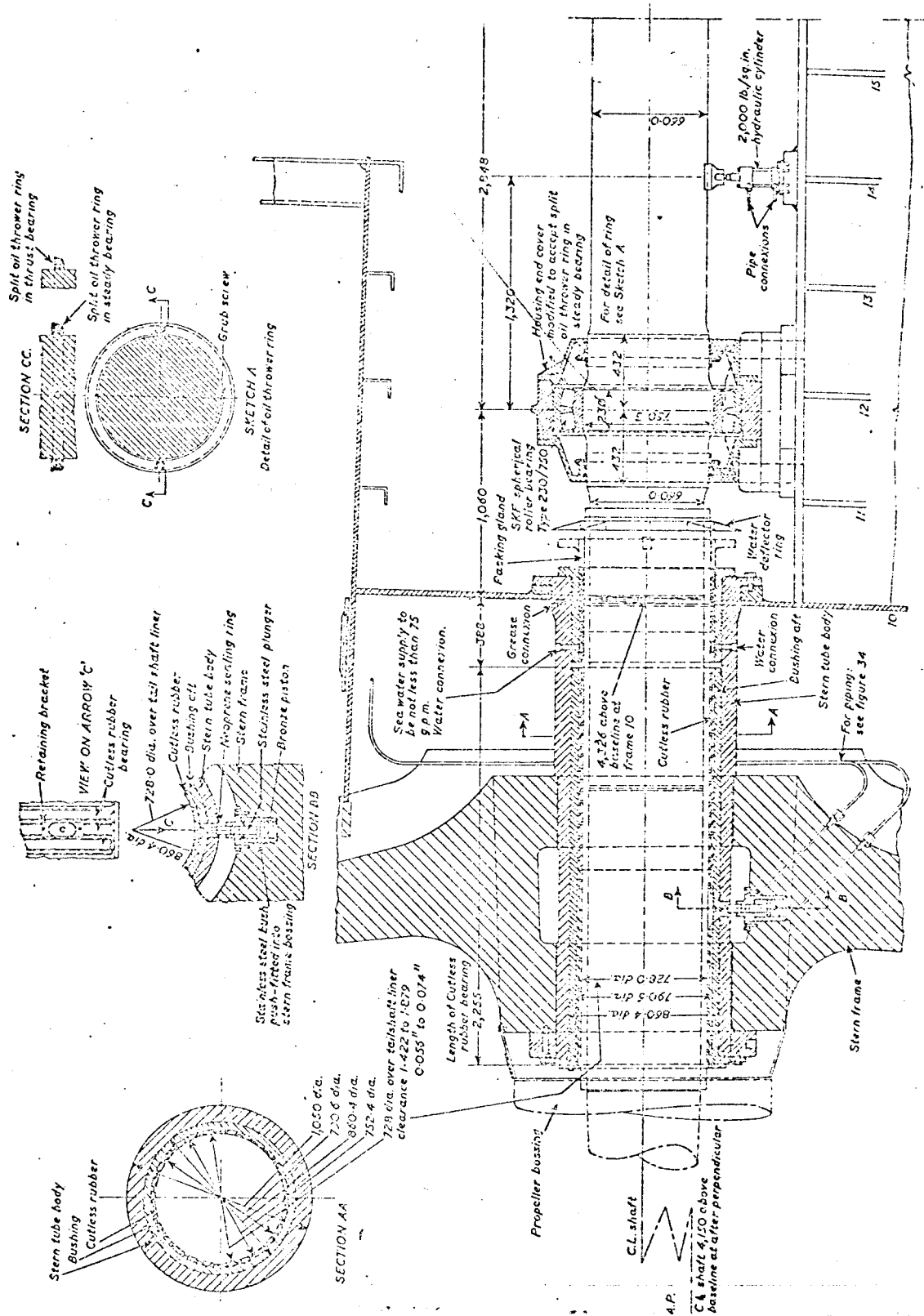

ALGONQUIN STERN GEAR

FIG. 32

4. SEALING

With water lubricated stern bearings it was not necessary to seal the after end of the stern tube against water but obviously the for'd end had to be sealed to prevent excessive leakage of water into the ship. The for'd seal was usually a simple gland which, in order to run cool, was slackened back sufficiently to allow some water flow into the bilges. Even the large diameter shafts described in the Algonquin proposals use simple for'd end glands. Some water lubricated stern bearings have been fitted with complex sealing in order to permit recycling of clean water as the lubricant but it is for the oil lubricated bearing that sealing is essential. Not only is an after seal needed to prevent water leakage into the bearing or loss of oil to the sea but it is no longer possible to use a simple gland at the for'd end.

Without leakage such a gland would run excessively hot and a constant flow of oil to waste is totally unacceptable.

Both lip seals and mechanical seals have been developed but the most the modern type of seal seems to be the mechanical face seal. A typical split seal of modern design is shown in Fig. 33.

A split mounting ring is rigidly fixed to the stern frame. Clamped to this ring is a split bellows piece which supports the face carrier. The seal face generally of filled p.t.f.e., is replaceable and is held in the face carrier. Upon the propeller/shaft flange or, in the case of a taper fit propeller, on the propeller boss is clamped a drive sleeve which carries a seat mating with the p.t.f.e. face.

The face remains stationary and the seat rotates with the shaft. The bellows piece is of spring wires coated with a rubber sleeve and it is the compression of this bellows piece which maintain the necessary pressure between the rotating seal seat and the stationary face.

Inside the mechanical seal is a secondary fixed sealing chamber. This chamber is an annulus around the shaft fixed to the stern frame and having a close clearance where it abuts the propeller boss or flange. The annular space so formed divided into two compartments by a radial plate having a close clearance around the shaft. Oil flows from the bearing into the for'd part of this space returning through suitable passages to the lubricating oil pumps. The oil which leaks from this space finds its way into the outer (mechanical) seal where it mixes with any sea water leakage and drains to a sump tank.

The for'd seal produced by the same manufacturer is similar in design but is of lighter construction and advantage has been taken of the increased room for installation to simplify manufacture.

The advantage of a split seal is that it can be removed and serviced without the necessity of drawing the tail-shaft, and all the manufacturers of these seals emphasise the ease with which they can be maintained.

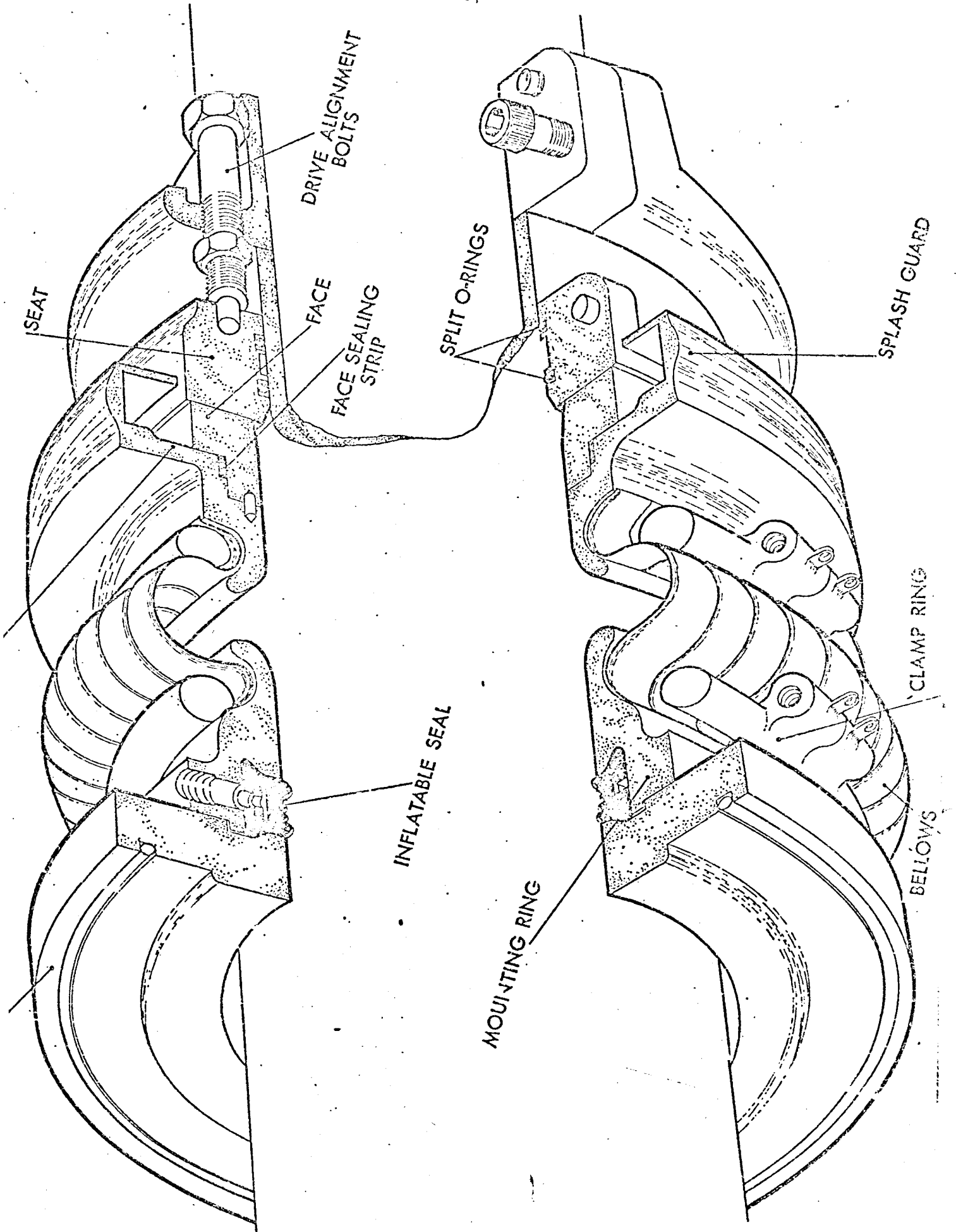

CRANE SPLIT SEAL

FIG. 33

5. COMPARISON OF PRESENT STERN GEARS

From a mere standpoint of simplicity the water lubricated stern bearing has much to recommend it. Sealing problems are minimal and, in the event of lubricant supply failure the bearing has a built in "get you home" ability. It is obviously an advantage for any bearing to be lubricated by the fluid which surrounds it but although this is apparently so with the water lubricated bearing it must be remembered that in estuarine waters there will be considerable silt and abrasive matter which, when stern leakage is used to supply water, can cause rapid deterioration of the bearing surfaces. Nor is silt only found in the immediate vicinity of the estuary. If this were the case the short term abrasive wear may be acceptable. However rivers such as the Amazon deposit silt water many hundreds of miles out to sea. Ocean going vessels also have to make extended river passages along the Amazon, Mississippi and other rivers. As well as the problem of silt in estuarine waters some polluted estuaries and canals are highly corrosive.

The practice of staving water lubricated stern bearings enables much silt to be flushed from the bearing but reduces bearing area. However staving does enable repairs to local damage to be carried out without completely renewing the bearing.

Because of its inability to support any great load, the viscosity of water being low, the water lubricated bearing has to be long in relation to its diameter and will have less ability to tolerate misalignment, which the loading analysis has shown can be considerable.

Cameron (5) has dealt with acceptable misalignment, his work suggesting that a misalignment which takes up almost all the availability film thickness at one end is acceptable provided the shafting is effectively pivoting about the centre of the bearing, i.e. if the calculated film thickness for a well aligned bearing is "x" then the shaft may be misaligned to zero film at one end and 2x at the other. In practice this is hard to confirm or accept and for a calculated film of "x" a total misalignment of "x" giving a film of $\frac{3x}{2}$ at one end and $\frac{x}{2}$ at the other is the kind of misalignment that can be tolerated although no bearing manufacturer is likely to commit himself to this amount. No matter what the actual degree of misalignment, the short oil lubricated bearing will be able to accept about twice as much angular misalignment as the longer water lubricated bush for the same film thickness. Alignment problems have to some extent been overcome by Glacier by the provision of a spherical seat at the aft end of the bush and limited adjustment at the forward end.

The conventional oil lubricated bush shares with the water lubricated bearing one major disadvantage in that for examination of the bearing the propeller and tail-shaft must be drawn. Such a major operation requires that the vessel be dry docked.

The oil lubricated stern bearing is manufactured with a longitudinal oil groove and cannot take load in this direction. It is necessary therefore to turn the bush on installation so that the load line passes through the crown of the bearing. Load in stern bearing varies considerably in direction so such a directional feature is undesirable. Since the water lubricated bearing is end-fed it does not have this feature.

The Glacier & Turnbull systems are designed primarily for ease for servicing in comparison to more conventional bearings. Both bearings can be withdrawn into the ship without the need to draw the tail-shaft. Sealing against flooding is achieved by an inflatable seal in addition to the normal aft seal. This double sealing is necessary since bearing damage is often associated with seal damage (or vice-versa) so that bearing examination or change is usually accompanied by a change of the (split) seal.

The advantage of inboard dismantling and inspection is achieved at the expense of increased size and cost of the bearing.

The space necessary to accommodate the bearing necessitates fuller stern lines. In way of the stern bearing the transverse width of the vessel has to be increased considerably for both the split bearings. This increase in width gives very full lines adjacent to the propeller resulting in greater disturbance to flow.

In spite of the increase in space required for dismantling neither of the split designs gives an engineer very much space in which to work and dismantling these bearings in the confined space available is not the simple task the manufacturers claim. The Turnbull bearing seems to have the added disadvantage that in most versions it requires that a special section of stern frame be aligned and welded into place. It is not apparent from the information available but it is presumed that the assembly of this stern frame section takes place when the vessel is on the stocks, whereas it would be much more convenient to deal with this part of the ship on its side in the prefabrication shop. Milne (17) has described the method of welding the Turnbull frame into place.

This description certainly concerns the welding in place of this large structure to very close alignment limits while the ship is on the stocks. Neither the Turnbull or Glacier bearings attempt to improve the reliability of stern bearings but seem to accept a degree of unreliability and cater for ease of repair. The Algonquin system tries to improve the reliability. The use of roller bearings for large shafting is not popular at sea. These bearings have acquired a reputation for false brinelling and subsequent failure which with the technology applied by reputable roller bearing manufacturers is today largely unfounded. However the majority of these bearings are not split so that to replace the aftermost bearing of the Algonquin system would require the ship to be docked and the tail-shaft drawn. (Cooper split roller bearings are an exception). The Turnbull and Glacier stern gear and the Algonquin stern gear all require access beyond the normal after peak bulkhead space. Whether in the long term this is acceptable has yet to be seen.

Mansfield (16) discussing Hill's paper suggests that access to the working space would normally be by trunking from above the bulkhead deck rather than through a watertight door in the after peak bulkhead. However after due consideration access from the engine room had been allowed by the classification society. Ship designs incorporating Glacier & Turnbull designs have a continuous bulkhead at the appropriate frame position but the Algonquin system does not show this.

Since the Algonquin system requires inboard withdrawal of the tail-shaft the fitting of a complete bulkhead may introduce difficulties. Compared with the two oil lubricated systems the Algonquin system does not seem to have attracted many sales. Personal correspondence from a Lloyds inspector in January 1974 gave heresay evidence that failure had occurred in service of the early models. The system has been produced in Canada, a country without a major shipbuilding or ship owning industry and this combined with early failures may be the reason for lack of sales.

From a purely operational aspect the split, oil lubricated stern gear have no advantages over the conventional oil lubricated bush. In terms of maintenance and inspection they benefit but they are much more expensive in first cost terms and require much more space. Additional water tight doors are required and the ship structure is more complex.

6. STERN BEARING FAILURES

Details of bearing failures in ships at sea are difficult to come by. Owners have no wish to publicise their problems nor do builders wish to give details of failures which rightly or wrongly may be attributed to their workmanship.

With earnings of over £10,000 per day for a large tanker these attitudes are hardly surprising.

The writer has personally investigated several stern bearing failures, unfortunately each of these (5.1 5.2 and 5.3) has been of water lubricated bearing and because of this the oil lubricated failures reported are from other sources.

6.1 Twin Screw Passenger Vessel (Failed 1965)

This vessel of relatively fine lines had experienced no operating trouble at sea but when dry docked for survey it was found that there were bands of corrosion or cavitation damage along the bronze tail-shaft liner. Close examination showed that as well as ^{well} defined bands of shallow damage 1/8" deep there were pin holes which almost penetrated the tail-shaft liner. Calculations performed at the time (not by the writer) showed the shafting resonance frequency to be close to blade order frequency if the stern bearing were neglected. Detailed examination of the liner damage suggested cavitation to be the cause of the major damage but electrical discharge to be the cause of the pitting. The stern bearing of lignum vitae was not excessively worn nor damaged but the wear pattern indicated shaft contact over all its area.

It was therefore postulated that the shaft was indeed vibrating excessively although no complaints had been received of this vibration. The vibration magnitude was considered sufficient to cause cavitation in the water. It was thought then when contacting the bearing there had been some electrical discharge from the shaft. No theory was put forward as to how this current had been generated.

The action taken was to re-line the tail-shaft and to realign the aftermost bearing to put greater load on the stern bearing. As far as is known this action was successful.

6.2 Single Screw Bulk Carrier (1972)

No trouble had been reported during the voyage of this vessel but when it was drydocked for survey the tail-shaft liner was found to be cracked on several places.

These cracks were all in the same band around the liner, at a position equivalent to $2/3$ the bearing length from the aft end of the bearing. The largest crack was about six inches long and penetrated through the liner allowing the tail-shaft to rust. Cracks ran both longitudinally and circumferentially.

The bearing itself showed excessive wear for the length of service and there was some evidence of charring.

The liner was sectioned for metallurgical examination and tensile specimens prepared. These showed the bulk of the liner to be correctly cast and of good quality. In way of the cracks the crystal structure showed evidence of gross overheating.

Some time prior to docking the vessel had run aground in the Mississippi and the engine room log showed that in order to free her the engine had been slowly revolved alternately ahead and astern for several hours. Under this treatment no hydrodynamic film would be generated and considerable heating would result. Also a lot of silt would find its way into the bearing. It was concluded that the damage occurred during this grounding incident.

6.3 Single Screw Cargo Ship

This vessel had been in service for several years without any trouble and had had her tail-shaft drawn several times for inspection. However she suddenly started to overheat in the for'd gland and to throw packing. The packing was changed with no appreciable change until eventually the ship had to be docked.

Fig. 34 shows the state of the tail-shaft at that time. The liner was replaced and the cause of damage attributed to corrosion but trouble recommenced with the new liner.

At this point the writer investigated the problem and discovered that the sister ship also was having stern gear troubles. In the writer's opinion the damage to the liner was typical of cavitation although in this case the damage was in the for'd bush of a two bush system whereas cavitation more usually occurs in the central annular space. A previous metallurgical examination had reported the damage to be de-zincification.

In view of his opinion of cavitation the writer pursued the question of vibration and discussion with the chief engineer, who also had served on the sister ship, revealed that stern and shafting vibration had become a problem about a year previously.

The chief engineer also confirmed that it was not the practice to supply water to the stern tube, leakage being considered adequate. The onset of vibration of both ships coincided with the ships changing service from a fully loaded condition to a lightly loaded condition in which the propeller blades broke the surface of the sea. It was postulated that this induced vibration caused cavitation damage, the system being more prone to damage of this nature because of the lack of positive pressure in the water space. To remedy this the first action was to supply water from the engine room pumps to the central annular space. To prevent continued vibration it was necessary to alter the amount of ballast the ship could carry to ensure full propeller immersion.

6. 4 Failure of Oil Lubricated Bearings

According to Koons (14) the evidence suggests that misalignment is the most common cause of stern bearing failure. In the context of his paper he is referring to bearing failure when no sealing damage has occurred. Due to non-uniform loading the whitmetal overheats and wipes. This process continues along the bearing until complete failure occurs. He does point out that alignment can change and a ships bearing may fail some time after commissioning.

Fig. 35 is reproduced from Koons paper and shows a stern bearing in which the whitmetal has failed by fatigue. In the case in question there seems to be some doubt as to the bond strength but there must have been considerable variations on the loading to produce such a failure. Most bearing failures seem to be associated with seal failure and according to Archer (1) and Hill (12) the majority of bearing failures of oil lubricated stern gear have been caused by prior seal failure. It seems reasonable to suppose that a major cause of seal failure is the relative radial movement between shaft and seal. In the face seal design this may not be too critical but with the radial lip seal (lips) this must present problems. This is acknowledged by Koons (14) who has written "The excursions of the shaft operating within the confines of the bearing can promote wear". Both types of seal may suffer leakage if the seal area is too large because this will allow sufficient hydrodynamic pressure to be generated to open the seal.

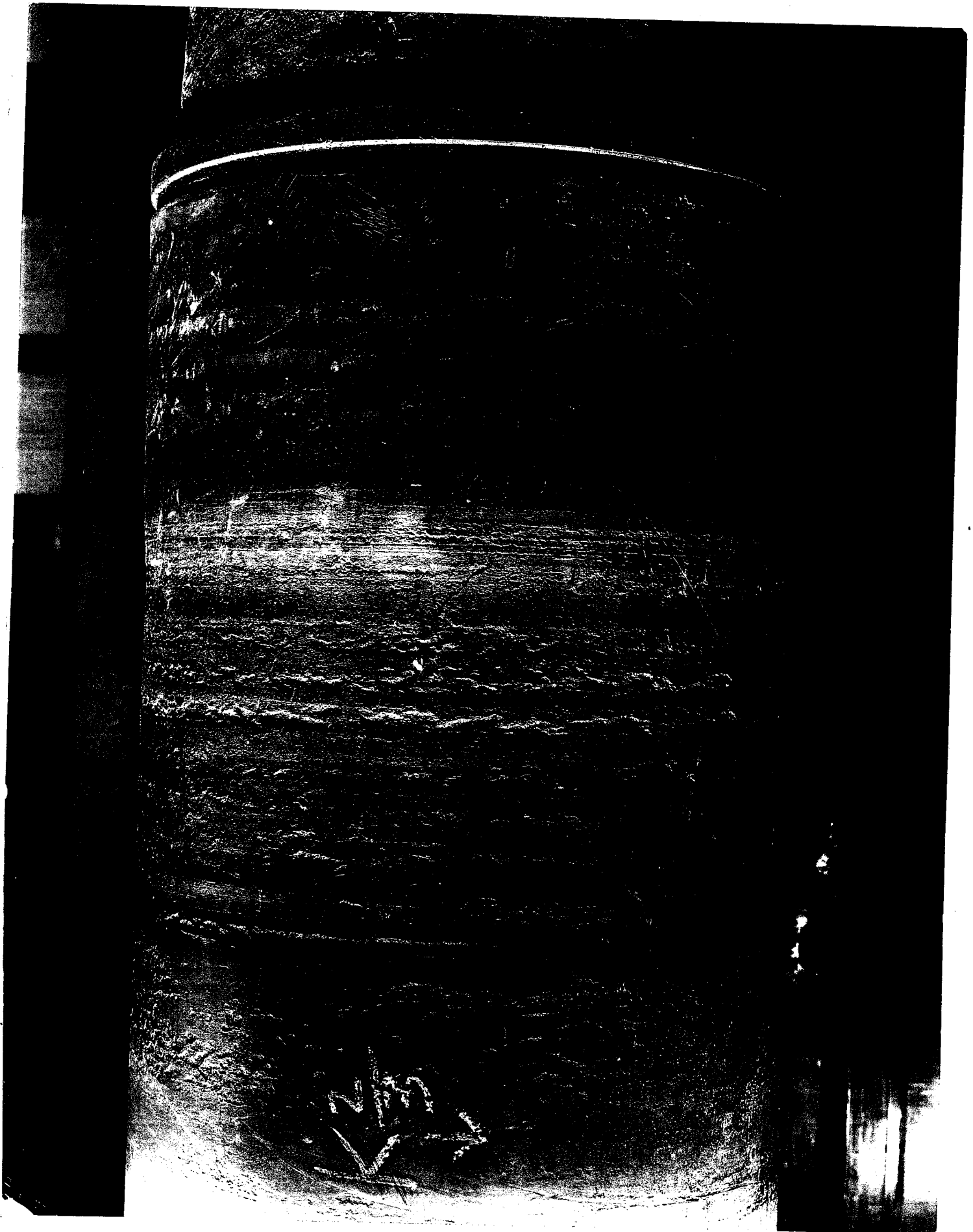

CAVITATION DAMAGE

FIG. 34

The most common cause of seal failure is wear, generally abrasive wear due to sand or silt in the water or grit left in the oil system. Koons in describing lip type seals quotes several instances of elastomer deterioration. Crane seals have reported several seal failures due to tail-shaft vibration. The vibration had resulted in failure of the heavy duty springs in the bellows piece of their seal.

In another case the clamping lugs had sheared, later inspection revealing this to be a fatigue failure.

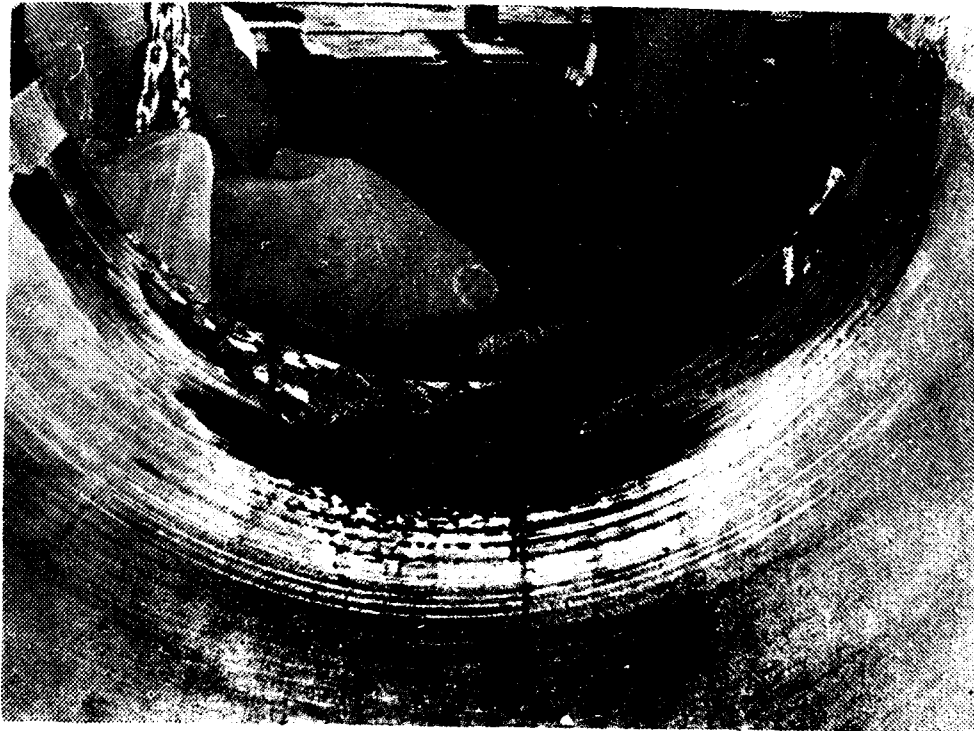

-Failed oil lubricated bearing-bond and fatigue



-Distressed area of bearing

7. DISCUSSION OF PRESENT DESIGNS

From the rate of failure of stern gear it does not seem too sweeping a statement to say that present designs are inadequate for the duties they have to perform.

The water lubricated bearing is inadequate at lower speeds, is prone to damage from silt and suffers from misalignment and propeller induced movements.

Propeller induced movements at full speed seem to result in the majority of failures as illustrated by the examples given previously and by the failures reported by Campbell and Laskey.

On the other hand the simplicity of water lubricated confers advantages. Major sealing problems are avoided. Temporary lubricant supply failure is unlikely to result in catastrophic bearing failure. Even after fairly severe damage the water lubricated bearing can be operated and the vessel can reach port without the assistance of tugs. Even under adverse weather conditions, steerage way can be maintained. The advantage of oil lubrication is that more adequate lubricant films can be maintained and that low speed hydrodynamic lubrication is possible. Even so, full lubrication is not obtained in practice below 20 r.p.m. on large tankers. Undoubtedly once a condition of boundary lubrication occurs the whitemetal bearing is less able to operate satisfactorily than either wood or plastic bearings. Wear down is more rapid.

The susceptibility of white metal bearings to turning gear damage is clearly shown in Appendix V where catastrophic failure of an aftermost bearing is shown to be caused by turning gear wear. The stern bearing does not have an oil supply limited by the ability of an oil ring to delivery oil. However the positive head of oil supplying a stern bearing is only likely to prolong life rather than prevent excessive wear down over the life of the ship.

This wear down is also likely to result in seal failure, the resultant loss of oil or massive leakage of water into the bearing accelerating the final failure condition.

The patented split designs offer few advantages as far as performance is concerned. One of them has a self-aligning feature which can be used during assembly. However as far as maintenance and inspection is concerned these bearings do have considerable advantages. Because of high docking charges and demurrage the added first cost of these bearings and the installation difficulties are rapidly offset when the ship is in service.

The tilting pad bearing is self aligning in service but at the speeds and loads of a normal tail-shaft will result in smaller film thickness than the plain bush. Where tail-shaft vibration is encountered, and this seems a common cause of trouble, the tilting pad bearing will give greater restraining forces.

Unfortunately under oscillating load conditions the pivots of tilting pad bearings hammer flat, this rapidly increasing bearing clearance. The pads are comparatively easy to remove and examine, this operation being possible with the ship afloat.

The Algonquin system has the advantages of water lubrication but because of the position of the aftermost bearing is very lightly loaded and in some ways acts only as a stern gland. The tail-shaft is short and hence stiff. In this way excessive tail-shaft movement and vibration is avoided.

Overall it seems that the patented split bearings are the most suitable for large vessels. They do require most space than conventional tubes but this is not too great a problem on full lined ships. On fine lined ships such as fast container vessels or in twin screwed ships the space requirements and interference with stern lines may present difficulties.

8. STERN BEARING REQUIREMENTS

From the foregoing the requirements for a reliable stern bearing for cargo vessels are:-

- (a) It must be able to accept initial and operational misalignment. Initial misalignment can be accommodated by the use of some form of spherical or pivot seating which would enable the bearing to be aligned to the shaft during assembly. Alignment varies when the ship is in service and the friction in a spherical seat is too high to permit self alignment after assembly. Pivoted pads while being able to align themselves in service suffer from pivot deterioration and low film thickness. The only practical answer to the alignment problem seems to be to adopt a shorter bearing than at present used. If the conventional bush or a split bush is used hydrodynamic oil films would not be generated during manoeuvring and the constant stop start operation would cause rapid wear. Overheating in service is another possibility.
- (b) Films must be generated at manoeuvring speeds. With present oil lubricated stern gear this criteria is not always met.
- (c) The stern bearing must be able to accept loads in several directions. This is true for the water lubricated bearing but the provision of an oil entry slot makes this difficult for oil lubricated bearings.
- (d) The tail-shaft ought to be held steady i.e. the stern bearing system ought to be stiff.

With a circular bush this could be accomplished by using tight clearances but such a bearing would rapidly overheat and would not have the ability to accept misalignment. In respect of stiffness it would be useful if the stiffness were a design variable to that resonant conditions could be modified. Unfortunately the stiffness is not a design variable in the sense that it can be varied over significant limits by the designer. The designer's first criteria is to provide adequate load carrying capacity without overheating. This leads to certain bearing dimensions which in turn determine stiffness.

Acceptable (from load carrying aspects) changes in the length clearance and diameters of the hydrodynamic bearing have little significant effect on stiffness.

Basically none of the existing bearings are able to sustain load, without shaft contact, at low speeds. The ability to withstand low speed operation seems therefore a basic design criteria to be applied to all types of stern bearing. Not only would this reduce failure rate of existing types but is also a requirement to be added to those designs whose specific function is to withstand load in any direction or to have a stiffer oil film.

If, during slow speed operation high pressure lubricant is introduced into slots or pockets in the lower half bearing, the shaft will be lifted sufficiently to prevent contact. Such systems have been proposed in 1971 by Koons (14) in 1972 by Mitsubishi Heavy Industries (2) and by Rose and Hill 1974 (35).

It is interesting to note that the Koons proposal was for the use of jacking oil with tilting pad stern bearings. In the event the tilting pad type of bearing did not find ready acceptance and only one such unit (fitted with jacking oil) has been fitted.

Possibly as a result of the comments of Hill and Rose in early 1974 (made at a time of considerable ship ordering activity) several bearings ordered in mid 1974 have had jacking oil systems specified and if present trends are followed such systems seem likely to become standard on the large (800mm) stern bearings.

If it is accepted that jacking systems are necessary to provide lubrication at speeds below about 20 - 25rpm it seems logical to investigate whether the provision of a full hydrostatic bearing will confer any further advantages to stern gear.

A full hydrostatic bearing is considered to be one in which high pressure lubricant is supplied to pockets around the full circumference of the bush. It is this pressure which sustains the lubricant film rather than the film being generated by shaft rotation.

One obvious advantage of such a bearing over a plain bush is that it can accept load in all directions since the film is maintained all round the clearance space. This ability to accept load in all directions is an advantage shared by the tilting pad bearing.

Hydrostatic bearings have been used in the machine tool industry; one of the major advantages claimed for these bearings is that they are stiffer than conventional bearings.

In order to counter tail-shaft movement it seems desirable to restrict the clearance of the stern bearing and to fit a bearing with as great an oil film stiffness as possible.

Fig. (36) has been prepared to show the difference in lubricant film stiffness for different types of stern bearing. In preparing these graphs a bearing load equivalent to Lloyds maximum of 90 p.s.i. has been assumed and, where necessary a viscosity of 12×10^{-6} Reyn at 110°F used.

The graphs are shown to a base of shaft diameter and an average speed of 110 r.p.m. assumed. In practice the likelihood is that shafts of lower diameter (say 24 inch) will rotate at 110 r.p.m. while the largest (34inch) will rotate at 80 to 90 r.p.m.

The stiffness figures for the plain bush and for the tilting pad bearings have been calculated using the graphs of Hagg and Sankey.

Recent discussions between the writer and Swan Hunter Shipbuilders would suggest that the application of these graphs to bearings as large as those under consideration may lead to inaccuracy in the absolute value of stiffness but that the relative figures so produced are reasonably accurate. For this reason the differences between the plain bush of 0.002 clearance ratio and the hydrostatic bush of 0.002 clearance ratio may not be as great as shown. However, it seems likely that their relative positions will remain unchanged. The plain bush clearance ratio of 0.002 which gives the least stiffness is that clearance normally required by Lloyds and other classification societies. Under pressure from Shipbuilders and Bearing Manufacturers there has been a tendency to allow this to be reduced to 0.0015. Even so, a hydrostatic bearing with these clearance ratios gives a film stiffness which is slightly greater than this.

The reasons given by the classification societies for the large clearances demanded is to prevent overheating of the bush and also to accept a greater degree of misalignment.

As will be shown later a clearance ratio of 0.002 would be unacceptable for hydrostatic bearings and a ratio of 0.0008 has been proposed. The overheating argument advanced against the tight clearance bush cannot be upheld in this case since the area of the bearing with tight clearance is low when compared with the plain bush and the shearing loss in the lubricant supply pockets is small. Added to this is the high lubricant flow.

If the 33 inch diameter bearing described later is considered, the friction loss of the hydrostatic design is given as 2.7 HP whereas for a hydrodynamic bush of 0.0015 clearance ratio the loss would be about 14 HP. The lubricant flow to the hydrostatic bearing is 50 g.p.m. and to the plain bush 35 g.p.m.

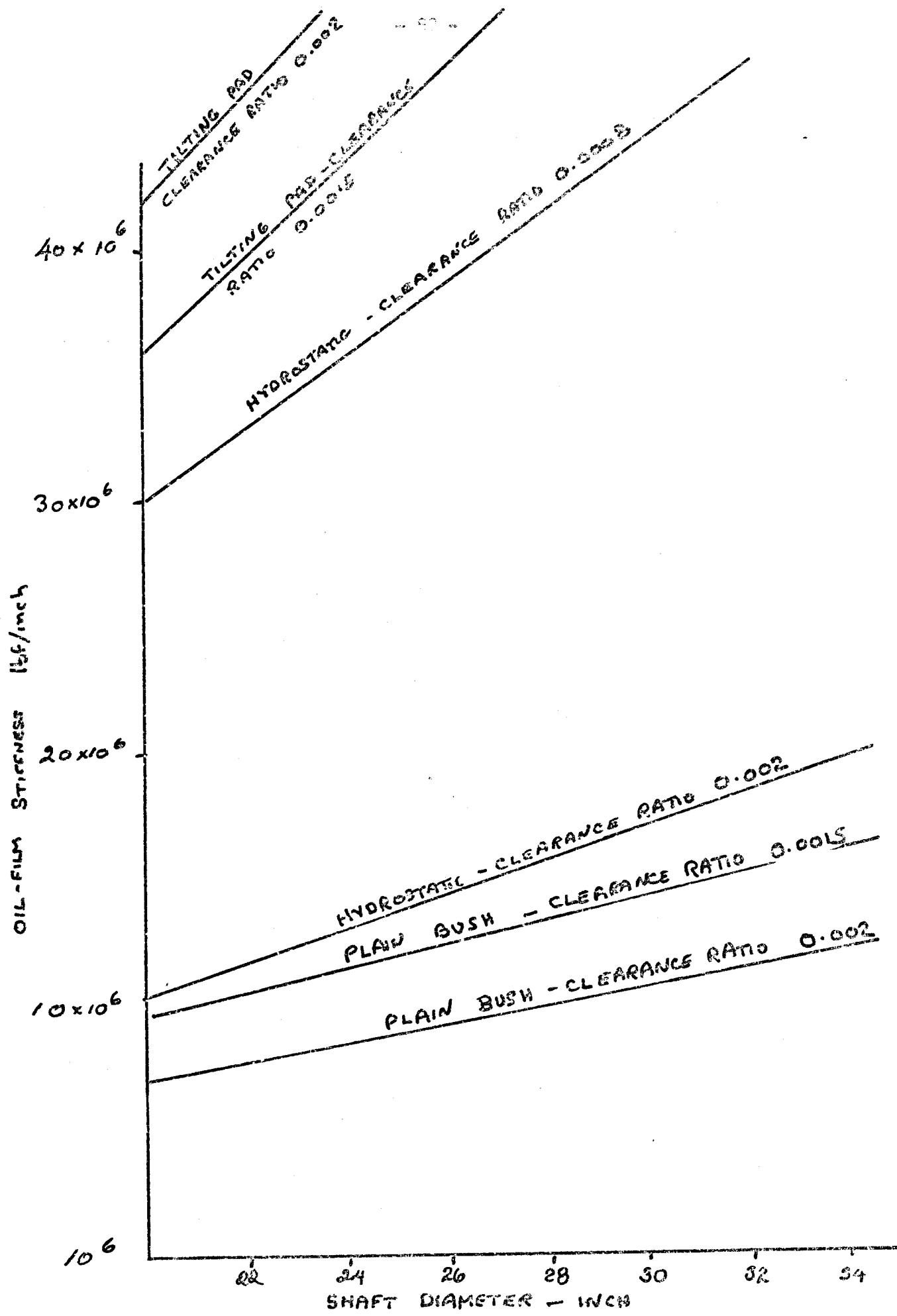

FILM STIFFNESS AT 100 RPM

FIG. 36

The temperature rise within the lubricant film of the hydrostatic (tight clearance) bearing is therefore only 13% of that of the plain bush. Once a tight clearance hydrostatic bearing can be employed then all the criteria required by a stern bearing can be met. Re-iterating, the hydrostatic bearing:-

- (1) Has a lubricant film separating the mating parts at all speeds.
- (2) Can accept loads in all directions.
- (3) Is considerably stiffer than the plain stern bearing bush.

It is agreed that this latter comparison is made with a bush of different clearance but it is nevertheless valid since the duty has been maintained similar and (of considerable importance in reality) both bearings are likely to satisfy classification society rules.

The tilting pad bearing is not advanced as a possible bearing since

- (a) Its operation film thickness is low.
- (b) It will require jacking oil to operate satisfactorily. The provision of jacking oil connections limits tilting ability.
- (c) Manufacturing experience in other fields has shown that pivot damage is likely in service.

The remainder of this thesis examines the various hydrostatic designs and suitable materials in order to produce suitable designs for shipboard use and to predict service performance.

In view of the advantages to be gained by merely providing a simple jacking system a simple method of deriving pressure and oil flow is given in addition to the design charts for full hydrostatic operation.

9 HYDROSTATIC PRINCIPLES

The stern bearings so far described have been considered to be hydrodynamic bearings. That is the mating surfaces are separated by a film of lubricant (oil or water) this film being generated and maintained by the rotation of the shaft.

The principles may be described in qualitative terms if one considers a shaft lying in a circular bearing, the diameter of the bearing being larger (in practice about 1.001 times larger).

By virtue of the different diameters, the space between the shaft and bearing is converging, and normally filled with lubricant.

As the shaft is rotated it draws the lubricant into the tapered space. Since the entrance to the wedge is greater than the exit the speed of the lubricant must increase or its direction must change. This change in velocity must be produced by an increase in pressure within the film. When equilibrium is achieved the pressure generated supports the shaft, separating it from the bearing.

The pressure generated is a complex function of clearance, speed, film thickness and lubricant viscosity.

The lower the speed or the lower the viscosity then the film thickness for any load is less. It is for this reason that surface to surface contact occurs at manoeuvring speeds on stern bearings.

It is not proposed to enter into the mathematics of the hydrodynamic bearing lubricant film. This has been done many times and innumerable design methods exist based upon solutions of the equations. The availability of computers has made the use of complex design methods possible but the simpler methods using charts such as those of Raimondi & Boyd (21) or Burke and Neale (4) are generally favoured by designers. Whether too much reliance may be placed upon the absolute value of film thickness calculated is a matter of argument but after using the design methods for a number of years the bearing manufacturer or individual designer tends to apply a comparative method of design.

If, instead of the shaft drawing in a wedge of oil, a pocket is built into the bearing as shown in Fig. 37 and lubricant under pressure is supplied to the pocket then the shaft will be lifted by the applied pressure.

The amount of lift will depend upon the applied load, the pressure supplied and the pressure drop in the leakage path between the shaft and the bearing. This is the basic principle of the hydrostatic bearing and a variation of this is commonly used for heavily loaded bearings which have to start at full load. In this application the oil is not supplied to a large pocket but merely to a small depression or groove in the loaded area. The groove is of such proportion so as not to interfere with the hydrodynamic action once the shaft is rotating.

A simple hydrostatic bearing like the one shown is only suitable for a constant downward force and low speed action. For normal industrial or marine application a full cylindrical bush such as shown in Fig. 38 is needed. The bearing has four or more pockets each connected to a constant pressure manifold via compensators which may be capillaries, orifices or constant flow valves. With these compensators in place the pocket pressures vary as the journal position varies.

As the journal approaches a pocket the pressure builds up, tending to restore the journal back to its equilibrium position, while the pressure in the opposite pocket falls. This fall in pressure assists the return to the running position.

The bearing shown only has a single row of pockets in the axial direction. Because of this there is no righting couple when the shaft becomes misaligned. To provide lateral stability either another journal bearing needs to be provided or the bearing must have two rows of pockets. To resist the turning moments in the tail-shaft two rows of pockets will generally be provided.

As well as illustrating the general principle of the hydrostatic bearing Fig. 38 also shows the pressure distribution across the end lands of the bearing. For the bearing clearances and land widths normally used sufficient accuracy is obtained if the pressure is assumed to fall linearly across the end lands. In a hydrostatic system the flow (Q) from a pocket is proportional to the pocket pressure (P) the cube of film thickness (h) and inversely proportional to the absolute viscosity (μ)

i.e. $Q = \frac{-h^3 P}{\mu} (K)$ where (K) is a constant

$$P = \frac{-Q \mu}{(K)h^3}$$

Load carried is equal to pocket pressure and equivalent area (A)

$$W = PA$$

substituting for P gives

$$W = \frac{-QA}{h^3(K)}$$

If Q is assumed constant (i.e. a small change in load)

$$\begin{aligned} \frac{dW}{dh} &= \frac{-3A}{K} \cdot \frac{Q}{h^4} = \frac{-QA}{h^3(K)} \cdot \frac{3}{h} \\ &= \frac{-3W}{h} \end{aligned}$$

i.e. stiffness is inversely proportional to film thickness and directly proportional to load.

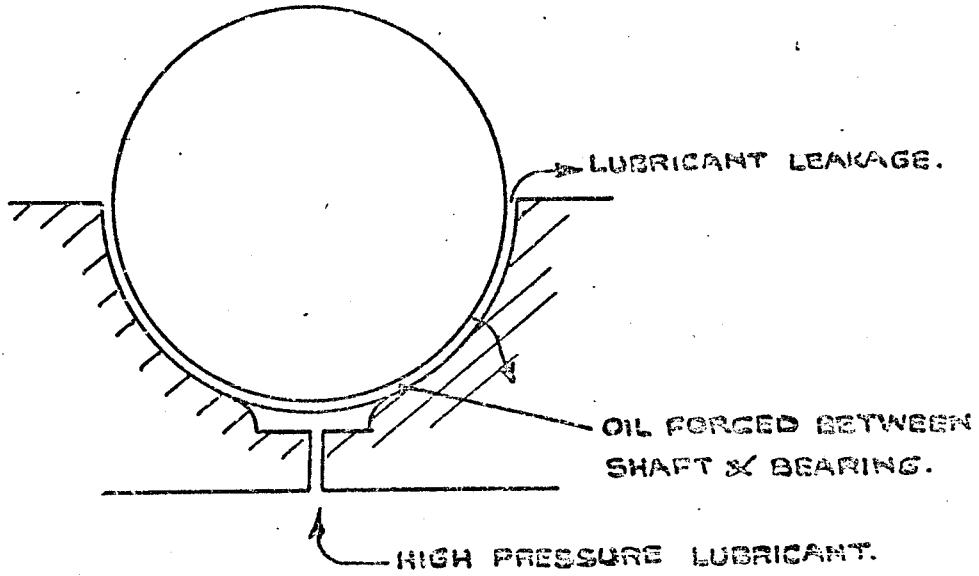
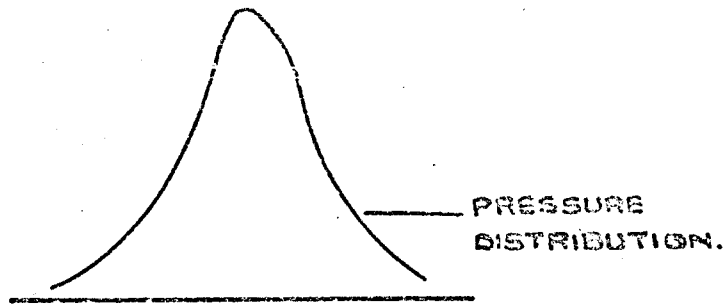

PARTIAL HYDROSTATIC BEARING

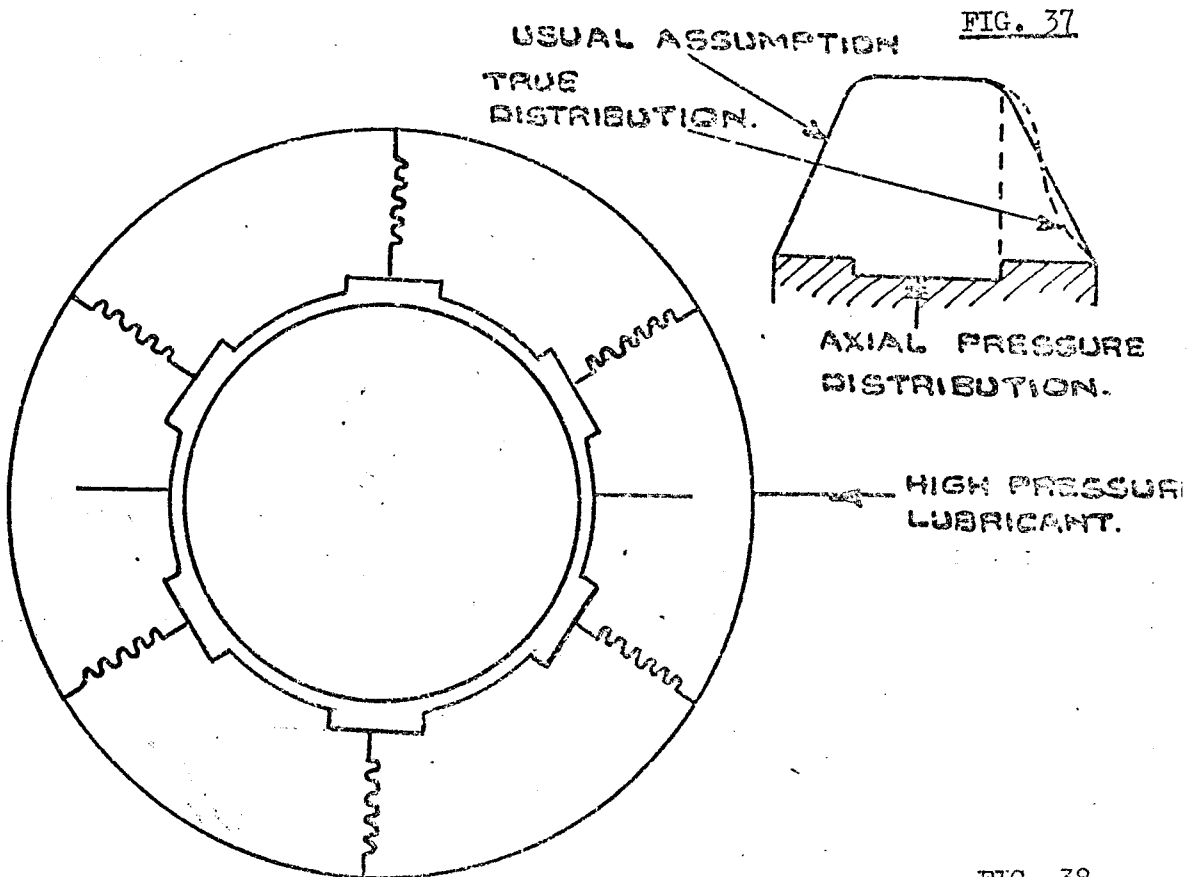

FULL HYDROSTATIC BEARING

FIG. 38

The stiffness of the hydrostatic bearing can be made higher by the use of special compensating control valves, and advantage has been taken of these very high stiffnesses in the machine tool industry which mounts precision grinding heads on this type of bearing. However the small size of grinding head spindles is hardly relevant to a ship's tail-shaft and a larger more heavily loaded example has been sought.

This is provided by the steel industry where hydrostatic bearings are used for roll neck bearings.

The first hydrostatic bearing application on a steel mill was in 1961 when a rolling mill was commissioned for the Jones and Laughlin Steel Corporation, Pennsylvania. In particular the Corporation required a stiff bearing capable of high load, low speed operation. This installation was successful and between 1961 and 1969, 117 mill stands were supplied by the Morgan Construction Corporation incorporating this form of lubrication. Rickley and Bjork (25) quote examples of 44" diameter bearings operating satisfactorily. Such sizes are directly applicable to shipboard shafting. Loads in rolling mills are much higher than marine bearing loads and shock loads are common. The successful operation of these roll neck bearings is considered to be evidence that hydrostatic bearings will operate satisfactorily on marine propeller shafts.

Design curves for hydrostatic bearings based upon flow conditions have been prepared by Wilcox and Booser (32) Raimondi and Boyd (21) and O'Donoghue and Rowe (18). This latter is the fullest reference on the subject and for design work considered to be the most definitive. The design curves presented in following sections will be calculated from the O'Donoghue and Rowe data.

10. LUBRICANTS

As has been pointed out the load carrying capacity of a hydrostatic bearing is dependent only upon supply pressure and bearing geometry and not on speed and viscosity. Since the load carrying capacity is not viscosity dependent a much wider range of lubricants can be used. The two obvious lubricants are, in fact, oil and water which will be examined below.

10.1. Oil as Lubricant

The use of oil as a lubricant has stemmed historically from its high viscosity and its non-corrosive nature. In a hostile marine environment oil is not only non-corrosive but will often coat the parts and help prevent corrosion. The higher viscosity of oil as compared to water will result in marginally higher film thickness during operation because of (a) a small hydrodynamic effect and (b) the resistance to leakage across the lands being higher. This increase in film thickness is negligible and is not thought to be a significant advantage. The non-dependence of hydrostatic bearings upon viscosity mean however that the same oil can be used for the main engines and for the stern tube, there being no need to employ the thicker type of oil usually used on stern tubes. The same lubricating oil system cannot however be used since contamination of the stern tube oil with sea water is a possibility and salt water contaminated oil cannot be used on main machinery because of the serious corrosion problems likely to be encountered. Nevertheless the use of the same oil for all engine room duties will simplify storage and where a fleet of vessels is concerned result in direct cost savings.

Since lubricating oil is non-corrosive conventional established bearing materials can be used. The tail-shaft may be of plain carbon steel and the bearing bush gunmetal or whitemetalled cast iron. In the latter case however it would be necessary to make provision to prevent ingress of high pressure oil into any bonding flaws between cast iron and whitemetal. This need not present a problem since the jacking oil connections on large turbine sets are arranged on cast iron whitemetal lined bushes.

In addition to using conventional (and relatively cheap) materials for the bearing components the use of oil as the lubricant would enable conventional materials to be used in the pumps and ancilliary equipment. The advantages of this with regard to piping would be small but will be greater when pump parts are considered. Reciprocating and centrifugal pumps are manufactured from materials readily able to withstand salt water attack but if a gear pump were necessary considerable investigations into the gear wheel materials may be needed if sea water were the lubricant.

The major disadvantage of the use of oil as the lubricant is that outboard seals would need to be provided in order to contain the oil within the system. The outboard oil seal is probably the single most expensive item on a stern gear system and if it can be dispensed with considerable cost savings will be made.

The outboard seal is also the least reliable part of the system. It has been argued that the higher stiffness of the hydrostatic bearing will help prevent seal failure but merely by virtue of its position this seal must be considered vulnerable.

In the event of seal failure, bearing failure is unlikely because the high lubricant pressure will prevent ingress of water to the bearing mating parts. The outflow and consequent loss of lubricant will be high. As complete seal failure is unlikely sufficient lubricant to combat loss can be carried on board but sea water leakage into the oil drains is likely to take place. Corrosion of the bearing and pump parts designed for oil lubrication is therefore a possibility.

10.2 Water as a Lubricant

If water is to be used as the lubricant two sources are available. Fresh water seems to have few advantages over lubricating oil. To conventional bearing parts it is corrosive, it takes up space on board ship and outboard seals are necessary to contain it inboard. Sea water on the other hand is abundant and outboard seals are not necessary.

The main problems in using sea water are corrosion and wear. In considering both these problems it must be remembered that a ship must operate in estuarine as well as oceanic waters. The composition of sea water is fairly constant throughout the world but estuarine waters vary in composition considerably. Most ports are sited on rivers polluted by chemicals and sewerage; both highly corrosive. Estuarine waters also contain considerable amounts of silt which if introduced into a bearing are likely to cause rapid bearing wear. On the other hand it can be argued that the performance of the older type of water lubricated bearing was sufficiently good to warrant the use of sea water. Wear rates were high with these bearings but it has been argued that they regularly operate under conditions of low or zero film thickness under which abrasive wear would be rapid. The hydrostatic bearing it has been argued will have adequate films at all times.

The main advantages of using sea water as the lubricant must be that the stern tube outboard seal can be dispensed with and the overall simplicity that can be achieved.

Materials capable of resisting sea water corrosion yet at the same time providing suitable bearing surfaces are available. The experimental work of the next section describes some of these. Filtration to remove all but the finest particles can be incorporated into the system.

Overall it is felt that reliability will be greater when sea water is the lubricant, the system is simpler and the disadvantages can be overcome by proven methods.

However one great difficulty is encountered with water as the lubricant. Because of its low viscosity (1.5×10^{-7} Reyn) when compared with oil (3×10^{-6} Reyn) the flow of lubricant to the bearing may be excessive when water is used.

The flow through the bearing is proportional to viscosity and hence for the same pressure supply 20 times more water would need to be pumped to a water lubricated bearing than to an oil lubricated type. It seems likely that there may be a limit placed by pumping capacity upon the size of bearing than can be lubricated by water.

Gear pumps are often specified for use with hydrostatic bearings.

This is the one piece of ancilliary equipment where it is felt that sea water is likely to pose a major problem. The usual steel gears will not tolerate sea water. If stainless steel is used galling of the gear teeth or even seizure is likely. Bronze is unlikely to withstand abrasion in this application. Suction filters may overcome this but these are not considered reliable enough for this situation. Centrifugal pumps resist abrasion and therefore will be used in preference to gear pumps.

Designs, wherever possible will be based on sea water lubrication but each case needs to be decided on individual merit. Curves for both oil and water will be prepared.

11. BEARING MATERIALS

If the premise that the mating parts of a hydrostatic bearing are never in contact when rotating almost any material of adequate strength with the ability to resist corrosion by the lubricant will be suitable for bearing manufacture. This premise cannot however be used for the basis of design and it must be assumed that relative motion and contact will take place during the life on the ship. The following specific cases have to be considered.

- (i) Complete permanent failure of the lubricating system which would necessitate the bearing to be operated as a normal hydrodynamic stern bearing, probably at reduced r.p.m. but with full shaft weight. At reduced r.p.m. propeller induced dynamic loads could be small.
- (ii) Temporary electrical failure which would require the propeller shaft to decelerate to standstill under full load but with no hydrostatic supporting film.
- (iii) Turning gear operation during repair. It is to be expected that when a turbine ship is on turning gear during warming up or when in port the hydrostatic lubricating system will be in operation.

It is therefore necessary that the bearing faces should be of materials which are compatible with each other (which rules out many stainless steels) and have low wear rates.

Even with careful filtration it must be assumed that foreign particles will be introduced into the lubricant and the bearing surface must therefore be able to resist abrasive wear and to absorb grit particles.

With normal oil lubrication a steel shaft running in a whitemetalled bush meets these requirements whereas for the water lubricated bearings previously used gunmetal running on wood or phenolic resin was satisfactory.

For the hydrostatic bearing under consideration neither wood nor phenolic resin are likely to be satisfactory in view of the fluid pressures which have to be transmitted through the bearing wall or the pressures which have to be contained.

The shaft material has obviously to be steel. Stainless steel is too expensive and is also a poor bearing material so a coated steel is the most likely shaft material.

The coating may take the form of a metal coating, say chrome plating, a plastic coating or it may be sleeved with a gunmetal liner in the traditional manner.

The bush itself will need the strength of steel or gunmetal. The bearing surface needs to be internally bonded to this unless the shaft has a compatible coating. However it is reasonable to suppose that one of the bearing surfaces will be of metal and the other will be of a softer material. Obviously it is a prime requirement for both surfaces that they should be immune to corrosive attack from sea water, or estuarine water.

11.1 Material Tests

In order to establish in the first instance the bearing properties of certain materials a series of experimental tests have been carried out. Initially none of the material tests were carried out with a view to stern bearing design but were carried out for specific bearing projects.

These were:-

(i) Rance Bulb Turbine Project

During the preliminary design stages of the machinery to be fitted to the Range Barrage the author's Company was approached to supply journal and thrust bearings for the turbines. Although oil lubricated bearings were eventually supplied initial specifications suggested water lubricated bearings. At the time the Company had supplied many bearing sets coated with an epoxy resin (ZSV) but was expecting difficulties in supply and was considering the use of other materials and the work was carried out to compare other materials with the (ZSV) resin. In the event, however, before completion of the tests a (ZSV) licence was acquired by the Company and the tests continued to fully investigate the merit of the material.

It may be noted that some materials normally associated with water lubricated bearings such as "D.U." and "Tufnol" were not included. This was because these materials were manufactured by companies who were also bearing manufacturers and the author's Company felt that it could not be dependent upon potential competitors for raw material supplies.

TABLE IV - MATERIALS TESTED

| GENERAL CLASSIFICATION | TRADE NAME | MANUFACTURE |
|--------------------------|----------------------|----------------|
| P.T.F.E. Sheet | Tygaflor SKAP/010/00 | Tygadure |
| Glass Cloth -PTFE filled | Tygaflor 28AP/10T/00 | Tygadure |
| Acetal Copolymer | Alkon (.012" Sheet) | I.C.I. |
| P.T.F.E. Sheet | Tygaflor SKAE/010/00 | Tygadure |
| Nylon-Unfilled | Maranyl Nylon B.100 | I.C.I. |
| Nylon-Glass filled | Maranyl Nylon A.190 | I.C.I. |
| Nylon-Unfilled | Nylatron | Polypenco |
| Nylon-Graphite Filled | Maranyl Nylon A.198 | I.C.I. |
| Nylon-Unfilled | Maranyl Nylon F.103 | I.C.I. |
| Nylon-Graphite Filled | Maranyl Nylon A.100E | I.C.I. |
| Nylon-Graphite Filled | Maranyl Nylon A.108 | I.C.I. |
| Acetal Copolymer | Alkon (.066" Sheet) | I.C.I. |
| P.T.F.E. Filled | "Rulon" | Crossleys |
| ZSV Epoxy Resin | - Z.S.V. 111 | ZSV |
| Nylon - Unfilled | Maranyl - B.100 | I.C.I. |
| P.T.F.E. - Filled | Rulon | Crossleys |
| Acetal Copolymer | Alkon | I.C.I. |
| P.T.F.E. - Unfilled | Fluon V.S.E.070 | I.C.I. |
| P.T.F.E. - Filled | Fluon V.S.B.60 | I.C.I. |
| P.T.F.E. - Filled | Fluon V.S.G.15Z40 | I.C.I. |
| P.T.F.E. - Filled | Fluon V.S.R.33 | I.C.I. |
| P.T.F.E. - Filled | Fluon V.S.N.60 | I.C.I. |
| P.T.F.E. - Filled | Fluon V.102 | I.C.I. |
| Resin | Rezolin L.930 | Rezolin-France |
| Resin | D.R. 19299 | Bakelite |
| P.T.F.E. - Filled | Rulon | Crossleys |
| P.T.F.E. - Filled | Rulon | Crossleys |
| Acetal Copolymer | Alkon | I.C.I. |
| Resin | Rezolin L.930 | Rezolin-France |
| Resin | Rezolin L.930 | Rezolin-France |
| Resin | Bakelite DR.19299 | Bakelite |
| Resin | Bakelite DR.19299 | Bakelite |
| Resin | Araldite A.T.1. | Araldite |

TABLE IV CONED.

| GENERAL CLASSIFICATION | TRADE NAME | MANUFACTURE |
|--|---|--|
| Resin Resin - P.T.F.E. filled Nylon - Glass filled P.T.F.E. filled P.T.F.E. filled | Epcphen EHM2/E.L.5. Emralon 815 Durethan BKV Fluorinoid 115 Fluorsint | Borden Chem. Acheson Colloids Bayer Fluorocarbon Ltd. Polypenco Ltd. |

M E C H A N I C A L P R O P E R T I E S

| MATERIAL | ULT. TENSILE STRESS LB./IN. ² | ELASTIC MODULUS LB./IN. ² | COMPRESSION MODULUS LB./IN. ² | COMPRESSIVE STRENGTH LB./IN. | SPECIFIC GRAVITY |
|--|--|--------------------------------------|--|------------------------------|------------------|
| Unfilled P.T.F.E. | 2500 - 4000 | 50,000 - 90,000 | 60,000 | 700 - 1800 | 2.3 |
| P.T.F.E. + 15% Glass Fibre | 2800 - 3600 | | 85,000 - 99,000 | | 2.22 |
| P.T.F.E. + 20% Glass Fibre | 2100 - 2700 | | 100,000 - 120,000 | | 2.26 |
| P.T.F.E. + 60% Bronze | 1800 - 2000 | | 110,000 - 112,000 | | 3.97 |
| P.T.F.E. + 20% Glass Fibre + 5% Graphite | 1600 - 2300 | | 90,000 - 95,000 | | 2.25 |
| P.T.F.E. + 15% Glass Fibre + 5% MoS ₂ | 2200 - 3200 | | 110,000 - 120,000 | | 2.28 |
| Unfilled F.E.P. | | | | | |
| Nylon 6:6 | 1300 | 66,700 | 66,700 | 7000 - 16000 | 1.14 |
| Nylon 6 | 11800 | | | | 1.13 |
| Nylon 610 | 10500 | | | | 1.09 |
| Nylon 610 | 8500 | | | | 1.04 |
| Nylon 11 | 8200 | 42,500 | | 7800 | 1.14 |
| Nylon 6:6 + MoS ₂ | 12300 | | | | 1.42 |
| Delrin | 10000 | 430,000 | | 18000 | .96 |
| H.D. Polythene | 3100 - 5500 | 80,000 - 150,000 | | 2400 | .94 |
| U.H.D. Polythene | 3100 - 3600 | 71,000 | | | |
| ZSV 111 | | | | | |
| ZSV 198 | | | | | |
| ZSV 206 | | | | | |
| ZSV 216 | | | | | |
| Fluon VX1 | 2250 | | 70,000 | | 2.32 |

TABLE V

M E C H A N I C A L P R O P E R T I E S

(Continued)

| MATERIAL | ULT. TENSILE STRESS LB/IN. ² | ELASTIC MODULUS ² LB/IN ² | COMPRESSION MODULUS ² LB/IN ² | COMPRESSIVE STRENGTH ² LB/IN | SPECIFIC GRAVITY |
|-----------------|---|---|---|---|------------------|
| Fluon VX2 | 1550 | | 50,000 | | 3.6 |
| Fluon VX3 | 1250 | | 100,000 | | 4.9 |
| Fluorosint | 1000 - 2500 | 190,000 | | | 2.3 |
| Glacier DU | | | 3,000,000* | 45,000 | |
| Glacier DX | | | 2,000,000* | | |
| Fulon | | | 100,000* | | |
| Fluoroglass | 17000 - 25000 | | | 18,000 - 26,000 | 2.2 |
| Fluorinoid | 2000 - 3000 | | | | 2.15 - 2.3 |
| VP 25 | 1500 - 2200 | | | | 2.1 |
| White Metal | 10,400 | | | | 7.2 |
| Mild Steel | 56,000 | 30×10^6 | | 4,500 | 7.8 |
| Stainless Steel | 78,000 | 30×10^6 | | | 7.8 |
| Cast Iron | 27,000 | 12×10^6 | | 114,000 | 7.2 |
| Bronze | 18,000 | 9.17×10^6 | | 10,500 | 7.4 - 8.9 |

TABLE V (CONT.)

THERMAL PROPERTIES

| MATERIAL | COEFF. LINEAR EXPANSION $10^{-5}/^{\circ}\text{C}$ | THERMAL CONDUCTIVITY $\text{CAL. CM.}/\text{CM}^2 \cdot ^{\circ}\text{C. SEC.} \cdot 10^{-4}$ | MELTING POINT $^{\circ}\text{C}$ | MAX. WORKING TEMP. $^{\circ}\text{C}$ | HEAT DISTORTION $^{\circ}\text{C}$ a) @ 66 p.s.i. b) @ 264 p.s.i. |
|--|---|--|-------------------------------------|--|---|
| Unfilled P.T.F.E. | 10 | 6 | 327 | 250 | 125 49 |
| P.T.F.E. + 15% Glass Fibre | 5.29 | 9 | 327 | 250 | |
| P.T.F.E. + 20% Glass Fibre | 7.54 | 11 | 327 | 250 | |
| P.T.F.E. + 60% Bronze | 7.88 | 11.5 | 327 | 250 | |
| P.T.F.E. + 20% Glass Fibre + 5% Graphite | 4.7 | 8.86 | 327 | 256 | |
| P.T.F.E. + 15% Glass Fibre + 5% MoS ₂ | 6.32 | 7.95 | 327 | 250 | 70 |
| Unfilled F.E.P. | 10 | 4.9 | 327 | 200 | 51 182 |
| Nylon 6:6 | 10 | 5.2 - 5.8 | 264 | | 75 |
| Nylon 6 | 9.5 | 6 | 222 | 90 | 132 66 |
| Nylon 610 | 12 | 5.3 | 222 | | 150 57 |
| Nylon 11 | 10 - 15 | 7 | 185 | 60 | 144 55 |
| Nylon 6:6 MoS ₂ | 6.3 | | 260 | | 232 163 |
| Delrin | 8.1 | 5.5 | 175 | 65 | 170 100 |
| H.D. Polythene | 11 - 13 | 11-12.4 | 120 | | 60 |

| MATERIAL | COEFF. LINEAR EXPANSION 10 ⁻⁵ /°C | THERMAL CONDUCTIVITY CAL./CM. ² °C.SEC. 10 ⁻⁴ | MELTING POINT °C | WORKING TEMP °C | HEAT DISTORTION TEMP °C a) @ 66 p.s.i. b) @ 264 p.s.i. |
|------------------|---|--|---------------------|--------------------|---|
| U.H.D. Polythene | 20 | | 135 | | 95 |
| ZSV 111 | | | | | |
| ZSV 198 | | | | | |
| ZSV 206 | | | | | |
| ZSV 216 | | | 327 | 250 | |
| Fluon VX1 | 6 - 8 | | 327 | 250 | |
| Fluon VX2 | 5.3 | | 327 | 250 | |
| Fluon VX3 | 5.5 | | 327 | 250 | 250 104 |
| Fluorosint | 2 | | | | |
| Glacier DV | 3 | | 327 | 280 | |
| Glacier DX | 2.7 | | 360 | 110 | |
| Rulon | 8 | 12.7 | 320 | | |
| Fluoroglass | 1.26 - 1.84 | | | | |
| Fluorinoid | 6.5 | | | | |
| VP25 | 6.2 | 10 | | | |
| White Metal | 2.4 - 2.8 | 700 - 900 | | | |
| Mild Steel | 1.3 | 1150 | | | |
| Stainless Steel | 1.08 | 430 | | | |
| Cast Iron | 1.06 | 1240 | | | |
| Bronze | 1.87 | 2041 | | | |

(ii) Cargo Pumps for Chemical Carriers

In response to enquiries for pump bearings to be used on the shafts of deep well pumps on chemical carriers it was proposed to use bearings lubricated by the chemicals pumped. A rig was set up to investigate both the bearing design and the most suitable materials. Much of the basic testing was carried out with water as the lubricant since this was a convenient low viscosity lubricant as well as being the most commonly pumped fluid.

(iii) Pump Bearings to Operate with Sea Water at 30° C.

The conditions called for on a bearing order were for a bearing to operate with sea water as the lubricant, surface speed 0.145 ft/sec. to 8.7 ft/sec. For the stern bearing application under present consideration the most interesting aspect of that investigation is that the lubricant used in the test was unfiltered River Tyne water taken at Scotswood during an average high tide. It is felt that materials shown to be able to resist attack by this water are unlikely to suffer damage in normal shipboard use.

The full list of materials tested is shown in Table IV. Table V and VI have been prepared from published data and manufacturers' literature to give the mechanical and thermal properties of the majority of these materials as well as some common engineering materials.

The full test procedure and detailed results are given in Appendix II, III and IV, the relevant results and materials being discussed below.

11.1.1 Bulb Turbine Tests

Thrust pads faced with the various materials were run against a phosphated steel collar in a water bath. 250 loaded starts were made at a load equivalent to 20 p.s.i. followed by 4 x 100 hour steady running tests at loads increased stepwise to 400 p.s.i. Of the initial list only the following materials could be considered successful in that they exhibited little wear down:

0 - .001" wear Epoxy Resins (- Z.S.V. III
Bakelite DR19299
Rezolin L930)

Bronze filled P.T.F.E. - (Rulon)

.001 - .002" wear P.T.F.E. impregnated glass cloth - (Tygador)

.002 - .003" wear Glass filled Nylon (I.C.I. A90)
Graphite filled Nylon (I.C.I. A100)

11. 1.2. Pump Bearings

These bearings were tested on a totally enclosed journal bearing test rig. Because of the nature of many of the potential lubricants only inert, carbon filled p.t.f.e. was considered and testing concentrated upon this material. Mechanical creep was a problem and only after a design capable of accommodating creep had been produced were successful runs obtained. Design seemed critical but eventually a 44 hour run with negligible wear was carried out.

11. 1.3. Sea Water Pump Bearings

Only the epoxy resin material ZSV III was used in this test since at the time of testing the writers company was a licensee of ZSV and considerable field experience had been obtained. The significant point of this test was that it was successfully carried out at 32°C as well as at 16°C. Twenty loaded starts at 65 p.s.i. were carried out followed by 200 hours running at 16°C and 55 hours at 32°C without measurable wear. The lubricant was particularly relevant to the stern tube application being unfiltered Tyne water.

11.2 Other Materials

As has been indicated the materials tested were limited to those which are readily available to the writers Company and commercial as well as technical reasons were taken into account in their selection. This leaves out some well established water lubricated materials.

- Glacier DU - a p.t.f.e. layer over sintered bronze backing.
- Railko Ferrobestos - an asbestos reinforced cresylic.
- Tufnol - a cotton reinforced cresylic.

Since the surface of DU is part p.t.f.e. it is likely to behave in a manner similar to the pure p.t.f.e. tested until wear to the sintered layer has taken place. On test this material was considered to have failed by excessive wear after 100 loaded starts. Once the p.t.f.e. overlay has been removed it is possible that the DU will act as the bronze filled p.t.f.e. material tested in which case satisfactory running is likely.

The test results published by the manufacturer suggest this to be the case. Test figures for phenolics are given by Wilcock and Booser (32) and show wear rates roughly 10 x those of filled p.t.f.e.

In spite of this the established performance of these materials at sea is such that they must be considered as possible materials.

11.3 Possible Materials

The previous sections have shown that certain specific plastics may be suitable for use as bearing surfaces. They form four basic groups, Nylons, p.t.f.e., cresylic resins and epoxy resins. Accepting that these will provide suitable rubbing surfaces these materials would be examined for their general and specific engineering properties.

11.3.1 Nylon

Nylons (polyamides) are thermoplastics. They have relatively low melting points (about 250°C) and are generally processed by injection moulding. They can however be used as coating media or can be massively cast using low pressure techniques. All can be machined using conventional techniques and a range of adhesives is available to bond nylon components to steel and other metals.

Nylons are manufactured by the reaction between molecules containing amino (NH_2) and carboxylic acid (COOH) groups. Both these groups are contained in amino acids and manufacture is by the polymerisation of these acids. The variety of amino acids available results in a range of nylons being available. Each type is named after the number of carbon atoms in the acid used to produce it. Only four types of nylon are commercially available these are types 66, 610, 6 and 11, the latter being uncommon. Types 66 and 610 were tested in the experimental phase with both the successful types being type 66.

Type 6 was not tested. Retrospectively this is unfortunate since one manufacturer (Rislant) manufactures this in powder form suitable for polymerisation in a mould by adding a catalyst to the monomer. Nylon components are usually produced by injection moulding. At the present time the largest injection moulding available in U.K. is 44 oz. and hence components such as stern bearings are impossible to produce in this manner. Even if smaller sub assemblies could be used to produce stern bearings the mere cost of moulding small quantities would be prohibitive. Nylon however can be cast (using special techniques) and can be supplied in bulk solid form or in sheet.



The bulk form is unlikely to be large enough for tube manufacture but staves such as have been used in older lignum vitae stern bushes would be available. The size of this is unlikely to be sufficient to produce the required pocket geometry for the hydrostatic bearing. Sheet nylon however does seem a possible candidate for the lining material. Sheet is readily available in metre square panels $3/8$ inch thick. Although fairly rigid the sheet can be formed when warmed to less than 100°C . Nylon however does not bond to metal and it must be held in place by screws or adhesive. Neither of these methods seem ideal in a stern tube.

Furthermore the pocket for the fluid would have to be cut in the nylon and its depth is such that the nylon would be penetrated. It is unlikely that a pressure tight seal could be made between nylon and bush, hence leakage from the pockets could be a major problem. This leakage could reduce the film thickness between shaft and bearing and also would be likely to cause distortion of the plastic.

Based upon the experience of hydrostatic bearings where high pressure oil has penetrated the interface between whitmetal and bush this latter would be the potentially more troublesome.

If it were possible to cast sufficiently large nylon pads the problem of creep and water absorption would have to be faced. At 500 p.s.i. nylon would acquire a 0.5% permanent strain within one year while at 1000 p.s.i. 1% strain would be achieved.

When it is considered that these are steady load figures it would seem that serious deformation of the nylon is likely to occur in service. In the type of bearing considered the diametral clearance is likely to be .03". If a nylon thickness of 1.0" is assumed this clearance will increase by between .01" and .005" during 9 years service. The short term creep figure is perhaps more significant. Every time nylon is loaded it acquires a permanent set. At 500 p.s.i. this is .1%, hence with an oscillating load the clearance may be expected to increase considerably. Nylon absorbs water. For small sections the time to reach an equilibrium water content is short but thick section take a considerable length of time to achieve equilibrium.

At the present time it would appear that nylon in bulk form is unlikely to be a satisfactory material from which to manufacture such a large bearing.

Some companies do claim to be able to coat steel successfully with Nylon 66 but to date none to the writer's knowledge have coated steel with carbon or glass filled Nylon 66. If this can be achieved nylon must be re-considered as a bearing material.

11. 3.2 P.T.F.E.

Although not tested in this thesis the p.t.f.e. material DU has been used in water lubricated applications. However this material consists of a steel back upon which a layer of bronze and a layer of p.t.f.e. have been sintered. If it is assumed that the material could be formed into pads large enough to be mounted onto a stern bush the problem of high pressure supply would need to be overcome.

The high pressure lubricant would tend to leak into the sintered layer (Fig. 39) and cause it to rupture.

Creep too is a major problem with p.t.f.e. This problem caused most failures in the experimental work described in Appendix IV. Throughout the test work on carbon filled p.t.f.e. bushes held in steel housings it was impossible to maintain secure fitting of the p.t.f.e. This was a 2" diameter bush.

Adhesives were used successfully to bond thin sheet p.t.f.e. to steel for the earlier series of tests and p.t.f.e. bonded to steel and aluminium is readily available on the market (often these plates are used in bridge bearings).

However once again there is the question of fixing these plates to the inside of a bush and providing a pressure tight joint.

Certain grades of p.t.f.e. can be bonded direct to steel and such items as frying pans and saws often have such a layer on them. P.T.F.E. in the unfilled form wears quickly as evidenced by the first series of tests. The p.t.f.e. layers so formed are also porous and therefore do not provide any protection against corrosion of the underlying material.

11. 3.3 Reinforced Cresylic Resins

These materials have been widely used as stern bearing materials for a number of years. The older type water lubricated bearing was fitted with staves of reinforced resins but more recently the material has been supplied in bulk form.

The more recent designs of bush have been for oil lubricated stern bearings which under emergency conditions can be operated with water as the lubricant.

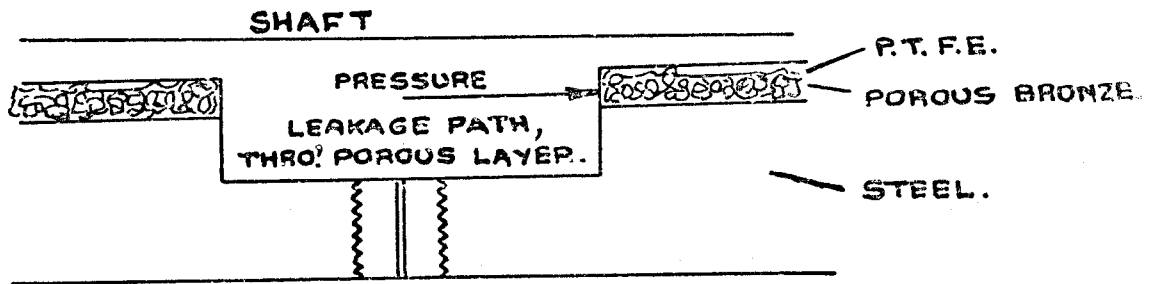

LEAKAGE PATH IN "D.U" MATERIAL.

FIG. 39

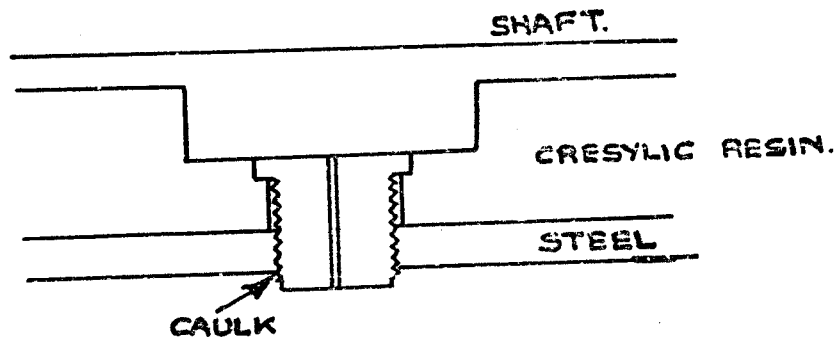

FEED POCKET RESIN BUSH.

FIG. 40

With water it is unlikely that a film is generated and a condition of boundary lubrication occurs. However the service performance of these materials shows them capable of operating under this condition without excessive wear. This is not to say they may operate permanently in this manner and water lubrication of a large bush of say 33" diameter is considered only as a "get you home" measure.

For the hydrostatic bearing under discussion the resin would need to be supplied in bush form. At the present time manufacturing facilities exist to provide bushes of up to 50" diameter. Typical bushes supplied to the marine industry to date are 33" bore and have a wall thickness of 6". These bushes are interference fits in cast iron stern tubes, the interference being about 0.03".

A feature of the material is its poor heat transfer coefficient and it is therefore essential that adequate cooling is supplied to the bush. Dry running cannot be tolerated and in the event of hydrostatic water failure provision must be made to circulate water through the bush.

This is not the case where thinner plastic layers are used. In these cases heat may be conducted by the metallic backing material to the after peak. Reinforced cresylic bushes, because they require an interference fit, cannot be used in split bearings.

If the machining of hydrostatic pockets is considered then the inability to split the bearing may be a major drawback.

The material is sufficiently thick to allow the pockets to be machined without breaking through to the backing material. Leakage is less of a problem since a small diameter pipe can be passed through the bush wall as shown in Fig. 40 to supply lubricant at pressure.

This is not the final preferred material but its properties are such that the proprietors of the material could produce hydrostatic bushes using it.

11. 3.4 Epoxy Resins

Epoxy resins are well established engineering materials generally associated with adhesives, protective paints and electrical components. A major advantage they enjoy over the other materials tested is that they will bond directly to metals.

The only surface preparation required is that the surfaces are thoroughly cleaned. This is usually accomplished by grit blasting and washing with organic solvents. The bond produced is a strong chemical bond whereas the bonds produced between p.t.f.e. and metal or nylon and metal is a mechanical bond between the plastic and asperities on the metal.

In the case of nylon the bonding is assisted by the shrinking of the nylon during cooling. Because of this nylon coats tend to be better when applied to outside surfaces rather than internal surfaces. Once broken, nylon coatings readily peel.

This is not true however of epoxy coatings which can withstand chipping and cutting through to the base material without spoiling the integrity of the entire film.

Epoxies may be applied as liquids or powders. It is usual for the liquid epoxies to be two pot systems in which the bulk epoxy is mixed with a catalyst which causes them to harden. The hardening time is dependent upon the amount of catalyst and the temperature. The liquids are fairly viscous and are applied by brush or spray. Typical coating thickness are .008" when wet, drying to .005" cured thickness. Better build up than this cannot be achieved on normal surfaces in one coating and previous coats have to dry before additional coats can be applied. High build up on flat horizontal surfaces is obtained by damming around the surface and casting the resin.

The time needed to achieve sufficiently thick layers for bearing operations are probably too high for the commercial use of the liquid resins. To absorb grit and to give some degree of conformability a finished layer of about .015" is needed, this being machined from a .025" applied layer. Of the epoxies tested giving adequate wear resistance Araldite and Rezolin were liquid systems. In the event of other materials being unsuitable, their bond strength and bearing properties would merit investigation into means of achieving high build up. Since other materials were found suitable it is not considered that designs should be based upon them.

The method of applying the powder resins tested was first to coat the clean metal with a film of powder dissolved in ethyl glycol this layer preventing oxidation of the metal during subsequent heating. The metal is then heated to 175°C and the powder sprinkled or sprayed onto the surface. Immediately in contact with the heated metal the powder fuses and powder is added until a sufficient layer has been achieved.

The epoxy is then cured by raising the temperature to 220°C and maintaining it for one hour.

The tests carried out have clearly demonstrated the epoxy ZSV III to be a suitable bearing surface with sea or harbour water as the lubricant. The layer is securely bonded and is not porous. The underlying metal therefore need not be corrosion resistant which is a major advantage from a cost point of view.

Considerable service experience has been gained with ZSV bearings in the pump and submersible motor industry. Approximately 200 complete bearings per year of these bearings lubricated with water are commissioned. Loads are typically up to 150 p.s.i. surface speeds ranging up to 80 ft. per second. In most cases the bearings start under full load. This service experience coupled with test data up to 400 p.s.i. and the ease of application is felt to be sufficient to warrant the use of this particular epoxy for the stern bearing application where loads will be up to 250 p.s.i. and surface speeds of about 13 ft/sec.

ZSV III is a trade name of a product of the German ZSV Company. Its composition is:

| | | |
|--------------------------------|---|--------|
| Epikote 1007 | - | 70.24% |
| Melamine | - | 1.76% |
| Fe ₂ O ₃ | - | 13% |
| Mica | - | 13% |
| Carbon | - | 2% |

11. 3.5 Overall Material Specification

Of the materials tested certain nylons, p.t.f.e. and epoxy resins were shown to have suitable bearing properties. Nylon and p.t.f.e. have been rejected for manufacturing reasons.

Ease of manufacture and previous operating experience have led to the selection of ZSV III epoxy resin as a preferred material. Operational experience of bushes of reinforced cresylic resin has led to the decision to preserve this as an alternative although it has not been tested.

The resin selected is only one of the mating surfaces. Similar materials are not likely to be ideal bearing combinations.

In order to resist corrosive attack the other material must be stainless steel or bronze.

The use of stainless steel is ruled out on cost grounds and it is proposed to use the more traditional bronze. When the cresylic resin bush is used tradition will be closely followed. It is proposed to mount the cresylic bush as an interference fit on a spherical graphite cast iron bush. The tail-shaft will be of carbon steel of minimum U.T.S. of 28 Tons/in² and it will be lined with a bronze liner of U.T.S. 28 Tons/in² with a thickness given by $(\frac{\text{diameter of shaft} + 9}{32})$ inches.

Where epoxy resin is used as one surface it would be traditional to coat the bearing bush with the epoxy and to line the shaft with a bronze liner. If a cast iron bush is used it is imperative that there is no defect on the coating otherwise corrosion will set in. During machining it will be difficult not to damage the coating. If the hydrostatic pressure pockets are machined into the bush two machining operations will be necessary. In the first the pockets will be machined into the backing material then the epoxy will be applied followed by normal machining of the bore of the bush.

If however the epoxy is applied to the shaft certain advantages become apparent. Firstly an expensive component, the bronze shaft liner, can be dispensed with. Secondly a more even epoxy film can be applied to a shaft slowly rotating between centres than can be applied to the bore of a split or full bush. Indeed the application of the epoxy to the bore of a full bush could present major difficulties. Thirdly bush manufacture is simplified. One machine setting is required and special provision for pressure connections breaking the coating need not be made.

The basic material specification for the epoxy lined system will be:

Shaft - 28 ton carbon steel coated with a .015" layer of ZSV III

Bush - Cast bronze machined to size.

The composition of bronze for shaft liners is not given by European

Classification Societies but ABS specification Type 2 Bronze is suggested:-

| | | |
|-----------|---|------------|
| Copper | - | 55-60% |
| Tin | - | 1.0% Max. |
| Lead | - | 0.4% Max. |
| Iron | - | 0.4 - 2.0% |
| Manganese | - | 1.5% Max. |
| Aluminium | - | 0.5 - 1.5% |
| Nickel | - | 0.5% Max. |
| Zinc | - | Remainder |

12. LUBRICANT SUPPLY

The lubricant may be supplied to the bearing on a basis of constant volume or constant pressure. In a constant volume system each pocket is individually supplied with lubricant from a positive displacement pump. Such a system undoubtedly gives the stiffest oil film. In practice the performance of a constant flow system is limited by pump performance since a pressure relief valve must be fitted into the system to prevent pump stalling. Hence at high eccentricities constant volume performance is likely to approach constant pressure performance.

The system applied to a marine unit also has some serious practical difficulties. For correct operation a hydrostatic journal bearing needs at least four lubricant inlets around the circumference and for lateral stability requires two rows of inlets axially. The requirements are therefore for at least eight pressure inlets. It would therefore be necessary to supply eight pump sets. For safety and reliability each set would require duplication and hence the system would become expensive and complex. The problem of multiple pumps can be overcome by the use of constant flow valves. One valve to each pocket is required and the valves themselves being pressure operated variable orifice valves. It is not felt that complication of these valves is justified in a marine environment. In a constant pressure system the load carrying pockets are supplied with fluid from constant pressure manifolds.

The maintenance of constant pressure in these manifolds is relatively easy if pumps of sufficient capacity are used. Two pumps are required, one for normal use, the other as standby.

If hydrostatic bearings are developed for merchant ship use the requirements for stiffer bearings may necessitate constant flow devices. However at this stage the basis of design will be constant pressure with the emphasis on reliability.

12.1 Lubricant Admission and Control

The control of the flow of the lubricant to a hydrostatic bearing from a constant pressure system may be by orifice or by capillary. In both cases an increase in flow due to shaft movement results in an increased pressure drop across the orifice or capillary thus altering the local bearing pressure. The characteristics of the orifice or capillary obviously therefore affect the dynamic characteristics of the bearing.

In general the orifice controlled bearing is a stiffer bearing and, other things being equal, orifice control would be desirable. In practical terms the characteristics of a capillary may be made to match fairly closely those of an orifice. By altering the dimensions of either the most suitable stiffness characteristics can be probably achieved. In terms of manufacture and design the orifice seems to offer most advantages. Firstly it is compact and may be a simple drilled plate. If a variable orifice is required then readily available needle valves are simple to obtain.

O'Donoghue & Rowe (19) have produced dimensionless groups to describe the stiffness of various types of flow control: for a six recess bearing they give the stiffness parameters as:

$$\begin{array}{rcl}
 \text{Capillary} & = & \frac{4.3\beta(1-\beta)}{1+0.5\gamma(1-\beta)} \\
 \text{Orifice} & = & \frac{8.60\beta(1-\beta)}{2-\beta+\gamma(1-\beta)}
 \end{array}
 \left. \begin{array}{l} \\ \\ \end{array} \right\} \begin{array}{l} \beta = \frac{\text{Recess pressure}}{\text{supply pressure}} \\ \\ \gamma = \frac{\text{Axial flow resistance}}{\text{circumferential flow resistance}} \end{array}$$

In order to illustrate the differences between optimum orifice and capillary control Fig. 41 has been prepared showing the variation in stiffness with change in supply pressure for the two systems. In the derivation of these graphs γ has been assumed to be 2 which will be typical for a 32 inch bearing with 6 recesses of near equal boundaries.

The orifice control is shown to have a slightly higher stiffness than that obtainable by capillary control but since the designs represented by the curves are at their optimum operating condition slight changes in operation will reduce the differences in stiffness between the two systems.

For the ship's stern gear under consideration the simplicity of installation and the ease of variation render the orifice the more useful and practical means of flow control and this has been used in the designs produced.

The lubricating fluid is introduced via the orifice into pockets on the bearing surface. The general term pocket is used to describe any recess in the bearing surface. In the case used to compare orifice and capillary control a pocket of general rectangular form with equal boundaries was used. Most literature recommends such a shape suggesting that the edge of the pocket should be $\frac{1}{4}$ x bearing axial length from the edge of the bearing.

However the shape of the pocket can vary from one having equal boundaries to a long pocket best described as an axial slot or to a shape approaching a circumferential slot. Both these shapes are used in gas lubricated bearings but find little favour in liquid hydrostatic bearings. Since however the objective of this exercise is stiffness it is as well to examine Rowe's stiffness parameter.

$$\lambda = \frac{8.6 \beta (1 - \beta)}{2 - \beta + \gamma (1 - \beta)}$$

$$\gamma = \frac{\text{axial flow resistance}}{\text{circumferential flow resistance}}$$

if $\gamma = 0$ axial flow resistance is small in comparison to circumferential flow and the pocket approaches an axial slot. If on the other hand γ is large the pocket form more resembles a circumferential slot. For any fixed recess pressure $\gamma = 0$ gives the greatest stiffness while $\gamma = \text{infinity}$ will give zero stiffness, hence variation in pocket shape between these two limits may be used to some extent to optimise bearing characteristics. Two factors tend however to limit the extent that the pocket can approach slot form. The first is the available pressure. The smaller the pocket in effective area than the greater the pocket pressure must be. For reliability and ease of supply, pressure must be maintained to reasonable limits and as illustrated by Fig. 41 it is necessary to maintain a supply to pocket ratio of approximately 2. The axial slot is also limited by end leakage. As the slot approaches the end of the bearing lubricant flow increases. Fig. 42 has been prepared to show the effect of pocket shape upon stiffness parameter (λ):-

$$\lambda = \frac{(\text{supply pressure} \times \text{effective bearing area})}{\text{radial clearance}}$$

This has been shown for the range = 0.1 to 10.

This particular curve has been drawn for a pocket to supply pressure ratio of 0.5. Reference to Fig. 41 will show that the optimum ratio is slightly above 0.6. The lower figure has been chosen so that as pocket pressure increases i.e. shaft approaching the pocket, stiffness will also increase.

Shape of inlet pocket has been shown to affect stiffness to a considerable degree and lubricant flow is also affected, this being inversely proportional to the distance from the edge of the pocket to the edge of the bearing.

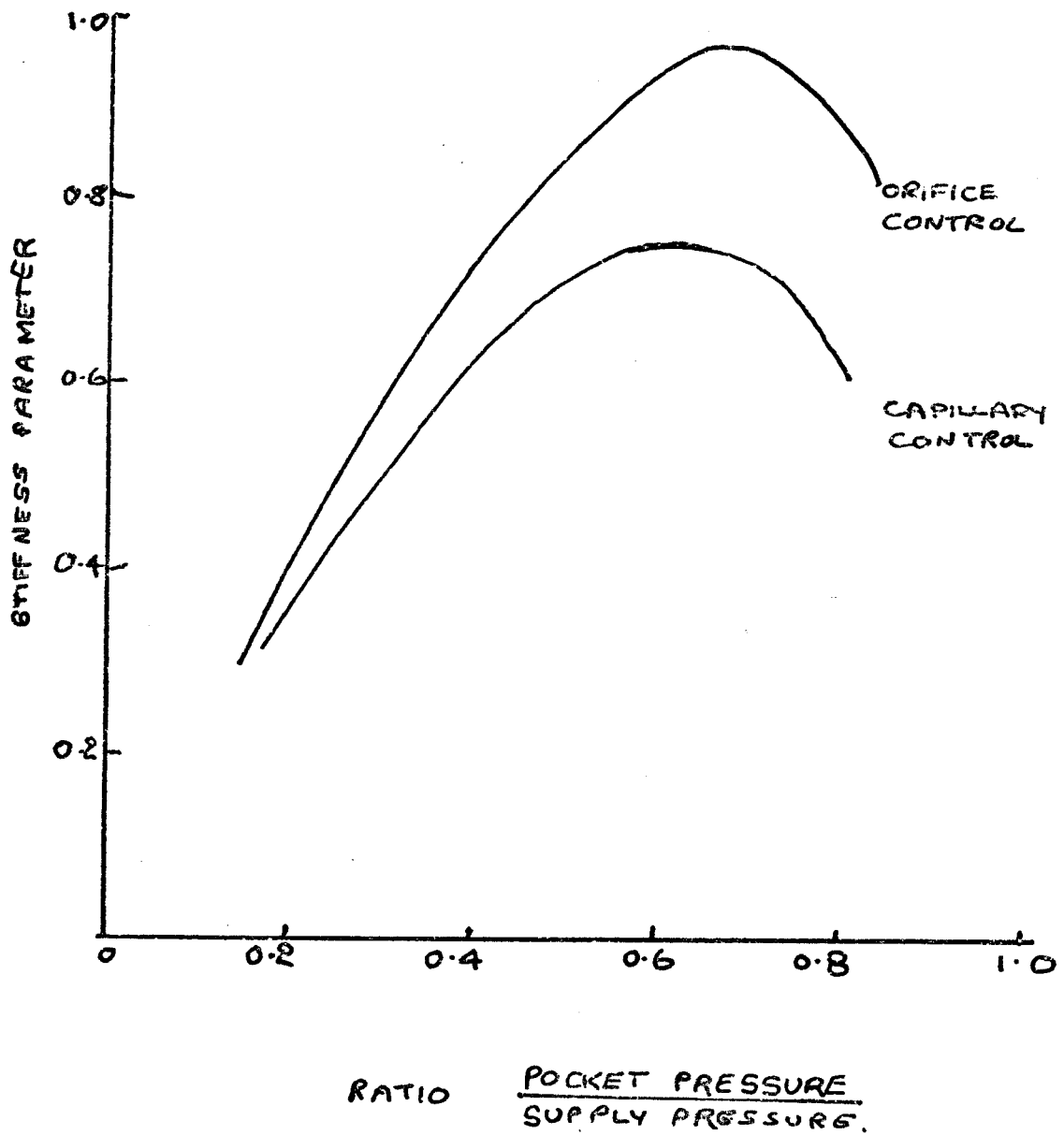

EFFECT OF CONTROL UPON STIFFNESS FIG. 41

In order to make the graph more meaningful as a design aid pocket proportions are shown by sketches of the bearing projected area at three points.

In preparing Fig. 42 it has been assumed that flow between pockets due to pressure differences between pockets is negligible and that isobars representing the pressure distribution between the pockets and the ends of the bush are parallel to the ends of the bush.

Over the greater part of the range of pocket shapes shown this is reasonably true but as the pockets approach circumferential slots, (i.e. δ increasing) the inter-pocket flow becomes significant. At very low values of δ the pockets tend to become isolated pressure pockets and the isobars deviate from the assumed pattern (see diagrams on Fig. 42) The effect of this is to reduce the stiffness parameter at the extreme ends of the curve. This is shown (qualitatively) on Fig. 42 and it is recommended that only the centre portion shown be used for stiffness calculation.

Power loss is also affected by pocket shape although to some extent absolute pocket size is more significant in this respect.

The torque on a plain journal bearing is directly proportional to the speed of rotation, the developed area of the bearing surface, the viscosity of the lubricant and the radius of the shaft, and is *inversely* proportioned to the radial clearance.

In the hydrostatic bearing that part of the area represented by pockets will have a radial clearance about 30 x that of the plain area. Thus the larger the area occupied by pockets the lesser the direct torque on the bearing. The larger the pockets however, the larger is the power required to pump the lubricant because of increased flow requirements.

It is therefore important that pocket area is optimised (or compromised) between bearing power loss and pumping power loss. Most authorities indicate that a system in which the pockets are surrounded by equal length lands are the best compromise and also indicate the bearing land should be approximately one quarter the length of the bearing. Extreme accuracy does not seem necessary and it is usual to round off the land length to convenient whole or fractional sizes. On the basis of this section it is recommended that the basic pocket design should fulfil this general pattern and that orifice control should be used. If variable orifices are needed then needle valves may be used.

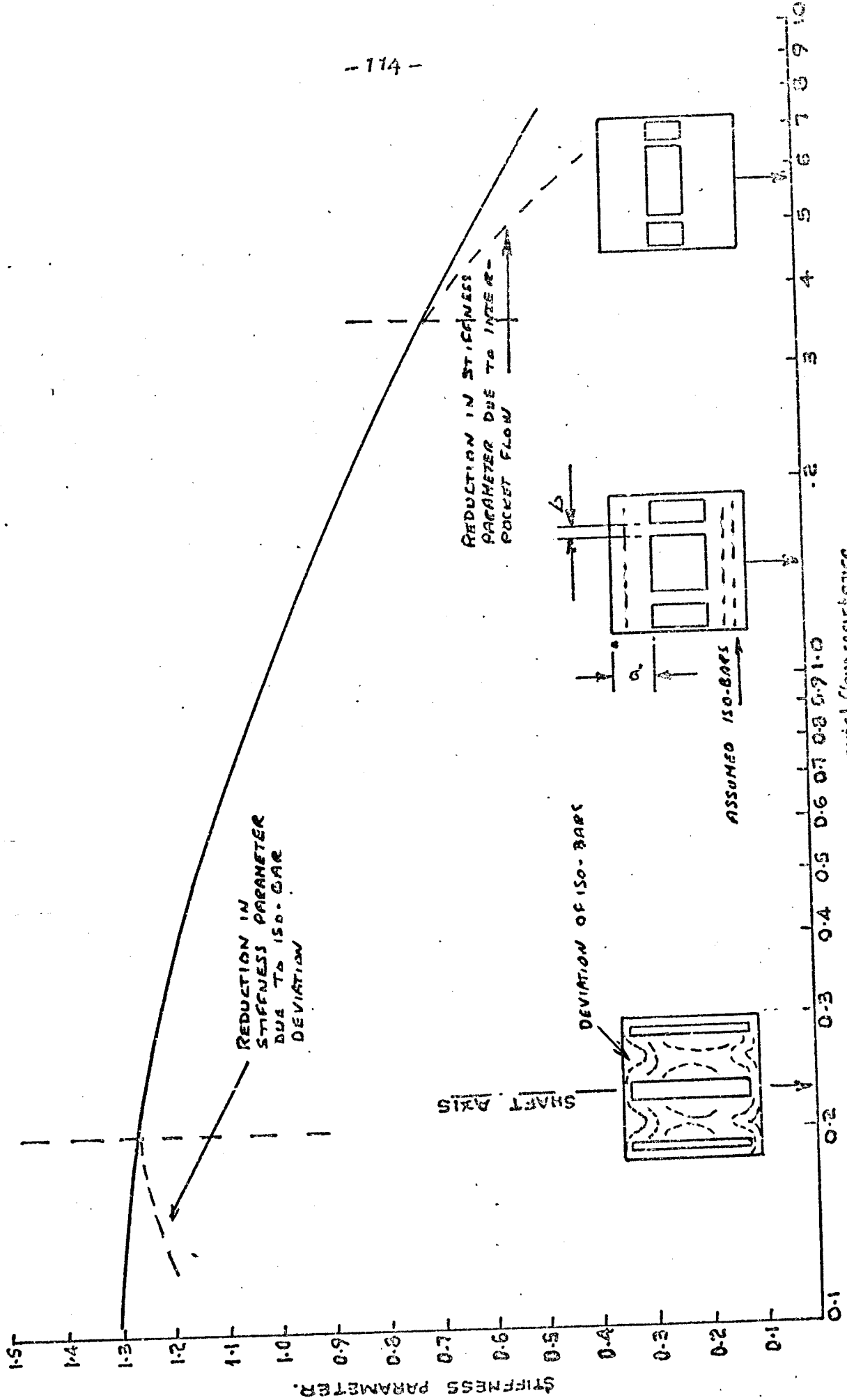

$$y = \frac{\text{axial flow resistance}}{\text{circumferential flow resistance}}$$

EFFECT OF POCKET SHAPE ON STIFFNESS.

FIG 42

13. DESIGN DATA FOR FULL HYDROSTATIC BEARINGS

Design data are presented in the form of charts. Some of these are presented in dimensionless form but most are drawn to a base of shaft diameter. The reason for this is to present the data in a form which will allow its immediate use to obtain a working system.

13. 1 Stiffness

Figs. 41 and 42 have already been used to illustrate the effect of supply pressure and pocket shape but they also serve a design function in that they allow stiffness to be calculated.

A stiffness parameter λ is plotted against supply ratio and a factor γ which is the ratio of axial and circumferential flow. In terms of bearing dimensions γ compares flow areas and may be calculated by:

$$\gamma = \frac{na(L-a)}{\pi Db}$$

where a and b are the circumferential and axial land widths respectively.

Fig. 41 is best treated as guide to pressure ratio which is generally recommended to be 0.5 while Fig. 42 shows the variation of stiffness parameter at a pressure ratio of 0.5.

Stiffness may be derived from the dimensionless factor by:

$$\text{Stiffness} = \frac{\lambda PsA}{r}$$

where Ps = supply pressure
A = effective area
r = radial clearance

13.2 Clearance

Lubricant flow and stiffness are both considerably affected by the clearance of the bearing. As can be seen from the previous section stiffness is inversely proportional to clearance. Flow of a fluid between parallel plates is proportional to the cube of the distance between them. The flow out of the end of a hydrostatic bearing is similarly proportional to the cube of the radial clearance. From these two factors it is fairly clear that tight clearances need to be specified for the bearings under consideration. In deciding suitable clearances not only most manufacturing tolerances be considered but shaft deflexion also must be taken into account. Fig. 43 has been drawn to show suggested preliminary design clearances. To some extent the selection of .0008" diametral clearance per inch diameter is somewhat arbitrary. At 30" shaft size the shaft deflexion totals about .006" - .007", the tolerances on the shaft will be $\pm .002$ " with similar limits on the bearing.

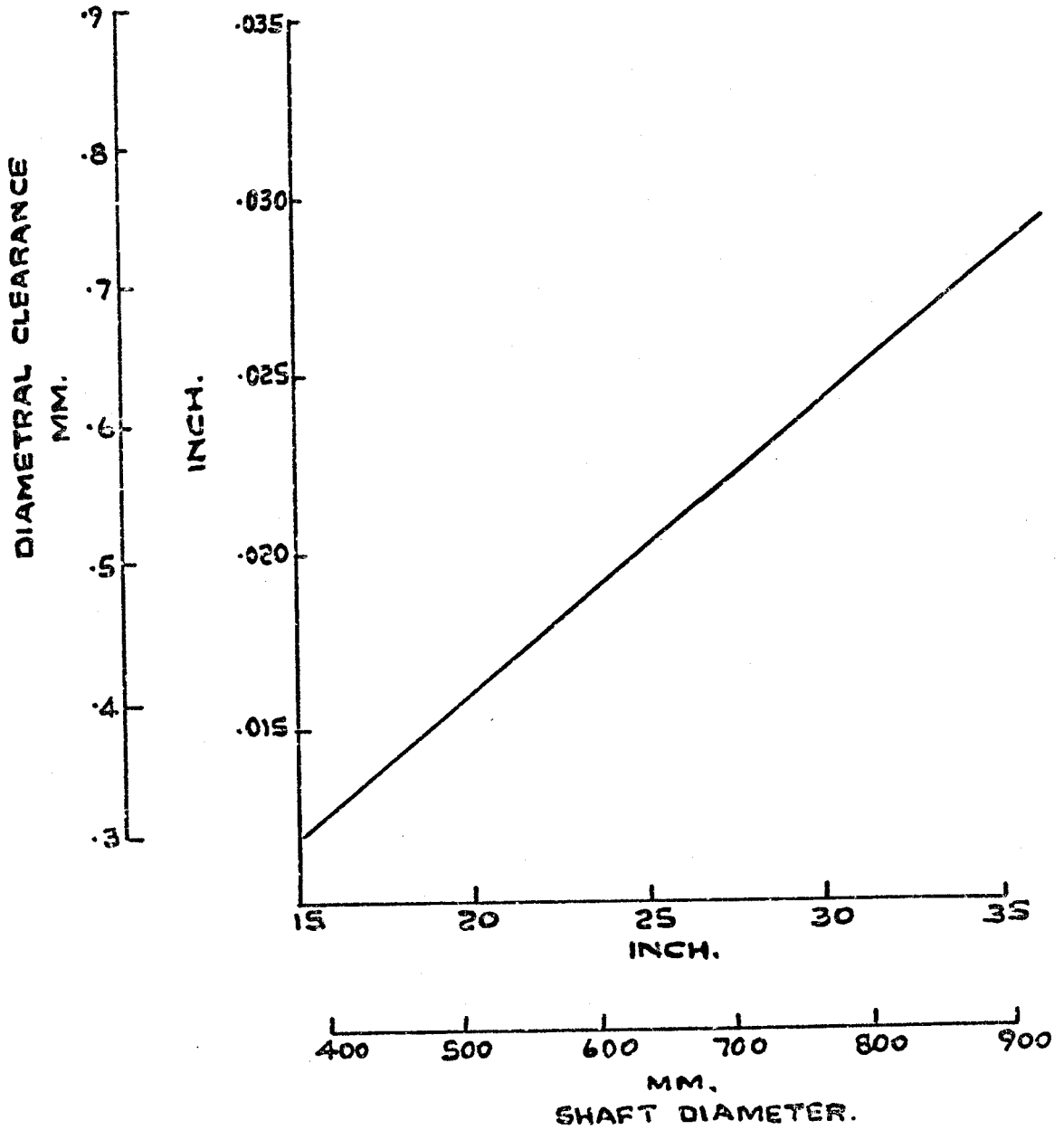

SUGGESTED CLEARANCES.

FIG. 43

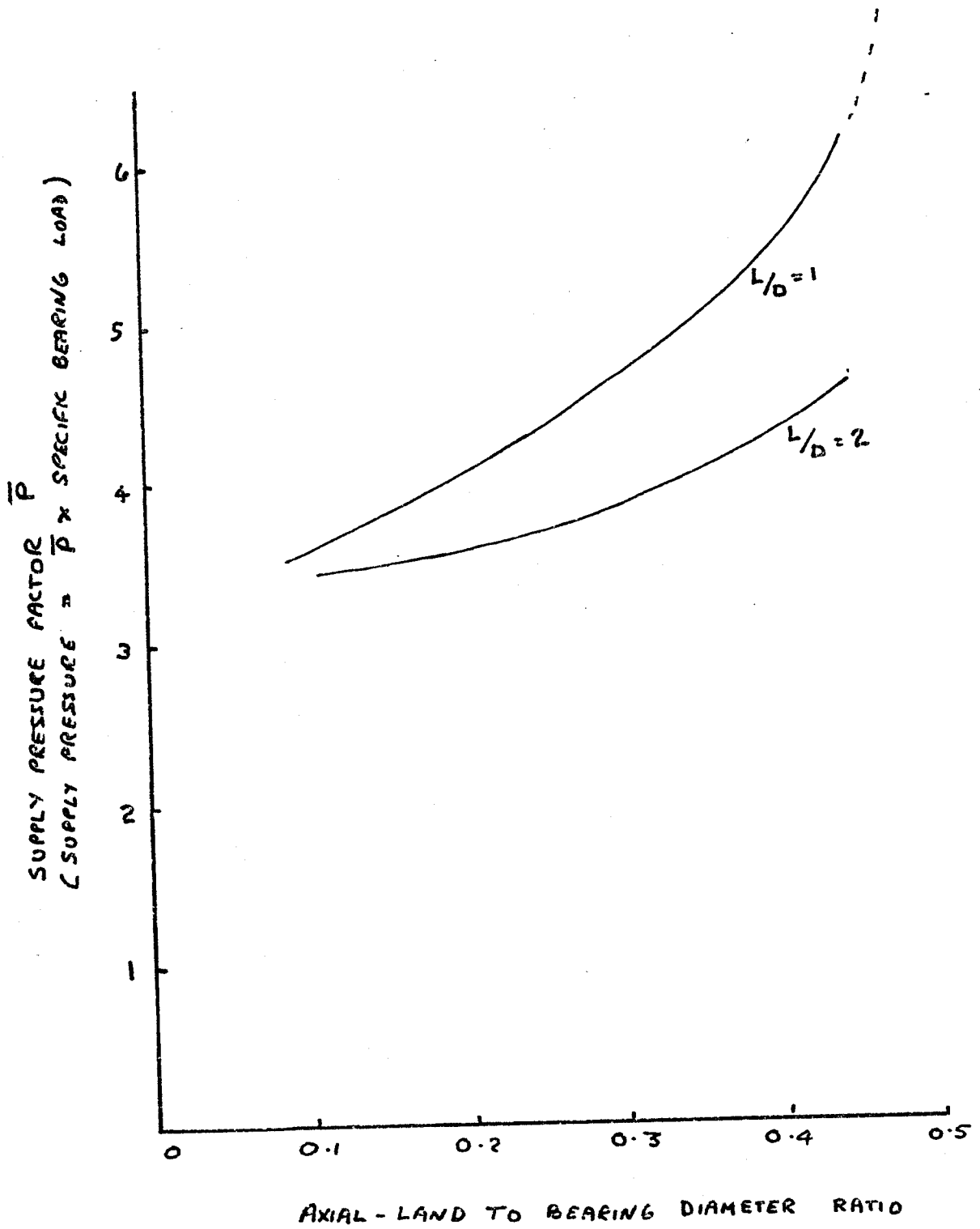

Assuming the highest shaft size and the lowest bearing size the resulting diametrial clearance will be .020". This size would easily accommodate shaft deflexion of .007". Even lower clearances seem possible and it will be shown that a reduction to .0005 inch per inch clearance may be desirable in some cases if only to reduce lubricant flow. The use of Fig. 43 is to determine preliminary clearances which may require some modification as design proceeds.

13.3. Supply Pressure

It is common practice to specify bearing load in terms of specific bearing pressure (i.e. total load \div total bearing projected area) Fig. 44 has been produced to enable the designer to link bearing pressure to supply pressure. This pressure has been based upon the O'Donoghue & Rowe data. (19)

Two cases are given (a) L/D ratio equal to unity, accepted as the optimum ratio in most cases and (b) L/D = 2 which satisfies classification society rules. Bearings with L/D = 2 require two sets of slots to impart lateral stability. If as is sometimes the case these two rows of slots are separated by a circumferential exhaust slot then pressures should be determined as if two "square" bearings were mounted side by side.

Lubricant flow is reduced if no circumferential slot is used since not only is the pocket pressure reduced but only two instead of 4 leakage paths are present.

In preparing the graphs the axial land length has been expressed as a fraction of diameter so that any ratio represents a land of similar absolute size when comparing an L/D 1 bearing (or 2 x L/D 1) and L/D = 2 bearings.

Once bearing load, diameter and land length have been determined supply pressure may be read directly from this graph. Alternatively when limitations are placed upon supply pressure then land length can be ascertained.

13.4 Lubricant Flow

When a viscous fluid flows between parallel plate the flow per unit of width is given by:

$$q = \frac{-dp}{dx} \frac{h^3}{12\mu} \quad \text{where } h \text{ is the distance between the}$$

plates and μ is the viscosity of the fluid.

If we assume that the shaft is centrally situated in a bearing then for a radial clearance c , an axial land width "a" and a pocket pressure " P_p " the flow from one end of the bearing will be given by:

$$\frac{P_p}{a} \frac{c^3}{12\mu} \pi D$$

since flow is from both ends the total flow is double this i.e.

$$\frac{P_p}{a} \frac{c^3}{6\mu} \pi D$$

The basic design of bearing has used an L/D of unity and "a" has been expressed as a fraction of L. If $a = yL$ and if Q is converted to gallons per minute the pressure flow relationship becomes:

$$Q = \frac{p c^3}{\mu y} \times (0.114) \text{ g.p.m.}$$

where p = pocket pressure in p.s.i.

μ = viscosity in Reyn

c = radial clearance in inches

Flow can now be defined as pocket pressure multiplied by a factor which varies with bearing size. Using the clearance specified in Fig. 43 this flow factor has been plotted in Fig. 45 to a base of shaft diameter for bearings of $L/D = 1$. It is shown for a series of land/length ratios and also for two fluids; water at 1.5×10^{-7} Reyn viscosity and Esso Mar 85 a typical stern bearing oil at a viscosity of 4.5×10^{-6} Reyn (temperature of oil assumed to be 90°F). To find flow the designer needs to determine pocket pressure from the supply pressure in Fig. 44 and merely multiply by the flow factor in Fig. 45.

It seems likely that early designs of bearing will be limited to about 100 p.s.i. specific load. To achieve such low loadings a bearing of a total length of two diameters will be required in most cases although some smaller cargo vessels (less than 10,000 tons gross) may achieve such loadings with $L/D = 1$. The total length of two diameters may be achieved by using two $L/D = 1$ bearings separated by an exhaust slot or may use an $L/D = 2$ bearing with two pockets and no separating slot.

In order to cover the range of cases envisaged, four graphs have been plotted.

- (1) $L/D = 1$ water lubricated, flow plotted against diameter assuming 100 p.s.i. load (Fig. 46)
- (2) $L/D = 2$ water lubricated, flow plotted against diameter assuming 100 p.s.i. load (Fig. 47)

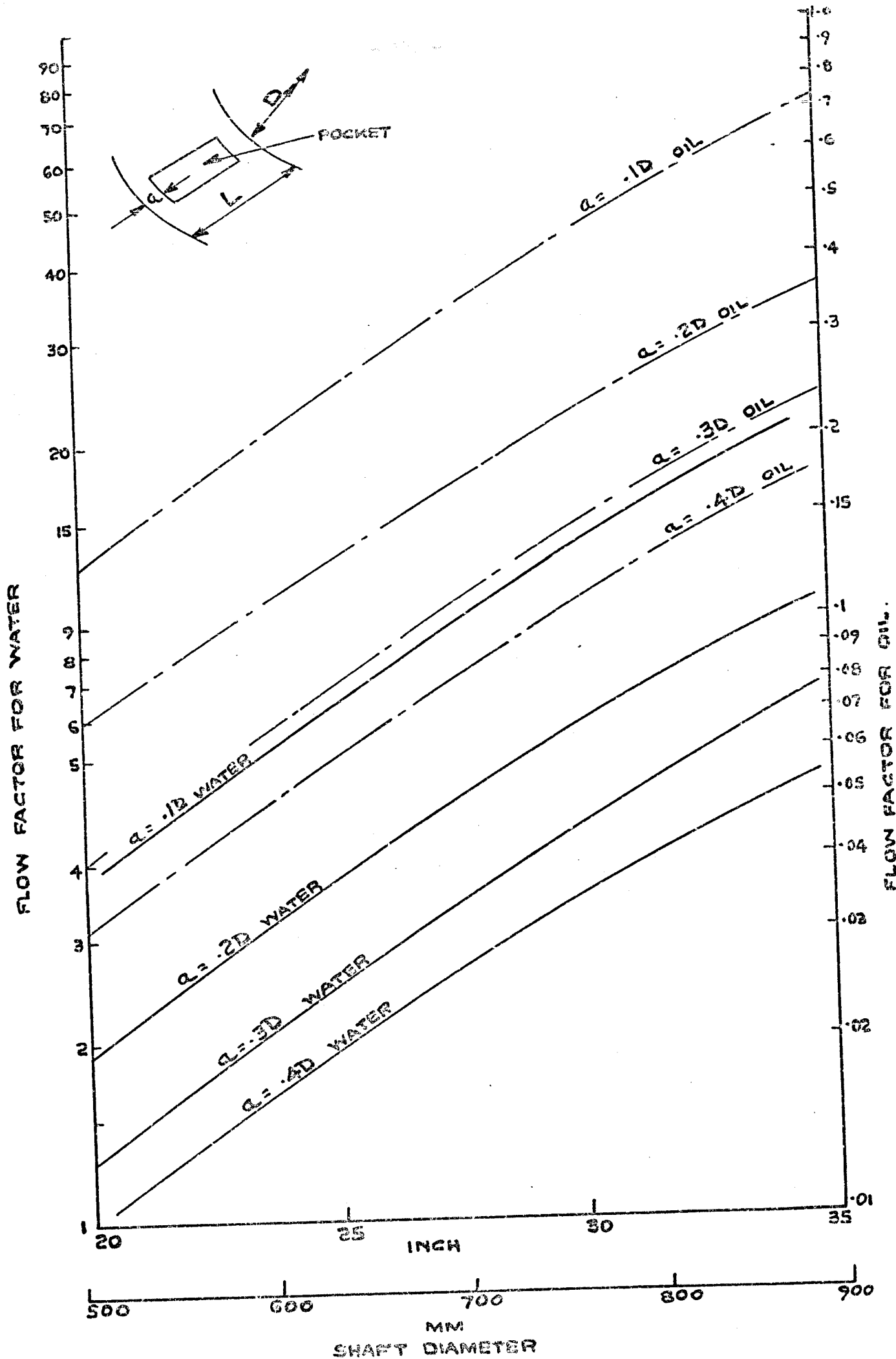

FLOW FACTOR V SHAFT DIAMETER.

- (3) L/D = 1 oil lubricated with Esso Mar 85, flow plotted against diameter assuming 100 p.s.i. load (Fig. 48)
- (4) L/D = 2 oil lubricated with Esso Mar 85, flow plotted against diameter assuming 100 p.s.i. load (Fig. 49)

It can be seen that when water is used as the lubricant very high flows are required if the recommended clearances of .0008" per inch diameter are used. This is particularly so if two square bearings are used when the water flow shown on the L/D = 1 graph would require doubling.

However, by reducing clearance ratio to .0005, it is suggested that acceptable flows can be achieved for shaft sizes up to 25" diameter. This precludes the largest tankers and such clearances are nearing acceptable marine engineering limits.

With a "full" L/D = 2 bearings and recommended clearance water flows are reduced but even so, tighter than normal clearances would be required. Overall it is felt that only by using a bearing of total length of one diameter and using a tight clearance can a case be made for using a water lubricated bearing for a large bulk carrier (say 30" shaft)

It must be conceded however that at the present time it is unlikely that the average marine engine works would be prepared to work to the tolerances required.

Figs. 48 and 49 show oil flows to be reasonable over the entire shaft diameter range. Depending upon the type of design selected oil flows range from about 20 to 40 g.p.m. for a typical 35 inch diameter bearing.

At the present time the specified oil flow for a hydrodynamic stern bearing of similar size is about 40 g.p.m.

Since at this diameter water lubrication is unlikely to appeal to the shipbuilder on grounds of high pumping rates, it can be seen that for the same pumping cost and basic bearing system cost a considerable increase in stiffness and reliability is possible by utilising hydrostatic bearings.

13.5 Power Loss

With design curves for stiffness, pressure and flow available in various forms the only remaining design requirement is to specify power loss in the bearing. The shearing of the lubricant in the pockets will have negligible effect on the torque resisting the turning of the shaft. This will almost entirely consist of the shearing loss on the lands.

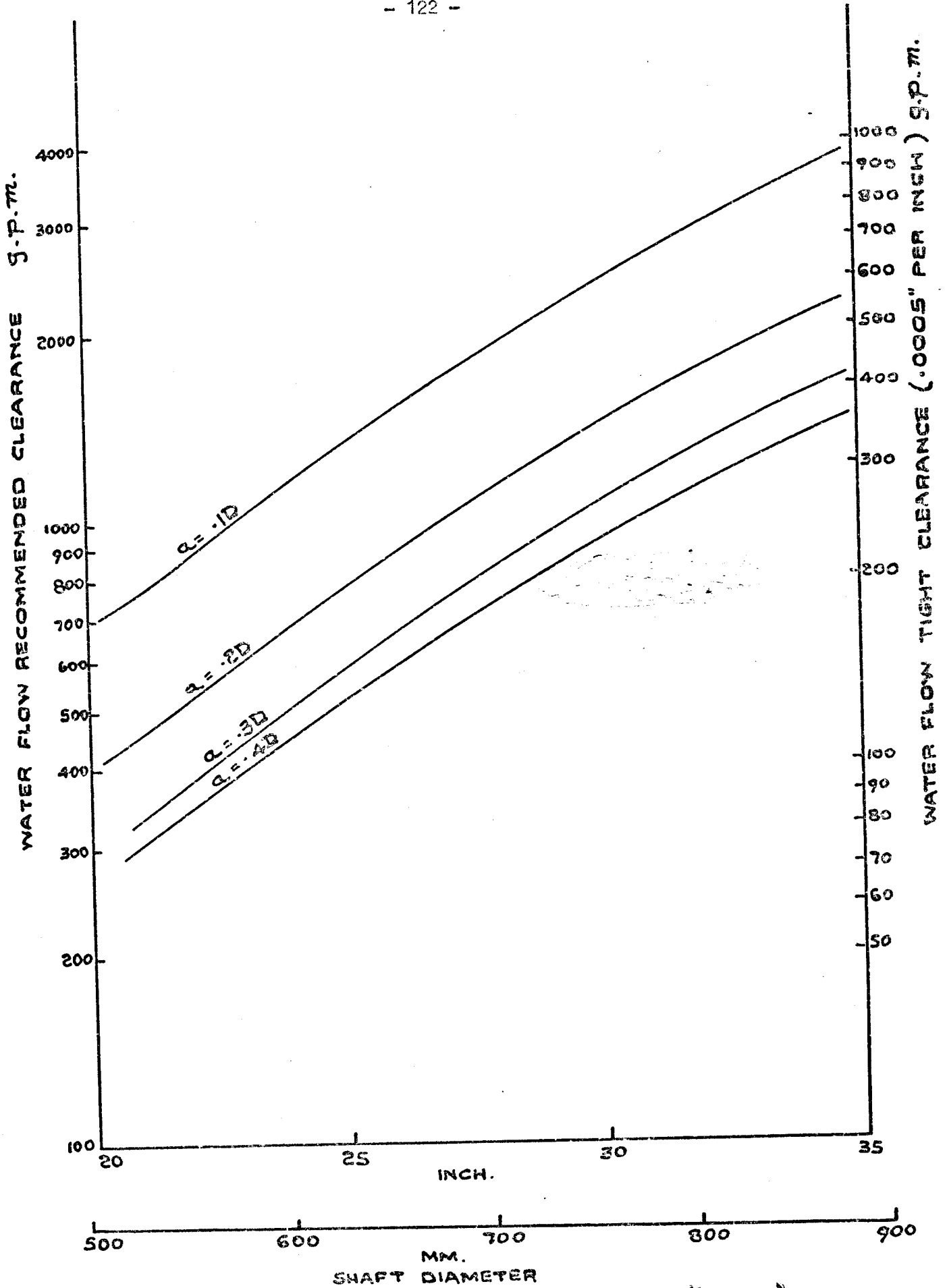

WATER FLOW PER 100 P.S.I. LOAD. ($L/D = 1$)

FIG. 46

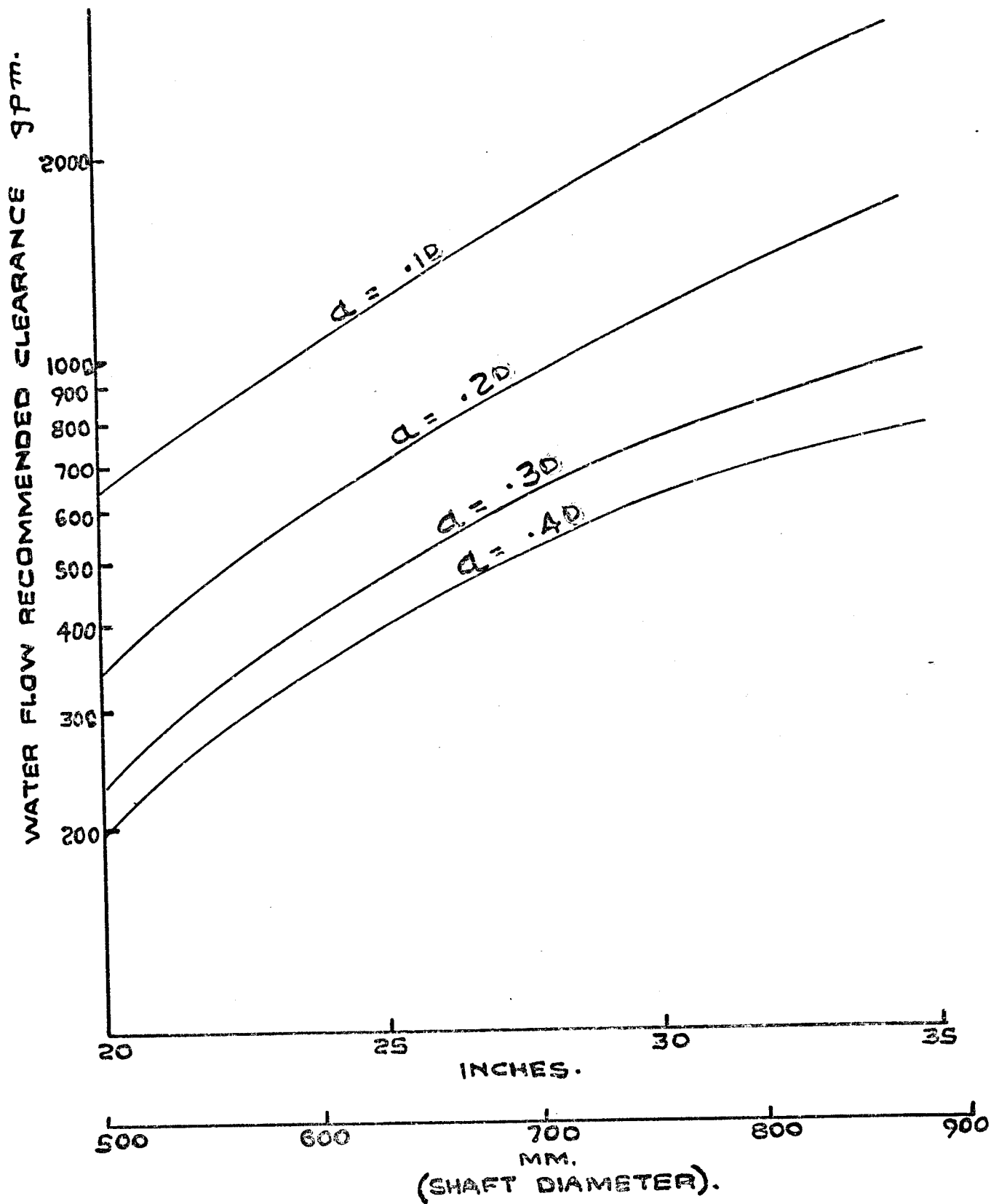

WATER FLOW FOR 100 ψ si LOAD ($L/D = 2$).

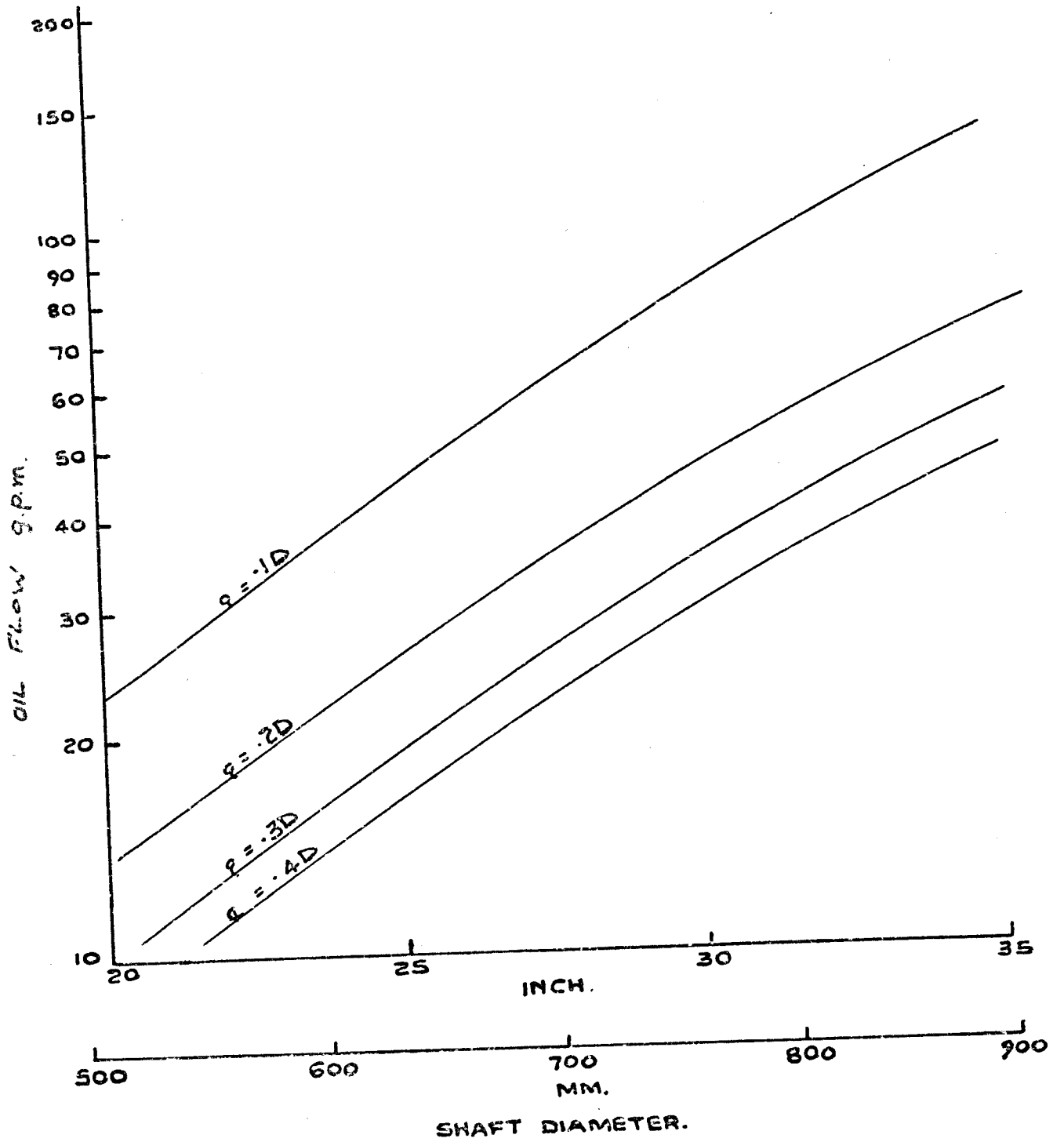

OIL FLOW PER 100 P.S.I. BEARING LOAD. ($\frac{1}{D}=1$)

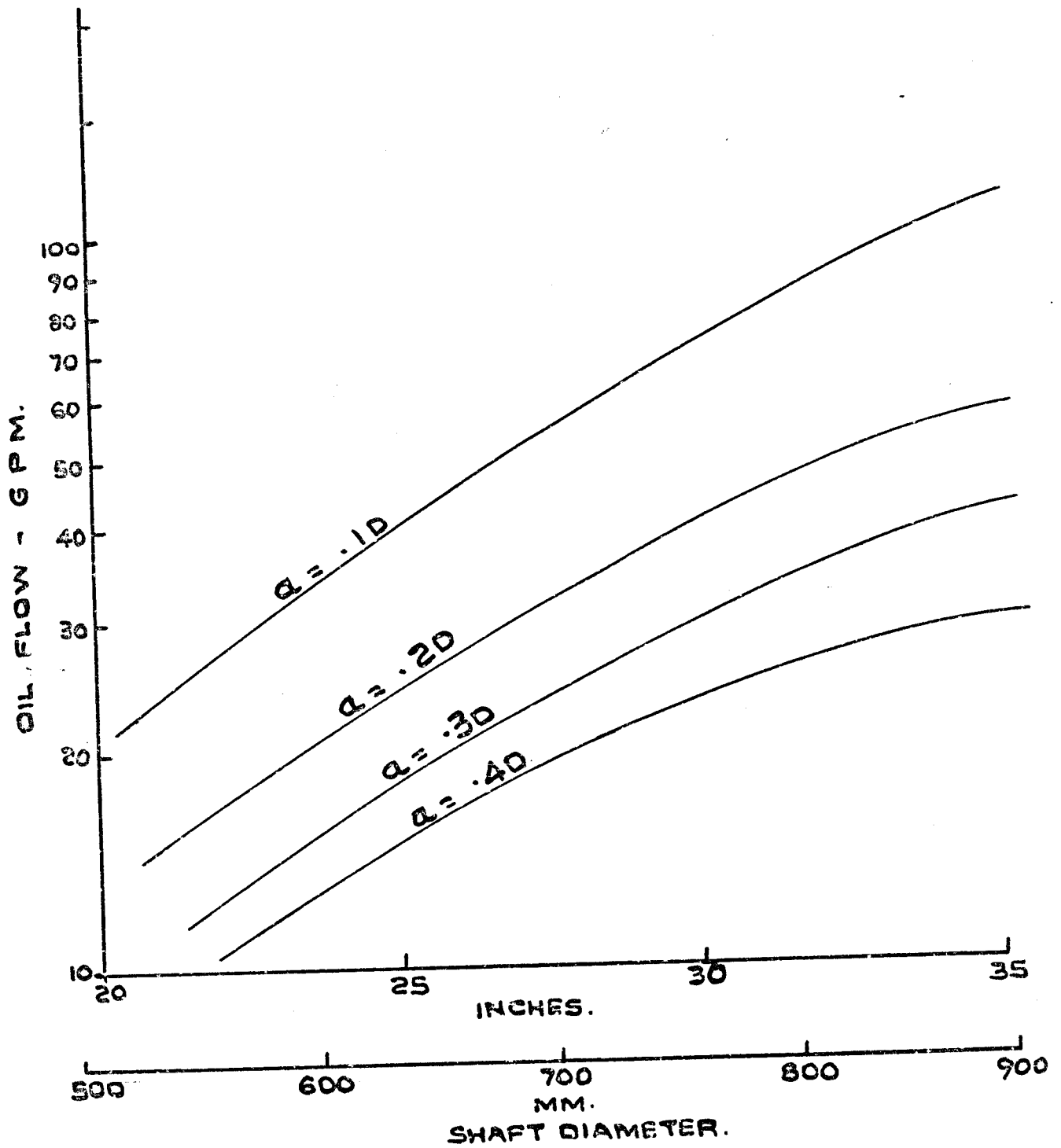

OIL FLOW PER 100 ψ s² BEARING LOAD
FOR $L/D = 2$.

FIG. 49

If a centrally running shaft is assumed then Petrof's law defines torque.

$$\text{Torque} = \frac{\mu_R U}{C} \quad \text{X wetted area}$$

which reduces to

$$4.15 \frac{\mu D^3 L N^2}{d} \quad \text{X } 10^{-7} \text{ H.P.}$$

where "d" is diametral clearance.

This gives a typical power loss of 1 HP for a 33" stern bearing using a clearance ratio of .0008.

13.6 Dynamic Characteristics

Several authors referred to earlier show that tail-shaft resonance is a practical possibility. The increased stiffness possible with the tail-shaft bearing proposed renders this less likely.

Referring to Fig. 36 it can be seen that the film stiffness of the proposed .0008 clearance ratio hydrostatic bearing is about three times the stiffness of the alternative plain hydrodynamic stern bearing. The stiffness ranges from 3×10^7 lb/in at 20 inch diameter to 45×10^7 lb/in at 30 inch.

Overall system stiffness is probably more significant but this unfortunately cannot be calculated for the general case. Taking the case of the 30" diameter shaft referred to above and assuming the bearing point of support to be 250" from the encastré position the shaft stiffness would be derived from the general deflexion equation of $y = \frac{WL^3}{3EI}$

$$\text{i.e. stiffness } \frac{W}{y} = \frac{3EI}{L^3}$$

which gives a stiffness of 2.35×10^5 lb. per inch. In this case then the bearing stiffness is of such a higher degree of magnitude than the shaft stiffness that, when considering shaft movement, only this needs to be taken into account. Since the system is approximately 3 times stiffer than the amplitude of the tail-shaft movement under the transverse propeller loads is reduced by this factor.

14. DESIGN DATA FOR JACKING SYSTEMS

As has been indicated previously jacking oil systems guarantee satisfactory operation of stern bearings at low speeds. These low speeds will occur when manœuvring in and out of port, approaching moorings or when the vessel is on turning gear.

It is probably this latter condition which is the most serious from a wear standpoint.

In order to prevent rotor damage, all steam turbine machinery is rotated after use while it cools down. A minimum recommended period is six hours but in the case of tankers and container ships it is standard practice to keep the engine turning for the entire period in port (12 to 24 hours).

Tankers at single buoy moorings do not engage turning gear but periodically turn the engines on live steam. This is done to maintain turbine readiness in case of emergency and also to keep the vessel headed to the buoy under adverse weather conditions.

To prevent wear during this type of operation a simple jacking system is adequate. Fig. (50) shows the system proposed by Hill which uses a system of four admission slots. A two slot system would have the advantage of causing less interference with the generation of a hydrodynamic film and for this reason axial slots each one quarter the length of the bearing and situated at each end of the bearing are proposed as being suitable jacking oil admission pockets. Fig. 51 shows their situation. Each is connected to a constant volume (positive displacement) pump.

Using the jacking oil system proposed by Fuller (34) (a method in regular use by bearing manufacturers) such a system would require a pocket pressure of four times the bearing specific load when the pocket proportions proposed above are used (i.e. for the normal maximum load on a stern bearing pocket pressure requires to be 360 p.s.i.) Fig. (52) has been prepared to show the oil flows to be expected from such a system. In the preparation of this graph a film thickness of 0.007 inches has been assumed for a shaft of 33" diameter and films for other diameters have been proportioned.

The basis of this assumption has been to just prevent end contact when the shaft is bent into a catenary under the weight of the propeller.

Two slots are required for lateral stability, but even if only one pump were operational the lift obtained and the presence of lubricant in the loaded area would undoubtedly reduce turning gear wear. In view of this plus the fact that the device is not in regular use during voyage and also that catastrophic failure is unlikely to occur if the jacking oil is not supplied for a short period a duplex pump system is not considered necessary.

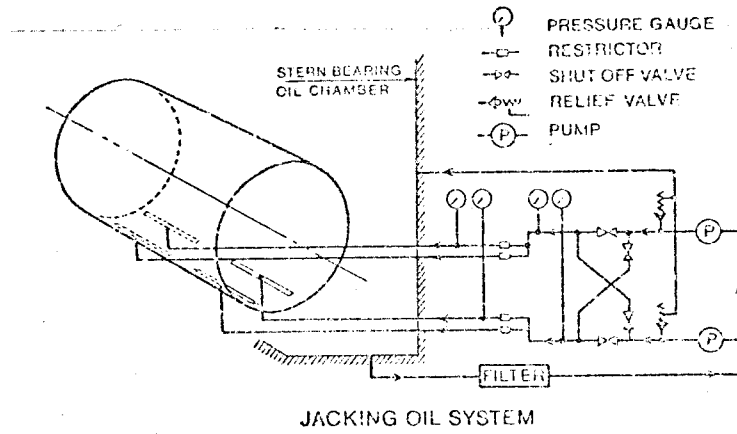

JACKING SYSTEM PROPOSED BY HILL
FIG. 50

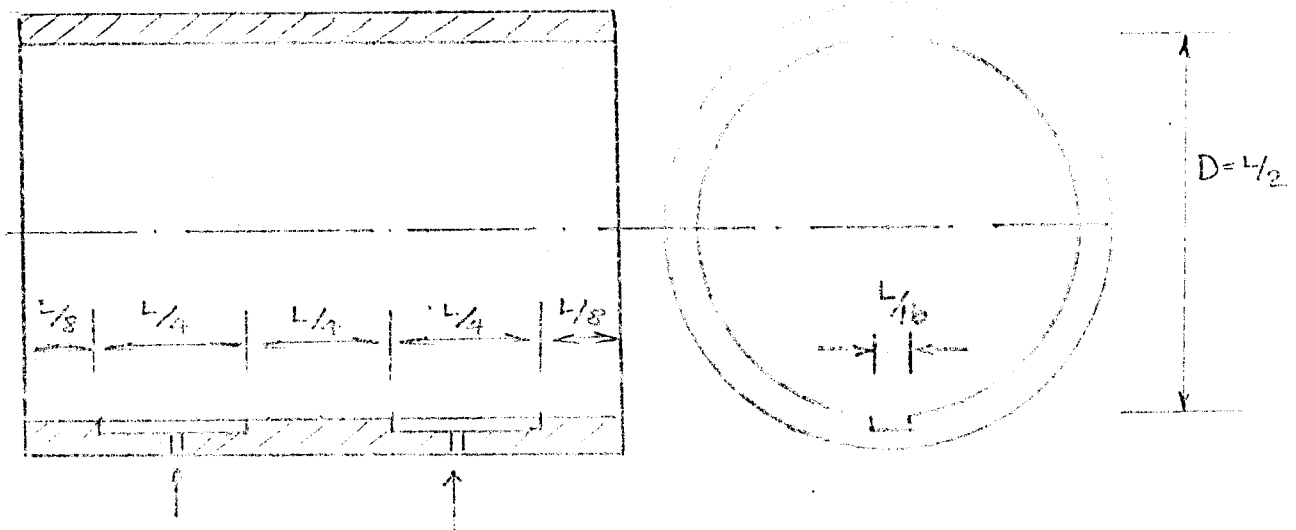

DIMENSIONS OF TWO SLOT TAPER SYSTEM

FIG. 51

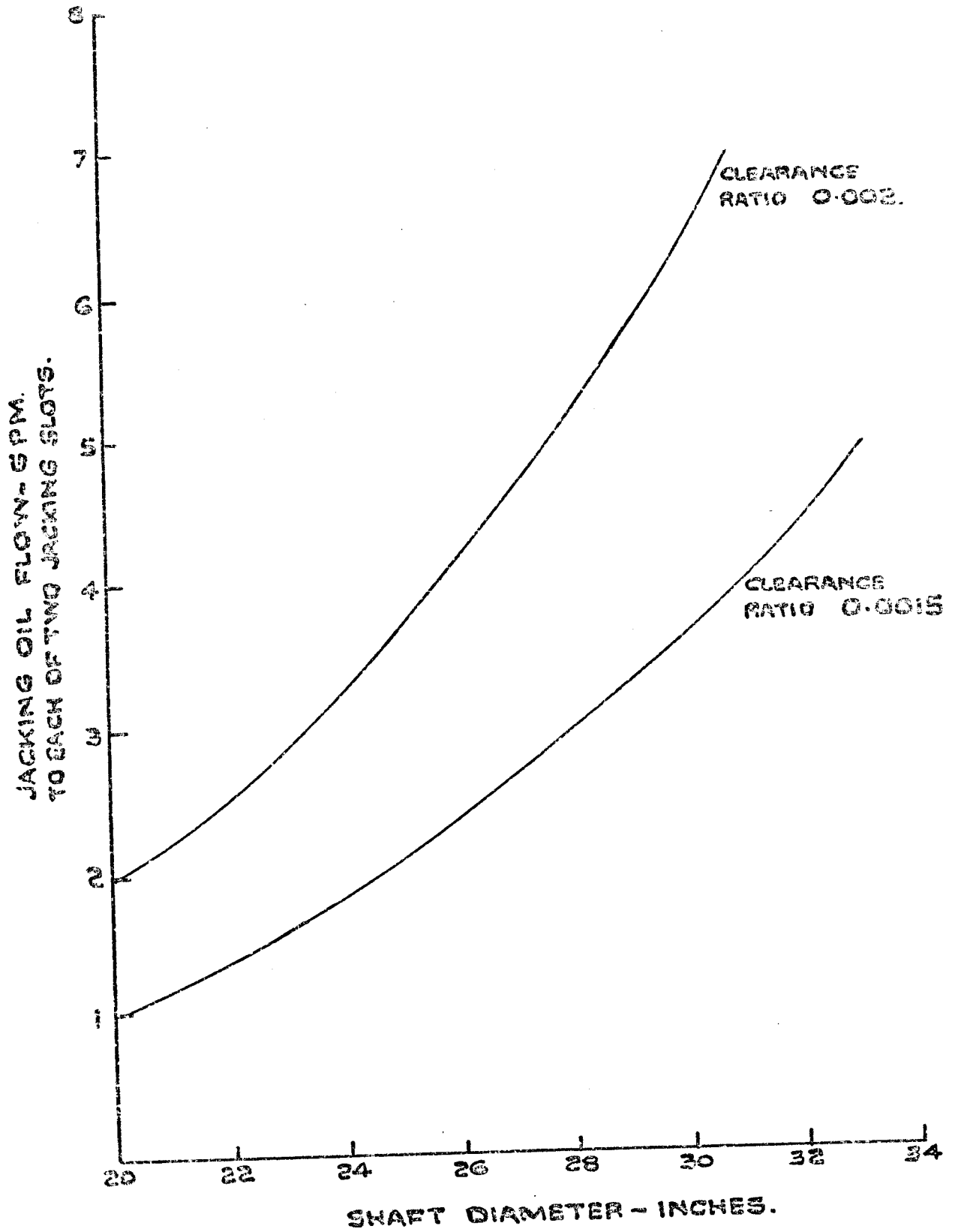

GUIDE TO JACKING OIL FLOW.

FIG. 52

15. TYPICAL DESIGNS

Three designs will be outlined to show the application of the design charts. These will be for the following ships:

- (i) Medium lined cargo vessel, shaft diameter 20".
- (ii) Fine lined fast tanker, 20" shaft.
- (iii) Full bodied bulk carrier, 33" shaft.

15.1 Medium Lined Cargo Vessels

The after lines of this type of vessel are such that as little diametral space as possible needs to be taken up by the stern bearing. For this reason an unsplit bearing is proposed.

Section 2.2 indicates that in the full away condition the load on the stern bearing of such a ship is a little over half the nominal static load. At turning gear speeds and slow ahead the stern bearing load will be the same as the static load.

With L/D ratio of 2 for the entire stern bearing it is unlikely that 20" shafting will be loaded to the maximum of 90 p.s.i. and a load of 75 p.s.i. is realistic. This is then taken as the basis of design:-

| | | |
|----------|---|---------------------------------------|
| Diameter | - | 20" |
| Length | - | 40" |
| Load | - | $20 \times 40 \times 75 = 60,000$ lb. |

Because wake induced loads are at a minimum with this type of ship optimisation of stiffness characteristics is not the major consideration and the general basis of axial lands equal to .25 the diameter will be taken. In his 1973 paper (35) Rose proposed two sets of pockets separated by an exhaust slot, in effect producing two bearings of $L/D = 1$ in the tube. For a land length of .25D Fig. 44 shows that the supply pressure needs to be 4.4 x the specific load i.e. in this case the supply pressure should be:

$$75 \times 4.4 = 330 \text{ p.s.i.}$$

Clearance is based upon a ratio of .0008 hence the diametral clearance will be a nominal .016".

Water flow using this clearance is 350 g.p.m. for one bush but is reduced to 80 g.p.m. with a tight clearance of .0005 inch per inch.

Using the tighter clearance a total of 160 g.p.m. is called for and this is the final recommended clearance.

It is not felt necessary to vary water flows to the stern bearing of this type of vessel so simple orifices in the pockets are proposed. Since a pocket to supply pressure ratio of 0.5 is aimed for the orifice needs to reduce a flow of $(160 - 12) = 148$ g.p.m. (6 pockets per half bush) from 330 p.s.i. to 165 p.s.i. Orifice flow $Q = C_d \sqrt{2gH}$ and from this an orifice diameter of 0.255" with a coefficient of discharge of 0.6 is required. Rounding off to imperial drill sizes gives the choice of $\frac{1}{4}$ or 17/64 inch, the latter giving an increased pocket to supply ratio and a slightly stiffer bearing.

A bronze bushing is recommended with a resin coated tail-shaft.

In construction a double tube has been proposed in which an annular space between the manifolds forms the pressure manifold. Pockets are machined in the bore while still in the boring machine and form a series of arcs within the bore. Water supply is to the manifolds and passes through the after peak. The water supply piping needs to be austenitic steel; 3" bore is suggested which will have a pressure drop of about 20 p.s.i. per 100 ft. About 50 ft. of piping will be needed so pump pressure will be 340 p.s.i.

Fig. 53 has been prepared to show the details of this stern arrangement.

It will be noted that no outboard seal is required. However a 40 ft. head of water will exist outside the bearing due to propeller submersion so it is necessary that this extra pressure be supplied.

Final pump pressure needs to be 360 p.s.i.

A seven stage centrifugal pump such as the high speed Mather and Platt 2 $\frac{1}{2}$ " Plurovane Pump is suggested for the duty.

Overall length of the pump is 41 inches, it is 20 inches high and 20 inches wide. Pumping power will be 42 HP.

If an L/D of 2 is used and the pockets are not separated by an exhaust slot not only is pumping pressure and flow reduced but a much simpler and cheaper bearing results.

This is shown in Fig. 54.

Reference to Fig. 44 shows the supply pressure factor to be 3.5 resulting in a supply pressure of 262 p.s.i.

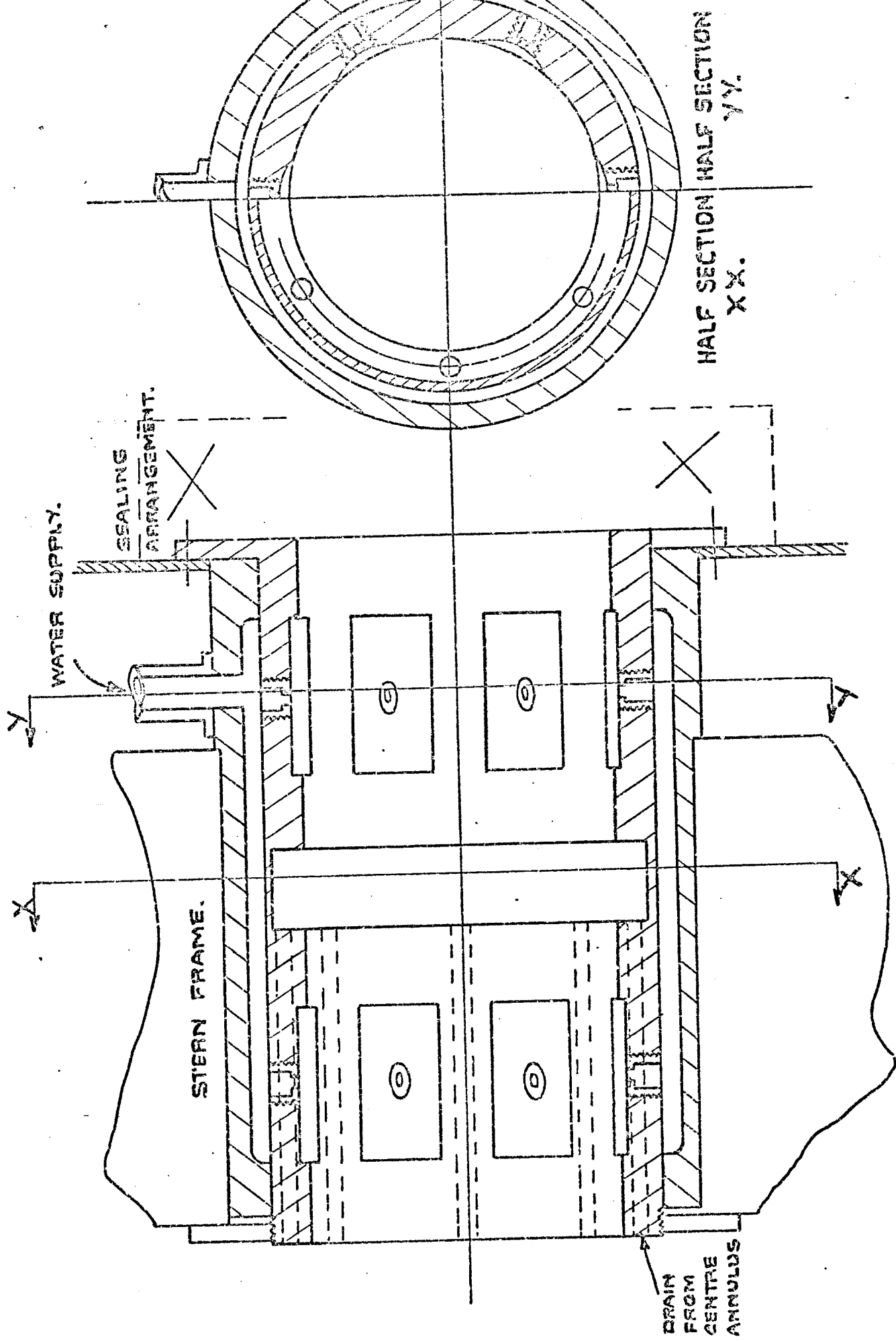

WATER-LUBRICATED HYDROSTATIC STERN-BEARING WITH CENTRAL ANNULAR SPACE

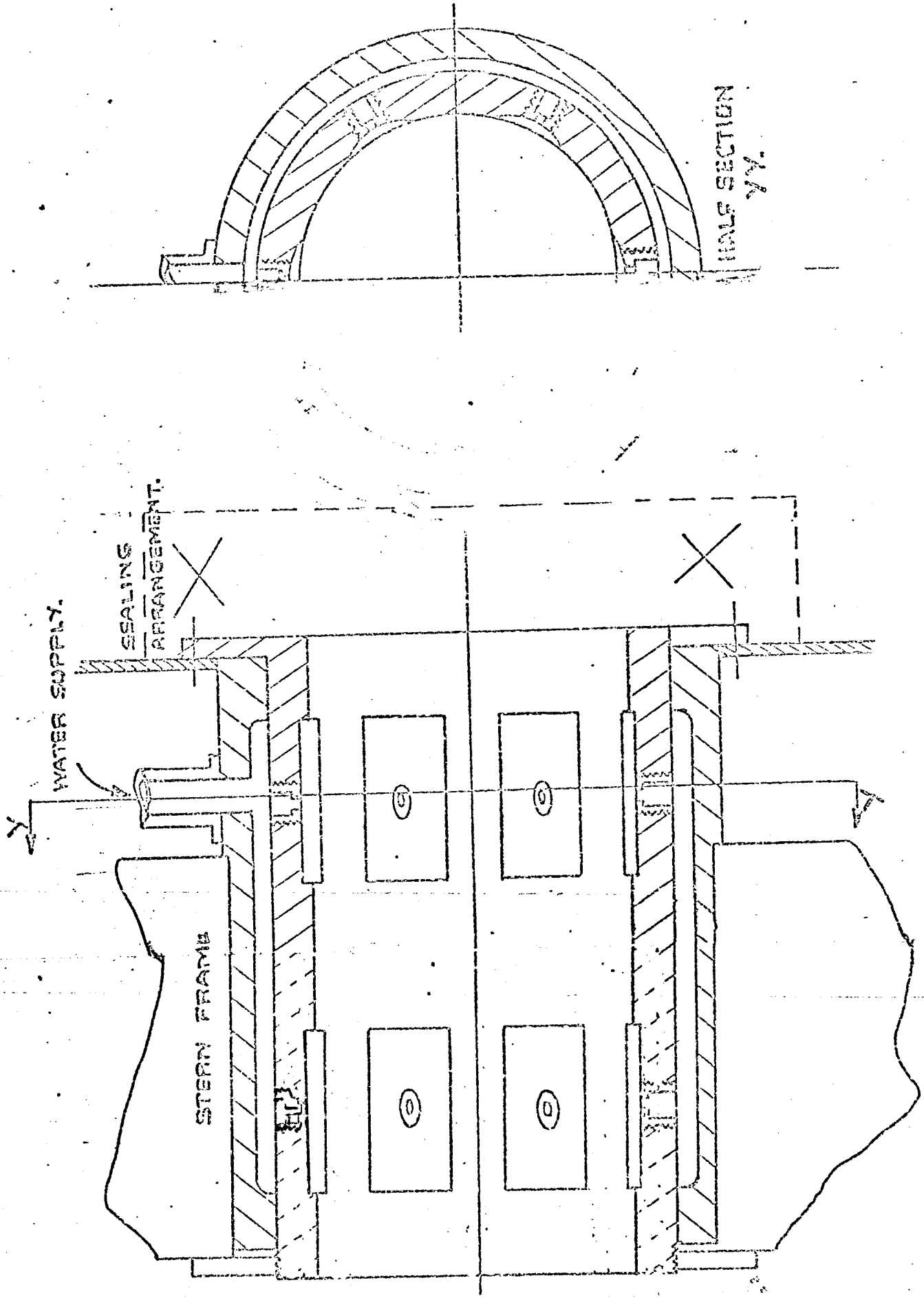

PREFERRED DESIGN OF WATER LUBRICATED STERN BEARING FIG. 54

If the higher clearance ratio of .0008 is maintained giving a .016 inch diametrical clearance water flow is still high at 300 g.p.m. even though much less than the total of 700 g.p.m. for the circumferential slot design. It is again felt necessary to reduce the clearance but rather than going to the .0005 clearance ratio a ratio of .00065 (diametrical clearance .013") is proposed reducing the flow to the 160 g.p.m., a total considered acceptable for the previous designs. Orifice size is $17/64$ inch. Pumping power is reduced to 40 H.P.

15.2 Fine Lined Fast Tanker

Here again space is at a premium because of the fine lines of the ship. Although the same size shafting is called for, the variation in load is higher than for the cargo ship and a load of 1.3 x static load must be catered for. The simplest means of doing this is to adopt the same design of bearing as before but to increase the supply pressure. This in turn will increase the flow by the same ratio.

The force variations are higher for this type of vessel and hence a correspondingly stiffer bearing is called for. Again this can be achieved simply by increasing the supply pressure since stiffness of hydrostatic journal bearings is directly proportional to supply pressure.

Using the same basic bearing dimensions as before the pump pressure needs to be 460 p.s.i. and the water flow 210 g.p.m.

A 3" Flurovane pump is suggested for this duty with 8 stages. Overall length of this pump will be 56 inches.

15.3 Full Bodied Bulk Carrier

As shown earlier the load on the stern bearing of a full bodied bulk carrier varies in the range $\pm 125\%$ of the static load at a frequency of 5 x propeller speed (assuming five bladed propeller).

A typical load on such a bearing is equivalent to 86 p.s.i. over the projected area hence the design load needs to be 106 p.s.i.

Stiffness is a design criteria with this bearing but lubricant flow needs to be kept as low as is reasonable. Oil will have to be the lubricant. A

reduction in axial land length increases stiffness but also increases flow.

A land of 5" will give a flow 70 g.p.m. from each of a pair of bearings in the stern bush.

This figure is on the high side for a gear pump and it is suggested that the land be increased to 6.6" reducing the total flow to 100 g.p.m. Supply pressure (Fig.44) will need to be 350 p.s.i. Stiffness is increased (at the expense of power consumed) when the lands between the pockets are increased. This feature being shown in Fig. 42 If a six inch wide pocket is chosen the land width between pockets becomes approximately 10" and the ratio of flows becomes unity i.e. a stiffness parameter of 1.1 when a pocket pressure of half supply pressure is used. Clearance ratio of .0008 is to be used giving a diametral clearance of .026". Because of the extra space available and the service advantages of split stern gear there seems to be some advantage in incorporating the hydrostatic principle into one of the proprietary split stern bushes. This has the added advantage of allowing external piping to the stern bearing and thus giving space to fit control valves rather than simple orifices. Pocket pressure ratio is then to some extent controllable. The valves should be modified to ensure that they cannot completely cut off lubricant supply. If orifices are used their diameter needs to be 1/8". Fig. 55 shows the machining requirements for the bore of the bearing and also the means of fixing orifices.

Fig. 56 shows the simplification to be obtained by dispensing with the central circumferential groove.

Total flow is reduced to 47 g.p.m. while supply pressure can be reduced from 350 p.s.i. to 330 p.s.i. Pumping power is reduced from 26 to 23 H.P. Pump power required to supply the oil to the bearing will be approximately 26 HP. It has been argued earlier that short bearings ought to be more suitable for ships hydrostatic stern gear. The L/D ratios here used are those which at this time would find favour with classification societies.

If an L/D ratio of unity is to be used then supply pressure must be doubled. Lubricant flow will remain the same since only two end leakage paths will be present. The shorter bearing will permit closer clearances and if these can be manufactured then flow can be reduced and stiffness increased.

FORM PACKETS
BY BORING IN
5" DIAM. IN
CENTRE OF CASE
FROM BEARING
CENTRE BY 12.5"

PLUG INSERTED
BEFORE METALLING
BY DRILLED AFTER.

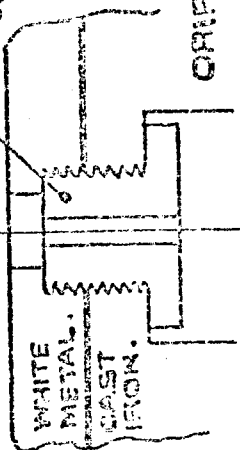
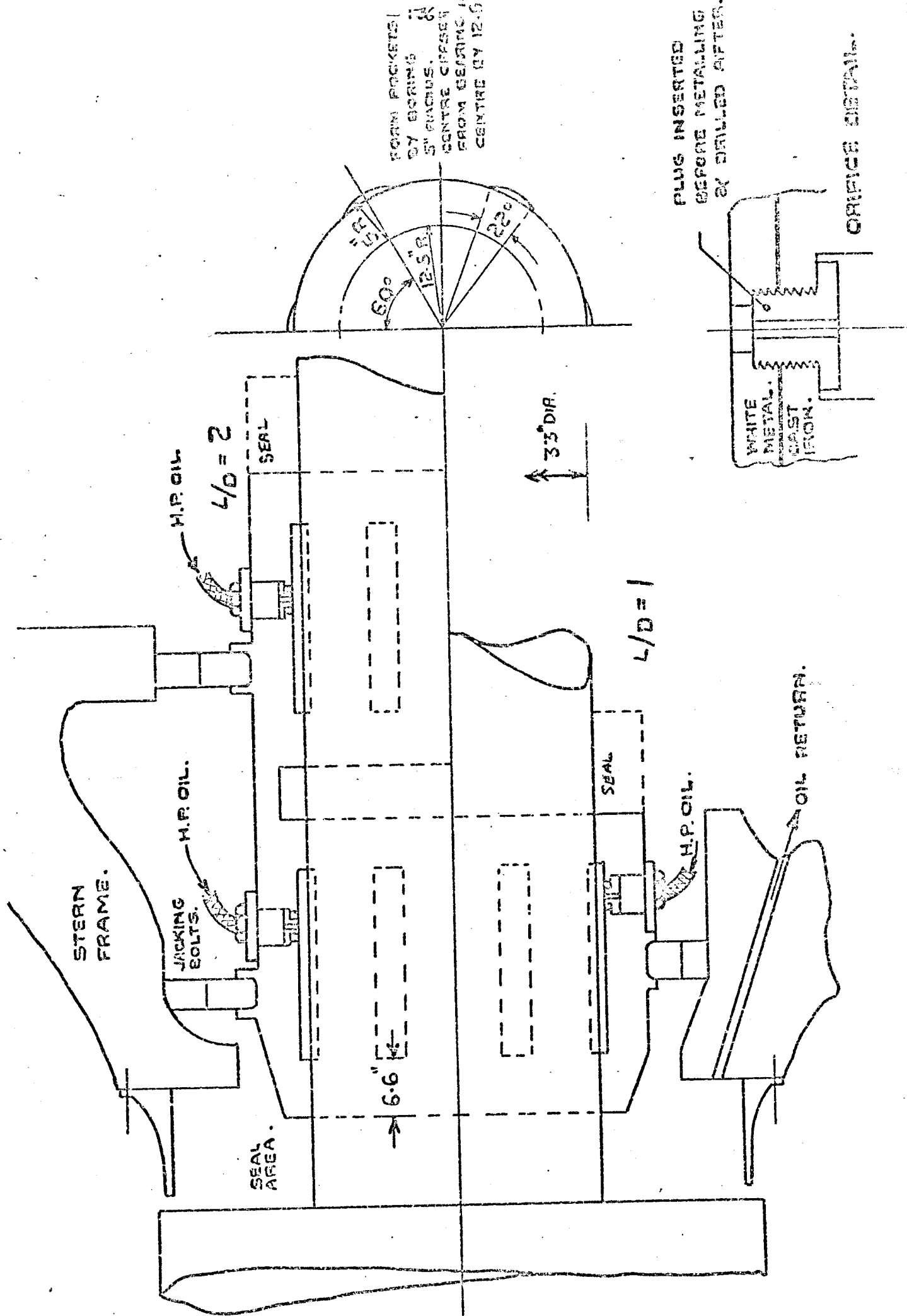

OIL LUBRICATED HYDROSTATIC STERN BEARINGS
ANNULAR SPACE ON $L/D=2$

FIG. 55

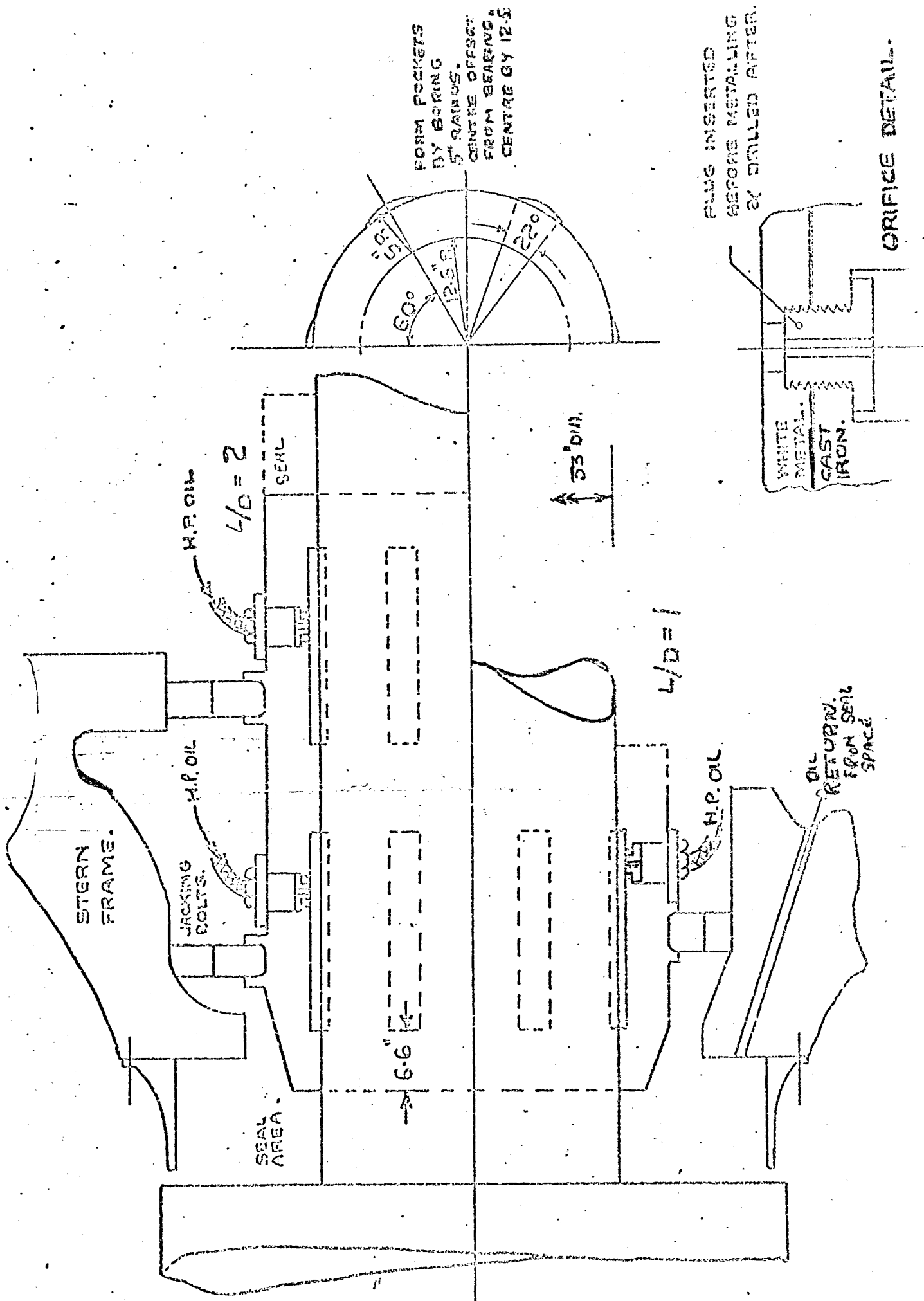

PREFERRED OIL LUBRICATED HYDROSTATIC STERN BEARING
 FIG. NO.

16. POWER REQUIREMENTS

The pumping requirements for the cases outlined above have been taken directly from pump manufacturers' charts. To these must be added the shearing losses within the bearing.

Using the Petroff law given in Section 12 the total power requirements for the hydrostatic bearings are given below.

(a) Pockets separated by annulus

| | | | |
|--------------|---------------|-----------------|-----------|
| Cargo Ship | 42 HP pumping | + 1 HP Friction | = 43 H.P. |
| Fast Tanker | 55 HP " | + 1 HP " | = 56 H.P. |
| Bulk Carrier | 26 HP pumping | + 2.7 Friction | = 29 H.P. |

(b) Preferred designs - Two Pocket ; no separation.

| | | | |
|--------------|---------------|-----------------|-----------|
| Cargo Ship | 40 HP pumping | + 1 HP Friction | = 41 H.P. |
| Fast Tanker | 50 HP " | + 1 HP Friction | = 51 H.P. |
| Bulk Carrier | 23 HP " | + 2.7 Friction | = 26 H.P. |

17. ECONOMIC APPRAISAL

Although a technical case can be made for the introduction of hydrostatic stern gear such a step can only be taken if economically sound. The bearings proposed will not only cost more for the bearing parts but will require more expensive ancillary equipment.

In order both to define the cost the bearing and its ancillary equipment Table VII has been prepared. This table compares, for each of three ship types, the original bearing and the suggested hydrostatic. In the case of the large bulk carrier both plain and split bushes are shown.

It will be noted that two lubricant supply pumps are shown. One is considered to be a standby. Rather than have switching mechanism to start the standby should the pressure drop to a certain limit, it is proposed that both hydrostatic pumps run in parallel each being capable of supplying the necessary lubricant flow. Examination of this chart shows that in one instance, that of the fast tanker, there is a first cost benefit in favour of the hydrostatic bearing. This is only so because it has been possible to use a water lubricated bearing in place of an oil bearing and dispense with a seal. When water lubricated bushes are replaced with water hydrostatic bearings there is almost a 50% increase in first cost. This needs to be offset against savings in maintenance. Even without the cavitation failures referred to earlier savings due to wear-down prevention would more than pay for the increase in first cost.

When oil lubricated bearings are replaced with oil hydrostatics the increase in cost is negligible, and are such that less than a days increased life for the bearing system would account for the difference in first cost.

It must be noted that the costs in table VII are not up to date and because of the present rapid changes in costs should be taken to be relative only.

| Ship Type | Cargo Ship | | | | Fast Tanker | | | Large Bulk Carrier | | | | | |
|-------------------------|---------------------|--------------------|-------------------|--------------------|-------------------|--------------------|---------------------------------|--------------------|-------------------|------------------|--------------------------------|-------------------|------------------|
| | 20" | | | | 20" | | | 33" | | | | | |
| Bearing Type | Water Hydro Dynamic | Water Hydro Static | Oil Hydro Dynamic | Water Hydro Static | Oil Hydro Dynamic | Water Hydro Static | Plain Bush Oil Hydro Dynamic | Oil Hydro Static | Oil Hydro Dynamic | Oil Hydro Static | Split Bush Oil Hydro Static | Oil Hydro Dynamic | Oil Hydro Static |
| Plain Bush | 1200 | 1200 | 1200 | 1200 | 1200 | 1200 | 4000 | 4500 | - | - | - | 4500 | - |
| Split Bush | - | - | - | - | - | - | - | - | - | - | - | 4500 | 5000 |
| Shaft Liner | 600 | 500 | 500 | 500 | 500 | 500 | - | - | - | - | - | - | - |
| Resin Coat | - | 2200 | - | 2600 | - | 2600 | - | 1200 | - | - | - | - | 1200 |
| High Pressure Pumps (2) | 1000 | - | 1300 | - | 1300 | - | 1300 | - | 900 | 900 | 1300 | 900 | 900 |
| Low Pressure Pumps (2) | - | - | 800 | - | 800 | - | 900 | 600 | 600 | 600 | 900 | 600 | 600 |
| Cooler | - | - | 500 | - | 500 | - | 2000 | 2000 | 2000 | 2000 | 2000 | 2000 | 2000 |
| Cooling water pump | - | - | 1200 | - | 1200 | - | 300 | 300 | 300 | 300 | 300 | 300 | 300 |
| Seal | - | 200 | 200 | 200 | 200 | 200 | 9100 | 9500 | 9500 | 9500 | 9500 | 9500 | 9500 |
| Filter | 2800 | 4100 | 5200 | 4500 | 5200 | 4500 | 9100 | 9500 | 9500 | 9500 | 9500 | 9500 | 9500 |
| TOTAL | | | | | | | | | | | | | |

£ - Sterling (1973)

COSTS
TABLE VII

18. CONCLUSION

Examination of stern bearing failures and existing designs has led to a proposal for the use of hydrostatic bearings for ship's stern gear.

It is postulated that such bearings will be more reliable in that damaging vibrations are contained and wear at low speeds is prevented.

Design charts are given and bearings for typical ships have been presented.

A simplified economic appraisal shows in most cases the first cost of the hydrostatic is higher than the bearing it replaces but that this cost is more than offset by reduced maintenance costs.

Design charts are also given for enable jacking oil system to be fitted to conventional stern bushes. The provision of such systems considerably reduces wear at low speeds and their systems are likely to be in service operation within the next two or three years.

REFERENCES

1. ARCHER S. Contribution to: Hill, Stern Gear Design for Maximum Reliability. Trans.1 Mar.E. 1972
2. ASHANABE G. Theoretical and Experimental Investigation on
AKANOSHI M. Stern Tube Bearing Lubrication - Technical
MATSUNOBU T. Review, Mitsubiski Heavy Industries.
3. Bulletin De Bureau Veritas
4. BURKE A.E. & NEALE M. A method of Designing Journal Bearings for steady loads. Proc. 1. Mech.E. Conference Lubrication and Wear 1957.
5. CAMERON A. Principles of Lubrication, Longmans 1966.
6. CAMERON A. Basic Lubrication Theory, Longmans 1971.
7. CAMPBELL & LASKEY. Stern Gear Design for High Powered Single Screw Tankers and Bulk Carriers. Trans. I. Mar.E. Canadian Division Supplement 1963.
8. COUCHMAN A.A.J. Contribution to Rose - Marine Bearings Trans.I. Mar.E. 1967.
9. CROMBIE & CLAY An improved stern bearing system. Designs features and operating experience with Turbull Split Stern Bearings. Trans. I. Mar.E. 1972
10. ELWELL R. & FINDLAY Design of Pivoted Pad Journal Bearings. Trans. ASMF 1968
11. HOSHINO & KUME Propeller Excited Bending Moments in the Propeller Shaft. Proceedings 1.M.A.S. Conference Trans.I. Mar. 1969.
12. HILL A. Stern Gear Design for Maximum Reliability Trans.I. Mar.E. 1972.
13. JASPER Vibrations of Propulsion Shafting System. Trans. SNAME 1949.
14. KOONS Stern Bearings and Seal Failures Trans.I. Mar.E. 1971.
15. Lloyds List.

16. MANSFIELD Contributions to Hill - Stern Gear Design for Maximum Reliability Trans. I. Mar.E. 1972.
17. MILNE Contribution to Hill Stern Gear Design for Maximum Reliability. Trans.I. Mar.E. 1972.
18. MOTT I.K. & FLEETING R. Design aspects of Marine Propulsion Shafting Systems. Trans. I. Mar.E. 1967.
19. O'DONOGHUE J.P. & ROWE W.I. Hydrostatic Bearing Design, Tribology Feb. 1969.
20. PANAGOPALUS E. Design Stage Calculations of Torsional, Axial and Lateral Vibration of Marine Shafting. Trans. SNAME 1950.
21. RAIMONDI A.A. & BOYD J. Applying Bearing Theory To Analysis and Design of Journal Bearings J. Appl. Mech. 1951.
22. ROSE A. Marine Bearings Trans. I. Mar.E. 1967.
23. ROSE A. Contribution to Koons, Stern Bearings and Seal Failures Trans. I. Mar.E. 1971.
24. ROSE A. Contribution to Sinclair Emerson & Milne, Propulsion of a Million Ton Tanker. Trans.I. Mar.E. 1971.
25. RICKLEY S.S. & BJORK J.A. Oil Film Roll Neck Bearing characteristics in the Rolling Process. Proc. Conference Tribology in Iron & Steel Works, Iron Steel Inst. 1969.
26. SINCLAIR L. EMERSON A. MILNE P. The Propulsion of a Million Ton Tanker. Trans. I. Mar.E. 1971.
27. SINCLAIR L. & EMERSON A. The Design and Development of Propellers for High Powered Merchant Vessels. Trans.I. Mar.E. 1968.
28. TSANKONAS S. BRISLIN S. MILLEKI M. Correlation and Application of an Unsteady Flow Theory for Propeller Forces. Trans. SNAME 1967.
29. VEDELER A. Operational Problems with Stern Tube Bearing Marine Technology 1964.
30. VOLCY G.C. Damage to Main Gearing Related to Shafting Alignment. Proc. IMAS Conference Trans.I. Mar.E. 1969.

31. WERRELSMA R. Experimental Determination of Thrust
Eccentricity and Transverse Forces Generated by a
Screw Propeller. Shipbuilding Progress
July 1962.
32. WILKINS T. Some theoretical and practical aspects of shaft
alignment Proc. IMAS 1975.
33. WILCOCK D.P. & BOOSER E.R. Bearing Design and Application, McGraw - Hill 1957.
34. A.S.M.E. Lubrication Hand Book (Pub. McGraw Hill)
35. ROSE A. Hydrostatic Stern Gear - Trans. N.E.C.I.E.E. 1974
36. MILNE P. Contribution to (35)

APPENDIX I

MANUFACTURING PROCESS
WHITEMETAL STERN BUSHES

CAST IRON

The bushes are rough-turned, bored and split. After joining they are finished-bored prior to tinning operations. Next the bush is shot-blasted to remove all graphite from the surface, alternatively the cast iron may be degraphitised by the "Kolene" process in which the cast iron is suspended in a bath of molten sodium hydroxide at 500°C while a current of 100 to 200 Amps per square foot is passed between the iron shell and a steel electrode in the bath. The bush is the anode in this process.

Following the caustic bath the bush is thoroughly washed.

Following shot blast the bushes are degreased either by:-

- (a) Alkali bath, in which the bearing is dipped in a series of weired tanks and thoroughly scrubbed, followed by neutralisation of the alkali by dilute hydrochloric acid and water washing.
- (b) Organic solvent degreasing plants; part which are not to be tinned are stopped with whitewash or proprietary products.

If the Kolene process has been used to de-graphitise the bearing there is no need for a separate degreasing process.

The cast iron is then tinned. The recommended method uses two tin baths. The first is pure tin at a temperature of 320°C upon which a layer of flux (zinc chloride 73 percent, sodium chloride 18 percent ammonium chloride 9 percent) floats. This flux is activated by a water spray just prior to the bearing being dipped.

The cast iron is allowed to remain until the tin bath temperature, which drops with the entry of the cool cast iron, regains $310-320^{\circ}\text{C}$ after which it is removed and dipped in another (unfluxed) bath at 536°F (280°C).

When the cast iron is removed from the final bath it is at the correct temperature for metalling and should be rapidly transferred to a spinning machine. As the hot tin is exposed to atmosphere, yellow tin oxide is formed on the surface. Some manufacturers remove this by a spray of hydrogen chloride.

It is not always practicable to handle hot heavy bearings on to metalling tables or spinning machines and they are allowed to cool prior to metalling. In this case they must be reheated before metalling and, particularly with ferrous backing materials, this can result in poor bonding.

Excess heat causes the formation of a thick (0.005 in.) layer of iron tin which is extremely brittle. During cooling or machining this layer invariably fractures, leaving unbonded white metal.

Metal is centrifugally cast while the stern bearing is spinning at between 100 and 200rpm depending upon size.

For a large stern bearing weighing about 5 tons, 4 tons of whitemetal will be cast. As soon as pouring the whitemetal has ceased the bush is rapidly cooled by fine water sprays. Too slow a cooling results in segregation of the component metals in the whitemetal alloy. Too rapid a cooling below the whitemetal solidus causes high stressing which may rupture the whitemetal/iron bond.

STEEL

The treatment for steel is similar to that for cast iron except that as graphite is not present, shot blasting is not necessary. Nor is it necessary to use activated flux in the tin bath, normal fluxing being preferable.

APPENDIX II

RESULTS OF TESTS ON A RANGE OF PLASTIC FACED THRUST BEARINGS

OBJECT

To determine the suitability of various plastic materials for duties as water lubricated bearings.

APPARATUS

The apparatus is shown in Fig.1 and comprises of a shaft driven via a variable speed unit from a 5 HP electric motor. Five collars are mounted on the shaft each collar being submerged in fresh water in a steel tank. A cover over the tank prevents splashing during testing. To prevent corrosion the collar and shaft are phosphated. Test bearings are tilting pad thrust bearings faced with the test materials. The pads are hydraulically loaded against the collars and are arranged to grip the collars in the manner of disc brakes. No thrust is therefore transmitted to the drive motor.

TESTS

All materials were bonded to numbered thrust pads and machined and lapped to the correct finish. Bonding was to the manufacturers instructions. As a preliminary test all samples were subject to 250 (or earlier failure) start - stop tests in which the rig was started under a load of 20 p.s.i. (approximately 136KN/m^2) run up to a speed of 200 r.p.m. and suddenly stopped. Materials which completed this test were then tested at 1000 r.p.m. (24 ft/sec) (7.3m/sec.) with loads increasing stepwise at 50 p.s.i. 100 p.s.i. 200 p.s.i. and 400 p.s.i. Pad thickness was measured at intervals to determine wear down.

RESULTS

Table I summarises the results obtained. Replacement specimens appear in these tables. These replacements were necessary to balance the loading system and also allowed repeat test.

The term "failed" in the tables indicates a sudden loss of material causing a sudden drop in hydraulic pressure as opposed to a gradual wear down.

CONCLUSIONS

Of the specimens tested only the following materials exhibited suitable wear properties.

0 - 001" wear

Epoxy Resins { ZSV 111
 { Bakelite DR 19299
 { Rezolin L930

Bronze filled P.T.F.E. (Rulon)

.001 - .002" Wear

P.T.F.E. impregnated glass cloth -(Tygador)

.002 - .003" Wear

Glass filled nylon - (ICI A90)
Graphite filled nylon - (ICI A100)

| MATERIAL | ADHESIVE | RESULT |
|---|---------------|---------------|
| Tygador SKAP/010/00 P.T.F.E. | Self adhesive | Failed |
| Tygador 28AP/10T/00 Glass Cloth P.T.F.E. Impreg. | " | .0017" wear |
| I.C.I. Kematal (.012" Sheet) | Boscoprene | Bond failure |
| Tygador SKAE/010/00 P.T.F.E. | " | " |
| I.C.I. Maranyl B100 Nylon | " | Not tested |
| I.C.I. Maranyl A19 Glass Filled Nylon | " | .0024" wear |
| Polypenco Nylatron | " | Bond failure |
| I.C.I. Maranyl A198 Graphite filled Nylon | " | .005" wear |
| I.C.I. Maranyl F103 Nylon | " | Bond failure |
| I.C.I. Maranyl A100E Graphite filled Nylon | " | .002" wear |
| I.C.I. Maranyl A108 Graphite filled Nylon | " | .010" wear |
| I.C.I. Kematal (.066" Sheet) | " | Failed |
| Crossley Rulon - filled P.T.F.E. | Loose | .0005" wear |
| ZSV 111 Resin Epoxy | Cast | .0005" wear |
| ZSV 111 Resin Repeat | Cast | 0 Wear |
| I.C.I. Kematal | Araldite AT1 | Bond failure |
| I.C.I. Fluon VSE 070 Filled P.T.F.E. | " | Failed |
| I.C.I. Fluon VSE 60 " " | " | Failed |
| I.C.I. Fluon VSG 15Z40 " " | " | .0023" Wear |
| I.C.I. Fluon VSR 33 " " | " | .002" Wear |
| I.C.I. Fluon VSN 60 " " | " | .0035" Wear |
| I.C.I. Fluon V102 " " | " | .0025" Wear |
| Rezolin L930 Epoxy | Cast | .0002" Wear |
| Bakelite DR 19299 Epoxy | Cast | Note recorded |

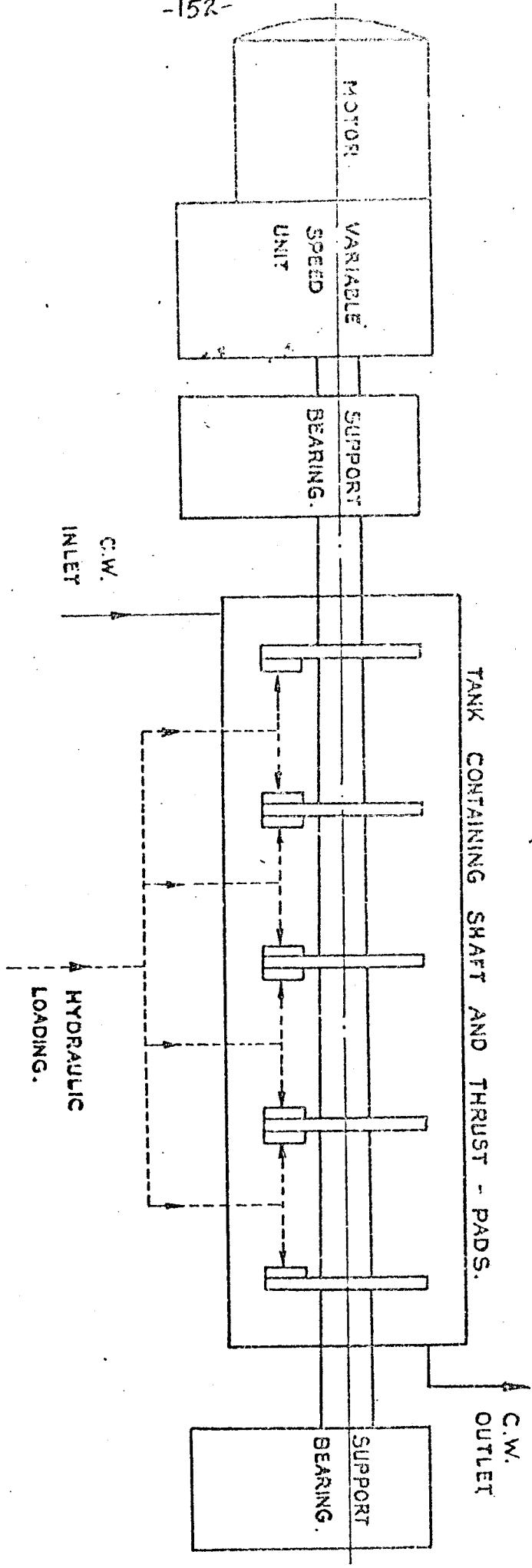

TEST RIG

FIG. A11 - 1

APPENDIX III

TESTING OF CHEMICALLY INERT BEARINGS

INTRODUCTION

The material tests in this appendix were part of a much fuller design study. This concerned pump bearings to be lubricated with the fluid pumped. It was necessary for the bearings to be chemically inert and for this reason p.t.f.e. based materials were tested.

Three materials are tested for this appendix:

- (1) Fluorinoid 115 which is p.t.f.e. + 25% Carbon
- (2) Fluorsint which is p.t.f.e. + mica
- (3) Fluon VP 25 filled p.t.f.e. in tape form

For reason of commercial confidentiality only outline results are given while details of fixing methods are not disclosed.

OBJECT

To investigate the wear properties of certain plastics with low-viscosity lubricants.

APPARATUS

Fig. 1 shows the test rig consisting of:

1. Electric Motor
2. Variable Speed Gear Box
3. Test Shaft (Stainless Steel)
4. Support Bearings
5. Test Bearings
6. Lubricant Containers
7. Peristaltic Pump
8. Pipework
9. Hydraulic Cylinder
10. Load Meter

Fig. 2 shows the test bearing used. The material to be tested is housed in a stainless steel bush.

METHOD OF TEST

All bearings were tested at 1500 r.p.m. at various loads on the projected area.

RESULTS

The following results were obtained.

- Test No.1: Material Fluorinoid 115
 Lubricant Water @ 20°C
 Duration of Test 300 hours
 Load 100 p.s.i.
 Result - No detectable wear
- Test No.2: Material Fluorinoid 115
 Lubricant Water @ 20°C
 Load 24 p.s.i.
 Result - Bearing failure after 44 hours due to overheating
 and excessive expansion following lubricant supply failure.
- Test No.3: Material Fluorosint
 Lubricant Glycerine
 Load 24 p.s.i.
 Result - Failure after 4 hours due to lubricant supply
 failure.
- Test No.4: Material Fluorosint
 Lubricant Trichloroethylene
 Load 24 p.s.i.
 Result - Thermal deformation of Fluorosint caused failure
 after 2 hours.
- Test No. 5: Material Fluorinoid 115
 Lubricant Trichloroethylene
 Load 24 p.s.i.
 Result - Thermal deformation of Fluorinoid caused failure
 after 44 hours.

After this test the bearing design was modified to prevent distortion,
Successful running of fluorosint was obtained.

CONCLUSION

Purely as a mating surface the filled p.t.f.e. materials appear suitable for
bearing applications. However the difficulties encountered due to distortion
render the materials unsuitable except for high cost applications.

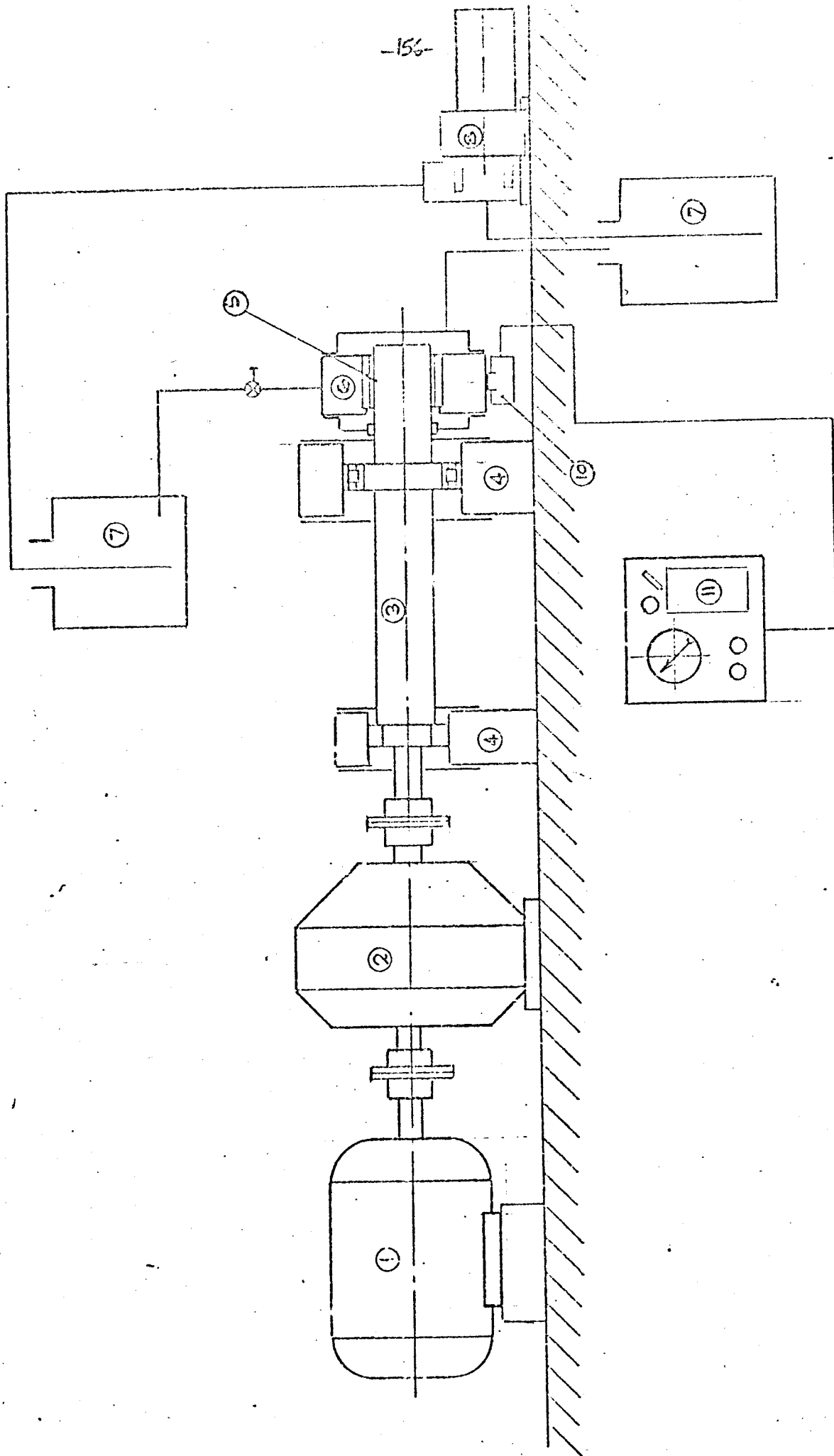

TEST RIG

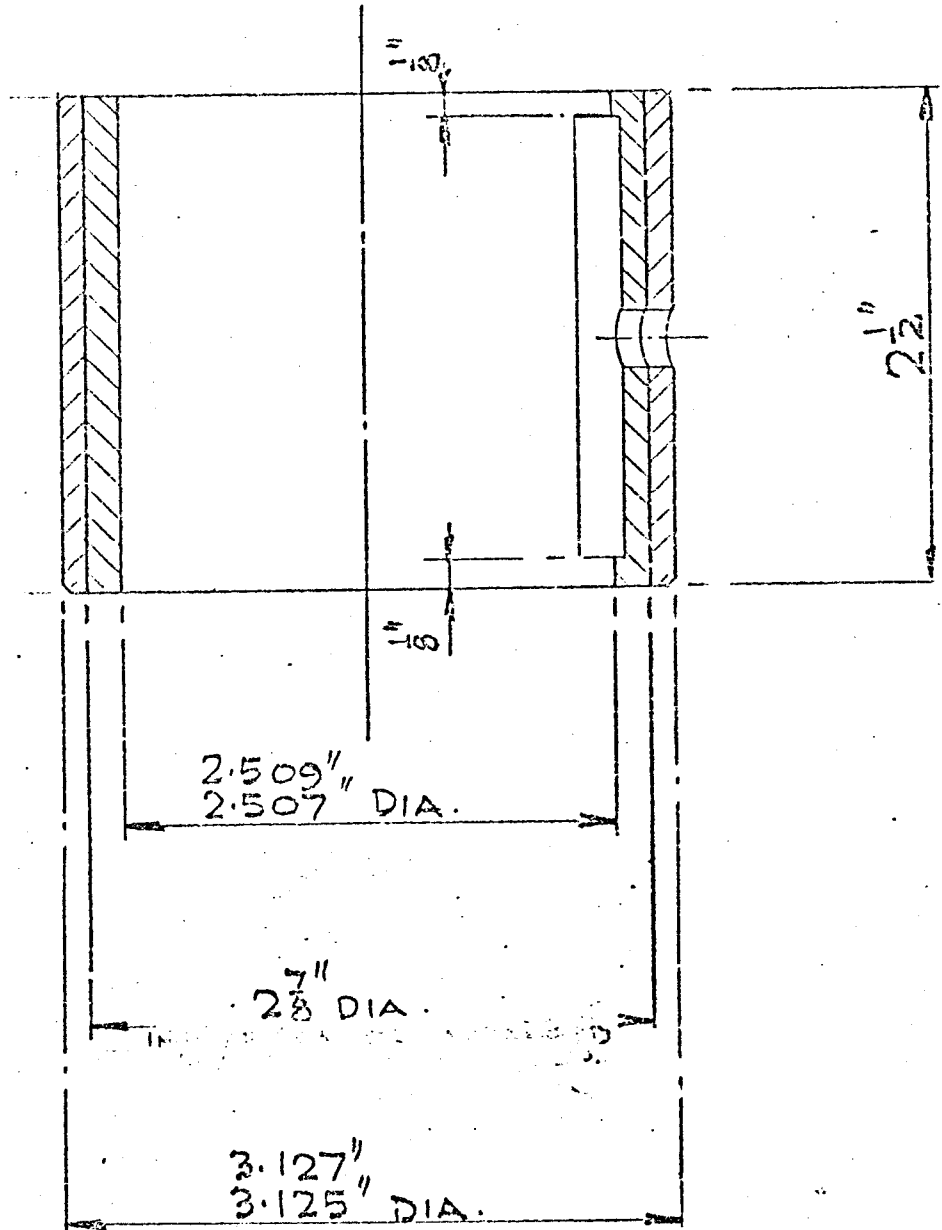

TEST BEARING

FIG. A111 - 2

APPENDIX IV

TEST ON ZSV 111 IN CONTAMINATED SALT WATER AT 90°F

OBJECT

To determine the suitability of ZSV 111 as a bearing material lubricant with sea water at temperatures up to 90°F.

APPARATUS

The equipment of Appendix 11 was used but in this case the test shaft and collars were chrome plated. Heating the salt water was carried out by heating tapes around the water tank.

METHOD

The tank was filled with River Tyne water taken at Scotswood at high tide plus a little disinfectant.

At ambient temperature and at 90°F two series of tests were carried out, both at a pressure on the test bearing of 63 p.s.i. (428 KN/m²).

- (1) 12 loaded starts with speed run up to 8.7 ft/sec.
- (2) Extended run at 8.7 ft/sec. (approx 2.7 metres/sec)

RESULTS

Twelve loaded starts and 200 hours continuous running at ambient temperature produced .0005" wear of the resin. This wear all took place within the first 10 hours continuous running.

Twelve loaded starts and 55 hours running at 90°F produced no measurable wear.

APPENDIX V

OIL FILM THICKNESS MEASUREMENTS ON AN AFTERMOST
PLUMMER BEARING OF A TWIN SCREW CONTAINER VESSEL

ABSTRACT

Following failure to the starboard aftermost bearing of a twin screw container vessel measurements of oil film thickness were taken on a U.K. - Far East - U.K. voyage.

Adequate oil films were shown to exist at all engine speeds but it was demonstrated that the tail-shaft lifted under the action of the propeller, the lift being a function of speed but a full shaft speed probably loading the upper half of the bearing.

It seems probable that the centre of the tail-shaft described a closed loop at shaft speed. Insufficient data were obtained to quantify this loop.

Failure was found to be due to the inability of the bearing to generate an oil film at turning gear speeds (1 rev. in 5 minutes).

1. OBJECTIVES

1.1 Primary Objectives

To determine the cause of repeated failure to the starboard aftermost bearing of a twin screw contained vessel.

1.2 Secondary Objectives

- (i) To measure the oil film thickness separating the shaft and bearing pads on the starboard aftermost bearing of the vessel.
- (ii) To derive the steady state and dynamic load pattern on this bearing under various conditions.
- (iii) To ascertain the degrees of misalignment of the shaft relative to this bearing under various conditions.

2. INTRODUCTION

The vessel is one of a class of container ships and has had a history of failure of the aftermost bearing.

As normal examination did not give an indication of the failure the author was invited to measure oil film thickness on a voyage.

Since the results of these measurements, albeit carried out on a plunger bearing indicate the degree of shaft misalignment and movement as well as showing the susceptibility of ships bearings to turning gear failure they are considered relevant to the stern bearing problems discussed in the body of the thesis.

The owner has kindly given permission for the results to be put forward but wishes not to have the vessel identified.

This report describes the measurements taken on voyage, analyses the results, and makes recommendations to help prevent further damage.

3. INSTRUMENTATION

During normal hydrodynamic bearing operation the shaft is separated from the bearing by a film of oil. The thickness of this film is a function of bearing load, rotational speed, and viscosity of the lubricant. The function is complex but film thickness decreases if load increases or if the rotational speed or lubricant viscosity decreases. There is a point at which decreasing film thickness results in contact of the moving and stationary parts.

During contact, wear will take place. In most bearing applications the duration of time at which metal to metal contact takes place is small enough or the loads light enough for this wear to be negligible. Sufficient published data are available to enable the film thickness to be calculated from a knowledge of the other variables or, conversely, one of the other variables may be derived if the film and two other variables are known. To measure the load on a plunger block during passage would be difficult but to measure the distance to a rotating part is a relatively easy matter. Two contactless methods are available (a) capacitive or (b) inductive. If the shaft is considered to be one plate of a capacitor and another plate is connected close to it then the capacitance of the system, when subject to an alternating voltage, is a measure of the distance between the plates. The capacitance of the system also varies according to the dielectric strength of the medium between the plate. Hence in a bearing application the capacitance would be affected by the presence of oil or air. Also it is necessary for electrical connexion to be made to the rotating shaft. Neither of these criteria apply to an inductive method of measurement. If a two pole magnet is close to a magnetic material then the inductance of the magnet varies as the distance between the magnet and the other material. Provided that the medium separating the shaft and magnet is non-magnetic it has no effect on the inductance. This system of oil film thickness was therefore adopted. Fig.1 shows the basic principle involved. In practice the magnet or inductive transducer is a proprietary item in which the inductance varies linearly with gap over a fairly wide range. The necessary bridge circuiting is contained in proprietary "proximeters" and a stabilised power supply is used to maintain a voltage across the bridge. The bridge out-of-balance voltage is fed from the proximeters to either a cathod ray oscilloscope or an accurate voltmeter. The actual circuit used is shown in Fig.2.

3.1. Calibration

The four inductive transducers were calibrated at room temperature using a micrometer screw arrangement. The temperature calibrations were carried out in the test house oven, the probes being positioned in a lower flat steel plate while a second steel plate rested on the surface.

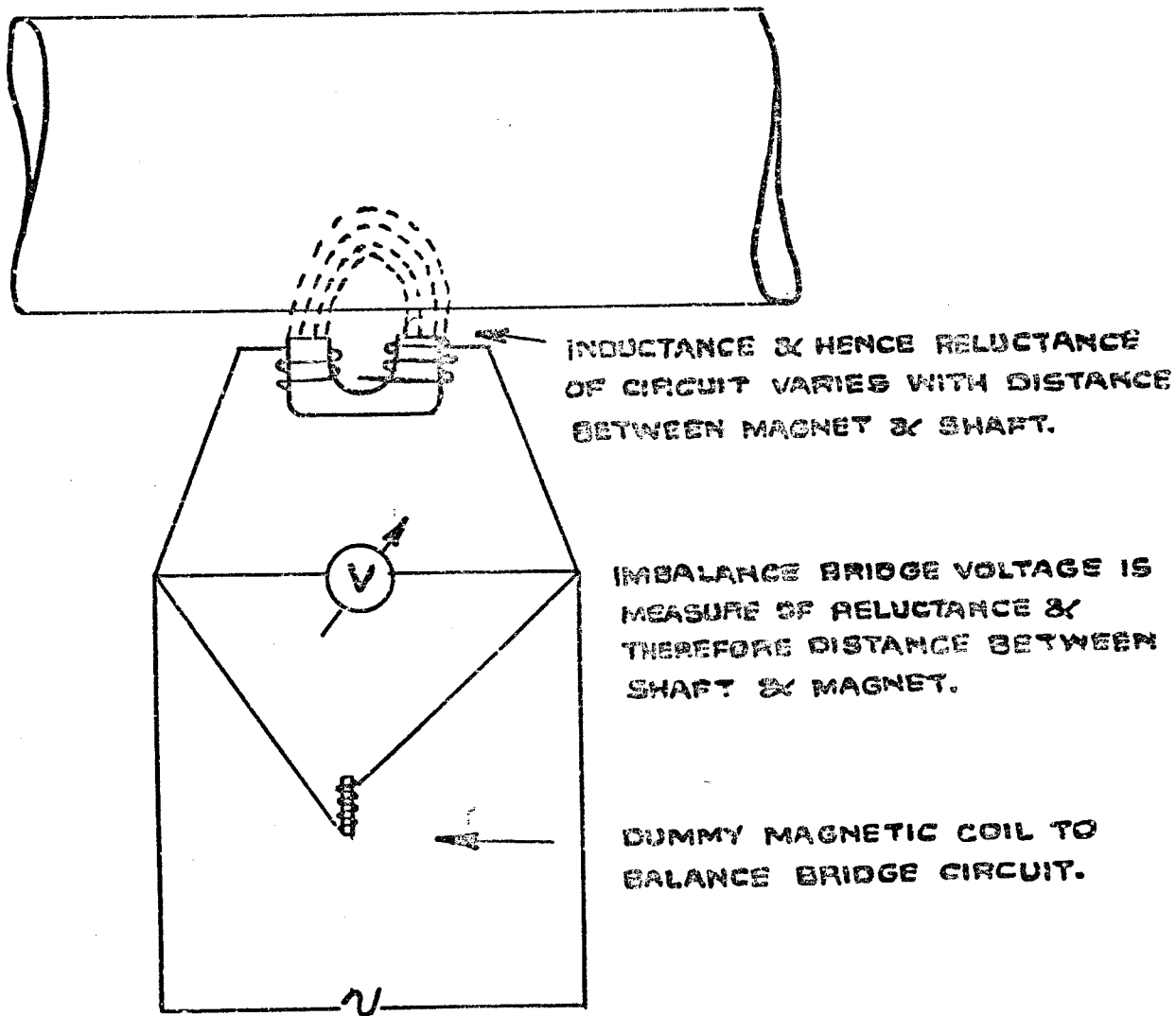

PRINCIPLE: METHOD OF FILM MEASUREMENT.

FIG. 1 (AV)

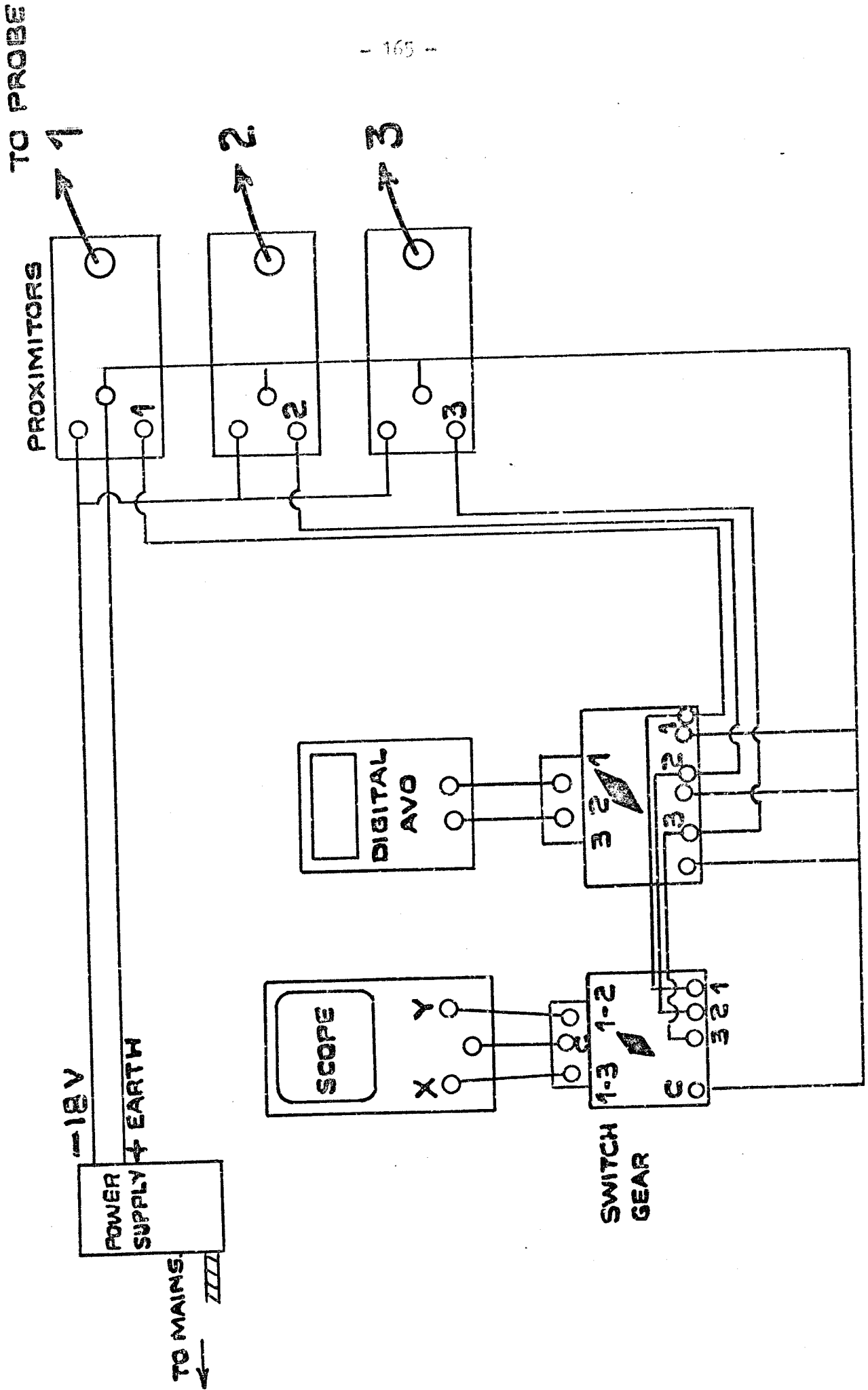

CIRCUIT DIAGRAM.

FIG 2(AV)

CALIBRATION No 1 PROBE.

DISTANCE - INCH.
-0.030
-0.020
-0.010
0

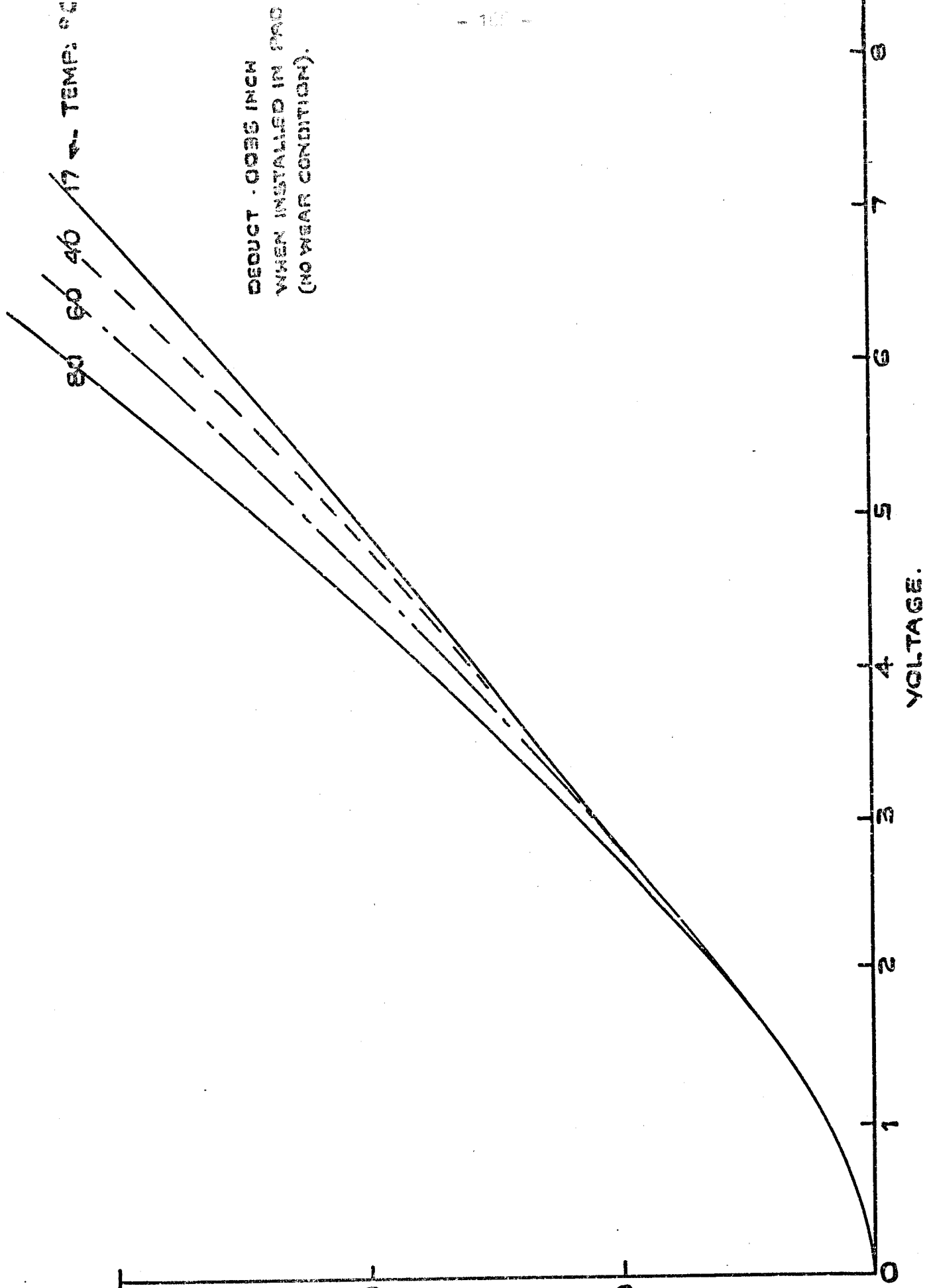
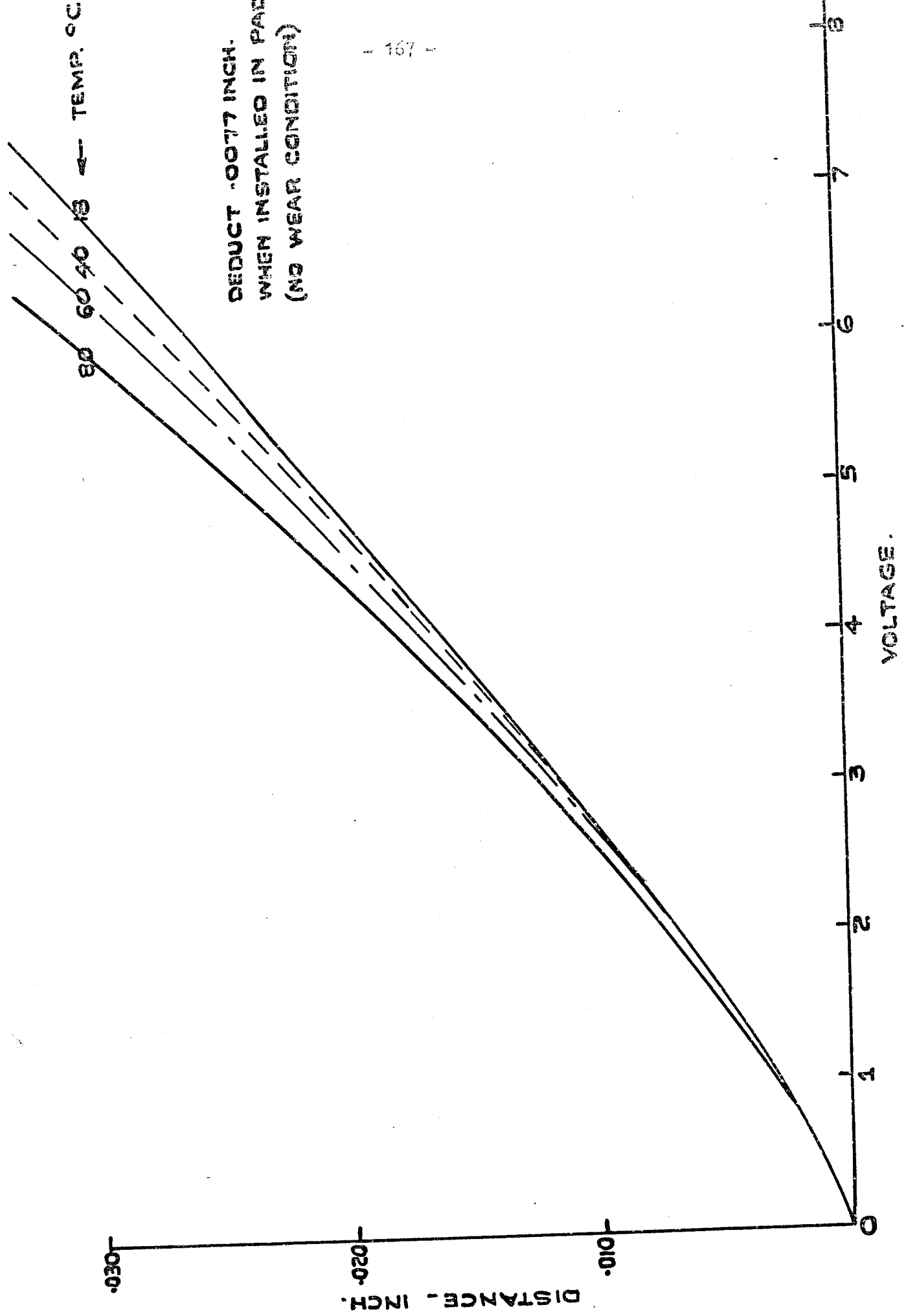

FIG. 3 (AV)

DEDUCT .0025 INCH
WHEN INSTALLED IN PAD.
(NO WEAR CONDITION).

80 60 40 17 TEMP: °C



CALIBRATION No 2 PROBE.

FIG. 4 (AV)

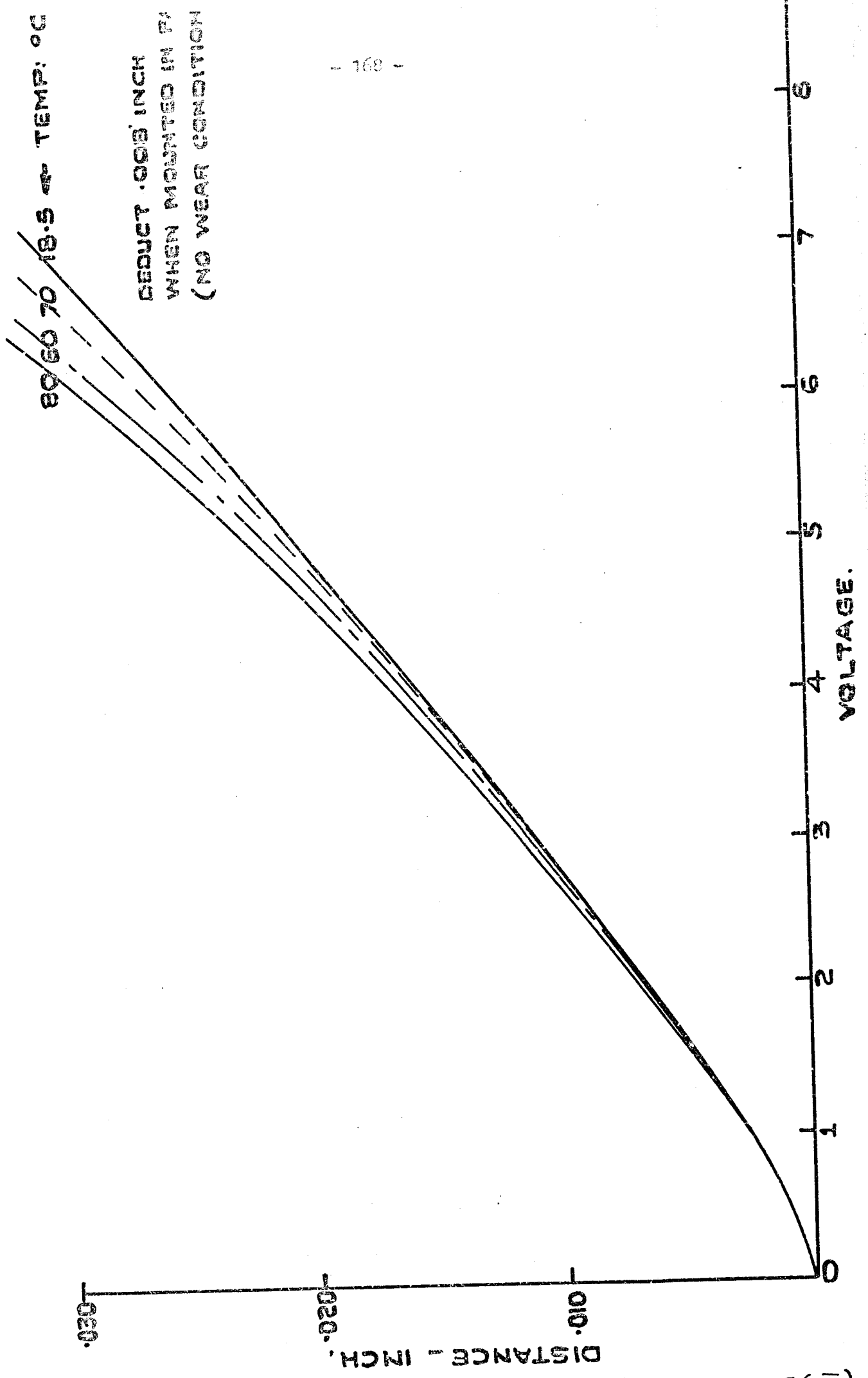

CALIBRATION No 3 PROBE.

FIG 5(AV)

The distance between the plates was varied using pairs of feeler gauges as shims. A thermocouple was placed in the lower plate, adjacent to the transducer, giving accurate temperature measurement at the probe.

The results of the calibration are given in Figs. 3 - 5.

The transducers were mounted by drilling two journal pads to accept the probes which were fitted using high temperature proof araldite (X83/466) and hardener (HY 932). The resin was cured for 16 hours at a temperature of 80°C.

One probe having been damaged during preliminary calibration, only three probes were installed in the pads, the remaining hole being filled with the araldite. The probes were positioned approximately 1" from the edge of each pad on the pivot line and about .005 to .008 inch below the whitemetal surface, this depth being chosen such that the expected readings in operation should be relatively temperature invariant.

Thermocouples were placed in the pads, adjacent to the probes and just beneath the whitemetal surface. Four thermocouples were used, the fourth being placed for the missing probe.

The araldite holding the probes was scraped flush with the whitemetal surface and, using specially machined mandrel segments, the depth of the probe tips beneath the whitemetal surface was ascertained. The mandrels had been machined with a slight taper, thus oversize feeler gauges were placed between the pad and mandril, directly above the probes. The probe voltages obtained for these conditions are shown by the dotted lines in Figs. 3 - 5 giving corresponding depths.

The electrical equipment was finally checked, the oscilloscope calibrated using output from the probes and the digital avometer and the equipment boxed and transported to Southampton.

3.2 Installation

As soon as engines were cool enough to allow turning gear to be disconnected starboard aft bearing top casing was removed and the shaft jacked to take the load off the bottom pads. The three lower pads were removed and replaced with two instrumented pads and one pad from the ship's spares. The pad fitted with two probes was fitted at the bottom of the bearing while the pad with the single probe was fitted on the inboard side (normal upward side of rotation).

The probes were situated as follows:-

| | | |
|-----------------|---|-----------|
| No. 1 Lower pad | - | aft end |
| No. 2 Lower pad | - | for'd end |
| No. 3 Side pad | - | aft end |

Thermocouple leads and transducer leads were threaded through the oil annulus behind the pads and led from the bearing via a hole drilled in the perspex cover above the oil scraper.

The bearing pedestal was cleaned and the sump refilled with clean EssoMar 56 oil. A sample of the old oil which was darkened was removed for analysis and photographs taken of the journal pads.

With the exception of the proximitors and the probes, the equipment was stationed approximately fifty yards along the starboard tunnel from the aftermost bearing. This equipment consisted of a stabilised power supply to the proximitors, a digital avometer measuring the proximitor output voltage, an oscilloscope connected in parallel to the avometer to observe shaft loci and a Leeds and Northrup temperature recorder connected to the thermocouples. Switchgear enabled the avometer to monitor each probe individually and also allowed a coupled input into the oscilloscope. Thus a locus was traced on the oscilloscope by a combination of two probe outputs into the X and Y channels respectively. A circuit diagram of the electrical system is shown in Fig.2. The proximitors were mounted by a flange arrangement onto the aftermost bearing casing and all connexions made. All circuits were checked and shown to be operative. The digital avometer calibration was checked and the power supply voltage adjusted to - 18V.

Outputs were obtained from all three probes showing positive oil films in all cases.

4. TEST PROCEDURE

After installation the vessel sailed to Hamburg and returned to Southampton. The datum readings of the probes were taken while the shaft was on turning gear and all equipment re-checked.

Readings of transducer voltage and temperature were taken at various shaft speeds during normal port and Solent manoeuvring. Once "full away" regular reading of voltage, temperature and shaft speed were made throughout the Atlantic crossing to the Panama Canal.

It had been hoped that various weather conditions would be encountered but the weather and sea states remained moderate throughout the voyage. The effect of full helm in each direction was noted in a special test in a calm sea.

Throughout the canal passage readings were taken at various speeds.

During the Balboa, Far East, Balboa, Canal passage part of the voyage ship's personnel took regular readings of all parameters but due to a defect developing on the voltmeter did not take any eastbound Atlantic readings.

At two points during the voyage the voltage between shaft and earth was checked.

Prior to the ship leaving Southampton on her return to Far East, but after having called at European ports to discharge and load containers, the bearing pads were removed, examined and measured (to detect wear).

As a separate test a plummer bearing bottom half casing was hydraulically loaded by the manufacturer and its deflexions noted.

5. RESULTS

5.1 Oil Analysis

Oil removed upon pad installation was found to be darkened. An analysis of oil sample indicated -

| | |
|---|----------------|
| Percentage insoluble material - approx. | 0.02% Wt/Wt |
| Acidity | 0.078 mg KOH/g |

Tin and copper were the major elements present with faint traces of aluminium, iron, vanadium, silicon, antimony, magnesium, barium and lead. Tin, copper and antimony are the major constituents of whitemetal while aluminium is likely to be a result of slight wear on the oil thrower ring. Iron is the same component of the shaft while all the remaining elements are likely to be found as permissible components of both shaft material or whitemetal. Oil viscosity is shown in Fig.7.

5.2 At Installation

Plates 1,2 and 3 show the pads removed from the lower half casing in order to instal the set of new pads. The lower pad shows an all over wear pattern while the polished zones of the side pads are concentrated towards the for'd end.

The instrument checks and readings taken at this stage agree with the datum readings taken earlier.

5.3 Pre-Voyage Check

A pre-voyage check of electronics and of datum, showed that a datum change of 0.00115 inches on the for'd (No.2) probe had occurred in European waters. This was assumed to be pad wear-down for the purpose of further readings.

5.4 Voyage Results

From the results the following tables and graphs have been prepared.

| <u>Table No.</u> | <u>Content</u> |
|------------------|---|
| II | "Full Away" shaft speed, pad temperature and film thickness at approximately daily intervals and shaft alignment. |
| III | Film thickness, shaft alignment, speed during manoeuvring at Southampton. |
| IV | Film thickness, shaft alignment speed during speed reduction at end of westbound Atlantic passage. |
| V | Film thickness and shaft speed during application of Port and Starboard helm. |

These figures have been summarised in a series of graphs:

Graph I - This shows the variation in film thickness throughout the voyage as recorded by probes 1 and 2. Since the shaft speed varies by a small amount from day to day the figures recorded have been corrected to assume a constant 120 r.p.m. and 49°C pad temperature. The design curves shown in "Standard Handbook of Lubrication Engineering" published by McGraw Hill under the sponsorship of the American Society of Lubrication Engineers have been used to effect this correction.

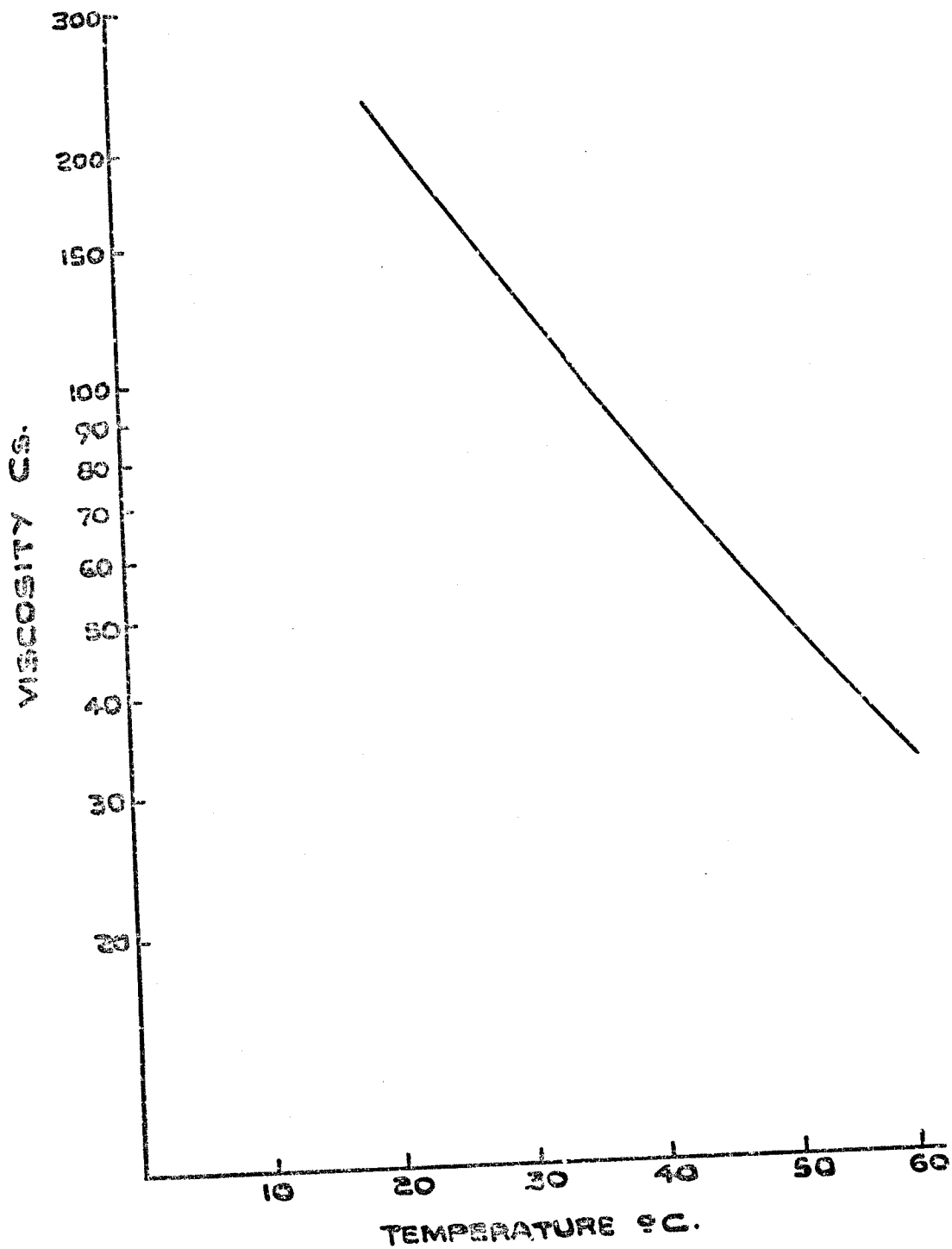

VISCOSITY OF ESSOMAR 56.

FIG. 6 (AV)

Graph II -

has been prepared to show the variation in alignment throughout normal passage. Also shown on this graph are the variations in shaft speed and sea temperature. Sea temperature is included in order to detect whether it caused hull distortion and, hence, shaft alignment change.

Graph III & IV

Enter into greater detail of the variations in film thickness and shaft alignment with shaft speed. The film thickness given is merely the mean film, the for'd and after end film thickness not being given separately.

TABLE II
SHAFT SPEED, FILM THICKNESS, PAD TEMPERATURES AND
MISALIGNMENT

| Date | Time | Speed and Probe (2) | | | Aft Probe Temp °C | | Misalignments 103 ins. | | |
|----------|------|---------------------|--------------------|---------|--------------------|---------|---------------------------|---------------------|--------------------|
| | | RFM | Film x 103 ins. | Temp °C | Film x 103 ins. | Temp °C | | | |
| 24.7.74. | 0800 | 100 | 1.88 | 37 | 3.9 | 37 | 3.17 | ATLANTIC WEST BOUND | |
| 25 | " | 125 | 1.79 | 46 | 4.6 | 46 | 4.01 | | |
| 26 | 0900 | 125 | 1.64 | 47 | 4.7 | 48 | 4.21 | | |
| 27 | " | 125 | 1.54 | 49.5 | 4.55 | 50 | 4.16 | | |
| 28 | " | 120 | 1.45 | 49.5 | 4.55 | 51 | 4.15 | | |
| 29 | " | 116 | 1.45 | 50.5 | 4.45 | 51 | 4.15 | | |
| 30 | " | 116 | 1.5 | 50.5 | 4.5 | 51 | 4.15 | | |
| 31 | " | 116 | 1.54 | 50.5 | 4.5 | 51 | 4.11 | | |
| 2.8.74. | 1000 | 116 | 1.59 | 50 | 4.6 | 50.1 | 4.16 | PACIFIC WEST BOUND | |
| 3 | " | 116 | 1.54 | 50.2 | 4.5 | 50.7 | 4.11 | | |
| 4 | " | 115 | 1.5 | 51 | 4.45 | 51.5 | 4.1 | | |
| 5 | " | 116 | 1.66 | 49.6 | 4.6 | 50.0 | 4.09 | | |
| 6 | " | 112 | 1.88 | 45.8 | 4.8 | 46 | 4.07 | | |
| 7 | " | 112 | 1.69 | 45.7 | 4.65 | 46 | 4.11 | | |
| 8 | " | 112 | 1.69 | 46.5 | 4.6 | 47.1 | 4.11 | | |
| 9 | " | 117 | 1.64 | 48.5 | 4.6 | 49 | 4.11 | | |
| 10 | " | 117 | 1.59 | 49.2 | 4.55 | 49.9 | 4.11 | | |
| 11 | " | 117 | 1.64 | 50 | 4.55 | 50.3 | 4.06 | | |
| *13 | " | 116 | 1.69 | 49.8 | 4.55 | 50.2 | 4.01 | | |
| 14 | " | 111 | 1.74 | 48.5 | 4.6 | 49 | 4.01 | | |
| 15 | " | 112 | 1.78 | 49.5 | 4.5 | 50 | 3.87 | | |
| 28.8.74. | " | 120 | 1.45 | 47.8 | 4.9 | 48.5 | 4.1 | | PACIFIC EAST BOUND |
| *28 | " | 120 | 1.45 | 47.5 | 4.45 | 48.5 | 4.15 | | |
| 29 | " | 120 | 1.35 | 48 | 4.45 | 48.9 | 4.25 | | |
| 30 | " | 120 | 1.35 | 49 | 4.25 | 49.8 | 4.05 | | |
| 31 | " | 120 | 1.4 | 48.8 | 4.5 | 49.5 | 4.05 | | |
| 1 | " | 120 | 1.45 | 48 | 4.35 | 48.8 | 4.05 | | |
| 2 | " | 120 | 1.06 | 48.8 | 4.15 | 50.5 | 4.24 | | |
| 3 | " | 120 | 1.20 | - | 4.1 | 52.5 | 3.99 | | |
| 4 | " | 120 | 1.3 | 52.6 | 4.15 | 53.5 | 4 | | |
| 5 | " | 115 | 1.5 | 50.4 | 4.25 | 51.2 | 3.9 | | |
| 6 | 0600 | 115 | 1.4 | 51 | 4.15 | 52 | 3.9 | | |

* International Date Line

TABLE III

FILM THICKNESS AND SHARP ALIGNMENT DURING
MANOEUVRING AT SOUTHAMPTON

| <u>Speed</u> <u>RPM</u> | <u>Mean Film x 10³ inch</u> | <u>Misalignment x 10³ inch</u> |
|----------------------------|--|---|
| 30 | 2.73 | 4.39 |
| 50 | 3.79 | 4.88 |
| 70/80 | 4.4 | 5.1 |
| 25 | 2.17 | 3.94 |
| 30 | 2.68 | 4.09 |
| 60 | 3.64 | 4.77 |
| 70 | 3.94 | 4.78 |
| 70 | 3.82 | 4.82 |
| 70 | 3.37 | 4.72 |
| 20 | 2.09 | 3.48 |
| 75 | 3.55 | 4.86 |
| 95 | 3.89 | 4.78 |
| 106 | 3.84 | 4.58 |
| 105 | 3.84 | 4.58 |
| 120 | 3.86 | 4.44 |
| 125 | 3.81 | 4.43 |
| 100 | 3.47 | 4.38 |
| Creep | 0.55 | 215 |

TABLE IV

FILM THICKNESS AND SHAFT ALIGNMENT DURING SPEED
REDUCTION AFTER WEST BOUND ATLANTIC PASSAGE

| <u>Speed</u> <u>rpm</u> | <u>Mean Film x 10³ inch</u> | <u>Misalignment x 10³ inch</u> |
|----------------------------|--|---|
| 116 | 2.95 | 4.15 |
| 111 | 3 | 4.15 |
| 107 | 2.95 | 4.15 |
| 104 | 2.9 | 4.1 |
| 101 | 2.85 | 4.05 |
| 97 | 2.8 | 3.95 |
| 71/76 | 2.55 | 3.74 |
| 69 | 2.43 | 3.59 |
| 58 | 2.48 | 3.79 |
| 29 | 2.08 | 3.09 |
| 5 | 1.27 | 1.94 |

TABLE V

FILM THICKNESS VARIATION DURING APPLICATION
OF HENM

| | <u>Time</u> | <u>Speed</u> <u>RPM</u> | <u>For'd. Film</u> <u>x 10² inch</u> | <u>Aft Film</u> <u>x 10² inch</u> | <u>Misalignment</u> <u>x 10² inch</u> |
|-----------------|----------------------------------|----------------------------|--|---|---|
| Stbd Helm On | 0958 | 125 | 1.83 | 4.8 | 4.12 |
| | 0959 | 110 | 1.54 | 4.35 | 3.96 |
| | 0950 ¹ / ₂ | 102 | 1.5 | 4.2 | 3.85 |
| | 1000 | 96 | 1.26 | 4 | 3.89 |
| | 1002 | - | 1.3 | 4.05 | 3.9 |
| | 1004 | 108 | 1.45 | 4.15 | 3.85 |
| | 1006 | 118 | 1.83 | 4.55 | 3.87 |
| Port Helm On | 1007 | 110 | 1.69 | 4.3 | 3.76 |
| | 1008 | 110 | 1.59 | 4.35 | 3.91 |
| | 1009 | 110 | 1.64 | 4.25 | 3.76 |
| | 1010 | 110 | 1.59 | 4.2 | 3.76 |
| | 1012 | 110 | 1.59 | 4.5 | 4.06 |
| | 1013 | 110 | 1.74 | 4.5 | 3.91 |
| | 1014 | 119 | 1.74 | 4.6 | 4.01 |

The effect of putting helm hard over, first to starboard then to port, is shown in graph V. In the upper diagram actual measured films are given but, as is usual during a turn, shaft speed varied during the turn and in order to check film change on a common basis the lower graphs show the film thicknesses corrected to a constant 120 r.p.m.

It should be noted that figures of misalignment are quoted relative to the "as new" surface of the bearing pads i.e. relative to the axis of the bearing casing. Film thicknesses however are corrected for the (assumed) degree of wear which took place on the Southampton - Hamburg - Southampton voyage which immediately preceded the Atlantic crossing. Any subsequent wear is not taken into account.

During normal full-away condition the film thickness was observed to vary at shaft frequency. This is probably due to a combination of load variation and of possible shaft out of roundness. The oscillation is in both the vertical and horizontal planes. The apparent locus of the shaft centre at full away was an ellipse with its major axis vertical. The major axis was measured to be between 0.0006 and 0.0007 inches the minor axis being about 0.0005 inches.

5.5 Post Voyage Examination

Plates 4, 5, 6 show the state of the bearing pads upon completion of the test voyage. It can be seen that the lower pad is the most heavily marked. Measurements of pad wear-down are shown in Fig.7. Wear of whitemetal in way of the pivot at the aft end was 0.0025 inches, wear at the for'd end 0.003 to 0.0045. The position of maximum wear was displaced from the pivot position in the direction of motion.

5.6 Voltdrop between shaft and earth

The voltage difference between shaft and earth was measured on two occasions. With brush gear clean and dry an a.c. volt difference of 20 to 50 millivolts and a d.c. volt difference of 360 to 410 millivolts was detected; no current flow could be detected in the brush gear earth strap. On another occasion a 600 millivolt d.c. and a 50 to 100 millivolt a.c. difference between shaft and earth was detected with brush gear lifted. With brush gear in contact with the shaft the d.c. volt differences dropped to between 200 and 300 millivolts and no a.c. volt difference could be detected. With brush gear down no current could be detected flowing to earth.

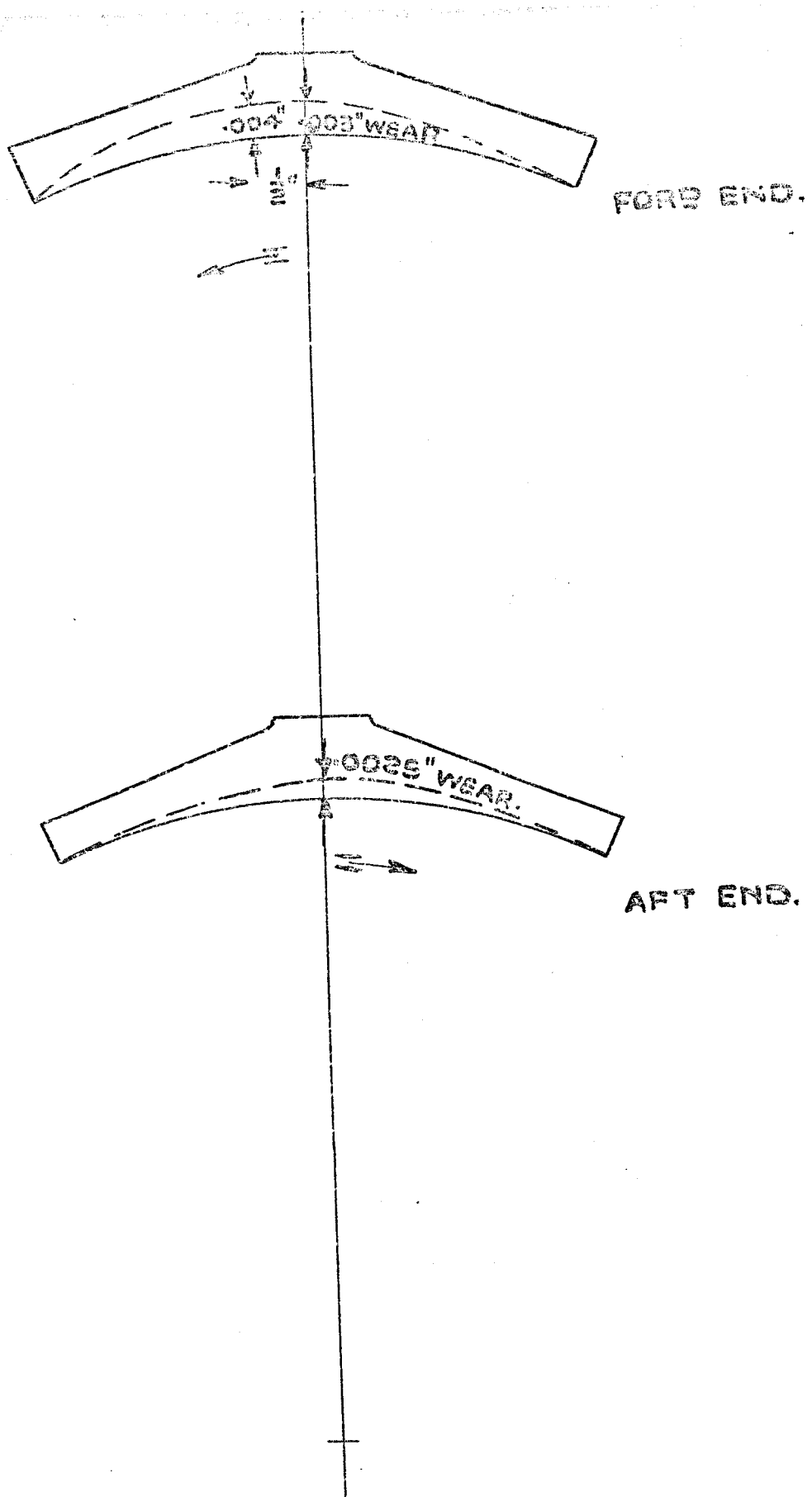

PAD WEAR DOWN.

FIG 7 (AV)

5.7

Casing Deflexion

When a plummer bearing is chocked in the normal manner at each corner the load impressed upon it causes deflexion in the vertical direction; this deflexion is accompanied by a horizontal deflexion the effect of which is to reduce bearing clearance at the horns of the bearing. Graph VI shows the total reduction in clearance at the horns of a 23" plummer block loaded at the manufacturers factory. This bearing is a frame size smaller than the bearings in question and for a given load it is expected that its deflexion would be greater.

The bearing was not bolted down as securely as it would be in a ship nor was the casing top fitted. Both these differences in mounting would lead to shipboard deflexion being less than test deflexion. Although not relevant to the argument in this report Graph VII has also been included to show the amounts of deflexion recorded in the vertical direction.

6.

DISCUSSION

Figures of oil film thickness have been measured which indicate that at all times during normal service and manoeuvring speed adequate oil films are generated. At speeds of as low as 20 - 25 r.p.m. the minimum film at the for'd end seems to be in excess of .0007 inches.

Using the film thicknesses recorded on voyage and calculating back to a load, again using the ASLE publication, gives a load of only 20 tons compared with loads derived by jacking of 27 tons. This may suggest error in measurement or in calculation method. The calculation method is reasonably well established although because of the idealised nature of design methods (which tend to be experimentally checked on small scale rigs) and the size of the bearing in question some error must be assumed. In order to study the effect of measurement error Graph VIII has been prepared. In this the effect of absolute error in measuring upon the calculated load has been shown.

It can be seen that to produce the difference in load referred to above (35%), an error of less than 0.0003 inches in the absolute measurement of film thickness is necessary.

Since, as will be discussed in following paragraphs and as is shown in the photographs (Plates 1 and 2), wear of the whitemetal took place during the voyage, a 0.0003 inch error in film thickness measurement is reasonable to expect. There seems little reason to doubt the relative values of film thickness, particularly since the degree of misalignment shown by the transducers at the slowest speed is in reasonable agreement with the measured distribution of whitemetal wear-down. Accepting, therefore, that the relative changes in film thickness are relatively accurate any change in loading shown by transducer signal variation is also likely to be reasonably accurate.

Based upon "Full Away" film variation the load is shown to vary by $\pm 13.8\%$ upon the steady state load. This variation was at shaft frequency superimposed upon a low amplitude wave of 3 to 3.3 cycles per minute. That the frequency was a shaft frequency is a little odd since, on an aftermost bearing, a load variation at blade frequency would more likely be expected. The (very) low amplitude variation at 3.3 cycles per minute suggests hull movement possibly due to wave encounter. At the time of the frequency measurement a moderate swell was running. An encounter period of 3.3 cycles per minute suggests a wave length of about 150 yards.

When starboard helm is applied there is a clear reduction in film thickness which when corrected for shaft speed indicates a 21% increase in load upon the aftermost bearing. The change in alignment during this test was slight. A change in alignment is to be expected with starboard helm since the action of such helm is to increase propeller torque and hence reduce shaft speed. At the same time there is an increase in the axial component of the wake. Thus the angle of attack of the propeller is decreased giving thrust and, in all probability, giving a decreased thrust eccentricity. The upward bending moment on the propeller is decreased and the aftermost tunnel bearing load increased. Port helm can be expected to have little effect on the starboard shaft. As can be seen from Graph V this is in fact the case.

Misalignment of the shaft has been plotted both as a function of time (Graph II) and of shaft speed (Graph IV). Speed and sea temperature are also plotted on Graph II and from this graph it seems that shaft speed has the greatest effect on alignment over most of the voyage. On the Tokyo to Balboa leg of the voyage however, sea temperature seems to have some modifying effect upon alignment.

Where alignment is plotted directly against speed it can clearly be seen that as shaft speed increases so does misalignment. During manoeuvring in Southampton the spread of misalignment figures varies over a wider range than during the speed reduction prior to anchoring at Christobal. This has been attributed to the difficulty in precisely associating speed and transducer voltage during rapid speed changes at Southampton as opposed to the greater ease with which the signals could be synchronised during the steady speed reduction after the westward Atlantic passage.

The alignment change is such that the shaft lifts at the after end of the bearing. That the alignment should change in the manner is reasonable since with an increase on speed both thrust and thrust eccentricity increase. Thrust centre on an outward turning starboard propeller is usually in the upper starboard part of the disc and hence increase in thrust tends to increase the upward bending moment on the propeller shaft.

The magnitude of the alignment change such as to indicate the propeller induced shaft bending moment is sufficient to completely overcome the downward moment due to propeller weight and to either transfer the stern bearing load to the upper half or at least completely unload the stern bearing.

When film thickness recorded by the transducers is corrected for temperature and speed and plotted to a base of time any wear down of the whitmetal (remembering that the transducers are below the metal surface) will be indicated by an apparent reduction in film thickness. Either the film thickness reduction will be gradual (if the wear down is taking place more or less continuously during the voyage) or, if wear down takes place at certain specific points in the voyage, then a step or steps are introduced into the graph.

Such a step occurs on Graph 1 during the ship's stay in Tokyo when almost .0005 inches of wear appear to take place. Similar periods of high wear took place between the vessel leaving Southampton and returning to Southampton during a short European loading voyage prior to the test and again after calling at several European discharge and loading ports at the end of the test voyage. If it is assumed that no wear took place on the westward Atlantic voyage - a reasonable assumption in view of the lack of wear on other parts of the voyage - then the following pattern of wear seems to have taken place.

| | | |
|----------------------------|--------|---------|
| Southampton to Southampton | .001" | approx. |
| Tokyo | .0005" | " |
| Southampton to Southampton | .0015" | " |

The common feature about the periods during which wear apparently took place is that the engines would be on turning gear for extended periods. Turning gear speed is about one shaft revolution in 5 minutes and at this speed no film is likely to be generated. Failure at sea could be explained by the fact that gradual deterioration of bearing surface took place during turning gear operation. This deterioration, if this hypothesis is correct, would be progressive until the bearing surface ultimately was so damaged as to hinder full speed oil film generation.

Considerable numbers of bearings are in service which do not fail even with similar turning gear speeds. However if the 27 ton load derived by jacking is correct then, compared with other bearings, this particular one is overloaded by about 30%.

It can be shown that such a load is within the capability of a bearing of the dimension of the one investigated provided that reasonable shaft speeds are maintained at all times. At low speeds the overload becomes significant.

The analysis of the darkened oil sample is similar to the obtained when wear has taken place but such an analysis would also be obtained following failure due to shaft currents being earthed through the bearing.

The voltages recorded on passage have been known to induce currents of sufficient magnitude to cause bearing failure, indeed voltages of lower magnitude have been responsible for failure. However when clean dry brush gear was mounted on the shaft no current flowed to earth. When the relative resistances of oil film and brush gear are compared it seems unlikely that shaft current of sufficient magnitude to cause bearing damage flowed to earth via the bearing oil film and whitmetal.

Also, unless there is a fault in the ships electrical system, shaft currents are more likely to be generated when the machinery is at full speed than when slowly rotating. The evidence on the other hand points to damage at lower speeds. Photographs of pads taken from the ship all show marking on the side pads. This marking may be attributed either to lack of side clearance or to the shaft "climbing" without a substantial oil film during slow speed operation. The deflexion tests show sufficient side clearances even under heavily loaded conditions.

The conditions to be drawn from this discussion is that the results indicate that the wear taking place when the engines are on turning gear is responsible for bearing failure.

Obviously all bearings must wear when on turning gear, this wear being a function of load. The loads on the aftermost bearings of this class of vessel are higher than normally encountered which may explain to some extent the preferential failure of an aftermost bearing. This test however has failed to indicate the reason for failure of the starboard bearing and not the port bearing. Pure supposition is that the loads on port and starboard bearings are slightly different or that the port bearing scrapers deliver marginally greater volumes of oil on turning gear, this margin being sufficient to prevent failure.

Wear rate is also dependent upon the shaft surface finish. At the time of installation the surface was not noted as being abnormally rough. However surface roughness is notoriously difficult to estimate without measuring instruments or comparitors so it is felt that, before adopting the following recommendations, shaft surface finish is checked.

7. RECOMMENDATIONS

If wear down on turning gear is to be entirely prevented then the shaft and bearing must be fully separated during slow speed operation. The only method of doing this is to supply high pressure jacking oil to small pools on the lower pad. Oil would be drawn from the bearing sump and delivered via flexible pipes to the bottom pad.

Since all bearings wear at low speed and generally speaking failure is uncommon, methods of reducing wear on this bearing will probably increase bearing life to that enjoyed by most marine shaft bearings.

Accepting the owners reluctance to modify bearing load by lowering it (since this may result in stern bearing failure) it is suggested that a greater supply of oil to the bearing will probably increase life. When on turning gear the scraper delivers only a small volume of oil to the bearing and some of this volume is lost down the sides of the oil pick-up ring. The volume of oil delivered on turning gear can be increased by fitting a modified scraper and an oil ring which instead of being the usual I section is manufactured so as to contain a series of "pockets" which pick up oil from the sump to large quantities than a plain ring. Such rings are used on cement kiln bearings. Such a ring although delivering much greater quantities may have the disadvantage of increasing oil churning at full speed resulting in a hotter bearing oil sump. Also slight modification to the casing top would be required.

Alternatively an oil of higher viscosity may be used but unless fed in sufficient volume is not likely to be more efficacious than the present oil. The bearing may also be supplied with a greater oil volume on turning gear by mounting a small circulating pump outside the bearing which draws oil from the sump through one of the drain plugs and delivers a stream of oil between the upper pads. Connexions can be made through the upper inspection door to accomplish this.

8. CONCLUSIONS

Film thickness measurements have been made on the starboard aftermost bearing of a container ship using inductive transducers. It has been shown that although minor inaccuracies limit the use of this method as a means of deriving load, considerable data can be obtained as to the running condition. Wear and changes in alignment are particularly easy to detect.

Based upon the measurements taken it has been concluded that the starboard aftermost bearing of the ship suffers excessive wear down when on turning gear. The excessive wear down is most likely due to the fact that the bearing is loaded well in excess of its design load. Nevertheless it is felt that provision of continuous supplementary oil supply during turning gear operation will increase bearing life to that enjoyed by most marine tunnel bearings. Alternatively, high pressure jacking oil may be supplied to the lower pad to prevent any metal to metal contact.

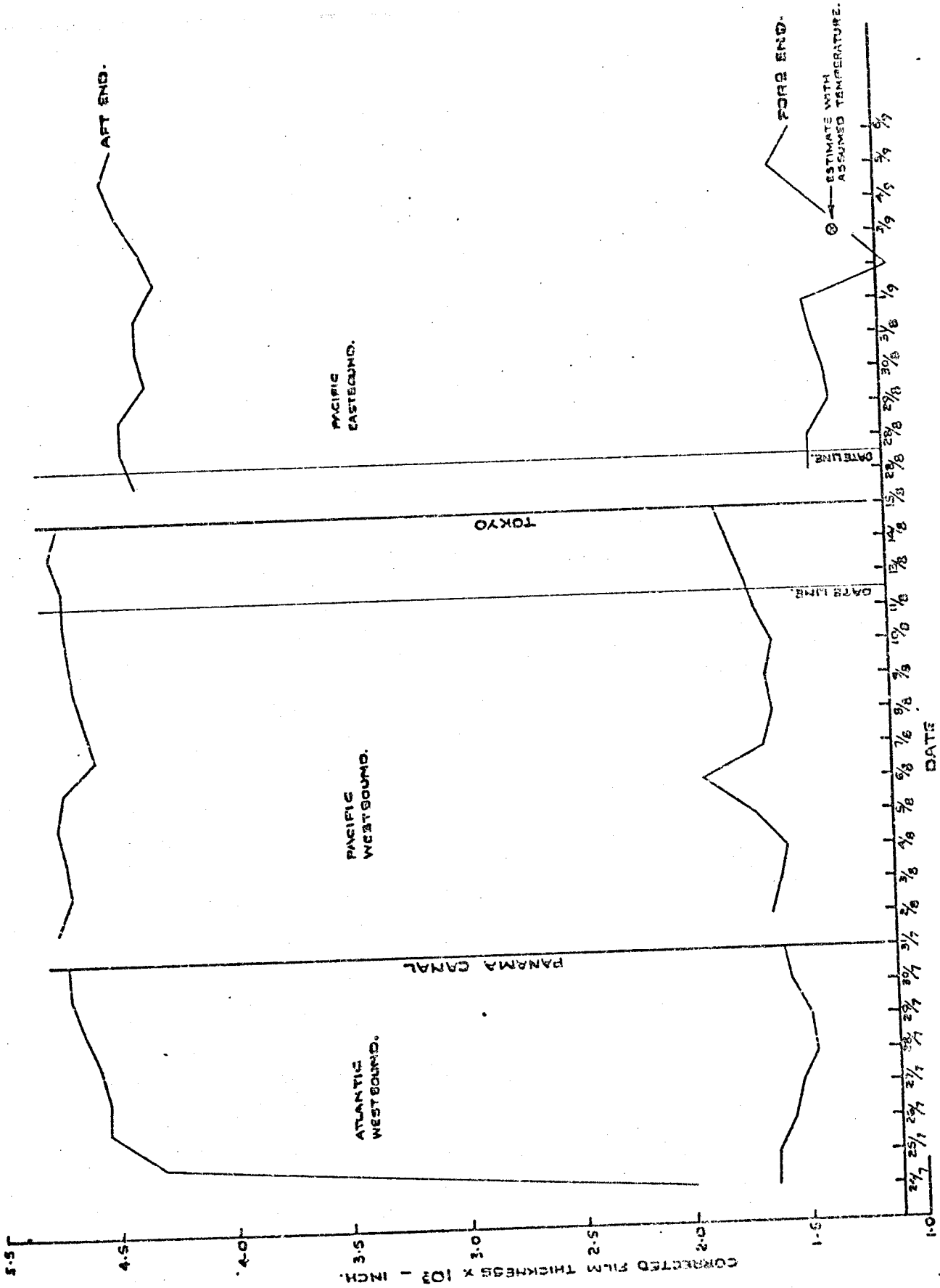

VARIATION IN FILM THICKNESS.

GRAPH I.

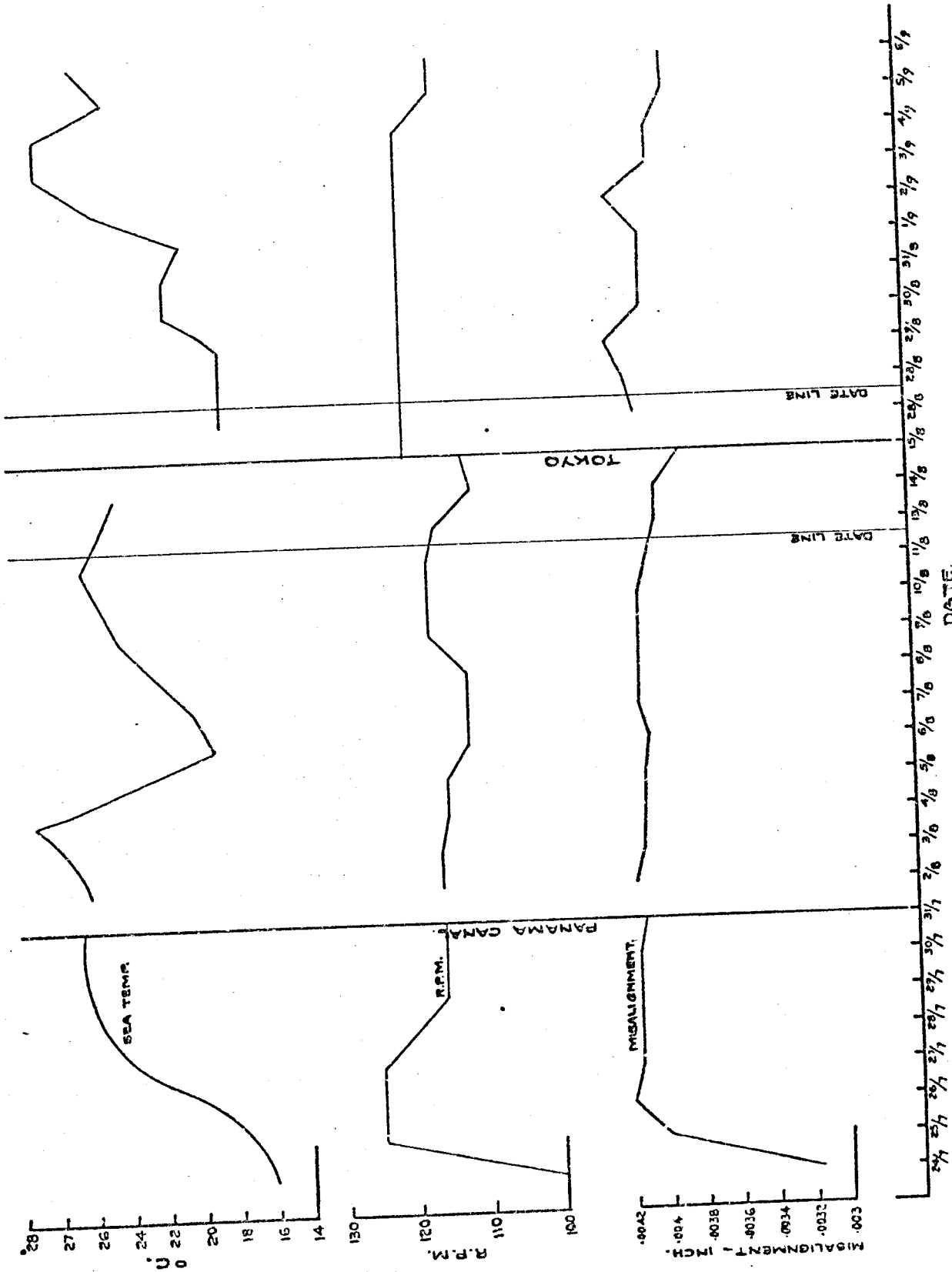

GRAPH II (A)

VARIATION IN ALIGNMENT AND SPEED.

GRAPH II.

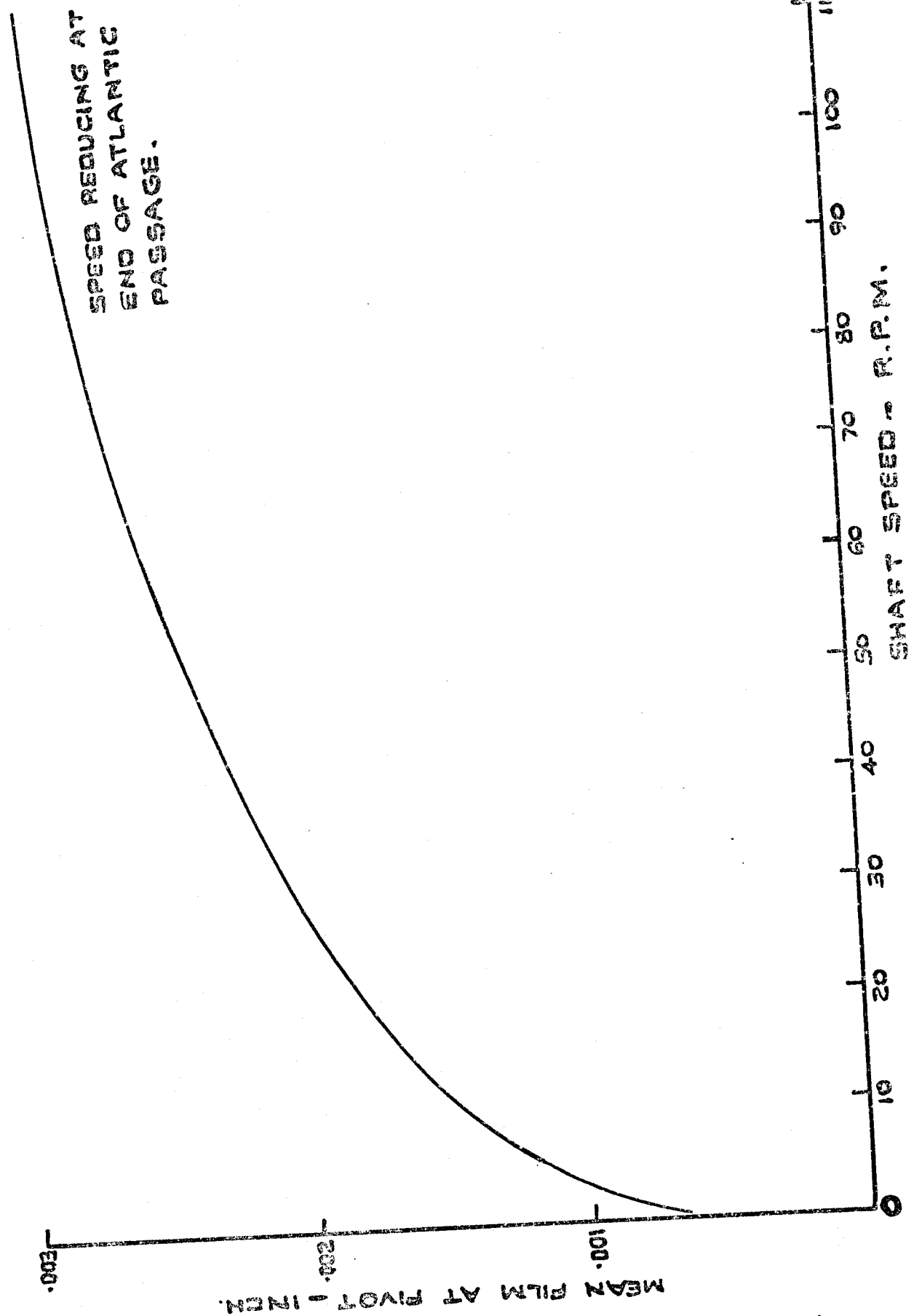

FILM THICKNESS & SHAFT SPEED

GRAPH III

(AV)

RANGE IN ALIGNMENT

V SHAFT SPEED.

GRAPH IV

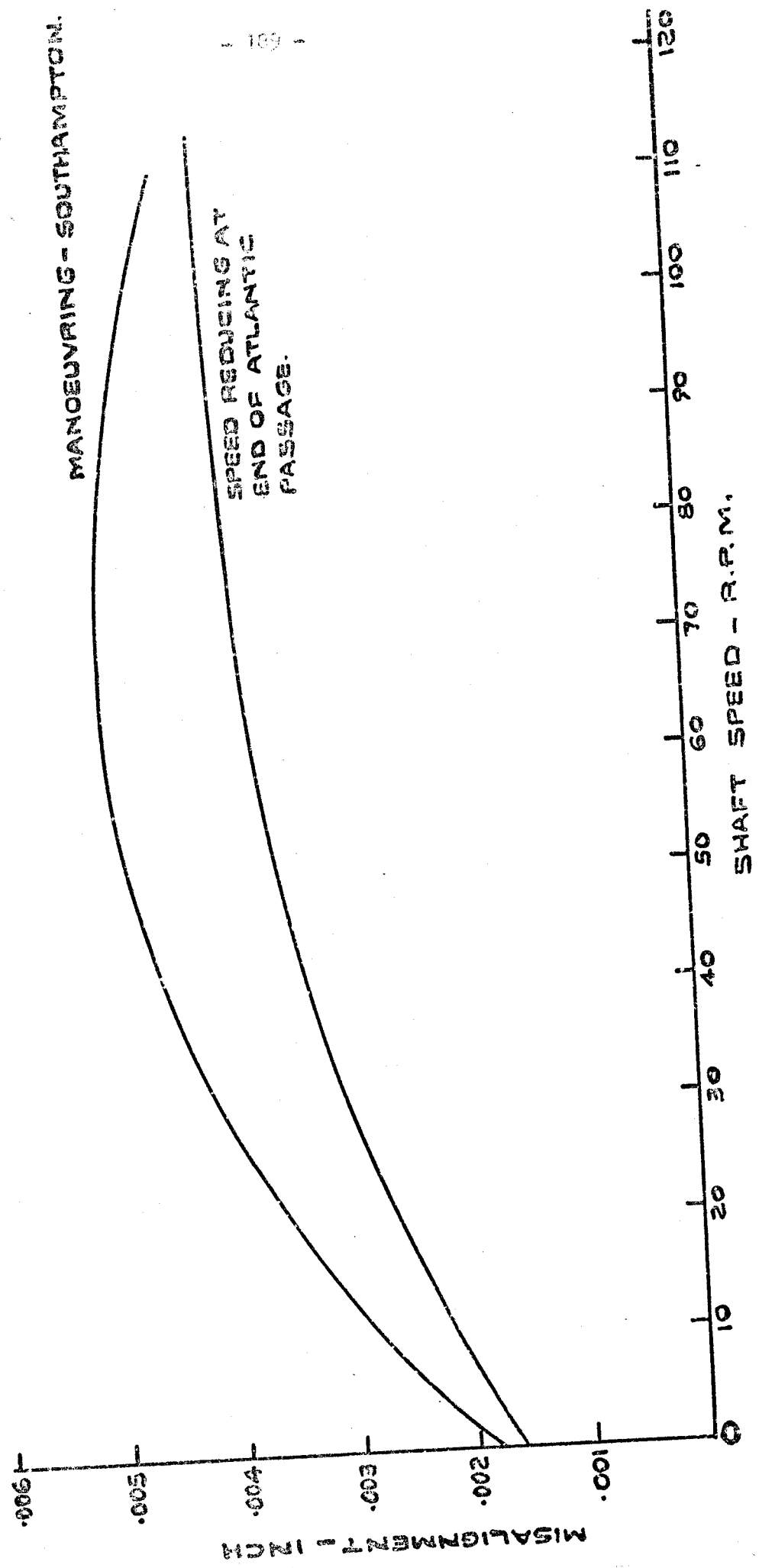

MISALIGNMENT - INCH

SHAFT SPEED - R.P.M.

MANOEUVRING - SOUTHAMPTON.

SPEED REDUCING AT
END OF ATLANTIC
PASSAGE.

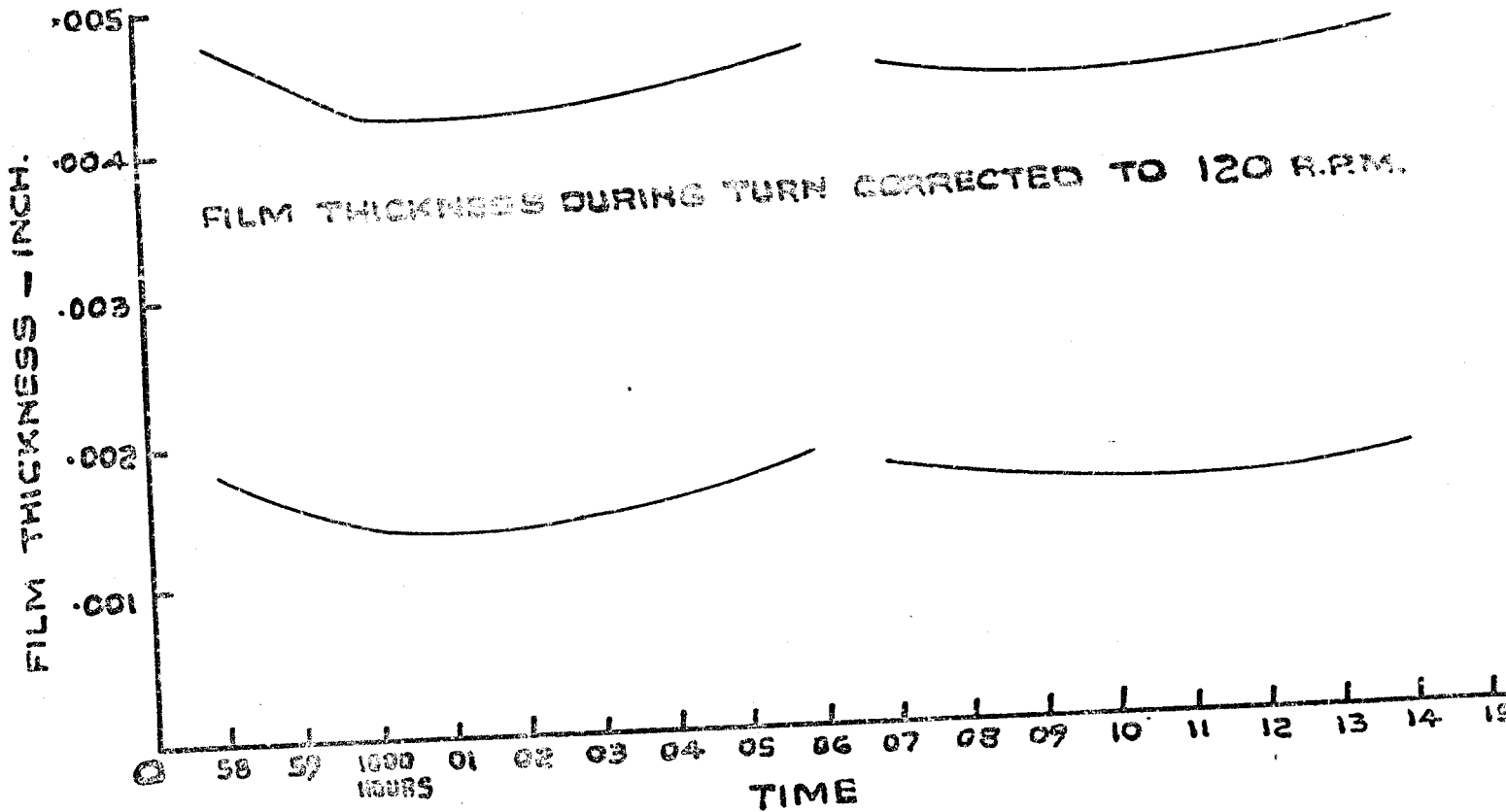
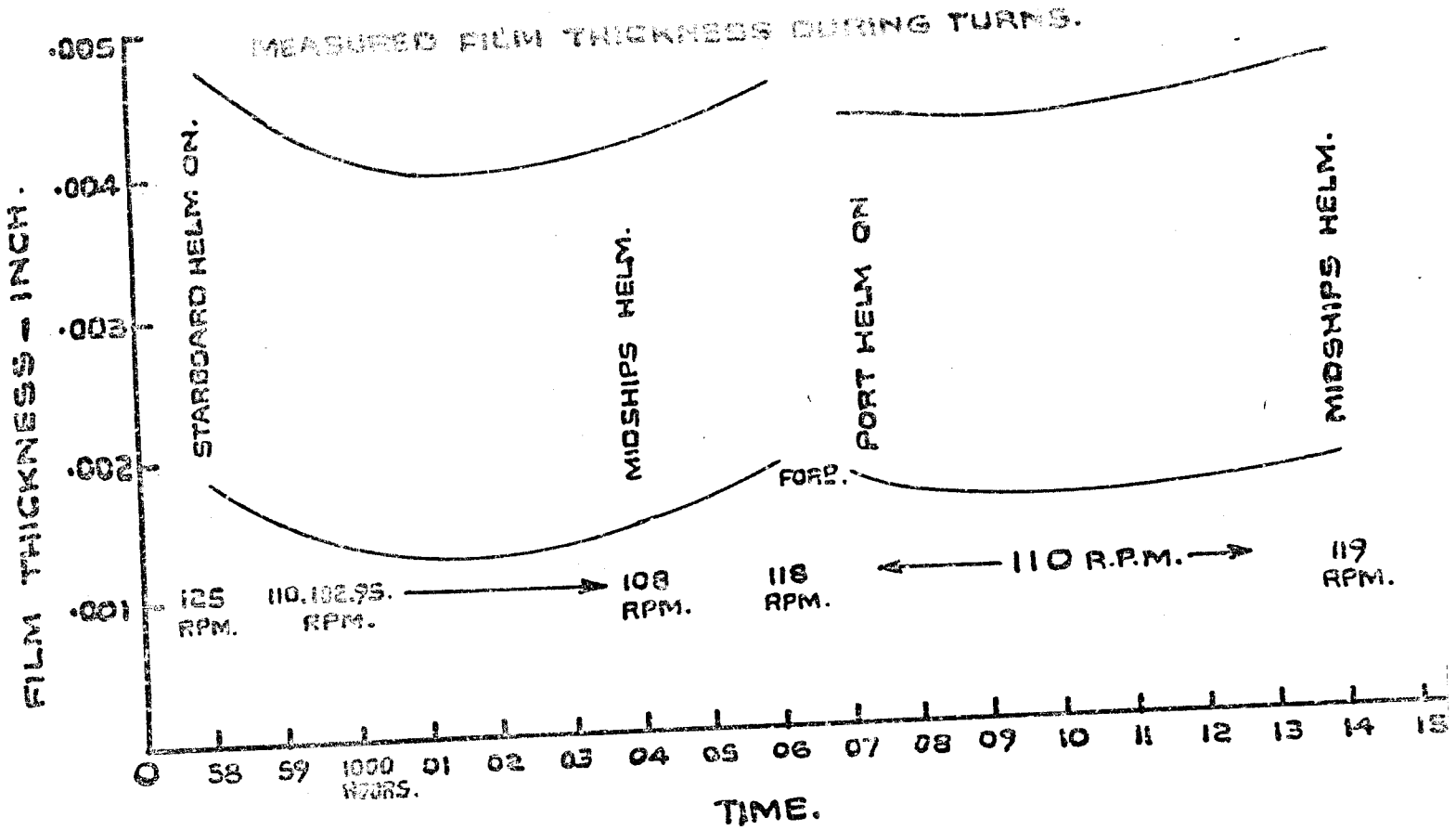

REDUCTION IN HORIZONTAL CLEARANCE - INCH.

.013
.012
.011
.010
.009
.008
.007
.006
.005
.004
.003
.002
.001

10,000 20,000 30,000 40,000 50,000 60,000 70,000

BEARING LOAD - LBS. GRADE VI (AV)

REDUCTION IN HORIZONTAL CLEARANCE V LOAD.



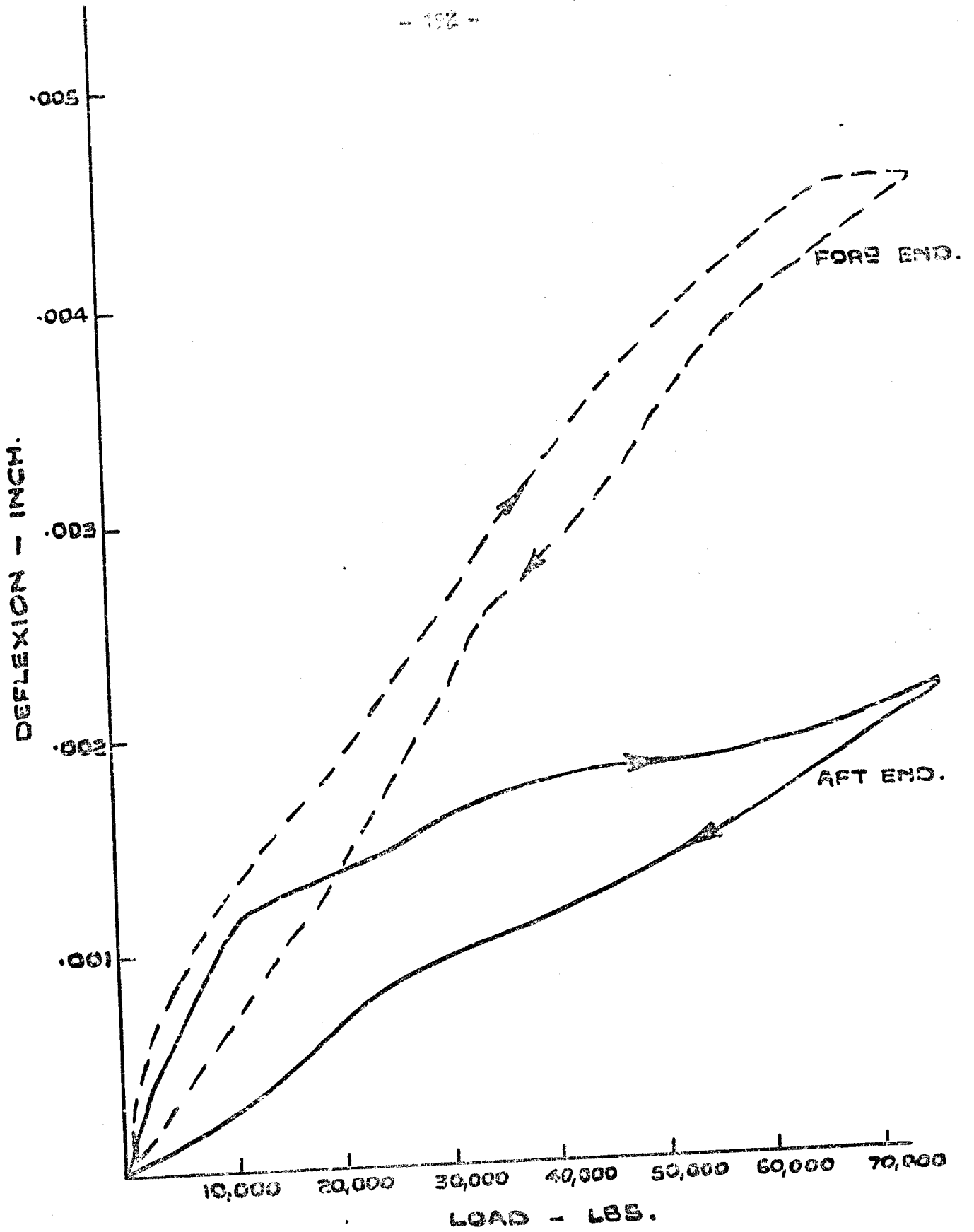

VERTICAL DEFLEXION OF 23" PLUMMER BEARING UNDER LOAD.

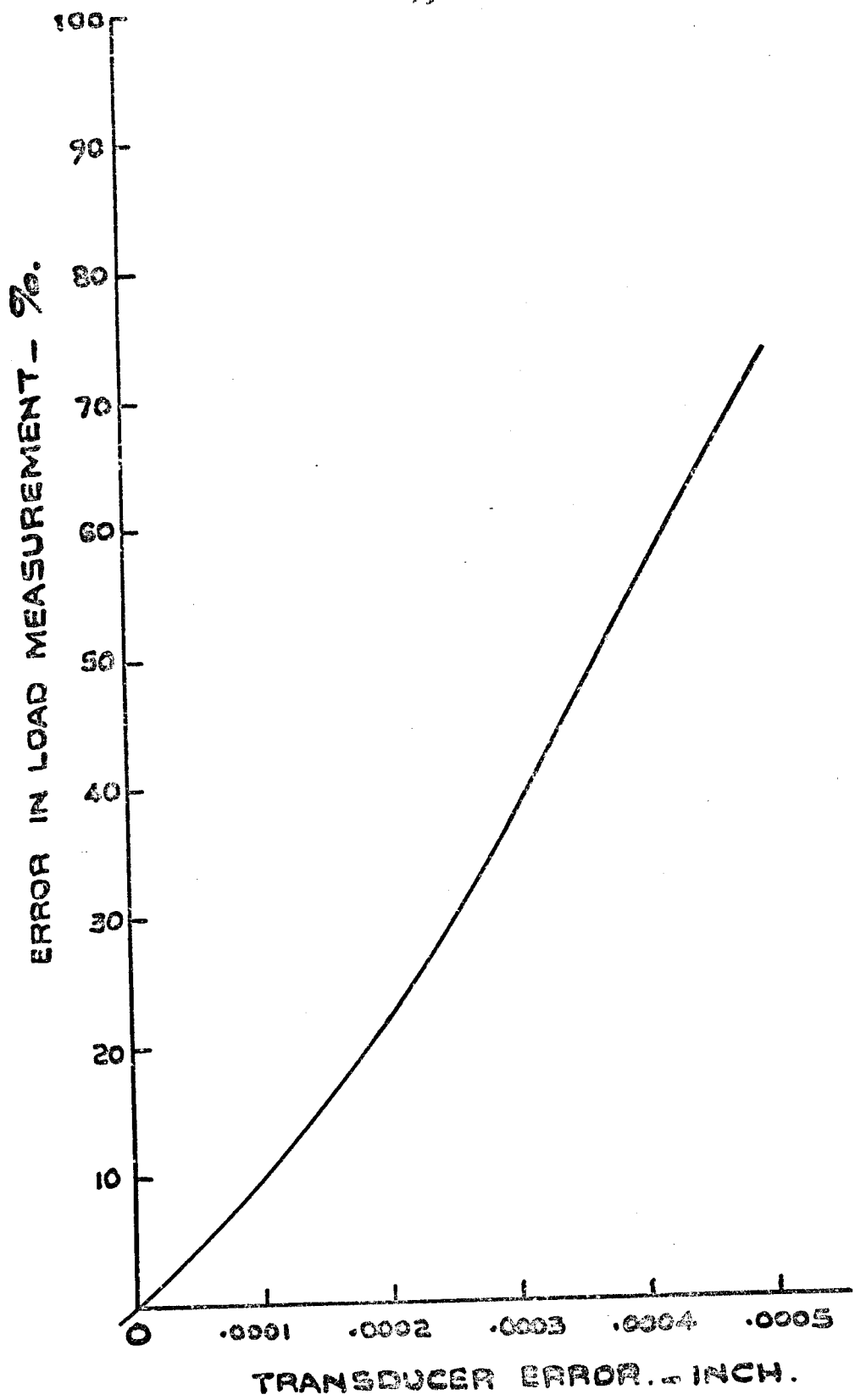

EFFECT OF FILM THICKNESS ERROR
UPON CALCULATED LOAD.

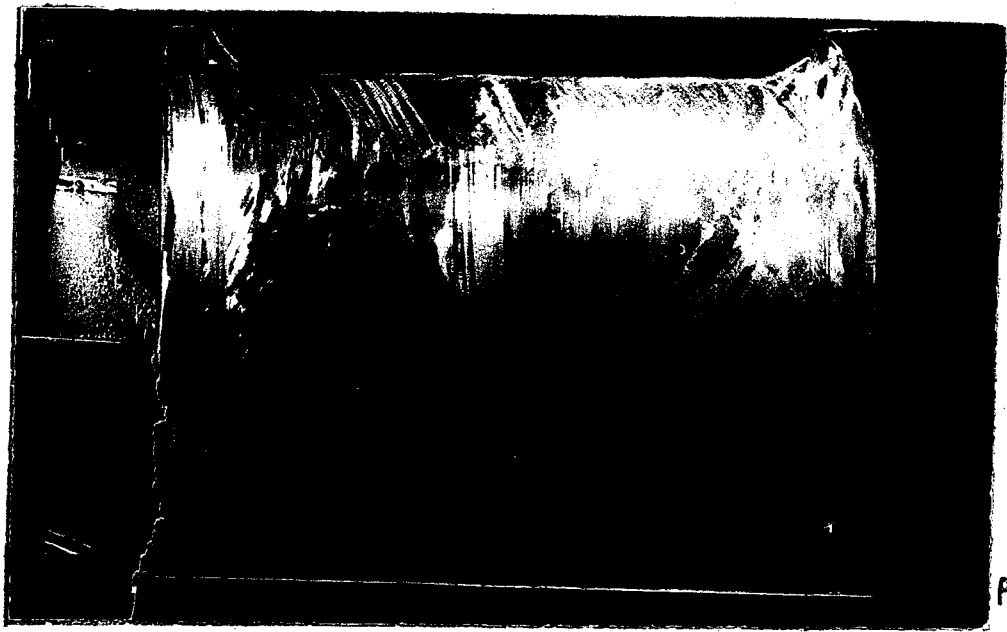
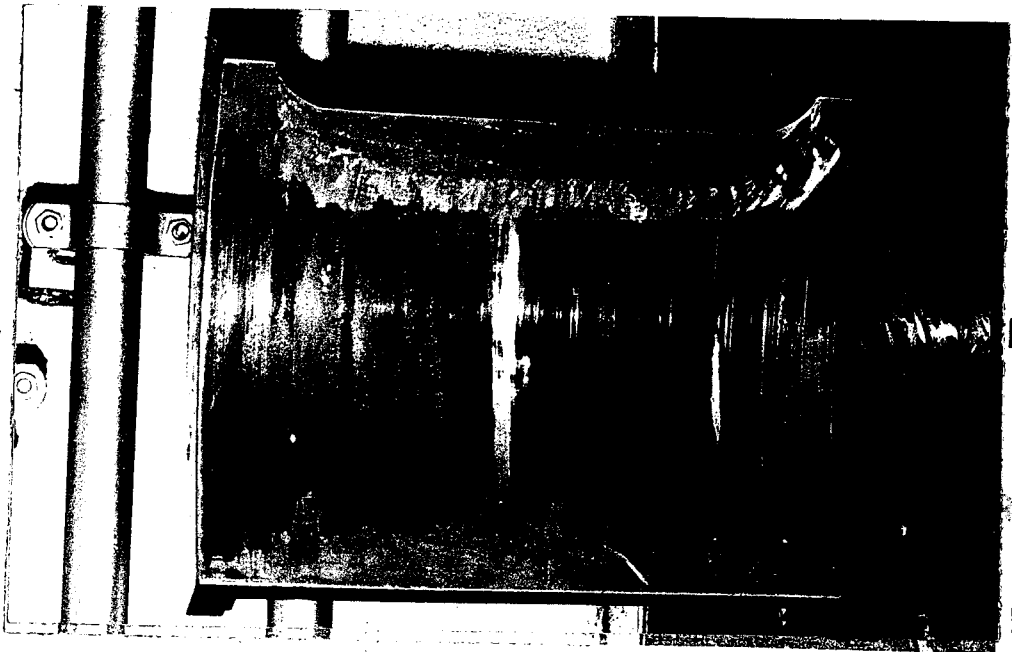

Plate 1.



AHEAD
ROTATION.

Plate 2



Plate 3.

PADS REMOVED PRIOR TO TEST.

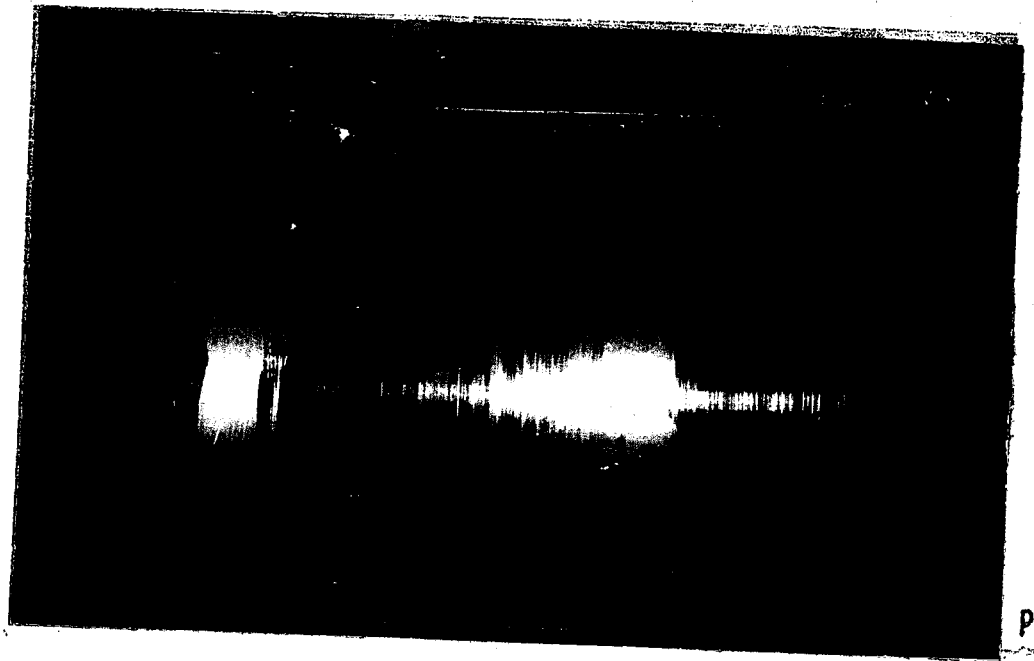
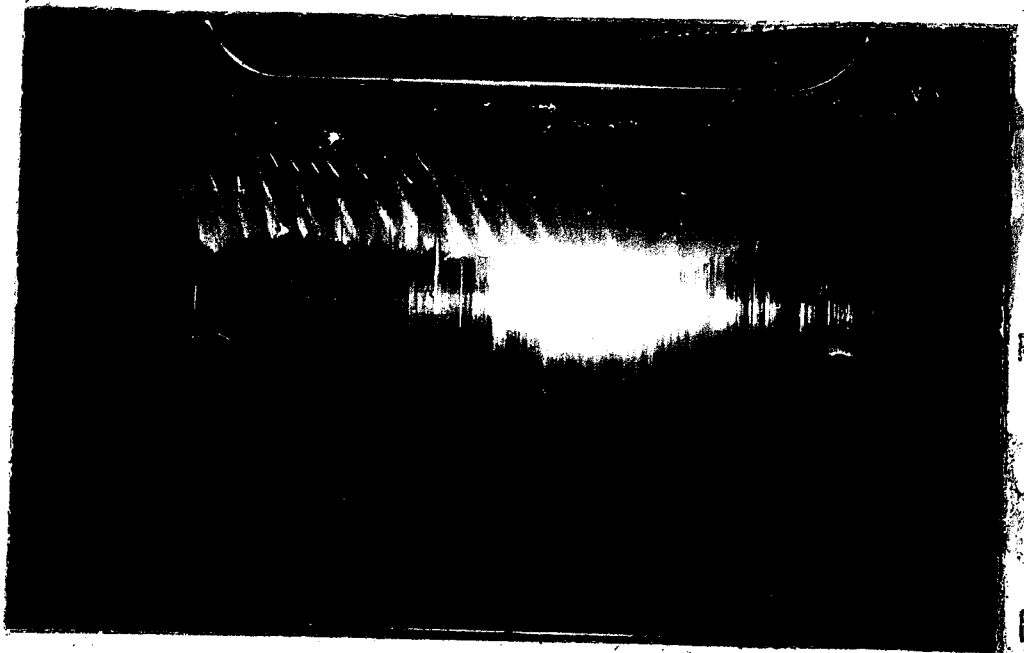

Plate 4.



AHEAD
ROTATION.
↓

Plate 5.

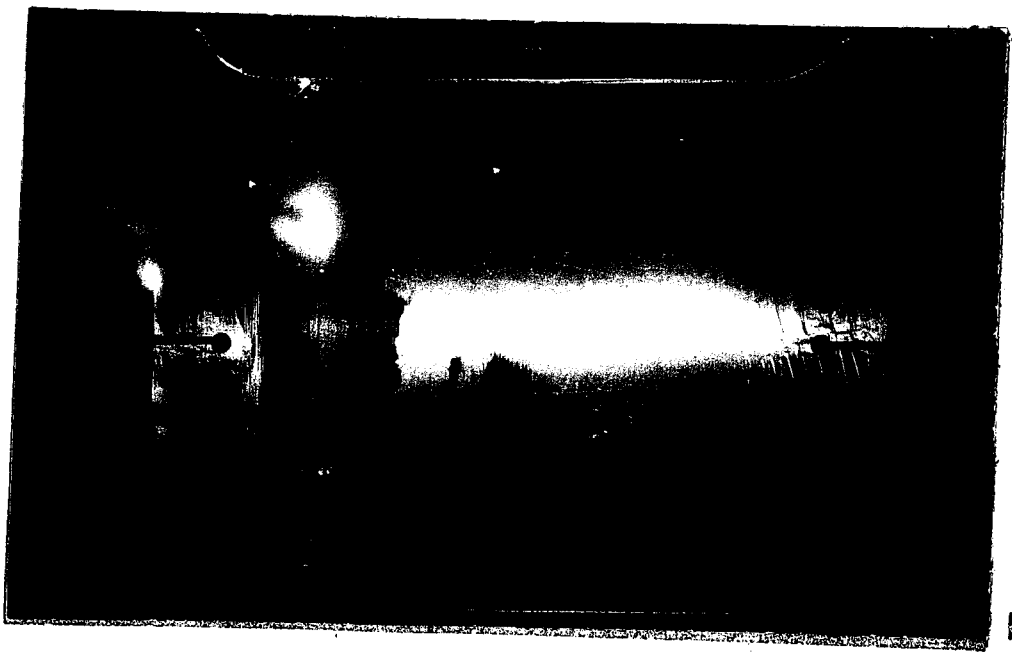

Plate 6.

PADS REMOVED AFTER TEST.