

Durham E-Theses

Some aspects of primary productivity in an old field system near Durham

Knox, David A.

How to cite:

Knox, David A. (1966) *Some aspects of primary productivity in an old field system near Durham*, Durham theses, Durham University. Available at Durham E-Theses Online:
<http://etheses.dur.ac.uk/8919/>

Use policy

The full-text may be used and/or reproduced, and given to third parties in any format or medium, without prior permission or charge, for personal research or study, educational, or not-for-profit purposes provided that:

- a full bibliographic reference is made to the original source
- a [link](#) is made to the metadata record in Durham E-Theses
- the full-text is not changed in any way

The full-text must not be sold in any format or medium without the formal permission of the copyright holders.

Please consult the [full Durham E-Theses policy](#) for further details.

Some aspects of
primary productivity
in an old field system
near Durham

David A. Knox

September 1966

Thesis submitted as part of the requirements
for the degree of M.Sc. in Ecology.

INTRODUCTION

Following the classical studies of Lindemann, E.P. and H.T. Odum, and others, on energy flow in natural or semi-natural ecosystems, several papers have been published on estimates of primary productivity in 'old-field' systems. These systems, where a field has been taken out of agricultural use and left undisturbed, offer a possibility of studying the changes in productivity and energy relationships as a secondary succession takes place.

It was felt that it would be of interest to try and estimate the productivity in a field owned by the biological departments at Durham University. This field had been in use as a pasture until about 4 years ago, since when it has been left to develop with minimum interference.

The field is about half a mile south of the Durham University Science Laboratories, and extends from Hollingside Lane down a west-facing slope to a very small stream in a ditch at the bottom. (See sketch map in Appendix.)

The soils around Durham are mostly of glacial and fluvioglacial origin. Willimott and Shirlaw (1960), examining soils at the Science Labs. site, found they were mostly sandy loams of fair nutrient status; the dominant clay mineral was illite.

Part of the field is wooded, the trees being mostly oak (Quercus robur) and beech (Fagus sylvatica). Only at the base of one beech tree is there no ground flora at all; in some other shaded parts, Deschampsia flexuosa is the dominant species of the ground flora.

It was decided to try and examine the primary productivity - i.e. production by autotrophic plants - in different parts of the field, in relation to different amounts of shading and different intensities of grazing by field voles and other small mammals. The selection of experimental areas for this purpose

was restricted by the difficulty of finding areas of suitable size which appeared to be reasonably homogeneous.

AIMS OF THE PROJECT

1. To collect data on productivity in an old field system near Durham.
2. To try to observe the effects on productivity of excluding small grazing mammals (mainly field-voles) from selected areas in the field.
3. To compare productivity in parts of the field shaded to different extents by trees.

METHODS

1. Selection of areas for study.

Within the Zoology Dept. field, 4 areas were chosen, as follows:-

- a. Areas A and D, near the top of the field. (Locations shown on sketch map in appendix.) A had a slope of about 5° , to WSW, D was virtually flat. The most prominent plants were Dactylis glomerata and Alopecurus pratensis.
- b. Area B, further down the slope, had an angle of slope of about 20° , also to WSW, and was closer to some beech trees about 50' high which were rooted further down the slope.
- c. Area C was about 10 yards down the slope from B, and had an angle of slope of about 30° . The southern end of the area was under the canopy of a beech tree.

2. Measurement of productivity.

- a. Collection of tree litter. Between 29th. October 1965 and 4th. November 1965 all the tree leaf litter was removed from 1 square metre in each of the areas A, B and C, collected in polythene bags and air-dried in the lab.. It was then sorted into species, and weighed in the air-dry state. 2 small sub-samples of beech litter (by far the most abundant type) were oven-dried at $105^{\circ}\text{C}.$, and a conversion factor obtained to estimate the oven-dry weight of the whole.
- b. Two methods were used to try and estimate the productivity of the ground vegetation:-
 - (i) Standing crop - cut and weigh how much plant material is present at a particular time.

- (ii) Paired plots - measure the rate of disappearance of dead material.

STANDING CROP MEASUREMENTS.

- i. Selection of locations to cut.
- a. Size. Starting the project in the late autumn, the material was mostly too dead to make estimations of minimal areas easy. 25 cm. x 25 cm. was chosen as the size for each clip-plot, being generally fairly suitable for grasslands in Britain.
 - b. Shape. Square clip-plots were used, to try and keep the edge effect reasonably small while having a shape which fitted easily into plots. This latter point was important because the cost of fencing had to be taken into account. Really long quadrats, which might be expected to give better representation of different parts of any pattern present, would have led to a serious edge effect in cropping, unless they were very big.
 - c. Spacing. All the areas were gridded, and samples selected for cutting by coordinates taken from a table of random numbers. No space was left between adjacent grid units, again owing to the cost of fencing. A 25 cm. - wide strip adjacent to the fencing round the plot was left unused, to try and avoid edge effects from the fencing.
- ii. Parts of plants cropped. It would obviously have been desirable to estimate root as well as shoot production. Trials produced a water-current device (see appendix) which was moderately effective at separating roots from soil particles but failed to separate live and dead bits of root. Eventually, it was decided to crop everything above soil level.

iii. Cropping methods.

The first problem which arose was that the plants were not all vertical, but leaning over in one direction or another. The criterion for deciding what lay inside a particular quadrat had to be repeatable. 2 obvious alternative procedures were:-

- a. Cut all material coming within the quadrat.
- b. Cut all material rooted inside the quadrat.

The first alternative was ruled out, because the consequent cutting of live stems and blades in their central portions would have created too much dead material in adjacent quadrats. The second procedure was therefore followed. In the crops taken in March and May, both live and dead stems and leaves were pulled through and cut according to where they were rooted; later on, the dead material had largely sunk into a mat just above the ground, and was cut where it lay.

Two obvious disadvantages of this method were that:-

- a. A lot of the plant material overlying leeward quadrats was removed, exposing soil and the bases of plant stems.
- b. The weights of creeping plants recorded for quadrats in which they were rooted were sometimes much greater than the weight of above-ground parts present within the boundaries of the quadrats. This problem arose particularly with Veronica chamaedrys.

In the case of Heracleum sphondylium, the very large leaves of which made nonsense of the normal procedure, the parts of the plants which were covering any part of a sample quadrat were cut off and included in the sample. As the leaves had not grown to an appreciable size until the time of the July and August samples, the fact that this procedure increased dead weights elsewhere was not

so important: as it happened, in no case was a subsequent quadrat affected.

Each month except August, 10 clip-plots were cut in each of the following areas:-

- A, inside the fence (designated Ai)
- A, outside the fence (designated Ao)
- B
- C
- D, outside the fence (Do)
- D, inside the fence (Di)

In August, 10 plots were cut in Ai and Ao, but only 5 in each of the other areas listed above.

The sampling periods were 23-26 March, 4-10 May, 2-9 June, 19-22 July and 19-24 August. Exact dates are given in the appendix.

- iv. Storage. After collection, the crops were kept in paper bags in a deep-freeze. Most material seemed to be unchanged in appearance by this treatment, though buttercup leaves tended to blacken. By contrast, dried-out material was very difficult to sort into live and dead material, different species losing their 'live' appearance at different rates.
- v. Sorting. It was decided to sort the whole of the contents of each bag (i.e. the whole crop from each clip-plot), rather than take an aliquot. The main reason for this decision was that the material consisted, in the main, of long grass leaves (with other material mixed in with them) which had been put in in handfuls, as it had been cut. The contents of each bag were thus structured in such a way as to promote bias in any attempted sub-sampling, as handfuls drawn out would be very likely to coincide with handfuls which had been put in.

The categories into which material was sorted were as follows:-

- a. Live vs. dead. An attempt was made to separate dead material from live. The basic criterion for deciding whether material was live or not was green colour. Material which was going yellow naturally presented some difficulty, and it was attempted to allocate half of this 'doubtful' material to the live category, and half to the dead. If an appreciable portion of a leaf was dead, but the basal part was live (a common occurrence in grasses), the 2 parts were separated.

It is possible that, of the May collection from area B, a greater proportion of the 'doubtful' material was allocated to the live category than in later collections, because there was less green material to compare it with.
- b. Grass vs. non-grass. This was quite straightforward, though it is possible that a small quantity of Luzula spp. may have been put into the "grass" category.
- c. Sorting the live material into species: This was first attempted with the May collection, where it proved very difficult, as many of the plants had not grown to an easily recognizable stage - very small blades of grass tended to look very much alike - and with the July collection, where it proved more practicable. Only some of the May material was sorted - 9 plots from area B - and subsequent experience cast doubt on some of the identifications, particularly "Cynosurus cristatus", which was probably Agrostis stolonifera. Subsequent comments apply to the July material only.

Sorting non-grass species was not too difficult, though some of the buttercup leaves (Ranunculus bulbosus and R. acris) seemed almost to grade into one another. Identification of some leaves without flowers was not completely certain, but in general probably reasonably accurate.

Sorting the grass into species produced several serious problems, aggravated by the fact that the specimens were often incomplete, parts having been separated during the cutting. (To have cut each plant separately would have greatly increased the length of time necessary to cut the samples - probably to about a fortnight.)

The main confusions arose when attempting to separate vegetative parts of the following species, using the key to the vegetative parts, and descriptions, given by Hubbard ()::

Alopecurus pratensis

Agrostis stolonifera

Agrostis tenuis

Alopecurus myosuroides/*Agrostis gigantea*.

The grasses identified with the key as *Alopecurus myosuroides* or *Agrostis gigantea* are probably *Alopecurus pratensis*, as one plant was found with vegetative parts which would certainly have been identified as *Alopecurus myosuroides* or *Agrostis gigantea*, but bearing the flowering head of *Alopecurus pratensis*. They have been treated as *A. pratensis* in the construction of the association tables.

There seemed to be no clear division between the material categorised into the spp. *A. pratensis*, *Agrostis stolonifera* and *Agrostis tenuis*. As no flowering heads of *Agrostis tenuis* were found in any of the collections, it is possible that this species was not present at all, and the material identified as *A. tenuis* was really *A. stolonifera*, flowering heads of which were widespread in all the areas studied.

Some *Festuca vivipara* was found in A in August; this species (or any other form of *F. ovina*) had not been previously identified from collections from any of the plots.

The material designated as *Holcus lanatus* contains some *H. mollis* in a few plots, probably mostly in area C.

vi. Weighing. The sorted material was put into paper bags and dried at 105°C. to constant weight. The bags with contents were then weighed on a torsion balance accurate to 0.1 gm., and the weight of a similarly dried empty paper bag subtracted. It would have been more accurate to weigh each empty paper bag afterwards, but this would have greatly increased the time taken and in view of the small size of the discrepancies mentioned below was not thought worth while.

Some of the sorted material from the May and June collections was kept for a while before drying, and some of the bags so kept were attacked by white fungal hyphae. As little external disintegration of the plant material seemed to have occurred, and no suitable correction for this mishap could be devised, no correction was made for any material so respired away.

The choice of the particular torsion balance was dictated by convenience. A more accurate machine would have been useful for weighing some of the smaller quantities of material. In a few cases the weight of the bag + grass was indicated as being equal to or even (rarely) 0.1 gm. less than the weight of the standard dried paper bag.

Instances where less than 0.1 gm. weight were obtained have been indicated in the results by the letter 't'.

PAIRED PLOTS

Following Wiegert and Evans (1964), this technique was used to try and obtain an estimate of the rate of disappearance of dead material.

The basic procedure is:-

- i. Select a number of pairs of adjacent plots, each member of a pair being, as far as possible, exactly similar to the other plot of the pair.

- ii. At the beginning of the month or other time interval, treat each pair of plots (a and b) as follows:-
- (1) Remove all live plant material from (a). Dry, weigh.
 - (2) Remove all dead plant material from (a). Dry, weigh.
 - (3) Remove all live material from (b). Dry, weigh.
- iii. At the end of the time interval,
- (4) Remove from (b) all the remaining dead material.
Dry, weigh.
- iv. Then, assuming that originally the 2 plots of the pair both contained the same weight of dead plant material, we can calculate the amount which disappeared during the time interval which elapsed.
- Comparison of the weights of living material on each plot gives some idea of how similar the plots in each pair are. If the relationship between the weights of live and dead material is known (e.g. if one is proportional to the other), allowance can be made for any starting difference.
- v. At the end of the growing season, productivity over the season can then be estimated from figures obtained at (e.g.) monthly intervals, as follows:
- Productivity (or, more strictly, net primary productivity), is equal to
- the sum of the amounts of dead material disappearing each month,
- plus the amount of live + dead material left at the end of the season,
- minus the amount of dead + live material present at the beginning of the season.
- vi. This method is designed to take into account the amount of plant material which grows and dies during the growing season without featuring in the maximum standing crop. Wiegert and Evans found that, in an old field in Michigan, net primary production estimated in this way was more than twice as much as the sum of the peak standing crops of the constituent species.

The procedure followed in this investigation was:-

1. 2 pairs of plots, 25 cm. square, which were thought to be more or less representative of the type of vegetation on the experimental areas, were selected near each of the areas A, B and C. In the 2 pairs near A, the dominant plants (in terms of both bulk and cover) were Dactylis glomerata and Alopecurus pratensis. In those near B, Festuca rubra, Agrostis stolonifera and Holcus lanatus were commonest. In those near C, A. stolonifera, Anthoxanthum odoratum and (in the pair away from the tree) F. rubra seemed to be dominant. One of the pairs near C was at the end of C nearest the overhanging beech tree, the other at the opposite end.
2. In one plot of each pair (denoted a), the live vegetation was removed and put into paper bags. Then the dead material was similarly removed and bagged. Where grass leaves were dead except for the basal part and the sheath, they were cut at the base of the dead part, and dead pieces put with the other dead material.
3. In the other plot of each pair (denoted b), the live vegetation only was removed, and the dead left behind. Partially dead leaves were cut as in the (a) plots.
4. A month later, all the material remaining on the second plot was harvested. The live plants, including any dead parts on them, were discarded.

All the material collected was dried and weighed in the usual way (105°C., constant weight).

Only one set of paired plots was set up, starting in July and ending in August. (Exact dates in appendix). It had been intended to set up a larger number, but the selective cutting necessary in each plot proved very time-consuming, particularly where there were tussocks of plants with many thin stems, like Festuca rubra.

3. Estimation of amounts of light falling on the areas.

Broadly speaking, methods of estimation of the amounts of incident light can be classified into 2 groups:-

- i. Measuring the amount of light falling onto the plot, using some sort of meter.
- ii. Estimating the amount of obstruction of light, compared with the situation at a hypothetical point situated in a large plane with no obstructions above the horizon.

In view of the shortage of time and money, it was decided not to attempt the construction of any solarimeters, but to measure the obstruction of light by photographs of the surroundings. One of the special cameras at Cambridge University Botany School was borrowed for the purpose, by kind permission of Drs. G.C. Evans and M. Anderson.

This camera is fitted with a Hill lens, giving a field of view of 180° and an equiangular projection onto the negative (i.e. the sky included in 5° of view in any part of the sky is represented by an equal distance on the negative - see diag.).

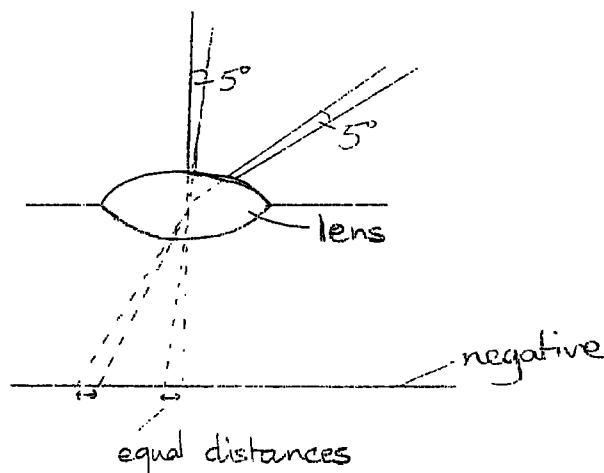

In late April, just before the tree canopies opened, 4 photographs were taken with this camera at areas B and C, one halfway along the side of each plot. In addition, 2 were taken at A and 2 at D - in each case, one in the middle of the fenced area, one in the middle of the unfenced area. The camera was supported on a plane table, as close to the ground as possible

(about 15 cms. above soil level), making the lens about 25 cms. above soil level. The camera was levelled and aligned due North-South for each photograph.

Onto the photographs so obtained were drawn in, by eye, the approximate outlines of the tree canopies. (It was not possible to borrow the camera later in the year, when the canopies had opened, and as the important trees on the photographs were beech trees which usually have practically no gaps in the canopy [these particular ones turned out to be no exception], it was felt that the error arising from this course of action would not be excessive.)

A special grid, from Anderson (1964) was then superimposed on each photograph in turn. This grid is divided into segments, each of which represents 0.1% of the total radiant illuminance from a standard overcast sky. The number of grid segments which were more than half obscured by tree canopy or sloping ground or other obstructions were counted for each photograph in turn, and a percentage obstruction calculated for each photograph. For areas B and C, a mean value was calculated (from only 3 photographs for B: one of the plates was severely fogged); A1, A0, D1 and D0 had just one photograph, and hence one value, each. In the results are given the percentages of total illuminance which were not obscured, to act as a guide to the relative amounts of light which the different areas might be expected to receive while the trees were in leaf. The tree leaves opened during the first week in May, the canopies being effectively complete within 10 days.

4. Vole-proofing.

In each of areas A and D, a plot 3m. x 4m. was fenced round with 0.25" Weldmesh wire netting supported on a wooden frame. The netting was dug into the ground to a depth of 1' below the soil surface, and extended to a height of 2' above

the soil. This was considered sufficient to prevent any of the species of field voles in the area (Apodemus sylvaticus, Microtus agrestis and Clethrionomys glareolus) from tunnelling under or jumping over.

Before the fencing round each plot was complete, pre-baited 'Longworth' traps (baited box-like traps, with their doors fixed in the open position so that voles could pass freely in and out) were left in the areas for 2 or 3 days, to enable the animals to become accustomed to them. After the fencing was closed, the traps were re-set to catch any voles entering them, so that any voles left in the enclosures could be caught and removed. Traps were left in throughout the summer to try and check whether any voles had entered the fenced areas; none was caught at any time.

When the netting had been completed, the top of the fence was coated with "Sticktite" - a non-setting, 'gooey' substance - to discourage voles from climbing over.

In late June, the grass around the fenced plots, particularly in area A, had grown so tall that in many places it looked as though it might be possible for a vole to climb up some grass stems touching the fencing and get into the enclosures in this way. The grass surrounding the fencing on the outside was therefore cut with shears; that inside was left untouched.

5. Soil analysis.

Between 27 and 31 August, 10 soil samples were taken from each area (Ai, Ao, B, C, Di and Do). Each sample consisted of a core 5 cm. in diameter and 10-12 cm. deep, and was obtained with a soil corer pushed into the soil after the loose dead plant material had been cleared away from the surface. The upper zone that was sampled in this manner contained most of the non-tree root material (as found in preliminary samples taken the previous autumn).

The 10 samples in each area were taken from a random selection of sites which had not been used for other samples.

In general, the soil from Ai and Ao looked blacker and was more crumbly than the soil from the other areas. About 10 cms. down in Ai and Ao was a gravelly deposit of a dark grey substance resembling coke, mixed with pieces of coal of a similar size.

The³ soil in C tended to contain more dead organic material on and mixed in with its surface. The material seemed to be mostly dead beech leaves.

The soil in Di and Do seemed to be deeper and more silty than the soil from the other areas.

In the lab., the samples were passed through a 2 mm. sieve, and the samples from each area then pooled to give one amalgamated sample each for Ai, Ao, B, C, Di and Do. Sub-samples of each were dried at 105°C. to determine moisture content.

Estimation of cations. About 80 gms. fresh weight of the 2 mm. fraction of each amalgamated sample was shaken with 1N Ammonium Acetate solution and left to stand overnight. 2 blanks were run on the same volume of reagent. The following day, the soil samples were leached in a Buchner funnel with more 1N Ammonium Acetate solution until each sample had been extracted with 500 ccs. of solution altogether. (The leaching in the Buchner funnel took about 2 hours for each sample.)

The resulting extracts were analysed on an EEL flame photometer for potassium, and on an EEL atomic absorption spectrophotometer for magnesium and calcium. The determinations of calcium were made first without and then with the addition of lanthanum chloride solution at a concentration of ppm. to suppress interference from other ions, particularly phosphate. As, except for the extract from area C, the presence of lanthanum chloride made a considerable difference to the result (roughly doubling it), the figures given in the results are those obtained with lanthanum chloride present.

Calibration curves were used for all 3 ions; the standard solution used for potassium was 1000 ppm., those for Mg and Ca each 100 ppm..

6. Cleared squares.

One square metre in each of A, B, C and D was cleared of all plant material in November. In the spring, on area B growth seemed to be more lush on the square and on a small area to the leeward of it than in the rest of the area. On area C, no such obvious difference was discernible. On areas A and C, the disturbed zone next to the fencing passed over the cleared squares, preventing further observations.

Several possible explanations of the apparently enhanced growth might be suggested. For example:

1. The removal of dead material allowed more light to reach the young shoots in the spring, so increasing the amount of growth possible.
2. The cutting itself stimulated growth.
3. The square in B happened to have been located at a place where there were unusually large numbers of vigorous shoots.

In the absence of further observations, it is impossible to decide between these and other alternatives. If the extra growth in B is not purely fortuitous, it is possible that no effects were noticeable in area C because (a) there were fewer shoots per sq. m. to show a response, and (b) there was more tree litter there to blow around and fill in the gap.

RESULTS

Of the results given below, the following are given both in tables and as graphs or histograms, to make them easier to follow:

Mean weights and standard errors of plant material collected from each area in the various sampling periods.

Changes in weight, corrected for different lengths of time between sampling periods.

Amounts of K^+ , Mg^{++} and Ca^{++} in soils.

In the association tables, the dry weight in grams of each species is given for each plot. Above the column for each plot are given figures indicating where, within the area, the plot was.

These coordinates are derived as follows:

1. Along the edges of each area, distances of 25 cms. were marked out.
2. In the unfenced areas, the first 25 cm. was given the number 1, the next 2, and so on, along each edge. The numbers ran from north to south and from east to west. Inside the fenced areas, a 25 cm.-wide strip just inside the fencing was left unused and un-numbered.
3. Of the pair of numbers (e.g. 8,7) making up the coordinates for each clip-plot, the first number quoted belongs to the longer side of the plot, the second to the shorter. So, in areas B and C, the clip-plot at the extreme south-west corner has the coordinates 24,16 (as the areas are 6m. by 4m.).

Small quantities of moss occurred in a few of the clip-plots, but, since the amount was never more than a few milligrams dry weight, they were left out of the analysis.

Plant names given in the tables correspond to those given in "Excursion Flora of the British Isles" by Clapham, Tutin and Warburg (1959).

SOILS

1. NUTRIENT STATUS. Cations in mg/100 gm. dry soil.

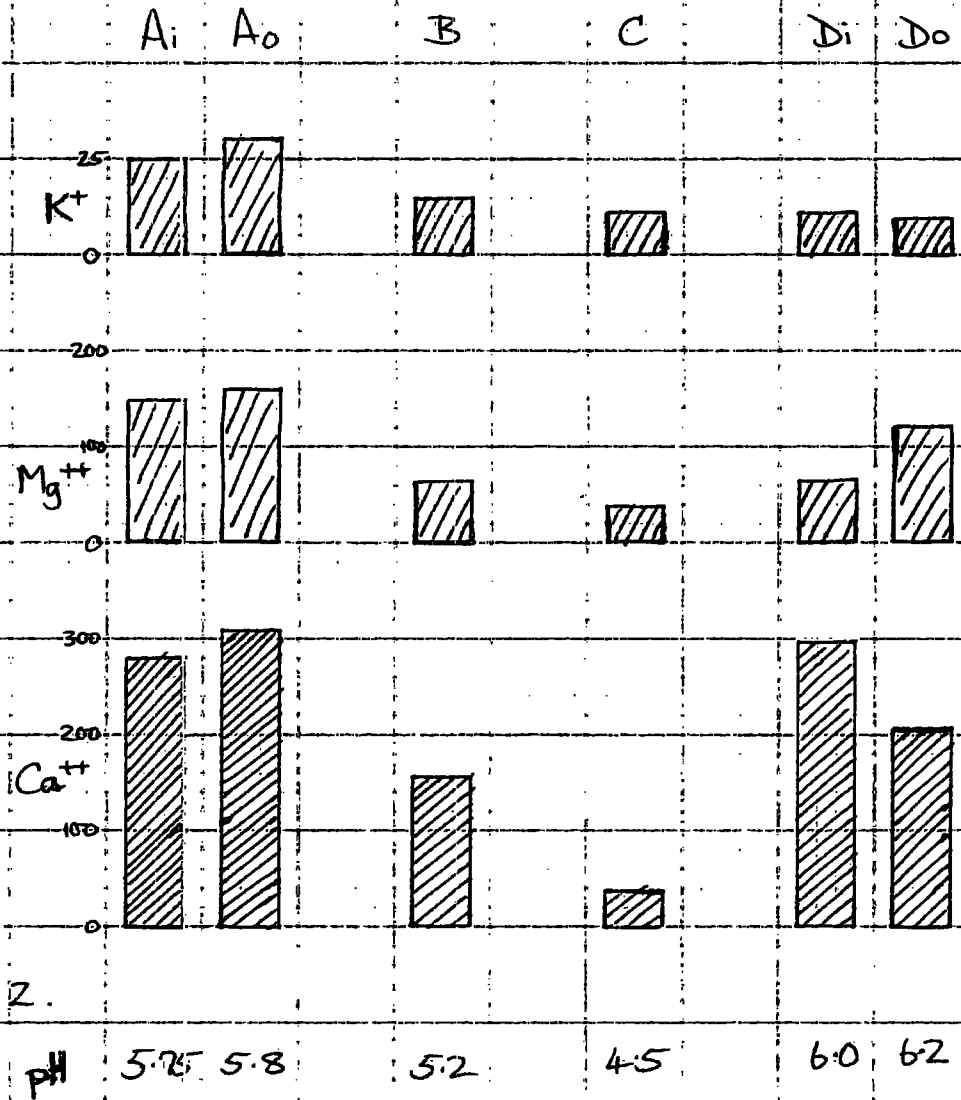

Soil analysis results.

	Ai	Ao	B	C	*Di	Do
pH	5.75	5.8	5.2	4.5	6.0	6.2
K ⁺ (mg/ 100 gm. dry wt.)	25	31	15	12	12	9
Mg ⁺⁺ (same units)	150	160	65	38	66	123
Ca ⁺⁺ (same units)	280	308	157	38**	298	205

* Only 8 samples instead of 10 were used to make the 'amalgamated sample'.

** There was no difference between the readings obtained with and without lanthanum chloride. In all the other samples, the presence of lanthanum chloride made a large difference. The main substance normally involved in interference with Ca⁺⁺ in the estimation is phosphate. From this, it seems likely that there is very little phosphate in C, compared with the levels in the other areas.

Weights of tree litter from 1 square metre

	Fresh weights:	Dry weights estimated (to nearest gm.)
A.	Beech 44.9 gm. Oak 2.5 " Other 0.15 gm. (mainly birch)	40 gm.
B.	Beech 88.3 gm. Oak 3.3 gm. Other 0.75 gm.	78 gm.
C.	Beech 500.9 gm. Oak 23.3 gm. Other 2.0 gm.	442 gm.

Estimated amounts of light reaching the plots

The figures given here represent the estimated percentage of total irradiance (from a standard overcast sky) which is unobstructed.

Ai	87.3	
Ao	89.3	
B	87.4	
	82.2	mean 85.0
	85.3	
C	11.8	
	30.3	mean 33.6
	39.9	
	52.8	
Di	90.1	
Do	90.6	

DRY WEIGHTS OF MATERIAL COLLECTED
FROM AREA A, INSIDE FENCE

Live plant material: —•— Total plant material: x—x
Dead plant material: - - -

I shows one standard error each side of point
representing mean value for the month

Dry
wt.
(gms)

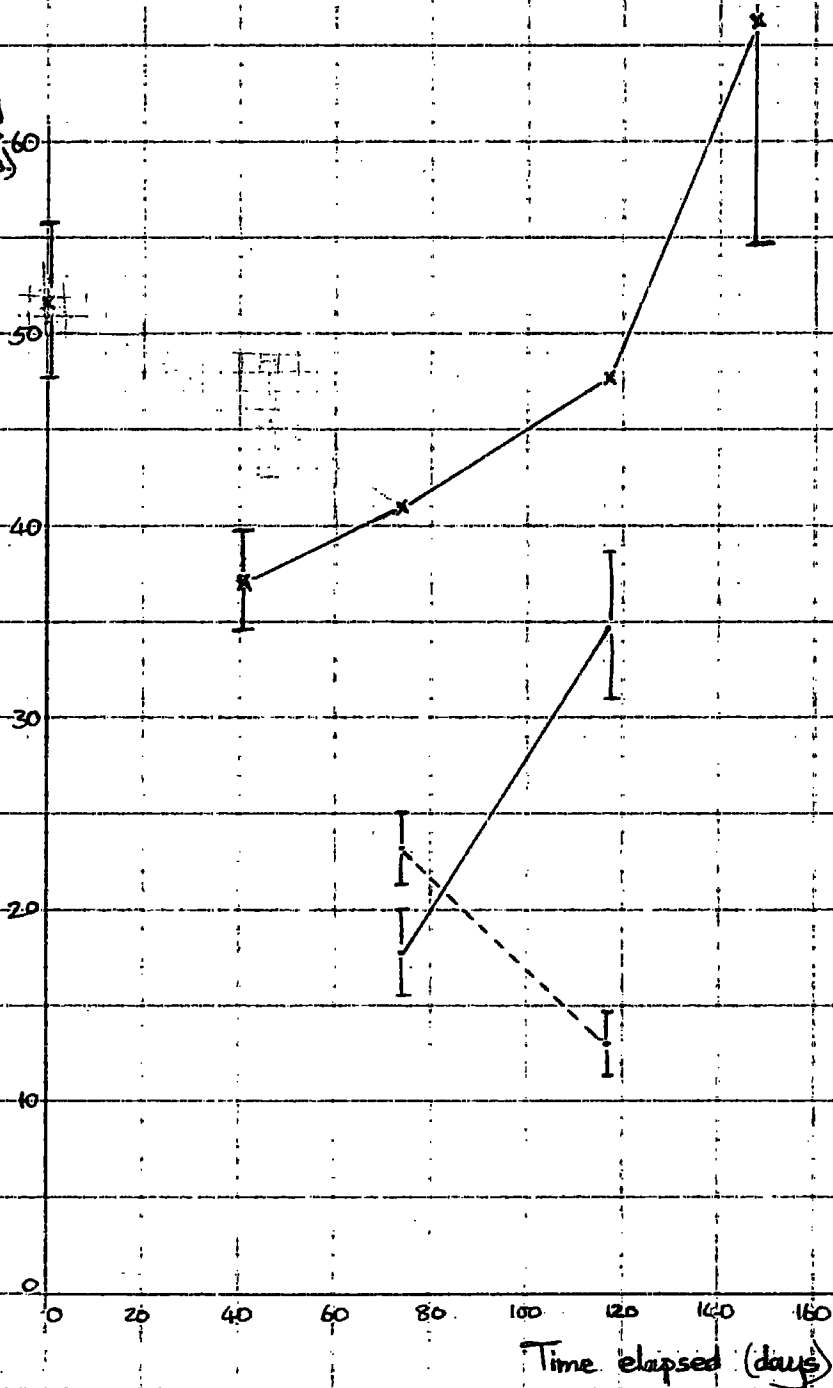

Dry weights of material collected from area A,
outside the fence.

Live plant material: — x — x
Dead plant material: - - -

I shows one standard error each side of point
representing mean value for the month

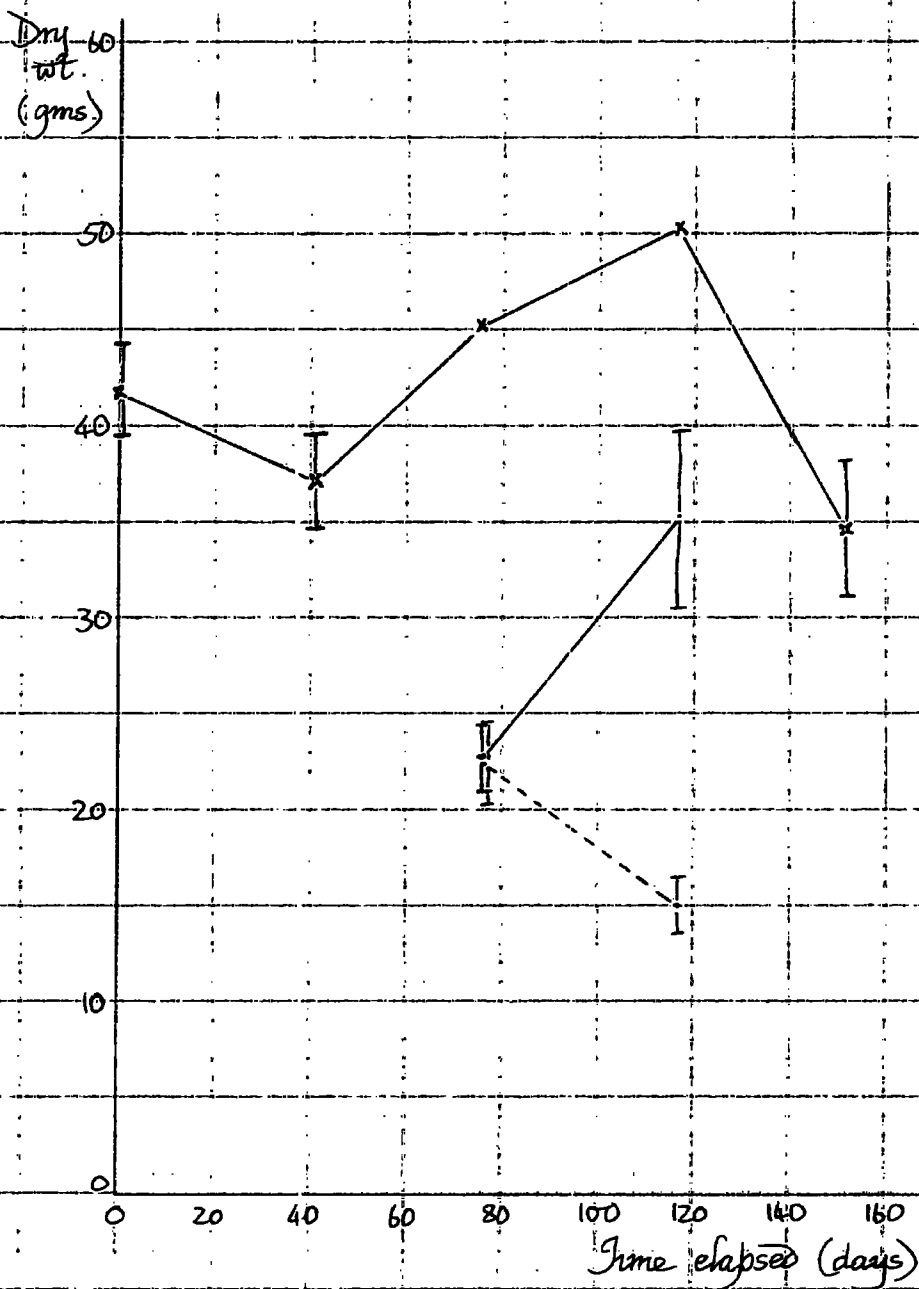

DRY WEIGHTS OF MATERIAL COLLECTED
FROM AREA B.

Live plant material: —
Dead plant material: - - -
Total plant material: x — x

I shows one standard error each side of point
representing mean value for the month.

Dry wt.
(gms.)

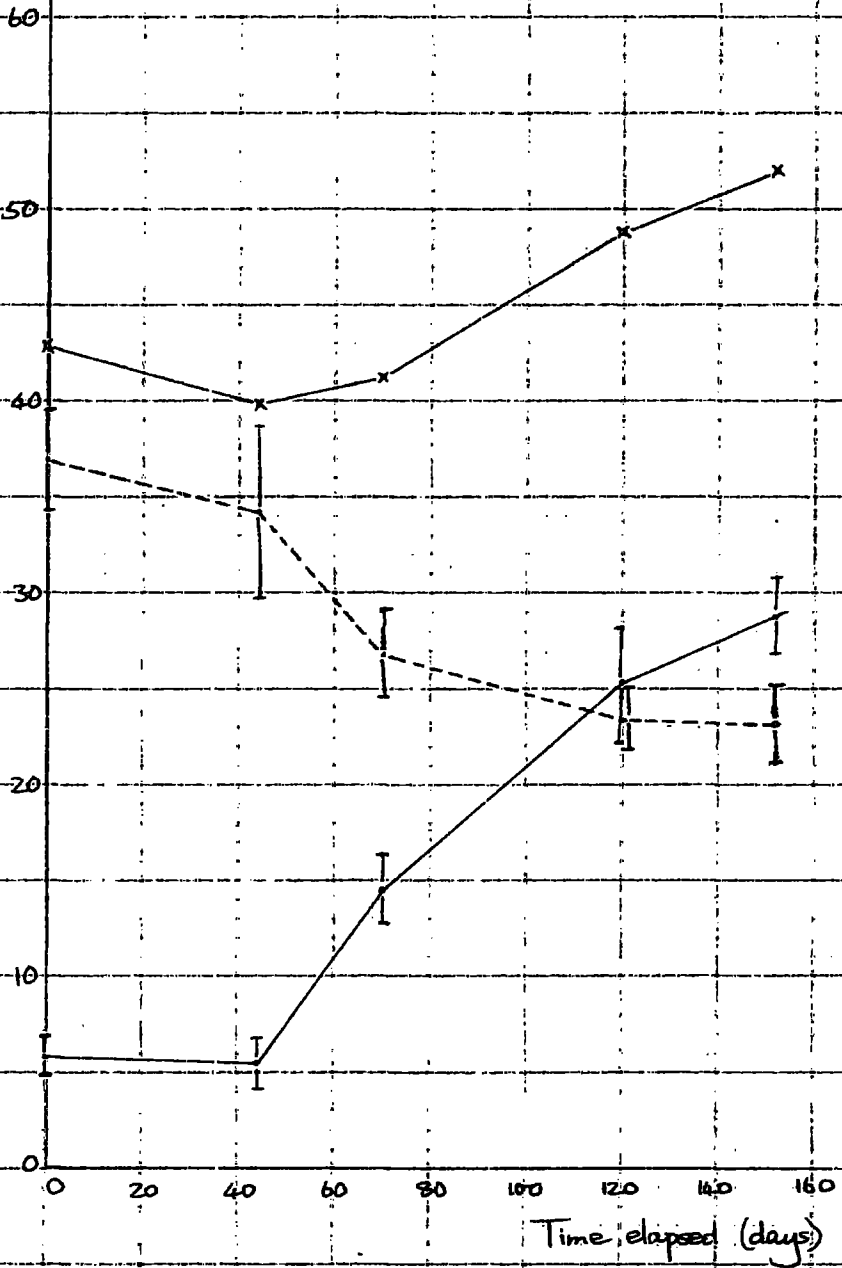

Dry wt. of material collected from area C

Live plant material: — Total plant material: x — x
Dead plant material: - - -

• shows one standard error each side of point representing mean value for the month.

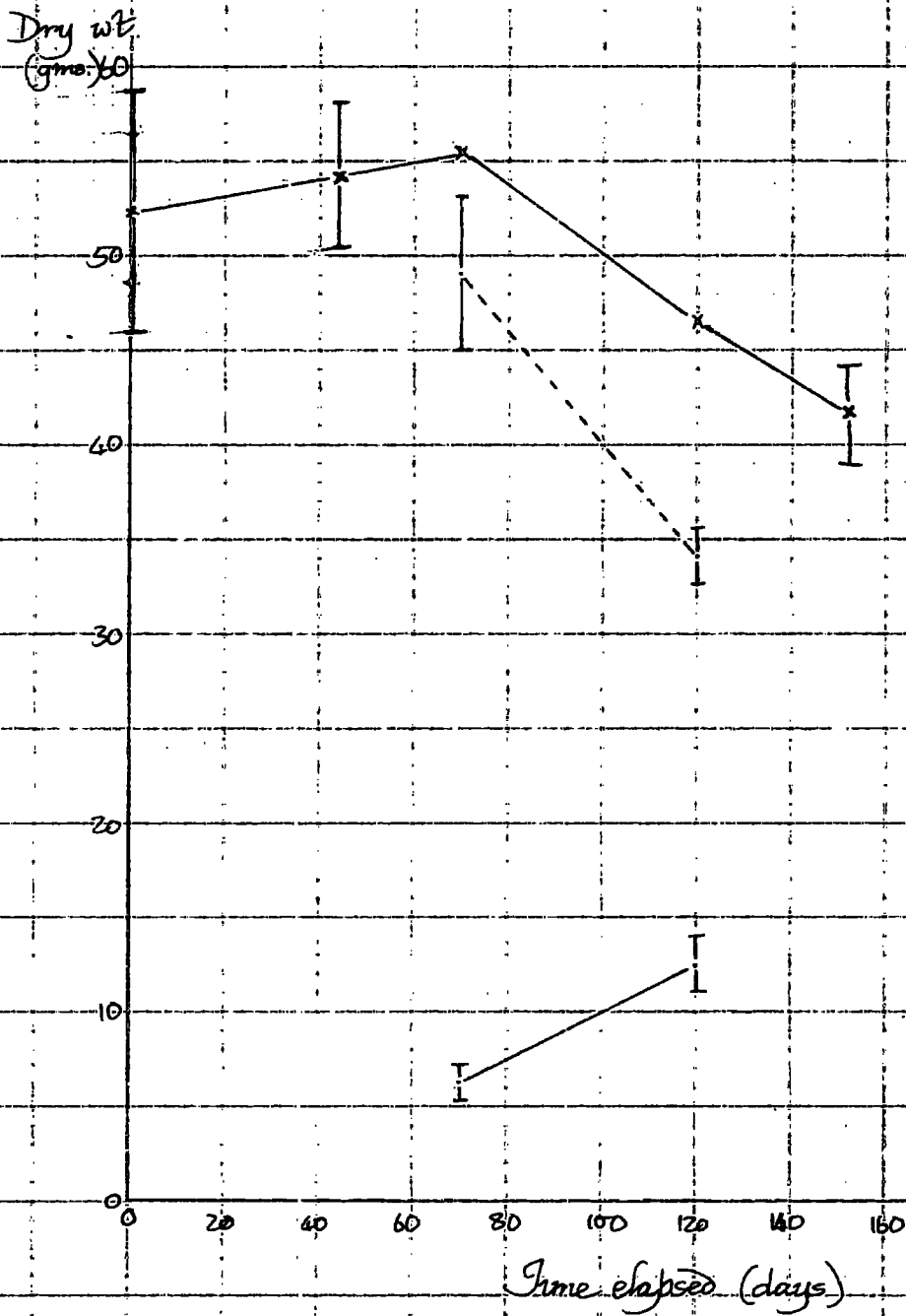

Dry wt. of material collected from area D,
inside the fence.

Live plant material: —•—
Dead plant material: - - - x - - - Total plant material: x - - - x

I shows one standard error each side of point
representing mean value for the month.

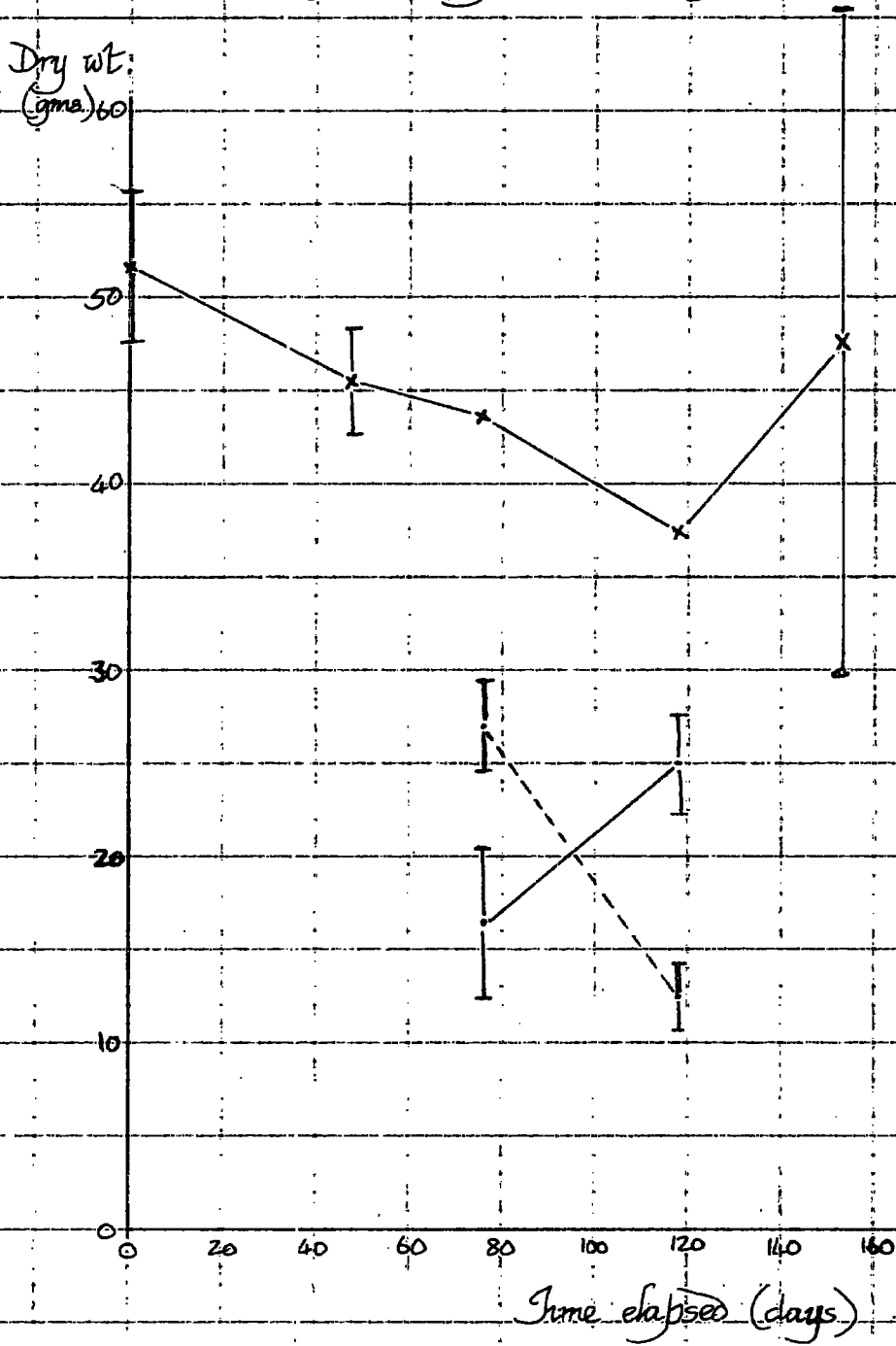

Dry wt. of material collected from area D, outside the fence.

Live plant material: ———

Dead plant material: - - - -



Total plant material: x — x

I show one standard error each side of mean

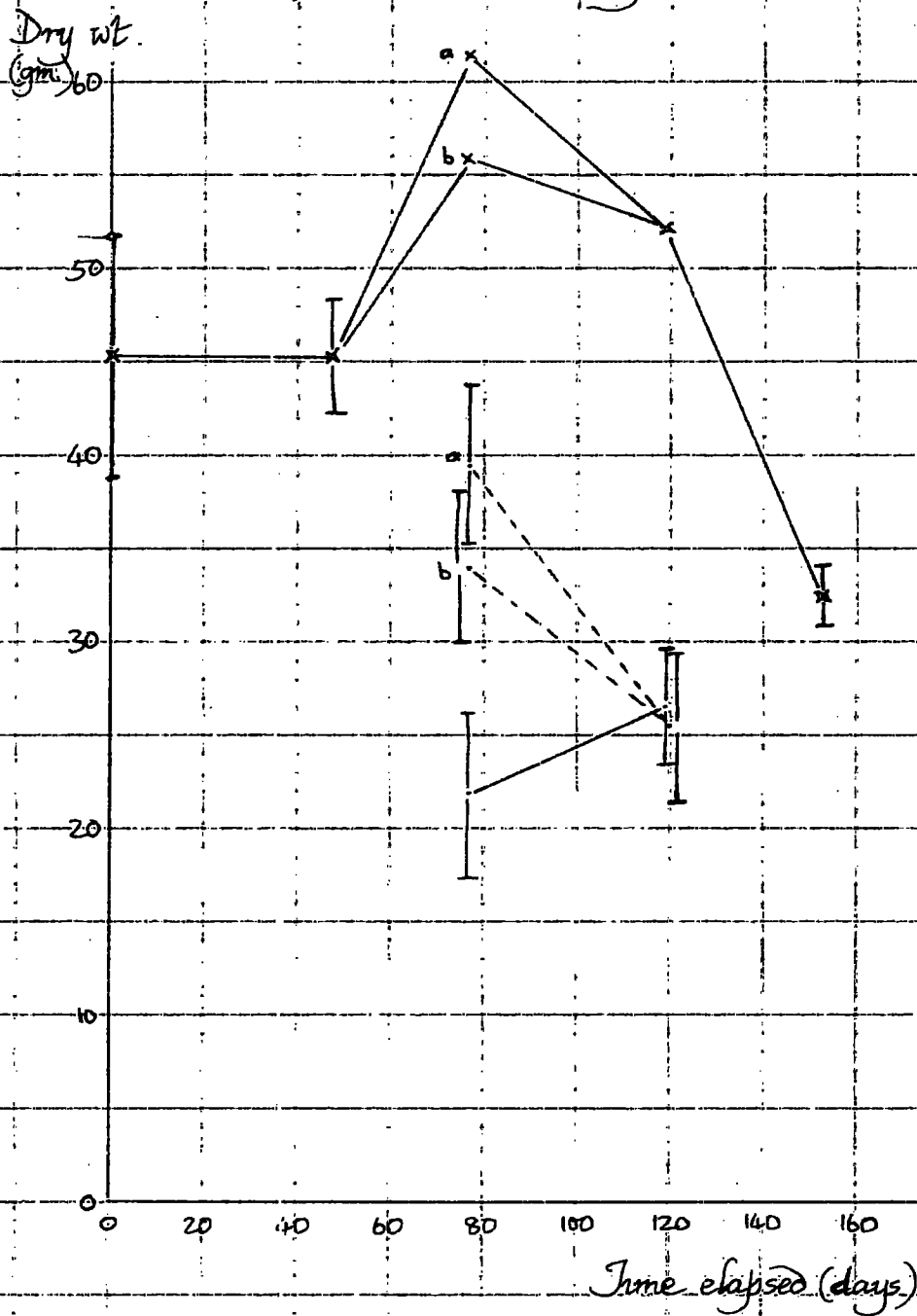
3 samples of live material were lost from the June collection.
Alternative values (a) for dead and total weights were calculated using only the 7 dead samples corresponding to the surviving live samples; the values (b) were calculated using all ten.



Changes in mean sample weight, corrected for different lengths of time between sampling periods.

Live material:  Dead:  Total: 

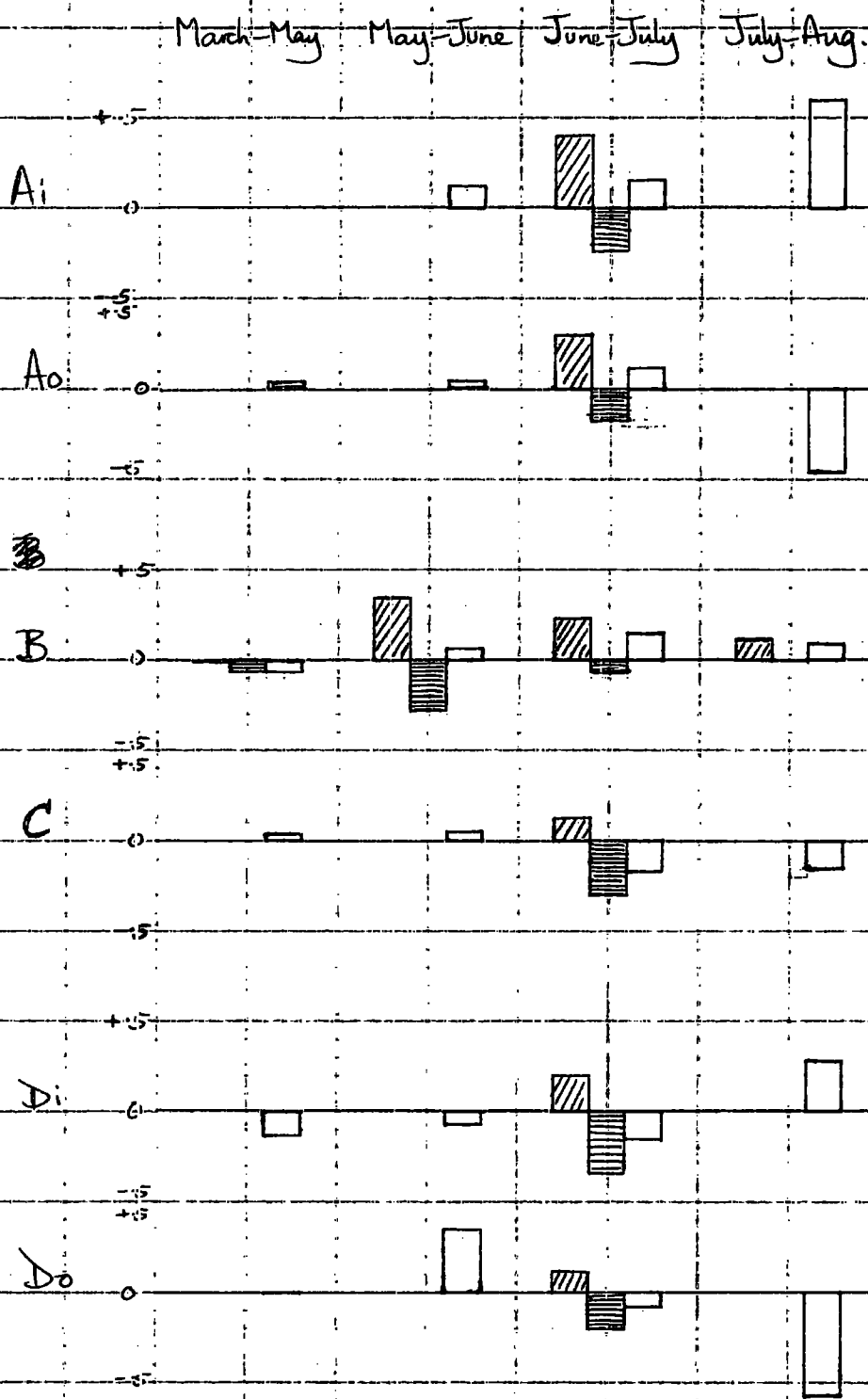

Mean weights and standard errors

		March		May		June		July		August	
Ai.	Live					17.78	2.28	34.76	3.87		
	Dead					23.24	1.88	12.99	1.73		
	Total			37.06	2.51	41.02		47.75		66.2	10.7
Ao.	Live					22.75	1.69	35.27	4.61		
	Dead					22.45	2.07	15.04	1.43		
	Total	41.8	2.32	43.56	3.92	45.20		50.31		34.6	3.6
B.	Live	5.92	1.04	5.59	1.46	14.57	1.84	25.35	3.05	28.8	1.97
	Dead	36.96	2.65	34.2	4.43	26.82	2.25	23.47	1.64	23.2	1.95
	Total	42.88		39.79		41.39		48.82		52.0	
C.	Live					6.34	0.93	12.55	1.51		
	Dead					49.07	4.05	34.06	1.35		
	Total	52.4	6.60	54.2	3.89	55.41		46.61		41.7	2.8
Di.	Live					16.64	4.08	24.98	2.64		
	Dead					27.02	2.44	12.5	1.82		
	Total	51.6	3.99	45.51	2.90	43.36		37.48		47.6	17.6
Do.	Live					21.9	4.25	26.66	3.07		
	Dead					*33.95	4.08	25.53	4.14		
	Total	45.37	6.69	45.28	3.00	*55.85		52.19		32.5	1.7

* These figures were obtained from all 10 samples. 3 of the 'live' bags were mislaid. The mean dead weight calculated from the 7 samples for which live material was available is 39.5 (S.E. 4.39), and the total weight becomes 61.4.

(Differences between the means of consecutive samples) divided by the number of days elapsing between the sampling intervals. + = increase, - = decrease

Ai.	Mar.-May	May-June	June-July	July-August
Live			+ 0.395	
Dead			- 0.238	
Total		+ 0.120	+ 0.157	+ 0.596
Ao.				
Live			+ 0.298	
Dead			- 0.176	
Total	+ 0.042	+ 0.050	+ 0.122	- 0.462
B.				
Live	- 0.0075	+ 0.345	+ 0.220	+ 0.105
Dead	- 0.0627	- 0.284	- 0.0684	- 0.0082
Total	- 0.070	+ 0.0615	+ 0.152	+ 0.0964
C.				
Live			+ 0.124	
Dead			- 0.300	
Total	+ 0.041	+ 0.0466	- 0.176	- 0.153
Di.				
Live			+ 0.199	
Dead			- 0.346	
Total	- 0.132	- 0.0717	- 0.147	+ 0.289
Do.				
Live			+ 0.113	
Dead			*- 0.200	
Total	- 0.0019	+ 0.352	*- 0.0871	- 0.579

* These figures were obtained from all 10 samples. 3 of the 'live' bags were mislaid. The figures calculated using only the 7 samples for which live material was available are -0.333 for the dead material, and - 0.219 for the total.

Results from paired plots.

Plot	Wt. of dead matl.	Wt. of live matl.	Ratio of dead/live in 1st. plot of pair	Initial dead wt. 'A'	Initial dead wt. 'B'	Uncorrected loss	Corr'd loss 'A'	Corr'd loss 'B'
A c	21.6	45.2	0.478					
A d	13.8	64.0		30.6	18.5	7.8	16.8	4.7
B a	25.2	24.3	1.037					
B b	15.1	21.8		22.6	18.5	10.1	7.5	3.4
B c	22.5	33.0	0.682					
B d	15.6	29.6		20.2	25.1	6.9	4.6	9.5
C a	45.9	11.9	3.86					
C b	38.9	7.1		27.4	18.9	7.0	-11.5	-20.0
C c	21.5	13.9	1.55					
C d	19.8	5.7		8.8	15.2	1.7	-11.0	-4.6

"Initial dead weight 'A'" is an estimate of the initial wt. of dead material on the second plot of each pair, knowing the live weight at the start and assuming the ratio of live:dead material to be the same on both plots in each pair.

"Initial dead weight B" is an estimate of the initial wt. of dead material on the second plot of each pair, assuming the live:dead ratio to be equal to the mean value of this ratio for the area (A, B or C). ~~xxxxxxxxxx~~

The corrected losses A and B are calculated using the values for the initial dead wt. estimated by the 2 methods. The uncorrected loss is obtained simply by subtracting the wt. of dead material on the second plot at the end of the period from the dead wt. on the first plot at the start of the period.

Ao - Association Table compiled from July samples

Position in grid:-	3,5	3,6	4,3	6,4	7,1	8,6	9,2	12,4	14,7	15,7
<i>Dactylis glomerata</i>	4.9	11.4	43.0	61.3	29.0	3.1	5.8	6.0	34.2	11.6
<i>Alopecurus pratensis</i>	9.7	9.9	0.2	5.1	7.4	10.4	12.7	16.2	6.0	21.9
<i>Agrostis stolonifera</i>	0.2	0.8	1;2	1.0	0.3	5.0	1.1	0.3	0.8	0.2
<i>Agrostis tenuis</i>	0.1	0.1	t	0.6	1.2	0.3	0.2	0.3	0.1	0.2
<i>Holcus lanatus</i>	2.8	2.0	17.7	2.7	13.7	4.9	1.6	1.3	1.7	0.4
<i>Rumex acetosa</i>		0.4	2.9	0.7	1.2	1.0	1.4	0.6	0.2	1.4
<i>Poa pratensis</i>			t		0.8	0.4		t	0.3	
<i>Plantago lanceolata</i>	0.3	0.3	0.9						0.2	0.5
<i>Veronica chamaedrys</i>	4.7		1.4	5.3						
<i>Festuca rubra</i>			0.4			t				0.3
<i>Ranunculus acris</i>	0.1								0.5	0.2
<i>Ranunculus bulbosus</i>	0.4	0.3		t						
<i>Geranium pratense</i>	t									
<i>Taraxacum officinale</i>				0.8						
<i>Chrysanthemum leucanthemum</i>						t			t	
<i>Cerastium vulgatum</i>							0.1			

Do - Association Table compiled from July samples.

Position on grid:-	3,5	3,6	4,3	6,4	7,1	8,6	9,2	12,4	14,7	15,7
<i>Alopecurus pratensis</i>				2.9	6.4	1.4	11.1	7.0	15.7	8.3
<i>Agrostis tenuis</i>	t	t	0.2	1.0	0.7	0.2	1.0	0.7	0.3	
<i>Agrostis stolonifera</i>	1.2	0.1	2.6	1.9	1.0	0.3	1.0	t	0.8	
<i>Rumex acetosa</i>	t	t	t	t	0.2	t	t	t	t	0.4
<i>Holcus lanatus</i>	1.6	1.8	t	3.0	2.0		6.8	2.5	0.2	0.2
<i>Festuca rubra</i>		0.3	0.7	0.9	0.1	1.0	2.3	0.6	2.6	19.7
<i>Dactylis glomerata</i>	3.8	37.3	17.6	7.5	0.5	36.1		.	5.1	
<i>Poa pratensis</i>	2.6	1.3	5.8					t	0.9	
<i>Veronica chamaedrys</i>	1.9	3.8					0.1	3.2	1.9	0.8
<i>Ranunculus acris</i>	1.2	0.4			0.9					
<i>Ranunculus bulbosus</i>	0.3			0.1						
<i>Anthoxanthum odoratum</i>				0.5						
<i>Cerastium vulgatum</i>	t									
<i>Conopodium majus</i>				0.2						
<i>Helictotrichon pubescens</i>					2.0					
<i>Plantago lanceolata</i>					16.9					
<i>Medicago lupulina</i>					t					
<i>Arrhenatherum elatius</i>								1.0		

DISCUSSION

Criticisms of methods

The following criticisms of the methods employed became apparent during the course of the work, and should be borne in mind, particularly if the data are to be compared with data from other sources.

a. Collection of leaf litter. It would have been more desirable to collect this in litter baskets as it fell; this would have been easier as well as giving a better idea of the amount of litter falling through the air. Unfortunately, work on the project did not start until nearly all the tree leaves had fallen, so this course of action was no longer open.

To what extent litter baskets placed on or near the ground give results resembling the weights of litter which accumulate in and on the ground vegetation is difficult to say. The aerodynamics of litter baskets and natural vegetation are unlikely to be identical, and, since dead tree leaves continue to be blown around the ground for at least several weeks after leaf fall is complete, there is a possibility that litter may accumulate in pockets in the vegetation, and be more unevenly distributed than litter basket results might suggest. This problem was not investigated in the course of this project. Litter was collected from one square metre only in A, B and C so as to avoid interfering with the habitat more than could be helped.

b. Selection of experimental areas. From the results of the partial soil analysis, and the weights of litter collected per square metre, it is obvious that the difference in shading is far from being the only appreciable difference between areas B and C. Had the soil analysis been carried out at the start of the project, instead of near the end, this would have been more obvious, and different areas might have been chosen for comparison. As it is, it is impossible, from the data gathered in this study,

to say which factors are likely to be most important in limiting production in area C as compared with area B.

In general, selection of experimental areas might have been easier if they had been examined earlier in the year, before most of the grass was dead.

c. Spacing of clip-plots. The lack of any space between adjacent clip-plots may have led to unwitting encroachment on some of the plots scheduled for cropping later in the season. As new growth occurred on plots which had been cut, it was difficult to tell whether such encroachment had happened.

Perhaps a more important disadvantage of the contiguous spacing was that trampling on experimental plots was inevitable, particularly inside the fenced plots. (It was because of this that the plots in the unfenced sections of areas A and D were also contiguously spaced.) However, since it was both possible and more convenient to crop plots near the edges of A₀ and D₀ while standing outside the experimental area, it is probable that the plots in A₀ and D₀ were less trampled than those inside the fencing. No measurements were made of the amount of trampling which occurred, nor any attempt made to measure its effects.

Another obvious consequence of contiguous clip-plot spacing was that cutting one plot would tend to increase the exposure of sides of adjacent plots. This was perhaps most important in removing dead material overlying leeward plots in the spring. It had been intended to compare the results from plots which had been exposed in this way with the results from plots which had not, but the variation between clip-plots was so great that this procedure did not seem worth while.

Whether the extra exposure of adjacent plots would be appreciable in the case of plots cut later in the growing season is more doubtful, as the dimensions of the clip-plot were not large compared with the height of surrounding vegetation.

d. Edge effects of fencing. 2 main groups of edge effects are likely to have been present:-

i. Reduction of light intensity and wind speed. Grass was prevented from piling up around the outside, but grass inside tended, mostly along the leeward edges, to adhere to the "Sticktite" when it (the grass) had grown to about 45-50 cms. high, and this probably accentuated the reduction in light transmission in the fence region. No estimate was made of the extent of any such reduction. (The definition of objects at the edge of the field of the Hill lens used in light estimations was very poor.

No attempt was made to compare wind speeds inside and outside the fenced portions, nor were any dummy fences erected elsewhere to see what differences in vegetation were noticeable (if any).

ii. Modification of drainage, and other soil changes.

Installing the fencing involved digging a groove in the soil about 30 cms. deep, inserting the wire netting, and then replacing the soil. Attempts to replace the turf on top were not really successful. There is thus a possibility that soil conditions near the fence were changed sufficiently to affect the vegetation nearby. No attempt was made to measure such changes. The experimental areas A₀ and D₀ were 1m. away from the fence, to avoid the disturbed zone. All trampling and other disturbance during fence installation was restricted to the ground outside the fence, the area inside being left untouched.

e. Lack of controls in sorting. The writer did all the sorting of plant materials in the project, taking some specimens to the Botany Dept. for identification. There was thus no external check on the accuracy of the sorting, and so comparisons of the weights of individual species with any obtained by other workers must be more tentative than would have been the case if there had been some check.

The main reasons for the lack of any check were:-

- a. It was only really feasible to sort material which was in a fresh condition, or had been preserved in such a state in a deep-freeze. During sorting on the bench in the lab., the material inevitably started to dry up. No method was devised of ensuring that the material could be brought to a standard, repeatable fresh weight, analogous to the dry weight. Consecutive sortings could therefore not be compared, and the material varied so much from one clip-plot to another that comparison of the results of sorting different plots would have been useless as a check on sorting accuracy.
- b. Sorting into species was rather time-consuming - each bag from a 25 cm. x 25 cm. clip-plot took several hours - and some hesitation was felt in asking people to give up an appreciable length of time to this rather tedious pursuit.

It might have been possible to make a check in the following manner:-

- i. Sorter A sorts the material into species and weighs them in their condition at the time. He then mixes them up again. Re-structuring of the bag contents inevitably would occur, particularly in the cutting of leaves into live and dead portions, but this seems unavoidable.
- ii. Sorter B takes the mixture and sorts it, dries and weighs the species.
- iii. Each sorter then expresses the weights of species as percentages of the total weight he got at the end of his sorting.
- iv. Fresh samples of the different species are laid out to dry in the lab. and weighed at intervals, to check that different species dry at the same rate. If they don't, corrections would have to be applied to the percentages calculated by the first sorter, knowing the total length of time elapsed from taking the samples out of the bag to the weighing of species by sorter A.

v. Reciprocal sortings would have to be done (A sorts bag 1, B sorts bag 2, both weigh, then exchange remixed bags and sort again), in case consistent errors of identification arise as the material dries.

f. Soil analyses.

Many important properties were not examined at all - e.g. the proportion of different sizes of soil particles, total cation exchange capacity, concentrations of phosphate and nitrate and other important nutrients. No soil pits were dug in the field to make detailed examinations of the soil in situ. In consequence, the picture we have of the soils is exceedingly sketchy, and indicates little more than that there is appreciable variation between the different areas.

In the interests of speed, the 2 mm. fractions from all soil samples within each area were combined, so that we have only one value for each property measured, for each area. The results therefore give no indication of the variability of soil conditions within each area. Although some pooling of soil samples is a fairly common procedure to minimize measurement of very local variations which are not important for plants whose root systems cover a wider area, the writer does not think that pooling of samples to the extent done in this case is really desirable. Although no root systems of plants in the field were traced out, it seems unlikely that the root system of any individual plant would cover an area anything like as big as 3m. x 4m..

The restriction of sampling to the surface layers can also be criticised; at least some of the roots extended much further down than the samples, and it is possible that they might be particularly important in supplying cations (e.g.) to the plants. Analysis of successively deeper samples from the same sites would have given a much more complete picture. In particular, we might have learnt whether the marked differences shown in the figures for area C are merely surface phenomena, or occur deeper down in the soil as well.

g. Light intensity estimations

When the sun is shining, the contribution of direct sunlight to the total amount of light energy falling on the plant is usually much more important than the contribution of diffuse light. The rapid estimation done in this project does not take this into account; time was not available to calculate the solar tracks and work through the meteorological records. If it had been desired to estimate, in absolute terms, the amounts of light falling on the areas, it would also have been necessary to have, during the season, a continuously recording pyrheliometer or bimetallic actinograph or other similar instrument, to indicate just how much energy was coming from a cloudy sky on a particular day, and so on.

No estimations have been made at the moment of the relative amounts of light reaching the areas when the trees are not in leaf, though from the photographs taken such estimates could easily be made, for a standard overcast sky. In consequence, the estimates given do not apply to the March-May interval between samples (as the canopy opened in the first week in May).

There is considerable variation in the amount of shading between the 2 ends of area C (one end receives only 11.8% of the irradiance from a standard overcast sky, the other end 52.8%, if transmission of useful light (for photosynthesis) through the tree canopies is assumed to be negligible). So, although the least shaded part of C is much more shaded than the most shaded part of B (which gets 82.2% of total possible light), comparison of mean values for C with other values, with a view to looking for differences attributable to reduced light intensity, should be undertaken with great caution.

Comments on the results.

No attempt is made here to summarise the whole of the results; instead, a few comments are offered on particular features.

Comparing the weights of live plant material on the different areas, the most striking feature is the marked lack of growth recorded for C, compared with the figures for B. The data we have here are, of course, quite insufficient to enable us to attempt any evaluation of the relative importance of the factors involved, particularly as variations between clip-plots are so great that significant differences between plots in different parts of the same area are difficult to establish. In any case, we do not have separate figures for soil properties in different parts within an area.

Another very interesting feature is the contrast between the drop in the weights of total material in the August samples for A₀ and D₀, and the rise in A₁, D₁ and B. A and D are both near the hedge by Hollingside Lane, on the other side of which is a mixed wood; Zoology Honours students doing trapping experiments in June in the field had found appreciable numbers of voles only near the hedge.

It seems possible that we are observing a grazing effect, in which field voles are eating a greater proportion of the growth in A₀ and D₀ than in B (where the total weight rises). It is not immediately obvious, from the data we have, what other factors could cause this rather striking difference between the fenced and unfenced parts of A and D, which for A₁ and A₀ at least approaches statistical significance. The fact that there were only 5 plots each cropped in D₁ and D₀ in August, compared with 10 in A₁ and A₀, may partly explain the substantially larger standard error for D₁, compared with A₁.

Early in the spring, several holes eaten in grass tussocks, apparently by voles, had been seen in the area of Do.

It seems unlikely that a difference as large as that between Ai and Ao, and Di and Do, could have been caused simply by the removal of dead material from outside, but not from inside, the fenced areas.

No evaluation of insect populations was made, so we cannot say whether or not there might have been differential grazing outside and inside the fenced areas by herbivorous insects.

The very much larger standard errors for Ai and Di than for Ao and Do lead one to wonder whether tussocks and hollows are becoming more pronounced inside the fenced parts than outside, or whether in some other way a pattern whose scale is similar in size to the 25 x 25 cm. quadrats used has become more pronounced inside the enclosures than outside, towards the end of the summer. By mid September, when this statistical feature was discovered, there were no very obvious differences between the appearances of the vegetation inside and outside the enclosures. Nor do there seem to be any striking differences shown in the association tables given.

As far as we can see from the data given, there is a decline in the amount of dead material during the summer. Wiegert and Evans (1964), working in an old field in Michigan, found the weight of dead material to be approximately constant throughout the season. Part of the explanation of the difference probably lies in the fact that there is an appreciable input of tree litter in this field, whereas there were no trees near Wiegert and Evans's plots.

Starting from the weights of tree litter collected in the previous autumn, we can say that, if there is to be no accumulation of this material over the years, then, between one autumn and the next, at least 40 gm. of tree material per square metre must be decomposed in A, about 80 gm/m² in B and about 520 gm/m² in C.

In Durham there is no period of continual frost, so it should be possible for decomposition to occur most of the time, even if very slowly.

In the sorting of material collected in May from area B, tree litter was distinguished as a separate category; the mean weight per clip-plot was 5.2 gm. dry wt. (standard error 0.53 gm.). The estimate from the previous autumn of 78 gm/m² is equivalent to just under 5.0 gm/clip-plot; so this original estimate seems to have been a slight under-estimate. If it is not a fairly substantial under-estimate, little decomposition can have occurred before May.

Most of the tree litter seemed to have decomposed by the time of the July sampling period; appreciable quantities were only to be found in the samples from area C. It was because of the general lack of tree litter that such litter was not given a separate category in the detailed sorting of the July samples.

If nearly all the tree litter was decomposed between the May and July sampling periods, we would expect the following approximate losses in weight of dead material per clip-plot, on these grounds:-

A	$\frac{40}{16}$	or about 2.5 gms..
B	$\frac{80}{16}$	or about 5.0 gms..
C	$\frac{440}{16}$	or about 27.5 gms..

The observed losses in weight of dead material during the same period (May-July samplings) were:-

A	10.25 gms. + an unknown amount between May and June samplings.
B	7.4 gms.
C	15.01 gms. + an unknown amount, at least 5.1 gms., between May and June samplings.

Of course, this year's (1966) growth of ground vegetation is producing dead plant material, as basal leaves and sheaths of grasses die.

If we assume that, during the period between the May and July samplings, decomposition of dead ground vegetation kept pace with the production of dead material, then there would be no net addition to the total amount of dead material. This assumption seems fairly reasonable; if it were not true, then either the amount of dead material per unit area would increase over the years, or the rate of decomposition after mid July would need to be substantially greater than that between May and mid July. Unfortunately, in the time available it was not possible to analyse meteorological records to see if there was any change weather conditions which might be likely to cause such a difference. No productivity data were collected from the areas during 1965, and so the possibility of an increase in the total amount of dead material cannot be ruled out. Some increase in the 4 years since the field was last used as a pasture could reasonably be expected, though it is uncertain whether such an increase would still be continuing at the time of this project.

On areas A₀ and B it would obviously, from the figures given above, be possible for all the tree litter to have been decomposed during the period between the May and June sampling intervals. In fact, at least 7.75 gms. of other dead material on A₀ (per clip-plot), and 2.4 gms. on B, must have decomposed in the same interval.

On area C there was still a little tree litter left in July, but it looks as though it would be easily possible for the remainder, and other dead material produced by the 1966 ground vegetation, to have decomposed in August.

All these comments have had to be based on autumn litter figures about whose variability, and hence reliability, we have no information. If larger areas had been chosen and a detailed plan of collections and croppings worked out before the autumn, it might have been possible to be more precise about the dynamics of the system.

In any subsequent work on ecosystems where tree litter forms a substantial part of the total plant material at some time during the year, tree litter should obviously be separated from other plant material during sorting.

Paired plots results

The results from the paired plots re-emphasize the variability of the communities under study, from one point to another. (A quick examination of the association tables shows the great variations between plots in the same areas.) Despite the fact that care was taken in selecting plots which were as similar as possible for pairing, the plots for area C appear to have been distinctly dissimilar, and some of the results obtained quite unrealistic. The ratio of live:dead material, as well as the actual weights of material on different plots, varies widely. It is obvious that in any future work much larger numbers of paired plots will be required, and a mean value used for calculations. In view of the unsatisfactory nature of the data assembled here, only a few general comments can reasonably be made.

Despite the peculiar results from the C plots which suggest a gain in the weight of dead material (obviously anomalous in view of the substantial decreases in dead weight recorded from the ordinary clip-plots), the general picture is one of an appreciable loss of dead material. It is particularly interesting to compare the loss of very roughly 6 gms per plot given by the 2 pairs of plots near area B with the decline in weight of dead material of only 0.27 gms. shown in the figures for the ordinary clip-plots. If the figure of 6 gms. is about right, it would imply that the total net primary production per plot in B during the July-August interval is about 9 gms. (6 gms. shown by the paired plots, minus 0.27 gm. found by comparing the figures for weights of dead material from the July and August clip-plots, plus 3.45 gms. increase in the weight of live material shown from the clip-plots).

The same calculation may perhaps be clearer if we lay it out as follows:-

Let

Wt. of material dead at start
of interval = x gms.

Wt. of material which dies
during interval = y gms.

Wt. of material which
decomposes during interval = z gms..

Then Wt. of dead material at end
of interval = x + y - z .

Inserting the figures for B in the July-August interval, we have

$$\begin{aligned} 23.2 &= 23.47 + y - 6.00 \\ \therefore y &= 23.2 - 23.47 + 6.00 \\ &= 5.73 \end{aligned}$$

Now, total net production (i.e. the excess of photosynthesis over respiration) during the interval will be equal to:

[difference between weights of live material at start and finish]
+ [amount of material which dies during the interval but is replaced by new live material] .

In this case, total net production will be equal to

$$3.45 + 5.73 \text{ gms.}, \text{ i.e. } 9.18 \text{ gms..}$$

(The retention of 2 decimal places in the calculations shown above is not intended to imply a corresponding degree of accuracy, but simply to make the calculations easier to follow. The same comment applies to subsequent calculations using this estimate of 6 gms. from the paired plots.)

If, for area B, we assume that decomposition during the interval between the June and July samplings was also 6 gms., we could then estimate the total net production in the same way, as follows:-

Dead material at end of month = x + y - z.

$$\begin{aligned} \text{Inserting the figures: } 23.47 &= 26.82 + y - 6.00 \\ \therefore y &= 23.47 - 26.82 + 6.00 \\ &= 2.65. \end{aligned}$$

Whence total net production would be 10.78 + 2.65, i.e. 13.43 gms..

We should note here that this method of calculation does not take into account tree litter, coming from outside the ground vegetation system we have been considering in this model, and is therefore not strictly applicable in this particular case. If we attempt the same calculation for the May-June interval, again for area B, and again assuming z to be 6 gms., we get a negative value for y , as the decrease in the weight of dead material per plot (7.38 gm.) was more than 6 gm. during this interval. Of course, we might then argue that at least (7.38 - 6.0) gm. of tree litter per plot must have decomposed in the interval; but to argue in this way is of little value and certainly going far further than our present inadequate data could justify. The real need is for separate data on the amounts of tree litter throughout the year.

Estimation of productivity.

We can obtain a minimum estimate of productivity on the areas by subtracting the total weight of plant material at the March sampling from the highest total weight recorded, and then adding to the estimate so obtained the weight of litter estimated to have fallen onto the area in the autumn from trees. In doing this, we have assumed that all the tree litter has decomposed by the date the highest weight is recorded, and we are neglecting altogether the decomposition of non-tree dead plant material, and the production of material which has grown and died before the time we recorded the highest total weight.

Doing this, we get the following estimates of productivity per plot over the season:-

Ai:	66.2 - 37.06 + 2.5	= 27.64 gm.
Ao:	50.31 - 41.8 + 2.5	= 10.81 gm.
B:	52.0 - 42.88 + 5.0	= 14.12 gm.
C:	41.7 - 52.4 + 27.5	= 16.8 gm.
Di:	47.6 - 51.6 + ?	= -4.0 + ? gm.
Do:	55.85 - 45.37 + ?	+ 10.48 + ? gm.

Di and Do would probably receive about the same amount of litter as A, i.e. about 2.5 gm..

For area C, the assumption that all the tree litter has

decomposed by August is wrong. When the fresh litter was being collected the previous autumn, a layer of obviously much older tree litter lying on top of the soil was seen, implying that the complete decomposition of a year's tree litter takes longer than a year to accomplish.

For comparison with the last table of figures, the known increases in the amounts of live material present are as follows:

Ai	16.98	(June-July interval only)
Ac	12.52	(" " " ")
B	22.88	(March-August)
C	6.21	(June-July interval only)
Di	8.34	(" " " ")
Do	4.76	(" " " ")

This exercise effectively demonstrates the futility of trying to estimate productivity, in a system like this where dead material lies over the winter, from the total weight of plant material only. It can be seen that it is essential at least to separate live material from dead, and weigh it separately.

We just do not have enough data from the paired plots to make further calculations using them worth-while.

Comparisons with other work.

The known productivity of area B was 22.88 gm./clip-plot. This is equivalent to 366 gm./m².

We can compare this estimate with some other figures estimated by comparable methods. Welch and Rawes (1964), reporting on the effect of excluding sheep from Pennine grazings, quote standing crops, in plots from which sheep had been excluded for 7 years, of 160, 218 and 265 gm./m² (dry wt.). These weights exclude the bottom 4-7 cms. of the aerial parts of the plants.

Wiegert and Evans (1964), working in an old field in Michigan, divided the field into 'upland' and 'swale' areas. The soil of the upland parts of the field is stated to be a grey-brown podzolic sandy loam; "this soil is porous and, in a well-drained area such as the Old Field, dries out quickly, especially with the low precipitation in the latter part of the growing season. In the swales [shallow, poorly drained depressions] the original soil profile has been covered by as much as 1 m of alluvial silt. These surface deposits in the swales retain considerably more moisture and have a higher organic content than the sandy soils of the uplands."

Wiegert and Evans quote peak standing crops of about 130 gm/m² (dry wt.) for the upland parts, and about 225 gm/m² for the swale. It is interesting that in this field, previously farmland, they are getting peak standing crops no higher than Welch and Rawes record for plots more than 2200' above sea level in the northern Pennines. Wiegert and Evans also estimate, from a series of paired plot experiments throughout the growing season, that, on the upland, the ratios of annual growth to peak standing crop of green material are about 2.5:1, and on the swale about 4.7:1.

Westlake (1963) quotes an approximate organic productivity for temperate terrestrial herbs of 2 kg/m²/yr., with a range of about 25% each way. Lolium spp., in a good site in New Zealand,

produced a seasonal maximum biomass (dry wt.) of 2.2 kg/m². Hence the productivity in this part of the old field at Durham is far below agricultural crop yields - as indeed is obvious on the most cursory inspection of the site.

Golley and Gentry (1966), working on a 12-year abandoned field near the Savannah River Plant in the U.S.A., found a net harvest production of 485 gm/m²/yr.. This figure was obtained by summing the peak standing crops for each species throughout the year (different species reaching their maximum productivities at different times), and was about a third greater than the peak standing crop for the community as a whole at any one time.

Compared with the wealth of information available for agricultural crops, there are very few estimations of the productivity of semi-natural or natural grassland ecosystems. From what is available, it is obvious that a good deal more work is needed before the outlines of any broad picture of productivity in this sort of ecosystem can be drawn.

APPENDIX

BIBLIOGRAPHY

- Anderson, M.C. (1964). Studies of the woodland light climate. I. The photographic computation of light conditions. *J. Ecol.* 52: 27-42.
- Clapham A.R., Tutin T.G. and Warburg E.F. (1959). Excursion flora of the British Isles. Cambridge University Press.
- Golley F.B. and GENTRY J.E. (1966). A comparison of variety and standing crop of vegetation on a 1-year and a 12-year abandoned field. *Oikos* 15 (2): 185-199.
- Lindemann, R.L. (1942). The tropic-dynamic aspect of ecology. *Ecology* 23: 399-418.
- Odum, H.T. (1957). Trophic structure and productivity of Silver Springs, Florida. *Ecol. Monogr.* 27: 55-112.
- Odum H.T. and Odum E.P. (1955). Trophic structure and productivity of a windward coral reef community on Eniwetok Atoll. *Ecol. Monogr.* 25: 291-320.
- Welch D. and Rawes M. (1964). The early effects of excluding sheep from high-level grasslands in the north Pennines. *J. appl. Ecol.* 1: 281-300.
- Westlake, D.F. (1963). Comparisons of plant productivity. *Biol. Rev.* 38: 385-426.
- Wiegert R.G. and EVANS F.C. (1964). Primary production and the disappearance of dead vegetation on an old field. *Ecology* 45: 49-63.
- Willimott S.G. and Shirlew D.W.G. (1960). Soils and deposits in the Durham area. 1. Fluvioglacial soils. *Proc. Univ. Durham Phil. Soc.* 13 (Series A): 133-147.

Water-current device for separating roots from soil.

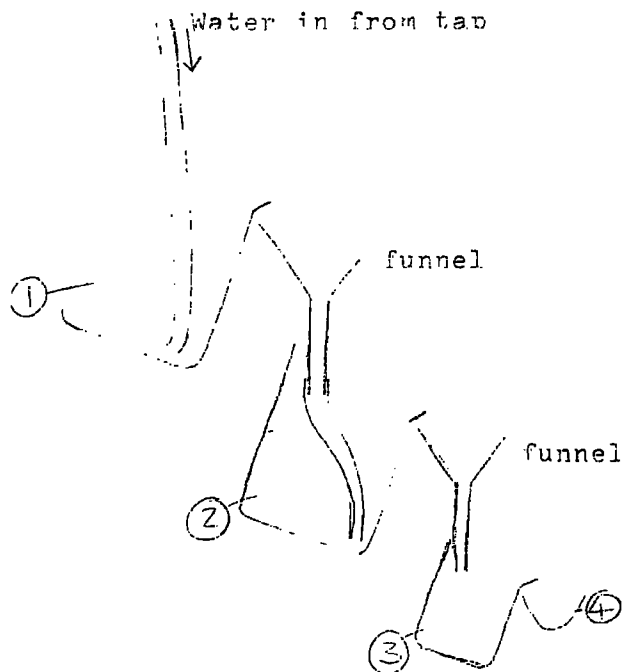

1 and 2 are 1-litre beakers; 3 is a 500 cc. beaker.

4 is a net made of nylon mesh with 64 meshes to the inch. A finer net (200 meshes/inch) may be placed underneath the coarser, if desired.

The soil + roots sample, after initial breaking up of the crumbs under water, is put in beaker 1, and the tap turned on. The water flow must be sufficient to keep the mixture in beakers 1 and 2 fairly well stirred. Large roots collect in the first beaker, being unable to get over the lip of the beaker; the smallest roots collect in the net.

Sketch map of field.

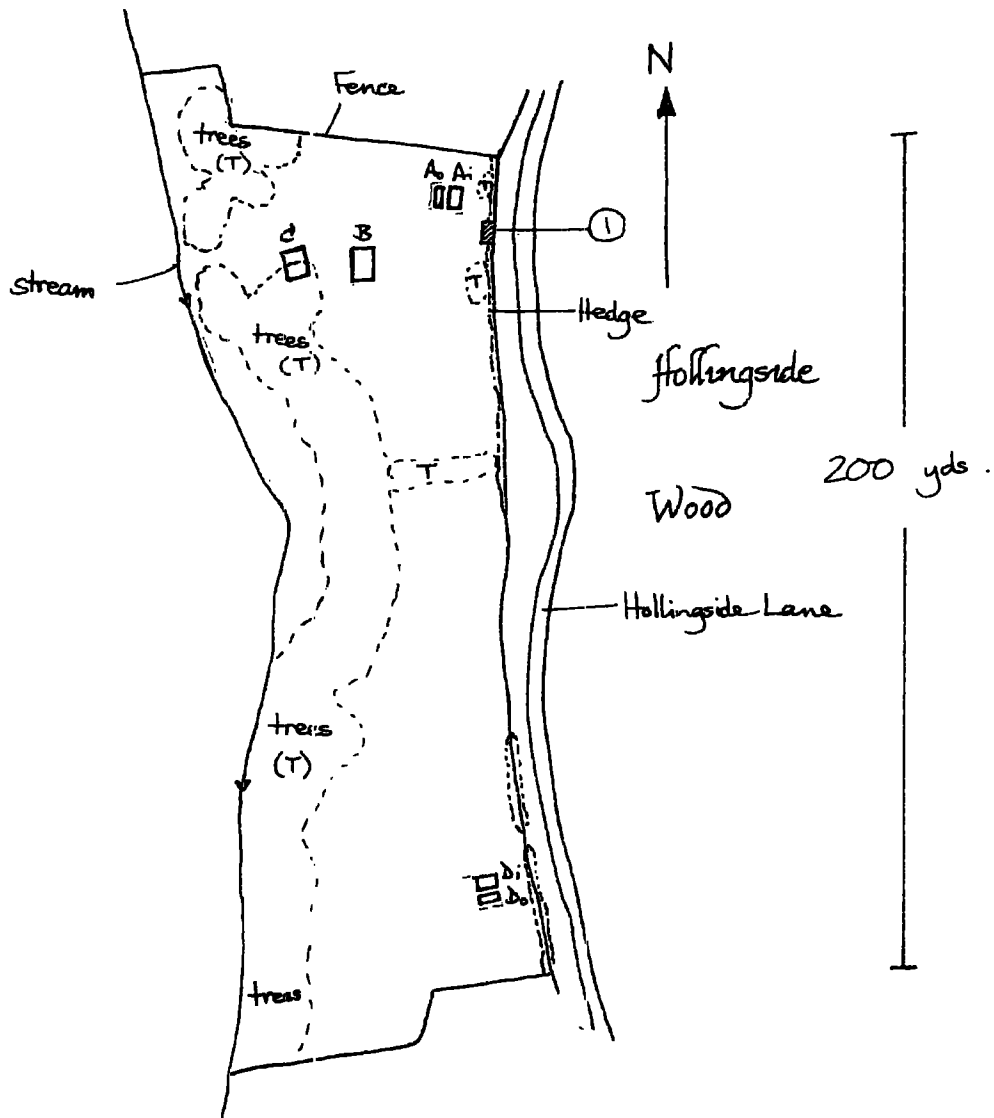

① : Location of hut shown on 6" O.S. map, but now disappeared .

Experimental areas not necessarily to scale .

Dates of collection of samples.

	Date of collection	no. of days since 24 March	time elapsed (days) since last crop
Ai	May 4	41	41
Ao	May 5	42	42
B	May 7	44	44
C	May 7	44	44
Di	May 9	46	46
Do	May 10	47	47
Ai	June 6	74	33
Ao	June 7	75	33
B	June 2	70	26
C	June 2	70	26
Di	June 8	76	30
Do	June 9	77	30
Ai	July 19	117	43
Ao	July 19	117	42
B	July 21	119	49
C	July 22	120	50
Di	July 20	118	42
Do	July 21	119	42
Ai	August 19	148	31
Ao	August 22	151	34
B	August 23	152	33
C	August 23	152	32
Di	August 24	153	35
Do	August 24	153	34

Paired plots:-

	First crop of dead material	Second crop of dead material	No. of days elapsed.
A c/d	9 July	13 August	35
B a/b	11 July	13 August	33
B c/d	14 July	19 August	36
C a/b	18 July	19 August	32
C c/d	18 July	19 August	32

Weights of plant material collected on clip-plots

March.

	Plot	Total wt.	Live grass	Live herbs	Plot	Total wt.	Live grass	Live herbs
Ao	2,4	45.6			B 7,9	34.5	2.9	0.7
	6,1	43.7			14,9	39.8	3.5	0.1
	6,6	26.9			10,4	52.2	9.9	t
	7,4	37.4			15,15	36.6	2.5	3.5
	8,8	41.4			19,4	52.3	6.4	0.1
	10,4	47.0			C7,9	33.0		
	10,5	40.8			10,14	40.0		
	13,3	37.6			12,3	64.7		
	15,2	56.9			14,7	66.0		
	15,4	40.7			14,9	59.2		
					15,15	76.7		
					23,15	27.2		
	Di	2,6	64.5			Do 2,6		
2,4		56.8			2,9	54.7		
3,4		64.5			6,1	27.9		
4,1		32.7			6,6	82.2		
5,9		71.1			8,8	29.8		
6,3		54.2			13,3	33.4		
6,10		37.6			15,2	49.9		
10,3		48.6			15,4	39.7		
12,1		41.5						
<u>May</u>								
Ai	3,6	45.4			Ao 4,4	32.0		
	4,2	45.0			5,1	55.0		
	2,5	21.2			6,2	45.9		
	6,2	28.9			6,5	41.5		
	4,10	45.3			7,2	31.0		
	7,1	37.5			8,5	33.0		
	11,6	45.4			10,8	41.6		
	13,5	29.9			15,8	29.3		
	13,9	43.4			16,3	66.4		
8,5	34.3			16,6	59.9			
B	5,8	52.5	3.6	1.2	C 5,8	52.2		
	6,14	45.4	16.4	0.2	6,14	66.8		
	7,2	42.5	5.6	0.6	7,2	36.2		
	13,5	47.1	5.6	1.3	8,9	56.9		
	13,15	35.5	2.8	0.1	9,1	61.2		
	13,16	48.4	2.9	1.6	13,5	59.8		
	15,1	42.5	2.5	3.4	13,15	35.0		
	21,5	44.1	2.5	0.0	13,16	72.6		
					15,1	60.7		
				21,5	40.6			

Weights of plant material continued - sheet 2

<u>May</u>					<u>June</u>				
	Plot	Total wt.	Live grass	Live herbs	Plot	Total wt.	Live grass	Live herbs	
Di	2,5	42.5			Do	4,4	52.5		
	3,6	42.0				5,1	35.8		
	4,2	51.3				6,2	56.9		
	6,2	37.6				6,5	36.7		
	7,1	35.7				7,2	32.7		
	8,5	67.2				8,5	55.6		
	4,10	39.9				10,8	43.6		
	11,6	44.7				15,8	34.4		
	13,5	39.5				16,3	46.9		
13,9	54.7			16,6	57.7				
<hr/>									
Ai	1,6	54.6	25.9	3.4	Ao	3,3	45.1	24.5	2.6
	3,2	44.1	19.9	2.0		4,1	38.6	6.9	12.2
	5,5	21.2	4.2	1.1		8,3	56.2	15.5	10.5
	8,3	48.5	14.7	1.8		8,7	28.9	13.0	5.1
	8,9	44.4	12.1	2.1		9,1	60.4	16.3	1.1
	9,2	47.3	15.3	4.9		11,2	36.1	1.2	11.9
	9,3	28.2	6.0	3.5		11,6	43.1	26.8	0.4
	9,7	50.7	26.8	0.9		12,1	51.1	19.2	3.0
	10,4	26.2	6.2	6.8		14,3	55.3	23.5	2.4
	11,2	43.0	18.3	1.0		16,4	47.2	25.1	1.3
	B	1,8	37.0	7.2		8.6	C	1,8	39.7
2,1		28.5	5.7	3.6	2,1	58.4		8.0	3.6
7,3		53.4	16.1	3.0	7,3	76.1		3.1	1.6
9,9		44.5	10.4	5.1	9,9	49.0		4.6	1.5
9,13		42.3	23.8	0.1	9,13	64.5		0.6	0.0
12,14		56.2	9.6	4.2	12,14	61.0		7.5	1.7
14,15		35.0	2.0	2.3	14,15	36.5		5.0	1.0
16,7		40.6	10.7	4.0	16,7	52.7		5.6	0.2
23,4		46.4	16.4	5.2	23,4	66.0		3.3	0.1
24,11		30.0	1.4	6.4	24,11	49.2		7.4	0.0
<hr/>									
Di	1,6	47.0	12.4	1.9	Do	3,3	61.3	12.2	3.0
	3,2	40.6	5.0	2.9		4,1	35.4	13.8	0.8
	5,5	36.0	10.9	4.1		8,3	44.9	13.0	0.8
	8,3	47.3	9.4	5.0		8,7	88.4	44.6	0.0
	8,9	34.8	20.0	2.6		9,1	dead 22.8	-	1.1
	9,2	39.7	5.7	6.3		11,2	dead 19.0	15.4	-
	9,3	24.2	3.9	3.5		11,6	44.1	8.4	2.4
	9,7	90.2	51.8	1.0		12,1	66.2	21.4	2.7
	10,4	36.1	4.9	0.9		14,8	89.9	28.4	2.0
	11,2	40.7	7.8	8.1		16,4	dead 21.0	17.7	-

Weights of plant material continued - sheet 3

	Plot	Total wt.	Live grass	Live herbs	Plot	Total	Live grass	Live herbs
<u>August</u>								
Ai	3,7	138.2			Ao2,8	25.8		
	3,10	91.8			4,2	20.7		
	5,3	25.1			5,7	56.7		
	6,7	58.5			8,4	32.6		
	10,5	55.3			10,7	36.5		
	12,7	48.0			11,5	51.2		
	12,9	26.6			12,7	37.0		
	12,10	49.8			16,5	23.2		
	14,6	63.4			16,7	24.3		
	14,9	88.2			16,8	37.9		
B	6,12	57.9	29.5	0.2 xxx	C 6,12	34.8		
	7,6	49.3	16.5	12.4	7,6	49.0		
	10,7	54.2	32.2	2.2	12,2	45.9		
	12,2	53.7	23.8	6.1	13,7	32.4		
	16,8	40.0	12.4	8.8	16,8	44.3		
Di	3,7	24.8			Do	4,2		
	5,3	126.3				xxx		
	10,5	30.3				xxx		
	12,7	28.8			4,2	29.2		
	14,6	27.8			5,7	35.1		
					10,7	30.5		
					11,5	29.5		
					16,5	38.3		

DELMONTE UNIVERSITY
 - 5 NOV 1974
 SECTION