

Durham E-Theses

Tracer studies of reaction mechanisms: the photolysis of acetone labelled with (¹⁴C)

Mitchell, N. T.

How to cite:

Mitchell, N. T. (1958) *Tracer studies of reaction mechanisms: the photolysis of acetone labelled with (¹⁴C)*, Durham theses, Durham University. Available at Durham E-Theses Online:
<http://etheses.dur.ac.uk/8857/>

Use policy

The full-text may be used and/or reproduced, and given to third parties in any format or medium, without prior permission or charge, for personal research or study, educational, or not-for-profit purposes provided that:

- a full bibliographic reference is made to the original source
- a [link](#) is made to the metadata record in Durham E-Theses
- the full-text is not changed in any way

The full-text must not be sold in any format or medium without the formal permission of the copyright holders.

Please consult the [full Durham E-Theses policy](#) for further details.

THESIS

presented in candidature for the degree of

DOCTOR OF PHILOSOPHY

by

N.T. Mitchell, B.Sc.(Dunelm), A.R.I.C.

Being an account of work carried out at the Londonderry Laboratory for Radiochemistry, in the Durham Colleges Division of Durham University, during the period SEPTEMBER 1955 - JULY 1958, under the supervision of Mr. G.R. Martin.

TRACER STUDIES OF REACTION MECHANISMS:

THE PHOTOLYSIS OF ACETONE LABELLED WITH ^{14}C .

Investigations of the primary photochemical process
and the reaction of radicals formed on photolysis
of acetone in the presence of oxygen and iodine.



CONTENTS

<u>CHAPTER</u>		<u>PAGE</u>
1.	Introduction	1
2.	The Photolysis of Acetone: A Review	
(A)	The Primary Process	3
(B)	Photolysis of Acetone in the Presence of Iodine	9
(C)	Studies of the Fluorescence of Acetone	20
(D)	Photolysis of Acetone in the Presence of Oxygen	32
3.	Aims of the Present Investigation	61
4.	Experimental Techniques	
(A)	Preparation of Samples for Irradiation	63
(B)	Irradiation	73
(C)	Analysis	80
(D)	Radioactive Measurements	106
	Appendix: The Radioactive Impurity in ^{14}C -labelled acetone	118
5.	The Photolysis of Acetone	
(A)	Calibration: The Photolysis of Acetone alone	121
(B)	The Photolysis of Acetone in the Presence of Oxygen	124

<u>CHAPTER</u>		<u>PAGE</u>
(C)	The Photolysis of Acetone in the Presence of Oxygen and Iodine	129
	Appendix: Deactivation in the Photolysis of Acetone	136
6.	Acetone Fluorescence: The Effect of Iodine	139
7.	Discussion of Results	
(A)	Acetone-Iodine-Oxygen	155
(B)	Acetone-Oxygen	165
8.	Summary	188
	Bibliography	
	Reaction Key	
	Acknowledgments	

FIGURE

1	Iodine Sample Preparation	67
2	Filling System for Reaction Vessel	69
3	Irradiation System	73
4	Chairs Used on Irradiation Bench	73
5	Filter System Components: Absorption Spectra	75
6	Gas Analysis	80
7	Low Temperature Regulator (for -152°C)	86
8	Methane Combustion	90
9	Formaldehyde Analysis	97
10	Bromo-Cresol Green. Absorption Spectra	103
10(A)	Acetic Acid: Calibration	104
11	Counter Filling System	107
12	Dilution of Labelled Acetone	114
13	Φ CO vs. Oxygen Pressure	126
14(A)(B)	Φ CH ₂ O vs. Oxygen Pressure	126
15	Φ CH ₃ I vs. Oxygen Pressure (Constant Iodine Pressure)	130
16	Φ CH ₂ O vs. Oxygen Pressure (Constant Iodine Pressure)	133
17	Φ CH ₂ O vs. Iodine Pressure (Constant Oxygen Pressure)	134
18	Fluorescence Apparatus (Schematic)	140

FIGURETO FACE PAGE:

19	Fluorescence Apparatus Circuitry .	141
20	Fluorescence Measurement: Circuitry	144
21	Fluorescence of Acetone: Sample Apparatus	149

TABLE

1	Calibration Runs	122
2	Photolysis of Acetone in the Presence of Oxygen	124
3	Photolysis of Acetone in the Presence of Oxygen and Iodine	129
4	Fluorescence of Acetone Vapour	152
5	Fluorescence of Acetone Vapour in the Presence of Iodine Vapour	152
6	Fluorescence of Acetone: Summary of Results	152

1. INTRODUCTION

The photolysis of acetone has been the subject of a great number of investigations in many laboratories during the last thirty or so years. Interest has resulted to a great extent through it providing a most convenient source of methyl radicals, and in the past few years much work has been carried out on methyl radical reactions using the photolysis of acetone as their means of production⁽¹⁾. In pure acetone, the quantum yield of acetone decomposition, Φ_d , has been conclusively shown to lie close to unity at temperatures above 100°C,⁽²⁾ and be unaffected by increase in temperature above this point over a considerable range. It is thus possible to obtain and maintain reproducible and controllable rates at which methyl radicals may be formed by due attention to the concentration of acetone vapour irradiated, and to the intensity of ultra-violet radiation incident upon it.

The reaction is not, however, as simple as has often been supposed, the primary process involving formation of acetyl radicals in addition to the sought-after methyls. Though acetyl radicals do to a greater or lesser degree result in formation of more methyl radicals, (depending on other circumstances) their existence can and does



lead to complications in the form of secondary reactions. In particular, the exact course of the primary process must be known since it cannot be assumed without experimental justification that it will remain unaffected by addition of foreign molecules. Indeed, as has been demonstrated by Martin and Sutton⁽³⁾ in this laboratory and by workers⁽⁴⁾ elsewhere, Iodine has a profound effect on the primary process, reducing Φ_d to a value well below that found in its absence. More recently, Hoare⁽⁴⁷⁾ has shown that carbon dioxide and nitrogen can bring about changes in the primary quantum yield.

The ideal which should be the ultimate goal of any worker in this field is to be in a position to be able to predict what course reactions would take upon addition of any substance. This would require a very considerable amount of knowledge, comparatively little of which is, as yet, available. With this ideal in mind, it has been the aim of this present investigation to extend the work already carried out in this direction in these laboratories.

2. THE PHOTOLYSIS OF ACETONE:

A REVIEW

(A) THE PRIMARY PROCESS

Papers dealing with the photolysis of acetone alone are legion. Several good reviews are available - ones which are worthy of particular mention are those by Davis⁽⁵⁾ and by Steacie⁽¹⁾. It is therefore not intended to attempt a comprehensive review here of this particular aspect of the field. The primary process will, however, be discussed in so far as it is necessary to understand the systems - those where iodine and/or oxygen have been added - which have been studied in this investigation.

It may confidently be stated that the primary process, following absorption of a quantum of radiation, $h\nu$, (reaction (1)) entails the rupture of a carbon-carbon linkage to form an acetyl radical and a methyl radical (reaction (2)).

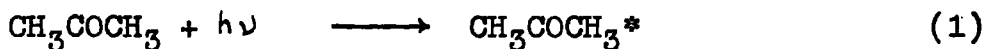

The possibility of a non-free radical split has been suggested by several workers (see for instance⁽⁶⁾):

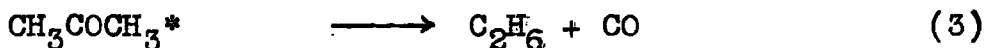

However, there has now accumulated a considerable mass of evidence to disprove it as a reaction of any importance. For instance, Benson and Falterman⁽⁷⁾, photolysing 1+1 mixtures of acetone and fully deuterated acetone, CD_3COCD_3 , found that mass spectrometric analyses of the ethane formed agreed within 2% with the results predicted on the basis of a totally free radical split. The ethane was, of course, formed by the secondary reaction:

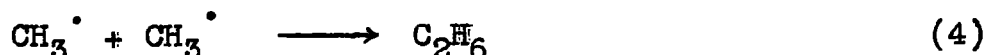

More evidence is given by the photolysis of acetone in the presence of iodine⁽⁴⁾, when no detectable amounts of ethane were formed. These are but two of the many arguments in favour of discarding reaction (3).

A further possible primary reaction may be represented by (5):



This, however, can be interpreted as the succession of reaction (6) below upon reaction (2).

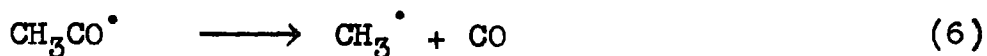

Photolysis of acetone-iodine mixtures⁽³⁾, where iodine

acts as a very efficient radical "trap", has shown that reaction (5) is certainly negligible at temperatures in the region of 100-120°C. This is indicated by extremely low yields of carbon monoxide relative to those found under conditions identical except for the absence of iodine.

A primary split which may be mentioned here, (7), is held responsible for occurrence of hydrogen when U.V. of short wavelength (below 2000Å.) is used. (18)

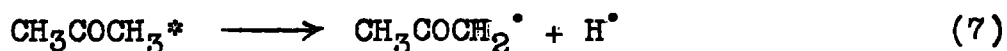

The following reactions, (8) to (15) inclusive, following on reactions (4), (6) and (7) (above), have been put forward to account for the products which have been isolated. These are carbon monoxide, methane, ethane, biacetyl, biacetylonyl, methyl ethyl ketone and acetone (re-formed by (12)). Hydrogen has been detected as discussed above (reactions (7) and (13)), and there is evidence for the formation of ethylene and ketene at high temperatures. (Above 250°C).

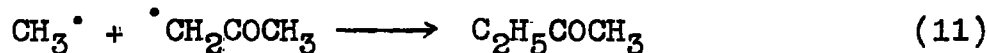
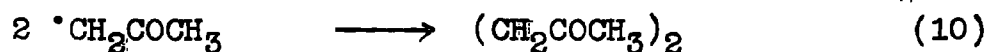
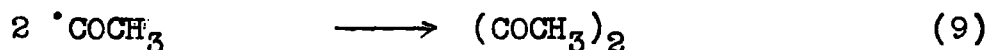

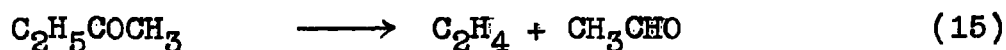
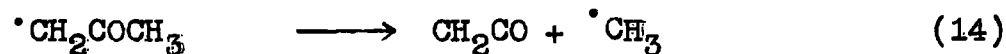
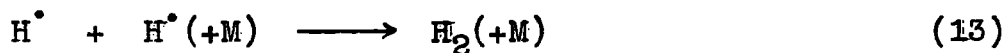
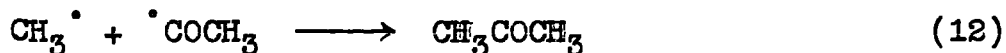

Several points are of sufficient importance to be discussed here, and these can be conveniently summarised under the effects of temperature, pressure and wavelength of absorbed radiation.

Temperature:

Several distinct trends can be recognised. Φ_d , which, on absorption of radiation in the bonded region of wavelength of about 3130\AA , lies around 0.3 at room temperature, rises to a value very close to unity at temperatures in excess of 100°C . This value is maintained over a considerable range to 300°C ⁽¹⁹⁾, or even to 400°C ⁽²⁰⁾.

Ethane is a major product at 25°C . As the temperature rises, $\Phi_{\text{C}_2\text{H}_6}$ decreases in favour of increasing yields of methane, the result of competition between reactions (4) and (8). This is particularly evident at temperatures above 100°C . Formation of biacetyl, a major product at 25°C is negligible above 100°C . This is due to removal of acetyl radicals by reaction (6) before recombination

can take place (9). The increasing importance of reaction (6) as temperature rises is illustrated by the increase in $\bar{\Phi}_{CO}$ which reaches a value of almost unity at temperatures in the vicinity of 100°C.

The variation of $\bar{\Phi}_d$ is of particular importance. Re-formation of acetone via (12) has often been used to explain the way in which it falls off at temperatures below 100°C. It is, however, quite probable that another factor, which should not be overlooked, is the possibility of collisional deactivation of the excited acetone molecule $CH_3COCH_3^*$. A further effect is that due to reversion of $CH_3COCH_3^*$ to the ground state with the emission of light—that is, fluorescence. The latter, however, is of comparatively little importance judging from the absolute fluorescent efficiency data which is available.

Pressure:

When the pressure of acetone is increased at temperatures below 100°C, an initial sharp decrease in $\bar{\Phi}_d$ is observed, the curve levelling out to a nearly constant value as the pressure is further increased. At all temperatures it tends to, or very near to, unity as the acetone pressure tends to zero. As the temperature increases, ^{pressure dependence} decreases in magnitude until, at temperatures in excess of 100°C, it has become negligible. This forms extra

evidence for collisional deactivation of excited acetone molecules.

Wavelength of exciting radiation:

The above remarks were made with particular reference to excitation by U.V. of wavelength 3130\AA . The same qualitative results are found for light of shorter wavelengths, down to the point (in the region of λ about 2000\AA) where other primary processes begin to be important. Little work has been done at these very short wavelengths and, since the present investigation was confined to irradiations at 3130\AA , the effects of shorter wavelength light will not be considered further.

2. (B) PHOTOLYSIS OF ACETONE IN THE PRESENCE OF IODINE
~~ACETONE~~

It is essential to the understanding of results of the acetone-iodine-oxygen system (used in this investigation) to have a clear knowledge of the acetone-iodine system. As it produces results which show interesting comparisons with those from investigations of the fluorescence of acetone, it is convenient to consider the acetone-iodine system first.

The earliest work on this system is due to Gorin⁽⁸⁾⁽⁹⁾. Subsequent investigations have been made by Benson and Forbes⁽¹⁰⁾, Martin and Sutton⁽³⁾, and Pitts and Blacet⁽⁴⁾.

The work of Gorin is open to numerous doubts and objections. His assumed value of 0.17 for Φ_{CO} at 80-100°C is low by a factor of about 4 to 5 on recent estimates. In consequence his estimates of methyl iodide and acetyl iodide quantum yields are low, and recalculation gives improbably high values for Φ_{CH_3I} of 4 to 5. Carbon monoxide yields are higher than those reported in later work and, in addition, consistency is poor. His experimental techniques have yet to be reproduced and the whole work is of questionable reliability and value.

The work of Benson and Forbes⁽¹⁰⁾, despite some rather erratic results, served to establish some important

facts. They recognised the absence of biacetyl and of ethane from the reaction products; yields of carbon monoxide reported are very high in comparison with later work. In common with all other workers since Gorin, insuperable difficulties were encountered when attempts were made to analyse for acetyl iodide. It is noteworthy that they tried and failed to reproduce Gorin's acetyl iodide method.

In general, techniques used in both these investigations were inferior to those used by later workers. For the purpose of this discussion, use will only be made of the results of Pitts and Blacet, and Martin and Sutton. Whilst different analytical techniques were used in each of these two latter investigations, admirable agreement was reached in results where a direct comparison is possible. The following is a summary of the results from the two papers:

- (a) Products isolated consisted principally of methyl iodide, acetyl iodide and, to a smaller extent, carbon monoxide. Only traces of methane were detected and then only at the highest temperature (177°C) and shortest wavelength (2654\AA) used. No ethane was detected.
- (b) No reliable quantitative data on acetyl iodide could

be obtained. Experiments with known amounts of acetyl iodide showed that it decomposed rapidly in contact with mercury and was sensitive to visible light. In view of the near absence of carbon monoxide and the complete absence of biacetyl, yields of acetyl iodide close to those found for methyl iodide would be expected.

(c) Carbon monoxide yields were very small, Φ_{CO} being generally of the order of 0.01 or less. Yields showed a steady rise with temperature whilst increase in either acetone or iodine pressure decreased Φ_{CO} , which increased as the wavelength of the absorbed radiation decreased.

(d) Methyl iodide yields showed generally similar trends to those shown by Φ_{CO} . The sharp decrease with increase in acetone pressure was particularly noticeable.

Discussion of the data:

The variation of Φ_{CO} with changes of temperature and frequency of absorbed radiation can be explained as a case of competition between two reactions between acetyl decomposition (6) ($E_{act} \approx 18$ k.cal./mole⁽¹⁾) and reaction with iodine (16 (a, b))



It is evident, from examination of product quantum yields, that Φ_d is subject to some variation but is considerably less than unity. Assuming that methyl iodide can arise from acetyl radicals only as a result of prior decomposition of the radical via (6), then:

$$\Phi_d = \Phi_{\text{CH}_3\text{I}} - \Phi_{\text{CO}}$$

Φ_{CO} is in general less than 1% of the corresponding value of $\Phi_{\text{CH}_3\text{I}}$. It is therefore possible, within the limits set by experimental error, to write:

$$\Phi_d = \Phi_{\text{CH}_3\text{I}}$$

Mechanism: Martin and Sutton

Pitts and Blacet obtained results under only four separate sets of conditions. Only temperature (80°C to 177°C) was varied to a marked extent. In the absence of sufficient data no mechanism was postulated, and it was left to Martin and Sutton to provide a theory to fit the accumulated evidence.

In the photolysis of acetone vapour, absorption of a quantum of radiation forms, initially, a highly excited state of acetone which, in the absence of molecules other than acetone, undergoes rapid decomposition to the extent

of almost 100% at temperatures above 100°C.



It is postulated that this electronically excited state, A', is susceptible to partial deactivation by iodine (reaction (17)) in competition with decomposition via (2(a))

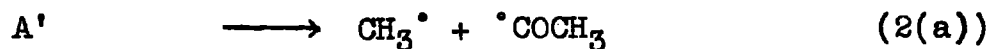
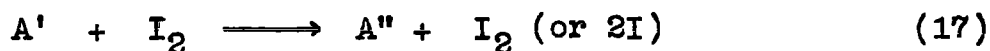

A'' is a second electronically excited state which, whilst having lost some of energy gained in its initial excitation, still retains sufficient to decompose into free radicals (Reaction 2(b)):

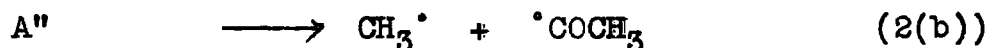

A'' can then disappear by two routes: either by decomposition as above (2(b)), or by deactivation by collision with either acetone or iodine (Reaction (18)):

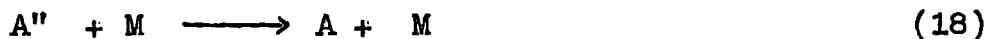

This scheme may be summed up graphically:

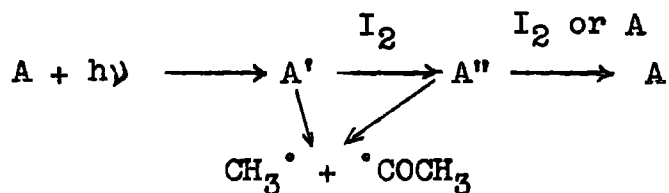

It should be noticed that no collisional deactivation of A' by acetone molecules is suggested.

The following scheme of reactions is postulated as the means by which the radicals disappear. Reactions (16) and (19) are presumed fast enough to quench secondary reactions of the radicals concerned.

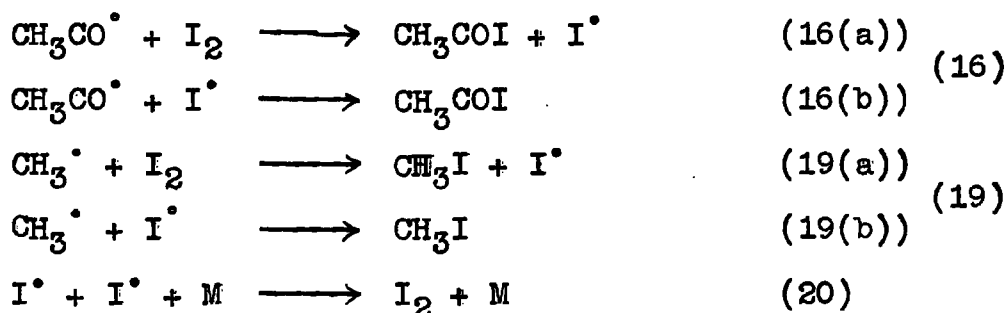

In order to explain the appearance of carbon monoxide (though in small amounts) reaction (6) is included in the scheme, competing rather unfavourably with (16) as the mode of removal of acetyl radicals. This is preferred to a direct intra-molecular split (3), since no ethane has been detected in this system. Accordingly, and since biacetyl is also absent, reactions (4), (9) and (12) have been disregarded. By the usual steady state treatment for

A' and A'', the following kinetic equation was produced:

$$\frac{\Phi_{\text{CH}_3\text{I}}}{\Phi_{\text{CO}}} = 1 - \left\{ 1 + \frac{k_{2(a)}}{k_{17} [\text{I}_2]} \right\}^{-1} \times \left\{ 1 + \frac{k_{2(b)}}{k_{18} [\text{M}]} \right\}^{-1} \quad (21)$$

Test of this equation, assuming equal efficiencies for iodine and acetone as the deactivating molecule M, and using the 'best fit' values of $\frac{k_{2(a)}}{k_{17}}$ and $\frac{k_{2(b)}}{k_{18}}$, shows excellent agreement over the range of $(\frac{\Phi_{\text{CH}_3\text{I}}}{\Phi_{\text{CO}}})$ values experimentally available.

Alternative mechanism:

An alternative scheme, modifying that reproduced above, is possible, as proposed by Brown⁽¹¹⁾. The fundamental change is the reversal of the species supposed responsible for deactivating A' and A''. If A' is supposed susceptible to deactivation by both iodine and acetone, an equation, (24), is derived which is kinetically similar to (21) and which still fits the experimental data. Reactions (17) and (18) are replaced by (22) and (23) respectively:

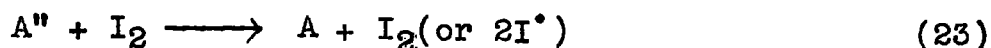

Reaction (24) appears in place of (21):

$$\begin{aligned} \overset{\cdot}{\text{O}} \text{CH}_3\text{I} - \overset{\cdot}{\text{O}} \text{CO} = 1 - \left\{ 1 + \frac{k_{2(a)}}{k_{22}[\text{M}]} \right\}^{-1} \\ \times \left\{ 1 + \frac{k_{2(b)}}{k_{23}[\text{I}_2]} \right\}^{-1} \end{aligned} \quad (24)$$

This revised scheme has two attractive features to commend its inclusion in preference to the earlier mechanism:

- (i) Both excited states would still be present in the absence of iodine. The particular importance of this point will be appreciated when the fluorescence of acetone is discussed (Section (c) of this chapter).
- (ii) It can still be assumed that the reaction (25) has some probability of occurrence. (Of necessity very much less than (23)):

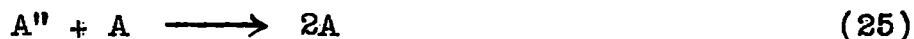

Thus the behaviour of $\overset{\cdot}{\text{O}} \text{I}$ in pure acetone at temperatures below 100°C can be provided with a qualitative explanation. As the temperature is lowered, reaction (25) would compete more and more favourably against radical formation (reaction 2(b) for the species A'').

Some additional comments from the Martin and Sutton paper are of sufficient interest to justify discussion

here:

- (1) A point of some dispute has been the possibility and relative importance of reaction (5), where it has been assumed that a fraction of the acetyl radicals formed in reaction (2) carry over sufficient excess energy to decompose, via reaction (6), before other reactions of the acetyl radical can occur. In most systems it is not possible to give a direct estimate of the extent of this reaction. Noyes and Dorfman⁽¹²⁾ suggest a value of 0.07 for acetone at 130 mm pressure at 25°C, photolysed by 3130Å radiation. Assuming that the radicals arising from A' are equivalent to those formed in the photolysis of pure acetone without added reagents, Martin and Sutton were able to set an upper limit of 1% to the fraction of acetyl radicals decomposing in this way. This was done by extrapolating the ratio $\frac{\Phi_{CO}}{\Phi_{(CH_3I)_{A'}}$ to infinite acetone pressure. The quantity $\Phi_{(CH_3I)_{A'}}$, that is to say, the quantum yield of methyl iodide originating from decomposition of A', is given by the expression:

$$\Phi_{(CH_3I)_{A'}} = \left\{ 1 + \frac{k_{17}}{k_{2(a)}} \cdot [I_2] \right\}^{-1} \quad (26)$$

No estimate could be made for the shorter wavelength used ($2537\overset{\circ}{\text{A}}$) because of lack of sufficient information.

- (ii) Two experiments were carried out using large quantities of carbon dioxide - 19.4 cm, added to 19.4 cm of acetone. Photolysis was carried out by irradiation with U.V. of wavelength $3130\overset{\circ}{\text{A}}$ (Temperature 120°C). A slight decrease in Φ_{CO} to 0.93 ± 0.03 was observed. This, however, represents a negligible decrease compared with that produced by a much smaller amount of iodine.
- (iii) Some experiments were performed using visible light in addition to U.V. of wavelength $3130\overset{\circ}{\text{A}}$. Irradiation with visible light alone gave no appreciable amounts of products, but with the mixed light, the visible component of which was sufficient to produce an iodine atom concentration 1000 times that in a normal photolysis, a slight increase in $\Phi_{\text{CH}_3\text{I}}$ was detected. The authors attributed this to a reaction between iodine atoms and one of the excited acetone intermediates which, it was concluded, must have a lifetime of at least 10^{-5} sec. On this evidence they suggest A" has a minimum lifetime of 10^{-5} sec.

- (iv) Assuming that each collision between A' and I₂ is effective in promoting reaction (17), then, making a reasonable estimate for the collision diameter for this reaction, an estimate was made of k_{17} and hence the half life of A' by spontaneous decomposition. The estimate of 4×10^{-7} sec. was close enough to prompt identification of A' with the first excited state in the fluorescence mechanism of Groh, Luckey and Noyes. (13)
- (v) Positive identification of the authors' A'' with the second excited state of the fluorescence scheme was not possible because of requirements with regard to this latter state. Nor could it be identified with that postulated by Spence and Wild in the direct photolysis of acetone. (40) A suggestion was made that A'' might be a complex aggregate of acetone and iodine. If, however, we accept the revised iodine mechanism of Brown then such a state would seem unlikely. It may well be that the fluorescence mechanism is incorrect, at least in its requirements for the second, longer lived, state. Further discussion on this point will be left for the next section.

2. (C) STUDIES OF THE FLUORESCENCE OF ACETONE

The property of acetone of exhibiting fluorescence when irradiated with ultra-violet radiation has been known for more than 25 years, and its importance as a process in competition with decomposition into free radicals has long been recognised. It has been the subject of numerous investigations but only the two most recent need be discussed in detail here. They are due to Luckey and Noyes⁽¹⁴⁾, and Groh, Luckey and Noyes⁽¹³⁾, and contain a useful and complete bibliography to earlier work, most of which is, however, covered or amended by these two investigations. Their results were obtained on the 'blue' fluorescence - the 'green' fluorescence so well known is generally recognised to be due to biacetyl,⁽¹⁵⁾⁽¹⁶⁾ a fact which confused many earlier workers.

The following is a summary of the main facts from these papers:

- (a) The fluorescence is complex, as shown by flash excitation. Decay does not occur in a simple fashion, but is composed of a very fast decay from a state of estimated half-life 8×10^{-8} sec (at 25°C), followed by a slower decay which follows an exponential pattern. The state responsible for this slower decay was estimated to have a lifetime of $2 \times$

10^{-4} sec at 25°C , and bad, at this temperature, a demonstrable structure. The fluorescence efficiency of the latter state was some 5 to 10 times that of the former at 25°C . Their absolute values were each less than 1%.

- (b) The spectrum of the fluorescence covers a band from about 3800\AA to 4700\AA . It shows a broad maximum which at 25°C lies about 4550\AA . The position of this maximum is sensitive to changes in temperature and to the addition of certain foreign gases.
- (c) Effects of temperature, acetone pressure, intensity and frequency of absorbed radiation, and addition of foreign gases have been studied.

(i) Temperature:

Both excited states are susceptible to temperature changes. Whereas, however, the longer lived state is very quickly quenched by increase of temperature over the range 25 to 100°C , the shorter lived state is relatively insensitive to such variations, and, in fact, persists, though at reduced efficiency at temperatures, in the region of 100°C . About 100°C the structure hitherto observed is undetectable, which is therefore entirely due to the longer-lived state.

The position of the maximum in the fluorescence spectrum moves from about 4550\AA at 25°C to about 4300\AA at 150°C .⁽¹⁴⁾ This can be attributed to quenching of the longer-lived state.

(ii) Intensity of absorbed radiation:

It has been noted that the half life of the fluorescence decreases on increase of the absorbed intensity.⁽¹⁷⁾ No information is available as to any difference of effect on the two states.

(iii) Wavelength of absorbed radiation:

Acetone absorbs U.V. radiation over the range from 3400\AA to below 2000\AA . It has been shown qualitatively that the efficiency is somewhat diminished as wavelength is decreased. No difference in the spectral distribution was observed.

(iv) Acetone pressure:

The fluorescent efficiency of both states is diminished by increase in acetone pressure at constant temperature and absorbed intensity. A Stern-Volmer⁽⁴⁸⁾ relationship is obeyed, that is, the inverse efficiency, $\frac{1}{\tau}$, is directly proportional to acetone pressure.

(v) Foreign gases:

Addition of hydrogen and nitrogen had no effect. Oxygen and nitric oxide produced identical effects, both qualitatively and quantitatively. The long-lived state was quenched completely whilst the shorter-lived state was unaffected.

(vi) The intensity of the fluorescence from the shorter-lived state was independent of the rate at which the longer lived state was removed. The latter is not formed reversibly from the former, though this cannot be said to discount irreversible formation.

(vii) It has been suggested that the longer lived state may be a triplet.⁽¹⁴⁾⁽²¹⁾ This is supported by its properties of being quenched by increase in temperature, and by introduction of paramagnetic molecules.

MECHANISM:

Groh, Luckey and Noyes put forward the following scheme. They wrote the initial steps:



(where D represents free radical dissociation products)



was not included on the grounds that it was not required to explain the facts - reactions (29) and (30) must be fast reactions, and the mole fraction of oxygen in the experiments was always low. These authors went onto postulate the following secondary reactions:

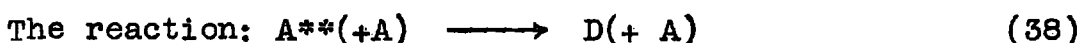
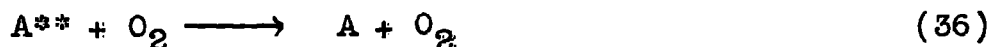

was ignored on the grounds that, whilst it cannot be excluded as a possibility, A^{**} is always present in small amounts. This, however, cannot be allowed to pass without some comment since it is ~~an~~ ^{an} assumption made by the authors and not an experimentally observed fact. The concentration of A^{**} is of considerable interest and importance in other systems - where iodine and oxygen are added, and a reliable knowledge of its relative value

would be very useful. It may be noted that, at 25°C and in the absence of foreign gases, the fluorescence efficiency of A** is some five times that of A*. However, without further knowledge of relative amounts of A* and A** produced such information is of little use, save for indicating that A** cannot be written off as a state without quantitative significance.

Reactions (39) and (40), below, are ignored by this mechanism, presumably on account of their assumption that A** is always present in small amounts.

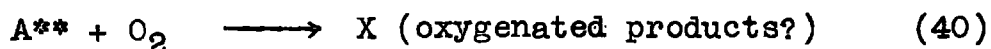

In a later paper, Marcotte and Noyes⁽²⁴⁾ found that oxygen did not alter $\bar{\Phi}_d$, and produced this evidence in support of their assumption that concentrations of A** were always small. As will be seen from later discussion, (section (D) of this chapter), their measurements being limited to low oxygen pressures do not form conclusive proof of the constancy of $\bar{\Phi}_d$.

This scheme is attractive in that it produces a kinetic equation for the overall fluorescent efficiency which is of the correct form.

Alternative Schemes:

In a system as complex as this it will be readily appreciated that there may well be more than one mechanism which will agree with the experimental evidence and predict kinetic equations of the correct form.

One of the features of the fluorescence, not so far explained, is the structure observed in fluorescence from the long-lived state. The bands are evenly separated - estimated⁽²²⁾ at 122 ± 10 to 15 cm.^{-1} . Little attention has been turned to this aspect so far. A possible explanation is that fluorescence occurs from a number of different vibrational energy levels of the electronic level, designated by A^{**} , to a similar set of energy levels of the (electronic) ground state of acetone.

It is difficult to assess the extent to which reaction (28) occurs:



It is generally supposed that before sufficient time has elapsed for the absorbed energy to distribute itself into the appropriate vibrational modes necessary to effect bond rupture, a number of collisions with other acetone molecules will have occurred sufficient to deactivate A^x

producing the state designated⁽¹³⁾ by A^* . This differs from A^X in either vibrational energy content, alone, or in both that and the level of electronic excitation. The true picture may be more complicated than this in that decomposition (34) might occur from a number of states intermediate between A^X and A^* . The fact that there is a large energy difference (about 30800 cm.^{-1}) between the low frequency limit in absorption and the high frequency limit of the fluorescence spectrum has been taken to suggest that there is a difference of level of electronic excitation between A^X and the states responsible for fluorescence. It would therefore appear that one single collision (without implying every collision) would be sufficient to bring about this change, if different energy levels are involved.

Population of numerous vibrational levels of A^* is likely, according to normal statistical distribution. Together with similar distribution of the vibrational levels reached after emission of fluorescent radiation, this could explain the spread of the fluorescence spectrum. Such a wide band as is covered by the fluorescence from A^* can be interpreted as a series of bands, unresolvable by present techniques. Indeed the bands due to fluorescence from A^{**} are only faintly discernable, though, at the maximum, the fluorescence efficiency of this state is

at least five times as large as that from A*.

Of alternative schemes, the following is perhaps the most attractive, particularly in that it agrees with the revised acetone-iodine mechanism (Section (B) of this chapter). The basic difference from the scheme of Groh, Luckey and Noyes⁽¹³⁾ is that reaction (30) is replaced by (41), below, as the means of production of A**:



In order not to violate experimentally established facts, this must be accepted as an irreversible reaction. In its favour is the point that agrees, qualitatively, at least, with the observed decrease in fluorescent efficiency of A* as acetone pressure increases. The possibility of large concentrations of A** must be admitted, as must be the inclusion of reaction (38). It does, however, complicate the kinetic expressions for fluorescent efficiencies and for Φ_d . Though these are still of the right form it would be virtually impossible to derive any useful quantities from them, by use of which a test of this theory could be made.

A further alternative, also kinetically similar to the above modification, replaces reactions (29) and (30) by (42) and (43) respectively:



Reaction (42) represents the result of transfer of vibrational energy from A^X by normal collisions with (unexcited) acetone molecules. Reaction (43) represents the formation of a different electronic state (by a specific $A^X - A$ collision), a state which has already been suggested may be a triplet.

The fate of A^{**} is open to some debate. Assuming that its concentration can be quite large - of the same order as that of A^* , it should make an appreciable contribution to the photochemistry. Reactions, which it may be supposed to take part in, can be summarised:

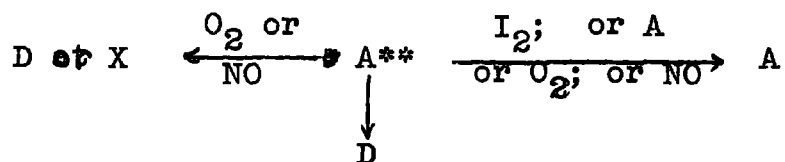

The main doubt concerns the relative contributions of the three possible reactions ((36), (39) and (40)) in which oxygen is concerned. It is in the reaction product that these reactions differ. If Φ_d is maintained at unity in the presence of oxygen, a condition still in doubt beyond 300 microns pressure of oxygen, then reactions

(39) and (40) must take the major share. Choice between (39) and (40) is difficult. Recourse to the acetone-iodine-oxygen system suggests that (39) is the more likely since oxygenated products are formed to very little extent compared with iodinated products. There is, however, the further aspect that, in competition with reaction (38), neither (39) nor (40) may be of any importance as a means by which A^{**} disappears from the sphere of reaction. Indeed, it is doubtful why A^{**} should be more likely to decompose into radicals after first losing energy to oxygen molecules. (It will be remembered that the energy of A^{**} above the ground state A cannot be much in excess of that required for breakage of a carbon-carbon bond). The course of these reactions may be supposed to involve assistance by the oxygen molecule in redistributing the excess energy within the acetone molecule to enable bond rupture to occur. Such a reaction would appear, at first sight, to be less efficient than (36).

The fate of A^{**} would, therefore, seem to be shared by reactions (36) and (38), with reactions (35) and (37) playing a part which increases as temperature decreases below the region of 100°C .

It must be emphasised that much of the foregoing is highly speculative. Without more information on these

reactions, no more than possibilities can be shown.

Comparisons with photochemical work would be of great use in elucidating the course of the primary process. It is unfortunate that there is, as yet, so little evidence of any value from the photo-oxidation of acetone. The acetone-oxygen system (discussed in the next section) still lacks a satisfactory room-temperature mechanism, and those put forward at higher temperatures are far from satisfactory. Conclusions which can be drawn are qualitative rather than quantitative. Much less accuracy can be claimed for the photo-oxidation mechanisms than for the fluorescence.

The position with regard to iodine is more encouraging. Whilst the photochemistry is fairly complete (in comparison with other acetone systems), no work has, as yet, been attempted on the fluorescence of acetone in the presence of iodine. If we accept the modified iodine mechanism, immediate comparison may be made between this and fluorescence scheme of Groh, Luckey and Noyes, modified by inclusion of reaction (41) or (43) for (30). It seems very probable that A' and A^* are identical, and, on comparing half-lives and properties, it is tempting to identify A^{**} with A'' . The main doubt must lie with the long lived states in each system.

2(D) PHOTOLYSIS OF ACETONE IN THE PRESENCE OF OXYGEN

The first paper on this aspect⁽²³⁾ was published by Marcotte and Noyes in 1951. Since then a succession of publications have appeared, most of the work having been carried out in Noyes's laboratory. Following the work of Marcotte and Noyes, it appeared that the reaction of oxygen with radicals produced in the photolysis of acetone might be a relatively simple process. Subsequent investigations have shown many of the original ideas to be false, and the position at the outset of this investigation was already very complex, and, from the point of view of mechanisms which have been advanced, one which is anything but satisfactory.

The first⁽²³⁾ and second⁽²⁴⁾ papers, both by the same authors can, for the purposes of this review, be discussed together. Their main findings, for the temperature range 120 to 225°C, using acetone at 131 mm pressure, may be summarised as under:

- (a) Ethane was absent over the whole range of temperature used, even when the oxygen pressure was as low as 0.01 mm.
- (b) Methane is formed but only at very low oxygen pressures. Production is favoured by elevation of temperature, but increase in oxygen pressure invariably effects a rapid decrease. The oxygen pressure required to prevent

methane formation entirely rises from about 0.05 mm at 120°C to more than 0.2 mm at 200°C. As oxygen pressure decreases below these values, $\bar{\Phi}_{\text{CH}_4}$ reaches values in the region of unity, and, in some cases, in excess of this figure.

(c) The quantum consumption of oxygen $\bar{\Phi}_{-\text{O}_2}$ stays approximately constant at about 4 over the whole range of oxygen pressures studied (0.018 to about 2 mm). There is however some doubt, particularly at the higher pressures, whether this is really constant, a doubt which cannot be resolved because of the very considerable spread of results.

(d) Carbon Monoxide: The largest values observed were $\bar{\Phi}_{\text{CO}} = \text{about } 3$ at very low oxygen pressures (about 0.04 mm). This compares with $\bar{\Phi}_{\text{CO}} = 1$ in the absence of oxygen, inferring a very sharp rise to the maximum which must occur very near to $p_{\text{O}_2} = 0$. Values of $\bar{\Phi}_{\text{CO}}$ decrease as p_{O_2} is raised, until a nearly constant value is reached at oxygen pressures in excess of about 1 mm. This high oxygen pressure value of $\bar{\Phi}_{\text{CO}}$ is less than unity at 120°C but increases with increase in temperature. It is not possible to ascertain whether the maximum value attained by $\bar{\Phi}_{\text{CO}}$, at the oxygen pressure which produces it, are temperature depen-

dent. From graphic representation of the results, it can readily be seen that Φ_{CO} falls much more rapidly from the maximum at lower temperatures within this range than at the higher ones.

- (e) Carbon Dioxide: Rising from a value of zero at zero oxygen pressure, Φ_{CO_2} reaches a maximum value which appears to be approximately constant at 1.9 over the whole range of temperature. As temperature rises the maximum becomes noticeably broader.
- (f) Comparison of the carbon monoxide and carbon dioxide yields shows that up to an oxygen pressure of about 0.3 mm the sum of Φ_{CO} and Φ_{CO_2} is approximately constant at about 3, the former falling while the latter is rising.
- (g) Over the pressure range where methane is formed, the sum of Φ_{CH_4} , Φ_{CO} and Φ_{CO_2} is always in excess of 3. This is clear indication that more than one acetone molecule is being consumed per quantum of radiation adsorbed.

Photo-oxidation at room temperature:

A small amount of work was carried out at 25°C and at 131 mm pressure of acetone. The principal results may be summarised:

- (1) All yields were low in comparison with those at

the higher temperature range studied.

- (ii) $\bar{\Phi}_{-O_2}$ was approximately constant, independent of variations in oxygen pressure, at a value of about 0.5.
- (iii) No ethane or methane was detected over the oxygen pressure range studied (0.02 to 0.25 mm).
- (iv) $\bar{\Phi}_{CO}$ was reduced by introduction of oxygen, reaching an approximately constant level at the higher oxygen pressures.
- (v) $\bar{\Phi}_{CO_2}$ was, in all cases studied, higher than $\bar{\Phi}_{CO}$.

Whilst the above evidence has been claimed by the authors, it must be realised that only four different oxygen pressures were used. Experimental error shown by the spread of the quoted values makes any inferences made from the apparent trends open to some doubt.

Mechanism:

The following series of reactions was proposed by Marcotte and Noyes:

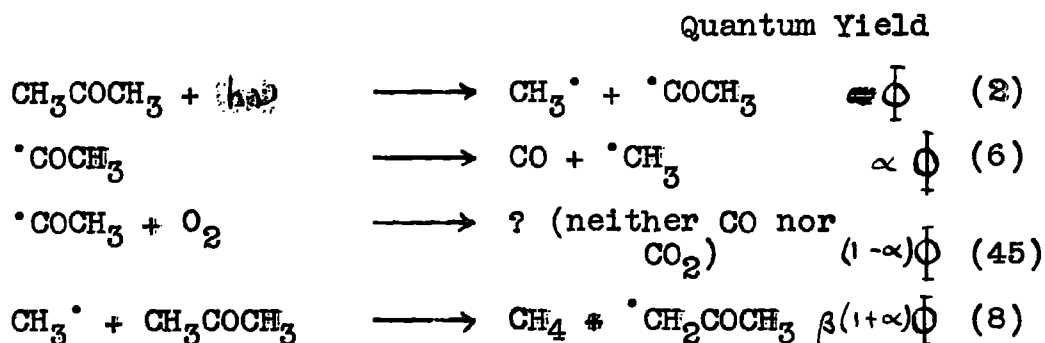

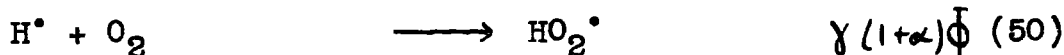
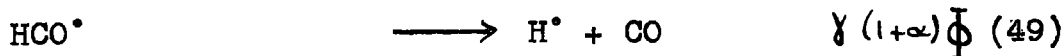
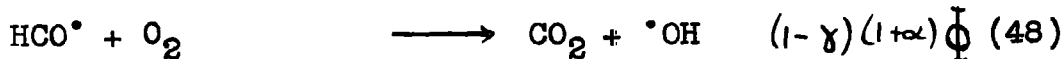
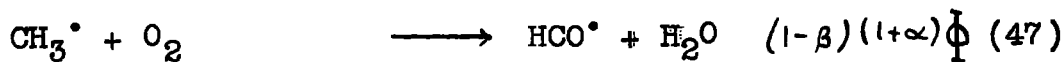

The constant α represents the fraction of acetyl radicals which dissociate, β the fraction of methyl radicals following reaction (8), and γ the fraction of formyl radicals which dissociate.

Discussion:

Several pieces of evidence are proffered to show that $\bar{\Phi}_a$ does not deviate from unity. $\bar{\Phi}_{\text{CO}}$ reaches a value of 3 at very low oxygen pressures which, it is suggested, indicates that each acetyl radical formed (by reaction (2)) dissociates via (6), and both methyl radicals are oxidised to carbon monoxide. A serious omission is made here - that of neglecting the presence of methane which must obviously result from the methyl group, and almost certainly from a methyl radical formed in (2). Whilst the largest observed values of $\bar{\Phi}_{\text{CO}}$ were approximately 3, there still exists the possibility of finding still larger values in the region of oxygen pressure between the lowest studied and zero, a region which was experimentally

inaccessible. One point which is beyond all reasonable doubt is that oxygen in these small proportions does not show the deactivating properties exhibited by iodine.

A further argument of Marcotte and Noyes concerns the effect of oxygen on the fluorescence. They suppose that increase of temperature, rather than admission of oxygen, is responsible for the reduction in fluorescence. It is difficult if not quite impossible to decide which of the two possible factors is responsible when both are operative. Many of the yields quoted are large, sufficient in themselves to discount the presence of any strong deactivating agent. Such results are, however at very low oxygen pressures and the few results produced by Marcotte and Noyes which are at "appreciable" oxygen pressures (of the order of 2 mm pressure) are sufficient in themselves to suggest that a case could be put for oxygen taking over as the more important effect.

Some observations were made on the consumption of oxygen per quantum absorbed, Φ_{-O_2} . On the basis of the published data it was deduced that:

$$\Phi_{-O_2} = (3 + \alpha) \Phi \quad (51(a))$$

If $\alpha = 1$, then Φ_{-O_2} becomes equal to 4 Φ as observed experimentally. However, α is not always equal

to unity. As shown by the variation of $\bar{\phi}_{CO}$ it can be much less. A variation of $\bar{\phi}_{-O_2}$ from 3 to 4 could be expected, larger than that which is in fact observed. Equation (51(a)) could, therefore, not be upheld and reaction (45) was therefore discredited. The authors, in their second paper, assumed as a substitute that a sequence of events is started which causes two molecules of oxygen to disappear. Justification for this is found in the fact that it fits experimental results in predicting oxygen consumption as (51(b)).:

$$\bar{\phi}_{-O_2} = 4 \bar{\phi} \quad (51(b))$$

Low temperature mechanism

A scheme was advanced in the earlier paper⁽²³⁾ to account for the photo-oxidation at room temperature. The high temperature mechanism was quite unacceptable in that it ~~predicted~~ ^{required} negative values of α . In addition to the likelihood of peroxide formation, other reactions not important at the higher temperatures are likely at 25°C. Marcotte and Noyes⁽²³⁾ assumed that all the carbon monoxide arose from dissociation of acetyl radicals, and that all the carbon dioxide from reaction of acetyl radicals with oxygen, via (45(a)) below:



This reaction was abandoned in the second paper⁽²⁴⁾ since it did not fit in with the authors' proposed mechanism for high temperatures.

Upon such assumptions it is surprising that values of $\bar{\Phi}_d$ and $\bar{\Phi}_{-O_2}$ were predicted which agree well with the observed data, well within the apparent experimental error.

INVESTIGATION BY HOARE

The next work published on this subject appeared in 1953, the result of some investigations by Hoare⁽²⁵⁾, working in Noyes's laboratory. He aimed at correlating work performed on the photolysis of the systems acetone-oxygen, formaldehyde-oxygen and acetone-formaldehyde, with investigations on the photolysis of the tertiary mixture acetone-formaldehyde-oxygen.

Hoare's work on the acetone-oxygen system, performed with acetone at a pressure of 131 mm, at 120°C, agreed essentially with the work of Marcotte and Noyes. It emphasized the fact that whilst the sum of $\bar{\Phi}_{CO}$ and $\bar{\Phi}_{CO_2}$ remains approximately constant over the range of oxygen pressure from 15 to 300 microns, increase beyond this range brings about a gradual decrease until a value of about unity is reached at an oxygen pressure of 5 mm.

Products were analysed mass-spectrometrically and were found to contain carbon monoxide, carbon dioxide, methane, formaldehyde, acetaldehyde, acetic acid, methanol and water, with possibly a little methyl formate. No formic acid was detected, neither was ethane. Formaldehyde was usually found in quantities approaching or exceeding unit quantum yield. This last piece of information is particularly interesting in that it would appear to conflict with Noyes's scheme for the acetyl and methyl radicals ending up as carbon monoxide or carbon dioxide. It is unfortunate that no quantitative data were published but such were soon forthcoming in a paper by Christie.⁽²⁶⁾

Difficulties were encountered in the analysis of formaldehyde. Some contamination of the carbon dioxide fraction with formaldehyde was experienced, and vice-versa. Trouble was also encountered from the rapid polymerisation which formaldehyde undergoes when it comes into contact with very cold surfaces.

The principle object of Hoare's investigation was to discover whether the formyl radical, HCO^\bullet , is an intermediate in the acetone-oxygen system. The results are complicated by formaldehyde being itself sensitive to photolysis under the conditions used (U.V. of wavelength

3130Å, temperature of 120-200°C). As a result of his investigations, Hoare affirmed that in the series of reactions (47(a)), (48(b)), and (49(a)) below, (equivalent to (47), (48) and (49) of the Marcotte and Noyes mechanism⁽²⁴⁾), R[•] is not the formyl radical:

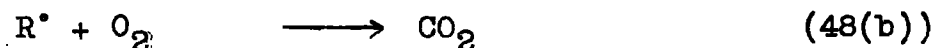

(each in one or more steps).

In the photo-oxidation of formaldehyde⁽⁵¹⁾ the primary process has been identified with fair certainty as a dissociation into hydrogen atoms and formyl radicals:



In that system, the formyl radical must be intermediate in the formation of both carbon monoxide and carbon dioxide. Hoare's chief argument in his denial that R[•] may be identified as HCO[•], was that no similarity existed between the CO₂/CO ratios in this system and the photo-oxidation of acetone. Indeed, it may be noted that in other photo-oxidation systems which undoubtedly involve formation of methyl radicals, CO₂/CO ratios are found which are different again. Reliability of this argument

is felt to be questionable since oxidation of methyl radicals, stepwise or otherwise, need not be the only route by which carbon dioxide or carbon monoxide is formed. The acetone-oxygen system is by far the most complex of these systems and has an essential difference - that of involving acetyl radicals in addition to methyl radicals. It can be logically inferred that the formyl radical is not the only radical intermediate in the formation of carbon monoxide and carbon dioxide but it is difficult to see how this can be taken to show that it positively does not act in this way to any extent. In view of the complexity of this system, it would seem probable that such relatively simple molecules as carbon monoxide and carbon dioxide could be produced in a number of ways.

Some further points are to be noted concerning the acetone-formaldehyde-oxygen system. In particular,

$\frac{\bar{\Phi}}{I} - O_2$ falls to a minimum value of about 2 on addition of a sufficiency of formaldehyde. ($P_{CH_2O} : P_{O_2}$ about 10:1)

As this excess is decreased (either by increasing the oxygen pressure or decreasing that of formaldehyde), values intermediate between 2 and 4 were observed. $\frac{\bar{\Phi}}{I} CO$ increases to a value of about unity on increasing the

$p_{\text{CH}_2\text{O}} : p_{\text{O}_2}$ ratio to about 10:1, and under similar conditions, $\bar{\Phi}_{\text{CO}_2}$ decreased to quite low values compared with those found in the absence of formaldehyde. These results apply specifically to 120°C and though somewhat similar trends were observed at 200°C, the results at this higher temperature are less reliable because corrections were necessary. These were caused by chain photo-oxidation of acetone and of formaldehyde, effects which become appreciable at this temperature.

Hoare attempted to explain these facts by considering competition for a radical R' between formaldehyde and oxygen. The identity of R' was unspecified but it was tentatively suggested as possibly being the acetyl radical.

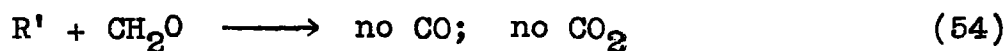

Evidence for (54) had already been found⁽²⁵⁾ in the acetone-formaldehyde system. Reaction (55) was put forward to explain the increase in carbon monoxide:

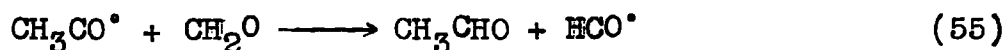

This reaction, as an alternative to (45) and in addition (54), competing favourably with (53), was cited as res-

possible for the fall of oxygen consumption.

The position as a result of this work was little clearer. Evidence which cannot be held to be conclusive suggested that the formyl radical was not an important intermediate in carbon dioxide formation. Enough support was available for the belief that the acetyl radical plays some role. Little progress had been made in the elucidation of the fate of the acetyl radical.

INVESTIGATION BY CHRISTIE

A further contribution from Noyes's laboratory, published in 1954 by Miss M.I. Christie⁽²⁶⁾, was directed at a quantitative assessment of formaldehyde. A pressure of 131 mm acetone was employed throughout and two temperatures were used, 120°C and 175°C.

Formaldehyde was analysed by two separate colorimetric methods which used, basically, phenyl hydrazine and p-hydroxy-biphenyl, respectively, for the development of the colour reaction. Estimation of acetaldehyde using the p-hydroxy-biphenyl method was also undertaken. It was only detected at very low oxygen pressures, the largest amount found being a quantum yield of 0.3.

The way in which $\dot{\Phi} \text{CH}_2\text{O}$ varied with oxygen pressure was similar at both temperatures, though the actual values

were different. Yields rose very sharply to a maximum at an oxygen pressure of the order of tenths of a millimetre (0.2 mm at 120°C, 0.4 mm at 175°C; approximately). They then fell off, initially very sharply, reaching values at oxygen pressures of the order of 1 mm which were practically unaltered by further increase in oxygen pressure. The high oxygen pressure value was higher at 175°C than at 120°C yet the maximum value was hardly affected by temperature.

An interesting innovation was the use of acetone labelled with the radioactive ^{14}C isotope on the methyl carbons: $^{14}\text{CH}_3\text{CO}^{14}\text{CH}_3$. By use of this material an estimate of an acid was made. (This was presumed to be acetic acid on the qualitative evidence of Hoare⁽²⁵⁾). Those reaction products which were not volatile at -100°C were condensed into barium hydroxide solution in company with unused acetone. Acetone and water were removed by evaporation to dryness followed by ignition at 450°C. It was stated that results (details of which were not published) indicated quantum yields of acetic acid of "at least unity". There is an objection to this method, which lies in the danger (apparently not realised by this author) of polymerising acetone and so contaminating any barium acetate left in the residue after evaporation.

In view of this the results must be viewed with some caution.

Results of further experiments were reported where an estimate of the radioactive content of the carbon dioxide was made, from which was calculated the extent to which carbon dioxide resulted from the methyl section of the acetone molecule. Results were again only semi-quantitative and though quoted as indicating that most if not all of the carbon dioxide was radioactive, no actual values were given. Reliability of this result was undermined by the observation that an impurity in the radioactive acetone caused results of Φ CO₂ to be higher than when inactive material was used. In view of this, both carbon dioxide and acetic acid results must be viewed with some caution.

Mechanism:

The scheme advanced by Marcotte and Noyes⁽²⁴⁾ was amended to the following:

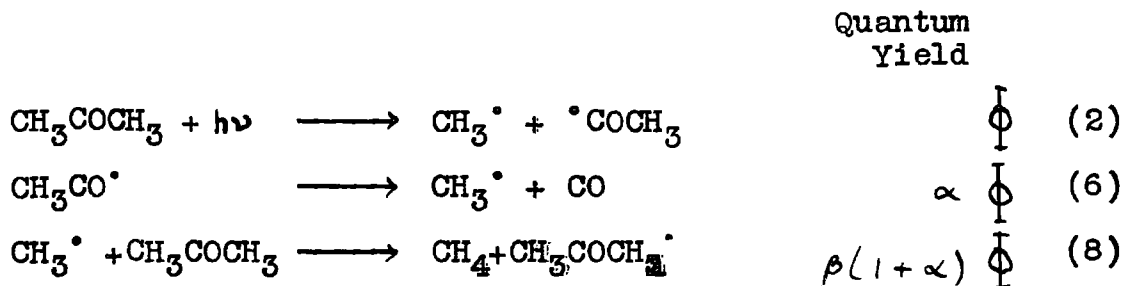

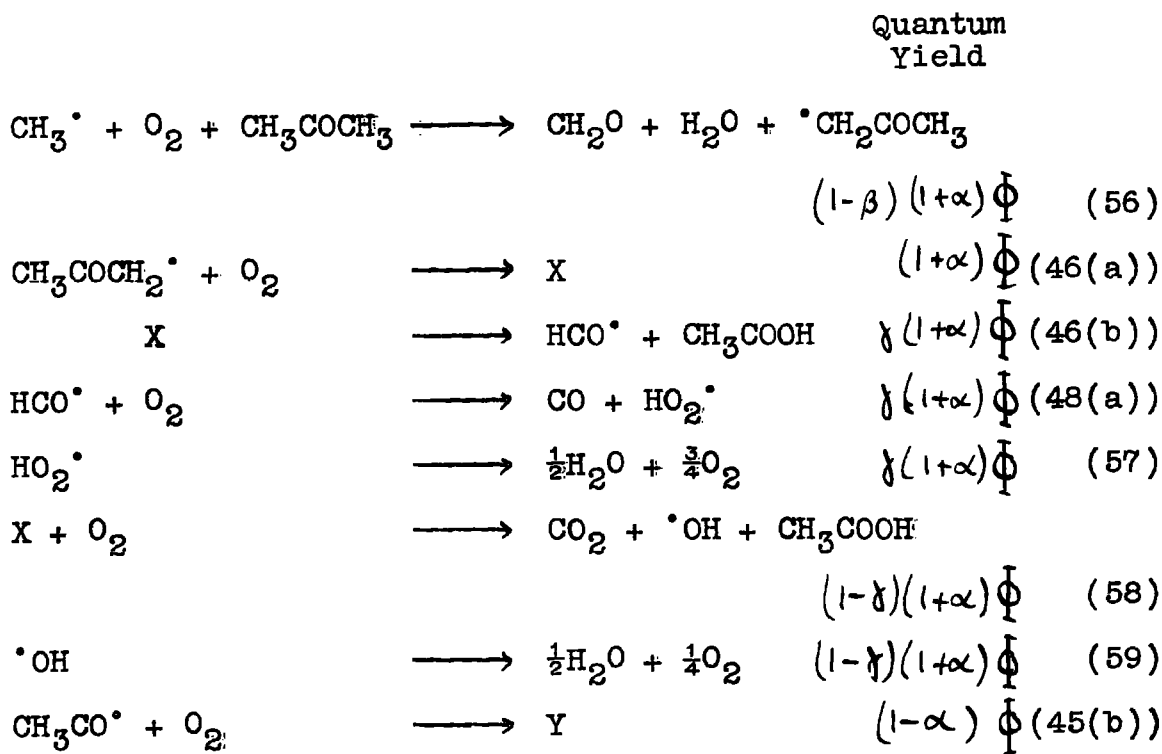

Reactions (57) and (59) were tentative suggestions primarily made to explain the observed absence of peroxides. By consideration of the various values which can be assumed for α , β and γ , a successful explanation of the factual data was claimed. One notable exception to this is in the case of formaldehyde. The above mechanism predicts an upper limit of 2 whilst the highest value observed was 2.5.

Writing of (56) in the above form was not meant to infer a one-step reaction according to that equation. Rather, it was suggested that this reaction is complex and may proceed by either of the following sequences:

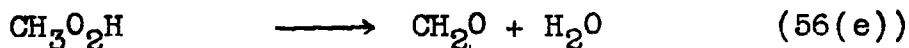
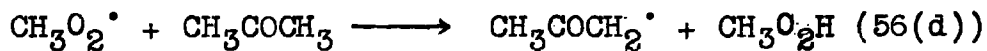
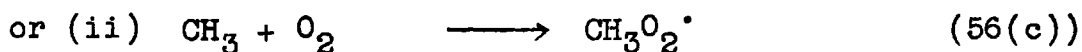
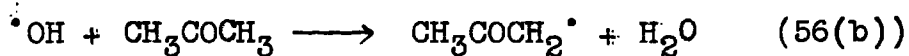

Suppositions along these lines cannot be wholly justified by experimental data and are somewhat speculative. It was noted in support of 56(a) that this reaction has often been postulated in methyl radical - oxygen reactions. Whilst no evidence is available to show that hydroxyl radicals abstract hydrogen from acetone, it was suggested as a likely reaction in view of the strongly exothermic nature of reaction 56(a). (About 50 k.cal/mole⁽⁵²⁾) was suggested). A hydroxyl radical formed in this way would thus carry over considerable excess energy. On the other hand, methyl hydroperoxide has been isolated from the mercury-photosensitized oxidation of methane⁽⁵³⁾ at room temperature. This is considered as justifying its inclusion as a possible intermediate at higher temperatures. Methyl glyoxal has been suggested as a possible intermediate in the oxidation of acetyl radicals produced in photo-oxidation of liquid acetone⁽⁵⁴⁾. If this were also true of this system, then X could be replaced by: $\text{CH}_3\text{COCHO} + \cdot\text{OH}$.

Whilst it is possible to fit the variation of many of the products into the scheme which was advanced, this by no means constitutes a satisfactory proof of the mechanism. Indeed, as has already been discussed, the position with regard to formaldehyde is unsatisfactory and the proposed scheme does nothing to elucidate the position with regard to the acetyl radical. It is curious how use is made of methyl radicals in an attempt to explain the major reaction products, to the almost complete exclusion of the acetyl radical. If $\alpha = 1$ over the whole range of oxygen pressure, this might be reasonable but this is definitely not so - as shown by low values of ϕ_{CO} . Reactions such as (45) cannot help in this matter until we can identify the actual reaction products:

INVESTIGATIONS OF BROWN:

This work⁽¹¹⁾, undertaken in this laboratory, can be divided into two sections; photolysis of the system acetone-oxygen, and photolysis of the system acetone-iodine-oxygen. Whilst the latter belongs more to the acetone-iodine section (B) of this chapter than to this section, it is more convenient to discuss the whole here.

Many of the techniques which Brown used in this work have been adopted for use in this investigation and will be described in Chapter (4). In particular, use was made of acetone labelled with ^{14}C on the methyl carbons, a device which proved to be very useful in analysis of the products. The findings of this investigation can be summarised:

(a) Acetone-Oxygen System

Analyses were made for carbon monoxide and carbon dioxide, with particular reference to the proportion of each coming from the carbonyl and from the methyl carbon atoms. This was estimated by specific activity measurements, ^{14}C -labelled acetone being photolysed. Pressures of acetone used ranged from 32 to 129 mm at 120°C , 37 and 72 mm at 175°C .

(i) Carbon Monoxide:

The majority came from the methyl group. Whilst the proportion decreased with increasing oxygen pressure at 63 and 32 mm of acetone (120°C), the reverse was observed at 129 mm (120°C) and at both pressures used (37 and 72 mm) at 175°C . No generalisation can thus be drawn-likewise no effect was evident on varying acetone pressure at constant oxygen pressure.

(ii) Carbon Dioxide:

This was to a large extent inactive and indicated that around 90% came from the carbonyl carbon atom. Part, if not all, of the radioactivity observed in this fraction was thought to be due to contamination by formaldehyde which would mean that even less than 10% had its origin in the methyl group.

(iii) The sum# of $\bar{\Phi}_{CO}$ and $\bar{\Phi}_{CO_2}$ for methyl and carbonyl sources was noted. At 120°C the methyl contribution varied little from a mean value of 0.35, change in neither oxygen nor acetone having any appreciable effect. This, however, is not true at 175 °C. Whilst increase of oxygen pressure at 72 mm of acetone had little effect, at 37 mm a noticeable decrease of the value of $\bar{\Phi}_{CO} + \bar{\Phi}_{CO_2}$ occurred. The contribution from the carbonyl carbon is particularly interesting in that under all conditions studied values in excess of unity were observed. The largest value found was 2.06 at 175°C, 37 mm of acetone, 0.48 mm of oxygen. The significance of these results is that they show greater consumption of carbonyl carbon atoms than can be supplied from the acetyl radicals formed in the primary process. This indicates that a secondary reaction is occurring involving the consumption of acetone.

It is unfortunate that these results lay on the higher pressure side (in terms of oxygen pressure used) of Marcotte and Noyes's experimental conditions. Hence very little overlap was obtained.

An attempt was made to analyse for acetic acid using, as basis, the method adopted by Christie. It was, however, abandoned, very high and inconsistent blanks being obtained which made the method of very doubtful reliability.

(b) Acetone-Iodine-Oxygen System:

One temperature, only, was used (120°C), and attention was centred almost entirely on acetone at 32 mm pressure.

(i) Carbon Monoxide and Carbon Dioxide

Yields were very much lower than these found in the absence of iodine. Little variation was noted in the few sets of data available but, as found in the acetone-oxygen system most of the carbon monoxide came from methyl groups whilst most of the carbon dioxide came from carbonyl groups.

(ii) Methyl Iodide:

Yields were almost identical with those found at the same acetone and iodine pressures in the absence of

oxygen. At low iodine pressures (constant oxygen pressure), $\Phi_{\text{CH}_3\text{I}}$ values rose but levelled out at the lowest iodine pressures employed (0.15 and 0.30 mm).

Mechanism:

Recognising the comparative lack of detailed data on established products and of complete absence of information on other products such as acetic acid on which firm faith could be placed, no attempt was made to formulate a rigorous mechanism. However, much useful information has emerged.

It is obvious from the above results on inactive carbon monoxide and carbon dioxide that primary dissociation (reaction (2)) alone is not sufficient to satisfy the magnitude of both carbon dioxide and carbon monoxide yields. A mechanism is needed which includes an additional scheme whereby carbonyl groups produce carbon monoxide and carbon dioxide, though principally the latter. (The carbon monoxide of carbonyl origin can easily be accommodated by reaction (6)). Three alternatives were considered:

- (a) Production of acetyl radicals from an unidentified source. These would then follow the same course of reactions as acetyl radicals formed in the primary process.

(b) Decomposition of acetonyl radicals (formed by secondary reactions of the radicals from the primary process or of intermediates in their subsequent reactions). Then either:

(i) Acetyl radicals could be formed via (60) or (61) which would react as those whose origin lies in the primary process.

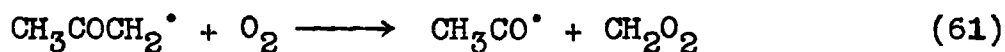
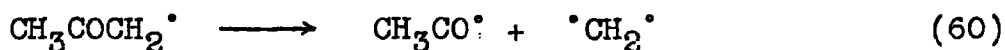

or (ii) Acetonyl radicals, formed as described above, could react with oxygen forming, amongst other possible products, carbon dioxide from the carbonyl section of the molecule, without intermediate formation of acetyl radicals. This last course was considered to be the most likely and the following scheme of reactions, (62) and (63), were suggested:

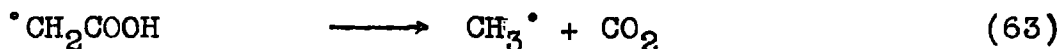
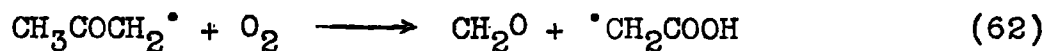

This is attractive in that it forms an additional source of formaldehyde. As has been seen in previous discussion, observed formaldehyde yields are too high to be explained on the basis of formation from methyl radicals

formed in reactions (2) and (6). Secondary production of methyl radicals (63) does not necessarily constitute an objection. Provided that the formation of acetyl radicals does not exceed one per quantum of light absorbed then successive methyl radical formation via reactions (56), (62) and (63) becomes a convergent series and no branched chain characteristics would be expected.

Reactions (46(a)) and (46(b)), followed by (49), were suggested as the scheme by which most of the carbon monoxide was formed, the rest being due to acetyl radical dissociation (6).

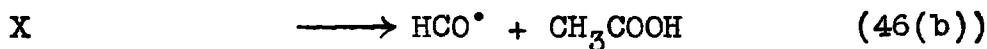

Reaction 45(a) is considered as a source of "inactive" carbon dioxide (that is, of carbonyl origin).

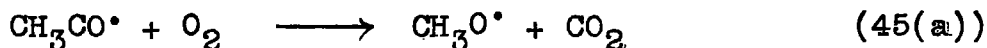

Reaction (64) was then supposed to remove methoxy radicals:

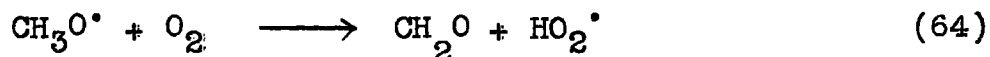

It should be noted that reaction (64) is quite unnecessary unless methanol be proved absent. Hoare⁽²⁵⁾ claimed to

have detected it but gave no indication of its quantitative significance.

Acetone-Iodine-Oxygen System

The results from this system were discussed in some detail. Due to experimental difficulties no acetyl iodide measurements were attempted and interest was confined to reactions of the methyl radical.

Overwhelming evidence is available to show that reaction of methyl radicals with iodine is very much faster than with oxygen. This was based to a large extent on comparison of inactive carbon monoxide yields in this system and those in the acetone-oxygen system, though the few formaldehyde measurements made bore out the findings from those of carbon monoxide. It was suggested that whilst reaction of methyl radicals with iodine is more efficient than reaction of methyl radicals with oxygen, it is not itself very efficient compared with a reaction such as the recombination of methyl radicals (4), which is believed to be effective at every collision:

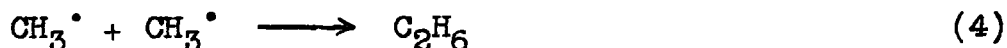

The position regarding the acetyl radical is far less satisfactory. With little experimental data on which to base conclusions, these must be viewed with some

caution. Since the carbon monoxide yields of methyl origin were similar to the carbon dioxide yields of carbonyl origin, it was suggested that both came from the same radical - that is, acetyl. Carbon monoxide yields from methyl origin being less than formaldehyde yields, it was considered that the former did not come from the methyl radical. There seems little justification for the latter suggestion since the two entities are not formed in the same reaction. In any case, in the acetone-oxygen system formaldehyde yields are, with the possible exception of very low oxygen pressures, always higher than carbon monoxide of methyl origin, and often greater by a considerable margin.

One of the most interesting aspects of this work is the way in which methyl iodide yields vary and the conclusions which can be drawn with regard to the primary process. As iodine pressure is decreased at constant oxygen pressure, yields of oxidation products increase and $\bar{\Phi}_d$ increases. The assumption was made that:

$$\bar{\Phi}_d = \bar{\Phi}_{\text{CH}_3\text{I}} + \bar{\Phi}_{\text{CH}_2\text{O}}$$

($\bar{\Phi}_{\text{CO}}$ is negligible by comparison being of the same magnitude as or less than experimental error on $\bar{\Phi}_{\text{CH}_3\text{I}}$). $\bar{\Phi}_d$ increases but the significant point is that its rate

of increase as iodine pressure is reduced is apparently greater than in comparable acetone-iodine system conditions - in the absence of oxygen.

The scheme suggested to account for this phenomenon is one of competition for the second excited state of acetone A^{**} . It was suggested that oxygen effects formation of radicals, contrasting with deactivation to unexcited acetone by iodine. This however is followed by iodine removing the majority of the extra radicals so formed.

INVESTIGATIONS BY DUNN AND KUTSCHKE

Following the work of Christie⁽²⁶⁾ and in particular her assertion that all the carbon dioxide had its origin in the methyl carbon atoms, Dunn and Kutschke⁽²⁸⁾ decided to check this by a completely independent method. They photolysed acetone in the presence of oxygen enriched with the ^{18}O isotope to the extent of 2.83% ^{18}O . (This compares with 0.34% in natural oxygen). Mass spectrometric assay was performed on the carbon monoxide and carbon dioxide produced.

Their experiments are in substantial agreement with Brown's carbon dioxide results. Exact comparison is in many cases the result of some extrapolation as the conditions

only rarely coincided in all respects. Their results suggest that the degree of contamination of the carbon dioxide fraction by formaldehyde in the work of Brown was very small. (No such interference would assert itself in mass-spectrometric analyses).

The data on carbon monoxide ~~is~~^{are} not quite so reassuring. The fraction from the carbonyl group was found to decrease to zero at an oxygen pressure of 0.5 mm at 120°C, whereas Brown found a small but definite amount ($\phi_{\text{CO}_{(\text{carbonyl})}} = 0.04$) even at 1.68 mm. Brown's work may be the one at fault since the value observed was close to experimental error. A further possibility is that this apparent contribution from the carbonyl group is due to an isotope effect in the methyl group reactions, $^{12}\text{CH}_3$ reacting faster than $^{14}\text{CH}_3$: On the other hand the limit of sensitivity of Dunn and Kutschke's measurements is not known. The carbon monoxide results do, however, lend further evidence to underline the extent to which the acetyl radical is stable, even at temperatures as high as 175°C, and the part it must play in the photo-oxidation of acetone.

SUMMARY

The position at this stage, summing up the work so far published, and that of Brown in addition, is not one which lends itself to a clear exposition of course of

reactions in the system. Much of the evidence conflicts, which is all the more regrettable when to be able to predict mechanisms with confidence a great deal more is required. Such mechanisms as have been put forward appear to consist of much speculation round a comparatively small core of established principles. This is unavoidable when there is such a dearth of evidence on which reaction schemes can be based.

There would seem to be good evidence for methyl acetyl and acetyl radicals being of major importance, responsible for the formation of products. Evidence on these products is still far from complete, but, so far, principally attention has been paid to reactions of the methyl radical. The acetyl radical has on many occasions been almost ignored, though it has been established that it has a part to play in this system at temperatures at least as high as 175°C . It does not, as has been thought, decompose entirely into methyl radicals and carbon monoxide. The importance of the acetyl has only recently been fully realised. It may easily turn out to be of key importance in the elucidation of this complex system.

3. AIMS OF THE PRESENT INVESTIGATION

The position at the outset of this investigation will be evident from the previous chapter. The simple picture resulting from earlier work had been shown to be false, and it was quite clear that a considerable amount of information had still to be gleaned before reliable mechanisms of the acetone-oxygen system could be put forward. Information on many possible products of the photo-oxidation was lacking and quantitative data on many established products was far from complete. Photolysis of the acetone-iodine-oxygen had been shown by Brown to be a useful approach. More results were, however, necessary before a serious start could be made on the elucidation of the complete course of reactions.

The aims of the present investigation can then, be summarised:

- (a) The study of the photolysis of the acetone-oxygen system with particular reference to analysis of products such as formaldehyde, acetic acid, methanol, etc. on which information was either particularly lacking or of doubtful reliability.
- (b) Extension of the acetone-iodine-oxygen work of Brown initially along the lines of analysis developed by him. In particular data on methyl iodide and formalde-

hyde needed augmentation.

- (e) A study of the effect of iodine on the fluorescence of acetone was planned. Whilst it was believed that iodine had a profound effect on the primary process in the photochemistry of acetone, no information was available as to its effect on the fluorescence. Using this approach, it was hoped that some progress might be made in elucidating the primary photochemical process of acetone. In addition it seemed probable that a choice between the proposed mechanisms for the acetone-iodine system could be made.

4. EXPERIMENTAL TECHNIQUES

(A) PREPARATION OF SAMPLES FOR IRRADIATION

Along with many of the basic experimental and analytical techniques used in this investigation, the procedure adopted here follows that evolved by Brown⁽¹¹⁾ closely. The materials used - acetone, oxygen and iodine, their production, purification and storage, will be discussed first, followed by the method adopted for production of an homogeneous sample of acetone, iodine and oxygen in the vapour phase, suitable for irradiation.

Acetone:

'AnalaR' grade acetone was dried and distilled through a column packed with glass helices, the middle third, only, being retained. Both magnesium perchlorate ('Anhydrone') and anhydrous magnesium sulphate were used as drying agents. Samples of identical purity (as measured by the reactivity to potassium permanganate and by their refractive index) were produced by each, so magnesium sulphate was normally used, being safer to handle. Reaction of the purified material with potassium permanganate was very slow - slower than that of the original material. This may be taken to indicate absence of unsaturated compounds.

Trotman-Dickenson and Steacie⁽⁵⁰⁾ have found no difference between repurified and normal analytical grade acetone, their conclusions being based on the results of photolyses with such materials. However, for the experiments involved in this investigation, acetone was purified to make quite sure of a good degree of purity. Acetone was stored in a blackened reservoir (R_1 in the apparatus shown in figure 2), isolated by means of a mercury cut-off. It was introduced by distillation in vacuo and before use was vigorously degassed by pumping on the sample held at a temperature of -78°C . (Drikold-acetone-ethanol mixture). For the normal size of sample purified (30 ml), pumping was required for (0 to 15 hours to produce the desired degree of purification. By this means the amount of permanent gases was reduced to below detectable limits, and the content of gases volatile at -140°C (largely carbon dioxide) was reduced to a very low level. This level amounted to about 10^{-9} gm. mol. per 0.08 ml of acetone. (The volume of liquid acetone required for a normal irradiation).

Radioactive Acetone:

Acetone labelled with ^{14}C on the methyl groups only, $^{14}\text{CH}_3\text{CO}^{14}\text{CH}_3$, was obtained from the Radiochemical Centre, Amersham, in amounts of 100 microcuries. Specific

activity was high, 30 to 40 millicuries per gram, and for work described here this was reduced to about 40 microcuries per gram by dilution with acetone purified as described above.

The radioactive acetone was found to contain an impurity which was not easily removed. It was of very low volatility at -196°C but, being volatile at -150°C , it contaminated the carbon dioxide fraction in the analysis of products - as found by Brown⁽¹¹⁾. It constituted only about 1% of the acetone activity but compared with that of the carbon dioxide produced in the photo-oxidation, it represented an embarrassingly large amount. Removal was effected by pumping on the diluted radioactive-labelled acetone, as stored ready for use, at -78°C . This was carried out for periods of about 5 minutes at approximately daily intervals over a period of 6 to 8 weeks. In this way the level of the impurity was reduced to a suitably low level. To quote one particular example, it was reduced to 19 counts per minute in a sample of acetone sufficient to fill the reaction vessel for a normal photolysis experiment. At this temperature, little depletion of the acetone was experienced, and for a small sacrifice (less than 10% of the impure material) the impurity was effectively removed.

A discussion of investigations to identify this impurity will be found in section (D) of this chapter.

Oxygen:

The method used for production of known amounts of high purity oxygen was that of Brown⁽¹¹⁾. Potassium chlorate solution (from 'AnalaR' grade material) was weighed into a pyrex thimble and evaporated to dryness in an oven at 80°C, aided by a jet of hot compressed air. In this way it was possible to dispense the very small amounts required (of the order of a few milligrams) to a good degree of accuracy (better than 1 per cent). At the same time, it was prepared in a thin film, in which form it was ideally suitable for its subsequent decomposition. It was then dusted with slightly moist ferric oxide which acted as a catalyst for the decomposition. At a temperature reputed to be only 110°C⁽⁵⁵⁾, reaction proceeded smoothly, in vacuo, according to the following equation:



It is notable that reaction proceeds with the production of only 1 molecule of oxygen per molecule of potassium chlorate, in contrast to the figure of $1\frac{1}{2}$ for the

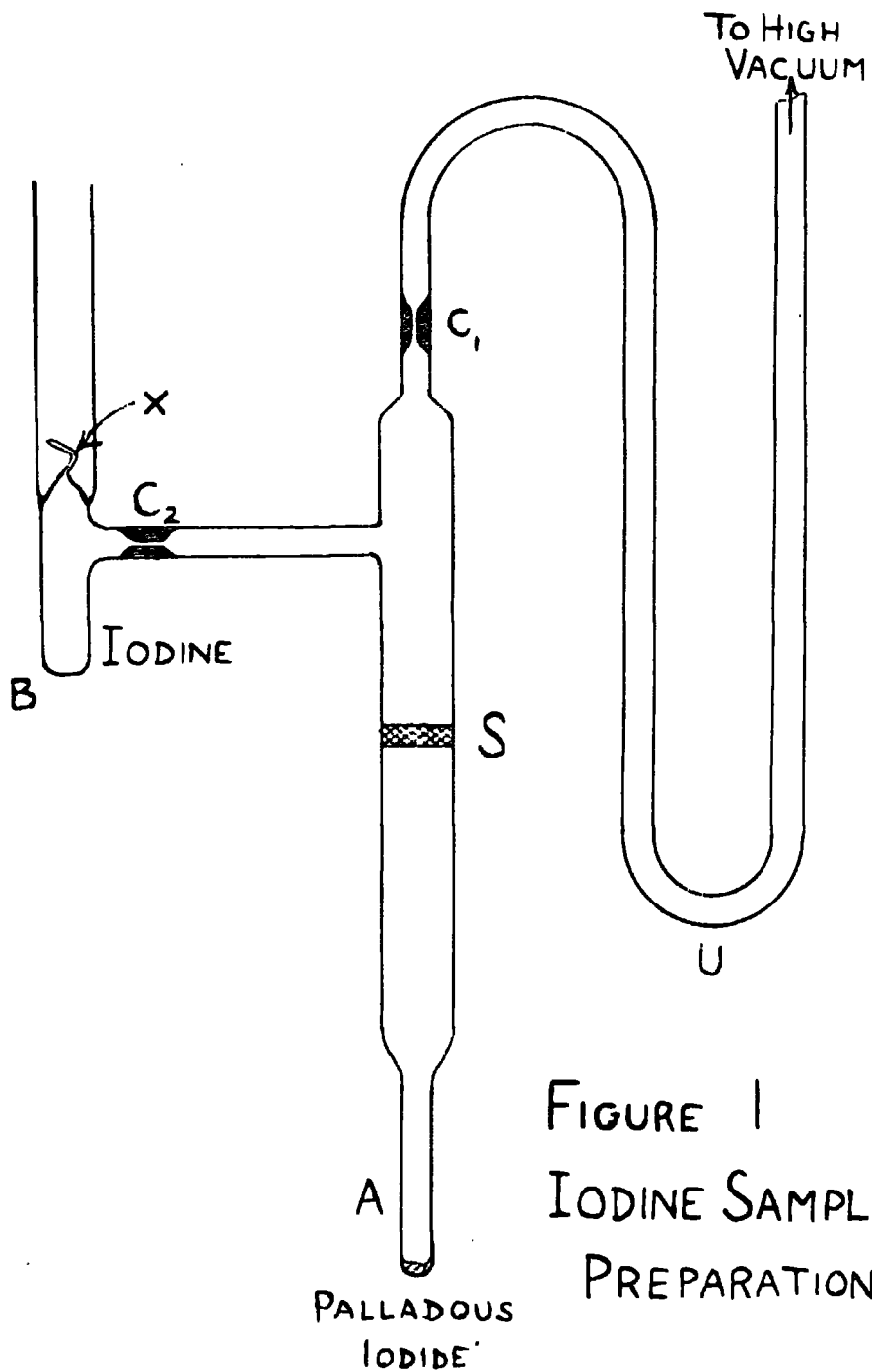
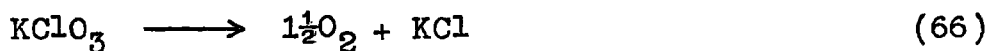

FIGURE 1
 IODINE SAMPLE
 PREPARATION

A
 PALLADOUS
 IODIDE

normal high temperature decomposition:



However, recourse to strong heating was avoided by this method which was all the more desirable since the catalyst contained oxygen.

In the course of the heating, a yellow volatile material was produced along with the oxygen. This, together with any traces of moisture was separated from the oxygen by passing through a trap immersed in liquid nitrogen.

Iodine:

Production and storage of small (milligram) quantities of pure iodine posed a manipulative problem of some magnitude. Contact with mercury (liquid or vapour), and with tap-grease, must at all times be avoided. To this end, samples were prepared for storage in phials using the apparatus shown in figure 1. This was reconstructed for each sample (and consequently for each iodine run), a time-consuming procedure but one which was satisfactory in all other respects.

Palladous iodide was used as a source of iodine. It was prepared by precipitation from a 1 per cent solution of palladous chloride (Johnson, Matthey and Co. Ltd.) in

1 per cent aqueous hydrochloric acid. Potassium iodide (AnalaR grade) was added as a 1 per cent aqueous solution until no further precipitated palladous iodide was allowed to stand for 24 hours before removal by centrifuging. After several washings with warm very dilute hydrochloric acid (about $\frac{N}{1000}$), it was dried in an oven at 110°C and stored in a dark, well-stoppered bottle.

Approximately 10 mgm. PdI_2 was required to produce a pressure of 1 mm of iodine in the reaction vessel. (Measured at 120°C - the usual working temperature). The required amount was weighed out in the thimble 'A' (figure 1), which was subsequently sealed in position. The apparatus was pumped down to a hard vacuum (MacLeod gauge "sticking"), and after the two constrictions C_1 and C_2 had been warmed near to collapsing point, (to de-gas the surface), C_1 was sealed. Until this point, the U-tube U was cooled in liquid nitrogen to prevent entry of mercury vapour. The palladous iodide was decomposed by heating at A, the iodine being condensed out at B by immersion in liquid nitrogen. C_2 was then sealed and the phial drawn off. Provision of a ~~co~~^{as}ase (no. 1) sinter S ensured that flakes of palladium could not be carried through to B with the iodine.

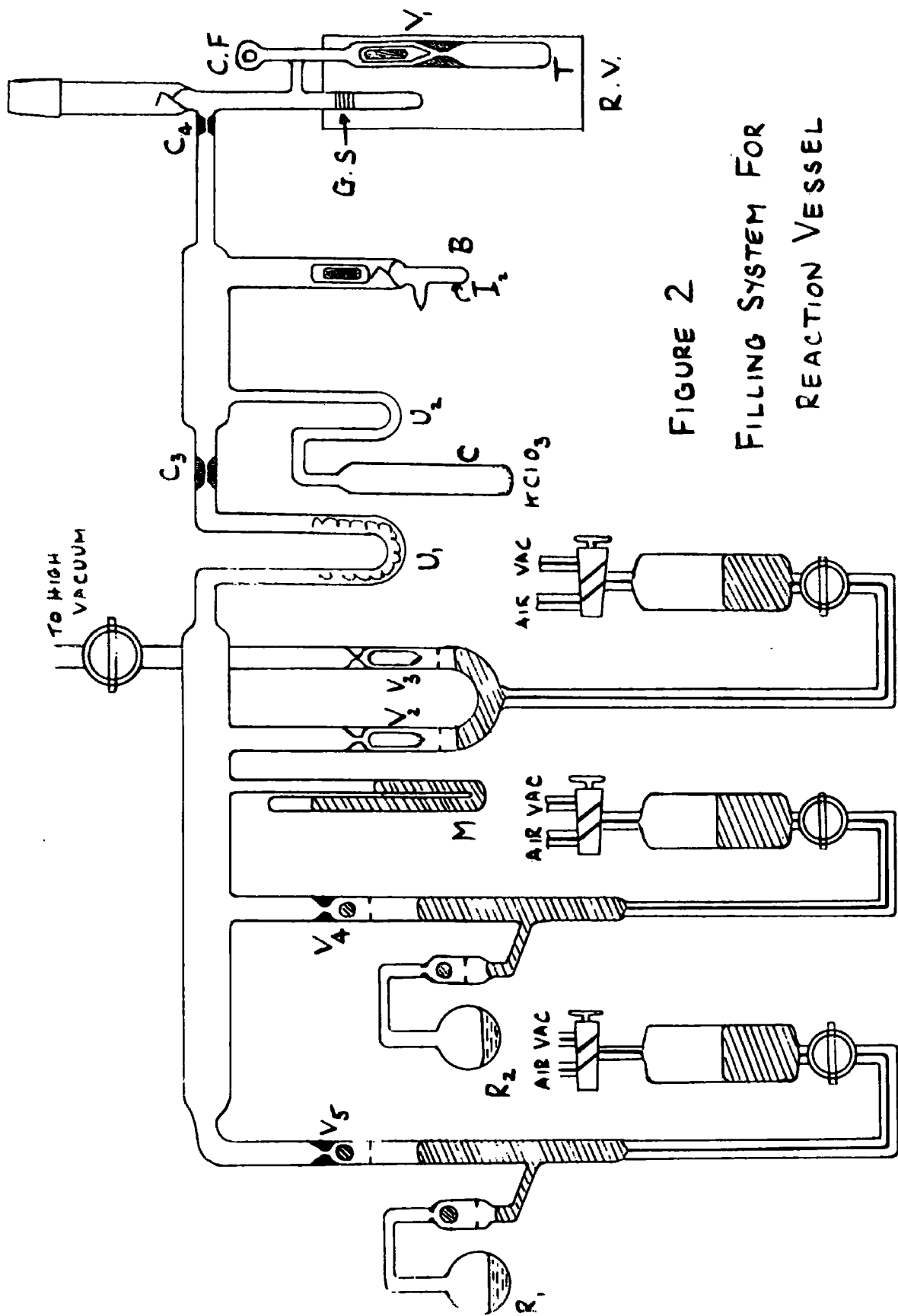

FIGURE 2

FILLING SYSTEM FOR
REACTION VESSEL

Experimental Procedure in Preparing a Sample for Irradiation

The procedure for preparation of a sample of acetone, oxygen and iodine, suitable for irradiation will be described in full. The amended procedure when either iodine or oxygen (or both) was omitted from the irradiation mixture will then be obvious. Reference will be made, in the first instance, to figure 2.

The reaction vessel was scrupulously cleaned before each irradiation. It was steeped (internally) with a chromic-sulphuric acid mixture. Complete washing from this mixture was essential and was effected by about fifteen successive washings with portions of 150 to 200 ml distilled water, particular attention being paid to the side-arm section. The apparatus to the right of the U tube U_1 in figure 2 was then assembled (having been previously fabricated in sections) with the iodine and potassium chlorate-ferric oxide samples prepared as described above. The air and water in the system was pumped out and, when a "sticking" vacuum had been attained, the system was isolated from the main vacuum line by raising the mercury float valves V_2 , V_3 .

Acetone was allowed to evaporate into the system, inactive material from reservoir R_1 or radioactive material R_2 . From a knowledge of the volumes of the various

sections of the filling system and the reaction vessel, the amount needed could be calculated. The whole volume of the reaction vessel and the filling system (about 800 ml) needed to be filled to a pressure of about 19.7 mm at normal room temperature to produce a pressure of 32 mm at 120°C when contained in the reaction vessel (664 ml). The pressure could be measured to $\pm 0.5\%$ by means of a millimetre scale behind the manometer, aided by use of a pocket magnifying glass. The acetone was then quickly condensed into the side-arm at T and the valve V_1 closed. (It had been held open, previously, by use of a magnet). The U-tube U_1 , packed with gold foil was immersed in liquid nitrogen, as soon as all the acetone had condensed at T, in order to prevent entry of mercury past this point. Constriction C_3 was then sealed.

Iodine was next introduced. The thin glass seal at X (figure 1) was broken by dropping on it a heavy plunger made of soft iron encased in glass. The iodine was thus allowed to evaporate into the system and was condensed out on the lower end of the reaction vessel cooled with liquid nitrogen.

Once the transfer of iodine was complete, the U tube U_2 (figure 2) was immersed in liquid nitrogen and the potassium chlorate decomposed by warming with a gas

flame. The unwanted decomposition products stayed behind at C and U_2 , and the oxygen diffused over that part of the system still open to C. (That is, the section to the right of C_3 in figure 2). After allowing sufficient time for the oxygen to diffuse evenly through this volume, the reaction vessel was removed by sealing constriction C_4 and drawing off at this point.

Special attention was paid to the way in which the reactants were allowed to warm up when iodine present. Then, the iodine was warmed up first and not until the whole of the reaction vessel had attained room temperature was the acetone allowed to thaw. So as to reduce the possibility of iodine and acetone reacting, the acetone was made to push its way past valve V_1 . This obviated the possibility of iodine condensing in the cold acetone at T as could have happened if V_1 had been held open.

The reaction vessel was then cleaned externally, the main object being to remove grease which fluoresces under the action of ultra-violet light. Weak "Teepol" solution was followed by rinsing in distilled water, the reaction vessel finally being dried and polished. It was then ready for transfer to the irradiation oven.

It will be noted that, contrary to Brown's procedure, it was found unnecessary to pump on the sample

of acetone at -140°C . Blanks on the acetone as used showed that the amount of impurity volatile at -196°C was effectively nil and the amount volatile at -140°C was so low as to be less than the experimental error on the carbon dioxide fraction which it would contaminate. This was only possible following careful degassing of the acetone at the time of its transfer to the reservoir.

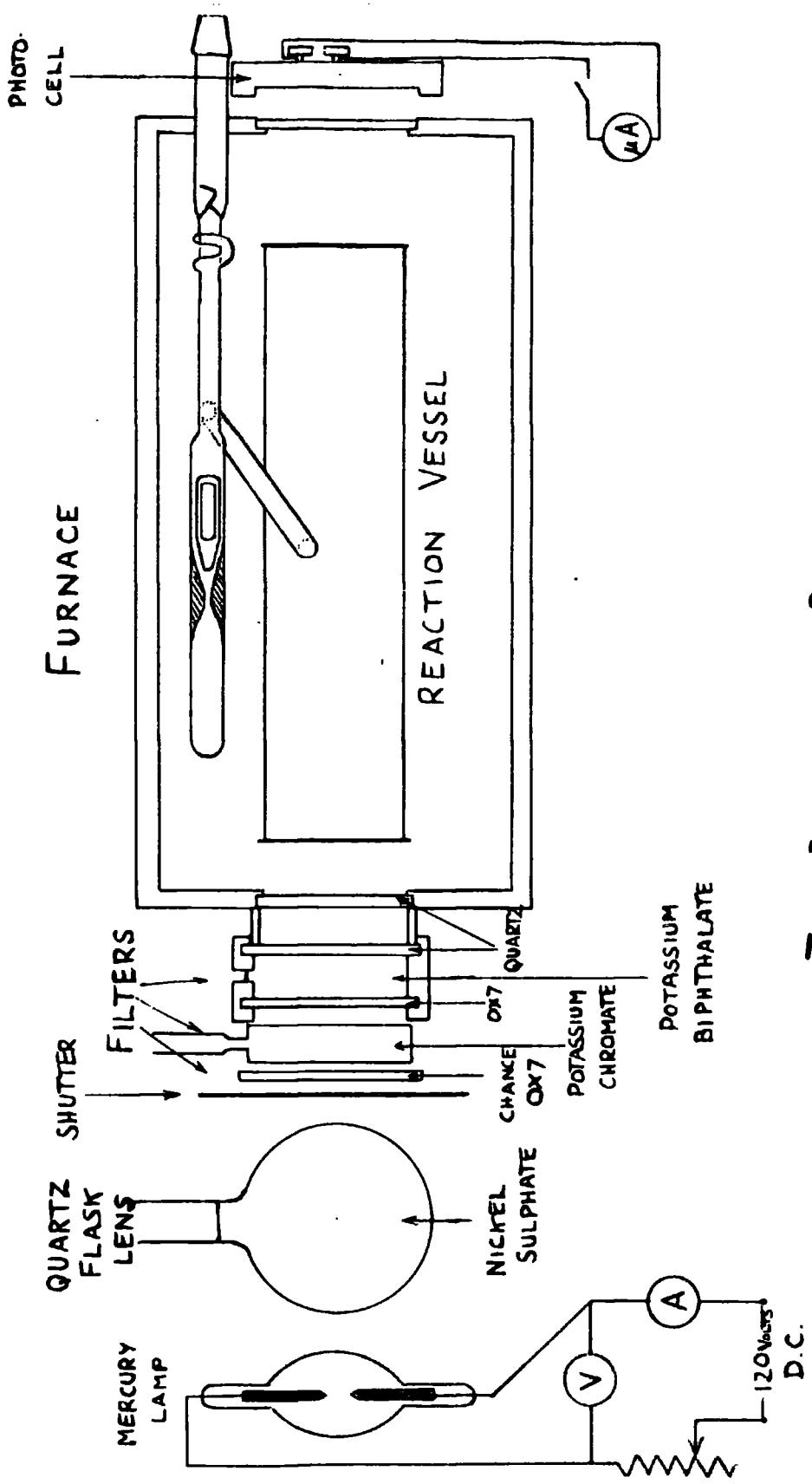

FIGURE 3 IRRADIATION SYSTEM

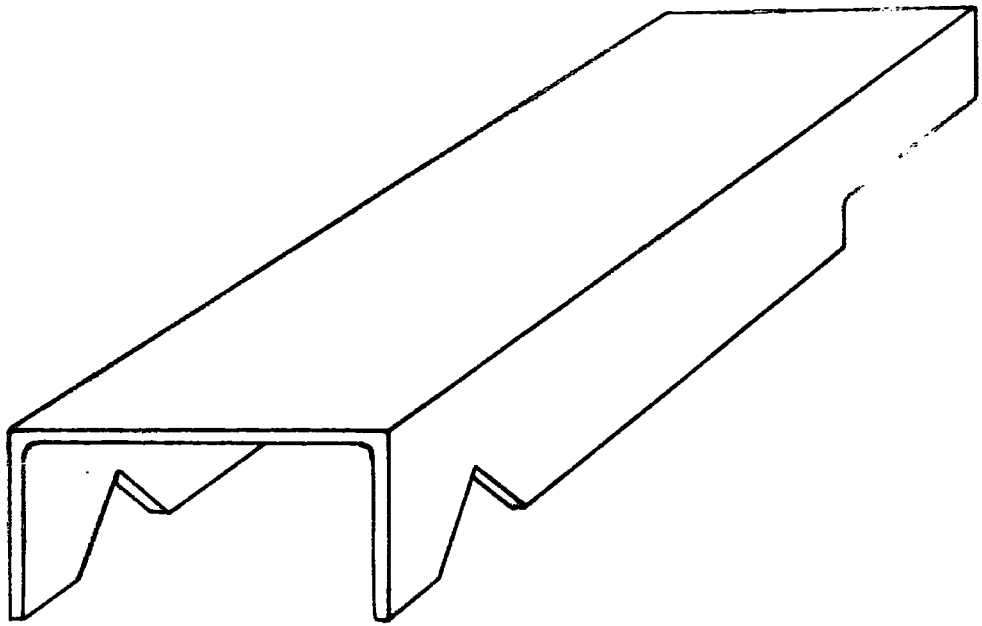

FIGURE 4 a . GENERAL VIEW

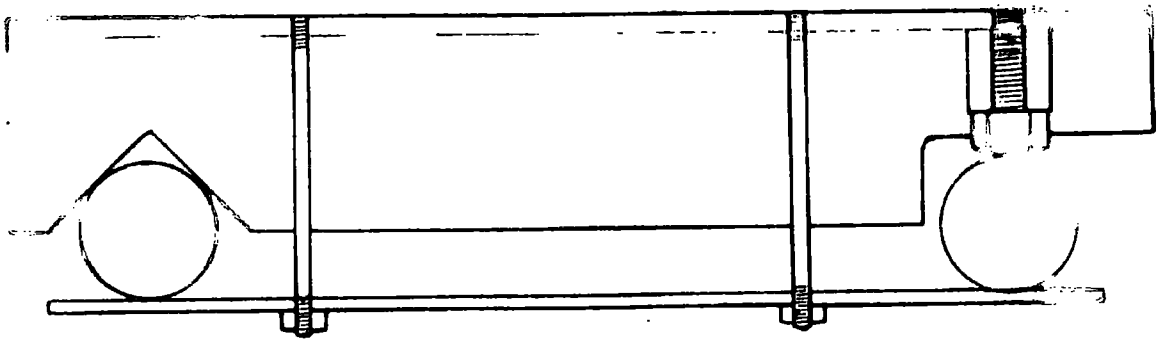

FIGURE 4 b SECTION

FIGURE 4

'CHAIRS' USED ON
IRRADIATION BENCH

4. (B) IRRADIATION

The scheme of the apparatus is shown in figure 3. This part of the apparatus was reconstructed before commencing this series of investigations and some details will be mentioned here. The foundation was an optical bench made from 1 inch diameter round mild steel bars mounted 6 inches apart. This formed the "track" for a number of "chairs" (shown in figures 4(a)(b)) on which were mounted the various sections of the irradiation and optical apparatus, together with the furnace and measuring photocell. In this way, rigidity and accuracy of the mounting could be ensured to quite close limits. In addition, the relative separations of various parts of the apparatus could be altered, the exact positions being accurately reproducible. These chairs were made from mild steel, channel section (3 ins \times 1 $\frac{1}{2}$ ins).

A B.T.H. type ME/D medium pressure mercury arc burner was used as the source of ultra-violet radiation. It was mounted on a 'chair' of the above-mentioned design and enclosed by its protective steel casing from which the Wood's glass window had been removed. It was operated from laboratory 120 volt D.C. supply with a heavy duty rheostat in series. Though rated as a 250 watt lamp

it usually dissipated about 140 watts under these conditions (3.5 to 4.0 amps at 40 to 35 volts). The slight variations in the current and voltage which were observed had no detectable effect on the output of radiation of the wavelength used, namely 3130\AA .

The optical system follows the pattern of that proposed by Kasha⁽²⁹⁾. The aim was to produce a parallel beam of monochromatic radiation of wavelength 3130\AA . The spectrum of the lamp used was rich in such radiation, due to a strong group of emission lines in that region. A 200 ml spherical quartz flask filled with nickel sulphate solution ($50\text{ gm NiSO}_4/\text{litre}$), placed at a suitable distance from the lamp (found by trial and error), produced a nearly parallel beam. The shutter was placed behind this flask (on the far side from the lamp) and was immediately in front of the filter system. This consisted of three parts:

- (a) A disc shaped quartz cell, 10 mm between plane polished faces containing potassium chromate solution ($0.48\text{ gm K}_2\text{CrO}_4/\text{litre}$) to which sodium hydroxide ($0.40\text{ gm NaOH}/\text{litre}$) had been added. The purpose of the sodium hydroxide was to prevent dichromate formation.
- (b) A 2 mm thick plate of filter type OX7 (Chance Bros.Ltd.)

(c) A cell containing potassium tetrakisbipthalate (5 gm $C_6H_4(COOK)_2$ / litre) between a 2 mm plate of OX7 glass at the leading end and a quartz optical 'flat' at the other. (The body of this cell was made from 'Tufnol'). The effective diameter of each component was 6 cm.

The absorption spectrum of each component was plotted using measurements obtained with a 'Unicam' type SP500 spectrophotometer, and are reproduced in figure 5. The lines of importance between 3400\AA and 3000\AA in the spectrum of the lamp used are (a) a group of lines about 3022\AA ; (b) a further group about 3130\AA ; (c) a single line at 3342\AA . The relative intensities of each contribution are about 0.4: 1.0: 0.1. In addition there is a small amount of continuum which amounts to about one-fifth the intensity of the 3130\AA group. With the above filter system absorption is more than 99.9% at 3022\AA , 92% at 3130\AA , (where transmission is at a maximum), and about 99.8% at 3342\AA . It will thus be seen that the beam after passage through this system is very nearly monochromatic. The only wavelengths present other than the 3130\AA group are close to this wavelength (from continuum) and are of relatively little magnitude.

This degree of purity (over 97%) has only been attained at the expense of intensity, more than 90% of the

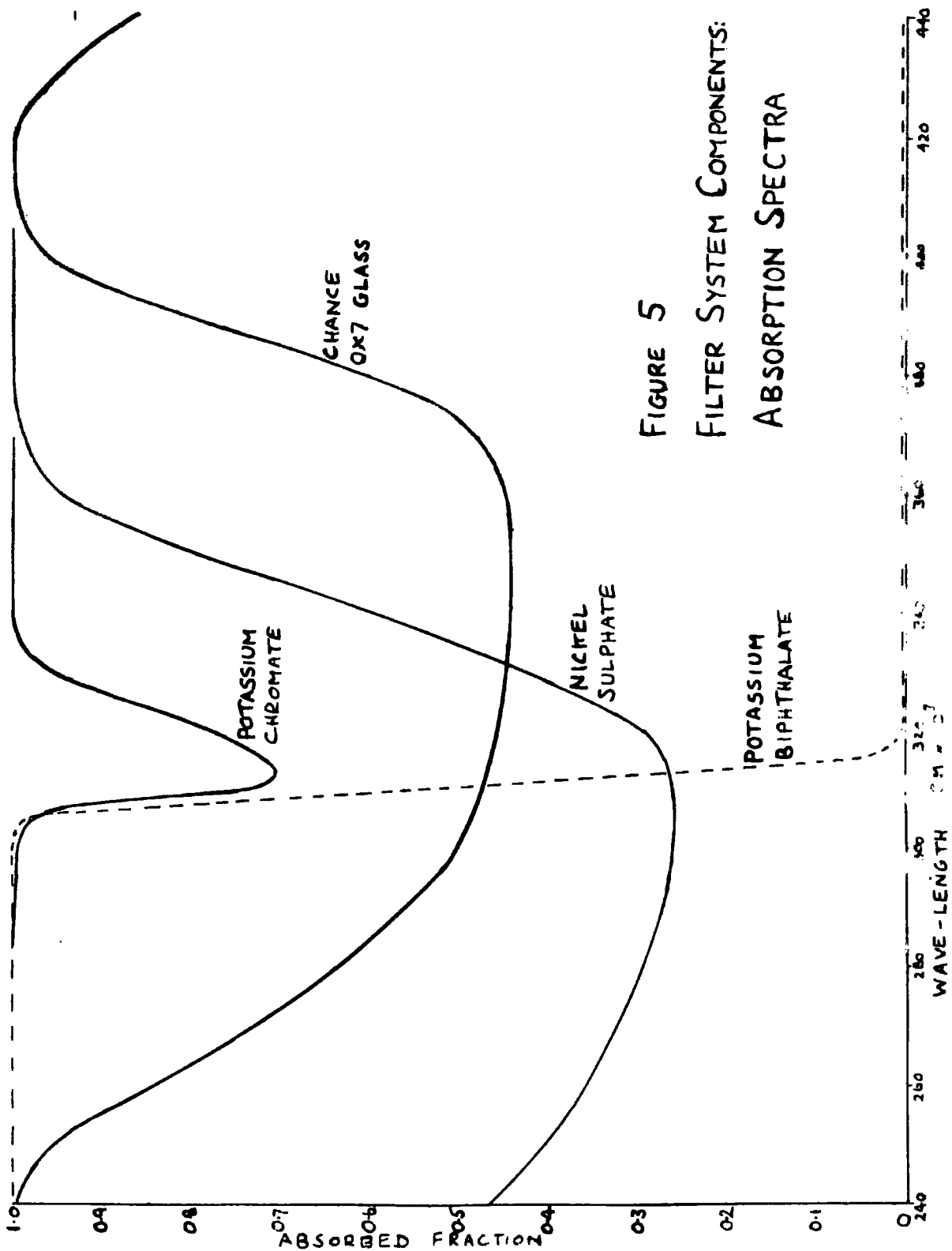

FIGURE 5
 FILTER SYSTEM COMPONENTS:
 ABSORPTION SPECTRA

available light of the desired wavelength being lost in the process. The intensity of the beam does compare quite favourably with that of other workers. In these experiments (for acetone at 32 mm, 120°C) absorbed intensity varied from 46×10^{12} to 2×10^{12} quanta. ml⁻¹ sec⁻¹. (The efficiency of the lamp decreased slowly on use over a long period).

The furnace was of a cylindrical shape, some 40 cm long by 16 cm internal diameter. Heating was provided by a nichrome element wound uniformly round the insulated shell, fed by 240 volts A.C. (laboratory stabilised supply) via a 'Sunvic' type TYB Energy Regulator. It was heavily lagged to keep heat losses to a minimum, and was mounted on two "chairs". Temperature could always be maintained within 1°C of the required value (120°C) and, though never needed, it was possible to reach temperatures as high as 220°C with this equipment. The ends of the furnace were closed with 3/16" thick asbestos sheet. Quartz optical 'flats' were set into either end through which passed the U.V. beam. The rear end was so constructed that the reaction vessel could be introduced and withdrawn quickly - in a matter of seconds. The reaction vessel lay horizontally on two glass covered steel bars and was effectively filled by the U.V. beam.

The transmitted beam was absorbed by a selenium barrier-layer type photocell (Evans Electro Selenium Ltd) placed hard up against the rear face of the furnace. This type of cell requires no applied voltage for its operation and for use here it was connected directly across a 'Unipivot' microammeter. (Basic movement 111 ohms). It has been shown experimentally⁽¹¹⁾ that the magnitude of the current from this cell bears a linear relationship to the amount of energy incident up it provided that the resistance in the circuit was below 200 ohms. The photocell was rigidly mounted on a chair free to slide along the optical bench. It was pushed up against the furnace end such that it was about 1 mm from it yet in an accurately reproducible position. The lamp and optical system being enclosed in an almost light tight enclosure, the photocell measure only radiation which had first travelled through the reaction vessel. The reaction vessel was of pure fused quartz (The Thermal Syndicate, Ltd.) It was a cylinder, 24 cm long and 6 cm (external) diameter, with plane polished ends. Its volume was 655 ml. A side-arm connected to it by a quartz-pyrex graded seal (G.S., figure 2) included a cold finger (C.F.) whose importance lay in calibration runs. Connection to the analytical apparatus was facilitated by means of a

B14 joint, this outlet being closed by a thin glass seal.

IRRADIATION PROCEDURE

Before each run the filter solutions were examined being either topped up with distilled water or replaced, as necessary. The potassium chromate and nickel sulphate solutions required only very occasional replacement whilst the potassium biphthalate quickly deteriorated and was replaced about every 7 days or after 40 minutes irradiation - whichever was the sooner.

The lamp was started through a large resistance, which was steadily reduced over a period of 10 to 15 minutes to about 20 ohms - the setting at which the lamp was allowed to run during the irradiation. At least one hour was allowed for warming up, by which time the beam was of constant intensity as shown by the photocell current in the subsequent run. Overall fluctuations (usually in the form of a slow drift) never amounted to more than 5% in a 15 minute run - the longest run normally used. The average intensity of the transmitted beam could be calculated from frequent regular readings of the photocell current.

In normal runs the lamp was switched off immediately after the end of the run. The reaction vessel was then removed, allowed to cool and transferred to the analytical

apparatus. In calibration runs, however, a further operation was necessary before the lamp was extinguished, this being a measurement of the intensity of the beam incident on the reaction vessel. Following closing of the shutter at the end of the irradiation the reaction vessel was partially removed from the furnace to expose the cold finger. Its contents were frozen out at this point with liquid nitrogen, the reaction vessel speedily replaced and the end built up again. This operation could be completed in less than two minutes. With the contents temporarily frozen out and, therefore, a vacuum in the reaction vessel, the shutter was re-opened long enough for the required reading to be made. (Normally only a few seconds). Speed of operation was essential here; partially to ensure that the reaction vessel was free from acetone vapour but also to reduce possible error due to the beam intensity having changed during the intervening period.

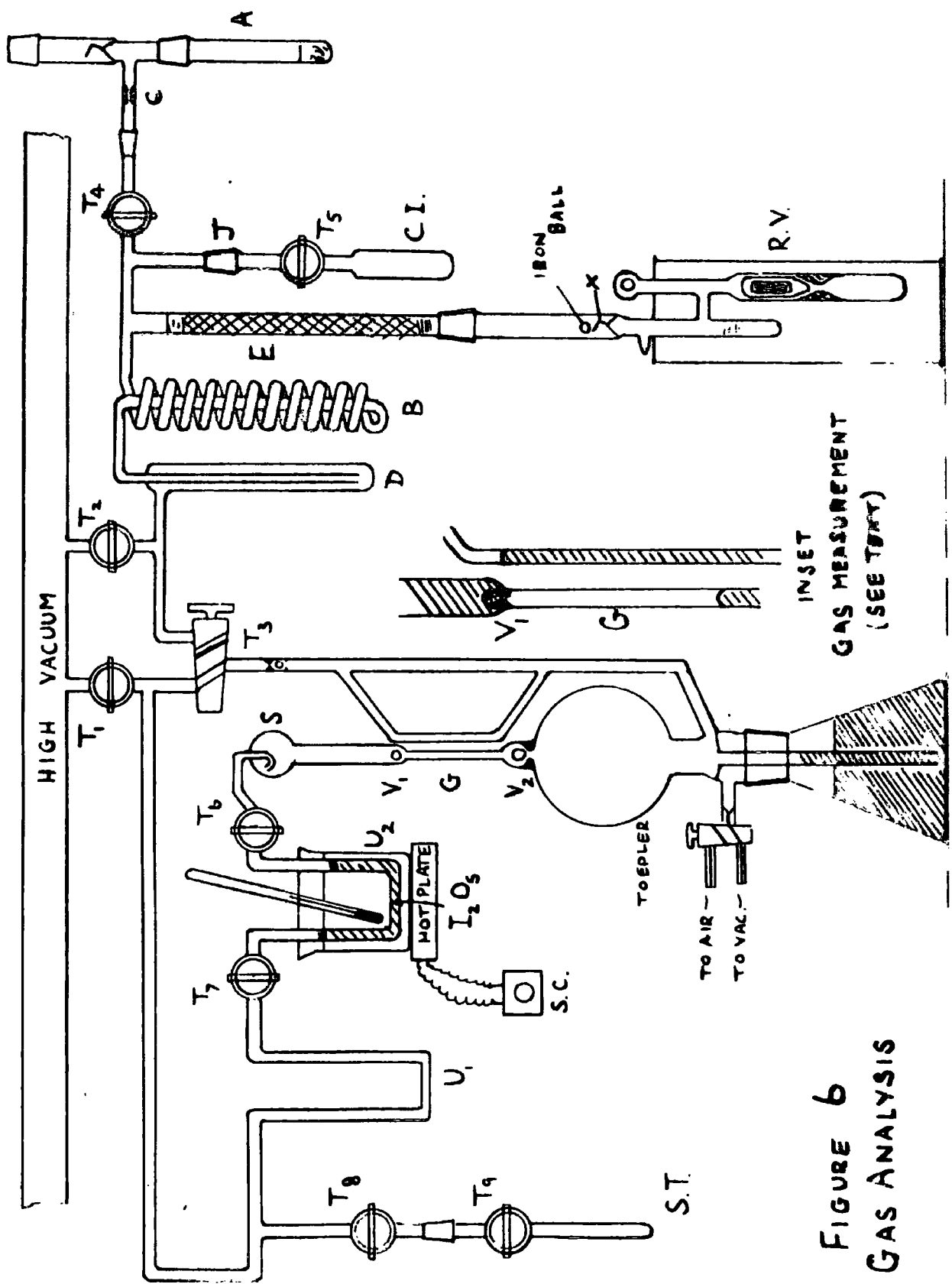

FIGURE 6
GAS ANALYSIS

4. (C) ANALYSIS

(a) Preliminary Operations

After removal from the irradiation furnace the reaction vessel was allowed to cool before being connected to the apparatus shown in figure 6. The section thus filled with air (bounded by taps T_2 , T_3 , T_4 , T_5 and the break-seal X on the reaction vessel) was evacuated until a "sticking" vacuum was attained. The spiral B and trap D were then immersed in liquid nitrogen and, after a lapse of several minutes to ensure complete chilling, tap T_2 was closed (T_3 , T_4 and T_5 being already closed) and the break-seal opened by dropping a magnetically operated plunger. The condensible products and unused acetone were condensed out in the spiral, trap D collecting any which got through. (In the earlier experiments, only the trap D was used, the spiral being incorporated when high oxygen pressures (about 2 mm) were first used). It was important to ensure that condensible material was removed efficiently as it reached the cold zone since, once having passed it, it would diffuse back very slowly through the atmosphere of gases (carbon monoxide, and oxygen when used) non-condensable at liquid nitrogen temperature. Iodine, when used, was removed before it could reach the spiral by absorption on silver powder supported on glass wool

(Column E).

(b) Extraction of "permanent" gases: Carbon Monoxide Analysis

In runs where oxygen was present, the gases volatile at -196°C consisted of carbon monoxide and oxygen, as also when photolysis had been performed in the presence of iodine. In calibration runs methane and carbon monoxide were the 'permanent' gases, volatile at -196°C .

Iodine pentoxide, I_2O_5 , was used for the estimation of carbon monoxide. At a temperature of 150°C reaction follows the equation (67) below and is quite specific for carbon monoxide:



In the apparatus shown in figure 6, the U-tube U_2 was packed with granules of iodine pentoxide. Each end was packed with plug of silver gauze and silver wire to absorb the iodine liberated. The temperature of the U-tube was maintained within 1°C of 150°C by immersing it in a bath of a silicone fluid (Midland Silicones Ltd, MS 550) heated by a hotplate which was controlled by a Sunvic Energy Regulator (Type TYB). Reaction was quite fast with the small quantities of carbon monoxide to be oxidised - of the order of 1×10^{-6} g. mol. or less.

Certain precautions had to be taken to ensure speedy oxidation. In addition to purely manipulative ones, particularly slow passage of the gas through the U-tube, the condition of the surface of the iodine pentoxide was found to be of the utmost importance. It appeared that whenever it was exposed to air (occasionally inevitable when taps had to be re-greased) it adsorbed something which could only be removed by heating to 190°C or above and pumping on it for a considerable time. In practice, whenever such treatment was necessary, pumping was continued for 12 to 18 hours by which time a "sticking" vacuum could be maintained, contrary to the condition at the beginning of this period when considerable quantities of a gas non-condensable at -196°C could be removed. In view of this evidence, it seems likely that the adsorbed material was oxygen and/or nitrogen, and disproves any possibility of decomposition being responsible. It is to be noted that the manufacturers recommend strong heating before use.

The sequence of manipulations of this fraction depended on whether or not oxygen was present.

(1) In the absence of oxygen the amount of gases volatile at -196°C was very small (about 10^{-6} g. mol, being principally carbon monoxide). This amount of material

could be accommodated in a 10 cm length of 3 mm standard-bore tubing (G). It was transferred from the section to the right of tap T_3 by means of a Toepler pump. A seal was made at V_1 by means of a ball-bearing held down onto a ground seating by a suitable head of mercury (10 to 15 cm). A similar seal was made at V_2 (but with only a few mm of mercury) to contain the gas in G. V_2 was thus used as a non-return valve. (At the instant of making these seals, the ball was seated by use of a magnet).

Procedure

The quantity of permanent gases extracted into G was measured. This could be estimated by measurement of the length of tube G filled by the gas and the pressure at which it was being contained. (The cross-sectional area of the tube was already known). All measurements were made with a cathetometer. Correction was made for surface tension effects at the menisci M_1 and M_2 . The heights of these menisci were measured and correction applied using the formula quoted in the International Critical Tables⁽³⁰⁾.

The gas was then circulated through the hot iodine pentoxide and carbon dioxide condensed out as it was formed at U_1 , which was cooled with liquid nitrogen. When oxidation was complete - as shown by the volume of permanent

gas falling to a constant level, this non-oxidisable gas was collected in G and estimated by measuring pressure and volume. By subtraction, the volume of the carbon monoxide originally present was calculated. This method was preferred to the alternative direct estimation of the carbon dioxide formed since it gave more consistent results. Estimates of this carbon dioxide were always higher than the estimate of carbon monoxide by difference, and the discrepancy decreased as the tap-grease aged. This was taken to indicate that some condensible material was being drawn out of the tap-grease on continued circulation of this small amount of gas.

(ii) In the presence of oxygen the procedure was more complicated due to the larger volume of permanent gas to be handled. This varied from 0.3 to 15×10^{-4} g. mol. of oxygen. The carbon monoxide was never more than 5% of the oxygen present and was often much lower, particularly at high oxygen pressures.

Procedure

The volume was such that it could not be accommodated in G. On extraction from the reaction vessel, condensible products were frozen out on the way (at the spiral or at the trap D), and the permanent gases were pumped into the

section between tap T_6 and valve V_2 (V_1 was held open magnetically). The gases were then circulated and carbon dioxide formed by oxidation of carbon monoxide was condensed out at U_2 with liquid nitrogen. When oxidation was complete, the amount of carbon dioxide as measured in G reached a constant value. (Unoxidised material was isolated between T_6 and V_1). This was used directly to estimate the carbon monoxide content of the original sample. No complications were encountered from tap-grease and it is therefore assumed that the higher pressures of gas being circulated suppressed any tendency for the grease to out-gas. The purity of the carbon dioxide condensed out at U_2 was usually checked by circulating it through U_2 at -140°C (Freezing $40^\circ/60^\circ$ Petroleum Ether) and collecting the gas which did not freeze out. Some condensible material was found in this way which was probably acetone carried through from the reaction vessel. This volume was subtracted to give the true estimate of carbon dioxide. This behaviour was only found when comparatively high oxygen pressures were used. It was eliminated by incorporating the spiral to improve condensing out of the reaction vessel contents.

(c) Extraction of the 'Second' Fraction: Estimation of Carbon Dioxide

Whilst carbon dioxide has a vapour pressure of about

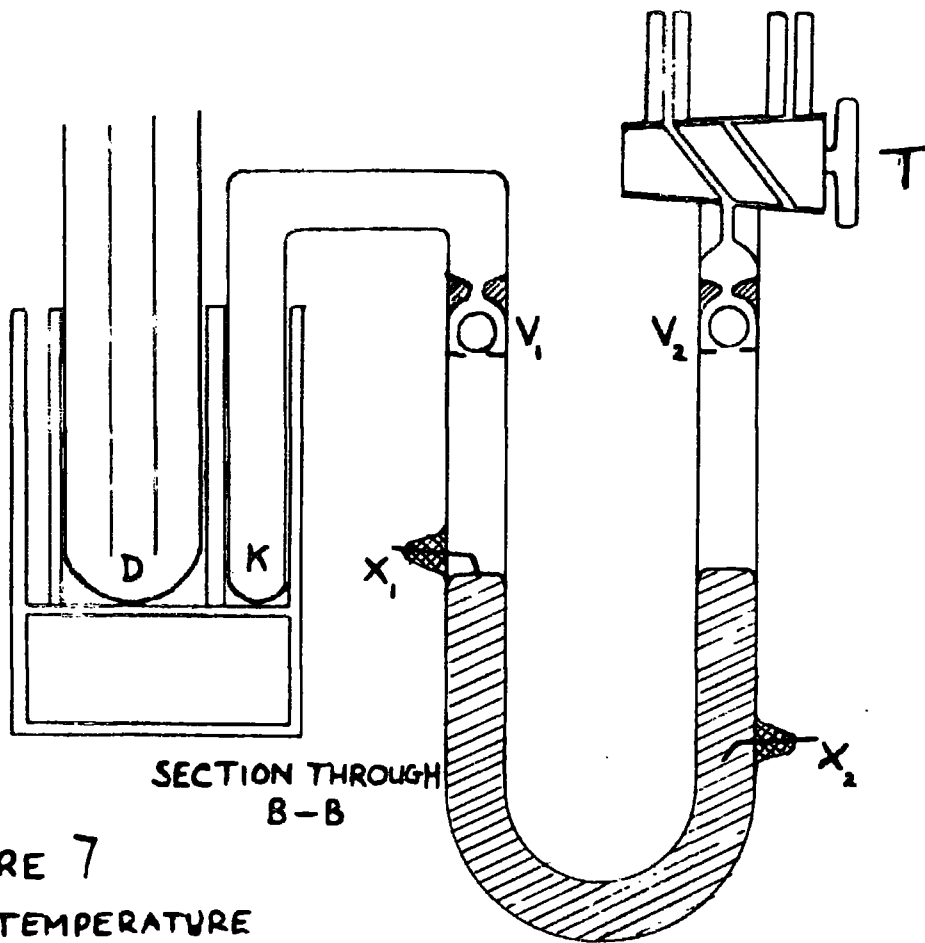

SECTION THROUGH
B-B

FIGURE 7
LOW TEMPERATURE
REGULATOR FOR -152°C .

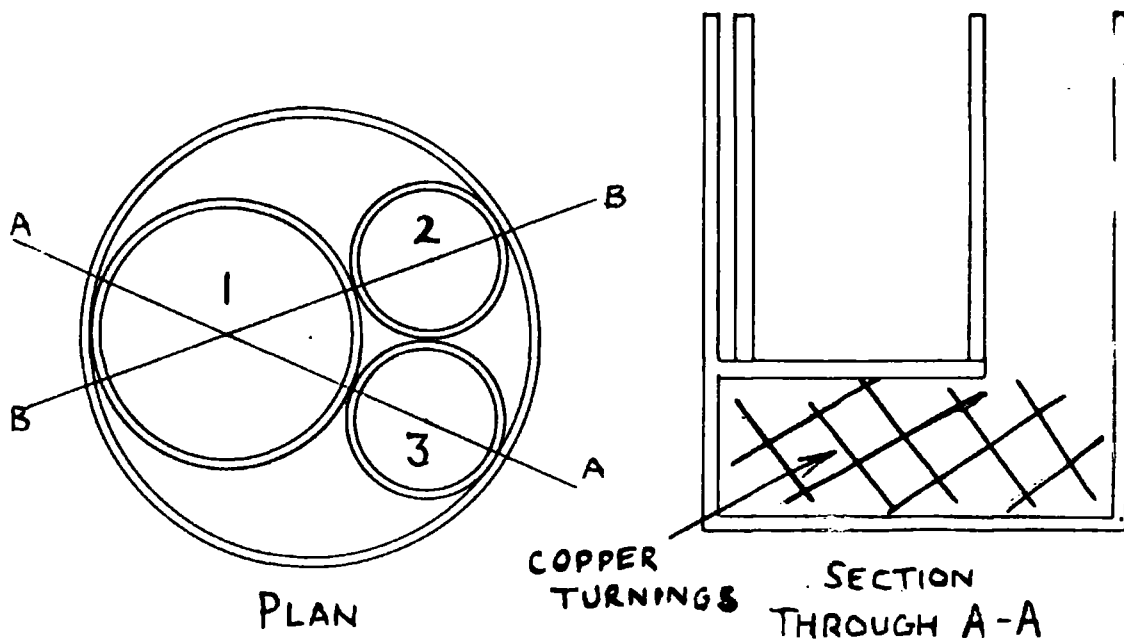

PLAN

COPPER
TURNINGS

SECTION
THROUGH A-A

10^{-5} mm at -196°C , it has a vapour pressure of 0.07 mm at -150°C ⁽³¹⁾ and can be extracted from acetone and other products involatile at -196°C by distillation. The gas was collected in G and measured, several thawings of the acetone frozen in trap D being required before all the carbon dioxide was extracted.

The device used for attaining and maintaining the temperature required is shown in figure 7. The block was of copper and the lower cavity was filled with copper turnings. It was heavily lagged and housed in a Dewar flask. Hole 1 contained the lower end of trap D, and into hole 2 was placed the tube K which contained Krypton gas. Liquid nitrogen was blown through hole 3 to cool the apparatus.

The principle underlying its operation is that krypton has a vapour pressure of 76 cm at -152°C . Liquid nitrogen was pumped into the apparatus until it was cooled to this temperature, when the mercury levels became equal. (Tap T open to the atmosphere). X_1 and X_2 were metallic contacts - tungsten wire sealed through the walls of the U-tube. They were so arranged that mercury just touched X_1 when the levels were equal. Electrical contact was thus made between X_1 and X_2 closing a circuit and tripping a relay (Sunvic E.A.2). This, in turn, was used to close an electromagnetically operated valve in the com-

pressed air line which had been blowing liquid nitrogen into the apparatus. Thus when the temperature fell to -152°C the supply of liquid nitrogen was halted; when the temperature rose above this point the circuit was broken and coolant re-admitted. In practice the temperature fell below -152°C on the first spell of cooling, V_1 being provided to stop the mercury from going too far. At the other side of the U tube V_2 was used to contain the krypton gas at room temperature.

This device was extremely sensitive to changes in temperature as will be realised from the table below: (31)

TEMPERATURE ($^{\circ}\text{C}$)	KRYPTON VAPOUR PRESSURE (ATMOSPHERES).
-159.0	0.53
-152.0	1.00
-143.5	2.00

In the immediate region of -152°C the vapour pressure changes at the rate of about 7 cm per degree centigrade. Once equilibrium heat transfer conditions had been attained in the apparatus above, the levels could be held equal to within about 3 cm or better so that the temperature was maintained to within $\pm 0.5^{\circ}\text{C}$ of the required -152°C .

In addition to measurement of the total amount of carbon dioxide, it was usual to estimate its specific activity and make an estimate of that fraction resulting from methyl groups. Following measurement in G, it was mixed with some inactive carbon dioxide introduced from the sample tube S.T. (figure 6). Complete mixing was effected by circulating several times using the Toepler pump before condensing back into the sample tube and transferring to the counter filling apparatus. With more carbon dioxide and carbon disulphide it was used to make up a counter filling and counted. These techniques will be found discussed in section (D) of this chapter.

Methyl Iodide

The method used was identical with that of Brown⁽¹¹⁾ except for one small modification—Methyl iodide was reduced to methane which was burnt to carbon dioxide, this being separated and its specific activity measured. Zinc-copper couple was used as the reducing agent together with methanol which also acted as a solvent for the methyl iodide. Since methyl iodide can only come from methyl groups, the yield could readily be calculated from the specific activity measurements.

Reagents:

Methyl iodide in methanol was used as carrier. Concentration was approximately 5% w/w. The methanol was 'AnalaR' grade and the methyl iodide, of purity unspecified, was redistilled and estimated gravimetrically by precipitation of silver iodide. It was generally about 97% pure.

Zinc-copper couple was made fresh for each experiment. Attempts to produce it and store it in bulk as Brown did failed, reaction with such material being sluggish and incomplete. It was concluded that the zinc-copper couple was responsible since when it was prepared fresh for each experiment without allowing the material to become dry, excellent yields of methane were obtained within a few hours. The procedure adopted is as follows:

Several small pieces of arsenic-free zinc were placed in a clean test-tube fitted with a B14 cone. Three successive portions of 10 ml 2% copper sulphate were added, each for about five minutes. The zinc-copper couple so formed was washed several times with water to remove all traces of copper sulphate and then with several changes of dry methanol to remove the water. It was left just covered with methanol to exclude air and after degassing it was stored frozen under vacuum until required for use.

HIGH VACUUM

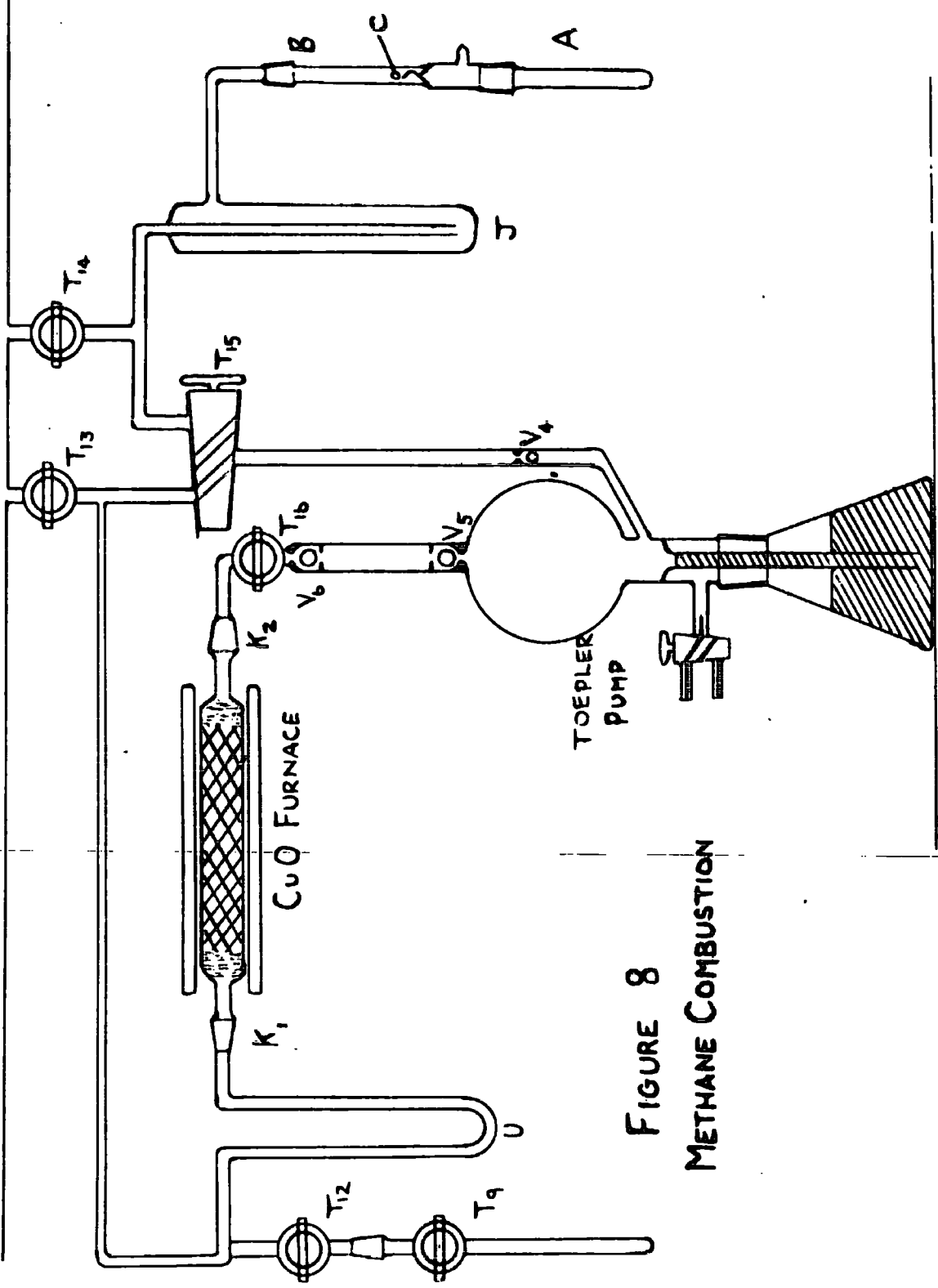

FIGURE 8
METHANE COMBUSTION

Procedure:

To the whole of the reaction products and unused acetone, was added methyl iodide/methanol mixture, condensed into D on top of the reaction products. This had previously been weighed out into the sample tube (C.I. + figure 6) and degassed. When mixing was complete, the whole was distilled into the tube A, which contained zinc-copper couple and methanol. This section was then sealed and drawn off at C whilst the contents of A were still frozen out with liquid nitrogen. The contents were allowed to warm up slowly. When the temperature reached about 0 to 10°C reaction between the zinc-copper couple, methyl iodide and methanol began and, without any assistance, reduction carried on smoothly and quickly. It was allowed to proceed overnight, by which time it had reached completion. Blanks showed that reaction went to within 20% of completion in less than 3 hours but in practice it was found advisable to allow reaction to go to completion in order to eliminate possible errors from isotopic separation during the reaction.

Manipulation of the methane so produced was effected in the apparatus shown in figure 8. The apparatus in which it was contained was inserted at B, and the section let down to air to do this was evacuated. Taps T₁₄ and T₁₅ were closed and, with liquid nitrogen surrounding A

and Trap J, the break seal C was opened. The methane was drawn off by the Toepler pump into the furnace section, a small additional amount being freed by thawing A and allowing the condensable material (everything except methane) to distil as far as J. In this way a very clean separation of methane was achieved, particularly from acetone.

Combustion was brought about by circulating the methane through the furnace at a temperature of about 750°C . The furnace was packed with copper oxide containing 1% of ferric oxide (Murdock, Brooks and Zahn⁽³²⁾). The furnace was constructed from a piece of silica tube sealed into the pyrex apparatus with standard B14 joints, K_1 and K_2 , which were made gas-tight with black wax. (Apiezon type W). Heating was provided by a nichrome element wound on a insulated steel tube which enclosed the silica tube. This heating former was heavily lagged with asbestos paper and string. About 200 watts were consumed in maintaining a temperature of 750°C . The temperature was measured by means of a chromel-alumel thermocouple situated in the annulus between the silica tube and the steel tube. Accuracy of measurement at this temperature was about $\pm 20^{\circ}\text{C}$.

A considerable proportion of the copper oxide was reduced during each oxidation. Following each run, the

packing was re-oxidised by exposing it to the atmosphere at a temperature of 400°C for about 20 minutes.

The methane sample was completely oxidised, the products (carbon dioxide and water) being condensed out at U with liquid nitrogen, on formation. Separation was effected by raising the temperature of U to -78°C and distilling the carbon dioxide into the sample tube, to be frozen out there with liquid nitrogen. A very good separation was thus achieved, water having a very low vapour pressure at this temperature. (less than 10^{-3} mm). Taps T_9 and T_{12} were closed and the sample tube, still containing the carbon dioxide frozen at its tip, transferred to the counter filling apparatus (figure 11).

The space between taps T_2 and T_3 (figure 11) was evacuated before the carbon dioxide sample was allowed to evaporate into the space bounded by taps T_1 , T_4 , valve V_1 and the mercury in the manometer. The volume of this section had been calibrated previously. It was therefore possible to calculate the amount of carbon dioxide in this sample by measuring the temperature and pressure (manometer M_1) and making use of the gas laws. This sample was then mixed with more (inactive) carbon dioxide and with carbon disulphide, and transferred into a Geiger-Müller counter for radioactive assay. The proce-

dure adopted for this and the subsequent counting will be found in section (D) of this chapter.

From a knowledge of the specific activity of the sample, thus gained, the specific activity of the methyl groups in the radioactive acetone and the percentage recovery of methyl iodide produced in the photolysis, the photolytic yield can be calculated. If 'a' gm. mole of methyl iodide is produced by photolysis, 'b' gm. mole of carrier methyl iodide added and 'c' gm. mole of carbon dioxide recovered after combustion of the methane, then the true recovery is given by $c/(b+a)$. If the counting data indicate a yield of "m" g.mol. of photolytic methyl iodide then $a = \frac{m}{c} (b+a)$ and $a = mb/(m+c)$. In practice "m" was found to be so much less than "c" that the expression $a = \frac{mb}{c}$ was accurate to within normal experimental error.

This method does not require complete recovery of the methyl iodide produced during the photolysis provided that complete mixing with the carrier was achieved. It is essential that no exchange of radio-carbon occurs between methyl iodide and acetone. That no such exchange takes place has been experimentally verified by Brown.⁽¹¹⁾ It is also essential that there should be no "isotope effect" - separation due to isotopes having

different rates of reaction. Provided yields are high in both reduction and oxidation steps, there can be no danger of error from this source. Yields in both these steps were regularly in excess of 95%. Any isotope effect in the oxidation is likely to be very small and probably insignificant on account of the elevated temperature used.

Formaldehyde

The first instance of formaldehyde being recognised as a product of the photo-oxidation of acetone was reported by Hoare⁽²⁵⁾ who detected it, qualitatively, using a mass-spectrometer. Later, Christie⁽²⁶⁾ used two colorimetric methods to estimate it. These depended, for their colour reaction, on p-hydroxy biphenyl^(33,34) and with phenyl hydrazine^(33,35). The former method was the simpler and attention was turned to it as the more promising method. (The latter method employs numerous solutions and is probably more liable to error on this account).

The p-hydroxy biphenyl method depends on the formation of a coloured product between formaldehyde and p-hydroxy biphenyl on heating in concentrated sulphuric acid solutions. It was found to be quite sensitive but

not specific. Acetone also formed a coloured compound under these conditions which had a similar spectrum to the formaldehyde compound. In the excess in which it was normally present after an irradiation, the acetone compound masked the formaldehyde compound. Attempts to separate formaldehyde from acetone by distillation at -78°C . met with very little success. With a synthetic sample representing a normal formaldehyde-acetone sample after irradiation, 10% distilled in 30 minutes. This method was therefore discarded in favour of an alternative, due to Bricker and Johnson.⁽³⁶⁾

This method, also discussed by MacFadyen⁽³⁷⁾ employs chromotropic acid to develop the colour reaction. The solvent is again hot concentrated sulphuric acid. This had been found to work quite well in some exploratory experiments performed by Brown⁽¹¹⁾ in collaboration with the present author.

The complex has a reddish violet colour, its spectrum showing a maximum at $570\text{ m}\mu$. The colour could be developed by heating at a temperature in the range 60 to 100°C in sulphuric acid of minimum concentration 12 Normal. The time of heating required varied inversely with the temperature, being as short as 15 minutes at 100°C . An excess of at least 100:1 in favour of the

chromotropic acid was required. Sensitivity was about 0.5 μ gm. These are the findings of Bricker and Johnson who worked with rather large volumes, being concerned with quantities of formaldehyde rather larger than those available from this work. Some development of this method was undertaken with a view of increasing the sensitivity.

Preliminary investigations brought several points to light. Whilst acetone formed no coloured reaction product itself, under these conditions, and showed no deleterious effect on the ultimate intensity of the coloured solution, it did slow down the rate at which the colour developed. Whilst 30 minutes heating at 60°C was sufficient for a sample without added acetone, in the presence (of about 0.08 ml - the normal sample taken for photolysis) 45 minutes was required. About 35 minutes was required at 100°C but at such higher temperatures the colour density of the blank (the colour developing solution and acetone without formaldehyde) increased more rapidly than when developed at lower temperatures. Chromotropic acid itself is not completely transparent to light at 570 m μ , the wavelength at which colour density measurements were made. It was found possible to reduce the amounts of chromotropic acid used, whilst still maintaining the required excess, such that the optical

HIGH VACUUM

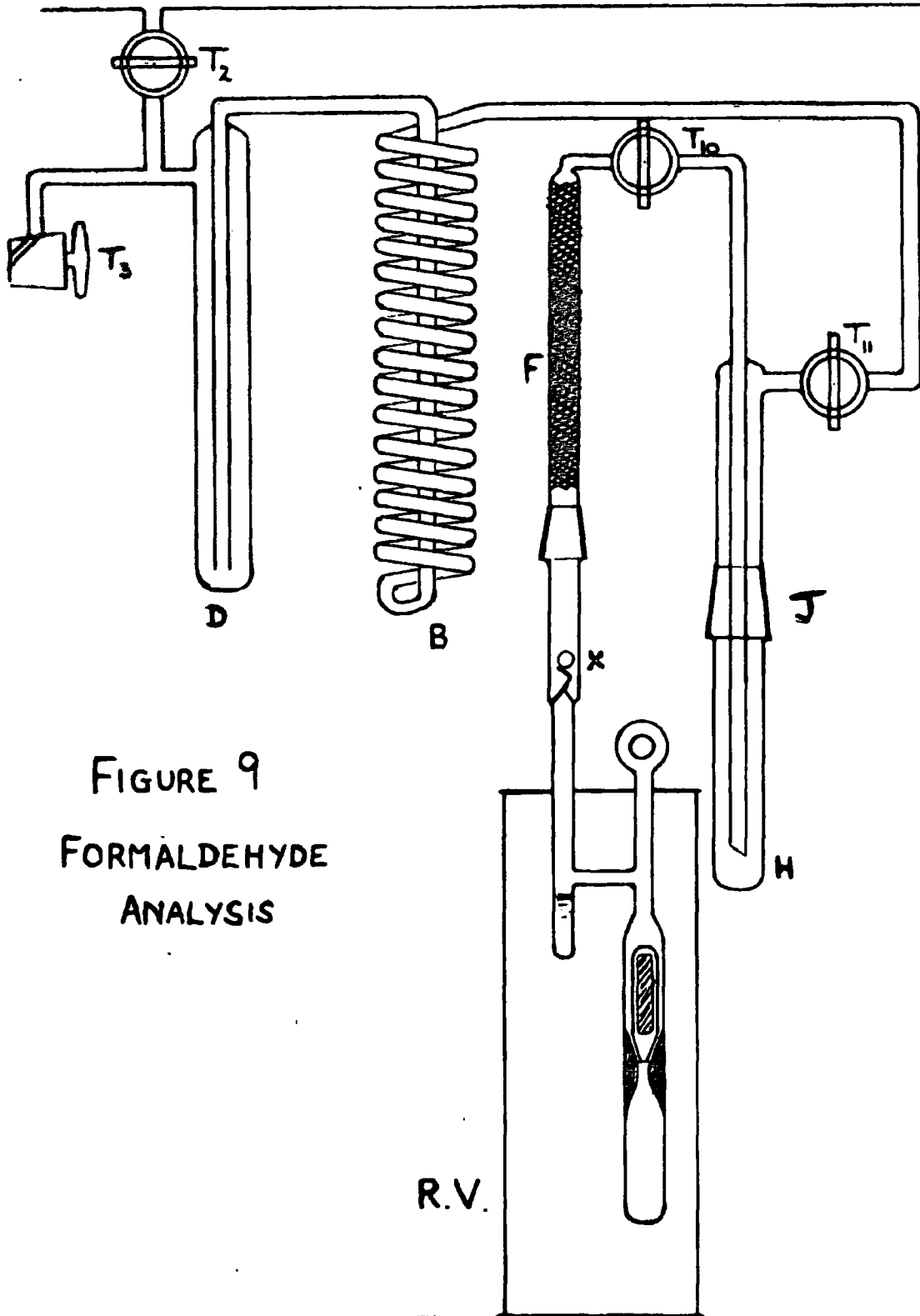

FIGURE 9
FORMALDEHYDE
ANALYSIS

density of the blank was no more than 15% of that of the formaldehyde compound, and in many cases the proportion was much less - quite often as low as 6%. Despite storage in the dark the aqueous solution of chromotropic acid darkened with age. Consequently fresh solutions were made up frequently.

Procedure:

(a) Extraction after Irradiation

Formaldehyde very readily goes over to an involatile polymeric form, a reaction which is favoured by very low temperatures. Special precautions were taken to ensure that no formaldehyde was lost in this way.

The section to the right of taps T_2 and T_3 , referring to figure 9, was pumped down to a 'sticking' vacuum, having previously been let down to air to admit the reaction vessel. With T_{10} and T_{11} closed and the thimble H cooled in liquid nitrogen, seal X was broken. T_{10} was then opened just sufficiently to allow very slow passage of gas. T_{11} was then opened to a similar very small degree and the non-condensable gases pumped away - either through the pumps to the atmosphere, or via the Toepler pump to the gas analysis section. Acetone and condensable products, including the formaldehyde were

thus collected at H which contained 0.20 ml of previously de-gassed distilled water. With the contents still frozen and taps T₁₀ and T₁₁ closed, tube H was pulled off at the standard joint J. It was quickly transferred to an ice-bath and the colour development carried out, as below.

Colorimetric Analysis

Prior to reception of the above sample, a stock solution of 5.0 ml 2% aqueous solution of chromotropic acid (disodium salt) and 49.8 ml 98% sulphuric acid had been mixed at 0°C. 4.90 ml of this solution were added to the formaldehyde sample, the temperature being held at 0°C by use of an ice bath. Three blanks were prepared by adding 4.90 ml of the above chromotropic - sulphuric acids mixture to a mixture of 0.2 ml water and the appropriate amount of acetone. (Equal to the amount used for the irradiation). The tubes were sealed with polythene stoppers and heated in a water bath at 75-80°C for 45 minutes. This was increased to 1 hour when more acetone was used. When very small amounts of formaldehyde were expected - that is, when acetone-iodine-oxygen mixtures were irradiated, the chromotropic acid concentration was reduced to 0.2% aqueous stock solution, and in a very few cases to 0.02%. This was necessary to keep

the optical density of the blank solution to a suitably small fraction of that of the solution being measured.

The solutions were allowed to cool after development and the optical densities measured. On a number of occasions the solution had to be diluted in order to produce an optical density which could be measured with accuracy. This normally meant diluting by 5. The wavelength used for these measurements of optical density was $570\text{ m}\mu$. The amount of formaldehyde in the sample could then be read off directly from a calibration graph.

It was customary to run a check calibration with each unknown solution. This was produced by adding 0.2 ml of a known formaldehyde or methylal solution to the appropriate amount of acetone, followed by 4.90 ml of the chromotropic acid - sulphuric acid solution. Methylal was usually used since though impure (see below) it could easily be prepared fresh. Once the purity of the stock reagent was known it could be used as a standard. Formaldehyde had to be redistilled from formalin each day and at the same time estimated volumetrically.

Calibration of the Method: Formaldehyde Standards.

Several methods of producing standard solutions of formaldehyde were tried, for the purpose of preparing a

calibration graph of amount of formaldehyde versus optical density at 570 m μ . A primary standard would have been the ideal, but commercially available formaldehyde must be redistilled before use for such purposes as these, the stock reagent containing unknown amounts of various polymeric forms. This necessitates estimation of this distilled material before use.

Two readily available compounds yield formaldehyde on hydrolysis.

- 1) Methylal is hydrolysed, quantitatively it is reputed, by strong sulphuric acid solutions:

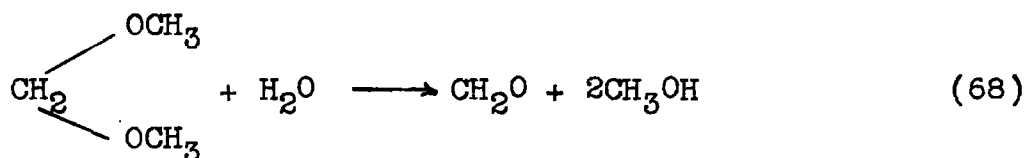

Whilst giving consistent results this method gave results which were about 85% of those from formaldehyde solutions and which were lower than those from hexamethylene tetramine. It was thus thought that the material was impure. Though impure and therefore unsuitable as a primary standard, it was found useful for 'check' calibrations with unknown samples.

- 2) Hexamethylene tetramine can be obtained very pure (B.P. standard, better than 99%). It is hydrolysed by dilute acid:

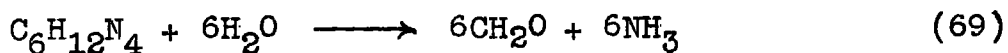

The reaction above does not, however, appear to be quantitative. It proceeded to the extent of about 90% but was somewhat variable.

For the calibration, resort had to be made to formaldehyde distilled from 'AnalaR' formalin. Some of the distillate was diluted to a level suitable for formaldehyde colorimetric analysis using the exact procedure described above. More was diluted for volumetric analysis.

Estimation of the formaldehyde was made by the method of Donnally⁽³⁸⁾. The procedure was as follows:

An excess of standard (about $\frac{N}{10}$) sodium metabisulphite solution was added to a suitable volume of formaldehyde solution. The solution was made alkaline by addition of sodium carbonate. Under these slightly alkaline conditions the excess bisulphite can be titrated against standard iodine solution. The end-point (starch) showed a tendency to fade in these alkaline conditions. As a



check, the solution was acidified by addition of sodium bicarbonate and acetic acid. The formaldehyde-bisulphite compound was broken up by these acid conditions and the bisulphite, equivalent to the formaldehyde, was titrated directly against standard iodine solution, starch again being used as indicator. With care, the two methods gave good agreement.

Calibration was carried out using a range of different amounts of formaldehyde such as to give optical densities of the developed colour ranging from 0 upto 1.0. Beer's Law was found to hold for this range, within the limits of experimental error. No attempt was made to calibrate higher optical densities than 1.0, since the accuracy of measurement falls off over this part of the Unicam scale.

Acetic Acid. Development of a Method

Hoare⁽²⁵⁾ claimed to have detected acetic-acid, using the mass-spectrometer as his analytical tool. Christie⁽²⁶⁾ claimed to have found it in quantities corresponding to quantum yields of at least unity, but, as already discussed, the reliability of this result seems questionable on account of the method used. Consequently an entirely new and reliable method was sought.

None of the known methods of colorimetric analysis of acetic acid are of adequate sensitivity and in the

FIGURE 10

BROMOCRESOL GREEN: ABSORPTION SPECTRA

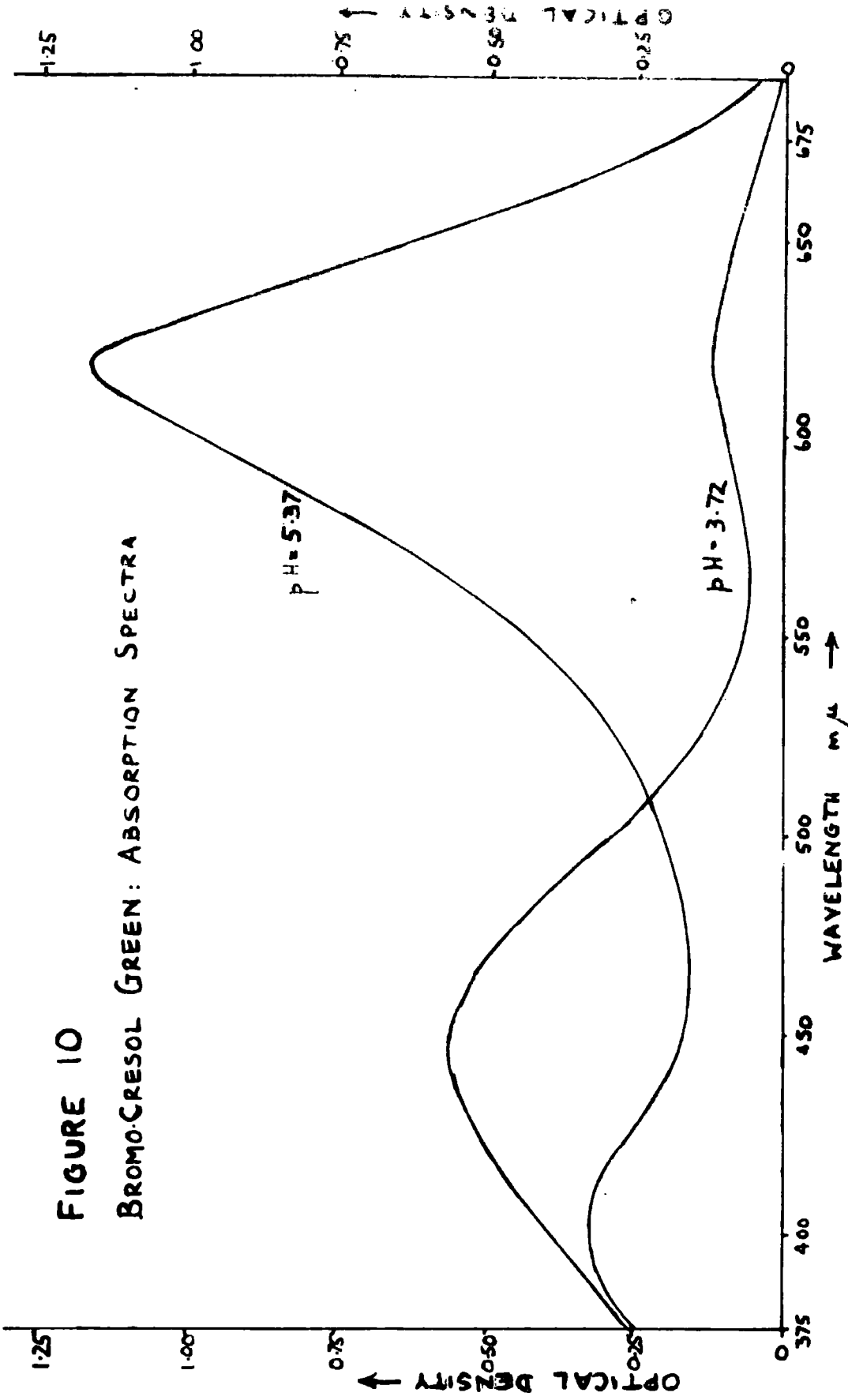

absence of a ready means of separating acetic acid specifically from acetone and the other reaction products resort was made to a physical property - that of being an acid.

The only acidic products are carbon dioxide and acetic acid. Formic acid can be ruled out since Hoare could not detect any with the mass-spectrometer. Carbon dioxide can be easily removed by distillation. The pH of solutions of small (micro) quantities of acetic acid in small volumes of water is quite sensitive to changes of concentration. Two examples will illustrate this point:

10^{-7} g. mol in 4 ml water - pH = 5.5

10^{-6} g. mol in 4 ml water - pH = 4.2.

The method devised was basically an 'indicator' one, using the colour change of tetrabromophenol-sulphone-phthalein (Bromocresol green) which, in aqueous solutions is blue at pH 5.4 and yellow at pH 3.8. A series of buffer solutions was made up from sodium acetate and acetic acid. To 4 ml samples 0.1 ml of a solution of the above indicator (sodium salt) in ethanol (1 gm/100 ml) was added. The absorption spectrum of each solution was plotted using the Unicam SP500 spectrophotometer. Two typical plots are shown in figure 10. Each solution

FIGURE 10 (A)
ACETIC ACID ANALYSIS:
CALIBRATION CURVE

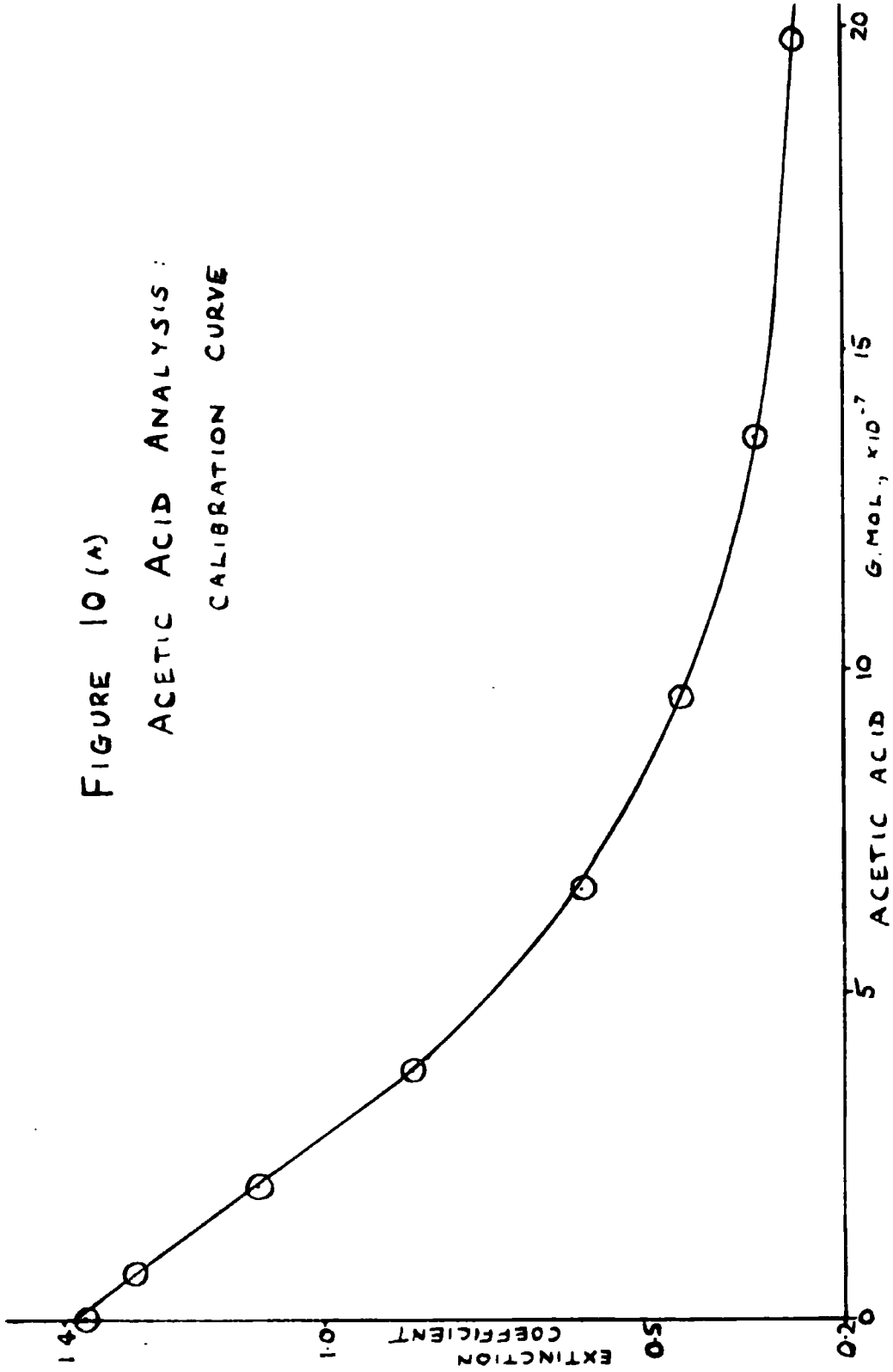

showed a peak in its absorption curve at 615 to 620 $m\mu$. On this basis some standard solutions of acetic acid in acetone (AnalaR reagents) were made up. 0.08 ml of each of a series of standards to give from 0 to 20×10^{-7} g.mol acetic acid was added to portions of 4 ml distilled water (see below) to which 0.1 ml of the Bromocresol green indicator had been added. Optical density at 617 $m\mu$ was plotted against acetic acid composition. The result of these measurements is shown in figure 1D(A). The water used was redistilled from an all-glass apparatus, the middle third being taken. It was stored in a full bottle before use, so as to exclude carbon dioxide.

Following demonstration that a sample of acetic acid in acetone could be completely recovered by this method after normal manipulations in the high-vacuum apparatus, in the way described below, this method of analysis was adopted for use in analysis of the products of photo-oxidation.

Procedure

The apparatus is as shown in figure 6 with the exception that the silver powder tube (E) was removed and the tube C.I. was replaced by a simple tube with a B14 cone.

The condensible products of the irradiation together with unused acetone were condensed out at B and D in the usual way, permanent gases being pumped away. This condensed material was transferred into D whose temperature was raised to about -135°C (Melting $40^{\circ}/60^{\circ}$ petroleum ether). Carbon dioxide was easily removed at this temperature, 20 minutes being allowed to ensure complete removal. The remaining material was then transferred into the thimble inserted at J, which contained 0.2 ml of re-distilled water having a pH in the region of 6.5 to 7.0. They were allowed to mix on melting and after being frozen down again the thimble was removed. A further 3.8 ml of water of the same quality was added and 0.1 ml of the indicator. The optical density of this solution at $617\text{ m}\mu$ was measured and the amount of acetic acid calculated from the calibration graph (figure 10(A)).

Good quality water, as already discussed, was essential to this work but, above all, absolute cleanliness was of paramount importance. All apparatus, including the distillation apparatus, was cleaned before use with concentrated sulphuric-nitric acids mixture, followed by thorough washing with good quality distilled water.

4. (D) RADIOACTIVE MEASUREMENTS

Introduction:

The radioactive isotope used in this work was carbon-14, very long-lived (half life 5720 ± 47 years⁽³⁹⁾) which decays by emission of a β^- particle (energy 156 k.e.v.)⁽⁶⁰⁾ No γ -ray emission accompanies the decay.

The methods available for its assay include counting as a solid source, either beneath an end-window Geiger-Müller tube or in a proportional flow-counter, and internally as the actual filling of a Geiger-Müller tube. Use of solid samples suffer from the low energy of the emitted β -particle. Self-absorption losses are high, as are absorption losses in the window when counted externally. To overcome these losses higher specific activities must be used than with isotopes where such losses are small. In addition, there is a real danger of exchange between atmospheric carbon dioxide and barium carbonate - the form usually adopted for presenting the ^{14}C to the counter. Internal gas-counting using the sample as the filling gas for operation in the Geiger-Müller region has many advantages ^{over} its two alternatives and was the method chosen for this investigation. Counting efficiency is very high (approaching 100%) even for such a weak β particle as this

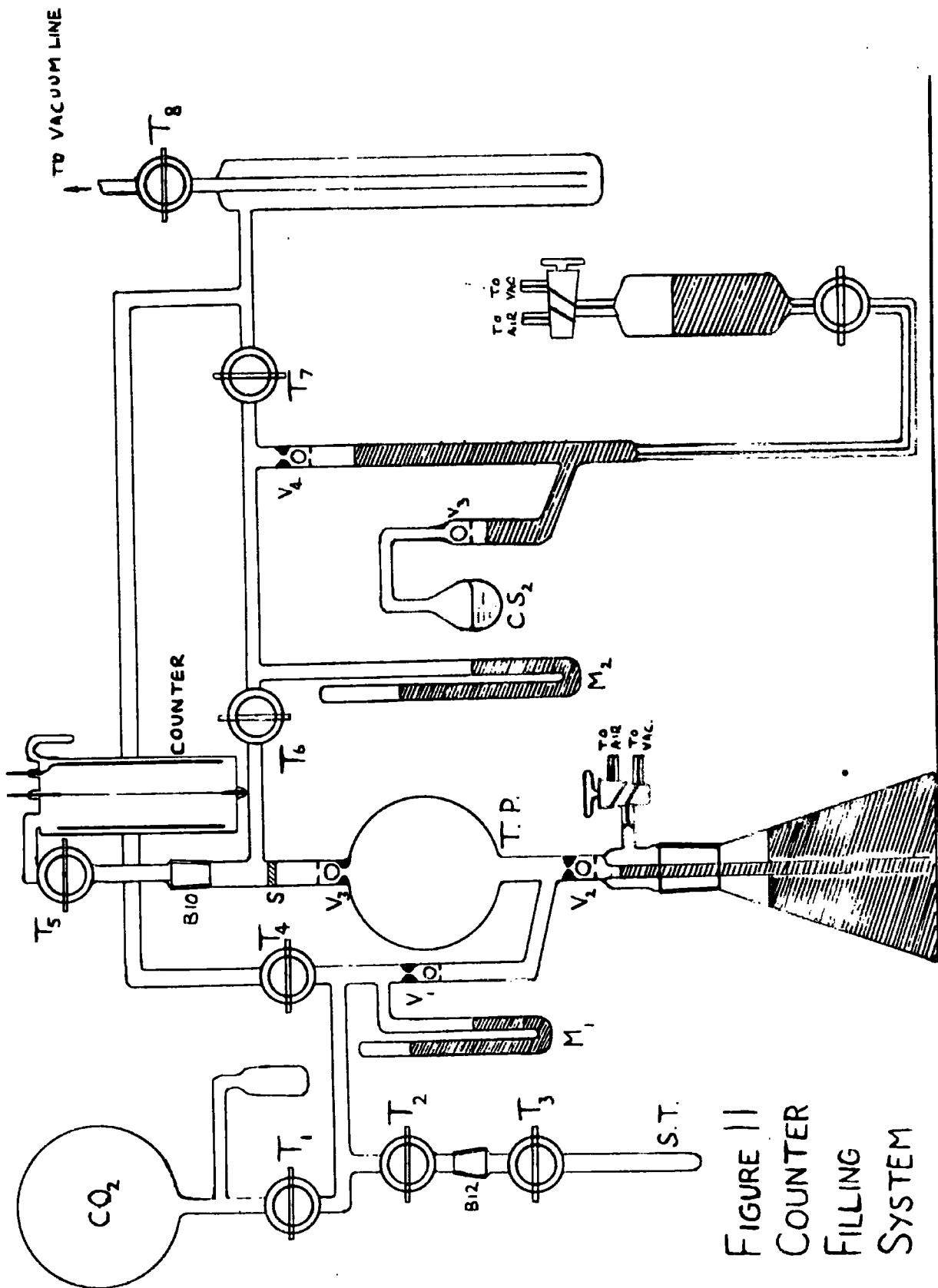

FIGURE 11
 COUNTER
 FILLING
 SYSTEM

since there are no self-absorption or window-absorption losses to contend with. By careful attention to the design of counter, the sensitive volume can be as high as 90% of the total volume occupied by the gas. The specific activity of the starting material (in this case acetone) can be kept to a minimum so reducing the extent of radiolytic decomposition. Its only disadvantage lies in the complexity of the apparatus required. A new counter filling has to be prepared for each determination and a second (blank) filling for background determination is also required. The electrical equipment normal to Geiger-Müller counting has also to be modified. The net result, however, is a counting system which is believed to be superior to any other.

Apparatus:

The counter, shown diagrammatically in figure 11, consisted of a copper cathode in the shape of a tube, set coaxially with a length of tungsten wire (100 microns diameter) in an enclosing envelope of pyrex glass. The cathode (2 cm internal diameter) was a good fit inside the envelope and with the volume of the cold finger and inlet tubing (as far as the tap) kept to a minimum, the proportion of the total volume sensitive to ionisation

was very high. It was detachable from the filling apparatus at a standard joint (B10). This facilitated transfer of the counter to a lead 'castle' for the counting operations. Better shielding could be obtained in this way than by building a lead enclosure round the counter set in the vacuum apparatus.

The filling gas employed consisted of carbon dioxide (10 cm pressure) with carbon disulphide (2 cm pressure). This is identical with the system adopted by Brown⁽¹¹⁾ after extensive investigations in this laboratory. Röhlinger and Broda⁽⁴¹⁾ have successfully counted ^{14}C using carbon dioxide alone as the filling gas. High voltages were required at relatively high gas pressures. Attempts to reproduce their system in this laboratory failed⁽¹¹⁾ and in common with other workers⁽⁴²⁾⁽⁴³⁾, satisfactory results could be obtained only on addition of a chemical quenching agent. It is understood⁽⁴⁴⁾ that extreme purity of the carbon dioxide is required, particularly from minute traces of oxides of nitrogen, if carbon dioxide is to be used alone. The system adopted here proved very convenient in use and, more important, it was found to be very reliable, conditions being easily reproducible. Carbon disulphide is not the only quenching agent which

could be used, an alternative tried with success⁽⁴⁵⁾ being ethanol.

The function of the carbon disulphide is believed to lie in the formation of CS_2^+ ions by charge transfer from the CO_2^+ ions which result initially from ionisation along the path of the β -particle. It is believed that CO_2^+ ions, on reaching the cathode, form CO_2^- ions in preference to neutral CO_2 molecules and so re-initiate the discharge. It is very probable that CS_2^+ ions do not behave in this way but form neutral molecules.

Counting Equipment:

This consisted of a modified 1014 A probe unit and a 1009 A scaler. Variable positive E.H.T. was supplied from laboratory supply via a 1007 potentiometer unit to the anode. The cathode was held ^{at} a potential of 1.1 kV negative relative to earth potential. Thus the operating voltage of the counter could be varied from 1.1 to 3.1 kV, a range which was more than adequate to fill existing needs. This arrangement was more stable than a 4 kV power pack (type 200) which had been used on some preliminary work. In addition it afforded more sensitive variation of the applied voltage.

The probe modifications consisted of increasing the magnitude and duration of the quenching pulse. This,

in the form of a square wave of 1 millisecond duration, lowered the anode potential by 360 volts after each pulse. It has been found^(11,46) that this modification effects a significant improvement on the slope and length of the plateau.

Experimental Procedure:

a) Counter Filling:

The apparatus is shown in figure 11. Carbon dioxide was stored in a 2-litre sphere behind tap T_1 and carbon disulphide behind a mercury cut-off. Each was purified before storage, ready for use, by repeated vacuum distillation at -78°C . In this way water and air were quantitatively removed, these being the impurities which have particular effect in impairing the performance of the filling gas.

Carbon disulphide was first admitted to the counter at 2 cm pressure. Tap T_5 was then closed. Carbon dioxide was admitted, either from the reservoir for a background determination or from a sample plus additional reservoir inactive material, so as to fill the counter to 10 cm pressure of carbon dioxide in either case. This was effected by filling the space bounded by taps T_1 and T_4 , valve V_1 and the right-hand limb of manometer M_1

(of a previously calibrated volume) to a suitable pressure such that when the gas was transferred into the counter it filled it to a pressure of 10 cm. For this operation the volume of the counter had to be calibrated. The transfer was carried out by either pumping it in, using the Toepler pump, or by distillation into the cold finger using liquid nitrogen. Adequate mixing was essential and was most easily effected by rapid condensation of the filling into the cold finger followed by equally rapid re-evaporation. This was performed several times before the counter was removed to the castle for counting.

Counting Procedure:

The starting voltage showed small but definite variations. Consequently a plot of the plateau was made for each filling and from it the optimum operating voltage assessed (One-third of the way along the plateau). The operating voltage fell in the region of 2240 to 2300 volts and the plateau (140 to 170 volts long) had a slope of 3 to 5 per cent per hundred volts length. Plateau determinations were aided where necessary by the use of an (external) ^{60}Co source.

Accuracy of Measurement

In actual counting measurements wherever possible, a minimum of 10,000 disintegrations were recorded. In consequence, standard deviation was kept to a maximum of 1%.

The gas volumetric part of the overall measurement can be held accurate to $\pm 2\%$ or better. (A basic assumption made for estimates of carbon dioxide yields from methane estimation was that carbon dioxide behaves as a perfect gas. This assumption was also made for volume calibration). It seems probable that the overall error of the overall measurement is about $\pm 3\%$. It may be noted that very good agreement was found between duplicate analyses of specific activity measurements. ($\pm 1\%$ in each of two separate pairs of determinations).

A common error by which this work was, fortunately, not affected, is that of the "memory" effect. "Background" determinations were made between successive assays of radioactive samples, but showed no significant variation over the whole course of these investigations. It has often been found in the past that part of the activity is left behind in the counter.

Use of Radioactive Measurements

The potentialities of such a tool in a problem of

this nature are very great. It can be used for qualitative as well as quantitative measurements. In these investigations it was used chiefly in the method for methyl iodide analysis, though some use was made of the method as used by Brown,⁽¹¹⁾ for the estimation of the relative contribution of methyl and carbonyl groups to the carbon dioxide yield. It can also be used for similar estimates of other products - carbon monoxide may be mentioned as one particular example. It will be remembered that in this case the methyl carbon atoms, only, were labelled with ^{14}C . If a generally labelled acetone molecule had been used, no such estimates could have been made.

Specific Activity of the Labelled Acetone

Two methods are available for the estimation of this quantity, each of which entails the ultimate formation of carbon dioxide for counting in the usual way. It can either be formed by complete combustion of the acetone itself or by combustion of a product of the photolysis such as methane or ethane. In the latter case it is known that such products are, in the case of photolysis of acetone alone, the sole products of methyl radicals and as such would give the specific activity of the methyl groups. To give this specific activity using the first

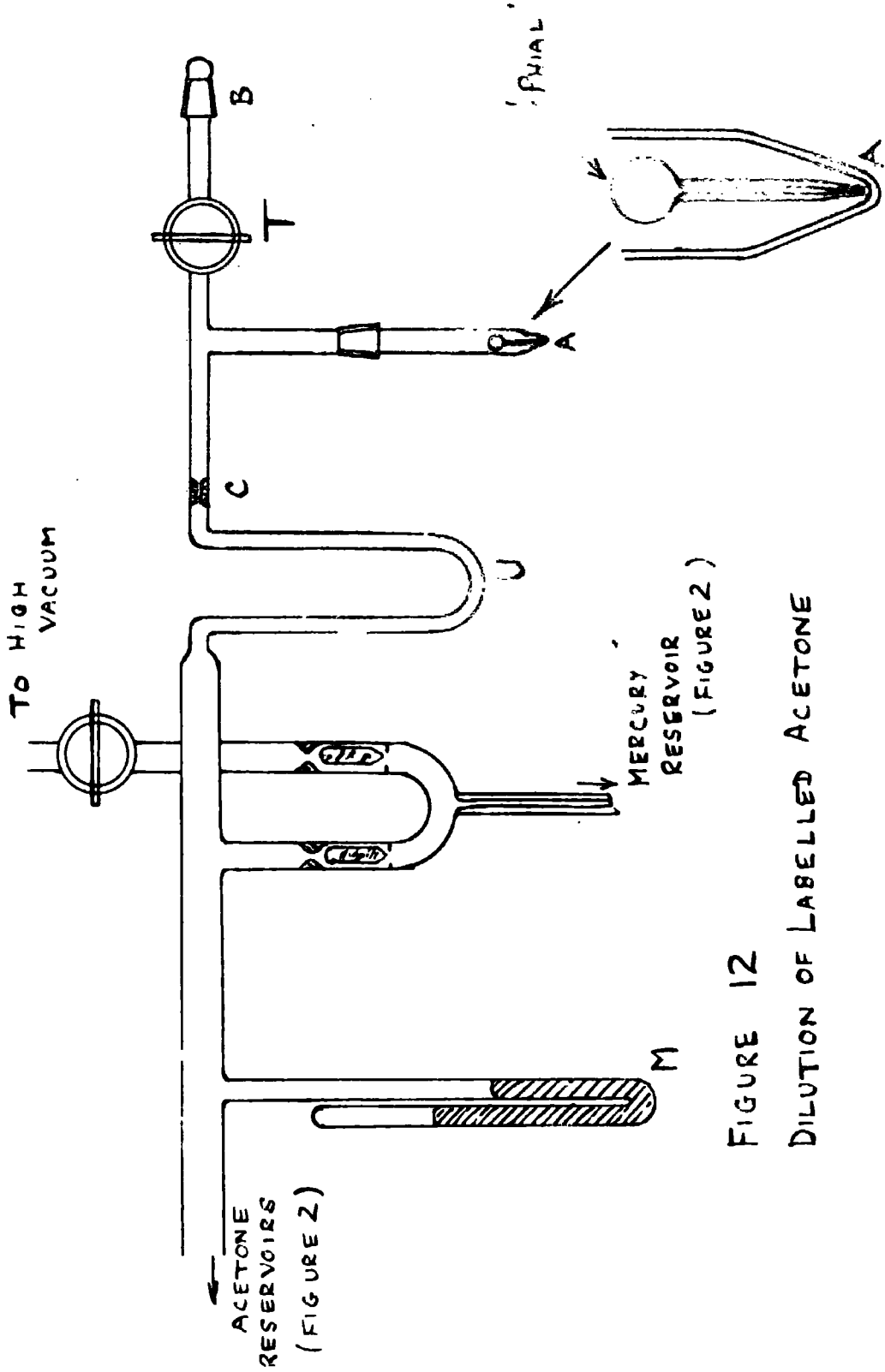

FIGURE 12
DILUTION OF LABELLED ACETONE

method the measured specific activity would need to be multiplied by 1.5, the carbonyl group having been oxidised to CO_2 , always inactive. It was felt that the acetone combustion is more direct and open to less error than the methane / ethane method (which would require prolonged photolysis), and was the method chosen for this work.

Purified radioactive acetone was used, freed from the radioactive impurity as described in section (A) of this chapter. Even as stored ready for use its specific activity was still too high for this determination. Consequently a sample from a further dilution was burned.

Dilution Procedure

The apparatus is shown in figure 12, being attached to the acetone storage reservoir section. Its purpose was to withdraw a small sample of acetone in a way which allowed direct weighing. At the same time the sample had to be kept sealed between withdrawal from stock and dilution with a known amount of inactive acetone.

The phial, made from a piece of drawn-down pyrex tubing, was placed with its tapered end at the lowest point of the thimble at A. After evacuating and isolating the apparatus, acetone was admitted from the reservoir of radioactive material, to a pressure such that about 100 mgm. would be present. (The volume had previously

been calculated), It was quickly condensed at the tip of A by means of liquid nitrogen. A further Dewar flask of liquid nitrogen was placed round the U-tube U (packed with gold foil) as soon as the bulk of the acetone had condensed. This prevented condensation of mercury into A whilst the next stage was in progress. The constriction C was then sealed. The acetone was allowed to melt by placing round A a 'Drikold' bath (-78°C). The plug at B was removed and T was slowly opened. This had the effect of filling the phial by the difference in pressure so produced. The phial was removed and sealed by dipping the end (only about 2 mm) in a small but hot oxy-coal gas flame. This seal had the merit of not causing any loss of glass or contents. Accordingly by weighing it with the acetone, the weight of acetone taken could be accurately found, the phial having been weighed empty beforehand. This is a much more accurate method than the alternative of gas volumetric dosing.

About 5 gm of 'AnalaR' grade acetone was accurately weighed into a test-tube fitted with a standard ground joint and stopper. The phial was dropped in and its contents released by crushing with a glass rod. After mixing the diluted radioactive acetone was ready for use.

Combustion

About 0.01 ml of the diluted acetone was placed in a thimble in the methane combustion apparatus (figure 8) in the place where a methane sample was normally introduced (B). It was frozen with liquid nitrogen whilst the section was evacuated. It was then transferred into the furnace section and circulated until combustion was complete. It was possible to judge when it had gone to completion by the increase in volume of the gas which, as represented by the equation below, would be six-fold.

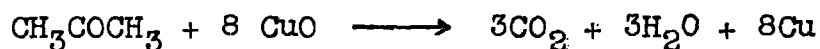

In practice small droplets of water began to condense in the tubing around the U-tube U when oxidation was nearing completion.

Estimation

Carbon dioxide and water, the products of the combustion, were condensed out at U with liquid nitrogen. This was then replaced by a bath, of melting $40^\circ\text{-}60^\circ$ petroleum ether (at about -135°C) allowing the carbon dioxide to evaporate away from the water, to be condensed again in the sample tube S.T. In this way any traces of unburnt acetone were left behind with the water at U. This carbon dioxide was transferred to the filling

system. After estimation of the amount of carbon dioxide in the sample, it was made up into a filling in the way already described and counted.

From a knowledge of the amount of carbon dioxide obtained from the combustion and the dilution, the amount of the original (reservoir) acetone could be calculated and hence the specific activity of the stored radioactive material.

Two such estimates were made from each of two dilutions. Agreement was good, both between duplicate analyses from any one dilution, and between the mean of each dilution. (About 1% and rather less than 2% respectively). The mean value of all analyses was taken for use in calculation of product yields.

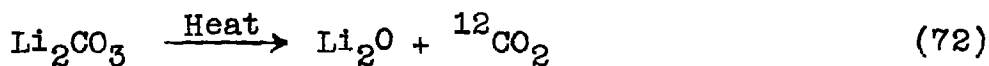

Attempts were made to remove the impurity by passing it through a column packed with 'Carbosorb' (self-indicating soda-asbestos) but were completely unsuccessful. It was concluded that the impurity was definitely not carbon dioxide.

An important observation was made in the course of a run using radioactive acetone. Photolysis had been carried out in the presence of oxygen and the carbon dioxide fraction showed an activity of 70 ± 2 counts per minute. A 'blank' check ^{was} made by adding a small amount of carbon dioxide (about 10^{-6} g. mole) to a sample of radioactive acetone equal to the amount previously photolysed. On extracting and counting, the carbon dioxide was found to have an activity of 65 ± 3 counts per minute. Some seven months previously, a similar blank check had shown an activity of 19 ± 2 counts per minute. It was therefore evident that the impurity was growing in the stored acetone. This is good indication that the impurity was being produced by radiolysis. Photolysis by stray U.V. could be ruled out because the acetone had been stored in the dark-surrounded by black paper. In view of the behaviour of its vapour pressure, of the possible products of radiolysis it can only be ethane.

This conclusion, whilst gratifying in so far as identifying the impurity, did not assist in its removal. Being so chemically inert the only satisfactory method is that of fractional distillation. It does, however, pose a problem - that of the extent of other impurities. This is a problem which would require a detailed knowledge of the β -radiolysis of acetone before a reliable answer could be formulated. Whilst on the basis of the rate of decay of the parent acetone, the level of impurities such as ethane can become quite high they are still far from being of chemically quantitative significance. Radiochemically, the impurities might result in an error in the specific activity as measured. It is however gratifying to note that Brown⁽¹¹⁾ obtained identical results from calibration runs on radioactive acetone as with inactive material.

5. THE PHOTOLYSIS OF ACETONE(A) CALIBRATION: THE PHOTOLYSIS OF ACETONE ALONE

The photolysis of acetone alone was not studied except insofar as it provided a basis for calibration of the system and estimation of yields per quantum of radiation absorbed - ~~the so-called "quantum of radiation absorbed"~~ the so-called "quantum yield". It has long been established⁽²⁾ that the quantum yield of carbon monoxide on photolysis of acetone at temperatures around 100°C or higher is equal to, or very close to, unity. It therefore provides a very convenient actinometric standard.

The absorption of U.V. by acetone vapour follows the relationship:

$$I_t = I_0 e^{-\mu p}$$

where $I_t = I_0$ are the intensities of the transmitted and incident radiation, p the pressure of acetone and μ a constant. Consequently:

$$I_0 - I_t \text{ (= absorbed intensity, } I_a) = (e^{+\mu p} - 1) I_t$$

Thus if p is held constant we may write

$$I_a = k I_t \text{ (where } k \text{ is a constant)}$$

An arbitrary measure of I_a may thus be achieved by

RUN NO.	ACETONE PRESSURE (MM Hg AT 120°C)	DURATION OF IRRADIATION (MINUTES)	TRANSMITTED INCIDENT		$\frac{I_0 - I_t}{I_0}$	CARBON MONOXIDE YIELD G.MOL; x 10 ⁻⁷	I ABSORBED QUANTA/ML/SEC x 10 ¹²	CALIBRATION FIGURE G.MOL CO/MIN/UNIT I _t x 10 ⁻⁹
			(I _T) ARBITRARY	INTENSITY (I ₀) UNITS *				
C1	32.2	3.0	106.8	-	-	10.1	5.67	3.15
C2	32.8	3.0	106.3	137	0.226	10.0	5.60	3.13
C3	32.5	4.0	117.5	145	0.177	14.4	6.06	3.06
C4	32.3	4.0	97.7	122	0.199	11.2	4.72	2.87
C5	33.5	4.0	93.0	123	0.244	11.3	4.76	3.05
E1	130.8	10.0	24.0	62.5	0.616	15.8	2.66	6.59
E2	130.2	10.0	23.6	59.6	0.596	14.8	2.49	6.28
G33	32.6	8.0	47.3	57.7	0.184	12.2	2.57	3.23
G36	33.3	10.0	37.7	48.3	0.230	12.3	2.07	3.26
G37	32.8	10.0	51.8	61.0	0.185	17.0	2.86	3.28
G38	32.0	10.0	42.6	-	-	14.0	2.36	3.29
G45	32.6	10.0	41.9	53.4	0.214	13.7	2.31	3.27
J1 ^X	32.0	10.0	41.4	50.8	0.185	15.7	2.65	3.79
J2 ⁺	32.7	10.0	37.9	47.2	0.197	14.6	2.46	3.85
J3	32.8	10.0	38.8	46.9	0.190	15.1	2.54	3.89

* Comparable only between runs headed by the same initial letter.

X 4.4 mm. n-hexane added; + 8.2 mm n-hexane added.

TABLE 1. CALIBRATION RUNS

measuring I_t - a quantity much more easily measured than I_a which requires a knowledge of I_0 .

In the course of a calibration run, the average value of I_t during irradiation was recorded (as also in other runs) in terms of the current produced by the action of the transmitted beam on the photocell (see Chapter 4). Following the estimation of the yield of carbon monoxide, the yield of any product of a subsequent irradiation to be expected per unit quantum yield could be calculated from a knowledge of the value of I_t during the irradiation. By comparing this figure with the observed yield, the quantum yield of the product could be calculated.

Details of calibration runs are set out in Table 1. Acetone pressure was held effectively constant such that no correction due to variation of acetone pressure was required. At constant I_0 :

$$\frac{(I_t)_1}{(I_t)_2} = e^{-\mu(p_1-p_2)} \approx 1 - \mu(p_1-p_2)$$

Experimentally observed values of I_t/I_0 enable μ to be calculated. The average found was about 0.006. It will be seen that with normal variation of acetone pressure (usually less than ± 0.5 mm.) the correction is quite insignificant.

Calibration runs were performed fairly frequently - usually at the beginning and end of a set of runs. It was essential that the response of the photocell should remain constant. Towards the end of this work it did begin to falter and some runs were discarded in consequence. Only sets of runs between calibration runs showing reasonable agreement have been accepted. Other factors influencing the value of I_t as measured, such as the position of the photocell and reaction vessel relative to the beam, did not alter - being exactly maintained from run to run.

RUN NO.	ACETONE PRESSURE (MM. Hg AT 120°C)	OXYGEN PRESSURE (MM. Hg AT 120°C)	DURATION OF IRRADIATION (MINUTES)	I TRANSMITTED (ARBITRARY UNITS)	I ABSORBED QUANTA/ML/SEC x 10 ⁻¹²	Φ_{CO}	Φ_{CH_2O}	
C16	32.9	0.095	0.50	95.8	4.91	0.97	↑ NOT DETER- MINED ↓	
C14	31.9	0.18	1.0	81.1	4.16	0.72		
C13	32.5	0.43	2.0	78.9	4.09	0.41		
C10	33.5	0.68	2.0	82.1	4.21	0.34		
C17	32.4	1.08	3.0	84.2	4.32	0.26		
C12	32.8	1.51	3.0	84.1	4.31	0.19		
C19	32.9	2.20	4.0	87.3	4.48	0.20		
C18	32.1	4.09	4.0	89.8	4.61	0.20		
C15	32.3	5.04	3.0	83.4	4.28	0.22		
C24	32.7	0.099	0.50	87.8	4.50	↑		2.30
C23	32.8	0.22	1.0	78.0	4.00	↑		1.82
C22	32.1	0.51	2.0	87.1	4.47	↑		1.14
C20	32.7	1.08	3.0	74.6	3.83	NOT DETER- MINED		0.90
C25	32.1	2.45	4.0	80.1	4.11	NOT DETER- MINED		0.76
C21	32.2	4.30	4.0	75.6	3.88	NOT DETER- MINED		0.69
E9	129.0	0.076	0.33	22.9	2.45	↓	1.28	
E8	128.0	0.147	0.67	27.6	2.95		2.17	
E7	128.0	0.30	1.25	22.6	2.42		2.04	
E6	128.8	0.52	3.0	23.5	2.52		1.26	
E5	130.5	1.20	5.0	25.3	2.71		0.77	
E4	129.9	2.41	10.0	24.1	2.58		0.58	
E3	130.2	4.86	7.0	24.6	2.63		0.44	
H2	32.1	1.08	10.0	45.2	2.47	Φ_{CH_2COOH} 0.01 ± 0.01		
H1	32.2	3.07	15.0	43.2	2.36	0.01 ± 0.005		
H3	32.9 to 32.3	45 to 2.7	100.0	38.4	2.10	0.002 ± 0.001		

TABLE 2. PHOTOLYSIS OF ACETONE IN THE PRESENCE OF OXYGEN.

5(B) THE PHOTOLYSIS OF ACETONE IN THE PRESENCE OF OXYGEN

Following development of suitable techniques as described in the previous chapter, a programme of work was undertaken in which acetone was photolysed in the presence of oxygen. This work is a direct extension of that of Brown⁽¹¹⁾ working in this laboratory. The products studied consisted of carbon monoxide, formaldehyde and acetic acid. Detailed results are shown in Table 2.

Oxygen:

The pressures quoted are calculated means on the assumption that the quantum consumption of oxygen ($\bar{\Phi}_{-O_2}$) was 4. This is the value found by Marcotte and Noyes^{(23), (24)} for oxygen pressures up to 0.5 mm. It should be noted that no values are available for oxygen pressures in excess of this, though there is a suggestion from the results of Marcotte and Noyes that it may decrease at higher oxygen pressures. A reliable mean could therefore be calculated for low oxygen pressures (below 0.5 mm). Though the calculation for higher pressures was subject to a possible error, the proportion consumed was less and the error was thought to be negligible. An example will illustrate this point. At an oxygen pressure of 0.1 mm, 10 per cent of the oxygen

was consumed whilst at 4 mm consumption was only 2 per cent. (Each calculation based on $\bar{\Phi}_{-O_2} = 4$). Ideally the oxygen pressure should be maintained constant throughout. The constancy achieved was felt to be sufficiently close.

Acetone.

Pressures were maintained from run to run in a particular series to within ± 3 per cent measurement could be made to ± 0.5 per cent or better, depending on the particular value (32 or 130 mm). Consumption of acetone was very low - less than 0.2 per cent, so that the pressure was constant for all practical purposes.

Temperature.

This was maintained at 120°C within less than 0.5°C. No other temperature was used in these studies.

CARBON MONOXIDE

The production of carbon monoxide was studied over a range of oxygen pressures (0.095 to 5.04 mm) at one acetone pressure only (32 mm). Estimates were made of total yield, no separate assay being made of the relative contributions from methyl and carbonyl groups.

The results show a trend similar to that found by other workers^(24,11). In particular they show good agreement with

poor at higher pressures but it is noticeable that Christie's results vary by as much as 30 per cent between the two methods, and the reproducibility is only good to 10 per cent at best. This compares with a reproducibility better than ± 2 per cent found in duplicate runs here.

ACETIC ACID

Hoare⁽²⁵⁾ reported the presence of acetic acid in the products of photo-oxidation. This was followed by a claim of Christie that it was present in quantum yield "of at least unity". Her method being suspect following critical examination of the work and from the work of Brown⁽¹¹⁾, some experiments were undertaken in an attempt to elucidate the position. The analytical method was that previously described in Chapter 4(C).

An acetone pressure of 32 mm was employed for all runs. Two runs (H1, H2), at 1 and 3 mm oxygen pressure respectively, failed to detect any acetic acid. A further run (H3) of unusually long duration (100 minutes) also failed and in so doing set the upper limit for Φ CH₃COOH at below 0.01. It is possible that some may be found under ^{other} conditions though this is somewhat doubtful. In any event it seems hardly likely that it could constitute a major product.

it is easily conceivable that values might be obtained which are in the region of 3. This clearly indicates that the mechanism proposed by Christie⁽²⁶⁾ is inadequate as far as formaldehyde is concerned. Alternative or additional reactions are required, a topic which will be discussed in a later chapter (7).

Work at 130 mm acetone pressure by Marcotte and Noyes suggests that the maximum value of $\bar{\Phi}_{CO}$ is attained at an oxygen pressure of 0.02 mm or less. This is very much smaller (about $\frac{1}{10}$) than that at which $\bar{\Phi}_{CH_2O}$ attains its maximum value. The way in which the yields fall off as oxygen pressure is increased do however show striking similarity. A quantitative similarity can be seen on comparing results obtained at an acetone pressure of 32 mm. Though the accuracy of the values of $\bar{\Phi}_{CO}$ are generally inferior to those of $\bar{\Phi}_{CH_2O}$ (and particularly so at oxygen pressures above 1 mm), it appears that $\bar{\Phi}_{CH_2O}$ is still decreasing when $\bar{\Phi}_{CO}$ has reached an apparently constant value.

Mention may be made of a comparison of these results against those of Christie. Results agree tolerably well at the lower end of the range of oxygen pressure and, indeed, with regard to the position of the maximum. Agreement is

those of Brown⁽¹¹⁾, filling in some of the detail missing from his results. It is evident from a graphical representation of the results (figure 13), bearing in mind that the value of $\bar{\Phi}_{CO}$ in the absence of oxygen is unity, that there must be a peak in the region 0 to 0.1 mm of oxygen. It is unfortunate that it was beyond the limitations of the apparatus to investigate $\bar{\Phi}_{CO}$ in this region.

FORMALDEHYDE:

Studies were made over a range of oxygen pressure (0.08 to 5 mm). Two acetone pressures were employed - 32 and 130 mm.

The results (Table 2) are set out graphically in figures 14A and 14B. It will be seen that the peak appears to lie in the region of 0.15 and 0.20 mm oxygen pressure at the lower and higher acetone pressures respectively. Whilst the exact position of the maximum cannot be located with certainty it does appear probable that its magnitude decreases as acetone pressure increases - a trend shown at all comparable oxygen pressures.

The absolute values of $\bar{\Phi}_{CH_2O}$, and particularly the higher ones are of especial interest. It has been clearly established (runs C23, C24, E7, E8) that values in excess of 2.0 occur and in the case of acetone at 32 mm pressure

FIGURE 14B
ACETONE PRESSURE = 130 MM Hg

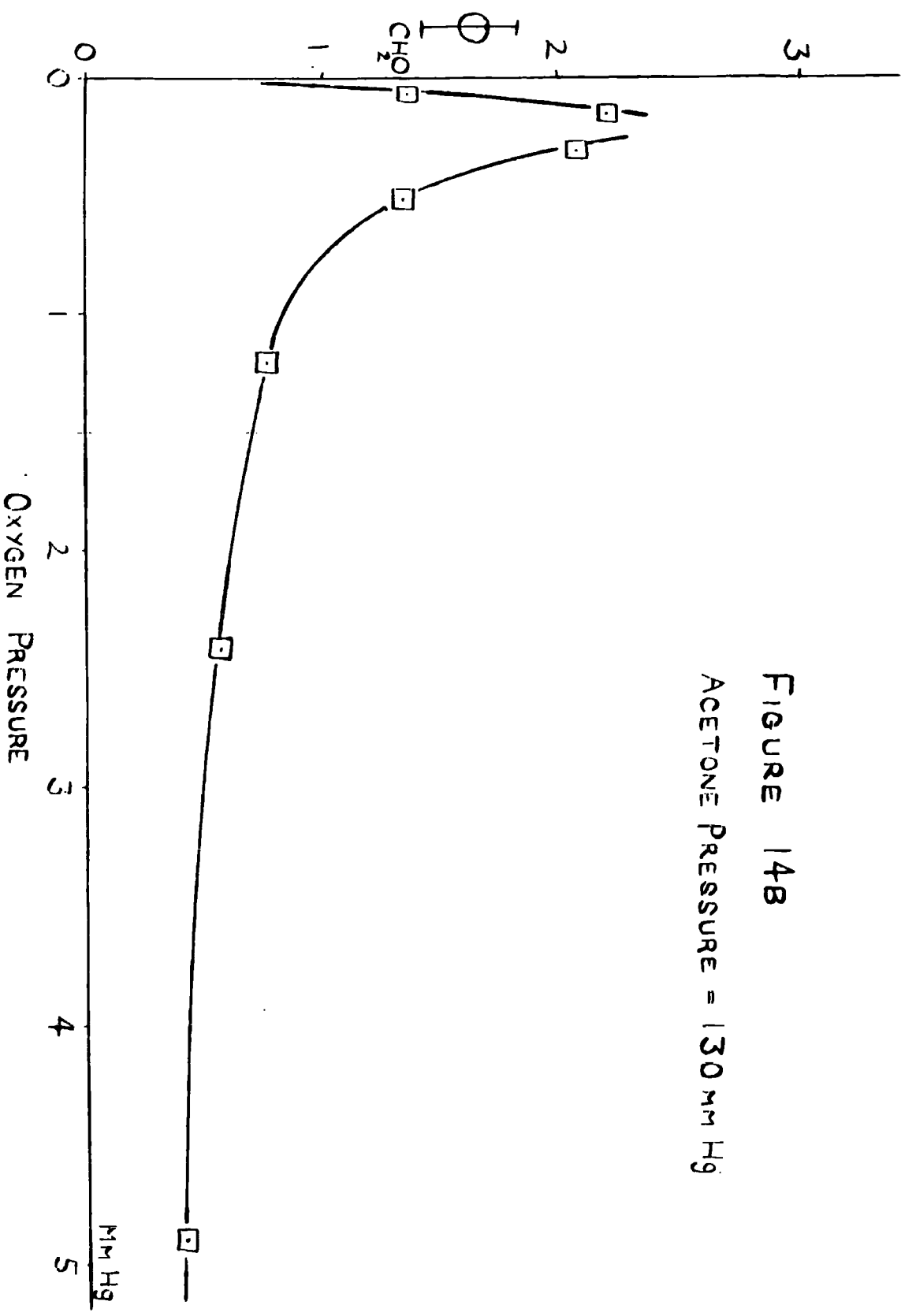

FIGURE 14A

ACETONE PRESSURE = 32 mm. Hg

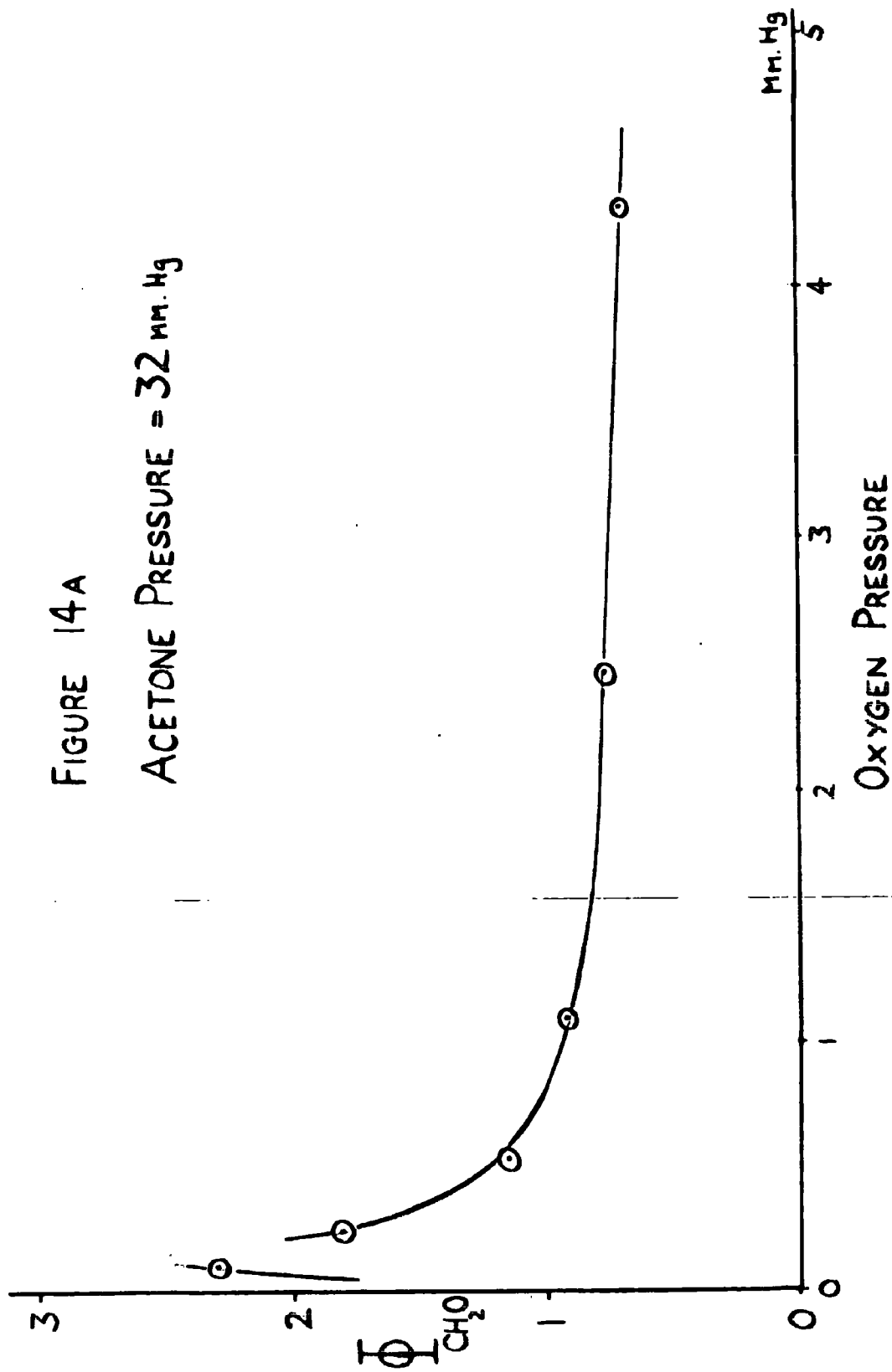
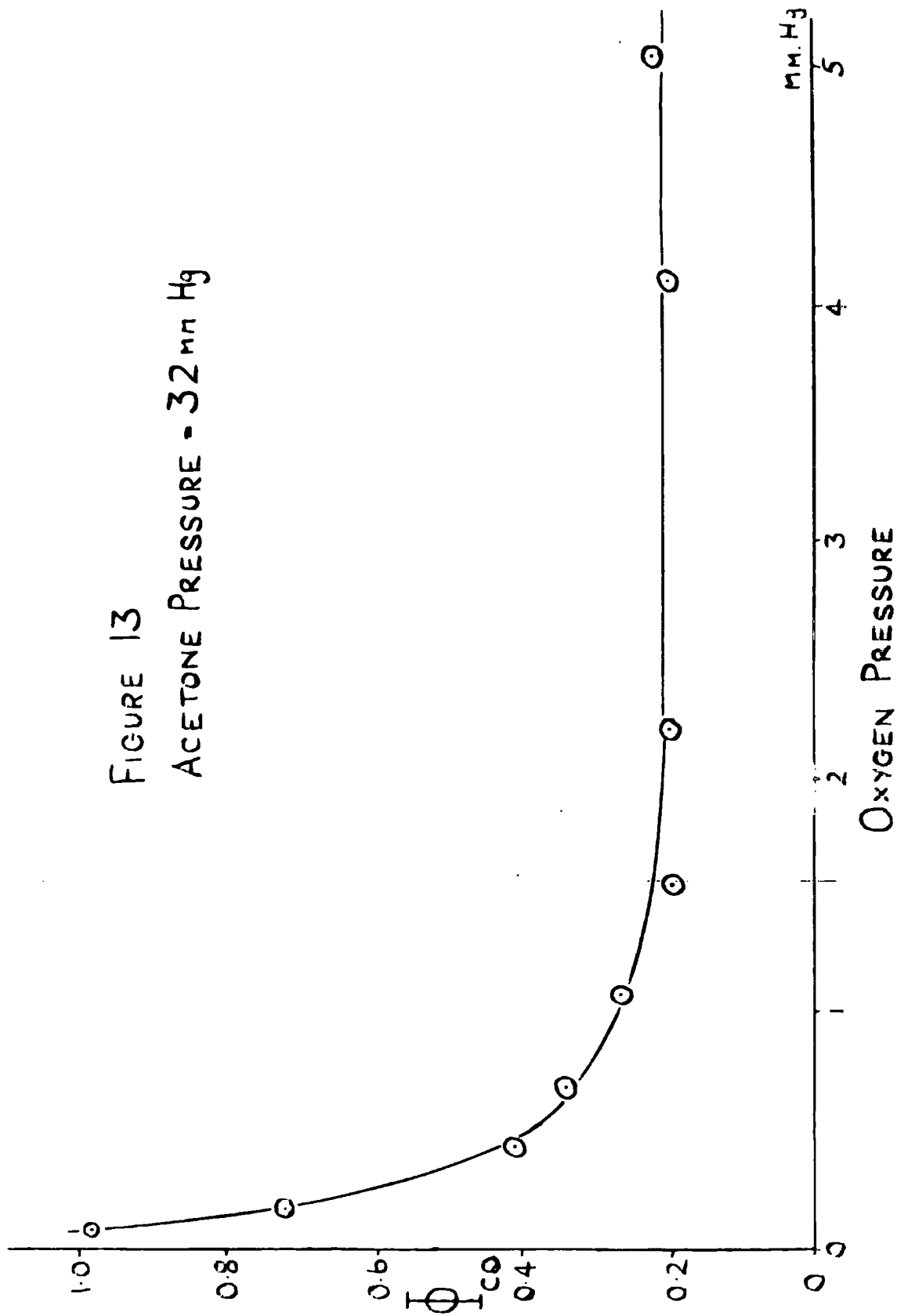

FIGURE 13
ACETONE PRESSURE = 32 mm Hg



RUN NO.	ACETONE PRESSURE (MM. Hg AT 120°C)	OXYGEN PRESSURE (MM. Hg AT 120°C)	IODINE PRESSURE (MM. Hg AT 120°C)	DURATION OF IRRADIATION (MINUTES)	I TRANSMITTED (ARBITRARY UNITS)	I ABSORBED QUANTA/ML/SEC $\times 10^{12}$	Φ_{CH_2O}	Φ_{CH_3I}
F8	32.6	0.057	1.11	15.0	78.9	4.05	0.0015	↑ NOT DETERMINED ↓
F3	32.0	0.184	1.06	10.0	72.4	3.72	0.0055	
F9	32.4	0.44	1.12	15.0	82.9	4.25	0.0040	
F2	32.6	0.69	1.03	10.0	71.4	3.66	0.0033	
F4	33.2	3.04	1.10	7.0	82.1	4.21	0.0033	
F16	32.1	5.49	1.10	12.0	75.0	3.85	0.0032	
F6	32.9	7.05	1.12	10.0	63.7	3.27	0.0034	
F13	32.4	3.32	0.077	2.0	68.0	3.49	0.069	
F14	32.1	3.32	0.135	4.0	73.5	3.77	0.044	
F11	32.7	3.34	0.28	8.0	68.6	3.52	0.014	
F10	32.8	3.30	0.58	12.0	66.8	3.43	0.0028	
G39	32.3	0	1.16	15.0	39.2	2.07	↑ NOT DETERMINED ↓	0.368
G40	32.3	1.02	1.16	15.0	41.9	2.29		0.356
G41	32.6	2.03	1.15	15.0	43.3	2.37		0.375
G34	32.7	2.50	1.16	15.0	47.8	2.61		0.379
G42	32.4	3.07	1.15	15.0	40.3	2.20		0.409
G43	32.1	4.11	1.16	15.0	36.1	1.97		0.427
G44	32.1	5.18	1.16	15.0	38.6	2.10		0.442
G35	33.3	5.98	1.14	20.0	51.3	2.80		0.01

TABLE 3. PHOTOLYSIS OF ACETONE IN THE PRESENCE OF OXYGEN AND IODINE.

TABLE 5

FLUORESCENCE OF ACETONE VAPOUR IN THE PRESENCE OF IODINE VAPOUR.

E.H.T. APPLIED TO PHOTOMULTIPLIER _____			900 VOLTS (-ve)		1000 VOLTS (-ve)	
TEMP- ERATURE C.	ACETONE PRESSURE CM. Hg	IODINE PRESSURE MM. Hg	R_Q/R_P		R_Q/R_P	
			OBSERV- ED	CORRECT- ED	OBSERV- ED	CORRECT- ED
51°C	9.4	1.02	0.16	0.08	0.37	0.21
	0.0	0.0	0.08	0.00	0.16	0.00
85°C	10.4	1.14	0.16	0.06	0.39	0.16
	0.0	0.0	0.10	0.00	0.23	0.00

TABLE 6

SUMMARY OF RESULTS

TEMPERATURE °C.	ACETONE PRESSURE CM Hg	IODINE PRESSURE MM Hg	FLUORESCENCE EFFICIENCY Q*		Q IN PRESENCE OF I ₂ Q IN ABSENCE OF I ₂	
			900 v.	1000 v.	900 v.	1000 v.
51°C	9.4	0.0	0.32	0.72	0.25	0.29
	9.4	1.02	0.08	0.21		
85°C	10.4	0.0	0.17	0.43	0.35	0.39
	10.4	1.14	0.06	0.16		

VALUES OF $Q_{51°C}/Q_{85°C}$

PHOTOMULTIPLIER APPLIED VOLTAGE	IN PRESENCE OF IODINE	IN ABSENCE OF IODINE
900	1.3	1.9
1000	1.3	1.7

* Fluorescence efficiency quoted in arbitrary units —

that is values of R_Q/R_P .

5(C) THE PHOTOLYSIS OF ACETONE IN THE PRESENCE OF OXYGEN AND IODINE

The idea of photolysing acetone in the presence of a mixture of both oxygen and iodine was first put into practice by Brown⁽¹¹⁾. Iodine and oxygen compete for the radicals formed from acetone and also for the acetone molecules excited by absorption of radiation. Comparison of the behaviour of these two reagents in this way can tell us much of the systems acetone-oxygen and acetone-iodine and, in addition, of the primary process. Brown's work was therefore extended, the present investigation being almost entirely concerned with a study of the production of methyl iodide and formaldehyde. Results are shown in table 3.

METHYL IODIDE

Brown's work had shown that, at constant acetone pressure (32 mm) and at constant oxygen pressure, the methyl iodide quantum yield, $\Phi_{\text{CH}_3\text{I}}$ was unaffected by variations in iodine pressure at the low pressure end (0.15 to 0.50 mm) of the range used but decreased considerably at higher values (2.4 mm). In addition, the effect of oxygen on acetone-iodine mixtures of various proportions was studied, acetone pressure being constant at 32 mm. The results

FIGURE 15

ACETONE PRESSURE = 32 mm Hg

IODINE PRESSURE = 1.16 mm Hg

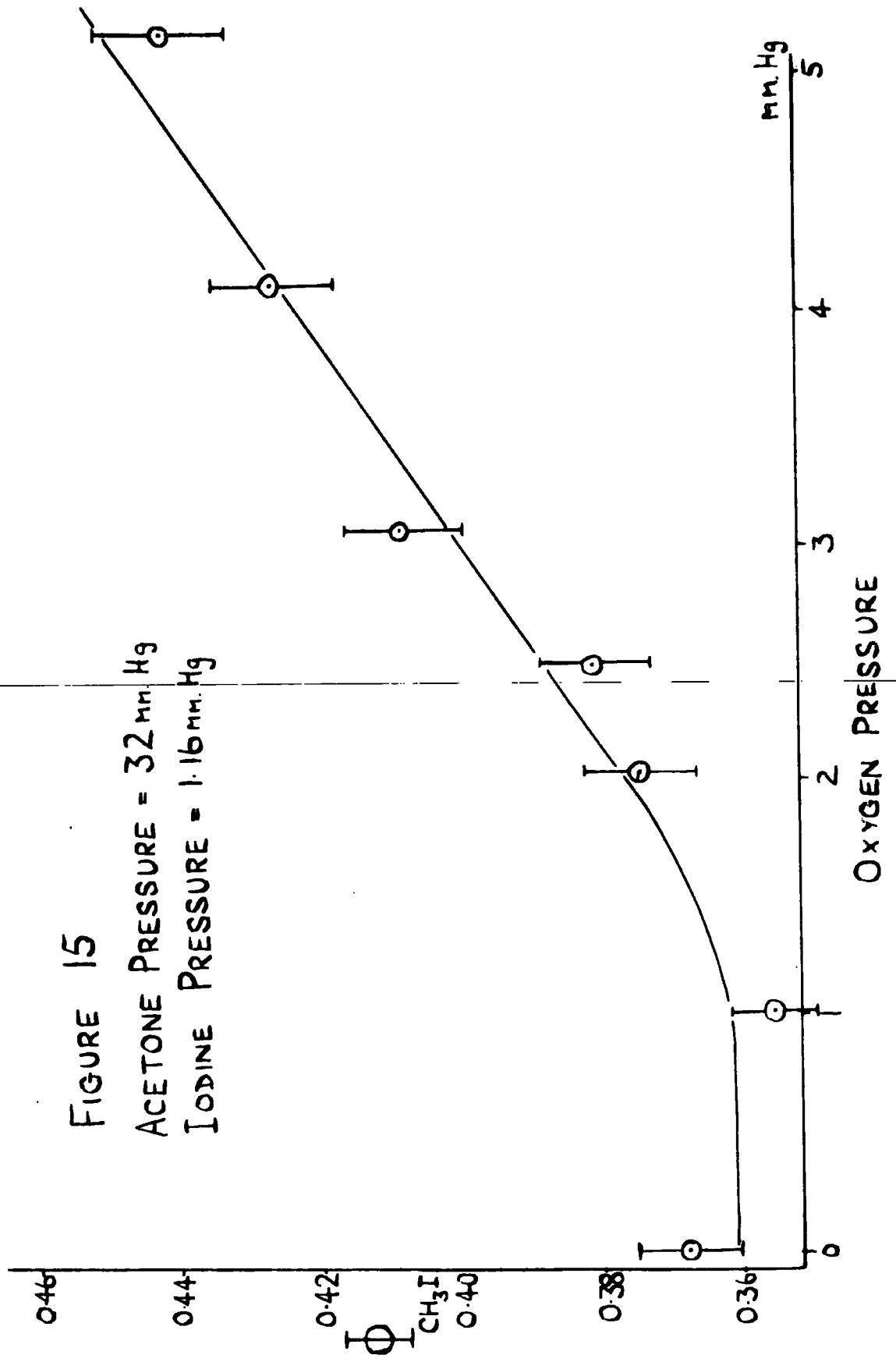

show that $\bar{\Phi}_{\text{CH}_3\text{I}}$ increases with increasing oxygen pressure at all iodine pressures except the highest used (2.44 mm).

Some experiments were performed to investigate this somewhat unexpected trend rather more fully than had been possible previously. An iodine pressure of 1.15 mm was chosen - intermediate between the two extremes used by Brown. The amount of iodine consumed during a run was always less than 3 per cent. (This was based on an assumed value for the quantum consumption of iodine of 0.5). The values of iodine pressure quoted in table 3 are mean pressures calculated on the basis of this assumption. Oxygen pressure was varied from 0 to about 5 mm. So little oxygen was consumed that its pressure remained constant to within less than 1 per cent.

The results are displayed graphically in figure 15. Bearing in mind the experimental errors to which the determinations were subject, it is suggested that the results can be relied on to ± 2 per cent but not closer. These are the errors shown in the graph. It will be seen that the trend shown by Brown to be characteristic of lower iodine pressures is displayed by these results though to a lesser extent. A characteristic not previously detected is the behaviour of $\bar{\Phi}_{\text{CH}_3\text{I}}$ over the lower oxygen pressure region.

Between 0 and 1 mm of oxygen, it is constant within the limit set by experimental error. At oxygen pressures higher than 1 mm, $\bar{\Phi}_{\text{CH}_3\text{I}}$ increases, the significant feature being that this part of the graph is approximately linear. This suggests that the increase is the result of a reaction (or sequence of reactions) dependent on oxygen to the first order.

In the course of this work it was possible to fill in part of the detail of Brown's work at constant oxygen pressure. Interpolation between runs G42 and G43 suggests $\bar{\Phi}_{\text{CH}_3\text{I}} = 0.42$ at $p_{\text{I}_2} = 1.15$ mm, $p_{\text{O}_2} = 3.36$ mm, a value in good agreement with values at other iodine pressures used in Brown's work. ($\bar{\Phi}_{\text{CH}_3\text{I}} = 0.47$, $p_{\text{I}_2} = 0.51$ mm; $\bar{\Phi}_{\text{CH}_3\text{I}} = 0.37$, $p_{\text{I}_2} = 2.43$ mm). Where a direct comparison is possible agreement is good.

CARBON DIOXIDE

This quantity was estimated in only one run (G35). From Brown's data it appeared probable that $\bar{\Phi}_{\text{CO}_2}$ increases as oxygen pressure increases. This was indeed found to be so in the one experiment carried out. Oxygen and iodine pressures employed were 5.98 mm and 1.14 mm, respectively. A value of $\bar{\Phi}_{\text{CO}_2}$ of 0.44 was found, of which less

than 0.01 was of methyl origin. This is far in excess of any values found by Brown which were at lower oxygen pressure. Whilst it might have been useful to investigate this aspect further, it was not possible to carry out any more of this type of experiment in the time available. We are thus left with the suggestion that, ^{as with} the methyl iodide, $\bar{\Phi}_{\text{CO}_2}$ is dependent on oxygen pressure in that it increases as oxygen increases.

FORMALDEHYDE:

Yields of this product in the presence of iodine are very small. A highly refined technique was needed to estimate such small quantities (often no more than 9×10^{-9} g.mol.). This was provided by the colorimetric analysis technique modified as already described. It was however not possible to maintain the degree of reproducibility hitherto attainable. The lowest values of $\bar{\Phi}_{\text{CH}_2\text{O}}$ are probably reliable to no more than ± 10 per cent though higher yields are dependable to a greater degree.

Studies were confined to one acetone pressure (32 mm). Both iodine and oxygen pressures were varied. The former is quoted as an estimated mean on the assumption that $\bar{\Phi}_{-\text{I}_2} = 0.5$. This is approximately true at very low iodine

FIGURE 16

ACETONE PRESSURE = 32 mm. Hg

IODINE PRESSURE = 1.15 mm Hg

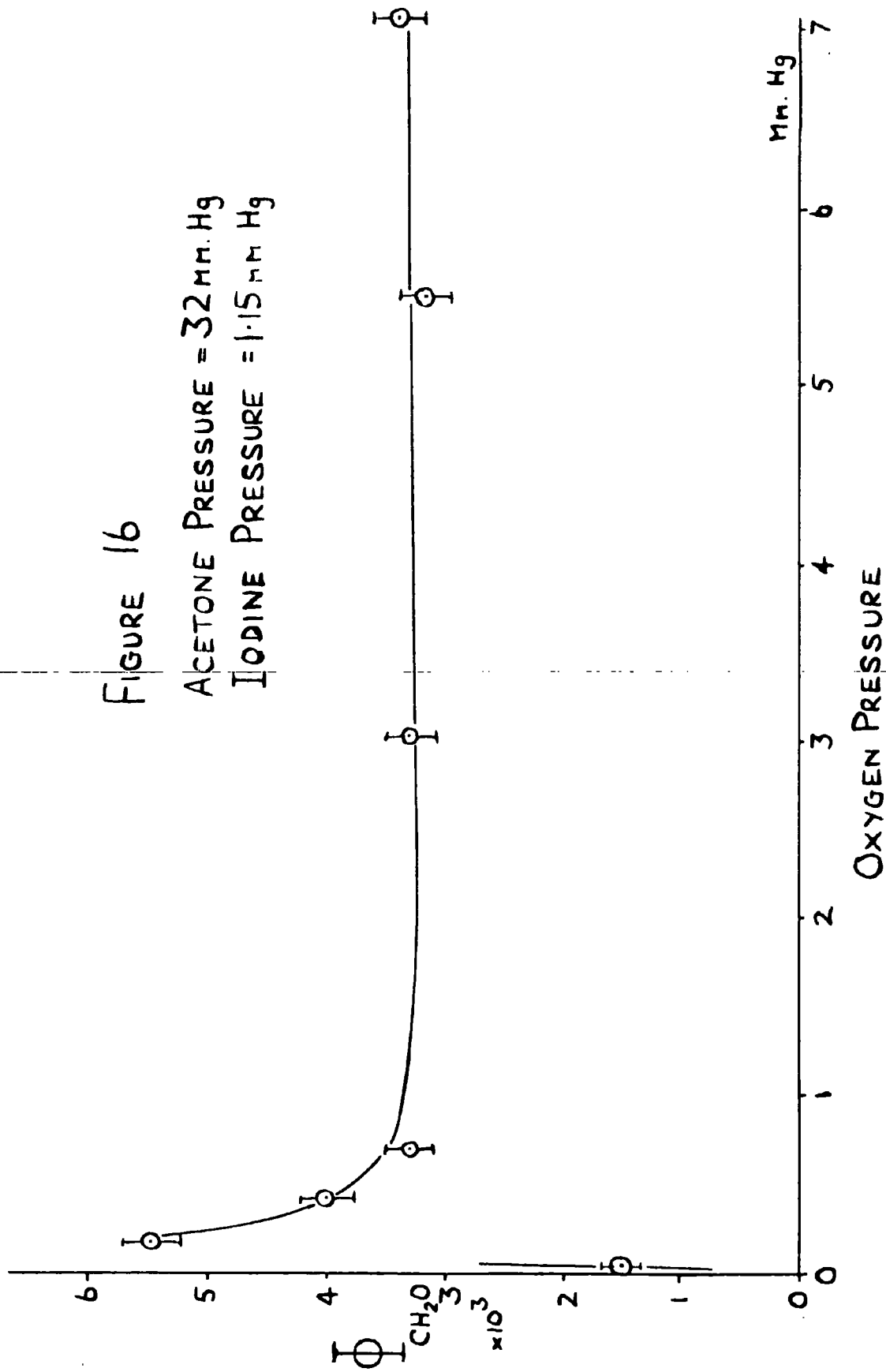

pressures - the region where the correction was most significant. In extreme cases as much as 10 per cent of the iodine is calculated to have been consumed. At 1.15 mm iodine pressure only 3 per cent was consumed. The amount of oxygen consumed, on the basis of yields of oxygenated products, was so small that the pressure remained effectively unaltered. The investigations fall into two sections - at constant iodine pressure, oxygen pressure being varied; and vice-versa.

At a constant iodine pressure of 1.15 mm, oxygen pressure was varied over the range 0.057 to 7.05 mm. The results (table 3) are shown graphically in figure 16. The shape is similar to that found in the absence of iodine and, as far as can be determined by comparison with figure 14(A), the position of the 'peak' is not altered by addition of iodine. The factor responsible for the presence of this peak is therefore still active in the presence of iodine though to a very much less extent. It seems probable, though not proven, that the maximum never attains as high a value relative to that at high oxygen pressures in the presence of iodine as in its absence.

At constant oxygen pressure (3.32 mm) iodine pressure was varied over the range 0 to 1.15 mm. (Values for 0

FIGURE 17

ACETONE PRESSURE = 32 mm. Hg

OXYGEN PRESSURE = 3.32 mm. Hg

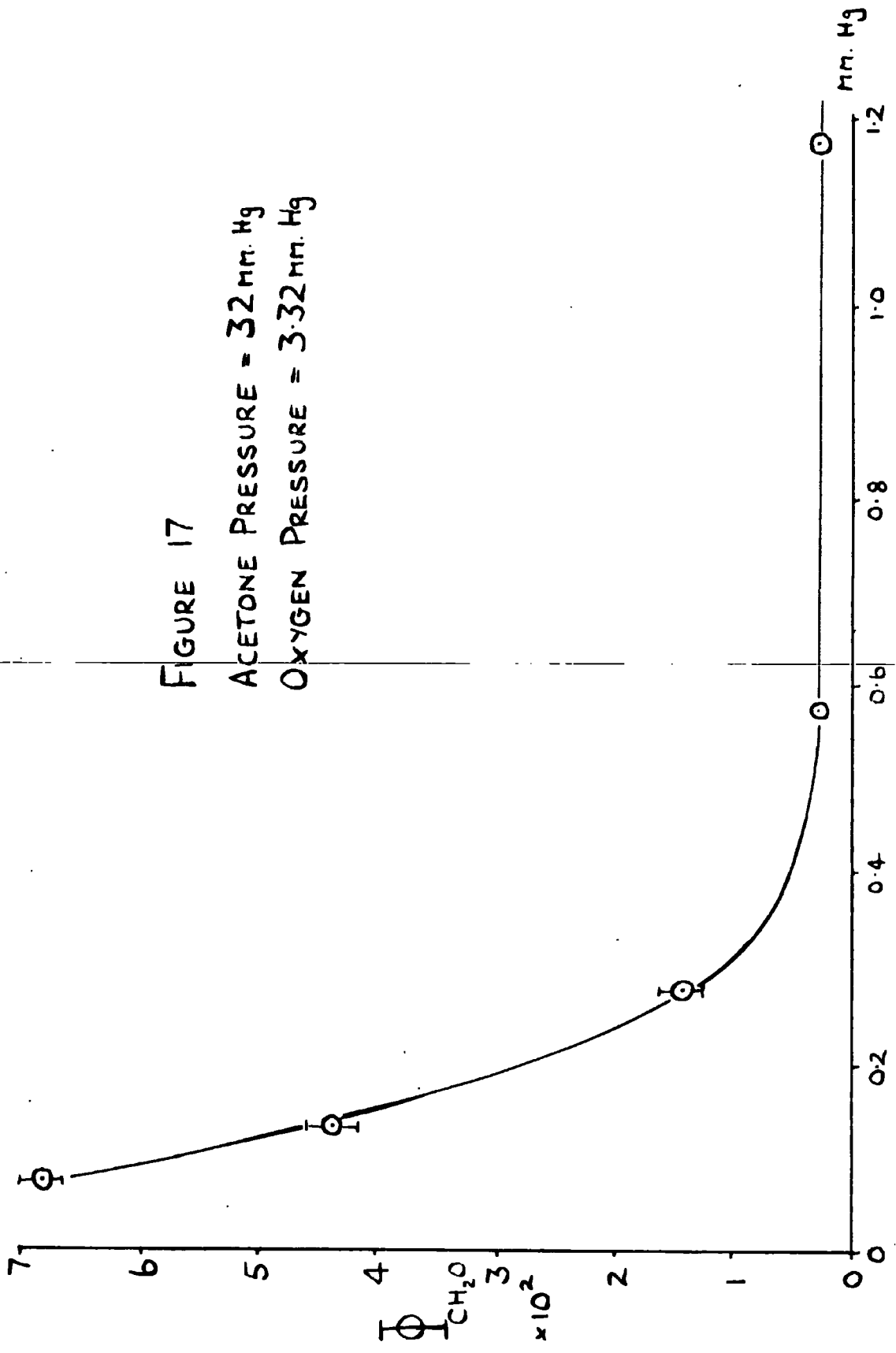

IODINE PRESSURE

mm. Hg

and 1.15 mm were obtained by interpolation of figures 14(A) and 16 respectively). The results (table 3, figure 17) demonstrate how quickly $\bar{\Phi}_{\text{CH}_2\text{O}}$ is reduced to almost negligible proportions by the addition of very small amounts of iodine.

Apart from the obvious qualitative significance of these results some important quantitative conclusions regarding the relative efficiencies of iodine and oxygen as methyl radical 'catchers' can be drawn. Not until the iodine pressure was reduced to below 0.5 mm (when $p_{\text{O}_2} : p_{\text{I}_2}$ was about 6:1) did the value of $\bar{\Phi}_{\text{CH}_2\text{O}}$ begin to increase. At an excess $p_{\text{O}_2} : p_{\text{I}_2} = 40:1$ the greater efficiency of iodine as a radical trap was sufficient to reduce $\bar{\Phi}_{\text{CH}_2\text{O}}$ to $\frac{1}{10}$ th of the value it showed in the absence of iodine. (These remarks refer to an oxygen pressure of 3.32 mm - figure 17). From the high oxygen pressure portion (about 1 mm) of figures 14(A) and 15, it will be seen that one part of iodine to six of oxygen is sufficient to bring down $\bar{\Phi}_{\text{CH}_2\text{O}}$ to about $\frac{1}{200}$ th of its former value. The extent of this reduction appears to be even greater at the peak region - about $\frac{1}{500}$! where direct comparison is possible. There is some uncertainty in assessing the extent of these ratios precisely but they are accurate enough to

show that the relative effect of iodine and oxygen is not quantitatively constant over the whole range of oxygen pressure. This is an important result as will be appreciated later.

APPENDIX: DEACTIVATION IN THE PHOTOLYSIS OF ACETONE

From studies of the photolysis and fluorescence of acetone it is firmly established that acetone, in certain state(s), after absorption of U.V. radiation, is susceptible to deactivation. Such deactivation can be brought about by oxygen, iodine, and, though with a lower efficiency, by acetone itself (in the 'ground' state). These are established examples of molecules which have this property, a property which may very likely be found to be exhibited by other substances. The topic of energy transfer in gaseous collisions has been the subject of a review by McCoubrey and McGrath⁽⁵⁷⁾. One generalisation which can be drawn from this paper is that polyatomic molecules show much greater efficiency than diatomic and monatomic molecules as agents for the transfer of energy from highly excited molecules such as those involved in the primary process in acetone photolysis. An investigation was planned in an attempt to discover other molecules which would deactivate the excited states of acetone. Relatively little work has been done in this direction, attention being turned to another aspect of this general field - the effect of iodine on such excited molecules as shown by its effect on their fluorescence.

The compound chosen for this investigation was n-hexane. Hopkin and Williams ~~laboratory~~ laboratory grade material was distilled through a small distillation column, the middle third, only, being taken. After checking its transparency to U.V. in the range 3,000 to 4,000 \AA , it was introduced into a storage bulb in the filling system and degassed at -130°C .

Photolysis of mixtures of n-hexane and acetone were carried out and analysis made for carbon monoxide (Runs J1 and J2, table 1). Comparison with a normal calibration run (acetone only - J3) shows that, in the proportions used, n-hexane has no detectable activating effect on acetone. (The consistency of values of I_t/I_0 is such that it can be assumed that n-hexane has no effect, in the proportion used, on the absorption coefficient of acetone.) The deactivating effect, if any, is probably smaller than for acetone itself, though further data would be required to be certain on this point. In any event its effect is so weak as to be quite negligible in comparison with the effects of oxygen and iodine.

This aspect of the work was, regrettably, left in an unsatisfactory state. Any such programme of work is likely to have to be extensive in order to be comprehensive.

Until some theory of high energy transfers of this type appears any such work must be of the 'trial and error' type.

6. ACETONE FLUORESCENCE: THE EFFECT OF IODINE.Introduction.

Current ideas on the mechanism of acetone-iodine photolysis require the postulation of two electronically-excited states, designated (Chapter 2(B)) by A' and A". A full discussion will be found in that chapter. Two mechanisms, as stated by Martin and Sutton⁽³⁾, and by Brown⁽¹¹⁾, each fit the data at present available. Their only difference lies in the deactivating role assigned to the acetone molecule and to the iodine molecule. Recapitulating:

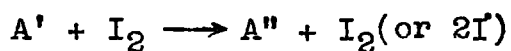
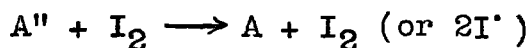
Martin & Sutton:Brown:

A' appears to be identical with state A* of the fluorescence mechanism (Chapter 2(C)) and A'' is possibly identical with A**, though this point has yet to be proved. In the absence of deactivating molecules and at temperatures below about 100°C, A** is responsible for more fluorescence, in terms of the intensity of light produced, than A*. Introduction of iodine should, if Martin and Sutton's scheme is correct, effect either (a) very little change in the intensity of fluorescence or (b) effect an increase. Case (a)

FIGURE 18 FLUORESCENCE APPARATUS (SCHEMATIC)

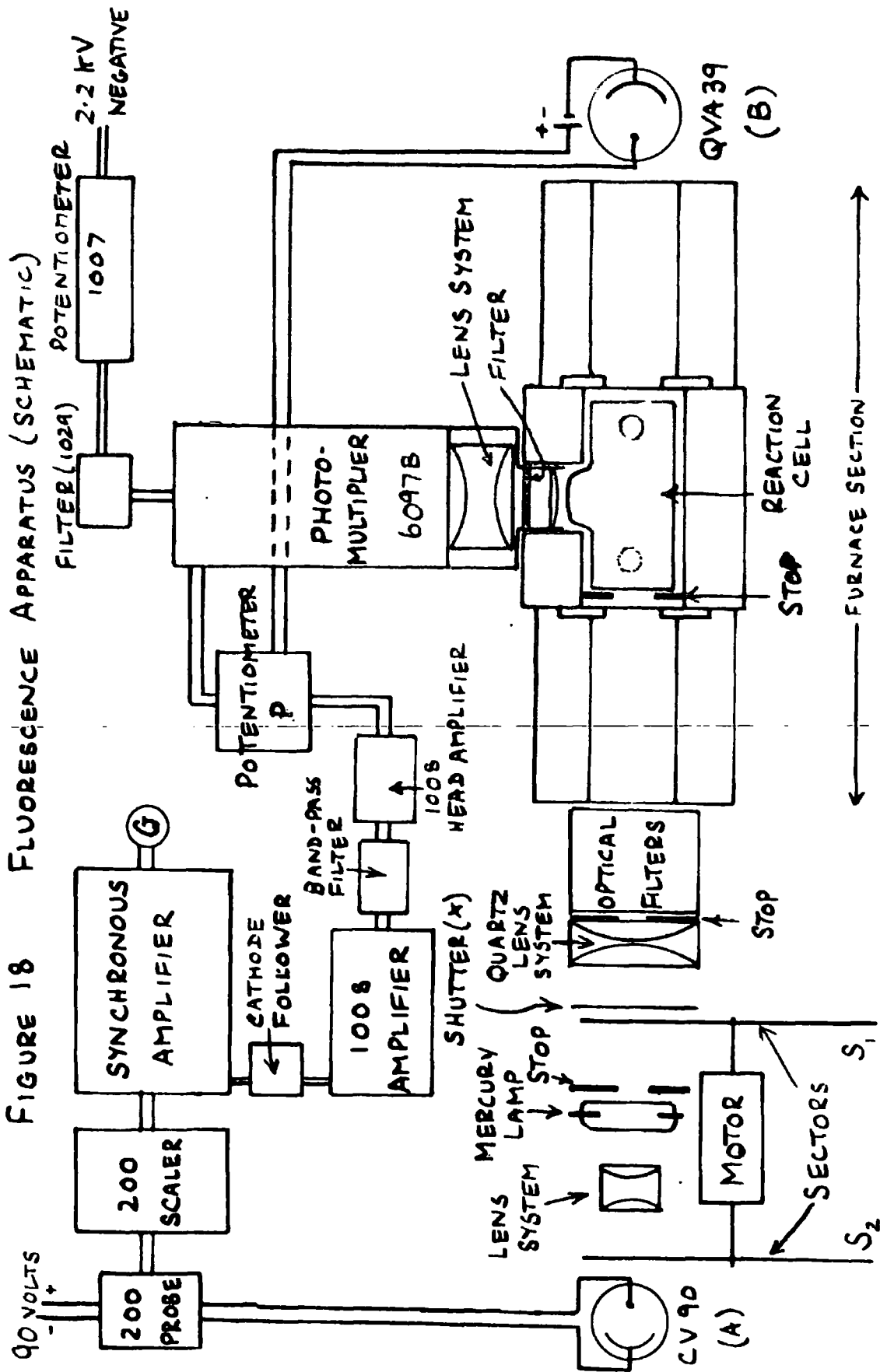

would be consistent with A" being an acetone-iodine complex, whilst case (b) would indicate that A" is identical with A** . On the basis of this scheme a decrease in the intensity is not to be expected, whilst, according to Brown's scheme, which cannot accommodate A" as an acetone-iodine complex, the intensity should show a noticeable decrease on introduction of iodine. The magnitude of this decrease should be quite considerable - to less than half the intensity in the absence of iodine.

Here, then is a promising method of elucidating a major problem in the theory of acetone-iodine photochemistry. In addition it might well make a significant advance in the study of the fluorescence of acetone and the primary photochemical process of acetone.

Apparatus

The general scheme of the apparatus is shown in figure 18, without the details which will be described as follows.

U.V. Source:

This was a 125 watt 'Metrovick' mercury lamp stripped of its outer protective glass envelope. This produced a very compact source, the discharge being contained in a

PHOTOMULTIPLIER TUBE 6CA7B

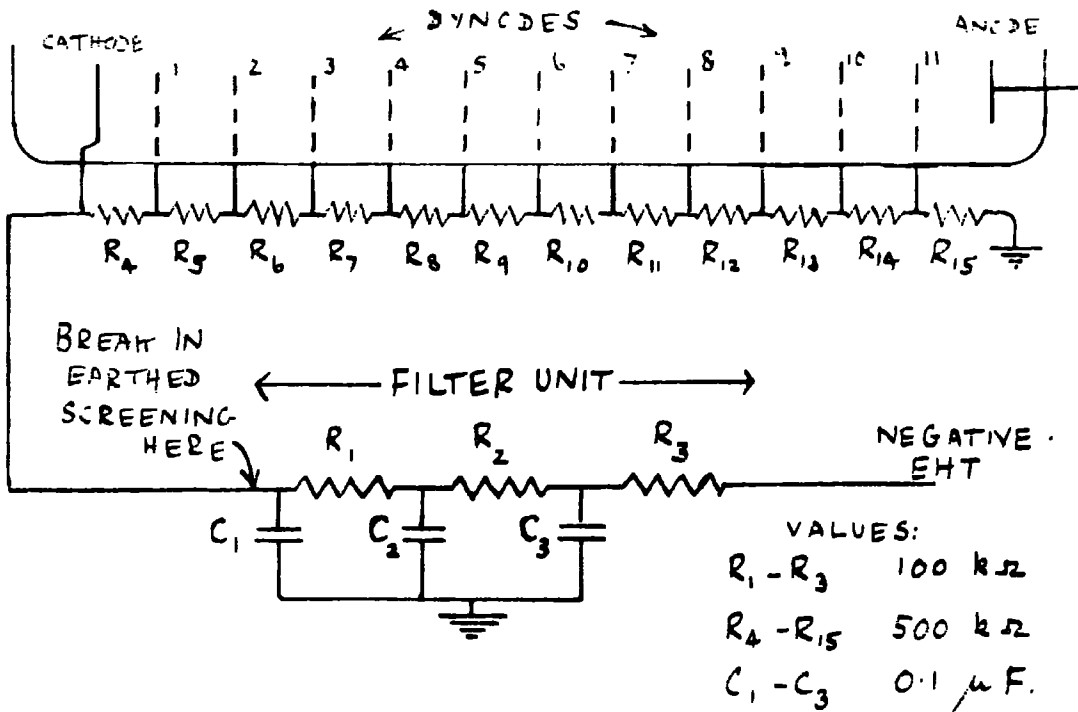

FIGURE 19a
PHOTOMULTIPLIER CIRCUIT.

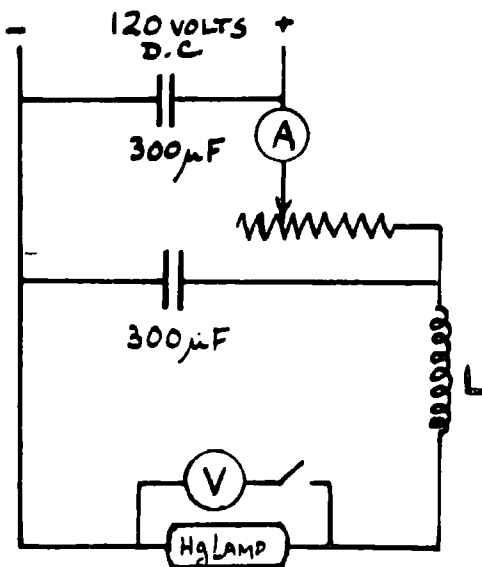

FIGURE 19b
MERCURY LAMP
CIRCUIT

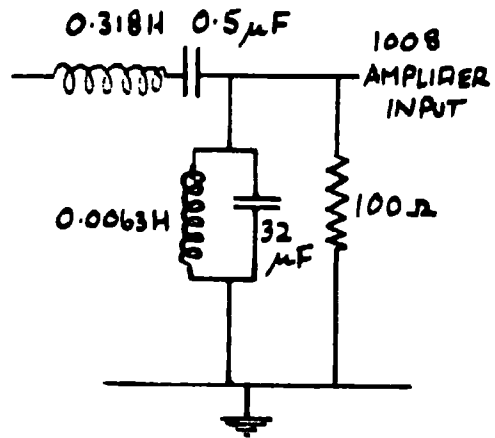

FIGURE 19c
BAND-PASS
FILTER
(APPROX. 240 - 300 c.p.s.)

tube some 25 mm in length and 10 mm in diameter. It was fed by the laboratory 120 volt D.C. supply. Whilst intended for A.C. operation it did work quite well on D.C. though, as used, it consumed only 15 watts. For reasons which will be apparent from the later discussion a smooth power supply was required free from regular variations such as the alternating polarity of A.C. The D.C. supply, having been rectified from 50 c.p.s. A.C. still showed a 100 c.p.s. ripple which was reflected in the intensity of the light source. This ripple was smoothed to a very considerable degree by means of the circuit shown in figure 19(b). The inductance L was of unknown value being the primary winding of a large transformer.

The light beam was approximately parallel, being produced by the lens system L (figure 18). Two 2-inch diameter quartz lenses were used. Each were of focal length 5 inches so that the assembly had a focal length of approximately $2\frac{1}{2}$ inches. The stop S was 8 mm. in diameter.

Filtering of the beam was achieved by a system similar to the one used previously in the photolytic work. It consisted of a Chance OX7 filter glass followed by a disc shaped cell 10 mm between plane polished faces of a Chance OX7 plate at the leading end and a silica plate at the

other end. This was filled with a solution of potassium biphthalate (5 gm./litre). The beam then passed through the reaction cell lying in the furnace block. Whilst this beam was not monochromatic the bulk of the energy was of wavelength in the 3130\AA banded region. A small amount of 3342\AA radiation would be present but little of wavelength 3660\AA (about 99.5 per cent being absorbed by the filter system). It is regrettable that more efficient filtering could not be used but some sacrifice had to be made in order to obtain a beam of sufficient intensity.

The sectors, S_1 and S_2 , were driven at about 5,600 r.p.m. by an electric motor run from laboratory 24 volt D.C. supply. This supply was smoothed using two 0.1 m.f.d. condensers and two small chokes in what was essentially a π -circuit. Sector S_1 , interrupting the beam passing through the cell had 3 60° cut-outs (arranged symmetrically) whilst sector S_2 , which interrupted the beam falling on photocell 'A', had 6 symmetrically arranged 30° cut-outs. The reason for this difference is described later.

A small amount of the beam from the divergent penumbra was scattered into the photomultiplier. This was reduced to a very large degree by the insertion of a 15 mm. diameter stop on the leading face of the reaction cell. All internal

surfaces of the furnace section and the walls of the reaction cell were coated with 'A-quadag' colloidal graphite.

The furnace consisted of a central solid aluminium block, halved and drilled to accommodate the reaction cell, with two heavily lagged copper tubes at either ends. These served to eliminate temperature gradients at the ends of the centre block. The furnace was heated by two 150 watt Edwards diffusion pump heaters connected in series. Power was supplied by mains A.C. controlled by a 'Variac' autotransformer.

Photocells:

Cell (A) (figure 18), producing the "controlling" signal, was a Mullard caesium-cathode photocell type CV90. A potential of 90 volts was supplied from dry batteries through the probe unit to the type 200 scaler.

Cell (B) which absorbed the U.V. beam after passage through the reaction cell was a special cell having a quartz envelope and a high sensitivity to long wavelength U.V. ($\lambda > 3000\text{\AA}$). It was a 20th Century Electronics type QVA39. A potential of 15 volts was supplied from a miniature "deaf-aid" dry battery. It was chosen because of its compactness, it being essential to screen this from stray A.C. pickup. This was an essential requirement of

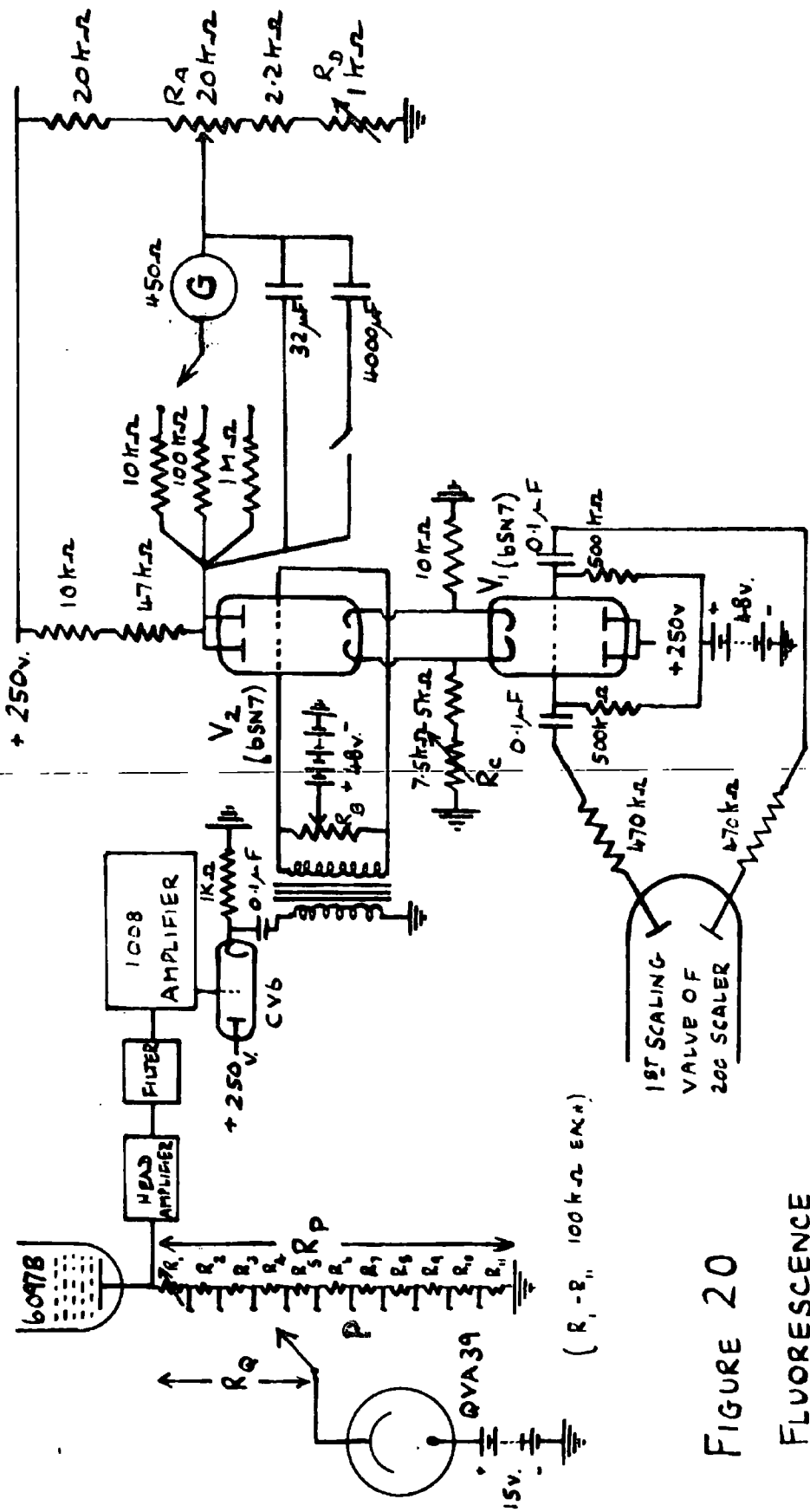

FIGURE 20
 FLUORESCENCE
 MEASUREMENT

all signal-carrying leads.

The photomultiplier (C) was an E.M.I. type 6097B. Fluorescent light from the reaction cell was focussed onto its photocathode by a lens system which incorporated a filter to remove stray U.V. This was of a type used as a photographic 'haze' filter. Absorption was 100 per cent below 3570\AA whilst transmission of light above 3700\AA through the visible region and into the near infra-red was constant at 89 per cent. Variable E.H.T. (negative) was applied to the photomultiplier from a type 1007 potentiometer upto a maximum of 2 kV. A filter was incorporated between the potentiometer and the photo-multiplier. This was a type 1029 E.H.T. filter modified by replacing the 100 megohm resistors by ones of value 0.1 megohm. The circuit, including the potentiometer chain between the various plates of the photomultiplier is shown in figure 19(a).

Principles of Operation.

This may be briefly stated as follows:

The signals from the QVA39 and the photomultiplier were applied to the potentiometer network (P) (figure 18 - show in detail in figure 20) in opposite phase. The two signals were of the same frequency and wave characteristics. This signal from the CV90, after amplification in the scaler,

was used to vary the potential of the cathodes of the 6SN7 mentioned above. The variation, at the same frequency as the signal being fed onto its grids, ensured that it would only conduct as a result of a signal of that particular frequency. The two halves of the valve conducted alternately resulting in a steady current which was reflected in potential of the anodes of this valve.

The aim in measuring the intensity of fluorescence was to estimate its magnitude as a fraction of the intensity of the exciting beam. This was done by balancing the output from the photomultiplier against that from the QVA39 and reading the values of the resistances involved. The state where balance was achieved was detected by means of the potential of the anodes of the 6SN7 valve. A simple potentiometer network was used with a galvanometer as detector as shown in figure 20. When balance of the two signals was achieved the potential of these anodes returned to its value before the signals were applied.

The most noteworthy feature of this circuit is that it only takes account of signals of the one particular frequency - about 280 c.p.s. Consequently it should be free from disturbances of other frequencies. This was not altogether true, the photomultiplier being responsible for a

large amount of noise. Much of this was removed by a band-pass filter. It may be noted that the 6097 B photomultiplier was far superior to the best of three RCA931A tubes originally employed. The RCA931A is a much smaller tube and therefore easier to incorporate into the apparatus but did not reach the required level of performance in use.

Lining-up

Before any use could be made of the apparatus the two signals had to be brought into phase as they were fed into the synchronous amplifier. They were subject to unknown degrees of phase shift along their respective routes. This was effected by feeding the signals onto a laboratory cathode ray oscilloscope equipped with two sets of plates. The traces were brought into phase by setting the sectors at a suitable angle relative to each other, the exact position being found by trial and error.

It was found during this procedure that the sector interrupting the light beam falling on the CV90 photocell needed to produce pulses at a frequency double that of the other sector (S_1). This is due to the nature of the scaler unit which only responds to pulses of a particular sign - positive-going or negative-going according to choice.

Procedure for measurement of Fluorescence

Each section of the apparatus was turned on and left for a minimum of 30 minutes to "warm up". The mercury lamp was started by bringing a Tesla coil "leak tester" close to the lamp. (About 3 to 4 cms was sufficient - it was never necessary to allow a spark from it to reach the lamp). After this initial warming-up period the motor was set running and after about 5 minutes the apparatus was ready for use.

- 1) With the shutter X (figure 18) closed, R_3 (figure 20) was adjusted until the square wave originally at the anodes of valve V_2 as detected by a cathode ray oscilloscope disappeared. The two halves of the value were then balanced - in that, subject to an equal signal on its grid, either half would pass the same current.
- 2) Resistances R_A and R_B were adjusted until the galvanometer was brought to centre zero. This was done stepwise on three sensitivity ranges. The large condenser C_1 (4000 mfd) was not switched in until an approximate balance had been achieved since it had a rating of only 1 volt.
- 3) The shutter X was opened - this produced a somewhat distorted square wave at the anodes of V_2 , a signal from the QVA coming onto its grids. (No voltage yet applied

to the photomultiplier. R_g was adjusted until this square wave disappeared, which indicated that the signal was appearing on each grid to an equal extent.

4) The shutter was then closed, and E.H.T. (varying from 900 to 1100 volts negative as required) applied to the photomultiplier. This invariably caused the galvanometer to move off zero. It was brought back again by use of R_A and R_B .

5) Shutter X was once again opened. The combination of signals from the QVA39 and the photo-multiplier caused the galvanometer to be deflected. This could only be detected on the most sensitive range - all shunts cut out. The resistance down which the QVA39 signal passed was varied until the galvanometer returned to zero.

This resistance was read from the calibrated scales on the potentiometer box. The total resistance down which the QVA39 signal passed was also recorded. Denoting these resistances by R_Q and R_p respectively:

$$\frac{R_p}{R_Q} = \frac{\text{QVA39 Current}}{\text{Photomultiplier current}}$$

This, then, gave a measure of the intensity of fluorescent light in terms of the intensity of the exciting beam.

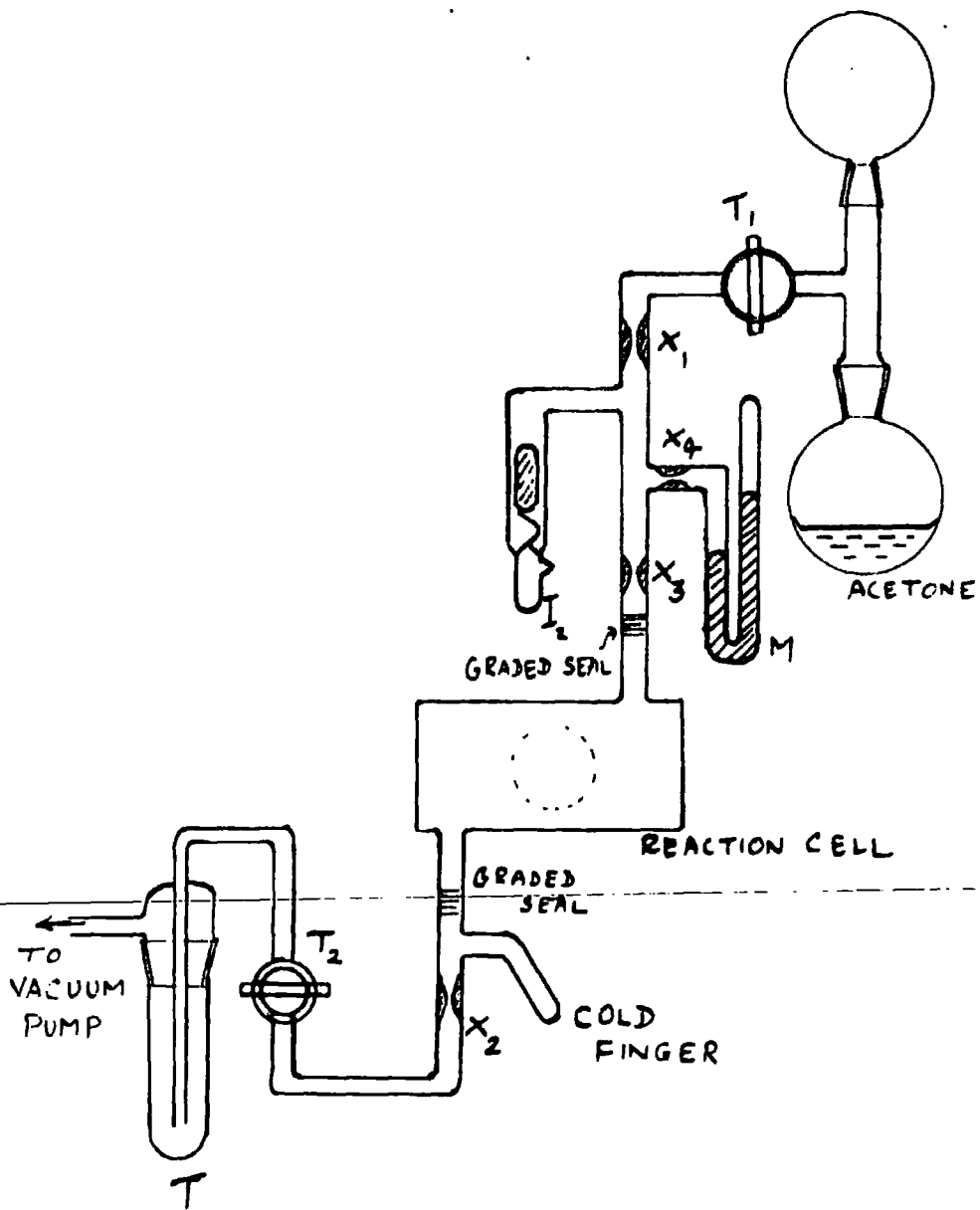

FIGURE 21
 FLUORESCENCE OF ACETONE

6) The "fluorescent" light so measured included, in addition to that from genuine acetone fluorescence, some light from U.V. scattered from the exciting beam, this despite precautions taken to eliminate such light. Its magnitude was very small but appreciable in comparison with the intensity of "fluorescent" light being measured. A measure of this contribution to the light entering the photomultiplier was obtained by freezing out the contents of the reaction cell. The intensity of fluorescence due to the contents of the reaction cell could then be calculated.

PREPARATION OF SAMPLES FOR IRRADIATION

This apparatus is shown in figure 21. It incorporated a means of producing pure acetone and also mixtures of acetone and iodine. Acetone, of AnalaR grade, once distilled, was stored in the large reservoir R (100 ml capacity). It was freed from dissolved gases by evacuation of the system with the acetone maintained at -78°C .

Iodine was produced batch wise in the way previously described in Chapter 4(A). Samples were freshly prepared and attached to the apparatus as shown in figure 21.

The reaction cell was approximately 33 mm external diameter (29 mm internal) with an overall length of 72 mm. It had a volume of 44 ml. The window formed in the side for

"viewing" the fluorescent light was approximately 20 mm in diameter. It was constructed of silica, chosen for its transparency to U.V. Connections were made to the rest of the apparatus by means of silica—pyrex graded seals.

Experimental Procedure

Fluorescence of Acetone:

For such experiments freedom from biacetyl was essential. Its sensitizing effect, even in minute traces, is well known. Consequently a flow system was required, biacetyl being produced by the photolysis at such temperatures as were used (all below 100°C).

Acetone from the reservoir flowed through the system through taps T_1 and T_2 , being condensed out in the trap T. By fine control on the tap openings the flow-rate could be controlled and at the same time the acetone pressure was capable of variation as required. A fairly slow flow-rate was maintained - about 1000 ml-cm. per minute. In terms of a retention time it meant that, for example, acetone at 10 cm pressure was replaced every half-minute.

An estimate of the flow rate could be made to an accuracy sufficient for these experiments by opening T_1 slightly with T_2 closed. The rate of increase of pressure in the section was timed. When a suitable rate had been achieved - as close as possible to the 'standard' rate of

1000 ml-cm/minute, T_2 was opened to an extent sufficient to maintain the pressure at the value required.

Fluorescence of Acetone in the Presence of Iodine

The production of biacetyl being effectively nil in this system, static conditions could be used. The space between taps T_1 and T_2 was filled with acetone sufficient to exert the required pressure when contained between constrictions X_2 and X_3 . This acetone was condensed in the cold finger after which X_1 , X_2 and X_4 were sealed. The iodine was then released and condensed higher up the cold finger, whereupon X was also sealed. The acetone and iodine were then vaporised - quickly so as to minimise the risk of reaction in the liquid phase. The exposed sections of the apparatus were heated by wrapping an "Electrothermal" heating tape round them. The mixture was given about 2 hours to become homogeneous before use.

RESULTS:

These are shown in tables 4, 5 and 6.

The values headed "measured" are the total "fluorescence" observed - composed of light from fluorescence of acetone and stray U.V. etc., reflected into the photomultiplier. The contribution made by the latter has been subtracted from the total to give the amount of true fluorescence. (Columns headed "corrected"). In each case the values of R_Q/R_P are quoted. Two sets of results were obtained - for two values of the E.H.T. applied to the photomultiplier.

The accuracy of the readings is no better than ± 0.01 (It was at all times difficult to keep the galvanometer anywhere near steady). Consequently there is an uncertainty of at least ± 0.02 on each of the "corrected" values. Each recorded reading is the mean of at least two and usually three readings obtained under the same conditions.

In view of the disturbances affecting the apparatus (it was especially prone to vibration in addition to electrical disturbances) it is gratifying to note how well the results differing only in photomultiplier voltage agree.

CONCLUSIONS:

In view of the incompleteness of the results and their suspected lack of precision no exact quantitative

conclusions can be drawn. The main value of these results lies in their qualitative significance. They show, beyond reasonable doubt, that over the temperature range studied iodine decreases the fluorescence efficiency of acetone vapour. This is a good indication that Brown's mechanism for the photolysis of acetone-iodine mixtures is the correct one. Furthermore, the observed reduction being greater in extent at 51°C than at 85°C , these results lend support to the belief that A'' is, in fact, identical with A^{**} . (The fluorescence efficiency of A^{**} decreases much more rapidly with increase of temperature than that of A^*). These results may also be taken to indicate that A^{**} still contributes to the total fluorescence at 85°C to an appreciable extent. The results obtained here suggest the relative contributions from A^{**} and A^* to be about 2 to 1 at 85°C and 3 to 1 at 51°C . The latter figure is in approximate agreement from the work of Groh, Luckey and Noyes. (See figure 2 of their paper⁽¹³⁾).

Further Work

Whilst further work, on the lines of the investigation already reported, was intended, this could not be carried out due to lack of time. In particular, an extension

of the temperature range and comparison of the effect of iodine with that of oxygen should prove to be useful lines of approach. It was found that, with the apparatus as described, the maximum temperature which could be used was about 90°C. This was due to the photomultiplier getting warm - with consequent increase of the amount of "noise" it produced. Installation of a water cooling system, incorporated in the lens system focussing fluorescent light onto the photomultiplier, eliminated this limitation but no opportunity remained to take advantage of it.

The apparatus is basically sound and with further refinements - particularly greater electrical stability, it should be capable of producing accurate and useful results.

7. DISCUSSION OF RESULTS:(A) ACETONE-IODINE-OXYGEN

This system will be discussed before the acetone-oxygen system since results and the deductions which can be made from them are of considerable value in understanding the latter system. This comes about as a result of the competition between iodine and oxygen for the radicals. This competition is ^{so} much in favour of iodine that secondary reactions which complicate the acetone-oxygen system are almost completely suppressed.

The work of Brown⁽¹¹⁾ has been extended and theories to account for the results of these extensions can be made. Investigations on this system are not by any means complete and in consequence the theories are, in part, speculative. Perhaps the most significant advance has been in recognising the longer-lived excited state of acetone A" as the one susceptible to deactivation by iodine. In this system there is competition for the radicals between iodine and oxygen and, it must be presumed, for the excited states of the acetone molecule. This does not now seem as simple as might have been expected but certain conclusions can be reached from the work.

The Primary Process.

The way in which formaldehyde quantum yields vary with oxygen pressure at constant iodine pressure is very similar to the manner in which they vary in the absence of iodine. It may thus be supposed that the factor(s) responsible for this variation in the absence of iodine are also in operation in its presence. If the factor responsible for the reduction of quantum yields after reaching a maximum is correctly recognised as a deactivation of A^{**} by oxygen, then it must be concluded that oxygen is still exerting this effect in the presence of iodine, which may be acting on the same species. This suggests that either oxygen and iodine deactivate different species, or that oxygen is more efficient than iodine in deactivating A'' . The latter seems the more plausible and has the support of the known high-efficiency which paramagnetic molecules show in deactivating excited molecules in the triplet state. An immediate objection might be raised on the grounds that Φ_{MeI} should decrease on the addition of oxygen in increasing amounts. In fact deactivation has probably reached its maximum by the addition of small amounts of either agent. In fact Φ_{MeI} is not even constant - with the exception of the range of 0 to 1 mm oxygen pressure (1.15 mm of iodine). As discussed below, this is believed to be due to a secondary effect.

COMPETITION BETWEEN IODINE AND OXYGEN FOR RADICALSAcetyl:

Though very little direct evidence is available on the reactions of this radical it will be dealt with first since it is believed that herein lies the explanation of two phenomena which at first sight look very surprising. They both involve quantum yields of products which rise with oxygen pressure - even at high values. The products are carbon dioxide (of carbonyl origin) and methyl iodide.

A competition for the acetyl radical between iodine and oxygen may be supposed which is generally assumed to favour reaction with iodine. The extent to which acetyl is removed by each of these reactants has not been established by analysis since previous attempts to analyse acetyl iodide have been a complete failure. It is known to be a very unstable molecule, unstable to oxygen amongst other things. It is reasonable to suggest that any acetyl iodide formed is susceptible to oxidation either by reaction (83) or by dissociation and subsequent oxidation of the acetyl radical (83(a)); 45(d))

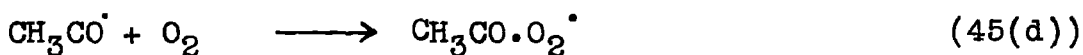
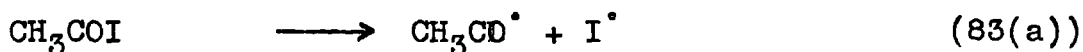
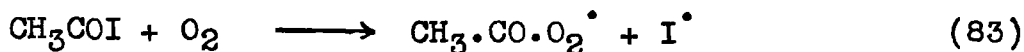

The latter alternative approximates to saying that reaction of acetyl radicals with oxygen is favoured over reaction with iodine. It appears from the results that the balance is in fact fairly even - much more so than in many of the competition reactions in this system, and, accordingly, small changes of the two competing molecules have a noticeable effect. The course which reaction of $\text{CH}_3\text{CO}\cdot\text{O}_2^\cdot$ would take is inevitably open to conjecture particularly with so little evidence available on product yields. Reaction (73) would explain why large yields of carbon dioxide are formed but would not provide a means of formation of more methyl radicals - required to explain the increase of $\Phi \text{CH}_3\text{I}$

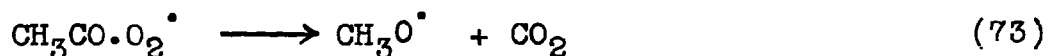

Methyl iodide, and at the same time carbon dioxide, would be formed by the following series of reactions:

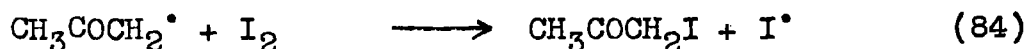
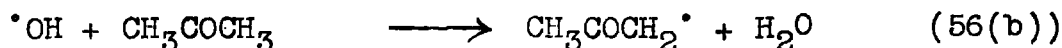
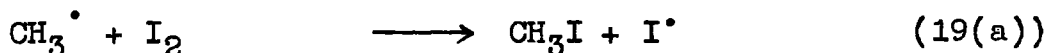
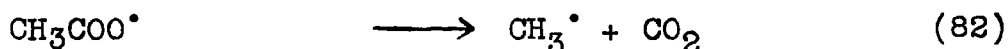
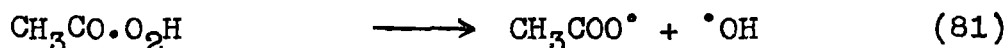
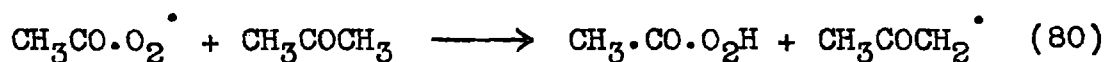

Reaction (84) is preferred to (61(a)) or (63(a)) which involve reaction with oxygen since the yields of formaldehyde

are very minute. Justification for this series of reactions lies entirely with its qualitative success in explaining the behaviour of $\Phi_{\text{CH}_3\text{I}}$ and $\Phi_{\text{CO}_2(\text{carbonyl})}$ with increasing oxygen pressure. It does appear that $\Phi_{\text{CO}_2(\text{carbonyl})}$ is increasing more rapidly than $\Phi_{\text{CH}_3\text{I}}$. This is based on much less experimental data than methyl iodide. If this is true a plausible explanation could be produced by combining the above series of reactions with (73). Analysis for methanol would be a useful pointer, as would be analysis for acetyl iodide, the $\text{CH}_3\text{O}^\bullet$ radical reacting via (73)

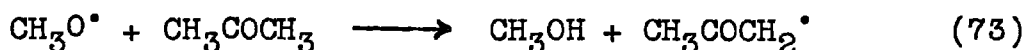

On this basis quantum yields of all products of the methyl radical should show a similar trend to that shown by methyl iodide. The slope is so slight that it cannot be established whether formaldehyde yields are increasing to this extent or not. As can be seen in figure 16, $\Phi_{\text{CH}_2\text{O}}$ is approximately constant from about 1 mm pressure of oxygen upwards. This is distinctly different from the behaviour in the absence of iodine (figure 14A) where $\Phi_{\text{CH}_2\text{O}}$ is steadily decreasing. This provides good evidence for believing that there is here a source of formaldehyde, and therefore of the methyl radical, which is not

effective in the absence of iodine. The above theory is one, of which there may be others, which can account for this. Further tests could be made by examining the variation of carbon monoxide and carbon dioxide yields - with reference to their origin. Very little data on these products ~~is~~^{are} available, and such as ~~is~~^{are}, ~~is~~^{are} not of sufficient accuracy, the yields being so small. In addition, as already indicated, information on acetyl iodide and methanol should be revealing.

Methyl:

In the presence of iodine and oxygen the same oxidation products of the methyl radical may be expected as found in the presence of oxygen alone. The magnitude of the yields of such products is very much reduced, the majority of methyl radicals producing methyl iodide. The ease with which methyl iodide can be isolated and the reproducibility of such results indicates that methyl iodide is stable under these conditions and is not susceptible to oxidation as appears to be the case for acetyl iodide. Following the work of Bates and Spence⁽⁵⁸⁾ on the system methyl iodide-oxygen, the very near absence of formaldehyde observed in this system precludes the occurrence of any such reaction here.

Possibly the most valuable result that this system has

produced comes from examination of the yields of formaldehyde and other products whose origin lies in the methyl group. Utilizing the work of Brown for values of $\bar{\Phi}_{\text{CO(methyl)}}$ and $\bar{\Phi}_{\text{CO}_2(\text{methyl})}$ it can be seen that at an oxygen pressure of 1.68 mm these quantities are reduced on addition of iodine by a factor not exceeding 10 and probably less. (The precision of the results does not allow a more accurate estimate). $\bar{\Phi}_{\text{CH}_2\text{O}}$ on the other hand is reduced under similar conditions by a factor of 300. This indicates that formaldehyde is not a direct product of methyl radicals but is produced by a secondary radical. This radical is very probably acetyl. The amount of acetyl radicals cannot at present be estimated but is probably very much larger than the tiny yields of formaldehyde. Such as are formed will be subject to the same competition as are the radicals in the sequence of reactions which form them. Analysis for acetyl iodide would, combined with formaldehyde yields, if significant by comparison, give an idea of the extent to which acetyl radicals are formed. It seems likely by comparison with methyl radical reactions that acetyl iodide would be formed in greater yield than its oxidation products.

The average lifetime of the methyl radical in this system will be considerably reduced. It may be supposed, therefore, that products of a termolecular methyl radical-

oxygen reaction will be suppressed more than the bimolecular reaction. On this assumption it is interesting to note a difference of behaviour of formaldehyde yields in this system from those in the acetone-oxygen system. In the latter system $\bar{\Phi}_{\text{CH}_2\text{O}}$ and $\bar{\Phi}_{\text{CO}_2(\text{methyl})}$ follow each other quite closely except in the region of the "peak" where $\bar{\Phi}_{\text{CH}_2\text{O}}$ is considerably greater. In the presence of iodine the formaldehyde peak is less pronounced and it is thus tempting to ponder whether this "excess" formaldehyde is due to a termolecular reaction. Unfortunately values of $\bar{\Phi}_{\text{CO}_2(\text{methyl})}$ are much higher than formaldehyde - which, though thought to be due to the acetyl iodide-oxygen reaction does not indicate that much progress is likely to be achieved in comparing $\bar{\Phi}_{\text{CH}_2\text{O}}$ and $\bar{\Phi}_{\text{CO}_2(\text{methyl})}$ in the region of the formaldehyde peak.

Summary:

Work to date on this system has already shown how it can play a very useful part in a study of the photo-oxidation of acetone. ^{Many} ~~much~~ more potentially valuable results have yet to be gleaned. An accurate idea of the relative efficiencies of iodine and oxygen in reaction with the methyl radical is still lacking. Brown supposed that

$$\frac{\bar{\Phi}_{\text{CH}_2\text{O}}}{\bar{\Phi}_{\text{MeI}}} = \frac{k_{56(a)}}{k_{19(a)}} \cdot \frac{[\text{O}_2]}{[\text{I}_2]}$$

In view of the doubt as to whether formaldehyde even in the small amounts found here is a direct product of the methyl radical, and therefore a measure of the extent to which it reacts with oxygen, it would be safer to use the sum of $\bar{\Phi}_{\text{CO(methyl)}}$ and $\bar{\Phi}_{\text{CO}_2(\text{methyl})}$ as a measure of methyl radical reaction with oxygen. This would inevitably produce a rather more complicated expression which might not then be of direct use. Such a revised expression would be

$$\frac{\bar{\Phi}_{\text{CO(methyl)}} + \bar{\Phi}_{\text{CO}_2(\text{methyl})}}{\bar{\Phi}_{\text{CH}_3\text{I}}} = \frac{k_{56(c)} \left\{ (k_{48} + k_{48(a)}) [\text{O}_2] + k_{49} \right\} [\text{O}_2]}{k_{19(a)} [\text{I}_2]}$$

For such a test to be made more data on $\bar{\Phi}_{\text{CO(methyl)}}$ and $\bar{\Phi}_{\text{CO}_2(\text{methyl})}$ would be required with, if possible some refinement of the analytical technique to increase its precision. As discussed above, other data which would be welcome includes yields of acetyl iodide and methanol. A further product, information on which could be of considerable use is hydrogen iodide. It is regrettable that work in this system is from the point of view of manipulation

so time consuming. Such efforts however promise rich rewards.

7.(B)

ACETONE - OXYGEN:Introduction:

At the outset of this investigation, knowledge of this system was such as to suggest that it was of a very complex nature and chances of proposing a successful mechanism seemed slight. Whilst it could hardly be claimed that it now appears any less complex, it is believed that a mechanism can now be put forward. It is not possible for a mechanism proposed at this stage to be complete in every respect since there are still considerable gaps in our knowledge of the system. In particular, much is lacking of our knowledge of the primary products at low oxygen pressures and the importance of one product reported to be present (methanol) has yet to be determined.

The findings of previous workers have been discussed in detail in chapter 2 and a lengthy recapitulation here is not necessary. Combining the findings of this investigation with those previously discussed, the primary products may be listed as carbon monoxide, carbon dioxide and formaldehyde. Methane~~l~~ merits such classification only at extremely low oxygen pressures. It should be borne in mind that the fraction of carbon monoxide formed from the carbonyl group, whilst considerable at low oxygen pressures,

decreases as oxygen pressure rises to proportions which may be regarded as negligible except at high temperatures. The carbon dioxide yield is predominantly of carbonyl group origin but some does come from the methyl group. The proportion of methyl origin is slightly dependent on oxygen pressure, increasing as oxygen pressure increases. Methanol is at present an unknown quantity. Its presence has been reported from qualitative analysis of the products (Hoare⁽²⁵⁾), and, having been found in considerable yield in the photo-oxidation of azo-methane⁽⁵⁶⁾, it may well be a major product of this system. However, in a system of such complexity, it would be unwise to make any firm predictions about its importance. Further products on which information is lacking include water and a number of peroxy products. The former can fairly safely be assumed to be present in appreciable amounts, though some quantitative idea from direct experimental work would be reassuring.

The Primary Process.

As has been seen from fluorescence and photo-iodination studies, the primary process itself is far from simple. The long-lived excited state, designated by A**, has been conclusively shown to be sensitive to ^{reaction} ~~deactivation~~

by oxygen. In view of the suppression of oxidation products when oxygen pressures of the order of several millimetres are used, it can be supposed that the reaction is:

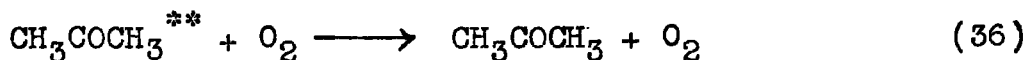

and not:

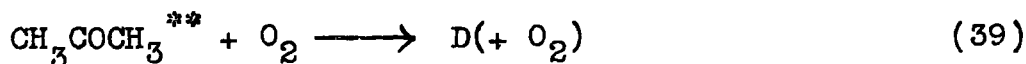

(D represents products)

The chief attraction of this theory is that it explains why yields of all known products of the photo-oxidation decrease (after passing through a maximum) as oxygen pressure increases. The extent of this effect decreases with increase in temperature, as would be expected on such a theory.

A number of objections can be made though, with one exception, they can be shown to be of no importance. This exception is that, although no product has yet been found where the quantum yield continues to increase no matter how far oxygen pressure is increased, it cannot be presumed that such a product is non-existent, particularly when knowledge of the products is so far from being complete. Other objections may be grouped together in that they are taken to indicate that reaction (36) is of no quantitative

significance. Noyes and Marcotte⁽²⁴⁾ suggest this following certain observations, the important ones being:

- a) That the fluorescence from A** is quenched by increase of temperature (100°C being sufficient) in addition to being quenched by oxygen.
- b) That as the temperature increases, the effect of oxygen on the fluorescence decreases.

It is pertinent at this point to enquire by what means the respective "deactivations" are brought about. In the absence of foreign gases, Φ_d is maintained very close to unity over a considerable range of temperature, the lower limit being about 100°C. The so-called deactivation which is effected by increase in temperature does not reduce the excited molecule A** to the ground state A. The result of this thermal deactivation is still capable of dissociation but not of producing "fluorescent" radiation. One would expect A** to have more energy as temperature rises and it is suggested that here may lie the key to the situation. A** has a lifetime which is relatively long for a fluorescently-active state. As temperature increases this lifetime will decrease and the proportion existing long enough for fluorescence to occur will decrease - eventually to negligible proportions. The effect of oxygen can be

either deactivation of A** to an energy level lower than the minimum from which fluorescence can occur, or, alternatively, a reaction such as (40) which in removing A** decreases its lifetime such that no fluorescence occurs. The former is thought to be more likely since if the latter were the case product yields should increase to a maximum which would be maintained on further increase in oxygen pressure.

A criticism of observation (b) is worthy of repetition here. It is that whilst the effect of oxygen decreases with increase in temperature, as measured by its effect on the fluorescence, this is no indication that its effect on A** is any less pronounced at high temperatures than low temperatures.

A useful test of the function of oxygen could be made by use of $^{18}\text{O}_2$. If reaction (36) occurs, and if, as seems very likely, A** is a triplet, then the mechanism should be:

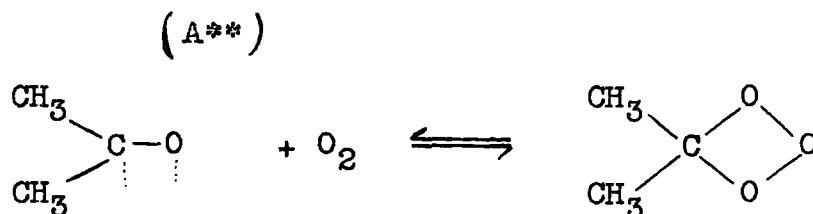

This would lead to exchange of $^{18}\text{O}_2$ which could be detected in the acetone by means of a mass spectrometer.

A quantity which would give a firm indication of the

effect of oxygen is the quantum consumption, $\bar{\Phi}_{-O_2}$. This has only been measured by one set of workers - Noyes and Marcotte^(23,24), and with the exception of two experiments, results are only quoted for the range 0 to 0.5 mm. There is an unfortunate spread on the results such that it cannot be established whether $\bar{\Phi}_{-O_2}$ is really constant or whether it is decreasing slowly at the upper end of the oxygen pressure range. Two experiments (reported in their earlier paper⁽²³⁾) at approximately 1 and 2 mm of oxygen suggest that $\bar{\Phi}_{-O_2}$ is decreasing, and sharply too. These results were, however, placed in brackets which suggests that they were perhaps not completely reliable. No mention was made of these results in the text.

Summarising the evidence; there is strong indication that deactivation of acetone via (36) occurs. Whilst in the absence of certain information, particularly on $\bar{\Phi}_{-O_2}$, the existence of deactivation cannot be firmly established, it appears to be the only way in which, on present evidence, the variation of the major products can be explained at oxygen pressures which are greater than about 0.3 mm.

Radical Reaction with Oxygen

Methyl:

The reaction of methyl radicals with oxygen has been given much attention. Nevertheless, there is considerable

uncertainty about its kinetics and about the way by which products are formed. Prior to a publication of Hoare and Walsh⁽²⁷⁾ it had always been presumed second order. On this basis (47(a)):



~~is~~ has been shown to require very little activation energy in comparison with reaction (4):



which is known to a fair degree of certainty to have zero activation energy. However, the rate of reaction is very slow and requires the inclusion of a very low p factor - about 4×10^{-4} on current estimates⁽²⁷⁾. It is difficult to see why such a reaction should be subject to steric hindrance to such an extent and a more plausible explanation with considerable experimental support has been put forward by Hoare and Walsh. Such a reaction as (47(a)) must proceed by some sort of transition complex which may be denoted by $\text{CH}_3 \cdot \text{O}_2$. This is a very energy-rich aggregate and without an agent to remove some of that energy dissociation will occur (74):



before rearrangement into a form suitable for product forma-

tion can occur. Accordingly Hoare and Walsh suggest that the methyl-oxygen reaction is third order:

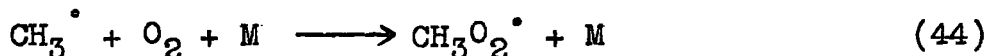

They do not ignore the possibility of a bimolecular reaction being successful in product formation - in fact this is probably significant at very low oxygen pressures. The argument proposed with regard to $\text{CH}_3\text{O}_2^\cdot$ formed by the bimolecular reaction is slightly different from that suggested here.

The Acetyl Radical

Study of the reactions of this radical has been practically neglected. In the past it has often been supposed that the dissociation:



is the only important reaction of this radical. Recent work has shown just how false this assumption is when oxygen is present. In particular reference may be made to the work of Brown⁽¹¹⁾ and Dunn and Kutschke⁽²⁸⁾. Whilst dissociation occurs to a considerable extent at low oxygen pressures it decreases to negligible proportions as oxygen pressure increases into the range of millimetres. The position can best be appreciated by an example - at an

oxygen pressure of 0.08 mm (Acetone pressure = 130 mm, temperature 120°C), $\bar{\Phi}$ CO(carbonyl) is 0.25. Deactivation by oxygen has not yet begun to show any appreciable effect as shown by $\bar{\Phi}$ CO₂ and $\bar{\Phi}$ CH₂O which are still on the increase. A considerable fraction of the acetyl radicals formed (approaching $\frac{3}{4}$) are reacting in some other way. There is an indication⁽²⁶⁾ that some acetaldehyde is formed at low oxygen pressures but information is insufficient to show whether enough is formed by reaction (55) to account for the acetyl radicals which do not dissociate.

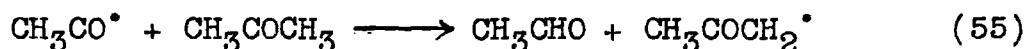

Acetaldehyde has not been detected at oxygen pressures higher than about 0.25 mm., so it seems reasonably certain that reaction occurs in some way with oxygen.

The result of reaction with oxygen is open to conjecture. Some kind of initial complex $\text{CH}_3\text{CO}\cdot\text{O}_2^\bullet$ can be envisaged which would react further by either breakdown or hydrogen abstraction. The obvious results from breakdown would be carbon dioxide and the methoxy radical:

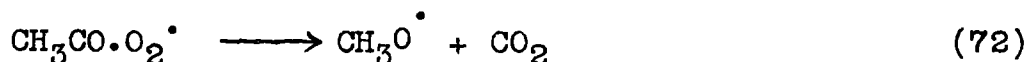

The methoxy radical might then disappear in a number of ways, the most obvious being:

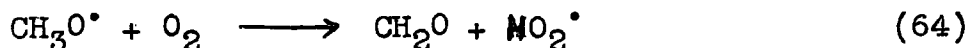
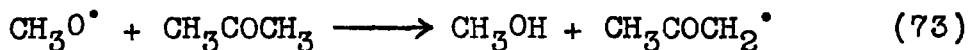

Reactions such as (78) and (79) below seem rather unlikely in view of the small concentrations of the reactants.

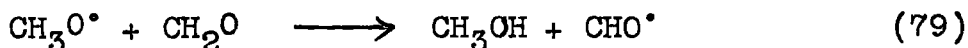
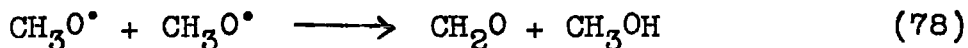

A further scheme of reactions for which there is some justification in the system acetone-oxygen-iodine depends on abstraction of hydrogen by the radical $\text{CH}_3\text{CO}\cdot\text{O}_2^\bullet$ prior to breakdown:

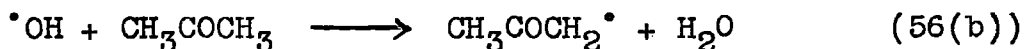
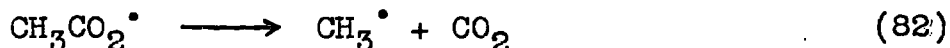
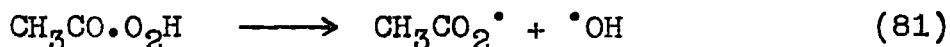
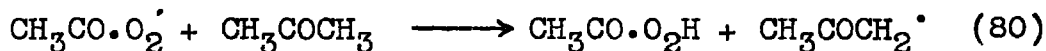
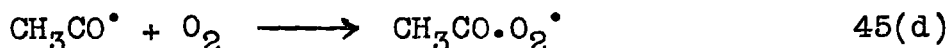

Until some quantitative information is available on methanol no firm idea of the importance of these reactions is likely to be drawn. It is worth noting that Taylor and Blacet⁽⁵⁹⁾ have found methanol as a product of the photo-oxidation of biacetyl but compared with other products, notably formaldehyde and carbon dioxide it was almost negligible. On the other hand Hoey and Kutschke⁽⁵⁶⁾ have found substantial quantities in the photo-oxidation of azo-methane so

that it would appear that methanol is a product of the methyl radical-oxygen reaction. The results of Taylor and Blacet, where oxygen was used which had been enriched in ^{18}O , suggest that such methanol as was formed was the result of methyl radical reactions rather than those of the methoxy radical. (The oxygen in the product was wholly of molecular origin). The formaldehyde was similar in its ^{18}O content - inferring that it too was the result of methyl radical reactions. It is interesting to note that the carbon dioxide had an ^{18}O content indicative of equal contributions from the two sources. This is in agreement with formation by such a reaction as (82) rather than by (72).

No firm conclusions can be drawn from these results as to acetyl radicals in the photo-oxidation of acetone since in particular the two systems are different in many respects. In addition the results of Taylor and Blacet are, to quote the authors, "more erratic than one would have liked". It will, however, be readily seen that such studies could be of considerable value and further examination of the photo-oxidation of biacetyl would be most welcome.

The Acetonyl Radical.

Before discussing the way in which formation of products from methyl radical oxidation can be explained it is necessary

to consider the reactions of the acetyl radical. Whilst not a primary radical it is a radical of hardly less importance, being the result of hydrogen abstraction reactions. Methyl radicals abstract hydrogen in this way:

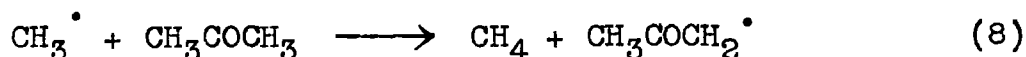

This is only of importance at very low oxygen pressures. Formation of acetyl over the whole range is probably mainly due to hydrogen abstraction by hydroxy radicals:

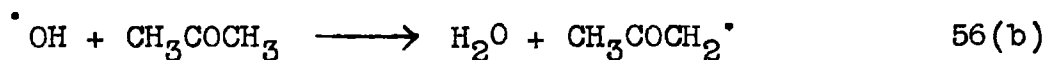

A further reaction which should be considered is (75):

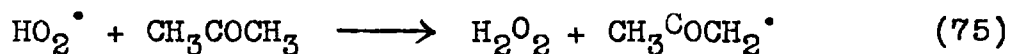

No attention has been paid in the literature to the kinetics of the reaction between the acetyl radical and oxygen. Being a relatively complex molecule in comparison with methyl a bimolecular reaction is much more likely, acetyl having many more degrees of freedom capable of absorbing the excess energy.

The acetyl radical can be visualised in any of four forms:

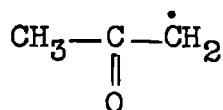

(A)

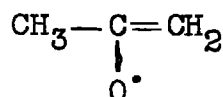

(B)

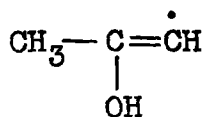

(C)

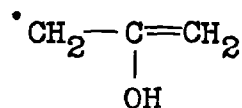

(D)

Of these (A) and (B) can be recognised as resonant structures by comparison with the well known structures of acetone. (C) and (D) are less likely to contribute to a resonant hybrid since they involve movement of protons away from the normally accepted positions.

It may be reasonably supposed that reaction with oxygen will proceed via the step which requires the least activation energy. In the absence of quantitative data some idea can be gained of the course by which reaction is likely to proceed from examination of the established products and comparison with the products which might be formed by reaction of the above forms with oxygen.

Considering first the forms which are not likely to be found in appreciable proportion, (C) and (D), we may see that there is no practical support for these forms taking part in acetyl radical-oxygen reaction. (C) would be expected to result in acetic acid formation, whereas none is formed. Since oxygen would attack at the point where the unpaired valency electron is situated, (D) would have to undergo considerable rearrangement before breaking down into products, the most obvious being acetaldehyde and formic

acid, neither of which are found in the conditions used in these investigations.

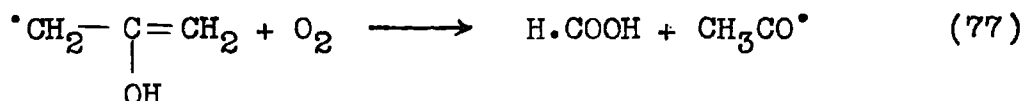
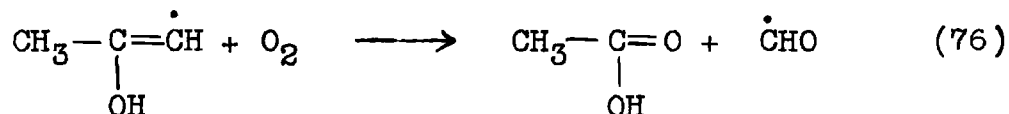

In the case of the canonical forms (A) and (B), a clear choice is possible between the two. (A) would require considerable activation energy to undergo the reaction:

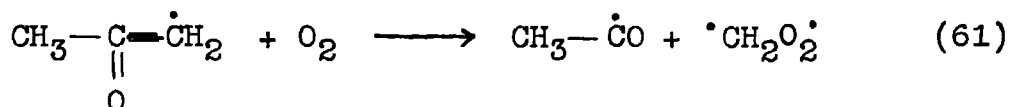

$\cdot\text{CH}_2\text{O}_2$ would probably rearrange to formic acid which is not found amongst the products. We are left then with (B) which, reacting as in reaction (63(a)):

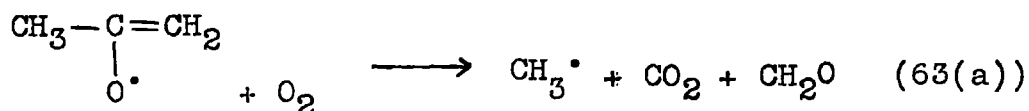

This has the strong backing of experimental evidence since large yields of formaldehyde and large yields of carbon dioxide of carbonyl origin are found. As will be remembered the yields of both these products attain such levels as to preclude their formation from primary radicals alone.

Reactions of the $\text{CH}_3\text{O}_2^\cdot$ Radical:

In reactions of, or through, this radical lies the key to a considerable part of the problems of acetone photo-oxidation. There exist several probable ways in which it may react. It must be remembered that it probably exists in at least two forms - differing in their state of excitation, depending on whether produced by a bimolecular or termolecular reaction. The $\text{CH}_3\text{O}_2^\cdot$ complex formed by bimolecular reaction will have a shorter lifetime and having a larger energy content than that formed termolecularly is more likely to react via (47(b)) and (47(c)) than by a hydrogen abstraction reaction such as (56(d)). Methanol may be expected to be a result of the termolecular reaction formed by such a scheme as shown below in reactions (56(d)), (56(f)), (73) and (56(b)) below.

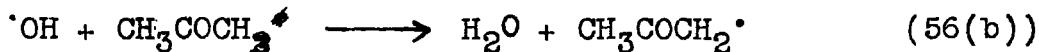
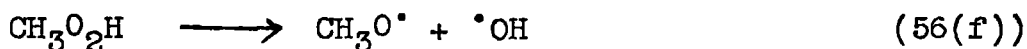
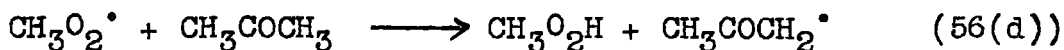
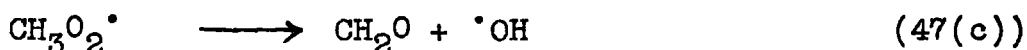
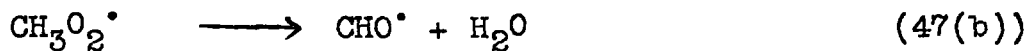

An alternative reaction for methyl hydroperoxide is (56(e)):

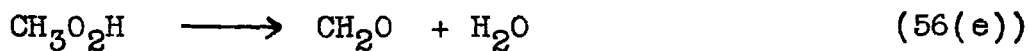

If the existence of methanol as a major product is verified then reaction 56(e) is unlikely. Justification for consideration of methanol as a possible major product depends largely on qualitative observations together with the findings of Hoey and Kutschke⁽⁵⁶⁾ who have found it in large quantities in the photo-oxidation of azomethane. Though this system is not strictly comparable it undoubtedly involves methyl radicals.

Justification for 47(b) is easy to find in that it affords the only plausible explanation of the existence of carbon monoxide and carbon dioxide (each of methyl origin) amongst the products:

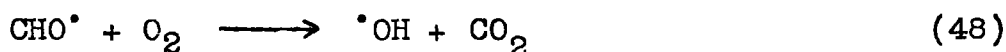

Justification for 47(c) is easy to find in view of the large yields of formaldehyde found. This does not mean that it is in fact an important reaction since, in this case, there are alternative means by which formaldehyde may be formed. Indeed, as seen from previous discussion it seems likely that reaction 47(c) is of no practical importance at all.

A further reaction which could account for a relatively stable $\text{CH}_3\text{O}_2^\cdot$ radical is (85):

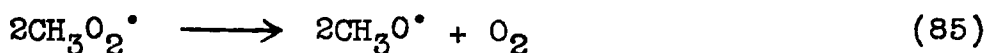

In view of the small standing concentration of $\text{CH}_3\text{O}_2^\cdot$ reaction (85) would have to be favoured by a very high reaction efficiency to play a significant part.

Variations of product yields:

Examination of the variations of yields of the known products cannot as yet fix the series of reactions by which the methyl peroxy radical decomposes. Sufficient is however known to enable some valuable conclusions to be drawn and speculation about others.

The very sharp peak in the value of $\bar{\Phi}_{\text{CO}}$ has been somewhat puzzling. It has been suggested⁽²⁴⁾ that it represents all three carbon atoms from the fragments of primary dissociation but this now seems a very much oversimplified point of view. Whilst the acetyl radical probably dissociates to an extent approaching 100 per cent. at low oxygen pressures some of the methyl radicals do react ~~in~~ otherwise as seen by the yields of methane, formaldehyde and carbon dioxide - yields which, though each relatively small, make an appreciable total. Under the conditions used by Brown⁽¹¹⁾ and by Dunn and Kutschke⁽²⁸⁾ carbon

monoxide is always predominantly of methyl origin and the quantum yield of carbon dioxide of methyl origin is always considerably less than that of carbon monoxide (methyl). This indicates that reaction (48) plays a lesser role than reactions (49) and (48(a)). Whilst some of the decrease in Φ_{CO} as oxygen pressure increases, is no doubt due to reaction 48(a) coupled with a decrease in the extent to which acetyl radical dissociates, it seems likely that some other factor is involved to make the drop so sharp. At the same time $\Phi_{CO_2(\text{carbonyl})}$ and Φ_{CH_2O} are each increasing rapidly and it seems reasonable to infer that a reaction involving $CH_3O_2^{\cdot}$ alternative to the formation of the formyl radical is taking place. Such a scheme as that suggested above which involves formation of methanol seems very plausible particularly in view of the simultaneous formation of acetyl radicals which could account for the large yields of carbon dioxide and formaldehyde. This is a further case where data on methanol is much needed.

If the above suggestion as to the changing mode of reaction of $CH_3O_2^{\cdot}$ is correct then it would appear necessary to assume that in the termolecular reaction oxygen is much more efficient as the third body than acetone. As yet there seems no independent justification for such an assumption which thus detracts something of the attractive-

ness of this theory. Increase of oxygen concentration over the range in question makes no significant change in the total reactant concentration.

An explanation of the way in which formaldehyde and carbon dioxide yields themselves decrease after reaching their maxima can be found in another function of the oxygen molecule. This is its role as an agent for the deactivation of the excited acetone state A^{**} which would otherwise decompose into radicals. Whilst it is not suggested that this is the only possibility, other schemes seem rather less likely since an alternative reaction for acetyl would have to be found which involves formation of neither formaldehyde nor carbon dioxide. Such alternative reaction(s) have yet to be established - by identification of products or otherwise, whilst the deactivating action of oxygen on acetone is well established. In this direction it will be of especial interest to observe whether methanol yields decrease in the same way and over the same range of oxygen pressure as formaldehyde and carbon dioxide.

REVIEW:

It will be seen that though work is far from complete, a general idea can be gained of the principal reactions involved and to some extent their quantitative significance considered relative to each other. Accordingly the

reactions which are thought to be important are set out below. Justification for these reactions will have become apparent from the previous discussion.

This scheme is not claimed to be either comprehensive or unique. There is every chance of others being required either to add to those below or supersede them, particularly as more information becomes available. Nor is it suggested that this represents the only way in which the existing information can be interpreted. It does seem to the author the most plausible way at the present stage but it is not, unfortunately, without its anomalies. In particular, the need to assume that oxygen is a more efficient "third-body" in the termolecular methyl radical-oxygen reaction. For further progress to be made much additional information is necessary. The spheres in which activity is likely to be useful are many but certain fields are likely to be more productive than others.

Much work remains to be done on the acetone-oxygen system itself. Particularly at the lower end of the range, some further analysis of the yields of known major products— with reference to their origin, from methyl or carbonyl groups of the acetone molecule, would be useful. Methanol is outstanding as a product whose quantitative significance has yet to be investigated, though it might be worth looking

for acetaldehyde at low oxygen pressures.

Further information on reactions of the acetyl radical and the acetonyl radical with oxygen is called for. This would best be done in systems free from further complications where the radical concerned is the only one being generated. Acetyl can be produced easily enough by photolysis of biacetyl but acetonyl sets a particular problem. Photolysis of biacetonyl is unlikely to produce acetonyl radicals alone, cleavage into two unequal fragments being probable. The photolysis of acetonyl chloride, $\text{CH}_3\text{COCH}_2\text{Cl}$, is said to form acetonyl radicals⁽¹⁾ but adds its own complication in that chlorine atoms are also produced.

Information on the hydroxy and hydro-peroxy radicals and hydrogen atoms is still lacking and forms one of the more unsatisfactory aspects of this field. Reactions of these radicals are, in the absence of firm evidence, open to more speculation than most. Though a plausible scheme can be found for hydroxyl it is by no means certain that this accounts for all hydroxyl radicals which are formed.

Carbon-14 has been the only tracer used in investigations in this laboratory, and has been shown to be of great value. Another tracer, use of which should seriously be considered, is oxygen-18, preferably in the molecular oxygen. In certain applications its use could prove invaluable.

MECHANISM: PROPOSED PRINCIPAL REACTIONS:

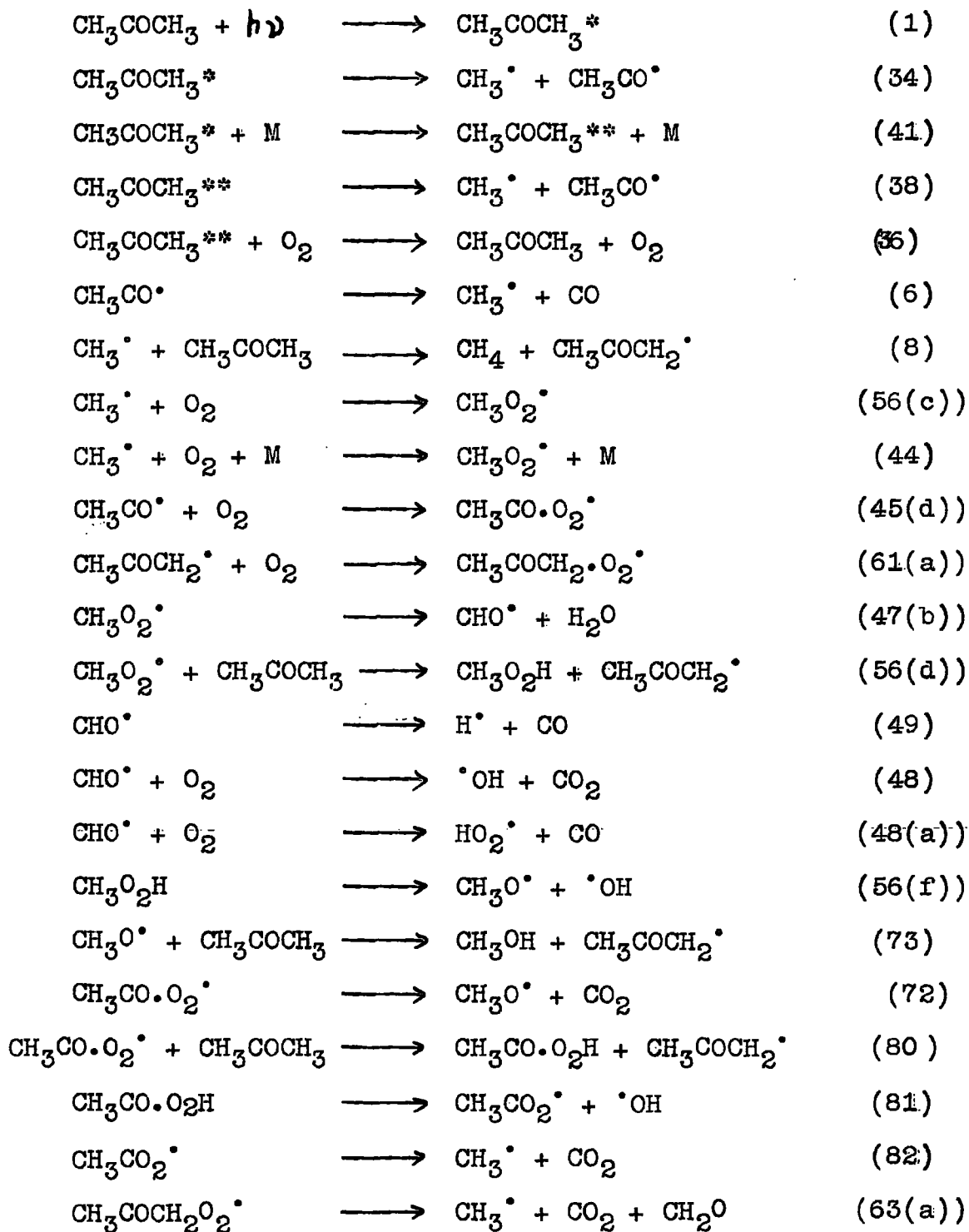

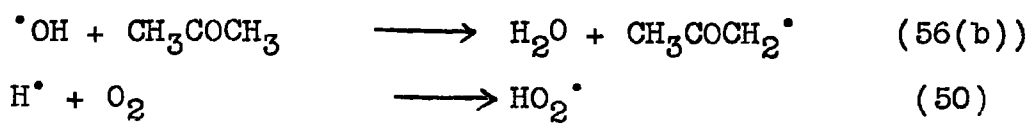

8.

SUMMARY:

A study has been made of the photolysis of acetone in mixtures of oxygen and iodine with the aim of elucidating some of the problems of the photo-oxidation of acetone and of the primary photolytic process. Fluorescence of acetone-iodine mixtures was also studied. All photochemical work was done at 120°C, and 3130Å radiation was used throughout, the absorbed intensity ranging from 2 to 6 x 10¹² quanta. ml⁻¹. sec⁻¹.

Labelled acetone, ¹⁴CH₃¹²CO¹⁴CH₃, was employed in certain parts of the work as necessary.

The analytical techniques were based on those used by Brown¹¹, modified where necessary. The irradiation apparatus was reconstructed but resembled that of Brown in principle. New techniques were developed for formaldehyde and acetic acid, that for methyl iodide was modified. The formaldehyde method was developed to detect levels as low as 10⁻⁹ g. mol.

From the results of these investigations together with previous knowledge in this field, it has been possible to propose schemes to cover much of the known field of acetone photo-oxidation. Though there are still considerable gaps in our knowledge of this system some important conclusions have been drawn. In particular, formaldehyde has been identified as being predominantly a product of the acetyl

radical, and the methyl radical-oxygen is probably to some extent termolecular. There is strong indication that deactivation by oxygen is occurring in the higher part of the oxygen pressure range.

Much remains to be done in this field but with further analytical information it seems probable that a sound mechanism can in due course be advanced. This will probably feature the two excited states active in the fluorescence, the second being susceptible to deactivation by oxygen. The radicals involved in the various stages will inevitably be many but the principal participants can probably be recognised as methyl, acetyl and acetylonyl.

BIBLIOGRAPHY:

- (1) STEACIE, "ATOMIC AND FREE RADICAL REACTIONS", 2ND ED.,
REINHOLD PUBLISHING CO., NEW YORK, 1954.
- (2) HERR AND NOYES, J. AM. CHEM. SOC., (1940), 62, 2052.
- (3) MARTIN AND SUTTON, TRANS. FARADAY SOC., (1952), 48,
812.
- (4) PITTS AND BLACET, J. AM. CHEM. SOC., (1952), 74, 455.
- (5) DAVIS, CHEM. REVIEWS, (1947), 40, 201.
- (6) FELDMAN, BURTON, RICCI AND DAVIS, J. CHEM. PHYSICS,
(1945), 13, 440.
- (7) BENSON AND FALTERMAN, J. CHEM. PHYSICS, (1952), 20,
201.
- (8) GORIN, ACTA PHYSIOCHEMICA, U.R.S.S., (1938), 8, 513,
and (1939), 9, 681.
- (9) GORIN, J. CHEM. PHYSICS, (1939), 7, 256.
- (10) BENSON AND FORBES, J. AM. CHEM. SOC., (1943), 65,
1399.
- (11) BROWN, PH.D. THESIS, DURHAM, 1956.
- (12) NOYES AND DORFMANN, J. CHEM. PHYSICS, (1948), 16,
788.
- (13) GROH, LUCKEY AND NOYES, J. CHEM. PHYSICS, (1953), 21,
115.
- (14) LUCKEY AND NOYES, J. CHEM. PHYSICS, (1951), 19, 227.

- (15) MATHESON AND ZABOR, J. CHEM. PHYSICS, (1939), 7, 236.
- (16) ALMY AND ANDERSON, J. CHEM. PHYSICS, (1940), 8, 805.
- (17) KASKAN AND DUNCAN, J. CHEM. PHYSICS, (1950), 18, 427.
- (18) KHAN, NORRISH AND PORTER, PROC. ROY. SOC. (LONDON),
(1953), A219, 312.
- (19) WINKLER, TRANS. FARADAY SOC., (1935), 31, 765.
- (20) LEEMAKERS, J. AM. CHEM. SOC., (1934), 56, 1899.
- (21) McCLURE, J. CHEM. PHYSICS, (1949), 17, 905.
- (22) LUCKEY, DUNCAN AND NOYES, J. AM. CHEM. SOC., (1949),
69, 1415.
- (23) NOYES AND MARCOTTE, DISC. FARADAY SOC., (1951), 10,
236.
- (24) MARCOTTE AND NOYES, J. AM. CHEM. SOC., (1952), 74,
783.
- (25) HOARE, TRANS. FARADAY SOC., (1953), 49, 1292.
- (26) CHRISTIE, J. AM. CHEM. SOC., (1954), 76, 1979.
- (27) HOARE AND WALSH, TRANS. FARADAY SOC. (1957), 53,
° 1102.
- (28) DUNN AND KUTSCHKE, CAN. J. CHEM., (1958), 36, 421.
- (29) KASHA, J. OPT. SOC. AMER., (1948), 38, 929.
- (30) INTERNATIONAL CRITICAL TABLES, VOL. I., 70.
- (31) ALLEN AND MOORE, J. AM. CHEM. SOC., (1931), 53, 2522.
- (32) MURDOCH, BROOKS AND ZAHN, ANAL. CHEM., (1948), 20,
65.

- (33) GOMER AND NOYES, J. AM. CHEM. SOC., (1950), 72,
101.
- (34) STOTZ, J. BIOL. CHEM., (1943), 148, 585.
- (35) MATSUKAWA, J. BIOCHEM. (TOKYO), (1939), 30, 386.
- (36) BRICKER AND JOHNSON, ANAL. CHEM., (1945), 17, 400.
- (37) MACFADYEN, J. BIOL. CHEM., (1945), 158, 107.
- (38) DONNALLY, ANAL. CHEM., (1933), 5, 91.
- (39) ENGELKEIMER, HAMILL, INGRAM, AND LIBBY, PHYS. REVIEWS,
(1949), 75, 1825.
- (40) SPENCE AND WILD, NATURE, (1936), 138, 206 and
J. CHEM. SOC., (1937), 352.
- (41) ROHRINGER AND BRODA, Z. FUR NATURFORSCH. (1953),
8(b), 159.
- (42) BROWN AND MILLER, REV. SCI. INSTR., (1947), 18,
496.
- (43) EIDENOFF, ANAL. CHEM., (1950), 22, 529.
- (44) PEISACH, COUNCIL FOR SCIENTIFIC AND INDUSTRIAL RESEARCH,
PRETORIA, S.A., Private Communication.
- (45) FELDSTEIN AND BRODA, NATURE, (1951), 168, 599.
- (46) HENSON, BRIT. J. APPLIED, PHYSICS, (1953), 4, 217.
- (47) HOARE, TRANS. FARADAY SOC., (1957), 53, 791.
- (48) STERN AND VOLMER, PHYSIK. Z., (1919), 20, 183.
- (49) THE RADIOCHEMICAL CENTRE, AMERSHAM, Private Communication.
- (50) TROTMAN-DICKENSON AND STEACIE, J. CHEM. PHYSICS,
(1950), 18, 1097.

- (51) STYLE AND SUMMERS, TRANS. FARADAY SOC., (1946), 42,
388.
- (52) WALSH, TRANS. FARADAY SOC., (1947), 43, 297.
- (53) GRAY, J. CHEM. SOC., (1952), 3150.
- (54) FRANKENBURG AND NOYES, J. AM. CHEM. SOC., (1953),
75, 2847.
- (55) MELLOR, A Comprehensive Treatise of Inorganic and
Theoretical Chemistry, Vol. I., p. 350.
- (56) HOEY AND KUTSCHKE, CAN. J. CHEM., (1955), 33, 496.
- (57) MCCOUBREY AND McGRATH, QUART. REV. CHEM. SOC., (1957),
11, 87.
- (58) BATES AND SPENCE, J. AM. CHEM. SOC., (1931), 53,
381, 1659.
- (59) TAYLOR AND BLACET, IND. ENG. CHEM., (1956), 48,
1505.
- (60) LANGER, COOK, AND PRICE, BULL. AM. PHYS. SOC.,
(1948), 23 (No. 4), 15.

REACTION KEY:

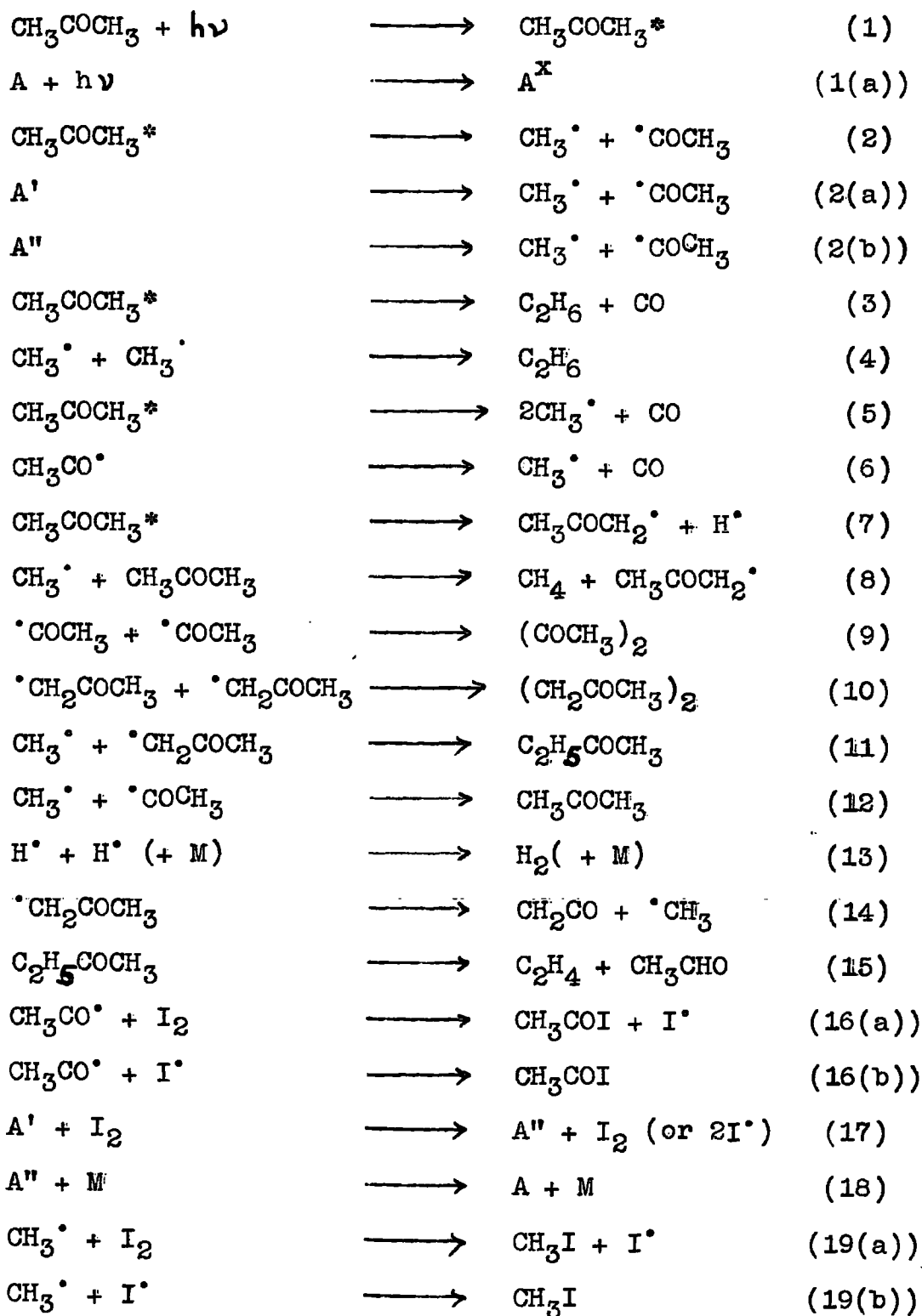

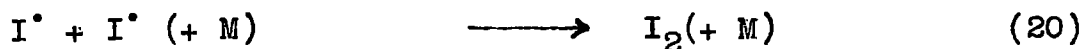

$$\Phi_{CH_3I} - \Phi_{CO} = 1 - \left\{ 1 + \frac{k_{2(a)}}{k_{17}[I_2]} \right\}^{-1} \left\{ 1 + \frac{k_{2(b)}}{k_{18}[M]} \right\}^{-1} \quad (21)$$



$$\Phi_{CH_3I} - \Phi_{CO} = 1 - \left\{ 1 + \frac{k_{2(a)}}{k_{22}[M]} \right\}^{-1} \left\{ 1 + \frac{k_{2(b)}}{k_{23}[I_2]} \right\}^{-1} \quad (24)$$



$$\Phi_{CH_3I} = \left\{ 1 + \frac{k_{17}}{k_{2(a)}} [I_2] \right\}^{-1} \quad (26)$$

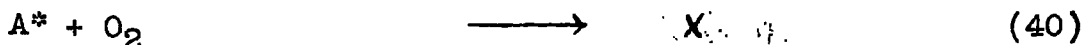
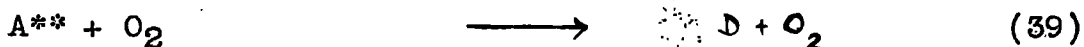
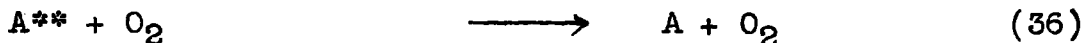
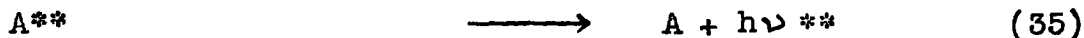

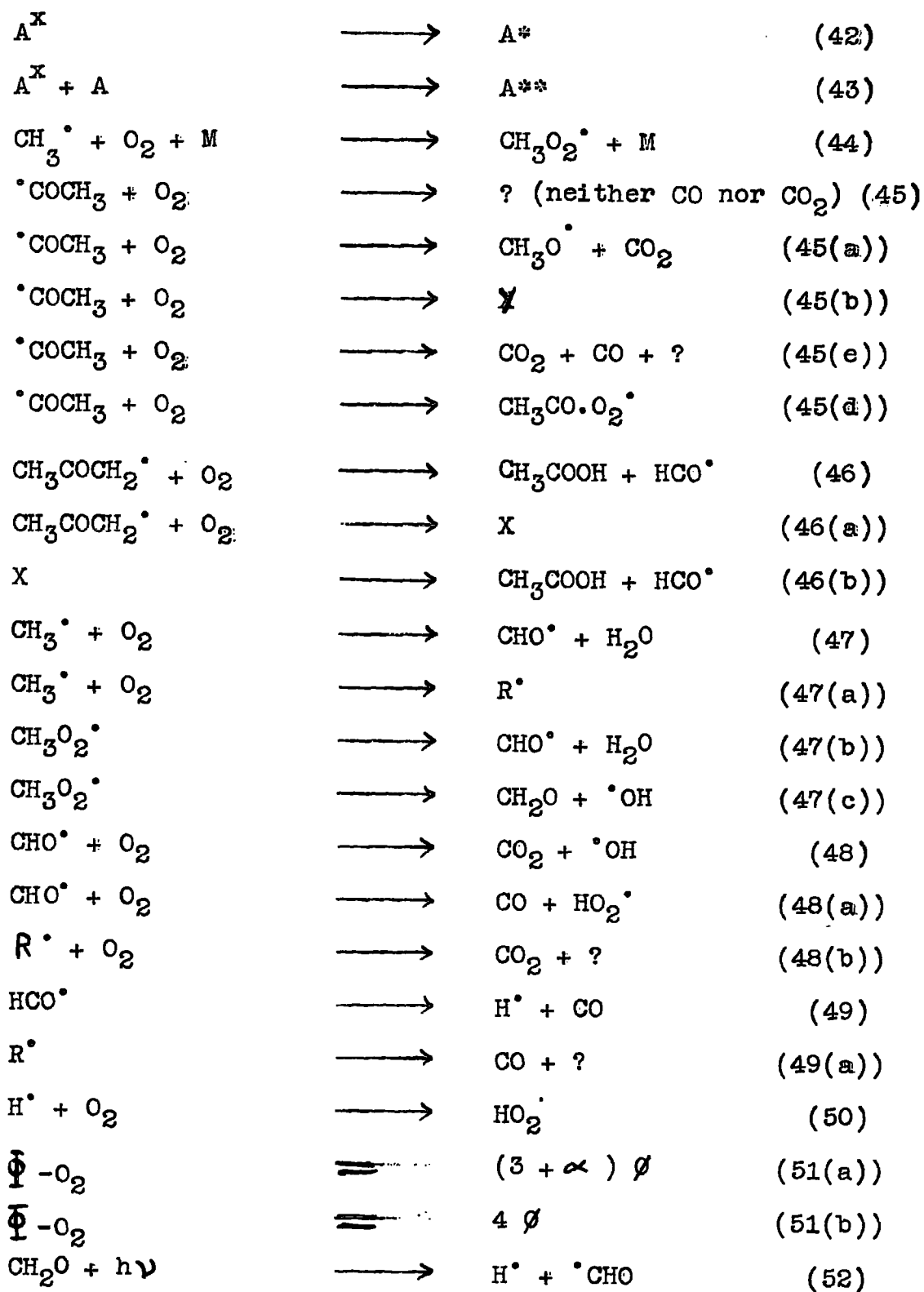

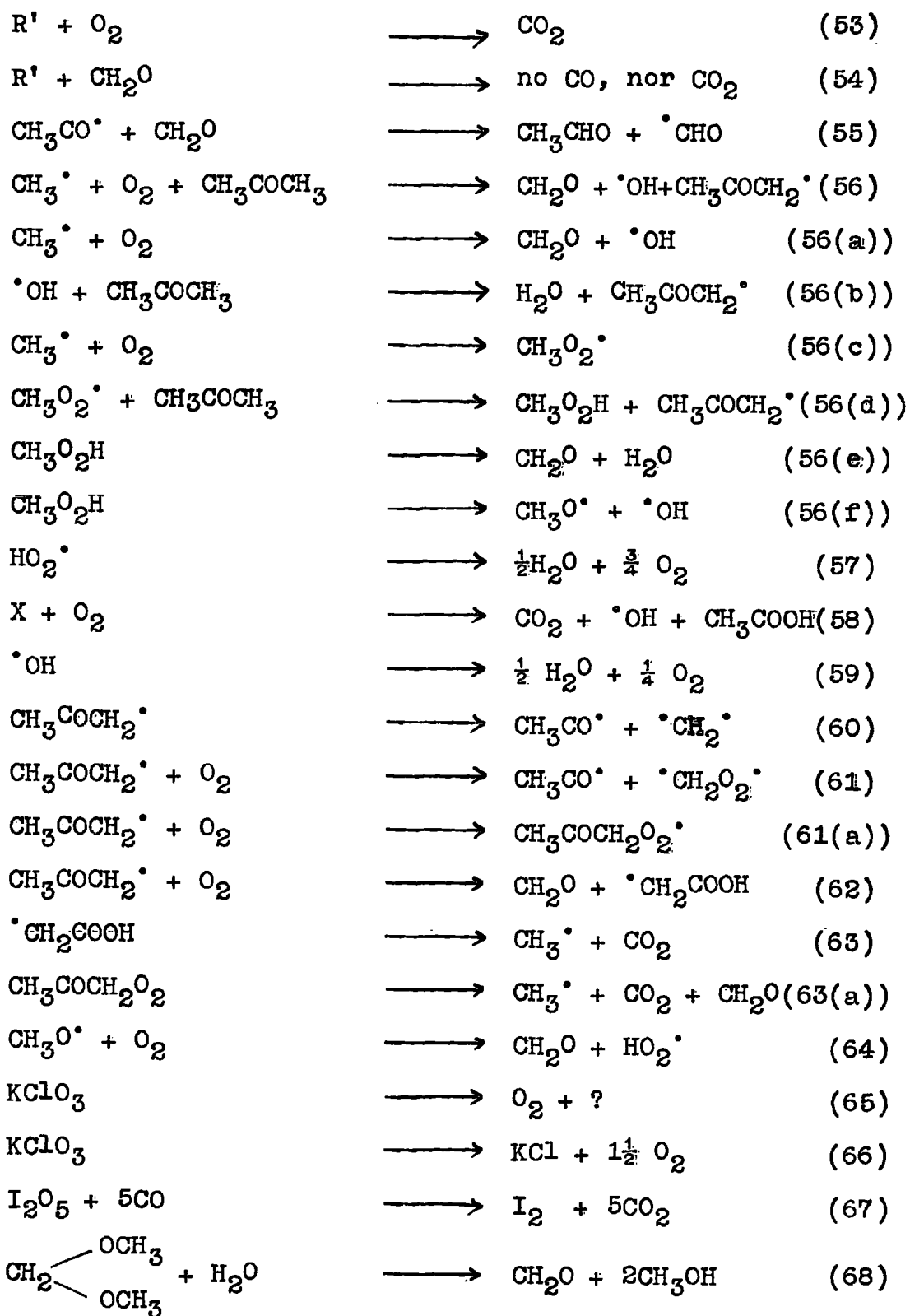

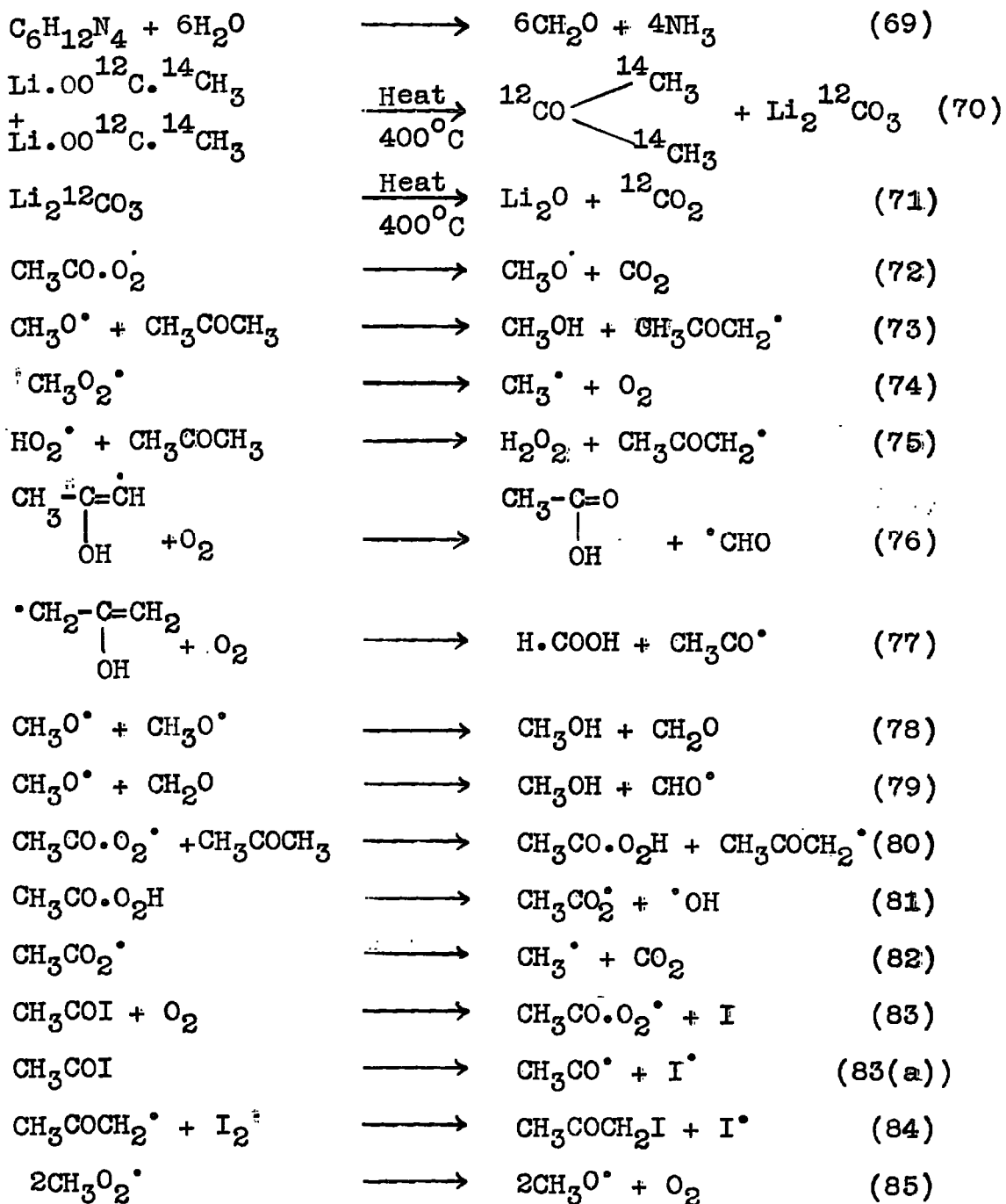

TABLE 4

FLUORESCENCE OF ACETONE VAPOUR

E.H.T. APPLIED TO PHOTOMULTIPLIER		900 VOLTS (-ve)		1000 VOLTS (-ve)	
		ACETONE PRESSURE (CM. Hg)	R_Q/R_P OBSERVED	R_Q/R_P CORRECTED	R_Q/R_P OBSERVED
TEMP. = 51°C	0.00	0.08	0.00	0.17	0.00
	5.5	0.27	0.19	0.59	0.42
	8.5	0.35	0.27	0.80	0.63
	11.9	0.52	0.44	"	"
TEMP. = 85°C.	0.00	0.10	0.00	0.23	0.00
	4.5	0.18	0.08	0.44	0.21
	8.4	0.23	0.13	0.55	0.32
	10.4	0.26	0.16	0.64	0.41
	13.4	0.32	0.22	0.81	0.58

ACKNOWLEDGMENTS

It is with great pleasure that I record my sincere thanks to Mr. G.R. Martin, B.Sc., A.R.C.S., F.R.I.C., for suggesting the problem, and for his unfailing interest and encouragement throughout this work.

I should also like to record my thanks to the technical staff of the laboratory and to my typist, Mrs. M. Oliver, for their willing and friendly co-operation.

I am also indebted to the Ministry of Education for extension of a State Scholarship, latterly as a State Studentship, without which this work would not have been possible.

Neil T. Mitchell

Neil T. Mitchell.

