



Durham E-Theses

Germyl derivatives of iridium and gold

Wilbey, M. D.

How to cite:

Wilbey, M. D. (1969) *Germyl derivatives of iridium and gold*, Durham theses, Durham University.
Available at Durham E-Theses Online: <http://etheses.dur.ac.uk/8655/>

Use policy

The full-text may be used and/or reproduced, and given to third parties in any format or medium, without prior permission or charge, for personal research or study, educational, or not-for-profit purposes provided that:

- a full bibliographic reference is made to the original source
- a [link](#) is made to the metadata record in Durham E-Theses
- the full-text is not changed in any way

The full-text must not be sold in any format or medium without the formal permission of the copyright holders.

Please consult the [full Durham E-Theses policy](#) for further details.

GERMYL DERIVATIVES OF IRIDIUM AND GOLD

by

M.D. Wilbey, B.Sc.

(Graduate Society)

A Thesis submitted in candidature for the degree of
Doctor of Philosophy in the University of Durham

July 1969



Acknowledgement

The author wishes to thank Dr. Glockling for his help and encouragement throughout the work described in this thesis.

The author is also indebted to the Science Research Council for a maintenance award.

Note

The work described in this thesis was carried out at the University of Durham between September 1966 and June 1969. The work has not been submitted for any other degree and is the original work of the author except where acknowledged by reference.

Part of the work described has been the subject of the following publications:

Gold-Germanium Complexes. J.Chem.Soc.(A). 1968, 2168.
(with F. Glockling)

Formation of Germyliridium Hydrides. Chem. Comm.
1969, 286. (with F. Glockling)

Germyl-Iridium Complexes. J.Chem.Soc.(A). In press.
(with F. Glockling).

CONTENTS

	Page
<u>SUMMARY</u>	
<u>INTRODUCTION</u>	
The Co-ordination Chemistry of Copper, Silver and Gold	2
Phosphine and Arsine complexes	3
Hydride complexes	5
Carbonyl complexes	6
Organometallic complexes	7
The Chemistry of Iridium	9
The complexes $(R_3P)_2Ir(CO)Cl$ and $(R_3As)_2Ir(CO)Cl$	10
The <u>Trans</u> -effect and <u>Trans</u> -influence	23
Identification of stereoisomers of square planar and octahedral metal complexes	28
Transition Metal-Group IVb Bonded Complexes	43
Synthesis of transition metal-group IVb bonds	43
The complexes	48
Reactions of the complexes	55
<u>DISCUSSION</u>	64
<u>Section A.</u> Organogermyl-gold complexes	65
<u>Section B.</u> Organogermyl-iridium complexes	83

	Page
<u>EXPERIMENTAL</u>	113
<u>Section A. Organogermyl-gold complexes</u>	114
1. Preparation of triphenylgermyltriphenylphosphine-gold(I), $\text{Ph}_3\text{PAuGePh}_3$	114
2. Preparation of trimethylgermyltriphenylphosphine-gold(I), $\text{Ph}_3\text{PAuGeMe}_3$	114
3. Reactions of triphenylgermyltriphenylphosphine-gold(I)	115
(a) 1.2.-Dibromethane	115
(b) 1.2.-Dichlorethane	115
(c) Carbon tetrachloride	116
(d) Hydrogen chloride	116
(e) Mercuric chloride	116
(f) Methyl iodide	116
(g) Hydrogen	117
(h) Water and oxygen	117
(i) Potassium cyanide	118
(j) Phenylacetylene	118
(k) 1.2.-Bisdiphenylphosphinoethane	119
(l) Triphenylphosphine	119
(m) Triethylphosphine	119
(n) Tin(IV)tetrachloride	120
(o) Magnesium bromide	121
(p) Carbon monoxide	122
4. The reaction of $\text{Ph}_3\text{PAuGePh}_3$ and Ph_3PAuCl	123
5. The reaction of $\text{Ph}_3\text{PAuGePh}_3$ and <u>cis</u> $(\text{Et}_3\text{P})_2\text{PtCl}_2$	124

	Page
6. Reaction of $\text{Ph}_3\text{PAuGePh}_3$ and $(\text{Ph}_3\text{P})_2\text{Ir}(\text{CO})\text{Cl}$	124
7. The reaction of Ph_3PAuCl and $(\text{Ph}_2\text{PCH}_2\text{CH}_2\text{PPh}_2)\text{Pt}(\text{GePh}_3)_2$	124
8. Reaction of Ph_3P and Ph_3PAuCl	125
9. Reaction of Ph_3PAuCl and carbon monoxide	125
10. Reaction of Ph_3P , Ph_3PAuCl and SnCl_2	125
11. The preparation of bis(triphenylphosphine)gold trichlorostannate	125
12. The reaction of triphenylphosphinegold(I)chloride and stannous chloride	126
13. Preparation of ethylene(bistriphenylphosphonium)-dichloride	126
14. Preparation of ethylene(bistriphenylphosphonium)-bis(tetraphenylborate)	126
15. The reaction of Ph_3PAuCl and trimethylgermane	127
16. The reaction of pyridine gold trichloride and trimethylgermane	127
17. The reaction of pyridine gold trichloride and triphenylgermyl-lithium	127
18. The reaction of $\text{Et}_3\text{PAuGePh}_3$ and 1,2-dibromethane	127
19. The reaction of $(\text{Et}_3\text{P})_2\text{Pd}(\text{GePh}_3)_2$ and Ph_3PAuCl	128
20. The reaction of $(\text{Ph}_3\text{P})_3\text{AuSnCl}_3$ and phenyl-lithium	128
21. The reaction of $\text{Ph}_3\text{PAuGePh}_3$ and triphenylsilane	128
22. The reaction of $[(\text{Ph}_2\text{PCH}_2\text{CH}_2\text{PPh}_2)\text{Pt}(\text{Et}_3\text{P})\text{GeMe}_3]\text{Cl}$ and Ph_3PAuCl	129

	Page
23. The reaction of $[(\text{Ph}_2\text{PCH}_2\text{CH}_2\text{PPh}_2)\text{Pt}(\text{Et}_3\text{P})\text{SiMe}_3]\text{Cl}$ and Ph_3PAuCl	129
24. The reaction of $(\text{Ph}_2\text{PCH}_2\text{CH}_2\text{PPh}_2)\text{AuGePh}_3$ and trimethylgermane	130

Section B. Organogermyl-iridium complexes

25. The preparation of chloro(carbonyl)bis(triethylphosphine)- iridium(I), $(\text{Et}_3\text{P})_2\text{Ir}(\text{CO})\text{Cl}$	131
26. The reaction between $(\text{Et}_3\text{P})_2\text{Ir}(\text{CO})\text{Cl}$ and triphenyl- germane	131
27. The reaction between $(\text{Et}_3\text{P})_2\text{Ir}(\text{CO})\text{Cl}$ and trimethyl- germane	132
28. The reaction between $(\text{Et}_3\text{P})_2\text{Ir}(\text{CO})(\text{H})_2\text{Cl}$ and sodium iodide	132
29. The preparation of chloro(carbonyl)bis(dimethylphenyl- phosphine)iridium(I), $(\text{Me}_2\text{PhP})_2\text{Ir}(\text{CO})\text{Cl}$	132
30. The reaction of $(\text{Me}_2\text{PhP})_2\text{Ir}(\text{CO})\text{HCl}_2$ with sodium methoxide	133
31. The reaction of a mixture of $(\text{Me}_2\text{PhP})_2\text{Ir}(\text{CO})\text{Cl}$ and $(\text{Me}_2\text{PhP})_2\text{Ir}(\text{CO})\text{HCl}_2$ with triethylgermane	133
32. The reaction of $(\text{Me}_2\text{PhP})_2\text{Ir}(\text{CO})\text{Cl}$ and trimethylgermane	133
33. The preparation of chloro(carbonyl)bis(triphenyl- phosphine)iridium(I), $(\text{Ph}_3\text{P})_2\text{Ir}(\text{CO})\text{Cl}$ (Method 1)	134
34. The preparation of chloro(carbonyl)bis(triphenyl- phosphine)iridium(I), $(\text{Ph}_3\text{P})_2\text{Ir}(\text{CO})\text{Cl}$ (Method 2)	135

	Page
35. The reaction of $(\text{Ph}_3\text{P})_2\text{Ir}(\text{CO})\text{Cl}_3$ with zinc and dimethylformamide	136
36. The reaction of $(\text{Ph}_3\text{P})_3\text{IrH}_2\text{Cl}$ and sodium iodide	136
37. The reaction of $(\text{Ph}_3\text{P})_3\text{IrH}_2\text{Cl}$ and triphenylgermyl-lithium	137
38. The reaction of $(\text{Ph}_3\text{P})_3\text{IrH}_2\text{Cl}$ and triethylgermane	137
39. The reaction of $(\text{Ph}_3\text{P})_3\text{IrH}_2\text{Cl}$, triethylgermane and triethylamine	137
40. Reactions of <u>trans</u> -chloro(carbonyl)bis(triphenylphosphine)iridium(I), $(\text{Ph}_3\text{P})_2\text{Ir}(\text{CO})\text{Cl}$	138
(a) Trimethylsilane	138
(b) Trimethylgermane	138
(c) Triethylgermane	139
(d) Tri-isopropylgermane	140
(e) Trimethylbromgermane	140
(f) Triethylbromgermane	140
(g) Triphenylgermane	140
(h) Trichlorogermyl-caesium	141
(i) Trichlorogermene	141
(j) Bis(trimethylgermyl)mercury	142
(k) Triphenylgermyl-lithium	142
41. Reactions of the complexes, $(\text{Ph}_3\text{P})_2\text{Ir}(\text{CO})(\text{H})_2\text{GeR}_3$ (R = Me or Et)	143
(a) 1,2-Dibromethane (R = Me)	143
(b) Iodine (R = Et)	143

	Page
(c) Hydrogen chloride (R = Me)	144
(d) Hydrogen chloride (R = Et)	144
(e) Sodium iodide (R = Me)	145
(f) Hydrogen (R = Me)	145
(g) Hydrogen (R = Et)	145
(h) Hydrolysis (R = Me)	145
(i) Pyrolysis (R = Me)	145
(j) Oxygenation (R = Me)	146
(k) Triethylphosphine (R = Me)	146
(l) 1.2.-Bis(diphenylphosphino)ethane (R = Et)	146
(m) 2-Hexene (R = Et)	147
(n) Ethylene (R = Et)	147
(o) Ethylene (R = Me)	147
(p) α -Furoyl azide (R = Et)	148
(q) Mercuric chloride (R = Et)	148
42. The reaction of $(\text{Ph}_3\text{P})_2\text{Ir}(\text{CO})(\text{HgCl})\text{Cl}_2$ with triphenylphosphine	148
43. The reaction of $(\text{Ph}_3\text{P})_2\text{Ir}(\text{CO})\text{GeR}_3$ with hydrogen	149
44. The preparation of <u>trans</u> -chloronitrogenbis(triphenylphosphine)iridium(I), $(\text{Ph}_3\text{P})_2\text{Ir}(\text{N}_2)\text{Cl}$	149
45. Reaction of $(\text{Ph}_3\text{P})_2\text{Ir}(\text{N}_2)\text{Cl}$ with triethylgermane	150
46. Reactions of $\text{Ph}_3\text{P}(\text{CO})\text{Ir}(\text{H})(\text{Cl})\text{GePh}_3 \cdot \frac{1}{2}(\text{C}_6\text{H}_{12})$	150
(a) Sodium iodide	150
(b) Triethylphosphine	151

	Page
Experimental Methods	152
Preparation of Starting Materials	153
<u>APPENDIX A</u>	
Hydrogenation of organogermanes and organodigermanes	154
<u>APPENDIX B</u>	
Recovery of iridium	156
<u>REFERENCES</u>	158

Summary

The thesis describes the preparation, properties and reactions of some germyl-gold and germyl-iridium complexes.

The complex, $\text{Ph}_3\text{PAuGePh}_3$ has been prepared by the reaction of Ph_3PAuCl and Ph_3GeLi . It is air stable and could only be oxidised in the presence of peroxides. The gold-germanium bond is cleaved by a variety of halides (HCl , HgCl_2 , CCl_4 , $\text{C}_2\text{H}_4\text{Cl}_2$, $\text{C}_2\text{H}_4\text{Br}_2$, CH_3I , Ph_3PAuCl , $(\text{Et}_3\text{P})_2\text{PtCl}_2$, MgBr_2 and SnCl_4). With magnesium bromide, a germyl-Grignard complex, Ph_3GeMgBr was formed whilst reaction with tin(IV) chloride formed gold-tin complexes, $(\text{Ph}_3\text{P})_n\text{AuSnCl}_3$ ($n = 1, 2$ or 3). Triethylphosphine and the chelating phosphine, $\text{Ph}_2\text{PCH}_2\text{CH}_2\text{PPh}_2$, displace triphenylphosphine to form $\text{Et}_3\text{PAuGePh}_3$ and $(\text{Ph}_2\text{PCH}_2\text{CH}_2\text{PPh}_2)\text{AuGePh}_3$ respectively. Reaction with carbon monoxide gave evidence of a gold (0) carbonyl complex. The complex, $\text{Ph}_3\text{PAuGeMe}_3$, was prepared in low yields by the reaction of Ph_3PAuCl and $(\text{Me}_3\text{Ge})_2\text{Hg}$.

Four co-ordinate iridium(I) complexes, $(\text{R}_3\text{P})_2\text{Ir}(\text{CO})\text{X}$ add a wide variety of reagents to yield six co-ordinate iridium(III) products. The present work has been concerned with the addition of germanium hydrides, R_3GeH ($\text{R} = \text{Cl}, \text{Me}, \text{Et}, \text{Pr}^i$ or Ph) to the iridium complex, $(\text{Ph}_3\text{P})_2\text{Ir}(\text{CO})\text{Cl}$. The course of the reaction is dependant on the nature of R; thus Me_3GeH , Et_3GeH and Cl_3GeH yield a dihydrido-iridium(III) complex, $(\text{Ph}_3\text{P})_2\text{Ir}(\text{CO})(\text{H})_2\text{GeR}_3$ and R_3GeCl whereas the more sterically hindered Pr^i_3GeH does not react. Triphenylgermane behaves differently to form 5 co-ordinate $\text{Ph}_3\text{P}(\text{CO})\text{Ir}(\text{H})(\text{Cl})\text{GePh}_3$.

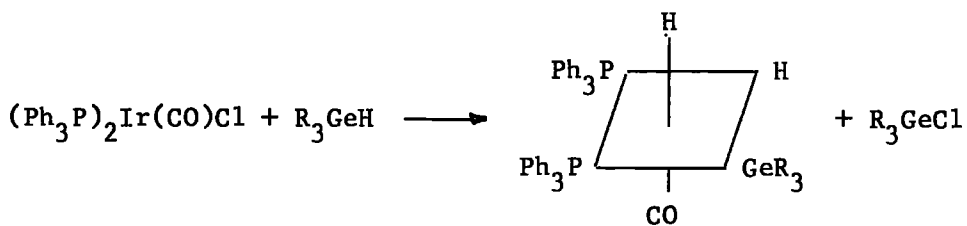

(R = Me, Et or Cl)

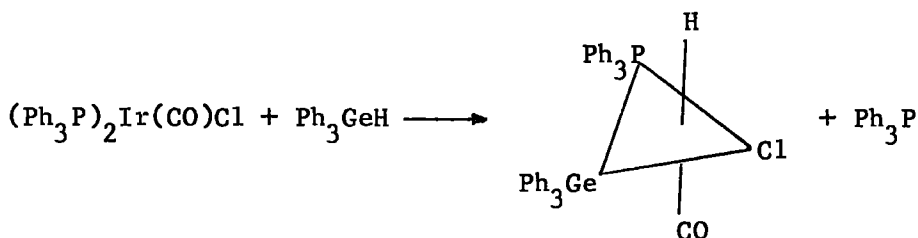

Reactions of $(\text{Ph}_3\text{P})_2\text{Ir}(\text{CO})(\text{H})_2\text{GeR}_3$, (R = Me or Et) with HgCl_2 , HCl , I_2 , H_2 , O_2 , $\text{C}_2\text{H}_4\text{Br}_2$, Et_3P and $\text{Ph}_2\text{PCH}_2\text{CH}_2\text{PPh}_2$ are reported. Attempts were made to prepare 4 co-ordinate germyl-iridium(I) complexes by direct reaction such as $(\text{Ph}_3\text{P})_2\text{Ir}(\text{CO})\text{Cl}$ and Ph_3GeLi but these were inconclusive. This class of complex was finally prepared by dehydrogenation of $(\text{Ph}_3\text{P})_2\text{Ir}(\text{CO})(\text{H})_2\text{GeR}_3$ with ethylene.

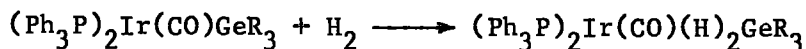
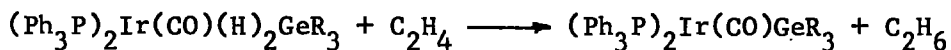

This system would constitute a homogeneous hydrogenation system.

$(\text{Et}_3\text{P})_2\text{Ir}(\text{CO})\text{Cl}$ does not form a germyl-iridium complex with trimethylgermane, $(\text{Et}_3\text{P})_2\text{Ir}(\text{CO})\text{H}_2\text{Cl}$, Me_6Ge_2 and hydrogen being formed.

INTRODUCTION

The co-ordination chemistry of Copper, Silver and Gold

Copper, silver and gold have the electronic structure $nd^{10}, (n + 1)s^1$ and hence are positioned in group I of the periodic table. This is, of course, misleading for except for superficial resemblances such as the occurrence of the +1 oxidation state and formal stoichiometries no common chemistry exists between the 'coinage' and the alkali metals.

Consideration of the first electron ionization potential of the metals indicates that whilst the alkalies will form ionic compounds, the 'coinage' metals form predominantly co-valent compounds. The large difference in the two groups of ionization potentials can be accounted for by the poor shielding of an s electron from the nuclear charge by the d electrons

Table 1. The first ionization potentials of the group I metals.

Cu	7.72 ev	Na	5.1 ev
Ag	7.57	K	4.3
Au	9.92	Rb	4.1
		Cs	3.9

The common oxidation states and stereochemistry are listed below

<u>Oxidation state</u>	<u>co-ordination number</u>	<u>geometry</u>	<u>examples</u>
Cu^I, d^{10}	4	tetrahedral	$CuI, [Cu(CN)_4]^{3-}$
Cu^{II}, d^9	4	square	$CuO, (CuCl_4)^{2-}$
	6	distorted octahedral	$K_2CuF_4, CuCl_2$
Ag^I, d^{10}	2	linear	$[Ag(CN)_2]^{-}, AgSCN$
	4	tetrahedral	$[Ag(PPh_3)_4]^+ ClO_4^{-}, (AgIPh_3)_4$

<u>Oxidation state</u>	<u>co-ordination number</u>	<u>geometry</u>	<u>examples</u>
Au ^I , d ¹⁰	2	linear	(AuI) _n , [Au(CN) ₂] ⁻ , Et ₃ PC≡CPh
Au ^{III} , d ⁸	4	planar	AuBr ₄ ⁻ , (Et ₂ AuBr) ₂ , R ₃ PAuX ₃

Less common states such as Au(II) are known but require specialist ligands such as diethyldithiocarbamate to stabilize them e.g.

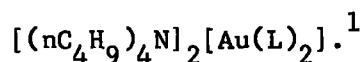

In this brief review only complexes relevant to this thesis will be mentioned, such as phosphine and arsine, carbonyl and hydride complexes, whilst bonds involving group Ib metals to halogens, nitrogen and the chalcogenides will be excluded.

(a) Phosphine and Arsine complexes

Phosphine and arsine complexes of the transition metals have recently been reviewed.^{1a} Copper and silver generally exhibit the +1 oxidation state although examples of the +2 oxidation level are known. Some of the latter have however later been found to be diamagnetic e.g. (Ph₃P)₂CuCl₂.² Gold however forms stable complexes in both the +1 and +3 oxidation states.

Copper exhibits variable metal to ligand ratios ranging from 1:1 to 1:4. With methyldiphenylarsine a complete series is formed,³ i.e. [Ph₂MeAsCuCl]₄, [(Ph₂MeAs)₄Cu](CuX₂), (Ph₂MeAs)₃CuX and [(Ph₂MeAs)₄Cu]X. The 1:1 complexes are the best characterised and are all tetrameric. X-ray analysis of Et₃AsCuI⁴ showed the copper atoms lying at the apexes of a tetrahedron whilst the halide atoms are above the centre of each face. The 2:1 complexes vary in composition, the diphenylmethylarsine compound

(above) being ionic whereas $(\text{PhMe}_2\text{P})_2\text{CuI}$ is a non electrolyte.⁵ The 3:1 complexes readily dissociate while the 4:1 class require a poorly co-ordinating ligand such as a perchlorate ion e.g. $[(\text{Ph}_3\text{P})_4\text{Cu}]\text{ClO}_4$.⁶ The strong tendency for 4 co-ordination is observed with bidentate ligands where two series of complexes are formed e.g. $(\text{chel})_2\text{CuX}$ and $[(\text{chel})_2\text{Cu}]\text{CuX}_2$.^{7,8} $(\text{Ph}_3\text{P})_2\text{CuBH}_4$ and $(\text{Ph}_3\text{P})_2\text{AgBH}_4$, in which a BH_4^- group acts as a chelating ligand forming hydrogen bridges between the metal and the boron atoms, have been reported.^{9,10}

Silver bears a close resemblance to copper in its chemistry whilst gold shows a large number of differences. Usually with transition metals, the second and third row metals are similar in properties e.g. palladium and platinum. A series of analogous complexes to copper are formed by silver, $[\text{R}_3\text{MAgI}]_4$,¹¹ $(\text{PhMe}_2\text{As})_2\text{AgX}$,¹² and $[(\text{Ph}_3\text{P})_4\text{Ag}]\text{ClO}_4$.⁶ With a particular bidentate ligand, either $(\text{chel})_2\text{AgX}$ or $[(\text{chel})_2\text{Ag}]\text{AgX}$ is formed but not both.

Gold complexes are usually monomeric, two co-ordinate with gold(I) and four co-ordinate for gold(III). The 1:1 complexes are long established, Levi-Malveno found Ph_3PAuCl to be monomeric in benzene (1908).¹³ Two to one complexes are more unusual, examples being $(\text{pMe}_2\text{NC}_6\text{H}_4\text{PMe}_2)_2\text{AuI}$,¹⁴ $(\text{Ph}_3\text{P})_2\text{AuCl}$ and $[(\text{Ph}_3\text{P})_2\text{Au}]\text{ClO}_4$.¹⁵ Co-ordination numbers of 3 and 4 are shown by the complexes $[(\text{Ph}_3\text{P})_3\text{Au}]\text{NO}_3$ and $[(\text{Ph}_3\text{P})_4\text{Au}]\text{ClO}_4$. Gold cluster compounds such as $\text{Au}_5(\text{Ph}_3\text{P})_4\text{Cl} \cdot 1.4(\text{solvent molecules})$ have also been prepared.¹⁵ Upon refluxing in methanol, 4/5 of the gold is recovered as the metal, with $(\text{Ph}_3\text{P})_2\text{AuCl}$ being isolated from the solution and a gold(o) species is therefore postulated. Formation of gold(III) complexes can be accomplished

by the addition of halogens to a gold(I) complex

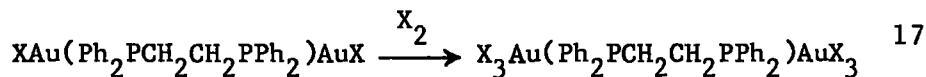
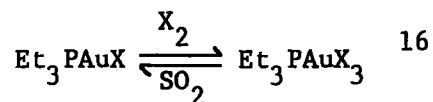

The complexes $\text{Et}_3\text{PAuXX}'\text{X}''$ are square planar for no evidence of optical activity has been reported.¹⁶ Bidentate complexes are similar to copper, for instance with o-phenylenebis(dimethylarsine), $[(\text{diars})_2\text{Au}](\text{ClO}_4)_3$ has been isolated.¹⁸ A gold cluster complex, comprising two groups of three gold atoms bridged by two 1,2-bisdiphenylphosphinoethane ligands has been postulated for the complex $[\text{Au}_6(\text{Ph}_2\text{PCH}_2\text{CH}_2\text{PPh}_2)_2\text{Cl}]\text{BPh}_4$.¹⁹

(b) Hydride Complexes

No fully characterised complexes of copper, silver and gold bonded to a hydrogen atom have been reported.²⁰ An unstable brown-red precipitate obtained by the action of hypophosphorus acid on copper sulphate was reported as long ago as in 1844.^{21,22} Attempts to prepare a gold hydride by the reaction of lithium aluminium hydride on gold trichloride have been unsuccessful.²³ A bridging hydride complex,^{9,10,24} (see preceding section) has been proposed for the complex

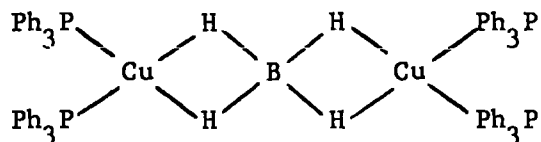

Carbonyl complexes

A number of carbonyl complexes of the formula MX(CO) have been prepared. They are all rather unstable reacting with either air or water. The copper complex, CuCl(CO), can be prepared by passing carbon monoxide over cuprous or cupric oxide, presumably chlorine contaminated.^{25,26,27,28} The complex CuX.CO.nNH₃ has been prepared by the reactions,²⁹

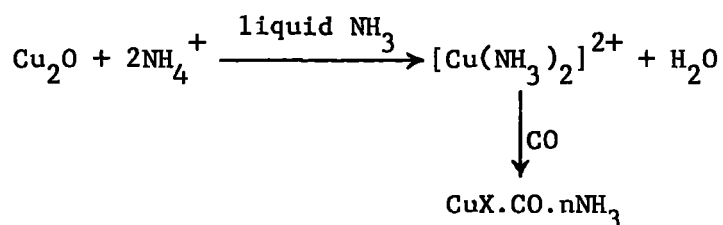

The only silver carbonyl reported is Ag₂SO₄.CO prepared by bubbling carbon monoxide into a sulphuric acid solution of silver sulphate.^{30,31}

The gold complex, AuCl(CO), is directly prepared from AuCl and AuCl₃.^{32,33} It is quite stable in air, dissolving in acetone or benzene with only slight loss of carbon monoxide. The carbonyl stretching frequency was reported as 2152 cm⁻¹, one of the highest values found for a carbonyl compound.³⁴

Organometallic complexes

Few copper or silver derivatives are known and these are much less stable than the gold analogues. Complexes of the type R_nM are ill characterised, unstable and frequently explosive.

Polymeric methyl copper is a yellow, ether insoluble compound which detonates at room temperatures, to form methane, ethane and copper.^{35,36,37}

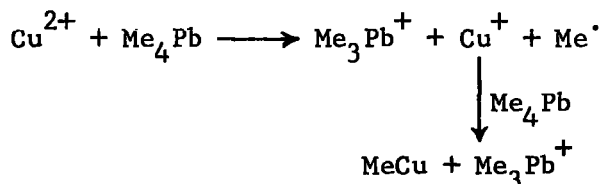

Phenylcopper³⁸ is more stable decomposing only at 80°

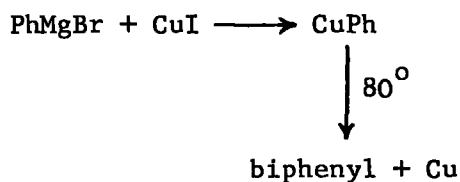

The most stable copper complex prepared to date is $(\text{Et}_3\text{P})(\text{C}_5\text{H}_5)\text{Cu}$, the infrared spectrum of which, indicates the cyclopentadienyl ion to be σ bonded.³⁹

Methyl^{36,40} and phenyl silver^{38,41} are similar to copper but are less stable and consequently have not been isolated in a pure state. There is no information on their structures.

Gold complexes have been known for many years, and occur both in the +1 and +3 oxidation states; the gold(I) complexes being two co-ordinate whereas gold(III) is four co-ordinate. No complexes, RAu , are known but trimethylgold, Me_3Au , has been prepared at -65° .⁴² A gold mirror forms at -35° as the complex decomposes. Trimethylphosphine⁴³ or ethylenediamine⁴² stabilise the complex, the latter complex, $\text{Me}_3\text{Au} \cdot \text{NH}_2\text{CH}_2\text{CH}_2\text{NH}_2 \cdot \text{AuMe}_3$, for instance decomposing at 95° , Gibson and co-workers have produced a number of halogen-bridged gold complexes of two types e.g. $\text{Me}_4\text{Au}_2\text{I}_2$ and $\text{Et}_2\text{Au}_2\text{Br}_4$.

Olefine complexes are generally unstable and difficult to isolate. One to one complexes are formed by copper and silver e.g. $\text{C}_2\text{H}_4\text{CuCl}$ ⁴⁴ and $\text{C}_7\text{H}_8\text{AgNO}_3$.⁴⁵ Only recently have the first gold-olefine complexes been isolated when 1.5-cyclo-octadiene and chlorauric acid give $\text{C}_8\text{H}_{12}\text{Au}_2\text{Cl}_2$. A σ cyclopentadienyl complex similar to copper has been reported.⁴⁷

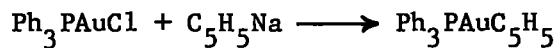

A number of complexes, $\text{R}_3\text{PAuR}'$, ($\text{R}' = \text{alkyl, aryl and ethynyl}$) are known.⁴⁸ They are air stable and monomeric in benzene except with chelating ligands when complexes of the type $\text{R}'\text{Au}(\text{chelate})\text{AuR}'$ are formed. Copper and silver analogues are only known for ethynyl complexes,^{49,50} a co-ordination number of 4 being postulated for these associated complexes in contrast to the two co-ordinate gold monomers.

The Chemistry of Iridium

Iridium metal

Atomic number	77	Atomic weight	192.2
Electron configuration	$5d^7 6s^2$	Stable isotopes	191 (37.3%)
Melting point	2454 ^o		193 (62.7%)
Boiling point	5300 ^o		

There has been a considerable number of publication on iridium chemistry during the past decade, for which several reasons can be advanced. The possible catalytic properties, (although iridium complexes are generally inferior to those of rhodium); the advent of modern techniques such as infrared and, particularly, nuclear magnetic resonance spectroscopy (making, for instance, the detection and elucidation of stereochemistry of hydrides possible); and the interesting nature of the chemistry, have all contributed to this rapid expansion. The fact that iridium is an extremely expensive metal, (favouring again modern spectral techniques where characterisation of complexes can be accomplished with small quantities of materials) and that no general satisfactory method of iridium analysis exists,⁵¹ must have discouraged investigations into the chemistry of iridium, and possibly a re-investigation of complexes postulated during the last century would be a rewarding study.

Only aspects of iridium chemistry which have proved relevant to the work of this thesis are reviewed, namely complexes of the type

$(R_3P)_2Ir(CO)Cl$ and $(R_3As)_2Ir(CO)Cl$, the trans effect and the identification of stereoisomers. The most common oxidation states of iridium and their stereochemistries are listed below.

<u>Oxidation State</u>	<u>Co-ordination Number</u>	<u>Geometry</u>	<u>Examples</u>
Ir^I, d^8	4	Planar	$(R_3P)_2Ir(CO)Cl$
	5	Trigonal Bipyramidal	$(Ph_3P)_3Ir(CO)H$
Ir^{III}, d^6	5	Trigonal Bipyramidal	$(R_3P)_2IrH_3$
	6	Octahedral	$IrCl_6^{3-}, (Ph_3P)_3IrX_3$
Ir^{IV}, d^5	6	Octahedral	$IrCl_6^{2-}, [Ir(C_2O_4)_3]^{2-}$

Reviews covering aspects of iridium chemistry have been published.^{51,52,53,54}

The complexes $(R_3P)_2Ir(CO)Cl$ and $(R_3As)_2Ir(CO)Cl$

These complexes, and $(Ph_3P)_2Ir(CO)Cl$ in particular are probably the most extensively studied derivatives of iridium(I). These 'unsaturated' iridium(I) complexes readily add a large variety of molecules, in a number of cases reversibly. Possibly for linguistic reasons the complex, $(Ph_3P)_2Ir(CO)Cl$, is often known as 'Vaska's compound', for Vaska and DiLuzio⁵⁵ (1961) are often regarded as having reported the complex first. Angoletta⁵⁶ however had prepared the complexes $(Ph_3P)_2Ir(CO)Cl$ and $(Ph_3P)_2Ir(CO)Br$ two years earlier (1959) although he formulated the chloride incorrectly as $(Ph_3P)_2Ir(CO)_2Cl$.

The complexes, $(R_3E)_2Ir(CO)X$, have been prepared by three main routes, each of which has its own disadvantages. Firstly, an iridium(III) or iridium(IV) halide, such as $(NH_4)_2IrCl_6$ or $IrCl_3 \cdot (H_2O)_x$ and a large excess of phosphine or arsine are refluxed in alcohol for up to 24 hours, time, solvent and temperature being critical. (Table 2).

Table 2

Ligand	Solvent	time	temp- erature	main product	yield	refer- ence
Ph ₃ P	ethylene glycol	7 hr.	190°	(Ph ₃ P) ₂ Ir(CO)Cl	75%	55
	diethylene glycol	2 hr.	240°	(Ph ₃ P) ₂ Ir(CO)Cl	76%	55
	ethylene glycol		190°	(Ph ₃ P) ₃ IrH ₂ Cl	89%	57
Ph ₃ As	ethylene glycol		170°	(Ph ₃ As) ₂ Ir(CO)HCl ₂		55
Ph ₃ P	2-methoxyethanol		100°	(Ph ₃ P) ₃ IrHCl ₂	95%	57

The carbonyl group has been shown to originate from the solvent by use of C¹⁴ enriched ethylene glycol.⁵⁵

The second method involves bubbling carbon monoxide gas through alcoholic solutions of 'iridium chloride', to form Ir(CO)₃Cl.

Stoichiometric quantities of phosphine are then added. A number of phosphines have been used, for example, Ph₃P,^{56,58,59} Et₃P,^{59,60} Et₂PhP⁵⁹ and Et₂PhAs,⁵⁹ but with Me₂PhP⁶⁰ an inseparable mixture of (Me₂PhP)₂Ir(CO)Cl and (Me₂PhP)₂Ir(CO)HCl₂ is formed.

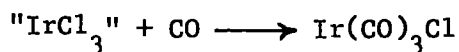

The third method involves ligand exchange or extraction of halogens or hydrogen halides, a variety of reagents being used.

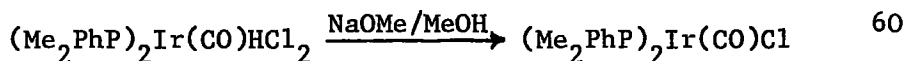
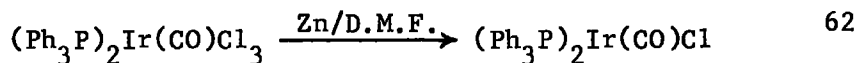
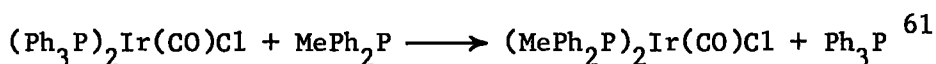
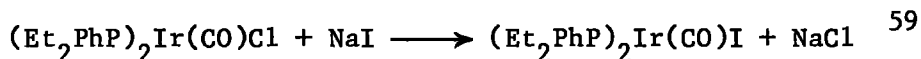

Most of the complexes prepared are yellow, air stable, crystalline solids, the two phosphine ligands being mutually trans in a square planar configuration.⁵⁵

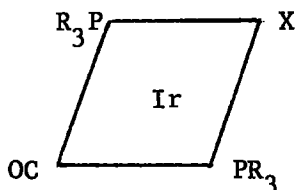

The chemistry will be discussed with specific examples although it can generally be assumed that the type of reactions involved apply to the whole series, $(\text{R}_3\text{E})_2\text{Ir(CO)X}$.

Although $(\text{Ph}_3\text{P})_2\text{Ir(CO)Cl}$ is air stable as a solid, it readily takes up oxygen in toluene solution, from which brown crystals of $(\text{Ph}_3\text{P})_2\text{Ir(CO)(O}_2\text{)Cl}$

separate.^{62,63} However the reaction can be reversed in solution under an atmosphere of nitrogen. Thus, this reversible reaction giving a 1:1 complex is similar to the haemoglobin-oxygen system, except, of course, that the iridium-oxygen adduct is isolable. The iodide analogue, $(\text{Ph}_3\text{P})_2\text{Ir}(\text{CO})(\text{O}_2)\text{I}$ absorbs oxygen ten times more quickly,^{63,64} and requires more stringent conditions (boiling dimethylformamide) to release its oxygen. X-ray crystal structure analyses have been reported for the complexes $(\text{Ph}_3\text{P})_2\text{Ir}(\text{CO})(\text{O}_2)\text{Cl}$ ^{65,66,67,68} and $(\text{Ph}_3\text{P})_2\text{Ir}(\text{CO})(\text{O}_2)\text{I}\cdot\text{CH}_2\text{Cl}_2$ ^{68,69} (see Figure 1)

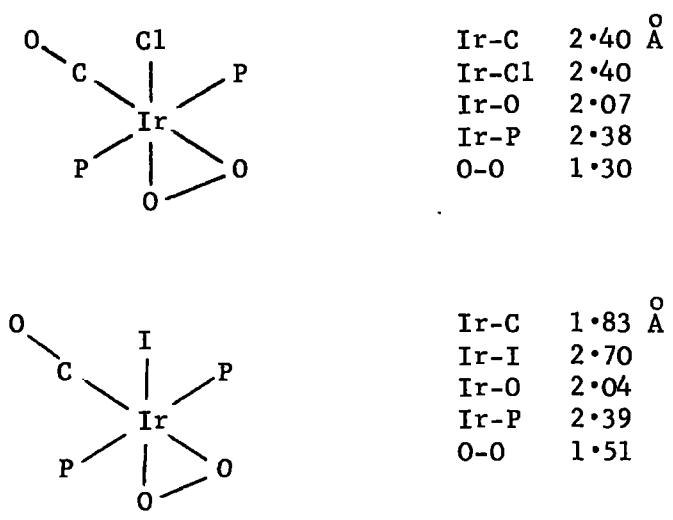
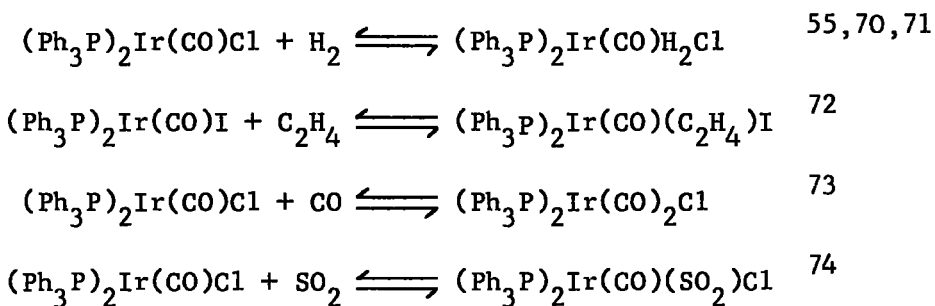

Figure 1. Some bond lengths in $(\text{Ph}_3\text{P})_2\text{Ir}(\text{CO})(\text{O}_2)\text{Cl}$ and $(\text{Ph}_3\text{P})_2\text{Ir}(\text{CO})(\text{O}_2)\text{I}\cdot\text{CH}_2\text{Cl}_2$.

The O-O bond length in the oxygen molecule is 1.21Å , for an O_2^- entity 1.28Å , and in a peroxide, O_2^{2-} , 1.49Å . Both molecules are distorted

octahedra, the O-O length for the chloride being similar to those for an O_2^- species, whilst the longer O-O bond length in the iodide resembles that in a peroxide. The extent of back donation of electrons from d orbitals of iridium to the π^* orbitals of oxygen depends upon the availability of electrons on the metal. Thus there is greater electron availability in the iodide complex, and, consequently the oxygen is more tightly bound, this being reflected on the greater stability of the iodide complex as well as the larger O-O bond length. Other molecules too add reversibly to $(Ph_3P)_2Ir(CO)X$ examples being hydrogen, ethylene, carbon monoxide and sulphur dioxide.



The sulphur dioxide adduct, $(Ph_3P)_2Ir(CO)(SO_2)Cl$ ⁷⁵ has been shown to be non octahedral by X-ray analysis (Figure 2), though no explanation of its non octahedral nature was suggested.

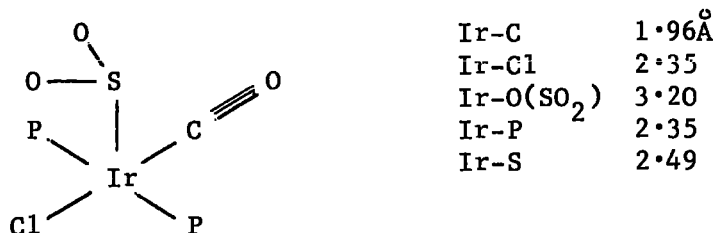
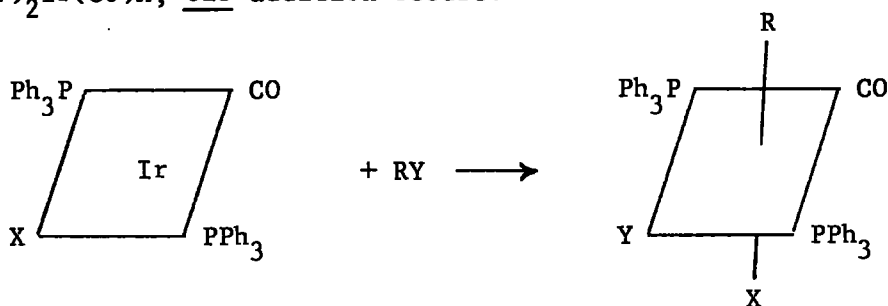

Figure 2. Some bond lengths in the complex, $(Ph_3P)_2Ir(CO)(SO_2)Cl$

Only a few stereochemical and kinetic studies have been reported to date, the results being somewhat contradictory. The stereochemical observations indicate both cis and trans addition, the mode of addition depending upon the phosphine group, the addendum and whether heterogeneous or homogeneous conditions apply. When gases are reacted with solid $(\text{Ph}_3\text{P})_2\text{Ir}(\text{CO})\text{X}$, cis addition occurs.⁷⁶



(X = Cl, Br, I or SCN; RY = HF, HCl, DCl, HBr, HI or H₂S)

Under these conditions, rearrangement possibilities are minimised. Cis addition is also reported for the solution addition of halogens or methyl iodide.⁷⁷

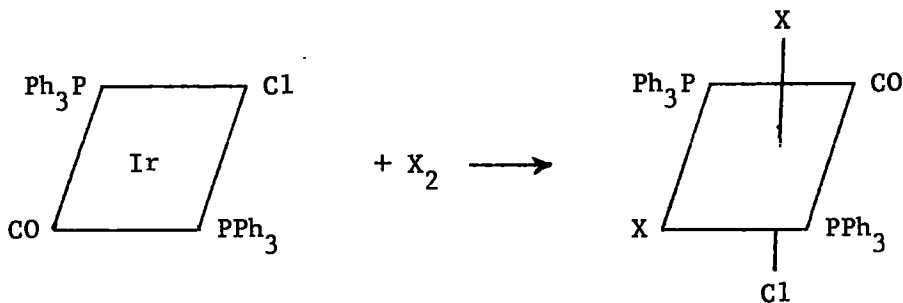

(X₂ = Cl₂, Br₂ or I₂)

However it has been reported that addition of halogens⁷⁸ or methyl halides^{78a} to $(\text{MePh}_2\text{P})_2\text{Ir}(\text{CO})\text{Cl}$ ⁷⁸ or $(\text{Me}_2\text{PhP})_2\text{Ir}(\text{CO})\text{Cl}$ ^{78a} results in trans addition.

Two inter-convertible isomers, $(\text{MePh}_2\text{P})_2\text{Ir}(\text{CO})(\text{CH}_3)\text{ClBr}$ have been prepared by the following reaction scheme.⁷⁸

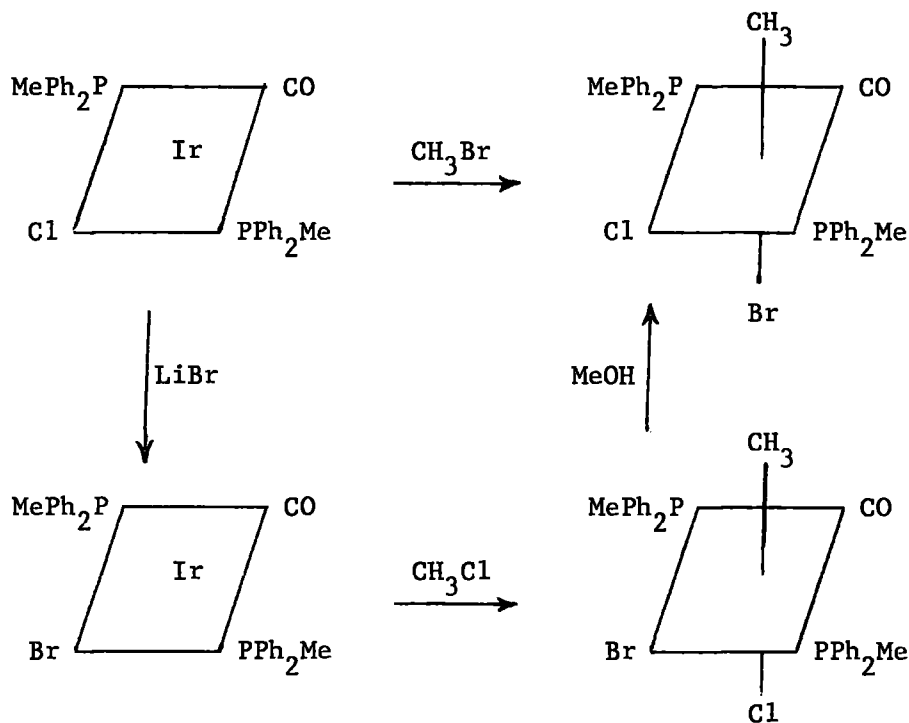

Thus it appears that methyl halides add cis with the triphenylphosphine complex but trans with the methyldiphenylphosphine or dimethylphenylphosphine complexes. Hydrogen adds cis in every case reported to date. With HD and $(\text{Ph}_3\text{P})_2\text{Ir}(\text{CO})\text{Cl}$, scrambling of the HD molecule occurs.⁷⁹

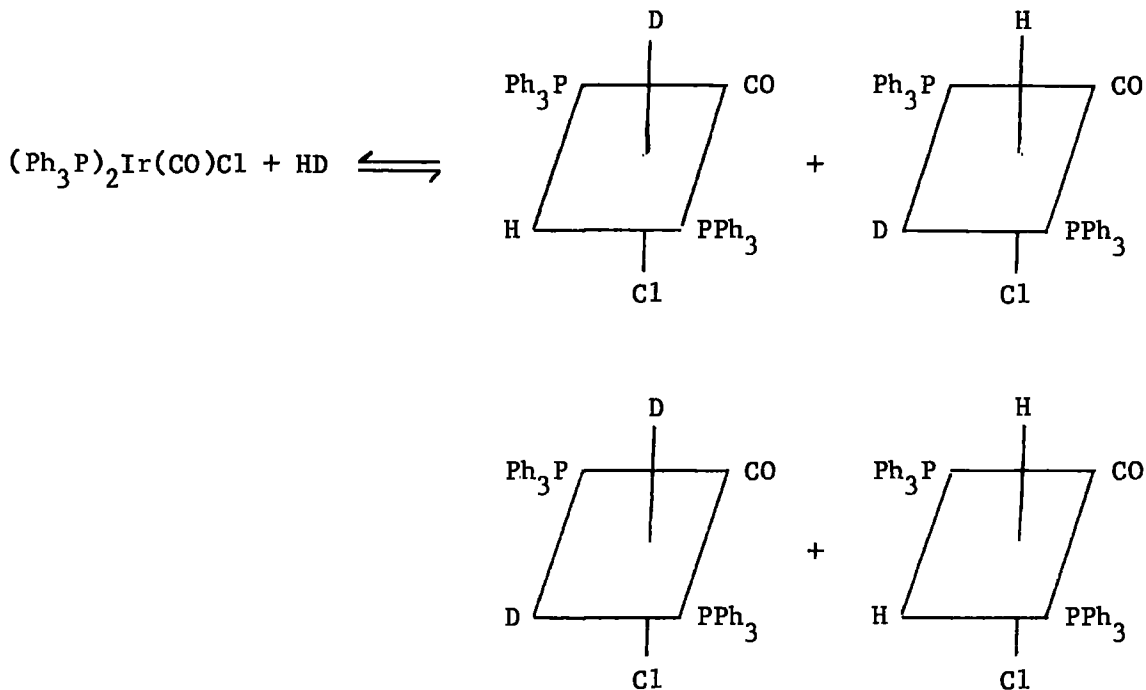

With one exception, it has been found that the two phosphine groups remain mutually trans. The exception is the addition of allyl halides to $(\text{Me}_2\text{PhP})_2\text{Ir}(\text{CO})\text{Cl}$ when a cis phosphine adduct is isolated.⁸⁰

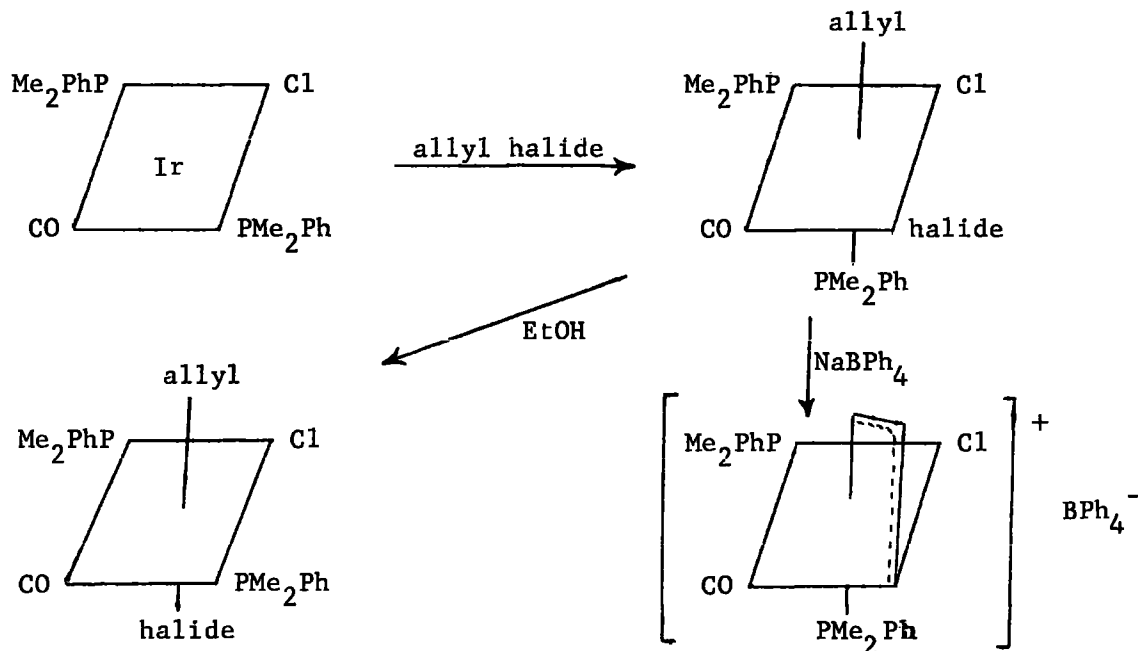

Recrystallisation with ethanol leads to isomerisation, the phosphines assuming trans positions. The importance of the solvent should be noted for it is possible that in the reported trans additions, a cis addition may initially occur followed by rearrangement.

Studies on the addition of hydrogen, oxygen and alkyl halides to $(\text{Ph}_3\text{P})_2\text{Ir}(\text{CO})\text{X}$ indicate, not surprisingly, 2nd order kinetics.⁶⁴ However two patterns of addition were observed, one for oxygen and hydrogen where cis addition occurs, the other for alkyl halides (trans addition). Other factors affecting the rates of addition were solvent polarity and the halide, X, of the square planar complex.

With oxygen and hydrogen, a polar transition state is postulated for the reaction rate increases in the order $\text{Cl} < \text{Br} < \text{I}$, and with increasing solvent polarity (dimethylformamide $<$ benzene). A large negative entropy of activation is observed suggesting an ordered polar transition state or, less likely, unusually stringent stereochemical conditions. Finally addition of deuterium to the square planar complexes has little effect on the rate, indicating that the breaking of the H-H or D-D bond is not involved in the rate determining step.

In contrast, the rate of addition of methyl iodide to the complexes $(\text{Ph}_3\text{P})_2\text{Ir}(\text{CO})\text{X}$, (X = Cl, Br or I), was found to be $\text{Cl} > \text{Br} > \text{I}$. Reaction takes place at a faster pace in dimethylformamide than in benzene. The overall reaction rates were much lower than with hydrogen and oxygen.

Other reactions were unsuitable for kinetic studies, the reaction

times being either too fast (hydrogen chloride or bromide) or too slow (methyl bromide).

A few additions are now mentioned in some detail whilst a brief summary of other principal reactions follow. With the chelating phosphine, 1,2-bis(diphenylphosphino)ethane, a five co-ordinate 'saturated' iridium(I) complex, (Figure 3), is formed which loses carbon monoxide reversibly on heating.^{58,81,82} The resultant complex, $[(\text{Ph}_2\text{PCH}_2\text{CH}_2\text{PPh}_2)_2\text{Ir}]\text{Cl}$, reacts non-reversibly with oxygen and hydrogen.

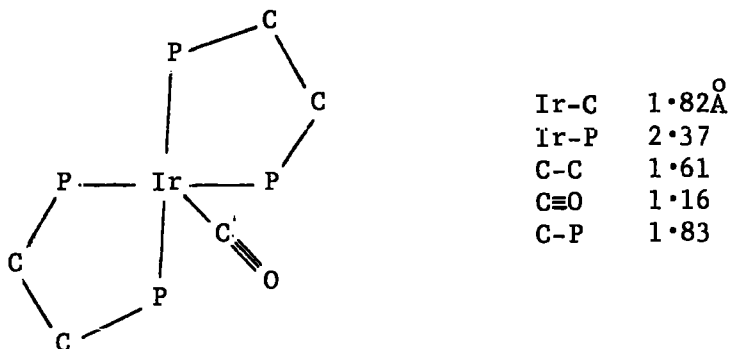
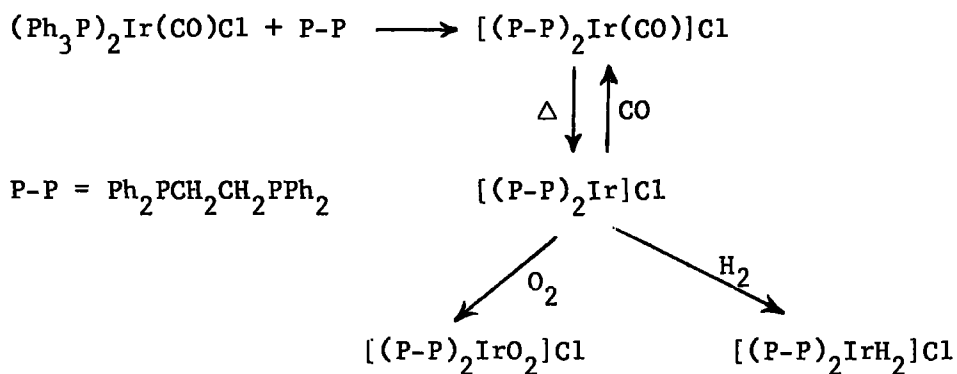
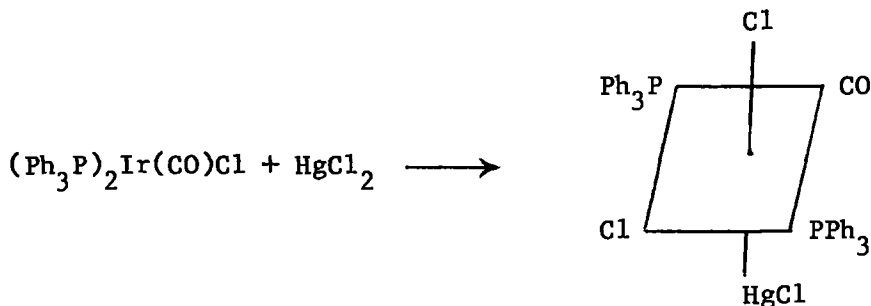

Figure 3. Some bond lengths in $[(\text{Ph}_2\text{PCH}_2\text{CH}_2\text{PPh}_2)_2\text{Ir}(\text{CO})]\text{Cl}$.⁸³

Mercuric chloride reacts with $(\text{Ph}_3\text{P})_2\text{Ir}(\text{CO})\text{Cl}$ to form an air and moisture stable complex containing an iridium-mercury bond.^{84,85}



The addition of NO^+BF_4^- to Vaska's compound results in the formation of penta-co-ordinate $[(\text{Ph}_3\text{P})_2\text{Ir}(\text{CO})(\text{NO})\text{Cl}]\text{BF}_4$ which contains the only proven example of a bent metal-nitrogen-oxygen bond (Figure 4).⁸⁶ The bond angle (124°) corresponds approximately to sp^2 hybridised nitrogen, the bent bond being accounted for if no suitable metal orbitals are available to back donate to the nitrosyl group. This seems to be the case for a long Ir-N bond length was found.

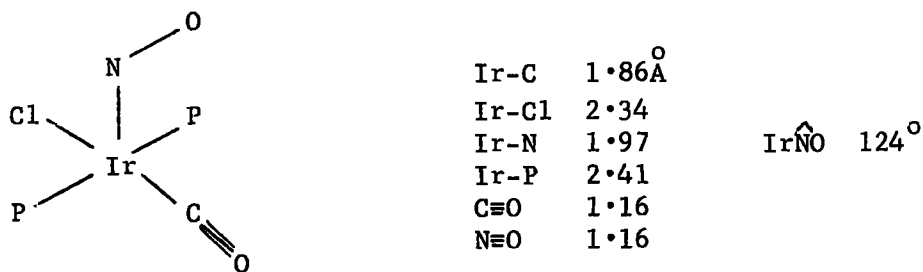
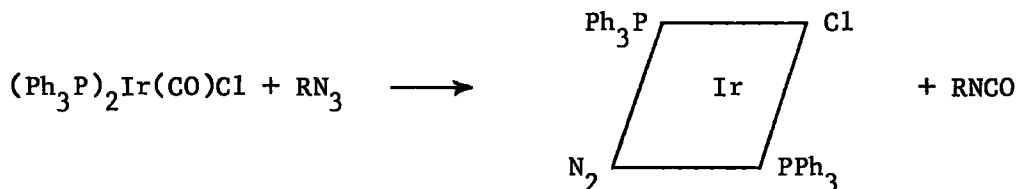
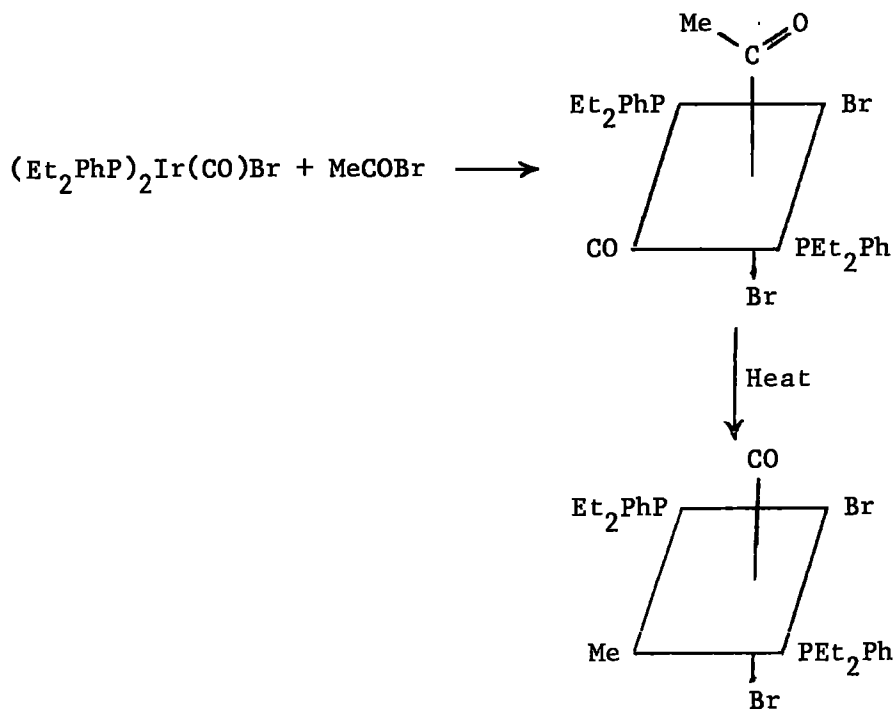

Figure 4. Some bond lengths in $[(\text{Ph}_3\text{P})_2\text{Ir}(\text{CO})(\text{NO})(\text{Cl})]\text{BF}_4$

A complex containing a nitrogen molecule bound to iridium has been prepared by reacting an organic azide with $(\text{Ph}_3\text{P})_2\text{Ir}(\text{CO})\text{Cl}$.^{87,88,89}
 (see p.109)



The addition of group IVb hydrides, such as HSiCl_3 and R_3SnH are discussed later (p.83.). Reactions with acetylbromide,⁵⁹ hydrazine,⁹⁰ hydrogen cyanide,⁹³ and perfluoroethylene,^{91,92} are summarised.



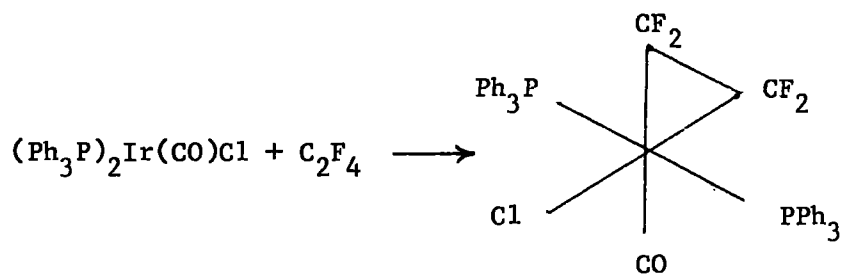
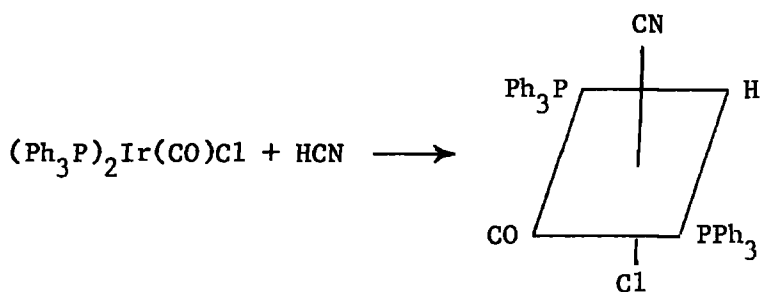
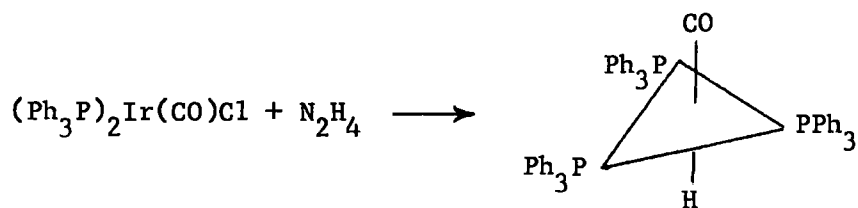

Catalytic activity too has been investigated⁹⁴ but results to date suggest the complex, $(\text{Ph}_3\text{P})_2\text{Ir}(\text{CO})\text{Cl}$, to be a poor catalyst; for instance, with hydrogen and ethylene or acetylene only small conversions have occurred after 18 hours at 60° .⁷²

The Trans-effect and Trans-influence

Ligands in square planar complexes have been classified for many years according to their trans directing properties i.e. the tendency for "a group co-ordinated to a metal to direct an incoming group into a position trans to itself".⁹⁵ Thus, by a variety of means such as relative rates of substitution a series based on the relative effectiveness of a ligand to direct a substituent into a trans position to itself has been built up.⁹⁶

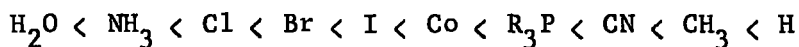

The classic illustration is the preparation of the cis⁹⁷ and trans⁹⁸ isomers of the complex ion, $[\text{PtCl}_2(\text{NH}_3)_2]^{2-}$. As chloride ions have a higher trans effect than ammonia, substitution always occurs at a position trans to a chloride ligand.

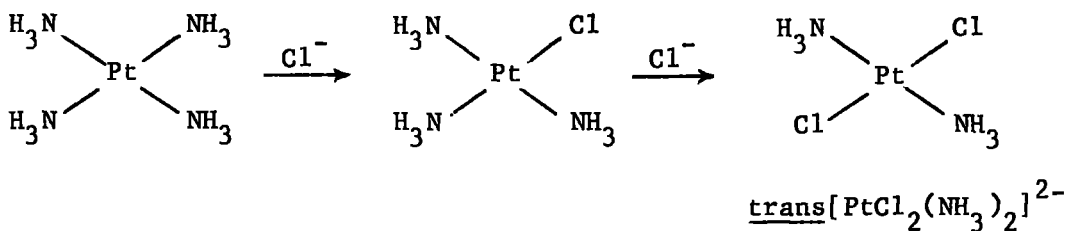
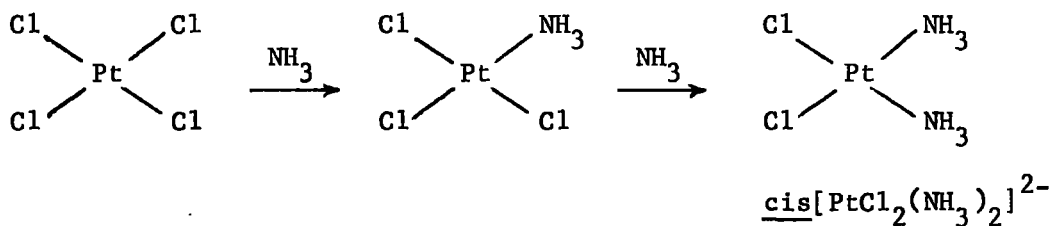

A number of theories have been advanced to explain the trans effect but none are wholly comprehensive. These can be grouped into two main categories namely the inductive or polarisation theory and secondly the mesomeric or π bonding theory.

In a square planar platinum complex, LPtX_3 , (Figure 5), the metal will induce a dipole in ligand L, which will, in turn, induce a dipole on the metal which will be unfavourable to X, provided L is more polarisable than X.

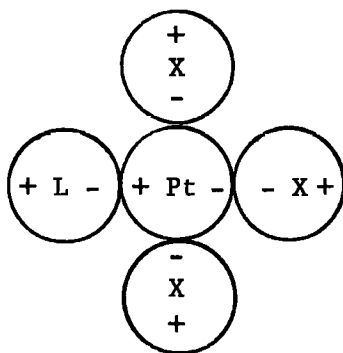
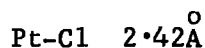
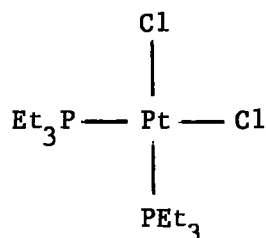
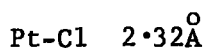
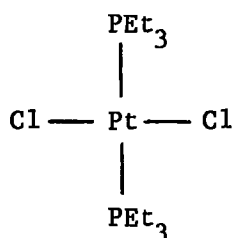

Figure 5

The dipoles induced in LPtX_3 by polarisation of ligand L

The repulsive force between Pt and X will weaken the Pt-X bond and X-ray structure determinations confirm that high trans effect groups lengthen the trans bond.⁹⁹



The theory satisfactorily explains many experimental facts such as the correlation between trans effect and polarisability in a series of ligands and that the trans effect is more pronounced in Pt(II) complexes than those of the less readily polarised Pd(II) and Pt(IV). The induced dipole, in the simple model (Figure 5), thus repells the trans group, but, is neutral to cis groups, again in accordance with experimental observations. Thus the emphasis with the polarisation theory is on bond weakening through σ bonds.

Although an ethylene group greatly labilises a trans amine group (e.g. in trans $[\text{PtCl}_2(\text{Me}_2\text{NH})(\text{C}_2\text{H}_4)]$ ¹⁰⁰ X-ray structure determinations show no bond lengthening. Ethylene, in common with carbon monoxide and tertiary phosphines, is considered capable of forming strong π bonds by removal of electrons from the filled platinum d orbitals into π^* (ethylene and carbon monoxide) or empty d orbitals (tertiary phosphines). Except in the case of ethylene, donation through the σ bond must be more important than π electron removal since bond lengthening occurs. (e.g. cis and trans

(Et_3P) $_2\text{PtCl}_2$). The π bonding or mesomeric theory proposes that stabilisation of an activated complex intermediate accounts for the kinetic trans effect.^{95,101} If a trigonal bipyramidal activated complex is assumed (Figure 6) for the reaction trans $\text{PtA}_2\text{LX} \longrightarrow$ trans PtA_2LY , then removal of charge from the platinum can be effected by ligand L through π bonding. Emphasis is thus on the removal of charge from the platinum atom encouraging the addition of Y to form a 5 co-ordinate species and on the increased stability of the intermediate as electron density in the Pt-X and Pt-Y bonds is reduced by π bonding (Figure 6).

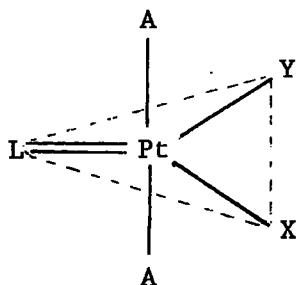

Figure 6

Activated complex for the reaction trans (PtA_2LX) \longrightarrow trans (PtA_2LY)
 where L is a π bonding ligand.¹⁰¹

The theory thus predicts a retention of configuration and that Y and L will effect the reaction rate, for which experimental agreement is reported. The theory does not however explain the very high trans effect of groups such as H^- or CH_3 where π bonding cannot be invoked.

Recently p.m.r. examination of J(Pt-P) coupling on a series of square planar platinum complexes¹⁰² has led to the hypothesis that π bonding is only a minor factor in the bonding of tertiary phosphines, and that the trans effect for this class of complexes is primarily transmitted through σ bonds. Theory shows that J(Pt-P) coupling is proportional to the s character in a bond and (because of the symmetry of s orbitals) reflects the electron distribution of σ systems. The p.m.r. results show Pt-P bonds to be stronger in cis complexes, ($\text{Pt}^{\text{II}}\text{X}_2\text{P}_2$ or $\text{Pt}^{\text{IV}}\text{X}_4\text{P}_2$), the difference in s character from the corresponding trans complexes being similar in both the Pt(II) and Pt(IV) compounds. If $d\pi-d\pi$ bonding played a significant role, considerable differences between Pt(II) and Pt(IV) complexes would be expected, since Pt(IV) has two less d electrons and an increased formal charge. Gray and Langford¹⁰³ based a theory of the trans-effect on the magnitude of σ overlap integrals. If in a complex, PtA_2LX , (L trans X), L has a greater σ overlap with the metal $p\sigma$ orbital than X, then the M-L bond is strengthened whilst the M-X bond is weakened and consequently lengthened. X-ray measurements for a series of platinum(II) complexes give a similar order of ligands to the overlap integral calculations.¹⁰⁴

Many other investigations into observable ground state effects of the trans group, using particularly infrared or nuclear magnetic resonance spectroscopy, have been reported in the last decade. These ground state phenomena (an equilibrium property) are often designated trans influence to distinguish from the primarily kinetic trans effect. It is how the trans

influence can be used to interpret spectra and hence determine the stereochemistry of square planar and octahedral complexes that will now be discussed in detail in the following sections.

Identification of stereoisomers of square planar and octahedral metal complexes

A number of physical methods are available for the elucidation of a structure although often a combination of techniques is required to assign an isomer unambiguously.

X-ray studies are, of course, a general technique and a number of iridium complexes have been so analysed (see preceding sections). X-ray analysis is a lengthy, specialist technique unsuited for day to day applications and, of course, is unable to detect hydrogen atoms, a major disadvantage in iridium chemistry.

Chemical properties. It can be inferred from the ease of substitution of a particular ligand, in a square planar or octahedral complex, which group is trans to the ligand. For example, chloride replacement of a hydride can be effected with dilute hydrochloric acid¹⁰⁵ provided the hydride ligand is trans to a high trans-directing group such as a tertiary phosphine. Thus, hydrogen is rapidly evolved when complex (I) is treated with dilute hydrochloric acid in ethanol.¹⁰⁵

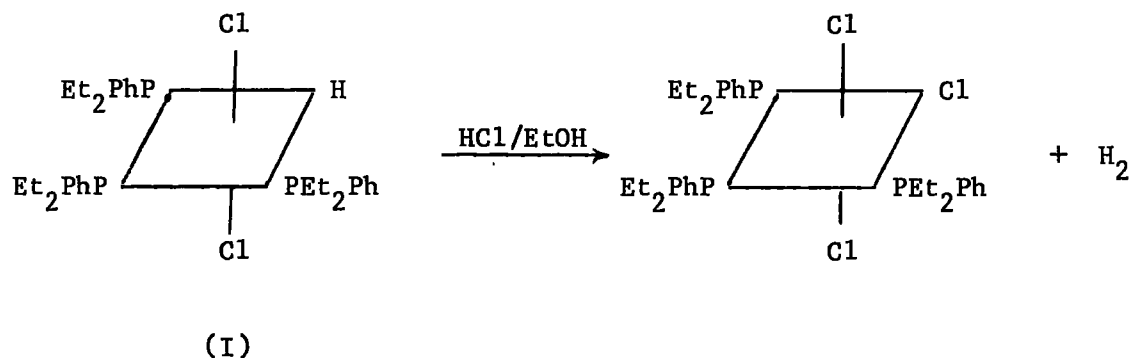

However, when a hydride group is trans to a low trans-effect ligand, substitution does not occur. Hence only one of the two hydrogen atoms is substituted in complex (II) (i.e. trans PEt_2Ph).¹⁰⁵

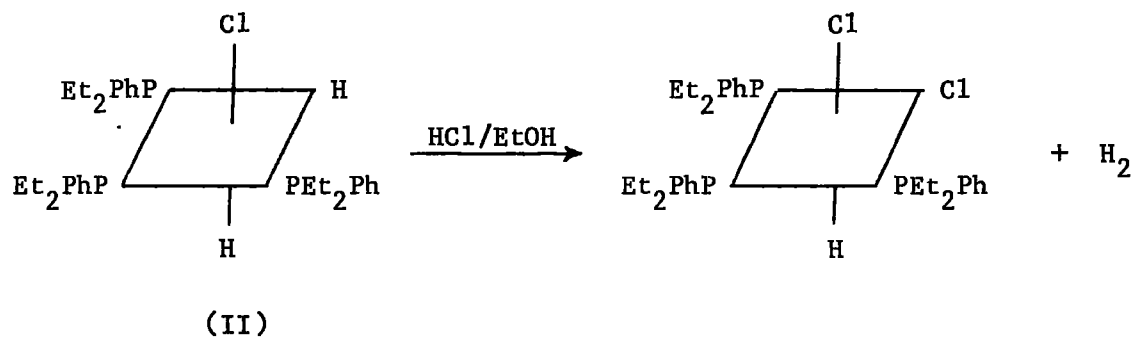

Another illustration showing a similar dependence on trans bond weakening is the reverse substitution, viz chloride for hydride, using alcoholic potash. Thus complex (III) undergoes a single substitution (Cl trans Et_2PhP) whilst complex (IV) (Cl trans to Cl or CO) is inert to alcoholic potash.¹⁰⁶

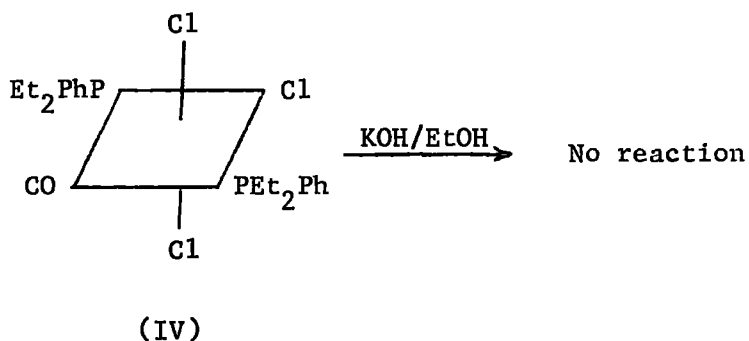
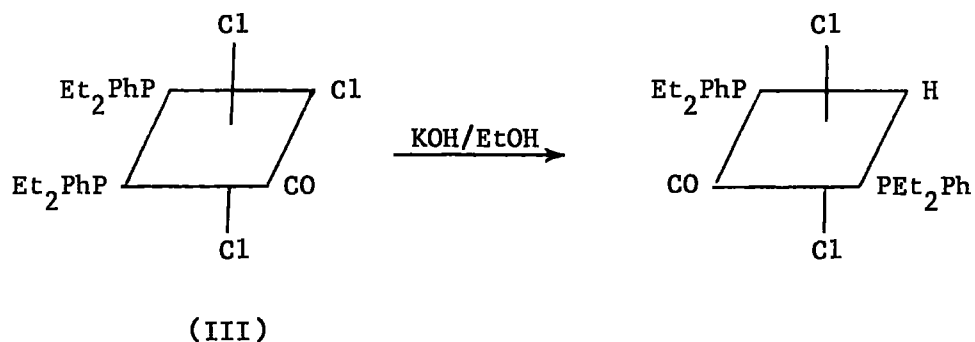

Similarly it is found that if complex (V) is refluxed with sodium iodide in acetone, a single substitution occurs within a few minutes whilst several hours are required, for the remaining chlorides to be labilised to give complex (VI).

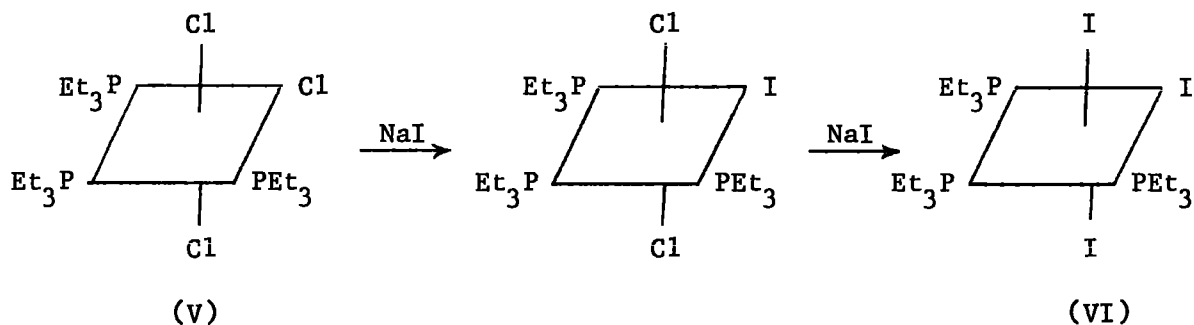

Phosphine or arsine exchange too, only occurs when the phosphine or arsine group is trans to a hydride ligand (very high trans-effect). e.g. in complex (VII) only one arsine group is replaced.¹⁰⁸

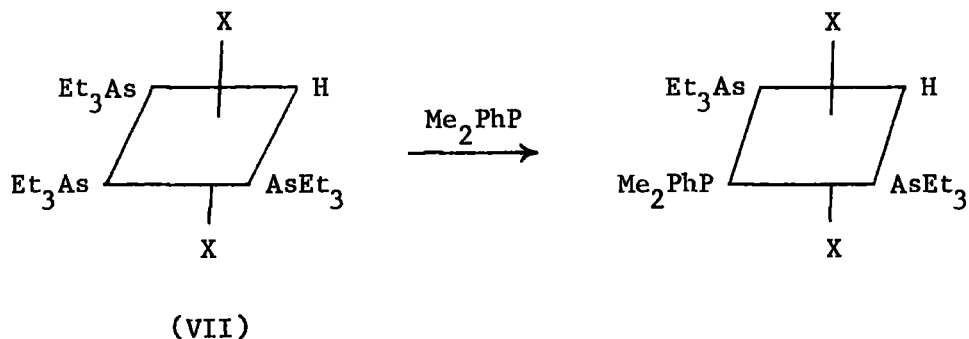

It should be noted too that reports of correlation between the colour of a complex and its structure exist. Thus the series of complexes of structure (VIII) are found to be white whilst its isomers (IX) are yellow.¹⁰⁶ Any generalisation though would be unwise on such a basis.

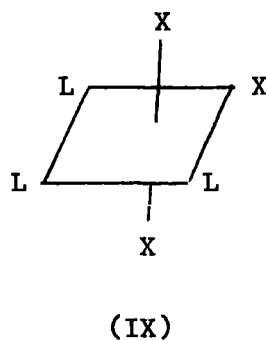
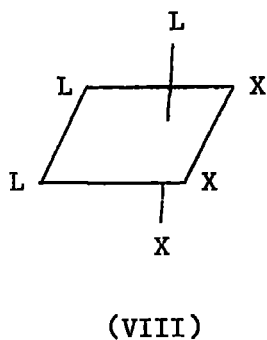

Dipole moments. Evaluation of dipole moments provide a ready method of distinguishing between isomers. The complexes (X) and (XI) have dipole moments of 2.6D and 6.9D respectively.¹⁰⁵

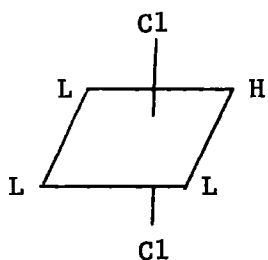

L = Et₃P

(X)

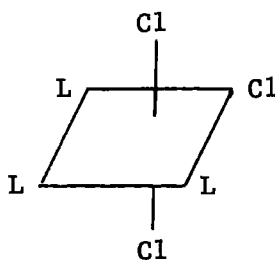

L = Et₃P or
Et₂PhP

(XI)

As the L-Ir-L and Cl-Ir-Cl vectors have zero moments, the moments of the $\overset{+}{L}$ -Ir- $\overset{-}{H}$ and $\overset{+}{L}$ -Ir- $\overset{-}{Cl}$ vectors must be 2.6D and 6.9D respectively. By subtraction, the $\overset{+}{H}$ -Ir- $\overset{-}{Cl}$ vector has a moment of 4.3D. As iridium complexes are square planar or octahedral, dipole moments for unknown compounds can readily be calculated by simple arithmetic. Good agreement with experimental values are found, some examples being given in Table 3.¹⁰⁵

The three possible isomers of the complex, L₂Ir(CO)Cl₃ (XII-XIV) have been prepared and these too are readily distinguishable by their dipole moments.¹⁰⁶

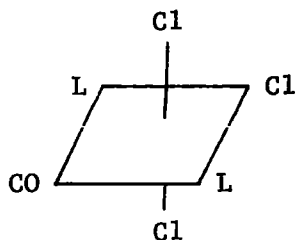

(XII)

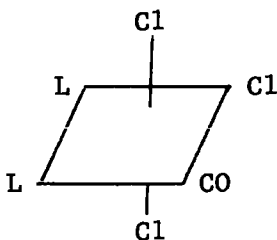

(XIII)

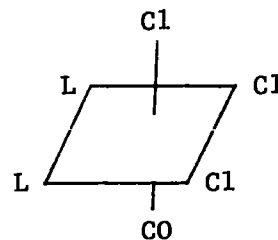

(XIV)

L = Et₃P 2.8D
Bu₃P 2.35D

9.5D
9.55D

-
12.35D

Table 3

Some calculated and experimental dipole moments

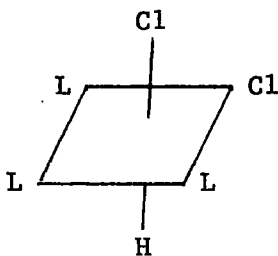
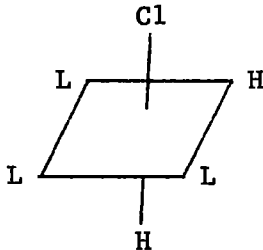
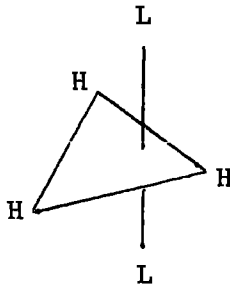
<u>Complex</u>	<u>Calculated dipole moment</u>	<u>Experimental dipole moment</u>
	$\sqrt{(6 \cdot 9)^2 + (4 \cdot 3)^2} = 8 \cdot 1 \text{D}$	<p>L = Et₃P 8·0D Et₂PhP 7·95D</p>
	$\sqrt{(2 \cdot 6)^2 + (4 \cdot 3)^2} = 5 \cdot 0 \text{D}$	<p>L = Et₂PhP 5·05D Et₂PhAs 4·8D</p>
	<p>= 0 D</p>	<p>L = Et₃P 0·8D</p>

Infrared spectra

(a) Near infrared spectra. The strong iridium-hydrogen and carbonyl stretching frequencies are readily observable in the near infrared in a region clear of other absorptions. The exact position of the iridium-hydrogen bond too is dependant on the trans group, another illustration of trans-influence or bond weakening. The ranges found experimentally for the $\nu(\text{Ir-H})$ absorption are, about 1750 cm^{-1} (trans hydrogen), $2000\text{-}2100 \text{ cm}^{-1}$ (trans phosphine or carbonyl), and $2180\text{-}2200 \text{ cm}^{-1}$ (trans chlorine). Some examples are quoted in Table 4.¹⁰⁵

The position of the $\nu(\text{Ir-H})$ band also shows good correlation with the lability of the hydride. The position of this absorption depends too upon the solvent in which it is measured. The spectra¹⁰⁹ of the complexes $(\text{Et}_3\text{P})_3\text{IrHCl}_2$, $(\text{Et}_3\text{As})_3\text{IrHCl}_2$, $(\text{Et}_2\text{PhP})_3\text{IrH}_2\text{Cl}$ and $(\text{Et}_2\text{PhP})_2\text{Ir}(\text{CO})\text{HCl}_2$ have been recorded in a series of solvents, the lowest frequency recorded being in hexane, and the greatest in chloroform (the least and most polar solvents used). The difference, $(\nu_{\text{chloroform}} - \nu_{\text{hexane}})$ was found to be 7 (trans Et_3P), 0 (trans Et_3As), 34 (trans Cl) and 0 (trans Et_2PhP) and 40 cm^{-1} (trans Cl) respectively. It was suggested that differences in behaviour may be due to the ability of phosphine or arsine groups to attract d electrons across the metal atom by π bonding.

Although from the $\nu(\text{C}\equiv\text{O})$ absorptions, stereochemistry cannot be assigned, deuteration does shift the $\nu(\text{C}\equiv\text{O})$ band if the hydride or deuteride and carbonyl ligands are mutually trans.¹¹⁰

Table 4

Some infrared iridium-hydrogen stretching frequencies (C_6H_6)

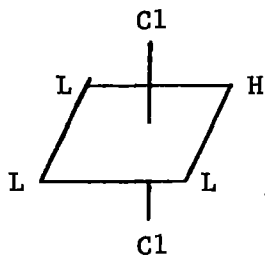

L = Et_3P 2090 cm^{-1} (trans L)
 Et_2PhP 2069

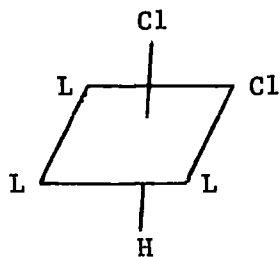

L = Et_3P 2194 cm^{-1} (trans Cl)
 Et_2PhP 2186

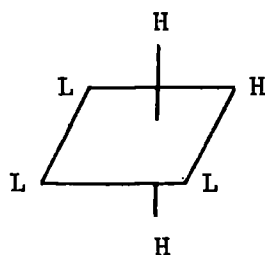

L = Et_2PhP 2037 cm^{-1} (trans L)
 1740 (trans H)
 Ph_3P 2104 (trans L)
 1755 (trans H)

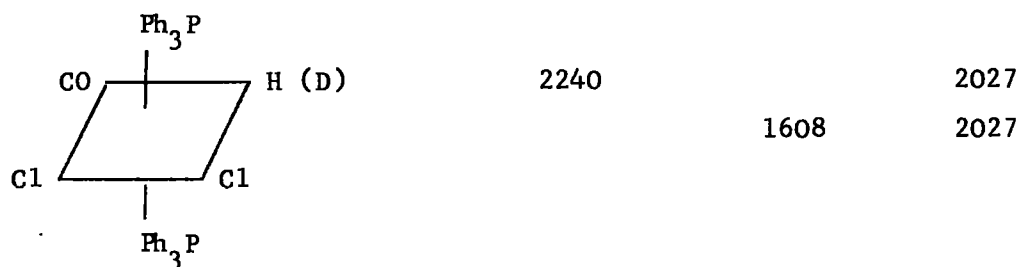
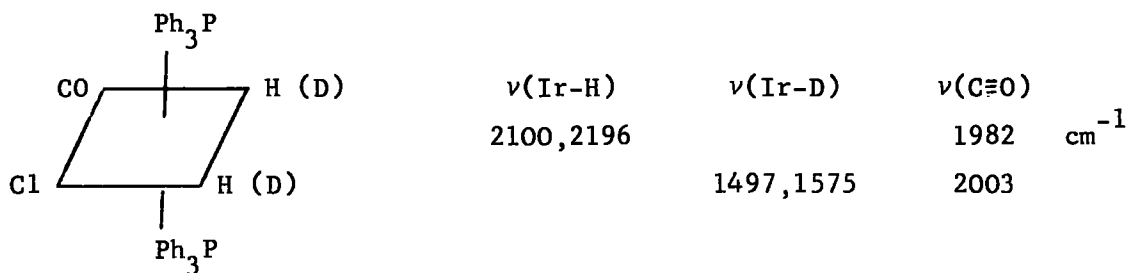

(b) Far infrared spectra studies have concentrated on the iridium-chlorine stretching frequencies. The $\nu(\text{Ir-Cl})$ band is readily identified in the $200\text{-}400\text{ cm}^{-1}$ region as it is the strongest band present, usually exhibiting a shoulder at a lower wave number due to the ^{37}Cl isotope.^{77,107} Confirmation that the $\nu(\text{Ir-Cl})$ band is correctly assigned can be obtained by bromide or iodide substitution, for the assigned absorption should be absent in the exchanged complex. The position of the $\nu(\text{Ir-Cl})$ absorptions fall into the range, $246\text{-}9\text{ cm}^{-1}$ (trans H or allyl), 255 cm^{-1} (trans CH_3), $260\text{-}90\text{ cm}^{-1}$ (trans R_3P or R_3As), $304\text{-}15\text{ cm}^{-1}$ (trans CO), and $303\text{-}30\text{ cm}^{-1}$ (trans halogen), the same order obtained for the kinetic trans-effect. Some examples are given in Table 5. Only two absorptions are observed for the trichlorides, probably due to the trans chlorines being so nearly

Table 5

Some $\nu(\text{Ir-Cl})$ absorbtions (cm^{-1}). 60,77,107

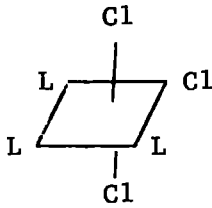
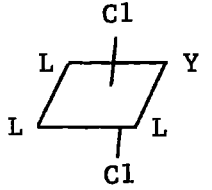
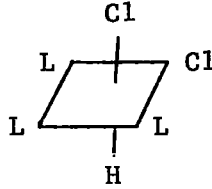
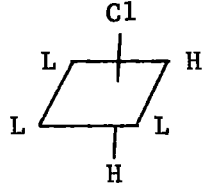
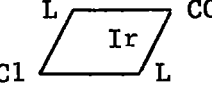
	<u>L</u>	<u>Y</u>	<u>trans H</u>	<u>trans P</u>	<u>trans CO</u>	<u>trans Cl</u>
	Et_3P			262		313
	Pr^n_3P			268		313
	Me_2PhP			276		315
	Et_3P	H				314
		I				312
	Pr^n_3P	H				308
	Me_2PhP	H				313
		Br				314
	Me_2PhP		246	273		
	Me_2PhP		249			
	Me_2PhP				311	
	Et_3P				309	
	Ph_3P				317	

colinear that symmetric stretching vibration causes hardly any change in dipole moment and hence no absorption. The cis group has little effect on the $\nu(\text{Ir-Cl})$ absorption cf. $(\text{Et}_3\text{P})_3\text{IrHCl}_2$ and $(\text{Et}_3\text{P})_3\text{IrICl}_2$, and $(\text{Me}_2\text{PhP})_3\text{IrHCl}_2$ and $(\text{Me}_2\text{PhP})_3\text{IrBrCl}_2$.

Proton Magnetic Resonance Spectroscopy can in many cases unambiguously ascribe the stereochemistry of a complex. Provided that the complex to be studied is fairly soluble (100 mg. in 1 ml. of solvent permits the hydride of a tertiary phosphine-iridium-hydride to be readily observed), the identification can be completed in a matter of minutes. When phosphines such as Me_2PhP , MePh_2P or Et_3P are used, it is usually possible to establish whether they are present in positions cis or trans to one another.

For example, the p.m.r. of free Me_2PhP shows a complex multiplet in the phenyl region and a doublet in the methyl region. The latter is due to spin-spin interaction with the phosphorous atom (^{31}P , spin $\frac{1}{2}$, abundance 100%). When two or more phosphines are co-ordinated to iridium, a 1:1 doublet is still observed if the phosphines occupy cis positions, but if they are mutually trans they exhibit a 1:2:1 triplet due to strong coupling between the two trans phosphorous atoms.^{111,112} The spectrum of $(\text{Me}_2\text{PhP})_3\text{IrCl}_3$ is shown in Figure 7, showing both a doublet and a triplet.¹¹¹ The value of $J(\text{CH}_3\text{-P})$ is found to be smaller in trans complexes.

A well defined triplet is observed too for complex (XV) but a less defined triplet is recorded in its isomer (XVI).¹¹³

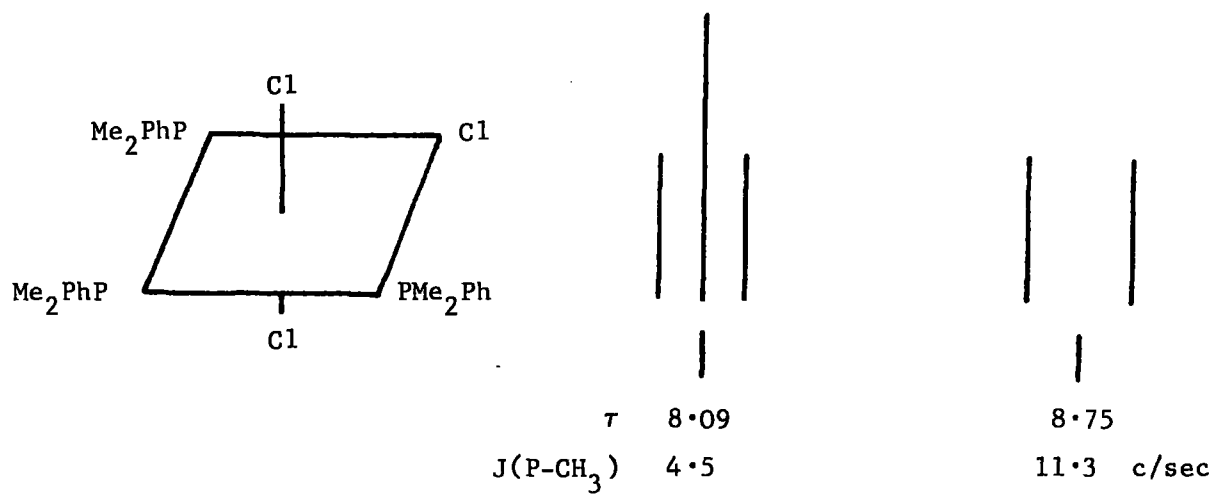

Figure 7

Part of the p.m.r. spectrum of $(\text{Me}_2\text{PhP})_3\text{IrCl}_3$

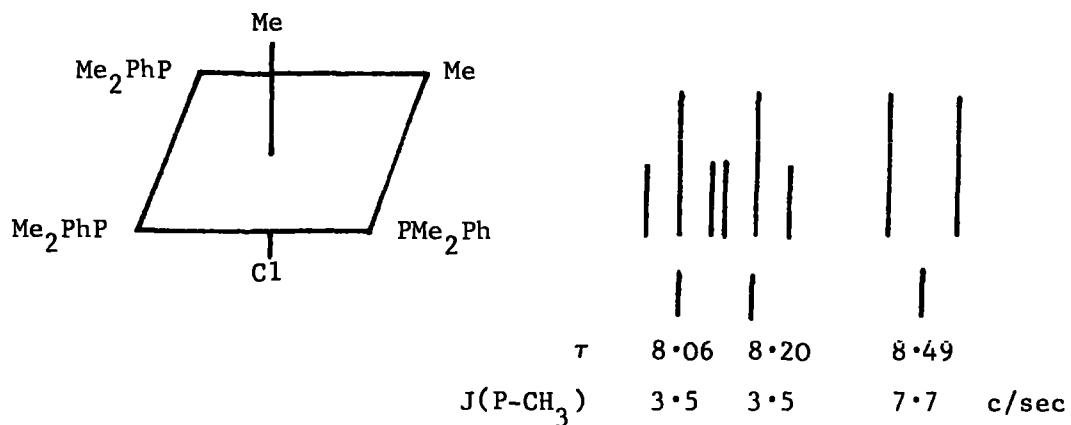
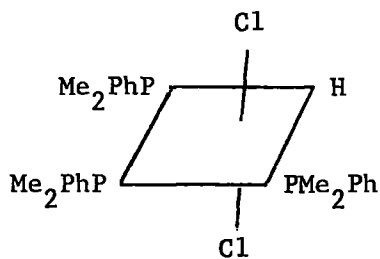
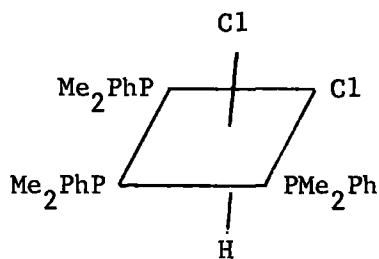

Figure 8

Part of the p.m.r. spectrum of $(\text{Me}_2\text{PhP})_3\text{IrMe}_2\text{Cl}$ excluding methyl groups directly attached to iridium



(XV)



(XVI)

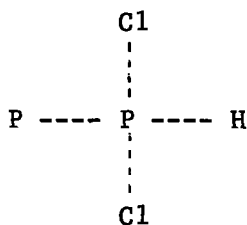

(XVa)

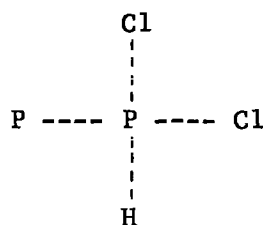

(XVIa)

View along the P-Ir-P axis

If the symmetry of these isomers is considered by viewing along the P-Ir-P axis, (XVa and XVIa), it can be seen that (XV) has a line of symmetry which (XVI) does not possess.

Consequently the methyl groups in (XVI) experience slightly different environments. In the complex, $(\text{Me}_2\text{PhP})_3\text{IrMe}_2\text{Cl}$ (Figure 8) this difference is such as to separate the trans groups into two separate 1:2:1 triplets.¹¹⁴ With the dimethylphenylarsine analogue, $(\text{Me}_2\text{PhAs})_3\text{IrMe}_2\text{Cl}$ no coupling is possible with the arsenic atom and consequently the spectrum consists of three singlets of equal intensity.¹¹⁴

Similarly it is possible to assign stereochemistries when triethylphosphine¹¹⁵ and methyldiphenylphosphine⁷⁸ are co-ordinated to the metal.

Much information too can be gleaned from the p.m.r. spectra of metal hydrides. Iridium hydrides are observed in the region $\tau = 20-35$, hydrides trans to low trans-influence groups absorbing at the high field end. The hydrogen atom couples with both cis and trans phosphorous atoms, with coupling constants of 10-25 and 80-170 cycles sec^{-1} respectively. Coupling (3-10 cycles sec^{-1}) occurs too between hydrogens in dihydrides.

The complex L_3IrHCl_2 , ($L = Et_3P$ or Et_2PhP) shows two 1.2.1 triplets centred at $\tau = 22.55$ (Figure 9).¹⁰⁵

In isomeric $(Et_2PhP)_3IrHCl_2$ (H trans Cl), $J(H-P_1) = J(H-P_2) = J(H-P_3) = 15$ cycles sec^{-1} and consequently a 1:3:3:1 quartet is observed, this being at much higher field. (Figure 10).¹⁰⁵

Coupling with arsenic atoms is not shown, so that $(Et_2PhAs)_3IrH_2Cl$ exhibits only two doublets arising from hydrogen-hydrogen coupling (Figure 11).¹⁰⁵

Finally the complexes L_2IrH_3 ($L = Et_3P$ or Et_2PhP) were shown to have configuration (XVII), as a single 1:2:1 triplet is observed indicating the hydrogens to be equivalent. In addition the complex has an almost zero dipole moment, (Table 3).¹⁰⁵

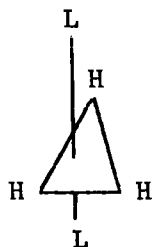

(XVII)

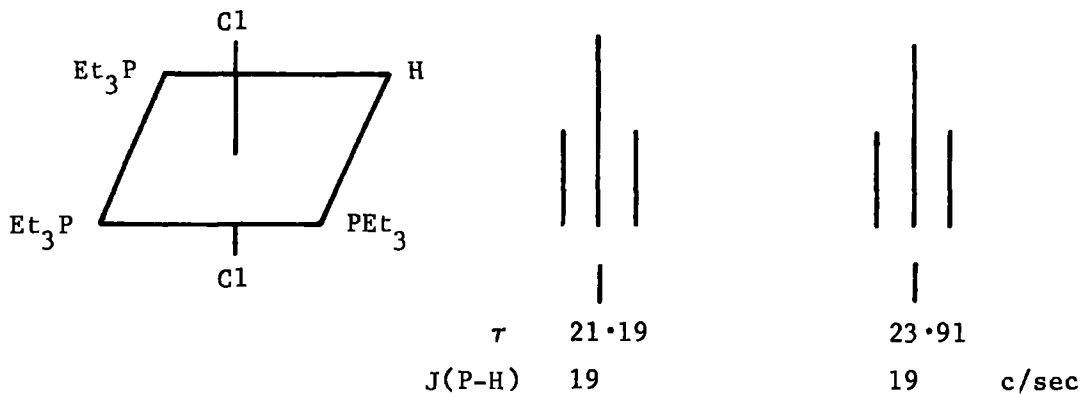

Figure 9

Part of the p.m.r. spectrum of $(\text{Et}_3\text{P})_3\text{IrHCl}_2$

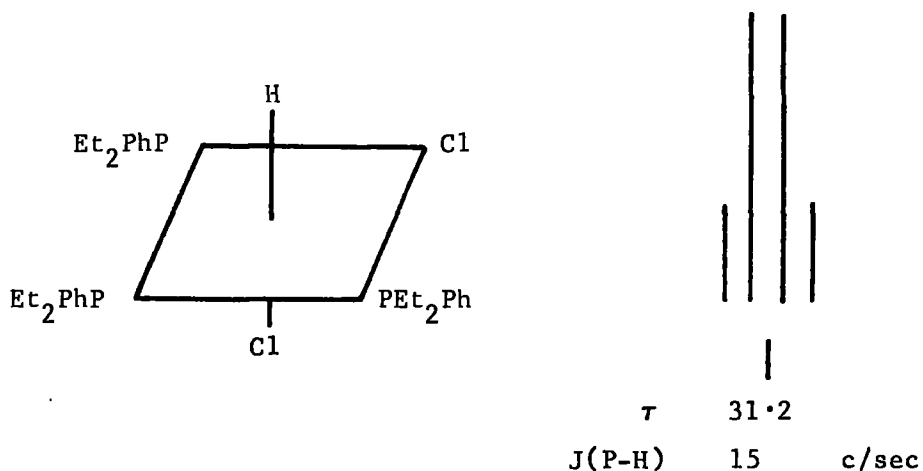

Figure 10

High field p.m.r. spectrum of $(\text{Et}_2\text{PhP})_3\text{IrHCl}_2$

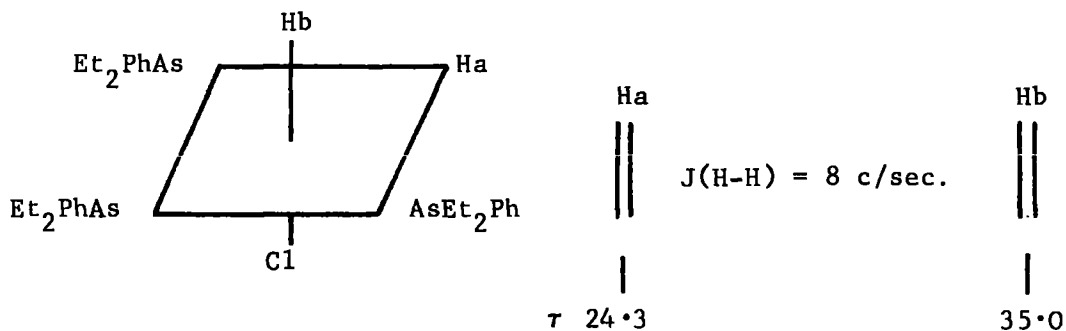

Figure 11

High field p.m.r. spectrum of $(\text{Et}_2\text{PhAs})_3\text{IrH}_2\text{Cl}$

Transition Metal-Group IVb Bonded Complexes

Although it has been known for many years that red solutions are produced when stannous chloride is added to platinum salts¹¹⁶, it is only in the last 15 years that an upsurge of interest in transition metal-group IVb bonded complexes has occurred. So much so, that many combinations are now known, for example, silicon bonded to fourteen different transition metals has been reported. Aspects of transition metal-group IVb bonded complexes have been reviewed.¹¹⁷⁻¹²⁰

The group IVb elements, silicon, germanium, tin and lead exhibit the characteristics and trends associated with a main group in the periodic table. As the group is descended the following changes are observed (a) a decrease in catenation due in part to decreasing strength of the M'-M' bond; (b) the elements become more electro-positive; and (c) the dominance of the +2 over the +4 oxidation level. In all transition metal-group IVb complexes reported to date the group IVb element is 4 co-ordinate and approximately tetrahedral, including moieties in a formal +2 oxidation level, such as the SnCl_3^- group.

Synthesis of transition metal-group IVb bonds †

Various methods, using standard experimental techniques are available for these syntheses. These are outlined, together with any details of interest.

† Abbreviations used: M = transition metal; M' = group IVb element.

(a) Elimination of an alkali metal halide

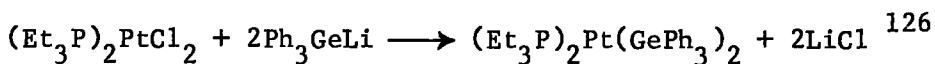
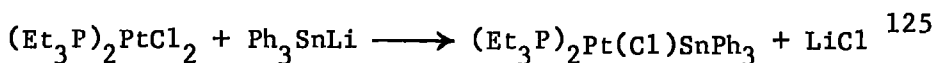
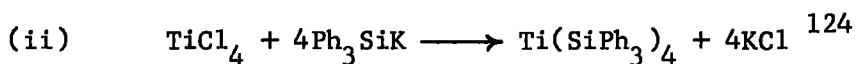
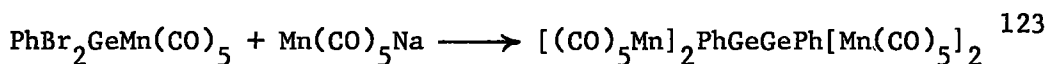
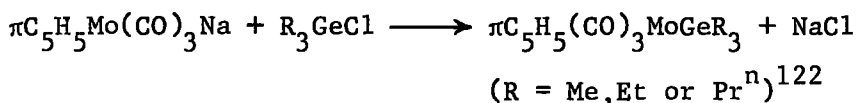
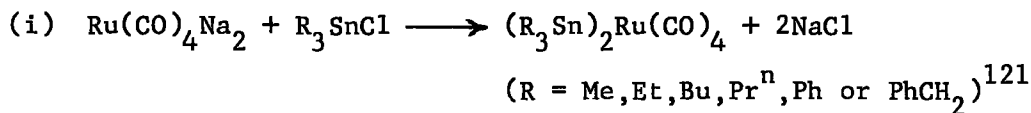

Limitations: If equimolar quantities of platinum dihalide and some lithium reagents (e.g. Ph_3GeLi or Ph_2MeSiLi) are used, instead of the mono-substituted complex, a mixture of unreacted materials and the di-substituted complex is obtained. Secondly some alkali metal derivatives employed are not readily prepared, e.g. trimethylgermyl-lithium has to be made from bis(trimethylgermyl)mercury, $(\text{Me}_3\text{Ge})_2\text{Hg}$, and transition metal anions are generally known only for cyclopentadienyl and carbonyl complexes

(b) Elimination of hydrogen or hydrogen halides

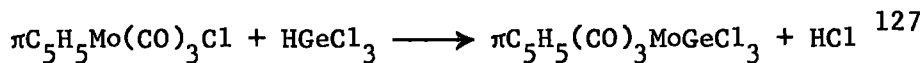
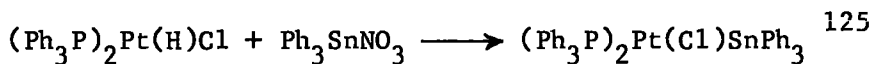

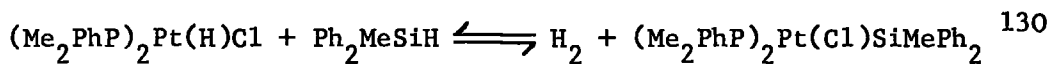
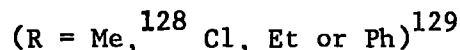
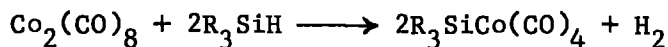

The latter reaction proceeded identically for lithium-germanium complexes but with tin analogues only intractable materials were obtained.

$\text{Mn}(\text{CO})_5\text{H}$ and GeH_4 give the complex $\text{H}_2\text{Ge}[\text{Mn}(\text{CO})_5]_2$ but possible intermediates such as $\text{HGe}[\text{Mn}(\text{CO})_5]_3$ and $\text{H}_3\text{Ge}[\text{Mn}(\text{CO})_5]$ were not observed.¹³¹

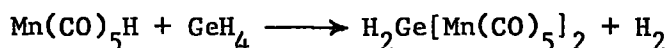

(c) Insertion reactions

This particular method, involving insertion of a Ge^{II} or Sn^{II} halide, has been extensively used.

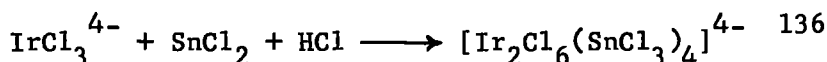
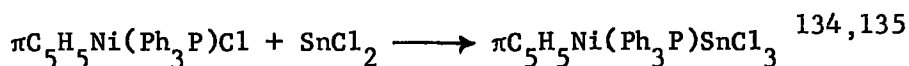
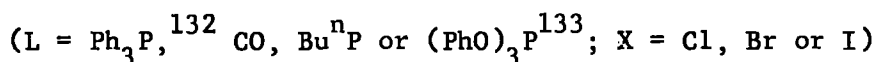

Whereas SnCl_2 quickly adds to $\pi\text{C}_5\text{H}_5(\text{CO})_2\text{FeI}$ to form $\pi\text{C}_5\text{H}_5(\text{CO})_2\text{FeSnCl}_2\text{I}$, no reaction at all occurs between SnCl_2 and $\pi\text{C}_5\text{H}_5(\text{CO})_3\text{MoI}$ even after 2 days.¹³⁷ It thus appears the reaction does not proceed via substitution, and consequently the iodine must remain associated with the iron atom (involving

a 7 co-ordinate iron intermediate) followed by an intramolecular re-arrangement.

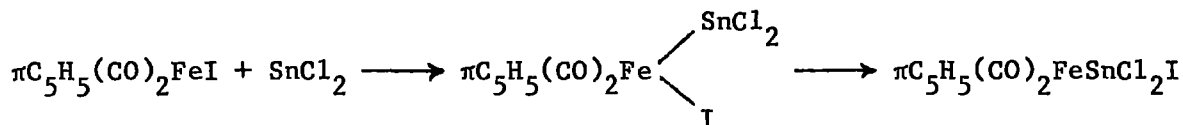

Assuming the molybdenum complex reacts by a similar mechanism, an 8 co-ordinate intermediary would be formed, with the result that reaction with SnCl_2 is very slow.

(d) From metal halides or metal-metal complexes

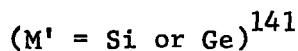
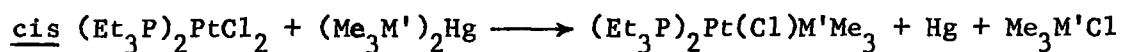
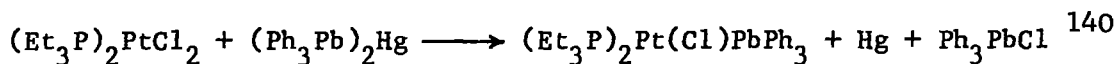
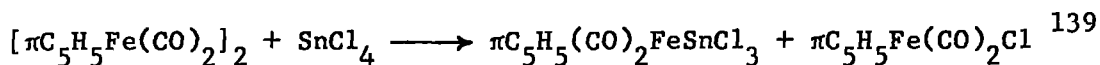
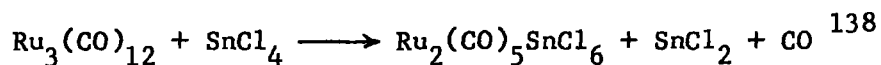

If a 2:1 ratio of bis-(silyl or germyl)mercury complex to platinum dihalide is employed, brightly coloured solutions are obtained from which only poor yields of the mono-substituted complex can be isolated. No evidence of a di-substituted complex $(\text{Et}_3\text{P})_2\text{Pt}(\text{M}'\text{Me}_3)_2$ has been found. This could be due to the very high trans effect of the SiMe_3 group.

(e) Miscellaneous reactions

(i) Cleavage of amides

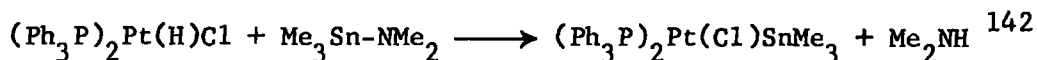

(ii) Addition reactions. The +1 and +3 oxidation levels of rhodium and iridium have similar energies and consequently addition of molecules to the square planar metal(I) complexes occurs quite readily.

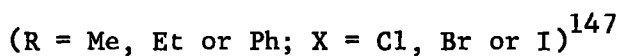
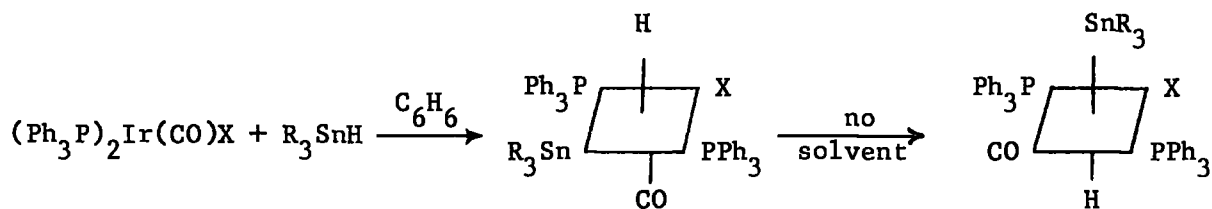
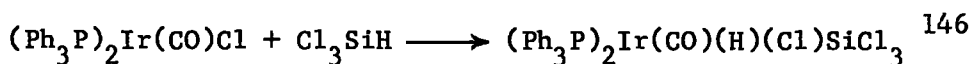
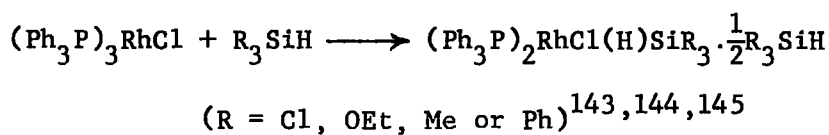

(iii) Finally tetrakis(triphenylphosphine)platinum reacts with a number of group IVb halides to form a transition metal-group IVb bonded complex.

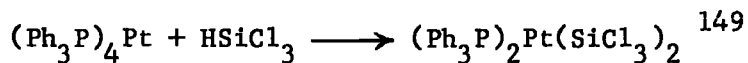
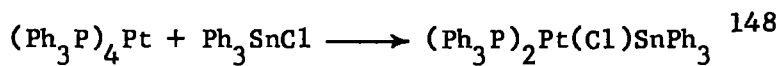

The complexes

As might be expected the physical properties of these complexes, which contain such a range of elements, show considerable variations in oxidative, thermal and hydrolytic stabilities. Whereas, the complexes $\pi\text{C}_5\text{H}_5(\text{CO})_3\text{Me}.\text{GeR}_3$ ($\text{M} = \text{Mo}$ or W , $\text{R} = \text{Me}$, Et or Pr^n)¹²² can be sublimed, $\text{Me}_3\text{SiCo}(\text{CO})_4$ decomposes above -30° .¹⁵⁰ However it is now possible from the large number of complexes described to infer which combination of ligands and metals will lead to the formation of stable complexes.

(a) The Transition Metal. If in a given series of complexes, the transition metal is the only variant, then it has been observed that the complex containing the third row transition metal is the most stable and that with the 1st row metal the least. For example, whilst the platinum compound, $(\text{Et}_3\text{P})_2\text{Pt}(\text{GePh}_3)_2$,¹⁵¹ is air and water resistant, decomposing only at 150° , the palladium analogue, $(\text{Et}_3\text{P})_2\text{Pd}(\text{GePh}_3)_2$ decomposes at 97° as a solid and at -20° in toluene solution.^{152,153} The nickel complex could not even be made by the same preparative route, $(\text{Ph}_3\text{GeLi} + (\text{Et}_3\text{P})_2\text{NiCl}_2)$ only hexaphenyldigermene and an intractable tar being isolated.¹⁵³ Similarly organo-platinum¹⁵⁴ complexes are far more stable than those of organo-palladium.¹⁵⁵

It has been reported for the series of complexes $\pi\text{C}_5\text{H}_5(\text{CO})_3\text{M-M}'\text{R}_3$ [$\text{M} = \text{Cr}$, Mo or W ; $\text{M}' = \text{Ge}$, Sn or Pb ; $\text{R} = \text{Me}$ or Ph]¹⁵⁶ that for a particular $\text{M}'\text{R}_3$ moiety, decomposition under nitrogen at room temperature occurs after several weeks with chromium complexes, whereas molybdenum and tungsten

analogues are stable indefinitely. These trends are also reflected in chemical reactivity for the Re-Ge bond in $(\text{CO})_5\text{ReGePh}_3$ is unbroken by halogens whilst the Mn-Ge bond in $(\text{CO})_5\text{MnGePh}_3$ is.

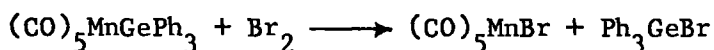
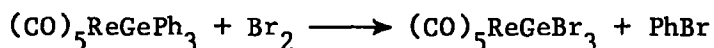

A number of factors such as degree of orbital overlap and electronegativity differences probably account for the stability of complexes involving the heavier transition metals.

(b) Ligands bound to the transition metal. In virtually every reported complex, π bonding ligands, such as tertiary phosphines or carbon monoxide, are bound to the transition metal, exceptions being $\text{Ti}(\text{SiPh}_3)_4$ ¹²⁴ and $\text{Li}[(\text{Ph}_3\text{Ge})_2\text{Au}].4\text{Et}_2\text{O}$.¹⁵⁷ The nature and number of these groups can have a profound effect on the stability of transition metal-group IVb bonded complexes. Whereas $\text{Ph}_3\text{PAuGePh}_3$ is exceedingly stable to oxidation or hydrolysis, $\text{Me}_3\text{PAuGePh}_3$ decomposes almost immediately on exposure to air. This difference in behaviour can in part be attributed to the greater crystal lattice stabilisation for the more symmetrical triphenylphosphine complex, but the possibility of π bonding into the aromatic rings may also be important.

When $(\text{R}_3\text{P})_2\text{PtCl}_2$ and Ph_3GeLi are reacted satisfactorily yields are obtained when $\text{R} = \text{Et}$ or Pr^n , but for $\text{R} = \text{Ph}$ only ill defined polymeric materials could be isolated. Ligand exchange of Et_3P or Pr_3^nP by Ph_3P could not be effected either.¹⁵¹

The series $(\text{Ph}_3\text{P})_n\text{MGePh}_3$ ($n = 1$ or 3 ; $\text{M} = \text{Cu}, \text{Ag}$ or Au) strikingly demonstrates the importance of the co-ordination number of the transition metal. Only the very stable $\text{Ph}_3\text{PAuGePh}_3$ is known for gold. The corresponding copper and silver complexes however could not be purified for rapid decomposition occurs, but addition of excess triphenylphosphine permits the purification of the air sensitive compounds, $(\text{Ph}_3\text{P})_3\text{CuGePh}_3$ and $(\text{Ph}_3\text{P})_3\text{AgGePh}_3$. Presumably greater electron removal from the metal can occur in the trisphosphine complex leading to more stable compounds. The trichlorostannane complexes $(\text{Ph}_3\text{P})_3\text{MSnCl}_3$ ($\text{M} = \text{Cu}, \text{Ag}$ or Au) are by contrast all air stable, the monophosphine complexes being unknown even for gold.¹⁵⁸

(c) The group IVb atom. In the series of complexes, $\text{Ph}_3\text{M}'\text{Mn}(\text{CO})_5$, ($\text{M} = \text{Si}, \text{Sn}$ or Pb), stability increases in the order $\text{Sn} > \text{Pb} > \text{Si}$.¹⁵⁹ Likewise when $(\text{Ph}_3\text{P})_2\text{Pt}(\text{H})\text{Cl}$ is reacted with $\text{Ph}_3\text{M}'\text{NO}_3$ ($\text{M}' = \text{Sn}$ or Pb), only the tin complex $(\text{Ph}_3\text{P})_2\text{Pt}(\text{Cl})\text{SnPh}_3$ can be isolated pure, for the lead analogue tends to decompose to give $\text{Pb}(\text{II})$ derivatives.¹²⁵ Some silicon complexes are readily hydrolysed, an example being $(\text{Et}_3\text{P})_2\text{Pt}(\text{Cl})\text{SiMe}_3$. The germanium analogue however, is considerably more stable even in aqueous diglyme,¹⁴¹ and aryl silicon complexes are more hydrolytically stable than their alkyl analogues. $\text{CH}_3\text{Co}(\text{CO})_4$ is reported to decompose above -30° , whilst a 30% recovery of $\text{H}_3\text{SiCo}(\text{CO})_4$ can be made after heating the complex at 100° for 30 minutes.¹⁵⁰ The increased stability has been ascribed to $d\pi-d\pi$ bonding in the silicon-cobalt bond. Thus, information available suggests that stability for a series of complexes, $\text{LnMM}'\text{R}'_3$ decreases in the order $\text{Sn} \sim \text{Ge} > \text{Pb} > \text{Si} > \text{C}$.

(d) Effect of substituents on the group IVb atom. If R is varied for a given series, $L_nMM'R_3$, the order of stability is found to be halogens > aryl > alkyl > hydride. An illustration is that whereas $Cl_2Ge[Fe(CO)_2\pi C_5H_5]_2$ is resistant to air, $Me_2Ge[Fe(CO)_2\pi C_5H_5]_2$ is less so, whilst solutions of $H_2Ge[Fe(CO)_2\pi C_5H_5]_2$ are rapidly decomposed. The latter complex, in fact, reacts in chloroform solution to give $Cl_2Ge[Fe(CO)_2\pi C_5H_5]_2$.¹⁶⁰ Similarly, the first prepared silicon complex, $\pi C_5H_5(CO)_2FeSiMe_3$,¹⁶¹ is unstable to oxygen whilst the phenyl analogue is unreactive.¹⁵⁶ The $\nu(C\equiv O)$ frequency shifts to higher frequency in the series, $(CO)_4CoGeR_{3-n}X$ (R = alkyl or aryl; X = halogen) as n is increased. (Table 6).

Table 6

$\nu(C\equiv O)$ frequencies for the complexes $(CO)_4CoGePh_{3-n}Cl_n$.¹⁶²

$(CO)_4CoGeCl_3$	2112, 2069, 2050 cm^{-1}
$(CO)_4CoGePhCl_2$	2112, 2056, 2038, 2027 cm^{-1}
$(CO)_4CoGePh_2Cl$	2101, 2043, 2026, 2010 cm^{-1}
$(CO)_4CoGePh_3$	2091, 2030, 2006 cm^{-1}

In these complexes both ligands compete for electrons from the 3d filled orbitals of the metal. Replacement of the alkyl groups by halogens on the germanium atom, leads to electron withdrawal from the germanium. To compensate, electrons are drawn towards the germanium atom in the

germanium-cobalt bond reducing $d\pi-p\pi$ bonding between the metal and the carbonyl group. Consequently an increase in carbon-oxygen π bonding results and a shift of the $\nu(C\equiv O)$ frequency is observed.¹⁶²

Similarly the series, $(Ph_3P)_2Rh(H)(SiR_nCl_{3-n})Cl$ [R = Me or Et] shows a progressive increase in thermal stability as n decreases. (Table 7).

Table 7

Stability of the complexes $(Ph_3P)_2Rh(H)(SiMe_nCl_{3-n})Cl$.¹⁴⁵

<u>Complex</u>	<u>decomposition temp</u>	<u>solution stability</u>
$(Ph_3P)_2Rh(H)(SiMe_3)Cl$	95°	instantly dissociates
$(Ph_3P)_2Rh(H)(SiMe_2Cl)Cl$	125°	slow dissociation
$(Ph_3P)_2Rh(H)(SiMeCl_2)Cl$	145°	
$(Ph_3P)_2Rh(H)(SiCl_3)Cl$	170°	stable

(e) Number of transition metal-group IVb bonds

Several types of complexes with more than one transition metal-group IVb bonds have been reported. (XVIII - XXI).

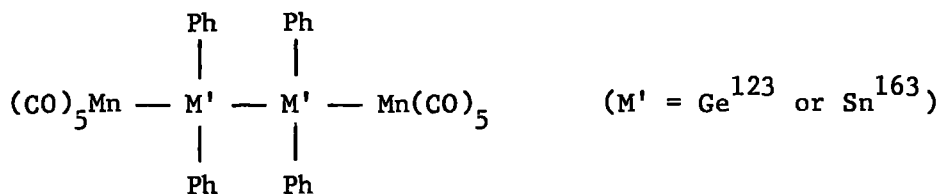

(XVIII)

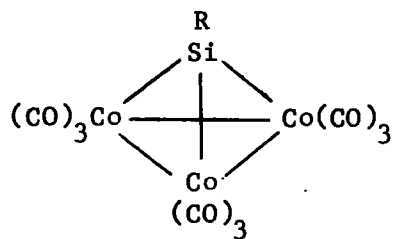

(XIX)

(R = CH=CH₂,¹⁶⁴ Me, Ph or halogen¹⁶⁵)

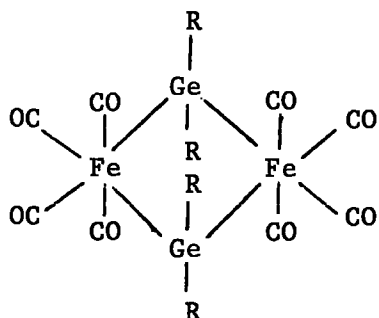

(XX)

(R = Me or Et¹⁶⁶)

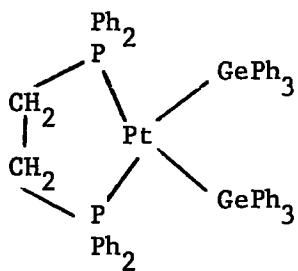

(XXI)¹⁶⁷

The effect of having more than one transition metal-group IVb bond in a complex depends greatly upon the nature of the ligands attached to both the metal and group IVb element. For instance, $(\text{CO})_4\text{XFeM}'\text{X}_3$ readily dissociates in solution to form $(\text{CO})_4\text{Fe}(\text{M}'\text{X}_3)_2$. The greater stability of the FeM'_2 complex can be attributed to more π acceptor character ($\text{M}'\text{X}_3$ group) and less π donor character (X group) being available.¹⁶⁸ However complexes of the type $\text{R}_2\text{Sn}[\text{Mn}(\text{CO})_5]_2$ are found to be less oxidatively stable than complexes $\text{R}_3\text{SnMn}(\text{CO})_5$.¹⁵⁹

The nature of the transition metal-group IVb bond

Evidence of $d\pi-d\pi$ bonding in transition metal-group IVb complexes has been previously mentioned in several sections. X-ray data, too, confirms that multiple bonding is present in the metal-metal bond as bond lengths are generally shorter than would be expected from the sum of co-valent atomic radii. (Table 8).

Substitution of a carbonyl group by triphenylphosphine (lower π acceptor properties) shortens the Sn-Mn bond, which is consistent with an increase in Sn-Mn multiple bond character. This arises because there is less competition for the d electrons involved in the Mn-Sn linkage. The Mn-Sn bond is found to be longer in $\text{Ph}_2\text{Sn}[\text{Mn}(\text{CO})_5]_2$ than in $\text{Ph}_3\text{SnMn}(\text{CO})_5$. Competition for the d orbitals of tin might be expected to reduce the π contribution to each Mn-Sn bond.

The Fe-Sn bond in the series, $[\pi\text{C}_5\text{H}_5\text{Fe}(\text{CO})_2]\text{SnX}_2$ (X = Cl, ONO, C_5H_5 or Me) has been measured (Table 8). It was found that the Fe-Sn bond shortens

Table 8Bond lengths for some transition metal-group IVb bonded complexes

<u>Complex</u>	<u>Bond Length</u>	<u>Contraction from sum of co-valent radii</u>	<u>ref:</u>
$\text{Ph}_3\text{SnMn}(\text{CO})_5$	2.67 Å	0.10 Å	169
$\text{Ph}_3\text{SnMn}(\text{CO})_4\text{Ph}_3\text{P}$	2.63	0.14	170,171
$\text{Ph}_2\text{Sn}[\text{Mn}(\text{CO})_5]_2$	2.70	0.07	172
$\text{Me}_3\text{SnMn}(\text{CO})_5$	2.67	0.10	173
$[\pi(\text{C}_5\text{H}_5)\text{Fe}(\text{CO})_2]_2\text{Sn}(\text{C}_5\text{H}_5)_2$	2.57	0.10	174
$[\pi(\text{C}_5\text{H}_5)\text{Fe}(\text{CO})_2]_2\text{Sn}(\text{ONO})_2$	2.56	0.11	175
$[\pi(\text{C}_5\text{H}_5)\text{Fe}(\text{CO})_2]_2\text{SnMe}_2$	2.60	0.07	176
$[\pi(\text{C}_5\text{H}_5)\text{Fe}(\text{CO})_2]_2\text{SnCl}_2$	2.49	0.18	177

as the electronegativity of the tin substituents is increased. Increases in electronegativity decrease the positive charge on the group IVb element, and decrease iron-tin repulsion as well. Consequently the transition metal-group IVb bond length shortens.

Reactions of the complexes

Although numerous complexes containing a M-M' bond have been prepared, few reactions have been investigated. The main types of reactions are cleavage of the transition metal-group IVb bond and ligand exchange.

(a) Halogens and hydrogen halides

With halogens, attack generally occurs at the M-M' bond giving the

corresponding transition metal and group IVb halides.

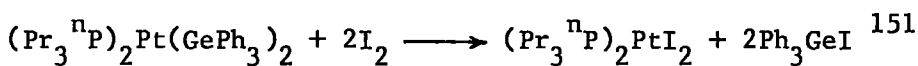
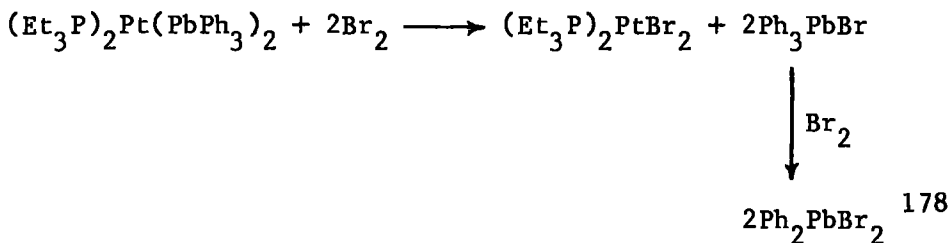

In the latter reaction even if equimolar quantities of iodine and the platinum-digermyl complex are used, no evidence of single cleavage e.g.

$(\text{Pr}_3^{\text{n}}\text{P})_2\text{Pt}(\text{I})\text{GePh}_3$ is obtained.

However it is the Sn-C bond in the manganese-tin complex, $(\text{CO})_5\text{MnSnPh}_3$, which is cleaved by chlorine in refluxing carbon tetrachloride yielding

$(\text{CO})_5\text{MnSnCl}_3$.¹⁵⁹

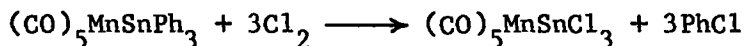

In the complex $[(\text{CO})_5\text{Mn}]_2\text{SnPh}_2$, one of the metal-metal bonds is cleaved by chlorine and a variety of products can be isolated.

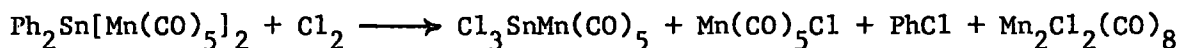

By varying the reaction conditions, either employing varying molar ratios or using hydrogen halides which are more selective, different products can be obtained.

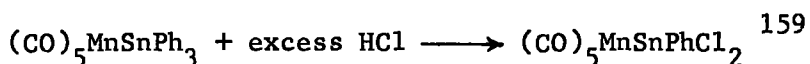

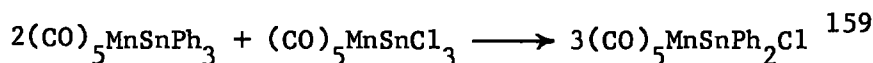

In most other reported cases, hydrogen chloride gas cleaves the metal-metal bond in a straightforward manner.

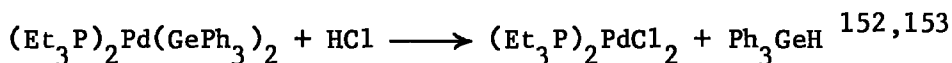
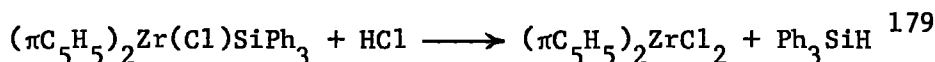

With the analogous platinum complex, $(\text{Et}_3\text{P})_2\text{Pt}(\text{GePh}_3)_2$, several products are isolated suggesting that the reaction may proceed via an octahedral platinum(IV) intermediate.¹⁵¹

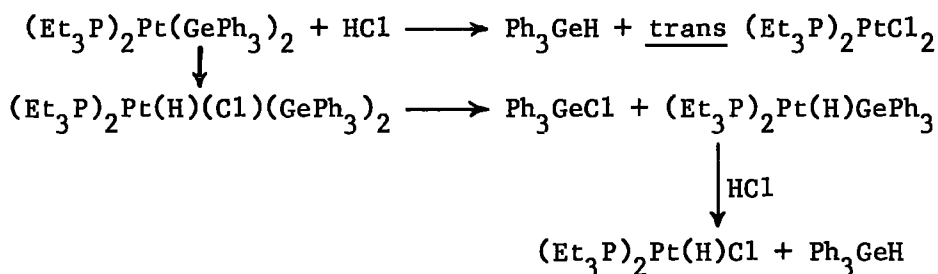

During the reaction between HCl and $[(\text{Ph}_2\text{PCH}_2\text{CH}_2\text{PPh}_2)\text{Pt}(\text{GeMe}_3)\text{Et}_3\text{P}]\text{Cl}$, a white solid was precipitated which was thought to be $[(\text{Ph}_2\text{PCH}_2\text{CH}_2\text{PPh}_2)\text{Pt}(\text{H})(\text{Cl})(\text{GeMe}_3)\text{Et}_3\text{P}]\text{Cl}$,¹⁸⁰ but subsequent examination showed this complex to be the platinum(II) complex, $[(\text{Ph}_2\text{PCH}_2\text{CH}_2\text{PPh}_2)\text{Pt}(\text{GeMe}_3)\text{Et}_3\text{P}]\text{HCl}_2$.¹⁸¹

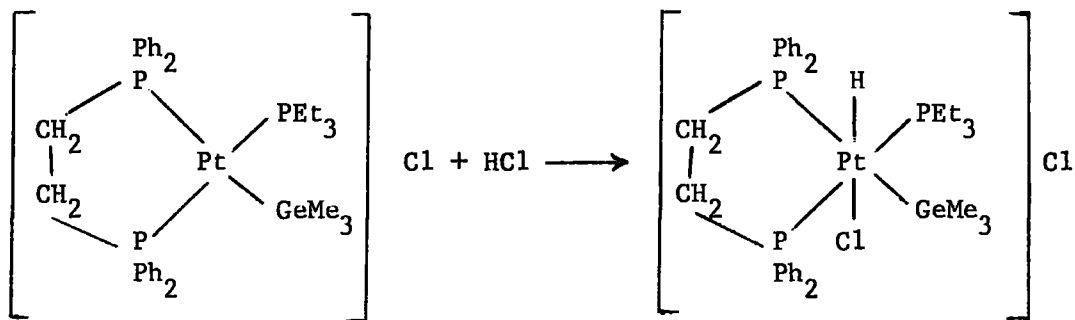

or an isomer (XXII)

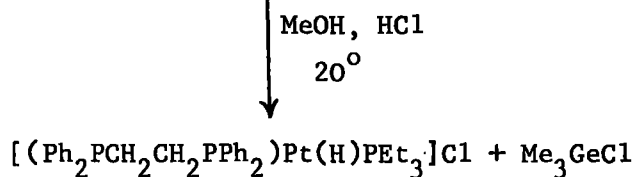
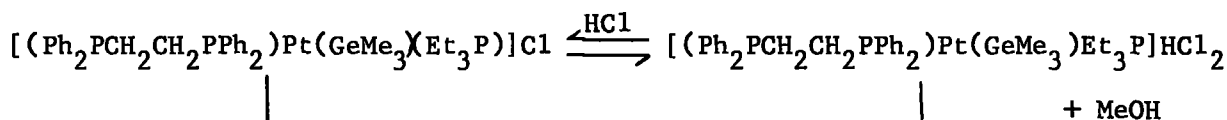
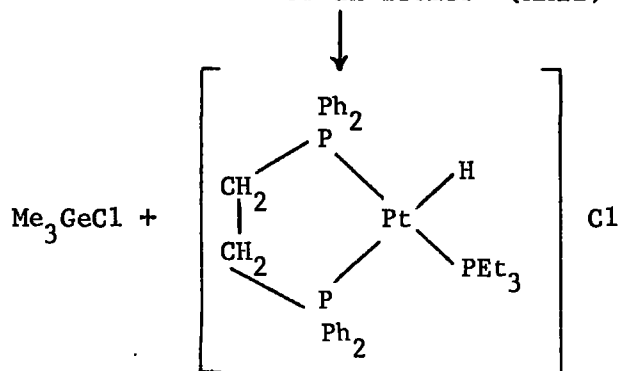

Evaporate 0°

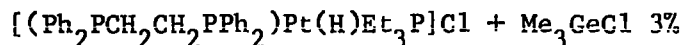
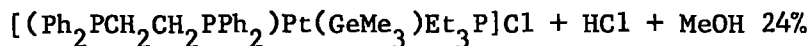
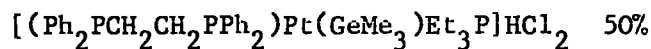

Although a platinum(IV) intermediate has not been isolated from HCl cleavages, such complexes are known e.g. $(Et_3P)_2Pt(H)_2(Cl)_2$.¹⁸²

Using a 1:1 ratio of HCl to $(Me_2PhP)_2Pt(SiMePh_2)_2$ a single M-M' bond is cleaved. A second mole of hydrogen chloride will cleave the remaining bond.¹⁸³

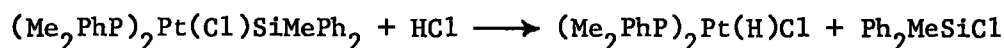
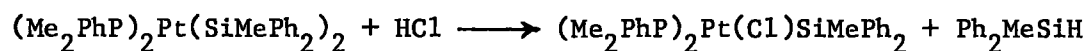

It should be noted that the two cleavages of the Pt-Si bonds occur in opposite senses, and this too has been attributed to the very high trans effect of the $SiMePh_2^-$ group.

(b) Organic and Inorganic halides

Cleavage of the metal-metal bond occurs in reaction with organic halides.

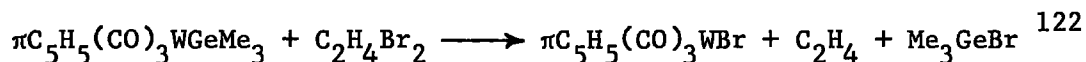

The reactions between magnesium and mercuric salts with several transition metal-group IVb bonded complexes have been reported. With molybdenum- or tungsten-germanium complexes, tungsten-Grignard and molybdenum- or tungsten-mercury compounds were isolated.¹²²

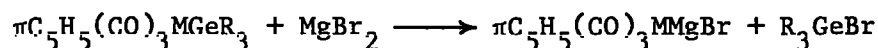
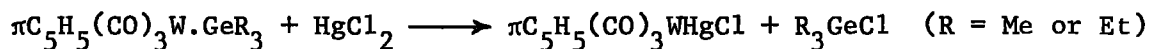

(M = Mo or W; R = Me or Et)

The tungsten-mercury complex readily exchanges with other transition metal-group IVb compounds.

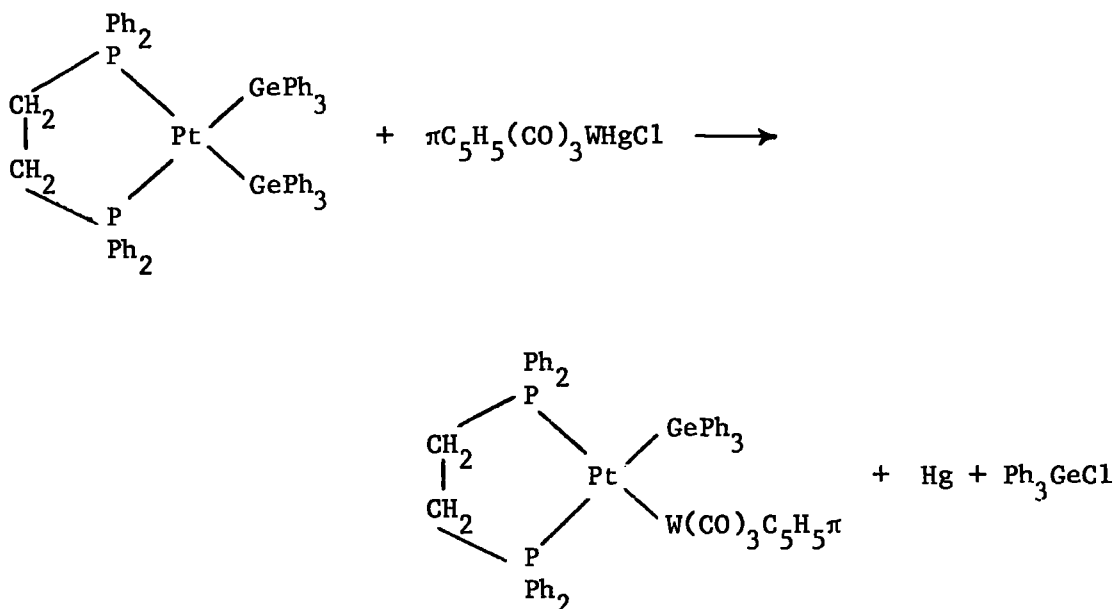

(c) Hydrogenation

The reactions with hydrogen are possibly the most interesting interactions of the complexes. The reaction conditions required, vary considerably from room temperature and less than one atmosphere pressure, to elevated temperatures and high pressures.

One platinum-germanium bond in $(\text{Et}_3\text{P})_2\text{Pt}(\text{GePh}_3)_2$, for instance, is cleaved under very mild conditions.¹⁵¹

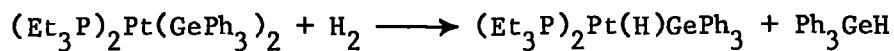

This particular reaction can be quite selective, in the mixed platinum-group IVb complex, $(Et_3P)_2Pt(GePh_3)M'Me_3$ ($M' = Ge$ or Si) only the $Pt-M'Me_3$ bond is cleaved.¹⁸⁴

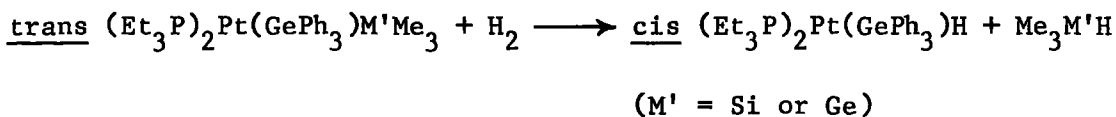

By contrast the palladium-germanium compound, $(Et_3P)_2Pd(GePh_3)_2$ ¹⁵³, requires more drastic conditions (100 atmospheres pressure of hydrogen whilst the molybdenum complex, $\pi C_5H_5(CO)_3MoGeMe_3$ will not hydrogenate even under 300 atmospheres.¹²² The ease of reaction may be related to the ease with which a metal can increase its co-ordination number.

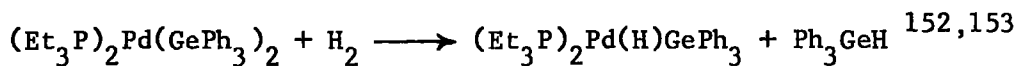

A reversible hydrogenation occurs with $(Et_3P)_2Pt(Cl)GeMe_3$ and again it is tempting to postulate a six co-ordinate platinum(IV) intermediary.¹⁸⁴

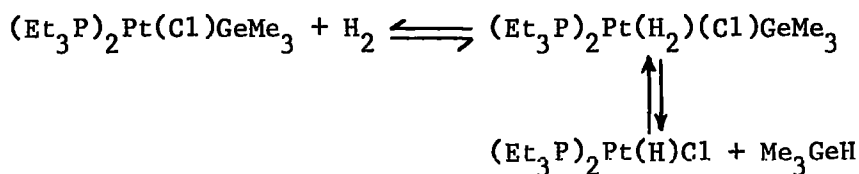

(d) Ligand exchange reactions

Very few ligand exchange reactions have been investigated. One molecule of carbon monoxide, but no more, can be displaced from several complexes by phosphines or arsines.

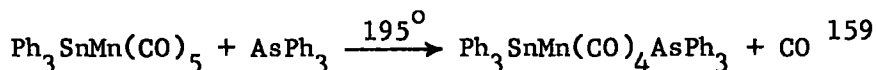

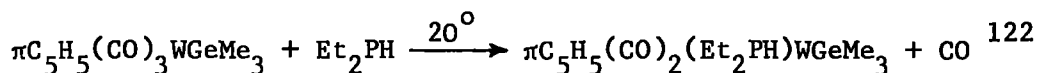

Both the chelating phosphine, $\text{Ph}_2\text{PCH}_2\text{CH}_2\text{PPh}_2$, and potassium cyanide will displace triethylphosphine in platinum- or palladium-group IVb complexes.

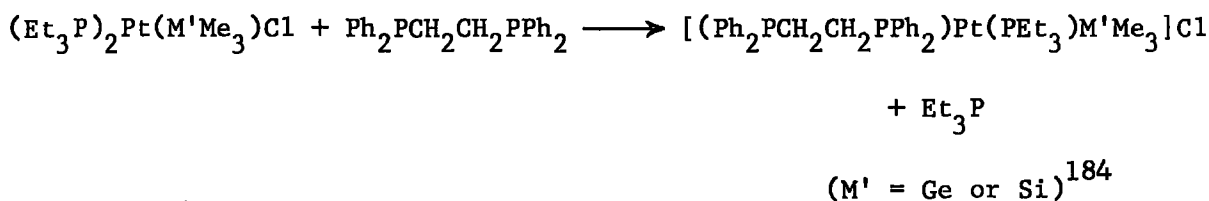
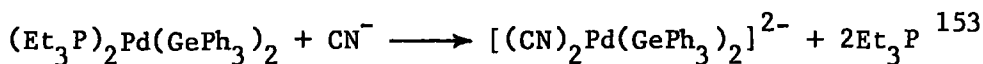
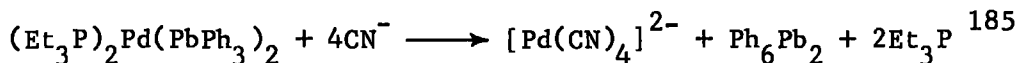

The cleavage of SnR_3 and GeR_3 moieties by halogens was discussed in section (a). The reverse process, ($\text{SnX}_3 \rightarrow \text{SnR}_3$), can be effected using standard reagents such as Grignard, organo-lithium and borohydride complexes.

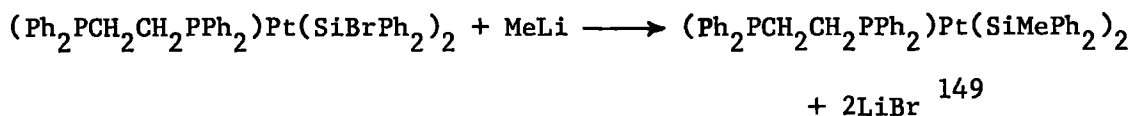
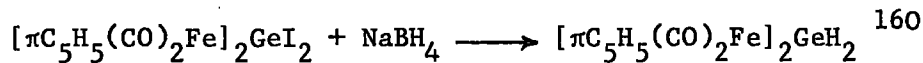
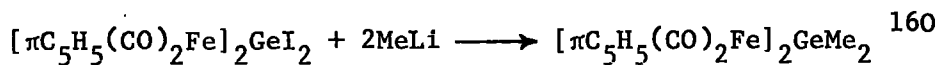
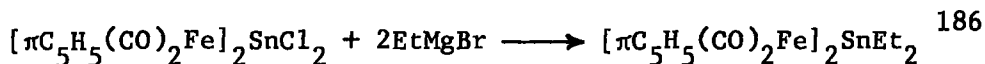

The silyl group can be displaced from $(\text{Et}_3\text{P})_2\text{Pt}(\text{Cl})\text{SiH}_2\text{Cl}$ by chlorogermane. ¹⁸⁷



Catalysis

Some transition metal-group IVb bonded complexes and particularly those involving platinum and tin, catalyse addition to unsaturated organic molecules. A few examples are given.

Quantitative reduction by hydrogen of ethylene and acetylene, at ambient pressures and temperatures, is catalysed by methanolic solutions of tin(II) chloride and chloroplatinic acid.¹⁸⁸ Probably both hydrogen and ethylene are co-ordinated during the reaction to platinum as evidence for $[\text{Pt}(\text{H})(\text{SnCl}_3)_4]^{3-}$ ¹⁸⁹ and $\text{K}(\text{PtCl}_3 \cdot \text{C}_2\text{H}_4) \cdot \text{H}_2\text{O}$ ¹⁸⁸ has been reported. Silicon halides too, add across double bonds in the presence of chloroplatinic acid.^{190,191} However the formation of transition metal-group IVb complexes will inhibit additions.¹²⁹ Finally isomerisation of butenes has been reported using $\text{Rh}_2\text{Cl}_2(\text{SnCl}_2 \cdot \text{solv})_4$ and $\text{Pt}(\text{SnCl}_2 \cdot \text{solv})_5$.¹⁹²

DISCUSSION

Section A. Organogermyl-gold complexes.

Over the last few years a number of complexes containing group Ib-group IVb bonds have been prepared. These are $(\text{Ph}_3\text{P})_n\text{MGePh}_3$ ($n = 1, 3$; $\text{M} = \text{Ag}$ or Cu), $\text{Me}_3\text{PAuGePh}_3$ and $\text{Ph}_3\text{PAuGePh}_3$ ¹⁵⁷, $\text{Ph}_3\text{PAuSiPh}_3$ ¹²⁵, $(\text{Ph}_3\text{P})_3\text{MSnCl}_3$ ($\text{M} = \text{Cu}, \text{Ag}, \text{Au}$)¹⁵⁸, $\text{Au}_2(\text{SnI}_3)(\text{Ph}_3\text{P})_2$ and $\text{Au}_5(\text{Ph}_3\text{P})_4\text{SnCl}_3$.¹⁵

The thermal stability and resistance to aerial oxidation is greatest with gold, the third row transition element. For example, where $\text{Ph}_3\text{PAuGePh}_3$ is stable over long periods (greater than 6 years in air), $\text{Ph}_3\text{PAgGePh}_3$ is susceptible to oxidation whilst $\text{Ph}_3\text{PCuGePh}_3$ fumes in air. Addition of triphenylphosphine to the copper and silver complexes yielding the four co-ordinate species $(\text{Ph}_3\text{P})_3\text{MGePh}_3$ considerably increases their stability. This may be associated with greater electron back donation from the metal to the phosphine systems through $d\pi-d\pi$ bonding. The order of stability, $\text{Au} > \text{Ag} > \text{Cu}$ is also illustrated with metal-carbon bonded compounds for a relatively large number of gold complexes are known whereas those of silver and copper are few in number, being generally poorly characterised and unstable.¹⁹³ Similarly the order of stability $\text{Ge} > \text{Sn} > \text{Si} > \text{Pb}$ is illustrated by the two complexes $\text{Ph}_3\text{PAuGePh}_3$ and $\text{Ph}_3\text{PAuSiPh}_3$ for the former is not at all air sensitive whilst the latter is sensitive to light and air, especially in solution. Other examples of these trends will be discussed in the following text.

Few chemical reactions have been reported on these types of metal-metal complexes and the present work has been an examination of a wide

range of chemical reactions of the gold-germanium complex, $\text{Ph}_3\text{PAuGePh}_3$. This complex has the advantages of high stability and ready preparation. Triphenylgermyltriphenylphosphinegold(I) could be regarded as a standard for transition metal-group IVb complexes as complications such as rapid decomposition (cf. germyl-palladium complexes¹⁵³) or different stereoisomers do not arise as gold is invariably two co-ordinate.

Triphenylgermyltriphenylphosphinegold(I) has previously been prepared by the reactions¹⁵⁷

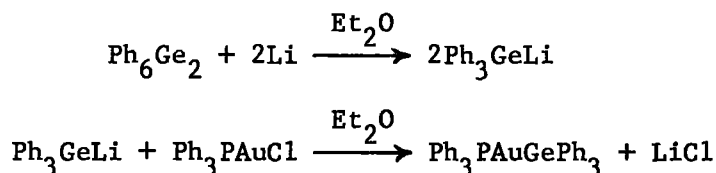

In the present work triphenylgermyl-lithium was prepared from triphenylgermane and n-butyl-lithium

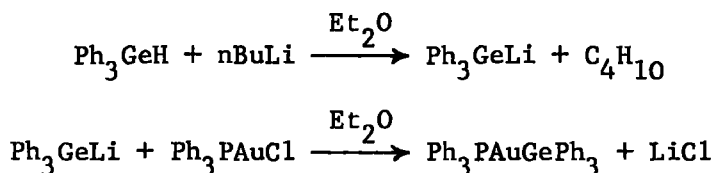

Two forms of the gold-germanium complex are isolable, the yellow unsolvated form crystallises from acetone and the white solvate, $\text{Ph}_3\text{PAuGePh}_3 \cdot \text{C}_6\text{H}_6$, from benzene. The infrared spectrum of the solvated form (in KBr) is recorded in table 9. Of the two absorption bands at 1105 cm^{-1} and 1087 cm^{-1} the former is attributable to phenyl groups attached to phosphorus and the latter to phenylgermanium groups (Whiffen's X-sensitive mode, q^{194}). These bands are reliably diagnostic of phenylphosphine and phenylgermanium groupings. The solvate shows two

bands at 1040 and 1030 cm^{-1} whilst the unsolvated compound has only a single band at 1026 cm^{-1} .

Previously reported reactions are with 1,2-dibromethane, phenyl-lithium¹⁵⁷ and π -cyclopentadienyltricarbonyltungsten mercury chloride, $\pi\text{-C}_5\text{H}_5(\text{CO})_3\text{WHgCl}$.¹²² The reaction with 1,2-dibromethane is a diagnostic test for a transition metal group IVb bond, immediate cleavage occurring with the germylgold complex

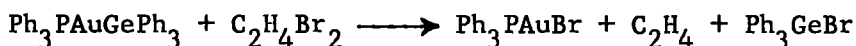

With phenyl-lithium in ether, an insoluble, unstable white solid, $\text{Li}[(\text{Ph}_3\text{Ge})_2\text{Au}]\cdot 4\text{Et}_2\text{O}$ was formed which deposited gold on standing. This compound can be stabilised by addition of tetraethylammonium iodide, $(\text{Et}_4\text{N})^+\text{I}^-$, to give $\text{Et}_4\text{N}[(\text{Ph}_3\text{Ge})_2\text{Au}]$. These two complexes are unusual in that no π bonding ligand, such as tertiary phosphine or carbonyl group, is present to stabilise the metal-metal bond.

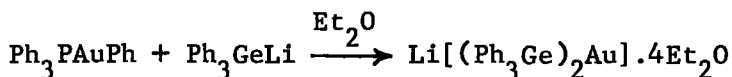
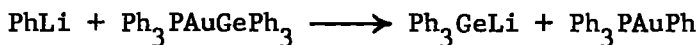

The tungsten-mercury complex immediately yields π -cyclopentadienyltricarbonyltungsten-triphenylphosphinegold, mercury and triphenylchlorogermane

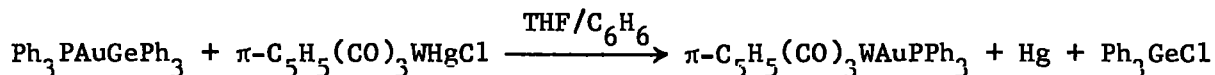

As has been stated the gold-germanium complex is stable in air due in part to its symmetrical nature. A series of reactions varying the

components oxygen, benzene, water and diglyme, established that oxygenation occurs in diglyme solution. This is perhaps due to peroxydic effects although hydrogen peroxide solution added to a benzene solution under oxygen produced no reaction

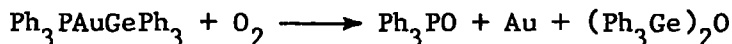

Many halogen containing reagents cleave the gold-germanium bond. With 1,2-dichlorethane, in contrast to 1,2-dibromethane, at room temperature, a slow reaction occurs giving only a 30% reaction after 5 weeks. At 65^o, however, a more complicated reaction occurred, as gold was deposited in 5 days and work up after 5 weeks gave triphenylchloro-germane (84%), triphenylphosphinegold(I) chloride, gold (78%) ethylene (37%) and ethylene(bistriphenylphosphonium)dichloride

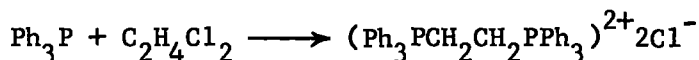
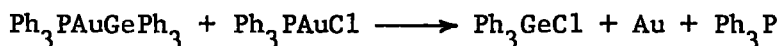
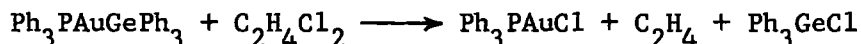

Confirmation of this scheme was obtained by reacting Ph_3PAuCl and $\text{Ph}_3\text{PAuGePh}_3$ in refluxing benzene, when small amounts of bis(triphenylphosphine)gold(I) chloride were isolated

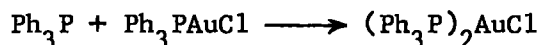

Ethylene(bistriphenylphosphonium)dichloride can be prepared by the direct reaction of triphenylphosphine in 1,2-dichlorethane.

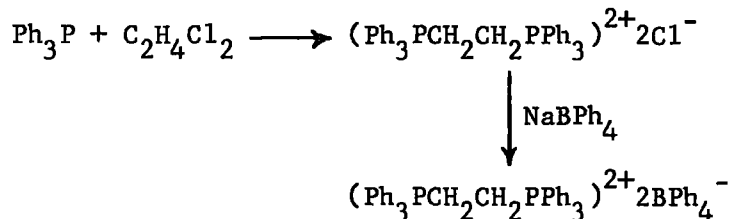

Slowness and side reactions, often indicating radical attack, are characteristic of the gold-germanium complex. For instance, with carbon tetrachloride, a long radical induction period occurred. No reaction was visible for 10 days when the solution developed a pale yellow colouration, and then within a few hours the whole went into solution. On evaporation of the solvents on work up, the white solid yellowed as the last traces of solvent were removed; possibly due to $:\text{CCl}_2$ recombination although no trace of the fate of this species could be found

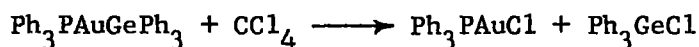

In the reaction with mercuric chloride no evidence of a gold-mercury intermediate was found; in contrast to the tungsten-germanium complex.¹²²

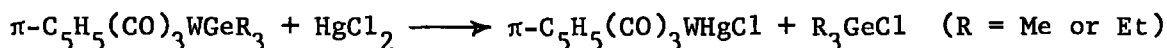
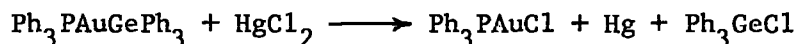

The reactions with hydrogen chloride and methyl iodide are rapid and indicate the bond polarity $\text{Au}(\delta^+)-\text{Ge}(\delta^-)$ although the latter proceeds via a radical mechanism for methane, ethane and gold were isolated in small

yields. These reactions gave no evidence for increased metal co-ordination intermediates (cf. platinum¹⁵¹)

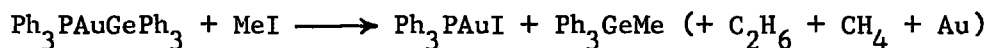
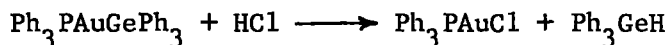

Potassium cyanide, in methanol, cleaved the metal-metal bond after several weeks at 50° forming triphenylgermane, triphenylphosphine and potassium aurocyanide, $\text{KAu}(\text{CN})_2$.

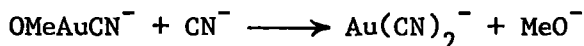
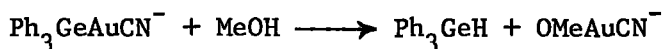

With the palladium complex, $(\text{Et}_3\text{P})_2\text{Pd}(\text{GePh}_3)_2$ ¹⁵³ however ligand exchange occurs

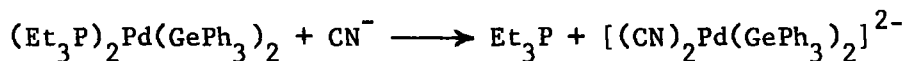

Hydrogenation with transition metal-germanium complexes shows many contrasts in reaction conditions, intermediates of increased oxidation number being postulated in some cases. The germyl-gold complex does not hydrogenate at room temperature under 1 atmosphere of hydrogen. High pressure conditions (125 atmos., 45°) effect reaction, triphenylgermane, gold and triphenylphosphine being isolated in quantitative yields. That this is a genuine hydrogenation of the complex and not of the decomposition product hexaphenyldigermane, Ph_6Ge_2 is illustrated by the unsuccessful

hydrogenation attempts on digermanes (Appendix A)



Interesting reactions occur with stannic chloride. With an excess of tin(IV) chloride, orange crystals immediately form but these turned to a purple tar within 30 minutes. Work up gave gold, triphenylchlorogermane and bis(triphenylphosphine)goldtrichlorostannate.

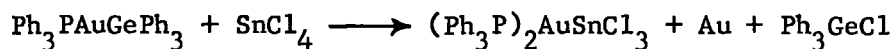

The latter reacts with triphenylphosphine to give the known compound tris(triphenylphosphine)goldtrichlorostannate $(\text{Ph}_3\text{P})_3\text{AuSnCl}_3$ prepared by the reaction¹⁵⁸

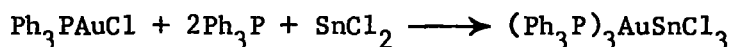

It is possible to remove one molecule but not two of Ph_3P per molecule of $(\text{Ph}_3\text{P})_3\text{AuSnCl}_3$ by continuous extraction with petroleum ether or by sublimation, to give bis(triphenylphosphine)goldtrichlorostannate identical to the reaction product formed above

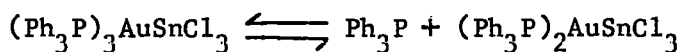

With equimolar ratios of tin(IV) chloride and the complex, the orange crystals thought to be the monophosphine gold-tin complex, $\text{Ph}_3\text{PAuSnCl}_3$ are formed but only once was it possible to recrystallise these, decomposition to triphenylphosphinegold(I) chloride and stannous chloride normally occurring. The infrared spectrum of the complex (a single band at 1091 cm^{-1} due to Ph_3PAu , indicating the absence of the Ph_3Ge group) agrees with the

formulation, $\text{Ph}_3\text{PAuSnCl}_3$ but satisfactory analysis figures were not obtained. Quantitative yields of triphenylchlorogermane were always obtained.

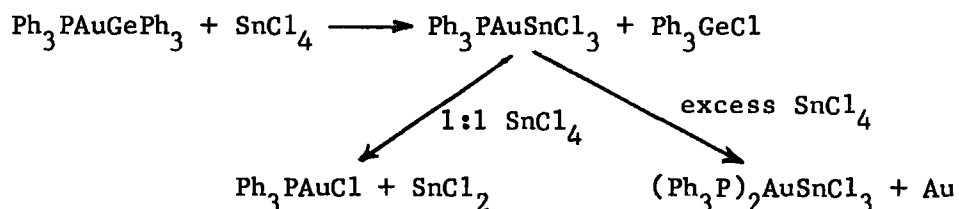

Attempts to prepare $\text{Ph}_3\text{PAuSnCl}_3$ from the reaction of Ph_3PAuCl and SnCl_2 resulted only in reduction to gold metal.

Slow cleavage of the metal-metal bond also occurs with magnesium bromide. Hydrolysis of a withdrawn sample yielded triphenylgermane.

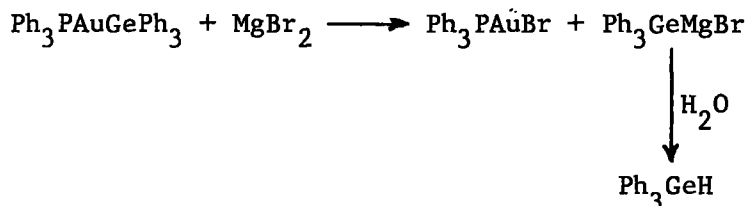

The postulated gerymyl-Grignard intermediate would be present in the ether layer but evaporation of the solvent gave an orange oil which could not be recrystallised or reacted with an amine to give an isolable adduct.

A short series of reactions with phosphines aimed at ligand replacement were investigated as previous reactions had all resulted in the cleavage of the gold-germanium bond. The complex could not be induced to add further triphenylphosphine, in contrast to the copper and silver analogues which readily take up additional triphenylphosphine to give the trisphosphine

compounds, $(\text{Ph}_3\text{P})_3\text{MGePh}_3$. This illustrates the greater stability of the third row transition metal complexes as previously mentioned.

With the chelating phosphine, $\text{Ph}_2\text{PCH}_2\text{CH}_2\text{PPh}_2$, a compound of low solubility, triphenylgermylgold-(1,2-bisdiphenylphosphinoethane), $(\text{Ph}_2\text{PCH}_2\text{CH}_2\text{PPh}_2)\text{AuGePh}_3$ (i.r. table 9) probably containing three coordinate gold is synthesised, with quantitative isolation of the displaced triphenylphosphine.

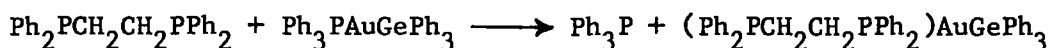

An equilibrium reaction occurs with triethylphosphine, unreacted starting complex, triphenylphosphine and triphenylgermyltriethylphosphine-gold resulting.

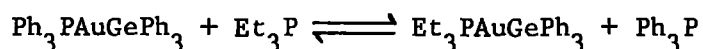

This new gold-germanium complex (i.r. table 9) reacts with 1,2-dibromethane in the usual way

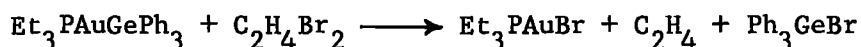

This complex, $\text{Et}_3\text{PAuGePh}_3$, is the only gold-germanium complex prepared which exhibits a molecular ion in its mass spectrum. Two series of high mass fragment ions but no metastables were observed. (Diagram)

Triphenylgermyltriphenylphosphinegold and triphenylgermylgold-1,2-bis(diphenylphosphinoethane) show only the decomposition products, Ph_3P or $\text{Ph}_2\text{PCH}_2\text{CH}_2\text{PPh}_2$ and hexaphenyldigermene and their subsequent decomposition patterns in their mass spectra.

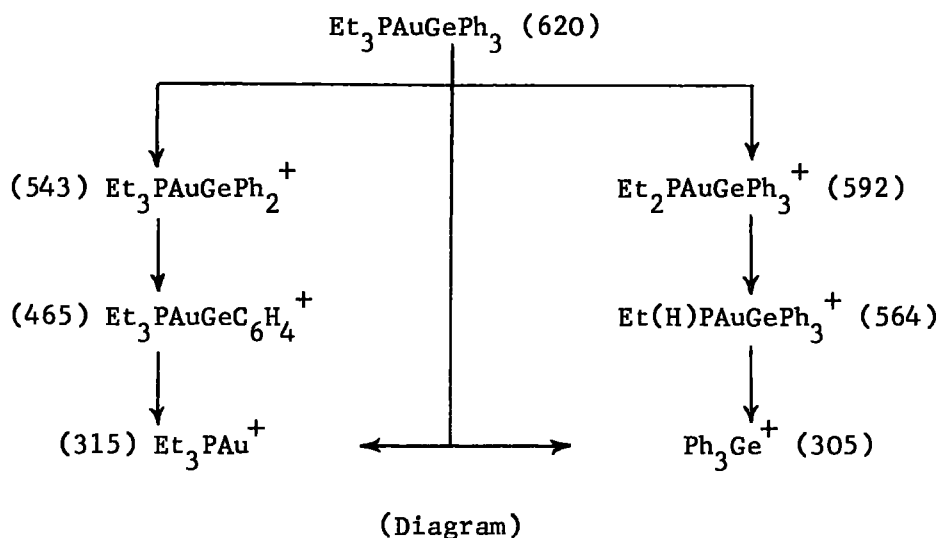

In another experiment with triethylphosphine adventitious admittance of a limited amount of air resulted in the isolation of triphenylphosphine, hexaphenyldigermoxane and a white crystalline solid, m.p.121^o, soluble in benzene and stable in air. This compound shows only bands attributable to Et₃P groups in its infrared spectrum and is postulated as a gold cluster compound, (Et₃P)_xAu_y. Analysis (carbon and hydrogen) suggest (Et₃P)₆Au₃ whilst the molecular weight was found to be only 560 [(Et₃P)₃Au = 551]. The greatest ion in its mass spectrum corresponds to Et₃PAu⁺ (315) and the p.m.r. spectrum (100 mc/s) shows only one type of phosphine group to be present which are weakly coupled together. Repetition with free access of air lead only to an intractable oil which showed germoxane and complexed triethylphosphine to be present.

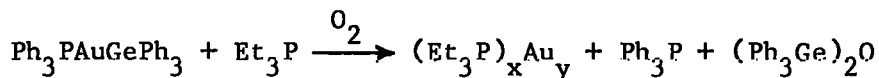

For complexes, triphenylgermylphosphinegold, R₃PAuGePh₃ the effect of

the phosphine on stability would appear to be in the order $\text{Ph}_2\text{PCH}_2\text{CH}_2\text{PPh}_2 > \text{Et}_3\text{P} > \text{Ph}_3\text{P} > \text{Me}_3\text{P}$. A similar order has been found for other metals, for instance with palladium¹⁵³ the complexes $(\text{Ph}_2\text{PCH}_2\text{CH}_2\text{PPh}_2)\text{Pd}(\text{GePh}_3)_2$ and $(\text{Et}_3\text{P})_2\text{Pd}(\text{GePh}_3)_2$ were isolated but not with the corresponding reaction from which would have formed $(\text{Ph}_3\text{P})_2\text{Pd}(\text{GePh}_3)_2$.

The reaction with carbon monoxide is also temperamental. From this potentially interesting experiment, was isolated hexaphenyldigermoxane (conceivably formed by accidental oxidation) together with a crystalline gold complex containing triphenylphosphine groups and carbonyl groups (4 infrared bands in the region $1900\text{--}2100\text{ cm}^{-1}$, simplifying to 3 in solution). It is stable in air and this is in direct contrast to $\text{Au}(\text{CO})\text{Cl}$ ^{32,33} the only previously known gold carbonyl which is light, air and water sensitive. The yield of pure material was low and inconsistent analyses were obtained. Repetition on many occasions under apparently identical conditions or with a potential catalyst added, either at high pressures or by bubbling carbon monoxide through solutions of $\text{Ph}_3\text{PAuGePh}_3$ gave no reaction or slight decomposition to gold.

Finally no reaction occurs with phenyl acetylene at room temperature over several weeks.

The preparative method, involving bis(trimethylgermyl)mercury and a tertiary phosphine metal halide has been extended to gold

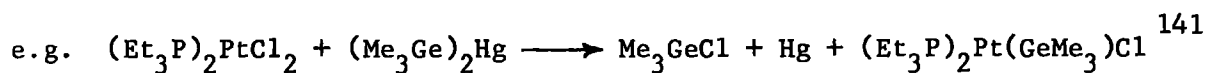

In refluxing benzene, using triphenylphosphinegold(I) chloride, complete decomposition occurred but at 15° trimethylgermyltriphenylphosphine-

gold(I) was isolated in 15% yields

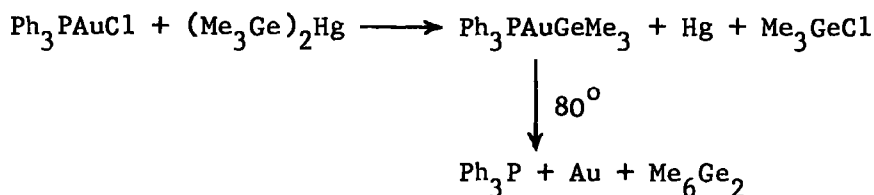

This compound is quite stable as a solid but in benzene solution, the ^1H n.m.r. signal of the methyl protons ($\tau = 9.20$) diminished by one half during six days at 25° hexamethyldigermene ($\tau = 9.70$) and hexamethyldigermoxane ($\tau = 9.79$) being formed.

Triphenylphosphinegold(I) chloride and trimethylgermane not surprisingly did not react at room temperature. Pyridine gold trichloride, with both trimethylgermane and triphenylgermyl-lithium resulted in rapid decomposition.

A short study of reactions between transition metal halides and complexes containing a transition metal to germanium or silicon bond was undertaken to see if exchange reactions occur.

i. e.

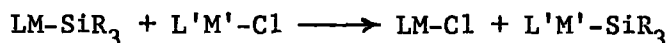
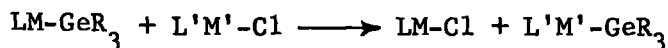

The reactions with the gold-germanium complex and either bis(triphenylphosphine)iridium(I)carbonyl chloride, $(\text{Ph}_3\text{P})_2\text{Ir}(\text{CO})\text{Cl}$ or with triphenylsilane, Ph_3SiH , results only in slight decomposition.

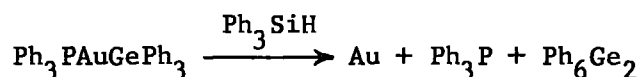
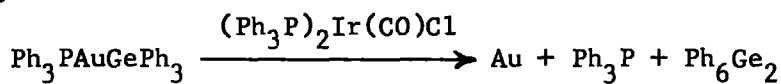

No reaction at all occurred between Ph_3PAuCl and $(\text{Ph}_2\text{PCH}_2\text{CH}_2\text{PPh}_2)\text{Pt}(\text{GePh}_3)_2$ but with $(\text{Et}_3\text{P})_2\text{Pd}(\text{GePh}_3)_2$ a variety of products were obtained. Some were decomposition products such as gold, palladium, triethylphosphine and hexaphenyldigermane. However bis(triethylphosphine)-palladium dichloride, $(\text{Et}_3\text{P})_2\text{PdCl}_2$, was obtained presumably due to exchange, although no gold-germanium complex was detected.

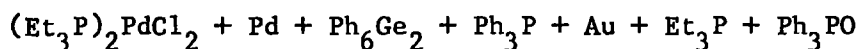
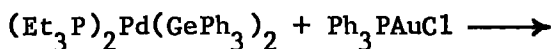

From $\text{Ph}_3\text{PAuGePh}_3$ and $\text{cis}(\text{Et}_3\text{P})_2\text{PtCl}_2$ a yellow oil resulted. Its infrared spectrum and solubility in petroleum ether resemble $(\text{Et}_3\text{P})_2\text{Pt}(\text{Cl})\text{GePh}_3$ ¹⁸⁴ whilst its mass spectrum revealed PtGe and PtGeCl patterns. Triphenylphosphinegold(I) chloride was also identified

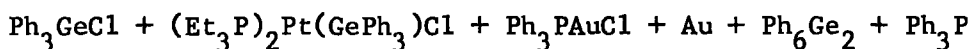
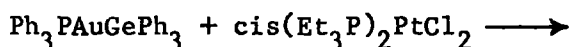

Fairly rapid reactions occur between Ph_3PAuCl and the complexes $[(\text{Ph}_2\text{PCH}_2\text{CH}_2\text{PPh}_2)\text{Pt}(\text{MMe}_3)\text{Et}_3\text{P}]\text{Cl}$ (M = Si or Ge).¹⁸⁰ In both cases, a number of products are formed including bis chelateplatinumdichloride $[(\text{Ph}_2\text{PCH}_2\text{CH}_2\text{PPh}_2)_2\text{Pt}]\text{Cl}_2$ and the complexes $(\text{Ph}_2\text{PCH}_2\text{CH}_2\text{PPh}_2)\text{Pt}(\text{MMe}_3)\text{Cl}$ (M = Si or Ge) in which the platinum-group IVb bond remains uncleaved.

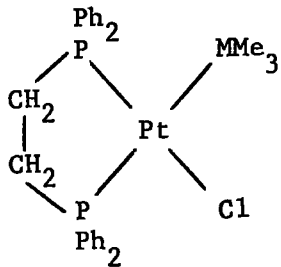
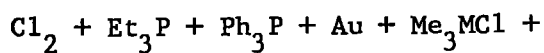
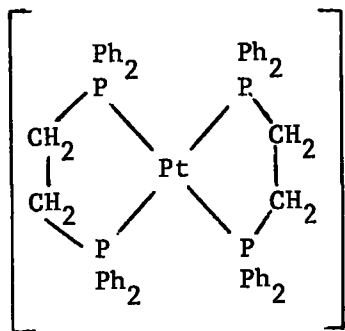
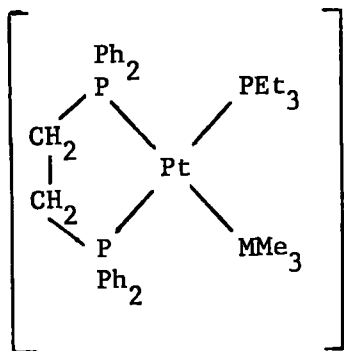

[M = Si or Ge]

Finally with $(\text{Ph}_2\text{PCH}_2\text{CH}_2\text{PPh}_2)\text{AuGePh}_3$ and trimethylgermane an equilibrium reaction occurred, for triphenylgermane, hexamethyldigermane, gold metal and unreacted $(\text{Ph}_2\text{PCH}_2\text{CH}_2\text{PPh}_2)\text{AuGePh}_3$ were detected.

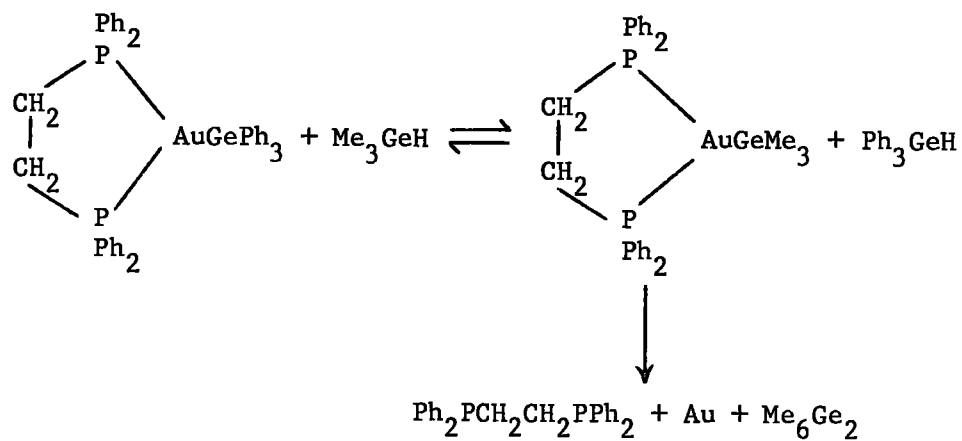

Summary of some reactions of $\text{Ph}_3\text{PAuGePh}_3$

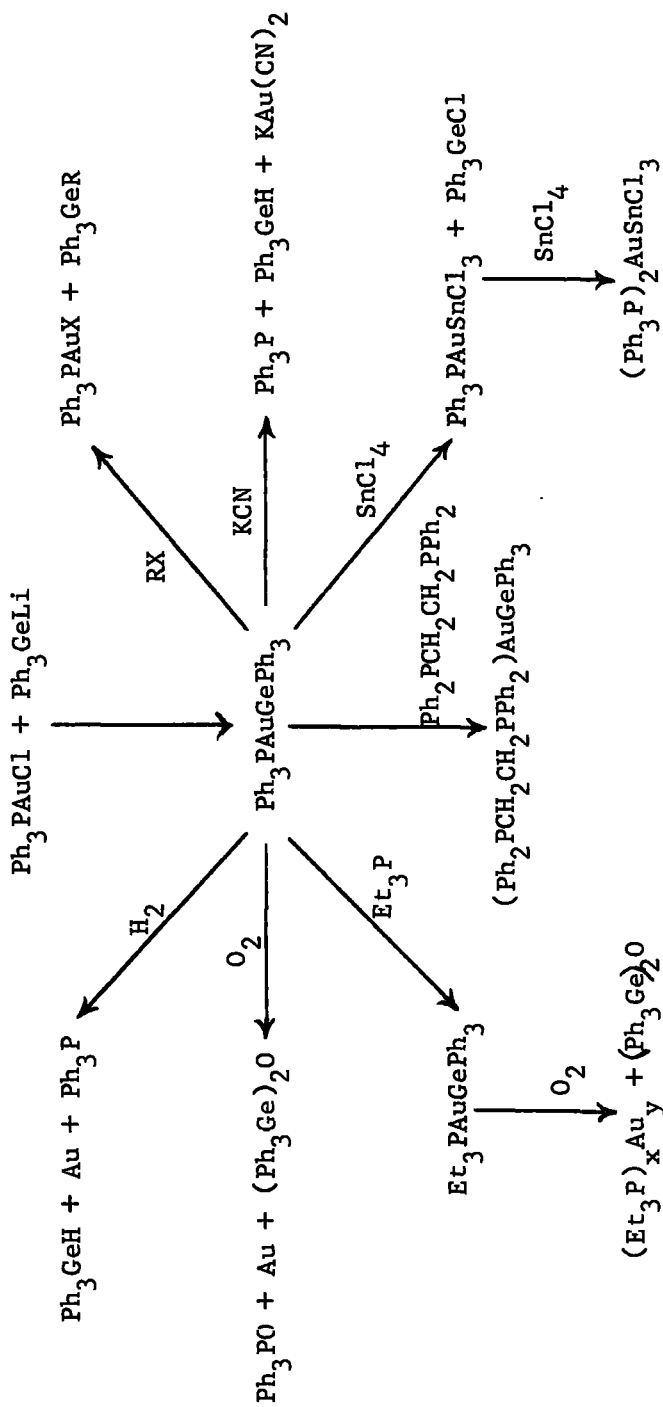

Table 9.

The infrared absorbances of the gold-group IV complexes (cm⁻¹)Ph₃PAuGePh₃·C₆H₆ (KBr)

3058m, 3039m, 1968, 1894, 1838, 1587, 1486s, 1441sh, 1431s, 1333, 1309m, 1266, 1190m, 1105s, 1087s, 1068, 1040m, 1031s, 1001m, 755sh, 750sh, 743s, 712sh, 704s, 692s, 526s, 495s, 457s, 431m, 321m, 307m.

Et₃PAuGePh₃ (KBr)

3048m, 3021sh, 3015, 2983, 2957m, 2922, 2898, 2865, 1955, 1893, 1878, 1819, 1762, 1642, 1620, 1583m, 1478s, 1456sh, 1447m, 1428s, 1409s, 1376m, 1312, 1300, 1261, 1184, 1101, 1082s, 1063, 1044s, 1023m, 997m, 988sh, 906, 855, 771sh, 763s, 753s, 741s, 732s, 698s, 665m, 631, 618, 461s.

(Ph₂PCH₂CH₂PPh₂)AuGePh₃ (KBr)

3062, 2984, 1587m, 1488s, 1442sh, 1430s, 1337, 1310, 1268, 1189, 1176, 1160, 1101s, 1082s, 1027m, 1001m, 749sh, 734s, 700s, 694sh, 682s, 670s, 515m, 465s, 339, 323m, 304m.

Phosphinegoldcarbonyl complex (KBr)

3060, 3021, 3000, 2051s, 2000s, 1974s, 1949s, 1598, 1588, 1492m, 1478s, 1454, 1433s, 1382, 1326, 1305, 1264, 1210, 1181, 1153, 1147, 1095s, 1072, 1059, 1036m, 997m, 972, 909, 762s, 748sh, 741s, 736sh, 694s, 623s, 616sh, 518s, 502s, 458m.

(benzene) 2052, 2008, 1939.

(Ph₃P)₂AuSnCl₃ (KBr)

3040, 1479m, 1434s, 1381, 1324, 1307, 1179, 1143, 1098s, 1068, 1022m, 997m, 747sh, 743s, 711s, 691s, 520s, 506s, 498s.

Ph₃PAuGeMe₃ (KBr)

3062, 3033, 3005, 2960m, 2884m, 1588, 1479s, 1436s, 1409m, 1328m, 1301,
1290, 1211, 1178m, 1161, 1102s, 1071, 1026m, 999, 997, 853m, 844, 812s, 744s,
737sh, 710s, 691s, 567s, 551s, 524s, 498s, 456m.

(Et₃P)_xAu_y (KBr)

2960m, 2932m, 2897m, 2875m, 1457sh, 1450s, 1412m, 1376s, 1263s, 1241m,
1050s, 1041sh, 999m, 778s, 765s, 755sh, 738sh, 701m, 645m, 394, 344.

s = sharp; m = medium; sh = shoulder.

Section B. Organogermyl-iridium complexes

Complexes containing iridium bound to silicon, germanium and tin have been reported, a number concurrently with these present investigations. Examples of iridium-group IVb complexes are listed in Table 10.

The silyl complexes prepared, contained only strongly electronegative groups bound to the silicon atom, no reaction occurring with trimethylsilane or triphenylsilane. Even so, the complexes readily dissociated in solution or upon warming with the result that p.m.r. data, which might have established their stereochemistries, was not available. The germanium complex, $\text{Ph}_3\text{P}(\text{CO})_3\text{IrGePh}_3$, one of a series of iridium to main group or transition metal bonded complexes, decomposed over several weeks in air. The analogous tin complexes were more air resistant as were the octahedral compounds. P.m.r. data on the soluble octahedral stannyl-iridium complexes revealed the phosphine groups to be mutually trans. Few reactions of any of the complexes have been reported.

The studies reported in this section on germyl-iridium complexes, were undertaken to provide additional information on the reactivity of metal-metal bonds especially in comparison with similar types of complexes which have been or are currently being investigated in these laboratories. It was further hoped to prepare two classes of complexes in which the iridium metal existed in both the formal (+1) and (+3) oxidation levels.

Although $(\text{Et}_3\text{P})_2\text{Ir}(\text{CO})\text{Cl}$ and $(\text{Me}_2\text{PhP})_2\text{Ir}(\text{CO})\text{Cl}$ were used as the basic iridium starting material for a few reactions, the ubiquitous complex,

Table 10

Some iridium-group IVb bonded complexes

Element	Complex	Preparation	Ref.
<u>Silicon</u>	$(\text{Ph}_3\text{P})_2\text{Ir}(\text{CO})(\text{H})(\text{Cl})\text{SiR}_3$	$(\text{Ph}_3\text{P})_2\text{Ir}(\text{CO})\text{Cl} + \text{R}_3\text{SiH}$	146
	$(\text{R}_3 = \text{Cl}_3 \text{ or } (\text{EtO})_3$		143
	$= \text{Cl}_3, \text{Cl}_2\text{Ph}, \text{Cl}_2\text{Et} \text{ or } (\text{OEt})_3$		
<u>Germanium</u>	$\text{Ph}_3\text{P}(\text{CO})_3\text{IrGePh}_3$	$\text{Na}[\text{Ir}(\text{CO})_3\text{PPh}_3] + \text{Ph}_3\text{GeCl}$	195
<u>Tin</u>	$[\text{Ph}_3\text{P}(\text{CO})_3\text{Ir}]_2\text{SnMe}_2$	$\text{Na}[\text{Ir}(\text{CO})_3\text{PPh}_3] + \text{Me}_2\text{SnCl}_2$	195,196
	$\text{Ph}_3\text{P}(\text{CO})_3\text{IrSnR}_3$	$\text{Na}[\text{Ir}(\text{CO})_3\text{PPh}_3] + \text{R}_3\text{SnCl}$	195,196
	$(\text{R} = \text{Me} \text{ or } \text{Ph})$		
	$(\text{R}'_3\text{P})_2\text{Ir}(\text{CO})(\text{H})(\text{Cl})\text{SnR}_3$ (two isomers p.47)	$(\text{R}'_3\text{P})_2\text{Ir}(\text{CO})\text{Cl} + \text{R}_3\text{SnH}$	147
	$(\text{R}'_3\text{P} = \text{Ph}_3\text{P}, \text{Ph}_2\text{MeP} \text{ or } \text{Ph}_2\text{EtP}; \text{R} = \text{Me}, \text{Et} \text{ or } \text{Ph})$		
	$(\text{Ph}_3\text{P})_3\text{Ir}(\text{H})_2\text{SnCl}_3$	$\text{Na}_2\text{IrCl}_6 + \text{Ph}_3\text{P} + \text{SnCl}_2$ $(\text{Ph}_3\text{P})_3\text{IrH}_2\text{Cl} + \text{SnCl}_2$	197
	$(\text{Ph}_3\text{P})_2\text{Ir}(\text{CO})(\text{H})(\text{Cl})\text{SnCl}_3$	$(\text{Ph}_3\text{P})_2\text{Ir}(\text{CO})\text{HCl}_2 + \text{SnCl}_2$	197
$\text{Ph}_3\text{P}(\text{CO})\text{Ir}(\text{Cl})_2\text{SnCl}_3$	$(\text{Ph}_3\text{P})_2\text{Ir}(\text{CO})\text{Cl} + \text{SnCl}_2$	197	

$(\text{Ph}_3\text{P})_2\text{Ir}(\text{CO})\text{Cl}$ ("Vaska's Compound") was generally employed. This bright yellow compound has the advantage of being much more easily prepared and purified than the triethylphosphine or dimethylphenylphosphine analogues, and is a high melting, air stable solid. The position of the carbonyl stretching frequency provides a ready indication whether reaction has taken place, and the numerous addition reactions reported in the literature enable comparative identifications of products to be made.

The initial attempt to prepare Vaska's compound, using the first method (p.11), did not produce the required complex. Instead two crystallographic forms of the complex, $(\text{Ph}_3\text{P})_3\text{IrH}_2\text{Cl}$ (H trans Cl) and $(\text{Ph}_3\text{P})_3\text{IrCl}_3$ were isolated. Different crystallographic forms have been reported for several complexes, e.g. $(\text{Ph}_3\text{P})_3\text{IrHCl}_2$ ¹⁹⁷ and trans $(\text{Ph}_3\text{P})_2\text{Pt}(\text{H})\text{Cl}$ ¹⁹⁸ and in some cases may be due to varying degrees of solvation

$(\text{Ph}_3\text{P})_3\text{IrH}_2\text{Cl}$	Form A	$\nu(\text{Ir-H})$	2100 and 2208 cm^{-1}	$\nu(\text{Ir-Cl})$	261 cm^{-1}
	B		2154 and 2184 cm^{-1}		256 cm^{-1} .

Other workers too have found the above preparative method unreliable,⁵⁹ and so method two (p.11) was used on all subsequent occasions.

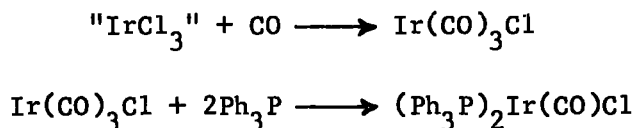

Yields of recrystallised material were generally in the range 60-70% although on one occasion, under apparently identical conditions, less than 5% was isolated together with $(\text{Ph}_3\text{P})_2\text{Ir}(\text{CO})\text{Cl}_3$ and $(\text{Ph}_3\text{P})_2\text{Ir}(\text{CO})\text{HCl}_2$. The

mixture of $(\text{Ph}_3\text{P})_2\text{Ir}(\text{CO})\text{Cl}_3$ and $(\text{Ph}_3\text{P})_2\text{Ir}(\text{CO})\text{HCl}_2$ was however converted to the desired product by refluxing with triethylamine which converted the hydridodichloride to $(\text{Ph}_3\text{P})_2\text{Ir}(\text{CO})\text{Cl}$; separation from $(\text{Ph}_3\text{P})_2\text{Ir}(\text{CO})\text{Cl}_3$ being effected by Soxhlet extraction with benzene

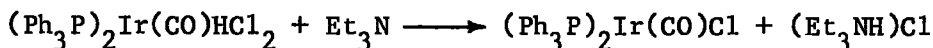

Partial conversion in about 15% yields of insoluble $(\text{Ph}_3\text{P})_2\text{Ir}(\text{CO})\text{Cl}_3$ to $(\text{Ph}_3\text{P})_2\text{Ir}(\text{CO})\text{Cl}$ was accomplished using zinc in dimethylformamide.⁶²

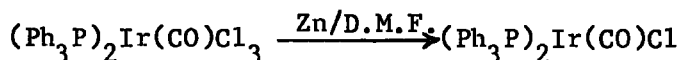

The triethylphosphine and dimethylphenylphosphine analogues were also prepared by the second method but difficulties were experienced with both preparations. The triethylphosphine complex, $(\text{Et}_3\text{P})_2\text{Ir}(\text{CO})\text{Cl}$, is low melting ($54-8^\circ$), difficult to recrystallise and exhibits two carbonyl stretching frequencies in the infrared which have been attributed to cis and trans isomers.⁵⁹ Both bands persisted in solution (thus excluding crystallographic forms) but p.m.r. examination revealed a 1.4.6.4.1 quintet indicative of a trans configuration (Table 11). This complex however reacted with acetyl bromide to give a single product.⁵⁹

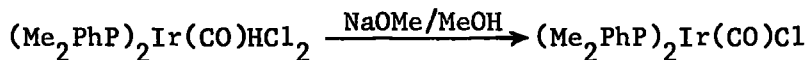

TABLE 11

Triethylphosphine iridium complexes [p.m.r. data (C_6H_6)]

Complex	$\tau(CH_2)$ multiplet	$\tau(CH_3)$ quintet	$J(CH_3-CH_2)$ cycles/sec	$J(CH_3-P_{cis})$ $J(CH_3-P_{trans})$ cycles/sec	Hydride (triplet)		
					τ	$J(H-P)$ cycles/sec	$J(H-H)$ cycles/sec
$(Et_3P)_2Ir(CO)Cl$	8.22	9.05	7.5	7.2			
$(Et_3P)_2Ir(CO)H_2Cl$	8.32	9.11	8.4	7.5	18.27	13.8	5.4
$(Et_3P)_2Ir(CO)H_2I$	8.27	9.16	7.8	7.2	29.45	13.2	5.4
					20.20	18.7	5.1
					27.50	13.9	5.1

The dimethylphenylphosphine preparation gave an inseparable mixture of $(\text{Me}_2\text{PhP})_2\text{Ir}(\text{CO})\text{Cl}$ and $(\text{Me}_2\text{PhP})_2\text{Ir}(\text{CO})\text{HCl}_2$. We found however that reaction of the mixture with sodium methoxide produced $(\text{Me}_2\text{PhP})_2\text{Ir}(\text{CO})\text{Cl}$ in poor yields.⁶⁰



One possible route for synthesising an iridium-germanium bond was the reaction between an iridium halide and $(\text{Me}_3\text{Ge})_2\text{Hg}$. When bis(trimethylgermyl)-mercury was added to a refluxing benzene solution of $(\text{Ph}_3\text{P})_2\text{Ir}(\text{CO})\text{Cl}$ in equimolar ratios, a vivid cherry red colour was initially produced which lightened to give an orange solution. Considerable quantities of unreacted iridium complex were recovered together with mercury, trimethylchlorgermane, hexamethyldigermane and a buff solid. Preliminary investigations suggested it to contain an iridium-mercury bond, $(\text{Ph}_3\text{P})_2\text{Ir}(\text{CO})\text{HgGeMe}_3$. Studies were discontinued as it was learnt that Dr. K.A. Hooton (U.M.I.S.T.)¹⁹⁹ was currently investigating this particular reaction.

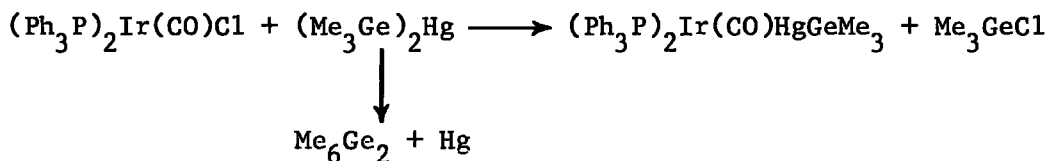

The addition of trimethylgermane and triethylgermane to $(\text{Ph}_3\text{P})_2\text{Ir}(\text{CO})\text{Cl}$ did not proceed by simple addition (c.f. silanes and stannanes) for the dihydrido-complex, $(\text{Ph}_3\text{P})_2\text{Ir}(\text{CO})(\text{H})_2\text{GeR}_3$, (R = Me or Et), and the corresponding triorganochlorgermane, R_3GeCl , were formed.

The reactions required several weeks at room temperature or 12 hours in

refluxing benzene during which time the yellow colour due to trans $(\text{Ph}_3\text{P})_2\text{Ir}(\text{CO})\text{Cl}$ faded. With less than 2:1 ratios of germane to Vaska's compound, no evidence for $(\text{Ph}_3\text{P})_2\text{Ir}(\text{CO})(\text{H})(\text{Cl})\text{GeR}_3$ was obtained; only unreacted materials and the dihydrido-complex being isolated. The presence of a base, such as triethylamine, did not affect the reaction course, suggesting that, either a reaction intermediate of composition, $(\text{Ph}_3\text{P})_2\text{Ir}(\text{CO})(\text{H})(\text{Cl})\text{GeR}_3$ was not formed or else the hydride and chloride ligands in such an intermediate are mutually trans. Possibly initial substitution of hydride for chloride forming a transient species such as $(\text{Ph}_3\text{P})_2\text{Ir}(\text{CO})\text{H}$ took place, immediately followed by addition of the germane

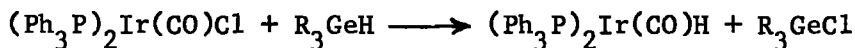

When R = Me or Et, the complexes were recrystallised from cyclohexane to give white spheres whilst careful recrystallisation from benzene gave colourless crystals. These crystals (R = Me) have been the subject of an X-ray analysis²⁰⁰ and are shown to contain one molecule of solvent benzene for every two molecules of the germyl-iridium complex. The cyclohexane crystallised product was solvent free.

The p.m.r. spectrum of $(\text{Ph}_3\text{P})_2\text{Ir}(\text{CO})(\text{H})_2\text{GeMe}_3$ is reproduced in Figure 13, and summarised in Table 12. The high field p.m.r. spectrum consisted of a series of doublets, centred around $\tau = 19.50$ and 20.50 and is only consistent with two structures (XXIII) and (XXIV).

Table 12

Octahedral germyl-iridium complexes [P.m.r. data (C_6H_6 or C_6D_6)]

Complex	R_3Ge group		hydride			
	$\tau(CH_2)$	$\tau(CH_3)$	τ	J(H-P _{trans}) cycle/sec	J(H-P _{cis}) cycle/sec	J(H-H) cycle/sec
$(Ph_3P)_2Ir(CO)(H)_2GeMe_3^*$		9.20	19.50		15,19	3.5
$(Ph_3P)_2Ir(CO)(H)_2GeEt_3^*$		8.72	20.50	117	18	3.5
$(Me_2PhP)_2Ir(CO)(H)_2GeMe_3^a$	8.89	8.72	19.77		16,22	4
$(Et_3P)_2Ir(CO)(H)_2GeMe_3^b$		9.07	20.86	117	18.5	4
$(Ph_2PCH_2CH_2PPh_2)Ir(CO)(H)_2GeEt_3^c$		9.17	21.31		19.2	4
			21.80	114	19.2	4
	8.62 ^c		20.04	121	11	
			20.82		19	

* The author is grateful to Dr. J. Walker (I.C.I. Petrochemical and Polymer Laboratories) for running these spectra.

^c not resolved

^a Phosphine methyls: doublet. τ , 8.46; J(P-CH₃), 8.1 cycle/sec.

^b Phosphine methyls: 1,2,2,2,1 quintet. τ , 9.21; J(CH₃-CH₂), 7.5; J(CH₃-P), 15 cycle/sec.

^c Ratio: phenyl:methylene:ethyl groups 4 : 2 : 3

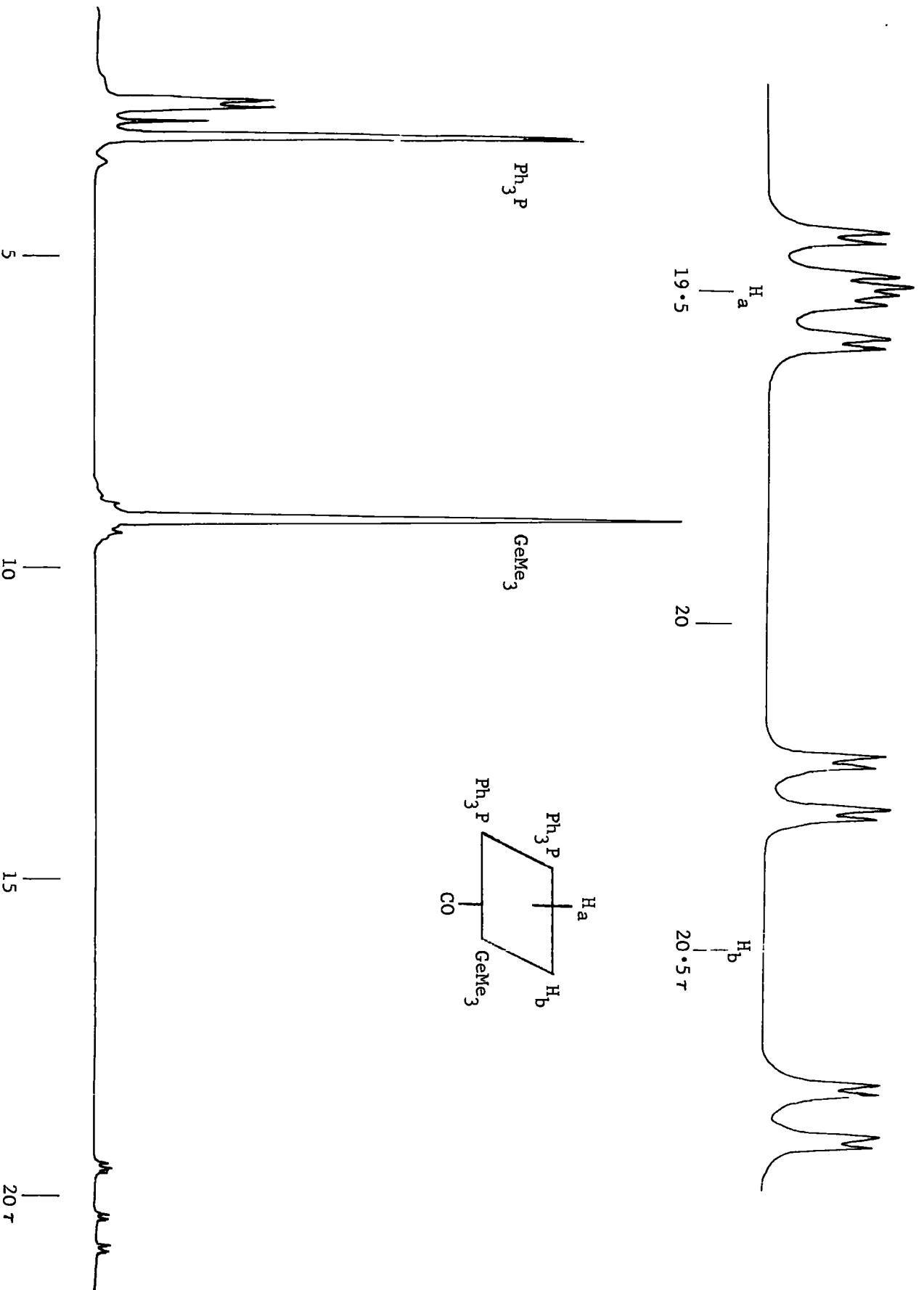
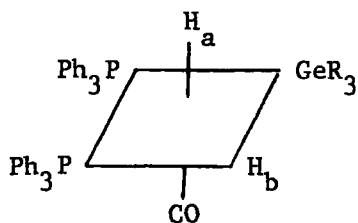
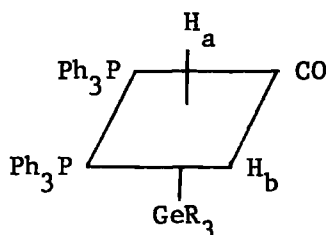

Figure 13. P.m.r. spectrum of $(\text{Ph}_3\text{P})_2\text{Ir}(\text{CO})(\text{H})_2\text{GeMe}_3$



(XXIII)



(XXIV)

These structures were based on the following arguments. H_a will couple with both cis phosphorus atoms to give two doublets, which almost form a 1:2:1 triplet since the phosphorus atoms are in nearly identical environments. Cis phosphorus coupling would be expected to be in the range 15-25 cycles/sec. Further coupling with the other hydrogen atom, H_b , is also expected, the coupling constant being in the range 3-10 cycles/sec (p.41). This in fact was observed, for the 4 doublets centred around $\tau = 19.50$. H_b will strongly couple with the trans phosphorus atom (80-150 cycles/sec) to give a doublet which will be further split into doublets by the cis phosphorus and cis hydrogen atoms. Four doublets are again observed centred around $\tau = 20.50$, in accordance with structures (XXIII) or (XXIV). Both the absence of long range coupling, $^1\text{H-}^1\text{H-}^1\text{H-Ge-CH}_3$, and infrared spectra of the methyl and ethyl complexes favour structure (XXIII) for if the hydride were trans to a germyl group, a low value for the Ir-H stretching frequency would be predicted as trialkylgermyl groups have a very high trans-influence.¹⁸⁴ Moreover the similarity of $\nu(\text{Ir-H})$ and $\nu(\text{C}\equiv\text{O})$ absorbances for the methyl and ethyl complexes suggest the R_3Ge group to be cis to both hydrogen atoms. The

crystal structure of $(\text{Ph}_3\text{P})_2\text{Ir}(\text{CO})(\text{H})_2\text{GeMe}_3$ (Figures 14 and 15) confirmed these predictions.²⁰⁰ It should be noted that groups of very high trans effect (i.e. H and GeR_3) assumed mutually cis positions, resulting in the phosphine groups being mutually cis, a comparative rarity in bis(phosphine)-iridium(III) complexes.

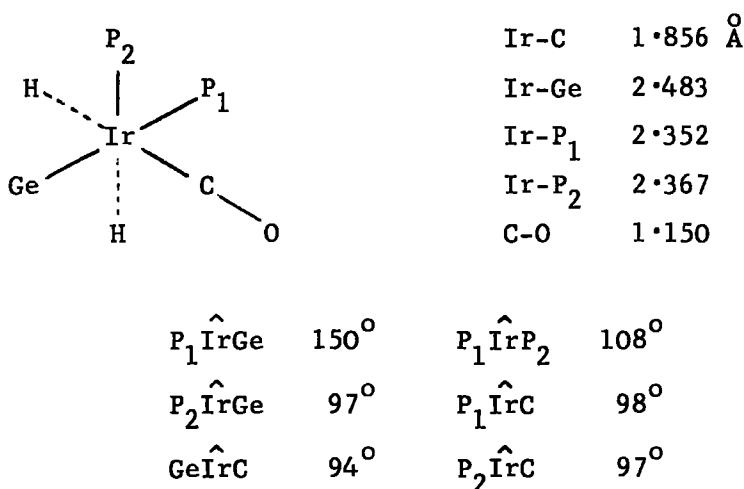

Figure 14

Some bond lengths and angles in $(\text{Ph}_3\text{P})_2\text{Ir}(\text{CO})(\text{H})_2\text{GeMe}_3 \cdot \frac{1}{2}\text{C}_6\text{H}_6$

The bond lengths are similar to complexes whose structures have previously been determined, (Figures 1-5). The Ir-P₂ (trans H) length is greater than Ir-P₁ (trans GeMe_3) probably indicative that hydrogen has a greater trans-influence than a germyl group. Considerable distortions of bond angles from 90° are observed, due to steric crowding, the phosphines bending into the open areas around the hydride ligands. Into the hole

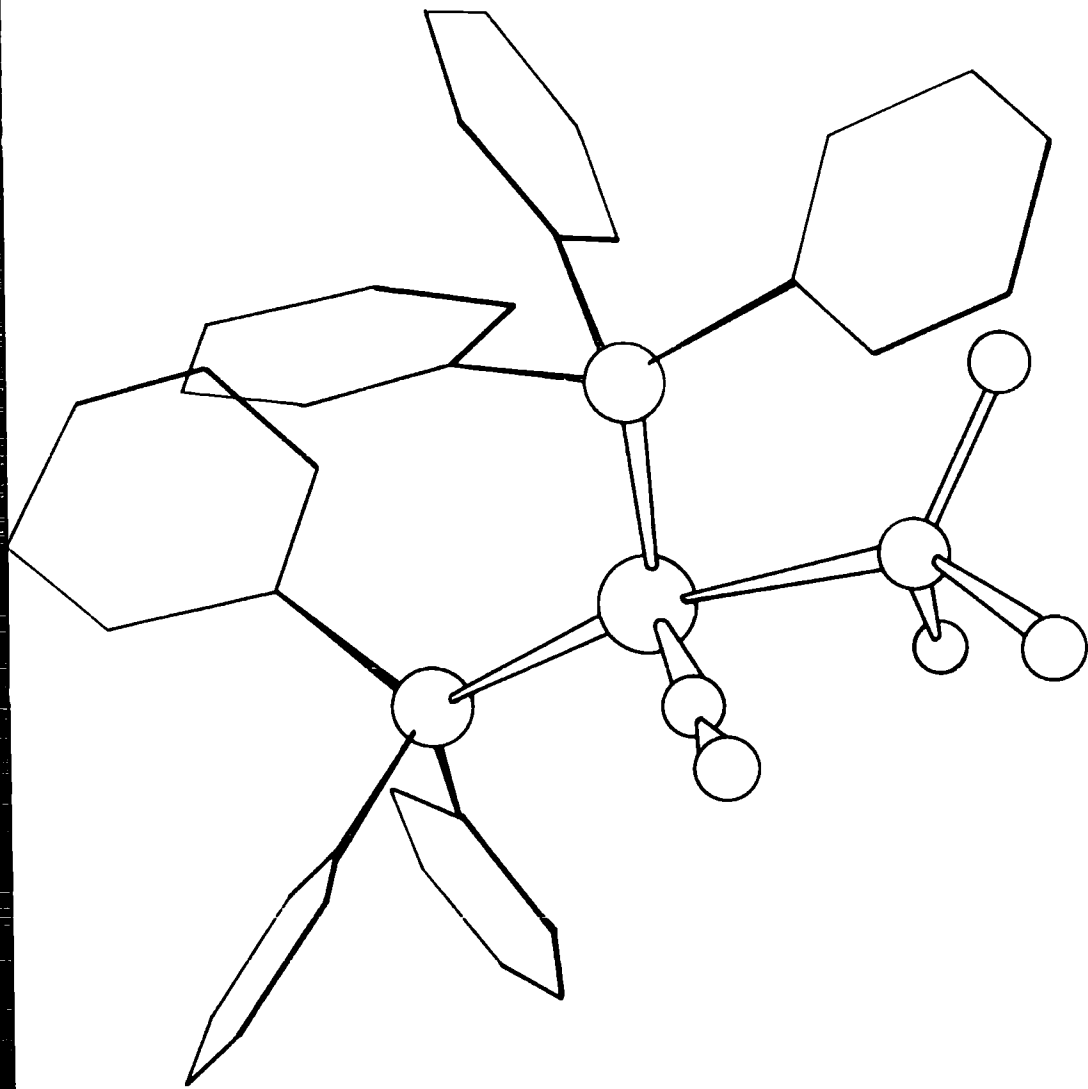
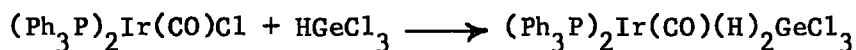

Figure 15. Molecular structure of $(\text{Ph}_3\text{P})_2\text{Ir}(\text{CO})(\text{H})_2\text{GeMe}_3 \cdot \frac{1}{2}\text{C}_6\text{H}_6$ showing triphenylphosphine, carbonyl and germyl groups and iridium.

between two molecules of $(\text{Ph}_3\text{P})_2\text{Ir}(\text{CO})(\text{H})_2\text{GeMe}_3$ can fit a molecule of benzene but not cyclohexane which has a puckered structure. This accounts for crystals only forming from benzene solutions and not from cyclohexane.

With silanes, $(\text{Ph}_3\text{P})_2\text{Ir}(\text{CO})\text{Cl}$ reacts only when electronegative groups are attached to silicon. Similar trends were found for germanes since HGeCl_3 reacted much more quickly with "Vaska's compound" than triorganogermanes. A white precipitate formed immediately upon addition of HGeCl_3 to a yellow solution of $(\text{Ph}_3\text{P})_2\text{Ir}(\text{CO})\text{Cl}$. Although this product was too insoluble for p.m.r. examination, analyses and its infrared spectrum (3 bands in the 2000 cm^{-1} region; $\nu(\text{Ir}-\text{Cl})$ absent and $\nu(\text{Ge}-\text{Cl})$ present), indicated that the reaction proceeded analogously to the trimethyl- and triethyl-germane.



When equimolar ratios of $(\text{Ph}_3\text{P})_2\text{Ir}(\text{CO})\text{Cl}$ and CsGeCl_3 were refluxed in ether, the yellow colour due to the iridium complex disappeared only after 14 days. The white solid isolated, showed three bands in its infrared in the 2000 cm^{-1} region, $\nu(\text{Ir}-\text{Cl})$ being absent whilst $\nu(\text{Ge}-\text{Cl})$ was present. In addition a very broad band at 934 cm^{-1} was observed and was attributed to Ge-O stretching. Thus the complex may be $(\text{Ph}_3\text{P})_2\text{Ir}(\text{CO})(\text{H})_2\text{GeCl}_3$ as above in which the GeCl_3 is partially hydrolysed. The fact that reaction occurred so slowly suggests that reaction only took place as the caesium salt was hydrolysed, possibly by residual water in the ether.

Vaska's compound did not react with triisopropylgermane, Pr_3^iGeH , even after weeks at reflux temperatures, probably for steric reasons. Triphenyl-

germane reacted differently to trimethyl- and triethyl-germane and the reaction will be discussed later. No reaction occurred between $(\text{Ph}_3\text{P})_2\text{Ir}(\text{CO})\text{Cl}$ and Me_3GeBr , though halide exchange took place with the triethyl analogue.

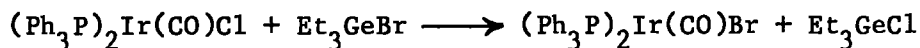

All the reactions studied on octahedral iridium-germanium complexes have employed either $(\text{Ph}_3\text{P})_2\text{Ir}(\text{CO})(\text{H})_2\text{GeMe}_3$ or $(\text{Ph}_3\text{P})_2\text{Ir}(\text{CO})(\text{H})_2\text{GeEt}_3$. Both complexes are stable to air as solids and do not decompose or hydrolyse in solution if kept under nitrogen. When air was freely admitted to a benzene solution of the trimethylgermyl complex, the solution gradually turned dark green, probably forming an iridium(IV) complex together with hexamethyldigermoxane. P.m.r. observation showed 50% decomposition over a month at 20° .

Partial pyrolysis of the benzene solvate, $(\text{Ph}_3\text{P})_2\text{Ir}(\text{CO})(\text{H})_2\text{GeMe}_3 \cdot \frac{1}{2}\text{C}_6\text{H}_6$ gave volatiles, hydrogen, trimethylgermane (85%) and benzene (58%). Infrared comparison of the residual black semi-solid suggested it to be similar to a mixture obtained by several workers.

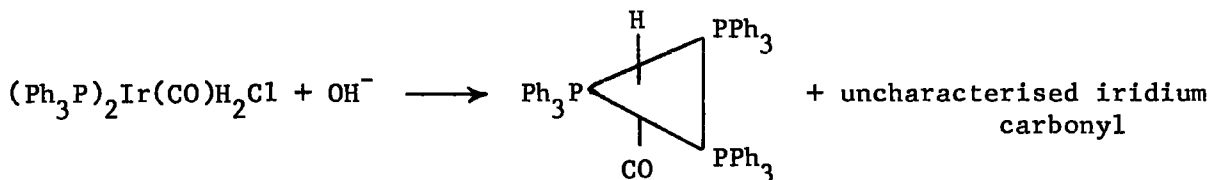

$$\nu(\text{Ir-H}) \quad \nu(\text{C}\equiv\text{O}) \quad 1925 \text{ and } 2070 \text{ cm}^{-1} \quad 1985 \text{ cm}^{-1} \quad (\text{CH}_2\text{Cl}_2)^{202}$$

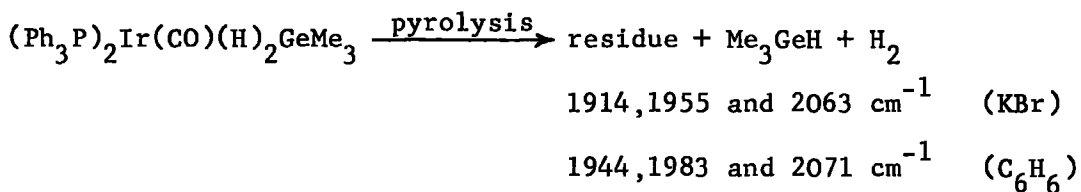
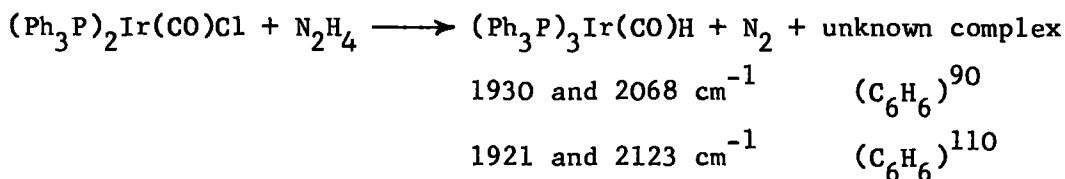
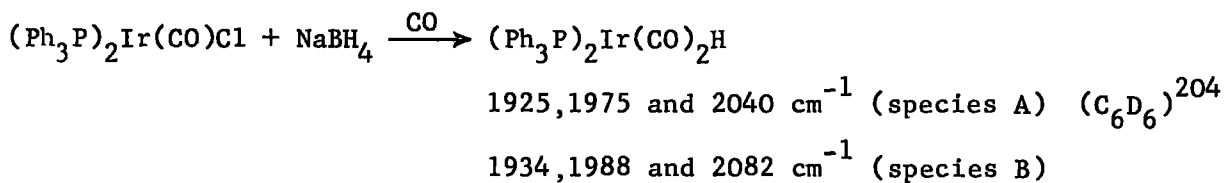
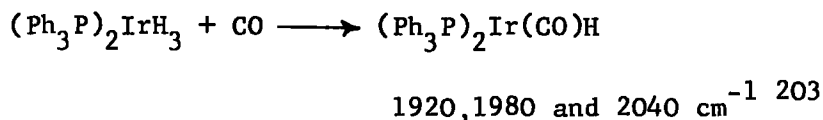

The iridium-germanium bond has been cleaved by a variety of halogen-containing reagents as well as by hydrogen.

1.2.-Dibromomethane

The complex (XXIII) (R = Me) and 1.2.-dibromomethane slowly evolved ethylene and trimethylbromogermane quantitatively, together with small volumes of hydrogen. The residual solid was identified as a mixture of

$(\text{Ph}_3\text{P})_2\text{Ir}(\text{CO})\text{H}_2\text{Br}$ and $(\text{Ph}_3\text{P})_2\text{Ir}(\text{CO})\text{Br}$, the latter presumably arising from hydrogen loss. The reaction of the complex, $(\text{Ph}_3\text{P})_2\text{Ir}(\text{CO})\text{Cl}$, with hydrogen is known to be reversible (p.14).

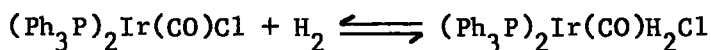

The dihydrido complex, $(\text{Ph}_3\text{P})_2\text{Ir}(\text{CO})\text{H}_2\text{Br}$ was too insoluble for p.m.r. examination but its infrared spectrum in the $\nu(\text{Ir-H})$ and $\nu(\text{C}\equiv\text{O})$ region (2028, 2078 and 2232 cm^{-1}) showed H trans Br but not H trans H, and consequently only two structures are possible, (XXV) and (XXVI). Complex (XXVI) has been reported (1982, 2105 and 2200 cm^{-1})⁶⁴, and so the complex, isolated from the 1,2-dibromethane cleavage, is either a different crystallographic form of complex (XXVI), or more plausibly, isomer (XXV), since the phosphines remain mutually cis.

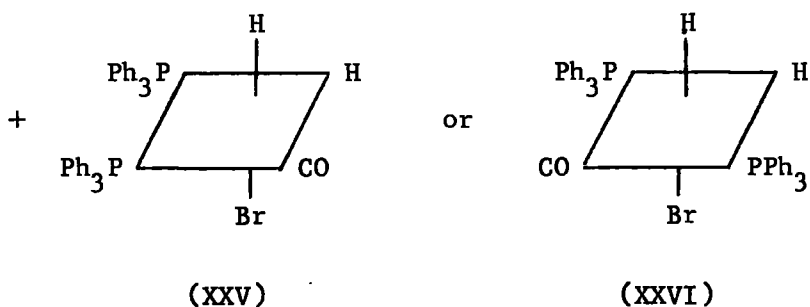
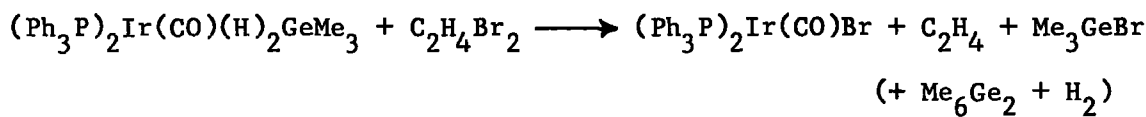

Iodine

Straightforward cleavage, with equimolar ratios of iodine and $(\text{Ph}_3\text{P})_2\text{Ir}(\text{CO})(\text{H})_2\text{GeEt}_3$, gave triethyliodogermane and $(\text{Ph}_3\text{P})_2\text{Ir}(\text{CO})\text{H}_2\text{I}$. The square planar compound $(\text{Ph}_3\text{P})_2\text{Ir}(\text{CO})\text{I}$ was not found for, reversibility of hydrogen addition to $(\text{Ph}_3\text{P})_2\text{Ir}(\text{CO})\text{X}$ increases in the order $\text{Cl} > \text{Br} > \text{I}$. The

complex $(\text{Ph}_3\text{P})_2\text{Ir}(\text{CO})\text{H}_2\text{I}$ was also insufficiently soluble for p.m.r. examination though its infrared spectrum showed the hydrogen atoms to be trans to either phosphines or carbonyl ligands. Therefore two structures are possible (XXVII) and (XXVIII), the former being the more likely since the relative positions of the groups correspond exactly to the iridium-germanium complex from which it is derived.

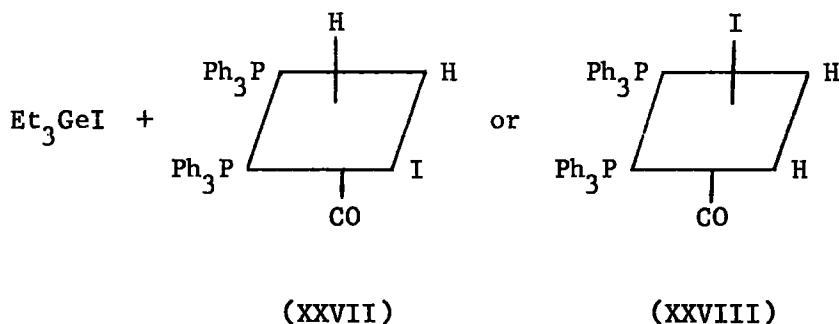
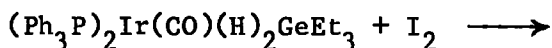

Hydrogen chloride

The reaction of (XXIII) with hydrogen chloride resulted in the formation of products indicative of cleavage of the iridium-germanium bond in opposite senses. From $(\text{Ph}_3\text{P})_2\text{Ir}(\text{CO})(\text{H})_2\text{GeMe}_3$, hydrogen, trimethylgermane (16%) and trimethylchlorgermane were identified, together with $(\text{Ph}_3\text{P})_2\text{Ir}(\text{CO})\text{Cl}$ (presumably formed by hydrogen loss from $(\text{Ph}_3\text{P})_2\text{Ir}(\text{CO})\text{H}_2\text{Cl}$ and $(\text{Ph}_3\text{P})_2\text{Ir}(\text{CO})\text{H}_3$). In the case of the triethylgermyl analogue, the ratio of Et_3GeCl to Et_3GeH was 9:2 whilst the residual solid showed infrared absorbances, at 1790, 1954, 1970, 1998, 2022 and 2069 cm^{-1} in the $\nu(\text{Ir-H})$ and $\nu(\text{C}\equiv\text{O})$ region. The

absorbances at 1790, 1970 and 2069 cm^{-1} were ascribable to $(\text{Ph}_3\text{P})_2\text{Ir}(\text{CO})\text{H}_3$ ²⁰³, whilst the remaining bands were most probably due to a specific isomer of $(\text{Ph}_3\text{P})_2\text{Ir}(\text{CO})\text{H}_2\text{Cl}$. Attempted separation of the two components led to the isolation of only $(\text{Ph}_3\text{P})_2\text{Ir}(\text{CO})\text{Cl}$ and $(\text{Ph}_3\text{P})_2\text{Ir}(\text{CO})\text{H}_3$

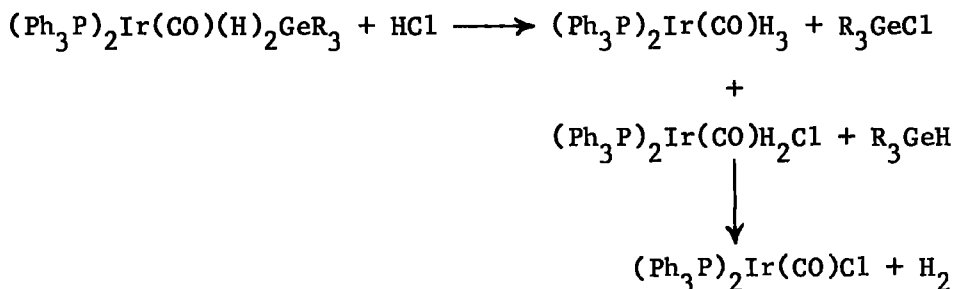

Cleavage of germyl-platinum complexes, too, result in the formation of a variety of products and a platinum(IV), 6 co-ordinate intermediate has been postulated (p.57). For iridium, an 8 co-ordinate iridium(V) intermediary is necessary, but this seems extremely unlikely as only iridium(V) fluoride complexes are known and these are octahedral.

It is possible that cleavage occurred in only one sense, and an equilibrium exchange reaction was set up between the products e.g.

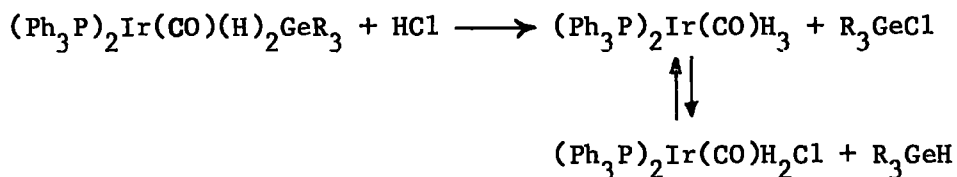

Hydrogen

Hydrogenation of the complexes (XXIII) required raised pressures, no reaction occurring at one atmosphere. The iridium-germanium bond in

$(\text{Ph}_3\text{P})_2\text{Ir}(\text{CO})(\text{H})_2\text{GeEt}_3$ was cleaved at 80 atmospheres and 25° .



Trans-germyl-platinum complexes¹⁵¹ are cleaved under mild conditions, whilst cis-complexes require conditions similar to those required for iridium-germanium bonded complexes. It has been suggested that hydrogenation proceeds via a Pt(IV) six co-ordinate intermediate.

Germly-transition metal complexes in which an increase in oxidation and co-ordination number of the transitional metal is unlikely require forcing conditions [e.g. $\text{Ph}_3\text{PAuGePh}_3$ and $(\text{Et}_3\text{P})_2\text{Pd}(\text{GePh}_3)_2$ ¹⁵³] or do not react at all [e.g. $\pi\text{C}_5\text{H}_5(\text{CO})_3\text{MoGeR}_3$ and $\pi\text{C}_5\text{H}_5(\text{CO})_3\text{WGeR}_3$ ¹²²]. A similar mechanism to the Pt-Ge complexes, for germly-iridium complexes involve 8 co-ordinate iridium(V) intermediates, though if the possibility of momentary phosphine dissociation were admitted the intermediate might have only a co-ordination number of 6 or 7. Another possible mechanism is a 4-centred reaction of the type,

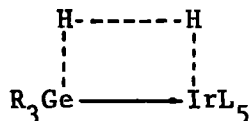

Mercuric chloride

Triethylchlorgermane was isolated from the reaction of excess mercuric chloride with $(\text{Ph}_3\text{P})_2\text{Ir}(\text{CO})(\text{H})_2\text{GeEt}_3$ together with a sparingly soluble white solid, $(\text{Ph}_3\text{P})_2\text{Ir}(\text{CO})(\text{HgCl})\text{Cl}_2$.^{84,85} Hydrogen chloride was presumably evolved but this was not detected.



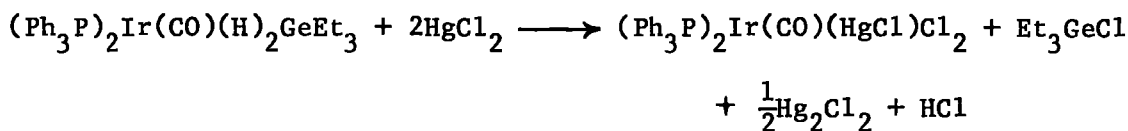

The complex, in accordance with a literature report⁸⁵, reacted with triphenylphosphine to form "Vaska's compound".

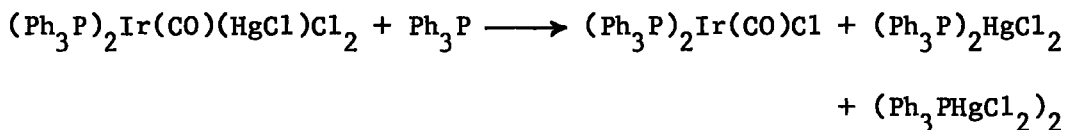

The residue from recrystallisation showed other products to be present, perhaps containing more than one iridium-mercury bond, but these could not be characterised. However the complex $(\text{Ph}_3\text{P})_2\text{Ir}(\text{CO})(\text{HgCl})\text{Cl}_2$ was the sole product from reaction of several iridium complexes with both mercurous and mercuric halides.^{84,85}

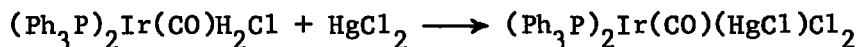
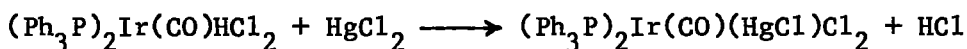
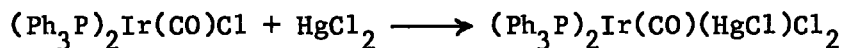

Phosphine exchange

Triethylphosphine and 1.2-bis(diphenylphosphino)ethane both displace triphenylphosphine from $(\text{Ph}_3\text{P})_2\text{Ir}(\text{CO})(\text{H})_2\text{GeR}_3$. Substitution readily occurred as both triphenylphosphine groups are trans to high trans effect ligands (H and GeR_3). The p.m.r. of the phosphine methyls of the triethylphosphine complex, $(\text{Et}_3\text{P})_2\text{Ir}(\text{CO})(\text{H})_2\text{GeMe}_3$ indicated the phosphine ligands to be cis

in solution. The hydride region of the bis(triethylphosphine) and chelating phosphine complexes showed them to have analogous structures to the tri-phenylphosphine complexes, $(\text{Ph}_3\text{P})_2\text{Ir}(\text{CO})(\text{H})_2\text{GeR}_3$.

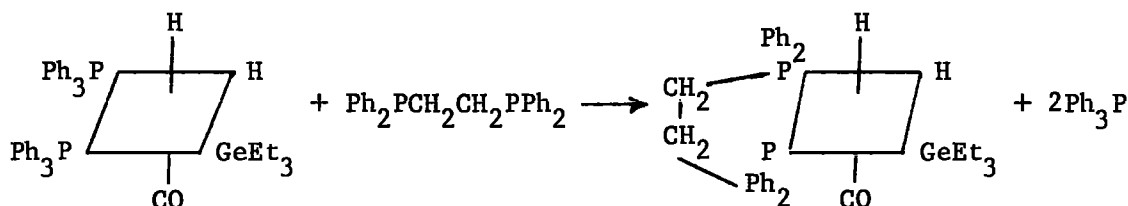
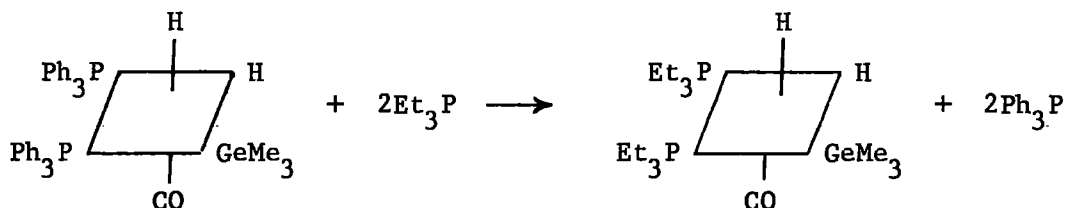

Ethylene

A most interesting reaction occurred with ethylene, for hydrogen was abstracted to give iridium(I) complexes. A benzene solution of the trimethylgermyl compound, $(\text{Ph}_3\text{P})_2\text{Ir}(\text{CO})(\text{H})_2\text{GeMe}_3$ was heated at 60° under one atmosphere of ethylene. After two days a white solid precipitated out, and quantitative yields of ethane were isolated as well as the square planar complex, $(\text{Ph}_3\text{P})_2\text{Ir}(\text{CO})\text{GeMe}_3$, (Table 13).

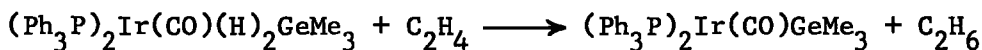

(XXIX)

Table 13

4 and 5 co-ordinate germyl-iridium complexes [p.m.r. data (C_6H_6 or C_6D_6)]

<u>Complex</u>	<u>$\tau(CH_2)$</u>	<u>$\tau(CH_3)$</u>	<u>$\tau(H)$</u>	<u>$\frac{J(P-H)}{(\text{cycle/sec})}$</u>
$(Ph_3P)_2Ir(CO)GeMe_3$		9.48		
$(Ph_3P)_2Ir(CO)GeEt_3$	8.89	8.58		
$Ph_3P(CO)Ir(H)(Cl)GePh_3 \cdot \frac{1}{2}(C_6H_{12})$			18.50	15.6 cyclo- hexane: $\tau = 8.54$

The iridium(I) complex (XXIX), which was air stable as a solid, reacted with hydrogen in solution to regenerate the iridium(III) compound,

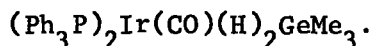

With platinum complexes, trans- $(Et_3P)_2Pt(X)GeMe_3$ a singlet is observed for the germanium methyls whilst in complexes cis- $(Et_3P)_2Pt(X)GeMe_3$, a doublet is seen due to long range coupling, trans- $CH_3-Ge-Pt-P$. As no evidence for $CH_3-Ge-Ir-P$ coupling was found in the iridium(III) complex,

$(Ph_3P)_2Ir(CO)(H)_2GeMe_3$, it is not possible to assign whether $(Ph_3P)_2Ir(CO)GeMe_3$ is the cis or trans isomer. The reversibility of the reaction however suggests the phosphines may remain cis.

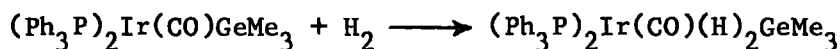

The analogous reaction with the triethylgermyl complex did not proceed in such a precise manner. Ethane was evolved in smaller yield (63%) whilst

the iridium(I) complex, $(\text{Ph}_3\text{P})_2\text{Ir}(\text{CO})\text{GeEt}_3$ was difficult to recrystallise and gave an unsatisfactory analysis. Hydrogenation, however took place to form the germyl-iridium(III) compound.

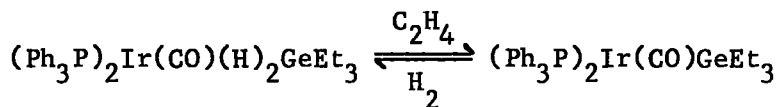

Both of the square planar germyl-iridium(I) complexes deserve further examination as many potentially interesting reactions can be formulated. For instance, equimolar quantities of iodine, which normally cleave a metal-metal bond, could alternatively add to give an iridium(III) complex,

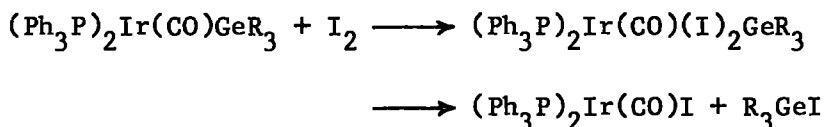

Furthermore this type of system is of potential interest in connection with homogeneous catalytic hydrogenation reactions, particularly as a specific hydrogenator. No reaction occurred with 2-hexene, and $(\text{Ph}_3\text{P})_2\text{Ir}(\text{CO})(\text{H})_2\text{GeEt}_3$, (the only reaction investigated) probably for steric reasons.

The ethylene reaction may be regarded as filling a gap in the proposed mechanism for homogeneous hydrogenation with such compounds as $(\text{Ph}_3\text{P})_3\text{RhCl}$, as the species $(\text{Ph}_3\text{P})_2\text{RhH}_2\text{Cl}\cdot\text{solv}$ was not isolated.²⁰⁸

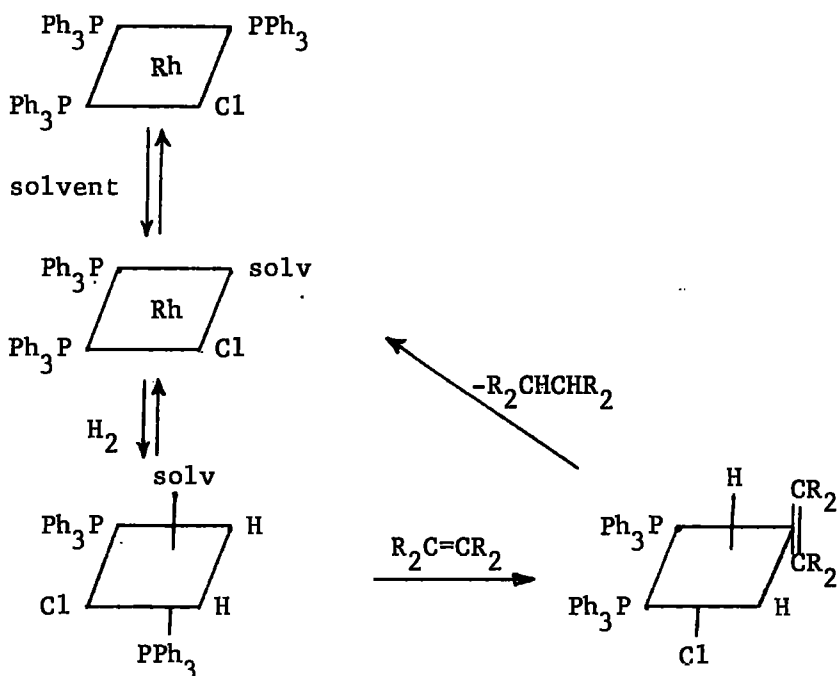

As previously mentioned triphenylgermane and $(\text{Ph}_3\text{P})_2\text{Ir}(\text{CO})\text{Cl}$ required more stringent conditions for reaction. A five co-ordinate germyl-iridium complex involving loss of triphenylphosphine and not $(\text{Ph}_3\text{P})_2\text{Ir}(\text{CO})(\text{H})_2\text{GePh}_3$, was isolated. The complex, $\text{Ph}_3\text{P}(\text{CO})\text{Ir}(\text{H})(\text{Cl})\text{GePh}_3$ crystallised from cyclohexane as a solvate $\text{Ph}_3\text{P}(\text{CO})\text{Ir}(\text{H})(\text{Cl})\text{GePh}_3 \cdot \frac{1}{2}(\text{C}_6\text{H}_{12})$.

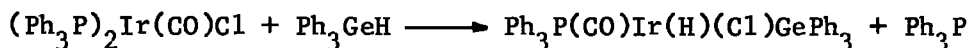

The complex is presumably trigonal bipyramidal in common with the few other five co-ordinate iridium species reported e.g. $(\text{R}_3\text{P})_2\text{IrH}_3$,¹⁰⁵ $(\text{R}_3\text{P})_3\text{Ir}(\text{CO})\text{H}$ ^{90,205} and $(\text{Ph}_3\text{P})_2\text{Ir}(\text{CO})_2\text{H}$.²⁰⁴ The rhodium-silicon complexes $(\text{Ph}_3\text{P})_2\text{Rh}(\text{H})(\text{Cl})\text{SiR}_3 \cdot \frac{1}{2}(\text{solvent})$ are also of this geometry, the phosphine ligands probably occupying axial positions.¹⁴⁵

The p.m.r. spectrum of $\text{Ph}_3\text{P}(\text{CO})\text{Ir}(\text{H})(\text{Cl})\text{GePh}_3$ (Table 13) indicated the hydrogen atom to be axial and the phosphine equatorial or vice versa. No complexes have been reported in which both hydride and phosphine ligands occupy equatorial positions and consequently the expected value of $J(\text{P-H})$ for such a complex is unknown. The position of the $\nu(\text{Ir-H})$ and $\nu(\text{C=O})$ absorptions are similar to $(\text{Ph}_3\text{P})_3\text{Ir}(\text{CO})\text{H}$ (XXX) and so the hydride and carbonyl groups in $\text{Ph}_3\text{P}(\text{CO})\text{Ir}(\text{H})(\text{Cl})\text{GePh}_3$ probably occupy axial positions (XXXI).

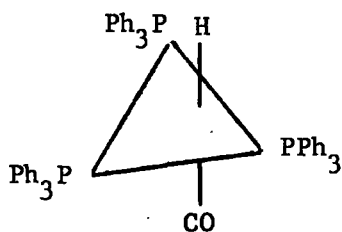

(XXX)

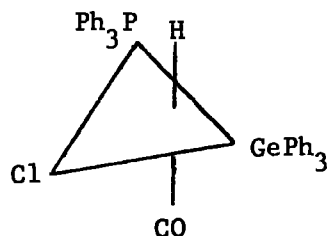

(XXXI)

Neither excess triethylphosphine nor sodium iodide reacted with the complex, which showed that neither the triphenylphosphine nor chloride ligands were trans to a high trans-influence group (i.e. H or GePh_3), confirming structure (XXXI).

Trimethylgermane and $(\text{Et}_3\text{P})_2\text{Ir}(\text{CO})\text{Cl}$ did not react to give a germyl-iridium complex, $(\text{Et}_3\text{P})_2\text{Ir}(\text{CO})\text{H}_2\text{Cl}$ being formed instead.

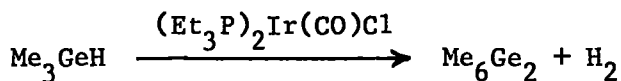

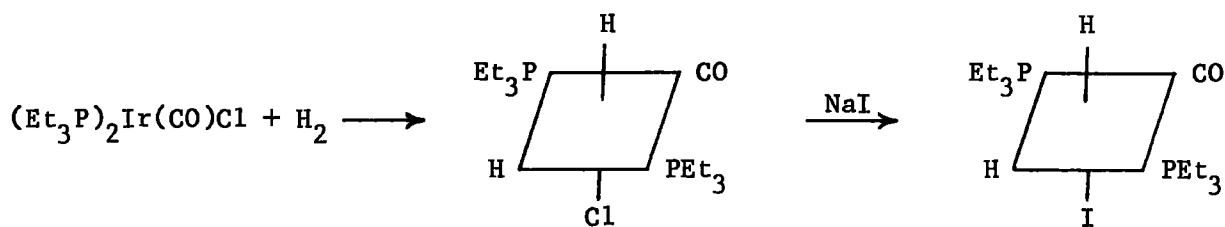

In both complexes, the triethylphosphine groups were mutually trans¹¹⁵ (p.m.r. Table 11), with the halides trans to hydrogen.

A third possible route to a germyl-iridium complex involves the use of a germyl-lithium reagent. Although $(\text{Ph}_3\text{P})_2\text{Ir}(\text{CO})\text{Cl}$ reacted with triphenylgermyl-lithium, the resultant products could not be characterised.

Several additional reactions were examined but none led to the formation of a characterised germyl-iridium complex.

A white precipitate formed when triethylgermane was added to refluxing $(\text{Ph}_3\text{P})_3\text{IrH}_2\text{Cl}$ in benzene but the precipitate proved to be the alternative crystal form. The trihydride, $(\text{Ph}_3\text{P})_3\text{IrH}_3$ ¹⁰⁵ was isolated from solution.

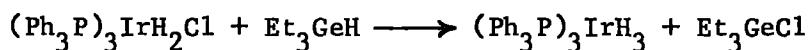

No reaction occurred between $(\text{Ph}_3\text{P})_3\text{IrH}_2\text{Cl}$ and triphenylgermyl-lithium. With sodium iodide however, a complex which showed only a single $\nu(\text{Ir-H})$ band (2157 cm^{-1} trans Ph_3P) was initially isolated but after several weeks under nitrogen the complex had isomerised and showed the two expected $\nu(\text{Ir-H})$ frequencies (2083 and 2222 cm^{-1} , trans phosphine and iodide respectively). Other examples of slow isomerisation have been reported.²⁰⁶

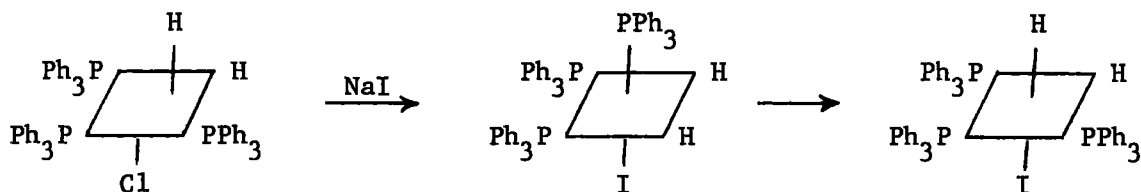

Finally reactions involving iridium-nitrogen complexes were briefly investigated. The complex, $(\text{Ph}_3\text{P})_2\text{Ir}(\text{N}_2)\text{Cl}$ was prepared from $(\text{Ph}_3\text{P})_2\text{Ir}(\text{CO})\text{Cl}$ by reaction with α -furoyl azide.^{87,89,207}

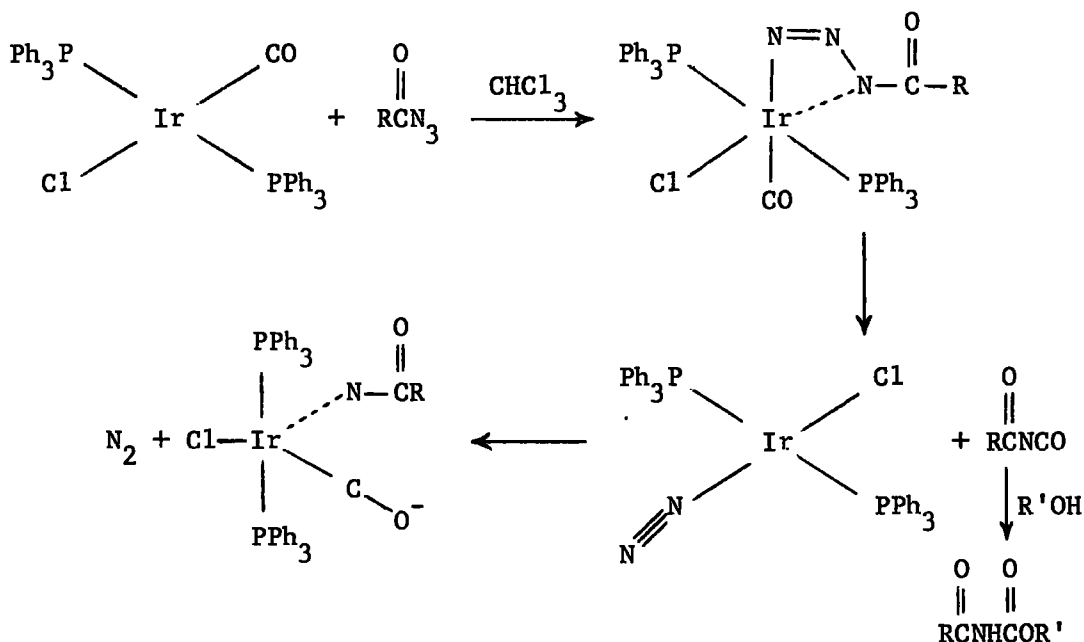

The presence of small quantities of alcohol were required to prevent the isocyanate, RCNCO , produced, reacting to form an iridium-isocyanate complex. The complex, $(\text{Ph}_3\text{P})_2\text{Ir}(\text{N}_2)\text{Cl}$ was prepared in about 33% yield.

When triethylgermane was added to this complex, a gas, presumably

nitrogen, was continuously evolved over several hours. Triethylchlorgermane and a golden brown solid were isolated. This solid showed a single $\nu(\text{Ir-H})$ absorption in chloroform solution, but despite a 7% chlorine analysis, a $\nu(\text{Ir-Cl})$ band was absent. P.m.r. indicated the ratio of triphenylphosphine to triethylgermyl groups to be 2:1 but the complex was insufficiently soluble for detection of a hydride.

The complex $(\text{Ph}_3\text{P})_2\text{Ir}(\text{CO})(\text{H})_2\text{GeEt}_3$ did not react with α -furoyl azide.

Mass Spectra

Most complexes decomposed in the mass spectrometer, and showed only decomposition products. However the complexes, $(\text{R}_3\text{P})_2\text{Ir}(\text{CO})\text{X}$, produced satisfactory spectra and the fragmentation patterns are reproduced. Observed meta-stable peaks are recorded to the left of the appropriate fragment loss.

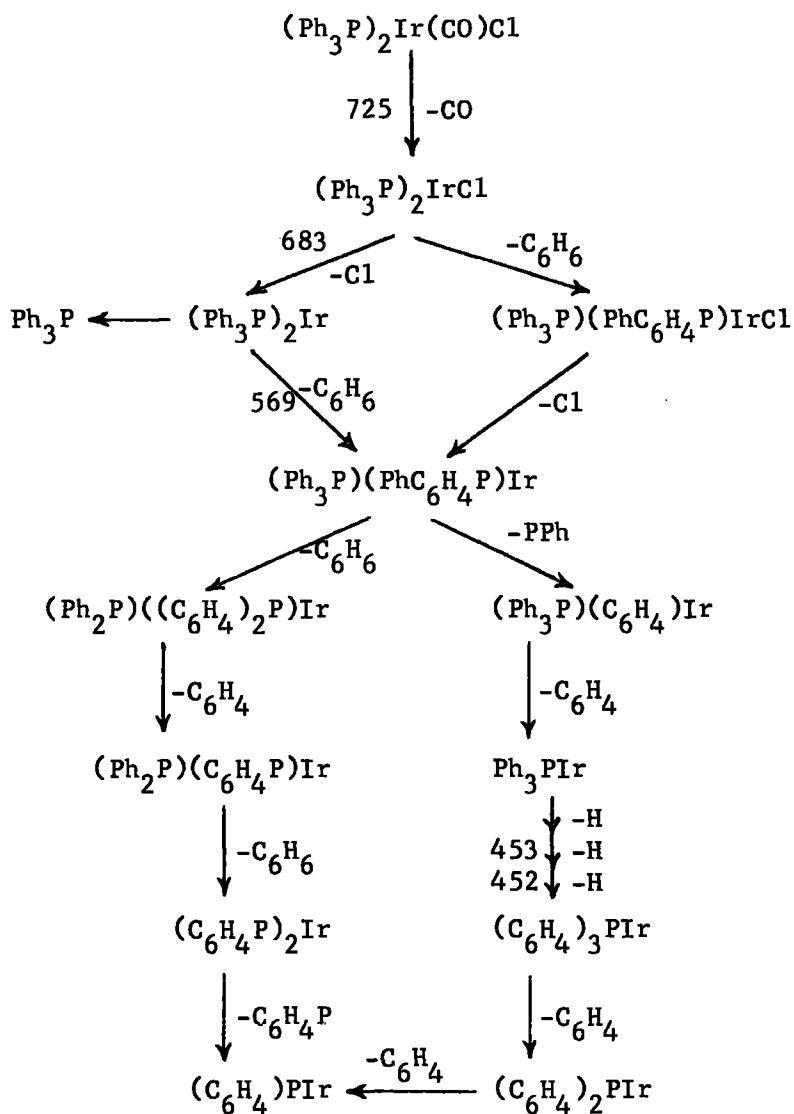
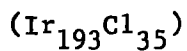
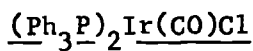

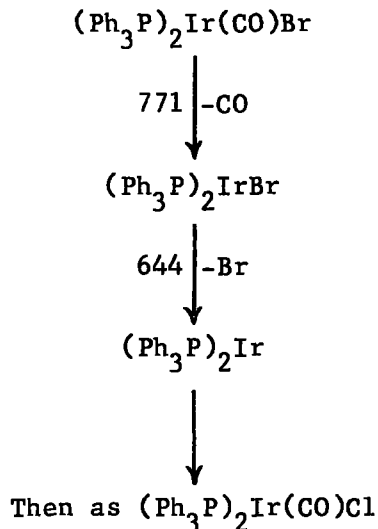
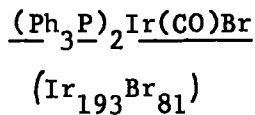

The mass spectra of $(\text{Me}_2\text{PhP})_2\text{Ir}(\text{CO})\text{Cl}$ and $(\text{Et}_3\text{P})_2\text{Ir}(\text{CO})\text{Cl}$ are similar to that of $(\text{Ph}_3\text{P})_2\text{Ir}(\text{CO})\text{Br}$, with the former an additional series due to methane loss was observed. The spectrum of $(\text{Et}_3\text{P})_2\text{Ir}(\text{CO})\text{Cl}$ was assignable only down as far as $(\text{Et}_2\text{PH})_2\text{IrCl}$ after which each fragment showed a wide range of masses (up to 15 units) due to loss of hydrogen, ethylene or ethane.

EXPERIMENTAL

Section A. Organogermyl-gold complexes.

1. Preparation of triphenylgermyltriphenylphosphinegold(I). $\text{Ph}_3\text{GeAuPPh}_3$ ¹⁵⁷

To a stirred suspension of triphenylphosphinegold(I)chloride (6.0 g. 0.012 mmole) in 90 ml. of ether was added dropwise a slight excess of triphenylgermyl-lithium (prepared from triphenylgermane and n-butyl-lithium in hexane). A brown solid formed and after 60 minutes, the mixture was hydrolysed and filtered. The residue, crude triphenylgermyltriphenylphosphinegold(I) was recrystallised from acetone, giving the unsolvated yellow form or from benzene yielding the colourless solvate, $\text{Ph}_3\text{PAuGePh}_3 \cdot \text{C}_6\text{H}_6$. [yield = 5.4 g., 59%].

2. Preparation of trimethylgermyltriphenylphosphinegold(I). $\text{Me}_3\text{GeAuPPh}_3$

(a) Bis(trimethylgermyl)mercury (1.3 g., 3mmole) in 10 ml. of benzene was added dropwise to a refluxing suspension of triphenylphosphinegold(I)chloride (1.5 g., 3mmole) in benzene (200 ml.). The solution turned brown and then colourless with a dark precipitate of mercury and gold. After filtration, the benzene was pumped off giving a yellow semi-solid, triphenylphosphine.

(b) Bis(trimethylgermyl)mercury (0.8 g.) in benzene (5 ml.) was added slowly to a suspension of triphenylphosphinegold(I)chloride (0.9 g.) in benzene at room temperature. The benzene was pumped off giving a black oil. Extraction with light petroleum and recrystallisation from toluene/petroleum ether gave buff crystalline trimethylgermyltriphenyl-

phosphinegold(I). m.p. 128° (decomp.) [Found: C, 43.2; H, 3.60%].

$C_{21}H_{24}AuGeP$ required C, 43.6; H, 4.17% N.m.r. (benzene) Me_3Ge singlet $\tau = 9.20$].

3. Reactions of triphenylgermyltriphenylphosphinegold(I).

(a) 1.2.-Dibromethane.¹⁵⁷ An excess of 1.2.-dibromethane (c.6 ml.) was condensed on to $Ph_3PAuGePh_3$ (0.216 g.) in a sealed vacuum system. Upon warming to room temperature, a slight gold mirror had formed. The volatiles yielded 5.48 N c.c. (97%) of ethylene. Triphenylbromogermane (96 mg., 88%) was extracted with petroleum ether from the solid residue leaving triphenylphosphinegold(I)bromide.

(b) 1.2.-Dichlorethane. (i) $Ph_3PAuGePh_3$ (202 mg.) and 1.2.-dichlorethane were sealed together in a vacuum tube. After 5 weeks work as above, yielded ethylene (1.45 N c.c. 27%), triphenylchlorogermane, triphenylphosphinegold(I)chloride and unreacted starting material.

(ii) $Ph_3PAuGePh_3$ (991 mg.) and 1.2.-dichlorethane were sealed together and heated at 65° . A gold mirror had formed after 5 days. After 5 weeks ethylene (10.73 N c.c. 37%) was isolated. Extraction with petroleum ether gave triphenylchlorogermane (368 mg., 84%). The residue was extracted with hot benzene yielding soluble triphenylphosphinegold(I)chloride leaving a white insoluble solid, (recrystallised from 1.2.-dichlorethane), ethylene(bistriphenylphosphonium)dichloride m.p. $277-9^{\circ}$ (see section 13) and gold (200 mg., 78%).

(c) Carbon tetrachloride. $\text{Ph}_3\text{PAuGePh}_3$ (202 mg.) was shaken with carbon tetrachloride (2 ml.) in a sealed vacuum tube. No visible reaction occurred for 10 days, when the solution went pale yellow. Within a few hours all the solid had gone into solution. After 19 days the solvent was evaporated and a white solid obtained which yellowed as the last traces of solvent were removed. Triphenylgermylchloride was extracted with benzene leaving triphenylphosphinegold(I)chloride as residue.

(d) Hydrogen chloride. The complex in diethylether was treated with an equimolar quantity of dry hydrogen chloride. The complex immediately went into solution and crystals were precipitated after a few minutes. The solvent was evaporated, and triphenylgermane extracted from the residue, with ether, leaving triphenylphosphinegold(I)chloride.

(e) Mercuric chloride. Diethylether (6 ml.) was added to an equimolar mixture of mercuric chloride (79 mg.) and the complex, (217 mg.) Immediate blackening occurred, with a grey solid being deposited. The whole was filtered and evaporation of the solvent yielded triphenylchlorogermane (80 mg., 81%). From the residue, triphenylphosphinegold(I)chloride was extracted with benzene leaving a black deposit of mercury.

(f) Methyl iodide. Methyl iodide (4 ml.) and triphenylgermyltriphenylphosphinegold (241 mg.) in an evacuated sealed tube deposited gold during three hours. The tube was opened to a vacuum system and methane (0.3 N c.c.) and ethane (1.1 N c.c.) were separated. The sticky

brown residue yielded methyltriphenylgermane (85 mg., 84%) by extraction with pentane, triphenylphosphinegold(I)iodide from benzene, leaving gold metal (7 mg., 11%).

(g) Hydrogen. (i) The complex (213 mg.) in xylene (20 ml.) was stirred in a closed system under an atmosphere of hydrogen. After two months, a faint purple colour had developed. Removal of the solvent however gave unchanged complex.

(ii) The complex (207 mg.) in benzene (40 ml.) was shaken with hydrogen (125 atmospheres) for six days at 45°. The lid of the bomb was coated with gold. Evaporation of the benzene yielded a mixture of triphenylphosphine and triphenylgermane.

(h) Water and oxygen. (i) The complex $\text{Ph}_3\text{PAuGePh}_3$ (216 mg.), diglyme (5 ml.) and water (0.5 ml.) were stirred in a vacuum system. A gold mirror was deposited after 2 days. Work up after 5 weeks gave complex (130 mg., 65%) and a mixture of hexaphenyldigermoxane and triphenylphosphine oxide.

(ii) The complex, $\text{Ph}_3\text{PAuGePh}_3 \cdot \text{C}_6\text{H}_6$, (204 mg.) and benzene (20 ml.) were stirred under an atmosphere of oxygen. The solvent was removed after 3 months to give unchanged complex.

(iii) The complex, $\text{Ph}_3\text{PAuGePh}_3$, (205 mg.), water (0.5 g.) and diglyme (20 ml.) were stirred under an atmosphere of oxygen. The mixture went dark red within a day and a gold mirror formed a few hours later. The solution was filtered and the solvent evaporated. The residual solid

was washed with ethanol, leaving $(\text{Ph}_3\text{Ge})_2\text{O}$ whilst evaporation of the filtrate gave mainly triphenylphosphine oxide with a minority of digermoxane.

(iv) $\text{Ph}_3\text{PAuGePh}_3$ (109 mg.), benzene (15 ml.) and water (0.2 ml.) were stirred under an atmosphere of oxygen. No visible reaction occurred even when a few drops of hydrogen peroxide solution were added. After a week, addition of a few drops of diglyme caused a darkening of the solution within an hour. Further addition of diglyme gave a purple gold colouration. Work up, as above, yielded hexaphenyldigermoxane and triphenylphosphine oxide.

(i) Potassium cyanide. (i) To a suspension of $\text{Ph}_3\text{PAuGePh}_3$ (200 mg.) in methanol was added an equimolar solution of potassium cyanide (17 mg.) in methanol (5 ml.). The whole was stirred at 40° overnight. The suspension was filtered giving unchanged $\text{Ph}_3\text{PAuGePh}_3$. The filtrate also yielded unchanged complex and potassium cyanide.

(ii) $\text{Ph}_3\text{PAuGePh}_3$ (215 mg.), potassium cyanide (18 mg.) and methanol (3 ml.) were sealed together in a vacuum tube at 45° for 3 weeks. A white solid had appeared when the solvent was removed. The solid was washed with water, and the water layer evaporated to give a white solid, $\text{KAu}(\text{CN})_2$, which when pyrolysed gave metallic gold. From the residue, a mixture of Ph_3GeH and Ph_3P was extracted with methanol, leaving $\text{Ph}_3\text{PAuGePh}_3$ (126 mg., 59%).

(j) Phenylacetylene. The complex (208 mg.) and phenylacetylene

(c.2 ml.) were sealed together in a vacuum system. Work up after 5 weeks showed that no hydrogen had been evolved, and removal of volatiles gave unchanged complex.

(k) 1,2-Bisdiphenylphosphinoethane. The complex (560 mg.) and the diphosphine (293 mg.) were refluxed in benzene (40 ml.) for 12 hours. Extraction with hexane of the residue gave triphenylphosphine (203 mg., 105%) leaving crude triphenylgermylgold-(1,2-bisdiphenylphosphinoethane) which was recrystallised from benzene m.p. 227° (decomp.) [Found: C, 57.9; H, 4.3; P, 6.8% M (osmometer) 910. $C_{44}H_{39}AuGeP_2$ requires C, 58.7; H, 4.3; P, 6.9% M 900].

(1) Triphenylphosphine. $Ph_3PAuGePh_3 \cdot C_6H_6$ (194 mg.) and triphenylphosphine (257 mg.) were refluxed in benzene (25 ml.) for 5 days. The solvent was removed and triphenylphosphine (237 mg., 92%) was extracted with petroleum ether, leaving unreacted $Ph_3PAuGePh_3 \cdot C_6H_6$.

(m) Triethylphosphine. (i) To the complex (563 mg.) in benzene (12 ml.) was added triethylphosphine (1 ml.). The complex immediately went into solution giving a yellow colouration. After one hour the benzene and triethylphosphine were pumped off. Washing the yellow semi-solid residue with petroleum ether gave triphenylphosphine (75 mg.). Recrystallisation with benzene of the residue gave two crops of $Ph_3PAuGePh_3 \cdot C_6H_6$. The benzene solution was evaporated and the solid recrystallised from a benzene-petroleum ether mixture giving white triphenylgermyltriethylphosphinegold(I), $Et_3PAuGePh_3$ m.p. 159° [Found; C, 45.5;

H, 4.7% M (osmometer) 656. $C_{24}H_{30}AuGeP$ requires C, 46.5; H, 4.9% M 620] (N.m.r. (deuterobenzene) $Et_3PAuGePh_3$ requires ratio phenyl hydrogen: ethyl hydrogen:: 1 : 1, found 1.03 : 1. Ethyl protons centred at $\tau = 9.22$).

(ii) $Ph_3PAuGePh_3 \cdot C_6H_6$ (325 mg.), and triethylphosphine (1 ml.) were stirred in refluxing benzene. The solution went yellow and after 2 days bright green. The solvent was removed, and the residual solid extracted with hexane to yield triphenylphosphine (143 mg. >100%). Recrystallisation several times with benzene and light petroleum gave first a crop of hexaphenyldigermoxane and subsequently a white solid, m.p. 121° [Found: C, 31.06; H, 6.27% M (osmometer) 560. Its infrared spectrum (2.5-50 microns) showed only bands attributable to Et_3P groups and the largest mass spectrum ion was Et_3PAu^+ (315). N.m.r. (100 mc/s) showed only one type of Et_3P group to be present, weak coupling being observed].

(iii) The above experiment was repeated but only triphenylphosphine, unreacted complex and triphenylgermyltriethylphosphinegold were isolated. The mixture was further refluxed with air admitted for 2 days. Removal of solvent gave an intractable oil which showed ν_{Ge-O} and ethyl bands in its infrared spectrum. Attempts to separate the components were unsuccessful.

(n) Tin(IV) tetrachloride. (i) The complex (206 mg.) and tin(IV) tetrachloride (3 ml.) were sealed up in a vacuum tube. Orange crystals

were immediately deposited but after 30 minutes a purple solid formed. The filtrate gave triphenylchlorogermane and bis(triphenylphosphine)gold trichlorostannate (from methanol) (see section 11) leaving gold. The bisphosphine complex was heated in methanol with triphenylphosphine at 50° for 24 hours yielding tris(triphenylphosphine)gold trichlorostannate.¹⁵⁸

(ii) $\text{Ph}_3\text{PAuGePh}_3$ (213 mg.), and tin tetrachloride (73 mg.) were stirred in benzene (6 ml.) in a Schlenk tube. An orange precipitate formed and the suspension was filtered. The filtrate yielded triphenylchlorogermane (79 mg., 84% ex petroleum ether), triphenylphosphinegold(I)chloride (ex benzene) and stannous chloride.²⁰⁹ The orange residue was recrystallised from benzene to give orange needle crystals, presumably triphenylphosphinegold trichlorostannate, [Found: C, 37.7; H, 3.31; Cl, 11.89% M (osmometer) 303. $\text{Ph}_3\text{PAuSnCl}_3$ requires C, 31.6; H, 2.19; Cl, 15.5%; M 684. $\text{Ph}_3\text{PAuSnCl}_3 \cdot \text{C}_6\text{H}_6$ requires C, 37.7; H, 2.8; Cl, 14.0%].

(iii) In subsequent experiments similar to above, attempts to isolate or recrystallise the orange crystals resulted in their decomposition to stannous chloride and triphenylphosphinegold(I)chloride.²⁰⁹

(o) Magnesium bromide. A solution of magnesium bromide in ether, freshly prepared from an excess of magnesium with 1,2.-dibromethane in ether, was added to a stirred ether suspension of the gold-germanium complex. After a week the suspension went pink which gradually darkened. After 3 weeks a sample was withdrawn and hydrolysed. The water layer contained a basic magnesium salt. The ether layer was evaporated and

Ph_3GeH was extracted with light petroleum ether leaving a residue of triphenylphosphinegold(I)bromide. The remainder of the reaction mixture was filtered, the residue yielding Ph_3PAuBr and a basic magnesium salt as above. The filtrate was evaporated and an orange semi-solid obtained. This did not give an infrared spectrum due to decomposition and attempts to recrystallise it from benzene or to form an adduct from 1,2.-bis-(dimethylamino)ethane, $\text{Me}_2\text{NCH}_2\text{CH}_2\text{NMe}_2$, were unsuccessful, only triphenylgermane being identified.

(p) Carbon Monoxide. (i) $\text{Ph}_3\text{PAuGePh}_3 \cdot \text{C}_6\text{H}_6$ (220 mg.) and benzene (50 ml.) were shaken with carbon monoxide (300 atmos) at 25° for 6 days, when a clear pale green solution formed. Removal of benzene and crystallisation from hexane gave a white solid m.p. $119-120^\circ$ and a green oil. The white solid showed in its infrared spectrum (KBr) bands at 2051, 2000, 1974 and 1949 cm^{-1} and (benzene solution) 2052, 2008 and 1939 cm^{-1} . Variable analyses were obtained (C, 57-69; H, 5-6%) and the infrared spectrum of the green oil showed the white solid to be a constituent and the mass spectrum showed hexaphenyldigermoxane to be present.

(ii) The above experiment was repeated twice but only unchanged complex was obtained. In a fourth attempt 2 crystals of $(\pi\text{C}_5\text{H}_5)\text{Mo}(\text{CO})_3\text{GeMe}_3$ were added as these were used in preceding 'bomb' reaction to (i) above, but only unchanged complex was obtained. On another occasion a mixture of CO (230 atmos) and H_2 (40 atmos) was used but only unchanged complex was recovered.

(iii) In another experiment using 475 mg. of complex, due to thermostat failure, the temperature rose to 80° . From this a green oil, showing carbonyl bands in the infrared was obtained, but only triphenylphosphine was isolated.

(iv) Carbon monoxide was bubbled through a suspension of the complex (788 mg.) in benzene (50 ml.) for 6 days. A film of gold formed. Work up gave mainly unreacted complex with a trace of the carbonyl containing compound.

(v) Carbon monoxide was bubbled through a suspension of the complex (1.4 g.) in benzene (100 ml.) with a crystal of $\text{Na}_3\text{IrCl}_6 \cdot 12\text{H}_2\text{O}$ present. No reaction occurred after 12 days and a slow stream of air was then also admitted. Slight decomposition occurred. Work up after a further 6 days gave unreacted complex together with a pentane soluble semi-solid which showed $\nu_{\text{Ge-O}}$ and $\nu_{\text{P=O}}$ stretching in its infrared spectrum.

4. The reaction of $\text{Ph}_3\text{PAuGePh}_3$ and Ph_3PAuCl .

$\text{Ph}_3\text{PAuGePh}_3$ (210 mg.) and Ph_3PAuCl (136 mg.) in benzene (3 ml.) were heated at 65° in a sealed vacuum tube for 3 months. The solvent was evaporated off to give a brown solid. Triphenylchlorogermane was extracted with petroleum ether and crystallisation from benzene yielded unreacted $\text{Ph}_3\text{PAuGePh}_3 \cdot \text{C}_6\text{H}_6$ (165 mg., 72%). From the residue, was crystallised Ph_3PAuCl (ethanol), leaving gold metal and bis(triphenylphosphine)gold(I)chloride, m.p. 201° (see section 8).

5. The reaction of $\text{Ph}_3\text{PAuGePh}_3$ and $\text{cis}(\text{Et}_3\text{P})_2\text{PtCl}_2$.

$\text{Ph}_3\text{PAuGePh}_3$ (307 mg.) and $\text{cis}(\text{Et}_3\text{P})_2\text{PtCl}_2$ (106 mg.) in benzene (6 ml.) were sealed together in a vacuum tube for 3 months at room temperature. Filtration gave metallic gold (66 mg., 83%). The solvent was evaporated and a yellow oil extracted from the residual solid with petroleum ether. Ph_3PAuCl was extracted with ethanol, leaving insoluble hexaphenyldigermene (< 10 mg.). The yellow oil could not be crystallised with a variety of solvents, ethanol, petroleum ether or acetone. Its infrared spectrum¹⁸⁴ and solubilities resembled bis(triethylphosphine)triphenylgermyl platinum(II)chloride, $(\text{Et}_3\text{P})_2\text{Pt}(\text{Cl})\text{GePh}_3$. The mass spectrum showed PtGe and PtGeCl patterns as well as triphenylphosphine and triphenylchlorogermene to be present.

6. Reaction of $\text{Ph}_3\text{PAuGePh}_3$ and $(\text{Ph}_3\text{P})_2\text{Ir}(\text{CO})\text{Cl}$.

$(\text{Ph}_3\text{P})_2\text{Ir}(\text{CO})\text{Cl}$ (209 mg.) and $\text{Ph}_3\text{PAuGePh}_3$ (204 mg.) were refluxed in benzene (10 ml.) for several weeks in a sealed vacuum tube. A slight gold mirror had formed. The benzene was pumped off, and triphenylphosphine extracted with petroleum ether from the residue. Fractional crystallisation with benzene gave unreacted starting materials.

7. The reaction between Ph_3PAuCl and $(\text{Ph}_2\text{PCH}_2\text{CH}_2\text{PPh}_2)\text{Pt}(\text{GePh}_3)_2$.

$(\text{Ph}_2\text{PCH}_2\text{CH}_2\text{PPh}_2)\text{Pt}(\text{GePh}_3)_2$ (126 mg.) and Ph_3PAuCl (103 mg.) were refluxed in benzene (4 ml.) in a sealed vacuum tube for 3 months. The solvent was removed, and triphenylphosphinegold(I)chloride extracted with ethanol, leaving unchanged $(\text{Ph}_2\text{PCH}_2\text{CH}_2\text{PPh}_2)\text{Pt}(\text{GePh}_3)_2$.

8. Reaction of Ph_3P and Ph_3PAuCl .

Ph_3PAuCl (143 mg.) and Ph_3P (76 mg.) in benzene (12 ml.) were refluxed for 24 hours. A white solid, bis(triphenylphosphine)gold(I)-chloride, m.p. 196-200°, [ν Au-Cl 326 cm^{-1} . Found: C, 57.0; H, 3.62; Cl, 4.50. $\text{C}_{36}\text{H}_{30}\text{P}_2\text{AuCl}$ requires C, 57.2; H, 3.97; Cl, 4.63] crystallised out on cooling.

9. Reaction of Ph_3PAuCl and carbon monoxide.

Ph_3PAuCl (604 mg.) in benzene was shaken with carbon monoxide (270 atmos) at 40° for 9 days. Evaporation of volatiles left unchanged Ph_3PAuCl .

10. The reaction of Ph_3P , Ph_3PAuCl and SnCl_2 .¹⁵⁸

Triphenylphosphinegold(I)chloride (1.03 g.), triphenylphosphine (1.06 g.) and stannous chloride (0.68 g.) were stirred in 70 ml. of acetone. Tris(triphenylphosphine)gold trichlorostannate, $(\text{Ph}_3\text{P})_3\text{AuSnCl}_3$, m.p. 193-5° slowly formed as white crystals.

11. The preparation of bis(triphenylphosphine)gold trichlorostannate.

(a) $(\text{Ph}_3\text{P})_3\text{AuSnCl}_3$ (110 mg.) was Soxhlet extracted with 60/80 petroleum ether. From the solvent triphenylphosphine (28 mg., one molecule Ph_3P per $(\text{Ph}_3\text{P})_3\text{AuSnCl}_3 = 24$ mg.) was extracted, whilst the thimble yielded bis(triphenylphosphine)gold trichlorostannate, $(\text{Ph}_3\text{P})_2\text{AuSnCl}_3$ m.p. 189° [Found: C, 44.6; H, 2.87; Cl, 11.01% $\text{C}_{36}\text{H}_{30}\text{P}_2\text{AuSnCl}_3$ requires C, 45.6; H, 3.17; Cl, 11.29]. Continued extraction with petroleum ether did not produce any more free triphenylphosphine.

(b) Triphenylphosphine (23 mg., 63%) was sublimed from tris(triphenylphosphine)gold trichlorostannate (167 mg.) under vacuum at 110° for 48 hours. The residue was identified by i.r. spectrum as a mixture of the bis and tris phosphines.

12. The reaction of triphenylphosphinegold(I)chloride and stannous chloride

Ph_3PAuCl (482 mg.), and stannous chloride (257 mg.) were refluxed in acetone (40 ml.). Over 2 days the solution darkened and gold was deposited. The solvent was removed and from the tarry solid, Ph_3PAuCl was recrystallised from methanol. The solution was evaporated and Ph_3P extracted from the residual tar with hexane. No evidence for $\text{Ph}_3\text{PAuSnCl}_3$ was obtained.

13. Preparation of ethylene(bistriphenylphosphonium)dichloride

Triphenylphosphine (1.04 g.) was dissolved in 1,2-dichlorethane (9 ml.) and refluxed for 24 hours. Cooling and filtration give a white solid (recrystallised from 1,2-dichlorethane), ethylene(bistriphenylphosphonium) dichloride $(\text{Ph}_3\text{PCH}_2\text{CH}_2\text{PPh}_3)^{2+}(\text{Cl}^-)_2$ m.p. 277° [Found: C, 71.98; H, 5.42; Cl, 12.02; P, 10.60% $\text{C}_{38}\text{H}_{34}\text{P}_2\text{Cl}_2$ requires C = 73.1; H, 5.49; Cl, 11.37; P, 9.94%].

14. Preparation of ethylene(bistriphenylphosphonium)bistetraphenylborate

To a methanolic solution of $(\text{Ph}_3\text{PCH}_2\text{CH}_2\text{PPh}_3)^{2+}(\text{Cl}^-)_2$ was added a solution of sodium tetraphenylborate in methanol. An instant white precipitate formed which was filtered and washed with water and methanol to give ethylene(bistriphenylphosphonium)bistetraphenylborate

$(\text{Ph}_3\text{PCH}_2\text{CH}_2\text{PPh}_3)^{2+}(\text{BPh}_4^-)_2$ [Found: C, 85.6; H, 6.47; P, 5.06% $\text{C}_{86}\text{H}_{64}\text{P}_2\text{B}_2\text{Na}_2$ requires C, 86.7; H, 6.22; P, 5.22%].

15. The reaction of Ph_3PAuCl and trimethylgermane

On to Ph_3PAuCl (201 mg.) was condensed 2 ml. of trimethylgermane in a evacuated tube. After 2 months at room temperature the volatiles were evaporated leaving unchanged Ph_3PAuCl .

16. The reaction of pyridine gold trichloride and trimethylgermane

1.5 ml. of trimethylgermane was condensed on to pyAuCl_3 (201 mg., 5.25×10^{-4} mole) and sealed off. Immediate reaction occurred and gold was deposited. Permanent gas, hydrogen, ($24.7 \text{ N c.c.} \cdot 10 \times 10^{-3}$ mole), trimethylchlorogermane (vpc identification) and gold (91 mg., 4.64×10^{-4} mole) were identified.

17. The reaction of pyridine gold trichloride and triphenylgermyl-lithium

To a stirred suspension of pyAuCl_3 (3 g.) in ether (40 ml.) was added dropwise a triphenylgermyl-lithium solution (prepared from triphenylgermane (7.16 g.) in ether (25 ml.) and n-butyl-lithium). The whole immediately went dark brown. After hydrolysis a black solid was filtered off, and continuous extraction with chloroform gave hexaphenyldigermane leaving a gold residue. The ether solution was evaporated giving triphenylgermane.

18. The reaction of $\text{Et}_3\text{PAuGePh}_3$ and 1,2-dibromethane

Triphenylgermyltriethylphosphinegold(I) (29 mg.) and 1,2-dibromethane (2 ml.) were sealed together in a vacuum tube. Work up gave

ethylene (0.7 N c.c. 70%) and extraction of the residue with petroleum ether gave triphenylbromogermane leaving triethylphosphinegold(I) bromide.

19. The reaction of $(Et_3P)_2Pd(GePh_3)_2$ and Ph_3PAuCl

Ph_3PAuCl (277 mg.) and $(Et_3P)_2Pd(GePh_3)_2$ (287 mg.) were sealed in a vacuum tube with benzene (8 ml.). The solution went orange immediately and then through dark red until after 24 hrs. the solution was black. Traces of a gold mirror were observed. The volatiles were removed and methyl iodide added to these. After pumping no solid, such as $[Et_3PMe]^+I^-$, remained although triethylphosphine could be smelt. From the residue bis(triethylphosphine)palladium(II) dichloride, $(Et_3P)_2PdCl_2$, was extracted with hexane together with triphenylphosphine. Benzene extraction gave triphenylphosphinegold(I) chloride and triphenylphosphine oxide leaving a mixture of black metallic palladium and hexaphenyldigermane.

20. The reaction of $(Ph_3P)_3AuSnCl_3$ and phenyl-lithium

Phenyl-lithium, prepared from iodobenzene (0.45 ml.) and n-butyl-lithium in hexane, was added to a stirred suspension of $(Ph_3P)_3AuSnCl_3$ (834 mg.) in benzene (50 ml.). The suspension was stirred for 24 hours, hydrolysed and filtered to give unchanged $(Ph_3P)_3AuSnCl_3$.

21. The reaction of $Ph_3PAuGePh_3$ and triphenylsilane

$Ph_3PAuGePh_3 \cdot C_6H_6$ (327 mg.), Ph_3SiH (107 mg.) and benzene (5 ml.) were sealed in a vacuum tube and heated to 60° for 2 months. Work up gave no

hydrogen gas only unreacted materials (>90%) together with small amounts of gold metal and hexaphenyldigermane.

22. The reaction of $[(\text{Ph}_2\text{PCH}_2\text{CH}_2\text{PPh}_2)_2\text{Pt}(\text{Et}_3\text{P})\text{GeMe}_3]\text{Cl}$ and Ph_3PAuCl
 $[(\text{Ph}_2\text{PCH}_2\text{CH}_2\text{PPh}_2)_2\text{Pt}(\text{Et}_3\text{P})\text{GeMe}_3]\text{Cl}$ (202 mg.) and Ph_3PAuCl (116 mg.)
 were sealed in a vacuum tube with benzene (6 ml.). A green solid, and traces of a gold mirror were observed after 4 days. The solvent was evaporated and Me_3GeCl was identified in the volatiles (v.p.c.). This volatile liquid mixture was stirred with silver nitrate, dilute nitric acid and methanol. After an hour, silver chloride (11 mg.) was isolated (Equivalent to a 33% yield of trimethylchlorogermane). The solid residue was washed with benzene leaving a white solid, bis(1,2-bisdiphenylphosphinoethane)platinum dichloride, $[(\text{Ph}_2\text{PCH}_2\text{CH}_2\text{PPh}_2)_2\text{Pt}](\text{Cl})_2$ (24 mg.) The benzene was evaporated and from methanol a mixture of triethylphosphine and triphenylphosphine was left after crystallising out a buff solid (1,2-bisdiphenylphosphinoethane)trimethylgermylplatinum chloride, $(\text{Ph}_2\text{PCH}_2\text{CH}_2\text{PPh}_2)_2\text{Pt}(\text{GeMe}_3)\text{Cl}$. m.p. 176° [Found: C, 46.89; H, 4.40; P, 8.29; Cl, 6.21%. $\text{C}_{29}\text{H}_{33}\text{P}_2\text{ClPtGe}$ requires C, 46.8; H, 4.42; P, 8.3; Cl, 4.7%].

23. The reaction of $[(\text{Ph}_2\text{PCH}_2\text{CH}_2\text{PPh}_2)_2\text{Pt}(\text{Et}_3\text{P})\text{SiMe}_3]\text{Cl}$ and Ph_3PAuCl
 $[(\text{Ph}_2\text{PCH}_2\text{CH}_2\text{PPh}_2)_2\text{Pt}(\text{Et}_3\text{P})\text{SiMe}_3]\text{Cl}$ (211 mg.) and Ph_3PAuCl (127 mg.)
 were sealed in a vacuum tube with benzene (3 ml.). Within 24 hours a gold mirror formed and a green precipitate was observed. Similar work up to section 22 yielded Me_3SiCl (35%), $[(\text{Ph}_2\text{PCH}_2\text{CH}_2\text{PPh}_2)_2\text{Pt}]\text{Cl}_2$, Et_3P and Ph_3PO .

A benzene soluble orange semi-solid could not be crystallised. Its mass spectrum showed ions at 686 $(\text{Ph}_2\text{PCH}_2\text{CH}_2\text{PPh}_2)\text{Pt}(\text{SiMe}_2)\text{Cl}$, 663 $(\text{Ph}_2\text{PCH}_2\text{CH}_2\text{PPh}_2)\text{PtCl}_2$, 628 $(\text{Ph}_2\text{PCH}_2\text{CH}_2\text{PPh}_2)\text{PtCl}$ and 593 $(\text{Ph}_2\text{PCH}_2\text{CH}_2\text{PPh}_2)\text{Pt}$ suggesting that the orange semi-solid contained $(\text{Ph}_2\text{PCH}_2\text{CH}_2\text{PPh}_2)\text{Pt}(\text{SiMe}_3)\text{Cl}$.

24. The reaction of $(\text{Ph}_2\text{PCH}_2\text{CH}_2\text{PPh}_2)\text{AuGePh}_3$ and trimethylgermane

On to $(\text{Ph}_2\text{PCH}_2\text{CH}_2\text{PPh}_2)\text{AuGePh}_3$ (100 mg.) in a vacuum tube was condensed trimethylgermane (20 N c.c.) and benzene (3 ml.). The system was heated at 60° and a gold mirror formed. No hydrogen gas was detected and trimethylgermane (17.5 N c.c.) was isolated. Me_6Ge_2 was identified in the volatiles by n.m.r. and mass spectrometry. Petroleum ether extraction of the residual solid gave triphenylgermane (20 mg., 59%) leaving gold metal and unreacted $(\text{Ph}_2\text{PCH}_2\text{CH}_2\text{PPh}_2)\text{AuGePh}_3$.

Section B. Organogermyl-iridium complexes

25. The preparation of chloro(carbonyl)bis(triethylphosphine)iridium(I),
 $(\text{Et}_3\text{P})_2\text{Ir}(\text{CO})\text{Cl}$ ⁵⁹

Carbon monoxide was bubbled through a refluxing solution of $\text{Na}_3\text{IrCl}_6 \cdot 12\text{H}_2\text{O}$ (5.0 g) in 2-methoxyethanol (75 ml.) for 4.5 hours. After cooling to room temperature, triethylphosphine (3.52 g., 4.4 ml.) was added to the golden brown suspension. The reaction mixture, which turned yellow immediately, was refluxed for 15 minutes and then stirred at room temperature overnight. Sodium chloride was filtered off and the solution evaporated. Crystallisation of the residue from 60-80° petroleum ether gave two crops of crystals of chloro(carbonyl)bis(triethylphosphine)iridium(I), $(\text{Et}_3\text{P})_2\text{Ir}(\text{CO})\text{Cl}$, 2.4 g., 74% [crop one, $\nu(\text{C}\equiv\text{O})(\text{KBr})$ 1950 and 2015 cm^{-1} , (cyclohexane) 1951 and 2015 cm^{-1} , $\nu(\text{Ir}-\text{Cl})$ 303 and 307 cm^{-1} , m.p. 54-8°; crop two, $\nu(\text{C}\equiv\text{O})(\text{KBr})$ 1950 cm^{-1} , (cyclohexane) 1951 cm^{-1} , $\nu(\text{Ir}-\text{Cl})$ 307 cm^{-1}].

26. The reaction between $(\text{Et}_3\text{P})_2\text{Ir}(\text{CO})\text{Cl}$ and triphenylgermane

$(\text{Et}_3\text{P})_2\text{Ir}(\text{CO})\text{Cl}$ (898 mg.), Ph_3GeH (700 mg.) and benzene (10 ml.) were sealed together in an evacuated tube and heated at 60° for 7 weeks. No permanent gas was evolved and the volatiles were evaporated to give a green oil from which a solid product could not be crystallised with benzene or methanol. Treatment with 60-80° petroleum ether gave crystals of hexaphenyl-digermaxane, $(\text{Ph}_3\text{Ge})_2\text{O}$, leaving a residue of the unreacted iridium(I) complex.

27. The reaction between $(Et_3P)_2Ir(CO)Cl$ and trimethylgermane

$(Et_3P)_2Ir(CO)Cl$ (1.075 g.), Me_3GeH (85 N c.c.) and benzene (8 ml.) were sealed in an evacuated tube for 6 days. Hydrogen (1.23 N c.c.), and trimethylgermane (23 N c.c.) were isolated and Me_6Ge_2 identified by its mass spectrum in the residual volatiles. The residual yellow oil was crystallised twice from 60-80° petroleum ether to give a pale yellow solid, dihydrido(chloro(carbonyl)bis(triethylphosphine)iridium(III)), $(Et_3P)_2Ir(CO)(H)_2Cl$, m.p. 62° [0.82 g., 76%; $\nu(Ir-H)$, $\nu(C\equiv O)(KBr)$ 1967, 2081 and 2193 cm^{-1} , (cyclohexane) 1976, 2077 and 2172 cm^{-1} ; $\nu(Ir-Cl)$ 252 (sh 260) cm^{-1}].

28. The reaction between $(Et_3P)_2Ir(CO)(H)_2Cl$ and sodium iodide

$(Et_3P)_2Ir(CO)(H)_2Cl$ (100 mg.) and sodium iodide (1.0 g.) were refluxed in acetone (10 ml.) for 90 minutes. The acetone was pumped off and an orange semi-solid extracted with benzene. This was recrystallised from 60-80° petroleum ether to give a yellow-green solid, dihydridoiodo(chloro(carbonyl)bis(triethylphosphine)iridium(III)), $(Et_3P)_2Ir(CO)H_2I$, m.p. 114°, [$\nu(Ir-H)$ $\nu(C\equiv O)(KBr)$ 1975, 2080 and 2159 cm^{-1} , (cyclohexane) 1979, 2085 and 2150 cm^{-1}].

29. The preparation of chloro(carbonyl)bis(dimethylphenylphosphine)-iridium(I), $(Me_2PhP)_2Ir(CO)Cl$ ⁶⁰

Carbon monoxide was bubbled through a refluxing solution of $Na_3IrCl_6 \cdot 12H_2O$ (10 g.) in 2-methoxyethanol (100 ml.) for 14 hours. The golden brown suspension was cooled to 60° and Me_2PhP (4.3 ml., 4.06 g.) added. The mixture was brought to reflux and then cooled when a white

precipitate separated out. This was recrystallised from benzene to give hydridodichloro(carbonyl)bis(dimethylphenylphosphine)iridium(III),

$(\text{Me}_2\text{PhP})_2\text{Ir}(\text{CO})\text{HCl}_2$, 1.25 g., m.p. 148-50^o(d) [$\nu(\text{Ir-H})$ $\nu(\text{C}\equiv\text{O})(\text{KBr})$ 2027 and 2188 cm^{-1} , (Nujol) 2027 and 2189 cm^{-1} , $\nu(\text{Ir-Cl})$ 245 and 305 cm^{-1}].

Found: C, 36.9; H, 3.92%. $\text{C}_{17}\text{H}_{23}\text{Cl}_2\text{IrOP}_2$ requires C, 35.9; H, 4.1%]. To the remaining yellow solution, water was added precipitating a yellow mixture of $(\text{Me}_2\text{PhP})_2\text{Ir}(\text{CO})(\text{H})\text{Cl}_2$ and $(\text{Me}_2\text{PhP})_2\text{Ir}(\text{CO})\text{Cl}$, 5.5 g., which could not be separated despite numerous recrystallisation attempts.

30. The reaction of $(\text{Me}_2\text{PhP})_2\text{Ir}(\text{CO})\text{HCl}_2$ with sodium methoxide⁶⁰

To $(\text{Me}_2\text{PhP})_2\text{Ir}(\text{CO})\text{HCl}_2$ (1.25 g.) in methanol (10 ml.) was added a solution of sodium methoxide (215 mg. of sodium in methanol (5 ml.)). After refluxing for 15 minutes, yellow crystals separated, chloro(carbonyl)-bis(dimethylphenylphosphine)iridium(I), $(\text{Me}_2\text{PhP})_2\text{Ir}(\text{CO})\text{Cl}$, 0.1 g., [$\nu(\text{C}\equiv\text{O})(\text{KBr})$ 1939 cm^{-1} , $\nu(\text{Ir-Cl})$ 312 cm^{-1}] leaving unreacted $(\text{Me}_2\text{PhP})_2\text{Ir}(\text{CO})\text{HCl}_2$ in solution.

31. The reaction of a mixture of $(\text{Me}_2\text{PhP})_2\text{Ir}(\text{CO})\text{Cl}$ and $(\text{Me}_2\text{PhP})_2\text{Ir}(\text{CO})\text{HCl}_2$ with triethylgermane

To the mixture of $(\text{Me}_2\text{PhP})_2\text{Ir}(\text{CO})\text{Cl}$ and $(\text{Me}_2\text{PhP})_2\text{Ir}(\text{CO})\text{HCl}_2$ (section 29) in benzene (12 ml.) was added triethylgermane (0.6 ml.). After refluxing for one day the orange solution had turned dark brown. The volatiles were collected and concentrated, triethylchlorogermane being identified by mass spectrometry. The residual semi-solid could not be crystallised.

32. The reaction of $(\text{Me}_2\text{PhP})_2\text{Ir}(\text{CO})\text{Cl}$ and trimethylgermane

Trimethylgermane (50 N c.c.) and benzene (5 ml.) were condensed on to

$(\text{Me}_2\text{PhP})_2\text{Ir}(\text{CO})\text{Cl}$ (47 mg.) and heated to 60° for 5 days. Hydrogen (4.9 N c.c.), and trimethylgermane were isolated and trimethylchlorogermane identified in the volatiles by mass spectrometry leaving a residual yellow oil, dihydrido(carbonyl)trimethylgermylbis(dimethylphenylphosphine)iridium(III), $(\text{Me}_2\text{PhP})_2\text{Ir}(\text{CO})(\text{H})_2\text{GeMe}_3$ [$\nu(\text{Ir-H})$ $\nu(\text{C}\equiv\text{O})$ (Nujol) 1943, 1978(sh), 2000 and 2045 cm^{-1} , (C_6H_6) 1943, 1999 and 2048 cm^{-1}].

33. The preparation of chloro(carbonyl)bis(triphenylphosphine)iridium(I), $(\text{Ph}_3\text{P})_2\text{Ir}(\text{CO})\text{Cl}$ (Method 1)⁵⁵

$\text{Na}_3\text{IrCl}_6 \cdot 12\text{H}_2\text{O}$ (5 g.) and triphenylphosphine (22 g.) in ethylene glycol (150 ml.) were refluxed for seven hours. After one hour the solution was pale yellow and clear but after five hours a yellow solid had formed. The yellow solid was filtered and Soxhlet extraction with benzene left an insoluble white solid which discolours in air, dihydrido-chloro-tris(triphenylphosphine)iridium(III)⁵⁷, $(\text{Ph}_3\text{P})_3\text{IrH}_2\text{Cl}$, m.p. 251° [8.1 g., $\nu(\text{Ir-H})$ (KBr) 2100 and 2208 cm^{-1} , $\nu(\text{Ir-Cl})$ 261 cm^{-1} , Found: C, 63.3; H, 3.71% $\text{C}_{54}\text{H}_{47}\text{ClIrP}_3$ requires C, 63.84; H, 4.63%]. From the benzene solution yellow and orange solids separated on cooling. Washing this solid with cold benzene gave a white solid, dihydrido-chloro-tris(triphenylphosphine)iridium(III)²¹², $(\text{Ph}_3\text{P})_3\text{IrH}_2\text{Cl}$, m.p. 198° [1.1 g., $\nu(\text{Ir-H})$ (KBr) 2154 and 2184 cm^{-1} , $\nu(\text{Ir-Cl})$ 256 cm^{-1} , Found: C, 64.38; H, 4.97; Cl, 3.64% $\text{C}_{54}\text{H}_{47}\text{ClIrP}_3$ requires C, 63.84; H, 4.63; Cl, 3.45%]. Evaporation of the benzene gave an orange crystalline solid, (0.1 g.), probably trichloro-tris(triphenylphosphine)iridium(III), $(\text{Ph}_3\text{P})_3\text{IrCl}_3$.

34. The preparation of chloro(carbonyl)bis(triphenylphosphine)iridium(I),
 $(\text{Ph}_3\text{P})_2\text{Ir}(\text{CO})\text{Cl}$ (Method 2)⁵⁹

(i) Carbon monoxide was bubbled through a refluxing suspension of $\text{Na}_3\text{IrCl}_6 \cdot 12\text{H}_2\text{O}$ (9.7 g.) in 2-methoxyethanol (75 ml.) for $4\frac{1}{2}$ hours. The golden brown solution was cooled to room temperature, triphenylphosphine (7.7 g.) added and then refluxed for 30 minutes. The yellow suspension was cooled and stirred overnight. Filtration and Soxhlet extraction with benzene gave trans-chloro(carbonyl)bis(triphenylphosphine)iridium(I), $(\text{Ph}_3\text{P})_2\text{Ir}(\text{CO})\text{Cl}$, which was recrystallised from benzene, (8.6 g., 75%). The white recrystallisation residue (0.1 g.) was identified as mainly trichloro(carbonyl)bis(triphenylphosphine)iridium(III), $(\text{Ph}_3\text{P})_2\text{Ir}(\text{CO})\text{Cl}_3$, [$\nu(\text{C}\equiv\text{O})$ (KBr) 2072 cm^{-1} , 224 $\nu(\text{Ir}-\text{Cl})$ 301 and 325 cm^{-1} 77].

(ii) A red solution of chloroiridic acid, H_2IrCl_6 , (4.5 g., 53% iridium) in water (10 ml.) was neutralised with sodium carbonate. The resulting yellow solution was evaporated, and the preparation continued as above. An almost black solid was precipitated, but Soxhlet extraction with benzene gave chloro(carbonyl)bis(triphenylphosphine)iridium(I), $(\text{Ph}_3\text{P})_2\text{Ir}(\text{CO})\text{Cl}$, (6.55 g., 68%) leaving a residue of iridium metal (0.25 g., 11%).

(iii) On one occasion under apparently identical conditions to (i), a cream solid was precipitated. Extraction with toluene gave $(\text{Ph}_3\text{P})_2\text{Ir}(\text{CO})\text{Cl}$ (0.4 g.), leaving an insoluble mixture of $(\text{Ph}_3\text{P})_2\text{Ir}(\text{CO})\text{Cl}_3$ and $(\text{Ph}_3\text{P})_2\text{Ir}(\text{CO})\text{HCl}_2$ [$(\text{Ph}_3\text{P})_2\text{Ir}(\text{CO})\text{Cl}_3$; $\nu(\text{C}\equiv\text{O})$ (KBr) 2080 cm^{-1} 70,77,84 , $\nu(\text{Ir}-\text{Cl})$ 303 and 324 cm^{-1} 77 $(\text{Ph}_3\text{P})_2\text{Ir}(\text{CO})\text{HCl}_2$; $\nu(\text{Ir}-\text{H})$ $\nu(\text{C}\equiv\text{O})$ (KBr) 2023 and

2242 cm^{-1} ⁸⁵, $\nu(\text{Ir-Cl})$ 265 and 313 cm^{-1} ^{76,77}]. The mixture in benzene (15 ml.) and triethylamine (2 ml.) was refluxed for two days. Soxhlet extraction with benzene left insoluble $(\text{Ph}_3\text{P})_2\text{Ir}(\text{CO})\text{Cl}_3$, (2.90 g.), giving an orange solution of $(\text{Ph}_3\text{P})_2\text{Ir}(\text{CO})\text{Cl}$, 1.0 g. [$\nu(\text{C}\equiv\text{O})$ (Nujol) 1950 cm^{-1} (CHCl_3) 1944 cm^{-1} ¹⁹⁸, $\nu(\text{Ir-Cl})$ 317 (311sh) cm^{-1} ⁷⁷].

35. The reaction of $(\text{Ph}_3\text{P})_2\text{Ir}(\text{CO})\text{Cl}_3$ with zinc and dimethylformamide⁶²

A mixture of $(\text{Ph}_3\text{P})_2\text{Ir}(\text{CO})\text{Cl}_3$ (2.8 g.) and zinc (1.9 g.) in dimethylformamide (50 ml.) was refluxed for 24 hours. The volatiles were pumped off, and the brown residue Soxhlet extracted with benzene. The benzene was evaporated to give a brown semi-solid which, on washing with acetone, left yellow crystals of $(\text{Ph}_3\text{P})_2\text{Ir}(\text{CO})\text{Cl}$, (0.4 g., 15%).

36. The reaction of $(\text{Ph}_3\text{P})_3\text{IrH}_2\text{Cl}$ and sodium iodide

A suspension of $(\text{Ph}_3\text{P})_3\text{IrH}_2\text{Cl}$ ($\nu(\text{Ir-H})$ (KBr) 2108 and 2193 cm^{-1}), 826 mg., and sodium iodide (1.0 g.) in acetone (30 ml.) was refluxed for 15 minutes. The solvent was evaporated and the residual solid extracted with benzene from which a white, light sensitive solid was isolated, dihydridoiodotris(triphenylphosphine)iridium(III), $(\text{Ph}_3\text{P})_3\text{IrH}_2\text{I}$, m.p. 226° ($\nu(\text{Ir-H})$ (KBr) 2157 cm^{-1}). After several weeks under nitrogen, the complex was yellow and crystallisation from a benzene-hexane mixture gave a cream solid, which turned yellow in air, dihydridoiodotris(triphenylphosphine)iridium(III), $(\text{Ph}_3\text{P})_3\text{IrH}_2\text{I}$, m.p. 197° [$\nu(\text{Ir-H})$ (KBr) 2083 and 2222 cm^{-1} . Found: C, 58.45; H, 4.30; I, 11.31%. $\text{C}_{54}\text{H}_{47}\text{IIP}_3$ requires C, 58.53; H, 4.24; I, 11.47%].

37. The reaction of $(\text{Ph}_3\text{P})_3\text{IrH}_2\text{Cl}$ and triphenylgermyl-lithium

To a suspension of $(\text{Ph}_3\text{P})_3\text{IrH}_2\text{Cl}$, 1.942 g., ($\nu(\text{Ir-H})$ (KBr) 2108 and 2193 cm^{-1}) in ether (200 ml.), was added a solution of Ph_3GeLi (prepared from Ph_3GeH (611 mg.) and n-butyl-lithium) in hexane. The mixture was stirred overnight and hydrolysed. Filtration gave unreacted $(\text{Ph}_3\text{P})_3\text{IrH}_2\text{Cl}$ whilst evaporation of the ether layer left triphenylgermane.

38. The reaction of $(\text{Ph}_3\text{P})_3\text{IrH}_2\text{Cl}$ with triethylgermane

A suspension of $(\text{Ph}_3\text{P})_3\text{IrH}_2\text{Cl}$, 1.053 g., ($\nu(\text{Ir-H})$ (KBr) 2100 and 2208 cm^{-1}), in Et_3GeH (0.5 ml.) and benzene (15 ml.), was refluxed. The solid dissolved to give an orange solution but after 2 hours a white precipitate formed. The suspension was filtered to give dihydrido-chloro-tris(triphenylphosphine)iridium(III), $(\text{Ph}_3\text{P})_3\text{IrH}_2\text{Cl}$, [$\nu(\text{Ir-H})$ (KBr) 2154 and 2184 cm^{-1}]²¹². The volatiles were removed from the filtrate, leaving white, trihydrido-tris(triphenylphosphine)iridium(III), $(\text{Ph}_3\text{P})_3\text{IrH}_3$, [$\nu(\text{Ir-H})$ (KBr) 1749 and 2086 cm^{-1} , (C_6H_6) 1755 and 2094 cm^{-1}]. Triethylchlorogermane was identified in the volatiles by mass spectrometry.

39. The reaction of $(\text{Ph}_3\text{P})_3\text{IrH}_2\text{Cl}$, triethylgermane and triethylamine

$(\text{Ph}_3\text{P})_3\text{IrH}_2\text{Cl}$ (639 mg.) in triethylamine (1 ml.) and benzene (10 ml.) were refluxed for several hours. Triethylgermane (0.8 ml.) was added and a white precipitate formed after 90 minutes. After one day the volatiles were removed leaving only trihydrido-tris(triphenylphosphine)iridium(III), $(\text{Ph}_3\text{P})_3\text{IrH}_3$, [Found: C, 66.2; H, 4.89%. $\text{C}_{54}\text{H}_{48}\text{IrP}_3$ requires C, 66.0; H, 4.90%]. Triethylchlorogermane was again identified in the volatiles.

40. Reactions of trans-chloro(carbonyl)bis(triphenylphosphine)iridium(I)

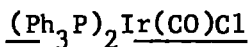

(a) Trimethylsilane.¹⁴³ Trimethylsilane (0.5 ml.) and benzene (5 ml.) were condensed onto $(\text{Ph}_3\text{P})_2\text{Ir}(\text{CO})\text{Cl}$ (303 mg.). Yellow translucent crystals formed but evaporation of the volatiles left only $(\text{Ph}_3\text{P})_2\text{Ir}(\text{CO})\text{Cl}$.

(b) Trimethylgermane (i) Trimethylgermane (2 ml.) and benzene (8 ml.) were condensed onto $(\text{Ph}_3\text{P})_2\text{Ir}(\text{CO})\text{Cl}$ (432 mg.) in a sealed vacuum tube. After two weeks, the yellow solid had dissolved to give a green solution. Hydrogen gas (0.85 N c.c.) was isolated, and trimethylchlorogermane, Me_3GeCl , identified (p.m.r. and mass spectra) in the volatiles. The residual buff solid was recrystallised from 60-80° petroleum ether or cyclohexane to give white spheres of dihydrido(carbonyl)trimethylgermylbis-(triphenylphosphine)iridium(III), $(\text{Ph}_3\text{P})_2\text{Ir}(\text{CO})(\text{H})_2\text{GeMe}_3$, m.p. 153-5°, 382 mg., 78% [$\nu(\text{Ir-H})$, $\nu(\text{C}\equiv\text{O})$ (KBr) 1956, 2071 and 2123(sh) cm^{-1} , (cyclohexane) 1969, 2076 and 2114(sh) cm^{-1} . Found: C, 55.6; H, 4.75%.

$\text{C}_{40}\text{H}_{41}\text{GeIrOP}_2$ requires C, 55.6; H, 4.32%]. Recrystallisation of the complex from benzene gave colourless crystals of $(\text{Ph}_3\text{P})_2\text{Ir}(\text{CO})(\text{H})_2\text{GeMe}_3 \cdot \frac{1}{2}\text{C}_6\text{H}_6$.

(ii) Onto $(\text{Ph}_3\text{P})_2\text{Ir}(\text{CO})\text{Cl}$ (1.055 g.) in benzene (25 ml.) under vacuum was condensed trimethylgermane (90 N c.c.). After 2 months, hydrogen (1.52 N c.c.) and unreacted trimethylgermane (34.8 N c.c., 39%) were isolated, and Me_3GeCl and Me_6Ge_2 identified (mass spectrum). From the residual solid, $(\text{Ph}_3\text{P})_2\text{Ir}(\text{CO})(\text{H})_2\text{GeMe}_3$ (656 mg., 57%) was extracted with cyclohexane leaving trans $(\text{Ph}_3\text{P})_2\text{Ir}(\text{CO})\text{Cl}$ (349 mg., 33%).

(iii) A similar experiment using $(\text{Ph}_3\text{P})_2\text{Ir}(\text{CO})\text{Cl}$ (1.011 g.), trimethylgermane (50 N c.c.) and triethylamine, Et_3N , gave only unreacted $(\text{Ph}_3\text{P})_2\text{Ir}(\text{CO})\text{Cl}$ (0.2 g., 20%) and $(\text{Ph}_3\text{P})_2\text{Ir}(\text{CO})(\text{H})_2\text{GeMe}_3$.

(c) Triethylgermane. (i) Triethylgermane (1 ml., 1.009 g.) was added to a refluxing yellow solution of $(\text{Ph}_3\text{P})_2\text{Ir}(\text{CO})\text{Cl}$ (991 mg.) in benzene (20 ml.). Within 24 hours the solution had turned colourless. Benzene was then distilled from the volatiles, leaving a mixture of mainly Et_3GeCl and unreacted Et_3GeH together with a little Et_6Ge_2 (mass spectral identification). The residual solid was recrystallised from 60-80° petroleum ether or cyclohexane to give colourless crystals or white spheres of dihydrido(carbonyl)-triethylgermylbis(triphenylphosphine)iridium(III), $(\text{Ph}_3\text{P})_2\text{Ir}(\text{CO})(\text{H})_2\text{GeEt}_3$, m.p. 148°, 1.015 g., 88% [$\nu(\text{Ir}-\text{H})$ $\nu(\text{C}\equiv\text{O})$ (KBr) 1953, 2081 and 2119 cm^{-1} , (cyclohexane) 1966, 2077 and 2124 cm^{-1} . Found: C, 56.80; H, 5.30; P, 7.74; Cl, 0.00%. $\text{C}_{43}\text{H}_{47}\text{GeIrOP}_2$ requires C, 56.89; H, 5.19; P, 6.84; Cl, 0.00%].

(ii) To a refluxing solution of $(\text{Ph}_3\text{P})_2\text{Ir}(\text{CO})\text{Cl}$ (1.022 g.) in benzene (10 ml.), triethylamine (1 ml.) and triethylgermane (0.8 ml., 0.81 g.) were added. After 2 days, the volatiles were removed but work up gave only triethylchlorgermane and $(\text{Ph}_3\text{P})_2\text{Ir}(\text{CO})(\text{H})_2\text{GeEt}_3$, (1.06 g., 89%).

(iii) Triethylgermane (0.3 ml., 0.31 g.) and benzene (2 ml.) were condensed on $(\text{Ph}_3\text{P})_2\text{Ir}(\text{CO})\text{Cl}$ (381 mg.) in a vacuum tube. Hydrogen gas (1.75 N c.c.) was isolated as well as $(\text{Ph}_3\text{P})_2\text{Ir}(\text{CO})(\text{H})_2\text{GeEt}_3$ (360 mg., 67%).

(iv) $(\text{Ph}_3\text{P})_2\text{Ir}(\text{CO})\text{Cl}$ (551 mg.), Et_3GeH (0.2 ml., 210 mg.) and benzene (10 ml.) were refluxed for two days. The volatiles were removed (C_6H_6 , Et_3GeCl and Et_6Ge_2) and from the residual solid $(\text{Ph}_3\text{P})_2\text{Ir}(\text{CO})\text{Cl}$ (23 mg.) and $(\text{Ph}_3\text{P})_2\text{Ir}(\text{CO})(\text{H})_2\text{GeEt}_3$ were isolated.

(d) Tri-isopropylgermane. $(\text{Ph}_3\text{P})_2\text{Ir}(\text{CO})\text{Cl}$ (424 mg.), Pr^i_3GeH (0.6 ml.) and benzene (10 ml.) were refluxed for three weeks. Removal of the volatiles gave only unreacted $(\text{Ph}_3\text{P})_2\text{Ir}(\text{CO})\text{Cl}$.

(e) Trimethylbromgermane. $(\text{Ph}_3\text{P})_2\text{Ir}(\text{CO})\text{Cl}$ (395 mg.), Me_3GeBr (0.5 ml.) and benzene (5 ml.) were refluxed for three weeks. Evaporation of the volatiles left only unchanged $(\text{Ph}_3\text{P})_2\text{Ir}(\text{CO})\text{Cl}$.

(f) Triethylbromgermane. $(\text{Ph}_3\text{P})_2\text{Ir}(\text{CO})\text{Cl}$ (441 mg.), Et_3GeBr (0.4 ml.) and benzene (4 ml.) were refluxed for three weeks. Evaporation of the volatiles gave a dark yellow solid trans $(\text{Ph}_3\text{P})_2\text{Ir}(\text{CO})\text{Br}^{77}$ [$\nu(\text{C}\equiv\text{O})$ (KBr) 1959 cm^{-1} , $\nu(\text{Ir}-\text{Br})$ 210 cm^{-1}]. Et_3GeCl was identified in the volatiles by its mass spectrum.

(g) Triphenylgermane. (i) Benzene (8 ml.) was condensed onto $(\text{Ph}_3\text{P})_2\text{Ir}(\text{CO})\text{Cl}$ (394 mg.) and Ph_3GeH (156 mg.) in a vacuum tube. After 3 weeks at 60° , no hydrogen was formed and unreacted triphenylgermane was extracted with diethylether leaving unreacted $(\text{Ph}_3\text{P})_2\text{Ir}(\text{CO})\text{Cl}$.

(ii) $(\text{Ph}_3\text{P})_2\text{Ir}(\text{CO})\text{Cl}$ (329 mg.), Ph_3GeH (565 mg.) and benzene (10 ml.) were refluxed for a week. The volatiles were evaporated and the residual solid washed with $60-80^\circ$ petroleum ether. The extract contained triphenylphosphine, triphenylchlorogermane and excess triphenylgermane (mass spectral identification). The petroleum ether

insoluble residue was recrystallised from a cyclohexane-benzene mixture to give buff hydrido(chloro)(carbonyl)triphenylgermylmonotriphenylphosphine-iridium(III), $\text{Ph}_3\text{P}(\text{CO})\text{Ir}(\text{H})(\text{Cl})\text{GePh}_3 \frac{1}{2}(\text{C}_6\text{H}_{12})$, m.p. 157° 301 mg., 83% [$\nu(\text{Ir-H})$ $\nu(\text{C}\equiv\text{O})$ (KBr) 1968 and 2083 cm^{-1} (Nujol) 1968 and 2084 cm^{-1} (C_6H_6) 1970 and 2088 cm^{-1} ; $\nu(\text{Ir-Cl})$ 312 cm^{-1} . Found: C, 56.0; H, 4.3; Cl, 4.17%. $\text{C}_{40}\text{H}_{37}\text{ClGeIrOP}$ requires C, 55.6; H, 4.3; Cl, 4.11%].

(h) Trichlorogermyl-caesium. $(\text{Ph}_3\text{P})_2\text{Ir}(\text{CO})\text{Cl}$ (844 mg.), and CsGeCl_3 (337 mg.) in ether (10 ml.) were refluxed for 14 days. The cream suspension was filtered and recrystallised from benzene to give a white solid, probably partially hydrolysed dihydrido(chloro)(carbonyl)trichlorogermylbis(triphenylphosphine)iridium(III), $(\text{Ph}_3\text{P})_2\text{Ir}(\text{CO})(\text{H})_2\text{GeCl}_3$ [$\nu(\text{Ir-H})$ $\nu(\text{C}\equiv\text{O})$ (KBr) 2041, 2077 and 2132 cm^{-1} , $\nu(\text{Ge-Cl})$ 378 cm^{-1} (broad), $\nu(\text{Ge-O})$ 934 cm^{-1} (very broad), $\nu(\text{Ir-Cl})$ absent. Found: C, 40.84; H, 3.16%. $\text{C}_{37}\text{H}_{32}\text{Cl}_3\text{GeIrOP}_2$ requires C, 47.9; H, 3.45%].

(i) Trichlorogermane. To a solution of $(\text{Ph}_3\text{P})_2\text{Ir}(\text{CO})\text{Cl}$, (520 mg.) in benzene (5 ml.) was added a solution of HGeCl_3 (0.5 ml., 1.0 g.) in benzene (3 ml.). The white precipitate, which formed immediately, was filtered and then recrystallised from a large volume of benzene to give white dihydrido(chloro)(carbonyl)trichlorogermylbis(triphenylphosphine)iridium(III), m.p. 184° , 325 mg., 49%. [$\nu(\text{Ir-H})$ $\nu(\text{C}\equiv\text{O})$ (KBr) 2055(sh), 2065 and 2084 cm^{-1} (C_6H_6) 2051(sh), 2058 and 2082 cm^{-1} , $\nu(\text{Ge-Cl})$ 353(sh), 372 and 388(sh) cm^{-1} , $\nu(\text{Ir-Cl})$ absent. Found: C, 45.25; H, 3.35; Cl, 12.48%. $\text{C}_{37}\text{H}_{32}\text{Cl}_3\text{GeIrOP}_2$ requires C, 47.9; H, 3.45; Cl, 11.44%].

(j) Bis(trimethylgermyl)mercury.²¹³ To a refluxing solution of $(\text{Ph}_3\text{P})_2\text{Ir}(\text{CO})\text{Cl}$ (1.45 g.) in benzene (100 ml.), was added dropwise a solution of $(\text{Me}_3\text{Ge})_2\text{Hg}$ (0.8 g.) in benzene (10 ml.). A vivid cherry colour formed immediately, which gradually lightened to give an orange solution. After two hours, filtration gave mercury (242 mg., 67%), and the volatiles were pumped off. Trimethylchlorogermane was identified in the volatiles. The residual orange solid was recrystallised from benzene giving two crops of unreacted $(\text{Ph}_3\text{P})_2\text{Ir}(\text{CO})\text{Cl}$ (700 mg., 49%); and leaving a buff solid after evaporation. This buff solid separated from cyclohexane when hexane was added, probably giving carbonyl(trimethylgermylmercury)bis(triphenylphosphine) iridium(I), $(\text{Ph}_3\text{P})_2\text{Ir}(\text{CO})\text{HgGeMe}_3$ m.p. $130^\circ(\text{d})$. [$\nu(\text{C}\equiv\text{O})$ (KBr) 1979 cm^{-1} , (cyclohexane) 1974 cm^{-1} , $\sigma(\text{CH}_3)$ 809 cm^{-1} , $\nu(\text{Ir}-\text{Cl})$ absent. P.m.r. spectrum: $\tau(\text{CH}_3)$ 9.67. Phenyl: methyl hydrogens, 31:9. Found: C, 50.7; H, 4.47%. $\text{C}_{40}\text{H}_{39}\text{GeHgIrOP}_2$ requires C, 45.7; H, 3.71%. $\text{C}_{40}\text{H}_{39}\text{GeIrOP}_2$ requires C, 55.7; H, 5.2%].

(k) Triphenylgermyl-lithium. To $(\text{Ph}_3\text{P})_2\text{Ir}(\text{CO})\text{Cl}$ (900 mg.) in ether (50 ml.) was added dropwise triphenylgermyl-lithium (prepared from triphenylgermane (550 mg.) and n-butyl-lithium in hexane). The solution immediately darkened and after one day, the mixture was hydrolysed, the water layer giving a positive test for chloride ions. The ether layer was evaporated to give an orange oil, which yielded a pink solid upon washing with $60-80^\circ$ petroleum ether. The petroleum ether was evaporated to give a mixture of triphenylphosphine, triphenylgermane and triphenylchlorogermane (mass spectrum).

The pink solid could not be recrystallised with a variety of solvents (ether, benzene, methanol or petroleum ether). [$\nu(\text{Ir-H})$ $\nu(\text{C}\equiv\text{O})$ (KBr) 1968 and 2069 cm^{-1} , $\nu(\text{Ir-Cl})$ absent. Found: C, 58.46; H, 4.60%. Mass spectrum shows only peaks attributable to Ph_3Ge or Ph_3P groups].

41. Reactions of the complexes, $(\text{Ph}_3\text{P})_2\text{Ir}(\text{CO})(\text{H})_2\text{GeR}_3$ (R = Me or Et)

(a) 1,2.-Dibromethane (R = Me) (i) 1,2.-dibromethane (4 ml.) was condensed onto the complex (259 mg.) in an evacuated tube and heated to 70° for 3 days. Hydrogen (1.0 N c.c.) and ethylene (7.18 N c.c. > 100%) were isolated and Me_3GeBr and Me_6Ge_2 were identified in the remaining volatiles. From the residual solid, dark yellow trans $(\text{Ph}_3\text{P})_2\text{Ir}(\text{CO})\text{Br}$, [$\nu(\text{C}\equiv\text{O})$ (KBr) 1959 cm^{-1} , $\nu(\text{Ir-Br})$ 210 cm^{-1}] ⁷⁷ was extracted with benzene, leaving a cream solid, (insoluble in benzene, methanol or chloroform), dihydridobromo-(carbonyl)bis(triphenylphosphine)iridium(III), $(\text{Ph}_3\text{P})_2\text{Ir}(\text{CO})(\text{H})_2\text{Br}$ [$\nu(\text{Ir-H})$ $\nu(\text{C}\equiv\text{O})$ (Nujol) 2028, 2073 and 2232 cm^{-1} . Found: C, 53.90; H, 3.94%. $\text{C}_{37}\text{H}_{32}\text{BrIrOP}_2$ requires C, 53.75; H, 3.87%].

(ii) In a similar experiment, no reaction had occurred after 24 hours at room temperature.

(b) Iodine (R = Et) To a stirred solution of $(\text{Ph}_3\text{P})_2\text{Ir}(\text{CO})(\text{H})_2\text{GeEt}_3$ (342 mg.) in benzene (10 ml.), a solution of iodine (101 mg.) in benzene (5 ml.) was added. Immediate decolourisation was observed, and the volatiles were then evaporated. Fractional distillation of the volatiles gave first benzene and then triethyliodogermane (p.m.r. (C_6H_6) ethyl multiplet, $\tau = 8.76$; and mass spectra identification). Recrystallisation of the

residual solid with benzene gave colourless crystals, m.p. 242° , of dihydridoiodo(carbonyl)bis(triphenylphosphine)iridium(III), $(\text{Ph}_3\text{P})_2\text{Ir}(\text{CO})(\text{H})_2\text{I}$ 295 mg., 90%. [$\nu(\text{Ir-H})$ $\nu(\text{C}\equiv\text{O})$ (KBr) 1987, 2045 and 2092 cm^{-1} (C_6H_6) 2004, 2046 and 2069 cm^{-1} (CCl_4) 2003, 2047 and 2067 cm^{-1} . Found: C, 50.4; H, 3.58%. $\text{C}_{37}\text{H}_{32}\text{IIrOP}_2$ requires C, 50.9; H, 3.64%].

(c) Hydrogen chloride (R = Me) Hydrogen chloride gas (10 N c.c.) and benzene (5 ml.) were condensed onto the complex (395 mg.) in a sealed vacuum tube. The solution went cloudy within a few minutes and then turned yellow. From the volatiles, hydrogen (3.29 N c.c.) and trimethylgermane (1.60 N c.c., 16%) were isolated by fractionation and trimethylchlorgermane and hexamethyldigermane identified by p.m.r. (C_6H_6 , $\tau = 9.43$ and 9.80 respectively) and mass spectra. From the residue, $(\text{Ph}_3\text{P})_2\text{Ir}(\text{CO})\text{Cl}$ was recrystallised with benzene, leaving in solution trihydrido(carbonyl)bis(triphenylphosphine)iridium(III), $(\text{Ph}_3\text{P})_2\text{Ir}(\text{CO})\text{H}_3$ 203 [$\nu(\text{Ir-H})$ $\nu(\text{C}\equiv\text{O})$ (KBr) 1787, 1968 and 2070 cm^{-1} , $\delta(\text{Ir-H})$, 801 and 843 cm^{-1}].

(d) Hydrogen chloride (R = Et) Hydrogen chloride gas (10 N c.c.) and benzene (5 ml.) were condensed onto the complex (405 mg.). Work up as above produced hydrogen (1.91 N c.c.), and Et_3GeCl and Et_3GeH were identified by p.m.r. (ratio 9:2) and mass spectra. From the yellow residual solid [$\nu(\text{Ir-H})$ $\nu(\text{C}\equiv\text{O})$ (KBr) 1790, 1954, 1970, 1998, 2022 and 2069 cm^{-1}], recrystallisation with benzene yielded $(\text{Ph}_3\text{P})_2\text{Ir}(\text{CO})\text{Cl}$ (88 mg., 25% Ir). Evaporation of the benzene solution yielded trihydrido(carbonyl)bis(triphenylphosphine)iridium(III), $(\text{Ph}_3\text{P})_2\text{Ir}(\text{CO})\text{H}_3$ [$\nu(\text{Ir-H})$ (KBr) 1790, 1970 and 2069 cm^{-1}].

(e) Sodium iodide (R = Me) The complex (116 mg.) and sodium iodide (600 mg.) in acetone (15 ml.) were refluxed for 30 minutes. The acetone was evaporated and extraction of the residue with benzene yielded unreacted $(\text{Ph}_3\text{P})_2\text{Ir}(\text{CO})(\text{H})_2\text{GeMe}_3$.

(f) Hydrogen (R = Me) The complex (212 mg.) in benzene (20 ml.) was stirred under hydrogen ($\frac{1}{4}$ atmosphere pressure) for 6 days. No trimethylgermane was formed and evaporation of the benzene gave unchanged $(\text{Ph}_3\text{P})_2\text{Ir}(\text{CO})(\text{H})_2\text{GeMe}_3$.

(g) Hydrogen (R = Et) The complex (215 mg.) in benzene (20 ml.) was shaken for 5 days under 80 atmospheres of hydrogen at room temperature. The volatiles were removed leaving trihydrido(carbonyl)bis(triphenylphosphine)-iridium(III), $(\text{Ph}_3\text{P})_2\text{Ir}(\text{CO})\text{H}_3$, 155 mg., 88%. [$\nu(\text{Ir-H})$ $\nu(\text{C}\equiv\text{O})$ (KBr) 1790, 1968 and 2070 cm^{-1} , $\delta(\text{Ir-H})$ 801 and 843 cm^{-1}].²⁰³ Removal of benzene from the volatiles by distillation left triethylgermane (p.m.r. and i.r. spectral identification).

(h) Hydrolysis (R = Me) The complex (129 mg.) in acetone (10 ml.) and water (1 ml.) was stirred for six days. The volatiles were evaporated to give unchanged $(\text{Ph}_3\text{P})_2\text{Ir}(\text{CO})(\text{H})_2\text{GeMe}_3$.

(i) Pyrolysis (R = Me) The complex, 115 mg., (recrystallised from benzene) was heated in vacuum at 150° for three days, during which time the complex blackened. Hydrogen (1.0 N c.c.), trimethylgermane (2.60 N c.c., 85%) and benzene (0.9 N c.c., 58%) were isolated, leaving a black sticky residue, probably containing hydrido(dicarbonyl)bis(triphenylphosphine)-

iridium(I), $(\text{Ph}_3\text{P})_2\text{Ir}(\text{CO})_2\text{H}$ ²⁰⁴ or a mixture of hydrido(carbonyl)tris(tri-phenylphosphine)iridium(I), $(\text{Ph}_3\text{P})_3\text{Ir}(\text{CO})\text{H}$ and an uncharacterised phosphine-iridium-carbonyl complex.²⁰² [$\nu(\text{Ir-H})$ $\nu(\text{C}\equiv\text{O})$ (KBr) 1914, 1955 and 2063 cm^{-1} (C_6H_6) 1944, 1983 and 2071 cm^{-1}].

(j) Oxygenation (R = Me) The decomposition of the complex (45 mg.) in benzene was observed by p.m.r. spectroscopy. The methyl singlet due to the complex ($\tau = 9.20$) diminished as a peak attributable to hexamethyldigermoxane ($\tau = 9.70$) increased. [% of $(\text{Ph}_3\text{P})_2\text{Ir}(\text{CO})(\text{H})_2\text{GeMe}_3$ present: initially 100%; 13 days, 80%; 20 days, 70%; 27 days, 57%]. The volatiles were evaporated to give a dark green solid [$\nu(\text{Ir-H})$ $\nu(\text{C}\equiv\text{O})$ (KBr) 1961, 2008 and 2012(sh) cm^{-1} in addition to bands attributable to $(\text{Ph}_3\text{P})_2\text{Ir}(\text{CO})(\text{H})_2\text{GeMe}_3$].

(k) Triethylphosphine (R = Me) To the complex (496 mg.) in benzene (8 ml.) was added triethylphosphine (0.5 ml., 400 mg.). Upon addition the greenish solution turned yellow, and after several hours the volatiles were removed leaving a green oil. Recrystallisation with 60-80° petroleum ether gave triphenylphosphine (185 mg., 64%). Evaporation of the petroleum ether gave a tacky yellow solid, dihydrido(carbonyl)trimethylgermylbis(triethylphosphine)iridium(III), $(\text{Et}_3\text{P})_2\text{Ir}(\text{CO})(\text{H})_2\text{GeMe}_3$ [$\nu(\text{Ir-H})$ $\nu(\text{C}\equiv\text{O})$ (contact film) 1914sh, 1948 and 2058 cm^{-1} (C_6H_6) 1919sh, 1945 and 2061 cm^{-1} , $\rho(\text{CH}_3)$ 797 cm^{-1}].

(l) 1,2.-Bis(diphenylphosphino)ethane (R = Et) A benzene solution of $(\text{Ph}_3\text{P})_2\text{Ir}(\text{CO})(\text{H})_2\text{GeEt}_3$ (628 mg.) and $\text{Ph}_2\text{PCH}_2\text{CH}_2\text{PPh}_2$ (292 mg.) were stirred for 2 days. The volatiles were removed leaving a green semi-solid. Washing with 60-80° petroleum ether gave a white solid, dihydrido(carbonyl)triethyl-

germyl[1.2.-bis(diphenylphosphino)ethane]iridium(III),

$(\text{Ph}_2\text{PCH}_2\text{CH}_2\text{PPh}_2)\text{Ir}(\text{CO})(\text{H})_2\text{GeEt}_3$, m.p. 196° , 437 mg. 85%] [$\nu(\text{Ir-H})$ $\nu(\text{C}\equiv\text{O})$ (KBr) 1902, 1951 and 2070 cm^{-1} (cyclohexane) 1922, 1969 and 2059 cm^{-1} (Nujol) 1910, 1959 and 2062 cm^{-1}]. Evaporation of the petroleum ether layer left a semi-solid from which sublimation (10^{-6} mm.Hg pressure, 90°) yielded triphenylphosphine [230 mg., 64%].

(m) 2-Hexene (R = Et) The complex (386 mg.) was heated in 2-hexene (5 ml.) for 14 days. Evaporation of the volatiles gave unreacted $(\text{Ph}_3\text{P})_2\text{Ir}(\text{CO})(\text{H})_2\text{GeEt}_3$.

(n) Ethylene (R = Et) The complex (535 mg.) in benzene (8 ml.) was heated at 60° under an atmosphere of ethylene (100 N c.c.). After one hour the colour of the solution had darkened and after one day the volatiles were removed. The volatiles were reacted with bromine, and then fractionated, ethane (8.3 N c.c., 63%) being isolated. The brown residue was recrystallised twice from cyclohexane-benzene to give a buff solid, carbonyl(triethylgermyl)-bis(triphenylphosphine)iridium(I), $(\text{Ph}_3\text{P})_2\text{Ir}(\text{CO})\text{GeEt}_3$, m.p. 152° (d) [$\nu(\text{C}\equiv\text{O})$ (KBr) 1955 cm^{-1} (Nujol) 1957 cm^{-1} (cyclohexane) 1961 cm^{-1} . Found: C, 50.7; H, 4.3%. $\text{C}_{43}\text{H}_{45}\text{GeIrOP}_2$ requires C, 57.1; H, 4.98%].

(o) Ethylene (R = Me) The complex (600 mg.) in benzene (12 ml.) was heated under an atmosphere of ethylene (100 N c.c.) at 60° . The solution slowly darkened and after two days a white solid precipitated out. Work up as above, gave ethane [15.6 N c.c., 100%] and a white solid (recrystallised from benzene), carbonyl(trimethylgermyl)bis(triphenylphosphine)iridium(I),

$(\text{Ph}_3\text{P})_2\text{Ir}(\text{CO})\text{GeMe}_3$, m.p. 116-24^o(d) 510 mg. 84% [$\nu(\text{C}\equiv\text{O})$ (KBr) 1933 cm^{-1} , $\rho(\text{CH}_3)$ 811 cm^{-1} (Nujol) 1936 cm^{-1} . Found: C, 54.5; H, 4.77%. $\text{C}_{40}\text{H}_{39}\text{GeIrOP}_2$ requires C, 55.6; H, 4.52%].

(p) α -Furoyl azide (R = Et) α -Furoyl azide (142 mg.) (prepared from sodium azide and α -furoyl chloride)²⁰⁷ in ether (3 ml.) was added to a solution of $(\text{Ph}_3\text{P})_2\text{Ir}(\text{CO})(\text{H})_2\text{GeEt}_3$ (572 mg.) in ether (10 ml.) and ethanol (0.4 ml.). The solution was stirred for a day, and then refluxed for a further day when the volatiles were removed, giving unreacted α -furoyl azide and $(\text{Ph}_3\text{P})_2\text{Ir}(\text{CO})(\text{H})_2\text{GeEt}_3$.

(q) Mercuric chloride (R = Et) Mercuric chloride (0.7 g.) was added to the complex (500 mg.) in benzene (10 ml.). The orange solution immediately turned yellow-green and a white precipitate began to form after 10 minutes. After 3 hours the volatiles were removed, giving a buff solid. Benzene was distilled from the volatiles, leaving Et_3GeCl (mass and p.m.r. spectral identification). The buff solid was washed several times with benzene and methanol and then recrystallised with a large volume of ethanol to give white dichloro(carbonyl)bis(triphenylphosphine)monochloromercury-iridium(III), $(\text{Ph}_3\text{P})_2\text{Ir}(\text{CO})(\text{HgCl})\text{Cl}_2$, m.p. 276^o 85,84 [$\nu(\text{C}\equiv\text{O})$ (KBr) 2039 cm^{-1}]. Found: C, 40.9; H, 2.66; Cl, 8.33%. $\text{C}_{37}\text{H}_{30}\text{Cl}_3\text{HgIrOP}_2$ requires C, 42.3; H, 2.86; Cl, 10.5%]. The buff residue showed two $\nu(\text{C}\equiv\text{O})$ bands [(KBr) 2002 and 2020 cm^{-1}].

42. The reaction of $(\text{Ph}_3\text{P})_2\text{Ir}(\text{CO})(\text{HgCl})\text{Cl}_2$ with triphenylphosphine⁸⁵

To a suspension of $(\text{Ph}_3\text{P})_2\text{Ir}(\text{CO})(\text{HgCl})\text{Cl}_2$ in benzene was added a large excess of triphenylphosphine. The suspension slowly turned yellow, and

after several hours the suspension was filtered. The filtrate was evaporated down to give a mixture of triphenylphosphine and trans-chloro-(carbonyl)bis(triphenylphosphine)iridium(I), $(\text{Ph}_3\text{P})_2\text{Ir}(\text{CO})\text{Cl}$ [$\nu(\text{C}\equiv\text{O})$ (Nujol) 1950 cm^{-1}].

43. The reaction of $(\text{Ph}_3\text{P})_2\text{Ir}(\text{CO})\text{GeR}_3$ with hydrogen

(a) R = Me Carbonyl(trimethylgermyl)bis(triphenylphosphine)iridium(I) (32 mg.) in benzene (10 ml.) was heated at 40° under one atmosphere of hydrogen (c. 100 N c.c.). After an hour the solution had lightened and the volatiles were removed after a day. The residual solid was identified as dihydrido(carbonyl)trimethylgermylbis(triphenylphosphine)iridium(III), $(\text{Ph}_3\text{P})_2\text{Ir}(\text{CO})(\text{H})_2\text{GeMe}_3$ by infrared and p.m.r. comparison.

(b) R = Et A similar reaction using $(\text{Ph}_3\text{P})_2\text{Ir}(\text{CO})\text{GeEt}_3$ (40 mg.) resulted in the identification of dihydrido(carbonyl)triethylgermylbis(triphenylphosphine)iridium(III), $(\text{Ph}_3\text{P})_2\text{Ir}(\text{CO})(\text{H})_2\text{GeEt}_3$.

44. The preparation of trans-chloronitrogenbis(triphenylphosphine)iridium(I),

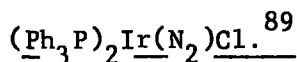

α -Furoyl azide²⁰⁷ (500 mg.) in chloroform (10 ml.) was slowly added over 20 minutes to an ice cooled suspension of $(\text{Ph}_3\text{P})_2\text{Ir}(\text{CO})\text{Cl}$ (1.674 g.) in chloroform (15 ml.) and ethanol (0.4 ml.). The suspension turned dark brown and after 30 minutes, the suspension was filtered into 200 ml. of hexane. The yellow precipitate formed was filtered and washed several times with hexane and then ether to give trans-chloronitrogenbis(triphenylphosphine)-

iridium(I), $(\text{Ph}_3\text{P})_2\text{Ir}(\text{N}_2)\text{Cl}$, 540 mg., 33% [$\nu(\text{N}\equiv\text{N})$ (Nujol) 2096 cm^{-1}].

45. Reaction of $(\text{Ph}_3\text{P})_2\text{Ir}(\text{N}_2)\text{Cl}$ with triethylgermane

Triethylgermane (0.8 ml.) was added to a brown suspension of $(\text{Ph}_3\text{P})_2\text{Ir}(\text{N}_2)\text{Cl}$ (500 mg.)⁸⁹ in benzene (5 ml.) and ether (5 ml.) and stirred at -5° . A gas (presumably nitrogen) was continuously evolved over several hours. The volatiles were removed, triethylchlorgermane and triethylgermane being identified as a residue after distilling off benzene and ether from the volatiles. The residual tacky brown semi-solid was washed with 60-80 $^\circ$ petroleum ether and then recrystallised with benzene to give a golden brown solid m.p. 205 $^\circ$ (d), 170 mg. [$\nu(\text{Ir}-\text{H})$ (KBr) 1957 (1966sh) cm^{-1} , (CHCl_3) 1967 cm^{-1} , $\nu(\text{Ir}-\text{Cl})$ absent. P.m.r. spectrum: Et_3Ge , multiplet, $\tau = 8.94$. Ratio $\text{Ph}_3\text{P}:\text{Et}_3\text{Ge} = 2:1$. Found: C, 50.53; H, 4.40; Cl, 6.87; P, 5.76; N, 1.03%].

46. Reactions of $\text{Ph}_3\text{P}(\text{CO})\text{Ir}(\text{H})(\text{Cl})\text{GePh}_3 \cdot \frac{1}{2}(\text{C}_6\text{H}_{12})$

(a) Sodium Iodide A suspension of sodium iodide (1.1 g.) and $\text{Ph}_3\text{P}(\text{CO})\text{Ir}(\text{H})(\text{Cl})\text{GePh}_3 \cdot \frac{1}{2}(\text{C}_6\text{H}_{12})$ (584 mg.) in acetone (5 ml.) was refluxed for 30 minutes and then stirred for 12 hours. The volatiles were removed and the residue extracted with benzene. The benzene soluble material was recrystallised from a 60-80 $^\circ$ petroleum ether-benzene mixture to give unsolvated hydridochloro(carbonyl)triphenylgermylmono(triphenylphosphine)-iridium(III), $\text{Ph}_3\text{P}(\text{CO})\text{Ir}(\text{H})(\text{Cl})\text{GePh}_3$ m.p. 205 $^\circ$ [Found: C, 54.5; H, 3.70%. $\text{C}_{37}\text{H}_{31}\text{ClGeIrOP}$ requires C, 54.1; H, 3.77%].

(b) Triethylphosphine. Triethylphosphine (0.5 ml., 400 mg.) was added to a solution of $\text{Ph}_3\text{P}(\text{CO})\text{Ir}(\text{H})(\text{Cl})\text{GePh}_3 \cdot \frac{1}{2}(\text{C}_6\text{H}_{12})$ (476 mg.) in benzene (5 ml.). After 12 hours, the volatiles were removed and the residual semi-solid washed with hot 60-80° petroleum ether, leaving only unreacted $\text{Ph}_3\text{P}(\text{CO})\text{Ir}(\text{H})(\text{Cl})\text{GePh}_3$.

Experimental Methods

Nitrogen. All operations, unless stated otherwise, were carried out in an atmosphere of dry, oxygen-free nitrogen. Purification was effected by passing commercial nitrogen through copper turnings at 400° to remove oxygen and then through a molecular sieve column to remove water. In addition, the nitrogen was then passed through a spiral trap at -196° .

Solvents. Benzene, toluene, petroleum ether, ether and cyclohexane were dried by standing over sodium wire for a week. Acetone was dried using molecular sieve.

Analyses were carried out either in the microanalytical laboratory in this department or by Drs. Weiler and Strauss, Banbury Road, Oxford.

Infrared Spectra in the region $2.5-25\mu$ were recorded on a Grubb-Parsons Spectromaster or G.S.2A. Spectrophotometer. Solids were examined as pressed discs in KBr or as Nujol mulls. A Grubb-Parsons DM2 spectrophotometer was used to examine the region $20-50\mu$, solids being examined as Nujol mulls between polythene protected CsI plates.

Proton Magnetic Resonance spectra were recorded, usually in benzene or deuterobenzene on a Perkin-Elmer R10 spectrometer. Benzene ($\tau = 2.82$) was used as internal standard.

Mass spectra were recorded on an A.E.I. MS9 instrument.

Molecular weights were measured on a Mechrolab Osmometer using acetone or benzene solutions. All measurements were made at 37°, and triphenylphosphine or biphenyl were used as standards.

Preparation of Starting Materials. Most starting materials were available in the department or prepared by literature methods, e.g. trimethylgermane, triethylgermane, triphenylgermyl-lithium²¹⁰ and triphenylphosphinegold(I) chloride.²¹¹

Preparation of Trichlorogermyl-caesium.²⁰¹ To H₃PO₂ (23.3 g.) and 3M hydrochloric acid (60 ml.) stirring in a 1000 ml. beaker was added germanium tetrachloride, GeCl₄, (9.4 g., 5.1 ml.). The solution was heated to 85° for 5 hours, then allowed to cool to 50° whereupon caesium iodide (11.9 g.) was added. The caesium iodide dissolved momentarily before a fluffy white precipitate formed. Filtration gave white trichlorogermyl-lithium, (11.2 g., 78%).

Preparation of α furoyl azide.²⁰⁷ To a solution of α furoyl chloride (1 ml.) in acetone (2.5 ml.) was added a solution of sodium azide (0.5 g.) in water (5 ml.). The whole was vigorously stirred, and a white solid gradually formed. Water was added to precipitate out α furoyl azide, which was then filtered and washed several times, (0.93 g. $\nu(\text{N}\equiv\text{N})$ (KBr) 2136 cm⁻¹).

Appendix A

Hydrogenation of organogermanes and organodigermanes

Chronologically the first section of this thesis was the attempted hydrogenolysis of tetraphenylgermane and hexabenzylidigermane. It has been found that tetraphenylsilane, Ph_4Si , is hydrogenated to tetracyclohexylsilane, $(\text{C}_6\text{H}_{11})_4\text{Si}$ using a commercial Nickel or Raney nickel catalysts in high yields. ^{214,215,216}

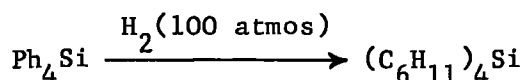

Surprisingly a similar reaction on tetraphenylgermane produced only a small percentage of an unidentified oil, whilst the corresponding stannanes and plumbanes showed no reaction at all.

It was hoped to find a route from tetraorganogermanes to triorganogermanes in a one stage route.

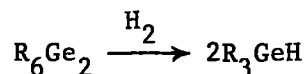
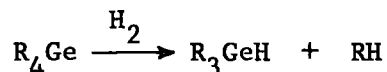

instead of

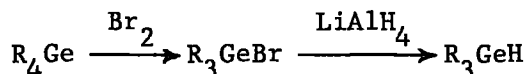

However in three reactions tried on Ph_4Ge and hexabenzylidigermane with different catalysts, starting materials were recovered (>80%) together with small amounts of oils which showed no $\nu\text{Ge-H}$ bands but aliphatic $\nu\text{C-H}$ in their infrared spectra.

Experimental

1. Tetraphenylgermane (2.6 g.), palladium black (0.2 g.) was shaken in methanol (20 ml.) under a hydrogen pressure of 400 atmospheres at 300° for a day. Removal of solvent gave a green oil, which was washed with hexane to give an indistinct oil, leaving unreacted Ph_4Ge (2.4 g.).

2. Hexabenzylidigermane (1.0 g.), palladium black (0.1 g.) was shaken in benzene (50 ml.) under hydrogen (430 atmos) at 300° for 3 days.

Work up as above gave an indistinct oil and unchanged digermane.

3. Hexabenzylidigermane (0.6 g.), lithium aluminium hydride (0.08 g.) in diethylether (30 ml.) were shaken under hydrogen (360 atmos) at 200° for a day. The mixture was hydrolysed and evaporation of the ether part gave unchanged hexabenzylidigermane (0.5 g.).

Appendix B

Recovery of Iridium

Iridium residues, largely on paper, were digested with concentrated sulphuric acid. Organic matter was oxidised by cautious addition of concentrated nitric acid until brown fumes were no longer evolved. The dark brown suspension was filtered through a sinter funnel, the residue being well washed with water and then acetone. The residual grey solid was heated to 800° to ignite remaining organic material, to give a residue of grey-black iridium metal.

Preparation of $(\text{NH}_4)_2\text{IrCl}_6$.²¹⁷

Chlorine gas was passed over an intimate mixture of crude iridium (3.0 g.) and sodium chloride (6.5 g.) heated to c 625° for 30 minutes. The melt was transferred to a 100 ml. beaker with boiling water (20 ml.), and boiled to dissolve all soluble matter. Filtration gave a dark solution which was then boiled with aqua regia (10 ml.) to oxidise any iridium(III) complexes present to Ir(IV). NH_4Cl (4.0 g.) in boiling water (10 ml.) was added to the dark red solution. The solution turned green and on cooling black crystals separated, which were filtered and washed with portions of 20% NH_4Cl (20 ml.), 95% ethanol (20 ml.) and then diethylether (30 ml.) to give $(\text{NH}_4)_2\text{IrCl}_6$ (2.0 g., 30%).

Iridium Trichloride

It was found impossible to use a sample of iridium trichloride for any

preparations. The complex was completely insoluble in water, alcohols or aqua regia. Iridium trichloride and sodium chloride did not fuse at 650° in a stream of chlorine.

References

1. H.B. Gray and J.H. Waters, J. Amer. Chem. Soc. 1965, 87, 3534.
- 1a. G. Booth, Adv. Inorg. Chem. Radiochem. 1964, 6, 1.
2. W. Schweckendiek, Chem. Abstr. 1958, 52, 9193.
3. R.S. Nyholm, J. Chem. Soc. 1952, 1257.
4. F.G. Mann, D. Purdie and A.F. Wells, J. Chem. Soc. 1936, 1503.
5. R.C. Cass, G.E. Coates and R.G. Hayter, J. Chem. Soc. 1955, 4007.
6. F.A. Cotton and D.M.L. Goodgame, J. Chem. Soc. 1960, 5267.
7. A. Kabesh and R.S. Nyholm, J. Chem. Soc. 1951, 38.
8. W. Cochran, F.A. Hart and F.G. Mann, J. Chem. Soc. 1957, 2816.
9. F. Cariati and L. Naldini, Gazz. Chim. It. 1965, 95, 3.
10. F. Cariati and L. Naldini, Gazz. Chim. It. 1965, 95, 201.
11. F.G. Mann, A.F. Wells and D. Purdie, J. Chem. Soc. 1937, 1828.
12. G.J. Burrows and R.H. Parker, J. Amer. Chem. Soc. 1933, 55, 4133.
13. M. Levi-Malvano, Atti. Accad. Lincei. 1908, 17, 847.
Chem. Abstr. 1910, 43068.
14. R.C. Cass, G.E. Coates and R.G. Hayter, Chem. and Ind. 1954, 1485.
15. L. Malatesta, L. Naldini, G. Simonetta and F. Cariati, Co-ordination
Chem. Rev. 1966, 1, 255.
16. F.G. Mann and D. Purdie, J. Chem. Soc. 1940, 1235.
17. C.E. Wymore and J.C. Bailar, J. Inorg. Nuclear Chem. 1960, 14, 42.
18. C.M. Harris and R.S. Nyholm, J. Chem. Soc. 1957, 63.

19. L. Naldini, F. Cariati, G. Simonetta and L. Malatesta, Chem. Comm. 1966, 647.
20. B. Siegel, J. Chem. Educ. 1961, 38, 496.
21. A. Wurtz, Compt. rend. 1844, 18, 702.
22. W. Feitknecht and J.C. Warf, Helv. Chim. Acta. 1950, 33, 613.
23. H. Neumann and E. Wiberg, Inorg. Nuclear Chem. Letters. 1965, 1, 35.
24. F. Cariati and L. Naldini, J. Inorg. Nuclear Chem. 1966, 28, 2243.
25. M.G. Bertrand, Compt. rend. 1923, 177, 997.
26. N-D. Zelinski, Compt. rend. 1923, 177, 1041.
27. W.A. Jones, J. Amer. Chem. Soc. 1899, 22, 287.
28. P.L. Robinson and K.R. Stainthorpe, Nature. 1944, 153, 24.
29. Von. R. Nast and C.L. Schultze, Z. anorg. Chem. 1961, 307, 15.
30. W. Manchot, J. König and H. Gall, Ber. 1924, 57, 1157.
31. W. Manchot and J. König, Ber. 1927, 60, 2183.
32. W. Manchot and H. Gall, Ber. 1925, 58, 2175.
33. H.S. Isbell and M.S. Kharasch, J. Amer. Chem. Soc. 1930, 52, 2919.
34. G. Calvin, Ph.D. Thesis, University of Durham.
35. H. Gilman, R.G. Jones and L.A. Woods, J. Org. Chem. 1952, 17, 1630.
36. C.E.H. Bawn and F.J. Whitby, Discuss. Faraday Soc. 1947, 2, 228.
37. D.T. Hund and E.G. Rochow, J. Amer. Chem. Soc. 1945, 67, 1057.
38. R. Reich, Compt. rend. 1923, 177, 322.
39. T.S. Piper and G. Wilkinson, J. Inorg. Nuclear Chem. 1956, 2, 32.
40. L. Riccoboni and G. Semerano, Ber. 1941, 74, 1089.

41. H. Gilman and J.M. Straley, *Rec. Trav. chim.* 1936, 55, 821.
42. H. Gilman and L.A. Woods, *J. Amer. Chem. Soc.* 1948, 70, 550.
43. G.E. Coates and C. Parkin, *J. Chem. Soc.* 1963, 421.
44. M. Berthelot, *Ann. Chim. Phys.* 1901, 23, 32.
45. A.C. Cope and L.L. Estes, *J. Amer. Chem. Soc.* 1950, 72, 1128.
46. A.J. Chalk, *J. Amer. Chem. Soc.* 1964, 86, 4733.
47. R. Hüttel, U. Raffay and H. Reinheimer, *Angew. Chem. Internat. Edn.* 1967, 6, 862.
48. G.E. Coates and C. Parkin, *J. Chem. Soc.* 1962, 3220.
49. G.E. Coates and C. Parkin, *J. Inorg. Nuclear Chem.* 1961, 22, 59.
50. D. Blake, G. Calvin and G.E. Coates, *Proc. Chem. Soc.* 1959, 396.
51. L. Malasta, *Helv. Chim. Acta.*, Werner Commemorative Volume. 1967, 147.
52. J.P. Collman and W.R. Roper, *Adv. Organometallic Chem.* 1968, 7, 54.
53. G. Wilkinson, *Plat. Metal. Rev.* 1968, 12, 50.
54. M.L.H. Green and D. Jones, *Adv. Inorg. Chem. Radiochem.* 1965, 7, 115.
55. J.W. DiLuzio and L. Vaska, *J. Amer. Chem. Soc.* 1961, 83, 2784.
56. M. Angoletta, *Gazz. Chim. It.* 1959, 89, 2359.
57. L. Vaska, *J. Amer. Chem. Soc.* 1961, 83, 756.
58. W. Hieber and V. Frey, *Ber.* 1966, 99, 2607.
59. J. Chatt, N.P. Johnson and B.L. Shaw, *J. Chem. Soc.(A)*. 1967, 604.
60. A.J. Deeming and B.L. Shaw, *J. Chem. Soc.(A)*. 1968, 1887.
61. J.P. Collman and Jung W. Kang, *J. Amer. Chem. Soc.* 1967, 89, 844.
62. L. Vaska, *Science.* 1963, 140, 809.

63. L. Vaska. Proceedings of the 9th Internat. Conf. on Co-ord. Chem.
p.332.
64. Pwen Boon Chock and J. Halpern, J. Amer. Chem. Soc. 1966, 88, 3511.
65. J.A. Ibers and S.J. La Placa, Science. 1964, 145, 920.
66. J.A. Ibers and S.J. La Placa, J. Amer. Chem. Soc. 1965, 87, 2581.
67. J.A. Ibers and S.J. La Placa. Proceedings of the 8th Internat. Conf.
on Co-ord. Chem. p.95.
68. J.A. McGinnety, R.J. Doedens and J.A. Ibers, Science. 1967, 155, 709.
69. J.A. McGinnety, R.J. Doedens and J.A. Ibers, Inorg. Chem. 1967, 6, 2243.
70. J.W. DiLuzio and L. Vaska, J. Amer. Chem. Soc. 1962, 84, 679.
71. L. Vaska. Proceedings of the 8th Internat. Conf. on Co-ord. Chem.
p.99.
72. R.E. Rhodes and L. Vaska. J. Amer. Chem. Soc. 1965, 87, 4970.
73. L. Vaska, Science. 1966, 152, 769.
74. S.S. Bath and L. Vaska, J. Amer. Chem. Soc. 1966, 88, 1333.
75. J.A. Ibers and S.J. La Placa, Inorg. Chem. 1966, 5, 405.
76. L. Vaska, J. Amer. Chem. Soc. 1966, 88, 5325.
77. M.A. Bennett, R.J.H. Clark and D.J. Milner, Inorg. Chem. 1967, 6, 1647.
78. J.P. Collman and C.T. Sears Jr. Inorg. Chem. 1968, 7, 27.
- 78a. A.J. Deeming and B.L. Shaw, J. Chem. Soc.(A). 1968, 1128.
79. L. Vaska, Chem. Comm. 1966, 614.
80. A.J. Deeming and B.L. Shaw, Chem. Comm. 1968, 751.
81. L. Vaska and D.L. Catone, J. Amer. Chem. Soc. 1966, 88, 5324.

82. C.F. Nobile, M. Rossi and A. Sacco, Chem. Comm. 1966, 589.
83. J.A.J. Jarvis, R.H.B. Mais, P.G. Owston and K.A. Taylor, Chem. Comm. 1966, 906.
84. R.S. Nyholm and K. Vrieze, Chem. and Ind. 1964, 318.
85. R.S. Nyholm and K. Vrieze, J. Chem. Soc. 1965, 5337.
86. D.J. Hodgson, N.C. Payne, J.A. McGinnety, R.G. Pearson and J.A. Ibers, J. Amer. Chem. Soc., 1968, 90, 4486.
87. J.P. Collman and Jung Wong Kang, J. Amer. Chem. Soc. 1966, 88, 3459.
88. J.P. Collman, M. Kubota, F.D. Vastine, J.Y. Sun and Jung Wong Kang, J. Amer. Chem. Soc. 1968, 90, 5430.
89. J.P. Collman, M. Kubota, Jui-Yuan Sun and F. Vastine, J. Amer. Chem. Soc. 1967, 89, 169.
90. S.S. Bath and L. Vaska, J. Amer. Chem. Soc. 1963, 85, 3500.
91. R. Cramer and G.W. Parshall, J. Amer. Chem. Soc. 1965, 87, 1392.
92. F.N. Jones and G.W. Parshall, J. Amer. Chem. Soc. 1965, 87, 5356.
93. H. Singer and G. Wilkinson, J. Chem.Soc.(A), 1968, 2516.
94. B.R. James and N.A. Memon, Canad.J. Chem. 1968, 46, 217.
95. J. Chatt, L.A. Duncanson and L.M. Venanzi, J. Chem. Soc. 1955, 4456.
96. F. Basolo and R.G. Pearson, Progr. Inorg. Chem. 1962, 4, 381.
97. M. Peyrone, Ann. Chem. Liebigs. 1845, 51, 15.
98. J. Reiset, Compt. rend. 1844, 18, 1103.
99. A. Pidcock, R.E. Richards and L.M. Venanzi, J. Chem. Soc.(A). 1966, 1707.

100. J. Chatt, G.A. Gamlen and L.E. Orgel, J. Chem. Soc. 1958, 486.
101. L.E. Orgel, J. Inorg. Nuclear Chem. 1956, 2, 137.
102. L.M. Venanzi, Chem. in Britain. 1968, 4, 162.
103. H.B. Gray and C. Langford, Ligand Substitution Processes
(Benjamin, New York, 1966).
104. R. McWeeny, R. Mason and A.D.C. Towl, Discuss. Faraday Soc. Cambridge
1969.
105. J. Chatt, R.S. Coffey and B.L. Shaw, J. Chem. Soc. 1965, 7391.
106. J. Chatt, N.P. Johnson and B.L. Shaw, J. Chem. Soc. 1964, 1625.
107. J.M. Jenkins and B.L. Shaw, J. Chem. Soc. 1965, 6789.
108. J. Powell and B.L. Shaw, J. Chem. Soc.(A). 1968, 617.
109. D.M. Adams, Proc. Chem. Soc. 1961, 431.
110. L. Vaska, J. Amer. Chem. Soc. 1966, 88, 4100.
111. J.M. Jenkins and B.L. Shaw, Proc. Chem. Soc. 1963, 279.
112. J.M. Jenkins, M.S. Lupin, B.L. Shaw and A.C. Smithies, Proceedings
of the 9th Internat. Conf. on Co-ord. Chem. p.346.
113. J.M. Jenkins and B.L. Shaw, J. Chem. Soc.(A). 1966, 1407.
114. B.L. Shaw and A.C. Smithies, J. Chem. Soc.(A). 1967, 1047.
115. G.W. Parshall, J. Amer. Chem. Soc. 1965, 87, 2133.
116. R.J. Kane, Phil. Mag. 1835, 7, 399.
117. J.F. Young, Adv. Inorg. Chem. Radiochem. 1968, 11, 92.
118. B.J. Aylett, Adv. Inorg. Chem. Radiochem. 1968, 11, 295.
119. F. Glockling. The Chemistry of Germanium,(Academic Press, 1969)
120. N.S. Vyazankin, G.A. Razuvaev and O.A. Kruglaya, Organometallic
Chem. Rev. 1968, 3, 323.

121. J.D. Cotton, S.A.R. Knox and F.G.A. Stone, Chem. Comm. 1967, 965.
122. A. Carrick and F. Glockling, J. Chem.Soc.(A). 1968, 913.
123. A.N. Nesmeyanov, K.N. Anisimov, N.E. Kolobova and A.B. Antonova,
Chem. Abs. 1968, 68, 69099.
124. E. Hengge and H. Zimmermann, Angew. Chem. Internat. Edn. 1968, 2, 142.
125. M.C. Baird, J. Inorg. Nuclear Chem. 1967, 29, 367.
126. R.J. Cross and F. Glockling, Proc. Chem. Soc. 1964, 143.
127. A.N. Nesmeyanov, K.N. Anisimov, N.E. Kolobova and M. Ya. Zakharova,
Chem. Abs. 1968, 68, 78386.
128. Y.L. Baay and A.G. MacDiarmid, Inorg. Nuclear Chem. Letters. 1967,
3, 159.
129. A.J. Chalk and J.F. Harrod, J. Amer. Chem. Soc. 1967, 89, 1640.
130. J. Chatt, C. Eaborn, S. Ibekwe and P.N. Kapoor, Chem. Comm. 1967, 689.
131. A.G. Massey, A.J. Park and F.G.A. Stone, J. Amer. Chem. Soc. 1963, 85,
2021.
132. D.J. Patmore and W.A.G. Graham, Inorg. Chem. 1966, 5, 1405.
133. F. Bonati, S. Cenini, D. Morelli and R. Ugo, J. Chem. Soc.(A).
1966, 1052.
134. M. van den Akker and F. Jellinek, J. Organometallic Chem. 1967, 10, p37.
135. P.A. McArdle and A.R. Manning, Chem. Comm. 1967, 417.
136. J.F. Young, R.D. Gillard and G. Wilkinson, J. Chem. Soc. 1964, 5176.
137. A.R. Manning, Chem. Comm. 1966, 906.
138. R.K. Pomeroy, M. Elder, D. Hall and W.A.G. Graham, Chem. Comm.
1969, 381.

139. R.C. Edmondson and M.J. Newlands, Chem. and Ind. 1966, 1888.
140. G. Deganello, G. Carturan and P. Uguagliati, J. Organometallic Chem. 1969, 17, 179.
141. F. Glockling and K.A. Hooton, Chem. Comm. 1966, 218.
142. D.J. Cardin and M.F. Lappert, Chem. Comm. 1966, 506.
143. R.N. Haszeldine, R.V. Parish and D.J. Parry, J. Organometallic Chem. 1967, 9, p.13.
144. F. de Charentenay, J.A. Osborn and G. Wilkinson, J. Chem. Soc. 1968, 787.
145. R.N. Haszeldine, R.V. Parish and D.J. Parry, J. Chem. Soc.(A). 1969, 683.
146. A.J. Chalk and J.F. Harrod, J. Amer. Chem. Soc. 1965, 87, 16.
147. M.F. Lappert and N.F. Travers, Chem. Comm. 1968, 1569.
148. A.J. Layton, R.S. Nyholm, C.A. Pneumaticakis and M.L. Tobe, Chem. and Ind. 1967, 445.
149. J. Chatt, C. Eaborn and P.N. Kapoor, J. Organometallic Chem. 1968, 13, p.21.
150. W. Hieber, O. Vohler and G. Brawn, Z. Naturforsch. 1958, 13b, 192.
151. R.J. Cross and F. Glockling, J. Chem.Soc. 1965, 5422.
152. E.H. Brooks and F. Glockling, Chem. Comm. 1965, 510.
153. E.H. Brooks and F. Glockling, J. Chem. Soc. 1966, 1241.
154. J. Chatt and B.L. Shaw, J. Chem. Soc. 1959, 705.
155. G. Calvin and G.E. Coates, J. Chem. Soc. 1960, 2008.

156. H.R.H. Patel and W.A.G. Graham, Inorg. Chem. 1966, 5, 1401.
157. F. Glockling and K.A. Hooton, J. Chem. Soc. 1962, 2658.
158. J.A. Dilts and M.P. Johnson, Inorg. Chem. 1966, 5, 2079.
159. R.D. Gorsich, J. Amer. Chem. Soc. 1962, 84, 2486.
160. N. Flitcroft, D.A. Harbourne, I. Paul, F.G.A. Stone and P.M. Tucker, J. Chem. Soc.(A). 1966, 1130.
161. T.S. Piper, D. Lemal and G. Wilkinson, Naturwiss. 1956, 43, 129.
162. D.J. Patmore and W.A.G. Graham, Inorg. Chem. 1967, 6, 981.
163. J.A.J. Thompson and W.A.G. Graham, Inorg. Chem. 1967, 6, 1875.
164. S.F.A. Kettle and I.A. Khan, Proc. Chem. Soc. 1962, 82.
165. D.J. Patmore and W.A.G. Graham, Inorg. Chem. 1966, 5, 2222.
166. O. Khan and M. Bigorgne, Compt. rend. 1966, 262C, 906.
167. E.H. Brooks, R.J. Cross and F. Glockling, Inorg. Chim. Acta. 1968, 2, 17.
168. R. Kummer and W.A.G. Graham, Inorg. Chem. 1968, 17, 1208.
169. H.P. Weber and R.F. Bryan, Chem. Comm. 1966, 443.
170. R.F. Bryan, Proc. Chem. Soc. 1964, 232.
171. R.F. Bryan, J. Chem. Soc.(A). 1967, 172.
172. B.T. Kilbourn and H.M. Powell, Chem. and Ind. 1964, 1578.
173. R.F. Bryan, Chem. Comm. 1967, 355.
174. B.P. Bir'yukov, Y.U.T. Struchkov, K.N. Anisimov, N.E. Kolobova and V.U. Skripkin, Chem. Comm. 1968, 1193.
175. B.P. Bir'yukov et al. Chem. Comm. 1967, 750.
176. B.P. Bir'yukov et al. Chem. Comm. 1968, 159.

177. J.E. O'Connor and E.R. Corey, *Inorg. Chem.* 1967, 6, 968.
178. G. Deganello, G. Carturan and U. Belluco, *J. Chem. Soc.(A)*. 1968, 2873.
179. D.J. Cardin, S.A. Keppie, B.M. Kingston and M.F. Lappert, *Chem. Comm.* 1967, 1035.
180. F. Glockling and K.A. Hooton, *J. Chem. Soc.(A)*. 1968, 823.
181. K.A. Hooton, *J. Chem. Soc.(A)*. 1969, 680.
182. J. Chatt and B.L. Shaw, *J. Chem. Soc.* 1962, 5075.
183. J. Chatt, C. Eaborn and S. Ibekwe, *Chem. Comm.* 1966, 700.
184. F. Glockling and K.A. Hooton, *J. Chem. Soc.(A)*. 1967, 1066.
185. G. Carturan, G. Deganello, T. Boschi and U. Belluco, *J. Chem. Soc.(A)*. 1969, 1142.
186. F. Bonati and G. Wilkinson, *J. Chem. Soc.* 1964, 179.
187. J.E. Bentham, S. Cradock and E.A.V. Ebsworth, *Chem. Comm.* 1969, 528.
188. R.D. Cramer, E.L. Jenner, R.V. Lindsey Jr., and U.G. Stolberg, *J. Amer. Chem. Soc.* 1963, 85, 1691.
189. R.V. Lindsey Jr., G.W. Parshall and U.G. Stolberg, *J. Amer. Chem. Soc.* 1965, 87, 658.
190. J.W. Ryan and J.L. Speier, *J. Amer. Chem. Soc.* 1964, 86, 895.
191. J.L. Speier, J.A. Webster and G.H. Baines, *J. Amer. Chem. Soc.* 1957, 79, 974.
192. J.C. Bailar and H. Itatani, *J. Amer. Oil Chemists' Soc.* 1967, 44, 147.
193. G.E. Coates. *Organometallic Compounds (2nd Edition)* p.348.
194. D.H. Whiffen, *J. Chem. Soc.* 1956, 1350.

195. J.P. Collman, F.D. Vastine and W.R. Roper, J. Amer. Chem. Soc. 1968, 90, 2282.
196. J.P. Collman, F.D. Vastine and W.R. Roper, J. Amer. Chem. Soc. 1966, 88, 5035.
197. R. Craig Taylor, J.F. Young and G. Wilkinson, Inorg. Chem. 1966, 5, 20.
198. A.F. Clemmit and F. Glockling, J. Chem. Soc. (in the press).
199. K.A. Hooton. Private Communication.
200. M.L. Schneider and H.M.M. Shearer. Unpublished Observations.
201. P.S. Poskozim, J. Organometal. Chem. 1968, 12, 115.
202. J.F. Harrod, D.F.R. Gibson and R. Charles, Canad. J. Chem. 1969, 47, 1431.
203. L. Malatesta, G. Caglio and M. Angoletta, J. Chem. Soc. 1965, 6974.
204. G. Yagupsky and G. Wilkinson, J. Chem. Soc.(A). 1969, 725.
205. S.J. LaPlace and J.A. Ibers, Acta. Cryst. 1965, 18, 511.
206. P.R. Brookes and B.L. Shaw, Chem. Comm. 1968, 919.
207. P.A. Smith. Org. Reactions. 19 , 3, 373.
208. J.A. Osborn, F.H. Jardine, J.F. Young and G. Wilkinson, J.Chem.Soc.(A). 1966, 1711.
209. F. Feigl, Spot Tests p.60.
210. E.H. Brooks, Ph.D. Thesis, University of Durham.
211. P.S. Dixon, Ph.D. Thesis, University of Durham.
212. M. Angoletta and A. Araneo, Gazz. Chim. It. 1963, 93, 1343.

213. W.A. Dutton, C. Eaborn, F. Glockling and K.A. Hooton, J. Organometallic Chem. 1967, 9, 175.
214. G.R. Buell, C.W. Harris and L. Spialter, J. Org. Chem. 1965, 30, 375.
215. V.N. Ipatiev and B.N. Dolgov, Ber. 1929, 62, 1220.
216. H. Adkins and H.R. Billica, J. Amer. Chem. Soc. 1948, 70, 695.
217. G.B. Kauffmann and L.A. Teter, Inorg. Synth. 8, 223.

