



Durham E-Theses

The comparative biology of terns, sterna spp

Langham, N. P. E.

How to cite:

Langham, N. P. E. (1968) *The comparative biology of terns, sterna spp*, Durham theses, Durham University. Available at Durham E-Theses Online: <http://etheses.dur.ac.uk/8606/>

Use policy

The full-text may be used and/or reproduced, and given to third parties in any format or medium, without prior permission or charge, for personal research or study, educational, or not-for-profit purposes provided that:

- a full bibliographic reference is made to the original source
- a [link](#) is made to the metadata record in Durham E-Theses
- the full-text is not changed in any way

The full-text must not be sold in any format or medium without the formal permission of the copyright holders.

Please consult the [full Durham E-Theses policy](#) for further details.

THE COMPARATIVE BIOLOGY OF TERNS, STERNA spp.

N.P.E. Langham, B.Sc. (Dunelm)

Grey College

being a thesis presented in candidature for
the degree of Doctor of Philosophy in the
University of Durham, 1968

The copyright of this thesis rests with the author.
No quotation from it should be published without
his prior written consent and information derived
from it should be acknowledged.



CONTENTS

	Page
INTRODUCTION	1
THE STUDY AREA	7
NEST SITE PREFERENCES	12
OCCUPATION BY BLACK-HEADED GULLS AND TERNS : OCCUPATION AND SPECIES ASSOCIATION	18
LAYING	26
SANDWICH TERN	27
COMMON TERN	29
ARCTIC TERN	30
ROSEATE TERN	31
DURATION OF LAYING	31
ANNUAL VARIATION IN LAYING	35
SYNCHRONISATION OF LAYING	38
CLUTCH SIZE	44
CLUTCH SIZE VARIATION WITH LATITUDE	47
COMMON TERN	48
ARCTIC TERN	49
ROSEATE TERN	50
SANDWICH TERN	51
CLUTCH SIZE VARIATION WITH SEASON	51
COMMON TERN	52
ARCTIC TERN	54
ROSEATE TERN	55
SANDWICH TERN	56

	Page
THE INTER-RELATION OF SUN AND WIND ON THE WEIGHT INCREASE OF COMMON TERN CHICKS	121
THE INTER-RELATION OF WIND AND RAIN	123
THE EFFECT OF WEATHER ON THE GROWTH RATE OF ARCTIC TERN CHICKS	125
THE INTER-RELATION OF SUN AND WIND	126
THE INTER-RELATION OF RAIN AND WIND	126
THE EFFECT OF WEATHER ON THE GROWTH RATE OF ROSEATE TERN CHICKS	129
THE INTER-RELATION OF WIND AND SUN	129
THE INTER-RELATION OF WIND AND RAIN	130
COMPARISON OF THE EFFECT OF WEATHER ON THE GROWTH RATE OF TERN CHICKS	131
THE EFFECT OF WIND SPEED	131
THE EFFECT OF RAIN	134
THE EFFECT OF SUNSHINE	136
CONCLUSION	139
THE FOOD OF TERNS	146
SIZE OF FISH TAKEN BY EACH SPECIES	158
THE FISHING AREA DURING THE BREEDING SEASON	165
DIURNAL ACTIVITY WITH RESPECT TO FEEDING OF THE CHICKS ...	173
ADULT TERN WEIGHTS AND MEASUREMENTS	176
SEASONAL MOVEMENTS OF TERNS	179
METHODS	180
LOCATION OF RECOVERIES	182
RECOVERIES USED IN THE ANALYSIS	184
COMMON TERN : DISPERSAL	186
MIGRATION	188

	Page
ARCTIC TERN : DISPERSAL	191
MIGRATION	193
ROSEATE TERN : DISPERSAL	198
MIGRATION	199
SANDWICH TERN : DISPERSAL	200
MIGRATION	203
COMPARISON OF THE MOVEMENTS OF THE FOUR SPECIES : DISPERSAL	213
MIGRATION : THE FIRST AUTUMN	215
THE SECOND "SUMMER"	217
THE THIRD "SUMMER"	217
THE FOURTH AND SUBSEQUENT "SUMMERS"	218
DISCUSSION : (a) COLONIAL BREEDING AND SYNCHRONISATION	220
(b) COMPETITION AND CLOSELY RELATED SPECIES	233
SUMMARY	25
APPENDIX 1. SANDWICH TERN SUBCOLONIES IN THREE YEARS ON COQUET ISLAND ..	261
APPENDIX 2a. CLUTCH SIZE VARIATION IN SANDWICH TERN SUBCOLONIES IN 1965	262
2b. " " " " " 1966	263
2c. " " " " " 1967	264
APPENDIX 3. SUBCOLONY SIZE AND HATCHING SUCCESS IN THE SANDWICH TERN.	266
APPENDIX 4. AVERAGE GROWTH RATE OF COMMON TERN CHICKS WITH BROOD SIZE AND ORDER OF HATCHING	267
APPENDIX 5. WEIGHT INCREASES OF FIRST AND SECOND CHICKS OF BROODS OF TWO AND THREE	268

	Page
APPENDIX 6. DAILY WEIGHT INCREASES (a) COMMON TERN	269
(b) ARCTIC TERN	270
(c) ROSEATE TERN	271
APPENDIX 7. THE ORIGIN OF RINGED TERNS SEEN ON COQUET ISLAND IN 1965, 1966 and 1967 ...	272
APPENDIX 8. SANDWICH TERN EGGS.	273
REFERENCES	

ACKNOWLEDGMENTS

I would like to acknowledge the encouragement and help given by Dr. J.C. Coulson throughout this work. I am grateful to Professor D. Barker for the facilities available in the Zoology Department, University of Durham.

Also, I am indebted to J. Adam, N. Januszewicz and Miss Ella Oøsterkamp for translating certain papers, to Mr. Gill and J. Tinnion who gave valuable assistance with field work in 1966 and 1967 respectively, and Mrs. J. Horobin who allowed me to use her results of the effect of weather on the feeding of the Arctic Tern on the Farne Islands in 1965 and 1967.

I would like to thank Mrs. R. Reed for showing much patience and diligence in the typing of this thesis.

The Ringing Committee of the British Trust for Ornithology allowed me to use the ringing recoveries of terns.

J. Matthews and his sons, at Amble, provided transport to and from Coquet Island on many occasions, and members of 202 Squadron, R.A.F. Acklington, did the same in rough weather. The Duke of Northumberland and the Elder Brethren of Trinity House allowed me to work on Coquet Island, and the lighthouse keepers extended many facilities to make my stay more comfortable.

Finally, I would like to thank my parents for helping me to pursue my interest in wildlife which led to this research.

INTRODUCTION

The principal object of this present study was to examine and compare the biology of four species of terns occurring in the same geographical region, and often in close proximity. Since all four species, the Sandwich Tern, Sterna sandvicensis Lath., Roseate Tern, S.dougallii Mont., Common Tern, S.hirundo L., and the Arctic Tern, S.paradisaea (= macrura) Brünn,* bred on the same island, it was possible to study their breeding biology simultaneously. This occurrence ensured that environmental factors were similar, giving specific comparisons greater validity. In addition, post-fledging dispersal and migration in the four species was examined from ringing recoveries.

Darwin (1859) realised the importance of competition in the evolution of species through natural selection; and in more recent times its evolutionary significance has been stressed by Lack (1966) and Mayr (1963). Darwin emphasised the struggle for existence, but Mayr has pointed out that it is erroneous to assume that because there is no physical combat there is no competition. However, whilst realising the importance of natural selection, Birch & Ehrlich (1967) have expressed grave doubts as to the value of evolutionary ecology in interpreting present situations. They consider that such ecological theory is necessarily based on non-falsifiable hypotheses and that it is under-estimating the efficacy of natural selection in

*Classification of Sternini follows that of Moynihan (1959).



resorting to the evolutionary past to explain the adaptations of the present. They refute that the present divergence of species is explicable through competition in the past. However, Lack (1944, 1945, 1947b, 1954) has shown that closely related species tend to occupy different niches in the same habitat, and if one species was absent the related species often occupied the equivalent station. The former occurs in the Titmice Parus spp. (Gibb, 1954; Hartley, 1953) and the latter in Chaffinches Fringilla spp. in certain of the Canary Islands (Lack & Southern, 1949). Also, where two closely related species overlap in part of their range, they tend to differ markedly in this area, structurally, as well as in plumage, which suggests niche divergence, e.g. Rock Nuthatches, Sitta neumayer Michahelles and S. tephronata Sharpe of Eurasia.

It appears the study of such congeneric species assists in discrimination of their niches. Gause (1934) has said that "it is admitted that as a result of competition two similar species scarcely ever occupy similar niches, but displace each other in such a manner that each takes possession of certain peculiar kinds of food and modes of life in which it has advantage over its competitor". Gause has deduced this from experiments on Protozoa, and had extended his idea with the information provided by Formasov and others. Andrewartha & Birch (1954) stated that mathematical models of Lotka (1925) and Volterra (1926) and the experiments of Gause were quite

unlike natural situations, yet Lack (1966) considers that "although Gause used mathematical equations and laboratory demonstrations his concept does not essentially depend on them, for it is a logical consequence of natural selection". The latter author believes that where "two species have identical ecology the chance that both are equally well adapted is negligible, so that one will inevitably replace the other where they meet". It seems that the phytophagous insects studied by Andrewartha & Birch were not limited by food supply, and therefore Gause's concept relating to food niches would not apply. However, Wynne-Edwards (1962) has expressed doubt as to the validity of the Gause hypothesis and has suggested that related species may form a single dispersionary unit, i.e. each setting up a territory so as to exclude the other. This suggestion embodies the hypothesis that food resources are not over-exploited by restricting competition to a conventional substitute such as territory. Whether such a situation exists is debatable, but further consideration of these views will be discussed later with particular reference to the terns.

The ecology of closely related species has been examined in many cases (see Mayr, 1963). Detailed studies have been made on spiders (Tretzel, 1955) and psocids (Broadhead, 1958) amongst invertebrates, and on snakes (Carpenter, 1952), lizards (Milstead, 1957, 1961) and fish (Nilsson, 1955, 1960) among vertebrates. However, most studies have dealt with closely related species of birds. Lack (1945, 1946, 1947b)

has examined the ecology of the Cormorant, Phalacrocorax carbo L. and the Shag, P. aristotelis L., various birds of prey, species of ground Finches, Geospiza spp. on the Galapagos Islands, while Lack & Southern (1949) have made similar studies on the Chaffinches, Fringilla spp. of the Canary Islands. The biology of the Herring Gull, Larus argentatus Pontopp. and the Lesser Black-backed Gull, L. fuscus L. have been compared (Paludan, 1951; Harris, 1964; Brown, 1967). Several workers, notably Hartley (1953) and MacArthur (1958), have studied closely related species of passerines. In addition, the British Ornithologists' Union Centenary Expedition to Ascension Island, near the equator, studied several closely related species of seabird, including the boobies, Sula spp. (Dorward, 1962), the tropic birds, Phaethon spp. (Stonehouse, 1962), the noddies, Anous, spp. (Ashmole, 1962; Dorward & Ashmole, 1963). However, these latter studies were principally concerned with examination of the breeding seasons rather than competition between the species.

Previous studies on the biology of terns have been largely carried out on individual species and have been mainly behavioural studies. The Sandwich Tern behaviour has been studied by Desselberger (1929), Steinbacher (1931), Dircksen (1932) and Assem (1954a, 1954b). The behaviour of the Common Tern has had more detailed treatment by Southern (1938), Tinbergen (1934), Palmer (1940, 1941) and Austin (1946b, 1947, 1949, 1951); and also the Arctic Tern (Cullen, 1956), but

there is no detailed study of the behaviour of the Roseate Tern. Some comparative studies have been made on these species (Cullen, 1960a, 1960b). Ecological studies are fewer and are mainly confined to the Common Tern (Austin, 1929 and subsequent) and the Arctic Tern (Pettingill, 1939; Bullough, 1942; Hawksley, 1950, 1957; Cullen, 1956, 1957; Grosskopf, 1957; Belopolskii, 1961; Norderhaug, 1964). Also, there is a recent comparative study by Boecker (1967) on these two species. Ecological studies on the Sandwich Tern (Dircksen, 1932) and the Roseate Tern (Serventy & White, 1951; Guichard, 1955) are brief. Comparative studies on terns are few. There is the study of Cullen (1960a) relating to nesting adaptations in terns, that of Boecker (1967) comparing the Common and Arctic Terns, and the general account by Marples & Marples (1934). Also, Gause (1934) refers to the work of A.N. Formosov (1934, cited from mss.) who investigated the ecology of the Sandwich Tern, Common Tern, Gull-billed Tern, Sterna (= Gelochelidon) nilotica Gm., and the Little Tern, Sterna albifrons Pall. in 1923 on the island of Jorilgatch in the Black Sea. Although no evidence was provided, it was stated that these four had distinctive feeding niches; so that competition for food was avoided.

The present study has examined the breeding biology of the Sandwich, Roseate, Common and Arctic Terns in as many aspects as possible in order to determine whether any of these species were competing to any extent for the same resources.

The main resources considered were nesting sites and food, and these tern species were investigated to determine whether any specific adaptations existed so as to reduce competition to a minimum. However, any resource had to be limited before competition was likely to become important in survival, and provision made for the possibility that the ecosystem of the study area was unstable. By studying the breeding biology over three seasons, 1965, 1966, and 1967, it was possible to examine seasonal effects within a species and between species.

Although emphasis was laid on a comparison between the four species of tern, this study provides further information on these species, especially on the Sandwich and Roseate Terns. These two species have been little studied, so that the opportunity to study the Sandwich Tern in more detail was taken, especially as it appears less akin than the other three species, having sometimes been considered as belonging to a separate genus, Thalasseus, comprising the Crested Terns. The only other species of tern nesting in the British Isles at the present day is the Little Tern which did not nest in the locality of the present study. In fact this species is, perhaps, the least common of the five British breeding species of terns (Parslow, 1967).



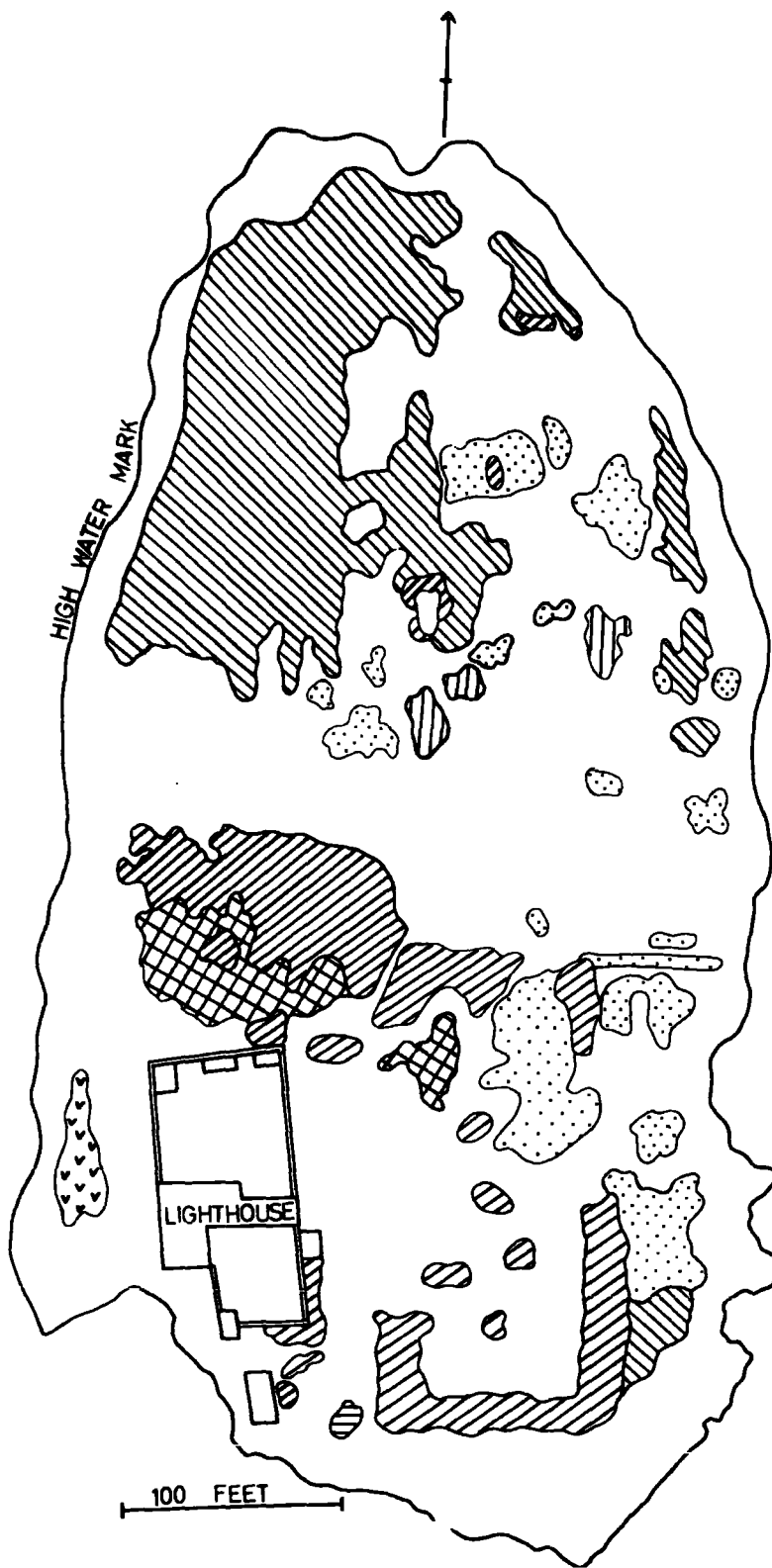





FIGURE 1. MAP OF COQUET ISLAND, NORTHUMBERLAND : SHOWING DISTRIBUTION
OF DOMINANT VEGETATION TYPES.



HIGH WATER MARK

LIGHTHOUSE

100 FEET

-  RUMEX ACETOSA
-  SENECIO JACOBÆEA
-  URTICA DIOICA
-  CIRSIUM VULGARE
-  HOLCUS MOLLIS
-  AMMOPHILA ARENARIA
-  HOLCUS LANATUS
-  FESTUCA OVINA

THE STUDY AREA

The study area was on Coquet Island, Northumberland (grid reference : NU 293045), $55^{\circ} 37'N$. $1^{\circ} 37'W$, off the coast, and about 20 miles S.S.E. of the Farne Islands, the nearest breeding station for the four species of tern. The nearest colonies south of Coquet Island are those in Norfolk which do not contain Arctic or Roseate Terns, about 185 miles south-east. Coquet is a low island, not rising more than about 30. ft above sea level, and has an area of nearly 70,000 square metres, principally covered in vegetation. It is composed of a sandstone and its erodible nature has left it with extensive shelves of rock which are exposed at low tide. The island itself has steep edges with an almost flat top. On the east side, the seaward side, there are several very small coves, and a rock and pebble beach off the south-east end. At the south-west end there is a sandy beach, backed with Marram grass, Ammophila arenaria L.

The vegetation is indicated on the map (Fig.1). The lighthouse buildings and gardens at the south end of the island occupy about 3,000 sq.metres. The areas surrounding the lighthouse buildings, the sandy beach, and the areas of dense Stinging Nettles, Urtica dioica L. are not occupied by terns and comprise a further 18,000 sq.metres. This leaves the area occupied by the various species of terns nesting on the Island an area of about 49,000 sq.metres. The Island lies about $3/4$ mile from the coast and $1.1/4$ miles from the

mouth of the River Coquet. To the north and south there are large sandy bays, Alnmouth and Druridge, respectively. These provide suitable fishing grounds, particularly for the Sandwich Tern. The close proximity of these areas rich in fish, together with other neighbouring areas, are important in the continued success of the tern colony here.

Apart from the tern species mentioned, there is a small colony of Black-headed Gulls, Larus ridibundus L. which has grown considerably over the three seasons of this study. This will be described briefly in relation to the behaviour and ecology of the terns. Also, there are about 200 nests of the Eider, Somateria mollissima L. which nest nearer the lighthouse, especially in the Marram near the sandy beach, than any other seabird. Other breeding species include 14 or 15 pairs of Oystercatchers, Haematopus ostralegus L. which prefer to nest on the top of the Island, but usually near the edge; 5 or 6 pairs of Ring Plovers, Charadrius hiaticula L. In recent years the number of Puffins, Fratercula arctica L. occurring on the Island has increased to about 100 - 150 birds, and it is likely that they have been breeding since 1965 at least.

In 1967 the first pair of Herring Gulls bred on the Island and raised two young, and two pairs of Lesser Black-backed Gulls nested, of which one pair raised two young, and the other deserted its three eggs. It is very likely that

these two large gull species will increase on the Island if left unmolested by man, and probably to the detriment of the terns, since the two groups are incompatible. This appeared to happen on the Isle of May in the Firth of Forth (Eggeling, 1960). Also, nesting on the Island are three or four pairs of Skylarks, Alauda arvensis L., about ten pairs of Rock Pipits, Anthus spinoletta petrosus (Mont.), three or four pairs of Shelduck, Tadorna tadorna L., and two pairs of Starlings, Sturnus vulgaris L. and an occasional Swallow, Hirundo rustica L. in the lighthouse buildings.

Marples & Marples (1934) quote a reference to Coquet Island written in 1830 which said that the Sandwich Terns had "deserted a particular islet of the Fern (Farne) group and fled to Coquet Island". Whether the birds originated from the Farne Islands is conjecture, but at least it is known that Sandwich Terns were breeding on there at that time. Also, Hewitson, writing about the Roseate Tern in 1831, said that "upon the Fern and Coquet Islands it is very limited, a few pairs mixed with Arctic and Sandwich Terns in many thousands". As the Marples (1934) point out, this seems to be a reliable account as the species was only recognised as such a few years previously which would have been very unlikely if more numerous. The Marples report that the Arctic Tern is supposed to have bred in large numbers on Coquet Island, but in 1912 none had bred for at least 50 or 60 years, and were considered to originate from the Farnes. Hancock (1874) reports that the Common Terns were

abundant on Coquet Island a few years earlier, but were diminishing with human interference. It is unlikely that Arctic Terns have ever been numerous on the Island and reports of their abundance are probably wrong identification.

There had previously been a Priory on Coquet Island for several centuries, but in 1834 the present lighthouse was built, and associated buildings were constructed at the south end of the Island. These buildings were to house the families of two lighthouse keepers, and the family of the buoy-keeper. These inhabitants began to cultivate the Island, including the plots north of the centre of the Island. Also, they kept sheep, a donkey, dogs, and probably cows. Such intrusions evidently disturbed the terns breeding on the Island and led to their final disappearance in about 1882 (Marples, 1934). Although it is likely that the Eider continued to breed, it was not until 1958 that the first Common Terns (two pairs) began to breed (J.C.Coulson, pers.comm.). Subsequently, other species have come in and started to breed. The pairs of each species nesting on Coquet Island is given in Table 1 for the three years of this study. The counts for the Sandwich and Roseate Terns are complete in all years, but in 1965 and 1966 the total number of Arctic and Common Terns has been estimated. The numbers in brackets refer to those in the study area (see later for explanation of Common Tern nest fluctuations).

TABLE 1. THE NUMBERS OF TERNS AND BLACK-HEADED GULLS
BREEDING ON COQUET ISLAND

Species	1965	1966	1967
Sandwich Tern	313	797	c.1,750
Roseate Tern	85	179	102
Common Tern	c.1,200 (360)*	c.1,000 (195)	1,212 (157)
Arctic Tern	c.500 (55)	c.500 (75)	560 (100)
Black-headed Gull	10	57	68

' Pairs.

* Study area was increased by one quarter in 1965

NESTS AND NEST SITE PREFERENCES

The four species of terns breeding on Coquet Island provide an opportunity to examine their nesting situations in order to see whether a species has any particular preference. Apart from the account of Boecker (1967), the description of the nesting situations for the tern species studied have been general (Kirkman, 1908; Bent, 1921; Marples & Marples, 1934; Hawksley, 1950). The actual nest construction was usually minimal and depended on the proximity of nesting materials, although no elaborate nest was made by any species. Boecker (1967) plotted the height and density of vegetation in which Arctic and Common Tern nests were found. The Arctic Tern tended to nest in areas of low vegetation where the density was high, or else in areas of high vegetation with low density. However, the Common Tern choose areas where the vegetation was both high and dense. The Arctic Tern nested in areas where the bent Agropyron junceum L. Beauv. was the dominant plant, or in areas where Creeping Fescue, Festuca rubra L. and Sea Poa, Puccinella maritima Huds. Parl. were the main dominants. Where this species nested in sand dunes, Marram Grass, and Lyme Grass, Elymus arenarius L. comprised the principal vegetation. The Common Tern was found nesting principally in areas dominated by Creeping Fescue, but a few occurred in areas of Sea Poa.

On Coquet Island the vegetation which overlies rock contains fewer halophytes than on Wangeroog where Boecher worked.

However, the Common Tern is restricted almost entirely to areas dominated by Sheep's Sorrel, Rumex acetosa L. The only other plant of which there are a few small clumps in which the Common Tern nests is Yorkshire Fog Grass, Holcus lanatus L. (see Fig.1). The distribution of these two plants determined the distribution of the Common Tern on Coquet Island. Both these plants grow rapidly from the time the Common Tern starts to nest and reach a height of 50 - 80 cm. This vegetation then provides suitable refuges for the Common Tern chicks from predators and inclement weather.

The Arctic Tern either nests amongst the rocks and shingle along the east shore (about one quarter of the nesting population) or in areas of short vegetation on top of the Island. The Rabbit, Oryctolagus cuniculus L., the only mammal on the Island, feeds principally on Sheep's Fescue, Festuca ovina L. which is grazed to a few centimetres in the summer. It is in these areas, principally in the centre and along the east side, that the Arctic Tern nests. Therefore, although the vegetation is different from that on Wangeroog, these two species of tern occupy distinctive nesting sites on Coquet Island. In fact, there is very little integration of the two species, the only overlap occurring where the two vegetation types intergrade.

Since the Arctic Tern occurred in areas of short vegetation (2 - 5 cm), or of no vegetation, their nests were

merely depressions supplemented by an accumulation of rabbit droppings, a few odd bones and sticks, whereas the Common Tern frequently had its scrapes made into cups with stems and leaves of Sheep's Sorrel. The growth of tall vegetation seems to deter the Arctic Tern from nesting as Austin (1940) noticed that the growth of bushes forced the Arctic Tern on Hopkins Island, North America, to nest elsewhere. However, the spread of the Stinging Nettle excludes not only the Arctic Tern, but the other terns as well, as evidenced both on Coquet Island and the Farne Islands.

The Roseate Tern, as noticed by Bent, (1921, quoting Audubon, 1840), Marples & Marples (1934); Austin (1929); Serventy & White (1951) and Guichard (1955), prefer to nest under some sort of shelter. On Coquet Island in 1965, the following nesting situations were recorded : 33 in burrows; 22 under Sheep's Sorrel; 15 in hollows; 14 amongst rocks, and 1 under Stinging Nettles. In 1966, there was a higher proportion of nests amongst the rocks on the shore, but in 1967 none nested there, probably because of an increase in the number of Black-headed Gulls and a pair of Herring Gulls nesting there. The Roseate Tern choose to nest in groups, but the density of these depended on the density of suitable nest sites. However, in some situations, such as on Pelsart Island, Western Australia, many nests were reported "under a foot apart" (Serventy & White, 1951), and in the Bahamas and

West Indies this species seems to nest "in open situations with Cabot * and Sooty Terns, laying their eggs in hollows in the sand, on bare ground, or on rocks without any attempt at concealment" (Bent, 1921). However, on Coquet Island, brooding Roseate Terns in rabbit burrows are usually invisible from the surface and depend on their mates and other tern species for warning of danger. Also, this species has longer claws than the other terns, especially noticeable in the chick, which aids movement in burrows and over rocks.

Austin (1929), considering a mixed ternery, stated that the comparatively long legs of the Roseate Tern (19 - 21 mm) were adapted to walking about and nesting in fairly long vegetation, the proportionately shorter legs of the Common Tern (19 - 21 mm) were more suited to nesting in less vegetated areas, whilst the very short legs of the Arctic Tern (15 - 17 mm) were more suited to nesting on bare ground (measurements of tarsi after Witherby et al, 1946). However, in the Faroes, where only the Arctic Tern occurs, this species nests freely in low annual vegetation and grass (Fisher & Lockley, 1954); and in Norfolk, where the Roseate and Arctic Tern are absent, The Common Tern nests on sand and shingle.

The Sandwich Tern, as noted later, either nests in close proximity to Black-headed Gulls, and/or amongst other tern species. The Sandwich Tern on Coquet Island choose

* Sandwich Tern

areas of level ground where high nesting densities are possible, so that nests are just over a beak's stretch apart - Schnabelbereich (Steinbacher, 1931), but where vegetation intervenes, the nests may become closer together. Odd pairs of Roseate Terns are often associated with this species. Both the Roseate and Sandwich Tern made little attempt at nest construction and their eggs were normally laid in a bare scrape.

TABLE 2. THE DENSITY OF TERN NESTS ON COQUET ISLAND

Species	Maximum Density per sq. metre	Average Density per sq. metre
Common Tern	0.13 (350)	0.06 (113)
Arctic Tern	-	0.02 (175)
Roseate Tern	0.41 (20)	-
Sandwich Tern	2.06 (19)	-

Figures in brackets refer to number of nests

The density of the nests of each species varied as shown in Table 2. Only maximum densities were recorded for the Sandwich and Roseate Tern since these refer to sub-colonies. Although there is no estimate of the maximum nesting density attained by the Arctic Tern, this was considerably lower than that of the Common Tern. The terrain affects the density in the Arctic Tern for on the beach the intervention of rocks and

debris permitted a higher density than that on the top of the Island. The lower density of nests is correlated with pugnacity in a species, the Arctic, Common, Roseate and Sandwich Terns representing a series of decreasing aggressive behaviour, and this in turn is correlated with a decreased reliance on camouflage of nests and eggs (Cullen, 1960a).

OCCUPATION BY BLACK-HEADED GULLS AND TERNS

Occupation and species association

The first birds to establish themselves on Coquet Island in the spring are the Black-headed Gulls. The numbers nesting on Coquet Island have increased markedly over the three years of the present study. In 1965 there were 10 nests with eggs, 57 in 1966, and 68 in 1967. In addition to these breeding pairs, there were several other birds (at least some of which were immature from plumage characters) which often formed pairs and constructed nests, but did not lay. The numbers of these non-laying gulls also increased over this period. It is thought that most of these birds enter the colony in early April and begin laying near the end of that month. In 1966, the peak of egg-laying was in the first week of May and normally most gulls have laid their eggs at the end of the month.

Although this species is often found nesting in colonies devoid of other species, the Black-headed Gull is often associated with groups of nesting terns. At Ravenglass, in Cumberland, Sandwich Terns nest amongst the large colony of Black-headed Gulls there (pers. obs.), and at the Sands of Forvie, Aberdeenshire, this gull is associated with nesting tern species (A. Smith, pers. comm.) and many other examples exist. Coquet Island is no exception, and my observations suggest that this association is no mere accident. However, since the Black-headed

Gull is the first species to arrive on the Island, it is the tern species that should be considered to be associated with it, rather than vice-versa. Nevertheless, these species of tern nest in colonies where the Black-headed Gull is absent, so that the association is in no way a necessary requisite for breeding. In 1964, the Sandwich Terns laid before the Black-headed Gulls (J.C. Coulson, pers. comm.).

The observations on Coquet Island indicate that the Sandwich Tern is influenced by the presence of nesting Black-headed Gulls, but this gull does not appear to influence the Common and Arctic Terns. When the Sandwich Tern first settles on the island, it is usually close to the already nesting gulls, and the first eggs are usually laid in this area. Subsequent sub-colonies tend to occur near Black-headed Gull nests, with few exceptions. The Sandwich Terns first settled on the island on 9th May in 1965 and 1966 and began laying on 13th May, by which time considerable numbers of Common and Arctic Terns had begun to set up territories on the island. The Common and Arctic Terns do not start laying until the end of May, and the Roseate Tern even later. It is not certain whether the Roseate Terns prefer to nest close to Black-headed Gulls' nests, but their nests are often associated with Sandwich Tern nests. However, the sub-colonies (i.e. small groups of Roseate Tern nests) are often distinct from both species although, at least, surrounded by either Common or Arctic Tern nests.

What is the function of this association between the Black-headed Gull and the Sandwich Tern? It is well known that the Black-headed Gull is an aggressive species when guarding its nest, particularly when they have eggs or newly hatched young, and will dive-bomb human and other intruders in the vicinity of the colony (Kruuk, 1964; Patterson, 1965). Earlier in the season the Black-headed Gulls tend to fly up and circle round in a flock above the nests, but with the laying of the eggs they become more pugnacious. However, their pugnacity is limited to the colony area, and Carrion Crows, Corvus corone L. continue to pillage the Eider nests on the island, temporarily left unguarded by the duck. It seems that the Sandwich Tern nests as close as possible to the gulls so as to benefit from the protection afforded by the gulls' pugnacity to aerial predators such as crows, as has been suggested elsewhere (Assem, 1954a; Lind, 1963). The Sandwich Tern is not an aggressive species, a corollary of its dense nesting habit, and although they sit tight on their eggs when aerial robbers are about (Cullen, 1960a), the chances of predation by crows of temporarily unattended nests is much reduced if they are nesting amongst Black-headed Gulls. Also, this tern leaves its nest when disturbed by a ground predator, such as a fox or man, and forms a dense flock hovering above the colony, but the aggressiveness of Black-headed Gulls would serve to deter, or at least distract, a ground predator. However, Salomonsen (1943) reports

that the owner of a solitary Sandwich Tern nest swooped at the intruder, and the same thing was seen on Coquet Island in 1965 when the chipping eggs of a solitary clutch were being examined. This contrasts with the aggressive flight at human intruders, common throughout the nesting season, in a colony of Arctic Skua, Stercorarius parasiticus L., but which is absent from the behaviour of solitary pairs (Williamson, 1949). The same author reports that Arctic Terns strike an intruder more readily in a large than a small colony. Such behaviour seemed to occur in the Arctic Tern colonies on the Farne Islands. However, Taverner (1965) has suggested that certain individual Sandwich Terns may be unusually aggressive, but it is not known if this is a cause or a result of nesting solitarily.

This association with Black-headed Gulls or with small tern species has been discussed before (Salomonsen, 1943; Lind, 1963), and its protective function suggested by Cullen (1960a). On the Farne Islands where the Black-headed Gull is absent, the Sandwich Tern nests amongst Arctic and Common Terns where they seem to benefit from ^{the} pugnacity of these smaller species towards crows and large gulls (Cullen, 1960a, pers. obs.). In fact, the first egg-laying of the Sandwich Tern coincides with the first large scale influx of Common and Arctic Terns on to Coquet Island. At this point the Carrion Crow leave the island, chased off by the terns. It might be thought that with the arrival of the other tern species on the island, the

necessity of laying in close proximity to Black-headed Gull nests would no longer seem important, yet the Sandwich Tern sub-colonies continue to originate from such areas. A closer inspection reveals that although the other tern species have begun to set up territories, they do not begin laying until the end of May, and are therefore not so aggressive as the gulls which are mainly incubating. The first Black-headed Gulls' eggs hatch about 22nd May and will be at their most aggressive then. By the time the majority of the other terns have laid, most of the Sandwich Terns have laid as well and will have chosen a site proximate to a gull's nest. However, there are insufficient gulls' nests to enable all the Sandwich Terns on Coquet Island to nest beside one, and it is the initial nesting tern, or group of terns, of a particular sub-colony, that benefit from being closer to a gull's nest. Subsequent nesters are usually surrounded by, or even interspersed with, Common or Arctic Terns. Lind (1963) reports that Sandwich Terns associated with Black-headed Gulls derive more advantages than those associated with other terns. There are severe depredations by Herring Gulls in the tern-protected colonies on the Frisian Islands (Dircksen, 1932; Goethe, 1939), but none in the "ridibundus-protected" colonies on the Poldene.

However, the Sandwich Terns suffer certain disadvantages from their association with Black-headed Gulls, although they are usually minor. Assem (1954b), Rooth (1958) and Lind (1963)

have examined these disadvantages. All found the predation on eggs and chicks very minor and Assem found only those unattended for some time were taken, although he thought the habit of taking eggs might be acquired by more gulls creating a serious problem. On Coquet Island, only deserted eggs seemed to be eaten by the gulls. However, food parasitism may be a more serious matter. All three authors reported this, and Rooth suggested that it might result in a high mortality amongst young chicks during bad weather, when food was short anyway. Where there are large numbers of gulls and relatively few terns, food parasitism may result in starvation of Sandwich Tern chicks, as appeared to have happened on Havergate Island, Suffolk (P. Olney, pers.comm.). Only in 1967 did food parasitism by the gulls become noticeable on Coquet Island, when a large sub-colony of about 300 Sandwich Tern nests provided a suitable area for the gulls to focus their attention on. As Assem (1954b) found, it was mainly those gulls without eggs or young that specialised in food parasitism of the terns. These gulls flew or hovered in the wind above the brooding terns, waiting for adults to fly in with food, and as soon as they landed, the gulls would swoop in and grab the fish. However, the number of gulls on Coquet Island was too few to have any serious effect on Sandwich Tern chick survival.

The Common Tern usually comes on to the top of Coquet Island in the second week of May : 8th May in 1965, 9th May in 1966. The occupation is not so rapid as in the Sandwich Tern. Instead, there is a continual build-up of numbers, unless there is some adverse environmental factor which puts a halt to this. The scarcity of fish at the beginning of the 1966 season appeared to be responsible for the slight delay in laying. Subsequently, many eggs, including complete clutches, were deserted. Including both complete and incomplete clutches, 34 were definitely deserted, a further 15 were probably deserted, being about 25% of all clutches laid in the study area. This proportion may have been higher, as in 81 nests, eggs failed to hatch, but many of these birds, deserting early, re-nested. Also, unlike the Sandwich Tern, egg-laying does not begin until about a fortnight after the first landing on the island. The significance of this difference is discussed later. The Common Tern shows no preference for nesting near Black-headed Gulls, although late nesters come into the areas previously occupied by the gulls, after the latter have moved with their chicks into areas of dense vegetation, or on to the rocks along the shore. The Common Tern does, however, prefer to nest away from the light-house, away from human habitation, like most of the other species nesting on Coquet Island.

When the Arctic Terns arrive on Coquet Island they settle on the rocks like the other species, at a similar date to the Common Tern. Yet in 1966, the delay was greater, and none were seen on the island until 19th May. As in other species, the arrivals tend to leave the island for the rocks and elsewhere for roosting, and only gradually do they remain to spend the night on the island. With the laying of the first eggs, 29th May in 1966, the birds remained overnight to incubate the eggs. The Arctic Terns show no preference for nesting with Black-headed Gulls, but nest in those areas of short vegetation, or on rocks, shingle, and sand. Remarkably, no terns lay on the sandy beach, probably because of its south-westerly aspect rather than its proximity to the lighthouse. This beach is exposed to the prevailing winds, and therefore nests and their contents would be liable to being buried or washed away at high tide. This contrasts with the Inner Farne Island where many Arctic Terns nest in Cuthbert's Cove, a sandy beach with an easterly aspect.

The first Roseate Terns appear on the island very soon after the first Common Tern. In both years, Roseate Terns were first seen on the island on 13th May. However, this species does not begin laying until much later. In 1965, the first eggs were laid on 29th May, but in 1966 it was not until 9th June. As mentioned previously, a minority of pairs of Roseate Terns nested in association with Sandwich Terns, and exceptionally amongst Common Terns. However, the small groups or sub-colonies

of this species show no particular preference for associating with a particular species, but choose those areas with suitable nest sites.

Laying

TABLE 3. THE FIRST ARRIVAL ON COQUET ISLAND AND THE DATE OF FIRST LAYING IN 1965 AND 1966

Species	1965			1966			Average Diff.
	Arrival	Laying	Diff. (in days)	Arrival	Laying	Diff. (in days)	
Sandwich Tern	9/5	11/5	2	9/5	13/5	4	3
Roseate Tern	13/5	(29/5)	c.16	13/5	9/6	27	c.21
Common Tern	8/5	22/5	14	9/5	27/5	18	16
Arctic Tern	8/5	24/5	16	19/5	29/5	10	13

Sandwich Tern

In 1965, on 9th May, a group of Sandwich Tern moved up on to the top of the Island at the North end with a group of Common Terns as the tide rose to cover the rocks at 11.00 hours. The rapid occupation by this species is illustrated in Figure 2. Pair flights and mounting were witnessed on the island, as occurred previously on the rocks, but it was not until 11th May that coition was definitely observed. During this occupation the birds were easily disturbed. In some cases passing pigeons caused "up-flights" (Lind, 1963) or "panics", but on other occasions there appeared to be no cause. In each "up-flight", the birds which had congregated in a flock flew up together, circled round, and settled again, close to the original spot. As mentioned previously, the Sandwich Tern groups are usually associated with Black-headed Gulls' nests.

Although the first egg was laid on 11th May, it was deserted almost immediately, and so were some of the others laid on the subsequent few days. It was not until 16th May that two definite centres of laying (sub-colonies) were established, near the Black-headed Gulls, and were consistently brooded. Previous to this, brooding birds appeared to leave the island at night and return in the morning to their eggs, as suggested in the Caspian Tern, *Sterna* (= Hydroprogne) tschegrava Lepechin. (Bergman, 1953). The strong northerly winds of 17th, 18th, and 19th May seemed responsible for

FIGURE 2. OCCUPATION OF COQUET ISLAND BY SANDWICH TERNS IN 1965.

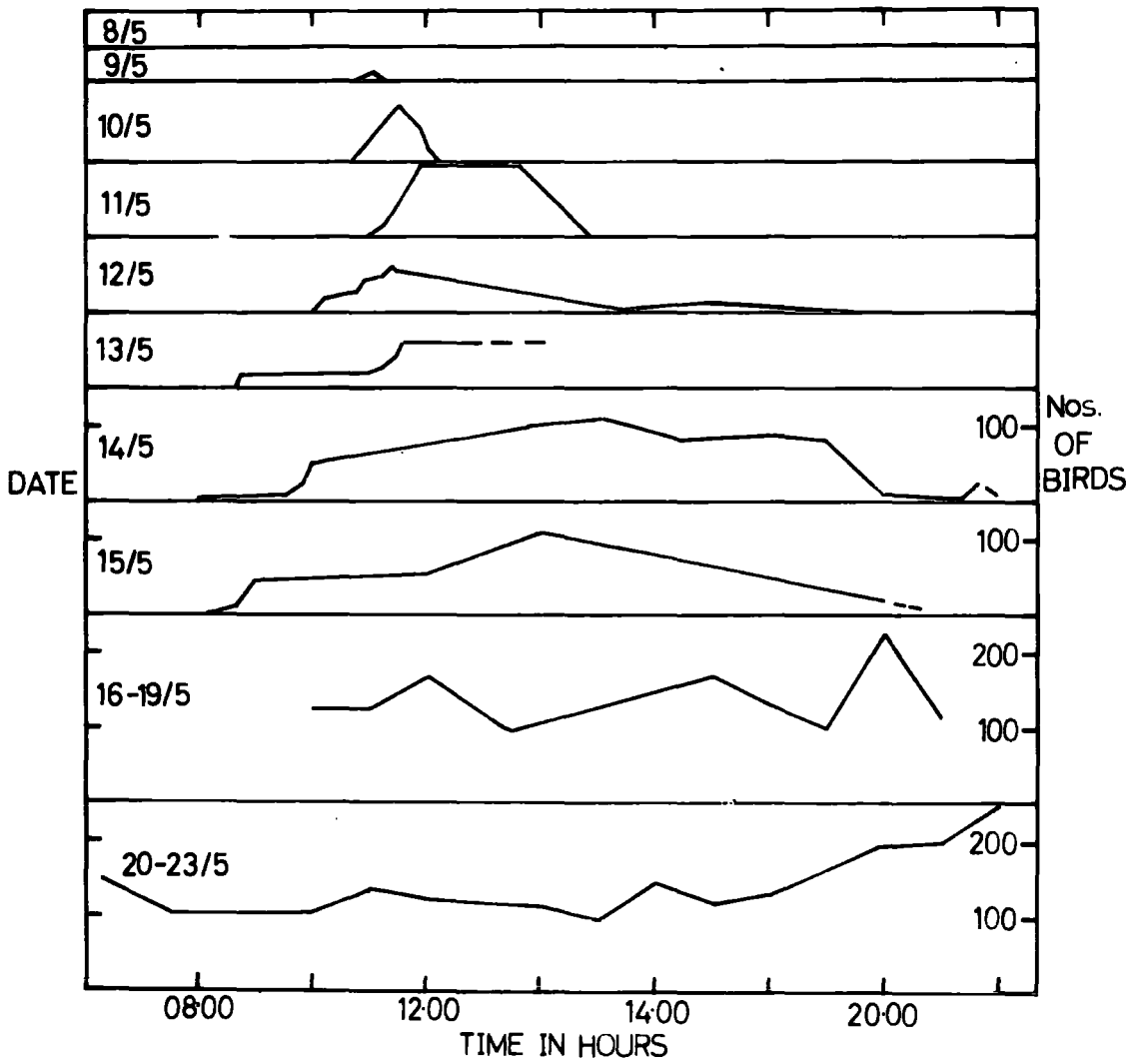

subsequent sub-colonies to be established further south than the initial ones. However, after this most birds nested on the east side, forming a sub-colony of 179 nests, about two-thirds of the birds nesting that year.

In 1966, a similar process of occupation of the island was observed. The Sandwich and Common Terns coming on to the island when most of the rocks were covered by the tide, and then vacating the island as the water receded. Again the Sandwich Terns congregated near the Black-headed Gulls in the centre. The gulls choose this area as it contained raised earth walls enclosing disused garden plots and old upright posts. The posts and walls were used as perches and look-out sites. The Sandwich Terns began laying on 13th May, when mounting and coition was observed on the rocks and in the flocks formed on top of the island. As in 1965, the circling up-flights occurred, accompanied by the characteristic noisy "chatter" of the re-settling birds which seemed to attract more birds to the group. Although the first sub-colonies were formed in and near the plots amongst most of the gulls, subsequent ones were near the north end of the island, but usually around an odd gull's nest. However, in this year there were several colonies of similar size and nearly three times as many nests as in 1965.

In 1967, the occupation of the colony was not observed, but assuming an incubation period of 25 days, the first egg was laid on 11th May. Again the first sub-colonies were formed near the main concentrations of Black-headed Gulls, and subsequent

FIGURE 3. THE LAYING OF THE FIRST EGGS OF SANDWICH TERN CLUTCHES
IN 1965, 1966 and 1967.

SANDWICH TERN - LAYING

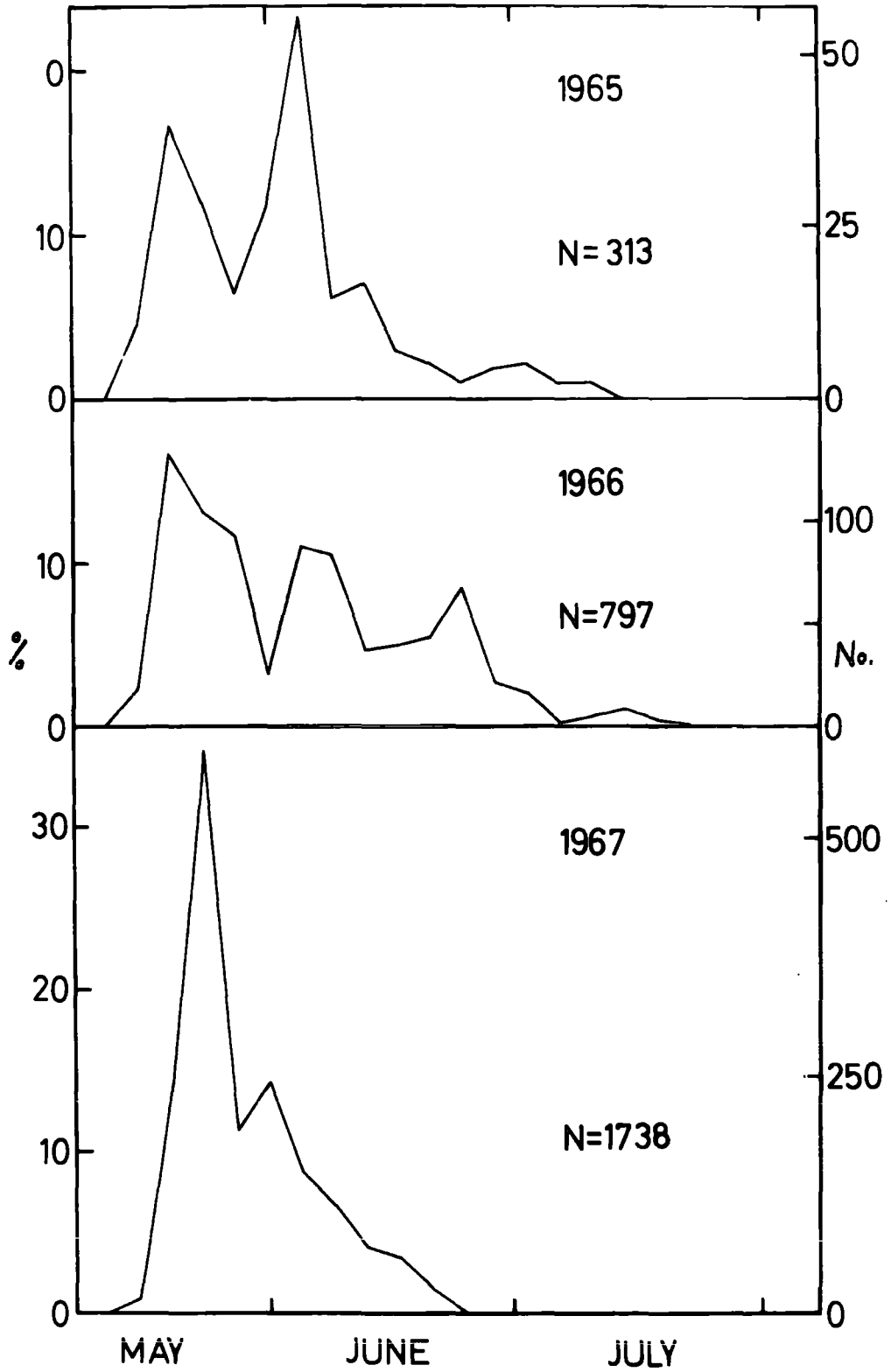

sub-colonies were usually formed near one or more gulls' nests. In this year, over 1700 pairs nested, more than twice as many as in 1966, with three large sub-colonies and 15 smaller ones.

If the eggs laid per four days are expressed as a percentage of the total laid that season, certain differences are apparent between the three years. In 1965, the laying curve is bimodal, with the second peak higher than the first. In 1966, the laying curve is trimodal, with peaks of diminishing size as the season progresses. In 1967, the laying is more or less unimodal, with a marked peak early in the season (Fig.3). Usually the laying curves for birds which normally have one clutch per season are unimodal, so that the distribution for 1965 and 1966 is exceptional.

Common Tern

The laying curves of the Common Tern are more typical (see Fig.4). In all years, there is a rapid build-up to a peak of laying in early June, followed by a gradual tailing off which does not stop until the end of July. However, in 1966, there was a smaller second peak due to the relaying of birds which had deserted earlier clutches. The reason for this desertion was suspected to be the shortage of fish which also may have delayed the start of laying in the Arctic and Roseate Terns and caused the irregular laying of the Sandwich Tern. Although the study area was reduced by one fifth in 1966 and 1967 from that used in 1965, just under 300 Common Terns would be expected

FIGURE 4. THE LAYING OF THE FIRST EGGS OF COMMON TERN CLUTCHES
IN 1965, 1966 and 1967.

COMMON TERN-LAYING

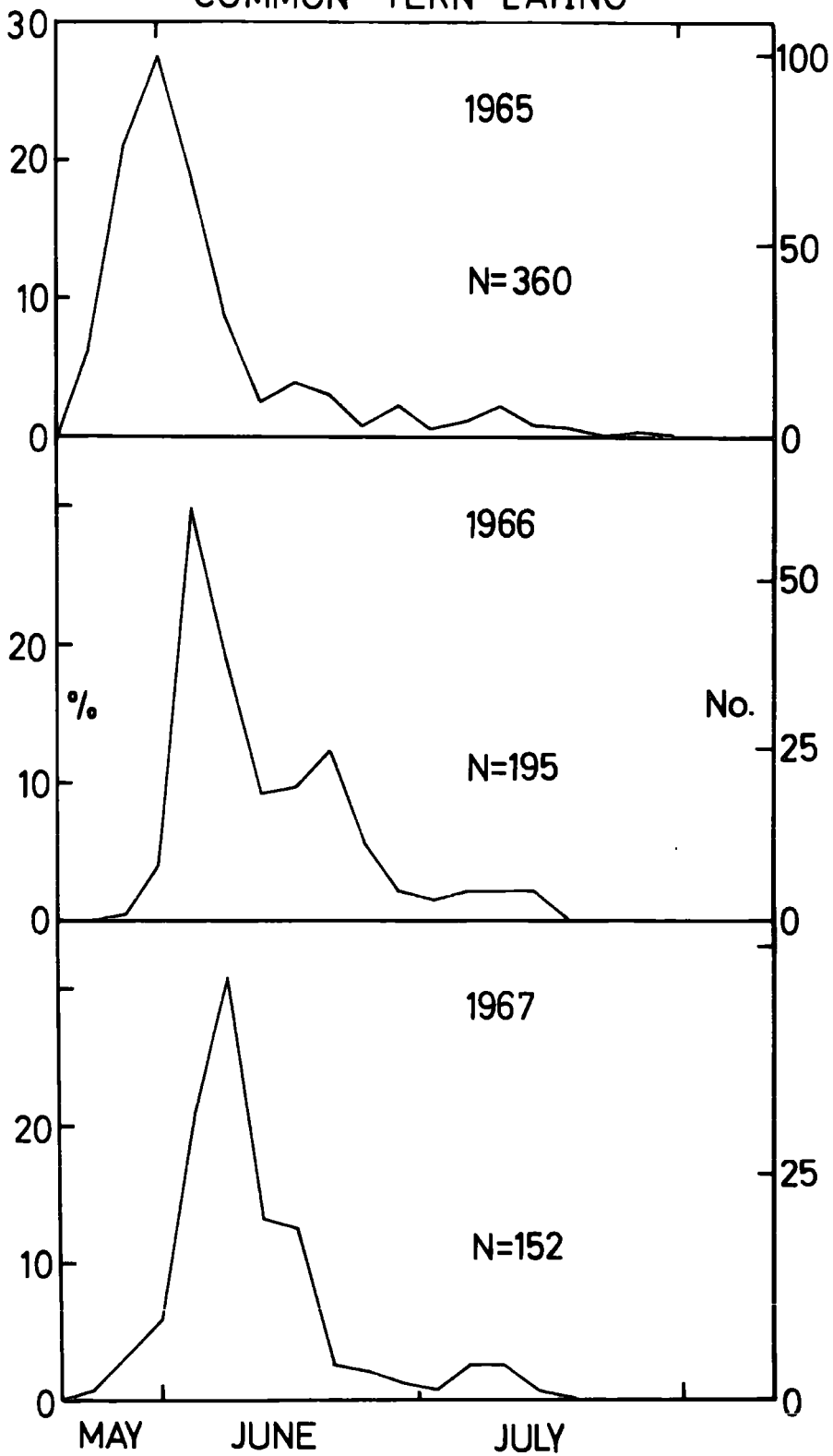
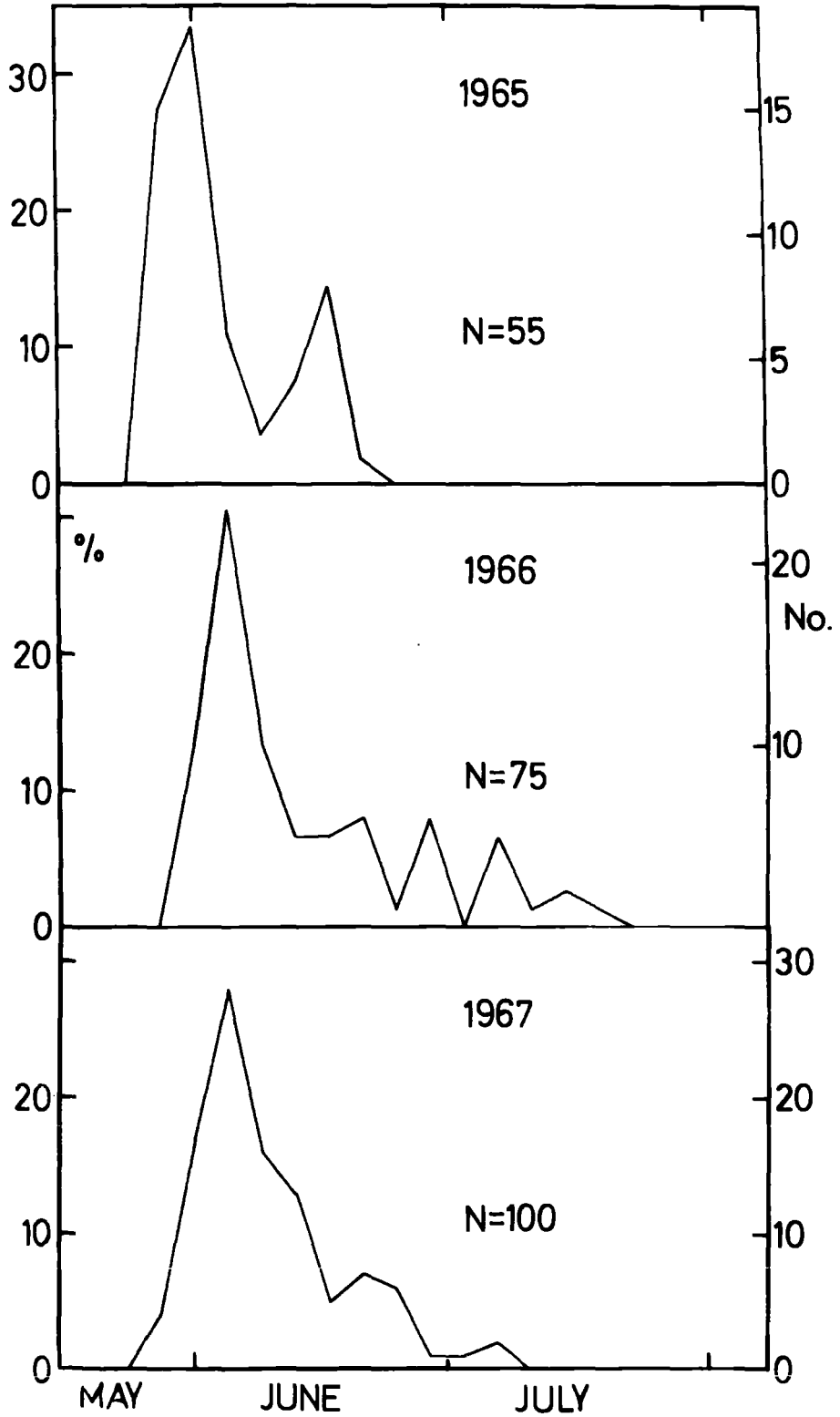

FIGURE 5. THE LAYING OF THE FIRST EGGS OF ARCTIC TERN CLUTCHES
IN 1965, 1966 and 1967.

ARCTIC TERN - LAYING



to nest instead of under 200 as was the case. In fact, there were 192 clutches in 1966 which also included some relayings. This suggests that 1966 was a poor year for breeding. The low number of pairs in the study area in 1967 results from some of the Sandwich Terns nesting within this area and thus forcing the Common Tern to nest elsewhere. In this year, more Common Terns nested at the south end of the island and closer to the lighthouse buildings than in previous years. One pair even nested on the shingle beach amongst the Arctic Terns.

Arctic Tern

The Arctic Tern has unimodal laying curves in all three years, with a slight suggestion of a second peak in 1965, possibly of relayings, although the sample was small (see Fig.5). The increase in numbers of pairs nesting within the same study area over the three years suggests that this species is increasing on the island. All the Arctic Terns caught with rings, not used on Coquet Island, are from the Farne Islands. One of the breeding birds on Coquet Island had been marked the previous year whilst nesting on the Inner Farne, indicating that some adults as well as juveniles have moved to a new colony. The more prolonged laying observed in 1966 and 1967 compared with 1965 may be a result of young birds coming into the colony and coming into breeding condition later. However, although there are indications of this occurring, more detailed observations are required.

FIGURE 6. THE LAYING OF THE FIRST EGGS OF ROSEATE TERN CLUTCHES
IN 1965, 1966 and 1967.

ROSEATE TERN - LAYING

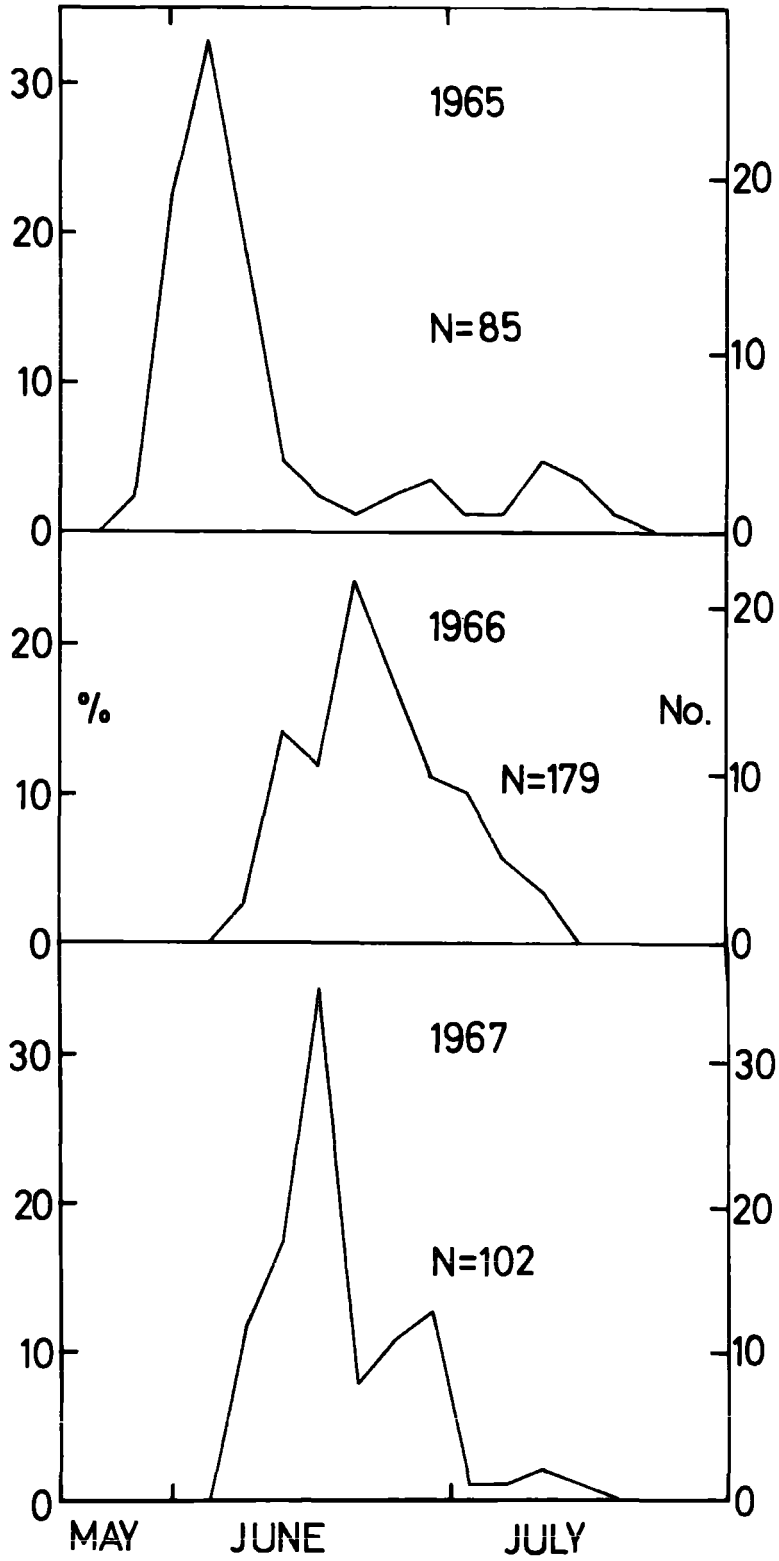

Roseate Tern

The Roseate Tern has unimodal laying curves in all three years, although they are differently skewed (Fig.6). This results from the more contracted laying in 1966 and 1967, when the birds started laying later than in 1965, yet finished in mid-July as before. Although a few birds nesting in the vegetation may have been overlooked, this does not explain the different number of clutches recorded in the three years.

The duration of laying

In order to examine the duration of laying between the four species of tern over three years, the time when 5% of the clutches were started, to when 95% were started, was compared. This restriction avoided biasing the results with exceptional records (see Table 4, Fig.7).

FIGURE 7. COMPARISON OF THE LAYING CURVES OF THE FOUR SPECIES
IN 1965, 1966 and 1967.

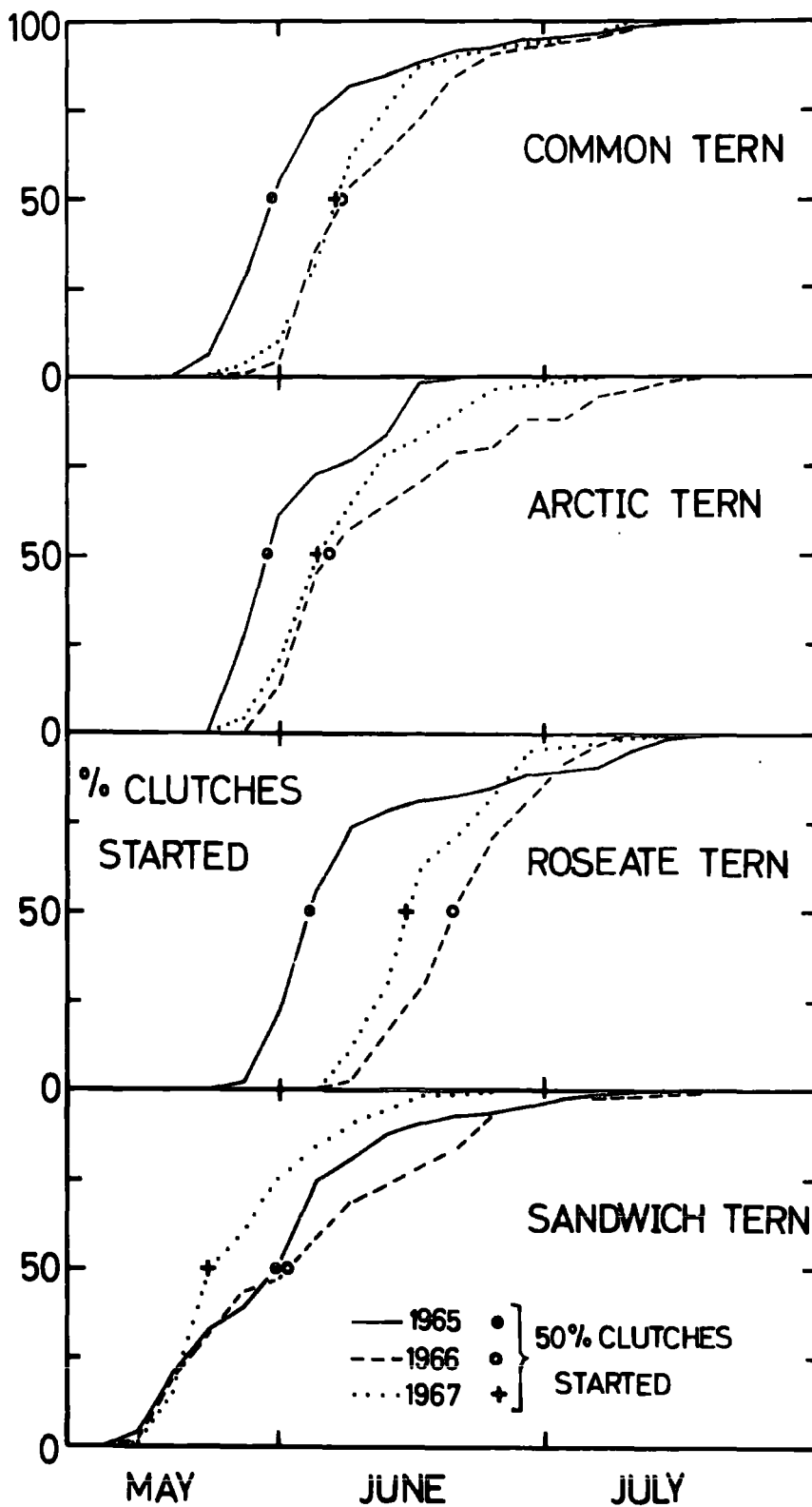

TABLE 4. THE DURATION OF LAYING IN FOUR SPECIES OF TERN OVER THREE YEARS

Species	Year	5% Started	Difference (days)	50% Started	Difference (days)	95% Started	Duration (days)	Av. Duration (days)
Sandwich Tern	1965	16/5	15	31/5	27	27/6	42)	33.3
	1966	17/5	15	1/6	27	28/6	42)	
	1967	17/5	6	23/5	20	12/6	26)	
Roseate Tern	1965	29/5	6	4/6	34	8/7	40)	29.0
	1966	10/6	16	26/6	10	6/7	26)	
	1967	7/6	8	15/6	13	28/6	21)	
Common Tern	1965	23/5	8	31/5	30	30/6	38)	36.3
	1966	1/6	6	7/6	29	6/7	35)	
	1967	30/5	8	7/6	28	5/7	36)	
Arctic Tern	1965	25/5	5	30/5	17	16/6	22)	28.3
	1966	29/5	8	6/6	31	7/7	39)	
	1967	29/5	7	5/6	17	22/6	24)	

It can be seen that the Sandwich Tern shows extremely little annual variation in the start of laying which suggests that it is responding more to environmental factors that are relatively constant from year to year. The Arctic Tern is similar, although this species has been recorded as delaying its nesting until the tundra is no longer flooded (Lack, 1933). The extreme variation over 6 years in an Arctic Tern colony on the Seven Islands, East Murman, was 12 days (Belopolskii, 1961). However, on Coquet Island the nesting sites were always suitable at this time of year, and it has been noted that arctic species nesting in southerly latitudes tend to start laying at a similar time each year, e.g. the Kittiwake, Rissa tridactyla L. (Coulson, pers.comm.). The start of laying in the Common Tern may vary by over a week, which suggests that this species is influenced more by variable environmental factors and, in particular, the scarcity of fish in 1966. However, it is the Roseate Tern which has the greatest variation - nearly two weeks - indicating that this species is greatly influenced by fluctuating environmental factors. This susceptibility to environmental changes is probably the reason why this species is in a minority on Coquet Island and along the east coast of England.

The median laying dates of the Sandwich, Common and Arctic Tern - when 50% have started laying - varies by about a week, but whereas it is the extremes of 1965 contrasting

with the other two years in the Common and Arctic Tern, it is the contracted synchronised laying of 1967 compared with the other two years in the Sandwich Tern. However, the extreme variation in the Roseate Tern is more than three weeks, emphasising the variability of laying in this species. The dates when 95% of the clutches have started are variable, being about three weeks in the Arctic Tern. The variation observed in the Arctic Tern is due to the late starting and drawn out laying of 1966, but that of the Roseate Tern to a contracted season in 1967. The variation of 16 days in the Sandwich Tern results from the synchronised laying in 1967, whereas the Common Tern shows little variation; rarely are 95% laid until the beginning of July.

The difference in days between 5% started and 50% started, and between 50% and 95% started, gives the skewness of the laying distribution. In all cases, except one, the laying is obviously positively skewed. The exception is the Roseate Tern in 1966, when it took twice as long as in 1965 and 1967 to attain the median laying date, yet finished as in 1965. The greatest positive skew occurs in the Common Tern where it takes about five times as long for 95% clutches to be laid as it does for 50%. In the Arctic Tern it is three to four times as long for 95% clutches to be started as 50%; and in the Sandwich Tern two to three times as long. The Roseate Tern shows wide variation from taking seven times as long for 95% of the clutches to be started than 50% in 1965, to having a negatively skewed laying distribution in 1966.

It can be seen that laying begins (5%) and stops (95% laid) earlier in the Sandwich Tern than in the other species; so that it has a similar duration of laying as the other terns. The Common and Roseate Terns tend to stop about the end of June, or the first week of July, but since the Roseate Tern starts later, it has a shorter laying season. The Arctic Tern has the shortest laying season as might be expected in a species particularly adapted to the short Arctic summer. However, in the peculiar 1966 season it had an extensive laying season comparable with the other tern species.

Annual Variation in laying

In comparing the variation in the 5% started, median and 95% started laying dates for the four species, the differences between the extremes have been considered (see Table 5).

TABLE 5. ANNUAL VARIATION OF LAYING IN DAYS DERIVED FROM THE EXTREMES IN 1965, 1966 and 1967

Species	5% started	50% started	95% started	Duration.
Sandwich Tern	1	9	16	16
Roseate Tern	12	22	10	19
Common Tern	9	7	6	3
Arctic Tern	4	7	21	17

The variation in the duration of the laying season is similar in the Arctic, Roseate and Sandwich Tern. The variation of 16 days in the Sandwich Tern is due to the exceptionally synchronised laying of 1967; that of the Arctic Tern to the prolonged laying season of 1966, and that of 1965 in the Roseate Tern. The reason for the prolonged laying of 1966 in the Arctic Tern is hard to account for and must involve specific conditions as it is absent in the other species. The prolonged laying of the Roseate Tern in 1965 results from an early start of laying in that season which compares with the Common and Arctic Tern. But since the laying started much later in 1966 and 1967, the difference in duration is marked. Further, the short laying season of 1967 in this species corresponds with a decrease in the number of birds laying. This may indicate that only the birds capable of laying in June are the only ones capable of breeding that year. In the Common Tern, there is little variation in the duration of laying which suggests this species is better adapted to environmental changes occurring in this region than the Roseate or Arctic Tern.

In conclusion, it appears that the Common Tern shows least variation in all these respects. The Sandwich and Arctic Tern show least variation in starting date, and the small variation in median laying date is comparable with the Common Tern. The large variation in date when 95% of the clutches had been started results from a prolonged season in

1966 in the Arctic Tern, and to a marked synchronised season in the Sandwich Tern in 1967. If the records for 1966 and 1967 are excluded from the Arctic and Sandwich Tern results, respectively, the variations observed are even less than in the Common Tern. The greatest variation occurs in the Roseate Tern where the extremes are not dependent on one particular year, which indicates that this species is least adapted of the four species to this region.

THE SYNCHRONISATION OF LAYING

By mapping and recording the number of clutches started each day, it has been shown that the duration of laying is similar in the four species of tern examined. It has been mentioned that the Sandwich Tern nests in sub-colonies, i.e. groups of nests belonging to the same species spatially separated from one another. Neither the Common or Arctic Tern show any such subdivision, but the Roseate Tern shows a tendency to nest in sub-colonies. The larger sub-colonies of the Sandwich Tern can be further subdivided into smaller groups of nests, but here the definition of the units usually depends on the time of laying which is unsatisfactory in this instance since it is hoped to demonstrate synchronisation within a sub-colony. Sometimes, rather than form a spatially separate group, birds nest adjoining an already established sub-colony. What determines that a pre-nesting flock should start a new sub-colony, rather than adhere to an existing one, is not known, but it may depend on the degree of difference in the breeding cycle between the two groups.

Unlike the other species, the Sandwich Tern begins laying within a few days of settling on top of the island for the first time. By being already paired before they enter the colony, this species can start laying as soon as the nest site is approved. It is in these first few days before, and at the start of, laying that the Sandwich Tern is most easily

disturbed and may desert the colony altogether for that season (Cullen, 1960a). This behaviour has survival value where ground predators threaten the colony.

Copulation in this species may be carried out on the rocks, or on the edge of the sub-colony, but was rarely seen amongst nesting birds. Since this species nests in dense colonies (up to 2.06 nests per square metre) it would suffer interference in mating if attempted within the sub-colony. The copulation on the rocks, also noted by Assem (1954a) amongst large groups of birds along the water line in Holland reduces the time spent on the nesting site prior to laying. In the Sandwich Tern it is usual for the first few eggs laid not to be in a group, and they may be deserted soon after laying. Within another day or two, laying occurs at a definite centre, and subsequently new centres are formed which develop into distinct sub-colonies. It appears that the first few eggs to be incubated persistently are left for the night, as in the Caspian Tern (Bergman, 1953), the birds returning to incubate at daybreak. The first ten birds to lay in 1965 and 1966 departed at night, but only some of these returned to incubate at dawn.

TABLE 6. THE AVERAGE DURATION OF LAYING IN SUB-COLONIES
AND TOTAL COLONY IN THE SANDWICH TERN

	1965		1966		1967	
	Subcolony	Colony	Subcolony	Colony	Subcolony	Colony
Number of days duration	18.0	57	18.3	67	21.2	42
Average number of nests	29.4	294	56.9	797	94.8	1706

It can be seen that although the total duration of the colony may vary by as much as 25 days, the average duration of the sub-colony varies very little, suggesting that there is normally a limit on the growth of a sub-colony (see Table 6). The larger sub-colonies show little increase in the duration of laying. If the sub-colonies for the Sandwich Tern are examined in 1965, 1966 and 1967 (see Appendix I), although larger sub-colonies tend to have longer laying periods, there is no direct correlation with sub-colony size and duration of laying. In fact, only very small sub-colonies have short laying periods, and if the larger sub-colonies are sub-divided into smaller groups of nests, these groups then have much shorter laying periods. However, in this study no attempt has been made to sub-divide the larger sub-colonies; instead geographical isolation has been the criterion used in sub-colony determination.

Whether total duration of laying, or 95% duration based on two standard deviations either side of the mean, or actual duration of laying from 5 to 95% of the clutches are compared with sub-colony size, there is no positive or negative correlation (see Appendix I). In 1965, the large sub-colony of 179 nests had a similar duration to one of 21 nests, and therefore the former is more synchronised. In the sub-colonies with more than 25 nests, there is only a small increase in duration of laying with size, so that the large sub-colonies will therefore tend to be much more synchronised (see Table 7). The more synchronised a sub-colony, the less tendency there is for desertion by its members, therefore hatching success will be greater in the sub-colonies (see section on hatching success).

TABLE 7. THE AVERAGE TOTAL AND 95% DURATION OF LAYING
WITH SUB-COLONY SIZE

Size of subcolony	< 25	26-75	76-100	100-350
Total duration	11.5	20.1	26.6	29.0
4 Stand. deviation	13.0	17.9	23.1	22.4
No. of subcolonies	16	11	7	7

The Roseate Tern, when nesting in sub-colonies, have their nests close to one another (up to 0.41 nests per square metre), but unlike the Sandwich Tern they spend about three weeks on the island before they begin egg laying.

Although their sub-colonies are small, they show a reduction of laying over the total colony. This reduction is not very marked in 1966 as laying was delayed and resulted in a much shorter season (see Table 8).

TABLE 8. THE AVERAGE DURATION OF LAYING - COMMON AND ROSEATE TERN "SUB-COLONIES" AND TOTAL COLONY IN 1966

	Common Tern		Roseate Tern	
	Subcolony	Colony	Subcolony	Colony
Number of days duration	38.7	48	23.9	36
Average number of nests	15.3	195	15.9	179

Also, the nests of Common Tern in the study area could be divided into geographical groups, mainly determined by the vegetation. These were then analysed as if they were distinct sub-colonies. Although the laying duration of these "sub-colonies" was less than overall duration as might be expected, it was not appreciably synchronised.

The total time spent by each species within the vicinity of the nest is summarised in Table 9. Although no estimate was made of the duration of laying in a "sub-colony" of Arctic Tern, this was taken to be slightly less than in the Common Tern. By allowing for time spent on the nest prior to laying, incubation period, and time taken before chicks leave

TABLE 9. TOTAL TIME (DAYS) SPENT WITHIN THE NEST VICINITY

Species	Pre-laying	Laying	Incubation	Post-Hatching	Total
Sandwich Tern	4	18	25	5	52
Roseate Tern	20	24	22	5	71
Common Tern	15	39	22	20	96
Arctic Tern	10	35	22	20	87

the vicinity of the nest, together with the time taken for the duration of laying in a "sub-colony", the amount of time each tern species spends in a restricted area can be calculated. From the results, it can be seen that the Sandwich Tern spends least time in the sub-colony area, whereas the Roseate Tern is intermediate between this species and the Arctic and Common Tern. In each case, the pre-laying time spent on the island is assumed to be the same throughout the season.

CLUTCH SIZE

The clutch size of a bird is that number of eggs laid which form the total clutch which is then incubated. The average clutch size of a species is the total number of eggs laid divided by the number of clutches involved. Only those clutches where incubation had proceeded so that at least one egg showed one week of embryonic development were considered in the estimations of clutch size. This precaution avoids an underestimate of the clutch size by including incomplete clutches. Since there is usually a certain amount of variability in the number of eggs laid by a species, even in the same locality, the average clutch size embodies a fraction of an egg.

The clutch size of the four tern species is shown in Table 10. The average clutch size within a species does not vary very much from year to year, but because of the large samples used the differences are significant, except for the clutch size of the Arctic Tern in 1966 and 1967. In all the species, the clutch size recorded in 1966 is the lowest of the three years, 1967 the intermediate, and 1965 the highest. This conformity of annual average clutch size variation between species strongly suggests that a common environmental factor is responsible. In the three estimates of average clutch size for the year, almost the total population of Sandwich and Roseate Terns were sampled, but only a fraction of the Common and Arctic Terns.

TABLE 10. THE CLUTCH SIZE OF THE TERNS ON COQUET ISLAND
IN THREE YEARS.

Species	1965	N	1966	N	1967	N	Unweighted mean
Common Tern	2.54	265	2.31	118	2.38	115	2.48
Arctic Tern	1.86	55	1.80	45	1.81	82	1.82
Roseate Tern	1.59	85	1.38	117	1.54	74	1.50
Sandwich Tern	1.41	164	1.15	454	1.24	1664	1.27

In the Sandwich and Roseate Terns, there is no definite trend of clutch size with colony size. The Roseate Tern does have its lowest clutch size when the population was highest (in 1966), and has similar clutch sizes when the populations were about the same (in 1965 and 1967), but although the Sandwich Tern has its highest clutch size when the population is lowest (in 1965), it has an intermediate clutch when the population is highest (in 1967). Also, if all four tern species are considered together, the highest population occurred in 1967 and the lowest in 1965. Nevertheless, in 1966, in all the terns, except the Sandwich Tern, laying began later, and all species except the Roseate Tern had extended seasons. The later period of laying in 1966 would tend to lower the clutch since there tends to be a seasonal decline in clutch size.

The clutch sizes vary between the four species, but as Lack (1954) has said, "it is much harder to suggest reasons for the differences between species, as species differ from each other in so many ways. In general, the amount of food provided by the parents has probably been the basic factor determining evolution of clutch size, but various modifying factors complicate the rate of growth of the nestlings, the predation rate, and the share of the sexes in feeding the young". In the tern species studied, the share of feeding between the sexes appears to be similar, and the effect of predation is minimal on Coquet Island. The growth rates vary a certain amount since the Sandwich Tern chick has the greatest growth rate, followed by the Common Tern and Arctic Tern, and the Roseate Tern has the slowest growth rate of all, but this is mostly related to size.

The Sandwich and Common Terns appear to be similar in being primarily inshore feeders, taking a high percentage of Sprats, although these are usually much larger in the Sandwich Tern. The Arctic and Roseate Terns are offshore species, taking smaller food items. Lack (loc.cit.) has pointed out that inshore or littoral species tend to have higher clutch sizes, and therefore higher brood sizes, with chicks of a faster growth rate, compared with similar species feeding offshore or in a pelagic environment. Since the four species nest on the same island, the difference is not a large one, and there is no close adherence to the different feeding areas. However, although Lack's hypothesis might explain

the difference between the Common Tern on the one hand, and the Arctic and Roseate Terns on the other, it does account for the low clutch size in the Sandwich Tern which is principally a feeder in sandy bays.

Clutch size variation with latitude

Lack (1947^a) recorded that the published information on terns was inadequate "to show whether there are any regional differences in the clutch size within Europe, but there appear not to be." However, records of the clutches of the Roseate Tern, Black Tern Sterna (=Chlidonias) nigra L. and White-winged Black Tern Sterna (=Chlidonias) leucoptera Temm. indicated that there was a definite trend to greater clutch sizes from the tropics northward. Yet, even at the present, accurate information on the clutch sizes of the four species studied is insufficient to give a clear cut picture. The Laridae (gulls and terns) are intermediate between nidicolous and nidifugous as the parents feed the young until they are fully fledged, and for some time afterwards. Therefore it might be anticipated that in Laridae, as in nidicolous birds, brood size would be limited by the amount of food which parents collect (Lack, 1947^a).

In the Common Tern, there is only the record of clutch size by Austin (1932) outside Europe which is insufficient to indicate whether there is an increase in clutch size with latitude, or not (see Table 11). There are several records for the Arctic Tern which are shown in Table 12. In this species, there is

TABLE 11. AVERAGE CLUTCH SIZE IN THE COMMON TERN

Clutch Size	Sample	Place	Latitude	Authority
2.30	?	Cape Cod, U.S.A.	41°50'N.	Austin, 1932
2.51	2088	British Isles	c.53°N.	Marples & Marples, 1934
2.00	236	Wangeroog, Germany	53°47'N.	1962
2.87	220			1963
2.79	182			1964
2.54	265	Coquet Island	55°20'N.	1965 pers.obs.
2.35	118			1966 " "
2.38	115			1967 " "

sufficient information to indicate that there is an increase in clutch size with an increase in latitude. Two of the four records from 60°N or more have an average clutch size of two or more eggs, whereas two of the three records at latitudes of less than 50°N have an average clutch size of under 1.50. The average clutch sizes recorded in the British Isles fluctuate very little, the extremes being 1.67 and 1.94.

There are several records of clutch sizes for the Roseate Tern, but there are comparatively few from Europe. Although the evidence is not entirely satisfactory, there appears to be a trend of increasing clutch size with increasing latitude, with the highest average clutch size of 1.70 at Ravenglass, England.

TABLE 12. AVERAGE CLUTCH SIZE OF THE ARCTIC TERN

Clutch size	Sample	Place	Latitude	Authority
1.70	209	Ravenglass, Eng.	54°N.	Bickerton, 1942
1.80	127	Southampton Isles, Canada	64°N.	Sutton, 1932
1.92	82	Norderoog, Germany	55°N.	Dircksen, 1932
1.88	92	British Isles	55°N.	Marples & Marples, 1934
1.44	100	Machias Seal Island, Canada	45°N.	Pettingill, 1939
1.70	279	Greenland	62°N.	Eklund, 1944
2.01	82	Bolshoi Nitskii Island, U.S.S.R.	73°N.	V.S. Uspenskii, (in Belopolskii, 1961)
2.00	45	S.E. Alaska, U.S.A.	60°N.	R.B. Williams, 1947
1.19	130)	Machias Seal Island, Canada	45°N	1947) Hawksley, 1948) 1950
1.73	125)			
1.69	92	Farne Island, England	55°40'N	1954)
1.76	29	" "	")
1.91	90	" "	") Cullen, 1957
1.94	49	" "	") 1955)
1.87	1116	" "	"	1961) B.P. Springett
1.67	782	" "	"	1962) (pers. comm.)
1.70	101	" "	"	1964 (pers. obs.)
1.62	208)			1962)
2.23	210)	Wangeroog, Germany	53°47'N.	1963) Boecker, 1967
2.01	172)			1964)
1.86	55	Coquet Island England	55°20'N.	1965)
1.80	45	" "	") (pers. obs.)
1.81	82	" "	"	1967)

TABLE 13. AVERAGE CLUTCH SIZE OF THE ROSEATE TERN

Clutch size	Sample	Place	Latitude	Authority
1.00	?	Djerka, Tunisia	34° N.	Saunders, 1896
1.70	209	Ravenglass, Eng.	54° N.	Bickerton, 1942
1.43	373	Ireland	52° N.	Marples & Marples, 1934
1.38	207	Ireland	52° N.	Williamson & Rankin, 1943
1.00	7+	Africa	-	Moreau, 1944
1.03	2656	Abrolhos Group, W. Australia	30° S.	Serventy & White, 1951
1.10	?	Ile Dumet, France		Guichard, 1955
c.1.50	?	Netherlands Antilles	12° N.	Voous, 1963
1.59	85	Coquet Island, England	55° N.	1965 (pers. obs.)
1.38	117	" "	"	1966 " "
1.54	74	" "	"	1967 " "

The evidence is inadequate to indicate whether the Sandwich Tern shows an increase in clutch size with latitude. The only tropical record concerned the Cayenne or Yellow-billed Sandwich Tern *S. sandvicensis eurygnatha** Saunders which does have a lower clutch size.

Summarising the evidence for variation of clutch size with latitude, there appears to be little evidence of variation in European latitudes, but tropical records tend to be lower. The reasons for the lower clutch size are not beyond dispute, but the

TABLE 14. AVERAGE CLUTCH SIZE OF THE SANDWICH TERN

Clutch size	Sample	Place	Latitude	Authority
1.58	104	Ravenglass, 1906	54°N.	Bickerton, 1942
1.45	3831	Norderoog, Germany	55°N.	Dircksen, 1932
1.41	5249	East Coast, Britain	c.54°N.	Marples & Marples, 1934
1.67	?	2 English & 2 Irish Colonies	c.54°N.	" " "
1.04*	?	Netherlands Antilles	12°N.	Voous, 1963
1.41	164	Coquet Island, Eng.	55°N.	1965 (pers.obs.)
1.15	454	" " "	"	1966 " "
1.24	1664	" " "	"	1967 " "

relatively impoverished state of tropical waters suggests that food requirements are primarily responsible for tropical species of terns having longer fledging periods, slower growth rates and smaller broods (Ashmole, 1963). However, there is need of comparative data on the European species where these breed in the tropics.

Clutch Size variation with season

Individuals of a particular species do not all start laying at the same time and those that begin laying earlier tend to have larger clutches than those laying at the end of the season. Lack (1954) has agreed that the clutch size is related to the number of offspring the parents can raise, so that the smaller size of later clutches means that conditions must have deteriorated,

and when conditions deteriorate sufficiently so that breeding is no longer biologically profitable, breeding ceases. Perrins (1965) has stated that in Great Tits, Parus major L. which have larger and more successful broods early in the season, there will be selection pressure to breed even earlier, but that this must be prevented by some adverse factor. It is usually considered that a bird must lay in anticipation of abundant food, and fitter birds will achieve this earlier than less fit birds; whilst the laying of a diminished second or repeat clutch occurs when food is abundant. Therefore, it appears that it is not the food supply at the time of laying that directly controls the clutch size, but, perhaps together with other environmental factors, ensures that approximately the most profitable clutch size is laid.

Common Tern

The clutch size variation in this species shows a significant decline with season in 1965, but not in 1966 and 1967. However, the combined seasons of 1965 and 1967 show a significant decline in clutch size with season (see Figure 8 and Table 15).

TABLE 15. COMMON TERN CLUTCH SIZE VARIATION WITH SEASON

Year	Until 31 May				1 June onwards				Diff. in clutch	Size
	1 egg	2 egg	3 egg	Mean clutch size	1 egg	2 egg	3 egg	Mean clutch	χ^2	$P = <$
1965	5	69	140	2.63	6	31	14	2.16	38.15	0.001
1966	4	38	22	2.28	4	27	23	2.31	0.92	0.50
1967	2	37	31	2.41	4	21	20	2.36	3.28	0.10
Total*	7	106	171	2.58	14	52	34	2.25	24.94	0.001

* Excluding abnormal year of 1966

FIGURE 8. THE VARIATION IN AVERAGE CLUTCH SIZE WITH SEASON IN THE
COMMON TERN IN 1965, 1966 and 1967.

COMMON TERN

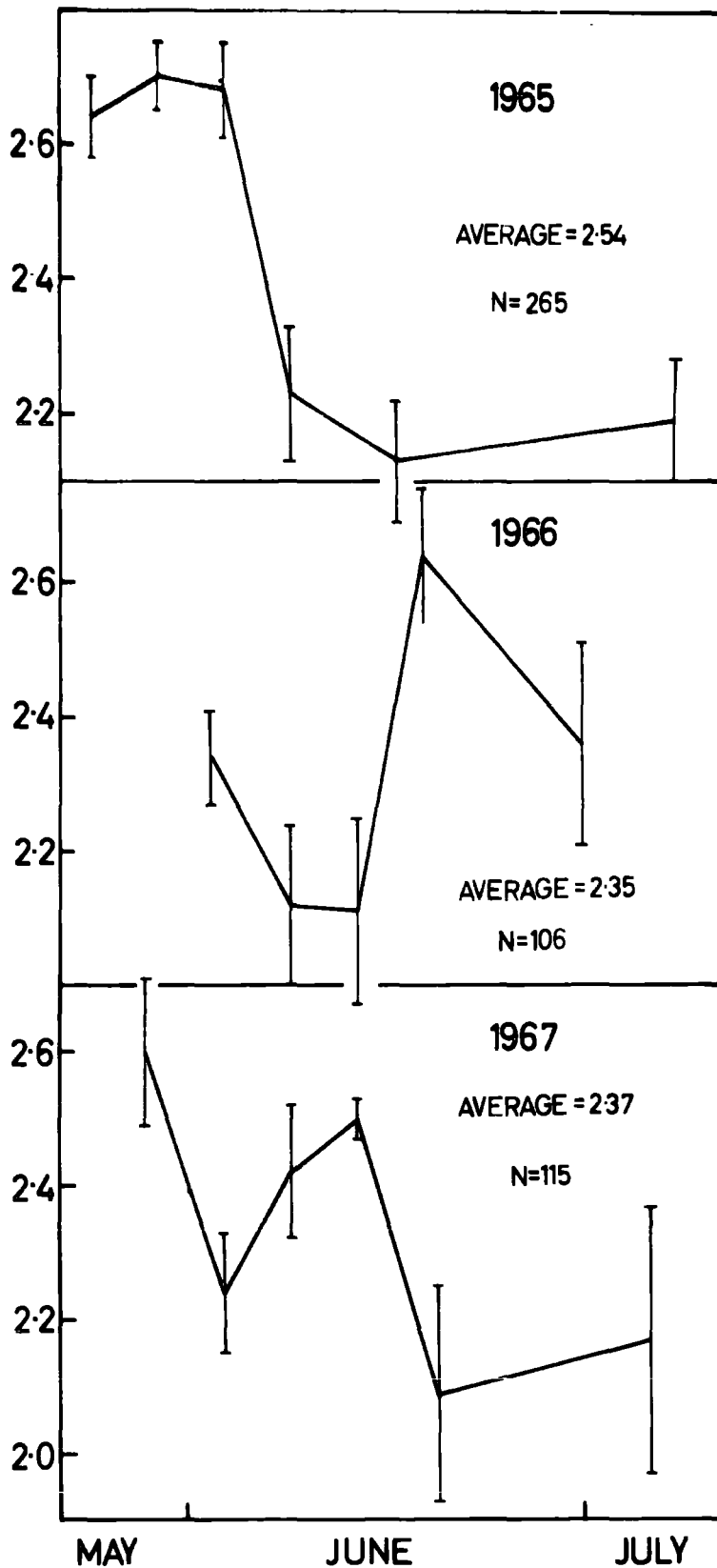

In 1965 and 1967, the maximum clutch size was attained early in the season when the majority of the birds were laying three egg clutches. This period tends to coincide with the maximum incidence of laying, indicating that most of the birds breed at the most favourable period. After this period, the clutch size and the number of birds attempting to lay declined. Unfortunately, it is not known how many birds were relaying in this later period. However, several 1964 pulli were seen breeding late in 1967 which suggested that the younger element predominated in the breeding population at this time. It has been said that the appearance of a second peak of laying in the more extended season of 1966 appeared to be due to a failure in principal food supply of clupeoids and sand eels. Whether this affected those birds incubating eggs indirectly through lack of fish in feeding the mate on the nest and assisting in change-overs and courtship, or whether it directly affected them, so that they had to spend the daylight hours looking for food rather than incubating, the result was that a large number of clutches were deserted. The low clutch size reported at this time probably reflects the desertion of incomplete clutches rather than a direct limitation of the number of eggs laid through food shortage. Subsequently, three weeks after the normal starting date and two weeks later than the normal period of maximum clutch size, the laying of maximum clutch sizes occurred, represented by a second peak in actual laying.

The peak clutch size for the five-day period is lower than that experienced in 1965 and 1967, and the overall clutch size for 1966 is lower (i.e. excluding those clutches that were deserted, since it cannot be ascertained if they were complete or not). Nevertheless, the maximum clutch size in that five-day period for 1966 occurs in mid-June, and is higher than the clutch size for the corresponding period in 1965 and 1967 by about 0.3 egg. This indicates that birds laying in 1966 at this time were better than those that normally laid then, and it is likely that these were older, or more experienced, or at least fitter individuals and would normally have laid earlier. The slight drop in maximum clutch in 1966 could correspond to a decline in environmental conditions. Therefore the failure of the first clutch of some of the birds in 1966 allowed the effect of fitness or maturity on clutch size to be separated from the effect of the normal deterioration of environmental factors. However, it could be argued that the smaller maximum clutch size of the five-day period in 1966 was due to the early laying birds not having fully recovered.

Arctic Tern

Cullen (1957) demonstrated a seasonal decline in the clutch size of this species when considering the combined data of two seasons. From the data obtained on Coquet Island over three seasons, there is only a significant difference between the first and latter part of the season in 1965. However, this species has a brief season and variation will tend to be small as it usually lays one or two eggs (see Figure 9).

FIGURE 9. THE VARIATION IN AVERAGE CLUTCH SIZE WITH SEASON IN THE
ARCTIC TERN IN 1965, 1966 and 1967.

ARCTIC TERN

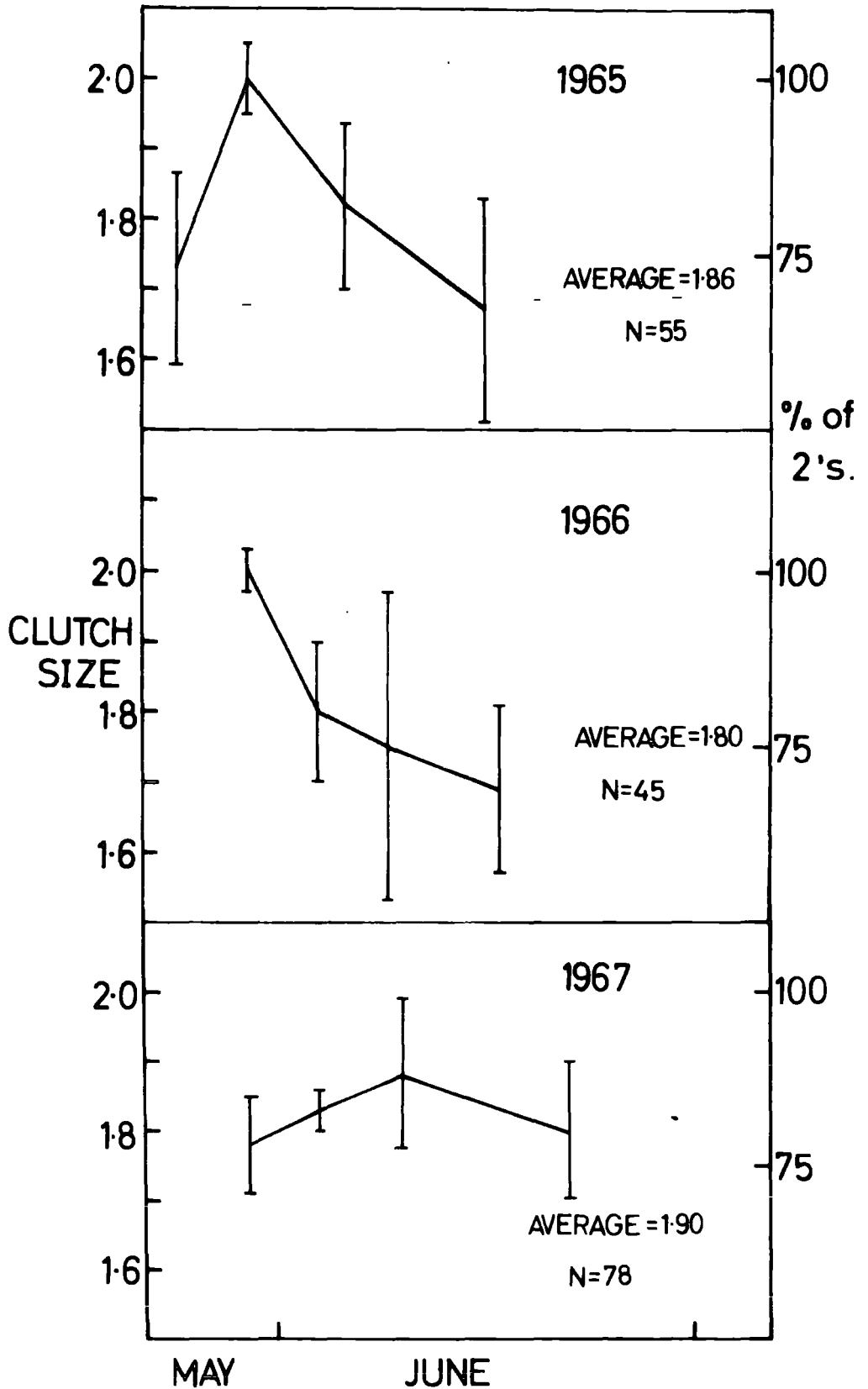

TABLE 16. ARCTIC TERN CLUTCH SIZE VARIATION WITH SEASON

Year	Up to 5 June				After 5 June			χ^2	P=<
	1 egg	2 eggs	3 eggs	Mean clutch size	1 egg	2 eggs	Mean clutch size		
1965	6	36	3	1.93	5	8	1.62	7.52 for 2 d.f.	0.05
1966	4	20	(1)	1.88	6	14	1.70	1.32 for 1 d.f.	0.2
1967	13	45	(1)	1.76	4	19	1.83	0.36 for 1 d.f.	0.5
Total	23	101	5	1.86	15	41	1.73	4.56 for 2 d.f.	0.1

Roseate Tern

In 1965 and 1967, there is a significant decline in clutch size with season, but in 1966 there is no decline (see Figure 10). However, 1966 has been noted as a late season and resulted in desertions in the Common Tern. In the Roseate Tern, laying began later with reduced clutch sizes and then reached a peak, approximately coinciding with peak laying, before declining again. This species appears to find the environment more hostile than the other terns, and the shortage of fish not only delayed laying, but the maximum clutch sizes were not laid until mid-June. Nevertheless, over all the seasons, this species shows a very significant decline in clutch size with date of laying. Although the season is comparatively short, conditions must soon become severe so that those individuals laying only one egg are at an advantage over those laying two.

FIGURE 10. THE VARIATION IN AVERAGE CLUTCH SIZE WITH SEASON IN
THE ROSEATE TERN IN 1965, 1966 and 1967.

ROSEATE TERN

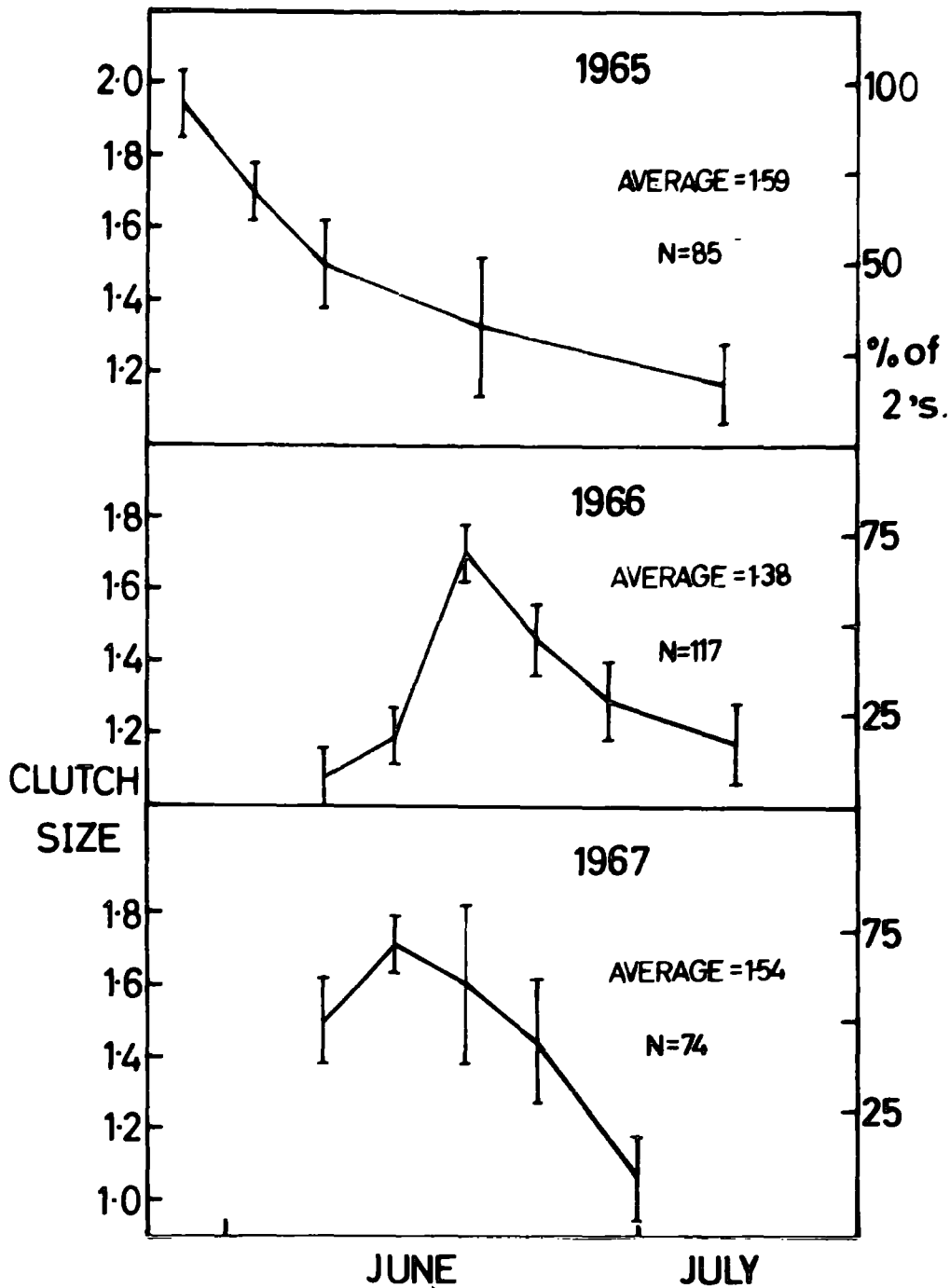

TABLE 17. ROSEATE TERN CLUTCH SIZE VARIATION WITH SEASON

Year	Up to 20 June			After 20 June			χ^2 for 1 d.f.	P= <
	1 egg	2 eggs	Mean clutch size	1 egg	2 eggs	Mean clutch size		
1965	22	48	1.69	13	2	1.13	16.50	0.001
1966	42	29	1.41	31	15	1.33	0.62	0.3
1967	20	34	1.56	14	6	1.30	6.91	0.01
Total	84	111	1.57	58	22	1.28	20.39	0.001

Sandwich Tern

In this species, only in 1967 is there a significant difference between the clutch sizes laid in May and those in June. In this case, it is a rise in clutch size with season, and owing to the preponderance of birds laying in this year, it gives the overall total a significant rise in clutch size with season. Examination of the clutch size variation with season (see Figure 11) shows a drop and then a rise in 1967, while in 1966 the reverse appears true, and in 1965 there is a tendency for the clutch size to decline with season. The two peaks occurring in the laying frequency of 1966 correspond with the two peaks of maximum clutch size, and there is a similar correspondence with the single peak clutch size in 1965, but the picture for 1967 is more complicated. However, it was decided to examine the clutch size variation within a subcolony.

FIGURE 11. THE VARIATION IN AVERAGE CLUTCH SIZE WITH SEASON IN THE
SANDWICH TERN IN 1965, 1966 and 1967.

SANDWICH TERN

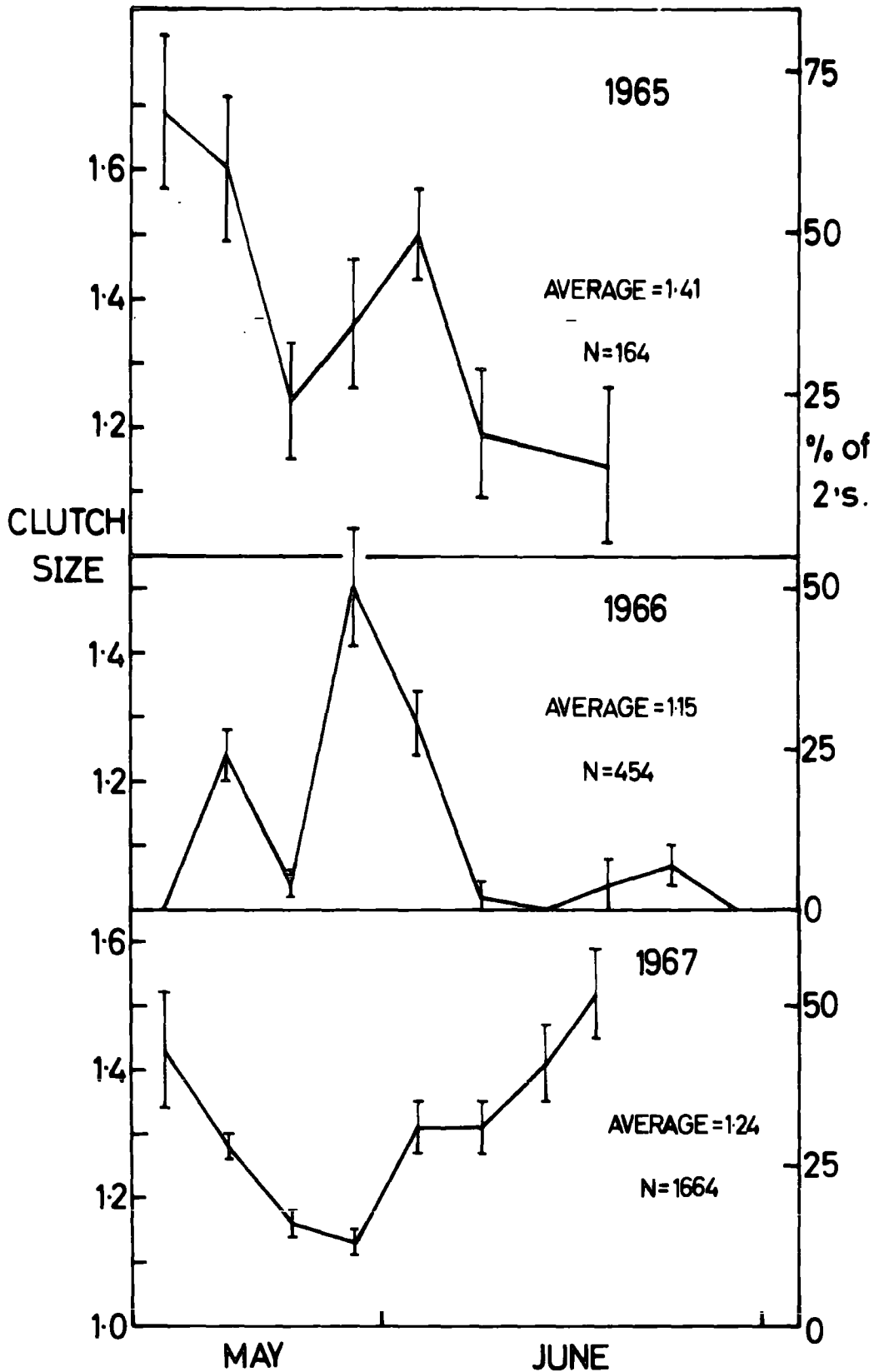

TABLE 18. SANDWICH TERN CLUTCH SIZE VARIATION WITH SEASON

Year	May			June and July			χ^2 for 1 d.f.	P= <
	1 egg	2 eggs	Mean clutch size	1 egg	2 eggs	Mean clutch size		
1965	45	37	1.45	51	31	1.38	0.90	0.3
1966	168	38	1.19	218	30	1.12	3.41	0.1
1967	1005	266	1.21	264	129	1.33	23.89	0.001
Total	1218	341	1.22	533	190	1.26	7.49	0.01

Clutch size variation within Sandwich Tern subcolonies

In order to examine the clutch size variation within the Sandwich Tern subcolonies, the average clutch size for each of the four-day periods of the duration of the subcolony was tabulated (see Appendix 2a, b & c), for the three years. In 1965, the six main subcolonies were taken and the average clutch size for each four-day period was considered. Of the five smaller of the six subcolonies examined (12 - 23 nests apiece), all tended to show an initial average maximum of 1.5 to 2 eggs per clutch which declined to one egg per clutch. In the single large subcolony of 179 nests, the clutch size rises to a peak at the maximum laying frequency and then declines. In the five smaller subcolonies, the initial maximum clutch size coincides with the peak in laying frequency.

In 1966, ten subcolonies were examined. In most cases, the maximum clutch size coincided with the peak laying frequency

which usually occurred early in the duration of the subcolony. However, in some of the later subcolonies, the clutch size remained low with very few clutches of two eggs being laid. These phenomena resulted in the increase and decrease in clutch size observed with season in the colony as a whole.

In 1967, 18 subcolonies were considered. In most cases, the maximum clutch sizes within a subcolony corresponded with the peak in laying in that particular subcolony. If the clutch sizes for the first four-day period for each subcolony is totalled, and so on, and the total average clutch size derived with the duration of the subcolonies, there is found to be very little variation in clutch size (see Table 19). This contrasts with the clutch size variation observed for the whole colony which declines from an initial peak and then rises to a peak at the end of the season.

TABLE 19. CLUTCH SIZE VARIATION WITH DURATION OF THE
SUBCOLONIES IN 1967

4-day period	1	2	3	4	5	6 - 9
Average clutch size	1.22	1.24	1.22	1.20	1.33	1.22
Sample	251	451	456	265	101	107

In 1965, only one subcolony was large enough for the hatching success and clutch size of the perimeter nests to be compared with those in the centre. The clutch size was higher in the nests in the centre (1.28) compared with those on the perimeter (1.11), but the difference was not significant

($X^2 = 0.195$ for 1 d.f.). However, the hatching success was higher in the centre (76.4%) compared with those nests on the perimeter (61.9%) and the difference was significant ($X^2 = 6.19$, $p = < 0.02$ for 1 d.f.). The reasons for these differences are uncertain, since three quarters of the clutches considered in the centre were laid before any of the perimeter ones, so that time may be responsible for the variation in clutch size, if not the variation in hatching success.

In 1966, two neighbouring subcolonies formed on the one hand of a dispersed group of which 15 nests were mapped, and on the other, a compact group of which 35 nests were mapped. The latter subcolony was formed after the dispersed one and consisted of single egg clutches. The average clutch size in the dispersed group was 1.13. The hatching success of the dispersed subcolony was 64.7% and that of the compact one 74.3%, but the difference was not significant ($X^2 = 0.149$ for 1 d.f.). However, there is a tendency suggesting that compact subcolonies have a greater success than dispersed ones, but this requires further examination than was possible in this present study.

Therefore in the Sandwich Tern, the clutch size appears to vary with one distinct factor, i.e. the number of birds laying at a particular time within a subcolony. Where the season is prolonged, as in 1966, there is a tendency for most later clutches to be single eggs, but it is insignificant. In addition, it is very likely that age of the birds will affect

the clutch size, as in the Yellow-eyed Penguin Megadyptes antipodes (Hombron & Jacquinot), (Richdale, 1949), and the Kittiwake (Coulson, 1960). Although the effect of age was not examined in the terns, it may relate to the factor mentioned. Also, clutch size may vary with the position of the scrape within the subcolony, but this is complicated by the other factors.

The significance of clutch size has been discussed by Lack (1947, 1948, 1954). He considered the food requirements of the brood as the ultimate factor where "clutch size evolved through natural selection to correspond with the largest number of young for which the parents on average can find food." However, the abundance of food is not directly related to the clutch size, as the seasonal decline in clutch size evidenced in the Common, Arctic and Roseate Terns coincides with an increase in food. There is little evidence that terns show an increase in clutch size with latitude, although the extremes of day length in the Arctic may permit the Arctic Tern to raise more chicks, on average, than on Coquet Island. The increase in clutch size observed at periods of peak laying within subcolonies of the Sandwich Tern suggests that social stimulation is responsible. It might be argued that the correlation observed between maximum clutch size and laying was a result of favourable conditions. However, consideration of Appendix 2 shows that the period of peak laying and maximum clutches is not consistent between subcolonies in any particular year. Since there is no evidence to

suggest that subcolonies have a different composition, it is suggested that the synchronised activity of many pairs will increase the social stimulation and result in larger clutches being laid. This, together with the absence of a correlation between the total numbers of nesting pairs and clutch size, suggests that a self-regulatory mechanism for population, such as that proposed by Wynne-Edwards (1962), does not operate in the terns on Coquet Island.

INCUBATION PERIOD

The "incubation period" is here defined as that period of time taken from the laying of the egg until its hatching, where a chick is considered hatched when it is free from the shell. If incubation (i.e. the brood patch is applied to the egg to increase its temperature and aid development) begins with the first egg, the "incubation period" should be the same for each egg of the clutch. On the other hand, if it begins with the laying of the last egg, all the eggs will hatch about the same time, and therefore earlier laid eggs will have longer "incubation periods." By recording the "incubation periods" of eggs in certain clutch sizes it should be possible to determine when incubation begins. It was possible to estimate the time of hatching to within twelve hours by daily visits and examination of the age of the chick (deduced from drying of down etc.), but first laid eggs may have been overlooked. However, where two or more eggs were laid, it was possible to deduce the time the first egg was laid, so that only in single egg clutches would there be a tendency to underestimate the "incubation period." The results are listed in Table 20 where the average "incubation periods" for eggs in different clutch sizes are shown.

Common Tern

In clutches of two eggs, the first egg has a slightly longer "incubation period" than the second. This indicates that incubation does not begin immediately after the first egg is laid,

TABLE 20. INCUBATION OF EGG ACCORDING TO CLUTCH SIZE AND LAYING ORDER *

Species	C L U T C H S I Z E					
	1	2		3		
		First	Second	First	Second	Third
Common	-	22.97 [±] 3.82	22.31 [±] 1.29	23.49 [±] 0.51	22.52 [±] 0.46	22.50 [±] 0.43
Tern N=		37	29	81	62	16
Arctic	22.00 [±] 0.94	22.45 [±] 0.81	22.50 [±] 0.71	-	-	-
Tern N =	9	20	16	-	-	-
Roseate	21.68 [±] 1.74	21.84 [±] 0.66	21.93 [±] 5.27	-	-	-
Tern N =	29	19	14	-	-	-
Sandwich	25.23 [±] 1.19	25.00 [±] 1.04	25.00 [±] 1.27	-	-	-
Tern N =	134	46	20	-	-	-

* Values are in days [±] 1 standard deviation.

but before the laying of the second, since the two eggs are laid one to two days apart. In a three egg clutch, the first two eggs tend to hatch on the same day, suggesting that incubation begins with the laying of the second egg. The third egg hatches later, and this asynchronous hatching may have survival value when the parents find it difficult to raise all three chicks, as the first two chicks will dominate the third. The difference in hatching is shown in Table 21.

TABLE 21. THE DIFFERENCE IN THE HATCHING OF COMMON TERN EGGS

Clutch size	Difference between	D I F F E R E N C E I N D A Y S					N
		0	1	2	3		
2	1 + 2 egg	5	38	5	0	48	
3	1 + 2 egg	11	11	4	0	26	
	1 + 3 egg	0	6	9	11	26	
	2 + 3 egg	1	12	13	0	26	

Arctic Tern

There is normally an interval of about one day between the laying of the first and second egg, but since both have a very similar "incubation period," they tend to hatch with a similar interval as in laying.

Roseate Tern

The situation in this species is similar to that of the Arctic Tern, except that in a two egg clutch the second egg is laid two days after the first and therefore hatches with the same interval.

Sandwich Tern

period"
The "incubation" is about 25 days in both single and two egg clutches. In the latter, the hatching interval will depend on the laying interval as incubation begins with the first egg in a two egg clutch (see Table 22). In some cases, the laying interval was five days and the chipping egg was often left in the nest and the chick failed to hatch. This difference was thought

to be the result of asynchronous laying in small subcolonies. The young are led away from the scrape within five days after hatching so that eggs that have failed to hatch by that time are left.

TABLE 22. THE DIFFERENCE IN LAYING AND HATCHING IN TWO EGG CLUTCHES OF THE SANDWICH TERN

	D i f f e r e n c e i n D a y s						N	Mean
	0	1	2	3	4	5		
Laying	-	1	18	21	7	2	49	2.82
Hatching	-	6	24	13	5	1	49	2.41

HATCHING SUCCESS

In estimating the hatching success (i.e. the number of eggs that hatch of those laid, expressed as a percentage), the Common and Arctic Terns nesting in the study area were considered, and almost all the Roseate and Sandwich Terns nesting on the Island. In all cases the pairs used in these estimates involved those used to determine the average clutch size. In the estimations of 1965 and 1966, the hatching success has been related to clutch size, but not to the order of hatching within the clutch as this is not easy to determine with any certainty. In 1967, visits to the colony were not frequent enough to obtain a correct picture of the hatching successes of the various clutch sizes, so only the overall hatching success has been recorded.

Common Tern

In 1966, this species had a lowered hatching success owing to a large proportion of desertions of early clutches. These desertions seemed to be the result of a failure in the principal food supply. Normally, the overall hatching success is about 80% instead of the 55% recorded in that year. In 1965, the overall hatching success was 87.6% and the 72 eggs that failed are accounted for in Table 23 .

TABLE 23. CAUSE OF FAILURE TO HATCH IN COMMON TERN EGGS

Cause of Failure	Number of Eggs	Percentage
Deserted	28	39
Eaten	16	22
Damaged	11	15
Addled/Infertile	10	14
Died Chipping	7	10
Total	72	100

TABLE 24. THE HATCHING SUCCESS OF THE COMMON TERN

Clutch Size	1965	N	1966	N	1967	N
1	42.9	21	40.0	20	-	-
2	83.6	152	51.0	216	-	-
3	91.4	407	60.2	186	-	-
OVERALL	87.6	580	54.5	422	81.2	303

N = Number of eggs in sample

It can be seen that the single egg clutches have lower hatching success in both years. In most cases, these were eggs deserted soon after laying and probably represent incomplete clutches and were not used in estimation of average clutch size.

Arctic Tern

This species has a reduced hatching success in 1966, but the difference is not so marked as in the Common Tern. Also, the very low hatching success of single egg clutches probably represents a large proportion of incomplete clutches that have been deserted (Table 25). The difference in hatching success of singles between 1965 and 1966 is significant ($\chi^2 = 6.46$, $p = < 0.02$ for 1 d.f.).

TABLE 25. THE HATCHING SUCCESS OF THE ARCTIC TERN

Clutch size	1965	N	1966	N	1967	N
1	69.2	13	34.4	32	-	-
2	70.3	74	77.9	86	-	-
3	100.0	9	66.7	3	-	-
OVERALL	72.9	96	66.1	121	87.7	163

Pettingill (1939) in a study of 100 nests of the Arctic Tern on Machias Seal Island, Canada, recorded a hatching success of 63% for one year (1937); whilst Hawksley (1950) on the same island recorded 59.2% and 82.8% for 1947 and 1948, respectively. These values are similar to those recorded on Coquet Island.

The causes of failure are recorded in Table 26 where the proportion of addled and infertile eggs is similar, although other differences exist. It is possible that those recorded "eaten" on Coquet Island contained dead embryos and were only predated after desertion. Hawksley (1950) recorded an overall hatching success of about 64%, with those of single eggs having a hatching success of 59.3%, and those with two eggs of 68.9%. On the Farne Islands, overall hatching successes of 52.3% and 45.0% were recorded in 1963 and 1964, respectively (Springett, 1967). These low hatching successes were principally due to predation by Starlings. Although the Starling occurs on Coquet Island, it has been seen only to eat deserted eggs.

TABLE 26. THE CAUSE OF FAILURE OF EGGS TO HATCH IN THE
ARCTIC TERN

Cause of Failure	PETTINGILL		HAWKSLEY		COQUET ISLAND	
	No.	%	No.	%	No.	%
Addled/Infertile	8	16	31	28	6)	24
Dead embryos	14	27	23	21	0)	
Mammals (& man)	10	20	20	18	0	0
Damaged	8	16	10	9	5	19
Deserted	0	0	3	3	4	15
Eaten	0	0	0	0	8	31
Disappeared & others	11	21	24	21	3	11
TOTAL	51	100	111	100	26	100

Roseate Tern

The hatching success in this species is consistently high, between 80 - 95%. The clutches of two tend to have slightly greater success, but the differences are not significant. The reason for the comparatively high hatching success is not clear, but their choice of nesting site offers better protection against the elements and aerial predators than in the other species.

TABLE 27. THE HATCHING SUCCESS OF THE ROSEATE TERN

Clutch size	1965	N	1966	N	1967	N
1	82.2	45	90.3	82	-	-
2	89.7	78	95.0	80	-	-
Overall	87.0	123	92.6	162	95.2	99

In 1965, 16 (13%) eggs failed to hatch. Of these 16 eggs, 5 (31%) were deserted, 7 (44%) were either addled or infertile, and 4 (25%) disappeared, and were probably predated.

Sandwich Tern

The hatching success of this species has shown a consistent increase with total colony size on Coquet Island over the three years examined (see Table 28). It has been shown that in the large subcolony of 1965, the hatching success in the centre was significantly higher than that in the perimeter nests; and that in 1966, there was a tendency for a more compact subcolony to have a greater hatching success than one with diffuse

TABLE 28. THE HATCHING SUCCESS OF THE SANDWICH TERN

Clutch size	1965	N	1966	N	1967	N
1	41.6	219	72.0	722	-	-
2	66.2	83	73.1	78	-	-
Overall	53.9	302	72.2	800	95.7*	1982

* Assuming those eggs not found again hatched;

otherwise overall H.S. = 81.9%.

nesses. Also there appears to be a correlation of hatching success with subcolony size. In general, the subcolonies seem to have become consistently larger with the increase in the total colony, and have a higher hatching success (see Appendix 3). If the subcolonies for 1965 and 1966 of less than 20 nests and more than 20 nests are considered with respect to hatching success, there is a significant difference in both years (see Table 29).

TABLE 29. THE HATCHING SUCCESS IN SMALL AND LARGE SUBCOLONIES OF SANDWICH TERN

Year	Subcolony <20 nests				Subcolony >20 nests				x ² for 1 d.f.	p = <
	No. Laid	No. hatched	Hatching Success	N	No. Laid	No. Hatched	Hatching Success	N		
1965	80	44	55.0	7	279	193	69.2	3	5.82	0.02
1966	41	22	53.7	4	823	609	74.0	9	8.35	0.01
Total	121	66	54.5	11	1102	802	72.8	12	16.74	0.001

However, the situation is not as simple as this for in some cases very small subcolonies have high hatching successes. In these cases it is usually duration (i.e. synchronization) that is important in ensuring a high success. Also, in the larger subcolonies, the nests can be grouped into smaller units that are highly synchronized, and it is these units that have high hatching success apparently owing to the synchronous activities of their members. In diffuse and less synchronised subcolonies, birds deserted their nests frequently, and this appeared to be the main reason for the lowered hatching success. The two small subcolonies of 1966 which enjoyed a comparatively high hatching success (75 - 80%) were extremely synchronised in both cases. Even in the large subcolonies, synchrony favours hatching success; for example, in the large subcolony of 1965, between 20 May and 13 June, 155 clutches (190 eggs) were laid and had a hatching success of 70%; whilst between 14 June and 11 July, 34 clutches (37 eggs) were laid with a success of 54%. This difference is not significant ($X^2 = 3.68$, $p = < 0.1$ for 1 d.f.).

In comparison, both the Common and Arctic Terns have a low hatching success in 1966 which reflects the shortage of food, but this is not seen in the Roseate Tern. However, the latter species nested much later than the other two species, i.e. not attempting to nest while the conditions were adverse. The hatching success of the Sandwich Tern was 20% lower in 1966 than in 1967, but was much lower (40%) in 1965 when the subcolonies

were not very synchronised. Apart from the Common and Arctic Terns in 1966 and the Sandwich Tern in 1965, all the four species show a relatively high hatching success which reflects the lack of predation on clutches compared with peninsular colonies. In colonies adjoining the mainland, rats, foxes and Mustelids are very destructive of eggs and chicks; and also on the Inner Farne Island, Northumberland, where the Starlings' newly acquired habit greatly affects hatching success.

FLEDGING SUCCESS

The estimation of fledging success (i.e. the number of chicks which fledged expressed as a percentage of those that hatched) was derived from the study areas of Common and Arctic Terns and most of the population of Sandwich and Roseate Terns, and so could be directly related to the clutch sizes and hatching successes obtained. In estimating the fledging success, it was assumed that individuals that were not seen after about five days from hatching fledged successfully. In order to reduce the error, thorough and regular searches were made of the island to locate any dead chicks. In the enclosures used for weighing chicks, the daily collections of chicks enabled a more accurate determination of fledging success to be made by a more systematic search for chicks. Chicks less than five days old died within the vicinity of the nest, which aided discovery, whereas older chicks moved greater distances, but were easier to find. In order to avoid recording a dead chick twice, it was either removed from the area or a foot was cut off. In these estimations of fledging success, every effort was made to ring chicks on, or the day after, birth so that the success of each individual could be recorded. Such regular ringing allowed not only the success of individual broods to be followed, but also the success with respect to the order of hatching within a brood to be calculated.

TABLE 31. THE FLEDGING SUCCESS WITH BROOD SIZE AND ORDER
OF HATCHING IN THE COMMON TERN

Brood Size	Order of hatching	1965		1966		1967	
		Fledging Success	N	Fledging Success	N	Fledging Success	N
B1	1	81.8	11	37.5	20	87.5	8
B2	1	81.9	72	78.7	61	91.5	71
	2	46.5	71	58.3	48	79.2	48
B3	1	85.2	88	90.5	42	94.1	51
	2	51.7	88	75.0	40	93.5	46
	3	10.5	76	18.5	27	68.2	22
Overall fledging success		59.0	406	67.0	238	87.8	246

N. = No. of chicks in sample

It can be seen that although the overall fledging success varies in the three years, second chicks hatching in a brood of two have a lower fledging success than the first chicks. Also, in broods of three, the fledging success is highest for the first chicks to hatch, lower in the second chicks, and often very much lower in the third chicks. In 1965 and 1967, the single chicks and the first chicks of the broods of two and three had a similar fledging success, but this is not the case in 1966, where the fledging success of this chick increases with brood size. In 1965, the second chick of broods of two and three had similar fledging success, but in 1966 and 1967, it had a higher success

FIGURE 12. COMMON TERN : THE NUMBER OF CHICKS DYING WITH AGE IN 1965.
a = third chick. b & c = second and first chicks.

COMMON TERN 1965

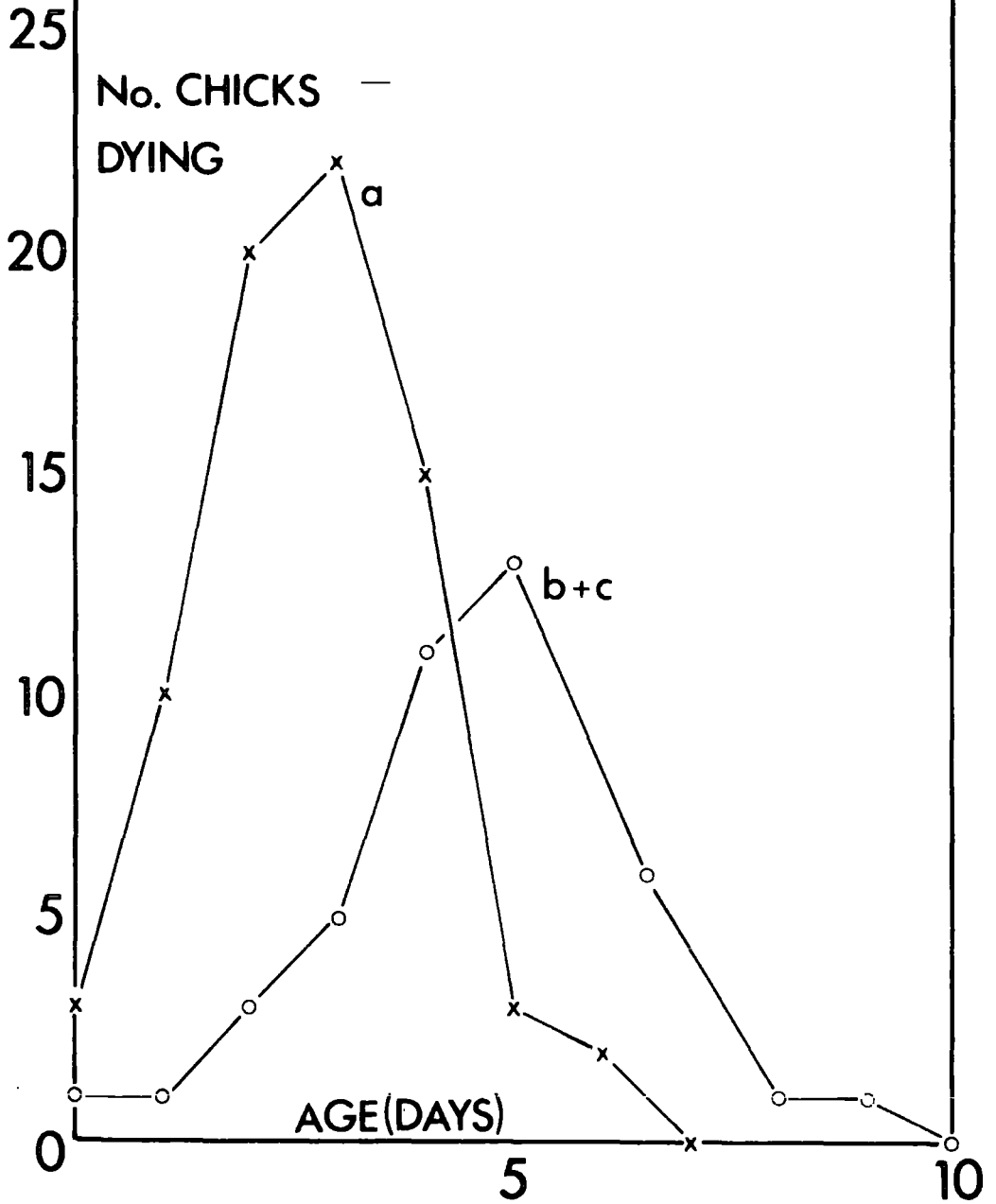

in broods of three. However, in 1967, the fledging success of the second chick of a brood of two was higher than that of a second chick in both broods of two and three in the other two years. The fledging success of the second chick of a brood of three in 1967 was comparable with the success of the first chick of this brood size in all three years. -

It might be expected that those birds with the lowest initial brood size would be more successful in raising their offspring, but this is clearly not the case. The information in Table 31 suggests that birds with an initial brood of three are more capable of rearing two chicks than those of an initial brood of two, although (apart from the odd year of 1966) first chicks seem to be equally successful in all brood sizes.

The main mortality of chicks occurs within the first week of hatching and usually in the first five days of life. In 1965, over 80% of the chicks dying did so when not more than five days old (see Figures 12 - 13), and similarly in 1966 (see Table 32). When age of chicks dying is considered with respect to order of hatching in broods of two, the second chicks tend to die earlier on average than first chicks. This difference is not significant in 1965 ($p = < 0.1$) and in 1966 ($p = < 0.2$) when considered separately. However, when the two years are combined, the second chicks die at a significantly earlier age ($p = < 0.01$), see Table 33. The same trend is shown in broods of three chicks, but there is a more pronounced difference between the age of death of the first

FIGURE 13. COMMON TERN : THE PERCENTAGE OF CHICKS DYING WITH AGE IN 1965.

a & b = first and second chicks, c = third chick.

COMMON TERN 1965

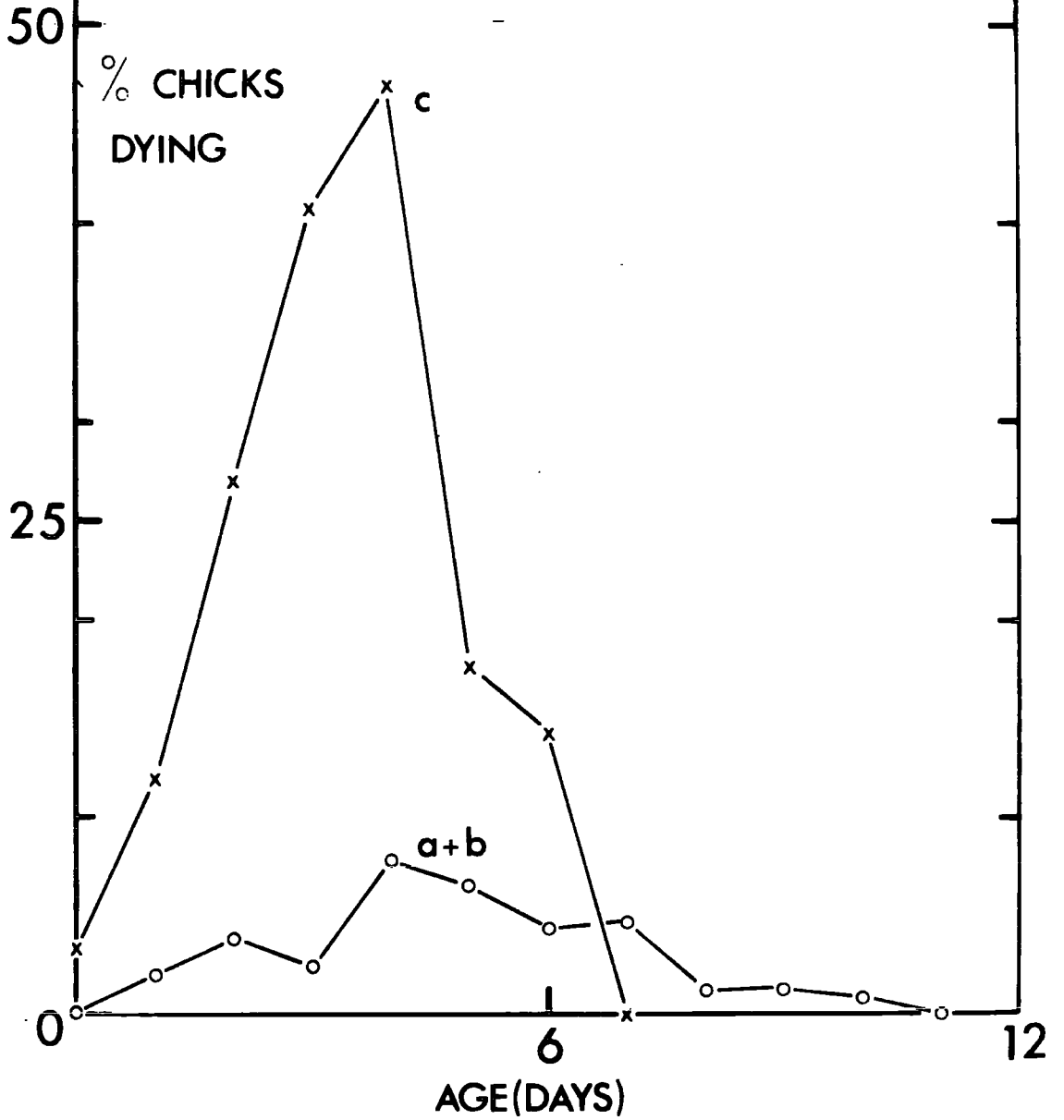

two chicks and the third chick (see Table 34). The difference between the ages of the first two chicks at death and the third chick is significant in 1965 ($p = <0.001$), but not in 1966 ($p = <0.5$).

TABLE 32. THE MORTALITY OF THE COMMON TERN CHICK WITH
RESPECT TO AGE

Age in days	1965		1966	
	No. dying	% of total	No. dying	% of total
0 + 1	21	11.6	19	30.2
2 + 3	63	34.8	19	30.2
4 + 5	62	34.3	14	22.2
6 + 7	26	14.4	4	6.3
8 + 9	6	3.3	4	6.3
10 + 11	2	1.1	2	3.2
12 +	0	0	0	0
Total	180	99.5	62	99.4

TABLE 33.

AGE AT MORTALITY IN BROODS OF TWO CHICKS

Age in days	1965		1966		Both Years	
	First	Second	First	Second	First	Second
0 + 1	1	4	1	5	2	9
2 + 3	2	10	1	10	3	20
4 + 5	4	13	2	1	6	14
6 + 7	4	5	1	2	5	7
8 + 9	0	3	0	0	0	3
10 + 11	1	0	1	0	2	0
over 11	0	0	0	0	0	0
Total	12	35	6	18	18	53
Average age	4.92 [±] 2.39	4.03 [±] 2.21	4.67 [±] 2.92	2.72 [±] 1.63	4.83 [±] 2.53	3.58 [±] 2.13

Since there are more chicks available to die at the earlier ages, it might bias the figures so as to suggest that the main mortality occurs in the first few days of life when, in fact, the proportion dying might be constant throughout the nestling period. In order to eliminate this bias, the number dying at a particular age can be presented as a percentage of the number alive at that time, i.e. those available to die (see Table 35). This table takes account of those chicks that have already died at earlier ages. However, the main percentage of deaths occur within the first five days to a week, as suggested in the earlier tables. Even when considering the first and second chicks of a

TABLE 34. THE AGE AT DEATH WITHIN BROODS OF THREE COMMON
TERN CHICKS

Age in days	1965				1966			
	1st	2nd	3rd	Total	1st	2nd	3rd	Total
0 + 1	1	1	9	11	1	2	8	11
2 + 3	2	6	39	47	1	2	6	9
4 + 5	5	19	16	40	0	4	5	9
6 + 7	1	11	2	14	0	1	2	3
8 + 9	1	1	0	2	2	0	1	3
10 + 11	0	0	0	0	0	0	1	1
over 11	0	0	0	0	0	0	0	0
Total	10	38	66	114	4	9	23	36
Av. age	4.77 \pm 1.8		2.79 \pm 1.3		3.69 \pm 2.66		3.13 \pm 2.77	

brood of three, the main mortality occurs within the first week (see Table 36).

TABLE 35. THE PERCENTAGE OF COMMON TERN CHICKS DYING IN
RELATION TO THE NUMBER AT RISK AND AGE

Age in days	1965			1966		
	No. dying	No. alive	% dying	No. dying	No. alive	% dying
0	4	435	0.9	7	229	3.1
1	17	431	3.9	12	222	5.4
2	33	414	8.0	12	210	5.7
3	30	381	7.9	7	198	3.5
4	40	351	11.4	9	191	4.7
5	22	311	7.1	5	182	2.7
6	14	289	4.8	2	177	1.1
7	12	275	4.4	2	175	1.1
8	3	263	1.1	2	173	1.1
9	3	260	1.2	2	171	1.1
10	2	257	0.8	1	169	0.6
11	0	255	0	1	168	0.6
over 11	0	255	0	0	167	0
Total	180	435	-	62	229	-

TABLE 36. THE PERCENTAGE OF FIRST AND SECOND COMMON TERN
CHICKS OF BROODS OF THREE DYING OF THOSE AT RISK,
WITH AGE

Age in days	1965			1966		
	No. dying	No. alive	% dying	No. dying	No. alive	% dying
0+ 1	2	176	1.1	3	82	3.7
2+ 3	8	174	4.6	3	79	3.8
4+ 5	24	166	14.5	4	76	5.3
6+ 7	12	142	8.5	1	72	1.4
8+ 9	2	130	1.5	2	71	2.8
10+11	0	128	0	0	69	0
Total	48	176	-	13	82	-

Arctic Tern

In this species, there is no definite trend for the fledging success to decline with season as in the Common Tern, but this may be less obvious in a shorter breeding season and in a smaller sample.

In all three years, there is a high fledging success of single chicks and first chicks of broods of two (over 80%). Second chicks in broods of two show a much lower fledging success in 1965 and 1966, but not in 1967, as in the Common Tern when there was an overall high fledging success (Table 38). Therefore, in some years such as 1965 the second chick has little success, but

TABLE 37. THE FLEDGING SUCCESS OF ARCTIC TERN CHICKS
WITH SEASON

5-day	1965			1966			1967		
	No. hatched	No. dying	Fledging Success	No. hatched	No. dying	Fledging Success	No. hatched	No. dying	Fledging Success
19-23/6	35	7	88.0	18	2	88.9	29	2	93.1
24-28/6	17	3	82.4	41	13	68.3	43	5	88.4
29/6-3/7	23	1	95.7	8	3	78.6	26	3	88.5
4-8/7	5	2	66.7	6	0		4	0	92.9
9-13/7	6	2		10	0	10	1		
14-18/7	1	0		5	2	87.5	6	0	92.3
19-23/7				1	0		4	0	
24/7 +							3	1	

TABLE 38. THE FLEDGING SUCCESS OF THE ARCTIC TERN WITH BROOD
SIZE AND ORDER OF HATCHING

Brood Size	Order of Hatching	1965		1966		1967	
		Fledging Success	N	Fledging Success	N	Fledging Success	N
B1	1	88.9	9	100.0	11	88.9	18
B2	1	81.8	22	97.1	34	91.87	61
	2	34.8		63.6		33	
Overall Fledging success		66.1	59	83.3	78	90.5	125

in others such as 1967 it has a success comparable with first chicks. Since first chicks differ very little in their fledging success with single chicks in all years, it can be concluded that the first chick very rarely suffers when conditions become unfavourable for rearing two chicks. It is the second chick which bears the brunt of any such environmental hazards. However, Hawksley (1950) found nests with one young had a fledging success of 70.8% compared with 35.2% where there were two young and a 54.3% overall fledging success. This makes broods of one and two equally productive, but on Coquet Island broods of two were always more productive, unlike the situation on Machias Seal Island, Canada.

The principal mortality occurs within the first week as in the Common Tern (see Table 39 & Fig. 14). Since nearly all the mortality involves second chicks, there is insufficient material for a comparison between these and first or single chicks.

TABLE 39. THE MORTALITY OF ARCTIC TERN CHICKS WITH RESPECT TO AGE

Age in days	1965		1966	
	No. dying	% of those dying	No. dying	% of those dying
0 + 1	3	14.3	3	23.1
2 + 3	8	38.1	5	38.5
4 + 5	6	28.6	4	30.8
6 + 7	3	14.3	0	0
8 + 9	1	4.8	1	7.7
over 9	0	0	0	0
Total	21	100.1	13	99.1

FIGURE 14. COMMON AND ARCTIC TERN : THE PERCENTAGE OF ALL CHICKS
DYING WITH AGE IN 1965. a = Arctic Tern, c = Common Tern.

COMMON and ARCTIC TERN

CHICK MORTALITY

50

% OF
TOTAL M.

25

0

5

10

15

20

AGE (DAYS)

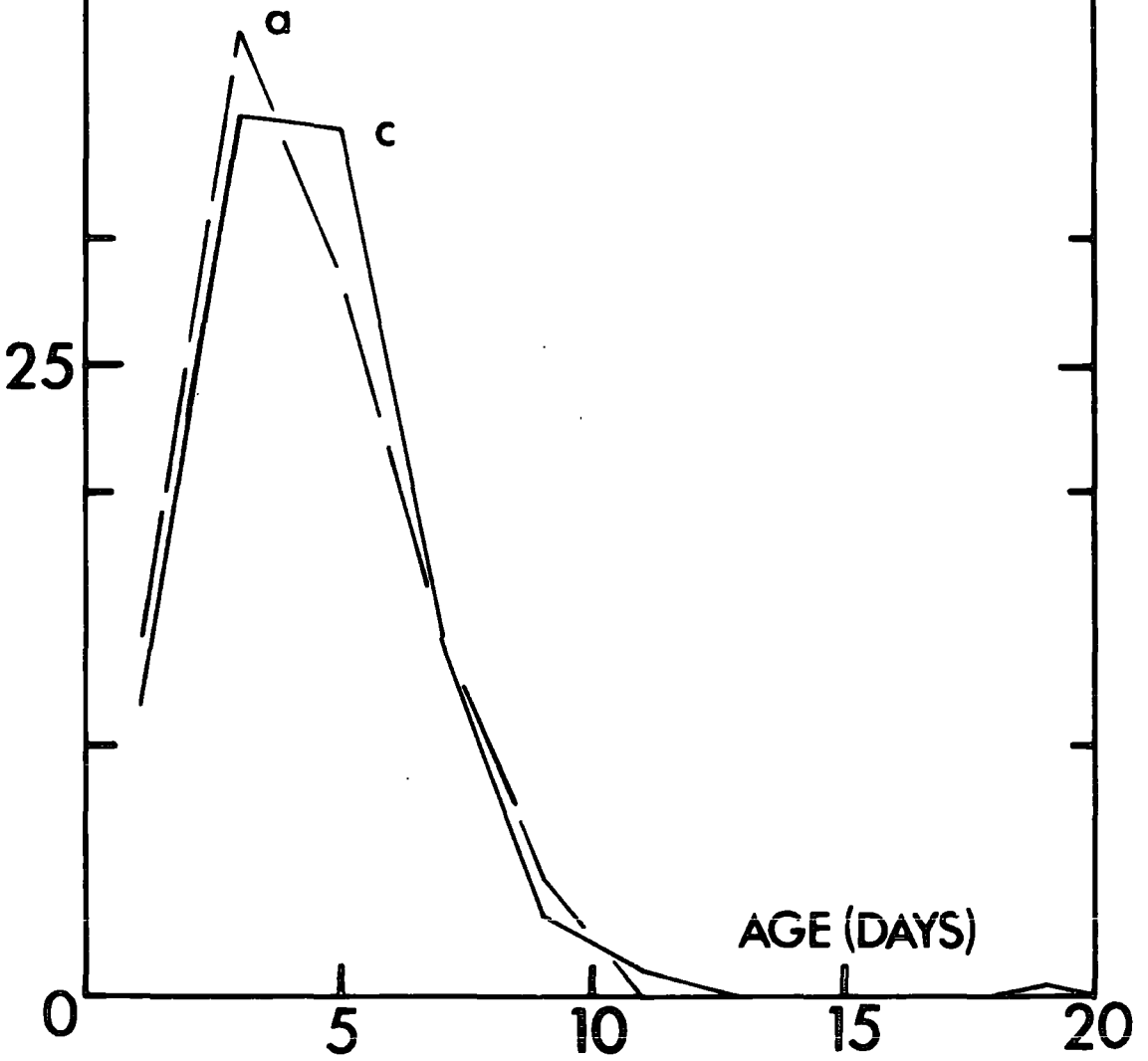

Roseate Tern

The fledging success of this species is high so that there is insufficient information to allow a seasonal examination of mortality. When the fledging success is examined with respect to brood size and order of hatching, it is found that single chicks and first chicks of broods of two have a similar fledging success. Second chicks have a lower fledging success than first chicks in all three years (see Table 40).

It can be seen that in the three years the fledging successes are very similar, apart from 1967 when the second chicks had a higher success. However, the principal mortality involves second chicks in broods of two, which accounted for over 80% of the deaths in 1965 and 1966.

TABLE 40. THE FLEDGING SUCCESS OF THE ROSEATE TERN WITH
BROOD SIZE AND ORDER OF HATCHING

Brood Size	Order of Hatching	1965		1966		1967	
		Fledging Success	N	Fledging Success	N	Fledging Success	N
B1	1	100.0	34	97.3	74	100.0	44
B2	1	96.3	27	97.7	43	97.8	45
	2	75.0	28	78.8	33	89.7	29
Overall fledging success		88.2	89	93.3	150	96.6	118

If the mortality of the chicks is considered with respect to age, it is found that the majority die within the first week of life (see Table 41). The information is inadequate to analyse the mortality of chicks with season.

TABLE 41. THE MORTALITY OF ROSEATE TERN CHICKS WITH
RESPECT TO AGE

Age in days	No. dying in 1965	No. dying in 1966	No. dying as % of those dying
0 - 1	1	2	17.7
2 - 3	3	2	29.4
4 - 5	2	2	23.6
6 - 7	2	2	23.5
8 - 9	0	0	0
10 -11	0	0	0
12 +	0	1	5.9
Total	8	9	100.1

Sandwich Tern

As in the Roseate Tern, the fledging success of this species is high and there appears to be no definite trend in this success with season (see Table 42). The mortality of chicks is comparable in single and first chicks of broods of two, but is much higher in second chicks of broods of two. It has been noted that second eggs were frequently deserted if the first chick hatched successfully, even when the second egg was chipping.

TABLE 42.

THE FLEDGING SUCCESS OF SANDWICH TERN CHICKS WITH SEASON

5-day Period	1965			1966			1967		
	No. hatched	No. dying	Fledging success	No. hatched	No. dying	Fledging success	No. hatched	No. dying	Fledging success
10-14/6	42	2	95.2	79	2	97.5	455	11	97.6
15-19/6	20	5	75.0	89	7	92.1	525	14	97.3
20-24/6	24	2	91.7	34	9	73.5	333	10	97.0
25-29/6	63	8	87.3	67	14	79.1	180	12	93.3
30/6- 4/7	25)	3)	90.6	75	17	77.3	133	7	94.7
5- 9/7	7)	0)		23	4	82.6	70	11	84.3
10-14/7	5)	1)	81.8	35	3	91.4	68)	1)	97.2
15-19/7	1)	0)		50	14	72.0	3)	1)	
20-24/7	2)	0)		13)	3)	83.3			
25/7	3)	2)		5)	0)				

Such behaviour was considered to be a result of asynchronous laying. Similarly, chicks which succeeded in hatching were not so fitted to follow their parents out of the nest area as first chicks. In some cases in this species, the second chick appeared to be a "runt" - being smaller than the first chick at the same age and often had thinner tarsi. The significance of these "runt" individuals was confusing, since they all appeared to succumb. Owing to the poor hatching success of second eggs, it is not known if such chicks are common (i.e. more than 10%), but if so, it should be possible to swap them for chipping first eggs to test their survival.

TABLE 43. THE FLEDGING SUCCESS OF SANDWICH TERN CHICKS WITH
BROOD SIZE AND ORDER OF HATCHING

Brood size	Order of hatching	1965		1966		1967	
		Fledging success	N	Fledging success	N	Fledging success	N
B1	1	92.5	169	88.0	550	-	-
B2	1	100.0	33	82.8	29	-	-
	2	66.7	33	48.3	29	-	-
Overall fledging success		88.1	235	85.9	608	95.2	1897

Unlike hatching success, the fledging success is very similar in all three years in the Sandwich Tern with a slightly better success in 1967. Although broods of two chicks were less

productive in 1966, the preponderance of single chicks in that year raised the overall fledging success. The age of chicks that die is similar to that found in the other species with the majority occurring in the first week. Both in 1965 and 1966, more than 75% of the chicks that died did so within the first week of life (see Table 44, Figure 15).

TABLE 44. THE MORTALITY OF SANDWICH TERN CHICKS WITH RESPECT TO AGE

Age in days	1965		1966	
	No. dying	% of those dying	No. dying	% of those dying
0 - 1	4	18.2	29	37.2
2 - 3	10	45.5	16	20.5
4 - 5	2	9.0	7	8.9
6 - 7	1	4.5	8	10.2
8 - 9	0	0	3	3.8
10 - 11	0	0	3	3.8
12 - 13	1	4.5	6	7.6
14 - 21	4	18.2	6	7.6
Total	22	99.9	78	99.6

In conclusion, the Common Tern is the only species that shows a decline in fledging success with season. In all four species the fledging success tends to be similar for single chicks and first chicks of broods of two and three. However, second chicks of

FIGURE 15. SANDWICH TERN : THE NUMBER OF CHICKS DYING WITH AGE IN
1965 and 1966.

SANDWICH TERN

% TOTAL
MORTALITY

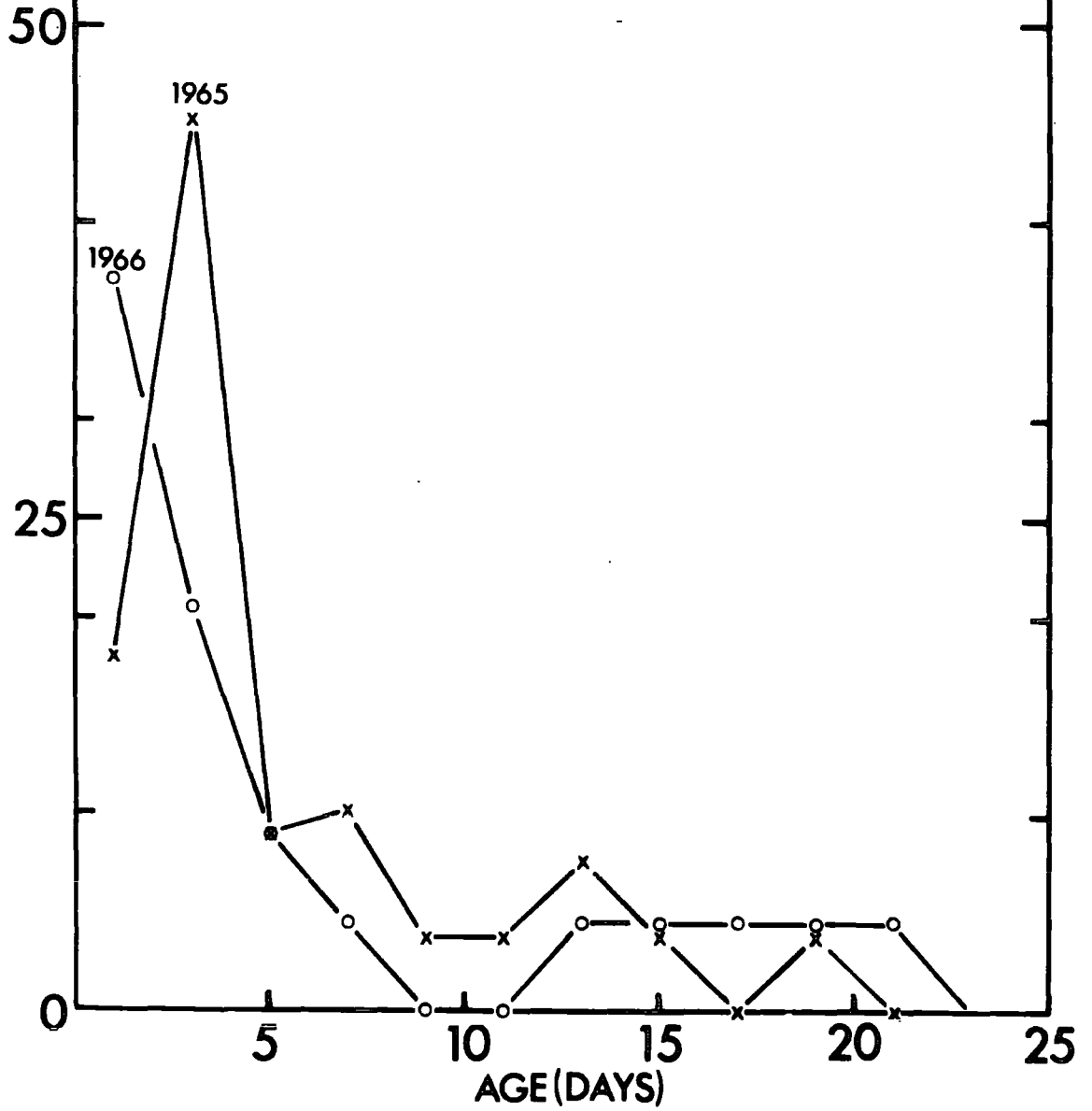

broods of two show a lower fledging success, and the third chicks in the Common Tern a very much reduced success. In all species, the majority of chicks that die do so within a week after hatching. The reasons for this mortality are examined next.

CHICK SURVIVAL WITH PARTICULAR REFERENCE

TO THE COMMON TERN

It is apparent from the section on fledging success that second and third chicks survive less well than first chicks, and that the main mortality occurs within the first five days after hatching. This higher mortality of second chicks in broods of two occurs in all four species of tern. Lack (1954) has considered the survival value of asynchronous hatching where the parent bird starts to brood the eggs before the clutch is complete. This phenomenon is particularly common in raptors, storks and corvids where it is well documented (e.g. Schmaus, 1938; Shuz, 1942, 1957; Lockie, 1955), but it occurs in various other species. Lack said the first chick to hatch received much food before the others hatched, and the latter were usually smaller and weaker and frequently die. He considered this a useful adaptation which ensured that when food was short it was not wasted by being fed to small chicks that would eventually die. By feeding being restricted to a few chicks and not evenly distributed, it was possible for the parents to fledge some offspring. In years when food was abundant, it may be possible for all chicks to be raised. However, whether this is the case in the terns studied will now be discussed.

There are four possible causes of chick mortality :

(1) predation, (2) adverse climatic factors, (3) disease, and (4) starvation. Predation of chicks (or eggs) occurred rarely on Coquet Island. There were no ground predators present on the island. Herring and Lesser Black-backed Gulls avoided the island and Black-headed Gulls rarely took small tern chicks, and only in abnormal circumstances when both parents were absent. On one occasion a Kestrel Falco tinnunculus L. visited the island and killed a chick, but was mobbed by Arctic and Common Terns and soon returned to the mainland. Also a Short-eared Owl Asio flammeus (Pontopp) made a brief visit to the island and killed a few chicks before being chased away. Carrion Crows vacated the island, and predation of the Eider nests ceased with the arrival of the terns in May. Therefore, predation was an unimportant influence in the survival of tern chicks.

Adverse climatic factors such as rainstorms did occur occasionally, but these did not usually affect those chicks that were being brooded by their parents. Anyway, such factors are unlikely to be selective for certain chicks within a brood and, besides, there was no correlation with chick mortality and the incidence of such factors. There was no evidence of disease being responsible for the death of chicks from post-mortems (conducted by J.W. MacDonald, M.A.F.F. Veterinary Laboratory, Eckgrove, Lasswade, Midlothian). In most cases death appeared to be the result of an adverse environmental factor; the crop

FIGURE 16. COMMON TERN, 1966 : WEIGHT WITH AGE OF BROODS OF TWO CHICKS.

a = first chick. b = second chick.

COMMON TERN 1966

BROODS OF TWO CHICKS

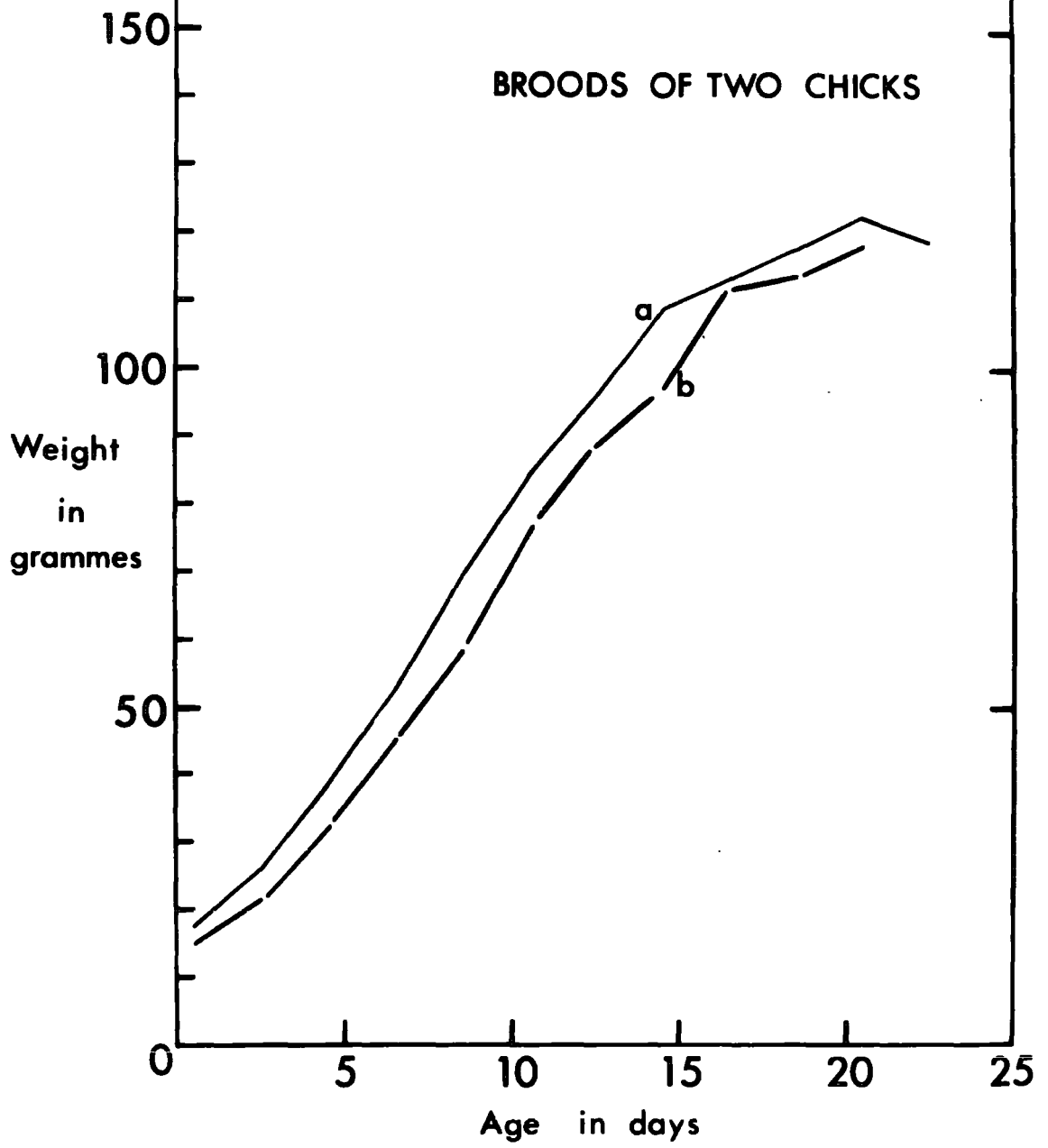

and gizzards were usually empty, and nephritis suggested that the chicks had been exposed to some stress. These factors were common to Arctic, Common and Sandwich Tern chicks and were probably the same in Roseate Tern chicks that died. These findings suggest that starvation was the main cause of the death of chicks.

In order to determine whether starvation was the cause of death, the growth rate of Common Tern chicks from different broods was examined. In this instance, weight increase is used as a measure of growth and this is tabulated in Appendix 4. Even on the day of hatching, a difference between first and later chicks is apparent. However, although the differences between first and second chicks in broods of two and three tend to increase in the first week, they rarely differ by more than ten grams and often much less (see Figures 16 & 17). Towards the end of the fledging period (16 + days), these differences become less obvious. With the third chick in a brood of three, the difference in weight between it and the other chicks is very marked in the first week to ten days, and although this becomes less later on, it is still noticeable. Unfortunately, few third chicks in broods of three survived in 1965 and 1966, so there are only a few weights to consider. From the information obtained on incubation periods, the second egg of a two-egg clutch tends to hatch at least one day later, so that the differences given in the Appendix will be magnified as in Table 45 .

FIGURE 17. COMMON TERN, 1966 : WEIGHT WITH AGE OF BROODS OF THREE
CHICKS INITIALLY. a = first chick. b = second chick.
c = third chick.

COMMON TERN 1966

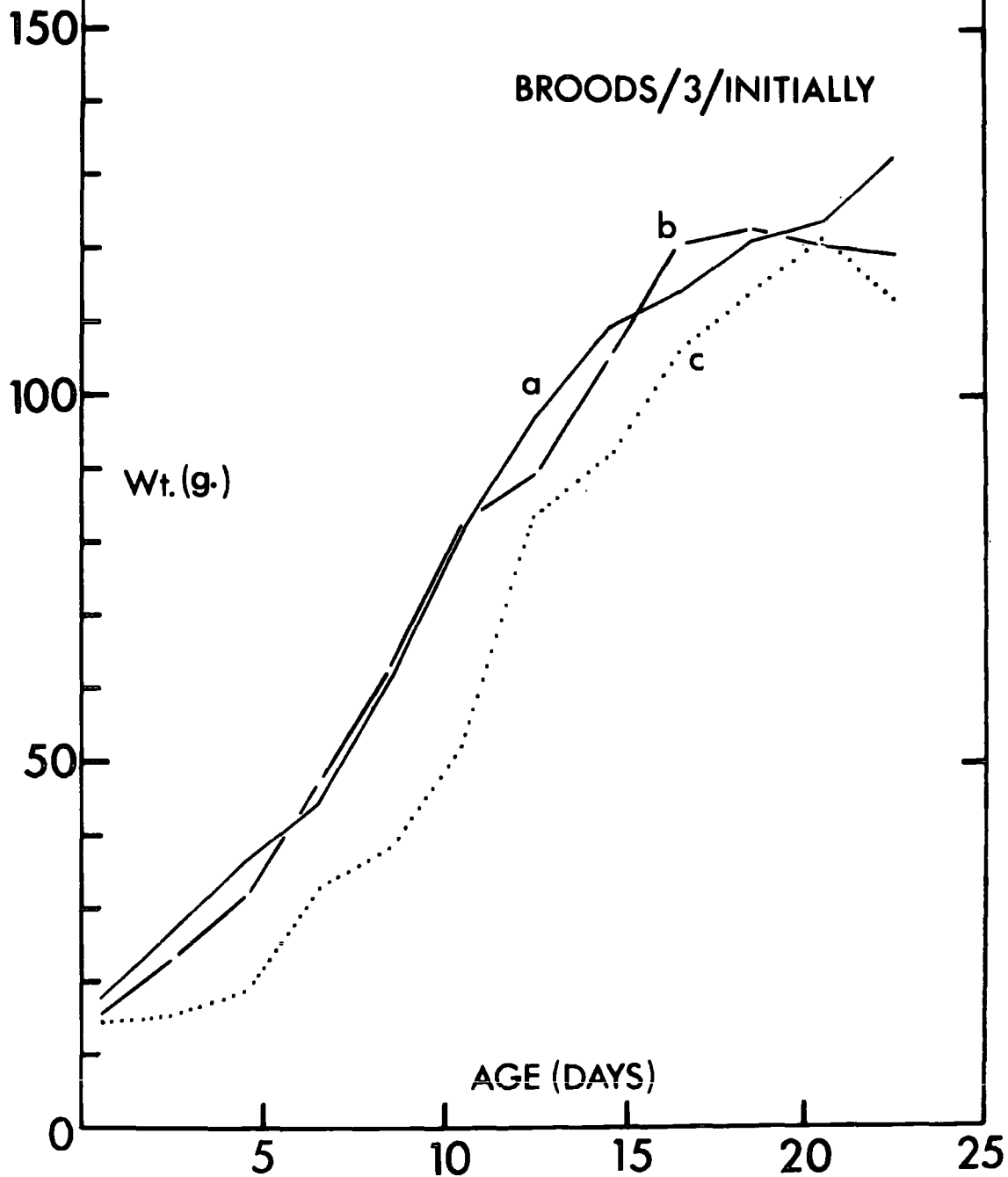

TABLE 45. THE MEAN WEIGHTS OF FIRST AND SECOND COMMON TERN CHICKS OF A BROOD OF TWO ON THE SAME DAYS

Chick Order	DAY AFTER FIRST CHICK HATCHED																					
	0	N	1	N	2	N	3	N	4	N	5	N	6	N	7	N	8	N	9	N	10	N
First	15.7	18	18.9	26	23.4	30	28.8	28	35.6	22	41.5	25	48.9	20	56.3	20	65.3	13	73.9	15	80.5	16
Second			13.8	26	16.5	31	19.4	33	24.2	28	29.7	25	36.1	21	41.5	16	48.6	18	53.6	15	64.2	13

TABLE 46. THE WEIGHTS OF THE THREE COMMON TERN CHICKS IN A BROOD OF THREE ON THE SAME DAYS

Chick Order	DAY AFTER FIRST CHICK HATCHED																					
	0	N	1	N	2	N	3	N	4	N	5	N	6	N	7	N	8	N	9	N	10	N
First	15.6	5	18.9	13	24.1	15	30.2	14	35.5	14	37.9	11	42.9	7	46.5	5	60.1	8	63.5	6	81.8	5
Second			13.4	11	17.4	15	21.5	14	24.9	15	27.6	13	36.9	10	44.8	8	49.5	9	58.7	9	71.4	5
Third							13.4	12	15.2	13	15.0	10	16.0	8	18.1	6	19.9	4	31.0	3	34.1	4

Similarly, in broods of three, the first and second chicks either hatch on the same day, or the second, one day later, whilst the third egg hatches two or three days later than the first; so that the differences are exaggerated as in Table 46 & Figure 18. In the case of a brood of three, there is a large difference in the weight of the third, and the first two chicks.

The average growth rate over five-day periods for chicks in various brood sizes shows that in the first period the third chick has a much lower average growth rate (i.e. weight increase) (see Table 47). These differences indicate that the third chick is undernourished and it results in many (89.5% in 1965, and 81.5% in 1966) dying of starvation whilst most of the first and second chicks survive.

The question now arises as to how does the third chick starve? There are two possibilities :

- (1) the lack of food available to the parents fishing so that food directly limits brood survival; or
- (2) the parents are unable to look after three chicks although food is relatively abundant as might occur if the third chick failed to stimulate the feeding response in the adult.

The first possibility is that suggested by Lack (1954) to be responsible for the differential survival in raptors, storks, corvids and swifts. Ashmole (1963) postulated that

FIGURE 18. COMMON TERN, 1966 : WEIGHT WITH TIME OF BROODS OF THREE
CHICKS INITIALLY. a = first chick. b = second chick.
c = third chick.

COMMON TERN 1966

BROODS/3/INITIALLY

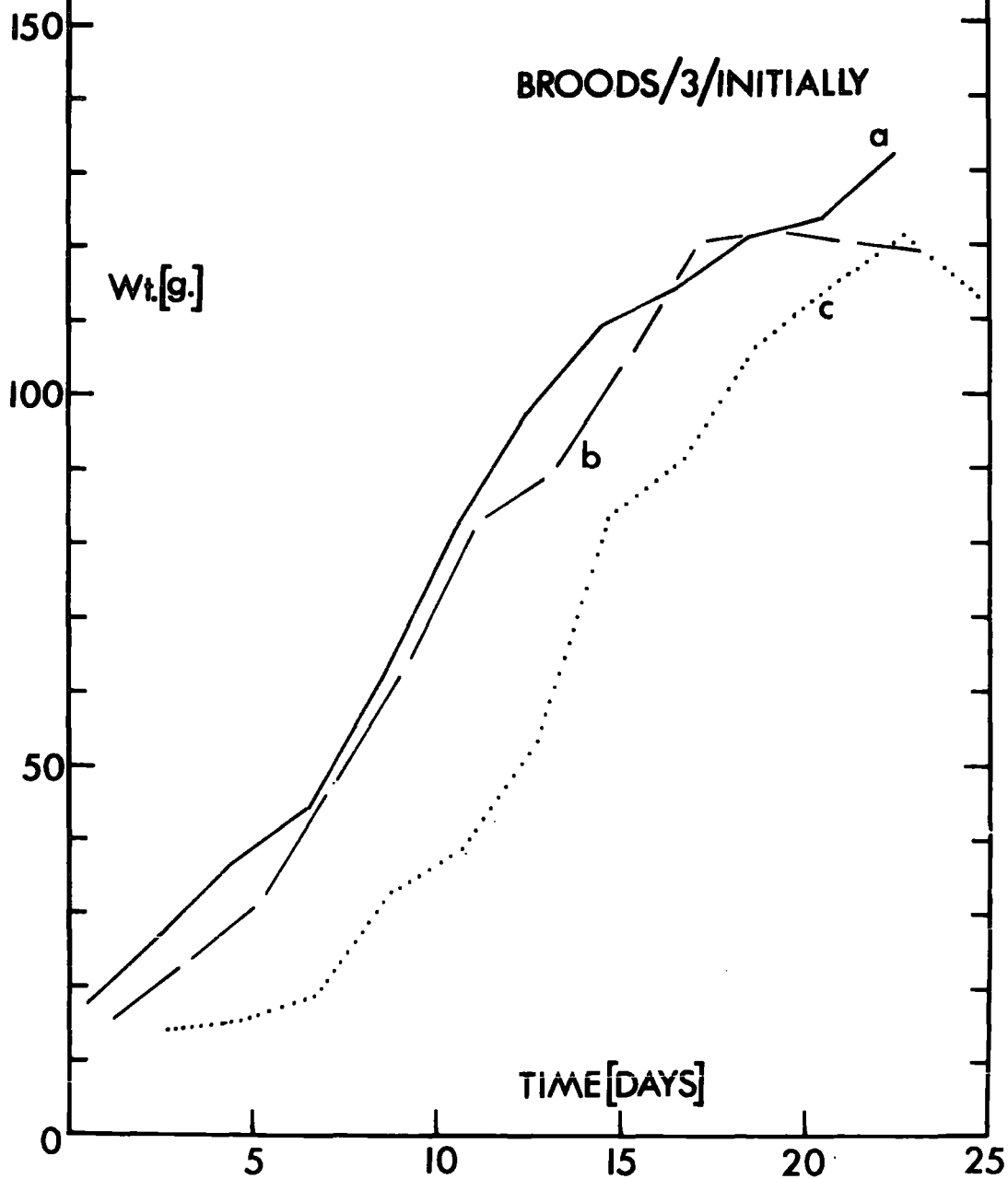

TABLE 47. AVERAGE DAILY GROWTH RATE (G.) IN COMMON TERN CHICKS
FROM VARIOUS BROODS, in 1966

Brood Size & Chick. Order	0-5 days	N	5-10 days	N	10-15 days	N	15-20 days	N
1 of B.1	5.0	9	6.9	7	7.9	7	1.4	7
1 of B.2	5.2	25	7.8	18	6.4	16	2.2	13
2 of B.2	4.5	27	7.5	16	5.0	14	4.2	14
1 of B.3	4.5	12	8.8	7	5.3	7	2.7	6
2 of B.3	4.7	13	8.1	8	6.7	6	2.4	6
3 of B.3	1.3	9	4.3	3	10.2	2	4.3	3

N = Average number of samples per day.

tropical sea-birds when breeding depleted the food resources (or at least, the available food resources) in the vicinity of the colony, so that their numbers were under a density-dependent control. However, Ashmole thought that other factors such as nest-site shortage would operate in more northerly latitudes before food became limiting. Nevertheless, Lack (1966) thought that actual populations of sea-birds are likely to be limited by food in winter even though the populations are dispersed. Yet, he has also interpreted the clutch size of a bird as being that from which the optimum number of chicks is produced which the

parents can nourish, and that the brood survival was governed by the available food.

In the present study, although there were fluctuations in the amount of food brought in on certain days with variation in fishing conditions, there was no correlation between this and third chick mortality. Therefore it was necessary to consider the food requirements of broods of two and three chicks in the Common Tern to see if the parents might be under some strain in feeding the larger brood.

From the work of Pearson (1964), the amount of food which was converted into flesh in three species of sea-bird (Kittiwake, Herring Gull and Guillemot) chicks amounted to 60% of that consumed, and was likely to be similar in the Common Tern. This means that for every gram of food consumed, above that required for maintenance, 0.6 grams of weight are put on. Pearson found that the amount of food required for maintenance, where the body weight was between 5 and 350 grams, adhered close to the regression ($r = +0.986$) when the slope was 3.49. Therefore, for every 3.49g of body weight, one gram of food was required for maintenance, i.e. the chicks required 29% of their own weight in food per day solely for maintenance.

From this information it was possible to determine the amount of food required for maintenance and weight increases in broods of two and three. By allowing for average differences in the asynchronous hatching of chicks, the food that the parents

must find to maintain and account for the observed weights in the two brood sizes is given in Table 48. The food requirements are based on the growth curves derived from daily weighings by chicks that fledge successfully.

TABLE 48. THE TOTAL FOOD REQUIREMENTS OF BROODS OF TWO AND THREE COMMON TERN CHICKS IN GRAMS/DAY

Brood size	TIME IN DAYS AFTER HATCHING OF FIRST CHICK						
	1	3	5	7	9	11	13
Where 2 chicks	7 *	18	26	34	42	47	49
Where 3 chicks	7 *	24	34	43	54	63	70

* Only one chick present at this stage.

From these results, it can be seen that it is not until nine days after the first chick hatched (or six days after the third chick hatched) that the requirements of a brood of three exceed those of a brood of two. Therefore, the demands of a brood of three do not exceed those of a brood of two until after the main mortality of third chicks. Therefore food does not seem to be a directly limiting factor.

From observations on broods of three, it appeared that the third chick failed to beg correctly and this resulted in it not being fed adequately, or at all, under certain conditions. It was thought that the begging of the first two chicks might be such as to stimulate both parents to look for food, thereby leaving the third chick unattended at a critical time. When about one or

two days old, the thermo-regulatory system of the third chick would not be sufficiently developed to prevent dangerous heat loss so that the chick became lethargic and failed to beg correctly with the result that it died from starvation. . . . However, analysis of watches made on broods of Common Terns in 1966 and 1967 suggests a different mechanism causing the death of the last hatched chick.

TABLE 49. THE AVERAGE TIME SPENT BROODING AND THE AVERAGE NUMBER OF FISH BROUGHT IN THE FIRST FIVE DAYS AFTER THE LAST CHICK HATCHED IN 1966

Average per 2 hours	Brood of 2	Total hours	Brood of 3	Total hours
Brooding	1 hr. 18 mins.	26	1 hr. 51 mins.	12
Fish	4.0		1.8	

In Table 49 , the average time one parent spends brooding is considered with the number of fish brought on various days between 07.00 and 09.00 hrs. for broods of two and three. As expected, there is a tendency for fewer fish to be brought in when one of the parents spends a longer time brooding. However, because of the small sample the difference in the number of fish caught is not significant ($p = < 0.1$ for 17 d.f.), neither in the average time spent brooding ($p = > 0.7$ for 17 d.f.). Also, it has to be remembered that the time spent brooding will depend on the climatic conditions. On wet days, most young chicks will

be brooded whereas on fine summer days very few are brooded. In the nests watched, of the two broods of three, each had two chicks die within the first week, while the broods of two had no mortality in this period. A similar mortality occurred in Arctic Terns with broods of three, where in two cases two chicks died from each brood, and one died from another. In the two broods of two Arctic Tern chicks, one chick died in each. This mortality gives some indication of the severity of the conditions during the time of these observations.

In 1967, conditions were not so severe, but over 110 hrs. were spent watching broods of Common Terns in about the first five days of life. It appears from the results (see Tables 50 & 51) that the fish brought to a brood of two is similar to that brought to a brood of three and that the latter is brooded more.

TABLE 50. A COMPARISON OF COMMON TERN BROODS OF ONE, TWO AND THREE FROM THE AVERAGES FROM THE SAME 4 DAYS, BASED ON 196 NEST-HOURS

	Brood 1	Brood 2	Brood 3	Average watch
Average time spent brooding (hrs.)	8.02	5.41	6.54	8.30
Average number of fish brought	6.75	8.67	9.00	-

TABLE 51. A COMPARISON OF COMMON TERN BROODS OF TWO AND THREE
FROM AVERAGES FROM THE SAME 11 DAYS, BASED ON 546 NEST-HOURS

	Brood of 2	Brood of 3	Average Watch
Average time spent brooding (hrs)	6.40	7.23	9.20
Average number of fish brought	9.8	9.0	-

Although fish was abundant, these observations suggest that in a brood of three, the third chick is brooded restricting the fishing potential of the parents. A similar situation has been observed in the Starling (Dunnet, 1955) where the last hatched chicks had a high mortality, although there was no evidence of a change in the abundance of food. In this instance, Carrick (in Dunnet, 1955) suggested that the demand of the last chick was insufficient to overcome the threshold of the brooding drive. A similar situation would seem to operate in the Common Tern where the first and second chicks beg vigorously until satiated, after which a parent will brood them, ignoring the weak begging of the newly hatched third chick.

In 1966, the broods of three were brooded for 92.5% of the watch compared with 65.0% in broods of two, in the first five days after hatching of the last chick. In 1967, the broods of three were brooded for 79.1% of the watch, and broods of two 71.4%, while artificial broods of four were brooded for 84.2% of



the watch. Also, while broods of two and three received about 9 fish over eight and a half hours, broods of four received over 13. The first and second chicks of a brood of three received about equal numbers of fish, but the third chick just over half of the number in 1967. Nevertheless, the third chicks are usually two days younger with a lower consumption and they appeared to fledge successfully in 1967. In 1966, the longer time spent brooding reduced fishing time and led to the starvation and death of many third chicks. In 1967, the time spent brooding was reduced, and although the number of fish brought in was increased only slightly, it included a higher proportion of heavier clupeoids.

Unfortunately, of the nine broods of three watched in the Common Tern study area in 1967, five had to be made up from broods of two which was done by substituting a chipping egg before the second egg chipped. This method of substitution interfered with the normal sequence of hatching in a brood of three and may have contributed to a higher survival rate, since the chicks hatched less asynchronously. However, in the four original broods of three, only one of the third chicks died, and the overall pattern in the main study area was one of high survival for 1967. In some years, although fish is not directly limiting the survival of the brood in the first week, it would seem to be an advantage for the third chick to succumb for the demands on the parents would be too great later on. Yet in other years, many more third chicks survive the first week of life, and therefore tend to fledge

successfully. This situation suggests that the food supply must be acting through some factor affecting the survival of the third chick, although the parents may be capable of collecting sufficient food for survival of all three chicks in all years. It is suggested that in poor years one parent cannot find sufficient food for all three chicks to be fed adequately, when it is still necessary for at least one chick to be brooded by the other parent. Whereas in good years, there is abundant food so that one parent can feed all three chicks. However, other observations are required on natural broods of three chicks of Common Terns in years of abundant and scarce food. It would seem probable that a similar situation could explain the differential survival in broods of two in this and the other species.

BREEDING SUCCESS AND CLUTCH SIZE

Breeding success is the combination of hatching and fledging success and represents the total eggs laid that produced fledged chicks (i.e. the number of fledged chicks expressed as a percentage of the number of eggs laid). Unfortunately, sea-birds tend to have a high post-fledging mortality which is usually an unknown, and probably significant, quantity. However, breeding success does give some relative measure of productivity. In Table 52 the breeding success is derived from the hatching successes of the appropriate clutch sizes and the fledging successes of corresponding brood sizes; this means that where only two eggs of a clutch of three hatched, the fledging success is accounted for in the broods of two. . Therefore, there is a slight error in the clutch size breeding successes.

In the Common Tern, the clutches of two have the highest breeding success in 1965, but they are very similar to the clutches of three in 1966. The overall breeding success was lowest in 1966 and highest in 1967. In the other three tern species, the highest breeding success occurred in 1967, but 1965 had the lowest success. It has been mentioned that the low success in the Common Tern in 1966 was due to a large scale desertion of early clutches. That the Sandwich Tern had a lower breeding success in 1965 than in 1966 appeared to be a result of poor synchronisation in the small sub-colonies in which many eggs were deserted. The Roseate Tern achieved a high success in 1966 by delaying its breeding season,

TABLE 52. THE PERCENTAGE BREEDING SUCCESS OF FOUR TERN SPECIES
IN THREE YEARS

SPECIES	Clutch size	1965		1966		1967	N
Common Tern	1	35.1	21	15.0	20	-	
	2	53.8	152	35.0	216	-	
	3	46.8	407	36.2	186	-	
	Mean	51.7	580	36.5	422	71.3	303
Arctic Tern	1	61.5	13	34.4	32	-	
	2	40.6	74	62.8	86	-	
	Mean	46.3	87	54.6	118	79.4	163
Roseate Tern	1	82.2	45	87.9	82	-	
	2	76.7	78	85.6	80	-	
	Mean	76.7	123	86.4	162	92.0	99
Sandwich Tern	1	38.5	219	63.4	722	-	
	2	56.1	83	47.9	78	-	
	Mean	47.5	302	62.0	800	91.1	1982

whilst the Arctic Tern may have found alternative food offshore. In the Arctic Tern, the greater breeding success from clutches of one in 1965 was reversed in 1966, but this was not significant ($P < 0.1$ for 1 d.f.). In the Roseate Tern the breeding success was only slightly lower in the clutches of two. Breeding success was generally low in the Sandwich Tern in 1965 due to poor hatching success, but the lowered breeding success of clutches of two in 1966

was mainly the result of a 50% mortality of second chicks.

If breeding success is examined with respect to clutch size (see Table 53), the average production of young per pair for a particular clutch size can be calculated. The overall breeding successes correspond closely to those obtained in Table 52 which indicates that the error in Table 52 is slight.

TABLE 53. THE FLEDGING PRODUCTION OF FOUR SPECIES OF TERN WITH RESPECT TO CLUTCH SIZE IN TWO YEARS

SPECIES	Clutch size	1965		1966	
		Breeding success	Fledged/ pair	Breeding success	Fledged/ pair
Common Tern	1	43.8	0.44	21.1	0.21
	2	59.3	1.19	39.7	0.79
	3	48.1	1.64	41.9	1.26
	Total	48.6	-	39.9	-
Arctic Tern	1	64.3	0.64	34.4	0.34
	2	52.1	1.04	66.3	1.33
	3	(77.8	2.33	66.7	2.01 *)
	Total	52.9	-	57.4	-
Roseate Tern	1	87.2	0.87	90.1	0.90
	2	77.1	1.54	81.7	1.63
	Total	79.8	-	86.6	-
Sandwich Tern	1	46.3	0.40	63.5	0.64
	2	57.7	1.15	58.1	1.16
	Total	47.0	-	62.5	-

* Based on only 4 clutches

In all instances, in both 1965 and 1966, the larger clutch sizes result in an increase in the number of offspring produced per pair. In 1967, with the increase in overall breeding success, it appeared that this trend was further emphasised. With increased clutch size resulting in more young being fledged per pair, according to Lack's hypothesis that the normal clutch size corresponds to the maximum number of young that on average the parents can successfully raise, it might be expected that there would be selection for the larger clutch sizes. However, Lack (1966) has argued that increased productivity as far as the fledging stage may be misleading and that post-fledging mortality may be greater in larger broods. In such instances, chicks fledging from larger broods are envisaged as fledging at lower weights than those in smaller broods. This situation is suggested in the Common Tern (see Appendix 4), although whether differences are significant is not known.

In terns, there is some post-fledging care of the young (pers. obs.) mainly involving feeding until the young can fish for themselves. Where there are more than two young, this would limit the care one parent could spend on one chick, and it is very likely to affect survival. Whether two chicks present a similar problem, notably in the Roseate and Sandwich Terns, is not known, but obviously one chick with two parents looking after it is at a definite advantage.

Besides post-fledging survival, another unknown is the effect of age and previous breeding experience on the clutch size and breeding success. These factors are known to influence the clutch size in many species, including some sea-birds. However, at the present, too little is known about terns in these respects to pursue this matter profitably. Nevertheless, Tables 54 and 55 show that overall chick production per pair varies relatively little in the two years examined, although the production per species is distinctive. If the age at first breeding is assumed to be similar in the four species, the differences would be explicable with differences in (a) adult mortality, or (b) post-fledging mortality, or a combination of both.

TABLE 54. THE NUMBER OF TERN CHICKS KNOWN TO HAVE FLEDGED SUCCESSFULLY PER PAIR IN 1965 AND 1966

Species	Year	OY	1Y	2Y	3Y	Total Young	Total Clutches	Young/ pair	Average
Common Tern	1965	22	63	50	1	166	136	1.22) 1.31
	1966	14	40	55	3	159	112	1.42	
Arctic Tern	1965	7	24	4	0	32	35	0.91) 0.91
	1966	5	10	1	0	16	18	0.89	
Roseate Tern	1965	5	16	7	0	30	28	1.07) 1.12
	1966	3	31	10	0	51	44	1.16	
Sandwich Tern	1965	25	50	3	0	56	78	0.72) 0.58
	1966	87	89	1	0	91	177	0.51	

TABLE 55. THE NUMBER OF TERN CHICKS FLEDGED PER PAIR IN
1965 AND 1966, INCLUDING ASSUMED SUCCESSES & DESERTIONS

SPECIES	No. of clutches raising X young					Total Young	Total Clutches	Young/ pair	Average
	Year	0Y	1Y	2Y	3Y				
Common	1965	38	85	99	14	325	236	1.37)) 1.19)
Tern	1966	90	40	57	4	166	191	0.87	
Arctic	1965	22	33	17	0	67	72	0.93)) 0.88)
Tern	1966	25	28	14	0	56	67	0.84	
Roseate	1965	12	47	7	0	61	66	0.93)) 1.04)
Tern	1966	10	87	23	0	133	120	1.11	
Sandwich	1965	129	121	22	0	165	272	0.61)) 0.62)
Tern	1966	242	374	11	0	396	627	0.63	

The number of chicks fledged per pair would be expected to decrease in the order : Common, Arctic, Roseate and Sandwich Terns, since their average clutch sizes decrease in that order. However, this situation would only occur if the parents were capable of hatching and rearing the same proportion of young on average, i.e. hatching and fledging success were the same for all species. However, previous examinations have shown that these successes vary between different species, and between years in the same species. Nevertheless, the Common Terns do produce the largest number of fledged young per pair, except when they suffered from a poor hatching success in 1966, and the Sandwich Terns the lowest number, in accordance with clutch size. Yet, the Arctic Terns with a higher than average clutch size than the Roseate Terns produce fewer young than the latter. This result is surprising considering the detrimental effect of high wind speeds on the feeding of Roseate Terns (see later). The reason for the higher hatching and fledging success of the Roseate Terns appear to be due to their less exposed nesting situations - their eggs and chicks are sheltered from the elements and predators, either under vegetation or down burrows, whereas the Arctic Terns' eggs and chicks are either on short turf or a shingle beach. In the latter situation, in which the Arctic Terns study area occurred, eggs are sometimes lost with fluctuating tide levels. However, Roseate Tern chicks had a slower growth rate than the other tern species, yet they fledged at about the same time. This meant that they fledged below the adult weight, unlike the Common Tern

chicks (see Figure 20), and might suffer a greater post-fledging mortality.

Consideration of the chicks fledged per pair with season (see Tables 56 and 57) indicates that there is little change in the Common Terns in 1965, which is striking, since the average clutch size and fledging success decline with season. However, there is a tendency for the number of chicks fledged per pair to decrease with season in 1966. In the brief season of the Arctic Terns in 1965, there is little indication of the number of fledged chicks to decline. However, in 1966, the longer season shows that late nesting Arctic Terns are very unproductive. In the Roseate Terns, there is a decline in 1965, and a rise followed by a similar decline in 1966. In both years, the Sandwich Terns show a slight rise followed by a decline. These seasonal changes indicate that the Common Terns are least affected and therefore benefit more from an extended nesting season than the other species.

TABLE 56. CHICKS FLEDGED PER PAIR WITH SEASON IN 1965

Date of Start of 5-day Period	COMMON TERN		ARCTIC TERN		ROSEATE TERN		SANDWICH TERN	
	Chicks	No. of Pairs	Chicks	No. of Pairs	Chicks	No. of Pairs	Chicks	No. of Pairs
13/5							0.81	32
18	1.40	10					0.47	60
23	1.43	47	1.13	16)			0.64	33
28	1.37	73	1.00	24)	1.38	13	0.68	38
2/6	1.30	47)			1.21	24	0.84	79
)	0.63	16				
7)					0.90	21	0.70	27
)								
12)	1.31	36)	1.00	16)1.14	7)0.61	23
)								
17)								
)								
22)))	
))	
27))1.00	10)	
)))0.38	21
2/7)))	
)))	
7)	1.41	17))	
))0.86	14)	
12))			
Av.	1.36	230	0.94	72	1.08	89	0.66	313

TABLE 57. CHICKS FLEDGED PER PAIR WITH SEASON IN 1966

Date of Start of 5-day Period	COMMON TERN		ARCTIC TERN		ROSEATE TERN		SANDWICH TERN	
	Chicks	No. of Pairs	Chicks	No. of Pairs	Chicks	No. of Pairs	Chicks	No. of Pairs
13/5							0.55	86
18							0.71	147
23)							0.65	121
)	1.15	13						
28)			1.25	16			0.94	49
2/6	1.25	77	0.73	22			0.84	118
7	1.25	28	0.75	8	1.10	21	0.64	70
12	0.92	24	1.67	6	1.14	21	0.63	41
17)			1.50	6	1.43	37	0.70	56
)								
22)	0.48	23)		1.09	33	0.67	60
))					
27))		1.00	9)		
))))		
2/7)			0.12	17))	0.53	36
))))		
7)	1.27	15)) 0.85	13)		
))))		
12))))		
Av.	1.10	180	0.84	75	1.16	134	0.70	784

THE EFFECT OF WEATHER ON THE FEEDING OF TERNS

In order to examine the effect of weather on the feeding of terns, the daily growth rate of their chicks was measured. . It had been suggested (Coulson, pers.comm.) that changes in the weight increase of tern chicks might relate to the fishing ability of their parents under various weather conditions.

Methods

In 1965, a preliminary investigation on variation in the daily growth rate of Common Tern chicks was made. In this instance, the growth rate was measured as the daily increase in weight. To measure the daily increase in weight, it was necessary to weigh the same chicks on successive days. Since Common Tern chicks tend to remain in the vicinity of the nest until fledging, the process of recapturing the same individuals was usually successful. However, in 1966, a 2'6" high fence of $\frac{1}{2}$ " mesh wire-netting was erected around the study area, measuring 100' x 200', and this prevented much movement, especially of individuals on the perimeter, out of the enclosure prior to fledging; and resulted in much saving of time searching for individuals.

The chicks of the Common Tern tend to have particular refuges in the vegetation surrounding the nest, to which they resort when the parents give the alarm call, at the entry of the observer into the area. In order to ensure that chicks were returned to their own refuges, a system of labelling was adopted in which numbered stakes corresponded to a numbered section in

in the collection box. The chicks were weighed each evening at approximately the same time in a hide situated just away from the study area, so as to reduce disturbance to a minimum. The chicks were weighed on a torsion balance which allowed an accuracy of 0.1 gram. A daily visit in the morning to the enclosure ensured that most chicks were ringed on hatching, and so could be aged to within 12 hours.

If the weight of the chicks is plotted against age, a growth curve is produced (figs. 19&20). It was found that the daily increase in weight of the chick from about three to sixteen days old was close to a constant rate. This constant weight increase occurs in all surviving chicks whether they are first, second or even third chicks. The only difference is that second and third chicks often take several days before their weight rises above 20 grams, but once this occurs, they assume a daily weight increment, typical of all healthy chicks. The difference in delay results from asynchronous hatching and unequal food intake which may affect survival. Chick survival with respect to brood size is considered elsewhere. The average weight increases during the periods concerned were 7.05 g/day in 1965, and 6.93 g/day in 1966. These differences are significant since large samples are used ($P = < 0.001$ for 733 d.f.). After 16 days, the daily weight change fluctuates widely, often resulting in a loss of weight which is mainly due to full size being attained.

FIGURE 19. COMMON TERN : AVERAGE GROWTH CURVE FOR FIRST AND SECOND
CHICKS COMBINED.

COMMON TERN

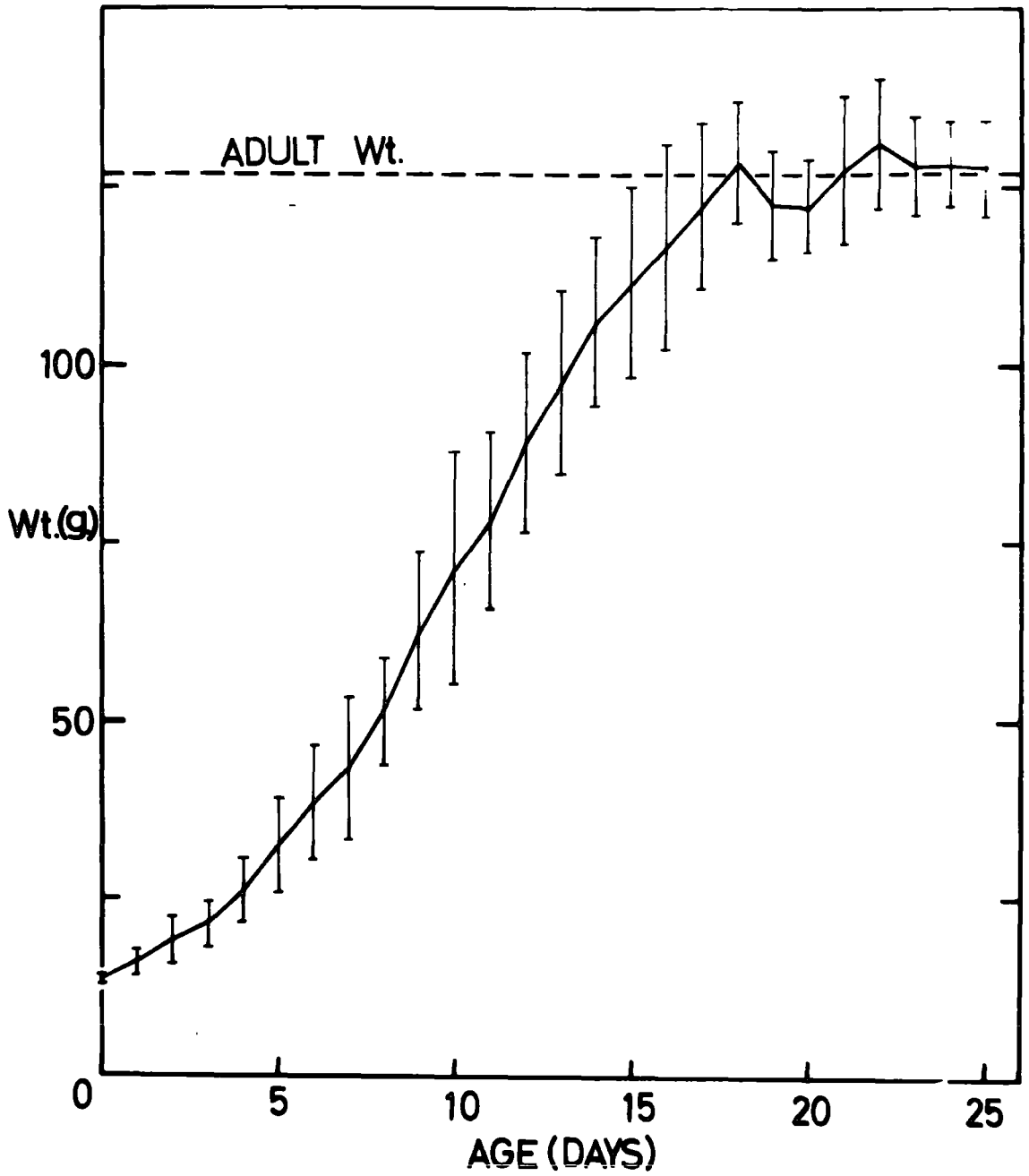
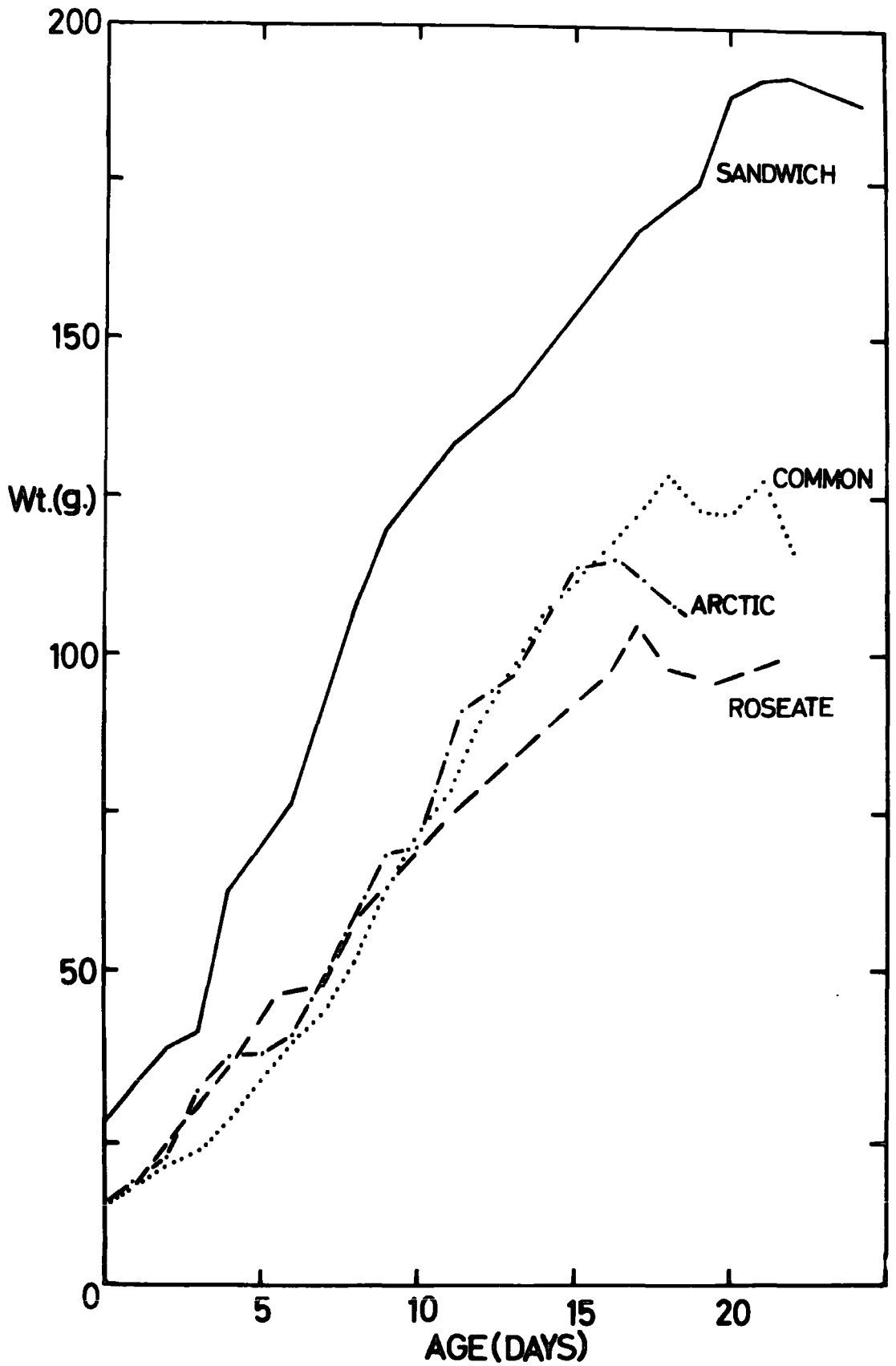

TABLE 58. AVERAGE DAILY WEIGHT INCREASE IN GRAMS IN
COMMON TERN CHICKS

Age in Days	1965	N	1966	N
0 - 2	2.7	28	3.5	105
2 - 4	3.6	32	5.1	105
4 - 6	6.3	28	6.7	75
6 - 8	6.4	22	7.1	62
8 - 10	10.0	15	8.9	53
10 - 12	9.0	16	7.5	54
12 - 14	8.5	15	5.6	56
14 - 16	5.2	11	5.4	56
Average	7.05		6.93	

From Table 58, it can be seen that the weight increase is not constant at certain ages between 2 and 16 days when the growth curve is fitted to straight lines. Although the overall average growth rate is similar for the two years, there are differences between 8 and 14 days old. However, by assuming a constant growth rate for the year in question, it is possible to apply a correction factor to the weights in the age group concerned; so that all daily weights considered are comparable. The correction factor is taken as the difference between the observed and the average expected weight increase over each period. These correction factors were then added or subtracted from the observed weight increases.

FIGURE 20. AVERAGE GROWTH CURVE FOR ALL FOUR SPECIES OF TERN IN 1965.



The daily weight increases observed in 1966, in first and second chicks of broods of two and three, are given in Appendix 5 . In most cases, the third chick succumbed soon after hatching, so that broods of three soon became broods of two. Only the weight increases of those chicks that survived were used as chicks that died were usually below average weight. It can be seen that the daily weight increase of the first and second chicks tend to fluctuate in parallel ($r = +0.5643$, $p = < 0.01$); this supports the idea that the factors resulting in the observed variation in the daily weight increases are not intrinsic, but environmental. Further, 25 days of observations could be divided into 15 days of good feeding (where combined average weight increase was 0.5 g. above average) and 10 days of poor feeding (where combined average weight increase was 0.5 g. below average). On good days, first chicks had a slightly higher average weight increase, but with greater fluctuation (7.37 ± 2.25 g.) compared with second chicks (7.11 ± 1.09). There appears to be no suggestion of a correlation ($r = +0.017$, $p = > 0.9$ for 13 d.f.). On days of poor feeding, first chicks have a higher average weight increase (4.35 ± 1.75 g.) compared with second chicks where the fluctuations are greater (3.67 ± 2.23 g.). On poor days there is a positive correlation, but this is not significant, probably because of the small sample ($r = +0.476$, $p = < 0.1$). From these results, the first chick has a greater weight increase than the second on both good and poor days, and

the difference is greater on poor days. Although the differences between the average weight increases are small, it is nearly three times as great on poor days. These observations suggest that the first hatched chick obtains more food than the second chick. However, even when food is short, the second chick still obtains a substantial proportion of the food. It may be concluded that the parent birds are not discriminating between first and second chicks, but are merely feeding the most hungry individual.

If the weight increases for all the chicks are grouped (~~see fig. 2~~), the daily figures can be seen to fluctuate around the average, but that these deviate more towards the end of the season (Appendix 5,6). Unfortunately, the information for the end of the 1965 season is inadequate, mainly because this was an early season. However, in 1966, the standard deviation of the average weight increase is much larger at the end of the season. The two major groups of factors governing the weight increases of the chicks will be climatic factors and the availability of food. However, since there are no definite trends in the weather elements observed in 1966, it suggests that food availability is responsible for the increased fluctuations at the end of the season. It would appear that the food supply is more predictable during late June and most of July, but begins to fluctuate in availability at the end of July and in August. Unfortunately, little is known concerning the seasonal abundance and behaviour of the sand eels and sprats which form the bulk of

the Common Tern chicks' diet. Therefore, the variation in daily growth weight has been examined with reference to weather conditions.

Weather Factors

In this study, three factors have been considered as likely to have an effect on the growth weight of tern chicks, and in particular Common Tern chicks. These factors are rainfall, hours of sunshine and wind speed. The meteorological data used in this analysis were obtained from general records made on Coquet Island, but detailed records were obtained from :

(a) Meteorological Station, R.A.F. Acklington, Northumberland. This station is about four miles to the south-west of Coquet Island, and three miles inland.

(b) Meteorological Station, Seahouses Coastguard, Northumberland. This station is situated on the coast about 17 miles just east of north of Coquet Island.

Personal observations on Coquet Island indicate that wind speeds are slightly under-estimated from the meteorological stations because the latter are less exposed, and that the hours of sunshine may be over-estimated occasionally owing to sea fog. However, since in most cases the differences should be relative, the original data were used.

RESULTS

In preliminary analyses of the results, the possible influence of sunshine, rain and wind were investigated. It was found that on some days rain had a depressive effect on the amount of food brought to the chicks, but this was not always demonstrated. There are very few days of continuous rain, and, as expected, fish brought to the chicks reaches a peak in the fine intervals on a wet day. One of the reasons for this depression of fishing seems to result from one parent remaining with the chicks to brood them, and so prevent them from getting wet and cold. In order to examine the importance of this necessity to brood the chicks during wet weather, a comparison of young downy chicks with older chicks would be desirable as old chicks are not brooded. However, since days of prolonged rain are rare and other factors help to complicate the picture, consideration of rain by itself has been found to have an inconsistent influence on the daily weight increase in Common Tern chicks. Rain has slight depressive effect on weight increase in the Arctic Tern chicks, but it appears to have a positive effect on Roseate Tern chicks. That rain will positively affect weight increase is very unlikely, and the observed effect is most likely correlated with another factor. In fact, rain tends to fall on days when the wind is not strong, so that the greater weight increase might result from lower wind speeds. On days when the wind speed is high, the growth rate of Common Tern chicks, as measured by weight increase, is lower. In contrast, there is

little correlation with Arctic Tern chicks' growth and wind speed. However, in the Roseate Tern chicks, the growth rate is much lower than in the Common Tern when there are high wind speeds. The reasons for these effects will be discussed later. The amount of sunshine was another factor considered, but this showed little effect except for a slightly positive one in the Arctic Tern.

The inter-relation of weather factors

In order to examine the effect of more than one climatic factor on a particular day, it was decided to adopt a multiple regression analysis. A similar analysis to the present one was carried out by Lack (1956) who was concerned with the daily weight changes in nestling Swifts Apus apus L. In his examination, Lack found that rain, wind, sun and temperature were all important in determining the average daily weight for a particular season. In the present analysis, results for 1965 and 1966 have been considered separately. Also, in order to simplify the mathematics, wind and sun have been considered together, and wind and rain have been considered together.

The inter-relation of sun and wind on the weight increase of Common Tern chicks

It is possible to consider the combined effects of wind and sunshine on the daily weight increase of chicks by using the regression equation :

$$u_1 = au_2 + bu_3$$

where,

a = the factor for wind speed

b = the factor for sunshine

u_1 = weight increase in grams

u_2 = wind speed in knots

u_3 = sunshine in hours

From the observations of 1965 :

$$a = -0.049, \text{ and } b = -0.114$$

$$\text{Then from } (u_1 - \bar{u}_1) = -0.049 (u_2 - \bar{u}_2) - 0.114 (u_3 - \bar{u}_3)$$

where \bar{u}_1 = mean weight increase in grams per day

\bar{u}_2 = mean daily wind speed in knots

\bar{u}_3 = mean hours of sunshine per day

$$\text{therefore } u_1 = 0.049u_2 - 0.114u_3 + 8.2063.$$

From this equation it is then possible to calculate the weight increase expected with a particular wind speed with so many hours sunshine, e.g. $u_2 = 10$ knots

$$u_3 = 5 \text{ hours}$$

$$u_1 = -0.049 \times 10 - 0.174 \times 5 + 8.2063$$

$$= -0.49 - 0.87 + 8.2063$$

$$= 7.15 \text{ grams.}$$

Then by considering the wind speed and hours of sunshine each day it is possible to calculate the expected weight increase to compare with the observed one. From these results a correlation coefficient can be derived using :

$$\text{Correlation coefficient} = \frac{\text{Covariance of } (u, v)}{\sqrt{\text{Variance } (u) \cdot \text{Variance } (v)}}$$

where u = observed weight increase

v = expected weight increase

for 1965, the correlation coefficient, $r = +0.3962$.

$p = < 0.1$ with 22 degrees of freedom.

The correlation coefficient indicates that only about 40 percent of the variation in weight increase can be attributed to these two factors, wind and sun.

If the results for 1966 are considered, the following regression equation is obtained :

$$u_1 = -0.296u_2 + 0.093u_3 + 7.9351.$$

$$r = +0.5588. \quad p = < 0.001 \text{ with } 35 \text{ d.f.}$$

In this instance, the correlation coefficient shows that more than half the variability observed can be attributed to these two factors; and that correlation is highly significant.

The inter-relation of wind and rain

If the results for 1965 are considered, with respect to wind and rain, using the equation : $u_1 = Au_2 + cu_4$

where c = the factor for rainfall.

u_4 = rainfall in mm. per day

and the other symbols are the same as before, the following equation is derived :

$$u_1 = -0.127u_2 - 0.045u_4 + 8.364.$$

In this instance both factors have a depressive effect on weight increase, but the correlation coefficient is low, $r = +0.3881$, and is not significant ($p = < 0.2$, for 22 d.f.). The poor

correlation obtained in 1965 in both instances is not clear, but the lower number of observations in this season may be responsible.

In 1966, the results give the regression equation :

$$u_1 = -0.299u_2 - 0.186u_4 + 8.77$$

In this instance, the correlation coefficient is higher than in 1965 ($r = +0.467$, $p = < 0.01$ for 35 d.f.) indicating that wind speed and rainfall are responsible for nearly half the observed variation.

These analyses indicate that wind and rain have a depressive effect on the growth rate of Common Tern chicks, but that the effect of sunshine is variable.

If the factors obtained are considered in conjunction with the daily mean value of a particular weather element, some indication of the relative importance of each can be assessed (see Table 59). Since the analysis of the results for 1966 have a significant correlation, only these have been tabulated.

TABLE 59. THE EFFECT OF WIND, SUNSHINE AND RAINFALL ON THE GROWTH OF COMMON TERN CHICKS

weather element	Regression factor	Ranged Mean \pm * element : 2 St.Dev.	Change effected by range (g)
Wind	a -0.30	0 - 14.31 knots	0 to - 4.29
Sun	b +0.09	0 - 14.29 hrs.	0 to + 1.29
Rain	c -0.19	0 - 6.36 mm.	0 to - 1.21

* Using Mean \pm 2 Standard deviations covers approx. 95% observed value

In both regressions for 1966, the factor obtained for wind are identical when corrected to two decimal places.

From Table 59, it can be seen that wind speed has the greatest effect, four times the effect of sunshine and nearly ten times the effect of rainfall. Both increased wind speed and rainfall have a depressive effect on the weight increase of Common Tern chicks, whereas sunshine positively affects daily weight increase. However, since sunshine produced a depressive effect in 1965, little weight can be attached to its influence in 1966. The factors a, b and c are meaningless by themselves, since their relative effect can be found only by consideration of the actual climate experienced, and their relative values will vary according to the scale by which these weather elements are measured. In this instance, although there is usually over six hours sunshine, the regression factor is low, so that this element has a reduced effect on chick growth. On the other hand, there is usually little rain whilst the regression factor is relatively large, also resulting in similar effect. However, the wind speeds are usually about seven knots with a relatively large regression factor, resulting in a greater effect on weight increase than the other factors.

The effect of weather on the growth rate of Arctic Tern chicks

In 1965 and 1966, similar information on the weight increases of chicks was obtained on the Inner Farne Island, about 20 miles N.N.E. of Coquet Island, on the Arctic Tern. Mrs. J. Horobi

has allowed me to use the results she collected in these two years for comparison between the effect of weather and the chick growth in the two species.

The inter-relation of sun and wind

As in the Common Tern, the effect of wind and sunshine operating together can be shown by using the multiple regression equation.

By using the results obtained in 1965, and the multiple regression equation,

$$u_1 = -0.132u_2 + 0.108u_3 + 6.646$$

is obtained; where u_1 = mean weight increase in grams per day

u_2 = mean daily wind speed in knots

u_3 = mean hours of sunshine per day

The correlation coefficient ($r = +0.4293$, $p = < 0.05$ for 25 d.f.) indicates that these two factors combined account for nearly half the observed variation.

Using the results for 1966,

$$u_1 = -0.0017u_2 + 0.171u_3 + 5.498$$

In this instance, the correlation coefficient accounts for about a third of the observed variability ($r = +0.354$, $p = < 0.10$ for 27 d.f.).

The inter-relation of rain and wind

If the results for 1965 are analysed, using the regression equation,

$$u_1 = au_2 + cu_4$$

where c = the factor for rainfall, the following equation is obtained :

$$u_1 = -0.09u_2 - 0.0126u_3 + 6.76$$

The correlation coefficient ($r = +0.7328$) ($p = <0.001$ for 25 d.f.) is high, so that these two factors contribute to about three-quarters of the weight variation observed.

In 1966, the effect of wind speed appears to be a tenth as important whereas the rainfall is ten times as important as in 1965.

$$u_1 = 0.009u_2 - 0.173u_3 + 6.97$$

The correlation coefficient ($r = +0.3647$ $p = <0.02$ for 27 d.f.) is much lower than in 1965, showing that the two factors are only contributing to a third of the variation observed. It is important to note that windspeed seems to affect weight increase positively in this instance.

Unlike the Common Tern, wind speed has little effect on the daily weight increase of Arctic Tern chicks. Also, when considering the years with a significant correlation between the expected weight increase and that observed, there is much variability although in 1965, the wind speed factor derived in one equation is only one and a half times that derived from the other equation. The relative importance of each factor has been considered by tabulating those factors with the greatest correlation and significance, i.e. those obtained in 1965, and the wind speed

factor derived when considering it with rain.

TABLE 60. THE EFFECT OF WIND, SUNSHINE AND RAINFALL ON THE GROWTH OF ARCTIC TERN CHICKS IN 1965

Weather element		Regression factor	Range of element: Mean \pm 2 St.Dev.	Change effected by range (g)
Wind	a	-0.09	1.05 - 15.05 knots	-0.09 to -1.35
Sun	b	+0.108	0 - 6.80 hours	0 to +0.73
Rain	c	-0.0126	0 - 10.60 mm.	0 to -0.13

From Table 60, it can be seen that both increased wind speed and rainfall have a depressive effect, and sunshine a positive effect, on the daily weight increase of Arctic Tern chicks as in Common Tern chicks. However, the effects are less marked. As in the Common Tern, the change in weight effected depends both on the regression factor and the values for the weather element obtained that season. For example, the hours of sunshine per day are much less in 1965, but the corresponding increase in the regression factor offsets this. In 1965, the effect of rain is very slight, yet in 1966 the effect is fifteen times as great, almost solely due to an increase in the regression factor.

The effect of weather on the growth rate of Roseate Tern chicks

Both the chicks of the Roseate Tern and the Sandwich Tern move out of the nest scrape within three to five days after hatching. The Sandwich Tern chicks move out of the nesting area and disperse over the island and continue to be particularly mobile. This behaviour makes them unsuitable animals to study with respect to daily weight increase, owing to the lack of a readily transportable balance and to the difficulty in finding the same chicks on successive days. However, the Roseate Tern chicks tend to move from the nest scrape into neighbouring rabbit burrows and remain there until they are nearly fledged. In 1966, it was found that by visiting the same burrows each day it was possible to collect a reasonable sample of chicks on successive days. Unfortunately, there are only fifteen such days, but they are sufficient to afford a comparison with the other two species already dealt with.

The inter-relation of wind and sun

Using a regression analysis on the fifteen days of observations :

$$u_1 = -0.266u_2 - 0.049u_3 + 7.27$$

This shows wind speed and sunshine to have a depressive effect on the weight increase of Roseate Tern chicks. The correlation coefficient ($r = -0.670$) indicates that these two factors are responsible for two thirds of the variation observed, and is significant ($p = <0.01$, for 13 d. of f.).

The inter-relation of wind and rain

When the weight changes are considered with respect to wind speed and rainfall :

$$u_1 = -0.279u_2 - 0.127u_4 + 7.12$$

From this, it is clear that both increased wind speed and rainfall depress the average daily weight increase. The correlation coefficient ($r = +0.477$) accounts for nearly half the variation observed, and it is not significant ($p = <0.1$ for 13 d. of f.). When considered in isolation, rainfall appeared to have a positive effect on weight increase, but this was due to a correlation with days of light winds, and, in fact, has a depressive effect. The two factors obtained for wind speed are very similar, but that derived with sunshine is tabulated since that equation had the most significant correlation.

TABLE 6₁. THE EFFECT OF WIND, SUNSHINE AND RAINFALL ON THE GROWTH OF ROSEATE TERN CHICKS IN 1966

Weather element	Regression factor		Range of element : Mean \pm 2 St.Dev.	Change effected by range (g)
Wind	a	-0.266	2.20 - 13.84	-0.59 to -3.68
Sun	b	-0.049	0 - 15.73	0 to -0.77
Rain	c	-0.127	0 - 2.44	0 to -0.31

From Table 61, it can be seen that, although all factors have a depressive effect on daily weight increase, wind is the most important. The depressive effect of rainfall is insignificant with the meagre rainfall experienced. The depressive effect of sunshine is rather anomalous, but may be the result of there being more sunshine on windy days.

Comparison of the effect of weather on the growth rate of tern chicks

TABLE 62. THE EFFECT OF WIND SPEED ON THE GROWTH OF TERN CHICKS

SPECIES	YEAR	Regression factor	Range of wind speed (Mean \pm 2 st.dev.)	Range of weight change (g)
Common	1966	-0.296 (with sun)	0-14.31 knots	0 to -4.24
Tern	1966	-0.299 (with rain)	0-14.31 knots	0 to -4.28
Arctic	1965	-0.09 (with rain)	1.05-15.05 k	-0.096-1.35
Tern	1966	+0.009 (with rain)	0-14.75 k	0 to +0.13
Roseate Tern	1966	-0.266 (with sun)	2.20-13.84 k	-0.59 to -3.68

* The different values obtained for different species in the same year is due to the mean being derived from the wind speed on different days.

In Table 62, the effect of wind speed on the average weight increase per day of the three species of tern chicks examined is listed. The regression factors are those where a significant correlation was obtained. The effect of wind speed

is a negative one on the average daily weight increase, except in 1966 when there is a slight positive effect in the Arctic Tern. However, since this effect is so slight and since the effect of wind speed, when calculated with sunshine, produced a negative regression factor, wind speed can be considered to depress the average daily weight increase.

The depression of weight increase caused by wind speed is most marked in the Roseate and Common Terns, but in order to compare the relative importance of wind speed, the percentage change in weight caused by this factor has been calculated. This has been derived by using the average daily change in weight caused by wind speed and the average daily weight increase for that particular species.

TABLE 63. THE PERCENTAGE CHANGE IN DAILY WEIGHT INCREASE CAUSED BY WIND SPEED

SPECIES	YEAR	Average growth rate per day (g)	Range of wt. change by wind (g)	% wt. change by wind
Common	1966	6.50	0 to - 4.24	0 to - 65.2
Tern	1966	6.50	0 to - 4.28	0 to - 65.8
Arctic	1965	6.12	-0.09 to -1.35	-1.5 to -21.8
Tern	1966	6.62	0 to + 0.13	0 to + 2.0
Roseate				
Tern	1966	4.81	-0.59 to -3.68	-12.3 to - 76.5

This information is collated in Table 63 . From this table,

it can be seen that wind speed has its most depressive effect on the weight increase of Roseate Tern chicks. In fact, a wind speed of ten knots will depress the daily weight increase by more than half. Wind speed affects the weight increase of Common Tern chicks significantly as well. A wind of ten knots depressing the daily weight increase by just less than half. The average wind speed experienced whilst most of the Common Terns are growing suppresses the weight increase by about 30%. In contrast, the Arctic Tern chick's daily weight increase is only affected by 0 - 10%; and on average by less than one-sixth of the effect on the Common Tern.

In Table 64 the effect of a ten knot wind on the daily weight increase of the chicks of each species is considered for more exact comparison, since the average wind speed experienced is determined by the time the chicks are growing.

TABLE 64. THE EFFECT OF A 10 KNOT INCREASE IN WIND OF.

TERN CHICKS

SPECIES	Daily weight increase in g.	Depression caused by wind (g)	% depression caused by wind
Common Tern	6.50	-2.97	45.7
Arctic Tern	6.37	-0.45	7.1
Roseate Tern	4.81	-2.66	55.3

This table serves to emphasise the different effect of wind on the Common and Roseate Terns compared with the Arctic Tern.

If a regression analysis is applied to the weight increases observed with respect to wind speed in these three species :

Roseate Tern : $r = -0.6437$ $p = < 0.01$ for 13 d. of f.

Common Tern : $r = -0.3369$ $p = < 0.01$ for 59 d. of f.

Arctic Tern : $r = -0.0905$ $p = < 0.6$ for 54 d. of f.

These correlation coefficients support the above conclusions concerning wind speed and chick growth. In the Roseate Tern, about two-thirds of the variation observed can be attributed to wind, about a third in the Common Tern, and less than one-tenth in the Arctic Tern.

The effect of rain

In the seasons when the effect of weather was studied, days with considerable rainfall (5mm.) were too infrequent for any statistical analyses to show significant correlations. For this reason it was not considered worthwhile to employ all three factors : wind, sun and rain, in a single multiple regression analysis. Nevertheless, if the regression factors obtained from those multiple regression analyses when wind and rain were considered together, they produce the factors shown in Table 65. However, since rainfall is not normally distributed, it was decided to tabulate the effect of the highest rainfall recorded during the weighings of each species in each year. The correspond-

TABLE 65. THE EFFECT OF RAINFALL ON THE WEIGHT INCREASE
OF TERN CHICKS

SPECIES	YEAR	Maximum rainfall recorded (mm.)	Regression factor	Change in weight (g)
Common	1965	4.8	-0.05	-0.24
Tern	1966	11.5	-0.19	-2.19
Arctic	1965	8.2	-0.01	-0.82
Tern	1966	17.9	-0.17	-3.04
Roseate Tern	1966	2.9	-0.13	-0.38

ing changes produced give some indication of the maximum effect likely from rainfall. As with wind speed, to compare the relative effect of rainfall between species, the percentage change in weight increase produced by rainfall is recorded in Table 66. However, as the maximum rainfall values vary, Table 67 is more suitable as a constant rainfall of 10 mm. has been assumed.

TABLE 66. THE PERCENTAGE CHANGE IN WEIGHT INCREASE WITH RAINFALL

SPECIES	YEAR	Average weight increase (g)	Wt. change by rainfall (g)	% wt. change by rainfall
Common	1965	7.18	-0.24	3.3
Tern	1966	6.50	-2.19	33.7
Arctic	1965	6.12	-0.82	13.4
Tern	1966	6.62	-3.04	45.9
Roseate Tern	1966	4.81	-0.38	7.9

As expected, there is no obvious difference between the species. In Table 67 the effect of 10 mm. rain is calculated, which was exceptional in the two years studied, but shows the effect of considerable rain. It can be seen that the greatest effect of rain was in 1966 when 10 mm. of rain would be expected to depress the daily weight increase by 25%. The lower effect in 1965 results from a lower regression factor in that year.

TABLE 67. THE EFFECT OF 10 mm. OF RAIN ON TERN CHICKS

SPECIES	YEAR	Daily wt. increase	Depression caused by rain (g)	% depression caused by rain
Common Tern	1965	7.18	-0.5	7.0
	1966	6.50	-1.9	29.2
Arctic Tern	1965	6.12	-0.1	1.6
	1966	6.62	-1.7	25.7
Roseate Tern	1966	4.81	-1.3	27.0

The effect of sunshine

The effect of sunshine was considered together with wind in a multiple regression analysis, and produced the factors listed in Table 68. As with rainfall, the change produced by the daily mean sunshine is low, but in this case it results from a low regression factor as the sunshine hours per day are

relatively high. However, in the Roseate Tern, sunshine has a depressive effect on the weight increase and this is also true of the Common Tern in 1965. The correlation coefficient for the regression of wind and sun for the Common Tern in 1965 is not significant, but if it is combined with 1966 it becomes significant, and the regression factor for sun becomes +0.008. This indicates that sunshine has little effect on the weight increase of Common Tern chicks. In contrast, sunshine may

TABLE 68. THE EFFECT OF SUNSHINE ON THE WEIGHT INCREASE
OF TERN CHICKS

SPECIES	YEAR	Regression factor	Range of sunshine Mean ± 2 St.Dev.	Range of change in wt. (g)
Common Tern	1965	-0.114	0.87 - 9.21	-0.10 - 1.05
	1966	+0.093	0 - 14.29 hrs.	0 - +1.33
Arctic Tern	1965	+0.108	0 - 6.80 hrs.	0 - +0.73
	1966	+0.171	0.31 - 13.29 hrs.	+0.05 - 2.27
Roseate Tern	1965	-0.049	0 - 15.73 hrs.	0 - 0.77

affect the weight increase of Arctic Tern chicks by over 15% when using the daily mean of sunshine. If the weight increase or decrease in the Roseate Tern, of the chicks on a day with ten hours sunshine (see Table 70) are considered, the difference between the species is emphasised.

TABLE 69. THE PERCENTAGE CHANGE IN WEIGHT INCREASE WITH
SUNSHINE

SPECIES	YEAR	Average wt. increase (g)	Range of wt. change by sunshine	% wt. change by sunshine
Common Tern	1965	7.18	-0.10 to -1.05	-1.4 to -14.6
Tern	1966	6.50	0 to +1.33	0 to +20.5
Arctic Tern	1965	6.12	0 to +0.73	0 to +11.9
Tern	1966	6.62	+0.05 to +2.27	+0.8 to +34.3
Roseate Tern	1966	4.81	0 to -0.77	0 to -16.0

TABLE 70. THE EFFECT OF 10 HOURS SUNSHINE ON TERN CHICKS

SPECIES	YEAR	Daily wt. increase	Wt. change (g)	% wt. change
Common Tern	1965	7.18	-1.14	-15.9
Tern	1966	6.50	+0.93	+17.5
Arctic Tern	1965	6.12	+1.08	+17.6
Tern	1966	6.62	+1.71	+25.8
Roseate Tern	1966	4.81	-0.49	-10.2

Conclusion

From these results it can be seen that wind speed is more important than rain and hours of sunshine in causing fluctuations in the daily weight increase in the Common Tern chicks. It is important in the Arctic Tern, except in 1966 when it appears to have little effect; and even in the other years it is less important than in the Common Tern. Wind speed

TABLE 71. THE PERCENTAGE CHANGE IN DAILY WEIGHT CAUSED BY WEATHER, USING DAILY MEAN WEATHER VALUE

SPECIES	YEAR	% change by wind	% change by rain	% change by sunshine
Common Tern	1965	-(12.0)*	-0.7	-8.4
	1966	- 31.1	-3.7	+8.8
Arctic Tern	1965	- 10.3	-0.3	+6.5
	1966	- 0.9	-4.5	+16.8
Roseate Tern	1966	- 44.3	-1.6	-6.8

* Mean of the two percentage values obtained that year.

has its greatest depressive influence on Roseate Tern chicks where it may decrease the daily weight gain by 50% under normal conditions. It can be concluded that increasing wind speed always has a depressive effect on the daily weight increase in the Common and Roseate Tern chicks, and may have a slight depressive effect on the Arctic Tern chicks in some years.

The reason for increasing wind speed producing an increasing loss in daily weight increment in tern chicks may be due to two causes :

(1) the chicks are using more food in compensating for heat lost by convection which increases with the greater airflow. This food would otherwise be responsible for the higher weight of the chick.,

or (2) the parents are finding it harder to obtain food in windy conditions.

Since the weight losses are not by any means uniform between the species, and since those species whose chicks have the heaviest losses in weight are those chicks which tend to be in less exposed situations, (2) seems more likely. The slight influence of wind speed on the Arctic Tern chicks could result from adaptations against this element, but lack of anatomical evidence means accepting (2) as the explanation. Why the parents find it difficult to obtain fish in windy conditions could be due to the ruffling of the surface of the sea, making the fish harder to see, or at least harder to judge their position. Also, the tern has to hover above the sea to position itself correctly for the dive which is likely to be difficult in a high wind. Another possibility is that shoals of fish may move away from the surface layers of the sea if it is ruffled by the wind, and since most fish are caught within a foot of the surface, fewer fish would be available.

In order to find out if weather affects the actual fishing success of terns, simultaneous watches were carried out on a group of Common and Arctic Tern nests. In these series of observations, the number of fish being brought in was recorded. Also, the number of chicks and the duration of the watch was noted, so that the number of fish brought in per chick per unit time could be ascertained. The values obtained were then plotted against wind speed for the appropriate period. From the subsequent regressions, a correlation coefficient of -0.486 ($p = < 0.1$) was obtained for the Common Tern, but that for the Arctic Tern was not linear. From this, it can be seen that wind has a depressive effect on the number of fish brought in by the Common Tern, whereas in the Arctic Tern there is a slight positive correlation. In addition, by calculating the slope of the regression using

$$y = mx + c,$$

where y = number of fish brought in to each chick every two hours

m = slope

x = windspeed in knots

c = constant,

it is possible to estimate the effect of a particular wind speed on feeding rate.

In a wind speed of ten knots,

$$y = 1.30 \text{ in the Common Tern.}$$

Since the regression is negatively correlated, the number of fish brought in is reduced by 1.3 per two hours, to each chick.

Similarly, for the Arctic Tern,

$$y = 2.91$$

so that a wind speed of ten knots increases the number of fish brought in to each chick by 2.9 for every two hours, since r is positive. Table 72 shows that up to wind speeds of 14 knots, the fish brought to Arctic Tern chicks decreases, but on two watches carried out at higher wind speeds the number of fish brought in rapidly increases. The difference between the number of fish brought in to the Arctic Tern chicks at 12 - 14 knots and 16 - 18 knots is statistically significant ($p = < 0.02$ for 28 d.f.).

TABLE 72. THE EFFECT OF WIND SPEED ON FISH BROUGHT TO
COMMON AND ARCTIC TERN CHICKS

Fish brought in per chick/2 hrs.

Wind Speed	Common Tern	No. of chicks	Arctic Tern	No. of chicks	Hours of watch
0 - 6	1.71	8	3.00	7	2
7 - 10	1.13	5	2.60	10	3
12 - 14	1.14	7	2.76	9	5.5
16 - 18	1.00	4	5.02	10	4

The average growth rate of Arctic Tern chicks was high on these two days when many fish were brought in, 7.84 and 7.19 grams (average = 6.62 for 1966), which may mean that the results were dependent on abundant food at that time. The majority of fish brought in by the two species were sand eels *Ammodytidae* which are

the predominant food of the Arctic Tern in this region, whereas the Common Tern tends to take more clupeoids and gadoids (considered elsewhere). It seems that the latter two types of fish were difficult to obtain on these two days. This availability may arise from the weather conditions or to some other factor not considered in this analysis.

The difference suggests that the Common Tern is at a disadvantage when attempting to breed in regions where strong winds are frequent. Its preference for feeding inshore and on inland waters contrasts with the Arctic Tern which is rarely seen feeding in these areas, and appears to emphasise the disadvantage the former species has when feeding in exposed areas. In contrast, wind seems to have little effect on the Arctic Tern, and may even benefit from windy weather; and this species appears to feed satisfactorily in windy weather with rough seas, but may be at a disadvantage when attempting to feed in areas suitable for the Common Tern.

The differences observed in food composition of the chicks' diet in these two species, and also the Roseate Tern which resembles the Common Tern, may be the result of food preference, or to the availability of food in the habitat searched. Only sophisticated sampling techniques could help elucidate this point. The Roseate Tern is a maritime species in which wind has a very marked depressive effect on the growth rate of its chicks. Presumably this species has difficulty in feeding in windy weather

and its minority status on Coquet Island may reflect this. However, it appears to feed offshore like the Arctic Tern, presenting a rather anomalous situation. It would seem that food preference in this species, considered elsewhere, determines its feeding area, but makes it vulnerable to windy weather in this region.

In summary, the effect of a 10 knot wind, six hours of sunshine and three mm. of rain on one day in 1966 on three species of tern chicks is tabulated.

This table illustrates the different effects of the same weather on different species of tern chicks, and, in particular, the different effect of wind. A 10 knot wind under the conditions tabulated is largely responsible for reducing the growth rate of Common Tern chicks to about half the average, and to less than a third in Roseate Tern chicks. Therefore it is likely that wind speed and frequency of wind is an important factor in determining the occurrence of breeding colonies of Common and Roseate Terns.

TABLE 73.

THE EFFECT OF WEATHER ON TERN CHICKS in 1966

	Common Tern	Arctic Tern	Roseate Tern
Average growth rate (g)	6.50	6.62	4.81
Effect of 10 knot wind (g)	-2.97	+0.09	-2.66
Effect of 3 mm. rain (g)	-0.57	-0.51	-0.39
Effect of 6 hrs. sun (g)	+0.56	+1.03	-0.29
Total change (g)	-2.98	+0.61	-3.34
Average wt.increase expected (g)	+3.52	+7.23	+1.47
Wt. increase expected as % of average	54.2	109.2	30.6

THE FOOD OF TERNS

The food of terns can be studied in three main ways :

- (1) by shooting birds and examining the stomach contents.
- (2) by collecting regurgitated samples from trapped birds.
- (3) by recording the food fed to chicks by the parents.

The first method was used by Collinge (1926) when investigating the food of terns at Blakeney Point in Norfolk, and by Belopolskii (1961) when examining the feeding ecology of sea-birds, including the Arctic Tern, in East Murman, bordering the Barents Sea. The second method is the least practical since it depends on catching birds with full crops and then forcing them to regurgitate. In both (1) and (2), the food items may be so masticated and digested as to make identification difficult. In the present study, the third method was adopted since this produced less interference with the birds' activities and so allowed other studies on the breeding biology to be conducted with the minimum of disturbance. However, this last method has its defects. It is only possible to examine the food fed to the chicks, although it is likely that the adults have a similar diet, and also it usually prevents specific identification of the food items. In addition, it is likely that small food items may be overlooked, except when watching a small group of nests from a hide.

In 1965, a series of watches were conducted from a fixed observation point on the south end of the island on terns coming in

with fish. By using 10 x 50 binoculars, it was possible to record the fish brought in and assign it either to the Ammodytidae (long slender fish) or to the Clupeoidea (broad fish with a bifid tail). However, a few gadoids (Whiting etc.) were included with the clupeoids, being broad fish sometimes caught in the area; and very small fish were difficult to assign to either category. Subsequent examination of all specimens collected in the ternery from 1965 to 1967 inclusive has shown all the Ammodytidae to belong to the species Ammodytes marinus Raitt (26 specimens), and all the Clupeoidea to the Sprat Clupea sprattus L. (35 specimens) which suggests that only these species were involved in the two categories in most cases. A number of Whiting Gadus merlangus L. (14 specimens) were identified, but these were large specimens, often too big for the chicks to eat, and so left, and therefore much less common in the diet than the number suggests.

In 1965, the counts were made every two hours, from 08.00 to 16.00 hours inclusive, for ten minutes each. These daily counts operated over two weeks and show a fluctuation in the proportion of sand-eels and clupeoids taken (Table 74). The proportion of clupeoids increases from about half the fish taken to nearly three-quarters in the second week (i.e. 17 to 21 July).

With some additional counts over the same period, it is possible to examine the proportion of each type of fish caught throughout the day (Table 75).

TABLE 74. DAILY TOTALS OF AMMODYTIDAE AND CLUPEOIDAE BROUGHT
INTO THE TERNERY IN 1965

Date	Ammodytidae		Clupeoidae		Total no. of fish
	Number	%	Number	%	
7 July	94	43.5	122	56.5	216
9 "	40	27.4	106	72.6	146
11 "	12	31.6	26	68.4	38
17 "	40	17.0	195	83.0	235
18 "	7	10.0	63	90.0	70
19 "	43	19.8	174	80.2	217
21 "	28	14.5	165	85.5	193
Total	264	23.7	851	76.3	1115

TABLE 75. THE PROPORTION OF AMMODYTIDAE AND CLUPEOIDAE TAKEN
THROUGH THE DAY DURING 7 - 21 JULY 1965

Time (B.S.T.)	Ammodytidae		Clupeoidae		Total	Sample
	No.	%	No.	%		
06.00	11	20.8	42	79.2	53	1
08.00	82	27.8	213	72.2	295	9
10.00	69	30.3	159	69.7	228	8
12.00	66	20.1	262	79.9	328	9
14.00	40	17.2	193	82.8	233	8
16.00	30	15.5	163	84.5	193	7
18.00	24	16.2	124	83.8	148	6
20.00	18	20.5	70	79.5	88	5
21.30	2	16.7	10	83.3	12	1
Total	342	21.7	1236	78.3	1578	54

The results show that the proportion of sand eels is fairly constant, about 15 - 30% of the total numbers of fish brought. Therefore the increasing number of clupeoids brought in is mainly a seasonal effect, but it may be the result of a change of a particular species or to observations of increasing numbers of a particular species with a preference for clupeoids.

The proportion of sand eels and clupeoids brought to the colony by each species was next considered (Table 76). Certain differences emerge. Principally, the Arctic Tern is different from the other three species in taking a much higher percentage of sand eels, nearly 50%, compared with under 15% in the other species. The observations were then divided into those

TABLE 76. THE PROPORTION OF AMMODYTIDAE AND CLUPEOIDAE BROUGHT TO THE COLONY BY EACH SPECIES IN 1965

SPECIES	Ammodytidae		Clupeoidae		Total
	No.	%	No.	%	
Sandwich Tern	57	11.2	452	88.8	509
Roseate Tern	9	8.8	93	91.2	102
Common Tern	78	13.8	489	86.2	567
Arctic Tern	218	47.3	243	52.7	461

made between 7 July and 11 July, and those made between 17 July and 21 July. In the first period, when sand eels were more abundant in the tern chicks' diet, the proportion brought in by Sandwich and Roseate Terns was still below 15%, but that of the Common Tern was nearly 30%, yet this is less than half the proportion of sand eels brought in by the Arctic Tern (Table 77).

TABLE 77. THE PROPORTION OF AMMODYTIDAE AND CLUPEOIDAE BROUGHT TO THE COLONY BETWEEN 7 AND 11 JULY 1965

SPECIES	Ammodytidae		Clupeoidae		Total
	No.	%	No.	%	
Sandwich Tern	8	7.6	97	92.4	105
Roseate Tern	5	14.7	29	85.3	34
Common Tern	67	28.6	167	71.4	234
Arctic Tern	111	61.7	69	38.3	180

When sand eels were less frequent in the fish brought to the chicks, the proportion of sand eels brought by the Sandwich, Roseate and Common Terns was under 15%, whilst sand eels composed more than a third of the fish brought by the Arctic Tern. The difference between the Arctic Tern and the other species is large and significant and may be the result of a different feeding area, or a different food preference, or both. All the species, except

TABLE 78. THE PROPORTION OF AMMODYTIDAE AND CLUPEOIDAE
BROUGHT TO THE COLONY BETWEEN 17 AND 21 JULY 1965

SPECIES	Ammodytidae		Clupeoidae		Total
	No.	%	No.	%	
Sandwich Tern	49	12.1	355	87.9	404
Roseate Tern	4	5.9	64	94.1	68
Common Tern	11	3.3	322	96.7	333
Arctic Tern	107	36.8	184	63.2	291

the Sandwich Tern, brought in a greater proportion of clupeoids in the second period. The proportion of clupeoids brought in by the Roseate only increases slightly, but in the Common Tern the proportion increases by about 25%. The Arctic Tern changes by about 25% also, but still has a greater proportion of sand eels in the fish it brings to the chicks than the other species. The reasons for these changes are obscure, but probably relate to the availability of the two fish types in different areas. Collinge (1926), when analysing the stomachs of adult Common Terns, found the proportion of sand eels to food fish (Whiting, Haddock, Herring and Whitebait*) approximately the same for May, June and July, but the proportion of good fish becoming about four times as abundant (by weight) than the sand eels in August. However, Belopolskii

*Whitebait presumably refers to Sprats, although this term is frequently employed when referring to Herring and Sprats.

(1961), referring to the adult Arctic Tern's diet in the Barents Sea, states that the proportion of sand eels increases in the latter half of the summer (from 26.9 to 59.3% in occurrence), whilst the proportion of Herring Clupea harengus L. declines towards the end of the summer (from 42.3 to 3.4%).

In 1966, a further series of counts were made, noting the type of fish brought to the ternery by each species. During these counts, of 15 minutes, there are only two days when more clupeoids than sand eels were brought in, and comprised only four counts. Unlike 1965, sand eels tended to become more common in all four species, although the earlier counts do not contain sufficient observations for adequate analysis. There were 526 sand eels (60.5%) brought in and 344 clupeoids overall, but only in the Arctic Tern was there a significantly high proportion of sand eels compared to clupeoids ($p = < 0.001$ for 1 d.f.). In the Common and Roseate Terns, slightly more sand eels were brought to feed the chicks, whereas in the Sandwich Tern there were more clupeoids (Table 79).

In a series of feeding watches made on groups of Arctic and Common Tern broods in 1966, the majority were conducted simultaneously for periods of one to two hours each. In Table 80 the number of sand eels and clupeoids caught by each species is recorded, and the number of sand eels is expressed as a percentage of the number of fish brought to the chicks. On each day, the number of sand eels brought in by these two species was greater

TABLE 79.

THE NUMBERS OF AMMODYTES AND CLUPEOIDS BROUGHT TO THE
TERNERY IN 1966

Date	Sandwich Tern		Roseate Tern		Common Tern		Arctic Tern		Sample 15 in counts	Total	
	Amm.	Clup.	Amm.	Clup.	Amm.	Clup.	Amm.	Clup.		Amm.	Clup.
2 July	0	15	0	0	0	3	6	4	3	6	22
3 July	1	4	0	0	0	0	8	1	1	9	5
19 "	6	12	2	3	7	8	15	3	1	30	26
24 "	6	27	5	3	11	19	23	10	1	45	59
28 "	29	34	8	3	20	1	52	5	6	109	43
29 "	25	24	14	7	51	47	35	2	6	125	80
30 "	37	24	9	16	38	28	47	14	6	131	82
31 "	27	13	4	0	11	13	29	1	4	71	27
Total	131	153	42	32	138	119	215	40	28	526	344

TABLE 80. THE NUMBER AND PERCENTAGE OF AMMODYTES AND CLUPEOIDS BROUGHT TO
THE YOUNG OF ARCTIC AND COMMON TERNS IN 1966

Date	Arctic Tern			Common Tern			Both species	
	No. Amm.	No. Clup.	% Amm.	No. Amm.	No. Clup.	% Amm.	No. Amm.	% Amm.
5 July	8	0	100	2	8	20	10	56
12 "	9	1	90	3	9	25	12	55
17 "	9	1	90	6	1	86	15	88
18 "	10	1	91	2	1	67	12	86
19 "	11	3	79	4	1	80	15	79
20 "	44	2	96	8	0	100	52	96
21 "	62	3	95	6	1	86	68	94
22 "	-	-	-	5	0	100	5	100
24 "	27	1	96	-	-	-	27	96
28 "	-	-	-	4	0	100	4	100
29 "	-	-	-	6	2	75	6	75
30 "	-	-	-	8	2	80	8	80
6 August	-	-	-	6	1	86	6	86
Total	180	12	94	60	26	70	240	88

than the number of clupeoids, and overall the sand eels comprised 88% of the fish by number. If there was no difference in the types of fish caught by the Common and Arctic Terns, it would be expected that they would take a similar percentage of sand eels. However, the difference between the two species is significant ($p = < 0.001$ for 1 d.f.); The Common Tern feeding its chicks on five times as many clupeoids as the Arctic Tern.

In 1967, a series of watches were made on groups of Common Tern nests from 26 June to 8 July inclusively. During these watches, a record was made of the type of fish fed to the chicks. The results show that the overall percentage of sand eels fed to chicks was very much lower than in 1966, but not so low as that in 1965. However, when the percentage of sand eels recorded in 1967 is compared with the percentage recorded in a similar period in 1965, there is little difference (26.3% in 1967, 28.6% in 1965). In 1967, apart from the first day, sand eels contribute about one quarter of the number of fish fed to Common Tern chicks (Table 81).

From the counts made in 1967, it was possible to see whether certain parents fed more exclusively on clupeoids than others, by comparing the types of fish brought to certain nests during the same period. For two periods, each containing three nests, no significant difference was found in the proportion of sand eels and clupeoids brought for the chicks. However, for another period with six different nests, a significant difference

TABLE 81. THE NUMBER AND PERCENTAGE OF AMMODYTES AND
 CLUPEOIDS BROUGHT TO COMMON TERN CHICKS IN 1967

Date	Ammodytes		Clupeoids		Total
	No.	%	No.	%	
26 June	31	49.2	32	50.8	63
27 "	14	25.4	41	74.5	55
28 "	19	23.5	62	76.5	81
29 "	26	20.8	99	79.2	125
30 "	11	20.8	42	79.2	53
1 July	36	38.3	58	61.7	94
3 "	4	10.8	33	89.2	37
4 "	2	8.7	21	91.3	23
5 "	12	28.6	30	71.4	42
6 "	15	27.8	39	72.2	54
7 "	21	24.4	65	75.6	86
8	8	18.6	35	81.4	43
Total	199	26.3	557	73.1	756

TABLE 82. THE PROPORTION OF AMMODYTES AND CLUPEOIDS
TAKEN BY DIFFERENT COMMON TERN PARENTS

Nests*		1		2		3		Significance
Duration		Amm.	Clup.	Amm.	Clup.	Amm.	Clup.	
28 June	No.	19	67	33	82	14	34	p = > 0.6 for 2 d.f.
- 8 July	%	22.1	77.9	28.7	71.3	29.2	70.8	
4 July	No.	17	25	7	15	9	15	p = > 0.8 for 2 d.f.
- 8 July	%	40.5	59.5	31.8	68.2	37.5	62.5	
26 June	No.	8	36	19	53	11	57	p = < 0.01 for 5 d.f.
	%	18.2	81.8	26.4	73.6	16.2	83.8	
- 3 July	No.	30	52	6	49	5	27	
	%	36.6	63.4	10.9	89.1	15.6	84.4	

* only those nests with a particular time period can be compared. was found between them ($\chi^2 = 17.91$, $p = < 0.01$ 5 d.f.). However, the greatest difference is not much more than 25% (Table 82). In each case, the number of each type of fish caught for the chicks is the result of two parents' fishing efforts. So that individual variation will be partly obscured. The results show that there is some variation, as one would expect, but the proportions are similar for the same period, indicating that general conclusions for this species, derived elsewhere, are correct.

When the records for the three years are summarised for the Common Tern, and 1965 and 1966 for the Arctic Tern, there is a considerable difference in the proportions of sand

TABLE 83. THE NUMBER AND PROPORTION OF AMMODYTES AND CLUPEOIDS
 FED TO CHICKS OF ARCTIC AND COMMON TERN CHICKS IN 1965, 1966
 AND 1967

Year	Arctic Tern		Common Tern	
	No. Amm.	No. Clup.	No. Amm.	No. Clup.
1965	206	240	102	514
1966	215	40	138	119
	28	10	79	64
1967	-	-	199	557
Total	449	290	518	1254
Percentage	60.8	39.2	29.2	70.8

eels and clupeoids taken by each species (Table 83). In the Common Tern, less than 30% of the chicks' fish diet is comprised of sand eels and in the Arctic Tern just over 60% is comprised of sand eels. The difference between the two species is very significant ($p < 0.01$ for 1 d.f.).

The size of fish taken by each species

In 1965, while recording the number of sand eels and clupeoids brought into the colony to feed the chicks, the size of these items was estimated using the length of the adult's bill as a guide (e.g. Sandwich Tern - 2", Roseate and Common Terns - $1\frac{1}{2}$ ", Arctic Tern $1\frac{1}{2}$ "). The average size of fish brought into the ternery, presumably to feed chicks in most cases, was .

TABLE 84. THE AVERAGE FISH SIZE TAKEN BY TERNS TO FEED
THEIR CHICKS IN 1965

SPECIES	Average Fish Size in inches	Standard Deviation	Sample
Sandwich Tern	4.74	1.68	515
Roseate Tern	2.83	0.62	100
Common Tern	2.96	0.92	623
Arctic Tern	2.56	0.74	447

calculated (Table 84). The difference in the size of fish taken by Sandwich Terns is significantly different from the other species ($p = <0.001$ in each case). The other species are significantly different from one another ($p = <0.001$ in all cases), but the significances are the result of large samples. Reference to the actual averages and standard deviations shows that these statistical significances are unlikely to have any biological significance. Only the Sandwich Tern takes fish of a size not often taken by the other three species.

When the two fish types are considered separately, the same differences appear to occur (Table 85). The fish sizes taken by each species are statistically ^{and} significantly different because of the large samples involved (except for the Ammodytes taken by the Roseate Tern, where the few fish do not make the comparisons significant). Therefore, the Sandwich Tern is the

TABLE 85. THE AVERAGE SIZE OF AMMODYTES AND CLUPEOIDS FED TO
TERN CHICKS IN 1965

SPECIES	Ammodytidae			Clupeoidae		
	Av.(Ins.)	St.Dev.	Sample	Av.(Ins.)	St.Dev.	Sample
Sandwich Tern	4.08	2.01	53	4.83	1.41	461
Roseate Tern	2.22	2.70	9	2.90	0.49	91
Common Tern	2.20	2.79	102	3.15	0.93	514
Arctic Tern	2.56	0.76	206	2.67	0.73	240

only species that is biologically different with respect to size of fish brought to its young, taking larger sand eels and clupeoids than the other three species. All the four species take larger sized clupeoids than Ammodytes which is probably the result of larger fish of this type being available.

In this year (1965), the proportion of sand eels taken to feed the chicks of Sandwich, Roseate and Common Terns was low (below 15%) compared with the Arctic Tern where about 50% of the fish taken during the watches were sand eels. It appeared that in the first three species sand eels were fed to very young chicks as these slender fish were more easily taken and swallowed. Small clupeoids were also fed to young chicks, but sufficient numbers may have been difficult to procure. In the Sandwich Tern in particular, hide watches revealed that a preponderance of sand

eels three to four inches long were fed to newly hatched chicks. After this period, large clupeoids formed the main diet of this species.

The reason why the Sandwich, Roseate and Common Terns go on to feed their chicks on a greater proportion of clupeoids is unknown. However, it is known that the Sandwich and Common Terns are inshore feeders and clupeoids may be more available in these areas than sand eels. Also, clupeoids are about two to three times heavier than sand eels of the same length, so there is more food per fish. Nevertheless, the Roseate Tern does not appear to feed in-shore, and yet it has a high proportion of clupeoids in the fish it brings to its chicks. However, on Coquet Island and the Farne Islands, this species clepto-parasitises other species as they return to the colony with food. It has been observed on Coquet Island many times.

The Roseate Tern flies up above the colony and circles round, above the other nesting birds and terns coming into and leaving the colony, with its conspicuous, rapid, shallow wing beats. From this vantage point, it is able to observe the other tern species returning with fish, and will fly off at a tangent, above a suitable target. At the appropriate moment, the Roseate Tern dives and snatches the fish from the bill of the returning tern. Such attempts are not always successful, and some returning terns are alert enough to take avoiding action. However, the Roseate Tern is very adept at this clepto-parasitism,

and has been seen to snatch fish from Sandwich Terns on the ground. Nevertheless, the majority of sorties are made on flying birds since the stoop can be faster as it needs less checking, and hence the surprise is greater. Whether this method is a major source of food to the Roseate Tern, at least during the breeding season, is uncertain. This species has been seen to dive for fish in the sea on a few occasions, but only two or three have been seen to be successful. This species has been seen to dive on birds returning over the sea, and this may be a common occurrence. Since the number of sorties observed on Coquet Island would seem to be insufficient for the sole supply of food for the chicks.

Therefore, it is possible that if the major source of food for the young Roseate Terns is derived from clepto-parasitism of other species, the preponderance of clupeoids in the diet may be explained. Since the Common and Sandwich Terns combined were three to five times more abundant than the Arctic Tern from 1965 to 1967, these will present greater opportunities for the Roseate Tern apart from any specific selection; and the Common and Sandwich Tern bring in far more clupeoids than sand eels.

In 1966, examination of the fish fed to young Arctic and Common Terns revealed that these were predominantly sand eels (Arctic Tern - 94%, Common Tern - 70%) when the counts were made in the second half of July. The number of clupeoids taken were too few to draw any definite conclusions, but the average sizes

recorded were 1.92" and 2.36" for the Arctic and Common Tern respectively. These values are similar in order to those obtained for 1965, when the Arctic Tern caught clupeoids 2.67" \pm 0.73 (1 St.Dev.) and the Common Tern caught clupeoids with an average size 3.15" \pm 0.93 (1 St.Dev.). The sand eels fed to Arctic Tern chicks in 1966 were smaller than those fed to Common Tern chicks, unlike 1965. The average sized sand eel brought by Arctic Terns was 1.77" \pm 0.71 (1 St.Dev.) and that by Common Terns was 2.65" \pm 0.93 (1 St.Dev.). Although there is considerable overlap in the size of fish taken, the difference is probably biologically significant. It is possible that with the fewer clupeoids being caught, the Common Tern is selecting larger sand eels. However, it could be that larger sand eels were more available in inshore areas.

Further records of the size of fish taken by Common Terns in 1966 and 1967 were made, but no comparable data for the Arctic Tern were collected. ~~in 1967~~ The available information is recorded in Table 86 and Table 87. In this instance, although the overall average size of clupeoids taken by Arctic and Common Terns is almost identical, such large samples result in a statistically significant difference ($p = <0.001$ for 1102 d.f.). However, such difference has no biological reality, especially when the fish lengths were only estimated to the nearest half inch. Similarly, with the sand eels, the overlap in size of fish taken is such to be biologically insignificant. Nevertheless,

TABLE 86. THE AVERAGE SIZE OF CLUPEOIDS TAKEN BY COMMON
AND ARCTIC TERN CHICKS

Common Tern	1"	1" +	2" +	3" +	4" +	5" +	6" +	Mean
1965	0	1	113	221	115	29	9	
1966	0	148	344	90	9	0	3	
1967	0	142	335	80	6	0	3	
TOTAL	0	291	792	391	130	29	15	2.44" (±0.55)
Arctic Tern								
1965	0	5	121	52	19	2		
1966	0	2	9	1	0	0		
TOTAL	0	7	130	53	19	2		2.43" (±0.73)

TABLE 87. THE AVERAGE SIZE OF SAND EEL TAKEN BY COMMON
AND ARCTIC TERN CHICKS

Common Tern	1"	1" +	2" +	3" +	4" +	5" +	6" +	Mean
1965	0	5	58	16	2	0	0	
1966	1	80	182	65	19	0	0	
1967	1	74	152	35	5	0	0	
TOTAL	2	159	392	116	26	0	0	2.11" ± 0.55
Arctic Tern								
1965	0	0	101	98	25	1	1	
1966	1	66	92	22	2	0	0	
TOTAL	1	66	193	120	27	1	1	2.34" (± 0.65)

differences observed in a particular year may be sufficient to be biologically significant. However, with the Arctic and Common Terns in this region, it is mainly the fish composition, sand eel or clupeoid, that is distinctive.

In the hide watches made on groups of Common and Arctic Tern nests simultaneously to determine the effect of weather, the Arctic Tern was found to have a higher feeding rate at all wind speeds. The number of fish brought to an Arctic Tern chick per two hours varied from 2.60 to 5.02, compared with 1.00 to 1.71 for a Common Tern chick. However, although these two tern species take similar sized fish, the Arctic Tern feeds its chicks on proportionally more sand eels (61%) compared with Common Tern (29%). The weight of a clupeoid 2.4" long is about 1.5 gm., and in 1966 when Common Terns brought in clupeoids with an average length of 3.2", the weight would be about 3.0 gm. In contrast, sand eels caught by the Arctic Terns had an average length of 2.3" which would weigh about 0.5 gms. (after Macer, 1965). This difference in the weight of the fish brought to the chicks would account for the overall difference in feeding rates of the chicks, although weather will modify these rates.

The fishing area during the breeding season

It has already been said that the diet of different species of terns, or at least the diet of the chicks of these species, may be the result of fishing in a particular area. This preference for a particular locality might be determined

by the type of fish occurring there, but, more likely, to the availability of certain fish there as a result of certain adaptations of the species of tern concerned. In order to find out if certain species preferred certain areas, a series of coastal counts was made along the neighbouring mainland in 1965. These counts, of five minutes each, were made at various stations about a quarter of a mile apart on July 12th. The area involved was the coast from Amble to Druridge Bay, Northumberland, which lies opposite and to the south-west of Coquet Island. There were 22 different stations, 14 of which were of sandy bays or beaches, and 8 of rocky bays or headlands. The number of terns seen flying at each station was recorded, together with the number of dives observed. Although a particular bird was only recorded once for each station, it could contribute several dives. The results are recorded in Table 88.

TABLE 88. THE NUMBERS OF TERNS SEEN IN DIFFERENT AREAS OF COASTLINE

SPECIES	NUMBER SEEN/5 mins.		NUMBER OF DIVES/5 mins.	
	SANDY	ROCKY	SANDY	ROCKY
Sandwich Tern	174	34	15	3
Roseate Tern	7	9	0	6
Common Tern	202	140	7	44
Arctic Tern	13	17	1	1
TOTAL	396	200	23	54

It can be seen that the majority of the records are of the Sandwich and Common Terns; the observations of Roseate and Arctic Terns are small, making differences tentative. However, the paucity of records of the two latter species suggests that these species are not feeding inshore. The relatively few records of Roseate Terns seen along this stretch of coast (B.Little, pers.comm.), and the sparcity of Arctic Tern records along the east coast of England on migration (R.A. Richardson, pers.comm.) support this contention.

The number of Sandwich Terns seen in sandy areas is significantly higher than those in rocky areas ($p = <0.001$ for 1 d.f.). In fact, very few Sandwich Terns were seen returning from offshore areas and concentrated their fishing along the sandy shores, particularly feeding in the breakers. Druridge Bay is a large shallow bay almost entirely sandy, and is the main fishing area for this species when nesting on Coquet Island. The number of dives recorded in sandy areas is not sufficient in this instance to be significant.

The number of Common Terns seen in sandy and rocky areas is not significantly different ($p = <0.1$ for 1 d.f.). However, there are significantly more Common Terns seen diving for fish in rocky areas ($p = <0.001$ for 1 d.f.). This indicates that although the Sandwich and Common Terns are the main tern species feeding

in inshore areas, they tend to feed in different areas. The number of Arctic Terns seen in rocky areas is significantly higher than those seen in sandy areas ($p = < 0.02$ for 1 d.f.), but the difference is not significant in the Roseate Tern ($p = < 0.1$ for 1 d.f.). However, as mentioned, these two species feed more offshore, although the few Roseate Tern observations are partly a result of its lesser abundance.

In 1966, a similar series of counts were made on 6th June, from Druridge Bay to Amble. There were twelve ten-minute counts; a total of two hours' watching. Seven were in sandy areas and five in rocky areas. Twelve Common Terns and thirty-two Sandwich Terns were seen, but no Roseate or Arctic Terns. Only seven dives were seen, all by Common Terns, of which five were in rocky areas and two in sandy areas. Only three of the dives were seen to be successful. These observations on diving are too few for analysis, but deserve further study. However, the counts show the occurrence of only Sandwich and Common Terns inshore. Twenty-one of the Sandwich Terns were seen in sandy areas and eleven in rocky areas; so that this species was twice as common in the former. There were six Common Terns in sandy areas and six in rocky areas. One might infer that whereas the Sandwich Tern has a preference for shallow sandy shores, with rollers, the Common Tern has no distinct preference. However, it should be noted that terns feeding inshore, passing along the coast, will pass over both rocky

and sandy areas whether they have a preference for either or not. If a bird prefers to fish in a particular area, it will occur more often there, but not exclusively so. Both species were seen to feed in the brackish water of Warkworth Harbour, although the Common Tern penetrated further up the river Coquet. It was seen as far as a mile up-river, and three-spined sticklebacks Gasterosteus aculeatus L. were brought to its chicks. However, these sticklebacks also occur in salt water.

Also, in 1966, the number of each species returning from the offshore side of Coquet Island were recorded, and whether they brought in fish. Similarly, the number of each species, and whether they had fish, was made on the side of Coquet Island facing the shore. These counts were from 10 - 20 minutes long, and one on the offshore side and one on the onshore side were made consecutively, each of the same duration. However, such a division of returning birds is not clear cut, since Coquet Island is about 3/4 mile offshore, with a deep channel between. Also, the shelving rocks on the east side extend offshore several hundred feet, offering shallow water comparable to some inshore areas. Nevertheless, some differences were observed (Table 89). There were fifteen pairs of counts, one on each side, conducted on different days from 26 May to 1 July.

The Sandwich Tern returns from inshore areas in larger numbers than offshore areas, as expected. The difference of 88 birds observed being significant ($p = < 0.02$ for 1 d.f.). On

some days, some Sandwich Terns were seen feeding in the breakers off the east side which might have reduced this significance. Unfortunately, the observations of Roseate Terns during this period were few, partly because few of the birds had chicks to feed at this stage. The 14 observations of this species suggest there is little difference in area of feeding ($p = >0.9$ for 1 d.f.). In the Common Tern, there are 52 observations of birds returning from an offshore direction, and 52 from an inshore direction, showing there is no difference in returning direction. However, on 27th June, 18 birds were observed returning in 10 minutes from a shoal of fish on the offshore side of the island, thereby biasing the results. Also, during the period of some of the observations fish appeared in short supply and terns and Black-headed Gulls Larus ridibundus L. were feeding on crustacea, as evidenced by their pink droppings. It is suspected that the Common Tern feeds mainly inshore, but further observations are required to substantiate this.

There were 154 observations of Arctic Terns returning to the ternery, and 128 of these were from offshore. This species seems to feed mainly offshore and were rarely seen feeding near the island. The difference here is significant ($p = <0.01$ for 1 d.f.). These observations support those of Kullenberg (1946), but not those of Burton & Thurston (1959) in Spitzbergen. The latter authors found that fishing was mainly carried out within 100 yards of the shore, with a

TABLE 89. THE RETURN OF TERNS FROM FEEDING AREAS

SEAWARD	Sandwich Tern		Roseate Tern		Common Tern		Arctic Tern	
	+	-	+	-	+	-	+	-
With or without fish								
NUMBER	5	5	0	8	15	37	56	72
TOTAL	10		8		52		128	
LANDWARD								
With or without fish								
NUMBER	36	42	1	5	8	44	9	17
TOTAL	78		6		52		26	

preference for feeding in sheltered areas on windy days. Although no data are given, the absence of other tern species in Spitzbergen may allow this species greater plasticity of feeding areas.

Besides, it has been suggested already that local abundances will encourage exploitation by several species, obscuring specific preference. Observations of returning terns made from a small dinghy on 1 June showed that the Arctic Tern feeds principally offshore, and occurs more in this area than any other species of tern. The observations on the other species are too few to show any significant differences, but in the Arctic Tern the number seen in offshore areas is significantly higher than those seen between Coquet Island and the mainland ($p = < 0.02$ for 1 d.f.) (Table 90).

TABLE 90. OBSERVATIONS OF TERNS IN DIFFERENT AREAS FROM
A SMALL BOAT IN 1966

Position	Sandwich Tern		Roseate Tern		Common Tern		Arctic Tern	
	+	-	+	-	+	-	+	-
*Seaward side	+	-	+	-	+	-	+	-
No./75mins	3	4	1	7	2	9	14	65
TOTAL	7		8		11		79	
No./hour	5		6		8		63	
**Landward	+	-	+	-	+	-	+	-
No./40mins	1	7	0	2	4	3	1	1
TOTAL	8		2		7		2	
No./hour	12		3		10.5		3	

+ = with fish - = without fish

* Based on three 15-minute counts at $3/4$, $1/2$ & $1/4$ miles out to sea, respectively.

** Based on three counts of 15 minutes at $1/4$, $1/2$ and $3/4$ mile onshore.

In conclusion, it can be said that the Sandwich and Common Terns are principally inshore feeders; the former favouring shallow sandy bays and beaches, and the latter rocky areas with water probably of a quieter nature. The Common Tern often has colonies beside inland bodies of water (Edberg, 1964),

but the Arctic Tern may set up inland colonies where this species is absent (Voous, 1960). However, the Arctic Tern is principally an offshore feeder. The zone of fishing for the Roseate Tern is uncertain, but it may obtain fish from clepto-parasitism of the other species - principally the Common Tern. These species feed their young principally on fish, but the diets usually vary in composition. The Sandwich, Roseate and Common Terns feed their young mainly on clupeoids, apart from the first few days after hatching when sand eels are favoured. However, the Arctic Tern has a high proportion of sand eels in the fish brought to its young. A further difference is that the Sandwich Tern brings its young larger fish, on average, than do the other three species. These differences and others, relating to fish composition of the chicks' diet and the fish size, tend to vary from year to year. The differences observed may reflect the different feeding areas exploited or specific food preferences.

Diurnal activity with respect to feeding of the chicks

During 1967, watches of Common Tern nests were made for extended periods in order to study the problem of chick survival. However, these watches gave information on diurnal activity of the adults as well. It was possible to consider the fishing rates of adults at different times of the day. From the watches conducted on six Common Tern broods from 26 June to 8 July, the number of fish brought to the chicks for each half hour period has been recorded (Table 91).

TABLE 91. THE NUMBER OF FISH BROUGHT TO SIX COMMON TERN
BROODS EACH HALF HOUR

Time $\frac{1}{2}$ hr watch started	Fish	N	Time	Fish	N	Time	Fish	N	Time	Fish	N
04.30	1.00	2	09.00	3.50	10	13.30	3.57	7	18.00	2.33	6
05.00	3.25	8	09.30	2.80	10	14.00	2.43	7	18.30	1.33	3
05.30	3.88	8	10.00	2.40	10	14.30	1.83	6	19.00	2.00	3
06.00	4.25	8	10.30	2.27	11	15.00	4.00	7	19.30	2.67	3
06.30	4.65	8	11.00	3.09	11	15.30	3.86	7	20.00	1.67	3
07.00	4.50	8	11.30	2.18	11	16.00	2.14	7	20.30	2.00	2
08.30	3.89	9	12.00	3.18	11	16.30	2.86	7			
08.00	3.33	9	12.30	2.80	10	17.00	3.17	6			
08.30	3.33	9	13.00	3.63	8	17.30	3.50	6			

N= number of watches.

There was very little activity before 04.30 hours, and subsequently watches were only begun just before this time. The feeding of the chicks gradually picks up and reaches a peak between 05.00 and 07.00 hours, after which it declines slowly until about midday. After midday, there is a partial resurgence followed by another lull early in the afternoon. There is another burst of feeding between 14.30 and 15.30 hours, and another between 16.30 to 17.30 hours, and another between 16.30 to 17.30 hours, after which feeding gradually diminishes, apart from a slight resurgence between 19.00 and 19.30 hours, to nil after 20.30 hours. In order to remove any slight or aberrant peaks, the results have been grouped into two hour periods (Table 92).

TABLE 92. THE NUMBER OF FISH BROUGHT TO SIX COMMON TERN
BROODS PER TWO HOURS

Time	No. fish/2 hrs	N
04.31 - 06.30 hrs	16.03	32
06.31 - 08.30 hrs	15.05	35
08.31 - 10.30 hrs	10.97	41
10.31 - 12.30 hrs	11.25	43
12.31 - 14.30 hrs	11.46	28
14.31 - 16.30 hrs	12.86	28
16.31 - 18.30 hrs	10.33	21
18.31 - 20.30 hrs	8.34	11

N= number of watches.

From the results, it can be seen that there is a peak of fishing early in the morning from 04.30 to 09.30 hours, or 09.00 hours more exactly, with 15 to 16 fish being brought to the six nests within two hours. The rate then drops to between about 11 and 13 fish per two hours, until after 16.30 hours, after which to just over 10, and just over 8 fish after 18.30 hours. Therefore, there are no periods of very little feeding, apart from the six hours, from 20.30 to 04.30 hours, when the light is very poor.

The results obtained by Burton & Thurston (1959) for one watch between 17.30 and 10.30 hours on a colony of Arctic Terns in Spitzbergen, where daylight is more or less continuous,

have certain differences. Their results showed an increase in activity, measured by visiting rate to colony, from a lull at midnight up to a maximum about 10.00 hours. There were smaller peaks at 03.00 and 18.00 hours. These other peaks may be the result of a longer period of daylight. They did not examine the period between 10.30 and 17.30 hours, so it is not possible to see if this species resembles the Common Tern in having a lull after a peak of activity early in the morning. This slackening off of feeding is most likely due to the satiation of the chicks, and therefore reduced begging, resulting in the parents spending less time fishing. Begging responses of the chicks are at their strongest after the absence of feeding during the night. If the weather is poor in the morning so that one parent has to brood the chicks, reducing the fishing rate, or because the fishing success is poor, then no early morning peak would be expected. Instead, feeding rate would tend to be constant with small peaks during fine periods, or when fishing is good. There is a suggestion that lowered success early in the morning on two days has resulted in a constant activity rate through the rest of the day, but this needs further observation.

Adult Tern Weights and measurements

Measurement of the wing lengths and weights were taken from the adult terns caught by traps and mist-nets when ringing. Nearly all of the Arctic and Sandwich Terns were caught using wire netting traps over the nests, and the birds can be considered

TABLE 93.

WEIGHTS AND WING LENGTHS OF TERNS

SPECIES	Weight (g)	St.Dev.	N	Wing Length (mm.)	St.Dev.	N	Weight Wing length
Arctic Tern	109.0	7.9	37	267.3	6.19	51	0.408
Common Tern	126.2	10.0	30	265.7	5.83	32	0.475
Roseate Tern	123.5	6.9	11	229.5	3.47	10	0.538
Sandwich Tern	228.9	12.3	20	306.3	5.96	24	0.747

to be breeders (incubating birds). However, most of the Common and Roseate Terns were caught in mist-nets, and therefore their status on Coquet Island is uncertain, although they are likely to be breeders. The values in Table 93 show that the Arctic Tern is the lightest tern, with the Roseate and Common Terns about 14 and 17 g. heavier, respectively. The Sandwich Tern is the largest tern of the four, being more than twice as heavy as the Arctic Tern. The Arctic and Common Terns have similar wing lengths of about 265 mm, but the Roseate Tern has a much shorter wing of about 230 mm. The shorter wing gives the Roseate Tern a characteristic flight, and appears to be suited to short rapid bursts and dives, as when this species clepto-parasitises Common Terns. Again, the Sandwich Tern has the largest wing span, but the difference is much less marked than in the weight.

The weights recorded in June and July for the Arctic and Common Terns were analysed separately to see if there was any difference (Table 94). Belopolskii (1961) found a slight diminution in weight of the Arctic Tern in the Seven Islands (East Murman) through the summer. On Coquet Island, there was no significant difference between the Common Tern weights ($p = >0.3$ for 28 d.f.) although there was a tendency for birds to be lighter in July. However, in the Arctic Tern the birds weighed in July were significantly lighter than those weighed in June ($p = <0.001$ for 35 d.f.). This difference in weights of incubating birds in the Arctic Tern in these two months suggests that those birds breeding in July are not in so good a condition as those breeding in June. This difference may be a result of age with the younger, lighter birds breeding later, or merely a difference in physiological condition.

TABLE 94. THE WEIGHT OF COMMON AND ARCTIC TERNS IN
JUNE AND JULY

SPECIES	MONTH	WEIGHT (g.)	ST. DEV.	SAMPLE
Arctic Tern	June	111.63	6.20	28
	July	100.99	3.69	9
Common Tern	June	128.50	7.36	14
	July	123.49	7.28	16

SEASONAL MOVEMENTS IN TERNS

The terns occurring in the northern latitudes all exhibit seasonal movements which can be classified broadly under two headings : dispersal and migration. Dispersal "denotes a more or less random centrifugal movement from the breeding locality in the off season" (Thomson, 1964), such that the centre of gravity of the population remains constant. The dispersal of young terns from their natal colony has been described by Dircksen (1932), Thomson (1943) and Radford (1961). How much of this movement is determined by the availability of food, or the behaviour of the parents which continue to feed the young after fledging (Nørrevang, 1960; pers.obs.) is uncertain. However, the post-fledging dispersal of terns intergrades with the migratory movements which are displayed by the adult terns as well. Migration has been defined as "a regular movement of birds between alternate areas inhabited by them at different times of the year, one area being that in which the birds breed and the other being an area better suited to support them at the opposite season" (Thomson, 1964). Besides the authorities mentioned above, migration of the Arctic, Common and Sandwich Terns has been variously described by Austin (1928, 1953), Marples & Marples (1934), Murphy (1936), Kullenberg (1946), Hawksley (1949), Salomonsen (1953, 1967), Fisher & Lockley (1954), Storr (1958) and Muller (1959).

Methods

The movements of four species of terns are described from the change in the distribution of ringing recoveries. In analysing the recoveries of the Arctic, Common, Roseate and Sandwich Terns, only those birds in their first autumn found more than five miles away from their natal colony, and all adult records, were considered. This measure avoids confusion with recoveries of non-fledged birds. The majority of the recoveries occur along the coastlines of land masses, since these areas are frequented by observers. Although the chances of recoveries at sea are remote, the distribution of the species reflected by ringing recoveries in the Common and Sandwich Terns, and possibly the Roseate Tern, may be close to the real one, as the first two species occur mainly in coastal waters. However, a bias is encountered when considering species that assume a pelagic existence after breeding, which is suggested in the Arctic Tern.

In this analysis, the recoveries occurring in July, August and September, after fledging, are examined with respect to dispersal. Towards the end of this period, and in subsequent months, migration becomes the predominant movement. In these three months, the majority of the recoveries occur along the coastline of the British Isles and, to a lesser extent, along the coastline of the other West European countries. This means that the radii on which the dispersed birds are found will be

mainly determined by the location of the natal colony and the neighbouring coastline configuration. Only these recoveries of birds found freshly dead, or still alive, are used; so that errors derived from recovered birds being carried to the area of detection by currents is minimised.

When considering the movement of terns away from their breeding colonies, and with a view to examining their migration rather than dispersal, it was found that longitudinal changes with season mainly indicated a deviation of coastline. Therefore, it was decided to relate the recoveries only to latitudinal changes when analysing the migration. This was done by placing all the recoveries into ten degree sectors north and south of the equator, and ignoring movements east and west.

The distant recoveries (i.e. those young recovered away from their natal colony, and all adult recoveries, except recaptures) have been grouped into fortnightly periods, but some of these have been grouped into months to give larger samples. The graphic representation of these has been done by grouping the place of recovery into latitude zones. The width of the "lozenge" in the figures produced represents the percentage of the total recoveries for that period found within that particular ten degree sector of latitude. In each period, the number of records is noted underneath so that the reliability can be gauged.

In order to standardise the recoveries with time, each year has been taken from 1 July to 30 June inclusively. In each case, it is assumed that the chick hatched on 1 July, irrespective of ringing date. This introduces only a slight error and, usually, it has been found that terms such as first winter and second summer are more convenient than first year of life, and so on. The graphs have been drawn so that a period of maximum movement within a season are not divided.

Location of recoveries

Muller (1959), referring to the sparcity of recoveries of Sandwich Terns from certain regions, has stated that "quantitative distribution based on recoveries of ringed birds obscures a large uncertainty, if not a source of error. This is because it is quite possible that the accumulation of the finds in certain places is due to human influence which means that it is caused by strong pursuit in the regions in question." Also, considering the same species, Thomson (1943) has said that "the absence of records from some parts of the African coastline which must obviously be traversed by the birds may be chiefly due to factors which influence reporting. The most important gap is that from Agadir to Dakar, some 15° of latitude, but this stretch is sparsely inhabited."

In the present analysis, the ten degree sector of latitude, from 20°N to 30°N, which closely corresponds to the area mentioned by Thomson, produces fewest recoveries in all

FIGURE 21. AFRICAN CONTINENT : SHOWING DENSITY OF POPULATION.

NUMBER OF PEOPLE PER SQUARE MILE

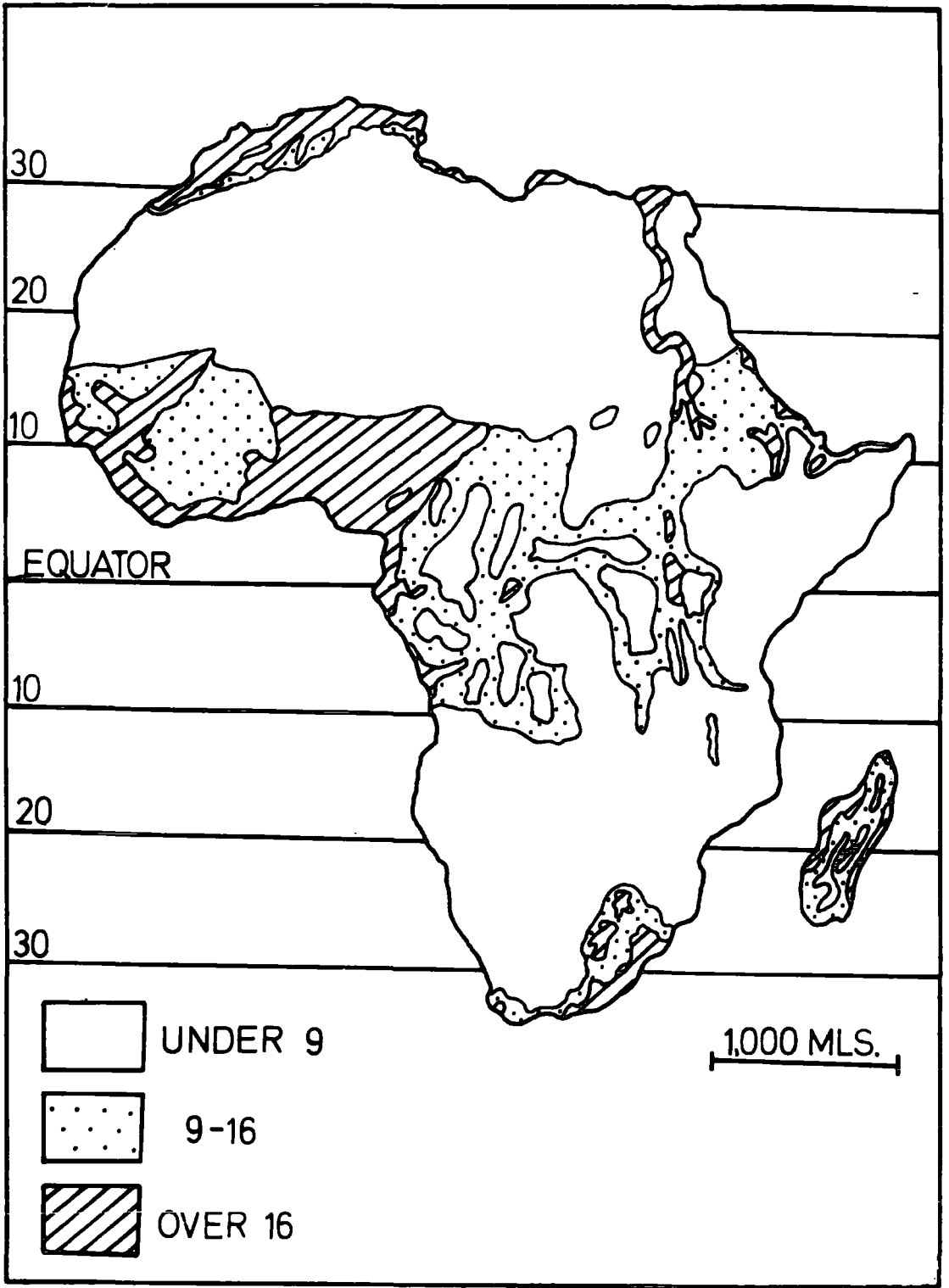

four species. Only one Roseate Tern, one Common Tern and five Sandwich Tern recoveries have been reported from this area. Consideration of Figure 21, showing the density of population of the African continent, indicates that the area in question is sparsely inhabited, since it is mainly semi-desert. However, there are some coastal towns in this region, e.g. Port Etienne, Villa Cisneros, Ifni and the Canary Islands' towns. The marked absence of recoveries suggests that the terns pass through this region quickly because of unfavourable conditions, otherwise one would expect more recoveries than is the case. Another possibility is that tern recoveries from Africa are usually through the local inhabitants trapping the birds, and the lack of records in this area may be due to an absence of catching. The paucity of records from Nigeria has been attributed by Bourdillon (in Thomson, 1943) to the relatively short coastline suitable to terns, and the shore not being readily accessible to man.

Additional support suggesting that it is not merely because this area (10-20°N.) is sparsely populated that it receives few recoveries is evidenced by the number of recoveries in the sector 10-20°S. In Figure 21, it can be seen that there is an area of sparse population beyond 10°S. of the Equator, corresponding to the southern part of Angola and all of south-west Africa. Although Common and Roseate Terns from Britain do not move this far south, Sandwich, Arctic, and Common Terns from Scandinavia are recovered in this sector, principally in Angola. In fact, Sandwich Terns have been recovered in this sector (10-20°S.) in

every month of the year, except September. Although there are only four Arctic Tern recoveries from this area, there are 89 Sandwich Tern ones. Nevertheless, these all come from the coastal towns of Luanda, Lobito, Benguela, Mossamedes and Porto Alexandre and therefore reflect the distribution of man along the coast.

Recoveries used in the analysis

The number of terns ringed and recovered by the end of 1965 are given by Spencer (1966). In addition to these, further recoveries notified before 1 November 1966 were used. The number of terns ringed in Britain and recovered, and those used in the analysis, are given in Table 95.

TABLE 95. RECOVERIES OF TERNS RINGED IN BRITAIN BY THE END OF 1965 AND THE NUMBER OF THESE USED IN PRESENT ANALYSIS

SPECIES	No. ringed	No. Recovered	% Recovered	No. Used	% used of total ringed	% used of total recovered
Common Tern	42,558	797	1.87	243	0.57	30.49
Arctic Tern	34,399	455	1.32	135	0.39	29.67
Roseate Tern	9,236	109	1.18	87	0.94	79.82
Sandwich Tern	54,068	1,010	1.87	719	1.33	71.19

The recovery rate is very low in all species, although lower in the Arctic and Roseate Terns. These values include, in part, recoveries used by Radford (1961) who analysed the Common Tern (1.34% recovered) and the Arctic Tern (1.34% recovered)

recoveries up to the end of 1958, and in some instances beyond, and are also comparable with the value given by Thomson (1943) analysing the Sandwich Tern (1.76% recovered) recoveries up to the end of 1942. The low percentage of suitable Common Tern recoveries, also found by Radford, is indicative of a large number of unfledged chicks being reported which are of no use in this analysis. The Arctic Tern is similar in this respect, but it is not so marked.

The reason for the low percentage is also a result of a considerable number of the recoveries being re-traps on the Farne Islands of adult birds which have been omitted from this analysis to make the species comparable. The higher proportion of usable recoveries in the Roseate and Sandwich Terns is due to fewer unfledged chicks being reported. This may be due to a higher fledging success in these latter species and possibly also to the dispersal of the chicks soon after hatching making them more difficult to find.

TABLE 96.

TOTAL RECOVERIES USED IN ANALYSIS

SPECIES	No. of recoveries in 1966 used	No. of these ringed in 1966	No. used till end of 1965	Total No. of recoveries used
Common Tern	27	10	243	270
Arctic Tern	18	11	135	153
Roseate Tern	4	0	87	91
Sandwich Tern	55	11	719	774

TABLE 97. COMPARISON OF THE NUMBER RECOVERED IN FIRST YEAR AND LATER YEARS

SPECIES	No. recovered	No. recovered in 1st year	No. recovered in subsequent years	% recovered in 1st year
Common Tern	270	204	66	76
Arctic Tern	153	98	55	64
Roseate Tern	91	67	24	74
Sandwich Tern	774	530	244	68

x^2 test for difference in number recovered in first year.

$$p = > 0.3$$

From Table 97 it can be seen that the number of recoveries is higher in the first year than in all of the subsequent years in the four species. The proportion of recoveries in the first year of life is not significantly different in the four species. The high recovery rate in the first year results from the high mortality of inexperienced juveniles and to a greater number of birds of that age group available to die.

COMMON TERN

Dispersal

There are 13 recoveries in July, 49 in August, and 61 in September of juveniles ringed in various colonies in Britain. The majority of these recoveries occur in Britain which indicates the delayed departure of this species from northern waters.

FIGURE 22. COMMON TERN : POST-FLEDGING DISPERSAL

1. July recoveries.

2. August recoveries

3. September recoveries

(numbers in this and subsequent figures refer to number of recoveries used)

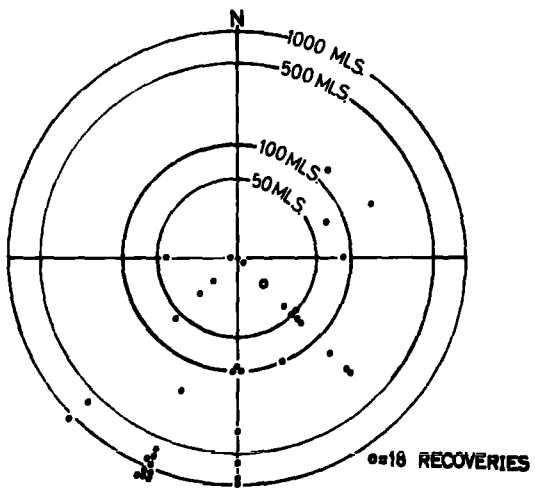
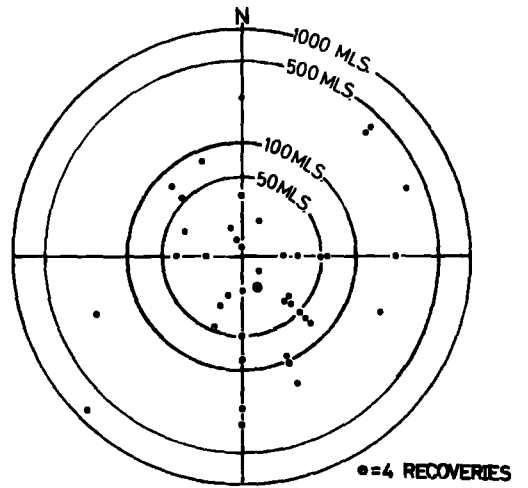
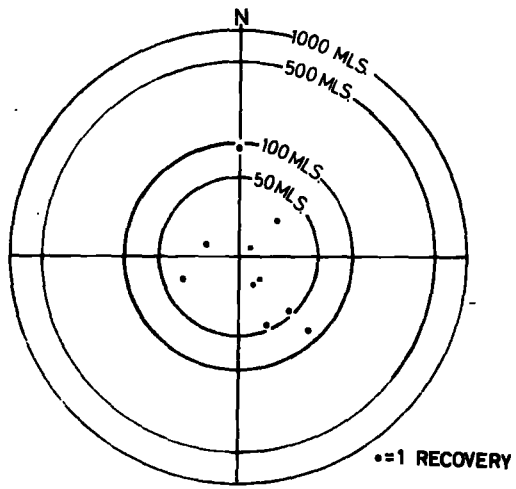

In July, there are four recoveries north and six south of the natal colonies (see Table 98, Figure 22a). Recoveries from all colonies are considered together with respect to dispersal, as there are insufficient from one colony, and therefore no coast-line trend is discernable. In contrast to the other species, the recoveries for this month are within 100 miles of the natal colony, suggesting a less vigorous dispersal. However, there are insufficient recoveries in July for the four species to confirm this difference.

TABLE 98. JULY COMMON TERN POST-FLEDGING RECOVERIES

Direction from Colony	50 miles	50-100 miles	Total
North	3	1	4
South	5	1	6

In August, there are 14 recoveries north of the natal colony and 28 south (see Table 99, Figure 22b^{*}) which suggests that the post-fledging dispersal is being modified by a southerly migratory movement. The greater number of recoveries in the east (24) compared with the west (15) is probably a consequence of the absence of land masses and their appropriate coastlines in the west. Table 99 shows the proportion of recoveries north and south of the natal colony with respect to distance. In each case, the proportion of recoveries in the north is about

* RECOVERIES <10 MILES FROM COLONY NOT ILLUSTRATED.

FIGURE 23. COMMON TERN : FIRST AUTUMN RECOVERIES

(numbers in this and subsequent figures refer to number of recoveries used)

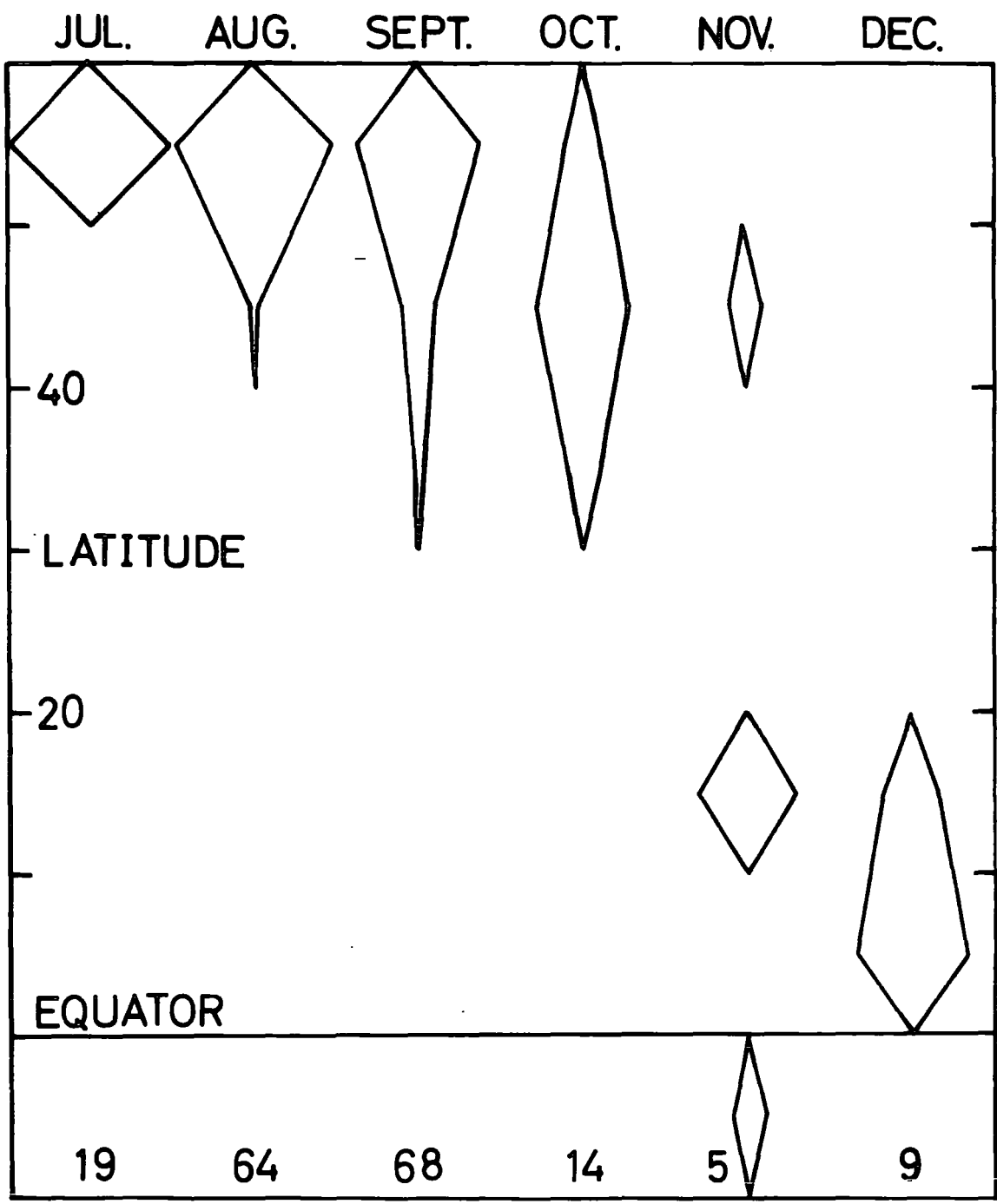

half those reported in the south.

TABLE 99. AUGUST COMMON TERN POST-FLEDGING RECOVERIES

Direction from Colony	50 miles	50-100 miles	100-500 miles	Over 500 miles	Total
North	8	3	3	0	14
South	16	5	6	1	28

In September, only five recoveries show a northerly movement and 51 a southerly one (see Table 100, Figure 22c). This indicates that a migratory movement is predominant in this month. The preponderance of recoveries within 100 miles of the natal colony is mainly due to 18 records from near one locality where the birds were trapped in fly nets.

TABLE 100 SEPTEMBER COMMON TERN POST-FLEDGING RECOVERIES

Direction from Colony	100 miles	100-500 miles	500-1000 miles	Over 1000 miles	Total
North	2	3	0	0	5
South	30	7	7	7	51

Migration

Figure 23 shows that in August, September and October the young birds gradually move southwards, so that by November there are few north of 20°N . (two of 12 recoveries). During the winter, until the following April, all the recoveries are found south of 20°N ., except for one February recovery at

FIGURE 24. COMMON TERN : SECOND "SUMMER" RECOVERIES.

JAN. FEB. MAR. APR. MAY JUN. JUL. AUG. SEPT. OCT. NOV. DEC.

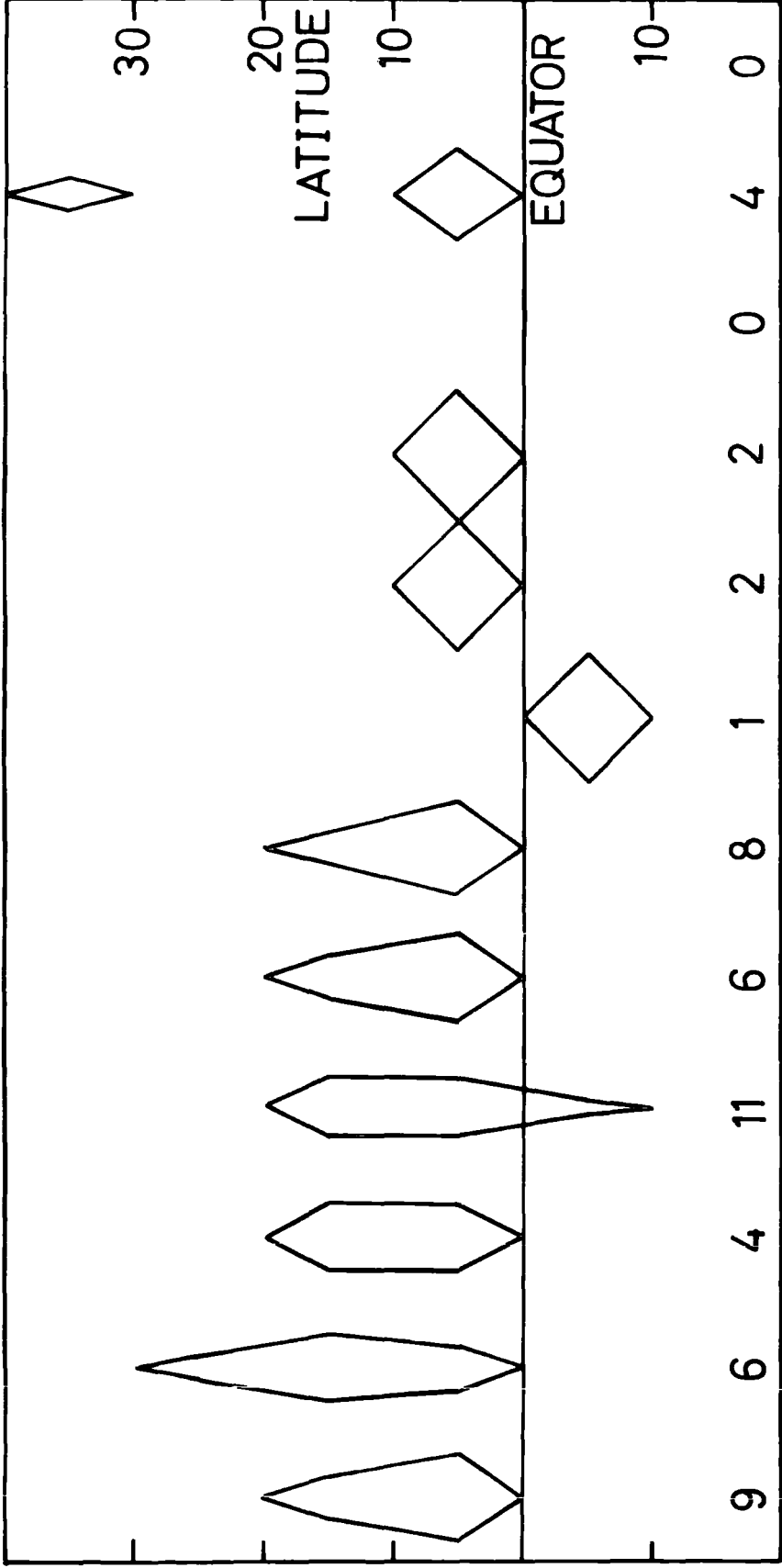

at $20^{\circ}54'N.$, near Port Etienne, Mauritania. However, it will be recalled that this sector, $20-30^{\circ}N.$ produces very few recoveries; in fact, this is the only Common Tern recovery from this sector. In the following spring and summer, there is no evidence of a northward movement. All the recoveries are found south of $20^{\circ}N.$ and north of $10^{\circ}S.$ From the previous December until the following September, there are 35 in the sector $0^{\circ}-10^{\circ}N.$, 20 in the sector $10-20^{\circ}N.$, two south of the Equator - one at Port Gentil, Gabon ($0^{\circ}40'S.$) in April, and one near Luanda, Angola ($8^{\circ}50'S.$) in July, and the recovery at Port Etienne, in February.

There are very few recoveries during the second winter. There are four, and these are all in November. Three of these are in the sector $0-10^{\circ}N.$, so that it seems that the birds continue to occupy the same winter quarters. The exception is a recovery from Lisbon, Portugal ($38^{\circ}45'N.$) (see Figure 24). There are five recoveries for the subsequent winter, three in November, one in December, and one in February. There is only one recovery of a bird in its third winter, and that is at Dakar, Senegal ($14^{\circ}53'n$); the other four records occur in the $0^{\circ}-10^{\circ}N$ sector. Therefore, the evidence from recoveries suggests that the Common Tern continues to winter in the same region as the first year birds.

In the third summer (i.e. end of 2nd year), there is no evidence of birds returning to Northern Europe until after mid-June (one recovery on 19 June) (see Figure 25). There are several recoveries for this region in July, August and September.

FIGURE 25. COMMON TERN : THIRD AND SUBSEQUENT "SUMMER" RECOVERIES.

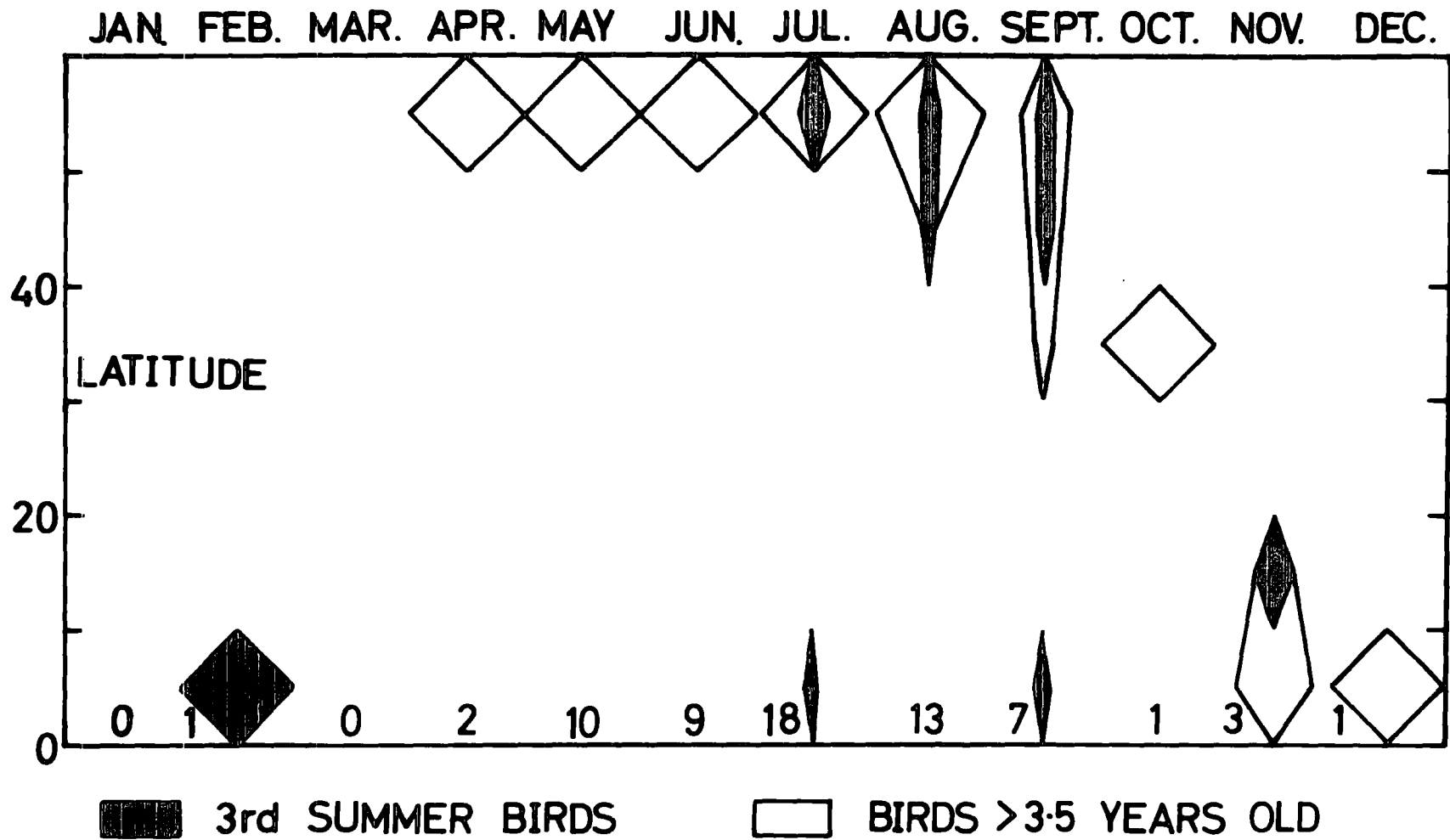

However, there is one July recovery near Freetown, Sierra Leone ($8^{\circ}30'N$), and a September recovery near Tema, Ghana ($5^{\circ}41'N$). It appears that many of the birds do not breed in their third summer (i.e. two years old), although several visit European waters. A small number of Common Terns are known to breed in their third summer (Austin, 1945; and pers.obs.), but it is not until the fourth summer that breeding usually occurs.

The Autumn migration of adult Common Terns appears very similar to that of the juveniles. In August, 12 of the 13 recoveries occur in the $50-60^{\circ}N$. sector, the exception being a third summer bird in Brittany, France ($48^{\circ}20'N$). In September, there is a strong movement south in all the birds, and there is only one October recovery and that is in Huelva, Spain ($37^{\circ}15'N$).

The distribution of the Common Tern in the winter months gives an example of partial allohiemy (i.e. where different populations tend to have different winter quarters). The Dutch recoveries are very similar to the British ones with a number from Senegal and Ghana, but none from Angola or South Africa (Radford, 1964). However, Salomonsen (1953) has said that all Scandinavian populations of the Common Tern appear to winter along the coast of South Africa. In Cape Province, there are winter recoveries (October - April) of one Danish, one Norwegian, four Swedish and seven Finnish birds. In addition, there is one extraordinary record of a Swedish Common Tern recovered on 7 January 1956, in the first year of life, near Freemantle, Australia.

ARCTIC TERNDispersal

Since most of the Arctic Terns ringed in Britain come from the Farne Islands, it was decided to restrict the analysis of dispersal to this colony. There are 70 recoveries of juvenile Arctic Terns for the months July, August and September, from the Farne Islands, 18, 44 and 12 respectively. From Figures 26a,b & c, the recoveries can be seen to occur on the N.W., S. and S.S.E. axes which correspond to the coastline. The number of recoveries reaches a peak in July when this species seems to be at maximum dispersal. By September, migration has become the predominating movement.

In July, there are 15 recoveries of which nine show a northward movement and six a southward one (see Table 101). There is an indication that in this month, the dispersal northwards is as marked as the southward movement. However, in August, there are 44 recoveries, of which 17 show a movement northwards, and 24 a movement southwards. As in July, the recoveries in the north are mainly west of the natal colony, and those in the south mainly east, since the coastline runs in this direction. In Table 102, it can be seen that up to about 100 miles, the number of recoveries north and south of the colony are similar. Beyond 100 miles, the number of recoveries becomes greatest in the south which indicates that migration is occurring. In fact, there is one recovery of an

FIGURE 26. ARCTIC AND ROSEATE TERN : POST-FLEDGING DISPERSAL.

1. Arctic Tern July recoveries

2. Arctic Tern August recoveries.

3. Arctic Tern September recoveries.

4. Roseate Tern August and
September recoveries.

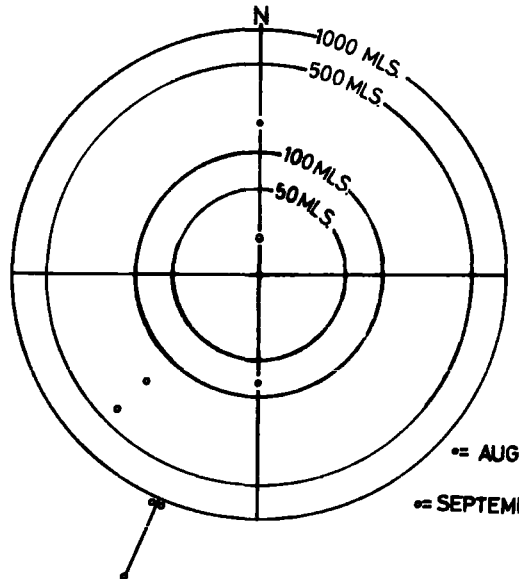
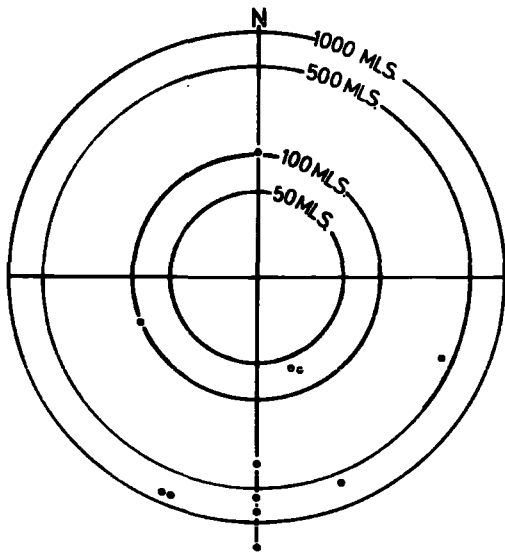
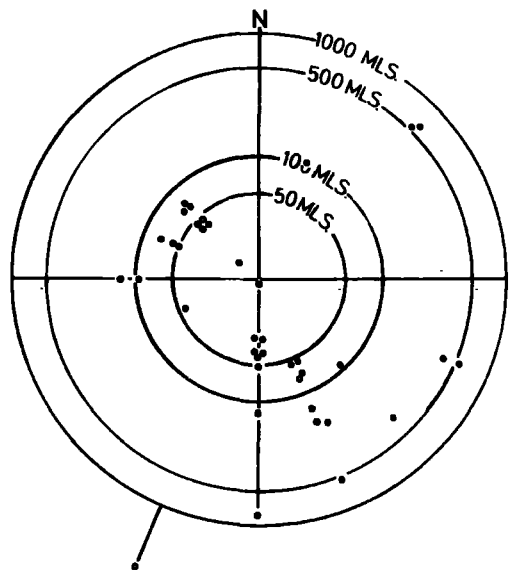
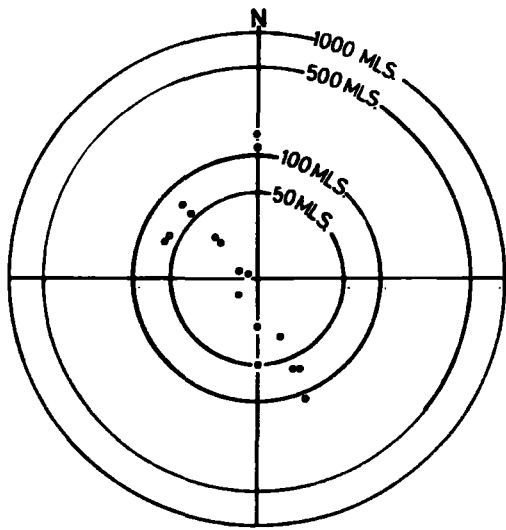

•• AUGUST
 •• SEPTEMBER

TABLE 101. JULY ARCTIC TERN POST-FLEDGING RECOVERIES

Direction from Colony	50 miles	50 - 100 miles	100 - 150 miles	Total
North	5	4	2	11
South	4	2	1	7

TABLE 102. AUGUST ARCTIC TERN POST-FLEDGING RECOVERIES

Direction from Colony	50 miles	50-100 miles	100-500 miles	Over 500 miles	Total
North	8	6	1	2	17
South	8	6	6	4	24

Arctic Tern in Monrovia, Liberia, about 3,800 miles S.S.W. on 15 August.

In September, there are only 12 recoveries of juveniles from the Farne Islands and an additional three from the colony on Anglesey. Only one of these recoveries is north of the natal colony, which suggests a marked migratory movement southwards. Of those occurring in the south, two are over 1,000 miles : one in Tamanar, Morocco, and the other near Freetown, Sierra Leone.

TABLE 103. SEPTEMBER ARCTIC TERN POST-FLEDGING RECOVERIES

Direction from Colony	100	500	1000	1000 +	Total
North	1	0	0	0	1
South	3	2	5 + 2*	1 + 1*	14

* Anglesey birds

Migration

Unfortunately, there are only 21 recoveries of Arctic Terns during the winter months.* There are 73 recoveries of Arctic Terns after the first year of life, of which 60 occur in the months May, June, July and August. The lack of winter recoveries is much more marked than in any of the other three species of tern examined. The most likely explanation is that the Arctic Tern winters in areas where birds are much less likely to be recovered.

It appears that the migration is to a large extent offshore. Fisher & Lockley (1954) state that "when on passage through Britain, it moves usually by coastal routes, and some Baltic and Frisian birds (by ringing records) join up with the passage along the east coast of England. In some years, Arctic Terns join the marked inland passage of Common Terns along English river valleys. But beyond Britain most of the passage becomes oceanic and the records in inland Europe and the eastern Mediterranean are very scanty." Also, these authors report that in late summer and autumn, many Arctic Terns are seen crossing the North Atlantic, mainly flying from the north-west to the south-east. This passage of birds in North America, Canada and Greenland has been supported by the following ringing recoveries :

* October - March inclusive.

North-west Atlantic Seaboard to Europe

RINGED	RECOVERED
1. Red Islands, Turnavik Bay, Labrador, 22 July 1927	La Rochelle, France 1 October 1927
2. Machias Seal Island, New Brunswick, 20 July 1935	St. Nazaire, France 8 October 1935
3. Machias Seal Island, New Brunswick, 1 July 1948	Kylestrone, W. Sutherland, Scotland, 30 September 1948
4. Disko Bay, West Greenland, 7 August 1949	Gloucestershire, England, 20 October 1948

North-west Atlantic Seaboard to Africa

RINGED	RECOVERED
1. Eastern Egg Rock, Maine, 3 July 1913	Mouth River Niger, Nigeria, August 1917
2. Red Islands, Turnavik Bay, 23 July 1928	Margate, nr. Shepstone, Natal, 14 November 1929
3. Machias Seal Island, New Brunswick, 5 July 1947	Wilderness, Eastern Cape Province, 10 November 1948
4. Ikamiuit, W. Greenland, 8 July 1951	Durban Harbour, Natal, 30 October 1951
5. Akunak, W. Greenland, 4 August 1961	Dakar, Senegal, 25 October 1961
6. Qegertag, Umanak district, W. Greenland, 18 Aug. '62	Capetown, S. Africa, 17 November 1963

The reason for this passage across the Atlantic is unknown as some individuals migrate down the east coast of America to Brazil. The Common Tern occurring in the U.S.A. (including

the Great Lakes) winter along the entire coast of the Gulf of Mexico, the West Indies, all of Central America and the east and west coasts of South America (Austin, 1953). From the recoveries analysed by Austin, it appears that only a few of these birds penetrate further south than Salvador in Brazil. However, specimens collected by Beck came from as far south as Patagonia (Murphy, 1936) which are probably birds from Canadian colonies, corresponding with the Common Terns from Scandinavia wintering in south-west Africa. One Arctic Tern ringed in Greenland on 7 August 1949 was recovered in Columbia on 16 June 1959. But it seems that the Arctic Tern tries to avoid the warm equatorial currents which pass up into the Caribbean and form the Gulf Stream. By crossing the Atlantic Ocean, the birds can reach the Cold Benguela Current passing up the West African coast. This movement is probably paralleled in the Pacific Ocean as Arctic Terns are quite numerous offshore along the coasts of Peru and Chile (Beck, in Murphy, 1936), where the cold Peruvian Current passes up the west coast of South America, whilst there are few records in the Eastern Pacific Ocean. A few 'stragglers' have been recorded in the Hawaiian Islands, possibly on passage to the west coast of America where the passage is detectable off the Californian coast (Fisher & Lockely, 1954).

The suggestion that the Arctic Tern migrates over cold waters, or relatively cold waters, producing upwellings and therefore having a high production of planktonic organisms was

proposed by Kullenberg (1946). He said that this species seems to avoid warm waters during both the breeding period and winter and as much as possible during migration. Although the Arctic Tern has a circumpolar distribution, he said that its absence from the eastern Asiatic coast south of the Tchuktch peninsula and at the Sea of Okhotsk depended on unsuitable hydrological conditions and to some extent the frequency of fog.

It would appear that Arctic Terns pass well into the southern Atlantic Ocean and even into the Antarctic Ocean - the cold Antarctic Drift. Previously, records of this species were doubted owing to confusion with the Antarctic Tern S.vittata, but the observations of W.H. Bierman in 1946-48 have supported these records (Bierman & Voous, 1950). In addition, there is a bird ringed near Copenhagen on 28 May 1958 and recovered at 65°S., 111°E. on 4 February 1959 - inside the Antarctic Circle, and a bird ringed on the Farne Islands on 22 July 1961 was recovered on colliding with a whaling vessel during a snowstorm at 56°20'S., 39°30'E. on 8 December 1961. With the confirmation of this species occurring in the Antarctic Ocean, it would seem plausible that the paucity of winter recoveries of the Arctic Tern is a result of their being offshore in this region and in the south Atlantic Ocean at this time of the year. Voous (1960) has said that the Arctic Tern leads a pelagic life whilst migrating as well as whilst wintering, and the principal wintering area is situated in the southern zone of pack-ice south to about 70°S.

FIGURE 27. ARCTIC TERN : FIRST AUTUMN RECOVERIES.

JUL. AUG. SEPT. OCT. NOV. DEC.

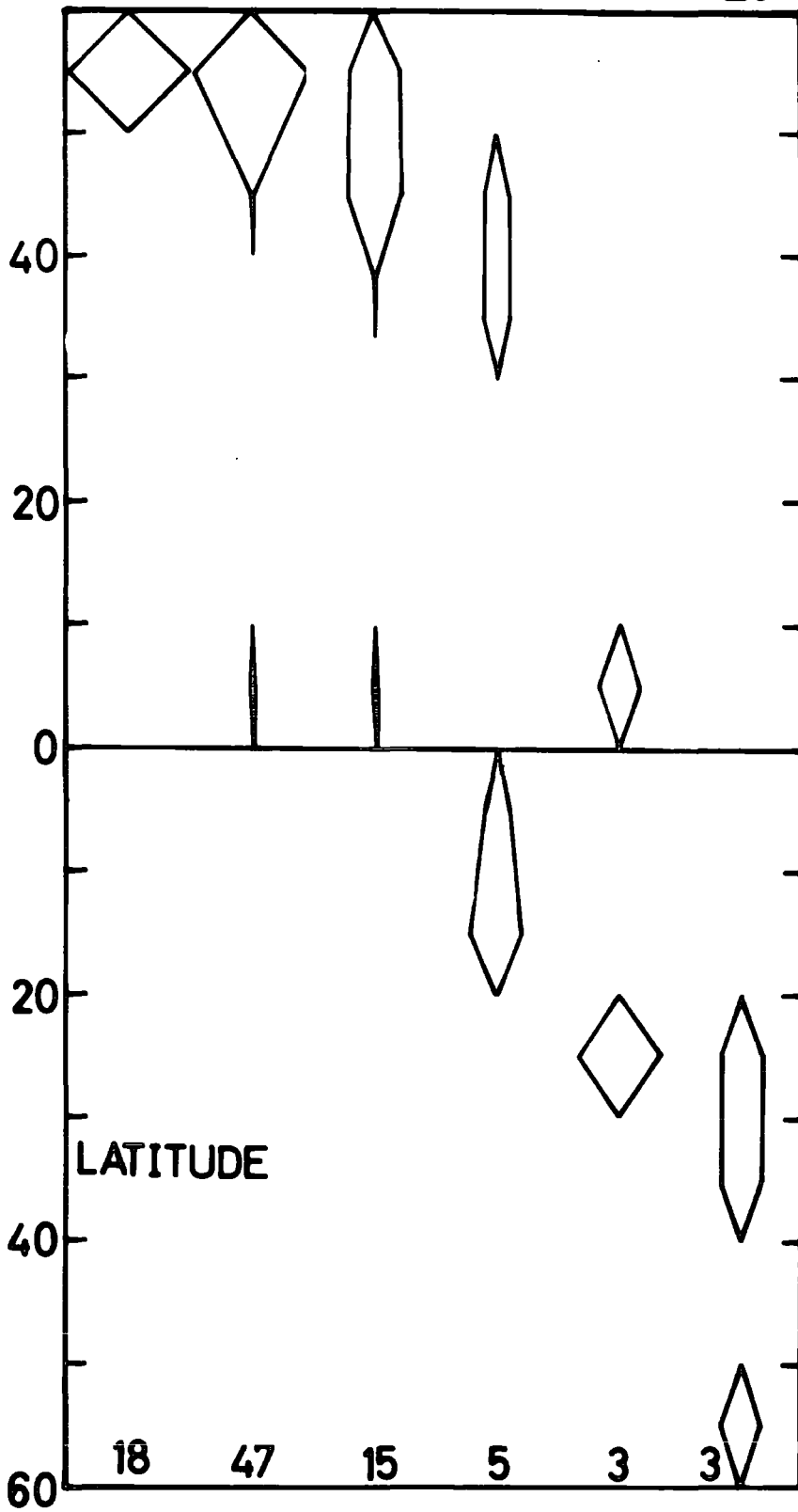

In this region, the Arctic Terns feed mainly on Euphausia, or "krill", a schizopodcrustacean. He gives the most southerly record of this species at about 78°S. , near the Antarctic continent.

Arctic Terns have been collected in the south Indian and south-west Pacific oceans - Amsterdam Island, south-west Australia, south Australia, Victoria and New Zealand (see Storr, 1958). One of these birds was ringed in north-west Russia and presumably came via the east Atlantic, and it seems likely that the others came the same way, as there are no records from the tropical Indian Ocean or the west Pacific Ocean. Storr (1958) has suggested that these birds have been carried eastward by the "roaring forties" while penetrating to the Antarctic Ocean.

From Figure 27, it can be seen that the juvenile Arctic Terns begin to move south in August, and one is recorded in Monrovia, Liberia, on 15 August. In September, there are recoveries down the European coast and one from Morocco and another from Freetown, Sierra Leone. By October, there are no recoveries in north European waters, and three out of the five recoveries are in Angola. In December and January, the four recoveries are south of 20°S. including the one at $56^{\circ}20'\text{S.}$, mentioned earlier.

There are only eight recoveries in the second year of life, presumably a result of the Arctic Tern continuing its pelagic existence. However, of the three recoveries, one in

FIGURE 28. ARCTIC TERN : SECOND "SUMMER" RECOVERIES.

JAN. FEB. MAR. APR. MAY JUN JUL. AUG. SEPT. OCT. NOV. DEC.

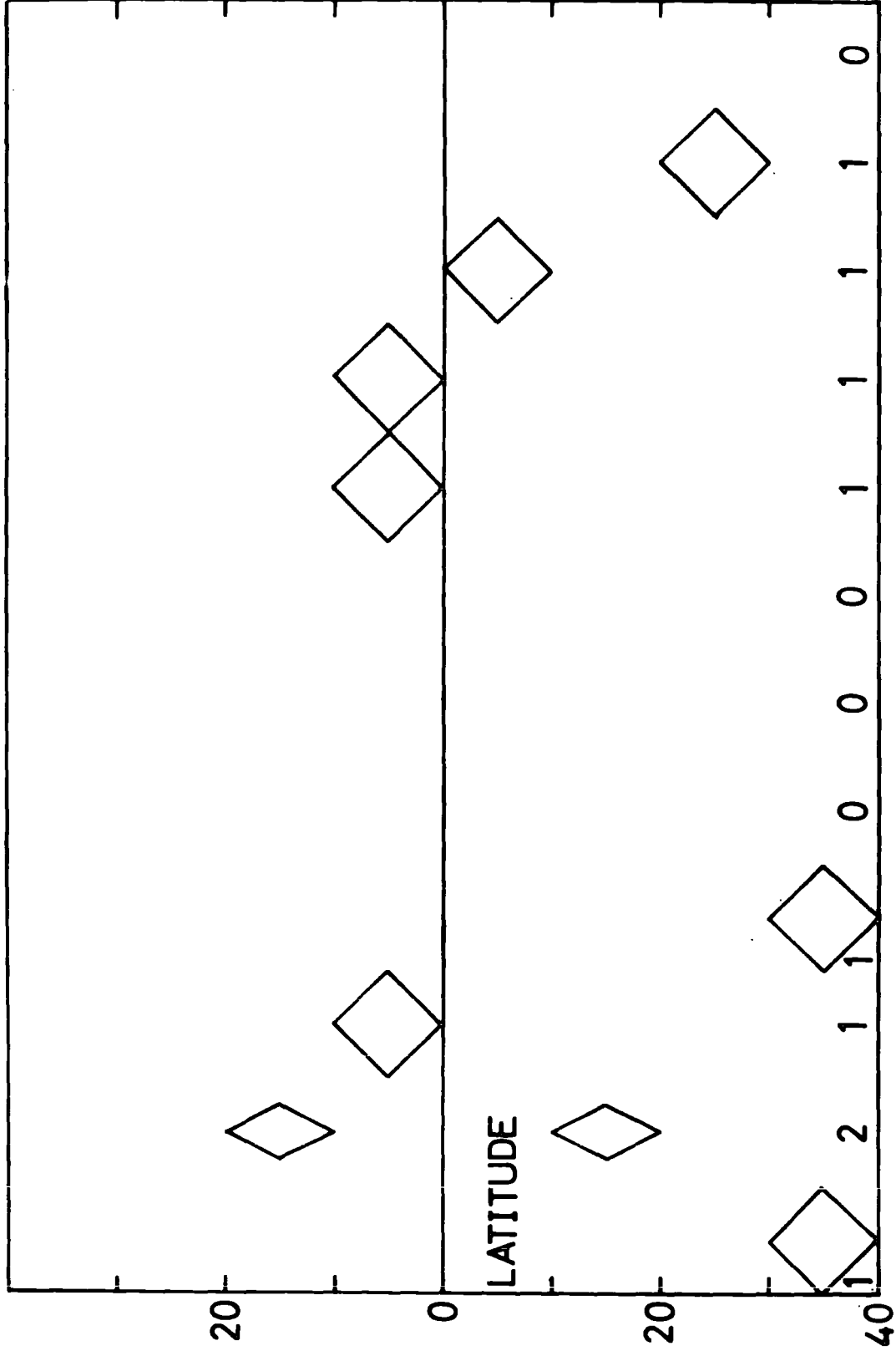
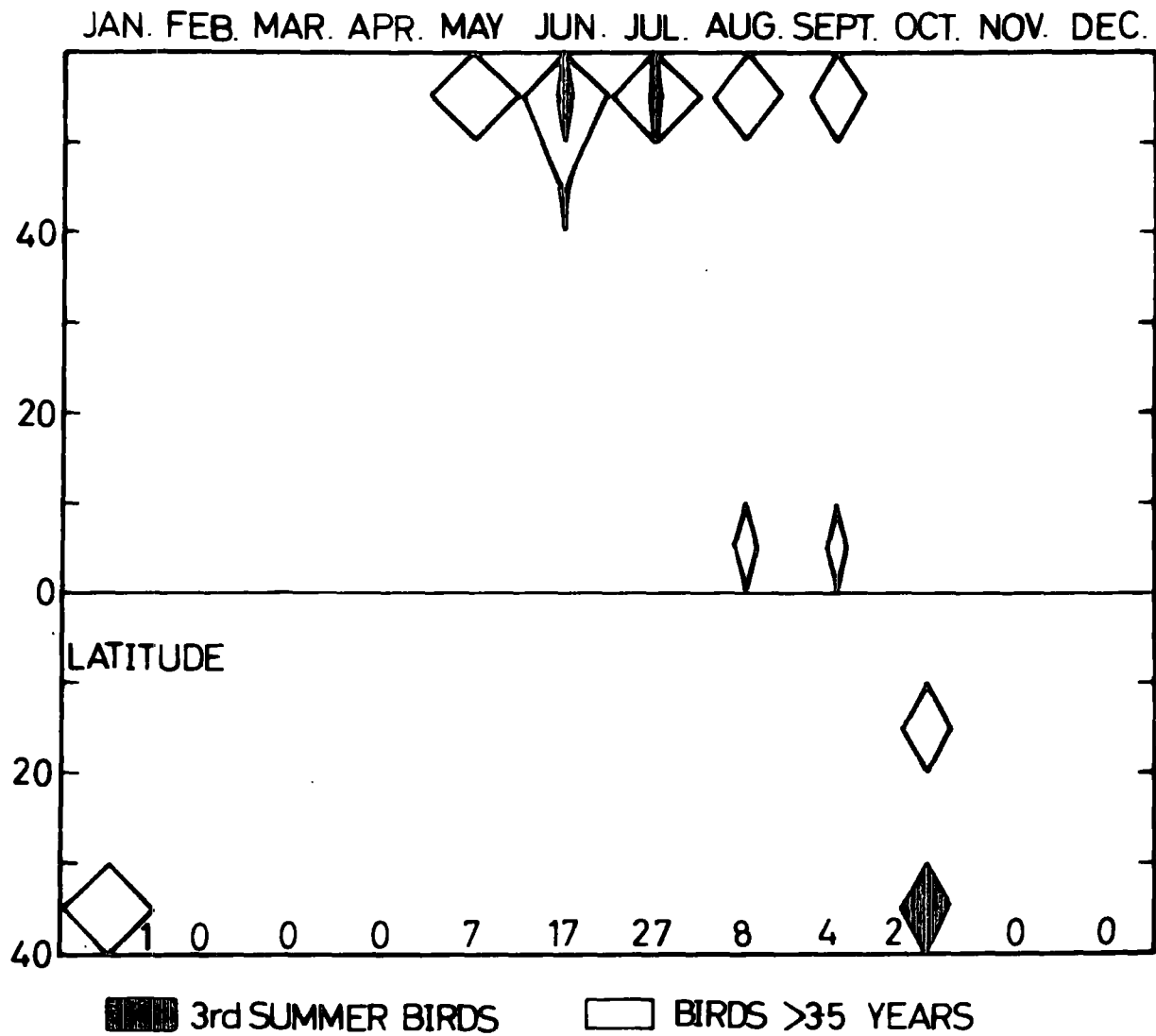

FIGURE 29. ARCTIC TERN : THIRD AND SUBSEQUENT "SUMMER" RECOVERIES.



August, September and October respectively, those in the first two months are just north of the Equator ($5^{\circ}55'N.$) and the October recovery just south ($8^{\circ}48'S.$). This suggests a movement north which is to be expected with the southern winter occurring at this time, making conditions unsuitable for the Arctic Tern. Then in November, there is one recovery at $28^{\circ}50'S.$ (see Figure 28).

In the third summer, the three recoveries in June, and the three in July, occur in north Europe. Three of these are on the British coast, one on the Danish coast, and two inland in Russia. Again, the single recoveries for September and October show a movement south. Personal observations indicate that these birds are merely visiting these areas and not attempting to breed at this stage.

The recoveries for subsequent years are concentrated in the summer months, i.e. when the birds are inshore in northern Europe. However, there are two recoveries in January in South Africa, two in August just north of the Equator, and one in October in South Africa (see Figure 29).

ROSEATE TERNS

Dispersal

The Roseate Tern has fewest recoveries of the four species analysed, with only five in August and five in September. Four of the five August recoveries show a northward movement and one a southerly movement indicating that this species has a similar post-

FIGURE 30. ROSEATE TERN : FIRST AUTUMN RECOVERIES.

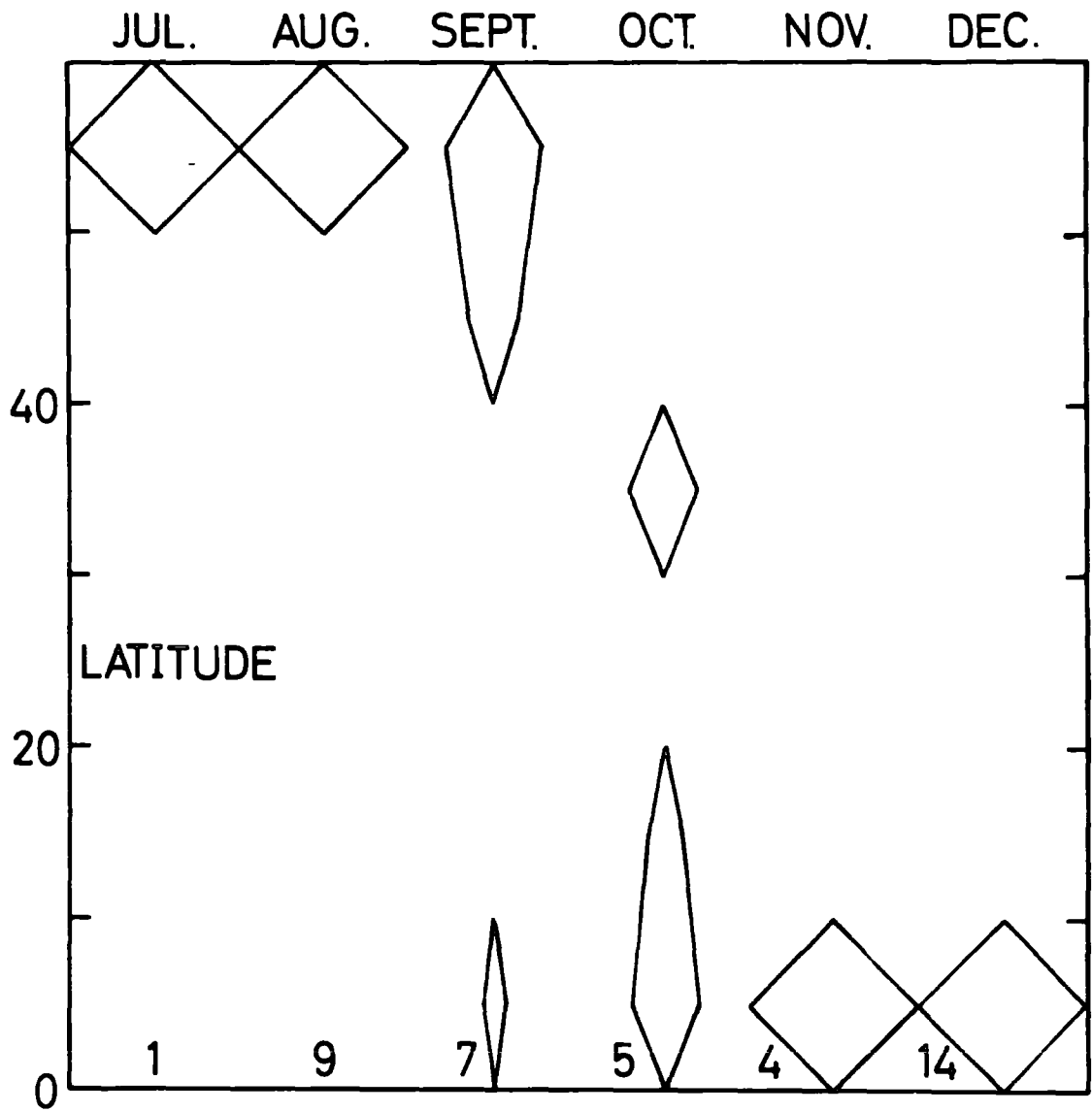

fledging dispersal. In September, all the recoveries are in the south to south-west sector (see Figure 26d) and range from 180 to 5,000 miles from the natal colony. This suggests that in the Roseate Tern, the young leave north European waters very rapidly. However, the limited number of recoveries for this species prevent any definite conclusions being formulated.

Migration

There are nearly 100 recoveries of Roseate Terns that are suitable for the analysis of migration. In September and October, the juveniles move rapidly south to their winter quarters just north of the equator (see Figure 30). In fact, the majority of recoveries in the winter quarters, as in the other species, are from birds in their first year of life (40 recoveries from November to April inclusive, but only 7 recoveries in these months in subsequent years). However, the location of the recoveries in both groups is similar, suggesting that the winter quarters are the same for all age groups.

In their second summer, the Roseate Terns remain in the Tropics (15 recoveries), although there is evidence of slight movement northwards as five of these recoveries occur north of 10°N . (see Figure 31). The farthest north recovery is on Virginia Island, off the Rio de Oro, $22^{\circ}12'\text{N}$. in August. The most southerly recoveries occur along the Ghanain coast, about $5^{\circ}00'\text{N}$. (9 recoveries).

FIGURE 31. ROSEATE TERN : SECOND "SUMMER" RECOVERIES.

FIGURE 32. ROSEATE TERN : THIRD AND SUBSEQUENT "SUMMER" RECOVERIES.

JAN. FEB. MAR. APR. MAY JUN. JUL. AUG. SEPT. OCT. NOV. DEC.

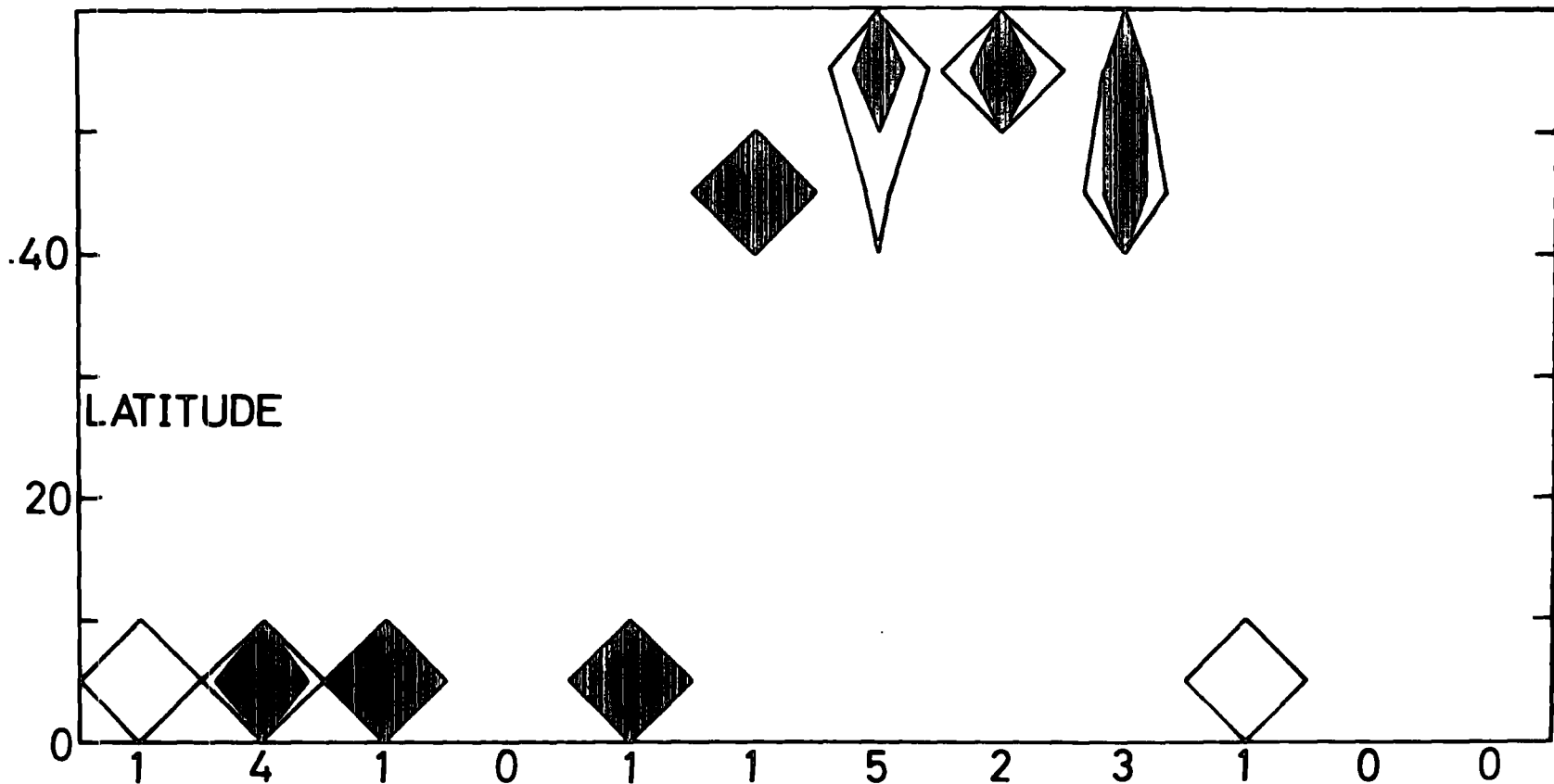

 3rd SUMMER BIRDS

In the third summer, at least some of the Roseate Terns return to north European waters (see Figure 32). This pattern is followed in subsequent years, with migration south in September and nearly complete by October. It is unlikely that those individuals penetrating into northern waters in their third summer actually breed, but probably breed the following summer as in the Arctic and Common Terns.

SANDWICH TERN

From all the colonies, there are 11 recoveries for July, 77 for August and 50 for September. Four of the recoveries in July show a northward movement, while three show a southward movement (see Table 104).

TABLE 104. JULY SANDWICH TERN POST-FLEDGING RECOVERIES

Direction from Colony	50 miles	50 - 100 m.	100-200 m.	Total
North	3	1	2	6
South	3	0	1	4

In August, there are 81 recoveries (see Table 105) of which 40 show a northerly movement and 37 a southerly one; 26

TABLE 105. AUGUST SANDWICH TERN POST-FLEDGING RECOVERIES

Direction	50 m.	50-100m.	100-200	200-300	300-400	+ 400	Total
North	11	14	11	1	3	0	40
South	13	7	12	3	1	1	37

FIGURE 33. SANDWICH TERN : POST-FLEDGING DISPERSAL.

1. July recoveries.

2. August recoveries.

3. September recoveries.

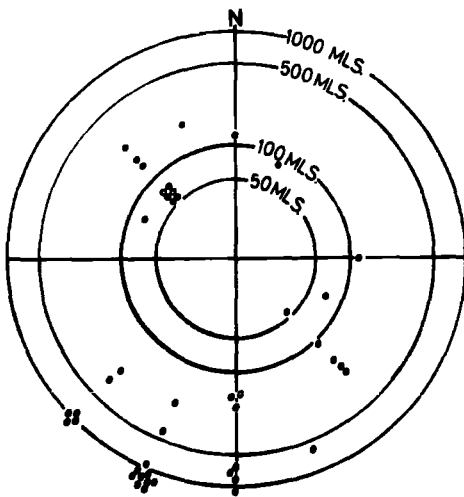
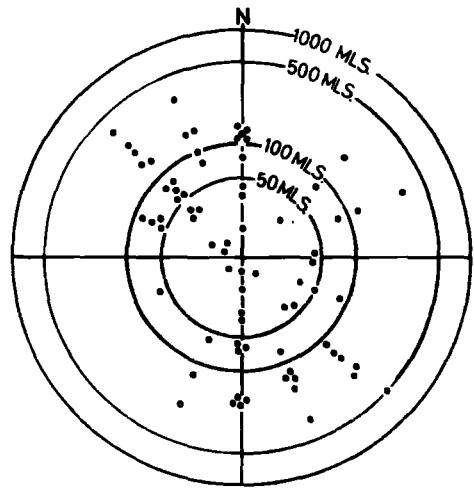
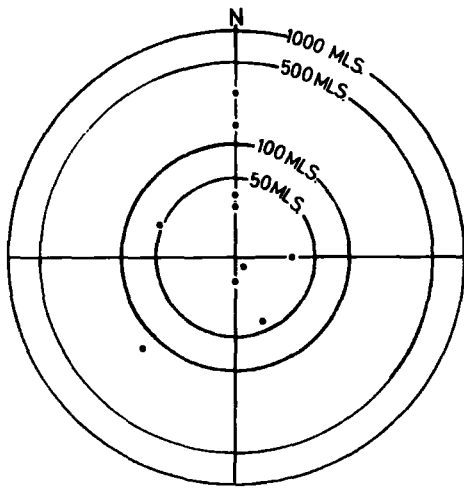

recoveries show an easterly movement and 30 a westerly one. Although most of these recoveries occur on the coastline, by grouping the recoveries from all colonies, the dispersion along the four compass points is fairly even. However, consideration of Figure 33b shows a preponderance of recoveries in the north and north-west, and south to south-east sectors. Since most of the Sandwich Tern colonies occur on the east coast of Britain, the majority of recoveries in this month will occur along the neighbouring east coast, which explains the aggregation shown.

TABLE 105. AUGUST SANDWICH TERN POST-FLEDGING RECOVERIES

Direction	50 m.	50-100m	100-200	200-300	300-400	+ 400	Total
East	8	4	8	3	2	1	26
West	7	2	6	3	2	0	30

If the recoveries for August from birds ringed on the Farne Islands are considered separately (see Table 107), it can be seen that there is a preponderance of recoveries in the north in the 51-200 mile sector, but almost absent within 50 miles north of the Farne Islands. In fact, all the 16 recoveries in the 50 - 200 mile sector are in the zone 52 - 160 miles, which

TABLE 107. AUGUST SANDWICH TERN FLEDGING RECOVERIES OF FARNE-RINGED BIRDS

Direction	50 m.	50-100 m.	100-200 m.	Over 200 m.	Total
North	2	8	8	0	18
South	6	3	5	3	17

corresponds to the area of the Firth of Forth up to the Moray Firth. This distribution seems to be due to the Sandwich Terns occurring in favourable areas, for the area just north of the Farne Islands to North Berwick consists of rocky coastline - unsuitable as a feeding area for Sandwich Terns.

If the 51 recoveries for September are considered (see Figure 33c), it can be seen that there is a definite indication of southerly migration. At the beginning of the month some birds have penetrated 1000 miles south to the Iberian peninsular (4 recoveries) and one bird has even reached Accra, Ghana. During the rest of the month, other recoveries are reported from the Iberian peninsular (10), and one near Freetown, Sierra Leone, and another near Dakar, Senegal. However, there are still recoveries north of the natal colony, although they form only one quarter of the total recoveries for September (see Table 108). As expected, these recoveries north of the natal colony occur mainly at the beginning of the month (see Table 109).

TABLE 109. SEPTEMBER SANDWICH TERN POST-FLEDGING RECOVERIES
WITH DISTANCE

Direction	50 m.	50-100 m.	100-500	500-1000	Over 1000	Total
North	0	8	5	0	0	13
South	3	1	11	8	13	36

TABLE 109. SEPTEMBER SANDWICH TERN POST-FLEDGING RECOVERIES
WITH DATE

Direction	0 - 10	11 - 20	21 - 30	Total
North	8	4	1	13
South	17	5	14	36

Migration

The Sandwich Tern has the highest recovery rate of the four species with 862 (93%) recoveries of which 539 (about 60%) are reported in the first year of life. The ringing recoveries of this species have been analysed previously. Thompson (1943) analysed the recoveries of British ringed birds reported up till the end of 1942, whereas Muller (1959) analysed the recoveries of European ringed Sandwich Terns up till the end of 1958. The latter author had 238 useful British recoveries in a total of 1,102 distant recoveries used in analysis (including those ringed in the Black Sea.

It is not until September that a southerly migration is definitely indicated, by which time some have reached the tropics (see Fig.34). In October, recoveries occur from France down to Angola in the southern tropics, with a predominance of recoveries in the latitude belts 30-40°N. and 0-20°N. However, the reduced number of recoveries from 20-30°N. may be the result of a lack of observers in this region. In November, apart from an absence in north European waters, the latitude

FIGURE 34. SANDWICH TERN : FIRST AUTUMN RECOVERIES .

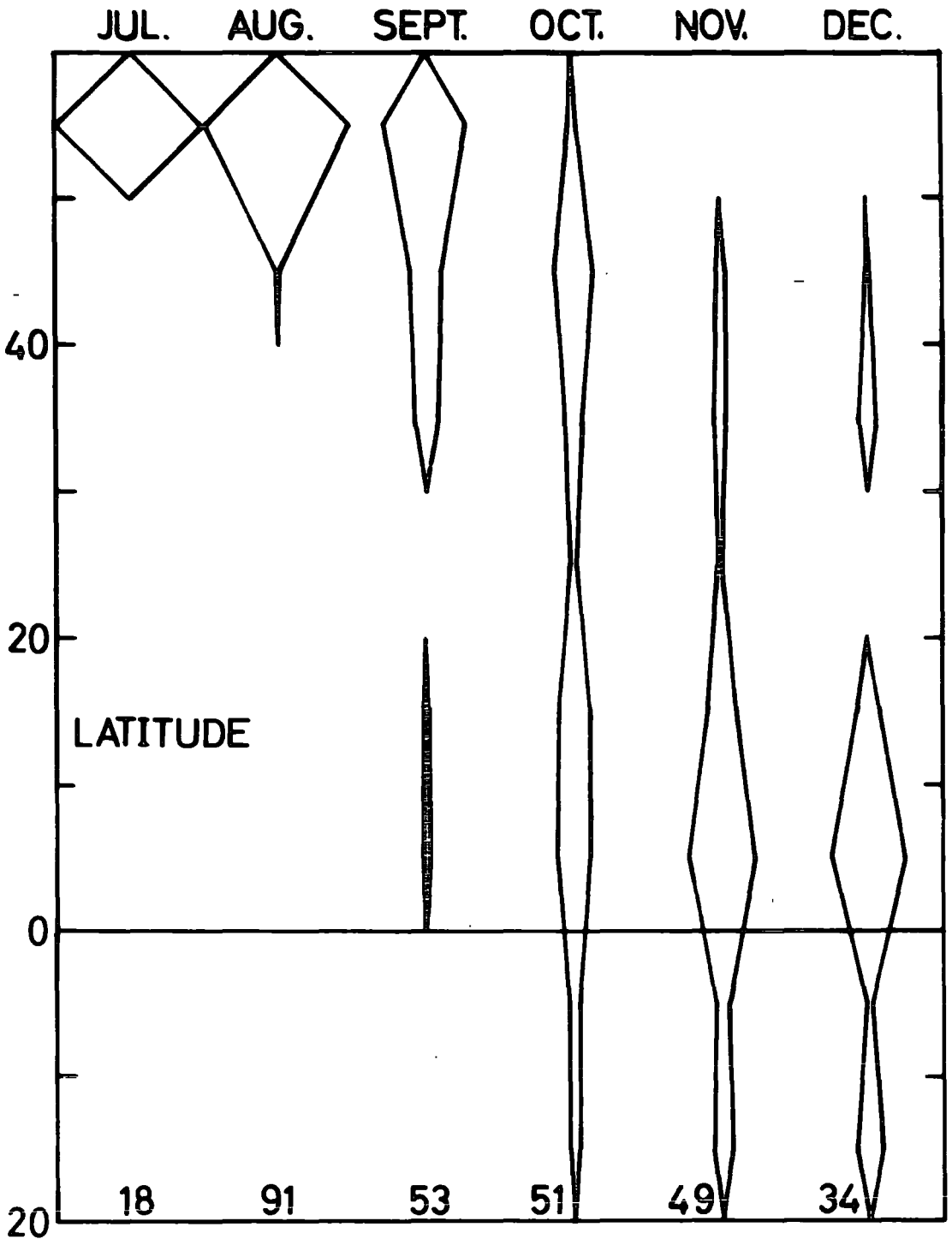

distribution is similar to the previous month, but with a preponderance of recoveries just north of the equator ($0-10^{\circ}\text{N.}$). The latitude distribution is the same in December with the preponderance of recoveries still between the equator and 10°N. (see Figure 35).

Muller (1959) has pointed out the wide longitudinal range of this species in the autumn of the first year of life. Some birds are in southern European Africa while others are still in northern Europe or the North Sea area at the same time. This situation results from different dates of departure from the colonies, or subcolonies within a colony. It is well known that some Sandwich Tern chicks have fledged and left the colony while others are still in the egg stage. Also, it may indicate dispersal in which some birds fly northwards before migrating southwards. Muller records that German birds are to be found from Denmark to Portugal in September; and in this analysis, there are three young British birds in the tropics (one in Senegal, one in Sierra Leone and one in Ghana) in this month. Even in November and December there are recoveries in the North Sea area. Several records for these months are unacceptable as the dates of death were unknown, but in some cases the birds were found alive. Muller reports two German birds in November, one in Germany and one in Holland; and also in this month, a Swedish bird in Holland and a Danish bird in Germany. There are two reports for December; one German bird found in Germany, but how long this bird had been

FIGURE 35. SANDWICH TERN : SECOND "SUMMER" RECOVERIES

JAN. FEB. MAR. APR. MAY JUN. JUL. AUG. SEPT. OCT. NOV. DEC.

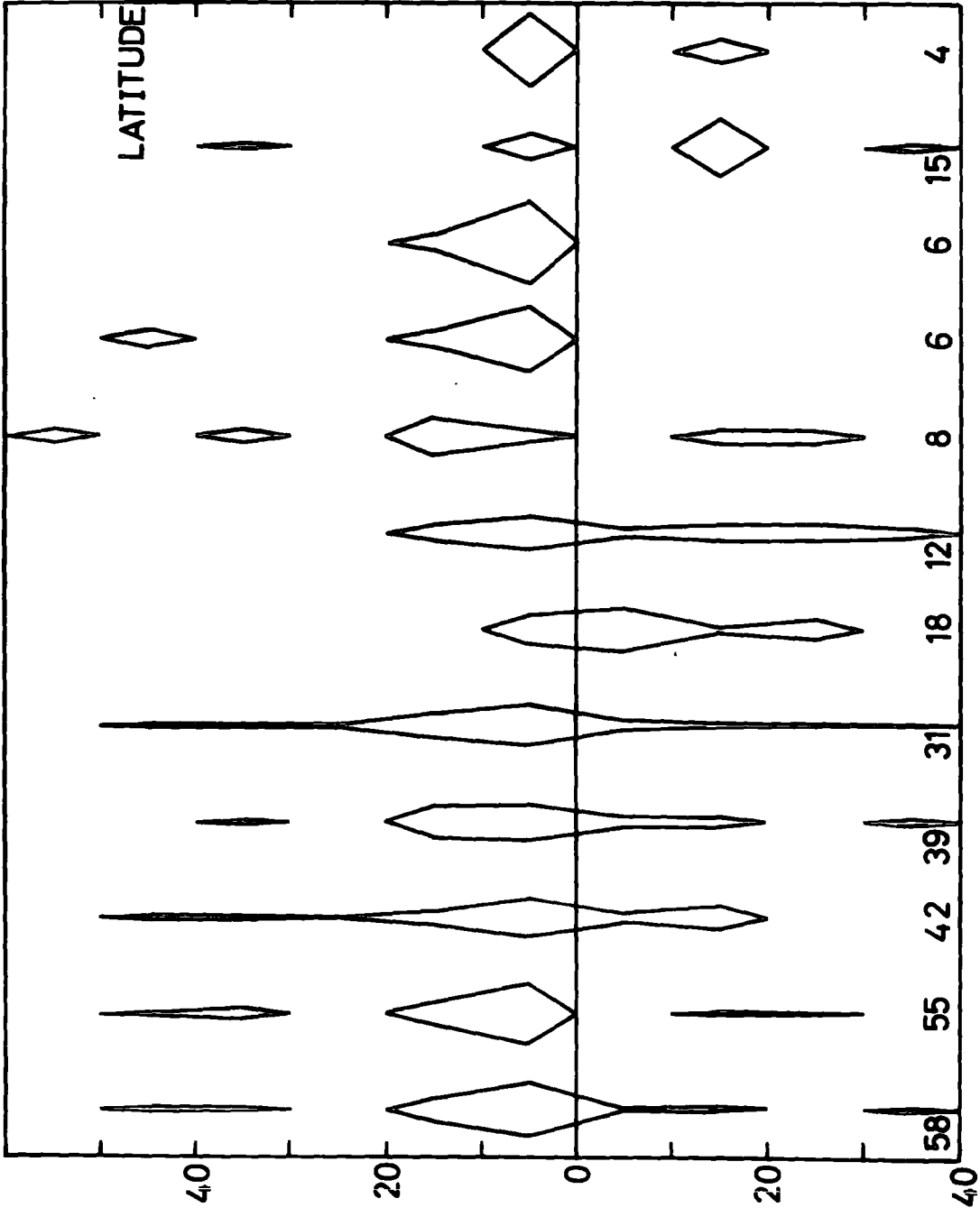

dead was doubtful; and a Danish bird in Germany.

Muller is of the opinion that the birds found between 30° and 40° N. are exceptional and that African recoveries are more representative of the true winter range of the Sandwich Tern. As in Muller's extensive analysis, the recoveries are mainly concentrated in the tropics north of the equator, that is, from Kela in Ghana ($5^{\circ}55'$ N., $1^{\circ}01'$ E) to Dakar in Senegal ($14^{\circ}38'$ N, $17^{\circ}27'$ W.). The first birds to reach this region in September, and there are numerous recoveries there in October; and after this until the end of May, in the first year of life, the majority of recoveries are found in this north tropical belt. However, the species occurs further south than this. In fact, there are eight recoveries in South Africa; three in January, one in February, three in April and one in May. The February recovery is from the St. Lucia estuary in Zululand, which is the farthest north recovery on the east coast of Africa.

In certain months, there is a considerable proportion of recoveries in Angola, and there are recoveries in this region from October through the rest of the first year of life. However, the number of recoveries in Angola is concentrated in November, December, March and June. Of a total 63 recoveries in Angola 37 occur in these four months. In addition to these recoveries, there are a further 18 from Angola - 14 from Nhime Beach near Benguela, and four near Porte Alexandre, for which the recovery dates are inaccurately known to preclude use in latitude distribution analysis.

TABLE 110. THE RECOVERIES IN THE FIRST YEAR OF LIFE IN AFRICA
WITH RESPECT TO TOWNS OR PORTS

Country	Town	No. recovered		Total recovered in country	% recovered in town
SENEGAL	Dahar	48	48	78	61.5
SIERRA LEONE	Freetown	21	21	34	61.8
IVORY COAST	Abijan	8)	13	23	56.5
	Port Bonet	5)			
GHANA	Accra	17)	59	97	60.8
	Keta	42)			
ANGOLA	Luanda	14)	41	57	71.9
	Port Amboine	7)			
	Benguela	10)			
	Mossamedes	10)			
		Total	182	289	63.0

In his analysis, Muller noted that in four places on the African coast the number of recoveries was very high, i.e. in Senegal, Ghana, Ivory Coast and Angola. He attributes this aggregation of recoveries mainly to the location of large cities and not to an abundance of suitable food. Thomson (1943) remarked on the absence of recoveries from Nigeria (which is no longer the case), for the coastline was not very accessible to man, nor very suitable for the Sandwich Tern. Even the five records from Nigeria come from the vicinity of Lagos, reflecting

the density of man. In the other areas mentioned, the abundance of recoveries is greatest where human population is densest (see Table 110).

According to Allison (1959), terns are caught by snares baited with fish, and occasionally by rat traps. The accumulation of finds in the vicinity of large towns is attributed to the reports from an urban population. Of the 350 recoveries occurring along the African coast, about 290 (83%) occur in the five countries listed in Table 110, and of these 290, 182 (63% of those in the 5 countries) were recovered or reported from the vicinity of large towns. Others were recovered often near small townships or villages.

In the second summer, the Sandwich Terns appear to remain in their winter quarters, although Muller mentions a spring migration and refers to three European recoveries: a Danish bird on Heligoland in May, another on the French Atlantic coast in June, and a German bird in Holland in this month. However, these recoveries appear exceptional as almost all the others are reported on the African coast, including one on the coast of Algeria in May, and one on the coast of Tunis in June. In this analysis, there are two Mediterranean recoveries in March, one in April and one in May, and one recovery on the Spanish Atlantic coast ($37^{\circ}25' N.$), but none in north Europe (see Figure 35).

Both in Muller's analysis and this present one, there is a tendency for most of the African recoveries to occur north of the equator in February, rather than in any other month from October until the end of the first year of life (see Table 111). Muller interprets this as a movement northwards, but it might mean a penetration south of those birds present in Angola (those contributing to most of the southerly bias) into South-west Africa. This latter area borders the Namib Desert and is therefore sparsely inhabited, giving few recoveries. However, this suggestion is speculative, for the tendency indicated in January as well assumes normality again in March.

Muller's analysis indicates a predominance in the north in June, but this is not so in the present analysis. It seems that the majority of Sandwich Terns spend the second summer in the tropics, although some may penetrate into northern waters. The two recoveries in North Africa were suggested by Muller as possibly visiting breeding places along this coastline. There is one record of a British bird found freshly dead in the Netherlands in August. Robinson (1910) reports of a one-year old bird breeding at Ravenglass, Cumberland, but no mention of brown flecking in the plumage makes this record unacceptable.

The Sandwich Tern appears to remain principally in the tropics, although some are found in South Africa and Iberia, through until the end of May in the third summer. From June to October inclusive, there is a preponderance of recoveries in north

TABLE 111. RECOVERIES IN AFRICA, NORTH AND SOUTH OF THE EQUATOR, ACCORDING TO MONTH IN FIRST YEAR OF LIFE

Month	Present Analysis			Muller's Analysis			Present T	Muller T
	No. North	No. South	% North	No. North	No. South	% North		
July								
Aug								
Sept	3	0	100	1	0	100	3	1
Oct	23	6	79.3	11	4	73.3	29	15
Nov	34	10	77.3	17	8	68.0	44	25
Dec	23	7	76.7	20	8	71.4	30	28
Jan	47	7	87.0	25	14	64.1	54	39
Feb	48	3	94.1	37	3	92.5	51	40
Mar	24	15	61.5	15	9	62.5	39	24
Apr	27	11	71.1	6	9	40.0	38	15
May	23	7	76.7	15	6	71.4	30	21
June	13	5	72.2	5	7	41.7	18	12

European waters. In June, there are two sight records of 2 year-old Sandwich Terns in the colony on Coquet Island and one was recovered near Bridlington, Yorkshire. Another was recovered near Venice, in Italy. In July, there are a further six sight records on Coquet Island, and four recoveries on the north coast of France. In August, September and October, there are recoveries in European latitudes, but three of the four October recoveries are in Iberia (Portugal). It seems that in the third summer, birds

FIGURE 36. SANDWICH TERN : THIRD "SUMMER" RECOVERIES.

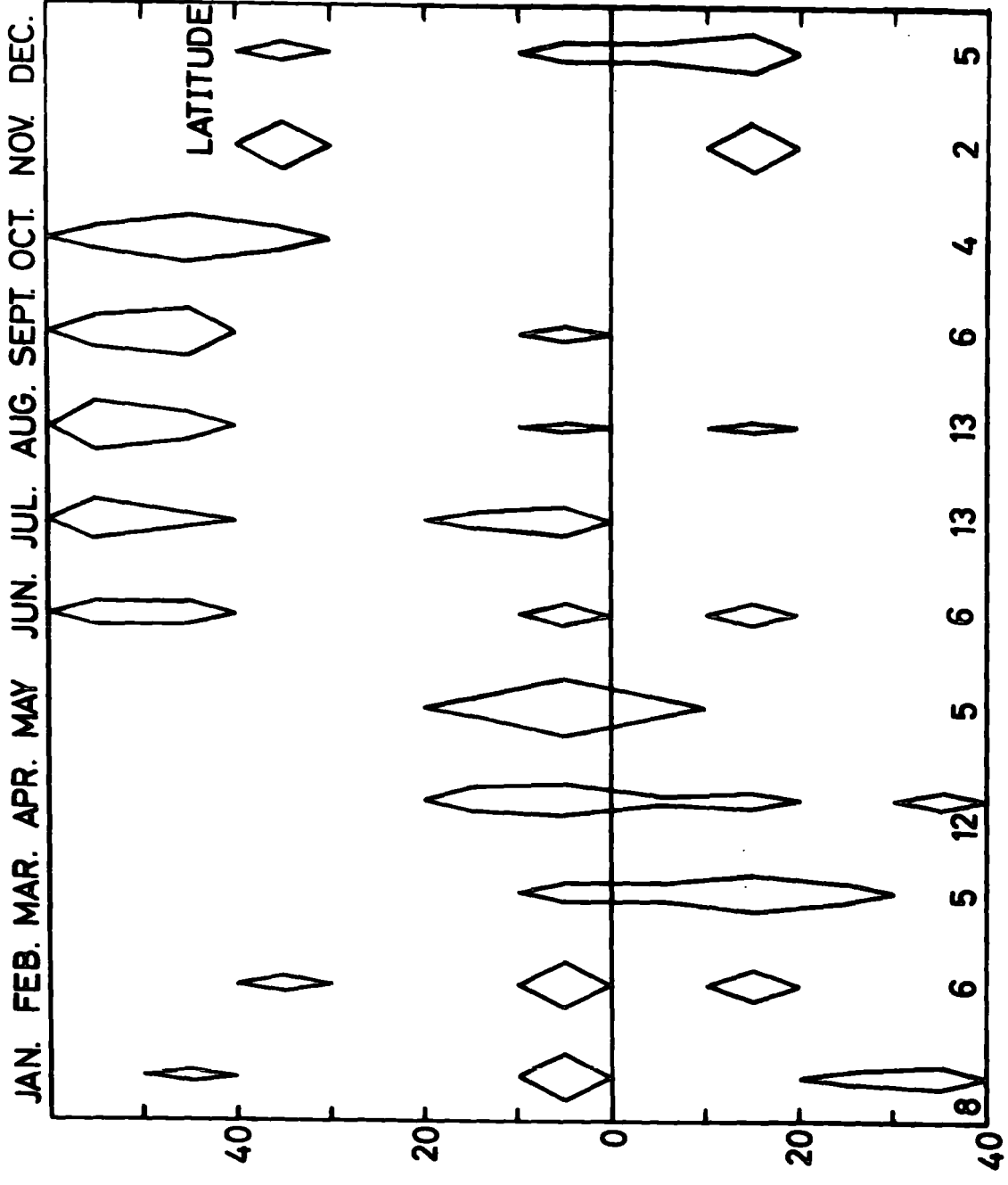

penetrate northerly waters later than breeding birds and do not reach these areas until June. However, there are still recoveries in Africa - a substantial number if allowance is made for population density - in these summer months, indicating that some birds remain in their winter quarters. In the winter months, the Sandwich Terns appear to return to the tropics as there are no recoveries north of 10°N . in January, February and March. At the beginning of November and December, there is respectively one recovery in southern Portugal, and the other five recoveries for these two months are in the tropics (see Figure 36).

In the fourth summer, there is evidence of a northward movement in April, but there are no recoveries in Europe until May. However, there are still recoveries in the tropics in this month, and in June and July as well. In May, there are two recoveries in the tropics, one in Italy, two in Scotland, and two in Holland. In June, July, August and September, recoveries predominate between the latitudes $40\text{-}60^{\circ}\text{N}$. There are no recoveries in October, but the November and December ones (5) are in the tropics (see Figure 37).

The birds older than 4.5 years, i.e. fifth summer and over, are grouped together since they are too few to warrant separate treatment and seem to follow similar migratory movements. In these birds, the recoveries from March to October inclusively, are predominantly above 40°N . In March, one of the two recoveries is in France ($45^{\circ}30'\text{N}$). In April, apart from one

FIGURE 37. SANDWICH TERN: FOURTH AND SUBSEQUENT "SUMMER" RECOVERIES.

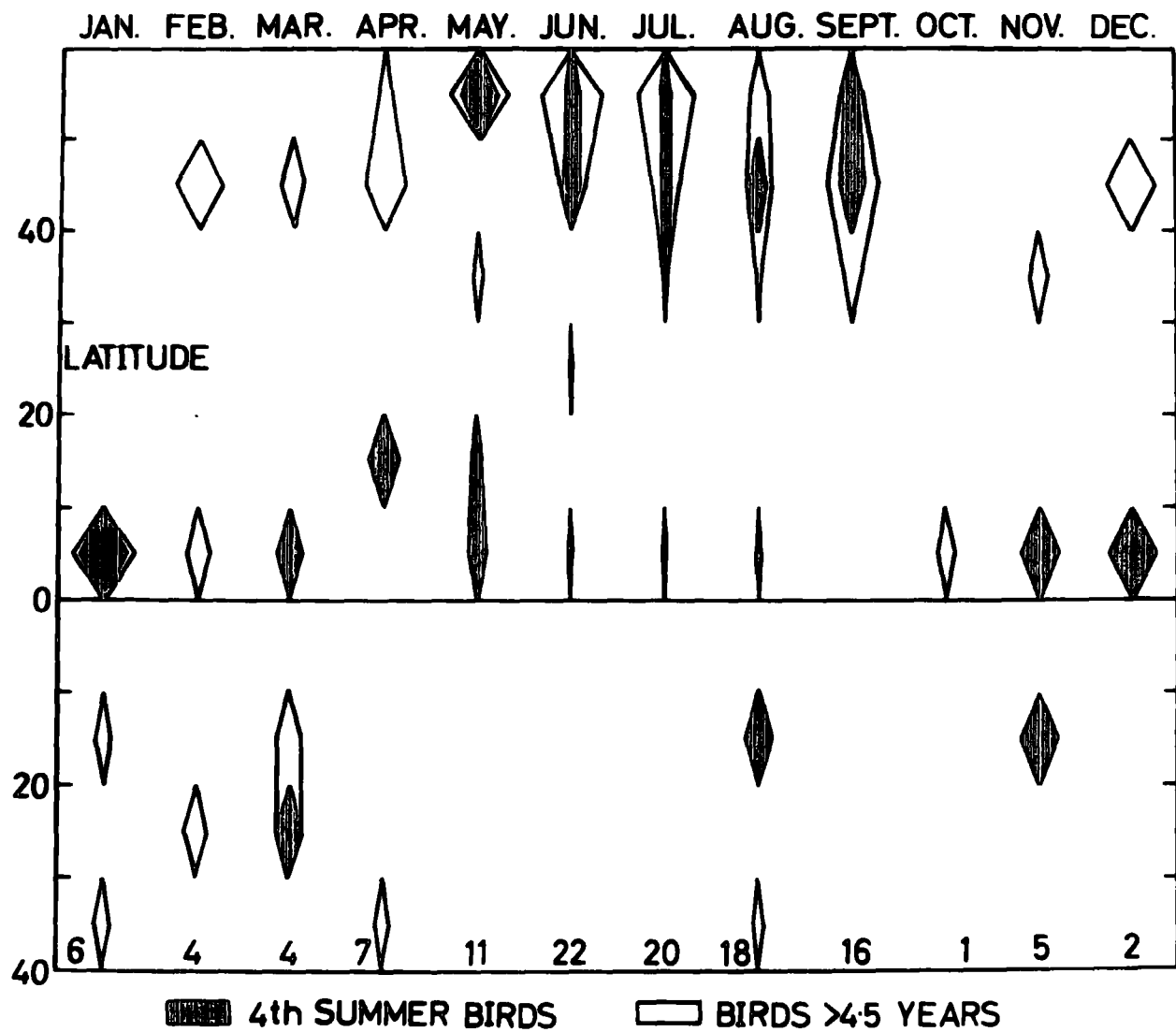

in South Africa, there are three in France and one in Spain. In May, there is one recovery in Ghana, but three in north Europe. It seems that although some birds breed in their fourth summer, it may not be until the fifth summer, when the birds are about four years old, that the majority begin breeding. Retraps and sight records support this, but are not included in this analysis. In June and July, all the recoveries are above 40°N . In August, there are ten recoveries, of which two are in South Africa and one in Ghana, three in northern Europe, and two in Portugal.

In September, there is evidence of a movement south, but there are no recoveries below 30°N . In October, there is only one recovery and that is from Ghana. In November and December, there are two recoveries, one in Portugal and one in France respectively. Despite the absence of recoveries in the winter months, it seems that the adult birds have the same winter quarters.

There are 23 recoveries of British ringed Sandwich Terns recovered in the Mediterranean. It is not known whether birds penetrating the Mediterranean return to the Atlantic and subsequently the North Sea. There may be a slight mixing of the young birds, but no Mediterranean or Black Sea ringed birds have been recovered in any North Sea colony or locality. Those Sandwich Terns from the Black Sea winter in the Mediterranean whilst those on the French Mediterranean coast may winter both

TABLE 112. MEDITERRANEAN RECOVERIES OF BRITISH SANDWICH TERNS

Year of Life	1	2	3	4	5	6	7	8	Total
No. in France	1	0	0	2	1	0	1	1	6
No. in Spain	6	1	0	0	0	0	0	0	7
No. in Algeria	2	1	0	0	0	0	0	0	3
No. in Italy	2	1	2	2	0	0	0	0	7
Total in Med.	11	3	4	3	2	0	1	1	23

in this region and down the African coast, as one of the three records mentioned by Muller is from Nigeria.

Apart from those juvenile recoveries, the Mediterranean recoveries from the second summer on are mainly during the summer months. 12 recoveries are reported from May to September inclusive, whilst there is one on the Spanish coast in January. Therefore, there is a strong suggestion of summering in the Mediterranean. This slight movement, presumably into the Mediterranean in summer, would tend to keep the North Sea population isolated from the Black Sea population which winters in this area. Although it is principally young birds from Britain that enter the Mediterranean, the decrease of finds of older birds may simply be a result of fewer individuals being available for recovery and to ring loss through wear.

Muller (1959) found that the summer recoveries (7) in the second summer came from Italy, Yugoslavia and Greece which is principally east of recoveries of North Sea birds. Older birds from July and August occur on the Algerian and Yugoslavian coasts, in Sicily, Northern Italy and in the Gulf of Lyon. It is interesting to note that no Black Sea birds were reported from the Red Sea or Gulf of Aden where they are commonly seen in passage, and it is likely that these are birds from the Caspian Sea population.

Comparison of the movements of the four species

Dispersal

In July, the dispersal pattern of the Common, Arctic and Sandwich Terns appears very similar, with an almost even distribution of recoveries north and south of the natal colonies. The recoveries for the Roseate Tern, which are only for August and September, are inadequate for comparison, but hint at a dispersal in August.

In August, the picture is more complicated. In the Arctic and Sandwich Terns, there is a north-west to south-east axis to the recoveries, corresponding to the coastline, as the principal colonies of ringed birds are on the east coast of Britain. In the Common Tern, there are more recoveries south (28) than north (18) of the natal colony, indicating that migration begins shortly after fledging. But in the Arctic Tern there are only a few more recoveries in the south (22) than in the

north (17) which suggests that migration begins later in this species than in the Common Tern. In the Sandwich Tern, the number of recoveries is slightly higher in the north (40) than in the south (37), indicating that dispersal is still occurring. This distribution can be interpreted two ways. Either the dispersal is still proceeding with all juveniles moving randomly on fledging, or that there is a principally northerly dispersal which is compensated for by earlier fledged birds beginning to migrate south by this time. Present knowledge does not allow a decision on these two alternatives to be taken.

In September, the pattern of distribution is similar, and all four species show a migratory element to varying extent. In the Roseate Tern, all five recoveries are in the south-west; some well towards the winter quarters. In the Common Tern there are 51 recoveries south of the natal colony and 5 north. Even if 18 recoveries from one locality are treated as one recovery, the migratory element is still obvious. However, there are still several recoveries within 50 miles of the natal colony, which is not the case in the Arctic Tern. This latter species has one recovery in the north and 14 in the south. The fewer recoveries of this species are partly due to its migration usually occurring offshore, and partly to its rapid departure from local waters. The reason for this rapid departure may be due to either the local conditions becoming less suitable for this species than the others, or because it has farther to go

to its winter quarters (which is most likely), or both.

In the Sandwich Tern there are still 13 recoveries in the north and 36 in the south. There are only 3 recoveries within a 50 mile radius, and these are in the south, which may refer to birds that originally dispersed northwards and are migrating south. All the recoveries over 500 miles (21) are in the south, and some of these have reached the winter quarters. Therefore, in this species, there is a greater range of distribution, which is also the case in the winter quarters, than in the other species.

Migration

The First Autumn

An average latitude value for each month was plotted for each species, derived from a weighted mean of the recoveries in each 10° sector. From Figure 38 it can be seen that the Common and Arctic Terns show a definite southerly migration in August which the other two species do not. Then in September, the Roseate and Sandwich Terns have caught the Arctic Tern up, but the Common Tern moves south more gradually. By October the average latitude value for the Arctic Tern is below 10°N , while that for the Roseate Tern is below 20°N , and that for the Sandwich Tern is just north of the tropics. In contrast, the Common Tern has an average latitude value of 45°N .

In November the Common Tern appears to move rapidly south, so that it is in the tropics with the Roseate and Sandwich

FIGURE 38. AVERAGE LATITUDE OF RECOVERIES OF ALL FOUR SPECIES IN
FIRST AUTUMN.

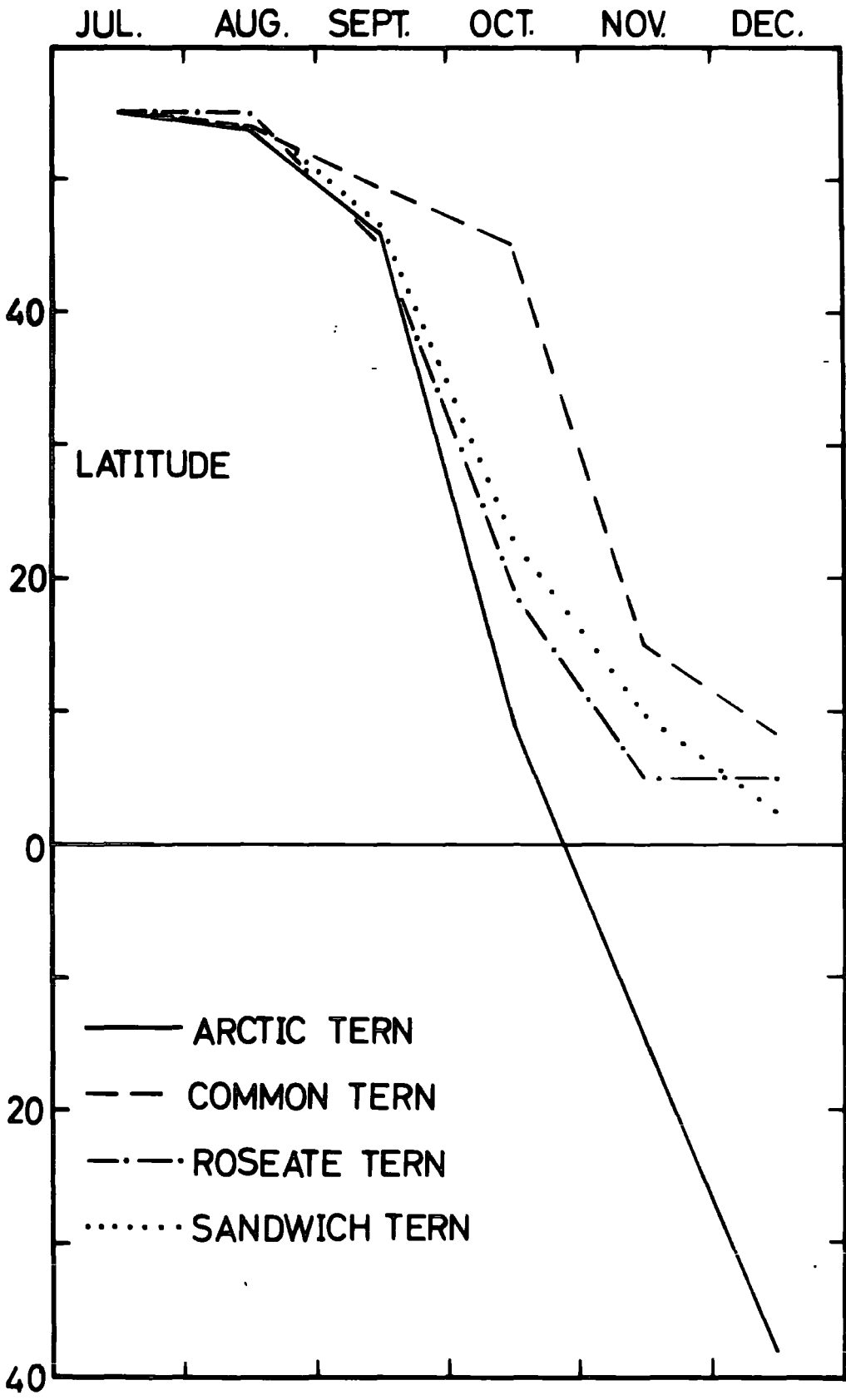

Terns. However, the Arctic Tern has moved south of the Equator (a. = 12.5°S .). In December the average latitude values for the Sandwich, Roseate and Common Terns are between the equator and 10°N . The Arctic Tern has moved much further south, and owing to the absence of land masses in the south the average latitude value (38.3°S .) may well be biased to the north.

The range of recoveries in the first autumn was considered in the four species (see Figure 39). From August to October inclusive, the range is large in the Arctic Tern due to some individuals migrating south rapidly. In November and December the latitude range has decreased markedly, since only those that have not penetrated the Antarctic Ocean are recovered in South Africa. In the Common Tern, the range of recoveries is more consistent for the same period, but with a similar reduction in range in December between 5°N . and 10°N . The Roseate Tern is a late breeder, and migration is not detected until September, but since some individuals migrate fast, it has an extensive range as in the Arctic Tern. However, by November the range becomes extremely restricted around 5°N . and is similar in December.

Migration is noticeable in August in the Sandwich Tern, and in the following months the range of latitude is very large. The extensive range in September and October can be attributed to the great variation in time of fledging of various groups, but this does not adequately explain the large

FIGURE 39. AVERAGE LATITUDE AND RANGE OF RECOVERIES OF ALL FOUR SPECIES

IN FIRST AUTUMN.

(numbers refer to recoveries used).

JUL. AUG. SEPT. OCT. NOV. DEC.

JUL. AUG. SEPT. OCT. NOV. DEC.

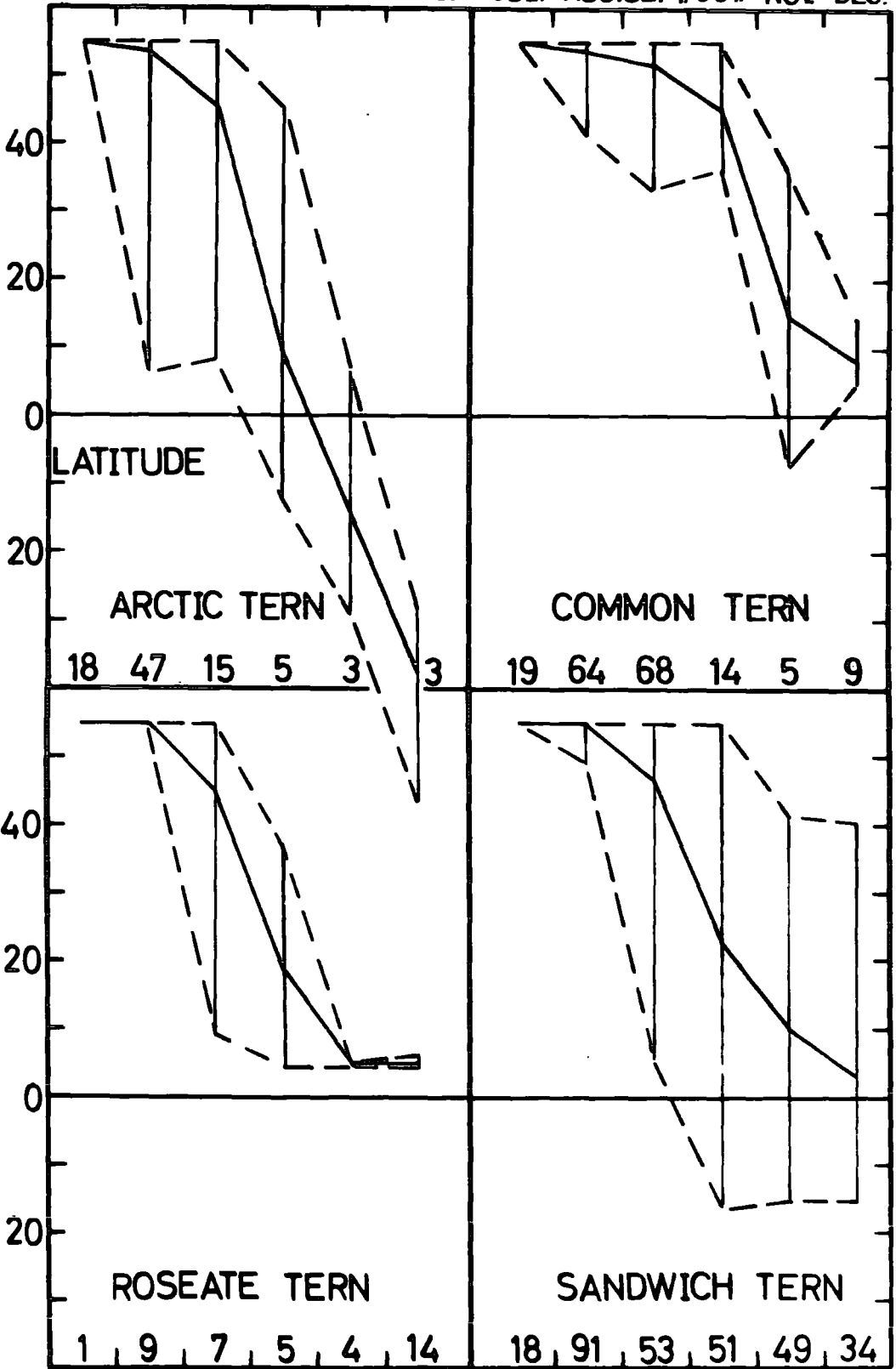

latitude range in November and December. Although the average latitude is just north of the equator, the recoveries range from Iberia to Angola. Since this is different from the distribution found in the other species, it suggests that the Sandwich Tern is better able to survive in a variety of winter quarters. The reasons for this require a study of the ecology of the tern species in their winter quarters.

The Second Summer

The Common, Roseate and Sandwich Terns are found predominantly in the north tropical belt in the second summer (see Figure 40). However, there is a suggestion that the Roseate and Sandwich Terns move slightly north in late summer before resuming their previous winter quarters. There is no evidence of a similar movement in the Common Tern. Although there are very few recoveries, there is a suggestion that the Arctic Tern moves up from the Antarctic Ocean into the tropics in summer. This is reasonable when one considers that this period corresponds to the southern winter whose short days and inclement weather would adversely affect the Arctic Tern. Apart from one Sandwich Tern recovery, there is no evidence of these four species penetrating into north European waters in the second summer at the end of the first year of life.

The Third Summer

In the third summer all the species show a penetration north from their tropical winter quarters in the Common, Roseate

FIGURE 40. AVERAGE LATITUDE OF RECOVERIES OF ALL FOUR SPECIES IN
THE SECOND "SUMMER".

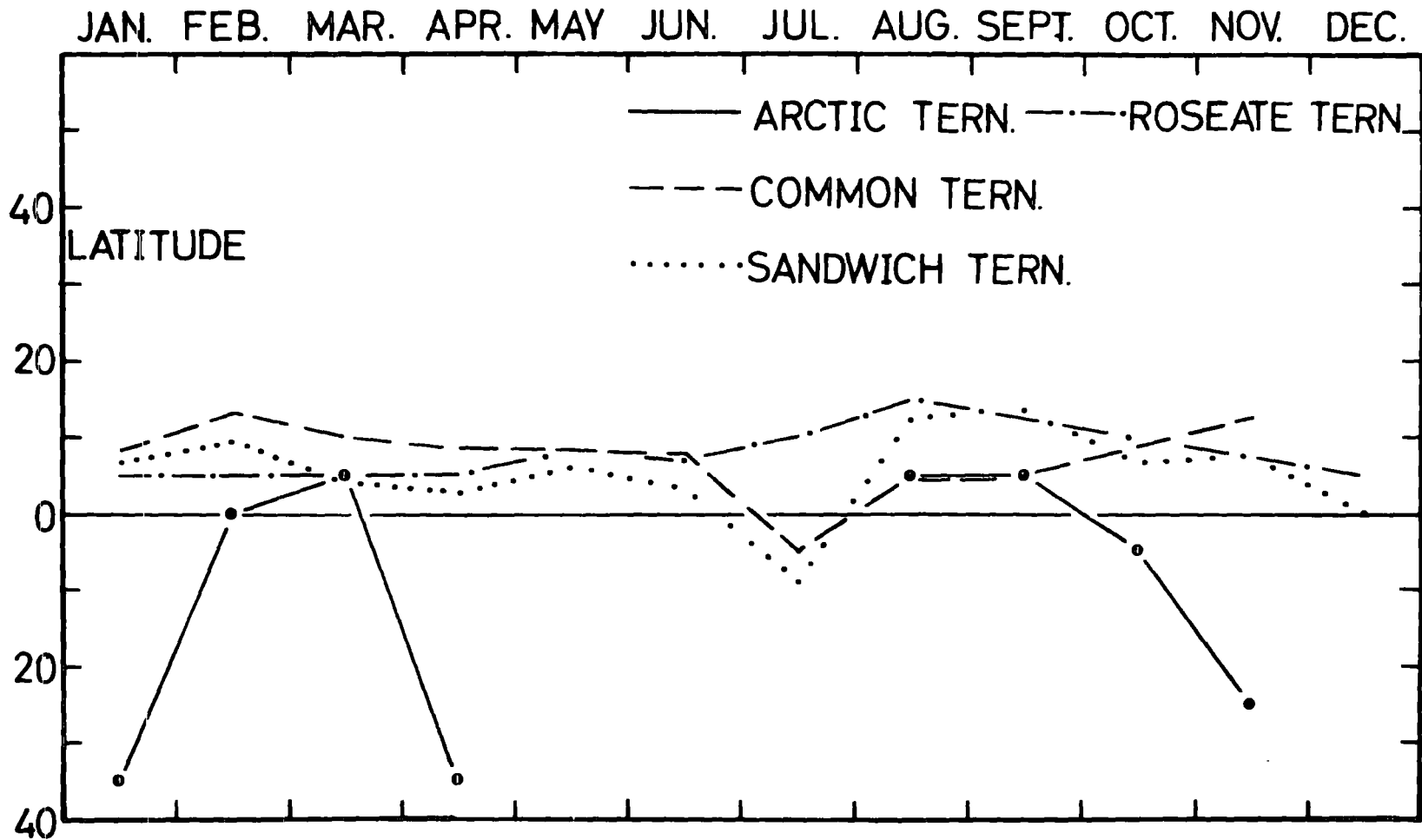

and Sandwich Terns, and from its south polar winter quarters in the Arctic Tern (see Figure 41). Although the average latitude range in the Arctic Tern assumes 55°N . (i.e. breeding area) in June, it is July in the Roseate Tern, and August in the Common Tern, and the Sandwich Tern's average latitude never penetrates above 50°N . (46.7°N .) in September.

These recovery dates suggest that the terns are arriving in their natal areas too late to breed in that year and are in fact merely visiting these areas. Studies of the breeding colonies show that only a few individuals breed in their third summer (Austin, 1945; pers.obs.).

These species, after penetrating northern latitudes, rapidly assume an average latitude corresponding to the winter quarters occupied in the two previous winters. Recoveries are few for this part of the terns' lives, mainly because many have died in their first year of life.

The Fourth and subsequent Summers

When an average latitude value is taken for the fourth and subsequent summers for each month of the year, recoveries of the Common Tern occur in northern Europe in April (see Figure 43. An average latitude of 55°N . is maintained in this species until, and including, August. This latitude average is attained in May, June and July in the Arctic Tern, and almost in July and August in the Roseate Tern. This suggests, and is supported by observation, that in these three tern species most individuals

FIGURE 41. AVERAGE LATITUDE OF RECOVERIES OF ALL FOUR SPECIES IN
THE THIRD "SUMMER".

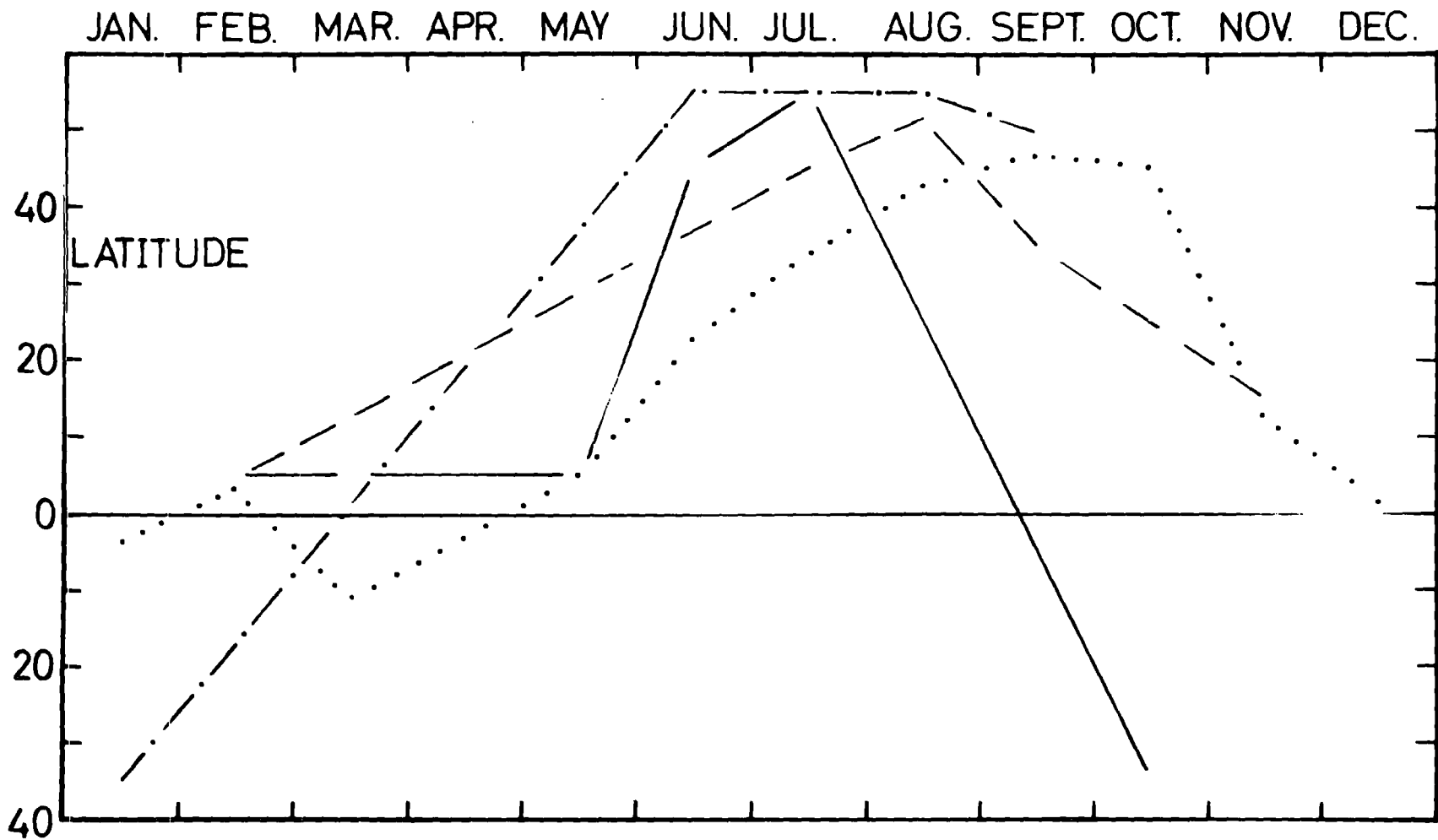

— ARCTIC TERN.

- · - · ROSEATE TERN

- - COMMON TERN

· · · · SANDWICH TERN

begin breeding in their fourth summer when about three years old. However, the average latitude value for the Sandwich Tern is highest in June (48.6°N.) and July (48.5°N.) and suggests that only a few individuals breed in their fourth summer.

If a monthly average latitude value is assumed for the Sandwich Tern recoveries in their fifth and subsequent summers, and average latitude value of 55°N. is attained in May (see Figure 42), this indicates that the majority of Sandwich Terns begin breeding in their fifth summer. The late appearance of the Roseate Tern in its breeding area is due to the complete absence of recoveries for April, May and June in these age groups. This species may be like the Sandwich Tern in usually deferring breeding until the fifth summer, but the lack of evidence neither confirms or disproves this idea.

In August and September, the four species exhibit migratory movements closely resembling those of the fledglings in their first autumn (see Figure 42). In the Common, Arctic and Roseate Terns, the winter quarters appear to be the same as that assumed in previous winters. However, in the Sandwich Tern, it has shifted north in November and December, but there are too few recoveries to make this definite. Besides, in January, there are two recoveries south of the equator (in Angola and South Africa) out of a total of three for this month. Nevertheless, there is a suggestion that older Sandwich Terns remain in a more northerly winter quarter.

FIGURE 42. AVERAGE LATITUDE OF RECOVERIES OF ALL FOUR SPECIES IN
FOURTH AND SUBSEQUENT "SUMMERS".

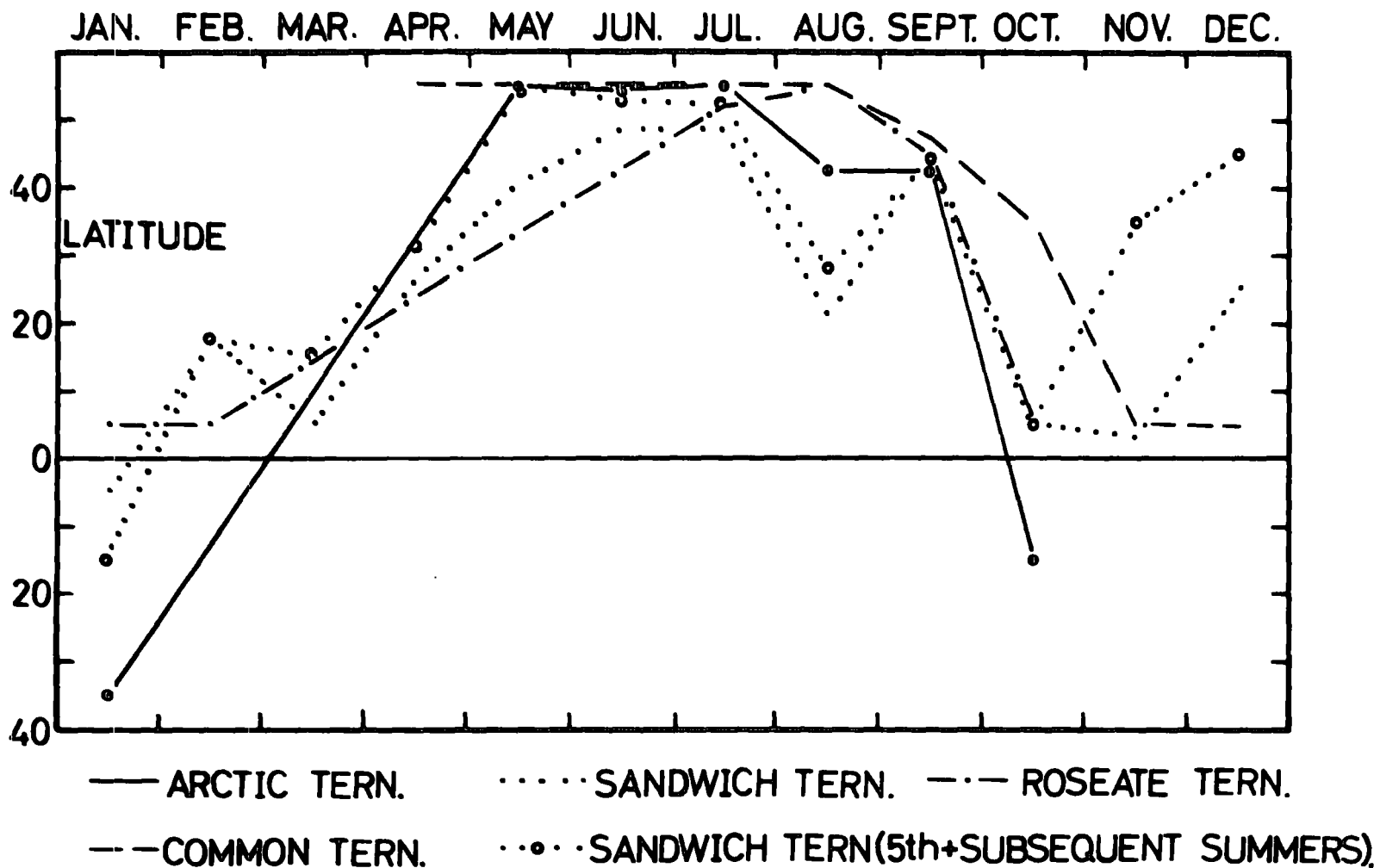

DISCUSSION

a) Colonial breeding and synchronisation

Most seabirds nest in colonies which means that during the breeding season a particular species is highly aggregated in certain areas so that its distribution is neither random nor even. This grouping of individuals during breeding means they are very vulnerable to ground predators. Some species, such as auks, greatly reduce this danger by nesting on inaccessible cliffs, or in crevices and burrows, but most gulls and terns nest on open flat ground. To reduce predation, larids have acquired various adaptations and the four species of terns studied are no exception (Cullen, 1960a). In many instances, these terns nest on islands or sand spits so that ground predators infrequently reach the colony. In the Common and Arctic Tern, the eggs and young are cryptic and are evenly dispersed over the area of the colony, possibly as an adaptation against both aerial and ground predators. Although the eggs and young of the Sandwich Tern appear to blend with the guano of the nesting colony, the colony itself is not cryptic and is very obvious. The Roseate Tern has a cryptic nest, eggs and young, but the nest site soon becomes obvious after the young hatch as they defaecate in the area of the scrape.

Two possible disadvantages of colonial breeding are a shortage of food and predation, since the species is restricted to certain areas forming a relatively high density. (Another possible disadvantage is the spread of disease in high population densities,

but this was discounted as rarely having any significant effect on seabird populations). In the first instance, there might be intra-specific competition for a limited amount of food in a restricted area, and in the second, predators would make serious inroads into a population once it had been located. Some of the adaptations terns have acquired to reduce predation have been mentioned, but some species such as the Sandwich Tern would appear to be more vulnerable to predation than others. However, this species exhibits distinct adaptations to overcome this danger. Its preference for nesting amongst more aggressive species such as Black-headed Gulls and other terns has been noted many times (e.g. Salomonsen, 1947; Assem, 1954a; Rooth, 1958; Cullen, 1960a). The more aggressive species attack predators which deters avian predators though it is less effective on mammalian predators (Kruuk, 1964). Cullen (1960a) has referred to the readiness of the Sandwich Terns to desert an entire colony if disturbed during egg-laying and incubation. He sees this as an adaptation against predation to which this species is very vulnerable. However, although much has been said of the Sandwich Tern deserting through disturbance, there is little evidence to support such conclusions. Colonies of this species do tend to change their nesting area from year to year (Marples & Marples, 1934), and such erratic behaviour may be an adaptation against predation without disturbance being primarily responsible.

A further anti-predator adaptation shown by the Sandwich Tern is its shortening of the time spent in the nesting area compared

with the other species. Although the entire colony has a similar duration to those of other species, the distinct subcolonies of the Sandwich Tern have a much shorter duration. The Sandwich Tern reduces the time spent on the island prior to breeding by being already paired on arrival, and the average duration of egg-laying in a subcolony is 18-21 days. Incubation is only slightly longer than in the other species, but the chick departs from the conspicuous nest area within five days so that adults and young are in a vulnerable situation for about 50 days which is little more than half the time spent by Common and Arctic Terns in the colony. Although the Roseate Tern spends nearly three weeks on the island prior to egg-laying, its young depart from the nest area within five days of hatching so that it is intermediate between the Sandwich Tern, and the Common and Arctic Terns with respect to time spent in the vicinity of the nest.

Cullen (1960a) concluded that the Sandwich Tern had developed the dense nesting habit at the expense of camouflage and benefited from association with more aggressive species. The dense nesting habit had necessitated a lowering of aggressive behaviour, and as in other dense nesting terns, the crest became an important attribute in breeding behaviour. By associating with species which still relied on camouflaged eggs and young and aggressive behaviour, the Sandwich Tern benefited from their attacks on aerial predators. The Sandwich Tern remained incubating on its clutch when crows or gulls were in the vicinity, but Cullen doubted

if it had any adaptation against ground predation, apart that the eggs may be difficult to discern amongst the guano-spattered colony.

Kruuk (1964) gives evidence to show that predation by Foxes Vulpes vulpes L. can be a serious threat to the Sandwich Tern - even to the adult bird on dark nights. It seems that the chance of a Fox finding the Sandwich Tern colony at Ravenglass, Cumberland, is reduced by being concentrated in a small area within a larger Black-headed Gull colony. It is likely that the division of a large Sandwich Tern colony into separate geographical units of dense nests - subcolonies - would favour survival where ground predation is likely.

Neither on Coquet Island, nor the Farne Islands, are there any ground predators, yet these situations are uncommon. At the Sands of Forvie, Aberdeenshire, Scolt Head and Blakeney in Norfolk, Ravenglass and others, where the colony is situated on a peninsular or an easily reached island, ground predators such as Foxes and Weasels Mustela nivalis L. are often common and a very real threat to the existence of the species. The habit of the Sandwich Tern to change its breeding ground will favour the perpetuation of the sub-colonial habit, even though ground predators may be absent, as on Coquet Island.

Crook (1965) in discussing avian social organisations states that food supply around the colony must be sufficient to allow recruitment, and that interspecific organisations may develop in protective sites where there is little competition for food between

species. Examination of the feeding of terns has shown that although certain preferences exist, there is often considerable overlap in size and species of food, and area fished, in the four species. It seems that there is an abundance of food, although its appearance may be sporadic in the form of shoals. All birds are restricted to land for breeding purposes, irrespective of whether they have a pelagic or coastal distribution during the non-breeding period. However, since these birds are adapted to collecting their food from the sea, their breeding colonies are usually restricted to areas close to the sea or large bodies of water.

Seabirds possess distinct breeding seasons which always occur in the summer in northern latitudes when there is usually a superabundance of food and favourable climate conditions. However, there is a similar synchronisation of breeding of seabirds occurring in equatorial waters where there is little environmental change through the year. For example, on Ascension Island in the tropics, although four species of seabird were known to breed throughout the year, they exhibited distinct peaks of breeding (Stonehouse, 1962). The sexual cycle of two species of tropic birds, Phaethon spp. , varied according to their success which in turn varied with the inverse ratio of the numbers breeding; so that it would be expected that the species would breed uniformly throughout the year. Ashmole (1962) considered that even if there were no seasonal variations in the environment, those species that could breed most frequently would be favoured, resulting in less than annual cycles, but this has not

happened in all species. His suggestion that certain food species may have a pronounced seasonal variability is a strong possibility, although there is no evidence of this. This variability would explain the differences in the lengths of breeding cycles in some species, but not why all the individuals of a species which is not tied to a definite breeding season should attempt to breed at approximately the same time.

The synchronous breeding of some species such as the Wideawake or Sooty Tern Sterna fuscata L. every nine to ten months can be considered an adaptation against predation, especially by cats (Ashmole, 1963a). The numbers of predators is controlled by the amount of food during the non-breeding season of the terns, so that the shorter the breeding season of the latter, the fewer predators there will be. Also, the shorter breeding season of the terns will limit the amount by which predators can increase in numbers, and therefore limit the amount of predation. However, the Black Noddy Anous tenuirostris (Temm.) has a synchronised breeding season but suffers little predation. Ashmole (1962) considers that individuals might be responsive to the breeding activities in other members of the colony, so that they would all tend to breed at the same time if there were no disadvantages. Although individuals in a colony are synchronised, the separate colonies are not, and this suggests that food availability is unimportant. Therefore, food availability and predation may make synchronised breeding an advantage in northern latitudes, but it may not explain the habit in tropical areas.

Wynne-Edwards (1962) has suggested a further advantage for synchronised breeding in animals. He considered that social assemblages of seabirds prior to and during breeding allowed individuals to regulate their reproductive output for that season, so that food resources would not be over-exploited. However, there is no conclusive evidence to prove this hypothesis which would require group selection, acting on discrete units of a species. Both Crook (1965) and Lack (1966) have extensively criticised this hypothesis. Present knowledge of synchronised breeding seasons, at least in northern latitudes, can be explained by food abundance, favourable climatic conditions, and an anti-predator function.

The mixed species colony results mainly from there being a restricted site, safe from ground predators, and near a good feeding area. The mixed species composition might represent an unstable situation, especially considering that only the Arctic and Common Tern populations have remained relatively constant over the three years of this study. However, the importance of colonial nesting and synchronisation of breeding between the species is an anti-predator function, as suggested for a single species by Darling (1938), Ashmole (1963a), and Kruuk (1964). Moynihan (1958) has referred to this interspecific gregariousness and noted the very similar patterns in these species, basically of white and grey with black caps. The similarities suggest a definite advantage to counteract the strong selection pressure favouring increasing morphological differences to assist in reproductive isolation.

It seems that larids rely often on small morphological and behavioural differences to maintain reproductive isolation (e.g. Brown, 1967). Moynihan, referring to gulls, thought that the principal advantage of their resemblance was that it assisted in their acting as one species where joint action was beneficial. On Coquet Island, the Common, Arctic, and Roseate Terns, and the Black-headed Gulls, readily attack avian predators, which is obviously to their mutual advantage.

The fact that most colonial seabirds are conspicuously coloured must confer an advantage to offset their conspicuousness to predators - either of themselves or their offspring. It has been suggested that the predominant white coloration of seabirds probably facilitates the congregation at the beginning of the breeding season. Also, this coloration will enable birds to detect others feeding, which is important when the food supply is sporadic in its abundance as it occurs as fish shoals (Armstrong, 1946, 1965). Another factor that might favour a light coloration in seabirds, especially the counter-shading with a lighter underside, is that the fish prey might not detect the bird hovering above the water.

It has been shown that the Sandwich Tern differs from the other species of terns studied in the shorter time it spends in the nesting area. Some of the difference is explicable by the adults arriving in the subcolony already paired, and by the departure of the young at an early stage, but the subcolonies themselves show a synchronised pattern of laying. It was found that different sub-

colonies often differed in the breeding stage of their members. Usually the differences were only a few weeks, although up to 57 days' difference was recorded in one case. A similar synchronisation within a subcolony occurred in the Roseate Tern. This phenomenon has been observed in the Greater Flamingo Phoenicopterus ruber roseus Pallas (Lomont, 1954; Gallet, 1949); Gentoo Penguin Pygoscelis papua Forster, and Rockhopper Penguin Eudyptes crestata Muller (Roberts, 1940); Black-headed Ibis Threskiornis melanocephala (Latham) (Hoogerwerf, 1937); Arctic Tern (Bullough, 1942); American White Pelican Pelecanus erythrorhynchos Gmelin (Behle, 1944); Kittiwakes Rissa tridactyla (L), Guillemots Uria aalge (Pontopp) and Razorbills Alca torda L. (Perry, 1940); Common Terns and Guillemots (Salomonsen, 1943) and Gannets (Nelson, 1967). Most of these observations were merely general impressions gathered from brief visits and, often, no attempt was made to record the difference in reproductive stage between the groups. However, these observations do suggest that synchronised groups are common in colonial birds.

The subcolonies of the Roseate Tern are less synchronised than those of the Sandwich Tern, and the density attained in the subcolonies of the former is much lower. Whether the difference in synchronisation is a function of the density is not known, but in the Common and Arctic Terns which nest much more dispersed, there are no subcolonies or extreme synchronisation. Although a function has been suggested for the synchronous subcolonial habit in the Sandwich Tern, it is questionable how the synchronisation is achieved. It may be

that pairs at a similar physiological state aggregate into a pre-breeding flock which subsequently forms a subcolony, or that pairs are able to influence each other so as to increase synchrony, or both. From the formation of subcolonies it would appear that the former is more likely, although the dense flocking and nesting behaviour would allow an improved synchronisation by mutual stimulation.

Social stimulation was first suggested by Darling (1938), where he said it allowed larger colonies of Herring Gulls to lay earlier and over a shorter space of time than small colonies. However, critical assessment of his data failed to reveal any significant difference with these factors in the colonies he compared. Also, Davis (1940) has criticised Darling's hypothesis since in larger colonies there is a greater chance of a bird meeting another of the same physiological state. Coulson & White (1960) have shown that in large colonies of Kittiwakes the duration of laying is longer than in small colonies, where they thought the greater range of densities lead to less synchrony in the former. In the Sandwich Tern subcolonies, size was not found to correspond to the duration of laying, except that very small colonies (<10 nests) had a short duration of laying.

The resemblances between the Sandwich Tern and the Greater Flamingo have been described by Swift (1960). Both species have high nesting densities with small compact groups or subcolonies, each synchronised. Swift considers that social stimulation in the

Flamingo results in synchronised laying within the group which allows the young to be reared in large groups, affording protection against predators. He concludes that social stimulation advances maturation, and subsequently laying and hatching, which is of survival value, where progress in drying up of the breeding site would allow mammalian predators access to the colony. However, social stimulation need not be invoked for the selection of rapid maturation of the Flamingoes' gonads. Also, synchronisation in the Sandwich Tern subcolonies may be effected by birds of similar maturation states forming pre-breeding groups, but since the average length of laying in a Sandwich Tern subcolony is 18 - 20 days, there appears to be a limit to the difference in the maturation state that can be incorporated into a subcolony. A similar criticism might be made of the study of three groups of Gannets on the Bass Rock, Scotland (Nelson, 1967). In the Gannet, a high degree of synchronisation would be selected so that hatching and fledging coincides with an abundant food supply.

The average clutch size normally shows either little variation or a seasonal decline in the other terns, but tends to reach a maximum in the Sandwich Tern when most individuals in a subcolony are laying. That the period of maximum clutch size is not consistent between subcolonies, since they are at different stages of reproduction, it cannot be closely correlated with abundant food supply. The selective advantage of laying a large clutch when most birds are laying is not known, but it might be that better

quality birds are able to synchronise their laying times more, which will be an advantage in a dense group where co-ordination of breeding activities will be less disruptive. The importance of this co-ordination is seen more clearly when considering hatching success, for desertions account for the major failure of eggs, and this is more prevalent when the majority of birds have hatched their eggs and after five days have led their chicks away from the conspicuous colony area.

In 1965, nests in the centre of the large Sandwich Tern subcolony were found to have a significantly higher hatching success than those on the perimeter; and in 1966, a compact subcolony tended to have a higher hatching success than a diffuse subcolony, although this difference was not significant. The lower success of birds nesting on the edge of groups has been recorded by Patterson (1965), where he found Black-headed Gulls nesting inside the colony were more successful than those nesting on the edge. Coulson (1968) has reported that in Kittiwakes the mortality of the adult male is significantly higher in those nesting at the edge of a colony, and that the average clutch size, hatching, and fledging success, is higher in the centre of the colony. This variation in success associated with the position in the colony, or subcolony, suggests that there is a graduation in the quality of birds from the centre to the edge, with better birds securing and maintaining positions in the centre of the group. In the Kittiwake, male birds nesting on the perimeter have been found to be significantly lighter in weight

which could reflect this difference in quality (Coulson, 1968).

However, in Sandwich Tern subcolonies of less than 20 nests, hatching success is significantly lower than in those with more than 20 nests ($p = <0.001$ for 1 d.f.); and although it might be argued that these small subcolonies have a higher proportion of birds nesting on the edge, the failure of eggs is due principally to desertion by unsynchronised birds. It is difficult to see how poorer quality birds would be forced to nest in small, rather on the edge of a large, subcolony since nest sites are not limiting in the Sandwich Tern nesting areas. However, it may represent a failure of the individuals to synchronise themselves sufficiently to join a large group. This would suggest that there is a gradation from the centre to the edge of a large subcolony, in the quality of birds nesting, and then to small subcolonies where birds were not capable of joining a large group. However, no examination has been made on the adults that comprise different subcolonies in a Sandwich Tern colony to ascertain the age, experience and weight of birds in different nesting positions.

The four species of tern nesting on Coquet Island all exhibit silent co-ordinated flights from the nesting area called "dreads" or "panics" (Marples & Marples, 1934) which are derived from escape behaviour, but seem to have acquired a synchronisation function. Those relating to the Sandwich Tern have a closer and more integrated flocking formation than the other terns, taking on the form of a silent collective upflight followed by much chattering

as the birds resettle. In this species, these upflights occur by subcolony which has been seen in the Roseate Tern as well (Serventy & White, 1951). Lind (1963) has described these upflights more fully and reports that they appear to occur periodically early in the season where they "may be due to an accumulation of escape behaviour", although he considers that such flights could help to synchronise early reproductive behaviour. It seems that this close flocking behaviour, occurring frequently in a spontaneous manner prior to laying, could provide a mechanism for greater synchronisation than is possible in the other species of tern studied.

b) Competition and closely related species

In "The Origin of Species", Darwin (1859) said that "competition is most severe between allied forms which fill nearly the same place in the economy of nature". Since then, several workers, notably Gause (1934) have dealt with the significance of competition. From Gause's observations, particularly of laboratory experiments, the so-called "Gause hypothesis" has been incorporated into biological thinking. This hypothesis has been given many definitions such as "two species with similar ecology cannot live in the same area" (Lack, 1945), "two species with identical ecological niches cannot survive together in the same environment" (Crombie, 1947) and "two species with identical ecological requirements would be subject to competition" (Mayr, 1948). However, Gilbert et al (1952) commented that Gause drew no general conclusion such as these bearing his name and was "content to show that in his cultures the equations

developed theoretically by Haldane, Volterra and Lotka for competing organisms appear to hold". Gause (1934) does refer to various observations, such as those of Formosov on terns where different species looked for food in different areas, and observations of this type have since been paralleled for many animals, and given as supporting evidence for the "Gause hypothesis".

Several workers, notably Gilbert et al (1952) and Klomp (1961) have indicated the looseness of the various definitions of the Gause hypothesis. The former refer to Formosov's observations as concerned with "ecologically similar" animals not living together, but supporting a Darwinian hypothesis that, in a population of a species, mechanisms which will reduce competition tend to persist. The phrase "ecologically similar" could refer to sessile animals which have a substrate in common, but where no close taxonomic relationship is necessarily involved. Gilbert et al say that "same ecology" does not imply "identical ecology" which they consider "an improbable state"! However, when considering competition, two types can be differentiated, one intraspecific and the other interspecific. If the concept of a species is to be upheld, intraspecific competition will involve animals with similar requirements living in similar niches, although certain individual variations will occur. However, in interspecific competition, close taxonomic affinity is usually considered to imply relatively minor morphological differences and therefore a close similarity in mode of life. This situation is considered to increase the likelihood of competition between the two or more species involved!

Most of the evidence that closely related species are frequently competing for the same environmental resources is the so-called "exclusion principle" (Mayr, 1963). This has been described by Lack (1949) when considering the four possible consequences when two closely related species overlap :

- (1) One species is superior and eliminates the other, but this can only be proved during displacements as with the introduction of the Grey Squirrel Scuirus carolinensis Gmelin and its effect on the Red Squirrel S. vulgaris L. in some areas (Shorten, 1954).
- (2) If one species is superior in one part of the range and the other in another part, so there is only slight geographical overlap.
- (3) One species is superior in some habitats and the other in other habitats so that there is geographical exclusion, as occurs in allopatric pairs, e.g. Jays Cissilopha spp. (Selander & Giller, 1959); Chaffinches Fringilla spp. (Lack & Southern, 1949).
- (4) When both species occur in the same habitat, but occupy different niches* and this includes most examples known.

It is necessary to consider the definition of competition since there is some confusion in the literature which has been deliberated upon by several authors (Crombie, 1947; Udvardy, 1951;

* niche = place in the total community that a species is enabled to occupy by virtue of its adaptations (Thompson, 1964).

Lack, 1954; Elton & Miller, 1954; Birch, 1957; Williamson, 1957; Milne, 1961; Klomp, 1961; Mayr, 1963). Milne (1961) considered the various definitions in the literature to that date and found that given by Clements & Shelford (1939) the least ambiguous - "the process (of competition) may be defined inclusively as a more or less active demand in excess of the immediate supply of material or condition on the part of two or more organisms". Milne thinks that competition should not include predation, unlike Crombie (1947), Williamson (1957), Odum (1959), whilst Nicholson (1933, 1957) treated competition as a density-dependent factor, and since predation is density-dependent, it is therefore a form of competition. Instead, Milne (1961) states that competition is only one component of the struggle for existence of which physical conditions, parasites and predators are others, and defines competition as "the endeavour of two (or more) animals to gain the same particular thing, or to gain the measure each wants from the supply of a thing when that supply is not sufficient for both (or all)."

In contrast, Thompson (1939), Ulliyet (1950) and Dobzhansky (1950) have suggested that the term "competition" be avoided because of its implications and ambiguity. Definitions include both intra- and interspecific competition and have one point in common : "the fact that two or more animals make use of the same resource of the environment the supply of which is short. " In other words, competition will occur when two or more animals cohabit and must share one or more of their needs with the effect that these

needs cannot be satisfied. Hence competition will have some deleterious effect on at least part of the animals" (Klomp, 1961). Competition will lead to an increased death rate or lowered birth rate, and this will lower the chance of survival, and competition will become more intense at higher densities. However, genetic variability will affect the chances of survival of the individuals involved which will be greater when more than one species is involved.

Park (1954) has demonstrated the elimination of one species by another in experiments involving grain beetles, but he showed that elimination could occur through the habitat becoming unsuitable and not because of competition. Therefore, it is necessary that both species should be able to exist in the habitat by themselves before competition can be held responsible for the elimination of one species. Park concluded that competitors are members of the same trophic level within the community and the intensity of competition is directly related to ecological similarity. Lack (1954) has said that the restricted fluctuations of animal populations imply some density-dependent mechanism, and concluded that there was a limited number of places for a particular species determined by a complex of factors. Klomp (1961) indicates that closely related species will be generally ecologically similar with respect to most, if not all the factors of the environment, so that mechanisms of control will overlap. He considers that one species may penetrate and occupy places belonging to another species, and so compete for a limited number set by the control. This suggestion is similar to that expressed by Wynne-

Edwards (1962) in which related species may form a single dispersionary unit, i.e. each setting up a territory to exclude the other. Wynne-Edwards considers that competition is restricted to the conventional substitute of territory, preventing over-exploitation of common food resources, so "presenting a radical antithesis of Gause's hypothesis". However, Wynne-Edwards fails to provide convincing evidence that animals are not directly limited by the available resources of the environment. Klomp (1961) considered that two species might compete for the same food with no evidence of a struggle and concluded that competition could be defined as "the process occurring between animals living in the same habitat or medium and the numbers of which are limited by the same mechanism of control". This definition is very similar to that proposed by Milne (1961), as it is the endeavour of animals to secure a requisite from a limited number.

Hinde (1959) has said that "in most cases where closely related species with similar ecology live together, their numbers are controlled by parasites or predators, so that they do not effectively compete". Klomp (1961) maintains that such a situation would only occur if the prey species is partly or wholly regulated by parasites or predators which is very doubtful in most vertebrates (Lack, 1954). Lotka (1932) showed that an equilibrium state could be reached under definite mathematical conditions, but this has not been achieved experimentally owing to the formation of microhabitats. However, most cases of stable polymorphism represent processes of

intraspecific competition resulting in co-existence (Klomp, 1961). This situation occurs when an allelomorph is at an advantage when rare, but at a disadvantage when common, but this has only been demonstrated for prey species, e.g. Cepaea spp. (Sheppard, 1959).

Elton (1946) found that from examination of the faunal lists of various areas that there was a strong tendency for several species of a particular genus to be distributed as ecotypes in different habitats, or unable to co-exist in the same area of the same habitat. Elton attributed this to a result of competition between congeneric species. Moreau (1948) in an examination of 172 species of birds in the African tropics belonging to 92 genera, giving a possible 173 congeneric overlaps and 1474 overlaps between species of the same family; 94% and 98% respectively, were ecologically isolated. The ecological exclusion of congeneric songbirds has been described (Lack, 1944); and similar species occurring together, but having distinctive diets have been described with reference to the Shag and the Cormorant (Lack, 1945). Some animals search for the same food in different areas as in the tits Parus spp. (Gibb, 1954; Betts, 1955), American Wood Warblers Dendroica spp. (MacArthur, 1958) and in psocids (Broadhead, 1958).

In this study, four closely related species of terns have been examined. They all nest in close proximity to one another on Coquet Island and obtain their food from the surrounding sea for themselves and their chicks. These four species are adapted to capturing small marine fish, crustaceans, squids, etc. by diving

from the air to just beneath the surface of the sea. There are size differences, the Sandwich Tern being considerably larger than the other three species. The Common Tern is only slightly heavier than the Roseate Tern, but the former has a larger wing span. The Arctic Tern is the smallest tern by weight, though its wing span is similar to that of the Common Tern. The Roseate Tern has a longer tail streamers than the other species. The tarsi of the Roseate and Common Tern are of similar length, but those of the Roseate Tern are proportionally longer. The tarsi are very short in the Arctic Tern. These various morphological differences will affect the aerodynamics, diving ability, and movement on the ground of these species.

Austin (1929) related the different tarsal lengths of Roseate, Common and Arctic Terns to their choice of nesting sites, each species choosing areas of vegetation that would allow easy passage to and from the nest. However, the difference becomes apparent only when these species nest together (Bent, 1921; Marples & Marples, 1934; Fisher & Lockley, 1954; Serventy & White, 1954; Boecker, 1967). On Coquet Island, the four species have distinct preferences, though the Sandwich Tern is less rigid in its choice of nest site, preferring level ground. The division of Arctic and Common Tern nest sites is a distinct geographical one, and the Roseate Tern nests in a different niche to the other species. These specific nest sites indicate that a species is at an advantage over the others when it nests in a particular area or niche. It appears

that the choice of distinctive nest sites avoids competition, for there was no evidence of active expulsion of one species by another species. However, although an Arctic Tern might find it difficult to nest in dense or tall vegetation, the reason why Common Terns do not nest in areas of short or no vegetation is not obvious, particularly when it does so when the Arctic Tern is absent (Marples & Marples, 1934). Also, Fisher & Lockley (1954) state that the Arctic Tern nests in areas of considerable vegetation in the Farne Islands where the Common Tern is absent. Since each species seems capable of nesting in the niche occupied by the other, the population on Coquet Island, at least of Common and Arctic Terns, appears to be limited by the available number of their respective niches.

The Roseate Tern is not short of suitable nest sites, especially since these situations vary from year to year and, also, the numbers nesting have had relatively large variations over the three years. Similarly, the Sandwich Terns have shown very marked changes in the numbers nesting in the three years. In contrast, the numbers of Common and Arctic Terns appear relatively stable, apart from the decrease caused by major environmental changes as in 1966. It would seem that the choice of nest site is governed by morphological adaptations, together with possible behavioural ones, but the actual securing of a nest site is determined by the numbers of each species present. Where one species is in a minority, sites normally occupied by it might be used by a more abundant species.

Site availability will only determine the total numbers of terns nesting which will vary from species to species according to the density of their nests. The relative numbers of each species laying is determined by environmental factors such as climatic conditions and relative abundance of certain foods. However, in 1967, the marked increase in the number of Sandwich Terns nesting forced Common and Arctic Terns to nest elsewhere, since the Sandwich Terns are the first to nest, and their dense nesting habit and guano-spattered nesting areas make it unsuitable for Common and Arctic Terns. This situation would restrict the numbers of Common and Arctic Terns nesting on a small island the size of Coquet. The numbers of Sandwich Terns nesting on Coquet Island will be determined by the suitability of the environment.

Since the island has become re-colonised by terns only since 1958, it cannot yet be viewed as a stable situation. Observations over three years (1965-67) indicate that there is a vegetative succession involving the colonisation of short grass by Sheep's Sorrel which will favour an increase in the numbers of Common Terns nesting at the expense of Arctic Terns. The less palatable sorrel is not checked to any extent by the Rabbits which are likely to suffer from this succession as well. The increase of Stinging Nettles is detrimental to all species of tern on the island; so that actual numbers of terns nesting on the island may be considered to be markedly influenced by the available sites.

The nature of interspecies differences in food selection has been outlined by Hinde (1959) who describes four types of differences :

- (1) Difference in feeding habitats, where closely related species take similar foods, but geographical separation avoids competition.
- (2) Difference in the location of feeding within a given habitat (niche selection) such as occurs in tits, where segregation depends on height and part of tree searched (Hartley, 1953; Gibb, 1954).
- (3) Differences in size of food taken, though by no means absolute; as in Hawaiian Honeyeaters Drepaniidae (Baldwin, 1953) and Galapagos finches Geospizinae (Lack, 1947; Bowman, 1961).
- (4) Differences in nature of food taken, as in the Great Tit Parus major L. which is the only tit to feed on hazel nuts.

The food of the four species of terns (at least that fed to their chicks) was similar, but closer examination revealed certain differences along the lines outlined above.

In considering the area of fishing of the four tern species, only the Sandwich and Common Terns frequented inshore areas. Unfortunately, observations of Roseate Terns were insufficient to discern any difference in the fishing area, but it is probably similar to the Arctic Tern which fed almost exclusively in offshore areas. The Sandwich Tern fished mainly in shallow sandy bays, whereas the Common Tern showed no preference. Unlike terrestrial

habitats, the sea is less distinct in its division of feeding niches for seabirds, and in species that have similar feeding methods, feeding habitats are not so distinct. Nevertheless, the Arctic Tern is quite distinct from the Sandwich and Common Tern which feed predominantly inshore. In areas where these latter species are absent, the Arctic Tern is found breeding and feeding in inland bodies of water (Voous, 1960).

Related to these differences in feeding area is the effect of weather, notably wind speed on the fishing activities of the Common, Roseate and Arctic Terns. The effect of wind speed on feeding was measured by recording the daily weight increase of the chicks of each species. It was found that wind speed had a far more detrimental effect on the feeding rate of the Common Tern, where a 10 knot wind reduced the average growth rate by half, than in the Arctic Tern where it had no effect. The greatest effect occurred with the Roseate Tern where a 10 knot wind reduced the average growth rate to about one third of the original weight increase. The advantage of the Common Tern feeding inshore is that it would decrease the effect of wind, especially since the prevalent winds are offshore, whereas the Arctic Tern is unaffected. However, the Roseate Tern is an anomaly since, although it is affected by wind the most, it appears to feed offshore.

The reasons why increasing wind speed should make fishing difficult could be due to the ruffling of the water's surface and the difficulty of hovering above the water, but why this should be

difficult for some species and not others is not obvious. Presumably, the difference depends on adaptations of a particular species. If the ratio of wing length to adult weight is considered for each species, there is a descending series from the Arctic Tern (2.45), Common Tern (2.15), Roseate Tern (1.86) to the Sandwich Tern (1.34); so that the Arctic Tern has the lightest wing loading of the four species. Although the Common and Roseate Terns have similar body weights, the latter has much shorter wings, hence the lower ratio. Although these ratios are based on wing length, and not wing area, their trend suggests that these differences may be responsible for the different effect of wind speed. The Sandwich Tern is a much larger bird, so that the ratio would be expected to be lower, but it would be valuable to know the effect of wind speed on its feeding rate.

In all three years, it was possible to observe some Roseate Terns clepto-parasitising the other species. Common Terns were most frequently robbed, although Sandwich and Arctic Terns were occasionally attacked. From these observations it appears that some Roseate Terns find robbing incoming terns more profitable than fishing for themselves. However, there were insufficient observations to detect whether clepto-parasitism was more common on windy days than calm days. Since the Roseate Tern finds it harder to feed its chick on the former, it might be expected to rob the other terns more, since the incoming fish would not be greatly reduced, although windy conditions also suppress the fishing success

of the Common Tern. Nevertheless, in 1967 when clupeoids were particularly abundant, several Common Terns specialised in robbing adults and chicks of their own species.

If the size of the food taken is considered for each species there are some differences; although there is considerable overlap between the three smaller species, the Arctic Tern takes slightly smaller fish. The Sandwich Tern takes larger fish than the other species. In general, the clupeoids taken by the four species are larger than the Sand eels, although the difference is very small in the Arctic Tern. This difference between clupeoids and sand eels is most likely determined by availability. That the Common Tern catches larger fish - a higher proportion of heavier clupeoids - than the Arctic Tern, may be partly due to its larger size and its different feeding area. Similarly, the larger Sandwich Tern catches a high proportion of clupeoids, also feeding inshore.

On Coquet Island, sand eels and clupeoids formed the bulk of the food of the chicks, and probably of the adults as well, although the latter may take more smaller items such as crustacea (see Collinge, 1926; Boecker, 1967). The percentage of clupeoids brought to the ternery increased during observations made through July in all three years, although only the food of the Common Terns was recorded in 1967. The proportion of clupeoids in the Sandwich, Roseate and Common Terns was usually 70 - 100%, although a higher proportion of sand eels was brought in during 1966. The Arctic

Tern fed its chicks on a much higher proportion of sand eels than the other tern species, since they formed 40-60% of the total fish. In 1966, these proportions rose to 94% in the Arctic Tern, and 70% sand eels in the Common Tern. Another independent watch over the same period (July) in 1966 resulted in the Arctic Tern taking 84% sand eels, the Common Tern 54%, the Roseate Tern 57%, and the Sandwich Tern 71%. Therefore, although the Arctic Tern feeds its young on more sand eels than the other species, there is a considerable overlap in prey species taken by the four terns.

The overlap in food species taken is similar to that occurring in birds of prey. Lack (1946), comparing the food of German Falconiformes and Strigiformes, found that no two species, whether congeneric or not, competed for the same food in the same habitat, except for the predators of the vole Microtus arvalis L. This vole is the staple food of several species of hawks and owls of which up to five, although none of these are congeneric, occur together in the same habitat. Lack suggested that these predators do not compete with each other because Microtus arvalis is super-abundant most of the time, and when its numbers are low each predator changes to a different prey. Also, Lack refers to the seasonal abundance of other foods such as caterpillars, fruits, and seeds in which the same food may be eaten by a variety of animals. He states that "the foods in question are temporarily so much more abundant than the requirements of their consumers

that the latter do not effectively compete with each other while eating them; and that this may still be true even if the food in question temporarily provides the bulk or even the whole of the diet of the species involved". It seems that a similar situation exists in the tern species studied which fed on abundant sand eels and clupeoids. In 1966, most species appeared to be feeding on crustaceans early in the season and, later, there was a much higher proportion of sand eels in the diet of the chicks of each species than in the other two years. In 1967, Sprats were abundant, as indicated by the large landings at North Shields from grounds north-east of the river Tyne, and Sprats were more common in the diet of the chicks in all species. This evidence suggests that the diet of the four species of terns will vary in parallel, according to the abundance of their principal prey, sand eels and Sprats. If sand eels and Sprats are superabundant during the breeding season, differences between the tern species as regards prey will be obscured. Observations on the convergence of several species on a shoal of sand eels or Sprats supports this suggestion. It appears that competition is unlikely to occur in obtaining food during the summer. It is considered that the food differences found are no more than specific preferences which are subject to marked variation, at least in the Arctic and Common Tern (Boecker, 1967), depending on the prey species present, and are not evidence of competition. However, studies on these terns in their winter quarters may indicate that these preferences avoid competition when food is not very abundant.

All the four species have a post-fledging dispersal, followed by a migration to the winter quarters, although the chick may still be dependent on the parents for some food in the early stages of this southward movement. The Common, Roseate, and Sandwich Terns over-winter mainly in the tropics, the first two species principally just north of the equator along the West African coast, while the Sandwich Tern is more wide-ranging. However, the Arctic Tern penetrates beyond these equatorial waters and into the Antarctic seas, which means that it has to migrate faster than the other species. Also, the Arctic Tern has to delay its wing moult until this long journey is completed, instead of having a gradual moult as it migrates south as in the other three species (Salomonsen, 1967). It is likely that the Common and Sandwich Terns maintain an inshore existence in the winter quarters, and possibly the Roseate Terns as well; whereas the Arctic Tern leads an even more offshore one, now that it is no longer tied to its breeding colony, and assumes a pelagic existence. In the second summer of life, the Common, Roseate, and Sandwich Terns are found in the tropical belt, although recoveries indicate that the two latter species move slightly northwards, yet it is rare for them to penetrate North European waters. The Arctic Tern moves north, which is necessary, considering that conditions are now adverse in the southern hemisphere - with food becoming scarcer and daylength shortening.

The different winter quarters of the Arctic Tern means that it does not compete with the other species in the poorer tropical waters. Also, its adaptation to feeding in high winds can be seen to have greater significance than permitting a distinct feeding area in the breeding season. There was relatively little overlap in the size of food taken by the Common and Sandwich Terns in the breeding season, and this is likely to be emphasised in the tropics. Although knowledge of the food and feeding area of the Roseate Tern is too inadequate to suggest any distinctive ecology, its morphological differences pre-suppose that it might have differences that were not detectable in the small colony on Coquet Island.

Apart from indirect exclusion in nest site selection, there is no evidence of effective competition between the four closely related tern species studied in the summer months in the vicinity of Coquet Island. However, preferences and/or differences exist in their food and feeding areas which may be of survival value when food is limited. Apart from a small zone in the breeding area, the Arctic Tern is separated geographically from the other three species, and it tends to expand its habitat when these species are absent. In the other three species there is considerable overlap in the breeding season, although this may be very much reduced in the winter. Also, the size differences of food and habitat differences may be exaggerated in the winter quarters. However, on Coquet Island at the moment, the populations

of terns seem capable of self-maintenance, though small environmental changes could cause temporary extinction at least, especially in a minority species like the Roseate Tern. Present conditions, such as mutual protection and food resources, suggest that the advantages of the four species breeding in close association with one another outweigh those favouring each forming an isolated colony.

SUMMARY

1. Introduction

The study of four closely related species of terns, nesting in close proximity, in order to compare their biology. The four species were the Common, Arctic, Roseate and Sandwich Tern. Their breeding biology was studied in 1965, 1966 and 1967 to find out whether any species competed for a common resource.

2. Study Area

Coquet Island, Northumberland, England. ($55^{\circ}37'N.1^{\circ}37'W$)
Description of vegetation and historical knowledge of bird population.

3. Occupation

Black-headed Gulls occupy the Island prior to the terns. The Sandwich Terns arrive first and begin to nest in groups around the Gulls' nests. Later, the Common and Arctic Terns nest, and lastly the Roseate Terns. These last three species do not begin laying until they have been on the island for two weeks.

4. Laying

The Sandwich Terns lay first, then the Arctic and Common Terns, and lastly the Roseate Terns. The variation in laying dates for three seasons is greatest in the Roseate Terns and least in the Sandwich Terns.

5. Nest site preferences

The Common Terns were found to nest almost exclusively in vegetation more than 10cm high, often composed of Sheep's Sorrel. The Arctic Terns nested in short vegetation, less than 5cm high, or on sand and rock. The Roseate Terns nested under vegetation, in burrows or depressions, or under rocks. The Sandwich Terns choose areas of level ground with variable vegetation.

6. Synchronisation of laying

Although all the species have synchronised laying, it is more pronounced in the Sandwich Terns. In this species, individual subcolonies have very synchronised laying. The duration of laying within subcolonies was similar in all three years, irrespective of size. This synchronisation contracted the time spent in the subcolony. The Roseate Terns were intermediate between this species and the Arctic and Common Terns.

7. Clutch Size

The average clutch size of the four species in 1965, 1966 and 1967 varies slightly over the three years, and was lowest in all species in 1966. There was no definite correlation of clutch size and population size. The clutch size is smallest in the Sandwich Terns, then the Roseate and Arctic Terns, and largest in the Common Terns. Clutch size variation with latitude was only discerned in the Arctic Terns. Variation in clutch size with season was found in the Common and

and Roseate Terns and possibly the Arctic Terns, but not in the Sandwich Terns. Clutch size variation within Sandwich Tern subcolonies was found to be positively correlated with the number laying at that time, suggesting that social stimulation may be important.

8. Incubation Period

The incubation of the four species was found to vary with species and clutch size. The variation with clutch size is caused by incubation not beginning with laying of the first egg, but before the second egg except in a three egg clutch.

9. Hatching success

This is examined with respect to clutch size and year. The Common and Arctic Terns had their lowest success in 1966, but the Roseate Terns had a consistently high hatching success in all years. The Sandwich Terns showed an increasing hatching success through the three years. In this species, hatching success was significantly greater in subcolonies of more than 20 nests which were more common in 1966 and 1967. Synchrony of laying was found to increase the hatching success.

10. Fledging success

This is examined with brood size and season. There was a seasonal decline in the Common Terns, but this was not found in the other species. The fledging success is similar for singles, and first chicks of broods of two and three, but lower for second chicks, and even lower for third chicks. In

all four species, the mortality of chicks occurs mainly in the first week of life.

11. Chick survival

The higher mortality of second and third chicks results from asynchronous hatching; and of the four possible causes of this mortality, (1) predation, (2) climatic factors, (3) disease, are discarded, but (4) starvation is most likely. However, food requirements of a brood of three Common Tern chicks in their first week is not sufficiently demanding to account for the death of most third chicks. From hide watches it seems that one parent cannot obtain sufficient food for all three chicks, since the other parent is stimulated to brood at least the last chick. The restriction of food finding to one parent in certain years results in the first and second chicks obtaining sufficient food, but the third chick dies of starvation. It is thought that a similar situation accounts for the higher mortality of second chicks in broods of two in this and other species. In years when food is very abundant, the mortality is much lower.

12. Feeding and weather

The effect of weather on the feeding of terns was studied by recording the daily weight increases of the chicks under various climatic conditions. First and second chicks of a brood of two Common Terns were found to fluctuate in parallel. On both days of good and poor feeding, the average weight increase

was largest in first chicks, but the differences were more noticeable on poor days. However, the second chicks still obtained a significant proportion of the food.

(a) Wind speed : This was the most important weather factor analysed. Its greatest effect occurs in the Roseate Terns where a wind of 10 knots reduces the growth rate to less than a third of the average. It has a less, but still marked, effect in the Common Terns where a 10 knot wind reduces the growth rate to about half the average. It has very little effect on the Arctic Terns; and in very strong winds observations showed this species to be bringing in more fish than when the wind was less strong.

(b) Rain : Days with adequate rainfall were too few for statistical analyses, but it always had a depressive effect on the growth of Common, Arctic and Roseate Terns.

(c) Sunshine : This has a variable effect in both Common and Roseate Terns, but has a consistent positive effect on the average weight increase in the Arctic Tern chicks.

13. Food of terns

The food of the different species was examined by recording the food brought in by the parents to feed the chicks.

(a) Species : Although the proportion of sand eels taken by all species was greater in 1966 than in 1965 and 1967, certain differences emerged in the proportions and the size of clupeoids and sand eels taken. In the Common Terns, less than 30% of the

chicks' diet was composed of sand eels, but in the Arctic Tern these comprised over 60%. The Sandwich and Roseate Terns were found to take a greater proportion of clupeoids, except in the abnormal year of 1966. Clupeoids are heavier than sand eels of equivalent length and so provide more food per fish.

(b) Size : The Sandwich Terns take significantly larger fish to feed their chicks, but the average differences between the other three species were not biologically significant with regard to the size of fish taken.

14. Feeding area

There were significant differences in the areas in which each species fished. The Sandwich and Common Terns occurred mainly inshore, and the former species preferred to fish in shallow sandy bays. The Arctic Terns were rarely seen inshore and were found to feed mainly offshore. There were too few observations on the Roseate Terns to ascertain their main feeding area, but they were rarely seen inshore. The different feeding areas may indicate the areas where the preferred prey is abundant : Sandwich and Common Terns finding clupeoids inshore, whereas Arctic Terns will obtain small sand eels offshore. However, the Arctic Terns occur as a breeding species on inland bodies of water only when the other species are absent, suggesting that competition may occur.

15. Diurnal feeding activity

The Common Terns were found to have a peak of activity early in the morning, after which activity dropped slightly until dusk when it stopped rapidly. However, the feeding rate was normally high throughout the day.

16. Adult measurements

The Arctic Terns, but not the Common Terns, showed a significant drop in adult weight during the breeding season. Weights and wing lengths showed that the Roseate Terns have a higher wing loading than the Common Terns which, in turn, have a higher wing loading than the Arctic Terns. The greatest wing loading occurs in the Sandwich Terns, but this is much larger than the other species.

17. Dispersal and migration

Analysis of the ringing recoveries of birds ringed in the British Isles revealed two main types of movement (1) a radial post-fledging dispersal, and (2) a north-south migration to and from the winter quarters to the breeding area. The post-fledging dispersal is similar in all species, but migration occurs more rapidly in the Arctic Terns. This species has to travel farthest to its winter quarters in the Antarctic oceans - a pelagic existence. The Common and Roseate Terns from Britain over-winter just north of the Equator, along the west coast of Africa, but the Sandwich Terns, also coastal, have a more extensive winter range down to South Africa. The Arctic Terns

move north in the second summer to avoid the southern winter. Most of the species visit breeding colonies in their third summer and begin breeding in their fourth summer, but normally it may be later in the Sandwich Terns. The winter quarters for the adults appear to be the same as those of the juveniles, except in the Sandwich Terns, where the adults may not penetrate so far south.

18. Discussion

(1) Colonial breeding and synchronisation : The advantages of colonial breeding in seabirds are discussed. The importance of social stimulation is described with particular reference to the Sandwich Terns. In this species, dense nesting favours social stimulation which increases synchronisation - resulting in the Sandwich Terns spending less time in a vulnerable situation. The Arctic and Common Terns are more reliant on camouflage and the more dispersed nests are not so vulnerable. The Roseate Terns are intermediate between these two types.

(2) Competition and closely related species : Definitions of competition are critically presented with examples of studies on closely related species. There is no evidence of active competition between the tern species on Coquet Island, but there is a distinct division of nest sites implying exclusion, since a species in question is more catholic in its choice of nest site when the other species are absent. Although differences were found in the proportions and size of fish, and area of

fishing in the species, related to various adaptations, there was often considerable overlap. It is possible that these differences are important in the winter months when food is not abundant. Nevertheless, in the breeding season the four species associate to form a multiple species colony.

APPENDIX I.

SANDWICH TERN SUB-COLONIES IN THREE YEARS ON COQUET ISLAND

Sub Col- onies	1965				1966				1967			
	Size	Dura- tion	4 S.D.	5-95%	Size	Dura- tion	4 S.D.	5-95%	Size	Dura- tion	4 S.D.	5-95%
1	6	27	45.6	27	114	44	33.7	28	40	29	34.6	27
2	9	3	2.0	3	99	27	23.0	25	107	27	19.4	21
3	5	3	3.5	3	58	15	12.6	11	296	24	12.5	11
4	21	46	46.8	31	51	14	11.5	13	61	21	12.8	18
5	15	11	5.8	11	17	8	10.0	7	77	13	10.1	9
6	9	3	3.5	3	7	6	7.5	6	88	24	17.4	18
7	15	7	13.7	7	53	17	21.0	16	70	20	15.2	15
8	12	12	13.0	10	145	18	15.8	15	209	23	17.4	17
9	23	18	20.0	13	79	33	26.0	17	67	21	19.9	19
10	179	45	36.0	35	56	16	12.0	10	99	26	23.4	24
11					8	3	3.0	3	37	22	23.8	20
12					6	3	3.1	3	25	11	8.0	9
13					87	34	29.1	24	50	23	11.1	14
14									12	12	11.1	5
15									51	23	22.7	23
16									14	11	12.2	11
17									314	22	22.3	19
18									89	29	32.6	28
Av.	29.4	18.0	19.0	14.3	56.9	18.3	16.0	13.7	94.8	21.2	18.2	17.1

APPENDIX 2a

CLUTCH SIZE VARIATION IN SANDWICH TERN

SUBCOLONIES IN 1965

4-day Period	S U B C O L O N I E S												Total Av.	Total N
	1	N	2	N	3	N	4	N	5	N	6	N		
start 1*			2.00	7									2.00	7
2	1.50	10	1.50	3	1.33	8	1.53	15	1.67	3			1.46	39
3	1.00	5	1.00	3	1.00	5	1.00	2	1.17	6	1.50	2	1.09	23
4			No eggs	0	No eggs	0	1.00	2	No eggs	0	1.22	18	1.20	20
5			" "	0	1.50	2	1.00	3	1.00	3	1.29	45	1.27	53
6			1.00	2			1.00	1			1.42	53	1.41	56
7			No eggs	0							1.13	23	1.13	23
8			" "	0							1.40	5	1.40	5
9			1.00	1							1.06	17	1.06	18
10			No eggs	0							1.50	2	1.50	2
11			" "	0							1.00	3	1.00	3
12			1.00	1							1.00	4	1.00	5
13											1.20	5	1.20	5
14											1.00	2	1.00	2
Total nests	15		17		15		23		12		179			261
Average Clutch Size	1.13		1.47		1.20		1.35		1.25		1.27			

1* - commences on 13 May in all three years

4-day Period	S U B C O L O N I E S																					
	1	N	2	N	3	N	4	N	5	N	6	N	7	N	8	N	9	N	10	N	11	N
Start 1	1.12	17	1.00	16	1																	
2	1.23	49	1.33	27	1.07	42			1.15	13												
3	1.00	20	1.07	30	1.00	11			1.00	4			1.07	28	1.08	47						
4	1.00	3	1.13	16	1.00	4							1.00	7	1.12	17						
5	1.55	11	1.25	4	1.00	2					1.43	14	1.43	7	1.25	4						
6	1.29	7	1.00	2							1.15	72	1.25	8	1.17	6						
7	1.00	2	1.00	3			1.00	17			1.03	39	1.00	1	1.00	2						
8	1.00	2					1.00	24			1.00	11			N.E.	0						
9	1.00	2					1.00	7			1.00	8			N.E.	0	1.00	5				
10	N.E.	0					1.00	3			1.00	1			1.00	2	1.13	28	1.00	14	1.13	8
11	1.00	1													1.00	1	1.05	20	1.07	33		
12																	1.00	2	1.00	24		
13																	1.00	1	1.00	7		
14																			1.00	1		
15																			1.00	4		
16																			1.00	1		
17																			1.00	1		
18																			1.00	2		
Total nests	114		99		58		51		17		145		51		79		56		87		8	
Avg Clutch Size	1.18		1.13		1.09		1.00		1.12		1.14		1.15		1.10		1.07		1.02		1.13	

N.E. = No. eggs laid in four-day period

4-day Period	S U B C O L O N I E S																	
	1	N	2	N	3	N	4	N	5	N	6	N	7	N	8	N	9	N
Start 1	1.28	18			1.00	1			2.00	2								
2	1.37	8	1.25	12	1.30	71	2.00	2	1.17	6			1.00	4			1.00	2
3	1.50	4	1.16	52	1.29	99	1.29	24	1.19	22	1.26	49	1.36	11	1.67	3	1.10	10
4	1.00	2	1.36	22	1.15	82	1.13	24	1.28	39	1.23	90	1.23	40	1.13	23	1.00	15
5	1.00	2	1.00	7	1.14	20	1.13	8	1.00	4	1.05	43	1.20	10	1.26	19	1.00	2
6	1.00	2	1.50	6	1.00	1	1.75	4	1.20	5	1.00	3	1.00	4	1.22	9	1.00	1
7	1.00	6	N.E.	0	1.00	2	1.00	4	1.00	1	1.25	8	1.00	2	1.30	10		
8	1.00	1	1.00	1	1.00	1					1.00	2			1.00	7		
9															N.E.	0		
10															1.42	12		
11															1.33	3		
Total nests	45		120		312		66		114		234		71		86		30	
Av. Clutch size	1.29		1.25		1.21		1.24		1.22		1.25		1.21		1.24		1.07	

Continued overleaf

4-day Period	S U B C O L O N I E S																		
	10	N	11	N	12	N	13	N	14	N	15	N	16	N	17	N	18	N	
Start 1					1.00	1													
2			1.32	19	N.E.	0	1.47	15											
3			1.27	26	1.50	2	1.44	23											
4			1.28	22	1.07	28	1.17	39							1.00	2			
5			1.18	17	1.00	4	1.14	7	1.15	28	1.25	8	1.17	29	1.27	11	1.06	52	
6			1.33	6			N.E.	0	1.13	8	1.14	7	1.00	5			1.21	75	
7	1.00	4	1.33	3			1.67	3	1.00	3	N.E.	0	1.00	2			1.40	73	
8	1.00	1	1.00	2			1.00	1	N.E.	0	1.00	1	1.00	1			1.36	66	
9	1.00	1							2.00	1			1.33	3			1.57	23	
10	1.71	7							1.00	1							1.29	39	
11	1.57	7															1.00	2	
12	1.33	3																	
13	1.50	2																	
Total Nests	25		107		80		102		45		17		45		17		330	*	
Average Clutch Size	1.44		1.34		1.28		1.35		1.13		1.18		1.20		1.18		1.29		

* Total nests may not correspond with number used to determine clutch size.

N.E. = No. eggs laid in 4-day period.

APPENDIX 3. SUBCOLONY SIZE AND HATCHING SUCCESS IN THE

SANDWICH TERN

1965 subcolonies		1966 subcolonies		1967 subcolonies	
Size	% Hatching Success	Size	% Hatching Success	Size	% Hatching success
6	57.1	114	70.1	40	80.4
9	84.6	99	65.2	107	95.4
5	28.6	58	66.7	296	98.2
21	75.9	51	76.5	67	92.2
15	0	17	47.4	77	100.0
9	18.2	7	28.5	209	97.0
15	33.3	53	63.9	70	94.9
12	53.3	145	88.5	89	99.0
23	58.1	79	72.4	37	95.0
179	67.4	56	78.3	25	93.3
		87	67.4	99	96.4
		8	77.8	61	98.4
		6	80.0	88	100.0
				50	91.1
				12	82.4
				51	88.5
				14	93.8
				346	95.0
294	53.9	780	72.3	1738	95.7

APPENDIX 4. AVERAGE GROWTH RATE OF COMMON TERN CHICKS WITH BROOD
SIZE AND ORDER OF HATCHING

Age In Days	Brood of One		Brood of Two				Brood of Three					
	Single	N.	First	N.	Second	N.	First	N.	Second	N.	Third	N.
0	14.39	8	15.74	18	13.77	26	15.58	5	13.35	11	13.40	12
1	17.22	20	18.93	26	16.50	31	18.78	13	17.36	15	15.16	13
2	20.12	17	23.44	30	19.44	33	24.11	15	21.54	14	15.02	10
3	26.47	18	28.76	28	24.26	28	30.16	14	24.85	15	15.95	8
4	32.42	18	35.64	22	29.65	25	35.54	14	27.63	13	18.08	6
5	38.21	12	41.54	25	36.07	21	37.87	11	36.88	10	19.88	4
6	46.41	12	48.90	20	41.54	16	42.86	7	44.80	8	30.97	3
7	54.51	8	56.32	20	48.56	18	46.46	5	49.54	9	34.08	4
8	62.14	11	65.26	13	53.56	15	60.10	8	58.68	9	33.50	2
9	67.76	10	73.90	15	64.24	13	63.50	6	71.42	5	42.33	3
10	81.90	11	80.48	16	73.35	15	81.80	5	77.58	4	41.53	3
11	91.05	11	87.77	17	78.85	15	81.98	6	90.17	3	69.60	2
12	100.43	12	92.98	16	84.30	13	93.11	7	82.82	6	-	-
13	106.06	8	98.78	17	92.37	15	101.93	7	96.12	6	83.55	2
14	111.18	10	105.20	15	96.13	16	110.78	5	98.53	7	90.03	3
15	115.45	11	112.67	15	98.26	12	108.06	9	110.83	7	92.43	3
16	117.97	9	111.67	14	113.28	17	109.63	7	117.80	5	101.65	2
17	119.85	8	114.75	12	110.54	16	118.59	7	121.95	6	109.43	3
18	124.34	7	115.62	12	111.98	14	118.78	4	123.03	6	115.83	3
19	125.87	9	119.38	13	115.58	13	123.05	6	121.27	7	112.30	2
20	121.59	8	123.52	13	119.08	11	121.42	5	122.76	5	114.10	2
21	119.41	7	121.09	10	117.04	9	126.06	5	118.30	5	(118.2)	1
22	119.68	4	119.50	11	118.23	9	139.94	5	117.20	4	116.45	2
23	116.83	6	117.27	7	118.45	8	120.27	3	123.25	2	110.45	2
24	118.53	4	119.98	8	119.55	8	-		117.80	2	116.80	3

* Chick hatches on day 0

APPENDIX 5. WEIGHT INCREASES OF FIRST AND SECOND COMMON TERN
CHICKS OF BROODS OF TWO AND THREE

Date	First Chick	Second Chick
30 June	3.59	6.20
1 July	5.44	2.85
2	6.31	6.40
3	6.55	7.63
4	6.73	7.20
5	6.95	5.70
6	8.88	8.46
7	7.09	5.74
8	6.06	8.11
9	6.95	6.90
10	4.33	6.59
11	8.72	8.25
12	5.23	4.26
13	6.10	6.15
14	5.07	5.58
15	6.41	3.24
16	8.29	5.76
17	4.49	4.39
18	7.12	8.38
19	7.96	4.64
20	4.20	-0.30
21	7.57	6.23
22	5.17	8.73
23	2.95	0.50
24	10.55	7.53
25	1.83	2.90
26	7.55	5.65
Average	6.23	5.69

APPENDIX 6

DAILY WEIGHT INCREASES

a. Common Tern19651966

Date	Wt.increase	Sample	Date	Wt.increase	Sample
18 June	4.20	4	29 June	8.92	5
19	8.84	10	30	6.14	12
20	8.20	12	1 July	5.01	13
21	8.48	14	2	8.31	15
22	7.54	17	3	7.98	21
23	5.75	14	4	7.19	28
24	7.98	13	5	7.46	28
25	6.57	16	6	8.37	29
26	5.87	11	7	6.07	27
27	8.43	7	8	5.69	17
28	3.62	10	9	6.67	17
29	6.57	10	10	3.75	22
30	7.45	11	11	9.38	30
3 July	5.90	10	12	5.45	32
4	8.18	5	13	7.36	36
5	6.26	11	14	6.60	31
8	8.88	5	15	4.78	31
9	10.93	4	16	8.17	24
17	6.00	4	17	5.26	22
18	8.98	6	18	7.35	20
19	4.04	9	19	6.12	17
20	8.69	8	20	2.04	14
21	6.86	5	21	6.72	12
27	5.63	5	22	9.45	15
2 Aug	6.55	4	23	3.65	14
			24	9.19	14
			25	4.08	13
			26	8.40	13
			27	8.49	9
			28	4.23	6
			30	6.13	4
			31	9.94	5
			6 Aug	7.94	7
			7	8.08	6
			8	4.63	4
			9	6.92	5
			10	-1.30	4

b. Arctic Tern19651966

Date	Wt.increase	Sample	Date	Wt.increase	Sample
20 June	7.23	7	23 June	3.90	12
23	5.75	9	24	3.68	14
24	5.53	14	25	8.05	13
25	5.52	26	26	8.04	23
26	4.93	26	27	6.02	38
27	5.65	24	28	8.04	48
28	3.85	26	29	7.27	64
4 July	7.33	35	30	9.15	71
5	5.87	40	1 July	5.46	69
6	6.23	52	2	6.34	73
7	6.07	46	3	9.13	70
8	6.83	43	4	7.43	67
9	5.78	38	5	7.79	68
10	6.33	34	6	7.33	60
11	6.53	36	7	5.91	45
12	6.54	35	8	6.63	34
13/14	5.67	30	9	5.22	23
15	4.88	39	10/11	5.78	5
16	7.85	28	12	5.45	12
17	7.16	25	13	6.76	14
18	4.58	13	14	4.23	16
19	6.89	15	15/16	7.44	11
20	4.59	16	17	5.57	12
21	7.54	16	18	7.66	10
22	7.61	7	19	6.68	7
23	3.40	7	20	7.84	7
24	5.00	5	21	7.19	8
			22	6.70	6
			23	5.34	5

c. Roseate Tern1966

Date	Wt.increase	Sample
17 July	5.02	25
18	4.80	22
19	5.22	20
20	3.26	26
21	3.66	28
22	6.56	16
23	3.82	13
24	5.70	15
25	6.97	17
26	3.39	10
27	3.47	12
28	6.14	9
29	5.31	8
30	5.44	8
31	3.20	7

APPENDIX 7.

THE ORIGIN OF RINGED TERNS SEEN ON COQUET ISLAND IN 1965, 1966 AND 1967

Origin	Coquet Island, North-umberland	Farne Islands, North-umberland	Firth of Forth	Forvie, Aberdeen-shire	Nairn, Moray-shire	Norfolk	Lanca-shire	Co.Down, Ireland	Total
Distance in miles (approx.)	0	20	80	140	185	c.200	c.110	205	-
Sandwich Tern	12*	18	5	6	1	8	1	1	52
Common Tern	10*	3	0	0	0	0	0	0	13
Arctic Tern	3	18	0	0	0	-	-	-	21
Roseate Tern	1	2	1	-	-	-	-	0	4

- denotes do not normally breed in that area

* one adult retrap included

(i) Measurements of single egg clutches from different subcolonies (in mm.)

Subcolony	Average length	St. Dev.	Average breadth	St. Dev.	Sample
1	51.8	4.4	35.0	0.8	35
2	52.3	2.0	35.2	1.0	54
3	51.9	1.8	35.3	1.1	32
4	52.2	1.4	34.8	1.0	40
Total	52.1	2.1	35.1	1.1	161

(ii) Measurements of two egg clutches (in mm.)

Year	FIRST EGG				SECOND EGG				No. of clutches in Sample
	Length	St.Dev.	Breadth	St.Dev.	Length	St.Dev.	Breadth	St.Dev.	
1965	51.3	1.6	36.1	1.0	49.5	1.8	35.3	0.9	62
1966	51.8	1.9	36.2	0.9	49.9	1.5	35.2	0.7	18
Total	51.4	1.5	36.2	0.9	49.6	1.7	35.3	0.9	80

The difference between the first and second eggs of a clutch in both years is very significant ($p = <0.001$, for 122 and 34 d.f. respectively).

The difference between the measurements of a first egg of a clutch of two and a single egg are significant. The first egg of a clutch is significantly shorter and wider ($p = <0.001$, for -39 d.f.). However, this difference is not so marked as that between first and second eggs of a clutch of two. In only 8 cases (10%) was the second

egg longer than the first, and in 8 cases was the second egg wider than the first.

Hellebrekers (1957) has suggested that 90% of the clutches in Holland consist of only one egg, or two eggs from two different females. In fact, only 40-50% occur as one egg per scrape. This suggestion is based on the differences between the two eggs of a clutch both in shape and colour. Hellebrekers collected 13 sets of two eggs, of which two sets were very similar.

From his data :

FIRST EGG				SECOND EGG				N
Length	St.Dev.	Breadth	St.Dev.	Length	St.Dev.	Breadth	St.Dev.	
51.9	1.9	36.4	1.2	51.4	2.3	36.3	1.0	13
Volume = 33008 cc.				Volume = 32516 cc.				

The sample is small, and although the trend discernible on Coquet Island is suggested, it is not significant (length : $p = >0.4$ for 24 d.f.; breadth : $p = >0.8$ for 24 d.f.). There was no evidence that two birds were responsible for the two egg clutches on Coquet Island, and it seems that first and second eggs differ normally. Similar differences have been noted in the shape of the first and second eggs and the third egg of the Common Tern (Gemperle & Preston, 1955). That in 90% of the cases, the second egg in the Sandwich Tern is smaller (493 cc. or 2.5% less in volume from Hellebreker's data, or 2,655 cc. or 8.2% less from Coquet Island data) makes Hellebreker's suggestion unacceptable. The wide variation in pigmentation of the

clutches of the two species, and the inadequate evidence of the participation of two females invalidates Hellebrekers' hypothesis. Also, this author recorded up to five or six days' difference in the incubation (laying date) of the two eggs, but in only four cases. In another six cases, Hellebrekers recorded a difference of three or four days, but such a difference was commonly observed on Coquet Island where it accounted for asynchronous hatching.

MEASUREMENTS OF SANDWICH TERN EGGS

Average (mm)		Maximum (mm)		Minimum (mm)		Sample	Authority
<u>Length</u>	<u>Breadth</u>	<u>Length</u>	<u>Breadth</u>	<u>Length</u>	<u>Breadth</u>		
50.8	x 36.0	<u>57.2</u>	x 32.9	<u>47.2</u>	x 35.0	41	Dircksen, 1932
vol. = 31603 cc.		49.3	x <u>38.0</u>	57.2	x <u>32.9</u>		
51.53	x 35.63	<u>56.5</u>	x 36.6	<u>49.4</u>	x 35.7	56	Marples & Marples, 1934.
vol. = 31317 cc.		50.5	x <u>37.5</u>	56.5	x <u>32.8</u>		
51.70	x 36.09	<u>56.5</u>	x 34.5	<u>44.0</u>	x 34.7	100	Witherby et al, 1946.
vol. = 32333 cc.		50.5	x <u>38.1</u>	51.5	x <u>33.6</u>		
52.11	x 35.05	56.45	x 34.80	<u>47.00</u>	x 35.00	161) Singles.) Pers.obs.
vol. = 32812 cc.		53.40	x 38.20	52.00	x <u>32.55</u>		
51.39	x 36.15	55.60	x 35.25	<u>47.3</u>	x <u>33.9</u>	80) 1st of two
vol. = 32320 cc.		55.0	x 38.6				
49.58	x 35.28	<u>53.7</u>	x 33.9	<u>46.1</u>	x 33.6	80) 2nd of two
vol. = 29666cc.		50.8	x <u>37.6</u>	49.8	x 33.3		

Volume in ccs. = $0.48 \times \text{breadth}^2 \times \text{length}$.

REFERENCES

- ALLEN, R.P. 1956. The Flamingos : their life history and survival. New York.
- ALLISON, F.R. 1959. High recovery rate of ringed terns in West Africa. The Ring, 2 : 130-131.
- ANDREWARTHA, H.G. & BIRCH, L.C. 1954. The distribution and abundance of animals. Chicago.
- ARMSTRONG, E.A. 1946. The coloration of seabirds. Birds of Britain, 2 : 15-19.
- ARMSTRONG, E.A. 1947. Bird display and behaviour. London. (Dover Edition, 1965).
- ASHMOLE, N.P. 1962. The Black Noddy Anous tenuirostris on Ascension Island. Ibis, 103b : 235-273.
- ASHMOLE, N.P. 1963a. The biology of the wideawake or Sooty Tern Sterna fuscata on Ascension Island. Ibis, 103b : 297-364.
- ASHMOLE, N.P. 1963b. The regulation of numbers of tropical oceanic birds. Ibis, 103b : 458-473.
- ASSEM, J.Van Den. 1954a. Waarnemingen over het gedrag van de Grote Stern. Levende Natuur, 57 : 1-9.
- ASSEM, J.Van Den. 1954b. Kokmeeuwen als belagers van Grote Sterns. Levende Natuur, 57 : 141-145.
- AUSTIN, O.L. Jr. 1928. Migration routes of the Arctic Tern Sterna paradisaea. Bull.N.E.Bird Banding Assoc., 4 : 121-125

- AUSTIN, O.L. Jr. 1929. Contributions to the knowledge of Cape Cod Sterninae. Bull.N.E.Bird Banding Assoc., 5 : 125-150.
- AUSTIN, O.L. Jr. 1932. Further contributions to the knowledge to Cape Cod Sterninae. Bird Banding, 3 : 123-129.
- AUSTIN, O.L. 1938. Some results of trapping in Cape Cod. Bird Banding, 9 : 12-25.
- AUSTIN, O.L. 1940. Some aspects of Individual Distribution in The Cape Cod colonies. Bird Banding, 11 : 155-169.
- AUSTIN, O.L. 1942. The life span of the Common Tern. Bird Banding, 13 : 150-176.
- AUSTIN, O.L. 1945. Role of Longevity in Successful Breeding by the Common Tern. Bird Banding, 16 : 21-28.
- AUSTIN, O.L. 1946a. Age record for the Arctic Tern. Bird Banding, 17 : 168.
- AUSTIN, O.L. 1946b. The status of the Cape Cod Terns in 1944. A behaviour study. Bird Banding, 17 : 10-27.
- AUSTIN, O.L. 1947. A study of mating of the Common Tern. Bird Banding, 18 : 1-16.
- AUSTIN, O.L. 1949. Site tenacity. A Behaviour Trait of the Common Tern Sterna hirundo. Bird Banding, 20 : 1-40.
- AUSTIN, O.L. 1951. Group adherence of the Common Tern. Bird Banding, 22 : 1-15.
- AUSTIN, O.L. 1953. The migration of the Common Tern Sterna hirundo in the Western Hemisphere. Bird Banding, 24 : 39-55.

- AUSTIN, O.L. & AUSTIN, O.L. Jr. 1956. Some Demographic aspects of the Cape Cod population of Common Terns Sterna hirundo. Bird Banding, 27 : 55-66.
- BALDWIN, P.H. 1953. Annual cycle, environment and evolution in the Hawaiian honeycreepers (Aves : Drepaniidae). Univ.Calif.Publ.Zool., 52 : 285-398.
- BEHLE, W.H. 1944. The pelican colony at Gunnison Island, Great Salt Lake, in 1943. Condor, 46 : 198-200.
- BELOPOLSKII, L.O. 1961. Ecology of sea colony birds of the Barents Sea. Moscow-Leningrad. (Trans. Jerusalem).
- BENT, A.C. 1921. Life histories of North American gulls and terns. Smithsonian Inst.Bull.U.S.Nat.Mus., 113.
- BERGMAN, G. 1953. Verhalten und Biologie der Raubseeschwalbe (Hydroprogne tschegrava). Acta Zool.Fenn., 77 : 1-50.
- BERGMAN, G. 1955. Die Beziehungen zwischen Bodenfarbe der Reviere und Farbe der Kucken bei Hydroprogne tschegrava und Sterna macrura. Ornis.Fenn., 32 : 69-83.
- BETTS, M.M. 1955. The food of titmice in oak woodland. J.Anim.Ecol., 24 : 282-323.
- BICKERTON, W. 1912. The home life of the terns or sea swallows. London.
- BIERMAN, W.H. & VOOUS, K.H. 1950. Birds observed and collected during the Whaling expeditions of the Willem Barendsz in the Antarctic, 1946-47 and 1947-48. Ardea 37, suppl.

- BIRCH, L.C. 1957. The meanings of competition.
Amer.Nat., 91 : 5-18.
- BIRCH, L.C. & EHRLICH, P.R. 1967. Evolutionary history and
population biology. Nature, 214 : 349-352.
- BOECKER, M. 1967. Verleichende Untersuchungen zur Nahrungsund
Nistökologie der Flusseeeschwalbe (Sterna hirundo L.)
und der Küstenseeschwalbe (Sterna paradisaea Pont.),
Bonn.Zool.Beitr., 18 : 15-126.
- BOWMAN, T.E. 1961. Morphological differentiation and adaptation
in the Galapagos finches. Univ.Calif.Publ.Zool., 58 : 1-302.
- BROADHEAD, E. 1958. The psocid fauna of larch trees in northern
England - an ecological study of mixed species populations
exploiting a common resource. J.Anim.Ecol., 27 : 217-263.
- BROWN, R.G.B. 1967. Species isolation between the Herring Gull
Larus argentatus and the Lesser Black-backed Gull L.fuscus.
Ibis, 109 : 310-317.
- BULLOUGH, W.S. 1942. Observations on the colonies of Arctic Terns
Sterna macrura Naumann on Farne Islands.
Proc.Zool.Soc.Lond., 112(A) : 1-12.
- BURTON, P.J.K. & THURSTON, M.H. 1959. Observations on Arctic Terns
in Spitzbergen. Brit.Birds, 52 : 149-161.
- CARPENTER, C.C. 1952. Comparative ecology of the common garter
snake (Thamnophis s.sirtalis), the ribbon snake (Thamnophis
s.sauritus), and Butler's garter snake (Thamnophis butleri)
in mixed populations. Ecol.Monographs, 22 : 235-238.

- CLEMENTS, F.E. & SHELFORD, V.E. 1939. Bio-ecology. New York.
- COLLINGE, W.E. 1926. An investigation of the food of terns at Blakeney Point, Norfolk. Trans.Norfolk & Norwich Nat. Hist.Soc., 12 : 35-44.
- COULSON, J.C. & WHITE, E. 1960. The effect of age and density of breeding on time of breeding of the Kittiwake, Rissa tridactyla. Ibis, 102 : 71-86.
- COULSON, J.C. 1968. Differences in the quality of birds nesting in the centre and on the edges of a colony. Nature, 217 : 478-479.
- CROMBIE, A.C. 1946. Further experiments on insect competition. Proc.Roy.Soc.London (B), 133 : 76-109.
- CROMBIE, A.C. 1947. Interspecific competition. J.Anim.Ecol., 16 : 44-73.
- CROOK, J.H. 1965. The adaptive significance of avian social organisations. Symp.Zool.Soc., 14 : 181-218.
- CULLEN, J.M. 1956. A study of the behaviour of the Arctic Tern (Sterna macrura). D.Phil.Thesis. Oxford University.
- CULLEN, J.M. 1957. Plumage, age and mortality of the Arctic Tern (Sterna macrura). Bird Study, 4 : 197-207.
- CULLEN, J.M. 1960a. Some adaptations in the nesting behaviour of Terns. Proc.XII.Int.Orn.Congr., Helsinki, 1958 : 153-157.
- CULLEN, J.M. 1960b. Aerial display of Arctic Tern and other species. Ardea, 48 : 1-37.

- CULLEN, J.M. & ASHMOLE, N.P. 1963. The Black Noddy Anous tenuirostris on Ascension Island. Ibis, 103b : 423-446.
- DARLING, F.F. 1938. Bird Flocks and the breeding cycle. A contribution to the study of avian sociality. Cambridge.
- DARWIN, C. 1859. On the origin of species by means of natural selection, or the preservation of favoured races in the struggle for life. London.
- DESSELBERGER, H. 1929. Soziologische Beobachtungen an Brandseeschwalben. Orn.Mber., 37 : 14-18.
- DIRCKSEN, R. 1932. Die Biologie des Austernfischers, der Brandseeschwalbe, und der Küstenseeschwalbe nach Beobachtungen auf Norderoog. J.Orn., 80 : 427-521.
- DOBZHANSKY, Th. 1950. Mendelian populations and their evolution. Amer.Nat., 84 : 401-418.
- DORWARD, D.F. 1962. Comparative biology of the White Booby and the Brown Booby, Sula spp. at Ascension. Ibis, 103b : 174-220
- DORWARD, D.F. & ASHMOLE, N.P. 1963. Notes on the biology of the Brown Noddy Anous stolidus on Ascension Island. Ibis, 103b : 447-457.
- DUNNET, G.M. 1955. The breeding of the Starling Sturnus vulgaris in relation to its food supply. Ibis, 97 : 619-662.
- EDBERG, R. 1964. Breeding frequency of the Common Tern (Sterna hirundo) on Lake Hjalmarén. Var Fagelvarld, 23 : 97-102.
- EGGELING, W.G. 1960. The Isle of May : a Scottish Nature Reserve. Edinburgh.

- EKLUND, C.R. 1944. Nesting notes on the Arctic Tern.
Auk, 61 : 648.
- ELTON, C.S. 1946. Competition and the structure of ecological communities. J.Anim.Ecol., 15 : 54-68.
- ELTON, C.S. & MILLER, R.S. 1954. The ecological survey of animal communities : with a practical system of classifying habitats by structural characters. J.Ecol., 42 : 460-496.
- FISHER, J. & LOCKLEY, R.M. 1954. Seabirds. London.
- GALLET, E. 1949. Les Flamants roses de Camargue. Lausanne.
- GAUSE, G.F. 1934. The struggle for existence. Baltimore.
- GEMPERLE, M.G. & PRESTON, F.W. 1955. Variation in shape of eggs of the Common Tern in clutch sequence. Auk, 72 : 184-198.
- GIBB, J. 1954. Feeding ecology of tits, with notes on tree-creeper and goldcrest. Ibis, 96 : 513-543.
- GILBERT, O., REYNOLDS, T.B. & HOBART, J. 1952. Gause's hypothesis : an examination. J.Anim.Ecol., 21 : 310-312.
- GOETHE, F. 1932. Seeschwalben beobachtungen auf Mellum.Beitr.
Fortpfl.Biol.Vogel., 8 : 129-134.
- GOETHE, F. 1939. Die Vogelinsel mellum. Abh.Vogelk.4 Vogelwarte Helgoland. Berlin.
- GOTZMAN, J. 1965. Environment preference in the grebes (Podicipedidae) during the breeding season.
Ekologia Polska (A), 13 : 289-301.
- GROSSKOPF, G. 1957. Das Durchschnittsalter der auf Wangerooge nistenden Kustenseeschwalben (Sterna macrura).
J.Orn., 98 : 65-70.

- GUICHARD, G. 1955. Notes sur la biologie de la Sterne de Dougall (Sterna D.Dougalli). Oiseau, 25 : 75-86.
- HANCOCK, J. 1874. The birds of Northumberland and Durham.
- HARDY, E. 1941. The Sandwich terns of Ravenglass. Aquarist.Lond., 11 : 19-21.
- HARRIS, M.P. 1964. Aspects of the breeding biology of the gulls, Larus argentatus, L.fuscus and L.marinus. Ibis, 106 : 432-456.
- HARTLEY, P.H.T. 1953. An ecological study of the feeding habits of the English titmice. J.Anim.Ecol., 22 : 261-288.
- HAWKSLEY, O. 1949. Transatlantic Arctic tern recoveries. Bird Banding, 20 : 185-186.
- HAWKSLEY, O. 1950. Study of the behaviour and ecology of the Arctic tern. Ph.D. Thesis. Cornell University.
- HAWKSLEY, O. 1957. Ecology of a breeding population of arctic terns. Bird Banding, 28 : 57-92.
- HELLEBREKERS, W.P.J. 1959. Over de authenticiteit der tweelegsels van Sterna sandvicensis Lath. in de Nederlandse kolonies. Limosa, 30 : 34-40. (English summary).
- HINDE, R.A. 1959. Behaviour and speciation in birds and lower vertebrates. Biol.Rev., 34 : 85-128.
- HOOGERWERF, A. 1937. Uit het leven der witte ibissen, Threskiornis aethiopicus melanocephalus. Limosa, 10 : 137-146.
- KIRKMAN, F.B. 1908. Variation in the nests of the Arctic and Common Terns. Brit.Birds, 2 : 78-82; 101-108.

- KLOMP, H. 1961. The concepts "similar ecology" and "competition" in animal ecology. Arch.Neerl.Zool., 14 : 90-102.
- KRUUK, H. 1964. Predators and anti-predator behaviour of the Black-headed Gull (Larus ridibundus L.) Behaviour Suppl., 11 : 1-129.
- KULLENBERG, B. 1946. Über Verbreitung und Wanderungen von vier Sterna-Arten. Arkiv.für Zoologi., 17 : 1-80.
- LACK, D. 1933. Nesting conditions as a factor controlling breeding time in birds. Proc.Zool.Soc.Lond., 1933 : 231-237.
- LACK, D. 1944. Ecological aspects of species-formation in passerine birds. Ibis, 86 : 260-286.
- LACK, D. 1945. The ecology of closely related species with special reference to Cormorant (Phalacrocorax carbo) and Shag (P.aristotelis). J.Anim.Ecol., 14 : 12-16.
- LACK, D. 1946. Competition for food by birds of prey. J.Anim.Ecol., 15 : 123-129.
- LACK, D. 1947a. Significance of clutch size. P.1. Intra-specific variation. P.2. Factors involved. Ibis, 89 : 302-352.
- LACK, D. 1947b. Darwin's finches. Cambridge.
- LACK, D. 1948. Significance of clutch size. P.3. Some interspecific comparisons. Ibis, 90 : 25-45.
- LACK, D. 1949. The significance of ecological isolation. In G.L.Jepsen, E. Mayr & G.G.Simpson, eds. Genetics, paleontology and evolution. Princeton.

- LACK, D. 1954. The natural regulation of animal numbers.
Oxford.
- LACK, D. 1956. Further notes on the breeding biology of the
Swift (Apus apus). Ibis, 98 : 606-619.
- LACK, D. 1966. Population studies of birds. Oxford.
- LACK, D. & SOUTHERN, H.N. 1949. Birds on Tenerife.
Ibis, 91 : 607-626.
- LIND, H. 1963. Nogle sociale reaktioner hos terner.
Dansk Orn.Foren.Tidsskr., 57 : 155-175.
- LOCKIE, J.D. 1955. The breeding and feeding of Jackdaws and
Rooks, with notes on Carrion Crows and other Corvidae.
Ibis, 97 : 341-369.
- LOMONT, H. 1954. Observations ornithologiques sur les Flamants.
La Terre et la Vie, 101 : 28-38.
- LOTKA, A.J. 1925. Principles of Physical Biology. Baltimore.
- LOTKA, A.J. 1932. The growth of mixed populations : two species
competing for a common food supply.
J.Wash.Acad.Sci., 22 : 461-469.
- MACER, C.T. 1965. Sand eels (Ammodytidae) in the South-western
North Sea; their biology and fishery.
Fish.Invest.,Lond., Ser.2, 24(6).
- MARPLES, G. & MARPLES, A. 1934. Sea terns or Sea Swallows.
London.
- MAYR, E. 1948. The bearing of the new systematics on genetical
problems. The nature of Species. Adv.Genet., 2 :
205-237.

- MAYR, E. 1963. Animal Species and Evolution. Oxford.
- MILNE, A. 1957. Theories of natural control of insect populations. Cold Spring Harbor Symp.Quant.Biol., 22 : 253-271.
- MILNE, A. 1961. Definition of competition among animals. Symp.Soc.Exptl.Biol., 15 : 40-71.
- MILSTEAD, W.H. 1957. Some aspects of competition in natural populations of whiptail lizards (genus Cnemidophorus). Texas J.Sci., 9 : 607-626.
- MILSTEAD, W.H. 1961. Observations of the activities of small animals (Reptilia and Mammalia) on a quadrat in South West Texas. Amer.Midland Nat., 65 : 127-138.
- MOREAU, R.E. 1944. Clutch size : a comparative study, with special reference to African birds. Ibis, 86 : 286-347.
- MOREAU, R.E. 1948. Ecological isolation in a rich tropical avifauna. J.Anim.Ecol., 17 : 113-126.
- MOYNIHAN, M. 1958. Some adaptations which help to promote gregariousness. Proc.XII.Int.Orn.Congr., 2 : 523-541.
- MOYNIHAN, M. 1959. A Revision of the Family Laridae (Aves). Amer.Mus.Novit.1928 : 1-42.
- MULLER, H. 1959. Zugverhältnisse der europäischen Brandseeschwalben (Sterna sandvicensis) nach Beringungsergebnissen. Die Vogelwarte, 20 : 91-115.
- MURPHY, R.C. 1936. Oceanic birds of South America. 2 vols. New York. Am.Mus.Nat.Hist.

- MACARTHUR, R.H. 1958. Population ecology of some warblers of North-eastern coniferous forests. Ecology, 39 : 599-619.
- NELSON, J.B. 1967. Colonial and cliff-nesting in the Gannet compared with other Sulidae and the Kittiwake. Ardea, 55 : 60-90.
- NICHOLSON, A.J. 1933. The balance of animal populations. J.Anim.Ecol., 2 : 132-178.
- NICHOLSON, A.J. 1957. The self-adjustment of populations to change. Cold Spring Harbor Symp.Quant.Biol., 22 : 153-173.
- NILSSON, N.A. 1955. Studies on the feeding habits of trout and char in north Swedish Lakes. Inst.Freshwater Research, Drottingholm, 36 : 163-225.
- NILSSON, N.A. 1960. Seasonal fluctuations in the food segregation of trout, char and whitefish in 14 North Swedish Lakes. Inst.Freshwater Research, Drottingholm, 41 : 185-205.
- NORDERHAUG, H. 1964. Studier av rodnebbternas (Sterna macrura) biologie pa Vestspitsbergen. Fauna, 17 : 137-154.
- NORREVANG, A. 1960. Nogle iagttagelser over trekkende terners opførsel. Dansk Orn.Foren.Tidsskr., 54 : 125-127.
(English summary).
- ODUM, E.P. 1959. Fundamentals of Ecology (2nd Edition). Philadelphia.
- PALMER, R.S. 1940. A behaviour study of the Common Tern, Sterna hirundo Linnaeus. Ph.D. Thesis, Cornell University.

- PALMER, R.S. 1941b. A behaviour study of the Common Tern.
Proc.Bost.Soc.Nat.Hist., 32 : 1-103.
- PALUDAN, K. 1951. Contribution to the breeding biology of
Larus argentatus and Larus fuscus.
Vidensk.Medd.Dansk.naturh.Foren., 114 : 1-128.
- PARK, T. 1954. Experimental studies of inspecies competition.
Physiol.Zool., 27 : 177-238.
- PARSLOW, J.L.F. 1967. Changes in status among breeding birds
in Britain and Ireland. Brit.Birds, 60 : 177-202.
- PATTERSON, I.J. 1965. Timing and spacing of broods in the
Black-headed Gull (Larus ridibundus) Ibis, 107 : 433-459.
- PEARSON, T.H. 1964. Aspects of the feeding biology of certain
sea-birds. Ph.D. Thesis, Durham University.
- PERRINS, C.M. 1965. Population fluctuations and clutch-size
in the Great Tit, Parus major. J.Anim.Ecol. 34 : 601-647.
- PERRY, R. 1940. Lundy : the Isle of Puffins. London.
- PETTINGILL, O.S. 1939. History of 100 nests of Arctic terns.
Auk, 56 : 420-428.
- RADFORD, M.C. 1961. A study of the British ringing records of
the Common Tern and Arctic Tern and comparison with
some foreign records. Bird Study, 8 : 174-184.
- RICHDALE, L.E. 1949. A study of a group of penguins of known age.
Biol.Monogr. 1.
- ROBERTS, B.B. 1940. The breeding behaviour of penguins with
special reference to Pygocelis papua (Forster). British
Graham Land Expedition, 1934-7, Scientific Reports, 1 : 195-
254.

- ROBINSON, H.W. 1910. Marked Sandwich Tern apparently nesting in its first year. Brit.Birds, 4 : 88.
- ROBINSON, W.H. 1940. The Sandwich Tern breeding in Winter Plumage and in immature plumage. Ibis, 14 : 150-151.
- ROOTH, J. 1958. Relations between Black-headed Gulls (Larus ridibundus) and Terns (Sterna spec.) in the Netherlands. VII. Bulletin of the Int.Comm. for Bird Preservation : 117-119.
- SALOMONSEN, F. 1943. Betydningen at social stimulans for Ungleforholdene i Fugelkolonier Dansk Orn.Foren.Tidsskr., 41 : 174-86.
- SALOMONSEN, F. 1947. Maagekolonierne paa Hirsholmene. Dansk.Orn.Foren.Tidsskr., 41 : 174-186.
- SALOMONSEN, F. 1953. Fugeltraekket og dets gader. Copenhagen.
- SALOMONSEN, F. 1967. Migratory movements of the Arctic Tern (Sterna paradisaea Pontoppidan) in the Southern Ocean. Det Kongelige Danske Videnskabernes Selskab Biologiske Medd., 24 : 1-39.
- SAUNDERS, H. & SALVIN, O. 1896. Catalogue of the Gaviae and Tubinares in the collection of the British Museum (Cat. of Birds in the Brit.Mus. v.25), London.
- SCHMAUS, A. 1938. Der Einfluss der Mansejahre auf das Brutgeschäft unseren Raubvogel und Eulen. Beitr.Fortpfl.Biol.Vogel, 14 : 181-184.

- SCHUZ, E. 1942. Bestandsregelnde Einflüsse in der Umwelt des Weissen Storchs (C.ciconia). Zool.Jb.(Systematik) 75 : 103-120.
- SCHUZ, E. 1957. Das Verschlingen eigener Junger ('Kronismus') bei Vögeln und seine Bedeutung. Vogelwarte, 19 : 1-15.
- SERVENTY, V. & WHITE, S. 1951. Roseate tern. Notes on nesting behaviour. Emu, 50 : 145-151.
- SHEPPARD, P.M. 1959. Natural selection and heredity. New York.
- SHORTEN, M. 1954. Squirrels. London.
- SOUTHERN, H.N. 1938. Posturing and related activities of the Common tern. Proc.Zool.Soc.Lond., 108(A) : 423-431.
- SPENCER, R. 1966. Report on bird-ringing for 1965. Brit.Birds, 59 : 441-491.
- SPRINGETT, B.P. 1967. The biology of Necrophorus (Col.) and the mortality of arctic terns (Sterna); an ecological study. Ph.D. Thesis, Durham University.
- STEINBACHER, G. 1931. Beiträge zur Brutbiologie von Silbermowe und Brandseeschwalbe. J.Orn., 79 : 349-353.
- STORR, G.M. 1958. Migration Routes of the Arctic Tern. The Emu, 58 : 59-62.
- SWIFT, J.J. 1960. Densité des nids et notion de territoire chez le Flamant de Camargue. Alauda, 28 : 1-14.
- SELANDER, R.K. & GILLER, D.R. 1959. Sympatry of the jays, Cissilopha beechei and C.san-blasiana in Nayarit. Condor, 61 : 52.

- STONEHOUSE, B. 1962. The Tropic Birds (genus Phaethon) of Ascension Island. Ibis, 103b : 124-161.
- SUTTON, G.M. 1932. The exploration of Southampton Island, Hudson Bay. Memoirs of the Carneg.Mus.12.
- TAVERNER, J.H. 1965. Observations on breeding Sandwich and Common Terns. Brit.Birds, 58 : 5-9.
- THOMPSON, W.R. 1939. Biological control and the theories of interactions of populations. Parasitology, 31 : 299-388.
- THOMSON, A.Lansborough. 1943. The migration of the Sandwich Tern. Brit.Birds, 37 : 62-69.
- THOMSON, A.Lansborough. 1964. A New Dictionary of Birds. London-New York.
- TINBERGEN, N. 1931. Zur Paarungsbiologie der Flussseseschwalbe (Sterna hirundo hirundo L.). Ardea, 20 : 1-18.
- TRETZEL, E. 1955. Intragenerische Isolation und interspezifische Konkurrenz bei spinen. Z.Morphol.u.Ökol.Tiere, 44 : 43-162.
- UDVARDY, M.F.D. 1951. The significance of interspecific competition in bird life. Oikos, 1 : 98-123.
- ULLYET, G.C. 1950. Competition for food and allied phenomena in Sheep-blowfly populations. Phil.Trans.Roy.Soc.(B), 234 : 77-174.
- VOLTERRA, V. 1926. Variazioni e fluttuazioni del numero d'individui in specie animali conviventi. Mem.Acad.Lincei., 2 : 31-113.
- VOOUS, K.H. 1960. Atlas of European birds. London-Amsterdam.

- VOOUS, K.H. 1963. Tern Colonies in Aruba, Curacao and Bonaire, South Caribbean Sea. Proc.XII.Int.Orn.Congr., 1214-1216.
- WILLIAMS, R.B. 1947. Notes on the Arctic Tern in Alexander Archipelago, south eastern Alaska. Auk, 64 : 143-144.
- WILLIAMSON, K. 1949. The distraction behaviour of the Arctic skua. Ibis, 91 : 307-313.
- WILLIAMSON, M.H. 1957. An elementary theory of interspecific competition. Nature, 180 : 422-425.
- WITHERBY, H.F. et al. 1946. The Handbook of British Birds. London.
- WYNNE-EDWARDS, V.C. 1962. Animal dispersion in relation to social behaviour. Edinburgh-London.

