



## Durham E-Theses

---

### *A study of some sulphur-nitrogen compounds*

Padley, J. S.

#### How to cite:

---

Padley, J. S. (1976) *A study of some sulphur-nitrogen compounds*, Durham theses, Durham University. Available at Durham E-Theses Online: <http://etheses.dur.ac.uk/8581/>

#### Use policy

---

The full-text may be used and/or reproduced, and given to third parties in any format or medium, without prior permission or charge, for personal research or study, educational, or not-for-profit purposes provided that:

- a full bibliographic reference is made to the original source
- a [link](#) is made to the metadata record in Durham E-Theses
- the full-text is not changed in any way

The full-text must not be sold in any format or medium without the formal permission of the copyright holders.

Please consult the [full Durham E-Theses policy](#) for further details.

A STUDY OF SOME  
SULPHUR-NITROGEN  
COMPOUNDS

-by-

J.S. PADLEY, B.Sc.

A thesis submitted for the Degree of Doctor of Philosophy  
in the University of Durham.

July 1967



Acknowledgements

The author wishes to express his sincere thanks to Dr. A.J. Banister, under whose direction this research was carried out, for his constant encouragement and valuable advice; to the Science Research Council for a maintenance grant; and to the Senate of the University of Durham for research facilities.

Memorandum

The work described in this thesis was carried out in the University of Durham between October 1964 and July 1967. This work has not been submitted for any other degree and is the original work of the author except where acknowledged by reference.

Parts of the work described in this thesis have been the subject of the following publications:

A.J. Banister, L.F. Moore and J.S. Padley,  
Inorganic Sulphur Chemistry (Ed. G. Nickless),  
Chapter 16, Elsevier, Amsterdam, (in press).

A.J. Banister and J.S. Padley, J. Chem. Soc., 1967  
(A), (in press).

A.J. Banister, L.F. Moore and J.S. Padley,  
Spectrochim. Acta., 1967, (in press).

Summary

The thesis can be conveniently divided into three parts:

(a) Sulphur-nitrogen-carbon compounds, (b) New routes to sulphur-nitrogen compounds and (c) Sulphur-nitrogen-metal compounds.

(a) Sulphur-nitrogen-carbon compounds.

Several possible new routes to both cyclic and acyclic sulphur-nitrogen-carbon compounds are reported and discussed. It has been shown that the compound  $\text{H}_2\text{NCH}_2\text{SO}_3\text{H}$ , unlike most other compounds containing  $-\text{NH}_2$ , does not react with  $\text{PCl}_5$  to form a trichlorophosphazo derivative, and that the introduction of a carbon atom between the sulphur and nitrogen atoms, has a profound effect on the chemical behaviour of such molecules. The reaction of sulphur monochloride with certain azomethines is also reported.

(b) New routes to sulphur-nitrogen compounds.

Several types of reaction have been considered as a basis for possible new routes to sulphur-nitrogen compounds. The use of condensation reactions by elimination of  $\text{H}_2\text{O}$ ,  $\text{CO}_2$  or  $\text{H}_2\text{S}$  and the possible use of  $\text{R}_3\text{N}\cdot\text{SOCl}_2$  compounds as dehydrating agents are discussed. Comment is made on the behaviour of sulphur (IV) compounds as Lewis acids. Reactions involving  $\text{S}_3\text{N}_2\text{O}_2$  and  $\text{S}_3\text{N}_2\text{Cl}_2$  are also reported.

(c) Sulphur-nitrogen-metal compounds.

The main part of the thesis deals with the synthesis of new sulphur-nitrogen-metal compounds. It is shown that the reactions between  $S_4N_4$  in thionyl chloride and metal halides lead to a variety of new sulphur-nitrogen-metal compounds.

The possible structures are discussed and in many cases the formation of new sulphur-nitrogen or sulphur-nitrogen-metal ring systems <sup>is</sup> ~~are~~ proposed. The reactions of  $S_4N_4$ -metal halide adducts with thionyl chloride are also reported and discussed.

CONTENTS

Page

INTRODUCTION

(a)	SULPHUR NITRIDES	
	(i) Tetrasulphur tetranitride	1
	(ii) Tetrasulphur dinitride	5
	(iii) Disulphur dinitride and Polysulphur nitride	7
	(iv) Sulphur nitride	8
	(v) $S_2N$ , $S_5N_2$ , $S_{15}N_2$ and $S_{16}N_2$	8
(b)	SULPHUR-NITROGEN HYDRIDES	
	(i) Cyclotetrathiotetraimine	9
	(ii) Heptasulphurimide	10
	(iii) Hexasulphurdiimide	11
	(iv) Sulphur imide and diimide	12
(c)	SULPHUR-NITROGEN OXIDES	
	(i) Thiodithiazyl dioxide	12
	(ii) Other sulphur-nitrogen oxides	14
(d)	SULPHUR-NITROGEN HALIDES	
	(i) Thiazyl bromide	15
	(ii) Thiazyl chloride	15
	(iii) Thiazyl fluoride	16
	(iv) Thiazyl trifluoride	17
	(v) $SN_2F_2$	18
	(vi) Thiodithiazyl monochloride	19
	(vii) Thiodithiazyl dichloride	19
	(viii) Thiodithiazyl difluoride	20

	Page
(ix) Trithiazyl monochloride	21
(x) Trithiazyl trichloride	21
(xi) Trithiazyl trifluoride	22
(xii) The thiotrithiazyl halides	24
(xiii) Tetrathiazyl tetrafluoride	26
(e) SULPHUR-NITROGEN OXYHALIDES	27
(f) SULPHUR-NITROGEN METAL COMPOUNDS	
(i) Compounds involving metals of Group VIII	29
(a) Type $\text{MeH}_2\text{N}_4\text{S}_4$ and $\text{MeN}_4\text{S}_4$	29
(b) Type $\text{MeHN}_3\text{S}_5$ and $\text{MeN}_2\text{S}_6$	31
(ii) Reaction products of the reaction between $\text{S}_4\text{N}_4 \cdot 2\text{NH}_3$ and metal salts	32
(iii) Reaction products of the reaction between $\text{S}_4\text{N}_4\text{H}_4$ and metal salts	32
(iv) Reaction products of the reaction between $\text{S}_7\text{NH}$ and metal salts	34
(v) Addition products of $\text{S}_4\text{N}_4$ and metal halides	34
(g) SULPHUR-NITROGEN CARBON COMPOUNDS	40

#### EXPERIMENTAL

Handling techniques	42
Spectra	42
Purification procedures	43
Preparation of starting materials	44



SULPHUR-NITROGEN-CARBON COMPOUNDS

Reaction between $\text{H}_2\text{NCH}_2\text{SO}_3\text{H}$ and $\text{PCl}_5$	48
Reaction between $\text{H}_2\text{NCH}_2\text{SO}_3\text{H}$ and $\text{SOCl}_2$	49
Effect of heat on $\text{H}_2\text{NCH}_2\text{SO}_3\text{H}$	49
Preparation of $\text{H}_2\text{NCH}_2\text{SO}_3\text{Na}$	50
Effect of heat on $\text{H}_2\text{NCH}_2\text{SO}_3\text{Na}$	50
Reaction between $\text{S}_2\text{Cl}_2$ and azomethines	51

SULPHUR-NITROGEN COMPOUNDS

Reaction between: $(\text{H}_2\text{N})_2\text{SO}_2$ and $\text{S}_8$	52
$(\text{CH}_3)_2\text{SO}$ and $(\text{H}_2\text{N})_2\text{SO}_2$	53
$(\text{CH}_3)_2\text{SO}$ and $p\text{-NO}_2\text{C}_6\text{H}_4\text{NH}_2$	53
$(\text{CH}_3)_2\text{SO}$ and $\text{PhNCO}$	53
$\text{Et}_3\text{N}$ and $\text{SOCl}_2$	54
$(\text{CH}_3)_3\text{N}$ and $\text{SOCl}_2$	54
$\text{C}_5\text{H}_5\text{N}$ and $\text{SOCl}_2$	55
$\text{S}_4\text{N}_4$ and $\text{SOCl}_2$	56
$\text{S}_3\text{N}_2\text{Cl}_2$ and $\text{SOCl}_2$	57
$\text{S}_3\text{N}_2\text{O}_2$ and $\text{Cl}_2$	57
$\text{S}_3\text{N}_2\text{O}_2$ and $\text{C}_5\text{H}_5\text{N}$	58
$\text{S}_3\text{N}_2\text{O}_2$ and $\text{C}_{10}\text{H}_{10}\text{N}_2$	58
$\text{S}_3\text{N}_2\text{O}_2$ and $(\text{C}_6\text{H}_5)_3\text{P}$	58
$\text{S}_3\text{N}_2\text{O}_2$ and $\text{S}_2\text{Cl}_2$	59
$\text{S}_3\text{N}_2\text{O}_2$ and <u>trans</u> 1,4-diphenyl-but-1,3-diene	59

	Page
SULPHUR-NITROGEN-METAL COMPOUNDS	
Reaction between: $S_4N_4$ and $Se_2Cl_2$ in $SOCl_2$	60
$S_4N_4 \cdot TeCl_4$ and $SOCl_2$	61
$S_4N_4$ and $TeCl_4$ in $SOCl_2$	61
$S_4N_4$ and $TiCl_4$ in $SOCl_2$	61
$S_4N_4 \cdot TiCl_4$ and $SOCl_2$	62
$S_4N_4$ and $ZrCl_4$ in $SOCl_2$	63
$S_4N_4$ and $CrCl_3$ in $SOCl_2$	64
$S_4N_4$ and $MnCl_2$ in $SOCl_2$	65
$S_4N_4$ and $CoCl_2$ in $SOCl_2$	65
$S_4N_4$ and $NiCl_2$ in $SOCl_2$	66
$S_4N_4$ and $CuCl_2$ in $SOCl_2$	67
$S_4N_4$ and $ZnCl_2$ in $SOCl_2$	68
$S_4N_4$ and $HgCl_2$ in $SOCl_2$	69
$S_4N_4$ and $BCl_3$ in $SOCl_2$	70
$S_4N_4$ and $PhBCl_2$ in $SOCl_2$	71
$S_4N_4$ and $SnCl_4$ in $SOCl_2$	71
$2S_4N_4 \cdot SnCl_4$ and $SOCl_2$	72
$S_4N_4$ and $SbCl_5$ in $SOCl_2$	73
$S_4N_4 \cdot SbCl_5$ and $SOCl_2$	73
$S_4N_4$ and $Ph_3AsCl_2$ in $SOCl_2$	74

	Page
MASS SPECTRA	74
$S_4N_4$	80
$SCl_2$	80
$S_2Cl_2$	82
$SOCl_2$	83
$S_4N_3Cl$	85
$S_3N_2O_2$	85
New compounds	88

DISCUSSION

a) Sulphur-nitrogen-carbon compounds	91
b) New routes to Sulphur-nitrogen compounds	102
c) Sulphur-nitrogen metal compounds	111

APPENDIX I

Experimental	143
Discussion	145

REFERENCES

148

APPENDIX II

Introduction	158
Spectroscopic investigations of sulphur-halogen bonds	159
Discussion	175
References to Appendix II	177

INDEX TO FIGURES

	Page
1. The structure of $S_4N_4$	4
2. Reactions involving $S_4N_4$	6
3. Input data for isotopic abundance patterns	76
4. Isotope abundance patterns of SN and $S_2N_2$	77
5. Isotope abundance patterns of $SOCl_2$ and $SeCl_6$	78
6. Isotope abundance patterns of $S_2Cl_2$ and $NSOCl$	79
7. Infrared spectra of $S_4N_3Cl$ and $SeS_2N_2Cl_2$	121
8. Infrared spectra of $S_2N_2ZnCl_2$ , $S_2N_2ZrCl_4$ , $S_2N_2CrCl_3$ and $S_2N_2TiCl_2$	127
9. Graph of $\lambda_{SN}$ against $d_{SN}$	131
10. Infrared spectra of $S_4N_4 \cdot SbCl_5$ and $S_3N_3SbCl_6$	132
11. Infrared spectra of $S_4N_4NiCl$ and $S_4N_4HgCl_6$	134
12. Infrared spectra of $S_3N_3SbCl_6$ and the niobium compound	147

INTRODUCTION

## Introduction

The chemistry of sulphur-nitrogen compounds may conveniently be divided into the following sections: (a) sulphur nitrides, (b) sulphur nitrogen hydrides, (c) sulphur nitrogen oxides, (d) sulphur nitrogen halides, (e) sulphur nitrogen oxyhalides, (f) sulphur nitrogen metal compounds, (g) sulphur-nitrogen carbon compounds and (h) other sulphur nitrogen compounds with e.g. phosphorus which will not be discussed here.

### (a) Sulphur nitrides.

The chemistry of the sulphur nitrides is dominated by the parent compound, tetrasulphur tetranitride,  $S_4N_4$ , which was first prepared by Gregory in 1835 and characterised in 1896, when a molecular weight determination proved its molecular formula.<sup>1</sup>

#### (i) Tetrasulphur tetranitride, $S_4N_4$ .

Tetrasulphur tetranitride is an orange-red crystalline substance, insoluble in water, but soluble in benzene, carbon disulphide, carbon tetrachloride and liquid ammonia. The melting point is  $178-180^\circ$  and impure samples have been known to explode at temperatures approaching the melting point.<sup>2</sup> The specific gravity is 2.2 ( $20^\circ$ ) and the dipole moment 0.72D. The solid is in the monoclinic system (space group  $C_{2h}^5$ ) with lattice constants:  $a = 8.74$ ,  $b = 7.14$  and  $c = 8.645$ . There are four  $S_4N_4$  molecules in the unit cell. The compound is diamagnetic, toxic

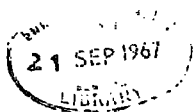

and has found limited use as a pesticide. Small quantities have been added to diesel fuels to facilitate ignition.

A variety of preparations are reported. The original synthesis<sup>1</sup> from ammonia and sulphur monochloride is still used. The mechanism of the reaction is not fully understood, but is thought to involve three main reactions:-

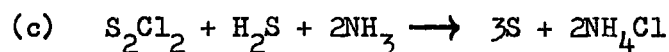
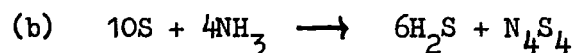

Other methods of preparation involve the use of the dichloride in benzene or ether solution, the use<sup>34</sup> of the fluoride,  $SF_4$ , or the reaction between elemental sulphur and ammonia, as in (b).<sup>1</sup> The reaction is reversible and the forward reaction is only favoured when the hydrogen sulphide is removed by the addition of a soluble silver salt to the liquid ammonia.

The structure of  $S_4N_4$  has been the subject of conjecture since its first preparation. Structures with polycyclic arrangements of atoms were proposed<sup>3</sup> as early as 1896. One of the earliest structures based on X-ray data postulated an arrangement of atoms as two concentric distorted tetrahedra. The fundamental assumption for this structure was that the crystal was orthorhombic. Later X-ray analyses have shown the crystal to be monoclinic.<sup>13</sup> The earliest proposed structure based on chemical properties was:

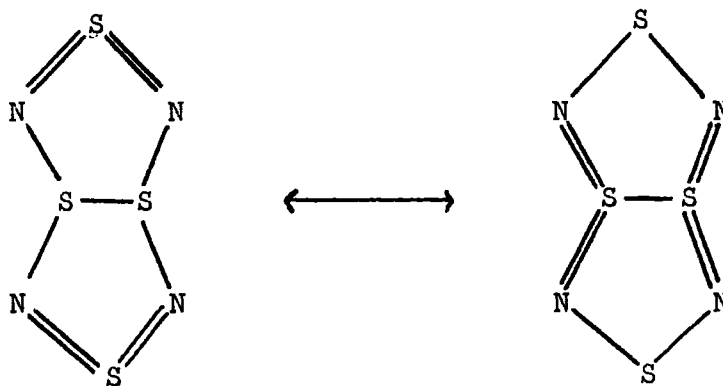

A more detailed X-ray examination,<sup>12</sup> vapour state electron diffraction measurements<sup>5</sup> and molecular orbital calculations<sup>122</sup> show a bisphenoid of sulphur atoms with nitrogen atoms along the four edges in square configuration. X-ray data of bond distances and angles are summarised in Figure 1, and these agree with those obtained from electron measurements.

Electron spin resonance measurements<sup>6</sup> give a value of 1.63Å for the S-N distance. This value lies between the value for an S-N single bond (1.74Å) and that for an S-N double bond (1.54Å). An S-N distance of 1.63Å corresponds<sup>7</sup> to a bond order of 1.5. This may be explained by a  $\pi$ -electron system due to  $p_{\pi} - d_{\pi}$  overlapping between the sulphur and nitrogen orbitals. For this, and similar ring systems (e.g. borazoles and phosphonitrilics) two concepts of the electron distributions are possible. Craig<sup>8</sup> explains the uniform S-N distances by assuming delocalised  $\pi$ -bonds, as in benzene, and this is supported by



Figure 1. Bond distances and angles in  $S_4N_4$ .

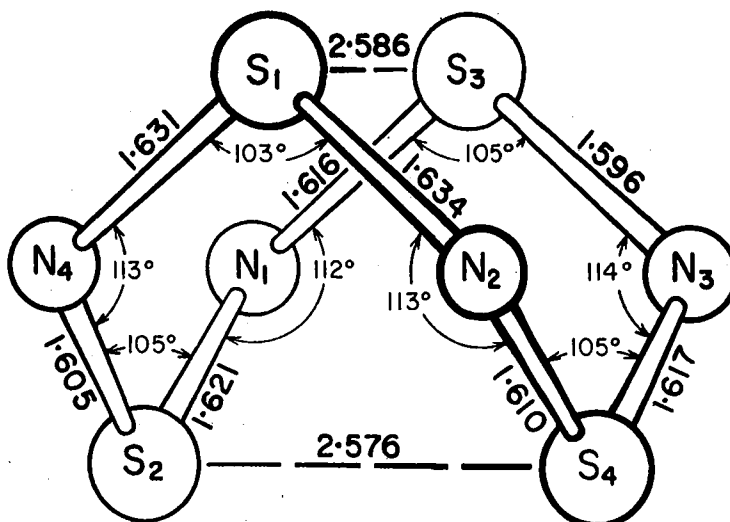

electron spin resonance measurements on sulphur nitride ions. Dewar,<sup>9</sup> on the other hand, regards the  $\pi$ -bonds as being separate and involving three-centre bonds, each involving one nitrogen and two sulphur atoms, with two electrons accommodated in each of the bonds. This explanation seems less probable. In the case of  $p_\pi - p_\pi$  overlapping, the delocalisation energy is greatly reduced in non planar rings. This effect is less marked in the case of  $p_\pi - d_\pi$  bonding because of the greater extension of the d-orbitals, and in the case of sulphur, the availability

of empty d orbitals.

The distance (2.58Å) between the sulphur atoms<sup>12</sup> not linked by a nitrogen atom, is substantially shorter than the sum of the van der Waals radii (3.7Å), and somewhat longer than an S-S bond (2.08Å). Lindqvist has suggested<sup>10</sup> that there is some interaction between these sulphur atoms and assumed this to take the form of a p-bond. Molecular orbital calculations<sup>122</sup> indicate a bond order of just less than 0.5 for the S-S bond. The equivalence of the sulphur atoms that results from the structure of the  $S_4N_4$  molecule has also been noted by Faessler and Becke-Goehring.<sup>11</sup> Apart from small refinements the structure of  $S_4N_4$  is now known with certainty. All data presently reported are consistent with a puckered eight membered ring or cage with S-N links and " $\frac{1}{2}$  bonds" between each pair of sulphur atoms on the same side of the square of nitrogen atoms.

It is from  $S_4N_4$  that many other sulphur-nitrogen compounds are synthesised, and the reactions of  $S_4N_4$  are summarised in Figure 2.

(ii) Tetrasulphur dinitride,  $S_4N_2$ .

Tetrasulphur dinitride,  $S_4N_2$ , may be prepared<sup>56</sup> by the reaction between  $S_2Cl_2$  and  $Hg_5(NS)_8$  in  $CS_2$ , or by combination of  $SO_2$  with  $NH_3$  at  $80^\circ$ , followed by hydrolysis.<sup>57</sup> Other products are formed in the latter reaction, including  $S_4N_4$ , sulphur, and sulphamic acid.

Reactions involving tetrasulphur tetranitride

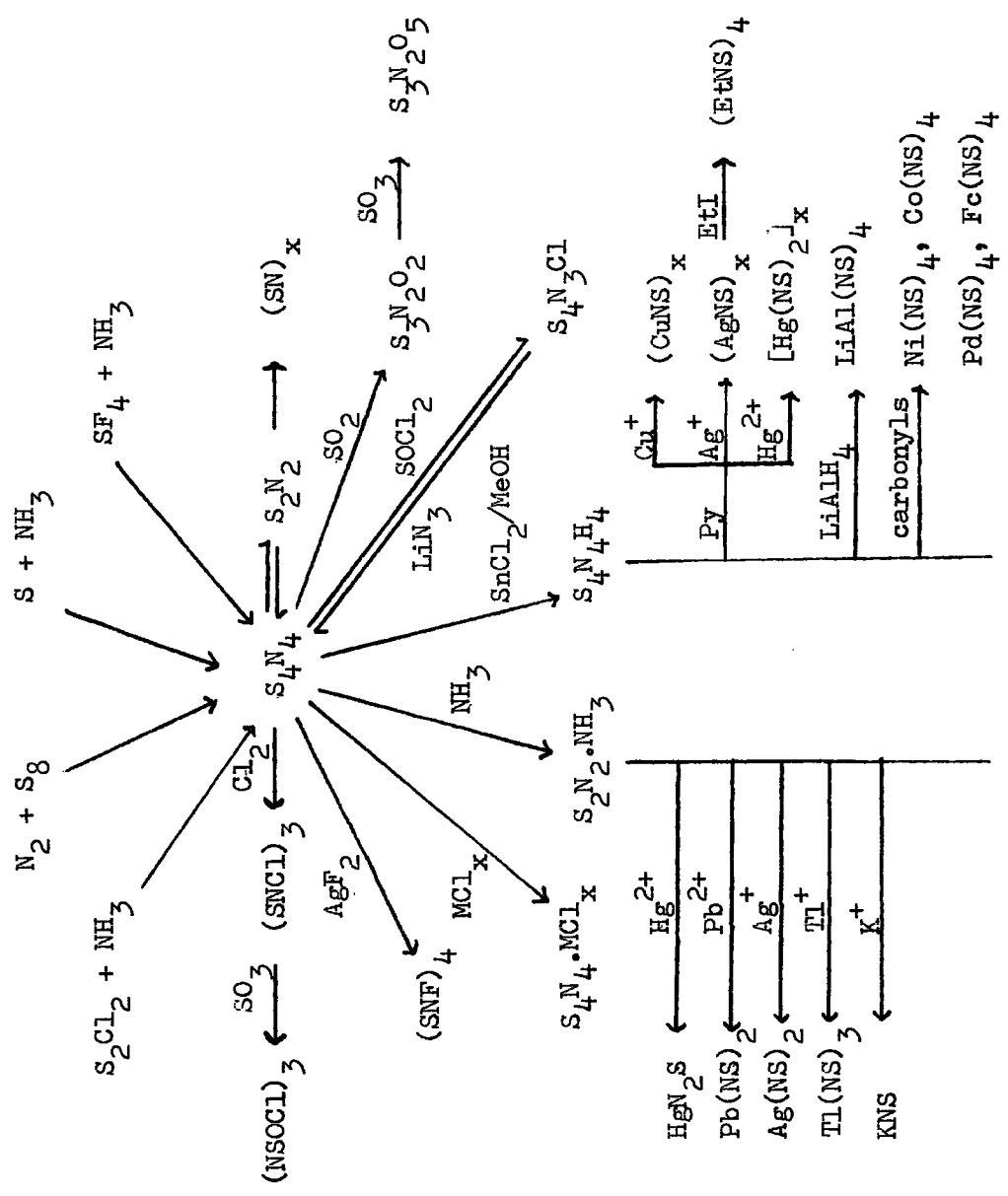
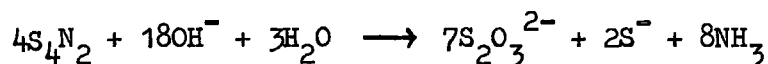
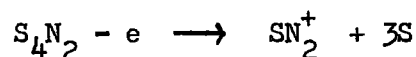

Figure 2.

$S_4N_2$  is a dark-red diamagnetic oil which solidifies at  $19.5^\circ$  and decomposes at  $25^\circ$ . It is soluble in benzene, nitrobenzene,  $CS_2$ ,  $CCl_4$  and diethyl ether.<sup>58</sup> Molecular weight determinations in benzene support the formula  $S_4N_2$ . It is quantitatively hydrolysed by sodium hydroxide:



and reduction<sup>59</sup> using  $SnCl_2$  or  $LiAlH_4$  in ether gives the imine  $S_4(NH)_2$ . The electron spin resonance spectrum<sup>60</sup> in conc.  $H_2SO_4$  gives a weak signal which may be due to the possible reaction:



(iii) Disulphur dinitride,  $S_2N_2$ , and Polysulphur nitride,  $(NS)_x$ .

Sublimation of  $S_4N_4$  at  $80^\circ$  and  $10^{-3}$  mm. through silver wool<sup>44,61</sup> heated to  $300^\circ$  gives a mixture of  $S_4N_2$  and  $S_2N_2$ . Disulphur dinitride,  $S_2N_2$ , may be recrystallised from diethyl ether at  $-70^\circ$ ; it is endothermic, explodes on rubbing, and although stable at  $-70^\circ$ , it polymerises slowly at room temperature to  $S_4N_4$  and  $(SN)_x$ . It is diamagnetic, a semiconductor, and is easily hydrolysed to  $NH_3$  and  $S_2O_3^{2-}$ . Reaction with  $S_2Cl_2$  gives  $S_4N_3Cl$ , and reaction with finely divided metals (e.g. Pd, Ni, Co) results in the formation of metal thionitrosyls:



Nickel carbonyl also reacts with  $S_2N_2$  to give  $Ni(SN)_4$ . Liquid ammonia

and  $S_2N_2$  react at  $-70^\circ$  to give a deep red, electrically conducting solution from which can be separated, a red unstable compound  $S_2N_2 \cdot NH_3$ . This reacts with  $NaCPh_3$  in ether to give the brown  $Na(NSNSNH_2)$ , which in excess of  $NaCPh_3$  gives the highly explosive  $Na_3(NSNSN)$ .

Polysulphur nitride may be prepared by the anhydrous polymerisation of  $S_2N_2$  at room temperature.  $(SN)_x$  is a dark blue compound with a metallic lustre. It is insoluble in organic solvents, and acts as a semiconductor.

(iv) Sulphur nitride, SN.

The diatomic species, SN, may be prepared by the action of an electric discharge on a mixture of sulphur and nitrogen vapours,<sup>62</sup> or on a mixture of elemental sulphur and nitrogen gas.<sup>63</sup> It has also been prepared by the reaction of  $H_2S$  with atomic nitrogen,<sup>64</sup> and its presence as an intermediate in reactions of some sulphur-nitrogen compounds has been invoked.<sup>40</sup> The emission spectrum has been studied in detail<sup>63-67</sup> and four bands have been observed at 3900, 3953, 3968 and  $4900\text{\AA}$  respectively. The interpretation of the spectrum is still the subject of controversy.

(v)  $S_2N$ ,  $S_5N$ ,  $S_{15}N_2$  and  $S_{16}N_2$ .

An electric discharge between aluminium electrodes at  $80-100^\circ$  produces a blue-black substance with an iodide like odour,  $S_5N_2$ , and a

deep black amorphous powder,  $S_2N$ . The latter decomposes above  $100^\circ$  to give a mixture of  $S_5N_2$  and  $S_4N_4$ , and reacts with HCl to give  $NH_4Cl$  and sulphur.<sup>68</sup>

Sulphur monochloride and sulphur dichloride react with  $S_7NH$  in  $CS_2$  to give the sulphur nitride compounds  $S_2(S_7N)_2$  and  $S(S_7N)_2$  respectively.<sup>69</sup>

b) Sulphur-nitrogen hydrides.

(i) Cyclotetrathiotetraimine,  $S_4N_4H_4$ .

Cyclotetrathiotetraimine is conveniently prepared by the reduction of  $S_4N_4$  using an alcoholic solution of  $SnCl_2$  in benzene.<sup>70-72</sup> The compound is readily reoxidised to  $S_4N_4$  by chlorine, and in air at  $110^\circ$  to  $120^\circ$  it is oxidised<sup>73</sup> to the tetrameric thionylimide  $(OSNH)_4$ .

$S_4N_4H_4$  is reduced<sup>46,74</sup> by Na/EtOH to sodium and ammonium sulphides, and hydrolysed by alkali to  $NH_3$  and  $S_2O_3^{2-}$ . The sodium salt,  $Na_4S_4N_4$  has been prepared by reaction of  $S_4N_4H_4$  with  $NaCPh_3$ , and is an orange red, highly explosive substance which detonates on exposure to moisture.<sup>75</sup>

Mercuric acetate in methanol reacts with  $S_4N_4H_4$  to give a compound  $Hg_5(NS)_8$ , which has been shown<sup>72</sup> to be a molecular complex of  $3Hg(NS)_2$  and  $Hg_2(NS)_2$ . Reaction with mercuric nitrate in dimethyl formamide<sup>76</sup> leads to a precipitate of the polymeric  $[Hg(NS)]_x$ .

The infrared and Raman spectra,<sup>77</sup> and X-ray diffraction studies<sup>78,79</sup> show  $S_4N_4H_4$  to consist of an eight membered puckered ring with alternate sulphur and nitrogen atoms. The S-N bond lengths are all equivalent

(1.674A), the dihedral angle is  $99^{\circ}24'$  and the bond angles N-S-N and S-N-S are  $108^{\circ}24'$  and  $122^{\circ}12'$  respectively. From a study of the infrared spectrum, the hydrogens are thought to be attached to the nitrogen, rather than the sulphur atoms,<sup>71</sup> and there is evidence of weak hydrogen bonding with a bond length of 3.16A.

$S_4N_4H_4$  has found limited use as an additive in the rubber industry. It increases and improves the physical properties of butyl rubbers and improves their resistance to ozone.<sup>80</sup>

(ii) Heptasulphurimide  $S_7NH$

The compound heptasulphurimide,  $S_7NH$ , is formed under conditions similar to those which give rise to  $S_4N_4$ , and is often a contaminant in the preparation of  $S_4N_4$ . The reaction between sulphur monochloride and ammonia at  $-15^{\circ}$ , and subsequent extraction of the product with methanol gives<sup>81</sup>  $S_7NH$ . Similar reactions at  $30^{\circ}$  to  $50^{\circ}$  in chloroform, carbon tetrachloride or dimethyl formamide give lower yields.<sup>82</sup> The reaction between ammonia and sulphur in  $S_2Cl_2$  is reported<sup>83</sup> to give a 19% yield (based on  $S_2Cl_2$ ) of  $S_7NH$ , and a chromatographic separation of the products of the  $S_2Cl_2/NH_3$  reaction gives a very pure product.<sup>84</sup>

$S_7NH$  may be recrystallised from methanol to give colourless rhombic pyramidal crystals. The melting point is  $109^{\circ}$  and it decomposes at  $250^{\circ}$  with the liberation of ammonia, and the formation of sulphur and  $S_5N_2$ .  $S_7NH$  is hydrolysed by bases to give  $NH_3$  and the polysulphides,

and it reacts with  $\text{Hg}(\text{OAc})_2$  to give  $\text{Hg}(\text{S}_7\text{N})_2$ . The sodium salt,  $\text{NaS}_7\text{N}$  has been formed by reaction with  $\text{NaCPh}_3$ , an acetate  $\text{S}_7\text{N}(\text{OAc})$  is also reported, and benzyl chloride reacts to give heptasulphur benzamide.<sup>76,85</sup> The reaction of  $\text{S}_7\text{NH}$  with sulphur chlorides has been used<sup>69</sup> to prepare  $\text{S}_{15}\text{N}_2$  and  $\text{S}_{16}\text{N}_2$ . Boron trichloride and tribromide react with  $\text{S}_7\text{NH}$  to give  $\text{S}_7\text{NBCl}_2$  and  $\text{S}_7\text{NBBR}_2$  respectively,  $\text{BI}_3$  causes destruction of the  $\text{S}_7\text{N}$  ring.<sup>86</sup>

The structure of  $\text{S}_7\text{NH}$  consists of an eight-membered puckered ring of orthorhombic symmetry<sup>87</sup> and has been postulated to arise by interaction of elemental sulphur with  $\text{S}_2\text{Cl}_2$  to give  $\text{Cl-S}_7\text{-Cl}$  followed by ring closure by reaction with  $\text{NH}_3$ .

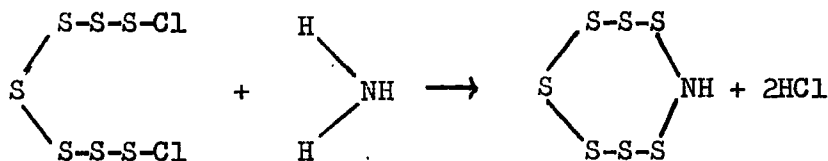

$\text{S}_7\text{NH}$  has found use as a fungicide and in the preparation of pharmaceuticals.<sup>82</sup>

(iii) Hexasulphurdiimide,  $\text{S}_6(\text{NH})_2$ .

Three isomers of hexasulphurdiimide,  $\text{S}_6(\text{NH})_2$ , are formed in low yields in the reaction between  $\text{S}_2\text{Cl}_2$  and  $\text{NH}_3$  in dimethylformamide at low temperature.<sup>88</sup> The three isomers are all eight membered puckered rings<sup>87</sup> analogous to  $\text{S}_8$  with two sulphur atoms replaced by NH, and have the structures (a), (b) and (c).



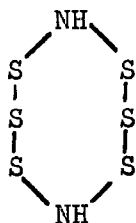

(a) m.p.  $155^{\circ}$

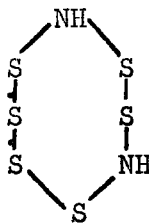

(b) m.p.  $133^{\circ}$

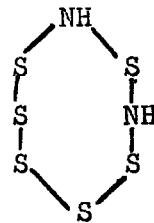

(c) m.p.  $130^{\circ}$

Pure samples crystallise as colourless rhombic crystals<sup>89</sup> from solutions in  $CS_2$ .

(iv) Sulphur imide,  $SNH$ , and diimide,  $S(NH)_2$ .

When  $S_4N_4$  is treated with a solution of  $KNH_2$  in  $NH_3$  at  $-33^{\circ}$ , a yellow precipitate is formed, and has been shown to be an equimolecular mixture of  $SNK$  and  $S(NK)_2$ . Both compounds are very moisture sensitive and decompose rapidly in air.<sup>90</sup> Mercuric iodide in liquid ammonia reacts with  $(SNCl)_3$  to give a greenish-yellow precipitate of  $HgN_2S.NH_3$ , which loses ammonia in vacuo at  $90^{\circ}$  to give<sup>91</sup> the yellow  $HgN_2S$ . The imides are only known in the form of metal derivatives, which are extremely moisture sensitive.

(c) Sulphur-nitrogen oxides.

(i) Thiodithiazyl dioxide,  $S_3N_2O_2$ .

Tetrasulphur tetranitride reacts with thionyl chloride, in the

presence of sulphur dioxide, arsenic trichloride or nitric oxide to give <sup>92</sup> S<sub>3</sub>N<sub>2</sub>O<sub>2</sub>. Becke-Goehring has used labelled sulphur in thionyl chloride to show that the sulphur atoms in the thiodithiazyl dioxide originate from the S<sub>4</sub>N<sub>4</sub> and SOCl<sub>2</sub>, but was unable to obtain any S<sub>3</sub>N<sub>2</sub>O<sub>2</sub> from the reaction of these compounds alone. Recent research in these laboratories however, has shown (see p.56 and ref. 40) that S<sub>3</sub>N<sub>2</sub>O<sub>2</sub> is formed in small yields in the reaction between SOCl<sub>2</sub> and S<sub>4</sub>N<sub>4</sub>, the major product of the reaction being S<sub>4</sub>N<sub>3</sub>Cl. S<sub>3</sub>N<sub>2</sub>O<sub>2</sub> is also obtained in the reaction between S<sub>4</sub>N<sub>4</sub> and certain metal halides in thionyl chloride, (see pp. 122 - 124 ). The author proposes that the mechanism of the reaction involves SN or S<sub>2</sub>N<sub>2</sub> fragments.

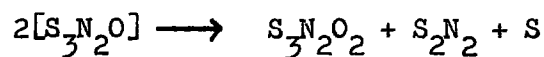
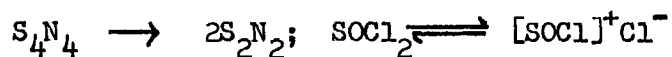

S<sub>3</sub>N<sub>2</sub>O<sub>2</sub> can also be prepared in about 10% yield (calculated on SOCl<sub>2</sub>), by passing thionyl chloride vapours over a mixture of hot sulphur or sulphur chloride and ammonium chloride.<sup>93</sup>

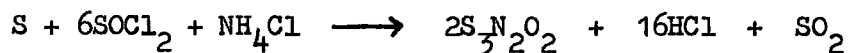

Thiodithiazyl dioxide is a yellow crystalline solid, m.p. 101°. It turns red on heating to 80° and at 300° it gives a yellow vapour which ignites

in air. It can be purified by sublimation in vacuo at 35°. Little is known of its chemical reactivity. It reacts with SO<sub>3</sub> to give an adduct<sup>94</sup>, S<sub>3</sub>N<sub>2</sub>O<sub>2</sub>.2SO<sub>3</sub>, which on heating forms SO<sub>2</sub> and S<sub>3</sub>N<sub>2</sub>O<sub>5</sub>. It also reacts with SbCl<sub>5</sub> and TiCl<sub>4</sub> to give S<sub>4</sub>N<sub>4</sub>.SbCl<sub>5</sub> and S<sub>4</sub>N<sub>4</sub>.2TiCl<sub>4</sub> respectively.<sup>95</sup> The structure of the latter is thought to involve chlorine bridging groups.

The crystal structure of S<sub>3</sub>N<sub>2</sub>O<sub>2</sub> has been reported by Weiss;<sup>96</sup> the molecule consists of a planar zig-zag chain of sulphur and nitrogen atoms, and is not cyclic as originally thought.<sup>97</sup>

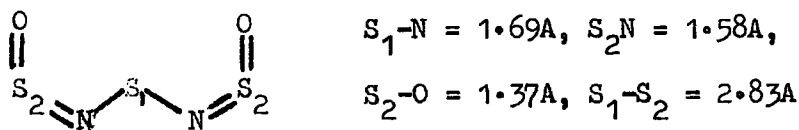

$$\text{NS}_1\text{N} = 95.3^\circ, \text{NS}_2\text{O} = 115.3^\circ, \text{S}_1\text{NS}_2 = 120^\circ.$$

(ii) Other sulphur-nitrogen oxides, S<sub>3</sub>N<sub>2</sub>O<sub>5</sub>, S<sub>4</sub>N<sub>2</sub>O<sub>5</sub>, S<sub>6</sub>N<sub>4</sub>O<sub>6</sub>, S<sub>8</sub>N<sub>4</sub>O<sub>12</sub>.

Tetrasulphur tetranitride reacts with SO<sub>3</sub> to give two adducts,<sup>94</sup> S<sub>4</sub>N<sub>4</sub>.2SO<sub>3</sub> and S<sub>4</sub>N<sub>4</sub>.4SO<sub>3</sub>. Thermal decomposition of these compounds at about 50°, or the reaction of excess of SO<sub>3</sub> on S<sub>4</sub>N<sub>4</sub> produces S<sub>3</sub>N<sub>2</sub>O<sub>5</sub>. Thiodithiazyl dioxide also forms a 1:1 adduct with SO<sub>3</sub>, which readily converts to S<sub>3</sub>N<sub>2</sub>O<sub>5</sub> on heating.<sup>94</sup> The structure of this is not known but Goehring and Heinke have postulated a six membered ring:

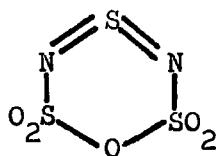

$S_5N_2O_5$  reacts vigorously with water, evolving  $SO_2$  and forming sulphamic acid and sulphamide.

Thionyl chloride reacts with  $Hg_5(NS)_8$  to give a red compound  $S_5N_2O$ . This compound is soluble in a variety of organic solvents and is decomposed by alkali;<sup>98</sup>

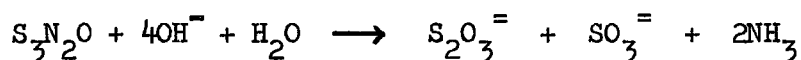

The compound is thought to be a diisothiazyl sulphoxide,  $(NS)_2SO$ .

(d) Sulphur-nitrogen halides.

(i) Thiazyl bromide  $(NSBr)_x$ .

When bromine is allowed to react with  $S_4N_4$  in  $CS_2$ , a bronze coloured compound,  $(NSBr)_x$  is formed. This compound, which was first synthesised<sup>39</sup> in 1896, has been little investigated since, and in the absence of a molecular weight determination is still formulated  $(SNBr)_x$ .

(ii) Thiazyl chloride,  $NSCl$ .

Reaction between  $NSF$  and  $Cl_2$  yields<sup>14</sup> gaseous  $NSCl$ , which can also be prepared by the thermal decomposition of  $N_3S_3Cl_3$  in vacuo.<sup>19</sup> The structure of thiazyl chloride is analogous to that of the fluoride.

(iii) Thiazyl fluoride, NSF.

Fluorination of  $S_4N_4$  with  $HgF_2$ , leads to the formation<sup>34</sup> of the unstable, colourless gas, thiazyl fluoride, NSF. The compound has a pungent odour and decomposes rapidly in the presence of moisture, probably via  $(HNSO)$ , to give<sup>15</sup> a blue precipitate, and decomposes further to  $SO_3^{=}$  and  $NH_4^+$ . On hydrolysis with dilute sodium hydroxide, NSF gives a yellow precipitate as an intermediate, which again decomposes to  $SO_3^{=}$ ,  $NH_4^+$  and  $F^-$ . The structure  $N\equiv S-F$  was deduced from the nature of the hydrolysis products and has been confirmed by infrared spectroscopy,<sup>16</sup> by measurement of its nuclear magnetic resonance spectrum,<sup>16</sup> by electron diffraction<sup>17</sup> and by microwave spectroscopy.<sup>17</sup> The infrared spectrum contains three strong bands, which correspond to the normal vibrations of a triatomic nonlinear molecule. The microwave spectrum indicated that it was sulphur which was the central atom, and that therefore the compound should be formulated as  $N\equiv S-F$ .

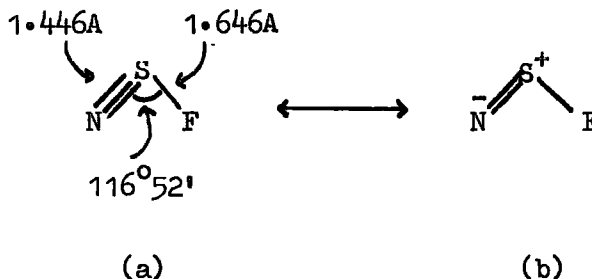

The NSF model agrees considerably better than the SNF model with the infrared data, since the S-N force constant derived from the infrared spectrum<sup>18</sup> corresponds to a bond order of 2.3, and the S-N distance

of 1.446A corresponds<sup>7</sup> to a bond order of 2.5. The S-N and S-F force constants based on an NSF model give values of 1.47A and 1.64A for the S-N and S-F distances, compared with the experimentally determined values of 1.446A and 1.646A.

(iv) Thiazyl trifluoride, NSF<sub>3</sub>.

Fluorination of NSF with silver difluoride leads to the formation of NSF<sub>3</sub>. Thiazyl trifluoride is also formed in addition to NSF when ammonia is introduced into a suspension of sulphur and silver difluoride in CCl<sub>4</sub>; the yield however is low.<sup>20</sup> Considerable amounts of NSF<sub>3</sub> have been reported<sup>29</sup> to form when S<sub>2</sub>F<sub>10</sub> is treated with NH<sub>3</sub>.

NSF<sub>3</sub> is a colourless gas with a pungent odour (m.p. -72.6°, b.p. -27.1°). It is stable up to 500° at which temperature it reacts rapidly with glass to give SiF<sub>4</sub>, SO<sub>2</sub>, S, N<sub>2</sub> and metal fluorides.<sup>14</sup> It does not react with hydrogen chloride, ammonia or dilute acids, and only reacts with metallic sodium on strong heating. Hydrolysis occurs in boiling sodium hydroxide and sulphamic acid has been detected as an intermediate product; this is converted quantitatively into SO<sub>4</sub><sup>=</sup> and NH<sub>4</sub><sup>+</sup> on acidification. Being a Lewis base, NSF<sub>3</sub> reacts with BF<sub>3</sub> to form colourless NSF<sub>3</sub>.BF<sub>3</sub>, which can be purified by sublimation.<sup>21</sup> Infrared measurements and molecular weight determinations have shown the gas phase to consist of a mixture of equivalent amounts of NSF<sub>3</sub> and BF<sub>3</sub>. The formulae (a) and (b) have been postulated for the structure of the adduct in the liquid and solid phases respectively.<sup>30</sup>

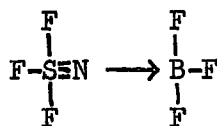

(a)

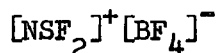

(b)

The instability of  $\text{NSF}_3 \cdot \text{BF}_3$  demonstrates the reduced effectiveness of the donor activity of the lone electron pair on the nitrogen atom caused by the S-N triple bond.

The structure of  $\text{NSF}_3$  has been deduced from studies of its infrared,<sup>16</sup> nuclear magnetic resonance,<sup>16</sup> and microwave spectra.<sup>31</sup>  $\text{NSF}_3$  has a similar structure to the tetrahedrally coordinated compound,  $\text{OPF}_3$ , and has  $\text{C}_{3v}$  symmetry. Calculation of the S-N bond strength from the force constants gives a bond order of 2.7, and these results are confirmed by the microwave spectrum.<sup>31</sup> The structural data are summarised in formula (c).

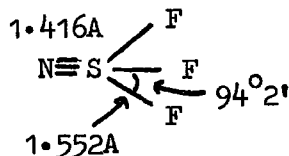

dipole moment = 1.91D.

(c)

(v)  $\text{SN}_2\text{F}_2$

A compound  $\text{SN}_2\text{F}_2$  has been isolated in the reaction between  $\text{S}_4\text{N}_4$  and  $\text{AgF}_2$  in  $\text{CCl}_4$ . The main product of the reaction,  $\text{S}_4\text{N}_4\text{F}_4$ , may also be converted into  $\text{SN}_2\text{F}_2$  by refluxing in  $\text{CCl}_4$  for long periods.<sup>28</sup>  $\text{SN}_2\text{F}_2$  decomposes at its boiling point ( $108^\circ$ ) into  $\text{SNF}_3$  and  $\text{SNF}$ .

(vi) Thiodithiazyl monochloride,  $S_3N_2Cl$ .

Thiodithiazyl monochloride,  $S_3N_2Cl$  may be prepared by the reaction of  $S_4N_4$  with  $S_2Cl_2$ , or by decomposition<sup>24</sup> of  $S_3N_2Cl_2$ . Becke-Goehring<sup>26</sup> has suggested that the reaction may be a complex one, and proceeds via some unknown intermediate. The compound may also be prepared by the reaction between  $S_4N_4$  and  $NOCl$ , or by reaction of nitric oxide with  $S_3N_3Cl_3$  in nitromethane.<sup>26</sup>

The compound hydrolyses rapidly in air, and its insolubility in organic solvents and low volatility may indicate some degree of polymerisation.

Thiodithiazyl monobromide has also been prepared,<sup>27</sup> but little information is available on its properties.

(vii) Thiodithiazyl dichloride,  $S_3N_2Cl_2$ .

Thiodithiazyl dichloride, is prepared<sup>21,22</sup> by heating  $S_3N_3Cl_3$  in  $S_2Cl_2$ . In the presence of excess of chlorine, it reverts to  $S_3N_3Cl_3$ , whilst further heating<sup>20,23,24</sup> in  $S_2Cl_2$ ,  $SCl_2$  or  $CCl_4$  gives  $S_4N_3Cl$ . Jolly *et alia*<sup>24</sup> have improved the synthesis of  $S_3N_2Cl_2$  by heating ammonium chloride and  $S_2Cl_2$  under an air condenser for several hours. The mechanism proposed for the reaction,

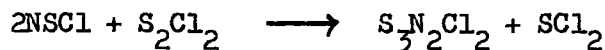
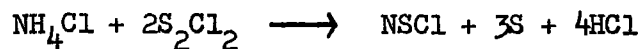

invokes the presence of  $NSCl$  in solution as an intermediate.



The structure of  $S_3N_2Cl_2$  has recently been elucidated,<sup>122</sup> and the compound has been shown to be ionic,  $S_3N_2Cl^+Cl^-$ . Unlike  $S_3N_2F_2$ , the molecule consists of a puckered sulphur-nitrogen ring:

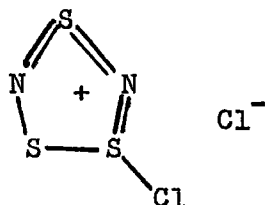

The use of  $S_3N_2Cl_2$  as an intermediate in the preparation of other thiodithiazyl compounds has recently been reviewed.<sup>25</sup> Sublimation of the compound in vacuo at 80-95° gives the dark green compound  $S_3N_2Cl$ . The chemistry of  $S_3N_2Cl_2$  has recently been reviewed.<sup>25</sup>

(viii) Thiodithiazyl difluoride,  $S_3N_2F_2$ .

Controlled decomposition of NSF gives green-yellow crystals which may be sublimed in vacuo to give two fractions at 40° and 65° respectively.<sup>20</sup> These sublimes seem to be polymorphous modifications of the same compound, thiodithiazyl difluoride,  $S_3N_2F_2$ , and Glemser<sup>20</sup> has postulated that of the two possible structures, (a) and (b), (a) is to be preferred since the different canonical forms possible could account for the intense colour of the compound, whereas in (b) the bonds are more localised:



(a)



(b)

(ix) Trithiazyl monochloride,  $S_3N_3Cl$ .

The preparation of the red-brick compound  $S_3N_3Cl$  was reported by Demarcay<sup>22</sup> in 1880, and Meuwsen<sup>23</sup> has reproduced the reaction by treating a hot solution of  $S_4N_4$  in chloroform with chlorine. Excess of chlorine leads to the formation of  $S_3N_3Cl_3$ .

(x) Trithiazyl trichloride,  $S_3N_3Cl_3$ .

Whilst on careful fluorination of  $S_4N_4$ , the ring remains intact, chlorination, using chlorine in  $CCl_4$ , leads to ring compression, and the formation of trithiazyl trichloride,  $S_3N_3Cl_3$ . The chloride is less sensitive to moisture than the fluoride, and is soluble in benzene, carbon disulphide and  $CCl_4$ . On heating it forms the monomeric gaseous  $NSCl$ , which readily reverts to  $S_3N_3Cl_3$  on cooling.<sup>19</sup>

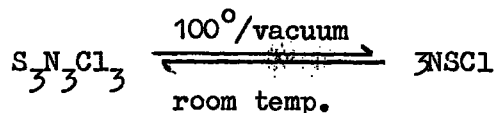

On careful hydrolysis, sulphite ions are formed which react with more  $S_3N_3Cl_3$  to give thiosulphate. With potassium cyanide,  $S_3N_3Cl_3$  forms  $SCN^-$  ions,<sup>36</sup> and in the presence of pyridine it reacts with  $S_4N_4H_4$  to give  $S_4N_4$ .

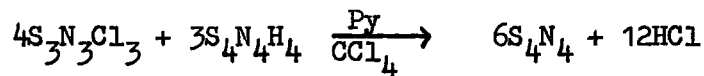

In contrast to  $S_4N_4F_4$ , the  $S_3N_3Cl_3$  molecule has only one S-N distance (1.605Å) and the ring is considered to be aromatic, since

delocalisation of the  $\pi$ -bonds is indicated.<sup>37</sup>

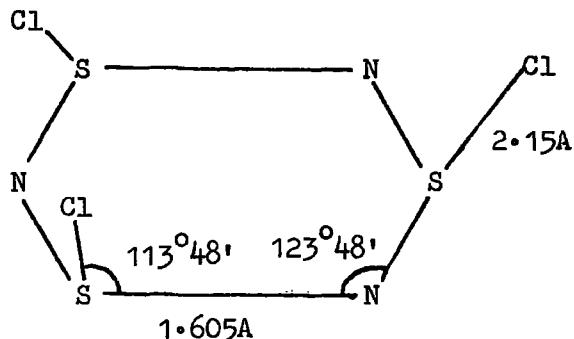

The ring is in the chair form, and the nitrogen atoms deviate by an average of 0.18 Å from the plane of the sulphur atoms. The chlorine atoms are located in the axial position.

(xi) Trithiazyl trifluoride,  $S_3N_3F_3$ .

$S_3N_3Cl_3$  reacts with silver difluoride in carbon tetrachloride to give the fluorine analogue  $S_3N_3F_3$ .

Trithiazyl trifluoride is a crystalline compound, soluble in benzene and  $CCl_4$ , and readily volatile at room temperature. It is stable in dry air, but easily hydrolysed to ammonium fluoride.<sup>38</sup>

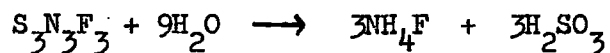

The nuclear magnetic resonance spectrum, like that of  $S_4N_4F_4$ , shows only one resonance signal, indicating equivalent fluorine atoms. The position of the absorption maximum again indicates that the fluorine atoms are attached to sulphur. The conclusion that  $S_3N_3F_3$ , like  $S_4N_4F_4$  contains localised double bonds seems justified, since the

nuclear magnetic resonance spectra indicate similar electron distributions in the two compounds.

Hence of the three cyclic halides,  $S_4N_4F_4$ ,  $S_3N_3F_3$  and  $S_3N_3Cl_3$ , the chloride contains delocalised molecular orbitals, whereas the two fluorides contain localised  $\pi$ -bonds. The reason for this is not difficult to explain; the polarization of the sulphur atoms by the fluorine atoms causes a decrease in the lone pair - lone pair repulsion between the sulphur and nitrogen atoms, and hence a decrease in bond length. The tendency to double bond formation is therefore enhanced. Alternating double and single bonds in the ring are also favoured with respect to equal bond orders when the gain in double bond energy exceeds the delocalisation energy for equal distances. Such is the case in  $S_4N_4F_4$ , where the position is intensified by the position of the fluorine atoms; the N=S-F angle being as wide as possible:

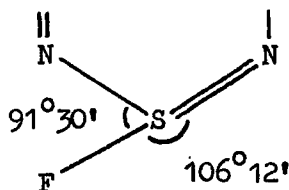

The same assumptions hold for  $S_3N_3F_3$ . In  $S_3N_3Cl_3$  however, the chlorine does not polarize the sulphur as strongly as the fluorine is able to in  $S_3N_3F_3$ , the S-N bonds are longer, the gain in delocalisation energy is therefore greater than the gain in double bond energy, and  $\pi$ -delocalisation occurs in the ring.

(xii) The thiotrithiazyl halides,  $S_4N_3X$ .

The thiotrithiazyl halides,  $S_4N_3X$ , were discovered by Demarcay<sup>22</sup> in 1880, and although moisture sensitive, represent the most stable of the sulphur-nitrogen halides. All four halides are known, but the chloride is by far the most thoroughly investigated.

Thiotrithiazyl chloride,  $S_4N_3Cl$  can be conveniently prepared by the chlorination of tetrasulphur tetranitride. Many chlorinating agents have been used, including  $S_2Cl_2$  in carbon tetrachloride,<sup>23</sup> thionyl chloride,<sup>40</sup> acetyl chloride,<sup>41</sup>  $S_2Cl_2$  and silver wool<sup>44</sup> and diselenium dichloride in carbon tetrachloride,<sup>42</sup> or thionyl chloride.<sup>40</sup> Chlorination of  $S_4N_4H_4$  also yields<sup>43</sup>  $S_4N_3Cl$ , via the intermediate adduct  $S_4N_4 \cdot 4HCl$ . All other sulphur-nitrogen halides can also be converted to  $S_4N_3Cl$ , e.g.  $S_3N_3Cl_3$  and  $S_3N_2Cl_2$  by heating with  $S_2Cl_2$  in  $CCl_4$ , or  $S_3N_3Cl$  by reaction with  $S_2Cl_2$  in the presence of chlorine and  $CCl_4$ . The reaction of  $S_2Cl_2$  with lithium azide in benzene also gives  $S_4N_3Cl$ ; excess lithium azide however, converts the chloride to  $S_4N_4$ .

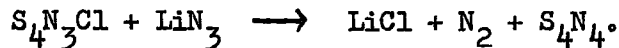

Thiotrithiazyl chloride is a yellow crystalline compound, stable in dry air. On heating it decomposes in vacuo at  $170^\circ$  with the formation of  $S_4N_4$ . It is insoluble in most solvents, except thionyl chloride and anhydrous formic acid. It can be recrystallised from the latter in the form of red needles.<sup>40</sup> In most organic solvents,

including acetone, benzene, acetic acid and chloroform it decomposes with the development of a red colour. The course of the hydrolysis is very much dependent on the reaction conditions;<sup>46</sup> in ice-cold sodium acetate solution, the first product formed is the black  $S_4N_3OH$ , whereas at room temperature the black  $(S_3N_3OH)_2$  is formed. These hydroxides are probably polymeric, and both revert to  $S_4N_4$  on standing. In dilute hydrochloric acid,  $NH_4Cl$  and sulphur are formed with the evolution of  $SO_2$ .

Thiotriithiazyl chloride undergoes metathetical reactions in which the chlorine may be replaced by other anions. Demarcay prepared the nitrate and hydrogen sulphate by reaction with concentrated nitric and sulphuric acids respectively,<sup>47</sup> and Muthmann and Seitter<sup>48</sup> obtained the yellow bromide and bronze coloured thiocyanate<sup>ate</sup> from concentrated solutions of  $S_4N_3Cl$  in anhydrous formic acid by precipitation with  $KBr$  and  $NH_4SCN$  respectively. The methods of preparing the thiotriithiazyl derivatives have now been refined notably by Becke-Goehring<sup>49</sup> and Meuwsen<sup>46</sup> and other derivatives e.g. tetraphenyl borate and hexachloro-antimonate<sup>have been</sup> prepared.

The ready exchange of the chlorine in  $S_4N_3Cl$  makes a salt like structure such as  $[S_4N_3]^+Cl^-$  probable. This supposition has now been verified by determining the molecular weight of the fluoride<sup>50</sup> and chloride,<sup>49</sup> and showing the cation  $[S_4N_3]^+$  to be monomeric in solution. The structure (a) was proposed<sup>51</sup> for the  $[S_4N_3]^+$  cation; this corresponds to the original formula (b) described by Muthmann and Seitter<sup>48</sup> in 1897.

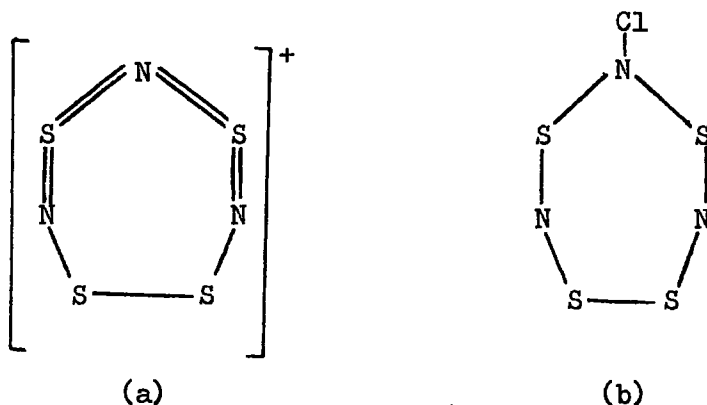

Weiss<sup>52</sup> has carried out an X-ray study of the nitrate and shown that the  $[S_4N_3]^+$  cation is a seven membered ring. Further work by Cordes *et alia*<sup>53,54</sup> and spectroscopic studies by Bailey and Lippincott<sup>55</sup> have shown the ring to be planar. The bond lengths and angles are summarised in Figure (C).

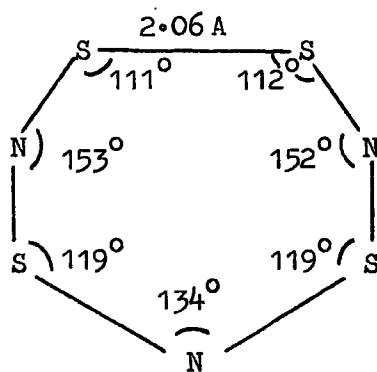

All S-N bond lengths are 1.54A.

(c)

(xiii) Tetrathiazyl tetrafluoride  $S_4N_4F_4$ .

Fluorination of  $S_4N_4$ , by silver difluoride suspension in  $CCl_4$  gives colourless crystals of tetrathiazyl tetrafluoride,  $S_4N_4F_4$ .

Tetrathiazyl tetrafluoride decomposes below its melting point ( $158^\circ$ ), and hydrolyses completely in hot sodium hydroxide solution:

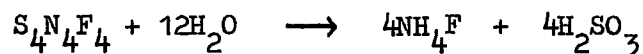

It acts as a Lewis base, and forms a green coloured adduct with  $BF_3$ , for which the structure (a) has been proposed. The adduct

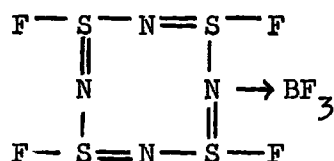

(a)

decomposes after a few hours, even in dry nitrogen.<sup>33</sup>

Measurement<sup>16</sup> of the fluorine nuclear magnetic resonance of  $S_4N_4F_4$  shows only one resonance signal, from which it follows that all the fluorines are in structurally analogous positions. The fluorine chemical shift deviates only slightly from that of  $SF_6$ , and hence it may be deduced that the fluorines are also attached to sulphur in the compound. The structure has been elucidated by Wiegers and Vos<sup>35</sup> and the molecule shown to consist of a puckered eight membered ring. Two different S-N distances (1.66A and 1.54A) which correspond to bond orders of 1.42 and 2.0 respectively, demonstrate the existence of localised double bonds, and hence the absence of resonance structures.

(e) Sulphur-nitrogen oxyhalides.

Of the sulphur-nitrogen oxyhalides, by far the most important and interesting are the sulphanuric halides and their derivatives.



Sulphanuric chloride, or 1,3,5-trichloro, 1,3,5-trioxo-trithiatriazine,  $(\text{NSOCl})_3$  was first prepared by Kirsanov<sup>99</sup> in 1952, when he obtained two isomers  $\alpha$ , and  $\beta$ , by the pyrolysis of trichlorophosphazosulphuryl chloride, prepared by the action of  $\text{PCl}_5$  on sulphamic acid.<sup>100</sup>

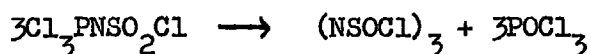
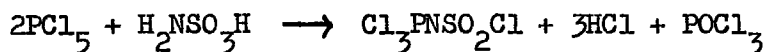

The reaction mixture obtained by Kirsanov contained at least three other isomers ( $\gamma$ ,  $\delta$  and  $\epsilon$ ) in addition to the main products.  $\alpha$ -Sulphanuric chloride (m.p.  $145.5^\circ$ ) is readily soluble in benzene and ether and can be recrystallised from petroleum ether.  $\beta$ -Sulphanuric chloride (m.p.  $47.5^\circ$ ) is much more soluble in petroleum ether, but may be purified by sublimation.

Sulphanuric chloride consists of a six membered sulphur-nitrogen ring, which can be described as aromatic, since there will be considerable  $\pi$ -delocalisation of the  $p_\pi - d_\pi$  orbitals in the ring. Sulphanuric chloride may also be prepared by the oxidation of  $(\text{NSCl})_3$  using  $\text{SO}_3$ , and from  $\text{S}_2\text{Cl}_2$  <sup>SOCl<sub>2</sub></sup> and  $\text{NH}_3$ , although only low yields are reported in the latter

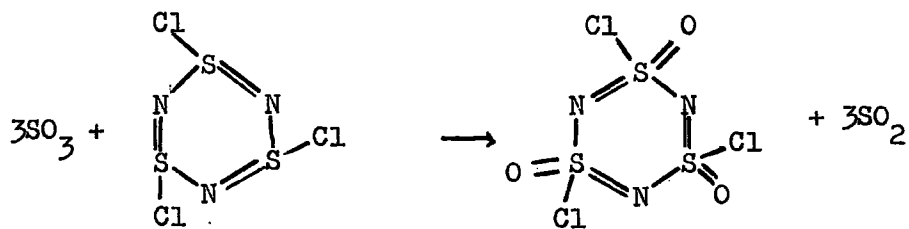

The chemistry of sulphauric chloride has recently been reviewed in detail.<sup>102</sup>

Other sulphur-nitrogen oxyhalides, e.g. derivatives of sulphamic acid are treated in detail in most text books on Inorganic Chemistry.

(f) Sulphur-nitrogen-metal compounds.

In 1904, Ruff and Geisel<sup>103</sup> obtained the ammonia adduct of two sulphur-nitrogen metal compounds,  $PbN_2S_2$  and  $HgN_2S$ , by the reaction of  $S_4N_4$  in liquid ammonia with  $PbI_2$  and  $HgI_2$  respectively. Later, Davis<sup>104</sup> obtained the compounds,  $SnCl_4 \cdot S_4N_4$ ;  $SbCl_6 \cdot S_4N_4$ ;  $WCl_4 \cdot S_4N_4$ ;  $Ti_2Cl_6 \cdot S_4N_4$  and  $MoCl_5 \cdot S_4N_4$ , and Wüibling<sup>105</sup> prepared  $TiCl_4 \cdot S_4N_4$ .

At present, the number of sulphur-nitrogen metal compounds and their organometallic derivatives known totals less than sixty, and these can be divided into the following classes: (i) compounds involving group VIII metals, which are of the type,  $MeH_2N_4S_4$ ,  $MeN_4S_4$ ,  $MeHN_3S_5$ ,  $MeN_2S_6$  (where Me represents a metal atom) and their derivatives, (ii) reaction products of the reaction between  $S_4N_4 \cdot 2NH_3$  and metal salts, (iii) reaction products of the reaction between  $S_4N_4H_4$  and metal salts, (iv) reaction products of the reaction between  $S_7NH$  and metal salts and (v) addition products of  $S_4N_4$  and metal halides.

(i) Compounds involving metals of group VIII

(a) Type  $MeH_2N_4S_4$  and  $MeN_4S_4$ .

Compounds of the type  $MeH_2N_4S_4$  are known where Me = nickel<sup>106-108</sup>,

cobalt<sup>106,108,109</sup>, palladium<sup>106,108,110</sup> and platinum<sup>108,110</sup>. They consist of chelate complexes involving two  $S_2N_2H$  groups and a metal atom, and are formed by the reaction between an alcoholic solution of the metal halide and  $S_4N_4$ .

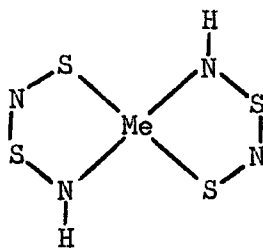

The platinum compound can also be prepared by the reaction of  $H_2PtCl_6$  with  $S_4N_4$  in dimethylformamide.<sup>106</sup> The compounds decompose on heating and are hydrolysed by water.

The compounds  $NiN_4S_4$ ,  $CoN_4S_4$  and  $FeN_4S_4$  can be prepared by the reaction of  $S_4N_4$  with the metal carbonyl in benzene.<sup>106,109</sup>



These compounds are similar to their  $N_4S_4H_2$  analogous in structure and physical properties.  $NiH_2N_4S_4$  is diamagnetic and  $CoH_2N_4S_4$  and  $FeN_4S_4$  are paramagnetic.

The hydrogen atoms in the compounds  $NiH_2N_4S_4$  and  $CoH_2N_4S_4$  have been replaced by numerous organic groups. Most of these derivatives have been prepared via the silver salts, formed by reaction with  $AgNO_3$  in alcoholic solution, or the lithium salts, formed by reaction

with methyl lithium. Both the mono- and di-substituted derivatives have been prepared and cis and trans isomers exist depending on the geometry of the substituent groups, e.g.  $\text{Ni}(\text{CH}_3\text{N}_2\text{S}_2)_2$  is trans, whilst  $\text{Ni}(\text{CH}_2\text{OS}_2\text{N}_2)_2$  exists in the cis form:-

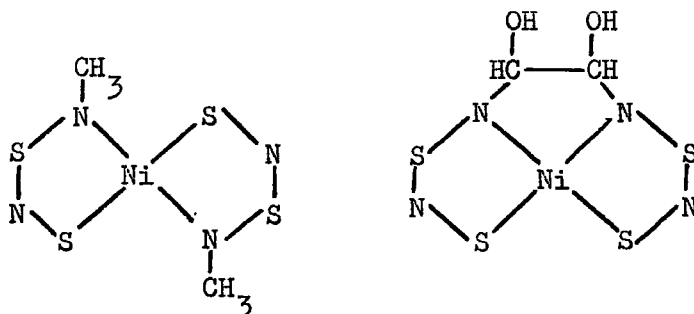

Examples of further derivatives of  $\text{NiH}_2\text{S}_4\text{N}_4$  are given in Table 2.

(b) Type  $\text{MeHN}_3\text{S}_5$  and  $\text{MeN}_2\text{S}_6$ .

In the reaction described above, which gave rise to the formation of  $\text{NiH}_2\text{S}_4\text{N}_4$  and  $\text{CoH}_2\text{S}_4\text{N}_4$ , smaller yields of other sulphur-nitrogen metal compounds have been obtained by a chromatographic separation of the products. Piper<sup>107</sup> has obtained, in this way, samples of  $\text{NiHN}_3\text{S}_5$  and  $\text{NiN}_2\text{S}_6$ , and similar compounds have been prepared for cobalt and palladium.<sup>111</sup>

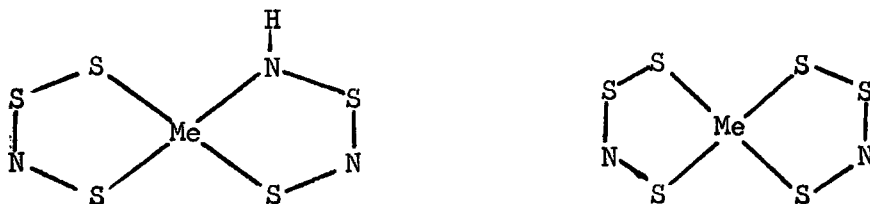

(ii) Reaction products of the reaction between  $S_4N_4 \cdot 2NH_3$  and metal salts.

$S_4N_4$  dissolves in liquid ammonia to form the adduct,  $S_4N_4 \cdot 2NH_3$ . Addition of metal salts to the solution leads to the formation of metal sulphur-nitrogen compounds, some of which are obtained in the form of adducts with  $NH_3$ . In these cases the ammonia adduct usually decomposes to give the free sulphur-nitrogen compound on heating in vacuo. The compounds listed in Table 3, have been made by this method, or by reaction of  $S_4N_4 \cdot 2NH_3$  with metal salts in alcohol or pyridine. The X-ray crystal structures  $PbN_2S_2 \cdot NH_3$ ,  $TlN_3S_3$  and  $HgN_2S$  indicate that in the case of the lead and thallium compounds, a cyclic metal-sulphur-nitrogen ring exists,<sup>114</sup>

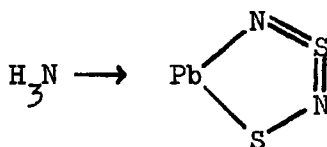

whereas the structure of  $HgN_2S$  is probably polymeric.

The compounds  $K_3N_3S_2$  and  $NaN_3S_2$  have also been prepared<sup>75,90</sup> by reaction of the  $S_4N_4 \cdot 2NH_3$  adduct with  $KNH_2$  and  $Ph_3CNa$  respectively.

(iii) Reaction products of the reaction between  $S_4N_4H_4$  and metal salts.

Mention has already been made of the reaction between  $S_4N_4H_4$  and  $NaCPh_3$  or  $Hg(OAc)_2$  to give  $Na_4S_4N_4$  or  $Hg_5(NS)_8$  respectively.<sup>72,75</sup>  $S_4N_4H_4$  also reacts with  $LiAlH_4$  to give<sup>117</sup> the highly explosive compound

$\text{Li}[\text{AlS}_4\text{N}_4]$ . Becke-Goehring and Zirker<sup>116</sup> have postulated that the structure is as represented in (a). The copper (II), silver (I) and mercury (I) compounds have also been prepared, and correspond to the general formula  $(\text{MeNS})_x$ , the structure of which may be represented by (b). The structure of the anion of the sodium salt,  $\text{Na}_4\text{S}_4\text{N}_4$ , is shown in (c). Copper (II) chloride reacts with  $\text{S}_4\text{N}_4\text{H}_4$  in the absence of moisture to give  $\text{Cu}_2\text{Cl}_2\text{H}_2\text{N}_4\text{S}_4$  the structure of which has been shown by Becke-Goehring to be similar to  $\text{S}_4\text{N}_4\text{H}_4$ , with two hydrogen atoms each replaced by  $\text{CuCl}$  as in (d).

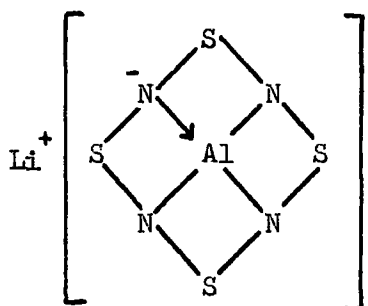

(a)

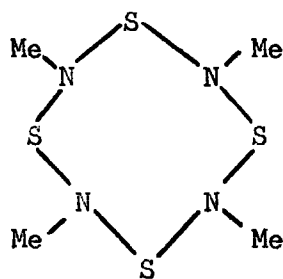

(b)

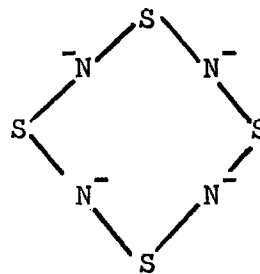

(c)

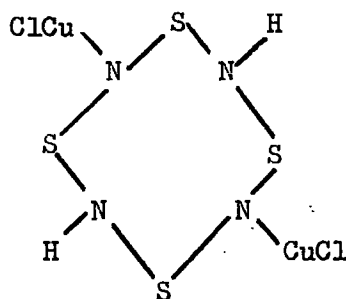

The products of this type of reaction are summarised in Table 4.

(iv) Reaction products of the reaction between  $S_7NH$  and metal salts.

The sodium, mercury (I) and mercury (II) 'salts' of  $S_7NH$  have been prepared. The sodium salt is olive green<sup>75</sup> and has a structure as represented by (a); the yellow<sup>81</sup>  $Hg(NS_7)_2$  and the bright yellow<sup>101</sup>  $Hg_2(NS_7)_2$  are shown in (b) and (c) respectively.

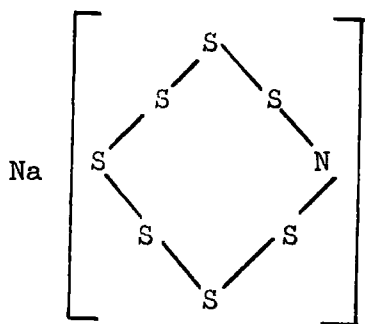

(a)

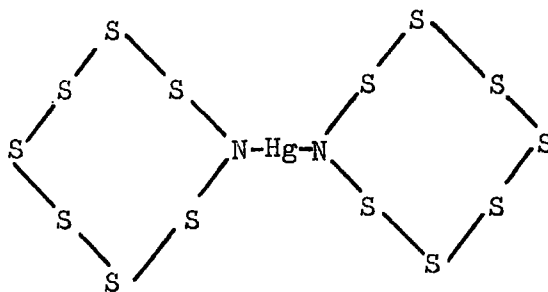

(b)

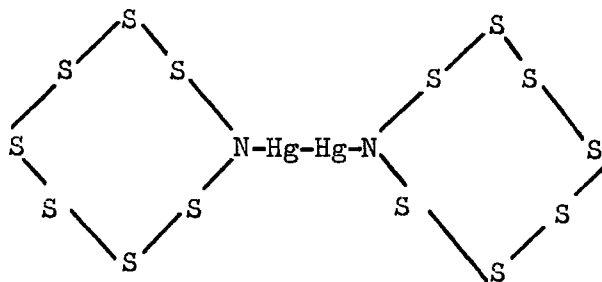

(c)

(v) Addition products of  $S_4N_4$  and metal halides.

$S_4N_4$  reacts with certain metal halides in organic solvents to give intensely coloured adducts. The adducts  $2S_4N_4 \cdot SnCl_4$ ,  $S_4N_4 \cdot SbCl_5$ ,  $S_4N_4 \cdot WCl_4$

and  $S_4N_4 \cdot MoCl_5$  were prepared by Davis<sup>104</sup> in 1906, by mixing chloroform solutions of  $S_4N_4$  and the metal halide. Davis was unable, at the same time to obtain adducts of  $AsCl_3$ ,  $SbCl_3$  or  $FeCl_3$ . Wölbling<sup>105</sup> repeated the work of Davis and also prepared  $S_4N_4 \cdot TiCl_4$  in 1908. Since then  $S_4N_4 \cdot TeBr_4$  has been prepared by Becke-Goehring<sup>94</sup> and Aynsley et al.,<sup>121</sup>  $S_4N_4 \cdot 4SbF_5$  by Cohen et al.<sup>117</sup> and  $4S_4N_4 \cdot BF_3$  by Glemser.<sup>33</sup> Wynn and Jolly<sup>118</sup> have recently obtained  $S_4N_4 \cdot BF_3$  by reaction of  $S_4N_4$  with  $BF_3$  in  $CH_2Cl_2$  and have suggested that the formation of  $4S_4N_4 \cdot BF_3$  may be the result of incomplete reaction since the adduct readily loses  $BF_3$ . These workers have also prepared  $S_4N_4 \cdot BCl_3$  by a similar reaction.  $S_4N_4 \cdot BCl_3$  is a moderately stable compound - in ~~comparison~~<sup>contrast</sup> to  $S_4N_4 \cdot BF_3$  - and sublimes in vacuo at  $115^\circ$  with only slight decomposition. In  $CH_2Cl_2$  solution the  $BF_3$  in the 1:1 adduct may be replaced by  $BCl_3$  or  $SbCl_5$ .

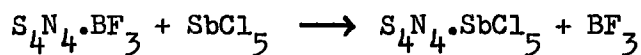
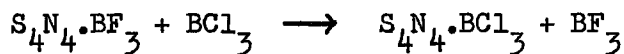

In an attempt to replace  $BCl_3$  by  $SbCl_5$  however, the compound  $S_4N_4 \cdot BCl_3 \cdot SbCl_5$  was prepared. The formation of the mixed adduct is surprising since neither of the diadducts of  $BCl_3$  or  $SbCl_5$  are known. The structure has not yet been determined but is thought to be either  $Cl_3B-S_4N_4-SbCl_5$  or  $[S_4N_4BCl_2]^+ [SbCl_6]^-$ .

Using hexane or toluene as solvents, Banister and Alange<sup>119</sup> have recently prepared  $2S_4N_4 \cdot SnBr_4$ ,  $S_4N_4 \cdot TeCl_4$  and  $S_4N_4 \cdot SeCl_4$  in these laboratories,



and Fluck and Becke-Goehring<sup>120</sup> have prepared  $S_2N_2 \cdot CuCl_2$  and  $S_2N_2 \cdot CuBr_2$  by reaction of the copper halide with  $S_4N_4$  in dimethyl formamide.

Only for  $S_4N_4 \cdot SbCl_5$  is the structure known with any certainty. An X-ray study has shown this adduct to have the structure as shown in (a)

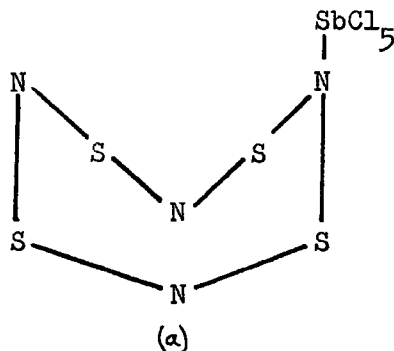

Few X-ray determinations of the structures of the adducts have been made. The difficulty lies in the lack of crystalline samples of the compounds due to their insolubility in most solvents. Becke-Goehring has postulated that by comparison with the adduct  $TiCl_4 \cdot POCl_3$ , most of the adducts should be dimeric and involve chlorine bridging, e.g.:-

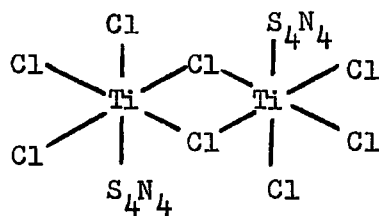

The products of the reaction of  $S_4N_4$  and metal halides are summarised in Table 5.

Table 1

Sulphur-nitrogen compounds of group VIII metals

<u>Compound</u>	<u>Reference</u>	<u>Compound</u>	<u>Reference</u>
FeN <sub>4</sub> S <sub>4</sub>	106	CoHN <sub>3</sub> S <sub>5</sub>	111
CoN <sub>4</sub> S <sub>4</sub>	109	NiHN <sub>3</sub> S <sub>5</sub>	107
NiN <sub>4</sub> S <sub>4</sub>	106	PdHN <sub>3</sub> S <sub>5</sub>	111
CoN <sub>2</sub> S <sub>6</sub>	111	CoH <sub>2</sub> N <sub>2</sub> S <sub>4</sub>	106, 108, 109
NiN <sub>2</sub> S <sub>6</sub>	111	NiH <sub>2</sub> N <sub>2</sub> S <sub>4</sub>	106-109
PdN <sub>2</sub> S <sub>6</sub>	111	PdH <sub>2</sub> N <sub>2</sub> S <sub>4</sub>	106, 108-110
		PtH <sub>2</sub> N <sub>2</sub> S <sub>4</sub>	108, 110-113

Table 2

Derivatives of NiH<sub>2</sub>S<sub>4</sub>N<sub>4</sub>

$RN_2S_2NiN_2S_2H$	R =	Colour	m.p. <sup>o</sup>
	CH <sub>3</sub>	black	144
	C <sub>2</sub> H <sub>5</sub>	dark blue	144
	CH <sub>2</sub> OH	black	-
	C <sub>6</sub> H <sub>5</sub>	black	164
	CoC <sub>6</sub> H <sub>5</sub>	copper	150
$R(N_2S_2NiN_2S_2)$	HOCHCHOH	black	-
	CH <sub>2</sub> OCH <sub>2</sub>	black	169
	CH <sub>2</sub> N(CH <sub>3</sub> )CH <sub>2</sub>	black	-
	CH <sub>3</sub> CHNHCHCH <sub>3</sub>	dark green	-

Table 3

Products of  $S_4N_4 \cdot 2NH_3$  reaction with metal salts.

<u>Compound</u>	<u>Colour</u>	<u>Reference</u>
$PbN_2S_2 \cdot NH_3$	red	103, 111, 114
$PbN_2S_2$	red-brown	103, 111, 114
$2TlN_3S_3 \cdot NH_3$	red-brown	115
$TlN_3N_3$	red-brown	115
$Tl_3N_8S_8$	brown	115
$CuN_2S_2$	brown	115
$AgN_2S_2$	black	115
$HgN_2S \cdot NH_3$	green	115
$HgN_2S$	green	115

Table 4

Salts of  $S_4N_4H_4$

<u>Compound</u>	<u>Colour</u>	<u>Reference</u>
$Li[AlS_4N_4]$	colourless	116
$Na_4S_4N_4$	orange-red	75
$Cu(NS)_x$	black-brown	115
$Ag(NS)_x$	red-brown	115
$Hg(NS)_x$	yellow	76
$Cu_2Cl_2H_2S_4N_4$	yellow	115

Table 5

Products of the reaction of  $S_4N_4$  with metal halides.

<u>Compound</u>	<u>Colour</u>	<u>Reference</u>
$S_4N_4 \cdot SbCl_5$	red	104
$S_4N_4 \cdot 4SbF_5$	-	117
$S_4N_4 \cdot MoCl_5$	brown	104
$S_4N_4 \cdot TiCl_4$	orange	105
$2S_4N_4 \cdot SnCl_4$	red	104
$2S_4N_4 \cdot SnBr_4$	red-brown	119
$S_4N_4 \cdot WCl_4$	brown	104
$S_4N_4 \cdot VCl_4$	brown	120
$S_4N_4 \cdot SeCl_4$	yellow	119
$S_4N_4 \cdot TeCl_4$	orange	119
$S_4N_4 \cdot TeBr_4$	orange	94, 121
$S_4N_4 \cdot BF_3$	burgundy	118
$S_4N_4 \cdot BCl_3$	red-orange	118
$S_4N_4 \cdot BCl_3 \cdot SbCl_5$	yellow	118

(g) Sulphur-nitrogen carbon compounds.

Compounds containing C-NS and C-SN links are numerous, and belong to many classes of compounds. Several excellent reviews have discussed them in detail,<sup>124-136</sup> and the more interesting cyclic compounds are summarised in Table 6.

Table 6.

Cyclic sulphur nitrogen carbon compounds.

<u>Compound</u>	<u>Synthetic route</u>	<u>Reference</u>
	$\text{ClCH}_2\text{CH}_2\text{CH}(\text{SO}_2\text{Cl})\text{CH}_3 + \text{NH}_3$	124
	$\text{RHN}(\text{CH}_2)_n\text{SO}_2\text{Cl}$ pyrolysis	125
	$\text{POCl}_3 +$ 	126
	$\text{H}_2\text{NSO}_2\text{NH}_2 + \text{RCOR}$	127

Table 6 (cont.)



128

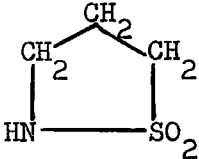
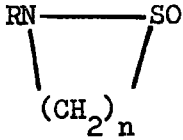
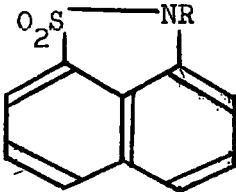
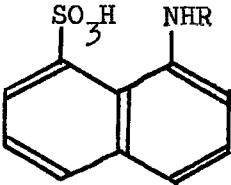
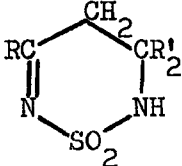
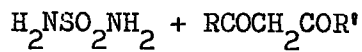
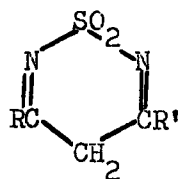
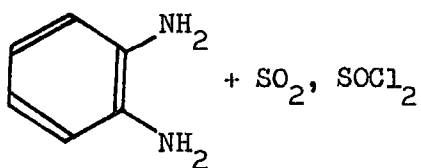
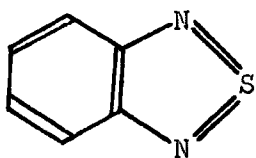

129-131

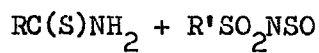
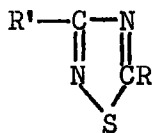

132, 133

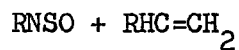
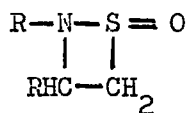

134, 135

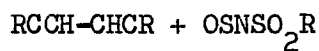
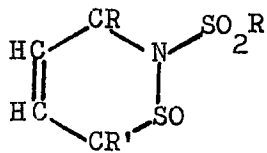

136

## EXPERIMENTAL

## Experimental

### Handling techniques.

Most of the compounds dealt with were air and moisture sensitive, and were therefore handled in a vacuum line or under an atmosphere of nitrogen. Before use the nitrogen was passed through a tower of heated copper turnings to remove oxygen and through two liquid air traps to remove water. Preparation of samples for infrared, ultraviolet and mass spectra was done in a glove box. The glove box used (Lintott IIIB) was set up in such a way that after purging the transfer tube and introducing the materials required into the box, the nitrogen could be recycled for several hours (or days if necessary) through the nitrogen purification system. This involved the use of a small pump fitted inside the box, thus removing small traces of oxygen and moisture which may have been introduced from the transfer tube. Two liquid air traps and a heated copper tower were placed in series in the recycling system. A further tower containing molecular sieve was also used originally in the system, but was found to be inefficient at the high flow rates used.

### Spectra.

Infrared spectra were recorded on Grubb-Parsons prism grating spectrophotometers, the GS2A and Spectromaster in the range  $4000-400\text{ cm.}^{-1}$  and the DM2/DB3 from  $475\text{ cm.}^{-1}$  to  $200\text{ cm.}^{-1}$ . Most samples were prepared in the form of nujol mulls between potassium bromide, sodium chloride or



caesium iodide plates. Where halogen exchange with the plates was possible, polythene sheets were inserted between the sample and the plates.

Ultraviolet and visible spectra were obtained on solutions in benzene, carbon tetrachloride, thionyl chloride or anhydrous formic acid with a Unicam SP800 spectrophotometer using quartz cells of 1 cm. path length.

In this section the following symbols are used to denote the relative intensity of the infrared absorptions: vs = very strong; s = strong; m = medium; w = weak; vw = very weak and sh = shoulder.

Mass spectra were obtained with an A.E.I. (MS9) mass spectrometer on samples mounted on an inert ceramic and introduced on a direct insertion probe.

#### Purification procedures.

Thionyl chloride was purified by two methods: (a) refluxed with flowers of sulphur for three hours and rapidly distilled. The distillate was fractionated and the first (coloured) fraction discarded; the second fraction was redistilled to give the pure material.<sup>137</sup> (b) Triphenyl phosphite (160 ml.) was added to the thionyl chloride (1 litre) with vigorous stirring for 30 mins. The mixture was fractionated through a twelve inch column packed with glass helices, connected to a reflux distilling head equipped with a calcium chloride drying tube. After a

small forerun, thionyl chloride was collected. Redistillation of this with more triphenyl phosphite gave pure 'water white' material.<sup>138</sup>

Formic acid was dried over anhydrous copper sulphate and boric anhydride and distilled as required; Trimethylamine was distilled onto potassium hydroxide and stored under nitrogen at  $-20^{\circ}$ ; Triethylamine was distilled onto barium oxide and stored under nitrogen; carbon tetrachloride was dried over  $P_2O_5$ ; diethyl ether, benzene, toluene, pentane, hexane and heptane were dried over sodium wire. Dimethyl sulphoxide was dried over molecular sieve (Linde 4A).

#### Preparation of starting materials.

##### Aminomethylene sulphonic acid.<sup>139,140</sup>

Aqueous formaldehyde (233.6 g. of a 38% solution) was stirred in a one litre conical flask. Ammonium bisulphite (195 mls. of a 1.33 g/ml. solution) ~~were~~ <sup>was</sup> added dropwise with stirring. When all the bisulphite had been added, the solution was heated to  $70^{\circ}$  for twenty minutes. The mixture was then cooled and maintained at  $40^{\circ}$ - $55^{\circ}$  and aqueous ammonia (270 mls. of S.G. 0.88) added dropwise. The solution was again heated to  $70^{\circ}$  for thirty minutes. Concentrated sulphuric acid (55.6 mls. of 98%) was then added at  $10^{\circ}$  and the mixture cooled in a salt/ice slush bath. A white precipitate of aminomethylene sulphonic acid formed on standing. The precipitate was filtered off and dried in a vacuum oven at  $60^{\circ}$ . Obtained  $NH_2CH_2SO_3H$  (125 g.) m.pt.  $184^{\circ}$  (decomp.) (found

C = 10.6; H = 4.5;  $\text{NH}_2\text{CH}_2\text{SO}_3\text{H}$  requires C = 10.8; H = 4.5%).

Diselenium dichloride. <sup>141,142</sup>

A 250 ml. flask was fitted with a gas inlet tube extending to the bottom of the flask, and a condenser, adapter and receiver. From the receiver an outlet tube was connected via bubblers containing conc. sulphuric acid to the fume chamber. Selenium (30 g.) was added slowly and with stirring to oleum (90 g. of 20%) in the reaction flask. A fast stream of dry hydrogen chloride was bubbled through the reaction mixture, which was carefully heated until the selenium began to volatilize. After fifteen minutes, crude diselenium dichloride was obtained in the receiver, and the rate was adjusted to give 25 g. of product in two hours. The crude product was shaken with conc.  $\text{H}_2\text{SO}_4$  and left to stand over anhydrous  $\text{BaCl}_2$  (heated in a vac. oven at  $120^\circ$  for 12 hrs.); finally filtered through glass sinter and stored in a sealed ampoule. A dark red oily liquid b.p.  $127^\circ$ , yield 25 g.

Tetrasulphur tetranitride. <sup>26,34,93,143,144</sup>

Dry chlorine gas was passed through a solution of  $\text{S}_2\text{Cl}_2$  in  $\text{CCl}_4$  (25 mls. in 700 mls.) in a one litre, round bottomed flask, and stirred briskly until a distinctly green-yellow layer of gas was seen over the solution. The flow of chlorine was stopped after 40 mins. and the flask was cooled in an ice-salt bath, whilst ammonia was passed into the solution. Initially copious white fumes of ammonium chloride were formed,

but these soon disappeared and the solution changed to a thick brown-red suspension. More  $\text{CCl}_4$  was added at intervals to maintain constant volume of solution. After four hours the solution was filtered and the solid slurried with 500 mls. water for 10 mins. The remaining solid was filtered off and allowed to dry in air. The dried solid was shaken with 150 mls. diethyl ether for 10 mins. to remove  $\text{S}_7\text{NH}$  and then extracted with dry benzene in a Soxhlet extractor and recrystallised from benzene. Yield 14 g., m.p.  $179^\circ$ .

Thiotrithiazyl chloride.<sup>23,40,41,46</sup>

Tetrasulphur tetranitride was dissolved in an excess of thionyl chloride to give a yellow solution which turned red on standing and deposited fine yellow needles of  $\text{S}_4\text{N}_3\text{Cl}$  after 48 hrs. at room temperature. The needles were filtered off and thiotrithiazyl chloride was recrystallised from anhydrous formic acid. The recrystallisation proved to be difficult, since the solubility of  $\text{S}_4\text{N}_3\text{Cl}$  in  $\text{HCOOH}$  only increases relatively little with increasing temperature, but indeed proved sufficient to facilitate recrystallisation. (Found S = 62.35; N = 20.6; Cl = 17.2, calculated for  $\text{S}_4\text{N}_3\text{Cl}$ : S = 62.3; N = 20.4; Cl = 17.2%).

Thiodithiazyl dioxide.<sup>101</sup>

Equal volumes of benzene and thionyl chloride were added to tetrasulphur tetranitride such that a small quantity remained undissolved.

Sulphur dioxide (dried by passing through concentrated  $H_2SO_4$ ) was passed through the solution, which was heated at  $70^\circ$  for 2 hours. The solution turned red-brown in colour and excess of thionyl chloride was distilled off under vacuum at room temperature to give a red-orange solid, from which  $S_3N_2O_2$  was sublimed at  $40^\circ$  and obtained as yellow crystals, m.p.  $101^\circ$ .

Tetrasulphur tetranitridoantimony pentachloride.<sup>104</sup>

Tetrasulphur tetranitride (0.92 g.) was dissolved in  $CCl_4$  (40 ml.) and a solution of antimony pentachloride (1.0 ml.) in  $CCl_4$  added at  $-20^\circ$ . A precipitate of red needles was formed immediately and filtered off at room temperature. The adduct  $S_4N_4 \cdot SbCl_5$  gave a characteristic infrared spectrum (see p.132) and decomposed at about  $220^\circ$ .

Bis tetrasulphur tetranitridotin tetrachloride.<sup>104,145</sup>

Tetrasulphur tetranitride (0.92 g.) was dissolved in  $CCl_4$  (20 ml.) and tin tetrachloride (1.3 g., freshly distilled) added at room temperature. A deep red precipitate of  $2S_4N_4 \cdot SnCl_4$  was formed immediately. The compound was purified by washing in  $CCl_4$  and pumped dry, m.p.  $165^\circ$  (decomp.).

Tetrasulphur tetranitridotitanium tetrachloride.<sup>105</sup>

Tetrasulphur tetranitride (0.92 g.) was dissolved in carbon tetrachloride (40 ml.) and titanium tetrachloride (0.81 g.) added at

room temperature. An immediate yellow-orange precipitate of  $S_4N_4 \cdot TiCl_4$  was obtained and filtered from the solution. The product was washed in  $CCl_4$  and pumped dry.

Tetrasulphur tetranitridotellurium tetrachloride. <sup>119,145</sup>

Tetrasulphur tetranitride (0.46 g.) was dissolved in toluene (20 ml.) and tellurium tetrachloride (0.73 g.) in toluene (10 ml.) added at room temperature. An immediate orange precipitate of  $S_4N_4 \cdot TeCl_4$  was formed and filtered off. The compound was washed in toluene and dried by pumping at room temperature. Infrared absorptions occur at: 499m, 549w, 562w, 597w, 671m, 727vw, 761s, 807m, 925w, 971vs, 990w, 1048vs; m.p. 140°.

Triphenyl arsenic dichloride.

Triphenyl arsenic dichloride is usually prepared by the direct reaction between triphenyl arsine and chlorine. The sample used in this case was prepared by the new route of the reaction between triphenyl arsine and sulphuryl chloride in toluene.<sup>102,146</sup> The yield was almost quantitative.

a) Sulphur-nitrogen-carbon compounds.

Reaction between aminomethylene sulphonic acid and phosphorus pentachloride.

Phosphorus pentachloride (165.6 g.) and aminomethylene sulphonic acid (43.7 g.) were heated under reflux for 74 hrs. in carbon tetra-

chloride (450 ml.). Hydrogen chloride was liberated and passed into three flasks containing 100 ml. of standard sodium hydroxide, and cooled to 0° by ice/salt baths. The volume of hydrogen chloride liberated in the course of the reaction was calculated by titration of the excess of sodium hydroxide against standard hydrochloric acid. After 74 hours the solution was allowed to cool and the residue removed by filtration. This was shown to be excess of aminomethylene sulphonic acid. The solution was evaporated to give a white solid which was recrystallised twice from cyclohexane. Found: C = 9.95, H = 1.82, Cl = 55.0, P = 8.91, N = 7.68, O (by difference) = 16.64, S = 0.00%. Empirical formula corresponds to  $C_6H_{12}N_4PCl_{11}O_7$ .

Reaction between aminomethylene sulphonic acid and thionyl chloride.

Thionyl chloride (49 g.) was added slowly to aminomethylene sulphonic acid (22 g.) and the mixture heated under reflux for 2 hrs. A further amount of thionyl chloride (25 g.) was added and heating continued for 6 hours. The mixture was allowed to cool and filtered to remove excess of aminomethylene sulphonic acid. The solution was evaporated to give a mixture of ammonium chloride and some unidentified brown coloured, glue-like solid.

Effect of heat on Aminomethylene sulphonic acid.

Amino methylene sulphonic acid was heated under vacuum in a flask fitted with a long air condenser and a liquid nitrogen trap. Heating

was continued at  $120^{\circ}$  for 100 hrs., during which time most of the acid was converted to ammonium sulphate, and spectroscopic study of the volatile fraction collected in the liquid nitrogen trap indicated that this was a mixture of  $\text{SO}_2$ ,  $\text{CH}_4$  and  $\text{CO}_2$ . Thermogravimetric analysis<sup>12</sup> of the compound showed that the thermal decomposition was slow and did not proceed via any discernable intermediate stages.

#### Preparation of Sodium aminomethylene sulphonate.

Aminomethylene sulphonic acid (5.5 g.) was dissolved in cold water, and a solution of sodium bicarbonate (4.2 g. in 20 mls.) added slowly. Carbon dioxide was evolved and a clear solution obtained. The sodium salt was precipitated with ethanol and filtered off. The hygroscopic solid obtained was taken up in a water/ethanol mixture and allowed to crystallise slowly. Found: C = 9.0; H = 3.0%;  $\text{NH}_2\text{CH}_2\text{SO}_3\text{Na}$  requires: C = 9.0; H = 2.2%; m.pt.  $278^{\circ}$  (decomp.). Similar preparations of the cobalt, silver, chromium, calcium and magnesium salts were attempted, but were unsuccessful.

#### Effect of heat on Sodium aminomethylene sulphonate.

Sodium aminomethylene sulphonate was heated to  $250^{\circ}$  under vacuum. The volatile pyrolysis products were collected in a liquid nitrogen trap and shown to be a mixture of sulphur dioxide and sulphur trioxide. A sublimate of sulphur was obtained on an air condenser attached to the flask and a black solid residue was obtained but not characterised.



Reaction between sulphur monochloride and diphenyl ketimine.

Sulphur monochloride (0.7 g.) was dissolved in hexane (20 ml.) and diphenyl ketimine (1.7 g.) added at  $-78^{\circ}$ . A white precipitate was obtained and the solution was warmed to room temperature. The solid was removed by filtration, washed in hexane and pumped dry. The infrared spectrum indicated that the compound was diphenyl ketimine hydrochloride.

Reaction between sulphur monochloride and diphenyl ketiminolithium.

Sulphur monochloride (0.7 g.) was dissolved in hexane (20 ml.) and diphenyl ketiminolithium (1.8 g.) added at  $-78^{\circ}$ . An immediate white precipitate was formed and the solution was warmed to room temperature. The solid was filtered off, washed several times in hexane and re-crystallised from ether to give bis diphenyl ketimine disulphide,  $[(C_6H_5)_2CN]_2S_2$ , m.p.  $152^{\circ}$ . Found: C = 74.5; H = 5.01; N = 6.9; S = 14.9;  $[(C_6H_5)_2CN]_2S_2$  requires: C = 73.6; H = 4.71; N = 6.6; S = 15.1%. Infrared absorptions occur at: 459w, 629w, 667sh, 671w, 693s, 704s, 741w, 777m, 784m, 914w, 950m, 999w, 1018w, 1155w, 1297m, 1316m, 1377m, 1404m, 1449m, 1550w.

Reaction between sulphur monochloride and tetramethyl guanidine.

Sulphur monochloride (1.35 g.) was dissolved in hexane (25 ml.) and tetramethyl guanidine,  $[(Me_2N)_2CNH]$  (2.3 g.) added at  $-78^{\circ}$ . A white precipitate was formed and on warming to room temperature this turned yellow and the solution became viscous until finally it solidified

into a yellow powder. Toluene (20 ml.) was added and the solid re-crystallised to give a white powdery solid. The insoluble residue was characterised as sulphur. The white solid product was characterised as the hydrochloride of tetramethyl guanidine. Found: C = 39.2; H = 8.9; calculated for  $(\text{Me}_2\text{N})_2\text{CNHCl}$ , C = 39.8; H = 8.7%.

The reaction between Sulphur monochloride and Tetramethyl guanidino-lithium.

Sulphur monochloride (0.2 g.) was added to a solution of tetramethyl guanidinolithium (0.3 g.) in hexane at  $-78^\circ$ . The solution turned lemon in colour and was warmed to room temperature. At room temperature a lemon coloured precipitate was formed slowly. The precipitate was filtered off and appeared as a white solid on the sintered glass filter when pumped dry. This was characterised as lithium chloride. The solution was pumped down to give a brown/orange oil, which was soluble in most organic solvents but would not solidify. Analysis figures indicate that the ~~compound~~<sup>substance</sup> is probably impure tetramethyl guanidino-sulphur chloride (Found: C = 30.2; H = 6.9; Cl = 49.7;  $(\text{Me}_2\text{N})_2\text{CNHCl}$  requires: C = 33.0; H = 6.6; Cl = 46.4%).

(b) Sulphur-nitrogen compounds.

Reaction between Sulphur and Sulphamide.

Sulphamide (1.2 g.) was heated to its melting point and flowers of sulphur (1.6 g.) added. No reaction occurred and the mixture was further

heated to 120° until both constituents were molten. The mixture remained as two separate layers, the sulphamide above the sulphur, throughout the temperature range 120-200°. Fumes were evolved at 200°, but no H<sub>2</sub>S was detected, and further heating to 300°C only resulted in the sublimation of the sulphur, and decomposition of the sulphamide.

Reaction between Dimethyl sulphoxide and Sulphamide.

Sulphamide (1.7 g.) was charged into a flask in a glove box, and dimethyl sulphoxide (9 g., freshly distilled) added under nitrogen. The mixture was refluxed at 80° for 108 hrs. under nitrogen. The solution was allowed to cool, and the solid material formed in the reaction filtered off. This was characterised as ammonium sulphate. The solution was distilled under reduced pressure, and the distillate characterised as dimethyl sulphoxide.

Reaction between Dimethyl sulphoxide and p-Nitroaniline.

Dimethyl sulphoxide (10 g.) and p-nitroaniline (10 g.) were dissolved in absolute alcohol (50 ml.) and refluxed for 6 hrs., in the presence of conc. hydrochloric acid (0.5 ml.). The mixture was allowed to cool and the solvent removed. Golden yellow crystals were formed on standing and these were filtered off and characterised as p-nitroaniline (9.85 g.).

Reaction between Dimethyl sulphoxide and Phenyl isocyanate.

(a) In the presence of moisture.

Phenyl isocyanate (5.9 g.) was dissolved in dimethyl sulphoxide

(3.9 g.) at room temperature and heated at  $100^{\circ}$  for 24 hrs. Crystals separated out on pumping and were characterised as  $(\text{PhNH})_2\text{CO}$ . Found: C = 73.5; H = 5.9; calculated for  $\text{C}_{13}\text{H}_{12}\text{NO}$  C = 73.6; H = 5.7%.

(b) In the absence of moisture.

Phenyl isocyanate (5.9 g.) was dissolved in dimethyl sulphoxide (3.9 g.) at room temperature and heated to  $100^{\circ}$  for 24 hrs. under nitrogen. Crystals separated out on pumping and were recrystallised from absolute alcohol to give  $(\text{PhNCO})_x$ ; Found: C = 71.3; H = 4.4; calculated for  $\text{C}_7\text{H}_5\text{NO}$ : C = 70.6; H = 4.2%. The infrared spectrum of the product indicated that it was the trimeric species  $(\text{PhNCO})_3$ .

Reaction between Triethylamine and Thionyl chloride in Chloroform.

Triethylamine (2.2 g.) was dissolved in chloroform (100 ml.) and thionyl chloride (1.2 g.) allowed to condense into the solution at  $-78^{\circ}$ . An immediate orange colouration appeared and the solution was allowed to warm up to room temperature, and evaporated to 30 ml. An equal volume of diethyl ether was added and a yellow precipitate obtained. This was recrystallised from a chloroform/diethyl ether mixture (1:1), and characterised as triethylamine hydrochloride. Found: C = 52.2; H = 11.7; Cl = 27.9; calculated for  $\text{C}_6\text{H}_{16}\text{NCl}$ , C = 52.5; H = 11.6; Cl = 25.7%.

Reaction between Trimethylamine and Thionyl chloride in Chloroform.

Trimethylamine (1.2 g.) was dissolved in chloroform (50 ml.) and thionyl chloride (1.2 g.) allowed to condense into the solution at  $-78^{\circ}$ .

The solution was allowed to warm to room temperature and white needles obtained. These were filtered off under nitrogen and pumped dry, m.pt.  $168.5^{\circ}$ , Found: C = 26.1; H = 6.1; Cl = 21.6%. The product was not characterised.

Reaction between Triethylamine and Thionyl chloride in Hexane.

Triethylamine (2.2 g.) was dissolved in hexane (30 ml.) and thionyl chloride (1.2 g.) allowed to condense into the solution at  $-78^{\circ}$ . A white solid was formed which decomposed rapidly on removal of the solvent. Similar results were obtained using pentane and petroleum-ether as solvents.

Reaction between Trimethylamine and Thionyl chloride in 40-60° Petroleum Ether.

Trimethylamine (1.2 g.) was dissolved in 40-60° petroleum ether and thionyl chloride (1.2 g.) allowed to condense into the solution at  $-78^{\circ}$ . The white solid product obtained was sublimed at  $35^{\circ}$ . Found: C = 31.6; H = 8.6; Cl = 42.3%. The product was not characterised.

Reaction between Pyridine and Thionyl chloride.

Reaction between neat pyridine and thionyl chloride is vigorous, exothermic and leads to the rapid formation of an evil smelling purple solid.

Pyridine (1.6 g.) was dissolved in hexane (25 ml.) and thionyl chloride (1.2 g.) allowed to condense into the solution at  $-78^{\circ}$ . A

mixture of white and green precipitates were formed which decomposed rapidly above  $-30^{\circ}$ .

Reaction between Trimethylamine and Thionyl chloride.

Trimethylamine (1.2 g.) was condensed into a flask at  $-196^{\circ}$  and thionyl chloride (1.2 g.) was condensed into another flask connected to the other by a length of glass tubing. The system was pumped down and the flasks allowed to warm up to  $-30^{\circ}$ . Mixing of the vapours caused the formation of white crystals above the surface of the thionyl chloride. The crystals were removed under nitrogen and allowed to warm up to  $-20^{\circ}$ . No sublimation occurred and the crystals did not melt below  $200^{\circ}$ . Many variations in procedure were attempted to increase the yield and to obtain a purer product but were unsuccessful, and inconstant analysis figures were obtained on each sample of product.

Reaction between Tetrasulphur tetranitride and Thionyl chloride.

Tetrasulphur tetranitride (4.5 g.) dissolved in excess of thionyl chloride (100 ml.) to give a yellow solution which was stirred for 30 minutes at  $40^{\circ}$ . On standing at room temperature for 48 hrs. the solution turned red and deposited fine yellow needles of thiotrithiazyl chloride (2.0 g.). These were filtered from the solution and characterised by their infrared spectrum (see p. 121) and analysis. (Found: S = 62.35; N = 20.6; Cl = 17.2. Calc. for  $S_4N_3Cl$ : S = 62.3; N = 20.4; Cl = 17.2%. The excess of thionyl chloride was removed from the solution by distillation at reduced pressure. The residue was

extracted with benzene and the solution allowed to evaporate slowly at room temperature under nitrogen. Yellow plates of thiodithiazyl dioxide were obtained, recrystallised and characterised by m.p. ( $101^{\circ}$ ) infrared spectrum and molecular weight (cryoscopically in benzene 152 and 161, calc. for  $S_3N_2O_2$ , 156.2). The infrared, ultra-violet and mass spectra of all the distillates, solutions and residues showed that no other compounds were present. The infrared spectrum of the insoluble residue indicated that it was a small amount of  $S_4N_3Cl$ .

Reaction between Thiodithiazyl dichloride and Thionyl chloride.

Thiodithiazyl dichloride (0.9 g.) dissolved in excess of thionyl chloride gave a red solution, which on warming to  $60^{\circ}$  turns dark green. After 24 hours at room temperature yellow crystals were obtained from the solution, filtered off under nitrogen and characterised as thiotri-thiazyl chloride (0.6 g.). The solution was distilled to give thionyl chloride and left a dark brown tarry residue which was not characterised.

Reaction between Thiodithiazyl dioxide and chlorine.

Thiodithiazyl dioxide (1.6 g.) was dissolved in benzene (100 ml.) at room temperature and chlorine passed through the solution. A slightly exothermic reaction occurred and the solution was refluxed for 30 minutes. After standing at room temperature for 12 hours, the benzene was pumped off to leave an oily residue from which a small amount of yellow solid was obtained with the addition of ether. The solid proved difficult to handle, was not easily ground, and immiscible with Nujol.

The presence of  $S_4N_3Cl$  as a reaction product was however shown by its characteristic infrared absorption spectrum. No other products were isolated.

Reaction between Thiodithiazyl dioxide and pyridine.

Pyridine (1.0 ml.) was added to a solution of thiodithiazyl dioxide (0.2 g.) in toluene (10 ml.) at room temperature. The solution turned red in colour but no precipitate was formed. Heptane (25 ml.) was added, the solution chilled, and left to stand for 12 hours. On slight evaporation of the solution, yellow plates were obtained and recrystallised from heptane. These were shown to be unchanged  $S_3N_2O_2$  (0.18 g.). The reaction was repeated at  $-30^\circ$  and  $60^\circ$  but only  $S_3N_2O_2$  was obtained on working up the reaction mixture.

Reaction between Thiodithiazyl dioxide and bipyridyl.

Bipyridyl (0.8 g.) in toluene (20 ml.) was added to a solution of thiodithiazyl dioxide (0.2 g.) in toluene (20 ml.). No immediate reaction occurred and the solution was heated at  $60^\circ$  for 30 minutes. On removing the solvent, only  $S_3N_2O_2$  (0.2 g.) was obtained.

Reaction between Thiodithiazyl dioxide and Triphenylphosphine.

Triphenyl phosphine (0.52 g.) in toluene (10 ml.) was added to a solution of thiodithiazyl dioxide (0.5 g.) in toluene (10 ml.). The solution turned orange slowly on standing at room temperature, and after 1 hour a red solid was precipitated. The solution was filtered off to



give a red tar-like solid, with an extremely strong odour. This compound appeared to have a melting point close to room temperature, and decomposed about  $25^{\circ}$  indicating that it was possibly  $S_4N_2$ . The yellow solution was evaporated to give triphenylphosphine oxide (Found: C = 78.3; H = 5.5; calculated for  $Ph_3PO$ , C = 77.7; H = 5.4%).

Reaction between Thiodithiazyl dioxide and Sulphur monochloride.

Sulphur monochloride (0.5 g.) was added to a solution of thiodithiazyl dioxide (0.1 g.) in benzene (20 ml.). No reaction occurred at room temperature and the solution was heated at  $50^{\circ}$  for 1 hour. On cooling the solution gave fine yellow crystals of unchanged  $S_3N_2O_2$  (0.1 g.)

Reaction between Thiodithiazyl dioxide and *trans* 1,4-diphenyl-but-1,3-diene.

A solution of thiodithiazyl dioxide (0.2 g.) in benzene (15 ml.) was added to diphenyl butadiene (0.3 g.) in benzene (15 ml.) at room temperature. No immediate reaction occurred and the solution was heated at  $60^{\circ}$  for 2 hours. On removal of the benzene, only unchanged starting materials were obtained. The reaction was repeated in refluxing benzene for 4 hours, but again only unchanged starting materials were obtained on working up the solution.

(c) Sulphur-nitrogen-'metal' compounds.

Reaction between Tetrasulphur tetranitride and Diselenium dichloride in Thionyl chloride.

Diselenium dichloride (6.0 g.) in thionyl chloride (30 ml.) was added dropwise with vigorous stirring to a solution of tetrasulphur tetranitride (4.5 g.) in thionyl chloride (70 ml.) at 40°. A yellow precipitate was formed immediately. After standing for 12 hours at room temperature the solution was filtered and the precipitate washed in  $\text{CCl}_4$ . Recrystallisation from anhydrous formic acid gave a yellow compound  $\text{SeS}_2\text{N}_2\text{Cl}_2$ , m.p. 85.5° (Found: Se = 30.0 ( $\pm$  3.0); Se + S analysed as S = 39.65; N = 11.8; Cl = 28.5.  $\text{SeS}_2\text{N}_2\text{Cl}_2$  requires Se = 32.6; Se + S analysed as S = 39.75; N = 11.6; Cl = 29.3). Infrared absorptions occur at: 212m, 227w, 247w, 254w, 281w, 303m, 330m, 463s, 555m(sh), 562s, 578w, 609w(sh), 614w, 643w, 667w(sh), 683s, 722w, 951vs, 1008vs, 1171vs. Ether (5 ml.) was added to the formic acid solution (20 ml.) and red crystals of  $\text{S}_4\text{N}_3\text{Cl}$  were slowly deposited. These were converted to their usual yellow form on grinding and were characterised by their infrared spectrum and analysis. Further quantities of  $\text{S}_4\text{N}_3\text{Cl}$  were obtained as a yellow precipitate by adding an excess of ether to the solution. No further products of the reaction were found. Solutions of thiotrithiazyl chloride in thionyl chloride, and thiodithiazyl dioxide in thionyl chloride were treated with diselenium dichloride at 40°. After standing for 24 hours at room temperature each solution was pumped dry and examined spectroscopically. In neither case were any products other than starting materials detected.

Reaction between tetrasulphur tetranitride and tellurium(IV)chloride  
in thionyl chloride.

A solution of tellurium tetrachloride (0.42 g.) in thionyl chloride (20 ml.) was added to tetrasulphur tetranitride (0.92 g.) in thionyl chloride (20 ml.) at room temperature. An immediate yellow-green precipitate was formed and filtered from the solution. On removal of the last traces of thionyl chloride, the solid apparently decomposed. The solid was also unstable in organic solvents and in formic acid.

Reaction between tetrasulphur tetranitrido tellurium tetrachloride and  
thionyl chloride.

Thionyl chloride (10 ml.) was added to tetrasulphur tetranitrido-tellurium tetrachloride at room temperature. The solution darkened to green immediately and was heated at 40° for 2 hours. A yellow precipitate was formed on standing. The solid was filtered off but decomposed to a purple solid on removal of the last traces of thionyl chloride. The thionyl chloride was evaporated to give more of the yellow compound, but this also decomposed on pumping dry.

Reaction between tetrasulphur tetranitride and titanium (IV) chloride in  
thionyl chloride.

Titanium tetrachloride (0.46 ml.) was added to a solution of tetrasulphur tetranitride (0.92 g.) in thionyl chloride (20 ml.) at 40°. The solution was heated with constant stirring at 40° for 21 hrs.

The immediate dark green colouration disappeared after about 2 hours and the solution became yellow in colour, with the formation of a yellow precipitate. The solid was filtered off, washed in thionyl chloride and pumped dry. Found, S = 21.02; N = 11.26; Cl = 45.70;  $S_3N_4TiCl_6$  requires: S = 20.70; N = 12.06; Cl = 45.77. Compound turns dark at  $135^\circ$  and melts with decomposition at  $142^\circ$ , with the formation of a black tar, and is insoluble in benzene, hexane,  $CCl_4$ ,  $SOCl_2$ , pentane and toluene. Infrared absorptions occur at: 226m, 260vw, 310w, 316w, 339m(sh), 345m(sh), 359m, 364m, 368m(sh), 386vs, 403vs, 415vs, 475s, 481s, 571w, 623w, 714w, 722w, 744m, 820s, 843vs, 848vs, 915w, 942m, 978vw, 1000vw, 1103w, 1193w, 1231vw.

Reaction between tetrasulphurtetranitrido titanium tetrachloride and thionyl chloride.

$S_4N_4 \cdot TiCl_4$  (0.37 g.) was dissolved in an excess of thionyl chloride (20 ml.) at room temperature. An immediate reaction took place and after 30 minutes a yellow precipitate began to form in the green solution. After 4 hrs. at room temperature the precipitate was filtered off, washed in thionyl chloride and pumped dry. Found: S = 28.80; N = 15.3; Cl = 32.75;  $S_2N_2TiCl_2$  requires S = 30.1; N = 13.2; Cl = 33.3; m.p.  $130^\circ$  (decomp.), insoluble in organic solvents. Infrared absorptions occur at: 472s, 505w(sh), 528w(sh), 533m, 557w, 570w, 612w, 680m, 730m, 842vs, 1010m(sh), 1021vs, 1111m, 1187s, 1228vs, 1333vw, 1412w.

The thionyl chloride solution was pumped down to give a red solid which on pumping turned yellow. Found: S = 57.6; N = 21.5;  $S_4N_4Ti$  requires S = 54.76; N = 23.0; m.p.  $92^\circ$  (decomp.). The compound hydrolyses rapidly in air, is insoluble in organic solvents, soluble in  $SOCl_2$  and absorbs in the infrared at: 213s, 227s, 339m(sh), 344s, 347s, 351w(sh), 353w(sh), 362w(sh), 373vs, 503w, 525w, 528vw, 548s, 552s, 658w, 687s, 700s, 708m(sh), 725m(sh), 727m, 761vw, 803vw, 928s, 1000w, 1020w, 1041s, 1101w, 1163m(sh), 1190vs.

Reaction of tetrasulphur tetranitride with zirconium (IV) chloride in thionyl chloride.

Zirconium tetrachloride (0.7 g.) was refluxed in thionyl chloride (20 ml.) for forty minutes and the solution allowed to cool to  $40^\circ$ . Tetrasulphur tetranitride (0.5 g.) was added with stirring and heated at  $40^\circ$  for sixteen hours. The immediate dark blue-green colouration slowly disappeared to yield a light orange coloured solution, from which precipitated an orange coloured solid, which was filtered from the solution and washed several times in thionyl chloride. The thionyl chloride solution was evaporated under vacuum to give a small amount of a dark green residue. The orange coloured solid on analysis gave S = 19.22; N = 8.51; Cl = 39.65;  $S_2N_2ZrCl_4$  requires: S = 19.72; N = 8.62; Cl = 43.50%. m.p.  $132^\circ$  (decomp.), insoluble in benzene, hexane,  $CCl_4$ ,  $SOCl_2$ , pentane and toluene. Infrared absorptions occur at:

227m, 233w, 242w, 247w, 250w, 278w, 305vs, 311vs, 321vs, 327vs, 329vs, 339vs, 357w, 418vs, 463m, 470m, 475m, 548vw, 570m, 608w, 670vw, 693w, 714s, 745s, 772m, 782w, 829m(sh), 849vs, 893vw, 942vs, 1000w, 1035w, 1111vw, 1169vw, 1262vw, 1408s.

Reaction between tetrasulphur tetranitride and chromium (III) chloride in thionyl chloride.

Chromic chloride hexahydrate (0.66 g.) was heated in refluxing thionyl chloride (40 ml.) for 4 hours. Tetrasulphur tetranitride (0.46 g.) was added at 50° with stirring. An immediate dark blue-black colouration developed and the solution was heated at 50° for 84 hrs. The colour of the solution lightened only slowly, turning dark green after 60 hrs. and finally light green, with the formation of a green precipitate. The precipitate was filtered off and the solution evaporated to dryness. Only a slight amount of a yellow solid was obtained from the solution. The precipitate was washed in thionyl chloride and pumped dry, Found: S = 26.5; N = 11.5; Cl = 40.9;  $S_2N_2CrCl_3$  requires: S = 25.91; N = 11.32; Cl = 41.75, m.p. greater than 360°, insoluble in benzene, hexane,  $CCl_4$ ,  $SOCl_2$ , pentane and toluene, hydrolyses rapidly in air with the formation of  $NH_4^+$ . Infrared absorptions occur at:- 204w, 225w, 256vw, 272vw, 284w, 305w(sh), 312w(sh), 318m, 324m, 329m, 333m, 339m, 344m, 351m, 357m, 364m(sh), 371w(sh), 377w(sh), 407vw, 420vw, 427vw, 465m, 565m, 667w, 676w, 719m, 738m, 806w, 860vs, 939m, 1018s, 1136w, 1174m, 1189m, 1220w, 1255w, 1316w, 1422m.

Reaction between tetrasulphur tetranitride and manganese (II) chloride in thionyl chloride.

Manganese (II) chloride tetrahydrate (0.5 g.) was refluxed in thionyl chloride for 3 hrs. A solution of tetrasulphur tetranitride (0.46 g.) in thionyl chloride (20 ml.) was added at room temperature. An immediate dark blue-green colouration was formed and the solution was heated at 50° for 25 hrs. with constant stirring. On standing the solution slowly turned from blue-green to a burgundy red and deposited a dark green solid. The solid was removed by filtration and washed in  $\text{SOCl}_2$ . Found: S = 18.59; N = 7.96; Cl = 43.8;  $\text{SNMnCl}_2$  requires: S = 18.63; N = 8.15; Cl = 41.25%. The compound turns light green on heating to 170° and yellow at 250° but does not melt below 360°. The colour changes which take place are irreversible. It is insoluble in benzene, hexane,  $\text{CCl}_4$ ,  $\text{SOCl}_2$ , and toluene, and infrared absorptions occur at: 227m, 248m, 258m, 270m, 282m, 292m, 320m, 355vw, 360vw, 442m(sh), 459m, 481s, 504m(sh), 521w(sh), 543w, 571w, 615w(sh), 646m(sh), 676s, 694m(sh), 725m, 806w(sh), 980vs, 1022m(sh), 1032s, 1143w, 1190m, 1212w(sh), 1266w, 1324w.

The solution was evaporated at room temperature to give a brownish plate-like solid with a metallic lustre. Recrystallisation of this from benzene gave  $\text{S}_3\text{N}_2\text{O}_2$ , characterised by m.p. and infrared spectrum

Reaction between tetrasulphur tetranitride and cobalt (II) chloride in thionyl chloride.

Cobalt chloride hexahydrate (0.85 g.) was refluxed in thionyl chloride for 4 hours, and allowed to cool to room temperature. A solution

of tetrasulphur tetranitride (0.46 g.) in thionyl chloride (40 ml.) was added at room temperature. The solution became dark green immediately on addition of the  $S_4N_4$  and after stirring at  $40^\circ$  for 1 hour turned light green. No further colour change occurred and the solution was stirred at  $40^\circ$  for a further 23 hrs. After this time a bright green precipitate was formed and the solution turned light brown in colour. After a total of 27 hrs. the precipitate was filtered from the solution at room temperature, and washed in  $SOCl_2$  and  $CCl_4$ . Found: S = 20.00; N = 8.9; Cl = 40.08;  $SNC_2Cl_2$  requires: S = 18.25; N = 8.00; Cl = 40.32%, m.p. greater than  $360^\circ$ . Insoluble in benzene, toluene,  $CCl_4$ ,  $SOCl_2$ , hexane and pentane. The thionyl chloride solution was evaporated down to give a dark brown solid which recrystallised from benzene to give  $S_3N_2O_2$ , characterised by m.pt. and infrared spectrum.  $SNC_2Cl_2$  absorbs in the infrared at: 248m, 254m, 260m(sh), 268m(sh), 289m, 296m, 306m, 341m, 442w(sh), 450w(sh), 475s, 563m, 570m, 609vw, 643vw, 681m, 720w, 735w(sh), 800m, 891vw, 1026s, 1092w, 1139w, 1182m, 1262m, 1412s.

Reaction between tetrasulphur tetranitride and nickel (II) chloride in thionyl chloride.

Nickel chloride hexahydrate (0.57 g.) was heated in refluxing thionyl chloride (40 ml.) for 4 hours. Tetrasulphur tetranitride (0.46 g.) was added at  $40^\circ C$  and the solution heated for 22 hrs. The immediate



green-black colouration turned brown after about 12 hours and a green coloured precipitate was obtained. The precipitate was filtered off, washed in thionyl chloride and pumped dry. Found S = 7.70; N = 6.61; Cl = 45.30;  $\text{Ni}_3\text{N}_2\text{S}_4\text{Cl}_5$  requires S = 7.75; N = 6.77; Cl = 42.87%, m.p. greater than  $360^\circ$ , decomposes rapidly in air to give  $\text{NH}_4^+$ . Insoluble in benzene, hexane,  $\text{CCl}_4$ ,  $\text{SOCl}_2$ , and toluene infrared absorption occur at: 227w, 250w, 271w, 280w, 284w(sh), 292w, 303w, 317w, 320w, 328vw, 439w, 522w, 562w, 680w, 724m, 733w(sh), 1012m, 1136w, 1176w, 1218m, 1316m, 1403s.

The  $\text{SOCl}_2$  solution from the filtration was pumped down to give a small amount (0.1 g.) of a dark green solid. The solid was dissolved in  $\text{SOCl}_2$  and the solution evaporated to about 4 ml. The solid was filtered from the solution and pumped dry. Found: S = 42.45; N = 22.00; Cl = 11.85;  $\text{S}_4\text{N}_4\text{NiCl}$  requires S = 46.08; N = 20.13; Cl = 12.74. Infrared absorptions occur at:- 227m, 249m, 330m, 340m, 374m, 466s, 474w(sh), 502vw, 526w, 548s, 551s, 565m, 581vw, 685s, 699s, 707s(sh), 726s, 767vw, 800vw, 927s, 943w, 961w, 976w, 1000s, 1042m, 1163s, 1190s, 1212w, 1264w, 1304w(sh), 1351w(sh), 1422m.

Reaction between tetrasulphur tetranitride and copper (II) chloride in thionyl chloride.

Cupric chloride dihydrate (0.85 g.) was heated in refluxing thionyl chloride (20 ml.) for 2 hours. Tetrasulphur tetranitride (0.92 g.) was added at  $50^\circ$  with constant stirring. An immediate black colouration

was formed and the solution was heated at  $50^{\circ}$  for 22 hrs. After one hour the black colouration lightened to green and after 3 hours to yellow-green. A light-green coloured precipitate was formed and filtered off. The precipitate was washed in thionyl chloride and pumped dry. Found: S = 16.01; N = 11.63; Cl = 34.85;  $\text{Cu}_2\text{S}_2\text{N}_3\text{Cl}_4$  requires: S = 17.08; N = 11.20; Cl = 37.82, m.p.  $285^{\circ}$  (decomp.), insoluble in benzene, hexane,  $\text{CCl}_4$  and  $\text{SOCl}_2$ . The thionyl chloride solution was pumped down to give a reddish tar like solid which on pumping crystallised to give silver-grey plates. These were recrystallised from hexane to give yellow plates of thiodithiazyl dioxide ( $\text{S}_3\text{N}_2\text{O}_2$ ), characterised by m.p. ( $101^{\circ}$ ) infrared and mass spectra (see p. 85).  $\text{Cu}_2\text{S}_2\text{N}_3\text{Cl}_4$  gives infrared absorptions at:- 214m, 226m, 237vw, 252w, 257w, 284w, 290m, 291m, 310w(sh), 317m, 327m, 450m, 463m, 477m, 568m, 676m, 683w(sh), 725w, 738w(sh), 805w, 862s, 1026s, 1042m(sh), 1170m, 1190w, 1250w(sh), 1282w(sh), 1316w(sh).

Reaction between tetrasulphur tetranitride and zinc (II) chloride in thionyl chloride.

Zinc chloride (0.34 g.) was refluxed in thionyl chloride (40 ml.) for 1 hr. Tetrasulphur tetranitride (0.46 g.) was added at room temperature and the mixture stirred at  $40^{\circ}$  for 90 hrs. An immediate wine colouration resulted on first addition of the  $\text{S}_4\text{N}_4$  and after 18 hrs. a fine yellow precipitate was formed. The solution gradually lightened in colour so that with the formation of more precipitate the solution finally

became a golden yellow colour after 90 hrs. The precipitate was filtered from the solution and washed in  $\text{SOCl}_2$ . Found: S = 30.90; N = 12.20; Cl = 27.70;  $\text{S}_2\text{N}_2\text{ZnCl}_2$  requires: S = 28.06; N = 12.27; Cl = 30.13%. The compound melts with decomposition above  $215^\circ$ , and is insoluble in organic solvents. Infrared absorptions occur at: 212w, 215w, 221w, 226w, 251w, 255w, 270w, 292m, 312m(sh), 317m, 324m(sh), 329m(sh), 345vw(sh), 357vw, 370vw, 395vw, 404vw, 433w(sh), 455m(sh), 480s, 568m, 575w, 580w, 599w, 613w, 619w, 644w, 649w, 676m, 725w, 735w, 800m, 1029s, 1094w, 1138w, 1175m, 1264m, 1305vw. The solution was evaporated to give a very small quantity of a tarry red solid.

Reaction between tetrasulphur tetranitride and mercury (II) chloride in  $\text{SOCl}_2$ .

Tetrasulphur tetranitride (1.84 g.) was dissolved in thionyl chloride (50 ml.) and a solution of mercury (II) chloride (0.68 g.) in thionyl chloride (50 ml.) added at room temperature. An immediate yellow precipitate resulted from the mixing of solutions and this was filtered off and washed in  $\text{SOCl}_2$  and  $\text{CCl}_4$ . The thionyl chloride solution was pumped down to give a further small amount of yellow solid. The infrared spectra of this and the original precipitate were identical. The precipitate (2.1 g.) was pumped dry at room temperature. Found: S = 21.70, N = 9.65, Cl = 37.05;  $\text{HgS}_4\text{N}_4\text{Cl}_6$  requires: S = 21.46; N = 9.43; Cl = 35.58%. Insoluble in benzene, hexane,  $\text{CCl}_4$  and  $\text{SOCl}_2$ , reacts with formic acid and pyridine. Infrared absorptions at: 225m, 233m(sh), 256m, 303m, 324s, 353w, 476vs, 525vw, 564m, 571m(sh), 612vw, 645w, 678m, 722w, 1018s, 1136w, 1175m, 1410vw.

Reaction between Tetrasulphur tetranitride and boron trichloride in thionyl chloride.

Tetrasulphur tetranitride (0.46 g.) was dissolved in thionyl chloride (100 ml.) and cooled to 0°. Boron trichloride was bubbled through the solution and condensed (b.p.  $\text{BCl}_3 = 12.5^\circ$ ). The solution turned deep red in colour immediately on first addition of the boron trichloride. The flow of gas was stopped after 90 minutes and the solution warmed to room temperature. The solution turned pale red on standing for 1 hr. The excess boron trichloride was boiled off at 40° and the solution stirred at this temperature for 36 hrs. The solution was evaporated at room temperature to give a yellow-orange solid. This was redissolved in thionyl chloride but would not recrystallise. The thionyl chloride solution was evaporated until about 5 ml. of solution remained, and the yellow-orange solid filtered off. The solid was pumped dry at room temperature and washed in  $\text{CCl}_4$ . Found: S = 8.69; N = 7.74; Cl = 33.80; original solid product gave S = 9.94; N = 7.09; Cl = 34.30.

Calculated analysis figures

	S%	N%	Cl%
Found	8.69	7.74	33.80
$\text{SN}_2\text{B}_{14}\text{Cl}_3$	10.02	8.82	33.48
$\text{SN}_2\text{B}_{15}\text{Cl}_3$	9.76	8.53	32.38
$\text{SN}_2\text{B}_{16}\text{Cl}_3$	9.45	8.24	31.35
$\text{SN}_2\text{B}_{17}\text{Cl}_3$	9.15	8.00	30.39
$\text{SN}_2\text{B}_{18}\text{Cl}_3$	8.80	7.76	29.47

Melting point of compound is greater than  $360^{\circ}$ . Infrared absorptions occur at: 208w, 227w, 249vw, 255vw, 270vw, 284vw, 290vw, 298vw, 304vw, 316vw, 345vw, 368m, 380w, 391m, 435w, 494m, 505w, 519w, 676m, 722s, 752m(sh), 813s, 844m(sh), 942s, 1012m, 1050m, 1094m.

Reaction between tetrasulphur tetranitride and phenyl boron dichloride in thionyl chloride.

Phenyl boron dichloride (0.40 g.) was dissolved in thionyl chloride (20 ml.) and tetrasulphur tetranitride (0.46 g.) added at room temperature. The mixture was warmed to  $40^{\circ}$  and stirred. The solution became claret red in colour on mixing and after 10 minutes a yellow precipitate began to form. After 40 minutes the precipitate redissolved and the solution became deep brown in colour. The solution was filtered after 21 hours to give a light brown solid which rapidly decomposed in dry nitrogen at room temperature. The thionyl chloride solution was evaporated to give a black tarry solid, from which could be sublimed at  $50^{\circ}$  a further yellow-orange tar. These were not investigated further.

Reaction between Tetrasulphur tetranitride and Tin (IV) chloride in  $\text{SOCl}_2$ .

Tin (IV) chloride (0.56 ml.) was added to a solution of  $\text{S}_4\text{N}_4$  (0.92 g.) in thionyl chloride (25 ml.) at  $-20^{\circ}$ . The solution became dark blue in colour on addition and slowly lightened in colour, so that after stirring for 15 minutes and allowing to warm to room temperature, the solution became yellow with the formation of a yellow precipitate.

The precipitate was washed in thionyl chloride and pumped dry at room temperature. Found: S = 15.80; N = 13.38; Cl = 34.25;  $\text{SnN}_4\text{S}_2\text{O}_2\text{Cl}_4$  requires: S = 15.50; N = 13.57; Cl = 34.37.  $\text{SnN}_4\text{S}_2\text{Cl}_4$  requires: S = 16.89; N = 14.78; Cl = 36.94, m.p.  $156^\circ$  (decomp.), insoluble in benzene, toluene,  $\text{CCl}_4$ ,  $\text{SOCl}_2$  and hexane. Forms a glue like solid with acetonitrile. Infrared absorptions occur at: 214w, 221w, 226w, 285w(sh), 303m, 342w, 408w, 506w, 535w, 568w, 619w, 668m, 702s, 720m, 738m, 803m, 906m(sh), 943s, 985m, 1031s, 1053s, 1198s, 1261m, 1325vw, 1342vw, 1408m.

Reaction between bis tetrasulphur tetranitridotin tetrachloride and thionyl chloride.

Bis tetrasulphur tetranitridotin tetrachloride ( $2\text{S}_4\text{N}_4 \cdot \text{SnCl}_4$ , 1.0 g.) was heated in thionyl chloride (40 ml.) at  $50^\circ$  for 20 hrs. A yellow precipitate was formed and filtered from the solution. The precipitate was washed in thionyl chloride and benzene and pumped dry. Found: S = 18.10; N = 10.61; Cl = 39.10;  $\text{S}_2\text{N}_3\text{SnCl}_4$  requires: S = 17.50; N = 11.4; Cl = 38.7%. On heating, the compound turns white at  $150^\circ$  and decomposes slowly above  $240^\circ$  to give green, white and red decomposition products as bands of solid in the tube above the heating block; does not melt below  $350^\circ$ . Infrared absorptions occur at: 214w, 221w, 226w, 245w, 296m, 310m, 403m, 426m, 463m, 483w, 513w, 571m, 621vw, 676vw, 697vw, 719s, 743m, 752m(sh), 800 vw, 943s, 988m, 1000w, 1036m, 1062m, 1087vw, 1170vw, 1233vw, 1266vw, 1412m.

Reaction between tetrasulphur tetranitride and antimony (V) chloride in  
SOCl<sub>2</sub>.

Antimony pentachloride (0.64 ml.) in SOCl<sub>2</sub> (10 ml.) was added to a solution of tetrasulphur tetranitride (0.92 g.) in SOCl<sub>2</sub> (30 ml.) at 5°. An immediate dark green colouration resulted in mixing the solutions, and the colour decreased in intensity, until after 1 hour the solution was pale green/yellow. The solution was stirred at room temperature for 16 hours and the resulting light green precipitate filtered off. The precipitate was washed in SOCl<sub>2</sub> and pumped dry at room temperature.

Found: S = 19.04; N = 8.96; Cl = 44.99; S<sub>3</sub>N<sub>3</sub>SbCl<sub>6</sub> requires: S = 20.36; N = 8.90; Cl = 45.02%, m.p. 138° (decomp.), soluble in benzene to give a red solution from which a green precipitate was obtained on concentration. The green precipitate was unstable on removal of solvent and decomposed on pumping via a colour range of brown and orange to a yellow compound. This compound turned green slowly on standing under nitrogen at room temperature. The infrared spectrum of the latter was very similar to that of S<sub>3</sub>N<sub>3</sub>SbCl<sub>6</sub>. Infrared absorptions occur at: 205m, 227m, 341vs, 373m, 420m, 435m, 450m, 461m, 532m, 569m, 625vw, 669vw, 678vw, 697w(sh), 707w(sh), 716m, 722m, 744m, 765m, 806vw, 942vs, 1005m, 1026m, 1053m, 1117m, 1170m, 1266vw, 1307vw, 1348vw, 1418vw.

Reaction between tetrasulphur tetranitridoantimony pentachloride and  
thionyl chloride.

Thionyl chloride (10 ml.) was added to tetrasulphur tetranitrido-

antimony pentachloride ( $S_4N_4, SbCl_5$ , 1.2 g.) and the mixture heated at  $50^\circ$  for 16 hours. A yellow precipitate was formed and filtered from the solution. The solid was washed in  $SOCl_2$  and pumped dry. Found: S = 19.65; N = 8.69; Cl = 44.10;  $S_3N_3SbCl_6$  requires: S = 20.36; N = 8.89; Cl = 45.02%; m.p.  $138^\circ$  (decomp.). Characterised by m.p. and infrared spectrum (see p.132 ).

Reaction between tetrasulphur tetranitride and triphenyl arsenic dichloride in thionyl chloride.

Triphenyl arsenic dichloride (0.5 g.) was dissolved in thionyl chloride (20 ml.) at room temperature. A solution of tetrasulphur tetranitride (0.25 g.) in thionyl chloride (20 ml.) was added. No colour change occurred on addition, and the solution was stirred for 18 hours at  $40^\circ$ . A yellow precipitate formed after 20 mins. but re-dissolved on standing to give a clear yellow solution. The solvent was removed by distillation under vacuum to give a mixture of yellow-green and white solids. The mixture was dissolved in toluene (20 ml.) to give a green solution which on warming to  $40^\circ$  turned red. The solution was pumped down to give a mixture of white, red and brown tarry solids, which were not investigated further.

Mass Spectra.

Mass spectra were obtained on an A.E.I./M.S.9. mass spectrometer at 70 e.v. accelerating potential using a direct insertion probe.



Isotopic mass and abundance patterns for the ions were obtained on an Elliott 803 computer using a programme designed for mass and abundance data of polyisotopic ions (Isocomb.4).<sup>147</sup> Data on the commonly occurring fragments involving sulphur, nitrogen, chlorine, oxygen and selenium were obtained in this way and examples of the data input, and the mass and abundance data obtained, are shown in Figures 3-6. The final data from the computer output tape are tabulated under nominal mass (integral mass number); multiplicity (number of combinations having the same nominal mass); spread (difference in extreme masses in p.p.m.); peak mass (weighted arithmetic mean of contributions to multiplet masses) and relative abundance (sum of abundance products of individual combinations, normalised to the most abundant as 100).

Copies of the mnemonic tape (Isocomb.4) in either Elliott 8-hole telecode; or an English Electric-Leo KDF9 coded version of the Elliott programme are available from the University Computer Unit.

Figure 3

Input data for isotopic abundance pattern in mass spectrum of compound  
containing one atom of sulphur and one of nitrogen.

One atom of sulphur and one of nitrogen?

2	
1 4	
1 2	
31.9822388	95.018
32.9819473	0.750
33.9786635	4.215
35.9785253	0.017
14.0075263	99.635
15.0048793	0.365

Input data for isotopic abundance pattern in mass spectrum of compound  
containing one atom of selenium and six of chlorine.

One atom of selenium and six of chlorine?

2	
1 6	
6 2	
73.94589	0.87
75.94334	9.02
76.94436	7.58
77.94209	23.52
79.94189	49.82
81.94216	9.19
34.9799720	75.529
36.9776573	24.471

Figure 4

Isotope Abundance Patterns.

Peak patterns in Mass spectra of Compounds containing one atom each of sulphur and nitrogen.

Isotope Combination (mass numbers)	Mass	Abundance Product
32 14	45.989765	18934.2
33 14	46.989474	149.452
34 14	47.986190	839.923
36 14	49.986052	3.38759
32 15	46.987118	69.3631
33 15	47.986826	.547500
34 15	48.983543	3.07695
36 15	50.983404	.012410

Number of combinations:- 8

Nominal Mass	multiplicity	spread (ppm.)	Peak Mass (wtd. mean)	Relative Abundance
46	singlet		45.989765	100.0000
47	2	50	46.988727	1.1557
48	2	13	47.986190	4.4389
49	singlet		48.983543	0.0163
50	singlet		49.986052	0.0179
51	singlet		50.983404	0.0001

Peak pattern in Mass spectrum of compound containing two atoms each of sulphur and nitrogen.

Nominal Mass	multiplicity	spread (ppm.)	Peak Mass (wtd. mean)	Relative Abundance
92	singlet		91.979530	100.0000
93	2	25	92.978491	2.3113
94	4	50	93.975958	8.8911
95	4	32	94.974530	0.1351
96	5	54	95.972907	0.2332
97	4	60	96.971010	0.0020
98	4	59	97.972233	0.0016
99	2	6.4	98.969595	0.0000
100	2	52	99.972069	0.0000
101	singlet		100.969456	0.0000
102	singlet		101.966809	0.0000

Figure 5

Isotopic Abundance Patterns.

<u>SOCl<sub>2</sub></u>				
Nominal Mass	multiplicity	spread (ppm.)	Peak Mass (wtd mean)	Relative Abundance
118	singlet		117.942182	100.0000
119	2	41	118.942111	0.8268
120	4	71	119.939809	69.4396
121	4	60	120.939826	0.5390
122	6	69	121.937360	13.5313
123	5	59	122.937604	0.0889
124	6	76	123.934473	0.5047
125	3	29	124.940307	0.0003
126	3	57	125.935575	0.0029
127	singlet		126.938377	0.0000
128	singlet		127.938723	0.0000
<u>SeCl<sub>6</sub></u>				
284	singlet		283.825721	0.5825
285	no combination			
286	2	.82	285.823208	7.1718
287	singlet		286.824190	5.0753
288	3	3.7	287.821456	28.4057
289	singlet		288.821877	9.8661
290	4	11	289.820419	73.8769
291	singlet		290.819560	7.9914
292	5	20	291.818908	100.0000
293	singlet		292.817245	3.4522
294	5	20	293.817158	76.2086
295	singlet		294.814930	0.8389
296	5	19	295.815320	35.1119
297	singlet		296.812617	0.1087
298	4	19	297.813465	10.0434
299	singlet		298.810302	0.0059
300	3	16	299.811625	1.7498
301	no combination			
302	2	8.6	301.809831	0.1704
303	no combination			
304	singlet		303.808101	0.0071

Figure 6

Isotopic Abundance Patterns.

<u>S<sub>2</sub>Cl<sub>2</sub>.</u>				
Nominal Mass	multiplicity	spread (ppm.)	Peak Mass (wtd mean)	Relative Abundance
134	singlet		133.924422	100.0000
135	singlet		134.922930	1.5786
136	3	9.3	135.921954	73.6772
137	2	9.2	136.920535	1.0930
138	5	25	137.919325	16.4828
139	3	16	138.918031	0.2114
140	5	25	139.916116	1.0843
141	2	15	140.914778	0.0075
142	4	31	141.913237	0.0254
143	singlet		142.914587	0.0000
144	2	15	143.912529	0.0002
145	no combination			
146	singlet		145.912365	0.0000
<u>NSOCl</u>				
97	singlet		96.969737	100.0000
98	3	73	97.968874	1.1932
99	6	85	98.967311	37.0432
100	8		99.966495	0.4069
101	9	84	100.964281	1.5315
102	8		101.963000	0.0067
103	6	70	102.965421	0.0088
104	4	69	103.963121	0.0000
105	2	29	104.968591	0.0000
106	singlet		105.965945	0.0000

As well as using the mass spectrum as a diagnostic tool in the characterisation of new compounds, the breakdown patterns of a number of known compounds have been established.

a) S<sub>4</sub>N<sub>4</sub>.

The most abundant peaks in the mass spectrum<sup>148,149</sup> of S<sub>4</sub>N<sub>4</sub> occur at mass numbers 46, 92 and 138, and correspond to the masses SN, S<sub>2</sub>N<sub>2</sub> and S<sub>3</sub>N<sub>3</sub>. Smaller amounts of S<sub>3</sub>N, S<sub>2</sub>N, S<sub>3</sub>N<sub>2</sub> and S<sub>4</sub>N<sub>2</sub> are also present. The major breakdown pattern would appear to proceed by loss of SN fragments:



These masses have relatively long 'lives' in the ion source and further subsidiary breakdowns by loss of S and/or N fragments also occur, e.g.

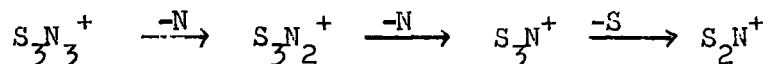

The relative mass abundances are given in Table 7.

b) SCl<sub>2</sub>.

The mass spectrum of SCl<sub>2</sub> is extremely simple and contains peaks at mass numbers 32, 35, 64, 67 and 102 corresponding to the ions S<sup>+</sup>, Cl<sup>+</sup>, S<sub>2</sub><sup>+</sup>, SCl<sup>+</sup> and SCl<sub>2</sub><sup>+</sup> (plus, of course, the peaks due to the other isotopic combinations of these masses).

Table 7

Mass spectrum of  $S_4N_4$

(70 e.v. accelerating potential, 100 - 120° ionisation chamber temperature)

<u>Mass number</u>	<u>Species</u>	<u>Relative abundance</u>
184	$S_4N_4^+$	$24 \pm 3$
156	$S_4N_2^+$	$0.25 \pm 0.1$
138	$S_3N_3^+$	100
124	$S_3N_2^+$	$1.5 \pm 0.2$
110	$S_3N^+$	$4.3 \pm 0.5$
92	$S_2N_2^+$	$66 \pm 5$
78	$S_2N^+$	$32 \pm 3$
64	$S_2^+$	$3 \pm 1$
46	$SN^+$	$99 \pm 5$
32	$S^+(S_2^{2+})$	$9 \pm 2$

Results at 65-90°, 130-140° and 220-240° agree within experimental error except the relative abundances of  $S_4N_2$ ,  $SN$  and  $S$ , which decrease with increase in temperature.

The breakdown pattern is therefore straightforward; initial loss of Cl to give  $\text{SCl}^+$  is followed by complete fragmentation to  $\text{S}^+$  and  $\text{Cl}^+$ . Scavenging of S by  $\text{S}^+$  also occurs to give  $\text{S}_2^+$ .

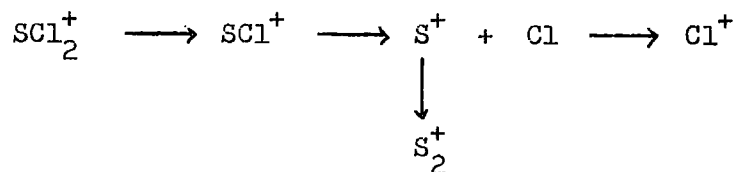

The relative mass abundances are given in Table 8.

Table 8

Mass Spectrum of  $\text{SCl}_2$

(70 e.v. accelerating potential, 60-80° ionisation chamber temperature)

<u>Mass number</u>	<u>Species</u>	<u>Relative abundance</u>
102	$\text{SCl}_2^+$	22 ± 3
67	$\text{SCl}^+$	41 ± 3
64	$\text{S}_2^+$	90 ± 3
35	$\text{Cl}^+$	5.4 ± 0.4
32	$\text{S}^+$	100

c)  $\text{S}_2\text{Cl}_2$ .

The mass spectrum of  $\text{S}_2\text{Cl}_2$  contains only three peaks, at mass numbers 32, 35 and 64, corresponding to the ions  $\text{S}^+$ ,  $\text{Cl}^+$  and  $\text{S}_2^+$ . There is no evidence of the parent peak nor of the ions  $\text{S}_2\text{Cl}^+$  or  $\text{SCl}^+$ .



Breakdown therefore proceeds by immediate loss of two chlorine atoms to give  $S_2^+$ .

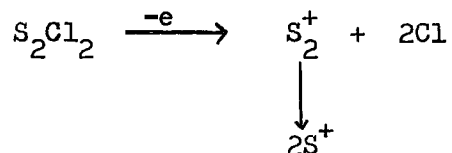

The relative mass abundances are given in Table 9.

Table 9

Mass spectrum of  $S_2Cl_2$ .

(70 e.v. accelerating potential, 200° ionisation chamber temperature)

<u>Mass number</u>	<u>Species</u>	<u>Relative abundance</u>
64	$S_2^+$	100
35	$Cl^+$	$4.2 \pm 0.6$
32	$S^+$	$7 \pm 0.8$

d)  $SOCl_2$ .

The use of the computed isotopic abundances has proved most useful in interpreting the mass spectrum of  $SOCl_2$ . Where more than one species occurs at the same mass number, e.g.  $S_2O^+$  and  $SO_3^+$ , these can be separated by a comparison of the peak pattern with the computed patterns for  $S_2O^+$  and  $SO_3^+$ . Thus it can be shown that the peak at mass number 80 is mainly due to  $S_2O^+$ , and similarly the peak at mass number 64 is mainly due to  $SO_2^+$  rather than  $S_2^+$ .

The breakdown proceeds by loss of Cl to  $\text{SOCl}^+$  and then to  $\text{SO}^+$ . Further breakdown to  $\text{S}^+$  and O, coupled with combinations of  $\text{SO}^+$ , S and O fragments gives the complete pattern.

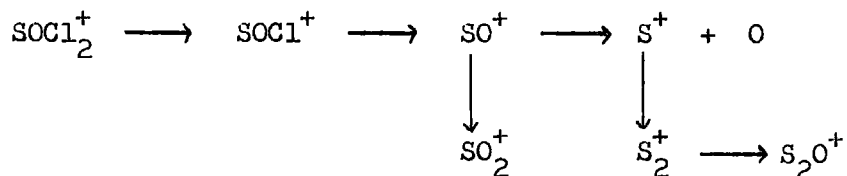

The relative abundances are given in Table 10.

Table 10

Mass Spectrum of  $\text{SOCl}_2$ .

(70 e.v. accelerating potential, 60-70° ionisation chamber temperature)

<u>Mass Number</u>	<u>Species</u>	<u>Relative Abundance</u>
118	$\text{SOCl}_2^+$	$0.16 \pm 0.02$
83	$\text{SOCl}^+$	$5.6 \pm 0.4$
80	$\text{S}_2\text{O}^+(\text{SO}_3^+)$	$13 \pm 1$
64	$\text{SO}_2^+(\text{S}_2^+)$	100
48	$\text{SO}^+$	$35 \pm 2$
35	$\text{Cl}^+$	$0.8 \pm 0.05$
32	$\text{S}^+$	$17 \pm 1$

e)  $S_4N_3Cl$ .

The breakdown of  $S_4N_3Cl^+$  is complicated, and the spectrum contains peaks resulting from almost every conceivable combination of sulphur and nitrogen atoms. The parent ion  $S_4N_3^+$  appears to break down in three possible ways, viz: by loss of S, N, or SN fragments. The major breakdown appears to be via loss of SN (cf.  $S_4N_4$ ) from  $S_4N_2^+$ ,  $S_4N_3^+$  and  $S_3N_3^+$ .

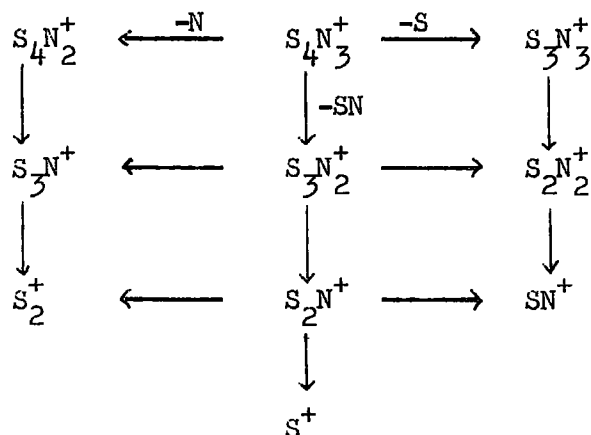

In addition, the species  $Cl^+$  is present in small amount and  $SNCl^+$  is also formed by combination of  $SN^+$  with  $Cl$  in the ionization chamber. The relative abundances are given in Table 11.

f)  $S_3N_2O_2$ .

The breakdown of  $S_3N_2O_2$  appears to proceed by two routes; either initial loss of  $SO$  or  $SN$ . The parent ion  $S_3N_2O_2^+$  is relatively abundant compared with the most abundant peaks due to  $SN^+$  and  $S_2N_2$ . The breakdown pattern can be represented by the sequence:

Table 11

Mass spectrum of  $S_4N_3Cl$

(70 e.v. accelerating potential,  $130^\circ$  ionisation chamber temperature).

<u>Mass Number</u>	<u>Species</u>	<u>Relative abundance</u>
170	$S_4N_3^+$	$0.45 \pm 0.04$
156	$S_4N_2^+$	$18 \pm 1$
138	$S_3N_3^+$	$11 \pm 1$
124	$S_3N_2^+$	$15 \pm 1$
110	$S_3N^+$	$6.3 \pm 0.07$
92	$S_2N_2^+$	$48 \pm 1.5$
81	$SNCl^+$	$3.6 \pm 0.1$
78	$S_2N^+$	$15 \pm 1$
64	$S_2^+$	$5.4 \pm 0.8$
46	$SN^+$	100
35	$Cl^+$	$3.6 \pm 0.1$
32	$S^+$	$6.3 \pm 0.1$

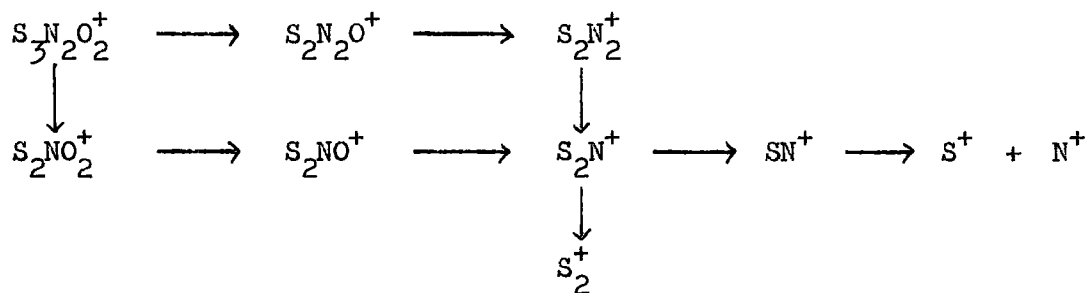

The relative abundances are given in Table 12.

Table 12

Mass spectrum of  $\text{S}_3\text{N}_2\text{O}_2$

(70 e.v. accelerating potential, 85-95° ionisation chamber temperature).

<u>Mass Number</u>	<u>Species</u>	<u>Relative abundance</u>
156	$\text{S}_3\text{N}_2\text{O}_2^+$	$16.5 \pm 0.9$
110	$\text{S}_2\text{NO}_2^+$	$3.75 \pm 0.25$
108	$\text{S}_2\text{N}_2\text{O}^+$	$0.15 \pm 0.01$
94	$\text{S}_2\text{NO}^+$	$11 \pm 1$
92	$\text{S}_2\text{N}_2^+$	$46 \pm 2$
78	$\text{S}_2\text{N}^+$	$6 \pm 0.5$
64	$\text{S}_2^+(\text{SO}_2)$	$6 \pm 0.5$
46	$\text{SN}^+$	100
32	$\text{S}^+$	$15 \pm 1$
16	$\text{O}^+$	$0.75 \pm 0.15$
14	$\text{N}^+$	$0.45 \pm 0.05$

g) New compounds.

The mass spectra of some new compounds, the syntheses of which are to be found earlier in this section are reported here. For brevity only the species present in the mass spectra are reported and not their relative intensity. Comments on the latter will be made later, where appropriate, in discussion of the compounds.

SeS<sub>2</sub>N<sub>2</sub>Cl<sub>2</sub>.

At 80° and 70 e.v. accelerating potential, peaks due to the following species were observed in the mass spectrum: S, Cl, SN, S<sub>2</sub>, SCl, Cl<sub>2</sub>, Se, SNCl, S<sub>2</sub>N<sub>2</sub>, SeN, SCl<sub>2</sub>, S<sub>3</sub>N, SeS, SeCl, S<sub>3</sub>N<sub>2</sub>, SeSN, S<sub>3</sub>N<sub>3</sub>, SeCl<sub>2</sub>, SeS<sub>2</sub>N, SeS<sub>2</sub>N<sub>2</sub>, SeCl<sub>3</sub>, SeS<sub>3</sub>N<sub>2</sub>, SeS<sub>3</sub>N<sub>3</sub>, SeS<sub>3</sub>NCl, SeS<sub>3</sub>NCl<sub>2</sub> and SeS<sub>3</sub>NCl<sub>3</sub>.

Ti(SN)<sub>4</sub>.

At 215° and 70 e.v. accelerating potential, peaks due to the following species were observed in the mass spectrum: S, SN, Ti, S<sub>2</sub>, TiN<sub>2</sub>, S<sub>2</sub>N, S<sub>2</sub>N<sub>2</sub>, TiSN, S<sub>3</sub>N, S<sub>3</sub>N<sub>3</sub>, S<sub>4</sub>N<sub>2</sub>, S<sub>4</sub>N<sub>4</sub> and TiS<sub>4</sub>N<sub>3</sub>.

Ti<sub>2</sub>S<sub>3</sub>N<sub>4</sub>Cl<sub>6</sub>.

At 205° and 70 e.v. accelerating potential peaks due to the following species were observed in the mass spectrum: S, Cl, SN, Ti, S<sub>2</sub>, S<sub>2</sub>N, TiCl, S<sub>2</sub>N<sub>2</sub>, TiSN, TiCl<sub>2</sub>, TiCl<sub>3</sub>, TiCl<sub>4</sub> and TiCl<sub>5</sub>.

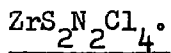

At 200° and 70 e.v. accelerating potential, peaks due to the following species were observed in the mass spectrum: S, Cl, SN, S<sub>2</sub>, SCl, S<sub>2</sub>N, SNCl, SCl<sub>2</sub> and ZrSN.

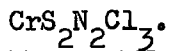

At 230° and 70 e.v. accelerating potential, peaks due to the following species were observed in the mass spectrum: S, Cl, SN, Cr, S<sub>2</sub>, S<sub>2</sub>N<sub>2</sub>, CrCl<sub>3</sub>, CrCl<sub>4</sub> and CrCl<sub>5</sub>.

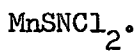

At 245° and 70 e.v. accelerating potential, peaks due to the following species were observed in the mass spectrum: S, Cl, Mn, S<sub>2</sub>, MnN, S<sub>2</sub>N, MnS, S<sub>2</sub>N<sub>2</sub>, MnCl<sub>2</sub> and S<sub>2</sub>N<sub>2</sub>Mn.

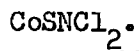

At 220° and 70 e.v. accelerating potential, peaks due to the following were observed in the mass spectrum: S, Cl, SN, Co, S<sub>2</sub>, CoN, S<sub>2</sub>N, CoCl, S<sub>3</sub>N, S<sub>3</sub>N<sub>2</sub>, CoCl<sub>2</sub>, S<sub>3</sub>N<sub>3</sub>, S<sub>4</sub>N<sub>2</sub>, S<sub>4</sub>N<sub>3</sub>, SNCoCl<sub>2</sub> and S<sub>4</sub>N<sub>4</sub>.

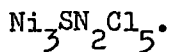

At 200° and 70 e.v. accelerating potential, peaks due to the following species were observed in the mass spectrum: S, Cl, SN, S<sub>2</sub>, S<sub>2</sub>N, S<sub>2</sub>N<sub>2</sub>, NiS<sub>2</sub> and S<sub>4</sub>N<sub>2</sub>.

NiS<sub>4</sub>N<sub>4</sub>Cl.

At 235° and 70 e.v. accelerating potential peaks due to the following species were observed in the mass spectrum: S, Cl, SN, Ni, S<sub>2</sub>, S<sub>2</sub>N, S<sub>2</sub>N<sub>2</sub>, S<sub>3</sub>N, S<sub>3</sub>N<sub>2</sub>, S<sub>3</sub>N<sub>3</sub>, S<sub>4</sub>N<sub>2</sub> and S<sub>4</sub>N<sub>4</sub>.

CuS<sub>2</sub>N<sub>3</sub>Cl<sub>4</sub>.

At 200° and 70 e.v. accelerating potential peaks due to the following species were observed in the mass spectrum: S, Cl, SN, Cu, S<sub>2</sub>, S<sub>2</sub>N<sub>2</sub>, S<sub>3</sub>N<sub>2</sub> and S<sub>4</sub>N<sub>2</sub>.

ZnS<sub>2</sub>N<sub>2</sub>Cl<sub>2</sub>.

At 185° and 70 e.v. accelerating potential peaks due to the following species were observed in the mass spectrum: S, Cl, SN, Zn, S<sub>2</sub>, SCl, ZnN, S<sub>2</sub>N, SNCl, S<sub>2</sub>N<sub>2</sub>, ZnS, ZnCl, ZnSN, S<sub>3</sub>N<sub>2</sub>, ZnS<sub>2</sub>, ZnCl<sub>2</sub>, S<sub>3</sub>N<sub>3</sub>, ZnS<sub>2</sub>N<sub>2</sub>, S<sub>4</sub>N<sub>4</sub>, and S<sub>2</sub>N<sub>2</sub>ZnCl<sub>2</sub>.

S<sub>2</sub>N<sub>3</sub>SnCl<sub>4</sub>.

At 120° and 70 e.v. accelerating potential peaks due to the following species were observed in the mass spectrum: S, Cl, SN, S<sub>2</sub>, S<sub>2</sub>N, S<sub>2</sub>N<sub>2</sub>, S<sub>3</sub>N, Sn, S<sub>3</sub>N<sub>2</sub>, S<sub>4</sub>N<sub>2</sub> and S<sub>4</sub>N<sub>4</sub>.

S<sub>3</sub>N<sub>3</sub>SbCl<sub>6</sub>.

At 240° and 70 e.v. accelerating potential, peaks due to the following species were observed in the mass spectrum: S, Cl, SN, S<sub>2</sub>, SCl, SNCl, S<sub>2</sub>, N<sub>2</sub>, Sb, S<sub>3</sub>N<sub>3</sub>, SbCl, SbCl<sub>2</sub>, SbCl<sub>3</sub> and SbCl<sub>4</sub>.



## DISCUSSION

## DISCUSSION

### a) Sulphur-nitrogen-carbon compounds.

- (i) The reaction between  $\text{H}_2\text{NCH}_2\text{SO}_3\text{H}$  and  $\text{PCl}_5$ .
- (ii) The reaction between  $\text{S}_2\text{Cl}_2$  and certain azomethines.

### b) New routes to sulphur-nitrogen compounds.

- (i) Condensation reactions (a) with elimination of  $\text{H}_2\text{O}$ ,  $\text{CO}_2$ , or  $\text{H}_2\text{S}$ .

(b) using  $\text{R}_3\text{N}\cdot\text{SOCl}_2$  as a dehydrating agent.

- (ii) Reactions involving  $\text{S}_3\text{N}_2\text{O}_2$ .
- (iii) Reactions involving  $\text{S}_3\text{N}_2\text{Cl}_2$ .

### c) Sulphur-nitrogen-metal compounds.

- (i) The reaction of  $\text{S}_4\text{N}_4$  with  $\text{SOCl}_2$ .
- (ii) The reaction between  $\text{S}_4\text{N}_4$  and  $\text{Se}_2\text{Cl}_2$  in  $\text{SOCl}_2$ .
- (iii) The reaction between  $\text{S}_4\text{N}_4$  and metal halides in  $\text{SOCl}_2$ .
- (iv) The reaction between  $\text{S}_4\text{N}_4$  - metal halide adducts and  $\text{SOCl}_2$ .

DISCUSSION

a) Sulphur-nitrogen-carbon compounds.

The work on sulphur-nitrogen-carbon compounds has involved the use of two preparative procedures: (i) the reaction between  $\text{H}_2\text{NCH}_2\text{SO}_3\text{H}$  and phosphorus pentachloride, and pyrolysis of the products and (ii) the reaction between sulphur monochloride and certain azomethines ( $\text{R}_2\text{CNH}$ ).

(i) The reaction between aminomethylenesulphonic acid and phosphorus pentachloride.

There are five main methods available for the preparation of non-metallic inorganic cyclic molecules containing nitrogen. To illustrate these types of reactions one may choose phosphorus and sulphur as examples of typical non metals ( $X = \text{halogen}$ ):

- a) The elimination of XY in the reaction between compounds of the type  $\text{YNR}_2$ ,  $\text{Y}_2\text{NR}$  or  $\text{Y}_3\text{N}$  (or their salts, e.g. hydrochlorides) and compounds containing P-X or S-X, e.g.:

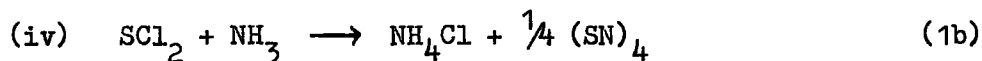
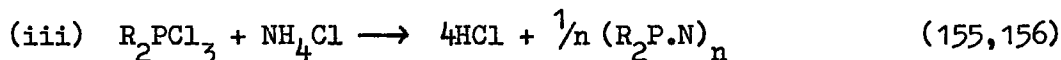
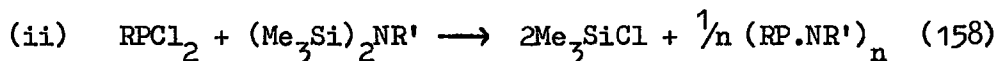
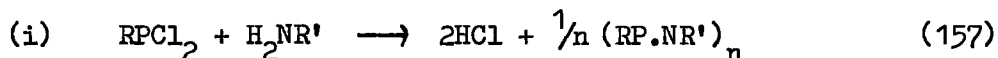

- b) Reaction between phosphorus halides and a source of labile nitrogen, e.g.:



c) Controlled halogenation of nitrides, e.g.:

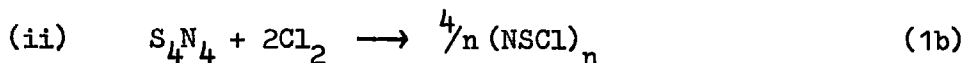
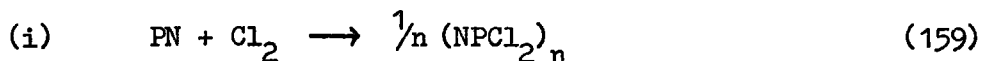

d) Pyrolysis of amides, e.g.

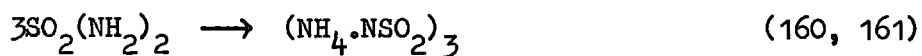

e) Pyrolysis of compounds of the type  $X_3P=NSO_2Y$ , with elimination of  $POX_3$  to give  $(NSOY)_n$ .

Very many examples are known which illustrate the importance of the first four methods, but the Kirsanov procedure<sup>100</sup> for the preparation of sulphauric chloride is the only example of method (e).

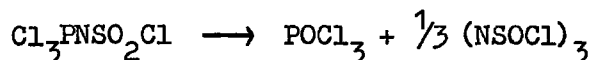

The aim of this section of the research programme was to investigate whether this route could be readily adapted for the preparation of cyclic molecules containing three elements, S, N and Z. It was felt that compounds  $H_2N-Z-SO_3H$  should in general react with  $PCl_5$  to give the trichlorophosphazo compound  $Cl_3P=N-Z-SO_2Cl$  and, if the group Z is inert, such compounds should pyrolyse in either (or both) of the following ways:

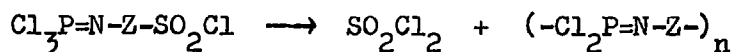
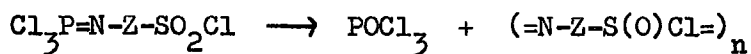

In either case a useful synthetic route would be established.

Aminomethylenesulphonic acid ( $\text{H}_2\text{NCH}_2\text{SO}_3\text{H}$ ), is one of the simplest and most accessible compounds of the type  $\text{H}_2\text{N}-\text{Z}-\text{SO}_3\text{H}$ , and moreover, amines and acid amides,  $\text{RNH}_2$ ,  $\text{RCONH}_2$ ,  $\text{RSO}_2\text{NH}_2$  are all known to give trichlorophosphazo derivatives with  $\text{PCl}_5$ . Consequently the reaction between  $\text{H}_2\text{NCH}_2\text{SO}_3\text{H}$  and  $\text{PCl}_5$  was chosen as a starting point for this work.

Phosphorus pentachloride reacts with aminomethylenesulphonic acid in refluxing  $\text{CCl}_4$  to give a white crystalline compound of empirical formula  $\text{C}_6\text{H}_{12}\text{N}_4\text{P}_2\text{Cl}_{11}\text{O}_7$ . Hydrogen chloride is evolved during the reaction and can be measured by dissolving the gas in standard sodium hydroxide and titrating against standard hydrochloric acid. In the case of the reaction of all other amines or acid amides with  $\text{PCl}_5$  the simple trichlorophosphazo compound can be isolated, in this case no evidence for its presence was detected and the high-chlorine containing product which is formed suggests a more vigorous and deep seated reaction has occurred.

The reaction was carried out using an excess of aminomethylene sulphonic acid to ensure that all the  $\text{PCl}_5$  reacted. The residual acid was recovered from the reaction mixture and in this way the stoichiometry of the reaction was deduced. It was found that the ratio of  $\text{PCl}_5$  to  $\text{NH}_2\text{CH}_2\text{SO}_3\text{H}$  involved in the reaction was 3.85 to 1. Comparison of this with the reaction between  $\text{H}_2\text{NSO}_3\text{H}$  and  $\text{PCl}_5$  shows that approximately twice

as much  $\text{PCl}_5$  enters into the reaction in this case. It is obvious that more  $\text{PCl}_5$  than is necessary for the conversion of the acid to the trichlorophosphazo derivative is involved and that therefore a completely different type of reaction mechanism is involved. It is possible that the trichlorophosphazo derivative is formed, but rapidly undergoes further reaction. Measurement of the hydrogen chloride evolved showed that 2.99 moles were obtained for every mole of acid present. Phosphorus oxychloride was formed in the reaction and condensed on a cold finger. That the compound obtained contains no sulphur is rather curious and disconcerting, since the sulphur must have been lost from the reaction vessel in the form of  $\text{SO}_2$ ,  $\text{SO}_3$ ,  $\text{SO}_2\text{Cl}_2$  or  $\text{SOCl}_2$ . This in turn means that the calculation of the amount of  $\text{HCl}$  evolved is in error. The curious empirical formula obtained for the product from the analysis figures would suggest that a highly chlorinated compound has been formed. It can be assumed that both the amino and sulphonic acid ends of the molecule have reacted with  $\text{PCl}_5$ , but that the  $\text{CH}_2$  group has remained intact. In spite of the fact that the reaction is different and more complicated than any other reaction between  $\text{PCl}_5$  and amines or acid amides it was decided to pyrolyse the product in the hope that simpler molecules may be formed as a result.

Pyrolysis of the compound  $\text{C}_6\text{H}_{12}\text{N}_4\text{P}_2\text{Cl}_{11}\text{O}_7$  gave a fluffy white sublimate at  $40^\circ$  and a viscous black tarry residue when heated above  $140^\circ$ . The sublimate contained carbon, hydrogen, chlorine, nitrogen and

phosphorus, but analysis figures on the compound were totally irreproducible

It may well be that in the case of  $\text{H}_2\text{NCH}_2\text{SO}_3\text{H}$ , the N-C and N-S bonds are broken by the vigorous action of  $\text{PCl}_5$ ; the evidence would suggest that this is certainly true in the case of the N-S bond. Since the reaction can be regarded as a conversion to the acid chloride followed by dehydration, it was decided to repeat the reaction using  $\text{SOCl}_2$  instead of  $\text{PCl}_5$ . The following reactions might be expected to occur:

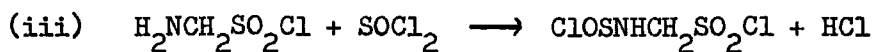
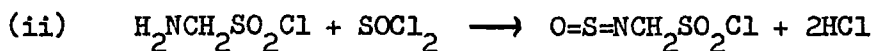
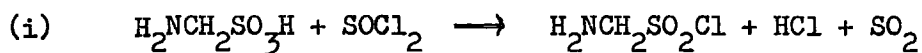

The reaction however proved to be as vigorous as that involving  $\text{PCl}_5$ . The main product isolated was ammonium chloride, indicating cleavage of the N-C bond. From the nature of the rest of the products, which were not isolated, it would appear quite likely that complete fragmentation of the aminomethylene sulphonic acid molecule occurs.

Finally the effect of heat on the free acid,  $\text{H}_2\text{NCH}_2\text{SO}_3\text{H}$  and on the sodium salt was investigated.

At  $120^\circ$  in vacuo aminomethylene sulphonic acid is almost totally converted into a mixture of  $(\text{NH}_4)_2\text{SO}_4$ ,  $\text{CH}_4$  and  $\text{SO}_2$ . A small quantity of  $\text{CO}_2$  is also evolved. Thermogravimetric analysis of the compound

shows that the decomposition is a slow process which does not proceed via any discernable intermediate stages. Similarly the decomposition of the sodium salt proceeds analogously at 250°, the main products being SO<sub>2</sub>, SO<sub>3</sub>, and a black solid residue containing a high percentage of carbon.

In conclusion therefore, the reaction between PCl<sub>5</sub> and H<sub>2</sub>NCH<sub>2</sub>SO<sub>3</sub>H does not follow the pattern,

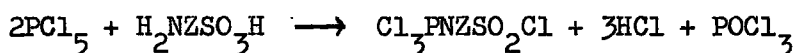

but results in the cleavage of the C-S bond and probably the N-C bond as well. The stoichiometry of the reaction suggests a very complex reaction which results in the formation of the compound/mixture of empirical formula C<sub>6</sub>H<sub>12</sub>N<sub>4</sub>P<sub>2</sub>Cl<sub>11</sub>O<sub>7</sub>. The use of the reaction between PCl<sub>5</sub> and H<sub>2</sub>NCH<sub>2</sub>SO<sub>3</sub>H as a route to cyclic sulphur-nitrogen-carbon molecules must therefore be ruled out for the particular reaction conditions investigated. Further, the use of the reaction between SOCl<sub>2</sub> and H<sub>2</sub>NCH<sub>2</sub>SO<sub>3</sub>H and the pyrolysis of H<sub>2</sub>NCH<sub>2</sub>SO<sub>3</sub>H or H<sub>2</sub>NCH<sub>2</sub>SO<sub>3</sub>Na would seem to be limited to the production of ammonium salts by novel routes.

#### Infrared spectrum of H<sub>2</sub>NCH<sub>2</sub>SO<sub>3</sub>H.

The infrared spectrum of H<sub>2</sub>NCH<sub>2</sub>SO<sub>3</sub>H is reported in Table 13. Comparison of the spectrum with that of sulphamic acid shows many similarities which can be attributed to the vibrational modes involving the H<sub>2</sub>N- and -SO<sub>3</sub>H groups. Aminomethylene sulphonic acid may exist in



the solid state either as a zwitter ion,  $\text{H}_3\overset{+}{\text{N}}\text{CH}_2\text{SO}_3^-$ , or as the molecular form  $\text{H}_2\text{NCH}_2\text{SO}_3\text{H}$ . The observed infrared spectrum can be satisfactorily explained in terms of the former, and indeed by comparison with sulphamic acid this is to be expected. The zwitter ion form should have no hydrogen modes below about  $1000 \text{ cm.}^{-1}$  and should have a broad intense absorption band in the low frequency N-H stretching region as does for example  $\text{CH}_3\overset{+}{\text{N}}\text{H}_3$ ,  $\overset{+}{\text{N}}\text{H}_3\text{OH}$  and  $\overset{+}{\text{N}}\text{H}_3\text{NH}_2$ . The molecular form would give a spectrum with a sharper and higher frequency N-H stretching bands,  $\text{NH}_2$  deformations below  $1000 \text{ cm.}^{-1}$ , an OH stretching mode at higher frequency than the N-H stretching mode and an OH bending mode.

Tentative assignments are given in Table 13 with the frequency of similar absorptions in the spectrum of  $\text{H}_2\text{NSO}_3\text{H}$  in brackets.

Table 13

Infrared Spectrum of  $\text{H}_2\text{NCH}_2\text{SO}_3\text{H}$

frequency ( $\text{cm.}^{-1}$ )	assignment
3209m(sh)	asym. $\text{NH}_3^+$ stretch (3200)
3158s	sym. $\text{NH}_3^+$ stretch (3140)
3030s	
2970m	sym. $\text{CH}_2$ stretch
2898m	asym. $\text{CH}_2$ stretch
2804m(sh)	
2653m	
1923w	
1610s	
1510s	asym. $\text{NH}_3^+$ deformation (1542)
1449w	sym. $\text{NH}_3^+$ deformation (1446)
1316m	asym. $\text{SO}_3^-$ stretch (1312)
1234s	sym. $\text{SO}_3^-$ stretch (1262)
1197s(sh)	
1172s	sym. C-N stretch
1075s	
1053s	sym. $\text{SO}_3^-$ deformation (1064)
1002s	asym. $\text{NH}_3^+$ rock (1000)
893m	
813s	
579s	
542s	
525s	asym. $\text{SO}_3^-$ deformation (526)

The reaction between sulphur monochloride and certain azomethines.

The aim of this section of the research programme was to synthesise acyclic sulphur-nitrogen-carbon compounds for use as chelating agents for metal halides or organometallic compounds. It was also hoped to obtain infrared data which would assist in vibrational assignments for other sulphur-nitrogen compounds. It was decided that a useful type of ligand would be  $R_2C=N-S-S-N=CR_2$  since reaction of this with metal halides or organometallic compounds may lead to compounds containing a) sulphur-sulphur bonds, b) sulphur-nitrogen-metal bonds and c) R groups of which many variations are possible.

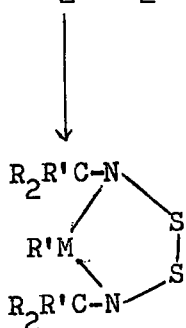
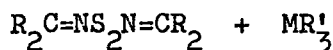
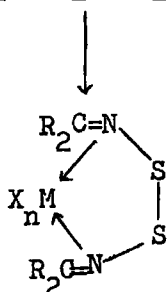
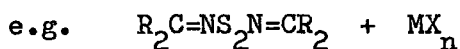

The reaction between diphenylketimine and  $S_2Cl_2$  was therefore investigated.

Diphenylketimine reacts with  $S_2Cl_2$  in hexane at  $-78^\circ$  to give diphenylketimine hydrochloride and sulphur. The formation of HCl therefore, from the initial reaction between  $Ph_2CNH$  and  $S_2Cl_2$  only serves to convert the diphenylketimine to the hydrochloride and does not result in the formation of an N-S bond. The reaction between  $S_2Cl_2$  and  $Ph_2C=NLi$  was therefore investigated next.

$Ph_2C=NLi$  is easily prepared by the reaction of methyl lithium with diphenylketimine at room temperature:<sup>168</sup>

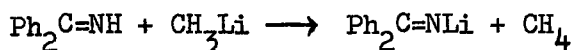

Diphenylketiminolithium was found to react with  $S_2Cl_2$  at  $-78^\circ$  to give LiCl and bis diphenylketimine disulphide,  $Ph_2C=N-S-S-N=CPh_2$ .

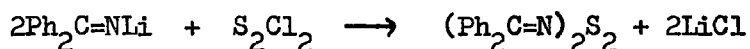

The analogous reaction between tetramethylguanidinolithium and  $S_2Cl_2$  was also carried out, but this was found to lead to the formation of the azomethine sulphur chloride,  $(Me_2N)_2C=NSCl$ .

One cannot say with any certainty why the disulphide should not be formed in this case. It would appear that the intermediate  $(Me_2N)_2C=NS_2Cl$  is unstable and decomposes to  $(Me_2N)_2C=NSCl$  and sulphur. It may well be that the alkyl derivatives  $R_2C=NS_2Cl$  are intrinsically unstable with respect to  $R_2C=NSCl$  and sulphur, but that the introduction of phenyl groups lends a measure of stability to the system. Similar effects have been observed in compounds of the type  $RSNSNSR$ .<sup>25</sup>

Thus it has been possible to synthesise compounds of the type  $R_2C=N-S-S-N=CR_2$  where  $R = \text{phenyl}$ , but not when  $R = \text{Me}_2\text{N}$ , by the reaction between  $R_2C=N\text{Li}$  and  $S_2Cl_2$ .

Bis-diphenylketimine disulphide,  $(\text{Ph}_2\text{C=N})_2\text{S}_2$ , is a white micro-crystalline solid, m.p.  $152^\circ$  which is soluble in most organic solvents and can be recrystallised from diethyl ether. The use of this compound as a ligand in reactions with metal halides or organometallic compounds has not yet been investigated since other reactions described in section (c) were thought to be more important and interesting.

A study of the infrared spectrum has resulted in the assignment of a broad weak band centred at  $459 \text{ cm.}^{-1}$  to the sulphur-sulphur stretching vibration. This compares with the values  $495-520 \text{ cm.}^{-1}$ ,  $450-500 \text{ cm.}^{-1}$ ,  $480-490 \text{ cm.}^{-1}$  and  $418-448 \text{ cm.}^{-1}$  in compounds of the type  $R_2S_2$ ,  $^{162-164}RS_nX$ ,  $^{165}(\text{MeN})_3S_5$  and  $RN(S)_nNR$   $^{167}$  respectively.



b) New routes to Sulphur-nitrogen compounds.

The following types of reactions were considered as a basis for possible new routes to cyclic sulphur-nitrogen compounds:

- (1) Condensation reactions (a) with elimination of  $H_2O$ ,  $CO_2$  or  $H_2S$   
(b) using  $R_3N \cdot SOCl_2$  as a dehydrating agent.
  - (2) Reactions involving  $S_3N_2O_2$ .
  - (3) Reactions involving  $S_3N_2Cl_2$ .
- (1a) Condensation reactions with elimination of  $H_2O$ ,  $CO_2$  or  $H_2S$ .

The aim of this section of the research programme was to study the reactions between readily available materials from which it might be possible to eliminate  $H_2O$ ,  $CO_2$  or  $H_2S$  to give new sulphur-nitrogen compounds.

The reaction between sulphamide and elemental sulphur was studied first, in the hope that  $H_2S$  might be eliminated with the formation of (e.g.)

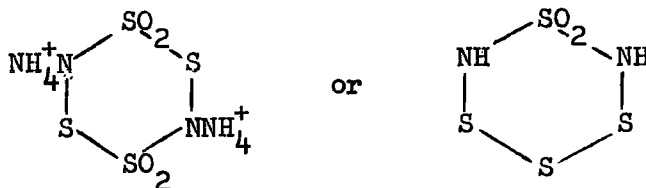

No reaction was found to occur below  $300^\circ$ , and indeed sulphur and sulphamide were found to be immiscible in the liquid phase. Heating above  $300^\circ$  only resulted in the sublimation of the sulphur and decomposition of the sulphamide.

The condensation reactions of ketones with organic amines are well established. Similarly the reactions between sulphoxides and isocyanates have been studied, and condensation reactions have been found to occur.<sup>174,175</sup>

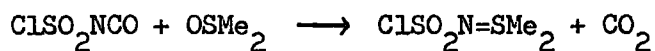
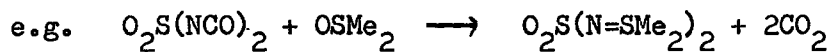

It was therefore decided to try the reaction between sulphoxides and amines as a possible synthetic route.

It was found that dimethyl sulphoxide does not react with p-nitroaniline in refluxing absolute alcohol. The reaction between dimethyl sulphoxide and sulphamide was then studied, in the hope that H<sub>2</sub>O might be more easily eliminated than with organic amines. The reaction sequence could be envisaged as follows:

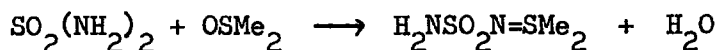

Heating sulphamide in refluxing dimethyl sulphoxide however, resulted in the formation of ammonium sulphate. It is conceivable that this is formed as a reaction product:

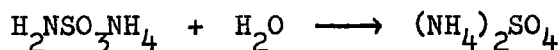
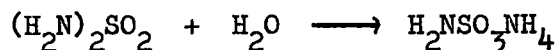
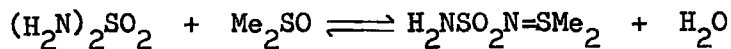

The reaction was repeated many times under various conditions, but no other product was obtained. One is led to the conclusion that if a condensation reaction does occur, then the  $H_2O$  formed immediately hydrolyses the product and an equilibrium is set up:

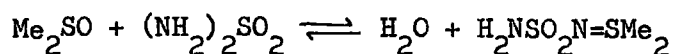

Attempts were then made to remove the water as it was formed and thus displace the equilibrium in favour of the formation of  $H_2NSO_2N=SMe_2$  by using conc. sulphuric acid. This had little effect, and at this stage the reaction was abandoned.

Finally the reaction between phenyl isocyanate and dimethyl sulphoxide was carried out. It was thought that the probable product would be triphenyl cyanurate, but there seemed a possibility that  $CO_2$  might be evolved with the formation of  $PhN=SMe_2$ . It was found however that dimethyl sulphoxide did cause the phenyl isocyanate to trimerise.

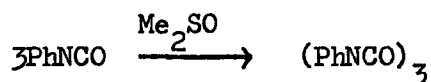

Hence the condensation reactions of dimethyl sulphoxide with sulphamide, p-nitroaniline and phenyl isocyanate, and the reaction between sulphur and sulphamide do not give rise to new sulphur-nitrogen compounds under the conditions investigated. The reaction between sulphamide and dimethyl sulphoxide may however deserve further investigation.



(1b) Condensation reactions using  $R_3N \cdot SOCl_2$  as a dehydrating agent.

The reactions of tertiary amines with thionyl chloride were studied for two reasons. First the reaction between  $NH_3$  and  $SOCl_2$  is reported to give a yellow solid of unknown composition which acts as a very good dehydrating agent.<sup>169-172</sup> The  $NH_3 \cdot SOCl_2$  complex is however rather unstable and decomposes to sulphur, ammonium chloride, sulphate and sulphamate.<sup>170</sup> It was hoped that the reaction between  $SOCl_2$  and tertiary amines would lead to more stable compounds which would be of greater use as dehydrating agents.

Secondly, the reactions were undertaken as a preliminary study of the availability of sulphur (IV) as an acceptor site in the formation of adducts.

Numerous phosphorus (V) adducts are known (e.g.  $Me_3N \cdot PF_5$ ,  $MeCN \cdot PF_5$ ) and in the phosphonitrilic halides,  $(NPX_2)_n$  appreciable  $d_{\pi} - p_{\pi}$  bonding occurs. This is probably partially replaced by external  $\sigma$  donation to phosphorus on adding a strong base e.g. pyridine.<sup>178</sup> Sulphur (VI) compounds, e.g.  $SO_3$  and  $SO_2Cl_2$  similarly form adducts by acting as Lewis acids to a wide variety of bases. The sulphur-nitrogen compound isoelectronic with  $(NPCl_2)_3$ ,  $\alpha$ -sulphanuric chloride, also readily forms adducts,<sup>102</sup> again suggesting that the ring  $d_{\pi} - p_{\pi}$  bonding can be partially replaced by external  $\sigma$  bonds. The formation of  $d_{\pi} - p_{\pi}$  bonding in the phosphonitrilic and sulphanuric halides is accompanied by slight angle widening at

nitrogen above the expected  $120^\circ$ . The wide nitrogen angle in the sulphur (IV) ring compound  $(\text{NSCl})_3$  might suggest therefore that unless lattice forces are solely responsible,  $\pi$ -bonding is also present here and that it may be possible to form adducts of  $(\text{NSCl})_3$  similar to those of  $(\text{NPCl}_2)_3$  and  $(\text{NSOCl})_3$ .

The synthesis of sulphur (IV) adducts with regard to this thesis is mainly on account of their possible use as dehydrating agents (with a view to the synthesis of new sulphur-nitrogen compounds); but the possibility of the formation of sulphur (IV) adducts with Lewis bases is a subject of wider importance, and a more detailed study of base adducts with sulphur oxyhalides and with cyclic sulphur-nitrogen compounds has been made by Banister and Moore.<sup>102</sup>

Whilst several adducts of  $\text{SeOCl}_2$  (e.g.  $2\text{C}_5\text{H}_5\text{N}.\text{SeOCl}_2$ ,  $\text{CH}_3\text{CN}.\text{SeOCl}_2$ )<sup>177</sup> and  $\text{SO}_2$  (e.g.  $\text{Me}_3\text{N}.\text{SO}_2$ ,  $\text{Et}_3\text{N}.\text{SO}_2$ )<sup>176</sup> are known, only one adduct of thionyl chloride has been reported; viz  $\text{Me}_3\text{N}.\text{SOCl}_2$ .

Schenk and Steudel<sup>173</sup> have reported the preparation of the adduct  $\text{Me}_3\text{N}.\text{SOCl}_2$  from  $\text{Me}_3\text{N}$  and  $\text{SOCl}_2$  at  $-30^\circ$ , and it was therefore decided to repeat this work before attempting to synthesise further adducts of the type  $\text{R}_3\text{N}.\text{SOCl}_2$ .

Following the procedure of Schenk and Steudel, thionyl chloride was added to a solution of trimethylamine in chloroform at  $-30^\circ$ . No compound analysing to  $\text{Me}_3\text{N}.\text{SOCl}_2$  was obtained from the reaction even after repeating the preparation many times. Instead, a white

solid of inconstant composition was obtained. This decomposed a) above  $-30^{\circ}$ , b) on removal of solvent and c) in excess thionyl chloride. (Schenk and Steudel report that  $\text{Me}_3\text{N}\cdot\text{SOCl}_2$  sublimes unchanged at  $-20^{\circ}$ ). The reaction was also carried out in hexane, ether and in the gas phase but in all cases no adduct was obtained. In the gas phase reaction colourless crystals were obtained in excess thionyl chloride vapour but these decomposed to a white powdery material when isolated.

The reaction between triethylamine and thionyl chloride in chloroform was found to lead to the formation of triethylamine hydrochloride, but in hexane, pentane and petroleum-ether no compound was isolated.

Similarly the reaction between pyridine and thionyl chloride did not yield any adduct. The reaction at room temperature is violent, giving highly coloured, evil smelling decomposition products; at  $-78^{\circ}$  in hexane a mixture of white and green precipitates was formed which decomposed rapidly above  $-30^{\circ}$ .

Hence it has not been possible to synthesise any  $\text{SOCl}_2$  adduct of  $\text{Me}_3\text{N}$ ,  $\text{Et}_3\text{N}$  or  $\text{C}_5\text{H}_5\text{N}$  under the conditions investigated. It is difficult to explain why the adducts are not formed. On the face of it all the conditions necessary for adduct formation would seem to be fulfilled. Sulphur (IV) possesses the necessary 'd' orbitals for accepting up to two donor molecules, the co-ordination is readily increased to six and both  $\text{SO}_2$  and  $\text{SeOCl}_2$  form adducts. One can postulate that the

adduct may in fact be formed, but with strong Lewis bases such as  $\text{Et}_3\text{N}$ ,  $\text{Me}_3\text{N}$  or pyridine the heat of formation of the adduct is sufficiently large to bring about the decomposition of the donor and hence the adduct. Indeed it has been noted that all three reactions are very exothermic. Similar reasoning has been used to explain the instability of some sulphur (VI) adducts,<sup>102</sup> notably  $\text{Et}_3\text{N} \cdot \text{SO}_2\text{Cl}_2$ . It may well be that use of weaker donors such as triphenyl phosphine or sulphur (IV) acceptors of higher thermal stability e.g.  $\text{SOF}_2$  may lead to stable adducts and that further research in this field would be most useful.

## 2) Reactions of Thiodithiazyl dioxide.

Few reactions of  $\text{S}_3\text{N}_2\text{O}_2$  are reported in the literature; it reacts with  $\text{SO}_3$  to give an adduct,<sup>94</sup>  $\text{S}_3\text{N}_2\text{O}_2 \cdot 2\text{SO}_3$ , which on heating forms  $\text{SO}_2$  and  $\text{S}_3\text{N}_2\text{O}_5$ . It also reacts with  $\text{SbCl}_5$  and  $\text{TiCl}_4$  to give  $\text{S}_4\text{N}_4 \cdot \text{SbCl}_5$  and  $\text{S}_4\text{N}_4 \cdot 2\text{TiCl}_4$  respectively.<sup>95</sup> No mechanism has been suggested for the formation of  $\text{S}_4\text{N}_4$  adducts from  $\text{S}_3\text{N}_2\text{O}_2$  but the reaction is presumably accompanied by evolution of  $\text{SO}_2$ :

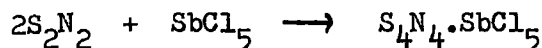

By analogy,  $\text{S}_3\text{N}_2\text{O}_2$  could possibly react with other covalent chlorides, leading to loss of  $\text{SO}_2$  and the assimilation of the  $\text{S}_2\text{N}_2$  fragment into new ring systems, e.g.

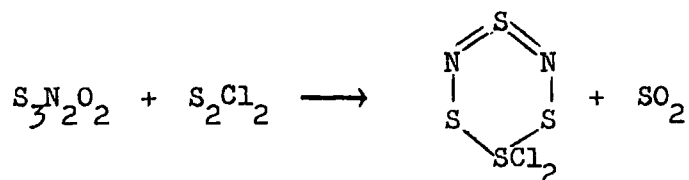

No reaction was found to occur however with either  $\text{S}_2\text{Cl}_2$  or  $\text{SOCl}_2$ . The reaction with chlorine gave  $\text{S}_4\text{N}_3\text{Cl}$  and a dark coloured residue which probably contained further sulphur-nitrogen compounds which were not isolated.

$\text{S}_3\text{N}_2\text{O}_2$  was found not to react with pyridine or bipyridyl. With triphenyl phosphine, reaction occurred to give triphenyl phosphine <sup>oxide</sup> and probably  $\text{S}_4\text{N}_2$ .

Although  $\text{S}_3\text{N}_2\text{O}_2$  may be regarded as the di-N-sulphinyllamine of sulphur,  $\text{S}(\text{N}=\text{S}=\text{O})_2$ , it does not undergo the characteristic reactions of N-sulphinyllamines, e.g. it does not react with dienes to give cyclic molecules

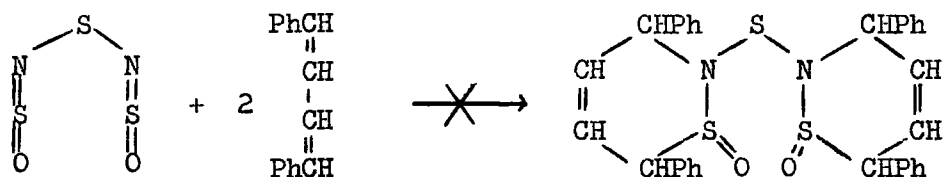

$\text{S}_3\text{N}_2\text{O}_2$  therefore appears to be rather chemically inert. The only reactions it has been found to undergo appears to be those in which the molecule breaks up to give an  $\text{S}_2\text{N}_2$  unit which then reacts.

3) Reactions of Thiodithiazyl dichloride.

A study of the reactions of thiodithiazyl dichloride,  $S_3N_2Cl_2$ , has recently been made in these laboratories.<sup>25</sup> Here, a further reaction is reported.

$S_3N_2Cl_2$  reacts with thionyl chloride at  $60^\circ$  to give thiotri-thiazyl chloride and a dark red tarry solid. The conversion of  $S_3N_2Cl^+$  to  $S_4N_3^+$  could be of great significance since it represents a simple route from a five membered sulphur-nitrogen ring to a seven membered ring. The mechanism of the reaction must be rather complex and may involve the four stages: cleavage of the S-Cl bond in the  $S_3N_2Cl^+$  cation, the cleavage of the  $S_3N_2$  ring, introduction of SN and ring closure. It is possible however that chlorine may be removed attached to sulphur to give  $S_2N_2$  and SCl units; reaction of  $S_2N_2$  with  $SOCl_2$  would then give  $S_4N_3Cl$ .

c) Sulphur-nitrogen-metal compounds.

Less than sixty sulphur-nitrogen-metal compounds (including organic derivatives) are at present known, (see pp. 29-39). Four main synthetic routes are available for the preparation of these compounds: a) reaction of  $S_4N_4 \cdot 2NH_3$  with metal salts, b) reaction of  $S_4N_4H_4$  with metal salts, c) reaction of  $S_7NH$  with metal salts and d) reaction of  $S_4N_4$  with metal halides in various solvents.

Routes a), b) and c) are well defined, in that similar products are obtained in each case, under a variety of conditions. The products obtained by using method d) however seem to depend largely on the solvent used. Group VIII metal halides react with  $S_4N_4$  in ethyl alcohol to give compounds of the type  $MeH_2S_4N_4$ ,  $MeHS_5N_3$  or  $Me_2S_6N_2$  (where Me = metal).<sup>106-113</sup> In dimethylformamide, compounds of the type  $S_2N_2CuX_2$  have been prepared by reaction of  $S_4N_4$  with copper halides.<sup>120</sup> The adducts  $S_4N_4 \cdot BF_3$ ,  $S_4N_4 \cdot SbCl_5$ ,  $S_4N_4 \cdot BCl_3$  and  $S_4N_4 \cdot BCl_3 \cdot SbCl_5$  have been prepared in methylene chloride<sup>118</sup> and several adducts  $S_4N_4 \cdot MCl_x$  have been prepared in chloroform, benzene, toluene or hexane.<sup>104, 105, 117-121</sup> The reaction between  $S_4N_4$  and  $Se_2Cl_2$  in thionyl chloride is reported to give the compound  $S_2N_2SeCl_5$ .

It was decided to use the reaction between  $S_4N_4$  and metal halides in thionyl chloride as a possible synthetic route to new cyclic sulphur-nitrogen-metal compounds in view of the curious odd-electron structure (I) suggested by Garcia-Fernandez<sup>42</sup> for the compound  $S_2N_2SeCl_5$ .

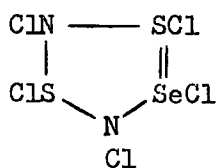

(I)

Since it is possible for this compound to be formed either by the reaction of  $\text{S}_4\text{N}_4$  with  $\text{Se}_2\text{Cl}_2$  in  $\text{SOCl}_2$ , or by reaction of  $\text{Se}_2\text{Cl}_2$  with some product of the reaction between  $\text{S}_4\text{N}_4$  and  $\text{SOCl}_2$  (if any), two preliminary investigations were carried out before embarking on the reactions of  $\text{S}_4\text{N}_4$  with metal halides in thionyl chloride. The reaction of  $\text{S}_4\text{N}_4$  with  $\text{SOCl}_2$  was investigated and the reaction of  $\text{S}_4\text{N}_4$  with  $\text{Se}_2\text{Cl}_2$  in  $\text{SOCl}_2$  reported by Garcia-Fernandez was repeated.

This section is therefore divided into four parts:

- i) The reaction of  $\text{S}_4\text{N}_4$  with  $\text{SOCl}_2$ ,
  - ii) The reaction between  $\text{S}_4\text{N}_4$  and  $\text{Se}_2\text{Cl}_2$  in  $\text{SOCl}_2$ ,
  - iii) The reaction between  $\text{S}_4\text{N}_4$  and metal halides in  $\text{SOCl}_2$ ,
  - and iv) The reaction between  $\text{S}_4\text{N}_4$ -metal halide adducts and  $\text{SOCl}_2$ .
- i) The reaction of  $\text{S}_4\text{N}_4$  with  $\text{SOCl}_2$ .

The reaction between tetrasulphur tetranitride and thionyl chloride at room temperature resulted in the formation of  $\text{S}_4\text{N}_3\text{Cl}$  and  $\text{S}_3\text{N}_2\text{O}_2$ . Although the reaction gives rise to only two products, the mechanism may well be very complex.



Tetrasulphur tetranitride probably exists in thionyl chloride in the form of sulphur nitrogen fragments, SN, S<sub>2</sub>N<sub>2</sub> or S<sub>3</sub>N<sub>3</sub> as well as S<sub>4</sub>N<sub>4</sub> molecules. It is also possible that S<sub>4</sub>N<sub>4</sub> may ionize in SOCl<sub>2</sub>, e.g. to give S<sub>3</sub>N<sub>3</sub><sup>+</sup>SN<sup>-</sup>. This is suggested by the rapid rise in conductance of thionyl chloride on adding S<sub>4</sub>N<sub>4</sub><sup>148</sup> (this could however be due to S<sub>4</sub>N<sub>3</sub><sup>+</sup>Cl<sup>-</sup> in solution before precipitation begins.)

Thionyl chloride can also provide a number of reactive species. First by ionization to give SOCl<sup>+</sup> and SOCl<sub>3</sub><sup>-</sup>;

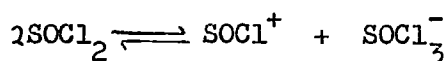

secondly by decomposition:

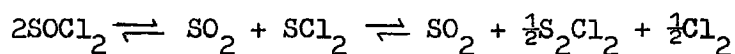

This reaction occurs slowly at the boiling point and is probably the reaction which results in the production of a yellow colour on standing at room temperature.

Given that both S<sub>4</sub>N<sub>4</sub> and SOCl<sub>2</sub> can provide such reactive species, a large number of initial reactions can be envisaged. Nevertheless three reaction routes (A, B and C) seem quite likely:

A. SO<sub>2</sub>, S<sub>2</sub>Cl<sub>2</sub> and Cl<sub>2</sub> all react with S<sub>4</sub>N<sub>4</sub> in inert solvents to give S<sub>3</sub>N<sub>2</sub>O<sub>2</sub>, S<sub>4</sub>N<sub>3</sub>Cl and (NSCl)<sub>3</sub> respectively.

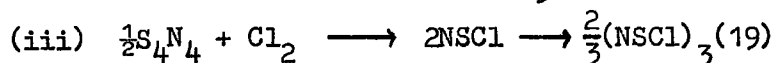
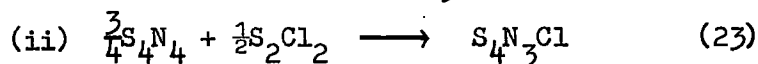
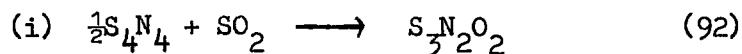

It is therefore possible that  $\text{SOCl}_2$  reacts with  $\text{S}_4\text{N}_4$  as if it were a mixture of these three breakdown products without any of  $\text{SO}_2$ ,  $\text{S}_2\text{Cl}_2$  or  $\text{Cl}_2$  being formed as such. No  $(\text{NSCl})_3$  was isolated from the reaction however and so any postulated mechanism which involves the production of chlorine must be viewed with some caution. It could be that  $(\text{NSCl})_3$  is in fact formed but reacts with  $\text{SOCl}_2$  to give  $\text{S}_4\text{N}_3\text{Cl}$  ( $(\text{NSCl})_3$  reacts with  $\text{S}_2\text{Cl}_2$  for example to give  $\text{S}_4\text{N}_3\text{Cl}$ ),<sup>23</sup> or is liberated in the form of gaseous  $\text{NSCl}$ . The most obvious reaction mechanisms which can be suggested do involve at some stage the liberation of some chlorine-rich species. In fact, without the escape of such a species from the reaction vessel, no equation can be made to 'balance' for this reaction. The liberation of chlorine or  $\text{NSCl}$  gas would however be more feasible than postulating the existence of some other product which was not isolated. No evidence for any other product in the solid or liquid phases was obtained even after careful scrutiny of the infrared and mass spectra of the products.

B.  $\text{S}_4\text{N}_4$  reacts with  $\text{EtO.SOCl}$  to form  $\text{EtO.SO.NS}$  which disproportionates on distillation to give  $\text{OS(NS)}_2$  and  $(\text{EtO})_2\text{SO}$ . Analogously therefore,  $\text{S}_4\text{N}_4$  may react with  $\text{SOCl}_2$  to give  $\text{ClSO.NS}$ . (For a balanced reaction one also anticipates the formation of  $\text{NSCl}$ ). Rearrangement of  $\text{ClSO.NS}$  could produce  $\text{ClS-NSO}$  which on disproportionation gives  $\text{S}_3\text{N}_2\text{O}_2$  and  $\text{SCl}_2$ .

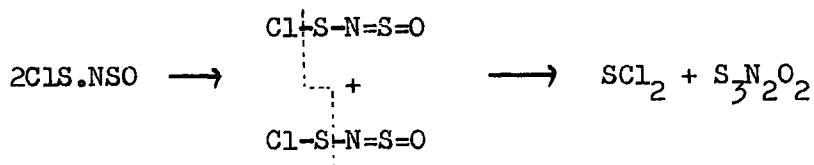

The  $\text{SCl}_2$  is then available for reaction with  $\text{S}_4\text{N}_4$  to give  $\text{S}_4\text{N}_3\text{Cl}$  as in A above.

C. Thionyl chloride may also react with for example  $\text{S}_2\text{N}_2$ . Reacting as a Lewis base, it may give rise to the as-yet unknown intermediate  $\text{S}_2\text{N}_2\text{O}$ :

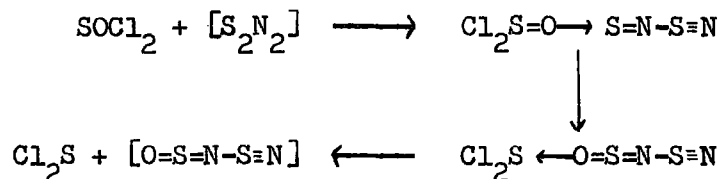

If  $\text{S}_2\text{N}_2\text{O}$  exists as an intermediate, then several possible steps are possible for its conversion to  $\text{S}_3\text{N}_2\text{O}_2$ . It has been shown (see p.109) that  $\text{S}_3\text{N}_2\text{O}_2$  is a poor acceptor, and one can assume a similar behaviour in  $\text{S}_2\text{N}_2\text{O}$ . Thionyl chloride may, therefore, now reverse its initial role and act as a Lewis acid in the second stage:

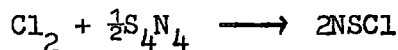
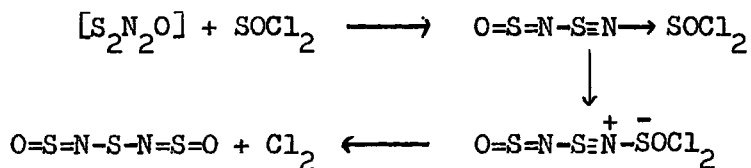

One can say no more than that these mechanisms are possible and feasible.

A further study of the  $\text{S}_4\text{N}_4-\text{SOCl}_2$  reaction could lead to more

positive evidence of the actual species involved. The reactions between a) NSCl and SOCl<sub>2</sub> and b) (NSCl)<sub>3</sub> and SOCl<sub>2</sub> should be carried out, and if the reaction between S<sub>4</sub>N<sub>4</sub> and SOCl<sub>2</sub> were followed conductimetrically it may be possible to say with more certainty whether species of the type S<sub>3</sub>N<sub>3</sub><sup>+</sup> are present. If S<sub>3</sub>N<sub>3</sub><sup>+</sup> exists in solution (and there is no reason why S<sub>4</sub>N<sub>4</sub> should not exist as trithiazyl thionitrosyl in a polar solvent), then it may be possible to isolate one of its salts. S<sub>3</sub>N<sub>3</sub><sup>+</sup> represents a very important 'gap' in sulphur-nitrogen chemistry. The five and seven membered cyclic cations are known but S<sub>3</sub>N<sub>3</sub><sup>+</sup>, which should be highly symmetrical and delocalised, is not.

(ii) Reaction between S<sub>4</sub>N<sub>4</sub> and Se<sub>2</sub>Cl<sub>2</sub> in SOCl<sub>2</sub>.

Garcia-Fernandez<sup>42</sup> has described the reaction between diselenium dichloride and tetrasulphur tetranitride in thionyl chloride solution. The precipitated product, after washing in CCl<sub>4</sub>, analysed as SeS<sub>2</sub>N<sub>2</sub>Cl<sub>5</sub> and a monomeric (and therefore odd-electron structure (I) was proposed).

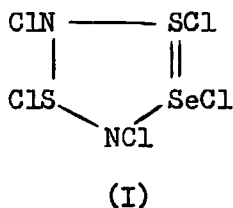

Following the experimental procedure of Garcia-Fernandez<sup>42</sup> we were unable to obtain selenium dithiazyl pentachloride. Analysis and infrared spectrum of the insoluble reaction product indicated that it was a

mixture of thiotrithiazyl chloride  $S_4N_3Cl$ , and a compound of empirical formula  $SeS_2N_2Cl_2$ , which could be recrystallised from formic acid.

The infrared spectrum of recrystallised  $(SeS_2N_2Cl_2)_n$  is very similar to that of  $[S_4N_3]^+Cl^-$ , (see Fig. 7) and so two of the most likely structures are:

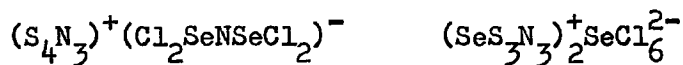

II

III

On the basis of analogy with existing compounds, III is more likely than II. The anion  $(Cl_2SeNSECl_2)$  is unknown in other compounds. Hexachloroselenates on the other hand are well known and the as yet unknown selenotrithiazyl cation is analogous to the thiotrithiazyl cation. The structure of the selenotrithiazyl cation may be postulated as a seven membered ring, having two possible structures IIIa and IIIb

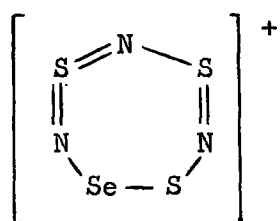

IIIa

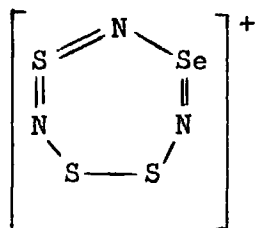

IIIb

The infrared spectrum of the compound is consistent with either structure IIIa or IIIb, and is compared with the infrared spectrum of  $S_4N_3Cl$  in Figure 7 and Table 14.

The strong band which occurs in the spectrum of  $(\text{SeS}_2\text{N}_2\text{Cl}_2)_n$  at  $951 \text{ cm.}^{-1}$  and which is absent from the spectrum of  $\text{S}_4\text{N}_3^+$  is probably due to the presence of a selenium-nitrogen bond. (S-N and S=N stretching vibrations generally absorb in the regions  $680\text{-}930 \text{ cm.}^{-1}$  and  $1280\text{-}1500 \text{ cm.}^{-1}$ ).<sup>7,179</sup> The band in  $\text{S}_4\text{N}_3^+$  which occurs at  $590 \text{ cm.}^{-1}$  is replaced in  $(\text{SeS}_2\text{N}_2\text{Cl}_2)_n$  by one at  $578 \text{ cm.}^{-1}$  and the latter may contain contributions from an Se-S stretching mode. (S-S stretching modes generally occur between  $320$  and  $670 \text{ cm.}^{-1}$ ).<sup>179</sup> It is probable that most absorptions in the spectra of both  $\text{S}_4\text{N}_3\text{Cl}$  and  $(\text{SeS}_2\text{N}_2\text{Cl}_2)_n$  result from overall ring modes and not from individual localised vibrations. Absorptions in the far infrared at  $303$ ,  $281$ ,  $254$  and  $212 \text{ cm.}^{-1}$  all fall within the ranges suggested<sup>181,182</sup> for  $\nu_{\text{Se-Cl}}$  in  $\text{Se}_2\text{Cl}_6$  and  $\text{SeCl}_6^{2-}$ .

In the formation of  $(\text{SeS}_2\text{N}_2\text{Cl}_2)_n$ ,  $\text{Se}_2\text{Cl}_2$  reacts with  $\text{S}_4\text{N}_4$  dissolved in  $\text{SOCl}_2$ . It has been established however that  $\text{Se}_2\text{Cl}_2$  readily chlorinates  $\text{S}_4\text{N}_4$  in  $\text{CCl}_4$  solution with the formation of  $\text{S}_4\text{N}_3\text{Cl}$  and elemental selenium,<sup>42</sup> and that  $\text{S}_4\text{N}_4$  reacts with  $\text{SOCl}_2$  to give  $\text{S}_4\text{N}_3\text{Cl}$  and  $\text{S}_3\text{N}_2\text{O}_2$  (see previous section). It is therefore possible that the  $\text{SeS}_2\text{N}_2\text{Cl}_2$  may be formed from  $\text{Se}_2\text{Cl}_2$  by reaction of one or more of:  $\text{S}_4\text{N}_4$ ,  $\text{S}_4\text{N}_3\text{Cl}$ ,  $\text{S}_3\text{N}_2\text{O}_2$ , some intermediate not isolated in the  $\text{S}_4\text{N}_4\text{-SOCl}_2$  reaction or an intermediate in the  $\text{S}_4\text{N}_4\text{-Se}_2\text{Cl}_2$  (chlorination) reaction. The last possibility is unlikely since no elemental selenium was found in the reaction product. In separate reactions, thionyl chloride

solutions of  $S_4N_3Cl$  and  $S_3N_2O_2$  were found not to react with  $Se_2Cl_2$ ; the former contrasts with the reaction between  $S_4N_3Cl$  and  $SeCl_4$  which is reported<sup>42</sup> to give a low yield of the 'selenium dithiazyl pentachloride'. The selenium compound is precipitated immediately on mixing the thionyl chloride solutions of  $Se_2Cl_2$  and  $S_4N_4$  and so the slow formation of  $S_4N_3Cl$  in the  $S_4N_4-SOCl_2$  reaction may be a further indication that  $S_4N_3Cl$  is not involved in the formation of the selenium compound. We therefore conclude that the  $(SeS_2N_2Cl_2)_n$  is probably formed by the reaction of the  $Se_2Cl_2$  with  $S_4N_4$  or  $(SN)_x$  fragments formed in the thionyl chloride solution and that the two products  $S_4N_3Cl$  and  $(SeS_2N_2Cl_2)_n$  are formed independently and simultaneously.

Table 14

Infrared spectra of  $S_4N_3Cl$  and  $(SeS_2N_2Cl_2)_n$

		$S_4N_3Cl$		$(SeS_2N_2Cl_2)_n$	
(a)	(b)	(c)	(d)	(a)	(a)
1160vs		1159s	1163s		1171vs
1125w			1125w		
			1102vw		
998vs		999vs	998vs		1008vs
					951vs
723w		717s			722w
682s		676s	678s		683s
676w(sh)					667w(sh)
639w					643w
					614w
608w			606w		609w(sh)
590vw					578w
565s		565s	561s		562s
555w(sh)					555m(sh)
463s		467s	466s		463s
451s		450s	451s		
330s	336m		317m		330m
	324m				
312w(sh)	312w(sh)				303m
					281w
					254w
249m	250m				247w
227w	226w				227w
212m	208w				212m

(a) This work, (b) spectrum obtained by Dr. B.P. Straughan (University of Newcastle-upon-Tyne) on an R.I.I.C. Fourier spectrophotometer (FS520) with a Melinex beam divider.

(c) O. Glemser and E. Wys<sup>z</sup>omirski, Chem. Ber., 1961, 94, 1443.

(d) R.T. Bailey and E.R. Lippincott, Spectrochim. Acta., 1964, 20, 1327.



FIGURE 7  
INFRARED SPECTRA

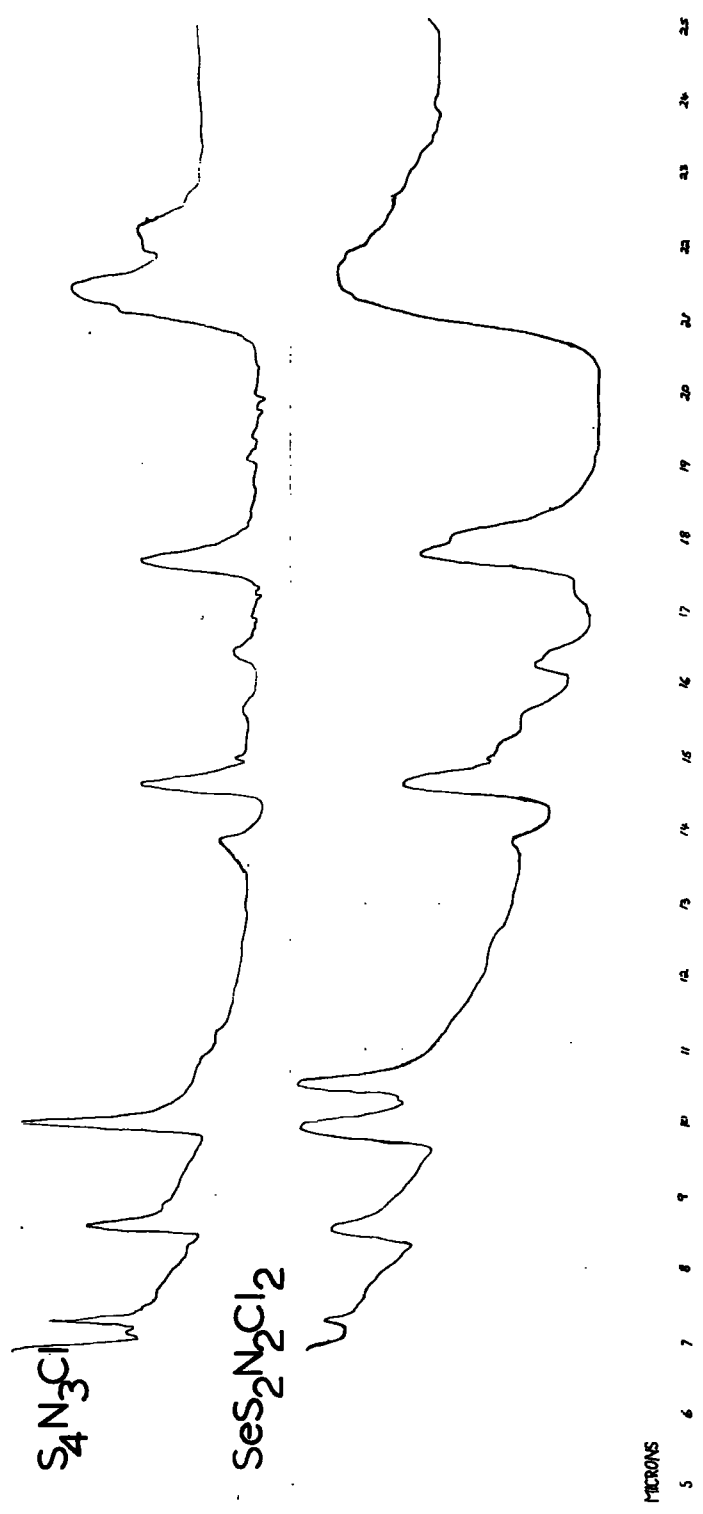

(iii) The reactions between  $S_4N_4$  and metal halides in thionyl chloride.

It has been shown that the reaction between  $S_4N_4$  and  $Se_2Cl_2$  in thionyl chloride gives rise to the new compound  $(SeS_2N_2Cl_2)_n$ , and that this is probably selenotrithiazyl hexachloroselenate,  $(SeS_3N_3)_2^+SeCl_6^-$ . The reactions of metal halides, therefore, with  $S_4N_4$  in thionyl chloride might be expected to give rise to new sulphur-nitrogen-metal compounds, and in particular to new cyclic systems.

We have studied the reaction of  $S_4N_4$  in thionyl chloride with fifteen metal halides or organo substituted metal halides and have shown that the empirical formulae of the products obtained can be subdivided into five types: (a)  $SNMeCl_x$ , (b)  $S_2N_2MeCl_x$ , (c)  $S_3N_3MeCl_x$ , (d)  $S_4N_4MeCl_x$  and (e) other compositions; (Me = metal, x = 1 to 6).

(a) Compounds of empirical formula  $SNMeCl_x$ .

Reaction of  $S_4N_4$  in thionyl chloride with  $MnCl_2$  and  $CoCl_2$  leads to the formation of  $SNMnCl_2$  and  $SNCocl_2$  respectively.  $S_3N_2O_2$  is also formed as a product of both reactions; no evidence for the formation of  $S_4N_3Cl$  is found in either case.

Since the oxygen-containing  $S_3N_2O_2$  is formed,  $SOCl_2$  must be involved in the reaction and so for a balanced equation a further chlorine-containing compound must also be formed (as was the case in the  $S_4N_4-SOCl_2$  reaction, see p.112). The required chlorine compound may have been gaseous  $Cl_2$  or  $NSCl$  or some chlorine-rich compound which was not isolated. In this case it may well be that  $S_2Cl_2$  is formed. The reaction

between  $S_4N_4$  and  $S_2Cl_2$  has not been reported, and it is possible that, either they do not react, or that when  $S_2Cl_2$  is formed all the  $S_4N_4$  has reacted. If  $S_2Cl_2$  or  $(NSCl)_3$  were formed then one would expect  $S_4N_3Cl$  to be a product of the reaction.

The reaction may therefore be represented by the equation:

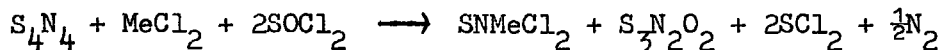

Both  $SNMnCl_2$  and  $SNCocl_2$  are insoluble in non-polar solvents and have melting points greater than  $360^\circ$ . This would suggest that they are either ionic or polymeric. Also, they are both insoluble in  $SOCl_2$ , whereas most sulphur-nitrogen ionic compounds, e.g.  $S_4N_3Cl$  and  $S_3N_2Cl_2$ , are at least slightly soluble. The infrared spectra are totally different from  $S_4N_4$  and  $S_4N_4$  adducts, hence considerably reducing the likelihood of structures of the type  $S_4N_4(MeCl_2)_x$ . The most likely structure would appear to be polymeric, involving  $S_2N_2$  units and chlorine bridges linking  $MeCl_2$  groups:

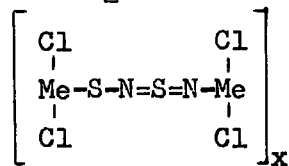

The mass spectra support a structure of this type, the most abundant fragments being  $MeCl_2$  and  $S_2N_2$ ; the fragments  $SNCocl_2$  and  $S_2N_2Mn$  also appear in the spectra of the Co and Mn compound, respectively. The mass spectrum of  $SNCocl_2$  has an unusually abundant peak due to chlorine. It may well be therefore, that on pyrolysis of this compound,

chlorine is easily liberated and further sulphur-nitrogen-cobalt compounds may result. The pyrolysis of these compounds would therefore be worth investigation.

(b) Compounds of empirical formula  $S_2N_2MeCl_x$ .

Compounds of empirical formula  $S_2N_2ZnCl_2$ ,  $S_2N_2ZrCl_4$  and  $S_2N_2CrCl_3$  have been prepared by reaction of  $S_4N_4$  in thionyl chloride with  $ZnCl_2$ ,  $ZrCl_4$  and  $CrCl_3$  respectively.

The compounds  $S_2N_2ZnCl_2$  and  $S_2N_2ZrCl_4$  appear to exist as simple molecules. This may be because in these instances a monomeric formula gives the metal atom its common complex co-ordination number:

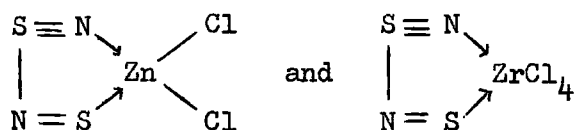

The mass spectrum of  $S_2N_2ZnCl_2$  strongly supports the structure proposed. The species  $SN$ ,  $Zn$ ,  $ZnN$ ,  $S_2N_2$ ,  $ZnS$ ,  $ZnCl$ ,  $ZnSN$ ,  $ZnCl_2$ ,  $ZnS_2N_2$  and  $ZnS_2N_2Cl_2$  are all present and there is no evidence for  $ZnCl_3$  or  $ZnCl_4$  species. It is possible that in the solid phase a certain amount of polymerisation occurs to give the zinc atom a co-ordination number of six, (this occurs especially in the case of nitrogen containing ligands e.g.  $Zn(NH_3)_6^{2+}$ ), but on the other hand tetrahedral symmetry is usually preferred, especially in the halides and halo-anions e.g.  $ZnCl_2$  and  $ZnCl_4^{2-}$ . There is no reason to suppose therefore that  $S_2N_2ZnCl_2$  is not a simple tetrahedrally co-ordinated

compound in the solid phase. Further work is necessary to establish the structure definitely.

The mass spectrum of  $S_2N_2ZrCl_4$  shows only a few species, the most abundant being SN and ZrSN. The compound has a low melting point ( $132^\circ$ ) and it is quite likely that the mass spectrum is obtained from discrete  $S_2N_2ZrCl_4$  molecules, unlike the chromium compound which probably decomposes thermally first. The low melting point and the absence in the mass spectrum of  $ZrCl_x$  fragments suggest that it is not polymeric or ionic.

The infrared spectrum of  $S_2N_2CrCl_3$  appears more complex than those of  $S_2N_2ZnCl_2$  and  $S_2N_2ZrCl_4$ . The melting point is greater than  $360^\circ$ , compared with  $132^\circ$  and  $215^\circ$  for the zirconium and zinc compounds respectively. The mass spectrum of  $S_2N_2CrCl_3$  also differs in character from those of the zirconium and zinc compounds; the most abundant species in  $S_2N_2CrCl_3$  are due to SN, Cl,  $S_2N_2$ , CrCl, CrCl<sub>2</sub>, CrCl<sub>3</sub>, CrCl<sub>4</sub>, CrCl<sub>5</sub> and CrCl<sub>6</sub>. The CrCl<sub>4,5,6</sub> peaks may originate from CrCl<sub>3</sub> decomposition products, since the chromium co-ordination number in solid CrCl<sub>3</sub> is six.<sup>182</sup>

The high melting point and insolubility indicate that the compound is either ionic or polymeric (or both). With these facts in mind, we propose the following possible structures:

(i)

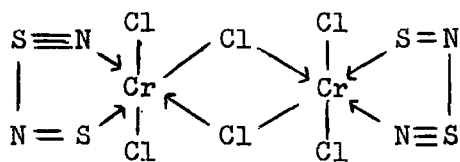

(ii)

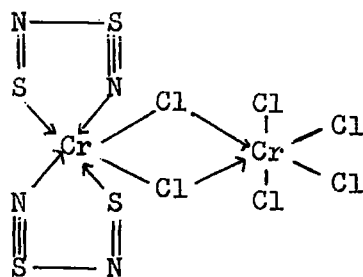

(iii)

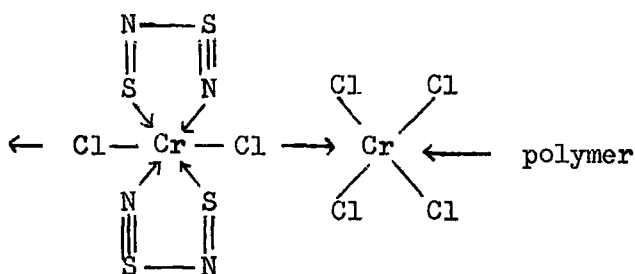

Structure (i) seems to be the most likely.

Further work on this compound is obviously needed before any structure can be established with certainty; for instance the visible, ultraviolet and far infrared should be studied. The latter would show if  $\text{CrCl}_6^{3-}$  ions are present.

The infrared spectra of  $\text{S}_2\text{N}_2\text{ZnCl}_2$ ,  $\text{S}_2\text{N}_2\text{ZrCl}_4$  and  $\text{S}_2\text{N}_2\text{CrCl}_3$  are shown in Figure 8.

# FIGURE 8

## INFRARED SPECTRA

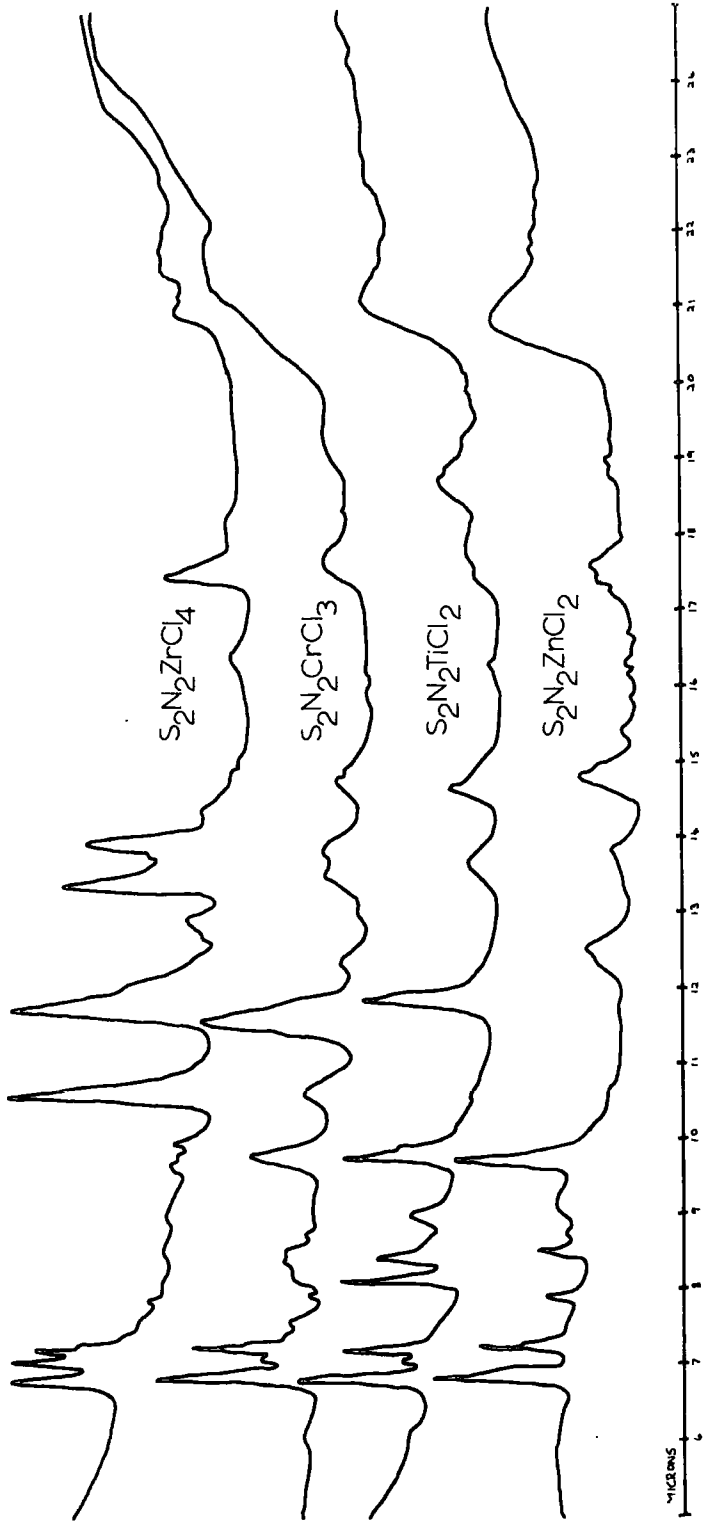

(c) Compounds of empirical formula  $S_4N_4MeCl_x$ .

The reaction between  $S_4N_4$  and  $SbCl_5$  in thionyl chloride leads to the formation of  $S_3N_3SbCl_6$ . The product which is light green is soluble in benzene giving a red solution, from which the compound may be recrystallised. The compound decomposes on pumping down at room temperature to give a yellow solid which on standing under nitrogen reverts to green  $S_3N_3SbCl_6$  after a few hours.

The infrared spectrum is relatively simple compared with the other sulphur-nitrogen-metal compounds prepared and this may indicate a high degree of symmetry. The mass spectrum contains major peaks due to the species  $SN$ ,  $Sb$ ,  $S_3N_3$ ,  $SbCl$ ,  $SbCl_2$ ,  $SbCl_3$  and  $SbCl_4$ . A simple structure  $S_3N_3^+SbCl_6^-$ , therefore, would seem most likely for this compound.

It has already been suggested (see p.113) that  $S_4N_4$  may exist in thionyl chloride as  $S_3N_3^+SN^-$ , and a large anion such as  $SbCl_6^-$  may stabilize the  $S_3N_3^+$  cation sufficiently to form salts.  $S_3N_3^+$  would be a highly symmetrical and delocalised cyclic cation:

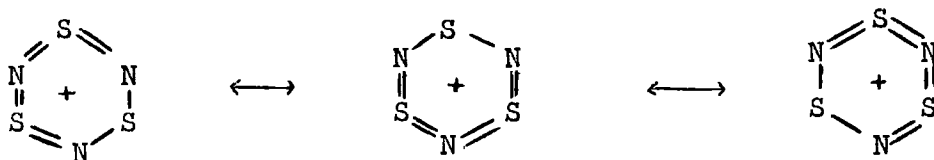

The infrared spectrum shows a single strong absorption in the region expected for  $S=N$ , at  $942\text{ cm.}^{-1}$ . The cations  $S_4N_3^+$  and  $S_3N_2Cl^+$  each have two strong absorptions in this region at  $1160$  and  $998\text{ cm.}^{-1}$ ,



and 1014 and 935  $\text{cm.}^{-1}$  respectively. The average values of these stretching frequencies for  $\text{S}_4\text{N}_3^+$  (1072  $\text{cm.}^{-1}$ ) and  $\text{S}_3\text{N}_2\text{Cl}^+$  (974.5  $\text{cm.}^{-1}$ ) and their respective average S-N bond distances (1.55A and 1.59A), fit quite closely the relationship which has been established<sup>7</sup> between stretching frequency and bond length: (see Figure 9).

$$d_{\text{SN}} = \frac{1}{\nu} [483 + 1.099\nu]$$

where  $d_{\text{SN}}$  = sulphur-nitrogen bond length in Angstroms and  $\nu$  = stretching frequency in  $\text{cm.}^{-1}$

Since only one strong absorption appears in the same region in the spectrum of  $\text{S}_3\text{N}_3\text{SbCl}_6$ , the average value of the symmetric and asymmetric stretching frequencies cannot be used, but the frequency of the one absorption which does appear predicts a value of 1.60A for the S-N bond length in  $\text{S}_3\text{N}_3^+$ ; this compares favourably with the values 1.59A and 1.55A for  $\text{S}_4\text{N}_3^+$  and  $\text{S}_3\text{N}_2\text{Cl}^+$ .

If the proposed structure ( $D_{3h}$ ) is correct, then the absorption which appears will be an asymmetric stretching mode. The totally symmetric stretching mode ~~should~~<sup>may</sup> be ~~inactive~~<sup>weakly</sup> for a planar molecule, but should appear in the Raman spectrum. A study of the Raman spectrum therefore should prove most useful.

In the far infrared a strong wide band appears centred at 341  $\text{cm.}^{-1}$ ; this compares with the absorptions reported at 349  $\text{cm.}^{-1}$  and 337  $\text{cm.}^{-1}$  for  $\nu_3$  in  $\text{K}^+\text{SbCl}_6^-$  and  $\text{NH}_4^+\text{SbCl}_6^-$  respectively,<sup>118</sup> and supports the mass

spectral evidence for the presence of the  $\text{SbCl}_6^-$  ion. A further absorption is to be expected near  $181 \text{ cm.}^{-1}$  due to  $\nu_4$ . The infrared spectrum is shown in Figure 10.

FIGURE 9

GRAPH OF  $\lambda_{SN}$  AGAINST  $d_{SN}$ .

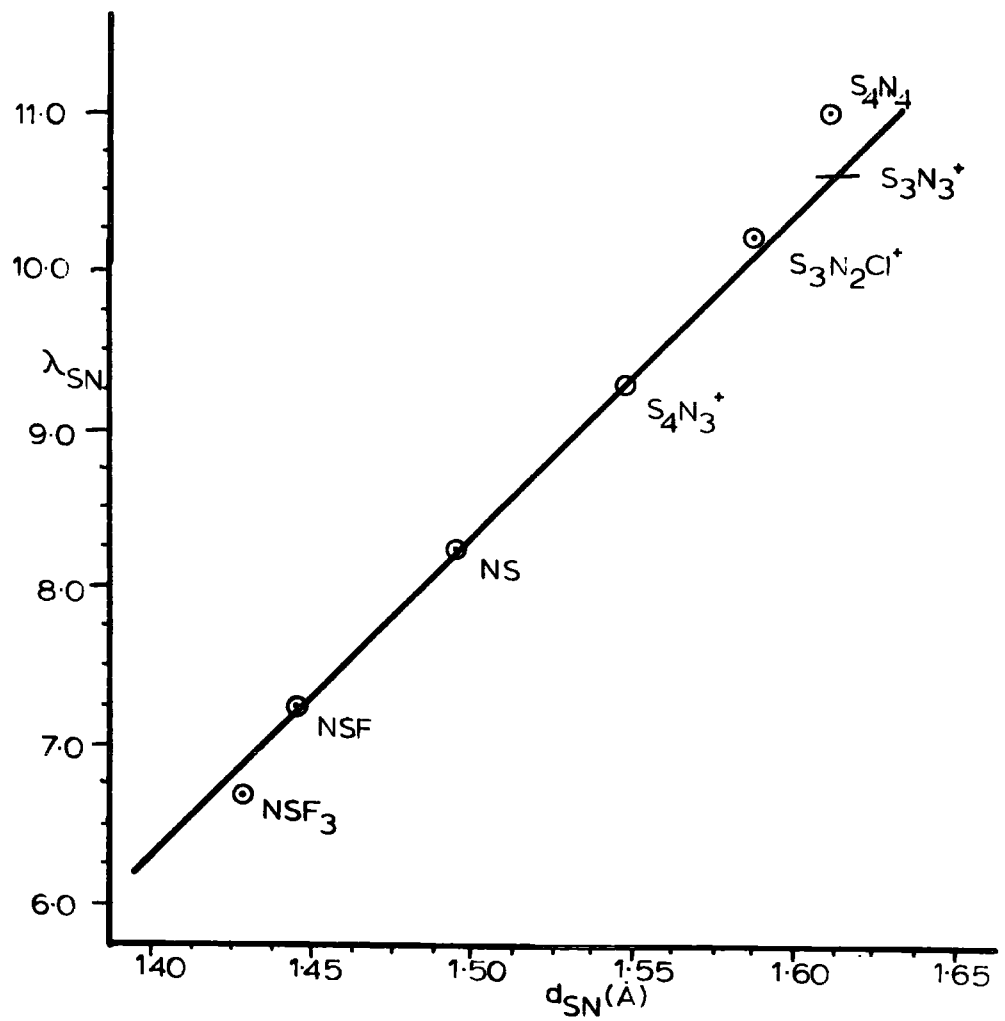
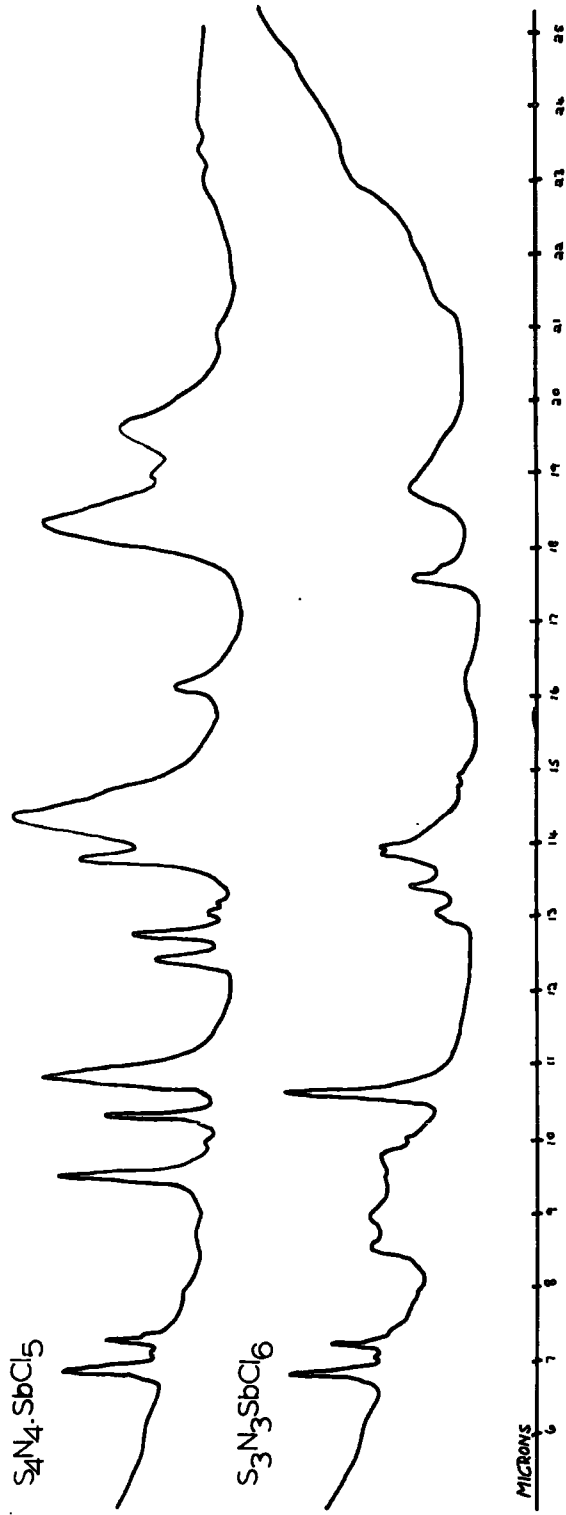

FIGURE 10  
INFRARED SPECTRA



d) Compounds of empirical formula  $S_4N_4MeCl_x$ .

The compounds  $S_4N_4HgCl_6$  and  $S_4N_4NiCl$  have been synthesised by the reaction of  $S_4N_4$  in thionyl chloride with  $HgCl_2$  and  $NiCl_2$  respectively. The formation of  $S_4N_4NiCl$  is also accompanied by formation of a product  $SN_2Ni_3Cl_5$ . The latter is probably a mixture of two or more compounds all of which melt above  $360^\circ$  and are insoluble in most solvents.

$S_4N_4NiCl$ , however, seems to be a well-defined compound with a sharp melting point ( $170^\circ$ ) and may be recrystallised from thionyl chloride. The empirical formula indicates that if the compound is monomeric it is either an odd-electron compound of Ni(II) or a compound of Ni(I). It is quite likely however that the compound is polymeric, and may be either ionic or covalent. There is no evidence from either the infrared or mass spectra to support any discussion of the structure.

The compound  $S_4N_4HgCl_6$  was only obtained in small amount and  $S_4N_3Cl$  was also obtained from the reaction. The infrared spectrum would suggest that the compound is similar in structure to  $S_4N_3Cl$  or  $(SeS_3N_3)_2SeCl_6$ , but the possible compounds which are analogous e.g.  $(S_4N_3)_2HgCl_6$ ,  $S_4N_3HgCl_3$ ,  $HgS_3N_3Cl$ ,  $(HgS_3N_3)HgCl_3$  and  $(HgS_3N_3)_2HgCl_6$  all require a much smaller percentage of chlorine than was found for this compound.

On account of the very great variety of nickel-sulphur-nitrogen and mercury-sulphur-nitrogen compounds which are possible, there seems little point in speculating on the possible structures of  $S_4N_4NiCl$  and  $S_4N_4HgCl_6$ .

The infrared spectra of these compounds are reported in Figure 11.

FIGURE 11  
INFRARED SPECTRA

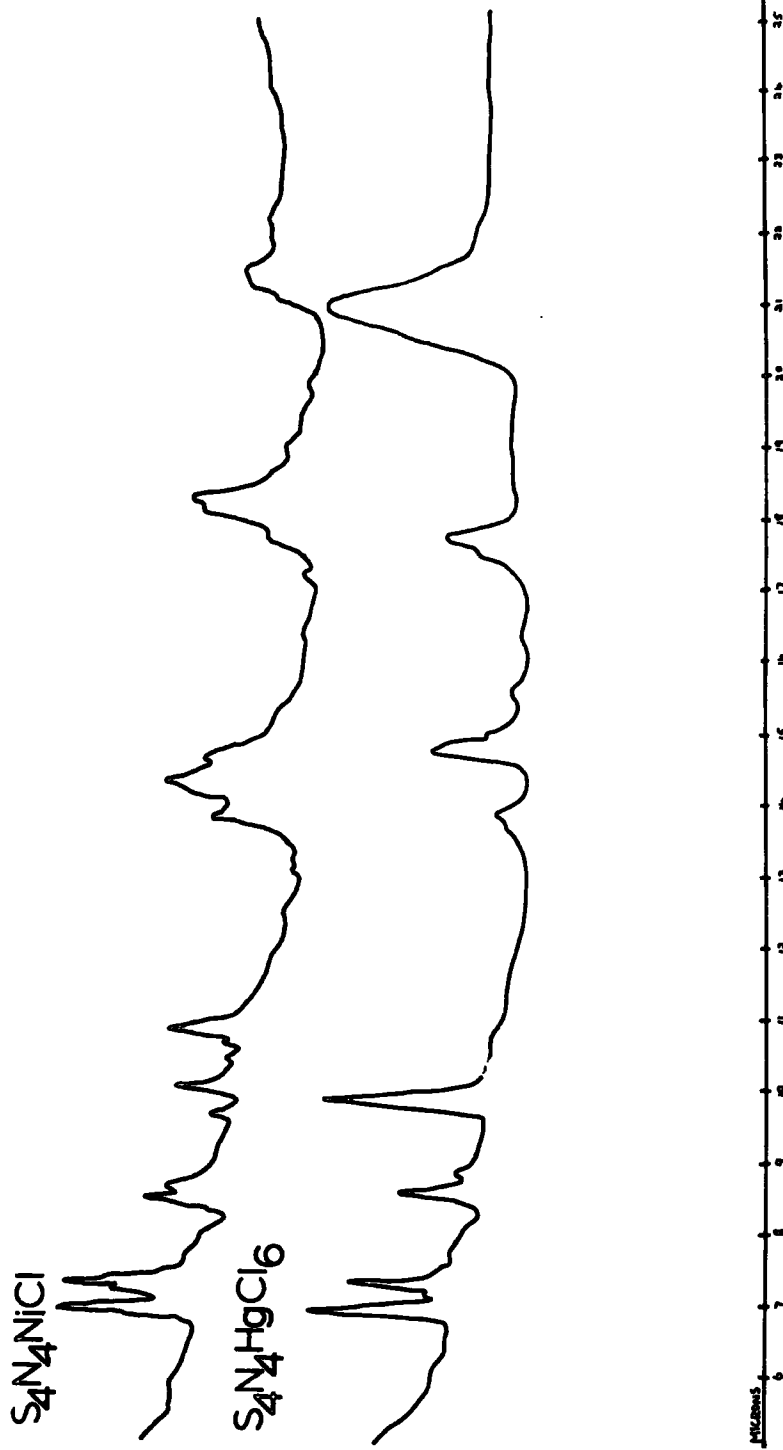

(e) Other compositions.

The reaction between  $S_4N_4$  and  $SnCl_4$  in thionyl chloride leads to the formation of the compound  $S_2N_4SnCl_4$ . The analysis figures on which this formula are based are in only moderately agreement with the calculated figures. If however, oxygen is present in the compound then the calculated analysis figures for  $S_2N_4SnCl_4O_2$  are in excellent agreement with those found (Found: S = 15.8; N = 13.38; Cl = 34.25; calculated for  $S_2N_4SnCl_4O_2$ : S = 15.5; N = 13.57; Cl = 34.37%). Without a metal analysis it is difficult to say with any certainty whether the compound does contain oxygen or not. If the compound is  $S_2N_4SnCl_4O_2$  then the only reasonable structure would be:

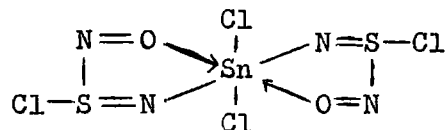

This is a similar type to that proposed for the compounds  $S_2N_2ZnCl_2$  and  $S_2N_2ZrCl_4$  (see p. 124). Further work on this reaction is obviously needed before any firm conclusions can be reached.

The reactions between  $CuCl_2$  and  $TiCl_4$  with  $S_4N_4$  in thionyl chloride lead to the formation of compounds which give analysis figures for sulphur, nitrogen and chlorine which correspond fairly well to the empirical formulae  $S_2N_3Cu_2Cl_4$  and  $S_3N_4Ti_2Cl_6$  respectively. If oxygen is present in the compounds then the formulae  $S_2N_3CuCl_4O_4$  and  $S_3N_4TiCl_6O_6$  also fit the analysis figures. Again, further investigations are needed

before any structural conclusions can be drawn from these data.

The reaction between  $\text{BCl}_3$  and  $\text{S}_4\text{N}_4$  in thionyl chloride leads to the formation of a compound having a ratio of sulphur:nitrogen:chlorine of 1.00:2.00:3.14. The elemental analyses require a large percentage of boron (even if a substantial amount of oxygen is present). The formulae suggested for this compound are of the type  $\text{SN}_{\frac{2}{x}}\text{B}_2\text{O}_y\text{Cl}_3$ , where  $x = 14$  to 18;  $y = 0$  to 4. If the analysis figures are reliable, the compound must therefore contain at least a duodecahedron of boron atoms. The implications of the formation of such a compound by a simple route are most important and further research on this reaction may lead to useful synthetic routes to molecules containing boron-boron bonds. The reactions between  $\text{S}_4\text{N}_4$  in thionyl chloride and  $\text{TeCl}_4$ ,  $\text{PhBCl}_2$  and  $\text{Ph}_3\text{AsCl}_2$  gave very air and moisture sensitive compounds which were not isolated.

Although no products were isolated in the reactions between  $\text{S}_4\text{N}_4$  and organometallic halides in  $\text{SOCl}_2$ , the reactions appeared to be completely analogous to those involving the metal halides; similar colour changes were observed and the products were formed in similar reaction times. It may well be that with more stable organometallic derivatives (e.g. those of Mg, Al or Ti) interesting compounds will be formed.

In conclusion therefore, the reactions of  $\text{S}_4\text{N}_4$  in  $\text{SOCl}_2$  with metal halides give rise to a variety of compounds of interesting structure.



This type of reaction as a route to new sulphur-nitrogen-metal compounds is obviously in its early stages of investigation. An idea of the different types of molecules formed and of the great number of possible reactions which need to be investigated has been given. The potential in this type of reaction is enormous and a more detailed and systematic study of the reaction in general is a clear necessity.

The reactions already discussed and the structures of the compounds postulated are summarised in Tables 15 and 16.

Table 15

Summary of the reactions of  $S_4N_4$  with metal halides in  $SOCl_2$

<u>metal halide</u>	<u>product(s)</u>	<u>colour</u>	<u>m.p.</u> <sup>o</sup>
$MnCl_2$	$SNMnCl_2, S_3N_2O_2$	dark green, yellow	>360, 101
$CoCl_2$	$SNCocl_2, S_3N_2O_2$	light green, yellow	>360, 101
$Se_2Cl_2$	$S_2N_2SeCl_2, S_4N_3Cl$	yellow, yellow	85.5, 170
$ZrCl_4$	$S_2N_2ZrCl_4$	orange	132
$CrCl_3$	$S_2N_2CrCl_3$	green	>360
$ZnCl_2$	$S_2N_2ZnCl_2$	yellow	215
$SbCl_5$	$S_3N_3SbCl_6$	light green	138
$HgCl_2$	$S_4N_4HgCl_6$	yellow	185
$NiCl_2$	$S_4N_4NiCl, SN_2Ni_3Cl_5$	green, green	>360, >360
$TiCl_4$	$S_3N_4Ti_2Cl_6$	yellow	142
$CuCl_2$	$S_2N_3Cu_2Cl_4$	light green	285
$SnCl_4$	$S_2N_4SnCl_4 \cdot O_2$	yellow	156
$BCl_3$	$SN_2B_{15}Cl_3$	yellow-orange	>360
$TeCl_4$	-	yellow	-
$PhBCl_2$	-	light brown	-
$Ph_3AsCl_2$	-	yellow	-

Table 16

Summary of the structures proposed for new sulphur-nitrogen-metal compounds.

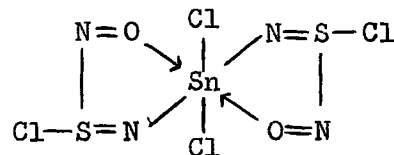
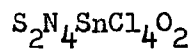
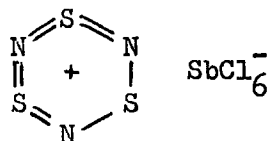
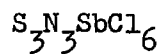
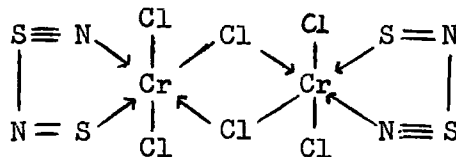
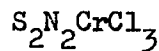
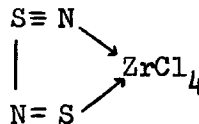
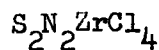
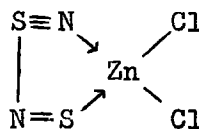
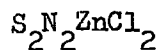
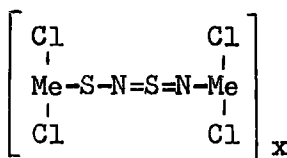
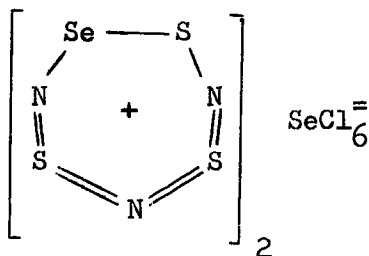
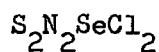

(iv) Reactions of  $S_4N_4$ -metal halide adducts with  $SOCl_2$ .

Adducts of  $S_4N_4$  with metal halides may be formed in hexane, benzene, toluene and methylene chloride. These adducts were found to react with thionyl chloride to give sulphur-nitrogen-metal compounds. The reactions between thionyl chloride and four  $S_4N_4$ -metal halide adducts have so far been studied.

$S_4N_4 \cdot TeCl_4$  reacts with  $SOCl_2$  to give a very unstable yellow solid (cf. the reaction between  $S_4N_4$  and  $TeCl_4$  in  $SOCl_2$ ) which has not been characterised.

$S_4N_4 \cdot SbCl_5$  reacts with  $SOCl_2$  to give  $S_3N_3SbCl_6$  which has also been synthesised by the reaction of  $S_4N_4$  with  $SbCl_5$  in thionyl chloride, and has already been discussed. This is the only reaction of those investigated which gives the same product by the two routes: (i)  $S_4N_4 + SOCl_2 + SbCl_5$  and (ii)  $S_4N_4 \cdot SbCl_5 + SOCl_2$ .

The reaction between  $S_4N_4 \cdot TiCl_4$  and thionyl chloride leads to the formation of two compounds,  $S_2N_2TiCl_2$  and  $S_4N_4Ti$ .

The infrared spectrum of  $S_2N_2TiCl_2$  is similar to those of  $S_2N_2ZnCl_2$  and  $S_2N_2ZrCl_4$  which have been discussed previously. An analogous structure would seem to be indicated, i.e.

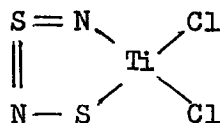

The melting point ( $130^\circ$ ) is very close to that of the zirconium compound

(132°). The infrared spectrum is reported in Figure 8.

Three of the likely structures for  $S_4N_4Ti$  are:

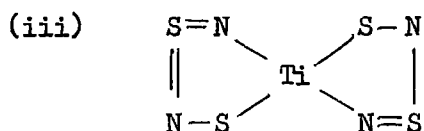
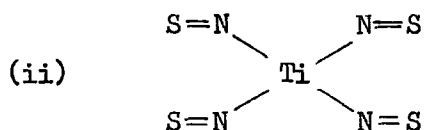
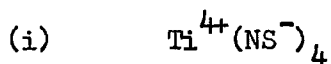

The fact that Ti(IV) compounds are usually covalent and the low melting point (92°) suggest the structure (iii) is quite likely. The mass spectrum shows the species  $TiN$ ,  $TiNS$  and  $TiN_4S_3$ , indicating titanium-nitrogen bonds, and the infrared spectrum shows similarities with  $S_2N_2TiCl_2$ , suggesting the presence of the  $S_2N_2Ti$  unit in the molecule.

The reaction between  $2S_4N_4 \cdot SnCl_4$  and thionyl chloride leads to the formation of  $S_2N_3SnCl_4$ .

The mass spectrum of  $S_2N_3SnCl_4$  contains the species,  $SN$ ,  $S_2N_2$ ,  $S_2N_3$ ,  $SnCl$ ,  $SnCl_2$ ,  $SnCl_3$ ,  $SnCl_4$ ,  $S_2N_2SnCl_2$  and  $S_2N_2SnCl_3$ , which would suggest the presence of an S-N-Sn-Cl molecule rather than ions of the type  $S_2N_3^+$  or  $SnCl_6^{2-}$ .

The reactions of metal halide  $-S_4N_4$  adducts with thionyl chloride are summarised in Table 17.

Table 17

Summary of the reactions of  $S_4N_4$ -metal halide adducts with thionyl

chloride

<u><math>S_4N_4</math> adduct</u>	<u>product(s)</u>	<u>colour</u>	<u>m.p. °</u>
$S_4N_4 \cdot SbCl_5$	$S_3N_3SbCl_6$	light green	138
$2S_4N_4 \cdot SnCl_4$	$S_2N_2SnCl_4$	yellow	>360
$S_4N_4 \cdot TeCl_4$	-	yellow	-
$S_4N_4 \cdot TiCl_4$	$S_2N_2TiCl_2$	yellow	130
	$S_4N_4Ti$	yellow	92

APPENDIX I

APPENDIX I

The reactions between  $S_4N_4$  in thionyl chloride and a further three metal halides have been studied and are reported here.

EXPERIMENTAL

The reaction between Iron (III) chloride and  $S_4N_4$  in  $SOCl_2$ .

Ferric chloride (0.41 g.) was refluxed with thionyl chloride (30 ml.) for 30 minutes and the slurry allowed to cool to room temperature.

$S_4N_4$  (0.46 g.) in thionyl chloride (20 ml.) was added at room temperature and the mixture heated at  $45^\circ$  for 24 hours. A burgundy red coloured solution was obtained which was filtered at room temperature and evaporated to dryness to give a black solid. The solid was dissolved in thionyl chloride and reprecipitated by the addition of hexane.

Found: S = 23.90; N = 10.74; Cl = 40.90;  $S_2N_2FeCl_3$  requires S = 25.22; N = 11.02; Cl = 41.73%. m.p.  $82-84^\circ$ . Absorptions occur in the infrared at: 207w, 214w, 227w, 323w, 324w, 357w, 373w, 400w, 420w, 429w, 526w, 568w, 573w, 617w, 670w, 676w, 694w, 718s, 741m, 758w, 781w, 810w, 820w, 940s, 966w, 990w, 1033m, 1053m, 1143m, 1168m, 1198w(sh), 1242w, 1264w, 1332w, 1351w, 1426m.

The reaction between beryllium chloride and  $S_4N_4$  in thionyl chloride.

Beryllium chloride (0.35 g.) was refluxed in thionyl chloride (20 ml.) for 30 minutes and the slurry allowed to cool to room temperature.



A solution of  $S_4N_4$  (0.80 g.) in thionyl chloride (40 ml.) was added at room temperature. A black oil was formed after five minutes on heating the mixture at  $40^\circ$ . After ten minutes the black oil dissolved and a fine yellow precipitate began to deposit in the Schlenk. The yellow solid was filtered from the orange coloured solution after 20 hours, washed in thionyl chloride and pumped dry. Found: S = 34.01; N = 15.06; Cl = 37.40; Be = 4.76; <sup>183</sup>  $S_2N_2BeCl_2O$  requires S = 34.10; N = 14.90; Cl = 37.70; Be = 4.79%. m.p.  $288^\circ$  (decomp.). Infrared absorptions occur at: 215m, 221m, 225m, 245w, 253w, 280w(sh), 291w, 317w(sh), 323m, 348w, 435m, 458w(sh), 463w(sh), 473w(sh), 479m, 568m, 636m, 678s, 694m, 719w(sh), 735w(sh), 758m, 885s, 910s, 1023m, 1162w, 1225w, 1266w(sh), 1316w(sh), 1403w.

The solution was evaporated to dryness to give a brownish-yellow solid which was characterised as  $S_5N_2O_2$  from the infrared spectrum and melting point ( $101^\circ$ ).

The reaction between niobium pentachloride and  $S_4N_4$  in thionyl chloride.

$NbCl_5$  (0.70 g.) was dissolved in thionyl chloride (40 ml.) at room temperature and the solution filtered.  $S_4N_4$  (0.46 g.) was added and the mixture stirred at  $40^\circ$ . An immediate dark green colouration developed which slowly gave way to a reddish colour. After two hours a red solid began to form, and after 24 hours the solid was filtered from the red-green solution. The solid was orange when pumped dry and was re-crystallised from thionyl chloride to give orange coloured needles.

m.p.  $111^{\circ}$ . Analysis figures are not yet available on this compound. Infrared absorptions occur at: 207m, 213m, 225m, 244w(sh), 246w, 282w(sh), 290w(sh), 294w(sh), 305m, 325s, 368w(sh), 377w(sh), 413m, 425w(sh), 433w(sh), 515m, 538w, 551w, 566m, 588w, 671w, 680m, 710m, 725s, 746s, 775m, 810s, 893m(sh), 934s, 976m, 1020s, 1162m, 1273m, 1309m

### DISCUSSION

The reaction between  $\text{FeCl}_3$  and  $\text{S}_4\text{N}_4$  in thionyl chloride leads to the formation of  $\text{S}_2\text{N}_2\text{FeCl}_3$ . The infrared spectrum of the compound is similar to that of  $\text{S}_2\text{N}_2\text{CrCl}_3$ , and it seems reasonable therefore to propose a similar structure:

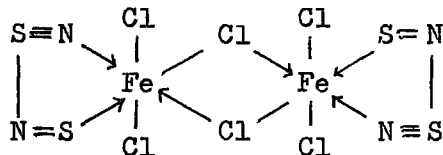

The reaction between  $\text{BeCl}_2$  and  $\text{S}_4\text{N}_4$  in thionyl chloride leads to the formation of  $\text{S}_2\text{N}_2\text{BeCl}_2\text{O}$  and  $\text{S}_3\text{N}_2\text{O}_2$ . The mass spectrum of the product before purification showed that sulphur was also present as a reaction product. The main species in the mass spectrum of  $\text{S}_2\text{N}_2\text{BeCl}_2\text{O}$  were  $\text{BeS}$ ,  $\text{BeCl}$ ,  $\text{SN}$ ,  $\text{S}_2\text{N}$ ,  $\text{BeCl}_2$ ,  $\text{S}_2\text{N}_2$ ,  $\text{SNO}$ ,  $\text{SN}_2\text{O}$ ,  $\text{SNOBe}$  and  $\text{SN}_2\text{OBe}$ . The infrared spectrum indicates that the structure may be similar to that of  $\text{S}_2\text{N}_2\text{ZnCl}_2$ . The mass and infrared spectra are consistent with either of the structures:

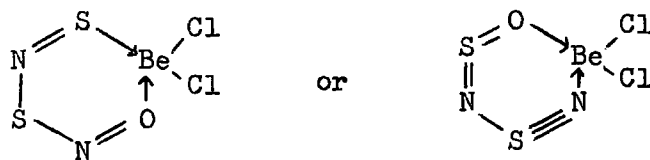

Analysis figures on the crystals obtained from the reaction between  $S_4N_4$  and  $NbCl_5$  in  $SOCl_2$  are not yet available, but the infrared spectrum is very similar to that of  $S_3N_3SbCl_6$  (see Figure 12). The mass spectrum shows the species  $SN$ ,  $S_3N$ ,  $S_2N_2$ ,  $Nb$ ,  $NbO$ ,  $S_3N_2$ ,  $NbCl$ ,  $S_3N_3$ ,  $NbOCl$ ,  $NbCl_2$ ,  $NbOCl_2$ ,  $NbCl_3$ ,  $NbOCl_3$ ,  $NbCl_4$  and  $NbCl_5$ . The infrared and mass spectral data suggest that the compound is a salt of the  $S_3N_3^+$  cation with a chloro or oxochloro-anion of niobium e.g.  $NbCl_6^-$ ,  $NbOCl_4^-$  or  $NbOCl_3^-$ .

This compound is more suitable than  $S_3N_3SbCl_6$  for further structural investigation since it can be readily obtained as well-formed crystals.

The similarity between the compounds obtained by reaction of  $S_4N_4$  in  $SOCl_2$  with  $SbCl_5$  and  $NbCl_5$  suggests that the  $S_3N_3^+$  cation may be most readily formed when the metal halide  $MX_n$  forms a stable halo anion  $MX_{n+1}^-$ . Similar compounds may therefore be prepared by reaction of  $S_4N_4$  in  $SOCl_2$  with e.g.  $PCl_5$  and  $TaCl_5$ .

FIGURE 12  
INFRARED SPECTRA

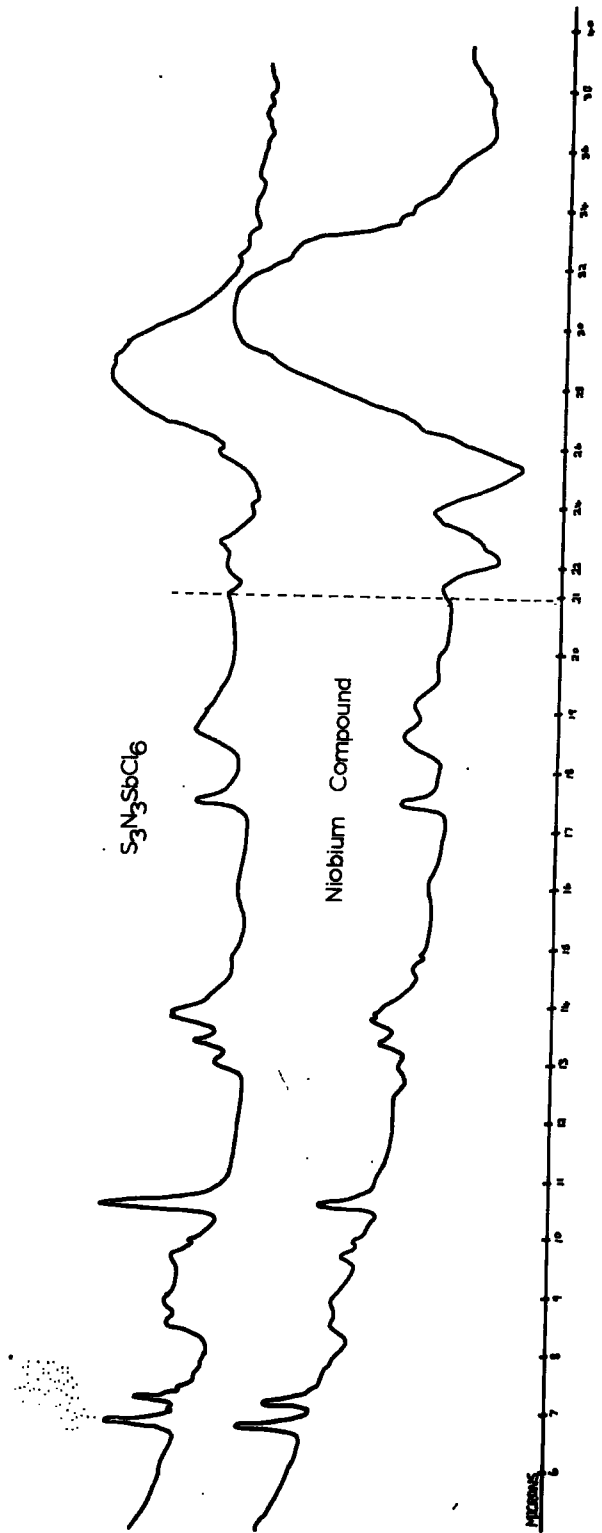

REFERENCES

References

1. a) M. Gregory, J. Pharm., 1835, 21, 315; b) M. Becke-Goehring, Quart. Revs., 1956, 10, 437; c) S.A. Vaznesenskii, Uspekhi Khim., 1955, 24, 440.
2. M.H.M. Arnold, J. Chem. Soc., 1936, 2, 1645.
3. a) J. Schenk, Annalen, 1896, 290, 171; b) W. Muthmann and A. Glever, Z. anorg. Chem., 1896, 13, 200.
4. M.H.M. Arnold, J. Chem. Soc., 1936, 2, 164.
5. S. Lu and J. Donahue, J. Amer. Chem. Soc., 1944, 66, 818.
6. D. Chapman and A.G. Massey, Trans. Faraday Soc., 1962, 58, 1291.
7. A.J. Banister, L.F. Moore and J.S. Padley, Spectrochimica Acta., (in press).
8. D.P. Craig, J. Chem. Soc., 1959, 997.
9. M.J.S. Dewar, E.A.C. Lucken and M.A. Whitehead, J. Chem. Soc., 1960, 2423.
10. I. Lindquist, J. Inorg. Nuclear Chem., 1958, 6, 159.
11. A. Faessler and M. Becke-Goehring, Z. Physik, 1955, 142, 558.
12. D. Clark, J. Chem. Soc., 1952, 1615.
13. B.D. Sharma and J. Donohue, Acta Cryst., 1963, 16, 891.
14. O. Glemser and H. Richert, Z. anorg. Chem., 1961, 307, 313.
15. P.W. Schenk, Chem. Ber., 1942, 75, 94.
16. O. Glemser and H. Richert, Z. anorg. Chem., 1961, 307, 328.

17. a) D. Chapman and T.C. Waddington, *Trans. Faraday Soc.*, 1962, 58, 1679; b) V. Schomaker and D.P. Stevenson, *J. Amer. Chem. Soc.*, 1941, 63, 37.
18. H. Siebert, *Z. anorg. Chem.*, 1953, 273, 170.
19. O. Glemser and H. Perl, *Naturwiss.*, 1961, 48, 620.
20. O. Glemser, *Angew. Chem.*, (Int. Ed.), 1963, 2, 530.
21. O. Glemser, H. Richert and H. Haeseler, *Angew. Chem.*, 1959, 71, 524.
22. E. Demarcay, *Compt. rend.*, 1880, 91, 854.
23. A. Meuwsen, *Chem. Ber.*, 1932, 65, 1724.
24. W.L. Jolly, K.D. Maguire and D. Rabinovitch, *Inorg. Chem.*, 1963, 2, 1304.
25. J.R. House, M.Sc. Thesis, Durham, 1966.
26. M. Becke-Goehring, *Progress Inorg. Chem.*, 1959, 1, 221.
27. M. Becke-Goehring and J. Heinke, *Z. anorg. Chem.*, 1953, 272, 297.
28. O. Glemser, *Z. anorg. Chem.*, 1955, 279, 281.
29. B. Cohen and A.G. MacDiarmid, *Chem. Ind.*, 1962, 1866.
30. F. Seel and O. Detmer, *Z. anorg. Chem.*, 1959, 301, 113.
31. W.H. Kirchoff and E.B. Wilson, *J. Amer. Chem. Soc.*, 1962, 84, 334.
32. O. Glemser, H. Schraeder and H. Haeseler, *Z. anorg. Chem.*, 1955, 279, 28.
33. O. Glemser and H. Ludemann, *Angew. Chem.*, 1958, 70, 190.
34. B. Cohen, T.R. Hooper and R.D. Peacock, *J. Inorg. Nuclear Chem.*, 1966, 28, 919.

35. G.A. Wiegers and A. Vos, *Acta Cryst.*, 1961, 14, 562; 1963, 16, 152.
36. D.A. Skoog and J.K. Bartlett, *Analytical Chem.*, 1955, 27, 369.
37. G.A. Wiegers and A. Vos, *Proc. Royal Soc.*, 1962, 387.
38. H. Schröder and O. Glemser, *Z. anorg. Chem.*, 1959, 298, 78.
39. A. Clever and W. Muthmann, *Chem. Ber.*, 1896, 29, 340.
40. A.J. Banister and J.S. Padley, *J. Chem. Soc.*, (in press).
41. A.G. MacDiarmid, *J. Amer. Chem. Soc.*, 1957, 78, 3871.
42. H. Garcia-Fernandez, *Compt. rend.*, 1961, 252, 411.
43. A.G. MacDiarmid, *Nature*, 1949, 164, 1131.
44. M. Becke-Goehring and D. Voigt, *Z. anorg. Chem.*, 1956, 285, 181.
45. M. Becke-Goehring and G. Magin, *Z. Naturforsch.*, 1965, 20b, 493.
46. A. Meuwsen and O. Jacob, *Z. anorg. Chem.*, 1950, 263, 200.
47. E. Demarcay, *Compt. rend.*, 1880, 91, 1066.
48. W. Muthmann and E. Seitter, *Chem. Ber.*, 1897, 30, 627.
49. M. Becke-Goehring and H.P. Latscha, *Z. Naturforsch.*, 1962, 17b, 125.
50. O. Glemser and E. Wyszomirski, *Chem. Ber.*, 1961, 94, 1443.
51. M. Becke-Goehring and D. Schuster, *Z. anorg. Chem.*, 1953, 271, 281.
52. J. Weiss, *Angew. Chem.*, 1962, 74, 216.
53. A.W. Cordes, R.F. Kruh and E.K. Gordon, *Inorg. Chem.*, 1965, 4, 681.
54. D.A. Johnson, G.D. Blyholder and A.W. Cordes, *Inorg. Chem.*, 1965, 4, 1790.
55. R.T. Bailey and E.R. Lippincott, *Spectrochim. Acta.*, 1964, 20, 1327.



56. A. Meuwsen, Z. anorg. Chem., 1951, 266, 250.
57. M. Becke-Goehring and H.W. Kaloumenos, Z. anorg. Chem., 1950, 263, 137.
58. M. Becke-Goehring, H. Herb and H. Wissemliet, Z. anorg. Chem., 1952, 267, 238.
59. H. Garcia-Fernandez, Bull. soc. chim., 1959, 760.
60. D. Chapman and A.G. Massey, Chem. Ind., 1962, 2088.
61. M. Becke-Goehring and D. Voigt, Naturwiss., 1953, 40, 482.
62. A. Fowler and C.J. Bakker, Proc. Royal Soc., 1932, A136, 28.
63. P.B. Zeemann, Canad. J. Phys., 1951, 29, 174.
64. G. Pannetier, P. Goudmand, O. Dessaux and N. Tavermir, Compt. rend., 1962, 255, 91.
65. N.A. Narasimham and K. Srikameswaran, Proc. Indian Acad. Sci., 1964, 59, 227.
66. J.J. Smith and B. Meyer, J. Mol. Spec., 1964, 14, 160.
67. J.A.S. Bett and C.A. Winkler, J. Phys. Chem., 1964, 68, 2735.
68. W. Moldenhauer and A. Zimmermann, Chem. Ber., 1929, 62B, 2390.
69. M. Becke-Goehring, H. Jenne and V. Rekalic, Chem. Ber., 1959, 92, 855.
70. A. Meuwsen, Chem. Ber., 1929, 62B, 1959.
71. E.R. Lippincott and M.C. Tobin, J. Amer. Chem. Soc., 1951, 73, 4990.
72. A. Meuwsen and M. Lösel, Z. anorg. Chem., 1953, 271, 217.

73. E. Fluck and M. Becke-Goehring, Z. anorg. Chem., 1957, 292, 229.
74. A. Meuwsen and H. Holch, Chem. Ber., 1931, 64B, 2301.
75. M. Becke-Goehring and R. Schwarz, Z. anorg. Chem., 1958, 296, 3.
76. M. Becke-Goehring and G. Zirker, Z. anorg. Chem., 1956, 285, 70.
77. E.R. Lippincott and M.C. Tobin, J. Chem. Phys., 1953, 21, 1559.
78. E.W. Lund and S.R. Svendsen, Acta. Chem. Scand., 1957, 11, 940.
79. R.L. Saas and J. Donohue, Acta. Cryst., 1958, 11, 497.
80. a) B.D. Stone and M.L. Nielsen, U.S., 2,900,358; b) H. Malz and D. Rosahl, Ger. 1,042,241.
81. A. Meuwsen and F. Schlassnagel, Z. anorg. Chem., 1953, 271, 226.
82. a) M. Becke-Goehring, H. Jenne and E. Fluck, Chem. Ber., 1958, 91, 1947; b) M. Becke-Goehring, Ger., 1,060,851; c) M. Becke-Goehring, H. Herb and W. Koch, Z. anorg. Chem., 1951, 264, 137.
83. V. Brustier and H. Garcia-Fernandez, Bull. soc. chim., 1955, 1299.
84. M. Villena-Blanco, U.S. Atomic Energy, Comm. UCRL 11081.
85. M. Becke-Goehring and W. Koch, Z. Naturforsch, 1952, 7b, 634.
86. H.G. Heal, J. Chem. Soc., 1962, 4442.
87. J. Weiss, Z. anorg. Chem., 1960, 305, 190.
88. P. Tavs, H.J. Schulze-Steinen and J.E. Colchester, J. Chem. Soc., 1963, 2555.
89. H.G. Heal, Nature, 1963, 199, 371.
90. W. Berg and M. Becke-Goehring, Z. anorg. Chem., 1954, 275, 273.
91. W. Berg, M. Becke-Goehring and H. Malz, Z. anorg. Chem., 1956, 283, 13.

92. M. Becke-Goehring and J. Heinke, Z. anorg. Chem., 1955, 278, 54.
93. W.L. Jolly and M. Goehring, Inorg. Chem., 1962, 1, 76.
94. M. Becke-Goehring, H. Hohenschutz and R. Appel, Z. Naturforsch, 1954, 9b, 678.
95. M. Becke-Goehring and G. Magin, Z. anorg. Chem., 1965, 340, 126.
96. J. Weiss, Z. Naturforsch, 1961, 16b, 477.
97. M. Becke-Goehring and J. Heinke, Z. anorg. Chem., 1953, 272, 297.
98. A. Meuwesen and M. Losel, Z. anorg. Chem., 1953, 271, 221.
99. A.V. Kirsonov, J. Gen. Chem. (USSR), 1952, 22, 93.
100. A.V. Kirsonov, J. Gen. Chem. (USSR), 1952, 22, 101.
101. M. Becke-Goehring, Scienta Chimica, Berlin, 1957, 9, 156.
102. L.F. Moore, Ph.D. Thesis, Durham, 1967.
103. O. Ruff and E. Geisel, Chem. Ber., 1904, 37, 1573.
104. O.C.M. Davis, J. Chem. Soc., 1906, 1575.
105. H. Wölbling, Z. anorg. Chem., 1908, 57, 281.
106. a) M. Becke-Goehring, K.W. Daum and J. Weiss, Z. Naturforsch, 1955, 10b, 298; b) M. Becke-Goehring and A. Debo, Z. anorg. Chem., 1953, 273, 319.
107. T.S. Piper, Chem. Ind., 1957, 32, 1101; T.S. Piper, J. Amer. Chem. Soc., 1958, 80, 30.
108. J. Weiss and M. Becke-Goehring, Z. Naturforsch, 1958, 13b, 198.
109. K.W. Daum, M. Becke-Goehring and J. Weiss, Z. anorg. Chem., 1955, 278, 260.
110. E. Fluck and J. Weiss, Z. anorg. Chem., 1956, 287, 51.

111. J. Weiss, Fortschritt, Chem., 1966, 5, 635.
112. I. Lindqvist and R. Rosenstein, J. Inorg. Nuclear Chem., 1958, 7, 421.
113. I. Lindqvist and J. Weiss, J. Inorg. Nuclear Chem., 1958, 6, 184.
114. J. Weiss and D. Neubauer, Z. Naturforsch, 1958, 13b, 459.
115. M. Becke-Goehring, J. Weiss and G. Zirker, Z. anorg. Chem., 1955, 278, 1.
116. M. Becke-Goehring and G. Zirker, Z. Naturforsch, 1955, 10b, 58.
117. B. Cohen, T.R. Hopper, D. Hugell and R.D. Peacock, Nature, 1965, 207, 748.
118. K.J. Wynne and W.L. Jolly, Inorg. Chem., 1967, 6, 107.
119. A.J. Banister and G. Alange, personal communication.
120. E. Fluck and M. Becke-Goehring, Z. Naturforsch, 1956, 11b, 756.
121. E.E. Aynsley and W.A. Campbell, J. Chem. Soc., 1957, 832.
122. A.G. Turner and F.S. Mortimer, Inorg. Chem., 1966, 5, 906.
123. M. Becke-Goehring, J. Heinke and G. Roos, Z. anorg. Chem., 1953, 273, 200.
124. J.H. Helberger, G. Manecke and H.M. Fischer, Ann., 1949, 23, 562.
125. H. Feichtinger and H. Tummes, Chem. Abs., 1956, 50, 8748.
126. F.G. Birdwell, M.L. Peterson and I.S. Rondestuedt, J. Amer. Chem. Soc., 1954, 76, 3950.
127. A. Ouchi and T. Moeller, J. Org. Chem., 1964, 29, 1865.
128. E.F. Degering and J.E. Wilson, J. Org. Chem., 1952, 17, 339.

129. W.T. Smith and W-Y. Chen, J. Org. Chem., 1962, 27, 676.
130. E.S. Levtschenko and A.V. Kirsanov, Z. org. Chim., 1965, 1, 300.
131. V.G. Pessin, A.M. Chalezki and T-T. Tschijao, Doklady Akad. Nauk., 1956, 106, 88.
132. G. Kresze and W. Wucherpfennig, Angew. Chem., (Int. Ed.), 1967, 6, 149.
133. F. Elog and R. Lenaers, Bull. soc. chim. Belges, 1965, 74, 129.
134. F. Effenberger and R. Gleiter, Chem. Ber., 1964, 97, 1576.
135. F. Effenberger and R. Gleiter, Chem. Ber., 1966, 99, 3963.
136. G. Kresze, A. Maschke, R. Albrecht and A. Trede, Angew Chem., (Int. Ed.), 1962, 1, 89.
137. D.L. Cottle, J. Amer. Chem. Soc., 1946, 68, 1380.
138. L. Friedmann and W.P. Wetter, J. Chem. Soc., 1967 (A), 36.
139. R.G. Lacoste and A.E. Martell, J. Amer. Chem. Soc., 1955, 77, 5512.
140. Armed Services Technical Information Service, A.D. 227931.
141. Handbook of Preparative Inorganic Chemistry, G. Brauer, Academic Press, 1963.
142. V. Lenher and C.H. Kao, J. Amer. Chem. Soc., 1926, 48, 1550.
143. W.L. Jolly, Synthetic Inorganic Chemistry, Prentice-Hall, 1960, p.166.
144. O. Glemser, A. Hass and H. Reinke, Z. Naturforsch, 1965, 20b, 809.
145. Thanks are due to Mr. G. Alange for a sample of this compound.
146. Thanks are due to Mr. L.F. Moore for a sample of this compound.

147. A. Carrick and F. Glockling, J. Chem. Soc., 1967 (A), 40.
148. A.J. Banister, personal communication.
149. A.J. Banister and J.R. House, personal communication.
150. C.P. Haber, "Inorganic Polymers", Chem. Soc. Special Publ. No.15, London, 1961, p.115.
151. D.L. Herring, Chem. and Ind., 1960, 717.
152. G. Tesi, C.P. Haber and C.M. Douglas, Proc. Chem. Soc., 1960, 219.
153. R. Schenck and G. Römer, Chem. Ber., 1924, 57B, 1343.
154. Stokes, J. Amer. Chem. Soc., 1897, 19, 782.
155. L.G. Lund, N.L. Paddock, J.E. Proctor and H.T. Searle, J. Chem. Soc., 1960, 2542.
156. M. Becke-Goehring and W. Koch, Chem. Ber., 1959, 92, 1188.
157. L. Horner and H. Oediger, Annalen, 1959, 627, 142.
158. E.W. Abel, D.A. Armitage and G.R. Willey, J. Chem. Soc., 1965, 57.
159. H. Moureu and G. Wetropff, Compt. rend., 1937, 204, 51.
160. Y. Ito, Kogyo Kagaku Zasshi, 1960, 63, 1198.
161. G. Hienze and A. Meuwsen, Z. anorg. Chem., 1954, 275, 49.
162. H.J.H. Bowen, Trans. Faraday Soc., 1954, 50, 452.
163. N. Sheppard, Trans. Faraday Soc., 1950, 46, 429.
164. D.P. Stevenson and J.Y. Beach, J. Amer. Chem. Soc., 1938, 60, 2872.
165. F. Feher and W. Kruse, Chem. Ber., 1958, 91, 2528.
166. B.D. Stone and M.L. Nielsen, J. Amer. Chem. Soc., 1959, 81, 3580.
167. C.N.R. Rao, R. Venkataraghavan and T.R. Kasturi, Canad. J. Chem., 1964, 42, 36.

168. I. Pattison, personal communication.
169. P.E. Gagnon, J.L. Boivin and J.H. Dickson, *Canad. J. Chem.*, 1959, 37, 520.
170. H. Schiff, *Annalen*, 1857, 102.
171. F. Ephraim and H. Piatrowski, *Chem. Ber.*, 1911, 44, 379.
172. P.W. Schenk, *Chem. Ber.*, 1942, 75, 94.
173. P.W. Schenk and R. Steudel, *Angew. Chem.*, 1963, 75, 793.
174. R. Appel and H. Rittersbacher, *Chem. Ber.*, 1964, 97, 852.
175. R. Appel and H. Rittersbacher, *Angew. Chem. (Int. Ed.)* 1964, 3, 809.
176. A.B. Burg, *J. Amer. Chem. Soc.*, 1943, 65, 1629.
177. B. Edgington and J.B. Firth, *J. Soc. Chem. and Ind.*, 1936, 55, 192.
178. S.M. Zhivukhin and V.V. Kireev, *Zh. Neorgan. Khim.*, 1964, 9, 2671.
179. A.J. Banister, L.F. Moore and J.S. Padley, *Inorganic Sulphur Chemistry* (Ed. G. Nickless), Chapter 16, Elsevier, Amsterdam, (in press).
180. H. Stammreich and R. Forneris, *Spectrochim. Acta.*, 1956, 8, 46.
181. N.N. Greenwood and B.P. Straughan, *J. Chem. Soc.*, 1966, 962.
182. A.F. Wells, *Structural Inorganic Chemistry* (3rd Edition), Clarendon Press, Oxford, 1962, p.147.
183. Thanks are due to N. Bell for beryllium analysis on this compound. Technique as in: L.F. Bamford, Ph.D. thesis, Durham, 1966.

APPENDIX II



## APPENDIX II

### Introduction

The characterisation of new compounds and a rationalisation of their structures relies to a large extent on the interpretation of their infrared spectra. In the synthesis of new sulphur-nitrogen compounds it has proved most useful to know in what regions of the infrared spectrum, absorptions due to sulphur-X vibrations (where X is any other element, including sulphur) are likely to occur. Since this thesis represents one of the first to be presented in this particular research 'school', it has been necessary to review the information at present in the literature, both from a direct relation to the present problem, and for the use of future workers in the same field.

The infrared data on numerous sulphur-X bonds have been collected together for a chapter of a book<sup>83</sup> which is shortly to be published. From these data three sections were found to be most relevant to our work, viz: the study of sulphur-nitrogen, sulphur-oxygen and sulphur-halogen bonds.

Although the preparatory literature survey on these three sections has been done jointly with L.F. Moore, the final writing for the first two sections has been the responsibility of Mr. Moore and that of the sulphur-halogen section has been mine. This section is now presented.

Spectroscopic Investigations of Sulphur-Halogen Bonds.

Many compounds containing sulphur-halogen bonds have been investigated spectroscopically, some in great detail, but there are few overall correlations or compilations to be found in the literature. The sulphur-halogen stretching frequencies of many inorganic compounds are tabulated and discussed.

a) Sulphur-fluorine bonds.

Sulphur fluorine stretching frequencies occur in the range  $496 \text{ cm.}^{-1}$  ( $\text{SO}_2\text{F}^-$ ) to  $941 \text{ cm.}^{-1}$  ( $\text{SF}_3^+$ ).

Table A1. Sulphur Fluorides.

compound	S-F stretching frequency ( $\text{cm.}^{-1}$ )		references
	$\nu_S$	$\nu_{AS}$	
$\text{FS}_2\text{F}$	745	807	1,2
$\text{SF}_4$	889	867,728	3-5
$\text{SF}_3^+$	941	908	6
$\text{S}=\text{SF}_2$	757	693	7
$\text{S}_2\text{F}_{10}$		938,826,684	8-11
$\text{SF}_6$	775	615	12, 13
$\text{SF}_5\text{Cl}$	706,854	908	14, 19
$\text{R}_3\text{CSF}_5$		850-903	15, 19
$\text{H}_2\text{NSF}_5$		694,885,930	16
$\text{F}_2\text{SNSF}_5$		714,760,879,910	17
$(\text{F}_3\text{C})_2\text{NSF}_5$		721,839,925	18

The high electronegativity of fluorine and its ability to participate in mesomeric electron release is responsible for the partial double bond character in many sulphur-fluorine compounds. The sulphur-fluorine bond order will be greatest when the mesomeric effect of fluorine is enhanced by a positive charge on the sulphur atom, as in  $SF_3^+$ . Here an appreciable amount of  $d_{\pi} - p_{\pi}$  bonding is to be expected.

Of the simple sulphur-fluorides,  $SF_6$ , in which the sulphur exhibits its maximum covalency, is expected to show little S-F double bonding character, and the stretching frequency of  $775\text{ cm.}^{-1}$  for the sulphur-fluorine bond might be close to that which one would expect for a 'pure  $S^{VI}-F$  single bond'. When one of the fluorine atoms in  $SF_6$  is replaced by chlorine fewer fluorine atoms are competing for the empty sulphur 3d orbitals and so increased S-F double bonding is not unlikely in  $SF_5Cl$ ; the S-F asymmetric stretching frequency increases from  $615\text{ cm.}^{-1}$  in  $SF_6$  to  $908\text{ cm.}^{-1}$  in  $SF_5Cl$ . The symmetric stretching frequency remains roughly constant, being  $775\text{ cm.}^{-1}$  in  $SF_6$ , and  $706$  and  $854\text{ cm.}^{-1}$  in  $SF_5Cl$ . Comparison of the stretching frequencies is however of doubtful validity on account of the different symmetry of the molecules.

The substitution of alkyl groups in  $SF_6$  to give  $RSF_5$  leads to sulphur-fluorine stretching frequencies of the order  $850-903\text{ cm.}^{-1}$ , which may represent still stronger S-F bonding.

In all the  $SF_5$  compounds known, strong absorptions have been observed at  $580-610\text{ cm.}^{-1}$  and very strong absorptions at  $860-910\text{ cm.}^{-1}$

By comparison with the spectrum of  $\text{SF}_5\text{Cl}$  these absorptions may be assigned to asymmetric and symmetric sulphur-fluorine stretching frequencies respectively. The band which occurs in the spectrum of  $\text{SF}_5\text{Cl}$  at  $706 \text{ cm.}^{-1}$  and is described as an  $\text{SF}_4$  stretching mode is often very weak or absent from the spectra of other  $\text{SF}_5$  compounds. The high stretching frequencies in  $\text{SF}_5$  compounds would suggest a bond order somewhat greater than one for the S-F bond, and the narrow range over which these vibrations occur suggests an almost constant S-F distance with varying R group. Unfortunately no structural data are at present available for these compounds.

The compounds  $\text{H}_2\text{NSF}_5$ ,  $\text{F}_2\text{SNSF}_5$  and  $(\text{F}_3\text{C})_2\text{NSF}_5$  all show a strong absorption between  $835 \text{ cm.}^{-1}$  and  $930 \text{ cm.}^{-1}$ , again suggesting a high S-F bond order.

The infrared and Raman spectra of  $\text{SF}_4$  are consistent with a trigonal bipyramidal structure with one equatorial position occupied by the sulphur lone pair. The frequency associated with the  $\text{SF}_2$  stretching mode ( $889 \text{ cm.}^{-1}$ ) in  $\text{SF}_4$  is much higher than that reported for the other sulphur (IV) fluoride  $\text{S}=\text{SF}_2$  ( $757 \text{ cm.}^{-1}$ ). This can be explained by assuming some 'd character' in the  $\sigma$  bonds in  $\text{SF}_4$  and postulating that the sulphur 'd' orbitals will be contracted by the approach of four fluorine atoms and will hence result in shorter and stronger S-F bonds.

Table A2. Sulphur oxyfluorides.

Compound	S-F stretching frequency (cm. <sup>-1</sup> )		references
	$\nu_S$	$\nu_{AS}$	
SO <sub>F</sub> <sub>2</sub>	801 <sup>R</sup>	721 <sup>R</sup>	21-24
SO <sub>F</sub> <sub>4</sub>	933	797,741	20
SO <sub>2</sub> <sup>F</sup> <sub>2</sub>	848	885	25-27
SO <sub>2</sub> <sup>F</sup> Cl	823		28,29
SO <sub>2</sub> <sup>F</sup> Br	814		20,31
RSO <sub>2</sub> <sup>F</sup>		780-852	32-34
ROSO <sub>2</sub> <sup>F</sup>		832-858	34,35
XOSO <sub>2</sub> <sup>F</sup>		820-850	33
SO <sub>2</sub> <sup>F-</sup>		496	36
S <sub>2</sub> O <sub>5</sub> <sup>F</sup> <sub>2</sub>		872 <sup>R</sup>	37
S <sub>2</sub> O <sub>6</sub> <sup>F</sup> <sub>2</sub>		843	33

'R' refers to Raman shift

Thionyl and sulphuryl fluoride have been studied by many workers.<sup>21-27</sup> Thionyl fluoride has C<sub>s</sub> symmetry; the symmetric and asymmetric SF<sub>2</sub> stretching frequencies occur at 801 cm.<sup>-1</sup> and 721 cm.<sup>-1</sup> respectively. Sulphuryl fluoride however has C<sub>2v</sub> symmetry and three vibrations which can be associated with the valency deformations of the SF<sub>2</sub> group (symmetric stretch at 848 cm.<sup>-1</sup>, asymmetric stretch at 885 cm.<sup>-1</sup> and a bending mode at 545 cm.<sup>-1</sup>).

By comparison with  $\text{SO}_2\text{F}_2$ , absorptions at  $823\text{ cm.}^{-1}$  and  $814\text{ cm.}^{-1}$  have been assigned to the sulphur-fluorine symmetric stretching frequency in  $\text{SO}_2\text{FCl}$  and  $\text{SO}_2\text{FBr}$  respectively. Substitution of alkyl groups in  $\text{SO}_2\text{F}_2$  to give  $\text{RSO}_2\text{F}$  has little effect on the sulphur-fluorine stretching frequency. This is to be contrasted with the large effect noted earlier when alkyl groups are substituted in  $\text{SF}_6$ . The presence of two sulphur oxygen double bonds and the reduction in the number of fluorine atoms substantially reduces the effect of further substituents on the sulphur atom.

The  $\text{SO}_2\text{F}^-$  anion has the lowest sulphur-fluorine stretching frequency reported ( $496\text{ cm.}^{-1}$ ). The reduced sulphur-oxygen bond order in  $\text{SO}_2\text{F}^-$  compared with  $\text{SO}_2\text{F}_2$  results in the frequency of the sulphur-oxygen vibrations being close to the frequency of the sulphur-fluorine modes, and mixing of vibrations almost certainly occurs, with the result that the S-F stretching frequency is reduced. Also, sulphur (IV) is less able to act as an acceptor to electronegative ligands than sulphur (VI) (cf. work on  $\text{SOCl}_2$  as a Lewis acid, p.107). The sulphur 'd' orbitals in  $\text{SO}_2\text{F}^-$  may therefore be less available for donation from fluorine in  $\text{SO}_2\text{F}^-$  than they are in, for example,  $\text{SO}_2\text{F}_2$  or  $\text{SF}_6$ .

Comparison of the sulphur-fluorine stretching frequencies in the pairs of sulphur (IV) - sulphur (VI) compounds in Table A3A shows that an increase in frequency is not associated with a decrease in bond length and so in these compounds any link between these two quantities is obscured by other effects.

Table A3. Nitrogen-sulphur-fluorine compounds.

Compound	S-F stretching frequency (cm. <sup>-1</sup> )		references
	$\nu_S$	$\nu_{AS}$	
NSF	640		38
NSF <sub>3</sub>	775	811	38
FCON=SF <sub>2</sub>	764	727	39
(RN) <sub>2</sub> SF <sub>2</sub>	833-883		40
F <sub>5</sub> SNSF <sub>2</sub>	714, 760, 879, 910		17
R <sub>2</sub> NSO <sub>2</sub> F	794-901		29, 41-43
(NSOF) <sub>n</sub>	833		41
RNSOF <sub>2</sub>	781-833		44, 45

This is not surprising in view of the different symmetries of the molecules and the differences in modes of vibration.

Table A3A. S-F stretching frequencies and bond lengths.

Sulphur IV				Sulphur VI			
$\nu_{SF}$ (cm. <sup>-1</sup> )		$d_{S-F}$	$\nu_{SF}$ (cm. <sup>-1</sup> )		$d_{S-F}$		
S	AS		S	AS			
NSF	640	1.446	NSF <sub>3</sub>	775	811	1.416	
SOF <sub>2</sub>	801	1.60	SOF <sub>4</sub>	933	797, 741	-	
SF <sub>4</sub>	889	1.58	SF <sub>6</sub>	775	615	1.56	

For the iminosulphur oxyfluorides,  $RN=SOF_2$ , sulphur-fluorine stretching frequencies fall within the range  $833-781\text{ cm.}^{-1}$ . The sulphur-fluorine stretching vibration in  $F_2NSO_2F$  is assigned to a strong band at  $846\text{ cm.}^{-1}$ ; the same mode in  $NF_2OSO_2F$  is displaced to  $838\text{ cm.}^{-1}$ . The asymmetric and symmetric sulphur-fluorine stretching frequencies in  $FN(SO_2F)_2$  occur at  $896$  and  $849\text{ cm.}^{-1}$  respectively; the same modes in pyrosulphuryl fluoride occur at  $873$  and  $824\text{ cm.}^{-1}$ .

b) Sulphur-chlorine bonds.

Sulphur-chlorine stretching frequencies fall within the range  $372-545\text{ cm.}^{-1}$ .

Table A4. Sulphur chlorides.

compound	symmetry class	S-Cl stretching frequency				d(S-Cl) A°	refs.
		I.R. (cm. <sup>-1</sup> )		Raman (cm. <sup>-1</sup> )			
		ν <sub>S</sub>	ν <sub>AS</sub>	ν <sub>S</sub>	ν <sub>AS</sub>		
S <sub>2</sub> Cl <sub>2</sub>	C <sub>2</sub>	438	538	443	537	1.99	46-50
SCL <sub>2</sub>	C <sub>2V</sub>	514	535	519	535	2.02	51-54
F <sub>5</sub> SCl	C <sub>4V</sub>			404		2.00	14,20

The infrared and Raman data for S<sub>2</sub>Cl<sub>2</sub> were originally interpreted in terms of a planar cis C<sub>2V</sub> model.<sup>46-48</sup> Raman polarisation measurements were both reinterpreted to support a non planar (C<sub>2</sub>) structure. The calculated frequencies for the C<sub>2</sub> model agree with observed values, so



that along with results obtained from electron diffraction,<sup>49</sup> the total evidence is in accordance with a non planar molecular arrangement. The infrared,<sup>51</sup> Raman spectrum,<sup>52</sup> electron diffraction data<sup>49,55</sup> and force constant calculations<sup>53</sup> for  $\text{SCl}_2$  are all consistent with  $C_{2v}$  symmetry.

Table A5. Sulphenyl chlorides.

Compound	Sulphur-chlorine stretching frequency cm. <sup>-1</sup>	reference
$\text{C}_6\text{H}_5\text{SCl}$	512	56
4- $\text{CH}_3\text{C}_6\text{H}_4\text{SCl}$	512	56
4- $\text{ClC}_6\text{H}_4\text{SCl}$	515	56
4- $\text{BrC}_6\text{H}_4\text{SCl}$	515	56
4- $\text{FC}_6\text{H}_4\text{SCl}$	520	56
5,2-( $\text{CH}_3$ ) <sub>2</sub> $\text{C}_6\text{H}_3\text{SCl}$	490	56
4,2-( $\text{CH}_3$ ) <sub>2</sub> $\text{C}_6\text{H}_3\text{SCl}$	490	56
$\text{NCSCl}$	520	57,58
$\text{NCSCl}_3$	524	57,58
$\text{Cl}_3\text{CSCl}$	532	60
$\text{F}_3\text{CSCl}$	535	59

The sulphur-chlorine stretching frequencies in the substituted sulphenyl chlorides show little deviation from those of the parent compound. The small shifts which do occur can be explained in terms of the inductive

effects of the substituents. The position of substitution in the benzene nucleus, similarly does not affect the sulphur-chlorine stretching frequency. The ultraviolet absorption spectra of these compounds show maxima in the range 240-252  $\mu$  and a second peak at about 220  $\mu$  appears in the spectra of disubstituted phenyl sulphenyl chlorides. The band at 520  $\text{cm.}^{-1}$  in the infrared spectrum of  $\text{NCSCl}$  is actually a doublet, with frequencies at approximately 523 and 516  $\text{cm.}^{-1}$ , of which the lower frequency is the weaker. The ratio of these frequencies is exactly that for the vibrations of the diatomic species  $\text{S}^{35}\text{Cl}$  and  $\text{S}^{37}\text{Cl}$ . The spectrum of  $\text{NCSCl}_3$  also shows this type of doubling in the 524  $\text{cm.}^{-1}$  band. Bands at 532  $\text{cm.}^{-1}$  and 535  $\text{cm.}^{-1}$  have been assigned to the S-Cl stretching vibration in  $\text{Cl}_3\text{C}\cdot\text{SCl}$  and  $\text{F}_3\text{C}\cdot\text{SCl}$  respectively; the small shift may be due to the effect of changing the electron withdrawing nature of the substituent on the S-Cl stretching frequency (cf. 438  $\text{cm.}^{-1}$  in  $\text{S}_2\text{Cl}_2$ ). This change could however be only a mass effect. Thionyl chloride shows six infrared and Raman active fundamental vibrations, and is consistent with a pyramidal ( $\text{C}_3$ ) structure giving rise to 4 polarised and 2 depolarised Raman lines. This structure is favoured rather than the planar ( $\text{C}_{2v}$ ) structure, which would give rise to 3 polarised and 3 depolarised Raman lines. A six constant Urey-Bradley-Simanouti force field has been investigated for  $\text{SOCl}_2$ , and although a set of force constants can be found which exactly reproduce the observed frequencies, these force constants are not satisfactorily consistent with the physical

Table A6. Sulphur oxychlorides.

Compound	S-Cl stretching frequency		other bands	reference
	$\nu_S$ (cm. <sup>-1</sup> )	$\nu_{AS}$ (cm. <sup>-1</sup> )	cm. <sup>-1</sup>	
SOCl <sub>2</sub>	492	455	344 ( $\delta$ S-Cl)	61-63
	490 <sup>R</sup>	443 <sup>R</sup>	284 ( $\rho$ S-Cl)	64
SO <sub>2</sub> Cl <sub>2</sub>	403	362 <sup>R</sup>	282 ( $\rho$ SCL <sub>2</sub> )	37,61,65
	408		218 ( $\delta$ SCL <sub>2</sub> )	28,66
OHSO <sub>2</sub> Cl	416 <sup>R</sup>		312 (torsion)	67
FSO <sub>2</sub> Cl		430		28
RSO <sub>2</sub> Cl		372-390		33-36,45,68-76
Cl <sub>3</sub> CSO <sub>2</sub> Cl		416		68
S <sub>2</sub> O <sub>5</sub> Cl <sub>2</sub>	412	427	200 ( $\omega$ SCl)	77,78
			235 ( $\omega$ SCl)	
S <sub>2</sub> O <sub>5</sub> FCl		432	204 ( $\omega$ SCl)	79
			231 ( $\omega$ SCl)	
S <sub>3</sub> O <sub>8</sub> Cl <sub>2</sub>	412	434	200 ( $\omega$ SCl)	78,79
			226 ( $\omega$ SCl)	

R represents Raman band;  $\delta$ , bend;  $\rho$ , rock; and  $\omega$ , wag.

model underlying the UBS field. The failure arises principally from a neglect of the interactions involving the lone pairs on the sulphur atom. The doubtful nature and extent of the effect of the lone pairs on the vibrational frequency of sulphur (II) and sulphur (IV) compounds is one of the main difficulties in trying to make  $S^{II}$ - $S^{IV}$ - $S^{VI}$  comparisons.

Raman<sup>28,37,65</sup> and infrared<sup>61,66</sup> data for sulphuryl chloride are consistent with a roughly tetrahedral molecule of  $C_{2V}$  symmetry. This gives rise to nine fundamentals, all of which are Raman active, and eight of which are infrared active. There has however been some disagreement over the assignments,<sup>37,61,65</sup> though those of Gillespie and Robinson<sup>37</sup> seem to be preferred by most authors. The symmetric and asymmetric  $S\text{Cl}_2$  stretching vibrations can be assigned to Raman shifts of 405 and 362  $\text{cm.}^{-1}$  respectively, and the  $S\text{Cl}_2$  rocking and bending modes to shifts of 282  $\text{cm.}^{-1}$  and 218  $\text{cm.}^{-1}$  respectively. The S-Cl stretching frequency in the mixed oxyhalide  $\text{SO}_2\text{ClF}$  occurs at 430  $\text{cm.}^{-1}$

The mean value of the S-Cl stretching frequency (the arithmetic mean of the symmetric and asymmetric modes) of the chlorides in the series  $\text{SCl}_2$  (525  $\text{cm.}^{-1}$ ),  $\text{SOCl}_2$  (466  $\text{cm.}^{-1}$ ) and  $\text{SO}_2\text{Cl}_2$  (383  $\text{cm.}^{-1}$ ) shows a marked decrease from  $S^{II}$  to  $S^{VI}$ . The decrease cannot be due to a weakening of the sulphur-chlorine bonds in the series, since the S-Cl bond distances are 2.02, 2.07 and 1.99 $\text{\AA}$  respectively.

The Raman spectrum of chlorosulphuric acid shows a strongly polarised line at 416  $\text{cm.}^{-1}$  which has been assigned to the S-Cl

stretching vibration, and a line at  $312 \text{ cm.}^{-1}$  is thought to be a torsional mode since it is the only low frequency depolarised line.<sup>67</sup> Organic sulphonyl chlorides have been studied by several workers<sup>33-36,45,68-76</sup> and these all show sulphur-chlorine stretching frequencies in the range  $372-416 \text{ cm.}^{-1}$ . Of these, virtually all the aromatic sulphonyl chlorides show a band within the range  $380 \pm 10 \text{ cm.}^{-1}$  which may be assigned to  $\nu_{\text{S-Cl}}$ . Introduction of electron withdrawing substituents is accompanied by a shift to higher frequencies. King and Smith<sup>68</sup> have shown that whilst there is no precise correlation with the ordinary Hammett parameters, a reasonably good linear plot may be obtained using Taft's  $\sigma$  values, indicating a direct connection between stretching frequency and the inductive effect of the substituents. With the aliphatic sulphonyl chlorides the same tendency of electron withdrawing substituents to raise the frequency of the absorption maximum is found, but the correlation with  $\sigma^*$  for example is less convincing. The following table illustrates the effect of electron withdrawing groups on the sulphur-chlorine stretching frequency. This effect of electron

Table A7. Sulphonyl chlorides.<sup>68</sup>

sulphonyl chloride	$\nu_{\text{S-Cl}}$ ( $\text{cm.}^{-1}$ )
$\text{C}_6\text{H}_5$	373
p.OH. $\text{C}_6\text{H}_4$	377
p.OMe. $\text{C}_6\text{H}_4$	377
p.Br. $\text{C}_6\text{H}_4$	379
p.O <sub>2</sub> NC $\text{C}_6\text{H}_4$	380
2.4.(O <sub>2</sub> N) <sub>2</sub> $\text{C}_6\text{H}_3$	390

withdrawing groups, led King and Smith<sup>68</sup> to suggest that of the two bands at  $379 \text{ cm.}^{-1}$  and  $416 \text{ cm.}^{-1}$  which occur in the spectrum of trichloromethane sulphonyl chloride, the band at  $416 \text{ cm.}^{-1}$  is probably the sulphur-chlorine stretching mode, even though the band at  $379 \text{ cm.}^{-1}$  falls within the normal range. It is useful to note that the S-Cl stretching frequency in  $\text{Cl}_3\text{CSCl}$  also occurs at a frequency ( $532 \text{ cm.}^{-1}$ ) which is higher than the normal range ( $490\text{-}520 \text{ cm.}^{-1}$ ) for organic sulphenyl chlorides.

The polysulphuryl chlorides,  $\text{S}_2\text{O}_5\text{Cl}_2$ ,  $\text{S}_3\text{O}_8\text{Cl}_2$  and  $\text{S}_2\text{O}_5\text{ClF}$  all show Raman shifts between  $410 \text{ cm.}^{-1}$  and  $435 \text{ cm.}^{-1}$  which can be assigned to the S-Cl stretching vibrations. It is interesting to note that the mean value of the S-Cl stretching frequency in  $\text{S}_2\text{O}_5\text{Cl}_2$  ( $433 \text{ cm.}^{-1}$ ) falls midway between those for  $\text{SO}_2\text{Cl}_2$  and  $\text{SOCl}_2$ , and as would be expected there is little difference in the stretching frequencies of any of the polysulphuryl chlorides.

c) Sulphur-bromine bonds.

Sulphur-bromine stretching frequencies occur in the range  $280\text{-}450 \text{ cm.}^{-1}$  Bradley et al.<sup>80</sup> have reported the infrared spectrum of  $\text{S}_2\text{Br}_2$ , and assigned bands at  $302 \text{ cm.}^{-1}$  and  $355 \text{ cm.}^{-1}$  to the symmetric and asymmetric sulphur-bromine stretching frequencies. From the simultaneous infrared spectra of  $\text{S}_2\text{Br}_2$  and  $\text{CS}_2$ , Ketelaar et al.<sup>82</sup> have obtained three fundamentals at  $176 \text{ cm.}^{-1}$ ,  $196 \text{ cm.}^{-1}$  and  $354 \text{ cm.}^{-1}$ . A fourth fundamental

Table A8. Sulphur-bromine compounds.

Compound	S-Br stretching frequency (cm. <sup>-1</sup> )	other bands (cm. <sup>-1</sup> )	refs.
S <sub>2</sub> Br <sub>2</sub>	302 (ν <sub>S</sub> ), 355 (ν <sub>AS</sub> )	175(a), 198(b)	80
SOBr <sub>2</sub>	405 (ν <sub>S</sub> ), 379 (ν <sub>AS</sub> )	120(δSBr <sub>2</sub> ), 223(ρ SBr <sub>2</sub> )	21
SO <sub>2</sub> BrF	270 (ν <sub>S</sub> )	176(ω SBr)	37
MeSO <sub>2</sub> Br	286 <sup>R</sup>		73
EtSO <sub>2</sub> Br	285 <sup>R</sup>		73
NCSBr	451		81
(NC) <sub>3</sub> SBr	450		58
BrN=C(Br)SBr	450		58

R represents Raman band; δ, bend; ρ, rock; ω, wag; (a) sym. δSBr angle def.; (b) antisym δSBr angle def.

vibration (531 cm.<sup>-1</sup>) was observed in the infrared spectrum of pure S<sub>2</sub>Br<sub>2</sub>, along with overtones and combination bands. The Raman spectrum<sup>82</sup> also shows a strong band at 355 cm.<sup>-1</sup>

The symmetry properties and point group of the thionyl halides have been discussed in the previous section. Thionyl bromide shows the same symmetry, and gives rise to six normal vibrations, of which four are Raman polarised. The assignments made by Stammreich<sup>52</sup> and

used by Long and Bailey<sup>21</sup> are given in Table A8. The infrared spectrum of sulphuryl bromofluoride,  $\text{SO}_2\text{BrF}$  has been reported by Crow and Lagemann,<sup>31</sup> who have assigned the observed frequencies in terms of the vibrations of the  $\text{SO}_2$  and  $\text{SBr}$  groups. Gillespie and Robinson<sup>37</sup> however have considered the S-F and S-Br bonds separately and assigned eight of the nine fundamentals in a manner consistent with the assignments which have been made for  $\text{SO}_2\text{Cl}_2$  and  $\text{SO}_2\text{F}_2$ . These authors assign the band at  $270 \text{ cm.}^{-1}$  to the S-Br stretching vibration, and a band at  $176 \text{ cm.}^{-1}$  to the S-Br wag. The band which occurs at  $353 \text{ cm.}^{-1}$  could also be assigned to an S-Br stretching vibration, but Gillespie and Robinson prefer to regard this as the first overtone of the S-Br wag.

The Raman spectra of some organic sulphonyl bromides<sup>75</sup> give an extraordinarily strong band at about  $285 \text{ cm.}^{-1}$ . By comparison with the corresponding chlorides and fluorides, this is assigned to an S-Br stretching vibration. Force constant and bond energy calculations indicate that in all cases the C-S bond is somewhat stronger than the S-Br bond.<sup>75</sup>

Bands at, or about  $450 \text{ cm.}^{-1}$  in the spectra of  $\text{NCSBr}$ ,  $(\text{NC})_3\text{SBr}$  and  $\text{BrN}=\text{C}(\text{Br})\text{SBr}$  have been assigned<sup>57,58</sup> to the S-Br stretching vibration. This is surprisingly high for this type of stretching frequency (cf.  $354 \text{ cm.}^{-1}$  in  $\text{S}_2\text{Br}_2$  and  $286 \text{ cm.}^{-1}$  in  $\text{H}_3\text{CSBr}$ ) and represents the highest frequency recorded for sulphur-bromine bonds.



(d) Sulphur-iodine bonds.

The sulphur-iodine stretching frequency in the dithian-I<sub>2</sub> adduct occurs<sup>84</sup> at 212 cm.<sup>-1</sup> The absorption due to S-I could not be located in other sulphur compound-I<sub>2</sub> adducts owing to the presence of other absorptions in this region.<sup>85</sup>

### Discussion

As would be expected, the change from fluorine to iodine in sulphur-halogen compounds is accompanied by a decrease in the sulphur-halogen stretching frequency. No simple correlation is found, however, and the shifts are apparently caused by a combination of five variables: mass and steric effects of groups attached to sulphur, mixing of vibrations, their inductive effect and  $\pi$ -donation of the halogen, particularly in the case of fluorine, where a strong mesomeric effect causes increase in the sulphur-halogen bond order. The relative contributions of these factors for the fluorides, chlorides and bromides appear to be markedly dependent upon the type of compound. Nevertheless, in any series of sulphur-halogen compounds, e.g. the thionyl halides, the sulphur-halogen stretching frequencies in general decrease in the order fluorine, chlorine, bromine; i.e. with (a) increasing size of halogen atom, (b) decreasing electronegativity and (c) increasing bond length. The decrease rarely seems to be related to one factor alone.

The effect of electronegative substituents on the characteristic frequency of other groups has been observed in several cases, e.g. for phosphoryl halides and for carbonyl compounds, and attempts have been made to devise quantitative relationships between vibration frequencies and effective electronegativity of the substituents. By assuming the Pauling values (4.0, 3.0 and 2.8) for the electronegativity of fluorine, chlorine and bromine respectively, Bell et al. have been able to show a correlation between the Raman shifts of the P=O group

and the sum of the electronegativities of the halogen attached to phosphorus in the phosphoryl halides. Robinson, however, has pointed out that the evaluation of electronegativities for groups is complicated by the probable occurrence of double bonding, and that in the case of phosphorus-fluorine bonds, a value of 3.6 is required for the electronegativity of fluorine to make the phosphoryl fluorides 'fit' the plot of  $\sum \psi$  against  $\nu_{P-O}$ . In view of the defects in calculations of the effective electronegativity he does not attempt to evaluate the electronegativities of groups attached to the  $SO_2$  group in sulphuryl compounds.

Some correlation between the inductive effect of substituents and the sulphur-halogen stretching frequency is found in the case of the aromatic sulphonyl chlorides, where there is a direct relationship between the Taft  $\sigma$  values and the S-Cl stretching frequency. In general however, correlations between physical properties and frequency shifts appear to work best when the comparison involves some experimental measurement of bond polarity e.g. change in covalent bond distance, ionisation potential or reactivity, and that correlations with more general functions such as electronegativity are less likely to be meaningful.

References to Appendix II

1. R.H. Hooge and J.A. Ketelaar, *Rec. trav. chim.*, 1958, 77, 902.
2. J.R.B. Matutano and C. Otero, *Anales real soc. espan. Fis. y. quim.*, 1955, 51B, 223.
3. K. Venkateswarlu and M.G.K. Pillai, *Optika. i. Spectroskopyia*, 1961, 11, 46.
4. M.G.K. Pillai, K. Ramaswamy and R. Pichai, *Canad. J. Chem.*, 1965, 43, 463.
5. M.G.K. Pillai, K. Ramaswamy and R. Pichai, *Austral. J. Chem.*, 1965, 10, 1575.
6. F. Seel and O. Detner, *Z. anorg. Chem.*, 1961, 301, 113.
7. F. Seel and H.D. Goelitz, *Z. anorg. Chem.*, 1964, 327, 32.
8. R.E. Dodd, L.A. Woodward and H.L. Roberts, *Trans. Farad. Soc.*, 1957, 53, 1545.
9. R.E. Dodd, L.A. Woodward and H.L. Roberts, *ibid.*, 1557.
10. D. Edelson, *J. Amer. Chem. Soc.*, 1952, 74, 262.
11. H.B. Harvey and S.H. Bauer, *J. Amer. Chem. Soc.*, 1953, 75, 2840.
12. R.E. Dodd, L.A. Woodward and H.L. Roberts, *Trans. Farad. Soc.*, 1956, 52, 1052.
13. R.T. Lagemann and E.A. Jones, *J. Chem. Phys.*, 1951, 19, 534.
14. L.H. Cross, H.L. Roberts, P. Goggin and L.A. Woodward, *Trans. Farad. Soc.*, 1960, 56, 945.
15. N.H. Ray, *J. Chem. Soc.*, 1963, 1440.
16. A.F. Clifford and L.C. Duncan, *Inorg. Chem.*, 1966, 5, 692.
17. A.F. Clifford and J.W. Thompson, *Inorg. Chem.*, 1966, 5, 1424.

18. R.C. Dobbie, J. Chem. Soc., 1966 (A), 1555.
19. L.H. Cross, G. Cushing and H.L. Roberts, Spectrochim. Acta., 1961, 17, 344.
20. P.L. Goggin, H.L. Roberts and L.A. Woodward, Trans. Farad. Soc., 1961, 57, 1877.
21. D.A. Long and R.T. Bailey, Trans. Faraday Soc., 1963, 59, 792.
22. J.K. O'Loane and M.K. Wilson, J. Chem. Phys., 1955, 23, 1313.
23. P. Bender and J.M. Wood, J. Chem. Phys., 1955, 23, 1316.
24. D.M. Yost, Proc. Indian Acad. Sci., 1938, 8A, 333.
25. D.P. Stevenson and H. Russell, J. Amer. Chem. Soc., 1939, 61, 3264.
26. R.M. Fristrom, J. Chem. Phys., 1952, 20, 1.
27. W.D. Perkins and M.K. Wilson, J. Chem. Phys., 1952, 20, 1791.
28. R.J. Gillespie and E.A. Robinson, Spectrochim. Acta., 1962, 18, 1473.
29. H.W. Roesky and A. Hoff, Chem. Ber., 1965, 98, 2429.
30. M. Lustig, Inorg. Chem., 1965, 4, 104.
31. T.T. Crow and R.T. Lagemann, Spectrochim. Acta., 1958, 12, 143.
32. N.S. Ham, A.N. Hambly and R.H. Laby, Austral. J. Chem., 1960, 13, 443.
33. F.B. Dudley and G.H. Cady, J. Amer. Chem. Soc., 1957, 79, 513.
34. W.P. Gilbreath and G.H. Cady, Inorg. Chem., 1963, 2, 496.
35. F.B. Dudley, G.H. Cady and D.F. Eggers, J. Amer. Chem. Soc., 1956, 78, 290.
36. J.M. Shreeve and G.H. Cady, J. Amer. Chem. Soc., 1961, 83, 4521.
37. R.J. Gillespie and E.A. Robinson, Canad. J. Chem., 1961, 39, 2171.
38. H. Richert and O. Glemser, Z. anorg. Chem., 1961, 307, 328.

39. A.F. Clifford and C.S. Kobayashi, *Inorg. Chem.*, 1965, 4, 571.
40. M. Lustig and J.K. Ruff, *Inorg. Chem.*, 1965, 4, 1441.
41. G.W. Parshall, R. Cramer, and R.E. Foster, *Inorg. Chem.*, 1962, 1, 677.
42. M. Lustig, C.L. Baumgardner, F.A. Johnson and J.K. Ruff, *Inorg. Chem.*, 1964, 3, 1165.
43. C.L. Baumgardner and M. Lustig, *Inorg. Chem.*, 1963, 2, 662.
44. F. Seel and G. Simon, *Angew. Chem.*, 1960, 72, 709.
45. R. Cramer and D.D. Coffmann, *J. Org. Chem.*, 1961, 26, 4010.
46. H. Gerding and R. Westrik, *Rec. Trav. chim.*, 1941, 60, 701.
47. K. Nakamoto, *Infrared Spectra of Inorganic and Coordination Compounds*, Wiley, New York, 1963, p.97.
48. S. Venkateswaran, *Indian J. Phys.*, 1931, 6, 275.
49. K.J. Palmer, *J. Amer. Chem. Soc.*, 1938, 60, 2360.
50. H.J. Bernstein and J. Powling, *J. Chem. Phys.*, 1950, 18, 1018.
51. C. Otero and J.R.B. Matutana, *Anales real Soc. espan. Fis., Quim.*, 1956, 52B, 291.
52. H. Stammreich, R. Forneris and K. Sone., *J. Chem. Phys.*, 23, 972.
53. G. Nagarajan, *Bull. Soc. chim. belges*, 1963, 72, 16.
54. G.M. Barrow, *J. Phys. Chem.*, 1955, 59, 987.
55. D.P. Stevenson and J.Y. Beach, *J. Amer. Chem. Soc.*, 1938, 60, 2872.
56. L. Almasi and A. Hantz, *Acad. Rep. Populare Romine*, 1963, 14, 147.
57. M.J. Nelson and A.D.E. Pullin, *J. Chem. Soc.*, 1960, 604.
58. F. Feher and K-H. Linke, *Chem. Ber.*, 1964, 97, 2413.
59. S.N. Nabi and N. Sheppard, *J. Chem. Soc.*, 1959, 3439.

60. J.A.A. Ketelaar and W. Vedder, *Rec. Trav. chim.* 1955, 74, 1482.
61. D.E. Martz and R.J. Lagemann, *J. Chem. Phys.*, 1954, 22, 1193.
62. C.A. McDowell, *Trans. Faraday Soc.*, 1953, 49, 371.
63. K.C. Schreiber, *Analyt. Chem.*, 1949, 21, 1168.
64. R. Vogel-Högler, *Acta. Phys. Austriaca*, 1948, 1, 311.
65. J. Cabannes and A. Rousset, *Ann. Physique*, 1933, 19, 229.
66. G.R. Hunt and M.L. Wilson, *Spectrochim. Acta.*, 1962, 18, 959.
67. R.J. Gillespie and E.A. Robinson, *Canad. J. Chem.*, 1962, 40, 644.
68. J.F. King and D.J.H. Smith, *Canad. J. Chem.*, 1965, 43, 1870.
69. L.K. Huber and H.C. Mandell, *Inorg. Chem.*, 1965, 4, 919.
70. J.K. Ruff, *Inorg. Chem.*, 1965, 4, 1446.
71. M. Lustig and G.H. Cady, *Inorg. Chem.*, 1963, 2, 388.
72. A. Rousset and R. Locket, *J. Phys. Radium*, 1945, 6, 57.
73. G. Geiseler and R. Kuschmiers, *Chem. Ber.*, 1960, 93, 2041.
74. A. Simon, H. Kriegsmann and H. Dutz, *Chem. Ber.*, 1956, 89, 1883.
75. G. Geiseler and K.O. Bindernage, *Z. Elektrochem.*, 1959, 63, 1140.
76. N.S. Ham and A.N. Hambly, *Austral. J. Chem.*, 1953, 6, 33.
77. H. Gerding and A.C. Linden, *Rec. trav. chim.*, 1942, 61, 735.
78. A. Simon and R. Lehmann, *Z. anorg. Chem.*, 1961, 311, 212.
79. R.J. Gillespie and E.A. Robinson, *Canad. J. Chem.*, 1962, 40, 675.
80. E.B. Bradley, C.R. Bennett and E.A. Jones, *Spectrochim. Acta.*,  
1965, 21, 1505.
81. M.J. Nelson and A.D.E. Pullin, *J. Chem. Soc.*, 1960, 604.

82. J.A. Ketelaar, F.N. Hooge and G. Blasse, Rec. trav. chim., 1956, 75, 220.
83. A.J. Banister, L.F. Moore and J.S. Padley, Inorganic Sulphur Chemistry, Chapter 16, Elsevier, (in press).
84. P.J. Hendra and N. Sadesivan, Spectrochim. Acta., 1965, 21, 1127.
85. D. Forster and D.M.L. Goodgame, J. Chem. Soc., 1966 (A), 170.

21 SEP 1967  
LIBRARY