



Durham E-Theses

A neuronal effect of testosterone

Kendrick, Keith M.

How to cite:

Kendrick, Keith M. (1979) *A neuronal effect of testosterone*, Durham theses, Durham University.
Available at Durham E-Theses Online: <http://etheses.dur.ac.uk/8376/>

Use policy

The full-text may be used and/or reproduced, and given to third parties in any format or medium, without prior permission or charge, for personal research or study, educational, or not-for-profit purposes provided that:

- a full bibliographic reference is made to the original source
- a [link](#) is made to the metadata record in Durham E-Theses
- the full-text is not changed in any way

The full-text must not be sold in any format or medium without the formal permission of the copyright holders.

Please consult the [full Durham E-Theses policy](#) for further details.

A NEURONAL EFFECT OF TESTOSTERONE

by

KEITH M. KENDRICK

A thesis submitted for the degree of Doctor of Philosophy
in the
University of Durham

Department of Psychology
Durham.

July, 1979

The copyright of this thesis rests with the author.
No quotation from it should be published without
his prior written consent and information derived
from it should be acknowledged.



PREFACE AND ACKNOWLEDGEMENTS

This thesis presents an analysis of the effects of castration and sex steroid hormone treatments on electrophysiological properties of identified single neurones in the corticomедial amygdala of the male rat. Many of the results are negative, and they can be tedious to read; but I have included them all for the reference of any future investigators in this field. The principal results have been published (Kendrick, K. M. and Drewett, R. F. (1979). Science, vol. 204, pp. 877-879).

My thanks are due mainly to my supervisor Dr. R. F. Drewett for his initial stimulation of my interest in the neuronal effects of sex steroids, and for his untiring support throughout.

I am grateful to Professor F. V. Smith and Professor M. J. Morgan for the opportunity of working in the Department of Psychology, and for the excellent research facilities made available to me.

I would also thank David Hyde for his helpful advice on neurophysiological techniques.

I am indebted to David Harper for Histology, Malcolm Rolling for graphics and photography and Marie Harper, Joan Emery and Marjorie Anderson for care and maintenance of experimental animals.

My sincere thanks are also due to Gwenneth Kell for her excellent typing of this thesis.

Finally I acknowledge the support of the Science Research Council.

ABSTRACT

Kendrick, K. M.: "A Neuronal Effect of Testosterone."

This thesis investigates the effects of testosterone and its metabolites on the electrical activity of single corticomedial amygdala neurones in the male rat. Experiments concentrate, in particular, on those corticomedial amygdala neurones which project directly to the medial preoptic/anterior hypothalamic junction. An attempt to relate the observed neuronal effects of testosterone to sexual behaviour has also been made.

The first Chapter reviews the electrophysiological experiments on the effects of sex steroids on single neurones in the central and peripheral nervous system. The second Chapter describes experiments which show that long term castration lengthens the absolute refractory periods of corticomedial amygdala neurones which project to the medial preoptic/anterior hypothalamic junction. Adjacent corticomedial amygdala neurones which project to the capsule of the ventromedial nucleus of the hypothalamus did not show this effect.

Chapter 3 describes an experiment which shows that long term testosterone treatment reduces the absolute refractory periods of corticomedial amygdala neurones which project to the medial preoptic/anterior hypothalamic junction, in castrated rats. Results show a direct effect of testosterone in the central nervous system.

Chapter 4 investigates the effects of two major metabolites of testosterone, oestradiol and dihydrotestosterone, on the absolute refractory periods of these corticomedial amygdala neurones. Oestradiol, but not dihydrotestosterone produces the same reduction effect as testosterone. Results provide direct evidence that oestradiol has the same effect as testosterone in the central nervous system.

Chapter 5 describes two similar experiments which show that the testosterone reduction of the absolute refractory periods of these corticomedial amygdala neurones is correlated with the time at which the hormone stimulates full sexual behaviour. Chapter 6 discusses the significance of the testosterone effect on corticomedial amygdala neurone absolute refractory periods.

TABLE OF CONTENTS

	Page
PREFACE and ACKNOWLEDGEMENTS	(i)
ABSTRACT	(ii)
CHAPTER 1: A Review of the Effects of Sex Hormones on the Electrical Activity of Single Neurones	1
1.1 Introduction	1
1.2 The effects of sex steroids on neuronal activity	1
1.2.1 Changes in the electrical activity of single neurones during the oestrous cycle	2
1.2.2 The effects of oestrogens on neuronal activity.....	5
1.2.3 The effects of oestrogens on peripheral nerve	13
1.2.4 The effects of progesterone on neuronal activity	15
1.2.5 The effects of combined oestrogens and progesterone on neuronal activity	16
1.2.6 The effects of testosterone on neuronal activity	16
1.2.7 Neuronal effects of androgens on the peripheral nervous system	19
1.3 General Discussion	19
CHAPTER 2: Electrophysiological Effects of Castration on Corticomедial Amygdala Neurones	21
2.1 Introduction	21
2.2 Experiment 1: The effects of castration on the electrical activity of corticomедial amygdala neurones which project to the medial preoptic/ anterior hypothalamic junction	22
2.2.1 Method	22
2.2.2 Results	38
2.2.3 Discussion	44
2.3 Experiment 2: The effects of castration on the electrical activity of CMA neurones which project to the capsule of the ventromедial nucleus	45
2.3.1 Method	45
2.3.2 Results	47

2.4	Comparison of results from Experiments 1 and 2	54
2.5	General Discussion	57
CHAPTER 3:	Electrophysiological Effects of Testosterone on Corticomedial Amygdala Neurones	60
3.1	Introduction	60
3.2	Experiment 3: The effects of testosterone on the absolute refractory periods of CMA neurones	60
3.2.1	Method	61
3.2.2	Results	61
3.3	Comparison of Results from Experiments 1 (Chapter 2) and 3	69
3.4	Discussion	69
CHAPTER 4:	Electrophysiological Effects of Oestradiol and Dihydrotestosterone on Corticomedial Amygdala Neurones	71
4.1	Introduction	71
4.2	Experiment 4: The effects of oestradiol and dihydrotestosterone on the absolute refractory periods of CMA neurones	71
4.2.1	Method	73
4.2.2	Results	74
4.3	Comparison of Results from Experiments 1 (Chapter 2) and 4	82
4.4	Discussion	84
4.5	Addendum: a note on the localisation of the effect	85
CHAPTER 5:	Time Course of the Effect of Testosterone on a Neuronal and a Behavioural Response	88
5.1	Introduction	88
5.2	Experiment 5: The time course of the effect of testosterone on CMA neurone absolute refractory periods and on sexual behaviour	89
5.2.1	Method	89
5.2.2	Results and Discussion	91
5.3	Experiment 6: The time course of the effect of testosterone on absolute refractory periods and on sexual behaviour (2)	94
5.3.1	Method	94
5.3.2	Results and Discussion	95

CHAPTER 6: Discussion of Results 99

APPENDIX 104

APPENDIX SECTION 1 (Experiments 1 and 2)..... 135

APPENDIX SECTION 3 (Experiment 3) 154

APPENDIX SECTION 3 (Experiment 4) 162

BIBLIOGRAPHY 174

CHAPTER 1

A REVIEW OF THE EFFECTS OF SEX HORMONES ON THE ELECTRICAL ACTIVITY OF SINGLE NEURONES.

1.1 Introduction.

Selective areas in the central nervous system take up and concentrate radioactively labelled steroid hormones in a number of species (see review by McEwen et al, 1972, 1974 for instance). This fact and the finding that hormone implants at specific brain sites can change behaviour (Lisk, 1962; Harris and Michael, 1964; Davidson, 1966), has stimulated investigations on the effect of steroid hormones on the activity of the brain.

The ensuing review of these studies is confined to the effects of sex steroid hormones on single neurones. The concentration on single neurone studies is prompted by the knowledge that most of the neuronal structures examined (particularly the hypothalamus) do not show homogeneous firing frequencies (Lincoln, 1967 for instance). This lack of homogeneity renders the direct interpretation of EEG and multiple unit studies difficult.

A discussion at the end of the review attempts to summarise some of the pitfalls of research in this field.

1.2 The effects of sex steroids on neuronal activity.

Oestrogens alone, or in combination with progesterone, stimulate full sexual behaviour in most female mammals (reviewed by Lisk, 1978). Similarly, testosterone reinstates full sexual behaviour in male mammals (reviewed in Beach, 1961; Young, 1961). Specific brain sites take up and concentrate oestradiol (Pfaff and Keiner, 1973), testosterone (Pfaff, 1968; Sar and Stumpf, 1973 a, b) and progesterone (Wade and Feder, 1972; Wade, Harding and Feder, 1973; Sar and Stumpf, 1973c), and implants of these hormones in the brain stimulate sexual behaviour (oestradiol: Lisk, 1962; Harris and Michael, 1964; testosterone: Davidson, 1966; progesterone: Morin and Feder, 1974).

A series of studies report attempts to measure direct effects of these



hormones on the electrical activity of single neurones.

1.2.1 Changes in the electrical activity of single neurones during the oestrous cycle.

In the rat, oestradiol and progesterone levels increase during prooestrus. Oestradiol levels begin to rise late on the day of dioestrus II and peak during the early part of prooestrus (Yoshinaga, Hawkins and Stocker, 1969; Naftolin, Brown-Grant and Corker, 1972). Approximately 12 hrs after plasma oestradiol levels rise to their peak, a surge of luteinizing hormone is seen (Naftolin et al, 1972). Within several hours of the luteinizing hormone surge, plasma progesterone levels also increase (Schneider, Piacsek and Gay, 1970). Onset of heat occurs on the evening of prooestrus, several hours after the increased plasma levels of progesterone (Feder, Resko and Goy, 1968). Ovulation occurs some 10 - 14 hrs after the luteinizing hormone surge (Schwartz, 1972).

In the female rat, increases in the spontaneous firing rates of single neurones have been found in a number of structures during prooestrus. They have most consistently been found in the medial preoptic/anterior hypothalamus (Cross and Dyer, 1970, 1972; Moss and Law, 1971; Dyer, Pritchett and Cross, 1972; Dyer, 1973; Wuttke, 1974; Kubo, Gorski and Kawakami, 1975: for an exception see Kelly, Moss and Dudley, 1976), and in the arcuate nucleus (Yagi and Sawaki, 1971; Kubo, Gorski and Kawakami, 1975). The effect in the medial preoptic/anterior hypothalamus is primarily localised in its more ventral region (Dyer, Pritchett and Cross, 1972). That these firing rate changes in the medial preoptic/anterior hypothalamus are due to direct hormonal influences on this area, as opposed to indirect ones produced by other structures which project to it, has been shown by work using hypothalamic islands. Cross and Dyer (1970, 1972) used the diencephalic island preparation developed by Cross and Kitay (1967). This technique involves aspirating the whole of the forebrain apart from a column including all the hypothalamus

and a portion of medial thalamus. Under these conditions where all extra-hypothalamic inputs to the medial preoptic/anterior hypothalamic area are destroyed Cross and Dyer still found spontaneous firing rate increases in the neurones of this area during prooestrus.

Increased spontaneous firing rates of single neurones during prooestrus have also been found in the medial and lateral septal areas by Kubo, Gorski and Kawakami (1975); however, in a previous study, Moss and Law (1971) found no such effect in the lateral septum. Moss and Law (1971) also found increased spontaneous firing rates in cingulate cortex neurones during metoestrus/dioestrus.

Dyer (1973) showed that those neurones in the medial preoptic/anterior hypothalamus which increased their spontaneous firing rate during prooestrus were not those which sent direct projections to the region of the mediobasal hypothalamus. Consequently, it is unlikely that such neurones are involved in the control of luteinizing hormone (LH) release and ovulation. There is further evidence for this belief. Urethane anaesthesia blocks ovulation in 50% of female rats (Lincoln and Kelly, 1972; Blake and Sawyer, 1972). This number is further increased by subjecting the rats to single unit recording procedures (Dyer, Pritchett and Cross, 1972). Thus the increased firing rates observed at prooestrus occurred even when ovulation was unlikely to take place.

Some studies have looked for other changes in neuronal activity during the oestrous cycle. Kawakami and Sakuma (1974) found that those preoptic area neurones which do project to the mediobasal hypothalamus (arcuate nucleus and median eminence) in the female rat are more responsive to iontophoretically applied LH on the day of prooestrus (units showed increased firing rates to LH). Similarly, arcuate nucleus neurones which projected to the median eminence were more responsive to luteinizing hormone releasing factor (LH-RF) and LH during prooestrus (mainly due to an increase in the number of inhibitory responses). Both these findings were in comparison with

neuronal activity during dioestrus I.

Kawakami, Sakuma and Akema (1978) recorded antidromic responses from mediobasal hypothalamic neurones (mostly the arcuate nucleus) after stimulation of the median eminence in the female rat. Two different types of antidromic response were recognised. In 83 out of 97 responses, repetitive shocks to the median eminence at 20 - 40 Hz induced a fractionation of the antidromically-driven action potentials into two components (A and B). In the remaining neurones, the antidromically stimulated action potentials were stable at high frequency stimulation. Threshold stimulation current tended to be higher during prooestrus than during dioestrus I for both types of response. However, in the fractionating unit group, it was observed that conditioning shocks to the median eminence were effective in decreasing the stimulus threshold for successive test pulses at prooestrus, but that this effect did not occur at dioestrus I. This result suggests the possibility that fluctuating hormone levels during prooestrus may alter the membrane properties of mediobasal hypothalamic neurones.

Kubo, Gorski and Kawakami (1975) observed that the threshold current required to stimulate increased activity of single neurones in the arcuate nucleus of the female rat was lowest during prooestrus and highest during dioestrus I. They further found that neurones in the medial preoptic area were inhibited by dorsal hippocampal stimulation at low currents during prooestrus and oestrus, while even high currents failed to have any effect during dioestrus I and II. Similarly, the spontaneous firing rates of neurones in the periventricular and dorsal parts of the arcuate nucleus were inhibited by stimulation of the dorsal hippocampus during prooestrus and oestrus, while neurones located ventrolaterally responded with an increase in firing rate. No such changes were observed during dioestrus I and II.

A further aim of research has been to investigate the effects of sensory stimulation (particularly vaginal stimulation) on neuronal activity

in the central nervous system. Much of this work has employed multiple unit recording techniques.

During the prooestrus/oestrus phases of the oestrous cycle, discharge patterns of neurones in the arcuate nucleus and lateral hypothalamus are facilitated in response to vaginal stimulation while neurones in the remaining mediobasal hypothalamus and along the midline of the anterior hypothalamic area decrease in discharge rate (Kawakami and Saito, 1967; Ramirez, Komisaruk, Whitmoyer and Sawyer, 1967; Zolovick and Eleftheriou, 1971). Such responses are, however, usually correlated with changes in EEG and therefore their specificity is questionable.

All the above findings, while difficult to interpret functionally, do suggest that sex hormones may have direct effects on the electrical activity of single neurones in the central nervous system. Changes almost invariably seem to occur during prooestrus. However, oestradiol (Yoshinaga et al, 1970), progesterone (Schneider et al, 1970) and corticosterone (Critchlow, Liebelt, Bar-Sela, Mountcastle and Lipscomb, 1963) levels all reach their peak during prooestrus. We now turn to studies using exogenous hormones.

1.2.2 The effects of oestrogens on neuronal activity.

Lincoln (1967) reported that neurones in the preoptic area of the urethaneanaesthetised female rat showed 22% more activity in animals which were ovariectomised than in those which were ovariectomised but had received 10µg oestradiol benzoate injections for 3 days after the operation. The same difference was found in the anterior hypothalamus and lateral septum. A difference in the opposite direction was found for the lateral hypothalamus. Thus oestradiol treatment appeared to suppress firing rates in the medial preoptic/anterior hypothalamus/lateral septal areas and increase them in the lateral hypothalamus.

Bueno & Pfaff (1976), also found that oestradiol (benzoate, 10µg/day for 10 days or more) changed spontaneous firing rates in ovariectomised female

rats. They, however, also found more cells were detected in untreated than treated rats in the bed nucleus of the stria terminalis and medial preoptic area. In the basomedial hypothalamus (a combination of the arcuate, ventromedial and dorsomedial nuclei) the opposite was the case. No overall difference in firing rates was found between the treatment groups, but in the bed nucleus of the stria terminalis and the medial preoptic area there were significantly fewer neurones in the lowest firing rate category in oestradiol treated rats. Again, in the basomedial hypothalamus, the opposite was the case - oestradiol increased the number of lowest frequency cells. Beuno and Pfaff proposed that oestradiol treatment suppressed the firing rate of their lowest frequency category cells to a point at which they were firing too slowly to be reliably sampled. Oestradiol, however, seemed to be facilitating the firing of these low frequency cells in the basomedial hypothalamus, thereby bringing more of them into the recorded sample.

Beuno and Pfaff's results differ from those of Lincoln in that he found an overall decrease in the mean firing rate of preoptic/anterior hypothalamic neurones after oestrogen treatment, whereas they did not.

Yagi (1970, 1973) examined the effects of intravenous injections of 50 μ g of 17 β -oestradiol or control injections (Locke's solution) on the firing rates of single units in urethane anaesthetised female rats. In the medial preoptic area 38% of units were initially excited by oestradiol followed by a period of long lasting depression. A further 38% of neurones responded to treatment with a long lasting depression of firing activity alone. The remaining 24% of neurones were unaffected by the oestradiol treatment. In the anterior hypothalamus 39% of neurones responded with the excitation/inhibition pattern after oestradiol treatment and the remaining 61% were unaffected. In the arcuate nucleus 19% of neurones responded with the excitation/inhibition pattern, 43% with the inhibition pattern alone and the remaining 38% were unaffected after oestradiol injections.

Mean firing rates during a period of 300 secs prior to the oestradiol injections were lower in units that were excited and then inhibited by oestradiol than in those which were just inhibited. This finding only reached significance for the arcuate nucleus however. Oestradiol treatment did not affect inter-spike intervals.

Control intravenous injections did not have an appreciable effect on unit firing rates, and therefore the observed changes in firing rates after oestradiol injections could neither have been due to the volume of liquid injected nor to Locke's solution in which the oestradiol was suspended.

As a further control for the possibility that changes in firing rates due to injection of oestradiol might have been due to non-specific causes, Yagi recorded activity from two neurones simultaneously during injection of oestradiol. He found that in 15 out of 22 pairs of units examined, one of the units responded while the other did not. This specificity of response was further emphasised by the finding that six medial preoptic neurones responding to oestradiol did not respond to another steroid (glucocorticoid).

The effect of repeated injections of 50 μ g or 400 μ g oestradiol was tested on 5 anterior hypothalamic neurones. All of these neurones responded with an increase in firing rate to each injection, though the duration of the response to 400 μ g oestradiol was longer, and the latency shorter, than for 50 μ g oestradiol injections.

Faure and Vincent (1971) recorded spontaneous single unit activity from conscious free moving rabbits in response to intravenous injections of estrone sulphate (approx 50 - 100 μ g). The firing rate of neurones in the posterolateral area of the hypothalamus slowed within 5 min of the estrone injection. This inhibition lasted for 10 - 20 min and was independent of the behavioural state of the animal.

In the ventromedial nucleus of the hypothalamus estrone injections usually accelerated firing rates for 25 - 45 mins. Again this change in

firing rates was unrelated to the behavioural state of the animal. Changes in firing rates of preoptic and dorsomedial neurones were related to EEG and therefore it seems that the action of estrone on these neurones was relatively non-specific and probably unrelated to sexual behaviour. However, firing rate changes in the posterolateral and ventromedial hypothalamus which were unrelated to EEG imply more specific estrone action, though their behavioural significance is difficult to assess.

Whitehead and Ruf (1974) investigated the action of intravenous injections of oestrogens (either 25 μ g sodium sulphate esters of oestrogen; 20 μ g Estradiol-17 β hémisuccinate or 10 - 50 μ g Estradiol-3-Benzoate) on the sensitivity of preoptic area neurones to iontophoretically applied catecholamines and glutamate in ovariectomised female rats. These oestrogens were found to have no effect on the dose response curves of preoptic neurones (antidromically identified after stimulation of the median eminence) to dopamine, norepinephrine or glutamate. However, injections with these oestrogens caused a 50 - 90% depression in the spontaneous discharge of 6 out of 10 antidromically identified preoptic neurones. In 3 of these neurones a short term depression in firing rate was observed with an average latency of 5 min and duration of 10 min after the oestrogen injection. The other 3 neurones showed a long lasting depression in firing rate with an onset latency of 10 - 30 min. In 3 of the above six units the depression effect of the oestrogens was preceded by a brief excitation. Excitatory effects of the oestrogens were also observed in 3 out of 10 preoptic units. These lasted for 10 - 20 min. Control vehicle injections produced no measurable changes in firing rates.

In essence Whitehead and Ruf's findings are in accord with those of Yagi, with the exception that Whitehead and Ruf found a group of preoptic units which responded to oestrogens in a purely excitatory manner. However Whitehead and Ruf state that this type of neuronal response to oestrogens was extremely fast and might therefore be related to changes in blood pressure.

Whitehead and Ruf suggest that oestrogens did not modify the dose-response curves of preoptic neurones to catecholamines and glutamate because they did not act directly on the neurone from which activity was being recorded but rather on a presynaptic site. As they point out, the excitatory action of glutamate and the inhibitory one of the catecholamines would be expected to change if the oestrogens were having a direct effect on the neurone itself. However, such an interpretation is still open to question since recordings were only made for 30 mins to 1h after injections and oestrogens may well have a different effect after a longer time course.

Kelly, Moss and Dudley (1976), assessed the action of oestradiol on the firing rates of preoptic/septal area neurones antidromically identified after stimulation of the median eminence. Instead of using intravenous injections however, they used an iontophoretic method of hormone administration (in ovariectomised female rats). They found that those units which were antidromically identified did not show a significant number of responses to 17 β -oestradiol hemisuccinate.

Kelly et al did find, however, variable responses of preoptic/septal units that did not project to median eminence to iontophoretically administered oestradiol across the oestrous cycle. The proportion of inhibitory responses was greatest in dioestrus II, closely followed by prooestrus and oestrus, and the smallest was during dioestrus I. Excitatory responses were greatest during dioestrus I and smallest in oestrus (dioestrus II and prooestrus were intermediate). Units that did not respond at all (the largest percentage) were found with approximately equal frequency across the cycle.

The results of Kelly et al do allow a further interpretation of those of Whitehead and Ruf. The main difference between their findings is that preoptic area neurones which do project directly to the median eminence respond to intravenous injection of oestrogens (Whitehead and Ruf), but not to iontophoretic administration (Kelly et al). This supports the hypothesis

put forward by Whitehead and Ruf that oestrogens operate at a site other than the cell membrane of the preoptic neurones since direct application of oestradiol onto the cell has no effect (Kelly et al). The exact site of action of the intravenously injected oestrogens still remains to be elucidated.

Another measure of the effects of oestrogens on neuronal activity in the central nervous system is the stimulation threshold. Kubo, Gorski and Kawakami (1975) observed that the threshold current for stimulating increased firing of neurones in the arcuate nucleus from the medial preoptic area was lower in ovariectomised, oestradiol benzoate primed female rats (10 μ g daily for 2 days) than in ovariectomised control rats (above 180 μ a in ovariectomised controls and between 40 - 60 μ a in oestradiol primed rats). Kubo et al also plotted the time course of the oestradiol effect using single 20 μ g subcutaneous injections of oestradiol benzoate. They found that the minimum threshold for preoptic stimulation of increased arcuate nucleus activity occurred at around 3.5 h after the oestradiol injection.

Kubo et al's time course measurement for the latency of their recorded oestradiol effect is the longest found in any experiments to date - though it should be added that they used subcutaneous injections rather than intravenous or iontophoretic administration of the hormone, thereby increasing the uptake time. It is known that ovariectomy causes an increase in plasma LH (Kalra, Fawcett, Krulich and McCann 1973 - for instance) and that single injections of oestradiol benzoate (particularly 1 μ g or more) bring about a marked reduction in this rise within 24 h. This negative feedback action of oestradiol on LH levels may well be reflected in the results of Kubo et al, in that they found an increased sensitivity of arcuate neurones to stimulation of the preoptic area within a short period after a single oestradiol injection.

Kawakami, Sakuma and Akema (1978) found, in addition to their results reported in the previous section, that thresholds for the antidromic stimulation of mediobasal hypothalamic units from the median eminence were decreased in

ovariectomised rats treated with oestradiol (10 μ g oestradiol benzoate for 2 days) when compared to untreated ovariectomised controls. However, they did not find a threshold decreasing effect to a test pulse following a conditioning pulse (previously described) after oestradiol treatment.

The functional significance of Kawakami, Sakuma and Akema's results is difficult to determine. While the units they have investigated may well be involved in the feedback actions of oestradiol on gonadotrophins it is difficult to go beyond this statement.

Other experiments have investigated the ways that treatment with oestrogens changes the responses of single neurones to sensory stimuli. The main aim of these studies was to examine the responses of neurones implicated in the control of the lordosis reflex. Since lordosis behaviour is generally only present at oestrus, and oestradiol can restore it in the ovariectomised animal (alone or in combination with progesterone), it was naturally assumed that oestradiol might change the activity of neurones responding to the types of sensory stimulation which occur during mating.

An early study by Barraclough and Cross (1963) showed that the proportion of neurones in the hypothalamus and other diencephalic regions excited by smell (ethyl acetate and cajuput) in the prooestrus rat was more than double that found in the oestrus and dioestrus rat. Oestrus rats had relatively more neurones which were unresponsive or inhibited by cold, pain, probing of the cervix, light and noise. Lincoln and Cross (1967) reported different effects of oestradiol on the responsiveness of hypothalamic and septal neurones. Oestradiol increased the proportion of inhibitory responses to pain, cold and cervical stimuli in the anterior hypothalamus, whereas in the septum the number of inhibitory responses was reduced. Both the above studies are difficult to interpret in terms of the direct action of hormones on the specified neurones. Most of Lincoln and Cross's recorded unit changes were correlated with EEG changes. Barraclough and Cross did not record EEG. It is

likely therefore that the alterations in unit firing observed by Lincoln and Cross were the results of non-specific arousal and not the direct action of the hormone. Consequently, since Barraclough & Cross did not record EEG changes simultaneous with unit firing their results may also have been due to non-specific arousal effects.

Bueno & Pfaff (1976) recorded the spontaneous firing rates of single units, in response to sensory stimulation. These authors used various somatosensory stimuli shown to be important in eliciting the lordosis response, and a pain stimulus. The percentage of single units responding to somatosensory stimuli was low. In the nucleus of the stria terminalis and the medial preoptic area there were significantly fewer units responding to somatosensory stimuli in ovariectomised rats treated with oestradiol (10 μ g/day for 10 or more days) than in untreated controls. In the medial anterior hypothalamus and in the basomedial hypothalamus those differences in responsiveness which were statistically significant were in the opposite direction. (Oestradiol treated animals tended to have a greater number of responsive units). A few responses to pain stimuli were observed; all of these were excitatory and there were no differences between treated and untreated rats.

Since Bueno & Pfaff used systemic administration of oestradiol in their experiments the effects observed (as they point out) could be due to either direct or indirect effects of the hormone.

The findings of the above experiments on the effects of oestrogens on neuronal activity are extremely difficult to interpret functionally. Those neurones which respond to oestrogens without corresponding changes in EEG or blood pressure appear to be predominantly inhibited by the hormone. They generally respond to the hormone quickly and only for a short time. Since, in the normal cycling female rat, peak oestradiol levels occur 12 hrs before the prooestrus luteinizing hormone surge which stimulates ovulation, it is difficult to relate such changes in neuronal activity to

the positive feedback action of oestrogens on luteinizing hormone release. Further problems of interpretation arise from the fact that many studies have not identified the afferents/efferents of those neurones whose hormone-sensitivity is being tested.

The sensitivity of hypothalamic neurones to somatosensory stimulation appears to be affected by oestrogens, but once again it is difficult to distinguish direct from indirect, and specific from non-specific, effects of the hormone treatment.

1.2.3 The effects of oestrogens on peripheral nerve.

Komisaruk, Adler and Hutchison (1972) and Kow and Pfaff (1973/4) have demonstrated an effect of oestradiol on the pudendal nerve of female rats in response to stimulation of the genital area.

Both Komisaruk, Adler and Hutchison (1972) and Kow and Pfaff (1973/4) used ovariectomised rats and compared animals given sufficient oestradiol to induce the lordosis response with controls. Both studies used manual stimulation of the perineal area (either using a brush - von Frey technique - or scratching the skin surface with a dissecting needle) while recording from the pudendal nerve. The male has been shown to touch this area of skin during copulation (Pfaff, 1970, 1971), and the lordosis reflex can be readily evoked in the oestrus female by manual stimulation of this region and abolished by its local anaesthetisation (Pfaff, Lewis, Diakow and Kelner, 1972). Adler, Davis and Komisaruk (1977) also found (using a staining technique where the penile region of the male was painted) that the male's penis makes contact with two areas of the female during intromission; the vaginal orifice, and an area approximately 1 cm lateral and 1 cm caudal to the vaginal orifice. These two points corresponded to the most sensitive areas of the pudendal nerve's sensory field.

The receptive field of the perineo-femoral branch of the pudendal

nerve (Kow and Pfaff, 1973/4) or the whole pudendal nerve (Komisaruk, Adler and Hutchison, 1972) was significantly increased by oestradiol, though both sets of authors found a large range of individual field sizes, causing considerable overlap between groups. This oestradiol effect only occurred for phasic pudendal nerve responses to stimulation (that is a vigorous short duration response to stimulation) as opposed to tonic ones (that is long duration responses to stimulation). Adler, Davis and Komisaruk (1977) have also found that the sensory field of the pudendal nerve was significantly larger in oestrus than in dioestrus rats.

The shapes and dimensions of the pudendal nerve sensory fields were not significantly altered by transection of the nerve, so the effect of oestradiol does not appear to be mediated by centrifugal influences. However, a centrifugal effect mediated by the autonomic system is still possible. The site of oestradiol action may well be the hair receptors, since Kow and Pfaff (1973/4) report that depilation abolishes the observed increases in receptive field sizes. However, it has not yet been shown whether the effect of oestradiol on somatosensory input, recorded peripherally, is generated peripherally or centrally.

Bereiter and Barker (1975) have recorded the effects of oestradiol on single fibres of the trigeminal nerve in response to mechanical stimulation of the face. The receptive fields for oestradiol treated rats were considerably larger than in untreated controls. Thus, the effects of oestradiol on tactile sensitivity do not seem to be restricted to the genital region, and it is possible that oestradiol treatment may increase the sensitivity of a variety of parts of the body.

The precise mechanisms by which oestradiol produces these effects are yet to be fully elucidated. For instance, as Bereiter and Barker suggest, it is possible that cutaneous sensitivity is indirectly altered by changes in the autonomic innervation of the skin and cutaneous vasculature induced

by oestradiol treatment. Further, Bereiter and Barker (1975) noticed changes in skin properties following oestradiol treatment and hypothesise that it alters viscoelastic properties of the skin so that a given mechanical displacement is transmitted over a larger area.

As a general conclusion therefore, the above studies do indicate important peripheral effects of oestradiol which may well be of behavioural significance, particularly for the female's adopting the correct posture to enable a successful intromission on the part of the male. However, the site of oestradiol action may be in the skin itself and one cannot be sure that these studies have shown a direct action of an oestrogen on nerve.

1.2.4 The effects of progesterone on neuronal activity.

Attempts to demonstrate direct effects of progesterone on single neurones in the central nervous system have been unrewarding. Experiments by Barraclough and Cross (1963), Komisaruk, McDonald, Whitmoyer and Sawyer (1967), Ramirez, Komisaruk, Whitmoyer and Sawyer (1967) and Lincoln (1969), which have reported inhibitory effects of progesterone on hypothalamic single units (whether for unit firing rates per se, or for unit responses to various forms of sensory stimulation) are difficult to interpret in terms of a direct action of the hormone. Where EEG or blood pressure changes were measured, changes in neuronal firing rates were mostly correlated with changes in them. Thus results could have been due to non-specific arousal effects.

A more recent study by Nakayama and Suzuki (1975) on female rabbits reported that intramuscular or intravenous injections of progesterone altered the firing rates of thermosensitive neurones in the preoptic area. These authors implanted a thermode in the preoptic area and measured the responses of preoptic neurones to locally applied warm and cold stimuli. Progesterone increased the firing rates of cold sensitive neurones and decreased those of warm sensitive neurones. Nakayama and Suzuki suggest that this effect of progesterone may underly the 0.5 °C rise in body temperature of the female

animal at or near ovulation and the sustained elevation of basal body temperature observed during early pregnancy. However, it is possible that the neuronal effect of progesterone observed by these authors may again be due to non-specific effects of the hormone, particularly since they did not make control EEG recordings.

1.2.5 The effects of combined oestrogens and progesterone on neuronal activity.

Although progesterone is known to synergise with oestrogens in reinstating sexual behaviour in the ovariectomised female rat (Boling and Blandau, 1939; Beach, 1942 and Whalen and Hardy, 1970), no neuronal manifestation of this synergism has been found. The only indirect evidence comes from Kawakami and Sawyer (1959). They found that oestrogens lowered the threshold of electrical stimulation of the preoptic/anterior hypothalamus necessary for the induction of paradoxical sleep in the rabbit. This reduction was accentuated by additional progesterone treatment.

1.2.6 The effects of testosterone on neuronal activity.

Very little work has been carried out on the neuronal effects of testosterone in the male. All the relevant work has used the rat.

Pfaff and his associates have examined the effects of testosterone on olfactory inputs to the hypothalamus. Olfactory information is important, though not indispensable in the control of sexual behaviour in the male rat. Heimer and Larsson (1967) found that lesions of the olfactory bulbs caused marked impairment of the sexual behaviour of male rats. It is known that the olfactory and accessory olfactory bulbs send projections to the medial preoptic/anterior hypothalamus (which is of major importance to the control of male sexual behaviour) via the amygdala (Lammers, 1972; de Olmos, 1972) and the hippocampus.

Pfaff and Pfaffman (1969a) found that some preoptic area neurones responded to electrical stimulation of the olfactory bulb in castrated male rats. Many neurones also responded to odours (amyl acetate or receptive female urine).

Olfactory bulb transection abolished preoptic units responses to

these odours, so it is unlikely that they were mediated by the trigeminal nerve. Neurons in the midbrain reticular formation also showed responses to odours, though these were more often correlated with changes in EEG than responses from the preoptic area or olfactory bulb. Responses to odours were generally excitatory, though inhibitory responses were also recorded.

Pfaff and Pfaffman tested the sensitivity of units which were sensitive to either olfactory bulb stimulation or to odours to intracerebral or systemic testosterone administration.

Application of testosterone (30 μ g) to the preoptic area increased the responses of preoptic units to both olfactory bulb stimulation and odours by 30 - 100%. Changes in unit activity began within 5 - 15 min and lasted until 25 - 50 min after testosterone administration. Control administration of saline or cholesterol had no measurable effect.

Intraperitoneal injections of testosterone (600 - 1000 μ g testosterone propionate) also increased the responsiveness of preoptic units to odours. The effects began within 5 - 15 min and lasted until 45 - 85 min after the injection. Systemic administration of testosterone caused not only changes in response magnitude but also reversals in response direction (i.e. from an excitatory response to an inhibitory one or vice versa).

Systemic testosterone administration also changed the responsiveness of olfactory bulb and midbrain reticular formation units.

Pfaff & Gregory (1971) and Pfaff & Pfaffman (1969b) found that many preoptic area units responded differently to oestrus female urine and ovariectomised female urine, while only few olfactory bulb units did. The opposite was the case for different responses to other odours. In agreement with the results of Pfaff & Pfaffman (1969a) however these differential responses did not seem to be androgen sensitive, since castration (or testosterone treatment - Pfaff & Pfaffman, 1969a) did not alter them in any way.

Pfaff & Gregory (1971), comparing castrated and intact male rats,

found that the proportion of odour sensitive preoptic units showing a significant correlation with EEG was larger in normal male rats than in castrated ones. No such difference was found for olfactory bulb units. Preoptic units which showed correlations with EEG increased activity significantly during EEG activation. Altogether 37% of preoptic units showed EEG correlation in castrated male rats whereas 70% showed similar correlations in intact males.

Preoptic units whose activity was related to EEG tended to change firing rate slightly before the EEG changed from desynchrony to synchrony but not before EEG changed back from synchrony to desynchrony. Thus it is possible that androgens might be facilitating some preoptic units' ability to trigger arousal while facilitating the responses of others to arousal.

These electrophysiological results of Pfaff and co-workers agree with behavioural work on the reactions of male rats to female rat odours. The preference of male rats for female urine odours, as measured by the time spent investigating these odours, appears to be androgen sensitive (Carr et al, 1965, 1966; Pfaff & Pfaffman 1969b). The detection and discrimination of female urine odours is not androgen sensitive however (Carr & Caul, 1962; Carr, Solberg & Pfaffman, 1962).

The work of Pfaff and co-workers does indicate, quite elegantly, androgen modulation of sensory information which is important for sexual behaviour to occur in the male rat. However, it is difficult to conclude from their work whether the effects of testosterone on unit activity are the result of direct or indirect influences of the hormone.

The most important problem with the results of Pfaff and his co-workers is the short time course of the testosterone mediated effects in castrated rats. Changes in unit activity after testosterone administration began within 5 - 15 min and lasted for 25 - 50 min. Testosterone treatment has to be continued for a matter of days before sexual behaviour is restored in the castrated male rat, hence the effects of testosterone administration

reported by Pfaff would not appear to be related to the restoration of sexual behaviour. Consequently, the exact functional significance of these findings has yet to be explained.

1.2.7 Neuronal effects of androgens on the peripheral nervous system.

Although Hart (1967) and Hart & Haugen (1968) have shown that testosterone can effect genital reflexes in spinally transected animals, no electrophysiological effects of testosterone on the peripheral nervous system have been recorded. Cooper & Aronson (1974) determined the effects of androgens on penile mechanoreceptor activity and sensitivity in the cat. They recorded first-order afferent responses, evoked by quantified tactile stimulation of the penis, from sexually experienced intact and castrated animals. Results however indicated that testicular androgens played no role in maintaining genital sensory fields, sensory thresholds, initiation of neural responses, conduction velocity, or amount of neural activity evoked by a particular stimulus. However, under some stimulus conditions, mean neural responses and intragroup variability were greater in the castrated group.

1.3 General Discussion.

Oestrogens, progesterone and testosterone clearly alter the activity of single neurones. What is still in question at present is (1) the specificity of these observed hormonal effects and (2) their behavioural significance.

(1) Many experiments cited in this review have reported that changes in single unit activity after sex hormone administration were correlated with EEG changes from synchrony to desynchrony or vice versa. Other experiments have reported similar correlations between sex hormone effects on single unit activity and changes in blood pressure. Still more experiments have not controlled for these possibilities. In all these cases, therefore, the specificity of sex hormone effects are questionable.

(2) In few experiments have the afferents and efferents of those neurones whose hormone sensitivity was being tested been identified. Without information of this kind it is difficult to determine the function of any observed effects. A further problem which has hampered interpretation of sex hormone effects on single neurones is that the latencies and durations of neuronal changes have sometimes fallen far short of the known time courses of the hormone-sensitive changes which regulate sexual behaviour. Other studies have not measured the time courses of their effects.

In view of these problems the following principles would appear to be important in this line of research:-

- (a) It helps to know the afferents and efferents of neurones in which sex hormone effects are being tested.
- (b) The time course of observed neuronal effects of sex hormones should be measured.
- (c) Adequate controls for the specificity of sex hormone effects on single neurones should be used.

CHAPTER 2

ELECTROPHYSIOLOGICAL EFFECTS OF CASTRATION ON CORTICOMEDIAL AMYGDALA NEURONES.

2.1 Introduction.

Sexual behaviour in the male rat is dependent on the presence of testosterone (reviewed in Beach, 1961; Young, 1961). Discrete sites in the brain take up and concentrate radioactively labelled testosterone (Sar and Stumpf, 1973 a,b). Implants of testosterone in the hypothalamus, and the medial preoptic area, of the castrated male rat restore sexual behaviour even though the accessory sex organs are atrophied (Davidson, 1966). Electrical stimulation of the medial preoptic area increases sexual activity in the intact male rat (Van Dis and Larsson, 1971; Malsbury, 1971; Merari and Ginton, 1975), and restores sexual interest, and to some extent copulatory performance, in the castrated male rat (Van Dis and Larsson, 1971). Lesions of the medial preoptic/anterior hypothalamus (particularly the junction of the two structures) severely impair, or completely abolish, sexual behaviour in the intact male rat (Heimer and Larsson, 1966/67). These findings implicate the medial preoptic/anterior hypothalamus in the control of sexual behaviour in the male rat.

A major source of olfactory efferents to the medial preoptic/anterior hypothalamus comes via the corticomedial amygdala, which takes up and concentrates radioactively labelled testosterone (Sar and Stumpf, 1973 a,b). The corticomedial amygdala receives projections from the olfactory and accessory olfactory bulbs (Lammers, 1972) and projects in turn to the medial preoptic/anterior hypothalamus via the stria terminalis (de Olmos, 1972). Lesions of the olfactory bulb (Heimer and Larsson, 1967; Larsson, 1971), corticomedial amygdala (Harris and Sachs, 1975) and stria terminalis (Giantonio, Lund and Gerall, 1970; Emery and Sachs, 1976) impair the timing and latency of sexual behaviour. Lesions of the bed nucleus of the stria terminalis (Emery and Sachs, 1976) and corticomedial amygdala (Harris and

Sachs, 1975) also impair the achievement of ejaculation. These findings suggest that olfactory information relayed to the medial preoptic/anterior hypothalamus via the corticomedia amygdala and thence the stria terminalis, is important in the control of sexual behaviour in the male rat.

Pfaff and Pfaffman (1969a) (reviewed in Chapter 1) have shown that direct odour stimulation, or electrical stimulation of the olfactory bulb, affects the activity of neurones in the preoptic area of castrated and intact male rats. Systemic administration of testosterone, or its direct application to the preoptic area, increases the sensitivity of preoptic neurones to odour stimulation in the castrated male rat. Increased sensitivity of olfactory bulb and midbrain reticular formation neurones was also observed after systemic testosterone administration. The effect of castration on odour sensitive preoptic area neurones was slight however, except that castration appeared to bring about a reduction in the number of odour sensitive neurones whose increased activity was correlated with changes in arousal (i.e. correlated with EEG changes).

The first experiment reported in this Chapter was designed to test whether gonadal hormones affect the electrophysiological characteristics of corticomedia amygdala neurones identified as projecting to the medial preoptic/anterior hypothalamic junction, since the many studies reviewed above appear to implicate this pathway in the control of sexual behaviour.

2.2 Experiment 1: The effects of castration on the electrical activity of corticomedia amygdala neurones which project to the medial preoptic/anterior hypothalamic junction.

Throughout this experiment the corticomedia amygdala will be referred to as the CMA and the medial preoptic/anterior hypothalamic junction as the MPH, and the stria terminalis as ST.

2.2.1 Method.

Thirty-two, adult male, sexually naive, Porton albino Wistar rats

(approximately 120 days of age; 400 - 600g) were maintained on a 12 hr reversed light-dark schedule. These rats were divided randomly into two groups. One group, designated 'intact' (16 rats) were gonadally intact, whereas the second group, designated 'castrate' (16 rats) were castrated under ether anaesthesia at least 8 weeks prior to electrophysiological recording. Male rats do not usually show any signs of copulatory activity 8 weeks after castration.

At the time of electrophysiological recording rats were at least 180 days of age and weighed between 400 and 675g.

Preparation of experimental animals for electrophysiological recording.

(1) ANAESTHESIA - animals were anaesthetised with urethane (ethyl carbamate, given as a 25% w/v solution). A dose of between 1.3 and 1.4 g/kg was administered by intraperitoneal injection. Animals were usually deeply anaesthetised within 30 min of these urethane injections, and no subsequent injections were required during the experiments themselves. Deep anaesthesia was confirmed before proceeding with surgical preparations by testing the hind limb withdrawal reflex to a sharp manual pinch, and the corneal reflex by blowing onto the surface of the eye.

(2) SURGICAL PREPARATION - animals were mounted in a conventional stereotaxic frame (David Kopf Instruments). The incisor bar was set to correspond to the coordinates of König & Klippel (1963). An incision was made in the skin over the skull, and the skin was reflected and removed with scissors to expose the temporal ridges. The membrane overlying the skull was then reflected and removed with fine scissors. The exposed skull was then bathed in a small amount of 70% alcohol, and allowed to dry in order to accentuate the landmarks on the surface of the skull (bregma and lambda). A line was cut into the skull with a scalpel, parallel to the most posterior part of bregma. A small amount of pontamine sky blue dye was placed into the groove made by the scalpel using a microsyringe. This technique provided a permanent, easily

recognised, reference point for bregma throughout each experiment.

Usually, a pear shaped flap of skull, stretching between lambda and about 2 mm anterior to bregma was removed using a dental drill and forceps (the thin end of the pear shaped flap being at the bregma end to avoid the total destruction of the bregma reference line). Care was taken not to damage the surface of the brain during drilling. The dura was then lifted and incised on both sides of the midline. This bilateral incision of the dura allowed the sagittal sinus to be tied off and cut using fine forceps and surgical thread. Fine curved forceps were used to pass a loop of surgical thread through the dural incision over one hemisphere, under the sagittal sinus (lying on the midline) and back out through the dural incision in the opposite hemisphere. The sagittal sinus was then tied off and cut. After this procedure was completed, the remaining dura overlying the hemisphere from which recordings were to be made was reflected, and the whole exposed brain flooded with a warm agar solution.

Electrophysiological apparatus.

(1) STIMULATING AND RECORDING ELECTRODES - monopolar stimulating electrodes were constructed from stainless steel insect pins. These were electrolytically etched in 0.1N hydrochloric acid and then insulated with 3 coats of varnish (Schenvar 31); 0.5 mm of varnish was then scraped from the tip of the electrode (under a low powered microscope) using a scalpel. The resistance of the electrode tip was normally in the region of 100 ohms.

Recording electrodes were glass micropipettes pulled in a conventional electrode puller and filled with pontamine blue (pontamine sky blue 6BX, George. T. Gurr Ltd., London) made up as a 2% solution in 0.5M sodium acetate (Hellon, 1971). Electrodes had an internal tip diameter of approximately 1 - 2 μ and resistances ranged from 10 - 20 megohms. Silver wire coated with silver chloride was used as a terminal.

(2) APPARATUS FOR STIMULATING AND RECORDING - this is shown schematically in

Figures 2.1 and 2.2. Recorded action potentials were amplified by a low noise differential AC amplifier (Grass, P15) with frequencies lower than 300 Hz and above 3 KHz filtered out. Action potentials and general electrical activity were displayed on a storage oscilloscope (Tektronix 7613) and a conventional differential oscilloscope (Bradley, Type 155 - two channel). Auditory feedback was also provided through an additional amplifier and loudspeaker system. Spontaneous action potentials were counted for 3 successive 100 sec intervals using a Schmitt trigger and 3 - 100 sec counter timers.

Constant voltage stimuli were provided from a Grass S4F single channel stimulator and stimulus isolation module (SIU4). Stimuli were converted to effectively constant current by using a 100 K Ω series resistor in the output to the stimulating electrode. A control unit was specially constructed to vary the output from the Grass stimulator. This enabled variable interval pulse pairs to be delivered, and regulated the stimulus frequency throughout the experimental session. This unit was also constructed for delayed collision tests (which will be outlined in more detail below) in that it could vary the time between a spontaneous action potential and its triggering of a stimulus pulse pair.

(3) CONTROL OF ARTIFACTS - the problem of stimulus artifact was overcome by using the circuit design shown in Figure 2.2. This system balances the stimulus artifact picked up by the recording electrode with the output from the stimulus isolation unit. This output goes from the reference point of a variable resistor between the outputs of the stimulus isolation unit to the differential input of the Grass P15 pre-amplifier. Fixed resistances were placed between the reference point on the potentiometer and the differential input of the pre-amplifier, and between the differential input of the pre-amplifier and ground. A capacitor between the differential input and the ground of the pre-amplifier was also used, though on occasion the value of this was changed. This system was effective in reducing stimulus

Schematic representation of apparatus used for electrophysiological recording.

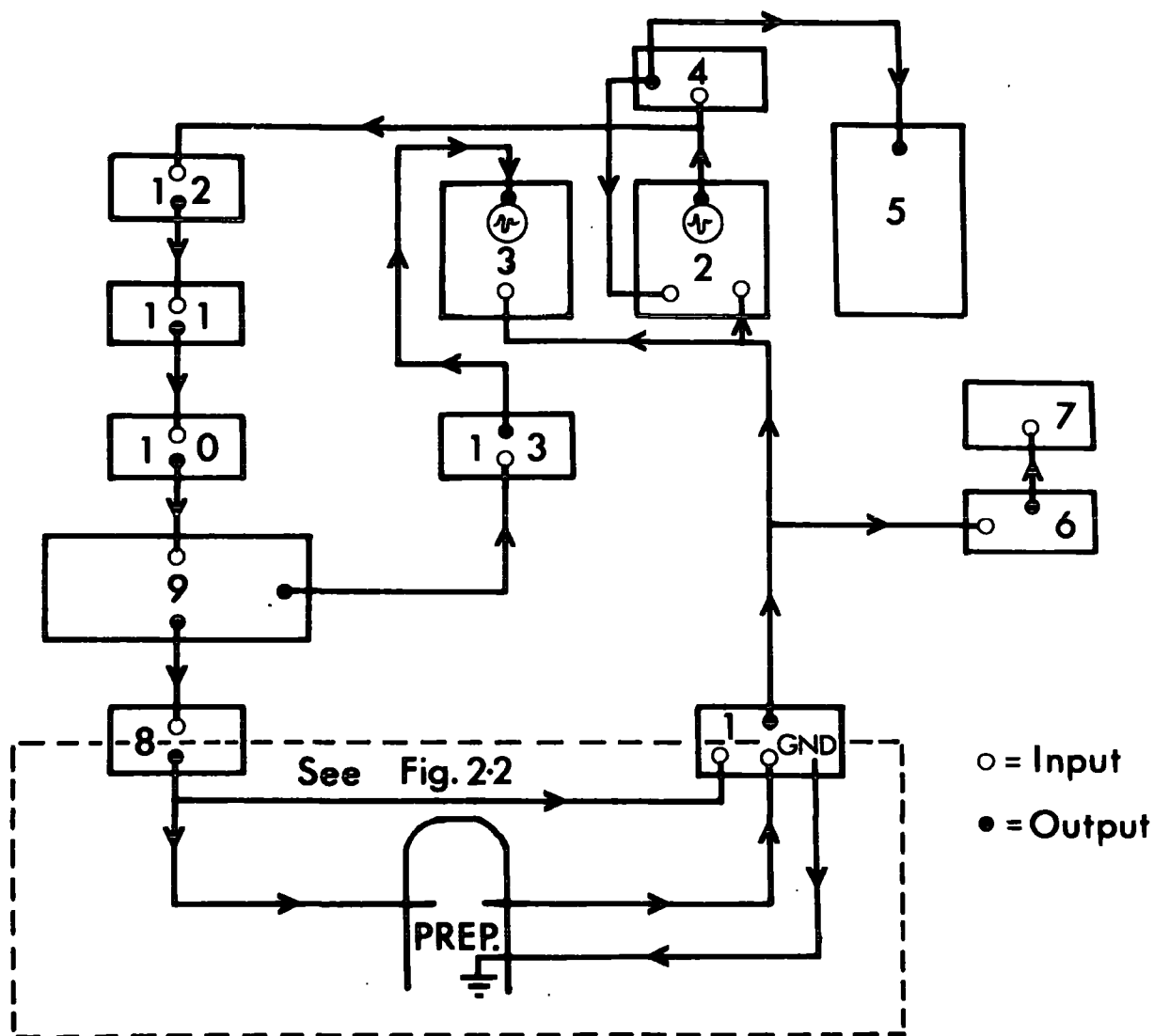

Key:

- | | |
|--|---|
| (1) Grass P15 Preamplifier | (2) Bradley Differential Oscilloscope. |
| (3) Tektronix 7613 Storage Oscilloscope. | (4) Schmitt trigger. |
| (5) 3 x 100 sec Counter Timers. | (6) Amplifier. |
| (7) Loudspeaker. | (8) Stimulus Isolation Unit (Grass SIU4). |
| (9) Stimulator (Grass S4). | |
- (10) Stimulus control unit - This controlled stimulus frequency and the production of pulse pairs for high frequency following tests and absolute refractory period measurements.
- (11) This interposed a variable delay for the delayed collision test described in the text. For normal collision tests this delay was set at zero.
- (12) A single shot Schmitt trigger for collision tests.
- (13) A variable delay interposed between the stimulus output from the Grass S4 and the automatic erase input on the Tektronix storage oscilloscope. This allowed a stimulus triggered sweep to be erased automatically just prior to the next stimulus triggered sweep.

Figure 2.2

Circuit diagram for the method employed to reduce stimulus artifact.

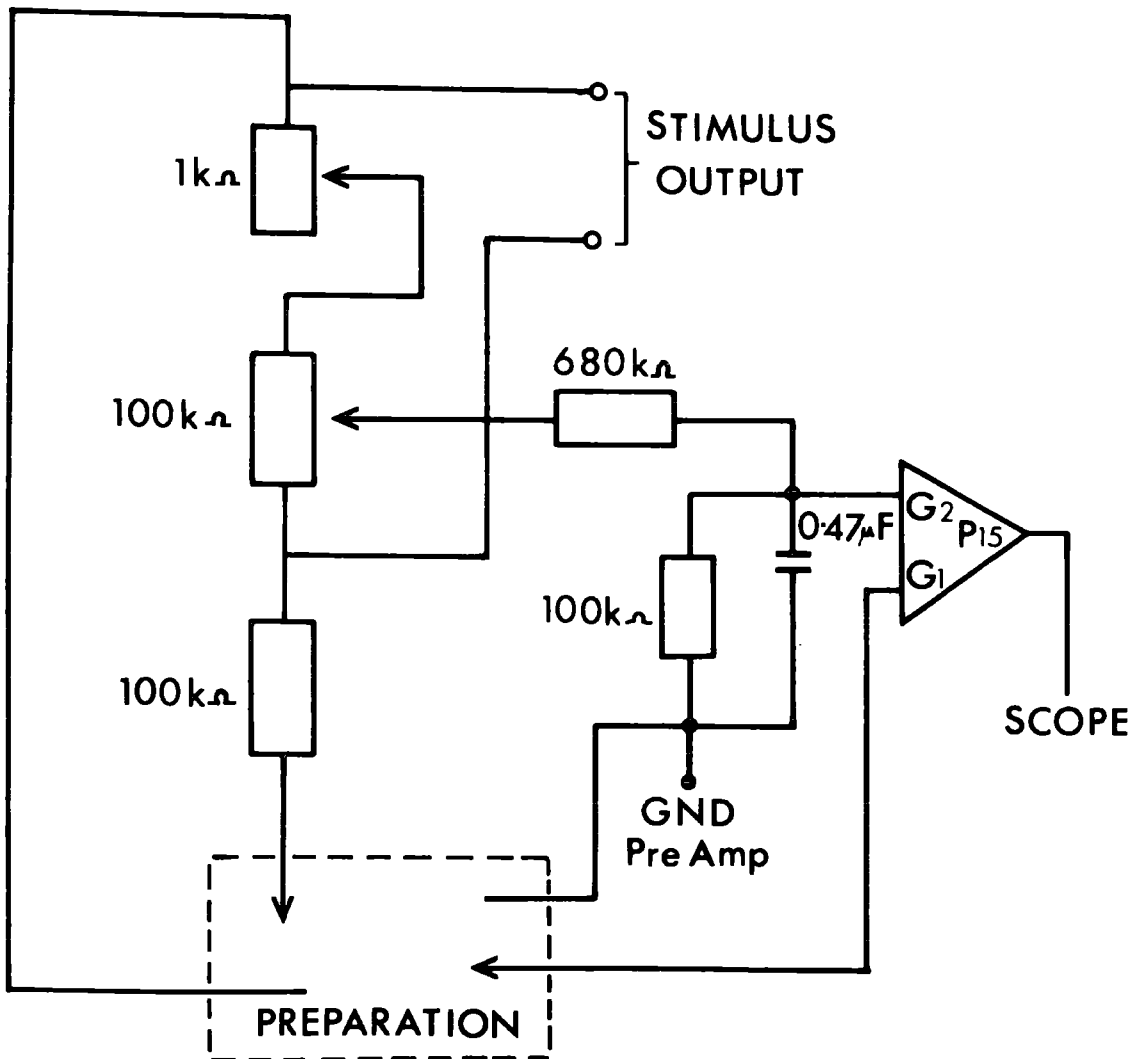

artifact to between 0.5 and 1.0 msec, and proved to be extremely reliable across preparations without incorporating unacceptably high sensitivity to minor changes in the resistance of the preparation.

The problem of mains 50 cycles interference during recordings was reduced by using a specially designed shielded electrode carrier (see Figure 2.3). Vibrational artifacts were reduced by using a table constructed of heavy paving stones separated by rubber strips. The stereotaxic apparatus was placed on the top paving stone and was thus protected from floor vibrations. The pre-amplifier and stimulus isolation unit were mounted on a frame which surrounded, but did not touch, the paving stones. Hence alterations to the pre-amplifier and stimulus isolation unit (which must of necessity be as close to the preparation as possible) could be made without upsetting recordings through sudden vibration.

Experimental design and procedure.

(1) COORDINATES - after surgical procedures, the stimulating electrode was lowered into the brain by means of a stereotaxic arm. Anterior/posterior coordinates were calculated by a combination of references to an absolute bregma zero point, and the actual position of bregma in any particular rat. This technique is similar to that reported by Whishaw et al (1977). This combination of references produced a more successful localisation than reference to either bregma or an absolute stereotaxic coordinate alone. Thus, for example, if the discrepancy between the absolute and the real position of bregma was 0.5 mm, this value was halved, and added to or subtracted from the absolute estimated position of the electrode for successfully entering the MPH, depending upon the direction of the difference. Bearing this in mind, coordinates for the MPH varied between 0.3 mm anterior and 0.7 mm posterior to an absolute zero value for bregma. Lateral coordinates were always between 0.3 and 0.5 mm from the midline. The depth of the stimulating electrode from the surface of the brain was normally around 8 mm, though this was sometimes varied between 7.6 and 8.3 mm during the experiment

Figure 2.3

Specially designed, shielded, micropipette recording
electrode holder

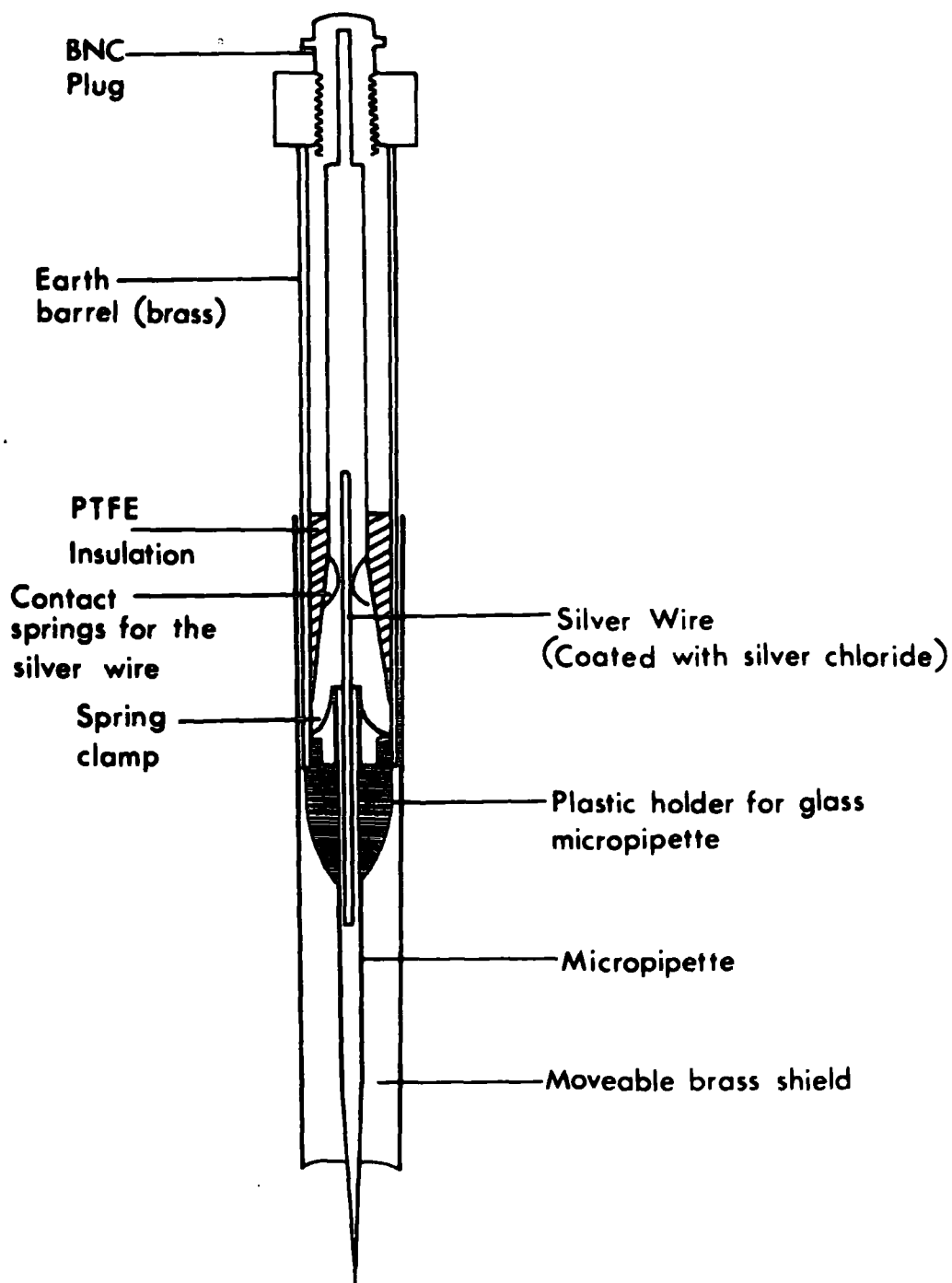

In an attempt to lower stimulus threshold currents for driving CMA neurones. Stimulating electrodes were always lowered into the brain in a vertical orientation. This vertical orientation did not disrupt the ST providing that the electrode was lowered close to the midline.

Recording electrode coordinates were calculated in the same way as stimulating electrode coordinates. The anterior/posterior extent of the CMA is large (approximately 2 mm), and location in this direction was not difficult. Coordinates ranged from 3.0 to 4.5 mm posterior to an absolute value of bregma and 2.8 to 3.8 mm lateral of the midline. The CMA was normally encountered at depths greater than 8.5 mm from the surface, though this varied to some extent, depending on the anterior/posterior and lateral positioning of the electrodes. Recordings were consequently made between 8 mm from the surface of the brain and the point at which the electrode touched the dura at the bottom of the brain. A microdrive attached to a stereotaxic arm was used to advance the recording microelectrode. Again a vertical orientation was used.

(2) STIMULUS PARAMETERS - single stimulus pulses were applied to the MPH during recording from CMA neurones at a frequency of 0.6 Hz. Each stimulus pulse triggered a stored sweep on the storage oscilloscope which was automatically erased just prior to the next stimulus pulse. Cathodal monophasic pulses of 0.5 msec duration were used, with a current range between 40 μ a and 0.6 Ma.

(3) SINGLE NEURONE RECORDINGS - single cell, extracellular recordings were made from CMA neurones. These neurones were characterised according to their responses to stimulation of the MPH, as follows:

(i) Antidromically invaded cells - these neurones responded with a fixed invariable latency to single pulse stimulation of the MPH. One stimulus pulse evoked a single action potential. In addition, they followed double pulse stimulation of threshold current at above 150 Hz (i.e. two

stimulus pulses with a separation of greater than 150 Hz consistently evoked two action potentials from the activated CMA neurone). These two criteria were used to identify a silent neurone as one projecting to the MPH.

In spontaneously active CMA neurones an additional criterion for antidromic identification was collision. A recorded spontaneous action potential was used to trigger a stimulus pulse pair, and collision was concluded if the first pulse of the stimulus pulse pair collided with the spontaneous action potential.

Occasionally a further criterion for antidromicity in spontaneously active CMA neurones was used. The delay between the recorded spontaneous action potential and its triggering of the potentially colliding stimulus pulse pair was varied. The delay at which negative collision should occur is predicted by Fuller & Schlag (1976) as:-

$$c = r + 1$$

where c = the minimum interval between a spontaneous action potential and the beginning of a stimulus which elicits an antidromic action potential.

r = the minimum interval between two stimuli of equal intensity applied at the same place, and producing two evoked action potentials, the second of which occurs 50% of the time.

1 = the interval between the beginning of a stimulus and the initiation of an evoked action potential (the stimulus being 1.2 times stronger than a threshold current which produced an evoked action potential 100% of the time).

(ii) Orthodromically activated cells - these showed variable latencies for stimulus evoked action potentials, and sometimes the response was absent. Generally these CMA neurones did not follow stimulus pulse pairs above 150 Hz but this criterion did not always reliably differentiate

orthodromic v antidromic activation. For spontaneously active CMA cells a further criterion of orthodromic activation was the absence of collision.

Although this type of cell normally responded by producing a single action potential for every stimulus pulse, a minority of cells classified in this group responded with between 2 and 6 action potentials for every stimulus pulse. The number of action potentials evoked by the stimulus was usually related to the current strength of the stimulus pulse, i.e. the higher the current, the more evoked action potentials. The latencies of this group were often very long, (50 - 100 msec) and probably indicate post inhibitory excitation. This group was treated separately from the more conventional shorter latency type of orthodromic unit described above.

(iii) Non-driven cells - these neurones were unaffected by stimulation of the MPH and as such were only detected if they were spontaneously active.

The tests for dromicity were displayed on the storage oscilloscope for all stimulus activated units. In the majority of cases photographic records of these tests were taken directly from the storage oscilloscope, using a 35 mm reflex camera loaded with cathode ray oscilloscope film (Kodak, RAR 2495). Occasionally units were lost before photographic records could be taken and in a few cases negatives were spoiled during the developing process. Photographic examples of various dromicity criteria tests are shown in Figure 2.4.

(4) ELECTROPHYSIOLOGICAL DATA - Between 1 and 6 recording tracks were made in either hemisphere, and the following data were recorded:-

(1) Spontaneous firing rates - the spontaneous firing rates of all types of cells were recorded over a period of 300 sec. Rates were taken as soon as a cell was isolated with an easily discriminable signal to noise ratio (4:1 or greater) and it was ascertained that only output from a single cell was being recorded (this was easily done by a comparison of action potential amplitudes; action potentials produced from the same cell have the same amplitude, though this amplitude will differ between cells).

Photographs of oscilloscope traces showing tests for antidromic and orthodromic stimulation of CMA neurones, and the measurement of the neuronal absolute refractory period.

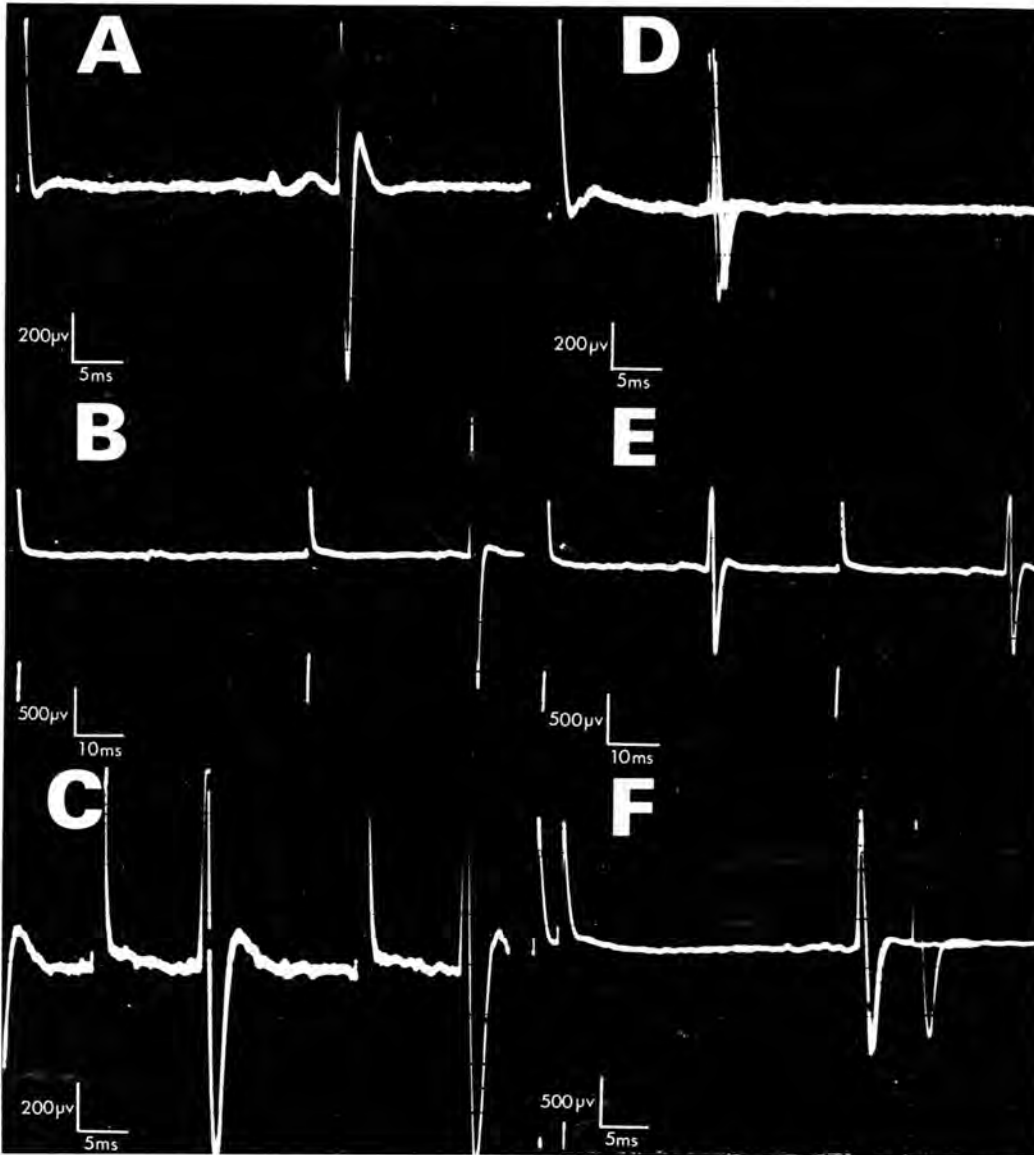

- A = 3 superimposed traces showing a constant latency response of CMA neurone to stimulation of the MPH. This indicates antidromic invasion.
- B = Collision demonstrated on an antidromically stimulated CMA neurone. The first stimulus pulse which is triggered by a spontaneous action potential collides with it and does not evoke an action potential. The second stimulus pulse evokes an action potential as normal.
- C = A delay interposed between a spontaneous action potential and its triggering of a stimulus pulse pair prevents collision (see text).
- D = 3 superimposed traces showing a variable latency response of a CMA neurone to stimulation of the MPH. This indicates orthodromic stimulation.
- E = The absence of collision. The spontaneous action potential does not collide with the first stimulus pulse which it triggers (unlike photograph B). This indicates orthodromic stimulation.
- F = Measurement of the neuronal absolute refractory period. The second stimulus pulse of two or more times threshold evokes an action potential half the time. The photograph shows two superimposed traces, the second evoked action potential occurring in only one of them.

Generally, at least 100 sec were allowed to elapse between the isolation of a unit and the recording of its spontaneous activity. Firing rates of CMA neurones were universally slow (often below 1 Hz); hence three successive 100 sec counts were used and the firing rate reduced to a 100 sec mean. Occasionally counts were only made for one or two 100 sec intervals when a unit was lost. No counts were made, however, when a recorded unit was obviously damaged - i.e. showed abnormal wave form.

(ii) Absolute refractory period - this was measured for units which satisfied the criteria for antidromicity. The method employed was essentially the same as that used by Rolls (1971). The threshold stimulus current was increased, and the interval between pulses of a stimulus pulse pair decreased, until the minimum interval which could be followed 50% of the time was reached. The current required for this was normally in the region of twice threshold (in accordance with Rolls), though occasionally as much as three times threshold current was required. The reduction of the refractory period was usually minimal with further increases above twice threshold current. A typical photograph of an oscilloscope trace illustrating the measurement of an absolute refractory period is shown in Figure 2.4.

The absolute refractory period of a CMA neurone was calculated to be the time interval between the end of the first stimulus pulse and the beginning of the second stimulus pulse of a pulse pair, at which the second evoked action potential occurred 50% of the time.

(iii) Occasionally estimations of rheobase currents and chronaxies were made. Rheobase current is the amount of current necessary to stimulate a long duration pulse. Chronaxie is the time on a constructed strength - duration curve for twice rheobase current (Ranck, 1975).

(iv) Approximate conduction velocities were also calculated for antidromically identified CMA neurones. The formula for this calculation is:-

$$\text{Conduction velocity} = \frac{\text{distance between the MPH and CMA}}{\text{Latency of evoked action potential}}$$

The distance along the ST from the CMA to the MPH was calculated to be approximately 8 mm. However, given the long looping course of the ST and the size of the CMA and MPH, this estimate is only rough.

(5) STATISTICAL TREATMENT OF DATA -

It is erroneous to treat individual neurones recorded from any particular animal as statistically independent, since all neurones recorded from a single animal must, to some degree, be dependent on the state of the animal, the electrode used and the fact that adjacent neurones on an electrode track may have similar properties. Consequently, for any particular rat, the latencies, chronaxies and the absolute refractory periods recorded were summed and reduced to a single mean. The same procedure was carried out for firing rates, except that median values were taken.

A Mann-Whitney U test was employed to compare these means or medians (firing rates, latencies, chronaxies, and absolute refractory periods) in 'intact' and 'castrate' rats, for different classes of CMA neurones.

(6) HISTOLOGY -

(i) Marking of stimulating and recording electrode positions - At the end of each experiment a 20 μ a anodal current was passed through the stimulating electrode for 1 - 2 min. A 10 μ a cathodal current (delivered using a 120 volts DC source) was passed down the recording microelectrode for 15 min or more. The exact current at the tip of the electrode varied according to the resistance of the electrode (5 - 15 megohms). The current passed down the stimulating electrode caused a deposition of iron in the surrounding tissue, which was stained Prussian blue by adding a small amount of potassium ferrocyanide to the formolsaline solution used for perfusion. The current passed down the recording microelectrode caused a small amount of pontamine blue to be ejected into the tissue surrounding the tip. The diameters of these blue spots were generally around 150 μ for the stimulating electrodes

and 20 - 40 μ for the recording microelectrodes.

After currents had been passed down the stimulating and recording electrodes the animals were given an overdose of sodium pentobarbital, and two minutes later perfused through the heart with a 5% neutral formosaline solution to which a small amount of potassium ferrocyanide had been added. Normally animals were perfused while still in the stereotaxic frame and with both recording and stimulating electrodes embedded in the brain, left for two or three hours in order to facilitate the localisation of electrode tracks. The animals were then decapitated and their heads stored for two weeks or more in 5% neutral formolsaline.

(ii) Histological procedure - The brains were removed from the animals' heads, dehydrated in increasing concentrations of alcohol, cleared in toluene or chloroform and impregnated in paraffin wax using an automatic tissue processor (Shandon Elliot). The brains were then blocked in paraffin wax, and cut at between 10 and 15 μ on a microtome (American Optical Ltd - "820" Spencer Microtome) at the orientation of the atlas of König and Klippel (1963). Sections were mounted on glass slides and stained in cresyl violet and luxol fast blue (Kluver and Barrera, 1953). Electrode tracks were located under a low power microscope.

(iii) Electrode track reconstruction - The structures from which the activity of single neurones was recorded were calculated by using stereotaxic reference coordinates in the brain; the depth from the surface of the brain either to the marked tip of the electrode, or to the bottom of the brain, was adapted to the atlas of König and Klippel. The locations of recorded neurones could then be calculated from these adapted König and Klippel coordinates, by reference to the stereotaxic depth at which they were encountered.

Photomicrographs of typical stimulating and recording sites are shown in Figure 2.5.

Figure 2.5

Experiment 1: Photomicrographs of coronal sections showing a typical recording site in the CMA and a stimulating site in the MPH.

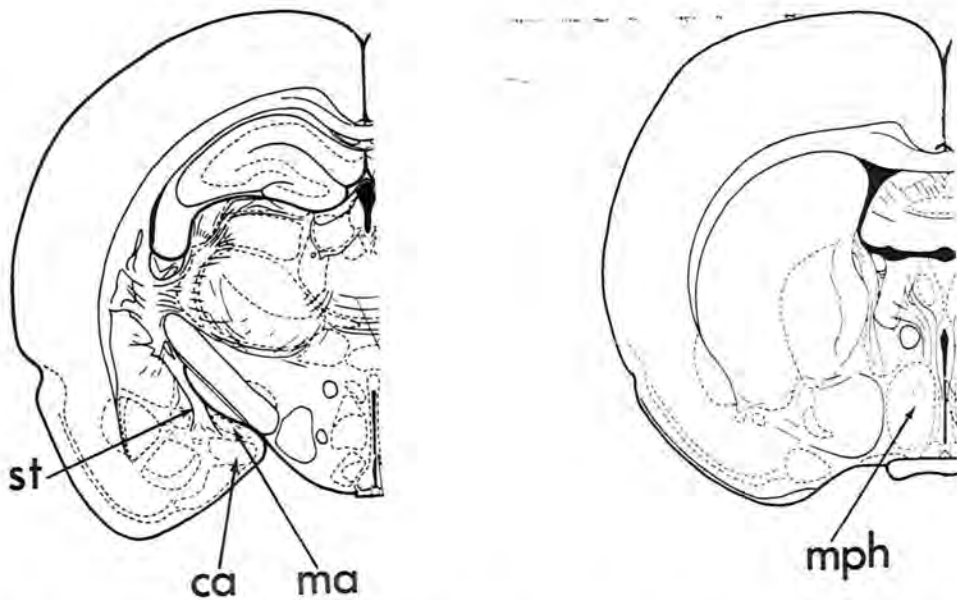
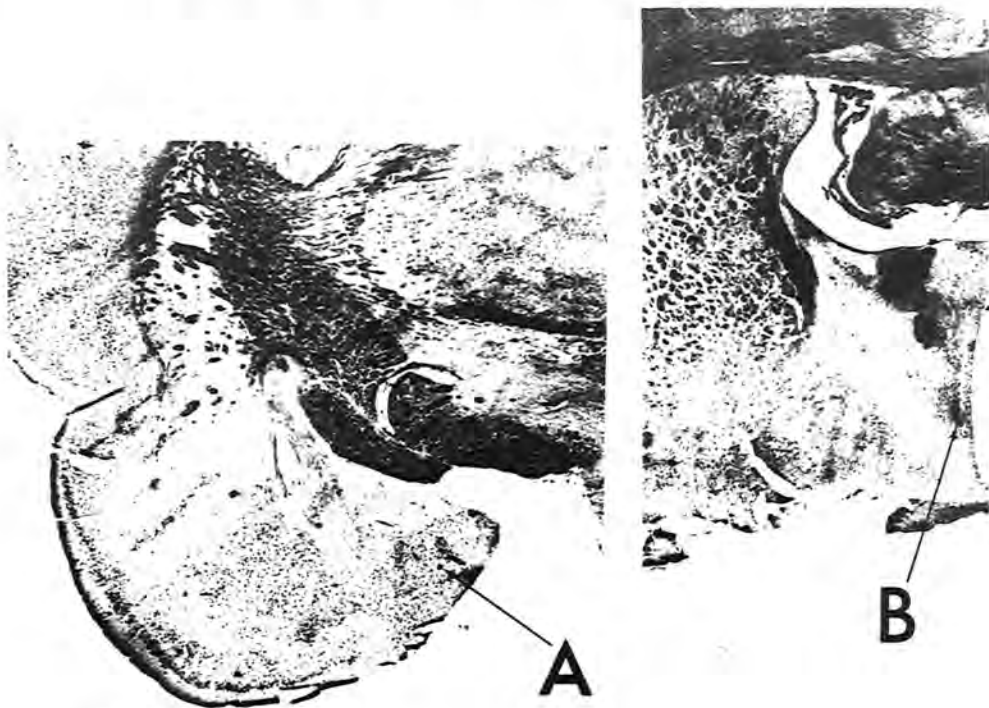

mph = medial preoptic anterior hypothalamic junction; ma = the medial amygdala; ca = the cortical amygdala; st = the stria terminalis.
 A = blue spot marking the tip of the recording electrode in the CA.
 B = blue spot marking the tip of the stimulating electrode in the MPH.
 Coordinates for the recording electrode and stimulating electrode placements are A 3990 μ and A 6360 μ respectively. (König and Klippel, 1963).

2.2.2. Results

Anatomical Loci of Recording and Stimulation Sites.

Histological analysis showed that antidromically stimulated neurones were always recorded from the CMA, whereas some orthodromic and non-driven neurones were also encountered in the ventral hippocampus. Results from these latter cells were not used in the analysis. Antidromically stimulated CMA neurones were encountered in the caudal portion of the CMA (between A 3990 μ and A2580 μ , König and Klippel, 1963), in accordance with anatomical evidence (de Olmos, 1972). The cell types were all represented in all parts of the caudal CMA; for example there was no difference between the characteristics of neurones encountered in the medial and cortical amygdaloid nuclei. A further comment on localization can be found in Chapter 4 (Section 4.5). Localisation of antidromically identified CMA neurones is shown in Figure 2A of the Appendix.

The placement of stimulating electrodes in the MPH was always between A 7020 μ and A 6060 μ (König and Klippel, 1963). The stimulation coordinates at which the smallest currents were needed to activate CMA neurones were between A 6670 μ and A 6360 μ ; that is the area of the junction between the medial preoptic area and the anterior hypothalamus.

Spontaneous Firing Rates.

(i) Antidromically identified CMA neurones - The spontaneous firing rates of 22 of these neurones were recorded from 13 'intact' rats, and of 18 neurones from 10 'castrate' rats. There was no significant difference between the median spontaneous firing rates in 'intact' v 'castrate' male rats (Mann-Whitney U test, $U = 77.5$, $n = 10,13$; $p > 0.05$). The overall mean of these median firing rates was 10.65 action potentials per 100 sec in 'intact' rats (range 1.00 - 44.50 action potentials per 100 sec) and 6.51 action potentials per 100 sec in 'castrate' rats (range 0.33 - 18.92 action potentials per 100 sec).

(ii) Orthodromically identified CMA neurones - This group only includes short latency stimulated units (9.5 - 37.0 msec). The spontaneous firing rates of 18 CMA neurones were recorded from 10 'intact' rats, and 15 neurones from 9 'castrate' rats. No significant difference was found between the median firing rates of the two groups ($U = 41$, $n = 9,10$; $p > 0.05$). The overall mean of these median firing rates was 65.88 action potentials per 100 sec for 'intact' rats (range 4.33 - 451.33 action potentials per 100 sec) and 89.07 action potentials per 100 sec for 'castrate' rats (range 0.67 - 305.33 action potentials per 100 sec).

(iii) Orthodromically identified CMA neurones with long latencies (over 50 msec) - Not enough of these were recorded to allow a comparison of spontaneous firing rates between the 'intact' and 'castrate' groups. In all only 2 of these CMA units were recorded with spontaneous firing rates of 64.00 ('intact' rat) and 87.33 ('castrate' rat) action potentials per 100 sec.

(iv) Non-Driven spontaneously active CMA neurones - 58 spontaneous, non-driven CMA neurones were recorded from 13 'intact' rats and 72 CMA neurones from 12 'castrate' rats. No significant difference was found between the median firing rates of CMA neurones in these groups ($U = 59$, $n = 11,13$; $p > 0.05$). The overall mean for the median firing rates in each group was 201.57 action potentials per 100 sec in 'intact' rats (range 23.50 - 473.83 action potentials per 100 sec) and 158.73 action potentials per 100 sec in 'castrate' rats (range 10.00 - 304.83 action potentials per 100 sec).

The median spontaneous firing rate values for each rat are given in Tables 2.1, a, b, of the Appendix.

Raw data values for all spontaneous firing rates are included in section 1 of the Appendix.

As a general observation it is clear that those CMA neurones which are

antidromically stimulated from the MPH have slower spontaneous firing rates than those CMA neurones which are orthodromically stimulated; CMA neurones which are not stimulated from the MPH have the highest spontaneous firing rates of all.

Absolute Refractory Periods.

(i) Spontaneously active CMA neurones antidromically stimulated from the MPH - The absolute refractory periods of 21 of these were measured in 12 'intact' rats, and of 16 neurones in 9 'castrate' rats. The mean absolute refractory periods of 'castrate' rats were significantly longer than those of the 'intact' rats ($U = 6, n = 9,12; p < 0.002$ two tailed). The overall mean absolute refractory period was 1.03 msec for 'intact' rats (range 0.60 - 1.70 msec) and 1.85 msec for 'castrate' rats (range 1.11 - 2.50 msec)

(ii) Silent CMA neurones antidromically stimulated from the MPH - The absolute refractory periods of 22 of these were measured in 10 'intact' rats and of 26 CMA neurones in 10 'castrate' rats. The mean absolute refractory periods were significantly longer in 'castrate' than in 'intact' rats ($U = 10.5, n = 10,10; p < 0.02$ two tailed). The overall mean absolute refractory period for these CMA neurones was 0.99 msec in 'intact' rats (range 0.63 - 1.26 msec) and 1.46 msec in 'castrate' rats (range 0.85 - 2.50 msec).

(iii) Combined spontaneous and silent CMA neurones antidromically stimulated from the MPH - When the absolute refractory periods of spontaneously active and silent CMA neurones were combined in each rat the following figures were obtained: 1.01 msec in 'intact' rats (range 0.70 - 1.52 msec) and 1.61 msec in 'castrate' rats (range 1.10 - 2.50 msec). Altogether, the absolute refractory periods of 43 neurones were recorded from 13 'intact' rats and of 42 neurones from 12 'castrate' rats. Again, the mean absolute refractory periods in 'castrate' rats were significantly longer than those in 'intact' rats ($U = 10, n = 12,13; p < 0.002$ two tailed).

The mean absolute refractory periods of these CMA neurones for rats in both groups are given in Table 2.2, and illustrated in Figure 2.6.

In those rats from which the absolute refractory periods of both silent and spontaneously active CMA neurones were recorded, there was no significant difference between the two types of unit (Wilcoxon Test - for 'intact' rats $n = 9$, $T = 22$; $p > 0.05$: for 'castrate' rats $n = 7$, $T = 9$; $p > 0.05$).

Raw data are given in section 1 of the Appendix.

Latencies and conduction velocities.

(i) Antidromically stimulated CMA neurones - The mean latencies and conduction velocities for CMA neurones antidromically stimulated from the MPH are given in Table 2.3 of the Appendix for both 'intact' and 'castrate' rats.

(i) Spontaneously active CMA neurones antidromically stimulated from the MPH - Latencies were recorded for 27 of these CMA neurones from 13 'intact' rats and for 22 CMA neurones from 11 'castrate' rats. There was no significant difference between the mean latencies recorded from the two groups ($U = 52$, $n = 11, 12$; $p > 0.05$). The overall mean latency for 'intact' rats was 19.45 msec (range 9.70 - 27.50 msec) and 23.82 msec (range 9.80 - 37.00 msec) for 'castrate' rats.

The overall mean conduction velocities were 0.48 m/sec (range 0.29 - 0.82 m/sec) for 'intact' rats, and 0.40 m/sec (range 0.22 - 0.82 m/sec) for 'castrate' rats.

(ii) Silent CMA neurones antidromically stimulated from the MPH - Latencies were recorded for 29 of these CMA neurones from 11 'intact' rats, and for 32 CMA neurones from 11 'castrate' rats. There was no significant difference between the mean latencies recorded from the two groups ($U = 50$, $n = 11, 11$; $p > 0.05$). The overall mean latency was 21.45 msec (range 7.40 - 33.50 msec) for 'intact' rats, and 21.98 msec (range 17.77 - 29.80 msec) for 'castrate' rats.

Figure 2.6

Experiment 1: Mean absolute refractory periods of CMA neurones antidromically stimulated from the MPH, 'Intact' v 'Castrate' rats.

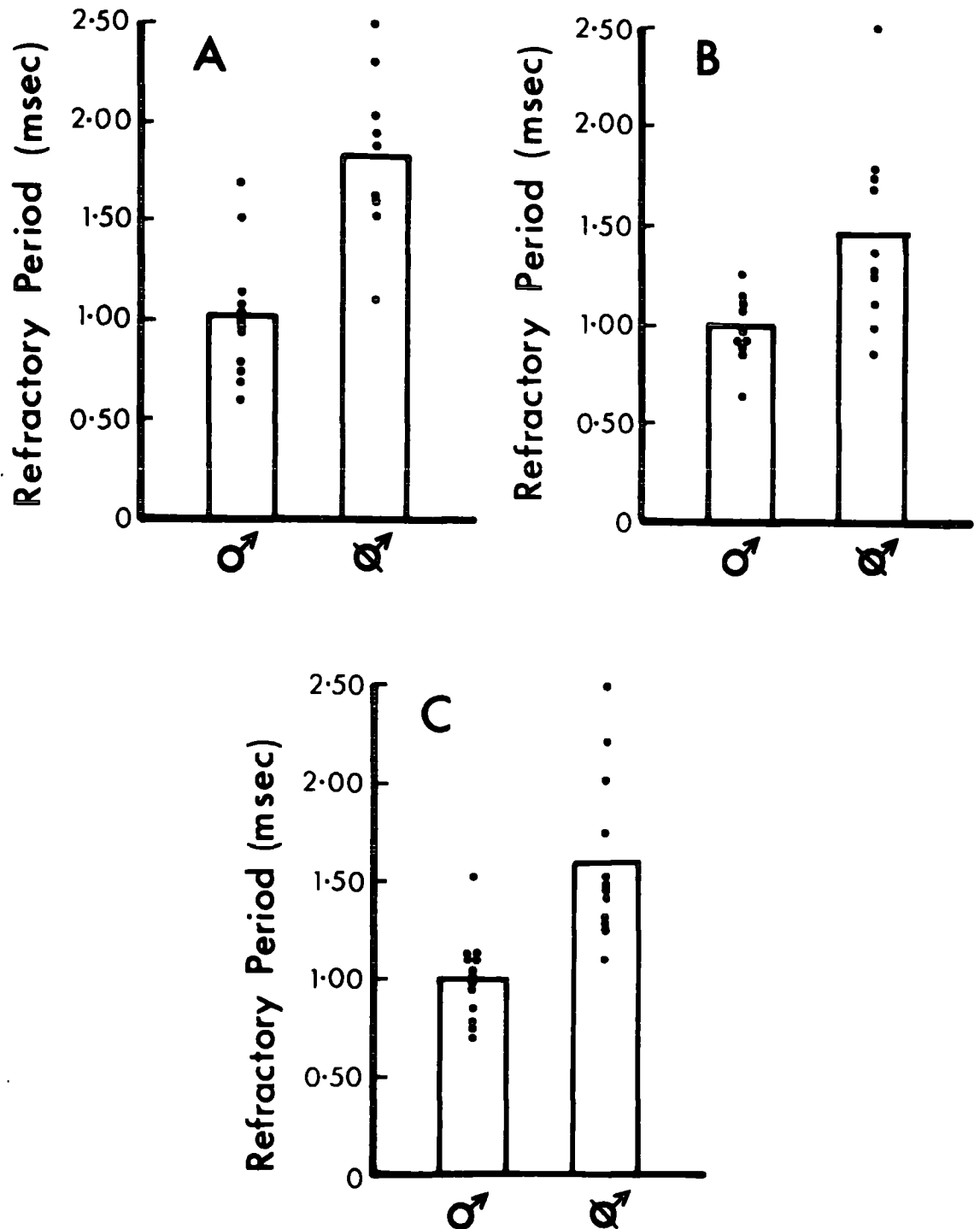

♂ = 'intact' rats.

♀ = 'castrate' rats.

A = spontaneously active CMA neurones; B = silent CMA neurones;

C = combined spontaneous + silent CMA neurones.

The overall mean conduction velocities were 0.46 m/sec (range 0.24 - 1.09 m/sec) for 'intact' rats, and 0.40 m/sec (range 0.29 - 0.57 m/sec) for 'castrate' rats.

(iii) Combined spontaneous and silent CMA neurones antidromically stimulated from the MPH - Altogether the latencies of 56 CMA neurones were recorded from 15 'intact' rats, and of 54 CMA neurones from 15 'castrate' rats. Again there was no significant difference between the mean latencies recorded from these two groups ($U = 83$, $n = 15,15$; $p > 0.05$). The combined, overall mean latency was 20.21 msec (range 9.70 - 30.50 msec) for 'intact' rats, and 23.02 msec (range 9.80 - 37.00 msec) for 'castrate' rats.

The combined, overall mean conduction velocities were 0.47 m/sec (range 0.26 - 0.82 m/sec) for 'intact' rats, and 0.41 m/sec (range 0.22 - 0.82 m/sec).

In those rats from which latencies of both silent and spontaneously active CMA neurones were recorded, there was no significant difference between the two types of unit (Wilcoxon Test - for 'intact' rats $n = 9$, $T = 19$; $p > 0.05$; for 'castrate' rats $n = 7$, $T = 4$; $p > 0.05$).

(2) Orthodromically stimulated CMA neurones - The variable latencies of these neurones were reduced to a mean value, and these figures are given in Table 2.4 of the Appendix. There were very few silent orthodromic units, hence comparisons between 'intact' and 'castrate' rats were only made between combined spontaneously active and silent CMA neurones. Altogether the latencies of 26 CMA neurones were recorded from 10 'intact' rats, and of 18 CMA neurones from 10 'castrate' rats. There was no significant difference between the mean latencies recorded from these two groups ($U = 40$, $n = 10,10$; $p > 0.05$). With the variable latencies reduced to a single mean, the combined, overall mean latency was 20.78 msec (range 9.90 - 29.00 msec) for 'intact' rats, and 23.39 msec (range 14.40 - 30.85 msec) for 'castrate' rats.

Raw data are given in section 1 of the Appendix.

Rheobase current and Chronaxie estimations for antidromically identified CMA neurones.

Rheobase currents and chronaxies were calculated for 17 of these CMA neurones from 8 'intact' rats, and for 11 CMA neurones from 7 'castrate' rats. There was no significant difference between the mean chronaxies for the two groups ($U = 19.5$, $n = 7,8$; $p = 0.183$ NS). In 'intact' rats the overall mean chronaxie was $487 \mu\text{sec}$ (range $363 - 690 \mu\text{sec}$), and in 'castrate' rats $417 \mu\text{sec}$ (range $250 - 580 \mu\text{sec}$).

These chronaxie estimations fall into the $200 - 700 \mu\text{sec}$ category described by Ranck (1975) for grey matter. As yet, however, the reasons for these long time constants are unknown. No elements in the central nervous system are known to have time constants in this range. It is possible that chronaxies in this range indicate that the point of stimulation is a node of ranvier as suggested by Ranck (1975); nodes of ranvier in grey matter might have longer time constants than in white matter. As yet there is no direct evidence for this suggestion though intracellular studies of central nervous system fibres have measured time constants of between $130 - 710 \mu\text{sec}$ (Frank & Fuortes, 1956; Hunt & Kuno, 1959) thereby giving some support to this possibility.

For the present, however, the time constants found in this experiment cannot be attributed for certain to any particular part of a neuronal process.

Mean rheobase currents and chronaxies for CMA neurones are given in Table 2.5 of the Appendix. Raw data for each rat are given in section 1 of the Appendix.

2.2.3 Discussion.

These results show that castration lengthens the absolute refractory period of CMA neurones which project to the MPH. No significant difference between 'intact' and 'castrate' rats was found for the spontaneous firing rates, latencies or chronaxies of CMA neurones.

Thus depletion of gonadal hormones through long term castration affects the membrane properties of CMA neurones which project to the MPH. The membrane must be affected since it is the absolute refractory period which is altered.

2.3. Experiment 2: The effects of castration on the electrical activity of CMA neurones which project to the capsule of the ventromedial nucleus.

This experiment was carried out to test the possibility that the castration induced lengthening of the absolute refractory periods of CMA neurones which project to the MPH was not simply due to a general, non-specific effect.

Neurones of the CMA project via the stria terminalis to the capsule of the ventromedial nucleus of the hypothalamus (VMC) (de Olmos, 1972) as well as to the MPH. Lesions of the ventromedial nucleus have no effect on sexual behaviour in the male rat (Ollivier, 1977). The CMA neurones which project to the VMC were therefore considered to be a good control for the possibility that the results obtained in Experiment 1 merely reflected a non-specific effect of castration in the central nervous system.

Figure 2.7 shows a schematic representation of the stria terminalis projections from the CMA to the MPH and VMC. This figure shows that whereas both the hypothalamic radiation and the retrocommissural division of the dorsal stria terminalis project to the MPH, only the hypothalamic radiation projects to the VMC (derived from de Olmos, 1972).

2.3.1 Method.

Experimental Animals.

Twenty-seven, adult male, sexually naive, Porton albino Wistar rats (approximately 120 days of age; weight 400 - 600g) were maintained on a 12 hr reversed light-dark schedule. The rats were divided randomly into an 'intact' group (14 rats) and a 'castrate' group castrated under ether anaesthesia at least 8 weeks prior to electrophysiological recording (13 rats).

Figure 2.7

Schematic representation of the stria terminalis projections from the CMA to the MPH and the VMC.

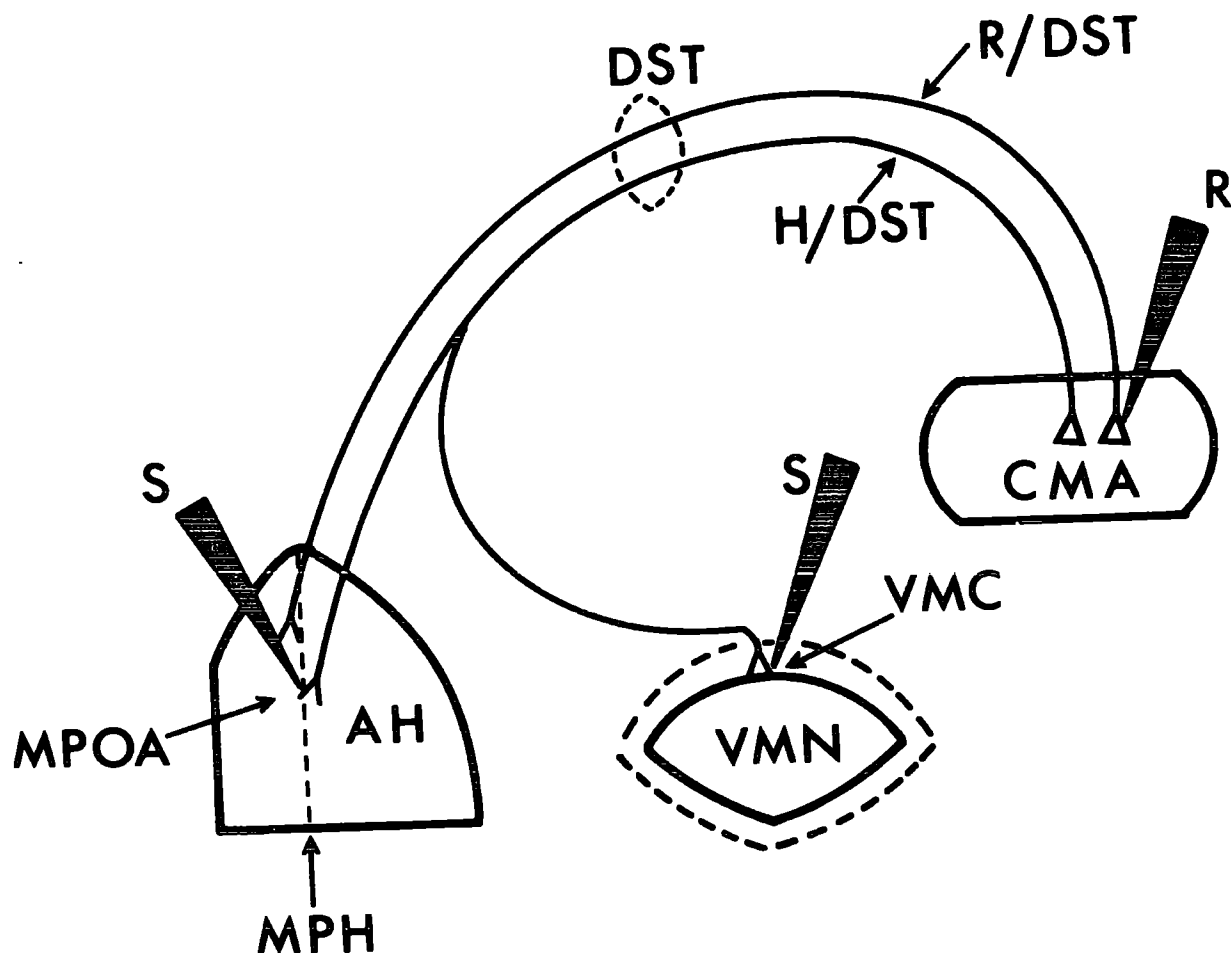

AH = anterior hypothalamus; CMA = corticomedial amygdala; DST = the dorsal stria terminalis; H/DST = the hypothalamic radiation of the DST; MPH = the medial preoptic/anterior hypothalamic junction; MPOA = the medial preoptic area; R/DST = the retrocommissural division of the DST; VMC = the capsule of the ventromedial nucleus; VMN = the ventromedial nucleus.

The black arrows labelled 'S' represent stimulating electrodes, and the black arrow labelled 'R' represents a recording electrode.

The H/DST is shown as projecting from the same type of CMA neurone to the MPH and the VMC. There is however no evidence to date that the same CMA neurones project to both of these areas.

(derived from de Olmos, 1972).

At the time of electrophysiological recording, rats were at least 180 days of age and weighed 400 - 675g.

Experimental apparatus and design and procedure.

These were essentially the same as described for Experiment 1, except that the VMC was used as the stimulation site as opposed to the MPH. A photomicrograph of a typical VMC stimulation site is given in Figure 2.8.

Stereotaxic coordinates for the VMC were 1.5 - 2.4 mm posterior to absolute bregma; depth 8.5 - 9.00 mm from the surface of the brain.

2.3.2 Results.

Anatomical Loci of Recording and Stimulation Sites.

Histology showed that antidromically stimulated neurones were always recorded from the CMA. Orthodromically stimulated neurones were also only found in the CMA. Non-driven neurones were encountered in the ventral hippocampus as well as the CMA, though these former units were not used in the analysis. Antidromically stimulated CMA neurones were encountered in the caudal portion of the CMA (between A 3990 μ and A 2580 μ König and Klippel, 1963), in accordance with anatomical evidence (de Olmos, 1972). The cell types were all represented in all parts of the caudal CMA: for example there was no difference between the characteristics of neurones encountered in the medial and cortical amygdaloid nuclei. Localisation of antidromically identified CMA neurones is shown in Figure 2B of the Appendix.

The placement of stimulating electrodes in the VMC was always between A 5340 μ and A 4110 μ . No particular placement was found to be optimal as far as stimulating current was concerned.

Spontaneous Firing Rates.

(i) Antidromically identified CMA units - Overall 33 of these spontaneously active CMA neurones were recorded from 13 'intact' rats, and 33 CMA neurones from 10 'castrate' rats. There was no significant difference between the median spontaneous firing rates of CMA neurones recorded

Figure 2.8

Experiment 2: A photomicrograph of a coronal section showing a typical stimulating site in the capsule of the ventromedial nucleus.

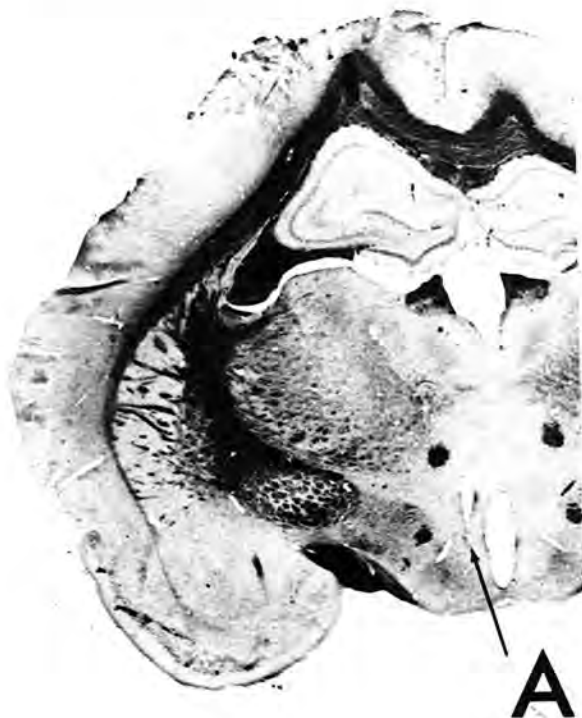

vmn = the ventromedial nucleus of the hypothalamus. The capsule of the ventromedial nucleus is a small band of cells which surround this nucleus.

A = blue spot marking the tip of a stimulating electrode in the area of the vmn. The coordinate for this placement is A 4620 μ . (König and Klippel, 1963).

from the two groups ($U = 52, n = 10,13; p > 0.05$). The overall mean of these median firing rates was 261.30 action potentials per 100 sec in 'intact' rats (range 45.33 - 485.67 action potentials per 100 sec) and 228.34 action potentials per 100 sec for 'castrate' rats (range 94.00 - 467.17 action potentials per 100 sec).

(ii) Orthodromically identified CMA units - This group only includes short latency stimulated units (3.6 - 41.0 msec). The spontaneous firing rates of 21 of these CMA neurones were recorded from 12 'intact' rats, and of 8 CMA neurones from 5 'castrate' rats. No significant difference was found between the median firing rates of the two groups ($U = 29, n = 5,12; p > 0.05$). The overall mean of these firing rates was 212.75 action potentials per 100 sec for 'intact' rats (range 29.33 - 588.67 action potentials per 100 sec) and 211.57 action potentials per 100 sec for 'castrate' rats (range 55.17 - 410.67 action potentials per 100 sec).

(iii) Orthodromically identified CMA units with long latencies (over 50 msec). Not enough of these were recorded to allow a comparison of spontaneous firing rates between 'intact' and 'castrate' rats. In all, the spontaneous firing rates of 3 such CMA neurones were recorded. One unit was recorded from an 'intact' rat and had a mean firing rate of 1411.0 action potentials per 100 sec. Two units were recorded from two 'castrate' rats with firing rates of 959.33 and 110.00 action potentials per 100 sec.

(iv) Non-driven spontaneously active CMA neurones - 41 of these CMA neurones were recorded from 11 'intact' rats and 50 CMA neurones from 12 'castrate' rats. No significant difference was found between the median firing rates of CMA neurones in these groups ($U = 45.5, N = 11,12; p > 0.05$). The overall mean of the median firing rates for each group was 158.01 action potentials per 100 sec in 'intact' rats (range 20.00 - 313.33 action potentials per 100 sec) and 159.03 action potentials per 100 sec in 'castrate' rats (range 12.67 - 558.00 action potentials per 100 sec).

The median spontaneous firing rate values for each rat are given in Tables 2.6 a,b of the Appendix.

Raw data are included in section 1 of the Appendix.

Absolute Refractory Periods.

(i) Spontaneously active CMA neurones antidromically stimulated from the VMC - The absolute refractory periods of 33 of these CMA neurones were measured in 13 'intact' rats and of 33 CMA neurones in 10 'castrate' rats. The mean absolute refractory periods were not significantly different between the two groups ($U = 54.5$, $n = 10,11$; $p > 0.05$). The overall mean absolute refractory period was 1.17 msec for 'intact' rats (range 0.84 - 1.52 msec) and 1.19 msec for 'castrate' rats (range 0.86 - 1.79 msec).

(ii) Silent (i.e. not spontaneously active) CMA neurones antidromically stimulated from the VMC - The absolute refractory periods of 30 of these CMA neurones were measured in 10 'intact' rats and of 30 CMA neurones in 12 'castrate' rats. The mean absolute refractory periods of the two groups were not significantly different ($U = 44$, $n = 10,12$; $p > 0.05$). The overall mean absolute refractory period was 1.18 msec for 'intact' rats (range 0.80 - 2.11 msec) and 1.26 msec for 'castrate' rats (range 0.93 - 1.79 msec).

(iii) Combined spontaneous and silent CMA neurones antidromically stimulated from the VMC - When the absolute refractory periods of spontaneously active and silent CMA neurones were combined in each rat the following figures were obtained: 1.23 msec in 'intact' rats (range 0.84 - 2.11 msec) and 1.21 msec in 'castrate' rats (range 0.97 - 1.79 msec). In all, the absolute refractory periods of 57 CMA neurones were measured in 13 'intact' rats and 59 CMA neurones from 13 'castrate' rats. Again there was no significant difference between the mean absolute refractory periods of the two groups ($U = 81$, $n = 13,13$; $p > 0.05$).

In those rats from which the absolute refractory periods of both silent and spontaneously active CMA neurones were measured there was no significant difference between the two types of unit (Wilcoxon Test - for 'intact' rats $n = 7$, $T = 9$; $p > 0.05$; for 'castrate' rats $n = 8$, $T = 13$; $p > 0.05$).

The mean absolute refractory periods of these CMA neurones for rats in both groups are given in Table 2.7 of the Appendix and illustrated in Figure 2.9. The raw figures for the absolute refractory period measurements of CMA neurones are given in section 1 of the Appendix.

Latencies and Conduction Velocities.

(1) Antidromically invaded CMA neurones - The mean latencies and conduction velocities of CMA neurones antidromically stimulated from the VMC are given in Table 2.8 of the Appendix. The distance between the CMA and the VMC via the stria terminalis was calculated to be 10 mm.

(i) Spontaneously active CMA neurones antidromically stimulated from the VMC - Latencies were recorded for 35 of these CMA neurones from 13 'intact' rats, and for 34 CMA neurones from 10 'castrate' rats. There was no significant difference between the mean latencies recorded from the two groups ($U = 58$, $n = 10, 13$; $p > 0.05$). The overall mean latency for 'intact' rats was 16.46 msec (range 10.00 - 24.20 msec) and 17.90 msec (range 6.67 - 31.00 msec) for 'castrate' rats. The overall mean conduction velocities were 0.70 m/sec (range 0.46 - 1.00 m/sec) for 'intact' rats and 0.70 m/sec (range 0.33 - 1.63 m/sec) for 'castrate' rats.

(ii) 'Silent' CMA neurones antidromically stimulated from the VMC - Latencies were recorded for 29 of these CMA neurones from 10 'intact' rats and for 33 CMA neurones from 12 'castrate' rats. There was no significant difference between the latencies recorded from the two groups ($U = 44$, $n = 10, 12$, $p > 0.05$). The overall mean latency for 'intact' rats was 18.22 msec (range 9.80 - 25.55 msec) and 20.11 msec (range 11.25 - 27.80 msec) for 'castrate' rats. The overall mean conduction velocities were 0.68 m/sec

Figure 2.9

Experiment 2: Mean absolute refractory periods of CMA neurones antidromically stimulated from the VMC. 'Intact' v 'Castrate' rats.

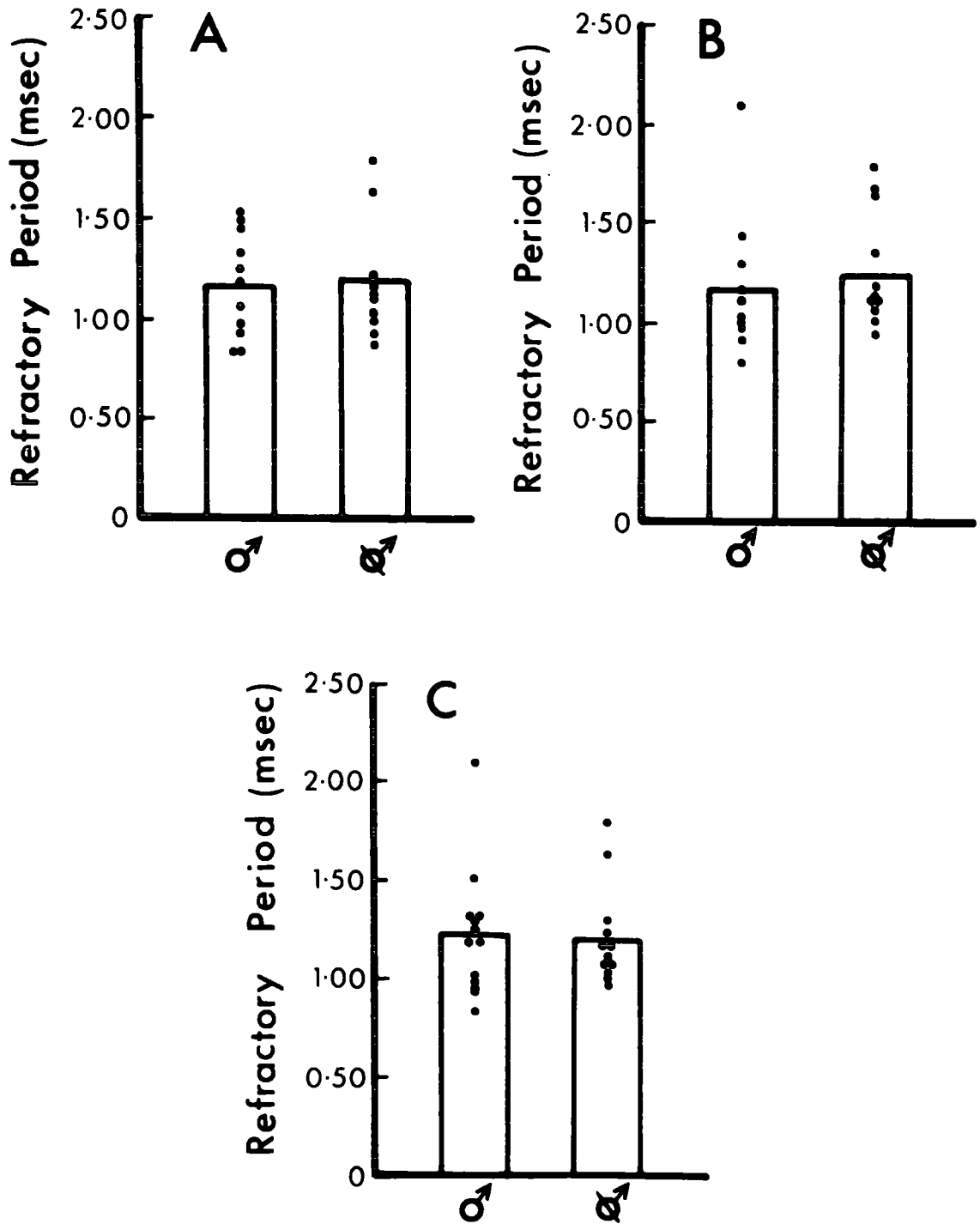

♂ = 'intact' rats.

♂ = 'castrate' rats.

A = spontaneously active CMA neurones; B = silent CMA neurones;

C = combined spontaneous + silent neurones.

(range 0.44 - 1.02 m/sec) for 'intact' rats and 0.60 m/sec (range 0.36 - 0.90 m/sec) for 'castrate' rats.

(iii) Combined Spontaneous and Silent CMA neurones antidromically stimulated from the VMC - Altogether, the latencies of 65 CMA neurones were recorded from 14 'intact' rats and of 67 CMA neurones from 13 'castrate' rats. Again there was no significant difference between the mean latencies recorded from the two groups ($U = 76$, $n = 13,14$; $p > 0.05$). The combined overall mean latency was 17.00 msec (range 10.00 - 25.55 msec) for 'intact' rats and 18.86 msec (range 11.80 - 28.62 msec) for 'castrate' rats. The combined, overall mean conduction velocities were 0.71 m/sec (range 0.52 - 1.00 m/sec) for 'intact' rats, and 0.66 m/sec (range 0.40 - 1.31 m/sec) for 'castrate' rats.

In those rats from which latencies of both silent and spontaneously active CMA neurones were recorded, there was no significant difference between the two types of unit (Wilcoxon Test - for 'intact' rats $n = 8$, $T = 21$; $p > 0.05$; for 'castrate' rats $n = 9$, $T = 20$; $p > 0.05$).

(2) Orthodromically stimulated CMA neurones - The variable latencies of these neurones were reduced to a mean value in order to calculate a mean latency for each rat. The mean latency for each rat is given in Table 2.9 of the Appendix. There were very few silent orthodromically stimulated units, hence comparisons between 'intact' and 'castrate' rats were only made between spontaneously active and silent CMA neurones combined. Altogether, the latencies of 27 CMA neurones were recorded from 12 'intact' rats and of 17 CMA neurones from 7 'castrate' rats. There was no significant difference between the mean latencies recorded from these two groups ($U = 24$, $n = 7,12$; $p > 0.05$). With the variable latencies reduced to a single mean, the overall mean latency was 18.13 msec (range 11.80 - 29.35 msec) for 'intact' rats, and 22.29 msec (range 17.35 - 34.05 msec) for 'castrate' rats.

The 6 CMA neurones which showed a post-inhibitory excitation type of

response had latencies of between 47 and 125 msec. Two of these units were recorded from 'intact' rats and 4 from 'castrate' rats; too few to allow a meaningful statistical comparison.

Raw data are given in section 1 of the Appendix.

Rheobase current and Chronaxie estimations for antidromically stimulated CMA neurones.

Rheobase currents and chronaxies were calculated for 7 CMA neurones from 5 'intact' rats and for 9 CMA neurones from 6 'castrate' rats. There was no significant difference between the mean chronaxies for the two groups ($U = 14$, $n = 5,6$; $p = 0.465$ Not Significant). In 'intact' rats the overall mean chronaxie was 432.0 μ sec (range 292 - 595 μ sec) and in 'castrate' rats 451.0 μ sec (range 250 - 772 μ sec). These chronaxie estimations fall (with one exception of 772 μ sec) into the 200 - 700 μ sec category described by Ranck (1975) for grey matter and discussed previously.

Mean rheobase currents and chronaxies for CMA neurones are given in Table 2.10 of the appendix. Data for individual neurones from each rat are given in section 1 of the Appendix.

2.4. Comparison of Results from Experiments 1 and 2.

Comparison of Spontaneous firing rates.

(i) Antidromically Identified CMA neurones - The median spontaneous firing rates of CMA neurones identified as projecting directly to the MPH were of a significantly lower frequency to those identified as projecting to the VMC for both 'intact' and 'castrate' rats (for 'intact' $U = 0$, $n = 13$; $p < 0.002$ two tailed; for 'castrate' $U = 0$ $n = 10,10$; $p < 0.002$ two tailed).

(ii) Orthodromically stimulated CMA neurones - The median spontaneous firing rates of CMA neurones identified as receiving projections from the area of the MPH in 'intact' rats were of a significantly lower frequency to those receiving projections from the area of the VMC ($U = 16$, $n = 10,12$;

Figure 2.10

Experiments 1 and 2: Comparison of mean absolute refractory periods in CMA neurones antidromically stimulated from the MPH v VMC.

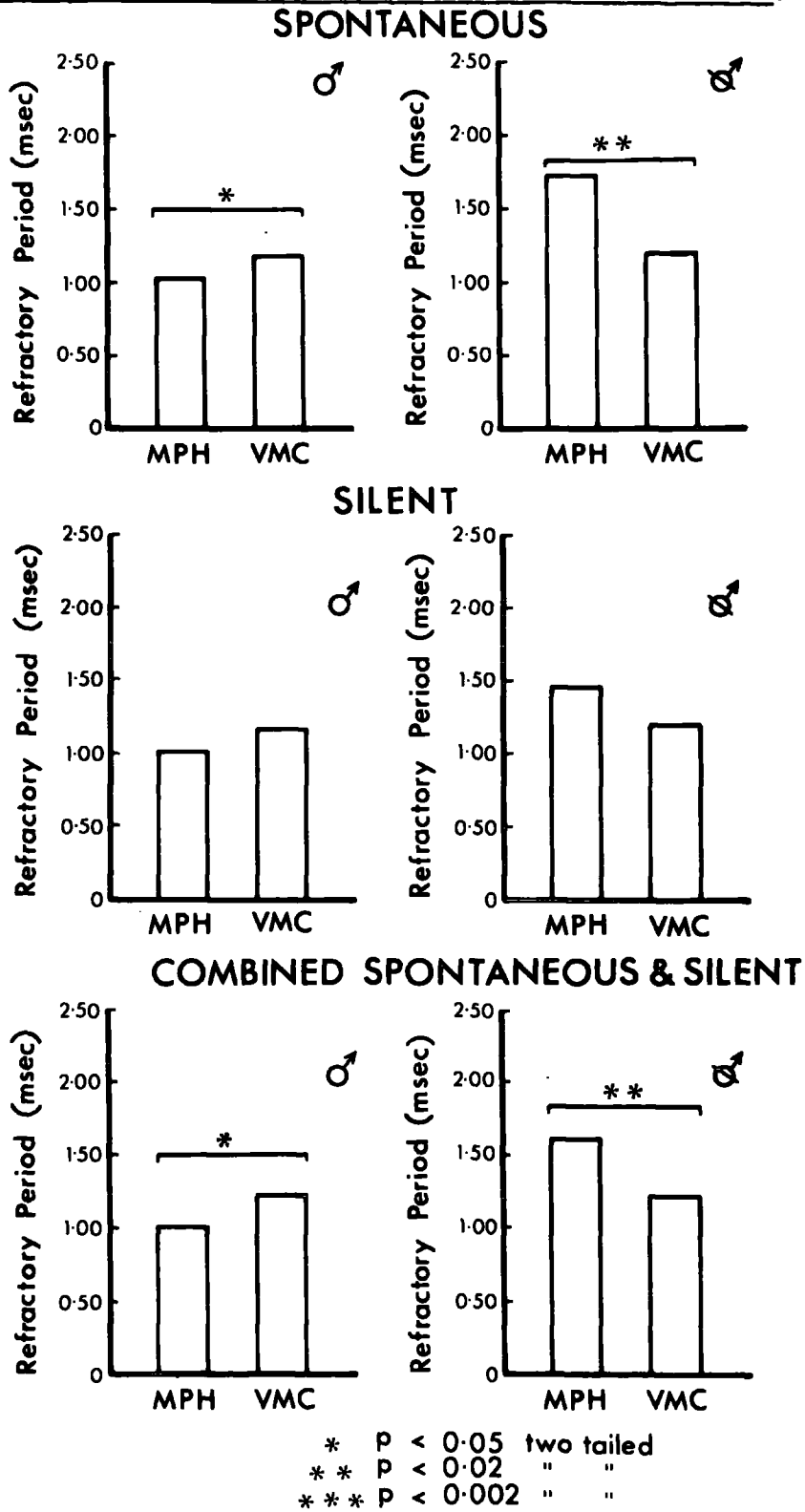

♂ = 'intact' rats.
 ♂ = 'castrate' rats.

$p < 0.02$ two-tailed). No significant difference was found for 'castrate' animals ($U = 10$, $n = 5,9$; $p > 0.05$) though the small number of rats in the VMC stimulation group (5), may have contributed to this negative finding.

Orthodromically stimulated CMA neurones which showed a post-inhibitory excitation type of response were insufficiently large in number to allow a meaningful statistical comparison.

(iii) Non-Driven CMA neurones - No significant differences were found for the spontaneous firing rates of CMA neurones which did not respond to MPH or VMC stimulation (for 'intact' rats $U = 64$, $n = 11,13$; $p > 0.05$: for 'castrate' rats $U = 49$, $n = 11,11$; $p > 0.05$).

The above comparisons are illustrated in Figure 2.11.

Comparison of Absolute Refractory Periods.

(i) Spontaneously active CMA neurones antidromically stimulated from the MPH v VMC - There were significant differences between the mean absolute refractory periods of CMA neurones stimulated from the MPH and VMC in both 'intact' and 'castrate' rats (for 'intact' rats $U = 30.5$, $n = 11,12$; $p < 0.05$ two-tailed: for 'castrate' rats $U = 11$, $n = 9,10$; $p < 0.02$ two-tailed).

(ii) Silent CMA neurones antidromically stimulated from the MPH v VMC - There were no significant differences between the mean absolute refractory periods of CMA neurones stimulated from the MPH and VMC in both 'intact' and 'castrate' rats (for 'intact' rats $U = 31.5$, $n = 10,12$; $p > 0.05$: for 'castrate' rats $U = 44.5$, $n = 10,12$; $p > 0.05$).

(iii) Combined spontaneous and silent CMA neurones antidromically stimulated from the MPH v VMC - There was an overall significant difference between the mean absolute refractory periods of CMA neurones stimulated from the MPH and VMC in both 'intact' and 'castrate' rats (for 'intact' rats $U = 44$, $n = 13,13$; $p < 0.05$ two-tailed: for 'castrate' rats $U = 25$,

$n = 12,13; p < 0.02$ two-tailed).

The above comparisons are illustrated in Figure 2.10.

Comparison of Latencies and Conduction Velocities.

- (1) Antidromically stimulated CMA neurones - There were no significant differences between the latencies and conduction velocities, for CMA neurones stimulated antidromically from the MPH v VMC, in either 'intact' or 'castrate' rats (for spontaneously active neurones - 'intact' rats $U = 61, n = 13,13$; 'castrate' rats $U = 38, n = 10,11$; for silent neurones - 'intact' rats $U = 36, n = 10,11$; 'castrate' rats $U = 55, n = 11,12$; for combined spontaneous + silent neurones - 'intact' rats $U = 71, n = 14,15$; 'castrate' rats $U = 69, n = 13,15$: In all cases $p > 0.05$).
- (2) Orthodromically stimulated CMA neurones - There were no significant differences between the latencies for CMA neurones, stimulated orthodromically from the MPH v VMC, in either 'intact' or 'castrate' rats (for 'intact' rats $U = 41, n = 10,12; p > 0.05$; for 'castrate' rats $U = 28, n = 7,10; p > 0.05$). There were too few orthodromically stimulated CMA neurones showing a long latency post-inhibitory type of activation to allow a meaningful statistical comparison between MPH and VMC stimulated units.

Comparison of Chronaxies.

There were no significant differences between the chronaxies estimated for MPH v VMC stimulation sites in either 'intact' or 'castrate' rats (for 'intact' rats $U = 15, n = 5,8; p > 0.05$; for 'castrate' rats $U = 20.5, n = 6,7; p > 0.05$).

2.5 General Discussion.

The results of the above experiments show that castration lengthens the mean absolute refractory periods of CMA neurones which project to the MPH. It has no effect on adjacent CMA neurones which project to the VMC, so its effect is specific. Castration did not affect the spontaneous firing rates of antidromically, orthodromically or non-driven CMA neurones identified by stimulation of either the MPH or the VMC, or the latencies/conduction

Figure 2.11

Experiments 1 and 2: Comparison of spontaneous firing rates in CMA neurones identified by stimulation of the MPH v VMC.

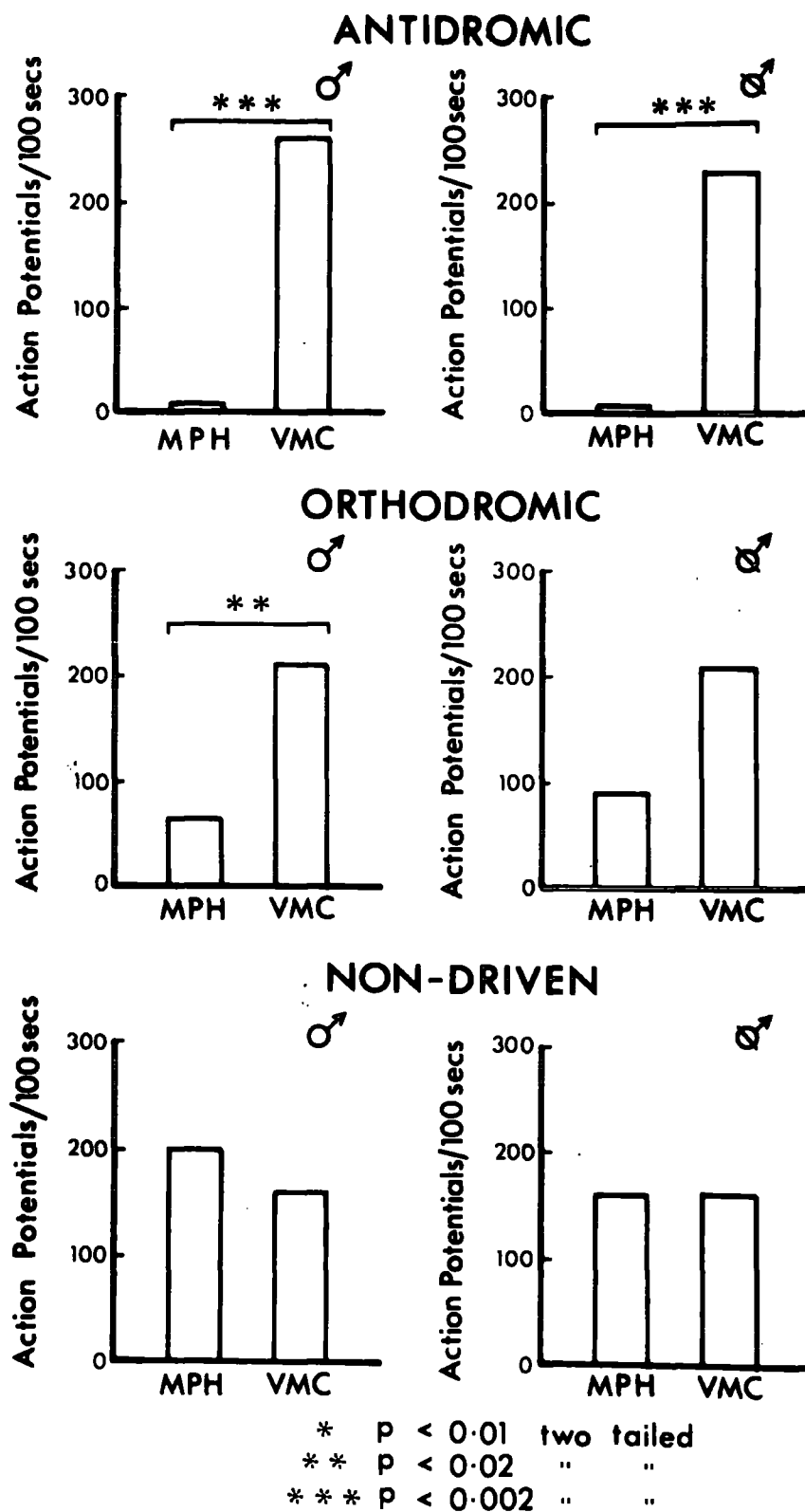

♂ = 'intact' rats.
 ♂ = 'castrate' rats.

velocities or chronaxies of CMA neurones stimulated from either the MPH or the VMC.

The mean absolute refractory periods of spontaneously active CMA neurones projecting to the MPH were significantly shorter than those projecting to the VMC, and the spontaneous firing rates of both antidromically and orthodromically stimulated neurones were significantly slower for units driven from the MPH as opposed to those driven from the VMC (with the exception of CMA neurones showing orthodromic activation in 'castrate' rats. This discrepancy may have been caused by the smaller sample in this group). Consequently it appears that the population of CMA neurones which project to the MPH is distinct from those which project to the VMC.

From the above results it can be concluded that castration affects membrane properties of CMA neurones which project directly to the MPH. The site of action of the hormone must be the membrane and not the synapse, since it is the absolute refractory period which is altered.

CHAPTER 3

ELECTROPHYSIOLOGICAL EFFECTS OF TESTOSTERONE ON CORTICOMEDIAL AMYGDALA NEURONES.

3.1 Introduction.

The experiments in Chapter 2 demonstrated that castration lengthened the absolute refractory periods of corticomedial amygdala (CMA) neurones which project to the medial preoptic/anterior hypothalamic junction (MPH). It is well established that testosterone can completely restore sexual behaviour in the castrated male rat (Beach, 1961; Young, 1961). In consequence, this Chapter describes an experiment designed to determine whether treatment of castrated rats with a sufficient dose of testosterone to restore full sexual behaviour would significantly reduce the lengthened absolute refractory periods of these CMA neurones, i.e., reverse the effect of castration.

3.2 Experiment 3: The effects of testosterone on the absolute refractory periods of CMA neurones.

3.2.1 Method.

Experimental Animals and Hormone Treatments.

Twenty three adult male, sexually naive, Porton albino Wistar rats (approximately 120 days of age; weight 400 - 600g) were used. All rats were maintained on a 12hr reversed light-dark schedule and castrated under ether anaesthesia at least 8 weeks prior to use. After 8 weeks the rats were divided randomly into two groups. The 12 rats in the experimental group were given daily subcutaneous injections of 200µg Testosterone Propionate (TP) (Koch-Light Laboratories) in 0.1 ml arachis oil for 18 - 22 days (a dose sufficient to restore full sexual behaviour -Pfaff, 1970; Baum and Vreeburg, 1973). The 11 rats in the second control group, received daily subcutaneous injections of 0.1 ml arachis oil for 18 - 22 days.

At the time of electrophysiological recording rats were at least 180 days of age, weighing 400 - 675g.

Experimental apparatus and design and procedure.

These were essentially the same as described in the Method section of Experiment 1 (in Chapter 2). The MPH was used as the stimulation site. Chronaxies and rheobase currents were not measured in this experiment.

3.2.2 Results.

Data were treated in the same manner as in Experiment 1.

Anatomical Loci of Recording and Stimulation Sites.

These were the same as in Experiment 1. Localisation of antidromically identified CMA neurones is shown in Figure 3A of the Appendix.

Absolute Refractory Periods.

(i) Spontaneously active CMA neurones antidromically stimulated from the MPH - The absolute refractory periods of 41 CMA neurones were measured in 11 rats treated with TP and of 30 CMA neurones in 11 controls treated with oil. The mean absolute refractory periods of TP treated rats were significantly shorter than those of oil treated control rats ($U = 4.5$, $n = 11, 11$; $p < 0.002$ two-tailed). The overall mean absolute refractory period was 0.98 msec for TP treated rats (range 0.65 - 1.25 msec) and 1.49 msec for oil treated rats (range 1.09 - 2.60 msec).

(ii) Silent CMA neurones antidromically stimulated from the MPH - The absolute refractory periods of 39 of these CMA neurones were measured in 12 TP treated rats and of 23 CMA neurones from 11 oil treated rats. The mean absolute refractory periods of the TP treated rats were significantly shorter than those of the oil treated control rats ($U = 15$, $n = 11, 12$; $p < 0.002$ two-tailed). The overall mean absolute refractory period was 1.01 msec for TP treated rats (range 0.58 - 1.19 msec) and 1.38 msec (range 0.94 - 2.15 msec).

(iii) Combined spontaneous and silent CMA neurones antidromically stimulated from the MPH - When the absolute refractory periods of spontaneously active and silent CMA neurones were combined in each rat the following figures

were obtained: 0.97 msec for TP treated rats (range 0.63 - 1.16 msec) and 1.48 msec in oil treated rats (range 1.03 - 2.38 msec). In all, the absolute refractory periods of 80 CMA neurones were recorded from 12 TP treated rats and of 53 CMA neurones from 11 oil treated rats. Again, there was a significant difference between the mean absolute refractory periods recorded from the two groups ($U = 5$, $n = 11, 12$; $p < 0.002$ two-tailed).

In those rats from which the absolute refractory periods of both spontaneously active and silent CMA neurones were measured, there was no significant difference between the two types of unit (Wilcoxon Test - for rats treated with TP $n = 11$, $T = 27.5$; $P > 0.05$; for rats treated with oil $n = 10$, $T = 21.0$; $p > 0.05$).

The mean absolute refractory periods of these CMA neurones in both groups are given in Table 3.2 of the Appendix and illustrated in Figure 3.1. The raw figures for the absolute refractory period measurements of CMA neurones are given in section 2 of the Appendix.

Other Measurements.

1. Spontaneous Firing Rates.

(i) Antidromically identified CMA neurones - The spontaneous firing rates of 36 of these CMA neurones were recorded from 11 TP treated rats and of 29 CMA neurones from 11 oil treated rats. There was no significant difference between the median spontaneous firing rates of these neurones in TP v Oil treated rats ($U = 42.5$, $n = 10, 11$; $p > 0.05$). The overall mean of these median spontaneous firing rates was 36.40 action potentials per 100 sec for TP treated rats (range 1.33 - 331.50 action potentials per 100 sec) and 32.47 action potentials per 100 sec for oil treated rats (range 3.17 - 196.34 action potentials per 100 sec).

(ii) Orthodromically identified CMA neurones - This group only includes short latency units (5.7 - 40.1 msec). The spontaneous firing rates of

Figure 3.1

Experiment 3: Mean absolute refractory periods of CMA neurones antidromically stimulated from the MPH. Castrated rats treated with TP v Oil.

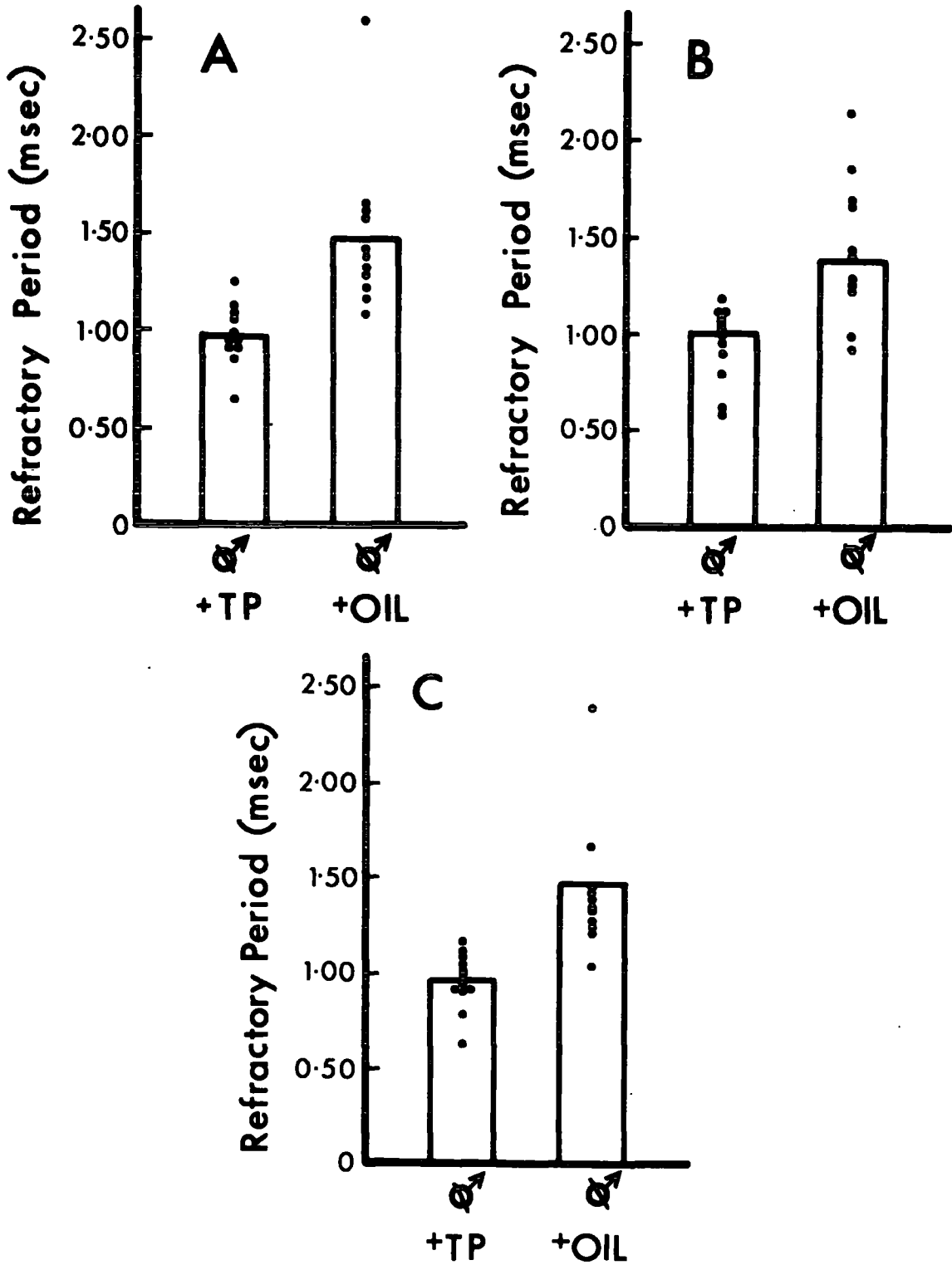

♂ = 'castrate' rats.

TP = testosterone propionate.

A = spontaneously active CMA neurones; B = silent CMA neurones;

C = combined spontaneous + silent CMA neurones.

19 CMA neurones were recorded from 8 TP treated rats and of 10 CMA neurones from 6 oil treated rats. No significant difference was found between the median spontaneous firing rates of the two groups ($U = 24, n = 6,8; p = 0.525$. Not Significant). The overall mean of these median spontaneous firing rates was 241.50 action potentials per 100 sec for the TP treated group (range 3.33 - 1410.00 action potentials per 100 sec) and 82.28 action potentials per 100 sec for oil treated rats (range 3.00 - 334.34 action potentials per 100 sec).

(iii) Orthodromically identified CMA neurones (with long latencies and showing a post-inhibitory excitation type of response) - Not enough of these units were recorded to allow a comparison of spontaneous firing rates between the TP and oil treated groups. In all, two of these neurones were recorded from oil treated rats (with spontaneous firing rates of 173.33 and 534.00 action potentials per 100 sec) and one from a TP treated rat (with a spontaneous firing rate of 670.67 action potentials per 100 sec).

(iv) Non-Driven spontaneously active CMA neurones - The spontaneous firing rates of 14 of these CMA neurones were recorded from 5 TP treated rats and of 18 CMA neurones from 8 oil treated rats. No significant difference was found between the median spontaneous firing rates of CMA neurones in these groups ($U = 9, n = 5,8; p = 0.472$. Not Significant). The overall mean for the median spontaneous firing rates in each group was 186.10 action potentials per 100 sec for TP treated rats (range 14.67 - 500.67 action potentials per 100 sec) and 247.06 action potentials per 100 sec for the oil treated rats (range 2.17 - 781.50 action potentials per 100 sec).

The median spontaneous firing rate values for each rat are given in Table 3.1 of the Appendix. Raw data values for all spontaneous firing rates are given in Section 2 of the Appendix.

Latencies and Conduction Velocities

1. Antidromically identified CMA neurones - The mean latencies and conduction velocities for CMA neurones antidromically stimulated from the MPH are given

in Table 3.3 of the Appendix for both TP and Oil treated rats.

(i) Spontaneously active CMA neurones antidromically stimulated from the MPH - Latencies were recorded for 41 of these CMA neurones from 11 TP treated rats and for 32 CMA neurones from 11 oil treated rats. There was no significant difference between the mean latencies recorded from the two groups ($U = 41, n = 11,11; p > 0.05$). The overall mean latency was 16.01 msec for TP treated rats (range 7.43 - 24.63) and 16.52 msec for oil treated rats (range 6.20 - 27.65 msec). The overall mean conduction velocities were 0.60 m/sec for TP treated rats (range 0.34 - 1.08 m/sec) and 0.62 m/sec for oil treated rats (range 0.30 - 1.29 m/sec).

(ii) Silent CMA neurones antidromically stimulated from the MPH - Latencies were recorded for 39 of these CMA neurones from 12 TP treated rats and for 23 CMA neurones from 11 oil treated rats. There was no significant difference between the mean latencies recorded from the two groups ($U = 50.5, n = 11,11; p > 0.05$). The overall mean latency was 18.63 msec for TP treated rats (range 13.90 - 27.00 msec) and 21.59 msec for oil treated rats (range 12.10 - 31.00 msec). The overall mean conduction velocities were 0.50 m/sec for TP treated rats (range 0.30 - 0.67 m/sec) and 0.44 m/sec for oil treated rats (range 0.27 - 0.66 m/sec).

(iii) Combined Spontaneous and Silent CMA neurones antidromically stimulated from the MPH - Altogether, the latencies of 80 CMA neurones were recorded from 12 TP treated rats and of 55 CMA neurones from 11 oil treated rats. Again there was no significant difference between the mean latencies recorded from the two groups ($U = 52, n = 11,12; p > 0.05$). The combined overall mean latency was 17.04 msec for TP treated rats (range 10.98 - 23.12 msec) and 18.47 msec for oil treated rats (range 9.15 - 29.18 msec). The combined overall mean conduction velocities were 0.56 m/sec for TP treated rats (range 0.44 - 0.85 m/sec) and 0.54 m/sec for oil treated rats (range 0.30 - 0.98 m/sec).

In those rats from which latencies of both silent and spontaneously

active CMA neurones were recorded there was no significant difference between the two types of unit for TP treated rats (Wilcoxon Test - $n = 11$, $T = 16$; $p > 0.05$). There was, however, a significant difference between the latencies of silent and spontaneously active CMA neurones for oil treated rats (Wilcoxon Test - $n = 11$, $T = 9.5$; $p < 0.05$ two-tailed).

2. Orthodromically stimulated CMA neurones - The variable latencies of these neurones were reduced to a single mean value (to one decimal place) and the overall mean latency for each rat calculated. The overall mean values are given in Table 3.4 of the Appendix. There were very few silent orthodromic units, hence comparisons between TP treated and oil treated rats were only made between spontaneously active and silent CMA neurones combined.

Altogether, the latencies of 26 CMA neurones were recorded from 9 TP treated rats and of 13 CMA neurones from 7 oil treated rats. There was no significant difference between the mean latencies recorded from these two groups ($U = 24$, $n = 7,9$; $p > 0.05$). With the variable latencies reduced to a single mean, the combined, overall, mean latency was 19.50 msec for TP treated rats (range 14.42 - 24.47 msec) and 17.84 msec for oil treated rats (range 13.40 - 26.75 msec).

The 3 CMA neurones which showed a post-inhibitory excitation type of response had latencies of between 44 and 125 msec. One of these units was recorded from a TP treated rat and two units from oil treated rats; too few to allow a meaningful statistical comparison between the groups.

The raw figures for latencies recorded from CMA neurones (both antidromically and orthodromically stimulated from the MPH) are given in section 2 of the Appendix.

3.3 Comparison of Results from Experiments 1 (Chapter 2) and 3.

Comparison of Absolute Refractory Periods

There were no significant differences between the mean absolute refractory

periods of CMA neurones in the 'intact' rats of Experiment 1 and the 'castrate' rats treated with TP of Experiment 3:-

- (i) Spontaneously active CMA neurones ($U = 65.5$, $n = 11,12$; $p > 0.05$).
- (ii) Silent CMA neurones ($U = 59.5$, $n = 10,12$; $p > 0.05$).
- (iii) Combined spontaneous and silent CMA neurones ($U = 71.5$, $n = 12,13$; $p > 0.05$).

There was a small significant difference between 'castrate' rats (Experiment 1) and 'castrate' rats treated with oil (Experiment 3) for:-

- (i) Spontaneously active CMA neurones ($U = 22.5$, $n = 9,11$; $p < 0.05$ two tailed. (I am doubtful that this is a genuine effect).

There were no significant differences in the silent and combined spontaneous and silent comparisons:-

- (ii) Silent CMA neurones ($U = 54.5$, $n = 10,11$; $p > 0.05$).
- (iii) Combined spontaneous and silent CMA neurones ($U = 49.5$, $n = 11,12$; $p > 0.05$).

The above comparisons are illustrated in Figure 3.2.

Comparison of Spontaneous Firing Rates.

There were no significant differences between the median spontaneous firing rates of CMA neurones in 'intact' rats and 'castrate' rats treated with TP:-

- (1) Antidromically identified CMA neurones ($U = 62$, $n = 11,13$; $p > 0.05$).
- (2) Orthodromically identified CMA neurones ($U = 40$, $n = 8,10$; $p > 0.05$).
- (3) Non-driven CMA neurones ($U = 28$, $n = 5,13$; $p > 0.05$).

Similarly, there were no significant differences between the median spontaneous firing rates of CMA neurones in 'castrate' rats (Experiment 1) and 'castrate' rats treated with oil (Experiment 3):-

- (1) Antidromically identified CMA neurones ($U = 25$, $n = 10,10$; $p > 0.05$).
- (2) Orthodromically identified CMA neurones ($U = 21$, $n = 6,9$; $p > 0.05$).
- (3) Non-driven CMA neurones ($U = 43$, $n = 8,11$; $p > 0.05$).

Figure 3.2

Experiments 1 and 3: Comparison of mean absolute refractory periods in CMA neurones antidromically stimulated from the MPH, 'Intact' v 'Castrate' rats and castrated rats treated with TP v Oil.

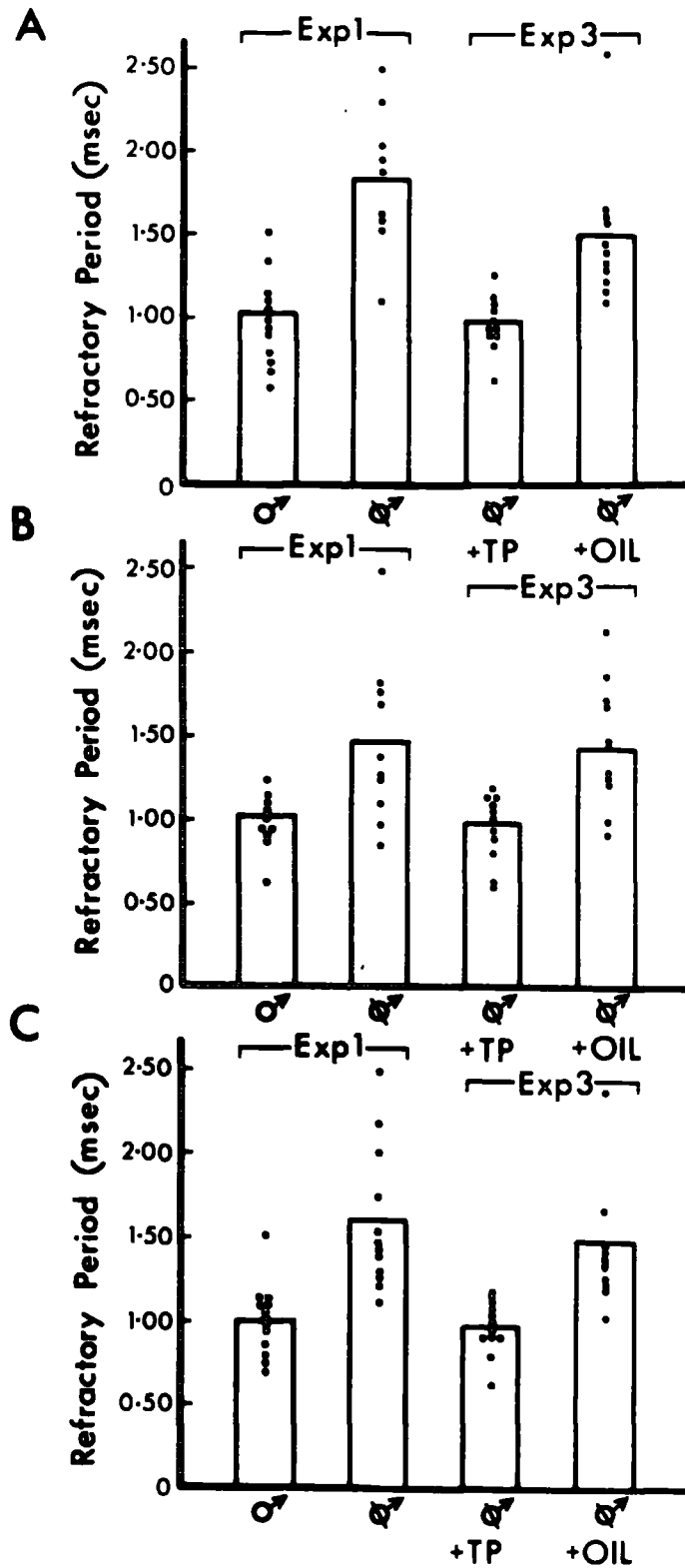

♂ = 'intact' rats.

♂ = 'castrate' rats.

TP = testosterone propionate.

A = spontaneously active CMA neurones; B = silent CMA neurones;

C = combined spontaneous + silent CMA neurones.

Comparison of Latencies.

There were no significant differences between the mean latencies of antidromically or orthodromically identified CMA neurones in 'intact' rats v 'castrate' rats treated with TP:-

(1) Antidromically identified CMA neurones:-

- (i) Spontaneously active CMA neurones ($U = 45, n = 11,13; p > 0.05$).
- (ii) Silent CMA neurones ($U = 44, n = 11,12; p > 0.05$).
- (iii) Combined spontaneous and silent CMA neurones ($U = 58.5, n = 12,15; p > 0.05$).

(2) Orthodromically identified CMA neurones:-

- (i) Combined spontaneous and silent CMA neurones ($U = 36, n = 9,10; p > 0.05$).

Similarly, there were no significant differences between the mean latencies of antidromically or orthodromically identified CMA neurones in 'castrate' rats (Experiment 1) and 'castrate' rats treated with oil (Experiment 3):-

(1) Antidromically identified CMA neurones:-

- (i) Spontaneously active CMA neurones ($U = 32, n = 11,11; p > 0.05$).
- (ii) Silent CMA neurones ($U = 57, n = 11,11; p > 0.05$).
- (iii) Combined spontaneous and silent CMA neurones ($U = 49, n = 11,15; p > 0.05$).

(2) Orthodromically identified CMA neurones:-

- (i) Combined spontaneous and silent CMA neurones ($U = 15, n = 7,10; p > 0.05$).

3.4 Discussion.

The results of Experiment 3 show that testosterone treatment significantly reduces the absolute refractory periods of CMA neurones in castrated rats. Testosterone treatment completely reverses the effect of castration: the mean absolute refractory period is reduced to the level found in gonadally intact rats.

This experiment, therefore effectively replicates the result of Experiment 1 with an entirely new set of animals, and confirms that the change in neuronal refractory period resulting from castration can be reversed by testosterone.

Testosterone treatment did not significantly alter the spontaneous firing rates of any types of CMA neurones recorded, or the latencies of antidromically or orthodromically identified CMA neurones.

CHAPTER 4

ELECTROPHYSIOLOGICAL EFFECTS OF OESTRADIOL AND DIHYDROTESTOSTERONE ON CORTICOMEDIAL AMYGDALA NEURONES.

4.1 Introduction.

Experiment 3 (described in Chapter 3) demonstrated that testosterone exerts a direct effect on corticomedial amygdala (CMA) neurones which project to the medial preoptic/anterior hypothalamic junction (MPH).

Testosterone itself is aromatized to oestradiol (reviewed by Naftolin, Ryan and Davies, 1976) and reduced to dihydrotestosterone (reviewed by Martini, 1976) at receptor sites in the brain and peripheral target tissues. It has generally been assumed that the active form of testosterone in the peripheral target tissues is the 5 α - reduced metabolite (dihydrotestosterone) whereas oestrogens are the active metabolites in the central nervous system.

These conclusions are based mainly on experiments which have shown that:-

(1) Oestradiol treatment stimulates sexual behaviour in castrated male rats (Davidson, 1969; Pfaff, 1970b; Södersten, 1973; Paup, Mennin and Gorski, 1975) without stimulating accessory sex organ growth (Larsson, Södersten and Beyer, 1973) or function (Price and Williams-Ashman, 1961). These results therefore imply that oestradiol is exerting its effect on sexual behaviour purely through the central nervous system.

(2) Dihydrotestosterone stimulates the growth of accessory sex organs such as the seminal vesicles, preputial, prostate and coagulating glands, and penile papillae (Wilson and Gloyna, 1970; Parrott, 1975), but does not stimulate mounting, intromission or ejaculatory behaviour in castrated male rats (McDonald et al., 1970; Feder, 1971; Whalen and Luttge, 1971). These results imply that dihydrotestosterone does not stimulate sexual behaviour since it does not have a central nervous system effect.

(3) Dihydrotestosterone does not produce sexual (hypothalamic) differentiation (Brown-Grant, Munck, Naftolin and Sherwood, 1971; McDonald, 1971;

McDonald et al., 1970) whereas oestrogens which are formed from androgens of testicular origin do (Reddy, Naftolin and Ryan, 1974).

Further indirect support for this distinction between the peripheral potency of dihydrotestosterone and the central potency of oestrogens comes from experiments which show that the effect of oestradiol on sexual behaviour in the castrated male rat is enhanced if it is combined with dihydrotestosterone (Larsson, Södersten and Beyer, 1973; Baum and Vreeburg, 1973; Södersten, 1973; Feder, Naftolin and Ryan, 1973). It has been assumed from these experiments that the synergistic action of dihydrotestosterone on sexual behaviour has been due to its stimulation of accessory sex organ growth (thereby improving peripheral feedback information to the central nervous system during sexual behaviour); oestradiol treatment alone is ineffective in stimulating accessory sex organ growth.

However, in spite of the above evidence for the distinction between the major sites of action of dihydrotestosterone and oestrogens, much conflicting evidence has now accumulated which suggests that the picture is somewhat more complex than was originally thought. Several studies have shown that dihydrotestosterone treatment may also act on the central nervous system to produce facilitatory influences on sexual behaviour in castrated male rats (Paup, Mennin and Gorski, 1975; Södersten, 1975). Further, the fact that dihydrotestosterone does not produce sexual differentiation is not conclusive since testosterone itself is also relatively ineffective in comparison with its propionate (Brown-Grant, Munck, Naftolin and Sherwood, 1971). This may be due to the slower metabolism of the propionate and suggests that a long exposure time is required for the action of androgen on the neonatal rat brain. It is possible therefore that the dihydrotestosterone used to date has been metabolised too quickly to produce positive effects.

The above conflicting evidence suggests the alternative possibility that the synergistic action of dihydrotestosterone on sexual behaviour when

combined with oestradiol may be due to a synergistic action of dihydrotestosterone with oestradiol within the central nervous system (on analogy with the synergistic effect of progesterone on oestradiol in the female). However, no direct evidence for such a synergism has yet been found.

This chapter describes an experiment designed to determine whether oestradiol or dihydrotestosterone (alone or in combination) are capable of mimicking the effects of testosterone on the absolute refractory periods of CMA neurones which project to the MPH. It was hoped that such an experiment would allow a direct test at the neuronal level of some of the alternatives mentioned in the above review regarding the central nervous system actions of these hormones.

4.2 Experiment 4: The effects of oestradiol and dihydrotestosterone on the absolute refractory periods of CMA neurones.

4.2.1 Method.

Experimental Animals and Hormone Treatments.

Thirty-two, adult male, sexually naive, Porton albino Wistar rats (approximately 120 days of age; weight 400 - 600g) were used. All animals were maintained on a 12 hr reversed light-dark schedule and castrated under ether anaesthesia at least 8 weeks prior to use for electrophysiology. After 8 weeks the rats were divided randomly into four groups of 8 (three experimental groups and one control group). The experimental groups were given daily subcutaneous injections of either (i) 5 μ g oestradiol benzoate (OB) (Sigma Chemicals, Poole); (ii) 1mg dihydrotestosterone propionate (DHTP) (Steroids, Wilton, N.H., U.S.A.) or (iii) 5 μ g OB + 1mg DHTP, for 18 - 22 days. All experimental treatments were injected in an arachis oil vehicle and the control group was injected with arachis oil alone. The propionate of dihydrotestosterone was used since the propionate of testosterone was used in Experiment 3 (Chapter 3).

In this experiment, all electrophysiological analyses were carried out blind.

The hormones and the oil were put into coded bottles by a research technician so that the experimenter did not know which group received which treatment until the code was broken at the end of the experiment. Since the OB + DHTP treatment necessitated the use of two separate daily injections, all groups were given their respective treatments as two daily 0.1 ml injections. In the case of the hormone treatments this involved giving 50% of the total daily dose in each injection. Arachis oil injections were administered in the same manner except that these simply involved giving two identical 0.1 ml injections.

At the time of electrophysiological recording, rats were at least 180 days of age and weighed 400 - 675g.

Experimental apparatus and design and procedure.

These were the same as described in the Method section of Experiment 1 (in Chapter 2). The MPH was used as the stimulation site. Chronaxies and rheobase currents were not measured in this experiment however and CMA neurones which showed a post-inhibitory excitation type of response were not noted as they were so rarely encountered.

4.2.2 Results.

Data were treated in the same manner as in Experiment 1. Since there were four treatment groups, a Kruskal-Wallis one-way analysis of variance was used to test for overall significance between the groups. Mann-Whitney U tests were used to make post-hoc comparisons between pairs of groups, (the significance levels given in the ensuing analysis for post-hoc comparisons are not corrected. If a correction is made $p < 0.002$ becomes $p < 0.01$).

Anatomical Loci of Recording and Stimulation Sites.

These were the same as in Experiment 1. Localisation of antidromic CMA neurones is given in Figures 4A and B in the Appendix.

Absolute Refractory Periods.

(1) Spontaneously active CMA neurones antidromically stimulated from

the MPH - The absolute refractory periods of 45 CMA neurones were recorded from OB treated rats and 47, 33 and 34 CMA neurones from OB + DHTP, DHTP and Oil treated rats respectively. Recordings were taken from 8 rats in each group. There was an overall significant difference between the four groups (Kruskal-Wallis, $H = 24.46$; $p < 0.001$ two tailed).

The overall mean absolute refractory periods and ranges for each group were:-

- (i) OB treated rats = 0.90 msec and 0.73 - 1.06 msec
- (ii) OB + DHTP treated rats = 1.00 msec and 0.91 - 1.14 msec
- (iii) DHTP treated rats = 1.38 msec and 1.21 - 1.55 msec
- (iv) Oil treated rats = 1.37 msec and 1.24 - 1.58 msec

The results of post-hoc comparisons between pairs of groups were:-

OB v Oil	U = 0	p < 0.002 two tailed.
DHTP + OB v Oil	U = 0	p < 0.002 two tailed.
DHTP v Oil	U = 29.5	p > 0.05 Not Significant
OB v DHTP + OB	U = 15.5	p > 0.05 Not Significant
OB v DHTP	U = 0	p < 0.002 two tailed.
DHTP + OB v DHTP	U = 0	p < 0.002 two tailed.

(ii) Silent CMA neurones antidromically stimulated from the MPH -

The absolute refractory periods of 35 CMA neurones were recorded from OB treated rats and 40, 41 and 35 CMA neurones from OB + DHTP, DHTP and Oil treated rats respectively. Recordings were taken from 8 rats in each group. There was an overall significant difference between the four groups (Kruskal-Wallis, $H = 23.70$; $p < 0.001$ two-tailed).

The overall mean absolute refractory periods and ranges for each group were:-

- (i) OB treated rats = 0.88 msec and 0.74 - 1.04 msec
- (ii) OB + DHTP treated rats = 0.97 msec and 0.87 - 1.16 msec
- (iii) DHTP treated rats = 1.41 msec and 1.19 - 1.69 msec
- (iv) Oil treated rats = 1.45 msec and 1.07 - 1.74 msec

The results of the post-hoc comparisons between pairs of groups were:-

OB v Oil	U = 0	p < 0.002 two tailed.
OB + DHTP v Oil	U = 1	p < 0.002 two tailed.
DHTP v Oil	U = 27	p > 0.05 Not Significant.
OB v OB + DHTP	U = 21.5	p > 0.05 Not Significant.
OB v DHTP	U = 0	p < 0.002 two tailed.
OB + DHTP v DHTP	U = 0	p < 0.002 two tailed.

(iii) Combined spontaneous and silent CMA neurones stimulated from the MPH -

When the absolute refractory periods of spontaneously active and silent neurones were combined in each rat the following figures were obtained.

In all, the absolute refractory periods of 80 CMA neurones were recorded from OB treated rats and 87, 74 and 69 CMA neurones from OB + DHTP, DHTP and Oil treated rats respectively. Recordings were taken from 8 rats in each group. There was an overall significant difference between the four groups (Kruskal-Wallis, $H = 24.11$; $p < 0.001$ two-tailed).

The overall combined absolute refractory periods and ranges for each group were:-

(i) OB treated rats	=	0.90 msec and 0.74 - 1.04 msec
(ii) OB + DHTP treated rats	=	0.98 msec and 0.93 - 1.15 msec
(iii) DHTP treated rats	=	1.40 msec and 1.20 - 1.55 msec
(iv) Oil treated rats	=	1.45 msec and 1.19 - 1.53 msec

The results of the post-hoc comparisons between pairs of groups were:-

OB v Oil	U = 0	p < 0.002 two-tailed.
OB + DHTP v Oil	U = 0	p < 0.002 two-tailed.
DHTP v Oil	U = 28.5	p > 0.05 Not Significant.
OB v OB + DHTP	U = 20	p > 0.05 Not Significant.
OB v DHTP	U = 0	p < 0.002 two-tailed.
OB + DHTP v DHTP	U = 0	p < 0.002 two-tailed.

Thus the above results clearly show that OB and OB + DHTP significantly reduce the absolute refractory periods of CMA neurones which project directly to the MPH. DHTP alone had no effect however. Further, the post-hoc analysis also showed that the combined treatment of OB + DHTP did not produce a significantly greater effect than OB alone. Hence, results do not indicate a synergistic effect of dihydrotestosterone on oestradiol in the central nervous system.

As in previous experiments, there was no significant difference between the absolute refractory periods of spontaneously active and silent CMA neurones (Wilcoxon Tests - for OB treated rats $T = 13.5$, $n = 7$; for OB + DHTP treated rats $T = 10$, $n = 8$; for DHTP treated rats $T = 18$, $n = 8$; and for Oil treated rats $T = 12$, $n = 8$ - in all cases $p > 0.05$).

The mean absolute refractory periods of these CMA neurones for all four groups are given in Tables 4.2a,b of the Appendix and illustrated in Figure 4.1. The raw data are given in section 3 of the Appendix.

Other Measurements.

(1) Spontaneous Firing Rates.

(a) Antidromically identified CMA neurones - The spontaneous firing rates of 37 of these CMA neurones were recorded from OB treated rats and 42, 29 and 32 CMA neurones from OB + DHTP, DHTP and Oil treated rats respectively. Recordings were taken from 8 rats in each group except the DHTP treated group where recordings were only taken from 7 rats. There was no significant difference between the median spontaneous firing rates of these neurones in the four groups (Kruskal-Wallis $H = 0.59$; $p > 0.05$). The overall means and ranges of these median firing rates were:-

(i)	OB treated rats	= 6.50 and 1.67 - 13.00	action potentials
			per 100 sec.
(ii)	OB + DHTP treated rats	= 8.87 and 2.67 - 21.00	" "
(iii)	DHTP treated rats	= 6.62 and 1.67 - 16.00	" "
(iv)	Oil treated rats	= 7.10 and 2.84 - 15.67	" "

Figure 4.1

Experiment 4: Mean absolute refractory periods of CMA neurones antidromically stimulated from the MPH. Castrated rats treated with either OB, OB + DHTP, DHTP or Oil.

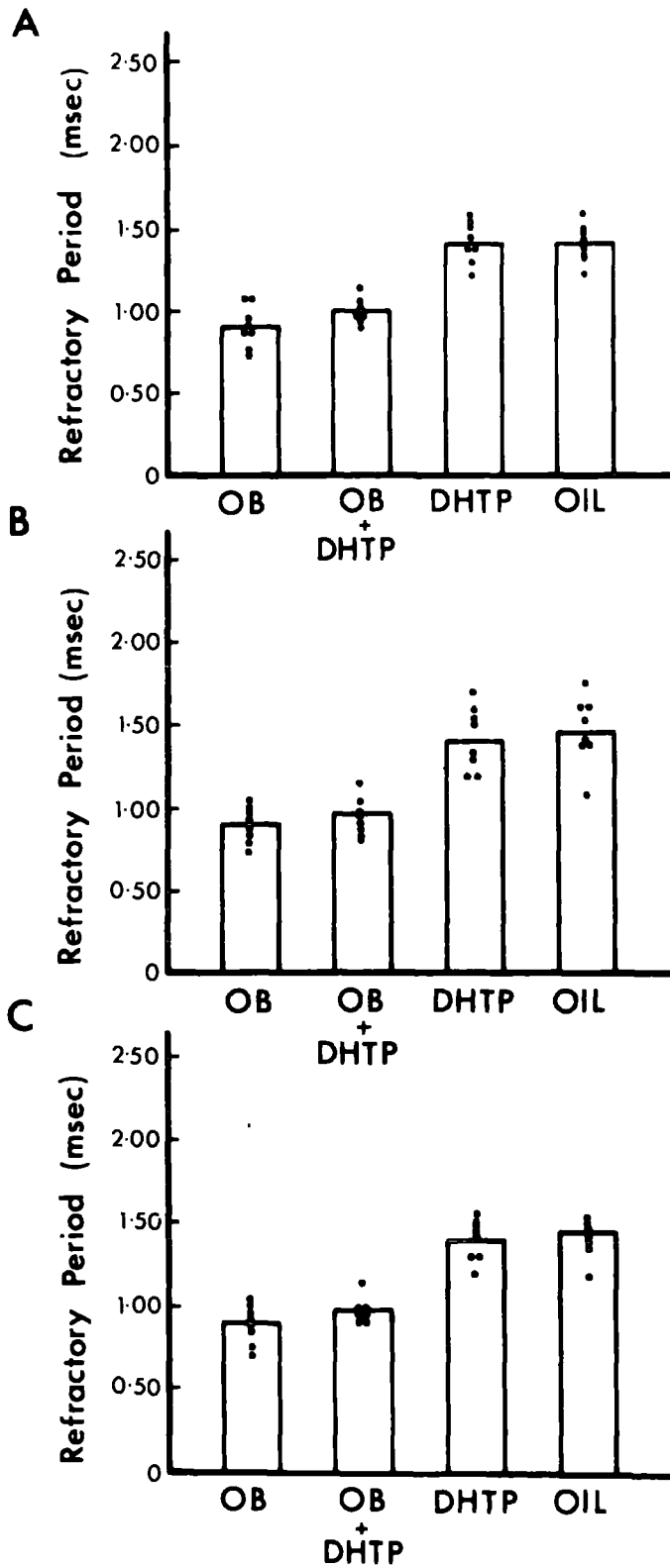

OB = oestradiol benzoate; DHTP = dihydrotestosterone propionate.

A = spontaneously active CMA neurones; B = silent CMA neurones;

C = combined spontaneous + silent CMA neurones.

The median spontaneous firing rate values for each rat are given in Tables 4.1 a, b of the Appendix.

(b) Orthodromically identified CMA neurones - The spontaneous firing rates of 9 of these CMA neurones were recorded from 5 OB treated rats; 3 CMA neurones from 3 OB + DHTP treated rats; 11 CMA neurones from 5 DHTP treated rats and 6 CMA neurones from 4 oil treated rats. There was no significant difference between the median spontaneous firing rates of the four groups (Kruskal-Wallis $H = 0.34$; $p > 0.05$). The overall means and ranges of these median firing rates were:-

(i) OB treated rats	=	146.50 and 32.67 - 292.17	action potentials
			per 100 sec
(ii) OB + DHTP treated rats	=	214.11 and 2.33 - 400.00	" "
(iii) DHTP treated rats	=	185.50 and 11.17 - 549.67	" "
(iv) Oil treated rats	=	145.21 and 0.67 - 317.50	" "

The median spontaneous firing rate values for each rat are given in Tables 4.2a, b of the Appendix.

(c) Non-driven CMA neurones - The spontaneous firing rates of 7 of these CMA neurones were recorded from 4 OB treated rats; 11 CMA neurones from 6 OB + DHTP treated rats; 11 CMA neurones from 5 DHTP treated rats and 10 CMA neurones from 7 Oil treated rats. There was no significant difference between the median spontaneous firing rates of CMA neurones in these groups (Kruskal-Wallis $H = 5.12$; $p > 0.05$). The overall means and ranges of these spontaneous firing rates were:-

(i) OB treated rats	=	462.88 and 123.00 - 781.67	action potentials
			per 100 sec
(ii) OB + DHTP treated rats	=	237.53 and 101.67 - 346.00	" "
(iii) DHTP treated rats	=	231.93 and 94.33 - 392.50	" "
(iv) Oil treated rats	=	291.24 and 34.00 - 758.67	" "

The median spontaneous firing rate values for each rat are given in Tables 4.2a, b of the Appendix.

Raw data are given in Section 3 of the Appendix.

Latencies and Conduction Velocities.

(1) Antidromically identified CMA neurones - The mean latencies and conduction velocities for CMA neurones antidromically stimulated from the MPH are given in Tables 4.3a, b of the Appendix for all treatment groups.

(a) Spontaneously active CMA neurones antidromically stimulated from the MPH - Latencies were recorded for 45 of these CMA neurones from OB treated rats and 47, 33 and 34 CMA neurones from OB + DHTP, DHTP and Oil treated rats respectively. Data were taken from 8 rats in each group. There was no significant difference between the mean latencies recorded from the four groups (Kruskal-Wallis $H = 2.15$; $p > 0.05$). The overall mean latencies and ranges were:-

(i) OB treated rats	=	16.57 and 12.07 - 26.30 msec
(ii) OB + DHTP treated rats	=	17.79 and 11.53 - 21.15 msec
(iii) DHTP treated rats	=	18.35 and 6.93 - 27.10 msec
(iv) Oil treated rats	=	17.40 and 12.68 - 22.00 msec

The overall mean conduction velocities and ranges were:-

(i) OB treated rats	=	0.60 and 0.32 - 0.86 m/sec
(ii) OB + DHTP treated rats	=	0.53 and 0.39 - 0.80 m/sec
(iii) DHTP treated rats	=	0.60 and 0.31 - 1.21 m/sec
(iv) Oil treated rats	=	0.52 and 0.37 - 0.66 m/sec

(b) Silent CMA neurones antidromically stimulated from the MPH - Latencies were recorded for 35 of these CMA neurones from OB treated rats and 41, 41 and 35 CMA neurones from OB + DHTP, DHTP and oil treated rats respectively. Data were taken from 8 rats in each group. There was no significant difference between the mean latencies recorded from the four groups (Kruskal-Wallis $H = 4.88$; $p > 0.05$). The overall mean latencies and ranges were:-

(i) OB treated rats	=	18.55 and 13.59 - 27.13 msec
(ii) OB + DHTP treated rats	=	19.17 and 11.53 - 28.23 msec
(iii) DHTP treated rats	=	21.71 and 13.35 - 26.20 msec
(iv) Oil treated rats	=	24.17 and 18.90 - 31.63 msec

The overall mean conduction velocities and ranges were:-

- (i) OB treated rats = 0.52 and 0.31 - 0.73 m/sec
 - (ii) OB + DHTP treated rats = 0.55 and 0.29 - 1.03 m/sec
 - (iii) DHTP treated rats = 0.44 and 0.32 - 0.73 m/sec
 - (iv) Oil treated rats = 0.38 and 0.27 - 0.49 m/sec
- (c) Combined Spontaneous and Silent CMA neurones antidromically stimulated from the MPH - Altogether, the latencies of 80 CMA neurones were recorded from OB treated rats and 88, 74 and 69 CMA neurones from OB + DHTP, DHTP and Oil treated rats respectively. Data were taken from 8 rats in each group. There was no significant difference between the mean latencies recorded from the four groups (Kruskal-Wallis $H = 2.83$; $p > 0.05$). The combined overall mean latencies and ranges were:-

- (i) OB treated rats = 17.43 and 13.13 - 26.60 msec
- (ii) OB + DHTP treated rats = 18.50 and 11.81 - 24.68 msec
- (iii) DHTP treated rats = 20.39 and 10.82 - 26.03 msec
- (iv) Oil treated rats = 21.44 and 14.10 - 29.20 msec.

The combined overall mean conduction velocities and ranges were:-

- (i) OB treated rats = 0.57 and 0.32 - 0.77 m/sec
- (ii) OB + DHTP treated rats = 0.53 and 0.34 - 0.83 m/sec
- (iii) DHTP treated rats = 0.49 and 0.34 - 0.86 m/sec
- (iv) Oil treated rats = 0.46 and 0.29 - 0.61 m/sec

There were significant differences between the latencies of spontaneously active and silent CMA neurones in the following groups:-

- (i) OB treated rats (Wilcoxon Test, $T = 3$, $n = 8$; $p < 0.05$ two-tailed).
- (ii) DHTP treated rats $T = 2$, $n = 8$; $p < 0.02$ two tailed
- (iii) Oil treated rats $T = 2$, $n = 8$; $p < 0.02$ two tailed

No significant difference was found for the OB + DHTP group ($T = 11$, $n = 8$; $p > 0.05$). In all the groups where this latency difference was significant the latencies of the silent CMA neurones were longer than those of the spontaneously active CMA neurones.

(2) Orthodromically stimulated CMA neurones - The variable latencies of these neurones were reduced to a single mean value (to one decimal place) and the overall mean latency for each rat calculated. The overall mean values are given in Table 4.4 of the Appendix. There were very few silent orthodromic units, hence comparisons between the treatment groups were only made between spontaneously active and silent CMA neurones combined.

Altogether, the latencies of 11 CMA neurones were recorded from 4 OB treated rats; 4 CMA neurones from 4 OB + DHTP treated rats; 14 CMA neurones from 6 DHTP treated rats and 9 CMA neurones from 6 Oil treated rats. There was no significant difference between the mean latencies recorded from these four groups (Kruskal-Wallis, $H = 1.81$; $p > 0.05$). With the variable latencies reduced to a single mean the overall mean latencies and ranges were:-

- (i) OB treated rats = 17.84 and 12.05 - 24.03 msec
- (ii) OB + DHTP treated rats = 18.98 and 11.30 - 31.30 msec
- (iii) DHTP treated rats = 20.30 and 11.78 - 28.00 msec
- (iv) Oil treated rats = 14.50 and 5.50 - 21.90 msec

The raw data are given in Section 3 of the Appendix.

4.3 Comparison of Results from Experiments 1 (Chapter 2) and 4.

The only comparison made in this section is between 'intact' rats and castrated rats treated with OB (Experiments 1 and 4 respectively).

Comparison of Absolute Refractory Periods.

There were no significant differences between the mean absolute refractory periods of CMA neurones in 'intact' rats v castrated rats treated with OB:-

- (i) Spontaneously active CMA neurones ($U = 37.5$, $n = 8,12$; $p > 0.05$).
- (ii) Silent CMA neurones ($U = 26$, $n = 8,10$; $p > 0.05$).
- (iii) Combined spontaneous and silent CMA neurones ($U = 33$, $n = 8,13$; $p > 0.05$).

The above comparisons are illustrated in Figure 4.2.

Figure 4.2

Experiments 1 and 4: Mean absolute refractory periods of CMA neurones antidromically stimulated from the MPH, 'intact' rats v 'castrate' rats treated with OB.

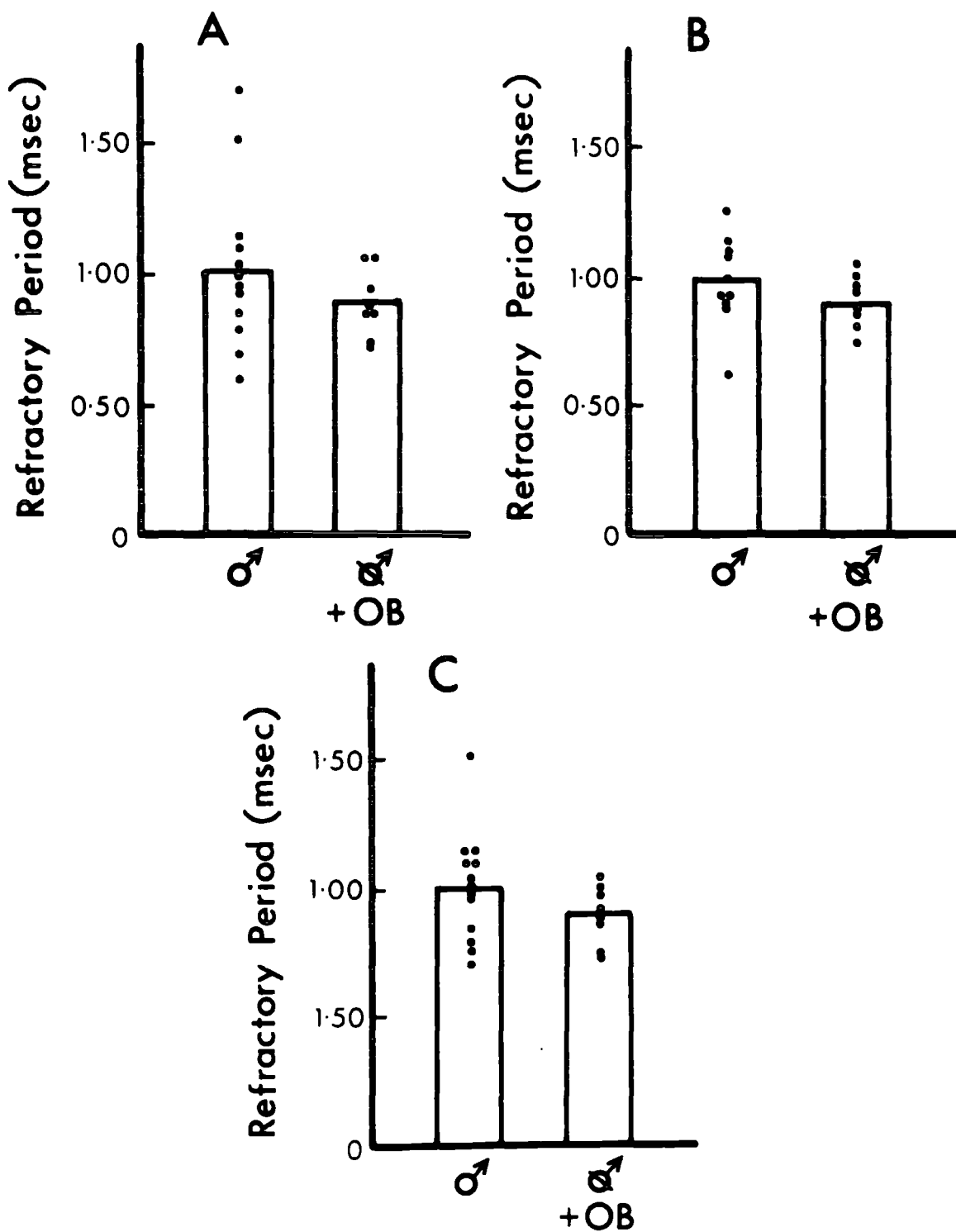

♂ = 'intact' rats.

♂ = 'castrate' rats.

OB = oestradiol benzoate.

A = spontaneously active CMA neurones; B = silent CMA neurones;

C = combined spontaneous + silent CMA neurones.

Comparison of Spontaneous Firing Rates.

There were no significant differences between the median spontaneous firing rates of CMA neurones in 'intact' rats v castrated rats treated with OB:-

- (1) Antidromically identified CMA neurones ($U = 52, n = 8,13; p > 0.05$).
- (2) Orthodromically identified CMA neurones ($U = 7, n = 4,10; p > 0.05$).
- (3) Non-driven CMA neurones ($U = 16, n = 4,13; p > 0.05$).

Comparison of Latencies.

There were no significant differences between the mean latencies of antidromically or orthodromically identified CMA neurones in 'intact' rats v castrated rats treated with OB:-

- (1) Antidromically identified CMA neurones:-
 - (I) Spontaneously active CMA neurones ($U = 37, n = 8,13; p > 0.05$).
 - (II) Silent CMA neurones ($U = 28.5, n = 8,11; p > 0.05$).
 - (III) Combined spontaneous and silent CMA neurones ($U = 39, n = 8,15; p > 0.05$).
- (2) Orthodromically identified CMA neurones:-
 - (I) Combined spontaneous and silent CMA neurones ($U = 15, n = 4,10; p > 0.05$).

4.4 Discussion.

These results show that oestradiol significantly reduces the mean absolute refractory periods of CMA neurones in the castrated male rats. This reduction is to a level which is not significantly different from that found in normal gonadally intact rats. Dihydrotestosterone, on the other hand, has no effect on the absolute refractory periods of these neurones, and does not enhance the effect of oestradiol treatment when given in combination with it. Thus oestradiol, like testosterone, has a direct effect on the absolute refractory periods of CMA neurones which project to the MPH.

These results therefore confirm that oestradiol rather than dihydrotestosterone is the metabolite of testosterone that is active in the central nervous

system, at least as regards the refractory periods of CMA neurones.

Once again these various hormone treatments did not affect the spontaneous firing rates or latencies of CMA neurones. However, the latencies of spontaneously active, antidromically stimulated, CMA neurones, were significantly shorter than those of silent CMA neurones in the OB, DHTP and Oil treated groups.

4.5 Addendum: a note on the localisation of the effect.

Experiments 1, 3 and 4 provide a control population of CMA neurones in 'castrate' animals, and a group treated with, and unaffected by, DHTP; Experiments 1, 3 and 4 also provide a group for 'intact', testosterone propionate treated, OB treated and OB + DHTP treated animals. It is rational to regard the first four groups as constituting one class of neurones, and the second four as another. Pooling in this way gives sufficient data to examine the locus of the effect more precisely as follows.

If the absolute refractory periods recorded from each individual rat are divided up into those recorded from the medial amygdala (MA) and those from the cortical amygdala (CA), then one can test whether the testosterone effect is localised in either of these structures. Further, Figures 2A, 3A, 4A and 4B in the Appendix, show that a sufficient number of antidromic units were recorded to split the CMA up into two anterior/posterior regions - (1) A 3990 - A 3430 μ and (2) A 3290 - A 2580 μ (i.e. pooled) (coordinates are from König and Klippel, 1963). Thus the mean absolute refractory periods can be calculated in individual rats for the MA and the CA split into two anterior/posterior regions. Pooled in this way, the mean absolute refractory periods for the four different regions within the CMA can be compared statistically using the Mann-Whitney U test;-

(i) 'Intact' MA (1) v 'Castrate' MA (1) - $U = 55$, $n = 20,21$; $p < 0.002$
two-tailed.

(ii) 'Intact' MA (2) v 'Castrate' MA (2) - $U = 19.5$, $n = 15,17$; $p < 0.002$
two-tailed.

Figure 4.3

Experiments 1, 3 and 4. Combined spontaneous and silent CMA neurone mean absolute refractory periods pooled across experiments and divided into specific regions of the CMA.

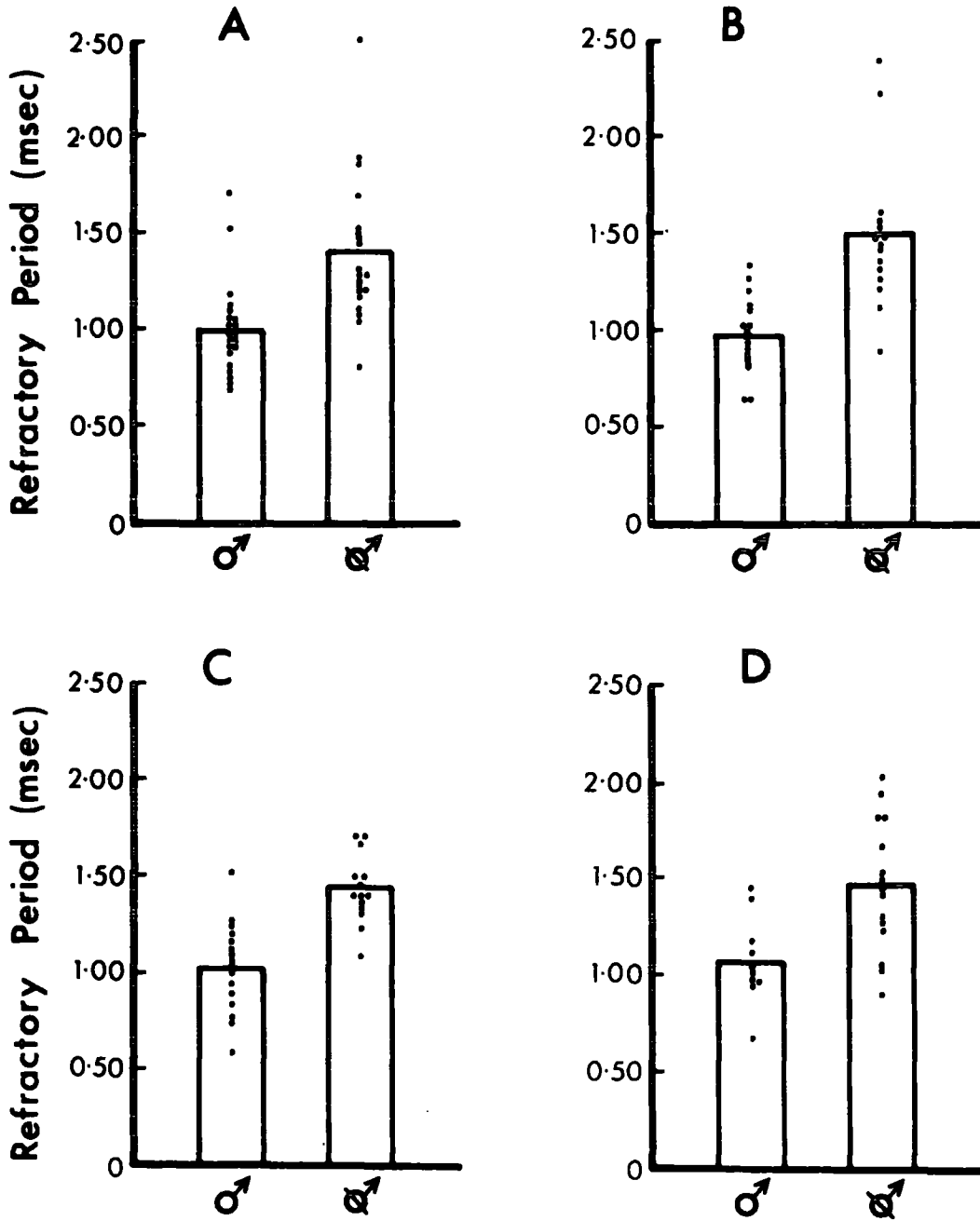

A = medial amygdala (A 3990 μ - A 3430 μ - König and Klippel, 1963)
 B = medial amygdala (A 3290 μ - A 2580 μ - " ")
 C = cortical amygdala (A 3990 μ - A 3430 μ - " ")
 D = cortical amygdala (A 3290 μ - A 2580 μ - " ")
 ♂ = pooled 'intact' groups (see text)
 ♂ = pooled 'castrate' group (see text).

(III) 'Intact' CA (1) v 'Castrate' CA (1) - $U = 17$, $n = 14,16$; $p < 0.002$
two-tailed.

(iv) 'Intact' CA (2) v 'Castrate' CA (2) - $U = 25$, $n = 10,15$; $p < 0.02$
two-tailed.

Thus there is a significant difference between the two pooled groups in all four regions. From this, the following conclusions can be drawn:-

(1) The effect of testosterone is not localised in any particular region within the CMA.

(2) Theoretically it is possible that the difference observed in the absolute refractory periods might be due to sampling errors - i.e. to more units being recorded from a specific region of the CMA in one group than another. This is unlikely since units were sampled on a random basis and the same effect was found in three independent experiments. Such a possibility is ruled out by the finding that the mean absolute refractory periods in the two groups are significantly different in each of the four regions within the CMA tested above.

Data are illustrated in Figure 4.3 and given in Tables 4.5a, b of the Appendix.

CHAPTER 5

TIME COURSE OF THE EFFECT OF TESTOSTERONE ON A NEURONAL AND A BEHAVIOURAL RESPONSE.

5.1 Introduction.

The experiments described in previous chapters have shown that the absolute refractory periods of corticomедial amygdala (CMA) neurones which project to the medial preoptic/anterior hypothalamic junction (MPH) are sensitive to testosterone, and to its metabolite oestradiol. Both the CMA and the MPH, and the pathway between the two structures, the stria terminalis (ST), are known to be important in the control of sexual behaviour (reviewed in Chapter 2). On the basis of anatomical and electrophysiological evidence it seems likely that the neurones of the CMA which project to the MPH relay olfactory information to this area; and olfactory information is important in the control of sexual behaviour in male rats (reviewed in Chapter 2).

Pfaff and Pfaffman (1969a) have shown that testosterone increases the sensitivity of preoptic neurone responses to odour stimulation and to electrical stimulation of the olfactory bulb (reviewed in Chapter 1). An important problem in the interpretation of these results is the short time course of the effect. Changes in unit activity began within 5 - 15 min and lasted only 25 - 50 min. Testosterone treatment has to be continued for a matter of days before sexual behaviour is restored in the castrated male rat; so it seems unlikely that the effects of testosterone reported by these workers could underly the restoration of sexual behaviour.

This Chapter describes two experiments which plot the time course of the testosterone reduction of corticomедial amygdala neurone absolute refractory periods and compare it with the time course of the hormones restoration of sexual behaviour.

5.2 Experiment 5: The time course of the effect of testosterone on CMA neurone absolute refractory periods and on sexual behaviour.

In this experiment the time course of the reduction of CMA absolute refractory periods by testosterone was plotted and compared with the time course for the hormone's stimulation of sexual behaviour, in the castrated male rat.

5.2.1 Method.

Experimental Animals and Hormone Treatment.

Twenty-four adult male, sexually naive, Porton albino Wistar rats (approximately 120 days of age; weight 400 - 600g) were used. Animals were maintained on a reversed light-dark schedule and castrated under ether anaesthesia at least 8 weeks prior to use. After 8 weeks the rats were divided randomly into 12 pairs. Each pair of rats received daily 200 μ g subcutaneous injections of Testosterone Propionate (TP) given in 0.1 ml of arachis oil. (One pair of rats, which acted as a control, received a 0.1 ml arachis oil injection). Pairs were then sampled at various times (given below) for experimentation. Rats were approximately 180 days of age and weighed 400 - 650g at the time of the experiment.

Five (sexually experienced) adult female Porton albino Wistar rats (approximately 140 days of age; 250 - 300g) were used for sexual behaviour tests. These animals were ovariectomised under ether anaesthesia and injected subcutaneously with 5 μ g Oestradiol Benzoate (OB) daily, for 4 or more days, and with 500 μ g Progesterone on the day of testing, in order to bring them into a receptive state. Once again these hormones were given in 0.1 ml arachis oil.

Experimental Design and Procedure.

One of each experimental pair was used for a sexual behaviour test and the other in an electrophysiological experiment. One pair was tested after a control oil injection on the day of the experiment, and the others

after 1, 3, 5, 7, 9, 11, 13 and 15 days of daily TP injections. Pairs were also sampled at 3, 5 and 7 days after the withdrawal of TP injections at 15 days. Injections were always given at 9.00 a.m.; (anaesthesia was administered at 9.30 a.m.) and electrophysiological recording begun at 11.00 a.m. The sexual behaviour test was given at 3.00 p.m.

The female rats which were used for the sexual behaviour test were given a progesterone injection at 9.00 a.m. on the morning of testing (having already received at least four days of OB treatment), and were thus fully receptive by 3.00 p.m.

(1) Electrophysiological Techniques:-

These were the same as described in the Method section of Experiment 1 (Chapter 2), the MPH being used as the stimulation site. However, in this experiment, only the absolute refractory periods of CMA neurones (antidromically identified from the MPH) were measured. Further, to avoid possible experimenter bias in the sampling of units, a limit of 10 CMA neurones was set as the maximum number to be recorded from each rat. In fact, this maximum number was achieved in every rat.

Due to the fact that only one rat was used for each data point only the combined mean absolute refractory period was used (i.e. spontaneously active and silent CMA neurones).

(2) Sexual Behaviour Tests:-

Rats were tested in a circular arena, 90 cm in diameter, with 30 cm high blackened walls. Since all animals were maintained on a reversed light-dark schedule, testing (at 3.00 p.m.) was carried out during the dark phase of the cycle. Testing was carried out in a quiet, darkened room, illuminated only by a 60 watt red light-bulb.

Both male and female rats were allowed to acclimatise to the testing arena for 30 min on the day preceding the experiment.

For the actual sexual behaviour test, the male rat was placed in the

arena and allowed to acclimatise for 15 min. After 15 min the female was placed in the testing arena with the male, and the following measures of the male's sexual behaviour recorded during a 30 min period - latency to first ano-genital nuzzling; total time spent ano-genital nuzzling; number of mounts; number of intromissions; number of ejaculations; mount latency; intromission latency and first ejaculation latency.

5.2.2 Results and Discussion.

The main experimental findings are illustrated in Figure 5.1.

Anatomical Loci of Recording and Stimulation Sites.

These were the same as in Experiment 1.

(1) Time course for the reduction of the mean absolute refractory period of CMA neurones.

As shown in Figure 5.1, the mean absolute refractory period of CMA neurones is reduced to the level found in 'intact' rats (Experiment 1) or long term TP treated rats (Experiment 3) after 7 days of TP injections (which is just over 6 days after the first TP injection). The mean absolute refractory period does appear to be reduced after 5 days of TP injections, though whether this is due to a gradual effect of the TP treatment or simply due to sampling is impossible to conclude.

5 days after the withdrawal of TP treatment at 15 days, the mean absolute refractory period had lengthened again to a level normally found in 'castrate' rats.

The mean absolute refractory period figures are given in Table 5.1.

(2) Time course for the restoration of sexual behaviour.

The figures for the various parameters of sexual behaviour are given in Table 5.1. Two parameters of sexual behaviour show a distinct correlation with the reduction of CMA neurone absolute refractory periods: mount latency and ejaculation (see Figure 5.1). These two parameters not only correlated

Experiment 5: The time course of the testosterone reduction of CMA neurone absolute refractory periods and restoration of sexual behaviour, in castrated rats.

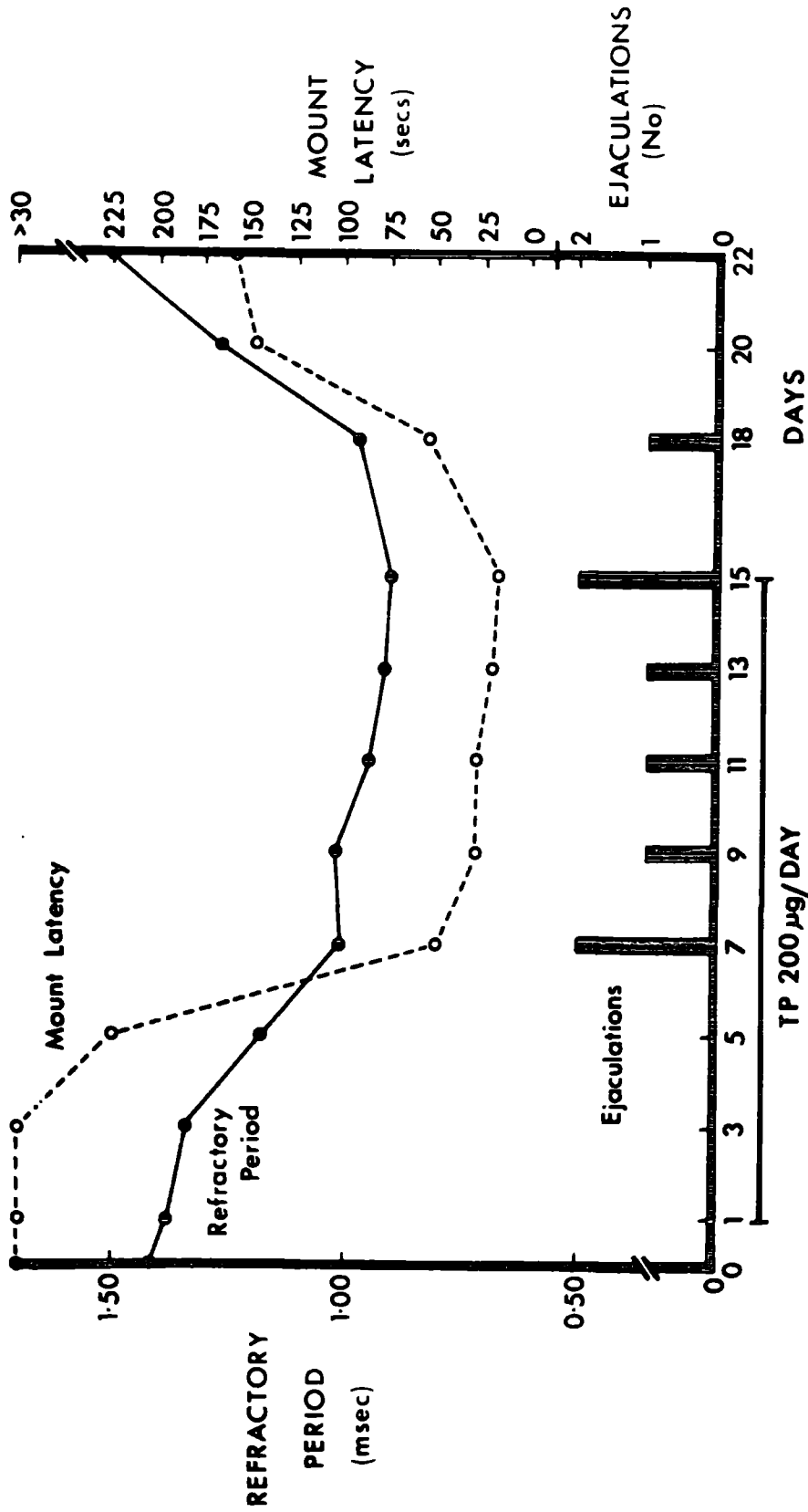

TP = Testosterone propionate.

TABLE 5.1

Experiment 5: Time course of testosterone effect on absolute refractory periods of CMA neurones and sexual behaviour.

Daily Injections of 200µg TP	Combined Mean Abs Refract Period (msecs)	Number of			Latency to 1st		Latency to 1st Ano-genital Nuzzling (secs)	Time spent Ano-genital Nuzzling (secs)
		M	I	E	M	I		
0	1.42	0	0	0	-	-	4	18
1	1.38	0	0	0	-	-	35	19
3	1.34	0	0	0	-	-	46	54
5	1.18	4	13	0	225	492	22	4
7	1.01	4	28	2	50	147	85	3
9	1.02	4	36	1	29	57	35	2
11	0.95	2	9	1	15	63	40	2
13	0.92	3	18	1	19	24	-	0
15	0.90	4	24	2	16	23	43	9
Withdrawal of TP								
3	0.97	4	26	1	55	153	29	14
5	1.28	5	8	0	148	191	30	20
7	1.51	12	12	0	160	213	74	1

M = Mounts
I = Intromissions
E = Ejaculations
TP = Testosterone propionate

with the reduction of the mean absolute refractory period but also with its lengthening after the withdrawal of TP treatment.

Mounts and Intromissions occurred after 5 days of TP injections (just over 4 days after the first TP injection) and persisted after the absolute refractory period lengthened when TP treatment was withdrawn. No dose related pattern could be seen for the latency to the first ano-genital nuzzling or the length of time spent ano-genital nuzzling during the 30 min test.

Thus the reduction in the mean absolute refractory period of CMA neurones to levels characteristic of intact animals is associated with the restoration of full sexual behaviour, that is the time at which rats display mounts, intromissions and ejaculations. There is also a correlation with a reduction in mount latency which, since it reflects the willingness of a male rat to initiate copulatory behaviour, is a good measure of sexual arousal.

The latency of the reduced absolute refractory periods of CMA neurones was around 6 days (after 7 daily TP injections), which is considerably longer than previously reported sex hormone effects on the central nervous system (see review in Chapter 1). In particular, this time course is longer than the 5 - 15 min latency reported by Pfaff and Pfaffman (1969a) for testosterone induced changes in preoptic area neuronal activity.

5.3 Experiment 6: The time course of the effect of testosterone on absolute refractory periods and on sexual behaviour (2).

The findings of Experiment 5 were only based on one rat for each data point. Consequently a second experiment was carried out. This experiment concentrates on the initial time course of the reduction in CMA neurone absolute refractory periods by more frequent sampling after fewer TP injections.

5.3.1 Method.

Experimental Animals and Hormone Treatment.

Eighteen, adult male, sexually naive, Porton albino Wistar rats (approximately 240 days of age; weight 400 - 600g) were used. Once again

rats were castrated under ether anaesthesia and after 8 weeks were divided randomly into pairs (9 in all). Hormone treatment was the same as in Experiment 5. Rats were approximately 300 days of age and weighed 400 - 625g at the time of the experiment. Four adult female, sexually experienced, Porton albino rats (approximately 200 days of age; weight 275 - 350g) were ovariectomised under ether anaesthesia and brought into receptivity using OB and progesterone treatment as in Experiment 5.

Experimental Design and Procedure.

This was the same as in Experiment 5 excepting that pairs of rats were sampled after 0 days (one oil control injection) and after 1, 2, 3, 4, 6, 8, 10 and 12 daily TP injections.

5.3.2 Results and Discussion.

The main experimental findings are illustrated in Figure 5.2.

Anatomical Loci of Recording and Stimulation Sites.

These were the same as in Experiment 1.

(1) Time course for the reduction of the mean absolute refractory period of CMA neurones.

As shown in Figure 5.2, the mean absolute refractory period of CMA neurones is reduced to the level found in 'intact' rats (Experiment 1) or long term TP treated rats (Experiment 3) after 8 days of TP treatment (which in real time is just over 7 days after the first TP injection). Once again the mean absolute refractory period does appear to be reduced slightly after 4 and 6 TP injections. Again this suggests the possibility of some form of gradual effect on these neurones as opposed to an all or nothing one. The fact that the reduction of the mean absolute refractory period had a slightly longer latency in this experiment (as compared with Experiment 5) may simply reflect a variation within the population. Also it is possible that the longer latency might have been due to the fact that the rats used in this experiment were somewhat older than those used in Experiment 5.

Figure 5.2

Experiment 6 - The time course of the testosterone reduction of CMA neurone absolute refractory periods and restoration of sexual behaviour.

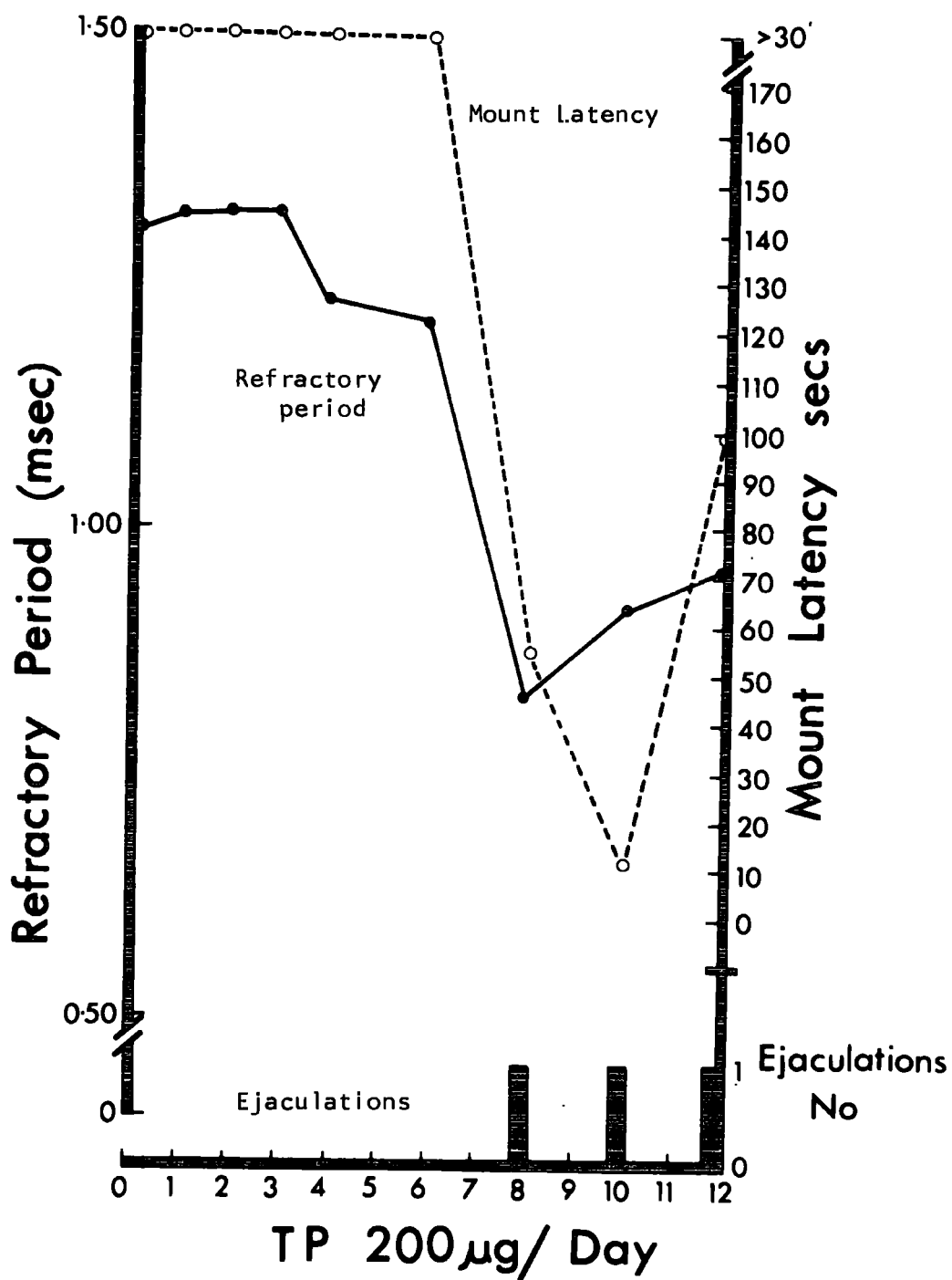

TP = testosterone propionate.

TABLE 5.2

Experiment 6: Time course of the testosterone effect on absolute refractory periods of CMA neurones and sexual behaviour.

Daily Injections of 200µg TP	Combined Mean Abs Refract Period (msecs)	Number of			Latency to 1st			Latency to 1st Ano-genital Nuzzling (secs)	Time spent Ano-genital Nuzzling (secs)
		M	I	E	M	I	E		
0	1.30	0	0	0	-	-	-	46	19
1	1.32	0	0	0	-	-	-	250	1
2	1.32	0	0	0	-	-	-	93	100
3	1.32	0	0	0	-	-	-	450	4
4	1.23	0	0	0	-	-	-	40	105
6	1.21	0	0	0	-	-	-	58	30
8	0.83	5	11	1	55	580	1544	20	75
10	0.92	3	22	1	12	14	1825	8	1
12	0.97	5	21	1	100	120	1444	110	14

M = Mounts

I = Intromissions

E = Ejaculations

TP = Testosterone propionate

The mean absolute refractory period figures are given in Table 5.2.

(2) Time course for the restoration of sexual behaviour.

The figures for the various parameters of sexual behaviour are given in Table 5.2. Once again the reduction of the mean absolute refractory period was correlated with the presence of the ejaculatory pattern, (see Figure 5.2). However, in this experiment there was no split between the restoration of mounting and intromission behaviour and that of ejaculation.

Once again there was no correlation with either of the ano-genital nuzzling parameters.

Thus, the reduction in the mean absolute refractory of CMA neurones is correlated with the restoration of full sexual behaviour in the castrated male rat even though the time course of the effect is slightly longer than that observed in Experiment 5.

CHAPTER 6

DISCUSSION OF RESULTS

The experiments described in this thesis show that castration lengthens the absolute refractory period of neurones which project directly from the corticomедial amygdala to the area of the medial preoptic/anterior hypothalamic junction via the stria terminalis. Adjacent corticomедial amygdala neurones which project to the capsule of the ventromедial nucleus of the hypothalamus are unaffected. So the effect of castration is anatomically specific.

This lengthening of the refractory periods is reversed if castrated rats are treated with testosterone. So the lengthening of the refractory periods in castrates is due to the absence of testosterone.

These findings imply that this pathway is involved either in the control of sexual behaviour (or some other androgen sensitive behaviour), or in the control of pituitary function. The obvious candidate here would be the negative feedback of testosterone on luteinizing hormone. That this is a real possibility is shown by the fact that surgical interruption of the stria terminalis increases secretion of luteinizing hormone (Brown-Grant and Raisman, 1972). Evidence from Experiments 5 and 6 indicates that the latency of the reduction of the refractory periods to the level found in intact rats is comparable with the time course of the restoration of sexual behaviour by the hormone: 6 days in Experiment 5 and 7 days in Experiment 6, and considerably longer than the time course of the negative feedback of testosterone on luteinizing hormone (24 to 48 hours: Kalra et al, 1973).

Further evidence for rejecting the possibility that these neurones are involved in the negative feedback of testosterone on luteinizing hormone comes from Experiment 4. This experiment shows that dihydrotestosterone does not reduce the absolute refractory periods of these neurones in castrated rats. Dihydrotestosterone is more effective than testosterone in suppressing luteinizing hormone levels in castrated rats (Swerdloff, Walsh and Odell, 1972; Naftolin and Feder, 1973), although it is less effective in stimulating

sexual behaviour. So the lack of effect of dihydrotestosterone on these neurones also implies that they are involved in the control of sexual behaviour and not in the negative feedback of testosterone on luteinizing hormone.

In what way might a lengthened neuronal refractory period effect sexual behaviour? The experiments carried out for this thesis do not provide any direct answers to this question. A hypothesis is that it might alter the number and patterning of action potentials reaching the medial preoptic/ anterior hypothalamic junction, a structure involved in the control of sexual behaviour (Chapter 2). Figure 6.1 shows how the lengthened absolute refractory periods of these neurones would reduce the input frequency which their output can reliably reproduce. In 'intact' rats the corticomедial amygdala neurones could, on average, follow input frequencies of up to 1000 Hz. In 'castrate' rats this frequency is reduced to 620 Hz. Both these figures would represent extremely high neuronal firing frequencies however, and that either would ever normally be challenged is dubious. But it is possible that a change in a neuronal absolute refractory period may correlate with a corresponding change in the relative refractory period (the period following the absolute refractory period during which action potentials may be stimulated but only by suprathreshold currents). The length of the relative refractory period is difficult to measure objectively as it is extremely variable, being dependent on the recent firing history of the cell. However, given that the relative refractory period is longer than the absolute refractory period, it is possible that high frequency olfactory inputs might challenge this period in castrated rats, so that castration might alter the amount and patterning of olfactory information reaching the medial preoptic/anterior hypothalamic junction.

Clearly we need to know whether these corticomедial amygdala neurones do receive direct olfactory inputs. Cain and Bindra (1972) have indeed shown that there are corticomедial amygdala neurones which respond to odour stimulation, but they did not identify the responsive neurones in terms of their

Figure 6.1

The effect of the lengthened absolute refractory periods of CMA neurones after castration on the input frequency which their output can reliably reproduce.

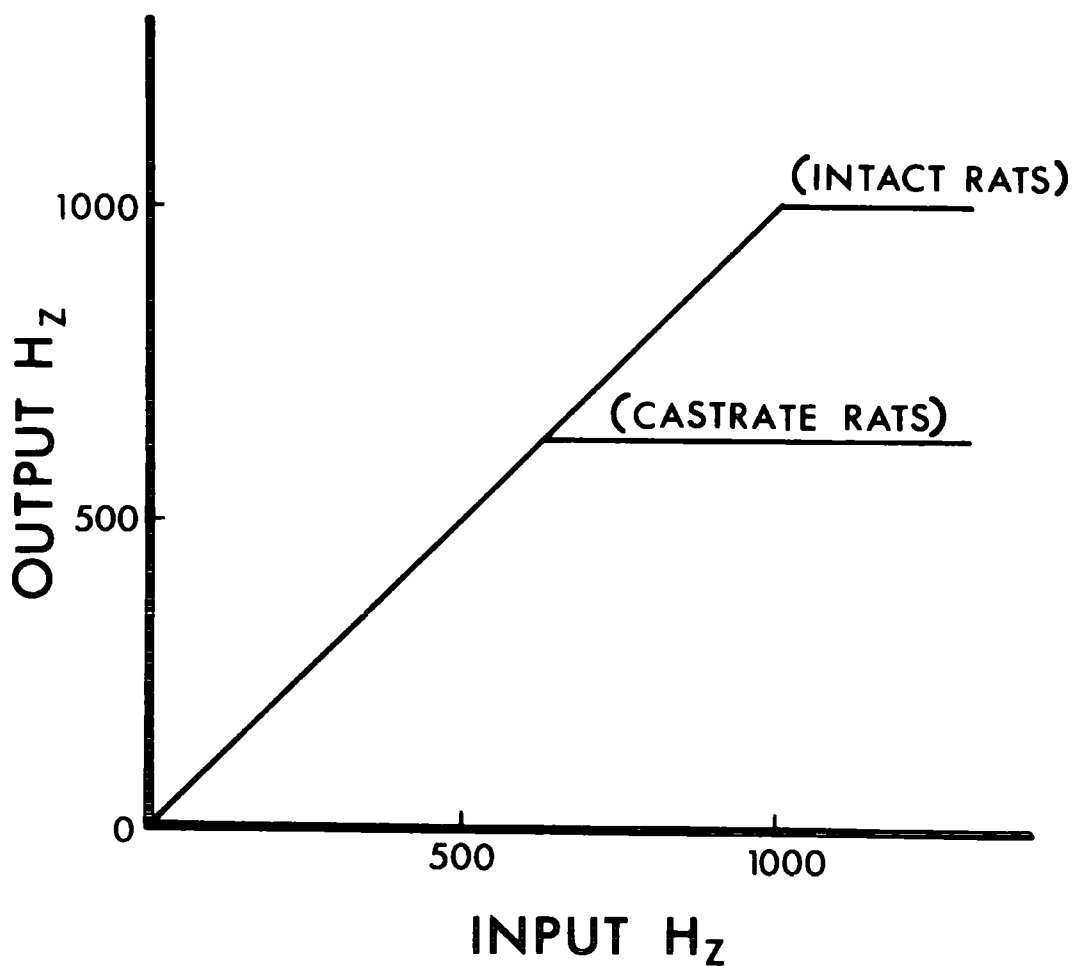

outputs. So it remains to be seen whether these testosterone-sensitive corticomедial amygdala neurones which project to the medial preoptic/anterior hypothalamic junction do indeed respond to olfactory inputs. Such an experiment would need to employ a double stimulation technique, with one stimulation electrode in the medial preoptic/anterior hypothalamic junction to identify those corticomедial amygdala neurones which project directly to it, and a second stimulating electrode in the olfactory bulb to confirm that these identified neurones do receive direct olfactory inputs. If these neurones do receive olfactory inputs, then a further experiment might investigate whether their firing frequencies are altered by natural odours, for example urinary or preputial gland odours from oestrus female rats. This latter experiment would also give some information on the firing frequencies of these corticomедial amygdala neurones in response to olfactory input, and allow us to evaluate the hypothesis that the lengthened refractory periods in castrated rats may be challenged by high frequency olfactory inputs.

The experiments carried out in this thesis are also relevant to two further areas:-

(1) Sexual Differentiation.

The effects of testosterone on behaviour are sexually differentiated (see review by Goldman, 1978). So it would be interesting to know whether the corticomедial amygdala neurones of female rats show the same response to testosterone as those of males. If sex differences are encountered, then experiments could investigate the effects of neonatal castration in male rats to see if this eliminates the effect of testosterone in the adult. Similar experiments could investigate whether neonatal androgenisation of female rats promotes testosterone sensitivity in these neurones in adulthood.

(2) The Aromatization Hypothesis.

Many experiments have suggested that testosterone may need to be aromatized to an oestrogen in order to produce its effect on the

central nervous system. For instance, sexual behaviour is readily restored in castrated male rats by androgens which can be aromatized to oestrogens, but not by those which cannot (Parrott, 1975). The results of Experiment 4 show that oestradiol mimicks the effect of testosterone on the absolute refractory periods of corticomедial amygdala neurones. Dihydrotestosterone (which is not aromatized to oestrogens) does not have this effect; neither does it enhance the effect of oestradiol benzoate when given in combination with it. So these experiments confirm existing data (see review in Chapter 4) which suggest that an oestrogen, rather than dihydrotestosterone, is the metabolite of testosterone which is potent in the central nervous system.

Experiment 4, however, although it proves that oestradiol can substitute for testosterone in the central nervous system, does not itself prove that testosterone has to be aromatized to an oestrogen to produce its neuronal effect. This could be investigated by injecting castrated rats with testosterone in combination with an aromatization inhibitor such as 1,4,6 - Androstatrien-3,17-dione.

A P P E N D I X

TABLE 2.1a

Experiment 1 - Median spontaneous firing rates of corticomедial amygdala neurones in 'intact' male rats.

Number Rat	Response to stimulation of the MPH		
	Antidromic (action potentials produced per 100 secs)	Orthodromic	Not-Driven
33B	3.50 (2)	21.00 (5)	473.83 (2)
35B	2.67 (1)	13.67 (5)	55.67 (5)
37B	-	4.33 (1)	-
40B	-	-	23.50 (2)
42B	-	-	394.00 (1)
46B	3.00 (1)	42.67 (1)	26.33 (5)
49B	8.83 (2)	-	238.00 (1)
51B	2.00 (1)	-	223.50 (14)
53B	5.67 (3)	5.67 (1)	125.50 (3)
55B	22.33 (1)	34.00 (1)	256.50 (8)
62B	1.33 (1)	43.50 (1)	131.67 (5)
66B	13.00 (1)	-	204.17 (6)
68B	44.50 (1)	20.67 (1)	128.59 (4)
69B	22.00 (1)	22.00 (1)	-
75B	8.67 (6)	451.33 (1)	339.17 (2)
77B	1.00 (1)	-	-
TOTAL	138.50 (22)	658.84 (18)	2620.43 (58)
MEAN	10.65	65.88	201.57
NUMBER	13	10	13

Figures in brackets (..) represent the number of corticomедial amygdala neurones from which the median firing rate value was calculated.

MPH = medial preoptic/anterior hypothalamic junction.

TABLE 2.1b

Experiment 1 - Median spontaneous firing rates of corticomedial amygdala neurones in 'castrate' male rats.

Number Rat	Response to stimulation of the MPH (action potentials produced per 100 secs)		
	Antidromic	Orthodromic	Not-Driven
14B	-	-	290.84 (4)
32B	14.33 (1)	1.67 (3)	-
34B	3.33 (1)	305.33 (1)	-
36B	2.67 (1)	103.33 (1)	101.33 (7)
39B	0.67 (1)	81.00 (1)	304.83 (2)
45B	18.92 (4)	12.00 (1)	250.34 (4)
50B	-	-	188.00 (11)
54B	3.67 (1)	-	-
58B	4.50 (2)	0.67 (3)	10.00 (9)
59B	0.33 (1)	6.00 (1)	235.33 (9)
60B	-	-	36.00 (3)
61B	-	222.00 (1)	219.67 (12)
65B	15.00 (4)	69.67 (3)	24.00 (6)
72B	1.67 (2)	-	85.67 (2)
TOTAL	65.09 (18)	801.67 (15)	1746.01 (69)
MEAN	6.51	89.07	158.73
NUMBER	10	9	11

Figures in brackets (..) represent the number of corticomedial amygdala neurones from which the median firing rate value was calculated.

MPH = medial preoptic/anterior hypothalamic junction.

TABLE 2,2

Experiment 1 - Mean absolute refractory periods of corticomедial amygdala neurones antidromically stimulated from the medial preoptic/ anterior hypothalamus in 'intact v 'castrate' male rats.

'Intact' Male Rats

Number Rat	Spontaneous (msec)	Silent (msec)	Combined Spontaneous + Silent (msec)
33B	1.52 (1)	-	1.52 (1)
35B	1.70 (1)	0.90 (3)	1.10 (4)
40B	-	1.15 (1)	1.15 (1)
46B	1.15 (1)	1.10 (6)	1.10 (7)
49B	1.00 (2)	1.26 (3)	1.15 (5)
51B	0.79 (2)	0.93 (1)	0.84 (3)
53B	0.95 (3)	0.99 (1)	0.96 (4)
55B	0.60 (1)	0.93 (1)	0.77 (2)
62B	0.86 (1)	1.09 (1)	0.98 (2)
66B	0.70 (1)	-	0.70 (1)
68B	1.04 (1)	-	1.04 (1)
75B	1.10 (6)	0.89 (4)	1.01 (10)
77B	0.94 (1)	0.63 (1)	0.79 (2)
TOTAL	12.35 (21)	9.87 (22)	13.11 (43)
MEAN	1.03	0.99	1.01
NUMBER	12	10	13

'Castrate' Male Rats

Number Rat	Spontaneous (msec)***	Silent (msec)**	Combined Spontaneous + Silent (msec)***
32B	2.50 (1)	-	2.50 (1)
34B	1.64 (1)	1.37 (3)	1.44 (4)
39B	1.96 (1)	2.50 (1)	2.23 (2)
45B	2.32 (3)	1.80 (4)	2.02 (7)
48B	-	1.28 (4)	1.28 (4)
50B	-	1.27 (1)	1.27 (1)
58B	1.53 (2)	-	1.53 (2)
59B	1.11 (2)	1.75 (2)	1.43 (4)
60B	2.04 (1)	0.85 (1)	1.45 (2)
65B	1.63 (2)	0.98 (2)	1.30 (4)
72B	1.88 (3)	1.69 (4)	1.77 (7)
74B	-	1.10 (4)	1.10 (4)
TOTAL	16.61 (16)	14.59 (26)	19.32 (42)
MEAN	1.85	1.46	1.61
NUMBER	9	10	12

*** $p < 0.002$ two tailed** $p < 0.02$ two tailed

Figures in brackets (..) represent the number of corticomедial amygdala neurones from which the mean absolute refractory period was calculated.

TABLE 2.3

Experiment 1 - Latencies and conduction velocities of corticomедial amygdala neurones antidromically stimulated from the medial preoptic/ anterior hypothalamus.

'Intact' Male Rats

Number Rat	Spontaneous		Silent			Combined Spontaneous + Silent			
	(msec)	(m/sec)	(msec)	(m/sec)		(msec)	(m/sec)		
33B	23.00	0.35	(2)	-	-		23.00	0.35	(2)
35B	27.50	0.29	(1)	19.00	0.46	(3)	21.13	0.42	(4)
40B	-	-		30.50	0.26	(1)	30.50	0.26	(1)
42B	-	-		20.00	0.43	(2)	20.00	0.43	(2)
46B	9.70	0.82	(1)	20.70	0.44	(6)	19.56	0.49	(7)
49B	22.65	0.37	(2)	22.93	0.37	(4)	22.83	0.37	(6)
51B	16.40	0.56	(4)	15.30	0.64	(2)	16.03	0.59	(6)
53B	22.93	0.38	(3)	28.65	0.30	(2)	25.22	0.35	(5)
55B	12.75	0.63	(2)	19.50	0.41	(1)	15.00	0.56	(3)
62B	26.90	0.30	(1)	33.50	0.24	(1)	30.20	0.27	(2)
66B	9.70	0.82	(1)	-	-		9.70	0.82	(1)
68B	19.00	0.42	(1)	-	-		19.00	0.42	(1)
69B	19.80	0.40	(1)	-	-		19.80	0.40	(1)
75B	17.56	0.52	(7)	18.48	0.47	(5)	17.94	0.50	(12)
77B	25.00	0.32	(1)	7.40	1.09	(2)	13.27	0.83	(3)
TOTAL	252.89	6.18	(27)	235.96	5.11	(29)	303.18	7.06	(56)
MEAN	19.45	0.48		21.45	0.46		20.21	0.47	
NUMBER	13	13		11	11		15	15	

'Castrate' Male Rats

Number Rat	Spontaneous		Silent			Combined Spontaneous + Silent			
	(msec)	(m/sec)	(msec)	(m/sec)		(msec)	(m/sec)		
14B	-	-		26.00	0.31	(1)	26.00	0.31	(1)
32B	25.20	0.32	(1)	-	-		25.20	0.32	(1)
34B	15.20	0.53	(1)	18.80	0.57	(3)	17.90	0.56	(4)
36B	9.80	0.82	(1)	-	-		9.80	0.82	(1)
39B	26.00	0.31	(1)	21.50	0.37	(1)	23.75	0.34	(2)
45B	34.83	0.23	(4)	29.80	0.30	(5)	32.03	0.27	(9)
48B	-	-		28.07	0.29	(6)	28.07	0.29	(6)
50B	-	-		22.75	0.36	(2)	22.75	0.36	(2)
54B	37.00	0.22	(1)	-	-		37.00	0.22	(1)
58B	17.10	0.57	(2)	-	-		17.10	0.57	(2)
59B	25.57	0.32	(3)	19.90	0.40	(2)	23.30	0.35	(5)
60B	17.50	0.46	(1)	18.00	0.44	(1)	17.75	0.45	(2)
65B	19.33	0.42	(4)	17.77	0.50	(3)	18.66	0.46	(7)
72B	34.47	0.24	(3)	18.73	0.45	(4)	19.03	0.36	(7)
74B	-	-		20.50	0.41	(4)	20.50	0.41	(4)
TOTAL	262.00	4.44	(22)	241.82	4.40	(32)	345.28	6.09	(54)
MEAN	23.82	0.40		21.98	0.40		23.02	0.41	
NUMBER	11	11		11	11		15	15	

Figures in brackets (..) represent the number of corticomедial amygdala neurones from which latencies/conduction velocities were taken.

TABLE 2.4

Experiment 1 - Latencies of corticomedial amygdala neurones Orthodromically stimulated from the medial preoptic/anterior hypothalamus.

'Intact' Male Rats'Castrate' Male Rats

Number Rat	Latency (msec)	Number Rat	Latency (msec)
33B	19.68 (5)	32B	23.73 (3)
35B	24.61 (7)	34B	14.40 (1)
37B	29.00 (1)	36B	26.40 (1)
46B	16.63 (3)	39B	28.50 (1)
53B	20.17 (3)	45B	28.00 (1)
55B	18.05 (2)	48B	30.85 (2)
62B	27.65 (2)	58B	17.45 (4)
68B	22.30 (1)	59B	18.80 (1)
69B	19.80 (1)	61B	26.30 (1)
75B	9.90 (1)	65B	19.50 (3)
TOTAL	207.78 (26)	TOTAL	233.93 (18)
MEAN	20.78	MEAN	23.39
NUMBER	10	NUMBER	10

Latency figures represent the mean variable latency recorded.

Figures in brackets (..) represent the number of CMA neurones from which the mean latency was calculated.

TABLE 2.5

Experiment 1 - Rheobase current and chronaxie estimations for corticomedial amygdala neurones antidromically stimulated from the medial preoptic/anterior hypothalamus.

'Intact' Male Rats'Castrate' Male Rats

Number Rat	Rheobase Current μa	Chronaxie μsec	Number Rat	Rheobase Current μa	Chronaxie μsec
33B	140	690 (1)	36B	50	500 (1)
35B	110	363 (3)	45B	90	580 (4)
40B	80	670 (1)	48B	70	380 (1)
46B	110	420 (3)	58B	120	420 (2)
49B	110	373 (3)	65B	200	290 (1)
51B	120	460 (2)	72B	40	500 (1)
53B	110	423 (3)	74B	20	250 (1)
75B	70	500 (1)			
TOTAL	850	3899 (17)	TOTAL	590	2920 (11)
MEAN	110	487	MEAN	80	417
NUMBER	8	8	NUMBER	7	7

Figures in brackets (..) represent the number of corticomedial amygdala neurones from which the mean rheobase current and chronaxie were calculated.

TABLE 2.6a

Experiment 2 - Median spontaneous firing rates of corticomедial amygdala neurones in 'intact' male rats.

Number Rat	Response to stimulation of the VMC (action potentials produced per 100 secs)		
	Antidromic	Orthodromic	Not-Driven
27B	413.33 (1)	29.33 (1)	31.42 (4)
31B	239.00 (2)	431.33 (1)	285.00 (3)
67B	485.67 (1)	221.00 (1)	276.00 (5)
70B	75.00 (3)	216.00 (2)	313.33 (5)
73B	211.33 (3)	256.00 (1)	150.00 (3)
76B	372.00 (1)	75.50 (1)	243.67 (3)
78B	210.00 (4)	588.67 (1)	57.33 (3)
79B	158.34 (4)	242.00 (3)	30.67 (5)
85B	329.84 (2)	41.17 (2)	20.00 (3)
87B	45.33 (3)	147.00 (1)	39.67 (4)
89B	382.25 (2)	-	-
91B	315.17 (2)	-	-
93B	-	249.67 (2)	-
95B	159.67 (5)	55.33 (5)	291.33 (3)
TOTAL	3396.93 (33)	2553.00 (21)	1738.09 (41)
MEAN	261.30	212.75	158.01
NUMBER	13	12	11

Figures in brackets (..) represent the number of corticomедial amygdala neurones from which the median firing rate was calculated.

VMC = capsule of the ventromедial nucleus of the hypothalamus.

TABLE 2.6b

Experiment 2 - Median spontaneous firing rates of corticomedia amygdala neurones in 'castrate' male rats.

Number Rat	Response to stimulation of the VMC (action potentials produced per 100 secs)		
	Antidromic	Orthodromic	Not-Driven
28B	302.33 (1)	-	36.67 (10)
30B	467.17 (4)	-	12.67 (3)
43B	-	-	105.50 (3)
54B	250.33 (3)	304.50 (2)	12.50 (6)
56B	331.50 (2)	158.84 (2)	558.00 (3)
82B	149.84 (4)	-	96.67 (10)
83B	123.59 (6)	128.67 (1)	63.00 (1)
84B	138.67 (5)	-	365.67 (5)
86B	116.17 (2)	410.67 (1)	250.67 (2)
88B	309.83 (2)	-	-
90B	-	55.17 (2)	33.00 (2)
92B	-	-	186.67 (1)
94B	94.00 (4)	-	187.34 (4)
TOTAL	2283.43 (33)	1057.85 (8)	1908.36 (50)
MEAN	228.34	211.57	159.03
NUMBER	10	5	12

Figures in brackets (..) represent the number of corticomedia amygdala neurones from which the median firing rate value was calculated.

VMC = the capsule of the ventromedial nucleus of the hypothalamus.

TABLE 2.7

Experiment 2 - Mean absolute refractory periods of corticomedial amygdala neurones antidromically stimulated from the capsule of the ventromedial nucleus in 'intact' v 'castrate' rats.

'Intact' Male Rats

Number Rat	Spontaneous (msec)	Silent (msec)	Combined Spontaneous + Silent (msec)
31B	1.52 (1)	-	1.52 (1)
67B	0.84 (1)	-	0.84 (1)
70B	0.94 (1)	1.41 (3)	1.30 (4)
73B	1.07 (2)	1.00 (4)	1.03 (6)
76B	-	2.11 (1)	2.11 (1)
78B	1.47 (4)	0.91 (4)	1.19 (8)
79B	1.32 (4)	1.17 (2)	1.27 (6)
85B	1.49 (2)	0.97 (3)	1.18 (5)
87B	0.84 (3)	1.12 (4)	1.00 (7)
89B	1.25 (2)	-	1.25 (2)
91B	1.19 (2)	0.80 (2)	0.99 (4)
93B	-	1.30 (6)	1.30 (6)
95B	0.97 (5)	0.99 (1)	0.97 (6)
TOTAL	12.90 (27)	11.78 (30)	15.95 (57)
MEAN	1.17	1.18	1.23
NUMBER	11	10	13

'Castrate' Male Rats

Number Rat	Spontaneous (msec)	Silent (msec)	Combined Spontaneous + Silent (msec)
28B	1.12 (1)	-	1.12 (1)
30B	1.79 (1)	1.79 (1)	1.79 (2)
43B	-	1.18 (1)	1.18 (1)
54B	0.94 (2)	1.68 (1)	1.18 (3)
56B	1.64 (1)	1.10 (3)	1.25 (4)
82B	1.11 (4)	1.07 (3)	1.09 (7)
83B	1.24 (6)	1.35 (4)	1.29 (10)
84B	1.15 (6)	1.12 (3)	1.14 (9)
86B	1.01 (2)	0.93 (2)	0.97 (4)
88B	1.04 (2)	1.13 (2)	1.09 (4)
90B	-	1.65 (2)	1.65 (2)
92B	-	1.02 (2)	1.02 (2)
94B	0.86 (4)	1.12 (6)	1.01 (10)
TOTAL	11.90 (29)	15.14 (30)	15.78 (59)
MEAN	1.19	1.26	1.21
NUMBER	10	12	13

Figures in brackets (..) represent the number of corticomedial amygdala neurones from which the mean absolute refractory period was calculated.

TABLE 2.8

Experiment 2 - Latencies and conduction velocities of corticomедial amygdala neurones antidromically stimulated from the capsule of the ventromedial nucleus.

'Intact' Male Rats

Number Rat	Spontaneous			Silent			Combined Spontaneous + Silent		
	(msec)	(m/sec)	()	(msec)	(m/sec)	()	(msec)	(m/sec)	()
27B	12.00	0.83	(1)	-	-		12.00	0.83	(1)
31B	15.10	0.68	(2)	-	-		15.10	0.68	(2)
67B	10.00	1.00	(1)	-	-		10.00	1.00	(1)
70B	13.40	0.76	(3)	18.87	0.66	(3)	16.13	0.71	(6)
73B	13.35	0.87	(4)	16.78	0.62	(4)	15.06	0.75	(8)
76B	13.80	0.72	(1)	15.00	0.67	(1)	14.40	0.70	(2)
78B	19.84	0.53	(5)	21.35	0.48	(4)	20.51	0.54	(9)
79B	14.58	0.74	(4)	19.20	0.54	(2)	16.12	0.68	(6)
85B	23.25	0.46	(2)	15.23	0.89	(3)	18.44	0.71	(5)
87B	17.67	0.64	(3)	22.88	0.44	(4)	20.64	0.52	(7)
89B	20.70	0.55	(2)	-	-		20.70	0.55	(2)
91B	24.20	0.55	(2)	17.50	0.78	(2)	18.35	0.67	(4)
93B	-	-		25.55	0.70	(6)	25.55	0.70	(6)
95B	16.06	0.80	(5)	9.80	1.02	(1)	15.02	0.83	(6)
TOTAL	213.95	9.13	(35)	182.16	6.80	(30)	238.02	9.87	(65)
MEAN	16.46	0.70		18.22	0.68		17.00	0.71	
NUMBER	13	13		10	10		14	14	

'Castrate' Male Rats

Number Rat	Spontaneous			Silent			Combined Spontaneous + Silent		
	(msec)	(m/sec)	()	(msec)	(m/sec)	()	(msec)	(m/sec)	()
28B	11.80	0.85	(1)	-	-		11.80	0.85	(1)
30B	28.25	0.36	(4)	25.13	0.49	(4)	24.56	0.42	(8)
43B	-	-		12.50	0.80	(1)	12.50	0.80	(1)
54B	6.67	1.63	(3)	27.80	0.36	(1)	11.95	1.31	(4)
56B	31.00	0.33	(2)	27.03	0.44	(3)	28.62	0.40	(5)
82B	12.03	0.88	(4)	19.37	0.78	(3)	15.17	0.84	(7)
83B	24.88	0.46	(6)	22.95	0.45	(4)	24.11	0.46	(10)
84B	26.38	0.41	(6)	15.43	0.74	(3)	22.70	0.52	(9)
86B	24.95	0.41	(2)	15.65	0.65	(2)	20.30	0.53	(4)
88B	13.10	0.77	(2)	11.25	0.90	(2)	12.18	0.83	(4)
90B	-	-		24.35	0.41	(2)	24.35	0.41	(2)
92B	-	-		19.40	0.53	(2)	19.40	0.53	(2)
94B	13.10	0.85	(4)	20.47	0.61	(6)	17.52	0.70	(10)
TOTAL	178.96	6.95	(34)	241.33	7.16	(33)	245.16	8.60	(67)
MEAN	17.90	0.70		20.11	0.60		18.86	0.66	
NUMBER	10	10		12	12		13	13	

Figures in brackets (..) represent the number of CMA neurones from which latencies/conduction velocities were calculated.

TABLE 2.9

Experiment 2 - Latencies of corticomедial amygdala neurones Orthodromically stimulated from the capsule of the ventromedial nucleus.

'Intact' Male Rats'Castrate' Male Rats

Number Rat	Latency (msec)	Number Rat	Latency (msec)
27B	22.63 (4)	28B	17.60 (6)
31B	17.50 (1)	30B	21.53 (3)
67B	14.30 (1)	54B	34.05 (2)
70B	8.65 (2)	56B	23.00 (2)
73B	20.80 (1)	83B	18.50 (1)
76B	22.20 (2)	86B	24.00 (1)
78B	11.80 (1)	90B	17.35 (2)
79B	18.60 (4)		
85B	17.40 (2)		
87B	16.50 (1)		
93B	29.35 (2)		
95B	17.83 (6)		
TOTAL	217.56 (27)	TOTAL	156.03 (17)
MEAN	18.13	MEAN	22.29
NUMBER	12	NUMBER	7

Latency figures represent the mean variable latency recorded. Figures in brackets (..) represent the number of CMA neurones from which the mean latency was calculated.

Experiment 2 - Rheobase current and chronaxie estimations for corticomедial amygdala neurones antidromically stimulated from the capsule of the ventromedial nucleus.

'Intact' Male Rats

'Castrate' Male Rats

Number Rat	Rheobase Current μ a	Chronaxie msec	Number Rat	Rheobase Current μ a	Chronaxie msec
27B	400	417 (1)	28B	150	250 (1)
31B	175	595 (2)	54B	173	455 (3)
70B	320	292 (2)	56B	290	301 (2)
73B	240	463 (1)	83B	50	643 (1)
79B	20	395 (1)	84B	190	286 (1)
			94B	70	772 (1)
TOTAL	1155	2162 (7)	TOTAL	923	2707 (9)
MEAN	231	432	MEAN	154	451
NUMBER	5	5	NUMBER	6	6

Figures in brackets (..) represent the number of corticomедial amygdala neurones from which the mean rheobase current and chronaxie were calculated.

TABLE 3.1

Experiment 3 - Median spontaneous firing rates of corticomedial amygdala neurones in castrate rats treated with Testosterone Propionate or oil.

Castrate rats + Testosterone Propionate.

Number Rat	Response to stimulation of the MPH (action potentials produced per 100 secs)		
	Antidromic	Orthodromic	Not-Driven
6CT	1.33 (3)	-	-
11CT	-	-	500.67 (3)
12CT	8.67 (2)	3.33 (4)	-
13CT	331.50 (2)	1410.00 (1)	-
14CT	4.34 (2)	7.00 (1)	-
15CT	12.00 (4)	3.33 (3)	54.50 (5)
16CT	4.00 (3)	4.67 (5)	-
17CT	8.67 (5)	173.00 (1)	-
18CT	4.00 (3)	285.84 (2)	291.67 (1)
19CT	8.50 (5)	-	69.00 (4)
21CT	1.67 (2)	-	-
23CT	15.67 (5)	44.84 (2)	14.67 (1)
TOTAL	400.35 (36)	1932.01 (19)	930.51 (14)
MEAN	36.40	241.50	186.10
NUMBER	11	8	5

Castrate rats + Oil.

Number Rat	Response to stimulation of the MPH (action potentials produced per 100 secs)		
	Antidromic	Orthodromic	Not-Driven
1CT	57.00 (5)	-	87.00 (5)
2CT	196.34 (2)	3.00 (1)	9.83 (2)
4CT	3.17 (2)	-	2.17 (2)
5CT	4.17 (2)	334.34 (2)	74.67 (1)
7CT	4.00 (3)	-	655.33 (3)
8CT	5.00 (6)	-	312.67 (2)
9CT	18.67 (2)	3.33 (3)	781.50 (1)
10CT	-	3.00	-
20CT	8.33 (2)	-	-
22CT	12.00 (3)	79.00 (1)	-
24CT	16.00 (2)	71.00 (2)	53.34 (2)
TOTAL	324.68 (29)	493.67 (9)	1976.51 (18)
MEAN	32.47	82.28	247.06
NUMBER	10	6	8

Figures in brackets (..) represent the number of corticomedial amygdala neurones from which the median firing rate value was calculated.

MPH = medial preoptic/anterior hypothalamic junction.

TABLE 3.2

Experiment 3 - Mean absolute refractory periods of corticomedial amygdala neurones antidromically stimulated from the medial preoptic/ anterior hypothalamus in castrate rats treated with Testosterone Propionate or Oil.

Castrate Rats + Testosterone Propionate

Number Rat	Spontaneous (msec)	Silent (msec)	Combined Spontaneous + Silent (msec)
6CT	0.98 (3)	0.91 (4)	0.94 (7)
11CT	-	0.79 (2)	0.79 (2)
12CT	0.86 (2)	1.11 (6)	1.05 (8)
13CT	0.97 (3)	1.11 (1)	1.01 (4)
14CT	1.25 (3)	1.02 (2)	1.16 (5)
15CT	0.97 (6)	1.19 (5)	1.07 (11)
16CT	1.12 (3)	1.10 (4)	1.11 (7)
17CT	0.91 (5)	1.03 (3)	0.96 (8)
18CT	0.65 (4)	0.58 (1)	0.63 (5)
19CT	1.09 (5)	1.04 (5)	1.06 (10)
21CT	0.91 (2)	0.96 (4)	0.94 (6)
23CT	1.06 (5)	0.62 (2)	0.94 (7)
TOTAL	10.77 (41)	11.46 (39)	11.66 (80)
MEAN	0.98	0.96	0.97
NUMBER	11	12	12

Castrate Rats + Oil

Number Rat	Spontaneous (msec) ***	Silent (msec) ***	Combined Spontaneous + Silent (msec) ***
1CT	1.43 (6)	1.41 (1)	1.42 (7)
2CT	1.61 (2)	0.94 (2)	1.27 (4)
4CT	1.59 (2)	1.23 (3)	1.38 (5)
5CT	1.23 (2)	1.28 (2)	1.25 (4)
7CT	1.09 (1)	1.00 (2)	1.03 (3)
8CT	1.44 (7)	1.44 (4)	1.44 (11)
9CT	1.64 (2)	1.68 (2)	1.66 (4)
10CT	2.60 (1)	2.15 (1)	2.38 (2)
20CT	1.16 (2)	1.25 (3)	1.45 (5)
22CT	1.31 (3)	1.67 (2)	1.21 (5)
24CT	1.27 (2)	1.85 (1)	1.46 (3)
TOTAL	16.37 (30)	15.90 (23)	14.74 (53)
MEAN	1.49	1.45	1.48
NUMBER	11	11	11

*** $p < 0.002$ two-tailed

Figures in brackets (..) represent the number of corticomedial amygdala neurones from which the mean absolute refractory period was calculated.

TABLE 3.3

Experiment 3 - Latencies and conduction velocities of corticomедial amygdala neurones antidromically stimulated from the medial preoptic/ anterior hypothalamus.

Castrate Rats + Testosterone Propionate

Number Rat	Spontaneous		Silent		Combined Spontaneous + Silent	
	(msec)	(m/sec)	(msec)	(m/sec)	(msec)	(m/sec)
6CT	16.13	0.50 (3)	15.13	0.58 (4)	15.56	0.54 (7)
11CT	-	-	15.00	0.54 (2)	15.00	0.54 (2)
12CT	14.40	0.56 (2)	14.55	0.67 (6)	14.51	0.64 (8)
13CT	15.73	0.65 (3)	27.00	0.30 (1)	18.55	0.57 (4)
14CT	24.63	0.40 (3)	20.85	0.53 (2)	23.12	0.45 (5)
15CT	15.78	0.61 (6)	18.92	0.51 (5)	17.21	0.56 (11)
16CT	7.43	1.08 (3)	14.00	0.58 (4)	11.19	0.80 (7)
17CT	15.32	0.56 (5)	24.43	0.38 (3)	18.74	0.49 (8)
18CT	10.25	0.92 (4)	13.90	0.58 (1)	10.98	0.85 (5)
19CT	18.34	0.46 (5)	22.40	0.41 (5)	20.37	0.44 (10)
21CT	14.60	0.55 (2)	18.13	0.48 (4)	16.95	0.51 (6)
23CT	23.44	0.34 (5)	19.25	0.47 (2)	22.24	0.38 (7)
TOTAL	176.05	6.63 (41)	223.56	6.03 (39)	204.42	6.77 (80)
MEAN	16.01	0.60	18.63	0.50	17.04	0.56
NUMBER	11	11	12	12	12	12

Castrate Rats + Oil

Number Rat	Spontaneous		Silent		Combined Spontaneous + Silent	
	(msec)	(m/sec)	(msec)	(m/sec)	(msec)	(m/sec)
1CT	27.65	0.30 (6)	25.50	0.31 (1)	27.34	0.30 (7)
2CT	16.60	0.49 (2)	27.10	0.30 (2)	19.35	0.39 (4)
4CT	26.45	0.34 (2)	31.00	0.27 (3)	29.18	0.30 (5)
5CT	23.20	0.38 (2)	17.30	0.60 (2)	20.10	0.49 (4)
7CT	11.47	0.70 (3)	13.70	0.62 (2)	12.36	0.67 (5)
8CT	23.46	0.37 (7)	27.48	0.34 (4)	24.92	0.36 (11)
9CT	14.15	0.57 (2)	19.35	0.42 (2)	16.75	0.50 (4)
10CT	6.20	1.29 (1)	12.10	0.66 (1)	9.15	0.98 (2)
20CT	13.80	0.59 (2)	14.30	0.63 (3)	14.10	0.61 (5)
22CT	8.93	0.96 (3)	22.40	0.36 (2)	14.32	0.72 (5)
24CT	9.85	0.82 (2)	27.20	0.29 (1)	15.63	0.64 (3)
TOTAL	181.76	6.81 (32)	237.43	4.80 (23)	203.20	5.96 (55)
MEAN	16.52	0.62	21.59	0.44	18.47	0.54
NUMBER	11	11	11	11	11	11

Figures in brackets (..) represent the number of corticomедial amygdala neurones from which latencies/conduction velocities were taken.

TABLE 3.4

Experiment 3 - Latencies of corticomедial amygdala neurones Orthodromically stimulated from the medial preoptic/anterior hypothalamus.

Castrate Rats + Testosterone Propionate

Castrate Rats + Oil

Number Rat	Latency (msec)	Number Rat	Latency (msec)
12CT	14.42 (6)	2CT	26.75 (1)
13CT	17.60 (2)	5CT	19.35 (2)
14CT	18.60 (3)	9CT	18.30 (4)
15CT	24.47 (3)	10CT	13.40 (1)
16CT	20.34 (5)	20CT	14.00 (1)
17CT	17.80 (1)	22CT	14.45 (1)
18CT	23.85 (2)	24CT	18.65 (3)
19CT	15.70 (2)		
23CT	22.80 (2)		
TOTAL	175.58 (26)	TOTAL	124.90 (13)
MEAN	19.50	MEAN	17.84
NUMBER	9	NUMBER	7

Latency figures represent the mean variable latency recorded. Figures in brackets (..) represent the number of CMA neurones from which the mean latency was calculated.

TABLE 4.1a

Experiment 4 - Median spontaneous firing rates of corticomедial amygdala neurones in castrated rats treated with OB or OB+DHTP.

Castrate Rats + OB

Number Rat	Response to stimulation of the MPH (action potentials produced per 100 secs)		
	Antidromic	Orthodromic	Not-Driven
1DE	13.00 (3)	-	-
8DE	10.50 (6)	183.17 (2)	-
9DE	1.67 (6)	32.67 (2)	-
15DE	3.33 (3)	-	-
16DE	5.67 (3)	-	123.00 (1)
23DE	4.50 (6)	292.17 (2)	726.17 (2)
24DE	7.34 (6)	78.00 (3)	781.67 (1)
30DE	6.00 (4)	-	220.67 (2)
TOTAL	52.01 (37)	586.01 (9)	1851.51 (6)
MEAN	6.50	146.50	462.88
NUMBER	8	4	4

Castrate Rats + (OB+DHTP)

Number Rat	Response to stimulation of the MPH (action potentials produced per 100 secs)		
	Antidromic	Orthodromic	Not-Driven
2DE	4.59 (4)	400.00 (1)	-
3DE	2.67 (5)	-	-
10DE	13.67 (6)	-	101.67 (1)
11DE	4.00 (7)	-	326.00 (2)
17DE	21.00 (5)	240.00 (1)	346.00 (5)
18DE	18.67 (4)	-	108.00 (1)
25DE	4.00 (6)	2.33 (1)	327.00 (1)
26DE	5.00 (5)	-	216.50 (1)
TOTAL	70.93 (42)	642.33 (3)	1425.17 (11)
MEAN	8.87	214.11	237.53
NUMBER	8	3	6

Figures in brackets (..) represent the number of corticomедial amygdala neurones from which the median firing rate value was calculated.

MPH = medial preoptic/anterior hypothalamic junction.

OB = Oestradiol Benzoate.

DHTP = Dihydrotestosterone Propionate.

TABLE 4.1b

Experiment 4 - Median spontaneous firing rates of corticomедial amygdala neurones in castrated rats treated with DHTP or Oil.

Castrate Rats + DHTP

Number Rat	Response to stimulation of the MPH (action potentials produced per 100 secs)		
	Antidromic	Orthodromic	Not-Driven
4DE	9.67 (2)	163.00 (2)	94.33 (2)
5DE	4.00 (7)	11.17 (2)	106.50 (5)
12DE	4.33 (5)	190.67 (3)	-
13DE	8.33 (3)	-	-
19DE	2.33 (3)	-	301.33 (1)
20DE	-	-	265.00 (1)
27DE	1.67 (6)	549.67 (1)	-
28DE	16.00 (3)	13.00 (3)	392.50 (2)
TOTAL	46.33 (29)	927.51 (11)	1159.66 (11)
MEAN	6.62	185.50	231.93
NUMBER	7	5	5

Castrate Rats + Oil

Number Rat	Response to stimulation of the MPH (action potentials produced per 100 secs)		
	Antidromic	Orthodromic	Not-Driven
6DE	9.00 (7)	-	71.33 (1)
7DE	5.00 (5)	0.67 (1)	44.00 (3)
14DE	5.67 (5)	101.67 (3)	323.00 (2)
21DE	2.84 (4)	161.00 (1)	34.00 (1)
22DE	6.00 (3)	-	758.67 (1)
29DE	2.92 (4)	317.50 (1)	592.00 (1)
31DE	15.67 (3)	-	215.67 (1)
32DE	9.67 (1)	-	-
TOTAL	56.77 (32)	580.84 (6)	2038.67 (10)
MEAN	7.10	145.21	291.24
NUMBER	8	4	7

Figures in brackets (..) represent the number of corticomедial amygdala neurones from which the median firing rate value was calculated.

MPH = medial preoptic/anterior hypothalamic junction.

DHTP = Dihydrotestosterone Propionate.

TABLE 4.2a

Experiment 4 - Mean absolute refractory periods of corticomедial amygdala neurones antidromically stimulated from the medial preoptic/ anterior hypothalamus in castrate rats treated with OB or OB + DHTP.

Castrate Rats + OB

Number Rat	Spontaneous (msec)	Silent (msec)	Combined Spontaneous + Silent (msec)
1DE	0.74 (3)	0.74 (7)	0.74 (10)
8DE	0.73 (7)	0.79 (4)	0.75 (11)
9DE	0.95 (7)	1.04 (4)	0.98 (11)
15DE	1.06 (4)	0.96 (6)	1.00 (10)
16DE	0.89 (4)	0.85 (2)	0.88 (6)
23DE	0.88 (8)	0.94 (3)	0.90 (11)
24DE	1.06 (7)	1.00 (3)	1.04 (10)
30DE	0.88 (5)	0.86 (6)	0.87 (11)
TOTAL	7.19 (45)	7.18 (35)	7.16 (80)
MEAN	0.90	0.88	0.90
NUMBER	8	8	8

Castrate Rats +(OB + DHTP)

Number Rat	Spontaneous (msec)	Silent (msec)	Combined Spontaneous + Silent (msec)
2DE	0.97 (5)	0.98 (6)	0.97 (11)
3DE	1.14 (6)	1.16 (6)	1.15 (12)
10DE	1.00 (6)	0.88 (7)	0.94 (13)
11DE	0.95 (7)	0.89 (3)	0.93 (10)
17DE	1.04 (6)	0.87 (3)	0.98 (9)
18DE	0.97 (4)	0.90 (4)	0.93 (8)
25DE	0.98 (6)	0.95 (4)	0.97 (10)
26DE	0.91 (7)	1.04 (7)	0.98 (14)
TOTAL	7.96 (47)	7.67 (40)	7.85 (87)
MEAN	1.00	0.96	0.98
NUMBER	8	8	8

Figures in brackets (...) represent the number of corticomедial amygdala neurones from which the mean absolute refractory period was calculated.

OB = Oestradiol Benzoate

DHTP = Dihydrotestosterone Propionate.

TABLE 4.2b

Experiment 4 - Mean absolute refractory periods of corticomедial amygdala neurones antidromically stimulated from the medial preoptic/ anterior hypothalamus in castrate rats treated with DHTP or oil.

Castrate Rats + DHTP

Number Rat	Spontaneous (msec)	Silent (msec)	Combined Spontaneous + Silent (msec)
4DE	1.30 (2)	1.51 (3)	1.43 (5)
5DE	1.36 (7)	1.69 (4)	1.48 (11)
12DE	1.53 (5)	1.33 (6)	1.42 (11)
13DE	1.50 (3)	1.19 (5)	1.31 (8)
19DE	1.36 (3)	1.53 (6)	1.47 (9)
20DE	1.55 (1)	1.28 (6)	1.31 (7)
27DE	1.21 (8)	1.19 (5)	1.20 (13)
28DE	1.44 (4)	1.61 (6)	1.55 (10)
TOTAL MEAN NUMBER	11.25 (33) 1.41 8	11.33 (41) 1.42 8	11.17 (74) 1.40 8

Castrate Rats + Oil

Number Rat	Spontaneous (msec)	Silent (msec)	Combined Spontaneous + Silent (msec)
6DE	1.24 (7)	1.07 (3)	1.19 (10)
7DE	1.36 (5)	1.39 (6)	1.38 (11)
14DE	1.45 (5)	1.74 (2)	1.53 (7)
21DE	1.34 (5)	1.59 (8)	1.49 (13)
22DE	1.58 (3)	1.39 (6)	1.46 (9)
29DE	1.33 (5)	1.59 (1)	1.37 (6)
31DE	1.44 (3)	1.40 (5)	1.42 (8)
32DE	1.43 (1)	1.52 (4)	1.50 (5)
TOTAL MEAN NUMBER	11.17 (34) 1.40 8	11.69 (35) 1.46 8	11.34 (69) 1.42 8

Figures in brackets (..) represent the number of corticomедial amygdala neurones from which the mean absolute refractory period was calculated.

DHTP = Dihydrotestosterone Propionate.

TABLE 4.3a

Experiment 4 - Latencies and conduction velocities of corticomedial amygdala neurones antidromically stimulated from the medial preoptic/ anterior hypothalamus.

Castrate Rats + OB

Number Rat	Spontaneous			Silent			Combined Spontaneous + Silent		
	(msec)	(m/sec)	(..)	(msec)	(m/sec)	(..)	(msec)	(m/sec)	(..)
1DE	12.07	0.68	(3)	13.59	0.73	(7)	13.13	0.71	(10)
8DE	14.14	0.60	(7)	13.65	0.67	(4)	13.96	0.62	(11)
9DE	26.30	0.32	(7)	27.13	0.31	(4)	26.60	0.32	(11)
15DE	21.23	0.38	(4)	24.90	0.34	(6)	23.43	0.36	(10)
16DE	12.86	0.86	(4)	13.95	0.58	(2)	13.23	0.77	(6)
23DE	12.86	0.78	(8)	20.00	0.44	(3)	14.81	0.69	(11)
24DE	18.67	0.46	(7)	18.33	0.52	(3)	18.57	0.48	(10)
30DE	14.32	0.73	(5)	16.87	0.54	(6)	15.71	0.63	(11)
TOTAL	132.45	4.81	(45)	148.42	4.13	(35)	139.44	4.58	(80)
MEAN	16.57	0.60		18.55	0.52		17.43	0.57	
NUMBER	8	8		8	8		8	8	

Castrate Rats + (OB+DHTP)

Number Rat	Spontaneous			Silent			Combined Spontaneous + Silent		
	(msec)	(m/sec)	(..)	(msec)	(m/sec)	(..)	(msec)	(m/sec)	(..)
2DE	20.64	0.39	(5)	23.76	0.35	(7)	22.46	0.37	(12)
3DE	21.15	0.39	(6)	28.23	0.29	(6)	24.68	0.34	(12)
10DE	20.35	0.43	(6)	19.27	0.45	(7)	19.77	0.44	(13)
11DE	19.20	0.43	(7)	24.60	0.34	(3)	20.82	0.40	(10)
17DE	16.73	0.56	(6)	11.53	1.03	(3)	15.00	0.72	(9)
18DE	11.53	0.80	(4)	12.10	0.85	(4)	11.81	0.83	(8)
25DE	14.50	0.71	(6)	13.23	0.64	(4)	14.00	0.68	(10)
26DE	18.23	0.53	(7)	20.66	0.43	(7)	19.44	0.48	(14)
TOTAL	142.33	4.24	(47)	153.38	4.38	(41)	147.98	4.26	(88)
MEAN	17.79	0.53		19.17	0.55		18.50	0.53	
NUMBER	8	8		8	8		8	8	

Figures in brackets (..) represent the number of corticomedial amygdala neurones from which the latencies/conduction velocities were taken.

OB = Oestradiol Benzoate

DHTP = Dihydrotestosterone Propionate.

TABLE 4.3b

Experiment 4 - Latencies and conduction velocities of corticomedial amygdala neurones antidromically stimulated from the medial preoptic/ anterior hypothalamus.

Castrate Rats + DHTP

Number Rat	Spontaneous			Silent			Combined Spontaneous + Silent		
	(msec)	(m/sec)	(...)	(msec)	(m/sec)	(...)	(msec)	(m/sec)	(...)
4DE	20.45	0.45	(2)	21.93	0.39	(3)	21.34	0.41	(5)
5DE	22.73	0.36	(7)	25.33	0.33	(4)	23.67	0.35	(11)
12DE	18.74	0.49	(5)	26.20	0.36	(6)	22.81	0.42	(11)
13DE	24.07	0.36	(3)	28.68	0.32	(5)	25.08	0.34	(8)
19DE	27.10	0.31	(3)	25.50	0.35	(6)	26.03	0.34	(9)
20DE	6.60	1.21	(1)	13.35	0.73	(6)	12.39	0.80	(7)
27DE	20.18	0.46	(8)	22.30	0.37	(5)	20.99	0.43	(13)
28DE	6.93	1.17	(4)	13.42	0.66	(6)	10.82	0.86	(10)
TOTAL	146.80	4.81	(33)	173.71	3.51	(41)	163.13	3.95	(74)
MEAN	18.35	0.60		21.71	0.44		20.39	0.49	
NUMBER	8	8		8	8		8	8	

Castrate Rats + Oil

Number Rat	Spontaneous			Silent			Combined Spontaneous + Silent		
	(msec)	(m/sec)	(...)	(msec)	(m/sec)	(...)	(msec)	(m/sec)	(...)
6DE	17.70	0.50	(7)	29.67	0.30	(3)	21.29	0.44	(10)
7DE	18.66	0.47	(5)	25.88	0.32	(6)	22.60	0.39	(11)
14DE	15.02	0.61	(5)	19.15	0.43	(2)	16.20	0.55	(7)
21DE	15.32	0.65	(5)	25.56	0.35	(8)	21.62	0.46	(13)
22DE	22.00	0.37	(3)	21.37	0.46	(6)	21.58	0.43	(9)
29DE	12.68	0.66	(5)	21.20	0.38	(1)	14.10	0.61	(6)
31DE	18.33	0.45	(3)	18.90	0.49	(5)	18.69	0.48	(8)
32DE	19.50	0.41	(1)	31.63	0.27	(4)	29.20	0.29	(5)
TOTAL	139.21	4.12	(34)	193.36	3.00	(35)	165.28	3.65	(69)
MEAN	17.40	0.52		24.17	0.38		21.44	0.46	
NUMBER	8	8		8	8		8	8	

Figures in brackets (...) represent the number of corticomedial amygdala neurones from which the latencies/conduction velocities were taken.

DHTP = Dihydrotestosterone Propionate.

TABLE 4.4

Experiment 4 - Latencies of corticomедial amygdala neurones Orthodromically stimulated from the medial preoptic/anterior hypothalamus.

Castrate Rats + OBCastrate Rats + (OB + DHTP)

Number Rat	Latency (msec)	Number Rat	Latency (msec)
8DE	12.05 (2)	2DE	31.30 (1)
9DE	24.03 (4)	3DE	18.90 (1)
23DE	21.85 (2)	17DE	14.40 (1)
24DE	13.43 (3)	28DE	11.30 (1)
TOTAL MEAN NUMBER	71.36 (11) 17.84 4	TOTAL MEAN NUMBER	75.90 (4) 18.98 4

Castrate Rats + DHTPCastrate Rats + Oil

Number Rat	Latency (msec)	Number Rat	Latency (msec)
4DE	16.10 (2)	7DE	21.90 (2)
5DE	26.25 (2)	14DE	12.93 (3)
12DE	11.78 (4)	21DE	5.50 (1)
13DE	28.00 (1)	22DE	15.10 (1)
27DE	22.92 (2)	29DE	17.00 (1)
28DE	16.77 (3)	31DE	14.60 (1)
TOTAL MEAN NUMBER	121.82 (14) 20.30 6	TOTAL MEAN NUMBER	87.03 (9) 14.50 6

Latency figures represent the mean variable latency recorded. Figures in brackets (..) represent the number of CMA neurones from which the mean latency was calculated.

OB = Oestradiol Benzoate.

DHTP = Dihydrotestosterone Propionate.

POOLED MEAN ABSOLUTE REFRACTORY PERIODS OF CORTICOMEDIAL AMYGDALA NEURONES STIMULATED FROM THE MPH (DIVIDED UP INTO SPECIFIC REGIONS).

(Figures represent combined spontaneous and silent neurones).

POOLED 'INTACT RATS'

Group	Number of Rat	Medial Amygdala Region (1) (msecs)	Medial Amygdala Region (2) (msecs)	Cortical Amygdala Region (1) (msecs)	Cortical Amygdala Region (2) (msecs)
A	33B	1.52	-	-	-
	35B	1.70	-	0.90	-
	40B	-	-	1.15	-
	46B	0.99	-	1.26	-
	49B	1.18	-	1.06	-
	51B	-	-	0.84	-
	53B	0.78	-	1.52	-
	55B	-	-	-	0.77
	62B	0.86	-	1.09	-
	66B	0.70	-	-	-
	68B	1.04	-	-	-
	75B	-	1.01	-	1.02
	77B	-	0.63	-	0.94
B	6CT	-	0.94	-	-
	11CT	-	0.79	-	-
	12CT	0.95	1.20	-	-
	13CT	-	1.01	-	-
	14CT	-	1.34	-	1.11
	15CT	-	1.12	-	1.03
	16CT	-	1.11	-	-
	17CT	-	-	-	0.96
	18CT	-	0.63	-	-
	19CT	1.06	-	-	-
	21CT	0.79	1.26	-	-
	23CT	0.69	0.98	-	-
C	1DE	0.76	-	0.58	-
	8DE	-	-	0.75	-
	9DE	0.98	-	-	-
	15DE	-	-	1.00	-
	16DE	1.00	-	0.76	-
	23DE	-	0.86	-	1.31
	24DE	1.04	-	-	-
	30DE	-	0.84	-	1.18
D	2DE	0.97	-	1.05	-
	3DE	1.11	-	1.24	-
	10DE	0.90	-	1.07	-
	11DE	0.94	-	0.93	-
	17DE	-	0.92	-	1.45
	18DE	-	0.81	-	0.97
	25DE	-	0.97	-	-
	26DE	0.92	-	1.19	-
TOTAL MEAN NUMBER		20.88 0.99 21	16.42 0.97 17	16.39 1.02 16	10.74 1.07 10

Regions: Medial Amygdala (1) = A 3990 - A 3430 μ (2) = A 3290 - A 2580 μ
 Cortical Amygdala (1) = A 3990 - A 3430 μ (2) = A 3290 - A 2580 μ
 (coordinates from König and Klippel, 1963).

Groups: A = Intact rats; B = testosterone propionate treated castrate rats.
 C = Oestradiol Benzoate (OB) treated castrate rats; D = OB + dihydrotestosterone propionate treated castrate rats.
 MPH = Medial preoptic/anterior hypothalamic junction.

TABLE 4.5B

POOLED MEAN ABSOLUTE REFRACTORY PERIODS OF CORTICOMEDIAL AMYGDALA NEURONES STIMULATED FROM THE MPH (DIVIDED UP INTO SPECIFIC REGIONS).

(Figures represent combined spontaneous and silent neurones).

POOLED 'CASTRATE' RATS

Group	Number of Rat	Medial Amygdala Region (1) (msecs)	Medial Amygdala Region (2) (msecs)	Cortical Amygdala Region (1) (msecs)	Cortical Amygdala Region (2) (msecs)
A	32B	2.50	-	-	-
	34B	-	-	1.44	-
	39B	-	2.23	-	-
	45B	-	-	-	2.02
	48B	1.28	-	-	-
	50B	1.27	-	-	-
	58B	-	1.53	-	-
	59B	1.43	-	-	-
	60B	1.45	-	-	-
	65B	-	1.43	-	0.91
	72B	1.88	1.12	-	-
	74B	1.10	-	1.09	-
B	1CT	-	-	-	1.42
	2CT	-	-	-	1.27
	4CT	1.19	-	1.50	-
	5CT	-	1.25	-	-
	7CT	-	-	-	1.03
	8CT	-	1.44	-	-
	9CT	1.68	1.59	1.68	-
	10CT	-	2.38	-	-
	20CT	-	1.21	-	1.24
	22CT	-	1.54	-	1.43
	24CT	-	1.46	-	-
	C	4DE	0.80	1.32	1.42
5DE		1.87	-	1.44	-
12DE		1.52	0.89	1.32	1.80
13DE		1.23	-	1.45	-
19DE		1.32	-	1.65	-
20DE		-	-	-	1.31
27DE		1.20	-	-	-
28DE		-	1.46	-	1.94
D	6DE	1.18	-	1.24	-
	7DE	-	-	1.38	-
	14DE	-	1.35	-	1.66
	21DE	1.29	-	1.68	1.53
	22DE	1.07	-	1.50	-
	29DE	1.04	-	1.44	-
	31DE	1.47	-	-	1.04
	32DE	-	-	-	1.50
TOTAL MEAN NUMBER		27.77 1.39 20	22.20 1.48 15	20.23 1.45 14	21.90 1.46 15

Regions: Medial Amygdala (1) = A 3990 - A 3430 μ (2) = A 3290 - A 2580 μ
 Cortical Amygdala (1) = A 3990 - A 3430 μ (2) = A 3290 - A 2580 μ
 (coordinates from Konig and Klippel, 1963).

Groups : A = Castrate rats; B and D = Castrate rats + oil.
 C = Castrate rats + dihydrotestosterone propionate.
 MPH = Medial preoptic/anterior hypothalamic junction.

Figure 2A

Experiment 1 - Localisation of antidromically identified CMA neurones after stimulation of the MPH.

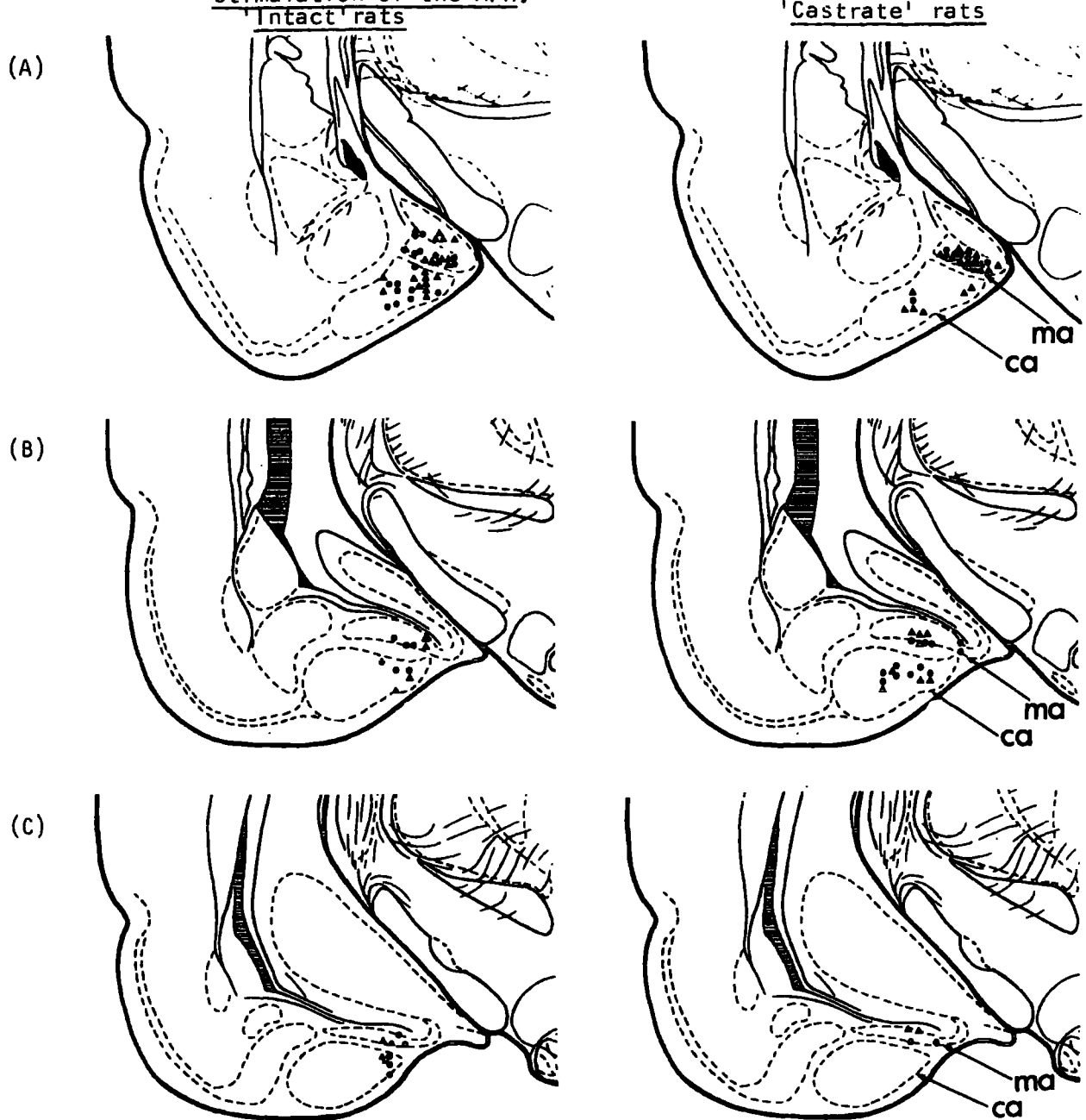

Key:-

- = Spontaneously active neurones.
 - ▲ = Silent neurones.
 - ca = Cortical amygdala nucleus.
 - ma = Medial amygdala nucleus.
 - CMA = Corticomедial amygdala.
 - MPH = Medial preoptic/anterior hypothalamic junction.
- (A) = A 3990 - A 3430
 (B) = A 3290 - A 3180
 (C) = A 2970 - A 2580
- Coordinates from
König & Klippel (1963).

Figure 2B

Experiment 2 - Localisation of antidromically identified corticomедial amygdala neurones after stimulation of the capsule of the ventromедial nucleus.

'Intact' Male rats

'Castrate' Male rats

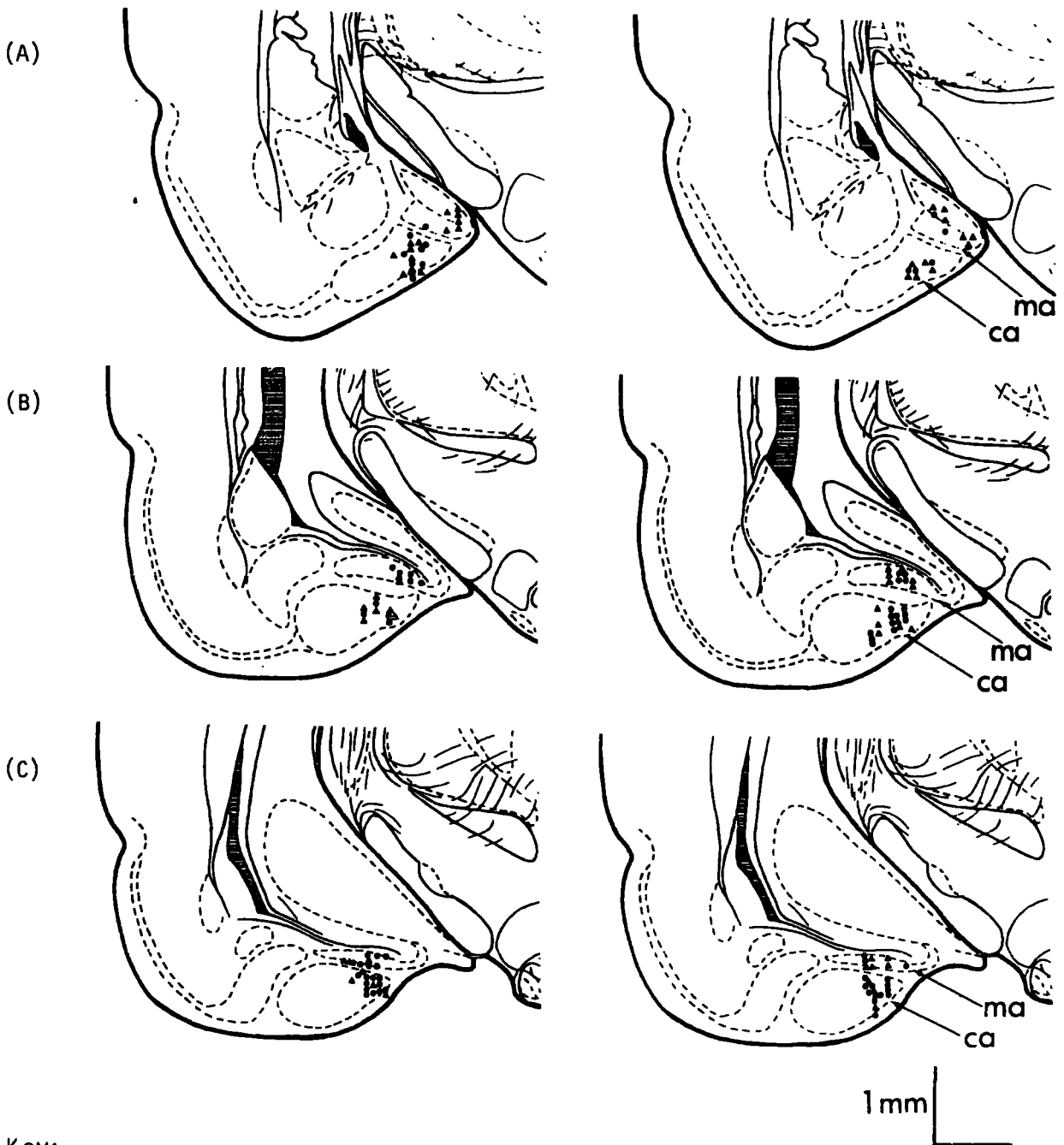

Key: -

- = Spontaneously active neurones.
 - ▲ = Silent neurones.
 - ca = Cortical amygdala nucleus.
 - ma = Medial amygdala nucleus.
 - CMA = Corticomедial amygdala.
 - VMC = Capsule of the ventromедial nucleus
- (A) = A 3990 - A 3430
 (B) = A 3290 - A 3180
 (C) = A 2970 - A 2580
- Coordinates from
König & Klippel (1963).

Figure 3A

Experiment 3: Localisation of antidromically identified CMA neurones after stimulation of the MPH.

'Castrate' rats + Oil

'Castrate' rats + TP

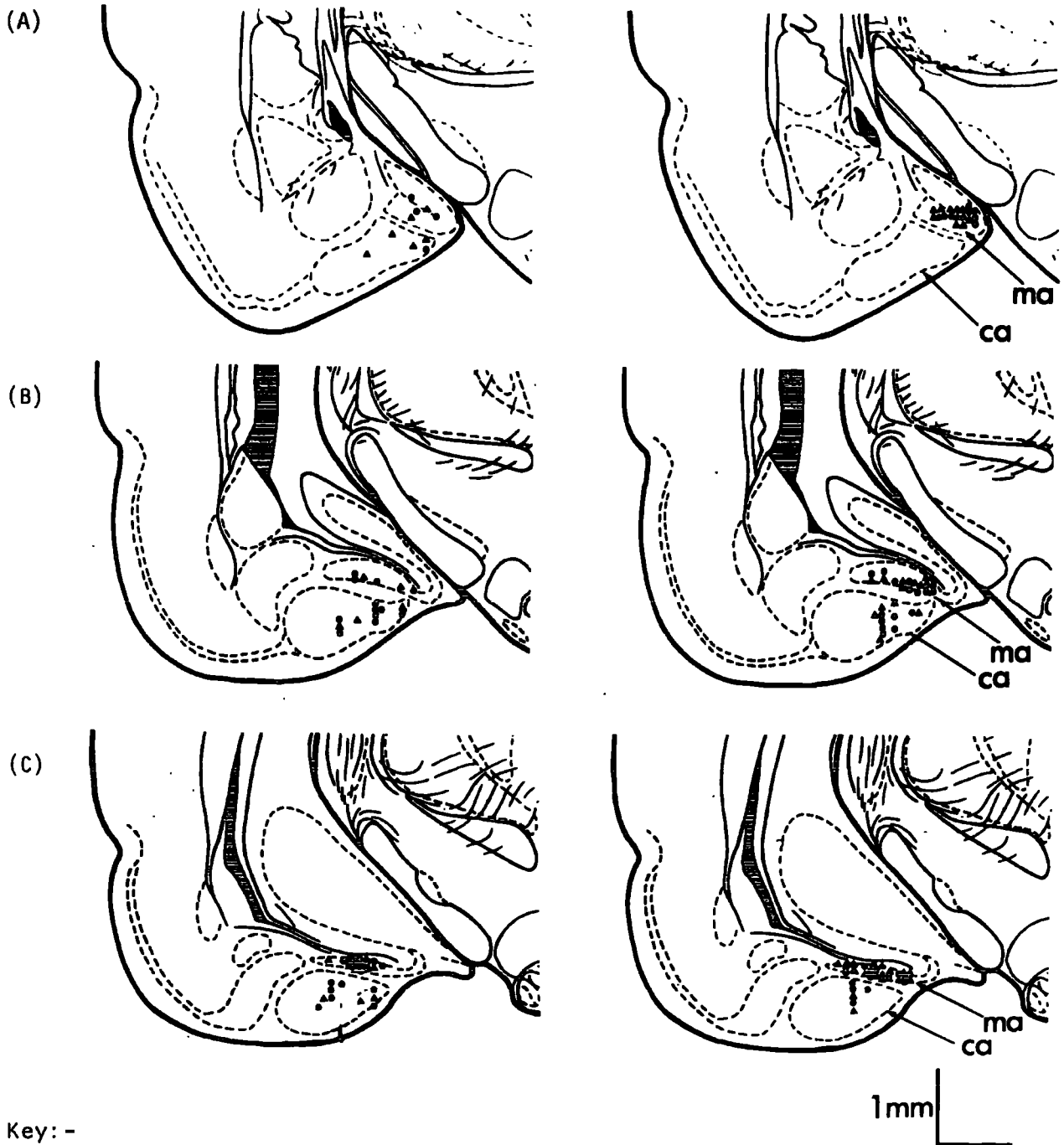

Key: -

TP = testosterone propionate.

● = Spontaneously active neurones.

▲ = Silent neurones.

ca = Cortical amygdala nucleus.

ma = Medial amygdala nucleus.

CMA = Corticomедial amygdala.

MPH = Medial preoptic/anterior hypothalamic junction

(A) = A 3990 - A 3430

(B) = A 3290 - A 3180

(C) = A 3970 - A 2580

Coordinates from
König & Klippel (1963).

Figure 4A

Experiment 4: Localisation of antidromically identified CMA neurones after stimulation of the MPH.

'Castrate' rats + OB

'Castrate' rats + (OB + DHTP)

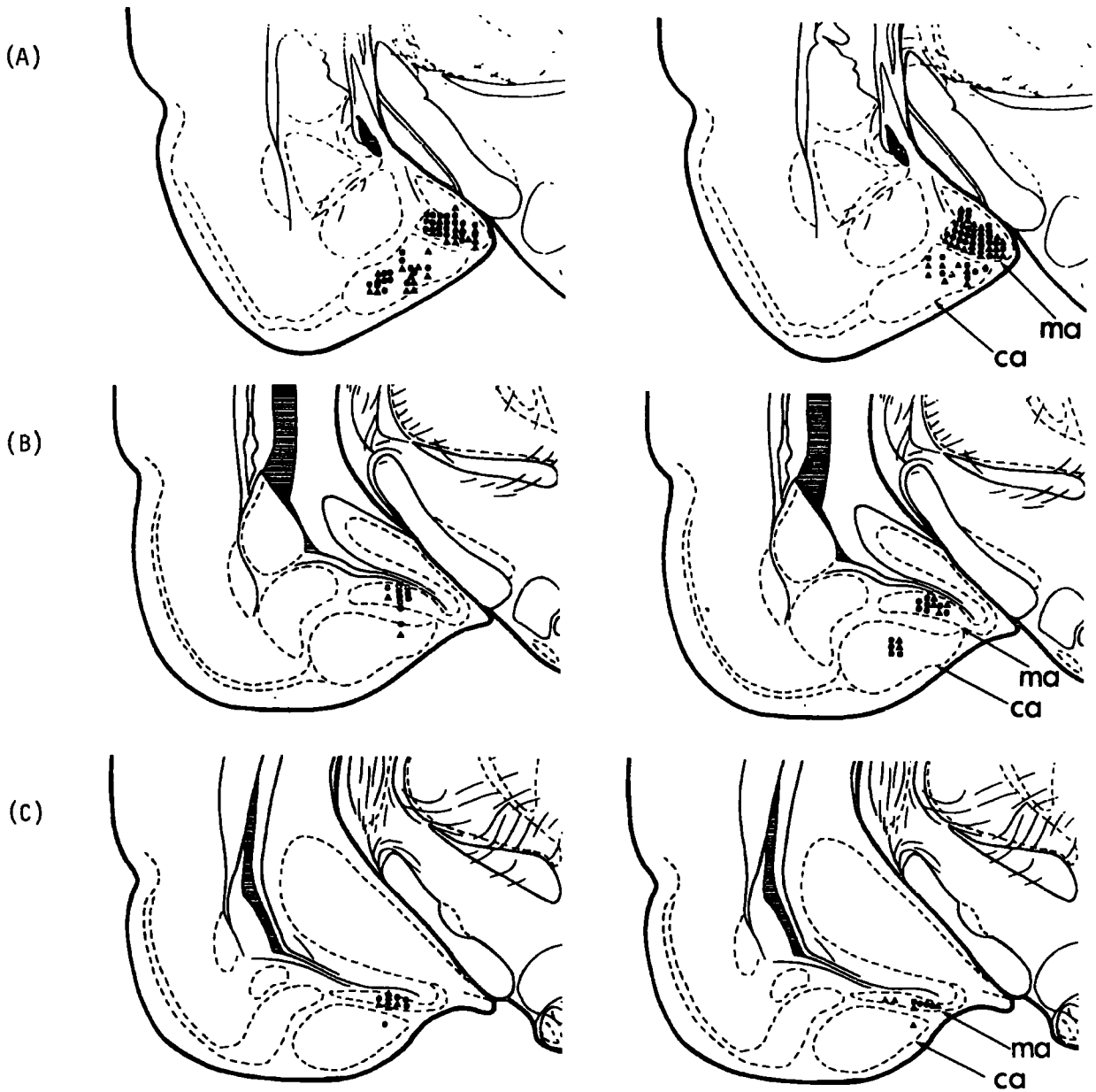

Key: -

- = Spontaneously active neurones;
- ▲ = Silent neurones.
- ca = Cortical amygdala nucleus;
- ma = Medial amygdala nucleus.
- CMA = Corticomедial amygdala.
- MPH = Medial preoptic/anterior hypothalamic junction.
- (A) = A 3990 - A 3430
- (B) = A 3290 - A 3180
- (C) = A 2970 - A 2580
- OB = Destradiol benzoate.
- DHTP = Dihydrotestosterone propionate.

Coordinates from
König & Klippel (1963).

Experiment 4 - Localisation of antidromically identified CMA neurones after stimulation of the MPH.

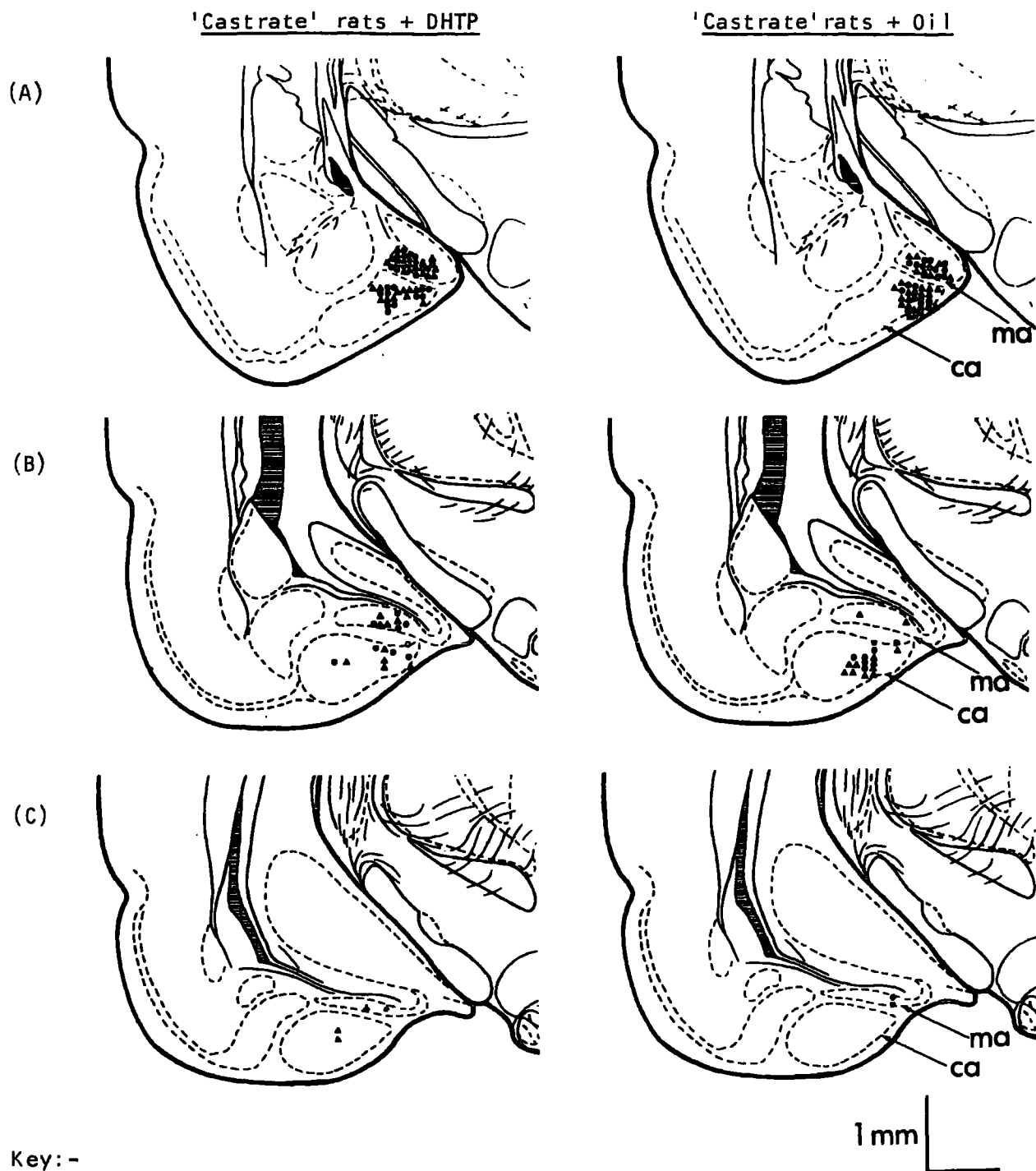

Key: -

● = Spontaneously active neurones.

▲ = Silent neurones.

ca = Cortical amygdala nucleus.

ma = Medial amygdala nucleus.

CMA = Corticomедial amygdala.

MPH = Medial preoptic/anterior hypothalamic junction.

(A) = A 3990 - A 3430

Coordinates from

(B) = A 3290 - A 3180

König & Klippel (1963).

(C) = A 2970 - A 2580

DHTP = Dihydrotestosterone propionate.

A P P E N D I X

SECTION 1

(Experiments 1 and 2)

Abbreviations:-

- CA = Cortical amygdala nucleus.
- MA = Medial amygdala nucleus.
- MPH = Medial preoptic/anterior hypothalamus.
- VMC = Capsule of the ventromedial nucleus of the hypothalamus.

SPONTANEOUS ANTIDROMIC NEURONES IN THE CORTICOMEDIAL AMYGDALA ACTIVATED
BY ELECTRICAL STIMULATION OF THE MPH. INTACT MALE RATS.

Number Rat	CA or MA	Latency (msecs)	Conduction Velocity (m/sec)	Abs Refract Period (msecs)	Rate 100 secs
33B	MA	25.0	0.32	1.52	4.00
33B	CA	21.0	0.38	-	3.00
35B	MA	27.5	0.29	1.70	2.67
46B	MA	9.7	0.82	1.15	3.00
49B	MA	17.7	0.45	0.93	0.33
49B	CA	27.6	0.29	1.06	17.33
51B	CA	18.5	0.43	0.74	2.00
51B	CA	16.6	0.48	-	-
51B	CA	22.2	0.36	0.84	-
51B	CA	8.3	0.96	-	-
53B	MA	19.8	0.40	0.74	5.67
53B	MA	16.0	0.50	0.60	1.00
53B	CA	33.0	0.24	1.52	18.33
55B	CA	12.4	0.65	-	-
55B	CA	13.1	0.61	0.60	22.33
62B	MA	26.9	0.30	0.86	1.33
66B	MA	9.7	0.82	0.70	13.00
68B	MA	19.0	0.42	1.04	44.50
69B	CA	19.8	0.40	-	22.00
75B	MA	28.6	0.28	1.27	3.00
75B	MA	15.4	0.52	0.71	3.67
75B	MA	27.7	0.29	1.52	114.00
75B	CA	12.4	0.65	1.20	14.33
75B	CA	12.0	0.67	1.04	9.33
75B	CA	15.1	0.53	-	-
75B	CA	11.7	0.68	0.83	8.00
77B	CA	25.0	0.32	0.94	1.00

SILENT ANTIDROMIC NEURONES IN THE CORTICOMEDIAL AMYGDALA ACTIVATED BY ELECTRICAL STIMULATION OF THE MPH. INTACT MALE RATS.

Number Rat	CA or MA	Latency (msecs)	Conduction Velocity (m/sec)	Abs. Refract Period (msecs)
35B	CA	26.8	0.30	0.93
35B	CA	13.2	0.61	0.61
35B	CA	17.0	0.47	1.16
40B	CA	30.5	0.26	1.15
42B	MA	15.0	0.53	-
42B	CA	25.0	0.32	-
46B	MA	23.0	0.35	0.71
46B	MA	13.9	0.56	0.74
46B	MA	26.5	0.30	1.34
46B	CA	31.8	0.25	1.37
46B	CA	22.0	0.36	1.79
46B	CA	10.0	0.80	0.62
49B	MA	16.2	0.49	1.32
49B	MA	31.0	0.26	1.52
49B	MA	22.5	0.36	-
49B	MA	22.0	0.36	0.93
51B	CA	8.8	0.91	-
51B	CA	21.8	0.37	0.93
53B	MA	35.5	0.23	-
53B	MA	21.8	0.37	0.99
55B	CA	19.5	0.41	0.93
62B	CA	33.5	0.24	1.09
75B	MA	29.6	0.27	-
75B	MA	12.8	0.63	0.71
75B	MA	14.8	0.54	1.04
75B	MA	18.0	0.44	0.83
75B	CA	17.2	0.47	0.99
77B	MA	6.8	1.18	0.63
77B	MA	8.0	1.00	-

SPONTANEOUS ANTIDROMIC NEURONES IN THE CORTICOMEDIAL AMYGDALA ACTIVATED BY ELECTRICAL STIMULATION OF THE MPH. CASTRATED MALE RATS (8 weeks +).

Number Rat	CA or MA	Latency (msecs)	Conduction Velocity (m/sec)	Abs Refract Period (msecs)	Rate 100 secs
32B	MA	25.2	0.32	2.50	14.33
34B	CA	15.2	0.53	1.64	3.33
36B	MA	9.8	0.82	-	2.67
39B	MA	26.0	0.31	1.96	0.67
45B	CA	38.0	0.21	-	12.50
45B	CA	34.5	0.23	2.50	47.33
45B	CA	38.0	0.21	2.60	25.33
45B	CA	28.8	0.28	1.85	3.33
56B	CA	37.0	0.22	-	3.67
58B	MA	10.0	0.80	1.27	8.33
58B	MA	24.2	0.33	1.79	0.67
59B	MA	28.2	0.28	1.02	0.33
59B	MA	20.0	0.40	1.20	-
59B	MA	28.5	0.28	-	-
60B	MA	17.5	0.46	2.04	-
65B	CA	19.0	0.42	-	9.00
65B	MA	16.4	0.49	-	8.00
65B	MA	23.8	0.34	1.34	21.00
65B	MA	18.1	0.44	1.91	40.00
72B	MA	31.5	0.25	1.52	2.00
72B	MA	40.8	0.20	2.60	0.33
72B	MA	31.1	0.26	1.52	-

SILENT ANTIDROMIC NEURONES IN THE CORTICOMEDIAL AMYGDALA ACTIVATED BY ELECTRICAL STIMULATION OF THE MPH. CASTRATED MALE RATS (8 weeks +).

Number Rat	CA or MA	Latency (msecs)	Conduction Velocity (m/sec)	Abs Refract Period (msecs)
14B	MA	26.0	0.31	-
34B	CA	17.8	0.45	1.79
34B	CA	30.5	0.26	1.58
34B	CA	8.1	0.99	0.74
39B	MA	21.5	0.37	2.50
45B	CA	28.0	0.29	-
45B	CA	46.0	0.17	2.11
45B	CA	21.6	0.37	1.24
45B	CA	19.6	0.41	2.50
45B	CA	33.8	0.24	1.34
48B	MA	23.8	0.34	0.99
48B	MA	26.2	0.30	1.52
48B	MA	26.0	0.30	-
48B	MA	27.6	0.29	1.09
48B	MA	30.8	0.26	-
48B	MA	34.0	0.24	1.52
50B	MA	25.5	0.31	1.27
50B	MA	20.0	0.40	-
59B	MA	20.0	0.40	2.50
59B	MA	19.8	0.40	0.99
60B	MA	18.0	0.44	0.85
65B	CA	25.5	0.31	0.91
65B	MA	11.3	0.71	-
65B	MA	16.5	0.48	1.04
72B	MA	14.0	0.57	1.82
72B	MA	26.7	0.30	1.95
72B	MA	18.0	0.44	1.88
72B	MA	16.2	0.49	1.12
74B	MA	21.3	0.38	1.22
74B	MA	21.8	0.37	0.93
74B	MA	23.7	0.34	1.15
74B	CA	15.2	0.53	1.09

SPONTANEOUS AND SILENT ORTHODROMIC UNITS IN THE CORTICOMEDIAL AMYGDALA
ACTIVATED BY ELECTRICAL STIMULATION OF THE MPH. INTACT MALE RATS.

Number Rat	CA or MA	Latency (msecs)	Mean (msecs)	Spontaneous	Silent	Rate (100 secs)
33B	MA	13.9-16.5	15.2	*		21.0
33B	MA	16.0-26.5	21.2	*		128.0
33B	MA	15.7-16.2	16.0	*		7.67
33B	MA	15.8-16.4	16.1	*		22.0
33B	MA	28.8-31.0	29.9	*		11.5
35B	MA	15.4-19.0	17.2		*	
35B	MA	18.8-24.8	21.8	*		23.67
35B	MA	29.0-31.0	30.0		*	
35B	MA	25.0-26.0	25.5	*		25.67
35B	MA	14.0-27.5	21.8	*		3.67
35B	CA	20.0-31.0	25.5	*		13.67
35B	CA	24.0-37.0	30.5	*		3.33
37B	MA	25.5-32.5	29.0	*		4.33
46B	MA	16.5-27.5	22.0		*	
46B	MA	14.4-16.3	15.4	*		42.67
46B	CA	12.0-13.0	12.5	*		-
53B	MA	21.5-22.8	22.2	*		5.67
53B	MA	16.3-17.3	16.8		*	
53B	CA	19.0-24.0	21.5		*	
55B	CA	20.0-20.5	20.3		*	
55B	CA	15.5-16.0	15.8	*		34.0
62B	MA	21.5-29.5	25.5	*		-
62B	MA	29.0-30.5	29.8	*		43.5
68B	MA	20.8-23.8	22.3	*		20.67
69B	MA	19.0-20.5	19.8	*		22.0
75B	MA	9.5-10.2	9.9	*		451.33

SPONTANEOUS AND SILENT ORTHODROMIC UNITS IN THE CORTICOMEDIAL AMYGDALA
ACTIVATED BY STIMULATION OF THE MPH. CASTRATED MALE RATS.

Number Rat	CA or MA	Latency (msecs)	Mean (msecs)	Spontaneous	Silent	Rate (100 secs)
32B	MA	32.5-32.7	32.6	*		14.33
32B	MA	26.0-32.0	29.0	*		1.67
32B	MA	9.5- 9.6	9.6	*		1.0
34B	CA	14.0-14.8	14.4	*		305.33
36B	MA	26.0-26.8	26.4	*		103.33
39B	MA	26.0-31.0	28.5	*		81.0
45B	MA	26.0-30.0	28.0	*		12.0
48B	MA	21.8-24.0	22.9		*	
48B	CA	37.5-40.0	38.8		*	
58B	MA	23.0-24.5	23.8	*		-
58B	MA	11.0-11.8	11.4	*		0.33
58B	MA	15.2-17.4	16.3	*		6.0
58B	MA	15.8-20.8	18.3	*		0.67
59B	MA	17.5-20.0	18.8	*		6.0
61B	CA	25.0-27.5	26.3	*		222.0
65B	MA	20.0-24.0	22.0	*		97.33
65B	MA	16.8-21.5	19.2	*		4.67
65B	CA	15.0-19.5	17.3	*		69.67

NON-DRIVEN SPONTANEOUS NEURONES IN THE CORTICOMEDIAL AMYGDALA.

(After stimulation of the MPH).

'Intact' Rats

Number Rat	CA or MA	Rate 100 secs	Number Rat	CA or MA	Rate 100 secs
33B	CA	599.33			
33B	CA	348.33	53B	MA	26.00
35B	MA	408.33	53B	MA	125.50
35B	MA	55.67	53B	MA	852.33
35B	CA	4.33			
35B	CA	20.67	55B	MA	57.00
35B	CA	341.00	55B	MA	316.00
40B	MA	22.00	55B	CA	9.33
40B	MA	25.00	55B	CA	363.00
42B	CA	394.00	55B	CA	14.33
46B	MA	47.50	55B	MA	399.67
46B	MA	281.00	55B	MA	197.00
46B	MA	22.00	55B	CA	484.67
46B	MA	26.33			
46B	MA	3.00	62B	MA	564.33
49B	MA	238.00	62B	MA	494.00
51B	MA	5.00	62B	CA	86.67
51B	MA	457.33	62B	MA	112.33
51B	MA	480.33	62B	MA	131.67
51B	CA	73.67			
51B	CA	349.33	66B	MA	302.33
51B	MA	320.00	66B	MA	342.00
51B	MA	356.00	66B	MA	106.00
51B	CA	387.00	66B	MA	721.33
51B	CA	19.00	66B	MA	24.33
51B	CA	207.33	66B	MA	4.00
51B	CA	239.67	68B	MA	215.50
51B	CA	139.33	68B	MA	4.00
51B	CA	37.00	68B	MA	41.67
51B	CA	4.67	68B	CA	621.67
			75B	MA	68.00
			75B	CA	610.33

NON-DRIVEN SPONTANEOUS NEURONES IN THE CORTICOMEDIAL AMYGDALA.(After stimulation of the MPH).'Castrate' Rats

Number Rat	CA or MA	Rate 100 secs	Number Rat	CA or MA	Rate 100 secs
14B	MA	413.00	58B	CA	330.00
14B	MA	168.67	58B	CA	0.33
14B	CA	770.00	58B	MA	9.33
14B	CA	4.33	58B	MA	0.33
36B	MA	101.33	58B	MA	10.00
36B	CA	133.00	58B	MA	138.33
36B	CA	14.33	59B	MA	8.67
36B	MA	9.33	59B	MA	178.00
36B	MA	284.00	59B	MA	235.33
36B	CA	208.67	59B	MA	428.67
36B	MA	440.33	59B	MA	70.50
39B	MA	169.33	59B	MA	38.67
39B	MA	440.33	59B	MA	558.00
45B	CA	392.50	59B	MA	261.00
45B	CA	192.00	59B	MA	488.33
45B	CA	308.67	60B	MA	407.00
45B	CA	128.67	60B	MA	36.00
50B	MA	775.50	60B	MA	11.00
50B	CA	324.33	61B	CA	835.00
50B	CA	153.00	61B	CA	0.33
50B	CA	184.67	61B	CA	425.33
50B	CA	188.00	61B	CA	346.00
50B	CA	291.33	61B	CA	203.33
50B	CA	174.50	61B	CA	125.00
50B	MA	897.67	61B	CA	267.67
50B	MA	19.33	61B	CA	668.00
50B	MA	45.00	61B	CA	236.00
50B	MA	366.67	61B	CA	69.00
56B	MA	806.33	61B	MA	5.33
56B	MA	27.33	61B	CA	111.33
56B	CA	558.00	65B	CA	9.00
58B	MA	239.33	65B	CA	0.33
58B	MA	270.00	65B	MA	343.00
58B	MA	1.00	65B	CA	4.67
			65B	CA	39.00
			65B	CA	51.00
			72B	MA	170.00
			72B	MA	1.33

RHEOBASE CURRENTS AND CHRONAXIES OF CORTICOMEDIAL AMYGDALA NEURONES
ANTIDROMICALLY STIMULATED FROM THE MPH.

'Intact' Rats

'Castrate' Rats

Number Rat	CA or MA	Rheobase Current μ a	Chronaxie μ sec	Number Rat	CA or MA	Rheobase Current μ a	Chronaxie μ sec
33B	MA	140	690	36B	MA	50	500
35B	MA	170	200	45B	CA	80	670
35B	CA	90	500	45B	CA	90	430
35B	CA	70	390	45B	CA	130	470
40B	MA	80	670	45B	CA	40	750
46B	MA	150	380	48B	MA	70	380
46B	MA	90	460	58B	MA	140	420
46B	CA	90	420	58B	MA	100	420
49B	MA	160	300	65B	MA	200	290
49B	MA	80	360	72B	MA	40	500
49B	CA	100	460	74B	CA	20	250
51B	CA	90	500				
51B	CA	150	420				
53B	MA	100	670				
53B	MA	150	210				
53B	MA	90	390				
75B	CA	70	500				

SPONTANEOUS ANTIDROMIC NEURONES IN THE CORTICOMEDIAL AMYGDALA ACTIVATED BY ELECTRICAL STIMULATION OF THE VMC. INTACT MALE RATS.

Number Rat	CA or MA	Latency (msecs)	Conduction Velocity (m/sec)	Abs Refract Period (msecs)	Rate 100 secs
27B	MA	12.0	0.83	-	413.33
31B	CA	17.0	0.59	-	245.00
31B	CA	13.2	0.76	1.52	233.00
67B	CA	10.0	1.00	0.84	485.67
70B	CA	13.4	0.75	-	18.00
70B	CA	11.6	0.86	-	75.00
70B	MA	15.2	0.66	0.94	264.00
73B	MA	8.0	1.25	1.01	267.00
73B	CA	12.5	0.80	-	211.33
73B	CA	10.1	0.99	-	-
73B	CA	22.8	0.44	1.13	183.33
76B	CA	13.8	0.72	-	372.00
78B	MA	11.9	0.84	0.79	-
78B	MA	30.5	0.33	2.19	396.00
78B	MA	29.9	0.33	0.53	400.00
78B	CA	13.9	0.72	1.91	122.00
78B	MA	13.0	0.77	0.98	75.00
79B	MA	13.0	0.77	1.79	248.00
79B	MA	10.3	0.97	0.88	75.00
79B	MA	12.8	0.78	1.18	241.67
79B	MA	22.2	0.45	1.44	4.33
85B	CA	18.0	0.56	1.24	404.67
85B	CA	28.5	0.35	1.74	255.00
87B	CA	27.0	0.37	0.83	45.33
87B	CA	14.0	0.71	0.81	34.00
87B	CA	12.0	0.83	0.88	81.67
89B	MA	13.5	0.74	1.59	755.00
89B	CA	27.9	0.36	0.91	9.50
91B	CA	12.0	0.83	0.73	566.00
91B	CA	36.4	0.27	1.64	64.33
95B	MA	17.8	0.56	1.11	8.33
95B	CA	8.2	1.14	0.58	159.67
95B	CA	29.5	0.34	0.94	283.00
95B	CA	7.3	1.37	0.81	9.33
95B	CA	17.5	0.57	1.39	350.00

SILENT ANTIDROMIC NEURONES IN THE CORTICOMEDIAL AMYGDALA ACTIVATED BY ELECTRICAL STIMULATION OF THE VMC. INTACT MALE RATS.

Number Rat	CA or MA	Latency (msecs)	Conduction Velocity (m/sec)	Abs Refract Period (msecs)
70B	CA	20.8	0.48	1.64
70B	CA	8.8	1.14	0.86
70B	CA	27.0	0.37	1.74
73B	CA	12.1	0.83	0.76
73B	CA	18.9	0.53	1.46
73B	CA	16.0	0.63	1.11
73B	CA	20.1	0.50	0.68
76B	CA	15.0	0.67	2.11
78B	MA	26.0	0.38	1.11
78B	MA	18.2	0.55	0.77
78B	MA	20.3	0.49	1.09
78B	CA	20.9	0.48	0.67
79B	MA	15.6	0.64	0.79
79B	MA	22.8	0.44	1.54
85B	CA	6.5	1.54	0.74
85B	CA	13.7	0.73	1.31
85B	CA	25.5	0.39	0.86
87B	CA	21.6	0.46	1.54
87B	CA	21.1	0.47	0.86
87B	CA	24.7	0.40	1.13
87B	CA	24.1	0.41	0.93
91B	CA	8.5	1.18	0.76
91B	CA	26.5	0.38	0.84
93B	MA	20.2	0.50	1.15
93B	MA	4.1	2.44	0.58
93B	MA	30.5	0.33	1.79
93B	MA	40.2	0.25	1.79
93B	MA	26.3	0.39	0.94
93B	MA	32.0	0.31	1.54
95B	CA	9.8	1.02	0.99

SPONTANEOUS ANTIDROMIC NEURONES IN THE CORTICOMEDIAL AMYGDALA ACTIVATED BY ELECTRICAL STIMULATION OF THE VMC. CASTRATED MALE RATS. (8 weeks +).

Number Rat	CA or MA	Latency (msecs)	Conduction Velocity (m/sec)	Abs Refract Period (msecs)	Rate 100 secs
28B	MA	11.8	0.85	1.12	302.33
30B	CA	26.5	0.38	-	546.67
30B	MA	22.5	0.44	-	616.00
30B	MA	31.0	0.32	-	387.67
30B	MA	33.0	0.30	1.79	160.00
54B	CA	6.8	1.47	1.04	250.33
54B	CA	4.4	2.27	-	65.00
54B	CA	8.8	1.14	0.83	398.00
56B	CA	28.5	0.35	1.64	243.00
56B	CA	33.5	0.30	-	420.00
82B	CA	16.2	0.62	1.15	43.33
82B	CA	10.9	0.92	1.18	248.00
82B	CA	12.5	0.80	1.18	151.67
82B	CA	8.5	1.18	0.93	148.00
83B	CA	31.5	0.32	1.15	158.50
83B	CA	25.5	0.39	1.04	233.33
83B	CA	21.8	0.46	1.15	88.67
83B	CA	10.8	0.93	1.21	593.67
83B	CA	33.2	0.30	0.99	47.33
83B	CA	26.5	0.38	1.91	4.67
84B	MA	25.8	0.38	1.04	60.33
84B	CA	38.8	0.26	1.34	168.67
84B	CA	27.5	0.36	1.31	138.67
84B	CA	20.8	0.48	1.12	214.33
84B	CA	28.6	0.35	1.24	100.00
84B	CA	16.5	0.60	0.85	-
86B	MA	21.7	0.46	1.09	216.33
86B	MA	28.2	0.35	0.93	16.00
88B	MA	13.5	0.74	1.11	355.33
88B	MA	12.7	0.79	0.97	264.33
94B	CA	18.2	0.55	0.83	7.33
94B	CA	15.0	0.67	0.86	72.00
94B	CA	7.5	1.33	0.79	116.00
94B	CA	11.7	0.85	0.94	361.67

SILENT ANTIDROMIC NEURONES IN THE CORTICOMEDIAL AMYGDALA ACTIVATED BY ELECTRICAL STIMULATION OF THE VMC. CASTRATED MALE RATS (8 weeks +).

Number Rat	CA or MA	Latency (msecs)	Conduction Velocity (m/sec)	Abs Refract Period (msecs)
30B	CA	25.5	0.39	-
30B	MA	17.5	0.57	-
30B	MA	20.0	0.50	-
30B	MA	20.5	0.49	1.79
43B	MA	12.5	0.80	1.18
54B	CA	27.8	0.36	1.68
56B	CA	38.4	0.26	1.12
56B	CA	28.8	0.35	0.91
56B	CA	13.9	0.72	1.27
82B	CA	22.2	0.45	1.15
82B	CA	29.5	0.34	1.09
82B	MA	6.4	1.56	0.97
83B	CA	25.8	0.39	0.85
83B	MA	18.5	0.54	1.46
83B	CA	21.5	0.47	1.31
83B	CA	26.0	0.38	1.79
84B	MA	16.5	0.61	1.27
84B	MA	8.8	1.14	0.74
84B	MA	21.0	0.48	1.34
86B	MA	14.8	0.68	1.04
86B	MA	16.5	0.61	0.81
88B	MA	10.2	0.98	1.24
88B	MA	12.3	0.81	1.02
90B	MA	22.0	0.45	1.68
90B	MA	26.7	0.37	1.61
92B	MA	22.5	0.44	1.12
92B	CA	16.3	0.61	0.91
94B	MA	26.8	0.37	1.07
94B	MA	24.8	0.40	1.21
94B	CA	30.5	0.33	0.94
94B	CA	8.2	1.22	0.80
94B	CA	20.5	0.49	1.61
94B	CA	12.0	0.83	1.09

SPONTANEOUS AND SILENT ORTHODROMIC UNITS IN THE CORTICOMEDIAL AMYGDALA
ACTIVATED BY ELECTRICAL STIMULATION OF THE VMC.

Intact Rats

Number Rat	CA or MA	LATENCY (msecs)	MEAN (msecs)	SPONTANEOUS	SILENT	RATE 100 secs
27B	MA	31.0-31.3	31.2	*		29.33
27B	MA	26.0-26.5	26.3		*	
27B	MA	21.0-21.5	21.3		*	
27B	MA	11.4-12.0	11.7		*	
31B	CA	17.0-18.0	17.5	*		431.33
67B	MA	14.0-14.5	14.3	*		221.00
70B	CA	3.6- 4.4	4.0	*		273.67
70B	MA	12.2-14.4	13.3	*		158.33
73B	CA	10.5-31.0	20.8	*		256.00
76B	MA	19.0-21.0	20.0	*		75.50
76B	CA	22.8-26.0	24.4	*		-
78B	MA	11.5-12.0	11.8	*		588.67
79B	MA	17.0-22.0	19.5	*		4.50
79B	MA	18.0-19.0	18.5	*		303.33
79B	MA	17.0-22.8	19.9	*		242.00
79B	MA	16.4-16.6	16.5		*	
85B	MA	6.8-12.6	9.7	*		11.00
85B	CA	23.2-27.0	25.1	*		71.33
87B	CA	15.5-17.5	16.5	*		147.00
93B	MA	23.5-39.5	31.5	*		56.00
93B	MA	27.0-27.3	27.2	*		443.33
95B	MA	22.5-26.5	24.5	*		-
95B	CA	17.5-18.0	17.8	*		55.33
95B	MA	17.5-17.9	17.7	*		5.00
95B	MA	16.2-19.8	18.0	*		5.00
95B	CA	16.2-17.5	16.9	*		62.67
95B	MA	11.4-12.8	12.1	*		217.50

SPONTANEOUS AND SILENT ORTHODROMIC UNITS IN THE CORTICOMEDIAL AMYGDALA
ACTIVATED BY ELECTRICAL STIMULATION OF THE VMC.

Castrate Rats

Number Rat	CA or MA	LATENCY (msecs)	MEAN (msecs)	SPONTANEOUS	SILENT	RATE 100 secs
28B	MA	8.5- 9.0	8.8		*	
28B	MA	32.0-32.5	32.3		*	
28B	MA	20.5-21.0	20.8		*	
28B	MA	16.2-16.8	16.5	*		-
28B	MA	7.6- 8.8	8.2	*		-
28B	CA	18.8-19.2	19.0		*	
30B	CA	29.0-29.3	29.2		*	
30B	MA	11.0-11.5	11.3		*	
30B	CA	24.0-24.2	24.1		*	
54B	MA	26.8-27.8	27.3	*		1.33
54B	CA	40.5-41.0	40.8	*		607.67
56B	CA	11.8-13.5	12.7	*		74.67
56B	CA	32.8-33.8	33.3	*		243.00
83B	MA	17.5-19.5	18.5	*		128.67
86B	MA	22.8-25.2	24.0	*		410.67
90B	MA	13.7-14.7	14.2	*		105.33
90B	MA	30.0-31.0	30.5	*		5.00

NON-DRIVEN SPONTANEOUS NEURONES IN THE CORTICOMEDIAL AMYGDALA(After stimulation of the VMC).Intact Rats

Number Rat	CA or MA	Rate 100 secs	Number Rat	CA or MA	Rate 100 secs
27B	MA	3.33	76B	MA	329.33
27B	MA	7.33	76B	CA	147.67
27B	MA	55.50	76B	CA	243.67
27B	MA	776.00			
31B	MA	24.33	78B	CA	521.33
31B	MA	285.00	78B	CA	30.00
31B	CA	307.67	78B	CA	57.33
67B	MA	134.33	79B	MA	4.33
67B	MA	3.00	79B	MA	108.33
67B	CA	1271.33	79B	MA	303.67
67B	CA	276.00	79B	MA	30.67
67B	CA	1063.67	79B	CA	1.67
70B	CA	486.67	85B	MA	20.00
70B	CA	65.50	85B	MA	61.33
70B	CA	58.67	85B	MA	1.33
70B	CA	313.33			
70B	CA	345.33	87B	MA	11.67
73B	CA	2.00	87B	MA	23.00
73B	CA	176.50	87B	CA	143.67
73B	CA	150.00	87B	CA	62.33
			95B	MA	416.33
			95B	MA	291.33
			95B	CA	11.33

NON-DRIVEN SPONTANEOUS NEURONES IN THE CORTICOMEDIAL AMYGDALA(After stimulation of the VMC).Castrate Rats

Number Rat	CA or MA	Rate 100 secs	Number Rat	CA or MA	Rate 100 secs
28B	MA	10.00	82B	CA	24.33
28B	MA	33.00	82B	CA	212.00
28B	MA	10.33	82B	CA	8.67
28B	MA	113.67	82B	CA	215.67
28B	MA	207.67	82B	CA	559.67
28B	MA	40.33	82B	MA	6.00
28B	MA	19.33	82B	CA	22.00
28B	MA	306.67	82B	CA	129.00
28B	CA	256.00	82B	CA	353.00
28B	CA	137.00	82B	CA	64.33
30B	MA	5.67	83B	CA	63.00
30B	MA	12.67	84B	MA	9.67
30B	MA	251.00		MA	740.00
43B	CA	18.67	84B	MA	773.33
43B	MA	235.33	84B	CA	365.67
43B	MA	105.50	84B	CA	324.00
54B	CA	5.33	86B	MA	42.33
54B	CA	5.33	86B	CA	459.00
54B	CA	19.67	90B	MA	52.00
54B	MA	108.67		MA	14.00
54B	CA	1.33	92B	MA	186.67
54B	CA	178.00			
56B	MA	806.33	94B	MA	19.67
56B	MA	27.33	94B	MA	7.00
56B	CA	558.00	94B	CA	355.00
			94B	MA	530.00

RHEOBASE CURRENTS AND CHRONAXIES OF CORTICOMEDIAL AMYGDALA NEURONES
ANTIDROMICALLY STIMULATED FROM THE VMC.

'Intact' Rats

'Castrate' Rats

Number Rat	CA or MA	Rheobase Current μ a	Chronaxie μ sec	Number Rat	CA or MA	Rheobase Current μ a	Chronaxie μ sec
27B	MA	400	417	28B	MA	150	250
31B	CA	190	664	54B	CA	200	433
31B	CA	160	525	54B	CA	160	650
70B	CA	220	386	54B	CA	160	281
70B	MA	420	197	56B	CA	240	263
73B	CA	240	463	56B	CA	340	339
79B	MA	20	395	83B	CA	50	643
				84B	MA	190	286
				94B	CA	70	772

A P P E N D I X

SECTION 2

(Experiment 3)

Abbreviations:-

CA	=	Cortical amygdala nucleus
MA	=	Medial amygdala nucleus
MPH	=	Medial preoptic/anterior hypothalamic junction
TP	=	Testosterone Propionate

SPONTANEOUS ANTIDROMIC NEURONES IN THE CORTICOMEDIAL AMYGDALA ACTIVATED
BY ELECTRICAL STIMULATION OF THE MPH. CASTRATED RATS (Injected with
200 µg TP/day for 18 - 22 days

Number Rat	CA or MA	Latency (msecs)	Conduction Velocity (m/sec)	Abs Refract Period (msecs)	Rate 100 secs
6CT	MA	18.0	0.44	1.27	1.33
6CT	MA	14.4	0.56	0.67	4.33
6CT	MA	16.0	0.50	0.99	0.33
12CT	MA	13.4	0.60	0.74	17.00
12CT	MA	15.4	0.52	0.97	0.33
13CT	MA	28.1	0.28	1.09	656.33
13CT	MA	9.9	0.81	0.68	6.67
13CT	MA	9.2	0.87	1.15	-
14CT	MA	12.3	0.65	1.34	5.67
14CT	CA	35.4	0.23	1.74	3.00
14CT	CA	26.2	0.31	0.67	-
15CT	MA	10.1	0.79	1.04	20.00
15CT	MA	8.0	1.00	0.71	108.33
15CT	CA	25.8	0.31	1.41	-
15CT	CA	10.9	0.73	0.68	4.00
15CT	CA	18.1	0.44	0.97	-
15CT	CA	21.8	0.37	0.99	2.33
16CT	MA	6.8	1.18	1.04	4.00
16CT	MA	7.5	1.07	1.04	0.67
16CT	MA	8.0	1.00	1.27	10.00
17CT	CA	13.5	0.59	0.71	7.67
17CT	CA	15.8	0.51	1.30	6.00
17CT	CA	14.5	0.55	0.63	8.67
17CT	CA	10.3	0.78	0.91	74.00
17CT	CA	22.5	0.36	1.02	32.33
18CT	MA	6.4	1.25	0.58	10.33
18CT	MA	12.8	0.63	0.54	0.67
18CT	MA	6.2	1.29	0.54	-
18CT	MA	15.6	0.51	0.93	4.00
19CT	MA	24.0	0.33	1.29	8.50
19CT	MA	16.5	0.48	1.18	266.33
19CT	MA	23.0	0.35	1.18	15.67
19CT	MA	12.2	0.66	0.74	6.00
19CT	MA	16.0	0.50	1.06	3.00
21CT	MA	13.8	0.58	0.57	0.33
21CT	MA	15.4	0.52	1.24	3.00
23CT	MA	23.5	0.34	0.77	9.33
23CT	MA	24.5	0.33	0.94	3.33
23CT	MA	23.0	0.35	1.38	15.67
23CT	MA	24.5	0.33	1.54	26.00
23CT	MA	21.7	0.37	0.68	37.00

SILENT ANTIDROMIC NEURONES IN THE CORTICOMEDIAL AMYGDALA ACTIVATED BY ELECTRICAL STIMULATION OF THE MPH. CASTRATED RATS (Injected with 200 μ g TP/day for 18 - 22 days).

Number Rat	CA or MA	Latency (msecs)	Conduction Velocity (m/sec)	Abs Refract Period (msecs)
6CT	MA	8.8	0.91	0.93
6CT	MA	18.0	0.44	1.27
6CT	MA	16.5	0.48	0.79
6CT	MA	17.2	0.47	0.64
11CT	MA	16.5	0.48	0.98
11CT	MA	13.5	0.59	0.60
12CT	MA	23.8	0.34	1.30
12CT	MA	14.2	0.56	0.85
12CT	MA	6.3	1.27	0.91
12CT	MA	11.8	0.68	1.15
12CT	MA	10.4	0.77	1.41
12CT	MA	20.8	0.38	1.04
13CT	MA	27.0	0.30	1.11
14CT	CA	9.9	0.81	1.04
14CT	CA	31.8	0.25	0.99
15CT	MA	12.4	0.65	1.34
15CT	MA	18.4	0.43	1.34
15CT	MA	10.5	0.76	1.15
15CT	CA	16.2	0.49	0.69
15CT	CA	37.1	0.22	1.41
16CT	MA	12.2	0.66	0.67
16CT	MA	14.4	0.55	1.38
16CT	MA	16.4	0.49	1.06
16CT	MA	13.0	0.62	1.30
17CT	CA	23.8	0.34	1.15
17CT	CA	14.0	0.57	0.97
17CT	CA	35.5	0.23	0.97
18CT	MA	13.9	0.58	0.58
19CT	MA	21.0	0.38	1.09
19CT	MA	25.0	0.32	1.15
19CT	MA	21.0	0.38	0.93
19CT	MA	10.5	0.76	0.97
19CT	MA	34.5	0.23	1.05
21CT	MA	12.2	0.66	0.84
21CT	MA	19.8	0.40	0.71
21CT	MA	26.5	0.30	1.02
21CT	MA	14.0	0.57	1.27
23CT	MA	25.5	0.31	0.55
23CT	MA	13.0	0.62	0.69

SPONTANEOUS ANTIDROMIC NEURONES IN THE CORTICOMEDIAL AMYGDALA ACTIVATED BY ELECTRICAL STIMULATION OF THE MPH. CASTRATED RATS (injected with 011 for 18 - 22 days).

Number Rat	CA or MA	Latency (msecs)	Conduction Velocity (m/sec)	Abs Refract Period (msecs)	Rate 100 secs
1CT	CA	24.4	0.33	1.68	-
1CT	CA	23.4	0.34	1.38	57.00
1CT	CA	33.8	0.24	1.20	20.00
1CT	CA	24.8	0.32	1.04	0.33
1CT	CA	31.5	0.25	1.79	103.67
1CT	CA	28.0	0.29	1.46	74.00
2CT	CA	14.7	0.54	1.68	261.67
2CT	CA	18.5	0.43	1.54	131.00
4CT	MA	18.0	0.44	1.27	5.00
4CT	CA	34.9	0.23	1.91	1.33
5CT	MA	16.6	0.48	0.95	2.33
5CT	MA	29.8	0.27	1.50	6.00
7CT	CA	10.0	0.80	-	4.00
7CT	CA	12.6	0.63	1.09	0.67
7CT	CA	11.8	0.68	-	14.00
8CT	MA	31.8	0.25	1.34	15.00
8CT	MA	26.9	0.30	1.95	307.67
8CT	MA	26.0	0.31	1.21	5.67
8CT	MA	20.9	0.38	1.97	-
8CT	MA	23.0	0.35	1.36	4.33
8CT	MA	11.8	0.68	1.21	0.33
8CT	MA	23.8	0.34	1.05	3.33
9CT	MA	14.4	0.56	1.68	4.00
9CT	MA	13.9	0.58	1.59	33.33
10CT	MA	6.2	1.29	2.60	-
20CT	MA	14.6	0.55	1.07	13.33
20CT	CA	13.0	0.62	1.24	9.33
22CT	CA	7.8	1.03	1.20	31.00
22CT	CA	6.8	1.18	1.74	12.00
22CT	CA	12.2	0.66	0.99	5.00
24CT	MA	10.6	0.75	1.52	30.00
24CT	MA	9.1	0.88	1.02	2.00

SILENT ANTIDROMIC NEURONES IN THE CORTICOMEDIAL AMYGDALA ACTIVATED BY STIMULATION OF THE MPH. CASTRATED MALE RATS (injected with Oil for 18 - 22 days).

Number Rat	CA or MA	Latency (msecs)	Conduction Velocity (m/sec)	Abs Refract Period (msecs)
1CT	CA	25.5	0.31	1.41
2CT	CA	30.2	0.26	1.02
2CT	CA	24.0	0.33	0.85
4CT	MA	21.5	0.37	1.11
4CT	CA	36.0	0.22	1.30
4CT	CA	35.5	0.23	1.29
5CT	MA	25.5	0.31	1.64
5CT	MA	9.1	0.88	0.92
7CT	CA	10.5	0.76	0.91
7CT	CA	16.9	0.47	1.09
8CT	MA	28.5	0.28	1.52
8CT	MA	14.2	0.56	1.48
8CT	MA	25.2	0.32	0.83
8CT	MA	42.0	0.19	1.91
9CT	CA	21.5	0.37	1.97
9CT	CA	17.2	0.47	1.38
10CT	MA	12.1	0.66	2.15
20CT	MA	21.8	0.37	1.74
20CT	MA	11.2	0.71	0.99
20CT	MA	9.9	0.81	1.02
22CT	MA	19.8	0.40	1.54
22CT	CA	25.0	0.32	1.79
24CT	MA	27.2	0.29	1.85

SPONTANEOUS AND SILENT ORTHODROMIC NEURONES IN THE CORTICOMEDIAL AMYGDALA
ACTIVATED BY ELECTRICAL STIMULATION OF THE MPH. CASTRATED MALE RATS
(Injected with 200µg TP for 18 - 22 days).

Number Rat	CA or MA	Latency (msecs)	Mean (msecs)	Spontaneous	Silent	Rate 100 secs
12CT	MA	21.3-21.5	21.4	*		1.33
12CT	MA	32.0-32.5	32.3	*		53.00
12CT	MA	5.8- 6.0	5.9	*		5.33
12CT	MA	8.1- 8.3	8.2	*		-
12CT	MA	9.8- 9.9	9.9	*		1.00
12CT	MA	8.7- 8.8	8.8		*	
13CT	MA	29.3-29.5	29.4		*	
13CT	MA	5.7- 5.9	5.8	*		1410.00
14CT	MA	9.8-10.0	9.9		*	
14CT	MA	12.2-12.4	12.3	*		7.00
14CT	CA	31.1-36.1	33.6		*	
15CT	MA	10.8-11.8	11.3	*		3.33
15CT	CA	21.5-22.5	22.0	*		25.00
15CT	CA	40.0-40.1	40.1	*		0.33
16CT	MA	10.0-10.1	10.1	*		4.00
16CT	CA	30.9-40.0	40.0	*		8.33
16CT	MA	14.6-14.8	14.7	*		4.67
16CT	MA	20.8-22.2	21.5			57.00
16CT	CA	14.9-15.8	15.4	*		1.00
17CT	CA	17.7-17.9	17.8	*		173.00
18CT	MA	22.2-23.2	22.7	*		316.67
18CT	CA	20.5-29.5	25.00	*		255.00
19CT	MA	16.2-16.4	16.3	*		-
19CT	MA	15.0-15.2	15.1		*	
23CT	MA	27.5-27.7	27.6	*		4.67
23CT	MA	16.0-20.0	18.0	*		85.00

SPONTANEOUS AND SILENT ORTHODROMIC NEURONES IN THE CORTICOMEDIAL AMYGDALA
ACTIVATED BY ELECTRICAL STIMULATION OF THE MPH. CASTRATED MALE RATS
(Injected with Oil for 18 - 22 days).

Number Rat	CA or MA	Latency (msecs)	Mean (msecs)	Spontaneous	Silent	Rate (100 secs)
2CT	CA	25.5-28.0	26.75	*		3.00
5CT	MA	7.0- 8.8	7.70	*		320.00
5CT	CA	30.0-32.0	31.00	*		348.67
9CT	MA	17.8-20.8	19.30	*		3.33
9CT	CA	16.9-19.5	18.20	*		17.00
9CT	CA	14.9-17.0	15.95	*		3.00
9CT	MA	18.0-21.5	19.75		*	
10CT	MA	13.3-13.5	13.40	*		3.00
20CT	CA	13.9-14.1	14.00		*	
22CT	CA	11.2-17.7	14.45	*		79.00
24CT	MA	12.2-15.2	13.70	*		30.00
24CT	MA	12.2-16.4	14.30	*		112.00
24CT	MA	27.8-28.1	27.95		*	

NON-DRIVEN SPONTANEOUS NEURONES IN THE CORTICOMEDIAL AMYGDALA (Stimulation of the MPH. CASTRATED MALE RATS. (Injected with 200µg TP/day for 18 - 22 days).

Number Rat	CA or MA	Rate (100 secs)
11CT	MA	180.67
11CT	MA	979.00
11CT	MA	500.67
15CT	MA	364.00
15CT	CA	9.50
15CT	CA	38.00
15CT	MA	54.50
15CT	CA	110.33
18CT	MA	291.67
19CT	MA	16.67
19CT	MA	764.00
19CT	MA	124.33
19CT	MA	16.67
23CT	MA	14.67

CASTRATED MALE RATS. (Injected with Oil for 18 - 22 days).

Number Rat	CA or MA	Rate (100 secs)
1CT	MA	87.00
1CT	MA	235.00
1CT	MA	3.33
1CT	MA	135.67
1CT	CA	39.00
2CT	CA	0.33
2CT	MA	19.33
4CT	CA	1.33
4CT	CA	3.00
5CT	CA	74.67
7CT	MA	655.33
7CT	MA	865.33
7CT	CA	31.33
8CT	MA	607.67
8CT	MA	17.67
9CT	MA	781.50
24CT	CA	30.67
24CT	CA	76.00

A P P E N D I X

SECTION 3

(Experiment 4)

Abbreviations:-

CA	=	Cortical amygdala nucleus.
MA	=	Medial amygdala nucleus.
MPH	=	Medial preoptic/anterior hypothalamus.
DHTP	=	Dihydrotestosterone Propionate.
OB	=	Oestradiol Benzoate.

SPONTANEOUS ANTIDROMIC NEURONES IN THE CORTICOMEDIAL AMYGDALA ACTIVATED BY ELECTRICAL STIMULATION OF THE MPH. CASTRATED MALE RATS (injected with 5µg Oestradiol Benzoate for 18 - 22 days).

Number Rat	CA or MA	Latency (msecs)	Conduction Velocity (m/sec)	Abs Refract Period (msecs)	Rate 100 secs
1DE	MA	14.6	0.55	0.92	17.00
1DE	MA	10.1	0.79	0.68	6.67
1DE	MA	11.5	0.79	0.63	13.00
8DE	CA	10.0	0.80	0.71	10.67
8DE	CA	13.8	0.58	0.74	50.00
8DE	CA	14.3	0.56	0.68	6.33
8DE	CA	12.2	0.66	0.72	18.33
8DE	CA	11.3	0.71	0.82	8.00
8DE	CA	17.0	0.47	0.66	10.33
8DE	CA	20.4	0.39	0.76	-
9DE	MA	20.0	0.40	0.77	2.67
9DE	MA	26.0	0.31	0.76	8.33
9DE	MA	19.0	0.42	0.76	1.00
9DE	MA	22.5	0.36	0.62	2.67
9DE	MA	33.0	0.24	1.18	0.67
9DE	MA	28.6	0.30	1.38	0.33
9DE	MA	35.0	0.23	1.18	-
15DE	CA	18.1	0.44	1.04	10.67
15DE	CA	22.0	0.36	1.04	-
15DE	CA	20.8	0.38	0.98	3.33
15DE	CA	24.0	0.33	1.18	1.33
16DE	MA	23.2	0.34	1.26	16.00
16DE	MA	14.4	0.56	0.87	2.67
16DE	CA	4.8	1.67	0.70	-
16DE	CA	9.1	0.88	0.74	5.67
23DE	MA	20.2	0.40	1.28	20.33
23DE	MA	7.5	1.07	0.54	-
23DE	MA	23.0	0.35	0.98	3.67
23DE	MA	6.2	1.29	0.83	-
23DE	MA	7.5	1.07	0.83	4.33
23DE	MA	10.0	0.80	0.46	31.33
23DE	MA	18.5	0.43	1.26	4.67
23DE	MA	10.0	0.80	0.88	0.67
24DE	MA	25.0	0.32	1.55	2.33
24DE	MA	25.5	0.31	0.74	5.00
24DE	MA	21.0	0.38	1.35	167.00
24DE	MA	13.0	0.62	0.78	9.67
24DE	MA	19.5	0.41	0.83	1.00
24DE	MA	12.7	0.63	1.07	38.33
24DE	MA	14.0	0.57	1.08	-
30DE	MA	12.2	0.66	0.78	4.50
30DE	MA	14.2	0.56	0.74	-
30DE	MA	6.2	1.29	0.74	6.00
30DE	MA	9.0	0.89	0.98	6.00
30DE	CA	30.0	0.27	1.18	44.00

SILENT ANTIDROMIC NEURONES IN THE CORTICOMEDIAL AMYGDALA ACTIVATED BY ELECTRICAL STIMULATION OF THE MPH. CASTRATED MALE RATS (injected with 5µg Oestradiol Benzoate for 18 - 22 days).

Number Rat	CA or MA	Latency (msecs)	Conduction Velocity (m/sec)	Abs Refract Period (msecs)
1DE	MA	10.7	0.75	0.58
1DE	MA	13.4	0.60	0.87
1DE	MA	11.2	0.71	0.82
1DE	MA	24.0	0.33	0.63
1DE	MA	8.0	1.00	0.56
1DE	CA	6.0	1.33	0.58
1DE	MA	21.8	0.37	1.12
8DE	CA	13.6	0.59	0.77
8DE	CA	10.1	0.79	0.64
8DE	CA	22.6	0.35	0.98
8DE	CA	8.3	0.96	0.77
9DE	MA	20.5	0.39	0.71
9DE	MA	32.0	0.25	1.63
9DE	MA	28.0	0.29	0.77
9DE	MA	28.0	0.29	1.06
15DE	CA	27.0	0.30	1.09
15DE	CA	16.8	0.48	1.04
15DE	CA	20.0	0.40	0.83
15DE	CA	28.8	0.28	1.09
15DE	CA	22.8	0.35	0.63
15DE	CA	34.0	0.24	1.09
16DE	MA	15.3	0.52	0.86
16DE	CA	12.6	0.63	0.83
23DE	MA	19.0	0.42	0.85
23DE	CA	28.0	0.29	1.31
23DE	MA	13.0	0.62	0.65
24DE	MA	29.8	0.27	1.18
24DE	MA	12.0	0.67	0.98
24DE	MA	13.2	0.61	0.85
30DE	MA	23.0	0.35	1.06
30DE	MA	21.0	0.38	0.79
30DE	MA	10.8	0.74	0.65
30DE	MA	13.0	0.62	1.10
30DE	MA	23.5	0.34	0.93
30DE	MA	9.9	0.81	0.63

SPONTANEOUS ANTIDROMIC NEURONES IN THE CORTICOMEDIAL AMYGDALA ACTIVATED BY ELECTRICAL STIMULATION OF THE MPH. CASTRATED MALE RATS (Injected with 5µg Oestradiol Benzoate & 1mg DHTP for 18 - 22 days).

Number Rat	CA or MA	Latency (msecs)	Conduction Velocity (m/sec)	Abs Refract Period (msecs)	Rate 100 secs
2DE	MA	16.6	0.48	0.76	6.67
2DE	MA	22.8	0.35	1.24	-
2DE	MA	20.8	0.38	0.89	2.50
2DE	MA	19.5	0.41	0.89	14.00
2DE	CA	23.5	0.34	1.05	1.67
3DE	MA	17.5	0.46	0.99	-
3DE	MA	17.5	0.46	1.09	5.00
3DE	MA	18.8	0.43	0.89	2.67
3DE	MA	25.4	0.32	1.38	0.67
3DE	MA	27.5	0.29	1.24	2.67
3DE	CA	20.2	0.40	1.27	119.67
10DE	MA	17.0	0.47	0.76	14.67
10DE	MA	13.0	0.62	0.91	12.67
10DE	MA	23.5	0.34	0.99	0.33
10DE	MA	23.0	0.35	1.21	24.00
10DE	MA	14.6	0.55	0.87	8.67
10DE	CA	31.0	0.26	1.24	36.33
11DE	MA	19.2	0.42	1.11	25.00
11DE	MA	22.7	0.35	0.93	4.00
11DE	CA	23.4	0.34	0.83	1.33
11DE	MA	20.0	0.40	0.98	6.67
11DE	CA	16.4	0.49	0.89	0.67
11DE	MA	17.2	0.47	0.95	0.33
11DE	CA	15.5	0.52	0.97	48.67
17DE	MA	26.2	0.31	1.04	81.50
17DE	MA	17.2	0.47	1.14	30.00
17DE	MA	24.0	0.33	1.26	-
17DE	MA	13.0	0.62	0.98	21.00
17DE	MA	8.8	0.91	0.87	0.67
17DE	MA	11.2	0.71	0.92	4.00
18DE	CA	11.8	0.68	0.88	26.33
18DE	CA	12.1	0.66	1.26	11.00
18DE	CA	5.8	1.38	0.74	58.00
18DE	CA	16.4	0.49	0.98	4.33
25DE	MA	18.5	0.43	0.88	2.00
25DE	MA	6.0	1.33	0.50	144.67
25DE	MA	8.3	0.96	0.59	1.67
25DE	MA	9.7	0.82	0.93	2.33
25DE	MA	25.5	0.31	1.55	10.00
25DE	MA	19.0	0.42	1.45	5.67
26DE	MA	22.0	0.36	1.07	5.00
26DE	MA	29.0	0.28	0.98	8.33
26DE	MA	11.4	0.70	0.66	2.00
26DE	MA	9.8	0.82	0.83	-
26DE	MA	13.7	0.58	0.88	130.00
26DE	MA	11.2	0.71	0.71	1.33
26DE	CA	30.5	0.26	1.26	-

SILENT ANTIDROMIC NEURONES IN THE CORTICOMEDIAL AMYGDALA ACTIVATED BY ELECTRICAL STIMULATION OF THE MPH. CASTRATED MALE RATS (injected with 5µg Oestradiol Benzoate + 1mg DHTP for 18 - 22 days).

Number Rat	CA or MA	Latency (msecs)	Conduction Velocity (m/sec)	Abs Refract Period (msecs)
2DE	MA	22.0	0.36	-
2DE	MA	22.5	0.36	0.79
2DE	MA	32.5	0.25	1.21
2DE	MA	22.5	0.36	1.09
2DE	MA	17.8	0.45	0.81
2DE	MA	25.0	0.32	0.89
2DE	MA	24.0	0.33	1.09
3DE	MA	24.5	0.33	0.92
3DE	MA	28.6	0.28	1.49
3DE	MA	30.1	0.27	0.88
3DE	CA	32.5	0.25	1.01
3DE	CA	23.8	0.34	1.12
3DE	CA	29.8	0.27	1.54
10DE	MA	18.5	0.43	0.87
10DE	MA	16.5	0.48	0.74
10DE	MA	21.0	0.38	0.93
10DE	MA	23.1	0.35	0.97
10DE	MA	10.0	0.80	0.70
10DE	CA	23.5	0.34	0.75
10DE	CA	22.3	0.36	1.21
11DE	CA	20.0	0.40	1.02
11DE	MA	21.0	0.38	0.85
11DE	MA	32.8	0.24	0.81
17DE	MA	4.6	1.74	0.54
17DE	CA	22.0	0.36	1.45
17DE	MA	8.0	1.00	0.63
18DE	MA	22.8	0.35	0.88
18DE	MA	6.4	1.25	0.74
18DE	CA	7.0	1.14	0.88
18DE	CA	12.2	0.66	1.10
25DE	MA	8.5	0.94	0.59
25DE	MA	15.2	0.53	1.18
25DE	MA	15.0	0.53	1.04
25DE	MA	14.2	0.56	0.98
26DE	MA	25.2	0.32	0.97
26DE	MA	17.5	0.46	0.83
26DE	MA	10.5	0.76	0.87
26DE	MA	15.0	0.53	1.18
26DE	MA	24.0	0.33	1.10
26DE	CA	25.2	0.32	1.39
26DE	CA	27.2	0.29	0.93

SPONTANEOUS ANTIDROMIC NEURONES IN THE CORTICOMEDIAL AMYGDALA ACTIVATED BY ELECTRICAL STIMULATION OF THE MPH. CASTRATED MALE RATS (injected with 1mg DHTP for 18 - 22 days).

Number Rat	CA or MA	Latency (msec)	Conduction Velocity (m/sec)	Abs Refract Period (msecs)	Rate 100 secs
4DE	CA	27.6	0.29	1.80	0.33
4DE	MA	13.3	0.60	0.80	19.00
5DE	CA	16.6	0.48	1.35	4.00
5DE	CA	18.2	0.44	1.48	0.67
5DE	CA	26.5	0.30	1.39	1.33
5DE	CA	19.8	0.40	1.63	60.67
5DE	CA	25.5	0.31	1.18	2.00
5DE	CA	25.0	0.32	1.13	12.33
5DE	CA	27.5	0.29	1.39	6.67
12DE	MA	9.4	0.85	1.91	2.67
12DE	MA	22.0	0.36	1.51	10.67
12DE	CA	14.5	0.55	1.41	2.33
12DE	MA	22.8	0.35	1.00	6.67
12DE	CA	25.0	0.32	1.80	4.33
13DE	CA	18.8	0.43	1.65	0.67
13DE	MA	19.5	0.41	1.43	8.33
13DE	MA	33.9	0.24	1.43	11.33
19DE	MA	19.0	0.42	0.97	0.67
19DE	CA	32.5	0.25	1.55	2.33
19DE	CA	29.8	0.27	1.55	4.00
20DE	CA	6.6	1.21	1.55	-
27DE	MA	15.7	0.51	1.35	15.67
27DE	MA	16.2	0.49	0.71	3.00
27DE	MA	25.0	0.32	0.88	0.33
27DE	MA	31.0	0.26	1.39	-
27DE	MA	11.7	0.68	0.95	-
27DE	MA	24.0	0.33	1.65	0.33
27DE	MA	28.0	0.29	1.51	0.33
27DE	MA	9.8	0.82	1.26	6.33
28DE	MA	6.5	1.23	1.07	4.33
28DE	MA	8.2	0.98	0.83	49.00
28DE	CA	6.2	1.29	1.92	-
28DE	CA	6.8	1.18	1.95	16.00

SILENT ANTIDROMIC NEURONES IN THE CORTICOMEDIAL AMYGDALA ACTIVATED BY ELECTRICAL STIMULATION OF THE MPH. CASTRATED MALE RATS (injected with 1mg DHTP for 18 - 22 days).

Number Rat	CA or MA	Latency (msecs)	Conduction Velocity (m/sec)	Abs Refract Period (msecs)
4DE	CA	18.0	0.44	1.80
4DE	MA	17.8	0.45	1.32
4DE	CA	30.0	0.27	1.42
5DE	CA	18.0	0.44	2.35
5DE	CA	26.1	0.31	1.30
5DE	MA	32.2	0.25	1.87
5DE	CA	25.0	0.32	1.22
12DE	MA	23.7	0.34	1.63
12DE	CA	17.5	0.46	1.18
12DE	CA	11.8	0.68	0.75
12DE	CA	37.2	0.22	1.95
12DE	MA	35.2	0.23	1.55
12DE	MA	31.8	0.25	0.89
13DE	MA	24.5	0.33	0.93
13DE	MA	27.8	0.29	0.91
13DE	CA	30.5	0.26	1.23
13DE	MA	18.8	0.43	1.43
13DE	CA	26.8	0.30	1.47
19DE	MA	20.0	0.40	0.98
19DE	MA	33.5	0.24	1.65
19DE	MA	15.4	0.52	1.43
19DE	MA	30.0	0.27	1.59
19DE	CA	16.9	0.47	1.95
19DE	CA	37.2	0.22	1.55
20DE	CA	6.1	1.31	0.73
20DE	CA	12.8	0.63	0.93
20DE	CA	9.5	0.84	1.55
20DE	CA	10.0	0.80	1.95
20DE	CA	18.7	0.43	1.04
20DE	CA	23.0	0.35	1.45
27DE	MA	16.0	0.50	1.18
27DE	MA	29.0	0.28	1.35
27DE	MA	21.5	0.37	1.31
27DE	MA	23.5	0.34	1.39
27DE	MA	21.5	0.37	0.70
28DE	MA	11.0	0.73	1.45
28DE	MA	19.0	0.42	1.80
28DE	MA	14.0	0.57	1.43
28DE	MA	12.5	0.64	2.26
28DE	MA	16.8	0.48	1.73
28DE	MA	7.2	1.11	1.01

SPONTANEOUS ANTIDROMIC NEURONES IN THE CORTICOMEDIAL AMYGDALA ACTIVATED
BY ELECTRICAL STIMULATION OF THE MPH. CASTRATED MALE RATS (injected with O11
18 - 22 days).

Number Rat	CA or MA	Latency (msecs)	Conduction Velocity (m/sec)	Abs Refract Period (msecs)	Rate 100 secs
6DE	MA	14.9	0.54	1.04	24.67
6DE	MA	10.0	0.80	1.09	9.00
6DE	MA	11.8	0.68	0.91	8.00
6DE	MA	23.0	0.35	1.80	4.33
6DE	MA	18.0	0.44	1.35	3.67
6DE	MA	26.2	0.31	1.39	13.00
6DE	CA	20.0	0.40	1.09	17.67
7DE	CA	10.8	0.74	1.31	0.67
7DE	CA	23.6	0.34	0.88	1.00
7DE	CA	23.3	0.34	1.42	6.33
7DE	CA	22.0	0.36	1.28	8.00
7DE	CA	13.6	0.59	1.92	5.00
14DE	MA	21.8	0.37	1.65	59.00
14DE	MA	19.0	0.42	0.74	30.33
14DE	CA	15.7	0.51	2.30	5.67
14DE	CA	8.8	0.91	0.95	4.00
14DE	CA	9.8	0.82	1.59	3.00
21DE	MA	10.6	0.75	0.87	2.67
21DE	MA	24.0	0.33	1.35	-
21DE	CA	7.0	1.14	0.99	24.33
21DE	CA	11.5	0.70	1.45	3.00
21DE	CA	23.5	0.34	2.03	0.33
22DE	CA	22.3	0.36	2.26	6.00
22DE	CA	24.5	0.33	1.21	6.00
22DE	CA	19.2	0.42	1.27	44.00
29DE	MA	15.3	0.52	1.04	2.00
29DE	CA	8.6	0.93	1.07	-
29DE	CA	12.0	0.67	1.63	9.67
29DE	CA	12.4	0.65	2.03	3.50
29DE	CA	15.1	0.53	0.88	2.33
31DE	MA	15.4	0.52	1.43	12.67
31DE	MA	16.8	0.48	1.51	183.33
31DE	MA	22.8	0.35	1.39	15.67
32DE	CA	19.5	0.41	1.43	9.67

SILENT ANTIDROMIC NEURONES IN THE CORTICOMEDIAL AMYGDALA ACTIVATED BY ELECTRICAL STIMULATION OF THE MPH. CASTRATED MALE RATS (injected with Oil for 18 - 22 days).

Number Rat	CA or MA	Latency (msecs)	Conduction Velocity (m/sec)	Abs Refract Period (msecs)
6DE	MA	21.2	0.38	0.80
6DE	MA	24.8	0.32	1.02
6DE	CA	43.0	0.19	1.39
7DE	CA	28.5	0.28	1.07
7DE	CA	29.8	0.27	1.55
7DE	CA	32.0	0.25	1.92
7DE	CA	25.0	0.32	1.22
7DE	CA	17.8	0.45	1.18
7DE	CA	22.2	0.36	1.39
14DE	MA	21.5	0.37	1.67
14DE	CA	16.8	0.48	1.80
21DE	MA	11.2	0.71	1.15
21DE	MA	24.5	0.33	1.80
21DE	CA	25.0	0.32	1.04
21DE	CA	28.0	0.29	2.40
21DE	CA	30.0	0.27	2.22
21DE	CA	27.2	0.29	1.10
21DE	CA	27.0	0.30	1.51
21DE	CA	31.6	0.25	1.51
22DE	MA	8.2	0.98	1.07
22DE	CA	17.5	0.46	1.35
22DE	CA	20.5	0.39	1.45
22DE	CA	30.0	0.27	1.04
22DE	CA	34.0	0.24	2.30
22DE	CA	18.0	0.44	1.15
29DE	CA	21.2	0.38	1.59
31DE	MA	24.5	0.33	1.64
31DE	MA	23.5	0.34	1.43
31DE	MA	10.5	0.76	1.35
31DE	CA	24.5	0.33	1.04
31DE	MA	11.5	0.70	1.55
32DE	CA	21.0	0.38	1.04
32DE	CA	39.5	0.20	1.95
32DE	CA	34.5	0.23	1.43
32DE	CA	31.5	0.25	1.65

SPONTANEOUS AND SILENT ORTHODROMIC CORTICOMEDIAL AMYGDALA NEURONES ACTIVATED
BY ELECTRICAL STIMULATION OF THE MPH.

Castrate Rats + OB

Number Rat	CA or MA	LATENCY (msecs)	MEAN (msecs)	SPONTANEOUS	SILENT	RATE 100 secs
8DE	CA	16.0-17.0	16.5	*		82.67
8DE	CA	7.0- 8.1	7.6	*		283.67
9DE	MA	25.2-25.5	25.4		*	
9DE	MA	19.0-20.0	19.5	*		54.33
9DE	MA	30.0-30.5	30.3		*	
9DE	MA	18.6-23.2	20.9	*		11.00
23DE	MA	20.0-20.8	20.4	*		330.33
23DE	CA	22.0-24.5	23.3	*		254.00
24DE	MA	18.5-20.0	19.3	*		904.33
24DE	MA	12.2-14.0	13.1	*		38.33
24DE	MA	7.8- 8.0	7.9	*		78.00

Castrate Rats + (OB + DHTP)

Number Rat	CA or MA	LATENCY (msecs)	MEAN (msecs)	SPONTANEOUS	SILENT	RATE 100 secs
2DE	MA	30.0-32.5	31.3	*		400.00
3DE	MA	17.5-20.2	18.9		*	
17DE	CA	13.8-15.0	14.4	*		240.00
25DE	MA	10.0-12.6	11.3	*		2.33

SPONTANEOUS AND SILENT ORTHODROMIC CORTICOMEDIAL AMYGDALA NEURONES ACTIVATED BY ELECTRICAL STIMULATION OF THE MPH.

Castrate Rats + DHTP

Number Rat	CA or MA	LATENCY (msecs)	MEAN (msecs)	SPONTANEOUS	SILENT	RATE 100 secs
4DE	CA	20.0-27.0	23.5	*		202.33
4DE	MA	8.3- 9.0	8.7	*		123.67
5DE	CA	21.5-22.5	22.0	*		21.00
5DE	MA	29.5-31.5	30.5	*		1.33
12DE	MA	13.9-16.4	15.2		*	
12DE	MA	7.8-12.0	9.9	*		14.00
12DE	CA	7.6- 8.0	7.8	*		421.67
12DE	CA	13.9-14.4	14.2	*		190.67
13DE	CA	27.0-29.0	28.0		*	
27DE	MA	7.2- 8.0	7.6		*	
27DE	CA	24.5-25.0	24.8	*		549.67
28DE	MA	11.0-14.1	12.6	*		9.33
28DE	CA	21.0-23.0	22.0	*		452.00
28DE	MA	14.2-17.2	15.7	*		13.00

Castrate Rats + Oil

Number Rat	CA or MA	LATENCY (msecs)	MEAN (msecs)	SPONTANEOUS	SILENT	RATE 100 secs
7DE	CA	17.6-22.3	20.0		*	
7DE	CA	22.0-25.5	23.8	*		0.67
14DE	MA	23.5-24.5	24.0	*		588.00
14DE	MA	7.5- 8.0	7.8	*		64.33
14DE	CA	6.2- 7.8	7.0	*		101.67
21DE	CA	5.0- 5.9	5.5	*		161.00
22DE	MA	13.9-16.2	15.1		*	
29DE	CA	16.5-17.5	17.0	*		317.50
31DE	MA	14.2-14.8	14.6		*	

NON DRIVEN SPONTANEOUS CORTICOMEDIAL AMYGDALA NEURONES (After stimulation of the MPH).

Castrate Rats + OB

Castrate Rats + (OB + DHTP)

Number Rat	CA or MA	Rate 100 secs	Number Rat	CA or MA	Rate 100 secs
16DE	MA	123.00	10DE	CA	101.67
23DE	MA	797.33	11DE	CA	429.67
23DE	MA	655.00	11DE	MA	128.00
24DE	CA	781.67	17DE	MA	778.33
30DE	MA	33.00	17DE	MA	346.00
30DE	CA	408.33	17DE	MA	90.67
			17DE	CA	442.00
			17DE	CA	345.67
			18DE	CA	108.00
			25DE	MA	327.00
			26DE	MA	216.50

Castrate Rats + DHTP

Castrate Rats + Oil

Number Rat	CA or MA	Rate 100 secs	Number Rat	CA or MA	Rate 100 secs
4DE	MA	73.33	6DE	MA	71.33
4DE	CA	115.33	7DE	CA	68.33
5DE	CA	106.50	7DE	CA	2.67
5DE	CA	553.33	7DE	CA	44.00
5DE	CA	205.00	14DE	MA	623.33
5DE	MA	77.00	14DE	CA	22.67
5DE	CA	73.00	21DE	CA	34.00
19DE	MA	301.33	22DE	CA	758.67
20DE	CA	265.00	29DE	MA	592.00
28DE	MA	144.00	31DE	MA	215.67
28DE	MA	641.00			

BIBLIOGRAPHY

- ADLER, N. T., DAVIS, P. G. and KOMISARUK, B. R. (1977). Variation in the size and sensitivity of a genital sensory field in relation to the estrous cycle in rats. Hormones and Behavior, vol. 9, pp. 334-344.
- BARRACLOUGH, C. A. and CROSS, B. A. (1963). Unit activity in the hypothalamus of the cyclic female rat: Effect of genital stimuli and progesterone. Journal of Endocrinology, vol. 26, pp. 339-359.
- BAUM, M. J. and VREEBURG, J. T. M. (1973). Copulation in Castrated Male Rats following Combined Treatment with Estradiol and Dihydrotestosterone. Science, vol. 182, pp. 283-285.
- BEACH, F. A. (1942). Importance of progesterone to induction of sexual receptivity in spayed female rats. Proceedings of the Society for Experimental Biology and Medicine, vol. 51, pp. 369-371.
- BEACH, F. A. (1961). Hormones and Behaviour, Cooper Square Publishers, New York.
- BEREITER, D. A. and BARKER, D. J. (1975). Facial receptive fields of trigeminal neurones: increased size following estrogen treatment in female rats. Neuroendocrinology, vol. 18, pp. 115-124.
- BLAKE, C. A. and SAWYER, C. H. (1972). Ovulation blocking actions of urethane in the rat. Endocrinology, vol. 91, pp. 87-94.
- BOLING, J. L. and BLANDAU, R. J. (1939). The estrogen-progesterone induction of mating responses in the spayed female rat. Endocrinology, vol. 25, pp. 359-364.
- BROWN-GRANT, K., MUNCK, A., NAFTOLIN, F. and SHERWOOD, M. R. (1971). The effects of administration of testosterone propionate alone or with a phenobarbitone and of testosterone metabolites to neonatal female rats. Hormones and Behavior, vol. 2, pp. 173-182.

- BROWN-GRANT, K. and RAISMAN, G. (1972). Reproductive function in the rat following selective destruction of afferent fibres to the hypothalamus from the limbic system. Brain Research, vol. 46, pp. 23-42.
- BUENO, J. and PFAFF, D. W. (1976). Single unit recordings in hypothalamus and preoptic area of estrogen treated and untreated ovariectomized female rats. Brain Research, vol. 101, pp. 67-78.
- CAIN, D. P. and BINDRA, D. (1972). Responses of amygdala single units to odors in the rat. Experimental Neurology, vol. 35, pp. 98-110.
- CARR, W. J. and CAUL, W. F. (1962). The effect of castration in rat upon the discrimination of sex odours. Animal Behaviour, vol. 10, pp. 20-27.
- CARR, W. J., LOEB, L. S. and DISSINGER, M. L. (1965). Responses of rats to sex odours. Journal of Comparative and Physiological Psychology, vol. 59, pp. 370-377.
- CARR, W. J., LOEB, L. S. and WYLIE, N. R. (1966). Responses to feminine odors in normal and castrated male rats. Journal of Comparative and Physiological Psychology, vol. 62, pp. 336-338.
- CARR, W. J., SOLBERG, B., and PFAFFMAN, C. (1962). The olfactory threshold for estrous female urine in normal and castrated male rats. Journal of Comparative and Physiological Psychology, vol. 55, pp. 415-417.
- COOPER, K. K. and ARONSON, L. R. (1974). Effects of castration on neural afferent responses from the penis of the domestic cat. Physiology and Behavior, vol. 12, pp. 93-107.
- CRITCHLOW, V., LIEBELT, R. A., BAR-SELA, M., MOUNTCASTLE, W. and LIPSCOMB, H. S. (1963). Sex difference in resting pituitary-adrenal function in the rat. American Journal of Physiology, vol. 205, pp. 807-815.

- CROSS, B. A. and DYER, R. G. (1970). Characterization of unit activity in hypothalamic islands with special reference to hormone effects. In "The Hypothalamus"; L. Martini, M. Motta and F. Fraschini (eds.) Academic Press, New York, pp. 115-122.
- CROSS, B. A. and DYER, R. G. (1972). Cyclic changes in neurons of the anterior hypothalamus during the rat estrous cycle and the effect of anesthesia. In "Steroid Hormones and Brain Function", C. H. Sawyer and R. Gorski (eds.), University of California Press, Los Angeles. pp. 95-102.
- CROSS, B. A. and KITAY, J. I. (1967). Unit activity in diencephalic islands. Experimental Neurology, vol. 19, pp. 316-330.
- DAVIDSON, J. M. (1966). Activation of the male rat's sexual behaviour by intracerebral implantation of androgen. Endocrinology, vol. 79, pp. 783-794.
- DAVIDSON, J. M. (1969). Effects of Estrogen on the Sexual Behaviour of Male Rats. Endocrinology. vol. 84, pp. 1365-1372.
- de OLMOS, J. S. (1972). The amygdaloid projection field in the rat as studied with the cupric silver method. In "The Neurobiology of the Amygdala Advances in Behavioral Biology, vol. 2". B. E. Eleftheriou (editor), Plenum Press, New York, pp. 145-204.
- DYER, R. G. (1973). An electrophysiological dissection of the hypothalamic regions which regulate the pre-ovulatory secretion of luteinizing hormone in the rat. Journal of Physiology, vol. 234, pp. 421-442.
- DYER, R. G., PRITCHETT, C. J. and CROSS, B. A. (1972). Unit activity in the diencephalon of female rats during the oestrous cycle. Journal of Endocrinology, vol. 53, pp. 151-160.
- EMERY, D. A. and SACHS, B. D. (1976). Copulatory Behavior in Male Rats with Lesions in the Bed Nucleus of the Stria Terminalis. Physiology and Behavior. vol. 17, pp. 803-806.

- FAURE, J. and VINCENT, J. D. (1972). Effects of estrogen on single unit activity in the hypothalamus of the behaving rabbit. In "Steroid Hormones and Brain Function", C. H. Sawyer and R. Gorski (eds.), University of California Press, Los Angeles. pp. 113-120.
- FEDER, H. H. (1971). The comparative actions of testosterone propionate and 5-~~α~~-androstane-17β-ol-3-one propionate on the reproductive behaviour, physiology and morphology of male rats. Journal of Endocrinology, vol. 51, pp. 241-252.
- FEDER, H. H., NAFTOLIN, F. and RYAN, K. J. (1974). Male and female sexual responses in male rats given estradiol benzoate and 5-~~α~~-androstane-17β-ol-3-one propionate. Endocrinology, vol. 94, pp. 136-141.
- FEDER, H. H., RESKO, J. A. and GOY, R. W. (1968). Progesterone levels in the arterial plasma of pre-ovulatory and ovariectomised rats. Journal of Endocrinology, vol. 41, pp. 563-569.
- FRANK, K. and FUORTES, M. G. F. (1956). Stimulation of spinal motoneurons with intracellular electrodes. Journal of Physiology, vol. 134, pp. 451-470.
- FULLER, J. H. and SCHLAG, J. D. (1976). Determination of antidromic excitation by the collision test: Problems of interpretation. Brain Research, vol. 112, pp. 283-298.
- GIANTONIO, G. W., LUND, N. L. and GERALL, A. A. (1970). Effect of Diencephalic and Rhinencephalic lesions on the Male Rat's Sexual Behaviour. Journal of Comparative and Physiological Psychology, vol. 73, pp. 38-46.
- GOLDMAN, B. D. (1978). Developmental Influences of Hormones on Neuroendocrine Mechanisms of Sexual Behaviour: Comparisons with other Sexually Dimorphic Behaviours. In "Biological Determinants of Sexual Behaviour", J. B. Hutchison (editor). Chichester: John Wiley and Sons. pp. 127-152.

- HARRIS, G. W. and MICHAEL, R. P. (1964). The activation of sexual behaviour by hypothalamic implants of oestrogen. Journal of Physiology, vol. 171, pp. 275-301.
- HARRIS, V. H. and SACHS, B. D. (1975). Copulatory Behaviour in Male Rats following Amygdaloid lesions. Brain Research, vol. 86, pp. 514-518.
- HART, B. L. (1967). Testosterone regulation of sexual reflexes in spinal male rats. Science, vol. 155, pp. 1282-1284.
- HART, B. L. and HAUGEN, C. M. (1968). Activation of sexual reflexes in male rats by spinal implantation of testosterone. Physiology and Behavior, vol. 3, pp. 735-738.
- HEIMER, L. and LARSSON, K. (1966/67). Impairment of mating behavior in male rats following lesions in the preoptic-anterior hypothalamic continuum. Brain Research, vol. 3, pp. 248-263.
- HEIMER, L. and LARSSON, K. (1967). Mating behavior of male rats after olfactory bulb lesions. Physiology and Behavior, vol. 2, pp. 207-209.
- HELLON, R. F. (1971). The marking of electrode tip positions in nervous tissue. Journal of Physiology, vol. 214, p.12P.
- HUNT, C. C. and KUNO, M. (1959). Properties of spinal interneurons. Journal of Physiology, vol. 147, pp. 346-363.
- KALRA, P. S., FAWCETT, C. P., KRULICH, L. and McCANN, S. M. (1973). The Effects of Gonadal Steroids on Plasma Gonadotrophins and Prolactin in the Rat. Endocrinology, vol. 92, pp. 1256-1268.
- KAWAKAMI, M. and SAITO, H. (1967). Unit activity in the hypothalamus of the cat: effect of genital stimuli, luteinizing hormone and oxytocin. Journal of the Physiological Society of Japan, vol. 17, pp. 466-486.

- KAWAKAMI, M. and SAKUMA, Y. (1974). Responses of hypothalamic neurons to the microiontophoresis of LH-RH, LH and FSH under various levels of circulating ovarian hormones. Neuroendocrinology, vol. 15, pp. 290-307.
- KAWAKAMI, M., SAKUMA, Y. and AKEMA, T. (1978). Effects of estrogen and aminergic drugs on thresholds of medial basal hypothalamic axons in the median eminence of the rat. Brain Research, vol. 151, pp. 533-544.
- KAWAKAMI, M. and SAWYER, C. H. (1959). Neuroendocrine correlates of changes in brain activity thresholds by sex steroids and pituitary hormones. Endocrinology, vol. 65, pp. 652-668.
- KELLY, M. J., MOSS, R. L. and DUDLEY, C. A. (1976). Differential sensitivity of preoptic-septal neurons to microelectrophoresed estrogen during the estrous cycle. Brain Research, vol. 114, pp. 152-157.
- KLUVER, H. and BARRERA, E. (1953). A method for the combined staining of cells and fibers in the nervous system. Journal of Neuropathology and Experimental Neurology, vol. 12, pp. 401-407.
- KOMISARUK, B. R., ADLER, N. T. and HUTCHISON, J. (1972). Genital sensory field: Enlargement by Estrogen treatment in female rats. Science, vol. 178, pp. 1295-1298.
- KOMISARUK, B. R., McDONALD, P. G., WHITMOYER, D. I. and SAWYER, C. H. (1967). Effects of progesterone and sensory stimulation on EEG and neuronal activity in the rat. Experimental Neurology, vol. 19, pp. 494-507.
- KÖNIG, J. F. R. and KLIPPEL, R. A. (1963). The Rat Brain, The Williams and Wilkins Company, Baltimore.
- KOW, L. M. and PFAFF, D. W. (1973/74). Effects of estrogen treatment on the size of the receptive field and response threshold of pudendal nerve in the female rat. Neuroendocrinology, vol. 13, pp. 299-313.
- KUBO, K. GORSKI, R. A. and KAWAKAMI, M. (1975). Effects of estrogen on neuronal excitability in the hippocampal-septal-hypothalamic system. Neuroendocrinology, vol. 18, pp. 176-191.

- LAMMERS, H. J. (1972). The neural connections of the amygdaloid complex in mammals. In "Neurobiology of the Amygdala. Advances in Behavioral Biology, vol. 2", B.E. Eleftheriou (editor), Plenum Press, New York, pp. 100-144.
- LARSSON, K. (1971). Impaired mating performances in male rats after anosmia induced peripherally or centrally. Brain, Behavior and Evolution, vol. 4, pp. 463-471.
- LARSSON, K., SÖDERSTEN, P. and BEYER, C. (1973). Sexual behavior in male rats treated with estrogen in combination with dihydrotestosterone. Hormones and Behavior, vol. 4, pp. 289-299.
- LINCOLN, D. W. (1967). Unit activity in the hypothalamus, septum and preoptic area of the rat: characteristics of spontaneous activity and the effect of oestrogen. Journal of Endocrinology, vol. 37, pp. 177-189.
- LINCOLN, D. W. (1969). Effects of progesterone on the electrical activity of the forebrain. Journal of Endocrinology, vol. 45, pp. 585-596.
- LINCOLN, D. W. and CROSS, B. A. (1967). Effect of oestrogen on the responsiveness of neurones in the hypothalamus, septum and preoptic area of rats with light-induced persistent oestrus. Journal of Endocrinology, vol. 37, pp. 191-203.
- LINCOLN, D. W. and KELLY, W. A. (1972). The influence of urethane on ovulation in the rat. Endocrinology, vol. 90, pp. 1594-1599.
- LISK, R. D. (1962). Diencephalic placement of estradiol and sexual receptivity in the female rat. American Journal of Physiology, vol. 203, pp. 493-496.
- LISK, R. D. (1978). The regulation of sexual 'Heat'. In "Biological Determinants of Sexual Behaviour", J. B. Hutchinson (editor). Chichester: John Wiley and Sons, pp. 425-466.
- MALSBURY, C. W. (1971). Facilitation of male rat copulatory behavior by electrical stimulation of the medial preoptic area. Physiology and Behavior, vol. 7, pp. 797-805.

- MARTINI, L. (1976). Androgen reduction by neuroendocrine tissues: physiological significance. In "Subcellular Mechanisms in Reproductive Neuroendocrinology", F. Naftolin, K. J. Ryan and J. Davies (eds.), Elsevier Scientific Publishing Company, Amsterdam, pp. 327-345.
- McDONALD, P. G. (1971). Some biological actions of dihydrotestosterone (DHT). Journal of Reproduction and Fertility, vol. 30, pp. 309-310.
- McDONALD, P., BEYER, C., NEWTON, F., BRIEN, B., BAKER, R., TAN, H.S. SAMPSON, C., KITCHING, P., GREENHILL, R. and PRITCHARD, D. (1970). Failure of 5 dihydrotestosterone to initiate sexual behavior in the castrated male rat. Nature, vol. 227, pp. 964-965.
- McEWEN, B. S., DENEFF, C. J., GERLACH, J. L. and PLAPINGER, L. (1974). Chemical studies of the brain as a steroid hormone target tissue. In "The Neurosciences". Third study program. F. O. Schmitt and F. G. Worden (eds.), MIT Press, Cambridge, Massachusetts. pp. 599-620.
- McEWEN, B. S., ZIGMOND, R. E. and GERLACH, J. L. (1972). Sites of steroid binding and action in the brain. In "Structures and Function of Nervous Tissue", Vol. 5, G. H. Bourne (editor), Academic Press, New York, pp. 205-291.
- MERARI, A. and GINTON, A. (1975). Characteristics of exaggerated sexual behavior induced by electrical stimulation of the medial preoptic area in male rats. Brain Research, vol. 86, pp. 97-108.
- MORIN, L. P. and FEDER, H. H. (1974). Hypothalamic, progesterone implants and facilitation of lordosis behavior in estrogen-primed ovariectomized guinea pigs. Brain Research, vol. 70, pp. 81-93.
- MOSS, R. L. and LAW, O. T. (1971). The estrous cycle; its influence on single unit activity in the forebrain. Brain Research, vol. 30, pp. 435-438.
- NAFTOLIN, F. BROWN-GRANT, K. and CORKER, C. S. (1972). Plasma and pituitary luteinizing hormone and peripheral plasma oestradiol concentrations

- in the normal oestrous cycle of the rat and after experimental manipulation of the cycle. Journal of Endocrinology, vol. 53, pp. 17-30.
- NAFTOLIN, F. and FEDER, H. H. (1973). Suppression of Luteinizing Hormone Secretion in male rats by 5α -Androstan-17 β -0L-3-one (Dihydro-testosterone) Propionate. Journal of Endocrinology, vol. 56, pp. 155-156.
- NAKAYAMA, T. and SUZUKI, M. (1975). Action of progesterone on preoptic thermosensitive neurones. Nature, vol. 258, pp. 80-82.
- OLIVIER, B. (1977). Ph.D. thesis, State University of Groningen, Netherlands, pp. 29-31.
- PARROTT, R. F. (1975). Aromatizable and 5α -Reduced Androgens: Differentiation Between Central and Peripheral Effects on Male Rat Sexual Behavior. Hormones and Behavior, vol. 6, pp. 99-108.
- PAUP, D. C., MENNIN, S. P. and GORSKI, R. A. (1975). Androgen-and Estrogen-Induced Copulatory Behavior and Inhibition of Luteinizing Hormone (LH) Secretion in the Male Rat. Hormones and Behavior, vol. 6, pp. 35-46.
- PFAFF, D. W. (1968). Uptake of testosterone - H^3 and estradiol - H^3 by the male and female rat brain. An autoradiographic study. Science, vol. 161, pp. 1355-1356.
- PFAFF, D. W. (1970a). Sexual Motivation. Discussion in: Stellar and Corbit, "Neural regulatory systems and the concept of motivation." Neuroscience Research Progress Bulletin.
- PFAFF, D. W. (1970b). Nature of sex hormone effects on rat sex behavior: Specificity of effects and individual patterns of response. Journal of Comparative and Physiological Psychology, vol. 73, No. 3, pp. 349-358.
- PFAFF, D. W. (1971). Movie analysis of female rat mating behavior. Eastern Psychological Association, New York, p.15 (Abstract).

- PFAFF, D. W. and GREGORY, E. (1971). Correlation between pre-optic area unit activity and the cortical electroencephalogram: difference between normal and castrated male rats. Electroencephalography and Clinical Neurophysiology, vol. 31, pp. 223-230.
- PFAFF, D. W. and KEINER, M. (1973). Atlas of estradiol-concentrating cells in the central nervous systems of the female rat. Journal of Comparative Neurology, vol. 151, pp. 121-158.
- PFAFF, D. W., LEWIS, G., DIAKOW, C. and KEINER, M. (1972). Neurophysiological analysis of mating behavior responses as hormone-sensitive reflexes. In "Progress in Physiological Psychology," vol. V, Stellar and Sprague (eds.), Academic Press, New York. pp. 253-297.
- PFAFF, D. W. and PFAFFMAN, C. (1969a). Olfactory and hormonal influences on the basal forebrain of the male rat. Brain Research, vol. 15, pp. 137-156.
- PFAFF, D. W. and PFAFFMAN, C. (1969b). Behavioral and electrophysiological responses of male rats to female rat urine odors. In "Olfaction and Taste", C. Pfaffman (editor), Rockefeller University Press, New York, pp. 258-267.
- PRICE, D. and WILLIAMS-ASHMAN, H. G. (1961). The accessory reproductive glands of mammals. In "Sex and Internal Secretions", W. C. Young (editor), vol. 1, third edition. The Williams and Wilkins Company, Baltimore, pp. 366-448.
- RAMIREZ, V. D., KOMISARUK, B. R., WHITMOYER, D. I. and SAWYER, C. H. (1967). Effects of hormones and vaginal stimulation on the EEG and hypothalamic units in rats. American Journal of Physiology, vol. 212, pp. 1376-1384.
- RANCK, J. B. (1975). Which elements are excited in electrical stimulation of mammalian central nervous system: A review. Brain Research, vol. 98, pp. 417-440.

- REDDY, V. V. R., NAFTOLIN, F. and RYAN, K. J. (1974). Conversion of androstenedione to estrone by neural tissues from fetal and neonatal rats. Endocrinology, vol. 94, pp. 110.
- ROLLS, E. T. (1971). Involvement of brainstem units in Medial Forebrain Bundle self-stimulation. Physiology and Behavior, vol. 7, pp. 297-310.
- SAR, M. and STUMPF, W. E. (1973a). Autoradiographic localization of radioactivity in the rat brain after the injection of 1,2-³H-testosterone. Endocrinology, vol. 92, pp. 251-256.
- SAR, M. and STUMPF, W. E. (1973b). Cellular and subcellular localization of radioactivity in the rat pituitary after injection of 1,2-³H-testosterone using dry-autoradiography. Endocrinology, vol. 92, pp. 631-635.
- SAR, M. and STUMPF, W. E. (1973c). Neurones of the Hypothalamus Concentrate (³H) Progesterone or its Metabolites. Science, vol. 182, pp. 1266-1268.
- SCHNEIDER, T., PIACSEK, B. and GAY, V. (1970). Simultaneous measurements of progesterone and 20 α -OH-pregn-4-ene-3 one in ovarian venous blood and of luteinizing hormone in systemic blood on the afternoon of proestrus in the rat. Fed. Proc., vol. 29, pp. 381 Abs.
- SCHWARTZ, N. B. (1972). Mechanisms controlling ovulation in small animals. In "Handbook of Physiology-Endocrinology II, Part I. American Physiological Society, Washington D.C., p.125.
- SMITH, E. R., RODGERS, C. H. and BLOCH, G. J. (1968) - unpublished data. Cited by Davidson, J. M. and Bloch, G. J. in "Neuroendocrine aspects of male reproduction." Biology of Reproduction, vol. 1, pp. 67-92.
- SÖDERSTEN, P. (1973). Estrogen-Activated Sexual Behavior in Male Rats. Hormones and Behavior, vol. 4, pp. 247-256.
- SÖDERSTEN, P. (1975). Mounting behavior and lordosis behavior in castrated

- male rats treated with testosterone propionate, or with estradiol benzoate or dihydrotestosterone in combination with testosterone propionate. Hormones and Behavior, vol. 6, pp. 109-126.
- SWERDLOFF, R. S., WALSH, P. C. and ODELL, W. D. (1972). Control of LH and FSH Secretion in the Male: Evidence that Aromatization of Androgens to Estradiol is not required for Inhibition of Gonadotrophin Secretion. Steroids, vol. 20, pp. 13-22.
- VAN DIS, H. and LARSSON, K. (1971). Induction of sexual arousal in the castrated male rat by intracranial stimulation. Physiology and Behavior, vol. 6, pp. 85-86.
- WADE, G. N. and FEDER, H. H. (1972). 1,2-³H Progesterone Uptake by Guinea-pig Brain and Uterus: Differential Localization, Time Course of Uptake and Metabolism, and Effects of Age, Sex, Estrogen Priming, And Competing Steroids. Brain Research, vol. 45, pp. 525-543.
- WADE, G. N., HARDING, C. F. and FEDER, H. H. (1973). Neural uptake of (1,2-³H) progesterone in ovariectomized rats, guinea-pigs and hamsters: Correlation with species differences in behavioral responsiveness. Brain Research, vol. 61, pp. 357-367.
- WHALEN, R. E. and HARDY, D. R. (1970). Induction of receptivity in female rats and cats with estrogen and testosterone. Physiology and Behavior, vol. 5, pp. 529-533.
- WHALEN, R. E. and LUTTGE, W. G. (1971). Testosterone, androstenedione, and dihydrotestosterone. Effects on mating behavior of male rats. Hormones and Behavior, vol. 2, pp. 117-125.
- WHISHAW, I. Q., CIOE, J. D. D. and KOLB, B. (1977). The variability of the interaural line vs the stability of bregma in rat stereotaxic surgery. Physiology and Behavior, vol. 19, pp. 719-722.

- WHITEHEAD, S. A. and RUF, K. B. (1974). Responses of antidromically identified preoptic neurones in the rat to neurotransmitters and to estrogen. Brain Research, vol. 79, pp. 185-198.
- WILSON, J. D. and GLOYNA, R. E. (1970). The intranuclear metabolism of testosterone in the accessory organs of reproduction. Recent Progress in Hormone Research, vol. 26, pp. 309-330.
- WUTTKE, W. (1974). Preoptic unit activity and gonadotrophin release. Experimental Brain Research, vol. 19, pp. 205-216.
- YAGI, K. (1970). Effects of estrogen on the unit activity of the rat hypothalamus. Journal of the Physiological Society of Japan, vol. 32, pp. 692-693.
- YAGI, K. (1973). Changes in firing rates of single preoptic and hypothalamic units following an intravenous administration of estrogen in the castrated female rat. Brain Research, vol. 53, pp. 343-352.
- YAGI, K. and SAWAKI, Y. (1971). Changes in the electrical activity of the hypothalamus during sexual cycle and the effect of castration in the female rat. Journal of the Physiological Society of Japan, vol. 33, pp. 546-547.
- YOUNG, W. C. (1961). The hormones and mating behavior, in "Sex and Internal Secretions," vol. 2. W. C. Young (editor), Williams and Wilkins, Baltimore, pp. 1173-1239.
- YOSHINAGA, K., HAWKINS, R. A. and STOCKER, J. F. (1969). Estrogen secretion by the rat ovary in vivo during the estrous cycle and pregnancy. Endocrinology, vol. 85, pp. 103-112.
- ZOLOVICK, A. J. and ELEFThERIOU, B. G. (1971). Hormonal modulation of hypothalamic unit activity and EEG response to vaginal stimulation in the deermouse. Journal of Endocrinology, vol. 49, pp. 59-69.

