



Durham E-Theses

The photochemistry of highly fluorinated pyridines

Middleton, Roderick

How to cite:

Middleton, Roderick (1977) *The photochemistry of highly fluorinated pyridines*, Durham theses, Durham University. Available at Durham E-Theses Online: <http://etheses.dur.ac.uk/8331/>

Use policy

The full-text may be used and/or reproduced, and given to third parties in any format or medium, without prior permission or charge, for personal research or study, educational, or not-for-profit purposes provided that:

- a full bibliographic reference is made to the original source
- a [link](#) is made to the metadata record in Durham E-Theses
- the full-text is not changed in any way

The full-text must not be sold in any format or medium without the formal permission of the copyright holders.

Please consult the [full Durham E-Theses policy](#) for further details.

UNIVERSITY OF DURHAM

A THESIS

entitled

THE PHOTOCHEMISTRY OF HIGHLY FLUORINATED PYRIDINES

Submitted by

RODERICK MIDDLETON, B.Sc.(DUNELM)

(Van Mildert College)

The copyright of this thesis rests with the author.
No quotation from it should be published without
his prior written consent and information derived
from it should be acknowledged.

A candidate for the degree of Doctor of Philosophy

.1977



To My Mother

MEMORANDUM

This work was carried out at the University of Durham between October 1973 and October 1976. It is the original work of the author unless indicated by reference and has not been submitted for any other degree.

Part of this work has been the subject of the following publications.

R. D. Chambers, R. Middleton and (in part)

R. P. Corbally, J. C. S. Chem. Comms., 1975,
731.

R. D. Chambers and R. Middleton, J. C. S. Chem. Comms., 1977, 154

R. D. Chambers and R. Middleton, J. C. S. Perkin I, 1977, 1500

ACKNOWLEDGEMENTS

I would like to express my gratitude to Professor R. D. Chambers for his help and encouragement and to Dr. R. S. Matthews for his assistance in interpretation of ^{19}F n.m.r. spectra.

I would also like to thank the many technical and laboratory staff for their assistance and Mrs. M. Towers for typing this thesis.

Thanks are also due to the S.R.C. for the provision of a maintenance grant.

SUMMARY

A series of highly fluorinated pyridines were irradiated using ultra violet radiation, in an attempt to detect rearrangements in these systems. The pyridines used were penta-, tetra-, tri- and di- substituted by perfluoroalkyl groups.

Perfluoro-4-ethyl-2,6-di-isopropyl-3,5-dimethylpyridine, upon prolonged irradiation, in solution, at both 253.7nm. and 300nm., isomerised to an inseparable mixture containing two remarkably stable azaprismanes, which were subsequently identified from their pyrolysis products. The mechanism for formation of this azaprismane mixture was shown to involve the rearrangement of a 2-azabicyclo[2.2.0]hexadiene intermediate to a 1-azabicyclo[2.2.0]hexadiene intermediate.

Irradiation of perfluoro-4-ethyl-2,6-di-isopropyl-3,5-dimethylpyridine, at both 253.7nm. and 300nm., for a short time, resulted in formation of a stable 1-azabicyclo[2.2.0]-hexa-2,5-diene derivative.

Irradiation of perfluoro-2,4,6-tri-isopropyl-3,5-dimethylpyridine, at 253.7nm., gave a single symmetrical azaprismane, the identity of which was confirmed from the pyrolysis product.

The penta-alkyl pyridines, obtained from the pyrolysis of azaprismanes, showed interesting features in their ^{19}F n.m.r. spectra which enabled their identification.

A transference technique was used for the irradiation of perfluorotetra- and tri-alkyl pyridines.

Perfluoro-2,6-di-isopropyl-3,5-dimethylpyridine isomerised, on irradiation, to a moderately stable 2-azabicyclo[2.2.0]hexadiene derivative. The thermal rearrangement of this derivative was studied using differential scanning calorimetry.

Irradiation of perfluoro-2,4,6-tri-isopropylpyridine gave the first stable derivative of 2-azabicyclo[2.2.0]hexa-2,5-diene. A 1-azabicyclo[2.2.0]hexadiene derivative was also obtained in low yield.

Irradiation of perfluoro-2,4,5-tri-isopropylpyridine gave a mixture containing a 2-azabicyclo[2.2.0]hexadiene derivative (55%) and a 1-azabicyclo[2.2.0]hexadiene derivative (45%).

The valence isomers obtained were shown to rearrange upon further irradiation.

The thermal stability of valence isomers is discussed and the half-lives of some isomers, obtained in this work, measured.

Valence isomers were not detected from irradiation of either perfluoro-2,5-di-isopropylpyridine or pentafluoropyridine.

Attempts were made to react valence isomers with NaOMe, bromine and furan.

Irradiations were also carried out on a few fluorinated azacyclohexadienes. Both isomerisation and fragmentation reactions were observed.

CONTENTS

	<u>Page</u>
<u>CHAPTER 1</u>	
<u>ISOMERISATION IN SIX MEMBERED</u>	
<u>AROMATIC RINGS</u>	
1.1 Introduction	1
1.2 The Photolysis of Benzene	1
1.3 Synthesis of Valence Isomers of Benzene	4
i) Bicyclo[2.2.0]hexa-2,5-diene (Dewar Benzene)	4
ii) Tricyclo[3.1.0.0 ^{2,6}]hex-3-ene (Benzvalene)	4
iii) Tetracyclo[2.2.0.0 ^{2,6} .0 ^{3,5}]hexane (Prismane)	6
1.4 Theoretical Treatment of Rearrangement of Benzene to its Valence Isomers	7
1.5 Theoretical Treatment of Rearrangements in Aromatic Rings	
i) Introduction	12
ii) Rearrangements proceeding via Benzvalene Intermediates	12
iii) Rearrangements Proceeding via Prismane Intermediates	14
1.6 Theoretical Rearrangements and Interconversions of Valence Isomers	
i) Introduction	15
ii) Interconversion of Dewar Benzene and Prismane	15
iii) Rearrangement of Benzvalenes	16

	<u>Page</u>
iv) Rearrangement of Benzvalene to Fulvene	16
v) Isomerisation of Benzvalene to Dewar Benzene	17
vi) Isomerisation of Prismane to Benzvalene	17
1.7 Photolysis of Labelled Benzenes	
i) Introduction	18
ii) Labelling using Deuterium	18
iii) Photochemical Rearrangement of Di-substituted Benzenes	
A. Di-t-butyl benzenes	20
B. Xylenes	22
iv) Photochemical Rearrangement of Tri-t-butyl benzenes	22
v) Photochemical Rearrangement of Tetra-substituted Benzenes	
A. Tetra-t-butyl benzenes	26
B. Tetrakis(trimethylsilyl) benzenes	27
vi) Valence Isomers of Hexamethylbenzene	30
1.8 Rearrangement of Heterocyclic Systems	
i) Pyridines	32
ii) The Photolysis of Pyridinium Ions	36
iii) Photolysis of Pyrones and Pirylium Cations	37
iv) Photoisomerisation of Pyrazines	42
1.9 Fluorinated Systems	44
i) Fluorinated Benzenes	44
ii) Valence Isomers from Perfluoro-alkyl Benzenes	45

	<u>Page</u>
iii) Rearrangement in Fluorinated Benzenes	48
iv) Pyridines	51
v) Rearrangement of Fluorinated Pyridazines	54
vi) Photoisomerisation of Fluorinated Pyrazines	56
1.10 Bicyclopropenyls	57
1.11 Ring Transpositions: a Suggested Notation	63
1.12 2,3-Diazabicyclo[2.2.0]hexa-2,5-diene	65

CHAPTER 2 THE SYNTHESIS OF POLYFLUOROALKYLPYRIDINES

2.1 Introduction	66
2.2 Pentafluoropyridine	66
2.3 Perfluoropolyisopropylpyridines	66
2.4 Reactions of Pentafluoropyridine and P.T.F.E.	69
2.5 Reactions Between Perfluoro-3,5-dimethylpyridine and Hexafluoropropene, in the Presence of Fluoride Ion	71
2.6 Nucleophilic Substitution in Perfluoro-3-methylpyridine by Heptafluoro-isopropyl Anion	73
2.7 Reaction Between Perfluoro-2,6-di-isopropyl-3,5-dimethylpyridine and Tetrafluoroethylene, in the Presence of Fluoride Ion	73
2.8 Reaction Between Perfluoro-3,5-dimethylpyridine and Pentafluoroethyl Anion	74

	<u>Page</u>
<u>CHAPTER 3</u>	
<u>THE PHOTOCHEMISTRY OF SOME PERFLUORO-</u>	
<u>ALKYL PYRIDINES</u>	
3.1 Introduction	76
3.2 The Photochemistry of Perfluoropenta- alkylpyridines	
1) A. Irradiation of Perfluoro-4- ethyl-2,6-di-isopropyl- 3,5-dimethylpyridine	77
B. Pyrolysis of Azaprismane Mixture	80
C. ¹⁹ F n.m.r. Spectra of Penta- alkylpyridines - Chemical Shifts	84
D. Pyrolysis of Azaprismane Mixtures of Varying Compositions	87
E. Deduction of Azaprismane Structures	88
F. Rearomatisation of Azaprismanes (<u>159</u>) and (<u>160</u>)	88
(1) Rearomatisation via Benz- valene Intermediates	90
(2) Rearomatisation via Para- bonded Intermediates	92
G. Mechanism for Formation of (<u>160</u>) from (<u>153</u>)	95
H. Mechanism for Formation of (<u>159</u>) from (<u>153</u>)	
(1) A One Stage Mechanism	96
(2) Mechanisms Which Involve Rearrangement of Para- bonded Isomers	97
I. Irradiation of Perfluoro-4- ethyl-2,6-di-isopropyl-3,5- dimethylpyridine (<u>153</u>), at 253.7 n.m. in a Transference System	103

	<u>Page</u>
ii) A. Irradiation of Perfluoro-2,- 4,6-tri-isopropyl-3,5- dimethylpyridine (<u>148</u>), at 253.7 n.m.	104
B. Pyrolysis of Perfluoro-2,4,6- tri-isopropyl-3,5-dimethyl-1- azatetracyclo[2.2.0.0.2, ⁶ .03,5] hexane (<u>179</u>)	105
iii) Irradiation of Perfluoro-2- ethyl-3,6-di-isopropyl-4,5- dimethylpyridine (<u>156</u>), at 253.7 n.m.	107
iv) Irradiation of Perfluoro-2-ethyl- 5,6-di-isopropyl-3,4-dimethyl- pyridine (<u>157</u>), at 253.7 n.m.	111
3.3 The Photochemistry of Perfluorotetra- alkylpyridines	
1) A. Introduction	112
B. Irradiation in a Transference System	112
ii) Irradiation of Perfluoro-2,6-di- isopropyl-3,5-dimethylpyridine (<u>149</u>), at 253.7 n.m.	
A. In Solution	113
B. In a Transference System	114
iii) Irradiation of Perfluoro-2,4,6- tri-isopropyl-3-methylpyridine (<u>151</u>), at 253.7 n.m.	116
3.4 The Photochemistry of Perfluorotri- alkylpyridines	
1) Irradiation of Perfluoro-2,4,6- tri-isopropylpyridine (<u>138</u>)	
A. Static Irradiations	119
B. In a Transference System	120
ii) Irradiation of Perfluoro-2,4,5- tri-isopropylpyridine (<u>137</u>), at 253.7 n.m. Under Transference	122
iii) Irradiation of Perfluoro-2- isopropyl-3,5-dimethylpyridine (<u>150</u>), at 253.7 n.m. Under Transference	124

	<u>Page</u>
iv) Irradiation of Perfluoro-4,6-di-isopropyl-3-methylpyridine (152), at 253.7 n.m. Under Transference	126
3.5 Irradiation of a Perfluorodi-alkylpyridine. Perfluoro-2,5-di-isopropylpyridine (139)	127
3.6 Irradiation of Pentafluoropyridine (136)	127
3.7 Irradiation of Perfluorotetra-kis-isopropylpyrazine (207)	128
3.8 Conclusions	129
<u>CHAPTER 4</u>	<u>THE THERMAL STABILITY AND PROPERTIES OF</u>
	<u>VALENCE ISOMERS OF PYRIDINES</u>
4.1 Introduction	132
4.2 D.S.C. as Applied to Valence Isomer Rearrangements	
i) Introduction	132
ii) Activation Energy from D.S.C.	133
iii) Valence Isomer Rearrangements Studied by D.S.C.	135
4.3 The Stability of Valence Isomers of Benzene	
i) Introduction	137
ii) Introduction of Alkyl Groups in Hydrocarbon Systems	138
iii) Valence Bond Isomers Containing Perfluoroalkyl Groups	139
4.4 Stability of Valence Bond Isomers from Heterocyclic Systems	
i) Di-aza Heterocyclic Systems	142
ii) Valence Isomers From Pyridines	143

	<u>Page</u>	
4.5	The Photolysis of Valence Isomers	150
4.6	Reactions of Valence Isomers	
	i) Introduction	151
	ii) Attempted Reactions with Fluoride Ion	152
	iii) Reaction Between Sodium Methoxide and Perfluoro-1,3,5-tri-isopropyl-2-azabicyclo[2.2.0]hexa-2,5-diene (<u>194</u>)	152
	iv) Other Attempted Reactions of Para-bonded Derivatives	153
<u>CHAPTER 5</u>	<u>THE PHOTOCHEMISTRY OF SOME FLUORINATED HETEROCYCLES</u>	
5.1	Introduction	154
5.2	Irradiation of Perfluoro-2,5-di-isopropyl-1,4-di-azacyclohexa-1,4-diene (<u>213</u>)	155
5.3	Irradiation of Perfluoro-4,6-di-isopropyl-1,3-diazacyclohexa-3,6-diene (<u>219</u>)	158
5.4	Irradiation of Perfluoro-4-isopropyl-1-azacyclohexa-1,3-diene (<u>222</u>)	160
5.5	Irradiation of Perfluoro-2,3,4-tri-isopropyl-1-azacyclohexa-1,3-diene (<u>229</u>)	163
5.6	Other Irradiations	164
EXPERIMENTAL		
	Instrumentation	165
<u>CHAPTER 6</u>	<u>EXPERIMENTAL FOR CHAPTER 2</u>	
6.1	Introduction	167
6.2	Reagents	167
6.3	Experimental Procedure used for Poly-fluoroalkylation Reactions	168
6.4	i) Preparation of Perfluoro-3,5-dimethylpyridine (<u>142</u>)	169
	ii) Preparation of Perfluoro-3-methylpyridine (<u>143</u>)	169

	<u>Page</u>
iii) Reactions of Perfluoro-3,5-dimethylpyridine (<u>142</u>) with Hexafluoropropene in the Presence of Fluoride Ion	170
iv) Preparation of Perfluoro-4-ethyl-2,6-di-isopropyl-3,5-dimethylpyridine (<u>153</u>)	172
v) Reaction of Perfluoro-3-methylpyridine (<u>143</u>) with Hexafluoropropene in the Presence of Fluoride Ion	173
vi) Preparation of Perfluoro-2,4,5-tri-isopropylpyridine (<u>137</u>)	173
vii) Preparation of Perfluoro-2,4,6-tri-isopropylpyridine (<u>138</u>)	174
viii) Reaction Between Perfluoro-2,4,5-tri-isopropylpyridine (<u>137</u>), Pentafluoropyridine (<u>136</u>) and Fluoride Ion	175
ix) Reaction Between Perfluoro-3,5-dimethylpyridine (<u>142</u>) and Tetrafluoroethylene, in the Presence of Fluoride Ion	176

CHAPTER 7 EXPERIMENTAL FOR CHAPTER 3

Reagents	177
Ultraviolet Light Sources	177
Experimental Procedure	179
7.1 Irradiation of Static Systems	
1) Irradiation of Perfluoro-4-ethyl-2,6-di-isopropyl-3,5-dimethylpyridine (<u>153</u>), in Solution, at 253.7nm., Using a Long Irradiation Time	179
ii) Irradiation of Perfluoro-4-ethyl-2,6-di-isopropyl-3,5-dimethylpyridine (<u>153</u>), in Solution, at 253.7nm., Using a Short Irradiation Time	180

- iii) Irradiation of Perfluoro-4-ethyl-2,6-di-isopropyl-3,5-dimethylpyridine (153), in Solution, at ca. 300 nm., Using a Short Irradiation Time 181
- iv) Irradiation of Perfluoro-4-ethyl-2,6-di-isopropyl-3,5-dimethylpyridine (153), in Solution, at ca. 300nm., Using a Long Irradiation Time 182
- v) Irradiation of Perfluoro-2,4,6-tri-isopropyl-3,5-dimethylpyridine (148), in Solution, at 253.7nm. 182
- vi) Irradiation of Perfluoro-2-ethyl-3,6-di-isopropyl-4,5-dimethylpyridine (156), in Solution, at 253.7nm. 183
- vii) Irradiation of Perfluoro-2-ethyl-5,6-di-isopropyl-3,4-dimethylpyridine (157), in Solution, at 253.7nm. 184
- viii) Irradiation of Perfluoro-2,6-di-isopropyl-3,5-dimethylpyridine (149), in Solution, at 253.7nm. 184
- ix) Irradiation of Perfluoro-2,4,6-tri-isopropylpyridine (138), in Solution, at 253.7nm. 185
- x) Irradiation of Perfluoro-2,4,6-tri-isopropylpyridine (138) by 253.7nm. light, in the Vapour Phase 185

7.2 Irradiation Under Transference Conditions

- i) Irradiation of Perfluoro-4-ethyl-2,6-di-isopropyl-3,5-dimethylpyridine (153), at 253.7nm., Whilst Under Transference 186
- ii) Irradiation of Perfluoro-2,6-di-isopropyl-3,5-dimethylpyridine (149), at 253.7nm., Whilst Under Transference 186

	<u>Page</u>
iii) Irradiation of Perfluoro-2,4,6-tri-isopropylpyridine (<u>138</u>), at 253.7nm., Whilst Under Transference	187
iv) Irradiation of Perfluoro-2,4,5-tri-isopropylpyridine (<u>137</u>), at 253.7nm., Whilst Under Transference	188
v) Irradiation of Perfluoro-2,4,6-tri-isopropyl-3-methylpyridine (<u>151</u>), at 253.7nm., Whilst Under Transference	189
vi) Irradiation of Perfluoro-2-isopropyl-3,5-dimethylpyridine (<u>150</u>), at 253.7nm., Whilst Under Transference	191
vii) Irradiation of Perfluoro-4,6-di-isopropyl-3-methylpyridine (<u>152</u>), at 253.7nm., Whilst Under Transference	192
viii) Irradiation of Perfluoro-2,5-di-isopropylpyridine (<u>139</u>) at 253.7nm., Whilst Under Transference	192
ix) Irradiation of Pentafluoropyridine (<u>136</u>), at 253.7nm., Whilst Under Transference	193
x) Irradiation of Perfluoro-2,4,6-tri-isopropylpyridine (<u>138</u>), at ca.300nm., Whilst Under Transference	194
7.3 Irradiation of Perfluorotetra-isopropylpyrazine (<u>207</u>)	
i) In Solution at 253.7nm.	194
ii) Under Transference, at 253.7nm.	195
iii) In a Static Vapour Phase Irradiation, at 253.7nm.	195

	<u>Page</u>
<u>CHAPTER 8</u>	<u>PROPERTIES OF VALENCE ISOMERS - EXPERIMENTAL</u>
8.1	Introduction 196
8.2	i) Pyrolysis of Mixtures of Perfluoro-4-ethyl-2,6-di-isopropyl-3,5-dimethyl-1-azaprismane (<u>160</u>) and Perfluoro-2-ethyl-4,6-di-isopropyl-3,5-dimethyl-1-azaprismane (<u>159</u>) 196
	ii) Pyrolysis of Perfluoro-2,4,6-tri-isopropyl-3,5-dimethyl-1-azaprismane (<u>179</u>) 197
	iii) Pyrolysis of Perfluoro-4-ethyl-2,6-di-isopropyl-3,5-dimethyl-1-azabicyclo[2.2.0]hexa-2,5-diene (<u>154</u>) 198
	iv) Flash Vacuum Pyrolysis of a Mixture of Azaprismanes (<u>159</u>) and (<u>160</u>) 198
8.3	Half-life Determinations
	i) Perfluoro-2,4,5-tri-isopropyl-1-azabicyclo[2.2.0]hexa-2,5-diene (<u>196</u>) 199
	ii) Perfluoro-1,3,5-tri-isopropyl-2-azabicyclo[2.2.0]hexa-2,5-diene (<u>194</u>) 199
	iii) Perfluoro-1,3-di-isopropyl-4,6-dimethyl-2-azabicyclo[2.2.0]hexa-2,5-diene (<u>188</u>) 200
	iv) On Unidentified Perfluorotri-isopropylmonomethylazaprismane (<u>B</u>) 200
8.4	Irradiation of Valence Isomers
	i) Irradiation of a Mixture of Azaprismanes (<u>159</u>) and (<u>160</u>) 201
	ii) Irradiation of Perfluoro-4-ethyl-2,6-di-isopropyl-3,5-dimethyl-1-azabicyclo[2.2.0]hexa-2,5-diene (<u>154</u>) at 253.7nm. 201
	iii) Irradiation of Perfluoro-1,3-di-isopropyl-4,6-dimethyl-2-azabicyclo[2.2.0]hexa-2,5-diene (<u>188</u>) 201

	<u>Page</u>
iv) Irradiation of Perfluorotri-isopropylmethylazaprismane (B)	202
v) Irradiation of Perfluoro-1,3,5-tri-isopropyl-2-azabicyclo[2.2.0]hexa-2,5-diene (194)	202
vi) Irradiation of a Mixture Containing Perfluoro-2,4,6-tri-isopropyl-1-aza- and Perfluoro-1,3,5-tri-isopropyl-2-azabicyclo[2.2.0]hexa-2,5-dienes (195) and (194)	202
vii) Irradiation of Perfluoro-2,4,5-tri-isopropyl-1-azabicyclo[2.2.0]hexa-2,5-diene (196)	203
8.5 Thermal Analysis of the Rearomatisation of Perfluoro-1,3-di-isopropyl-4,6-dimethyl-2-azabicyclo[2.2.0]hexa-2,5-diene (188) using D.S.C.	203
8.6 Reactions of Valence Isomers	
i) Fluoride Ion Attack on a Mixture of Azaprismanes (159) and (160)	204
ii) Fluoride Ion Attack on Perfluoro-4-ethyl-2,6-di-isopropyl-3,5-dimethyl-1-azabicyclo[2.2.0]hexa-2,5-diene (154)	205
iii) Attempted Reaction of Perfluoro-2,4,5-tri-isopropyl-1-azabicyclo[2.2.0]hexa-2,5-diene (196) with Furan	205
iv) Attempted Reaction of Perfluoro-1,3,5-tri-isopropyl-2-azabicyclo[2.2.0]hexa-2,5-diene (194) with Bromine	206
v) Reaction of Perfluoro-1,3,5-tri-isopropyl-2-azabicyclo[2.2.0]hexa-2,5-diene (194) with Sodium Methoxide	206
vi) Attempted Reaction of Perfluoro-1,3,5-tri-isopropyl-2-azabicyclo[2.2.0]hexa-2,5-diene (194) with Perfluoroisopropyl Anion	207

	<u>Page</u>
vii) Reaction Between Perfluoro- 2,4,5-tri-isopropyl-1-aza- bicyclo[2.2.0]hexa-2,5-diene (<u>196</u>) and Sodium Phenoxide	207
viii) Reaction Between Perfluoro- 1,3,5-tri-isopropyl-2-aza- bicyclo[2.2.0]hexa-2,5-diene (<u>194</u>) and Sodium Phenoxide	208
ix) Reaction Between Perfluoro- 1,3,5-tri-isopropyl-2-aza- bicyclo[2.2.0]hexa-2,5-diene (<u>194</u>) with Sodium Isopropoxide	209
CHAPTER 9 EXPERIMENTAL FOR CHAPTER 5	
9.1 Irradiation of Perfluoro-2,5-di- isopropyl-1,4-di-azacyclohexa-1,4- diene (<u>213</u>), at 253.7nm., in the presence of mercury	210
9.2 Irradiation of Perfluoro-4,6-di- isopropyl-1,3-diazacyclohexa- 3,6-diene (<u>219</u>), at 253.7nm., in the presence of mercury	211
9.3 Irradiation of Perfluoro-4-isopropyl- 1-azacyclohexa-1,3-diene (<u>222</u>), at 253.7nm.	212
9.4 Irradiation of Perfluoro-2,3,4-tri- isopropyl-1-azacyclohexa-1,3-diene (<u>229</u>), at 253.7nm.	213
9.5 Irradiation of Perfluoro-1,1',3- diazacyclohex-2-enyl (<u>231</u>), at 253.7nm., in the presence of mercury	213
9.6 Irradiation of Perfluoro-1-aza- cyclohex-1-ene (<u>230</u>) at 253.7nm., in the presence of mercury	214
APPENDIX 1 ¹⁹ F n.m.r. Spectra	215
APPENDIX 2 Infrared Spectra	239
APPENDIX 3 Ultraviolet Spectra	247
REFERENCES	254

CHAPTER 1

Isomerisation in Six Membered Aromatic Rings

1.1 Introduction

Since the identification of the first example of a bicyclo[2.2.0]hexa-2,5-diene (Dewar benzene)(1) in 1962,¹ many workers have studied the photolysis of aromatic systems. As a result, a series of valence bond isomers, namely Dewar benzenes (1), benzvalenes (2), and prismanes (3) have been isolated.

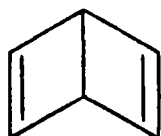

(1)

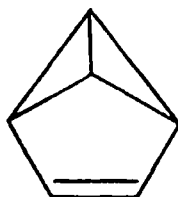

(2)

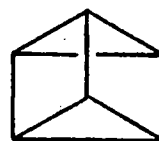

(3)

The intermediacy of valence bond isomers has been postulated, in many systems, in order to explain rearrangements observed in the aromatic ring.

1.2 The Photolysis of Benzene

Evidence for production of photoproducts, from the irradiation of benzene, was noted as early as 1955² but it was not until 1957 that fulvene (4) was identified as a

product.³ Irradiation of benzene, in quartz cells, was observed to produce fulvene (4) in a concentration of 0.1g/litre.

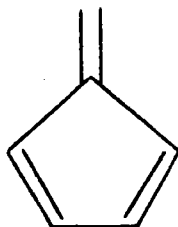

(4)

The products from photolysis of benzene were found to be dependent upon the wavelength of irradiation and whether it was carried out in the liquid or vapour phase. In the vapour phase, use of 180-200nm radiation produced fulvene (4), together with breakdown products.⁴

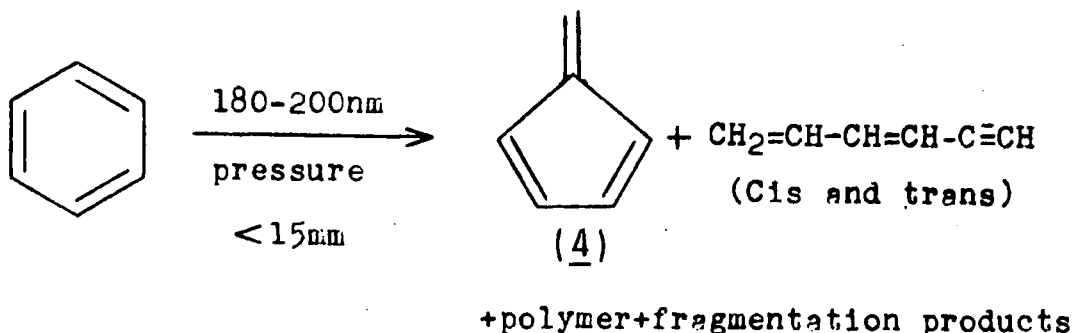

This is in contrast to the irradiation of liquid benzene, using 165-200 nm radiation, which gave benzvalene (2), Dewar benzene (1), and fulvene (4), in the ratio 5:1:2, together with a small amount of biphenyl.⁵

Irradiation at 254nm, a wavelength which populates the $S_1(^1B_{2u})$ state of benzene, resulted in production of benzvalene (2), and fulvene (4) only,^{6,7,8} so it can be seen that benzvalene (2) and fulvene (4) are formed from

S_1 benzene; some, if not all, of the fulvene formed from isomerisation of benzvalene.⁸

Benzvalene (2) production was shown to be enhanced if benzene was irradiated as a dilute solution, in hydrocarbon solvents; this appeared to be due to the solvent aiding vibrational relaxation of benzvalene (2). It was also shown to be produced, from excitation of the S_0-S_1 band of benzene, with a higher quantum yield as the wavelength of irradiation was decreased. This observation was explained on the basis that at a shorter wavelength a greater quantity of energy was introduced into the system and the excess energy gave vibrationally excited S_1 benzene, which could rearrange to form benzvalene (2).⁸

Destruction of benzvalene (2) was shown to be benzene photosensitized, i.e. benzene triplets transfer their energy to benzvalene, therefore irradiation of benzene vapour, using 254nm radiation, with addition of triplet quenchers enabled steady-state concentrations of benzvalene greater than 1% to be obtained.⁸

Dewar benzene (1) was produced in the liquid phase using 165-200nm radiation, a wavelength of radiation which populated both the $S_2(^1B_{1u})$ and $S_3(^1E_{1u})$ states and possibly the $T_1(^3B_{1u})$ state. Use of a triplet trap, together with selective irradiation of the S_0-S_2 band of benzene, gave Dewar benzene (1) which indicated that it was formed from the S_2 state.⁶ (1) was also formed when the S_3 state was selectively populated.

The photoisomerisation reactions of benzene have been summarised schematically.⁹ (See Fig. 1).

To date, prismane (3) has not been observed as a photolysis product of benzene.

1.3 Synthesis of Valence Isomers of Benzene

Synthesis of the isomers Dewar Benzene (1), benzvalene (2), and prismane (3) have all been reported.

1.3(i) Bicyclo[2.2.0]hexa-2,5-diene. (Dewar Benzene)

Dewar benzene (1) was the first of the isomers to be prepared by a synthetic route.¹⁰ Irradiation of cis-1,2-dihydrophthalic anhydride (5) gave (6) which on oxidative

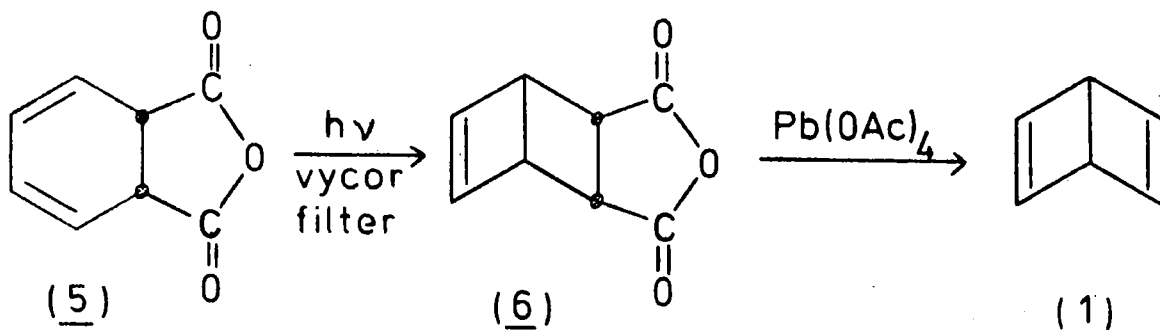

decarboxylation gave Dewar benzene (1). This was found to be unstable, with a half-life of two days at room temperature.

1.3(ii) Tricyclo[3.1.0.0^{2,6}]hex-3-ene. (Benzvalene)

Benzvalene (2) was synthesised in 1971 by Katz and coworkers.¹¹ Cyclopentadienyl anion was shown to react with dichloromethyl lithium to give the lithium salt (7), from which the carbene (8) was generated. Benzvalene (2) was formed by internal 1,2 or 1,4 addition of (8) whereas benzene (9) was produced on ring enlargement of (8),¹² in a competing process.

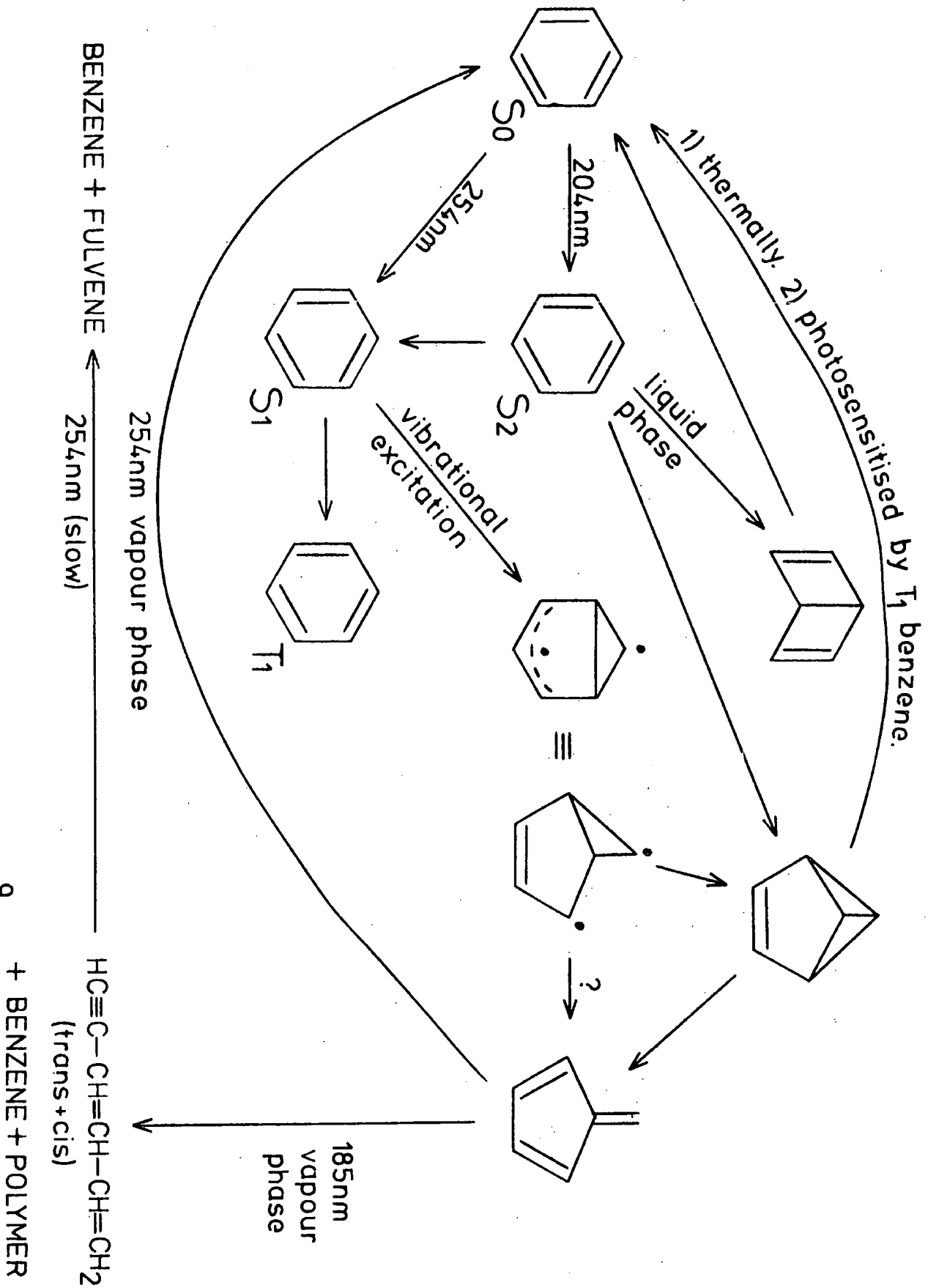
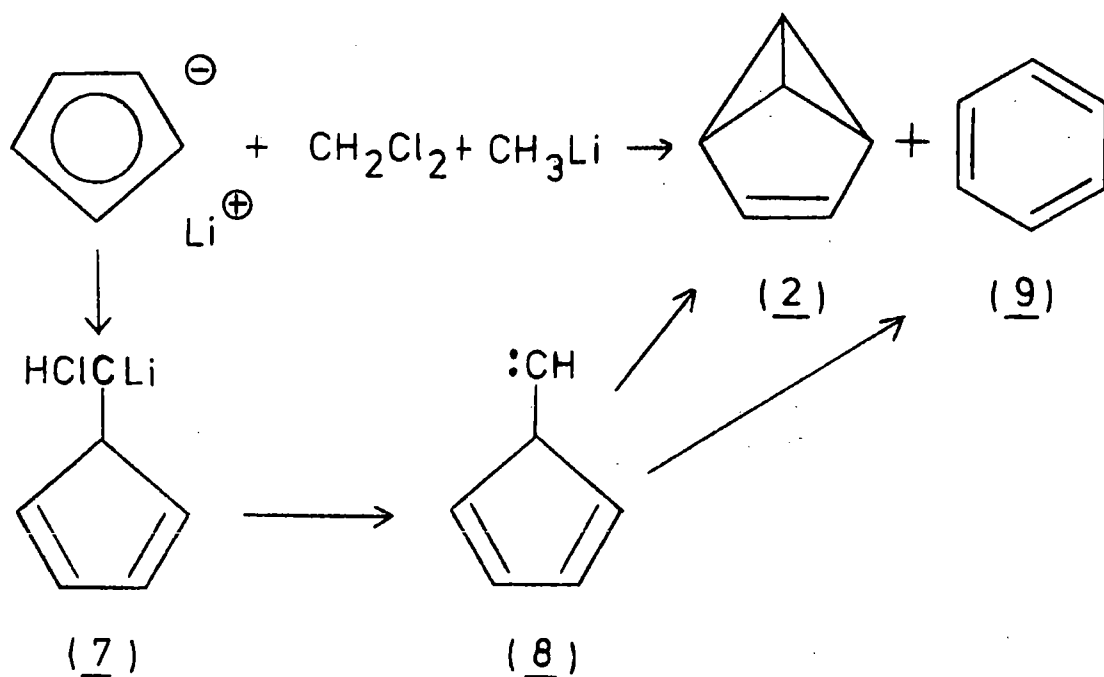

FIG.1. PHOTOISOMERISATION REACTIONS OF BENZENE. 9



Benzvalene (2) was found to be highly unstable, with a tendency to detonate when pure.¹¹

1.3(iii) Tetracyclo[2.2.0^{2,6}.0^{3,5}]hexane. (Prismane)

The same workers who prepared benzvalene (2) used it as a precursor in the synthesis of prismane (3).¹³

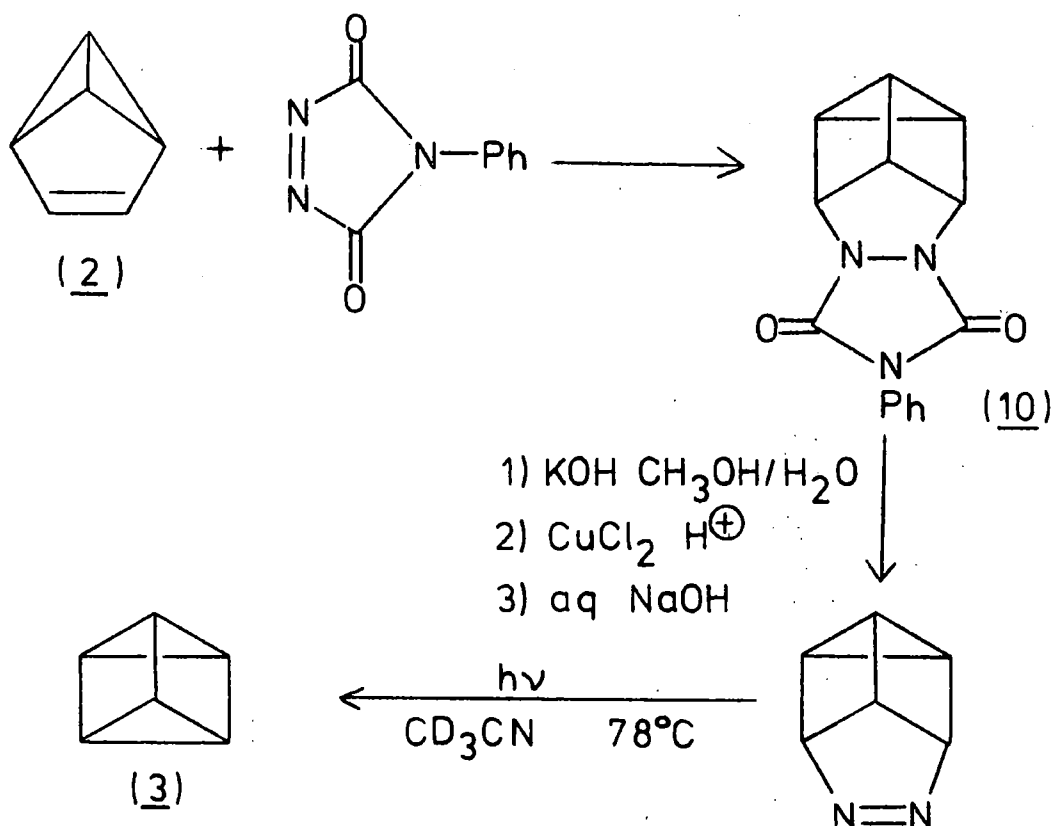

The mechanism for formation of the azo precursor (10) was determined by the use of 5,6-dideuterated benzvalene, which gave the adduct labelled as indicated.

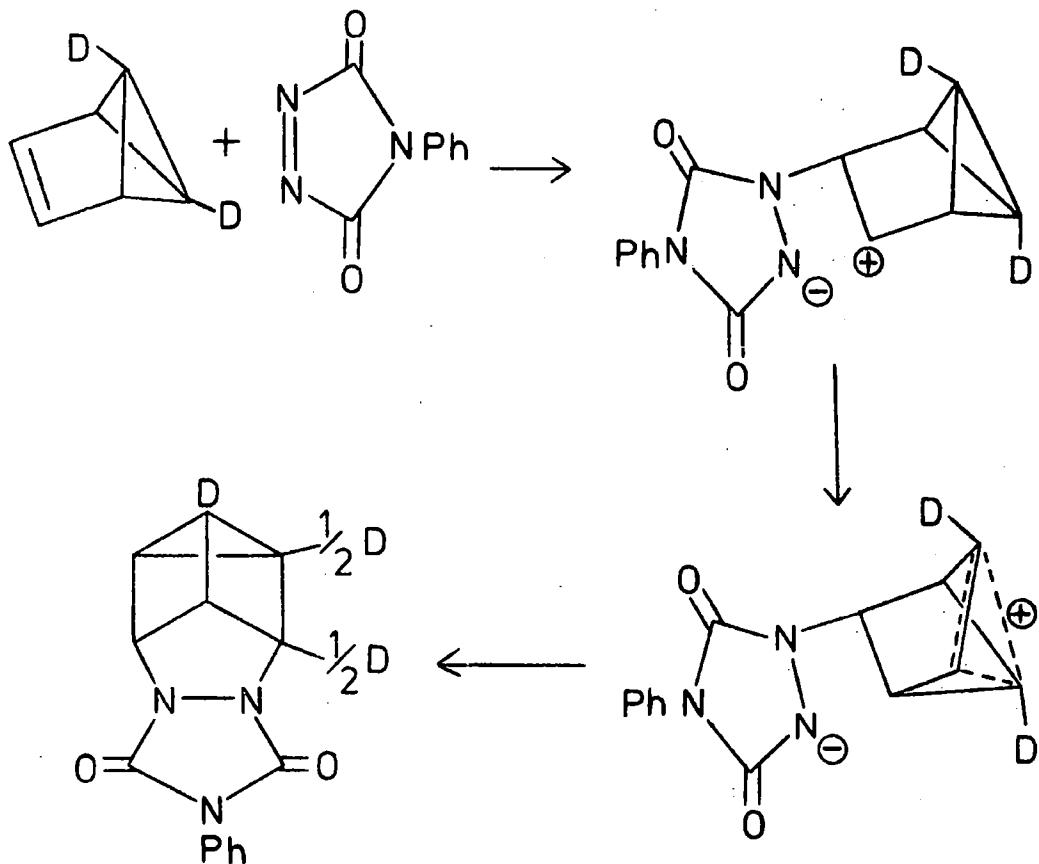

Prismane (3) decomposed to benzene at 90°C with a half-life of 11 hours but was found to be stable at room temperature.¹³

1.4 Theoretical Treatment of Rearrangement of Benzene to its Valence Isomers

Theoretical treatments have been employed by several workers in order to predict whether interconversion of benzene (9) to its valence isomers occur via thermal or photochemical routes.

One theoretical treatment, often used, involved construction of orbital and state correlation diagrams.¹⁴ The rearrangement of benzene (9) to Dewar benzene (1) has been covered using this treatment¹⁵ and is illustrated in Fig. 2a and 2b.

This treatment, which is based on the principle of symmetry conservation, indicated that the rearrangement of (1) to (9) was 'forbidden' in the ground state i.e. not occurring by a thermal route, and this method predicted that (1) could be formed by a photochemical pathway from the second excited state of benzene (9), the B_{1u} state. It also predicted that rearrangement could not occur from the first excited state of benzene (B_{2u} state). These predictions turned out to be consistent with experimental observations.

Orbital symmetry correlations have also been used to show that benzvalene (2) could be formed photochemically from benzene (9), from the S_1 and S_2 states. Formation of (2), from the benzene S_1 state could be considered to occur via the formation of preyalene (11), in a symmetry allowed process,^{9,15} which could then form benzvalene (2) by radical recombination.

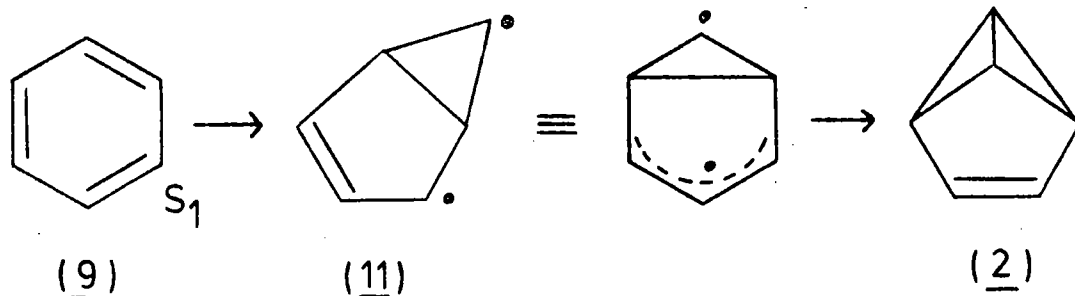

It has been suggested that formation of (2), from S_2 benzene, may occur via a species resembling cis,cis,-trans-cyclohexatriene (12), in a concerted process.⁹

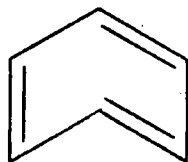

(12)

A second treatment of these rearrangements which has been employed is the use of theoretical MINDO calculations in which reaction pathways are determined. When the reaction under investigation is symmetry forbidden HOMO-LUMO crossings can be detected. Isomers which rearrange only via HOMO-LUMO crossing have been termed Lumomers,¹⁶ and it has been shown that both Dewar benzene (1) and prismane (3) are lumomers of benzene (9), i.e. the rearrangement of (9) to both (1) and (3) is symmetry forbidden in the ground state.

When these theoretical calculations were applied to the Dewar benzene (1) to benzene (9) transformation the activation energy was calculated to be 114.2 KJ mole⁻¹ and the HOMO-LUMO crossing was observed.¹⁷ These calculations also predicted an unsymmetrical transition state for the reaction.

When the treatment was used to study the benzvalene (2) to benzene (9) transformation the reaction was found to be exothermic ($\Delta H = -85\text{Kcal mole}^{-1}$) with an activation

energy of 21.5 Kcal mole⁻¹, but no HOMO-LUMO crossing was observed, since the calculated energy for the reaction pathway was found to be a smooth function of the reaction co-ordinate. As a result of these findings it was suggested that this was a thermally 'allowed' process.¹⁸ However other workers have disputed this reaction being termed 'allowed' and have suggested that since (2) can be isolated at ambient temperatures, that this indicates that the rearrangement to benzene (9) can only occur via highly activated routes, so they concluded that this rearrangement was 'forbidden' thermally.⁹ However recent results have indicated that this rearrangement is 'allowed' as benzene, produced from thermal rearrangement of (2), was not formed in its triplet state.¹⁹ The formation of benzene in the triplet state would be expected if the reaction was a 'forbidden' process.

The orbital symmetry treatment depends to a great extent upon the symmetry of the systems in question so that introduction of alkyl groups into the benzene ring, an operation which destroys the symmetry and perturbs the system, limits the usefulness of the treatments to the very simple cases, i.e. benzene itself and hexafluorobenzene.¹⁵ The theoretical calculations which have been carried out indicated that both rearrangement of (2) to (9) and (1) to (9) involved unsymmetrical transition states, so that the orbital symmetry treatment may not be wholly reliable.

1.5 Theoretical Treatment of Rearrangements in Aromatic Rings

1.5(1) Introduction

In this section theoretically possible rearrangements of the benzene ring are illustrated by the use of a benzene ring with each carbon atom separately numbered, so that the relative shifts of each carbon atom can be seen more easily. Examples of these rearrangements will be given in later sections.

1.5(ii) Rearrangements Proceeding via Benzvalene Intermediates

In theory if benzene rearranged via a benzvalene intermediate six isomers could be formed on rearomatisation and each one of the isomers is a result of the six possible 1,2-shifts in the ring.

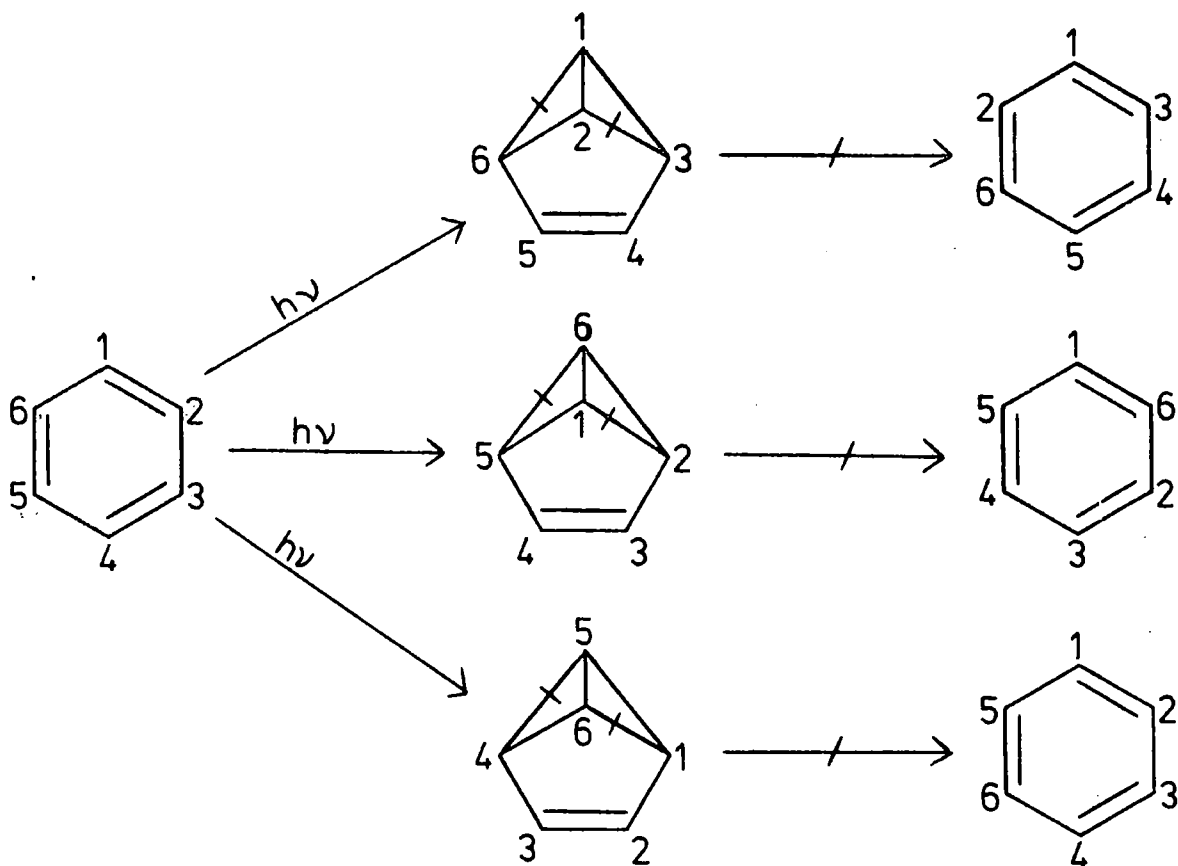

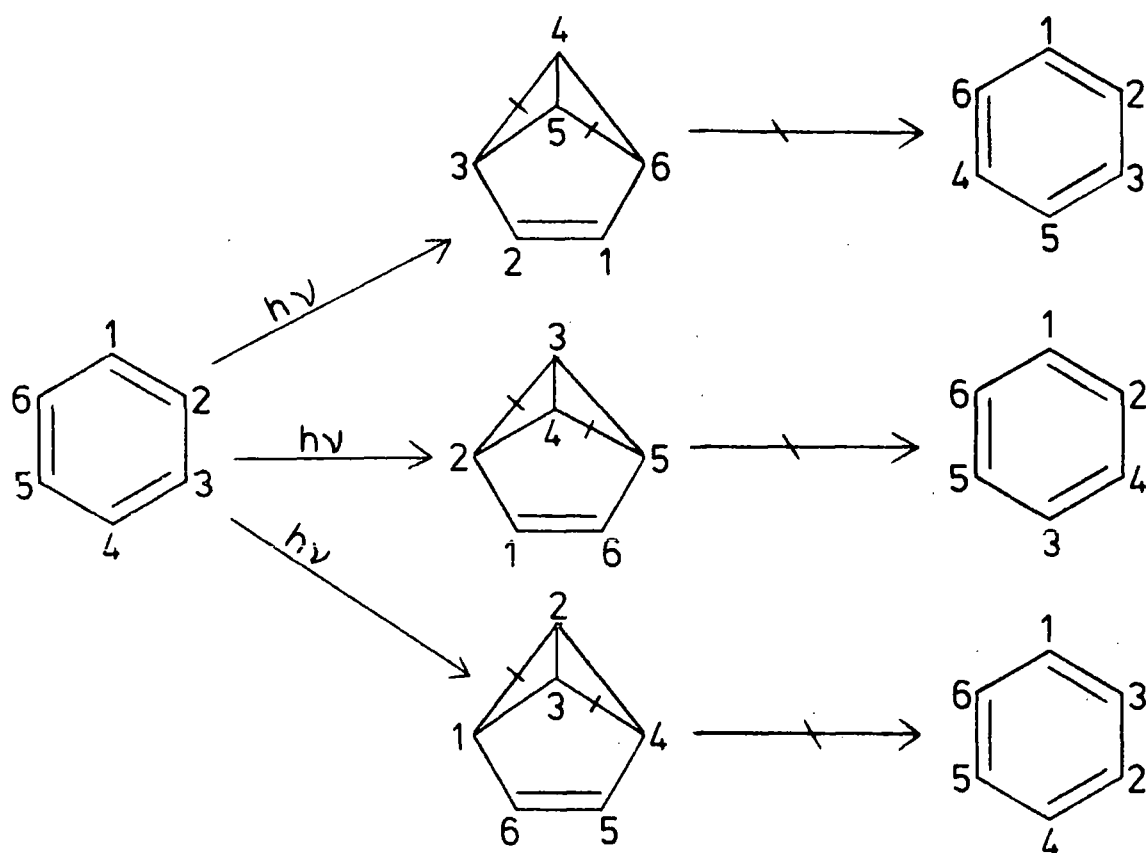

A single rearrangement, of an aromatic system proceeding via a benzvalene intermediate, would result in a 1,2-shift whereas if the aromatic system thus formed itself rearranged via a benzvalene intermediate then a 1,3-shift could occur. This 1,3-shift would be a product of two 1,2-shifts i.e.

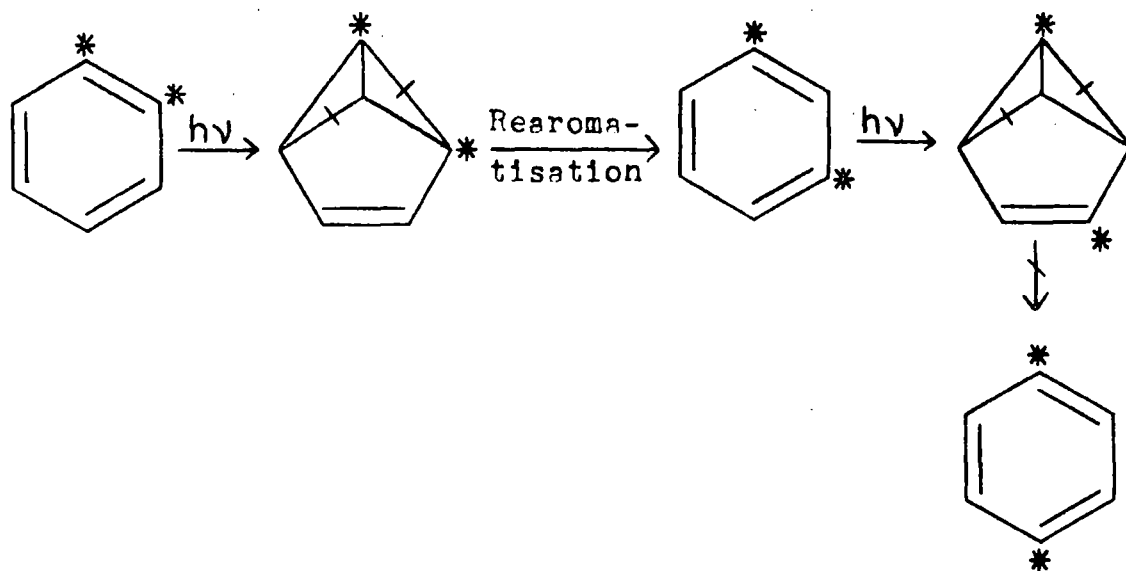

1.5(iii) Rearrangements Proceeding via Prismane Intermediates

In theory if benzene rearranged via prismane intermediates a total of six rearranged isomers could be obtained on rearomatisation. In the diagram given below, it can be seen that these isomers are different from those formed via benzvalene intermediates (Section 1.5(ii)).

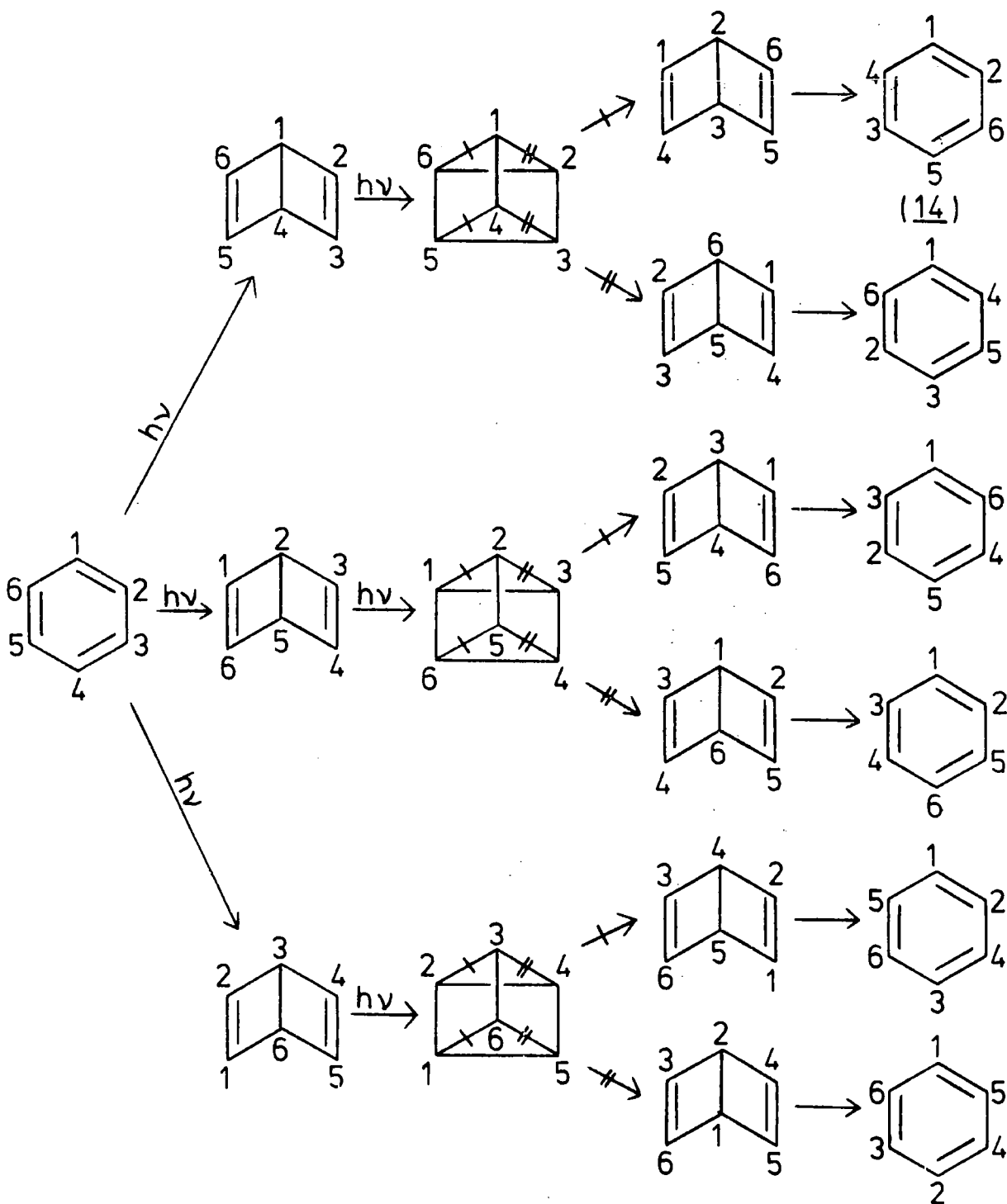

It is possible to observe both 1,2- and 1,3-shifts by this rearrangement mechanism. e.g. In the rearranged isomer (14) carbon atom 3 has undergone a 1,3-shift relative to position 2 but only a 1,2-shift relative to position 5.

1.6 Theoretical Rearrangements and Interconversions of Valence Isomers

1.6(i) Introduction

In this section the possible rearrangements and interconversions of valence isomers are described; some of these occur quite readily, whereas others are quite rare, but examples of all of them are given in later sections.

1.6(ii) Interconversion of Dewar Benzene and Prismane

There are a number of documented examples of this type of isomerisation, mainly in fluorocarbon systems.^{21,22,30,38,64}

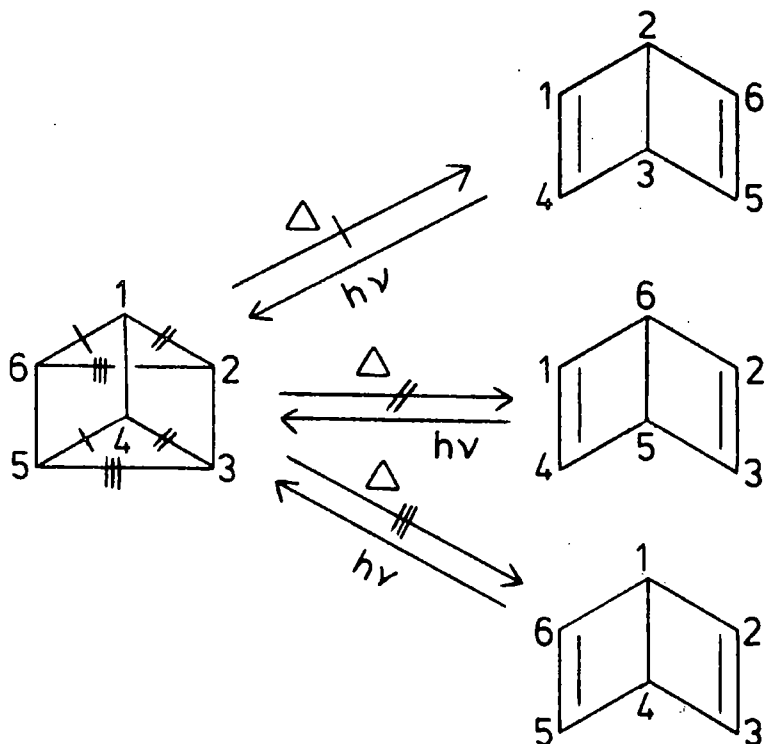

It is theoretically possible to obtain three different Dewar benzenes from the initial prismane, by the routes indicated.

1.6(iii) Rearrangement of Benzvalenes

There have been a few recorded examples of a benzvalene rearrangement which involves a 'cope type' mechanism which

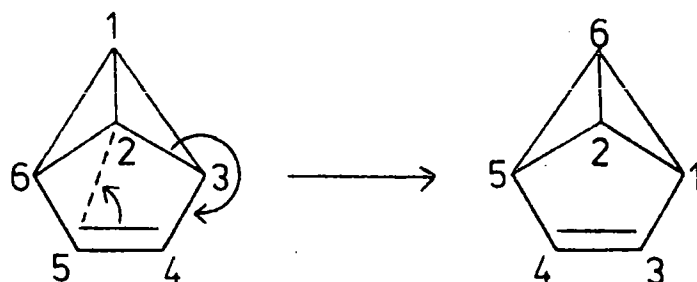

involved 1,2- and 1,3-shifts.^{26,31} In theory if the six intermediate benzvalenes, formed from labelled benzene (Section 1.5 (ii)), underwent this type of rearrangement a total of twelve benzene isomers could be formed from the initial labelled benzene.

1.6(iv) Rearrangement of Benzvalene to Fulvene

Some, if not all, of the fulvene (4) formed by the photolysis of benzene (9) could arise from isomerisation of initially formed benzvalene (2). It has been shown that this isomerisation is catalysed by quartz.⁸

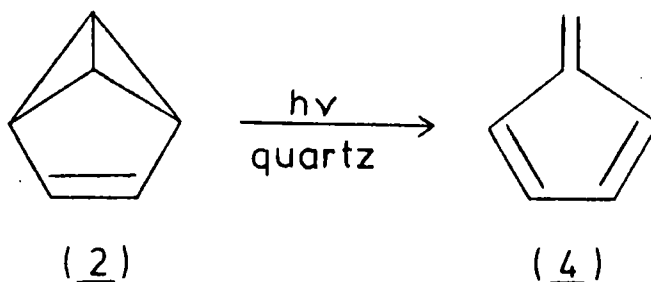

1.6(v) Isomerisation of Benzvalene to Dewar Benzene

A possible example of a non-reversible isomerisation of a benzvalene to a Dewar benzene has been reported,²⁰ but the possible mechanism for this rearrangement was not commented upon.

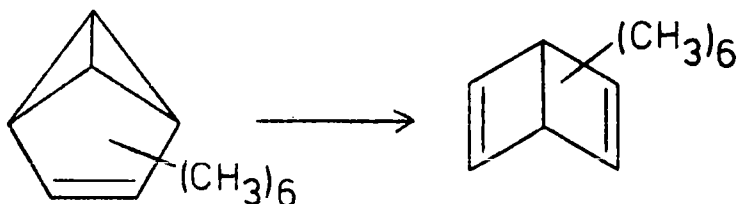

1.6(vi) Isomerisation of Prismane to Benzvalene

There is reported at least one example of a rearrangement of a prismane to a benzene derivative, in part via a benzvalene intermediate^{21,22} which has been suggested to involve a symmetry allowed concerted ground state pathway.²³

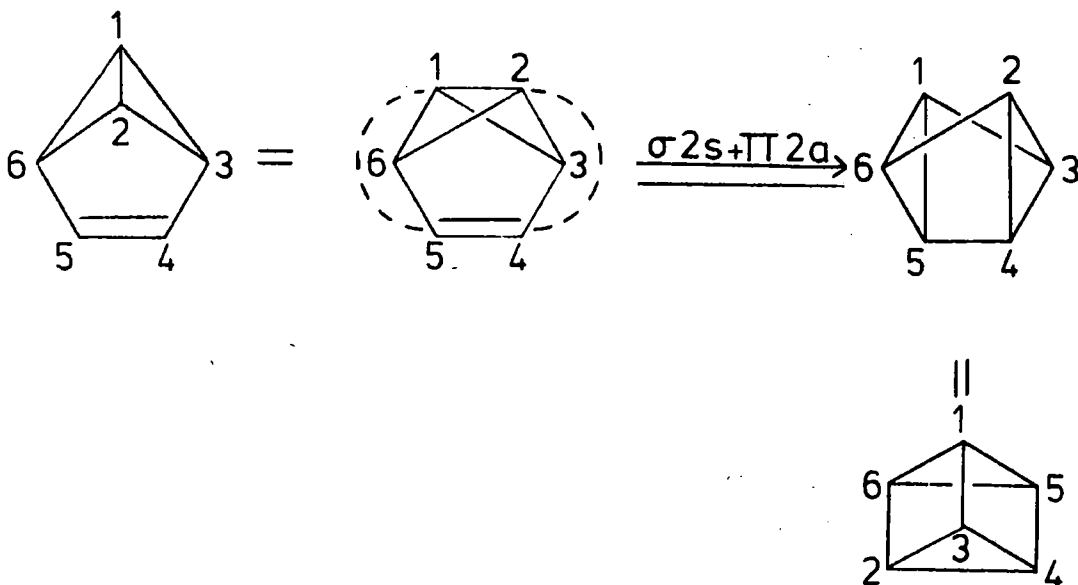

1.7 Photolysis of Labelled Benzenes

1.7(i) Introduction

Detection of photochemical transpositions of the aromatic ring has been carried out in many cases by labelling of the aromatic ring by inert alkyl groups, followed by determination of the transpositions of the alkyl groups after photolysis; examples of which are given in this section.

A most significant experiment, carried out in 1965, was the photolysis of mesitylene-1,3,5- C^{14} (15), using 253.7nm radiation, which gave 1,2,4-trimethylbenzene (16) with the C^{14} label also in positions 1,2 and 4.²⁴ This experiment confirmed that rearrangement in the benzene ring

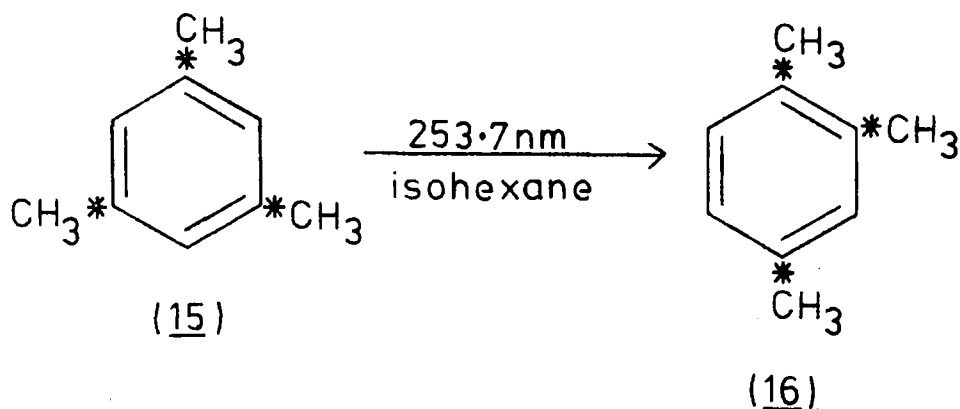

occurred via ring carbon interchange rather than alkyl group migrations, even though no intermediate valence isomers were detected.

1.7(ii) Labelling using Deuterium

Additional evidence that ring carbon interchange occurred on the photolysis of aromatic systems was presented

by Kaplan and co-workers who carried out a labelling experiment using benzene-1,3,5-d₃ (17)²⁵ and showed that irradiation, in both the vapour phase and in solution, using 250nm radiation led to the formation of benzene-1,2,4-d₃ (18).

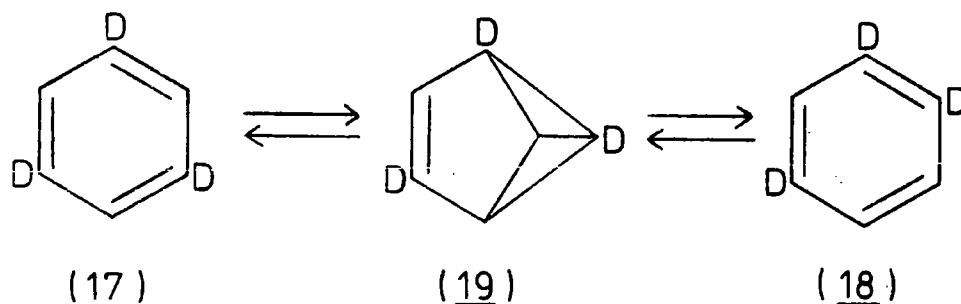

Benzvalene derivative (19) is the intermediate believed to take part in the rearrangement even though there was no direct evidence for its formation. Indirect evidence supported the theory that (19) was indeed the intermediate, in the rearrangement, as it has been shown that only benzvalene (2) and fulvene (4) are produced on irradiation of benzene (9) using 254nm radiation⁶, and also the deuteration in three positions, of benzene, would not be expected to perturb the system too greatly, so the production of benzvalene (2) would therefore be expected at that irradiation wavelength.

A rare example of isomerisation of benzvalenes was observed when the benzvalene derivative (20) was irradiated, using 253.7nm radiation, or irradiated in the presence of triplet sensitizers of energy between 53 and 65 Kcal mole⁻¹, and gave a second dideuteriobenzvalene (21).²⁶

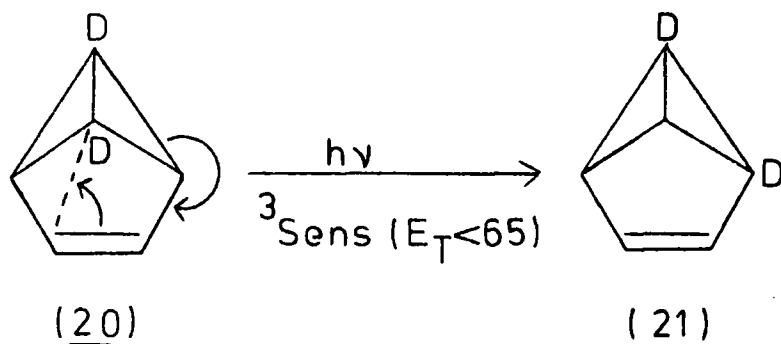

1.7(iii) Photochemical Rearrangement of Di-substituted Benzenes

1.7(iii)A. Di-t-butylbenzenes

Irradiation of di-t-butylbenzenes gave a photostationary mixture comprising of meta-di-t-butylbenzene (22) and para-di-t-butylbenzene (23) in the ratio 1:4.²⁷ On irradiation of the ortho-isomer (24) the first isomer detected was the meta isomer (22) whereas, the photostationary mixture was only produced after a long irradiation time.

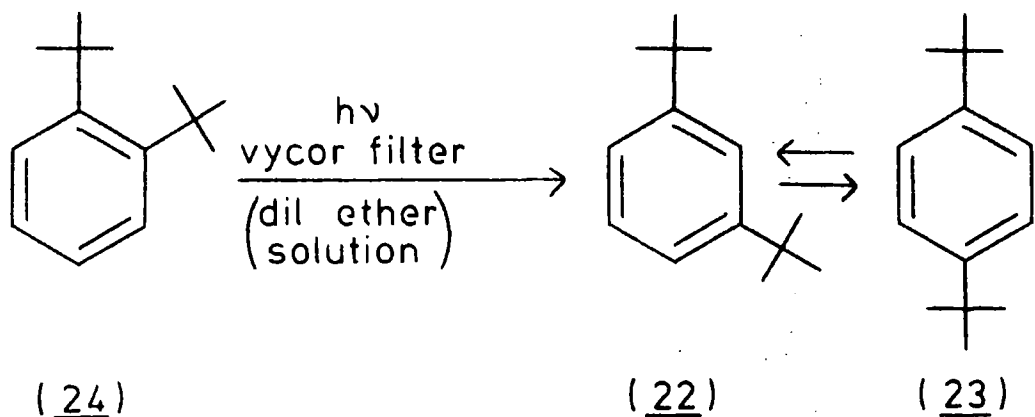

The production of isomer (23) from (24) is an example of a 1,3-shift, but experimental evidence indicated that this rearrangement proceeded via two 1,2-shifts which involved either benzvalene or prismane intermediates (see

Fig. 3), although no intermediate valence isomers were detected.

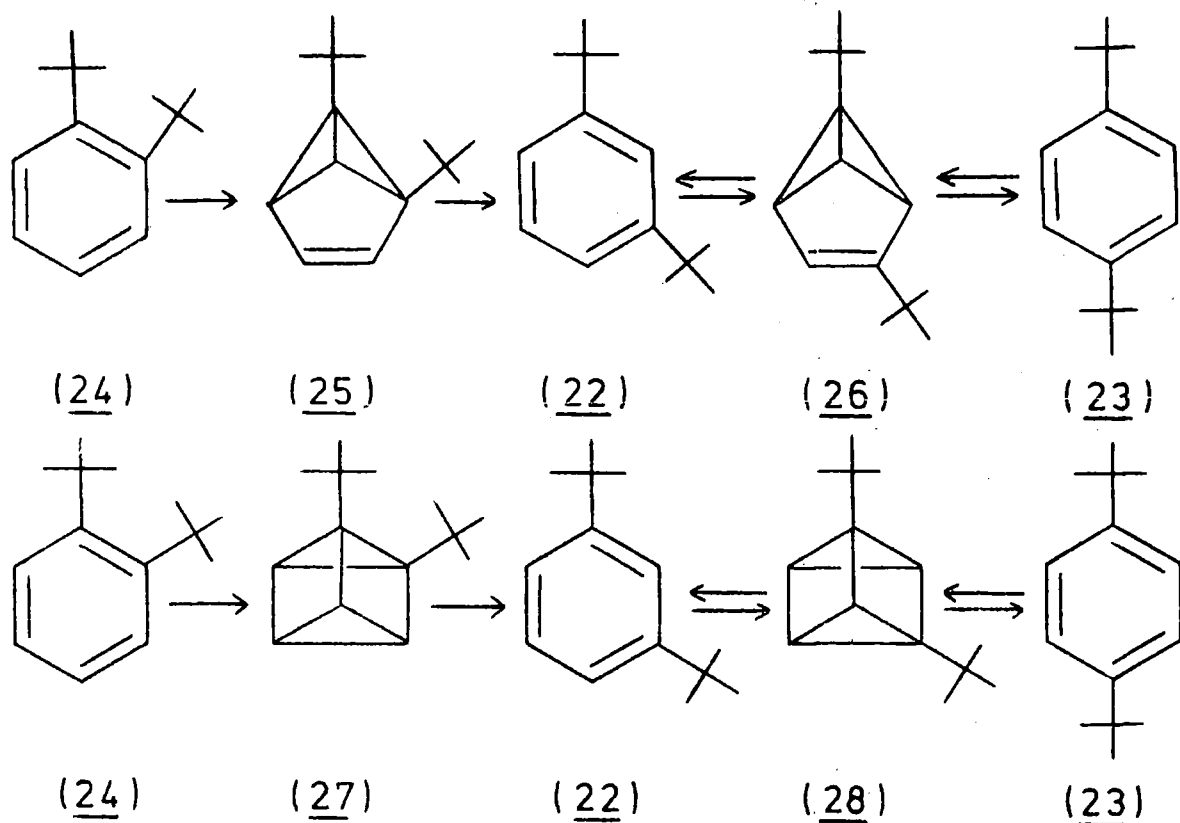
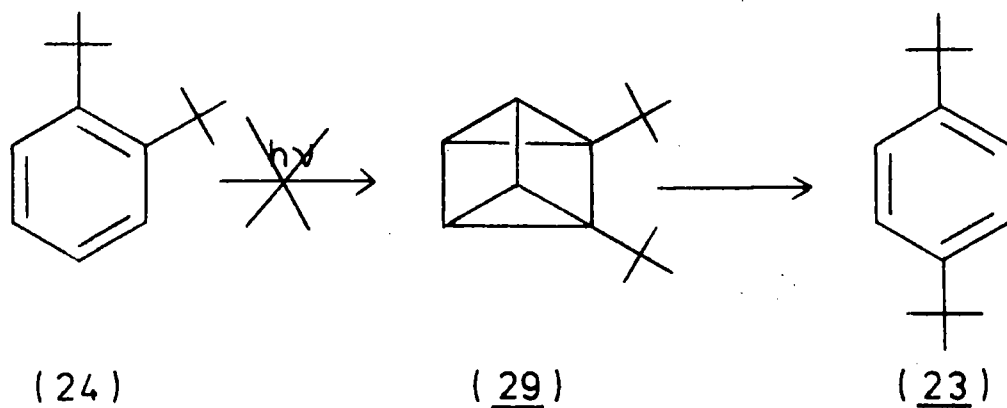
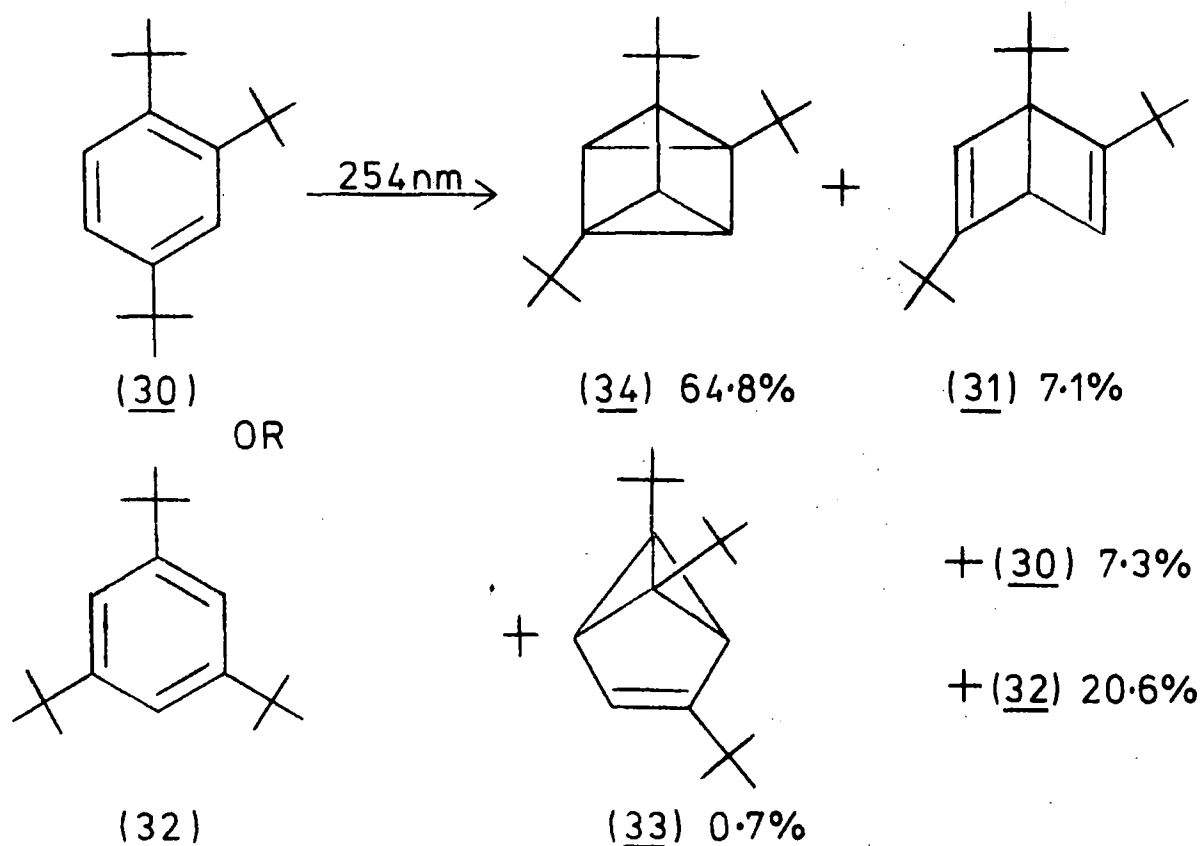

FIG. 3

From experimental evidence neither of the two mechanisms could be ruled out, but if prismane intermediates were involved then in theory the rearrangement of (24) to (23) could occur directly via a single prismane intermediate (29). However this was not observed.





(31), a benzvalene (33) and a prismane (34). Dewar benzene derivative (31) was shown to be the same one as that identified earlier by van Tamelen¹.

Over a very long irradiation time small quantities of fulvenes were detected, and a photostationary mixture obtained with the prismane (34) found to be the major constituent. Quantum yields and composition of the photostationary mixture were reported.³⁰

However this did not prove to be the complete picture for this series of rearrangements as further work resulted in the identification of a second benzvalene (35).³¹ Originally, suspicion that a second benzvalene was involved was based on the observation that photolysis of (30), in

methanol, gave a high yield of an adduct, identified as 4-methoxy-2,4,6-exo-tri-t-butylbicyclo[3.1.0]hex-2-ene (36).^{31,32}

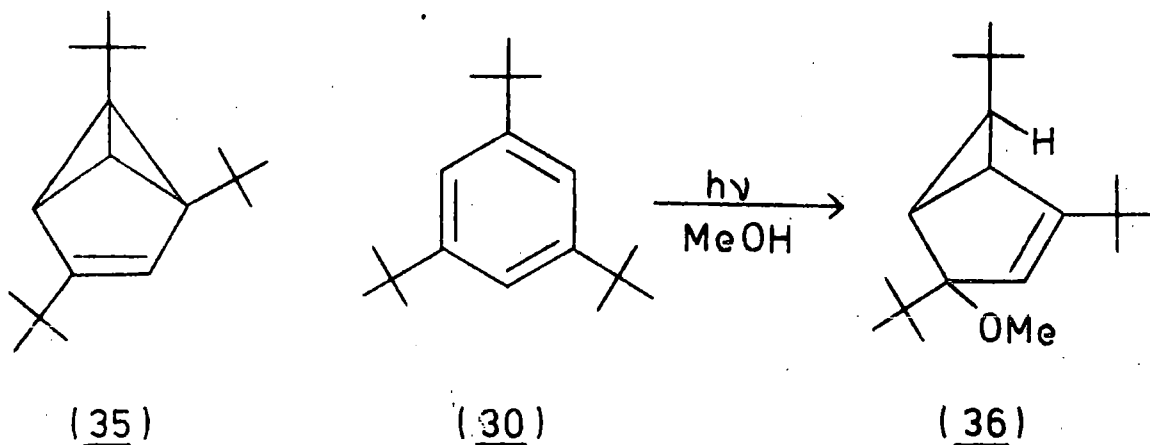

The second benzvalene was subsequently shown to be 1,2,4-tri-t-butyltricyclo[3.1.0.0^{2,6}]-hex-3-ene (35) which rearranged to (30) with a half life of 17 minutes at 25°C. Irradiation of benzvalene derivative (35) isomerised it to benzvalene (33) in a similar process to

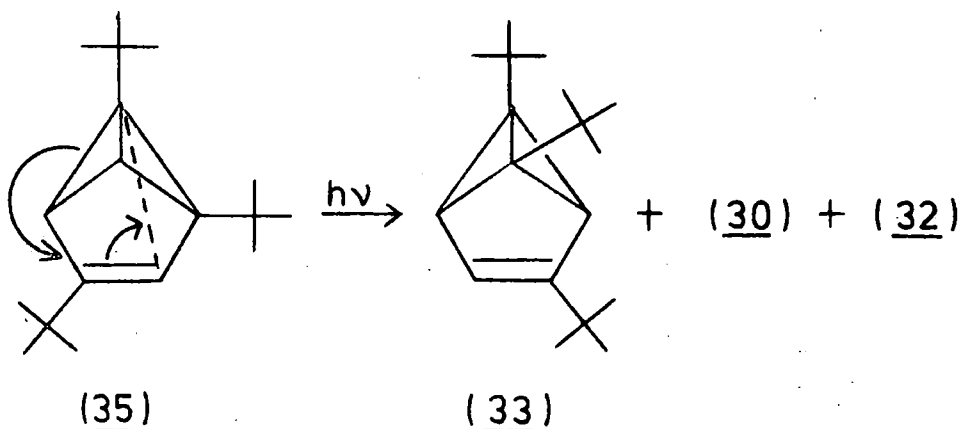

that observed when 5,6-dideuteriobenzvalene (20) was irradiated.²⁶ (Section 1.7(ii)). Furthermore it was shown that these benzvalenes were only isomerised photochemically, as the pyrolysis of benzvalenes (33) and (35) resulted in the formation of benzenes (32) and (30) respectively.

Quantum yields for these interconversions were reported so an overall scheme could be written.

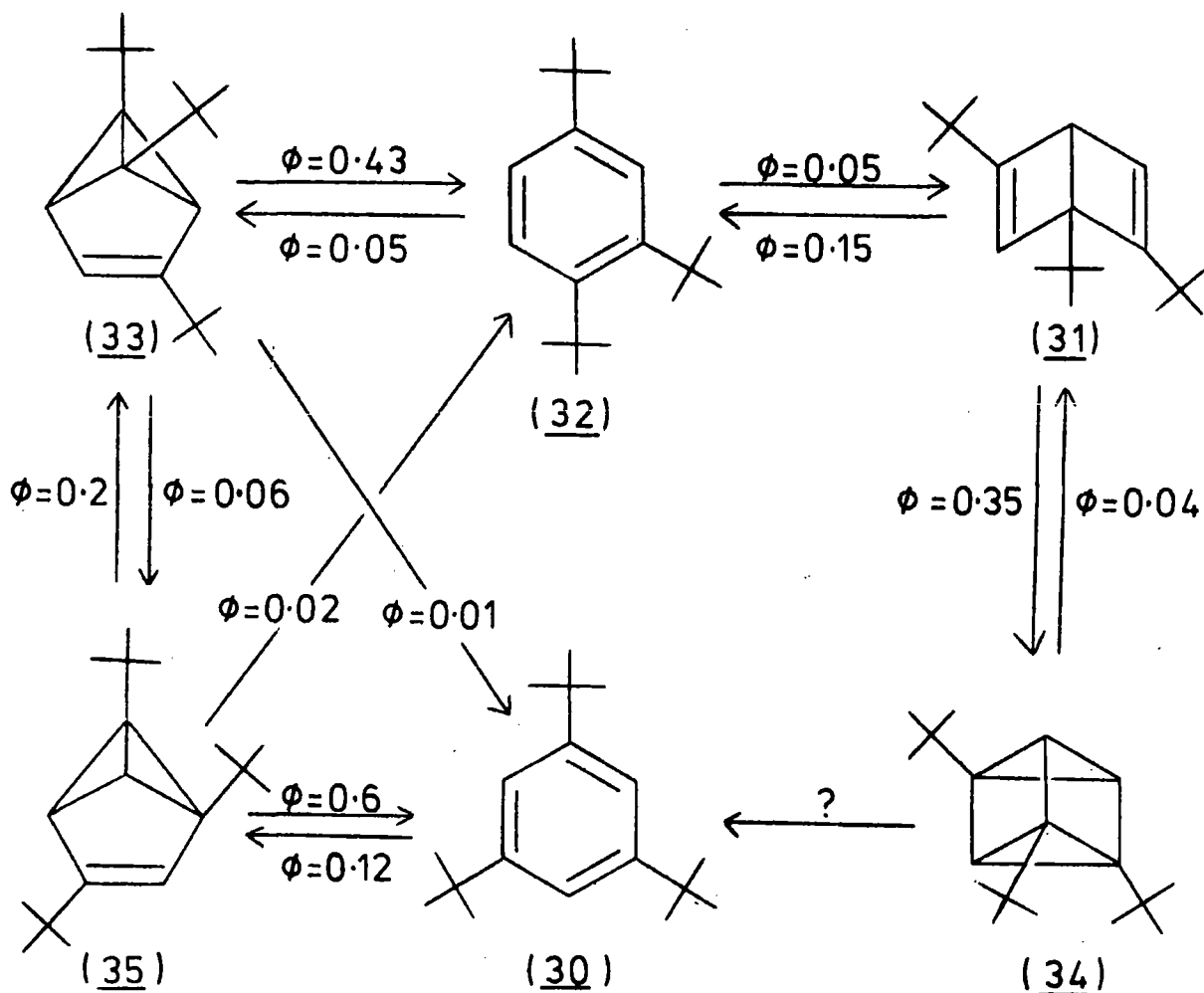

Pyrolysis of prismane (34) gave a mixture containing Dewar benzene derivative (31) and both benzene derivatives (30 and 32) and the pyrolysis of the Dewar benzene (31) gave the isomer (32). All these results could be easily explained i.e.

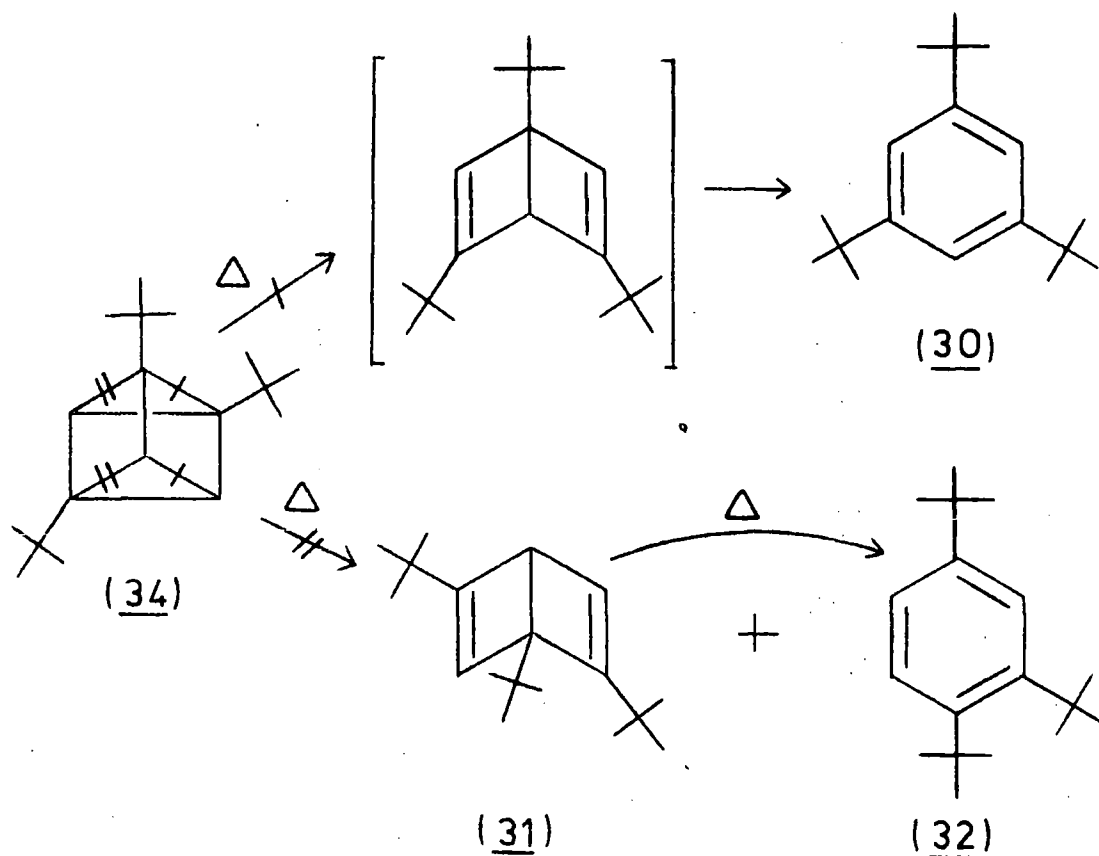

These results showed that (30) rearranged on photolysis to (32) via benzvalene intermediates (35 and 33) whereas the reverse isomerisation proceeded via the same benzvalene intermediates, (33) and (35), with the added possibility that a second mechanism which involved the Dewar benzene (31) and prismane (34) could also occur simultaneously.

1.7(v) Photochemical Rearrangement of Tetra-substituted Benzenes

1.7(v) A. Tetra-t-butylbenzenes

On irradiation of 1,2,4,5-tetra-t-butylbenzene (37), in solution, using 253.7nm radiation the production of 1,2,3,5-tetra-t-butylbenzene (38) was observed, together with a Dewar benzene derivative (39)³³ and since a Dewar benzene derivative (39) had been isolated it was suggested

that the rearrangement of (37) to (38) proceeded via a prismane intermediate, as opposed to a mechanism which involved benzvalene intermediates, although the latter could not be ruled out. The extent to which these rearrangements are reversible was not determined.

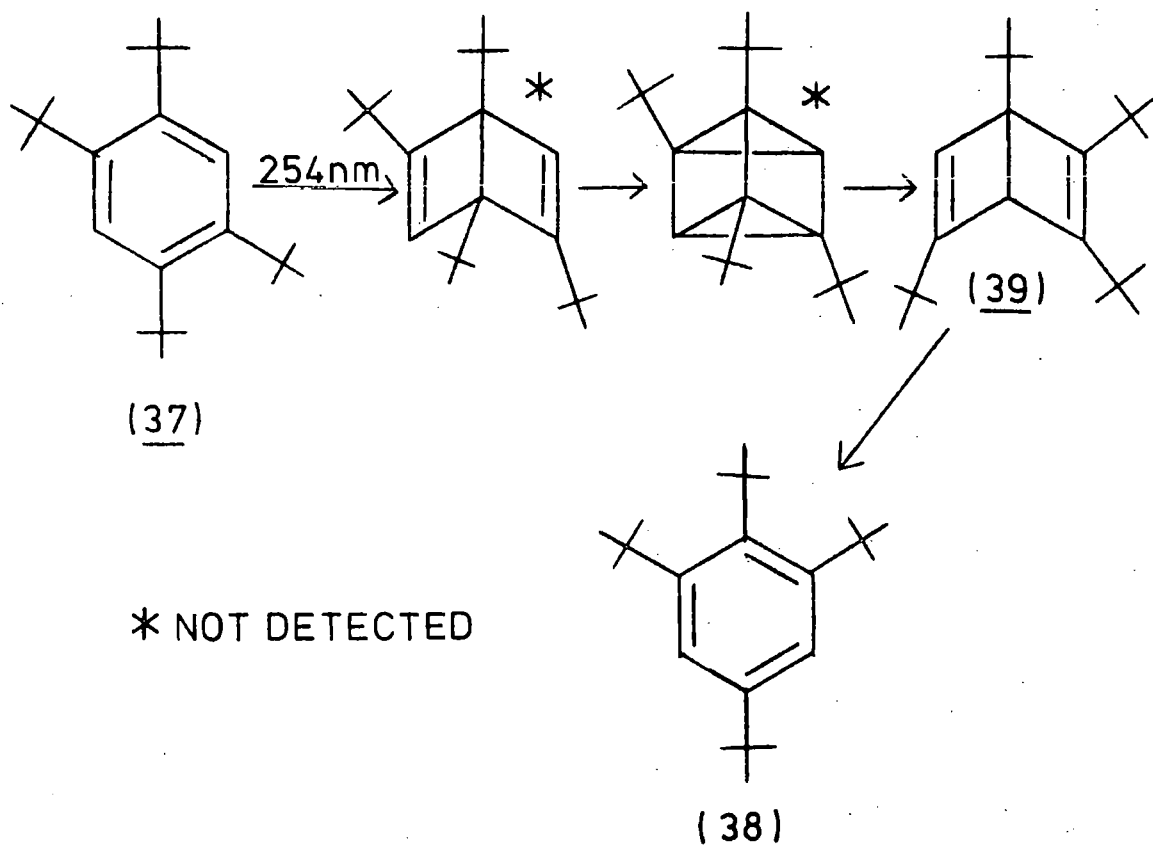

This contrasts with the di-*t*-butylbenzene irradiation²⁷ (see Section 1.7(iii)) where rearrangement was thought to proceed via benzvalene intermediates, but once again the alternative prismane mechanism could not be completely ruled out.

1.7(v)B. Tetrakis(trimethylsilyl)benzenes

Irradiation of 1,2,4,5-tetrakis(trimethylsilyl)benzene (40) gave five isomeric products which consisted of two benzvalene derivatives (42 and 43), two fulvenes

(44 and 45 a or b) and an isomeric benzene derivative (41)³⁴

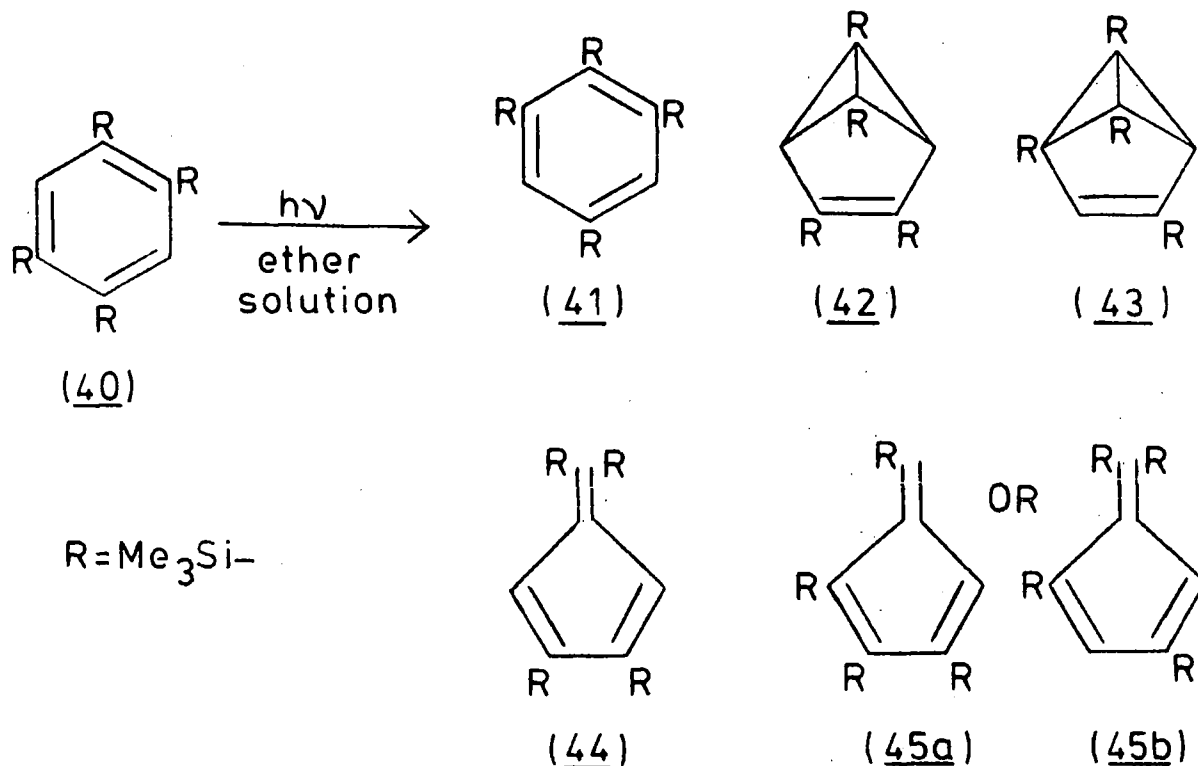

Initial irradiation of benzene derivative (40) gave a mixture containing two benzvalenes (42 and 43), whereas prolonged irradiation also produced benzene isomer (41) together with the isomeric fulvenes (44 and 45) while the concentration of (42) decreased.

An interesting result, not discussed by the authors, was obtained when benzvalene (42) was irradiated, as this resulted in the formation of benzvalene derivative (43) and fulvene derivative (44) together with traces of the aromatic isomers (40 and 41). It has already been shown that benzvalenes on photolysis can isomerise^{26,31} (Section 1.6.(iii)) but (43) could not be formed from (42) by this type of mechanism unless two such rearrangements occurred i.e.

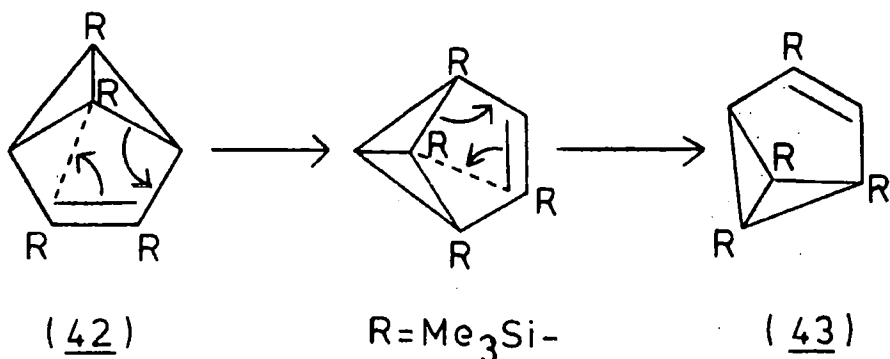

However in this photolysis traces of benzene derivative (41) were detected so the possibility that this rearrangement involved initial formation of (41) which then was isomerised to (43) is perhaps the more likely. Irradiation of benzvalene derivative (43) gave (41), (45a or 45b) and a trace of (42), but none of the benzene derivative (40). From these observations it was deduced that benzvalene derivative (42) could be an intermediate in the formation of all the other isomers and a scheme for the isomerisations could be written.

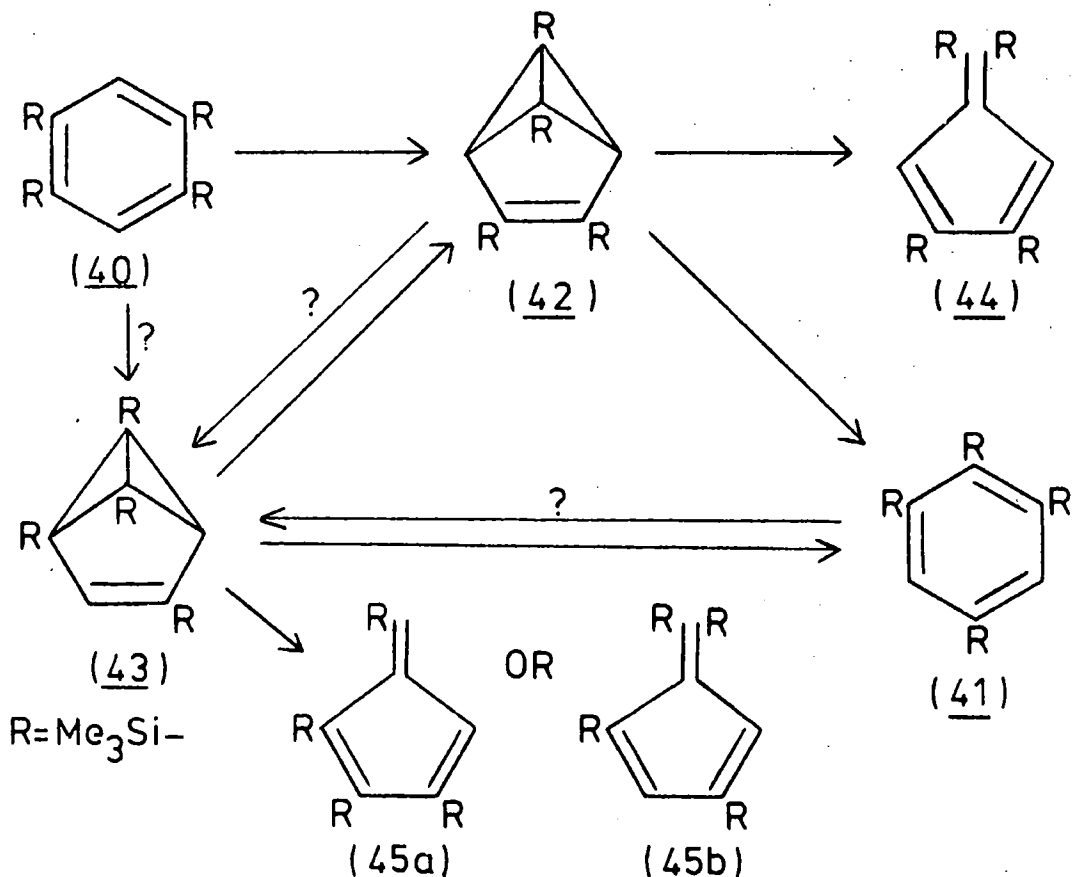

Unfortunately the scheme could be incomplete as the result of photolysis of benzene derivative (41) was not reported. It must be noted that there was no evidence for formation of any Dewar benzene or prismane derivatives. This is a contrast to the situation that occurred when 1,2,4,5-tetra-*t*-butylbenzene (32) was irradiated (Section 1.7(v)A.).³³

1.7(vi) Valence Isomers of Hexamethylbenzene (46)

Hexamethylbenzene (46) is insufficiently labelled for any rearrangements to be detected but its valence isomers can be formed easily and it illustrates some interesting isomerisations. Hexamethylbicyclo[2.2.0]hexa-2,5-diene (48) was synthesised by the bicyclotrimerisation of 2-butyne (47) in a process catalysed by AlCl_3 ^{35,36}. Hexamethylprismane (49) was obtained, in low yield, by the photolysis of hexamethylbicyclo[2.2.0]hexa-2,5-diene (48) in ether solution.^{37,38}

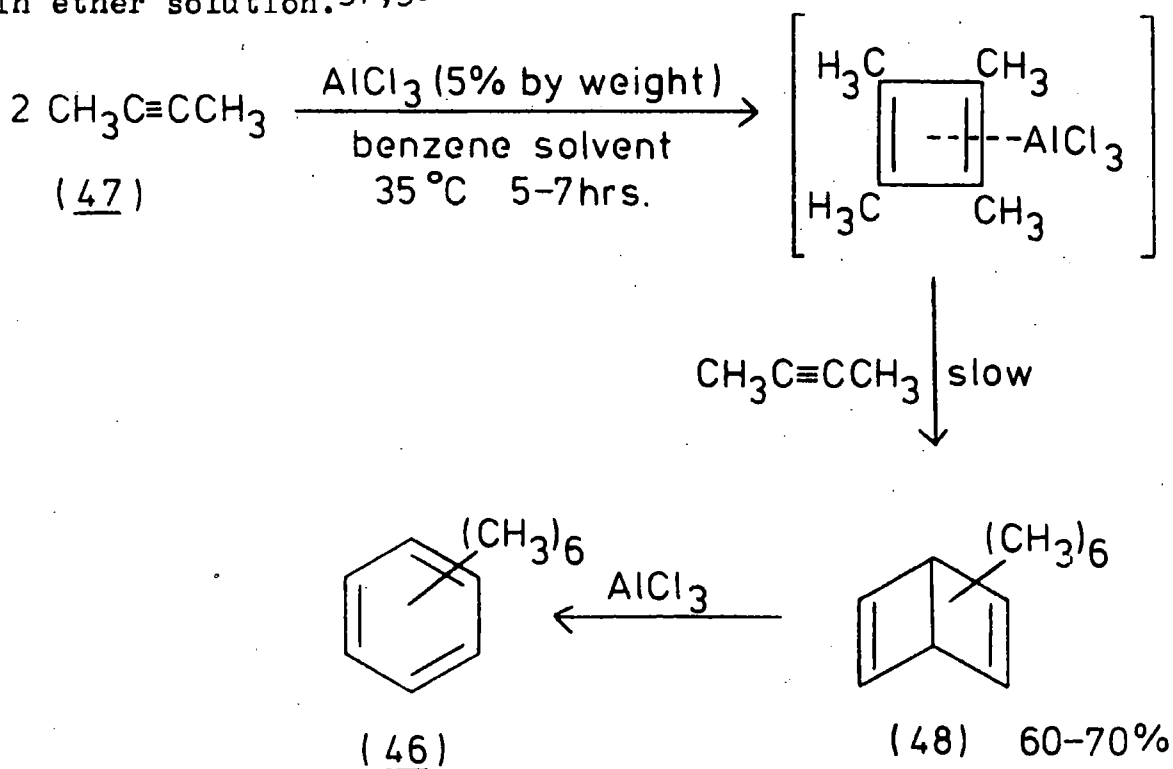

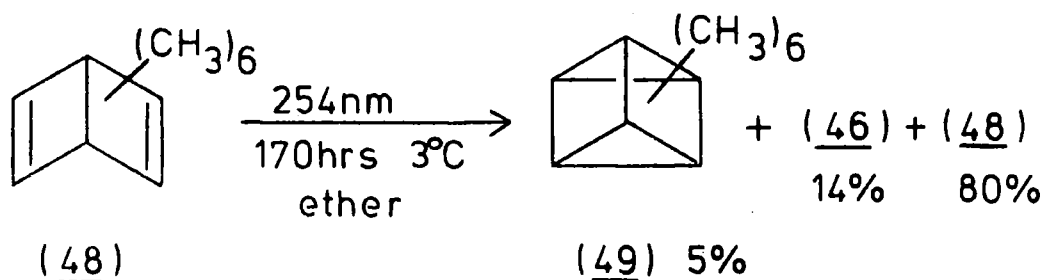

The thermal rearrangement of (49) was observed to proceed via two paths simultaneously.^{21,22,39} One path involved the Dewar benzene derivative (48) as an intermediate whereas the other path was thought to involve the intermediacy of a benzvalene derivative (50). The rate constants for the two processes were such that the concentration of (48) built up (i.e. $K_2 < K_1$) whereas the

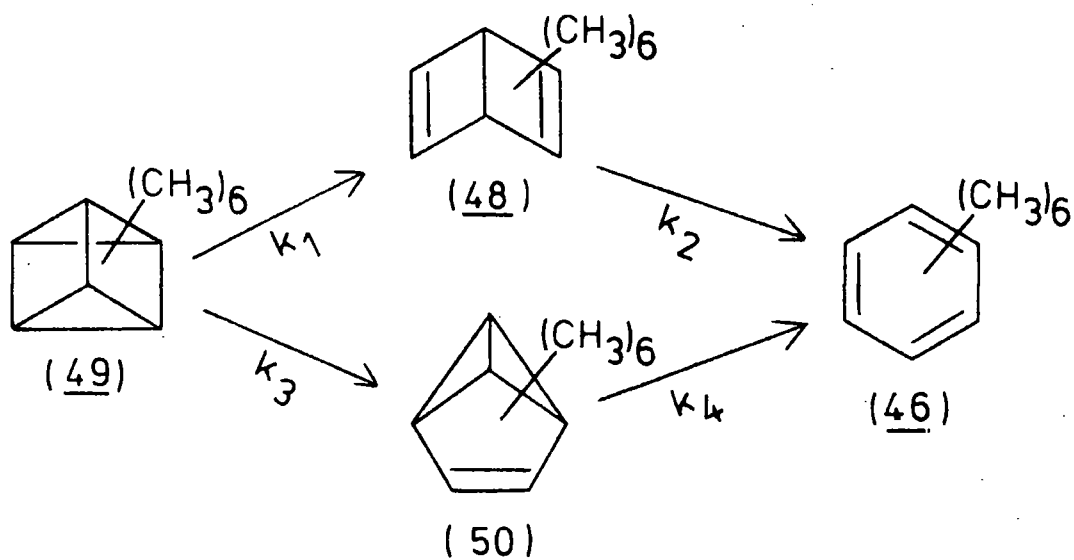

concentration of (50) remained small (i.e. $K_4 > K_3$) and never exceeded a molar fraction of 0.03. This illustrated a rearrangement of a prismane to a benzvalene. Rearrangement of (50) to (48) has also been observed.²⁰ (See Section 1.6 (v)).

1.8 Rearrangement of Heterocyclic Systems

1.8(i) Pyridines

Pyridine has been photoisomerised to 2-azabicyclo-[2.2.0]hexa-2,5-diene (51), which was shown to be an unstable species, which was characterised by reduction, using aqueous sodium borohydride, and hydrolysis.⁴⁰

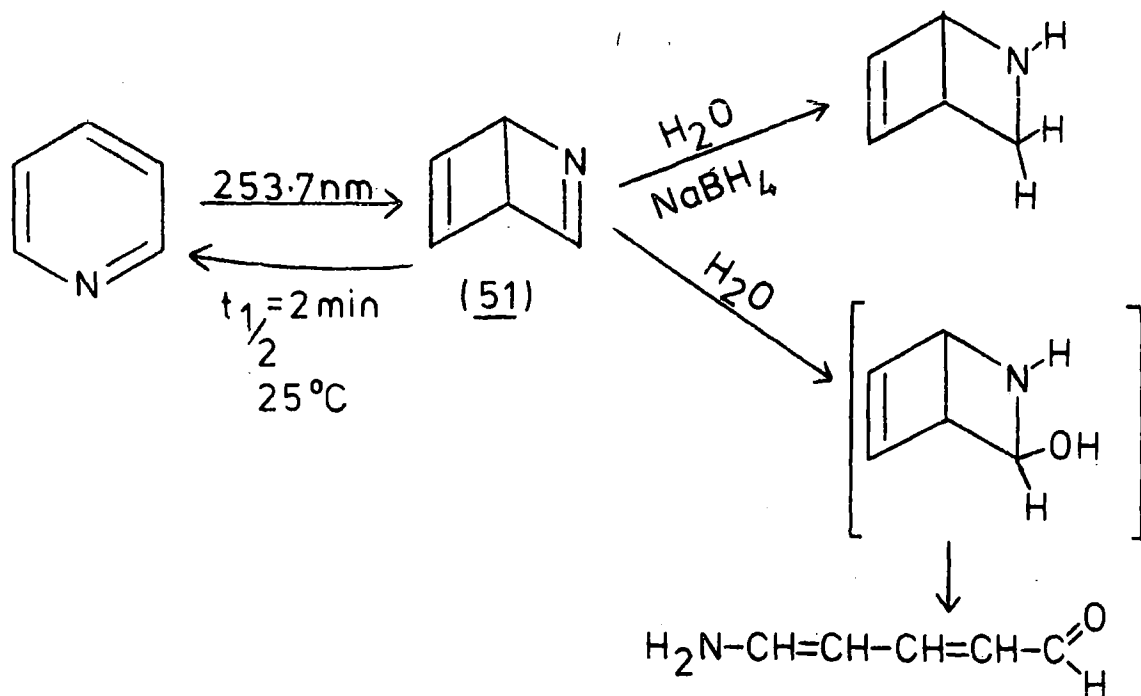

The gas and liquid phase photochemistry of 2- and 4-picoline has been studied.^{41,42} Isomerisation of 2-picoline (52) to 4-picoline (53), and vice versa, occurred with 254nm radiation, with a conversion of approximately 2%. This 1,3-shift could be accounted for by the formation of an unstable prismane intermediate. Under these conditions 3-picoline did not isomerise.

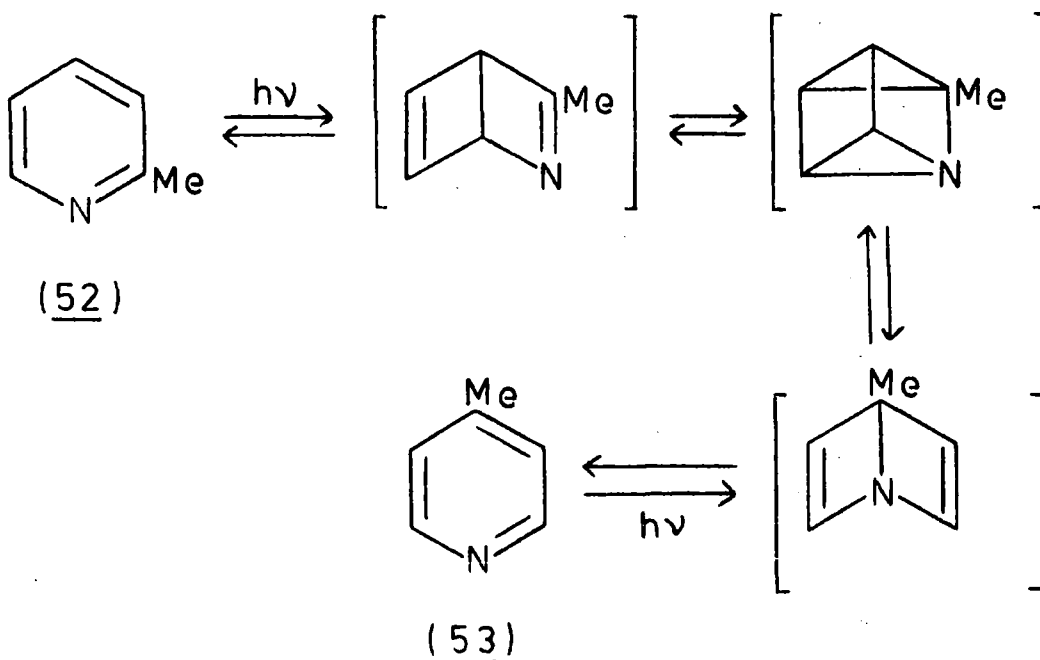

Lutidines were also shown to isomerise on irradiation in the vapour phase, using 253.7nm radiation, but once again large quantities of polymers were formed and only 1-2% conversion achieved.⁴¹ The 3,4- 2,5- and 2,3- isomers were shown to be interconvertible as were the 2,4- and 2,6- isomers, however the 3,5-lutidine could not be isomerised to any of the other isomers.

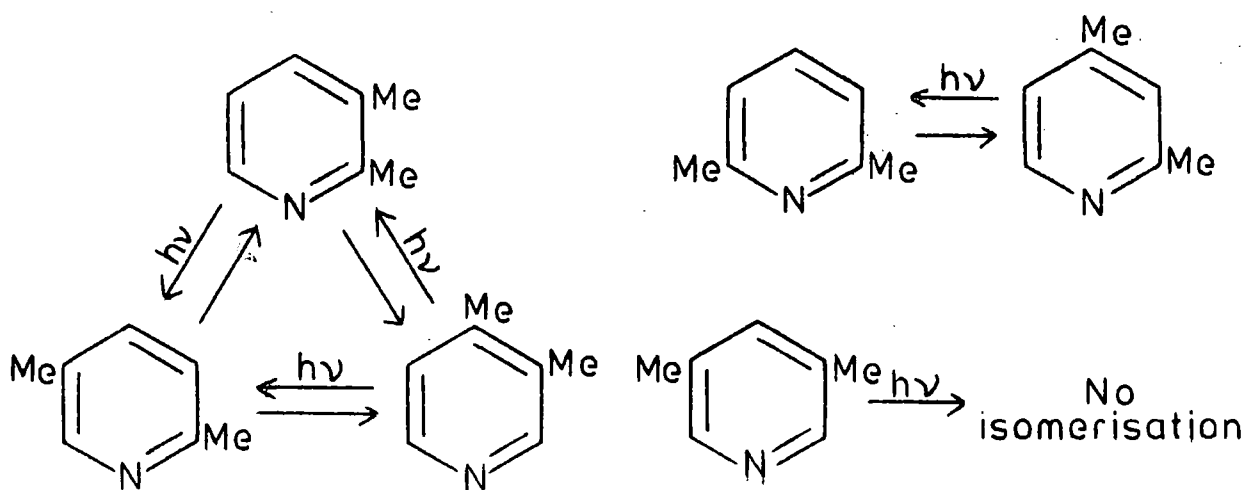

The observed rearrangements of lutidines were exclusively 1,3- shifts and a suggested mechanism involved intermediate azaprismanes. However if the rearrangement mechanism involved azaprismanes as intermediates then 1,2-shifts could occur. These are not observed.

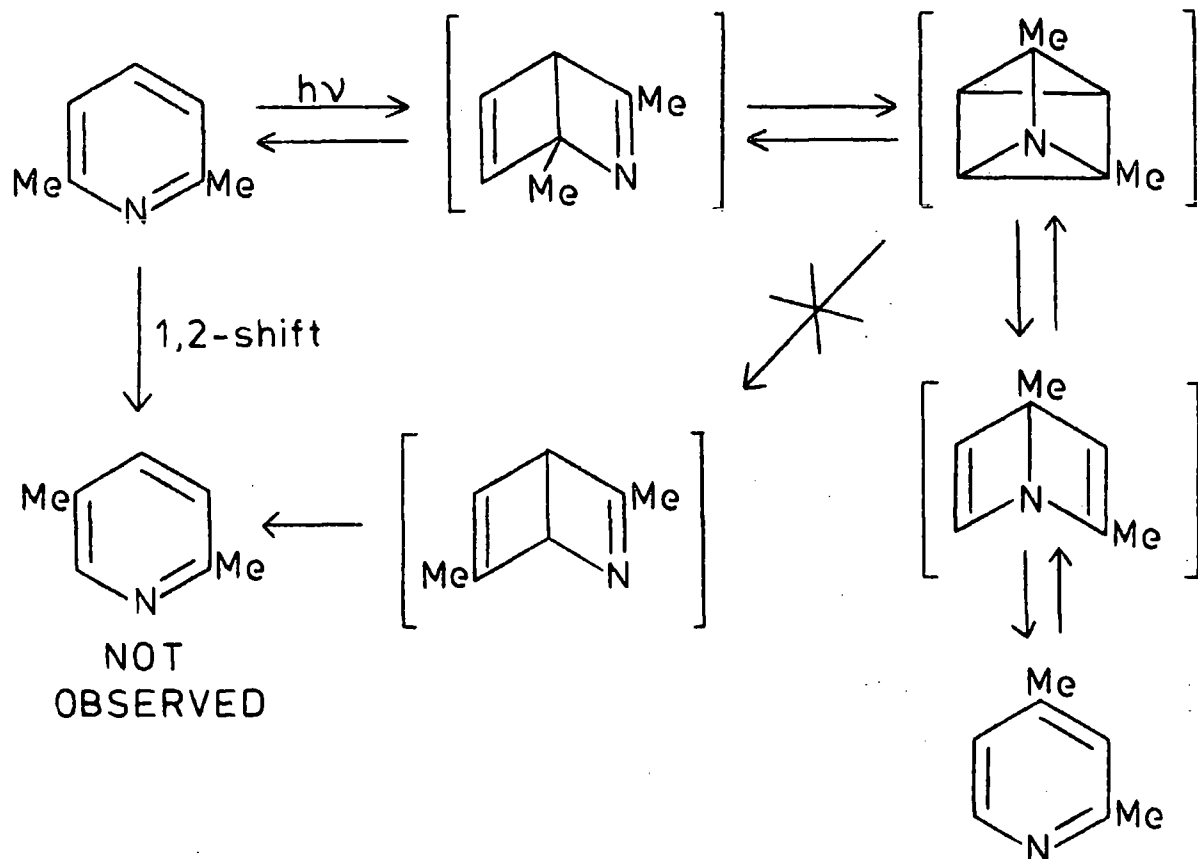

The production of para-bonded species was demonstrated to occur in these systems as the photolysis of 3,5-lutidine (54) in aqueous NaBH_4 gave a dihydro product⁴⁰ in an analogous process to that reported for irradiation of pyridine under the same conditions.

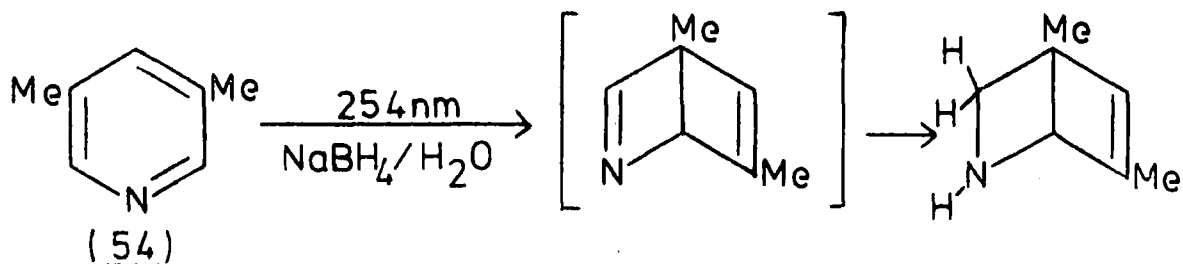

Bergen and Kellogg have reported the photolysis of a fully alkylated pyridine (55) in which skeletal rearrangement of the substituent groups was observed. (55) contained no fewer than four labelling groups (including ring nitrogen) and on photolysis three different isomers (56), (57) and (58) were obtained.⁴³

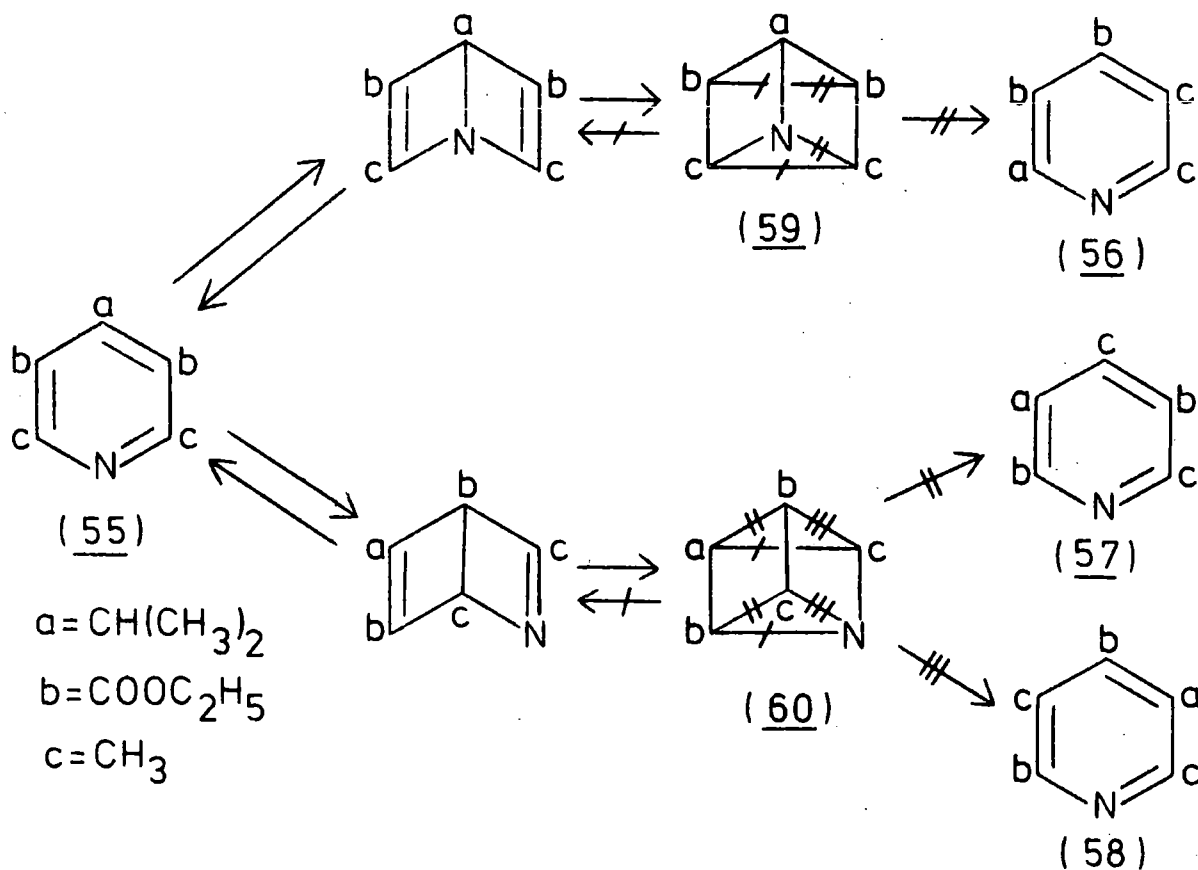

SCHEME 1

The substitution pattern, on the pyridines obtained, was such that the rearrangement was thought to proceed via intermediate azaprismane derivatives (59) and (60) and azabicyclo [2.2.0] hexa-2,5-dienes. The symmetrical azaprismane derivative (59) could lead to one new pyridine derivative (56) upon rearomatisation whereas the

unsymmetrical azaprismane derivative (60) postulated could lead to two new pyridine derivatives (57) and (58), as well as forming the starting pyridine derivative (55), in each case. Neither the azaprismane nor para-bonded intermediates were detected in this rearrangement, although the very specific labelling observed in the rearranged pyridines was adequately accounted for in terms of these intermediate valence isomers.

1.8(ii) The Photolysis of Pyridinium Ions

It has been suggested that heterocyclic analogues of benzvalene were formed as intermediates in the photolysis of pyridinium ions as irradiation, using 254nm radiation, of methylpyridinium chloride (61) in water gave 6-methylazabicyclo[3.1.0]hex-3-en-2-exo-ol (62) and the irradiation of 4-picoline methochloride (63) gave three

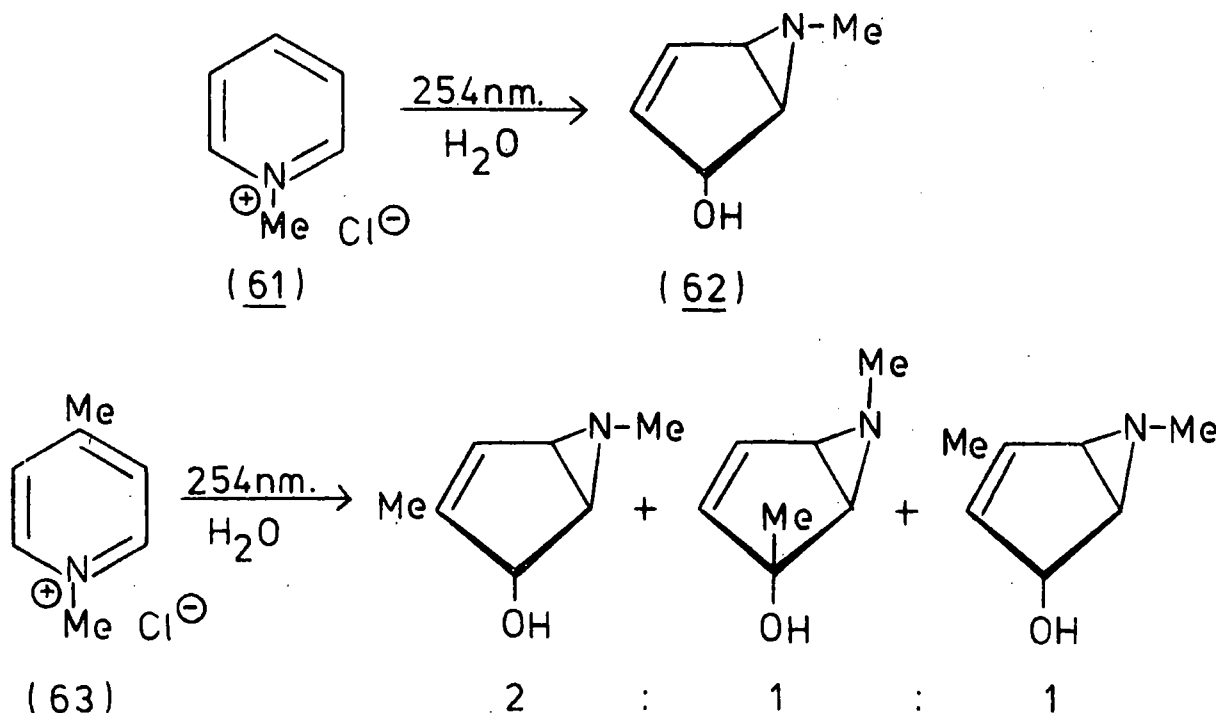

isomeric products in the ratio 2:1:1.⁴⁴ There was evidence for a 1,2-shift of nitrogen which indicated the formation of a 1-methylazoniabenzvalene (64) which could rearrange to one of two azabicyclohexenyl cations (65), (66) from which the observed products could be obtained, by hydration, in the correct ratio.

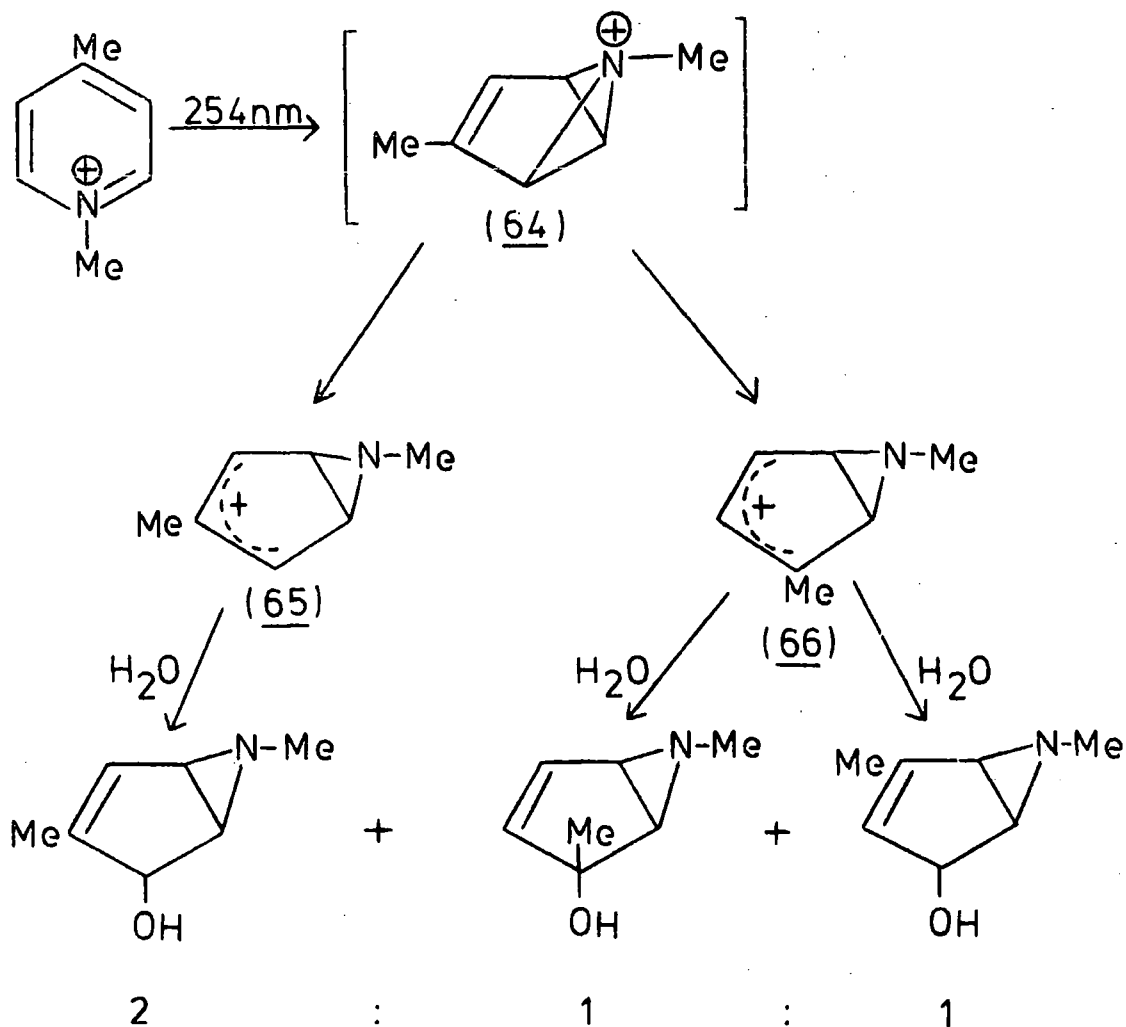

1.8(111) Photolysis of Pyrones and Pirylium Cations

Both pyrones and pyrylium cations have been demonstrated to undergo photoisomerisations. 2,6-Disubstituted 4-H-pyron-4-ones (67) on irradiation, in solution, gave head

to tail dimers (68) unless the photolysis was carried out on very dilute solutions⁴⁵, when a rearrangement to a 2-H-pyran-2-one(69) was observed^{46,47} whereas in the presence of acid, furaldehyde derivatives (70) were formed.

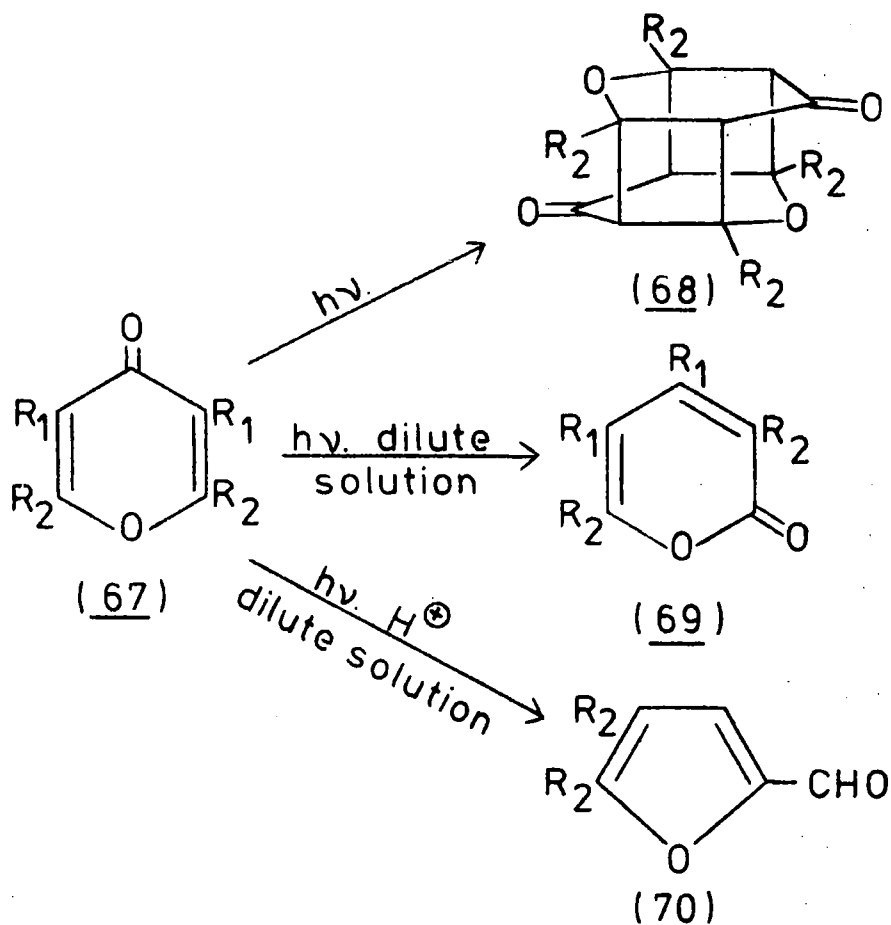

These rearrangements were shown to occur via an intermediate 4,5-epoxycyclopent-2-ene-1-one (71) which was thought to have originated by the mechanism shown (see over). Rearrangement of 4,5-epoxycyclopent-2-eneones to 2-H-pyran-2-ones, on photolysis, has been observed.^{48,49}

It has been suggested that oxygen analogues of benzvalene were present as intermediates in photoisomerisations of protonated 4-pyrone (pyrylium cations). Photolysis of the pyrylium salt 4-t-butyl-2,6-dimethylpyrylium perchlorate

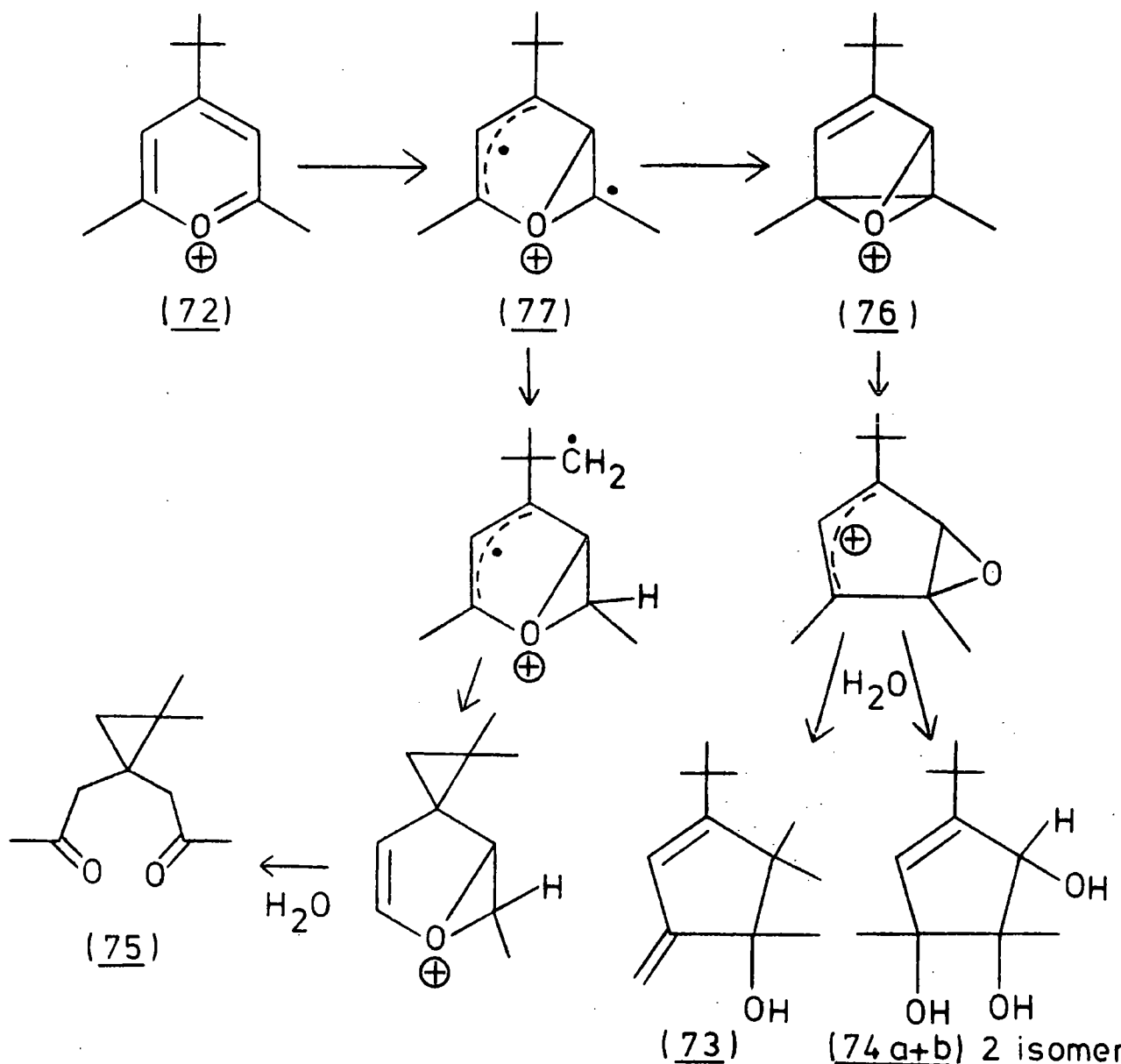

Several 4-hydroxypyrylium cations have been demonstrated to photoisomerise to 2-hydroxypyrylium cations,^{51,52,53} as illustrated below.

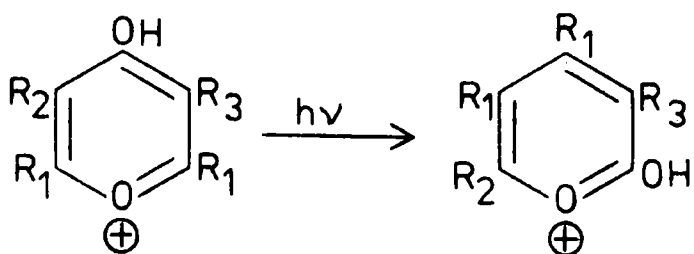

- a) $\text{R}_1 = \text{Me}$ $\text{R}_2 = \text{R}_3 = \text{Ph}$
- b) $\text{R}_1 = \text{Me}$ $\text{R}_2 = \text{Ph}$ $\text{R}_3 = \text{H}$
- c) $\text{R}_1 = \text{R}_2 = \text{R}_3 = \text{Me}$
- d) $\text{R} = \text{Me}$ $\text{R}_2 = \text{R}_3 = \text{H}$

The pyrylium cations were generated from the corresponding pyrones by dissolving the pyrone in concentrated acid; this was reversible on neutralisation. The rearrangements were believed to occur via the formation of an oxabicyclohexenyl cation (78) which rearranged via a 1,3-shift. There was also the possibility of the involvement of an oxianobenzvalene (79) as a primary photoproduct.^{51,53}

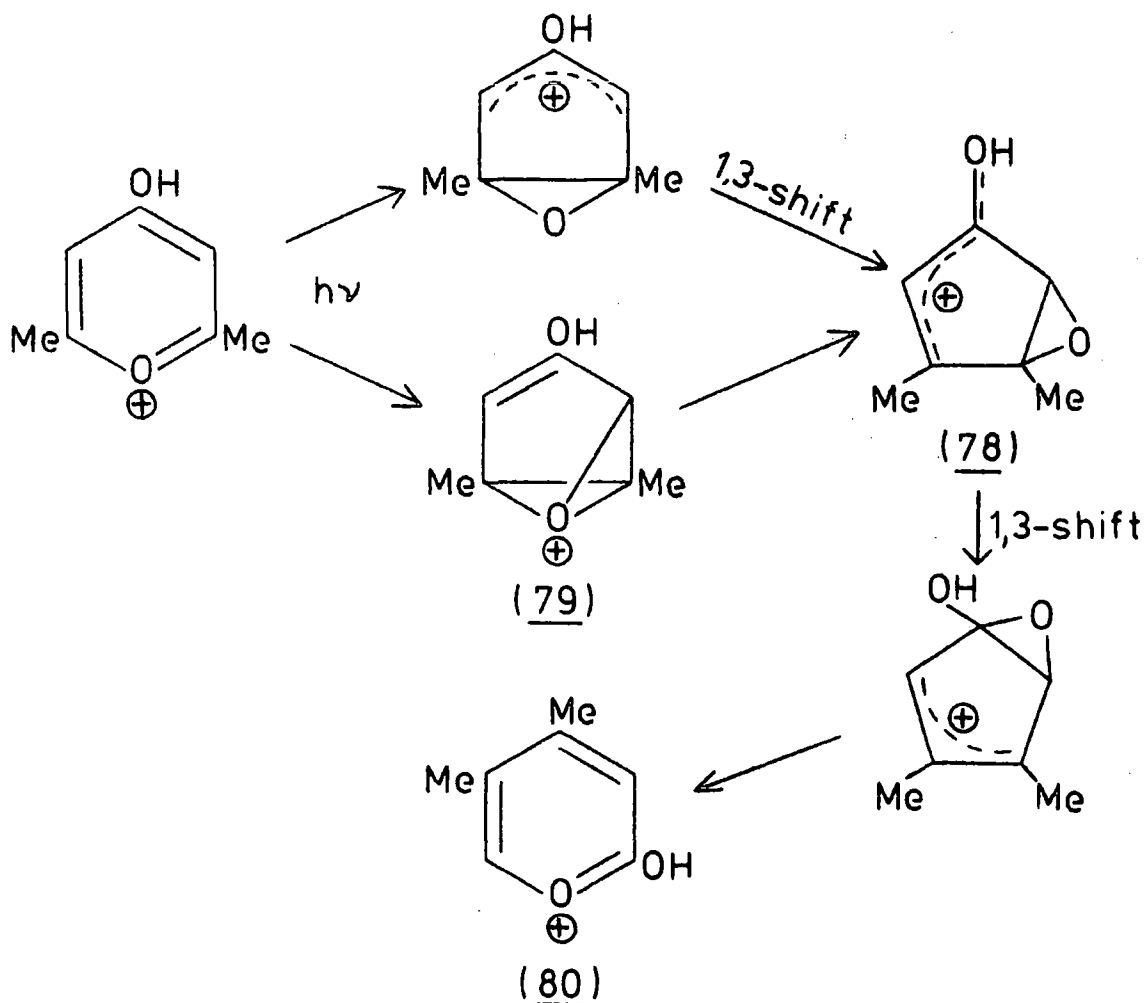

2-Hydroxypyrylium cation (80) was shown to photoisomerise, in a reversible rearrangement, to 5,6-dimethyl-2-hydroxypyrylium cation (81). The rearrangement mechanism was thought to involve the intermediacy of two bicyclo- β -lactones which were isomerised via an intermediate carboxylcyclobutenyl cation (82) as illustrated. Bicyclo- β -lactones were oxygen analogues of Dewar benzene.

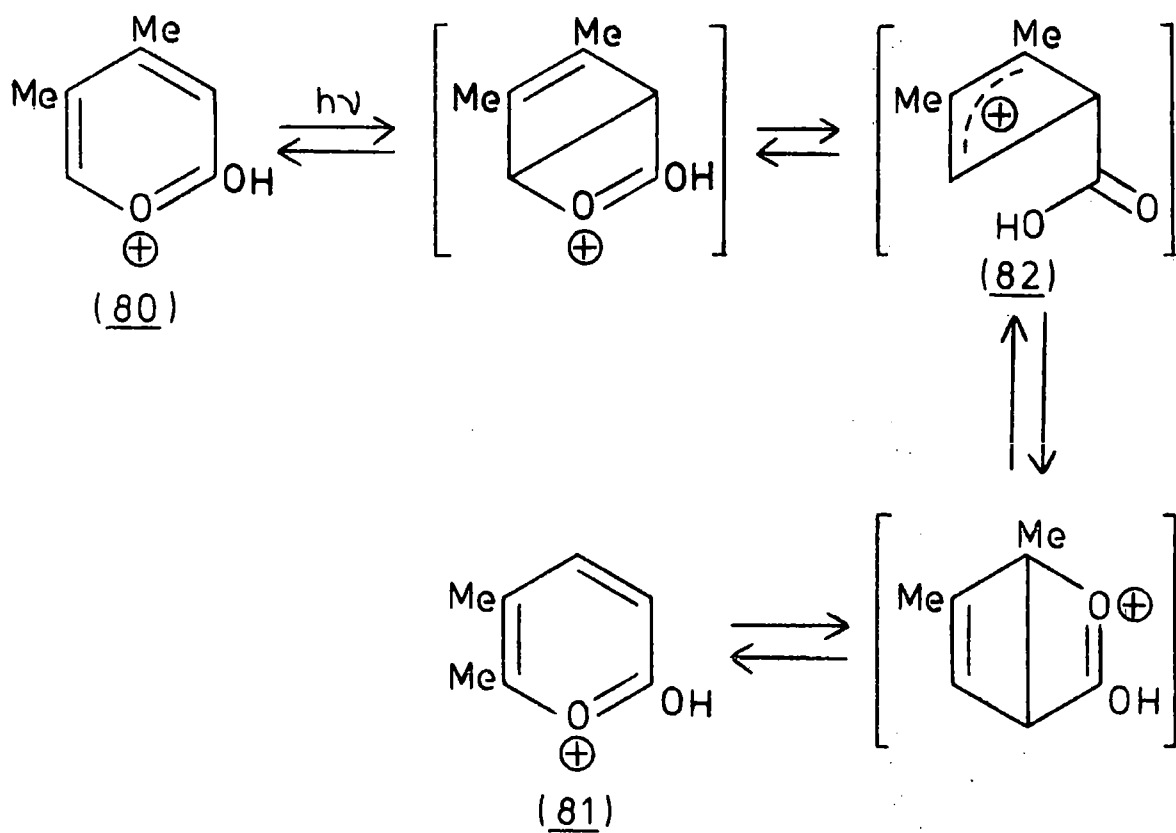

1.8(iv) Photoisomerisation of Pyrazines

Irradiation of pyrazine was carried out in the vapour phase using 254nm radiation and gave pyrimidine and under the same conditions 2-methylpyrazine isomerised to a mixture of three products, 4- and 5-methylpyrimidine with the third isomer thought to be 2-methylpyrimidine.⁵⁴

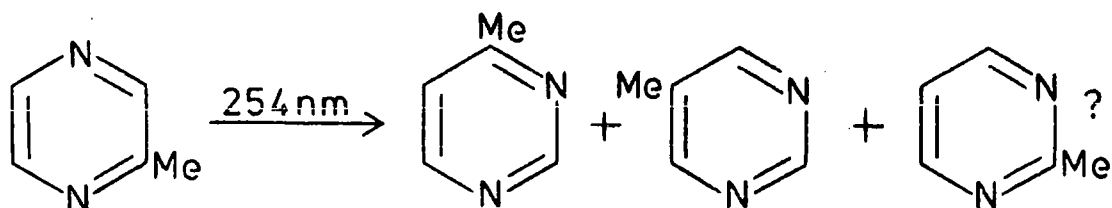

However 2-methylpyrazine was insufficiently labelled for a mechanism for this rearrangement to be suggested so photolysis of disubstituted pyrazines was carried out. Vapour phase irradiation, using 254nm radiation, of 2,5-dimethylpyrazine (83) gave 4,6- and 2,5-dimethylpyrimidine (84, 85) irradiation of 2,6-dimethylpyrazine (86) gave 4,5-dimethylpyrimidine (87)⁵⁴ as the only detectable product.

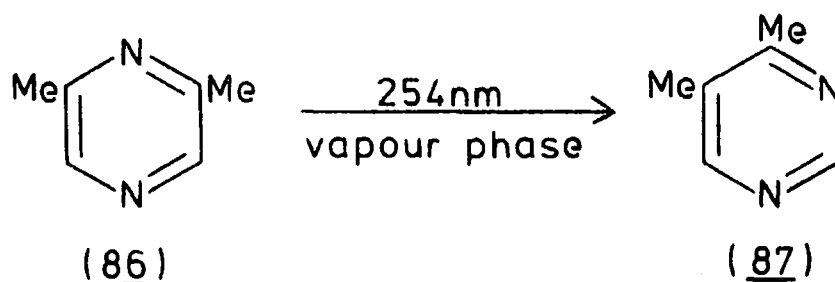

The substituent pattern in the products indicated that 1,2-shifts were involved and that the intermediates in these photoisomerisations were diazabenzvalenes and not diazaprismans. The rearrangement of 2,5-dimethylpyrazine

(83) via prismane intermediates would result in the formation of 2,4-dimethylpyrimidine (88) and 4,5-dimethyl pyrimidine (89). These pyrimidines were not the ones observed.

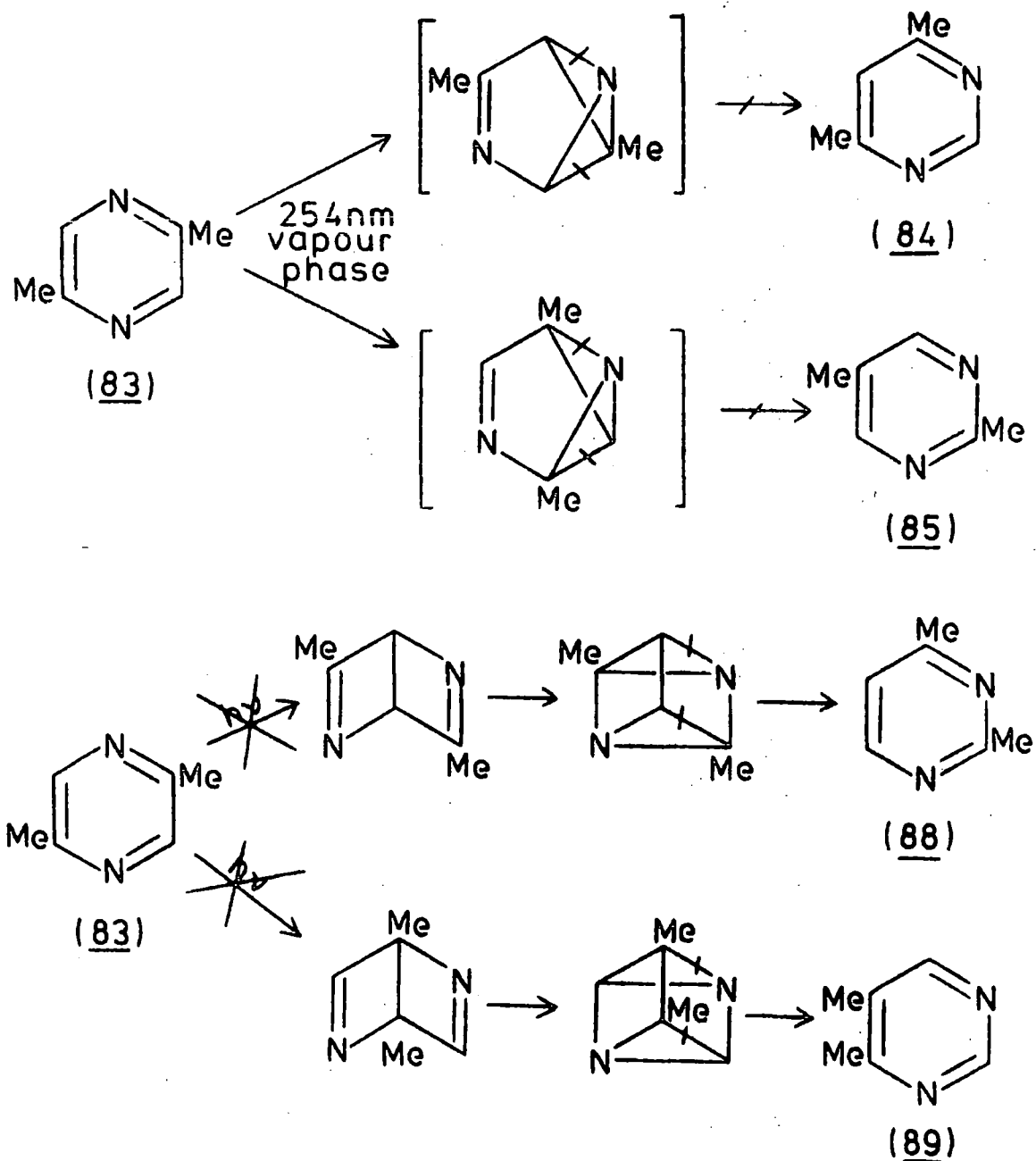

The intermediates in these rearrangements were not detected.

1.9 Fluorinated Systems

In general the introduction of fluorine or per-fluoroalkyl groups into an aromatic system has the effect of making its valence isomers more stable.

1.9(1) Fluorinated Benzenes

The irradiation of 1,2,4-trifluorobenzene using 253.7nm radiation, in the vapour phase has been shown to yield only two of the three possible para-bonded species.⁵⁵

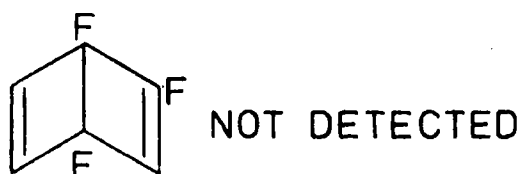
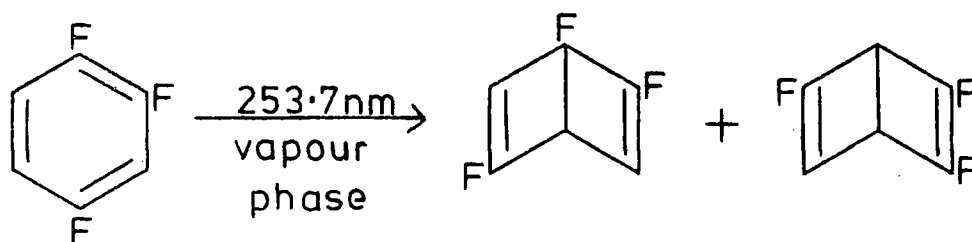

(90)

Nevertheless isomer (90) has been made from hexafluoro-bicyclo[2.2.0]hexa-2,5-diene and shown to be moderately stable.⁵³ Also the irradiation of pentafluorobenzene (91) gave a para-bonded species in 3% yield.⁵⁶

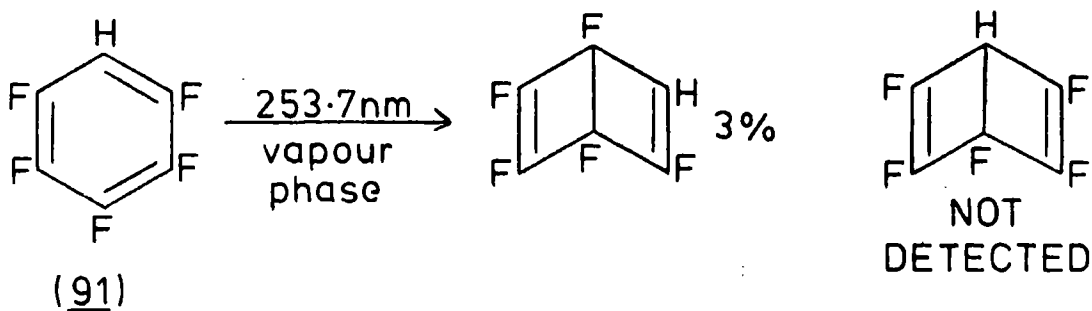

In contrast to the photolysis of benzene, which yielded Dewar benzene, benzvalene and fulvene^{3,5,9}, the irradiation of hexafluorobenzene gave only the para-bonded isomer.^{56,57,58} There were no benzvalenes, fulvenes or prismanes detected in these examples.

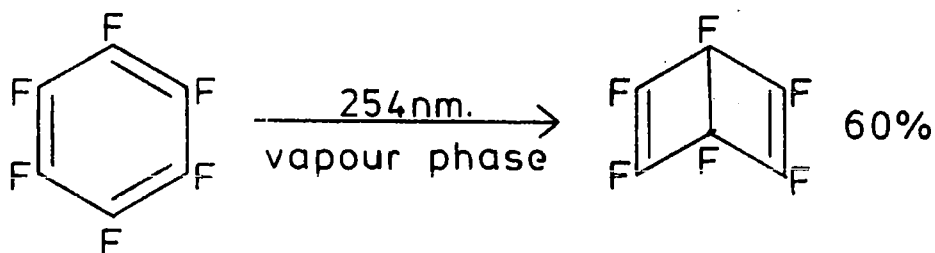

1.9(ii) Valence Isomers From Perfluoroalkylated Benzenes

The photolysis of octafluorotoluene (92) gave two para-bonded isomers in the ratio 2:1.

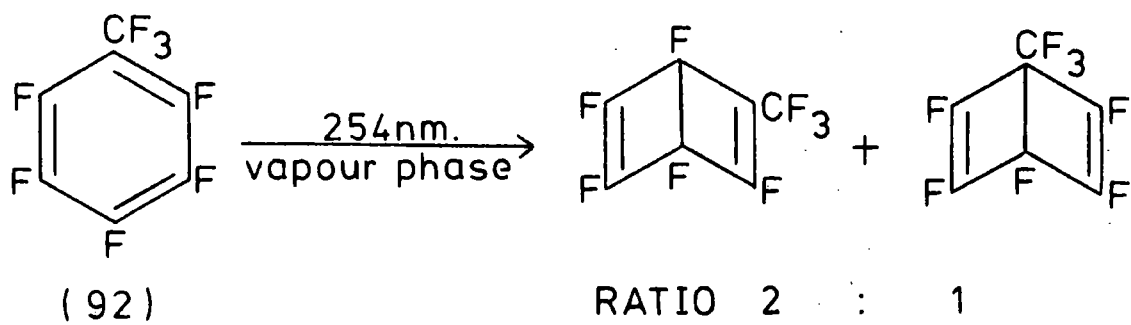

Irradiation of hexakis(trifluoromethyl)benzene (93) in solution, using a medium-pressure mercury lamp ($\lambda > 200\text{nm}$) gave three valence isomers^{59,60}, a prismane (94), a benzvalene (95), and a para-bonded isomer (96) which were the same products that could be obtained by photolysis of (93) in the vapour phase at 254nm,⁶¹ whereas irradiation ($\lambda > 270\text{nm}$) in solution gave only the benzvalene (95). Irradiation ($\lambda > 200\text{nm}$) of the individual isomers, in

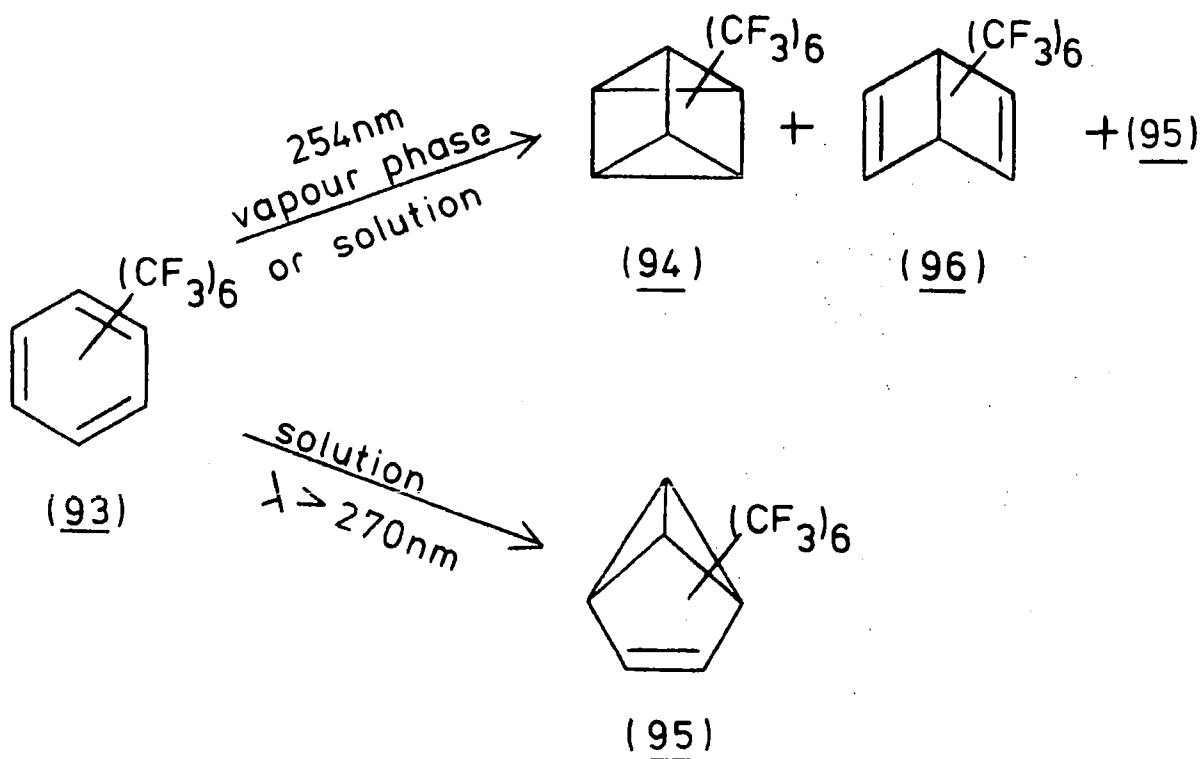

solution, was carried out and showed that benzvalene (95) was converted to (93), and the para-bonded isomer (96) gave both prismane derivative (94) and (93). The photostationary state, in solution ($\lambda > 200 \text{ nm}$), approached 100% prismane (94) whereas initially the benzvalene (95) and para-bonded isomer (96) were produced in a ratio of ca 5:1. The yield of (95) and (96) reached a maximum after 7 hours and 40 hours respectively.⁵⁷

Similarly the irradiation of hexakis(pentafluoroethyl)-benzene (97) has been reported to yield a prismane (98), a para-bonded isomer (99) but no benzvalene derivative,^{59,60} at wavelengths greater than 200 nm, whereas when $\lambda > 270 \text{ nm}$ then only the para-bonded isomer (99) was obtained.

The thermal stabilities of all these valence isomers has been determined and found to range from half lives of

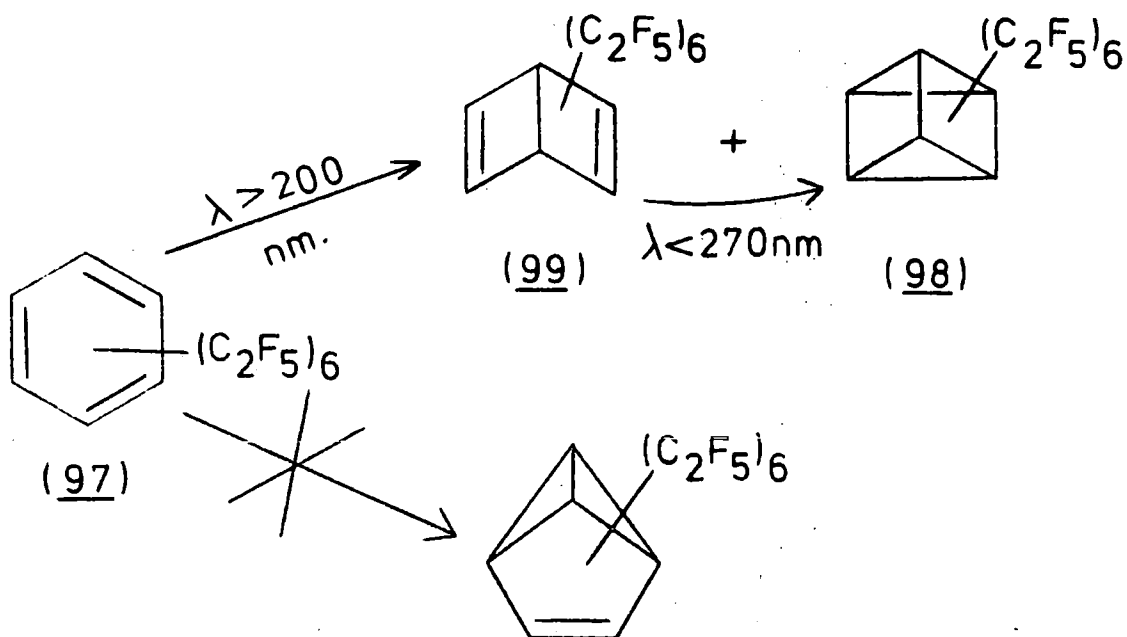

9 hours for benzvalene (95) to 135 hours for para-bonded isomer (96) at 170°C so this indicated that these valence isomers were very stable species. The thermal stabilities were found to be in the order (96) > (94) > (98) > (99) > (95).⁵⁷ The factors which affect valence isomer stabilities are discussed later.

Production of valence isomers thermally has been achieved from both hexakis(pentafluoroethyl)benzene⁶² and the lesser crowded perfluoro-1,2,3,5-tetraethyl-4,6-dimethylbenzene (100)⁶³ in a flow system at temperatures of 400°C and 550°C respectively. The intermediate

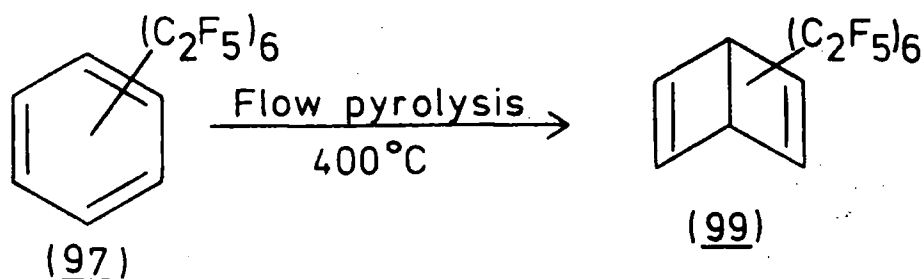

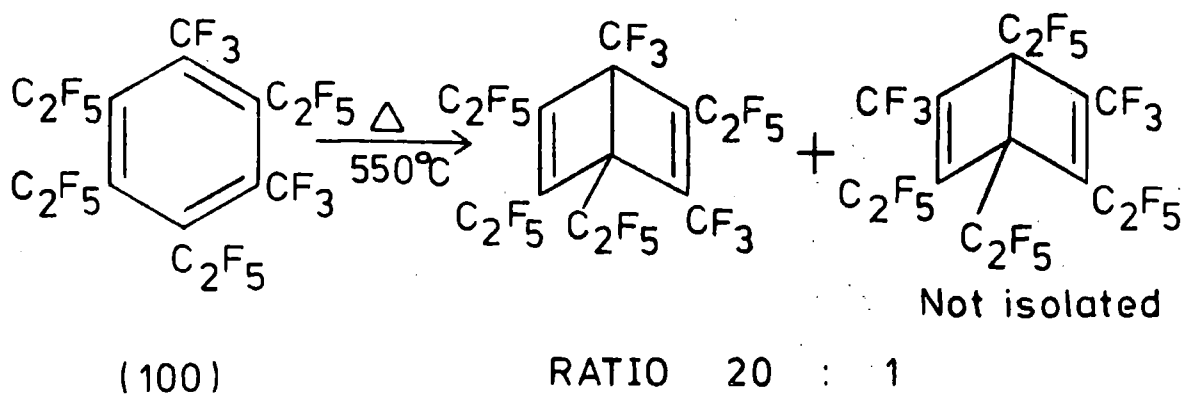

in this rearrangement has been suggested to be a non-planar para-diradical⁹, which on rapid quenching would form the para-bonded species obtained.

1.9(iii) Rearrangements in Fluorinated Benzenes

Perfluoro -1,3,5-trimethylbenzene (101) and perfluoro -1,2,4-trimethylbenzene (102) have been shown to be interconvertible on irradiation ($\lambda > 230\text{nm}$) in the presence of argon in the vapour phase. The mechanism for this rearrangement has been shown unambiguously to involve two para-bonded isomers and a prismane derivative as intermediates, since the para-bonded isomers were isolated and the prismane detected, but found to be too unstable to purify.⁶⁴ Photolysis of (102) however only yielded one para-bonded species directly i.e. none of isomer (103) was detected.

Photolysis of perfluoro-p-xylene (104) was originally reported to yield a mixture containing two para-bonded

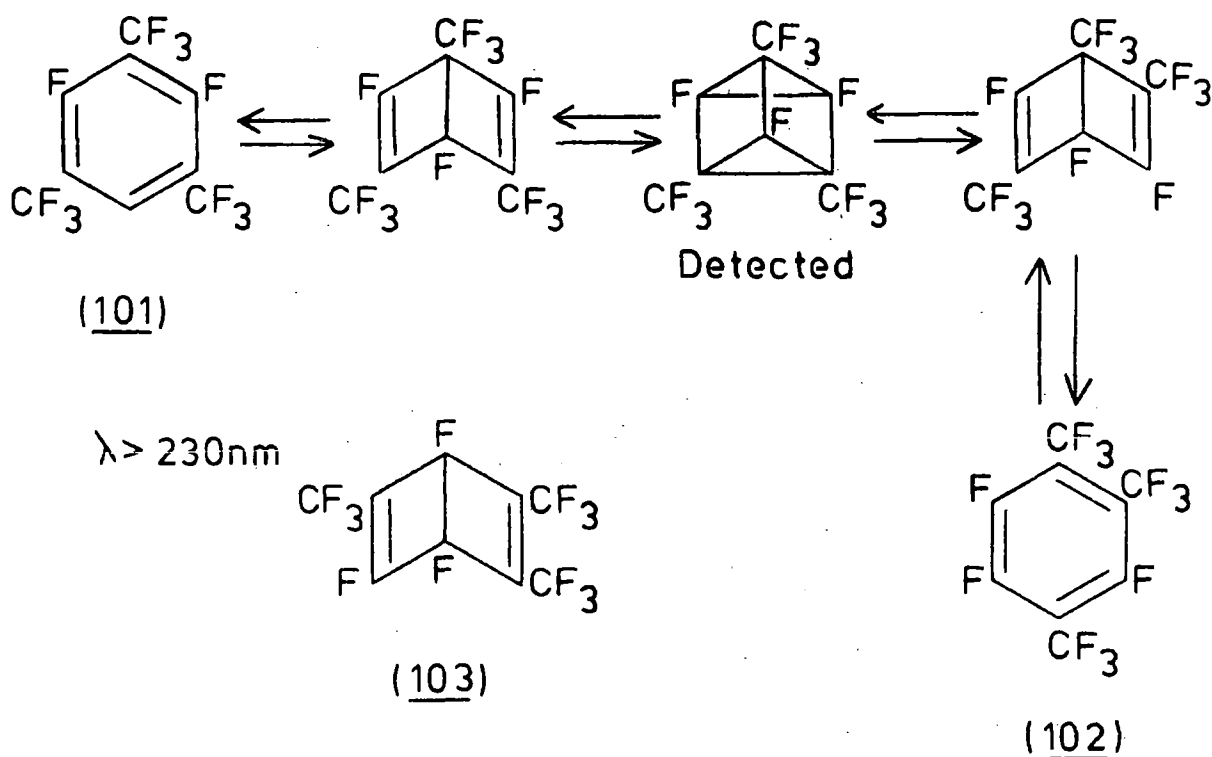

species (105) and (106) which were characterised by infra-red, mass spectrometry, thermal isomerisation and in the

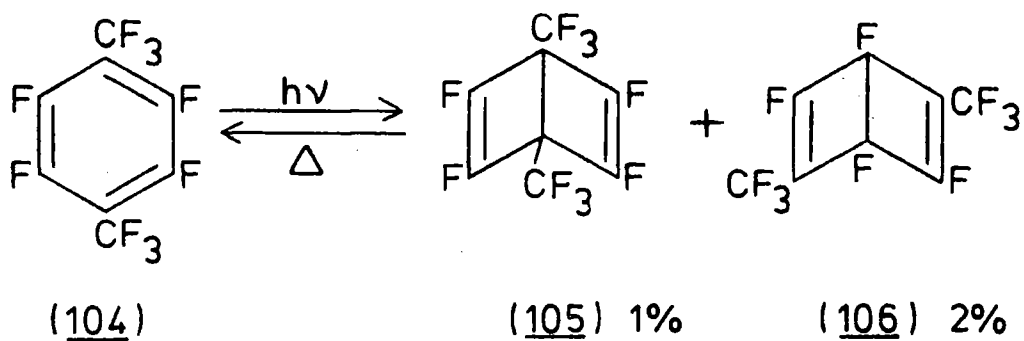

case of (106) also by its ^{19}F NMR spectrum.⁶⁵ However later workers in this field cast doubts on these assignments, as these results were inconsistent with their own findings.⁶⁶ All three perfluoroxylenes (104), (107) and (108) have now been irradiated and each of these gave a complex mixture of products.

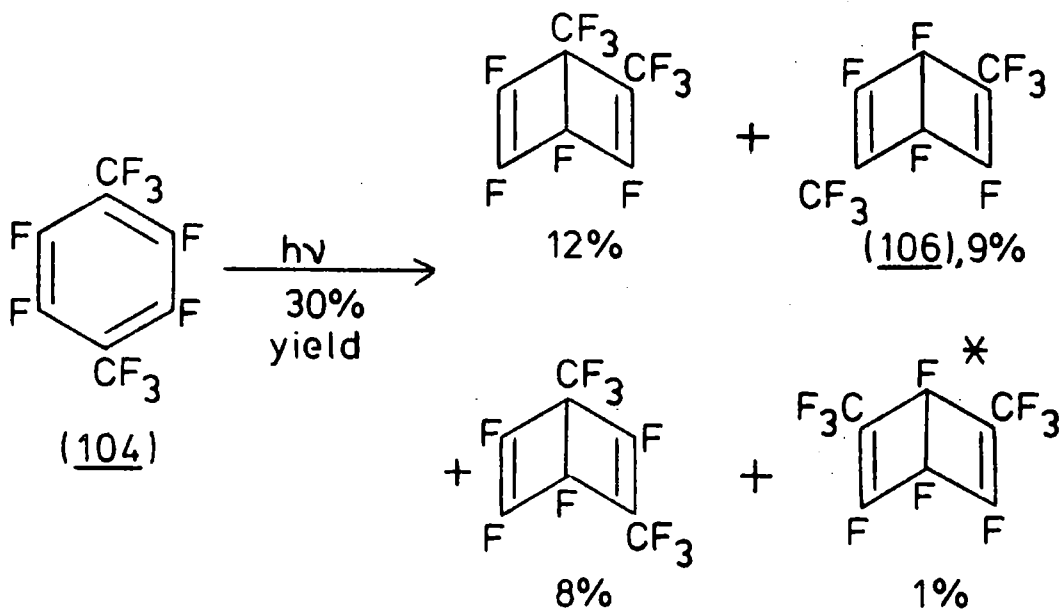
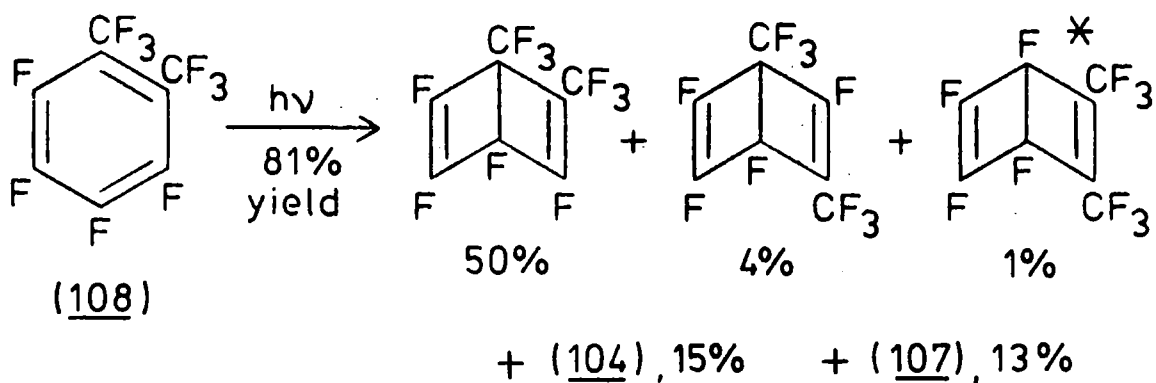
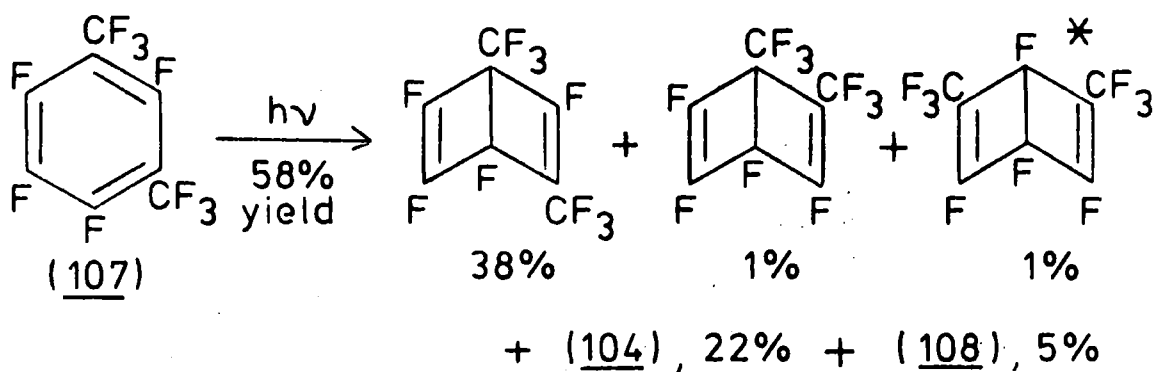

* Tentative identification

REF: 66

Irradiation ($\lambda > 230\text{nm}$) of the xylenes was carried out in the vapour phase, in the presence of argon, and the ortho and meta isomers were shown to photoisomerise to mixtures containing all three xylenes, whereas para-xylene (104) only gave para-bonded species on photolysis. The rearrangement of the xylenes was thought to occur via prismane intermediates, and the para-bonded isomers were also thought to be involved in the rearrangements, which could be rationalised into a scheme⁶⁶ (See Fig. 4). There was no evidence for the formation of benzvalene intermediates.

1.9(iv) Pyridines

The photochemistry of a series of pentafluoroethyl substituted pyridines has been investigated⁶⁷ and these have yielded some remarkably stable azaprismane and para-bonded derivatives. Irradiation ($\lambda > 200\text{nm}$) of pentakis(pentafluoroethyl)pyridine (109) in solution gave a mixture of pentakis(pentafluoroethyl)-1-azaprismane (110) and pentakis(pentafluoroethyl)-1-azabicyclo[2.2.0]hexa-2,5-diene (111), whereas when light of $\lambda > 270\text{nm}$ was used only (111) was formed.

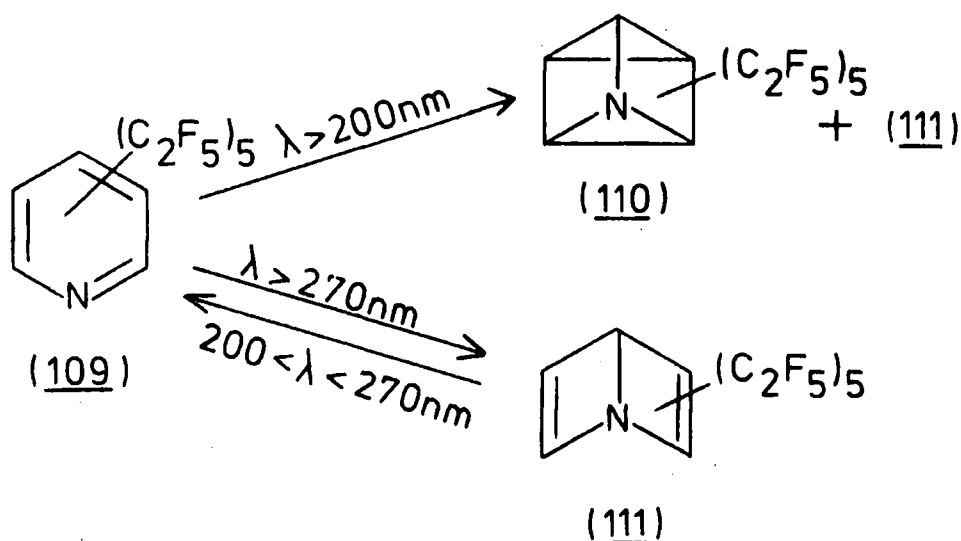

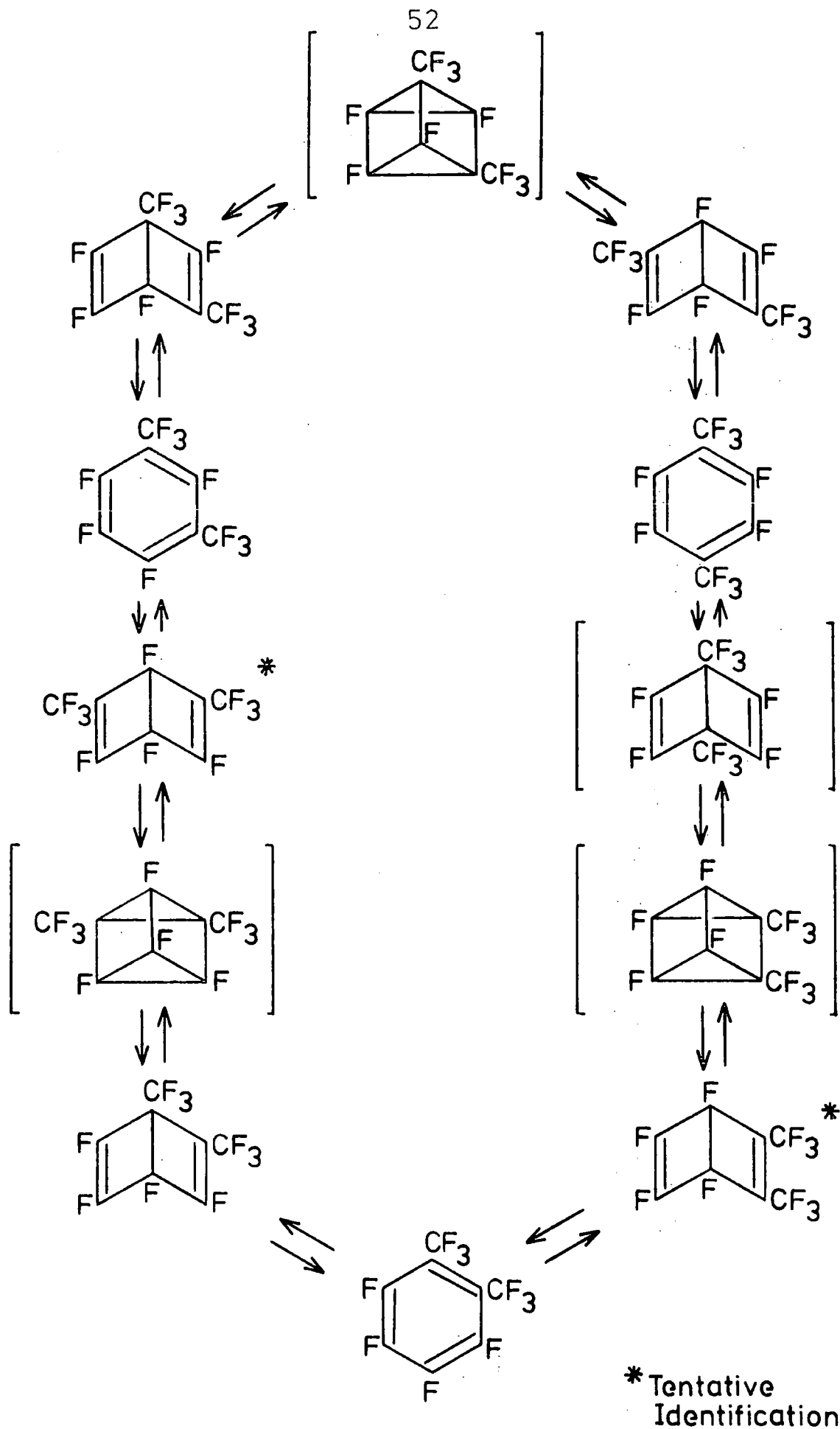
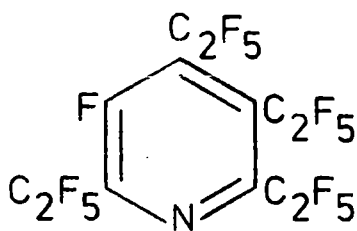

FIG 4. Vapour Phase Irradiation of the Perfluoroxylenes.⁶⁶

Although valence isomers could be isolated from this system there was no opportunity for skeletal rearrangements to be detected as (109) was insufficiently labelled.

Neither azaprismanes nor azabicyclo [2.2.0] hexadiene derivatives were obtained from the photolysis of perfluorotetra- or perfluorotriethyl pyridines (112) or (113).⁶⁷



(112)

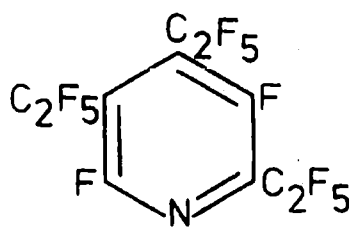

(113)

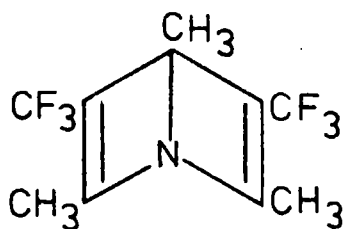

(114)

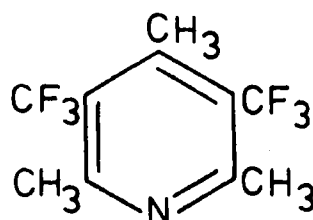

(115)

A 1-azabicyclo [2.2.0] hexa-2,5-diene derivative (114) was reported to be a stable species,⁶⁸ obtained by photolysis of pyridine derivative (115), which contained a similar substitution pattern to that in Scheme 1 (page 35) with $a = c = \text{CH}_3$ and $b = \text{CF}_3$.

1.9(v) Rearrangement of Fluorinated Pyridazines

Several perfluoroalkyl pyridazines have been reported to undergo photoisomerisation to pyrazines.^{69,70,71}

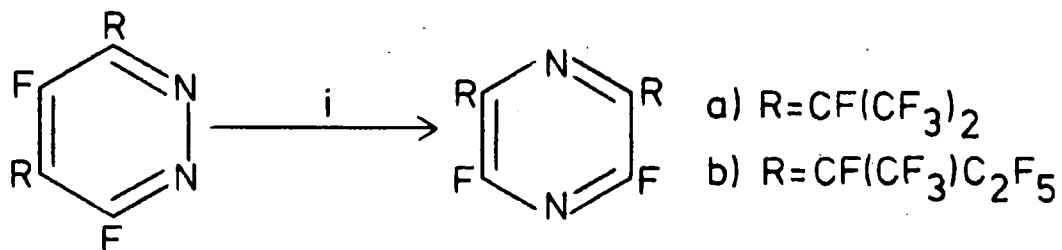
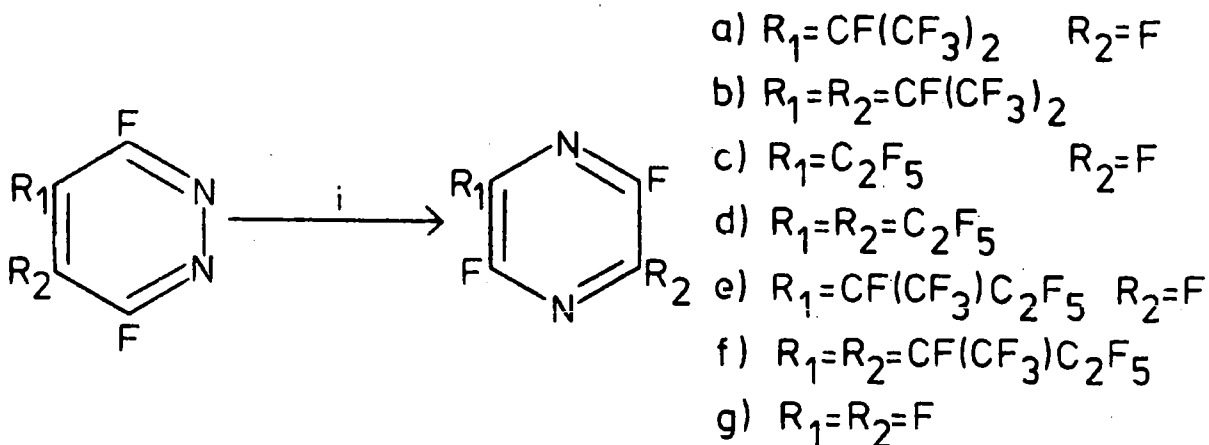

$i = 254$ or 300nm : vapour phase

The mechanism for these rearrangements was shown to involve intermediate 1,2-diazabicyclo[2.2.0]hexa-2,5-dienes (116) and 2,5-diazabicyclo[2.2.0]hexa-2,5-dienes (117),⁷² as examples of both types of para-bonded isomers were detected, and isolated, and rearrangement of para-bonded species (114) to (115) demonstrated to occur, both photochemically and thermally. Examples of valence isomer (116) were

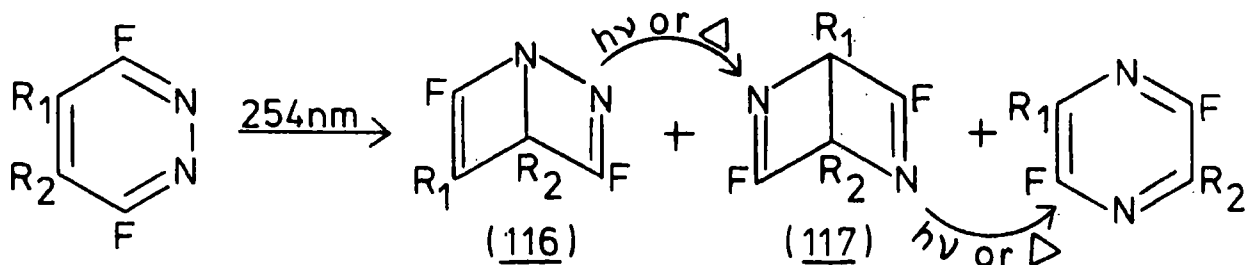

only isolated where $R_1 = R_2 = \text{CF}(\text{CF}_3)_2$ and $R_1 = R_2 = \text{CF}(\text{CF}_3)\text{C}_2\text{F}_5$. This type of rearrangement involved specific 1,3-shifts, and the driving force behind rearrangement of para-bonded species (116) to (117) was thought to be the removal of a weak N-N bond.

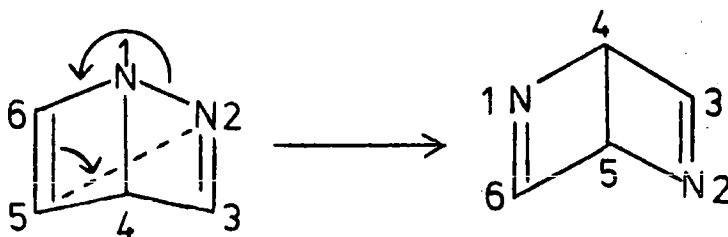

Thermal rearrangement of perfluoroalkylpyridazines to pyrimidines has been demonstrated.^{70,73,74} These rearrangements were thought to proceed via diazabenzvalene intermediates, even though no intermediates were isolated, or detected. In certain cases pyrazines were also formed and in this case also, diazabenzvalene intermediates were thought to be involved (see over). However these rearrangements only occurred in specific examples whereas with some other pyridazines, nitrogen elimination has been demonstrated.⁷⁵

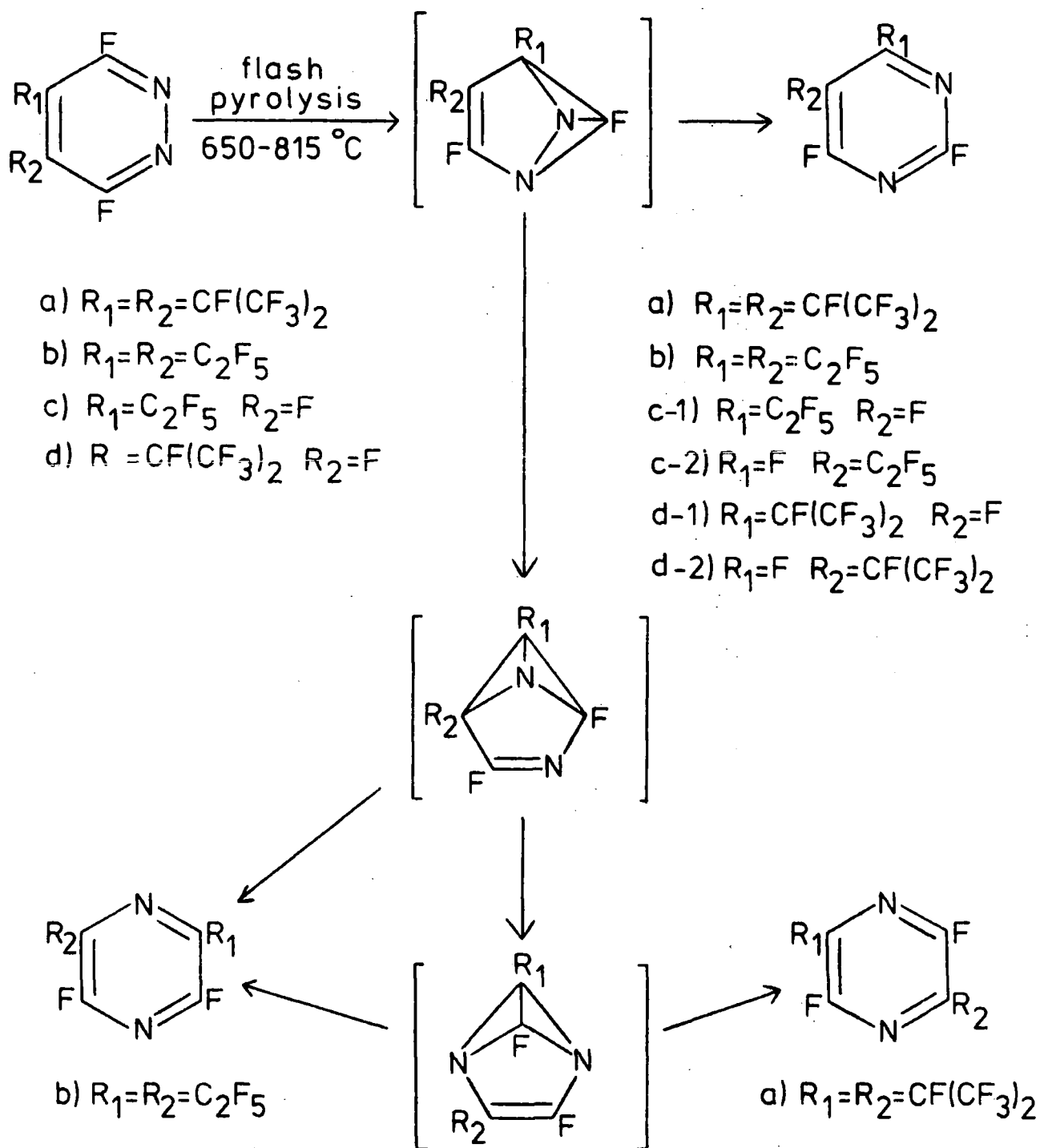

1.9(vi) Photoisomerisation of Fluorinated Pyrazines

Irradiation of perfluoro-2,5-di-isopropylpyrazine (118) in solution, using 254nm radiation, gave small quantities of a second pyrazine (119) and a pyrimidine (120).⁷¹ The pyrazine (119) was also shown to rearrange

back to (118) under the same conditions. The rearrangements were thought to involve the intermediacy of diazabenzvalenes, which could rearrange to give the observed products, although no diazabenzvalenes were detected or isolated.

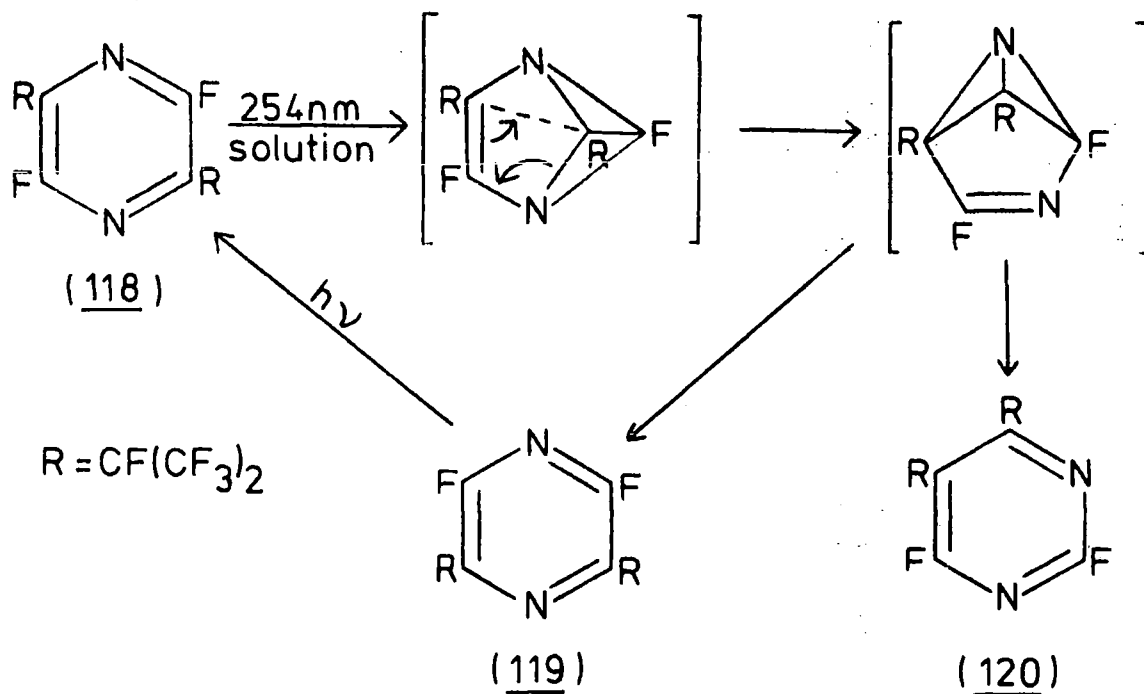

1.10 Bicyclopropenyls

Bicyclopropenyls are another type of valence isomer of benzene, but unlike the other valence isomers, there have been no reported examples of formation of them from a benzene, by either thermal or photochemical means. Bicyclopropenyls are the thermodynamically least stable of the benzene valence isomers⁷⁶ and can be rearranged to other valence isomers, both on photolysis and pyrolysis e.g. perfluorohexamethylbicyclopropenyl (121) on gas phase photolysis, using the full mercury arc, gave a mixture of four other

isomers,⁷⁶ however the exact order in which they were formed was not determined. Isomer (121) was shown to be

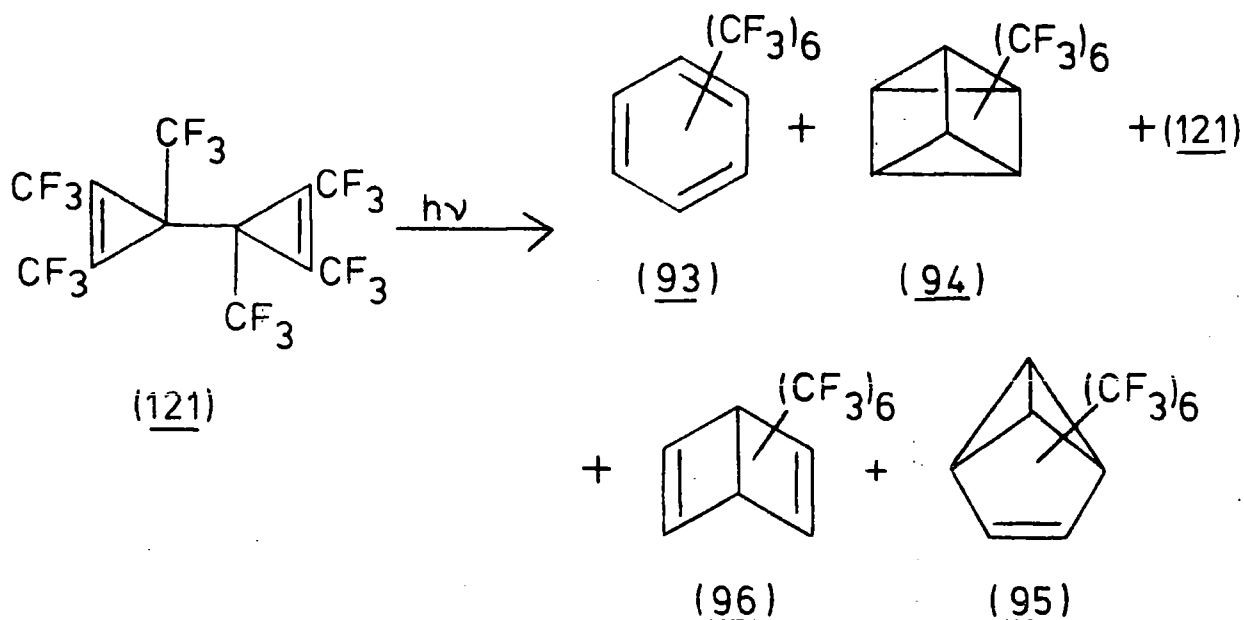

the most kinetically stable of this series of isomers, with a half-life greater than 2 hrs. at 360°C .

The mechanism for the thermal rearrangement of bicyclopropenyls was initially thought to involve prismane intermediates, since tetrasubstituted bicyclopropenyl (122) gave two benzenes, on heating, which could be formed from a prismane intermediate (123).⁷⁷ (See over)

However the same proportion of products were obtained when the reaction was Ag^{I} catalysed, and it had been demonstrated that these reactions only involved para-bonded intermediates.⁷⁸ Rearrangement of pentasubstituted bicyclopropenyl (124), in boiling CH_2Cl_2 , gave a mixture of two benzenes and one para-bonded species (125), which was shown to rearrange to benzene derivative (126), on

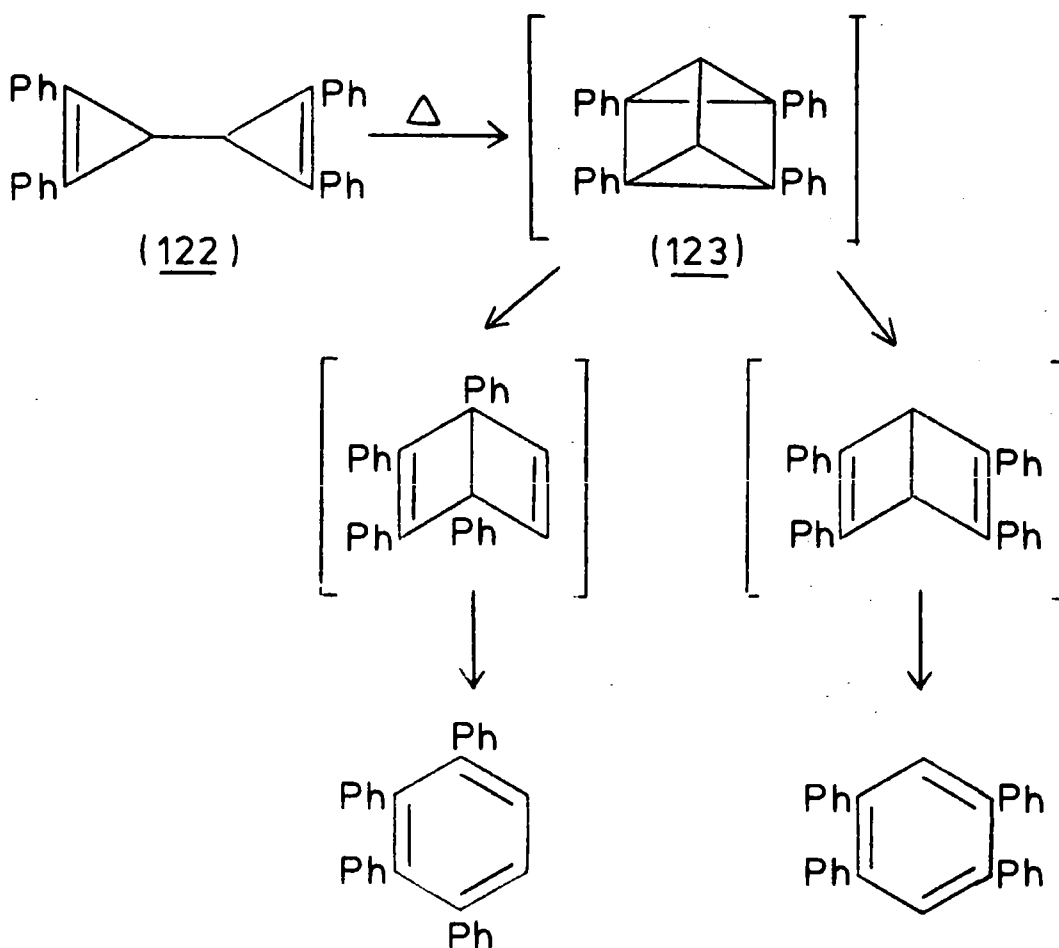

heating, so the identification of (125) indicated that thermal rearomatisation of bicyclopropenyls proceeded via

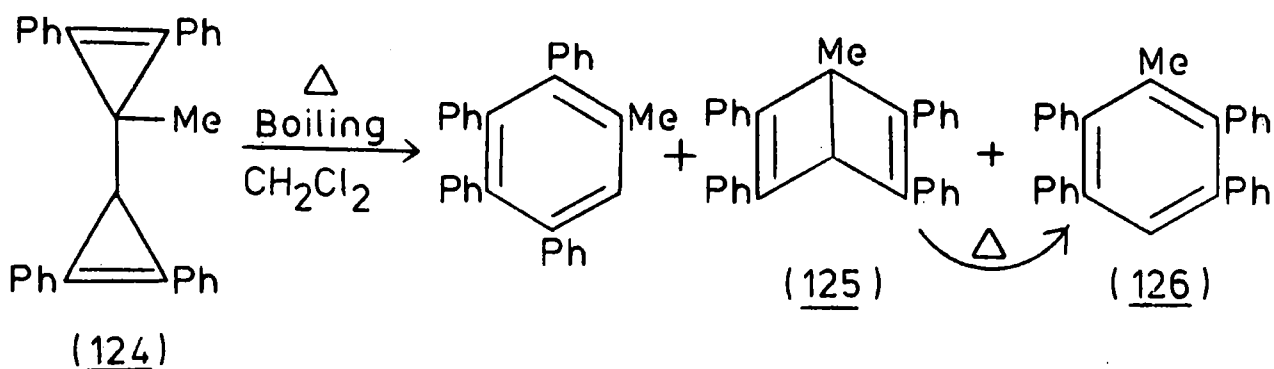

Dewar benzene intermediates. Other workers have detected intermediate Dewar benzenes, in this rearrangement, by the use of chemiluminescence.⁷⁹ It was found that of the isomers benzvalene, prismane, and Dewar benzene only Dewar benzene was capable of giving indirect chemiluminescence. The chemiluminescence detected from thermal rearomatisation of (127) was consistent with formation of an intermediate Dewar benzene derivative.

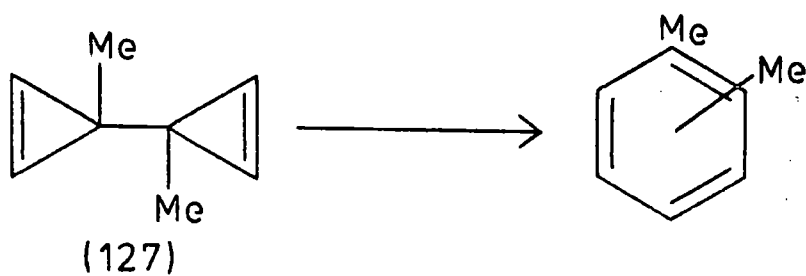

It has been suggested that the rearrangement mechanism involved ring opening, to give diradicals, followed by ring expansion and then ring closure to give the Dewar benzene intermediates which themselves ring open to give the benzene derivative.⁸⁰ (See over)

Formation of Dewar benzene derivatives from bicyclopropenyls has been demonstrated to be Ag^{I} catalysed. Both (129) and (130) have been identified as products from the Ag^{I} catalysed rearrangement of (128).⁸¹

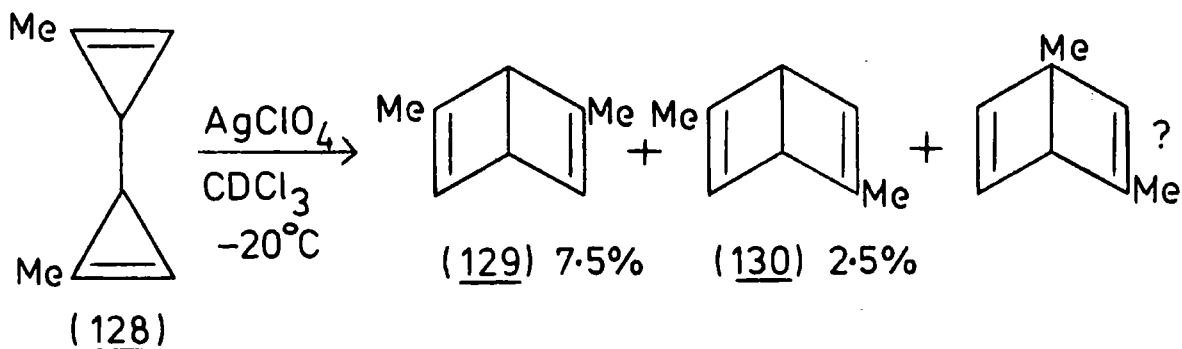

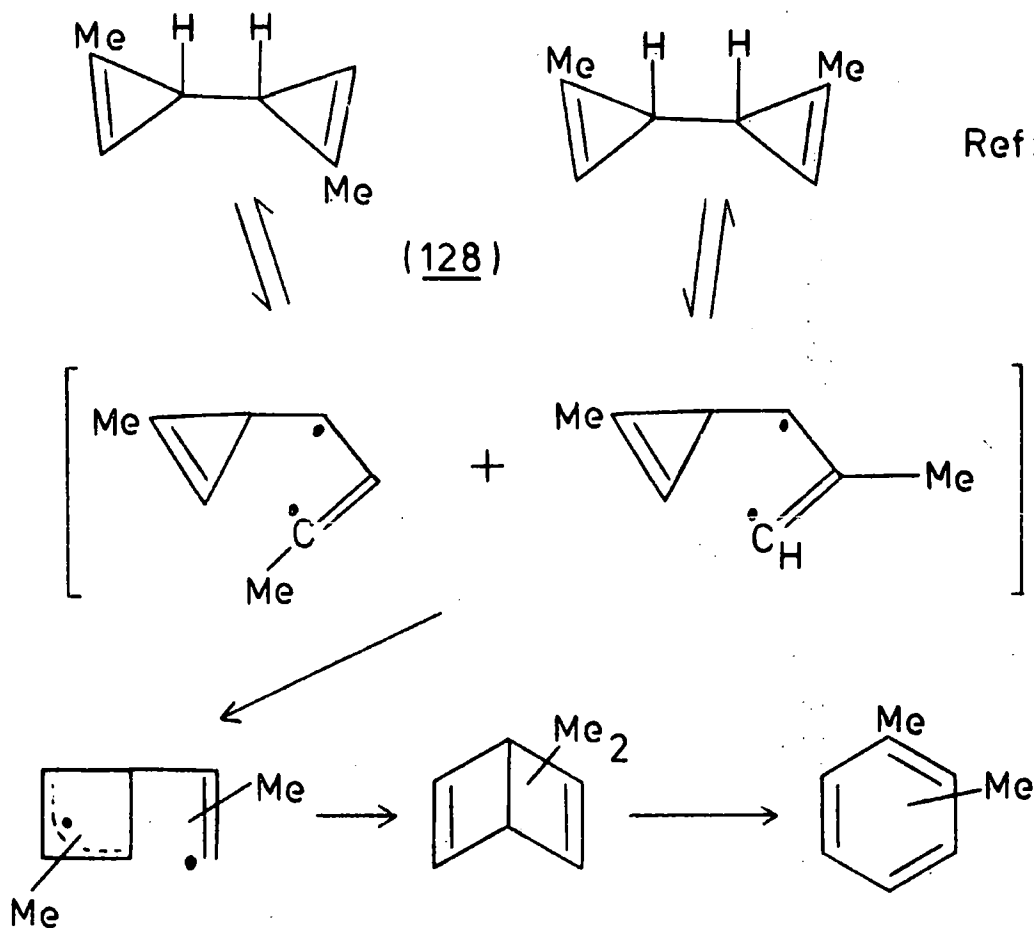

Bicyclopropenyls have been shown to undergo both thermal and photochemical Cope rearrangements. Dimethylbicyclopropenyl (127) gave a mixture of stereoisomers of (128) in a flow pyrolysis system,⁸¹ and on static pyrolysis gave a mixture containing all three xylenes, of which the formation of the ortho and para isomers could be explained by the mechanism proposed by Bergman et al,⁸⁰ but the meta isomer could only have been formed from (128). It was also shown that meta- and para-xylene were formed on pyrolysis of (128).⁷⁴

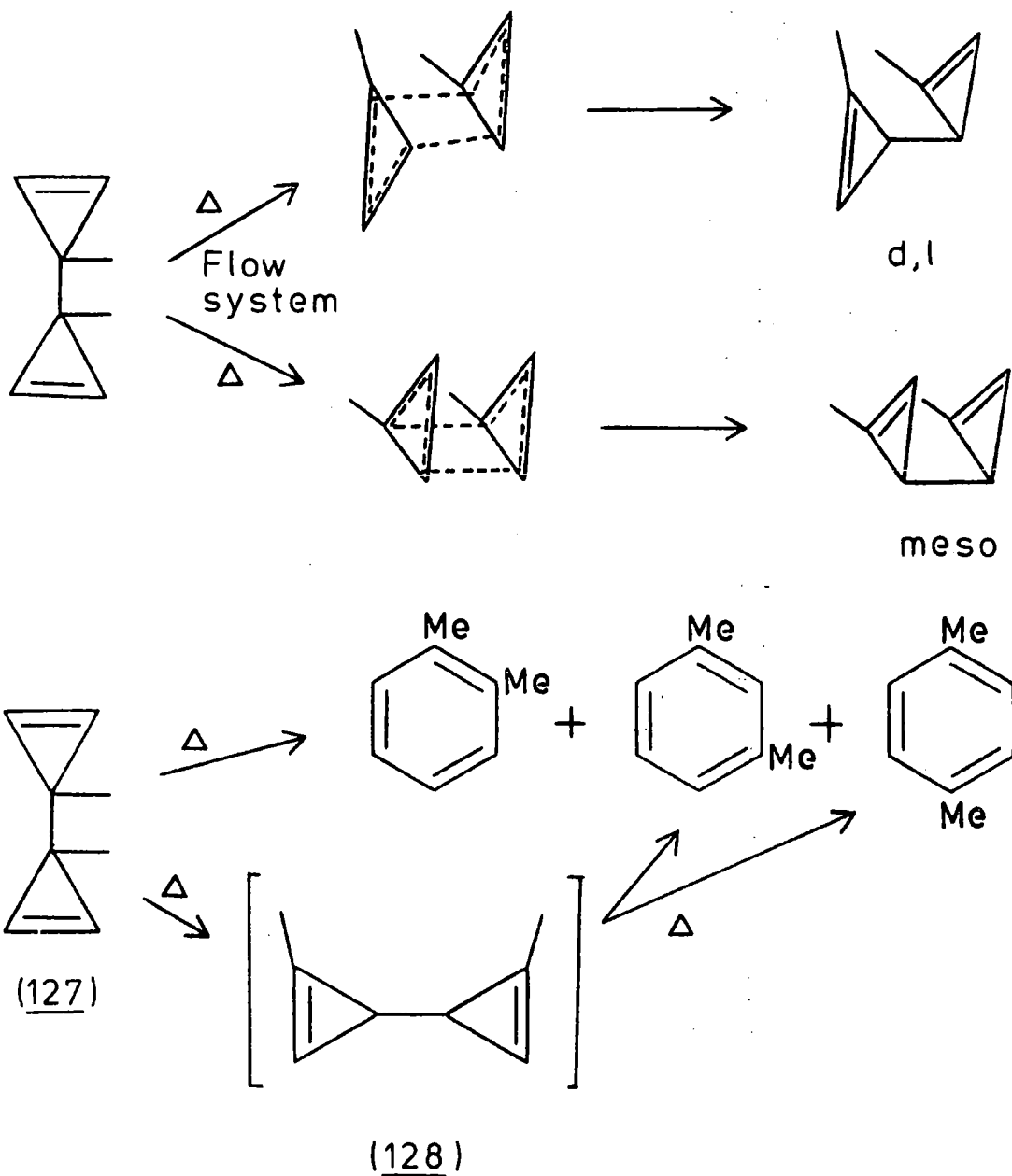

Photochemical rearrangement of bicyclopropenyls to benzenes was initially thought to involve prismane intermediates, but there was no conceivable prismane intermediate which could account for the photochemical rearrangement of 1-methyl-2,2',3,3'-tetraphenylbicyclopropenyl (131) to benzene derivatives (132) and (133).⁸² It was also shown

that bicyclopropenyl derivative (131) underwent a photochemical Cope rearrangement, which was reversible on

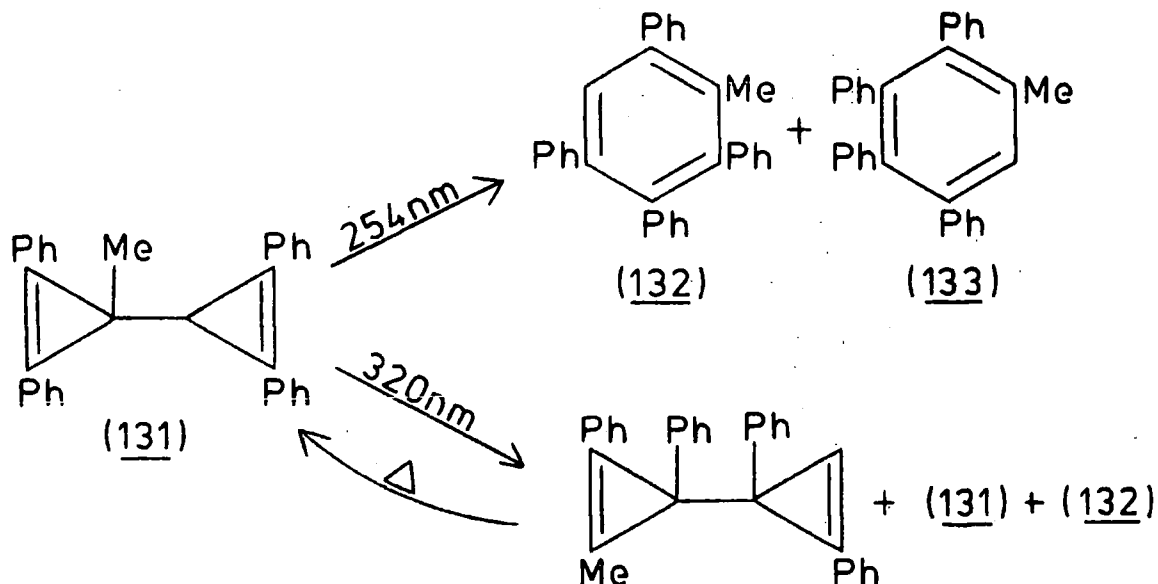

heating.⁸³ As a result of these findings the exact mechanism by which photochemical rearomatisation of bicyclopropenyl (131) occurred was not fully understood.

1.11 Ring Transpositions: a Suggested Notation

It has been suggested that transpositions in six-membered rings could be analysed in terms of a set of twelve permutation patterns (Fig. 5)⁸⁴ rather than speculation on valence isomer intermediates. In the proposed notation the outer hexagon represents initial ring connections, whereas the internal pattern shows connections in the product e.g. A ring transformation which involved a benzvalene intermediate would be represented by P₂ (see over).

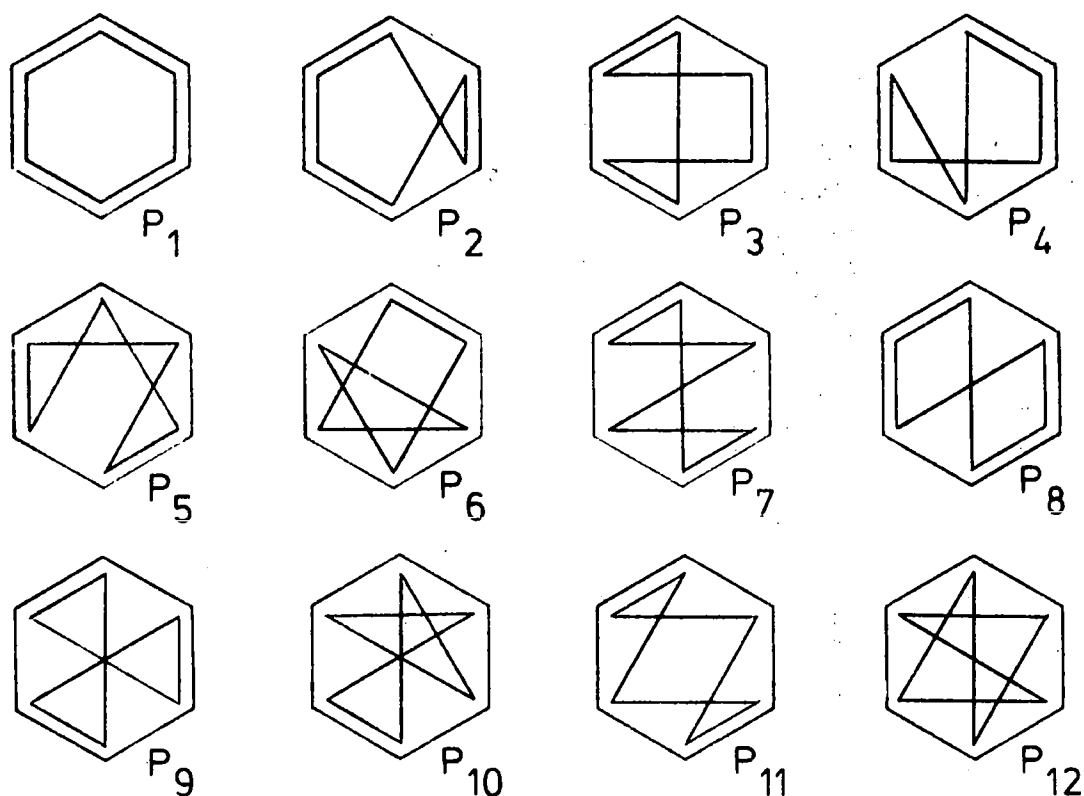
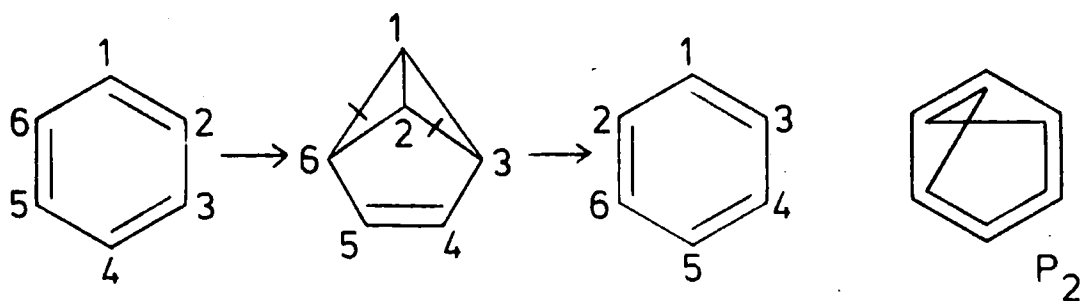
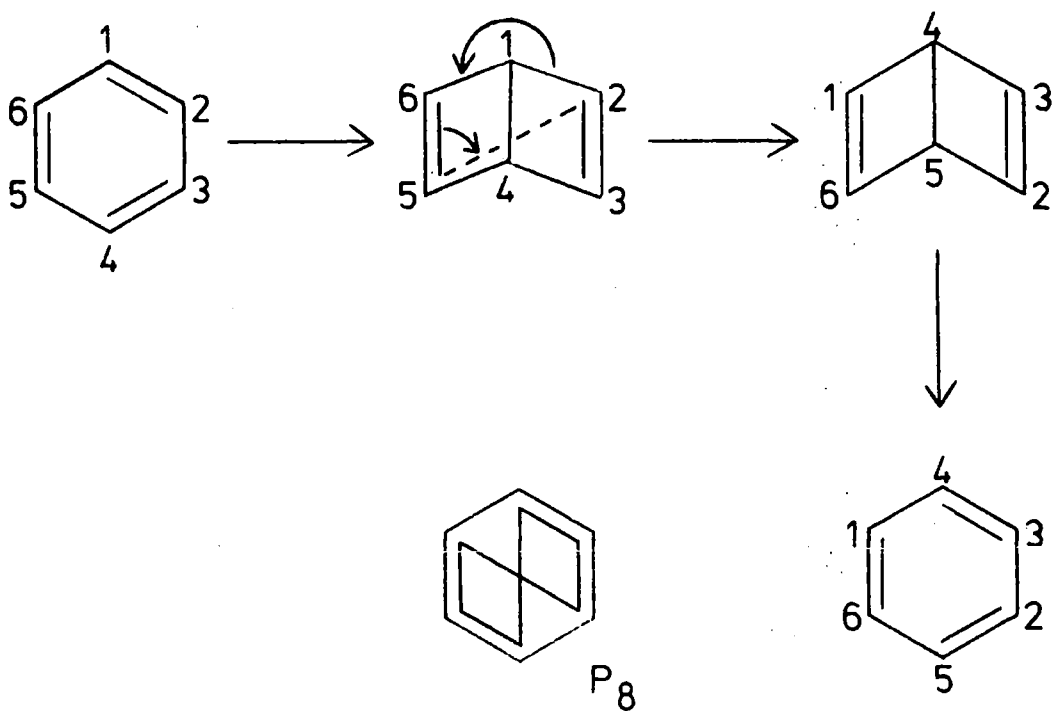

FIG. 5



Similarly it can be shown that transformations which involve prismane intermediates (Section 1.5(iii)) are P_4 types, whereas rearrangements which proceed via rearrangement of para-bonded species would be P_8 types (see over).



1.12 2,3-diazabicyclo[2.2.0]hexa-2,5-diene (134)

Photolysis of pyridazines has been shown to produce 1,2-diazapara-bonded isomers, in some fluorinated systems,⁷² but not the 2,3-diaza isomer. However (134) has been suggested to be an unstable intermediate, formed on mild oxidation of (135),⁸⁵ which readily loses nitrogen to give butadiene.

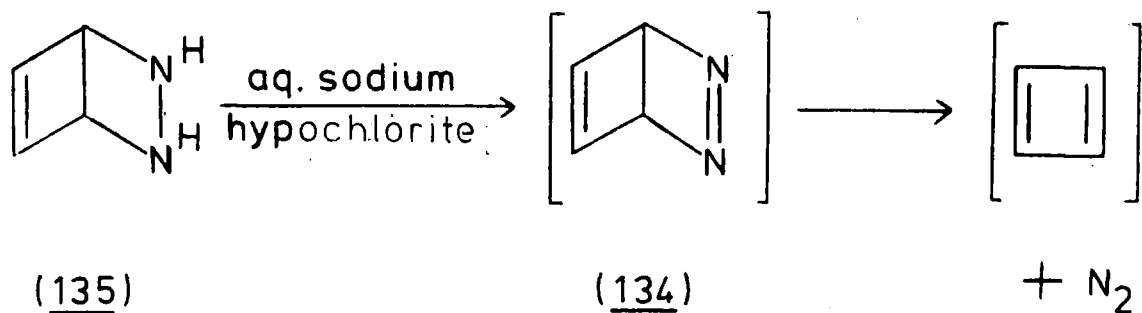

CHAPTER 2

The Synthesis of Polyfluoroalkylpyridines

2.1 Introduction

In this chapter the preparation of the perfluoroalkylpyridines which are photolysed, in this work, are described.

2.2 Pentafluoropyridine

Pentafluoropyridine (136) was prepared, by technical staff, by halogen exchange between pentachloropyridine and KF, using a method described in the literature.⁸⁶

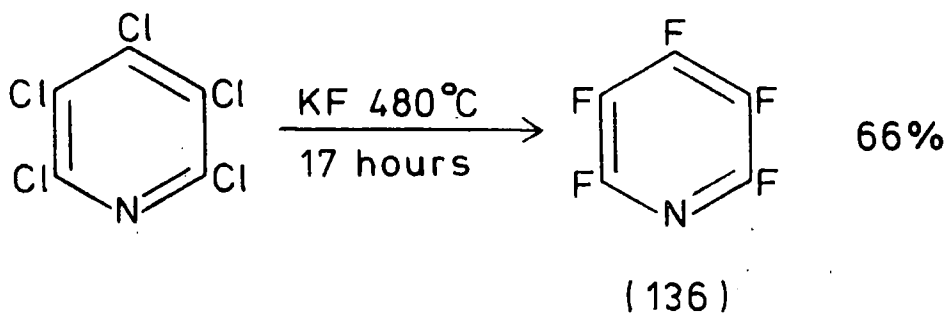

2.3 Perfluoropolyisopropylpyridines

Alkylation reactions between pentafluoropyridine (136) and hexafluoropropene, in the presence of fluoride ion, were carried out using an atmospheric pressure static gas system, developed at these laboratories by previous workers.^{87,88}

Pentafluoropyridine (136) undergoes nucleophilic substitution by the heptafluoro-isopropyl anion generated from

hexafluoropropene and fluoride ion. This type of reaction is complementary to the Friedel-Crafts reaction, in hydrocarbon chemistry.

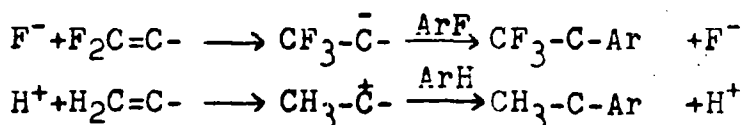

Reactions between (136), an excess of hexafluoropropene in sulpholan, in the presence of KF, gave a good yield of perfluoro-2,4,5-tri-isopropylpyridine (137), containing some of the 2,4,6 isomer (138).

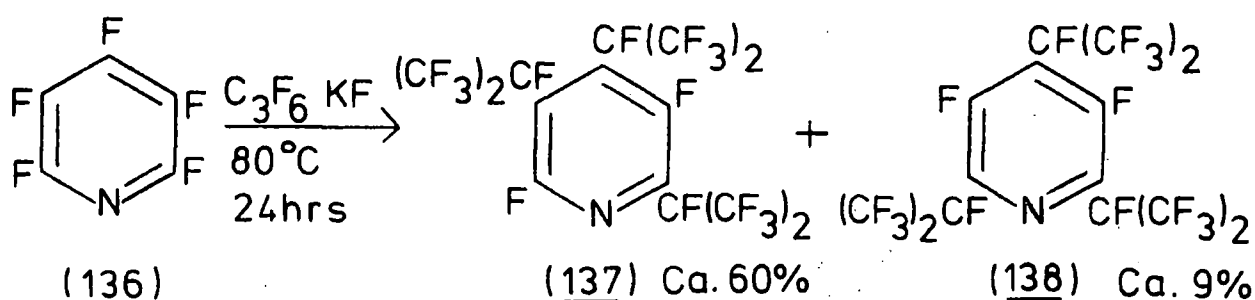

Perfluoro-2,4,6-tri-isopropylpyridine (138) was formed in greater yield by heating a mixture containing (137), and some (138), at 170°C , in sulpholan, in the presence of CsF as catalyst.⁸⁸ The intermolecular reaction which takes place at this temperature results in formation of the more thermodynamically stable of the tri-isopropyl derivatives, i.e. (138), as initial formation of (137) was as a result of kinetic control, which indicated that the 5 position was more susceptible to attack by C_3F_7^- , in this system.

Perfluoro-2,5-di-isopropylpyridine (139) was also obtained from (137) by heating with pentafluoropyridine (136), in sulpholan, at 165°C in the presence of CsF.⁸⁸

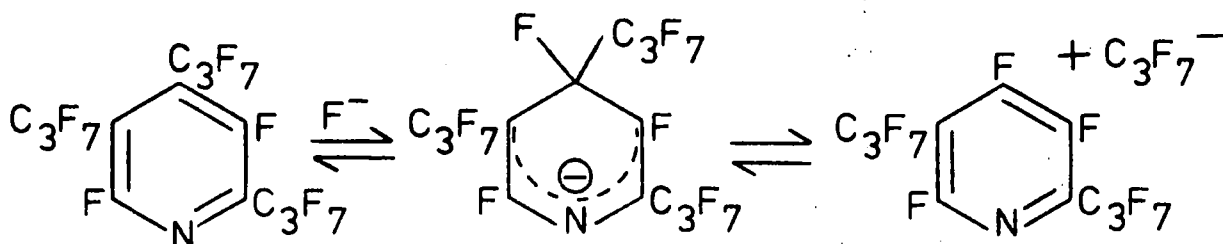

This differed from the reported synthesis of (139)⁸⁸ in that pentafluoropyridine (136) was used instead of perfluoroquinoline, as a trap for $(CF_3)_2CF^-$ anion.

2.4 Reactions of Pentafluoropyridine (136) and Polytetrafluoroethylene

Depending upon the conditions used the pyrolysis of P.T.F.E. and (136) gave either perfluoro-3,5-dimethylpyridine (142) or perfluoro-3-methylpyridine (143), as major products.^{87,89,90}

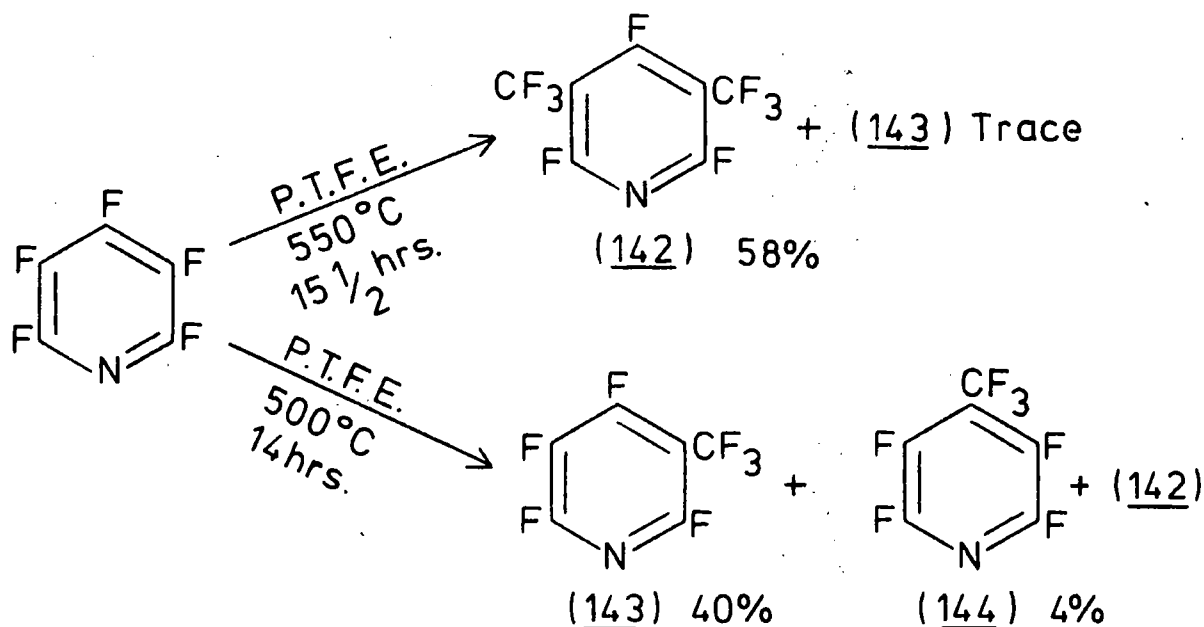

Under the conditions at which (143) was the major component of the products ca. 4% of perfluoro-4-methylpyridine (144) was detected, by ^{19}F n.m.r. and identified by comparison with literature ^{19}F n.m.r. data,⁹¹ but no perfluoro-2-methylpyridine (145) was observed. Previous reports of this reaction have been conflicting in that some workers detected all of the possible perfluoromethylpyridines (143), (144) and (145)⁸⁹, whereas others only detected (143).⁸⁷

It was suggested that this reaction involved addition of difluorocarbene to pentafluoropyridine (136),⁸⁷ since polytetrafluoroethylene was a convenient source of difluorocarbene at the reaction temperature (500°C). However the suggested mechanism, via an intermediate (146), could not account for the formation of (144).

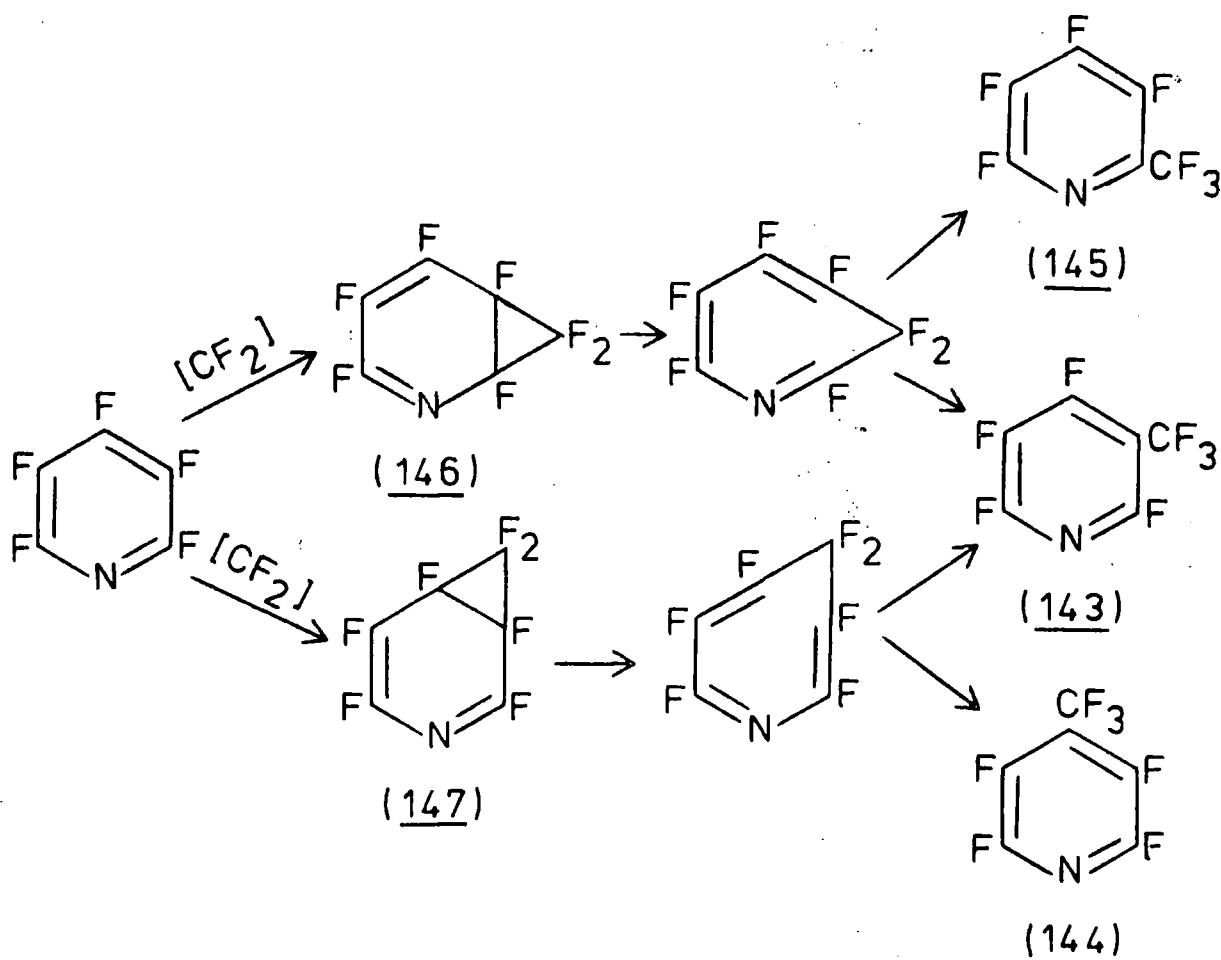

The formation of both (143) and (144) could occur via an analogous mechanism which involves (147) as an intermediate and under certain conditions both routes could occur simultaneously to give (143) as the major product, with (144) and (145) also formed.

2.5 Reactions between Perfluoro-3,5-dimethylpyridine (142) and Hexafluoropropene in the Presence of Fluoride Ion

Nucleophilic substitution of perfluoro-3,5-dimethylpyridine (142) with heptafluoro-isopropyl anion has been reported to yield perfluoro-2,4,6-tri-isopropyl-3,5-dimethylpyridine (148) and perfluoro-2,6-di-isopropyl-3,5-dimethylpyridine (149),⁸⁷ however this reaction was repeated on numerous occasions in an attempt to isolate samples of (148), but only a few of these gave small samples of (148), although good yields of (149) were obtained from these reactions.

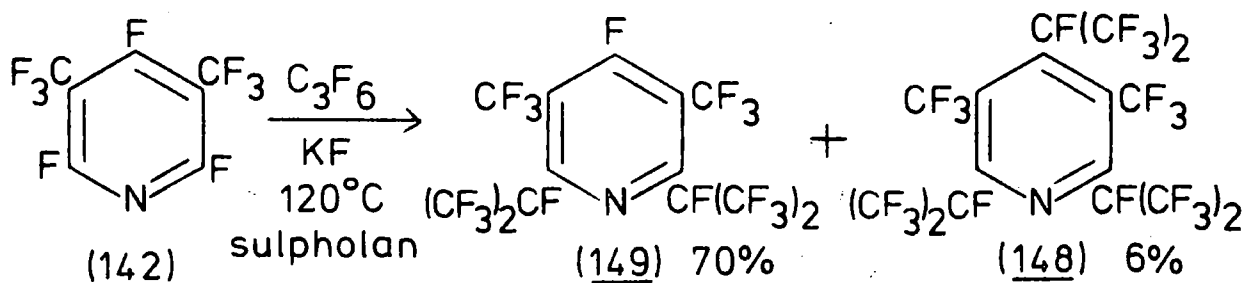

The reason for the failure to isolate (148) from most attempted reactions is not understood but the reported yield is low (6%⁸⁷) which is an indication of the difficulty of insertion of the third heptafluoro-isopropyl group at position 4 in the pyridine. The reaction conditions were varied in an attempt to isolate (148) but other conditions also gave unsuccessful reactions.

Reaction between hexafluoropropene and (142) in the molar ratio 2:1, using CsF as the fluoride ion source, gave a mixture containing (149) and perfluoro-2-isopropyl-3,5-dimethylpyridine (150).

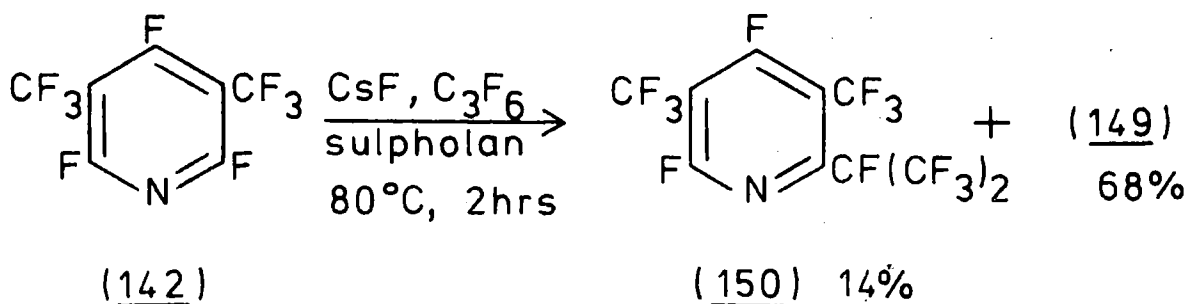

The structure of (150) was readily confirmed by ^{19}F n.m.r. as signals due to fluorine at positions C-4 and C-6 were observed at 88.0 and 55.5 p.p.m. (Upfield of CFCl_3) and mass spectrometry indicated a mono-isopropyl substituted derivative. A large through space coupling (50Hz) was observed between the tertiary fluorine, of C_3F_7 , and the adjacent ring CF_3 substituent, compared to a coupling of only 3Hz between the trifluoromethyl of C_3F_7 group and ring CF_3 . This would appear to indicate

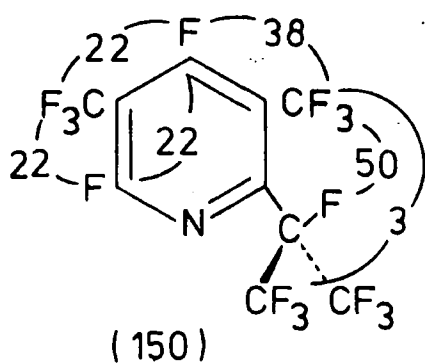

that the average conformation adopted by C_3F_7 is that shown with the CF_3 groups flanking ring nitrogen. The various couplings, in (150), are shown (couplings are in Hz). The ^{19}F n.m.r. spectra of substituted

pyridines (137), (138) and (140) have indicated that perfluoro-isopropyl substituted at positions C-2 and C-6

adopt conformations with the CF₃ groups flanking ring nitrogen,⁹² and this feature occurs in other pyridine derivatives. (Discussed later).

Compounds (148), (149) and (150) were all used in photolysis experiments.

2.6 Nucleophilic Substitution of Perfluoro-3-methylpyridine (143) by Heptafluoro-isopropyl Anion

Nucleophilic substitution on perfluoro-3-methylpyridine (143), using hexafluoropropene and potassium fluoride in sulfolan, gave good yields of perfluoro-2,4,6-tri-isopropyl-3-methylpyridine (151) and perfluoro-4,6-di-isopropyl-3-methylpyridine (152) which were identified by comparison of data with that from authentic samples, which have been prepared in an analogous manner.⁸⁷

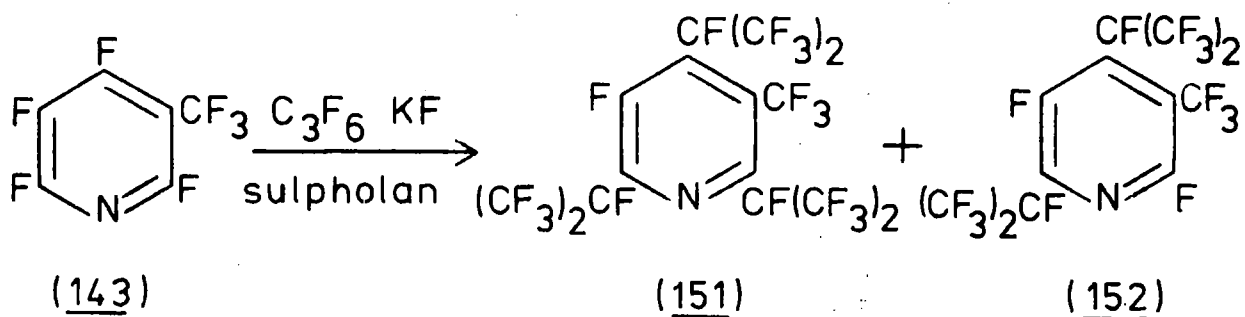

Both (151) and (152) were used in later photolysis experiments.

2.7 Reaction Between Perfluoro-2,6-di-isopropyl-3,5-dimethylpyridine (149) and Tetrafluoroethylene in the Presence of Fluoride Ion

Formation of pentafluoroethyl anion from tetrafluoroethylene and fluoride ion may be achieved by the use of a fluoride ion in an aprotic solvent. It has been shown

that caesium fluoride in tetraglyme was most effective in generation of pentafluoroethyl anion and subsequent nucleophilic attack by the anion. These conditions were used to effect substitution in the vacant position 4 in (149), by the same method reported, to give perfluoro-4-ethyl-2,6-di-isopropyl-3,5-dimethylpyridine (153).⁸⁷

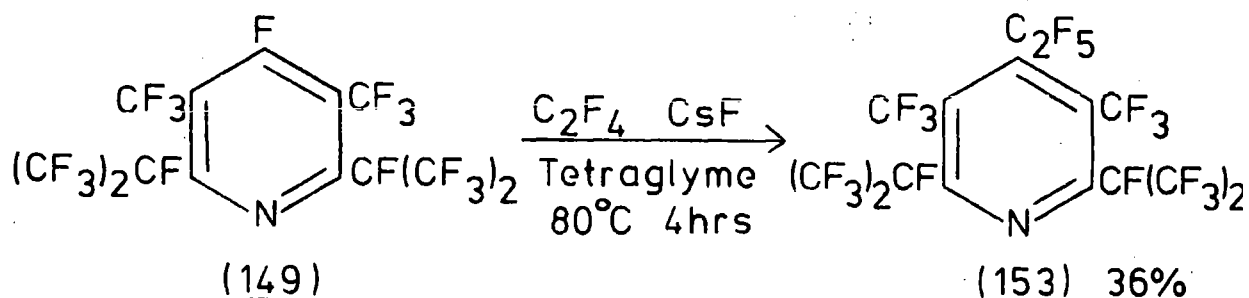

The yield of (153) was variable and an attempt to scale up the preparation from the scale reported in the literature resulted in an overall lower yield of (153). However the consistent preparation of (153) reflects on the relative ease of introduction of pentafluoroethyl into position 4, in (149), as compared to the bulkier, and less reactive heptafluoro-isopropyl anion.

2.8 Reaction between Perfluoro-3,5-dimethylpyridine (142) and Pentafluoroethyl Anion

An attempt to introduce C₂F₅ label into (142) using caesium fluoride and tetrafluoroethylene, in tetraglyme solvent, gave a small yield of a mixture of involatile components of high molecular weight and similar g.l.c. retention times, so that separation of the components could not be achieved. Some reactions of pentafluoroethyl anion have led to poor yields of products and production of high

molecular weight oils, and it has been suggested that these oils are formed by some process which couples perfluoro-alkylated rings,⁹³ possibly due to electron transfer from the pentafluoroethyl anion to the pyridine ring. This reaction was accompanied by a deep red colouration in the reaction mixture, so it is suggested that introduction of trifluoromethyl groups into pentafluoropyridine to form (142) has the effect of making the system a better electron acceptor than pentafluoropyridine (136).

CHAPTER 3

The Photochemistry of some Perfluoroalkyl Pyridines

3.1 Introduction

The aim behind this work is an investigation of photochemical rearrangements in the pyridine system. Many rearrangements of labelled benzenes are recorded in the literature but much less is known about rearrangement of heterocyclic systems. However some photolysis of pyridine derivatives has been carried out, by earlier workers in this field.

Lutidines and picolines have been shown to rearrange on photolysis^{41,42} and 2-azabicyclo[2.2.0]hexa-2,5-diene (51) was obtained as an unstable species from the photolysis of pyridine.⁴⁰ (Section 1.8(1)). Rearrangement of a highly labelled penta-alkylpyridine (55) was observed by Bergen and Kellogg⁴³ although no intermediates were detected in this rearrangement. Other workers have obtained valence bond isomers from fluorinated pyridines^{67,68} and pyrazines⁷² (see Chapter 1).

In this work a series of polyfluoroalkyl pyridines, including di-, tri-, tetra- and penta-alkyl substituted pyridines, were irradiated. The main requirement for the

study of ring rearrangements is the use of systems which contain a high degree of substituent labelling: in this study perfluoroalkyl groups have been used as passive labelling substituents, and pyridines containing up to four different labels (including ring N) have been irradiated. The preparation of these pyridines is contained in Chapter 2. The following contains a discussion of these irradiations.

3.2 The Photochemistry of Perfluoropenta-alkylpyridines

3.2(1)A. Irradiation of Perfluoro-4-ethyl-2,6-di-isopropyl-3,5-dimethylpyridine (153)

Compound (153) contains no fewer than four different labelling groups on the ring so amply satisfied the criteria required for the study of rearrangement in pyridines. Irradiation of (153) was carried out at both 253.7nm and ca.300nm.

At 253.7nm after irradiation of a solution of (153) in $\text{CF}_2\text{ClCFCl}_2$, for ca.200 hours, g.l.c. analysis showed disappearance of starting material (153) and formation of one new component. After distillation, to remove solvent, and preparative g.l.c. a colourless liquid was isolated. The U.V. spectrum of the liquid showed only end absorption (λ_{max} ca.212nm. $\epsilon \approx 300$) and the infra-red spectrum indicated the absence of C=C and C=N in the molecule. The ^{19}F n.m.r. spectrum indicated that a mixture of two compounds had been obtained whereas U.V. and i.r. data ruled out azabicyclo-[2.2.0]hexadiene, azabenzvalene and pyridine structures, so that the compounds were identified as having azaprismane structures.

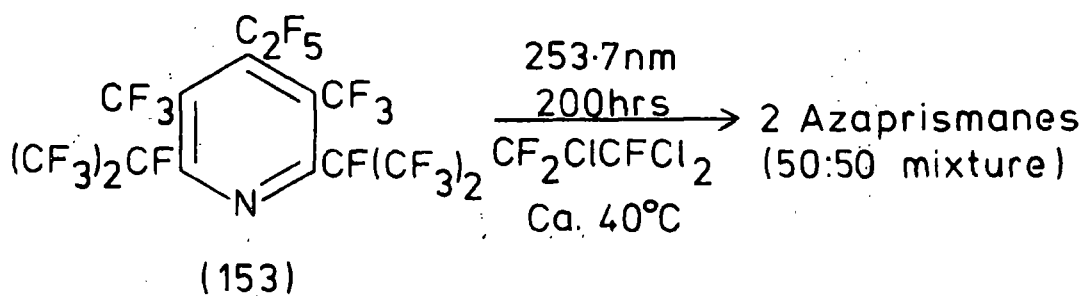

The structure of the azaprismanes in the mixture could not be deduced from the ^{19}F n.m.r. spectrum alone, although the data appeared to indicate the presence of one symmetrical isomer, and integration of the signals indicated that the two components were present in equal proportions. The presence of a mixture of isomers was confirmed by careful distillation of the mixture; a small quantity of distillate was obtained that was enriched by ca. 10% of the unsymmetrical isomer (as shown by ^{19}F n.m.r.). The azaprismanes were identified from their pyrolysis products. (See later.)

At 300nm irradiation of a solution of (153) in $\text{CF}_2\text{ClCFCl}_2$ gave a mixture containing four components, after ca. 24 hours, in which the most volatile component was identified as perfluoro-4-ethyl-2,6-di-isopropyl-3,5-dimethyl-1-azabicyclo[2.2.0]hexa-2,5-diene (154) from infra-red and ^{19}F n.m.r. spectra.

The other components in the mixture were identified as starting material (153) and the same mixture of azaprismanes as from the 254nm irradiation of (153).

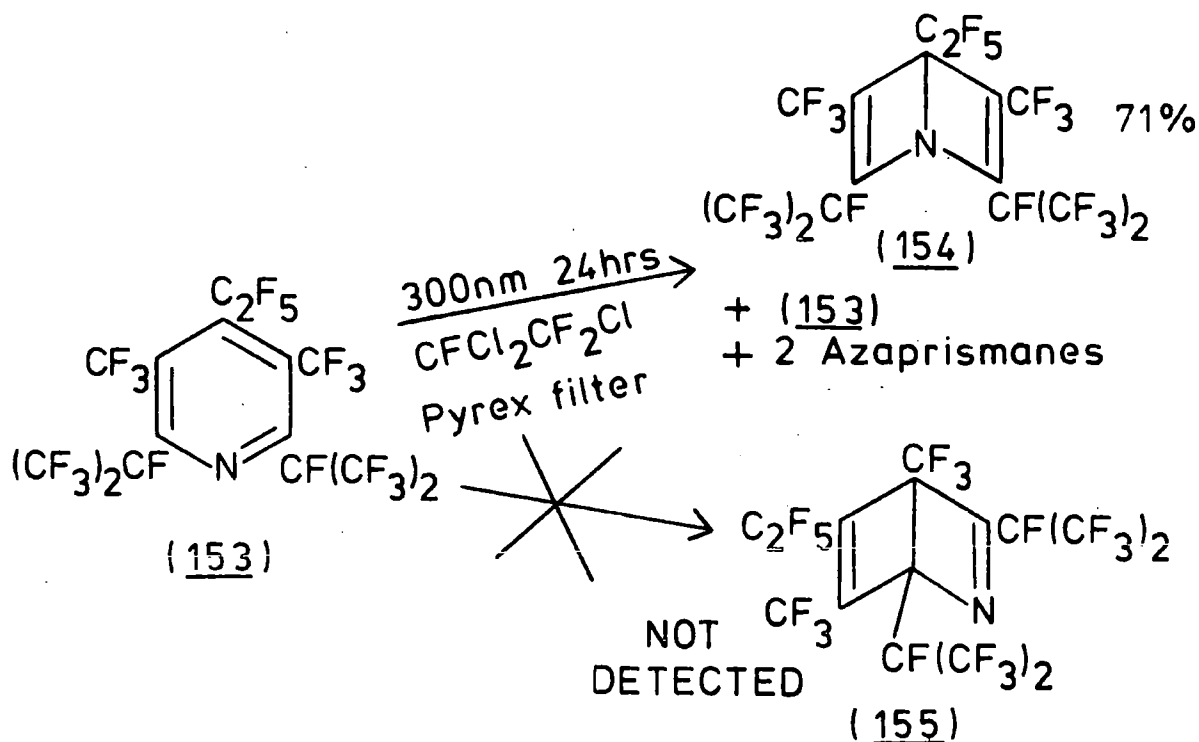

Only one para-bonded species (154) was isolated which showed a single absorption in its infra-red spectrum in the region expected for C=C, at 1693cm^{-1} (Cf. 1691cm^{-1} in (111)⁶⁷). The ultraviolet spectrum showed an absorption at 218nm ($\log \epsilon$ max 3.36). (Appendix 3 contains full details of u.v. spectra from azaprismanes, azapara-bonded species and pyridines.)

The symmetry of the ¹⁹F n.m.r. spectrum of (154) confirmed its structure. The ¹⁹F n.m.r. showed resonances at 64.5 p.p.m. (2 x CF₃, intensity 6), 84.5 p.p.m. (CF₂CF₃, intensity 3), 118.2 p.p.m. (CF₂CF₃, intensity 2) and 188.2 p.p.m. (2 x CF(CF₃)₂, intensity 2). This spectrum ruled out the possibility of azabenzvalene formation as signals observed from both CF₃ and tertiary fluorine indicated a high degree of symmetry in the molecule. However one interesting feature in the n.m.r. spectrum of (154) was the

non-equivalence of geminal CF_3 groups on C_3F_7 , which gave two broad singlets at 77.1 and 78.6 p.p.m. A possible

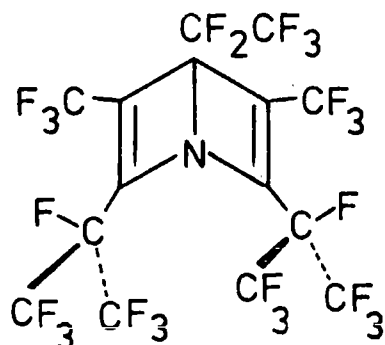

(154)

explanation of the non-equivalence of the geminal CF_3 groups is that due to the crowded nature of the molecule rotation of the C_3F_7 group only occurs slowly on the n.m.r. time-scale so on average

each CF_3 group is in a different magnetic environment so would have different chemical shifts. The ^{19}F n.m.r. spectrum of (154) was run at a high temperature, 150°C , but no change in the spectrum was observed.

In this photolysis the 2-azabicyclo[2.2.0]hexadiene derivative (155) was not detected. This result is in agreement with the irradiation of perfluoropentaethylpyridine (109) from which the 1-azapara-bonded derivative (111) was isolated.⁶⁷ A possible reason for these results is that less steric interactions occur between bulky perfluoroalkyl groups in (154) than (155), since (154) only contains three substituents in each four membered ring whereas (155) contains four groups in one four membered ring and three in the other.

3.2.(1)B. Pyrolysis of Azaprismane Mixture

As mentioned previously the structure of the azaprismane mixture, obtained from photolysis of (153) at both 254 and

300nm. could not be deduced directly from ^{19}F n.m.r. data. Pyrolysis of this azaprismane mixture gave three isomeric pyridines, as 34%, 48% and 12.5% obtained from a 50:50 mixture of azaprismanes. These were separable by g.l.c. and were identified as perfluoro-2-ethyl-3,6-di-isopropyl-4,5-dimethylpyridine (156), perfluoro-2-ethyl-5,6-di-isopropyl-3,4-dimethylpyridine (157) and perfluoro-3-ethyl-2,6-di-isopropyl-4,5-dimethylpyridine (158).

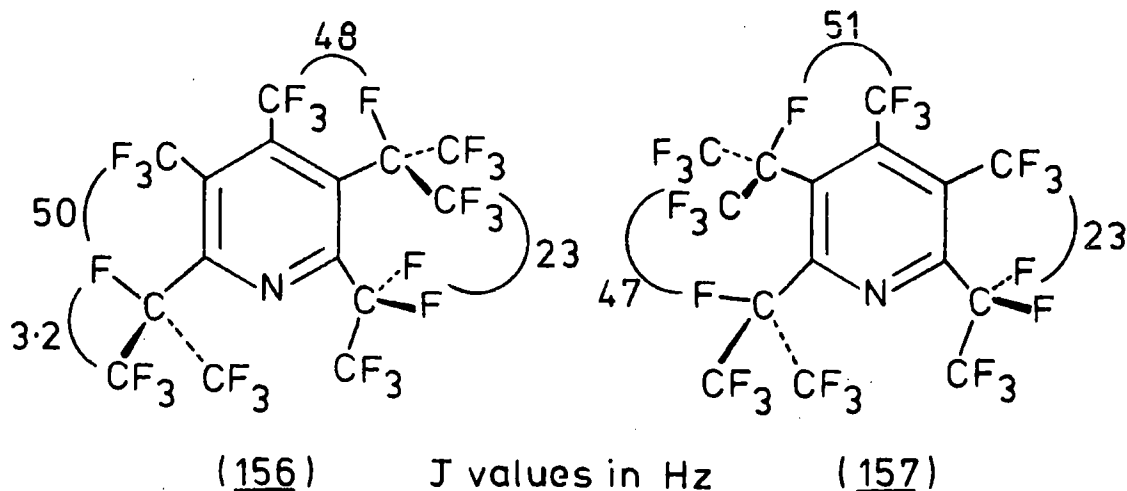

The ^{19}F n.m.r. spectra of these isomeric pyridines contained some interesting features which enabled their structures to be deduced.

In the ^{19}F n.m.r. spectrum of (156) sharp signals of relative intensities 6 and 3 were observed in the CF_3 region, at 72.4 and 78.8 p.p.m. (upfield of CFCl_3) which were assigned to $\text{CF}(\text{CF}_3)_2$ and CF_2CF_3 . The lack of coupling on these signals indicated that in (156) that the substituent groups adjacent to nitrogen were C_2F_5 and C_3F_7 with the CF_3 groups flanked around ring nitrogen.⁹² The methylene fluorines, of C_2F_5 , appeared as a septet which

was due to through space coupling with an adjacent C_3F_7 , therefore substituted at C-3, and in the orientation shown above. The only structure which fits the data is (156), which was confirmed by the presence of through space coupling between C_3F_7 and adjacent CF_3 groups. Further confirmation of this structure was obtained from chemical shift data and will be discussed later.

The second isomeric pyridine showed uncoupled signals in the CF_3 region, in the ^{19}F n.m.r., assigned to CF_2CF_3 and $CF(CF_3)_2$ which once again indicated that the substituents adjacent to ring nitrogen were C_3F_7 and C_2F_5 . The CF_2CF_3 signal appeared as a quartet ($J=23Hz$) due to through space coupling with an adjacent CF_3 group, hence at C-3, whereas tertiary fluorine signals had septet and quartet fine structure. These data lead to the structure (157) with orientation and coupling constants as above.

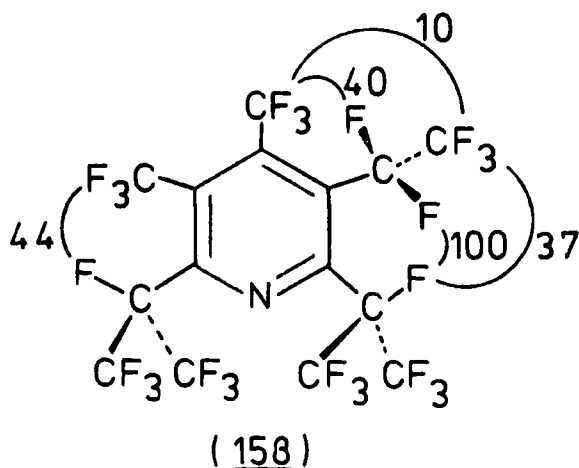

$$J_{AB} = \text{ca. } 300\text{Hz}$$

J values in Hz

The third isomeric pyridine gave a more complicated ^{19}F n.m.r. spectrum. A relatively sharp signal (integration of 12) was observed in the CF_3 region and was assigned to

$2xCF(CF_3)_2$ with both C_3F_7 groups adjacent to nitrogen (at C-2 and C-6), since it has been established that both C_3F_7 and C_2F_5 groups adjacent to nitrogen give sharp signals in the ^{19}F n.m.r. The only structure which fits these data is (158) as only two isomeric pyridines, containing the correct labels, which have both C_3F_7 groups adjacent to nitrogen can be postulated, these are (153) and (158), and it was readily established that the symmetrical isomer (153) had not been produced. The ^{19}F n.m.r. spectrum of (158) contained the interesting feature of a locked C_2F_5 group which results in non-equivalence of the methylene fluorines to give an AB signal ($J_{AB} \approx 30\text{CHz}$) in the n.m.r. spectrum.

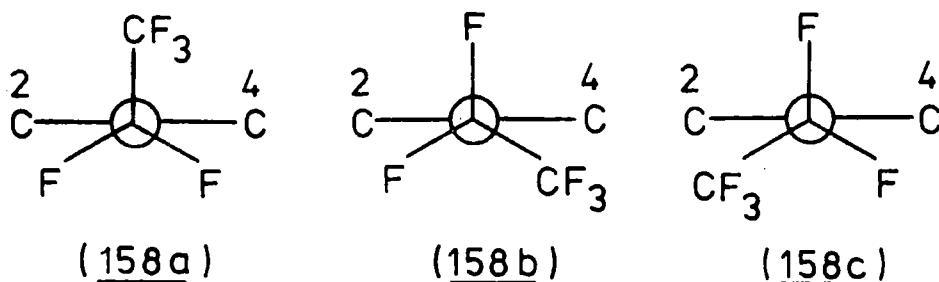

FIG. 6

The alternative orientations for the C_2F_5 group in (158) are shown in Fig. 6, and of the three orientations (158a) is the one which occurs. This is apparent from the coupling constants observed, as each of the methylene fluorines couples with only one of the adjacent perfluoroalkyl groups whereas coupling of CF_3 to both adjacent groups is observed. The ^{19}F n.m.r. spectrum of (158) was unaltered when run at 150°C .

A similar feature, namely non-equivalent geminal CF_2CF_3 fluorines, was observed in perfluoropentaethylpyridine (109)⁶⁷ and in this compound also $J_{\text{AB}} = \text{ca. } 30\text{Hz}$.

3.2.(1)C. ^{19}F n.m.r. Spectra of Penta-alkylpyridines:
Chemical Shifts

As mentioned previously confirming evidence for the structures of perfluoropenta-alkylpyridines (156)-(158) was obtained from chemical shift data. In these compounds the perfluoroalkyl substituents are in an essentially planar environment around the pyridine ring so as a result large steric interactions occur between adjacent perfluoroalkyl substituents. These interactions probably result in distortion of the alkyl groups and in addition repulsions between the electron clouds surrounding the fluorine nuclei resulted in the fluorine nuclei experiencing a certain degree of deshielding, an effect which showed in the values of chemical shift observed for these nuclei. The magnitude of this effect depended upon the number of bulky buttressing alkyl groups.

It was also found that interaction between adjacent bulky perfluoroalkyl groups resulted in each of the pyridines (156)-(158) being shown to exist in one preferred conformation, at room temperature, with other higher energy conformations not detected by ^{19}F n.m.r.

Interaction between perfluoroalkyl groups resulted in deshielding of fluorine atoms, so that the chemical shift of these fluorine atoms was shifted downfield. This

downfield shift was especially large for $-\underline{\text{CF}}(\text{CF}_3)_2$. A compound which illustrates this point is (148) in which the chemical shifts of tertiary fluorines are 181.3(2a),

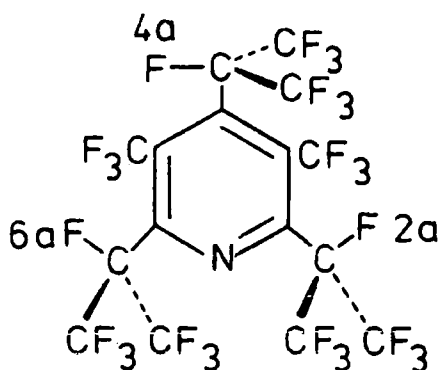

(148)

181.8(6a) and 143.6(4a) p.p.m.⁸⁷ so that the result of having two neighbouring alkyl groups, to $\text{CF}(\text{CF}_3)_2$ at C-4 is a net deshielding of ca.38 p.p.m. relative to fluorines 2a and 6a.

This effect occurs, to a lesser degree with perfluoropentaethyl pyridine (109) as the chemical shift of $\underline{\text{CF}}_2\text{CF}_3$

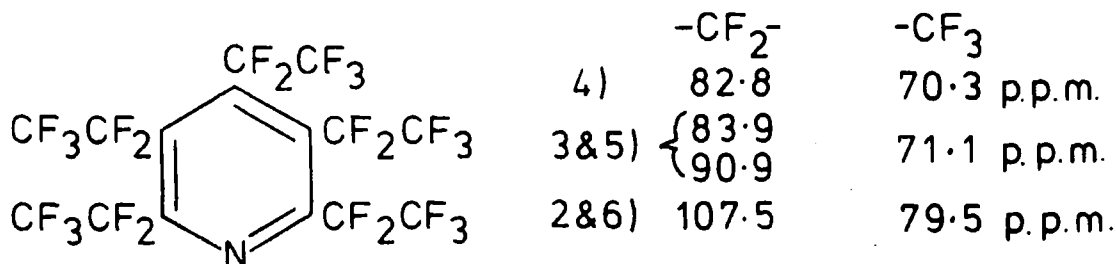

(109)

Ref : 67

at C-4 is ca.25 p.p.m. downfield from the equivalent fluorine resonance at C-2.

Chemical shift data for compounds (156)-(158) gave additional confirmation for the structures. In (156) signals assigned to $\underline{\text{CF}}(\text{CF}_3)_2$ were observed at 179.9 and 153.1 p.p.m. The former signal was attributed to C_3F_7 with one adjacent neighbour, i.e. singly buttressed so at position C-2 or C-6, whereas the downfield shift observed at 153.1 p.p.m. was assigned to a C_3F_7 substituent with two adjacent bulky groups i.e. substituted

at positions C-3, C-4 or C-5 in the pyridine ring. The CF_2CF_3 resonance, observed at 108.3 p.p.m. confirmed that this group was substituted at C-2 or C-6 as this shift corresponds to values for a singly buttressed group (cf. 107.5 p.p.m. in (109)).

Use of the same reasoning shows that in (158) only one perfluoroisopropyl substituent is adjacent to nitrogen since $(\text{CF}_3)_2\text{CF}$ resonances were observed at 178.1 and 151.3 p.p.m. which correspond to singly and doubly buttressed groups respectively. In addition confirmation that pentafluoroethyl was adjacent to nitrogen was obtained as a chemical shift of 108.3 p.p.m. was observed for CF_2CF_3 resonance i.e. a singly buttressed position.

In (157) resonances from singly buttressed $\text{CF}(\text{CF}_3)_2$ are found at 178.4 and 179.6 p.p.m. i.e. adjacent to nitrogen, whereas resonances for CF_2CF_3 were found as an AB signal at 80.6 and 90.1 p.p.m. ($J_{AB} \approx 300\text{Hz}$); a similar feature was observed from C_2F_5 at C-3 and C-5 in (109)⁶⁷. In addition the CF_3CF_2 resonance was also found shifted downfield, at 71.3 p.p.m. which provides further proof of substitution of C_2F_5 at C-3, C-4 or C-5 and is in full agreement with structure (157).

This effect is not confined to perfluoropenta-alkylpyridines and can be also observed in less highly substituted pyridines.⁹⁶

It has also been shown, in a series of perfluoromethylbenzenes, that downfield chemical shifts occur as a result

of interactions between adjacent trifluoromethyl substituents; for two adjacent CF₃ groups this appears to be of the order of 3 p.p.m. whereas for a CF₃ with two neighbouring substituents this is of the order of 3 p.p.m.⁹⁴

3.2.(i)D. Pyrolysis of Azaprismane Mixtures of Varying Composition

As mentioned previously the three pyridines (156), (157) and (158) were produced from pyrolysis of a mixture of azaprismanes. Mixtures of varying proportions of the azaprismanes were pyrolysed, the ratio of azaprismanes in the mixture were estimated from ¹⁹F n.m.r. and the ratio of pyridines (156), (157) and (158) determined by g.l.c. The results obtained from some of these pyrolyses are tabulated below.

Composition of azaprismane mixture		Yield of pyrolysis Products (%)			Conversion (%)
Symmetrical isomer(%)	Unsymmetrical isomer(%)	(156)	(157)	(158)	
50	50	34	48	12.5	94.5
50	50	34	48	13	95
45	55	38	41	15.5	94.5
42	58	40	40	16	96

These results show that, within experimental error, as the ratio of symmetrical:unsymmetrical azaprismane decreases a corresponding decrease occurs in the yield of (157) which

demonstrates that isomer (157) was produced on pyrolysis of the symmetrical azaprismane, whereas both (156) and (158) were formed from the unsymmetrical isomer.

The azaprismane structures were deduced on this basis.

3.2.(1)E. Deduction of Azaprismane Structures

In theory if rearomatisation proceeded via a mechanism which involved para-bonded species as intermediates then (156), (157) and (158) could each have been formed from one of three different azaprismanes, which are illustrated in Fig. 7. It is also illustrated in Fig. 7 that there is only one azaprismane which could rearomatise to give both (156) and (158) and that is azaprismane (159). Of the three azaprismanes which could in theory rearomatise to (157) only (160) is symmetrical. It was therefore deduced that photolysis of (153) gives a mixture of azaprismanes (159) and (160). Furthermore ^{19}F n.m.r. data was consistent with the formation of (159) and (160).

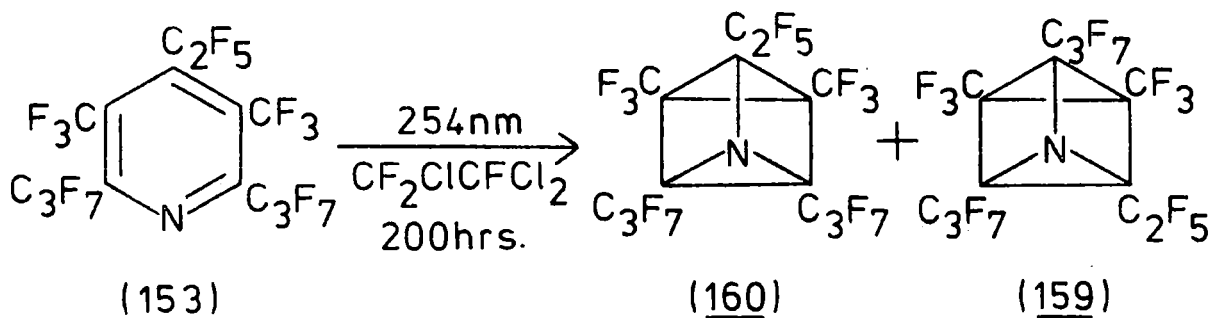

3.2.(1)F. Rearomatisation of Azaprismanes (159) and (160)

Rearomatisation of azaprismanes has been reported to proceed via benzvalene or para-bonded species as intermediates, however in this work no intermediates were

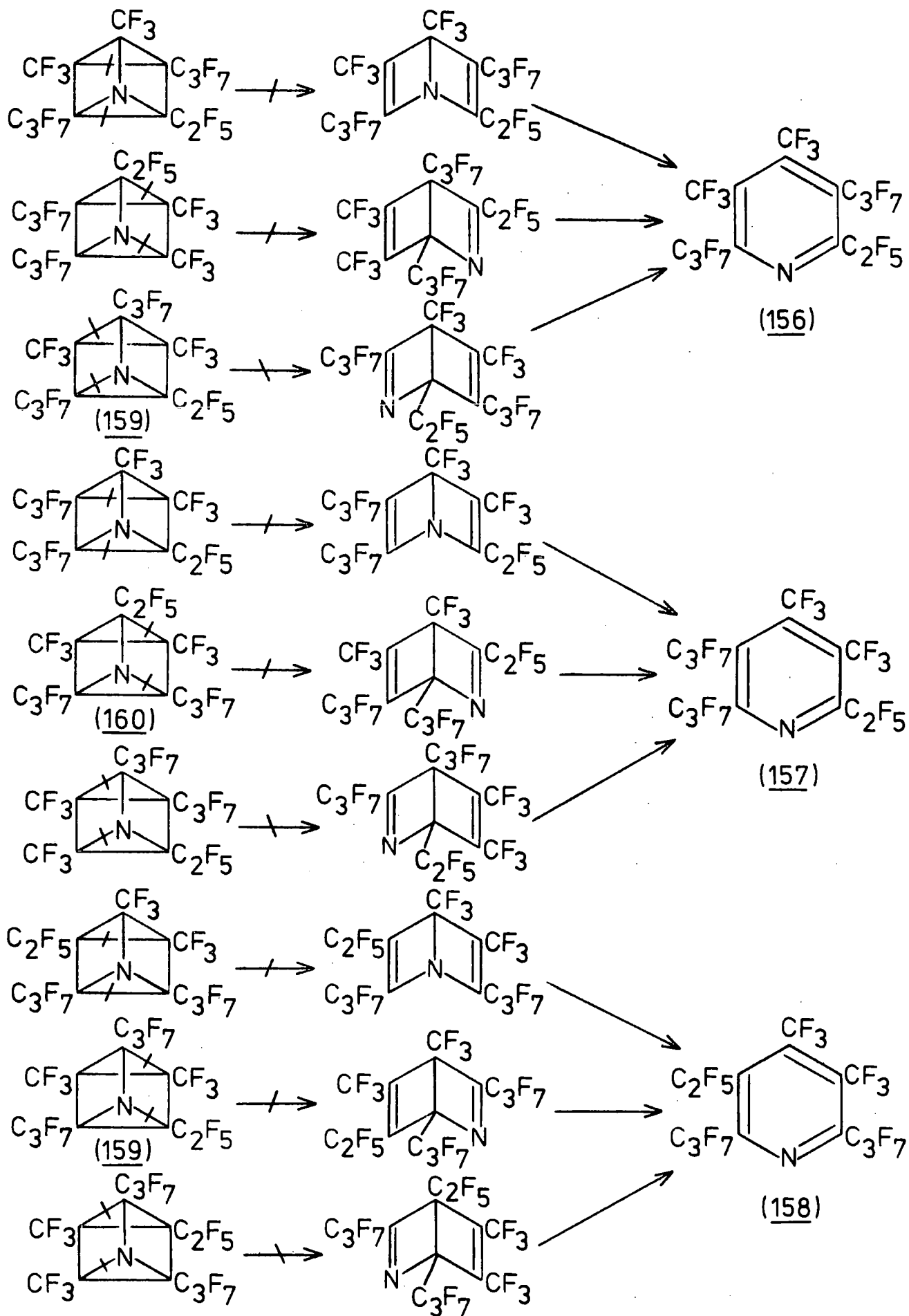

FIG. 7

detected in the static pyrolysis of a mixture containing (159) and (160).

The pyrolysis was also carried out in a flow system, under high vacuum, i.e. short contact time, at 350°C, and the products collected in a liquid air trap but this also failed to give intermediates as products.

The two possible rearomatisation mechanisms are now discussed.

3.2.(i)F.(1) Rearomatisation via Benzvalene Intermediates

In principle rearrangement of azaprismanes to pyridines could occur via azabenzvalene intermediates. As previous results have shown that (156) and (158) were obtained from the same azaprismane it is probable that if rearrangement proceeded via azabenzvalene intermediates that (156) and (158) would be formed from the same azabenzvalene which would have structure (161).

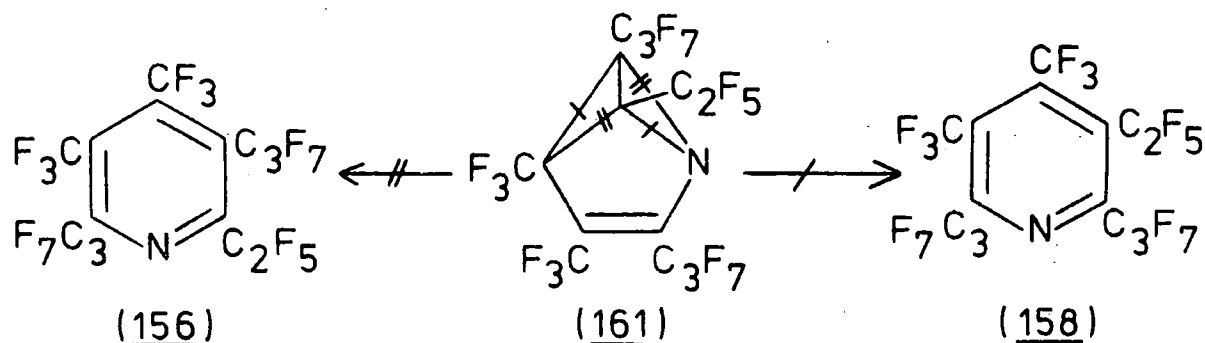

In theory the intermediate benzvalene (161) could be formed from one of two azaprismanes by the $-(2\pi a + 2\sigma s)$ mechanism, which has been suggested.²³ This rearrangement is shown overleaf.

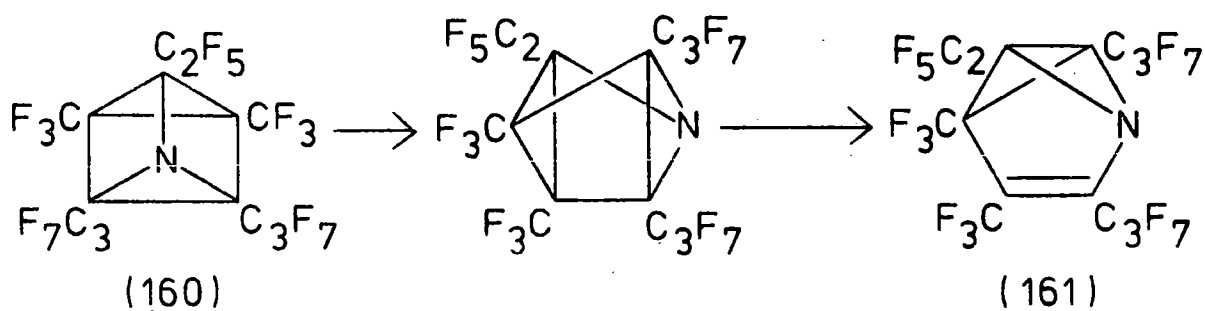
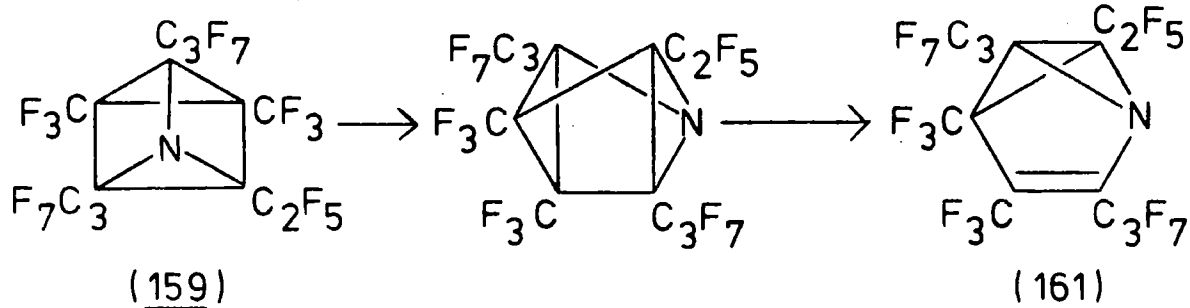

However such a mechanism cannot account for the observed specificity as rearomatisation of azaprismane (159) must give (161) exclusively via initial twisting of the molecule in the orientation shown. Other twisting modes would lead to the formation of the wrong azabenzvalenes. In addition the analogous rearrangement of (160), illustrated above, would also result in formation of (161) so that in theory if these azaprismanes rearomatise via azabenzvalene intermediates then a percentage of pyridine derivatives (156) and (158) would be formed from (160). This also is inconsistent with experimental evidence which clearly indicates that both (156) and (158) are formed solely from the unsymmetrical azaprismane (159) (see Section 3.2(1)D).

A possible mechanism for formation of (157) from (160) via a benzvalene intermediate can also be written.

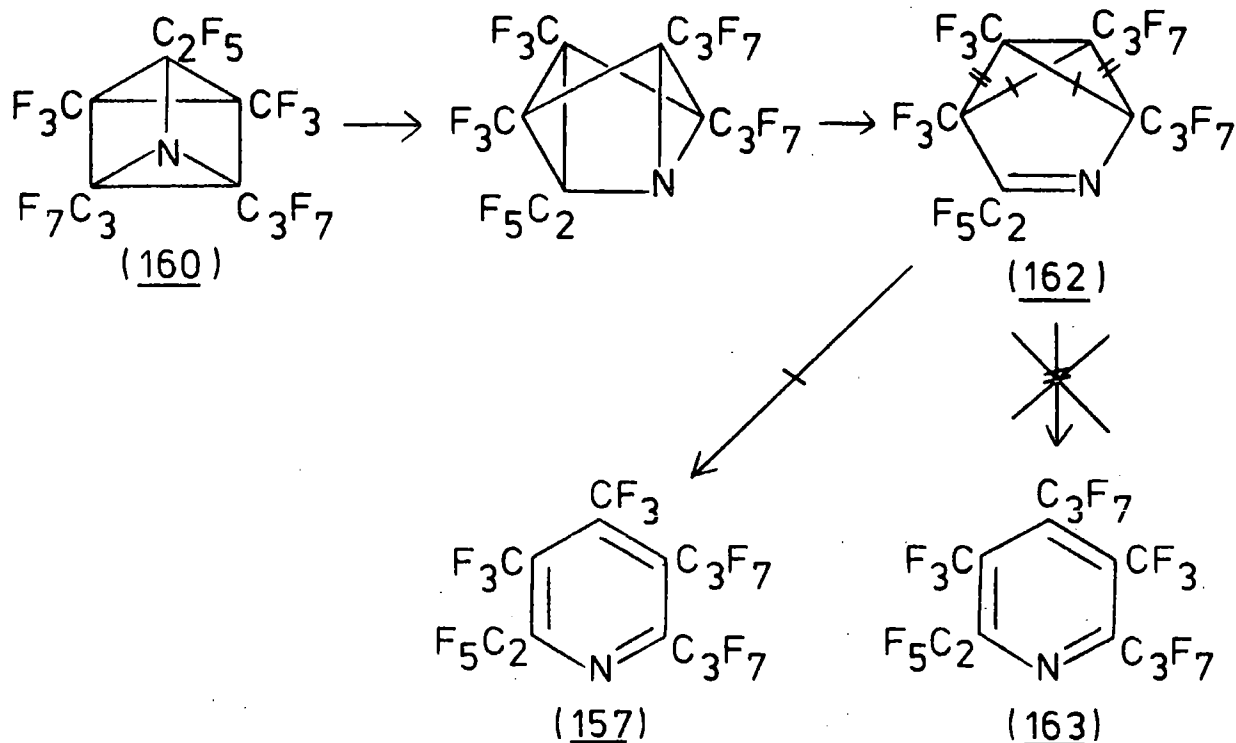

However the benzvalene (162) which would be the intermediate in formation of (157) from (160) should rearomatise by a second mechanism to form pyridine derivative (163). No presence of (163) was observed in the pyrolysis studies undertaken.

On the basis of the specificity of the pyrolysis of azaprismanes (159) and (160) it is suggested that these azaprismanes do not rearomatise via a benzvalene mechanism since a more complex pyridine mixture would be obtained if this were the mechanism. The simplicity of the product mixture obtained is inconsistent with an azabenzvalene rearomatisation mechanism.

3.2.(1)F.(2) Rearomatisation via Para-bonded Intermediates

A second possible rearomatisation mechanism could involve para-bonded species as intermediates.

Rearomatisation of (160) via intermediate para-bonded species could, in theory, give two pyridines (153) and (157) whereas (159) could rearomatise to give three pyridines (156), (158) and (163).

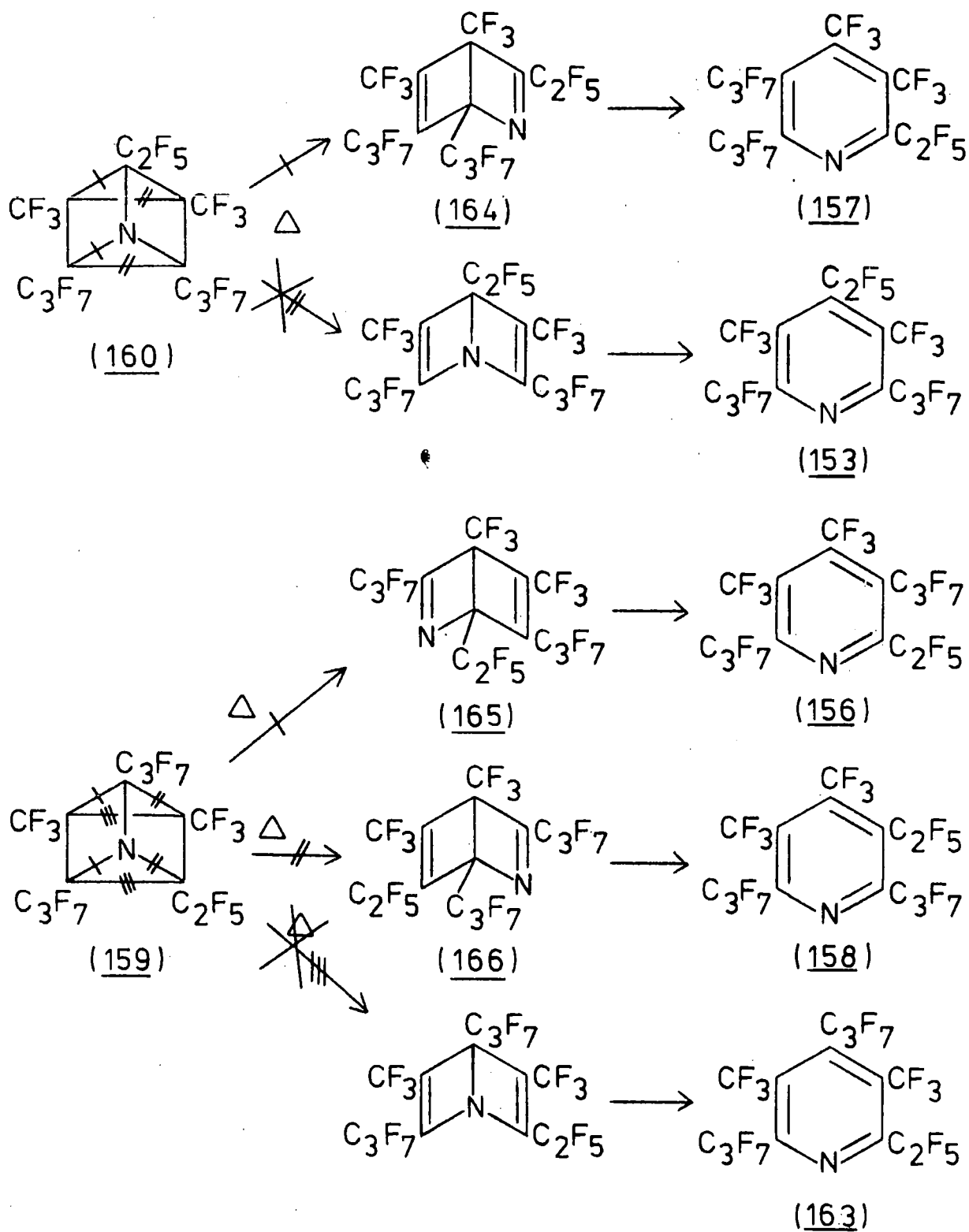

However the three products observed, in this pyrolysis, were (156), (157) and (158) and this was consistent with rearomatisation occurring solely via intermediate 2-azapara-bonded isomers (164), (165) and (166), so it is suggested that rearomatisation of (159) and (160) proceeded via this mechanism. These intermediates were however not detected in the pyrolysis of (159) and (160).

The conclusion that rearomatisation occurs via para-bonded intermediates is in agreement with observations of intermediates from thermal rearomatisation of pentakis-(pentafluoroethyl)azaprismane (110).

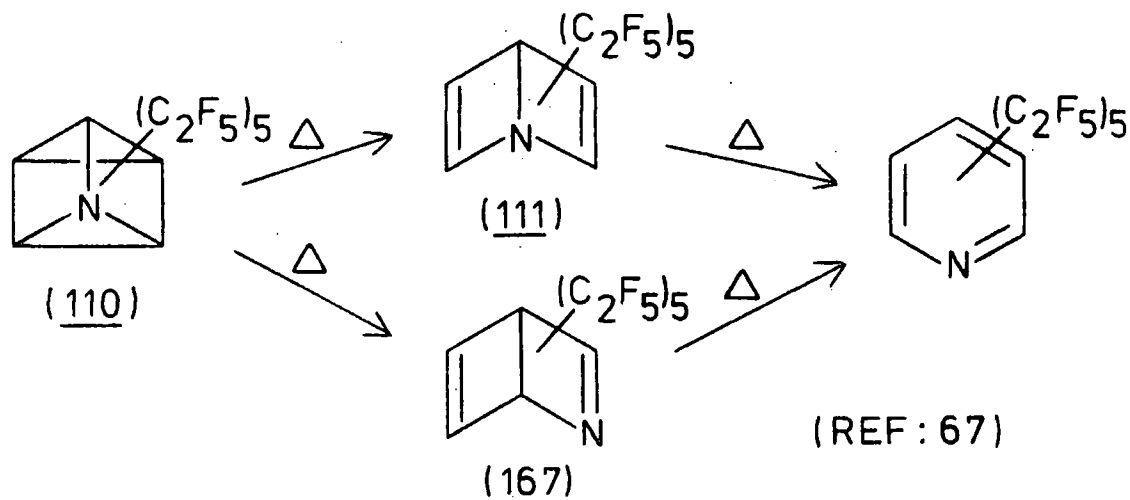

The intermediate para-bonded isomer (111) was isolated whereas (167) was detected by n.m.r. but was found to be too unstable for isolation. The rearomatisation of (110) was shown to proceed via both intermediate 1-aza and 2-aza-para-bonded isomers whereas, in this work, no para-bonded isomers were detected on pyrolysis of (159) or (160) and the reaction was found to proceed exclusively via the 2-azapara-bonded isomer. This is probably a result of the easier cleavage of C-N, rather than C-C.

3.2.(i)G. Mechanism for Formation of (160) from (153)

In principle irradiation of a labelled pyridine (168) containing the same substitution pattern as (153) should lead to the formation of two azaprismanes, one symmetrical (169), the other unsymmetrical (170) which could rearomatise, via para-bonded isomers, to three pyridine derivatives (171)-(173), in addition to reforming the starting pyridine derivative (168) (Scheme 2).

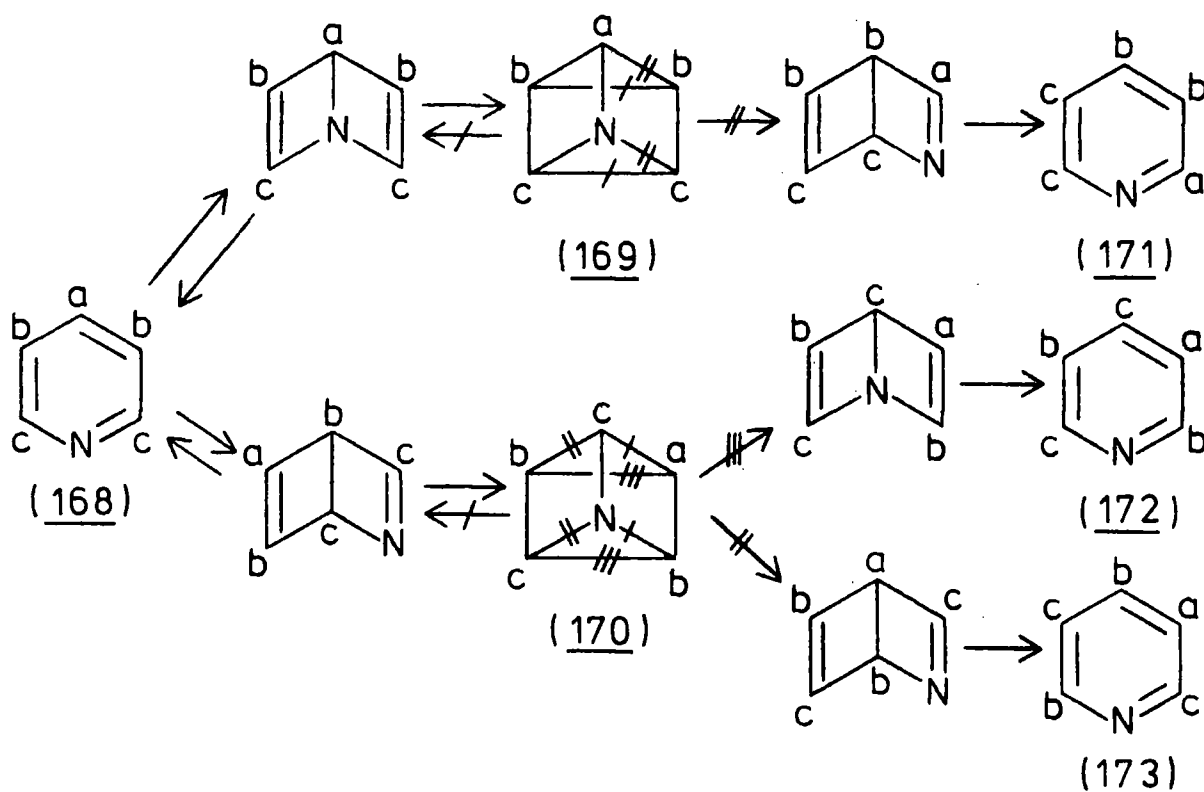

SCHEME 2

Van Bergen and Kellogg have photolysed a pyridine derivative which contained this substitution pattern⁴³ (a=CH(CH₃)₂, b=COOC₂H₅, c=CH₃) and isolated derivatives corresponding to (171), (172) and (173) (see Section 1.8(i)). However on comparison of structures of the

azaprismanes (159) and (160) with the theoretical patterns (169) and (170) in scheme 2 it is apparent that (160) contains the substitution pattern depicted in the symmetrical azaprismane (169) but no such correlation exists between unsymmetrical azaprismane (159) with the theoretical pattern in (170). This also occurs with the rearomatised pyridines in which (157) contains the substitution pattern as shown in (171), whereas the substitution patterns in (156) and (158) differ from (172) and (173), so the conclusion is reached that prior rearrangement has occurred before azaprismane derivative (159) is isolated, from the photolysis of pyridine derivative (153), so now possible rearrangement mechanisms are discussed.

3.2(1)H. The Formation of Azaprismane Derivative (159) from Photolysis of (153) - Possible Mechanisms

Introduction

In this section possible mechanisms for formation of (159) from (153) are discussed and evidence presented to justify the choice of mechanism which is suggested to occur.

3.2.(1)H(1) A One Stage Mechanism

The possibility that a one stage mechanism occurs must be considered. The formation of (159) from (153) would involve the formation of four new bonds in the apparently random manner illustrated to form a grossly distorted azaprismane. There is no evidence to support such a one step rearrangement which would have to occur in the

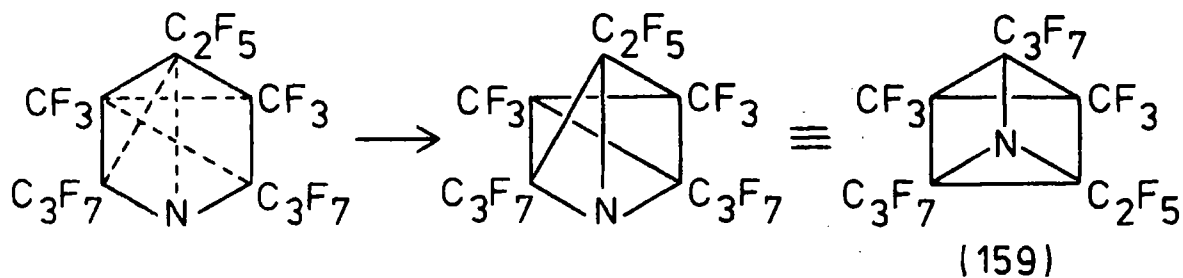

specific orientation illustrated only, to give the correct azaprismane (159).

3.2.(1)H(2) Mechanisms which Involve Rearrangement of Para-bonded Isomers

On comparison of the azaprismanes (159) and (160) formed from photolysis of (153) it is apparent that the only difference in labelling pattern is the interchange of C_2F_5 and $CF(CF_3)_2$ in going from (160) to (159) so that possible mechanisms which transpose substituents in

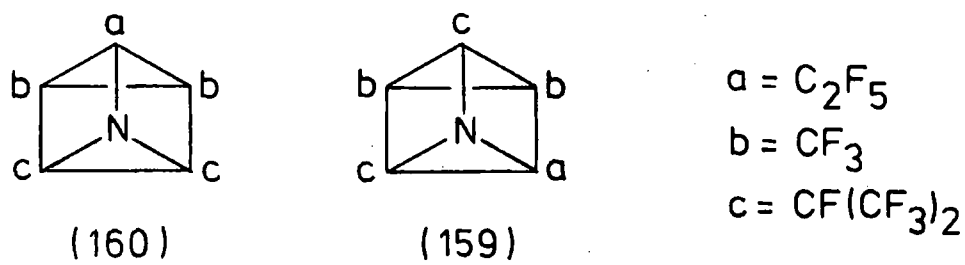

positions C-2 and C-4 must be considered.

Although no species conclusively proved to be intermediates have been isolated this does not rule out the presence of species resembling valence isomers, possibly in excited states, from being present as intermediates and

that rearrangement of intermediate species could occur. A rearrangement of para-bonded species, as found in the pyridazine to pyrazine rearrangement has the effect of transposing groups in the 2 and 4 positions.

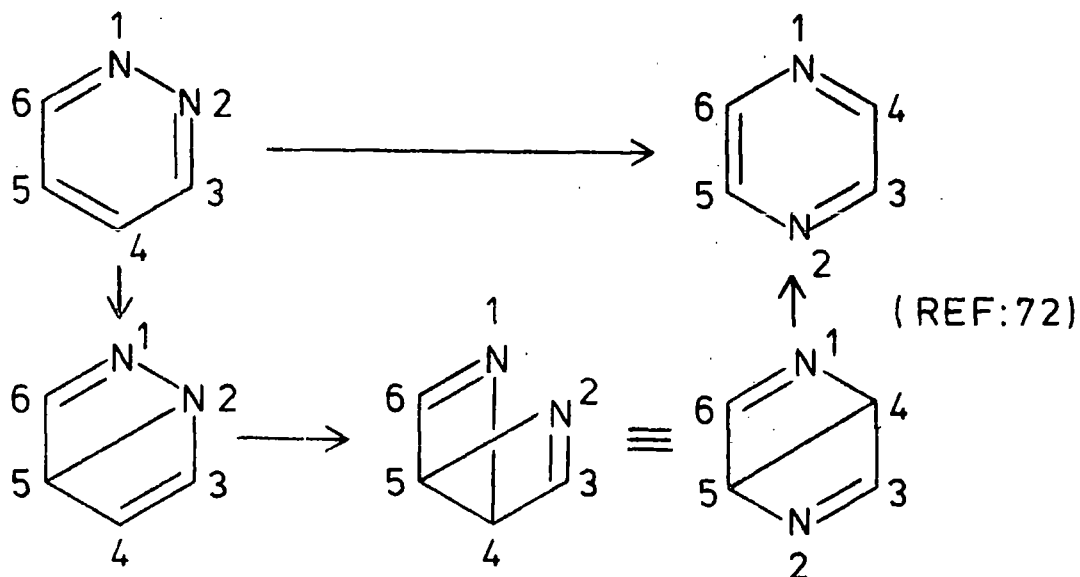

This type of rearrangement mechanism fulfills the conditions required in that interchange of substituents at C-2 and C-4 is achieved. It is suggested that the formation of azaprismene (159) from (153) proceeds via a mechanism which involves this type of rearrangement and that the participating para-bonded isomers are not detected. There are three such mechanisms which give the correct product. These are shown in Fig. 8.

In mechanism A the intermediacy of two 1-azapara-bonded isomers is postulated but no driving force for the rearrangement depicted is apparent. In mechanisms B and C it is postulated that interconversion of the two types of aza-para-bonded isomer occurs; in B this is rearrangement of a

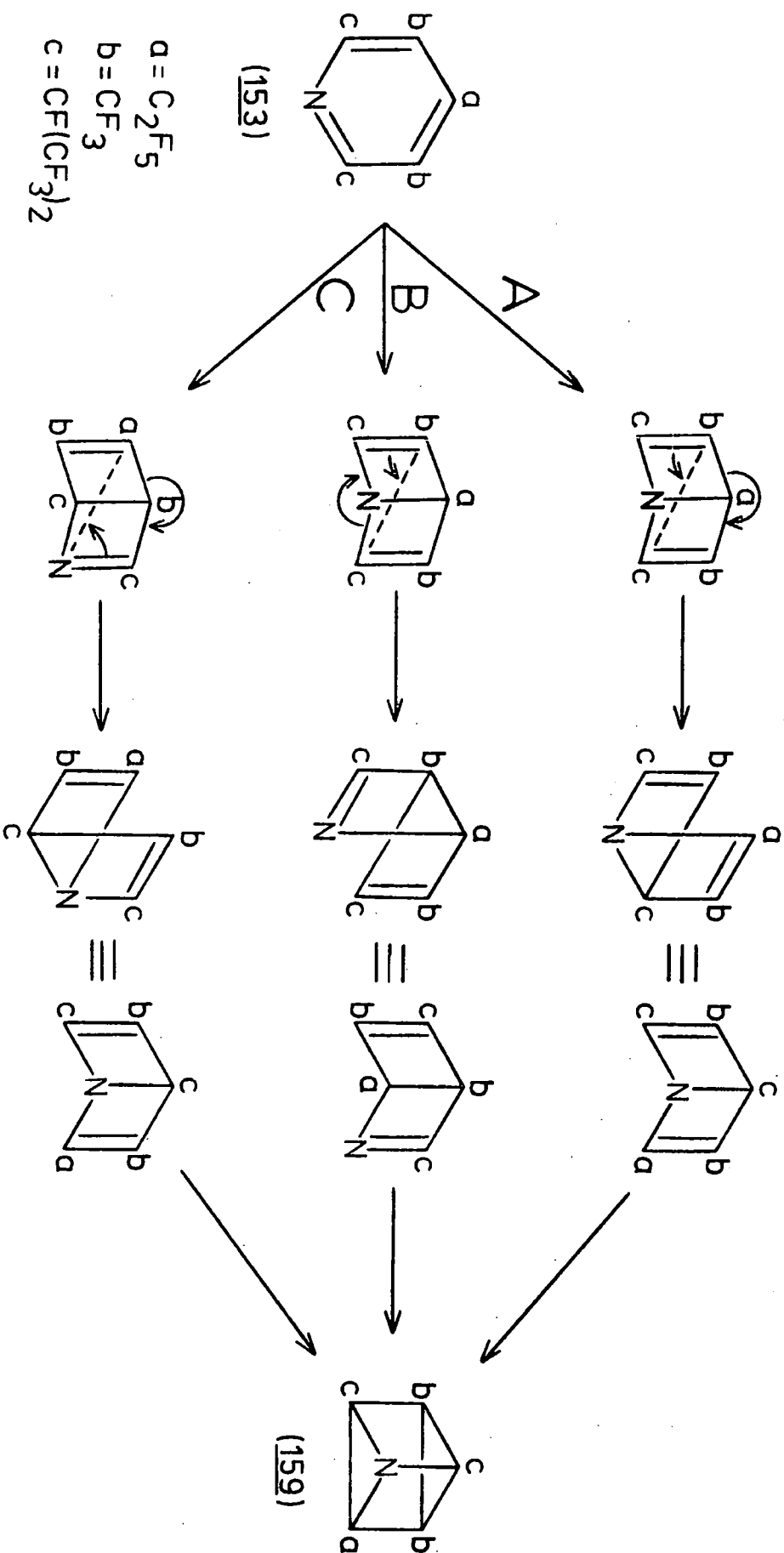
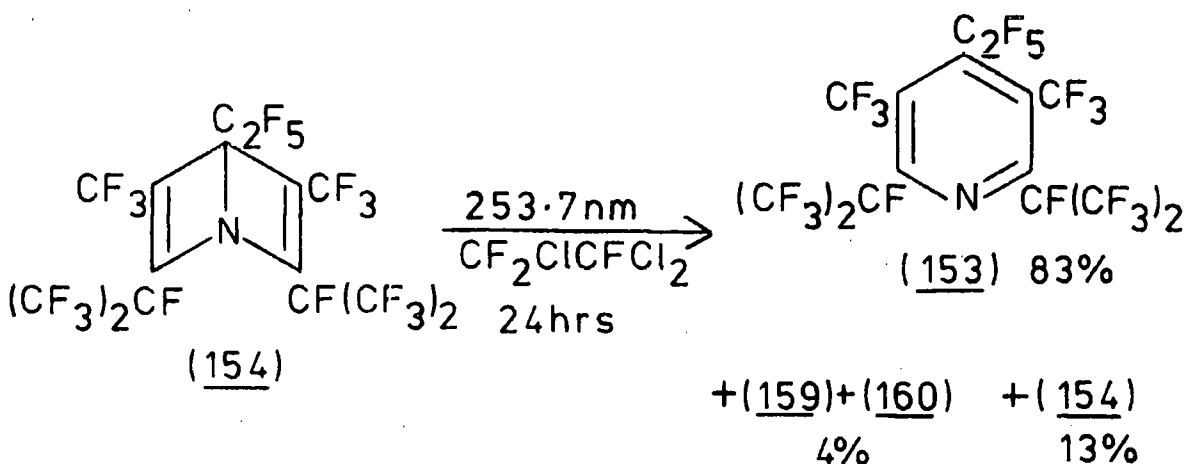

FIG. 8 Possible Mechanisms for the Formation of Azaprismane Derivative (159).

1-azabicyclo[2.2.0]hexa-2,5-diene derivative (154) to a 2-azabicyclo[2.2.0]hexa-2,5-diene whereas in mechanism C the reverse type of mechanism is postulated.

Further information was obtained by the irradiation of 1-azabicyclo[2.2.0]hexadiene derivative (154) at 253.7 nm. The major product was shown to be pyridine derivative (153) together with a trace of azaprismane mixture (159) and (160).



This result is significant since it illustrates the ease of re-formation of pyridine derivative (153) and shows that (154) is not necessarily an intermediate in the formation of (159) and (160) since these isomers could have been formed by irradiation of (153), which was re-formed on the photolysis of (154), so that none of the mechanisms can be ruled out from this result.

However, of the three rearrangement mechanisms it is suggested that mechanism A may be ruled out since no driving force for the rearrangement is apparent. The choice between B or C appears to be dependant upon the relative energies of 1-aza- and 2-aza-para-bonded isomers (174) and (175).

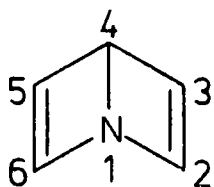

(174)

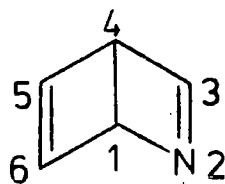

(175)

From a simple summation of bond energies (using value of C-C 82.6, C=C 145.8, C-N 72.8, and C=N 147 Kcal mole⁻¹⁹⁷) it was found that in terms of bond energies, isomer (175) was the more stable of the two by ca.20 Kcal mole⁻¹.

Indeed this conclusion was supported by the irradiation of pyridine which gave 2-azabicyclo[2.2.0]hexa-2,5-diene (51) as an unstable product.⁴⁰ However upon irradiation of fluorinated penta-alkylpyridines formation of 1-azabicyclo[2.2.0]hexa-2,5-diene (174) derivatives is prevalent. In this work irradiation of (153) gave the 1-azapara-bonded isomer (154), with the 2-aza isomer (155) not detected. Similarly irradiation of pentakis(pentafluoroethyl)pyridine (109) gave the 1-azabicyclo[2.2.0]hexa-2,5-diene derivative (111) only.⁶⁷ The reason for this preference for the 1-aza isomers is thought to be caused by the introduction of bulky perfluoroalkyl groups into the pyridine ring so that more steric interactions occur in the 2-azapara-bonded isomer.

As can be seen below the 1-azapara-bonded isomer (176) contains only three bulky substituents in each four membered ring, whereas the 2-aza isomer (177) contains four substituents in one ring and three in the other, so that greater

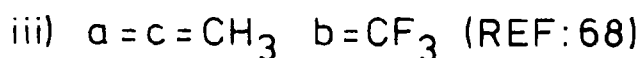
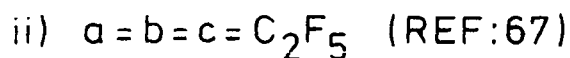
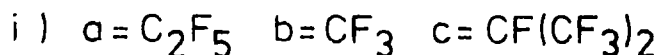
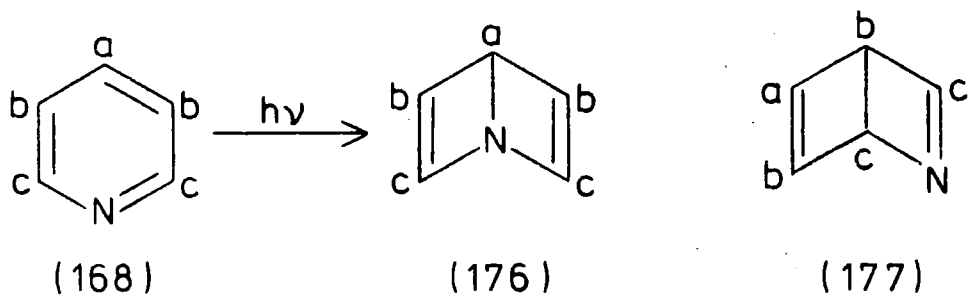

NOT
DETECTED

steric interactions are possible in (177) than in (176). In addition a 2-azabicyclo[2.2.0]hexa-2,5-derivative (167) was detected on pyrolysis of perfluoropentaethylazaprismane (110) but found to be an unstable species⁶⁷ (see Section 3.2(i)F.2), whereas the 1-azapara-bonded isomer (111) was remarkably stable. Therefore on this evidence it appears that on substitution by five alkyl groups the 1-aza skeleton (174) is lower in energy than the 2-aza skeleton (175).

In the rearrangement mechanism B postulated there is rearrangement of a 1-azapara-bonded species to a 2-azapara-bonded species i.e. from a more to a less stable species, whereas in mechanism C a driving force for the rearrangement is now apparent as rearrangement of a 2-azapara-bonded species to a 1-azapara-bonded species is postulated. This latter mechanism is the one suggested to occur. Neither of the para-bonded isomers (177) or (178) have been detected so it is probable that these intermediates are only

produced in excited states and proceed to rearrange before detection.

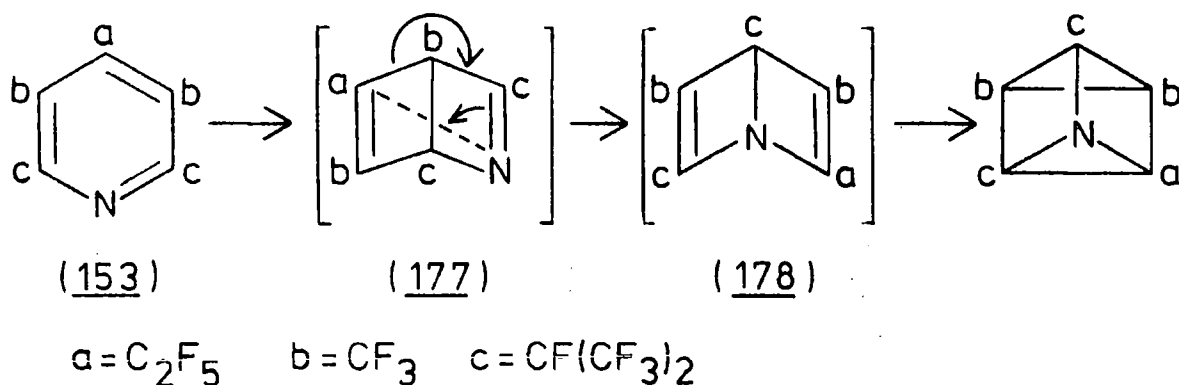

3.2.(1)I Irradiation of Perfluoro-4-ethyl-2,6-di-isopropyl-3,5-dimethylpyridine (153), at 253.7nm in a Transference System:

The formation of azaprismane derivatives (159) and (160), on the photolysis of (153) has involved postulation of intermediate para-bonded species. A transference technique has been used by other workers⁷² to isolate para-bonded isomers which were intermediates in the rearrangement of pyridazines to pyrazines. This technique, discussed later, was employed in the photolysis of (153).

Irradiation of (153), at 253.7nm., in a transference experiment (illustrated later, Fig. 9) gave a solid product shown to be starting material (153). None of the valence isomers (154), (159) or (160) obtained from irradiation of (153) in solution were detected, nor were the intermediate para-bonded isomers (177) or (178). The absence of valence isomers from this irradiation could be due to the low quantum efficiency in which the azaprismanes (159) and (160) are formed.

3.2(ii)A. Irradiation of Perfluoro-2,4,6-tri-isopropyl-3,5-dimethylpyridine (148) at 253.7nm.

Irradiation of pyridine derivative (148) gave a product which was in complete agreement with the above mechanism suggested for formation of azaprismanes on photolysis of (153). Irradiation of (148), in $\text{CF}_2\text{ClCFCl}_2$ gave a colourless liquid identified as perfluoro-2,4,6-tri-isopropyl-3,5-dimethyl-1-azatetracyclo[2.2.0.0^{2,6}.0^{3,5}]hexane (179).

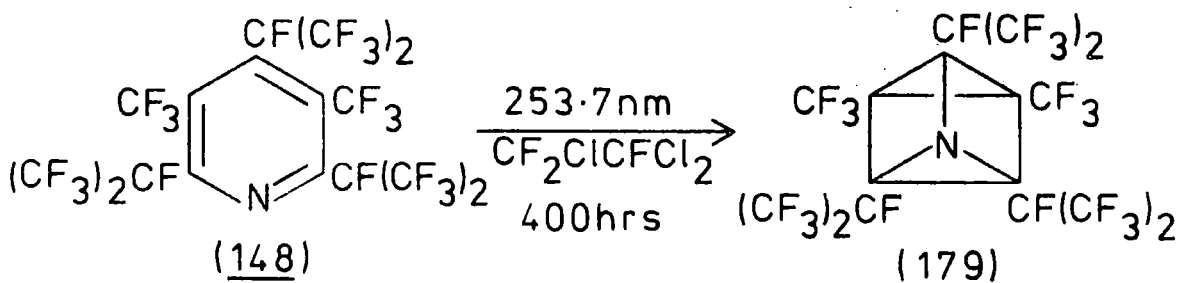

That an azaprismane had been formed was deduced from lack of bands corresponding to C=C or C=N stretches in the infra-red spectrum, and from the u.v. spectrum (λ_{max} 214nm, $\log \epsilon_{\text{max}}$ 2.72).

That (179) has a symmetrical structure follows from ^{19}F n.m.r. data which shows resonances at 64.3 p.p.m. (intensity 6, $2 \times \text{CF}_3$), overlapping signals at 76.3 and 76.7 p.p.m. (intensity 18, $3 \times \text{CF}(\text{CF}_3)_2$) with upfield resonances, assigned to tertiary fluorines, at 182.4 p.p.m. (intensity 2) and 189.5 p.p.m. (intensity 1). The structure of (179) was confirmed from its pyrolysis product.

The formation of only one azaprismane (179) from irradiation of (148) is predicted from both rearrangement mechanisms which were observed on photolysis of (153) i.e.

the direct formation of (179) via a 1-azabicyclo[2.2.0]-hexa-2,5-diene derivative (180) or rearrangement via a 2-azabicyclo[2.2.0]hexa-2,5-diene derivative (181). The rearrangement mechanism which involved a 1,3-shift does not lead to a second azaprismane since (148) only contains three labelling groups and if (181) were formed then rearrangement to (180) would occur and lead to the same azaprismane derivative (179). This has occurred since the substituents at C-2, C-4 and C-6 are identical i.e. perfluoroisopropyl.

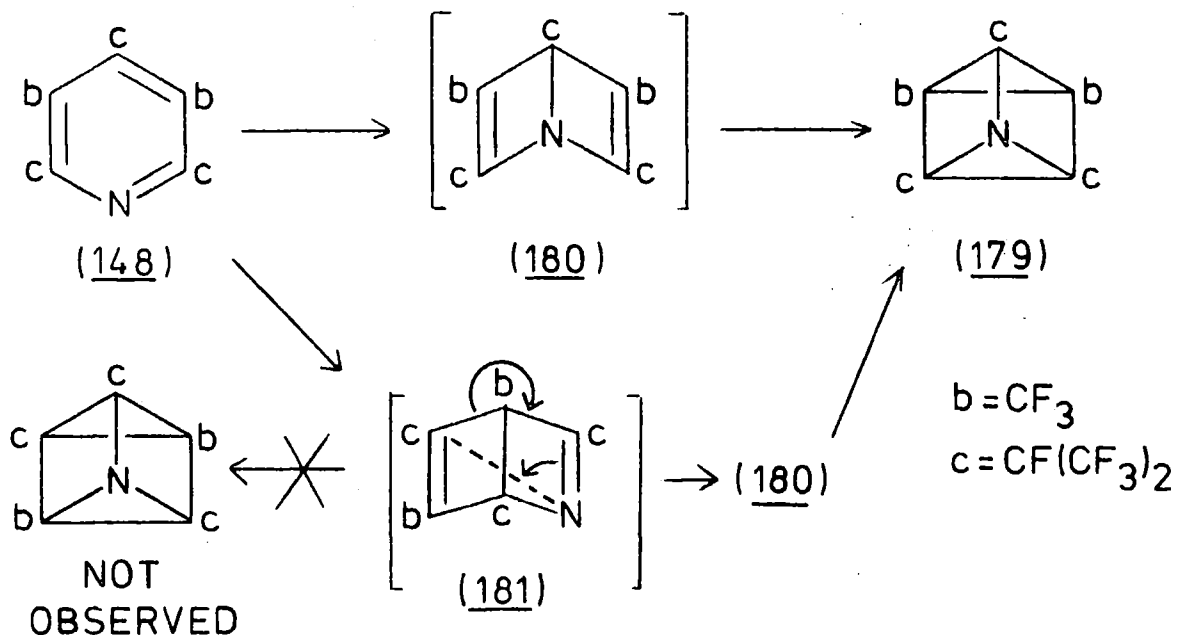

Unfortunately since only a limited quantity of (148) was available the effect of 300nm. irradiation was not studied.

3.2.(ii)B. Pyrolysis of Perfluoro-2,4,6-tri-isopropyl-3,5-dimethyl-1-azatetracyclo[2.2.0.0^{2,6}.0^{3,5}]-hexane (179)

Static pyrolysis, at 185°C, of azaprismane derivative (179) gave an isomeric product which was shown by its infra

red and u.v. data (λ_{\max} 218, 235nm. $\log \epsilon_{\max}$ 3.89 and 3.13) to be a pyridine derivative. The product was shown by ^{19}F n.m.r. data to be perfluoro-2,3,6-tri-isopropyl-4,5-dimethylpyridine (182) which adopted the conformation shown.

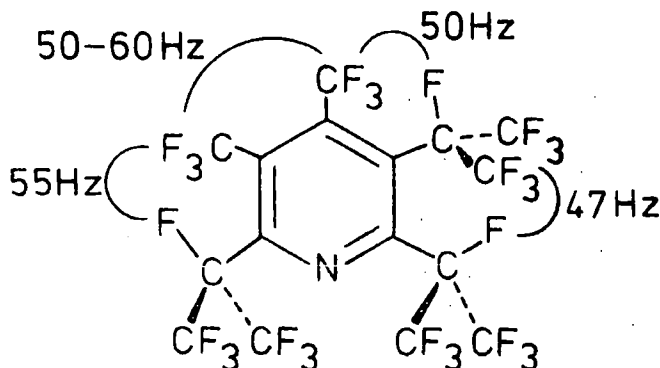

(182)

The ^{19}F n.m.r. spectrum showed two upfield tertiary fluorine signals at 180.7 and 179.3 p.p.m. These signals appeared in a region which corresponds to singly buttressed tertiary fluorines (see Section 3.2(1)C) which indicates that C_3F_7 substituents are at C-2 and C-6 and, in addition, the presence of two relatively sharp peaks in the CF_3 region confirmed this. The remaining tertiary fluorine was observed at 152.1 p.p.m., as a quartet, which corresponds to a doubly buttressed position in the ring, assigned to $\text{CF}(\text{CF}_3)_2$ at C-3. The observed fine structure confirmed the identity of the pyrolysis product as (182).

The formation of (182) on the pyrolysis of (179) is in complete accord with the rearomatisation mechanism observed on pyrolysis of (159) and (160) i.e. rearomatisation via a 2-azapara-bonded isomer formed by initial

cleavage of the C-N bond in (179) and not via a benzvalene intermediate.

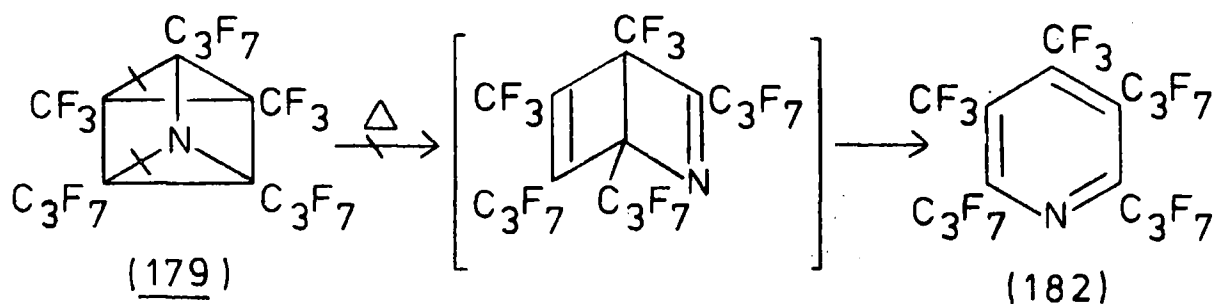

This result also provides additional confirmation for the structure of azaprismane derivative (179).

3.2.(iii) Irradiation of Perfluoro-2-ethyl-3,6-di-isopropyl-4,5-dimethylpyridine (156) at 254nm.

Irradiation of perfluoro-2-ethyl-3,6-di-isopropyl-4,5-dimethylpyridine (156) at 253.7nm. in CF₂ClCFCl₂ solution was carried out and resulted in the isolation of a colourless liquid which was identified as an azaprismane from u.v. (λ_{max} 220nm. ϵ 143) and infra-red spectra. The i.r. spectrum did not contain any peaks in the region expected for either C=C or C=N stretch.

A significant feature in the ¹⁹F n.m.r. of this azaprismane was the vastly different chemical shift values obtained for the CF₃ resonances, at 64.0 and 73.3 p.p.m. which indicates that these groups were in different environments. Signals from tertiary fluorines were observed at 177.6 and 185.0 p.p.m. and methylene fluorines gave a sharp resonance at 113.9 p.p.m. Other resonances were observed at 76.1 (CF(CF₃)₂), 77.1 (CF(CF₃)₂) and 84.6 p.p.m. (CF₂CF₃)

(all values relative to CFCl_3). However insufficient data was available from the n.m.r. spectrum for a structure of the azaprismane to be assigned, but this was possible after pyrolysis, although the number of resonances observed indicates that a single azaprismane had been formed.

Pyrolysis gave ca.89% of one involatile compound, together with two minor components which remained unidentified, but were isomeric with the azaprismane. The major pyrolysis product was identified as perfluoro-2-ethyl-3,5-di-isopropyl-4,6-dimethylpyridine (184).

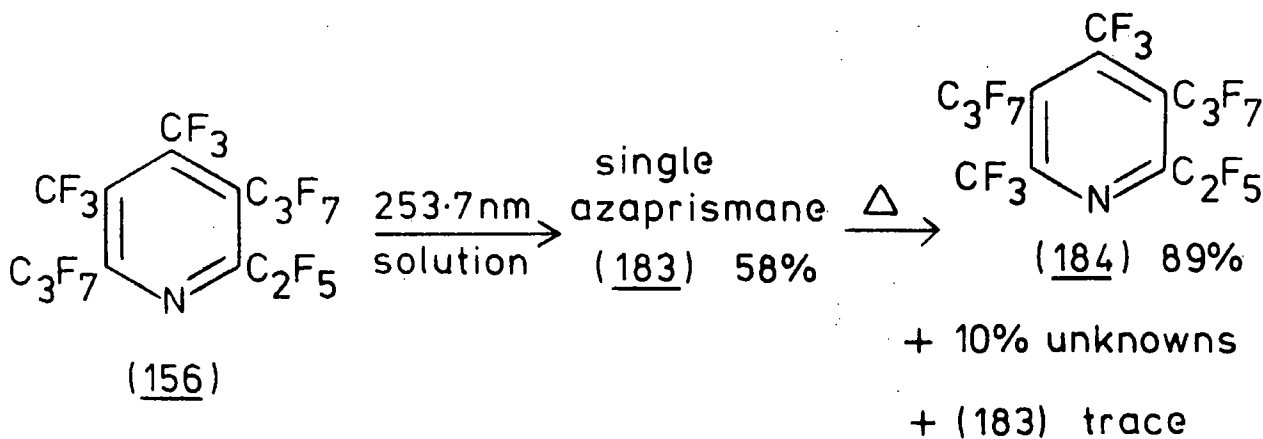

(184) was identified from its ^{19}F n.m.r. spectrum since this exhibited the same features as observed in pyridines (156)-(158) in that through space couplings were observed in the spectrum so that the average conformation of (184) was found to be as illustrated below.

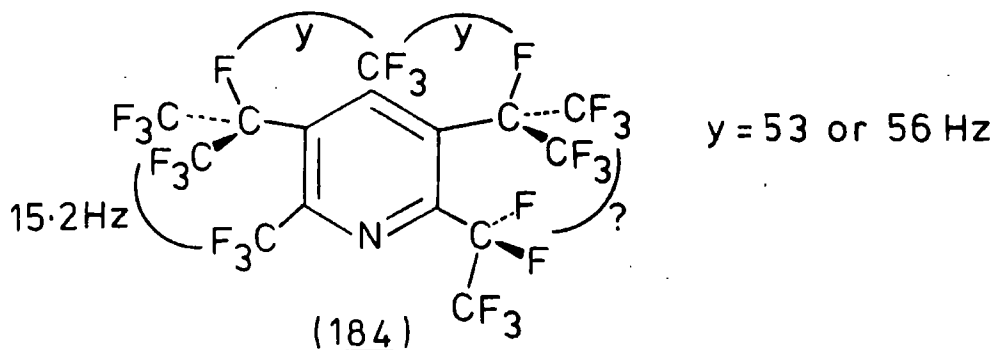

The ^{19}F n.m.r. of (184) showed two tertiary fluorine resonances at 154.9 and 156.1 p.p.m., whose signals were both quartets and overlapped. Both these signals were observed in the region expected for highly crowded tertiary fluorines and indicated that both C_3F_7 groups were substituted at C-3, C-4 or C-5. Resonances from CF_3 were observed at 49.9 and 62.5 p.p.m. The former resonances has been shown to be typical of CF_3 at either C-3 or C-4 in the pyridine whereas no examples of an observed resonance in the region of 62.5 p.p.m. have been reported in penta-alkylpyridines. However this value is not anomalous but arises from CF_3 substituted at C-2 or C-6 i.e. at carbon adjacent in nitrogen, and so (184) represents the first perfluoro-penta-alkyl pyridine with CF_3 substituent at a carbon adjacent to ring nitrogen. This assignment is consistent with further data as resonances of 79.2 and 109.6 p.p.m. (ratio 3:2) may be assigned to CF_2CF_3 at C-2 or C-6 which thus confirms structure (184). The ^{19}F n.m.r. spectrum of (184) is complex and not all the coupling constants were extracted. Identification of (184) thus enabled the structure of the azaprismane to be deduced.

Pyridine derivative (184) may have arisen from pyrolysis of one of three azaprismanes via an intermediate para-bonded isomer, as shown over.

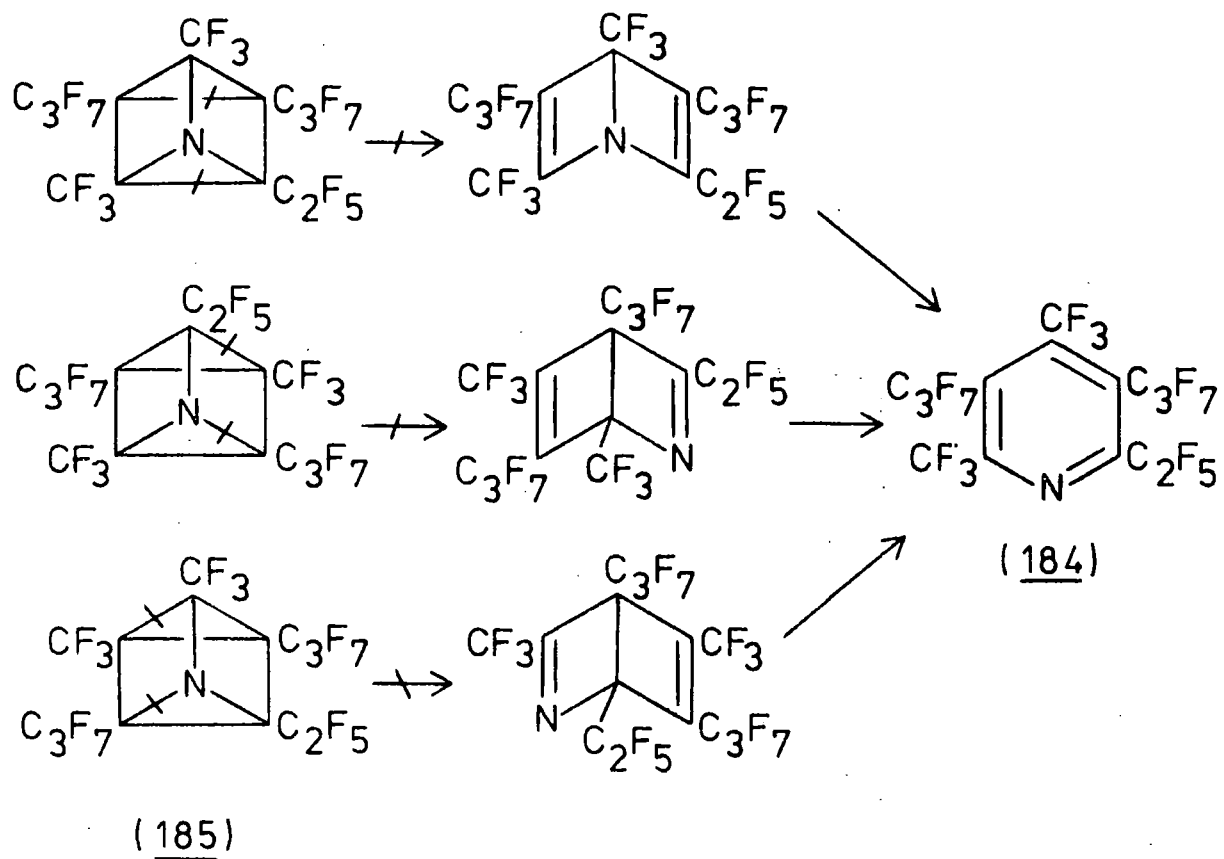

Of these three azaprismanes isomer (185) may be formed directly from (156) via an intermediate 1-azapara-bonded derivative (186) so it is suggested that the single azaprismane formed on irradiation of (156) has structure (185).

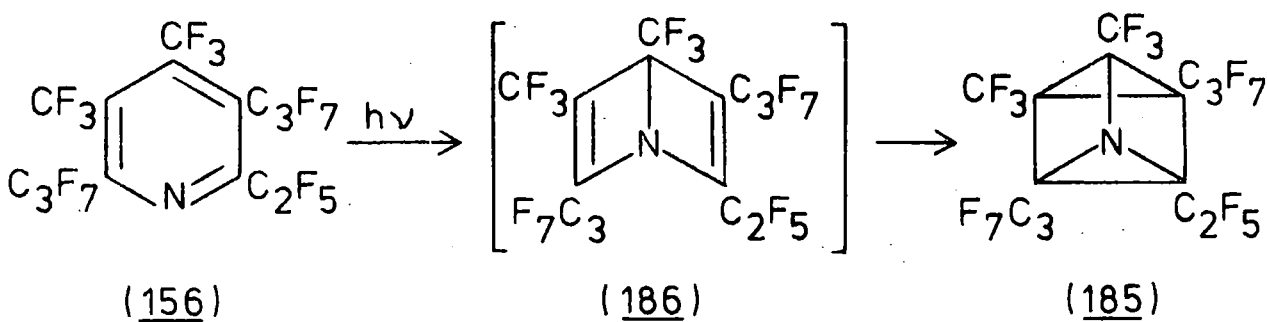

The ^{19}F n.m.r. data obtained from (183), although not sufficient to deduce structure (185) directly, may be accommodated in terms of structure (185) for the azaprismane (19F n.m.r. spectrum No. 6) so it appears that irradiation of (156) gives (185) directly with no evidence for a 1,3-shift rearrangement, since only a single azaprismane was found.

3.2.(iv) Irradiation of Perfluoro-2-ethyl-5,6-di-isopropyl-3,4-dimethylpyridine (157) at 254n.m.

Irradiation of (157) in $\text{CF}_2\text{ClCFCl}_2$ solution at 253.7nm. gave one new component which was shown by u.v. and i.r. spectra to be a saturated system i.e. an azaprismane A.

A possible structure for azaprismane A is (187) which can be formed directly from pyridine derivative (157) without prior rearrangement of intermediate para-bonded isomers.

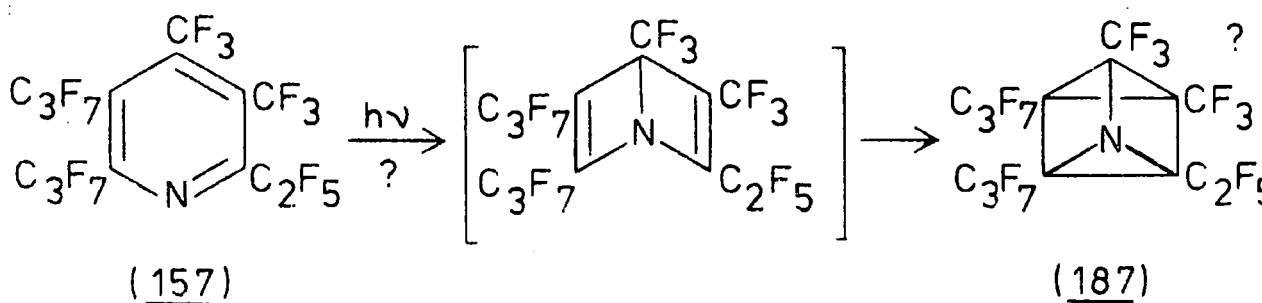

The ^{19}F n.m.r. of A showed resonances at 64.4 and 70.8 p.p.m. both CF_3 in different environments. Other signals were observed at 75.0 and 77.5 due to $\text{CF}(\text{CF}_3)_2$, 176.9 ($2 \times \text{CF}(\text{CF}_3)_2$), 84.5 (CF_2CF_3) and 119.1 p.p.m. (CF_2CF_3). Structure (187) was not eliminated by this ^{19}F n.m.r. data

but however it was insufficient to confirm the structure (187) as azaprismane A.

On pyrolysis of azaprismane A a mixture containing at least two pyridines was obtained, however the identity of these compounds was not ascertained so that no additional information as to the structure of azaprismane A is available.

3.3 The Photochemistry of Perfluorotetra-alkylpyridines

3.3.(1)A Introduction

In view of the successful isolation of valence isomers and the detection of rearrangements in perfluoropenta-alkylpyridines this study was extended to less highly substituted fluorinated pyridines. As it will be seen in later sections the irradiation of tetra- and tri-alkylpyridines, in static systems, failed to provide examples of valence bond isomers. As a result irradiations were attempted by the use of a transference system which is now described below.

3.3.(1)B Irradiation in a Transference System

This irradiation method involves the gradual transfer of the particular pyridine through the irradiation zone. The success of this irradiation method depends upon the relative volatilities of the valence isomer and the aromatic system being irradiated.

The apparatus used is illustrated below. As valence isomers are formed they are trapped in the cold trap (liquid air coolant) and so removed from the irradiation

zone. This method has been used in the isolation of intermediate para-bonded species formed in the photochemical rearrangement of pyridazines to pyrazines.⁷²

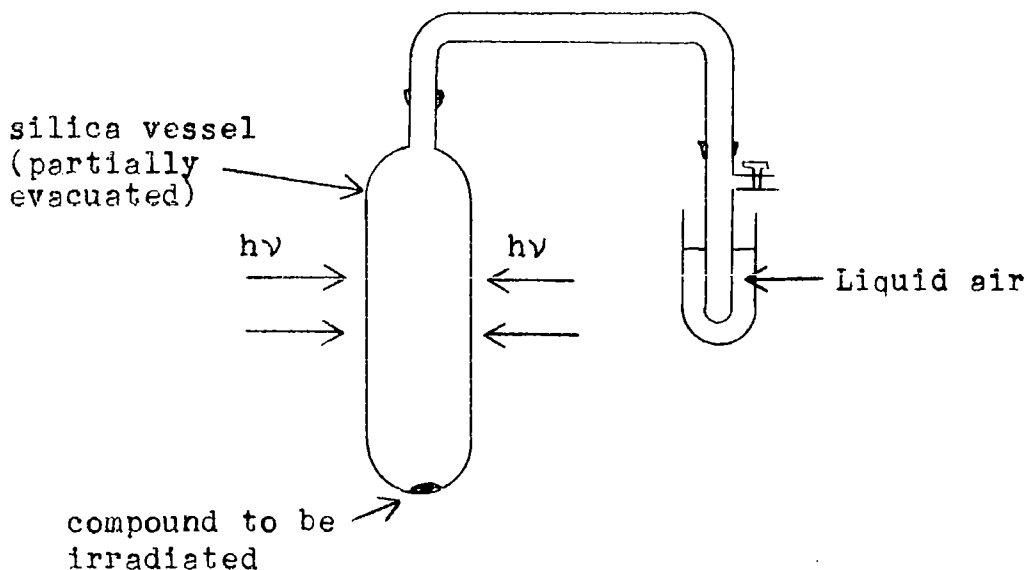

Fig. 9 The Transference Apparatus

The rate at which material transfers into the cold trap was dependent upon the residual pressure in the apparatus and this was varied so that the compounds transferred at approximately 1g/day.

3.3.(ii) Irradiation of Perfluoro-2,6-di-isopropyl-3,5-dimethylpyridine (149) at 253.7nm.

3.3.(ii)A In Solution

On irradiation of (149) at 253.7nm., in $\text{CF}_2\text{ClCFCl}_2$, slight decomposition was observed but unreacted starting material (149) was recovered. There was no evidence for rearrangement or valence isomer formation.

3.3.(11)B In a Transference System

Irradiation of (149) at 253.7nm. in silica using a transference system (Fig. 9) gave 43% conversion to perfluoro-1,3-di-isopropyl-4,6-dimethyl-2-azabicyclo [2.2.0]hexa-2,5-diene (188).

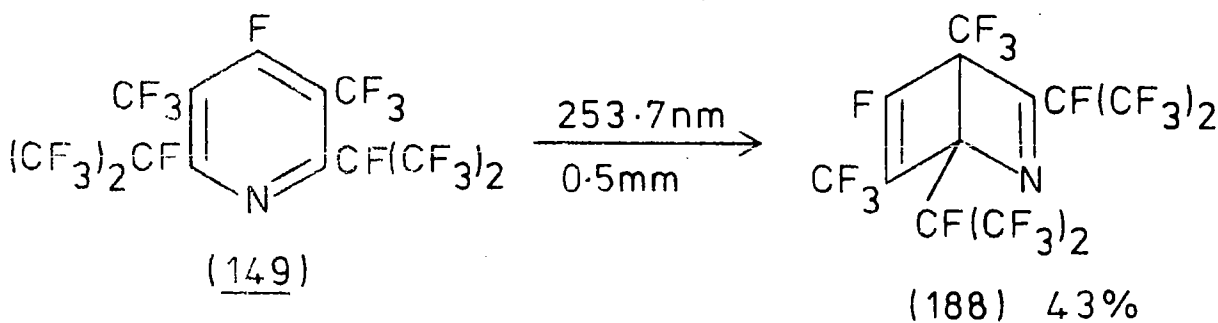

The para-bonded isomer (188) was identified from ^{19}F n.m.r., u.v. and infra-red spectra. The u.v. spectrum of (188) showed λ_{max} 218nm. (ϵ_{max} ca.600) and the i.r. spectrum showed ν_{max} 1720cm^{-1} (C=N stretch) and 1735cm^{-1} (C=C stretch) which indicated structure (188). Other workers⁷² have found ν_{max} 1735cm^{-1} (C=C stretch) in azapara-bonded species (116) although the values obtained for C=N stretch (ca 1675cm^{-1}) were different from that observed in (188),

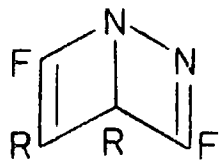

(116)

- i) $\text{R} = \text{CF}(\text{CF}_3)_2$
- ii) $\text{R} = \text{CF}(\text{CF}_3)\text{C}_2\text{F}_5$

^{19}F n.m.r. served to confirm the structure of (188) as it contained a resonance at 81.1 p.p.m. (C=CF) and two

tertiary fluorines at 179.1 and 185.9 p.p.m. in addition to signals obtained from CF_3 groups (at 66.4 and 66.9 p.p.m.). Once again non-equivalence of geminal CF_3 , on C_3F_7 , was observed. Assignment of signals in the ^{19}F n.m.r. was possible after decoupling.

One interesting feature, which arose in the decoupling study, was that a small coupling was observed between the vinylic fluorine (at C-5) and the CF_3 groups on C_3F_7 at C-3. This coupling may have arisen due to small interactions below the rings as the C_3F_7 on C-3 and the vinylic fluorine are in close proximity due to the dihedral angle in the molecule. The value of this coupling, however, could not be determined.

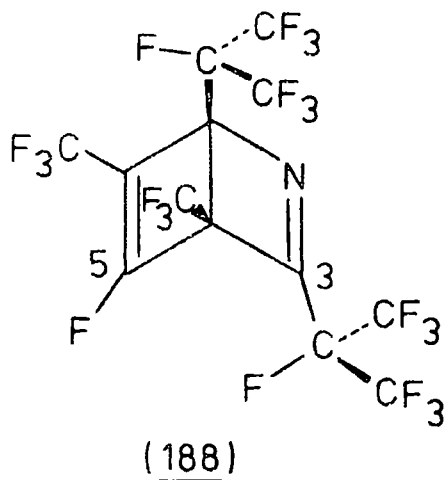

It was established that rearrangement of substituents had not occurred as pyrolysis of (188) gave pyridine derivative (149) as the sole product. The thermal stability of (188) is discussed later.

3.3.(iii) Irradiation of Perfluoro-2,4,6-tri-isopropyl-3-methylpyridine (151) at 253.7nm.

Pyridine derivative (151) is highly labelled as it contains four different labelling groups (including ring nitrogen) and has a different substitution pattern to any other pyridines irradiated previously.

Irradiation of (151) in a transference system, at 254nm. gave a mixture containing four components, as shown by g.l.c. in the ratio 35:5:30:30, in order of increasing retention time.

A pure sample of the first component (B) was obtained by reduced pressure fractional distillation. The ^{19}F n.m.r. of this component (B) showed four high field resonances at 179.0, 183.3, 191.3 and 193.2 p.p.m. which correspond to the presence of three tertiary fluorines and one 'bridgehead' fluorine. Other workers have shown that 'bridgehead' fluorine in diazapheno-bonded species⁷² and prismanes⁶⁴ absorb in this region and are characteristic of fluorine attached to a saturated carbon atom. Other signals in the ^{19}F n.m.r. were obtained for the CF_3 groups. The infra-red spectrum of (B) showed no bands in the region expected for C=N or C=C stretch and the u.v. spectrum (λ_{max} 210nm. ϵ_{max} 1060) which together indicated that (B) was not a pheno-bonded isomer nor a pyridine, therefore (B) must have an azaprismane structure.

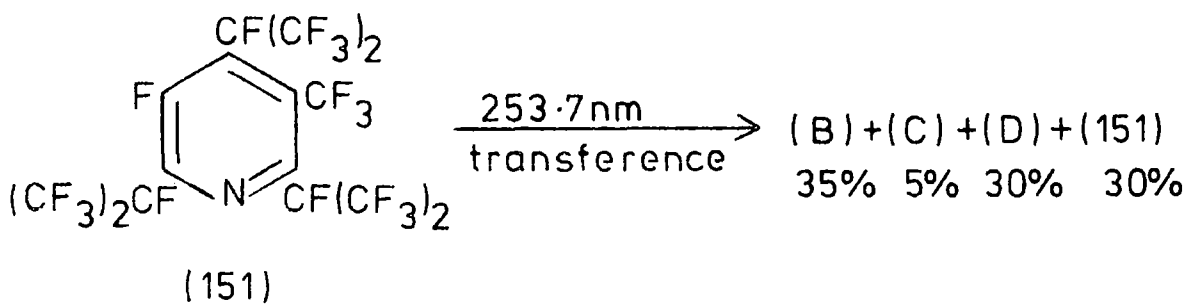

Insufficient information was available from the ^{19}F n.m.r. spectrum for (B) to be identified conclusively although of the three possible structures for (B), (189) and (190) would be the best alternatives as the $-\text{CF}_3$ group appeared at 62.2 p.p.m. in the ^{19}F n.m.r. of (B) and similar chemical shifts were observed for CF_3 at position C-3 or C-5 in the ring in compounds (159) and (160).

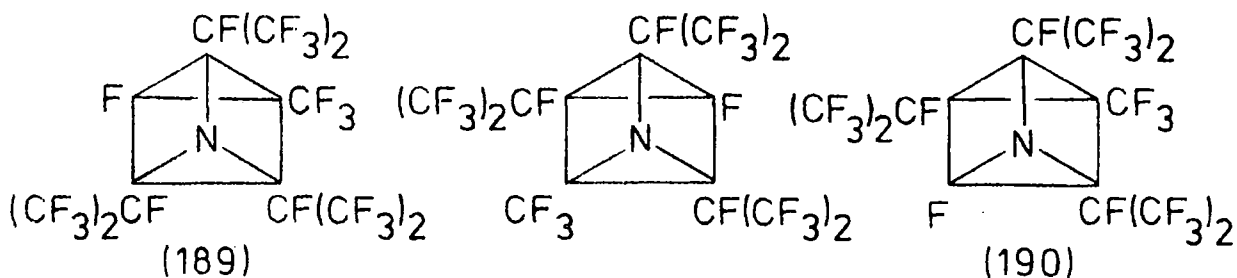

Alternative Structures for Azaprismane (B)

Component (C) had a similar g.l.c. retention time to (B) and could not be obtained pure; only as a mixture containing (B). (C) also could not be identified but significant peaks in the ^{19}F n.m.r. at 99.9 and 105.4 p.p.m. were assigned to $\text{CF}=\text{C}$ and the presence of resonances at 64.4 and 65.5 p.p.m. indicated that (C) was possibly a mixture of para-bonded isomers (191) and (192).

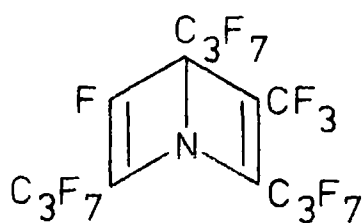

(191)

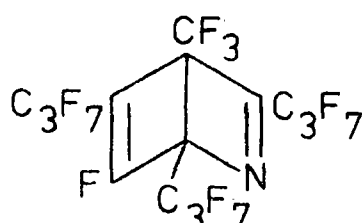

(192)

Component (D) had a similar g.l.c. retention time to starting material (151) and was only obtained as a mixture together with (151). (D) was thought to be a mixture of rotational isomers (193a) and (193b) with (193a) being the major component. Unfortunately this could not be confirmed since the $\text{CF}(\text{CF}_3)_2$ region of the ^{19}F n.m.r. was very complex and contained signals from (151) and this resulted in some signals being buried. The ^{19}F n.m.r. spectrum of (D) was

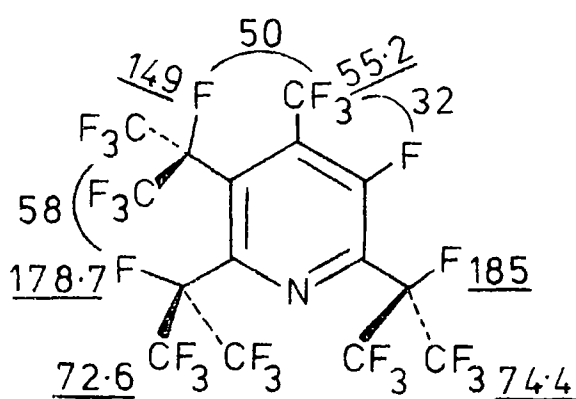

(193a)

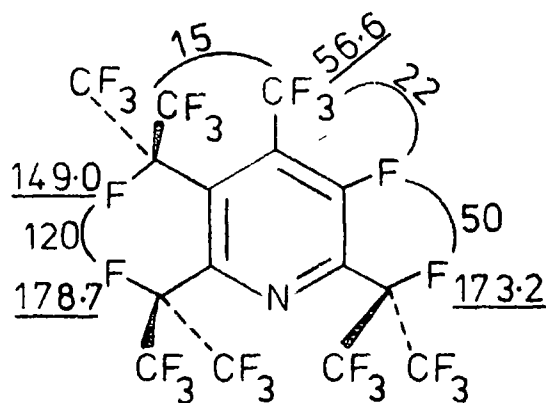

(193b)

unchanged at 150°C . The ^{19}F n.m.r. data for (D) is in the above diagram, chemical shifts are in p.p.m. and underlined, J values are in Hz.

Further information on this system was obtained by the pyrolysis and photolysis of (B). On pyrolysis isomer (B)

rearomatised to starting material (151) with a half-life of ca. 19 minutes at 143°C whereas on photolysis, at 254nm. the product was a mixture containing (D) and (151) in approximately the same proportions i.e. the same ratio as obtained in the transference system.

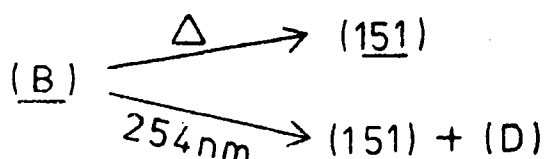

A tentative scheme can be suggested to account for the above observations.

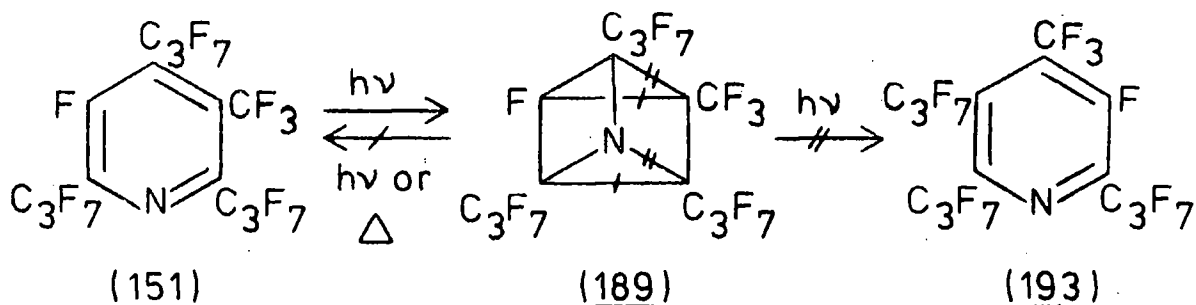

However these results are anomalous since the pyrolysis of (189), which is the most probable structure for (B), proceeds via initial C-C bond cleavage whereas in other examples, in this work, rearomatisation has proceeded via initial C-N bond cleavage.

3.4 The Photochemistry of Perfluorotri-alkylpyridines

3.4.(i) Irradiation of Perfluoro-2,4,6-tri-isopropylpyridine (138)

3.4.(i)A Static Irradiations

Irradiation of perfluoro-2,4,6-tri-isopropylpyridine (138), was carried out, at 253.7nm. both in $\text{CFCl}_2\text{CF}_2\text{Cl}$

solution and in the vapour phase both with and without degassing. Under these static reaction conditions starting material (138) was recovered, although generally some decomposition was observed. No evidence was obtained for either formation of valence isomers or rearrangement of the alkyl substituents in the pyridine skeleton.

The results are consistent with those of other workers⁶⁷ who have irradiated perfluorotriethylpyridine (113) in static systems and failed to observe the formation of valence bond isomers.

3.4.(i)B Irradiation of (138) Using a Transference System

Irradiation of (138) at 253.7nm., in silica, using a transference method gave 37% conversion to a mixture, shown to contain two azapara-bonded isomers in the approximate ratio 98:2, together with recovered starting material (138). Since (138) is symmetrical there are only two possible para-bonded isomers which may be obtained, unless some rearrangement of substituent groups has occurred; these are (194) and (195).

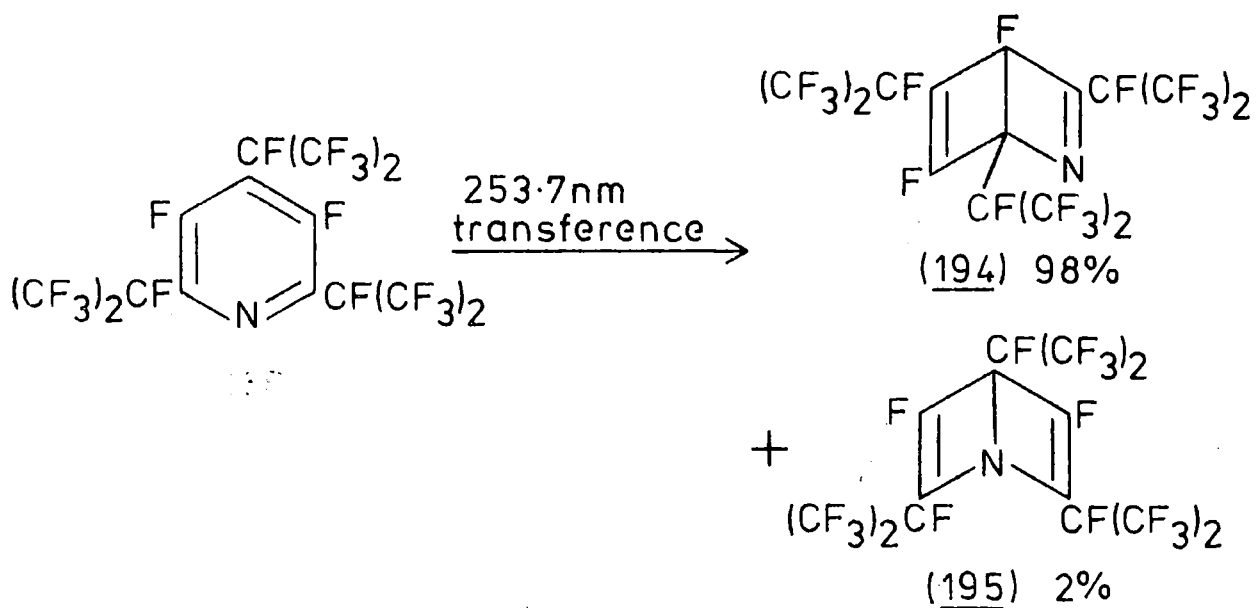

The major product from this irradiation was identified as perfluoro-1,3,5-tri-isopropyl-2-azabicyclo[2.2.0]hexa-2,5-diene (194) from ^{19}F n.m.r. evidence which showed the presence of four high field resonances at 179.6, 186.7, 189.1 and 191.3 p.p.m. (relative to CFCl_3), which were assigned to three tertiary fluorines and one bridgehead F. Full assignment of these signals to particular C_3F_7 groups was, however, not possible. Other signals were observed at 80.4 p.p.m. (int. 1), from $\text{CF}=\text{C}$, as well as resonances in the CF_3 region, from C_3F_7 groups. The i.r. spectrum showed bands at 1705cm^{-1} and 1740cm^{-1} which were due to $\text{C}=\text{N}$ and $\text{C}=\text{C}$ stretches respectively and the u.v. showed an absorption at ca. 210m μ . ($\epsilon=1100$). As it can be seen from above, this data was in agreement with structure (194) as the major product since (195) contains two vinylic fluorines and only three tertiary fluorines.

However it was possible to repeat this irradiation on a larger scale and on distillation, under reduced pressure, of the liquid product, a fraction which contained the second para-bonded species was obtained. The minor product was identified as perfluoro-2,4,6-tri-isopropyl-1-azabicyclo[2.2.0]hexa-2,5-diene (195) on the basis of its ^{19}F n.m.r. spectrum which contained two resonances at high field i.e. 184.6 and 191.3 p.p.m. (relative intensities 1 and 2 respectively) and a resonance at 102.7 p.p.m. (relative intensity 2). This data supports structure (195) as the high field signals may be assigned to tertiary fluorines and the resonance at 102.7 p.p.m. to $2\times\text{CF}=\text{C}$. Further support for

structures (194) and (195) was obtained by pyrolysis, as the sole pyrolysis product was the pyridine derivative (138).

Irradiation of (138) at 300nm. in a transference system, gave only 12% conversion to the para-bonded isomers (194) and (195). As in the photolysis at 253.7nm. only a trace of (195) was produced but the same products were produced since the same band is irradiated both at 300nm. and 253.7nm.

3.4.(ii) Irradiation of Perfluoro-2,4,5-tri-isopropyl-pyridine (137) at 253.7nm. Under Transference

Irradiation of (137) at 253.7nm. in a transference system gave 41% conversion of (137) to an isomeric liquid which was shown by ^{19}F n.m.r. and i.r. spectra to be a mixture containing two para-bonded isomers in the approximate ratio 55:45 (from integration of ^{19}F n.m.r. spectra).

In theory three para-bonded isomers may be obtained on photolysis of (137) if the relative positions of perfluoro-isopropyl groups are unchanged. These are (196)-(198).

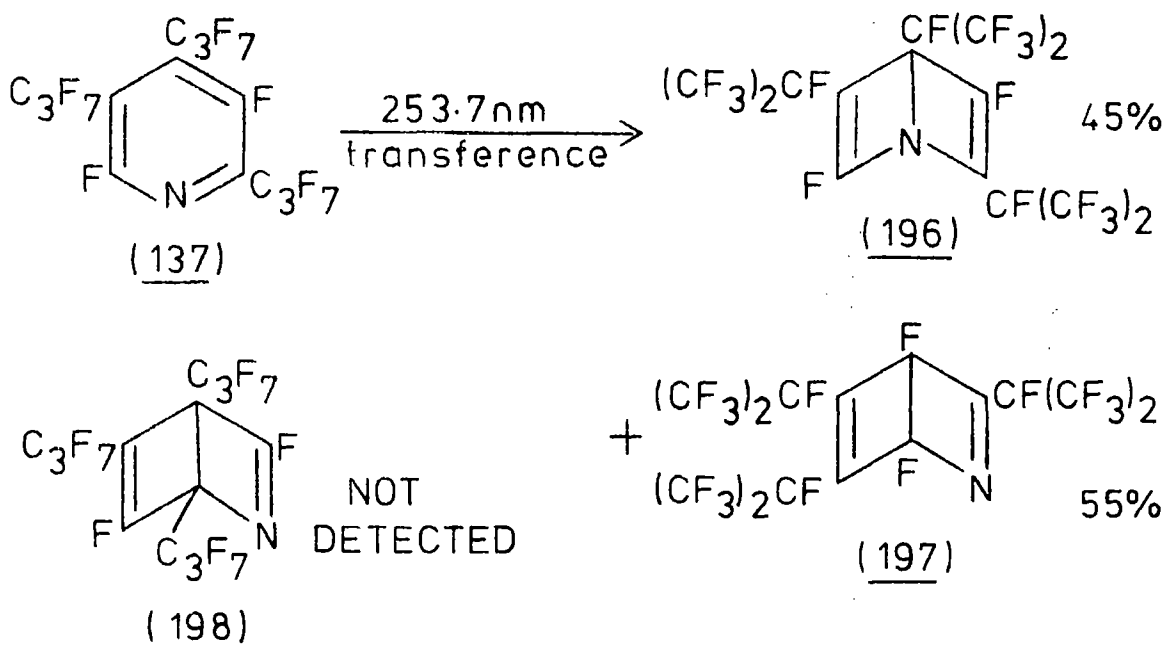

The components in the mixture were identified from ^{19}F n.m.r. spectra as perfluoro-3,5,6-tri-isopropyl-2-azabicyclo[2.2.0]hexa-2,5-diene (192) (55%) and perfluoro-2,4,5-tri-isopropyl-1-azabicyclo[2.2.0]hexa-2,5-diene (196) as 45% of the mixture. Isomer (196) was obtained pure by distillation, under reduced pressure.

The ^{19}F n.m.r. spectrum of (196) showed the presence of three tertiary fluorine resonances, at 177.0, 183.0 and 184.9 p.p.m. (all relative intensity 1, upfield of CFCl_3). Other signals in the n.m.r. were observed at 102.5 and 61.1 p.p.m. (both relative intensity 1) of which the former was attributed to $\text{CF}=\text{C}$. Examples of fluorine with low chemical shifts have been observed in diazaparabonded species⁷² where examples exist of imine fluorine and vinyl fluorine adjacent to nitrogen. From a comparison with values from (192) and (200) it can be seen that the value of 61.1 p.p.m. observed was consistent with structure (196).

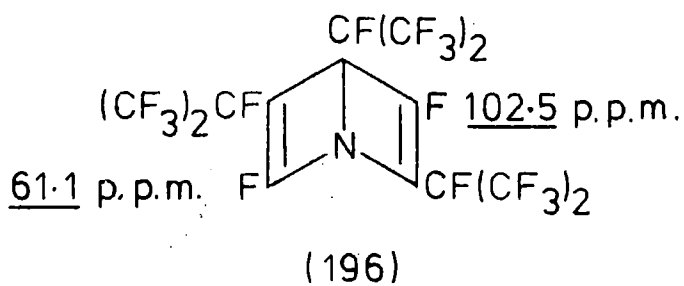
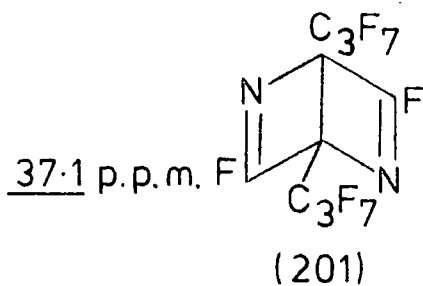
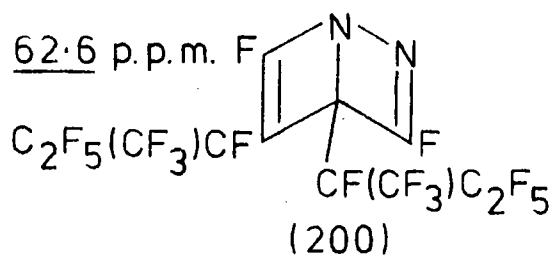
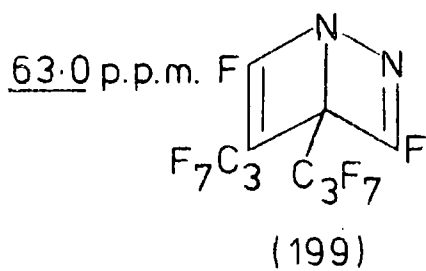

The i.r. spectrum of (196) showed a symmetrical absorption at 1742cm^{-1} (C=C stretch) and the u.v. spectrum showed one absorption at ca. 217nm . ($\epsilon \approx 2000$), which is also consistent with structure (196).

The second para-bonded isomer (197) was not obtained pure; only as a mixture containing (196). However ^{19}F n.m.r. and infra-red data confirmed the structure as the i.r. showed 1735cm^{-1} (C=C stretch) and 1705cm^{-1} (C=N stretch) and the ^{19}F n.m.r. spectrum showed five resonances at high field (176.6, 183.1, 186.8, 189.0 and 191.8 p.p.m. each intensity 1) which corresponds to three tertiary and two bridgehead fluorines in (197), although complete assignment could not be made.

Furthermore the structure of (196) and (197), were confirmed by rearomatisation of a mixture, by pyrolysis, to (137). The thermal stability of these isomers is discussed later.

3.4.(iii) Irradiation of Perfluoro-2-isopropyl-3,5-dimethylpyridine (150), at 253.7nm.

Whilst Under Transference

Para-bonded species were also obtained from irradiation of (150) at 253.7nm .; only the major product was identified, but not obtained pure.

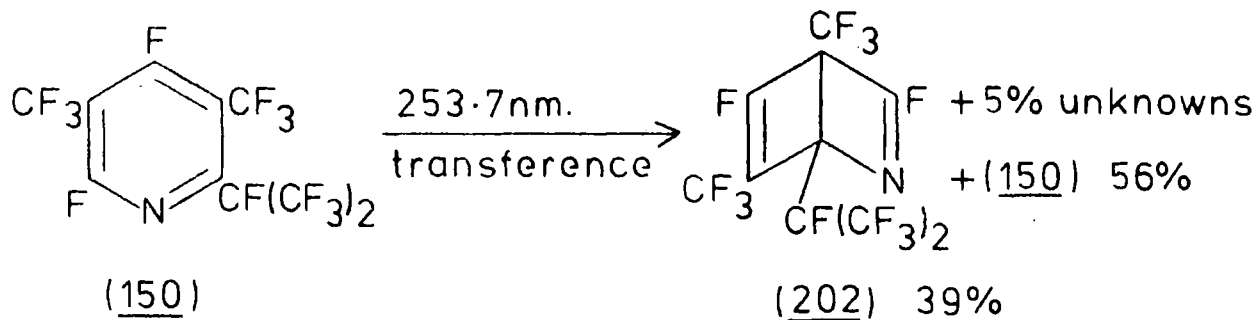

The major product was identified as perfluoro-1-iso-propyl-4,6-dimethyl-2-azabicyclo[2.2.0]hexa-2,5-diene (202) from ^{19}F n.m.r. and i.r. spectra. That the major product from irradiation of (150) had structure (202) and not either of the alternative structures (203) or (204) is

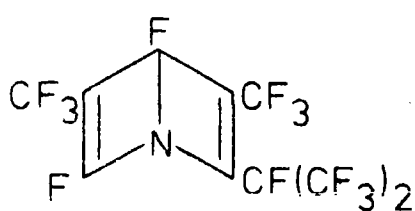

(203)

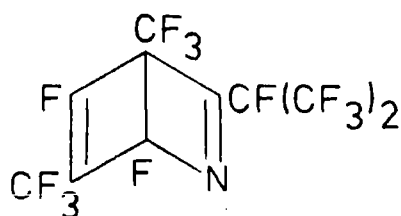

(204)

readily apparent from the ^{19}F n.m.r. which showed resonances at 180.9 p.p.m. ($\text{CF}(\text{CF}_3)_2$), 77.4 p.p.m. ($\text{CF}=\text{C}$) and 43.2 p.p.m. ($\text{CF}=\text{N}$) in addition to signals from tri-fluoromethyl groups. The signal with low chemical shift (43.2 p.p.m.) has been found to be typical of an imino fluorine in these environments as similar chemical shifts have been observed in

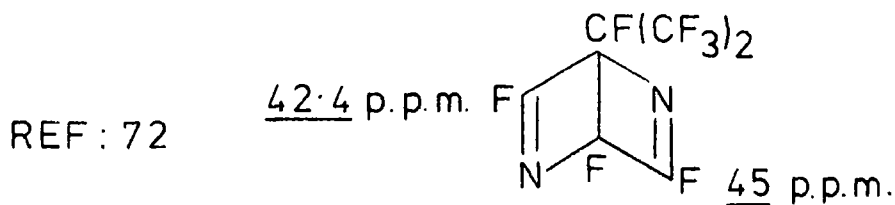

(205)

compounds (201) and (205). The observed n.m.r. spectrum ruled out structures (203) and (204) since both of these contain one tertiary fluorine and a bridgehead fluorine so are readily distinguishable from (202) by n.m.r. The i.r. spectrum of (202) showed bands at 1720cm^{-1} ($\text{C}=\text{N}$ stretch)

and 1740cm^{-1} (C=C stretch) which is also consistent with structure (202). It was not established whether the unknown components in this reaction contained any of (203) or (204). The para-bonded isomer (202) was found to be highly susceptible to hydrolysis.

3.4.(iv) Irradiation of Perfluoro-4,6-di-isopropyl-3-methylpyridine (152), at 253.7nm. Under Transference

Irradiation of (152) under transference, at 253.7nm., gave 46% conversion to a mixture of volatile species, shown by mass spectrometry to be isomeric with (152), together with recovered (152).

The volatile isomers could not be separated so were isolated as a mixture. The ^{19}F n.m.r. of the mixture showed resonances at 101.2 and 105.9 p.p.m. (probably $\text{CF}=\text{C}$) with four peaks in the 'tertiary' fluorine region, at 178.5, 180.0, 181.8 and 183.3 p.p.m. (in the ratio 2:2:1:6). The region 73 to 79 p.p.m. was very complex and contained many overlapping signals (from CF_3 groups). Other resonances were observed at 61.2, 63.3 and 64.5 p.p.m. The possible para-bonded isomer from (152) are shown over. None of these could be conclusively identified as being a component in the mixture but it is thought that isomer (206) was not formed as the $\text{CF}=\text{N}$ group has a characteristic resonance (at ca 43 p.p.m.) in these systems and no resonance, with this value, was observed in the ^{19}F n.m.r. of the mixture.

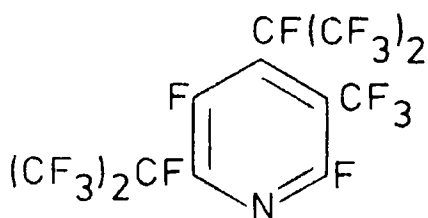

(152)

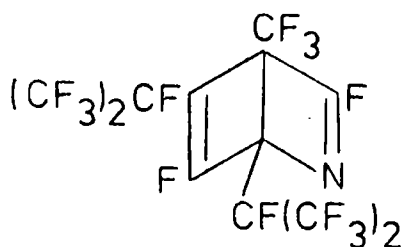

(206)

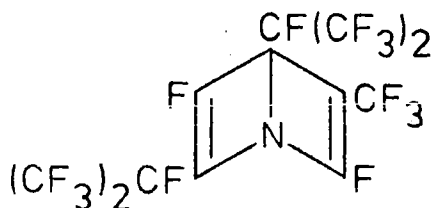
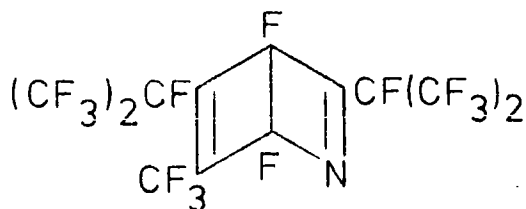

3.5 Irradiation of a Perfluoro-di-alkylpyridine:

Perfluoro-2,5-di-isopropylpyridine (139)

Only one example of a perfluoro-di-substituted pyridine was irradiated; this was (139).

Irradiation of (139) was carried out under transference at 253.7nm. on several occasions without success as on each occasion starting pyridine was recovered. An attempt to detect unstable valence-isomers from the running of low temperature ^{19}F n.m.r. spectra proved futile.

3.6 Irradiation of Pentafluoropyridine

Pentafluoropyridine (136) was irradiated in a transference system, at 253.7nm. but although much decomposition was observed on the walls of the silica transference vessel no valence isomers were detected.

This result is in agreement with those of other workers⁹⁵ who have irradiated pentafluoropyridine in a static vapour phase situation.

3.7 Irradiation of Perfluorotetra-kis-isopropylpyrazine (207)

Valence isomers have been isolated from pyridazines⁷² and pyridines^{67,68} but there have been no reports of valence isomers from photolysis of pyrazine or substituted pyrazines. Perfluorotetra-kis-isopropylpyrazine (207) was thought to be the most suitable compound for irradiation in view of results obtained from perfluoroalkyl pyridines and pyridazines.

Pyrazine derivative (207) was synthesised by nucleophilic attack by perfluoroisopropyl anion on tetrafluoropyrazine. The sample of (207) used in photolysis experiments was donated by Mr. R. D. Hercliffe.⁹⁸

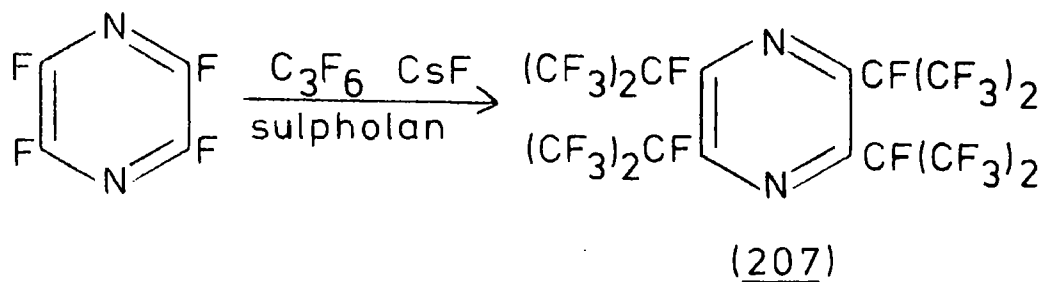

Irradiation of (207) was carried out at 253.7nm. in solution (in the presence and absence of oxygen), in the vapour phase and also in a transference system, but all reaction conditions failed to produce valence isomers from (207).

3.8 Conclusions

The occurrence of rearrangement of para-bonded species of the type previously identified in rearrangement of certain pyridazines to pyrazines^{71,72} was detected in the pyridine system. The overall scheme for rearrangement of penta-alkylpyridine (153) involved initial formation of an intermediate 2-azapara-bonded species (155) which rearranged to a 1-azapara-bonded isomer, and then the azaprismane (159). Structures of (159) and (160) were deduced by identification of their pyrolysis products (Fig. 10).

It has been observed that photochemical rearrangement of lutidines proceeds exclusively via 1,3-shifts⁴¹ and the rearrangement observed on photolysis of pyridazines^{71,72} and now in a pyridine system also result in an exclusive 1,3 shift overall. A mechanism of this type could account for the rearrangements observed on irradiation of lutidines and would account for the observation that 3,5-lutidine (54) does not rearrange on photolysis as the substitution pattern in (54) is such that 1,3 shifts do not lead to rearrangement i.e.

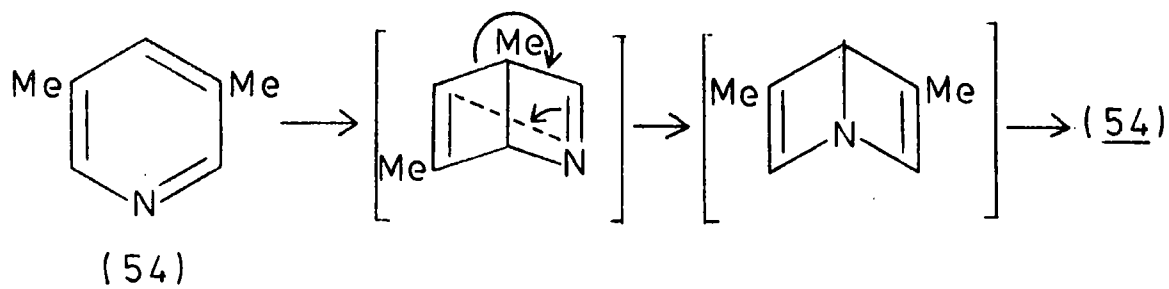

In addition para-bonded species have been detected in these systems.⁴⁰

The irradiation of tetra- and tri-alkylpyridines resulted in isolation of para-bonded isomers. (188) and (194) are examples of the first stable 2-azabicyclo[2.2.0]hexa-2,5-diene derivatives. (The stability of these isomers is discussed in the next chapter.) The failure of other workers to isolate stable derivatives from perfluorotetra- and tri-ethylpyridines (112) and (113)⁶⁷ probably stems from the wrong choice of irradiation conditions.

CHAPTER 4

The Thermal Stability and Properties of Valence Isomers of Pyridines

4.1 Introduction

This chapter contains a discussion of valence isomer stabilities and includes reference to a technique which has some use in this field (D.S.C.) and some attempted valence isomer reactions.

4.2 D.S.C. as Applied to Valence Isomer Rearrangements

4.2(1) Introduction

Differential Scanning Calorimetry (D.S.C.) is a thermal analysis technique developed in the last 15 years⁹⁹ which provides quantitative thermal data on the sample studied. The technique consists of heating a small quantity of sample, sealed in an aluminium sample pan, and a reference, which consists of an empty pan, through the temperature at which the transition, being studied, occurs. The pan temperatures are accurately monitored and the differential energy required to maintain both sample and reference pans at the same temperature is recorded. If an exothermic transition occurred, in the sample, then less energy would be required in order to maintain the correct heating rate, in the sample.

The data may be displayed on a chart recorder in which

case the area under the recorded curve is an exact calorimetric measure of the energy of the transition. Graphical presentation of results also contains temperature readings so that transition temperatures are easily obtained.

Only milligram quantities of material are required for the analysis.

4.2(ii) Activation Energy from D.S.C.

Whilst the area under a D.S.C. curve gives a direct measure of heat of reaction the shape of the curve may be used in order to calculate the activation energy for the process.

For a unimolecular process the rate constant at various temperatures may be obtained from the relation

$$k(T) = (dH/dt)/(A - a)$$

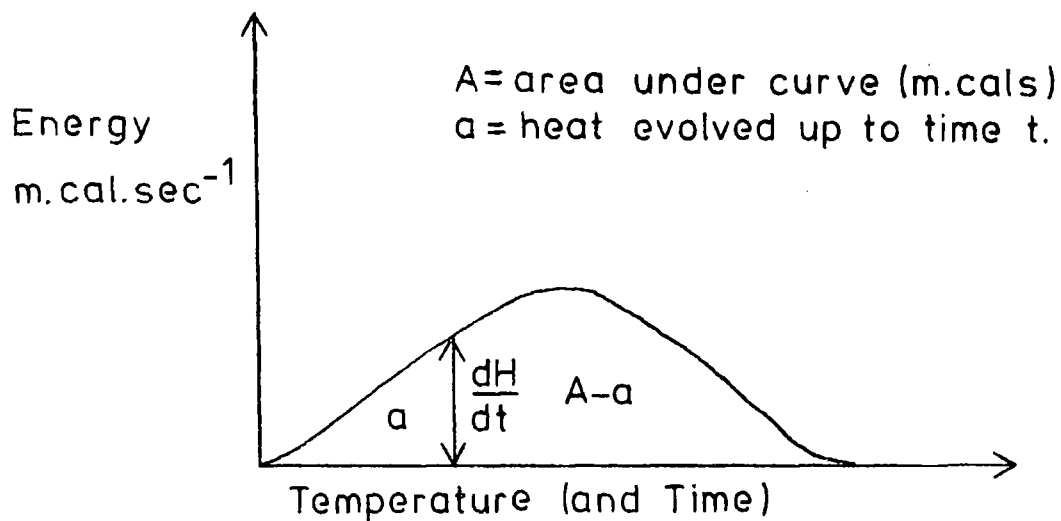

The expression for k is derived as follows.¹⁰⁰

It is assumed that the amount of heat evolved (a) is proportional to the number of moles reacted (n)

$$\frac{a}{A} = \frac{n}{n_0} \quad n_0 = \text{initial number of moles of reactant}$$

$$n = \frac{a}{A} \cdot n_0$$

Differentiate with respect to time.

$$\frac{dn}{dt} = \frac{n_0}{A} \cdot \frac{da}{dt} \quad \text{but} \quad \frac{da}{dt} = \frac{dH}{dt}$$

so

$$\frac{dn}{dt} = \frac{n_0}{A} \cdot \frac{dH}{dt}$$

Moles of reactant present at any time is given by

$$n' = n_0 - \frac{a \cdot n_0}{A} \quad \text{or} \quad n' = n_0 \left(\frac{A - a}{A} \right)$$

Rate of reaction = $k[\text{Reactant}]^x$ x = reaction order

$$= k \cdot \left(\frac{n'}{V} \right)^x \quad [\text{Reactant}] = \frac{n'}{V}$$

also: Rate of reaction = $\frac{d(\text{concentration})}{dt} = \frac{dn}{dt} \cdot \frac{1}{V}$

(V = volume)

Equating:

$$k \cdot \frac{n'^x}{V^x} = \frac{1}{V} \cdot \frac{n_0}{A} \cdot \frac{dH}{dt}$$

Substitute for n'

$$k \cdot \frac{n_0^x}{V^x} \cdot \frac{(A - a)^x}{A^x} = \frac{1}{V} \cdot \frac{n_0}{A} \cdot \frac{dH}{dt}$$

$$k = \frac{A^{x-1}}{n_0^{x-1}} \cdot \frac{V^{x-1}}{(A-a)^x} \cdot \frac{dH}{dt}$$

For a first order reaction $x = 1$

$$\therefore k = \frac{1}{A-a} \cdot \frac{dH}{dt}$$

Since this expression leads to values for rate constant k at different temperatures the value of activation energy for valence isomer rearrangement may be determined by an Arrhenius plot of $\ln k$ against $1/T$.

4.2(111) Valence Isomer Rearrangements Studied by D.S.C.

To date only a limited number of rearrangements have been studied by D.S.C. The isomerisation of hexamethylprismane (49) and hexamethylbicyclo[2.2.0]hexa-2,5-diene (48)³⁹ and their fully fluorinated isomers (94) and (96)²⁰ have all been looked at using this technique.

D.S.C. was used in order to determine the thermodynamic data for the rearrangement of valence isomers, the preparation of which has been described earlier, but was found to only give reproducible results for the rearrangement of bicyclo[2.2.0]hexadiene derivative (188) to the pyridine (149).

The shape of one trace obtained in this rearrangement is shown in Fig. 11. Analysis of the data yielded a value for activation energy (E_a) of 28.75 ± 0.5 k.cal.mole⁻¹ and a value for the enthalpy change (ΔH) of -47.7 ± 0.8 k.cal.mole⁻¹. These values were obtained by calculation of the mean value and the standard deviation from several runs.

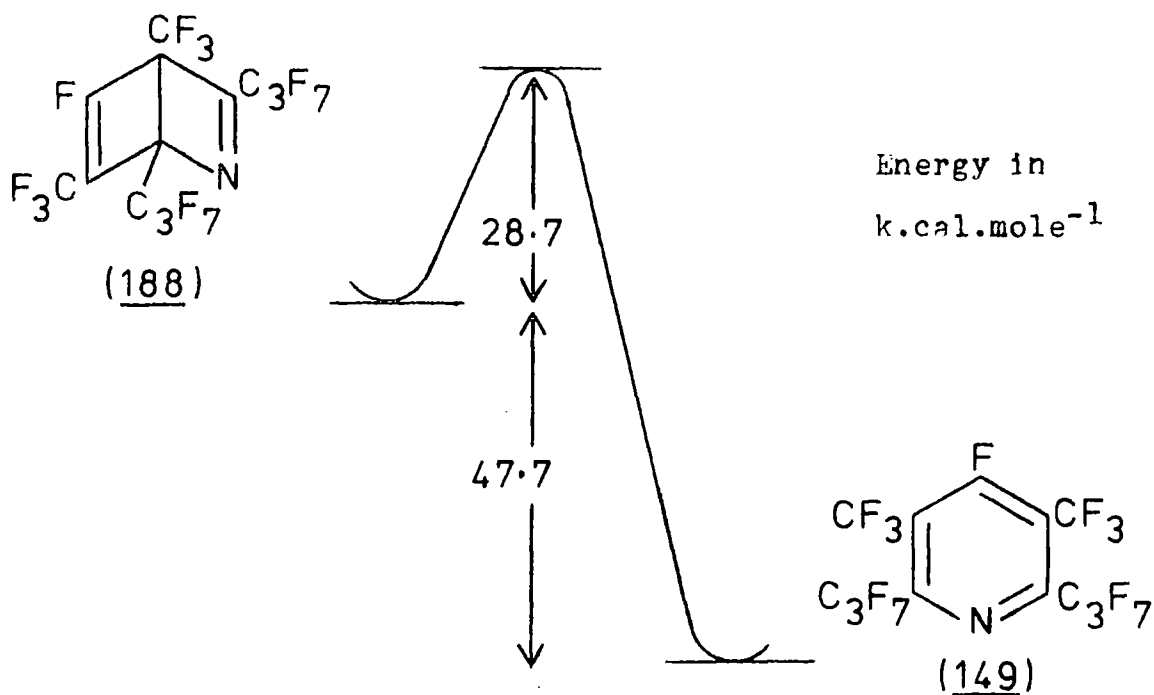

Energy Profile for Rearrangement of (188) to (149)

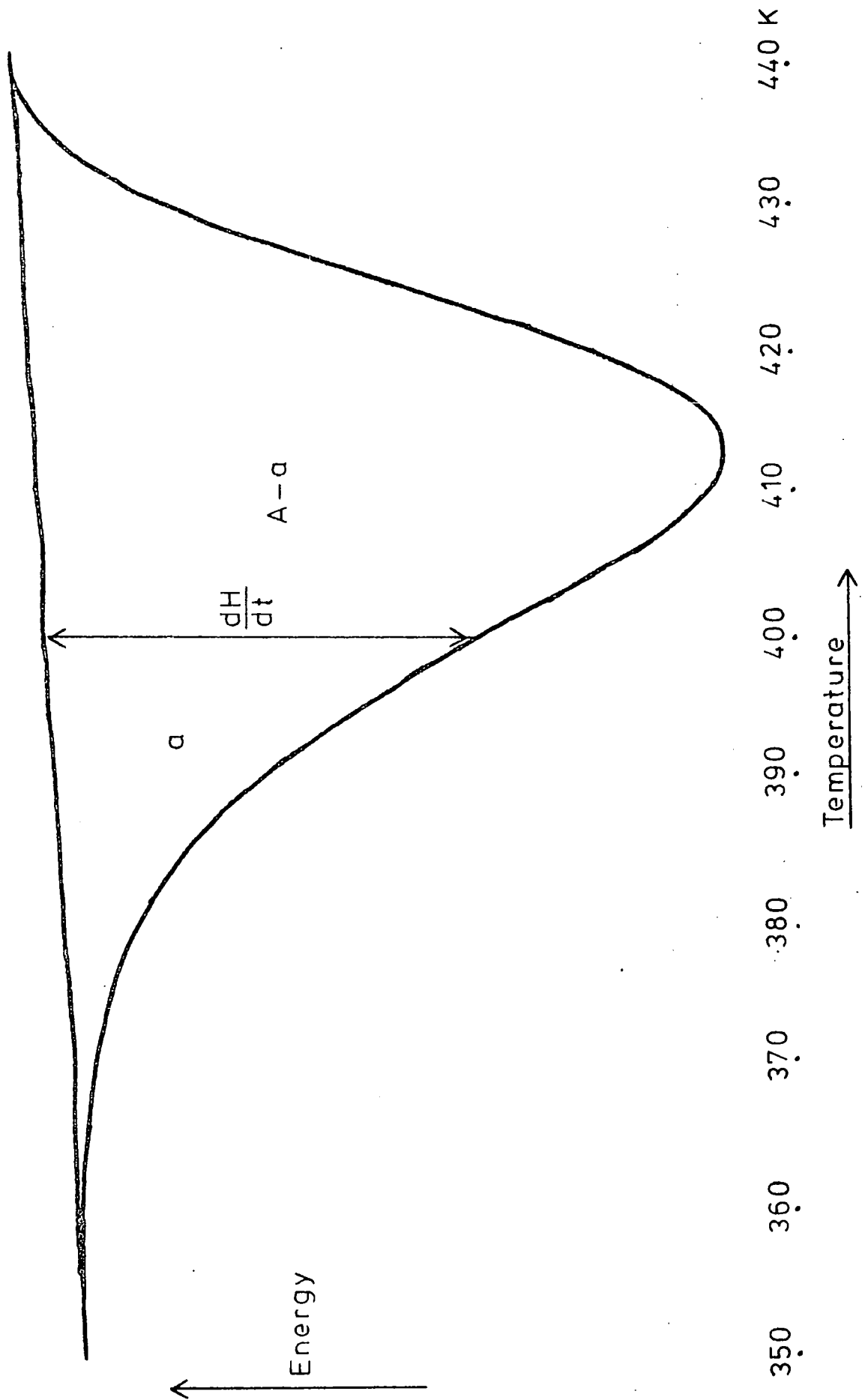
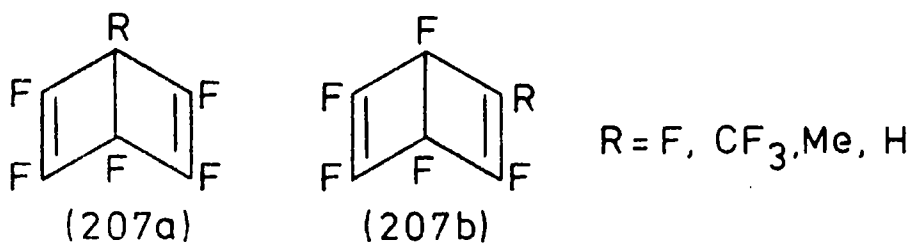

FIG.11. Typical D.S.C. Trace Obtained from Thermal Rearrangement of (188)

The activation energy was found to be comparable with values from 25.5 to 29.8 k.cal.mole⁻¹ obtained by other workers¹⁰¹ from the study of a series of parabonded isomers (207a) and (207b).



The variation in ΔH values for rearomatisation of substituted Dewar benzenes is large with the value of -56.2 k.cal.mole⁻¹ obtained for rearomatisation of hexamethylbicyclo[2.2.0]hexa-2,5-diene (48)³⁹ whereas for perfluorohexamethylbicyclo[2.2.0]hexa-2,5-diene (96)²⁰ the value was -28 k.cal.mole⁻¹. The value obtained from rearomatisation of (188) was in this range.

This para-bonded isomer (188) was the least stable isomer to be isolated pure (see later). The other para-bonded isomers and azaprismanes isolated in this work were found to be too stable for this technique to be utilised as the high temperatures requires for their rearomatisation approached, and in some cases exceeded, the boiling points of the samples, which caused the sample pans to either burst or leak during the runs.

4.3 The Stability of Valence Bond Isomers of Benzene

4.3(1) Introduction

Valence bond isomers of benzene are very strained systems and are thermodynamically unstable with respect to rearomatisation to benzene. The extent of this thermodynamic instability

can be illustrated from the values of ΔH for the rearomatisations. For the rearrangement of benzvalene (2) to benzene (9) a value of $-85 \text{ k.cal.mole}^{-1}$ has been calculated¹⁸ whereas for the rearomatisation of Dewar benzene (1) this is of the order $-60 \text{ k.cal.mole}^{-1}$.¹⁰²

Yet many isomers have been isolated and shown to be remarkably stable. This stability is thought to be due to lack of a concerted ground state pathway by which the valence bond isomer may rearomatise, i.e. these rearrangements are symmetry 'forbidden' with the result that a large activation energy is required for the rearomatisation to proceed, although it has been suggested that (2) rearranges via a symmetry 'allowed' manner, but with a high activation energy,¹⁸ but this point is at present unclear.⁹ Symmetry aspects have been dealt with earlier (Section 1.4).

It has been shown that rearrangement of Dewar benzene produces benzene in its triplet state, which is an indication that this rearomatisation does not occur via a concerted mechanism. The rearomatisation of benzvalene, however, does not produce triplet benzene.¹⁹

4.3(ii) Introduction of Alkyl Groups in Hydrocarbon Systems

There are examples of the introduction of alkyl groups into valence isomers acting to increase the stability of the isomer, relative to the substituted isomer, but this is not always the case as examples of the parent valence bond isomer having greater thermal stability are also known.

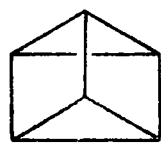

(3)

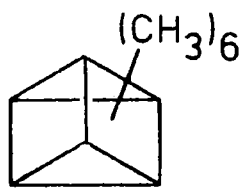

(49)

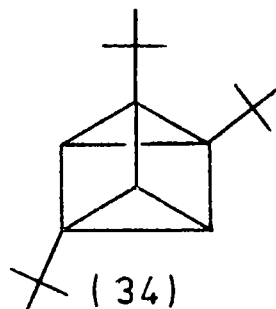

(34)

$t_{1/2}$ values 11 hr/90°C ca 2hr/110°C³⁷ ca 13-14 hr/115°C

Tri-t-butylprismane (34) has been shown to be more stable than either prismane (3) or hexamethylprismane (49) which appear to be of roughly the same stability.

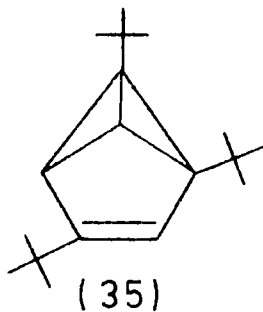

(35)

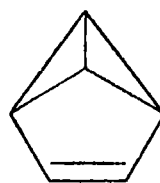

(2)

Isomer (35) rearomatises rapidly at room temperature ($t_{1/2}$ = 17 mins. at 25°C) whereas benzvalene (2) is more stable.

4.3(iii) Valence Bond Isomers Containing Perfluoroalkyl Groups

Introduction of perfluoroalkyl groups into valence-bond isomers in many cases has the effect of producing valence isomers which are more stable than their hydrocarbon counterparts. Isomers obtained from hexakis(trifluoromethyl)benzene (83) are more stable than their hydrocarbon counterparts from hexamethylbenzene (46)²⁰.

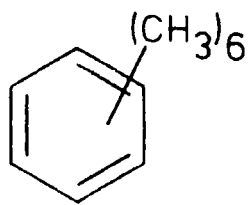

(46)

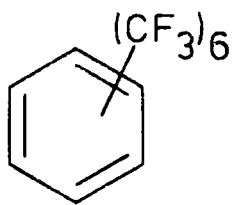

(83)

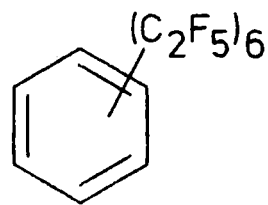

(87)

It has been suggested that valence-bond isomers of perfluoroalkyl systems owe at least part of their stability to severe non-bonding interactions between the perfluoroalkyl groups, in the parent benzene, which results in destabilisation of the benzene. Comparison of (83) with (46) has indicated that this effect can be quite large; for these systems the destabilisation of the benzene has been found to be of the order $30 \text{ k.cal.mole}^{-1}$. Interactions in hexakis(pentafluoroethyl)benzene (87) are even greater, and at high temperatures the para-bonded isomer (89) appears to be more stable than (87), and can be formed thermally from (87).⁶² However destabilization of the parent benzene cannot be the only factor on which valence isomer stability depends since on this basis the isomers of (83) would be less stable than valence bond isomers of (87). It has been shown that valence isomers of (83) are more stable with respect to rearomatization than the corresponding valence isomers of (87).⁶⁰

Thermodynamic and kinetic measurements carried out on the thermal isomerisation of (87) to (89) have shown that ΔH_0 for the reaction has a value of $37.6 \text{ k.Joules/mole}$.¹⁰³

A dramatic change in stability, was reported, in going from para-bonded isomer (89), which contained six C_2F_5 substituents, to (208) which was substituted by five C_2F_5 and

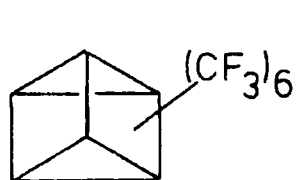

(84)

$t_{\frac{1}{2}} = 29\text{hrs. (170}^\circ\text{C)}$

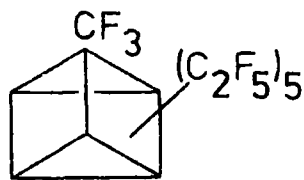

(208)

16hrs. (172.5°C)

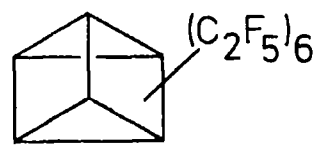

(88)

14hrs. (170°C)

← INCREASING STABILITY →

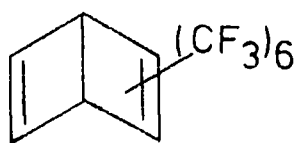

(86)

$t_{\frac{1}{2}} = 135\text{hrs. (170}^\circ\text{C)}$

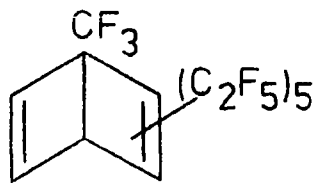

(89)

70hrs. (172.5°C)

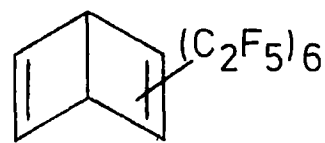

10hrs. (170°C)

one CF_3 substituent, in that (208) was much more stable ($t_{\frac{1}{2}} = 70$ hrs., 172.5°C ⁶³) than (89) with $t_{\frac{1}{2}} = 10$ hrs. at 170°C .

Irradiation of the perfluoroxylenes has led to the isolation of a series of perfluorodimethyl Dewar benzenes.⁶⁶ The thermal stability of these isomers was found to be in the order

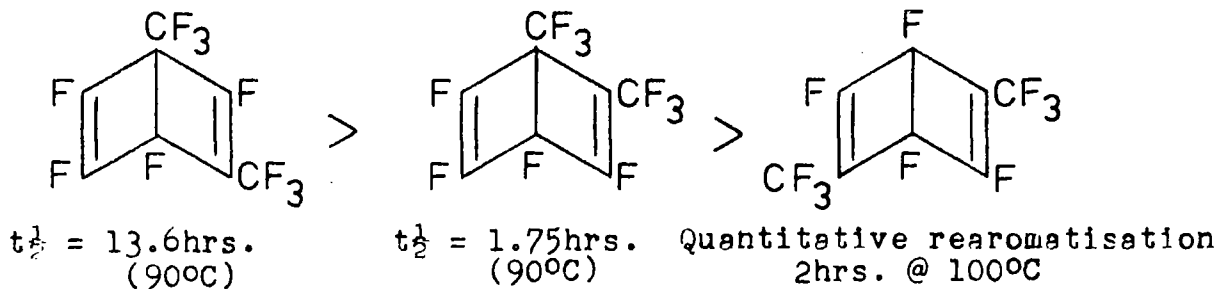

These examples serve to illustrate that position of substitution of perfluoroalkyl groups also affects valence isomer stability.

It has been suggested that after incorporation of fluorine and fluorocarbon groups into valence isomers that the isomer is protected from rearomatisation catalysed by electrophiles,²⁰ as perfluoroalkyl groups are electron withdrawing.

4.4 Stability of Valence-Bond Isomers from Heteroaromatic System

4.4(1) Di-aza Heterocyclic Systems

Valence-bond isomers have not been isolated from irradiation of either pyrimidines or pyrazines.

Both 1,2- and 2,5-diazabicyclo[2.2.0]hexa-2,5-diene derivatives have been isolated from irradiations of perfluoropyridazine derivatives.⁷²

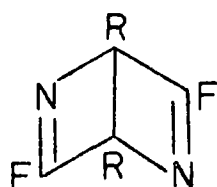

(209)

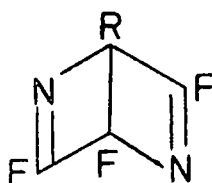

(210)

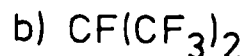
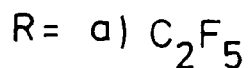

A decrease in stability of the isomers (209) and (210) was observed in the order $CF_2CF_3 > CF(CF_3)_2 > CF(CF_3)CF_2CF_3$ as stability of the isomers decreased in the order (209a) > (210a) > (210b) ≈ (210c) > (209b) > (209c). An interesting point to note is that in only one of these isomers was the dialkyl substituted para-bonded isomer more thermally stable than the monoalkyl isomer. This was the case when $R = C_2F_5$. Also stability of 2,5-diazabicyclo[2.2.0]hexadienes substituted by C_3F_7 decreased

in the order (210b) > (209b) > (211).

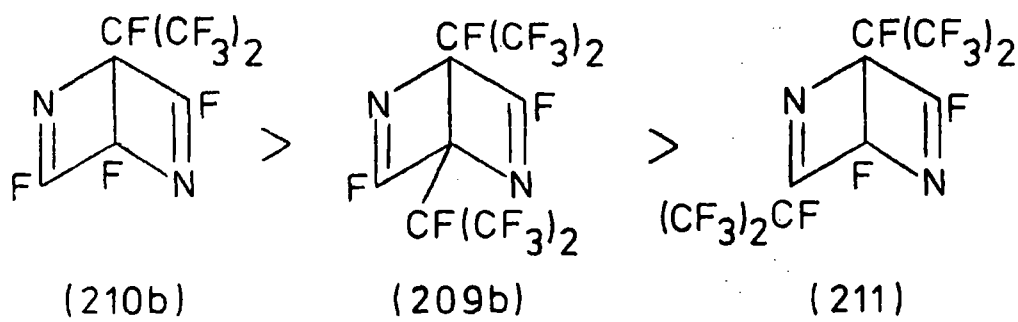

No diazaprismanes have been reported to exist.

4.4(ii) Valence-Bond Isomers from Pyridines

Pyridine has been reported to form a 2-azapara-bonded isomer (51) which rearomatized with $t_{1/2} = 2$ mins. at 25°C.⁴⁰

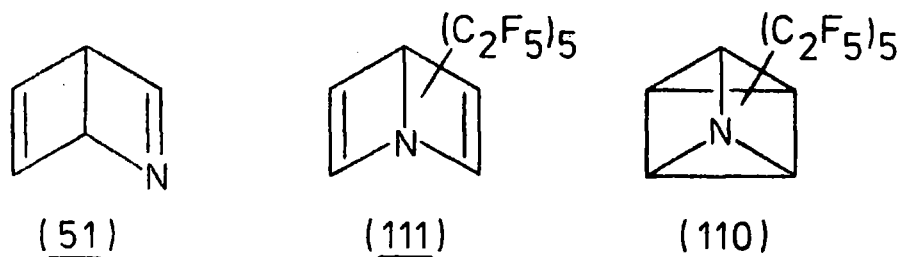

A very stable 1-azabicyclo[2.2.0]hexadiene isomer (111) ($t_{1/2} = 10^4$ hrs. at 170°C) and an azaprismane derivative (110) ($t_{1/2} = 1.1$ hrs. at 170°C) were produced on photolysis of perfluoropentaethylpyridine (109).⁶⁷

The half lives of the following azabicyclo[2.2.0]hexadienes have been determined in this work. (See over)

Although the half-life of (197) was not determined, it was established that (197) did not rearomatise at room temperature but was unstable at 90°C, and appreciable less stable

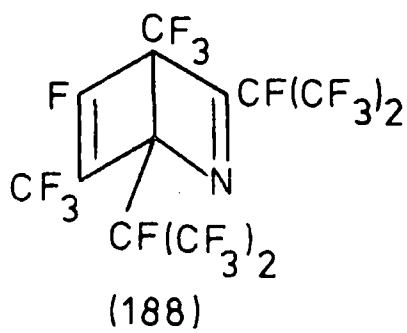

$t_{\frac{1}{2}} = 36$ minutes @ 104°C

Slow rearomatisation at room temperature

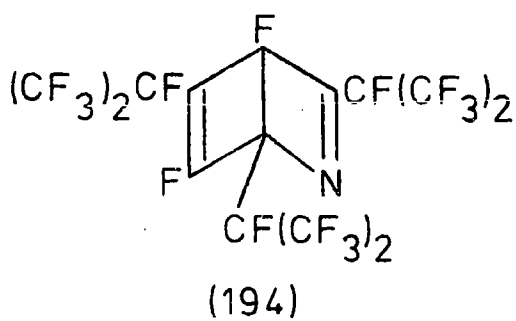

$t_{\frac{1}{2}} = 110$ minutes @ 140°C

STABLE at room temperature

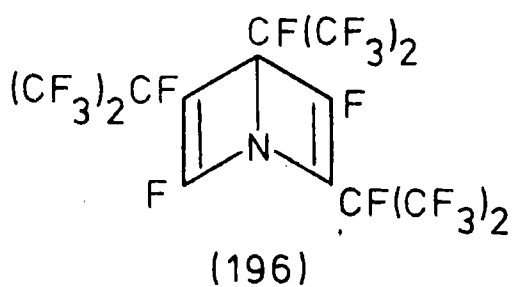

$t_{\frac{1}{2}} = 135$ minutes @ 140°C

STABLE at room temperature

than (196). The order of stabilities determined is shown in Fig. 12 (Page 145).

It is interesting to note that the tetrasubstituted valence isomer (188) is less stable than either of the trisubstituted valence isomers (196), (194) or (197) since it has been suggested that the CF_3 group is better at stabilising para-bonded isomers than C_3F_7 ⁷², therefore on this basis (188) should be the most stable compound in this series. However the available valence isomers each contained a different substitution pattern which made direct comparison of stability

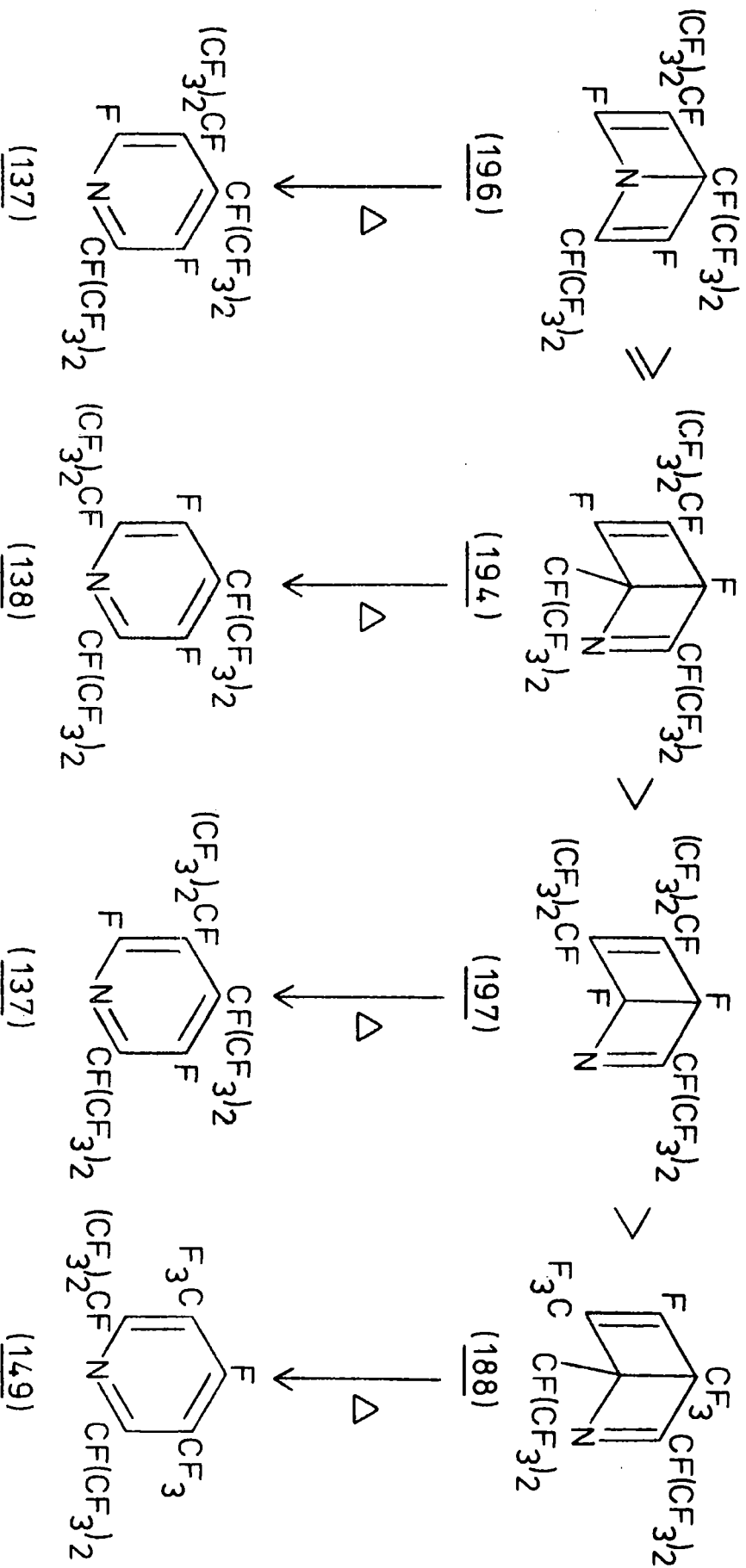
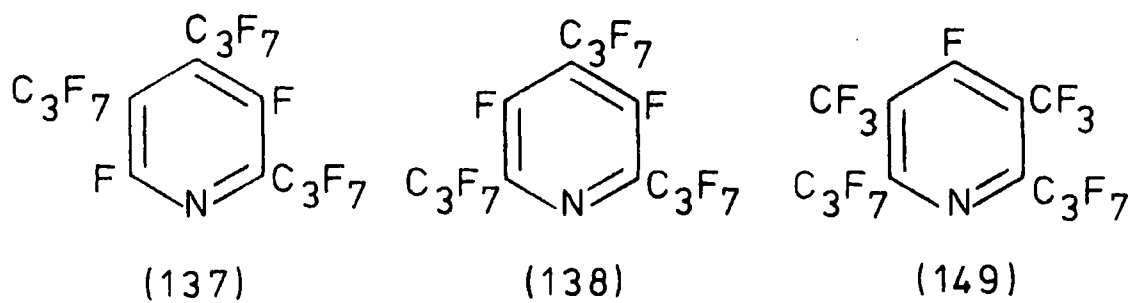

FIG. 12

difficult since other factors needed consideration. These are discussed below.

Valence isomer stability may be partially accounted for by consideration of the relative steric interactions which occur in the parent aromatic molecule, since in a highly crowded aromatic system the strain may be only relieved by a loss of planarity, with a resultant raising of ground state energy. In tri-isopropylpyridines (137) and (138) it has been demonstrated that (138) is the more stable of the two, since at high temperature (137) can be isomerised to (138) by fluoride ion.⁸⁸ In (137) interaction occurs between two adjacent bulky C_3F_7 groups.



The crowded nature of (137) and (138) is also illustrated by the drastic reaction conditions required to introduce a fourth C_3F_7 group into the pyridine ring. In (149) however even though the pyridine ring is tetrasubstituted the molecule contains two less bulky CF_3 groups.

Another factor to be considered is the interaction between the substituent groups in the valence isomer. These interactions, even though they are of a lesser magnitude than in the parent aromatic system, cannot be ignored. It has been suggested that a crowding effect is involved in the explanation for the relative stabilities of diazapa \bar{r} -bonded species,⁷²

as disubstituted para-bonded species (209b) and (209c) were found to be less stable than the corresponding mono-substituted derivatives (210b) and (210c). Since (188) has perfluoroalkyl groups substituted at both bridgehead positions its instability, relative to (197) and (194), may be partially due to interactions between the bridgehead substituents, in this example C_3F_7 and CF_3 groups. Also in (188) each cyclobutene ring contains three perfluoroalkyl groups so more steric interactions could occur in (188) than in either (194) or (197).

A comparison of the stabilities of the para-bonded isomers obtained in this work is complicated by the fact that the irradiated pyridines all contain different substitution patterns. However not all the possible aza-para-bonded isomers were detected on these irradiations and some information may be obtained from these results.

Irradiation of perfluoro-2,6-di-isopropyl-3,5-dimethylpyridine (149) gave exclusively the 2-aza isomer (188) with none of the 1-aza isomer (212) being detected. In this example the 2-aza skeleton was preferred even though more

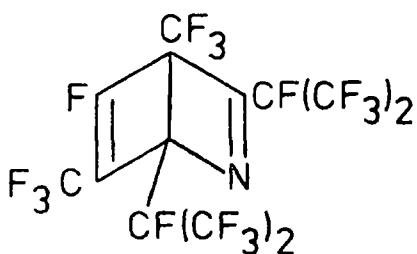

(188)

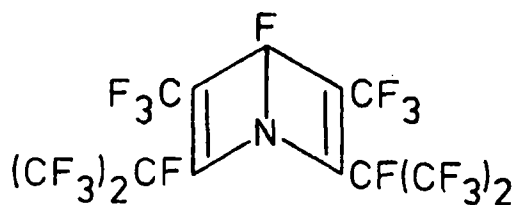

(212)

steric interactions could occur between the perfluoroalkyl groups in (188). The relative magnitude of these interactions

is not known but since the 2-aza isomer was the preferred product it is suggested that in this example the main contributory factor was the relative energies of the basic skeleton.

A similar situation arose from irradiation of perfluoro-2,4,6-tri-isopropylpyridine (138) in that once again the major product was the 2-aza isomer (194), but in this example ca. 2% of the 1-aza isomer (195) was detected.

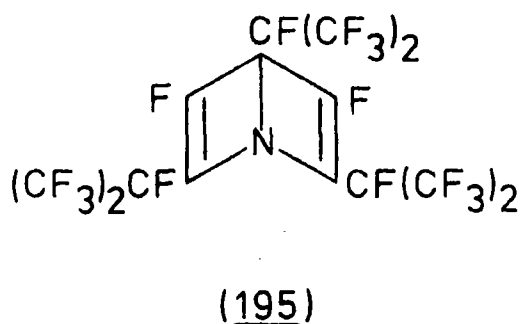
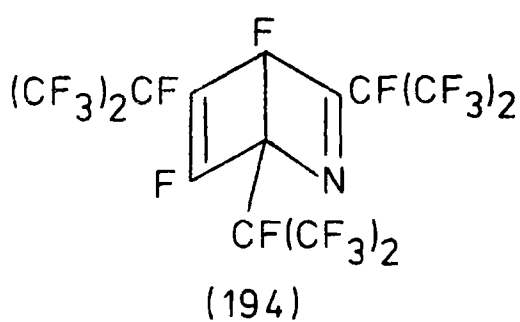

In this instance no steric interactions between the perfluoroalkyl groups are possible as these are not adjacent in either of the isomers (194) or (195), so that it is apparent that the dominant influence is again the production of the least energetic skeleton, i.e. the 2-azapara-bonded isomer.

A more interesting situation arose on irradiation of (137) as both the 1-aza- and 2-aza isomers (196) and (197) were obtained, in the ratio 45:55 so that only a marginally

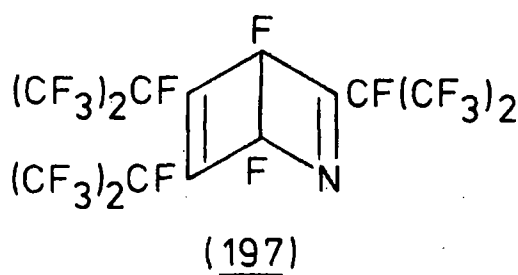
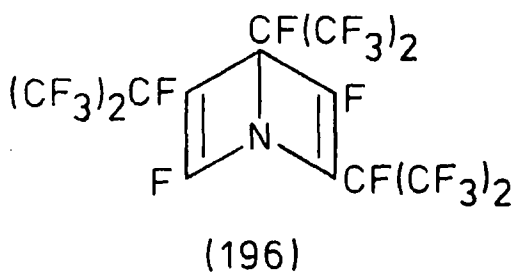

greater yield of the 2-aza isomer (197) was obtained. On comparison of (196) and (197) it can be seen that greater steric interactions are possible in the 2-aza isomer (197) between adjacent C_3F_7 substituents due to the geometry of the molecule as greater interactions between alkyl groups at C-5 and C-6, in (197), occurs than between C_3F_7 groups at C-4 and C-5, in (196). However the 2-aza skeleton was still preferred.

It was found that of the two isomers (196) was more stable. This probably stems from the different geometry in the transition state for rearomatisation. Also the transition state for rearomatisation of (196) would involve an increase in interaction between C_3F_7 groups at C-4 and C-5, as these are brought into a more planar environment, which would have the effect of raising the activation energy of rearomatisation of (196), relative to that of (197), where adjacent C_3F_7 groups are already in a planar environment.

It has been suggested that penta-alkyl-2-azabicyclo[2.2.0]-hexa-2,5-dienes are unstable due to crowding of the alkyl groups. No penta-alkyl substituted derivatives of this ring system have been isolated although an example containing five pentafluoroethyl substituents was thought to be formed on the pyrolysis of perfluoropentaethylazaprismane (110)⁶⁷, but pyrolysis of azaprismanes (159) and (160), in this work, failed to produce derivatives of this system.

The exact reasons behind the order of stabilities, of pyridine valence isomers, which were determined remains unclear but the various points to be considered have been indicated. The isomers obtained all had different substitution

patterns which also served to complicate the problem. In comparison of stability of the two different ring systems i.e. 1-aza and 2-aza-bicyclo[2.2.0]hexa-2,5-dienes it must also be recognised that these would have different transition states on rearomatisation and indeed the effect of the different substitution pattern on the transition states is also unclear. In addition it has been suggested that perfluoroalkyl groups strongly destabilise the transition state for rearomatisation of the prismane ring, in some manner not yet understood.²⁰

The most stable valence isomer isolated in this work was perfluoro-4-ethyl-2,6-di-isopropyl-3,5-dimethyl-1-azabicyclo-[2.2.0]hexa-2,5-diene (154) which was rearomatised back to (153) at 175°C with ca. 48% conversion after 38 hours, so the half-life of (154) could be estimated as ca. 40 hours at 175°C.

4.5 The Photolysis of Valence Isomers

The various bicyclo[2.2.0]hexa-2,5-dienes isolated, in this work, from substituted pyridines were re-irradiated in attempts to observe either rearrangements or azaprismane formation.

Para-bonded derivatives (188), (194), (197) and (195) were all irradiated at 254 n.m. under static conditions and each rearomatised readily to their respective parent pyridines. In none of these irradiations were azaprismanes detected or any other rearrangement observed to take place. These photolyses illustrate why these para-bonded isomers were not formed on photolysis of the parent pyridines in static irradiations,

since these valence isomers were easily rearomatised by 254 n.m. radiation so could only be isolated by use of the transference technique, which removes the valence isomer from the irradiation zone soon after formation. Para-bonded species (188), (194) and (197) all have small absorption in their u.v. spectra at 254 n.m. so this could account for the ease with which rearomatisation occurs at that wavelength. However the valence isomer obtained from (151) on photolysis at 254 n.m. did rearrange on further irradiation; this result was dealt with earlier (Section 3.3(iii)) as was the irradiation of (154).

The prolonged irradiation of azaprismane mixture (159) and (160), at 254 n.m., was carried out in $\text{CF}_2\text{ClCFCl}_2$ solution. The ratio of the azaprismanes remained unaltered, as shown by ^{19}F n.m.r.

4.6 Reactions of Valence Isomers

4.6(i) Introduction

This section contains details of reactions attempted upon valence isomers isolated in this work. Reactions were carried out using NaOMe , Br_2 and furan. Other workers have demonstrated that some fluorinated para-bonded species are susceptible to nucleophilic attack by NaOMe ^{64,66} and undergo Diels-alder reactions using furan^{104,105} and also that Br_2 may be added across the double-bond.^{56,66}

However not all para-bonded species are reactive with these reagents as it has been shown that perfluoropentaethyl-1-azabicyclo[2.2.0]hexa-2,5-diene (111) does not react with bromine, furan or fluoride ion.⁶⁷

4.6(ii) Attempted Reactions with Fluoride Ion

Both perfluoro-4-ethyl-2,6-di-isopropyl-3,5-dimethyl-1-azabicyclo[2.2.0]hexa-2,5-diene (154) and a mixture of azaprismanes (159) and (160) were found to be unreactive towards attack by fluoride ion, in solution.

4.6(iii) Reaction Between Sodium Methoxide and Perfluoro-1,3,5-tri-isopropyl-2-azabicyclo[2.2.0]hexa-2,5-diene (194)

Reaction between (194) and sodium methoxide in methanol gave a solid with M^+ 655, which corresponded to tri-substitution by methoxide. In addition n.m.r. showed three signals at 2.85, 3.06 and 3.59 p.p.m. (downfield from T.M.S.) of relative intensity 1:1:1 whereas ^{19}F n.m.r. showed two resonances in the region expected for 'tertiary' fluorine, at 179.2 and 185.9 p.p.m. The compound was not identified, however the i.r. spectrum showed ν_{max} 1642cm^{-1} and the mass spectrum showed tri-substitution, by methoxide, so it is suggested that a tri-substituted para-bonded species was produced and since no signal which could be assigned to $\text{CF}=\text{C}$ was observed in the ^{19}F n.m.r. spectrum it was thought that substitution occurred at C-6, in the ring.

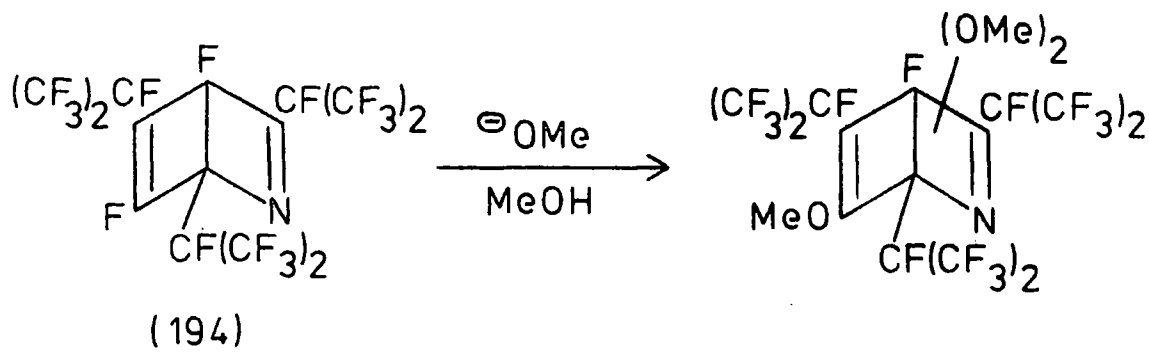

The other positions of substitution could not be deduced from the n.m.r. spectra.

4.6(iv) Other Attempted Reactions of Para-bonded Derivatives

On reactions of para-bonded derivatives (194) and (196) with both furan and bromine the valence isomers were recovered unreacted.

Nucleophilic substitutions on (194) and (196) using $^1\text{PrO}^-$ and PhO^- were also carried out but in each case the reactions gave poor yields of a complex mixture of products, of which the components were not identified.

CHAPTER 5

The Photochemistry of Some Fluorinated Heterocycles

5.1 Introduction

In view of the successful detection of rearrangement products from the irradiation of pyridines an attempt was made to observe similar rearrangements using partially saturated heterocycles. Some of the rearrangements described earlier could in theory be observed in partially saturated systems such as the rearrangement shown below, which is similar to the rearrangement observed in this work,

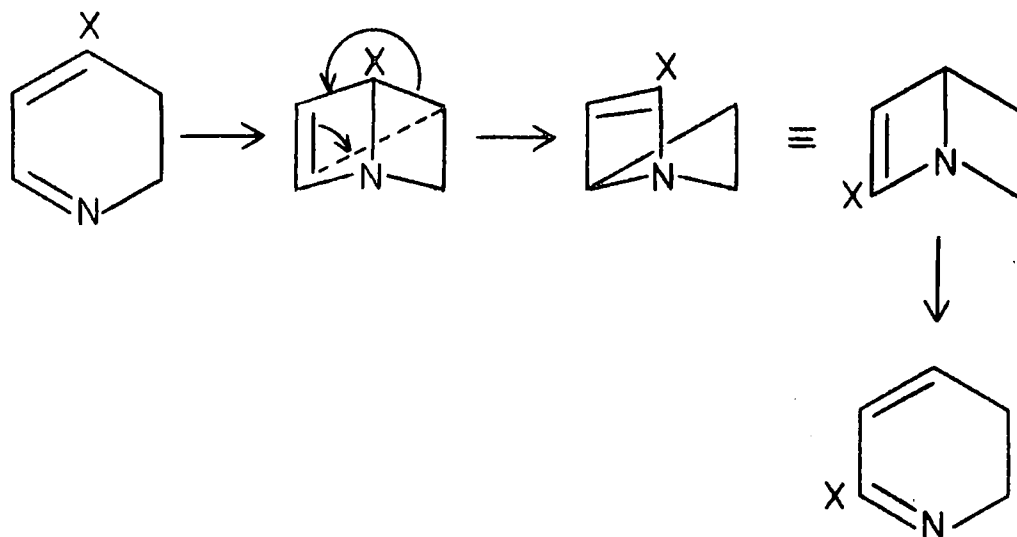

(Section 3.2(1)H(2)) and on the irradiation of highly fluorinated pyridazines.⁷¹

This study was carried out with the collaboration of Mr. R. D. Hercliffe, who supplied the compounds which were irradiated. These compounds were all the product of partial fluorination of heteroaromatic systems.

5.2 Irradiation of Perfluoro-2,5-di-isopropyl-1,4-diazacyclohexa-1,4-diene (213)

The di-imine (213) used in this irradiation was prepared by the fluorination of perfluoro-2,5-di-isopropylpyrazine (214).

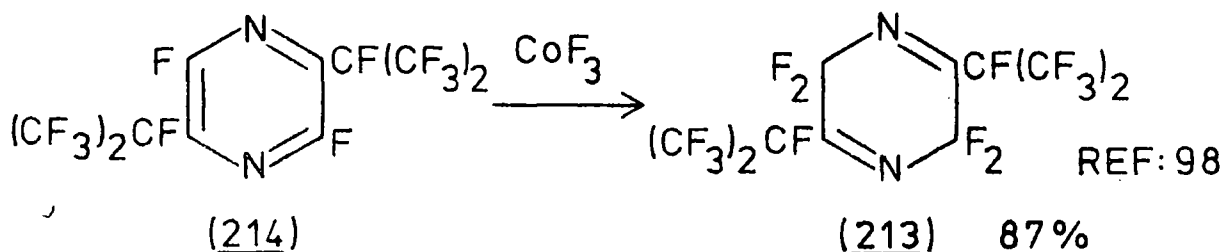

Irradiation of (213) at 253.7nm. in a static vapour phase irradiation in the presence of mercury sensitiser gave a brown liquid, which contained three components, in the ratio ca. 37:57:6 (from g.l.c.).

The first component was readily identified as perfluoro-isobutyronitrile (215) by comparison of i.r. and mass spec. data with those from an authentic sample.¹⁰⁶ The second component had a molecular weight of 295, from mass spec. data, which together with (215) have been obtained by fragmentation of (213). The third component was identified as starting material (213).

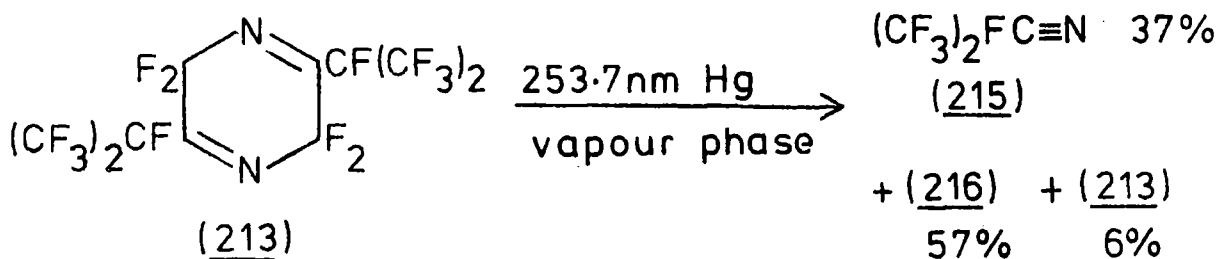

The second component (216) was found to be extremely susceptible to hydrolysis and consequently not obtained pure but it was identified as perfluoro-4-methyl-3-methylene-2-azapent-1-ene (216) from ^{19}F n.m.r.

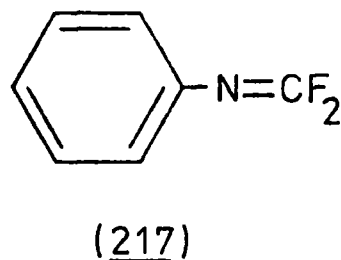
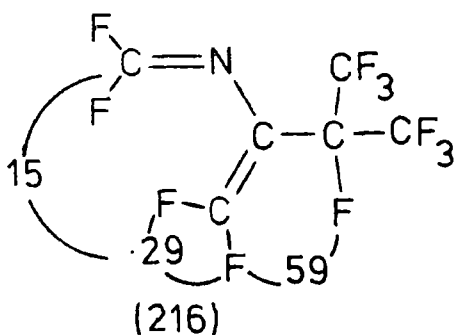

The ^{19}F n.m.r. of (216) showed peaks at 83.1 and 93.0 p.p.m. (both integrated to one) corresponding to $\text{CF}=\text{C}$, a peak at 187 p.p.m. (integration one) from $\text{CF}(\text{CF}_3)_2$, a singlet at 78.9 p.p.m. (integration six) from $\text{CF}(\text{CF}_3)_2$ and two broad peaks at 42.6 and 55.9 p.p.m. which were typical of $\text{N}=\text{CF}_2$. (In (217) signals from $\text{N}=\text{CF}_2$ were observed at 50.4 p.p.m. and 58.2 p.p.m. ¹⁰⁷ and were found to be very broad.) Furthermore the observed couplings were in agreement with structure (216) and are shown in the above diagram. The infrared of (216) showed ν_{max} at 1805 and 1732 cm^{-1} which were assigned to $\text{C}=\text{N}$ and $\text{C}=\text{C}$ stretches. This assignment was made after

comparison of stretching frequencies with values from some model compounds. Some examples are tabulated below.

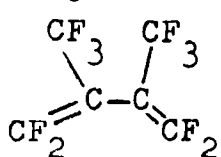
Compound	ν_{\max} (either C=C or C=N)	Reference
$C_6H_5N=CF_2$	1785 $cm.^{-1}$	107
$C_3F_7N=CF_2$	1815 $cm.^{-1}$ (5.51)	109
$C_2F_5N=CF_2$	1812 $cm.^{-1}$ (5.52)	109
$CF_3N=CF_2$	1808 $cm.^{-1}$ (5.53)	109
$CF_2=N-N=CF_2$	1739 $cm.^{-1}$ (5.75)	110
$(CF_3)_2C=CF_2$	1755 $cm.^{-1}$	108
	1735 and 1760 $cm.^{-1}$	111

The exact mechanism for fragmentation of (213) was not determined. However the reaction would be unlikely to be a concerted process as this would be a retro $2\pi+4\pi$ reaction, which has been shown to be forbidden photochemically on symmetry considerations.¹⁴ The fragmentation may involve an intermediate diradical (218) which undergoes rearrangement to (216).

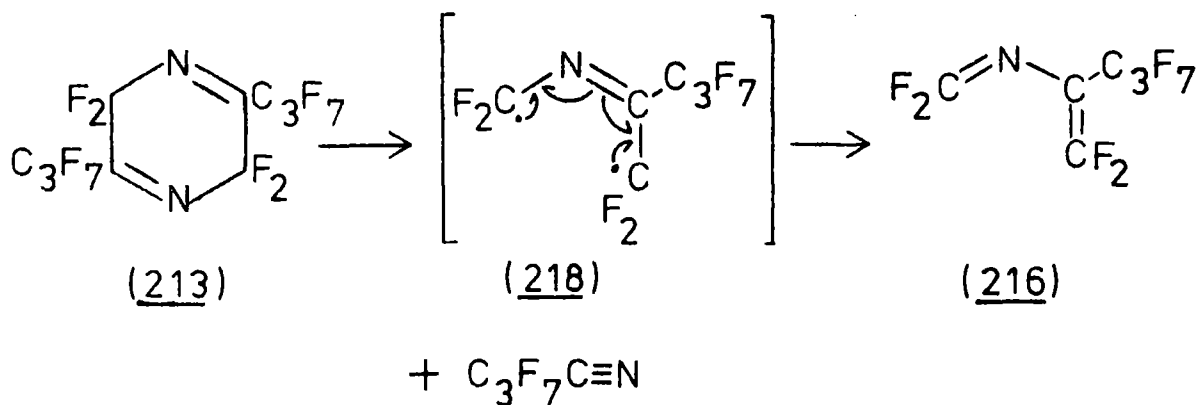

The hydrolysis product from (216) was thought to be the corresponding isocyanate since the mass spectrum of the impure (216) revealed an impurity with M of 273 which was in agreement with the hydrolysis of $-N=CF_2$ to $-N=C=O$.

5.3 Irradiation of Perfluoro-4,6-di-isopropyl-1,3-diazacyclohexa-3,6-diene (219)

The di-imine (219) used in this irradiation was prepared by the fluorination of perfluoro-4,6-di-isopropylpyrimidine (220).

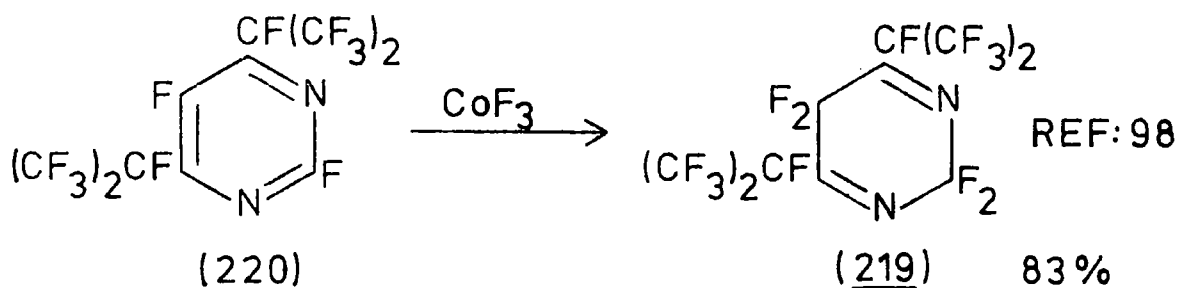

A mercury sensitised vapour phase irradiation, at 253.7 nm. of (219) gave a mixture containing 4 major products with two minor components also present. The first three major components in the mixture were readily identified from i.r. and mass spec. data as perfluoroisobutyronitrile (215), perfluoro-4-methyl-3-methylene-2-azapent-1-ene (216) and starting material (219). The products (215) and (216) had already been obtained from the irradiation of (213).

The major product (220) was obtained as 48% of the mixture and mass spec. data showed that (220) was isomeric with the starting material (219). The infrared spectrum of (220) contained ν_{max} at 1678, 1731 and 1799 cm^{-1} and the

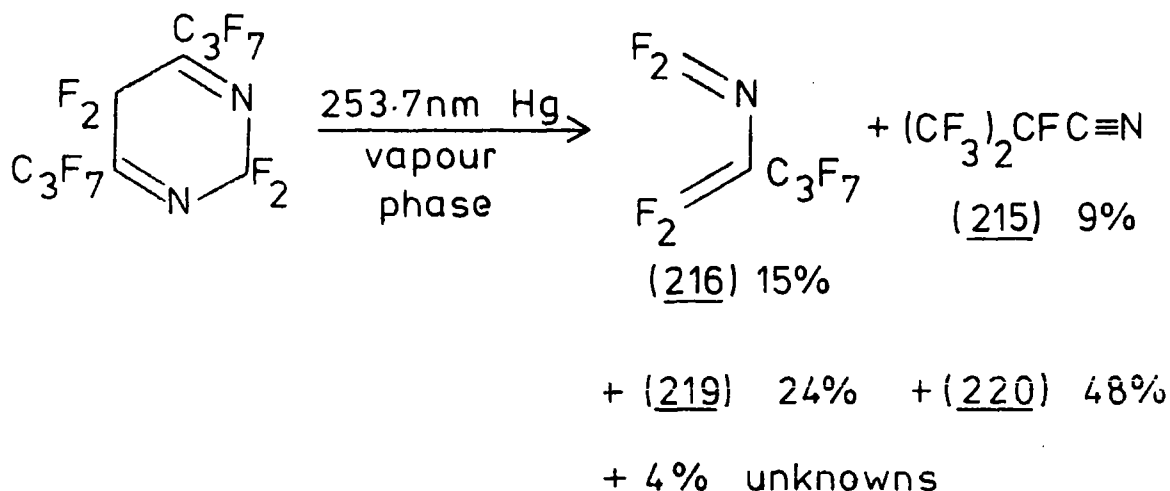

^{19}F n.m.r. showed the presence of two olefinic and two imine fluorines. The resonances were observed at 41.8 p.p.m. ($\text{N}=\underline{\text{CF}}$, integration 2), 77.7 p.p.m. ($\text{C}=\underline{\text{CF}}$, integration 1), 91.3 p.p.m. ($\text{C}=\underline{\text{CF}}$, integration 1), 76.6 and 77.9 p.p.m. ($\text{CF}(\underline{\text{CF}_3})_2$), and high field resonances at 182.2 and 185.9 p.p.m. (from $\underline{\text{CF}}(\text{CF}_3)_2$, each integration of 1). The structure of (220)

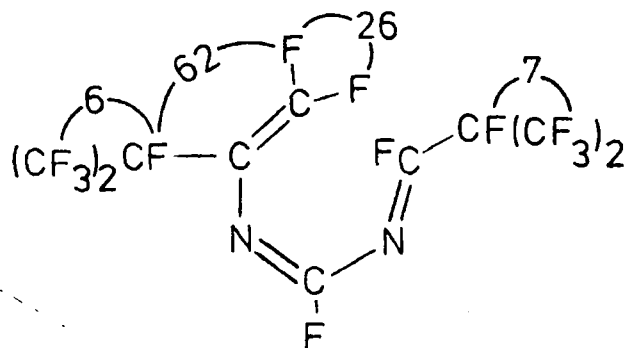

(220)

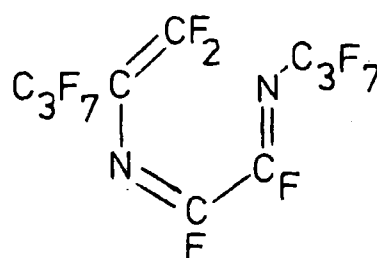

(221)

is shown above together with ^{19}F n.m.r. coupling constants. A second structure which could accommodate the ^{19}F n.m.r. data is (221). However (220) could be formed directly from

irradiation of (219) via a mechanism which involved a 1,3-migration of fluorine, as illustrated below, thus supporting structure (220).

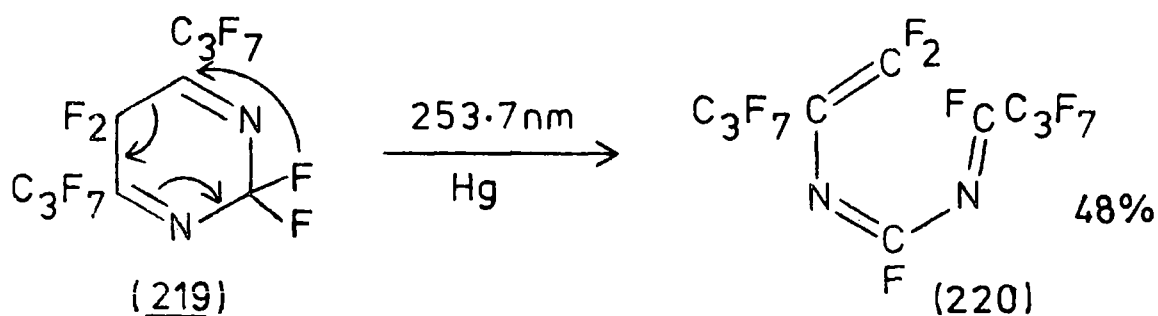

The other photolysis products were formed from fragmentation of (219) in an analogous reaction to the photolysis of (213) which gave the same products i.e.

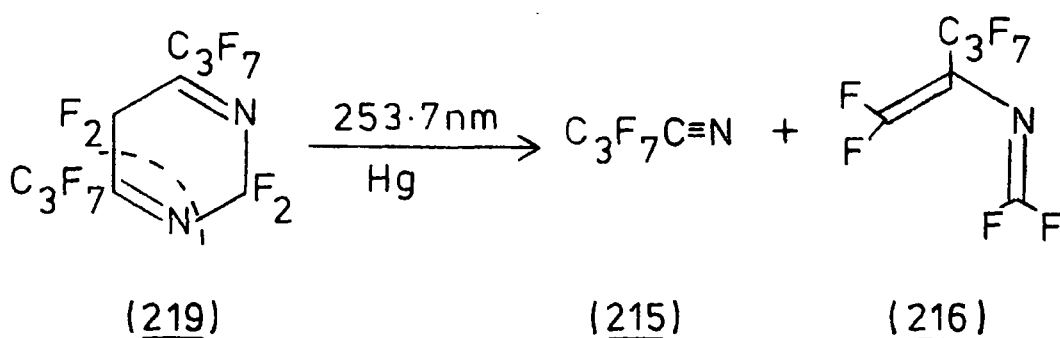

5.4 Irradiation of Perfluoro-4-isopropyl-1-azacyclohexa-1,3-diene (222)

The diene (222) was obtained from the fluorination of perfluoro-4-isopropylpyridine (223).

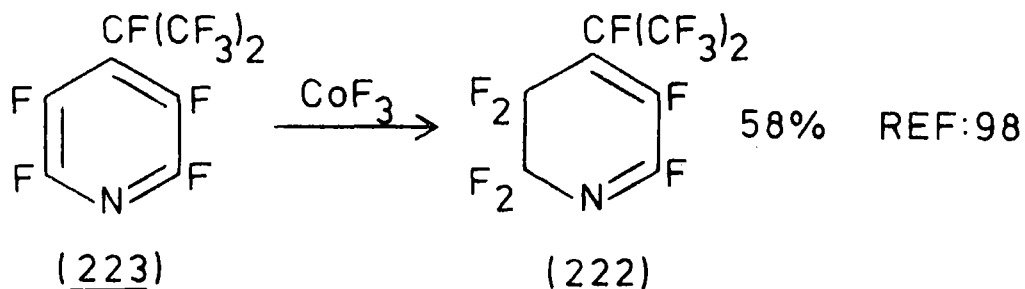

Irradiation of (222), at 253.7nm. in the vapour phase, resulted in the production of two major products in 70 and 20% yields (estimated from g.l.c.) together with three minor products.

Only the major component was obtained pure and this showed ν_{\max} at 1680, 1767 and 1775(shoulder) cm^{-1} in the infrared spectrum and was shown from mass spec. data to be isomeric with the starting material (222). The ^{19}F n.m.r. showed the presence of one tertiary fluorine (at 186.4 p.p.m.) and signals at 96.1, 113.8, 114.3 and 136.7 p.p.m. (all $\text{CF}=\text{C}$) with two broad signals at 32.9 and 51.2 p.p.m. which were typical of $-\text{N}=\text{CF}_2$. On this basis the major product was identified as (224) which could be formed by a photochemical

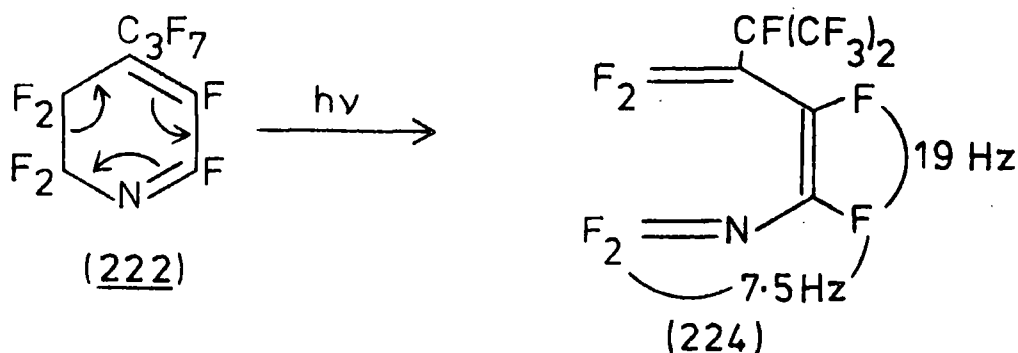

electrocyclic ring opening of (222). The observed ^{19}F n.m.r. couplings (shown above) confirmed that the cis isomer had been produced as generally olefinic F-F coupling constants of trans-fluorines are larger than cis-fluorines. In this example a coupling of 19Hz was observed.

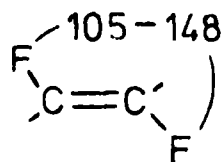
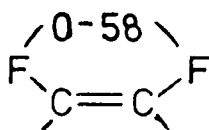

REF 112

Several isomers could be formed upon irradiation of cyclohexa-1,3-dienes. These include bicyclo[2.2.0]hex-2-enes (225), hexa-1,3,5-trienes (226), vinylcyclobutenes (227)

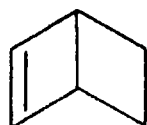

(225)

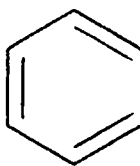

(226)

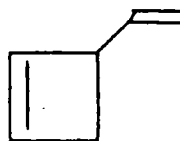

(227)

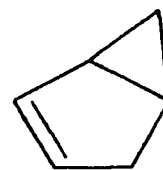

(228)

and bicyclo[3.1.0]hex-2-enes (228). If any bicyclo[2.2.0]-hex-2-ene derivatives were formed then in theory these may rearrange via a similar mechanism to that observed on photolysis of highly fluorinated pyridines and pyridazines i.e.

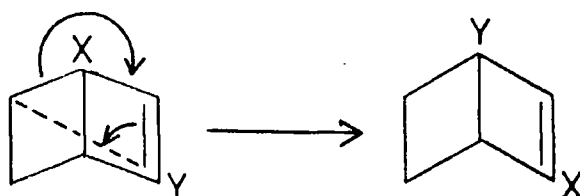

Examples of irradiation of cyclohexa-1,3-dienes have been shown to produce derivatives of (225), (226), (227) and (228).

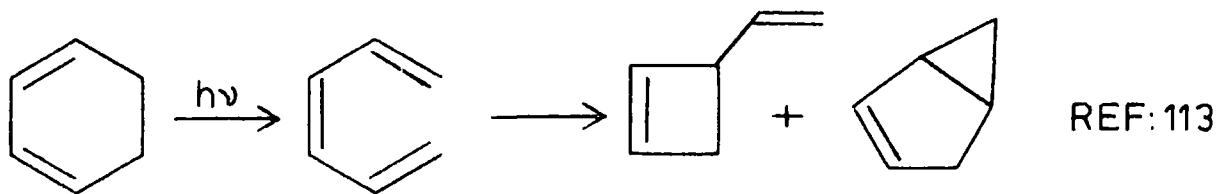

REF: 113

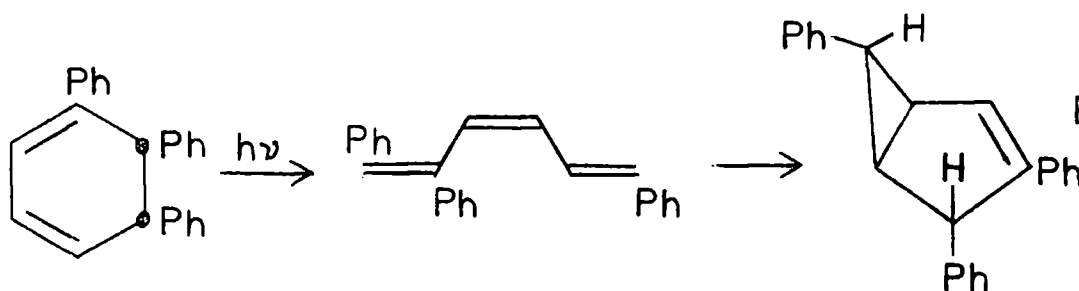

REF: 114

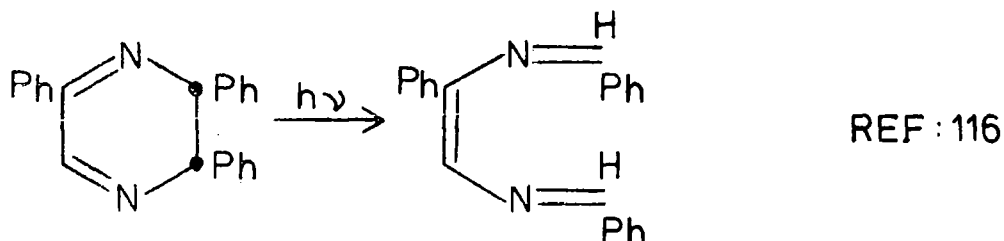
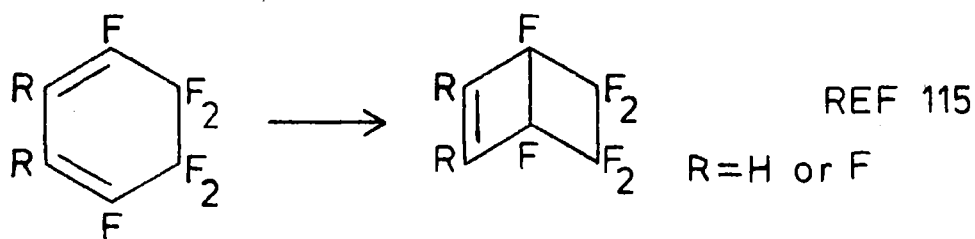

The only product identified on the irradiation of perfluoro-4-isopropyl-1-azacyclohexa-1,3-diene (222) was found to be a hexa-1,3,5-triene derivative (224). The other products obtained upon irradiation of (222) were not obtained pure so could not be identified.

5.5 Irradiation of Perfluoro-2,3,4-tri-isopropyl-1-azacyclohexa-1,3-diene (229)

Nucleophilic attack on (222) by perfluoroisopropyl anion gave (229) as the major product.⁹⁸

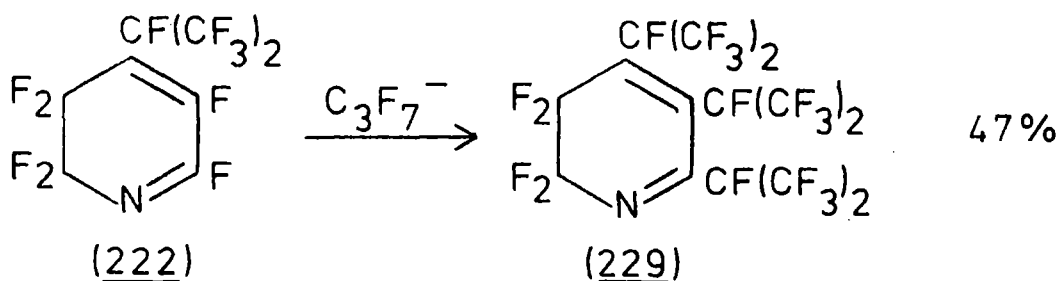

However although (229) was a derivative of (222) it did not undergo any photochemical reaction at 253.7nm., even

after prolonged irradiation. The reason for (229) failing to rearrange was not understood.

5.6 Other Irradiations

Perfluoro-1-azacyclohex-1-ene (230) and perfluoro-1,1'-bi-1,3-diazacyclohex-2-enyl (231), were prepared as described in the literature¹¹⁷ and irradiated at 253.7nm. In neither case was rearrangement observed.

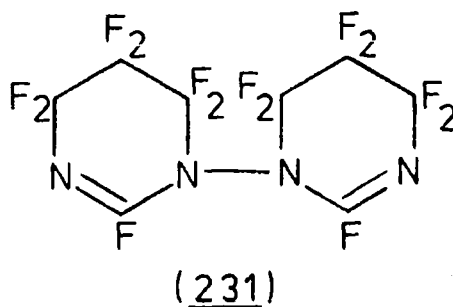
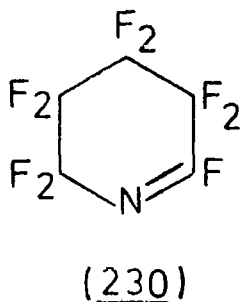

EXPERIMENTAL

INSTRUMENTATION

Infra-red spectra were recorded on Perkin-Elmer Model 457 or 577 'Grating Infra-red Spectrophotometers'. Liquid and low melting point solid samples were recorded in the form of thin contact films between potassium bromide plates. Solid samples were pressed into homogeneous thin disks with potassium bromide. Gaseous samples were introduced into an evacuated cylindrical cell with potassium bromide end windows.

Ultra violet spectra were recorded on a Unicam S.P.8000 or a Unicam S.P.800 spectrophotometer using Spectrosol grade cyclohexane as solvent.

Fluorine (^{19}F) nuclear magnetic resonance spectra were recorded on a Varian A56/60D spectrometer, operating at 56.4 MHz, or a Bruker HX90E operating at 84.67 MHz. All chemical shifts are quoted in p.p.m. relative to CFCl_3 . Decoupling could be performed using the HX90E instrument and a variable temperature facility was available on the A56/60D instrument.

Gas Liquid chromatographic analysis (g.l.c.) was carried out on a Griffin and George, D6, Gas Density Balance (G.D.B.) using columns packed with silicone gum rubber SE-30 on chromosorb P and di-isodecylphthalate on chromosorb P. For this instrument, when correctly standardised, the number of moles of any compound in a mixture is directly proportional

to its peak area. Preparative scale g.l.c. was performed on either a Perkin-Elmer 'F-21' instrument or a Varian 'Aerograph' instrument using the above columns in both instruments.

Mass spectra were recorded using an A.E.I. M.S.9 spectrometer or a VG Micromoss 12B fitted with a Pye 104 gas chromatograph. All molecular weights were determined using these instruments.

Carbon, nitrogen and hydrogen analyses were obtained using a Perkin-Elmer 240 Elemental Analyser. Analysis for fluorine was as described in the literature.¹¹⁸

Differential scanning calorimetry was performed using a Perkin-Elmer D.S.C.-2 instrument.

CHAPTER 6

Experimental for Chapter 2

6.1 Introduction

This chapter contains the preparation details of the perfluoroalkylpyridines used in later photolysis experiments.

6.2 Reagents

Pentafluoropyridine was prepared by technical staff, by the method described earlier,⁸⁶ and supplied on request.

Caesium fluoride was reagent grade and dried by heating under vacuum for several days, powdered, under dry nitrogen, in a glove bag and stored under nitrogen at room temperature. Potassium fluoride, reagent grade, was dried by heating, with a Bunsen, powdered under nitrogen in a glove bag and stored under dry nitrogen.

Tetrahydrothiophen dioxide (sulpholan) was purified by fractional vacuum distillation. 2,5,8,11,14-pentaoxapentadecane (tetraglyme) was vacuum distilled off sodium. Both were stored over dry molecular sieve (type 4A) under dry nitrogen, at room temperature.

Tetrafluoroethylene was prepared by the vacuum pyrolysis of P.T.F.E.¹¹⁹ Hexafluoropropene was purchased from Bristol Organics.

6.3 Experimental Procedure used for Polyfluoroalkylation Reactions

Polyfluoroalkylation reactions were carried out at atmospheric pressure using a method developed by earlier workers at these laboratories.⁸⁷

The apparatus consisted of a three necked flask, containing a magnetic stirrer, with the three necks

i) attached to a gas reservoir (a football bladder) and in some reactions also a reflux condenser.

ii) fitted with a serum cap.

iii) attached to a vacuum line.

The required quantities of dry aprotic solvent and either caesium or potassium fluoride were rapidly added to the dry, nitrogen purged, reaction apparatus, against a flow of dry nitrogen, and the apparatus evacuated, at which stage the solvent was degassed. The apparatus was then filled with the required quantity of perfluoroalkene gas. After injection of the pyridine, through the serum cap, the reaction mixture was vigorously stirred.

During these reactions colouration of the reaction mixture was always observed, together with collapse of the perfluoroalkene reservoir.

The reaction products were vacuum transferred from the reaction vessel into a trap cooled in liquid air, the vessel being heated up to ca. 90°C. The composition of the product was estimated by gas liquid chromatography (g.l.c.).

6.4(i) Synthesis of Perfluoro-3,5-dimethylpyridine (142)

This preparation was carried out on several occasions. Described below is a typical experiment.

Pentafluoropyridine (136) (25g., 148 m.moles) and P.T.F.E. granules (50g.) were sealed in a clean dry autoclave (ca. 550ml. capacity) which was heated at 550°C for 15½ hours. Volatile products were distilled from the hot autoclave, under high vacuum, into a cold trap, immersed in liquid air. The trap was allowed to warm to room temperature, in a fumes cupboard, and the mixture analysed by g.l.c. (G.D.B. Silicone elastomer, 78°C) and shown to contain (142) as the main component.

Separation was achieved on a spinning band column, the fraction boiling 118-120°C being collected and identified as perfluoro-3,5-dimethylpyridine (142) by comparison of g.l.c. retention time, i.r. and ¹⁹F n.m.r. spectra with those from an authentic sample obtained in a similar reaction.⁸⁷ Yields of (142) were variable, in one experiment a yield of 58% was achieved (Literature yield 60%).

The (142) obtained by this reaction was considered pure enough for further polyfluoroalkylation reactions.

6.4(ii) Preparation of Perfluoro-3-methylpyridine (143)

Pentafluoropyridine (50g, 296 m.moles) and P.T.F.E. granules (25g.) were sealed in a clean dry autoclave (ca. 550ml. capacity) which was heated at 550°C for 14 hours.⁸⁷ Volatile products were distilled from the hot autoclave, under vacuum, and collected in a trap immersed in liquid air.

The trap was allowed to warm to room temperature, in a fumes cupboard. G.L.C. analysis (G.D.B. silicone elastomer, 78°C) showed the presence of (143) as the major component.

Fractional distillation, on a spinning band column, gave a sample of perfluoro-3-methylpyridine (143)⁸⁷ on collection of the fraction boiling between 102-103°C. Analysis, by g.l.c. (Pye 104, di-n-decylphthalate, 70°C) showed the presence of an impurity which was shown by ¹⁹F n.m.r.⁹¹ to be perfluoro-4-methylpyridine (144) present as ca. 10% of the mixture. Further purification by preparative g.l.c. (Aerograph, di-isodecylphthalate, 55°C) gave a sample of perfluoro-3-methylpyridine (143) which was ca. 98% pure. Samples of this purity were used for further reactions.

6.4(iii) Reactions of Perfluoro-2,5-dimethylpyridine (142)
with Hexafluoropropene in the Presence of
Fluoride Ion

These reactions were carried out on numerous occasions. Described below is one such experiment.

The standard experimental procedure for polyfluoroalkylation was used (see Section 6.3). Potassium fluoride (10g., 172 μ . moles), tetrahydrothiophen dioxide (100mls.), hexafluoropropene (25g., 167 μ . moles), diluted by 40mm. of nitrogen, and perfluoro-3,5-dimethylpyridine (142) (10.0g., 13.8 μ . moles) were stirred at 80°C for 48 hours. Not all the hexafluoropropene was reacted. The volatile product (22.3g.) was isolated by transfer under vacuum and shown by g.l.c. (G.D.B. silicone elastomer, 78°C) to contain perfluoro-2,6-di-isopropyl-3,5-dimethylpyridine (149) (10.0g., 47.3%)

and perfluoro-2,4,6-tri-isopropyl-3,5-dimethylpyridine (148) (1.1g., 4.1%) together with dimers and trimers of hexafluoropropene.

The mixture was fractionally distilled using a Fischer-Spaltrohr microdistillation apparatus MMS 200 at reduced pressure (33mm.) and perfluoro-2,6-di-isopropyl-3,5-dimethylpyridine (149) obtained (B.pt. 86°C/33mm.) as a crystalline solid (Melting point 36-7°C, Lit. value⁸⁷ 37°C). The identity of pyridine derivative (149) was confirmed by comparison of i.r. and ¹⁹F n.m.r. data with those obtained from an authentic sample, prepared by a similar method.⁸⁷

The distillation residue was boiled with aqueous ammonia (880) to give perfluoro-2,4,6-tri-isopropyl-3,5-dimethylpyridine (148) after preparative g.l.c. separation (Aerograph. Di-isodecylphthalate, 100°C) which was identified by comparison of i.r. spectra, ¹⁹F n.m.r. spectra and mass spectra with those from an authentic sample.⁸⁷

The successful preparation of (148) was carried out on very few occasions, in most reactions only the tetrasubstituted pyridine (147) was obtained.

Under different reaction conditions the composition of the products was altered as below.

The standard experimental procedure for polyfluoroalkylation was adopted. Caesium fluoride (2.9g., 19.1 m.moles), tetrahydrothiophendioxide (140ml.), hexafluoropropene (17.0g., 113 m.moles) and perfluoro-3,5-dimethylpyridine (140) (14.8g., 55 m.moles) were stirred at 85°C for 2 hours. Complete collapse of the perfluoroalkene reservoir occurred.

Volatile products (26.5g.) were transferred under high vacuum to a trap immersed in liquid air. Analysis by g.l.c. (G.D.B. silicone elastomer, 78°C) showed pyridine derivatives (149) and (150) as the major components together with dimers and trimers of hexafluoropropene.

Separation by fractional distillation ('Fischer-Spaltrohr BMS 200', 33mm.) gave perfluoro-2-isopropyl-3,5-dimethylpyridine (150) as a colourless liquid (B.pt. 69°C/33mm., 3.1g., 13.5% overall yield) ^{19}F n.m.r. No. 1, i.r. spectrum No. 1, u.v. spectrum No. 15, [Found: F, 67.9%; M, 419. $\text{C}_{12}\text{F}_{15}\text{N}$ requires, F, 68.02%; M, 419] and pyridine derivative (149) (21.2g., 68% yield) as the fraction boiling at 85-86°C/33±2mm.

6.4(iv) Preparation of Perfluoro-4-ethyl-2,6-di-isopropyl-3,5-dimethylpyridine (153)

This reaction was carried out on several occasions. Described below is a typical experiment.

The standard experimental procedure for polyfluoroalkylation reactions was adopted. Caesium fluoride (5.1g., 33.6 m. moles), tetrafluoroethylene (9.1g., 91 m. moles), 2,5,8,11,14-pentaoxapentadecane (70ml.) and perfluoro-2,6-di-isopropyl-3,5-dimethylpyridine (149) (19g., 33.4 m. moles) were stirred at 85°C for four hours, after which time the reaction mixture was poured into water (ca. 300ml.). The aqueous layer was decanted off and ether added to the organic residue. The solid obtained was filtered and sublimed, under vacuum, to give perfluoro-4-ethyl-2,6-di-isopropyl-3,5-dimethylpyridine

(153)(8.7g., 38% yield) identical with an authentic sample,⁸⁷ prepared in the same manner.

6.4(v) Reaction of Perfluoro-3-methylpyridine (143) with Hexafluoropropene in the Presence of Fluoride Ion

The normal experimental procedure for polyfluoroalkylation reactions (Section 6.3) was used. Potassium fluoride (12g.), tetrahydrothiophen dioxide (100ml.), perfluoro-3-methylpyridine (8g., 36.5 m.moles, 98% pure) and hexafluoropropene (35g., 233 m.moles) were stirred at $88 \pm 3^\circ\text{C}$ for $17\frac{1}{2}$ hours. Complete collapse of the perfluoroalkene reservoir occurred. Volatile products were transferred under vacuum into a trap immersed in liquid air. The liquid obtained (36.7g.) was shown by g.l.c. (G.D.B. di-isodecylphthalate, 78°C) to contain (151)(13.1g., 57%) and (152)(4.1g., 22%) as the major products, together with dimers and trimers of hexafluoropropene.

Separation by fractional distillation ('Fischer-Spaltrohr MMS 200', 18mm.) gave samples of perfluoro-4,6-di-isopropyl-3-methylpyridine (152)(B.pt. $75^\circ\text{C}/18\text{mm.}$) and perfluoro-2,4,6-tri-isopropyl-3-methylpyridine (151)(B.pt. $84^\circ\text{C}/18\text{mm.}$) which were identical to authentic samples,⁸⁷ as shown by ^{19}F n.m.r. and i.r. spectra, prepared in a similar reaction.

6.4(vi) Preparation of Perfluoro-2,4,5-tri-isopropylpyridine (137)

This preparation⁸⁸ was repeated several times. Described below is a typical experiment.

The standard experimental procedure for perfluoroalkylation reactions (Section 6.3) was used. Potassium fluoride (6g.), tetrahydrothiophen dioxide (100ml.), pentafluoropyridine (136)(12.2g., 72.2 m.moles) and hexafluoropropene (42g., 270 m.moles) were stirred at 78°C for 23 hours. Not all the perfluoroalkene was absorbed. Volatile products (48.1g.) were transferred, under vacuum, into a trap immersed in liquid air. G.l.c. analysis (G.D.B. diisodecylphthalate, 78°C) showed (137) as the major component, together with dimers and trimers of hexafluoropropene. Fractional distillation, under reduced pressure ('Fischer-Spaltrohr Column MMS-200', 18mm.) gave a fraction 30.6g. (B.pt. 80-82°C) containing (137) and (138) which on seeding gave crystals of (137). The product was further purified by melting followed by fractional freezing until pure perfluoro-2,4,5-tri-isopropylpyridine (137)(7.9g., 17.7% overall yield) melting point 31-31.5°C, was obtained. Data obtained from this compound agreed with those from an authentic sample,^{92,88} obtained in a similar preparation.

6.4(vii) Preparation of Perfluoro-2,4,6-tri-isopropylpyridine (138)

This reaction⁸⁸ was carried out in a flat bottomed Carius tube (of ca. 90ml. capacity) containing a magnetic stirrer.

Caesium fluoride (15g.), tetrahydrothiophen dioxide (30ml.), perfluoro-2,4,5-tri-isopropylpyridine (137)(slightly impure, containing some (138))(30g., 52.7 m.moles) were introduced into the dry Carius tube which was sealed under high vacuum and heated at 170°C, for 16 hours, in an oil bath with

the mixture vigorously stirred. Volatile products (24.3g.) were transferred, under vacuum, into a trap immersed in liquid air. G.l.c. analysis (G.D.F. di-isodecylphthalate, 78°C) showed (138) as the major component together with dimers and trimers of hexafluoropropene. The product was purified by fractional distillation ('Fischer-Spaltrohr-Column', MMS-200, 18mm.) and the fraction b.pt. 79°C/18mm. collected which on standing gave perfluoro-2,4,6-tri-isopropylpyridine (138), as a colourless solid, melting point 25°C, which was shown to be identical to an authentic sample of (138)³⁸ prepared in an analogous manner.

6.4(viii) Reaction Between Perfluoro-2,4,5-tri-isopropylpyridine (137), Pentafluoropyridine (136) and Fluoride Ion

Caesium fluoride (3g.), perfluoro-2,4,5-tri-isopropylpyridine (137)(12.0g., 19.3 μ .moles), pentafluoropyridine (136)(4.0g., 23.6 μ .moles) and tetrahydrothiophen dioxide (30ml.) were introduced into a dry flat bottomed Carius tube, containing a magnetic stirrer, which was sealed under high vacuum and heated at 160-165°C in an oil bath with vigorous stirring, for 17.7 hours.

Volatile products were transferred, under vacuum, to a trap immersed in liquid air. Analysis by g.l.c. (G.D.B. silicone elastomer, 78°C) of the liquid product showed (136) (1.3g.), perfluoro-4-isopropylpyridine (140)(4.9g.) and a mixture of perfluoro-di-isopropylpyridines (139) and (141) (8.7g.) which contained mainly perfluoro-2,5-di-isopropylpyridine (139).

Fractional distillation using a Fischer-Spaltrohr Column MMS-200 apparatus and collection of the fraction boiling 158°C gave (139) containing ca. 2% of (141) (as shown by ^{19}F n.m.r.) identical to an authentic sample (Lit.³⁸ boiling point 159°C) prepared by similar cross over experiments.

6.4(ix) Reaction between Perfluoro-3,5-dimethylpyridine (142) and Tetrafluoroethylene, in the Presence of Fluoride Ion

The standard experimental procedure for perfluoroalkylation reactions was used. Caesium fluoride (14g., 92.1 m.moles), perfluoro-3,5-dimethylpyridine (142) (7.0g., 26 m.moles), 2,5,8,11,14-pentaoxapentadecane (100ml.) and tetrafluoroethylene (ca. 10g., 100 m.moles) were stirred at 80°C for four hours. Not all the perfluoroalkene was absorbed. An attempt to transfer volatile products, under high vacuum, into a trap cooled in liquid air yielded no volatile products.

The reaction mixture was poured into water, the lower layer separated, extracted into ether and dried (MgSO_4). Removal of ether using a rotary evaporator gave a viscous dark red residue (6.4g.) from which it was possible to vac. transfer 3.9g. of an oil which on examination by g.l.c. (G.D.B. silicone elastomer, 110°C) was shown to contain at least eight components. This reaction was not investigated further.

CHAPTER 7

Experimental for Chapter 3

Reagents

The pyridines used in photolysis experiments were all greater than 99.5% pure and were prepared as indicated in Chapter 6.

Ultraviolet Light Sources

Photochemical reactions were carried out in 'Rayonet' preparative photochemical reactors 'R.P.R.-204' and 'R.P.R.-208'. The 'R.P.R.-204' reactor contains four lamps whereas the 'R.P.R.-208' contains eight lamps. Two types of lamps were used in the irradiations to be described.

(i) Low pressure mercury lamps which each provided 15 watts of 253.7nm. light (Fig. 13) so that 120 watts of 253.7nm. light was available from the 'R.P.R.-208' reactor.

(ii) 'Sunlight phosphor' conversion lamps which have an emission envelope of wavelengths between 280 and 320nm. with maximum output at 300nm. (see Fig. 13). Eight of these lamps provide ca. 85 watts of ultraviolet light and will be referred to as 300nm. lamps.

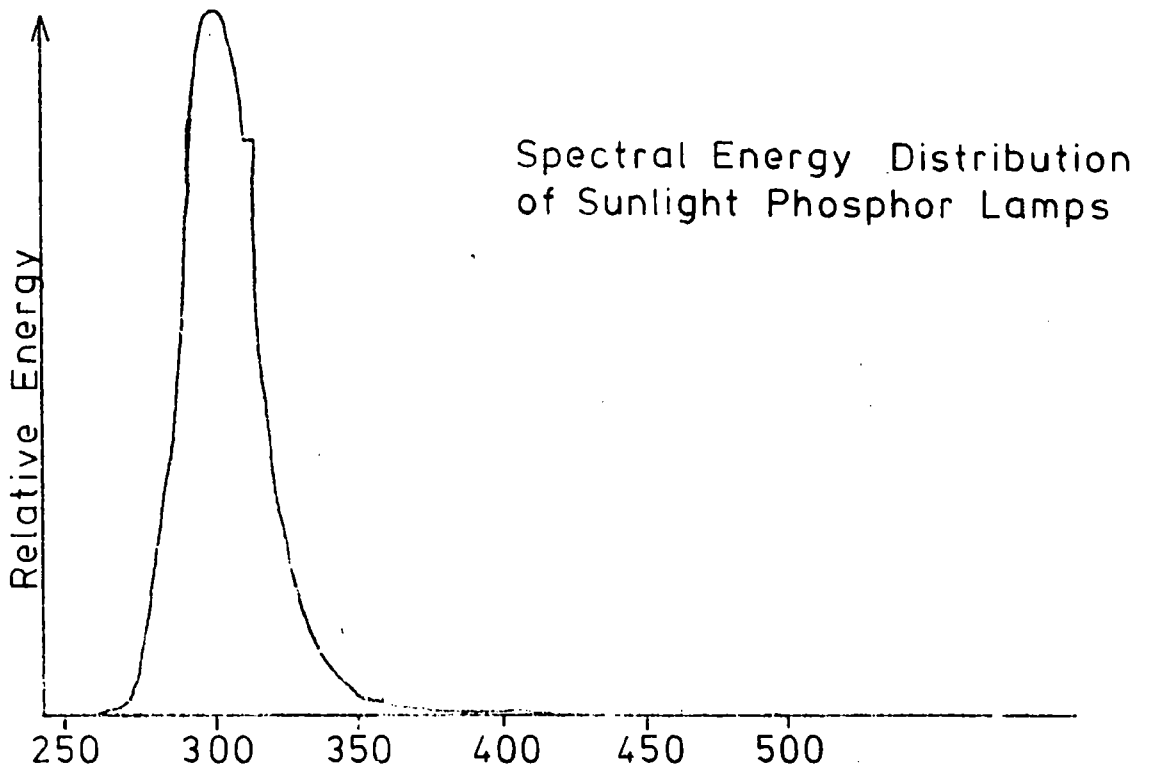
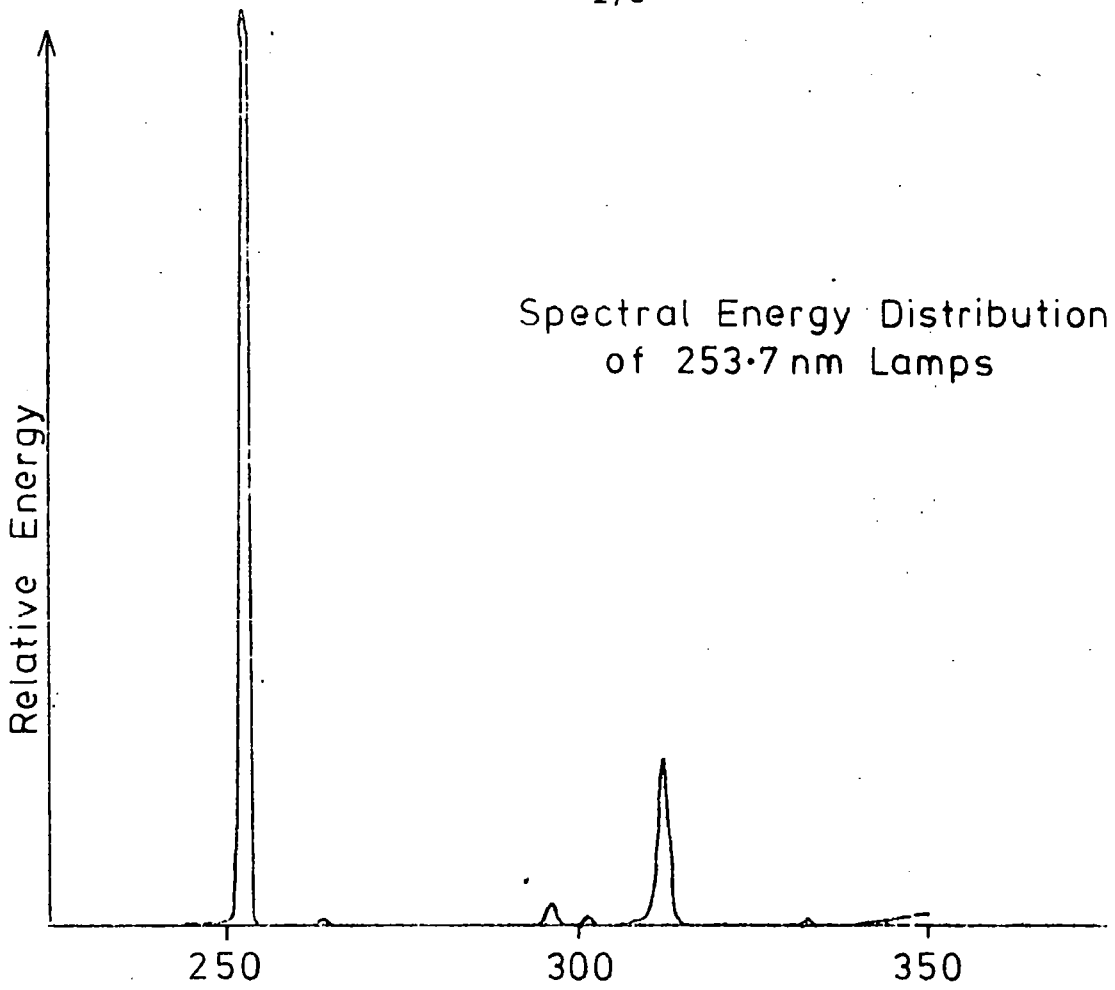

FIG. 13

The temperature reached within the irradiation zone when either 253.7nm. or 300nm. lamps were in use was ca. 40°C.

Experimental Procedure

Some experiments were carried out in solution in stoppered silica or Pyrex test tubes. In general the solvent used for these photolysis experiments was $\text{CF}_2\text{ClCFCl}_2$ (Freon 113) which was distilled before use. When the experiment was carried out in sealed silica tubes, under high vacuum, degassing was carried out.

When transference experiments were carried out the apparatus used was that illustrated in Fig. 9 (page 113). The compound to be irradiated was introduced into the large silica vessel and then the system was evacuated to the required pressure. The residual gas in the apparatus was air.

7.1 Irradiation of Static Systems

- (1) Irradiation of Perfluoro-4-ethyl-2,6-di-isopropyl-3,5-dimethylpyridine (153), in Solution, at 253.7nm., Using a Long Irradiation Time

This irradiation was performed several times. Described below is a typical experiment.

Perfluoro-4-ethyl-2,6-di-isopropyl-3,5-dimethylpyridine (153) (lg., 1.49 μ .moles), was dissolved in $\text{CF}_2\text{ClCFCl}_2$ (20ml) contained in a stoppered silica test-tube, capacity ca. 30ml, and irradiated for 196 hrs. at 253.7nm. (120 watts) after which time analysis by g.l.c. (G.D.B. silicone elastomer, 78°C)

showed the presence of one new component in the mixture and disappearance of starting material (153). Removal of solvent, by distillation, and purification of the residue by preparative scale g.l.c. ('Aerograph', silicone elastomer, 80°C) gave perfluoro-4-ethyl-2,6-di-isopropyl-3,5-dimethyl-1-azatetracyclo[2.2.0.0^{2,6}.0^{3,5}]hexane (160) and perfluoro-2-ethyl-4,6-di-isopropyl-3,5-dimethyl-1-azatetracyclo[2.2.0.0^{2,6}.0^{3,5}]hexane (159) as a colourless liquid mixture (Ca. 50:50 mixture as shown by ¹⁹F n.m.r.) [Found: F, 71.2%; M, 669. C₁₅F₂₅N requires F, 70.98%; M, 669] ¹⁹F n.m.r. spectra No. 2 and 3. The azaprismane structure followed from the i.r. spectrum (No. 2) which showed no peaks corresponding to C=C or C=N stretches and the u.v. spectrum (No. 1) which showed the products not to be aromatic.

On fractional distillation of this mixture, under reduced pressure (10mm., 'MMS 200' column) it was possible to obtain a small quantity of this azaprismane mixture (boiling at 65°C/10mm) which contained (159) and (160) in the ratio 55:45 (as shown by ¹⁹F n.m.r.).

Irradiation of (153) in solution in perfluoromethylcyclohexane in a sealed silica tube, under high vacuum and degassing, using 253.7nm. light (120 watts) gave (159) and (160) as an inseparable mixture.

(ii) Irradiation of Perfluoro-4-ethyl-2,6-di-isopropyl-3,5-dimethylpyridine (153), in Solution at 253.7nm., Using a Short Irradiation Time

Perfluoro-4-ethyl-2,6-di-isopropyl-3,5-dimethylpyridine (153) (4g, 5.97 m.moles) was dissolved in CF₂ClCFCl₂ (80mls)

contained in a stoppered silica tube (Capacity ca. 100ml) and irradiated by 253.7nm. light (120 watts) for 46.2 hrs, after which time g.l.c. analysis (G.D.B. silicone elastomer, 78°C) and g.l.c. mass spec. showed the presence of para-bonded species (154), azaprismane mixture (159) and (160), and (153) in the ratio ca. 20:15:65. Small samples of (154) and mixture (159) and (160) were obtained by reduced pressure distillation (column 'MMS 200', 18mm. Bpts 69° and 73°C respectively) and their identity confirmed by comparison of their ¹⁹F n.m.r. spectra with those of authentic samples.

(iii) Irradiation of Perfluoro-4-ethyl-2,6-di-isopropyl-3,5-dimethylpyridine (153), in Solution at ca. 300nm, Using a Short Irradiation Time

Perfluoro-4-ethyl-2,6-di-isopropyl-3,5-dimethylpyridine (153) (1.5g. 2.24 m.moles) was dissolved in 25ml. of CF₂ClCFC1₂ contained in a Pyrex test-tube, of ca.35ml. capacity, and irradiated at ca.300nm. (Ca.42 watts) for 24 hrs. The solvent was removed by distillation and the residue examined by g.l.c. (G.D.B. silicone elastomer, 78°C) and shown to contain three components.

The products from two such experiments (2.85g) were combined and separated by distillation (13mm. 'MMS 200' column) to give perfluoro-4-ethyl-2,6-di-isopropyl-3,5-dimethyl-1-azabicyclo[2.2.0]hexa-2,5-diene (154)(b.pt. 64°C ca.13mm) as a colourless liquid (1.16g, 38.6%) [Found: C, 27.0%; F, 70.7%; M, 669. C₁₅F₂₅N requires C, 26.93%; F, 70.9%; M, 669] i.r. spectrum No. 3, ¹⁹F n.m.r. spectrum No. 4, u.v. spectrum No. 6.

The pot residue (1.69g) was examined by g.l.c. (G.D.B. silicone elastomer, 78°C) and shown to contain para-bonded species (1.05g)(33%), azaprismane mixture (159) and (160) (0.32g, 10.5%) and (153)(0.25g, 8.3%) from g.l.c. retention times and g.l.c. mass spec. The yield of (154) was 71% overall.

(iv) Irradiation of Perfluoro-4-ethyl-2,6-di-isopropyl-3,5-dimethylpyridine (153), in Solution at ca. 300nm. Using a Long Irradiation Time

Perfluoro-4-ethyl-2,6-di-isopropyl-3,5-dimethylpyridine (153)(1.5g, 2.24m.moles) was dissolved in 25ml. of $\text{CF}_2\text{ClCFCl}_2$ contained in a pyrex test-tube (capacity ca. 35ml) and irradiated at ca.300nm. (ca.43 watts) for 359 hrs. The resulting solution was shown by g.l.c. (G.D.B. silicone elastomer, 78°C) to contain only one component. Removal of solvent by distillation gave a residue (1.45g) which was purified by preparative g.l.c. ('Aerograph', silicone elastomer, 80°C) and shown by ^{19}F n.m.r. to be a mixture of azaprismanes (159) and (160) in the approximate ratio 55:45.

(v) Irradiation of Perfluoro-2,4,6-tri-isopropyl-3,5-dimethylpyridine (148) in Solution at 253.7nm.

Perfluoro-2,4,6-tri-isopropyl-3,5-dimethylpyridine (148)(1.01g, 1.40m.moles) was dissolved in $\text{CF}_2\text{ClCFCl}_2$ (20ml), contained in a silica test-tube, (capacity ca.30ml) and irradiated by 253.7nm. light (60 watts) for 396 hrs.

after which time g.l.c. analysis (G.D.B. silicone elastomer 78°C) showed azaprismane (179) (61%) and (148) (39%) together with solvent. The solvent was removed by distillation and the residue purified by preparative g.l.c. ('Aerograph', silicone elastomer, 95°C) to give perfluoro-2,4,6-tri-isopropyl-3,5-dimethyl-1-azatetracyclo[2.2.0.0^{2,6}.0^{3,5}]-hexane (179) (0.45g 73.7% yield based on 61% conversion) as a colourless liquid. [Found: F, 71.5%; M, 719. C₁₆F₂₇N requires F, 71.35%; M, 719] ¹⁹F n.m.r. spectrum No. 5. The azaprismane structure for (179) followed from the i.r. data (spectrum No. 4) which showed no absorbances corresponding to C=C or C=N stretches and the u.v. data (spectrum No. 2, λ_{max} 214 (ε, 520) and ca. 256nm. (ε, 86)) which indicated the product was not aromatic. The second component in the mixture was identified as starting material (148).

(vi) Irradiation of Perfluoro-2-ethyl-3,6-di-isopropyl-4,5-dimethylpyridine (156) in Solution at 253.7nm.

Perfluoro-2-ethyl-3,6-di-isopropyl-4,5-dimethylpyridine (156) (0.50g, 0.74 m.moles) was dissolved in CF₂ClCFC₂ (10ml) contained in a stoppered silica test-tube, capacity ca. 30ml, and irradiated by 253.7nm. light (120 watts) for 101.5hrs. after which time g.l.c. analysis (G.D.B. silicone elastomer, 78°C) showed the presence of one new component, in solution, and showed the absence of starting material (156). Removal of solvent by distillation and purification of the residue by preparative g.l.c. ('Aerograph', silicone elastomer, 80°C) gave perfluoro-2-ethyl-3,6-di-isopropyl-4,5-dimethyl-1-azatetracyclo[2.2.0.0^{2,6}.0^{3,5}]hexane (185)

as a colourless liquid (0.29g, 58%) [Found: F, 70.8%; M, 669; $C_{15}F_{25}N$ requires F, 70.98%; M, 669] ^{19}F n.m.r. spectrum No. 6. The u.v. data, λ_{max} 220nm. (ϵ , 143) (Spectrum No. 3) and the absence of any absorbances corresponding to C=C or C=N stretches in the i.r. spectrum (No. 5) confirmed that the product had an azaprismane structure.

(vii) Irradiation of Perfluoro-2-ethyl-5,6-di-isopropyl-3,4-dimethylpyridine (157) in Solution at 253.7nm.

Perfluoro-2-ethyl-5,6-di-isopropyl-3,4-dimethylpyridine (157) (0.51g, 0.75 m. moles) was dissolved in $CF_2ClCFCl_2$ (10ml) contained in a stoppered silica test-tube, capacity ca. 30ml., and irradiated at 253.7nm. (120 watts) for 96 hrs. after which time the solution was analysed by g.l.c. (G.D.B. silicone elastomer, 78°C) and was shown to contain one new component, and absence of starting material (157). Solvent was removed by distillation and the residue purified by preparative g.l.c. ('Aerograph', silicone elastomer 80°C) to give an unidentified perfluoro-ethyl-di-isopropyl-dimethylazaprismane (A) (0.32g, 63%) as a colourless liquid [Found: F, 70.7%; M, 669; $C_{15}F_{25}N$ requires F, 70.98%; M, 669] i.r. spectrum No. 6, ^{19}F n.m.r. spectrum No. 7, u.v. spectrum No. 4.

(viii) Irradiation of Perfluoro-2,6-di-isopropyl-3,5-dimethylpyridine (149) in Solution, at 253.7nm.

Perfluoro-2,6-di-isopropyl-3,5-dimethylpyridine (149) (2.0g, 3.58 μ .moles) was dissolved in $CF_2ClCFCl_2$ (50ml) in

a clean dry silica Carius tube (Ca. 220 x 29mm). The solution was degassed and the tube sealed under high vacuum (0.003mm) and irradiated at 253.7nm. (120 watts) for 289 hrs. The solution discoloured, but removal of solvent and vacuum transference gave starting material (1.84g) as the only product (shown by comparison of i.r. and ^{19}F n.m.r. spectra with those from an authentic sample).

(ix) Irradiation of Perfluoro-2,4,6-tri-isopropylpyridine (138) in Solution, at 253.7nm.

Perfluoro-2,4,6-tri-isopropylpyridine (138) (2.02g, 3.26 m.moles) was dissolved in $\text{CF}_2\text{ClCFCl}_2$ (40ml) in a clean dry silica Carius tube (Ca. 28 x 215mm). The solution was degassed and the tube sealed under high vacuum (0.005mm), and irradiated by 253.7nm. light (60 watts) for 306.3hrs. Some discolouration of the solution occurred, but removal of solvent gave starting material (138) (1.77g) as the only product (As shown by g.l.c. i.r. and ^{19}F n.m.r.).

(x) Irradiation of Perfluoro-2,4,6-tri-isopropylpyridine by 253.7nm. light, in the Vapour Phase

Perfluoro-2,4,6-tri-isopropylpyridine (138) (1.65g., 2.67 m.moles) was introduced into a clean dry silica tube (25 x 210mm) which was sealed under high vacuum (0.001mm), after degassing, and irradiated at 253.7nm. (60 watts) for 306.3hrs. Slight discolouration of the solid occurred. The vacuum transferred product (1.52g) was shown by g.l.c. (G.D.B. silicone elastomer, 78°C) to be a single component

identified as starting material (138) from i.r. and ^{19}F n.m.r. spectra.

7.2 Irradiation Under Transference Conditions

(i) Irradiation of Perfluoro-4-ethyl-2,6-di-isopropyl-3,5-dimethylpyridine (153), at 253.7nm. Whilst Under Transference

Perfluoro-4-ethyl-2,6-di-isopropyl-3,5-dimethylpyridine (153) (1.10g., 1.64 μmoles) was introduced into the transference apparatus illustrated in Fig. 9 (Silica vessel used, 70 x 370mm). The system was evacuated to a pressure of 0.003mm, the residual gas being air, and then irradiated at 253.7nm. (120 watts) for 22.8 hrs., during which time all the material transferred into the liquid air cold trap. The transferred product (1.06g, 96.5%) was shown by i.r., mass spec. and g.l.c. to be recovered starting material (153).

(ii) Irradiation of Perfluoro-2,6-di-isopropyl-3,5-dimethylpyridine (149) at 253.7nm. Whilst Under Transference

Perfluoro-2,6-di-isopropyl-3,5-dimethylpyridine (3.0g., 5.27 μmoles) was introduced into the apparatus shown in Fig. 9 (Silica vessel 110 x 370mm) and the system evacuated to a residual pressure of air, of 0.5mm. and irradiated at 253.7nm. (120 watts) for 42.5 hrs. during which time all the material had transferred into the cold trap (liquid air). Slight decomposition was observed on the walls of the silica vessel.

The resulting liquid product (1.98g) was examined by g.l.c. (G.D.B. di-isodecylphthalate, 78°C) and shown to contain two major components, the one of longer retention time (0.69g) was subsequently shown to be starting material (149) by g.l.c. retention time and i.r. The component of shorter retention time was separated by g.l.c. ('F-21', di-isodecylphthalate, all parts at 50°C) and shown to be perfluoro-1,3-di-isopropyl-4,6-dimethyl-2-azabicyclo-[2.2.0]hexa-2,5-diene (188) (1.29g, 43% overall yield) [Found: C, 27.4%; F, 70.1%; M, 569. C₁₃F₂₁N requires C, 27.45%; F, 70.1%; M, 569] i.r. spectrum No. 7, ¹⁹F n.m.r. spectrum No. 8, u.v. spectrum No. 8.

A solid product (0.91g) obtained from the walls of the cold trap was identified by ¹⁹F n.m.r. as starting material (149).

(iii) Irradiation of Perfluoro-2,4,6-tri-isopropylpyridine (138) at 253.7nm. Whilst Under Transference

This photolysis was carried out on more than one occasion. A typical experiment is described below.

Perfluoro-2,4,6-tri-isopropylpyridine (138) (3.0g, 4.84 μmoles) was introduced into the apparatus shown in Fig. 9 (Silica vessel used, 110 x 370mm.) and the system evacuated to a residual pressure, of air, of 1.0mm. and irradiated for 64.9 hours at 253.7nm. (120 watts) during which time all the material had transferred into the cold trap. Slight decomposition was observed on the walls of the silica vessel.

G.L.C. analysis (G.D.B. di-isodecylphthalate, 78°C) of the liquid product showed two major components of which the one of longer retention time was shown to be starting material (138)(1.76g, 59%). 1.11g (37%) of the more volatile component was present (as estimated by g.l.c.).

The products from four such transference reactions were combined and distilled ('Fischer Spaltrohr-Column MMS 200' microdistillation apparatus) under reduced pressure (22mm) to give perfluoro-1,3,5-tri-isopropyl-2-azabicyclo[2.2.0]-hexa-2,5-diene (194), as a colourless liquid (Bpt. 66°C/22 ± 1mm.) [Found: F, 70.7%; M, 619. C₁₄F₂₃N requires F, 70.6%; M, 619] ¹⁹F n.m.r. spectrum No. 9, i.r. spectrum No. 8, u.v. spectrum No. 9 and 0.41g of a mixture (B.pt. 66.5-67°C/22mm) containing ca. 60% (194) and 40% of a second component identified from ¹⁹F n.m.r. as perfluoro-2,4,6-tri-isopropyl-1-azabicyclo[2.2.0]hexa-2,5-diene (195) ¹⁹F n.m.r. spectrum No. 10 [Found: M, 619. C₁₄F₂₃N requires M, 619] with an overall yield of Ca. 2%.

(iv) Irradiation of Perfluoro-2,4,5-tri-isopropylpyridine (137) at 253.7nm. Whilst Under Transference

This irradiation was carried out on more than one occasion. A typical experiment is described below.

Perfluoro-2,4,5-tri-isopropylpyridine (137)(2.1g, 3.39μmoles) was introduced into the transference apparatus (Fig. 9. 370 x 110mm. silica vessel) and the system evacuated to a residual pressure of 0.3mm. and irradiated by 253.7nm. (120 watts) for 21.6 hrs. during which time all the

material had transferred into the trap, cooled in liquid air.

Analysis by g.l.c. (G.D.B. silicone elastomer, 78°C) of the liquid obtained showed two major components, a volatile component (0.87g., 41%) and unreacted starting material (137). Separation by preparative g.l.c. ('F-21', di-isodecylphthalate, 60°C) gave a mixture containing perfluoro-2,4,5-tri-isopropyl-1-azabicyclo[2.2.0]hexa-2,5-diene (196) and perfluoro-3,5,6-tri-isopropyl-2-azabicyclo[2.2.0]hexa-2,5-diene (197) ^{19}F n.m.r. No. 12, i.r. of mixture spectrum No. 9, in the ratio 45:55 (as determined by ^{19}F n.m.r.).

The products from three such reactions were combined and an attempt made to separate the azaparabonded species (196) and (197) by distillation using a Fischer-Spaltrohr-column HMS500 distillation apparatus, under reduced pressure (8mm.). However the azaparabonded species (197) rearomatized during the course of the distillation but perfluoro-2,4,5-tri-isopropyl-1-azabicyclo[2.2.0]hexa-2,5-diene (196) was obtained as a colourless liquid (Bpt. 56°C/8mm.) [Found: F,70.4%; C,27.2%; M,619. $\text{C}_{14}\text{F}_{23}\text{N}$ requires F,70.6%; C,27.15%; M,619] ^{19}F n.m.r. spectrum No. 11, i.r. spectrum No. 10, u.v. spectrum No. 7.

(v) Irradiation of Perfluoro-2,4,6-tri-isopropyl-3-methylpyridine (151) at 253.7nm. Whilst Under Transference

Perfluoro-2,4,6-tri-isopropyl-3-methylpyridine (151) (3.0g., 4.48m.moles) was introduced into the apparatus shown in Fig. 9 and the system evacuated to leave a residual

pressure, of air, of 1.0mm. and irradiated at 253.7nm. (120 watts) for 64.2 hours during which time all the material had transferred into the cold trap.

Analysis of the liquid product (2.9g) by g.l.c. (G.D.B. di-isodecylphthalate, 78°C) showed two components, the more volatile present as 40.2% of the mixture (38.8% yield overall) whereas analysis by g.l.c. ('F-21' di-isodecylphthalate, 60°C) further resolved the volatile component into two components (relative ratio ca. 8:1) and the involatile component into two peaks (relative ratio Ca. 50:50). The products from three such irradiations were combined and distilled under reduced pressure (8.5mm) on a Fischer-Speltrohr Column HMS 200 microdistillation apparatus to give an unidentified compound thought to be a perfluorotri-isopropylmethylaza-prismane (E), due to the absence of either C=C or C=N stretches in the i.r. spectrum No. 11. [Found: F, 70.8%; M, 669. C₁₅F₂₅N requires F, 70.98%; M, 669] ¹⁹F n.m.r. spectrum No. 14 u.v. spectrum No. 5 (Ept. 53-4°C/8.5mm). A component boiling point 54-56°C/8.5mm contained the previous component and was also unidentified and had resonances in the ¹⁹F n.m.r. at 64.35, 65.48, 75.79, 76.64, 78.55, 99.95, 105.37, 179.2, 187.2, 188.1 and 188.7 p.p.m. and was shown by g.l.c. mass spec. to be isomeric with (151). The pot residue after removal of volatile components was shown by ¹⁹F n.m.r. to be a mixture which contained ca. 50% of starting material (151) together with a second unidentified pyridine, with M = 669 (as shown by g.l.c. mass spectrometry).

(vi) Irradiation of Perfluoro-2-isopropyl-3,5-dimethylpyridine (150), at 253.7nm. Whilst Under Transference

Perfluoro-2-isopropyl-3,5-dimethylpyridine (150)

(2.90g, 6.92m.moles) was introduced into the transference apparatus shown in Fig. 9 (Silica vessel, 370 x 110mm).

The liquid was frozen, using liquid air, while the vessel was evacuated to a pressure of 0.65mm. and then irradiated at 253.7nm. (120 watts) for a total of 40.6 hrs. during which time all the material had transferred into the cold trap.

G.l.c. analysis (G.D.B. di-isodecylphthalate, 35°C) showed three major components in the ratio ca. 34%:5%:59%, together with two very minor volatile components, in order of increasing retention time. Separation by preparative g.l.c. ('F-21', di-isodecylphthalate, 35°C) gave an impure sample identified as perfluoro-1-isopropyl-4,6-dimethyl-2-azabicyclo[2.2.0]hexa-2,5-diene (202) from its ¹⁹F n.m.r. (No. 13). Rearomatisation to (150) occurred during the separation so a pure sample was not obtained and the para-bonded species (202) was found to be extremely susceptible to hydrolysis, even if stored at -20°C. The least volatile component, present at 59% of the mixture, was identified as starting material (150) by comparison of i.r. and ¹⁹F n.m.r. spectra with those from an authentic sample. The component present as 5% of the mixture and the two minor components were unidentified.

(vii) Irradiation of Perfluoro-4,6-di-isopropyl-3-methylpyridine (152), at 253.7nm. whilst Under Transference

Perfluoro-4,6-di-isopropyl-3-methylpyridine (152) (3.2g, 6.26 μ moles) was introduced into the transference apparatus shown in Fig. 9 (Silica vessel used, 370 x 110mm). The liquid was frozen down and the apparatus evacuated to a residual pressure of 0.5mm. The vessel was allowed to warm to room temperature and irradiated by 253.7nm. lamps (120 watts) for 102 hours, during which time all the material had transferred into the side trap, cooled in liquid air.

The liquid product (3.04g) was analysed by g.l.c. (C.D.E. di-isodecylphthalate, 78°C) and showed one volatile component as 46% of the mixture, and 53% starting material (152). The volatile component was resolved into two major components and one minor component on further g.l.c. analysis ('F-21' silicone elastomer, 45°C), however resolution was poor and separation by g.l.c. ('F-21' Silicone elastomer, 45°C) gave samples of the mixture which was shown by mass spec. to be isomeric with starting material (152) but was not identified.

(viii) Irradiation of Perfluoro-2,5-di-isopropylpyridine (139), at 253.7nm. Whilst Under Transference

Perfluoro-2,5-di-isopropylpyridine (139) (3.15g) was introduced into the transference apparatus illustrated in Fig. 9 (Silica vessel, 370 x 110mm) and the liquid frozen down (liquid air) whilst the vessel was evacuated to a

residual pressure (of air) of 1.Cmm. The vessel was irradiated at 253.7nm. (120 watts) for 96.2 hours during which time all the material had transferred into the cold trap.

G.l.c. analysis of the liquid product (2.1g)(G.D.E. di-isodecylphthalate, 78°C) showed the presence of starting material (159), which was confirmed by i.r. and ¹⁹F n.m.r. data.

The experiment was repeated under similar conditions but the product was kept frozen down and transferred under high vacuum into an n.m.r. tube which was sealed and the liquid examined at -20°C, but no unstable valence isomers were detected.

(ix) Irradiation of Pentafluoropyridine (136) at 253.7nm.
Under Transference

Pentafluoropyridine (1.03g) was introduced into the transference apparatus shown in Fig. 9 (370 x 110mm. silica vessel) and frozen down, using liquid air, whilst the apparatus was evacuated to a pressure of Ca.12mm and the vessel irradiated at 253.7nm. (120 watts) for 63.5 hours during which time all the material had transferred into the liquid air cooled trap.

Much decomposition was observed on the walls of the silica vessel. The liquid product was transferred, under vacuum, into an n.m.r. tube and the liquid examined at -20°C and shown to be unchanged starting material (136) (0.42g, 41%). No new peaks were detected in the ¹⁹F n.m.r. of the product.

(x) Irradiation of Perfluoro-2,4,6-tri-isopropylpyridine (138), Under Transference at 300nm.

Perfluoro-2,4,6-tri-isopropylpyridine (138)(3.0g) was introduced into the transference apparatus, illustrated in Fig. 9 (Silica vessel, 370 x 110mm) and the system evacuated to a residual pressure of 1.0mm, of air, and irradiated at 300nm. (85 watts) for 64.3 hours during which time all the material had transferred into the cold trap.

G.l.c. analysis (G.D.B. Silicone elastomer, 78°C) of the liquid product (2.95g) showed two components in the ratio 12:88, the latter of which was shown to be starting material (138). Separation by preparative g.l.c. ('F-21', di-isodecylphthalate, 50°C) gave the volatile component identified by ¹⁹F n.m.r. as (194), containing a trace of (195), by comparison with an authentic sample.

7.3 Irradiation of Perfluorotetra-isopropylpyrazine (207)

(i) In Solution at 253.7nm.

Perfluorotetra-isopropylpyrazine (207)(0.60g, 0.3 m.moles) dissolved in Freon 113 (16ml) in a silica test tube (capacity ca. 30ml) was irradiated at 253.7nm. (120 watts) for 191.1 hours. Removal of solvent by distillation gave a brown solid from which unchanged starting material (207) (0.44g) was sublimed.

Pyrazine (207)(0.40g, 0.53 m.moles) was dissolved in CFCl₂CF₂Cl (10ml) in a silica Carius tube (20 x 200mm.) and sealed under high vacuum (0.001mm.) after vigorous degassing. Irradiation at 253.7nm. (120 watts) for 163.4 hours and

removal of solvent gave a brown solid identified as impure (207).

(ii) In a Transference Experiment, at 253.7nm.

Pyrazine (207)(0.50g, 0.66 μ mole) was introduced into the transference apparatus (Fig. 9. 70 x 370mm., silica vessel) which was evacuated to a pressure of 0.07mm. and irradiated at 253.7nm. (120 watts) for 16.7 hours. The transferred solid (0.46g) was shown by i.r. and g.l.c. to be unchanged starting material (207).

(iii) In a Static Vapour Irradiation at 253.7nm.

Perfluorotetra-isopropylpyrazine (207)(0.32g, 0.42 μ mole) was introduced into a silica Carius tube (ca. 19 x 210mm.) and sealed under high vacuum (0.0003mm.). Irradiation at 253.7nm. (120 watts) for 293 hours caused slight discolouration of the solid which was identified as starting material.

CHAPTER 8

Properties of Valence Isomers - Experimental

8.1 Introduction

This chapter contains experimental details on work carried out on valence isomers and mainly discussed in Chapter 4.

8.2(1) Pyrolysis of Mixtures of Perfluoro-4-ethyl-2,6-di-isopropyl-3,5-dimethyl-1-azatetracyclo[2.2.0.0^{2,6}.0^{3,5}]hexane (160) and Perfluoro-2-ethyl-4,6-di-isopropyl-3,5-dimethyl-1-azatetracyclo[2.2.0.0^{2,6}.0^{3,5}]hexane (159)

This pyrolysis was carried out on more than one occasion. A typical experiment is described below.

The mixture of azaprismanes (159) and (160) (Ca 50:50 mixture, 2.0g, 2.99 m.moles) was sealed, under high vacuum, in a thick walled pyrex Carius tube (70 x 10mm.) and heated in a thermostated oil bath at 175°C for ca. 50 hours. The liquid product was analysed by g.l.c. (G.D.B. di-isodecylphthalate, 78°C) and shown to contain three major components as 34%, 48% and 12.5% of the liquid product. Separation was carried out by preparative g.l.c. ('F-21', di-isodecylphthalate, 95°C) to give, in order of increasing retention time,

perfluoro-2-ethyl-3,6-di-isopropyl-4,5-dimethylpyridine (156)
as a colourless liquid, boiling point 190°C [Found: F, 71.0%;
M, 669; C₁₅F₂₅N requires F, 70.98%; M, 669] ¹⁹F n.m.r.
spectrum No. 15, i.r. spectrum No.12, u.v. spectrum No. 10,
perfluoro-2-ethyl-5,6-di-isopropyl-3,4-dimethylpyridine (157)
as a colourless solid, melting point 26°C [Found: F,71.1%;
M, 669; C₁₅F₂₅N requires F, 70.98%; M, 669] ¹⁹F n.m.r.
spectrum No. 16, i.r. spectrum No.13, u.v. spectrum No. 11,
and perfluoro-3-ethyl-2,6-di-isopropyl-4,5-dimethylpyridine
(158) as a colourless solid, melting point 71-72°C [Found: F,
70.7%; M, 669. C₁₅F₂₅N requires F, 70.98%; M, 669] ¹⁹F
n.m.r. spectrum No. 17, i.r. spectrum No.14, u.v. spectrum
No. 12.

Pyrolysis of an azaprismane mixture containing (159)
and (160) in the approximate ratio 55:45 (from ¹⁹F n.m.r.)
in a sealed tube, at 176°C for 119 hours, gave a mixture
containing (157), (158) and (159) in the approximate ratio
38%:41%:15.5% (as shown by g.l.c. analysis. G.D.B. di-
isodecylphthalate, 78°C). The identity of the pyridines
obtained was proved by g.l.c. mass spec.

8.2(11) Pyrolysis of Perfluoro-2,4,6-tri-isopropyl-3,5-
dimethyl-1-azatetracyclo[2.2.0.0^{2,6}.0^{3,5}]hexane (179)

Azaprismane (179)(0.35g.) was introduced into a clean,
dry pyrex n.m.r. tube which was sealed under high vacuum
(0.005 mm.) and heated, in an oil bath at 174-178°C, for
31.3 hours. The liquid product was analysed by g.l.c.
(G.D.B. di-isodecylphthalate, 78°C) and shown to contain
azaprismane (179)(17.5%), pyridine derivative (182)(79.5%)
and 3% unknowns.

The mixture was separated by preparative g.l.c. ('F-21', silicone elastomer, 100°C) to give perfluoro-2,3,6-tri-isopropyl-4,5-dimethylpyridine (182) as a colourless solid, melting point 41°C. [Found: F, 71.5%; M, 719; C₁₆F₂₇N requires F, 71.35%; M, 719] ¹⁹F n.m.r. spectrum No. 18; i.r. spectrum No. 15, u.v. spectrum No. 13.

2(iii) Pyrolysis of Perfluoro-4-ethyl-2,6-di-isopropyl-3,5-dimethyl-1-azabicyclo[2.2.0]hexa-2,5-diene (154)

Perfluoro-4-ethyl-2,6-di-isopropyl-3,5-dimethyl-1-azabicyclo[2.2.0]hexa-2,5-diene (154) (1.0g.) was introduced into a pyrex Carius tube (ca. 6 ml. capacity) which was sealed under high vacuum (0.003 mm.) and heated at 175±2°C for 38 hours.

The solid which appeared on cooling (0.42g.) was removed by filtration and shown by i.r. and ¹⁹F n.m.r. to be perfluoro-4-ethyl-2,6-di-isopropyl-3,5-dimethylpyridine (153). The resulting liquid (0.54g.) was analysed by g.l.c. (G.D.B. Silicone elastomer. 78°C) and g.l.c. mass spec. and shown to contain unchanged para-bonded species (ca. 0.45g., 45%) and pyridine derivative (ca. 0.09g., 9%).

2(iv) Flash Vacuum Pyrolysis of a Mixture of Azaprismanes (159) and (160)

A 50:50 mixture of azaprismanes (159) and (160) was passed through a hot silica tube (300 x 10mm.) under high vacuum; the products were collected in a trap cooled in liquid air. When the tube was at 380°C complete rearomatisation to a mixture of pyridines (156), (157) and (158) in the ratio 36:50:14 was obtained.

At 350°C the product contained azaprismane mixture (159) and (160), pyridines (156), (157) and (158) in the ratio 27:27:36:10%, which were identified by linked g.l.c. mass spectrometry. There was no evidence for intermediate para-bonded isomers.

8.3 Half-life Determinations

The half-lives of some of the valence-isomers obtained, in this work, were determined as below.

8.3(1) Perfluoro-2,4,5-tri-isopropyl-1-azabicyclo- [2.2.0]hexa-2,5-diene (196)

The diene (196) contained in a stoppered tube was heated in an oil bath maintained at 140°C. Samples were removed at regular intervals and examined by g.l.c. (G.D.B. di-isodecylphthalate, 78°C). The ratio of components was determined from the area under the g.l.c. trace. The half-life of the para-bonded species (196) was determined by graphical means as 135 ± 15 minutes and shown to be first order. The product from rearomatisation was shown to be perfluoro-2,4,5-tri-isopropylpyridine (137) by comparison with an authentic sample.

8.3(11) Perfluoro-1,3,5-tri-isopropyl-2-azabicyclo- [2.2.0]hexa-2,5-diene (194)

The diene (194) contained in a stoppered tube was heated, at 140°C, in an oil bath. The composition of the sample was periodically examined by g.l.c. (G.D.B. di-isodecylphthalate, 78°C). The para-bonded isomer (194) was shown, by graphical means, to rearrange with first order kinetics, with $t_{\frac{1}{2}} = 110 \pm 10$ minutes. The rearomatisation product was identified from spectra as perfluoro-2,4,6-tri-isopropylpyridine (138).

8.3(111) Perfluoro-1,3-di-isopropyl-4,6-dimethyl-2-azabicyclo[2.2.0]hexa-2,5-diene (188)

The diene (188) (Ca. 200 μ l.) was sealed in a pyrex n.m.r. tube and heated in the probe of an n.m.r. spectrometer (Varian A56/60D) at 104°C. The rearomatisation was followed by electronic integration of signals obtained from perfluoromethyl groups in starting material (188) and product (149). The para-bonded isomer (188) was shown by graphical means to decompose with first order kinetics $t_{1/2} = 36 \pm 4$ mins. at 104°C. The rearomatisation product was shown by ^{19}F n.m.r. to be perfluoro-2,6-di-isopropyl-3,5-dimethylpyridine (149).

8.3(iv) Half-life determination on unidentified perfluoro-tri-isopropylmethylazaprismane (B)

The azaprismane (B), formed from photolysis of (151), was heated at 143 \pm 2°C. After 75 minutes, Ca. 91.5% rearomatisation had taken place, as shown by g.l.c. (G.D.B. diisodecylphthalate, 75°C). This gave a half-life of 21 minutes.

$$\ln \frac{[A]_0}{[A]_t} = kt$$

$$\ln \frac{[A]_0}{[A]_{t_{1/2}}} = kt_{1/2}$$

$$2.303 \log \frac{100}{8.5} = 75.k$$

$$k = \frac{2.303 \times 1.0706}{75}$$

$$t_{1/2} = \frac{\log 2 \times 2.303}{k}$$

$$t_{1/2} = 21 \text{ minutes}$$

The rearomatisation product was identified as perfluoro-2,4,6-tri-isopropyl-3-methylpyridine (151).

8.4 Irradiation of Valence Isomers

Attempts were made to induce rearrangement of the valence isomers, obtained earlier, by photochemical means.

8.4(i) Irradiation of a Mixture of Azaprismanes (159) and (160)

The azaprismane mixture (159) and (160)(75 μ l.) in the ratio ca. 40:60 was mixed with ca. 120 μ l. of $\text{CF}_2\text{ClCFCl}_2$ in a silica n.m.r. tube. Irradiation at 253.7nm. (120 watts) for 270 hours did not alter the ratio of the azaprismanes (159) and (160)(as shown by ^{19}F n.m.r.). No other components were detected after photolysis.

8.4(ii) Irradiation of Perfluoro-4-ethyl-2,6-di-isopropyl-3,5-dimethyl-1-azabicyclo[2.2.0]hexa-2,5-diene (154), at 253.7nm.

The para-bonded isomer (154)(0.25g., 0.37 m.moles) was dissolved in $\text{CF}_2\text{ClCFCl}_2$ (3 ml.) in a silica test-tube and irradiated at 253.7nm. (60 watts) for 24 hours. Analysis of the mixture by g.l.c. (G.D.B. di-isodecylphthalate, 78 $^{\circ}\text{C}$) and g.l.c. linked mass spec. showed (154)(13%), azaprismane mixture (159) and (160)(4%), and pyridine derivative (153) (83%).

8.4(iii) Irradiation of Perfluoro-1,3-di-isopropyl-4,6-dimethyl-2-azabicyclo[2.2.0]hexa-2,5-diene (188)

The para-bonded isomer (188)(0.51g. 0.9 m.moles) in $\text{CF}_2\text{ClCFCl}_2$ (2ml.) contained in a silica tube, was irradiated at 253.7nm. (120 watts) for 43.7 hours after which time the solution was examined by g.l.c. (G.D.B. silicone elastomer, 78 $^{\circ}\text{C}$) and shown to contain one involatile component, which

on removal of solvent was identified as pyridine derivative (149), from i.r. spectra and g.l.c. retention time.

8.4(iv) Irradiation of Perfluorotri-isopropylmethylazaprismane(

The unidentified azaprismane (B)(250 μ l) was irradiated at 253.7nm. (120 watts) in a silica n.m.r. tube for ca. 24 hours. Examination of the product by ^{19}F n.m.r. showed the presence of perfluoro-2,4,6-tri-isopropyl-3-methylpyridine (151) and a second unidentified pyridine derivative (ca. 50:50 mixture) identical to the rearranged pyridine obtained previously from the 253.7nm. transference irradiation of (151)(Section 3.3(iii)).

8.4(v) Irradiation of Perfluoro-1,3,5-tri-isopropyl-2-azabicyclo[2.2.0]hexa-2,5-diene (194) at 253.7nm.

The para-bonded isomer (194)(0.43g. 0.69 m.moles) was dissolved in $\text{CF}_2\text{ClCFCl}_2$ (2 μ l.) contained in a stoppered silica tube and irradiated at 253.7nm. (120 watts) for ca. 24 hours. Analysis of the resulting solution by g.l.c. showed pyridine derivative (138) as the only product. This was confirmed by comparison of i.r. spectra, after removal of solvent.

8.4(vi) Irradiation of a Mixture Containing Perfluoro-2,4,6-tri-isopropyl-1-aza- and Perfluoro-1,3,5-tri-isopropyl-2-azabicyclo[2.2.0]hexa-2,5-dienes (195) and (194)

The mixture of para-bonded isomers (194) and (195) in the ratio ca. 80:20 (1.0g. 1.61 m.moles) was introduced into a large silica vessel, assembled for transference. The liquid

was frozen down (liquid air) and the vessel evacuated to a residual pressure of 0.1 mm. of air and irradiated at 253.7nm. (120 watts) for 23 hours, during which time all the material had transferred to the side trap cooled in liquid air. The product (0.95g.) was shown to contain pyridine derivative (138) (60.5%) and mixture of para-bonded isomers (195) and (194), in the approximate ratio 90:10.

8.4(vii) Irradiation of Perfluoro-2,4,5-tri-isopropyl-1-azabicyclo[2.2.0]hexa-2,5-diene (196) at 253.7nm.

The para-bonded isomer (196) (0.29g. 0.47 n.moles) was dissolved in $\text{CF}_2\text{ClCFCl}_2$ (2 ml.) contained in a stoppered silica tube and irradiated at 253.7nm. (120 watts) for ca. 48 hours. Analysis of the resulting solution by g.l.c. showed only one component, identified as perfluoro-2,4,5-tri-isopropylpyridine (137) by comparison of spectra with those from an authentic sample.

8.5 Thermal Analysis of the Rearomatisation of Perfluoro-1,3-di-isopropyl-4,6-dimethyl-2-azabicyclo[2.2.0]-hexa-2,5-diene (188) using D.S.C.

The rearomatisation of (188) was observed by D.S.C. on several occasions. A typical run is described below.

A small sample of the para-bonded isomer (188) (14.26 mg.) was sealed in an aluminium sample pan and placed in the D.S.C. machine sample holder. The reference holder contained an empty aluminium sample pan. The sample was heated from 340-430K at a rate of 10 degree/min. and the differential energy recorded on a chart recorder. The sample was cooled to 340K

and then re-run under identical conditions. This second run provided the baseline as it was run over the same chart-paper.

Analysis of the curve by the method described earlier (Section 4.2(ii)) provided the values of $\Delta H = -47.6 \text{ k.cal.mole}^{-1}$ and values of k_r as below.

Temperature	377	385	397	409	417	425 K
k_r ($\times 10^4$)	7.07	18.9	64.2	183	356	655

A plot of $\ln k_r$ against $1/T$ (Arrhenius) gave an activation energy of $28.53 \text{ k.cal.mole}^{-1}$

Over a series of runs, values obtained were:

$$\Delta H = -47.7 \pm 0.8 \text{ k.cal.mole}^{-1}$$

and $E_a = 28.75 \pm 0.5 \text{ k.cal.mole}^{-1}$

8.6 Reactions of Valence Isomers

The following contains details of the reactions attempted on the valence isomers from substituted pyridines.

8.6(i) Fluoride Ion Attack on Mixture of Azaprismanes (159) and (160)

The azaprismane mixture (159) and (160) (1.2g.) was injected into a flask containing a stirred mixture of caesium fluoride (ca. 2g.) in tetrahydrothiopen dioxide (25ml.) maintained at 42°C , and under a dry nitrogen atmosphere. After 20 hours, during which time a red colouration appeared in the solvent, volatiles (1.04g.) were transferred under high vacuum into a trap, immersed in liquid air. ^{19}F n.m.r. and g.l.c. analysis showed recovery of starting material (159) and (160), in the same ratio.

The solvent residue was added to water and ether extracted but failed to yield further material.

8.6(ii) Fluoride Ion Attack on Perfluoro-4-ethyl-2,6-di-isopropyl-3,5-dimethyl-1-azabicyclo[2.2.0]hexa-2,5-diene (154)

The para-bonded isomer (154)(0.8g.) was injected into a flask containing a stirred mixture of KF(ca.4g.) in tetrahydrothiopen dioxide (25ml.), under a nitrogen atmosphere, and maintained at 75-80°C for 42 hours. Volatiles (0.53g.) were transferred under high vacuum into a liquid air cooled trap and identified by g.l.c. and ¹⁹F n.m.r. to be unchanged starting material (154). Dilution of the pot residue, with water, followed by ether extraction failed to yield further material.

8.6.(iii) Attempted Reaction of Perfluoro-2,4,5-tri-isopropyl-1-azabicyclo[2.2.0]hexa-2,5-diene (196) with Furan

Para-bonded isomer (196)(1.0g, 1.61 m.moles) and furan (0.11g, 1.62 m.moles) were stirred at room temperature, in a sample bottle fitted with magnetic stirrer and serum cap, for 3 days. Furan was allowed to evaporate into a cold trap leaving starting material (196)(1.0g) unreacted.

Para-bonded species (196)(1.06g, 1.71 m.moles) and furan (1.12g, 12.1 m.moles) were sealed under vacuum in a pyrex Carius tube (ca. 10ml. capacity) and maintained at 50-60°C, with shaking, for six weeks, after which time analysis by g.l.c. showed unreacted starting material (196) which had shown a trace of rearomatisation to (137).

8.6(iv) Attempted Reaction of Perfluoro-1,3,5-tri-isopropyl-2-azabicyclo[2.2.0]hexa-2,5-diene (194) with Bromine

The para-bonded isomer (194) (1.0g., 1.61 m.moles) and an excess of bromine (ca. 1g.) in $\text{CF}_2\text{ClCFCl}_2$ (4ml.) contained in a stoppered flask was irradiated using bright light for 18 hours. Removal of solvent and bromine by distillation gave recovered starting material (194).

The para-bonded isomer (194) (1.0g., 1.61 m.moles), excess bromine (ca. 1g.) in $\text{CF}_2\text{ClCFCl}_2$ (ca. 10ml.) were refluxed (at 46°C) for a total of 20 hours. Starting material (194) (0.96g.), identified by g.l.c. and ^{19}F n.m.r. was recovered on removal of solvent and bromine by distillation.

8.6(v) Reaction of Perfluoro-1,3,5-tri-isopropyl-2-azabicyclo[2.2.0]hexa-2,5-diene (194) with Methoxide

Perfluoro-1,3,5-tri-isopropyl-2-azabicyclo[2.2.0]hexa-2,5-diene (194) (1g., 1.61 m.moles) was transferred under high vacuum into a Carius tube, frozen in liquid air, containing MeONa (1.63 m.moles) in methanol (17ml.). The Carius tube was allowed to warm to room temperature and then shaken for 100 minutes. The reaction mixture was added to water and the solid (340mg.) obtained removed by filtration and washed with cold ether.

The solid was thought to be a tri-methoxy derivative of (194) as it gave M^+655 in the mass spectrum [$\text{C}_{17}\text{F}_{20}\text{H}_9\text{O}_3\text{N}$ requires: M , 655]. The n.m.r. spectra showed ^1H 2.85, 3.06, 3.59 p.p.m. (downfield from external T.M.S.) ^{19}F , 70.7, 72.2, 72.9, 73.5, 179.2, 185.9 p.p.m. (upfield from external CFCl_3) in the ratio 3:9:3:3:1:1 and the i.r. spectrum showed ν_{max} 1642cm^{-1} which indicates the presence of a double bond (either $\text{C}=\text{C}$ or $\text{C}=\text{N}$).

8.6(vi) Attempted Reaction Between Perfluoro-1,3,5-tri-isopropyl-2-azabicyclo[2.2.0]hexa-2,5-diene (194) and Perfluoroisopropyl Anion

The standard polyfluoroalkylation apparatus was used for this reaction.

The para-bonded isomer (194)(2.03g., 3.27 m.moles), caesium fluoride (ca. 1g.) and a large excess of hexafluoropropene (5.1g., 34 m.moles) in 2,5,8,11,14-pentaoxapentadecane (10ml.) was stirred at room temperature for 55 minutes after which time the bladder had deflated.

Volatile products (6.95g.) were transferred, under high vacuum, into a trap immersed in liquid air. The mixture was shown by g.l.c. (G.D.B., di-isodecylphthalate, 78°C) to contain starting material (194) together with dimers and trimers of hexafluoropropene. There was no evidence for nucleophilic substitution of (194).

8.6(vii) Reaction Between Perfluoro-2,4,5-tri-isopropyl-1-azabicyclo[2.2.0]hexa-2,5-diene (196) and Sodium Phenoxide

The para-bonded isomer (196)(0.97g., 1.56 m.moles) was transferred under high vacuum into a Carius tube containing ca. 4.1ml. of 0.444M sodium phenoxide (1.82 m.moles) in D.M.F. frozen down in liquid air. The tube was sealed and allowed to warm to room temperature and shaken vigorously for 73 hours. A dark red colouration appeared in the reaction mixture.

The reaction mixture was added to water (20ml.). A lower layer formed which was removed. Examination by g.l.c. of this viscous liquid (0.37g.)(G.D.B., silicone elastomer, 125°C)

showed 5 components and g.l.c. mass spec. showed parent peaks for 3 of these components at 693 and 767 which corresponded to mono and di-substitution of (196) by phenoxide. The individual components were not identified.

The aqueous layer was ether extracted but no more material was isolated.

8.6(viii) Reaction Between Perfluoro-1,3,5-tri-isopropyl-2-azabicyclo[2.2.0]hexa-2,5-diene (194) and Sodium Phenoxide

The para-bonded isomer (194) (1.01g., 1.63 m.moles) was transferred under high vacuum into a Carius tube containing ca. 4ml. of 0.444M sodium phenoxide (1.78 m.moles) in D.M.F. which was frozen in liquid air. The tube was sealed and allowed to warm to room temperature. The mixture was shaken vigorously for 4 days.

The reaction mixture was added to distilled water (ca. 20ml.) where a lower layer (0.536g.) formed. This was shown by g.l.c. (G.D.B. silicone elastomer, 125°C) to contain at least 6 components. Two of these were shown by g.l.c. mass spec. to have M of 767 with two components having M 693, which corresponded to di and mono substitution of (194) by phenoxide. These components were not identified.

Ether extraction of the aqueous layer failed to yield more material.

8.6(ix) Reaction Between Perfluoro-1,3,5-tri-isopropyl-2-azabicyclo[2.2.0]hexa-2,5-diene (194) and Sodium Isopropoxide

The para-bonded isomer (194)(2.0g., 3.24 m.moles) was transferred, under high vacuum into a Carius tube containing 9.8ml. of 0.33 M sodium isopropoxide in isopropanol (3.23 m.moles).

The mixture was shaken vigorously for 10 hours at room temperature then poured into water (30ml.) and ether extracted. The ether was dried (MgSO_4) and removed on a rotary evaporator. The residue (0.473g.) was shown by g.l.c. (G.D.B., di-isodecylphthalate, 100°C) to contain at least seven components.

The mixture was not investigated further.

CHAPTER 9

Experimental for Chapter 5

This chapter contains the experimental details of the photolysis of a series of perfluoroalkyl heterocycles, which was discussed in chapter 5.

9.1 Irradiation of Perfluoro-2,5-di-isopropyl-1,4-di-azacyclohexa-1,4-diene (213), at 253.7nm. in the Presence of Mercury

Perfluoro-2,5-di-isopropyl-1,4-di-azacyclohexa-1,4-diene (213) (1.0g., 2.04 μ .moles) was transferred under high vacuum into a clean dry silica Carius tube (220 x 28mm.) which contained a drop of mercury. The tube was sealed under high vacuum (0.001mm.) and irradiated by 253.7nm. light (120 watts) for 335 hrs. Discolouration of the liquid occurred. Volatile products were transferred under high vacuum to a trap, immersed in liquid air, connected to a gas storage bulb. On warming to room temperature a gaseous product was obtained which was identified from its infrared and mass spec. to be perfluoro-isobutyronitrile (215) by comparison with data from an authentic sample.¹⁰⁶

The volatile liquid remaining after evolution of (215), (0.63g.) was shown by g.l.c. mass spec. (silicone elastomer,

room temperature) to contain three components giving parent ions at 176, 295 and 490, with the main component present as over 90% of the mixture, of which the minor components were identified as (215) and starting material (213).

Separation of the mixture by preparative g.l.c. (Aerograph, di-isodecylphthalate, 40°C) gave perfluoro-4-methyl-3-methylene-2-azapent-1-ene (216) as a volatile liquid, which was found to be extremely susceptible to hydrolysis. ^{19}F n.m.r. spectrum No. 20. The mass spectrum showed a parent ion at 295 ($\text{C}_6\text{F}_{11}\text{N}$ requires $M, 295$) but also a peak at 273 from the isocyanate hydrolysis product. The i.r. spectrum also showed the presence of hydrolysis product, and changed with time, but peaks at 1732cm^{-1} and 1805cm^{-1} were observed which were assigned as C=C and C=N stretches of (216).

9.2 Irradiation of Perfluoro-4,6-di-isopropyl-1,3-diazacyclohexa-3,6-diene (219), at 253.7nm, in the Presence of Mercury

Perfluoro-4,6-di-isopropyl-1,3-diazacyclohexa-3,6-diene (219) (1.51g., 3.08 m.moles) was transferred, under high vacuum, into a clean dry silica Carius tube (280 x 27mm.), which contained a drop of mercury. The liquid was degassed and the tube sealed under high vacuum (0.0003mm.) and irradiated at 253.7nm. (120 watts) for 117.2 hours. Discolouration of the liquid occurred. Volatile products were transferred, under high vacuum, into a trap immersed in liquid air.

The liquid product (1.46g.) was analysed by g.l.c. (G.D.B. silicone elastomer, 78°C) and showed four components in the

ratio 9%, 15%, 24%, 48% together with two minor components. The first three components were readily identified as (215), (216) and starting material (219) from g.l.c. mass spectra. Separation by preparative g.l.c. (Aerograph, silicone elastomer, 80°C) gave samples of (215), (216) and (219) together with perfluoro-2,8-dimethyl-7-methylene-4,6-di-azanona-3,5-diene (220) [Found: F, 69.6%; M, 490, $C_{10}F_{18}N_2$ requires F, 69.8%; M, 490] ^{19}F n.m.r. spectrum No. 21, i.r. spectrum No. 17.

9.3 Irradiation of Perfluoro-4-isopropyl-1-azacyclohexa-1,3-diene (222), at 253.7nm.

Perfluoro-4-isopropyl-1-azacyclohexa-1,3-diene (222) (4.3g., 12 m.moles) was transferred, under high vacuum, into a clean dry silica Carius tube (250 x 20mm.). The liquid was degassed and the tube sealed, under high vacuum and irradiated, at 253.7nm. (120 watts) for 116.7 hours. Slight decomposition was observed on the walls of the Carius tube and the liquid discoloured. Volatile material was transferred from the tube under high vacuum into a trap immersed in liquid air.

Analysis by g.l.c. (G.D.B. silicone elastomer, 78°C) of the liquid product (3.93g.) showed two major components as ca. 70% and 20% of the mixture together with three minor components, ca. 10%. Fractional distillation of the mixture ('Fischer-Spaltrohr Column MMS 200') gave the major component (Bpt. 98.5°C) as a colourless liquid identified as perfluoro-6-methyl-5-methylene-2-azahepta-1,3-diene (224) [Found: M, 357. $C_8F_{13}N$ requires M, 357] ^{19}F n.m.r. spectrum No. 22, i.r. spectrum No. 18. Satisfactory analysis figures were not obtained from this compound even though the sample was further

purified by preparative g.l.c. This was thought to be due to the analysis technique and has occurred with other samples containing C. F. and N.

The second major component was not obtained pure so could not be identified but was shown by g.l.c. mass spec. to be isomeric with starting material (222) i.e. had M 357. It contained resonances in the ^{19}F n.m.r. at 45.4, 65.97, 78.66, 114.1, 135.9 and 181.0 p.p.m.

9.4 Irradiation of Perfluoro-2,3,4-tri-isopropyl-1-azacyclohexa-1,3-diene (229) at 253.7nm.

Perfluoro-2,3,4-tri-isopropyl-1-azacyclohexa-1,3-diene (229) (0.53g., 0.81 m.moles) was introduced into a clean dry silica Carius tube (290 x 28mm.). The liquid was degassed and the tube sealed, under high vacuum, and irradiated at 253.7nm. (120 watts) for 203 hours. Volatile products (0.51g.) were transferred under high vacuum into a trap immersed in liquid air. The liquid product was shown by g.l.c. analysis and i.r. to be starting material (229).

9.5 Irradiation of Perfluoro-1,1'-bi-1,3-diazacyclohex-2-enyl (231) at 253.7nm. in the Presence of Mercury

Perfluoro-1,1'-bi-1,3-diazacyclohex-2-enyl (231) (1.03g., 2.46 m.moles) was introduced into a clean dry silica Carius tube (210 x 27mm.), which contained a drop of mercury, and degassed. The tube was sealed, under high vacuum (0.001mm.) and irradiated at 253.7nm. (120 watts) for 227 hours. Volatile products were transferred, under high vacuum, into a trap immersed in liquid air.

The liquid product was shown by i.r. and g.l.c. to be unchanged starting material (231).

9.6 Irradiation of Perfluoro-1-azacyclohex-1-ene (230),
at 253.7nm., in the Presence of Mercury

Perfluoro-1-azacyclohex-1-ene (230)(2.61g., 10.6 m.moles) was transferred, under high vacuum, into a clean dry silica Carius tube (220 x 28mm.) which contained a drop of mercury. The liquid was vigorously degassed and the tube sealed under high vacuum (0.0001mm.) and irradiated at 253.7nm. (120 watts) for 357 hrs. The vacuum transferred product was examined by g.l.c. (G.D.B. silicone elastomer, 60°C) and shown to contain only one component which was identified as starting material (230) from its g.l.c. retention time and i.r. spectrum.

APPENDIX 1

¹⁹F n.m.r. Spectra

Spectra Index

- 1 Perfluoro-2-isopropyl-3,5-dimethylpyridine (150)
- 2 Perfluoro-4-ethyl-2,6-di-isopropyl-3,5-dimethyl-1-azatetracyclo[2.2.0.0^{2,6}.0^{3,5}]hexane (160)
- 3 Perfluoro-2-ethyl-4,6-di-isopropyl-3,5-dimethyl-1-azatetracyclo[2.2.0.0^{2,6}.0^{3,5}]hexane (159)
- 4 Perfluoro-4-ethyl-2,6-di-isopropyl-3,5-dimethyl-1-azabicyclo[2.2.0]hexa-2,5-diene (154)
- 5 Perfluoro-2,4,6-tri-isopropyl-3,5-dimethyl-1-azatetracyclo[2.2.0.0^{2,6}.0^{3,5}]hexane (179)
- 6 Perfluoro-2-ethyl-3,6-di-isopropyl-4,5-dimethyl-1-azatetracyclo[2.2.0.0^{2,6}.0^{3,5}]hexane (185)
- 7 Perfluoroethyldi-isopropyldimethylazatetracyclo[2.2.0.0^{2,6}.0^{3,5}]hexane (A) Structure unknown
- 8 Perfluoro-1,3-di-isopropyl-4,6-dimethyl-2-azabicyclo[2.2.0]hexa-2,5-diene (188)
- 9 Perfluoro-1,3,5-tri-isopropyl-2-azabicyclo[2.2.0]-hexa-2,5-diene (194)
- 10 Perfluoro-2,4,6-tri-isopropyl-1-azabicyclo[2.2.0]-hexa-2,5-diene (195)

- 11 Perfluoro-2,4,5-tri-isopropyl-1-azabicyclo[2.2.0]-hexa-2,5-diene (196)
- 12 Perfluoro-3,5,6-tri-isopropyl-2-azabicyclo[2.2.0]-hexa-2,5-diene (197)
- 13 Perfluoro-1-isopropyl-4,6-dimethyl-2-azabicyclo[2.2.0]hexa-2,5-diene (202)
- 14 Perfluorotri-isopropylmethylazaprismane (B).
Structure unknown
- 15 Perfluoro-2-ethyl-3,6-di-isopropyl-4,5-dimethylpyridine (156)
- 16 Perfluoro-2-ethyl-5,6-di-isopropyl-3,4-dimethylpyridine (157)
- 17 Perfluoro-3-ethyl-2,6-di-isopropyl-4,5-dimethylpyridine (158)
- 18 Perfluoro-2,3,6-tri-isopropyl-4,5-dimethylpyridine (182)
- 19 Perfluoro-2-ethyl-3,5-di-isopropyl-4,6-dimethylpyridine (184)
- 20 Perfluoro-4-methyl-3-methylene-2-azapent-1-ene (216)
- 21 Perfluoro-2,8-dimethyl-7-methylene-4,6-diazanon-3,5-diene (220)
- 22 Perfluoro-6-methyl-5-methylene-2-azahepta-1,3-diene (224)

The following abbreviations have been used in the n.m.r. tabulations:

D = doublet
T = triplet
Q = quartet
S = septet
M = multiplet

1. Perfluoro-2-isopropyl-3,5-dimethylpyridine (150)

Shift (p.p.m.)	Fine structure Coupling constants in Hz	Relative Intensity	Assignment
52.84	D($J_{3,2a} = 50$) of D($J_{3,4} = 39$) of S($J_{3,2b} = 3.4$)	3	3
55.47	D($J_{6,4} = 21.6$) of Q($J_{6,5} = 21.6$)	1	6
58.06	D($J_{5,4} = 21.6$) of D($J_{5,6} = 21.6$)	3	5
72.72	Q($J_{2b,3} = 3.4$)	6	2b
88.01	D($J_{4,6} = 21.6$) of Q($J_{4,5} = 21.6$) of Q($J_{4,3} = 39$)	1	4
179.83	Q($J_{2a,3} = 50$)	1	2a

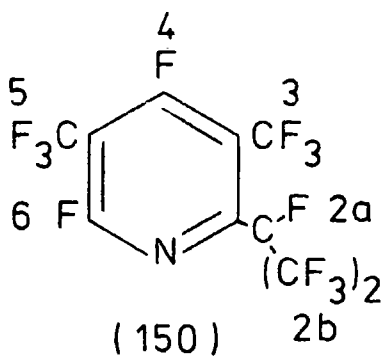

Recorded in acetone- d_6
solution with internal
 $CFCl_3$ reference at
84.67 MHz.

2. Perfluoro-4-ethyl-2,6-di-isopropyl-3,5-dimethyl-1-azatetracyclo[2.2.0.0^{2,6}.0^{3,5}]hexane (160)

Shift (p.p.m.)	Fine Structure Coupling constants in Hz	Relative Intensity	Assignment
61.22	Broad (Including $J_{5,4a} = 6.5\text{Hz}$)	6	3,5
73.43	Broad	12	2b,6b
82.57	Sharp singlet	3	4b
121.25	$2(J_{4a,5} = 6.5\text{Hz})$	2	4a
181.09	Sharp singlet	2	2a,6a

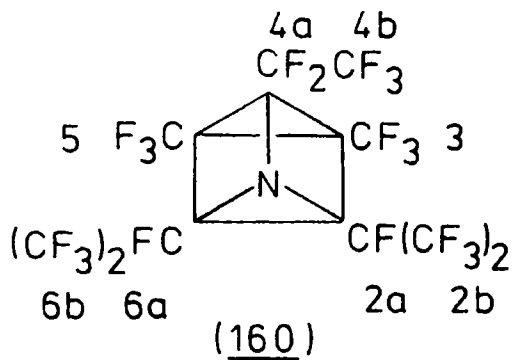

Recorded as a 50:50 mixture with (159) with internal CFCl_3 reference at 84.67 MHz.

3. Perfluoro-2-ethyl-4,6-di-isopropyl-3,5-dimethyl-1-azatetracyclo[2.2.0.0^{3,5}.0^{2,6}]hexane (159)

Shift (p.p.m.)	Fine Structure Coupling constants in Hz	Relative intensity	Assignment
62.09	Broad	6	3,5
73.43	Broad	12	4b,6b
82.57	Sharp singlet	3	2b
114.5	D($J_{2a',2a''} = 300$) of D($J_{2a',6a} = 35$)	1	2a'
119.3	D($J_{2a'',2a'} = 300$) of D($J_{2a'',6a} = 35$)	1	2a''
183.6	T($J_{6a,2a} = 35$) of M	1	6a
186.7	Symmetrical M	1	4a

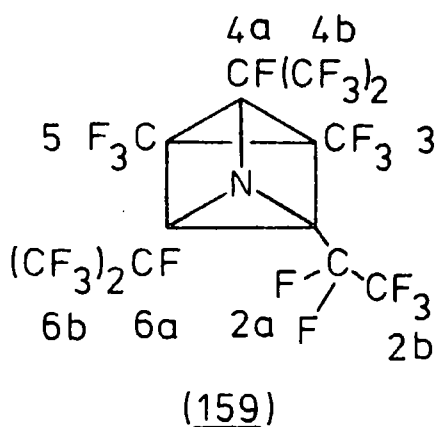

Recorded as a 50:50 mixture with (160) with internal $CFCl_3$ reference at 84.67 MHz

4. Perfluoro-4-ethyl-2,6-di-isopropyl-3,5-dimethyl-1-azabicyclo[2.2.0]hexa-2,5-diene (154)

Shift (p.p.m.)	Fine structure Coupling constants in Hz	Relative Intensity	Assignment
64.51	Broad	6	3,5
77.05	Broad singlet	6	2b',6b'
78.60	Broad singlet	6	2b'',6b''
84.46	Sharp singlet	3	4b
113.22	S($J_{4a,3/5}=6\text{Hz}$)	2	4a
188.2	Sharp singlet	2	2a,6a

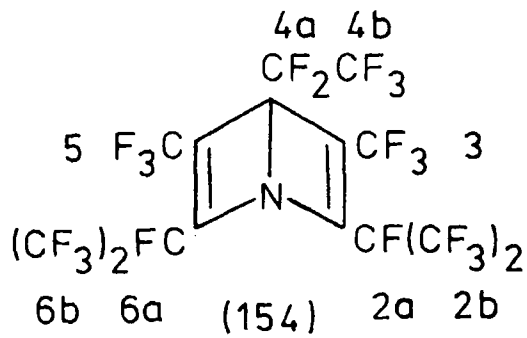

Recorded neat with
external CFCl₃ reference
at 56.4 MHz

5. Perfluoro-2,4,6-tri-isopropyl-3,5-dimethyl-1-azatetracyclo[2.2.0.0^{2,6}.0^{3,5}]hexane (179)

Shift (p.p.m.)	Fine structure Coupling constants in Hz	Relative Intensity	Assignment
64.32	Broad	6	3,5
76.26	Broad	18	2b,4b,6b
76.68	Broad		
182.4	Broad	2	2a,6a
189.5	Broad	1	4a

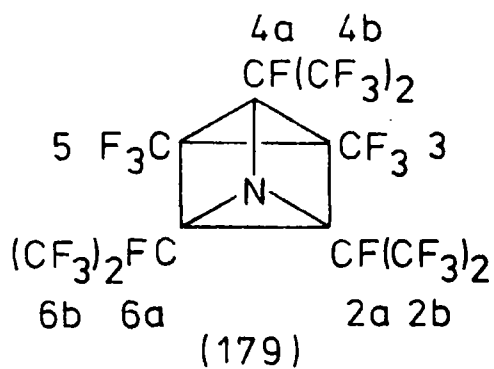

Recorded neat with external CFCl_3 reference. The peaks at 76.26 p.p.m. and 76.68 p.p.m. overlap.

6. Perfluoro-2-ethyl-3,6-di-isopropyl-4,5-dimethyl-1-azatetracyclo[2.2.0.0^{2,6}.0^{3,5}]hexane (185)

Shift (p.p.m.)	Fine structure Coupling constants in Hz	Relative Intensity	Assignment
64.04	Broad singlet	3	5
73.33	Broad singlet	3	4
76.06	Broad singlet	6	3b or 6b
77.12	Broad singlet	6	3b or 6b
84.61	Broad singlet	3	2b
113.9	Broad singlet	2	2a
177.6	Broad singlet	1	3a or 6a
185.6	Broad singlet	1	3a or 6a

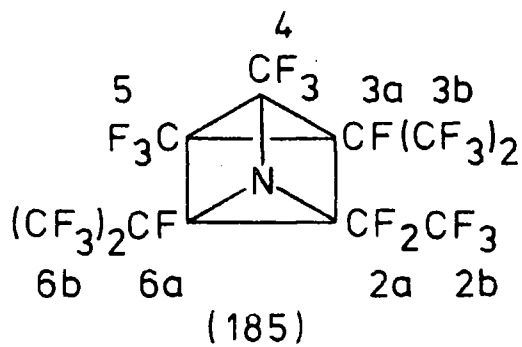

Recorded neat with
external CFCl_3 reference.
Run at 56.4 MHz.

7. Perfluoroethyldi-isopropyldimethylazetetracyclo-
[2.2.0.0^{2,6}.0^{3,5}]hexane (A). Structure unknown

Shift (p.p.m.)	Fine Structure Coupling constants in Hz	Relative Intensity	Assignment
64.39	Broad	3	-CF ₃
70.78	Sharp singlet	3	-CF ₃
75.03	Broad singlet	6	-CF(CF ₃) ₂
77.50	Broad singlet	6	-CF(CF ₃) ₂
84.54	Sharp singlet	3	-CF ₂ CF ₃
119.1	Broad	2	-CF ₂ CF ₃
176.9	Broad	2	2x-CF(CF ₃) ₂

Recorded neat at 56.4 MHz with external CCl₃ reference.

8. Perfluoro-1,3-di-isopropyl-4,6-dimethyl-2-azabicyclo-
[2.2.0]hexa-2,5-diene (188)

Shift (p.p.m.)	Fine Structure Coupling constants in Hz	Relative Intensity	Assignment
66.38	Broad (containing $D(J_{4,3a} = 15)$)	3	4
66.86	Broad M	3	6
75.27	Broad	3	1b'
75.85	Broad	3	1b''
77.55	Broad M (containing $D(J_{3b',3a} = 7.5)$)	3	3b'
77.96	Broad M (containing $D(J_{3b'',3a} = 7.5)$)	3	3b''
81.05	Broad (containing $Q(J = 15)$)	1	5
179.14	Broad	1	1a
189.45	$Q(J_{3a,4} = 15)$ of $S(J_{3a,3b} = 7.5)$	1	3a

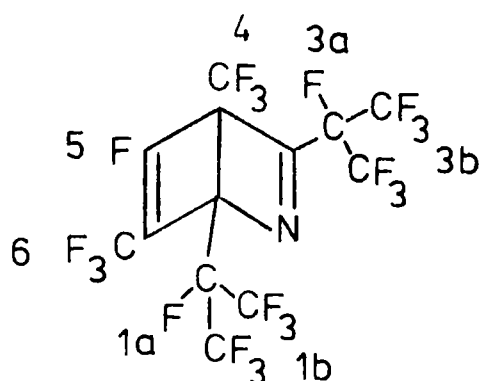

Recorded neat with external
 CFCl_3 reference at 56.4 MHz.

(188)

9. Perfluoro-1,3,5-tri-isopropyl-2-azabicyclo[2.2.0]hexa-2,5-diene (194)

Shift (p.p.m.)	Fine Structure Coupling constants in Hz	Relative Intensity	Assignment
75.51	Broad	3	-CF(CF ₃)
77.13	Broad	6	-CF(CF ₃) ₂
77.81	Broad M.	3	-CF(CF ₃)
79.40	Broad	6	-CF(CF ₃) ₂
80.43	Broad	1	6
179.61	Broad	1	} 3 tertiary and 1 bridge- head F
186.73	Broad	1	
189.11	Broad	1	
191.27	Broad	1	

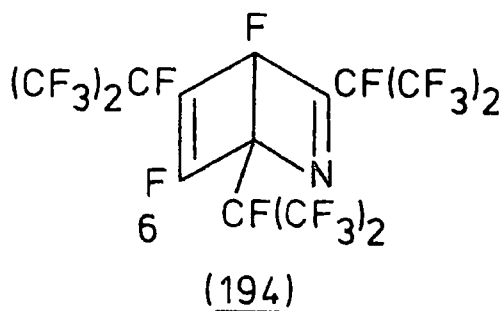

Recorded neat with
external CFC1₃ reference
at 56.4 MHz.

10. Perfluoro-2,4,6-tri-isopropyl-1-azabicyclo[2.2.0]hexa-2,5-diene (195)

Shift (p.p.m.)	Fine Structure Coupling constants in Hz	Relative Intensity	Assignment
76.43	Broad M.	6	4b
79.01	Sharp Singlet	12	2b,6b
102.75	Broad	2	3,5
184.57	Broad	1	4a
191.76	Broad	2	2a,6a

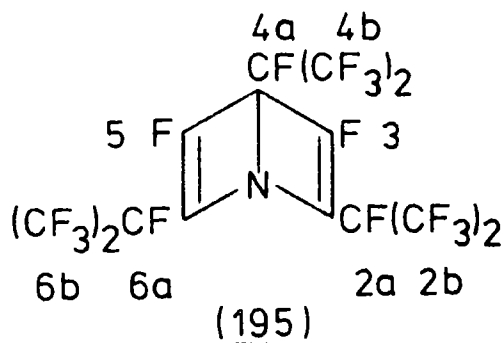

Recorded neat at 56.4kHz
as a 60:40 mixture with
(194). Values relative
to external CFCl_3 .

11. Perfluoro-2,4,5-tri-isopropyl-1-azabicyclo[2.2.0]-
hexa-2,5-diene (196)

Shift (p.p.m.)	Fine Structure Coupling constants in Hz	Relative Intensity	Assignment
61.09	Broad singlet	1	6
75.68	Broad M.	3	-CF(CF ₃)
76.36	Broad M.	3	-CF(CF ₃)
78.85	Broad	6	-CF(CF ₃) ₂
79.35	D(J = 10Hz)	3	-CF(CF ₃)
79.70	Broad M.	3	-CF(CF ₃)
102.53	Broad singlet	1	3
177.03	Broad	1	-CF(CF ₃) ₂
183.05	Broad	1	-CF(CF ₃) ₂
184.87	S(J = 9 Hz)	1	-CF(CF ₃) ₂

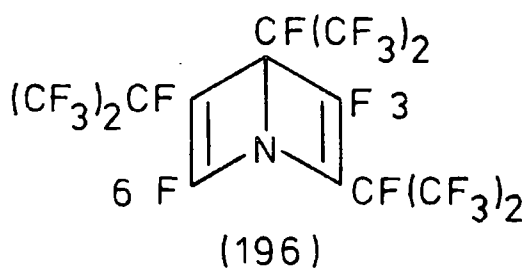

Recorded neat with external
CFCl₃ reference at 56.46 MHz.

12. Perfluoro-3,5,6-tri-isopropyl-2-azabicyclo[2.2.0]-
hexa-2,5-diene (197)

Shift (p.p.m.)	Fine Structure Coupling constants in Hz	Relative Intensity	Assignment
76.74	Broad M	3	CF(CF ₃)
77.12	Broad M	3	CF(CF ₃)
77.84	Broad M	6	CF(CF ₃) ₂
78.85	Sharp singlet	3	CF(CF ₃)
79.4	Broad singlet	3	CF(CF ₃)
179.61	Broad	1	3 'tertiary' and 2 bridgehead fluorines
183.05	Broad	1	
186.80	Broad	1	
189.04	Broad M	1	
191.80	Broad	1	

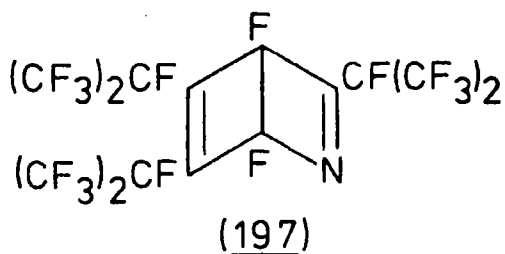

Run as a 55:45 mixture with
(196) using CFC1₃ as
external reference at
56.4 MHz.

13. Perfluoro-1-isopropyl-4,6-dimethyl-2-azabicyclo[2.2.0]-hexa-2,5-diene (202)

Shift (p.p.m.)	Fine Structure Coupling constants in Hz	Relative Intensity	Assignment
43.15	Sharp singlet	1	3
65.55	D($J_{6,5} = 10.5$) of Q($J_{6,1b''} = 17$)	3	6
66.19	S($J_{4,1b} = 6.5$)	3	4
73.99	Q($J_{1b',4} = 6.5$)	3	1b'
75.84	Broad (Containing $J_{1b'',4} = 6.5$, $J_{1b'',6} = 17$)	3	1b''
77.35	Q($J_{5,6} = 10.5$)	1	5
180.9	Broad	1	1a

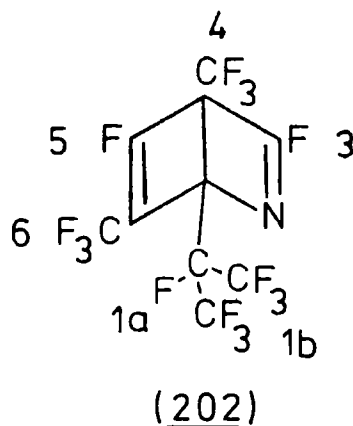

Recorded neat at -9.5°C with external CFCl_3 reference. The trifluoromethyl groups 1b' and 1b'' are non-equivalent because the C_3F_7 group is attached to an asymmetric centre.

14. Perfluorotri-isopropylmethylazaprismane (B)

Structure unknown

Shift (p.p.m.)	Fine Structure Coupling constants in Hz	Relative Intensity	Assignment
62.16	Septet (J = 7.5)	3	-CF ₃
75.25	Broad	3	-CF(CF ₃)
77.37	M	3	-CF(CF ₃)
78.08	Broad	6	-CF(CF ₃) ₂
79.29	Broad	3	-CF(CF ₃)
79.68	Broad	3	-CF(CF ₃)
179	Broad	1	} 3 tertiary and 1 bridgehead F
183.26	Broad	1	
191.35	Complex	1	
193.23	Broad	1	

Recorded neat at 40°C with external CFC1₃ reference

15. Perfluoro-2-ethyl-3,6-di-isopropyl-4,5-dimethyl-
pyridine (156)

Shift (p.p.m.)	Fine structure Coupling constants in Hz	Relative intensity	Assignment
52.08	Broad (containing $J_{4,3a} = 48$ and $J_{5,6a} = 50$)	6	4,5
69.08	T ($J_{3b,2a} = 23$)	6	3b
72.40	D ($J_{6b,6a} = 3.2$)	6	6b
78.78	Singlet	3	2b
108.31	S ($J_{2a,3b} = 23$)	2	2a
153.10	Q ($J_{3a,4} = 48$)	1	3a
179.94	Q ($J_{6a,5} = 50$) of S ($J_{6a,6b} = 3.2$)	1	6a

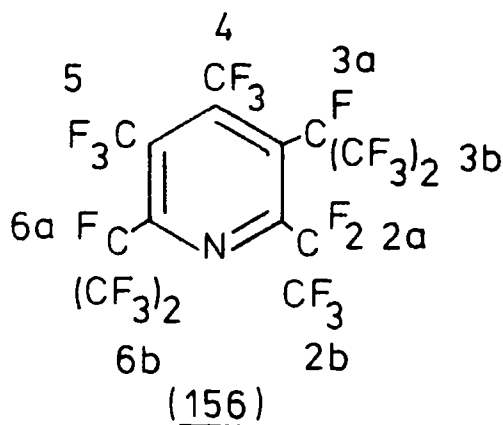

Recorded in acetone- d_6
with internal $CFC1_3$
reference at 84.67 MHz.

16. Perfluoro-2-ethyl-5,6-di-isopropyl-3,4-dimethyl-
pyridine (157)

Shift (p.p.m.)	Fine structure Coupling constants in Hz	Relative intensity	Assignment
51.43	Broad	3	3 or 4
53.61	Broad	3	3 or 4
69.04	$D(J_{5b,6a} = 47)$	6	5b
71.75	Sharp singlet	6	6b
80.33	Sharp singlet	3	2b
108.30	$Q(J_{2a,3} = 23.3)$	2	2a
151.30	$Q(J_{5a,4} = 51)$	1	5a
178.12	$S(J_{6a,5b} = 47)$	1	6a

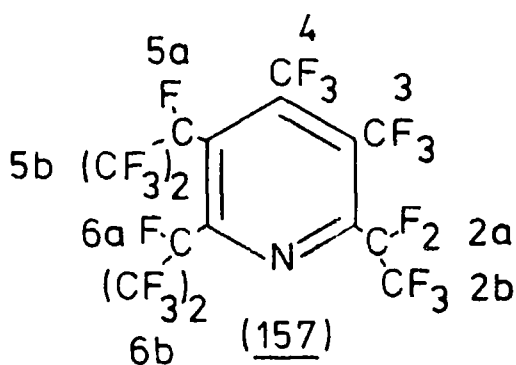

Recorded in acetone-d₆
solution with internal
CFCl₃ reference at 84.67
MHz.

17. Perfluoro-3-ethyl-2,6-di-isopropyl-4,5-dimethyl-
pyridine (158)

Shift (p.p.m.)	Fine structure Coupling constants in Hz	Relative intensity	Assignment
51.88	Broad (containing $J_{5,6a} = 44$ $J_{4,3a''} = 40$ and $J_{4,3b} = 10$)	6	4,5
71.34	D($J_{3b,2a} = 37$) of $Q(J_{3b,4} = 10)$	3	3b
72.16	Sharp singlet	12	2b,6b
80.63	D($J_{3a',3a''} = 300$) of $D(J_{3a',2a} = 100)$	1	3a'
90.14	D($J_{3a'',3a'} = 300$) of $Q(J_{3a'',4} = 40)$	1	3a''
178.43	D($J_{2a,3a'} = 100$) of $Q(J_{2a,3b} = 37)$	1	2a
179.61	$Q(J_{6a,5} = 44)$	1	6a

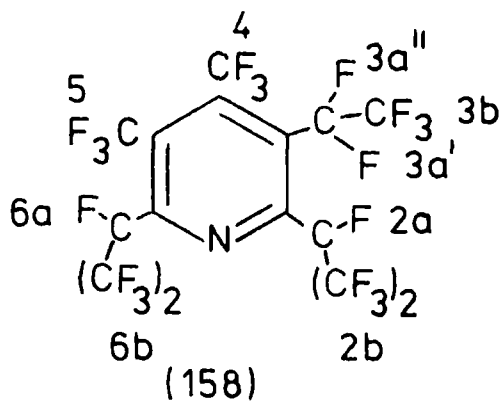

Recorded in acetone-d₆
with internal CFCl₃
reference at 84.67 MHz.

18. Perfluoro-2,3,6-tri-isopropyl-4,5-dimethyl-
pyridine (182)

Shift (p.p.m.)	Fine structure Coupling constants in Hz	Relative intensity	Assignment
50.71	Broad D($J_{4,3a} = 45$) of Q($J_{4,5} = 50-60$)	3	4
52.62	Broad D($J_{5,6a} = 51$) of Q($J_{5,4} = 50-60$)	3	5
69.82	D($J_{3b,2a} = 47$)	6	3b
72.69	Sharp singlet	6	2b or 6b
73.28	Sharp singlet	6	2b or 6b
152.10	Q($J_{3a,4} = 50$)	1	3a
179.83	S($J_{2a,3b} = 47$)	1	2a
180.77	Q($J_{6a,5} = 55$)	1	6a

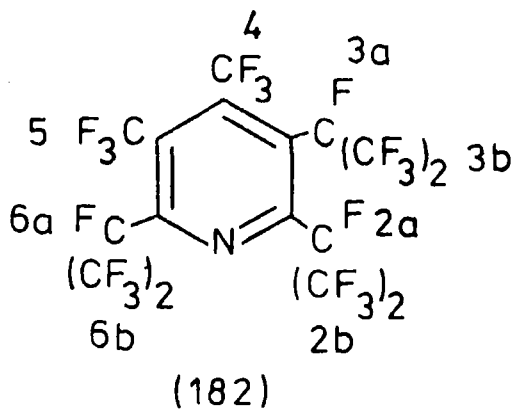

Recorded in acetone-d₆
solution with internal
CFCl₃ reference

19. Perfluoro-2-ethyl-3,5-di-isopropyl-4,6-dimethyl-
pyridine (184)

Shift (p.p.m.)	Fine structure Coupling constants in Hz	Relative intensity	Assignment
49.9	Broad	3	4
62.48	S($J_{6,5b} = 15.2$)	3	6
69.30	Broad M (containing $J_{5b,6} = 15.2$)	12	3b,5b
79.22	Singlet	3	2b
109.61	Broad	2	2a
154.87	Q($J_{3a,4}$ or $J_{5a,4} = 56$)	1	3a or 5a
156.08	Q($J_{3a,4}$ or $J_{5a,4} = 53$)	1	3a or 5a

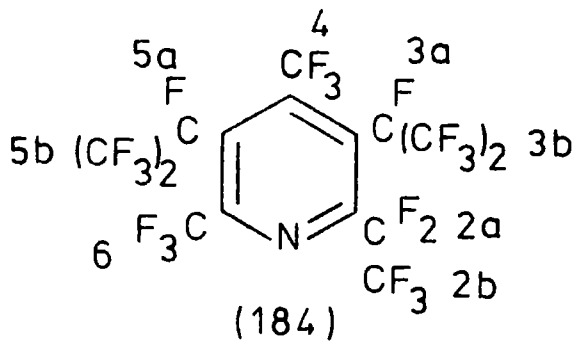

Recorded in acetone-d₆
with internal CFC1₃
reference at 84.67 MHz.

20. Perfluoro-4-methyl-3-methylene-2-azapent-1-ene (216)

Shift (p.p.m.)	Fine structure Coupling constants in Hz.	Relative intensity	Assignment
42.6	Broad	1	1a
55.9	Broad	1	1a
78.88	Singlet	6	4b, 5
83.05	D($J_{3a',3a''} = 29$) of T($J_{3a',1a} = 15$)	1	3a'
92.99	D($J_{3a'',4a} = 59$) of D($J_{3a'',3a'} = 29$)	1	3a''
187.0	Broad D($J_{4a,3a''} = 59$)	1	4a

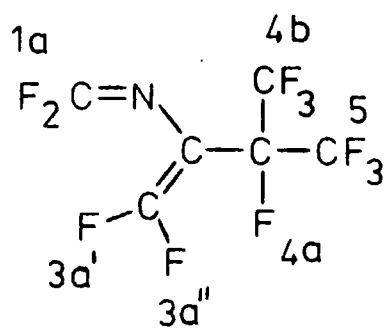

(216)

Recorded neat at 40°C
with external CFC1₃
reference.

21. Perfluoro-2,8-dimethyl-7-methylene-4,6-diazanona-3,5-diene (220)

Shift (p.p.m.)	Fine Structure Coupling constants in Hz.	Relative intensity	Assignment
41.78	Singlet	2	3,5
76.62	M	6	CF(CF ₃) ₂
77.67	D(J _{7a'} ,7a'' = 26)	1	7a'
77.93	M	6	CF(CF ₃) ₂
91.32	D(J _{7a'',8a} = 62) of D(J _{7a'',7a'} = 26)	1	7a''
182.2	S(J _{2a,1} and 2b = 7)	1	2a
185.9	D(J _{8a,7a''} = 62) of S(J _{8a,8b} and 9 = 6)	1	8a

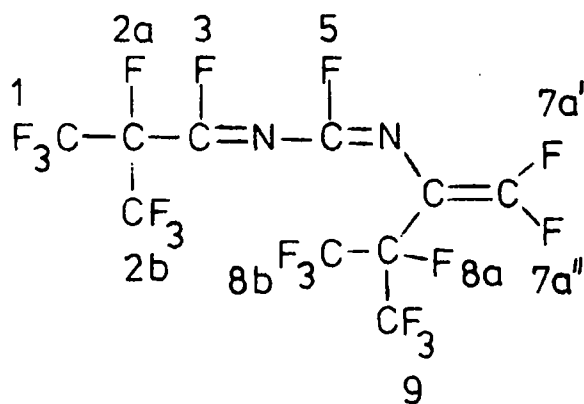

Recorded neat, at 40°C,
with external CFCl₃
reference.

22. Perfluoro-6-methyl-5-methylene-2-azahepta-1,3-diene (224)

Shift (p.p.m.)	Fine Structure Coupling constants in Hz.	Relative intensity	Assignment
32.9	Broad	1	1
51.2	Broad	1	1
78.19	M	6	6b,7
96.12	Broad	1	5a' or 5a''
113.8	Broad $D(J_{4,3} = 18)$	1	4
114.3	Broad	1	5a' or 5a''
136.7	$D(J_{3,4} = 18)$ of $T(J_{3,1} = 7.5)$	1	3
186.4	Broad	1	6a

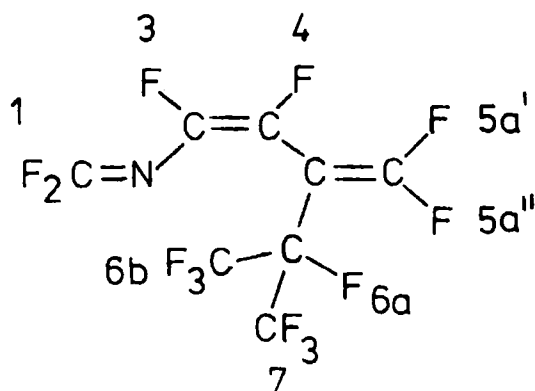

Recorded at 40°C with
external CFCl_3 reference
at 56.4 MHz.

(224)

APPENDIX 2

Infrared Spectra

- 1 Perfluoro-2-isopropyl-3,5-dimethylpyridine (150).
Contact film.
- 2 Perfluoro-4-ethyl-2,6-di-isopropyl-3,5-dimethyl-1-azatetracyclo[2.2.0.0^{2,6}.0^{3,5}]hexane (160) and Perfluoro-2-ethyl-4,6-di-isopropyl-3,5-dimethyl-1-azatetracyclo[2.2.0.0^{2,6}.0^{3,5}]hexane (159).
Contact film. (50:50 mixture)
- 3 Perfluoro-4-ethyl-2,6-di-isopropyl-3,5-dimethyl-1-azabicyclo[2.2.0]hexa-2,5-diene (154). Contact film.
- 4 Perfluoro-2,4,6-tri-isopropyl-3,5-dimethyl-1-azatetracyclo[2.2.0.0^{2,6}.0^{3,5}]hexane (179). Contact film.
- 5 Perfluoro-2-ethyl-3,6-di-isopropyl-4,5-dimethyl-1-azatetracyclo[2.2.0.0^{2,6}.0^{3,5}]hexane (185). Contact film.
- 6 Perfluoroethyl-di-isopropyl-dimethyl-azatetracyclo[2.2.0.0^{2,6}.0^{3,5}]hexane (A). Contact film.
- 7 Perfluoro-1,3-di-isopropyl-4,6-dimethyl-2-azabicyclo[2.2.0]hexa-2,5-diene (188). Contact film.
- 8 Perfluoro-1,3,5-tri-isopropyl-2-azabicyclo[2.2.0]-hexa-2,5-diene (194). Contact film.
- 9 Perfluoro-3,5,6-tri-isopropyl-2-azabicyclo[2.2.0]-hexa-2,5-diene (177) and Perfluoro-2,4,5-tri-isopropyl-1-azabicyclo[2.2.0]hexa-2,5-diene (196). Contact film.
(C₃. 55:45 mixture)

- 10 Perfluoro-2,4,5-tri-isopropyl-1-azabicyclo[2.2.0]hexa-2,5-diene (196). Contact film.
- 11 Perfluorotri-isopropylmethylazatetracyclo[2.2.0.0^{2,6}.-0^{3,5}]hexane (B). Contact film.
- 12 Perfluoro-2-ethyl-3,6-di-isopropyl-4,5-dimethylpyridine (156). Contact film.
- 13 Perfluoro-2-ethyl-5,6-di-isopropyl-3,4-dimethylpyridine (157). Contact film.
- 14 Perfluoro-3-ethyl-2,6-di-isopropyl-4,5-dimethylpyridine (158). KBr disc.
- 15 Perfluoro-2,3,6-tri-isopropyl-4,5-dimethylpyridine (182). Contact film.
- 16 Perfluoro-2-ethyl-3,5-di-isopropyl-4,6-dimethylpyridine (184). Contact film.
- 17 Perfluoro-2,8-dimethyl-7-methylene-4,6-diazanona-3,5-diene (220). Contact film.
- 18 Perfluoro-6-methyl-5-methylene-2-azasepta-1,3-diene (224). Contact film.

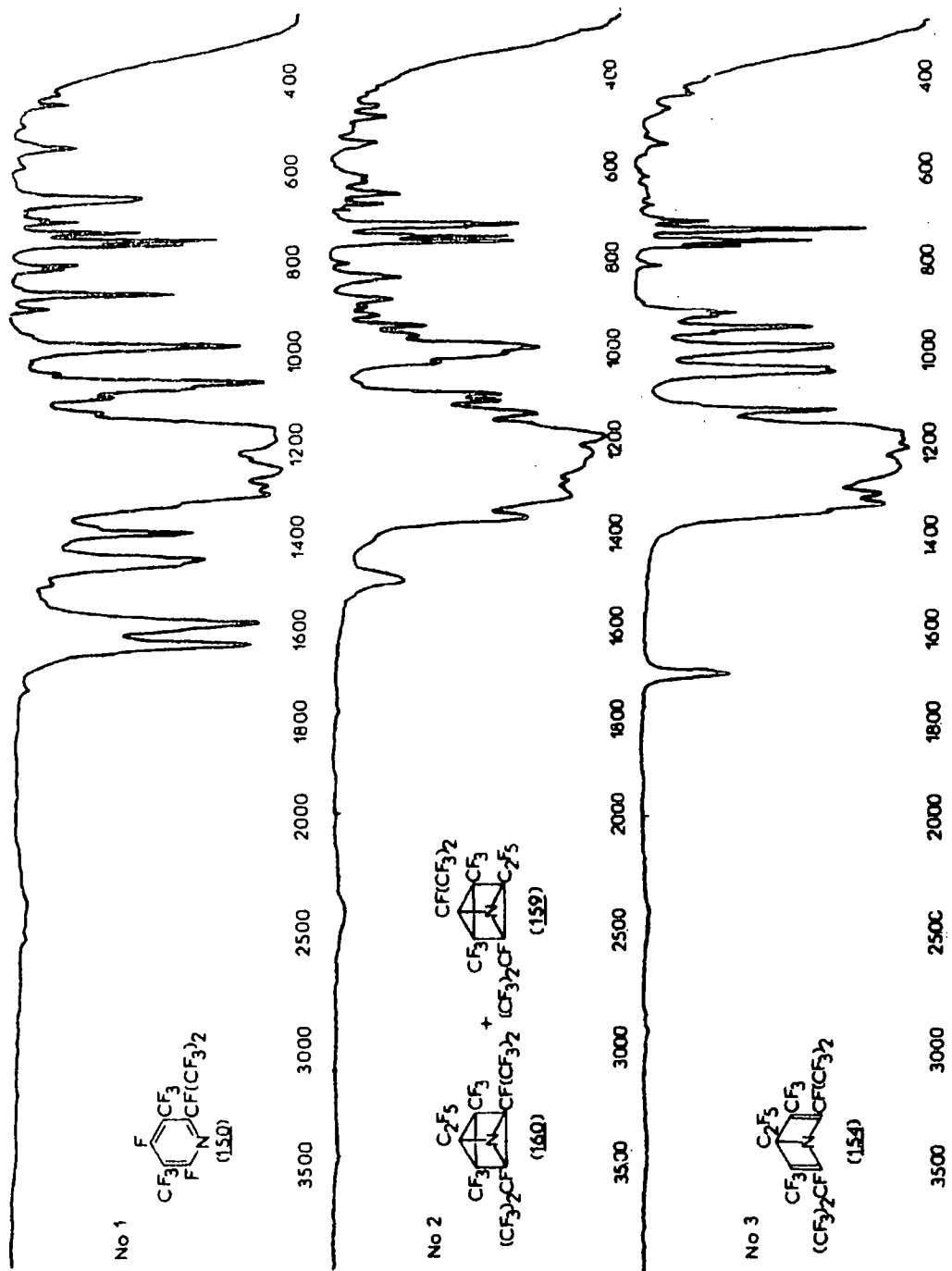

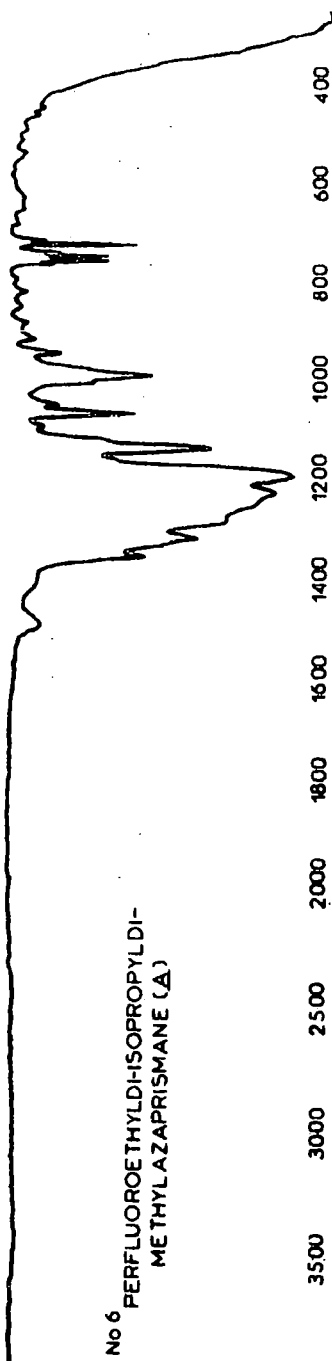
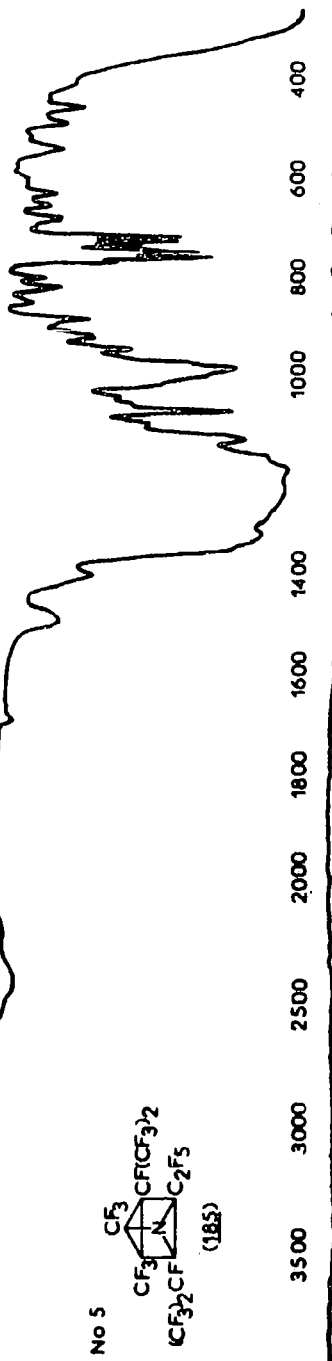
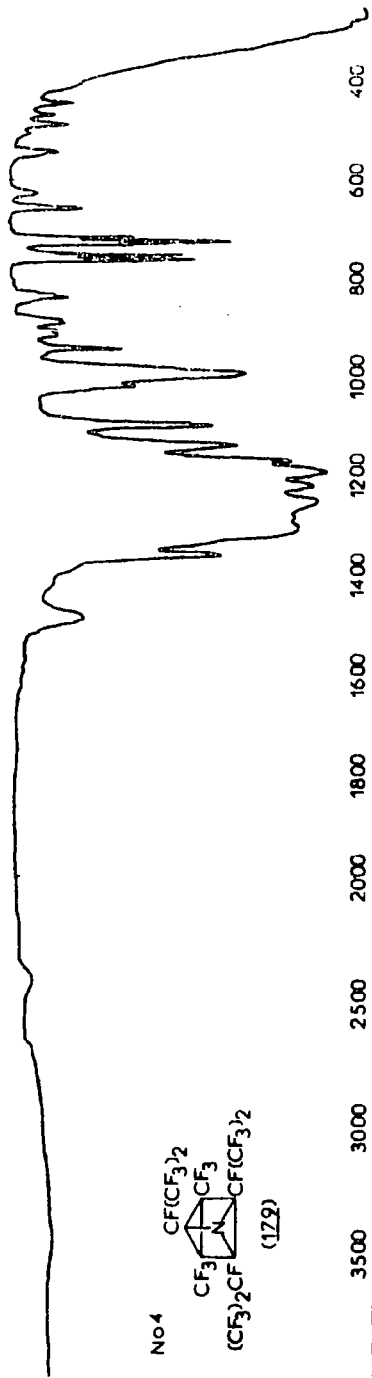

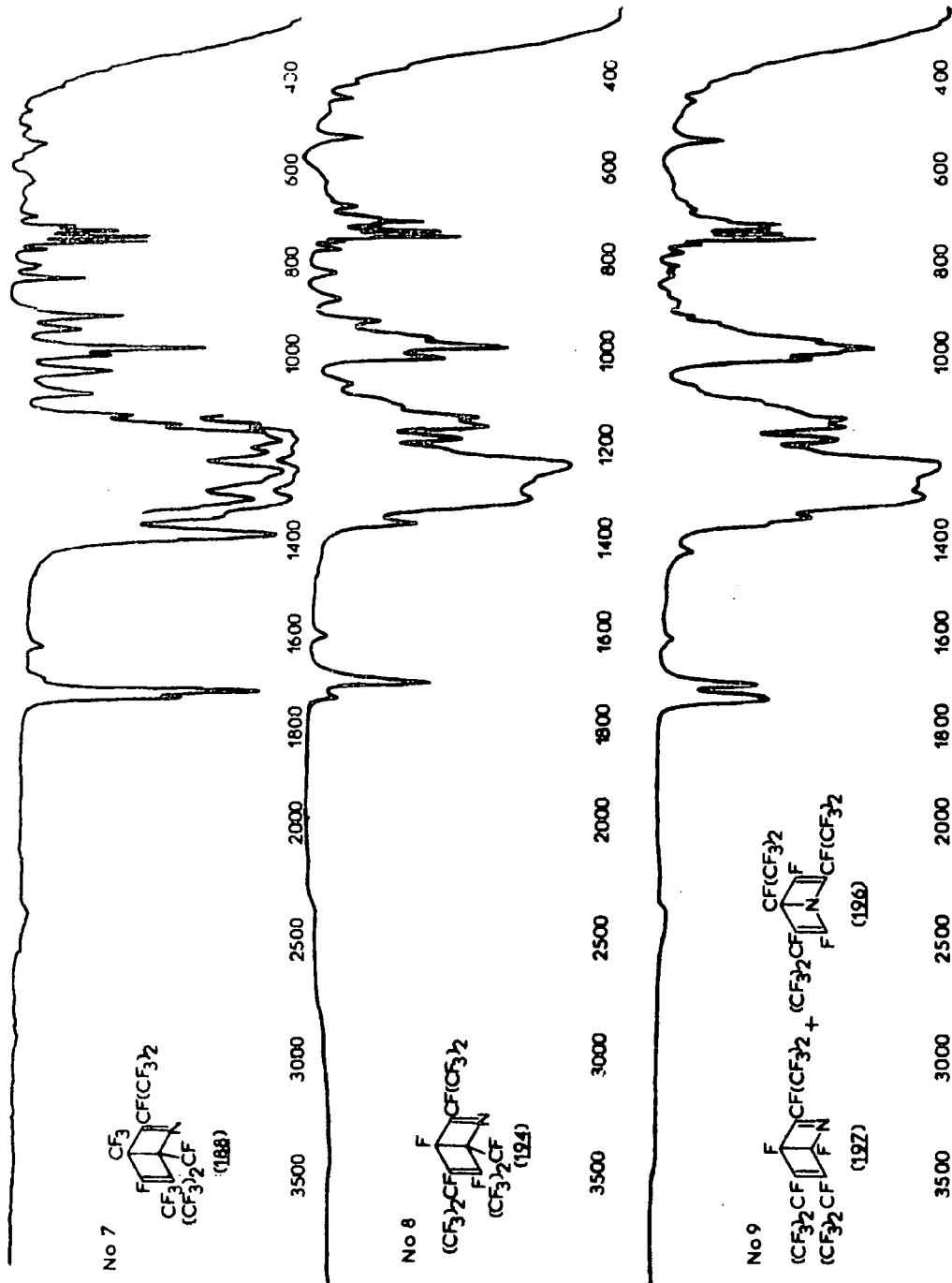

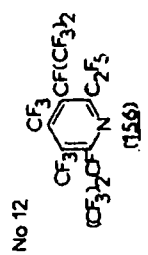
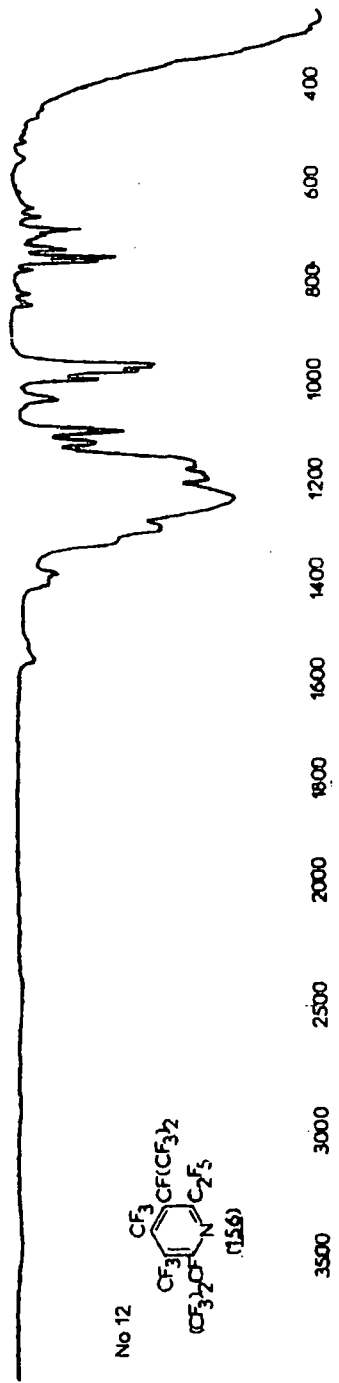
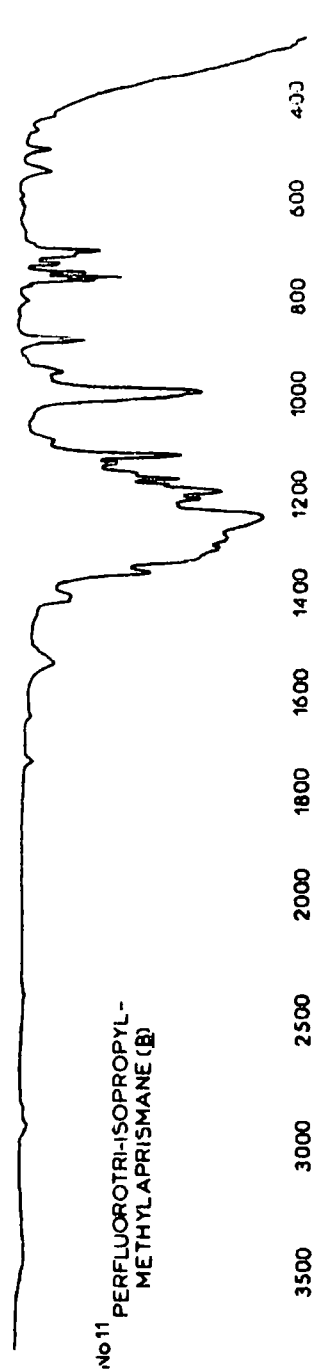
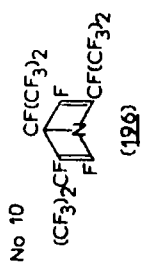
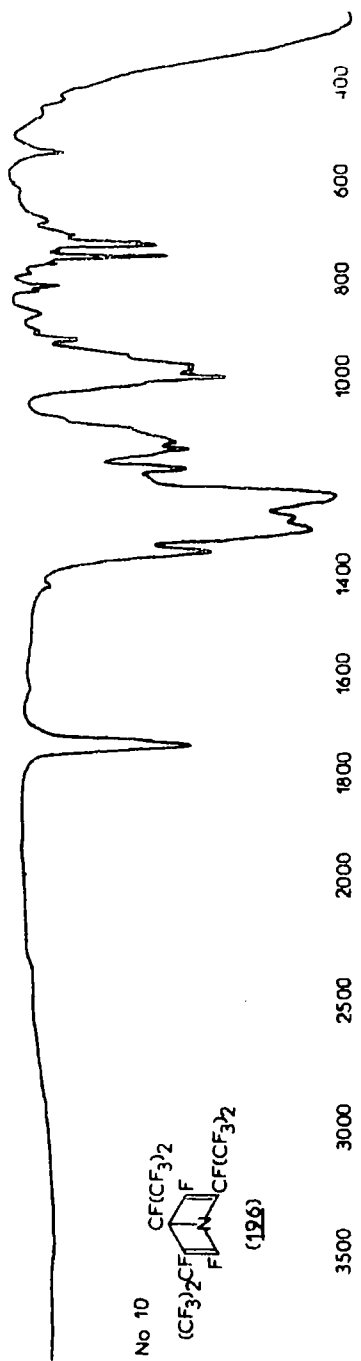

APPENDIX 3

Ultraviolet Spectra

- 1 Perfluoro-4-ethyl-2,6-di-isopropyl-3,5-dimethyl-1-azatetracyclo[2.2.0.0^{2,6}.0^{3,5}]hexane (160) and Perfluoro-2-ethyl-4,6-di-isopropyl-3,5-dimethyl-1-azatetracyclo[2.2.0.0^{2,6}.0^{3,5}]hexane (159) (50:50 mixture)
- 2 Perfluoro-2,4,6-tri-isopropyl-3,5-dimethyl-1-azatetracyclo[2.2.0.0^{2,6}.0^{3,5}]hexane (179)
- 3 Perfluoro-2-ethyl-3,6-di-isopropyl-4,5-dimethyl-1-azatetracyclo[2.2.0.0^{2,6}.0^{3,5}]hexane (185)
- 4 Perfluoroethyl-di-isopropyldimethylazaprismane (A) - structure unknown
- 5 Perfluorotri-isopropylmonomethylazaprismane (B) - structure unknown
- 6 Perfluoro-4-ethyl-2,6-di-isopropyl-3,5-dimethyl-1-azabicyclo[2.2.0]hexa-2,5-diene (154)
- 7 Perfluoro-2,4,5-tri-isopropyl-1-azabicyclo[2.2.0]-hexa-2,5-diene (196)
- 8 Perfluoro-1,3-di-isopropyl-4,6-dimethyl-2-azabicyclo[2.2.0]hexa-2,5-diene (188)
- 9 Perfluoro-1,3,5-tri-isopropyl-2-azabicyclo[2.2.0]-hexa-2,5-diene (194)

- 10 Perfluoro-2-ethyl-3,6-di-isopropyl-4,5-dimethylpyridine (156)
- 11 Perfluoro-2-ethyl-5,6-di-isopropyl-3,4-dimethylpyridine (157)
- 12 Perfluoro-3-ethyl-2,6-di-isopropyl-4,5-dimethylpyridine (158)
- 13 Perfluoro-2,3,6-tri-isopropyl-4,5-dimethylpyridine (182)
- 14 Perfluoro-2-ethyl-3,5-di-isopropyl-4,6-dimethylpyridine (184)
- 15 Perfluoro-2-isopropyl-3,5-dimethylpyridine (150)

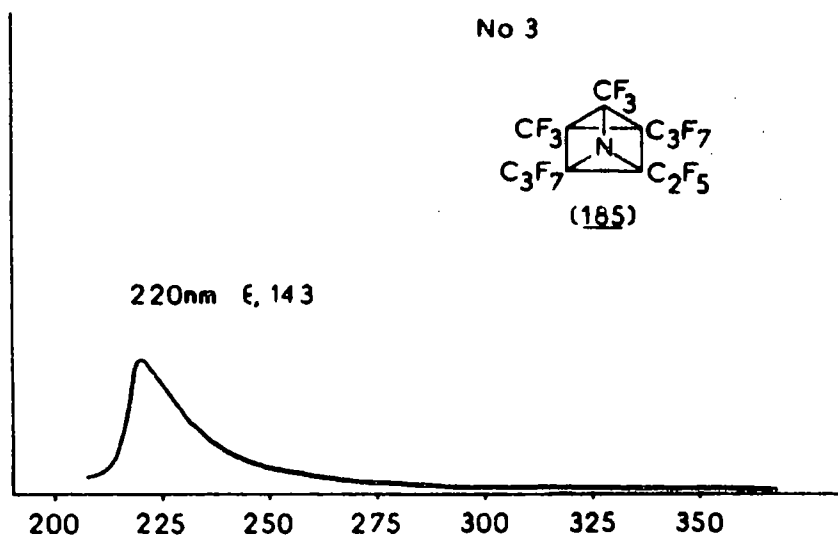
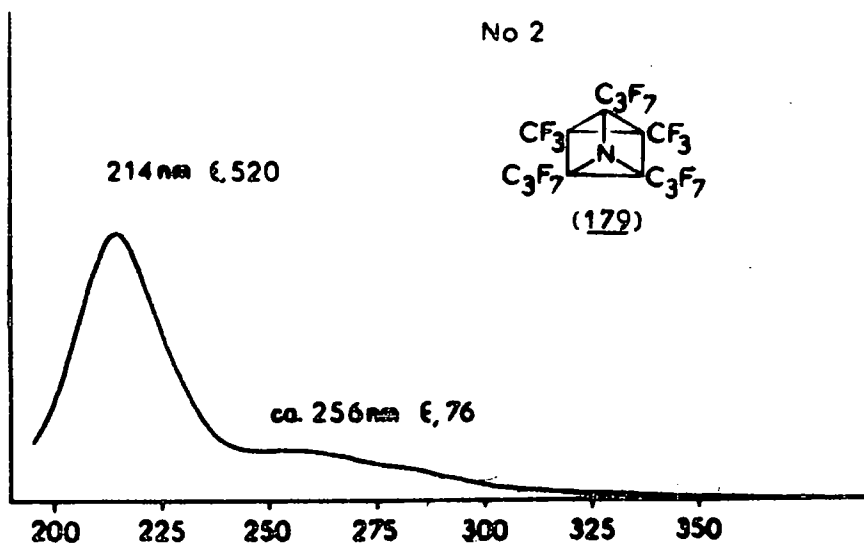
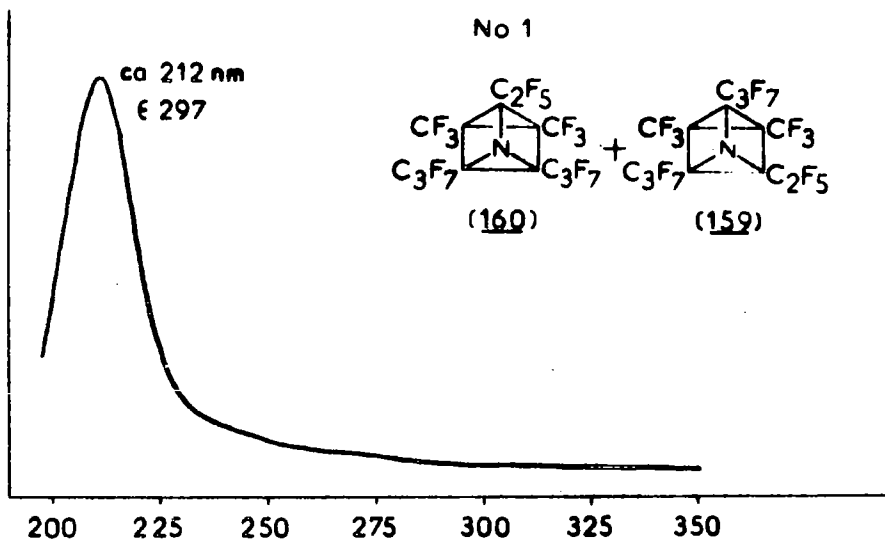

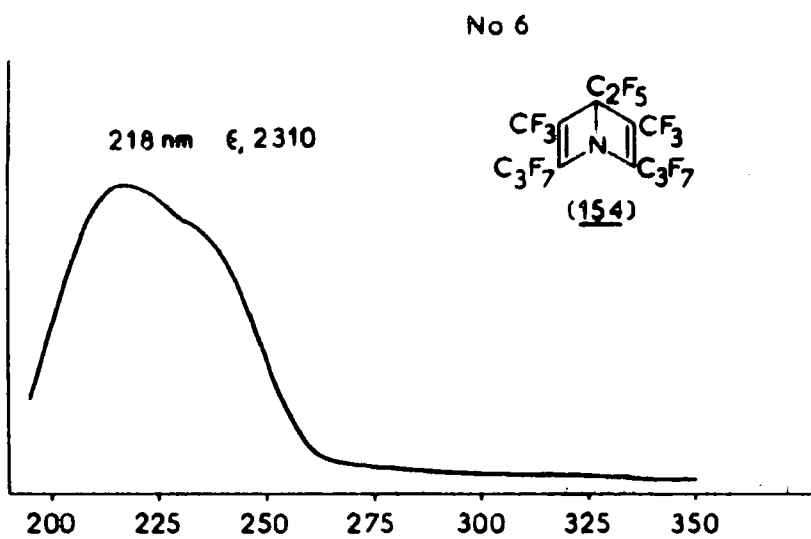
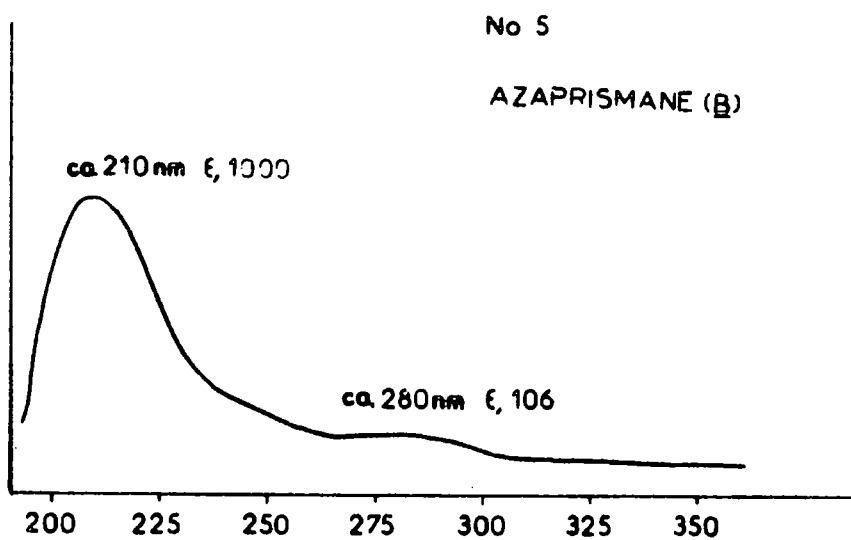
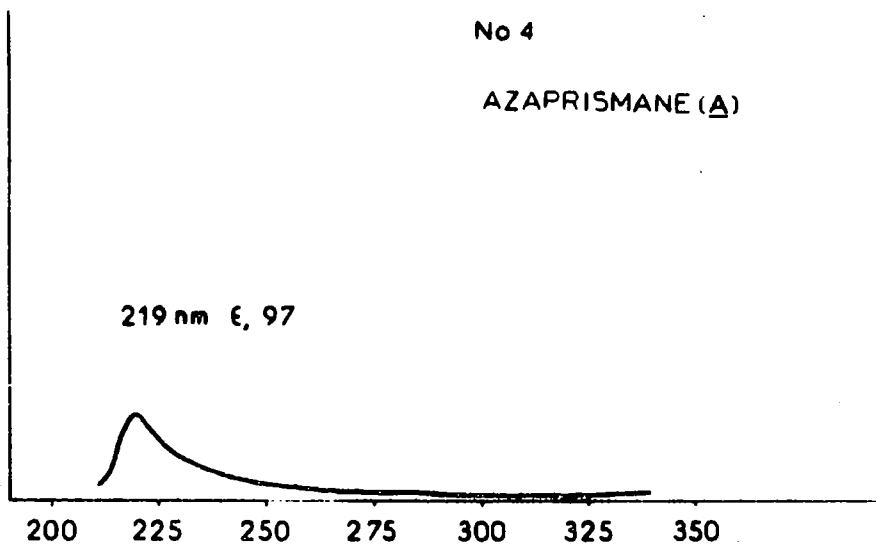

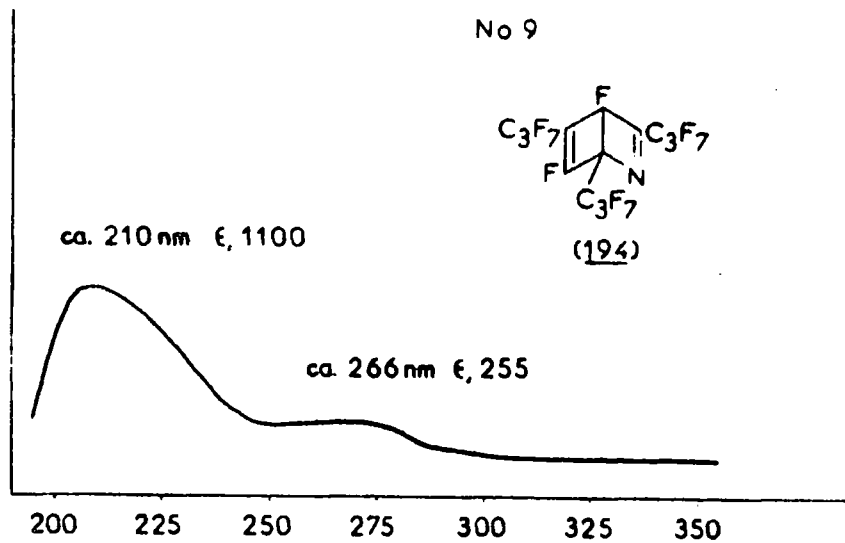
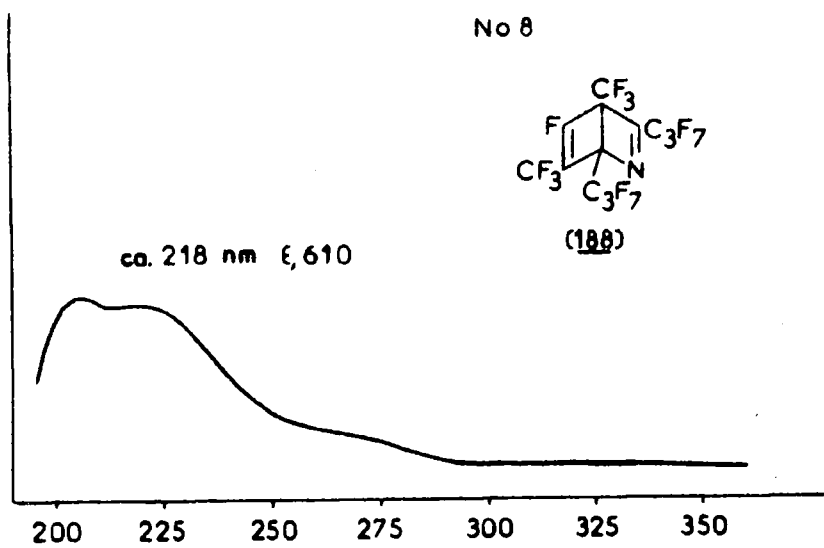
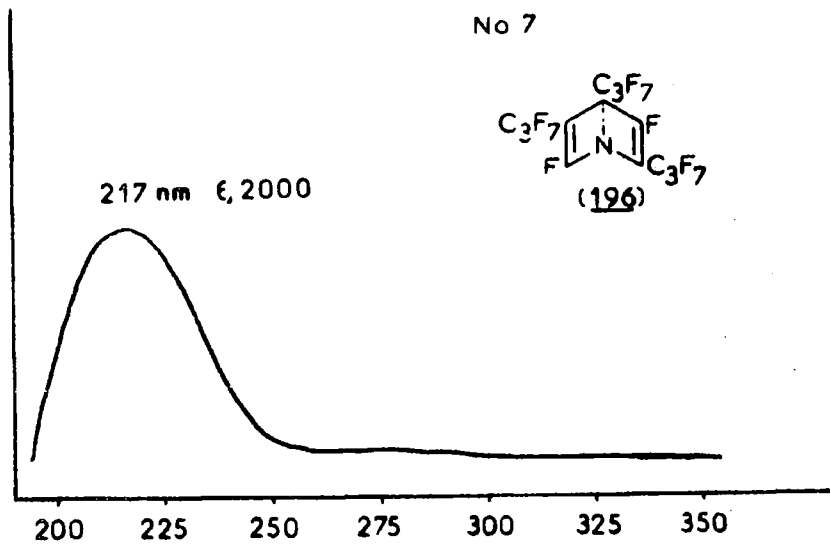

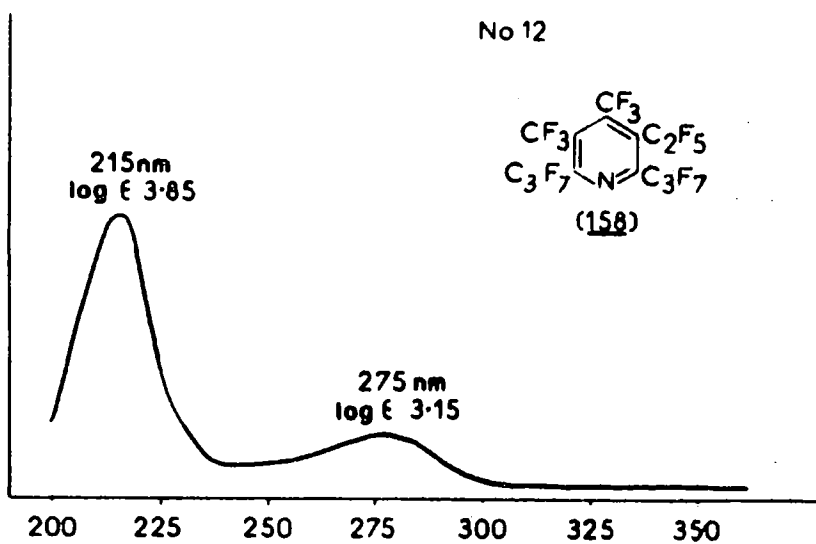
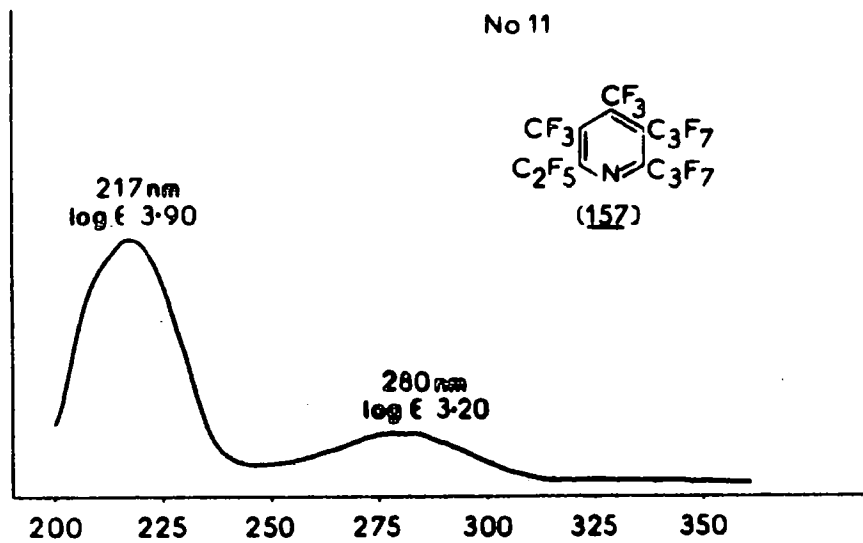
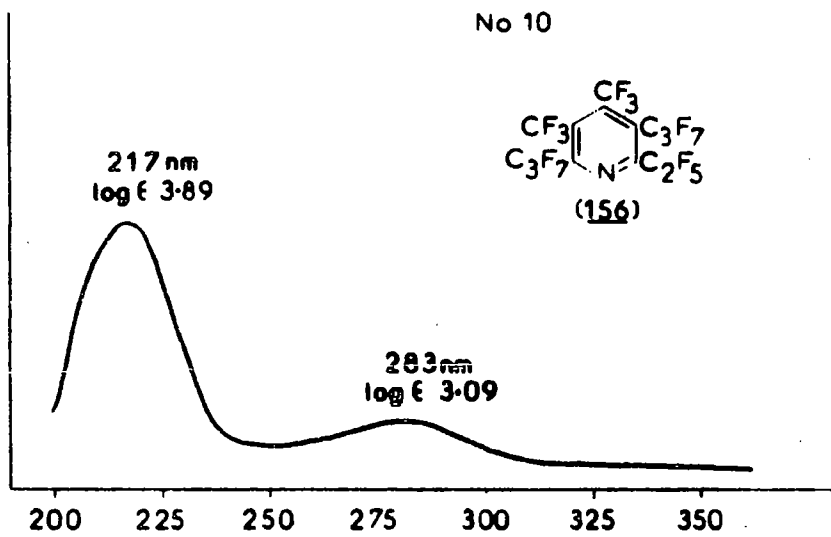

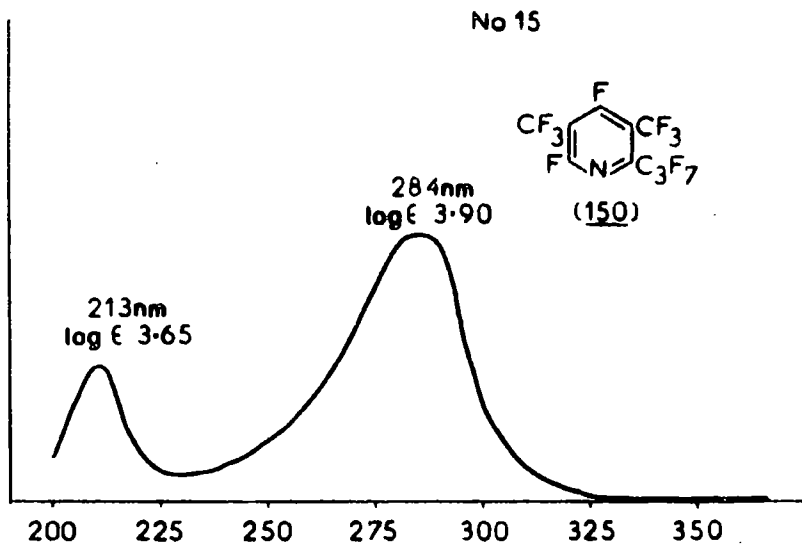
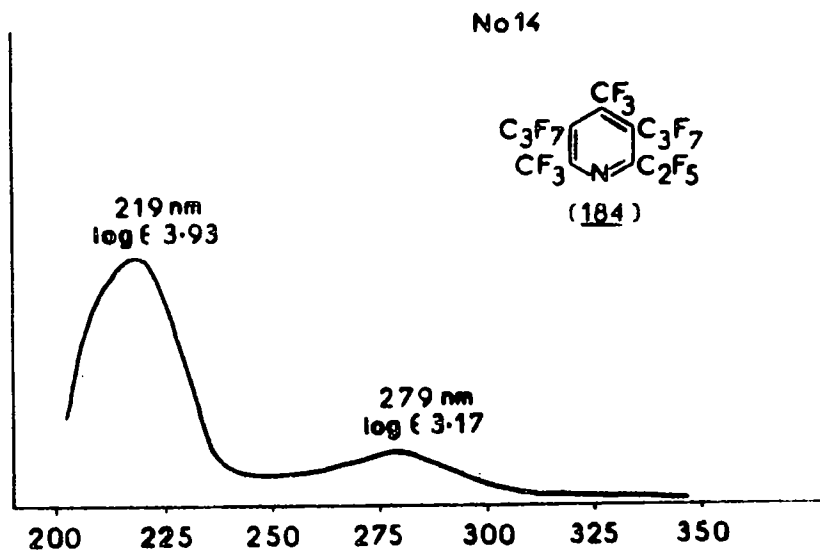
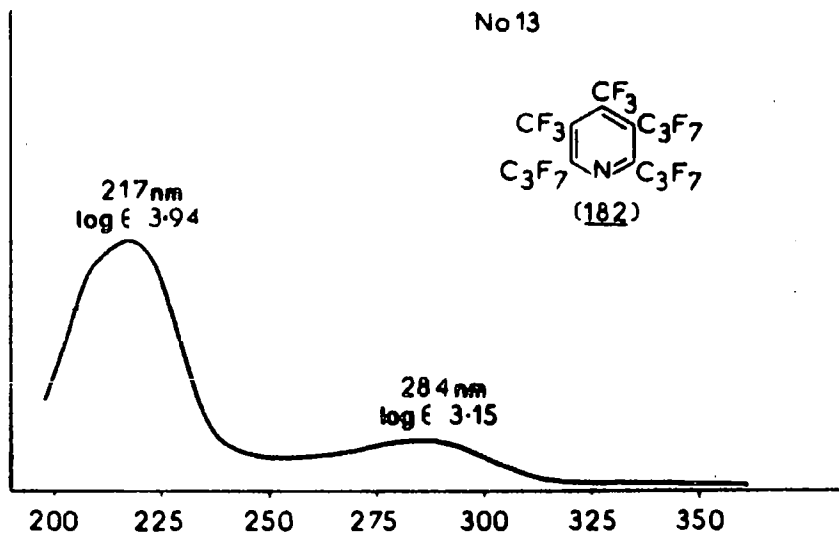

REFERENCES

1. E. E. van Tamelen and S. P. Pappas, J. Amer. Chem. Soc., 1962, 84, 3789
2. I. Norman and G. Porter, Proc. Royal Soc. A., 1955, 230, 399
3. J. M. Blair and D. Bryce-Smith, Proc. Chem. Soc., 1957, 287
4. H. R. Ward and J. S. Wishnock, J. Amer. Chem. Soc., 1968, 90, 5353
5. H. R. Ward and J. S. Wishnock, J. Amer. Chem. Soc., 1968, 90, 1086
6. D. Bryce-Smith, A. Gilbert, and D. A. Robinson, Angew. Chem. Int. Ed., 1971, 10, 745
7. K. E. Wilzbach, J. S. Ritscher, and L. Kaplan, J. Amer. Chem. Soc., 1967, 89, 1031
8. L. Kaplan and K. E. Wilzbach, J. Amer. Chem. Soc., 1968, 90, 3291
9. D. Bryce-Smith and A. Gilbert, Tetrahedron, 1976, 32, 1309
10. E. E. van Tamelen and S. P. Pappas, J. Amer. Chem. Soc., 1963, 85, 3297
11. T. J. Katz, E. J. Wang, and N. Acton, J. Amer. Chem. Soc., 1971, 93, 3782
12. U. Burger and F. Mazonod, Tet. Letters, 1976, 2881
13. T. J. Katz and N. Acton, J. Amer. Chem. Soc., 1973, 95, 2738
14. R. B. Woodward and R. Hoffmann, Angew. Chem. Int. Ed., 1969, 8, 781
15. I. Heller, J. Chem. Phys., 1967, 47, 1117
16. M. J. S. Dewar, S. Kirschner, and H. W. Kollmar, J. Amer. Chem. Soc., 1974, 96, 5240

17. M. J. S. Dewar and S. Kirschner, J.C.S. Chem. Comms., 1975, 463
18. M. J. S. Dewar and S. Kirschner, J. Amer. Chem. Soc., 1975, 97, 2932
19. N. J. Turro, C. A. Renner, T. J. Katz, W. B. Wiberg, and H. A. Connor, Tet. Letters, 1976, 4133
20. D. M. Lemal and L. H. Dunlap, J. Amer. Chem. Soc., 1972, 94, 6562
21. J. M. Oth, Rec. Trav. Chim. Pays-Bas, 1968, 87, 1185
22. J. M. Oth, Angew. Chem. Int. Ed., 1968, 7, 646
23. L. T. Scott and M. Jones, Chem. Reviews, 1972, 72, 181
24. L. Kaplan, K. E. Wilzbach, W. G. Brown, and S. S. Yang, J. Amer. Chem. Soc., 1965, 87, 675
25. K. E. Wilzbach, A. L. Harkness, and L. Kaplan, J. Amer. Chem. Soc., 1968, 90, 1116
26. C. A. Renner, T. J. Katz, J. Pouliquen, N. J. Turro, and W. H. Waddel, J. Amer. Chem. Soc., 1975, 97, 2568
27. A. W. Burgstahler, P. L. Chein, J. Amer. Chem. Soc., 1964, 86, 2940
28. K. E. Wilzbach and L. Kaplan, J. Amer. Chem. Soc., 1964, 86, 2307
29. H. R. Ward, J. Amer. Chem. Soc., 1967, 89 2367
30. K. E. Wilzbach and L. Kaplan, J. Amer. Chem. Soc., 1965, 87, 4004
31. I. E. D. Besten, L. Kaplan, and K. E. Wilzbach, J. Amer. Chem. Soc., 1968, 90, 5868
32. L. Kaplan, J. S. Ritscher, and K. E. Wilzbach, J. Amer. Chem. Soc., 1966, 88, 2881
33. E. M. Arnett and J. M. Bollinger, Tet. Letters, 1964, 3803
34. R. West, M. Furue, and V. N. M. Rao, Tet. Letters, 1973, 911
35. W. Schäfer, Angew. Chem. Int. Ed., 1966, 5, 669
36. W. Schäfer, and H. Hellman, Angew. Chem. Int. Ed., 1967, 6, 518
37. W. Schäfer, R. Creigee, R. Askaní, and H. Grüner, Angew. Chem. Int. Ed., 1967, 6, 78

38. D. M. Lemal and J. P. Lokensgard, J. Amer. Chem. Soc., 1966, 88, 5934
39. W. Adam and J. C. Chang, Inter. J. Chem. Kinetics, 1969, 1, 487
40. K. E. Wilzbach and D. J. Rausch, J. Amer. Chem. Soc., 1970, 92, 2178
41. S. Caplain and A. Lablanche-Comblie, J. C. S. Chem. Comms., 1970, 1247
42. S. Caplain, J. P. Catteau, and A. Lablanche-Comblie, J. C. S. Chem. Comms., 1970, 1475
43. T. J. van Bergen and R. M. Kellogg, J. Amer. Chem. Soc., 1972, 94, 8451
44. L. Kaplan, J. W. Pavlik, and K. E. Wilzbach, J. Amer. Chem. Soc., 1972, 94, 3283
45. P. Yates and I. W. J. Still, J. Amer. Chem. Soc., 1963, 85, 1208
46. N. Ishibe, M. Sunami, and M. Odani, J. Amer. Chem. Soc., 1973, 95, 463
47. N. Ishibe, M. Sunami, and M. Odani, J. C. S. Chem. Comms., 1971, 1034
48. J. M. Dunstan and P. Yates, Tet. Letters, 1964, 505
49. A. Padwa, Tet. Letters, 1964, 813
50. J. Barltrop, A. C. Day, and A. J. H. Summers, J. Amer. Chem. Soc., 1973, 95, 2406
51. J. W. Pavlik and E. L. Clennan, J. Amer. Chem. Soc., 1973, 95, 1697
52. J. W. Pavlik and J. Kwong, J. Amer. Chem. Soc., 1973, 95, 7914
53. J. Barltrop, R. Carder, A. C. Day, J. R. Harling, and C. Samuel, J. C. S. Chem. Comms., 1975, 729
54. F. Lahmani and N. Ivanoff, Tet. Letters, 1967, 3913
55. G. P. Semeluk and R. D. S. Stevens, J. C. S. Chem. Comms., 1970, 1720
56. G. Camaggi and F. Gozzo, J. Chem. Soc. (C), 1969, 489
57. G. Camaggi, F. Gozzo, and G. Cevidalli, J. C. S. Chem. Comms., 1966, 313

58. I. Heller, J. Amer. Chem. Soc., 1966, 88, 2070
59. M. G. Barlow, R. N. Haszeldine, and R. Hubbard, J. C. S. Chem. Comms., 1969, 202
60. M. G. Barlow, R. N. Haszeldine, and R. Hubbard, J. Chem Soc. (C), 1970, 1232
61. D. M. Lemal, J. V. Staros, and V. Austel, J. Amer. Chem. Soc., 1969, 91, 3373
62. E. D. Clifton, W. T. Flowers, and R. N. Haszeldine, J. C. S. Chem. Comms., 1969, 1216
63. M. G. Barlow, R. N. Haszeldine, and M. J. Kershaw, Tetrahedron, 1975, 1649
64. M. G. Barlow, R. N. Haszeldine, and M. J. Kershaw, J. C. S. Perkin I, 1974, 1736
65. L. Cavalli, J. Chem. Soc. (B), 1970, 1616
66. M. G. Barlow, R. N. Haszeldine, and M. J. Kershaw, J. C. S. Perkin I, 1975, 2005
67. M. G. Barlow, R. N. Haszeldine, and J. G. Dingwall, J. C. S. Perkin I, 1973, 1542
68. Y. Kobayashi and A. Ohsawa, Tet. Letters, 1973, 2643
69. R. D. Chambers, W. K. R. Musgrave, and K. C. Srivastava, J. C. S. Chem. Comms., 1971, 264
70. C. G. Allison, R. D. Chambers, Y. A. Cherburkou, J. A. H. McBride, and W. K. R. Musgrave, J. C. S. Chem. Comms., 1969, 1200
71. R. D. Chambers, J. R. Maslakiewicz, J. A. H. McBride, and K. C. Srivastava, J. C. S. Perkin I, 1975, 396
72. R. D. Chambers, J. R. Maslakiewicz, and K. C. Srivastava, J. C. S. Perkin I, 1975, 1130
73. R. D. Chambers, J. A. H. McBride, and W. K. R. Musgrave, J. Chem. Soc. (C), 1971, 3384
74. R. D. Chambers, M. Clark, J. R. Maslakiewicz, W. K. R. Musgrave, and P. G. Urben, J. C. S. Perkin I, 1974, 1513
75. R. D. Chambers, M. Clark, J. A. H. McBride, W. K. R. Musgrave, and K. C. Srivastava, J. C. S. Perkin I, 1974, 125
76. M. W. Grayson and D. M. Lemal, J. Amer. Chem. Soc., 1976, 98, 1278

77. R. Breslow, P. Gal, H. W. Chang, and L. J. Altmann, J. Amer. Chem. Soc., 1965, 87, 5139
78. R. Weiss and S. Andrae, Angew. Chem. Int. Ed., 1973, 12, 150
79. N. J. Turro, G. B. Schuster, R. G. Bergmann, K. J. Shea, and J. H. Davis, J. Amer. Chem. Soc., 1975, 97, 4758
80. J. H. Davis, K. J. Shea, and R. G. Bergmann, Angew. Chem. Int. Ed., 1976, 15, 232
81. W. H. de Wolf, I. J. Landheer, and F. Bickelhaupt, Tet. Letters, 1975, 179
82. R. Weiss and H. Kölbl, J. Amer. Chem. Soc., 1975, 97, 3222
83. R. Weiss and H. Kölbl, J. Amer. Chem. Soc., 1975, 97, 3224
84. J. A. Barltrop and A. C. Day, J. C. S. Chem. Comms., 1975, 177
85. S. Masamune, N. Nakamura, and J. Spador, J. Amer. Chem. Soc., 1975, 97, 918
86. R. D. Chambers, J. Hutchinson, and W. K. R. Musgrave, J. Chem. Soc., 1964, 3573
87. R. D. Chambers, R. P. Corbally, T. F. Holmes, and W. K. R. Musgrave, J. C. S. Perkin I, 1974, 108
88. R. D. Chambers, R. P. Corbally, and W. K. R. Musgrave, J. C. S. Perkin I, 1972, 1281
89. V. E. Platanov, N. V. Ermolenko, and G. G. Yakobson, Invest. Akad. Nauk. S.S.S.R. Ser. Khim., 1970, 2843. Chemical Abstracts 74:99825k
90. V. E. Platanov and G. G. Yakobson, Synthesis, 1976, 374
91. J. Lee and K. G. Orrell, J. Chem. Soc., 1965, 582
92. R. D. Chambers, J. A. Jackson, W. K. R. Musgrave, L. H. Sutcliffe, and G. J. T. Tiddy, Tetrahedron, 1970, 71
93. R. D. Chambers and M. Y. Gribble, J. C. S. Perkin I, 1973, 1405
94. S. P. Vdovin, Y. P. Egorov, E. V. Konavalov, A. D. Krasnoshchek, V. G. Lukmanov, E. P. Soenko, and L. M. Yagupolskii, Teor.i.eskp. Khim, 1975, 11, 44
95. R. E. Banks, W. M. Cheng, R. N. Haszeldine, and G. Shaw, J. Chem. Soc. (C), 1970, 55

96. Dr. R. S. Matthews - personal communication
97. Basic Principles of Organic Chemistry. J. D. Roberts and M. C. Caserio, Benjamin, New York, 1964
98. R. D. Hercliffe - unpublished results
99. E. S. Watson, M. J. O'Neill, J. Justin, and N. Brennen, Analytical Chem., 1964, 1232
100. K. E. J. Barrett, J. Applied Polymer Science, 1967, 11, 1617
101. P. Cadman, E. Ratajczak, and A. F. Trotman-Dickenson, J. Chem. Soc. (A), 1970, 2109
102. F. Lechtken, R. Breslow, A. H. Schmidt, and N. J. Turro, J. Amer. Chem. Soc. 1973, 95, 3025
103. A. M. Dabbagh, W. T. Flowers, R. N. Haszeldine, and P. J. Robinson, J. C. S. Chem. Comms., 1976, 323
104. M. G. Barlow, R. N. Haszeldine, and R. Hubbard, J. Chem. Soc. (C), 1971, 90
105. M. G. Barlow, G. M. Harrison, R. N. Haszeldine, R. Hubbard, M. J. Kershaw and D. R. Woodward, J. C. S. Perkin I, 1975, 2010
106. J. R. Maslakiewicz. Ph.D. Thesis. Durham 1974
107. W. A. Sheppard, J. Amer. Chem. Soc., 1965, 87, 4338
108. T. J. Bruce, J. D. LeZerte, L. J. Hals and W. H. Pearlson, J. Amer. Chem. Soc., 1953, 75, 2698
109. R. E. Banks, W. M. Cheng, and R. N. Haszeldine, J. Chem. Soc., 1962, 3407
110. R. A. Mitsch and P. H. Ogden, J. Org. Chem., 1966, 31, 3833
111. A. A. Lindley - personal communication
112. R. E. Banks, Fluorocarbons and Their Derivatives, Macdonald, London, 1970
113. J. Meinwald and P. H. Mazzocchi, J. Amer. Chem. Soc., 1966, 88, 2850
114. A. Padwa, L. Brodsky, and S. C. Clough, J. C. S. Chem. Comms., 1971, 417
115. W. K. R. Musgrave, W. J. Feast, and R. G. Weston, J. C. S. Chem. Comms., 1971, 709

116. A. Padwa, S. Clough, and E. Glazer, J. Amer. Chem. Soc., 1970, 92, 1778
117. R. D. Chambers, D. T. Clark, T. F. Holmes, and W. K. R. Musgrave, J. C. S. Perkin I, 1974, 114
118. R. E. Banks, F. Cuthbertson, and W. K. R. Musgrave, Anal. Chim. Acta. 1955, 13, 442
119. E. E. Lewis and A. A. Naylor, J. Amer. Chem. Soc., 1947, 69, 1968

