



## Durham E-Theses

---

### *Silicate stabilization of soft granular materials for sandwich plate cores*

Ong, Keng H.

#### How to cite:

---

Ong, Keng H. (1979) *Silicate stabilization of soft granular materials for sandwich plate cores*, Durham theses, Durham University. Available at Durham E-Theses Online: <http://etheses.dur.ac.uk/7865/>

#### Use policy

---

The full-text may be used and/or reproduced, and given to third parties in any format or medium, without prior permission or charge, for personal research or study, educational, or not-for-profit purposes provided that:

- a full bibliographic reference is made to the original source
- a [link](#) is made to the metadata record in Durham E-Theses
- the full-text is not changed in any way

The full-text must not be sold in any format or medium without the formal permission of the copyright holders.

Please consult the [full Durham E-Theses policy](#) for further details.

THE UNIVERSITY OF DURHAM  
Department of Engineering Science

Silicate Stabilization of soft granular materials  
for Sandwich Plate Cores

Thesis for Master of Science in Civil Engineering

Keng H. ONG, B.Sc.(Eng.)(SUSSEX)

November, 1979

The copyright of this thesis rests with the author.  
No quotation from it should be published without  
his prior written consent and information derived  
from it should be acknowledged.



IN CHRIST ALL THINGS WERE CREATED, IN  
HEAVEN AND ON EARTH, VISIBLE AND INVISIBLE.  
CHRIST IS BEFORE ALL THINGS, AND IN  
CHRIST ALL THINGS HOLD TOGETHER.

THE HOLY BIBLE

COLOSSIANS 1:(15-17)

# CONTENTS

	<u>Page</u>
ACKNOWLEDGEMENTS	(i)
ABSTRACT	(ii)
LIST OF SYMBOLS	(iii)
PREFACE	(iv)
CHAPTER 1 - SANDWICH PLATES CONSTRUCTION	
1.1 INTRODUCTION	1
1.2 THE CORE	2
1.3 CHOOSING A BINDER	2
1.4 THE USAGES OF SODIUM SILICATE	4
CHAPTER 2 - THE BINDERS	
2.1 CHEMICAL BINDERS IN FOUNDRIES	8
2.2 FUTURE AVAILABILITY OF RAW MATERIALS	9
2.3 THE SETTING OF SODIUM SILICATE	11
2.4 THE GEL OF SODIUM SILICATE	13
2.5 A REVIEW OF SODIUM SILICATE AS A BINDER IN THE FOUNDRY INDUSTRY	14
2.6 OTHER REAGENTS OR ADDITIVES USED IN CONJUNCTION WITH SODIUM SILICATES	17
CHAPTER 3 - SODIUM SILICATE COMPOSITE	
3.1 PHYSICAL AND CHEMICAL BONDINGS	20
3.2 ADHESION	20
3.3 REINFORCEMENT OF SODIUM SILICATE COMPOSITE	21
CHAPTER 4 - STANDARDISATION OF EXPERIMENTAL PROCEDURES	
4.1 INTRODUCTION	22
4.2 SELECTION OF MATERIAL OF MOULD FOR 2"x4" CYLINDRICAL SPECIMEN	23
4.3 MIXING	
4.3.1 Dilution	23
4.3.2 Heating Silicate Solution	
4.3.3 Viscosity	
4.3.4 Length of mixing time	
4.4 TRIAL MIX DESIGN	24
4.5 TEST APPARATUS	25
4.5.1 Mixing	
4.5.2 Compacting Apparatus	
4.5.2.1 AFS Rammer	
4.5.2.2 Modified Aggregate Impact Tester - BS 812	
4.5.2.3 Static Compaction System	
4.5.3 Strength Testing	
4.5.3.1 Unconfined Compression - 'E' type Tensometer	
4.5.3.2 Unconfined Compression - 'BS 1377' Triaxial Tester	
4.5.3.3 Torsion Tester	

4.6 GASSING TECHNIQUES	30
CHAPTER 5 - THE MATERIALS	32
5.1 AGGREGATES	33
5.2 BINDERS	34
5.3 FILLERS AND HARDENERS	38
CHAPTER 6 - TRIAL MIX DESIGN	
6.1 INTRODUCTION	40
6.2 GEL TESTS	40
6.3 SOME EXAMPLES OF THE MIXES	41
CHAPTER 7 - TEST EQUIPMENT	
7.1 INTRODUCTION	50
7.2 AFS SAND RAMMER (DIETERT DESIGN)	52
7.3 MODIFICATION TO THE AGGREGATE IMPACT TESTER	52
7.4 FINAL COMPACTION METHOD	54
7.5 COMPRESSION TESTER	55
7.6 TORSION TESTER	56
CHAPTER 8 - DETAILED TESTS ON CHOSEN MIXES	
8.1 OBJECTIVES	58
8.2 THEORY	59
8.2.1 Compression Test	59
8.2.2 Shear and Torsion Tests	60
8.3 DEFINITION OF FINAL MIXES	61
8.3.1 Wall paper/P84/FORMULA 2	
8.3.2 DSF/P84/SECAR (HAC)	
8.3.3 +2400 Shell Ep Beads/P84/(SECAR + LIME)	
8.3.4 Perlite/C112/CO <sub>2</sub>	
8.4 RELEVANT TEST RESULTS	64
8.4.1 Part I - Figure Legends	
8.4.2 Part II- Test Results	100
A - Type of Mixes	100
B - Summary of the different Composite systems	101
C - Comparison of G <sub>T</sub> and G <sub>S</sub>	102
D - Factors affecting the results of G <sub>T</sub> and G <sub>S</sub>	103
E - Factors affecting the strength and stiffness	105
8.5 CONCLUDING REMARKS	105
CHAPTER 9 - CONCLUSION	107
APPENDICES	
APPENDIX I	PHOTOGRAPHS
APPENDIX II	TEST APPARATUS
APPENDIX III	DERIVATION
APPENDIX IV	SIEVE ANALYSIS GRAPH SHEET & CHEMICAL ANALYSIS
REFERENCES	

ACKNOWLEDGMENTS

Many people have contributed a great deal to this thesis. Some are research scientists whose work produced the material that has been recorded here. Others have been co-operative correspondents who took the time to discover, communicate, and collate significant information. Information has been generously borrowed from all these people.

Those who deserve special thanks are my supervisor, Dr. Girvan Meir Parton, whose vision led to the creation of this project at this university; Mr. G. W. Houlbrooke and Mr. B. Malpass, Technical Marketing Department, Alkali Products, I.C.I. Mond Division, Cheshire, for providing technical information concerning the use of sodium silicate and their generosity towards the supply of raw materials to this work; Mr. L. J. Stewardson, Head of Information Services, British Cast Iron Research Association (B.C.I.R.A.), Alvechurch, Birmingham, for using their Library to carry out a literature search by means of the Library catalogue; and the British Library personnel, Lending Division, Boston Spa, Wetherby, West Yorkshire, who secured many references.

Mrs. J. M. Chisholm, the Inter-Library Loans Staff, deserves special thanks for her help in the acquisition of many invaluable sources of information.

I thank Mr. Brian P. Scurr, who at various times has helped with the preparation of the equipment and apparatus.

Finally, I thank Sean Martin, for checking and correcting the original manuscript.

ABSTRACT

This thesis summarises the research carried out at the Department of Engineering Science, University of Durham, on the mechanical properties and behaviour of silicate-stabilized materials used under laboratory conditions.

It deals with methods of assessing the suitability of stabilized materials for structural and non-structural sandwich plate cores and describes the types of materials that can be stabilized with Sodium Silicate (Soluble Silicate) and how their chemical and physical properties affect their suitability for stabilization. The influence of other factors such as temperature, moulding pressure, and dwelling time of a compressed specimen for a material stabilized by silicate are also discussed.

Little attempt has been made to improve the quality or cost effectiveness of products, processes, systems and services used in construction.

Relationships between the fabrication process variables and the final strength properties of the materials are established.

LIST OF SYMBOLS

The symbols listed below are those occurring frequently in the text. Other symbols used in one place only are defined where they occur and not included here.

$E_C$	Young's Modulus of the material, C designated for sandwich plate core. For steel, take $E = 20 \times 10^{10} \text{ N/m}^2$
$\nu$	Poisson's Ratio For steel $\nu = 0.291$
$\tau_c$	Shear stress of sandwich plate core
$G_C$	Shear modulus of sandwich plate core For steel, take $G = \frac{E}{2(1 + \nu)} = 7.8 \times 10^{10} \text{ N/m}^2$
$P$	Forming pressure, $\text{V/mm}^2$
B	Binder Content (%)
$\rho_D$	Dry Density, $\rho_D = \frac{\rho_B}{1 + \omega}$
$\rho_B$	Bulk Density, $\text{Kg/m}^3$
$\omega$	Moisture Content, (wet basis)
P	Forming Pressure or Moulding Pressure, $\text{N/mm}^2$
t	gassing time for $\text{CO}_2$ process, seconds
d.t.	dwelling time of material in mould under a given P, seconds
Strength	This is being referred to compression strength of a 2" x 4" specimen, $\text{N/mm}^2$ .
$\sigma(5\%)$	Compressive strength at 5% compression, e.g. sample of 100 mm height compressed to 95 mm.



PREFACE

Undesirable properties of the weak core and also difficulties of mass production in the field result in sandwich panel structures still causing problems in building construction. The objectives of development work are to:-

- (1) Improve the insulation, fire resistance and mechanical properties of the core.
- (2) Develop economic and simple construction techniques for mass production purposes. Consequently, it is hoped that the techniques proposed will help to establish guidance for standard design in the construction industry.

The conventional material (binder) to construct sandwich panels is Portland Cement. With mortar faces and some kind of cement stabilised porous core in the middle of the faces. Difficulties in handling, production, transportation and relatively low strength/weight ratio are the main disadvantages. Where timing is of prime concern in production, a search for a new material, which may already be established in another industry, is therefore necessary. Sodium Silicate is such a material and its importance in foundry industry will be discussed and reviewed in the following chapters.

This report consists of two parts. The first seeks to understand the background of some established British foundry processes which use sodium silicate to bound sand particles. It is then hoped to impart some of these ideas to manufacture cores for sandwich panels. The fabrication processes mentioned in the British foundry industry are irrelevant to this project for a variety of practical reasons. Where the former section is more concerned with silica sand as the main aggregate in the production

of moulds and cores, the latter will be concerned with many products using several different materials, such as pre-foamed polystyrene beads. The suitability of these soft materials for stabilization with sodium silicate is therefore a necessary subject for investigation.

Once the chemistry and fabrication techniques are understood, the second part will be devoted to the strength tests of end products.

The compressive strength, Young's modulus, shear modulus and shear stress are tabulated for each composite system.

On evaluating the shear modulus, a new approach of testing cylindrical specimens in shear and torsion has been proposed. Good repeatability and agreement of shear modulus obtained by torsion and shear methods is obtained, and the method proves useful for verifying the suitability of materials for stabilization and fabrication method.

As the work was mainly concerned with the evaluation of structural properties of silicate stabilized materials for sandwich plate cores, no attempts were made in actual sandwich beam construction.

CHAPTER 1

SANDWICH PLATES CONSTRUCTION

1.1 Introduction

Sandwich Plates (or Sandwich Panels) are a particular class of laminates having two thin strong sheets of dense material separated by a thick core of low-density material which is less stiff and strong. This arrangement combines stiffness with lightness, because the stiff faces are at a maximum distance from the neutral axis, similar to the flanges of an I-beam. The faces carry most of the axial loading and transverse bending stresses. The core carries most of the shear and also stabilizes the thin compressive faces against buckling. The bond between core and face must resist shear and transverse tensile stress resulting from the wrinkling tendency of the compressive face (Ref: 35).

Sandwich panels of a wide variety are used extensively for interior and exterior walls and roofs of buildings. Typical face materials include aluminium, fibre-reinforced plastics, plywood, gypsum board, asbestos cement, and concrete. Typical core materials include foamed polymers and inorganic cements and various structural corrugated shapes.

Corrugated and honeycomb cores are made in a wide variety of materials: paper, cotton, glass cloth, aluminium foil, and combinations with plastic foam. Plastic impregnates such as phenolics, nylon-phenolics, or polyesters are used with the first three to provide sufficient rigidity (Ref: 35).

The structural analysis and design optimization with examples is well exemplified and easily followed in Nicholl's book.

Structural efficiency on a larger scale can be gained by combining sandwich panels into various forms of folded plate structures (Ref: 6,7,4,75,23,25).



## 1.2 The Core

The basic requirements of a good core in sandwich plate construction are:

- (1) Rigidity - due to good bonding between binder/cement and granular materials.
- (2) Shrinkage is minimised.
- (3) Low density but high structural strength.
- (4) Low cost - single step method of construction.
- (5) Good thermal and sound insulation, together with fire resistance.
- (6) Low water and gas permeability - hence no condensation in the core and loss of thermal property.

## 1.3 Choosing a binder/cement

Sodium Silicate has long been known to the foundry industry and gradually, it is really being recognised for its true potential. This material is at present going through a most exciting period in its development.

Some processes which are still used frequently in the British foundry industry are very worth considering and this is reviewed and condensed in Chapter 2.

Sodium Silicate is a very versatile material. Commercially available in the U.K., it is sold by I.C.I. and others. Sodium Silicate may be used as an inorganic cement, or as a void filler or grout. It is usually available in viscous solution with weight ratios of  $\text{SiO}_2$  to  $\text{Na}_2\text{O}$  ranging from 1.6 to 3.3 in I.C.I. grades, and from 1.6 to 3.85 in Crosfield grades. The weight ratio of  $\text{SiO}_2$  to  $\text{Na}_2\text{O}$  not only determines whether the solution is more alkaline or more siliceous, but it affects also the setting time of the silicate gel, its solubility in water, rate of drying, chemical resistance, mechanical strengths, and many other properties. For example:

There are large differences in texture between liquids of the same viscosity. This is particularly evident at the highest viscosities where, with the most siliceous silicates, (i.e. higher  $\text{SiO}_2/\text{Na}_2\text{O}$  ratio), the elastic properties are met. The concentrated solutions have a jelly-like texture and are thixotropic, and in their semi-solid condition can be rolled into balls which bounce. (Ref: 67,68).

An average of many measurements shows an 80% coefficient of restitution, considerably better than a tennis ball! When subjected to sudden stress they break with a vitreous or conchoidal fracture, although they are still liquid in the sense that they will flow under their own weight if sufficient time is allowed.

By contrast, silicates containing more alkali relative to the silica are heavier (i.e. lower  $\text{SiO}_2/\text{Na}_2\text{O}$  ratio), they contain less water for a given viscosity, and although the highly viscous product can be rolled into balls, they have no tendency to bounce (Ref: 67,68). If an attempt is made to break them by the application of sudden stress, they may be drawn out into long fibrous streamers which have the appearance of spun glass (Ref: 67,68).

The viscosity of a given ratio of silicate cannot be determined accurately because of the following reasons:

- (1) Difficulty in preparing adequately homogeneous samples.
- (2) Various impurities like  $\text{CO}_2$  from the air, contamination from sodium salts introduced with water which has been softened, or  $\text{Ca}^{+2}$  and  $\text{Mg}^{+2}$  salts from hard water, will sufficiently affect the viscosity of the solution.

For this reason, no single figure can, generally, be quoted relating the viscosity of a silicate solution with mechanical strengths, and other structural properties.

#### 1.4 The Usages

Much of this information is obtained from Ref. 67,68. It is difficult to trace if some of the applications are still valid.

##### (1) Protection of Soft Metals

Much literature is available on the use of silicates to protect soft metals and their alloys from corrosion under varied conditions. This has developed because the silicate can be deposited on the metal surfaces in a thin film.

##### (2) Road Construction

Tars, bitumens, or pitch compositions sometimes contain sodium silicates to stabilize the cement and prevent ageing. Silicate has been used in conjunction with asphalt and bitumen emulsions and should, therefore, be compatible with petroleum/bitumen ground fillers.

##### (3) Protection of concrete structures

It is established that Portland Cement mortars after being fully set are improved by impregnating them with silicate solutions sufficiently dilute to penetrate deeply into the porous structure of the set body. Thus the permeability of the concrete is reduced, and its resistance to wear increased, as shown by hydraulic and abrasion tests and by long experience in the treatment of concrete surfaces to prevent dusting and the penetration of oily and aqueous liquid.

On curing concrete structures, sodium silicate is being used to cut down the cost of maintaining a wet surface during the curing of concrete road slabs in arid countries.

The technique is very simple. A single film of  $41^{\circ} \text{Be}'$   $\text{Na}_2\text{O}:3.3 \text{SiO}_2$  (I.C.I. P84) is brushed on the road surface. Silicate curing is attractive to the contractor on account of its simplicity and the fact that after curing no expense for removal of the curing medium is required. Natural surface colour of the finished work is another

desirable feature.

Portland cement made up with sea water is notoriously unsatisfactory. Mixtures of sodium silicates,  $\text{CaCl}_2$ , Alum, and aluminium hydroxide are said to largely overcome this difficulty. Mixtures said to provide improved flow (increase workability), greater strength and density, protection against the segregation of cement suspension, accelerated setting, and suitability for use below the temperature of freezing water. They consist of  $\text{CaCl}_2$ , amorphous silicate, sodium silicates, and impalpable fillers suspended in an aqueous tannin solution with or without the addition of inert colouring materials.

Powdered anhydrous silicates (a slowly soluble type, usually the high/silica ratios give the best results) have been added to the Portland cement to increase the water resistance, and decrease the density and setting time without lessening the hardness or decreasing the tensile strength. This refers to amounts of 5 to 10% on the weight of the Portland cement. Figure 1 shows one of the examples of silicates used in conjunction with ordinary Portland cement. The compressive strength of concrete is shown to be increased by the addition of sodium silicate powder.

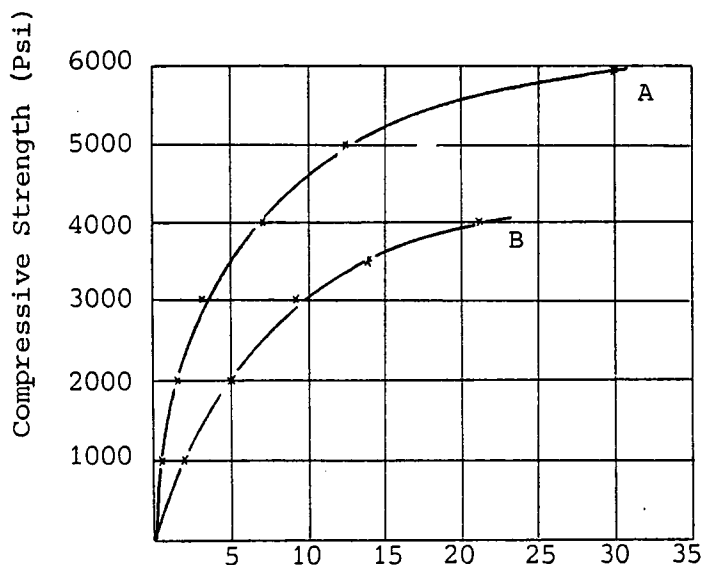

Figure 1

	A (lb)	B (lb)
Cement	15.4	15.4
Sand	34.2	34.2
Gravel	73.2	73.2
Special Mixture	1.6	-
Water/Cement	0.4	0.4

For Special Mixture

Sodium Silicate, e.g. P84,	0.57 lb
$\text{CaCl}_2$	0.23 lb
Potassium Alum	0.23 lb
Diatomaceous earths	0.57 lb

(4) Lutes and Sealing Cements

For very quick settings to give temporary stoppage of leaks, silicate solutions and dry portland cements are often useful, but such mixtures must be applied at once and should be backed up by a slower setting and ultimately stronger composition.

(5) Other areas

(a) Compounds for stopping inaccessible leaks in systems, where water circulates, as through an automobile radiator, are recommended for temporary, and sometimes permanent closure of small apertures.

(b) As leak sealing compounds for auto fires, pipes, refrigerator cooling pipes etc.

(c) As adhesive for paper boards and corrugated boxes.

(d) In the cutting tools industry grinding wheels are made from granular abrasives. Silicate binders may efficiently be matured to high strength at low temperatures.

(6) Sodium Silicate/High Alumina Cement

Sodium silicate/H.A.C. composites are used in many practical applications. For example, sodium silicate with high-alumina cement as a non-flamable replacement for the inorganic resins traditionally used for rock bolting purposes in the mining industry.

(7) Foundry Industry

Worldwide in the foundry industry sodium silicate is used as a non-flamable, non-toxic inorganic refractory cement for binding sand particles in cores and mould production.

(8) As a binder/cement

Numerous waste aggregates have been bonded with silicate and obviously any aggregate must be considered in its own right.



The application of silicates in the cement, ceramics and refractory fields is extremely diverse.

There are a number of patents, especially Japanese, covering mixtures of this sort, either for producing lightweight aggregates or for stabilizing liquid wastes.

## CHAPTER 2

### THE BINDERS

#### 2.1 Chemical Binders<sup>†</sup> in Foundries (Ref: 34)

British Cast Iron Research Association, Alvechurch (Birmingham, England) held a conference in 1976 dealing with the use of chemical binders in foundries. This covered not only the use of silicates, but also laid emphasis upon the use of other binders.

For a more detailed study, the reader is referred to the Conference Report.

##### (a) Sodium Silicate Binders (Inorganic) Cold Process

Sodium silicate as a binder for sand was first used in core making when it was hardened by carbon dioxide gas. This method of core production was developed in Germany during World War II. The first record of this process being introduced in a British foundry is in 1952. The American foundries in general did not seem to recognise the potential of this binder until as late as 1956-57.

Samples of carbon dioxide-silicate core after annealing at 1060°C for 13 hours result in a hard core, as hard as a house brick. This causes delays in production.

Other drawbacks of this binder besides the breakdown difficulty is that the sinter point of sand is reduced by the alkaline sodium silicate. This resulted in a quiet period in the development of sodium silicate as a binder. During this time we saw a prolific number of other cold-setting binders appearing on the market, e.g. furane distillates of Linseed oil and oxidising catalysts, etc. But these too had big drawbacks. They had good collapsibility, but lacked hot strength<sup>††</sup> to resist metal penetration, also they were very expensive.

---

† In construction and civil engineering terminology, 'stabilizer' is preferred.

†† Strength at high temperature.

So from 1964 on we see a gradual swing back to sodium silicate as it is relatively inexpensive and since the breakdown problem is being overcome.

(b) Resin binders (Organic) Cold/Hot Process

The core-making and moulding processes based on the use of resin binders have been used in the foundry industry for many years. For instance, the hot-box process and the shell process are long established and used widely throughout the foundry industry in all industrial countries.

Generally speaking the resin based processes are aimed at producing more accurate moulds and cores, thereby improving casting quality and production rates. At the same time much of the work entailed in the production of moulds and cores has been mechanised to speed up production rates and thereby overcome the declining availability of skilled moulders and core-makers.

Most raw materials used in the manufacture of foundry resins have their origin in the oil or petroleum industry. Certainly the commercial production of phenol and formaldehyde is today derived almost wholly from this source.

(c) Oil Binders (Organic) Hot process

2.2 Future Availability of Raw Materials (Ref: 34)

(I) Binders

Binder suppliers and foundries alike are dependent upon the adequate and continued availability of chemicals essential for the manufacture of binder formulations. Serious material shortages in the past have been caused, in nearly all cases, by relatively sudden changes of manufacture or marketing strategy within the basic feedstock industry from which the chemical raw materials are derived. In these circumstances

the binder supplier has little or no control.

In order to try to assess the future availability of binder raw materials, it is necessary to recognize the original source from which they are obtained.

Most raw materials used in the manufacture of foundry resins have their origin in the oil or petroleum industry. The continued availability of these materials is, therefore, fairly well assured provided that adequate oil sources and refining facilities are maintained. It is well known that world oil resources are being rapidly used up and that there is an urgent need to develop other sources of energy. Oil crises of the kind experienced early in 1974 can have a dramatic influence that may persist over a long period.

(A) Resin Binders (Organic) Cold/Hot Process

Examples are phenol, formaldehyde. Raw materials - petroleum; furfuryl alcohol (FA). Raw materials - oats, rice, etc.

(B) Oil Binders (Organic) Hot Process

The raw materials used for the manufacture of oil binders are mainly of vegetable origin, e.g. linseed, cotton seed, etc.

(C) Sodium Silicate Binders (Inorganic) Cold Process

For most countries, the required materials are indigenously and freely available. Raw materials, silica sand and sodium carbonate, are the only raw materials needed to produce the present range of silicate-sand binders.

(II) Catalysts/Hardeners/Gelling Agents

(A) For Resin Oil Binders

Catalysts for resin and oil binders are again, originated in the basic oil-refining processes. Others, like phosphoric acid, however,

are synthesized from naturally-occurring phosphate materials.

Perhaps phosphates should be reserved for agricultural and nutritional uses where they are indispensable, rather than for industrial processes.

(B) For Sodium Silicate Binders

The production of CO<sub>2</sub> gas has been largely unaffected by any raw material shortages. Production sources are totally adequate to meet predicted requirements.

On the other hand, the situation for ester-hardeners, required for cold-setting silicate processes, is somewhat different from CO<sub>2</sub>. The raw materials required for their manufacture include glycerol acetic acid, and ethylene glycol. For glycerol, it is partly derived from natural fats or oils extracted from animal livestock, and partly synthesized from propylene - which is an oil derivative. Acetic acid and ethylene glycol both originate from oil-fractionated products, so it can be seen that the ester-hardeners, in common with resins, are strongly dependent on the continued availability and processing of oil feedstock.

The foundry industry, in fact, is only a small consumer of these materials. Triacetin is used in cigarette filter-tips, diacetin, however, is less widely used elsewhere. Glycerol has extensive outlets in the manufacture of paint chemical intermediates, plastics, and drugs.

2.3 The Setting of Sodium Silicates

Consider the following reactions:-

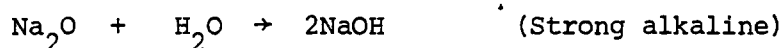
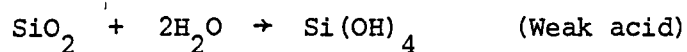

It is obvious that sodium silicate is the salt of a weak acid, silicic acid and a strong base sodium hydroxide. For this reason, the solutions

of sodium silicate can be mild alkaline or neutral.

The following equations mentioned in Warren's paper (Ref: 62) explain a number of chemical and physical properties.

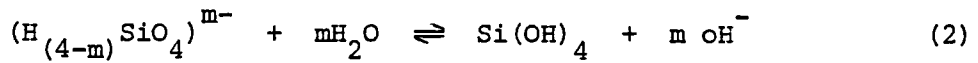
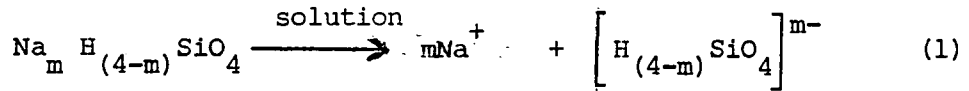

where m is dependent on the grade of the silicate and is a function of the ratio (SiO<sub>2</sub>:Na<sub>2</sub>O).

To eliminate the complicated explanation of the true picture of how soluble silicate is set or gelled by some known reagents/catalysts, a generalised theory can be drawn as follows:

Silicate is set by either the removal of Na<sup>+</sup> or H<sub>2</sub>O. The principle is to increase the viscosity. One way that Na<sup>+</sup> can be removed from Na<sub>2</sub>O is by precipitation. This increases the SiO<sub>2</sub>:Na<sub>2</sub>O ratio and hence dries out much quicker, and in addition there is a significant increase in viscosity.

Equation (2) suggests a reversible reaction. It goes favourably to the left when the pH value of the solution is reduced. A more alkaline condition promotes the reaction to go right. The reaction that goes to the left is sometimes called the chemical neutralization of the hydroxyl ion (OH)<sup>-</sup>. This leads to the acceleration of hardening process by reducing the pH value. This is further confirmed in many patents, which use CO<sub>2</sub>, boron phosphate (Ref: 14), organic esters or other hardeners.

To summarise:- The setting processes can be classified into three basic types:-

Type A Chemical neutralization of the  $\text{OH}^-$  in the solution (i.e. removal of  $\text{Na}^+$ )

Type B Physical or chemical dehydration of the silicate gel.

Type C The combination of Type A and Type B is no doubt one of the possible mechanisms to harden silicate.

#### 2.4 The Gel of Sodium Silicate

It has not been of direct concern in this project for a study to be made of the transition from silicate anions (e.g.  $\text{SiO}_3^{-2}$ ) to larger aggregations which become colloidal and eventually set into the solid gel. The reasons for coagulation, syneresis, ageing etc. are very well explained and exploited by colloidal chemists. This is also well described in Vail's book, Vol.1 (Ref: 68).

It has been felt advantageous to determine the true scale of the transformation from aqueous cloudy through to plastic gel and then finally to setting solid and bringing into consideration any appearance of efflorescence or deterioration.

The determination of gel time as used in foundry practice has been adopted in this project. The phenomenon took place with

- (1) a rise of viscosity,
- (2) an increase in the ability to scatter beams of light,
- (3) a change in colour from cloudy to milky (if no other coloured agents present),
- (4) setting occurred usually from upper level downward for the most silicious types, e.g. I.C.I. P84 grade.

The rate of formation of silicate gel varies with many factors: Such as type of hardener or catalyst used, concentration of silicate

solution, ratio of  $\text{SiO}_2$  to  $\text{Na}_2\text{O}$ , pH value of the mixture, temperature (notable when using organic esters), presence of impurities and mineral compounds and so forth. The reaction from colloidal solution to solid gel can be interrupted or under some conditions reversed (Ref: 68). The gel time ranges from instantaneous to an indefinite period. The longer the gel was allowed to set and synerize, the stronger it became (Ref: 68). During the syneresis process the gel was observed to shrink and in some cases it developed cracks.

It is interesting to find that fresh gels when broken and then allowed to rest show a tendency to reform, but not with their original strength. (Ref: 68). The excess water or fluid produced during the syneresis sequence can be adjusted by mechanical means.

The formation of excess  $\text{H}_2\text{O}$  after setting can be a problem when the mixture is compressed; losses of soft gel are usually associated with this. One way to practically overcome this is to select milder reagents to gel the silicate solution rather than more reactive types. Alternatively, one may change the weight ratio of  $\text{SiO}_2/\text{Na}_2\text{O}$  of silicate solution. Another method is to press the sample after the gel has set.

## 2.5 A Review of Sodium Silicate as a Binder in the Foundry Industry

Examples are given on the currently available processes in the British and foreign foundries based on Types A, B and C. No comments are given concerning the weaknesses of the various processes.

### Example 1 $\text{CO}_2$ Process (Types A and B) (Ref: 55,62)

This process was introduced originally in Great Britain using 1.6 or 2.0 ratio silicates (weight ratio). For more detailed reference there is an excellent book by Nicholas on 'The  $\text{CO}_2$ -Silicate Process in Foundries' (Ref: 88).



The mechanism of the CO<sub>2</sub> process is not fully understood. Materials used for this process should be dry, clean and free from clay. Recommended I.C.I. grades are C112, C100 and others with 'C' described before the figures.

Example 2: Nishiyama Process (Type B) (Ref: 69,55,13,62)

The method, which uses the reaction of sodium silicate and ferro-silicon in binding cores and facing sand for moulds, was first described by T. Nishiyama in 1963. An exothermic reaction takes place causing physical dehydration of the sand which permits the mould to be hardened. Care must be taken as hydrogen is evolved as a reaction product.

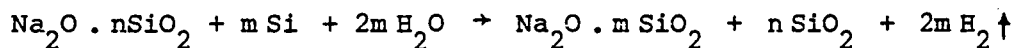

Recommended I.C.I. grades are C100, C112, E100.†

Example 3: Alkaset Process (Type A + Type B) (Ref: 55,62)

This is sometimes known as the Russian Fluid sand process, originally developed in Russia by Liass and Borsuk in the early 1960's. Alkaset (basically) contains di-calcium silicate (2CaO . SiO<sub>2</sub>), one of the main compounds of Portland Cement. A synthetic product which contains a smaller proportion of di-calcium silicate is under the trade name 'Cetos'.

Recommended I.C.I. grade is L96.†

Example 4: Organic Esters Process (Type A) (Ref: 55,63,10,62,72)

The hardening of Sodium Silicate by organic esters has been known for many years (Ref: 67). This process is believed to have originated

---

† The recommended I.C.I. grades are more suitable for bonding sand. Other ratios can be used, but the setting time and quality of bonding will be affected.

in the U.S.A. around 1967. It was not until 1969 that it was introduced into Great Britain (Ref: 37). The most commonly used esters are ethylene glycol Diacetate (EGDA), ethylene glycol Mono Acetate (EGMA), Diacetin (DIA) and Triacetin (TRI). The recommended I.C.I. grades of silicate are H100 and K95.

For refractory mortars and soil consolidation, (e.g. Juston Process) using esters and  $\text{CaCl}_2$ , the higher ratios P84 and Q79 are preferred (Ref: 48, 67). These latter grades are used with the slower hydrolysing esters such as Triacetin or ethyl acetate. The reactivity of these hardeners is generally in the following descending order of reactivity:-

DIA > EGMA > EGDA > TRIA

The reactivity is also temperature dependent.

Example 5: Calcium Salts Process (Type A) (Ref: 67)

Some examples extracted from Vail's Book (Ref: 67) are as follows, (soluble and insoluble  $\text{Ca}^{+2}$  Compounds).

(a)  $\text{CaCO}_3$  (Insoluble)

The reaction of calcium carbonate with sodium silicate is very sensitive to crystal form, temperature, and silicate ratio. The viscosity of mixtures with alkaline silicates rises rapidly, e.g. 2 ratio silicates, whereas with the siliceous ratios, there may be no apparent change for a long period, e.g. I.C.I. grades of silicate C140 and A140, began to set in six hours at  $30^\circ\text{C}$ , while at  $40^\circ\text{C}$  it began to set in less than two hours. High ratio (more siliceous) silicates like Q79 grade, at  $30^\circ\text{C}$  began to set at 100 hours and 20 hours at  $40^\circ\text{C}$ .

$\text{CaCO}_3$  occurs naturally in limestone (calcite) and chalk (aragonite), the latter being a reactive calcium carbonate:

(b)  $\text{CaCl}_2$  (Soluble)

Clay that is naturally high in calcium may be treated with sodium

silicate solutions. This provides a gelatinous texture. The said mixtures, if further treated with  $\text{CaCl}_2$  serve as plasticizing agents for Portland cements. For other uses in connection with fire retardant treatment, see reference 67.

(c) Cementitious Compounds (e.g. Portland Cement)

A mixture of about 10 parts OPC to one part of commercial waterglass will set within a few minutes, even with a water content of at least 50%.

There are a number of patents (especially Japanese) covering mixtures of this sort, either for producing lightweight aggregates or for stabilizing liquid wastes (Ref: 32), e.g. the slurry of freely divided limestone and sodium silicate (P84) is used to stabilise the coarse hard rock in road construction. (Ref: 67).

Example 6: Aluminium Compounds (Type B) e.g. High Alumina Cement

Since there is no free lime present in this cement, treatment of the surface of HAC concrete with sodium silicate solution has little beneficial action in ordinary circumstances (Ref: 32,11,48).

However, many aluminium compounds have been used to give the Type B reaction. Difficulties have been envisaged by the production of explosive hydrogen gas.

This is an example from the grinding industry where aluminous abrasive grains or granules are abundant. It has been used to repair grinding discs by applying abrasive grains in a silicate solution (A140 or C140 of 59.5 degree Baume coating). They are ready for use after 24 hours ~~air~~-drying.

2.6 Other Reagents or additives used in conjunction with sodium silicates

The reader should consult the references for the reasons for using these substances.

Example 1: Surfactant e.g. 'Pentrone ON' (Ref: 2)

Pentrone ON is not a hardener, but a surface active reagent with a controlled foam life and can be used with all the silicates. The alkalinity and concentration of the silicate does influence the length of the foam life.

Example 2: Resin

Some resin/silicate systems have been proposed. The most recent studies have been by the British Cast Iron Research Association and a phenolic resin CIRIO has been developed. (Ref: 15).

Example 3: Siliconate e.g. 'R221 and R222'

The use of masonry water repellents with sodium silicate, and the addition of esters to gel silicate are controlled by patents and information is not readily available. (Ref: 17,48).

Example 4: Portland Cement

Sodium silicate is used as a surface treatment for increasing the chemical resistance of Portland concrete by reacting with the free lime present.

Example 5: Powdered Anhydrite (CaSO<sub>4</sub>)

Powdered Anyhydrite reacts immediately with silicate solutions, making it difficult to form a coherent mass before the reaction has taken place. The finer the particles, the more reactive is the mixture. It is possible to blend +200 B.S. Mesh, CaSO<sub>4</sub> (75-80 μm) in various proportions with any of the known soluble silicate cements.

It is important to note that the properties of anhydrous sodium silicates (powder) are entirely different from those obtained with hydrated powders or solutions of the same ratio.

Other reactant materials which have been usefully coated with silicate films include  $\text{CuSO}_4$ ,  $\text{CaCl}_2$ ,  $\text{Fe}_2(\text{SO}_4)_3$ ,  $\text{MgCl}_2$  and  $\text{Al}_2(\text{SO}_4)_3$ . The list could be greatly extended.

CHAPTER 3

SODIUM SILICATE COMPOSITES

3.1 Physical and Chemical Bondings

In concrete, the bond strength between the aggregate and cement paste is usually the weakest link in the system and plays an important role in determining the properties of the composite material.

The forces which bind/stabilize silicate paste/gel to an aggregate may be physical and chemical.

The physical forces are due to adhesion and mechanical interlock. The chemical forces are due to the formation of surface reaction products, usually as a thin film deposit.

Catalysts or hardeners, when added with silicate solutions, should form a coherent mass before the chemical reaction has taken place, (i.e. a rise on viscosity of the binder).

3.2 Adhesion

The first criterion for good bonding is that the binder and the substrate must be in intimate contact. Thus, any flaws at the phase boundary between the adhesive and substrate must be bridged and the surface of the substrate wetted.

It is found that on leaving a drop of silicate solution on the surface of expanded polystyrene board, a sphere is formed, proving that the silicate solution cannot readily wet the expanded polystyrene surface. Pentrone-on, a surface active agent, was used and pre-mixed with the dry beads and this provided good workability and increased adhesion. Since the beads were of soft material little improvement in strength was found after coating.

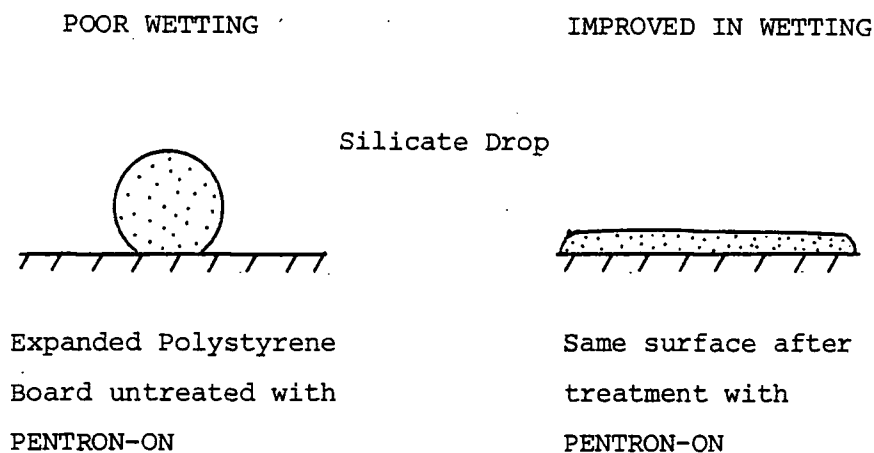

Figure 2

### 3.3 Reinforcement of Sodium Silicate Composite

The reinforcement of polymers and cements by fillers, both fibrous and particulate, is in common practice.

An attempt has been made in the laboratory to incorporate additional foreign fillers such as wood wool and different types of glass fibres. Although the attempts were not systematic, the trials were considered to be unsuccessful. The added fibres adversely affected both workability and strength because of poor adhesion between the fibres and the silicate matrix.

However, other fillers such as Leighton Buzzard sand, High Alumina Cement, quartz powders from solid glass spheres and artificial pozzolana like p.f.a all showed improvement in compressive strength when employed by this method

CHAPTER 4

STANDARDISATION OF EXPERIMENTAL PROCEDURES

4.1. Introduction

As mentioned in the Preface, the experimental study consists of two parts. The first seeks to understand the background of the established British foundry process which use sodium silicate to bond sand particles. The second section reviews the work which has been done while attempting to adapt some of these ideas to the manufacture of cores for sandwich panels.

The chemistry of sodium silicate and its wide practical applications in the foundry industry and in geotechnical work are well known. (Ref. 95)

However, very little information is available on the silicate bonding of soft granular materials, such as paper pulp and expanded polystyrene beads, to produce cores for sandwich panels with the characteristics mentioned in Chapter 1.2. For this reason, detailed sorting and strength testing programmes for such materials bonded with silicate were carried out.

As a first step in carrying out the strength testing programme it was necessary to devise a method of compacting the mixture of soft materials and sodium silicate binder which could be reproduced reliably. The compressive strength, Young's modulus, shear modulus and shear strength of a composite system can be evaluated reliably only when the Compaction System is satisfactory.

There are many materials that can be bonded with sodium silicate, and in view of the limitation in time and resources in the laboratory, it was deemed to be more important to investigate as many core materials as possible; no tests were made on actual sandwich beam construction.

The experimental investigation ended with the establishment of the relationships between the fabrication process variables and the final



strength properties of the core materials.

#### 4.2 Selection of material of mould for 2" x 4" cylindrical specimen

Perspex and steel are suitable materials for mould construction for use with sodium silicate.

Perspex, being transparent, provides a means of inspecting the actual compaction state of materials inside the mould. (Photographs 31 & 33). However, it is necessary to use steel moulds if the aggregate used is too hard and abrasive in nature. When conducting the torsion and shearing tests on specimens in their mould, these had to be constructed in steel.

#### 4.3 Mixing

The strength, hardness and density of sodium silicate like those of concrete, are directly related to the quantity of water and other agents for gauging. These wet admixtures must be kept to a minimum commensurate with adequate workability.

In this experimental work, liquid sodium silicate was used as this ensured the homogeneous quality provided by commercial suppliers. Viscosity in the range of 100 to 850 cP was found very suitable.

When gauging the samples the following points had to be strictly observed.

##### 4.3.1. Dilution

It is possible to add water to a tank containing one of the commercial silicate solutions. However, local differences of concentration are sufficient to affect the performance of the liquid if the mixture is stirred only superficially. (Ref. 48). So, dilution is generally avoided.

##### 4.3.2. Heating Silicate Solution

Water evaporates from the free surface of any silicate solution but does so most rapidly when the boiling point of water is reached, leaving

a skin which at first appears like a transparent plastic, and which, if not stirred well into the liquid, becomes progressively harder and thicker until a uniform mixture can only be achieved with great difficulty, if at all.

Such films are the result of the rapid rise of viscosity with small losses of water, (Ref. 67,68). This is characteristic, particularly, of the more siliceous products (for example, p.84) having high concentration. Therefore, in this work, heating silicate solution is avoided.

#### 4.3.3. Viscosity

Sodium silicate solutions are thermodynamically unstable and may eventually form crystals. If there is any loss of water, or carbon dioxide is absorbed from the atmosphere the solution would show an increase of viscosity in a much shorter time than intended in the commercial formulation of the solution. Also it is found that shelf life is affected by small amounts of impurities such as may be introduced by the use of hard water (Ref. 67,68).

#### 4.3.4. Length of Mixing time

It has been found from other researchers (Ref. 48) that a prolonged mixing time results in a decrease of the strength because of hardening before the mixture is placed and compacted. On the other hand, too short a mixing time cannot provide a proper distribution of the silicate on the aggregate grains.

4.3.5. Under no circumstances should one attempt to retemper casting silicates, by the addition of further silicate solution or by agitation after the set has commenced.

#### 4.4 Trial Mix Design

This is essential because it enables one to foresee the problems

will be encountered when mixtures of materials are unsuitable for compaction. It also enables one to find out the amount of Binder required (Optimal Binder Content) to mix with a particular type of aggregate or mixture of aggregates, to give the highest strength. This can be achieved by varying the quantity of silicate while keeping constant the amount of aggregates used. The conditions and method of preparation are kept as similar as possible. At least three specimens are required per batch and the results are presented in Chapter 6. Graphical presentation can be found in Chapter 8. Hence, the optimal binder content to give the best strength of a particular composite system can be established. By experience, mixtures which have strengths that fall in the region that cannot even facilitate safe handling will be discarded. The cylinder crushing strength of  $0.01 \text{ N mm}^{-2}$  is about the smallest which can be handled with safety. (Table 6.2. - 6.6.) in Chapter 6, show some of the findings.

The effect of adding one of a number of reagents to the silicate mixture was investigated. The results are shown in Chapter 6, Table 6.1.

#### 4.5 Test Apparatus

##### 4.5.1. Mixing

Apparatus is needed to create a uniform mixture. For this purpose a Hobarrt mixer was adopted, a mixing blade similar to a dough hook was used to perform the mixing in a stainless steel bowl.

##### 4.5.2. Compacting Apparatus

Several different techniques were investigated to assess their suitability for compacting soft granular materials to a prescribed density.

###### 4.5.2.1. A.F.S. Rammer

The first to be tried was the device used in the American foundry industry. Certain modifications were made in an attempt to make it suitable.

However, it was found to be unsuitable. It is impossible to compact paper pulp to high density using the A.F.S. rammer. This has a 14 pounds weight which is dropped from a height of six inches. This does not have the required effect on the relatively soft, resilient material. More critical is that no method could be devised for compacting annular specimens using this equipment. These are required for torsion and shear tests, two methods of obtaining the shear modulus. For these reasons, principally, the A.F.S. method, was discarded.

4.5.2.2. Modified Aggregate Impact Tester, BS 812 (Photograph 32).

The second to be tried was the device used in BS 812. (Ref. 82).

This apparatus was examined because it is provided with a 4.5. kg rammer which could be dropped from a maximum height of about 28 inches. This, as compared with the A.F.S. apparatus (which uses 14 pounds rammer dropping from a height of six inches) is a more promising piece of equipment to achieve good compaction on mixtures in the mould.

Another attractive feature was that ample space was provided to enable the compaction of annular specimens.

After considerable experimental investigation, it was found that a very high number of drops (blows) of this 4.5. kg rammer still could not compact satisfactory the highly resilient materials, such as expanded polystyrene beads. (Photograph 7). A number of blows as high as 50 were applied. The height had to be adjusted after each successive blow to ensure minimum constant impact energy for each blow. The number of blows for materials in the mould was found to be an unrelated parameter for design purposes.

Subsequent reflection on the possibilities offered by the impact apparatus gave rise to doubts about the usefulness of such a test in any possible industrial application.

This is because, in practise, it would be difficult to devise an apparatus to compact, say, 2 inches of sandwich plate core by impact energy; the mass

of the rammer would be enormous and it is doubtful whether it could ever produce cores of repeatable quality in a short time of operation.

However, for hard materials such as expanded foam slags, it was found that this device was usable, although not to be recommended. This is because the risk of breaking up the aggregates into smaller particles cannot be avoided at the expense of a higher number of blows. For these reasons, principally, the modified Aggregate Impact Tester, BS 812 was rejected.

#### 4.5.2.3. Static Compaction System

As energy of compaction/penetration can be applied either dynamically or statically, the third compacting apparatus to be tried was the one used in soil testing.

The loading frame is normally used in soil mechanics testing. (Photograph 15). It is the constant rate of strain mechanical/manual loading system used in the triaxial testing of soils.

After mixing the material/aggregate with sodium silicate in a Hobarrt mixer, the wet mixture had to be compacted to the correct volume, using the correct amount of material in weight. For these reasons, materials was first weighted, and carefully transferred into the perspex mould, (or steel in the case of annular specimens). Pressure was applied manually by rotating the handle and the pressure applied could be measured from the dial gauge permanently fixed on the proving ring. Assuming that lateral expansion due to internal pressure in the mould is negligible, the cross-sectional area of the mould remains unchanged. The volume of the specimen therefore can be calculated if its height (under compression) is known. It was critical that pressure should be maintained while the sample set. However, some loss of pressure is unavoidable due to creep of the aggregate. The whole process of operation was quick, simple and very reliable. For a given blend with known initial gelling time, static compaction has to be performed within a time limit. For this reason, catalysts were chosen that gave an initial

gelling time of ten minutes. This figure was derived by experience from the sum of 3 minutes mixing in the Hobarrt mixer,  $\frac{1}{2}$  minute for transfer of material into the mould with cappings, and  $1\frac{1}{2}$  minutes for observing and adjusting the static pressure applied to the material in the mould. The total time required to produce 3 sample cylinders was therefore estimated to be ten minutes.

In summary, this method provides:-

- (1) easy access for compacting annular and non annular specimens,
- (2) easy access to gassing with carbon dioxide or hot air, while pressure was maintained.
- (3) reliable, simple and quick operation for compacting soft materials and
- (4) moulding pressure was a prime fabrication parameter and therefore can be established for each composite material system.

#### 4.5.3. Strength testing

##### 4.5.3.1. Unconfined Compression - 'E' Type Tensometer

The method of testing was similar to concrete testing. Primarily, in principal, the rate of loading and the magnitude of a given load were the two important factors.

The E Type Tensometer tester was first investigated. This device was found to be unsuitable because it was essentially a tension device and was made to apply compression by means of a system of plates and sliding rods. The friction on the sliding rods was found to be significant despite an attempt to re-align the rods to provide vertical upward axial movement. For these reasons, the apparatus was abandoned.

##### 4.5.3.2. Unconfined Compression - BS 1377 triaxial tester

The second device investigated for unconfined compression strength testing was the constant strain testing apparatus with proving ring used in the triaxial compression testing of soil.

Although it was not an ideal tester, it was found to be reliable. It was finally decided to use this device to determine all crushing strength of cylinders and modulus of elasticity under compression.

The other method of obtaining shear modulus of an annular specimen by vertical shearing was found feasible in using this device.

In summary, the BS 1377 triaxial tester provides these features:-

- (1) for satisfactory compaction of soft materials in 2 inch inner diameter mould,
- (2) for evaluating the crushing strength and modulus of a cylinder, and

for evaluating the shear modulus of an annular specimen.

#### 4.5.3.3. Torsion Tester

The Swedish made torsion tester as shown in Photograph 18 was used for all torsion tests. This apparatus is designed to find the shear modulus and shear stress of stainless steel and other alloys. For this reason, the torque measured from a spring balance, was found unsuitable for the materials in this study. There was also another practical difficulty of how to assemble the relatively soft cylinders onto the tester.

First, to overcome the mounting problem, cappings were made so that they could be removed while compacting material into the mould and fixed rigidly for torsion testing (Photograph 24). The drawings of these caps are in the Appendices. To make the conversion less complicated, one piece of standard steel torsion specimen, with hexagonal heads, was cut into two pieces and they were separately fixed onto the caps. The shorter bar was welded on the base cap while the longer piece was screwed right into the centre steel rod spacer. (Photographs 25,26,27,28,19).

Secondly, to overcome the difficulty of getting torque readings from the spring scale, an indirect method was adopted for the measurement of the torque .

A twist-meter was attached to the length of steel rod between the specimen mounting and the chuck, measuring angle of twist on a 50 mm gauge length. This was calibrated to read torque. The test was stopped when there was no more travel of the needle on the twist-meter. At this torque, it was found that sample was not damaged by torsion at all and for this reason, the same sample was tested for shearing using an adaptation of the constant strain compression tester (Photograph 15). The material's properties had to be kept as similar as possible to draw any fair comparison between the two tests. For the shear test, the specimen was placed as shown in Photograph 15. Two dial gauges were used, one was needed to find the total vertical shearing displacement of the specimen, and the other was used in the proving ring to find the shear force applied to produce such displacement. The loading was at constant mechanical rate of straining.

1.125 mm/min.

#### 4.6. Gassing techniques

Two methods of applying carbon dioxide or a mixture of carbon dioxide with a compressed air were experimented. This was either blowing the gas from the bottom (Photographs 30 and 34) or spreading evenly from top to bottom from a central source. (Photographs 35,32,33).

The major problem to overcome first was to know the best gassing pressure to eliminate blockage and forcing the gas to penetrate evenly and as deeply as possible. Secondly, it was necessary to assess the suitability of either technique for blowing gas into the soft mixture, where, after successful compaction, very little pour spacing remains for the passage of the carbon dioxide.

The problems were not simple to tackle bearing in mind the limited time available to try on other catalyst hardened systems. To study these problems and experimentally, a simple approach was adopted. This was using the  $1\frac{1}{2}$



ton capacity vehicle hydraulic jack as a method of compacting the aggregates in the mould. The initial weight of materials were noted and the aggregates compressed by pumping the hydraulic jack to a specific height. Then the gas was blown either from the bottom upward or the top downward, as shown in photograph 34 and 35.

After a few unsuccessful attempts, the final choice was to use one size of probe. It was 130 mm in length, 5-6 mm internal diameter and was pierced randomly with 1 mm diameter fine holes from the top downward. The other extreme end was sealed to maintain a high pressure profile downward.

A few simple comparisons of the feasibility of the gassed specimens resulted showed that the bottom gassing technique was the most satisfactory and this was adopted. However, the lack of permeable voids in the soft specimens made gassing an unsatisfactory technique with these materials and it was abandoned after sufficient experience had been gained to justify this.

Expanded perlite, being harder and more angular material, although that it required more binder than other, less angular aggregates, could still be adequately gassed and gave adequate core strength. This demonstrated the fact only when easy passage of gas was available will the chemical bonding be effective. (See findings in Chapter 8, Part II, for perlite-silicate system).

To summarise, the Carbon dioxide methods had the following drawbacks

- (1) No guarantee of good penetration of gas into the mix (soft type)
- (2) Wastage was high
- (3) Gradual loss of strength as specimen absorbed water vapour from the air. (Ref. 36).

Therefore, the Carbon-Dioxide silicate process was found very doubtful to provide reliable reproducible strength findings.

CHAPTER 5

THE MATERIALS

It is important that the approximate cost of each material should be checked and compared before any decision is made about the suitability of the material. For instance, Sodium Silicate, a rather cheap and abundant material, would be an economical binder when used with sand because sand is not expensive either. However, other admixtures or aggregates must be found which will give the product the properties of particular interest in this project. In general, materials are needed that are widely available and chemically compatible with all other constituents. Aggregates that have good Fire rating, Lightness and low U value will be selected for study (F.L.U.) Materials that are well established, which may be mixed with little difficulty and have already attracted commercial interests are not subject to this research. For example, sand/sodium silicate mixed well together in the foundry industry. Other materials that have been found difficult to mix, will be subject to this investigation. For example, paper pulps/cement can be mixed only with great difficulty at average water/cement ratio.

The possibility of replacing cement grout by sodium silicate would be an interesting subject for investigation.

Finally, some understanding of the physical properties of each aggregate, such as its angularity, porosity, hardness and specific gravity are of some importance too. The rule of thumb is:

- (a) the harder the material the more difficult it is to be compressed or compacted.
- (b) Aggregate that is more porous tends to be less hard and easily crushed to powder by pressure during compaction.

- (c) Lack of roundness of aggregates will require higher binder content to give sufficient chemical bonding between two particles.
- (d) Higher binder content will result in a longer time for achieving complete dehydration, resulting in poor early development in strength.

This chapter is divided into three sections:

- 5.1 will deal with the types of aggregates used in this study. They are tabulated and the reasons of choosing particular aggregates will be discussed later.
- 5.2 will be devoted to describing the various aspects of using artificial fillers, catalysts, conditioners and pozzolanas, to improve setting rate and strength.
- 5.3 will outline the types of I.C.I. Sodium Silicate binder used. Their advantages and limitations will also be reviewed.

#### 5.1 Aggregates

The types of aggregate used in this work are tabulated in Table 5.1. It is difficult to obtain up to date information about the exact cost per tonne of each material. Information, if obtained, will soon be out of date and would be unrealistic to present to the reader. As a guide, £500 per tonne would be a very optimistic figure.

Expanded Perlite is the only material that has to rely completely on overseas supply (Greece and Iceland). The raw material before processing by Tilcon is called PUMICE. This is, essentially, a solidified aerated lava, usually acid in constituent character (Granitic).

The quality of pumice varies according to the season of eruption and also depends on the geological region of the volcano. For example, the Greek pumices are purer and whiter, and hence more expensive than

Icelandic types. One thing distinctively different between some pumice and perlite is in their pore structures; where pumice has closed cells, perlite on the other hand, has opened cells (interconnected). This explains why perlite is quite ready to absorb liquid from the surroundings. Because of their porous nature, both materials are light, fire resistant, and have good thermal insulation value.

The lightest of all aggregates was expanded polystyrene beads. Unfortunately, this material has no fire resisting capability and softens at 70°C. It has high resilient quality. Other disadvantages include its possible attack by some organic solvents. It was found that Diacetin dissolved the beads within an hour. Polystyrene concrete has been used successfully in light weight non-structural panels, flooring design, and marine concrete (Ref: 53). Segregation between the lighter beads and heavier mortar is still a construction problem to be solved. Poor strength of the final product is another area of concern. It was thought that by varying the cement/silicate ratios these problems can be tackled.

Vermiculite has all the 'F.L.U.' advantages as previously defined in the beginning of this chapter. It resembles sawdust when at same particle size. It will be shown later, by experience, that this material proved to be the easiest to handle, to compact, and has strength from moderate to high values.

Expanded perlite, expanded polystyrene beads and exfoliated vermiculite are used successfully in lightweight concrete. The materials are easily obtainable and have met most of the conditions previously defined in the beginning of this chapter. (F.L.U.)

Paper pulps, when recycled, are only used by the paper mill as a secondary fibre. The best optimum water content found by Scapa Engineering Ltd. was 40-50%. This enabled the compressed pulps to be

handled with little breakdown during transportation. However, the pulps we received from SCAPA contained some 60-70% water content, which was highly undesirable. But to enable parallel study with other four types of aggregate, it was decided to oven-dry the pulps before they were mixed with silicate. Later in the study the optimum water content required to be mixed with a type of silicate will be examined. The reason for choosing paper pulps was the obvious one. Today paper recycling is a fast expanding business.

Finally, reasons for choosing Vacu-blast beads were:

- (1) Economy
- (2) Very high  $\text{SiO}_2$  content
- (3) Hardest among the other four aggregates.

As explained earlier, certain chemicals that are present together with the material, may either speed up the setting time, or retard it.  $\text{SiO}_2$  content in the sand is believed to be responsible for the rapid setting in the sand/silicate/ $\text{CO}_2$  process.

## 5.2 Binders

Three types of I.C.I. sodium silicate were used in this study. They were P84 (silicious), C112 (alkaline) and K95 (moderate).

The chemical composition of these binders is tabulated in Table 5.2

There were several quite different reasons for choosing these binders. One of the reasons was the recommendation of I.C.I. Others, as already mentioned earlier in Chapter 2, are to do with the properties and behaviour. The more silicious material, (e.g. P84), dries quicker and gives more elastic bonding. On the other hand, the alkaline type, (C112), exhibits bondings that are less elastic and are more soluble in water than the silicious type, e.g. P84.

Table 5.1

Type	Commercial Name	Particle Size $1\mu\text{m} = 10^{-3}\text{mm}$	Approximate apparent density $\text{kg}/\text{m}^3$	Remarks
Polystyrene	1. Shell	+ 1200 to + 2400 $\mu\text{m}$	16	1. Pre-expanded type. White and spherical.
	2. Monsanto	+ 350 to + 800 $\mu\text{m}$	25	2. Non-expanded type, Semi-transparent and spherical. Both are softened at $70^\circ\text{C}$ . Impermeable by water but dissolved in most organic solvents.
Vermiculite	Dupre 1. DSF and 2. MICAFIL	1. $0 < \text{Fine} < 1000$ $\mu\text{m}$	Exfoliated: 1. 104 - 144 2. 88 - 112	Both are 'exfoliated' type. Brownish appearance. The DSF grade when compacted looks very much like compressed sawdust of the same particle size.
		2. $0 < \text{Fine} < 2000$ $\mu\text{m}$		
Perlite	Tilcon 6 JL	More than 50% retained on +1200 $\mu\text{m}$ sieve	126 - 142	Expanded Perlite is a white powdery product. The particles are angular and have irregular shapes. It is a type of pozzolana, which when mixed with water and lime provided cementitious value as cement.
Glass (solid)	Vacu-Blast beads	1. 400-600 $\mu\text{m}$ 2. 55-100 $\mu\text{m}$	1500	This is of solid soda-lime glass balls. It is largely used in impact finishing industry. Softening point at $730^\circ\text{C}$ .
Paper Pulp	Scapa Engineering	+ 2400 $\mu\text{m}$ to $\frac{1}{4}$ inch	Depending on moisture content of the pellets. Minimum moisture content at about 45%.	There are four types of wastepaper currently collected and recycled. They are: wallpaper, general use, domestic and advertisement pamphlets. Moisture content as high as 70% and they have to be dried out before use in this work.

Grade	Weight Ratio $\text{SiO}_2 : \text{Na}_2\text{O}$	Molecular Ratio $\text{SiO}_2 : \text{Na}_2\text{O}$	Specific Gravity Degree Baume	Approximate Viscosity at $20^\circ\text{C}$ (centipoises) <sup>†</sup>
A140	1.6	1.65	59.5	25,000
C140	2.0	2.05	59.5	90,000
C125	2.0	2.05	55.8	4,500
C112	2.0	2.05	51.8	850
C100	2.0	2.05	48.1	200
E100	2.2	2.28	48.1	220
H100	2.4	2.50	48.1	310
H112	2.4	2.50	51.8	2,500
K95	2.7	2.80	46.7	350
L96	2.85	2.95	46.8	500
M75	2.9	3.0	39.4	100
P84	3.2	3.3	42.7	850
Q79	3.3	3.4	40.8	350

<sup>†</sup>1 poise = 100 centipoise. Water has absolute viscosity of 1 centipoise. Olive Oil has a viscosity of 84 centipoise, Castor Oil has a viscosity of 990 centipoise (all at  $20^\circ\text{C}$ ).  
The pH of Sodium Silicate Solutions lie in the range 10 - 12.

Table 5.2      Some Typical Data for the Grades of Silicate

made by I.C.I. (Ref: 48)

### 5.3 Fillers and hardeners

In the concrete block manufacturing industry, the use of a filler, such as Pulverized ash, has two roles; to reduce the Portland Cement requirement and to provide a fine inert filler. A hardener, or sometimes called catalyst, is an agent that accelerates certain chemical reactions. Just as cement can be inorganic and organic, hardeners for silicate are also classified as inorganic and organic. They take the forms of powder, liquid and gas. For example, an ester (organic) is in liquid form, most calcium salts are in powder and  $\text{CO}_2$  is a gas obtained from pressurised cylinders.

In Chapter 2, Section 3 and Section 4, the mechanism involved in the hardening of silicate has been discussed. During the chemical reaction certain harmless by-products, like water and gas, should be controlled to the minimum. A rapid loss of water from the gel will cause a serious shrinkage problem. Massive production of gas will subsequently increase the amount of trapped air in the set gel. In both cases, strength will be critically reduced.

It is important to note that the speed of setting the silicate is independent of the final strength. For more reactive response, the initial strength can be higher than the less reactive ones. However, experience showed by other suggested that the final strength of a speedy reaction type is expecting to be lower than the milder reaction type. (Ref. 36 ). For this reason, the required proportion of a filler and a catalyst can be vital. It will be shown later that the amount used of a filler and a hardener is responsible for the stiffness and compressive strength of the end product.

The simple gel test suggested by Ref. 63 was adopted. For most preparation conditions, an initial gel time of fifteen minutes, was acceptable for practical reasons.

Table 5.3 shows the list of fillers and hardeners used and the general comments for their use.



Table 5.3

List of materials used.

Name	Filler or Hardener	General comments for its use
Burnt Lime, CaO	F + H	100% passing 3mm, 40% passing 150 microns. Active CaO content about 92%. Colour White
Hydrated Lime, Ca(OH) <sub>2</sub>	F + H	95% passing 75 microns. Colour white
Leighton Buzzard Sand	F	850 to 1200 microns, particle size.
Vacu-Blast Beads (Solid Glass Spheres, S.G.S.)	F	A type of soda-lime glass bubble. Bulk density about 1500 Kg/m <sup>3</sup> . Particle ranging from 400 to 600 microns, and 55-100 microns. Softening point at 730°C. £9.15 per 25 kg. Colourless. Largely used in impact finishing industry.
Cenospheres (p.f.a.)	F + H	A type of siliceous and aluminous material. No fire resistance. Spherical, mean diameter of 100 µm, apparent density 500 kg/m <sup>3</sup> . Cost virtually nothing. Grey in colour.
A.M.I. Atmospheres (Hollow Glass Sphere, H.G.S.)	F + H	Majority of the balloons falling in the 80-100 micron size. Also rich in siliceous content. Grey in colour.
SECAR 250	H	A type of high alumina cement. Very rich in aluminous content. White in colour.
DIACETIN (DIA)	H	Leek's Organic ester, Colourless. Attack polystyrene beads. Most reactive type. £600-£800 per metric ton.
TRIACETIN (TRI)	H	Leek's Organic ester, colourless. £600-£800 per metric ton.
Ethylene Glycol Mono Acetate (E.G.M.A.)	H	Leek's organic ester, colourless, £600-£800 per metric ton.
Ethylene Glycol Diacetin (E.G.D.A.)	H	Leek's Organic ester, colourless. The least reactive type. £600-£800 per metric ton.
Carbon Dioxide (CO <sub>2</sub> )	H	Distiller's type. In pressurised cylinder.
Ashland Organic Esters 3300 & 4000	H	Basically similar to the Leek's type mentioned above. An American product, hence expected to be more expensive than Leek's. Colourless in liquid form.
R221 & R222	Con- ditioner (liquid)	I.C.I. Masonry Water repellents. Compatible with all silicate and increase insolubility of the gel. Very expensive material.
PENTRON-ON	Con- ditioner (liquid)	A.B.M. Chemical's type. An anionic surface agent, the sodium salt of 2 ethylhexyl sulphate. It is basically assemble to washing-up liquid (hence cheap), which is believed to be the initiator. Foam life is affected by the alkalinity of the silicate (reduced). It can increase the workability of the mixture.

CHAPTER 6

TRIAL MIX DESIGN

6.1 Introduction

Paper pulp aggregate was initially chosen for mixing with silicate binder. This is because the department had been offered a large supply of the material by a commercial undertaking which planned to construct a plant for the recycling of waste paper nearby. This promised supply never materialised, however, so that other aggregates were sought and used, even though future prospects of paper-pulp pellets may be attractive.

Laboratory trials were attempted to produce paper pulp from waste hand-towels obtained from various places within the department. A Hobarrt mincer was borrowed to try to break down the paper fibre and hopefully to compress into paper pellets. The attempts were unsuccessful because there was not enough power to compress and cut down the paper into pulp. It was finally decided to use shredded paper as raw material. It was hoped that by boiling the shredded paper and further soaking for about one day, that the difficulties would be overcome. Later it was found and proved that the Hobarrt mincer was still incapable of handling paper.

As paper pulp was not available as promised, an attempt was made to find mixes that would produce similar results with available materials. This brought out the need to develop mixes which would satisfy the same requirements - lightweight, good insulation, sufficient shear stiffness and repeatability, and would be suitable for a similar range of assessment tests as would have suited the paper/silicate.

6.2 Gel tests

This test was intended to find out the time required to gel the sodium silicate solution by a given catalyst. The gel time is directly

related to the type of silicate used and to the quantity of the hardener employed. For a known silicate, 100 gm of this solution was mixed with 10 gm of a given catalyst suggested previously in Chapter 5. Gel time was taken as the time required to stop fluid from pouring from the corner of the container. By experience, semi-rigid gel was formed on the top surface. The final set time was the time taken when the gel changed completely into solid. The final colour of the solid depended very much on the original colour of the catalyst itself. Gel time greater than one hour was discarded. The test was repeated by increasing the amount of the catalyst. Catalysts that had been tried and found satisfactory are tabulated in Table 6.1. Some catalysts were known to be unsuitable under the conditions of the test, and would have proved unsuitable in practice. This was demonstrated in the laboratory before the materials were rejected.

### 6.3 Some examples of the mixes

#### Example 1: Perlite/C112/CO<sub>2</sub>

The aggregate was expanded perlite and the silicate used was I.C.I. C112 grade. The catalyst was CO<sub>2</sub> gas. The aggregates were sieved mechanically and collected as +300 μm, +600 μm and +850 μm.

The volume of the aggregate was measured from a beaker and the volume of silicate used was also noted. The mixing was done by a small portable electric mixer. Two problems arose during mixing. They were:

- (1) The aggregates absorbed quite readily the silicate present. For this reason, the final required silicate content was high in order to give a sufficiently wet mix.
- (2) Aggregates were found broken into smaller pieces and for this reason, mixing had to be carried out with extra care.

The mixture was transferred into the 2" diameter mould and finally compacted. The AFS sand rammer was used. This rammer is widely used in the foundry for compacting sand/silicate mixture. After some experience it was found that this rammer was not suitable. Larger particles were not suitably and easily compacted by a 14 pound weight rammer dropping from a height of approximately 6 inches. However, some samples were compacted and gassed by CO<sub>2</sub>. Table 6.2 shows the findings. It was discovered that the +300 (smallest) gave higher strength than the others.

As most of the particle rangings fell in +2400 region (see Appendix for particle distribution), it was decided to carry out tests using +2400 perlite. This time the analysis was carried out completely by weight. This made it possible to find the actual binder content used by weight. Table 6.3 shows the findings. The A.F.S. rammer was again used.

Example 2: Monsanto Beads/C112/CO<sub>2</sub>

The beads were unexpanded. Again, the A.F.S. hammer was used. As the beads were very much harder than perlite, satisfactory compaction would have been achieved more readily by vibration. Table 6.4 summarises the findings. CO<sub>2</sub> flow rate at 34 lit/min and at 20 p.s.i.,

In the above series of tests (Example 2), there was doubt about the penetration of CO<sub>2</sub> to the mixture eventually. For this reason, an organic catalyst was used. The A.F.S. rammer was used for compacting the particles. Table 6.5 shows the findings.

Example 3: +1200 Shell/C112/CO<sub>2</sub>

Expanded polystyrene beads of +1200 μm were supplied by Shell Petrochemical (U.K.) Limited. Aggregates containing particles that are larger than 1.2 mm were found unsuitable. This is because the resilient

property of the beads prevented the beads from being stuck together by the silicate. Experience showed that neither dynamic nor vibration compaction was appropriate. Static compaction by applying heavy loads on top of the specimen showed some elimination of the resilient recovery of the beads. Table 6.6 shows the findings.

The above examples suggest that strength is related to the method of compaction. Other factors are the angularity and size of the aggregates and their hardness. The CO<sub>2</sub> process was found to give much better strength development than the organic-ester method. Monsanto beads were found unsuitable for stabilization by sodium silicate. They formed a very dense specimen yet very weak in strength. Unless the method of compaction is modified for +1200 expanded polystyrene beads, there is little hope for expecting any cohesion among particles by the presence of sodium silicate binder. The examples demonstrate that the choice of method of compaction, for example, whether it should be dynamic or static, will depend on the type of aggregate to be used.

P84 GRADE

Types of Hardeners	EGDA	EGDA	EGDA	TRI	TRI	TRI	3400	4200	4300	4400	TRI/DIA (70/30)	CETOS	CETOS	CETOS/CaO (50/50)	CETOS/SGS (50/50)	CETOS/Pfa (50/50)	RHC	CETOS/Ca(OH) <sub>2</sub> (50/50)	CETOS	SFCAR/CaO (50/50)	Pfa/CaO (50/50)	
Composition (by wt.)	100/3	100/5	100/15	100/10	100/10	100/10	100/10	100/10	100/10	100/10	100/3	100/10	100/15	100/20	100/20	100/20	100/20	100/20	100/20	100/20	100/60	
Initial Gel (min.)	15	12	7	1 hr	1 hr	1 hr	50	2	15	1 1/2 hr	35	4 hrs	40	30	35	<1 hr	<1 hr	18	<20	<20	2	
Recommended Blends	P84/EGDA = 100/3 , P84/(TRI/DIA:70/30) = 100/3 , P84/RHC = 100/20 P84/EGDA = 100/5 , P84/(Cetos/RHC:50/50) = 100/20 , P84/(Pfa/CaO:50/50) = 100/30																					

C112 GRADE

Types of Hardeners	RHC	CaO	Ca(OH) <sub>2</sub>	RHC	RHC	CaO	OPC	OPC	SECAR/OPC (50/50)	Pfa/CaO (50/50)
Composition (by wt.)	100/10	100/30	100/50	100/30	100/25	100/50	100/20	100/40	100/20	100/20
Initial Gel (min.)	4 hrs	10	10	>1 hr	20	3	>1 hr	>1 hr	>1 hr	>4 hrs
Recommended Blends	C112/OPC = 100/20 , C112/(OPC/CaO:50/50) = 100/20 , C112/CaO = 100/30 , C112/(OPC/Secar:50/50) = 100/40 , C112/RHC = 100/10 , C112/(CaO/Pfa:50/50) = 100/30									

Types of hardeners	H100	K95	M75	C125	I96	C140
Recommended Blends	1. 30/70 DIA/EGMA 2. DIA 3. 50/50 DIA/EGMA 4. 40/60 DIA/EGMA All 100/10	1. 30/70 DIA/EGMA 2. 40/60 DIA/TRI 3. 50/50 DIA/EGDA All 100/10	1. +200 µm foam slag residue 2. +150 µm foam slag residue All 100/100	1. RHC (100/10) 2. Ca(OH) <sub>2</sub> (100/30)	1. RHC (100/20)	1. RHC (100/10)

Foot Notes: OPC-Blue Circle ordinary Portland cement      SECAR - High Alumina cement, SECAR 250      CaO - Burnt Lime  
 RHC-Rapid Hardening cement, Ferrocrete of Blue Circle cement      3000-4000 - Ashland Esters      Ca(OH)<sub>2</sub> - Hydrated Lime  
 DIA-Diacetin      TRI - Triacetin      EGMA - Ethylene Glycol Mono Acetate      EGDA - Ethylene Glycol Diacetate

TABLE 6.1

Table 6.2 Perlite/C112/CO<sub>2</sub>

CO<sub>2</sub> flow rate = 34 lit/min . at 20 psi

Particle size (μm)	Perlite/C112 (by vol.)	CO <sub>2</sub> gas-time (sec)	Age at test (day)	No. of blows of hammer	Height of specimen/diameter ratio	Comp. Strength (N/mm <sup>2</sup> )
+ 300	33 : 1	30	1	5	1.1	0.46
	51.6 : 1	30	1	5	0.7	0.89
	53.3 : 1	30	1	5	1.0	0.49
+ 600	15.3 : 1	30	1	5	0.6	0.09
	15 : 1	30	1	5	0.9	0.07
	24.6 : 1	30	1	5	1.0	0.22
	24.6 : 1	30	1	5	0.9	0.58
+ 850	10 : 1	30	1	5	0.6	0.15
	16 : 1	30	1	5	0.6	0.14
	16.5 : 1	30	1	5	0.6	0.23

Table 6.3: + 2400 Perlite/C112/CO<sub>2</sub>

CO<sub>2</sub> flow rate at 34 lit/min and at 20 psi

Perlite/ C112 (by wt.)	CO <sub>2</sub> gass- time (sec)	Age at test (day)	No of blows	Height/ diameter ratio	Binder Content, % by wt.	Bulk density Kg/m <sup>3</sup>	Comp. Strength (N/mm <sup>2</sup> )
129 gm/ 255 gm  0.5	30	1	5	0.8	66	1079	0.10
		1		1.2		990	0.04
		1		1.1		1054	0.05
		1		0.9		590	0.11
0.5	30	4	5	0.7	66	585	0.17
		4		0.7		573	0.16
		4		1.0		568	0.10
		4		1.2		592	0.07
		4		1.1		600	0.08

where:

$$\text{Binder Content} = \frac{\text{wt. of Silicate Binder}}{\text{wt. of Silicate Binder} + \text{wt. of Aggregate}} \times 100\%$$



Table 6.4: + 850 MONSANTO/C112/CO<sub>2</sub>

Monsanto/C112 by wt.	CO <sub>2</sub> gass- time (sec)	Age (day)	No. of blows	Height/ Diameter ratio	Binder Content % by wt.	Bulk Density Kg/m <sup>3</sup>	Comp. Strength (N/mm <sup>2</sup> )
797/76 = 10.5	30	2	3	1.5	8.7	717	0.13
						704	0.18
						702	0.16
797/117 = 6.8	30	1	3	1.0	13	612	0.13 <sup>†</sup>
							0.37 <sup>a</sup>
							0.37 <sup>b</sup>
							0.41 <sup>c</sup>

† without CO<sub>2</sub>

a without capping

b with wooden cappings

c with cinter-brass cappings

Table 6.5: + 850 MONSANTO/C112/EGMA

Monsanto/ C112 (by wt.)	EGMA (gm)	Age (day)	No. of blows	Height/ Diameter ratio	Binder Content % by wt.	Bulk Density Kg/m <sup>3</sup>	Comp. Strength (N/mm <sup>2</sup> )	Curing Method
797/119 = 6.7	0	2	3	1.0	13	1389	0.09 0.07 0.07	Baked at 70°C for 18 hrs. then followed by air drying
6.7	6	2	3	1.0	13	1389	0.03 0.01 0.01	Baked at 70°C for 1½ hrs. then followed by air drying
6.7	11	2	3	1.0	13	1389	0.06 0.03 0.06	

Table 6.6: + 1200 Shell/C112/CO<sub>2</sub>

CO<sub>2</sub> flow rate at 34 lit/min at 20 psi  
 30 pound dead load was applied on the top  
 of the specimen. During this process, some  
 binder was lost due to squeezing effect  
 by the load.

Shell/C112 (by wt.)	CO <sub>2</sub> gass- time (sec.)	Age (day)	Bulk Density Kg/m <sup>3</sup>	Binder Content (% by wt.)	Comp. Strength N/mm <sup>2</sup>
53/196	30	3	110	78	0.0094
≈ 0.27					0.0074
					0.0094
					0.0062
					0.0064
					0.0046
				Av.	0.0072

CHAPTER 7

TEST EQUIPMENT

7.1 Introduction

As described earlier in Chapter 6, expanded perlite, unexpanded beads and expanded polystyrene beads range from hard spherical particles to soft granular ones. The choice of compaction for soft material, like expanded polystyrene beads, would be either by the use of dropping a dead weight (dynamic method) or by a static loading method, for example, using a hydraulic loading method.

The ideal stage of compaction would be when aggregates achieved good interlocking by a mechanical means as well as good bonding strength achieved at adjacent aggregate particles by the assistance of a chemical binder. The physical (mechanical) bonding is predominantly important when chemical reaction is still progressing to achieve stronger bonds. A device was, therefore, needed which would be able to provide good mechanical compaction while chemical bonding by silicate was still taking place.

Several devices were suggested and tried in the laboratory. Their performances ranged from unacceptable to acceptable level. They were:-

- (i) A.F.S. sand rammer,
- (ii) BS 812 Aggregate Impact test apparatus
- (iii) BS 1377 Standard compaction apparatus
- (iv) Static loading using a mechanical loading device designed for use in soil mechanics testing.

(i) The A.F.S. sand rammer was designed specifically for the foundry industry where sand and silicate mixture can be readily compacted into 2" by 2" specimens. This method is very useful for aggregates having about the same particle size and hardness as sand. The basic principle is to allow a dead weight of a 14 pound rammer to drop from a height of

six inches. The degree of compaction is achieved by varying the number of drops of this rammer.

(ii) & (iii)

BS1377 suggests two dynamic methods; by allowing a 2.5 Kg rammer or a 4.5 Kg rammer to drop from a specified height. The apparatus resembles the British Standard Aggregate Impact tester. For the purpose of soil, this device enables the dry density moisture content relationship to be found. This was a more attractive apparatus because it provided much higher dynamic impact pressure than the A.F.S. sand rammer method. Another advantage was its ample space at the base plate where the steel mould is clamped. For this reason one can envisage that the rammer may be modified to enable an annular specimen to be satisfactorily compacted. This has important implications for later work in this project.

(iv) BS1377 Unconfined compression apparatus still remains an effective means of determining the shear strength of soils which are taken from shallow bore holes or trial pits during the design of roads, runways and light building construction. This apparatus utilises a 10 kN (2250 lbf) capacity mechanical load frame which can be supplied either hand operated or motorised. The load frame was ideally suited for the compaction of silicated-aggregates as well as for carrying out the unconfined compression test. This device, as will be discussed in the next section, was later adopted to compact most silicate/aggregate mixes. Samples were then stripped and tested in unconfined compression, using the same loading frame. With very little improvement of this apparatus, it will be shown in the next section how it was also adopted to find the shear modulus of an annular specimen by two methods.

7.2 A.F.S. Sand Rammer (Dietert Design) with accessories

The A.F.S. stands for American Foundry Standard. This rammer is intended for standard strength test under compression of a 2" by 2" sand/silicate specimen. Because sand is relatively harder and more uniform in shape than some of the soft, granular materials such as expanded perlite and expanded vermiculite, there is no difficulty in compacting satisfactorily by a small effort and hence a small rammer.

The general instruction concerning the use of this rammer has been discussed previously, but a more detailed description should be consulted in the Appendix.

As sand was not the interest of this work, one can envisage many disadvantages and problems arising when using it for compacting materials other than sand. One of the major reasons for abandoning this apparatus was that it left no choice for one to prepare annular specimens for torsion and shear tests, two methods of obtaining the shear modulus. This was an important aspect of this study. For this reason, it cannot be regarded as satisfying standard laboratory needs in this work.

7.3 Modifications to the Aggregate Impact Tester

The objective when working with this piece of apparatus was to design a dynamic compaction device to compact soft materials in a mould (either made from perspex or steel), with better compactive effort than can be achieved by the A.F.S. rammer.

The first, simple modification of the standard design enables specimens to be compacted, gassed and readily removed from the base plate.

A second rammer with a hollow section was designed so that specimens can be prepared for shear or torsion tests. The features and detailings are shown in the Appendix.

Major difficulties encountered were:

(i) It was found to be impossible to compact expanded polystyrene beads satisfactorily. This was mainly due to the high recover or resilient nature of the beads. This characteristic made it impossible, in practice, to form the specimens so that the ends were parallel and levelled with the platens of the compression tester. Clamps were designed in which the ends of the specimen could be made smooth and parallel after compaction. Other methods, such as applying static loads on the top of the mould, all proved very inefficient.

(ii) At high binder content, losses of silicate gels often occurred. The impact load forced the fluid to eject from the ends of the mould. The loss of gels was highly undesirable because the actual amount of gels left prior to hardening was difficult to determine. This often occurred with polystyrene/silicate mix as expanded polystyrene beads are highly impermeable and do not absorb any fluid or moisture easily.

(iii) The setting times of gels have to be chosen so that sufficient time is allowed for the formation and compaction of the specimen. Gel times of 30 minutes to one hour were found to be suitable.

(iv) The number of drops (or number of blows) of rammer was high for soft materials. This caused physical exhaustion in the operator. For example, 7 to 20 blows at a constant drop height.

(v) The present design did not provide an easy adjustment towards the control of height of the rammer.

(vi) There was a significant loss in compaction energy during each drop of rammer. Efficient compaction is not readily obtainable using this dynamics compaction technique with soft granular materials.

It was found that specimens prepared by this apparatus have relatively low strength, unless the required number of blows be drastically increased. With harder materials, for example, expanded perlite, no trouble was experienced in obtaining good compaction effort with a low number of blows. The steel mould was preferred to the perspex mould for harder materials. This is because harder materials could be compacted well enough to generate a large bursting force on the mould, whereas the resilience of the softer materials prevented this. For this reason, the perspex mould was not used for expanded perlite/silicate mix, this is to avoid damage to the mould.

The reasons for choosing perspex moulds were that they were 2" inner diameter and transparent. Therefore the instant calculation of the bulk density can be carried out because the volume could be assessed. They also provided easy access for the control of specimen height to 4 inches. The state of the compaction effort can be previewed. In some cases, compaction cracks can be spotted more easily. Compaction cracks were formed due to the local difference in density and moisture content at very high numbers of blows. The cracks were large enough to be visible and occurred radially along the plane of the specimen. When static loads were applied, perspex had been tested up to  $1.5 \text{ N/mm}^2$  of internal pressure (or moulding pressure) without any reinforcement by circular hose clips on the outer wall.

#### 7.4 Final Compaction Method

The two methods, by A.F.S. and the modified aggregate impact apparatus both have their limitations. They did not facilitate sufficiently good compaction. The results of strength tests later suggested that very high binder content was required because of the poor compaction achieved with the aggregate particles. To provide adequate void-filling, 40%-50% of binder content would have been required. At such high binder content,



loss of sodium silicate during dynamic compaction usually occurred. For this reason, strength test results gave poor repeatability.

As the number of drops of the rammer are directly proportional to the compactive effort, the dynamic energy can also be related to the equivalent static energy. It was decided finally to use the BS1377 unconfined compression apparatus as the final choice for the specimen's compaction.

The motive power for applying pressure can be either electrical, at uniform strain rate, or manual. Good repeatability was achieved and therefore the number of specimens required to obtain reliable results was greatly reduced.

The present moulding pressure (or forming pressure) can be operated from 0.0 to 4.9 N/mm<sup>2</sup> ( 0.0 to 715 psi). Provided that the maximum applied load does not exceed the allowable load of the proving ring and the mould sustained this pressure. Proving ring of 1 tonne (1000 kg) capacity was found more than adequate for compressing soft materials in the perspex mould.

#### 7.5 Compression Tester

This device, the BS 1377 unconfined compression apparatus, is a simple test for finding the strength of the material, and can be made to give a rough idea of the modulus, E. The loading rate for uniaxial - unconfined - compression test on cylindrical a specimen was 1.125 mm/min.

Another advantage of this simple device was its use in finding the shear modulus, G, of the specimen. There were two proposed methods of finding G from the same specimen. The first one was obtained by axial shearing and the other was by torsion. When the specimen was applied under shear or torsion, there is a method of obtaining its shear modulus.

The silicate mixture was first placed in the mould and compacted by static compression. The required pressure was noted. After the elapse of a given dwell time at a given pressure, the specimen was extracted and stored. This specimen was later used for finding the compressive strength and E. To find the shear modulus, a different specimen had to be prepared by slight modification on the compactive rammer. For preparing a shear specimen, the rammer had to be hollow so as to accommodate the steel rod (plunger). This specially drilled rammer was loaded on top of the mixture, while the steel rod was standing upright in the mould. The apparatus was carefully designed so that the friction between the mould and the rammer, and between the rammer and the plunger, were kept to a minimum. After successive application of loads, the charged mould was stored for one day. The mould together with the plunger, which was sticking out from the rim of the mould, was carefully placed on the compression tester. The load was gently applied initially by manual means until contact between the platen of the proving ring to the surface of the plunger was achieved. Then the tester was switched to electrical control to ensure uniform strain rate. The maximum deflection of the proving ring was recorded from the dial gauge and the force (or load) found. Shear modulus was found using the expression in Appendix III .

#### 7.6 Torsion Tester

The torsion tester is primarily designed for undergraduate laboratory work. The torsion specimen is usually an alloy bar with two hexagonal ends for attachment to the grips of the machine. This simple device enables one to determine the, G, the shear modulus, and the shear stress at the limit of proportionality and facilitates the study of the general characteristics of the material under the action of a torque. The specimen is mounted in the torsion testing machine. Load is applied and increased slowly to

failure. At each increment of load, the torsional strain is recorded using the angular measuring device and the angle of twist over a gauge length of 50 mm as recorded, by the torsion meter.

This device was the only means at hand for obtaining the modulus,  $G$ , by a torsion test. Before it could be used it was necessary to modify the apparatus so that a specimen can be mounted in the torsion tester. The method of applying torsion to the specimen was similar to that used for the more usual metal specimen. The socket has a permanent hexagonal attachment projecting axially from the base of the collar. The plunger was threaded so as to allow a hexagonal bar to be screwed into it. The collar ring was designed so that the mould can be rigidly mounted into it, this being the rotating end. It was contemplated that the tests be carried out on the same sample as had been used for the axial-load shear test. The annular specimen first tested under axial shearing, was then transferred to the torsion tester for a destructive torsion test. In the event, two specimens were made at the same compaction condition and binder content. One was tested in axial shear and the other by torsion. The results were compared with those obtained using the same specimen in both the tests. It was found that results of  $G$  for the specimen first tested by shear then by torsion were similar to the separated tests on two specimens. This justified a saving in time, reliability of the tests and also satisfied the intended design objective.

CHAPTER 8

DETAILED TESTS ON CHOSEN MIXES

8.1 Objectives

Four main types of composite mixes were finally chosen. They were (i) Wall Paper/Silicate, (ii) DSF Vermiculite/Silicate, (iii) Expanded Polystyrene Beads/Silicate and (iv) Expanded Perlite/Silicate. Four grades of I.C.I. Silicate were selected, namely, P84, L96, K95 and C112; the  $\text{SiO}_2/\text{Na}_2\text{O}$  ratios ranging from 3.3 to 2.0 respectively. There were four different powder hardeners used, namely, 50/50 by weight of CETOS/SGS,\* SECAR (H.A.C.), SECAR + Burnt Lime (CaO) and CETOS<sup>†</sup> alone. One ester blend was also used as a catalyst. This was 50/50 by weight of DIA/EGDA. Finally, for the  $\text{CO}_2$  process,  $\text{CO}_2$  gas was used as a catalyst.

The reasons for the final choice of these materials to be used were quite obvious. A diversity in the character of raw materials was intended, but there were general similarities. They were all lightweight when dried and in granular forms. They were also found to be easily mixed with Silicate and compatible to the compaction apparatus. This resulted in good repeatability and reduced in actual time for preparing a sample.

The test programme was centred upon two main areas of concern. First, there was a test to establish factors influencing the structural strength and stiffness of the materials and mixes; and secondly, a test for the evaluation and verification of the shear modulus of the materials by two methods.

The theoretical basis for the tests will also be outlined, and in particular, the proposed shear tests, which were originated in this project for this specific purpose.

---

\* SGS = Solid-Soda lime - glass spheres

† CETOS = Dicalcium Silicate.

## 8.2 Theory

### 8.2.1 Compression Test

The compressive strength test is used largely for concrete specimens and it was adopted for this work. This was a simple, conventional, unconfined compressive strength test on cylinder specimens. The height to diameter ratio was kept close to 2. All the height of specimens was controlled to 100 mm, and therefore, the diameter of the specimens was kept to 50 mm. Some variations in dimensions happened, especially in the more resilient aggregate, such as expanded polystyrene beads.

The actual amount of mixture (by weight) was measured and the compaction effort in terms of a pressure to form a specimen of height of 100 mm was also taken. By trial and error, the minimum quantity of material required to provide safe handling can be obtained.

A constant-rate-of-strain screw jack and loading frame such as may be used for triaxial testing of soils was used. The load was read from the proving ring attached to the mechanical load frame. The total deformation when compression took place was taken from a separate dial gauge, which was in contact with the platten.

Stress and strain at fracture and specimen modulus were obtained from the straight line stress-strain graphs.

8.2.2 Shear and torsion tests

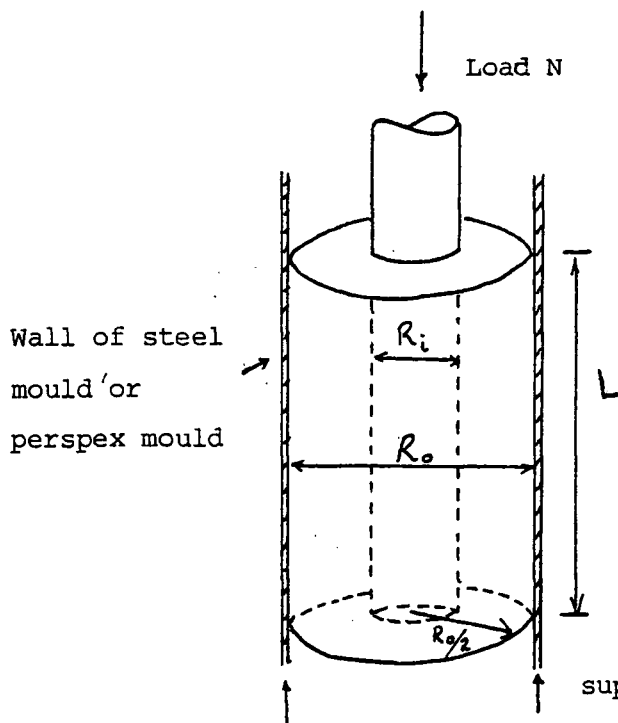

SHEAR TEST

$$\text{Stress} = \frac{N}{\text{Cross sectional Area}}$$

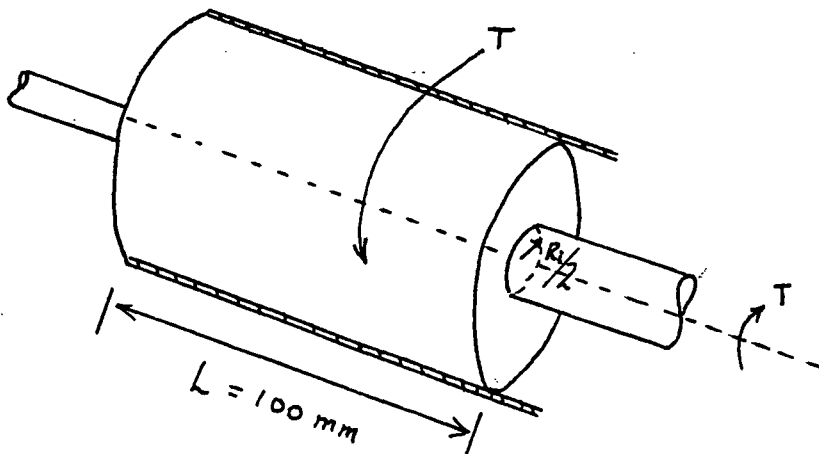

TORSION TEST

$$\begin{aligned} T &= \tau \times \text{area} \\ &= \tau_o \ 2\pi R_o \ L \\ &= \tau_i \ 2\pi R_i \ L \end{aligned}$$

$$\text{where } R_o = \frac{53.93}{2} = 26.96 \text{ (mm)}$$

$$R_i = \frac{19.05}{2} = 9.53 \text{ (mm)}$$

Therefore

$$\tau_{\text{max}} = \frac{T}{2\pi R_i L} = \frac{T}{5987.8}$$

and

$$\tau_{\text{min}} = \frac{T}{2\pi R_o L} = \frac{T}{16939.5}$$

The two tests were performed on the same specimen geometry. From the torsion test,

$$\theta = \frac{T}{4\pi L G_T} \left( \frac{R_o^2 - R_i^2}{R_o^2 R_i^2} \right) \quad (8.1)$$

and from shear test, it can be shown that ,

$$\Delta = \frac{N \ln \left( \frac{R_o}{R_i} \right)}{2\pi L G_S} \quad (8.2)$$

Derivation of these expressions may be found in the Appendix III.

### 8.3 Definition of final mixes

#### 8.3.1 Wall Paper/P84/Formula 2

The main difficulty concerned with the raw paper pulp ( $\frac{1}{4}$  to  $\frac{1}{2}$  inch granules) was the high amount of moisture content in it. As high as 60% was noted. Such a high moisture content would have impaired the strength of specimens due to dilution of the gel during mixing, and due to the loss of silicate gel during compaction. To avoid such undesirable results, the pulps were dried completely prior to mixing with the silicate.

The composite is a mixture of wall paper mixed with P84 sodium silicate, supplied by I.C.I., and hardened by the powder mixture known as 'formula 2' which was blended by 50% by weight of CETOS (+ 250  $\mu$ m) and 50% by weight of solid - soda lime - glass spheres (about -150  $\mu$ m).

A notable characteristic of this mixture was the extreme lightness of final product. The dry granular pellets were hard and light. In order to allow sufficiently wetting to the particles, the amount of P84 was considered to be high and mixing time usually longer than other mixes (about 5 minutes for 100 gm of dry paper pulps). In some instances, PENTRON-ON

solution was added to increase workability.

The binder content, B%, is the ratio of silicate by weight to the sum of the weights of dried aggregates and sodium silicate expressed as a percentage. A typical binder content as, say 58%. Other parameters referred to are:-

$$\text{Aggregate/Binder} = \frac{100}{138} = 0.2$$

and

$$\text{Hardener/Binder} = \frac{28}{138} = 0.2$$

These are referred to later in the chapter..

### 8.3.2 DSF/P84/SECAR (H.A.C.)

This composite referred to a mixture of DSF grade exfoliated vermiculite (+ 1200  $\mu\text{m}$ ) mixed with P84 grade I.C.I. silicate. The catalyst used was SECAR, a white powder of very high alumina content (+ 150  $\mu\text{m}$ ). SECAR is one of the blends of high alumina cement. DSF grade was chosen because of it resembled the sawdust.

Binder content was about as high as for paper pulp system, due to its physical nature in absorbing large quantities of liquid.

### 8.3.3 +2400 Shell EP Beads/P84/(Secar + Lime)

This refers to the mixing of +2400  $\mu\text{m}$  shell expanded polystyrene white beads with P84 grade I.C.I. silicate. The hardener was a mixture of SECAR (+ 150  $\mu\text{m}$ ) and burnt lime (+ 150  $\mu\text{m}$ ). The symbol of 50/50 SECAR/LIME signifies 50% by weight of SECAR, and 50% by weight of burnt lime in the powder mixture.

The +2400 beads gave a suitably low density associated with suitable workability in silicate environment. Larger beads were found very difficult to mix. The rule of thumb is that resiliency decreases as the density



of beads increase. This is not surprising since as the volume of beads increased there was more trapped air inside the beads, and therefore the mixture was found to be more resilient and lighter. The beads hardly absorbed any liquid at all.

An important characteristic was its resistance to wetness by silicate. For this reason, PENTRON-ON was mixed with beads prior to the addition of silicate solution. PENTRON-ON was not a hardener nor a retarder but is a type of foaming agent or sometimes is referred to as a water reducing agent, or wetting agent. However, little improvement in coating was found in the polystyrene beads system.

#### 8.3.4 Perlite/C112/CO<sub>2</sub>

Perlite is here referred to as expanded perlite. The silicate used was C112, I.C.I. grade. The catalyst was CO<sub>2</sub> gas supplied by the Distiller Company in the form of a cylinder. An unusual property of Perlite is its very high SiO<sub>2</sub> content. This resembles sand (silica sand) thus CO<sub>2</sub> - silicate process was chosen. The lack of roundness of its particles and its requirement to absorb a considerable amount of silicate for thorough wetting were the major drawbacks. Therefore, the perlite was sieved, mechanically, to a particle size distribution between 75 μm to 850 μm. It was hoped that the finer particles would stabilise the larger particles and provide a higher structural strength. For irregular particle sizes, like perlite, it was found that the binder content was also high. 52% was recorded.

8.4 Relevant Test Results

8.4.1 Figure Legends

- (i) For Wall Paper / Silicate System, see Figure A (1-14)
- (ii) For DSF / Silicate System, see Fig. B (1-75)
- (iii) For Shell EP Beads / Silicate System, see Fig. C (1-13)
- (iv) For Perlite / Silicate System, see Fig. D (1-12).

PART I

FIG. A. (1-2) on page 70

FIG. A, (3-6).

WALL PAPER/P84/H<sub>2</sub>O/FOR.2

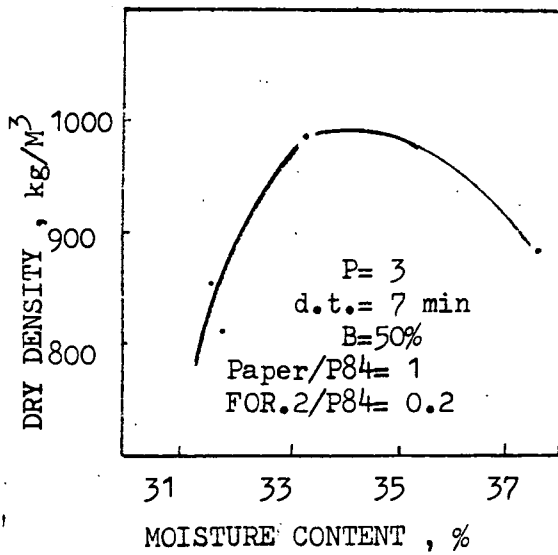

(3)

WALL PAPER/P84/H<sub>2</sub>O/FOR.2

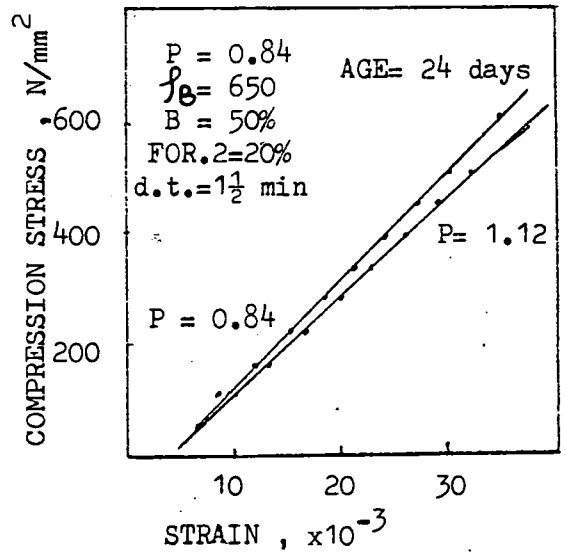

(5)

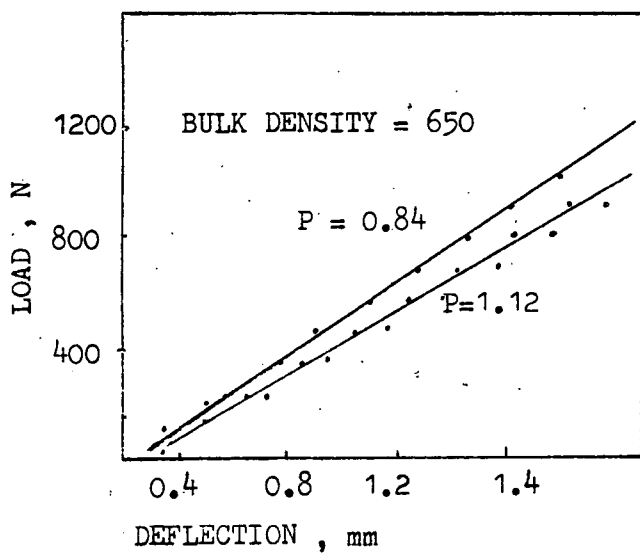

WALL PAPER/P84/H<sub>2</sub>O/FOR.2

(4)

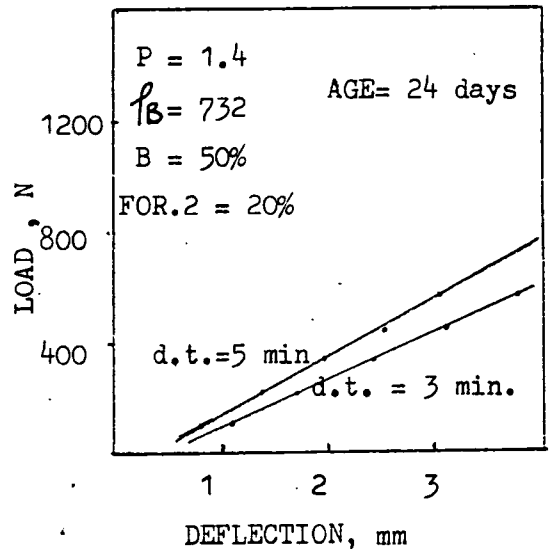

WALL PAPER/P84/H<sub>2</sub>O/FOR.2

(6)

FIG. A, (7-10)

WALL PAPER/P84/H<sub>2</sub>O/FOR.2

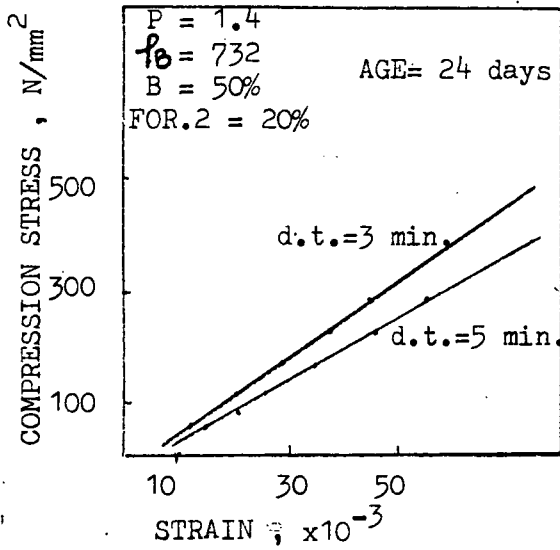

(7)

WALL PAPER/P84/FOR. 2

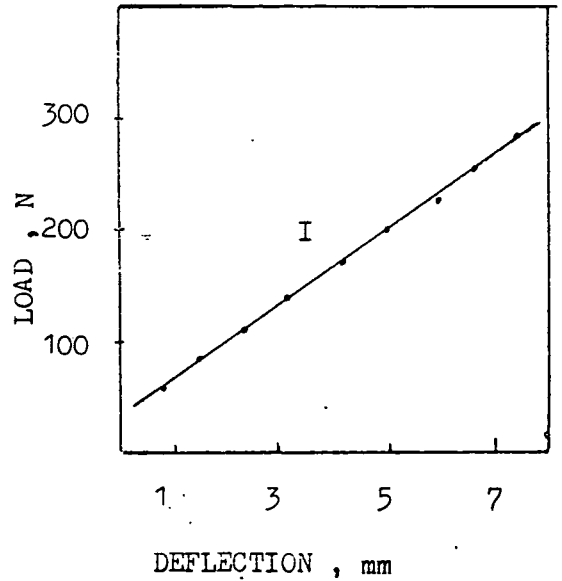

(9)

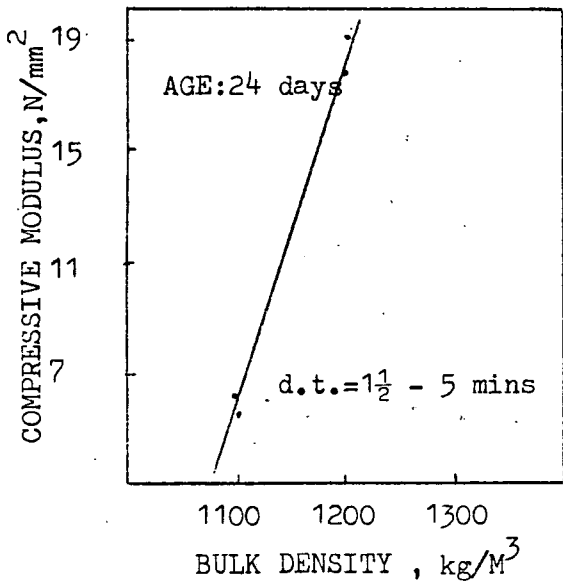

WALL PAPER / P84 / H<sub>2</sub>O / FOR.2

(8)

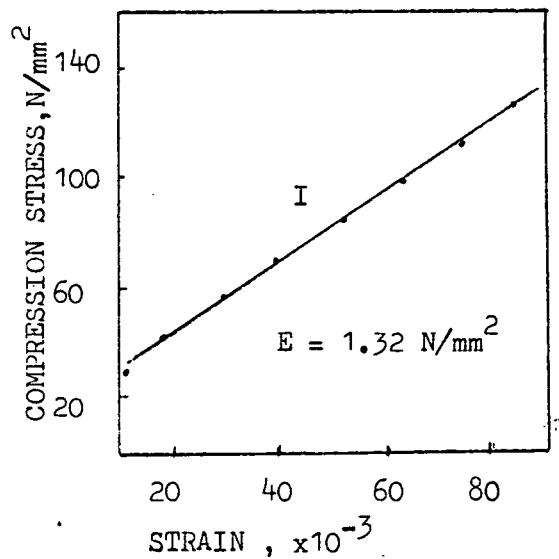

WALL PAPER / P84 / FOR. 2

(10)

CURVE I: B= 58%

w= 30.3%

d.t.=90 sec.

$\sigma(8.8\%) = 0.14 \text{ N/mm}^2$

PAPER/P84 = 0.724

$f_B = 710 \text{ kg/M}^3$

WALL PAPER/P84/FOR.2

FORMULAR 2/P84 = 0.2

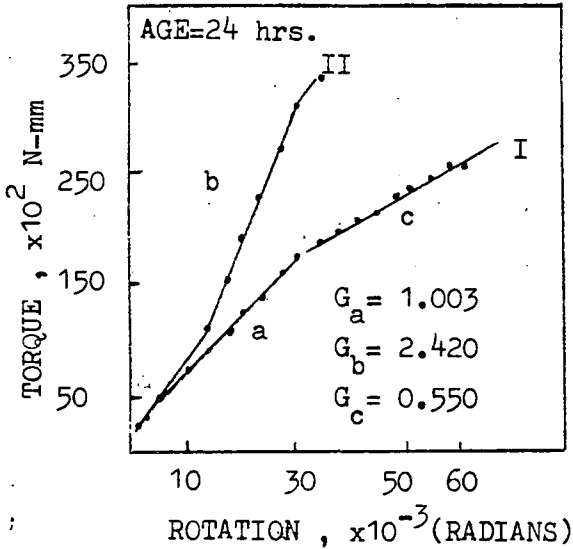

(11)

CURVE II: B= 50%

w=31.4%

d.t.=1800 sec.

$\sigma(15\%) = 0.75 \text{ N/mm}^2$

PAPER/P84=1.0

$f_B = 1000 \text{ kg/M}^3$

WALL PAPER/P84/H<sub>2</sub>O/FOR.2

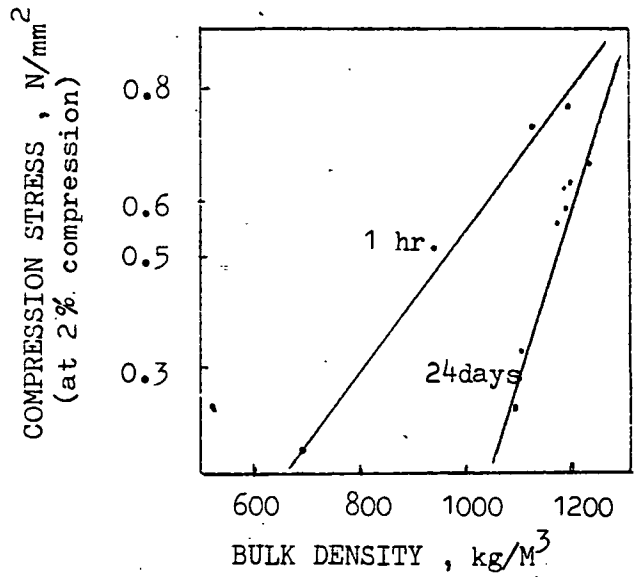

(13)

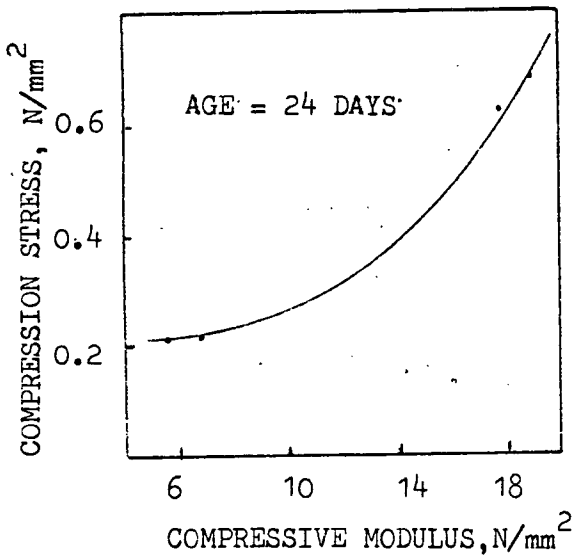

WALL PAPER / P84 / FOR.2

(12)

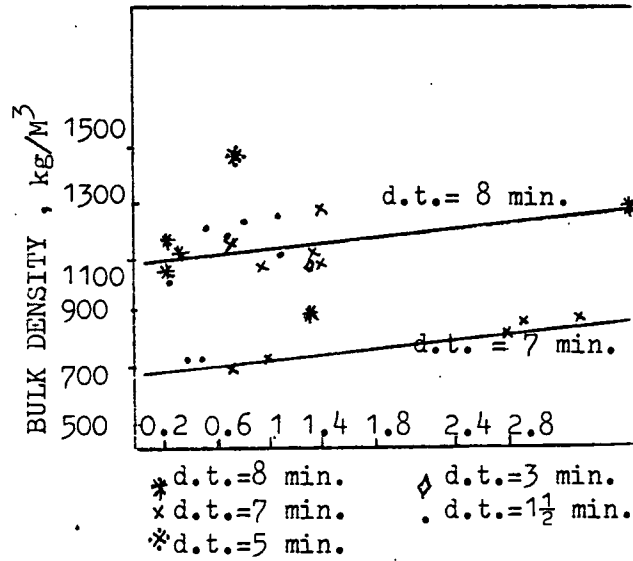

WALL PAPER / P84 / H<sub>2</sub>O/FOR.2

(14)

DSF / P84 / FORMULAR 2

- ⊗ HARDENER/BINDER=0.71 , B= 48.3%
- ⊕ HARDENER/BINDER=0.47 , B= 48.3%
- \* HARDENER/BINDER=0.28 , B= 48.3%
- ⊙ HARDENER/BINDER=0.83 , B= 48.3%
- ⊗ HARDENER/BINDER=0.80 , B= 33.3%
- ⊕ HARDENER/BINDER=0.00 , B= 33.3%
- \* HARDENER/BINDER=0.40 , B= 33.3%
- ⊙ HARDENER/BINDER=0.20 , B= 33.3%
- ⊗ HARDENER/BINDER=0.20 , B= 40%
- ⊕ HARDENER/BINDER=0.40 , B= 40%
- \* HARDENER/BINDER=0.20 , B= 46.7%

ALL d.t.t. at least 2½ minutes

ALL CURED IN AIR AFTER STRIPPED FROM MOULD.

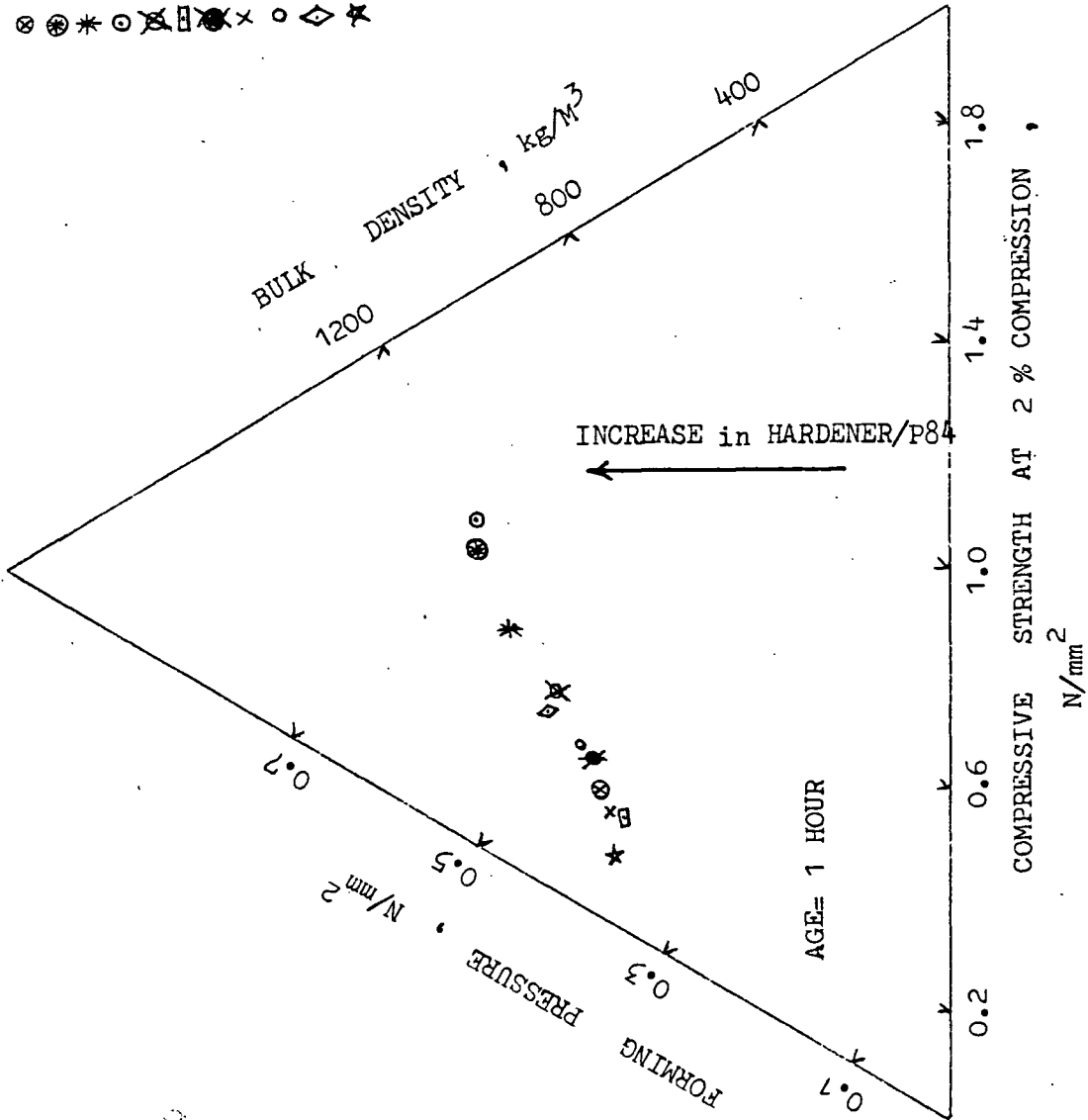

(1)

DSF / P84 / HARDENER

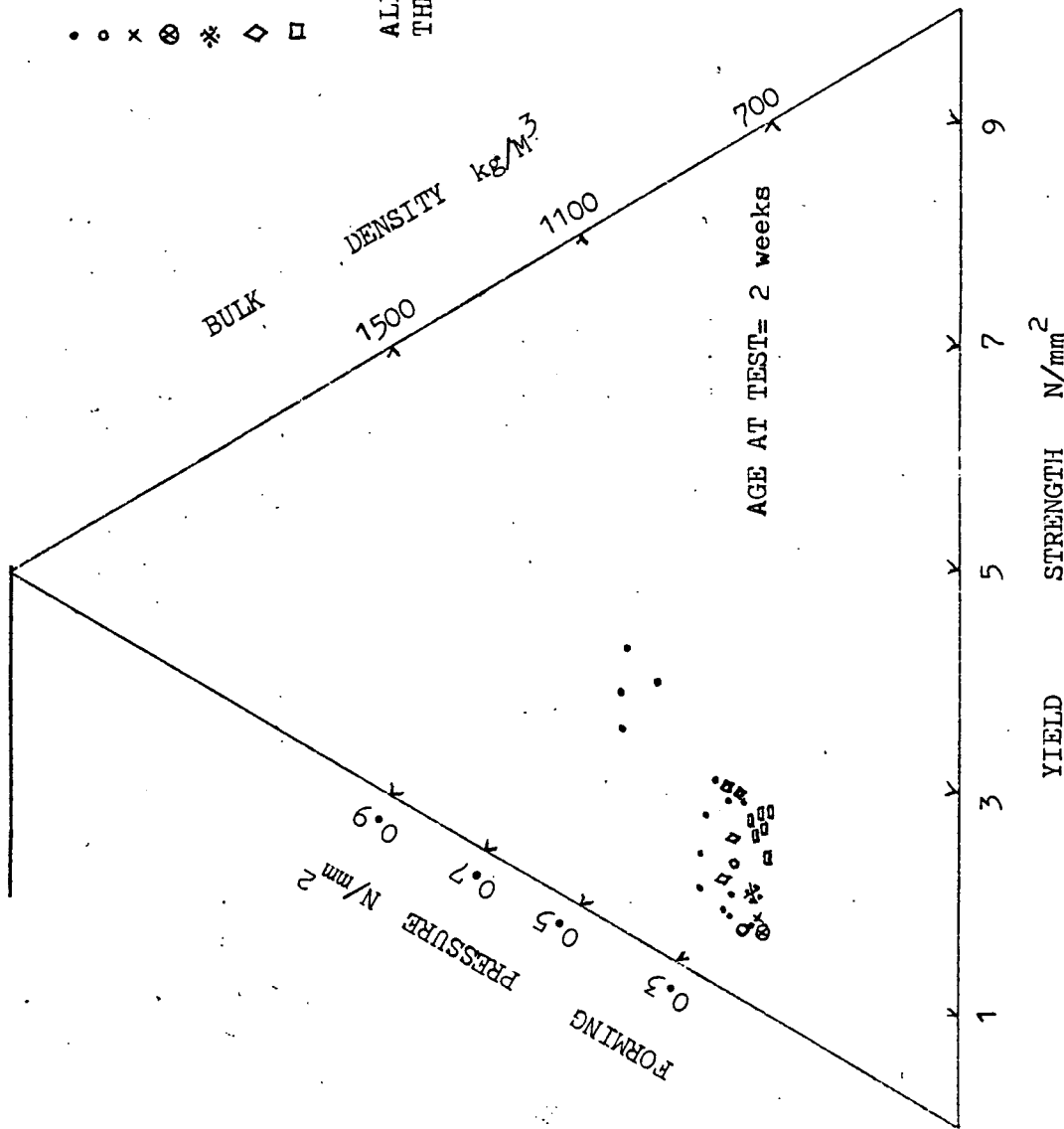

- DSF/P84/FOMULAR 2
- DSF/SAND/P84/FOMULAR 2
- × DSF/P84/FOMULAR 7
- ⊗ DSF/P84/FOMULAR 3
- \* DSF/P84/ CO<sub>2</sub>
- ◇ DSF/P84/ ESTER
- DSF/P84/ NO HARDENER

ALL CURED IN OVEN FOR 24 HOURS at 110°C,  
THEN LEFT FOR AIR DRIED.

(2)



FIG. B, (3-4)

DSF / P84 / SECAR

DSF VERMICULITE +1200

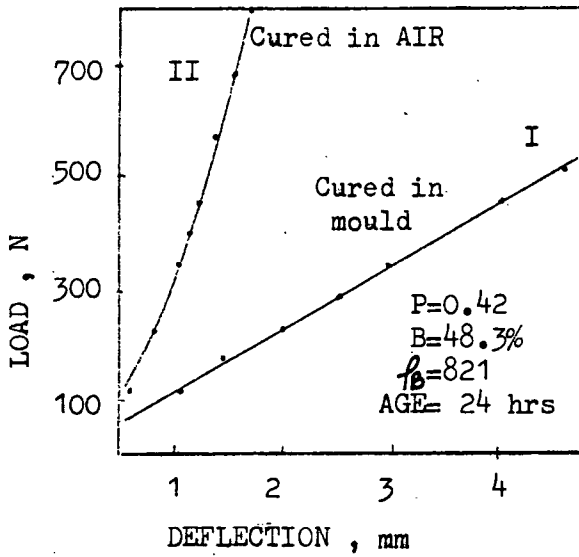

(3)

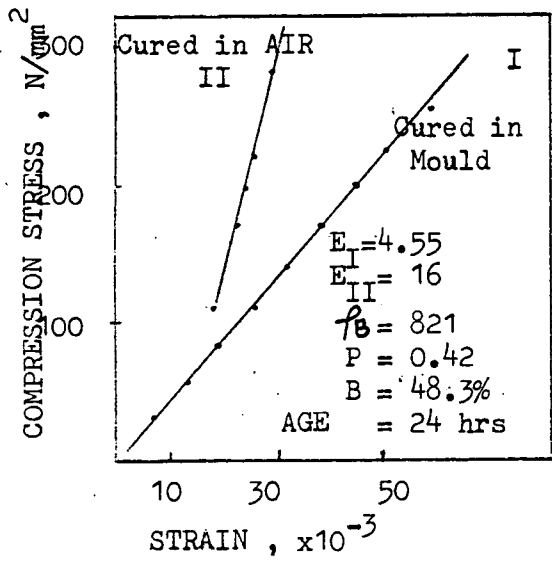

DSF / P84 / SECAR

(4)

FIG. A, (1-2)

WALL PAPER/P84/H<sub>2</sub>O/FOR.2

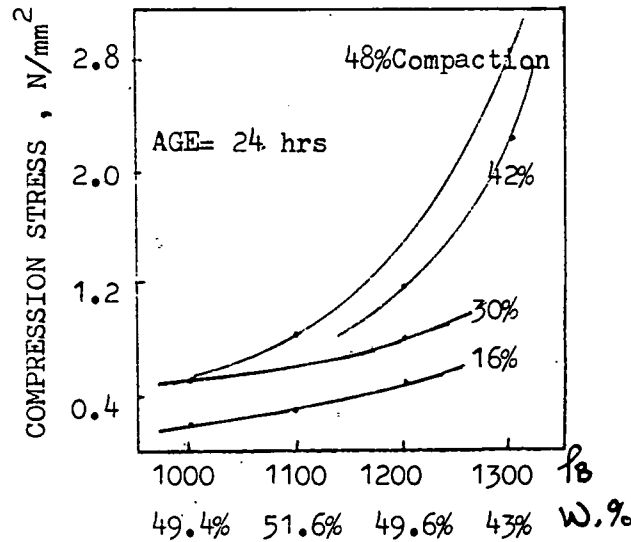

(1)

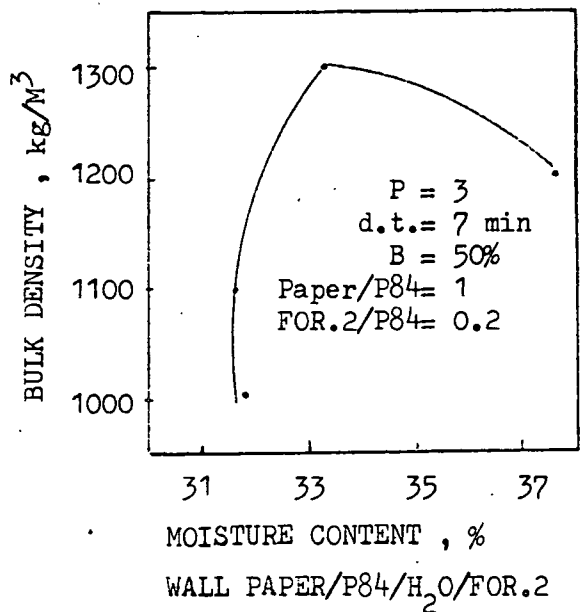

(2)

FIG. B, (5-8)

DSF / P84 / FORMULAR 2

+1200 DSF VERMICULITE

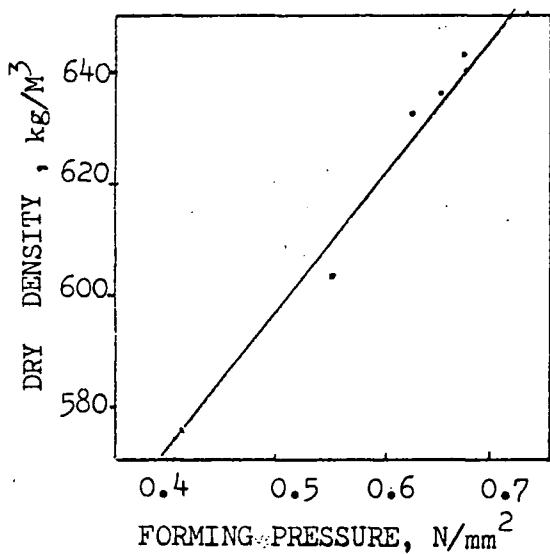

(5)

DSF / P84 / FORMULAR 2

+1200 DSF VERMICULITE

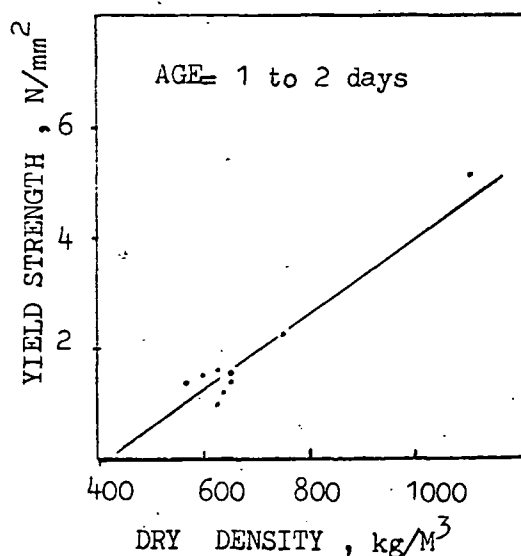

(7)

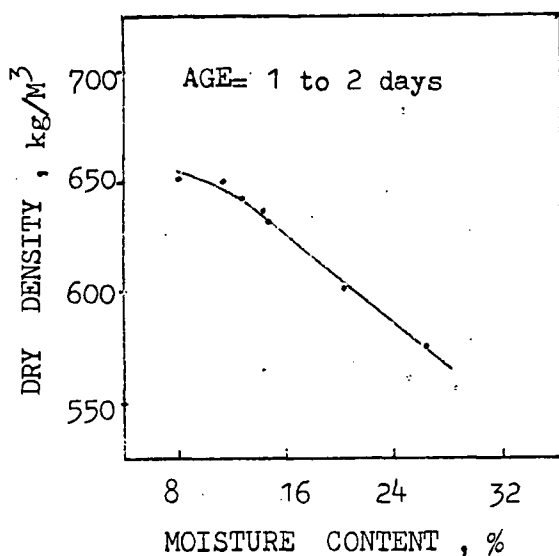

(6)

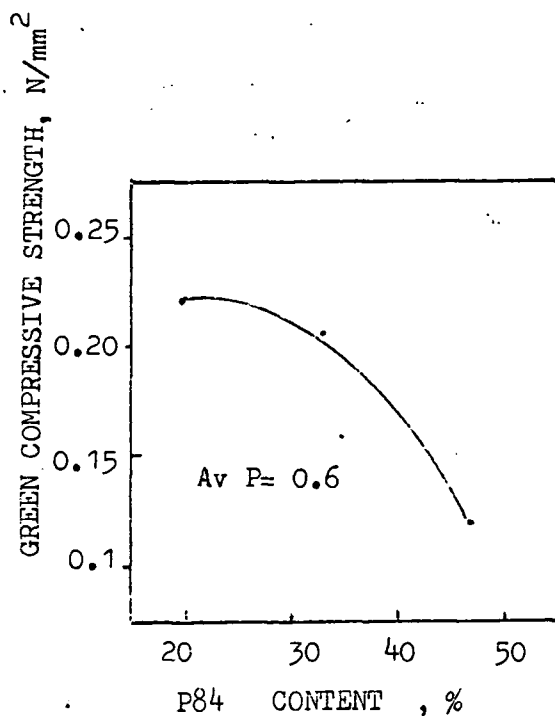

(8)

DSF / P84 / FORMULAR 2

DSF / P84 / FORMULAR 2

FIG. B, (9-12)

DSF / P84 / FORMULAR 2

+1200 DSF VERMICULITE

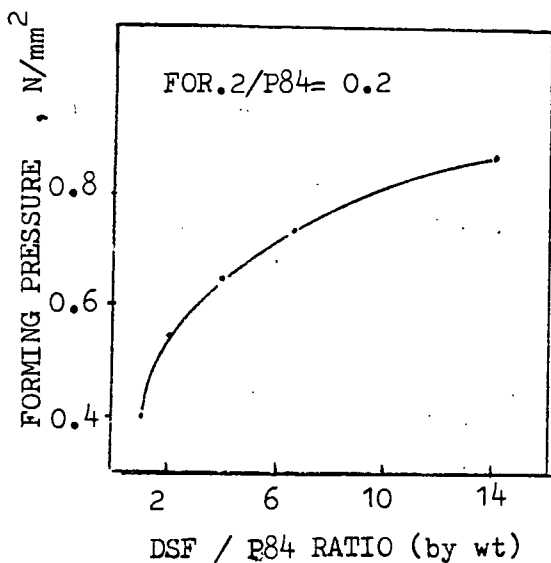

(9)

DSF / P84 / FORMULAR 2

+1200 DSF VERMICULITE

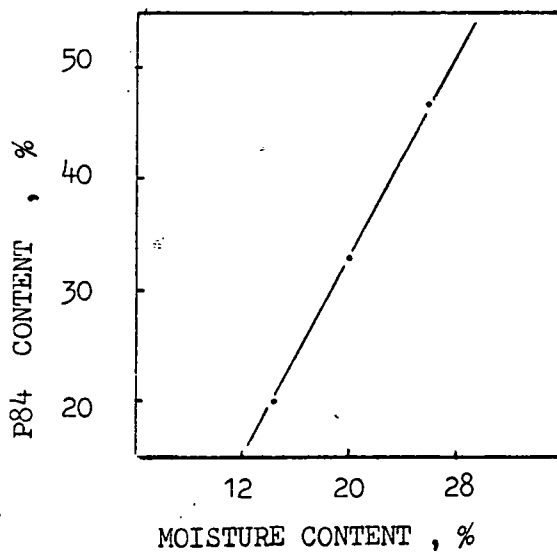

(11)

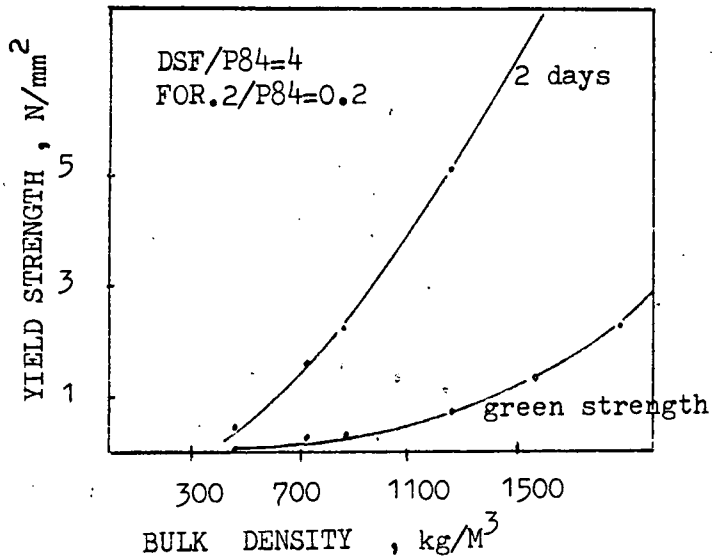

(10)

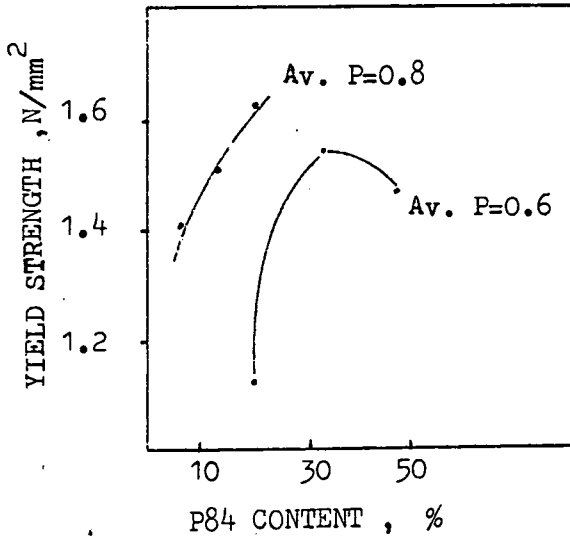

DSF / P84 / FORMULAR 2

(12)

FIG. B, (13-16)

DSF / P84 / NO HARDENER

+1200 DSF VERMICULITE

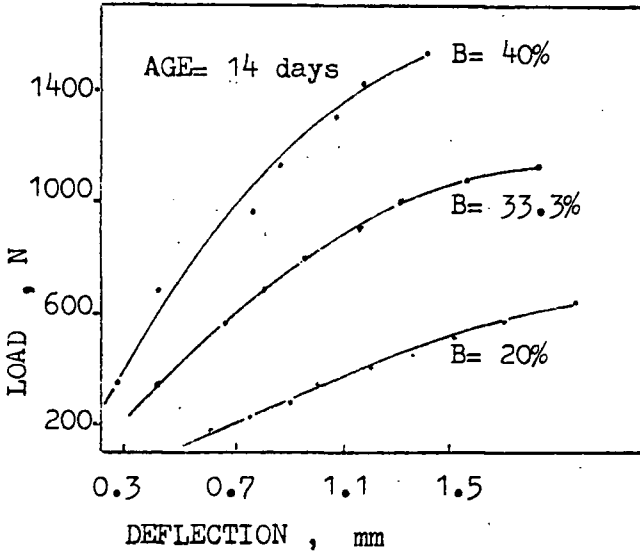

(13)

DSF / P84 / NO HARDENER

+1200 DSF VERMICULITE

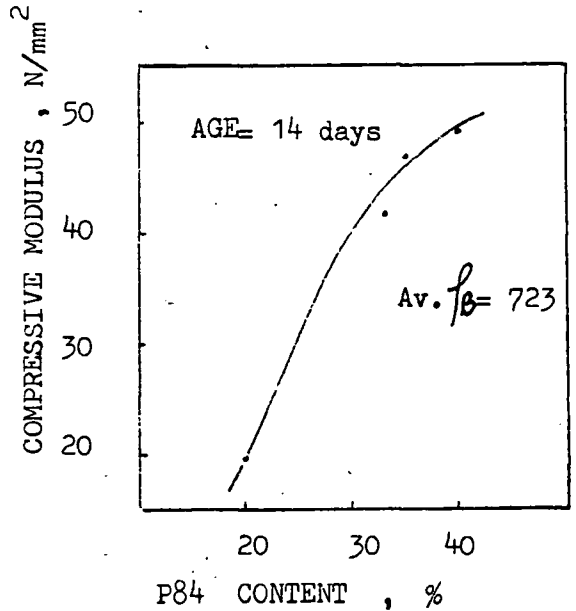

(15)

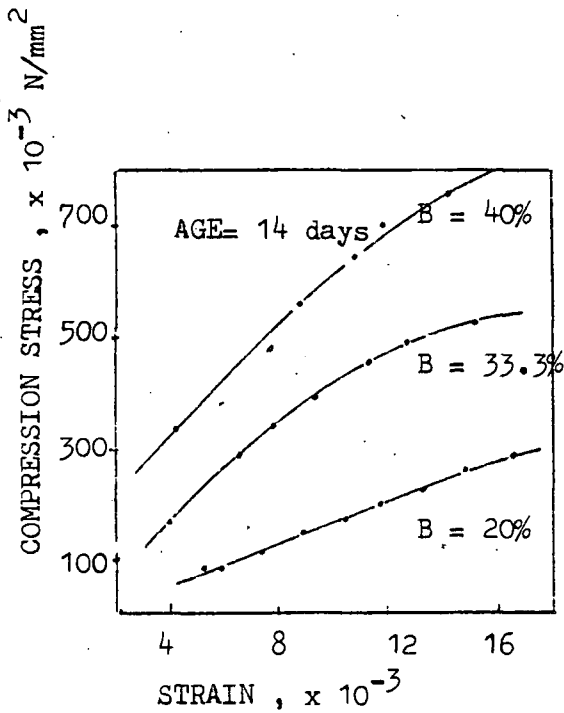

(14)

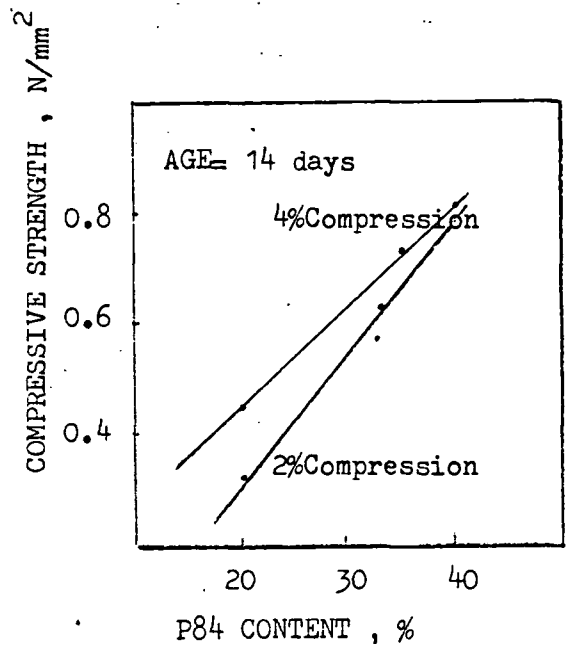

(16)

DSF / P84 / NO HARDENER

DSF / P84 / NO HARDENER

FIB. B, (17-20)

DSF / P84 / NO HARDENER

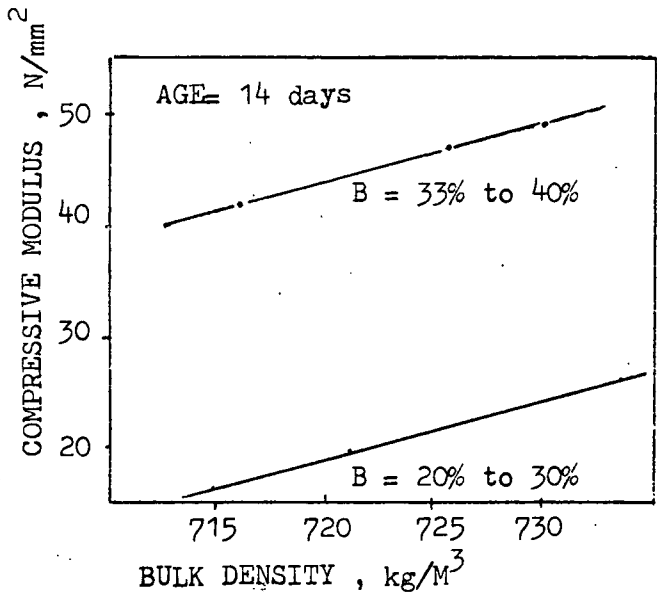

(17)

DSF / P84 / FORMULAR 2

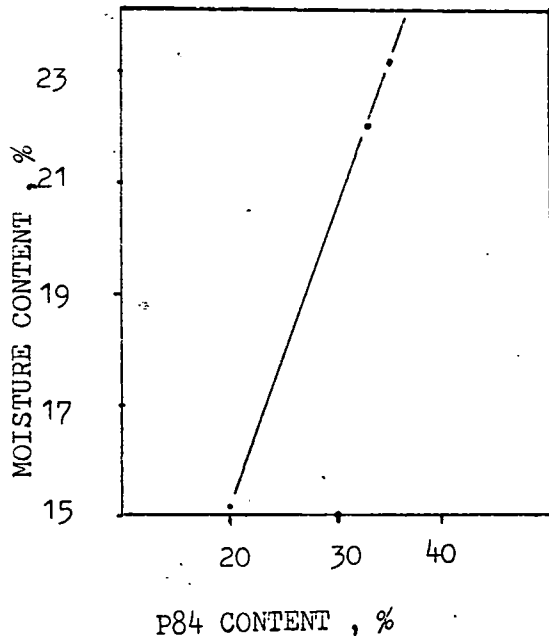

(19)

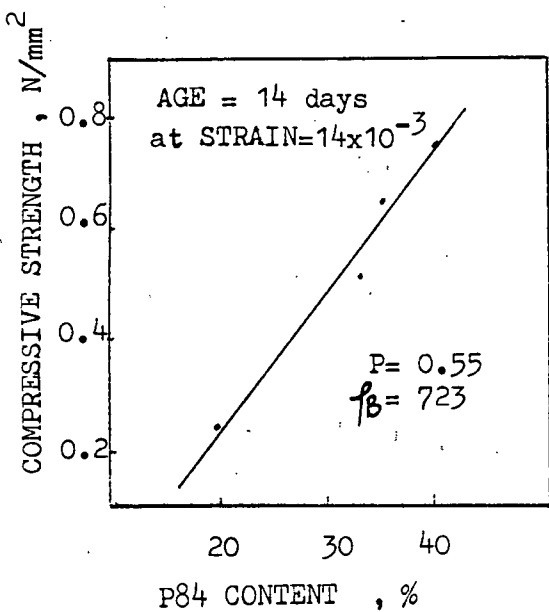

DSF / P84 / NO HARDENER

(18)

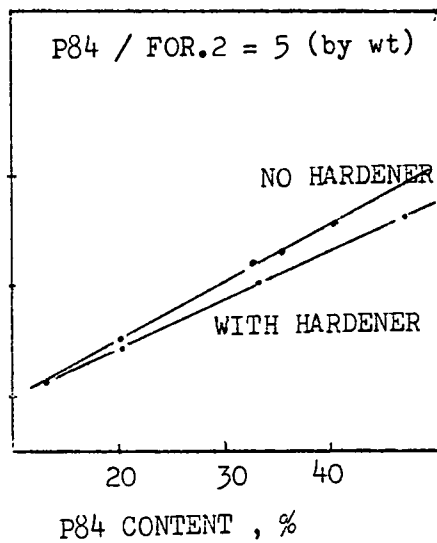

DSF / P84 / + HARDENER

(20)

FIG. B, (21-24)

DSF / P84 / NO HARDENER

+1200 DSF VERMICULITE

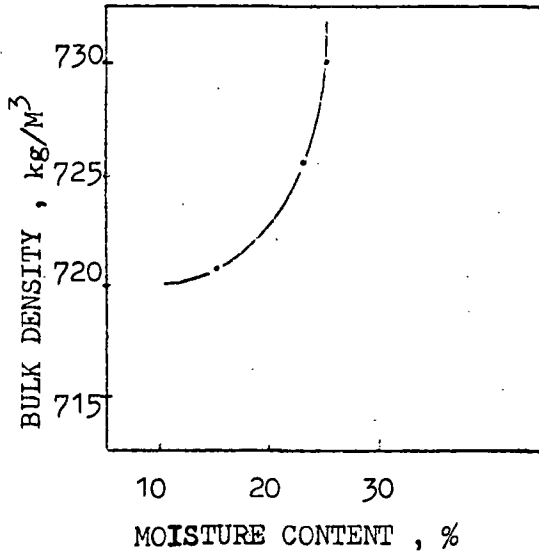

(21)

DSF / P84 / CO<sub>2</sub>

+1200 DSF VERMICULITE

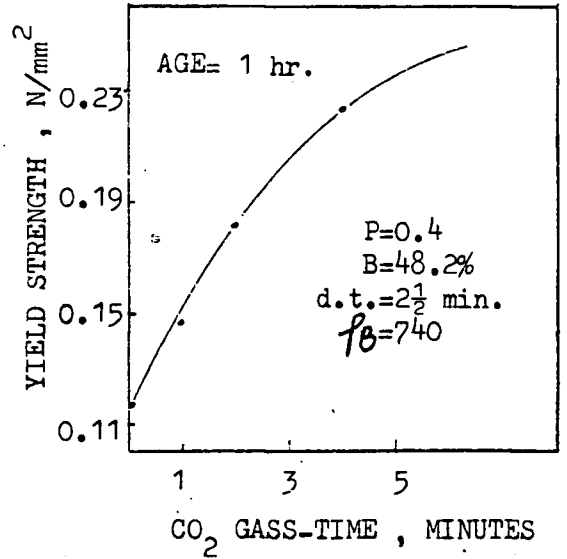

AGE= 1 hr.  
 P=0.4  
 B=48.2%  
 d.t.=2½ min.  
 fb=740

(23)

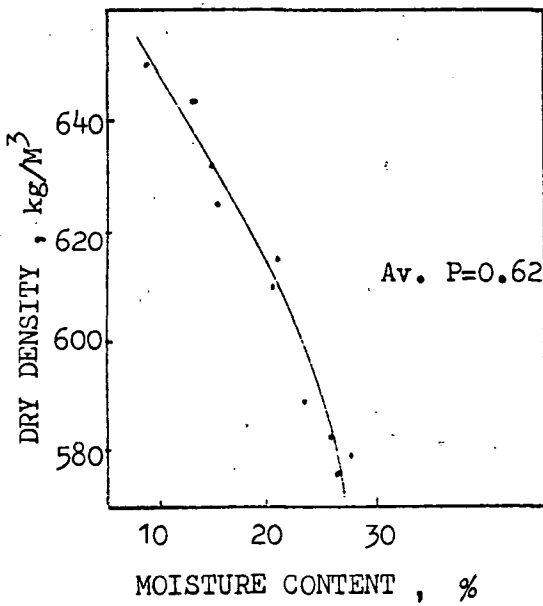

Av. P=0.62

DSF / P84 / NO HARDENER

(22)

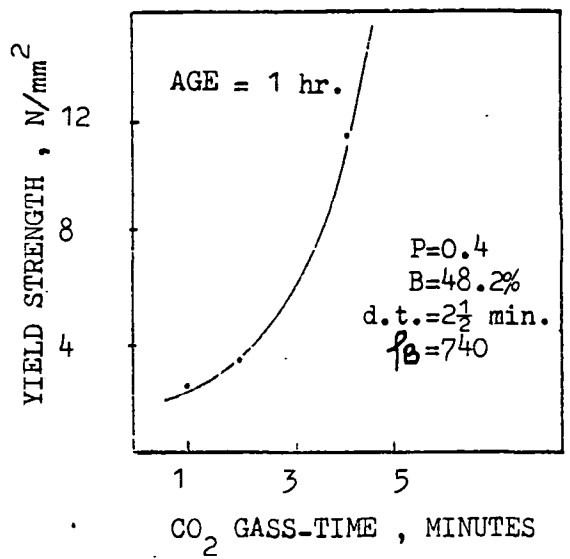

AGE = 1 hr.  
 P=0.4  
 B=48.2%  
 d.t.=2½ min.  
 fb=740

DSF / C112 / CO<sub>2</sub>

(24)

FIB. B, (25-28)

DSF / P84 / ESTER

ESTER = ASHLAND SERIES

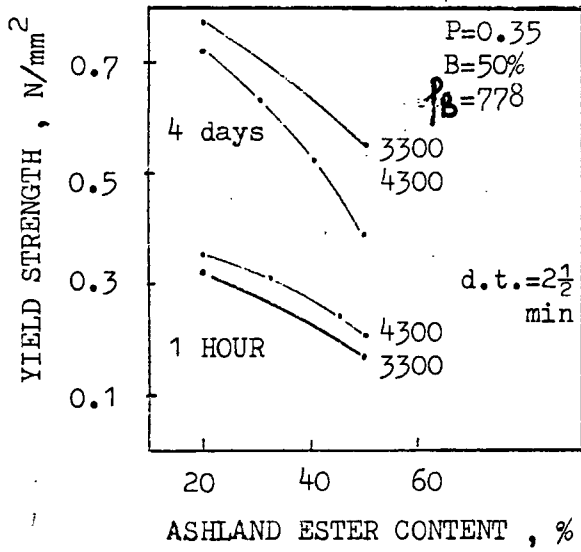

(25)

DSF / P84 / FOR. 2

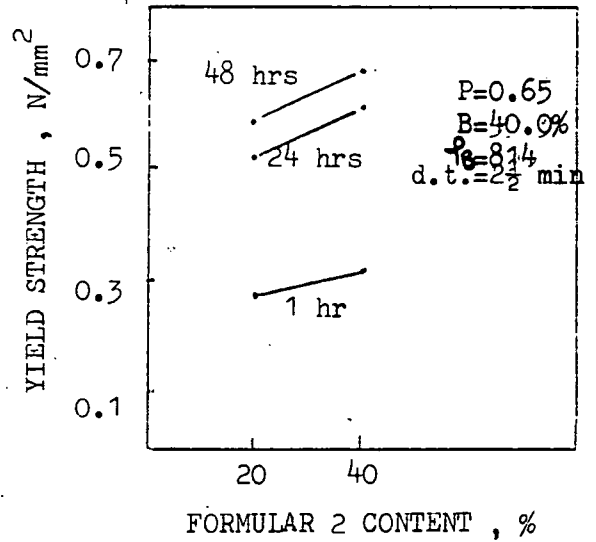

(27)

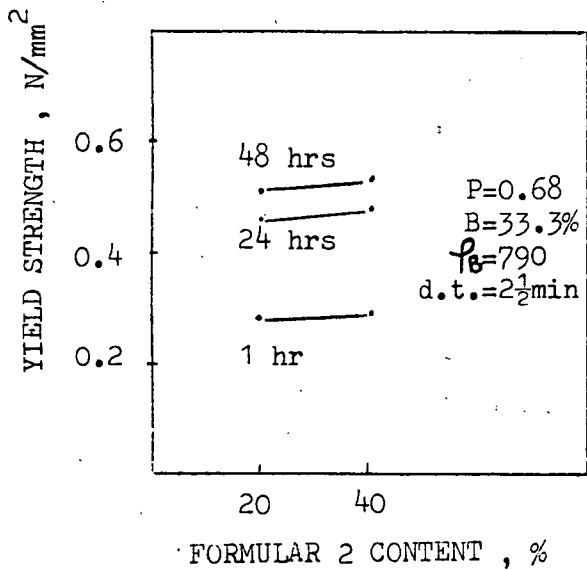

DSF / P84 / FOR.2

(26)

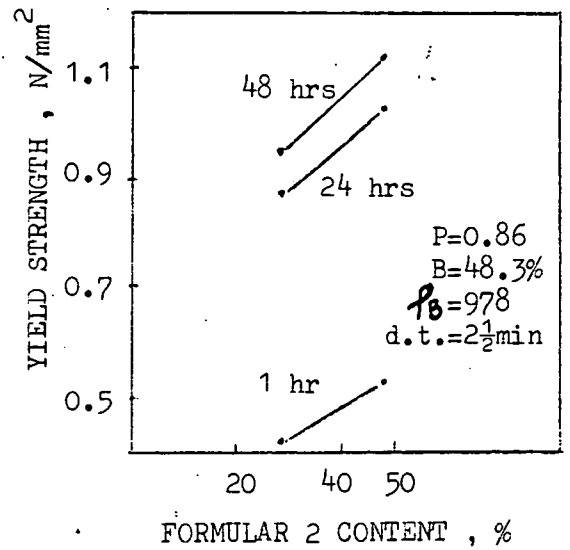

DSF / P84 / FOR.2

(28)

FIG. B, (29-32)

FORMULAR 2 : 50/50(by wt) CETOS/ SGS

FORMULAR 3 : 50/50(by wt) CETOS/ pfa

FORMULAR 7 : 100 % (by wt) CETOS

DSF / P84 / FOR.2

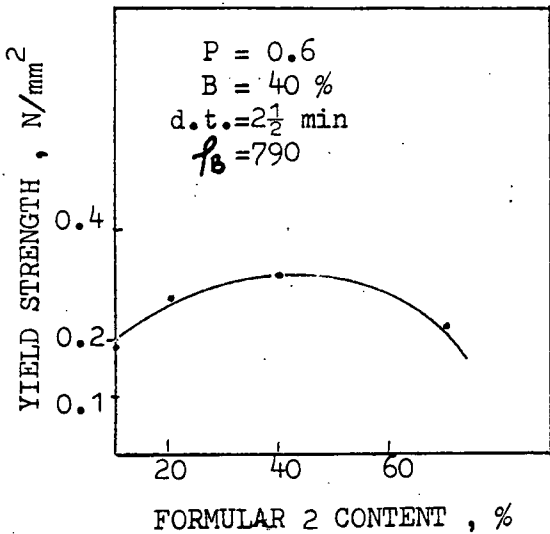

(29)

DSF / P84 / FOR.2

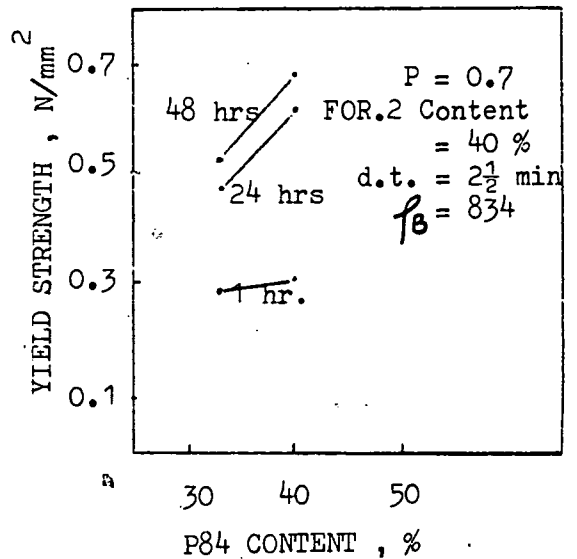

(31)

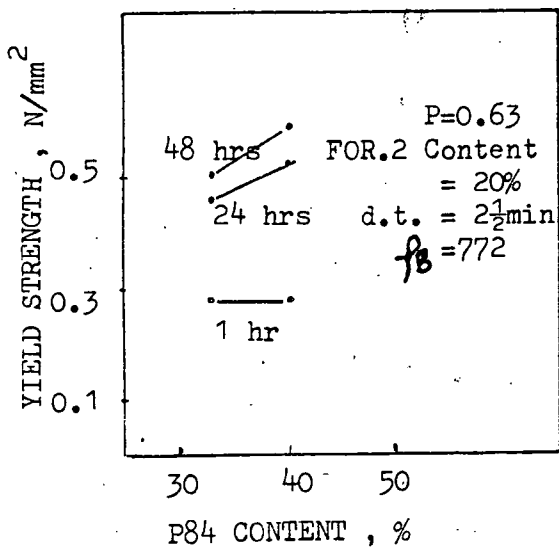

DSF / P84 / FOR. 2

(30)

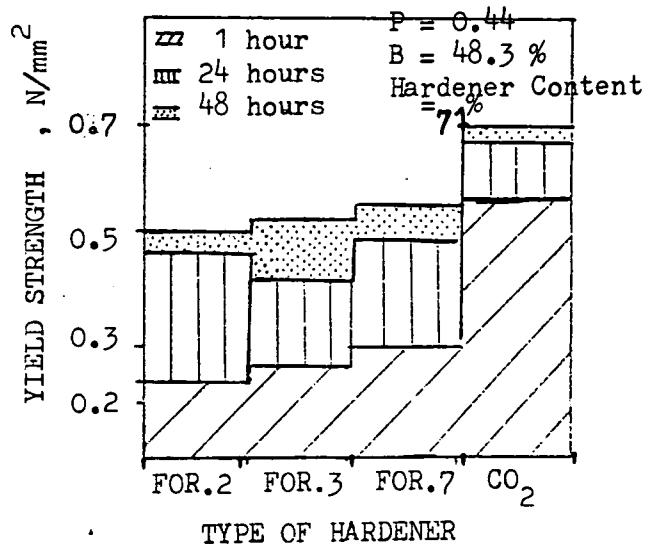

DSF / P84 / HARDENER

(32)



FIG. B, (33-36)

DSF / P84 / FORMULAR 2

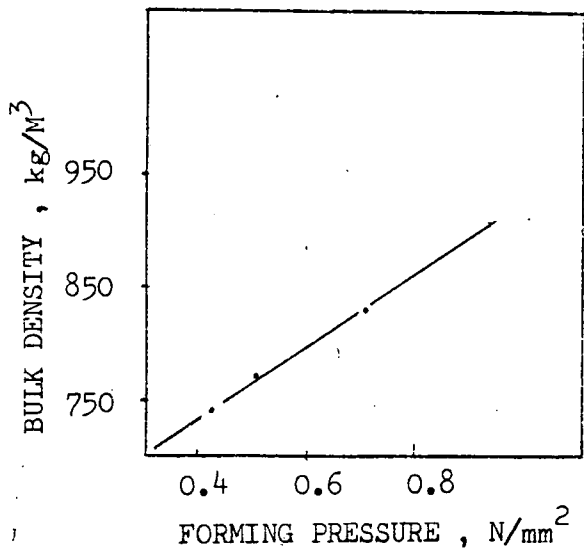

(33)

DSF / P84 / FORMULAR 2

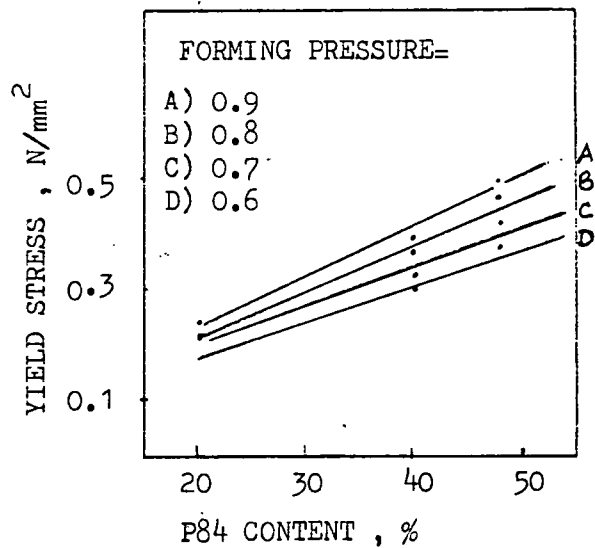

(35)

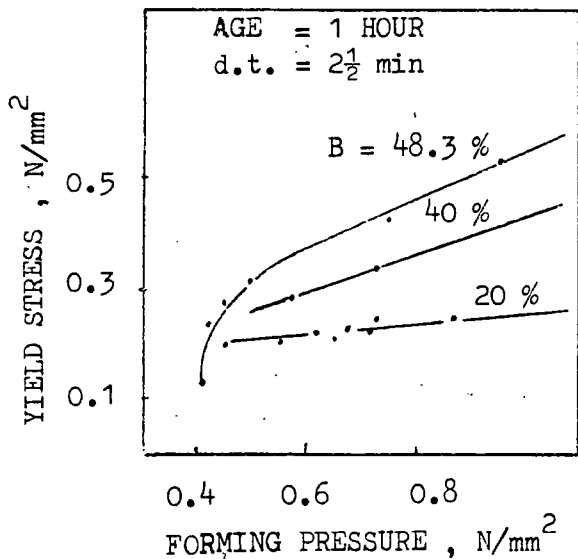

DSF / P84 / FORMULAR 2

(34)

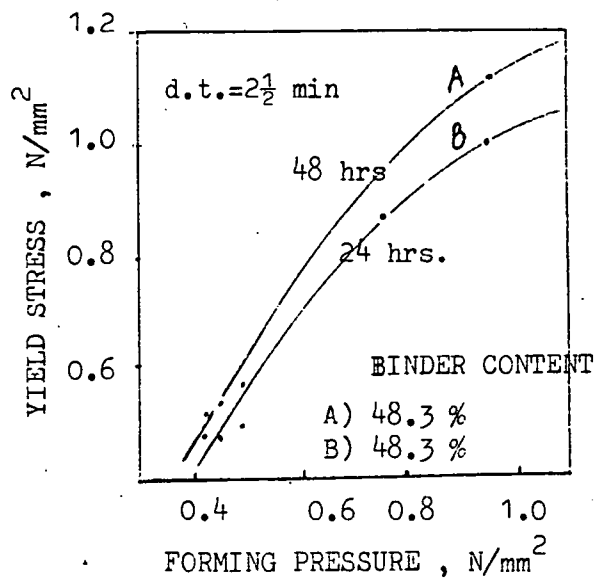

DSF / P84 / FORMULAR 2

(36)

FIG. B, (37-40)

DSF / P84 / FORMULAR 2

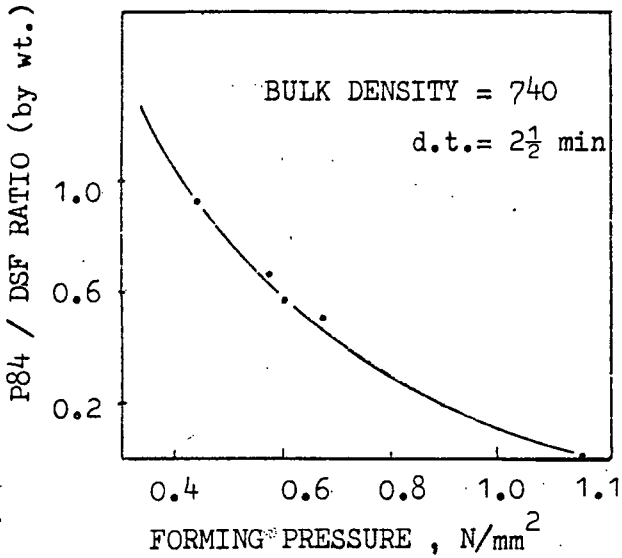

(37)

DSF / P84 / SECAR

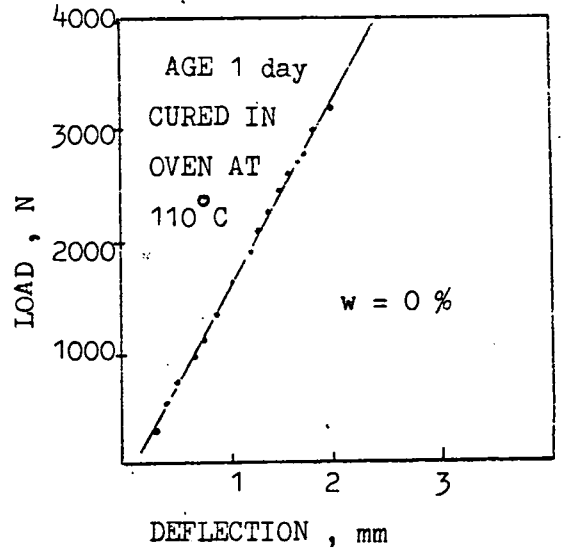

(39)

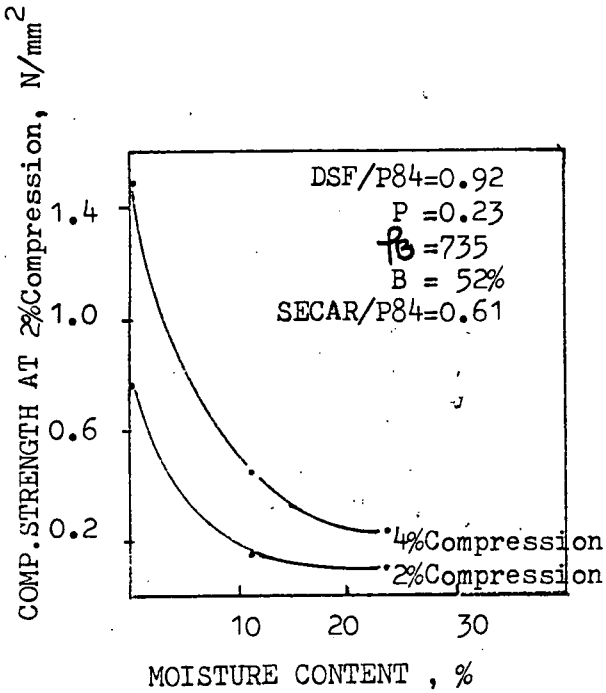

DSF / P84 / SECAR

(38)

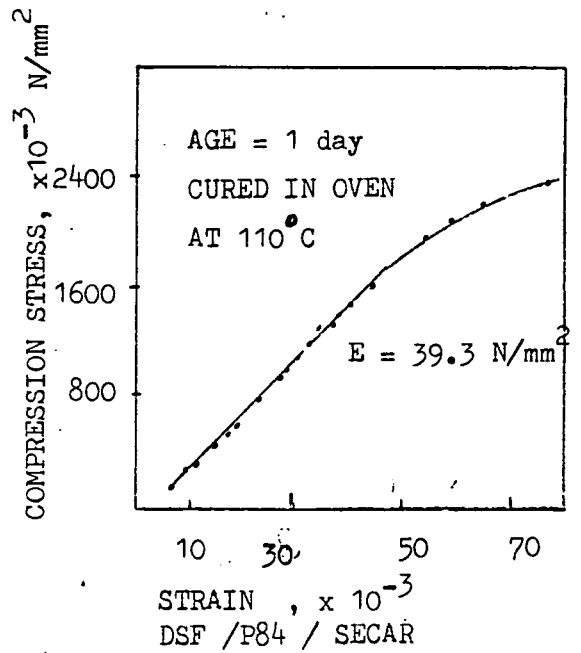

(40)

FIG. B, (41-44)

DSF / P84 / SECAR

---

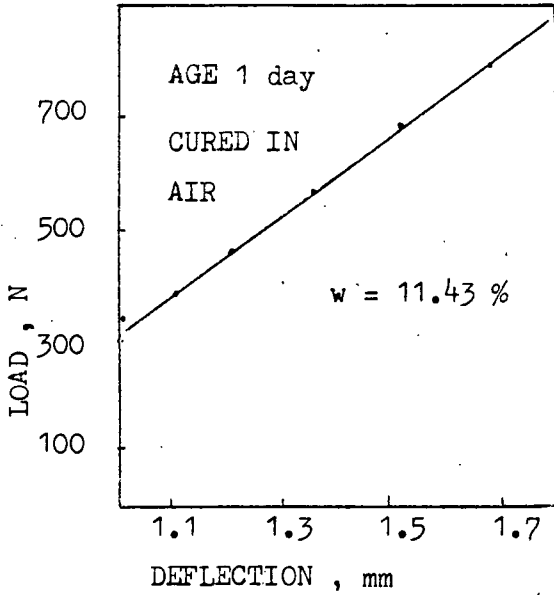

(41)

DSF / L96 / CETOS

---

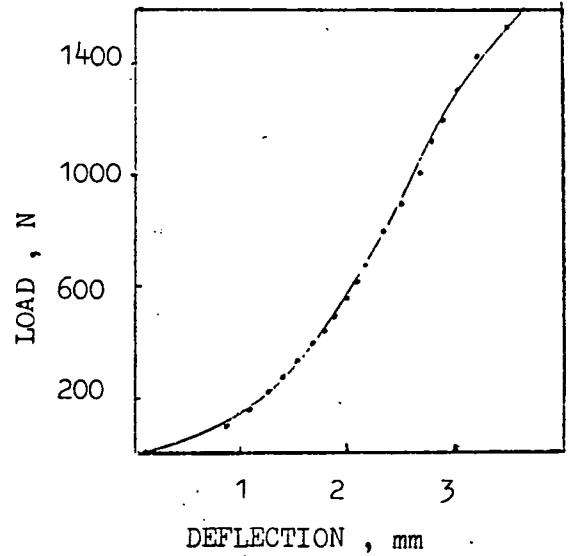

(43)

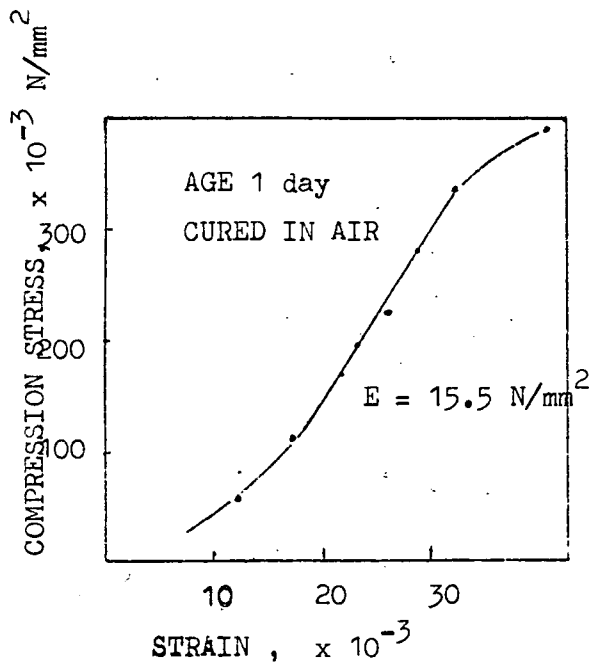

(42)

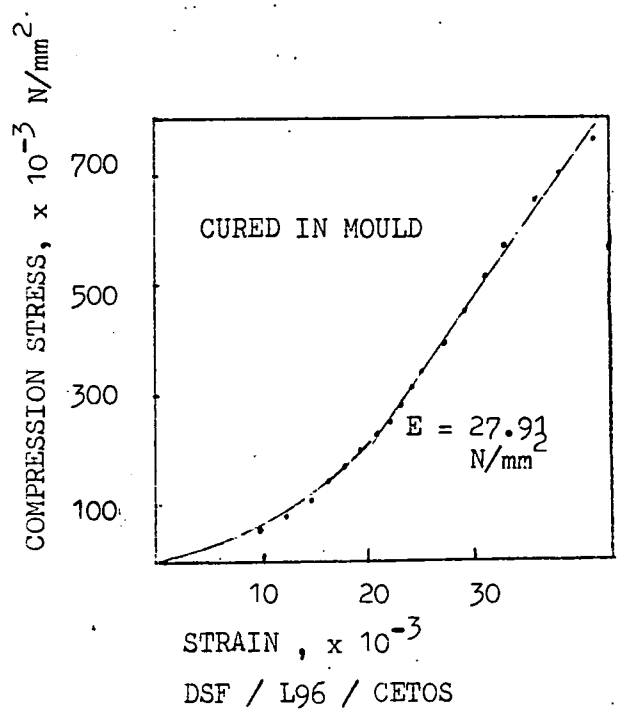

(44)

FIG. B, (45-48)

DSF / L96 / CETOS

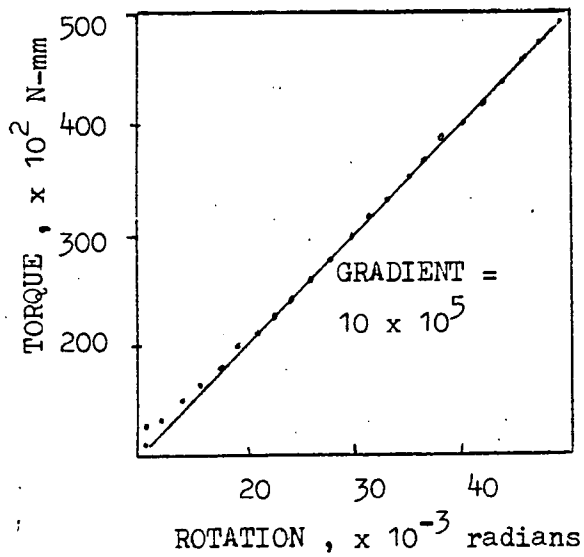

(45)

DSF / L96 / CETOS

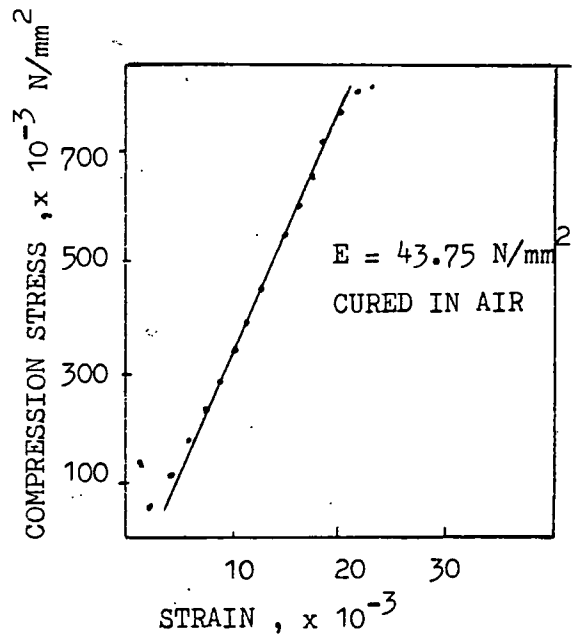

(47)

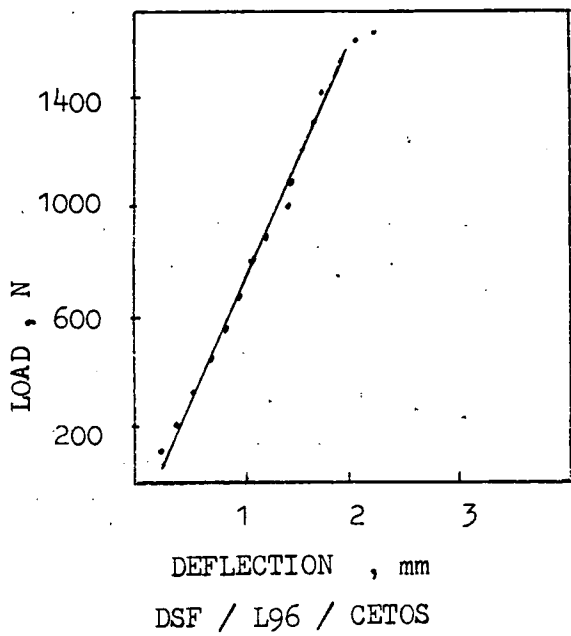

DSF / L96 / CETOS

(46)

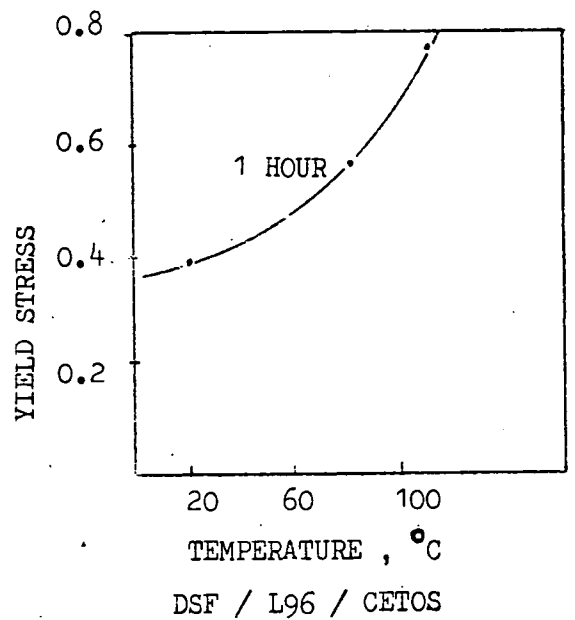

DSF / L96 / CETOS

(48)

FIG. B, (49 - 52)

DSF / K95 / ESTER

ESTER = 50%/50% DIA/EGDA

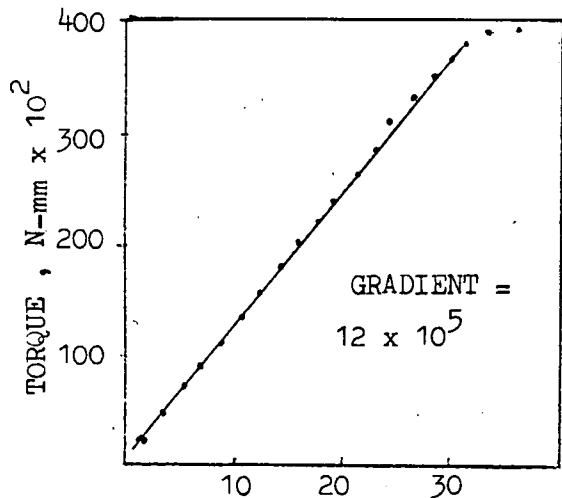

(49)

DSF / K95 / ESTER

ESTER = 50%/50% DIA/EGDA

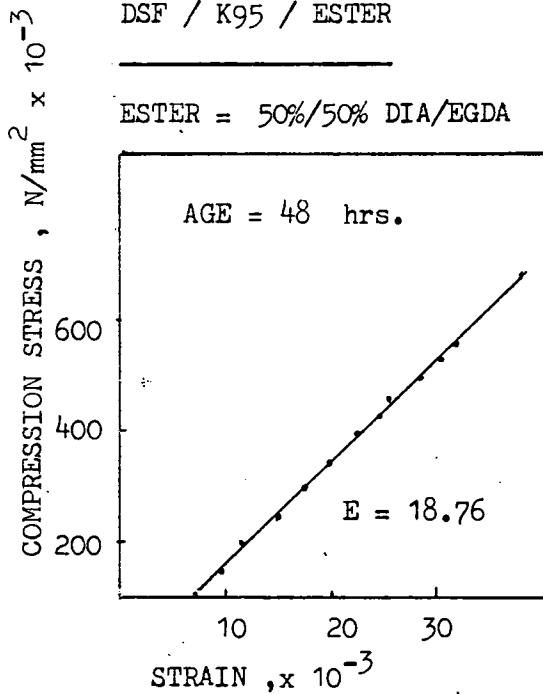

(51)

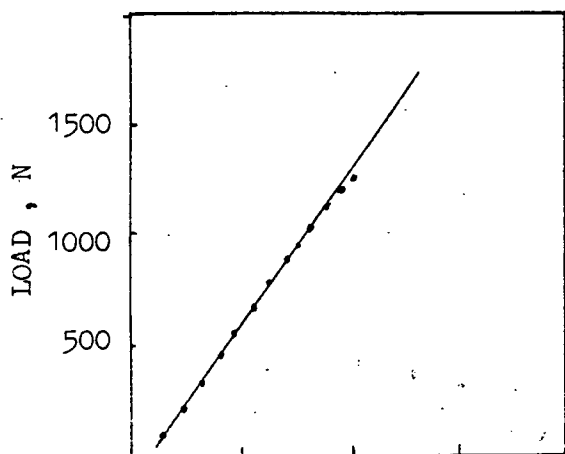

DSF / K95 / ESTER

(50)

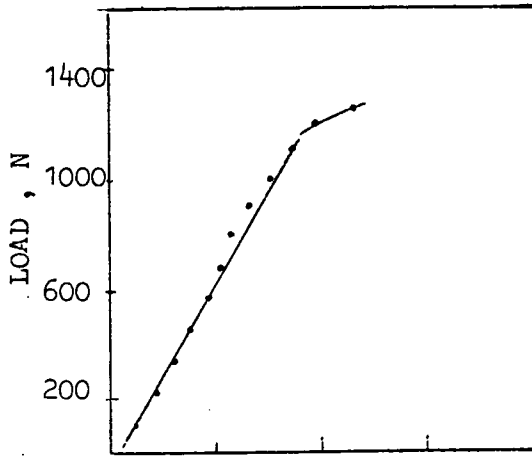

DSF / K95 / ESTER

(52)

Fig. B, (53-56)

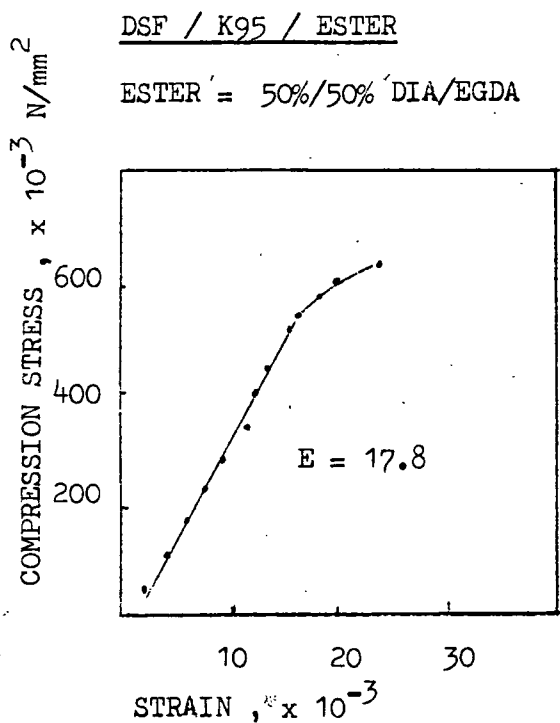

(53)

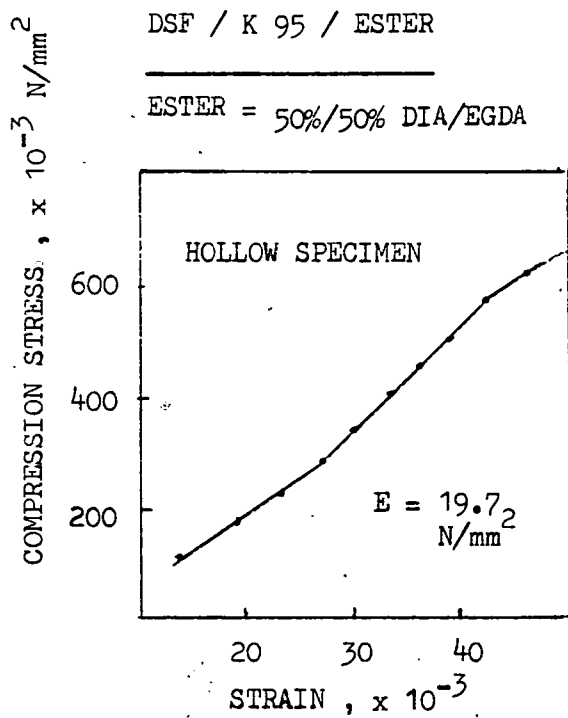

(55)

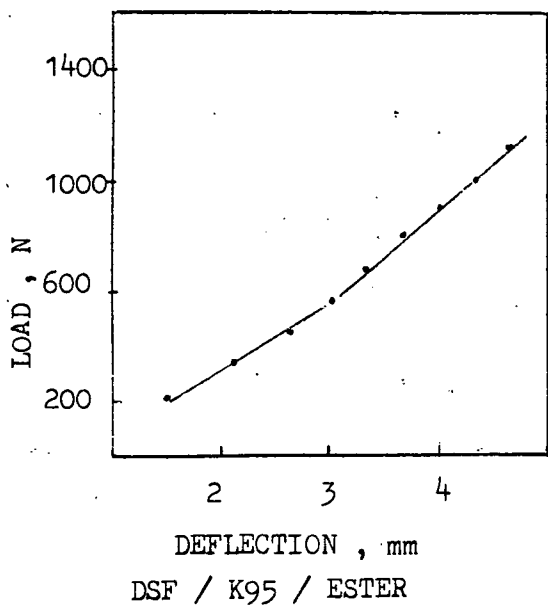

(54)

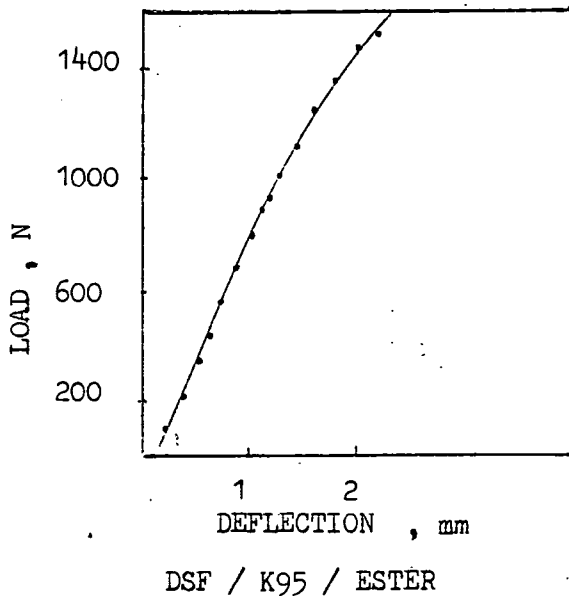

(56)

FIG. B, (57 - 60)

DSF / K95 / ESTER

ESTER = 50%/50% DIA/EGDA

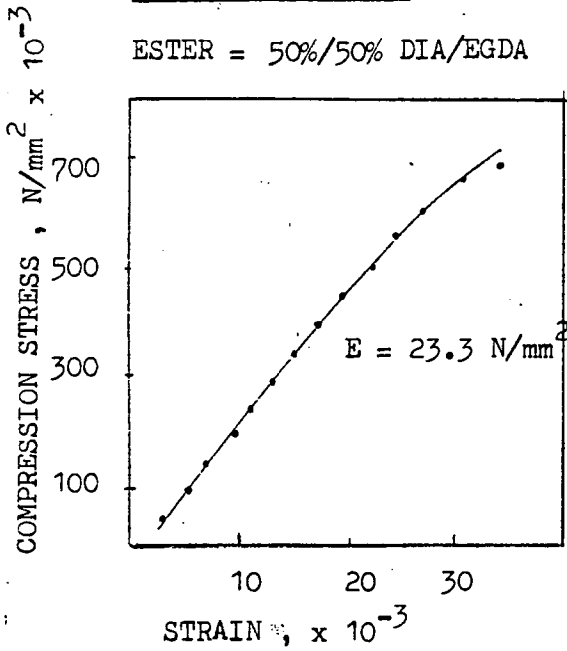

(57)

DSF / P84 / CO<sub>2</sub>

DSF VERMICULITE +1200

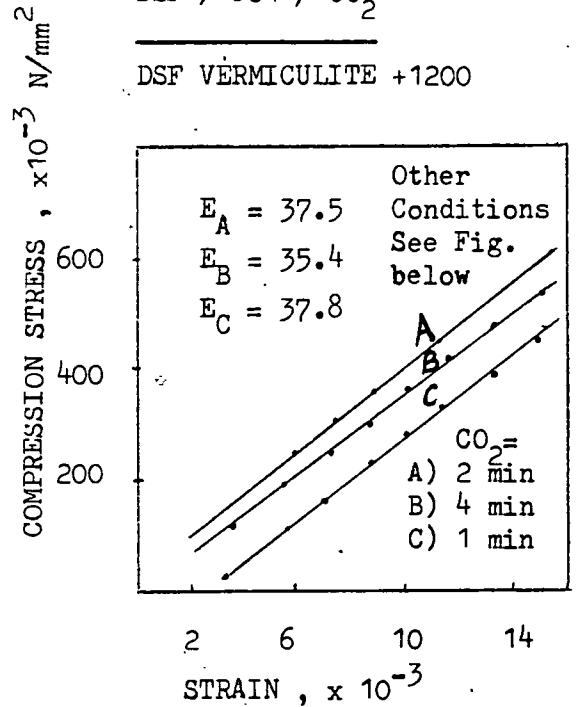

(59)

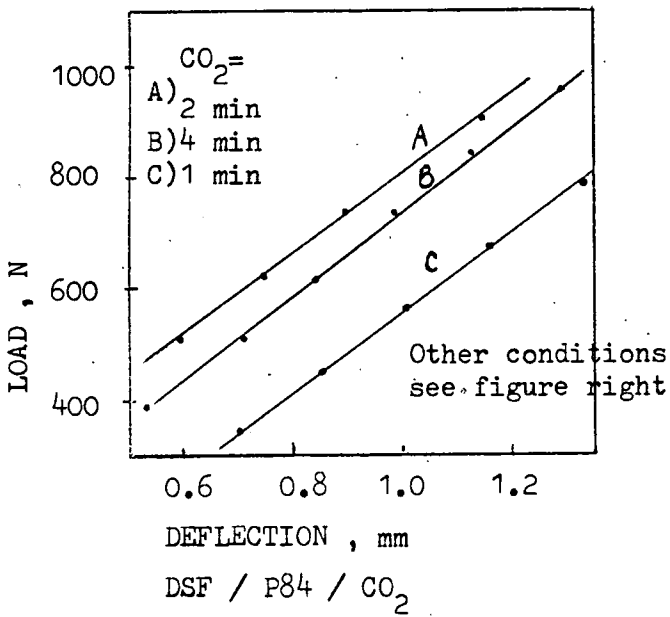

(58)

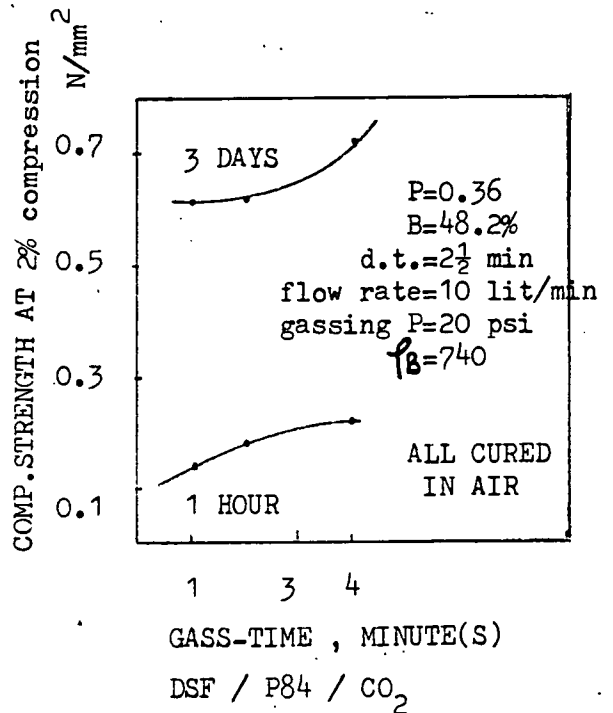

(60)

FIG. B, (61-64)

DSF / C112 / CO<sub>2</sub>

DSF VERMICULITE +1200

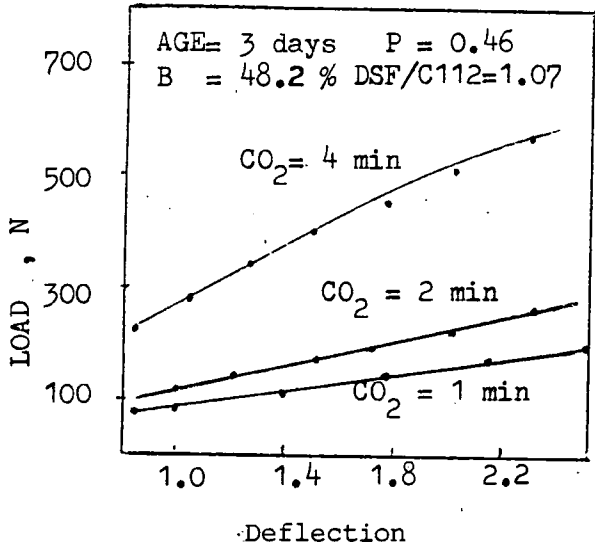

(61)

DSF / P84 / For.2

DSF VERMICULITE +1200

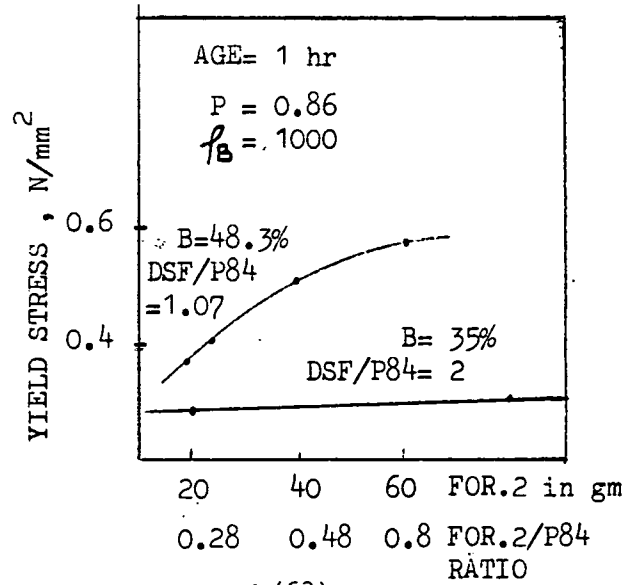

(63)

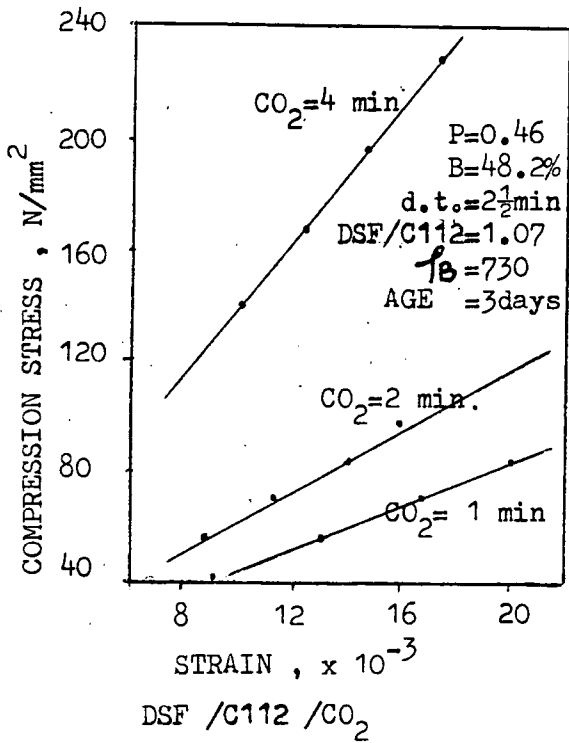

(62)

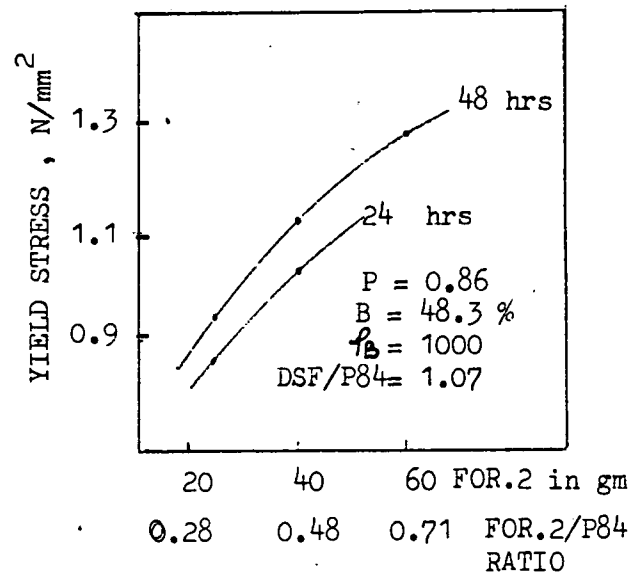

DSF / P84 / FOR. 2

(64)



FIB. B, (65-68)

DSF / P84 / FOR. 2

DSF VERMICULITE +1200

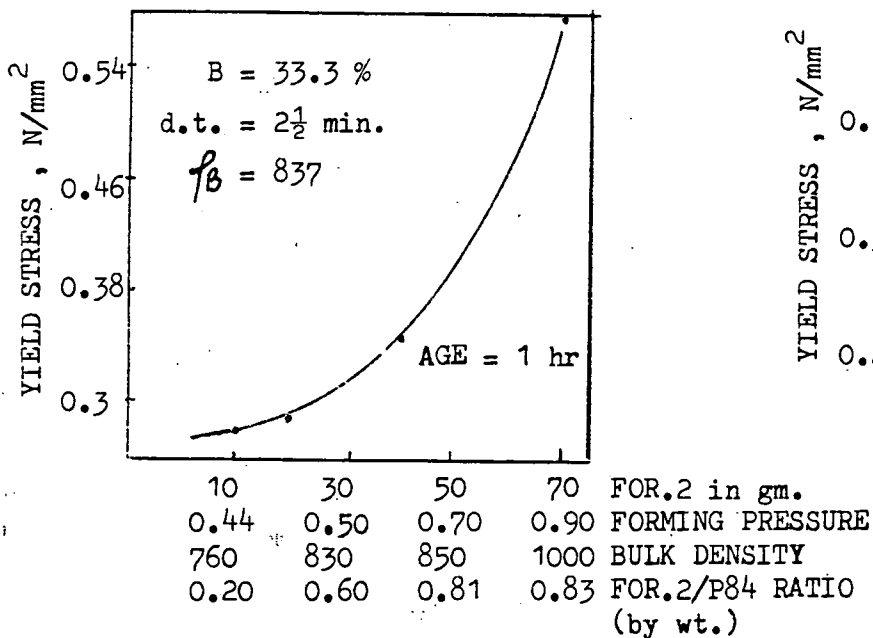

(65)

DSF / P84 /FOR. 2

DSF VERMICULITE +1200

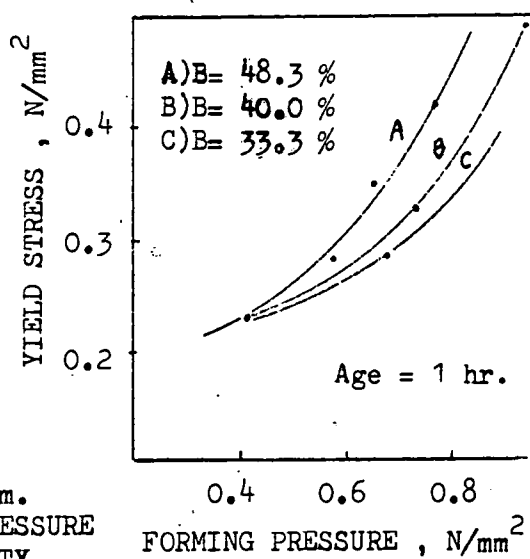

(67)

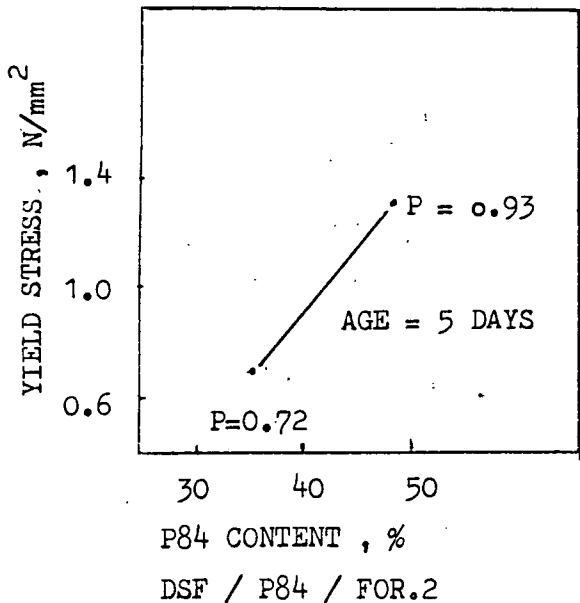

(66)

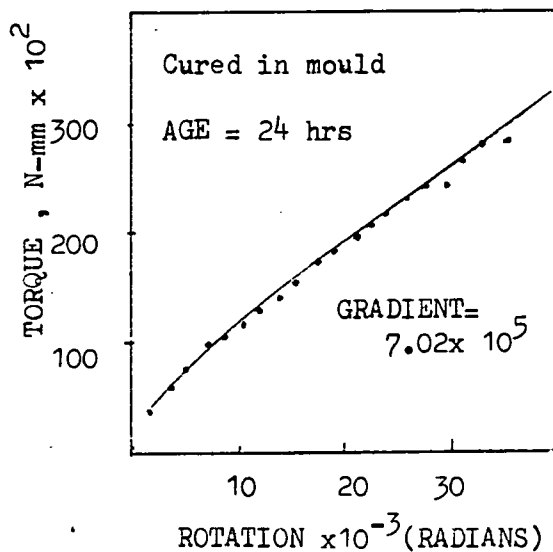

(68)

FIG. B, (69-70)

DSF+1200/P84

Cured 6 days at 110°C

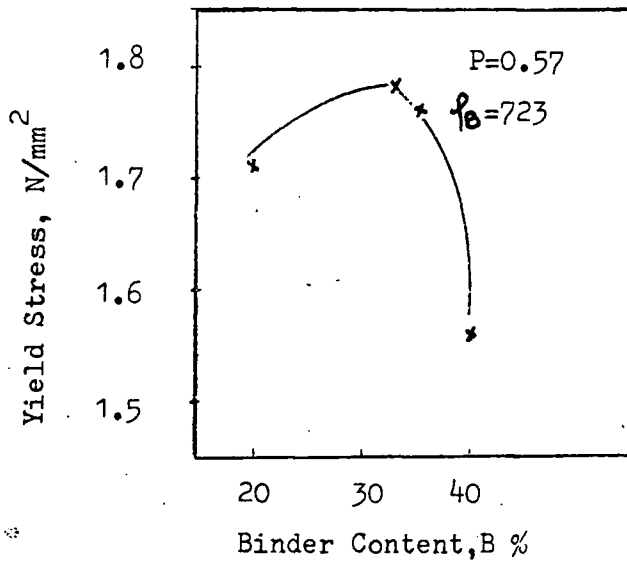

(69)

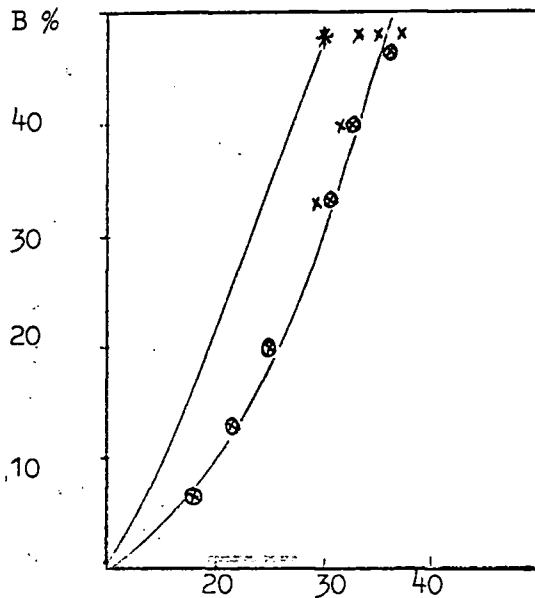

- ⊗ Hardener/P84=0.2
- × Hardener/P84=0.4
- \* Hardener/P84=0.7

DSF+1200/p84/Formular 2

(70)

FIG. B, (71)

DSF+1200/K95

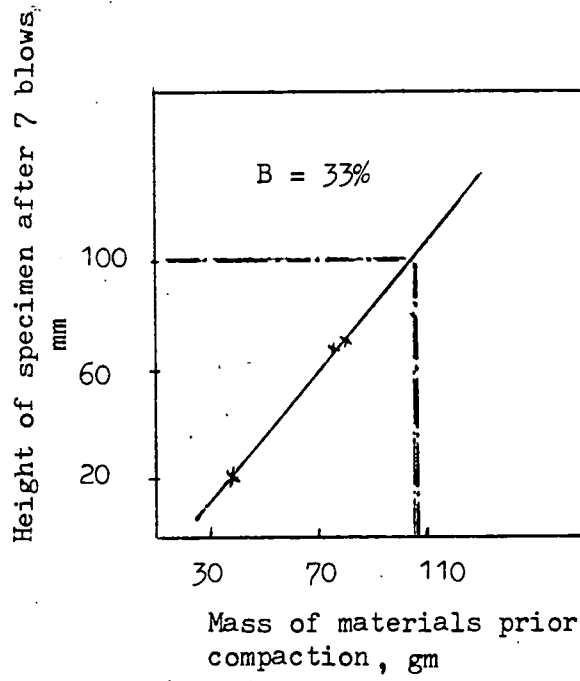

(71)

Using modified BS 812, aggregate impact tester.

FIG. B, (72)

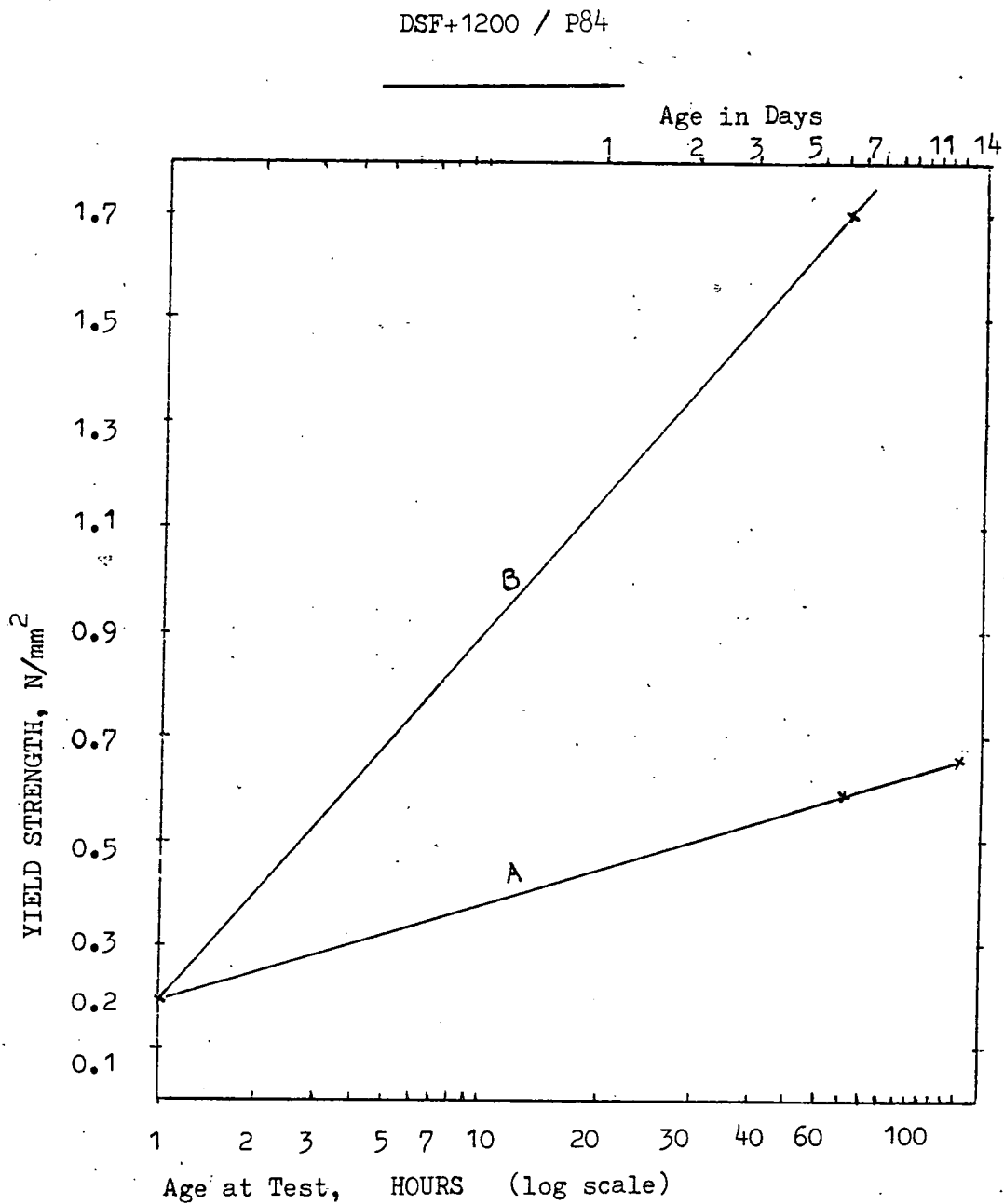

DSF+1200/P84

A) DSF/P84 = 67%/33% (NO HARDENER), Cured in Air.

P = 0.45 Bulk Density = 722

B) DSF/P84 = 67%/33% (NO HARDENER), Cured at 110°C for 6 days.

P = 0.50 Bulk Density = 730

FORMULAR 2 = (50/50 CETOS/SGS) = Powder Hardener

1a) DSF/P84=67%/33%, (50/50 CETOS/SGS)/P84=0.3, P=0.67,  $f_b=790$ , cured in Air.

1b) Same mix as 1a but cured at 110°C for 1 hour (initial curing method)

2a) DSF/P84=60%/40%, (50/50 CETOS/SGS)/P84=0.4, P=0.73,  $f_b=846$ , cured in Air.

2b) Same mix as 2a but first cured at 110°C for 1 hour then Air cured.

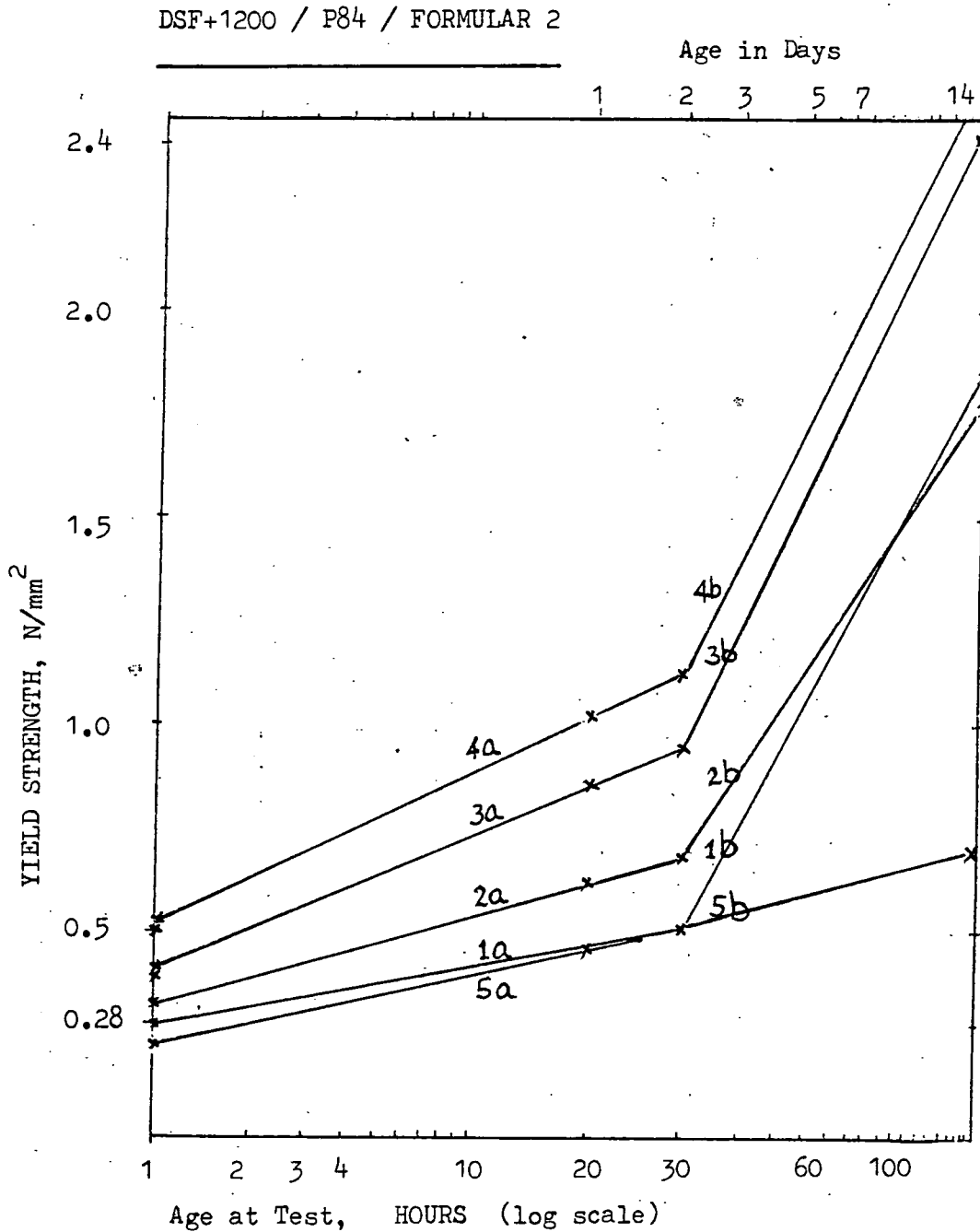

3a) DSF/P84=51.7%/48.3%, (50/50 CETOS/SGS)/P84=0.28, p=0.76,  $f_b=944$ , cured in Air.

3b) Same mix as 3a but cured at 110°C for 1 hour then followed Air cured.

\*\* 4a) DSF/P84=51.7%/48.3%, FORMULAR 2/P84=0.48, P=0.95,  $f_b=1000$ , cured in Air.

4b) Same mix as 4a but cured at 110°C for 1 hour then followed Air cured.

5a) DSF/P84=51.7%/48.3%, FORMULAR 2/P84=0.71, P=0.42,  $f_b=740$ , cured in Air.

5b) Same mix as 5a but cured at 110°C for 1 hour then followed Air cured.

\*\* THIS BLEND WAS SELECTED FOR STUDYING THE TERNARY COMPOSITE.

FIG. B, (74)

SUMMARY

DSF-VERMICULITE +1200 / SODIUM SILICATE / HARDENER  
BINARY COMPOSITE

DSF 52 %	+ 50/50 DIA/EGDA ESTER / K95 = 0.1	CURED 1 hr. at 110°C	→	$\sigma_y = 0.68, P=0.4, f_B = 740$
K95 48 %		$\sigma_y = 0.94, P=0.5, f_B = 786$		
				AGE = 2 DAYS.

DSF 52 %	+ CETOS CETOS / L96 = 0.8	CURED 1 hr. at 110°C	→	$\sigma_y = 0.39$	} P=0.84, $f_B = 1000$
L96 48 %		$\sigma_y = 0.77$			
				$\sigma_y = 0.81$	

DSF 67 %	+ NO HARDENER	CURED 6 DAYS at 110°C	→	$\sigma_y = 1.7, P=0.5, f_B = 730$
P84 33 %		$\sigma_y = 0.19, p=0.45, f_B = 711$		
				CURED IN AIR
				$\sigma_y = 0.59, P=0.55, f_B = 740$
				$\sigma_y = 0.63, P=0.45, f_B = 716$

ALL BY WEIGHT RATIO

Also DSF/C112/CO<sub>2</sub>, B 62

DSF/P84/CO<sub>2</sub>, see B58, B59, B60

DSF/P84/ For 2, B27 and B64 onwards

DSF/P84/SECAR, B40

FIG. B, (75)

DSF+1200/P84/LEIGHTON BAZZARD /(50/50 CETOS/SGS)  
TERNARY COMPOSITE

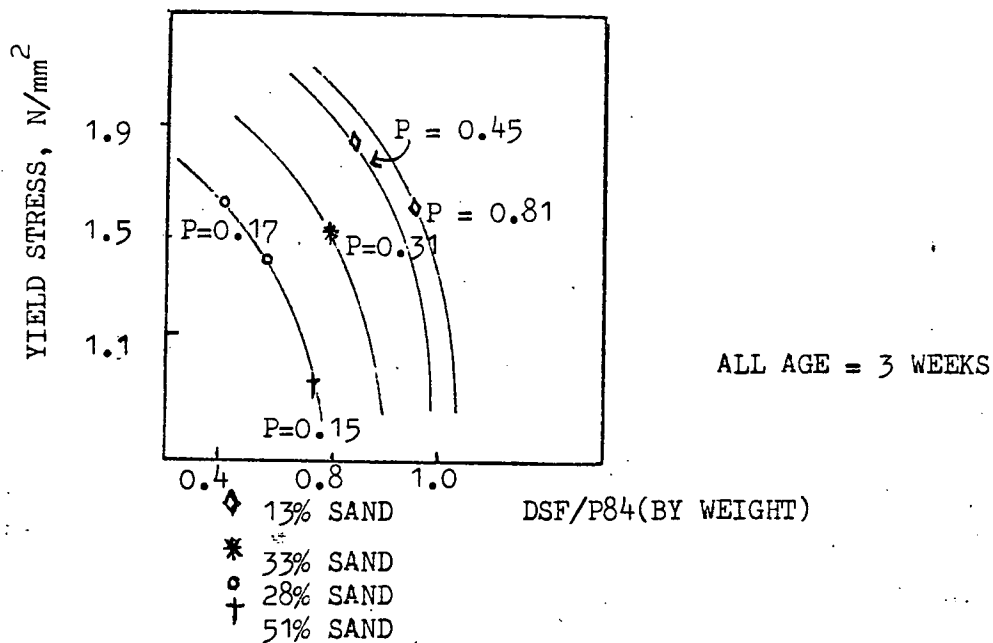
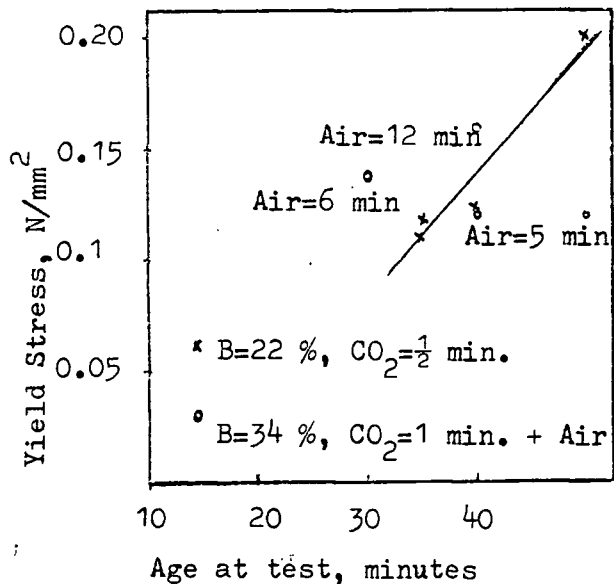

FIG. C, (1-4)

+1200 Shell EP Beads/C112/CO<sub>2</sub>+Air



(1)

+1200 Shell EP Beads/Special Blend

Shell Expanded Polystyrene Beads

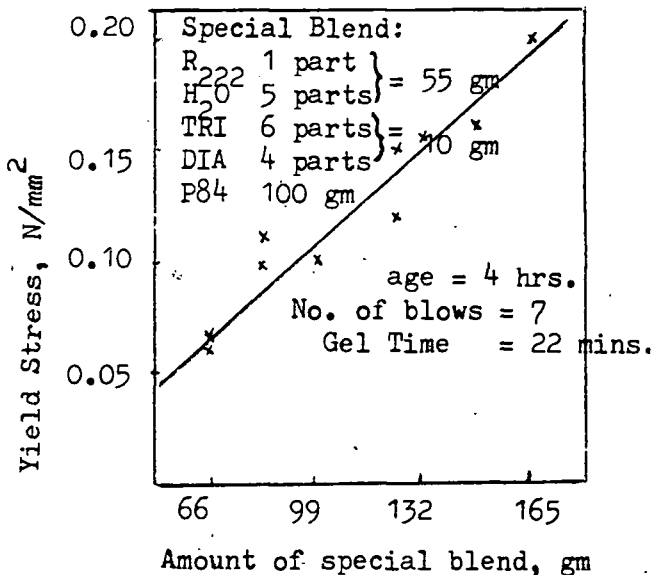

(3)

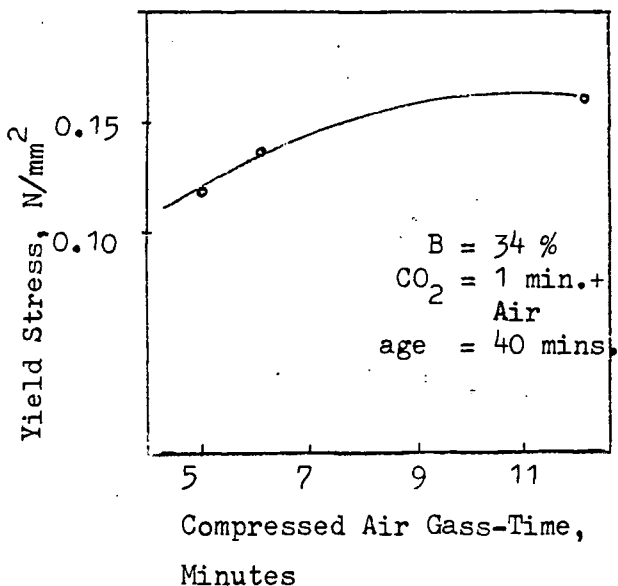

(2)

+1200 Shell EP Beads/C112/CO<sub>2</sub>+Air

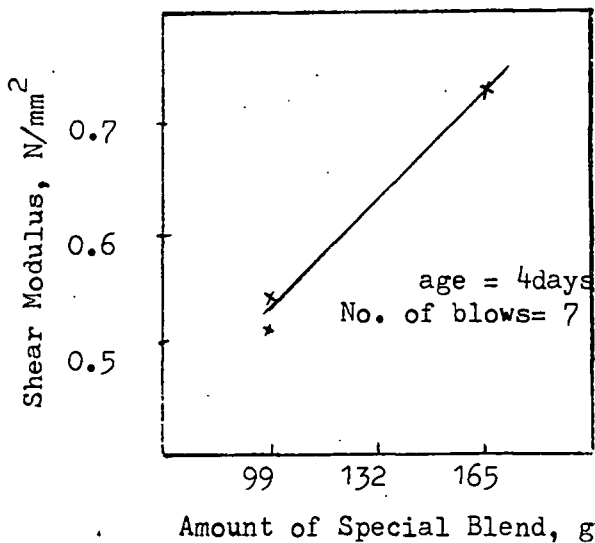

(4)

+1200 Shell EP Beads/Special Blend



- 1 gass time , t=30 s, B=22%
- 2 t= 30 sec + AIR , B=22%
- 3 t=1 min + 5 min AIR, B=34%
- 4 t=1 min + 2 min AIR, B=34%
- 5 t=1 min +12 min AIR, B=34%
- 6 t=1 min + 6 min AIR, B=43%

For Compressed Air:

P= 20 psi,

FLOW RATE= 7.5  
LIT/MIN.

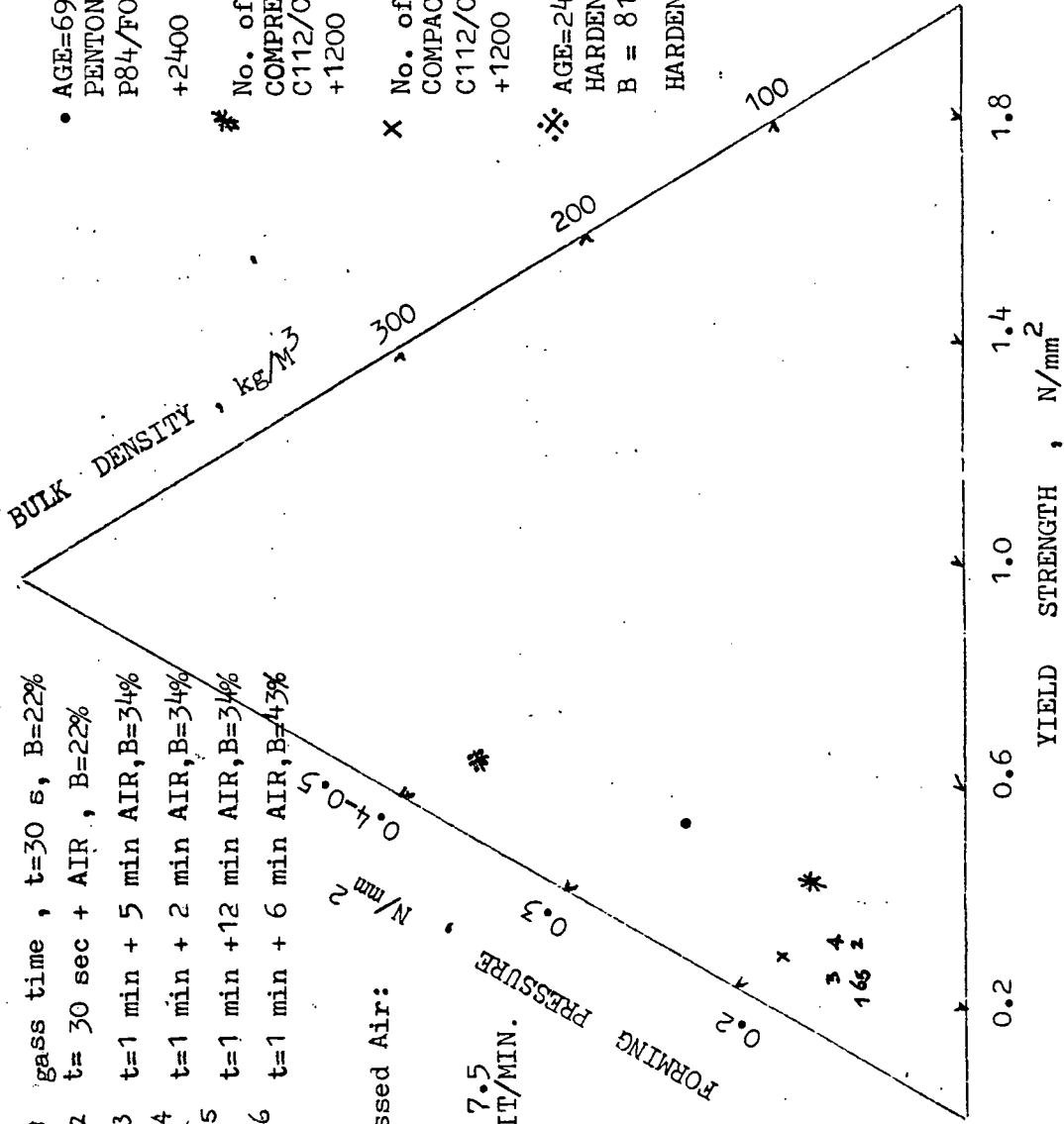

• AGE=69 days, B= 77% , BEADS PRECOATED with PENTON-ON solution.  
P84/FOMULAR 3 = 100/30 (by wt)  
+2400

\* No. of Blows = 25, B= 50%, AIR DRIED( BY COMPRESSED AIR ) for 20 minutes.  
C112/CO<sub>2</sub> , t=30 sec, flow rate= 10 lit/min.  
+1200

x No. of blows = 40, B= 50%, AIR DRIED for 60 mi  
COMPACTION CRACKS SPOTTED.  
C112/CO<sub>2</sub>, t= 30 sec, flow rate= 10 lit/min.  
+1200

\*: AGE=24 hours.  
HARDENER = SECAR/LIME ( 50%/50% by wt. )  
B = 81 %

HARDENER/P84 = 0.57 (by wt. )

FIG. C, (5)

FIG. C, (6-9)

SHELL EXPANDED POLYSTYRENE BEADS  
+1200 microns

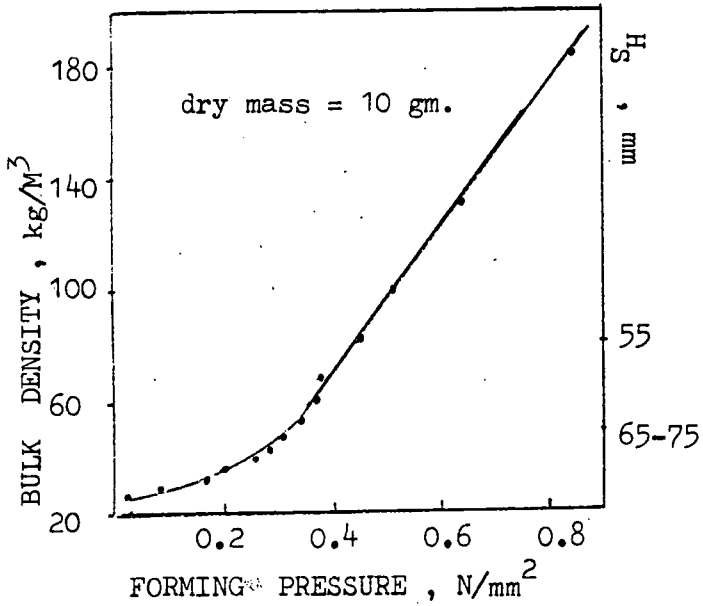

(6)

SHELL EXPANDED POLYSTYRENE BEADS  
+2400 microns

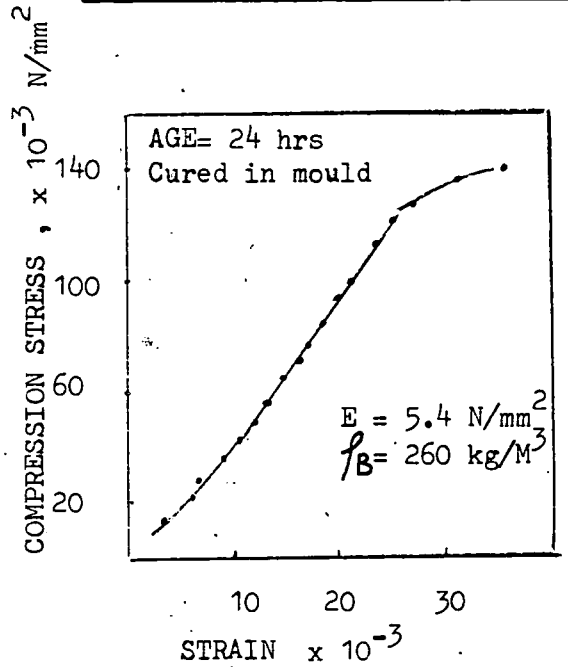

(8)

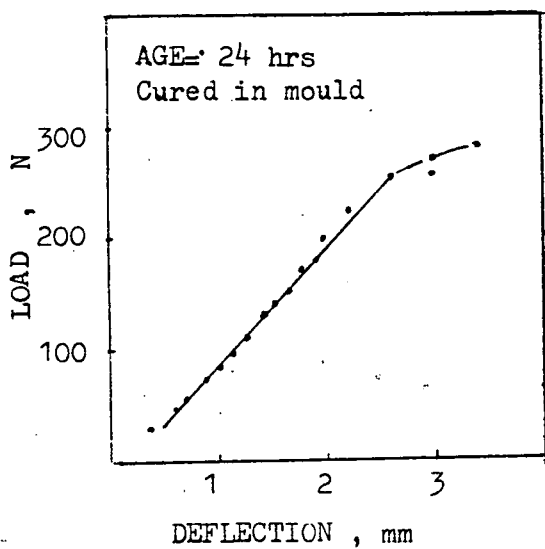

SHELL +2400 EPS/P84/SECAR+LIME

(7)

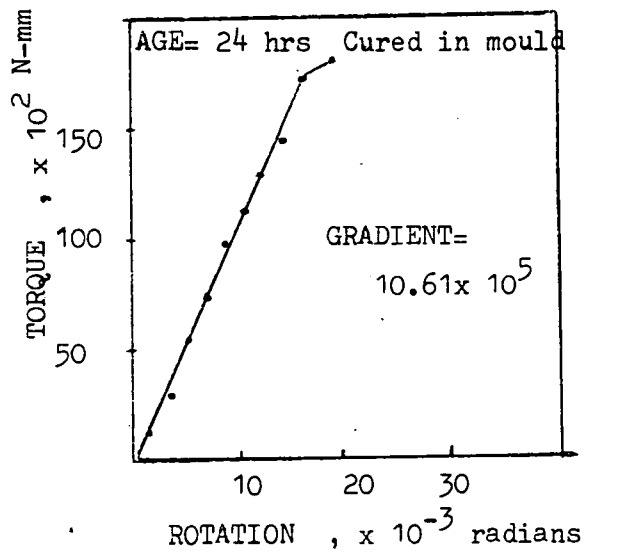

SHELL +2400 EPS/P84/SECAR+LIME

(9)

FIG. C, (10-13)

SHELL EXPANDED POLYSTYRENE  
+2400 BEADS

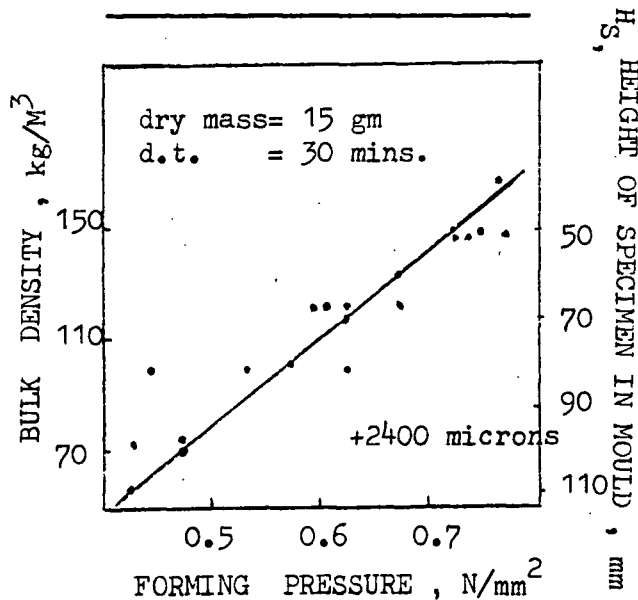

(10)

SHELL EXPANDED POLYSTYRENE (EPS)  
+2400 BEADS

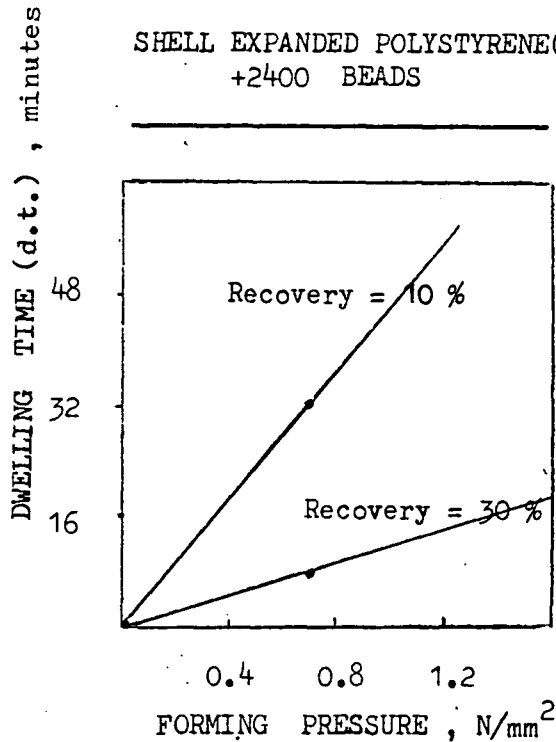

(12)

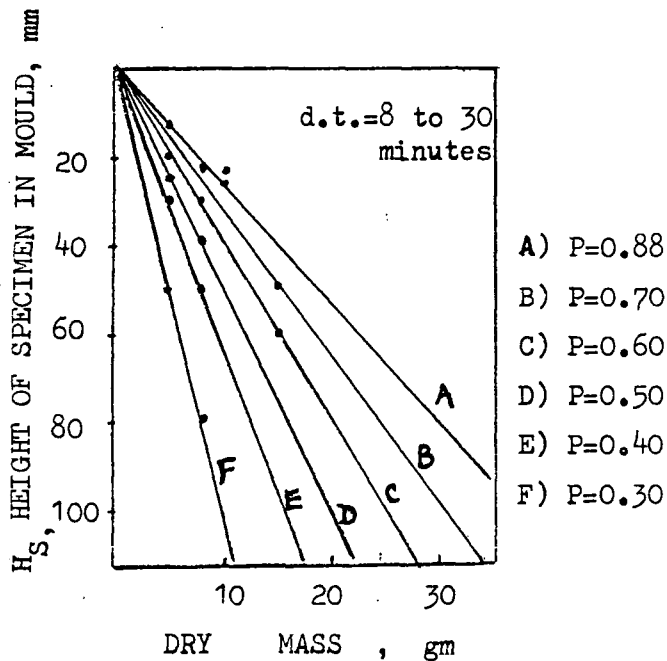

SHELL EPS BEADS ( DRY )

( FOR ANY EPS BEADS )

(11)

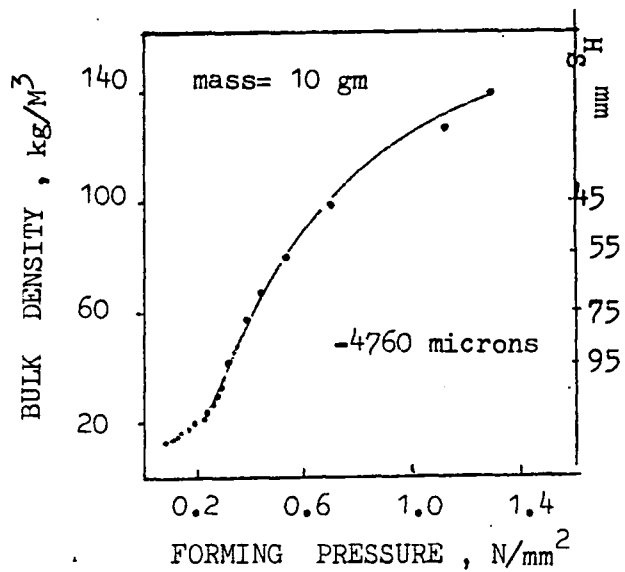

SHELL EPS BEADS ( DRY )

(13)

FIG. D, (1-4)

PERLITE / C112

FINE TO +850

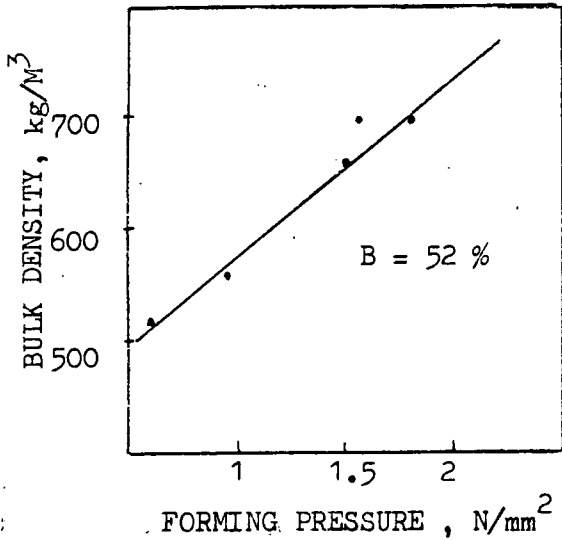

(1)

PERLITE / C112 / NO HARDENER

FINE TO +850

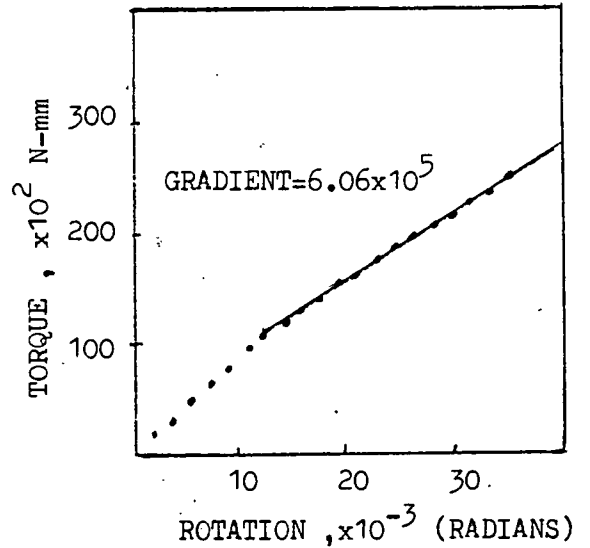

(3)

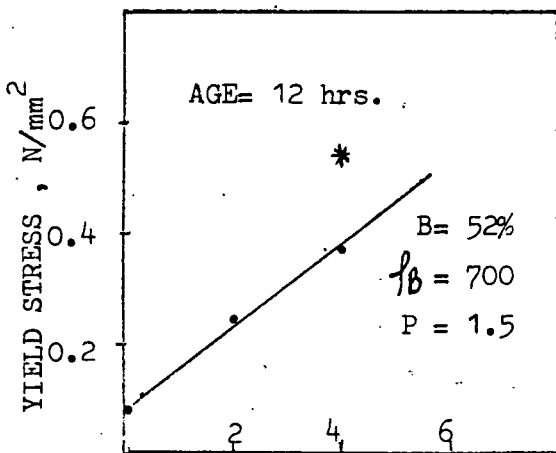

• AIR CURED  
\* HOT CURED-BAKED FOR 1 hr.  
AT 110 C

CO<sub>2</sub> GASS-TIME, MINUTE(S)

PERLITE / C112 / CO<sub>2</sub>

FINE TO +850

(2)

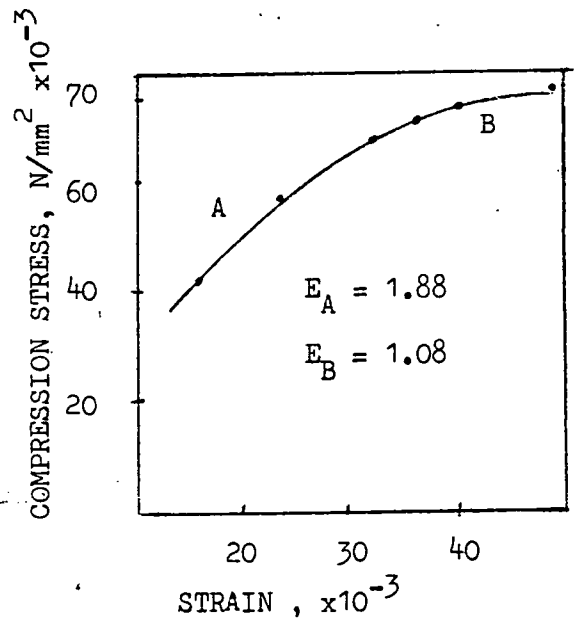

PERLITE / C112 / NO HARDENER

FINE TO +850

(4)

FIG. D, (5-8)

PERLITE/C112/CO<sub>2</sub>

FINE TO +850

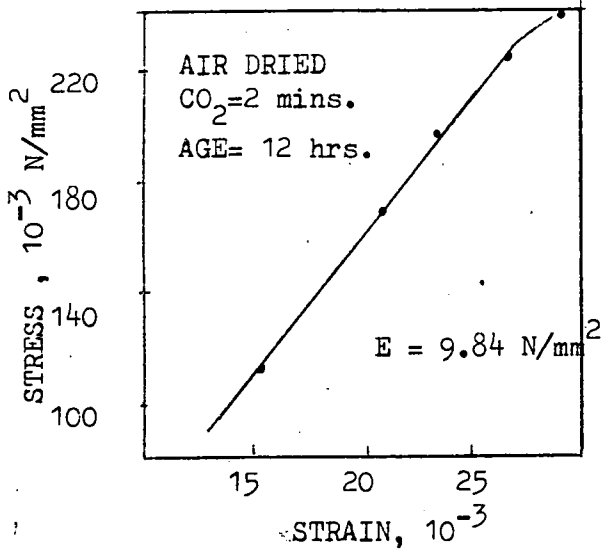

(5)

P84 / ESTER

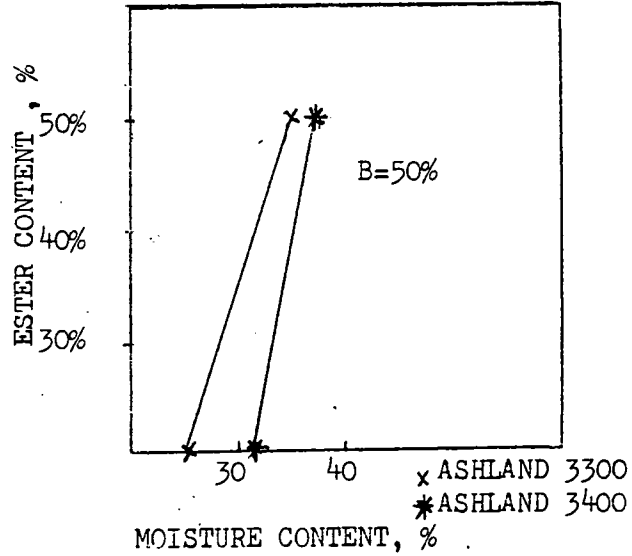

(7)

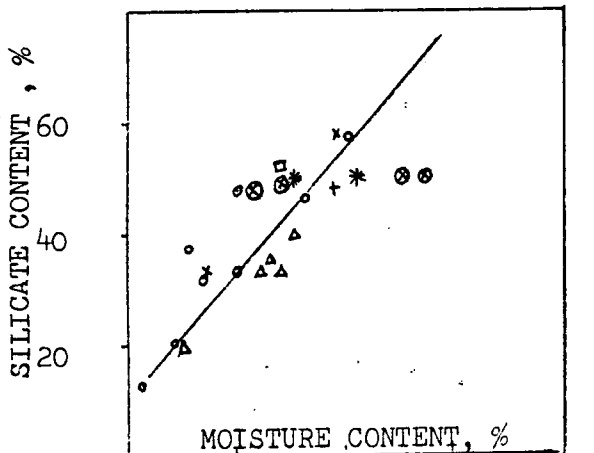

- x P84/SECAR
- \* P84/ESTER
- ⊙ P84/ESTER
- △ P84/NO HARDENER
- + P84/CO<sub>2</sub>
- ⊙ P84/FOR.2
- C112/CO<sub>2</sub>

P84 / ± HARDENER

(6)

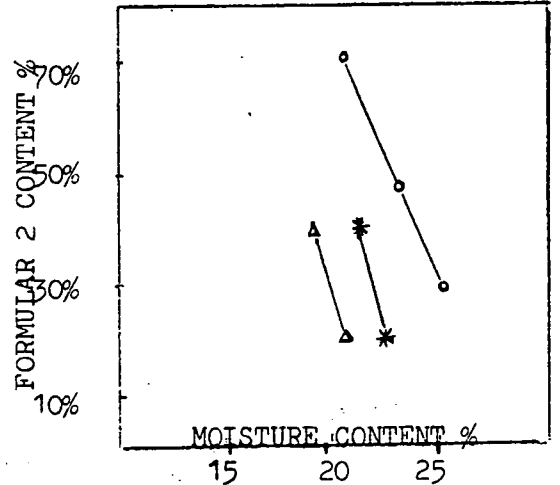

- △ B = 33 %
- \* B = 40 %
- ⊙ B = 48.3 %

P84 / FORMULAR 2

(8)

FIG. D, (9-12)

Perlite+2400/P84/CO<sub>2</sub>

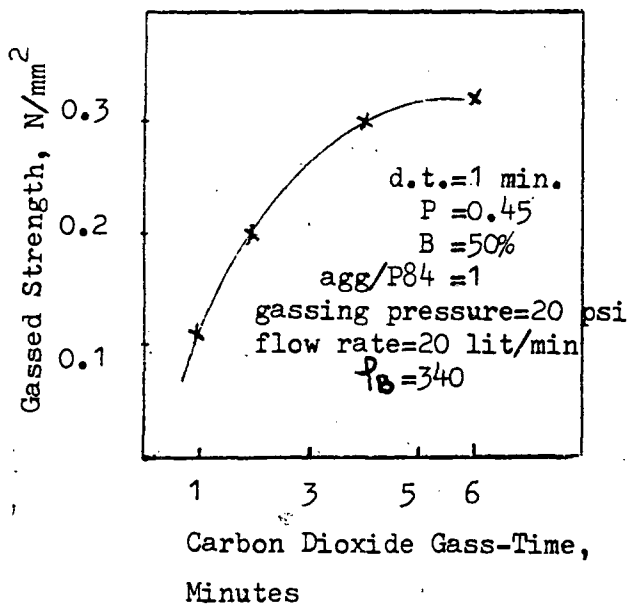

(9)

Perlite(Fine to +850)/P84/CO<sub>2</sub>

d.t. = 90 sec.  
 P=1.5  
 B=52%  
 agg/P84=0.92  
 av.  $f_B = 710$

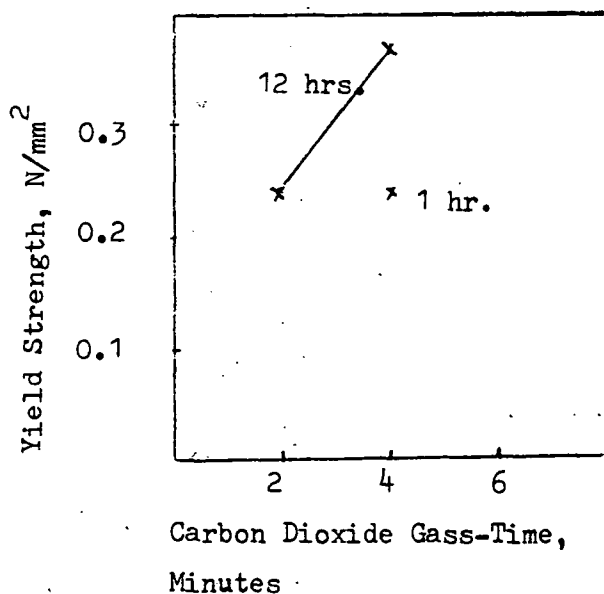

(11)

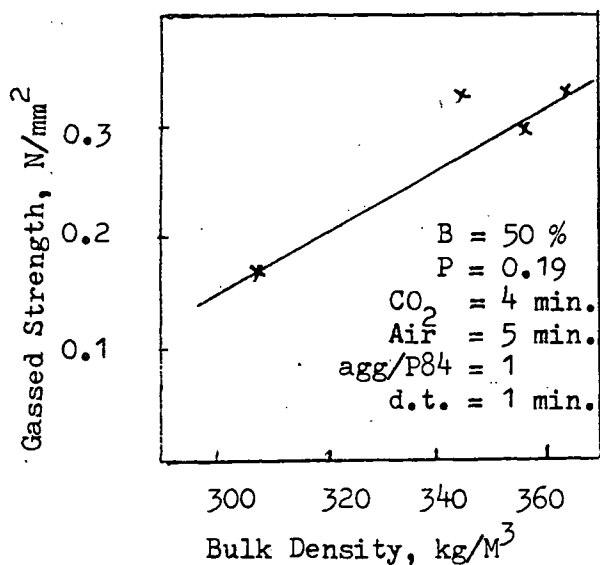

Perlite+1200/P84/CO<sub>2</sub>

(10)

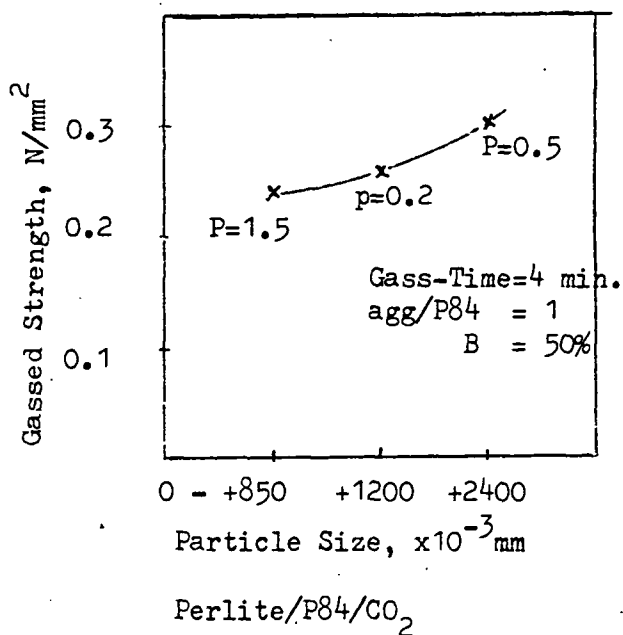

(12)

PART II

8.4.2 TEST RESULTS

(A) Type of mixes

Table 8.1

Type of aggregate	Type of Silicate	Type of Hardener	Quantity used (gm)		Agg/Binder	B, %	Catalyst/Binder	Mass of specimen (gm)	
			Agg.	Silicate				Compression	Shear & torsion
Wallpaper	P84	50/50 of Cetos/SGS	100	138	0.72	58	0.20	114	142
DSF, +1200 Vermiculite	P84	SECAR	90	98	0.92	52	0.61	82	150
Wallpaper + Water	P84	Cetos/SGS (50/50)	100 + 13 (H2O)	100	1.00	50	0.20	114	172
+2400 Shell Exp. Beads	P84	Secar/Lime (50/50)	25	105	0.24	81	0.57	53	52
DSF, +1200 Vermiculite	L96	CETOS	150	140	1.07	48	0.80	190	190
DSF, +1200 Vermiculite	K95	DIA/EGDA (50/50)	150	140	1.07	48	0.10	113 108	181 192
Expanded Perlite	C112	CO <sub>2</sub>	290	315	0.92	52	Varied	135	135

TABLE 8.1



B. Summary of the above different composite systems

	Wallpaper/P84/ For.2	DSF/P84/ SECAR	Wallpaper/P84/ For.2 (With H <sub>2</sub> O)	+2400 Shell Beads/P84/ SECAR+LIME	DSF/L96/ Cetos	DSF/K95/DIA/ EGDA	DSF/K95/DIA/ EGDA	Ex. Perlite/ C112
Forming Pressure, (N/mm <sup>2</sup> )	0.50	0.42	0.50	0.52	0.84	0.84	0.42	1.80
Binder Content, (B%)	58	52	50	81	48	48	48	52
Bulk Density (Kg/m <sup>3</sup> )	700	820	1000	260	1000	953	740	701
Dwelling time under pressure(seconds)	90	150	1800	2 hrs.	1380	600	300	600
Compressive Strength (N/mm <sup>2</sup> )	0.14 to 0.53 (7% & 15%)	0.44 (4%)	0.75 (15%)	0.095 to 0.142 (2% & 4%)	0.4 to 0.8 (2% & 4%)	0.6 (2.3%)	0.6 (5%)	0.08
Av. G <sub>C</sub> (N/mm <sup>2</sup> )	0.48* (24 hrs.)	1.36* (24 hrs.)	2.57* (24 hrs.)	1.98* (24 hrs.)	2.63(?)†† (24 hrs.)	2.56(?)†† (24 hrs.)	3.64(?)†† (24 hrs.)	1.17(?)†† (24 hrs.)
Av.EC. (N/mm <sup>2</sup> )	1.32†	4.55* to 16.0* (24 hrs.)	-	5.4* (24 hrs.)	27.9* (24 hrs.)	18.3* (24 hrs.)	21.5* (24 hrs.)	1.08 to 1.88* (24 hrs.)
Av.T (N-mm)	258.55 x 10 <sup>2</sup>	281.8 x 10 <sup>2</sup>	336.1 x 10 <sup>2</sup>	178.4 x 10 <sup>2</sup>	486.07 x 10 <sup>2</sup>	390.41 x 10 <sup>2</sup>	-	250.8 x 10 <sup>2</sup>
Av. T (N/mm <sup>2</sup> ) (max)	4.32	4.71	5.61	2.98	8.12	6.52	-	4.19
Av. moisture content ‡	29.3	23.7	31.4	40.0	20.6	27.8	28.1	24
Age attest	24 hrs. to 7 days	24 hrs. to 7 days	24 hrs.	24 hrs.	24 hrs. to 48 hrs.	24 hrs. to 48 hrs.	24 hrs. to 48 hrs.	12 hrs. to 24 hrs.

\* Cured in Mould

† Cured in Air

†† Cured 1 hr. at 110°C in oven, then air dried.

TABLE 8.2



(C) Comparison of  $G_T$  and  $G_S$

	$G_T$ (N/mm <sup>2</sup> )	$G_S$ (N/mm <sup>2</sup> )	Av. $G_C$ (N/mm <sup>2</sup> )	$G_T/G_S$
Wallpaper/P84/For.2	0.547	0.4215	0.48	1.30
DSF/P84/SECAR	1.420	1.29	1.36	1.10
Wallpaper/P84/For.2	2.420	2.72	2.57	0.89
+2400 Shell Ep.Beads /P84/(SECAR/LIME)	2.143	1.825	1.98	1.17
DSF/L96/CETOS	2.020	3.23	2.63	0.63
DSF/K95/DIA*/EGDA	2.424	2.7	2.56	0.89
DSF/K95/DIA*/EGDA	-	3.64	3.64	-
Ex. Perlite/C112	1.224	1.12	1.17	1.10

Table 8.3

\*DIA/EGDA = 50% by weight of DIACETIN and 50% by weight  
of Ethyleneglycol Diacetin.

(D) Factors affecting the results for  $G_T$  and  $G_S$

A good starting point to check the accuracy of  $G_T$  and  $G_S$  is to use the expression Poisson's Ratio,

$$\nu = \frac{E - 2G}{2G}$$

where  $\nu \neq 0.5$ .

There was strong indication that the accuracy of  $G_T$  and  $G_S$  was dependent on the curing and loading methods. Indications of this may be seen in the 6th row of Table 8.2. The  $G_C$  value here indicates that  $\nu$  would exceed 0.5, so that the results, in general, are in question.

By experience, one would guess that expanded polystyrene silicate composite has a lower shear modulus than expanded perlite composite. However, this was not so in our finding. It was believed that the bonding between the surface of the mould and the specimen was damaged or weakened due to shrinkage during the curing process of one hour in an oven at 110°C (see also Table 8.4).

The testing programmes were not originally intended to have close parallel examination on two composite systems at identical geometry or the same chemical and silicate composition. For this reason, we have no data on how the rise in curing temperature affects the accuracy of  $G_T$  and  $G_S$  with a standard curing method, under a controlled environment, e.g. cured in mould under general atmospheric condition.

However, a simple test was devised to aid understanding of the shrinkage behaviour of silicate gel or matrix under certain controlled environment. The amount of silicate and hardener was according to Table 6.1. After thorough mixing, the sample was placed in a fan-circulated oven at 100°C and observed frequently during a period of 24 hours. Table 8.4 showed some of the findings. Only the types of silicates mentioned earlier were chosen, i.e. P84, L96, K95 and C112. P84 was the readiest to loose its water while C112 was the slowest.

Type of mix	Amount used by weight (gm)	General comments
P84/FOR.2	138/28	Slow shrinkage after setting but progressive as temperature gradually increased to 100°C. Cracks propagated from top to bottom after 24 hrs., especially with P84/SECAR + LIME
P84/SECAR	98/60	
P84 (SECAR + LIME)	105/60	
L96/CETOS	140/112	Very similar to above
K95(DIA. + EGDA)	140/14	Faster shrinkage and texture changes. Crumble after 24 hrs.
C112/CO <sub>2</sub>	315 + 2 minutes CO <sub>2</sub> at 20 psi gassing pressure and 10 lit/min.	No sign of complete setting but top surface was hardened. Deep concave surface pattern showed after 24 hrs.

Table 8.4

From Table 8.4, it is evident that the amount of shrinkage in the environment of increase in temperature depended on the type of silicate and hardener chosen.

Other evidence suggested that the value of shear modulus was due to the dwelling time (d.t.) that a specimen was confined under a prescribed pressure. For example, Table 8.2 showed for the Wallpaper/P84/For.2 system, at column 1 and 3, that the two  $G_C$  values were very greatly different,

probably due to the difference in d.t. used, where d.t. = 90 seconds,  $G_C = 0.48 \text{ N/mm}^2$ , and d.t. = 1800 seconds,  $G_C = 2.57 \text{ N/mm}^2$ , which constitutes a difference of 435%.

(E) Factors affecting the strength and stiffness

In general, higher silicate contributed to better stiffness and more hardener indicated considerable increase in strength. (e.g. Fig. D2).

For example, Fig. B(1) showed that for the same binder content at 48.3% the higher compressive strength was noted for Hardener/Binder ratio at 0.83 then 0.28 and at B = 33.3%, when Hardener/Binder ratio equalled 0.00 (no hardener), the strength recorded was the lowest.

Fig. B(14) showed that as the binder content increased, there was an improvement in Young's Modulus.

8.5 Concluding Remarks

The first part of this study has been seeking an understanding of the affinity of different aggregates to P.84, L96, K95 and C112 grades silicate, notably DSF/silicate systems, where many different types of hardener have been tried in improving the strength of final products. Among the many systems investigated, the DSF/P84 system was found to be the most satisfactory. This was due to the combination of lightness, dryness, regular shapes, high thermal insulation quality and good fire rating, and not least, also the ease with which it could be compacted and its excellent workability when

mixing with silicate. This contrasts with mixes using sawdust, where the presence of other organic materials and impurities were found evidently affecting the strength of the final product. (Ref. 48).

The factors affecting strength were investigated and their effects classified for the named system. The results have been presented in graphical form.

The second part of the study has been devoted to the verification of the proposed techniques in finding the shear modulus of a composite. Six composite systems were finally chosen and results of tests on these materials were tabulated and summarized in Tables 8.1, 8.2 and 8.3.

The findings of these two parts of the study have been as far as possible in four groups of graphic presentation, namely, Fig.A (for Wall-paper/silicate), Fig.B (for DSF/silicate), Fig.C (for shell beads/silicate) and Fig. D (for Perlite/silicate).

There is evidence that the strength of a silicate composite sample in the form of 50 mm x 100 mm cylinder, was largely dependent on the following factors:

- (1) Type of hardener and silicate, e.g. Fig. B.32 and Fig. B.59 plus B.62 .
- (2) Forming pressure, e.g. Fig.B.65, B.34, B.35, B.36 and Fig.A.5, A.14.
- (3) Amount of hardener (or Hardener/silicate ratio), e.g. Fig.B.65, B.1.
- (4) Method of curing, i.e. temperature and dwelling time, e.g. Fig.B.72, B.48, B.40, B.42, B.72, B.73 and Fig. A.14., A.7, A.6.
- (5) Bulk density of final product, e.g. Fig.B.65, and A.14.

Finally, from Fig. B.13, B.14, B.15 and B.69, there was strong evidence that increases in binder content were accompanied by increases also in the stiffness of the specimen.

CHAPTER 9

CONCLUSION

The suitability of four types of soft granular materials for bonding and stabilization by soluble sodium silicates is believed to be affected primarily by the temperature of the mixture and the applied moulding pressure. The moisture content and the particular type of silicate binder will also have an influence.

The experiments and tests that have been performed were designed to show that nature of these relationships so as to give guidance when such materials are being developed for possible uses in structural components.

The experiments were very much simplified since no attempt was made to provide an external heat source, nor was any attempt made to provide hot gassing of the sample. However, relationships have been found between the strength, forming pressure and the binder content.

The materials to be bonded were often porous and had the capacity to absorb large amounts of liquid; and for this reason a large quantity of sodium silicate binder was often required. The difficulty in obtaining adequate dehydration led only to a slowly improving strength of the sample.

The virgin fibres in Paper Pulp were found to have a relatively high moisture content and they could be stably compacted at an elevated temperature without the need for any binder. However, this was not possible at room temperature. The optimal moisture content to facilitate stable compaction at high temperature can be determined experimentally, but this was not performed since this project was concerned only with cold processes. However, at a considerably high binder content, the use of elevated temperature treatments are, probably, not appropriate since sodium silicate differs a lot from water. In practice, its viscosity reduces at an elevated temperature. This can lead to inhomogeneity of the sample

because the sodium silicate will preferentially collect at the bottom of the sample. This is an undesirable effect and provides difficulties for experimental study of the warm/hot process.

Sodium silicate is being used as an inorganic binder in the foundry industry. This has been reviewed in Chapter 2. Very little work has been attempted previously to combine sodium silicate with types of aggregates such as paper pulp and vermiculite. In composite construction, the first step usually considered is to establish predictable strength - time relationship. Sodium silicate is capable of setting within seconds with the addition of other agents as already reviewed. This undoubtedly, upgrades the silicate from merely a glue to a very useful 'rapid hardening cement.' A product such as that obtained by mixing sodium silicate anhydrous and ordinary Portland cement is already recognised to provide better strength and water-tightness than other ordinary concrete.

In this work it has been shown that there are not less than seven agents, apart from ordinary Portland cement, which are seen to improve the quality of the silicate-stabilized products. (See Fig.B.32 and B.74). Provided the correct method of compaction is chosen, together with a basic understanding of the physical nature of the aggregate, (such as softness, for example), many materials can realistically be stabilized by 'sodium silicate cement' at a very much lower cost than would be in the case of using cement alone.

**DSF-Vermiculite**, for example, in this study has proved very suitable to mix with sodium silicate in the presence of other agents.

Also, it has been shown that Paper pulp provides some practical difficulties because of its high moisture content as supplied from the pulper, but that these may be overcome to produce a useful result. Another typical case where useful information has been obtained has been the identification of two materials which are totally incompatible. These are expanded polystyrene beads and sodium silicate systems. This is mainly



due to the problem of obtaining suitable mechanical interlocking among aggregates because of their high resilience and because the particles are spherical. Finally, expanded perlite, which resembles sand in its chemical content of silicon, is a possible material for adopting the CO<sub>2</sub>-gassing technique to obtain high-strength materials. A more suitable method of compaction would be a vibrating type rather than the static compaction used in these experiments. The disadvantage of the CO<sub>2</sub>-silicate process is its gradual loss in strength as the gassed-product absorbs moisture slowly from the atmosphere, although a layer of proprietary sealant can be used to achieve water resistance. In general, sodium silicate has not been successfully used in conditions of outdoor exposure because of its sensitivity to water and moist air. It is difficult, therefore, to draw any sensible comparison of its durability alone with other stabilizers such as plaster and cement.

The two tests, torsion and axial shear, attain an assessment of each others reliability when used in conjunction. This provides additional insight into the suitability of compacting soft materials to a required strength.

It is suggested that further work be conducted in the following areas:

- (1) A shear vane central piece could replace the circular rod currently used in this work. A piece of apparatus similar to a Laboratory shear vane tester used to obtain the shear strength of cohesive soil would be recommended.
- (2) The shear modulus obtained from the test described here should be more thoroughly verified by other methods.

Besides the many shortcomings found in using water-soluble silicate alone, there are many encouraging aspects when sodium silicate is mixed with agents like Portland cement and high alumina cement to provide potentially new stabilizers for very wide civil engineering applications.

APPENDIX I

---

PHOTOGRAPHS

10-10-10

(1)

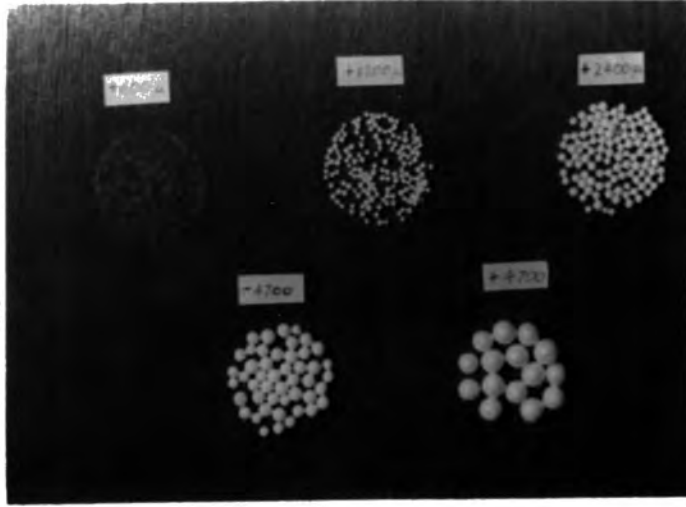

(2)

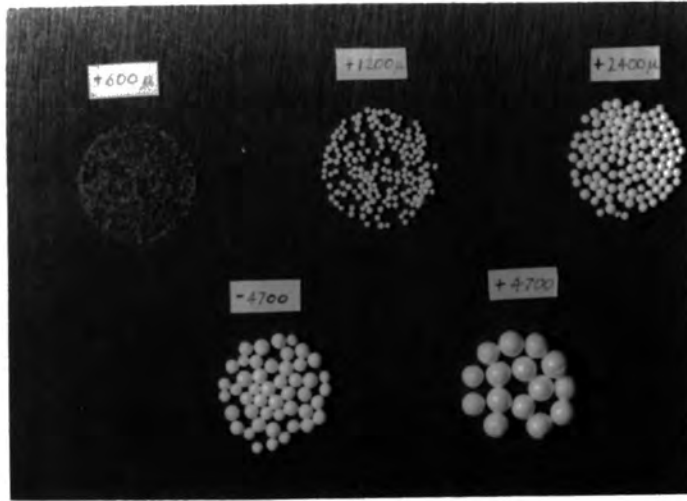

(3)

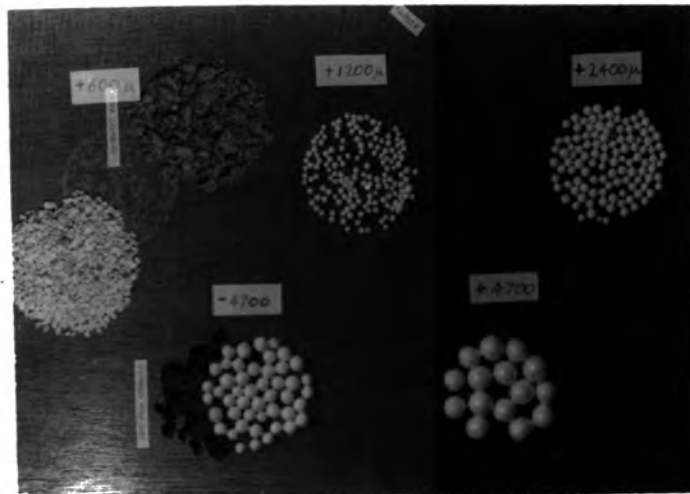

Range of granular materials studied, showing their particle sizes

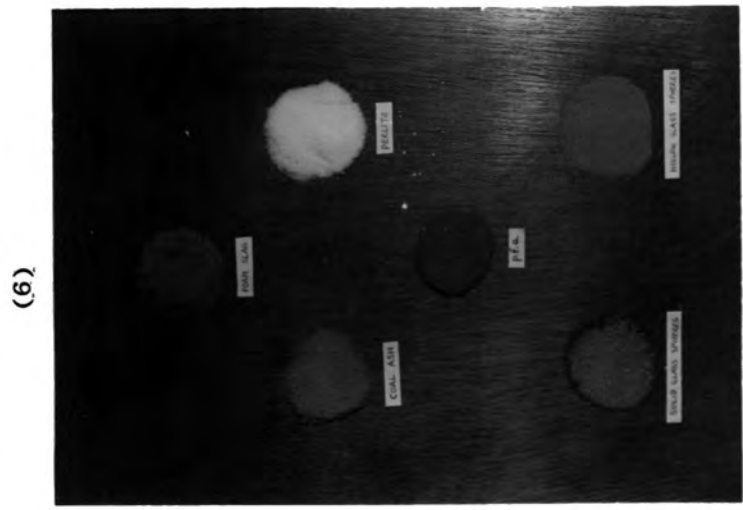
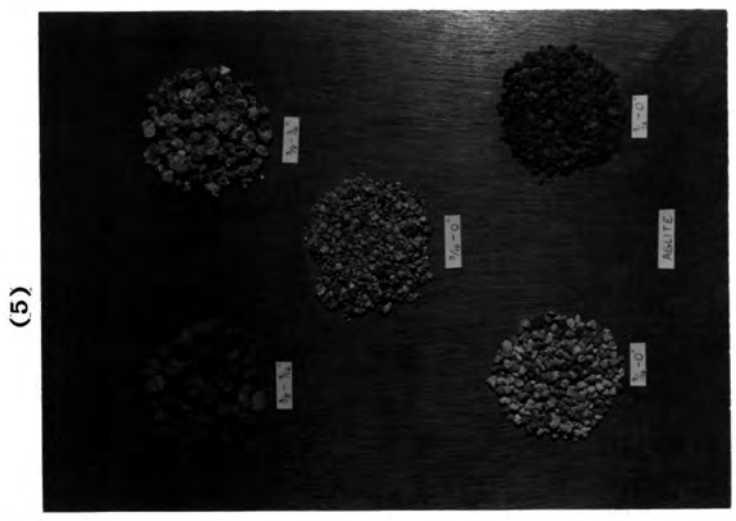
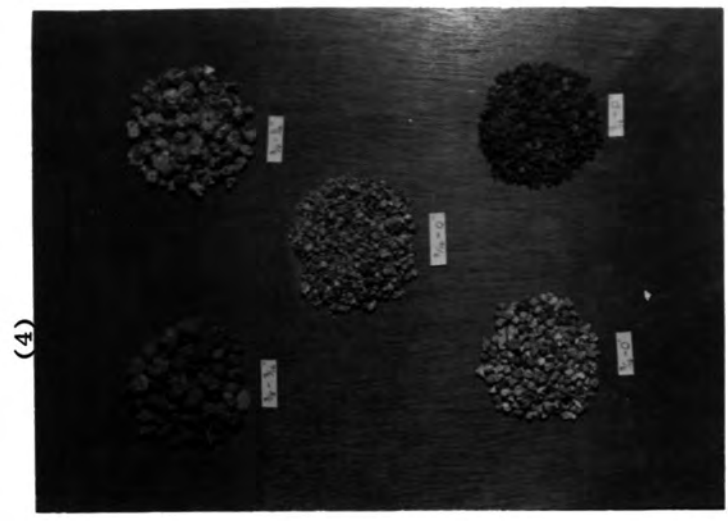

Range of materials studied

(9)



2" cylinders compacted in the laboratory. Black one was a bituminous specimen

(8)

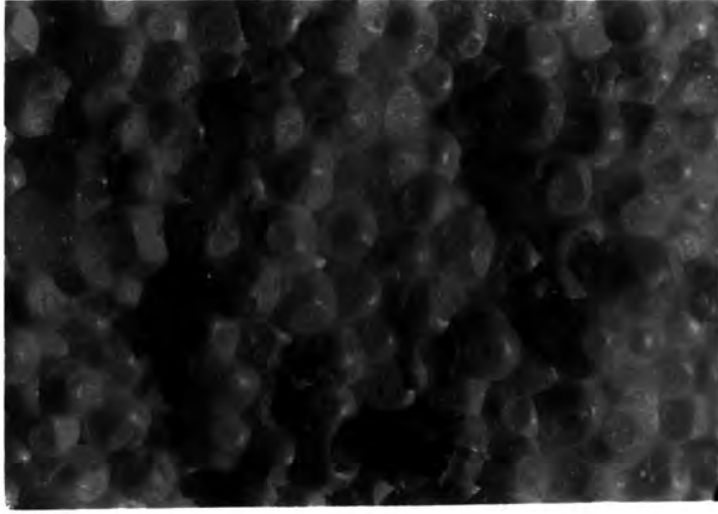

Cross-sectional view of commercial expanded polystyrene board showing good compaction

(7)

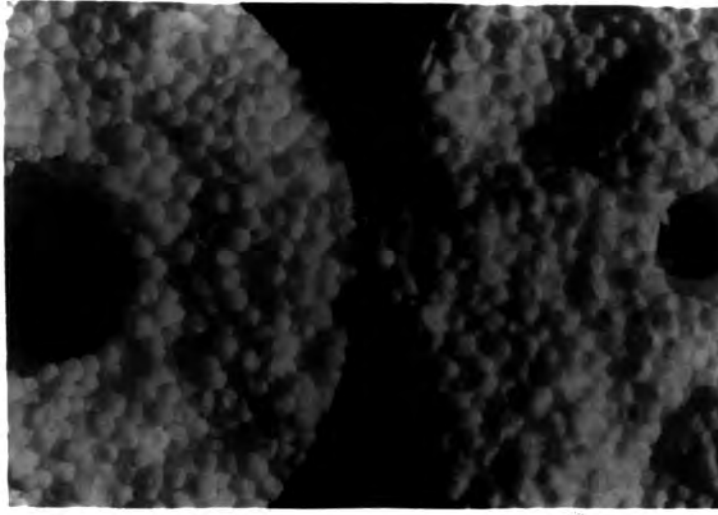

Poor compaction specimens prepared by modified aggregate impact tester

(12)



Undesirable failure of expanded polystyrene cylinder due to friction between top capping the loading plate

(11)



Dry expanded polystyrene beads alone of +1200 compressed to 40%, 86% and 90% reduction in volume, using static pressure. Background tubes showed the initial heights

(10)



General view of working space in the laboratory

f

(15)

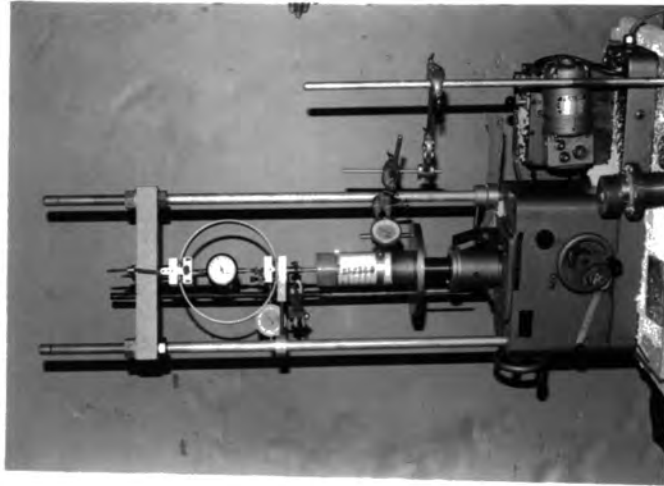

Constant strain triaxial tester used for unconfined compression and shear tests

(14)



Another view of photograph (13)

(13)



Extruding a sample using hydraulic jack,

(18)



Swedish made torsion tester

(17)



CO<sub>2</sub> - silicate process, a general set up showing the flow meter

(16)



Applying pressure using ordinary 2 ton car jack



(21)



Range of medium soft to hard materials studied

(20)

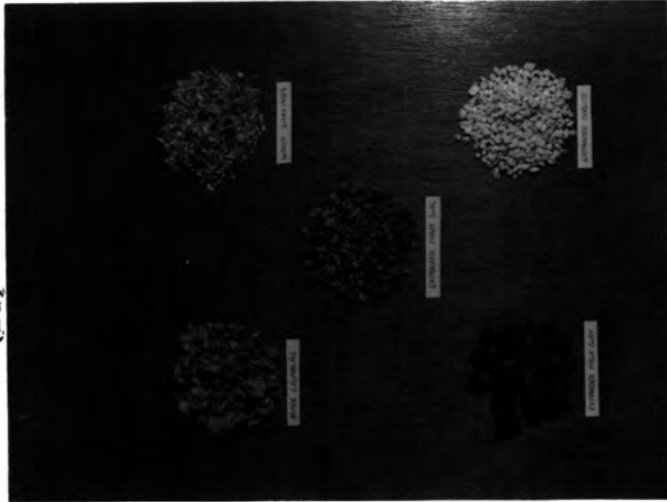

Range of materials studied

(19)



Hexagonal Steel rod

(24)

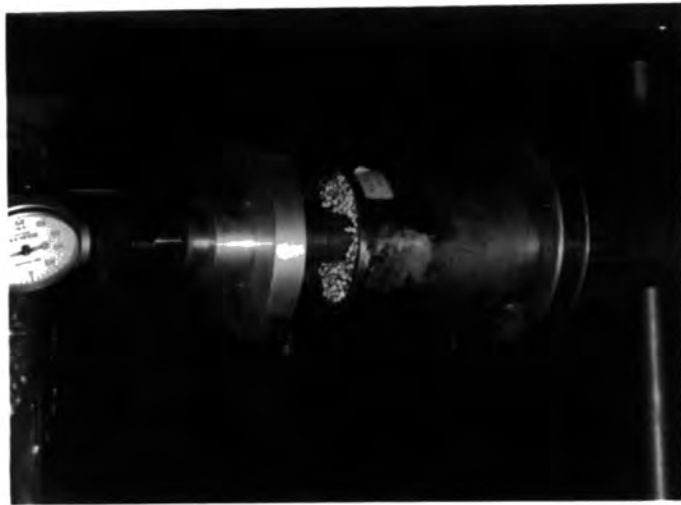

End capping to ensure permanent end fixing for torsion test

(23)

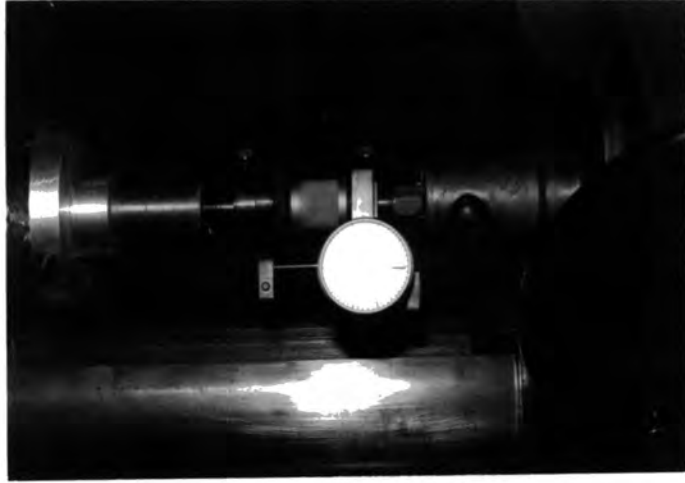

Twist-meter attaching to the length of steel rod between the specimen mounting and the chuck, measuring angle of twist on a 50 mm gauge length. This was calibrated to read torque

(22)



Revolution counter on Swedish torsion tester

8

(25)

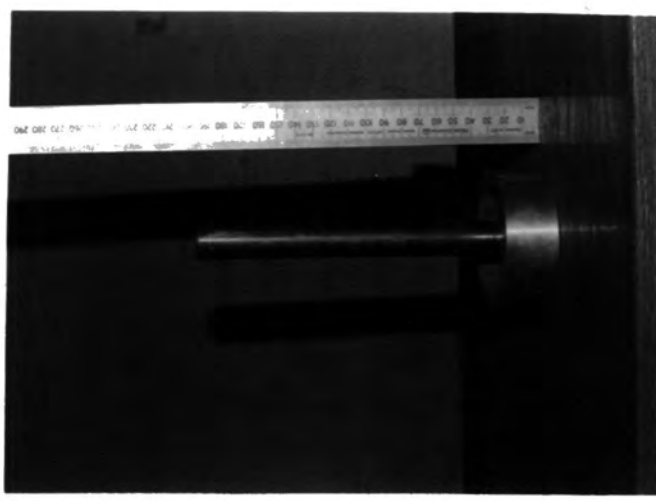

(26)

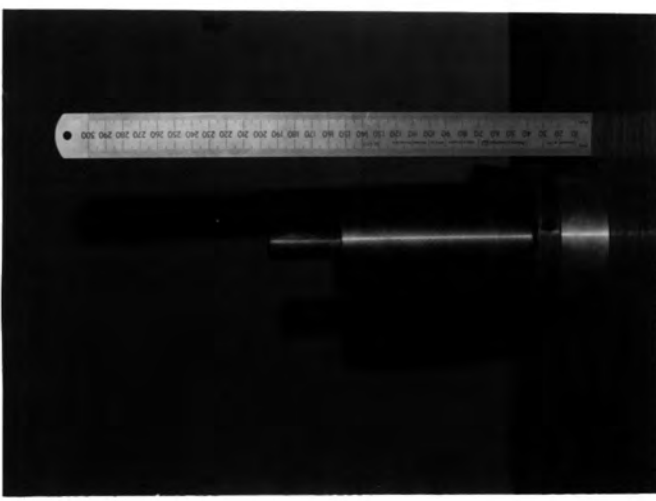

(27)

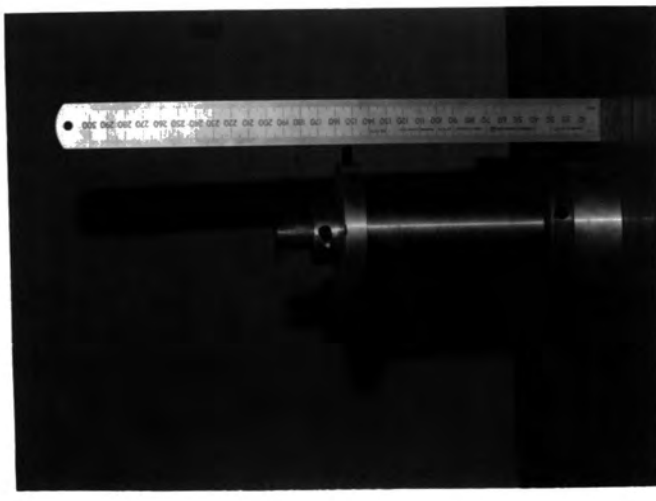

Step by step construction of mould for annular specimen

(28)



Compacted annular specimen in  
mould and end cappings ready to mount  
on torsion tester

(29)



Annular specimen ready for CO<sub>2</sub>  
gassing

(30)



Two types of CO<sub>2</sub> gassing devices  
The centre hole is for centre road  
spacer and is for annular specimen  
only

(33)



Close up of typical gassing method from top to bottom from a central source

(32)

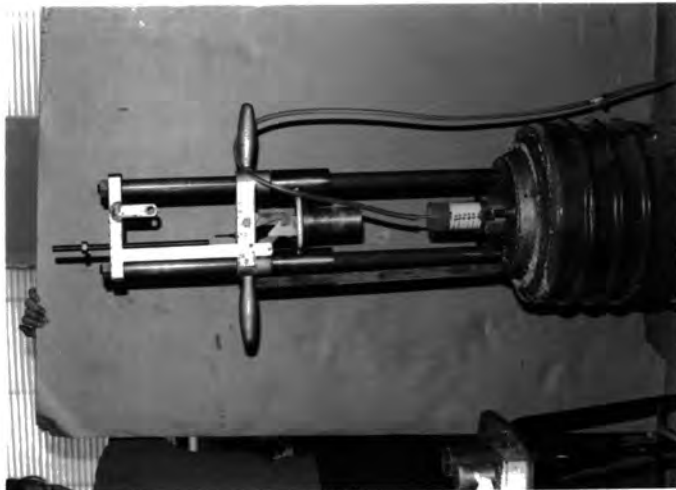

Modified BS 812 aggregate impact tester, showing specially made rammer for annular specimen. Note the gassing tube

(31)

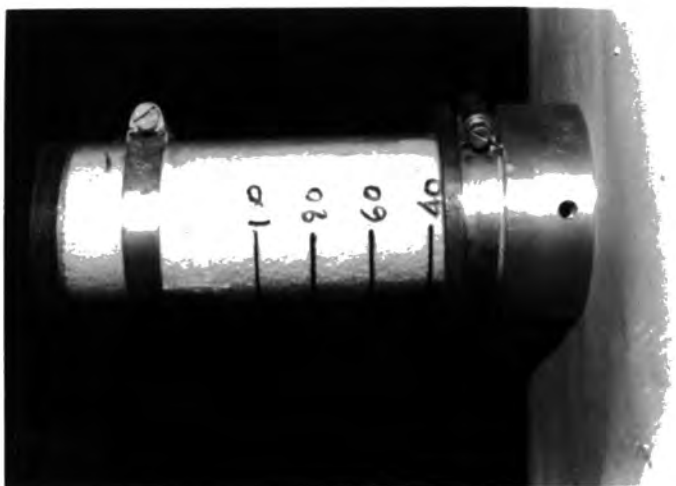

Ordinary water hose clips for reinforcement and extension of perspex tube. The hole is for CO<sub>2</sub> or Air inlet

(34)

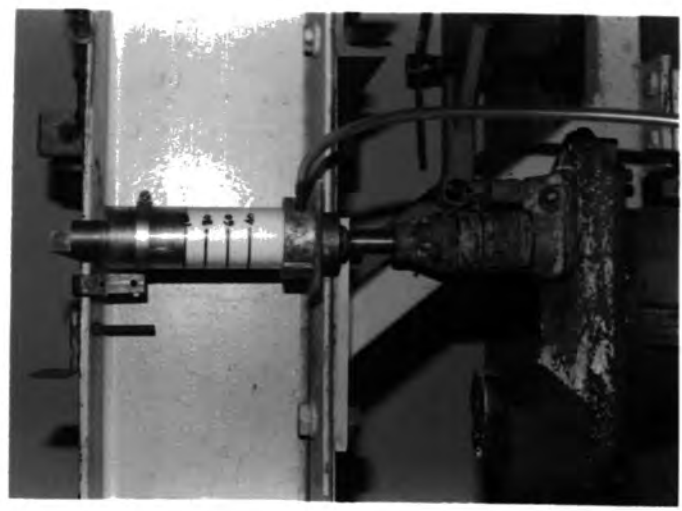

A sample under gassing from the bottom while still under pressure

(35)

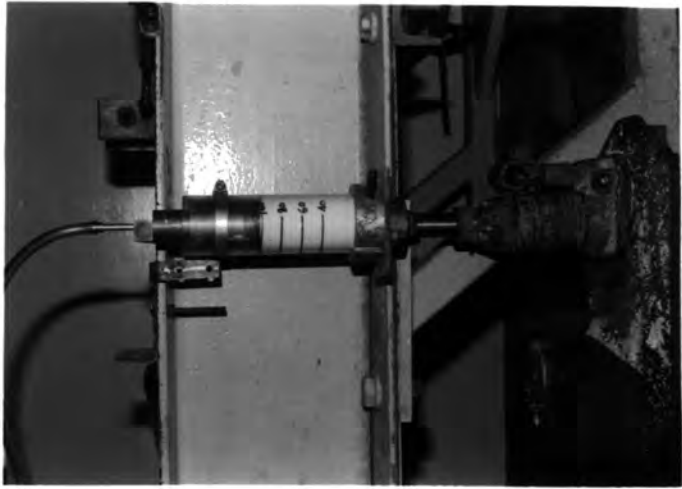

Another sample gassed from top to bottom from a central source while under pressure

(36)

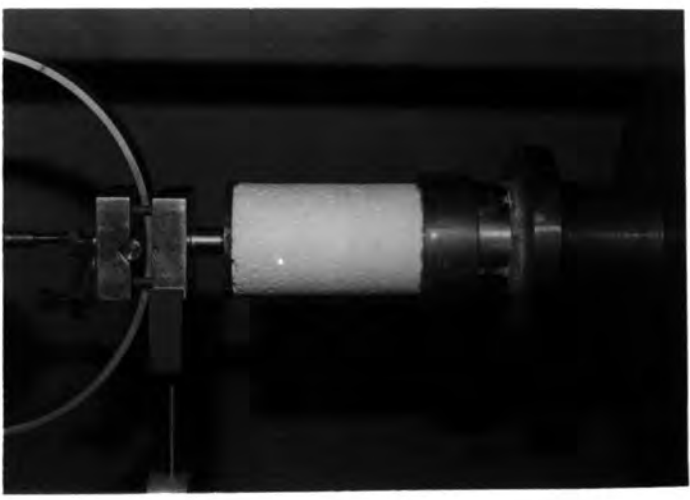

2"x4" silicate bonded expanded polystyrene beads specimen under uniaxial compression

APPENDIX II

TEST APPARATUS

MODIFIED AGGREGATE IMPACT TEST APPARATUS

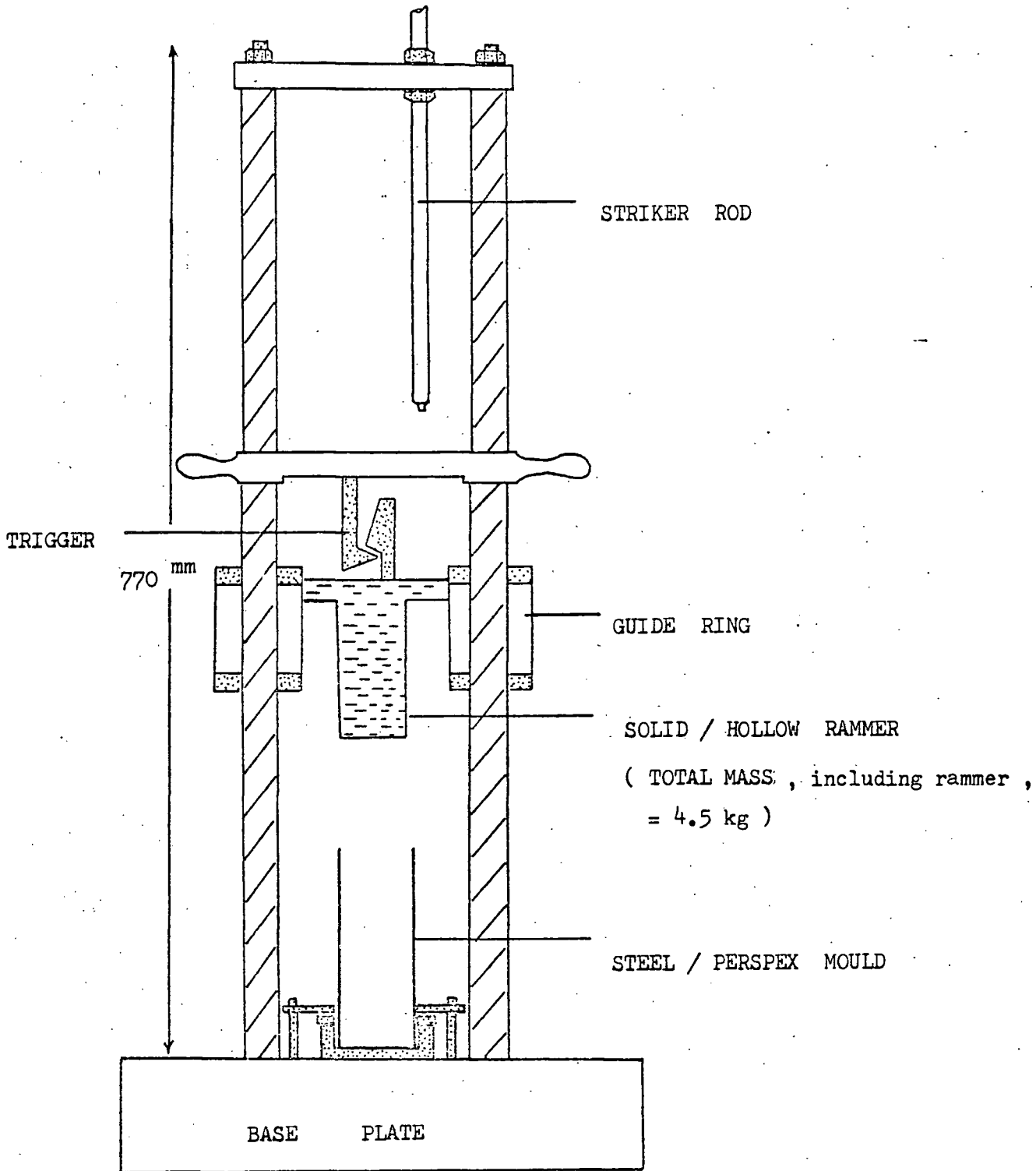

EXTENTABLE STEEL MOULD + BASE

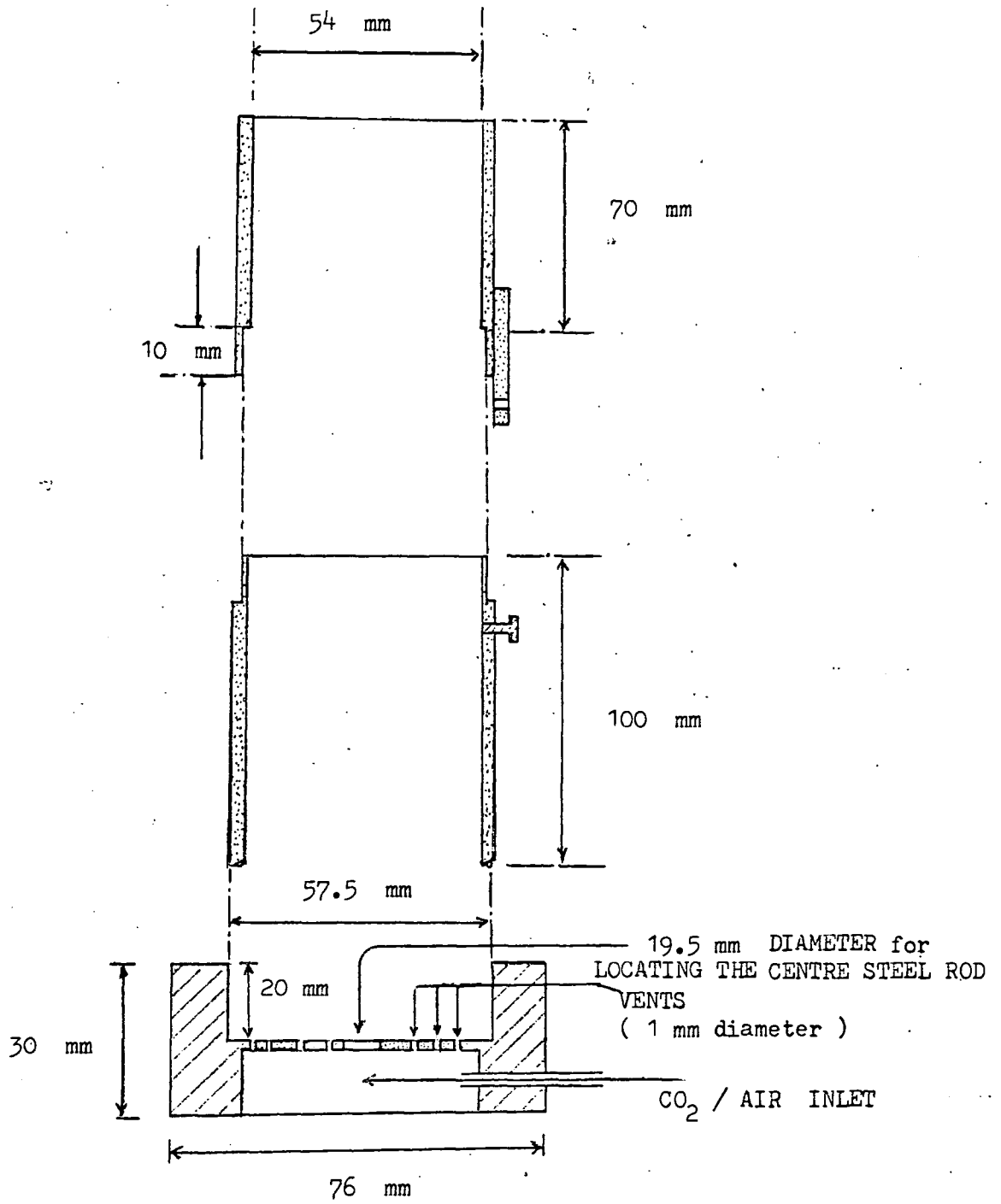



DETAILS OF THE MODIFIED AGGREGATE IMPACT TEST  
APPARATUS

---

MASS OF RAMMER (STEEL) = 1425 gm ( SOLID )  
DIAMETER OF RAMMER = 48 mm  
HEIGHT OF DROP OF RAMMER = ADJUSTABLE FROM 50 mm to 580 mm  
INNER DIAMETER OF MOULD = 56 mm (STEEL) , 50 mm (PERSPEX )  
INTERNAL HEIGHT OF MOULD = 130 mm / 100 mm  
WALL THICKNESS OF MOULD = 2.375 mm ( STEEL ) , 3.15 mm ( PERSPEX )  
TOTAL MASS OF COMPACTION  
APPARATUS ( MODIFIED) = 45.8 kg

MASS OF HOLLOW RAMMER(STEEL)= 1531 gm  
INNER DIAMETER = 19.25 mm  
OUTER DIAMETER = 50.85 mm  
WALL THICKNESS OF RAMMER = 15.8 mm  
HEIGHT OF HOLLOW RAMMER = 109 mm

## DERIVATION

For rigid rod ; end load ; SHEAR

$$\text{STRESS} = \frac{N}{2 \pi r L}$$

$$\delta v = 2 \pi r L \delta r$$

$$\text{STRAIN} = \frac{1}{G} * \frac{N}{2 \pi r L}$$

VIRTUE WORK

$$= \int \sigma \epsilon \, dv$$

$$= \frac{1}{G} \int_{R_i}^{R_o} \left[ \frac{N^2}{2 \pi r L} \right] dr$$

$$\Delta = \frac{N}{2 \pi G L} \int_{R_i}^{R_o} (dr/r)$$

$$\Delta = \frac{N \cdot \ln(R_o/R_i)}{2 \pi L G}$$

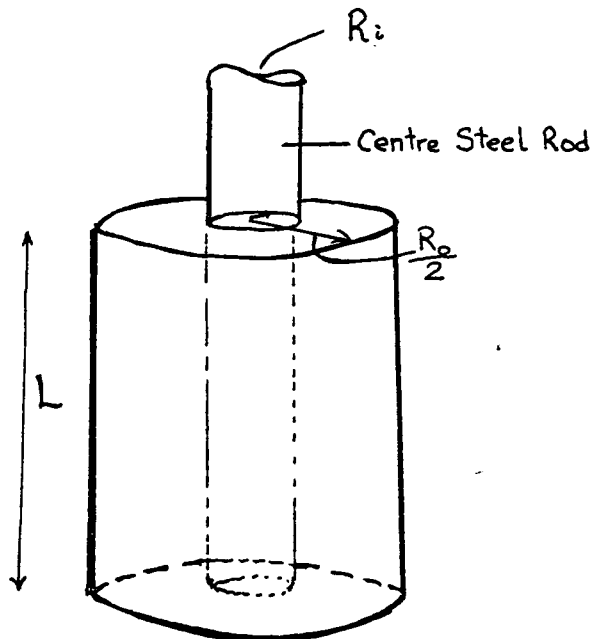

(ii)

Rigid rod - TORQUE

$$T = (2 \pi r L \tau) \cdot r$$

$$\tau = T / (2 \pi r^2 \cdot L)$$

$$T \theta = 1/G * \int_{R_i}^{R_o} T^2 / (4 \pi^2 r^4 L^2) \cdot (2 \pi r L) dr$$

$$\theta = T / (2 \pi L G) \int_{R_i}^{R_o} dr / r^3$$

$$\equiv T / (2 \pi L G) * \left( -\frac{1}{2} \cdot (R_o^{-2}) + \frac{1}{2} \cdot (R_i^{-2}) \right)$$

$$\theta = \frac{T}{4 \pi L G} \cdot \left[ \frac{R_o^2 - R_i^2}{R_o^2 \cdot R_i^2} \right]$$

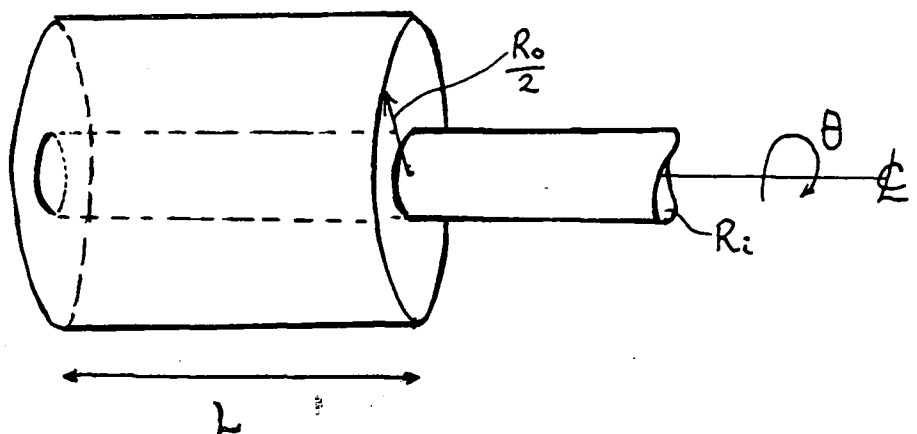

(iii)

As previously derived

For Torsion Test:

$$\theta = \frac{T}{4\pi LG} \cdot \left[ \frac{R_o^2 - R_i^2}{R_o^2 \cdot R_i^2} \right] \quad (1)$$

& For Shear Test:

$$\Delta = \frac{N \cdot \ln \left( \frac{R_o}{R_i} \right)}{2\pi LG} \quad (2)$$

To find T, assume

$E_{\text{steel}}$	=	200 GN/m <sup>2</sup>
$G_{\text{steel}}$	=	78 GN/m <sup>2</sup>
$\nu_{\text{steel}}$	=	0.291

from  $T = \frac{G_s \theta}{J_s} \cdot L_s$ , where  $L_s = 50$  mm

&  $J_s = \frac{\pi (6.41)^4}{32} = 165.74 \text{ mm}^4$

$\therefore T = \frac{(258.55 \times 10^3) \cdot \theta}{165.74} \quad (\text{N} - \text{mm})$

From general dimensions of moulds and steel bar, where

$$R_o = 53.93 \text{ mm}$$

$$R_i = 19.05 \text{ mm}$$

L = Length of specimen compacted

$$\frac{(R_o^2 - R_i^2)}{R_o^2 \cdot R_i^2} = 2.4117 \times 10^{-3} \text{ mm}^{-2} \quad (a)$$

&  $\ln \left( \frac{R_o}{R_i} \right) = 1.04 \quad (b)$

Substituting (a), (b) into (1) and (2), hence

$$G_T = \frac{\text{Gradient of } T \text{ vs } \theta \text{ curve}}{5210.58 * L} \quad (4)$$

$$\& G_S = \frac{0.1655 * N}{L * \Delta} \quad (5)$$

where  $N$  is the max. shear force measured from Proving Ring

$L$  is the length of compacted specimen, usually 95mm

$\Delta$  is the deflection measured when sample under compression load, using second dial gauge attached to the loading plate.

Calibration of Torque/Twist meter

$$E_{\text{steel}} = 200 \text{ GN/m}^2$$

$$G_{\text{steel}} = 78 \text{ GN/m}^2$$

$$\nu_{\text{steel}} = 0.291$$

$$\frac{T}{J_s} = \frac{G_s \theta}{L_s}$$

$$\therefore T = \left( \frac{G_s J_s}{L_s} \right) \cdot \theta$$

when  $L_s = 50 \text{ mm}$ , &  $J_s = \frac{\pi (6.41)^4}{32}$

$$\therefore T = (258.55 \times 10^3) \cdot \theta \quad (\text{N} - \text{mm})$$

Dimension of mould and steel bar for shear/torsion specimen

$$R_o = 53.93 \text{ mm}$$

$$R_i = 19.05 \text{ mm}$$

L = Length of test specimen

$$\frac{R_o^2 - R_i^2}{R_o^2 R_i^2} = 2.4117 \times 10^{-3} \text{ mm}^{-2}$$

$$\ln \left( \frac{R_o}{R_i} \right) = 1.04$$

Cross-sectional areas of mould

$$2'' \text{ Perspex mould} = 2026.83 \text{ mm}^2$$

$$\text{Steel mould} = 2284.3 \text{ mm}^2$$

APPENDIX IV

CHEMICAL ANALYSIS

Vacu-Blast-Beads

(S.G.S.)

Soda - lime glass type

Combined silica,	SiO <sub>2</sub>	72.8%
	CaO	8.5%
	MgO	3.4%
	Na <sub>2</sub> O	12.5%
	K <sub>2</sub> O	1.0%
	Al <sub>2</sub> O <sub>3</sub>	1.7%
	Fe <sub>2</sub> O <sub>3</sub>	0.16%

Source: Ref. 93



# SIEVE ANALYSIS GRAPH SHEET

BS. 400 350 300 240 200 170 150 120 100 85 72 60 52 44 36 30 25 22 18 16 14 12 10 9 7 6 5  
 I.S.T.M. 400 325 270 230 200 170 140 120 100 80 70 60 50 45 40 35 30 25 20 18 16 14 12 10 9 7 6

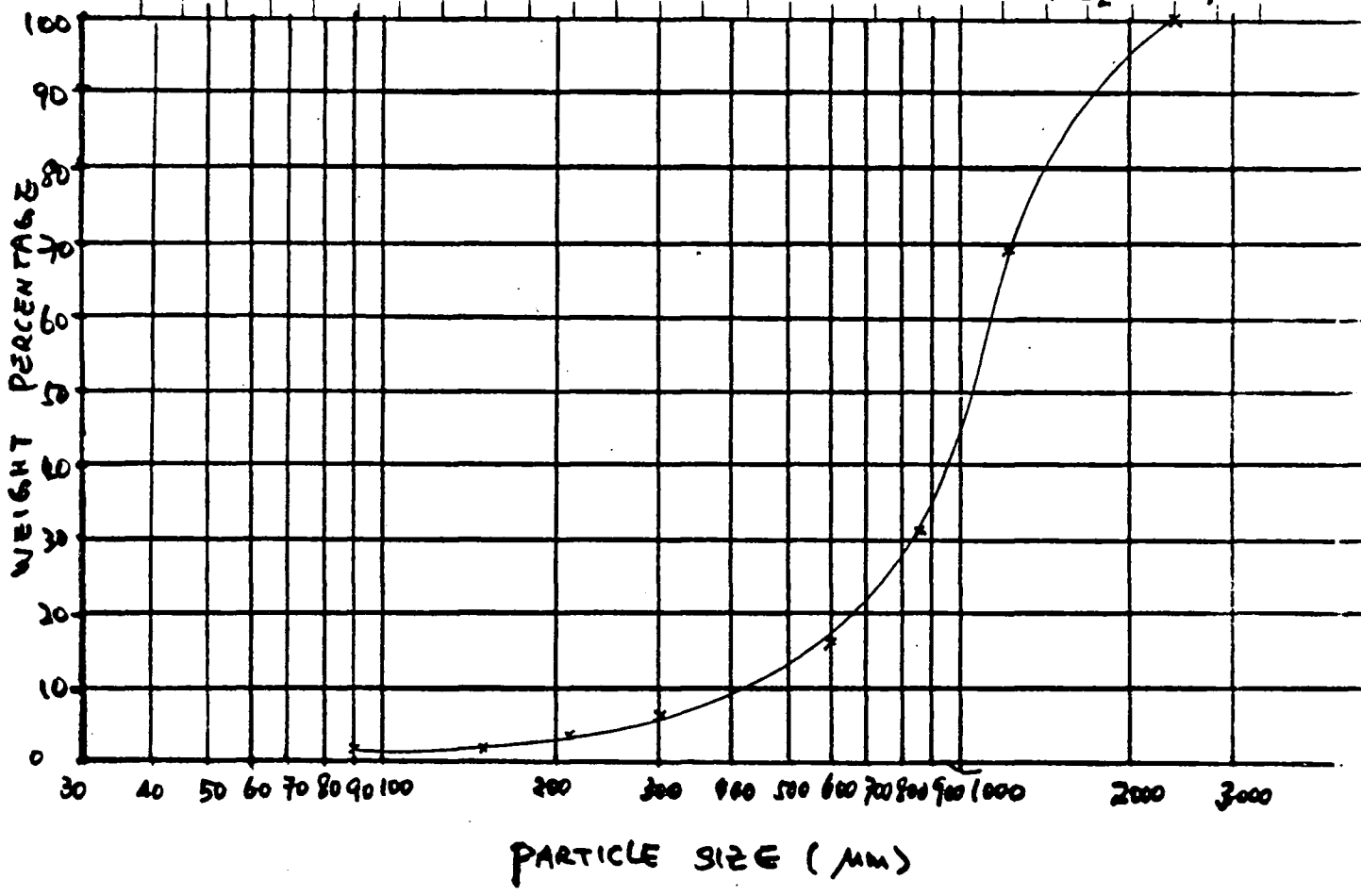

B.S. MESH	APERTURE MM	ANALYSIS 1		ANALYSIS 2	
		PERCENTAGE		PERCENTAGE	
		FRACTIONAL	CUMULATIVE	FRACTIONAL	CUMULATIVE
7	2400	0.0	100.0		
14	1200	31.0	69.0		
18	850	38.0	31.0		
25	600	15.0	16.0		
52	300	10.0	6.0		
72	210	2.5	3.5		
100	150	1.0	2.5		
170	90	0.5	2.0		
200	75				
	< 75				

REMARKS      D.S.F. Vermiculite ,      w/c = 2% 21/7/78

# SIEVE ANALYSIS GRAPH SHEET

B.S. 400 350 300 240 200 170 150 120 100 85 72 60 52 44 36 30 25 22 18 16 14 12 10 9 7 6 5  
 A.S.T.M. 400 325 270 230 200 170 150 120 100 90 75 60 50 45 40 35 30 25 20 18 16 14 12 10 9 7 6

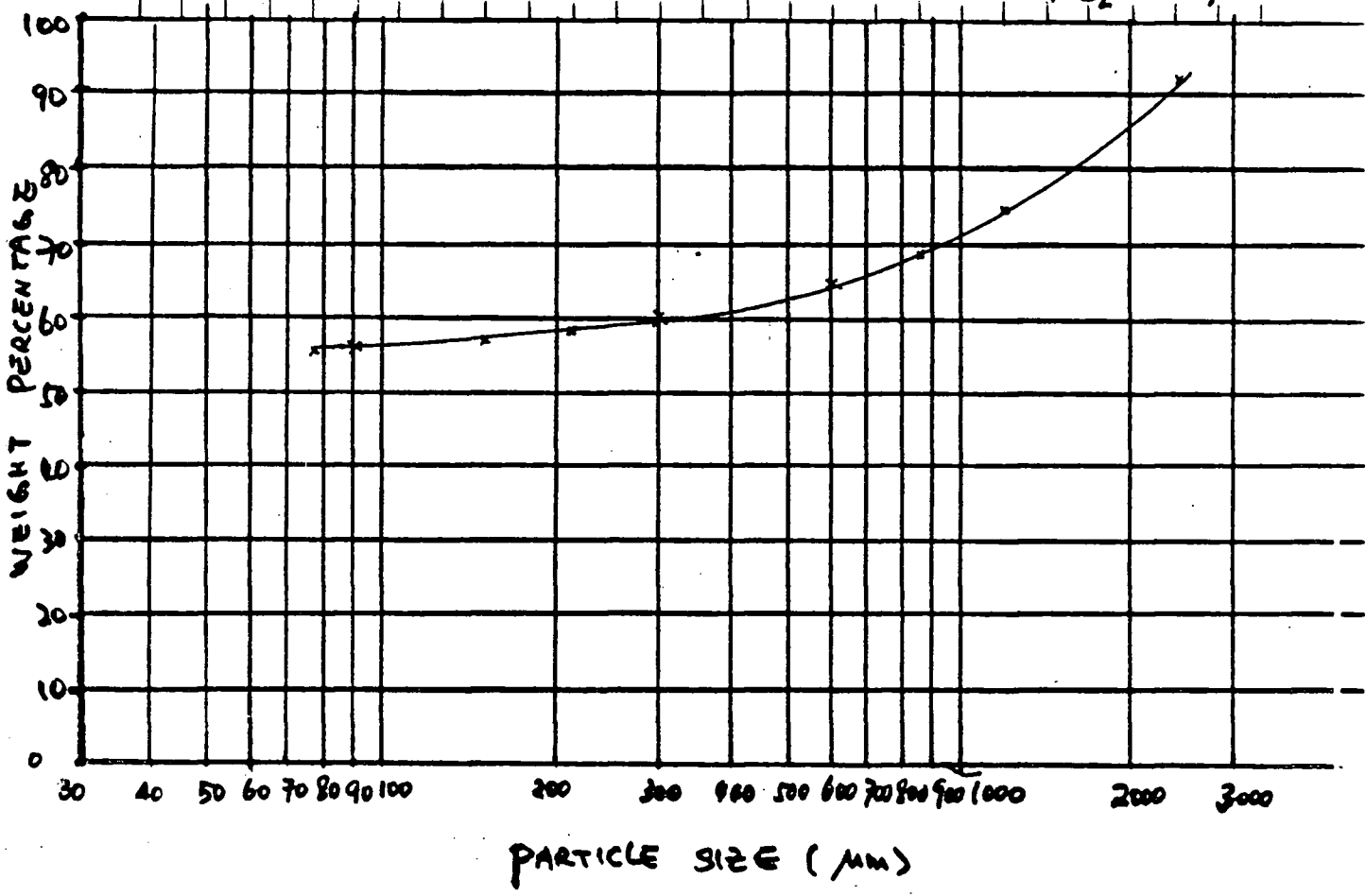

B.S. MESH	APERTURE MM	ANALYSIS 1		ANALYSIS 2	
		PERCENTAGE		PERCENTAGE	
		FRACTIONAL	CUMULATIVE	FRACTIONAL	CUMULATIVE
7	2400	8.5	91.5		
14	1200	17.0	74.5		
18	850	5.7	68.8		
25	600	4.3	64.5		
52	300	4.5	60.0		
72	210	1.8	58.2		
100	150	1.2	57.0		
170	90	1.0	56.0		
200	75	0.9	55.1		
	< 75	1.0	54.1		

REMARKS Exp. Perlite (dried) 14/8/78

**SIEVE ANALYSIS GRAPH SHEET**

B.S. 400 350 300 240 200 170 150 120 100 85 72 60 52 44 36 30 25 22 18 16 14 12 10 9 7 6 5  
 S.T.M. 400 325 270 230 200 170 150 120 100 80 70 60 50 45 40 35 30 25 20 18 16 14 12 10 9 7 6

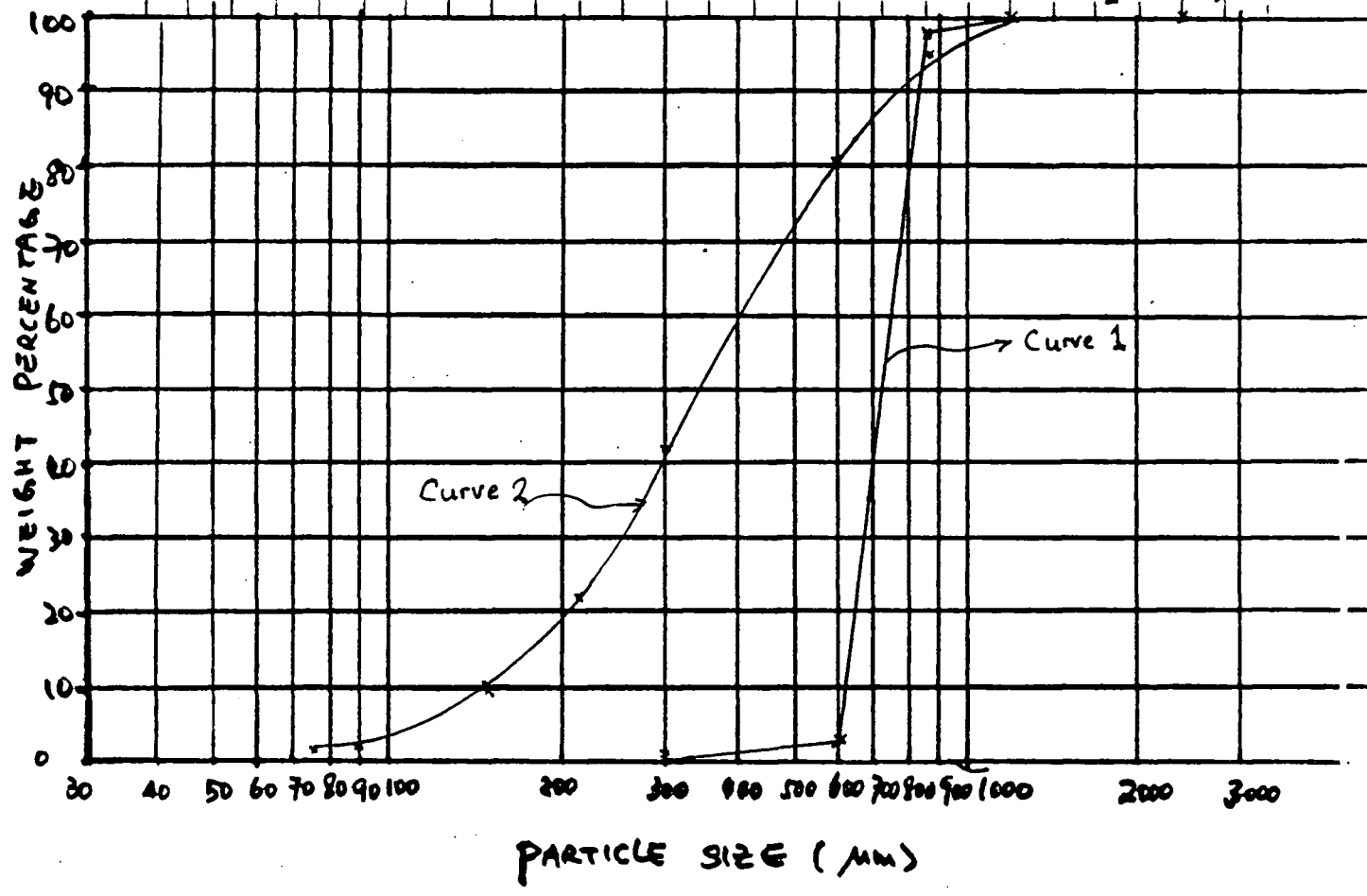

B.S. MESH	APERTURE MM	ANALYSIS 1 PERCENTAGE		ANALYSIS 2 PERCENTAGE	
		FRACTIONAL	CUMULATIVE	FRACTIONAL	CUMULATIVE
		7	2400	0.0	100.0
14	1200	0.0	100.0	0.5	99.5
18	850	2.0	98.0	4.5	95.0
25	600	95.0	3.0	14.5	80.5
52	300	1.5	1.5	38.5	42.0
72	210			20.0	22.0
100	150			12.0	10.0
170	90			7.5	2.5
200	75			0.5	2.0
	< 75			0.5	1.5

Curve 1 - Leighton Buzzard Sand  
 Curve 2 - Building Sand

REMARKS Analysis 1 = Leighton Buzzard Sand (dried)  
 Analysis 2 = Building Sand (dried)

## REFERENCES

```

*****
*
*
*   AUTHOR INDEX
*
*
*****

```

For 3rd copy

1  
2  
3  
4  
5  
6  
7  
8  
9  
10  
11  
12  
13  
14  
15  
16  
17  
18  
19  
20  
21  
22  
23  
24  
25  
26  
27  
28  
29  
30  
31  
32  
33  
34  
35  
36  
37  
38  
39  
40  
41  
42  
43  
44  
45  
46  
47  
48  
49  
50  
51  
52  
53  
54  
55  
56  
57  
58

- ( 1) ALLEN H.G. REF(5)
- ( 2) BAGEN C.&ETAL REF(53) & REF(54)
- ( 3) BCIRA REF(24)
- ( 4) BETIESS P. REF(6) & REF(7)
- ( 5) CHANCELLOR W.J. REF(45)
- ( 6) CLEM D. REF(29)
- ( 7) COLLINS D.L. REF(4)
- ( 8) CRAIG R.F. REF(65)
- ( 9) ELLICTT D.J. REF(75)
- (10) ICI REF(72)
- (11) ICI REF(55)
- (12) ICI REF(63)
- (13) ILENCA F.P. REF(89)
- (14) LANCASTER ETAL REF(79)
- (15) LEA REF(77)
- (16) MIDDLETON J.M. REF(78)
- (17) NEVILLE A.M. REF(60)
- (18) NICPOLAS K.E.L. REF(36)
- (19) NICPOLAS K.E.L. REF(88)
- (20) NICHCLAS K.E.L. REF(31)
- (21) NICHOLLS R. REF(35)
- (22) PARSONS A.W. REF(82)
- (23) PARTON G.M. REF(83)
- (24) REES E. REF(1)
- (25) SAGLAM B. REF(81)
- (26) SARKAR A.D. REF(40) & REF(41)
- (27) SARKAR A.D. REF(70) & REF(71)
- (28) SHELL REF(42)

59  
60  
61  
62  
63  
64  
65  
66  
67  
68  
69  
70  
71  
72  
73  
74  
75  
76  
77  
78  
79  
80  
81  
82  
83  
84  
85  
86  
87  
88  
89  
90  
91  
92  
93  
94  
95  
96  
97  
98  
99  
100  
101  
102  
103  
104  
105  
106  
107  
108  
109  
110  
111  
112  
113  
114  
115  
116  
117  
118

119  
120  
121  
122  
123  
124  
125  
126  
127  
128  
129  
130  
131  
132  
133  
134  
135  
136  
137  
138  
139  
140  
141  
142  
143  
144  
145  
146  
147  
148  
149  
150  
151  
152  
153  
154  
155  
156  
157  
158  
159  
160  
161  
162  
163

- (29) SHERWOOD P.T. ET AL REF (66)
- (30) SHERWOOD P.T. PFF (59)
- (31) SMITH ETAL REF (76)
- (32) SCOLE S. REF (90)
- (33) THOMPSON R.N. REF (58)
- (34) TROW-SMITH ETAL REF (66)
- (35) US ARMY REF (73) & REF (74)
- (36) VAIL J.G. REF (67) & REF (68)
- (37) WARREN C. REF (62)
- (38) WORTHINGTON R. REF (67)
- (39) ZIEGLER R. REF (50)

NL CF FILE

LISTING OF FILE REFERENCE(166,550)

10:42:32

SEP 28, 1978

TOTAL NUMBER OF REFERENCES = 94

REFERENCE

\*\*\*\*\*

169

\*\*\*\*\*

167

\*\*\*\*\*

168

\*\*\*\*\*

165

\*\*\*\*\*

160

\*\*\*\*\*

171

\*\*\*\*\*

172

\*\*\*\*\*

173

\*\*\*\*\*

174

\*\*\*\*\*

175

\*\*\*\*\*

177

\*\*\*\*\*

178

\*\*\*\*\*

180

\*\*\*\*\*

181

\*\*\*\*\*

182

\*\*\*\*\*

184

\*\*\*\*\*

185

\*\*\*\*\*

187

\*\*\*\*\*

189

\*\*\*\*\*

190

\*\*\*\*\*

192

\*\*\*\*\*

193

\*\*\*\*\*

194

\*\*\*\*\*

195

\*\*\*\*\*

197

\*\*\*\*\*

198

\*\*\*\*\*

199

\*\*\*\*\*

200

\*\*\*\*\*

201

\*\*\*\*\*

203

\*\*\*\*\*

204

\*\*\*\*\*

205

\*\*\*\*\*

206

\*\*\*\*\*

207

\*\*\*\*\*

209

\*\*\*\*\*

210

\*\*\*\*\*

211

\*\*\*\*\*

212

\*\*\*\*\*

214

\*\*\*\*\*

219

\*\*\*\*\*

220

\*\*\*\*\*

221

\*\*\*\*\*

222

REF( 1)  
A REVIEW OF (SODIUM SILICATE) AS A BINDER IN THE FOUNDRY INDUSTRY; REES E. CASTINGS, AUG. 1972, V. 18, PP 13-21

REF( 2)  
A.B.M. CHEMICALS LTD.; PRIVATE COMMUNICATION

REF( 2)  
A.R.C. CONCRETE LTD.; PRIVATE COMMUNICATION

REF( 4)  
AN EXPERIMENTAL ANALYTICAL STUDY OF HYPERBOLIC PARABOLIC SANDWICH PANELS; COLLINS, D.L.; PH.D. THESIS, DURHAM UNIV 1976

REF( 5)  
ANALYSIS AND DESIGN OF STRUCTURAL SANDWICH PANELS; ALLEN H.G.; PERGAMON PRESS; 1969

REF( 6)  
ANALYSIS OF POLYHEDRAL COMED STRUCTURES COMPOSED OF FLAT PLATES OF SANDWICH MATERIAL; BETTRESS, P;

REF( 7)  
ANALYSIS OF POLYHEDRAL COMED.....PH.D. THESIS, DURHAM UNIV 1971

REF( 8)  
ARMIFORM MARKETING LTD. INTERNATIONAL (ARPCSPHERES H.G.S.); PRIVATE COMMUNICATION

REF( 9)  
ASHLAND CHEMICALS LTD.; PRIVATE COMMUNICATION

REF(10)  
BIBLIOGRAPHY ON ESTER HARDENED SODIUM SILICATE BINDERS; PCIRA; PRIVATE COMMUNICATION

REF(11)  
ECKLEN (U.K) LTD.; PRIVATE COMMUNICATION

REF(12)  
BRITISH GYFUSUM LTD.; PRIVATE COMMUNICATION

REF(13)

224 BRITISH PATENT 1,086,577(1967)  
 225  
 226 REF(14)  
 227 BRITISH PATENT 1,233,899  
 228  
 229 REF(15)  
 230 BRITISH PATENT 1,267,370  
 231  
 232 REF(16)  
 233 BRITISH PATENT 1,358,241(1974)  
 234  
 235 REF(17)  
 236 BRITISH PATENT 1,420,924  
 237  
 238 REF(18)  
 239 BRITISH STANDARD 1377:1975;METHODS OF TEST FOR SCILS FOR CIVIL ENGINEERING PURPOSES  
 240  
 241 REF(19)  
 242 BRITISH STANDARD 1881:PART4:1970;METHODS OF TESTING CCNCRETE;CHEMICAL PROPERTIES  
 243  
 244 REF(20)  
 245 BRITISH STANDARD 2972:1975;METHODS OF TEST FOR INCRGANIC THERMAL INSULATING MATERIALS  
 246  
 247 REF(21)  
 248 BRITISH STANDARD 3681:PART2:1973;METHODS FOR SAMPLING AND TESTING OF LIGHTWEIGHT AGGREGATES FOR CONCRETE  
 249  
 250 REF(22)  
 251 BRITISH STANDARD 3797:PART2:1976;SPECIFICATION FOR LIGHTWEIGHT AGGREGATES FOR CONCRETE  
 252  
 253 REF(23)  
 254 BRITISH STANDARD 3984:1966;SPECIFICATION FOR SODIUM SILICATES  
 255  
 256 REF(24)  
 257 BRITISH STANDARD 5075:PART1:1974;SPECIFICATION FOR CONCRETE ADMIXTURES  
 258  
 259 REF(25)  
 260 BRITISH STANDARD 812:PART1:1975;SAMPLING, SIZE, SHAPE AND CLASSIFICATION  
 261  
 262 REF(26)  
 263 BRITISH STANDARD 812:PART2:1975;PHYSICAL PROPERTIES  
 264  
 265 REF(27)  
 266 BRITISH STANDARD 812:PART3:1975;MECHANICAL PROPERTIES  
 267  
 268 REF(28)



BRITISH STANDARD 812:PART4:1976; SAMPLING AND TESTING OF MINERAL AGGREGATES, SANDS AND FILLERS

REF(25)  
CAN A 103-YEAR OLD STEEL FOUNDRY GO MODERN?D.CLEM.VOL62.SEP.72.52-53

REF(30)  
CAPE INSULATION LTD.; PRIVATE COMMUNICATION

REF(31)  
CASTABLE (SAND) PROCESSES.KEL.NICHOLAS.BRITISH FOUNDRYMAN.VOL65.DEC.72.441-451

REF(32)  
CEMENT AND CONCRETE ASSOCIATION;PRIVATE COMMUNICATION

REF(32)  
CENTRAL FILM LIBRARY; PRIVATE COMMUNICATION

REF(34)  
CHEMICAL BINDERS IN FOUNDRIES;BCIRA;CONFERENCE PAPER(2),1976

REF(35)  
COMPOSITE CONSTRUCTION MATERIALS HANDBOOK, NICHOLLS,R; PRENTICE-HALL, INC., 1976

REF(36)  
CO2-SILICATE PROCESS IN FOUNDRIES. K.NICHOLAS. 1972

REF(37)  
CRANFIELD;SCHOOL OF MECHANICAL ENGINEERING; PRIVATE COMMUNICATION

REF(38)  
DISTILLERS COMPANY (CC2) LTD.; PRIVATE COMMUNICATION

REF(39)  
DUPRE VERMICULITE LTD; PRIVATE COMMUNICATION

REF(40)  
EFFECT OF ADDITIVES ON THE RETAINED STRENGTH OF A 4% (CC2/SODIUM SILICATE) BONDED SAND.AD.SARKAR.

REF(41)  
EFFECT OF ADDITIVES ON THE.....BRITISH FOUNDRYMAN.VOL54.OCT.61.436-439

REF(42)  
EXPANDED (POLYSTYRENE) IN BUILDING. DESIGN & PRACTISE (2 ED) JAN 1971. SHELL CHEMICALS

REF(43)

284  
285  
286  
287  
288  
289  
290  
291  
292  
293  
294  
295  
296  
297  
298  
299  
300  
301  
302  
303  
304  
305  
306  
307  
308  
309  
310  
311  
312  
313  
314  
315  
316  
317  
318  
319  
320  
321  
322  
323  
324  
325  
326  
327  
328  
329  
330  
331  
332  
333  
334  
335  
336  
337  
338  
339  
340  
341  
342  
343  
344  
345

349 EXPANDED POLYSTYRENE ASSOCIATION (EPS ASSOCIATION).; PRIVATE COMMUNICATION  
 345 REF(44)  
 344 FOAMSLAG (TEESIDE PRODUCTION) LTD.; PRIVATE COMMUNICATION  
 343 REF(45)  
 342 FORMATION OF HAY WAFERS WITH IMPACT LOADS;(CHANCELLOR W.J.;AGRICULTURAL ENGINEERING.MARCH.1962.136-138&149  
 341 REF(46)  
 340 GOLDEN FILMS.;STEWART HOUSE,WINDSOR(CC2/SILICATE); PRIVATE COMMUNICATION  
 339 REF(47)  
 338 HARRISON'S LIMESTONE LTD.; PRIVATE COMMUNICATION  
 337 REF(48)  
 336 ICI MCND DIVISION;PRIVATE COMMUNICATION  
 335 REF(49)  
 334 ICI, ORGANIC DIVISION (MASONRY WATER REPELLENTS).; PRIVATE COMMUNICATION  
 333 REF(50)  
 332 INVESTIGATION OF THE (CC2) PROCESS-FACTORS INFLUENCING STRENGTH.R.ZIEGLER.FOUNDRY TRADE.VOL7.19JUL'56.85-87  
 331 REF(51)  
 330 LAFARGE ALUMINOUS CEMENT COMPANY LTD.; PRIVATE COMMUNICATION  
 329 REF(52)  
 328 LEEK CHEMICALS LTD.; PRIVATE COMMUNICATION  
 327 REF(53)  
 326 MARINE FLOATING CONCRETE MADE WITH POLYSTYRENE EXPANDED BEADS; BAGCN C.S.ETAL MAGAZINE OF CONCRETE RESEARCH  
 325 REF(54)  
 324 MARINE FLOATING CONCRETE.....VOL28,NO97,DEC,76,225-229  
 323 REF(55)  
 322 MISCELLANEOUS SILICATE-BASED FOUNDRY PROCESS;ICI TECHNICAL NOTE  
 321 REF(56)  
 320 MCNSANTIC LTD.; PRIVATE COMMUNICATION  
 319 REF(57)  
 318 POZAMENT CEMENT LTD.;(PFA) PRIVATE COMMUNICATION  
 317 REF(58)  
 316

404 PRACTICAL GUIDE TO THE (CO2/SILICATE) PROCESS. RN THOMPSON. FOUNDRY TRADE J. 19NOV.64

405 REF(55) PROPERTIES OF (CEMENT) STABILIZED MATERIALS. RRL REPORT LR205,1968. PT SHERWOOD

406 REF(60) PROPERTIES OF CONCRETE;NEVILLE A.M.;PITMAN;1975

407 REF(61) PROPIUMETER LTD.; PRIVATE COMMUNUCATION

408 REF(62) RECENT DEVELOPMENTS IN (SILICATE) BASED FOUNDRY PROCESS.D.WARREN.BRITISH FOUNDRYMAN.VOL64.DEC.71.449-455

409 REF(63) SELF-SETTING SILICATE PROCESSES BASED ON LIQUID HARDENERS;ICI TECHNICAL NOTE

410 REF(64) SHELL CHEMICALS (U.K.) LTD.; PRIVATE COMMUNICATION

411 REF(65) SCIL MECHANICS;CRAIG R.F.;VAN ACSTRAND REINHOLD;1974

412 REF(66) SOLID STRAW;TRON-SMITH R;FARMERS WEEKLY,APRIL, 19/4/1975

413 REF(67) SOLUBLE SILICATES;THEIR PROPERTIES AND USES ;VOL-2:TECHNOLOGY; VAIL, J.G.

414 REF(68) SOLUBLE SILICATES;THEIR PROPERTIES AND USES VOL-1: CHEMISTRY,REINHOLD PUBLISHING CORP,N.Y. 1960

415 REF(69) SOME ANNOTATED REFERENCES ON THE N-PROCESS;STEEL CASTING RESEARCH AND TRADE ASSOCIATION,PRIVATE COMMUNICATION

416 REF(70) SOME PROPERTIES OF A FEW (CO2/SODIUM SILICATE) ENDED NCA-SILICEOUS MATERIALS.AD.SARKAR.BRITISH FOUNDRYMAN.

417 REF(71) SOME PROPERTIES.....VOL56.AUG.63.367-373

418 REF(72) STAEGEL S (ESTER) HARDENERS FOR SCIL GRUUTING. ICI PETROCHEMICAL DIVISION

419 REF(73)

STRENGTH PROPERTIES AND RELATIONSHIPS ASSOCIATED WITH VARIOUS TYPES OF FIBREGLASS REINFORCED FACING SANDWICH STRUCTURE

REF(74) STRENGTH PROPERTIES AND RELATIONSHIP.....ARMY FT. EUSTIS REPORT,65-15(AC621522)ASTIA.SPRINGFIELD,VA.:US ARMY AUG,1965

REF(75) STRUCTURAL PROPERTIES OF FLAT SANDWICH PANELS;ELICHT,G.J. M.SC.THESIS,DURHAM UNIV.,1970

REF(76) THE BRIQUETTING OF WHEAT STRAW;SMITH I.E.ETAL;J.AGRIC.ENGG RES.VOL22.1977.111-777

REF(77) THE CHEMISTRY OF CEMENT AND CONCRETE; LEA; 3RD EDITION;ARNOLD,1976

REF(78) THE KNOCK-OUT PROPERTIES OF (CC2) PROCESS CORE MIXTURES.JM.MIDDLETON.BRITISH FOUNDRYMAN.VOL57.APR'64.153-166

REF(79) THE MECHANICS OF MATERIALS;LANCASTER AND MITCHELL;MCGRAW-HILL;1967

REF(80) THE NEW DIMENSIONS OF (SODIUM SILICATE). MODERN CASTING,FEB 1975,V.64,PP 46-48, SCOVILLE SOULE

REF(81) THE PROPERTIES OF FIBRE REINFORCED CEMENT BASED SANDWICH BEAMS;SAGLAM,S, M.SC.THESIS,DURHAM UNIV 1976

REF(82) THE RAPID MEASUREMENT OF THE (MOISTURE) CONDITION OF EARTHWORK MATERIAL. TRRL REPORT NO.750. AK PARSONS,1977.

REF(83) THE STRUCTURAL BEHAVIOR OF POLYHEDRAL SANDWICH SHELLS;PARTON,G.M.PH.D.THESIS DURHAM UNIV 1974

REF(84) THE TESTING UNDER COMPRESSION OF GASED (CC2/SODIUM SILICATE) BONDED SAND TEST PILCFS.SUB-COMMITTEE TS 55.

REF(85) THE TESTING UNDER.....BRITISH FOUNDRYMAN.VOL55.JAN'62.28-32

REF(86) THE USE OF STABILIZED (PFA) IN ROAD CONSTRUCTION. PRL REPORT NO.49,1966. PT SHERWOOD ETAL

REF(87) THE (CC2/SILICATE) BOND, PART 4-ADVANTAGEOUS OF HIGHER RATIO. R.WORTHINGTON. IRCN&STEEL. VOL39.NOV'66 523-528

REF(88)

464  
465  
466  
467  
468  
469  
470  
471  
472  
473  
474  
475  
476  
477  
478  
479  
480  
481  
482  
483  
484  
485  
486  
487  
488  
489  
490  
491  
492  
493  
494  
495  
496  
497  
498  
499  
500  
501  
502  
503  
504  
505  
506  
507  
508  
509  
510  
511  
512  
513  
514  
515  
516  
517  
518  
519  
520  
521  
522  
523  
524  
525

525 4  
525 76  
525 77  
525 80  
525 81  
525 82  
525 83  
525 84  
525 85  
525 86  
525 87  
525 88  
525 89  
525 90  
525 91  
525 92  
525 93  
525 94  
525 95  
525 96  
525 97  
525 98  
525 99  
525 100

THE (CC2/SILICATE) PROCESS IN FOUNDRIES. KEL. NICHOLAS. BRITISH CAST. IRON RESEARCH ASSEC. BIRMINGHAM. 1972

REF(85)  
THE (CC2/SILICATE) WARM BOX PROCESS. FP. ILENDA. MODERN CASTING. VOL 63. APR '73. PAGE 63

REF(90)  
TILCON; TILING CONSTRUCTION SERVICES LTD.; PERLITE PRODUCTS; PRIVATE COMMUNICATION

REF(91)  
TRANSPORT AND ROAD RESEARCH LABORATORY; PRIVATE COMMUNICATION

REF(92)  
US PATENT 2,336,723(1943) & 2,393,557(1946)

REF(93)  
VACU-BLAST LTD.; PRIVATE COMMUNICATION

REF(94)  
VENCIL RESIL LTD., (EPS); PRIVATE COMMUNICATION

NO FILE REF (95)

Hong Kong Tunnel, New Civil Engineers 1 Nov., 79 page 6 and NCE 4 Jan. 79

For those denoted as 'private communication' in the above references, those authorities were consulted and supplied valuable information by private correspondence, now retained by the author.

