



Durham E-Theses

Arithmetic Hyperbolic Reection Groups

MCLEOD, JOHN,ANGUS

How to cite:

MCLEOD, JOHN,ANGUS (2013) *Arithmetic Hyperbolic Reection Groups*, Durham theses, Durham University. Available at Durham E-Theses Online: <http://etheses.dur.ac.uk/7743/>

Use policy

The full-text may be used and/or reproduced, and given to third parties in any format or medium, without prior permission or charge, for personal research or study, educational, or not-for-profit purposes provided that:

- a full bibliographic reference is made to the original source
- a [link](#) is made to the metadata record in Durham E-Theses
- the full-text is not changed in any way

The full-text must not be sold in any format or medium without the formal permission of the copyright holders.

Please consult the [full Durham E-Theses policy](#) for further details.

Arithmetic Hyperbolic Reflection Groups

John Angus Mcleod

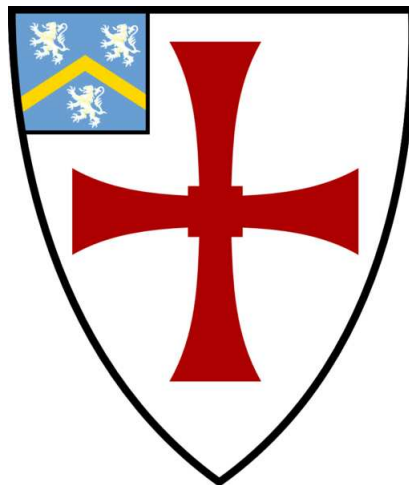

A thesis presented for the degree of
Doctor of Philosophy

Pure Mathematics
Department of Mathematical Sciences
Durham University

2013

Abstract

Arithmetic Hyperbolic Reflection Groups

This thesis uses Vinberg's algorithm to study arithmetic hyperbolic reflection groups which are contained in the groups of units of quadratic forms. We study two families of quadratic forms: the diagonal forms $-dx_0^2 + x_1^2 + \dots + x_n^2$; and the forms whose automorphism groups contain the Bianchi groups.

In the first instance we classify over \mathbb{Q} the pairs (d, n) for which such a group can be found, and in some cases we can compute the volumes of the fundamental polytopes.

In the second instance we use a combination of the geometric and number theoretic information to classify the reflective Bianchi groups by first classifying the reflective extended Bianchi groups, namely the maximal discrete extension of the Bianchi groups in $PSL(2, \mathbb{C})$.

Finally we identify some quadratic forms in the first instance and completely classify those in the second which have a quasi-reflective structure.

Declaration

The work in this thesis is based on research carried out in the Pure Mathematics Group at the Department of Mathematical Sciences, Durham University. No part of this thesis has been submitted elsewhere for any other degree or qualification and it is all my own work unless referenced to the contrary in the text.



Copyright © 2013 by John Mcleod.

“The copyright of this thesis rests with the author. No quotations from it should be published without the author’s prior written consent and information derived from it should be acknowledged” .

Acknowledgements

This thesis concerns work undertaken under the supervision of Dr Mikhail (Misha) Belolpetsky, between October 2009 and March 2013. I am extremely grateful to Misha for everything that he has done.

My thanks are extended to Professor John Parker and Dr Pavel Tumarkin who have acted (serially) as a second supervisor to great and significant effect.

I would also like to thank the wonderful people in the Department and outside who have made the last three and a half years in Durham such an extremely entertaining experience.

Finally I would like to thank my family who have been so supportive throughout my studies.

This thesis was partially supported by a EPSRC Doctoral Training Account Studentship (2009-2013), and a Willmore Pure Postgraduate Award (2009).

Contents

Title Page	i
Abstract	ii
Declaration	iii
Acknowledgements	iv
Contents	v
0 Introduction	1
0.1 Geometry	1
0.2 Groups	2
0.3 Hyperbolic Reflection Groups	3
0.4 Structure	5
1 Arithmetic Hyperbolic Reflection Groups	7
1.1 Reflection Groups of Hyperbolic Lattices	9
1.2 Arithmetic Hyperbolic Reflection Groups of rank 3	13
1.3 Bianchi Groups	14
1.3.1 Finiteness results	17
2 Hyperbolic Coxeter Polytopes	18
2.1 Convex Polytopes	18
2.1.1 Acute-Angled Polytopes	20
2.1.2 Coxeter Polytopes	21
2.2 Presentations of Coxeter Polytopes	22

2.2.1	Gram Matrix	22
2.2.2	Coxeter Diagram	24
2.3	Hyperbolic Coxeter Pyramids	27
3	The Quadratic Forms $f_d^n(x) = -dx_0^2 + x_1^2 + \dots + x_n^2$	33
3.1	f_d^n and $K = \mathbb{Q}$	35
3.1.1	Reflective quadratic forms f_d^2	38
3.1.2	Non-reflective quadratic forms f_d^2	38
3.1.3	f_3^n for $n > 2$	41
3.1.4	f_2^{15} is non-reflective	54
3.1.5	f_d^n for $n > 2$	56
3.1.6	Volume	60
3.2	f_d^n and $K = \mathbb{Q}[\sqrt{d}]$	61
3.2.1	$d = 3 + 2\sqrt{5}$	64
3.2.2	$d = -3 + 2\sqrt{5}$	65
4	The Bianchi Groups	69
4.1	Reflective Extended Bianchi Groups	70
4.2	Reflective Bianchi Groups	77
5	Quasi-Reflective Lattices	81
5.1	The quadratic forms f_d^n	82
5.1.1	The quadratic form f_6^3	82
5.1.2	The quadratic form f_{14}^3	84
5.1.3	The quadratic form f_7^4	85
5.2	The Bianchi and extended Bianchi groups	86
A	Infinite order isometries of the quadratic forms f_d^2	90
B	Infinite order isometries of the quadratic forms $f_d^n, n > 2$	105
B.1	Non-cocompact	105
B.1.1	$n = 3$	105
B.1.2	$n = 4$	107

Contents	vii
B.2 Cocompact	108
B.2.1 $n = 3$	108
C The list of finitely many Bianchi groups	109
D Infinite order isometries of the Bianchi and Extended Bianchi groups	111
E Tables of vectors from the quadratic forms f_d^n	148
F Tables of vectors from the Bianchi groups	154
References	164

Chapter 0

Introduction

He had said that the geometry of
the dream-place he saw was
abnormal, non-Euclidean, and
loathsomely redolent of spheres and
dimensions apart from ours.

Howard Phillips Lovecraft [41]

This thesis is a contribution to the study of arithmetic hyperbolic reflection groups, which is a long standing and active area of research in mathematics. We will begin this Chapter by reviewing the significant developments which have enabled this thesis to be. The historical narrative in Sections 0.1 and 0.2 closely follows Russell, Chapter 1, [55].

0.1 Geometry

Euclidean geometry, as codified in Euclid's *Elements* [24], was familiar to all schoolchildren until the introduction of the American *New Math* educational paradigm. It is such a natural setting that it was long considered to be inevitable, culminating with Kant's claim that anything else was unthinkable. It was useful for the production of this thesis that it is possible to think about different geometries. For a discussion the place of *a priori* in geometric knowledge circa 1897, see Russell [55].

The difficulty of the Euclidean system is the so-called "Parallel Postulate". The

question posed to Geometers was whether this statement was a logical consequence of the previous four postulates. Many attempts were made to prove that it was, but with the benefit of hindsight it is not surprising that this did not produce fruit.

The first successful conception of a geometry without the parallel postulate was due to Khayyām in 1077, a translation of which may be found in [33]. He did not reject the statement, but instead saw it as a consequence of a different (and more intuitive) postulate. This work eventually made its way into Europe, but was not able to topple Euclidean geometry from its ivory tower. A fundamentally non-Euclidean geometry, namely one which discounted the parallel postulate, was produced by Saccheri in 1772 [57]. Unfortunately Saccheri was so sure that Euclidean geometry was basic to the universe that, having developed a notion of non-Euclidean geometry, he devoted the second half of his book to disproving its existence.

Naturally it was left to the Princeps mathematicorum (c.f. [61], page 1188) to give the methodology of Saccheri credence. Gauss himself never published on the subject, but had at the tender age of 18 begun to construct a geometry without the troublesome postulate. This process was taken to its conclusion in two places simultaneously, at the hands of Lobachevsky [39] and Bolyai [13].

Now that the Euclidean orthodoxy had been reduced to rubble, three consistent geometries remain. Euclidean geometry can now be considered alongside *spherical geometry* (which is the natural geometry on the sphere) and what may be called (remaining true to mathematical naming conventions) Khayyām-Saccheri-Gauss-Lobachevsky-Bolyai geometry. In what follows, for brevity, this last geometry will be called *hyperbolic geometry*.

0.2 Groups

At this moment in history the notion of a group in geometry was not new, as they occur naturally as the (finite) collection of symmetries of geometric objects, but the two disciplines were not fully integrated. However, thanks to the efforts of the Princeps, the group was able to reach the terminus of the allegorically mythical Royal Road to Geometry (c.f. [50], p 57). Gauss developed the concept of the

curvature of a surface embedded in three dimensional (Euclidean) space. This was revolutionised by Riemann, who conceived of space of arbitrary dimension as a manifold, and to each point assigned a number which was a generalisation of Gauss' notion of curvature (c.f. [21]).

Lie's theory of continuous groups filled an important gap in Riemann's work, which was first addressed by Helmholtz. Lie's groups dispense with the need for Helmholtz's axiom of *Monodromy*, which may be stated: "As regards independence of rotation in rigid bodies ... If $(n - 1)$ points of a body remain fixed, so that every other point can only describe a certain curve, then that curve is closed" ([55], Chapter 1, §25, Axiom 4).

The isometry groups of the three geometries from the previous Section are examples of these continuous groups. We can now consider subgroups of these groups which are of interest for group theoretic reasons, or alternatively for geometric reasons coming from the way in which they act on the space. This was and remains a very exciting idea, which lead Klein to begin the Erlangen Program which aimed to specify the extent to which groups and geometries were able to interact [35].

0.3 Hyperbolic Reflection Groups

Subgroups of these Lie groups which are generated by reflections are of particular interest because they are strongly tied to the underlying geometry. The fundamental domains of these groups are polytopes which tessellate to fill the space completely, when copies of the polytopes are produced solely through reflecting in their sides. Simple examples are a square lattice or an equilateral triangle lattice in the two dimensional Euclidean plane.

In the Euclidean setting it is easy to see how to produce a cube from a square, and see that it fulfills the same requirements. There is a group which acts on three dimensional Euclidean space whose fundamental domain is a cube. In fact, one can construct an equivalent object in any number of dimensions, and with it there is an equivalent group. This is also true for the spherical space. In both of these settings the complete assembly of groups which are generated by reflections was found by

Coxeter [20].

We may ask the same question in the hyperbolic case. In this setting it is much more difficult to answer. In three dimensions, the question received a lot of attention due to its connection to the Bianchi groups, which are the generalisation of the modular group defined over groups of units of imaginary quadratic number fields.

The study of the Bianchi groups can demonstrate a distinguished heritage, being a contemporary application of the work of Klein and Fricke (as part of the Erlangen program) on elliptic modular functions. Bianchi's early work was concerned with differential geometry and functional theory, but by 1890 he was interested in Möbius transformations over integral values of imaginary quadratic fields, possibly influenced by Klein's solution to the quintic equation [34]. Initially applying geometric methods to number theoretic problems about these transformation groups [11] Bianchi then moved toward the more geometric question of considering subgroups of these groups that are generated by reflections in hyperplanes, culminating in his famous paper of 1892 [12] wherein he proves that for $m \leq 19$ ($m \neq 14, 17$) the Bianchi groups $Bi(m)$ were *reflective* (where m is a square-free positive integer).

At this stage, constructing new examples of hyperbolic reflection groups (in any dimension) was difficult. A classification of the groups whose fundamental domain was a simplex were possible, but these demonstrated that there was a ceiling on the dimension (c.f. [36] for the cocompact case, and [18] for the non-cocompact). Furthermore, a famous result of Vinberg states that there is a ceiling on the dimension of a compact arithmetic hyperbolic reflection group [71]. This was followed by the equivalent non-compact case due to Prokhorov [51]. This suggests that these groups are exceptional in a way that the Euclidean and spherical counterparts are not.

Towards the end of the 1960s, Vinberg initiated a program whose aim was to find all of these groups. This produced an algorithm which began to automate the production of new examples [70]. The most famous examples were constructed by Vinberg and Kaplinskaya [75] in dimensions $n = 18$, and 19, and then by Borchers [14] for $n = 21$.

Returning to the Bianchi groups, new examples of reflective groups were not

forthcoming until 1987 when a trio of papers appeared in [48] (English translations appeared in *Selecta Mathematica Sovietica*, Vol. 9, No. 4 (1990)). Here we see the study of reflective Bianchi groups drawn under the wider program of classification of reflective hyperbolic lattices initiated by È. B. Vinberg. He uses extensions of the Bianchi groups whose automorphism groups are contained in automorphism groups of particular quadratic forms, and proves that whether one is reflective depends on the order of the elements in the ideal class group of the underlying number field [73]. Vinberg's algorithm was used to produce examples of reflective groups which are in these extensions.

A wider classification continued into the 1990s, with a paper of Ruzmanov [56] introducing the *quasi-reflective* Bianchi groups, which are also known as *parabolic reflection groups* (cf. Nikulin [45]). A quasi-reflective group Γ_{QR} can be viewed as an infinite index extension of a reflection group, where the fundamental polyhedron of the reflection group has infinite volume and the action of the (infinite) symmetry group of the polyhedron preserves a particular horosphere on which it acts by affine transformations. Ruzmanov showed that within the class of groups with $m \leq 51$, or $m \equiv 1, 2 \pmod{4}$, the Bianchi group $Bi(m)$ is quasi-reflective for $m = 14, 17, 23, 31, 39$. In Nikulin's paper [45] it is shown that there are only finitely many quasi-reflective lattices in any dimension. Arguably the most interesting example of a quasi-reflective group appears in dimension 25, where the corresponding subgroup of affine transformations is the group of automorphisms of the Leech lattice. This example was first discovered by Conway [19].

0.4 Structure

The brief overview in the previous Sections hopefully gives some indication of the giants on whose shoulders this thesis rests. We will now review the arrangement of material in the forthcoming Chapters.

Chapter 1 contains the basic definitions and information that we will need for the later material. We present the group- and number- theoretic background, alongside the algorithm of Vinberg. Chapter 2 contains geometric and combinatorial informa-

tion about hyperbolic Coxeter polytopes. To finish Chapter 2 we will demonstrate the power of the combinatorial descriptions of hyperbolic Coxeter polytopes by completing the classification of hyperbolic Coxeter pyramids, and this material has been published by the author [44].

In Chapter 3 we study a two parameter family of quadratic forms and classify those members of this family whose group of units contains an arithmetic hyperbolic reflection group. Part of this Chapter has been published by the author [43]. To complete this Chapter we compute some volumes of the fundamental polytopes.

Chapter 4 completes the classification of the reflective Bianchi groups. This material is contained in the article [10].

The final Chapter contains a study of quasi-reflective groups. We complete the classification of the quasi-reflective Bianchi groups, which is contained in the article [10]. We also present some examples of quasi-reflective groups which were identified during the investigation in Chapter 3.

What would be more unsettling to one's sense of reality than to encounter physical examples of, say, hyperbolic geometry transplanted into our Euclidean world?

Chapter 1

Arithmetic Hyperbolic Reflection Groups

Arithmetic is where the answer is right and everything is nice and you can look out of the window and see the blue sky - or the answer is wrong and you have to start all over and try again and see how it comes out this time.

Carl Sandburg [58]

In this Section we shall recall a series of definitions which will form the basis of what follows. We will begin with a *Lie group*.

Definition 1.0.1 ([49], Part 1, Chapter 1, §1.1). A *Lie group* over the field K is a group G equipped with the structure of a differentiable manifold over K in such a way that the map

$$\mu : G \times G \rightarrow G, (x, y) \mapsto xy,$$

is differentiable.

Definition 1.0.2 ([76], Part II, Chapter 3, §3C, Definition 3.2). A Lie group G is *simple* if G has no nontrivial, connected, closed, proper, normal subgroups, and G is not abelian.

In addition to the Lie groups, we will recall another type of group namely the *algebraic group*.

Definition 1.0.3 ([30], Chapter 4, §4.1). A *linear algebraic group* is a subgroup of the general linear group $GL_n(\mathbb{C})$ if it is a subvariety, i.e. defined by polynomial equations in the matrix entries and the inverse of the determinant, and the group operations are morphisms between varieties.

Definition 1.0.4 ([30], Chapter 4, §4.1). An algebraic group is said to be defined over K if it is a variety defined over K and the morphisms are also defined over K .

The third strand of definitions which we will need recalls *quadratic forms*.

Definition 1.0.5 ([47], Part Two, Chapter IV, §41 C). An n -ary quadratic form is a homogeneous polynomial over \mathbb{R} , of degree 2 in n variables.

Definition 1.0.6 ([47], Part Two, Chapter IV, §41 C). Let f be a quadratic form whose coefficients lie in a number field K . If K is minimal with respect to this property, we say that f is defined over K .

We may now join these definitions together in order to define the setting in which we will be working for the rest of this thesis.

Let \mathcal{G} denote a Lie group with finitely many connected components, the connected component containing the identity, \mathcal{G}^0 , being a direct product of noncompact simple Lie groups without centre. Then let G be an irreducible algebraic group, defined over the number field K . We denote the L points of G by G_L .

We take \mathcal{G} to be the isometry group of hyperbolic n -space, \mathbb{H}^n , which consists of two connected components. One of these, \mathcal{G}^0 , is a noncompact simple Lie group without centre. Let f be a quadratic form defined over K . This form is equivalent to a diagonal form over \mathbb{R} , and the signs of the terms can be enumerated. The total number of negative terms in the diagonal quadratic form will be called the *negative inertia index* of f .

Definition 1.0.7. The form f is *admissible* if it has negative inertia index 1, and the conjugate form f^σ is positive definite for all Galois conjugates σ of K .

We denote by $\text{Ad } O(f)_{\mathbb{R}}$ the image of the orthogonal group of f under the adjoint representation, for f an admissible quadratic form. The group $\text{Ad } O(f)_{\mathbb{R}}$ can be identified with $\mathcal{G} \times C$, where C is a compact Lie group corresponding to the anisotropic Galois conjugates of f . Alternatively it may be embedded as a subgroup of index 2 in $O(f)_{\mathbb{R}}$. We have the following Lemma.

Lemma 1.0.8 ([69], Lemma 7). *Let Γ be a Zariski-dense (over \mathbb{R}) subgroup of \mathcal{G} containing reflections. Suppose, furthermore, that G is an irreducible algebraic group defined over the real number field K , and that ϕ is an isomorphism of $G_{\mathbb{R}}$ on \mathcal{G}^0 . If $\Gamma \cap \phi(G_K)$ is a subgroup of finite index in Γ , then*

1. $G \cong \text{Ad } SO(f)$, where f is a quadratic form with coefficients in K , and ϕ can be (uniquely) extended to an isomorphism of the group $\text{Ad } O(f)_{\mathbb{R}}$ on \mathcal{G} ;
2. If Γ is generated by reflections, then $\Gamma \subset \phi(\text{Ad } O(f)_K)$.

We recall the construction of hyperbolic space from an admissible quadratic form. Let $\{v_0, v_1, \dots, v_n\}$ be a basis of an $(n+1)$ -dimensional vector space $E^{(n,1)}$ with the scalar multiplication of signature $(n, 1)$ given by the quadratic form f . Consider

$$\{v \in E^{(n,1)} \mid (v, v) < 0\} = \mathfrak{C} \cup (-\mathfrak{C}),$$

where \mathfrak{C} is an open convex cone. The *vector model* of hyperbolic space \mathbb{H}^n is the set of rays through the origin in \mathfrak{C} , or $\mathfrak{C}/\mathbb{R}^+$, such that the isometries of \mathbb{H}^n are the orthogonal transformations of $E^{(n,1)}$ (c.f. [70]).

By constructing the hyperbolic space in this way there is a natural bilinear form (u, v) which is induced from the quadratic form f according to the formula

$$(u, v) = \frac{1}{2}(f(u+v) - f(u) - f(v)).$$

1.1 Reflection Groups of Hyperbolic Lattices

Let Γ be a discrete subgroup of $\text{Isom}(\mathbb{H}^n)$, and let Γ_r be its subgroup generated by all the reflections from Γ . Since a conjugation of a reflection in $\text{Isom}(\mathbb{H}^n)$ is again a reflection, the subgroup Γ_r is normal in Γ and we have the semi-direct decomposition

$$\Gamma = \Gamma_r \rtimes H. \tag{1.1}$$

Definition 1.1.1 ([10], Definition 4.1). A subgroup $\Gamma \subset \text{Isom}(\mathbb{H}^n)$ is called a *lattice* if it is a discrete subgroup of finite covolume.

A lattice Γ is called *reflective* if its non-reflective part H in the decomposition (1.1) is finite.

The non-reflective part H is comprised of three types of isometries: elliptic, parabolic, and loxodromic. These may be classified by their fixed point sets in the following way. An isometry of hyperbolic space is

- *elliptic* if it has at least one fixed point in the interior of the hyperbolic space;
- *parabolic* if it has precisely one fixed point which is at infinity, that is, a point in $\partial\mathbb{H}^n$;
- *loxodromic* otherwise.

Sometimes a finer categorisation is used which splits *loxodromic* into two distinct classes of isometry (c.f. [22], Proposition 1.4), but that will not be necessary in what follows.

The group Γ_r has a fundamental domain which is a polytope P (which may have infinitely many facets, and may also have infinite volume) in \mathbb{H}^n , whose faces are precisely the mirror hyperplanes of the hyperbolic reflections which generate Γ_r . From now on by *fundamental polytope* of Γ_r we will always mean this polytope. The group H in decomposition (1.1) can be identified with the symmetry group of P . This fact was proved in [69] for the case when the group H is finite, but the same argument works in general (see also [2, Lemma 5.2] where Vinberg's proof is repeated).

In the vector model of \mathbb{H}^n , a hyperplane is given by the set of rays in \mathfrak{C} which are orthogonal to a vector e of positive length in $E^{(n,1)}$, and contained in a hyperbolic subspace of $E^{(n,1)}$. A hyperplane Π_e divides the space into two *halfspaces*, which will be denoted Π_e^+ and Π_e^- , and a reflection which will be denoted R_e . The halfspace Π_e^- is defined as that which contains the specific normal vector e . For brevity, a hyperplane associated to a vector e_i will be denoted Π_i .

If $e = \sum_{j=0}^n k_j v_j$, where the v_j are the basis vectors of $E^{n,1}$, the reflection R_e is defined by,

$$R_e v_j = v_j - \frac{2(e, v_j)}{(e, e)} e. \quad (1.2)$$

From this definition we see that for $R_e \in \Gamma$, e must have rational coefficients, otherwise the hyperplanes normal to these vectors will not bound a fundamental polytope. Furthermore, the vector e may be normalised such that all the coefficients are coprime integers. With this normalisation we can assign to R_e a correctly defined number $k = (e, e)$ and call R_e a k -reflection. Note that k represents the spinor norm of R_e (cf. [22, p. 160] for further discussion.)

There is a further condition for R_e to be an element of Γ , namely the so-called *Crystallographic condition*: Any pair of reflections $R_\alpha, R_\beta \in \Gamma$ must satisfy

$$\frac{2(\alpha, \beta)}{(\beta, \beta)} \in \mathbb{Z}, \quad (1.3)$$

with respect to the quadratic form (c.f. [70]).

By linearity, we only need to check that R_e satisfy this condition when applied to the basis vectors v_j .

Vinberg's algorithm [70] constructs a fundamental polytope of the maximal hyperbolic reflection subgroup of the integral automorphism group of a quadratic form. It begins by considering the stabiliser subgroup $\Gamma_0 \subset \Gamma$ of a point x_0 which may lie inside or on the boundary of \mathbb{H}^n . The *polyhedral angle* at x_0 is defined by

$$P_0 = \bigcap_{i=1}^l \Pi_i^-,$$

with all the hyperplanes being *essential* (not wholly contained within another hyperplane). There is a unique fundamental polytope of Γ which sits inside P_0 and contains x_0 , and it shall be denoted P .

The algorithm continues by constructing further Π_i such that

$$P = \bigcap_i \Pi_i^-,$$

with the Π_i s being essential, ordered by increasing $\rho(x_0, \Pi_i)$ (where ρ denotes hyperbolic distance), and Π_i^- denoting the halfspace which contains x_0 . If the basis

vector v_0 is chosen such that it lies on the ray containing x_0 , then the hyperbolic distance between x_0 and the hyperplane Π_e is given by

$$\sinh^2 \rho(x_0, \Pi_e) = -\frac{(e, v_0)^2}{(e, e)(v_0, v_0)}. \quad (1.4)$$

In the case where v_0 is isotropic and x_0 lies on the boundary of hyperbolic space, we follow Shaiheev who generalised Vinberg's algorithm to this case [63].

When constructing the hyperplanes Π_i for $i \geq l + 1$, they must be chosen such that Π_i is the closest mirror of Γ to x_0 whose halfspace Π_i^- contains an inner point of the intersection of all previously constructed halfspaces (this is equivalent to the normal vector e_i having non-positive inner product with all previous normal vectors, with respect to the form f).

Each vector generated by the algorithm, and therefore which satisfies all of the above requirements is normal to a mirror in the reflection subgroup and will be called *admissible*.

The algorithm terminates if the mirrors generated bound a region which has finite volume. This region is the fundamental polytope of a reflection group which is contained in the automorphism group of the quadratic form. In this case we say that the quadratic form is *reflective*. An invariant of a lattice which is drawn from the quadratic form is the following.

Definition 1.1.2 ([46], §1.2). The *determinant* of a hyperbolic lattice Γ is

$$\det(\Gamma) = \det((e_i, e_j)), \quad (1.5)$$

where e_i are admissible basis vectors of Γ , and $(,)$ is the bilinear form on the lattice.

We can see that the determinant of the lattice is precisely the determinant of the underlying quadratic form. If a lattice has an element x which has odd (squared) length the lattice is said to be *odd*, whereas if no such elements are present the lattice is *even*.

1.2 Arithmetic Hyperbolic Reflection Groups of rank 3

A complete list of the hyperbolic reflection groups of rank 3 has been produced by Allcock [4]. This was based on the work of Nikulin, who classified the arithmetic reflective Fuchsian groups [46] in terms of the determinant of the lattice. In this section we will recall certain details of Nikulin's work, and present his results.

We begin by recalling the remaining invariants of a lattice Γ of rank 3, after the determinant.

Definition 1.2.1 ([46], §2.2). A lattice Γ has:

- $type = 0$ if the lattice is *even* ;
- $type = 1$ if the lattice is *odd*.

Before we reach the next invariant we recall the definition of the Legendre symbol.

Definition 1.2.2 ([62], Part I, Chapter I, §3.2). Let p be a prime number $\neq 2$, and let $x \in F_p^*$. The *Legendre symbol* of x , denoted by $\left(\frac{x}{p}\right)$, is the integer $x^{\frac{p-1}{2}} \pmod{p} = \pm 1$.

For odd p , we have a constant θ_p , which is defined in the following manner,

$$\theta_p = |\mathbb{Z}_p^*/(\mathbb{Z}_p^*)^2|,$$

from which we can construct the invariant η .

Definition 1.2.3 ([46], §2.2, equation 2.2.10). A lattice with square-free determinant d has the invariant

$$\eta = \{\eta_p : \text{odd } p|d\} \text{ where } \eta_p \in \{0, 1\} \text{ and } (-1)^{\eta_p} = \left(\frac{\theta_p}{p}\right).$$

Definition 1.2.4 ([46], §2.2, Definition 2.2.5). A hyperbolic lattice Γ of rank 3 and with a square-free determinant is called *main* if $type \equiv d \pmod{2}$. In other words, the lattice Γ should be even if the determinant d is even. If the determinant d is odd, then the lattice Γ will be necessarily odd. In particular, main hyperbolic lattices of rank three and with a square-free determinant are defined by the invariants (d, η) .

The value of the so-called main lattices is made clear by the following proposition (which is only partially reproduced).

Proposition 1.2.5 ([46], §2.2, Proposition 2.2.6). *All non-main hyperbolic lattices $\tilde{\Gamma}$ of rank three and with a square-free determinant are in one-to-one correspondence $\Gamma \leftrightarrow \tilde{\Gamma}$ with main odd hyperbolic lattices Γ of rank 3 and with a square-free determinant $d = \det(\Gamma) = \det(\tilde{\Gamma})/2$. The correspondance is defined by the embedding of lattices*

$$\Gamma(2) \subset \tilde{\Gamma} \tag{1.6}$$

where $\Gamma(2)$ is the maximal even sublattice of $\tilde{\Gamma}$ (it has index two).

The reflective lattices classified by Nikulin had the following determinants $d =$ 1, 2, 3, 5, 6, 7, 10, 11, 13, 14, 15, 17, 19, 21, 22, 23, 26, 29, 30, 33, 34, 35, 38, 39, 42, 51, 55, 57, 65, 66, 69, 70, 77, 78, 85, 87, 91, 93, 95, 102, 105, 110, 111, 130, 141, 155, 165, 170, 195, 205, 210, 219, 231, 255, 273, 285, 291, 330, 345, 357, 385, 390, 399, 429, 435, 455, 465, 483, 570, 615, 645, 651, 795, 1155, 1365.

This finite list will form the basis of Section 3.1.

1.3 Bianchi Groups

Concerning reflection groups in hyperbolic 3-space, there was a considerable leap forward around 1990. In the collection of papers *Voprosy teorii grupp i gomologicheskoi algebry*, Vinberg [73], Shvartsman [64] and Shaiheev [63] published significant contributions in which they identified several previously unknown examples and explored the number-theoretic and geometric aspects of these groups in great detail. They dealt with the Bianchi groups, non-cocompact groups which arise naturally from a model of hyperbolic 3-space. At the same time, Scharlau found many examples of maximal reflection groups which led to the statement that the list of such objects was complete [60]. Subsequently, in 1998, Shvartsman tightened the constraints upon reflective Bianchi groups much further [65]. An important paper of Agol [1] produced a finite list of arithmetic Kleinian groups which could be reflective and paved the way for a complete classification. In this section we present the Bianchi

groups, and develop the machinery we will need to complete the classification of the reflective Bianchi groups in Chapter 4.

Let O_m be the ring of integers of the imaginary quadratic field $K_m = \mathbb{Q}[\sqrt{-m}]$ (where m is a square-free positive integer). Denote by h_m the class number of this quadratic number field. Following Vinberg [73] we define the *Bianchi group* $Bi(m)$ by

$$Bi(m) = \mathrm{PGL}_2(O_m) \rtimes \langle \tau \rangle, \quad (1.7)$$

where τ is an element of order 2 that acts on $\mathrm{PGL}_2(O_m)$ as complex conjugation.

The group $Bi(m)$ can be regarded in a natural way as a discrete group of isometries of the hyperbolic 3-space (see below). Together with $Bi(m)$ we will also consider the *extended Bianchi group* $\widehat{Bi}(m)$, which is the maximal discrete subgroup of $\mathrm{Isom}(\mathbb{H}^3)$ containing $\mathrm{PGL}_2(O_m)$ (cf. [3]). The group $\widehat{Bi}(m)$ is defined by

$$\widehat{Bi}(m) = \widehat{\mathrm{PGL}}_2(O_m) \rtimes \langle \tau \rangle$$

where $\widehat{\mathrm{GL}}_2(O_m)$ denotes the group of matrices $\mathrm{GL}_2(K_m)$ which, under the natural action in the space K_m^2 , multiply the lattice O_m^2 by the fractional ideal of the ring O_m (whose square is automatically a principle ideal). The extended Bianchi group is a finite index extension of the Bianchi group, specifically $\widehat{Bi}(m)/Bi(m) \cong C_2(O_m)$, the 2-periodic part of the class group of K_m , whose order is given by

$$h_{2,m} = \begin{cases} 2^t & \text{if } m \equiv 1 \pmod{4}, \\ 2^{t-1} & \text{if } m \equiv 2, 3 \pmod{4}, \end{cases} \quad (1.8)$$

where t denotes the number of the prime divisors of m .

We have already seen in this Chapter the algorithm for constructing a reflection group within the automorphism group of a quadratic form. An extended Bianchi group is of use to us in that it can be identified with the automorphism group of a particular quadratic form.

Consider the space H_2 of second-order Hermitian matrices and define a quadratic form f on H_2 by the formula $f(x) = -2 \det x$. The quadratic form f has signature $(3, 1)$, therefore it defines on H_2 the structure of Lorentzian 4-space. Let H_2^+ denote the cone of positive definite matrices that are in one of the two connected components

of the cone of all $x \in H_2$ with $f(x) < 0$. The hyperbolic 3-space \mathbb{H}^3 can be represented as the quotient H_2^+/\mathbb{R}_+ , where \mathbb{R}_+ acts on H_2 by homotheties.

The transformations

$$g(x) = \frac{1}{|\det g|} g x g^* \quad (g \in \mathrm{GL}_2(\mathbb{C})), \quad (1.9)$$

where $*$ denotes the Hermitian transpose, are pseudo-orthogonal transformations of the space H_2 that preserve the cone H_2^+ . The orientation preserving isometries of \mathbb{H}^3 are induced by these transformations g , and the orientation reversing isometries are induced by compositions of g with the complex conjugation τ . Therefore, the group of isometries of the hyperbolic 3-space in this model is the group $\mathrm{PGL}_2(\mathbb{C}) \rtimes \langle \tau \rangle$, and furthermore its discrete subgroups $Bi(m)$ and $\widehat{Bi}(m)$ are discrete groups of isometries of \mathbb{H}^3 .

Under the action on the space H_2 the group $Bi(m)$ preserves the lattice L_m which consists of the matrices with the entries in O_m . Let $O_0(L_m)$ be the group of all pseudo-orthogonal transformations of the space H_2 that preserve the lattice L_m and the cone H_2^+ . It is an arithmetic subgroup of $\mathrm{Isom}(\mathbb{H}^3)$, and Vinberg showed that in fact $O_0(L_m) = \widehat{Bi}(m)$ (c.f. [73], §4). This implies in particular that the groups $Bi(m)$ and $\widehat{Bi}(m)$ have finite covolume.

Following Shaiheev [63], we can choose a basis of H_2 in which the elements $x \in L_m$ are given by

$$x = \begin{cases} \begin{pmatrix} x_1 & x_3 - \sqrt{-m}x_4 \\ x_3 + \sqrt{-m}x_4 & x_2 \end{pmatrix} & \text{if } m \equiv 1, 2 \pmod{4}, \\ \begin{pmatrix} x_1 & x_3 + \frac{1-\sqrt{-m}}{2}x_4 \\ x_3 + \frac{1+\sqrt{-m}}{2}x_4 & x_2 \end{pmatrix} & \text{if } m \equiv 3 \pmod{4}, \end{cases} \quad (1.10)$$

where $x_i \in \mathbb{Z}$. We see that, in these coordinates, f is written as

$$f = \begin{cases} -2x_1x_2 + 2x_3^2 + 2mx_4^2 & \text{if } m \equiv 1, 2 \pmod{4}, \\ -2x_1x_2 + 2x_3^2 + 2x_3x_4 + \frac{m+1}{2}x_4^2 & \text{if } m \equiv 3 \pmod{4}. \end{cases} \quad (1.11)$$

In our model of \mathbb{H}^3 , a hyperplane is given by the set of rays in H_2^+ which are orthogonal to a vector e of positive length, and contained in a hyperbolic subspace. As we have seen previously, a hyperplane defines two halfspaces and a reflection between them, which acts by equation (1.2).

1.3.1 Finiteness results

A finite list of candidates for reflective extended Bianchi groups (and hence Bianchi groups) was established by Agol [1]. Following on from Agol, numeric computations carried out in Section 4.3 of [7] demonstrate that there are 882 groups $\widehat{Bi}(m)$ which are the only cases that we will need consider, and these may be further filtered by the following Proposition which is due to Belolipetsky (this Proposition is only partially reproduced).

Proposition 1.3.1 ([10], Proposition 4.3, parts 1 and 2). *The class groups of the fields K_m satisfy:*

1. *If $Bi(m)$ is reflective then $C(O_m) \cong (\mathbb{Z}/2\mathbb{Z})^n, n \in \mathbb{Z}_{\geq 0}$;*
2. *If $\widehat{Bi}(m)$ is reflective then $C(O_m) \cong (\mathbb{Z}/2\mathbb{Z})^n \times (\mathbb{Z}/4\mathbb{Z})^l, n, l \in \mathbb{Z}_{\geq 0}$.*

Using GP/PARI we may apply this Proposition to the list of 882 groups and see that there are:

1. 65 candidates for reflective Bianchi groups and ;
2. 188 candidates for reflective extended Bianchi groups.

This finite list will form the basis of Section 4.1. The specific values of m can be found in Appendix C.

Chapter 2

Hyperbolic Coxeter Polytopes

“...Was your mother able to explain a tesseract to you?”
“Well, she never did,” Meg said.
“She got so upset about it. Why, Mrs Whatsit? She said it had something to do with her and father.”

Madeleine L'Engle [37]

There are two representations of Hyperbolic Coxeter polytopes that we will make use of in what follows. They are the Gram matrix and the Coxeter diagram. In this Chapter we shall present the necessary background on these two representations, and illustrate their utility by classifying the hyperbolic Coxeter pyramids.

2.1 Convex Polytopes

Hyperbolic n -space is a space of constant curvature, with sectional curvature equal to -1 . We denote by G the group of isomorphisms of \mathbb{H}^n .

Definition 2.1.1 ([74], Part 1, Chapter 1, §3.2, Definition 3.2). A non-empty set $Y \subset \mathbb{H}^n$ is said to be a *plane* if it is the set of fixed points for an involution $\sigma \in G$. The involution σ is called the *reflection* in the plane Y .

Significant planes are the following: 0-dimensional planes are *points* ; 1-dimensional planes are (straight) *lines* (this coincides with the definition of a geodesic in Riemannian geometry) ; and $(n - 1)$ -dimensional planes are *hyperplanes*. A hyperplane divides the space \mathbb{H}^n into two parts, which will be referred to as *half-spaces*. We will refer to the half-spaces of the hyperplane Π as Π^+ and Π^- . A hyperplane is a codimension one subspace, and its position in space is uniquely determined by a point and a normal vector.

In addition to the hyperplanes, hyperbolic n -space contains a particular type of what are known as *standard hypersurfaces*, namely the *horospheres*.

Definition 2.1.2 ([74], Part 1, Chapter 4, §2.2). Any n -dimensional subspace U of $E^{(n,1)}$ is defined by a non-zero vector e orthogonal to it. The standard hypersurfaces associated with U are of the form

$$H_e^c = \{x \in U : (x, e) = c\}.$$

In the case $(e, e) = 0$, the vector e defines a unique point p on the boundary of hyperbolic space, and it is in this case that the standard hypersurface H_e^c is said to be a *horosphere with centre p* .

Definition 2.1.3 ([74], Part 1, Chapter 1, §3.3, Definition 3.5). A set $P \subset \mathbb{H}^n$ is said to be *convex* if for any pair of points $x, y \in P$ it contains the segment xy .

We have the following Theorem.

Theorem 2.1.4 ([74], Part 1, Chapter 1, §3.3, Theorem 3.8). *Any closed convex set is an intersection of half-spaces.*

This Theorem leads naturally onto the following Definition.

Definition 2.1.5 ([74], Part 1, Chapter 1, §3.3, Definition 3.9). A *convex polytope* is an intersection of finitely many half-spaces H_i^- , having a non-empty interior:

$$P = \bigcap_{i=1}^s H_i^-. \quad (2.1)$$

The boundary of the polytope is the set of hyperplanes H_i which define the half-spaces.

We assume that there is no half-space H_j^- containing the intersection of all remaining halfspaces.

2.1.1 Acute-Angled Polytopes

Definition 2.1.6 ([74], Part 1, Chapter 6, §1.3, Definition 1.2). A family of half-spaces $\{H_1^-, \dots, H_s^-\}$ is said to be *acute-angled* if for any distinct i, j either the hyperplanes H_i and H_j intersect and the dihedral angle $H_i^- \cap H_j^-$ does not exceed $\frac{\pi}{2}$, or $H_i^+ \cap H_j^+ = \emptyset$. A convex polytope P (as Definition 2.1.5) is said to be *acute-angled* if $\{H_1^-, \dots, H_s^-\}$ is an acute-angled family of half spaces.

We have the following Theorem about families of half-spaces.

Theorem 2.1.7 ([74], Part 1, Chapter 6, §1.3, Theorem 1.3). *If $\{H_1^-, \dots, H_s^-\}$ is an acute-angled family of half-spaces, then for all i_1, \dots, i_t the intersections of the half-spaces $H_1^- \dots H_s^-$ with the plane $Y = H_{i_1} \cap \dots \cap H_{i_t}$ that are different from Y form an acute-angled family of half-spaces in the space Y such that the angle between any two intersecting hyperplanes $H_j \cap Y$ and $H_k \cap Y$ of the space Y does not exceed the angle between H_j and H_k .*

We say that a collection of hyperplanes is *indecomposable* if it can not be split into two non-empty families which are mutually perpendicular, and *non-degenerate* if these hyperplanes have no point in common and not perpendicular to a single hyperplane. Given a collection of hyperplanes with these properties, we have the following Theorem.

Theorem 2.1.8 ([74], Part 1, Chapter 6, §2.1, Theorem 2.1). *Let $\{H_1^-, \dots, H_s^-\}$ be an acute-angled family of half-spaces of the space \mathbb{H}^n such that the family of hyperplanes $\{H_1, \dots, H_s\}$ is indecomposable and non-degenerate. Let*

$$P^- = \bigcap_{i=1}^s H_i^- \quad \text{and} \quad P^+ = \bigcap_{i=1}^s H_i^+. \quad (2.2)$$

Then one of the following statements holds:

1. P^- has a non-empty interior, and P^+ is empty;
2. P^+ has a non-empty interior, and P^- is empty.

Acute-angled polytopes with finite volume in hyperbolic space, in contrast to the similar objects in other spaces of constant curvature, may have vertices at infinity.

Definition 2.1.9 ([74], Part 1, Chapter 6, §2.2, Definition 2.4). A point at infinity $p \in \partial\mathbb{H}^n$ is a *vertex at infinity* of a convex polytope $P \subset \mathbb{H}^n$ if $p \in \overline{P}$ and the intersection of P with a sufficiently small horosphere S_p with centre p is a bounded subset of this horosphere regarded as an $(n - 1)$ -dimensional Euclidean space.

The polytope $P \cap S_p$ is convex and has the same dihedral angles as P at the intersection, so it is an acute-angled Euclidean polytope. The combinatorial structure of the neighbourhood of the vertex at infinity is identified with the combinatorial structure of the Euclidean polytope, which is given by the following Theorem.

Theorem 2.1.10 ([74], Part 1, Chapter 6, §1.4, Theorem 1.5). *Any non-degenerate acute-angled polytope P on the sphere S^n (respectively, in the Euclidean space E^n) is a simplex (respectively, a direct product of a number of simplices and a simplicial cone).*

Hence $P \cap S_p$ is a direct product of simplices.

2.1.2 Coxeter Polytopes

Definition 2.1.11 ([74], Part 2, Chapter 5, §1.1, Definition 1.1). A convex polytope

$$P = \bigcap_{i=1}^s H_i^- \tag{2.3}$$

is said to be a *Coxeter polytope* if for all $i, j, i \neq j$, such that the hyperplanes H_i and H_j intersect, the dihedral angle $H_i^- \cap H_j^-$ is a submultiple of π .

Note that a Coxeter polytope is acute-angled, so two hyperplanes that are not adjacent as faces of the polytope do not intersect (c.f. [74]).

The value of Coxeter polytopes is demonstrated by the following Proposition.

Proposition 2.1.12 ([74], Part 2, Chapter 5, §1.2, Proposition 1.4). *Let Γ be a discrete reflection group, and P its chamber. Then P is a Coxeter polytope, and Γ is the group generated by reflections in the hyperplanes bounding P . In particular, P is a fundamental polytope of the group Γ .*

2.2 Presentations of Coxeter Polytopes

2.2.1 Gram Matrix

A complete presentation of a Coxeter polytope P is given by its *Gram matrix*. The Gram matrix $G = (g_{ij})$ of P is a symmetric matrix with entries:

$$g_{ij} = \begin{cases} 1 & \text{if } i = j, \\ -\cos(\frac{\pi}{k}) & \text{if } \angle(\Pi_i, \Pi_j) = \frac{\pi}{k}, \\ -1 & \text{if } \angle(\Pi_i, \Pi_j) = 0, \\ -\cosh(\rho(\Pi_i, \Pi_j)) & \text{if } \Pi_i \text{ and } \Pi_j \text{ do not intersect,} \end{cases}$$

where $\rho(\Pi_i, \Pi_j)$ is the minimum hyperbolic distance between the two hyperplanes. The entries of the Gram matrix may be computed directly from the normal vectors e_i to the hyperplanes Π_i as

$$g_{ij} = \frac{(e_i, e_j)^2}{(e_i, e_i)(e_j, e_j)},$$

where $(,)$ is the inner product in the space, and the vector e_i is normal to the hyperplane Π_i .

The matrix G either has negative inertia index 1 and is of rank $\leq n + 1$, or is positive semidefinite with rank $\leq n$. The polytope P is non-degenerate precisely when the rank of G is $n + 1$. When P has finite volume the Gram matrix defines it uniquely up to an isomorphism of the whole space.

The *direct sum* of matrices A_1, \dots, A_n is given by

$$\begin{pmatrix} A_1 & & & 0 \\ & A_2 & & \\ & & \ddots & \\ 0 & & & A_n \end{pmatrix},$$

up to a permutation of the rows, and the same permutation of the columns. If a matrix A cannot be presented as a direct sum of two non-empty matrices it is said to be *indecomposable*. Every symmetric matrix can be expressed as a direct sum of indecomposable matrices, up to a permutation of these blocks and the rows and columns of any individual block, and these are known as its *components*. Components of a matrix that will be used later on can be collected into three groups which are presented in Table 2.1.

Table 2.1: Components of a decomposable matrix

A^+	direct sum of all positive definite components of A ,
A^0	direct sum of all degenerate non-negative definite components of A ,
A^-	direct sum of all negative definite components of A .

If a Gram matrix is not positive definite, but all proper principal submatrices are, then the matrix is called *critical*.

Proposition 2.2.1 ([72]). *A critical matrix is indecomposable.*

Proof. Assume that a critical matrix M could be written as a direct sum of matrices $A_1 \oplus A_2 \oplus \dots \oplus A_k$. The determinant of M is then given by the product of the determinants of the A_i s. All proper, principal submatrices of M are positive definite, so all the determinants of the A_i s will be positive, giving the determinant of M as positive. However, M is critical, so it must have non-positive determinant. Hence M must be indecomposable. \square

A consequence of Theorem 2.1.8 is the following.

Theorem 2.2.2 ([74], Part 1, Chapter 6, §2.1, Theorem 2.1). *Any indecomposable symmetric matrix of signature $(n, 1)$ with 1's along the main diagonal and non-positive entries off it is the Gram matrix for some convex polytope in the space \mathbb{H}^n . This polytope is defined uniquely up to an isometry.*

Positive definite Gram matrices are called *elliptic*, while degenerate non-negative definite Gram matrices are *parabolic*. A collection of k hyperplanes in n dimensions whose associated Gram matrix is elliptic intersect in a lower dimensional linear subspace of dimension $n - k$. The equivalent parabolic case is slightly different in the hyperbolic world in that the intersection lies on the ideal boundary of the hyperbolic space.

The information contained in a Gram matrix is sufficient to determine whether the configuration of hyperplanes bound a region of finite volume. That this is possible illustrates the value of the critical matrix.

Let $P \subset \mathbb{H}^n$ be a non-degenerate, acute-angled, convex polytope, with each face defined by a vector e_i , $i \in I$ some finite index set, and let G be its Gram matrix.

Define

$$K = \{v \in E^{(n,1)} \mid (e_i, v) \leq 0, \forall i \in I\}.$$

Then, for any set $S \subset I$, let

$$K_S = \{v \in K \mid (e_i, v) = 0 \text{ for } i \in S\}.$$

In the same way, define G_S to be the submatrix of a matrix G defined by taking the rows and columns of G indexed by the elements of S .

Proposition 2.2.3 ([70], Proposition 1). *A necessary and sufficient condition for the polytope P to have finite volume is that, for any critical principal submatrix G_S of the matrix G , either*

1. *if G_S is degenerate non-negative definite, then there exists a $T \supset S$ such that $G_T = G_T^0$ and $\text{rank } G_T = n - 1$, or*
2. *if G_S is negative definite, then $K_S = \{0\}$*

Vinberg also provides an alternative approach which can simplify the verification of the second part of Proposition 2.2.3:

Proposition 2.2.4 ([70], Proposition 2). *Let the Gram matrix G of the polytope P be indecomposable. If S and $T \subset I$, S as in Proposition 2.2.3, are such that*

$$G_{S \cup T} = G_S \oplus G_T, \quad G_T = G_T^+,$$

then

$$K_{S \cup T} = \{0\} \implies K_S = \{0\}.$$

2.2.2 Coxeter Diagram

Another presentation of a Coxeter polytope which will be used is the Coxeter scheme (sometimes Coxeter Graph or Coxeter Diagram). It is a graph which reproduces most of the information in the Gram matrix, with the exception of the distance between non-intersecting planes. Each vertex of a Coxeter scheme corresponds to a hyperplane, and the edges are as presented in Table 2.2.

Table 2.2: The edges of a Coxeter diagram

Type of edge	Corresponds to
comprised of $m - 2$ lines, or labelled m	a dihedral angle $\frac{\pi}{m}$
a single heavy line	a dihedral angle of zero
a dashed line (or broken-line branch)	two divergent faces
no line	a dihedral angle $\frac{\pi}{2}$

Figure 2.1: An example of a Coxeter scheme would be:



Example 2.2.5 ([43], Example 1). The scheme in Figure 2.1 corresponds to a noncompact simplex in 3-dimensional hyperbolic space with dihedral angles $\frac{\pi}{6}$, $\frac{\pi}{3}$, and $\frac{\pi}{4}$ (and the remaining angles are right). The Gram matrix of a simplex can be recovered from its Coxeter scheme. In our case, we get

$$\begin{pmatrix} 1 & -\frac{1}{2} & 0 & -\frac{\sqrt{3}}{2} \\ -\frac{1}{2} & 1 & -\frac{1}{\sqrt{2}} & 0 \\ 0 & -\frac{1}{\sqrt{2}} & 1 & 0 \\ -\frac{\sqrt{3}}{2} & 0 & 0 & 1 \end{pmatrix}.$$

We will say that the determinant of a Coxeter scheme is precisely the determinant of the associated Gram matrix. A Coxeter scheme whose Gram matrix is elliptic is called elliptic, and the same for a parabolic Gram matrix. The connected elliptic and parabolic Coxeter diagrams were classified by Coxeter [20]. The elliptic diagrams are precisely those of the simplices in Spherical space, and connected parabolic diagrams represent Euclidean simplices. The combinatorial structure of the configuration of hyperplanes is encoded in the Coxeter scheme, and we can use this information to test whether a particular diagram represents a polytope of finite volume, which is the case where the Coxeter polytope is a fundamental polytope of a reflection group.

A connected Coxeter diagram all of whose proper subdiagrams are elliptic, and the whole diagram is not elliptic or parabolic, is called a *Lannér diagram*. These correspond to the bounded hyperbolic simplices. A connected Coxeter diagram all of whose proper subdiagrams are elliptic or parabolic, and the whole diagram is neither elliptic or parabolic, is called a *quasi-Lannér diagram*. These correspond to

the unbounded hyperbolic simplices of finite volume. Complete lists of Lannér and quasi-Lannér diagrams can be found in [74] (Part II, Chapter 5, §2.3, Tables 3 and 4).

Proposition 2.2.6 ([70]). *A polytope P has finite volume if, for any subgraph G_S (as in Proposition 2.2.3) of the diagram, either*

1. *if G_S is parabolic, then it is a connected component of a parabolic subgraph G_T of the diagram which has rank $n - 1$,*
2. *if G_S is a broken-line branch or Lannér subgraph, then by removing vertices the diagram can be disconnected into G_S and an elliptic subgraph G_T such that*

$$\text{rank } G_S + \text{rank } G_T = n + 1.$$

This latter condition is sufficient but not necessary for the polytope P to have finite volume.

Sometimes we will refer to a broken-line branch as a dashed edge.

We will use this Proposition in Chapter 3 to determine that Coxeter polytopes there have finite volume, but are non-cocompact. In Chapter 4 we will use a reformulation of these results which is due to Bugaenko. We cannot use Corollary 2.2.6 in these cases, as we cannot satisfy the statement about Lannér subgraphs.

Proposition 2.2.7 ([17], Proposition 1.1). *A Coxeter polytope is bounded if and only if any elliptic subscheme of rank $n - 1$ of its Coxeter scheme can be extended to an elliptic subscheme of rank n in precisely two ways.*

Proposition 2.2.8 ([17], Proposition 1.2). *A Coxeter polytope is of finite volume if and only if any elliptic subscheme of rank $n - 1$ of its Coxeter scheme can be extended to an elliptic subscheme of rank n or a parabolic subscheme of rank $n - 1$ in precisely two ways.*

Geometrically these statements mean that each edge of the polytope has two vertices, either one or both of which may be at the ideal boundary of the hyperbolic space. Reading the geometrical information encoded in a Coxeter diagram can be done with reference to the following Proposition. In this form it is due to Tumarkin [68].

Proposition 2.2.9 ([72], Theorems 3.1 and 3.2). *Let P be a hyperbolic Coxeter polytope. The vertex set of the Coxeter diagram which describes this polytope will be denoted J .*

1. *A subset $I \subset J$ determines a face of the polytope P (other than an ideal vertex) if and only if the subdiagram G_I is elliptic. In this case the codimension of the corresponding face is the order of I ;*
2. *A subset $I \subset J$ determines an ideal vertex if and only if the subdiagram G_I is not elliptic and there is a subset I' such that $I \subset I' \subset J$ and $S_{I'}$ is parabolic of rank $n - 1$.*

We can see from this proposition that if the order of a Coxeter diagram which determines a face of P is greater than n it must correspond to an infinitely distant vertex.

2.3 Hyperbolic Coxeter Pyramids

In this section we shall illustrate the power of the Coxeter diagram in the hyperbolic setting, where the combinatorial information alone is sufficient to define a polytope. We shall consider hyperbolic Coxeter polytopes which have the combinatorial structure of a pyramid. These objects were studied by Vinberg, who in 1985 constructed a pyramid with 19 faces in \mathbb{H}^{17} using his *general construction of unbounded Coxeter polytopes of finite volume* [72]. Tumarkin subsequently completed the classification of pyramids in \mathbb{H}^n with $n + 2$ faces [67], before extending it to pyramids with $n + 3$ faces [68]. His approach is entirely combinatorial, and naturally generalises to pyramids with $n + p$ faces which we will present here.

The following two lemmas are straightforward generalisations of Tumarkin's results. The second Lemma 2.3.2 is a generalisation of Tumarkin's Lemma 11 from [68].

Lemma 2.3.1. *If a hyperbolic Coxeter n -polytope P of finite volume is a pyramid with $n + p$ faces, then it is a pyramid over a product of p simplices of dimension $n - 1$.*

Proof. Suppose that P is a pyramid over some polytope P' . Then P' is the base of the pyramid above which is a distinguished vertex A . The boundary of the face P' contains k vertices, each of which is connected to A by a edge of P . All of the faces of $P \setminus P'$ meet at A , and hence it is the confluence of $n + p - 1$ faces. When $p = 1$ the polytope is a simplex, which is a pyramid over one simplex. For $p > 1$ we see that $n + p - 1 > n$, and so the Coxeter diagram of a vertex has order greater than n . We see from Proposition 2.2.9 that this forces A to be an infinitely distant vertex. By Theorem 2.1.10, the intersection of a sufficiently small horosphere h centred at A is a direct product of Euclidean Coxeter simplices and is the fundamental domain of a Euclidean reflection group.

The number of faces in an l dimensional product of m simplices is $l + m$, and we solve the following equation.

$$n + p - 1 = (n - 1) + m$$

Therefore P' is equivalent to the product of p simplices. □

The proof of the following is like that of Lemma 4 in [67].

Lemma 2.3.2. *Let P be a hyperbolic Coxeter pyramid over a product of p simplices for $p > 1$ and Σ be a Coxeter diagram of P . Then Σ satisfies the following three conditions:*

1. Σ is a union of p quasi-Lannér diagrams L_i . The intersection of the L_i is a unique node v . $L_i \setminus v$ and $L_j \setminus v$ for $i \neq j$ are not adjacent;
2. Each diagram $L_i \setminus v$ is parabolic. Any other subdiagram of L_i is elliptic;
3. For any p vertices $\{v_1, v_2, \dots, v_p\} \in \Sigma$ such that $v_i \in L_i \setminus v$ a diagram $\Sigma \setminus \{v_1, v_2, \dots, v_p\}$ is either elliptic or connected parabolic.

Any Coxeter diagram satisfying these conditions determines a hyperbolic Coxeter pyramid over a product of p simplices.

Proof. Let A be the distinguished vertex of the pyramid P (above the base) over a product of p simplices and v the node of Σ corresponding to the face opposite A .

By Proposition 2.2.9 as A is an infinitely distant vertex the Coxeter diagram $\Sigma \setminus v$ is parabolic of rank $n - 1$. The number of faces in the product of m simplices of dimension l is $l + m$, so the order of the Coxeter diagram is $n + p - 1$. For $p > 1$ the Coxeter diagram is parabolic and has p connected components which will be denoted S_i , $i \in \{1, \dots, p\}$, all of which are by definition not adjacent. Note that all the subdiagrams of a connected parabolic Coxeter diagram are elliptic.

The Coxeter diagram Σ is that of a convex polytope of finite volume, and is therefore connected ([72], §1.5). Hence all of the connected components S_i of $\Sigma \setminus v$ are connected to v by an edge, and Σ is the union of all of the $L_i = S_i \cup v$, intersecting in the common node v . All other proper subdiagrams of L_i determine a face of P , and so are elliptic or parabolic. The smallest parabolic diagram is of order two, and the order of the diagram is $n + p$, so the maximum order of an L_i is $n + p - 2(p - 1) = n - p + 2$, and the maximum order of a proper subdiagram of an L_i is $n - p + 1$ and hence for $p > 1$ it must be elliptic. We see that, by definition, each of the L_i are quasi-Lannér.

Any vertex of P except A corresponds to a subdiagram $\Sigma \setminus \{v_1, v_2, \dots, v_k\}$ such that none of the vertices v_i coincide with v . If $k > p$ then the order of the resulting diagram is less than n , and by Proposition 2.2.9 it determines a face of codimension $k - p > 0$, i.e. it does not determine a vertex. If $k < p$ then the order of the diagram is greater than n and the diagram must be parabolic, and at least one L_i remains without any vertices removed. This is a connected component of a parabolic diagram and is therefore parabolic, but it contains a parabolic diagram as a proper subdiagram. Hence $k = p$ and at least one v_i must be removed from each L_i .

Suppose that a Coxeter diagram Σ of order $n + p$ satisfies the three conditions of the lemma. Then $\text{Det}(\Sigma) = 0$ by Lemma 5.1 in [72]. By an argument identical to that in part **2.** of the proof of Lemma 4 in [67] the Coxeter diagram Σ determines a Coxeter polytope P in \mathbb{H}^n .

The polytope P is clearly a pyramid over the face v . Then by Lemma 2.3.1 it is a pyramid over a product of p simplices. \square

These Lemmas provide a precise description of the combinatorial structure of the Coxeter diagram of a hyperbolic Coxeter pyramid. We now make use of the

above results to find the remaining hyperbolic Coxeter pyramids with $p > 3$.

Lemma 2.3.3 ([44], Lemma 3.3). *Let $P \subset \mathbb{H}^n$ be a hyperbolic Coxeter pyramid with $n + p$ faces, then $p \leq 4$.*

Proof. Let Σ be the Coxeter diagram of P . Choose $v_i \in \Sigma$, $i \in \{1, \dots, p\}$, such that a connected component of $\Sigma \setminus \{v_i\}$ consists of v and at least one vertex from each of the quasi-Lannér diagrams L_i . The degree of v in the diagram $\Sigma \setminus \{v_i\}$ is not less than p , and by Lemma 2.3.2 part (3) the diagram is either elliptic or parabolic. By inspection of the elliptic and parabolic Coxeter diagrams the maximum degree of a vertex is equal to four, which is realised uniquely in the parabolic graph \tilde{D}_4 . \square

Note that the placement of the parabolic graph \tilde{D}_4 constrains the labelling of the edges connecting the vertex v to the rest of the graph such that they must all be of weight 3.

Corollary 2.3.4 ([44], Corollary 3.4). *Let $P \subset \mathbb{H}^n$ be a hyperbolic pyramid with $n + 4$ faces, then $n = 5$.*

Proof. Let Σ be the Coxeter diagram of P . Then Σ contains a particular \tilde{D}_4 as a subgraph, and the vertex of degree four is the base of the pyramid. For P to have finite volume, it is necessary that any parabolic subgraph of Σ must be a component of a parabolic graph of rank $n - 1$ ([72], Proposition 4.2). Therefore $n - 1 \geq 4$.

Assume that P has finite volume, and that $n > 5$. Then $\tilde{D}_4 \subset \Sigma$ is a connected component of $\Gamma' \subset \Sigma$, a parabolic graph of rank $n - 1$, and the graph $\Gamma = \Gamma' \setminus \tilde{D}_4$ contains a parabolic graph of rank $n - 5$. Therefore the connected components of Γ are all parabolic subdiagrams of the quasi-Lannér diagrams L_i . However, by Lemma 2.3.2 part (2), each of the L_i contain only one parabolic subdiagram, namely $L_i \setminus v$, so Γ is elliptic. Hence $n = 5$. \square

Proposition 2.3.5 ([44], Proposition 3.5). *A hyperbolic Coxeter pyramid P with $n + 4$ faces has a Coxeter diagram which is among those given in Figure 2.3.*

Proof. By Corollary 2.3.4, hyperbolic Coxeter pyramids with $n + 4$ faces exist in \mathbb{H}^5 only. Therefore we have nine vertices, distributed between four quasi-Lannér

Figure 2.2: The Coxeter diagrams of the quasi-Lannér diagrams of rank 2 which have the following restrictions: $2 \leq k, l \leq 3, \frac{1}{k} + \frac{1}{l} < 1$.

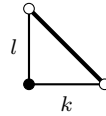
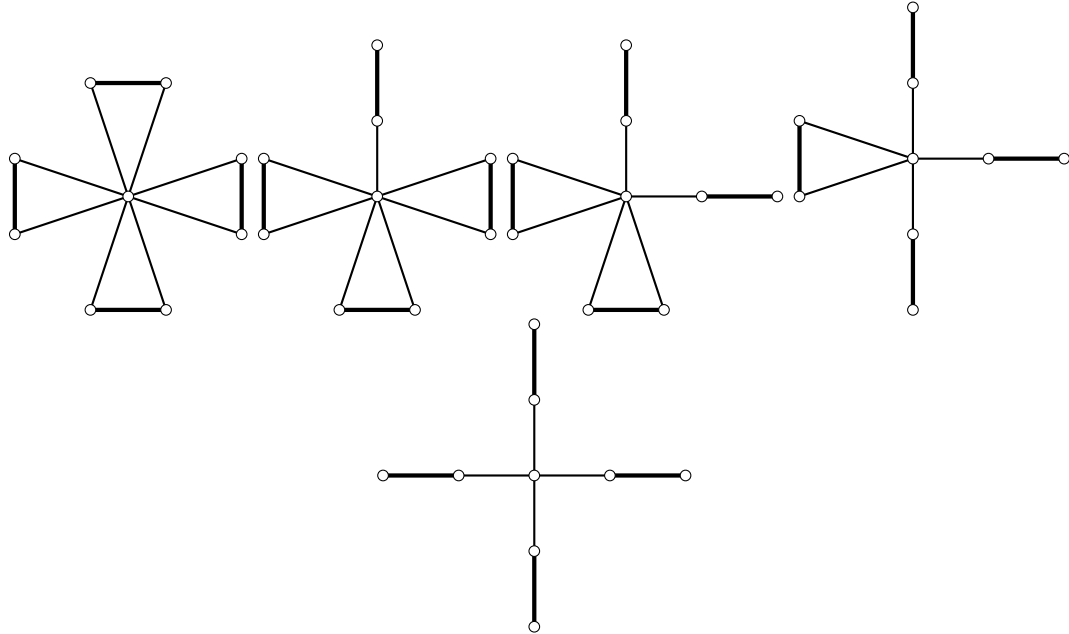

Figure 2.3: Coxeter diagrams of hyperbolic Coxeter pyramids with 9 faces in \mathbb{H}^5 .



diagrams which share a common vertex v . The smallest quasi-Lannér diagram is a family, each member of which is of rank 2 and has three vertices. Hence each of the four quasi-Lannér diagrams must be from this family, the members of which are shown in Figure 2.2.

We know that every edge connecting v to another vertex has weight 3. Therefore the common vertex between all four quasi-Lannér diagrams must be the filled vertex in Figure 2.2, and the two labels k and l must be either 2 or 3. We can see that there are only two quasi-Lannér diagrams with this restriction.

There are five ways to assemble these into a complete Coxeter diagram of a hyperbolic pyramid, and those are presented in Figure 2.3. □

All together, we have proven the following.

Theorem 2.3.6 ([44], Theorem 3.6). *Let P be a Coxeter polytope in \mathbb{H}^n with Coxeter diagram Σ of order $n + p$ for $p > 1$. The combinatorial type of P is a hyperbolic*

pyramid over a product of p simplices if and only if it is one of the following:

$p = 2$: among the list in Theorem 2 of [67];

$p = 3$: among the list in §4 of [68];

$p = 4$: when Σ corresponds to a diagram in Figure 2.3,

and this list is complete.

Remark 2.3.7. The two diagrams in Figure 2.3 with rotational symmetry of order four were among the root systems listed in Table 5.1 of [25].

Chapter 3

The Quadratic Forms

$$f_d^n(x) = -dx_0^2 + x_1^2 + \dots + x_n^2$$

He would be lying in the dark
fighting to keep awake when a faint
lambent glow would seem to
shimmer around the centuried
room, shewing in a violet mist the
convergence of angled planes which
had seized his brain so insidiously.

Howard Phillips Lovecraft [40]

We study the two parameter family of quadratic forms defined over a number field K given by

$$f_d^n(x) = -dx_0^2 + x_1^2 + \dots + x_n^2, \quad (3.1)$$

where d is a square-free integer in K . The structure of the automorphism group of these forms is of interest principally in terms of an eventual classification of hyperbolic reflection groups. We address the question of whether the automorphism group of these quadratic forms contains a finite index subgroup which is generated by reflections. From another direction, Belolipetsky [5] (see also [6]) and Belolipetsky-Emery [8] (c.f. [23]) have determined that arithmetic hyperbolic orbifolds of minimal volume were defined over quadratic forms in these families. Finally, the covolume of

the group of units of these quadratic forms over \mathbb{Q} (for d odd) was recently obtained by Ratcliffe and Tschantz and used to compute the volumes of some hyperbolic polytopes [54]. The covolumes of unimodular lattices had also been obtained by Belolipetsky and Gan [9].

Our principal tool is the algorithm due to Vinberg by which we construct the fundamental domain of the reflection subgroup of the integral automorphisms of the quadratic form. We know that there is an upper bound on the dimension in which arithmetic hyperbolic reflection groups exist, but we do not have to check each family of forms in each dimension (up to this limit) thanks to the following Theorem, which is due to Bugaenko.

Theorem 3.0.8 ([16], Theorem 2). *Suppose that a hyperbolic quadratic form f splits into the orthogonal sum of a hyperbolic form f' and a one-dimensional unimodular quadratic form. Then the fundamental polytope P' of the maximal reflection subgroup of the group of integral automorphisms of f' is a face of the fundamental polytopes P of the maximal reflection subgroup of the group of integral automorphisms of f .*

Hence, the question of the reflectivity of the integral automorphism group of a quadratic form in n dimensions necessarily requires an affirmative answer to the same question in $n - 1$ dimensions.

Now that we consider $f_d^n(x)$ we can make specific the requirements of Vinberg's algorithm which were introduced in Section 1.1.

If a vector $e = \sum_{i=0}^n k_i v_i$ then the action of R_e on the basis vectors v_i can be written as:

$$R_e v_j = \begin{cases} v_j - \frac{2k_j}{(e,e)} e, & j > 0, \\ v_j + \frac{2dk_j}{(e,e)} e, & j = 0. \end{cases} \quad (3.2)$$

The vectors $v_i, i > 0$, are the natural unit vectors with respect to the quadratic form. The remaining basis vector v_0 is orthogonal to all these with respect to the quadratic form, and has length $-d$.

We need each new reflection generated by the algorithm to satisfy the crystallographic condition, and by linearity we only need to check that R_e satisfy this condition when applied to the basis vectors. Therefore it is necessary that both $\frac{2k_j}{(e,e)}$ and $\frac{2dk_0}{(e,e)}$ are integers in K .

This last statement is a strong restriction on the lengths of vectors which may be generated by the algorithm. For example, if $K = \mathbb{Q}$, then (e, e) must take one of the values: $1, 2, d, 2d$. If the length is greater than 2 then each of the k_j , $j > 0$, must be divisible by d .

Among the vectors generated by the algorithm, we wish to choose that which is closest to the polyhedral angle. From equation (1.4), it is clear that finding the closest mirror is equivalent to minimising

$$\frac{(e, v_0)^2}{(e, e)} = \frac{k_0^2}{(e, e)}. \quad (3.3)$$

This quantity will be referred to as the *weight* of a vector.

3.1 f_d^n and $K = \mathbb{Q}$

The first case we will consider is the case where the field of definition is \mathbb{Q} . We refer to Godement's compactness criterion which implies that for $n \geq 4$ a lattice defined by a quadratic form is non-cocompact if and only if the form is defined over \mathbb{Q} (c.f. [38], Section 1). We consider quadratic forms of this type following Vinberg [69], [70], Belolipetsky [5] and Belolipetsky-Emery [8]. For certain values of d , these families have been studied, and the question as to whether the form is reflective has been answered. The unimodular case, or $d = 1$, was studied by Vinberg [70] (who also considered $d = 2$) and completed by Vinberg-Kaplinskaya [75] when they determined that the forms are reflective for $n \leq 19$. While not reflective for $n = 20$, this form is associated to a reflection group for $n = 21$, which was demonstrated by Borchers [14], but this reflection group is not contained in the group of units of the quadratic form. The case of $d = 3$ was investigated by the author [43], the details of which will be presented later in this chapter. When $d = 5$ the form was shown to be reflective when $n \leq 8$ by Mark [42].

We can use the results of Section 1.2 to write down the finite list of quadratic forms that are candidates for arithmetic reflection groups in the hyperbolic plane. We note that the lattices that Nikulin found to be reflective were maximal (not just groups of units), and are not necessarily defined by the quadratic forms f_d^2 , so we do not expect that all values of d will be reflective. As we investigate $n \geq 3$

Theorem 3.0.8 guides our steps when we require f_d^{n-1} to be reflective before f_d^n may be.

We present the case of $d = 3$ in some detail, echoing the contents of [43]. Where the remaining cases are reflective, it is for small n , so we will present those together.

We will prove the following Theorem.

Theorem 3.1.1. *The groups of units of the quadratic forms f_d^n contain a finite index subgroup generated by reflections precisely for those pairs (d, n) which are listed in Table 3.1. The vectors which are normal to the mirrors of the reflections can be found in Section E.*

Remark 3.1.2. When these quadratic forms are reflective and $n = 3, 4$, we may compare their fundamental domains to the complete list of maximal arithmetic non-cocompact reflection groups produced by Scharlau for $n = 3$ [59] and the list of such groups for $n = 4$ produced by Scharlau and Walhorn [60]. The results are included in Table 3.1.

In the case $n = 3$ there are two values of d in this set for which comparing with Scharlau is not possible. These are $d = 7$ and 15 when the lattice is cocompact.

For $n = 4$ Scharlau and Walhorn provide less information about each lattice, but we can still try to find these lattices in their list.

The group of units of these quadratic forms can be seen to contain reflections in hyperplanes which are normal to the following vectors:

$$e_i = -v_i + v_{i+1} \text{ for } 1 \leq i < n, \quad (3.4)$$

$$e_n = -v_n.$$

The intersection of these hyperplanes is a point which we may take to be a vertex of the fundamental domain, which is given by the vector v_0 . The stabiliser of this point is the Weyl group B_n .

These n vectors are the first vectors which form the starting point when we apply Vinberg's algorithm to the quadratic forms f_d^n . These data, when combined with Vinberg's algorithm, are sufficient to demonstrate that these quadratic forms are reflective, but to prove that such a quadratic form is not reflective we will need more information.

Table 3.1: The pairs (d, n) for which the group of units of the quadratic form f_d^n contains a finite index subgroup generated by reflections. The numbers N_3 and N_4 correspond to the numbering in the tables of maximal arithmetic non-cocompact reflection groups produced by Scharlau for $n = 3$ [59] and Scharlau & Walhorn for $n = 4$ respectively [60].

d	n	N_3	N_4
1	2, ..., 19	2	1
2	2, ..., 14	4	8
3	2, ..., 13	1	2
5	2, ..., 8	11	5
6	2		
7	2, 3		
10	2, 3	19	
11	2, 3, 4	20	12
13	2		
14	2		
15	2, 3		
17	2, 3	25	
19	2		
23	2		
30	2		
33	2		
39	2		
51	2		

3.1.1 Reflective quadratic forms f_d^2

In search of reflective quadratic forms we need only look among those quadratic forms which have a determinant d which is in Nikulin's list that can be found at the end of Section 1.2, or in the case where d is odd we may also consider $2d$ which may produce a non-main reflective lattice (c.f 1.2.5). The results are summarised in Table 3.1.

We will begin with the case of polytopes in the hyperbolic plane. When the algorithm terminates we have generated a polytope of finite area and we present the Coxeter diagram in Figure 3.1. Examining the Coxeter diagrams we see that the lattice is non-cocompact and of finite area precisely when $d = 1, 2, 5, 10, 13, 17$. We may compute the areas of the polygons using the following lemma.

Lemma 3.1.3 ([26], Chapter IX, §IX.2). *Let R be a convex polytope with m vertices, some of which may be at infinity, and let the interior angles be φ_v , $v = 1, \dots, m$. Then*

$$\text{Area}(R) = (m - 2)\pi - \sum_{v=1}^m \varphi_v. \quad (3.5)$$

In order to make use of this Lemma, we will tabulate the number and magnitude of the interior angles of the fundamental polytope shown in Figure 3.1. These data, and the areas are listed in Table 3.2.

3.1.2 Non-reflective quadratic forms f_d^2

Thus far we have only seen the cases in which Vinberg's algorithm terminated. In principle, we may have neglected to run the algorithm for long enough for it to terminate, therefore we will now prove that the remaining cases are non-reflective.

The smallest value of d which appears to be non-reflective is $d = 21$. Finding the reflections in the group of units of the quadratic form f_{21}^2 suggests that the fundamental polygon is bounded by infinitely many sides, but we have drawn the Coxeter diagram of the first 16 generated by Vinberg's algorithm as Figure 3.2 part a). We have omitted to draw the broken-line branches, as the underlying graph is highly connected, and they make it difficult to see what is going on. The hyperplanes represented in the graph can be matched into vertical pairs, and the distance between

Table 3.2: Data for the computations of the areas of the fundamental polytopes of the reflection groups in the groups of units of f_d^2 . The total number of vertices is labelled m , and the vertices which have interior angle $\frac{\pi}{n}$ are counted in the column v_n .

d	m	v_2	v_3	v_4	v_6	v_∞	Area
1	3	1		1		1	$\frac{\pi}{4}$
2	3	1		1		1	$\frac{\pi}{4}$
3	3	1		1	1		$\frac{\pi}{12}$
5	4	2		1		1	$\frac{3\pi}{4}$
6	4	3		1			$\frac{\pi}{4}$
7	4	2		2			$\frac{\pi}{2}$
10	4	2		1		1	$\frac{3\pi}{4}$
11	4	2	1	1			$\frac{5\pi}{12}$
13	8	4		2		2	$\frac{7\pi}{2}$
14	6	4		2			$\frac{3\pi}{2}$
15	4			4			π
17	7	5		1		1	$\frac{9\pi}{4}$
19	6	4		2			$\frac{3\pi}{2}$
23	6	2	2	2			$\frac{11\pi}{6}$
30	8	4		4			3π
33	12	8		4			5π
39	6		2	4			$\frac{7\pi}{3}$
51	6	4		2			$\frac{3\pi}{2}$

Figure 3.1: Coxeter diagrams of the fundamental domains of the arithmetic reflection groups f_d^2 .

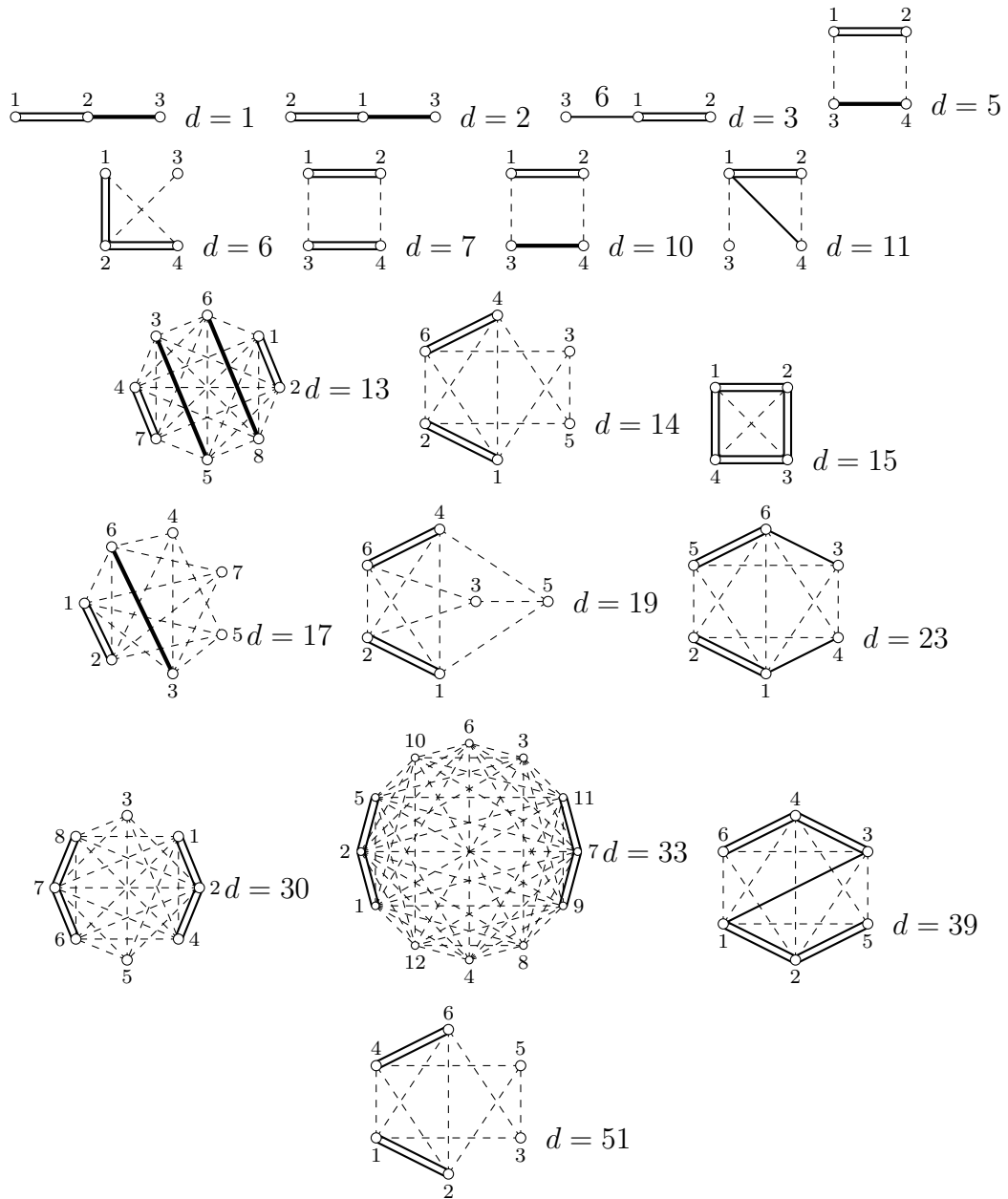

them can be measured. This distance alternates between two values as one proceeds either to the left or to the right, so we expect that this does not bound a fundamental polytope of finite volume. We can compute the isometry of the hyperbolic plane which acts as the obvious isometry of this (infinitely extended) diagram. It is of infinite order, and so the non-reflective part of this lattice is infinite, and it is not a reflection group by Definition 1.1.1. It is contained as an infinite-index subgroup

in the reflection group with fundamental polytope given in Figure 3.2 part b). The pair of reflections whose product is this infinite order isometry are marked.

Figure 3.2: a) Coxeter diagram of the first 16 vectors generated by Vinberg's algorithm which bound the fundamental polytope of the quadratic form f_{21}^2 (Broken-line branches intentionally omitted). b) Coxeter diagram of the reflection group of which a) is an infinite index subgroup.

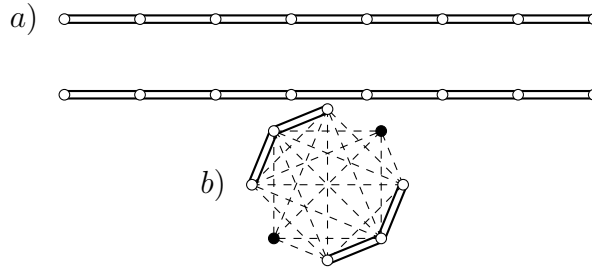

In all the cases which we claim are non-reflective, we can produce an integral matrix which preserves the integral lattice and whose action is loxodromic. We collect the matrices together in Appendix A.

3.1.3 f_3^n for $n > 2$

We have a list of values of d for which f_d^2 is reflective, to which we may apply Theorem 3.0.8 and attempt to produce arithmetic reflection groups in higher dimensions. We will present the details for f_3^n by proving the following Theorem. This quadratic form is of particular interest, as the work of Belolipetsky-Emery [8] determined that it defines the unique orientable arithmetic hyperbolic orbifold of minimal covolume when $n = 2r - 1$ and r even, i.e. $n = 7, 11, 15, \dots$

Theorem 3.1.4 ([43], Theorem 1). *The groups of integral automorphisms of the quadratic form f_3^n are reflective for $2 \leq n \leq 13$ and non-reflective for $n \geq 14$. The Coxeter diagrams of the fundamental polytopes of the corresponding maximal reflection subgroups for $n = 2$ to 13 are given in Figures 3.3 and 3.4.*

Reflective case

We recall that the vertex x_0 (defined by the vector v_0) of the polyhedron is stabilised by the set R_{e_i} , $1 \leq i \leq n$, listed previously as equation 3.4 all of which are easily

Figure 3.3: Coxeter diagrams of the fundamental polytopes of the discrete reflection group corresponding to the automorphism groups of the quadratic form f_3^n , for $n = 2$ to 8.

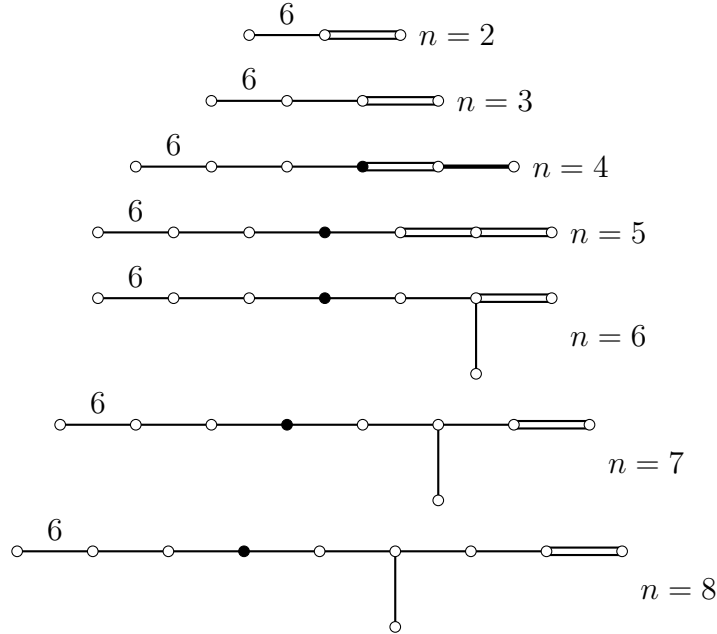

seen to lie in the group of units of the quadratic form.

Each new vector e_j , $j > n$, must have negative inner product with all previous vectors with respect to the form f_3^n . Therefore upon each new hyperplane corresponding to the normal vector $e_j = \sum_{i=0}^n k_i v_i$, there is the following ordering condition on the coefficients k_i , $i > 0$:

$$k_1 \geq k_2 \geq \dots \geq k_n \geq 0. \tag{3.6}$$

The halfspace associated to each new hyperplane is chosen to be the halfspace which contains x_0 . Therefore each new hyperplane corresponding to the normal vector e_j must satisfy:

$$(e_j, v_0) < 0,$$

where the bilinear form $(,)$ is the inner product defined by f_3^n . This statement implies that

$$k_0 > 0. \tag{3.7}$$

Recall that the crystallographic condition constrains the lengths of the vectors obtained by the algorithm, and in this case (e_j, e_j) could equal 3 or 6, as long as all

Figure 3.4: Coxeter diagrams of the fundamental polytopes of the discrete reflection group corresponding to the automorphism groups of the quadratic form f_3^n for $n = 9$ to 13.

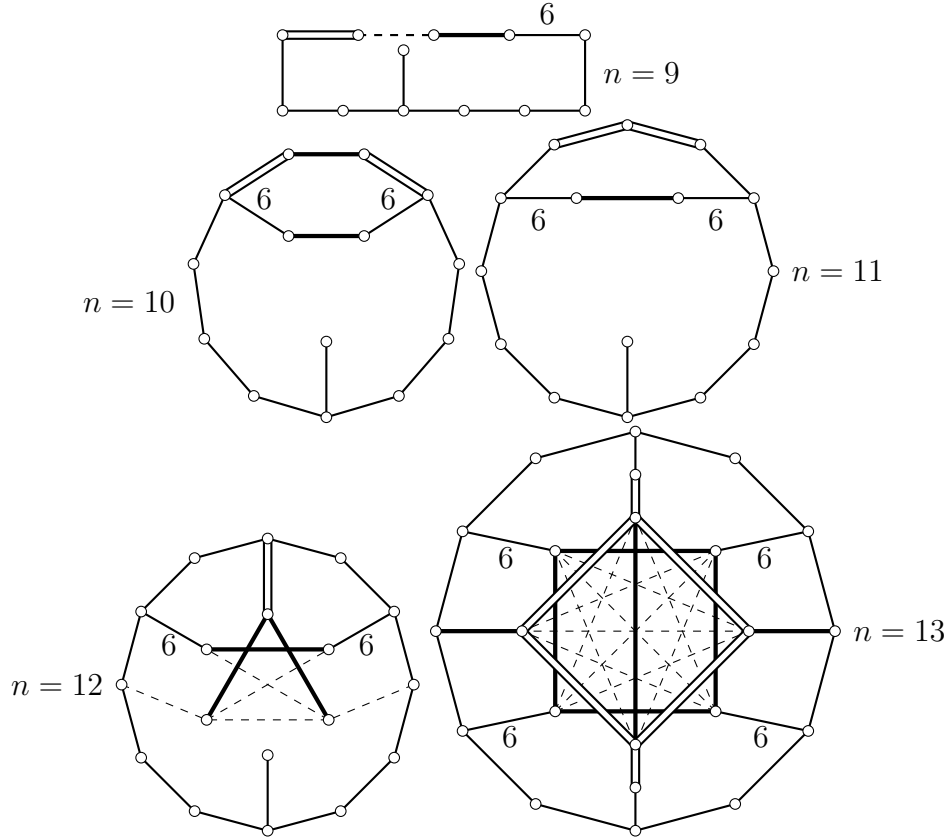

the k_j are divisible by 3. The possible values are given by the following lemma.

Lemma 3.1.5. *The vectors e_j which are generated by Vinberg's algorithm when applied to the quadratic form f_d^n defined over \mathbb{Q} must have lengths $|e_j|$ which satisfy the following.*

1. $|e_j|^2 \in \{1, 2, d, 2d\}$, for $d \equiv 1, 3 \pmod{4}$;
2. $|e_j|^2 \in \{1, 2, d\}$ otherwise.

Proof. By the crystallographic condition the length must be such that

$$\frac{2k_i}{|e_j|^2} \in \mathbb{Z},$$

for all $i \geq 1$. This statement comes from applying the reflection in the hyperplane normal to e_j to each basis vector (excluding v_0) in succession. The action of the

reflection on the basis vector v_0 is given by

$$v_0 + \frac{2dk_0}{|e_j|^2}e,$$

and hence

$$\frac{2dk_0}{|e_j|^2} \in \mathbb{Z},$$

We recall that we have scaled the vectors so that the coefficients are coprime, and therefore the quantity $|e_j|^2$ must divide $2dk_0$ and $2k_i$, $i \geq 1$, simultaneously. Hence if d divides k_i , $i \geq 1$, but not k_0 we have the statement numbered 1. in the lemma.

If the parameter d is even, then $2d$ is divisible by four and it must be that the k_i , $i \geq 1$, are even. Then the quantity

$$|e_j|^2 + dk_0^2 = 2d + dk_0^2 = \sum_{i=1}^n k_i^2, \quad (3.8)$$

is divisible by four. In order that the coefficients are pairwise coprime, k_0 must be odd, but then dk_0^2 is not divisible by four (d is square-free), and we have the second statement.

□

We reproduce the proof of Proposition 4 in [43].

Proposition 3.1.6 ([43], Proposition 4). *Given the preceding conditions, the sets of vectors which are found by the algorithm are presented in Table E.3.*

Proof. The algorithm searches for vectors (k_0, k_1, \dots, k_n) which satisfy the relations 3.6, 3.7 and Lemma 3.1.5. The vector must have non-positive inner product with all vectors which have been found before it. Finally, if the length is divisible by 3 then all the k_i , $i > 0$, must be also divisible by 3. Of all the vectors which satisfy these conditions, the vector which minimises the quantity 3.3 is chosen. This way we obtain the following vectors, which are listed below, and in each case the vector is followed by the details of its derivation.

1. $v_0 + 3v_1$

The vector which minimises 3.3 should have length 6 and $k_0 = 1$, so it remains to show that such a vector would satisfy the above constraints. By the crystallographic condition, if $(e, e) = 6$, all k_i s, $i > 0$, must be divisible by 3. Under these conditions, a solution is sought for the equation

$$(e, e) + 3k_0^2 = 9 = \sum_{i=1}^n k_i^2.$$

It is clear that this is solved by a single $k_i = 3$, and the remaining k_j , $i \neq j$, are all zero, and by the inequalities 3.6, $i = 1$.

As all subsequent vectors must have negative inner product with this vector, another constraint is imposed:

$$k_0 \geq k_1. \quad (3.9)$$

For $n = 3$ the algorithm terminates here, as the inclusion of this vector defines the acute-angled polytope of finite volume which has the Coxeter diagram in Figure 3.3 labelled $n = 3$.

2. $v_0 + v_1 + v_2 + v_3 + v_4$ and $v_0 + v_1 + v_2 + v_3 + v_4 + v_5$

After $\frac{1}{6}$, the next possible weights according to equation 3.3 are as follows:

- (a) $\frac{1}{3}$: $k_0 = 1$, $(e, e) = 3$,
- (b) $\frac{1}{2}$: $k_0 = 1$, $(e, e) = 2$,
- (c) $\frac{2}{3}$: $k_0 = 2$, $(e, e) = 6$,
- (d) 1: $k_0 = 1$, $(e, e) = 1$.

By the crystallographic condition, and the inequality 3.9, the cases $\frac{1}{3}$ and $\frac{2}{3}$ are not possible. The second case, $\frac{1}{2}$, is realised by a solution to the Diophantine equation

$$(e, e) + 3k_0^2 = 5 = \sum_{i=1}^n k_i^2,$$

where, by the inequalities 3.9 and 3.6, all the k_i must be bounded above by 1. Therefore this equation only has solutions in 5 or more dimensions, and produces

$$v_0 + v_1 + v_2 + v_3 + v_4 + v_5. \quad (3.10)$$

Now consider the final case in this list. This is realised by a solution to the Diophantine equation

$$(e, e) + 3k_0^2 = 4 = \sum_{i=1}^n k_i^2,$$

where again, by inequalities 3.9 and 3.6, all the k_i must be bounded above by 1. Therefore this equation has solutions in 4 or more dimensions, and produces

$$v_0 + v_1 + v_2 + v_3 + v_4. \quad (3.11)$$

A new vector is required in 4 dimensions to define an acute angled polyhedron of finite volume, and the vector 3.11 is sufficient. In 5 or more dimensions we must take the vector 3.10 as it has a smaller weight according to equation 3.3. Note that as the inner product of the vectors 3.10 and 3.11 is positive, the two vectors are not mutually admissible.

In 5 or more dimensions, the additional constraint coming from $v_0 + v_1 + v_2 + v_3 + v_4 + v_5$ is:

$$3k_0 \geq k_1 + k_2 + k_3 + k_4 + k_5. \quad (3.12)$$

3. $2v_0 + v_1 + \dots + v_{13}$ and $2(v_0 + v_1) + v_2 + \dots + v_{11}$

After 1, the next possible weights according to equation 3.3 are as follows:

- (a) $\frac{4}{3}$: $k_0 = 2$, $(e, e) = 3$,
- (b) $\frac{3}{2}$: $k_0 = 3$, $(e, e) = 6$,
- (c) 2: $k_0 = 2$, $(e, e) = 2$.

Again, by the crystallographic condition, and the inequality 3.9, the case $\frac{4}{3}$ is not possible. While the second case, $\frac{3}{2}$, is permitted by these two conditions, it requires a solution to the Diophantine equation

$$(e, e) + 3k_0^2 = 33 = \sum_{i=1}^n k_i^2 = 9 \sum_{i=1}^n k_i'^2,$$

where $k_i = 3k_i'$, and $9 \nmid 33$, so there are no solutions of this form.

Therefore consider the final case. This requires a solution to the Diophantine equation

$$(e, e) + 3k_0^2 = 14 = \sum_{i=1}^n k_i^2.$$

There are two partitions of 14 into sums of squares respecting both inequalities 3.9 and 3.12, and they are:

(a) 2, 1, 1, 1, 1, 1, 1, 1, 1, 1, 1;

(b) 1, 1, 1, 1, 1, 1, 1, 1, 1, 1, 1, 1, 1, 1.

The first of these represents the vector $2(v_0 + v_1) + v_2 + \dots + v_{11}$, and as such arises in 11 or more dimensions, while the second, $2v_0 + v_1 + \dots + v_{13}$, does not appear until $n = 13$. The inner product between them is zero, so they are mutually admissible.

4. Remaining vectors

The remaining vectors in Table E.3 arise in the same way, and we omit the details.

□

The Coxeter schemes corresponding to the hyperbolic reflection groups found by this algorithm are presented in Figure 3.3 and Figure 3.4. The diagrams have been split in this way to highlight the different approaches which must be employed to demonstrate that the polytopes have finite volume.

The diagrams in Figure 3.3 all have no broken-line branches or Lannér subgraphs, and each parabolic subgraph is a connected component of a parabolic subgraph of rank $n - 1$, so by Proposition 2.2.6, all have finite volume. This can be easily checked by inspection: removing the black vertex (where present) leaves a parabolic subscheme of rank $n - 1$.

Note that in the case $n = 2$ we get a Lannér graph and hence a compact polyhedron, while for $n \geq 3$ the polytopes are non-compact.

The diagrams in Figure 3.4 do include examples of broken-line branches, and Lannér subgraphs. Therefore, in addition to the parabolic subgraphs, in each case these may be addressed using the sufficient condition in the second part of Proposition 2.2.6. However, the parabolic subgraphs still need to be considered, as for the previous diagrams, and they can be seen by inspection to be connected components of parabolic subgraphs of the appropriate rank.

Consider $n = 9$. By deleting the two vertices which connect the broken-line branch to the rest of the diagram it can be seen that a copy of the elliptic graph E_8 remains. A broken-line branch has rank 2, and E_8 has rank 8, and therefore as $2 + 8 = 9 + 1 = n + 1$, the polytope has finite volume.

Now consider $n = 10$. As the graph is symmetric only one of the copies of the Lannér subgraph will be considered. Incidentally, this Lannér graph has already appeared, as the simplex when $n = 2$. Again, by deleting vertices which connect the Lannér subgraph to the rest of the diagram it can be seen that a copy of the elliptic graph E_8 remains. The Lannér subgraph has rank 3, and again E_8 has rank 8, and therefore as $3 + 8 = 10 + 1 = n + 1$, the polytope has finite volume.

The remaining graphs are dealt with in precisely the same way, and therefore the details will be omitted.

From the classifications of the hyperbolic simplices and the hyperbolic Coxeter pyramids ([18] and [67] respectively), it is possible to obtain a combinatorial structure of some of these Coxeter polytopes.

Corollary 3.1.7 ([43], Corollary 2). *For $n = 2, 3$, the combinatorial structure of the polytopes in Figure 3.3 is a simplex. In two dimensions it is compact, and in three dimensions it is non-compact.*

For $n = 4, \dots, 8$, the combinatorial structure of the polytopes in Figure 3.3 is a pyramid over a product of two simplicies. These are non-compact polytopes, and each have a single ideal vertex. In each of these cases, the hyperplane corresponding to the base of the pyramid is identified by a black vertex.

This illustrates a result of Vinberg [72] which states that parabolic subgraphs of rank $n - 1$ correspond to ideal vertices.

In dimensions 9-13, it is not possible to obtain a similarly precise combinatorial structure of the polytope. Geometric information which can be recovered from the Coxeter scheme is an enumeration of the ideal vertices of the polytope. By Proposition 2.2.9, part 2, an ideal vertex is a parabolic subgraph of rank $n - 1$.

We can also describe the symmetry groups of the Coxeter polytopes. Recall that the group Γ is decomposed into a semi-direct product $\Gamma_r \rtimes H$. The symmetry group $Sym P$, of which H is a subgroup, is naturally isomorphic to the symmetry group

of the Coxeter scheme of P . In our case we always have, $H = \text{Sym } P$. This can be seen by inspection of the Coxeter diagrams along with the data in Table E.3, in that any element $\eta \in \text{Sym } P$ swaps pairs of vectors (e_i, e_j) , and it can be seen that

$$(\eta(e_i), \eta(e_j)) = (e_i, e_j)$$

so $\text{Sym } P$ preserves the lattice.

Therefore, by analysing the diagrams in Figure 3.4, we can obtain the following corollary.

Corollary 3.1.8 ([43], Corollary 2). *For $n \leq 9$, $\text{Sym } P$ is trivial, while for $10 \leq n \leq 12$, $\text{Sym } P$ is isomorphic to \mathbb{Z}_2 .*

For $n = 9$ the polytope has two ideal vertices which are not symmetric to one another.

For $n = 10$ the polytope has three ideal vertices, two of which are symmetrically placed.

For $n = 11$ the polytope has five ideal vertices. These can be grouped into two pairs of symmetric vertices, and a single distinct vertex.

For $n = 12$ the polytope has six ideal vertices. These can be grouped into two pairs of symmetric vertices, and two distinct vertices.

For $n = 13$ the polytope has thirteen ideal vertices. The symmetry group $\text{Sym}(P) \cong \mathbb{Z}_2 \times \mathbb{Z}_2$.

Non-reflective case

The reflection groups presented so far are the only examples associated to this quadratic form. In this section, we prove that there are no higher dimensional examples, by showing that there is always a parabolic subgraph of insufficient rank, and it is impossible to produce a hyperplane which satisfies the crystallographic condition and completes the graph.

We now prove the second part of Theorem 3.1.4:

Proposition 3.1.9 ([43], Proposition 5). *There are no discrete reflection groups associated to the quadratic form $-3x_0^2 + x_1^2 + \dots + x_n^2$ in n -dimensions with $n \geq 14$ with finite covolume.*

Figure 3.5: The Coxeter schemes of a) the polyhedral angle along with the vectors in Table 3.3 and b) the isolated parabolic subgraph Γ_p .

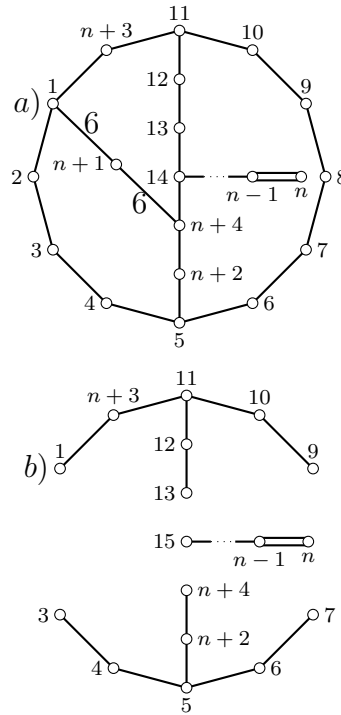

Lemma 3.1.10 ([43], Lemma 1). *For $n \geq 14$, the first four vectors generated by Vinberg’s algorithm when applied to $f_{11}^{\geq 5}$ are presented in Table 3.3.*

Table 3.3: The first four vectors produced by Vinberg’s algorithm applied to $f_3^{\geq 14}$.

i	e_i	(e, e)	$\frac{k_0^2}{(e, e)}$
$n + 1$	$v_0 + 3v_1$	6	0.167
$n + 2$	$v_0 + v_1 + v_2 + v_3 + v_4 + v_5$	2	0.5
$n + 3$	$2(v_0 + v_1) + v_2 + \dots + v_{11}$	2	2
$n + 4$	$2v_0 + v_1 + \dots + v_{14}$	2	2

The proof of this lemma proceeds in the same way as the proof of Proposition 3.1.6.

Consider the Coxeter scheme produced by taking the vectors in Table 3.3 on top of the polyhedral angle. This Coxeter scheme (Figure 3.5 (a)) describes a polyhedron which has infinite volume, and it can be used to prove Proposition 3.1.9.

A parabolic subgraph of this diagram is a pair of copies of \tilde{E}_6 (vertices 1, 9, 10,

Figure 3.6: Including the vector e in a) 15, b) 16 and c) ≥ 17 dimensions

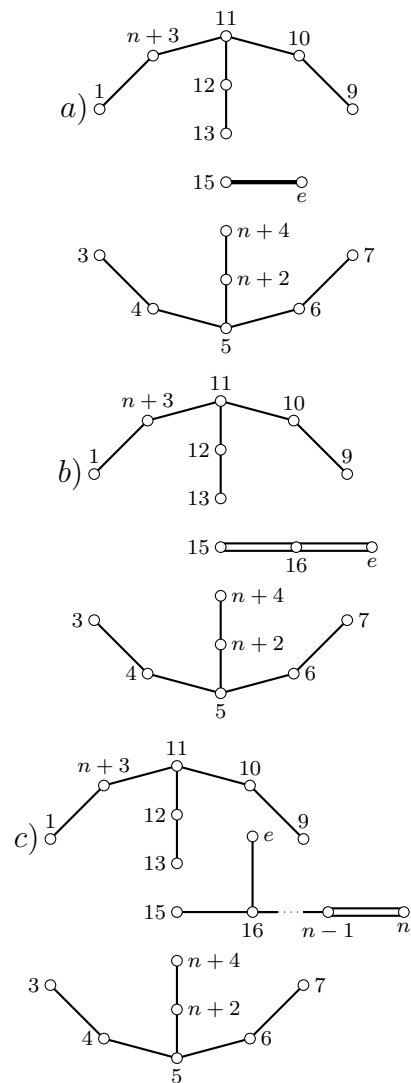

11, 12, 13, $n + 3$; and 3, 4, 5, 6, 7, $n + 2$, $n + 4$), which will be denoted Γ_p . Γ_p has rank 12, and by Proposition 2.2.6 in order for the polytope to have finite volume, it must be extended to have rank $n - 1$.

Deleting the vertices which are connected to Γ_p demonstrates that there are three connected components, shown in Figure 3.5 (b) (note that when $n = 14$ there are only two connected components). The third component is a copy of the elliptic graph B_{n-14} (note that in 15 dimensions the third component is a copy of the elliptic graph A_1). Therefore new vertices must be added to make another parabolic subgraph (possibly containing the elliptic graph) of rank $n - 13$. These new vertices must not have edges to Γ_p , otherwise they will immediately be deleted while isolating the parabolic subgraph.

Therefore the inner product of the new vectors with the vectors comprising Γ_p must be zero.

Proof. (Proposition 3.1.9) The new vector e will be written as

$$e = \sum_{i=0}^n k_i v_i.$$

All of the vectors numbered 1- $(n - 1)$ are of the form $-v_i + v_{i+1}$ and as e must have zero inner product with the vertices of the Γ_p labelled 1, 3, 4, 5, 6, 7, 9, 10, 11, 12, 13, we will define

$$\begin{aligned} k_1 = k_2 & =: m, \\ k_3 = k_4 = k_5 = k_6 = k_7 = k_8 & =: p, \\ k_9 = k_{10} = k_{11} = k_{12} = k_{13} = k_{14} & =: q. \end{aligned}$$

Consider the vertex labelled $(n + 2)$. If e has zero inner product with the vector $v_0 + v_1 + v_2 + v_3 + v_4 + v_5$ it implies that

$$3k_0 = 2m + 3p.$$

Now consider the vertex labelled $(n + 3)$. Similarly we get

$$6k_0 = 3m + 6p + 3q.$$

Finally, consider the vertex labelled $(n + 4)$. We get

$$6k_0 = 2m + 6p + 6q.$$

These last two expressions can be subtracted from one another to show that

$$3q = m,$$

which implies that

$$k_0 = 2q + p,$$

hence we can write e as

$$e = (2q+p)v_0 + 3q(v_1+v_2) + p(v_3+v_4+\dots+v_8) + q(v_9+v_{10}+\dots+v_{14}) + \sum_{i=15}^n k_i v_i. \quad (3.13)$$

This vector has (squared) length

$$|e|^2 = 3(p - 2q)^2 + \sum_{i=15}^n k_i^2. \quad (3.14)$$

By the crystallographic condition, this quantity must be 1, 2, 3, or 6, and if it is equal to 3 or 6 then all of the coefficients (including p and q) must be divisible by 3. Therefore equation (3.14) is given by

$$|e|^2 = 27(p' - 2q')^2 + 9 \sum_{i=15}^n k_i'^2,$$

where $p = 3p'$, $q = 3q'$, and $k_i = 3k_i'$. This cannot equal 3 or 6.

By the inequality 3.6 applied to the vector 3.13, we can see that $p \geq q > 0$, and $q \geq k_{15} \geq \dots \geq k_{n-1} \geq k_n \geq 0$, so in 14 dimensions, equation (3.14) cannot equal 1 or 2. Therefore, in 14 dimensions, the algorithm does not produce a polytope of finite volume. In 15 dimensions the vector can be of length 1 if $p = 2q$ and $k_{15} = 1$, and in higher dimensions the vector can be of length 2 if in addition, k_{16} is also 1. For fixed k_0 (as in this case) the longer vector represents a closer mirror, and so in dimension ≥ 16 we must consider e to have length 2.

As can be seen in Figure 3.6 (a) (respectively Figure 3.6 (b); Figure 3.6 (c)), in 15 (respectively 16; ≥ 17) dimensions, e forms a copy of \tilde{A}_1 (respectively \tilde{C}_2 ; \tilde{B}_{n-14}) with the vertex(es) labelled 15 (respectively 15 and 16; 15, 16, \dots , n). Along with

the copies of \tilde{E}_6 , this parabolic subgraph has rank 13 (respectively 14; $n - 2$), which is insufficient to produce a finite volume polytope. New vectors still have to satisfy all of the above constraints, and are therefore of the form (3.13), but they must now also have zero inner product with $e_{15} = -v_{15}$ (respectively $e_{15} = -v_{15} + v_{16}$ and $e_{16} = -v_{16}$; $e_i = -v_i + v_{i+1}$, $15 \leq i \leq n - 1$ and $e_n = -v_n$), so k_{15} must be zero (respectively k_{15} and k_{16} ; k_i , $i \geq 15$). Therefore the vector must satisfy

$$|e|^2 = 3(p - 2q)^2 = 1 \text{ or } 2$$

which, as we have already seen, is impossible. Therefore, in ≥ 14 dimensions, the algorithm does not terminate.

There is no possibility of enlarging Γ_p into a parabolic graph of rank $n - 1$, and the polytope will have infinite volume for $n \geq 14$, so there are no further hyperbolic reflective lattices associated to this quadratic form. This completes the proof of Theorem 3.1.4. \square

3.1.4 f_2^{15} is non-reflective

That the quadratic form f_2^n is reflective for $n \leq 14$ was proved by Vinberg [70], and it appears that there is no proof that it is not reflective in higher dimensions. In this section we will demonstrate that this is the case.

The vectors which are generated by the algorithm for $n \leq 14$ are presented in Table E.2. In higher dimensions the quadratic forms are non-reflective, as we will show, and therefore the algorithm does not terminate. We will only need to generate five vectors with the algorithm in order to have enough of the structure to prove that the lattice is non-reflective. The Coxeter diagram of these 20 mirrors is presented in Figure 3.7.

In the same way as $f_3^{\geq 14}$ we will identify a parabolic subgraph which has insufficient rank, which will be denoted Γ_p . This is depicted in Figure 3.8 and comprises a copy of \tilde{A}_{13} . For this diagram to represent a Coxeter polytope of finite volume this parabolic graph must be augmented with an orthogonal parabolic graph of rank 1, which must be a copy of \tilde{A}_1 .

The coefficients of a new vector $e = \sum_{i=0}^{15} k_i v_i$ which is orthogonal to the vectors

Figure 3.7: Partial Coxeter diagram of the fundamental domain of the reflection subgroup of the automorphism group of the quadratic form f_2^{15} .

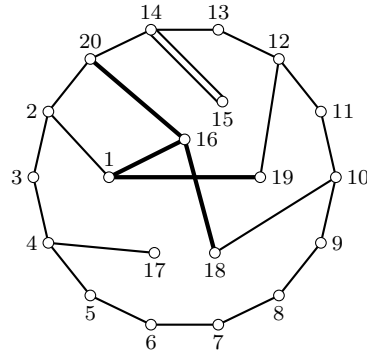
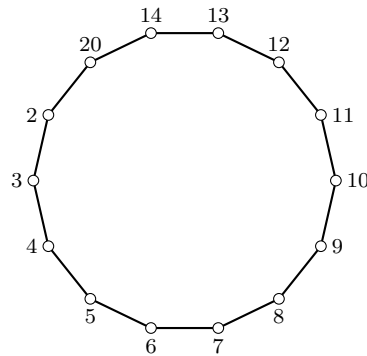

Figure 3.8: The isolated parabolic subgraph Γ_p from the partial Coxeter diagram representing the fundamental domain of the reflection subgroup from the automorphism group of the quadratic form f_2^{15} .



labelled $2, \dots, 14$ in this parabolic graph are subject to the following restraint:

$$k_2 = \dots = k_{15} =: m.$$

The remaining vertex (labelled 20 in the graph) introduces this additional requirement:

$$-3k_0 + k_1 + 7m = 0.$$

We may now measure the length of this vector with respect to the inner product inherited from the quadratic form, which has the following expression:

$$|e|^2 = \frac{7}{9}(k_1 - 2m)^2.$$

We know that k_1 and m are integral, so we search for an integer which, when squared, may be multiplied by $\frac{7}{9}$ to yield 1 or 2. Hence there are insufficient reflec-

tions in the group of units of the quadratic form f_2^{15} for it to be reflective, and we appeal to Theorem 3.0.8 for $n > 15$.

3.1.5 f_d^n for $n > 2$

In this section we will deal with the remaining quadratic forms which are left by applying Theorem 3.0.8 to the list of reflective two dimensional quadratic forms identified in Section 3.1.1. The case $d = 1$ was studied by Vinberg [70] and completed in Vinberg-Kaplinskaya [75]. This quadratic form is reflective for $n \leq 19$. Also in [70] can be found the case $d = 2$, which was completed in Section 3.1.4. In this Chapter, in Section 3.1.3, we have presented the case of $d = 3$. Continuing through the square-free values of d , the quadratic form f_5^n was studied by Mark and found to be reflective for $n \leq 8$ [42].

Therefore, in this Section, only a short list of quadratic forms remain to study. These are f_d^n for $d = 6, 7, 10, 11, 13, 14, 15, 17, 19, 23, 30, 33, 39, 51$. The results are contained in Table 3.1. As previously, we will identify the reflective lattices and then justify the non-reflectivity of the remaining cases.

We present the Coxeter diagrams of the reflective quadratic forms f_d^3 in Figure 3.9. Among the values of d that we are studying in this section, only one quadratic form f_d^4 is reflective, namely $d = 11$, and its Coxeter diagram can be found in Figure 3.10.

To show the remaining quadratic forms f_d^3 are non-reflective, we construct an isometry of the integral lattice which is of infinite order. The matrices of these isometries can be found in Appendix B. The quadratic form f_{11}^5 is also non-reflective, which we shall prove by another application of the method used in Section 3.1.3 and 3.1.4. The following Lemma produces sufficient data to demonstrate that f_{11}^4 is reflective as well as that f_{11}^5 is not.

Lemma 3.1.11. *For $n \geq 5$, the first four vectors generated by the algorithm are presented in Table 3.4.*

Proof. We will begin with the quadratic form f_d^n , and then specialise to the case $d = 11$. The first vector generated by the algorithm will be the vector which

Figure 3.9: Coxeter diagrams of the fundamental domains of the arithmetic reflection groups f_d^3 .

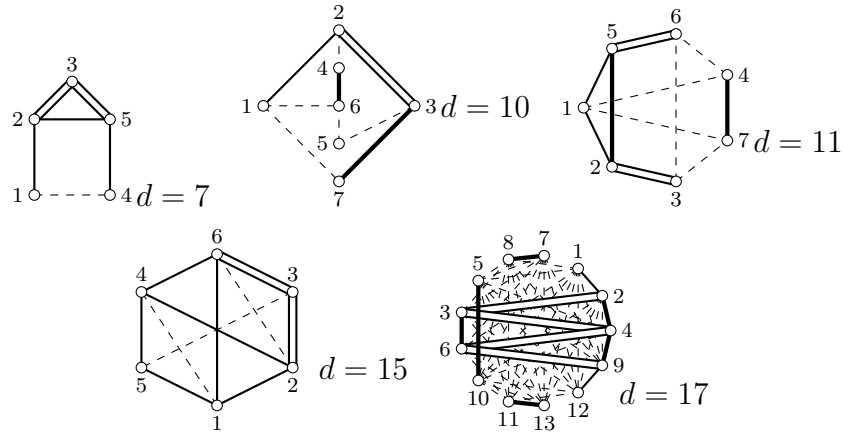

Figure 3.10: Coxeter diagrams of the fundamental domain of the arithmetic reflection group f_{11}^4 .

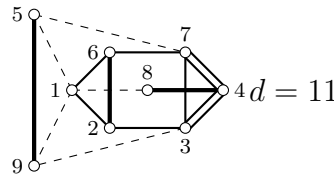

Table 3.4: The first four vectors produced by Vinberg’s algorithm applied to $f_{11}^{\geq 5}$.

i	e_i	(e, e)	$\frac{k_0^2}{(e, e)}$
$n + 1$	$3v_0 + 11v_1$	22	0.409
$n + 2$	$v_0 + 3v_1 + 2v_2$	2	0.5
$n + 3$	$v_0 + 2v_1 + 2v_2 + 2v_3 + v_4$	2	0.5
$n + 4$	$v_0 + 3v_1 + v_2 + v_3 + v_4 + v_5$	2	0.5

minimises equation 3.3 with respect to the quadratic form f_d^n . In accordance with Lemma 3.1.5 we shall look initially at vectors which are of length ϵd , where $\epsilon \in \{1, 2\}$. Then by the crystallographic condition we have that d divides all of the coefficients k_i , $i \geq 1$, and we will set $k'_i = \frac{k_i}{d}$. Therefore

$$d\epsilon + dk_0^2 = d^2 \sum_{i=1}^n (k'_i)^2,$$

and

$$\epsilon + k_0^2 = d \sum_{i=1}^n (k'_i)^2.$$

The k'_i are all integers and so we have a lower bound on k_0 , namely

$$k_0^2 \geq d - \epsilon.$$

We now turn to the case in which we are interested. The lower bound suggests that the first vector generated by the algorithm when applied to f_{11}^n should have $\epsilon = 2$ and $k_0 = 3$. The vector which satisfies these conditions is the first in Table 3.4, namely $3v_0 + 11v_1$. The combinations of k_0 s and lengths which generate smaller weights according to equation 3.3 do not satisfy the lower bound on k_0 and are therefore inadmissible.

The next pair of k_0 and length when ordered by weight are vectors with $k_0 = 1$ which are of length 2. Having generated $3v_0 + 11v_1$, the algorithm requires that the inner product of this and any new vectors be negative, with respect to the quadratic form $f_{11}^{\geq 5}$. Hence the coefficients of the new vectors must satisfy

$$3k_0 \geq k_1.$$

Computing the length of a vector for which $k_0 = 1$ and which has length 2 demonstrates that

$$2 + 11 = 13 = \sum_{i=1}^n (k_i)^2.$$

There are six partitions of thirteen into a sum of squares, namely the following.

1. 3, 2 ;
2. 2, 2, 2, 1 ;
3. 3, 1, 1, 1, 1 ;
4. 2, 2, 1, 1, 1, 1, 1 ;
5. 2, 1, 1, 1, 1, 1, 1, 1, 1 ;
6. 1, 1, 1, 1, 1, 1, 1, 1, 1, 1, 1.

Each of these partitions corresponds to a vector which is generated by the algorithm, and no two of these vectors have a (strictly) positive inner product, so they are all mutually admissible. We can see that in five dimensions the first three vectors in this list are the remaining three vectors in Table 3.4. \square

Figure 3.11: The Coxeter schemes of a) the polyhedral angle along with the vectors in Table 3.4 and b) the isolated parabolic subgraph Γ_p .

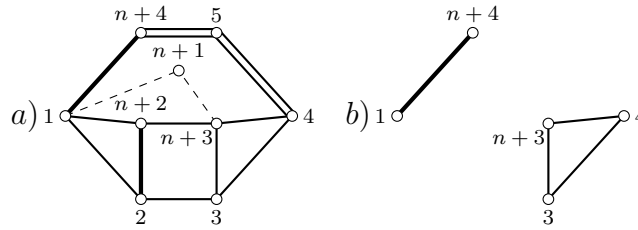

Restricting to $n = 5$, we can draw the Coxeter diagram of the polyhedral angle along with the first four vectors generated by the algorithm, and this is found in Figure 3.11 (a). As before, this diagram describes a configuration of hyperplanes which is unbounded and will be used to prove that the quadratic form f_{11}^5 is non-reflective.

A parabolic subgraph of this diagram is a copy of \tilde{A}_1 and copy of \tilde{A}_2 (vertices 1, $n + 4$ and vertices 3, 4, $n + 3$ respectively), which will be denoted Γ_p (Figure 3.11 (b)). Γ_p has rank 3, and by Proposition 2.2.6 in order for the polytope to have finite volume, it must be extended to have rank $n - 1 = 4$.

Neither of the connected components of Γ_p can be part of a larger connected parabolic graph, so we are searching for a vector $e = \sum_{i=0}^5 k_i v_i$ which is orthogonal to these five vectors, with respect to the quadratic form f_{11}^5 . Considering first the vectors labelled 1, 3 and 4, we have the following restrictions:

$$k_1 = k_2 \text{ and } k_3 = k_4 = k_5.$$

With these restrictions on the coefficients of a new vector, the inner products with the vectors labelled 8 and 9 coincide and introduce a new relation, namely

$$-11k_0 + 4k_1 + 3k_3 = 0.$$

Computing the length of the vector, given these relations on its coefficients leads to the following expression

$$|e|^2 = \frac{22}{3}(2k_0 - k_1)^2$$

This result, along with Lemma 3.1.5 states that we need to find an integer which, when squared, can be multiplied by $\frac{22}{3}$ to yield an integer which is no greater than

22. However, this integer must be divisible by 3, which is then squared, so $|e|^2 \geq 66$ which bounds this quantity away from the set of possible values. Hence there are no elements in the group of units of the quadratic form $f_{11}^{\geq 5}$ which can raise the rank of this parabolic subgraph Γ_p , and the polytope produced by the algorithm is not reflective for $n \geq 5$. With this statement we have completed the proof of Theorem 3.1.1.

3.1.6 Volume

To continue from the data regarding area in Table 3.2, we may ask about the volume of the fundamental polytopes of the other reflection groups f_d^n . In some of these cases this question can be answered. This is possible due to the work of Ratcliffe and Tschantz, who have produce a formula for the covolume of a group of units of such a quadratic form, with the requirement that d is odd [54]. They have computed the volumes of the fundamental polytopes for $d = 1$ and also for the case $d = 3$.

Before we can consider the formula itself, we must present some of the notation which was used in the paper. There are two functions, B, C , which are defined in order to simplify the expression of the formula. Concordantly we shall present these functions and their components beginning with the Bernoulli numbers.

Definition 3.1.12 ([29], Chapter 15, §1, p. 229). The Bernoulli numbers, B_n , are defined inductively from $B_0 = 1$ according to the rule

$$(n+1)B_n = -\sum_{k=0}^{n-1} \binom{n+1}{k} B_k.$$

We define a function B of n and C of n and d in the following manner.

Definition 3.1.13 ([54], Equation 23).

$$B = \prod_{k=1}^{\lfloor \frac{n}{2} \rfloor} \frac{B_{2k}}{2k}.$$

Definition 3.1.14 ([54], Equation 25).

$$C = \cos \left(\left(n + (-1)^{\frac{d+1}{2}} \right) \frac{\pi}{4} \right).$$

Denote by D the fundamental discriminant of the imaginary quadratic field $\mathbb{Q}[\sqrt{-d}]$. We will also need a Dirichlet L -series which has the following product formula.

Definition 3.1.15 ([54], Equation 13).

$$L(s, D) = \prod_p \left(1 - \left(\frac{D}{p} \right) p^{-s} \right)^{-1},$$

where $\left(\frac{D}{p} \right)$ is the Kronecker symbol.

Finally, we will denote by $\omega(d)$ the number of distinct prime divisors of d . Altogether we may now present the volume formula of Ratcliffe and Tschantz.

Theorem 3.1.16 ([54], Theorem 4). *Let d be an odd, square-free, positive integer, and let Γ_d^n be the discrete group of isometries of hyperbolic n -space \mathbb{H}^n corresponding to the group of positive units of the quadratic form f_d^n . The volume of \mathbb{H}^n/Γ_d^n is given by*

$$\text{vol}(\mathbb{H}^n/\Gamma_d^n) = \begin{cases} \frac{d^{\frac{n-1}{2}} B}{2^{n+\omega(d)}} (2^{\frac{n-1}{2}} + C) (2^{\frac{n+1}{2}} - \left(\frac{D}{2}\right)) \sqrt{d} \cdot L\left(\frac{n+1}{2}, D\right) & n \text{ odd,} \\ \frac{B}{2^{\frac{n}{2}+\omega(d)}} (2^{\frac{n}{2}} + 2^{\frac{1}{2}} C) \prod_{p|d} (p^{\frac{n}{2}} + \left(\frac{-1}{p}\right)^{\frac{n}{2}}) \cdot \frac{(2\pi)^{\frac{n}{2}}}{(n-1)!!} & n \text{ even.} \end{cases} \quad (3.15)$$

In order to compute the volume of these polytopes in terms of the groups of units, we refer to the decomposition 1.1. We will see that in each of these cases the volume of the polytope is the volume of the group of units multiplied by the order of the symmetry group of the polytope, as in these cases the symmetries of the polytopes are in the group of units and it is (as a group) maximal. This is a finite group by 1.1.1. Note that Theorem 3.1.16 can only be applied to the case where d is odd. The results for the volumes of the groups which are reflective for $n = 3$ can be found in Table 3.5, and $n = 4$ in Table 3.6.

3.2 f_d^n and $K = \mathbb{Q}[\sqrt{d}]$

In this section we will consider quadratic forms f_d^n which are defined over a totally real quadratic number field. By Godement's criterion we know we are working with cocompact groups.

Table 3.5: Volume computations for the fundamental polytopes of the reflective quadratic forms f_d^3 . For references, see [53] and [54].

d	$vol(\mathbb{H}/\Gamma_d^3)$	$ Sym(P) $	$vol(P)$
1	$\frac{1}{12}L(2, -4)$	1	$\frac{1}{12}L(2, -4)$
3	$\frac{5\sqrt{3}}{64}L(2, -3)$	1	$\frac{5\sqrt{3}}{64}L(2, -3)$
5	$\frac{5\sqrt{5}}{24}L(2, -20)$	2	$\frac{5\sqrt{5}}{12}L(2, -20)$
7	$\frac{7\sqrt{7}}{64}L(2, -7)$	2	$\frac{7\sqrt{7}}{32}L(2, -7)$
11	$\frac{55\sqrt{11}}{48}L(2, -11)$	2	$\frac{55\sqrt{11}}{24}L(2, -11)$
15	$\frac{15\sqrt{15}}{128}L(2, -15)$	2	$\frac{15\sqrt{15}}{64}L(2, -15)$
17	$\frac{17\sqrt{17}}{24}L(2, -68)$	2	$\frac{17\sqrt{17}}{12}L(2, -68)$

Table 3.6: Volume computations for the fundamental polytopes of the reflective quadratic forms f_d^4 . For references, see [53] and [54].

d	$vol(\mathbb{H}/\Gamma_d^4)$	$ Sym(P) $	$vol(P)$
1	$\frac{\pi^2}{1440}$	1	$\frac{\pi^2}{1440}$
3	$\frac{\pi^2}{288}$	1	$\frac{\pi^2}{288}$
5	$\frac{2\pi^2}{221}$	2	$\frac{4\pi^2}{221}$
11	$\frac{61\pi^2}{1440}$	2	$\frac{61\pi^2}{720}$

As we have noted already in this Chapter, Belolipetsky [5] and, more recently, Belolipetsky and Emery [8] derived the quadratic forms which define the arithmetic hyperbolic orbifolds of minimal covolume. They performed this computation both in the non-cocompact case that we have studied thus far, but also in the far more technically demanding world of cocompact lattices. Their results was that there are three quadratic forms which define the cocompact arithmetic hyperbolic orbifolds of minimal covolume, all of which are defined over the quadratic number field $\mathbb{Q}[\sqrt{5}]$. They have the form f_d^n , and are listed in Table 3.7.

We can ask the question again about these families of quadratic forms that we have been asking throughout this Chapter, namely whether they are reflective or not. The reflectivity of the quadratic form $f_{\frac{1+\sqrt{5}}{2}}^n$ was determined by Bugaenko, who was the first to apply Vinberg's algorithm in the cocompact setting, and the answer is that this quadratic form is reflective for $n \leq 7$ [15].

Table 3.7: Combinations of d and n for which the quadratic form f_d^n defines the cocompact arithmetic hyperbolic orbifolds of minimal covolume as presented in [5] and [8].

d	n
$3 + 2\sqrt{5}$	$n = 4r - 1 \geq 5$ for $r \in \mathbb{Z}$
$-3 + 2\sqrt{5}$	$n = 4r - 3 \geq 5$ for $r \in \mathbb{Z}$
$\frac{1+\sqrt{5}}{2}$	n even

Therefore we will tackle the remaining two quadratic forms, and ask whether they are reflective or not, and if they are then in how large a dimension do they remain so.

The coefficients of vectors normal to reflections in the group of units of quadratic forms defined over $K = \mathbb{Q}[\sqrt{d}]$ are elements of the ring of integers of K . The ring of integers of a quadratic number field is generated by a single element, called the *fundamental unit*. The fundamental unit ϕ is defined by d .

Proposition 3.2.1 ([47]). *The ring of integers O_K of a real quadratic number field $K = \mathbb{Q}[\sqrt{d}]$ is generated by -1 and the fundamental unit ϕ .*

$$\phi = \begin{cases} \sqrt{d} & \text{if } d \equiv 2, 3 \pmod{4}, \\ \frac{1+\sqrt{d}}{2} & \text{if } d \equiv 1 \pmod{4}. \end{cases}$$

The field of definition of the quadratic forms in which we are interested is $\mathbb{Q}[\sqrt{5}]$, and the specific generator of the group of units is $\phi = \frac{1+\sqrt{5}}{2}$.

The lengths of vectors are restricted more than in the non-cocompact case. Equation 3.2 suggests that once again we can have lengths 1, 2, d , and $2d$. However, as Bugaenko notes, if we have $f_d^n(d) = \epsilon d$ ($\epsilon = 1$ or 2) then we can take the Galois conjugate $\sigma(f_d^n)(\sigma(d)) = \epsilon \sigma(d)$ which evaluates a positive definite quadratic form to get a negative value.

In this setting we are searching for a set of algebraic integers, k_i , which satisfy the following equation ([15], equation (4)).

$$\sum_{i=1}^n k_i^2 = dk_0^2 + \epsilon, \quad (3.16)$$

where ϵ is the (squared) length of the vector, and is therefore equal to 1 or 2.

Following Bugaenko, we can write both sides of this equation in the form $A + B\phi$, with $A, B \in \mathbb{Z}$. The Galois conjugate of this expression limits the possible values of k_0 , as it must be a positive number, so we have that

$$|\sigma(k_0)| < \sqrt{\epsilon d}.$$

In the following discussions we shall emulate Bugaenko's argument, by computing the values of A and B for the right hand side of equation 3.16, sorted by the weight that a vector which contained this coefficient would have, and then compute the algebraic integers k_i which would provide the left hand side.

Altogether we will demonstrate the following.

Proposition 3.2.2. *The quadratic form $f_{3+2\sqrt{5}}^n$ is reflective for $n = 2$, and the quadratic form $f_{-3+2\sqrt{5}}^n$ is reflective when $n = 2$ and 3.*

3.2.1 $d = 3 + 2\sqrt{5}$

The data for k_0 values can be found in Table 3.8. This Table is sufficient for the case of $n = 2$. The vectors generated by Vinberg's algorithm can be found in Table 3.9. When $n = 2$ the algorithm terminates, and we have a reflective quadratic form whose fundamental polytope has the Coxeter diagram which can be found in Figure 3.12, and is quadrilateral. When $n = 3$ the quadratic form is not reflective. A patch of the infinite Coxeter diagram is shown in Figure 3.13. This diagram has translational symmetry, and we can compute the matrix of this isometry, which can be found in Section B.2.1. This is a loxodromic isometry, and therefore the quadratic form is not reflective.

Note that we may cut this fundamental domain with two hyperplanes which are both orthogonal to those which are labelled 2 and 4, and do not intersect to bound a polytope which has the Coxeter diagram in Figure 3.14. This is a hyperbolic Coxeter prism (c.f. [32]).

Figure 3.12: $d = 3 + 2\sqrt{5}$, and $n = 2$

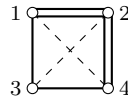

Figure 3.13: Part of the Coxeter diagram of the reflection subgroup of the automorphism group of the quadratic form with $d = 3 + 2\sqrt{5}$, and $n = 3$. In a departure from the established notation, the dashed line denotes orthogonal hyperplanes, while no edge connects hyperplanes that do not intersect. The infinite diagram is periodic, and the isometry which produces it maps vertex 5 to 7 and 1 to 9.

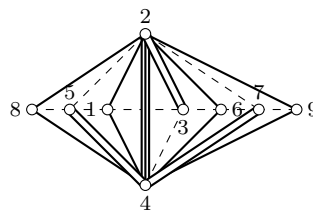
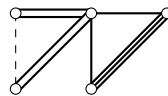

Figure 3.14: Triangular prismatic element section of the Coxeter diagram in Figure 3.13, produced by cutting the fundamental domain in Figure 3.13 with two hyperplanes which are both orthogonal to those which are labelled 2 and 4, and do not intersect.



3.2.2 $d = -3 + 2\sqrt{5}$

The first vectors orthogonal to mirrors of the reflective lattice which are generated by the algorithm are given in Table 3.10.

Figure 3.15: $\varphi = -3 + 2\sqrt{5}$, and $n = 3$. The combinatorial structure of this polytope is a cube.

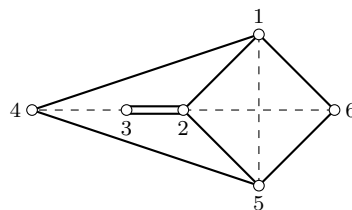

Figure 3.15 shows the Coxeter diagram for the fundamental domain for the reflective quadratic form $f_{-3+2\sqrt{5}}^3$. We do not know whether it is reflective in higher

dimensions.

Table 3.8: The data for the coefficient of v_0 , $k_0 = a_0 + b_0\phi$ when applying Vinberg's algorithm to f_d^n with $d = 3 + 2\sqrt{5}$, $n \geq 1$.

a_0	b_0	A	B	length	weight
1	0	3	4	2	0.5
1	0	2	4	1	1.0
0	1	7	9	2	1.309
2	0	6	16	2	2.0
-1	2	7	20	2	2.50
0	1	6	9	1	2.618
1	1	16	23	2	3.427
2	0	5	16	1	4.0
-2	3	3	37	2	4.072
3	0	11	36	2	4.5
-1	2	6	20	1	5.000
0	2	22	36	2	5.236
2	1	27	45	2	6.545
1	1	15	23	1	6.854
-1	3	24	55	2	7.42
1	2	39	60	2	8.972
0	2	21	36	1	10.47
3	1	40	75	2	10.66
0	3	47	81	2	11.78
2	1	26	45	1	13.09
2	2	58	92	2	13.70
-1	4	51	108	2	14.972
4	1	55	113	2	15.781
1	3	72	115	2	17.135
1	2	38	60	1	17.944
3	2	79	132	2	19.444
0	4	82	144	2	20.944
3	1	39	75	1	21.3262
2	3	99	157	2	23.489
0	3	46	81	1	23.5623
4	2	102	180	2	26.18
2	2	57	92	1	27.4164
1	4	115	188	2	27.91
3	3	128	207	2	30.84
0	5	127	225	2	32.72
5	2	127	236	2	33.91
1	3	71	115	1	34.270
2	4	150	240	2	35.88

Table 3.9: Results of Vinberg's algorithm applied to the quadratic form $f_{3+2\sqrt{5}}^n$.

i	e_i	(e, e)	n
$n + 1$	$v_0 + (1 + \phi)v_1 + \phi v_2$	2	≥ 2
$n + 2$	$(2 + 4\phi)v_0 + (7 + 10\phi)v_1 + v_2$	1	≥ 2
$n + 3$	$(4 + 7\phi)v_0 + (11 + 19\phi)v_1 + (1 + \phi)v_2 + (1 + \phi)v_3$	2	3
$n + 4$	$(8 + 14\phi)v_0 + (17 + 28\phi)v_1 + (11 + 18\phi)v_2 + (10 + 18\phi)v_3$	1	3
$n + 5$	$(50 + 82\phi)v_0 + (137 + 222\phi)v_1 + (11 + 18\phi)v_2 + (10 + 18\phi)v_3$	2	3
$n + 6$	$(14 + 22\phi)v_0 + (28 + 46\phi)v_1 + (18 + 28\phi)v_2 + (17 + 28\phi)v_3$	1	3

Table 3.10: Results of Vinberg's algorithm applied to the quadratic form $f_{-3+2\sqrt{5}}^n$.

i	e_i	(e, e)	n
$n + 1$	$(1 + \phi)(v_0 + v_1) + \phi(v_2 + v_3)$	1	≥ 3
$n + 2$	$(1 + 2\phi)v_0 + (2 + 2\phi)v_1 + v_2$	2	≥ 3
$n + 3$	$(1 + 2\phi)(v_0 + v_1) + 2\phi v_2$	2	≥ 3
$n + 4$	$(1 + 2\phi)v_0 + (1 + \phi)(v_1 + v_2 + v_3 + v_4)$	1	4
	$(1 + 2\phi)v_0 + (1 + \phi)(v_1 + v_2 + v_3 + v_4) + v_5$	2	≥ 5

Chapter 4

The Bianchi Groups

“...bianchi battuti a neve.”

Hervé This [66]

In this Chapter we will complete the classification of the reflective Bianchi groups. The route towards this classification will be to first classify the reflective extended Bianchi groups, by which we mean the maximal discrete extension of the Bianchi groups in $\mathrm{PGL}_2(\mathbb{C})$. The utility of the extended Bianchi group is that it can be identified with the automorphism group of a quadratic form, and therefore we may use Vinberg’s algorithm (and the mechanisms we have already developed) to study this collection of groups. The Definitions of these groups were presented in Section 1.3.

Before plunging into the extended Bianchi groups, we will first review the fundamental domains of $\mathrm{PGL}_2(O_m)$ for which a Coxeter diagram is given in Elstrodt, Grunewald and Mennicke [22]. In this volume they give such presentations of two groups: $\mathrm{PGL}_2(O_1)$ and $\mathrm{PGL}_2(O_3)$. The first group, $\mathrm{PGL}_2(O_1)$, is identified in Section 10.4 with an index four subgroup of the group with Coxeter diagram there referred to as **CT**(1). The second group, $\mathrm{PGL}_2(O_3)$, is identified with a subgroup of index 2 in the group with Coxeter diagram there referred to as **CT**(7). The Coxeter diagrams **CT**(1) and **CT**(7) are presented in Figure 4.1. Note that these groups $\mathrm{PGL}_2(O_m)$ are index 2 subgroups of the Bianchi groups as defined by equation 1.7.

Figure 4.1: ([22], Section 10.4, Table of Tetrahedral Groups): The Coxeter diagrams $\mathbf{CT}(1)$ and $\mathbf{CT}(7)$ of which the Bianchi groups $Bi(1)$ and $Bi(3)$ respectively are subgroups.

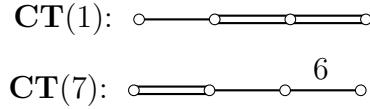

4.1 Reflective Extended Bianchi Groups

We saw in Chapter 1 that we will partition these groups according to the congruence class of m with respect to 4. Additionally we will need to consider the case of $m = 3$ separately. We are guided to this conclusion by the concept of a *good* reflection, which is due to Shvartsman.

Definition 4.1.1 ([64], §4). A reflection $R \in \widehat{Bi}(m)$ is said to be *good* if for any other reflection $R' \in \widehat{Bi}(m)$ the order of the group generated by the product of R and R' is $4n$, $n = 1, 2, \dots, \infty$.

Shvartsman goes on to prove the following Lemma.

Lemma 4.1.2 ([64], §4, Lemma 4). *If $m \equiv 1$ or $2 \pmod{4}$ and $m \neq 3$, then the reflection R which acts according to equation 1.9 with the matrix*

$$g = \begin{pmatrix} 1 & 0 \\ 0 & -1 \end{pmatrix},$$

in the group $\widehat{Bi}(m)$ is good.

The proof of this statement excludes $m = 3$ in a very natural way, and so we may ask if there are reflections in the group $\widehat{Bi}(3)$ which meet the reflection R in an angle of $\frac{\pi}{3}$, which violates the definition of a *good* reflection. The reflection in the Lemma, R , is a reflection in a hyperplane whose normal vector is $(0, 0, -1, 0)$. We can construct two such reflections, which are in hyperplanes with normal vectors $(1, 0, 0, 1)$ and $(0, 0, 1, -1)$ respectively. The Coxeter diagram of these three reflections is a copy of \tilde{A}_2 . This gibes with the statement that $Bi(3)$ should be related to the tetrahedral group $\mathbf{CT}(7)$. The four vectors which define the reflections which

Table 4.1: Vectors normal to hyperplanes defining the polyhedral angle when $m \neq 3$.

e_1	$(0, 0, -1, 0)$
e_2	$(1, 0, 1, 0)$
e_3	$(0, 0, 0, -1)$ for $m \equiv 1, 2 \pmod{4}$; or $(0, 0, 1, -2)$ for $m \equiv 3 \pmod{4}$
e_4	$(m, 0, 0, 1)$ for $m \equiv 1, 2 \pmod{4}$; or $(m, 0, -1, 2)$ for $m \equiv 3 \pmod{4}$

comprise the walls of the fundamental polytope are listed in Table F.3 and the Coxeter diagram can be found in Figure 4.2, labelled $m = 3$. The choice of e_4 which was made here follows Shaiheev [63], but we can see from [31] that this group and $\mathbf{CT}(7)$ are commensurable.

We shall illustrate Vinberg's algorithm in the case of the Bianchi groups by the following lemma. Let us fix $v_0 = (1, 0, 0, 0)$. If $m \neq 3$, the corresponding stabiliser subgroup consists of the reflections in hyperplanes defined by the vectors in Table 4.1 (cf. [63]).

Lemma 4.1.3. *For every $m \neq 3$, we have $e_5 = (-1, 1, 0, 0)$.*

Proof. First assume that $m \equiv 1, 2 \pmod{4}$. We know the first four vectors in L_m , the lattice of matrices with entries in O_m , and that all subsequent vectors must have non-positive inner product with them, so we have four inequalities which constrain the coefficients of the remaining vectors. Let $\mathbf{x} = (x_1, x_2, x_3, x_4)$ be the first vector that is to be found by the algorithm. The inequalities can be summarised as follows:

$$\begin{aligned} x_2 &\geq 2x_3 \geq 0, \\ mx_2 &\geq 2mx_4 \geq 0. \end{aligned}$$

The weight function ρ of \mathbf{x} is given by

$$\rho(u_0, \mathbf{x}) = \frac{x_2}{\sqrt{(\mathbf{x}, \mathbf{x})}},$$

which we want to minimise, so we can try choosing x_2 as small as possible. If $x_2 = 0$ then by the above inequalities we recover the isotropic vector u_0 (up to a scalar multiple), so $x_2 = 1$, and $x_3 = x_4 = 0$. Now $(\mathbf{x}, \mathbf{x}) = -2x_1$, so x_1 must be negative,

and by considering the crystallographic condition with respect to e_2 we can conclude that $x_1 = -1$. Therefore, \mathbf{x} has length 2 and $\rho(u_0, \mathbf{x}) = \frac{1}{\sqrt{2}}$.

That this is actually minimal can be confirmed by considering the crystallographic conditions associated to the vectors e_1 and e_2 :

$$\frac{2(\mathbf{x}, e_1)}{(\mathbf{x}, \mathbf{x})} = \frac{-2(x_4 + 2x_3)}{(\mathbf{x}, \mathbf{x})} \in \mathbb{Z}; \quad \frac{2(\mathbf{x}, e_2)}{(\mathbf{x}, \mathbf{x})} = \frac{-2x_2 + 2(x_4 + 2x_3)}{(\mathbf{x}, \mathbf{x})} \in \mathbb{Z},$$

which imply that $|(\mathbf{x}, \mathbf{x})| \leq |2x_2|$. We are therefore searching for a solution to the following inequality

$$\frac{x_2}{\sqrt{(\mathbf{x}, \mathbf{x})}} \leq \frac{1}{\sqrt{2}},$$

which, given that x_2 is strictly positive, implies that the only solution is $x_2 = 1$.

Now consider the case $m \equiv 3 \pmod{4}$. Here the situation is slightly different in that there are two vectors which achieve the lowest weight, but they are mutually admissible and so we may choose e_5 to be the first vector generated by the algorithm.

The inequalities constraining the coefficients of the vector are the following.

$$\begin{aligned} x_2 &\geq 2x_3 + x_4 \geq 0, \\ x_2 &\geq x_4 \geq 0. \end{aligned}$$

Again we wish to minimise the weight function, which has the same form as previously. By a similar argument, assume that $x_2 = 1$. Then $x_3 = 0$ and x_4 may be 0 or 1. Consider the crystallographic condition with the vector e_1 . This states that the (squared) length of the new vector must divide $2(2x_3 + x_4)$, which given the numerical constraints already in place evaluates to 0 or 2 respectively. Taking $x_4 = 1$, the (squared) length of the new vector is $-2x_1 + \frac{1}{2}(m + 1)$ which we have seen is bounded above by 2. Therefore we have a lower bound on x_1 . This (squared) length must also be strictly positive, in order for the orthogonal space to be a hyperplane in the model of hyperbolic 3-space, so we have also an upper bound on x_1 :

$$\frac{m-3}{4} \leq x_1 < \frac{m+1}{4}.$$

Given that $m \equiv 3 \pmod{4}$ and $x_1 \in \mathbb{Z}$, there is only one choice, namely $x_1 = \frac{m-3}{4}$. Therefore $(\frac{m-3}{4}, 1, 0, 1)$ is the advertised alternative vector for the candidacy of “first”.

We may also take $x_4 = 0$. Then the (squared) length of the vector is $-2x_1$. Now consider the crystallographic condition with respect to the vector e_2 , which provides an upper bound for the (squared) length, namely 2. As x_1 is an integer it must be that $x_1 = -1$, and we have produced $e_5 = (-1, 1, 00)$.

The inner product between these two vectors is $\frac{7-m}{4}$. Recall that $m = 3$ has been excluded, which gives the first possible value of m in this congruence class to be 7. For $m \geq 7$ this inner product is non-positive, so we see that both of these vectors will be produced by the algorithm, and we may choose the vector $(-1, 1, 0, 0)$ to be labelled e_5 .

□

We have seen that there are only finitely many values of m for which the extended Bianchi group may be reflective (c.f. Section 1.3.1). There are 188 values, and the largest is $m = 7315$. The complete list is included in Appendix C. As in Chapter 3, we shall run the algorithm until termination for the cases where the group is generated by reflections, and where this structure does not appear to be present we shall identify an isometry which is of infinite order. Asking for a reflective Bianchi group imposes very rigid requirements on the ideal class group along with the geometric structure of the reflection subgroup. In some cases we can explicitly demonstrate that the reflection subgroup has the wrong structure, namely for $m = 67, 163, 403$ and 427 . All together we shall prove the following Theorem.

Theorem 4.1.4 ([10], Theorem 2.2). *The extended Bianchi groups $\widehat{Bi}(m)$ are reflective for $m \leq 21, m = 30, 33$ and 39 , and this list is complete.*

The Coxeter diagrams of the fundamental polytopes of the reflective Bianchi groups are presented in Figures 4.2 and 4.3, and the vectors normal to the mirrors of reflections are listed in full in Appendix F together with their lengths (with respect to the appropriate quadratic form). The numbering of the vectors corresponds to the numbering of the vertices in the Coxeter diagrams. Shaiheev identified all of the reflective extended Bianchi groups which have Coxeter diagrams in Figure 4.2 with the exception of $m = 39$ as his investigation was limited to those groups with $m \leq 30$. Ruzmanov identified that the extended Bianchi group $\widehat{Bi}(39)$ was reflective

Figure 4.2: ([10], Figure 1): Coxeter diagrams of the fundamental domains of the reflective extended Bianchi groups $\widehat{Bi}(m)$ considered by Shaiheev and Ruzmanov. Vertices that are filled represent reflections which are in the group $\widehat{Bi}(m)$ but not in $Bi(m)$.

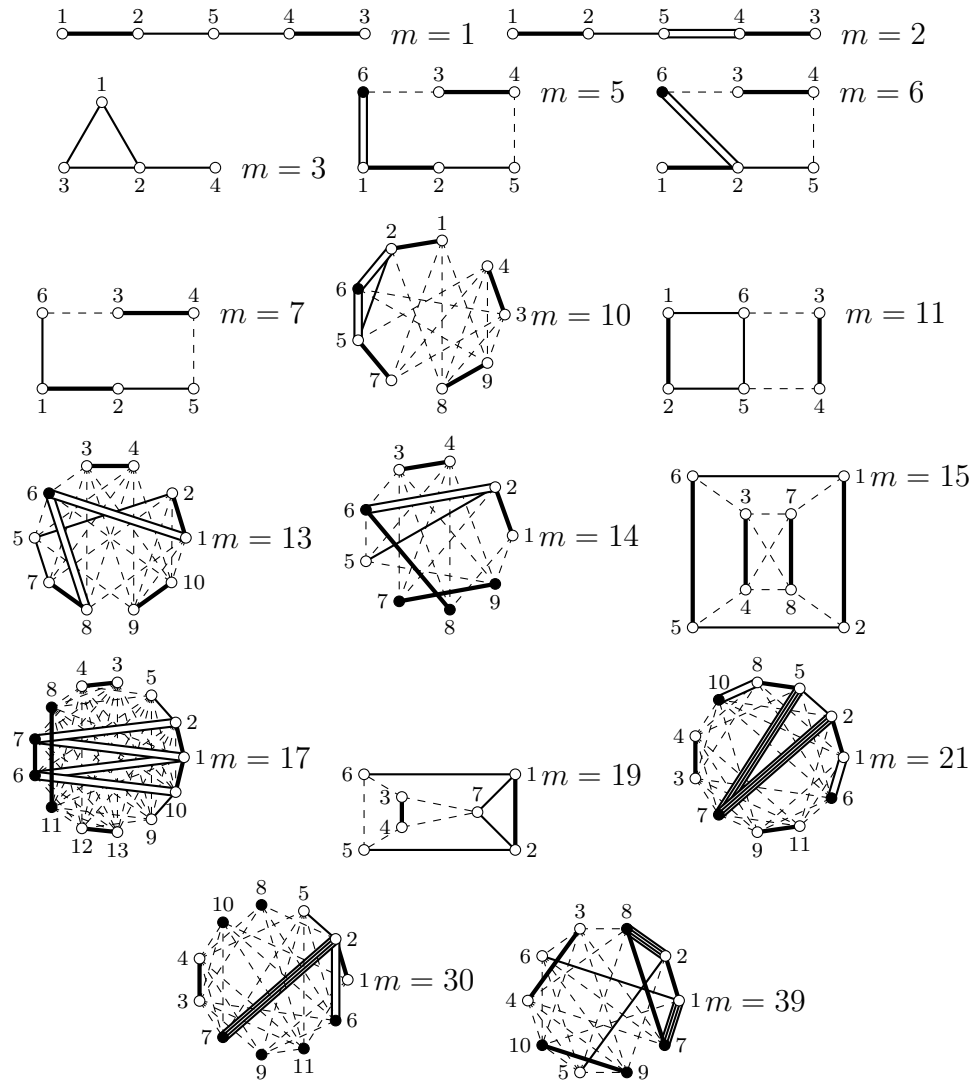

[56]. The final reflective extended Bianchi group $\widehat{Bi}(33)$ whose Coxeter diagram is presented in Figure 4.3 was identified in [10].

As this case had not appeared before, we shall use Proposition 2.2.8 to demonstrate that it has finite volume. Table 4.2 contains a list of elliptic subgraphs of Figure 4.3 which have rank 2. In accordance with the Proposition, we present the two completions of the elliptic graph which represent the vertices (either or both of which may be at infinity) at either end of these edges. When there is a pair of

Figure 4.3: ([10], Figure 2): Coxeter diagram of the fundamental polyhedron of the reflection subgroup of $\widehat{Bi}(33)$. The filled vertices represent reflections in $\widehat{Bi}(33)$ but not in $Bi(33)$.

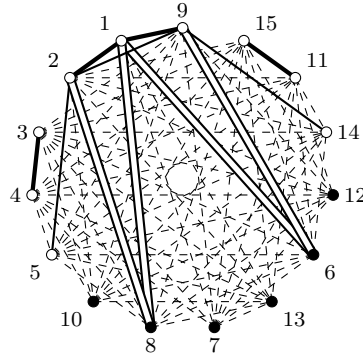

elliptic subgraphs which are identified by the diagram's symmetry of order 2, only one of the pair are listed in the table.

Each extended Bianchi group in Theorem 4.1.4 is generated by reflections, and they can each be identified with a maximal Kleinian group in the list due to Scharlau and this can be seen in Table 4.3.

In a similar manner to Chapter 3 we shall take the finite list of groups and produce an isometry of infinite order in most of the non-reflective cases. The matrices representing these isometries are presented in Appendix D. This list excludes the cases of $m = 67, 163, 403$ and 427 and we shall address them here. Vinberg's algorithm unveils the structure of the reflection subgroups of these groups, and we present the following Proposition which is due to Belolipetsky (this Proposition is only partially reproduced).

Proposition 4.1.5 ([10], Proposition 6.3, parts 1 and 2). *Let Γ be a lattice in $Isom(\mathbb{H}^3)$ and Γ_r its subgroup generated by (all) reflections. For Γ being reflective it is necessary that*

1. *if $\Gamma = Bi(m)$ then \mathbb{H}^3/Γ_r has at most $12h_m$ cusps ;*
2. *if $\Gamma = \widehat{Bi}(m)$ then \mathbb{H}^3/Γ_r has at most $12h_m h_{2,m}$ cusps.*

Recall the definition of h_m and $h_{2,m}$ from Chapter 1. Vinberg's algorithm is applied to these quadratic forms in the same way as we have seen previously. An

Table 4.2: ([10], Table 3): Elliptic subgraphs of the Coxeter diagram of the fundamental domain of the extended Bianchi group $\widehat{Bi}(33)$ which have rank 2, and their completions to either elliptic subgraphs of rank 3 or parabolic subgraphs of rank 2. (Only half are listed ; the remaining subgraphs are given by the symmetry of the Coxeter diagram e.g. 1,3 is equivalent to 1,15). In this table multiplication indicates a collection of orthogonal copies of the same subgraph, while addition indicates a graph comprising orthogonal components of different types.

Elliptic graph	First completion	Second completion
1,3	2,4 ; $2 \times \tilde{A}_1$	5 ; $3 \times A_1$
1,4	2,3 ; $2 \times \tilde{A}_1$	6 ; $A_1 + B_2$
1,5	3 ; $3 \times A_1$	10 ; $3 \times A_1$
1,8	10 ; $A_1 + B_2$	11 ; $A_1 + B_2$
1,10	5 ; $3 \times A_1$	8 ; $A_1 + B_2$
2,3	1,4 ; $2 \times \tilde{A}_1$	5 ; $A_1 + A_2$
2,4	1,3 ; $2 \times \tilde{A}_1$	6 ; $3 \times A_1$
2,5	3 ; $A_1 + A_2$	7 ; $A_1 + A_2$
2,6	4 ; $3 \times A_1$	9 ; B_3
2,7	5 ; $A_1 + A_2$	8 ; $A_1 + B_2$
2,8	7 ; $A_1 + B_2$	9 ; B_3
2,9	6 ; B_3	8 ; B_3
3,5	1 ; $3 \times A_1$	2 ; $A_1 + A_2$
4,6	1 ; $A_1 + B_2$	2 ; $3 \times A_1$
5,7	2 ; $A_1 + A_2$	10 ; $3 \times A_1$
5,10	1 ; $3 \times A_1$	7 ; $3 \times A_1$
7,8	2 ; $A_1 + B_2$	10 ; $3 \times A_1$
7,10	5 ; $3 \times A_1$	8 ; $3 \times A_1$
8,10	1 ; $A_1 + B_2$	7 ; $3 \times A_1$

Table 4.3: Identifying reflective extended Bianchi groups $\widehat{Bi}(m)$ with the maximal reflective groups in the list due to Scharlau [59]. The second row contains the indexes of these lattices in Scharlau's list.

m	1	2	3	5	6	7	10	11	13	14	15	17	19	21	30	33	39
	2	4	1	10	12	3	18	20	21	22	7	25	9	28	32	36	17

amplification may be found in either [63] or [10]. We run the algorithm until we have generated more distinct cusps in each of these four cases. We summarise the results in Table 4.4.

Table 4.4: Illustrating the use of Proposition 4.1.5 by comparing the number of cusps generated by running Vinberg's algorithm for a fixed length of time against the bounds.

m	67	163	403	427
h_m	1	1	2	2
$h_{2,m}$	1	1	2	2
$Bi(m)$ bound	12	12	24	24
$\widehat{Bi}(m)$ bound	12	12	48	48
# vectors generated	75	738	2462	2270
# cusps generated	30	245	1179	1012

4.2 Reflective Bianchi Groups

In each extended Bianchi group we can consider the reflections which are solely in the Bianchi group and not in the extension. We make this distinction with reference to the following lemma. This lemma was stated without proof by Shvartsman ([65], Lemma 1), and the proof which appears in [10] is due to Belolipetsky.

Lemma 4.2.1 ([10], Lemma 6.1). *The subgroup $\Gamma_r < Bi(m)$ of reflections consists of only 2- and $2m$ -reflections (where 2 and $2m$ respectively is the spinor norm of the reflection c.f. [22, p. 160]), and all such reflections in $\widehat{Bi}(m)$ lie in Γ_r .*

Given this result, we have identified the vertices of the Coxeter diagrams presented in Figures 4.2 and 4.3 which are in the extension but are not in the Bianchi group itself. We have done this with reference to the tables of vectors in Appendix F. Each vector in those tables whose length is neither 2 nor $2m$ (for the appropriate value of m) is in the quotient $\widehat{Bi}(m)/Bi(m)$, and the vertices in the Coxeter diagrams representing these vertices have been filled in.

The configuration of the filled vertices enables us to determine whether the Bianchi group is reflective or not by measuring the order of the group which is generated by these reflections. The Bianchi group is not reflective when this group has infinite order, for example in the case $m = 21$. In this case the pair of vertices labelled 6 and 10 are joined by a dashed edge, and therefore the product of the associated reflections is loxodromic.

Considering each of the reflective extended Bianchi groups along with with Lemma 4.2.1 proves the following Theorem.

Theorem 4.2.2 ([10], Theorem 2.1). *The Bianchi groups $Bi(m)$ are reflective for $m \leq 19$, $m \neq 14, 17$, and this list is complete.*

Proof. We observe that the Coxeter diagrams of the groups $\widehat{Bi}(m)$ for $m = 1, 2, 3, 7, 11, 15$ and 19 contain no filled vertices. Therefore the reflective subgroup of the Bianchi group is identified with that of the extended Bianchi group, which is borne out by computing the order of the quotient group $\widehat{Bi}(m)/Bi(m)$ according to equation 1.8. In these cases the Bianchi group is reflective. A complete list of these values for those extended Bianchi groups which are reflective is presented in Table 4.6. In the case $m = 1$ we refer to the discussion at the start of this Chapter regarding the presentation of $PGL_2(O_1)$ in [22]. It was said that $PGL_2(O_1)$ is an index 4 subgroup of the tetrahedral group $\mathbf{CT}(1)$. The polytope produced by reflecting in the filled vertex in Figure 4.4 is that which has the Coxeter diagram we computed for $\widehat{Bi}(1)$ in Figure 4.2. This relationship substantiates the claim at the start of the Chapter.

In Table 4.6 the reflection subgroup of $Bi(15)$ is an index 2 subgroup of the reflection subgroup of the extended group, but by Lemma 4.2.1 all of the reflections

Figure 4.4: ([22], Section 10.4, Table of Tetrahedral Groups): The Coxeter diagram $\mathbf{CT}(1)$.

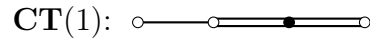

Table 4.5: Identifying pairs of filled vertices in the Coxeter diagrams of the reflective extended Bianchi groups for whom the product of the corresponding reflections is an isometry of infinite order.

m	First	Second	Product
14	6	8	Parabolic
17	6	7	Parabolic
21	6	10	Loxodromic
30	6	10	Loxodromic
33	6	7	Loxodromic
39	7	8	Parabolic

which are in the extended group are in the Bianchi group, and the Bianchi group is reflective.

When $m = 5, 6, 10$ and 13 there is precisely one filled vertex. Hence the reflection subgroup of the Bianchi group is contained in the reflection subgroup of the extended Bianchi group as an index 2 subgroup, which agrees with the data in Table 4.6.

In the remaining cases we can identify a pair of reflections among the filled vertices of a Coxeter diagram whose product is an isometry of infinite order. The results are presented in Table 4.5. We conclude that these Bianchi groups are not reflective.

□

Table 4.6: Orders of the factor group $\widehat{Bi}(m)/Bi(m)$ when $\widehat{Bi}(m)$ is reflective. The value of $h_{2,m}$ is computed by equation 1.8.

m	$m \pmod{4}$	t	$h_{2,m}$
1	1	1	1
2	2	1	1
3	3	1	1
5	1	1	2
6	2	2	2
7	3	1	1
10	2	2	2
11	3	1	1
13	1	1	2
14	2	2	2
15	3	2	2
17	1	1	2
19	3	1	1
21	1	1	2
30	2	3	4
33	1	2	4
39	3	2	2

Chapter 5

Quasi-Reflective Lattices

Quasi-quotation would have been convenient at earlier points but was withheld for fear of obscuring fundamentals with excess machinery.

Willard van Orman Quine [52]

When first stated, Definition 1.1.1 was restricted to reflective lattices. We can widen this definition to include *quasi-reflective* lattices, which are sometimes known as *parabolic reflective* lattices. The definition of the quasi-reflective lattice presented here is in the form originally due to Ruzmanov [56].

Definition 5.0.3 ([10], Definition 4.1). A lattice Γ is called *reflective* if its non-reflective part H in the decomposition (1.1) is finite, and *quasi-reflective* if H is infinite, has an infinitely distant fixed point $q \in \partial\mathbb{H}^n$, and leaves invariant a horosphere $S = \mathbb{S}^{n-1}$ of the maximal dimension with the centre at q .

From the definition it follows that quasi-reflective lattices are necessarily non-cocompact (which is clearly not the case for the reflective ones). The group H acts by affine isometries of S and is itself a lattice in $\text{Aff}(S)$. We will call its rank r the *quasi-reflective rank* of Γ , and denote it by $\text{QR-rank}(\Gamma)$. We will also say that Γ is a quasi-reflective group of rank r . The group H has a finite index subgroup generated

by translations of S (cf. [28, Section 4.2]), and the rank of H is equal to the number of the linearly independent translations in H_t , the translation subgroup of H .

The fundamental polyhedron P of the reflection subgroup of a quasi-reflective group Γ is an infinite volume infinite sided polyhedron in \mathbb{H}^n . Its symmetry group H is isomorphic to an affine crystallographic group of rank $\leq n - 1$ and P/H has finite volume. Following Ruzmanov [56] we will call such polyhedra *quasi-bounded*. A quasi-bounded polyhedron P has an infinitely distant point q such that the intersection of some horosphere with the centre q and P is unbounded. This point q is unique and it is called the *singular point* of P .

5.1 The quadratic forms f_d^n

In 1983, Conway demonstrated that the automorphism group of the quadratic form f_1^{25} contained a quasi-reflective lattice by finding an infinite sequence of fundamental roots that had inner product -1 with a given isotropic vector - the singular vector of the lattice [19]. In this section we shall present examples of quasi-reflective lattices which were encountered while searching for reflective lattices among the automorphism groups of other quadratic forms f_d^n , first in \mathbb{H}^3 and then in \mathbb{H}^4 .

Proposition 5.1.1. *The groups of units of the automorphism groups of the quadratic forms f_6^3 and f_{14}^3 are quasi-reflective of rank 1 and 2 respectively.*

Proposition 5.1.2. *The group of units of the automorphism group of the quadratic form f_7^4 is quasi-reflective of rank 1.*

5.1.1 The quadratic form f_6^3

That the quadratic form f_6^3 is not reflective has already been demonstrated. We noted that the non-reflective part of the decomposition 1.1 contained an element of infinite order (the matrix can be found in Section B.1.1, labelled $d = 6$). This element was a parabolic isometry, which indicates that this lattice may be quasi-reflective. A portion of the infinite Coxeter diagram is shown in Figure 5.1 a). In this Figure, part b) shows the Coxeter diagram of a reflection group in which this

parabolic isometry is represented by the product of the reflections in the two filled vertices.

Figure 5.1: a) Partial Coxeter diagram of the fundamental polytope of the quadratic form f_6^3 (Broken-line branches intentionally omitted). The vertex labelled b is orthogonal to all the vertices with the exception of the vertex labelled a . b) Coxeter diagram of the reflection group of which a) is an infinite index subgroup.

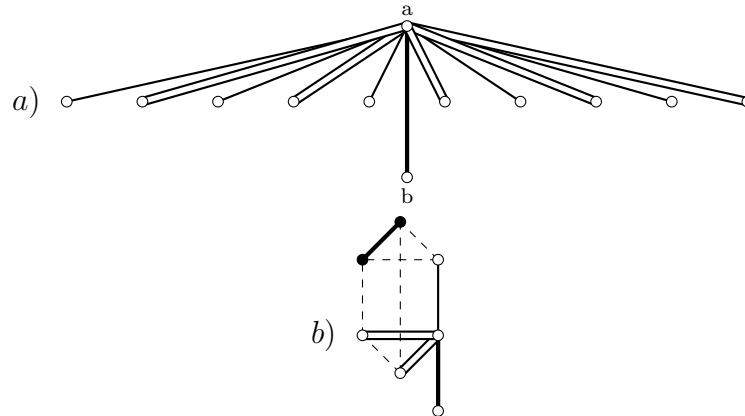

The parabolic isometry which acts on the (infinitely extended) Coxeter diagram of which a part is illustrated in Figure 5.1 preserves the isotropic vector $w = v_0 + 2v_1 + v_2 + v_3$. This vector is also preserved by the reflections in the hyperplanes labelled 2 and 4, and their product is also a parabolic isometry. The non-reflective part of the automorphism group of this quadratic form has one parabolic isometry and preserves an isotropic vector, and therefore the quadratic form has a quasi-reflective structure of rank 1. In line with Conway's work, w has inner product -1 with the vectors which are normal to the hyperplanes labelled 1 and 3 in Figure 5.1, and this inner product is transmitted along the diagram by the parabolic isometry which preserves w .

Remark 5.1.3. The reflection group with the Coxeter diagram that is Figure 5.1 part b) is an index 2 subgroup of the reflection group with the Coxeter diagram in Figure 4.2 which is labelled $m = 6$, namely $\widehat{Bi}(6)$. The former diagram is produced by reflecting the latter in the hyperplane which is there labelled 3.

5.1.2 The quadratic form f_{14}^3

As in the previous section, we have already produced an isometry of this lattice which is of infinite order, and demonstrated that it is not reflective (the matrix can be found in Section B.1.1, labelled $d = 14$). In addition, this isometry is parabolic which suggests further investigation may result in a quasi-reflective lattice. The Coxeter diagram of twenty reflections in the lattice (the polyhedral angle and the first seventeen from the algorithm) is shown in Figure 5.2.

Figure 5.2: Coxeter diagram of twenty reflections in the automorphism group of f_{14}^3 . (Broken-line branches intentionally omitted). The vertices that are not connected to the graph are orthogonal to some of the vertices which form a box around them. In particular, the vertex labelled 4 is orthogonal to 2, 3, 5 and 6, and this configuration is repeated in each of the boxes.

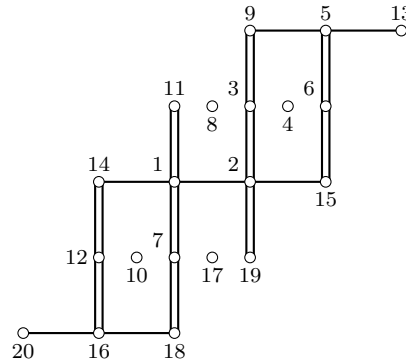

We see that this Coxeter diagram (infinitely extended) has two directions of translational symmetry: map the vertex labelled 1 to 9 ; and map the vertex labelled 1 to 2. The appropriate matrices for these isometries are

$$\begin{bmatrix} 71 & -14 & -10 & -8 \\ 224 & -44 & -32 & -25 \\ 140 & -28 & -19 & -16 \\ 28 & -5 & -4 & -4 \end{bmatrix}, \quad (5.1)$$

in the first instance and

$$\begin{bmatrix} 43 & -8 & -8 & -2 \\ 140 & -26 & -26 & -7 \\ 56 & -10 & -11 & -2 \\ 56 & -11 & -10 & -2 \end{bmatrix}, \quad (5.2)$$

in the second.

In both cases the eigenvalues are 1 with multiplicity four, so they are parabolic. By their action on the Coxeter diagram we can see that they are linearly independent. Finally, both isometries preserve the isotropic vector $v_0 + 3v_1 + 2v_2 + v_3$ so we can see that the lattice is quasi-reflective of rank 2.

5.1.3 The quadratic form f_7^4

The matrix listed in Section B.1.2 labelled $d = 7$ has a single eigenvalue 1 which has multiplicity 5. This isometry preserves the integral lattice and is parabolic which suggests that further investigation may reveal a quasi-reflective lattice. This isometry preserves an isotropic vector which is given by $v_0 + 2v_1 + v_2 + v_3 + v_4$. Three vectors in the integral lattice are orthogonal to this isotropic vector, and the subdiagram of the Coxeter diagram comprising these three vectors is a copy of \tilde{A}_2 .

We may compute two reflections which are not in the group of units of this quadratic form, whose product is the parabolic isometry in Section B.1.2, labelled $d = 7$. For example, we may take reflections in the hyperplanes with normal vectors $9v_0 + 21v_1 + 7v_2 + 7v_3 + 7v_4$ and $5v_0 + 7v_1 + 7v_2 + 7v_3 + 7v_4$. Discarding the vectors produced by the algorithm which have positive inner product with either of these leaves six vectors (and so including these that have been constructed we have a total of eight). The Coxeter diagram of these eight reflections is presented in Figure 5.3 and represents a Coxeter polytope of finite volume. The group of units of the quadratic form f_7^4 is contained in this group as an infinite index subgroup, and hence can be said to be quasi-reflective of rank 1.

The lattice in Figure 5.3 is present in the list of reflection groups in \mathbb{H}^4 due to Scharlau and Walhorn and is there numbered 15 [60].

Figure 5.3: Coxeter diagram of the reflection group of which the reflection subgroup of the group of units of the quadratic form f_7^4 is an infinite index subgroup. The filled vertices are those whose product is the parabolic isometry listed in Section B.1.2.

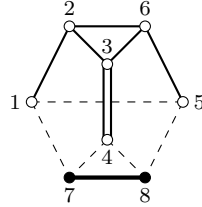

5.2 The Bianchi and extended Bianchi groups

The study of reflective quadratic forms has been made possible by the existence of finiteness results which limit the possible discriminants. In the quasi-reflective case these results must be emulated before we can proceed. A general proof of the finiteness of quasi-reflective lattices in each dimension has been given by Nikulin [45]. In this section we shall classify the quasi-reflective lattices as they arise among the Bianchi groups, and prove the following Theorem.

Theorem 5.2.1 ([10], Theorem 2.3). *The Bianchi groups $Bi(m)$ are quasi-reflective for $m = 14, 17, 23, 31$ and 39 , and this list is complete. The only quasi-reflective extended Bianchi groups are $\widehat{Bi}(23)$ and $\widehat{Bi}(31)$.*

A finite list of candidates for quasi-reflective extended Bianchi groups (which includes the case of the Bianchi groups) was established by Belolipetsky in Section 5 of [10], based on the Li-Yau conformal volume methods used so effectively in [1], [2] and [7]. Coincidentally we have the same list of groups that we saw in Section 1.3.1, and we present Proposition 1.3.1 in full to filter this list.

Proposition 5.2.2 ([10], Proposition 4.3). *The class groups of the fields K_m satisfy:*

1. *If $Bi(m)$ is reflective or quasi-reflective of rank 1 then $C(O_m) \cong (\mathbb{Z}/2\mathbb{Z})^n, n \in \mathbb{Z}_{\geq 0}$;*
2. *If $\widehat{Bi}(m)$ is reflective or quasi-reflective of rank 1 then $C(O_m) \cong (\mathbb{Z}/2\mathbb{Z})^n \times (\mathbb{Z}/4\mathbb{Z})^l, n, l \in \mathbb{Z}_{\geq 0}$;*

3. If $Bi(m)$ is quasi-reflective of rank 2 then $C(O_m) \cong (\mathbb{Z}/2\mathbb{Z})^n \times (\mathbb{Z}/3\mathbb{Z})^k$, $n \in \mathbb{Z}_{\geq 0}$, $k = 0$ or 1 ;
4. If $\widehat{Bi}(m)$ is quasi-reflective of rank 2 then $C(O_m) \cong (\mathbb{Z}/2\mathbb{Z})^n \times (\mathbb{Z}/3\mathbb{Z})^k \times (\mathbb{Z}/4\mathbb{Z})^l$, $n, l \in \mathbb{Z}_{\geq 0}$, $k = 0$ or 1 .

Using GP/PARI we may apply this Proposition to the list of 882 groups and see that there are:

1. 203 candidates for quasi-reflective Bianchi groups ;
2. 204 candidates for quasi-reflective extended Bianchi groups.

The specific values of m can be found in Appendix C (which includes the reflective case). As previously, we apply Vinberg's algorithm to the specific quadratic forms whose automorphism groups correspond to the extended Bianchi groups and then search for isometries of the reflective lattice. There were four cases we singled out previously for which the structure of the reflection subgroup was not reflective, and this was demonstrated by making use of the strong connection between the number field and the geometry. We present the full version of Proposition 4.1.5

Proposition 5.2.3 ([10], Proposition 6.3, parts 1 and 2). *Let Γ be a lattice in $\text{Isom}(\mathbb{H}^3)$ and Γ_r its subgroup generated by (all) reflections. For Γ being reflective it is necessary that*

1. if $\Gamma = Bi(m)$ then \mathbb{H}^3/Γ_r has at most $12h_m$ cusps ;
2. if $\Gamma = \widehat{Bi}(m)$ then \mathbb{H}^3/Γ_r has at most $12h_m h_{2,m}$ cusps.

For Γ to be quasi-reflective, let v be a vertex of the Coxeter diagram of Γ_r such that the reflection hyperplane corresponding to v does not pass through the singular point at infinity. The necessary conditions are

3. if $\Gamma = Bi(m)$ then v is adjacent to at most $12(h_m - 1)$ cusps ;
4. if $\Gamma = \widehat{Bi}(m)$ then v is adjacent to at most $12h_{2,m}(h_m - 1)$ cusps.

In the same way as before, we shall run the algorithm in these four cases for a finite length of time but this time we consider the location of the cusps. The results are summarised in Table 5.1. We have chosen v to be the hyperplane which is the confluence of the most cusps in the subset of reflections we have generated.

Table 5.1: Illustrating the use of Proposition 5.2.3 in the quasi-reflective case by comparing the number of cusps generated by running Vinberg's algorithm for a fixed length of time against the bounds.

m	67	163	403	427
h_m	1	1	2	2
$h_{2,m}$	1	1	2	2
$Bi(m)$ bound	0	0	12	12
$\widehat{Bi}(m)$ bound	0	0	24	24
# vectors generated	75	738	2462	2270
# cusps adjacent to v	2	10	27	27

When a loxodromic isometry can be found that preserves the lattice the group is not quasi-reflective. There are two lattices for which a loxodromic isometry can not be found, and these are $\widehat{Bi}(23)$ and $\widehat{Bi}(31)$, which are two of the quasi-reflective Bianchi groups of rank 2 identified by Ruzmanov. Patches of the infinite Coxeter diagrams are presented in Figures 5.4 and 5.5 respectively.

Figure 5.4: Partial Coxeter diagram of the reflection subgroup of the Bianchi group $Bi(23)$, a quasi-reflective Bianchi group. (Broken line branches intentionally omitted).

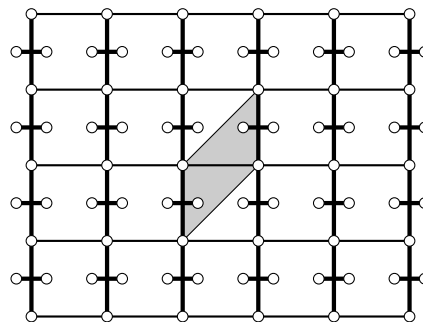

We also uncover a quasi-reflective Bianchi group when the extended Bianchi group is reflective, and the Bianchi group contains all of the same reflections with

Figure 5.5: Partial Coxeter diagram of the reflection subgroup of the Bianchi group $Bi(31)$, a quasi-reflective Bianchi group. (Broken line branches intentionally omitted).

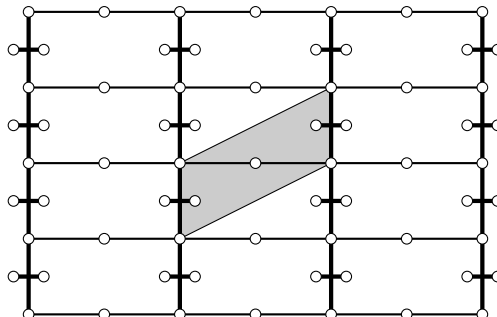

the exception of those mirrors which bound a single cusp. From the data in Table 4.5 we are lead to the three cases in which this appears, namely when $m = 14, 17$ and 39 . In each of these cases the Bianchi group is quasi-reflective of rank 2. This completes the proof of Theorem 5.2.1.

Appendix A

Infinite order isometries of the quadratic forms f_d^2

$$d = 21$$

$$\begin{bmatrix} 211 & -38 & -26 \\ 966 & -174 & -119 \\ 42 & -7 & -6 \end{bmatrix}$$

$$d = 22$$

$$\begin{bmatrix} 441 & -74 & -58 \\ 2068 & -347 & -272 \\ 44 & -8 & -5 \end{bmatrix}$$

$$d = 26$$

$$\begin{bmatrix} 339 & -62 & -24 \\ 1248 & -228 & -89 \\ 1196 & -219 & -84 \end{bmatrix}$$

$$d = 29$$

$$\begin{bmatrix} 579 & -78 & -74 \\ 3074 & -414 & -393 \\ 522 & -71 & -66 \end{bmatrix}$$

$$d = 34$$

$$\begin{bmatrix} 2721 & -364 & -292 \\ 15368 & -2056 & -1649 \\ 3944 & -527 & -424 \end{bmatrix}$$

$$d = 35$$

$$\begin{bmatrix} 456 & -55 & -54 \\ 2485 & -300 & -294 \\ 1050 & -126 & -125 \end{bmatrix}$$

$$d = 38$$

$$\begin{bmatrix} 2319 & -268 & -264 \\ 11704 & -1353 & -1332 \\ 8208 & -948 & -935 \end{bmatrix}$$

$$d = 42$$

$$\begin{bmatrix} 211 & -24 & -22 \\ 1344 & -153 & -140 \\ 252 & -28 & -27 \end{bmatrix}$$

$$d = 46$$

$$\begin{bmatrix} 231 & -26 & -22 \\ 1564 & -176 & -149 \\ 92 & -11 & -8 \end{bmatrix}$$

$$d = 55$$

$$\begin{bmatrix} 144 & -16 & -11 \\ 1045 & -116 & -80 \\ 220 & -25 & -16 \end{bmatrix}$$

$$d = 57$$

$$\begin{bmatrix} 1139 & -118 & -94 \\ 8322 & -862 & -687 \\ 2166 & -225 & -178 \end{bmatrix}$$

$$d = 58$$

$$\begin{bmatrix} 291 & -28 & -26 \\ 2204 & -212 & -197 \\ 232 & -23 & -20 \end{bmatrix}$$

$$d = 65$$

$$\begin{bmatrix} 3171 & -286 & -270 \\ 21450 & -1935 & -1826 \\ 13910 & -1254 & -1185 \end{bmatrix}$$

$$d = 66$$

$$\begin{bmatrix} 439 & -42 & -34 \\ 3564 & -341 & -276 \\ 132 & -12 & -11 \end{bmatrix}$$

$$d = 69$$

$$\begin{bmatrix} 919 & -84 & -72 \\ 7452 & -681 & -584 \\ 1656 & -152 & -129 \end{bmatrix}$$

$$d = 70$$

$$\begin{bmatrix} 729 & -74 & -46 \\ 6020 & -611 & -380 \\ 980 & -100 & -61 \end{bmatrix}$$

$$d = 77$$

$$\begin{bmatrix} 573 & -58 & -30 \\ 3850 & -390 & -201 \\ 3234 & -327 & -170 \end{bmatrix}$$

$$d = 78$$

$$\begin{bmatrix} 389 & -34 & -28 \\ 3432 & -300 & -247 \\ 156 & -13 & -12 \end{bmatrix}$$

$$d = 85$$

$$\begin{bmatrix} 579 & -50 & -38 \\ 5270 & -455 & -346 \\ 850 & -74 & -55 \end{bmatrix}$$

$$d = 87$$

$$\begin{bmatrix} 376 & -29 & -28 \\ 3219 & -248 & -240 \\ 1392 & -108 & -103 \end{bmatrix}$$

$$d = 91$$

$$\begin{bmatrix} 456 & -38 & -29 \\ 4186 & -349 & -266 \\ 1183 & -98 & -76 \end{bmatrix}$$

$$d = 93$$

$$\begin{bmatrix} 929 & -72 & -64 \\ 8928 & -692 & -615 \\ 744 & -57 & -52 \end{bmatrix}$$

$$d = 95$$

$$\begin{bmatrix} 324 & -24 & -23 \\ 3040 & -225 & -216 \\ 855 & -64 & -60 \end{bmatrix}$$

$$d = 102$$

$$\begin{bmatrix} 443 & -32 & -30 \\ 4080 & -295 & -276 \\ 1836 & -132 & -125 \end{bmatrix}$$

$$d = 105$$

$$\begin{bmatrix} 701 & -54 & -42 \\ 6930 & -534 & -415 \\ 1890 & -145 & -114 \end{bmatrix}$$

$$d = 110$$

$$\begin{bmatrix} 549 & -38 & -36 \\ 5720 & -396 & -375 \\ 660 & -45 & -44 \end{bmatrix}$$

$$d = 111$$

$$\begin{bmatrix} 184 & -16 & -7 \\ 1887 & -164 & -72 \\ 444 & -39 & -16 \end{bmatrix}$$

$$d = 114$$

$$\begin{bmatrix} 1139 & -92 & -54 \\ 12084 & -976 & -573 \\ 1368 & -111 & -64 \end{bmatrix}$$

$$d = 130$$

$$\begin{bmatrix} 339 & -22 & -20 \\ 3640 & -236 & -215 \\ 1300 & -85 & -76 \end{bmatrix}$$

$$d = 138$$

$$\begin{bmatrix} 781 & -48 & -46 \\ 8832 & -543 & -520 \\ 2484 & -152 & -147 \end{bmatrix}$$

$$d = 141$$

$$\begin{bmatrix} 941 & -58 & -54 \\ 10998 & -678 & -631 \\ 1974 & -121 & -114 \end{bmatrix}$$

$$d = 154$$

$$\begin{bmatrix} 2001 & -116 & -112 \\ 22792 & -1321 & -1276 \\ 9856 & -572 & -551 \end{bmatrix}$$

$$d = 155$$

$$\begin{bmatrix} 2016 & -115 & -114 \\ 23250 & -1326 & -1315 \\ 9455 & -540 & -534 \end{bmatrix}$$

$$d = 165$$

$$\begin{bmatrix} 749 & -54 & -22 \\ 9570 & -690 & -281 \\ 990 & -71 & -30 \end{bmatrix}$$

$$d = 170$$

$$\begin{bmatrix} 579 & -44 & -6 \\ 6120 & -465 & -64 \\ 4420 & -336 & -45 \end{bmatrix}$$

$$d = 174$$

$$\begin{bmatrix} 581 & -34 & -28 \\ 7656 & -448 & -369 \\ 348 & -21 & -16 \end{bmatrix}$$

$$d = 182$$

$$\begin{bmatrix} 519 & -34 & -18 \\ 6916 & -453 & -240 \\ 1092 & -72 & -37 \end{bmatrix}$$

$$d = 186$$

$$\begin{bmatrix} 311 & -18 & -14 \\ 4092 & -237 & -184 \\ 1116 & -64 & -51 \end{bmatrix}$$

$$d = 190$$

$$\begin{bmatrix} 1899 & -106 & -88 \\ 25460 & -1421 & -1180 \\ 6080 & -340 & -281 \end{bmatrix}$$

$$d = 195$$

$$\begin{bmatrix} 326 & -17 & -16 \\ 4485 & -234 & -220 \\ 780 & -40 & -39 \end{bmatrix}$$

$$d = 205$$

$$\begin{bmatrix} 5001 & -320 & -140 \\ 69700 & -4460 & -1951 \\ 16400 & -1049 & -460 \end{bmatrix}$$

$$d = 210$$

$$\begin{bmatrix} 349 & -18 & -16 \\ 5040 & -260 & -231 \\ 420 & -21 & -20 \end{bmatrix}$$

$$d = 219$$

$$\begin{bmatrix} 1096 & -61 & -42 \\ 16206 & -902 & -621 \\ 657 & -36 & -26 \end{bmatrix}$$

$$d = 222$$

$$\begin{bmatrix} 961 & -56 & -32 \\ 14208 & -828 & -473 \\ 1776 & -103 & -60 \end{bmatrix}$$

$$d = 231$$

$$\begin{bmatrix} 958 & -47 & -42 \\ 14553 & -714 & -638 \\ 462 & -22 & -21 \end{bmatrix}$$

$$d = 255$$

$$\begin{bmatrix} 1444 & -76 & -49 \\ 20145 & -1060 & -684 \\ 11220 & -591 & -380 \end{bmatrix}$$

$$d = 273$$

$$\begin{bmatrix} 2029 & -98 & -74 \\ 28938 & -1398 & -1055 \\ 16926 & -817 & -618 \end{bmatrix}$$

$$d = 282$$

$$\begin{bmatrix} 941 & -46 & -32 \\ 15792 & -772 & -537 \\ 564 & -27 & -20 \end{bmatrix}$$

$$d = 285$$

$$\begin{bmatrix} 1939 & -94 & -66 \\ 32490 & -1575 & -1106 \\ 3990 & -194 & -135 \end{bmatrix}$$

$$d = 291$$

$$\begin{bmatrix} 1648 & -87 & -42 \\ 22698 & -1198 & -579 \\ 16587 & -876 & -422 \end{bmatrix}$$

$$d = 310$$

$$\begin{bmatrix} 1551 & -88 & -4 \\ 21080 & -1196 & -55 \\ 17360 & -985 & -44 \end{bmatrix}$$

$$d = 330$$

$$\begin{bmatrix} 2749 & -108 & -106 \\ 43560 & -1711 & -1680 \\ 24420 & -960 & -941 \end{bmatrix}$$

$$d = 345$$

$$\begin{bmatrix} 599 & -28 & -16 \\ 11040 & -516 & -295 \\ 1380 & -65 & -36 \end{bmatrix}$$

$$d = 357$$

$$\begin{bmatrix} 1021 & -42 & -34 \\ 19278 & -793 & -642 \\ 714 & -30 & -23 \end{bmatrix}$$

$$d = 385$$

$$\begin{bmatrix} 2199 & -92 & -64 \\ 43120 & -1804 & -1255 \\ 1540 & -65 & -44 \end{bmatrix}$$

$$d = 390$$

$$\begin{bmatrix} 1351 & -54 & -42 \\ 25740 & -1029 & -800 \\ 7020 & -280 & -219 \end{bmatrix}$$

$$d = 399$$

$$\begin{bmatrix} 778 & -29 & -26 \\ 13566 & -506 & -453 \\ 7581 & -282 & -254 \end{bmatrix}$$

$$d = 410$$

$$\begin{bmatrix} 5329 & -240 & -108 \\ 78720 & -3545 & -1596 \\ 73800 & -3324 & -1495 \end{bmatrix}$$

$$d = 429$$

$$\begin{bmatrix} 2861 & -138 & -6 \\ 48906 & -2359 & -102 \\ 33462 & -1614 & -71 \end{bmatrix}$$

$$d = 435$$

$$\begin{bmatrix} 724 & -26 & -23 \\ 14790 & -531 & -470 \\ 3045 & -110 & -96 \end{bmatrix}$$

$$d = 438$$

$$\begin{bmatrix} 2191 & -76 & -72 \\ 45552 & -1580 & -1497 \\ 5256 & -183 & -172 \end{bmatrix}$$

$$d = 455$$

$$\begin{bmatrix} 1884 & -76 & -45 \\ 38675 & -1560 & -924 \\ 10920 & -441 & -260 \end{bmatrix}$$

$$d = 462$$

$$\begin{bmatrix} 1429 & -48 & -46 \\ 29568 & -993 & -952 \\ 8316 & -280 & -267 \end{bmatrix}$$

$$d = 465$$

$$\begin{bmatrix} 4589 & -198 & -78 \\ 75330 & -3250 & -1281 \\ 64170 & -2769 & -1090 \end{bmatrix}$$

$$d = 483$$

$$\begin{bmatrix} 806 & -33 & -16 \\ 17388 & -712 & -345 \\ 3381 & -138 & -68 \end{bmatrix}$$

$$d = 510$$

$$\begin{bmatrix} 2549 & -98 & -56 \\ 57120 & -2196 & -1255 \\ 7140 & -275 & -156 \end{bmatrix}$$

$$d = 546$$

$$\begin{bmatrix} 2029 & -68 & -54 \\ 41496 & -1391 & -1104 \\ 22932 & -768 & -611 \end{bmatrix}$$

$$d = 570$$

$$\begin{bmatrix} 1559 & -58 & -30 \\ 28500 & -1060 & -549 \\ 23940 & -891 & -460 \end{bmatrix}$$

$$d = 582$$

$$\begin{bmatrix} 4849 & -172 & -104 \\ 86136 & -3055 & -1848 \\ 79152 & -2808 & -1697 \end{bmatrix}$$

$$d = 615$$

$$\begin{bmatrix} 2174 & -74 & -47 \\ 48585 & -1654 & -1050 \\ 23370 & -795 & -506 \end{bmatrix}$$

$$d = 645$$

$$\begin{bmatrix} 3181 & -118 & -42 \\ 63210 & -2345 & -834 \\ 50310 & -1866 & -665 \end{bmatrix}$$

$$d = 651$$

$$\begin{bmatrix} 776 & -22 & -21 \\ 17577 & -498 & -476 \\ 9114 & -259 & -246 \end{bmatrix}$$

$$d = 690$$

$$\begin{bmatrix} 599 & -18 & -14 \\ 15180 & -456 & -355 \\ 4140 & -125 & -96 \end{bmatrix}$$

$$d = 714$$

$$\begin{bmatrix} 1021 & -38 & -4 \\ 19992 & -744 & -79 \\ 18564 & -691 & -72 \end{bmatrix}$$

$$d = 770$$

$$\begin{bmatrix} 2199 & -58 & -54 \\ 60060 & -1584 & -1475 \\ 10780 & -285 & -264 \end{bmatrix}$$

$$d = 795$$

$$\begin{bmatrix} 2651 & -74 & -58 \\ 74730 & -2086 & -1635 \\ 1590 & -45 & -34 \end{bmatrix}$$

$$d = 798$$

$$\begin{bmatrix} 1483 & -50 & -16 \\ 31920 & -1076 & -345 \\ 27132 & -915 & -292 \end{bmatrix}$$

$$d = 858$$

$$\begin{bmatrix} 4291 & -124 & -78 \\ 125268 & -3620 & -2277 \\ 10296 & -297 & -188 \end{bmatrix}$$

$$d = 870$$

$$\begin{bmatrix} 4351 & -112 & -96 \\ 125280 & -3225 & -2764 \\ 27840 & -716 & -615 \end{bmatrix}$$

$$d = 910$$

$$\begin{bmatrix} 4551 & -118 & -94 \\ 132860 & -3445 & -2744 \\ 34580 & -896 & -715 \end{bmatrix}$$

$$d = 930$$

$$\begin{bmatrix} 4589 & -138 & -60 \\ 139500 & -4195 & -1824 \\ 11160 & -336 & -145 \end{bmatrix}$$

$$d = 966$$

$$\begin{bmatrix} 2437 & -62 & -48 \\ 75348 & -1917 & -1484 \\ 7728 & -196 & -153 \end{bmatrix}$$

$$d = 1155$$

$$\begin{bmatrix} 274 & -7 & -4 \\ 9240 & -236 & -135 \\ 1155 & -30 & -16 \end{bmatrix}$$

$$d = 1230$$

$$\begin{bmatrix} 3199 & -88 & -24 \\ 88560 & -2436 & -665 \\ 68880 & -1895 & -516 \end{bmatrix}$$

$$d = 1290$$

$$\begin{bmatrix} 3181 & -88 & -10 \\ 103200 & -2855 & -324 \\ 49020 & -1356 & -155 \end{bmatrix}$$

$$d = 1302$$

$$\begin{bmatrix} 2171 & -56 & -22 \\ 75516 & -1948 & -765 \\ 20832 & -537 & -212 \end{bmatrix}$$

$$d = 1365$$

$$\begin{bmatrix} 2029 & -54 & -10 \\ 62790 & -1671 & -310 \\ 40950 & -1090 & -201 \end{bmatrix}$$

$$d = 1590$$

$$\begin{bmatrix} 2651 & -64 & -18 \\ 98580 & -2380 & -669 \\ 38160 & -921 & -260 \end{bmatrix}$$

$$d = 2310$$

$$\begin{bmatrix} 1429 & -28 & -10 \\ 50820 & -996 & -355 \\ 46200 & -905 & -324 \end{bmatrix}$$

$$d = 2730$$

$$\begin{bmatrix} 2029 & -32 & -22 \\ 103740 & -1636 & -1125 \\ 21840 & -345 & -236 \end{bmatrix}$$

Appendix B

Infinite order isometries of the quadratic forms f_d^n , $n > 2$

B.1 Non-cocompact

B.1.1 $n = 3$

$$d = 6$$
$$\begin{bmatrix} 37 & -10 & -8 & -8 \\ 84 & -23 & -18 & -18 \\ 24 & -6 & -5 & -6 \\ 24 & -6 & -6 & -5 \end{bmatrix}$$

$$d = 13$$
$$\begin{bmatrix} 40 & -7 & -7 & -5 \\ 143 & -25 & -25 & -18 \\ 13 & -2 & -3 & -1 \\ 13 & -3 & -2 & -1 \end{bmatrix}$$

$$d = 14$$

$$\begin{bmatrix} 71 & -14 & -10 & -8 \\ 224 & -44 & -32 & -25 \\ 140 & -28 & -19 & -16 \\ 28 & -5 & -4 & -4 \end{bmatrix},$$

$$d = 19$$

$$\begin{bmatrix} 58 & -8 & -8 & -7 \\ 247 & -34 & -34 & -30 \\ 38 & -5 & -6 & -4 \\ 38 & -6 & -5 & -4 \end{bmatrix}$$

$$d = 23$$

$$\begin{bmatrix} 70 & -10 & -8 & -7 \\ 322 & -46 & -37 & -32 \\ 92 & -13 & -10 & -10 \\ 23 & -4 & -2 & -2 \end{bmatrix}$$

$$d = 30$$

$$\begin{bmatrix} 89 & -10 & -10 & -8 \\ 480 & -54 & -54 & -43 \\ 60 & -6 & -7 & -6 \\ 60 & -7 & -6 & -6 \end{bmatrix}$$

$$d = 33$$

$$\begin{bmatrix} 98 & -11 & -11 & -7 \\ 561 & -63 & -63 & -40 \\ 33 & -3 & -4 & -3 \\ 33 & -4 & -3 & -3 \end{bmatrix}$$

$$d = 39$$

$$\begin{bmatrix} 883 & -98 & -98 & -28 \\ 5460 & -606 & -606 & -173 \\ 546 & -60 & -61 & -18 \\ 546 & -61 & -60 & -18 \end{bmatrix}$$

$$d = 51$$

$$\begin{bmatrix} 188 & -24 & -9 & -6 \\ 918 & -117 & -44 & -30 \\ 765 & -98 & -36 & -24 \\ 612 & -78 & -30 & -19 \end{bmatrix}$$

B.1.2 $n = 4$

$$d = 7$$

$$\begin{bmatrix} 295 & -90 & -38 & -38 & -38 \\ 546 & -167 & -70 & -70 & -70 \\ 322 & -98 & -41 & -42 & -42 \\ 322 & -98 & -42 & -41 & -42 \\ 322 & -98 & -42 & -42 & -41 \end{bmatrix}$$

$$d = 10$$

$$\begin{bmatrix} 51 & -9 & -9 & -7 & -7 \\ 110 & -19 & -20 & -15 & -15 \\ 110 & -20 & -19 & -15 & -15 \\ 30 & -5 & -5 & -4 & -5 \\ 30 & -5 & -5 & -5 & -4 \end{bmatrix}$$

$$d = 15$$

$$\begin{bmatrix} 76 & -13 & -12 & -6 & -6 \\ 255 & -44 & -40 & -20 & -20 \\ 120 & -20 & -19 & -10 & -10 \\ 60 & -10 & -10 & -4 & -5 \\ 60 & -10 & -10 & -5 & -4 \end{bmatrix}$$

$$d = 17$$

$$\begin{bmatrix} 52 & -7 & -7 & -6 & -5 \\ 187 & -25 & -25 & -22 & -18 \\ 102 & -14 & -14 & -11 & -10 \\ 17 & -2 & -3 & -2 & -1 \\ 17 & -3 & -2 & -2 & -1 \end{bmatrix}$$

B.2 Cocompact

B.2.1 $n = 3$

$$d = 3 + 2\sqrt{5}$$

$$\begin{bmatrix} 463 + 748\phi & -128 - 208\phi & -126\phi - 78 & -126\phi - 78 \\ 1256 + 2032\phi & -349 - 564\phi & -342\phi - 212 & -342\phi - 212 \\ 166\phi + 102 & -28 - 46\phi & -17 - 28\phi & -28\phi - 18 \\ 166\phi + 102 & -28 - 46\phi & -28\phi - 18 & -17 - 28\phi \end{bmatrix}$$

Appendix C

The list of finitely many Bianchi groups

The values of m for which the Bianchi groups $Bi(m)$ and the extended Bianchi groups $\widehat{Bi}(m)$ may be reflective and quasi-reflective, according to the restrictions on the structure of the ideal class group introduced by Proposition 5.2.2 (partially reproduced earlier as Proposition 1.3.1).

The 65 candidates for Reflective Bianchi groups are $Bi(m)$ for m in the following list: 1, 2, 3, 5, 6, 7, 10, 11, 13, 15, 19, 21, 22, 30, 33, 35, 37, 42, 43, 51, 57, 58, 67, 70, 78, 85, 91, 93, 102, 105, 115, 123, 130, 133, 163, 165, 177, 187, 190, 195, 210, 235, 253, 267, 273, 330, 345, 357, 385, 403, 427, 435, 462, 483, 555, 595, 627, 715, 795, 1155, 1365, 1435, 1995, 3003, 3315.

The 81 candidates for Quasi - Reflective Bianchi groups of rank 2 are $Bi(m)$ for m in the following list: 1, 2, 3, 5, 6, 7, 10, 11, 13, 15, 19, 21, 22, 23, 30, 31, 33, 35, 37, 42, 43, 51, 57, 58, 59, 67, 70, 78, 83, 85, 91, 93, 102, 105, 107, 115, 123, 130, 133, 139, 163, 165, 177, 187, 190, 195, 210, 211, 235, 253, 267, 273, 283, 307, 330, 331, 345, 357, 379, 385, 403, 427, 435, 462, 483, 499, 547, 555, 595, 627, 643, 715, 795, 883, 907, 1155, 1365, 1435, 1995, 3003, 3315.

The 188 candidates for Reflective Extended Bianchi groups are $\widehat{Bi}(m)$ for m in the following list: 1, 2, 3, 5, 6, 7, 10, 11, 13, 14, 15, 17, 19, 21, 22, 30, 33, 34, 35, 37, 39, 42, 43, 46, 51, 55, 57, 58, 65, 66, 67, 69, 70, 73, 77, 78, 82, 85, 91, 93, 97, 102, 105, 114, 115, 123, 130, 133, 138, 141, 142, 145, 154, 155, 163, 165, 177, 187, 190,

193, 195, 203, 205, 210, 213, 217, 219, 235, 238, 253, 258, 259, 265, 267, 273, 282, 285, 291, 301, 310, 322, 323, 330, 345, 355, 357, 385, 390, 403, 418, 427, 429, 435, 438, 442, 445, 462, 465, 483, 498, 505, 510, 553, 555, 561, 570, 595, 598, 609, 627, 645, 651, 658, 667, 690, 697, 715, 723, 742, 763, 777, 793, 795, 798, 805, 858, 870, 897, 910, 915, 955, 957, 987, 1003, 1005, 1027, 1045, 1065, 1105, 1110, 1113, 1122, 1131, 1155, 1185, 1227, 1243, 1290, 1302, 1353, 1365, 1387, 1411, 1435, 1443, 1507, 1555, 1635, 1645, 1659, 1771, 1785, 1947, 1995, 2035, 2067, 2139, 2145, 2163, 2310, 2379, 2451, 2667, 2715, 2755, 3003, 3243, 3315, 3355, 3507, 3795, 4123, 4323, 4515, 5115, 5187, 6195, 7035, 7315.

The 204 candidates for Quasi - Reflective Extended Bianchi groups of rank 2 are $\widehat{Bi}(m)$ for m in the following list: 1, 2, 3, 5, 6, 7, 10, 11, 13, 14, 15, 17, 19, 21, 22, 23, 30, 31, 33, 34, 35, 37, 39, 42, 43, 46, 51, 55, 57, 58, 59, 65, 66, 67, 69, 70, 73, 77, 78, 82, 83, 85, 91, 93, 97, 102, 105, 107, 114, 115, 123, 130, 133, 138, 139, 141, 142, 145, 154, 155, 163, 165, 177, 187, 190, 193, 195, 203, 205, 210, 211, 213, 217, 219, 235, 238, 253, 258, 259, 265, 267, 273, 282, 283, 285, 291, 301, 307, 310, 322, 323, 330, 331, 345, 355, 357, 379, 385, 390, 403, 418, 427, 429, 435, 438, 442, 445, 462, 465, 483, 498, 499, 505, 510, 547, 553, 555, 561, 570, 595, 598, 609, 627, 643, 645, 651, 658, 667, 690, 697, 715, 723, 742, 763, 777, 793, 795, 798, 805, 858, 870, 883, 897, 907, 910, 915, 955, 957, 987, 1003, 1005, 1027, 1045, 1065, 1105, 1110, 1113, 1122, 1131, 1155, 1185, 1227, 1243, 1290, 1302, 1353, 1365, 1387, 1411, 1435, 1443, 1507, 1555, 1635, 1645, 1659, 1771, 1785, 1947, 1995, 2035, 2067, 2139, 2145, 2163, 2310, 2379, 2451, 2667, 2715, 2755, 3003, 3243, 3315, 3355, 3507, 3795, 4123, 4323, 4515, 5115, 5187, 6195, 7035, 7315.

Remark C.0.1. The numeric values listed in this Appendix are not the fundamental discriminants of the imaginary quadratic number fields.

Appendix D

Infinite order isometries of the Bianchi and Extended Bianchi groups

$$m = 22$$
$$\begin{bmatrix} 19 & 62 & -20 & -308 \\ 19 & 61 & -18 & -308 \\ 3 & 8 & -3 & -44 \\ 4 & 13 & -4 & -65 \end{bmatrix}$$

$$m = 34$$
$$\begin{bmatrix} 32 & 155 & -16 & -816 \\ 19 & 89 & -10 & -476 \\ 8 & 39 & -5 & -204 \\ 4 & 19 & -2 & -101 \end{bmatrix}$$

$$m = 35$$
$$\begin{bmatrix} 11 & 39 & -1 & -123 \\ 9 & 35 & 0 & -105 \\ 3 & 12 & -1 & -36 \\ 3 & 11 & 0 & -34 \end{bmatrix}$$

$$m = 37$$

$$\begin{bmatrix} 103 & 575 & -10 & -2960 \\ 31 & 172 & -4 & -888 \\ 14 & 80 & -2 & -407 \\ 9 & 50 & -1 & -258 \end{bmatrix}$$

$$m = 42$$

$$\begin{bmatrix} 31 & 199 & -22 & -1008 \\ 13 & 82 & -8 & -420 \\ 5 & 34 & -3 & -168 \\ 3 & 19 & -2 & -97 \end{bmatrix}$$

$$m = 43$$

$$\begin{bmatrix} 44 & 49 & -14 & -308 \\ 9 & 11 & -3 & -66 \\ 0 & 0 & 1 & 0 \\ 6 & 7 & -2 & -43 \end{bmatrix}$$

$$m = 46$$

$$\begin{bmatrix} 47 & 361 & -38 & -1748 \\ 25 & 188 & -20 & -920 \\ 5 & 38 & -5 & -184 \\ 5 & 38 & -4 & -185 \end{bmatrix}$$

$$m = 51$$

$$\begin{bmatrix} 5 & 23 & -1 & -77 \\ 3 & 17 & 0 & -51 \\ 1 & 6 & -1 & -18 \\ 1 & 5 & 0 & -16 \end{bmatrix}$$

$$m = 55$$

$$\begin{bmatrix} 4 & 31 & 1 & -82 \\ 4 & 31 & -1 & -83 \\ 1 & 5 & 0 & -17 \\ 1 & 8 & 0 & -21 \end{bmatrix}$$

$$m = 57$$

$$\begin{bmatrix} 23 & 207 & -24 & -1026 \\ 23 & 206 & -22 & -1026 \\ 4 & 33 & -4 & -171 \\ 3 & 27 & -3 & -134 \end{bmatrix}$$

$$m = 58$$

$$\begin{bmatrix} 32 & 261 & 0 & -1392 \\ 29 & 242 & 0 & -1276 \\ 0 & 0 & 1 & 0 \\ 4 & 33 & 0 & -175 \end{bmatrix}$$

$$m = 59$$

$$\begin{bmatrix} 17 & 105 & -1 & -325 \\ 9 & 59 & 0 & -177 \\ 3 & 20 & -1 & -60 \\ 3 & 19 & 0 & -58 \end{bmatrix}$$

$$m = 65$$

$$\begin{bmatrix} 13 & 125 & 0 & -650 \\ 5 & 52 & 0 & -260 \\ 0 & 0 & 1 & 0 \\ 1 & 10 & 0 & -51 \end{bmatrix}$$

$$m = 66$$

$$\begin{bmatrix} 17 & 195 & -18 & -924 \\ 17 & 194 & -16 & -924 \\ 5 & 54 & -5 & -264 \\ 2 & 23 & -2 & -109 \end{bmatrix}$$

$$m = 69$$

$$\begin{bmatrix} 49 & 510 & -18 & -2622 \\ 13 & 133 & -4 & -690 \\ 4 & 39 & -2 & -207 \\ 3 & 31 & -1 & -160 \end{bmatrix}$$

$$m = 70$$

$$\begin{bmatrix} 17 & 153 & -18 & -840 \\ 17 & 152 & -16 & -840 \\ 3 & 24 & -3 & -140 \\ 2 & 18 & -2 & -99 \end{bmatrix}$$

$$m = 73$$

$$\begin{bmatrix} 73 & 841 & 0 & -4234 \\ 25 & 292 & 0 & -1460 \\ 0 & 0 & 1 & 0 \\ 5 & 58 & 0 & -291 \end{bmatrix}$$

$$m = 77$$

$$\begin{bmatrix} 11 & 63 & 0 & -462 \\ 7 & 44 & 0 & -308 \\ 0 & 0 & 1 & 0 \\ 1 & 6 & 0 & -43 \end{bmatrix}$$

$$m = 78$$

$$\begin{bmatrix} 82 & 1039 & -32 & -5148 \\ 25 & 313 & -10 & -1560 \\ 10 & 125 & -3 & -624 \\ 5 & 63 & -2 & -313 \end{bmatrix}$$

$$m = 82$$

$$\begin{bmatrix} 72 & 1027 & -24 & -4920 \\ 43 & 619 & -14 & -2952 \\ 12 & 171 & -3 & -820 \\ 6 & 86 & -2 & -411 \end{bmatrix}$$

$$m = 83$$

$$\begin{bmatrix} 27 & 93 & -1 & -457 \\ 25 & 83 & 0 & -415 \\ 10 & 33 & -1 & -166 \\ 5 & 17 & 0 & -84 \end{bmatrix}$$

$$m = 85$$

$$\begin{bmatrix} 71 & 811 & -22 & -4420 \\ 11 & 124 & -4 & -680 \\ 4 & 48 & -2 & -255 \\ 3 & 34 & -1 & -186 \end{bmatrix}$$

$$m = 91$$

$$\begin{bmatrix} 5 & 41 & 1 & -136 \\ 5 & 41 & -1 & -137 \\ 1 & 11 & 0 & -32 \\ 1 & 8 & 0 & -27 \end{bmatrix}$$

$$m = 93$$

$$\begin{bmatrix} 48 & 775 & 0 & -3720 \\ 31 & 507 & 0 & -2418 \\ 0 & 0 & 1 & 0 \\ 4 & 65 & 0 & -311 \end{bmatrix}$$

$$m = 97$$

$$\begin{bmatrix} 53 & 733 & -14 & -3880 \\ 32 & 437 & -8 & -2328 \\ 12 & 164 & -4 & -873 \\ 4 & 55 & -1 & -292 \end{bmatrix}$$

$$m = 102$$

$$\begin{bmatrix} 41 & 641 & -26 & -3264 \\ 23 & 362 & -16 & -1836 \\ 5 & 82 & -3 & -408 \\ 3 & 47 & -2 & -239 \end{bmatrix}$$

$$m = 105$$

$$\begin{bmatrix} 11 & 156 & -12 & -840 \\ 11 & 155 & -10 & -840 \\ 4 & 60 & -4 & -315 \\ 1 & 14 & -1 & -76 \end{bmatrix}$$

$$m = 107$$

$$\begin{bmatrix} 27 & 121 & -11 & -594 \\ 25 & 108 & -10 & -540 \\ 0 & 0 & -1 & 0 \\ 5 & 22 & -2 & -109 \end{bmatrix}$$

$$m = 114$$

$$\begin{bmatrix} 24 & 475 & 0 & -2280 \\ 19 & 384 & 0 & -1824 \\ 0 & 0 & 1 & 0 \\ 2 & 40 & 0 & -191 \end{bmatrix}$$

$$m = 115$$

$$\begin{bmatrix} 7 & 37 & -1 & -173 \\ 5 & 23 & 0 & -115 \\ 2 & 9 & -1 & -46 \\ 1 & 5 & 0 & -24 \end{bmatrix}$$

$$m = 123$$

$$\begin{bmatrix} 37 & 187 & -1 & -923 \\ 25 & 123 & 0 & -615 \\ 10 & 49 & -1 & -246 \\ 5 & 25 & 0 & -124 \end{bmatrix}$$

$$m = 130$$

$$\begin{bmatrix} 23 & 368 & -24 & -2080 \\ 23 & 367 & -22 & -2080 \\ 3 & 44 & -3 & -260 \\ 2 & 32 & -2 & -181 \end{bmatrix}$$

$$m = 133$$

$$\begin{bmatrix} 19 & 448 & 0 & -2128 \\ 7 & 171 & 0 & -798 \\ 0 & 0 & 1 & 0 \\ 1 & 24 & 0 & -113 \end{bmatrix}$$

$$m = 138$$

$$\begin{bmatrix} 54 & 1127 & 0 & -5796 \\ 23 & 486 & 0 & -2484 \\ 0 & 0 & 1 & 0 \\ 3 & 63 & 0 & -323 \end{bmatrix}$$

$$m = 139$$

$$\begin{bmatrix} 47 & 539 & 1 & -1876 \\ 47 & 539 & -1 & -1877 \\ 19 & 221 & 0 & -764 \\ 7 & 80 & 0 & -279 \end{bmatrix}$$

$$m = 141$$

$$\begin{bmatrix} 215 & 5079 & -18 & -24816 \\ 83 & 1964 & -8 & -9588 \\ 28 & 666 & -2 & -3243 \\ 11 & 260 & -1 & -1270 \end{bmatrix}$$

$$m = 142$$

$$\begin{bmatrix} 169 & 446 & -32 & -6532 \\ 103 & 271 & -18 & -3976 \\ 15 & 38 & -3 & -568 \\ 11 & 29 & -2 & -425 \end{bmatrix}$$

$$m = 145$$

$$\begin{bmatrix} 17 & 217 & -16 & -1450 \\ 10 & 133 & -10 & -870 \\ 5 & 66 & -4 & -435 \\ 1 & 13 & -1 & -86 \end{bmatrix}$$

$$m = 154$$

$$\begin{bmatrix} 14 & 275 & 0 & -1540 \\ 11 & 224 & 0 & -1232 \\ 0 & 0 & 1 & 0 \\ 1 & 20 & 0 & -111 \end{bmatrix}$$

$$m = 155$$

$$\begin{bmatrix} 19 & 51 & 1 & -387 \\ 19 & 51 & -1 & -388 \\ 2 & 7 & 0 & -47 \\ 3 & 8 & 0 & -61 \end{bmatrix}$$

$$m = 165$$

$$\begin{bmatrix} 33 & 845 & 0 & -4290 \\ 5 & 132 & 0 & -660 \\ 0 & 0 & 1 & 0 \\ 1 & 26 & 0 & -131 \end{bmatrix}$$

$$m = 177$$

$$\begin{bmatrix} 31 & 967 & -16 & -4602 \\ 24 & 739 & -12 & -3540 \\ 6 & 185 & -4 & -885 \\ 2 & 62 & -1 & -296 \end{bmatrix}$$

$$m = 187$$

$$\begin{bmatrix} 29 & 79 & -1 & -655 \\ 17 & 44 & 0 & -374 \\ 7 & 18 & -1 & -154 \\ 3 & 8 & 0 & -67 \end{bmatrix}$$

$$m = 190$$

$$\begin{bmatrix} 38 & 1125 & 0 & -5700 \\ 5 & 152 & 0 & -760 \\ 0 & 0 & 1 & 0 \\ 1 & 30 & 0 & -151 \end{bmatrix}$$

$$m = 193$$

$$\begin{bmatrix} 277 & 10048 & -128 & -46320 \\ 157 & 5693 & -74 & -26248 \\ 8 & 296 & -4 & -1351 \\ 15 & 544 & -7 & -2508 \end{bmatrix}$$

$$m = 195$$

$$\begin{bmatrix} 17 & 347 & -1 & -1073 \\ 3 & 65 & 0 & -195 \\ 1 & 22 & -1 & -66 \\ 1 & 21 & 0 & -64 \end{bmatrix}$$

$$m = 203$$

$$\begin{bmatrix} 57 & 471 & -1 & -2335 \\ 25 & 203 & 0 & -1015 \\ 10 & 81 & -1 & -406 \\ 5 & 41 & 0 & -204 \end{bmatrix}$$

$$m = 205$$

$$\begin{bmatrix} 115 & 4108 & -20 & -19680 \\ 72 & 2563 & -12 & -12300 \\ 30 & 1068 & -6 & -5125 \\ 6 & 214 & -1 & -1026 \end{bmatrix}$$

$$m = 210$$

$$\begin{bmatrix} 47 & 887 & -46 & -5880 \\ 20 & 383 & -20 & -2520 \\ 10 & 191 & -9 & -1260 \\ 2 & 38 & -2 & -251 \end{bmatrix}$$

$$m = 211$$

$$\begin{bmatrix} 65 & 1111 & -1 & -3904 \\ 49 & 844 & 0 & -2954 \\ 21 & 362 & -1 & -1267 \\ 7 & 120 & 0 & -421 \end{bmatrix}$$

$$m = 213$$

$$\begin{bmatrix} 83 & 314 & -34 & -4686 \\ 75 & 287 & -30 & -4260 \\ 30 & 115 & -13 & -1704 \\ 5 & 19 & -2 & -283 \end{bmatrix}$$

$$m = 217$$

$$\begin{bmatrix} 113 & 2221 & -22 & -14756 \\ 50 & 977 & -10 & -6510 \\ 15 & 293 & -2 & -1953 \\ 5 & 98 & -1 & -652 \end{bmatrix}$$

$$m = 219$$

$$\begin{bmatrix} 48 & 895 & -12 & -3072 \\ 19 & 349 & -5 & -1207 \\ 4 & 75 & -2 & -257 \\ 4 & 74 & -1 & -255 \end{bmatrix}$$

$$m = 235$$

$$\begin{bmatrix} 20 & 107 & -10 & -710 \\ 13 & 73 & -6 & -473 \\ 4 & 21 & -1 & -141 \\ 2 & 11 & -1 & -72 \end{bmatrix}$$

$$m = 238$$

$$\begin{bmatrix} 127 & 2711 & -50 & -18088 \\ 50 & 1073 & -20 & -7140 \\ 20 & 429 & -7 & -2856 \\ 5 & 107 & -2 & -713 \end{bmatrix}$$

$$m = 253$$

$$\begin{bmatrix} 17 & 734 & -18 & -3542 \\ 17 & 733 & -16 & -3542 \\ 6 & 265 & -6 & -1265 \\ 1 & 43 & -1 & -208 \end{bmatrix}$$

$$m = 258$$

$$\begin{bmatrix} 97 & 4696 & -40 & -21672 \\ 67 & 3241 & -26 & -14964 \\ 7 & 332 & -3 & -1548 \\ 5 & 242 & -2 & -1117 \end{bmatrix}$$

$$m = 259$$

$$\begin{bmatrix} 25 & 935 & 1 & -2460 \\ 25 & 935 & -1 & -2461 \\ 5 & 193 & 0 & -500 \\ 3 & 112 & 0 & -295 \end{bmatrix}$$

$$m = 265$$

$$\begin{bmatrix} 53 & 245 & 0 & -3710 \\ 45 & 212 & 0 & -3180 \\ 0 & 0 & 1 & 0 \\ 3 & 14 & 0 & -211 \end{bmatrix}$$

$$m = 267$$

$$\begin{bmatrix} 29 & 389 & -1 & -1736 \\ 27 & 356 & 0 & -1602 \\ 12 & 158 & -1 & -712 \\ 3 & 40 & 0 & -179 \end{bmatrix}$$

$$m = 273$$

$$\begin{bmatrix} 39 & 847 & 0 & -6006 \\ 7 & 156 & 0 & -1092 \\ 0 & 0 & 1 & 0 \\ 1 & 22 & 0 & -155 \end{bmatrix}$$

$$m = 282$$

$$\begin{bmatrix} 108 & 2353 & -36 & -16920 \\ 97 & 2122 & -32 & -15228 \\ 18 & 392 & -5 & -2820 \\ 6 & 131 & -2 & -941 \end{bmatrix}$$

$$m = 283$$

$$\begin{bmatrix} 883 & 44473 & -81 & -105458 \\ 83 & 4177 & -8 & -9909 \\ 13 & 659 & -2 & -1558 \\ 32 & 1611 & -3 & -3821 \end{bmatrix}$$

$$m = 285$$

$$\begin{bmatrix} 77 & 4280 & -20 & -19380 \\ 68 & 3773 & -16 & -17100 \\ 26 & 1450 & -6 & -6555 \\ 4 & 222 & -1 & -1006 \end{bmatrix}$$

$$m = 291$$

$$\begin{bmatrix} 27 & 607 & -9 & -2187 \\ 25 & 571 & -8 & -2041 \\ 3 & 67 & 0 & -242 \\ 3 & 68 & -1 & -244 \end{bmatrix}$$

$$m = 301$$

$$\begin{bmatrix} 142 & 365 & -62 & -7826 \\ 109 & 281 & -46 & -6020 \\ 27 & 71 & -12 & -1505 \\ 7 & 18 & -3 & -386 \end{bmatrix}$$

$$m = 307$$

$$\begin{bmatrix} 697 & 1133 & -298 & -15499 \\ 49 & 79 & -21 & -1085 \\ 7 & 11 & -2 & -154 \\ 21 & 34 & -9 & -466 \end{bmatrix}$$

$$m = 310$$

$$\begin{bmatrix} 107 & 2612 & -44 & -18600 \\ 82 & 2003 & -32 & -14260 \\ 32 & 786 & -13 & -5580 \\ 5 & 122 & -2 & -869 \end{bmatrix}$$

$$m = 322$$

$$\begin{bmatrix} 148 & 149 & -76 & -5152 \\ 37 & 37 & -18 & -1288 \\ 18 & 19 & -9 & -644 \\ 4 & 4 & -2 & -139 \end{bmatrix}$$

$$m = 323$$

$$\begin{bmatrix} 9 & 577 & -10 & -1297 \\ 9 & 576 & -8 & -1296 \\ 0 & 8 & 0 & -9 \\ 1 & 64 & -1 & -144 \end{bmatrix}$$

$$m = 330$$

$$\begin{bmatrix} 206 & 369 & -84 & -9900 \\ 41 & 74 & -16 & -1980 \\ 14 & 24 & -5 & -660 \\ 5 & 9 & -2 & -241 \end{bmatrix}$$

$$m = 331$$

$$\begin{bmatrix} 89 & 5092 & -14 & -12254 \\ 36 & 2069 & -6 & -4968 \\ 12 & 690 & -1 & -1656 \\ 6 & 344 & -1 & -827 \end{bmatrix}$$

$$m = 345$$

$$\begin{bmatrix} 37 & 1137 & -36 & -7590 \\ 10 & 313 & -10 & -2070 \\ 5 & 156 & -4 & -1035 \\ 1 & 31 & -1 & -206 \end{bmatrix}$$

$$m = 355$$

$$\begin{bmatrix} 20 & 1439 & -10 & -3200 \\ 19 & 1351 & -9 & -3022 \\ 4 & 288 & -1 & -640 \\ 2 & 143 & -1 & -319 \end{bmatrix}$$

$$m = 357$$

$$\begin{bmatrix} 19 & 475 & -20 & -3570 \\ 19 & 474 & -18 & -3570 \\ 2 & 45 & -2 & -357 \\ 1 & 25 & -1 & -188 \end{bmatrix}$$

$$m = 379$$

$$\begin{bmatrix} 101 & 6620 & -16 & -15926 \\ 36 & 2369 & -6 & -5688 \\ 12 & 790 & -1 & -1896 \\ 6 & 394 & -1 & -947 \end{bmatrix}$$

$$m = 385$$

$$\begin{bmatrix} 44 & 875 & 0 & -7700 \\ 35 & 704 & 0 & -6160 \\ 0 & 0 & 1 & 0 \\ 2 & 40 & 0 & -351 \end{bmatrix}$$

$$m = 390$$

$$\begin{bmatrix} 213 & 2933 & -54 & -31200 \\ 128 & 1757 & -32 & -18720 \\ 48 & 659 & -13 & -7020 \\ 8 & 110 & -2 & -1171 \end{bmatrix}$$

$$m = 418$$

$$\begin{bmatrix} 176 & 3811 & -88 & -33440 \\ 163 & 3521 & -82 & -30932 \\ 44 & 953 & -23 & -8360 \\ 8 & 173 & -4 & -1519 \end{bmatrix}$$

$$m = 429$$

$$\begin{bmatrix} 208 & 6481 & -104 & -48048 \\ 145 & 4509 & -72 & -33462 \\ 52 & 1620 & -25 & -12012 \\ 8 & 249 & -4 & -1847 \end{bmatrix}$$

$$m = 435$$

$$\begin{bmatrix} 11 & 89 & 1 & -652 \\ 11 & 89 & -1 & -653 \\ 3 & 27 & 0 & -188 \\ 1 & 8 & 0 & -59 \end{bmatrix}$$

$$m = 438$$

$$\begin{bmatrix} 11 & 89 & 1 & -652 \\ 11 & 89 & -1 & -653 \\ 3 & 27 & 0 & -188 \\ 1 & 8 & 0 & -59 \end{bmatrix}$$

$$m = 442$$

$$\begin{bmatrix} 344 & 631 & -112 & -19448 \\ 47 & 86 & -16 & -2652 \\ 16 & 28 & -5 & -884 \\ 6 & 11 & -2 & -339 \end{bmatrix}$$

$$m = 445$$

$$\begin{bmatrix} 107 & 268 & -28 & -7120 \\ 67 & 167 & -16 & -4450 \\ 7 & 16 & -2 & -445 \\ 4 & 10 & -1 & -266 \end{bmatrix}$$

$$m = 462$$

$$\begin{bmatrix} 647 & 25529 & -238 & -174636 \\ 89 & 3512 & -32 & -24024 \\ 41 & 1624 & -15 & -11088 \\ 11 & 434 & -4 & -2969 \end{bmatrix}$$

$$m = 465$$

$$\begin{bmatrix} 125 & 377 & -50 & -9300 \\ 113 & 338 & -46 & -8370 \\ 50 & 151 & -21 & -3720 \\ 5 & 15 & -2 & -371 \end{bmatrix}$$

$$m = 483$$

$$\begin{bmatrix} 492 & 1225 & -210 & -17010 \\ 49 & 123 & -21 & -1701 \\ 14 & 35 & -5 & -486 \\ 14 & 35 & -6 & -485 \end{bmatrix}$$

$$m = 498$$

$$\begin{bmatrix} 257 & 11499 & -102 & -76692 \\ 50 & 2243 & -20 & -14940 \\ 20 & 897 & -7 & -5976 \\ 5 & 224 & -2 & -1493 \end{bmatrix}$$

$$m = 499$$

$$\begin{bmatrix} 508 & 20663 & -146 & -72428 \\ 49 & 1997 & -14 & -6993 \\ 14 & 571 & -5 & -1999 \\ 14 & 570 & -4 & -1997 \end{bmatrix}$$

$$m = 505$$

$$\begin{bmatrix} 242 & 4257 & -174 & -45450 \\ 113 & 1985 & -80 & -21210 \\ 51 & 900 & -36 & -9595 \\ 7 & 123 & -5 & -1314 \end{bmatrix}$$

$$m = 510$$

$$\begin{bmatrix} 227 & 653 & -58 & -17340 \\ 147 & 422 & -36 & -11220 \\ 27 & 76 & -7 & -2040 \\ 8 & 23 & -2 & -611 \end{bmatrix}$$

$$m = 547$$

$$\begin{bmatrix} 556 & 961 & -186 & -17050 \\ 81 & 139 & -27 & -2475 \\ 18 & 31 & -7 & -550 \\ 18 & 31 & -6 & -551 \end{bmatrix}$$

$$m = 553$$

$$\begin{bmatrix} 284 & 3787 & -140 & -48664 \\ 71 & 947 & -36 & -12166 \\ 16 & 217 & -8 & -2765 \\ 6 & 80 & -3 & -1028 \end{bmatrix}$$

$$m = 555$$

$$\begin{bmatrix} 97 & 325 & -35 & -4180 \\ 13 & 43 & -4 & -557 \\ 2 & 5 & -1 & -75 \\ 3 & 10 & -1 & -129 \end{bmatrix}$$

$$m = 561$$

$$\begin{bmatrix} 100 & 1101 & -24 & -15708 \\ 93 & 1021 & -24 & -14586 \\ 18 & 195 & -4 & -2805 \\ 4 & 44 & -1 & -628 \end{bmatrix}$$

$$m = 570$$

$$\begin{bmatrix} 152 & 375 & 0 & -11400 \\ 15 & 38 & 0 & -1140 \\ 0 & 0 & 1 & 0 \\ 2 & 5 & 0 & -151 \end{bmatrix}$$

$$m = 595$$

$$\begin{bmatrix} 23 & 1093 & -1 & -3868 \\ 7 & 340 & 0 & -1190 \\ 3 & 146 & -1 & -511 \\ 1 & 48 & 0 & -169 \end{bmatrix}$$

$$m = 598$$

$$\begin{bmatrix} 46 & 637 & 0 & -8372 \\ 13 & 184 & 0 & -2392 \\ 0 & 0 & 1 & 0 \\ 1 & 14 & 0 & -183 \end{bmatrix}$$

$$m = 609$$

$$\begin{bmatrix} 25 & 226 & -26 & -3654 \\ 25 & 225 & -24 & -3654 \\ 4 & 39 & -4 & -609 \\ 1 & 9 & -1 & -146 \end{bmatrix}$$

$$m = 627$$

$$\begin{bmatrix} 241 & 547 & -1 & -9092 \\ 33 & 76 & 0 & -1254 \\ 13 & 30 & -1 & -495 \\ 7 & 16 & 0 & -265 \end{bmatrix}$$

$$m = 643$$

$$\begin{bmatrix} 173 & 9107 & -1 & -31829 \\ 49 & 2572 & 0 & -9002 \\ 21 & 1102 & -1 & -3858 \\ 7 & 368 & 0 & -1287 \end{bmatrix}$$

$$m = 645$$

$$\begin{bmatrix} 367 & 4063 & -142 & -61920 \\ 298 & 3303 & -114 & -50310 \\ 19 & 213 & -8 & -3225 \\ 13 & 144 & -5 & -2194 \end{bmatrix}$$

$$m = 651$$

$$\begin{bmatrix} 55 & 145 & -1 & -2279 \\ 31 & 84 & 0 & -1302 \\ 14 & 38 & -1 & -589 \\ 3 & 8 & 0 & -125 \end{bmatrix}$$

$$m = 658$$

$$\begin{bmatrix} 47 & 1400 & 0 & -13160 \\ 14 & 423 & 0 & -3948 \\ 0 & 0 & 1 & 0 \\ 1 & 30 & 0 & -281 \end{bmatrix}$$

$$m = 667$$

$$\begin{bmatrix} 151 & 487 & -1 & -7004 \\ 29 & 92 & 0 & -1334 \\ 12 & 38 & -1 & -552 \\ 5 & 16 & 0 & -231 \end{bmatrix}$$

$$m = 690$$

$$\begin{bmatrix} 347 & 3200 & -160 & -55200 \\ 338 & 3123 & -156 & -53820 \\ 26 & 240 & -11 & -4140 \\ 13 & 120 & -6 & -2069 \end{bmatrix}$$

$$m = 697$$

$$\begin{bmatrix} 97 & 725 & -50 & -13940 \\ 29 & 218 & -14 & -4182 \\ 5 & 35 & -2 & -697 \\ 2 & 15 & -1 & -288 \end{bmatrix}$$

$$m = 715$$

$$\begin{bmatrix} 187 & 268 & -132 & -5786 \\ 47 & 67 & -34 & -1447 \\ 2 & 4 & -2 & -73 \\ 7 & 10 & -5 & -216 \end{bmatrix}$$

$$m = 723$$

$$\begin{bmatrix} 79 & 1009 & -1 & -7592 \\ 75 & 964 & 0 & -7230 \\ 35 & 450 & -1 & -3375 \\ 5 & 64 & 0 & -481 \end{bmatrix}$$

$$m = 742$$

$$\begin{bmatrix} 109 & 1163 & -74 & -19292 \\ 67 & 716 & -44 & -11872 \\ 25 & 270 & -17 & -4452 \\ 3 & 32 & -2 & -531 \end{bmatrix}$$

$$m = 763$$

$$\begin{bmatrix} 239 & 387 & -183 & -8103 \\ 137 & 221 & -106 & -4631 \\ 16 & 27 & -13 & -552 \\ 13 & 21 & -10 & -440 \end{bmatrix}$$

$$m = 777$$

$$\begin{bmatrix} 338 & 533 & -146 & -23310 \\ 113 & 177 & -48 & -7770 \\ 11 & 18 & -4 & -777 \\ 7 & 11 & -3 & -482 \end{bmatrix}$$

$$m = 793$$

$$\begin{bmatrix} 333 & 557 & -168 & -23790 \\ 89 & 148 & -44 & -6344 \\ 33 & 56 & -16 & -2379 \\ 6 & 10 & -3 & -428 \end{bmatrix}$$

$$m = 795$$

$$\begin{bmatrix} 197 & 227 & -1 & -5963 \\ 53 & 60 & 0 & -1590 \\ 23 & 26 & -1 & -690 \\ 7 & 8 & 0 & -211 \end{bmatrix}$$

$$m = 798$$

$$\begin{bmatrix} 242 & 4559 & -208 & -59052 \\ 183 & 3452 & -156 & -44688 \\ 72 & 1354 & -61 & -17556 \\ 7 & 132 & -6 & -1709 \end{bmatrix}$$

$$m = 805$$

$$\begin{bmatrix} 140 & 207 & 0 & -9660 \\ 23 & 35 & 0 & -1610 \\ 0 & 0 & 1 & 0 \\ 2 & 3 & 0 & -139 \end{bmatrix}$$

$$m = 858$$

$$\begin{bmatrix} 323 & 6414 & -216 & -84084 \\ 99 & 1961 & -66 & -25740 \\ 33 & 654 & -23 & -8580 \\ 6 & 119 & -4 & -1561 \end{bmatrix}$$

$$m = 870$$

$$\begin{bmatrix} 118 & 3265 & -80 & -36540 \\ 73 & 2022 & -48 & -22620 \\ 28 & 780 & -19 & -8700 \\ 3 & 83 & -2 & -929 \end{bmatrix}$$

$$m = 883$$

$$\begin{bmatrix} 223 & 7877 & -179 & -39383 \\ 25 & 887 & -20 & -4425 \\ 5 & 178 & -5 & -886 \\ 5 & 177 & -4 & -884 \end{bmatrix}$$

$$m = 897$$

$$\begin{bmatrix} 31 & 124 & -32 & -3588 \\ 31 & 123 & -30 & -3588 \\ 8 & 30 & -8 & -897 \\ 1 & 4 & -1 & -116 \end{bmatrix}$$

$$m = 907$$

$$\begin{bmatrix} 239 & 7199 & -131 & -39520 \\ 121 & 3637 & -66 & -19987 \\ 33 & 992 & -19 & -5451 \\ 11 & 331 & -6 & -1818 \end{bmatrix}$$

$$m = 910$$

$$\begin{bmatrix} 35 & 416 & 0 & -7280 \\ 26 & 315 & 0 & -5460 \\ 0 & 0 & 1 & 0 \\ 1 & 12 & 0 & -209 \end{bmatrix}$$

$$m = 915$$

$$\begin{bmatrix} 141 & 301 & -123 & -6009 \\ 109 & 231 & -96 & -4623 \\ 23 & 50 & -21 & -986 \\ 8 & 17 & -7 & -340 \end{bmatrix}$$

$$m = 955$$

$$\begin{bmatrix} 109 & 5056 & -64 & -22952 \\ 59 & 2741 & -36 & -12433 \\ 19 & 888 & -11 & -4016 \\ 5 & 232 & -3 & -1053 \end{bmatrix}$$

$$m = 957$$

$$\begin{bmatrix} 232 & 427 & -116 & -19140 \\ 163 & 298 & -82 & -13398 \\ 58 & 107 & -30 & -4785 \\ 6 & 11 & -3 & -494 \end{bmatrix}$$

$$m = 987$$

$$\begin{bmatrix} 331 & 564 & -282 & -12972 \\ 319 & 541 & -271 & -12473 \\ 73 & 124 & -63 & -2852 \\ 20 & 34 & -17 & -783 \end{bmatrix}$$

$$m = 1003$$

$$\begin{bmatrix} 239 & 341 & -32 & -9043 \\ 53 & 76 & -8 & -2010 \\ 16 & 24 & -2 & -621 \\ 7 & 10 & -1 & -265 \end{bmatrix}$$

$$m = 1005$$

$$\begin{bmatrix} 164 & 4145 & -40 & -52260 \\ 101 & 2549 & -26 & -32160 \\ 22 & 560 & -6 & -7035 \\ 4 & 101 & -1 & -1274 \end{bmatrix}$$

$$m = 1027$$

$$\begin{bmatrix} 49 & 131 & 1 & -2567 \\ 49 & 131 & -1 & -2568 \\ 8 & 23 & 0 & -435 \\ 3 & 8 & 0 & -157 \end{bmatrix}$$

$$m = 1045$$

$$\begin{bmatrix} 278 & 317 & -118 & -18810 \\ 185 & 212 & -80 & -12540 \\ 15 & 18 & -6 & -1045 \\ 7 & 8 & -3 & -474 \end{bmatrix}$$

$$m = 1065$$

$$\begin{bmatrix} 387 & 643 & -192 & -31950 \\ 103 & 172 & -52 & -8520 \\ 39 & 64 & -20 & -3195 \\ 6 & 10 & -3 & -496 \end{bmatrix}$$

$$m = 1105$$

$$\begin{bmatrix} 293 & 353 & -236 & -19890 \\ 98 & 117 & -78 & -6630 \\ 33 & 39 & -27 & -2210 \\ 5 & 6 & -4 & -339 \end{bmatrix}$$

$$m = 1110$$

$$\begin{bmatrix} 335 & 3201 & -150 & -68820 \\ 281 & 2684 & -124 & -57720 \\ 65 & 618 & -29 & -13320 \\ 9 & 86 & -4 & -1849 \end{bmatrix}$$

$$m = 1113$$

$$\begin{bmatrix} 148 & 3661 & -112 & -48972 \\ 121 & 2997 & -90 & -40068 \\ 10 & 252 & -8 & -3339 \\ 4 & 99 & -3 & -1324 \end{bmatrix}$$

$$m = 1122$$

$$\begin{bmatrix} 73 & 403 & -74 & -11220 \\ 73 & 402 & -72 & -11220 \\ 29 & 162 & -29 & -4488 \\ 2 & 11 & -2 & -307 \end{bmatrix}$$

$$m = 1131$$

$$\begin{bmatrix} 155 & 309 & -21 & -7362 \\ 95 & 191 & -14 & -4531 \\ 26 & 53 & -3 & -1249 \\ 7 & 14 & -1 & -333 \end{bmatrix}$$

$$m = 1155$$

$$\begin{bmatrix} 491 & 1619 & -419 & -29662 \\ 29 & 95 & -25 & -1745 \\ 6 & 21 & -6 & -371 \\ 7 & 23 & -6 & -422 \end{bmatrix}$$

$$m = 1185$$

$$\begin{bmatrix} 557 & 5792 & -296 & -123240 \\ 482 & 5013 & -258 & -106650 \\ 43 & 444 & -23 & -9480 \\ 15 & 156 & -8 & -3319 \end{bmatrix}$$

$$m = 1227$$

$$\begin{bmatrix} 412 & 1587 & -138 & -28290 \\ 27 & 103 & -9 & -1845 \\ 6 & 23 & -3 & -410 \\ 6 & 23 & -2 & -411 \end{bmatrix}$$

$$m = 1243$$

$$\begin{bmatrix} 212 & 389 & -108 & -9998 \\ 53 & 97 & -26 & -2499 \\ 4 & 6 & -2 & -171 \\ 6 & 11 & -3 & -283 \end{bmatrix}$$

$$m = 1290$$

$$\begin{bmatrix} 384 & 5429 & -288 & -103200 \\ 221 & 3119 & -166 & -59340 \\ 48 & 679 & -37 & -12900 \\ 8 & 113 & -6 & -2149 \end{bmatrix}$$

$$m = 1302$$

$$\begin{bmatrix} 166 & 4921 & -112 & -65100 \\ 73 & 2166 & -48 & -28644 \\ 20 & 588 & -13 & -7812 \\ 3 & 89 & -2 & -1177 \end{bmatrix}$$

$$m = 1353$$

$$\begin{bmatrix} 167 & 2967 & -168 & -51414 \\ 167 & 2966 & -166 & -51414 \\ 79 & 1407 & -79 & -24354 \\ 4 & 71 & -4 & -1231 \end{bmatrix}$$

$$m = 1365$$

$$\begin{bmatrix} 1949 & 2441 & -814 & -158340 \\ 101 & 126 & -42 & -8190 \\ 17 & 21 & -8 & -1365 \\ 12 & 15 & -5 & -974 \end{bmatrix}$$

$$m = 1387$$

$$\begin{bmatrix} 137 & 368 & -44 & -8344 \\ 23 & 61 & -8 & -1391 \\ 4 & 12 & -2 & -257 \\ 3 & 8 & -1 & -182 \end{bmatrix}$$

$$m = 1411$$

$$\begin{bmatrix} 25 & 127 & -1 & -2117 \\ 17 & 83 & 0 & -1411 \\ 8 & 39 & -1 & -664 \\ 1 & 5 & 0 & -84 \end{bmatrix}$$

$$m = 1435$$

$$\begin{bmatrix} 171 & 685 & -60 & -12945 \\ 19 & 76 & -6 & -1438 \\ 3 & 14 & -1 & -246 \\ 3 & 12 & -1 & -227 \end{bmatrix}$$

$$m = 1443$$

$$\begin{bmatrix} 373 & 4783 & -256 & -50633 \\ 256 & 3277 & -176 & -34720 \\ 48 & 614 & -32 & -6509 \\ 16 & 205 & -11 & -2171 \end{bmatrix}$$

$$m = 1507$$

$$\begin{bmatrix} 257 & 311 & -156 & -10627 \\ 37 & 44 & -22 & -1518 \\ 7 & 8 & -5 & -277 \\ 5 & 6 & -3 & -206 \end{bmatrix}$$

$$m = 1555$$

$$\begin{bmatrix} 720 & 28099 & -300 & -177420 \\ 79 & 3079 & -33 & -19454 \\ 24 & 937 & -11 & -5915 \\ 12 & 468 & -5 & -2956 \end{bmatrix}$$

$$m = 1635$$

$$\begin{bmatrix} 332 & 605 & -110 & -18040 \\ 45 & 83 & -15 & -2460 \\ 12 & 22 & -3 & -656 \\ 6 & 11 & -2 & -327 \end{bmatrix}$$

$$m = 1645$$

$$\begin{bmatrix} 47 & 560 & 0 & -13160 \\ 35 & 423 & 0 & -9870 \\ 0 & 0 & 1 & 0 \\ 1 & 12 & 0 & -281 \end{bmatrix}$$

$$m = 1659$$

$$\begin{bmatrix} 151 & 400 & -52 & -9980 \\ 25 & 67 & -8 & -1663 \\ 5 & 12 & -1 & -316 \\ 3 & 8 & -1 & -199 \end{bmatrix}$$

$$m = 1771$$

$$\begin{bmatrix} 431 & 557 & -153 & -20443 \\ 337 & 436 & -118 & -15998 \\ 123 & 158 & -43 & -5818 \\ 17 & 22 & -6 & -807 \end{bmatrix}$$

$$m = 1785$$

$$\begin{bmatrix} 172 & 2667 & -84 & -57120 \\ 43 & 667 & -22 & -14280 \\ 16 & 252 & -8 & -5355 \\ 2 & 31 & -1 & -664 \end{bmatrix}$$

$$m = 1947$$

$$\begin{bmatrix} 269 & 537 & -123 & -16611 \\ 221 & 443 & -100 & -13679 \\ 18 & 37 & -9 & -1126 \\ 11 & 22 & -5 & -680 \end{bmatrix}$$

$$m = 1995$$

$$\begin{bmatrix} 1165 & 1797 & -450 & -64065 \\ 73 & 112 & -28 & -4004 \\ 21 & 32 & -9 & -1145 \\ 13 & 20 & -5 & -714 \end{bmatrix}$$

$$m = 2035$$

$$\begin{bmatrix} 97 & 257 & -1 & -7123 \\ 55 & 148 & 0 & -4070 \\ 26 & 70 & -1 & -1925 \\ 3 & 8 & 0 & -221 \end{bmatrix}$$

$$m = 2067$$

$$\begin{bmatrix} 257 & 419 & -160 & -14549 \\ 129 & 209 & -81 & -7275 \\ 5 & 9 & -4 & -294 \\ 8 & 13 & -5 & -452 \end{bmatrix}$$

$$m = 2139$$

$$\begin{bmatrix} 348 & 349 & -258 & -15102 \\ 25 & 25 & -19 & -1079 \\ 10 & 11 & -8 & -453 \\ 4 & 4 & -3 & -173 \end{bmatrix}$$

$$m = 2145$$

$$\begin{bmatrix} 367 & 588 & -72 & -42900 \\ 147 & 235 & -30 & -17160 \\ 18 & 30 & -4 & -2145 \\ 5 & 8 & -1 & -584 \end{bmatrix}$$

$$m = 2163$$

$$\begin{bmatrix} 31 & 157 & -1 & -3245 \\ 21 & 103 & 0 & -2163 \\ 10 & 49 & -1 & -1030 \\ 1 & 5 & 0 & -104 \end{bmatrix}$$

$$m = 2310$$

$$\begin{bmatrix} 223 & 5505 & -150 & -106260 \\ 97 & 2392 & -64 & -46200 \\ 29 & 720 & -19 & -13860 \\ 3 & 74 & -2 & -1429 \end{bmatrix}$$

$$m = 2379$$

$$\begin{bmatrix} 205 & 235 & -1 & -10706 \\ 183 & 208 & 0 & -9516 \\ 88 & 100 & -1 & -4576 \\ 7 & 8 & 0 & -365 \end{bmatrix}$$

$$m = 2451$$

$$\begin{bmatrix} 25 & 1201 & 1 & -8578 \\ 25 & 1201 & -1 & -8579 \\ 3 & 151 & 0 & -1054 \\ 1 & 48 & 0 & -343 \end{bmatrix}$$

$$m = 2667$$

$$\begin{bmatrix} 79 & 211 & 1 & -6667 \\ 79 & 211 & -1 & -6668 \\ 14 & 39 & 0 & -1207 \\ 3 & 8 & 0 & -253 \end{bmatrix}$$

$$m = 2715$$

$$\begin{bmatrix} 229 & 5260 & -170 & -57100 \\ 49 & 1129 & -37 & -12236 \\ 17 & 394 & -12 & -4259 \\ 4 & 92 & -3 & -998 \end{bmatrix}$$

$$m = 2755$$

$$\begin{bmatrix} 409 & 559 & -148 & -24869 \\ 205 & 279 & -75 & -12435 \\ 17 & 24 & -7 & -1048 \\ 11 & 15 & -4 & -668 \end{bmatrix}$$

$$m = 3003$$

$$\begin{bmatrix} 523 & 2427 & -522 & -60321 \\ 13 & 61 & -13 & -1508 \\ 5 & 23 & -4 & -580 \\ 3 & 14 & -3 & -347 \end{bmatrix}$$

$$m = 3243$$

$$\begin{bmatrix} 461 & 599 & -232 & -29303 \\ 179 & 233 & -89 & -11395 \\ 33 & 44 & -17 & -2124 \\ 10 & 13 & -5 & -636 \end{bmatrix}$$

$$m = 3315$$

$$\begin{bmatrix} 435 & 436 & -330 & -23370 \\ 31 & 31 & -23 & -1669 \\ 13 & 14 & -10 & -727 \\ 4 & 4 & -3 & -215 \end{bmatrix}$$

$$m = 3355$$

$$\begin{bmatrix} 79 & 3445 & -40 & -30215 \\ 44 & 1909 & -22 & -16786 \\ 10 & 434 & -6 & -3815 \\ 2 & 87 & -1 & -764 \end{bmatrix}$$

$$m = 3507$$

$$\begin{bmatrix} 293 & 4563 & -117 & -68445 \\ 75 & 1172 & -30 & -17550 \\ 5 & 78 & -1 & -1170 \\ 5 & 78 & -2 & -1169 \end{bmatrix}$$

$$m = 3795$$

$$\begin{bmatrix} 220 & 2929 & -110 & -49390 \\ 169 & 2256 & -84 & -37992 \\ 52 & 692 & -25 & -11673 \\ 6 & 80 & -3 & -1348 \end{bmatrix}$$

$$m = 4123$$

$$\begin{bmatrix} 97 & 3071 & 1 & -35045 \\ 97 & 3071 & -1 & -35046 \\ 10 & 311 & 0 & -3581 \\ 3 & 95 & 0 & -1084 \end{bmatrix}$$

$$m = 4323$$

$$\begin{bmatrix} 41 & 659 & -1 & -10808 \\ 33 & 524 & 0 & -8646 \\ 16 & 254 & -1 & -4192 \\ 1 & 16 & 0 & -263 \end{bmatrix}$$

$$m = 4515$$

$$\begin{bmatrix} 247 & 295 & -50 & -18085 \\ 123 & 148 & -24 & -9042 \\ 44 & 52 & -8 & -3207 \\ 5 & 6 & -1 & -367 \end{bmatrix}$$

$$m = 5115$$

$$\begin{bmatrix} 375 & 5471 & -150 & -102375 \\ 356 & 5201 & -142 & -97256 \\ 70 & 1021 & -27 & -19109 \\ 10 & 146 & -4 & -2731 \end{bmatrix}$$

$$m = 5187$$

$$\begin{bmatrix} 84 & 1549 & -42 & -25956 \\ 67 & 1243 & -34 & -20765 \\ 20 & 369 & -11 & -6180 \\ 2 & 37 & -1 & -619 \end{bmatrix}$$

$$m = 6195$$

$$\begin{bmatrix} 53 & 263 & -1 & -9293 \\ 35 & 177 & 0 & -6195 \\ 17 & 86 & -1 & -3010 \\ 1 & 5 & 0 & -176 \end{bmatrix}$$

$$m = 7035$$

$$\begin{bmatrix} 315 & 3251 & -210 & -84525 \\ 236 & 2441 & -158 & -63394 \\ 102 & 1053 & -69 & -27370 \\ 6 & 62 & -4 & -1611 \end{bmatrix}$$

Appendix E

Tables of vectors from the quadratic forms f_d^n

Table E.1: Results of Vinberg's algorithm applied to the quadratic form f_1^n ($n \leq 17$).
(c.f [70], Table 4).

i	e_i	(e, e)	n	$\frac{k_0^2}{(e, e)}$
$n + 1$	$v_0 + v_1 + v_2$	1	2	1
	$v_0 + v_1 + v_2 + v_3$	2	≥ 3	0.5
$n + 2$	$3v_0 + v_1 + \dots + v_{10}$	1	10	9
	$3v_0 + v_1 + \dots + v_{11}$	1	≥ 11	4.5
$n + 3$	$4v_0 + 2v_1 + v_2 + \dots + v_{14}$	1	14	16
	$4v_0 + 2v_1 + v_2 + \dots + v_{15}$	2	≥ 15	8
$n + 4$	$6v_0 + 2(v_1 + \dots + v_7) + v_8 + \dots + v_{16}$	1	16	36
	$4v_0 + v_1 + \dots + v_{17}$	2	≥ 17	16
$n + 5$	$6v_0 + 2(v_1 + \dots + v_7) + v_8 + \dots + v_{17}$	2	≥ 17	18

Table E.2: Results of Vinberg's algorithm applied to the quadratic form f_2^n . (c.f [70], Table 6).

i	e_i	(e, e)	n	$\frac{k_0^2}{(e, e)}$
$n + 1$	$v_0 + 2v_1$	2	≥ 1	0.5
$n + 2$	$v_0 + v_1 + v_2 + v_3$	1	3	1
	$v_0 + v_1 + v_2 + v_3 + v_4$	2	≥ 4	0.5
$n + 3$	$2v_0 + v_1 + v_2 + \dots + v_9$	1	9	4
	$2v_0 + v_1 + v_2 + \dots + v_{10}$	2	≥ 10	2
$n + 4$	$3(v_0 + v_1) + v_2 + \dots + v_{11}$	1	11	9
	$3(v_0 + v_1) + v_2 + \dots + v_{12}$	2	≥ 12	4.5
$n + 5$	$3v_0 + 2(v_1 + v_2) + v_3 + \dots + v_{13}$	1	13	9
	$3v_0 + 2(v_1 + v_2) + v_3 + \dots + v_{14}$	2	≥ 14	4.5
$n + 6$	$5v_0 + 2(v_1 + v_2 + \dots + v_{13})$	2	≥ 13	12.5

Table E.3: Results of Vinberg's algorithm applied to the quadratic form f_3^n . (c.f [43], Table 2).

i	e_i	(e, e)	n	$\frac{k_0^2}{(e, e)}$
$n + 1$	$v_0 + 3v_1$	6	≥ 1	0.167
$n + 2$	$v_0 + v_1 + v_2 + v_3 + v_4$	1	4	1
	$v_0 + v_1 + v_2 + v_3 + v_4 + v_5$	2	≥ 5	0.5
$n + 3$	$5v_0 + 3(v_1 + v_2 + \dots + v_9)$	6	≥ 9	4.167
$n + 4$	$2(v_0 + v_1) + v_2 + \dots + v_{10}$	1	10	4
	$2(v_0 + v_1) + v_2 + \dots + v_{11}$	2	≥ 11	2
$n + 5$	$3(v_0 + v_1 + v_2) + v_3 + \dots + v_{12}$	1	12	9
	$3(v_0 + v_1 + v_2) + v_3 + \dots + v_{13}$	2	≥ 13	4.5
$n + 6$	$5v_0 + 3(v_1 + v_2 + \dots + v_8) + v_9 + v_{10} + v_{11} + v_{12}$	1	12	25
	$5v_0 + 3(v_1 + v_2 + \dots + v_8) + v_9 + v_{10} + v_{11} + v_{12} + v_{13}$	2	≥ 13	12.5
$n + 7$	$2v_0 + v_1 + \dots + v_{13}$	1	13	4
$n + 8$	$8v_0 + 6(v_1 + v_2 + v_3) + 3(v_4 + \dots + v_{13})$	6	≥ 13	10.667
$n + 9$	$10v_0 + 6(v_1 + \dots + v_7) + 3(v_8 + \dots + v_{13})$	6	≥ 13	16.667

Table E.4: Results of Vinberg's algorithm applied to the quadratic form f_5^n . (c.f [42], Table 1).

i	e_i	(e, e)	n	$\frac{k_0^2}{(e, e)}$
$n + 1$	$v_0 + 2v_1 + v_2 + v_3 + v_4$	2	≥ 4	0.5
	$v_0 + v_1 + \dots + v_7$	2	≥ 7	0.5
$n + 2$	$2v_0 + 5v_1$	5	≥ 2	0.8
$n + 3$	$v_0 + 2v_1 + v_2 + v_3$	1	3	1
	$v_0 + v_1 + \dots + v_6$	1	6	1
$n + 4$	$3v_0 + 5v_1 + 5v_2$	5	≥ 2	1.8

Table E.5: Results of Vinberg's algorithm applied to the quadratic form f_6^n .

i	e_i	(e, e)	n	$\frac{k_0^2}{(e, e)}$
$n + 1$	$v_0 + 2(v_1 + v_2)$	2	2	0.5
$n + 2$	$2v_0 + 5v_1 + v_2$	2	2	2

Table E.6: Results of Vinberg's algorithm applied to the quadratic form f_7^n .

i	e_i	(e, e)	n	$\frac{k_0^2}{(e, e)}$
$n + 1$	$v_0 + 3v_1$	2	≥ 2	0.5
$n + 2$	$v_0 + 2v_1 + 2v_2$	1	2	1
	$v_0 + 2v_1 + 2v_2 + v_3$	2	3	0.5

Table E.7: Results of Vinberg's algorithm applied to the quadratic form f_{10}^n .

i	e_i	(e, e)	n	$\frac{k_0^2}{(e, e)}$
$n + 1$	$2v_0 + 5(v_1 + v_2)$	10	≥ 2	0.4
$n + 2$	$3v_0 + 10v_1$	10	≥ 2	0.9
$n + 3$	$v_0 + 2(v_1 + v_2 + v_3)$	2	3	0.5
$n + 4$	$v_0 + 3v_1 + v_2 + v_3$	1	3	1

Table E.8: Results of Vinberg's algorithm applied to the quadratic form f_{11}^n .

i	e_i	(e, e)	n	$\frac{k_0^2}{(e,e)}$
$n + 1$	$3v_0 + 11v_1$	22	≥ 2	0.409
$n + 2$	$v_0 + 3v_1 + 2v_2$	2	≥ 2	0.5
$n + 3$	$v_0 + 2(v_1 + v_2 + v_3)$	1	3	1
	$v_0 + 2(v_1 + v_2 + v_3) + v_4$	2	4	0.5
$n + 4$	$8v_0 + 11(2v_1 + v_2 + v_3)$	22	≥ 3	2.909
$n + 5$	$v_0 + 3v_1 + v_2 + v_3 + v_4$	1	4	1

Table E.9: Results of Vinberg's algorithm applied to the quadratic form f_{13}^n .

i	e_i	(e, e)	n	$\frac{k_0^2}{(e,e)}$
$n + 1$	$5v_0 + 13(v_1 + v_2)$	13	2	1.923
$n + 2$	$2v_0 + 7v_1 + 2v_2$	1	2	4
$n + 3$	$8v_0 + 26v_1 + 13v_2$	13	2	4.923
$n + 4$	$18v_0 + 65v_1$	13	2	24.923
$n + 5$	$12v_0 + 43v_1 + 5v_2$	2	2	72
$n + 6$	$47v_0 + 169v_1 + 13v_2$	13	2	169.923

Table E.10: Results of Vinberg's algorithm applied to the quadratic form f_{14}^n .

i	e_i	(e, e)	n	$\frac{k_0^2}{(e,e)}$
$n + 1$	$1v_0 + 4v_1$	2	2	0.5
$n + 2$	$2v_0 + 7v_1 + 3v_2$	2	2	2
$n + 3$	$3v_0 + 8(v_1 + v_2)$	2	2	4.5
$n + 4$	$4v_0 + 12v_1 + 9v_2$	1	2	16

Table E.11: Results of Vinberg's algorithm applied to the quadratic form f_{15}^n .

i	e_i	(e, e)	n	$\frac{k_0^2}{(e,e)}$
$n + 1$	$v_0 + 4v_1 + v_2$	2	≥ 2	0.5
$n + 2$	$2v_0 + 6v_1 + 5v_2$	1	2	4
	$2v_0 + 6v_1 + 5v_2 + v_3$	2	3	2
$n + 3$	$v_0 + 3v_1 + 2v_2 + 2v_3$	2	3	0.5

Table E.12: Results of Vinberg's algorithm applied to the quadratic form f_{17}^n .

i	e_i	(e, e)	n	$\frac{k_0^2}{(e, e)}$
$n + 1$	$4v_0 + 17v_1$	17	≥ 2	0.941
$n + 2$	$v_0 + 3v_1 + 3v_2$	1	2	1
	$v_0 + 3v_1 + 3v_2 + v_3$	2	3	0.5
$n + 3$	$v_0 + 4v_1 + v_2 + v_3$	1	3	1
$n + 4$	$7v_0 + 17(v_1 + v_2 + v_3)$	34	3	1.441
$n + 5$	$10v_0 + 34v_1 + 17(v_2 + v_3)$	34	3	2.941
$n + 6$	$4v_0 + 15v_1 + 7v_2$	2	≥ 2	8
$n + 7$	$13v_0 + 51v_1 + 17v_2$	17	≥ 2	9.941
$n + 8$	$24v_0 + 85v_1 + 51v_2$	34	≥ 2	16.941
$n + 9$	$6v_0 + 22v_1 + 11v_2 + 3v_3$	2	3	18
$n + 10$	$61v_0 + 221v_1 + 119v_2 + 17v_3$	34	3	109.441

Table E.13: Results of Vinberg's algorithm applied to the quadratic form f_{19}^n .

i	e_i	(e, e)	n	$\frac{k_0^2}{(e, e)}$
$n + 1$	$6v_0 + 19(v_1 + v_2)$	38	2	0.947
$n + 2$	$v_0 + 4v_1 + 2v_2$	1	2	1
$n + 3$	$13v_0 + 57v_1$	38	2	4.447
$n + 4$	$3v_0 + 13v_1 + 2v_2$	2	2	4.5

Table E.14: Results of Vinberg's algorithm applied to the quadratic form f_{23}^n .

i	e_i	(e, e)	n	$\frac{k_0^2}{(e, e)}$
$n + 1$	$v_0 + 5v_1$	2	2	0.5
$n + 2$	$2v_0 + 4v_1 + 3v_2$	2	2	0.5
$n + 3$	$6v_0 + 27v_1 + 10v_2$	1	2	36
$n + 4$	$12v_0 + 55v_1 + 17v_2$	2	2	72

Table E.15: Results of Vinberg's algorithm applied to the quadratic form f_{30}^n .

i	e_i	(e, e)	n	$\frac{k_0^2}{(e,e)}$
$n+1$	$v_0 + 4(v_1 + v_2)$	2	2	0.5
$n+2$	$2v_0 + 11v_1 + v_2$	2	2	2
$n+3$	$3v_0 + 16v_1 + 4v_2$	2	2	4.5
$n+4$	$4v_0 + 19v_1 + 11v_2$	2	2	8
$n+5$	$4v_0 + 20v_1 + 9v_2$	1	2	16
$n+6$	$6v_0 + 31v_1 + 11v_2$	2	2	18

Table E.16: Results of Vinberg's algorithm applied to the quadratic form f_{33}^n .

i	e_i	(e, e)	n	$\frac{k_0^2}{(e,e)}$
$n+1$	$8v_0 + 33(v_1 + v_2)$	66	2	0.9697
$n+2$	$v_0 + 5v_1 + 3v_2$	1	2	1
$n+3$	$4v_0 + 23v_1 + v_2$	2	2	8
$n+4$	$3v_0 + 17v_1 + 3v_2$	1	2	9
$n+5$	$6v_0 + 33v_1 + 10v_2$	1	2	36
$n+6$	$12v_0 + 65v_1 + 23v_2$	2	2	72
$n+7$	$16v_0 + 89v_1 + 23v_2$	2	2	128

Table E.17: Results of Vinberg's algorithm applied to the quadratic form f_{39}^n .

i	e_i	(e, e)	n	$\frac{k_0^2}{(e,e)}$
$n+1$	$v_0 + 5v_1 + 4v_2$	2	2	0.5
$n+2$	$v_0 + 6v_1 + 2v_2$	1	2	1
$n+3$	$4v_0 + 25v_1 + v_2$	2	2	8
$n+4$	$5v_0 + 31v_1 + 4v_2$	2	2	12.5

Table E.18: Results of Vinberg's algorithm applied to the quadratic form f_{51}^n .

i	e_i	(e, e)	n	$\frac{k_0^2}{(e,e)}$
$n+1$	$7v_0 + 51v_1$	102	2	0.480
$n+2$	$v_0 + 7v_1 + 2v_2$	2	2	0.5
$n+3$	$10v_0 + 51v_1 + 51v_2$	102	2	0.980
$n+4$	$v_0 + 6v_1 + 4v_2$	1	2	1

Appendix F

Tables of vectors from the Bianchi groups

The vectors listed in this appendix, except where noted, are listed in Shaiheev's study of the reflective Bianchi groups [63]. There are some errors in his lists, and the corrections here will be highlighted.

Table F.1: Results of Vinberg's algorithm applied to the extended Bianchi group $\widehat{Bi}(1)$.

i	e_i	(e, e)	$\frac{x_2}{\sqrt{(e,e)}}$
1	(0, 0, -1, 0)	2	
2	(1, 0, 1, 0)	2	
3	(0, 0, 0, -1)	2	
4	(1, 0, 0, 1)	2	
5	(-1, 1, 0, 0)	2	$\frac{1}{\sqrt{2}}$

Table F.2: Results of Vinberg's algorithm applied to the extended Bianchi group $\widehat{Bi}(2)$.

i	e_i	(e, e)	$\frac{x_2}{\sqrt{(e,e)}}$
1	(0, 0, -1, 0)	2	
2	(1, 0, 1, 0)	2	
3	(0, 0, 0, -1)	4	
4	(1, 0, 0, 1)	4	
5	(-1, 1, 0, 0)	2	$\frac{1}{\sqrt{2}}$

Table F.3: Vectors normal to the mirrors in the fundamental domain of the extended Bianchi group $\widehat{Bi}(3)$.

i	e_i	(e, e)	$\frac{x_2}{\sqrt{(e,e)}}$
1	(0, 0, -1, 0)	2	
2	(1, 0, 0, 1)	2	
3	(0, 0, 1, -1)	2	
4	(1, 1, 0, 0)	2	

Table F.4: Results of Vinberg's algorithm applied to the extended Bianchi group $\widehat{Bi}(5)$.

i	e_i	(e, e)	$\frac{x_2}{\sqrt{(e,e)}}$
1	(0, 0, -1, 0)	2	
2	(1, 0, 1, 0)	2	
3	(0, 0, 0, -1)	10	
4	(5, 0, 0, 1)	10	
5	(-1, 1, 0, 0)	2	$\frac{1}{\sqrt{2}}$
6	(2, 2, 1, 1)	4	1

Table F.5: Results of Vinberg's algorithm applied to the extended Bianchi group $\widehat{Bi}(6)$.

i	e_i	(e, e)	$\frac{x_2}{\sqrt{(e,e)}}$
1	(0, 0, -1, 0)	2	
2	(1, 0, 1, 0)	2	
3	(0, 0, 0, -1)	12	
4	(6, 0, 0, 1)	12	
5	(-1, 1, 0, 0)	2	$\frac{1}{\sqrt{2}}$
6	(2, 2, 0, 1)	4	1

Table F.6: Results of Vinberg's algorithm applied to the extended Bianchi group $\widehat{Bi}(7)$.

i	e_i	(e, e)	$\frac{x_2}{\sqrt{(e,e)}}$
1	(0, 0, -1, 0)	2	
2	(1, 0, 1, 0)	2	
3	(0, 0, 1, -2)	14	
4	(7, 0, -1, 2)	14	
5	(-1, 1, 0, 0)	2	$\frac{1}{\sqrt{2}}$
6	(1, 1, 0, 1)	2	$\frac{1}{\sqrt{2}}$

Table F.7: Results of Vinberg's algorithm applied to the extended Bianchi group $\widehat{Bi}(10)$.

i	e_i	(e, e)	$\frac{x_2}{\sqrt{(e,e)}}$
1	(0, 0, -1, 0)	2	
2	(1, 0, 1, 0)	2	
3	(0, 0, 0, -1)	20	
4	(10, 0, 0, 1)	20	
5	(-1, 1, 0, 0)	2	$\frac{1}{\sqrt{2}}$
6	(4, 2, 0, 1)	4	1
7	(8, 6, 3, 2)	2	4.2426
8	(30, 30, 10, 9)	20	6.708
9	(40, 40, 20, 11)	20	8.944

Table F.8: Results of Vinberg's algorithm applied to the extended Bianchi group $\widehat{Bi}(11)$.

i	e_i	(e, e)	$\frac{x_2}{\sqrt{(e,e)}}$
1	(0, 0, -1, 0)	2	
2	(1, 0, 1, 0)	2	
3	(0, 0, 1, -2)	22	
4	(11, 0, -1, 2)	22	
5	(-1, 1, 0, 0)	2	$\frac{1}{\sqrt{2}}$
6	(2, 1, 0, 1)	2	$\frac{1}{\sqrt{2}}$

Table F.9: Results of Vinberg's algorithm applied to the extended Bianchi group $\widehat{Bi}(13)$.

i	e_i	(e, e)	$\frac{x_2}{\sqrt{(e,e)}}$
1	(0, 0, -1, 0)	2	
2	(1, 0, 1, 0)	2	
3	(0, 0, 0, -1)	26	
4	(13, 0, 0, 1)	26	
5	(-1, 1, 0, 0)	2	$\frac{1}{\sqrt{2}}$
6	(6, 2, 1, 1)	4	1
7	(4, 3, 0, 1)	2	2.121
8	(4, 4, 2, 1)	26	2.828
9	(52, 39, 13, 12)	26	7.6485
10	(52, 52, 13, 14)	26	10.198

Table F.10: Results of Vinberg's algorithm applied to the extended Bianchi group $\widehat{Bi}(14)$.

i	e_i	(e, e)	$\frac{x_2}{\sqrt{(e,e)}}$
1	(0, 0, -1, 0)	2	
2	(1, 0, 1, 0)	2	
3	(0, 0, 0, -1)	28	
4	(14, 0, 0, 1)	28	
5	(-1, 1, 0, 0)	2	$\frac{1}{\sqrt{2}}$
6	(6, 2, 0, 1)	4	1
7	(7, 7, 0, 2)	14	1.87
8	(4, 4, 2, 1)	4	2
9	(28, 14, 7, 5)	14	3.74

Table F.11: Results of Vinberg's algorithm applied to the extended Bianchi group $\widehat{Bi}(15)$.

i	e_i	(e, e)	$\frac{x_2}{\sqrt{(e,e)}}$
1	(0, 0, -1, 0)	2	
2	(1, 0, 1, 0)	2	
3	(0, 0, 1, -2)	30	
4	(15, 0, -1, 2)	30	
5	(-1, 1, 0, 0)	2	$\frac{1}{\sqrt{2}}$
6	(3, 1, 0, 1)	2	$\frac{1}{\sqrt{2}}$
7	(15, 15, 4, 7)	30	2.7386
8	(15, 15, -4, 8)	30	2.7386

Table F.12: Results of Vinberg's algorithm applied to the extended Bianchi group $\widehat{Bi}(17)$. The vectors labelled 10 and 13 were misprinted in Shaiheev [63].

i	e_i	(e, e)	$\frac{x_2}{\sqrt{(e,e)}}$
1	(0, 0, -1, 0)	2	
2	(1, 0, 1, 0)	2	
3	(0, 0, 0, -1)	34	
4	(17, 0, 0, 1)	34	
5	(-1, 1, 0, 0)	2	$\frac{1}{\sqrt{2}}$
6	(8, 2, 1, 1)	4	1
7	(4, 4, 1, 1)	4	2
8	(68, 34, 17, 11)	68	4.123
9	(19, 8, 0, 3)	2	5.65685
10	(17, 9, 1, 3)	2	6.36396
11	(136, 68, 17, 23)	68	8.246
12	(85, 51, 0, 16)	34	8.746
13	(204, 102, 0, 35)	34	17.49

Table F.13: Results of Vinberg's algorithm applied to the extended Bianchi group $\widehat{Bi}(19)$.

i	e_i	(e, e)	$\frac{x_2}{\sqrt{(e,e)}}$
1	(0, 0, -1, 0)	2	
2	(1, 0, 1, 0)	2	
3	(0, 0, 1, -2)	38	
4	(19, 0, -1, 2)	38	
5	(-1, 1, 0, 0)	2	$\frac{1}{\sqrt{2}}$
6	(4, 1, 0, 1)	2	$\frac{1}{\sqrt{2}}$
7	(2, 2, 0, 1)	2	$\sqrt{2}$

Table F.14: Results of Vinberg's algorithm applied to the extended Bianchi group $\widehat{Bi}(21)$. The vectors labelled 8, 9, 10 and 11 were absent in Shaiheev [63], but are necessary for the fundamental domain to have finite volume.

i	e_i	(e, e)	$\frac{x_2}{\sqrt{(e,e)}}$
1	(0, 0, -1, 0)	2	
2	(1, 0, 1, 0)	2	
3	(0, 0, 0, -1)	42	
4	(21, 0, 0, 1)	42	
5	(-1, 1, 0, 0)	2	$\frac{1}{\sqrt{2}}$
6	(10, 2, 1, 1)	4	1
7	(6, 3, 0, 1)	6	1.22
8	(6, 4, 2, 1)	2	2.828
9	(42, 42, 21, 8)	42	6.48
10	(14, 14, 3, 3)	4	7
11	(63, 63, 21, 13)	42	9.72

Table F.15: Results of Vinberg's algorithm applied to the extended Bianchi group $\widehat{Bi}(30)$.

i	e_i	(e, e)	$\frac{x_2}{\sqrt{(e, e)}}$
1	(0, 0, -1, 0)	2	
2	(1, 0, 1, 0)	2	
3	(0, 0, 0, -1)	60	
4	(30, 0, 0, 1)	60	
5	(-1, 1, 0, 0)	2	$\frac{1}{\sqrt{2}}$
6	(14, 2, 0, 1)	4	1
7	(9, 3, 0, 1)	6	1.22
8	(5, 5, 0, 1)	10	1.581
9	(8, 4, 2, 1)	4	2
10	(6, 6, 3, 1)	6	2.449
11	(50, 10, 5, 4)	10	3.162

Table F.16: Results of Vinberg's algorithm applied to the extended Bianchi group $\widehat{Bi}(33)$. Note that this group does not appear in Shaiheev's work [63].

i	e_i	(e, e)	$\frac{x_2}{\sqrt{(e, e)}}$
1	(0, 0, -1, 0)	2	
2	(1, 0, 1, 0)	2	
3	(0, 0, 1, -2)	66	
4	(33, 0, -1, 2)	66	
5	(-1, 1, 0, 0)	2	$\frac{1}{\sqrt{2}}$
6	(16, 2, 1, 1)	4	1
7	(6, 6, 3, 1)	12	1.732
8	(8, 4, 1, 1)	4	2
9	(11, 3, 1, 1)	2	2.121
10	(11, 11, 0, 2)	22	2.345
11	(99, 33, 0, 10)	66	4.062
12	(121, 22, 0, 9)	22	4.69
13	(90, 18, 3, 7)	12	5.196
14	(37, 8, 0, 3)	2	5.65685
15	(264, 66, 0, 23)	66	8.124

Table F.17: Results of Vinberg's algorithm applied to the extended Bianchi group $\widehat{Bi}(39)$. Note that this group does not appear in Shaiheev's work [63], but that it is reflective was noted by Ruzmanov [56].

i	e_i	(e, e)	$\frac{x_2}{\sqrt{(e, e)}}$
1	(0, 0, -1, 0)	2	
2	(1, 0, 1, 0)	2	
3	(0, 0, 1, -2)	66	
4	(33, 0, -1, 2)	66	
5	(-1, 1, 0, 0)	2	$\frac{1}{\sqrt{2}}$
6	(9, 1, 0, 1)	2	$\frac{1}{\sqrt{2}}$
7	(3, 3, 1, 1)	6	1.22
8	(12, 3, -1, 2)	6	1.22
9	(26, 13, -3, 6)	26	2.5495
10	(39, 13, 3, 7)	26	2.5495

Bibliography

- [1] I. Agol. Finiteness of arithmetic Kleinian reflection groups. In *International Congress of Mathematicians. Vol. II*, pages 951–960. Eur. Math. Soc., Zürich, 2006.
- [2] I. Agol, M. Belolipetsky, P. Storm, and K. Whyte. Finiteness of arithmetic hyperbolic reflection groups. *Groups Geom. Dyn.*, 2(4):481–498, 2008.
- [3] N. D. Allan. The problem of the maximality of arithmetic groups. In *Algebraic Groups and Discontinuous Subgroups (Proc. Sympos. Pure Math., Boulder, Colo., 1965)*, pages 104–109. Amer. Math. Soc., Providence, R.I., 1966.
- [4] D. Allcock. The reflective lorentzian lattices of rank 3. *Mem. Amer. Math. Soc.*, 220, 2012.
- [5] M. Belolipetsky. On volumes of arithmetic quotients of $\mathrm{SO}(1, n)$. *Ann. Sc. Norm. Super. Pisa Cl. Sci. (5)*, 3(4):749–770, 2004.
- [6] M. Belolipetsky. Addendum to: “On volumes of arithmetic quotients of $\mathrm{SO}(1, n)$ ” [Ann. Sc. Norm. Super. Pisa Cl. Sci. (5) **3** (2004), no. 4, 749–770; mr2124587]. *Ann. Sc. Norm. Super. Pisa Cl. Sci. (5)*, 6(2):263–268, 2007.
- [7] M. Belolipetsky. On fields of definition of arithmetic Kleinian reflection groups. *Proc. Amer. Math. Soc.*, 137(3):1035–1038, 2009.
- [8] M. Belolipetsky and V. Emery. On volumes of arithmetic quotients of $\mathrm{PO}(n, 1)^\circ$, n odd. *Proc. Lond. Math. Soc. (3)*, 105(3):541–570, 2012.
- [9] M. Belolipetsky and W. T. Gan. The mass of unimodular lattices. *J. Number Theory*, 114(2):221–237, 2005.

- [10] M. Belolipetsky and J. McLeod. Reflective and quasi-reflective Bianchi groups. *arXiv:1210.2759v1 [math.GR]*, 2012.
- [11] L. Bianchi. Geometrische Darstellung der Gruppen linearer Substitutionen mit ganzen complexen Coefficienten nebst Anwendungen auf die Zahlentheorie. *Math. Ann.*, 38(3):313–333, 1891.
- [12] L. Bianchi. Sui gruppi di sostituzioni lineari con coefficienti appartenenti a corpi quadratici immaginari. *Math. Ann.*, 40(3):332–412, 1892.
- [13] J. Bolyai. *Appendix*, volume 138 of *North-Holland Mathematics Studies*. North-Holland Publishing Co., Amsterdam, 1987. The theory of space, Edited and with an introduction, comments and addenda by Ferenc Kárteszi, Translated from the Hungarian, With a supplement by Barna Szénássy.
- [14] R. Borcherds. Automorphism groups of Lorentzian lattices. *J. Algebra*, 111(1):133–153, 1987.
- [15] V. O. Bugaenko. Groups of automorphisms of unimodular hyperbolic quadratic forms over the ring $\mathbf{Z}[(\sqrt{5} + 1)/2]$. *Vestnik Moskov. Univ. Ser. I Mat. Mekh.*, 39(5):6–12, 1984.
- [16] V. O. Bugaenko. On reflective unimodular hyperbolic quadratic forms. *Selecta Math. Soviet.*, 9(3):263–271, 1990. Selected translations.
- [17] V. O. Bugaenko. Arithmetic crystallographic groups generated by reflections, and reflective hyperbolic lattices. In *Lie groups, their discrete subgroups, and invariant theory*, volume 8 of *Adv. Soviet Math.*, pages 33–55. Amer. Math. Soc., Providence, RI, 1992.
- [18] M. Chein. Recherche des graphes des matrices de Coxeter hyperboliques d'ordre ≤ 10 . *Rev. Française Informat. Recherche Opérationnelle*, 3(Ser. R-3):3–16, 1969.
- [19] J. H. Conway. The automorphism group of the 26-dimensional even unimodular Lorentzian lattice. *J. Algebra*, 80(1):159–163, 1983.

- [20] H. S. M. Coxeter. Discrete groups generated by reflections. *Ann. of Math. (2)*, 35(3):588–621, 1934.
- [21] M. P. do Carmo. *Geometria riemanniana*, volume 10 of *Projeto Euclides [Euclid Project]*. Instituto de Matemática Pura e Aplicada, Rio de Janeiro, 1979.
- [22] J. Elstrodt, F. Grunewald, and J. Mennicke. Discontinuous groups in three-dimensional hyperbolic space: analytic theory and arithmetic applications. *Uspekhi Mat. Nauk*, 38(1(229)):119–147, 1983. English translation: Russian Math. Surveys **38** (1983), no. 1, 137–168.
- [23] V. Emery. *Du volume des quotients arithmétiques de l'espace hyperbolique*. PhD thesis, University of Fribourg, 2009.
- [24] Euclid. *Euclid's Elements*. Green Lion Press, Santa Fe, NM, 2002. All thirteen books complete in one volume, The Thomas L. Heath translation, Edited by Dana Denmore.
- [25] A. Felikson and P. V. Tumarkin. Hyperbolic subalgebras of hyperbolic Kac-Moody algebras. *Transform. Groups*, 17(1):87–122, 2012.
- [26] W. Fenchel. *Elementary geometry in hyperbolic space*, volume 11 of *de Gruyter Studies in Mathematics*. Walter de Gruyter & Co., Berlin, 1989. With an editorial by Heinz Bauer.
- [27] T. Hull. H.P. Lovecraft: a Horror in Higher Dimensions. *Math Horizons*, 13(3):10–12, 2006.
- [28] J. E. Humphreys. *Reflection groups and Coxeter groups*, volume 29 of *Cambridge Studies in Advanced Mathematics*. Cambridge University Press, Cambridge, 1990.
- [29] K. Ireland and M. Rosen. *A classical introduction to modern number theory*, volume 84 of *Graduate Texts in Mathematics*. Springer-Verlag, New York, second edition, 1990.

- [30] L. Ji. *Arithmetic groups and their generalizations*, volume 43 of *AMS/IP Studies in Advanced Mathematics*. American Mathematical Society, Providence, RI, 2008. What, why, and how.
- [31] N. W. Johnson, R. Kellerhals, J. G. Ratcliffe, and S. T. Tschantz. Commensurability classes of hyperbolic Coxeter groups. *Linear Algebra Appl.*, 345:119–147, 2002.
- [32] I. M. Kaplinskaja. The discrete groups that are generated by reflections in the faces of simplicial prisms in Lobačevskiĭ spaces. *Mat. Zametki*, 15:159–164, 1974.
- [33] O. Khayyām. Discussion of difficulties in Euclid. *Scripta Math.*, 24, 1959. Translated by Ali R. Amir-Móez.
- [34] F. Klein. *Lectures on the ikosahedron and the solution of equations of the fifth degree*. Trubner & Co., London, 1888.
- [35] F. Klein. Vergleichende Betrachtungen über neuere geometrische Forschungen. *Math. Ann.*, 43(1):63–100, 1893.
- [36] F. Lannér. On complexes with transitive groups of automorphisms. *Comm. Sém., Math. Univ. Lund [Medd. Lunds Univ. Mat. Sem.]*, 11:71, 1950.
- [37] M. L’Engle. *A Wrinkle in Time*. Farrar, Straus & Giroux, New York, 1962.
- [38] J.S. Li and J. Millson. On the first Betti number of a hyperbolic manifold with an arithmetic fundamental group. *Duke Math. J.*, 71(2):365–401, 1993.
- [39] N. I. Lobachevsky. *Pangeometry*. Heritage of European Mathematics. European Mathematical Society (EMS), Zürich, 2010. Edited and translated from the French by Athanase Papadopoulos.
- [40] H. P. Lovecraft. The call of cthulhu. *Weird Tales*, 11(2):159–178, 1928.
- [41] H. P. Lovecraft. The dreams in the witch-house. *Weird Tales*, 22(1):86–111, 1933.

- [42] A. Mark. Reflection groups of the quadratic form $-5x_0^2 + x_1^2 + \dots + x_n^2$. *arXiv:1207.4822v1 [math.GR]*, 2012.
- [43] J. Mcleod. Hyperbolic reflection groups associated to the quadratic forms $-3x_0^2 + x_1^2 + \dots + x_n^2$. *Geom. Dedicata*, 152(1):1–16, 2011.
- [44] J. Mcleod. Hyperbolic Coxeter pyramids. *Advances in Pure Mathematics*, 3(1):78–82, 2013.
- [45] V. V. Nikulin. Reflection groups in Lobachevskiĭ spaces and an identity for the denominator of Lorentzian Kac-Moody algebras. *Izv. Ross. Akad. Nauk Ser. Mat.*, 60(2):73–106, 1996.
- [46] V. V. Nikulin. On the classification of hyperbolic root systems of rank three. *Tr. Mat. Inst. Steklova*, 230:256, 2000.
- [47] O. T. O’Meara. *Introduction to quadratic forms*. Springer-Verlag, New York, 1971. Second printing, corrected, Die Grundlehren der mathematischen Wissenschaften, Band 117.
- [48] A. L. Onishchik, editor. *Voprosy Teorii Grupp i Gomologicheskoi Algebry*. Yaroslavl, 1987.
- [49] A. L. Onishchik, editor. *Lie groups and Lie algebras. I*, volume 20 of *Encyclopaedia of Mathematical Sciences*. Springer-Verlag, Berlin, 1993. Foundations of Lie theory. Lie transformation groups, A translation of it Current problems in mathematics. Fundamental directions. Vol. 20 (Russian), Akad. Nauk SSSR, Vsesoyuz. Inst. Nauchn. i Tekhn. Inform., Moscow, 1988.
- [50] Proclus. *A commentary on the first book of Euclid’s Elements*. Princeton Paperbacks. Princeton University Press, Princeton, NJ, 1992. Translated from the Greek and with an introduction and notes by Glenn R. Morrow, Reprint of the 1970 edition, With a foreword by Ian Mueller.
- [51] M. N. Prokhorov. Absence of discrete groups of reflections with a noncompact fundamental polyhedron of finite volume in a Lobachevskiĭ space of high dimension. *Izv. Akad. Nauk SSSR Ser. Mat.*, 50(2):413–424, 1986.

- [52] W. V. Quine. *Mathematical Logic*. Harvard University Press, 1981.
- [53] J. G. Ratcliffe and S. T. Tschantz. Volumes of integral congruence hyperbolic manifolds. *J. Reine Angew. Math.*, 488:55–78, 1997.
- [54] J. G. Ratcliffe and S. T. Tschantz. On volumes of hyperbolic Coxeter polytopes and quadratic forms. *Geom. Dedicata*, 158:1–15, 2012.
- [55] B. A. W. Russell. *An essay on the foundations of geometry*. Dover Phoenix Editions. Dover Publications Inc., Mineola, NY, 2003. With a foreword by Morris Kline, Reprint of the 1956 edition [MR0077945], [On cover: it An essay on the foundations of modern geometry].
- [56] O. P. Ruzmanov. Subgroups of reflections in Bianchi groups. *Uspekhi Mat. Nauk*, 45(1(271)):189–190, 1990.
- [57] G. Saccheri. *Euclide vendicato da ogni neo*. Mathematica. Centro di Ricerca Matematica Ennio De Giorgi (CRM), 1. Edizioni della Normale, Pisa, 2011. With a companion volume containing a facsimile reprint of the 1733 Latin original, Introduction, translation and notes by Vincenzo De Risi.
- [58] C. Sandburg and T. Rand. *Arithmetic*. Harcourt Brace Jovanovich, San Diego, 1993.
- [59] R. Scharlau. On the classification of arithmetic reflection groups on hyperbolic 3-space. *Preprint, Bielefeld*, 1989.
- [60] R. Scharlau and C. Walhorn. Integral lattices and hyperbolic reflection groups. *Astérisque*, 209:15–16, 279–291, 1992. Journées Arithmétiques, 1991 (Geneva).
- [61] H. R. Schwarz, editor. *Oxford users' guide to mathematics*. Oxford University Press, Oxford, 2004. Translated from the 1996 German original by Bruce Hunt.
- [62] J.-P. Serre. *A course in arithmetic*. Springer-Verlag, New York, 1973. Translated from the French, Graduate Texts in Mathematics, No. 7.
- [63] M. K. Shaiheev. Reflective subgroups in Bianchi groups. *Selecta Math. Soviet.*, 9(4):315–322, 1990. Selected translations.

- [64] O. V. Shvartsman. Reflective subgroups of Bianchi groups. *Selecta Math. Soviet.*, 9(4):323–329, 1990. Selected translations.
- [65] O. V. Shvartsman. Reflectivity of Bianchi groups. *Uspekhi Mat. Nauk*, 53(6(324)):271–272, 1998.
- [66] H. This. *Rivelazioni gastronomiche*. Jaca Book, 1996.
- [67] P. V. Tumarkin. Hyperbolic Coxeter polytopes in \mathbb{H}^m with $n + 2$ hyperfacets. *Mat. Zametki*, 75(6):909–916, 2004.
- [68] P. V. Tumarkin. Hyperbolic n -dimensional Coxeter polytopes with $n + 3$ facets. *Trans. Moscow Math. Soc.*, pages 235–250, 2004.
- [69] È. B. Vinberg. Discrete groups generated by reflections in Lobačevskiĭ spaces. *Mat. Sb. (N.S.)*, 72 (114):471–488; correction, *ibid.* 73 (115) (1967), 303, 1967.
- [70] È. B. Vinberg. The groups of units of certain quadratic forms. *Mat. Sb. (N.S.)*, 87(129):18–36, 1972.
- [71] È. B. Vinberg. Absence of crystallographic groups of reflections in Lobachevskiĭ spaces of large dimension. *Trudy Moskov. Mat. Obshch.*, 47:68–102, 246, 1984.
- [72] È. B. Vinberg. Hyperbolic groups of reflections. *Uspekhi Mat. Nauk*, 40(1(241)):29–66, 255, 1985.
- [73] È. B. Vinberg. Reflective subgroups in Bianchi groups. *Selecta Math. Soviet.*, 9(4):309–314, 1990. Selected translations.
- [74] È. B. Vinberg, editor. *Geometry. II*, volume 29 of *Encyclopaedia of Mathematical Sciences*. Springer-Verlag, Berlin, 1993.
- [75] È. B. Vinberg and I. M. Kaplinskaja. The groups $O_{18,1}(Z)$ and $O_{19,1}(Z)$. *Dokl. Akad. Nauk SSSR*, 238(6):1273–1275, 1978.
- [76] D. Witte-Morris. Introduction to arithmetic groups. *arXiv:math/0106063 [math.DG]*, 2008.