

Durham E-Theses

The human metacarpophalangeal joint: quantification of stiffness and the effects of treatment

Yung, P.

How to cite:

Yung, P. (1981) *The human metacarpophalangeal joint: quantification of stiffness and the effects of treatment*, Durham theses, Durham University. Available at Durham E-Theses Online:
<http://etheses.dur.ac.uk/7700/>

Use policy

The full-text may be used and/or reproduced, and given to third parties in any format or medium, without prior permission or charge, for personal research or study, educational, or not-for-profit purposes provided that:

- a full bibliographic reference is made to the original source
- a [link](#) is made to the metadata record in Durham E-Theses
- the full-text is not changed in any way

The full-text must not be sold in any format or medium without the formal permission of the copyright holders.

Please consult the [full Durham E-Theses policy](#) for further details.

P. YUNG

THE HUMAN METACARPOPHALANGEAL JOINT: QUANTIFICATION OF STIFFNESS
AND THE EFFECTS OF TREATMENT.

ABSTRACT

A horizontal finger arthrograph has been developed to measure stiffness in the human metacarpophalangeal joint of the index finger. Data from the arthrograph has been shown to have reasonable reproducibility.

Stiffness is quantified in terms of dissipated energy, equilibrium position and absolute resistive torque measured from the equilibrium position. Three groups of experiments are reported. The first investigates the circadian variation of stiffness in normal subjects. The second investigates stiffness in normal subjects and patients with rheumatoid arthritis and the third looks at the effects of various techniques of physiotherapy in altering stiffness.

The results show a circadian variation of stiffness with increased stiffness in the early hours of the morning.

Male subjects exhibit higher dissipated energy than female subjects though no statistically significant differences could be found in other stiffness parameters. Within the range of values tested no statistically significant differences could be found between controls and patients in dissipated energy, resistive torque or equilibrium position. Correlation of these characteristics with other parameters, for example, grip strength and limb circumference has identified differences between controls and patients, and it is concluded that, in rheumatoid arthritis, stiffness mainly results from the involvement of immediate soft tissue periarticular structures.

The effects of physiotherapeutic techniques, usually administered to alleviate stiffness, are shown to be variable. Short wave diathermy and ultrasound effected a reduction in dissipated energy in the patient group and it is concluded that a reduction in the viscous and frictional properties of periarticular structures produces this effect. A shift in the equilibrium position is also shown to occur in this group following the application of short wave diathermy. Paraffin wax baths, ice and exercises had no effect on stiffness in the patient group and no treatment technique produced significant effects in the control group.

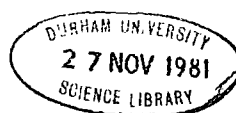

THE HUMAN METACARPOPHALANGEAL JOINT:
QUANTIFICATION OF STIFFNESS AND THE
EFFECTS OF TREATMENT

PETER YUNG

SUBMITTED IN FULFILMENT OF THE REQUIREMENTS
FOR THE DEGREE OF MASTER OF SCIENCE

UNIVERSITY OF DURHAM
DEPARTMENT OF ENGINEERING SCIENCE

1981

The copyright of this thesis rests with the author.
No quotation from it should be published without
his prior written consent and information derived
from it should be acknowledged.

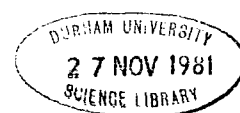

CONTENTS.

	<u>PAGE</u>
ABSTRACT.	1
TABLE OF CONTENTS.	3
LIST OF TABLES.	6
LIST OF FIGURES.	9
STATEMENT OF COPYRIGHT.	12
CHAPTER 1 - INTRODUCTION.	13
CHAPTER 2 - LITERATURE REVIEW.	16
CHAPTER 3 - MATERIALS AND METHOD.	35
3.1 The Arthrograph.	36
3.1.1 Drive Assembly.	36
3.1.2 Transducer.	36
3.1.3 Potentiometer.	41
3.1.4 Main Frame.	41
3.1.5 Arm Rest.	41
3.1.6 Calibration.	43
3.2 The Metacarpophalangeal Joint.	45
3.3 Method.	47
3.3.1 Pilot Study.	50
3.3.2 Reproducibility.	51
3.3.3 Investigation of the Circadian Variation of Stiffness.	51
3.3.4 The Effect of Physiotherapeutic Measures.	52
3.3.41 Short Wave Diathermy.	53
3.3.42 Paraffin Wax	54
3.3.43 Ultrasound Therapy.	54
3.3.44 Ice.	55
3.3.45 Exercise.	55

	<u>PAGE</u>
CHAPTER 4 - RESULTS.	56
4.1 Pilot Study.	57
4.2 Reproducibility.	62
4.3 Analysis of Results.	62
4.4 Investigation of the Circadian Variation of Stiffness.	66
4.5 Stiffness Parameters in Controls and Patients with Rheumatoid Arthritis.	78
4.5.1 Dissipated Energy.	78
4.5.2 Torque at 20 Degrees from the Equilibrium Position in the Direction of Flexion (Torque 20 (F)).	82
4.5.3 Torque at 20 Degrees from the Equilibrium Position in the Direction of Extension (Torque 20 (E)).	82
4.5.4 Equilibrium Position in the Direction of Flexion (Eq. (F)).	82
4.5.5 Equilibrium Position in the Direction of Extension (Eq. (E)).	85
4.6 Other Parameters.	86
4.6.1 Grip Strength.	86
4.6.2 Temperature	86
4.6.3 Limb Circumference.	89
4.6.4 Swelling and Tendon Involvement.	89
4.7 Correlation of Various Parameters.	93
4.8 The Effect of Various Forms of Physiotherapy Upon Stiffness Parameters.	96

	<u>PAGE</u>
4.8.1 Dissipated Energy.	96
4.8.2 Torque at 20 Degrees from the Equilibrium Position in the Direction of Flexion (Torque 20 (F)).	96
4.8.3 Torque at 20 Degrees from the Equilibrium Position in the Direction of Extension (Torque 20 (E)).	100
4.8.4 Equilibrium Position in the Direction of Flexion (Eq. (F)).	100
4.8.5 Equilibrium Position in the Direction of Extension (Eq. (E)).	100
4.9 Other Parameters.	108
4.9.1 Grip Strength.	108
4.9.2 Limb Circumference.	108
4.9.3 Temperature.	108
CHAPTER 5 - DISCUSSION.	114
5.1 Basic Elements.	115
5.2 Circadian Variation of Stiffness Parameters.	123
5.3 Stiffness Parameters in Normal Subjects and Patients with Rheumatoid Arthritis.	126
5.3.1 Dissipated Energy.	126
5.3.2 Torque 20 (F) and Torque 20 (E).	127
5.3.3 Equilibrium Positions.	129
5.4 Other Parameters.	130
5.5 The Effects of Physiotherapeutic Measures on Stiffness Parameters.	135

	<u>PAGE</u>
CHAPTER 6 - CONCLUSIONS AND RECOMMENDATIONS FOR FURTHER WORK.	140
6.1 Conclusions.	141
6.2 Recommendations.	143
APPENDIX 1 Subject data and measurement proforma.	144
APPENDIX 2 Description of short wave diathermy, ultrasound and paraffin wax.	146
APPENDIX 3 Stiffness data of male and female subjects.	150
APPENDIX 4 Stiffness data of control and patient groups pre and post treatment.	161
REFERENCES.	176
ACKNOWLEDGEMENTS.	185

LIST OF TABLES.

<u>TABLE</u>		<u>PAGE</u>
3.1	Calibration factors.	44
4.0	Coefficient of variation.	63
4.1	Values of dissipated energy, torque 20 (F) and 20 (E), equilibrium positions and skin temperature (subject S. S.).	69
4.2	Values of dissipated energy, torque 20 (F) and 20 (E), equilibrium positions and skin temperature (subject C. C.).	70
4.3	Mean values, t values and significance levels in subjects S. S. and C. C. for temperature, dissipated energy, equilibrium positions and torque 20 (F) and 20 (E).	73
4.4	Values of dissipated energy, torque 20 (F) and 20 (E), equilibrium positions and skin temperature (subject K. S.).	74
4.5	Mean values, standard deviations, t values and significance levels in male and female controls of dissipated energy, equilibrium position and torques 20 (F) and 20 (E).	80

<u>TABLE</u>	<u>PAGE</u>	
4.6	Mean values, standard deviations, t values and significance levels in male and female patients of dissipated energy, equilibrium position and torques 20 (F) and 20 (E).	81
4.7	Means and standard deviations of limb circumference measurements in male and female subjects.	90
4.8	Range of arm circumferences with means and standard deviations.	91
4.9	Spearman's rank order correlation coefficients between bony swelling and dissipated energy and between bony swelling and torque 20 (F) and 20 (E).	92
4.10	Correlation matrix - controls.	94
4.11	Correlation matrix - patients.	95
4.12	Dissipated energy - t values and significance levels pre and post treatment.	98
4.13	Torque 20 (F) - t values and significance levels pre and post treatment.	101
4.14	Torque 20 (E) - t values and significance levels pre and post treatment.	103

<u>TABLE</u>		<u>PAGE</u>
4.15	Eq. (E) - t values and significance levels pre and post treatment.	105
4.16	Eq. (E) - t values and significance levels pre and post treatment.	107
4.17	Grip strength - t values and significance levels pre and post treatment.	110
4.18	Limb circumferences - mean and standard deviations pre and post treatment - controls.	111
4.19	Limb circumferences - means and standard deviations pre and post treatment - patients.	112
4.20	Skin temperature - t values and significance levels pre and post treatment.	113

LIST OF FIGURES.

<u>FIGURE</u>		<u>PAGE</u>
3.1	General appearance of the horizontal finger arthrograph (side view).	37
3.2	General appearance of the horizontal finger arthrograph (front view).	38
3.3	Horizontal finger arthrograph with side panel removed.	39
3.4	Horizontal finger arthrograph with side panel removed to reveal scotch yoke mechanism and belt.	40
3.5	Horizontal finger arthrograph viewed from above.	42
3.6	Arthrograph with the hand in position showing thumb support and finger grip.	48
3.7	Aligning the centres of rotation.	49
4.1	Representative set of recordings commencing at 4 degrees.	58
4.2	Set of recordings commencing at 84 degrees.	59
4.3	Set of recordings over a small range of motion.	60
4.4	Set of recordings commencing at 54 degrees.	61
4.5	Dissipated energy in 2 female subjects at 2 hourly intervals.	67

<u>FIGURE</u>	<u>PAGE</u>	
4•6	Circadian variation of torque 20 (F) and torque 20 (E) (subject S. S.).	71
4•7	Circadian variation of torque 20 (F) and torque 20 (E) (subject C. C.).	72
4•8	Circadian variation of dissipated energy (subject K. S.).	76
4•9	Circadian variation of torque 20 (F) and torque 20 (E) (subject K. S.).	77
4•10	Scattergram of dissipated energies with means and standard deviations in the control and patient groups.	79
4•11	Scattergram of torque 20 (F) and torque 20 (E) with means and standard deviations in the control and patient groups.	83
4•12	Scattergram of equilibrium positions (F) and (E) with means and standard deviations in the control and patient groups.	84
4•13	Scattergram of grip strength with means and standard deviations in male and female patients.	87
4•14	Scattergram of skin temperatures with means and standard deviations in the control and patient groups.	88
4•15	Means and standard deviations of dissipated energy pre and post treatment	97

<u>FIGURE</u>		<u>PAGE</u>
4.16	Means and standard deviations of torque 20 (F) pre and post treatment.	99
4.17	Means and standard deviations of torque 20 (E) pre and post treatment.	102
4.18	Means and standard deviations of Eq. (F) pre and post treatment.	104
4.19	Means and standard deviations of Eq. (E) pre and post treatment.	106
4.20	Means and standard deviations of grip strength pre and post treatment.	109
5.1	Hooke elements.	116
5.2	Newtonian elements.	118
5.3	Coulomb element.	119
5.4	Proposed rheological models.	121

THE HUMAN METACARPOPHALANGEAL JOINT:
QUANTIFICATION OF STIFFNESS AND THE
EFFECTS OF TREATMENT

PETER YUNG

The copyright of this thesis rests with the author.
No quotation from it should be published without his
prior written consent and information derived from it
should be acknowledged.

CHAPTER ONE

INTRODUCTION

Rheumatoid arthritis affects approximately 1.5 million people in Great Britain with females accounting for 70 per cent of cases. Joint stiffness is one of the major symptoms of this disease and the duration of morning stiffness has been used as an indication of the activity of the disease. The subjective assessment of stiffness by patients may be confused with pain and lack of mobility. Hence, the need for more reliable means of quantifying stiffness has become apparent.

Various attempts have been made to measure stiffness objectively and the development of arthrographs has led to a greater understanding of this symptom. Many stiffness studies have concentrated on the design and development of arthrographs and the rheological analysis of joint motion. Previous finger arthrographs did not eliminate gravitational forces acting on the joint.

A horizontal finger arthrograph has been developed to eliminate gravitational forces on the human metacarpophalangeal joint of the index finger in the direction of flexion and extension. The reproducibility of the arthrograph is assessed, followed by, the quantification of stiffness in normal subjects and patients with rheumatoid arthritis.

A review of the literature has shown the need for a more objective approach to the assessment and validation of the treatment measures undertaken to reduce stiffness. In the field

of physiotherapy many treatment techniques are based on empirical knowledge. The clinician needs to know if his treatments, which are directed towards the alleviation of stiffness, are actually having the desired effect. The patient's feeling of well being following treatment may be due to relief of symptoms such as pain, which he associates with stiffness.

The horizontal finger arthrograph has made it possible to objectively measure the effects of some of the common physiotherapeutic techniques that are administered to relieve stiffness in patients with rheumatoid arthritis affecting the hands.

Perhaps in the final analysis the words of Benjamin Disraeli will be particularly apt:

"What we anticipate seldom occurs; what we least expect generally happens".

B. Disraeli, Earl of Beaconsfield, 1804-1881.

CHAPTER TWO

LITERATURE REVIEW

Stiffness has been recognised as one of the major criteria in the diagnosis of rheumatoid arthritis. Cobb et al., in a survey in Pittsburgh in 1953, state that morning stiffness is a usual symptom of rheumatoid arthritis and suggest that a series of questions about it may be of value as a screening test.

Lansbury (1956) states that morning stiffness is one of the most constant symptoms of the disease. He suggests a definition of morning stiffness as "a resistance on the part of the affected joints to motion on awakening in the morning,"; and regards the duration of morning stiffness as a reliable indication of the activity of the disease. Savage (1958) noted that the duration of morning stiffness, as assessed by Lansbury was entirely subjective. Ropes et al. in 1956 placed morning stiffness at the head of a list of criteria for the diagnosis of rheumatoid arthritis and in subsequent revision of the diagnostic criteria, two years later, morning stiffness retained its position.

Wright in 1959, whilst investigating morning stiffness, measured the grip strength of patients with rheumatoid arthritis and observed a diurnal variation. However, a similar diurnal variation was found in the non-arthritic control group. Wright and Johns in 1960 from preliminary observations suggested that morning stiffness was a feature of muscle weakness rather than joint stiffness.

There is, however, more than one interpretation of the term

stiffness. Many workers have used the term in relation to lack of mobility and in these instances a limited range of motion has become synonymous with stiffness. Tucker (1978) whilst investigating aspects of post-traumatic elbow stiffness interprets stiffness as loss of movement. Millis et al. (1976) state that there are "many causes of stiffness or decreased motion ..." and throughout the paper alternate between the term stiffness and loss of motion, implying that they are two terms having the same meaning. Some of the confusion surrounding the meaning of stiffness has consequently led to differing methods in the study of joint stiffness, whereby some researchers have investigated stiffness and others mobility or range of motion.

Early work in the investigation of mobility included studies by Harris and Joseph in 1949. They studied variations in range of motion in the interphalangeal and metacarpophalangeal joints of the thumb in male and female European, male Indian and male African groups by using lateral radiographs. Their results showed that female Europeans had a greater mean range of motion at the metacarpophalangeal joint compared with male Europeans. The converse was found at the interphalangeal joint and the mean range of motion were greater in the African and Indian groups than in the male European group.

Ellis and Bundick in 1956, whilst studying cutaneous elasticity and hyperelasticity, measured the extensibility of the fifth finger. The subject placed the extended hand on a flat surface and the fifth finger was extended as far as comfort would

allow. The angle of the finger to the flat surface was measured (in multiples of 15 degrees) using a protractor. Their results showed that younger persons had a greater degree of extensibility than older persons and that females were more mobile than males.

Loebl (1972) assessed the mobility of metacarpophalangeal joints by testing lateral stability of the joint in 90 degrees of flexion. The middle and ring fingers were held against a segment of a pulley and the pivot of each pulley was a continuation of the longitudinal axis of that finger. A protractor was centred at each pivot. The fingers were separated by a flange attached to each pulley and then to a spring balance via a further pulley. A force was applied via the spring balance and the fingers were abducted. Tests were performed on 108 males and 120 females and the results showed a normal distribution in relation to lateral mobility of the metacarpophalangeal joint. There were significant sex differences in joint mobility ($F \gg M$). There was no indication of a diurnal variation. Radiant heat for 15 minutes had no effect, whereas immersion in hot and cold water for 10 minutes showed a small (3 per cent) increase and decrease in mobility respectively.

Carter and Wilkinson (1964) used a method of scoring the ability of the individual to perform certain movements. The score was used to assess the existence or degree of hypermobility. Modification of this method was made by Beighton and Horan (1969) and further revision took place four years later (Beighton et al. 1973).

Quantification of joint extensibility was undertaken by Graham and Jenkins (1972), by applying a force of 2 lb via a push-pull gauge over the flexor aspect of the distal interphalangeal joint of the fifth finger. The palm of the hand was pressed firmly against a table and the angle of passive dorsiflexion of the metacarpophalangeal joint of the little finger was measured with a protractor. The authors demonstrated a significant difference ($P < 0.01$) in the range of extension of the metacarpophalangeal joint of 53 ballet dancers and 53 student nurses. The study also showed a greater degree of hypermobility in ballet dancers when assessed performing manoeuvres modified from the method of Beighton and Horan (1969).

Less et al. (1977) studied the effects of exercise on strength and range of motion of hand intrinsic muscles and joints. During the study 12 men exercised using an isometric hand gym (Hand Gym Inc., Point Lookout, NY.) three times daily for four weeks. All exercises were supervised by the investigator. Range of motion was measured with a hand goniometer. All metacarpophalangeal joints showed improvement in the range of movement (index finger = $P < 0.05$; middle, ring and little finger = $P < 0.01$).

More recently a hyperextensometer has been developed to quantify joint laxity in the metacarpophalangeal joint of the index finger by Jobbins et al. (1979). The forearm and hand of the subject was comfortably placed on a baseplate and the index

finger was secured in a "carrier". The axis of rotation of the metacarpophalangeal joint was visually aligned with the axis of the operating shaft. The joint could be rotated by a knurled knot which drives an operating shaft via a slipping clutch, which could be preset to slip at a given torque. The amplitude of rotation at the point of slip was indicated by a pointer, fixed to the operating shaft, against a protractor. The results showed a correlation of 0.67 with the Carter and Wilkinson scoring system of joint laxity and a correlation of 0.61 with the modified scoring system of Beighton.

Hunter and Whillans in 1951 studied stiffness of knees in cats. The femur of the cat was clamped and the tibia was dependant at an angle of 90 degrees. Muscle attachments were cut above and below the knee; the anterior and posterior cruciate ligaments remaining intact. A force was applied to the lower leg towards extension by means of a spring linked to a calibrated dial. This device was mounted on a worm gear. A pointed electrical contact on the heel of the limb was brought into contact with a copper plate to establish electrical continuity. The force required to break this contact was taken as a measure of stiffness. An increase in the force required to move the joint followed the application of cold.

In further experiments a force was applied via a thread to the severed patellar tendon and fixed to a worm gear as above. Stiffness was again measured as the force required to produce movement. Following exposure to chilling there was an increase in the force required to produce movement of the knee joint into

extension via the patellar tendon. Significance testing was not applied to these results.

In 1952, continuing their work, Hunter et al. studied the relationship between cooling and stiffness in the proximal interphalangeal joint of the index finger. In the experiments the subject's stiffness was assessed in terms of the mobility of that finger. Two push-buttons were separated by a "baffle". The procedure consisted of movement of the index finger around the "baffle" to make contact with the push-buttons. The number of times the subject successfully pressed the buttons in a 10 sec period was considered to be the measure of stiffness. The workers in this case were not measuring stiffness but something related to stiffness namely, mobility.

Unfortunately, the work of Hunter et al. in 1951 and 1952 was not in relation to the quantification of stiffness per se but to provide a reliable measure by which comparison could be made following the application of cooling. Cooling was applied randomly to three areas of the subject's arm or hand as follows:-

- (a) local chilling of the joint
- (b) chilling of the hand up to the wrist
- (c) chilling of the hand and arm up to the elbow

Chilling was performed until the skin temperature over the proximal interphalangeal joint was 54°F . Results showed that there was a lowering of the speed of finger movements following chilling, significant at the 0.01 level. This work was in fact measuring mobility and speed of mobility rather than stiffness.

In 1960 Wright and Johns published their work on an arthrograph which had been built to impose a sinusoidal motion upon the second metacarpophalangeal joint. The movement was produced by a pendulum which rotated a shaft. This shaft was attached to a lever which in turn was fixed to the finger under investigation. The axis of the shaft and axis of rotation of the metacarpophalangeal joint coincided. The frequency of the sinusoidal motion was varied between 0.57 and 1 cycle per sec and the torque required to produce this motion was recorded from strain gauges bonded to the lever. Amplitude of rotation was recorded by a low torque potentiometer attached to the pendulum shaft and instantaneous rotational velocity by a moving coil velocity transducer. A display in the form of a hysteresis loop was given on a dual cathode ray oscilloscope, which allowed simultaneous display of torque v rotational displacement and torque v rotational velocity. In this study, 97 normal subjects were tested (49 males and 48 females) and the age ranged from 4 to 72 years. The major components which contributed to overall stiffness were identified and measured as elasticity, viscosity, inertia, plasticity and friction. Elasticity and plasticity accounted for the majority of joint stiffness and viscous stiffness only accounted for 10 per cent of the overall stiffness. Frictional stiffness accounted for only 1 per cent of total stiffness and inertial stiffness, although it could not be measured directly, was found to be of the order of one hundredth that of elastic stiffness. Similar results were found in arthritic patients. The work continued by showing that elastic stiffness was increased by age, cold and venous occlusion and was decreased

by an increase of surface temperature to 45°C.

In 1964 Long et al., using a finger arthrograph, similar to that used by Wright and Johns illustrated the importance of wrist position when carrying out tests of this nature.

Investigations on the cat's paw by Johns and Wright (1962) with a similar arthrograph identified the structures which contributed to overall stiffness. The forelimb of the cat was fixed in a plaster of Paris bandage with a rod embedded in it to gain fixation. The wrist was placed in the modified arthrograph and a control reading taken. Serial dissections were undertaken and a reading was taken following each dissection. The reduction in torque following each dissection was assumed to be the torque which that structure contributed to the total torque. In the mid-range of movement the capsule was found to contribute 47 per cent to the total torque, muscle 41 per cent, tendons 10 per cent and skin 2 per cent. Tendons contributed more to the total torque at the ends of the range of motion.

At about the same time, Scott (1960) investigated joint stiffness by elevation of the relaxed second metacarpophalangeal joint from the neutral position by an extension spring. The spring was placed vertically over a wooden platform and clamped. The upper end was fixed and the position of the lower end was indicated by a pointer which moved along a vertical scale. Attached to the lower end was a horizontal bar, 4.25 cm above

the platform, which came to rest on the platform. The patient's hand and forearm were strapped on the platform with the skin crease opposite the distal interphalangeal joint of the second finger resting on the horizontal bar. The spring was released and the finger was lifted. The force required to extend the spring was 40 gm per cm. Joint stiffness was expressed in terms of the distance through which the finger was displaced. Results showed that elevation of the finger of rheumatoid patients increased in the evening, although there was considerable variation. Normal subjects showed little change. The study also included measurement of hand volume and grip strength, the latter recorded with a rubber bag attached to a sphygmomanometer. The hand volume of rheumatoid patients and normal subjects was greater in the morning than evening. Grip strength was greater in the evening with both groups.

Barnett and Cobbold (1962) studied frictional stiffness in the distal interphalangeal joint of the middle finger. The subject's supinated hand was held in an adjustable frame. The index, ring and proximal phalanx of the middle finger were extended. The middle phalanx of the middle finger was maintained flexed to the fullest extent so nullifying the effects of the flexor and extensor muscles acting over this joint. The frame was mounted at the end of a table and a clamp attached over the end of the middle finger. A pendulum was suspended from this clamp and set in motion by an electromagnet. Stiffness was assessed in terms of friction and the coefficient of friction between living articular surfaces was determined.

Further work by Barnett and Cobbold in 1968, using the same apparatus, measured the coefficient of friction in 111 adults. They found the mean coefficient of friction raised in the elderly and concluded that reduced mobility depended upon age changes in the synovial fluid, articular cartilage or ligaments.

Backlund and Tiselius in 1967, used a modification of Wright and Johns' arthrograph to study morning stiffness. They found that normal males were more stiff than normal females of the same age and confirmed the work of Wright, showing a diurnal variation in stiffness in patients suffering from rheumatoid arthritis. The strength of grip and pinching was found to bear an inverse relationship with joint stiffness in patients, although no such relationship could be found in normal subjects. Synovectomy of the second metacarpophalangeal joint produced marked decrease in joint stiffness. A close correlation was found between objective joint stiffness, as measured, and the patients's subjective feeling of the intensity of morning stiffness. A slight decrease in stiffness was noted when patients had their hands immersed in water at 43°C for 10 minutes and an increase in stiffness found when immersed in iced water at 10°C for the same time.

Wright and Plunkett (1966), using the arthrograph of Wright and Johns, investigated joint stiffness at the metacarpophalangeal joint, grip strength (recorded with a pneumatic dynamometer) and the ability to tie knots. The results showed a diurnal variation in all three parameters and a close

correlation between the ability to tie knots and joint stiffness. There was a reduction in stiffness with an increase in temperature, when the hand, covered with a rubber glove, was immersed in a water bath in which the temperature could be varied.

Hicklin et al. (1968), in an attempt to simplify the quantification of joint stiffness, developed a machine in which the finger under investigation was allowed to fall through a fixed arc. The joint under investigation acted as a pivot of an arm which fell through a light beam. The time taken for the arm to fall through a fixed arc was taken as a measure of the stiffness of the joint. In normal subjects the fall time was fairly constant with the standard deviation usually less than 1 msec. In patients suffering from rheumatoid arthritis the mean fall time and standard deviation were increased. Actual fall times and predicted fall times were compared. They also emphasised the importance of wrist position and the posture of the subject during the investigations. The mean fall time increased with the wrist in dorsiflexion (and the metacarpophalangeal joints palmar flexed) and decrease with the subject in a semi-recumbent position with the eyes closed.

Following the lead of Hicklin et al., Ingpen and Hume Kendall (1968) built a finger dropper to study joint stiffness at the metacarpophalangeal joint. The pivot for the movement was the second metacarpophalangeal joint and the finger plus an adjustable lever were allowed to drop through an arc of 10 degrees. The fall time was taken as a measurement of joint stiffness. Results showed that fall times in normal subjects (N = 150) were fairly constant

(97 per cent falling between 70 and 82 msec). In rheumatoid arthritic patients, fall times varied from within normal limits to 120 msec. The apparatus was used to measure the effect of "warming up" exercises and wax baths. The authors state that they produce a reduction in fall times up to 26 msec following these procedures, although further data is not provided.

Other work by Ingpen (1968), using the same apparatus, showed a circadian variation in stiffness with peaks of increased stiffness in the early morning and evening. There was a "fair" correlation between subjective pain and grip strength. No correlation was found between joint stiffness and grip strength. The author also states that there was a decrease in joint stiffness following exercise (repetition of finger drops). The maximum improvement occurring between 20 - 30 drops.

Goddard et al. (1969), using an arthrograph designed by Goddard, investigated stiffness at the knee joint. The apparatus was based on the principle of the finger arthrograph used previously by Wright and Johns. The subject was seated with the test leg attached to the drive arm of the apparatus at the foot and ankle; no movement was allowed at the ankle. The thigh was horizontal and the knee was aligned with the axis of rotation of the drive arm. Torque was recorded by a strain gauge connected to the drive arm and shaft. No lateral or vertical motion was allowed at the knee and the sinusoidal motion imparted to the joint was provided by a scotch yoke mechanism driven by a constant speed electric motor. The weight of the lower leg was counterbalanced

to nullify the effect of gravity. Results show that sex differences in knee stiffness were not as obvious as with the metacarpophalangeal joint and that there was a wide variation. There was an increase in overall stiffness with increasing age for both sexes. The effect of cooling the knee by surrounding it with a jacket containing iced water for 15 minutes, when the skin temperature fell to 23°C , produced an increase in stiffness. A corresponding decrease in joint stiffness was shown when the jacket was refilled with hot water at 60°C . The effect of short wave diathermy on osteoarthritic knee joints was found to produce a 20 per cent reduction in overall stiffness 10 minutes after treatment but the results were said to be transient. No data was given for this effect.

Continuation of the studies with the knee arthrograph led Such et al. in 1975 to investigate 70 knees (49 males and 21 females), with no history of joint problems. The results were interpreted in terms of elastic stiffness and dissipated energy. Elastic stiffness was unchanged with advancing years although the dissipated energy was found to increase with age. Women exhibited less elastic stiffness and lower dissipated energy levels than men.

Thompson et al. (1978) proceeded to build a knee arthrograph which eliminated the need for a counterbalance system. This arthrograph was designed so that measurements were taken with the knee in a horizontal position thus eliminating the effect of gravity. They indicate in their paper that previous studies in

the field of joint stiffness are difficult to compare because of inconsistencies in the terminology and a set of definitions is presented.

There is sparse literature on the effects of physiotherapy on joint stiffness and some of the literature is vague on these effects. Lopez (1978) suggests that modes of heat are used as a basis for the treatment of rheumatic diseases and the effects are to prevent or minimise the consequences of inflammation, for example, stiffness.

Apart from work previously cited, little has been performed on the effects of physiotherapy on joint stiffness. However, the effects of various forms of heat on other structures are well documented. Early work on the heating of areas of skin by various means have been shown to produce an increase in blood flow, (Barcroft and Edholm, 1943; Spealman, 1945; Ferris et al., 1947; Kerslake and Cooper, 1950; Roddie and Shepherd, 1956).

Tuttle and Fitts (1944) investigated the effects of short wave diathermy on the activity of muscle and found that the time for contraction of human gastrocnemius was reduced following a longitudinal application of condensor field short wave diathermy. The application was for a period of 20 minutes at "comfortable warmth".

Asmussen and Boje (1945) showed that an increase in temperature of muscle either by "warming up" exercises, by

diathermy or hot baths increases the capacity for work as measured on a bicycle ergometer. They suggest that the visco elastic properties of muscle are influenced in such a way that with an increase of temperature less energy is expended in overcoming viscous resistance.

Hollander and Horvath (1949) measured skin and joint temperatures in the knee joints of patients with rheumatic diseases prior to and following various therapeutic procedures. Passive movement, infra red irradiation, short wave diathermy, microwave, hydrotherapy and hot paraffin, all produced increased temperature at both sites. The greater elevation of joint temperature was produced by short wave diathermy and microwave.

Observations by Horvath and Hollander in 1949 on the effect of hot and cold packs applied to the skin produced a respective lowering and raising of intra-articular temperature. A seasonal variation was noted and although the joint temperature followed a similar pattern, the effects of the two treatments were diminished in the summer months.

Abramson et al. (1960) studied the effects of short wave diathermy on blood flow, oxygen uptake and tissue temperatures. They found that all three factors increased during a half hour application of the modality and the effects lasted for a further 30 minutes. The application was by plate electrodes, one over the shoulder, the other over the wrist and dorsum of the hand. Alteration of the plates was made until the subject perceived a comfortable sensation of heat at both sites. The average peak

temperature increase for skin was found to be 1.3°C ; for subcutaneous tissue 1.5°C and for muscle (upper forearm) 1.9°C .

More recent work by Verrier et al. (1977) has shown that short wave diathermy applied by the inductothermy technique produces a more efficient heating of the muscle, at minimal doses, than does the condenser field method. In this instance the short wave diathermy was localised to the calf muscles and intramuscular temperature was recorded in the soleus muscle. The condenser field method produced an average increase of 0.23°C whereas, the inductothermy produced an average increase of 2.3°C .

Abramson et al. (1960) studied the effects of ultrasound on blood flow, oxygen uptake and tissue temperatures by using two stationary sound heads, one situated over the belly of brachioradialis and the other over the distal portion of the dorsum of the forearm. The amount of energy delivered to the subject was the maximum tolerated without undue discomfort. The period of sonation was 18 - 21 minutes. In these experiments the average increase in temperature was found to be:- skin 0.9°C ; subcutaneous tissue 1.4°C and muscle 0.9°C .

In 1968 Kirk and Kersley studied the effects of heat and cold therapy on the knees of patients with chronic rheumatoid arthritis. Hot packs or ice packs were applied to the knee for a given time, followed by a standard exercise programme, for five days. Following a nine day treatment free period the other treatment was applied for a further five days. Assessment was

made on 20 knees by grading pain and stiffness on a 0 (none) to 5 (severe) scale. Range of movement and knee circumference were measured using a goniometer and cloth tape measure respectively. Joint temperature was assessed by hand over the knee, compared with the leg above and below, graded 0 (normal) to 3 (warm). Improvement in grades of pain and stiffness were found to coincide more with cold than with heat, though objective assessments did not show any measurable difference between the two treatments.

Pegg and Littler (1969) studied the effects of ice therapy and exercise in patients suffering from rheumatoid arthritis. Thirty-five joints in 10 patients were selected for the trial. Crushed ice was placed in two layers of damp terry towelling and applied circumferentially to a joint for 5 minutes. Hands were treated by immersion in iced water. Active and assisted exercises followed immediately after ice application. The treatment period was for two weeks. Recordings were made of pain, tenderness, stiffness and flare by using three grades of severity. The stiffness grades were assessed as:-

Slight - patient reported stiffness but no interference with activity

Moderate - stiffness affecting activity to a limited extent

Severe - considerable stiffness causing incapacity.

Range of movement and skin temperatures were also recorded and all measurements took place at the first, sixth and eleventh treatments. The results showed a beneficial effect on the relief of stiffness, with 91 per cent of treated joints improving immediately after the first treatment. Following the eleventh

treatment, all treated joints had improved and the improvement was maintained for more than four hours. Range of movement and pain also showed improvement, though not as marked as in stiffness. Unfortunately, it is difficult to assess the amount of subjectivity in this study particularly with reference to the assessment of degree of stiffness.

CHAPTER THREE

MATERIALS

3.1 THE ARTHROGRAPH

The arthrograph was produced to oscillate the metacarpophalangeal joint in a horizontal plane. Figures 3.1 and 3.2 show the general appearance of the arthrograph. Figure 3.3 shows the arthrograph with a side panel removed to reveal the drive mechanism.

3.1.1 The Drive Assembly

The drive assembly consisted of a motor and gear box unit, which drove a scotch yoke mechanism, producing a range of motion of 8 degrees and an amplitude of 4 degrees in the metacarpophalangeal joint. Any mean position of oscillation, between the neutral position and 90 degrees of flexion, could be selected by means of a traversing hand wheel. This allowed a sequence of small oscillations of the metacarpophalangeal joint to be obtained over the whole range of flexion. The scotch yoke mechanism drove the belt (Figure 3.4), which in turn drove the pulley assemblies and the drive arm which was connected to one of these. The drive arm had a fixed centre of rotation and the finger was placed coincidentally by means of a template. The provision of a movable arm rest facilitated this centring procedure. A torque transducer, attached to the drive arm, had variable height to allow for varying sizes of hand.

3.1.2 The Transducer

The transducer was a combined torque measuring device and

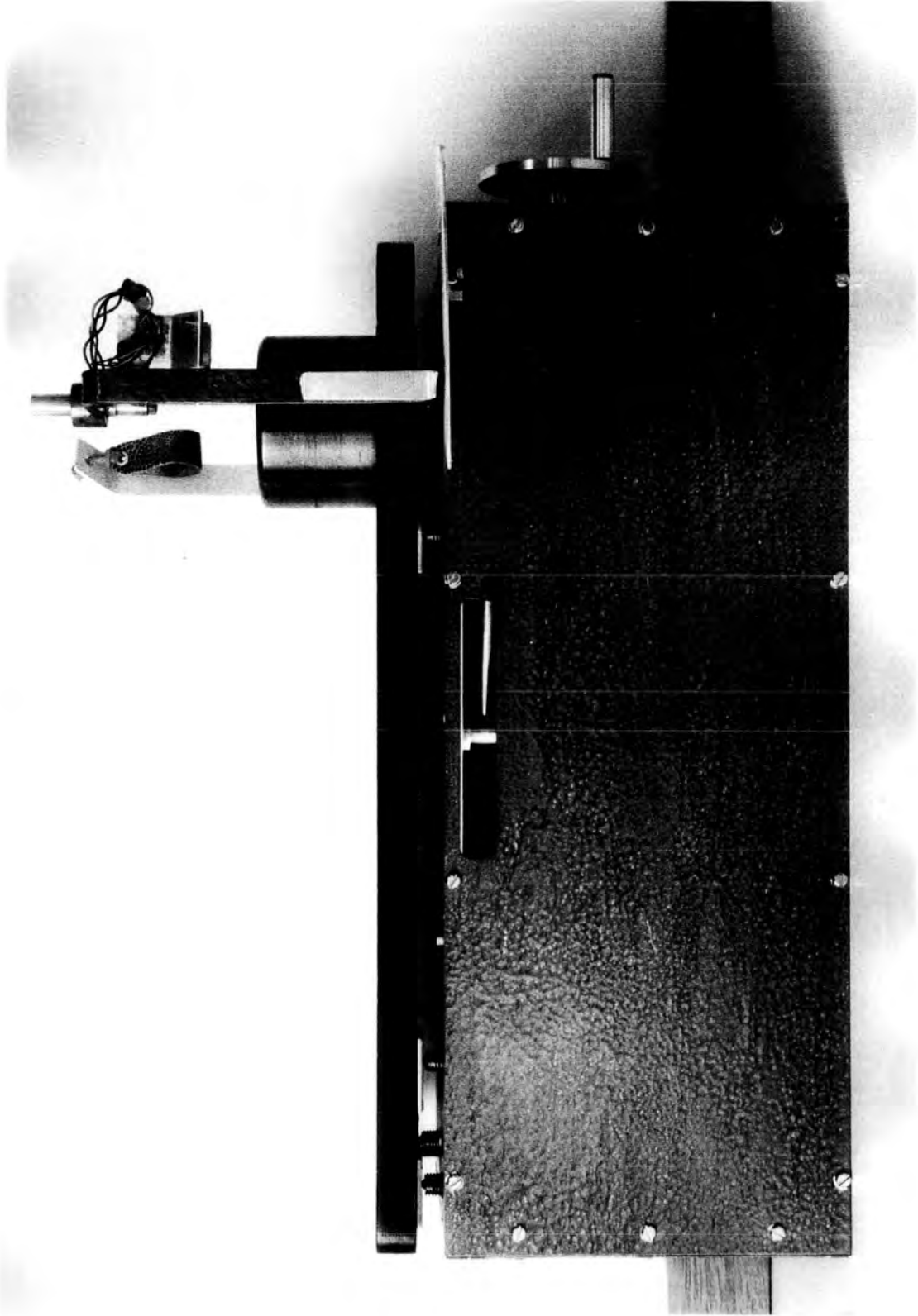

FIGURE 3.1. GENERAL APPEARANCE OF THE HORIZONTAL FINGER ARTHROGRAPH (SIDE VIEW).

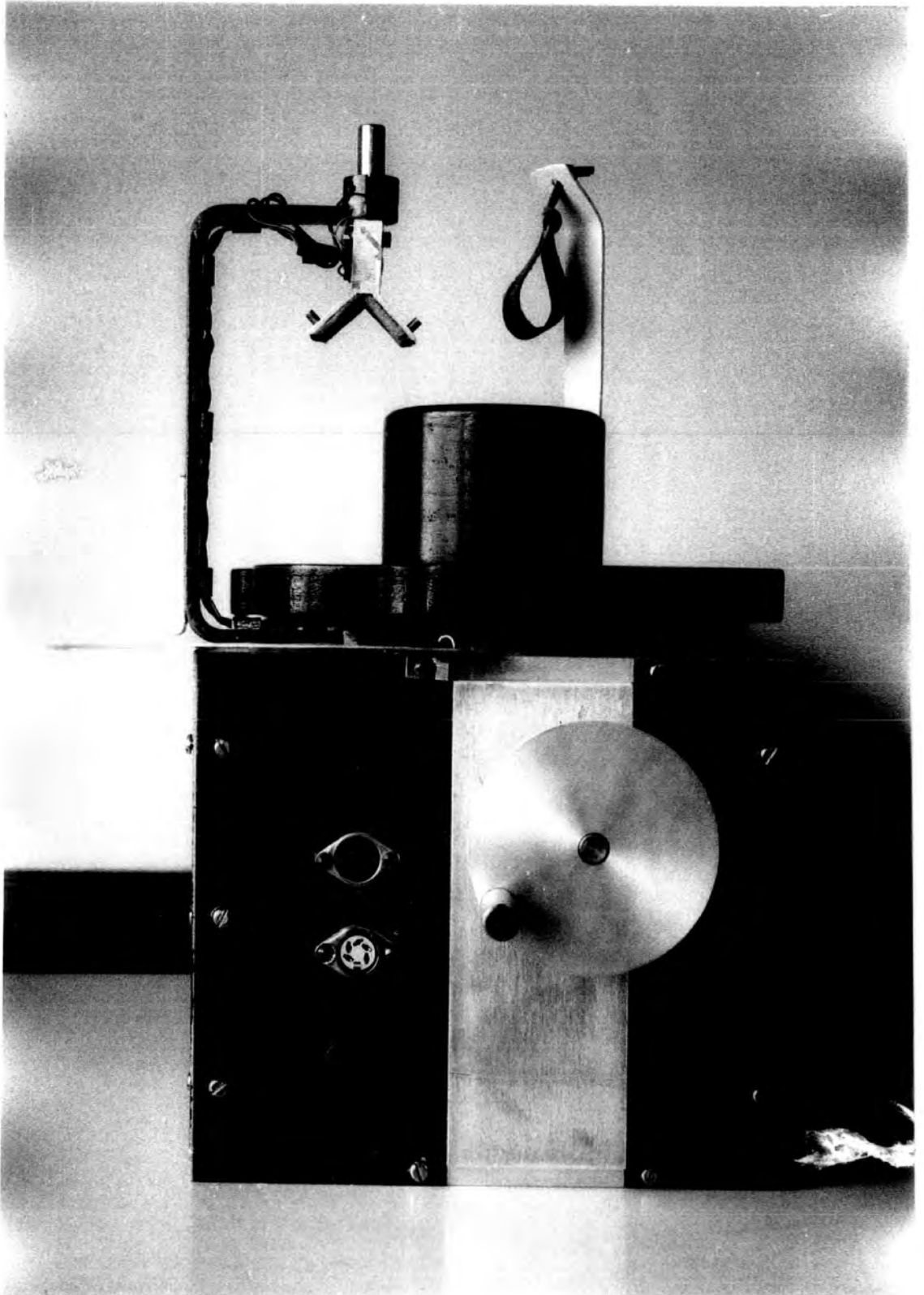

FIGURE 3-2. GENERAL APPEARANCE OF THE HORIZONTAL FINGER ARTHROGRAPH
(FRONT VIEW).

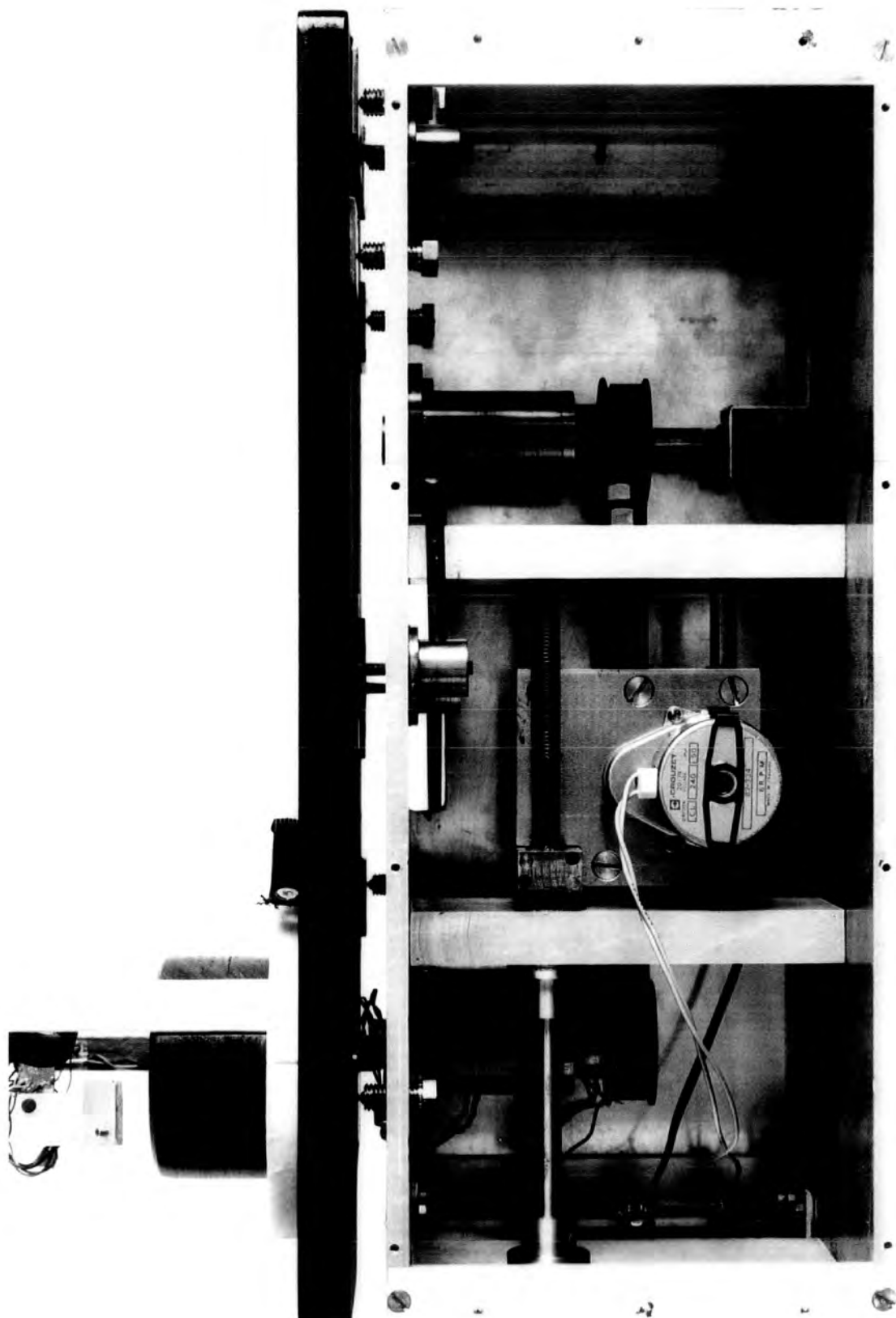

FIGURE 3•3. HORIZONTAL FINGER ARTHROGRAPH WITH SIDE PANEL REMOVED.

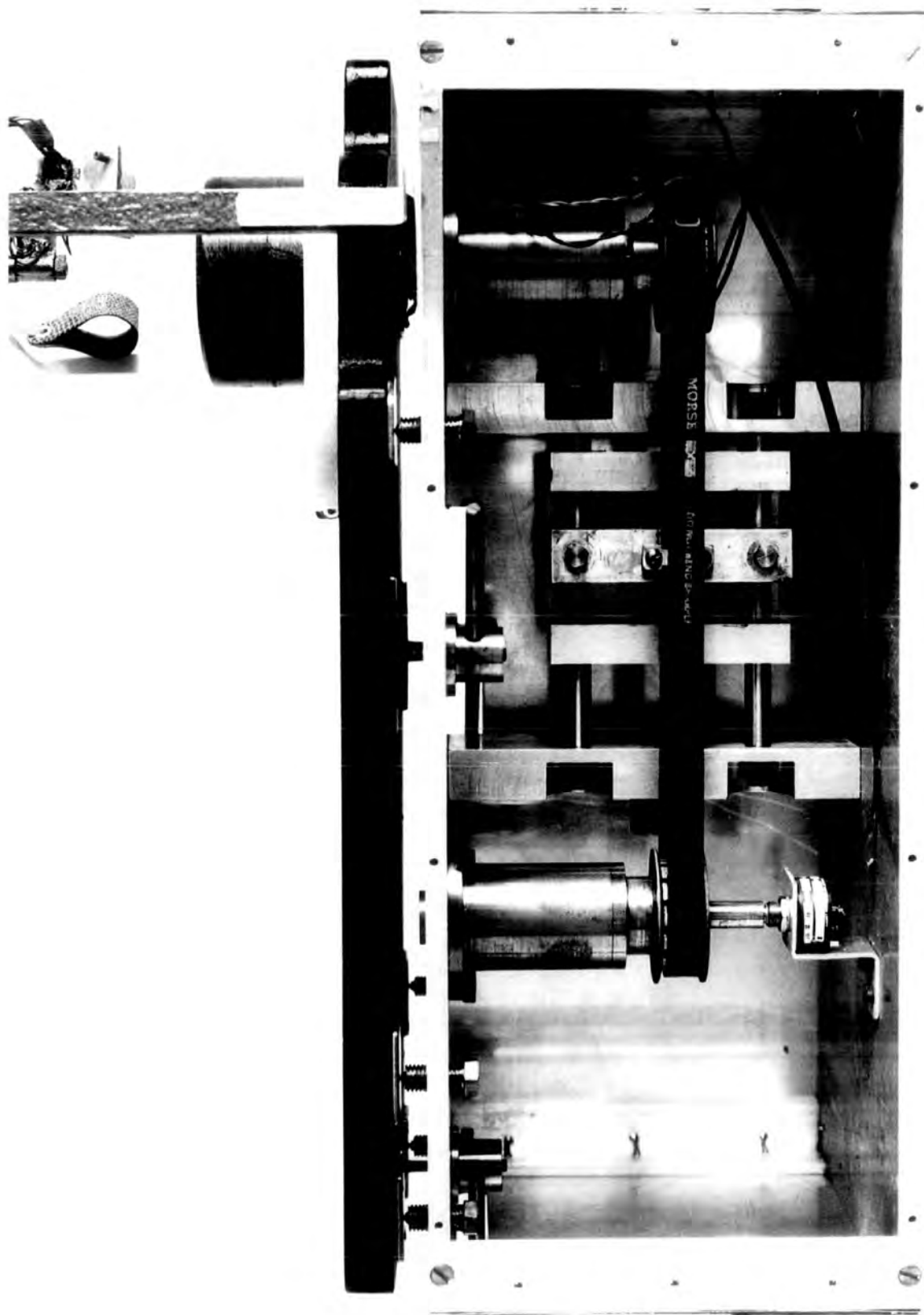

FIGURE 3-4. HORIZONTAL FINGER ARTHROGRAPH WITH SIDE PANEL REMOVED TO REVEAL SCOTCH YOKE MECHANISM AND BELT.

finger clamp, which consisted of a plastazote lined V block screwed to the end of a stainless steel cantilever. The opposite end of the cantilever was secured to the central pivot of the arthrograph. The cantilever had strain gauges mounted on both sides of it to record the torque produced due to the resistance of the metacarpophalangeal joint and associated soft tissues. The signal from these gauges was fed to an amplifier and then to the Y axis of an XYT recorder.

3.1.3 Potentiometer

A precision potentiometer was firmly fixed to the central axis of rotation to record the angular rotation of the metacarpophalangeal joint and the output from this was fed to the X axis of the XYT recorder.

3.1.4 Main Frame

The main frame, constructed from aluminium, supported the arm rest and drive assembly. The frame was a rectangular box with a base plate and an upper platform. Centrally mounted was the drive motor assembly and the traverse mechanism. The two pulley assemblies were suspended from the upper platform and connected by means of a toothed timing belt. A traversing hand wheel was also mounted on the main frame and is seen in Figures 3.1 and 3.2

3.1.5 The Arm Rest

The arm rest was a wooden board with a finger grip and thumb support mounted upon it, (Figures 3.2 and 3.5). The whole arm rest could be moved in any direction within a horizontal

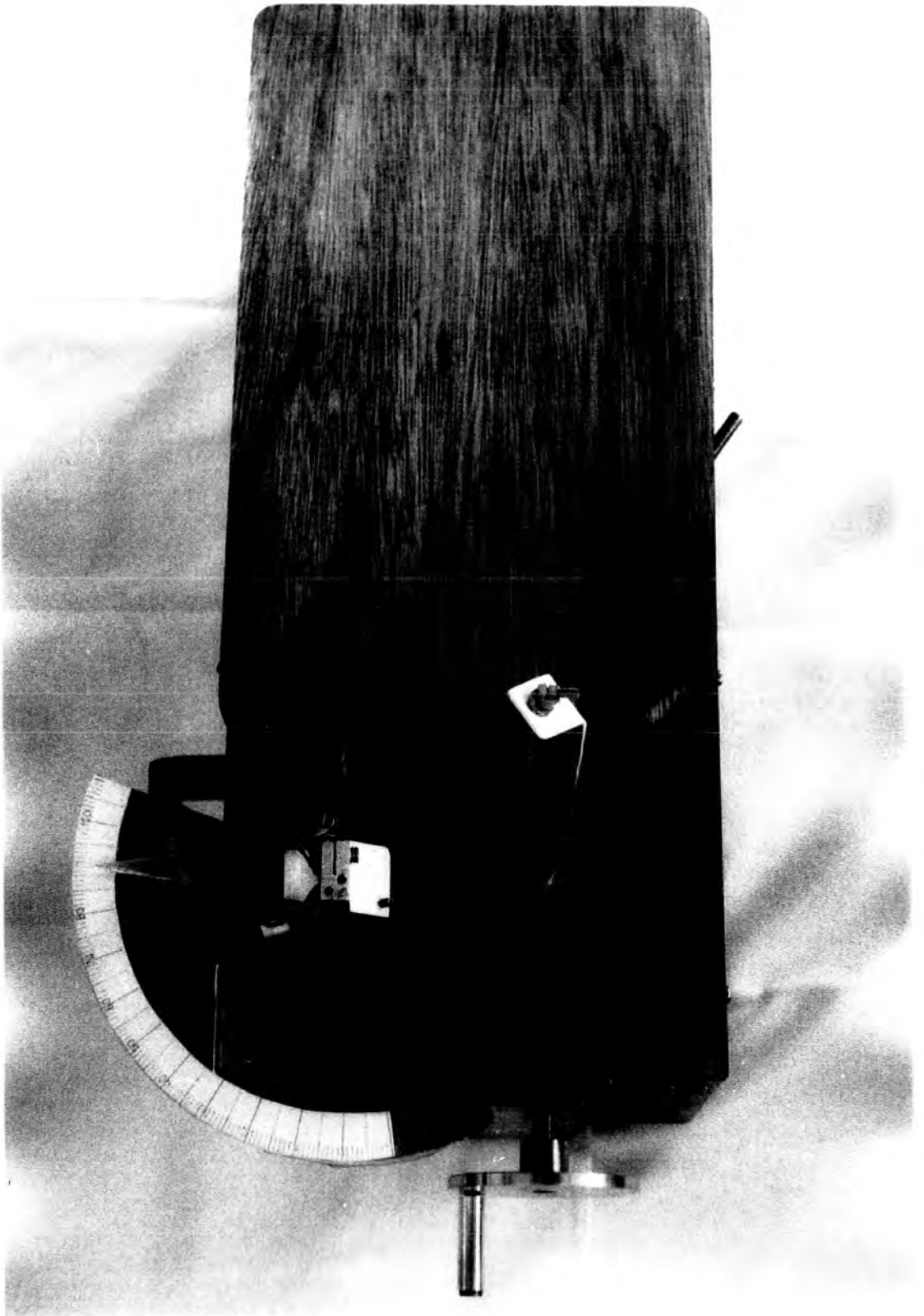

FIGURE 3•5. HORIZONTAL FINGER ARTHROGRAPH VIEWED FROM ABOVE.

plane to help align the centre of rotation of the finger with the centre of rotation of the arthrograph. Once alignment had been achieved, the board was locked by means of three levers mounted below the main frame.

3.1.6 Calibration

The apparatus was calibrated by direct application of known torques to the transducer and the deflection on the XYT recorder was noted. The torques were applied by hanging weights on a hook attached to a cord passing over a low friction pulley and attached to the transducer at a given radius from the centre of rotation. A number of torque ranges were calibrated to enable the sensitivity to be altered according to the stiffness of the joint. Angle measurements were calibrated against a large diameter precision protractor. The calibration factors are shown in Table 3.1.

TABLE 3.1. CALIBRATION FACTORS

TORQUE SCALE	AT $0.10\text{V}/\text{cm}^{-1} = 0.0017829 \text{ Nm}/\text{mm}$
	AT $0.25\text{V}/\text{cm}^{-1} = 0.0044412 \text{ Nm}/\text{mm}$
ANGLE SCALE = $0.009312 \text{ rad}/\text{mm}$	

3.2 THE METACARPOPHALANGEAL JOINT

The joint under investigation was the metacarpophalangeal joint of the index finger of the right hand.

The metacarpophalangeal joint is the joint between the head of the metacarpal and the base of the proximal phalanx. The head of the metacarpal is a rounded convexity and articulates with the reciprocally concave base of the proximal phalanx. The metacarpal is partially divided on its palmar surface by a slight ridge and on this aspect gives the impression of a condyloid surface. The articular surfaces are covered with hyaline cartilage and a capsule surrounds the joint margins. This capsule is weak on the extensor aspect where its place is taken by the expanded extensor tendon. On the palmar aspect of the joint is a plate of fibrocartilage, which is firmly attached to the proximal phalanx but only loosely connected to the metacarpal bone. This plate is connected to the deep transverse ligament of the palm which connects the four metacarpophalangeal joints.

The joint moves in the direction of flexion in which the finger is approximated to the palm and extension in which the finger moves away from the palm. It is also capable of abduction, (spreading the fingers apart) and adduction, (bringing the fingers together). During this investigation only the movements of flexion and extension were considered and the muscles responsible for producing these movements are given below:-

Extension - extensor digitorum; extensor indices

Flexion - flexor digitorum superficialis; flexor digitorum profundus.

These muscles all have proximal attachments in the forearm and distal attachments to the phalanges. The first lumbrical, dorsal and palmar interossei muscles also aid flexion of the metacarpophalangeal joint, as their angles of pull are on the palmar aspect of the axis of rotation of the joint.

Other soft tissues surround the joint and these include superficial and deep fascia which are situated superficial to the muscles and tendons. Skin forms the outermost covering of the joint.

Movements of flexion are limited by stretching of the structures passing over the extensor aspect of the joint and extension may be limited by structures passing over the flexor aspect of the joint. Movements are also limited by the configuration of the joint surfaces and its attendant fibrous capsule. The metacarpophalangeal joint has an active range of motion of approximately 10 degrees of extension and between 80 and 90 degrees of flexion. An increase in range of motion can be accomplished by passively moving the joint. At the limit of range further motion is prevented by a combination of the effects of loss of articular surface and tension of tendons, ligaments and other soft tissues passing over the joint. The inside of the fibrous capsule is lined by synovial membrane which secretes synovial fluid. This provides the lubrication and nutrition for the joint.

3.3 METHOD

The subject was seated comfortably in a chair and his right arm was placed on the arm rest of the arthrograph with the wrist in the neutral position and the forearm midway between pronation and supination. The shoulder was in approximately 45 degrees of abduction and midway between flexion and extension. The thumb was placed in the leather support (Figure 3.6) and the fingers rested lightly on the cylindrical grip. This allowed the index finger freedom to move in flexion and extension without catching on the grip or the thumb.

Small hands were accommodated in the arthrograph by a range of plastazote packings used to adjust the joint to the right position (Figure 3.6). Alternatively, the transducer could be lowered to accommodate small sizes of hand. The centre of rotation of the metacarpophalangeal joint was then aligned with the centre of rotation of the arthrograph. The centre of rotation of the arthrograph is marked by a hole through the central shaft of the finger clamp and this was used to position a template held against the metacarpophalangeal joint (Figure 3.7). The template was made to the average joint centre of rotation based on the work of Unsworth and Alexander (1979). Precise alignment of the two centres of rotation was facilitated by releasing the clamps securing the wooden arm rest, which could then move in any direction. Once the centres of rotation were aligned the clamps were then resecured. The proximal phalanx was held in the inverted V block by means of an elastic sling which provided firm but comfortable location of the finger. The drive was then switched on and readings taken.



FIGURE 3•6. ARTHROGRAPH WITH THE HAND IN POSITION SHOWING THUMB
SUPPORT AND FINGER GRIP.



FIGURE 3·7. ALIGNING THE CENTRES OF ROTATION.

The drive oscillated the joint through an amplitude of 4 degrees at a frequency of 0.1 Hz. This was found to be slow enough to prevent inertial effects of reflex muscle activity but fast enough not to hinder patient relaxation. The cycles were applied around mid-positions at 10 degree increments between 4 degrees and 84 degrees of flexion. This gave the limits of the system as neutral and 88 degrees of flexion.

3.3.1 Pilot Study

Considerable variation in results were originally obtained depending upon the position of the subject's arm and hand. This confirmed previous work by Long et al. (1964). The neutral position for forearm and wrist was therefore chosen as the standard position. Initial use of the arthrograph used ranges of motion between 4 degrees and 94 degrees. This, however, overloaded the strain gauges when some subjects were at the extremes of flexion and consequently the limit of flexion was reduced by 10 degrees. During this stage of the study it was assumed that it would not make any difference if the subject was cycled from flexion to extension or from extension to flexion. One subject was placed in the arthrograph as in the standard procedure. The drive was switched on and cycles were applied around mid-positions at 10 degree increments, commencing at 4 degrees and passing through flexion to 84 degrees. The subject was then cycled in the opposite direction without removal from the arthrograph. A second subject was placed in the arthrograph, the finger flexed to 84 degrees by means of the traversing hand wheel and cycles were commenced at 84 degrees passing through extension to 4 degrees and then recycled to 84 degrees. Further subjects were tested in various starting

positions between 4 degrees and 84 degrees. The direction of movement and overall range of movement were randomly varied during each test.

3.3.2 Reproducibility

Three subjects were tested in the arthrograph over a fixed range of motion up to 14 times each. Subject 1 remained attached to the arthrograph between readings but subjects 2 and 3 were removed for two minutes and then reattached between each test.

Coefficient of variation (standard deviation/mean) for energy loss/cycle, mid-line slope and the mid-position torque were calculated.

3.3.3 Investigation of the Circadian Variation of Stiffness

Studies were initially carried out to ascertain if there was a circadian variation in stiffness measurement as measured with the arthrograph.

Eight subjects (five females, three males) were tested, using the standard procedure in the arthrograph, at two hourly intervals for a period of 24 hours. Temperatures were measured using a Comark electronic skin thermometer, capable of measuring to 0.1°C , over the lateral aspect of the metacarpophalangeal joint. Subjects were allowed to perform normal functional activities during the day but asked not to involve themselves in any unusually strenuous activity involving the hands. There were allowed to sleep at the normal times during the night but woken on each occasion to allow a test to take place.

3.3.4 The Effect of Physiotherapeutic Measures

Several physiotherapy techniques were investigated. These were undertaken using normal physiotherapeutic equipment, which is available in most rehabilitation departments and the techniques used were those that could normally be expected to be performed during treatment of the affected joint. Prior to testing, the controls and the patients suffering from rheumatoid arthritis were subjected to various measurements as indicated in the proforma in Appendix 1.

Wrist and forearm sizes were measured circumferentially with a cloth tape measure.

The wrist size was measured at the level of the ulna and radial styloid processes.

The length of the forearm was taken as the distance between the ulna styloid process and the medial epicondyle of the humerus. Circumference measurements were then taken at a quarter, a half and three-quarters of that distance.

Grip strength was measured with a hand dynamometer (Boots Co. Ltd.). Three readings were taken and the mean value calculated. Reliability of the dynamometer was tested by applying known forces to the hand grip and recording the deflection on the dial. The dynamometer was found to have a linear scale over a range of one-and-a-half revolutions of the dial. Grip strengths recorded beyond 450 mm Hg were not considered reliable and were excluded from the analysis.

Subjective pain and stiffness were measured using visual analogue scales but these scales led to some confusion with the patients and so were abandoned early in the investigation. The remainder of the data was supplied by clinical assessment and from the patient's notes. Each subject was tested on the arthrograph prior to and following any physiotherapeutic measure. The total range of movement was between 0 and 88 degrees of flexion. Some patients were unable to attain this range of movement particularly into flexion and so a limit was imposed when the patients became uncomfortable. The subject was attached to the arthrograph, the arthrograph switched on and the subject was allowed to become familiar to the oscillations for approximately two minutes before the recorder was switched on.

3.3.41 Short Wave Diathermy

Short wave diathermy provides heating of the tissues principally by inducing vibration of ions within the tissues. The machine used to provide this treatment was the Erbotherm 110 operating at a frequency of $27.12 \text{ MHz} \pm 0.6$ per cent. The technique of short wave diathermy was the condensor field method, where the metacarpophalangeal joint of the index finger was placed between two electrodes, one malleable electrode measuring 80 mm x 120 mm and one rigid electrode with a diameter of 42 mm. The palmar aspects of the hand was placed on the malleable electrode with two insulating felt spacers intervening. The rigid electrode was placed approximately 15 mm above the dorsal aspect of the metacarpophalangeal joint. As with all short wave diathermy applications, it is difficult to assess the amount of heating of a particular structure, consequently, in accordance

with normal physiotherapy procedure, once the machine was switched on the patient was asked to tell the operator if he felt anything other than a gentle warmth. If the temperature became excessive, either locally or generally, the patient was also asked to tell the operator. The short wave diathermy was applied for a period of 20 minutes. This was followed by retesting in the arthrograph.

3.3.42 Paraffin Wax

Paraffin wax provides heating by utilising the latent heat of solidification of wax applied to the area of treatment. Wax was heated in a wax bath (Therax Wax Bath Mark 4) to a temperature of approximately 50°C. The subject was asked to place the hand in the molten wax so that a layer of wax would surround the hand as far as the wrist. The hand was removed from the bath and excess wax allowed to drain from the hand. The hand was subsequently reimmersed in the molten wax a further five times. Following this the hand was placed in a polythene bag and wrapped in terry towels to provide insulation. This was left in situ for 20 minutes in accordance with normal physiotherapeutic procedure.

3.3.43 Ultrasound Therapy

Ultrasonic energy is obtained by applying an alternating voltage to a crystal. Ultrasonic therapy is used to provide a high speed vibration of the tissues. The ultrasonic therapy machine used was the Therasonic Mark 3, which has a frequency of 1 MHz. The output was 1 watt per cm² and the treatment was pulsed at a ratio of one period on to 4 periods off. As it is the normal practice to carry out such therapy in water, a temperature controlled water bath was used to maintain constant temperature during the

investigation and to minimise any heating due to the ultrasonic therapy. The metacarpophalangeal joint of the index finger was subjected to the ultrasonic therapy for a period of three minutes, using a labile technique. The temperature of the bath was 35°C.

3.3.44 Ice

Ice is often used in cases of painful, swollen joints in an attempt to reduce the pain and the oedema present in that joint. Ice was applied locally to the subject's metacarpophalangeal joint by the use of ice packs (Cryogel ice packs, 3M Medical Division) which can be cooled in a domestic refrigerator. The cold pack was covered with gauze and then applied to the dorsal, lateral and palmar aspects of the index finger in the form of a cuff. The period of application was 10 minutes.

3.3.45 Exercise

Exercise has often been described as improving stiffness and is often considered advantageous for patients suffering from conditions in which stiffness is a major symptom. A simple "warming up" exercise was performed by the subjects. This exercise consisted of flexion of the fingers to make a tight grip followed by extension of the fingers, repeated one hundred times.

Further details of short wave diathermy, ultrasound and paraffin wax are contained in Appendix 2.

CHAPTER FOUR

RESULTS

4.1 Pilot Study

Initially it was assumed that there would be no difference in the recording whether the subject was cycled from flexion to extension or from extension to flexion. Figure 4.1 shows a representative set of recordings obtained from a series of sinusoidal displacement cycles, commencing at 4 degrees continuing to 84 degrees then returning to 4 degrees. It was apparent that the recordings taken in the direction of extension did not correlate with those taken in flexion and in fact the small hysteresis loops produced at each position contributed to one large hysteresis loop.

Figure 4.2 shows a similar set of recordings commencing at 84 degrees passing through extension to 4 degrees then returning to 84 degrees. The hysteresis loops had a similar pattern in that the loops produced in the direction of flexion were always above those produced in the direction of extension.

Variations in total ranges of motion and in the starting position produced a similar effect. Figure 4.3 shows a smaller range of motion between 44 degrees and 74 degrees commencing at 44 degrees passing to 74 degrees and returning to 44 degrees.

Figure 4.4 shows a large range of motion between 4 degrees and 94 degrees which commences at 54 degrees passed through extension and then through flexion and returned to 54 degrees.

FIGURE 4.1. REPRESENTATIVE SET OF RECORDINGS COMMENCING AT 4 DEGREES.

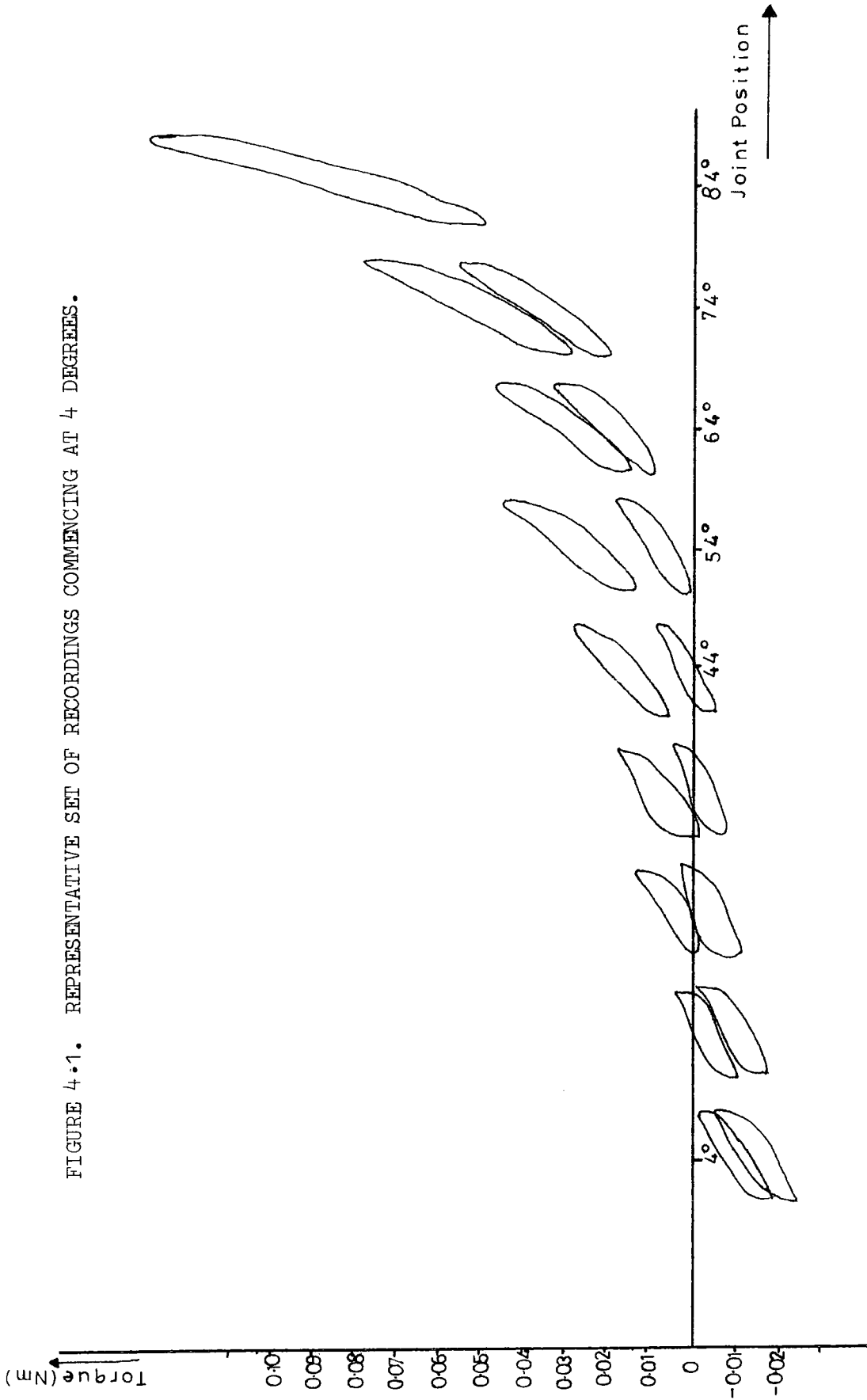
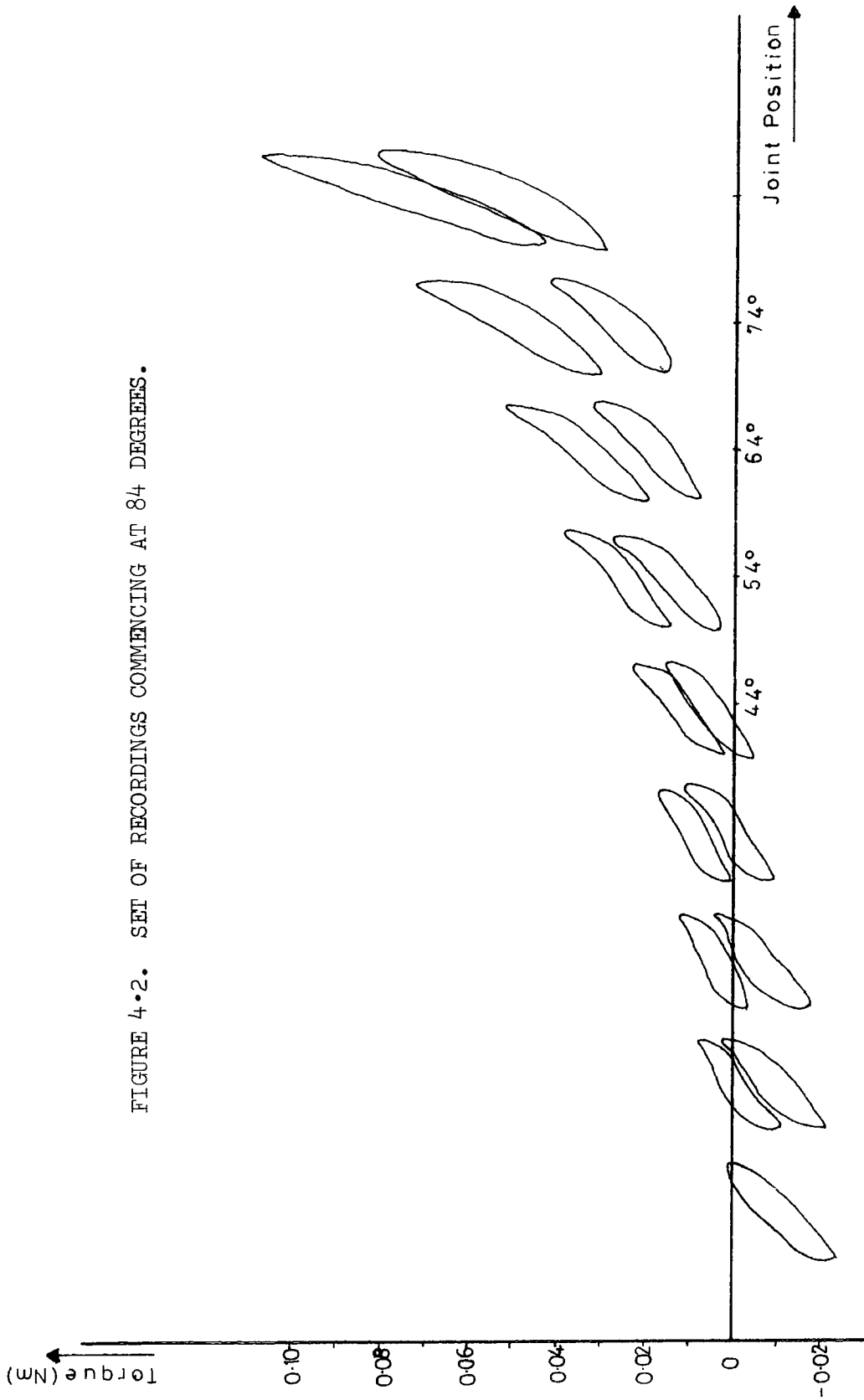

FIGURE 4.2. SET OF RECORDINGS COMMENCING AT 84 DEGREES.



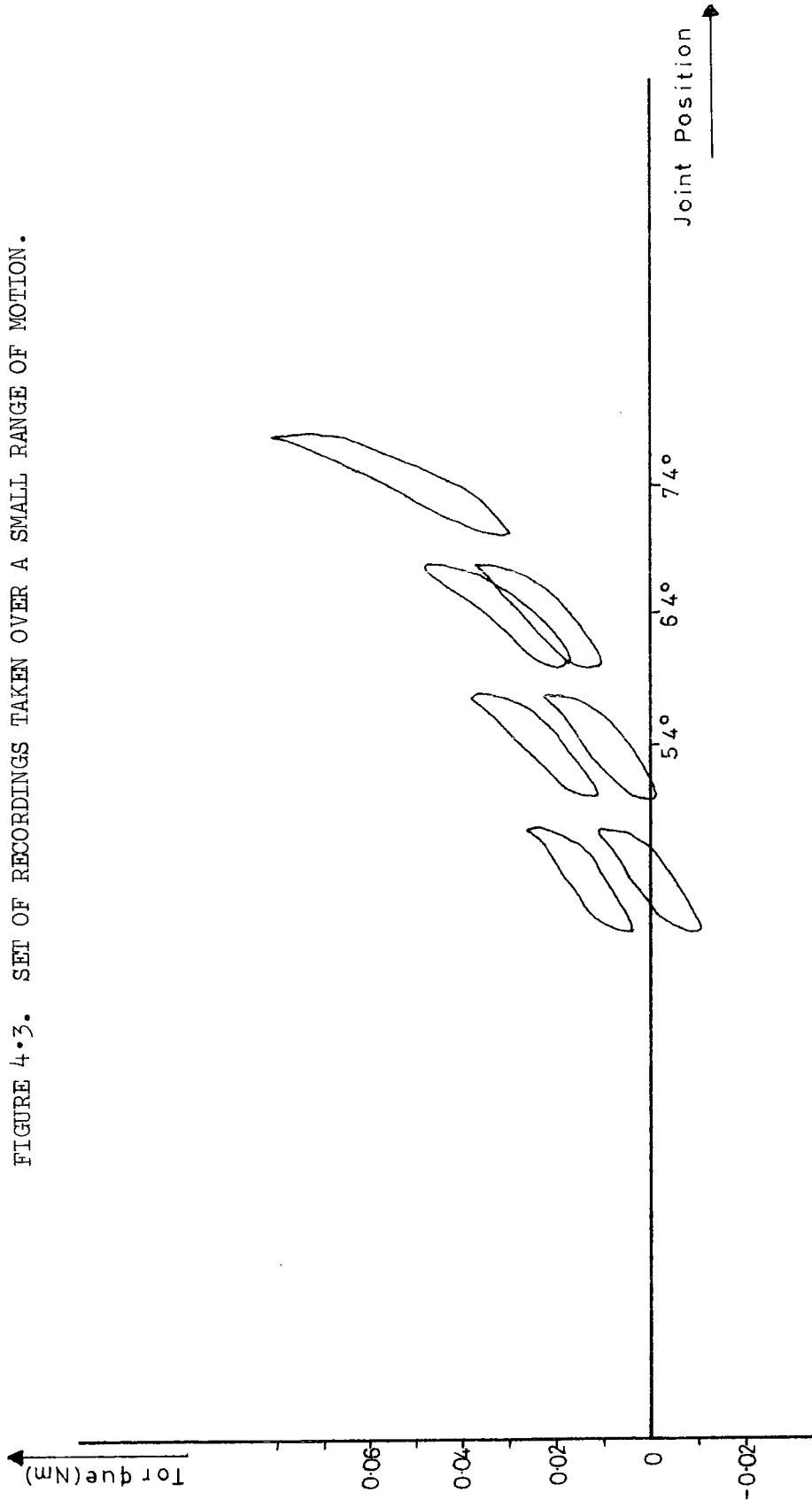
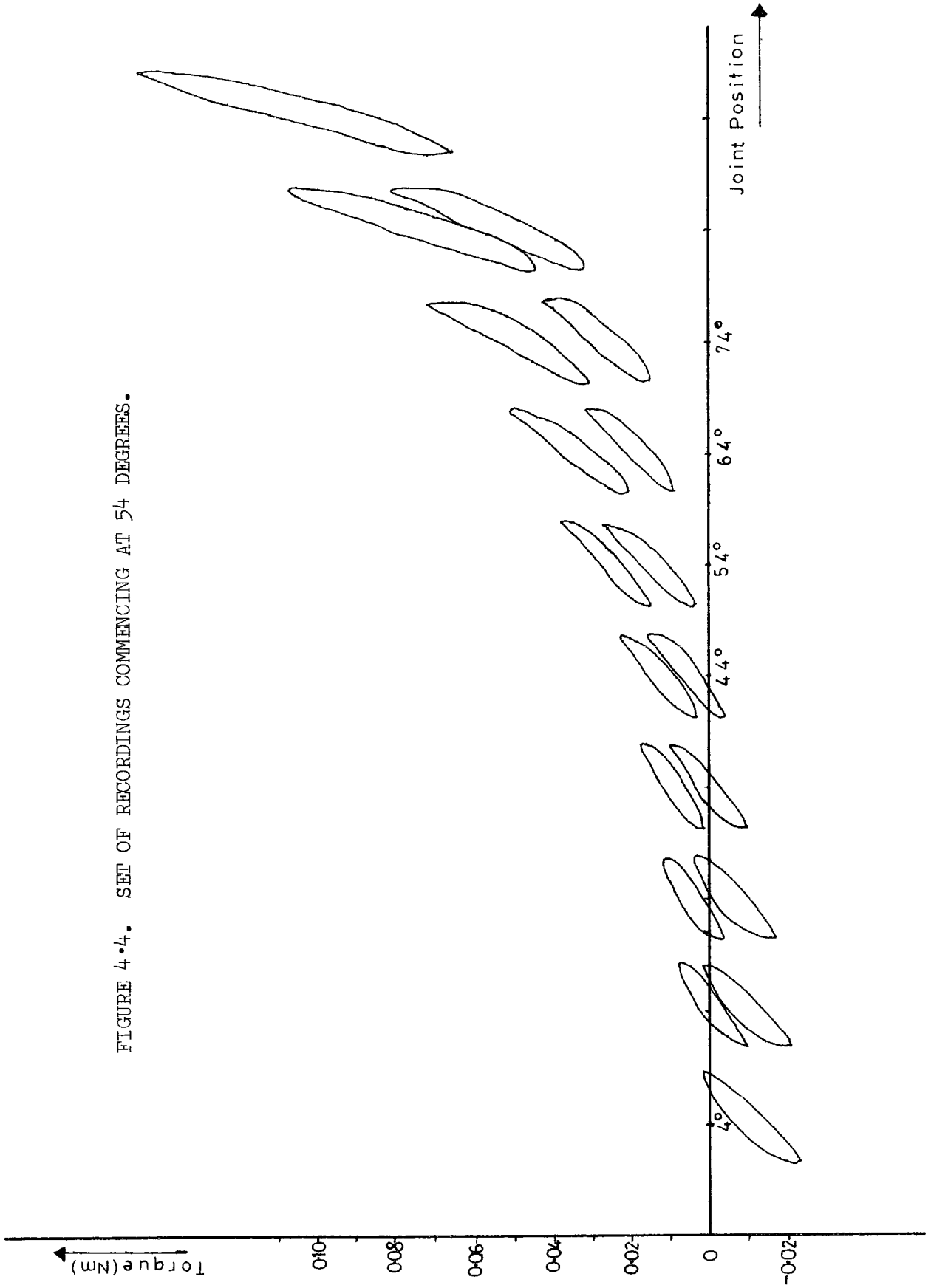

FIGURE 4.3. SET OF RECORDINGS TAKEN OVER A SMALL RANGE OF MOTION.

FIGURE 4.4. SET OF RECORDINGS COMMENCING AT 54 DEGREES.



4.2 Reproducibility

The results of the reproducibility study are shown in Table 4.0. Subject 1 shows a maximum coefficient of variation of 4 per cent whilst subjects 2 and 3 revealed coefficients of variation up to 13 per cent. The reproducibility demonstrated by subject 1 was unusually good for biological studies whereas the reproducibility of subjects 2 and 3 were not so good but remembering that stress relaxation has been demonstrated by previous workers this phenomenon would be influential in increasing the coefficient of variation of these results. Another important factor is that the direction of approach cannot be guaranteed when the finger is removed from the machine and returned again; this then has a greater influence than it would in a normal test as carried out to study treatment.

4.3 Analysis of Results

From each of the hysteresis loops produced, data was processed by mini-computers (Commodore Pet 2001 series and Exidy Ltd., Sorcerer) to provide the following information.

- (i) Dissipated Energy. This is represented by the area of individual hysteresis loops. Each area was found by applying Simpson's rule to each loop. The area of each loop was converted to dissipated energy per cycle. The standard units utilised are Newton metres per cycle ($\text{Nm/cycle} \equiv \text{Joules/cycle}$).
- (ii) The mean slope of the hysteresis loop was found by the least squares fitted line method. Thompson (1978) found that analysis of the mid-line slope of individual loops was a

TABLE 4.0. COEFFICIENT OF VARIATION

Subject	Energy loss/ cycle	Mean slope	Mid-position torque
1	3.4%	4%	3%
2	12.0%	7%	13%
3	5.0%	10%	8%

better measure of the elastic response of a joint, than the parameters used by previous workers, who, because of the large amplitude displacement cycles measured slopes at different positions, (at the mid-positions and end positions of displacement cycles).

A difficulty arose in attempting to compare mean slopes of individual loops because of the position of the loop along the displacement axis relative to the datum point (equilibrium position). If the datum point is taken as the equilibrium position, then any attempt at analysis of a loop at a fixed number of degrees from this position may not correspond to a position of a complete loop for analysis. Hence, this parameter was not used in analysis of data.

- (iii) Mid-position torque. This value of torque was found at the mid-point of the mid-line and provided a measure of the absolute resistance at the mid-position of a displacement cycle. This resistance consists mainly of elastic torque with some Coulomb torque. The slope of the line connecting the mid-position torques of individual loops provides a measure of the elastic characteristics of the joint.

The equilibrium position is the point where the line connecting the mid-position torques crosses the zero torque axis. Each recording shows two positions of equilibrium, one in the direction of flexion and the other in the direction of extension. The standard units of torque are Newton metres (Nm).

- (iv) Peak to peak value of the hysteresis loop gives a value of the overall elastic stiffness of the joint, a higher value indicating a higher degree of stiffness. This is dependant upon all of the dissipative components and does not give an absolute value of torque.

The parameters used in the analysis of hysteresis loops are summarised as follows:-

- (i) Dissipated energy (Nm/cycle)
- (ii) Mid-position torque (Nm) ⁺
- (iii) Equilibrium position (degrees) ^{*}

⁺ The following sign convention will be followed throughout:-

Positive when resisting flexion

Negative when resisting extension

^{*} Although degrees are not S. I. units it is common practise still in the scientific press and clinical situations to use degrees, rather than radians for the amount of flexion and extension of joints.

4.4 Investigation of the Circadian Variation of Stiffness

Figure 4.5 shows a graph of the overall dissipated energy (the sum of the dissipated energies of the individual loops) of 2 female subjects measured at 2 hourly intervals throughout the day. The graph shows a wide interpersonal variation in dissipated energy over a 24 hour period. There was a total of only 8 subjects (5 female, 3 male) who were not tested at the same hour of day and it was felt unjustified to gather mean data for all subjects or to compare overall male and female results. Consequently comparisons of data are presented with trends noted. The values for dissipated energies are shown to vary at 2 hourly intervals. The two subjects in Figure 4.5 show considerable variation in overall dissipated energy during the test period with higher values at the 0200, 0400 and 0600 hr test times. The range of dissipated energies for subject C. C. was 0.0217 Nm/cycle to 0.026 Nm/cycle and the range for subject S. S. was 0.0269 Nm/cycle to 0.0367 Nm/cycle and the difference was statistically significant at $P < 0.001$. The highest values in both subjects obtained at the 0400 hr test time. Although other subjects showed higher values during the night there was considerable variation in the time of the highest peak. One subject showed the highest dissipated energy at 0500 hr and another at 0200 hr.

Mid-position torques were calculated at 20 degrees from the equilibrium position in the direction of flexion (torque 20 (F)) and 20 degrees from the equilibrium position in the direction of extension (torque 20 (E)). It was felt that if useful comparisons were to be made with patients in later parts of the study, then it would be disadvantageous to calculate torques at greater distances

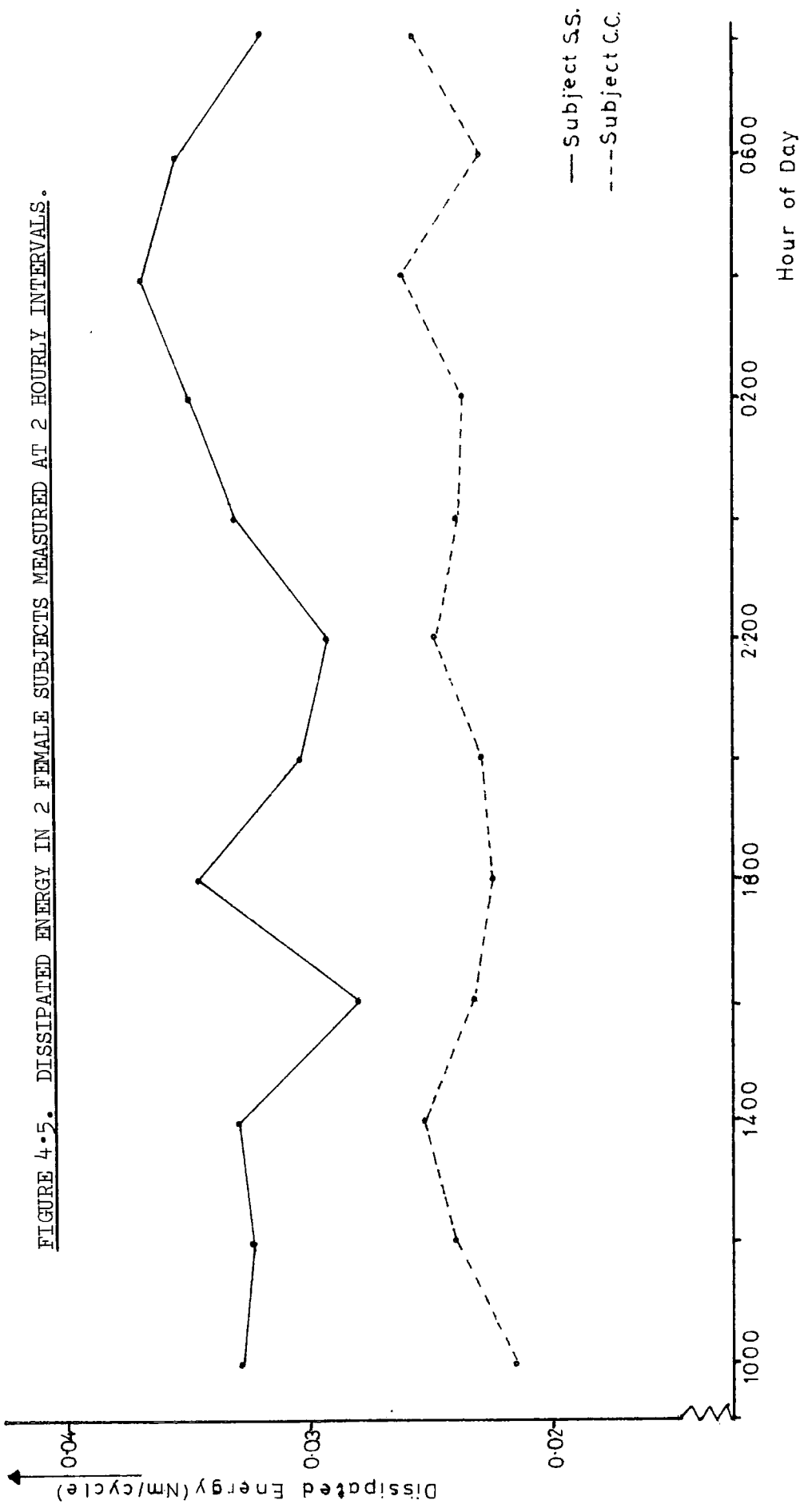

FIGURE 4.5. DISSIPATED ENERGY IN 2 FEMALE SUBJECTS MEASURED AT 2 HOURLY INTERVALS.

from the equilibrium positions. This was considered because many patients suffering from rheumatoid arthritis have a limited range of motion.

Values for overall dissipated energy, mid-position torques 20 (F) and 20 (E) with the corresponding equilibrium positions and skin temperature over a 24 hour period are shown in Tables 4.1 and 4.2 . These parameters show a circadian variation and graphs in the variations in torque are shown in Figures 4.6 and 4.7 . Comparison of the two sets of data shows a significant difference in the temperature recordings ($t = 4.389$, $P < 0.001$), the dissipated energies ($t = 9.704$, $P < 0.001$) and in the equilibrium position in the direction of flexion ($t = 9.2$, $P < 0.001$). The equilibrium positions in extension and the torques at 20 degrees from both the flexion and extension equilibrium positions show no significant difference. Comparison of the mean data with the significance levels are shown in Table 4.3.

The data shown in Table 4.1 indicates a correlation between skin temperature and overall dissipated energy though this is not shown in Table 4.2 . A correlation coefficient of $r = .7068$ was found for subject S. S. whereas a coefficient of $r = .1326$ was found for subject C. C . Equally there was a high value of torque 20 (F) associated with a higher temperature in subject S. S. ($r = .623$) whereas this was not shown in subject C. C. where the correlation coefficient was $r = .0874$.

Table 4.4 shows the values of temperature, dissipated energy, torques and equilibrium positions with the means and

TABLE 4.1.
 VALUES OF DISSIPATED ENERGY (Diss. E.), MID-POSITION TORQUES AT 20 (F) AND 20 (E),
 CORRESPONDING EQUILIBRIUM POSITIONS (Eq. (F) and Eq. (E)) AND SKIN TEMPERATURE
 (SUBJECT S. S.)

Test Time	Temp. °C	Diss. E. 4 - 84 degrees (Nm/cycle)	Eq. (F) (degrees)	Torque 20 (F) (Nm)	Eq. (E) (degrees)	Torque 20 (E) (Nm)
1000	24.2	0.0329	13.0	0.008	39.0	- 0.015
1200	25.9	0.0322	9.5	0.014	38.5	- 0.016
1400	27.4	0.0329	9.5	0.015	48.5	- 0.012
1600	24.3	0.0269	11.0	0.017	26.5	- 0.020
1800	24.5	0.0344	6.5	0.019	34.0	- 0.004
2000	24.9	0.0301	9.0	0.014	47.0	- 0.010
2200	23.7	0.0290	8.5	0.020	32.5	- 0.007
2400	24.9	0.0329	13.5	0.013	41.0	- 0.013
0200	30.8	0.0346	11.5	0.019	31.0	- 0.016
0400	32.9	0.0367	9.0	0.042	35.5	- 0.018
0600	33.9	0.0352	9.0	0.020	28.0	- 0.022
0800	27.6	0.0316	8.5	0.017	26.5	- 0.020
Mean	27.08	0.0325	9.88	0.018	35.7	- 0.014
S.D.	3.41	0.0026	1.93	0.0079	7.08	0.0052

TABLE 4-2.
 VALUES OF DISSIPATED ENERGY (Diss. E.), MID-POSITION TORQUES AT 20 (F) AND 20 (E),
 CORRESPONDING EQUILIBRIUM POSITIONS (Eq. (F) and Eq. (E)) AND SKIN TEMPERATURE
 (SUBJECT C. C.)

Test Time	Temp. °C	Diss. E. 4 - 84 degrees (Nm/cycle)	Eq. (F) (degrees)	Torque 20 (F) (Nm)	Eq. (E) (degrees)	Torque 20 (E) (Nm)
1000	32	0.0217	20.5	0.014	31.5	- 0.010
1200	29	0.0242	15.5	0.014	32.0	- 0.014
1400	29	0.0253	16.5	0.014	30.5	- 0.008
1600	33.8	0.0233	15.5	0.010	35.0	- 0.008
1800	33.2	0.0222	20.0	0.014	30.0	- 0.014
2000	30.6	0.0229	21.0	0.013	39.0	- 0.008
2200	33.6	0.0248	17.0	0.015	36.0	- 0.010
2400	33.3	0.0238	18.5	0.013	39.5	- 0.010
0200	32.1	0.0236	17.5	0.012	38.5	- 0.011
0400	32.6	0.0260	18.0	0.013	33.0	- 0.013
0600	32.6	0.0228	23.5	0.030	39.0	- 0.010
0800	33.0	0.0255	23.0	0.020	46.0	- 0.016
Mean	32.06	0.0238	18.875	0.015	35.8	- 0.011
S.D.	1.596	0.0013	2.607	0.005	4.552	0.0025

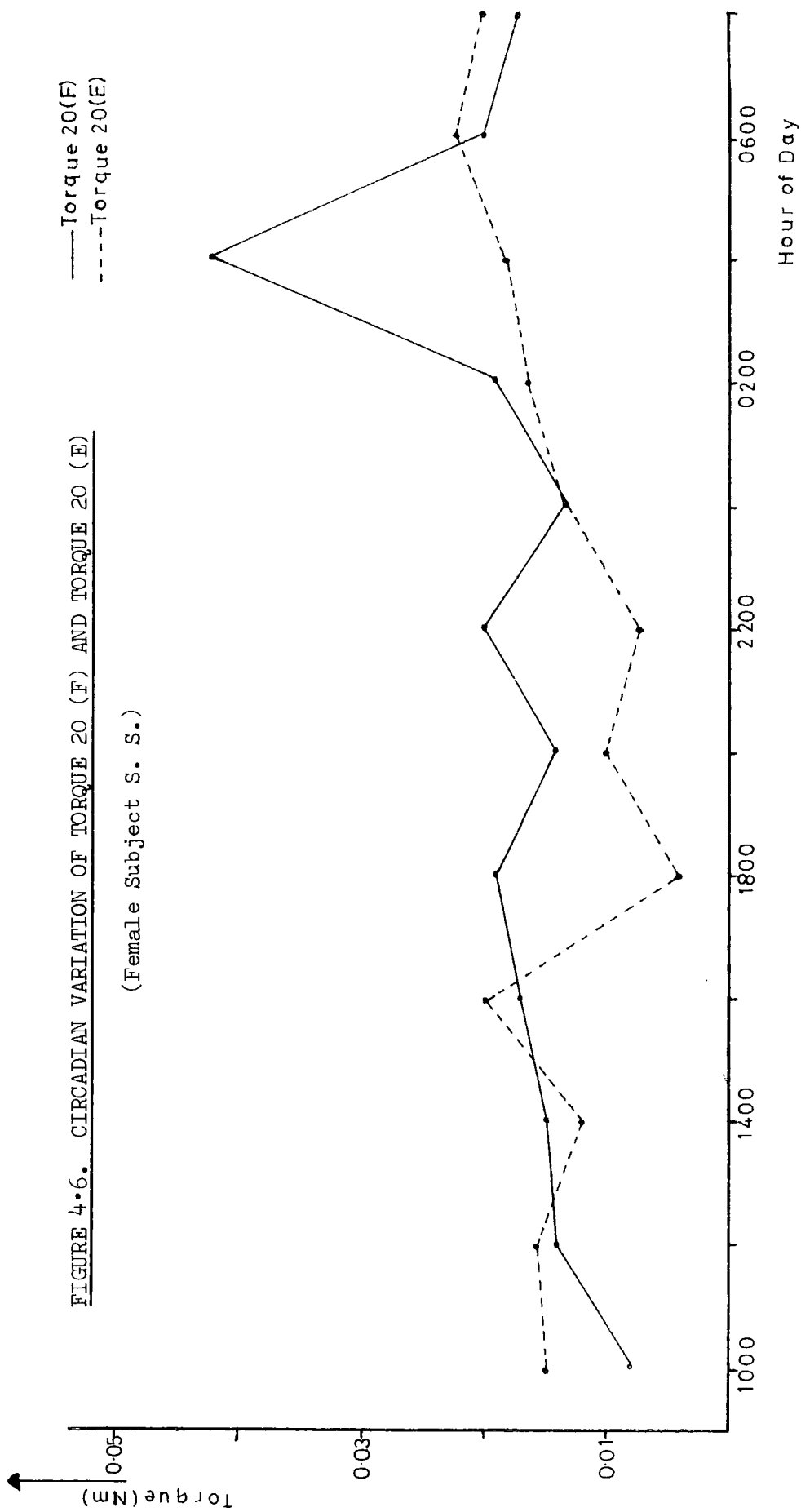

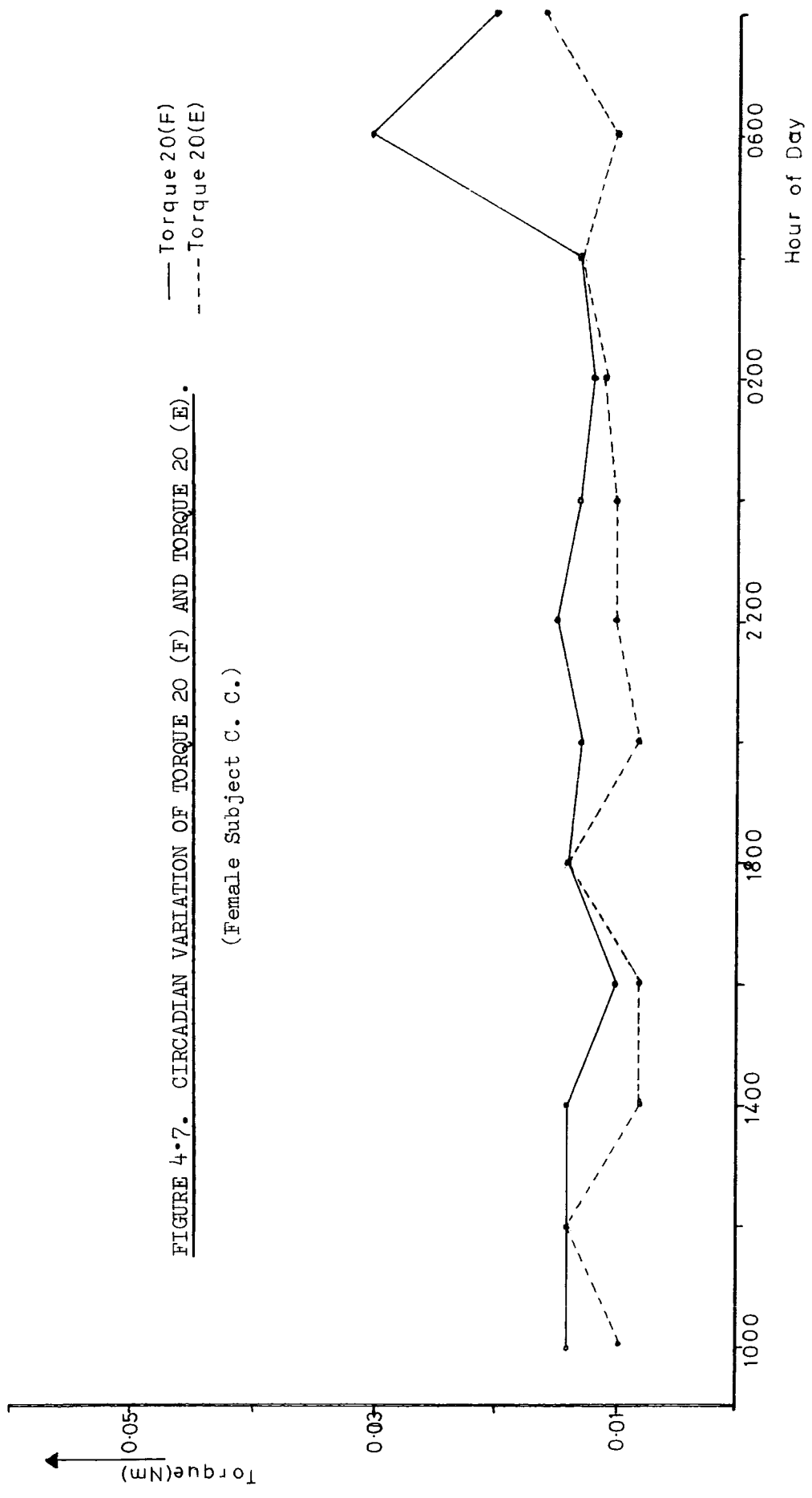

FIGURE 4.7. CIRCADIAN VARIATION OF TORQUE 20 (F) AND TORQUE 20 (E).
(Female Subject C. C.)

— Torque 20(F)
- - - Torque 20(E)

TABLE 4-3.
 MEAN VALUES, STANDARD DEVIATIONS, t VALUES AND SIGNIFICANCE LEVELS IN SUBJECTS S. S.
 AND C. C. FOR TEMPERATURE, DISSIPATED ENERGY, EQUILIBRIUM POSITION AND CORRESPONDING
 TORQUES 20 (F) AND 20 (E) FROM THE EQUILIBRIUM POSITION

	Subject 1		Subject 2		t Value	P
Temp. °C	Mean	27.08	32.06		4.389	< 0.001
	S.D.	3.41	1.596			
Diss. E. (Nm/cycle)	Mean	0.0325	0.0238		9.704	< 0.001
	S.D.	0.00264	0.0013			
Eq. (F) (degrees)	Mean	9.88	18.875		9.2	< 0.001
	S.D.	1.93	2.607			
Torque 20 (F) (Nm)	Mean	0.018	0.015		1.062	N.S.
	S.D.	0.0079	0.005			
Eq. (E) (degrees)	Mean	35.7	35.8		0.0656	N.S.
	S.D.	7.08	4.552			
Torque 20 (E) (Nm)	Mean	-0.014	-0.011		1.945	N.S.
	S.D.	0.0052	0.0025			

TABLE 4.4.
 VALUES OF DISSIPATED ENERGY (Diss. E.), MID-POSITION TORQUES AT 20 (F) AND 20 (E),
 CORRESPONDING EQUILIBRIUM POSITIONS (Eq. (F) and Eq. (E)) AND SKIN TEMPERATURE
 (SUBJECT K. S.)

Test Time	Temp. °C	Diss. E. 4 - 84 degrees (Nm/cycle)	Eq. (F) (degrees)	Torque 20 (F) (Nm)	Eq. (E) (degrees)	Torque 20 (E) (Nm)
1000	24.8	0.0197	21.0	0.024	38.5	- 0.007
1200	27.1	0.0275	23.5	0.024	50.0	- 0.005
1400	31.4	0.0242	13.0	0.030	30.5	- 0.017
1600	29.3	0.0202	28.0	0.016	45.0	- 0.008
1800	30.0	0.0175	9.5	0.003	29.0	- 0.009
2000	27.2	0.0197	8.5	0.015	30.5	- 0.005
2200	27.4	0.0215	5.0	0.009	24.0	- 0.018
2400	31.3	0.0215	8.0	0.010	38.5	- 0.002
0200	32.6	0.0347	21.5	0.016	36.5	- 0.011
0400	34.4	0.0294	14.0	0.055	42.5	- 0.007
0600	34.4	0.0317	20.5	0.018	38.0	- 0.019
0800	33.6	0.0310	14.0	0.012	41.0	- 0.007
Mean	30.29	0.0249	15.54	0.0193	37.0	- 0.0096
S.D.	3.05	0.0055	6.91	0.0129	7.09	0.0053

standard deviations in a male subject. High values of dissipated energy and torques are found in this subject at two of the test times during the night, with the result that the pen recorder exceeded the limit of the Y axis of the XYT recorder. Consequently overall dissipated energies were calculated in the loops between 4 degrees and 74 degrees.

Figure 4.8 shows a graph of the overall dissipated energy throughout the 24 hour period with the highest dissipated energy recorded at 0200 hr.

Figure 4.9 shows a graph of the circadian variation of torque 20 (F) and torque 20 (E). The greatest torques were produced at 0400 hr (flexion) and 0600 hr (extension). These results are similar to those of female subject S. S.

Other subjects also exhibited high values of dissipated energy and torques during the early hours of the morning.

FIGURE 4.8. CIRCADIAN VARIATION OF DISSIPATED ENERGY.

(Male Subject K. S.)

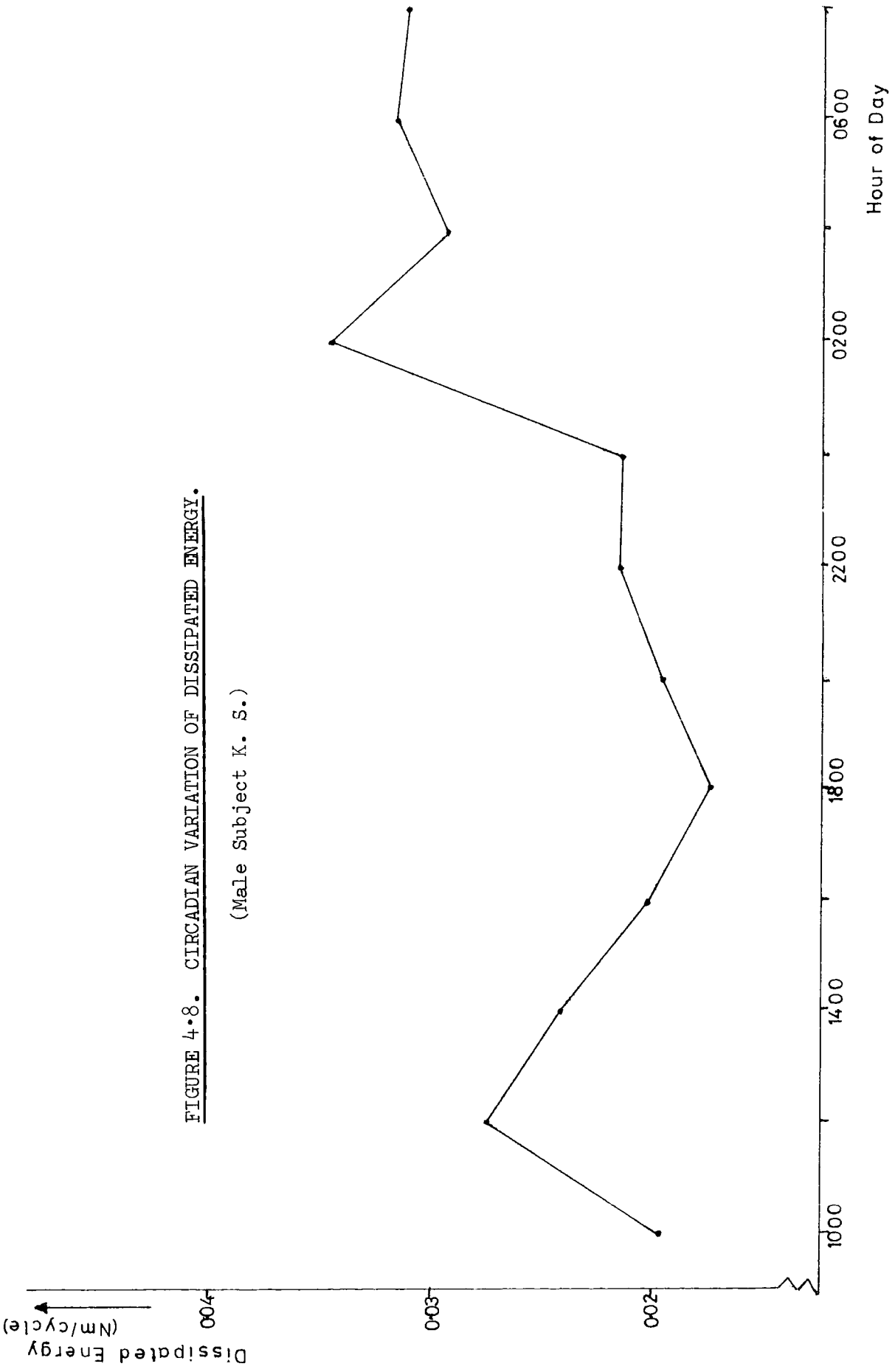

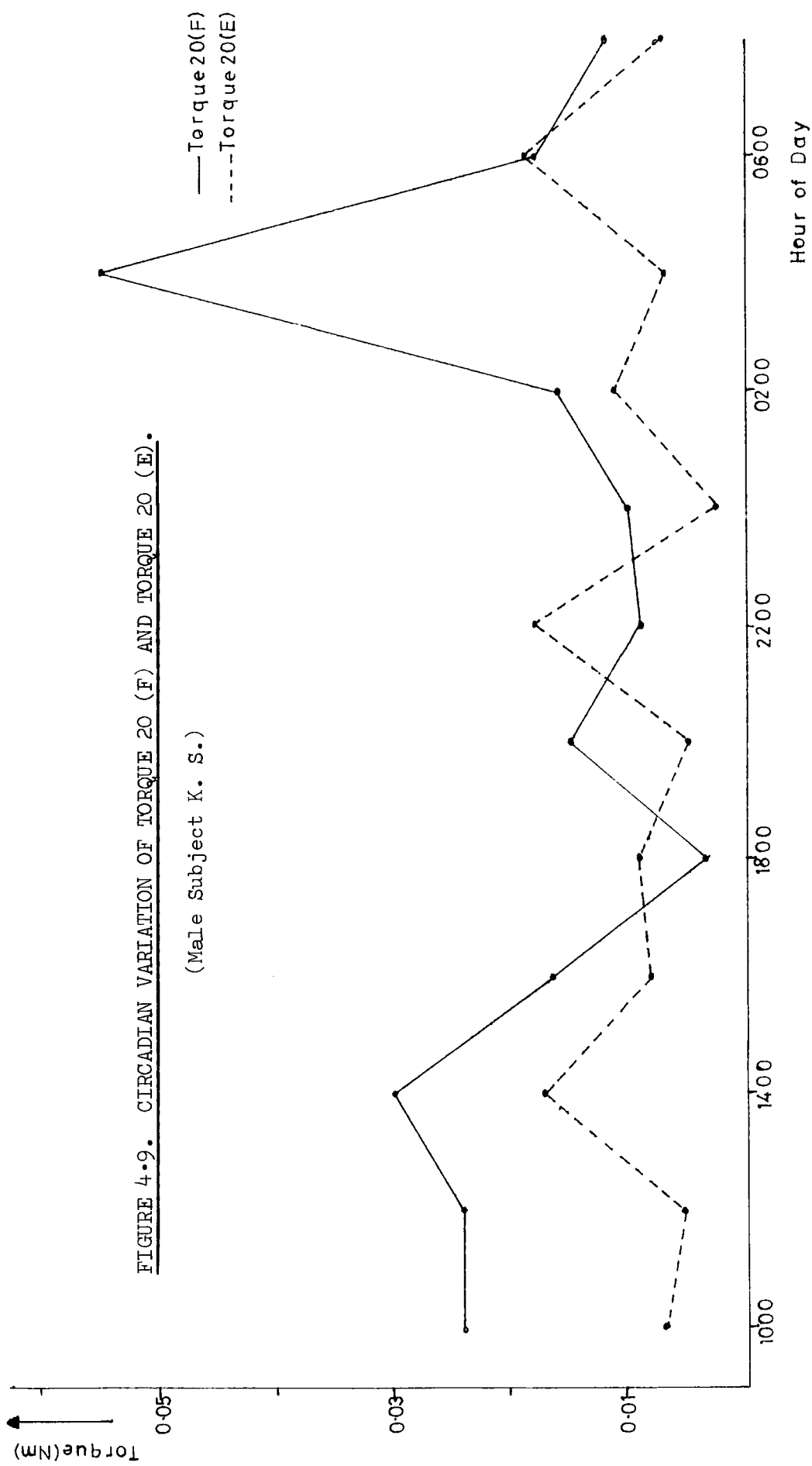

4.5 Stiffness Parameters in Controls and Patients with Rheumatoid Arthritis

4.5.1 Dissipated Energy

Many patients were unable to produce an active range of motion comparable with the control group. The limitation of movement occurred in the direction of flexion beyond 60 degrees, however, the majority of patients tested could attain the neutral position. The dissipated energy therefore was measured in the loops between 4 degrees and 54 degrees in flexion and extension in both groups in order that results could be compared. The results show the sum of the dissipated energies between 4 degrees and 54 degrees.

Figure 4.10 shows a scattergram of the dissipated energies with the means and standard deviations for the control and patient groups. The range of values for the control group was found to be 0.0052 Nm/cycle to 0.22 Nm/cycle (mean 0.01179 ± 0.00386) and for the patient group 0.0035 Nm/cycle to 0.242 Nm/cycle (mean 0.0122 ± 0.00465). The results show no significant difference between the two groups ($t = 0.1968$).

A difference in dissipated energies was noted between male and female subjects in both the control and patient groups. Male subjects had higher dissipated energies than female subjects and the results are shown in Tables 4.5 and 4.6.

FIGURE 4-10. SCATTERGRAM OF DISSIPATED ENERGIES WITH MEANS AND STANDARD DEVIATIONS IN THE CONTROL AND PATIENT GROUPS.

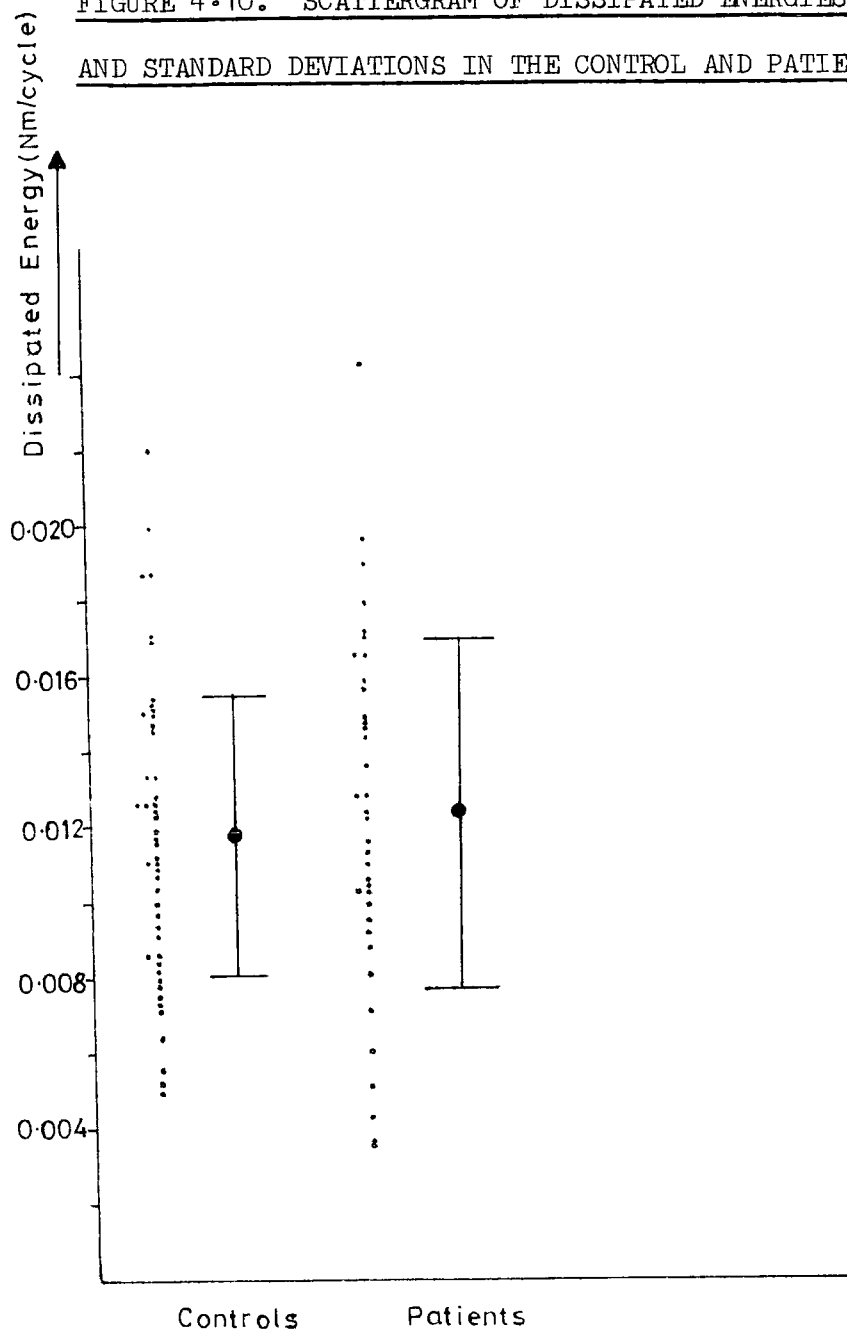

TABLE 4.5.

MEAN VALUES, STANDARD DEVIATIONS, t VALUES AND SIGNIFICANCE LEVELS IN
 MALE AND FEMALE CONTROLS OF DISSIPATED ENERGY, EQUILIBRIUM POSITION
 AND TORQUES 20 (F) AND 20 (E)

CONTROLS

	MALE	FEMALE	t Value and Significance
Diss. E. (Nm/cycle)	0.0149 \pm 0.0051 N = 6	0.0113 \pm 0.0034 N = 41	t = 2.172 P < 0.05
Eq. (F)	19.25 \pm 3.17 N = 6	17.51 \pm 6.31 N = 39	t = 0.6468 N.S.
Torque 20 (F)	0.0153 \pm 0.0039 N = 6	0.0139 \pm 0.0045 N = 39	t = 0.7385 N.S.
Eq. (E)	37.8 \pm 5.83 N = 6	35.84 \pm 8.51 N = 38	t = 0.5404 N.S.
Torque 20 (E)	-0.0142 \pm 0.0053 N = 6	-0.0116 \pm 0.0046 N = 35	t = 0.1951 N.S.

TABLE 4.6.

MEAN VALUES, STANDARD DEVIATIONS, t VALUES AND SIGNIFICANCE LEVELS IN
 MALE AND FEMALE PATIENTS OF DISSIPATED ENERGY, EQUILIBRIUM POSITION
 AND TORQUES 20 (F) AND 20 (E)

PATIENTS

	MALE	FEMALE	t Value and Significance
Diss. E. (Nm/cycle)	0.0144 ± 0.0053 N = 13	0.0111 ± 0.0039 N = 24	t = 2.188 P < 0.05
Eq. (F)	15.35 ± 5.55 N = 13	15.17 ± 6.17 N = 26	t = 0.1405 N.S.
Torque 20 (F)	0.0172 ± 0.0084 N = 13	0.0161 ± 0.00999 N = 24	t = 0.3191 N.S.
Eq. (E)	38.97 ± 11.73 N = 15	31.17 ± 13.35 N = 26	t = 1.834 N.S.
Torque 20 (E)	-0.0137 ± 0.0043 N = 13	-0.014 ± 0.0088 N = 17	t = 0.1126 N.S.

4.5.2 Torque at 20 Degrees from the Equilibrium Position in the Direction of Flexion (Torque 20 (F))

Figure 4.11 shows a scattergram of the torque 20 (F) with the means and standard deviations in both groups. The range of values for the controls was 0.004 Nm to 0.025 Nm (mean 0.014 \pm 0.00444) and for patients 0.002 Nm to 0.051 Nm (mean 0.0168 \pm 0.00954). The figure shows a greater mean value and larger standard deviation in patients although the difference is not significant ($t = 1.6706$).

Tables 4.5 and 4.6 indicate no difference between male and female subjects, at a statistically significant level.

4.5.3 Torque at 20 Degrees from the Equilibrium Position in the Direction of Extension (Torque 20 (E))

Figure 4.11 shows a scattergram of the torque 20 (E) with the means and standard deviations in the control and patient groups. The range of values for controls was found to be 0.005 Nm to 0.027 Nm (mean 0.012 \pm 0.0048) and the values for patients 0.003 Nm to 0.034 Nm (mean 0.014 \pm 0.0076). There is no significant difference between the two groups ($t = 1.606$).

Tables 4.5 and 4.6 indicate no difference between the sexes in this parameter, at a statistically significant level.

4.5.4 Equilibrium Position in the Direction of Flexion (Eq. (F))

The equilibrium position in the direction of flexion was found to be slightly higher in the control group. A scattergram comparing the two groups is shown in Figure 4.12. The range of

FIGURE 4.11. SCATTERGRAM OF TORQUE 20 (F) AND TORQUE 20 (E)
WITH MEANS AND STANDARD DEVIATIONS IN THE CONTROL AND PATIENT
GROUPS.

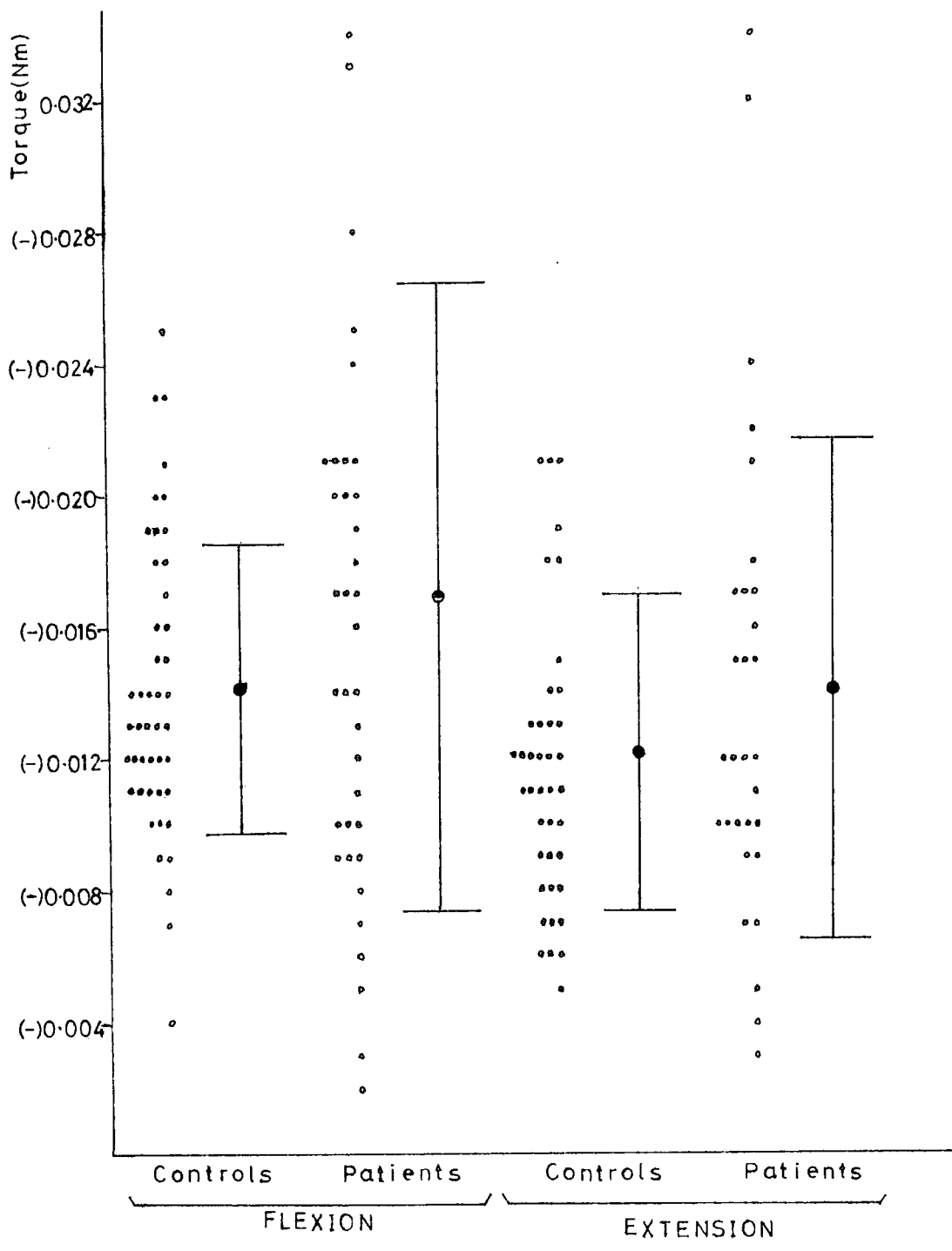

One patient gave a torque of 0.051 Nm at torque 20 (F).

FIGURE 4•12. SCATTERGRAM OF EQUILIBRIUM POSITIONS (F) AND (E)
WITH MEANS AND STANDARD DEVIATIONS IN THE CONTROL AND PATIENT
GROUPS.

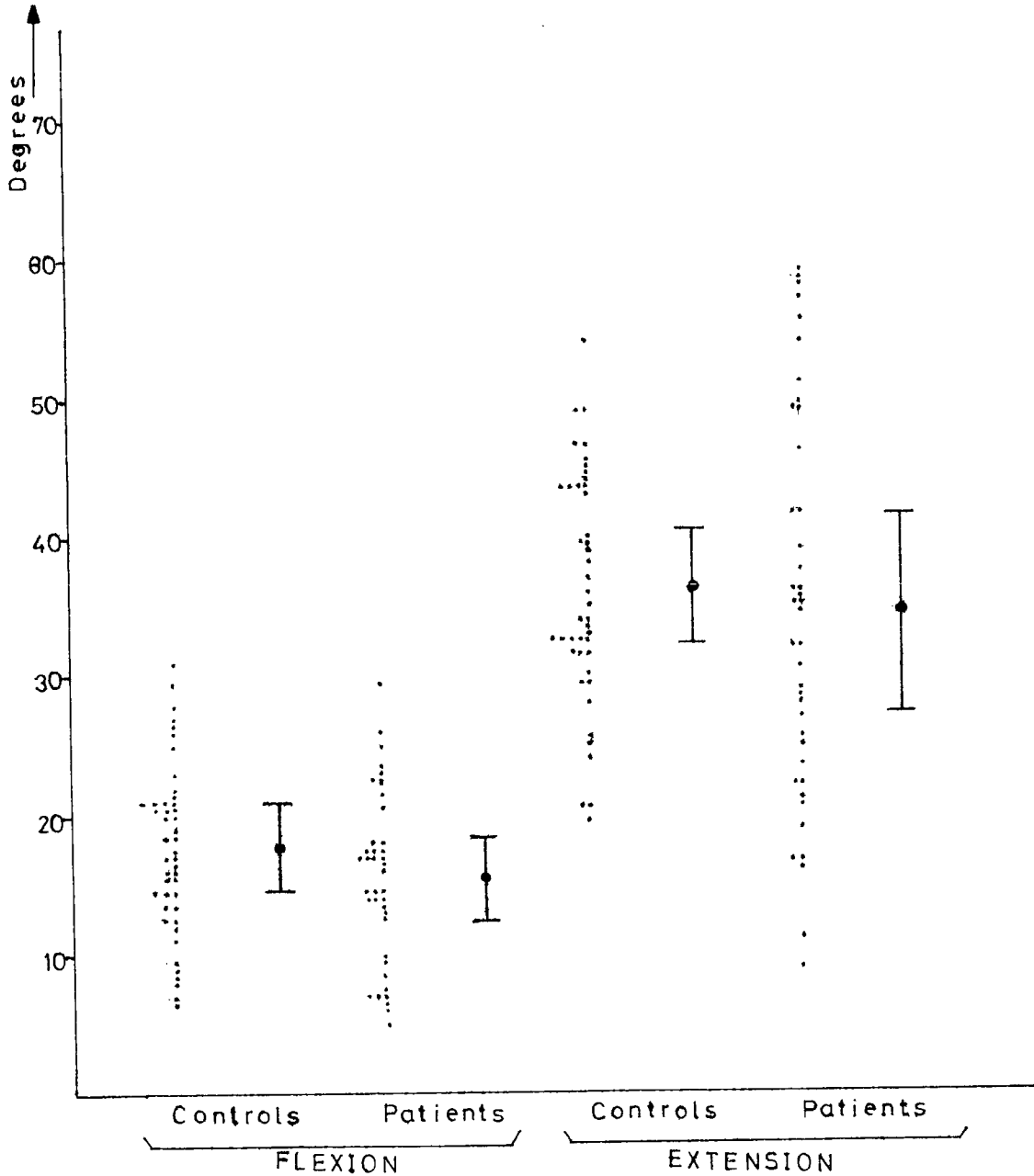

values for the control group was found to be 6.5 degrees to 31 degrees (mean 17.74 ± 6.015) and for patients 5 degrees to 29.5 degrees (mean 15.4 ± 6.027). There is no significant difference between the two groups ($t = 1.7412$).

There was no difference between the sexes in this parameter. The results are shown in Tables 4.5 and 4.6.

4.5.5 Equilibrium Position in the Direction of Extension (Eq. (E))

The results of the equilibrium position in the direction of extension are shown in Figure 4.12. The range of values for the control group was 19.5 degrees to 54 degrees (mean 36.11 ± 8.22) and for the patient group, 9 degrees to 59 degrees (mean 34.5 ± 13.847). There is no significant difference between the two groups ($t = 0.6456$).

Tables 4.5 and 4.6 show no difference between the sexes in this parameter, at a statistically significant level.

4.6 Other Parameters

4.6.1 Grip Strength (Measured in terms of pressures achieved in a hand held cuff)

Mean grip strength of the control group was found to be more than double that of the patient group, although both groups showed a large standard deviation. The range of values for the control group was 146 mm Hg to 450 mm Hg (mean 280.9 ± 80.5) and for the patient group 48.6 mm Hg to 300 mm Hg (mean 111.57 ± 68.06). These results are significant at $P < 0.001$ ($t = 10.388$).

It was not possible to compare male and female results in the control group as the males exceeded the limit of the dynamometer. Comparison of male and female patients gave a higher mean value for the male sample and the results were statistically significant at $P < 0.001$ ($t = 4.2942$).

Figure 4.13 shows the range of values with means and standard deviations in the male and female patient groups.

4.6.2 Temperature

Skin temperature measured on the skin on the lateral aspect of the metacarpophalangeal joint gave a range of values for the controls of 25°C to 35.9°C (mean $29.93^{\circ}\text{C} \pm 2.626$) and for patients 27.3°C to 35.6°C (mean $32.9^{\circ}\text{C} \pm 2.007$). These results are statistically significant at $P < 0.001$ ($t = 5.7435$).

These results are shown graphically in Figure 4.14.

FIGURE 4.13. SCATTERGRAM OF GRIP STRENGTH WITH MEANS AND STANDARD DEVIATIONS IN MALE AND FEMALE PATIENTS

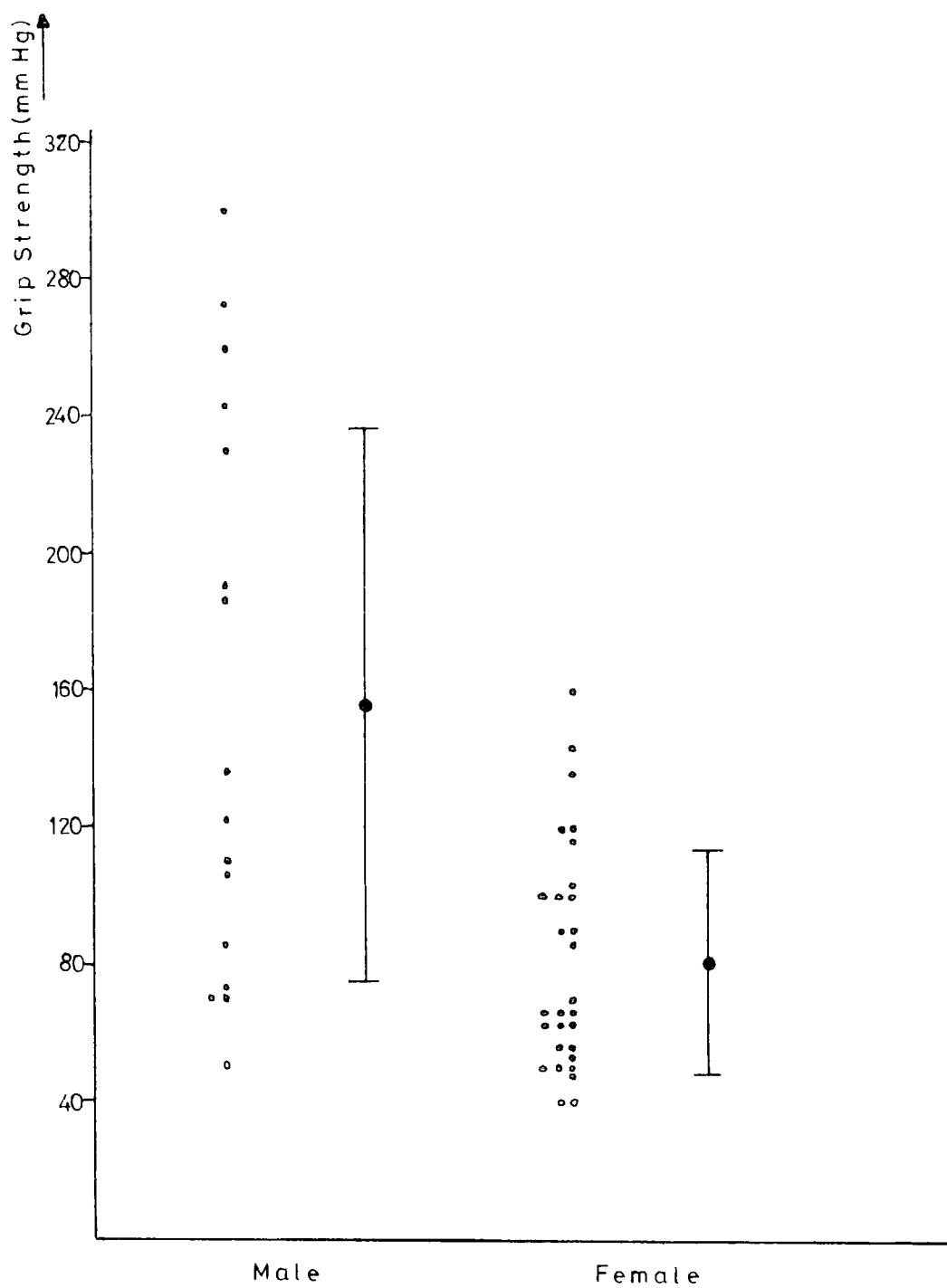
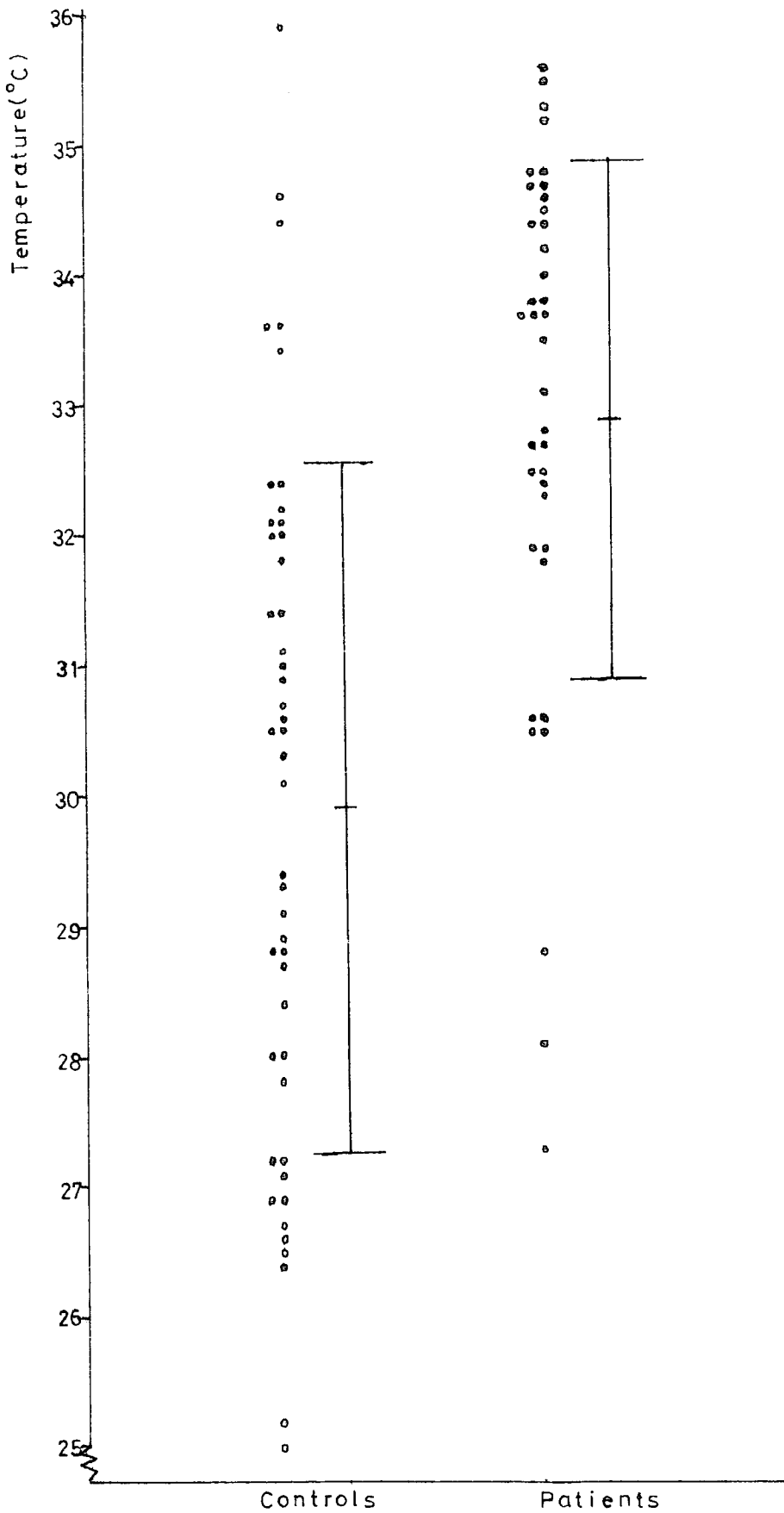

FIGURE 4.14. SCATTERGRAM OF SKIN TEMPERATURES WITH MEANS AND STANDARD DEVIATIONS IN THE CONTROL AND PATIENT GROUPS.



4.6.3 Limb Circumference

Table 4.7 shows the means and standard deviations for limb circumference measurements in male and female subjects. Male subjects had a greater mean circumference measurement at all recorded levels.

Comparison of the ranges of limb circumference in patients and controls with t values and significance levels is shown in Table 4.8 . The patient group had a greater mean wrist circumference and the difference between the control and patient group is significant at $P < 0.001$ ($t = 6.019$).

4.6.4 Swelling and Tendon Involvement

Insufficient numbers of patients presented with either soft tissue swelling around the metacarpophalangeal joint or with obvious tendon involvement. However, a number of patients did have bony swelling of the metacarpophalangeal joint. The degrees of swelling were assigned a rank of 1 (mild), 2 (moderate) and 3 (severe) and correlations with dissipated energy and torque 20 (F) and torque 20 (E) were computed using Spearman's rank order correlation coefficient.

The relevant correlation coefficients are shown in Table 4.9. Positive correlations were found between the degree of bony swelling and dissipated energy and between the degree of bony swelling and torque 20 (F) and torque 20 (E). The highest correlation was found between the degree of bony swelling and dissipated energy but none of the correlations achieved statistical significance.

TABLE 4.7. MEANS AND STANDARD DEVIATIONS OF LIMB CIRCUMFERENCE MEASUREMENTS (cm)
 IN MALE AND FEMALE SUBJECTS.

	CONTROLS		PATIENTS	
	MALE	FEMALE	MALE	FEMALE
Wrist	16.75 ± 0.95	15.47 ± 0.85	18.94 ± 0.93	16.33 ± 1.02
Forearm $\frac{1}{4}$	18.83 ± 1.31	17.00 ± 1.29	19.59 ± 1.46	17.19 ± 1.63
Forearm $\frac{1}{2}$	25.25 ± 0.99	21.89 ± 1.74	24.66 ± 2.07	21.50 ± 2.11
Forearm $\frac{3}{4}$	27.83 ± 1.14	24.11 ± 1.43	27.59 ± 1.86	24.07 ± 1.89

TABLE 4-8. RANGE OF ARM CIRCUMFERENCES WITH MEANS AND STANDARD DEVIATIONS

t VALUES AND SIGNIFICANCE LEVELS ARE SHOWN BETWEEN GROUPS

CONTROLS	PATIENTS
----------	----------

	Range (cm)	Mean (cm) and S.D.	Range (cm)	Mean (cm) and S.D.	t Value	Significance Level
Wrist	13.5 - 18	15.65 ± 0.948	15 - 21	17.27 ± 1.579	6.019	P < 0.001
Forearm $\frac{1}{4}$	15 - 21	17.21 ± 1.45	14.5 - 22.5	18.04 ± 1.94	2.254	P < 0.025
Forearm $\frac{1}{2}$	18.5 - 27	22.29 ± 2.02	18 - 28	22.608 ± 2.56	0.622	N.S.
Forearm $\frac{3}{4}$	21.5 - 30	24.75 ± 1.87	21 - 30	24.74 ± 4.39	1.503	N.S.

Wrist measurements recorded at level of ulna and radial styloid processes, forearm measurements recorded at $\frac{1}{4}$, $\frac{1}{2}$, and $\frac{3}{4}$ of the distance between the ulna styloid process and medial epicondyle of the humerus.

TABLE 4.9.
 SPEARMAN'S RANK ORDER CORRELATION COEFFICIENTS BETWEEN BONY SWELLING
 AND DISSIPATED ENERGY AND BETWEEN BONY SWELLING AND
 TORQUE 20 (F) AND TORQUE 20 (E)

PARAMETERS	Correlation Coefficients	Significance Level
Bony swelling v dissipated energy	.327	N.S.
Bony swelling v torque 20 (F)	.152	N.S.
Bony swelling v torque 20 (E)	.285	N.S.

4.7 Correlation of Various Parameters

In order to identify any correlation between the various parameters the results were subjected to Pearson's product moment correlation coefficient. All subjects, particularly in the patient group, did not have a full range of results in all parameters. Consequently only those subjects with a complete set of parameters are included in the analysis of results using the correlation coefficient.

A correlation matrix for the control group is shown in Table 4.10 and a correlation matrix for the patient group is shown in Table 4.11. The key for the correlation matrix factors is shown below.

CORRELATION MATRIX FACTORS

1. Age
2. Sex
3. Dissipated Energy
4. Torque 20 (F)
5. Torque 20 (E)
6. Equilibrium (F)
7. Equilibrium (E)
8. Grip Strength
9. Temperature
10. Wrist Circumference
11. Forearm $\frac{1}{4}$
12. Forearm $\frac{1}{2}$
13. Forearm $\frac{3}{4}$

Raw data of various parameters is contained in Appendix 3.

TABLE 4.10. CORRELATION MATRIX.

CONTROLS

	1	2	3	4	5	6	7	8	9	10	11	12
1												
2												
3	.1178	.2399										
4	.1183	.1074	.4058 ^o									
5	.1289	.0728	.6294 ^x	.4244 [□]								
6	.0073	.1546	.1318	.123	.0646							
7	.0698	.1735	.0165	.4538 [□]	.0464	.7544 ^x						
8	.1794	.6033 ^x	.5458 ^x	.2655	.291	.0832	.0436					
9	.0055	.0853	.0601	.237	.1521	.1989	.304	.0428				
10	.1065	.4203 [□]	.5057 [□]	.2662	.1236	.0407	.0401	.4365 [□]	.1272			
11	.1302	.3276 ^o	.4487 [□]	.0636	.2354	.0998	.0229	.4484 [□]	.1421	.9255 [•]		
12	.2585	.4262 [□]	.4742 [□]	.1458	.2571	.0894	.0544	.5536 ^x	.2094	.8359 [•]	.9124 [•]	
13	.323	.4514 [□]	.5326 ^x	.1183	.2634	.0219	.0157	.591 ^x	.2243	.7877 [•]	.8308 [•]	.940 [•]

□ P < 0.01
o P < 0.05
x P < 0.001
• P < 0.0005

TABLE 4.11. CORRELATION MATRIX.

	PATIENTS												
	1	2	3	4	5	6	7	8	9	10	11	12	
1	-												
2		-											
3			-										
4				-									
5					-								
6						-							
7							-						
8								-					
9									-				
10										-			
11											-		
12												-	
13													-

□ P < 0.01
 ○ P < 0.05
 × P < 0.001

4.8 The Effect of Various Forms of Physiotherapy Upon Stiffness Parameters

Pairs of subjects were tested prior to and following physiotherapeutic measures. The results were analysed and subjected to Students 't' tests for correlated samples.

4.8.1 Dissipated Energy

Figure 4.15 shows the means and standard deviations of dissipated energy in the patient and control groups prior to and following various physiotherapy measures. Ultrasound therapy and short wave diathermy produced the greatest mean decreases in the patient group but had no effect on the control group. Paraffin wax had the greatest influence on the control group and although there was a decrease in dissipated energy in the patient group this is not significant.

Table 4.12 shows the t values and significance levels in patients and controls in pre and post treatment dissipated energy.

4.8.2 Torque at 20 Degrees from the Equilibrium Position in the Direction of Flexion (Torque 20 (F))

Slight alterations in torque 20 (F) occurred following the treatment measures. Ultrasound and ice therapy produced an increase in the mean torque 20 (F) in both the control and patient groups though the difference was not significant. Figure 4.16 shows the means and standard deviations prior to and following treatment in the patient and control groups.

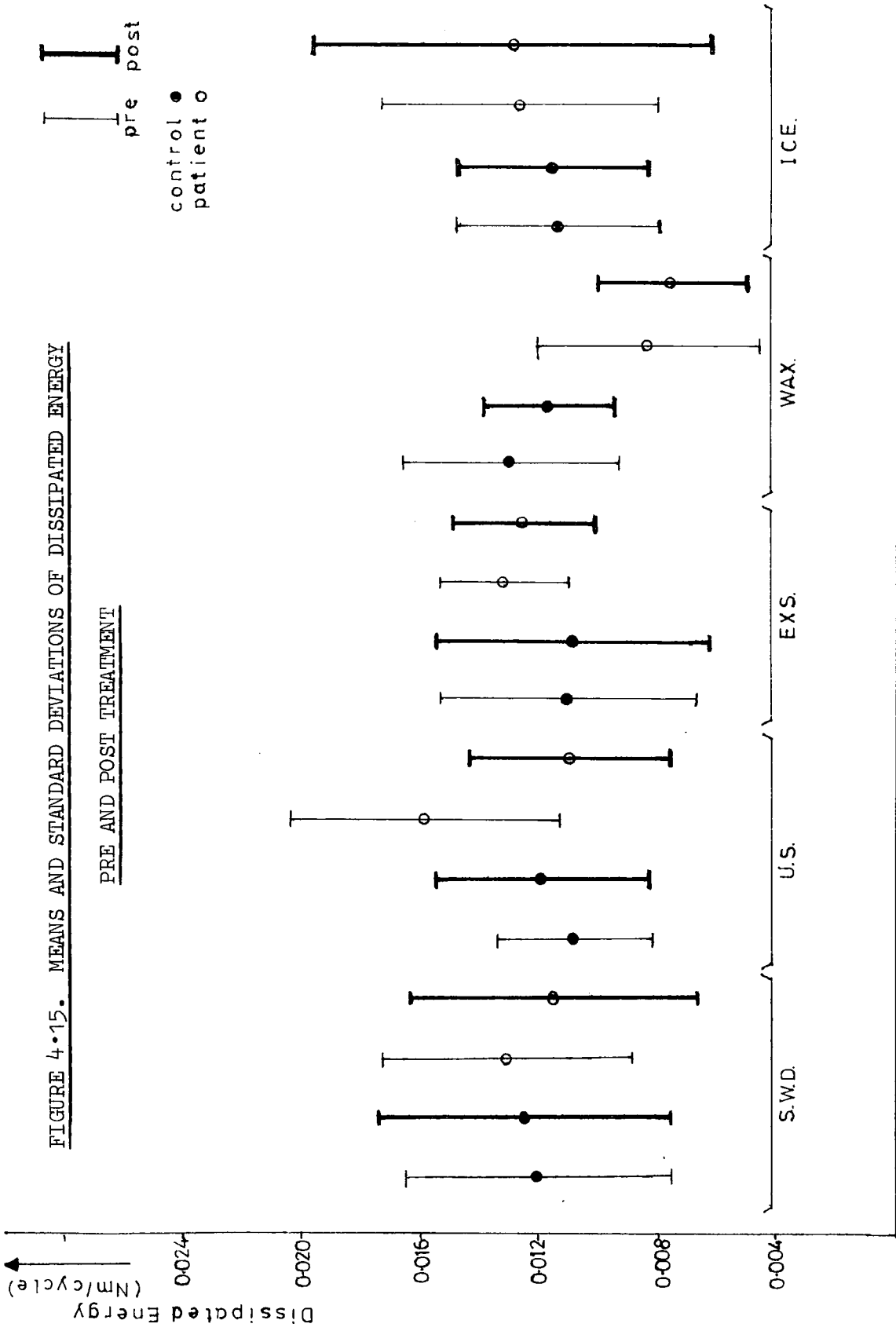

Treatment.

TABLE 4.12 DISSIPATED ENERGY (4 degrees - 54 degrees)
 t VALUES AND SIGNIFICANCE LEVELS PRE AND POST TREATMENT IN THE
 PATIENT AND CONTROL GROUPS

	Controls		Patients	
	t Value	Significance	t Value	Significance
S.W.D.	0.678	N.S.	3.211	$P < 0.025$
U.S.	1.377	N.S.	3.57	$P < 0.025$
EXS.	0.268	N.S.	0.561	N.S.
WAX	1.1854	N.S.	1.400	N.S.
ICE	0.266	N.S.	0.2056	N.S.

S.W.D. - Short wave diathermy

U.S. - Ultrasound

EXS. - Exercise

(N.S. - Not significant)

Data for individual subjects is contained in Table K of Appendix 4.

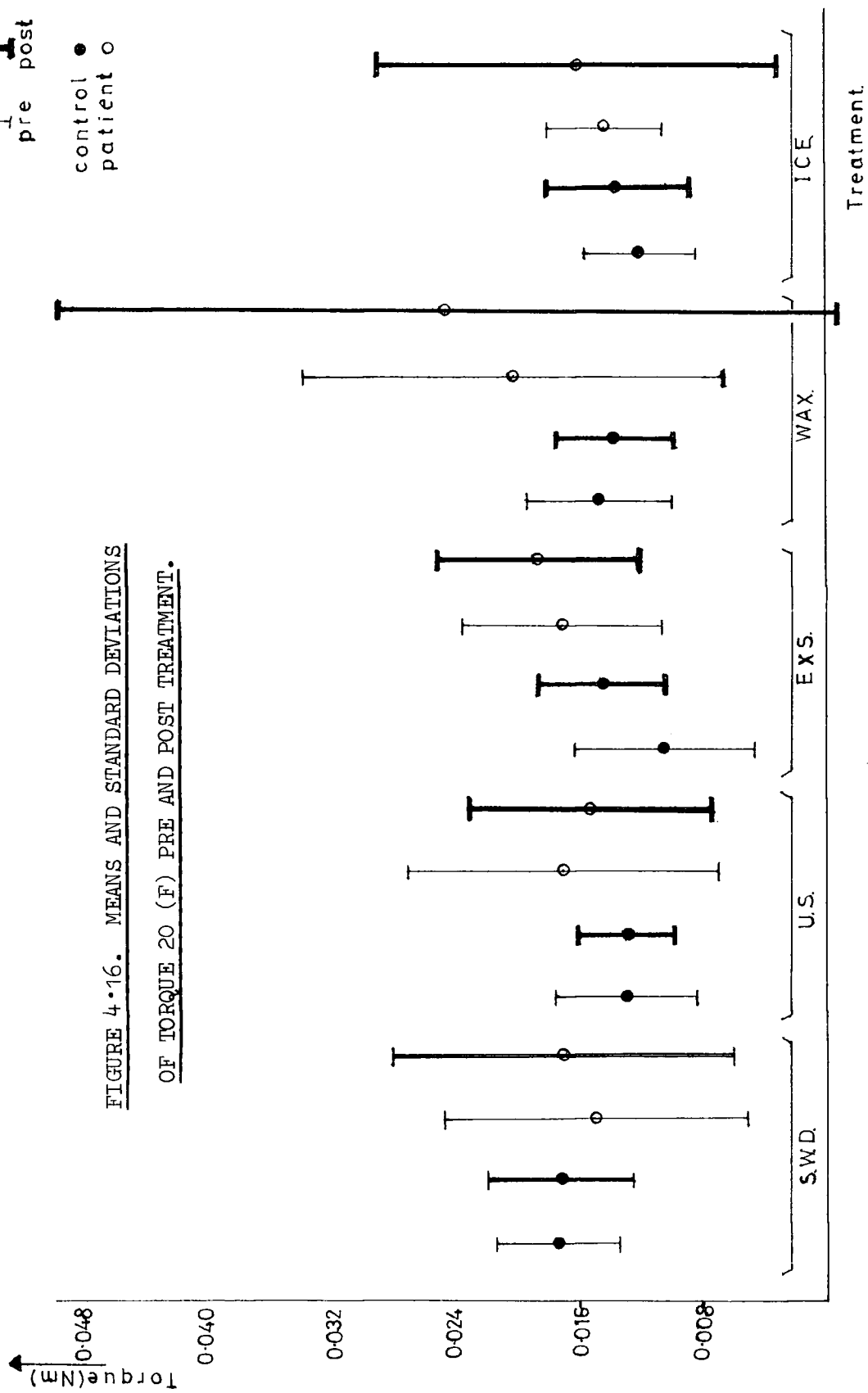

FIGURE 4*16. MEANS AND STANDARD DEVIATIONS OF TORQUE 20 (F) PRE AND POST TREATMENT.

Table 4.13 shows the t values and significance levels between pre and post treatment in parameter torque 20 (F).

4.8.3 Torque at 20 Degrees from the Equilibrium Position in the Direction of Extension (Torque 20 (E))

Figure 4.17 shows the means and standard deviations pre and post treatment in the patient and control group. Slight alterations in torque 20 (E) are shown but the differences are not significant as shown in Table 4.14.

4.8.4 Equilibrium Position in the Direction of Flexion (Eq. (F))

Figure 4.18 shows the means and standard deviations of parameter Eq. (F) pre and post treatment in the patient and control groups. There is a considerable variation in some of the means but only short wave diathermy in the patient group produced a significantly higher Eq. (F).

Table 4.15 shows the t values and significance levels for parameter Eq. (F).

4.8.5 Equilibrium Position in the Direction of Extension (Eq. (E))

Figure 4.19 shows the means and standard deviations of the Eq. (E) parameter in the patient and control groups prior to and following treatment. Treatment by short wave diathermy produced a lowering of the Eq. (E) in the control group which was not significant.

Table 4.16 gives the t values and significance levels for parameter Eq. (E).

TABLE 4.13 TORQUE 20 (F)

t VALUES AND SIGNIFICANCE LEVELS PRE AND POST TREATMENT IN THE
PATIENT AND CONTROL GROUPS

	Controls		Patients	
	t Value	Significance	t Value	Significance
S.W.D.	0.2027	N.S.	0.5687	N.S.
U.S.	0.3780	N.S.	0.4770	N.S.
EXS.	1.7140	N.S.	0.3497	N.S.
WAX	0.5129	N.S.	0.7478	N.S.
ICE	0.7993	N.S.	0.5178	N.S.

Data for individual subjects is contained in Table L of Appendix 4.



FIGURE 4.17. MEANS AND STANDARD DEVIATIONS
OF TORQUE 20 (E) PRE AND POST TREATMENT.

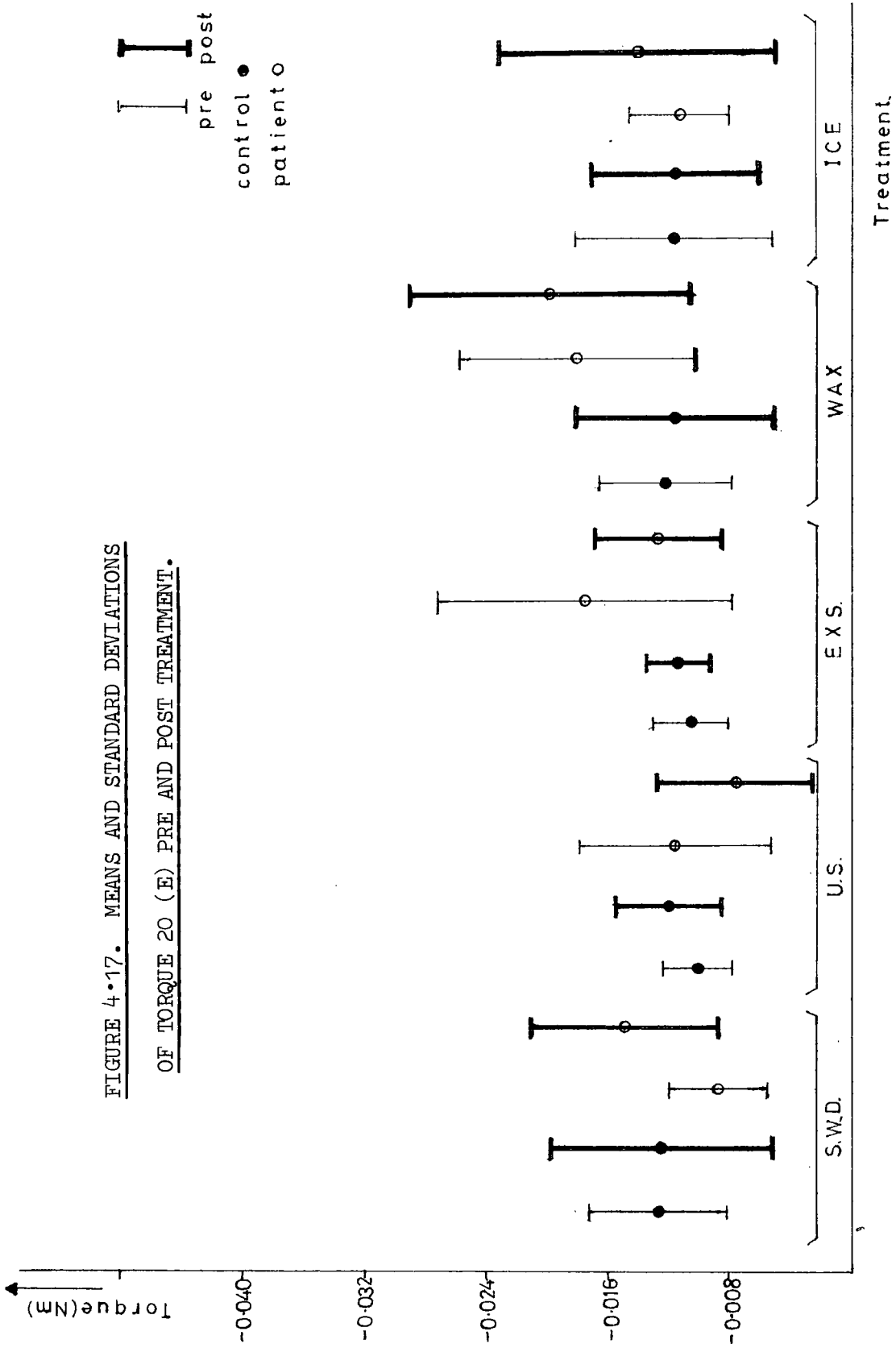

TABLE 4.14 TORQUE 20 (E)

t VALUES AND SIGNIFICANCE LEVELS PRE AND POST TREATMENT IN THE
PATIENT AND CONTROL GROUPS

	Controls		Patients	
	t Value	Significance	t Value	Significance
S.W.D.	0.1360	N.S.	1.4615	N.S.
U.S.	1.1180	N.S.	2.086	N.S.
EXS.	0.7820	N.S.	1.0739	N.S.
WAX	0.6446	N.S.	0.8858	N.S.
ICE	0.0021	N.S.	0.9562	N.S.

Data for individual subjects is contained in Table M of Appendix 4.

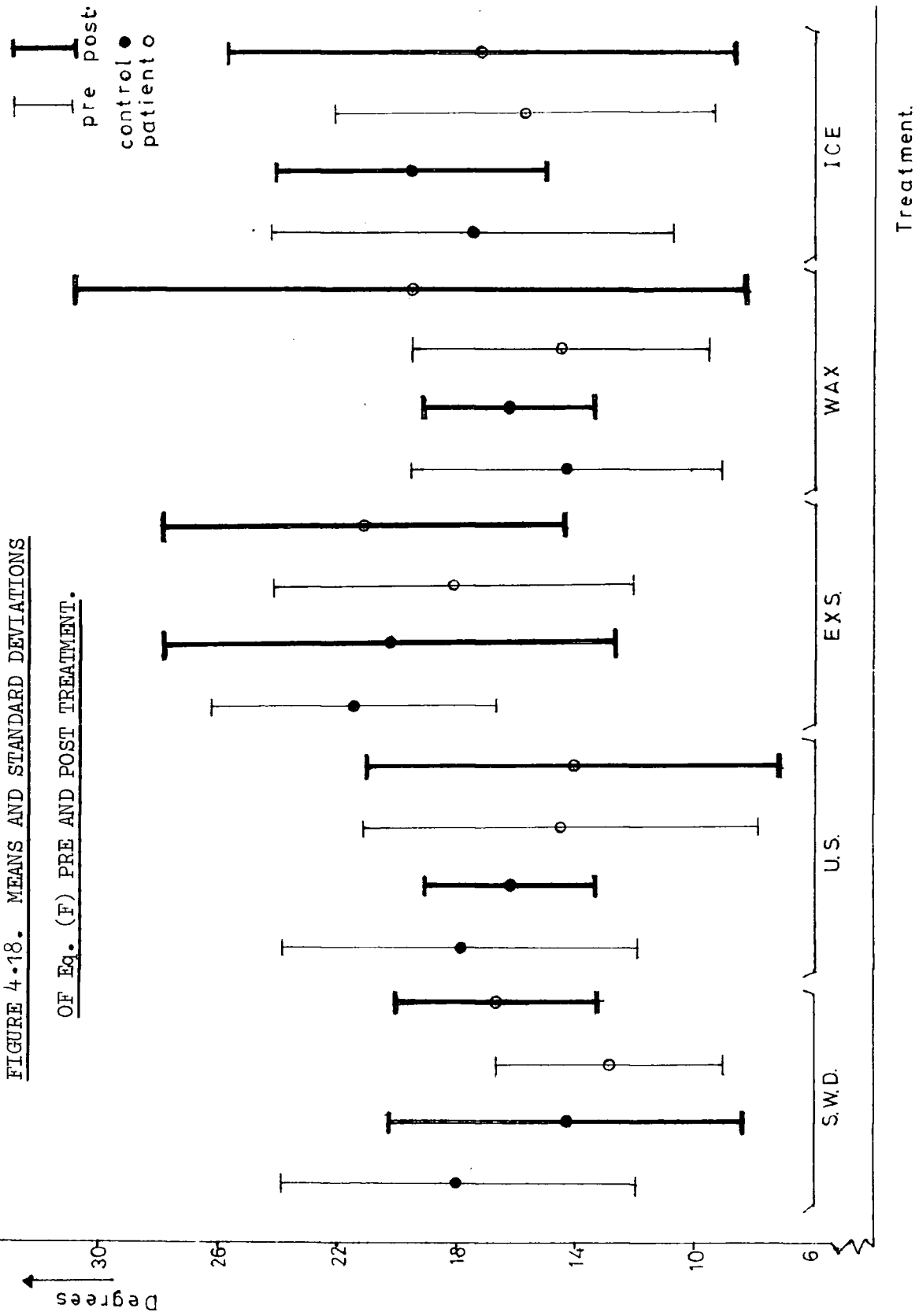

TABLE 4.15 Eq. (F)

t VALUES AND SIGNIFICANCE LEVELS PRE AND POST TREATMENT IN THE
PATIENT AND CONTROL GROUPS

	Controls		Patients	
	t Value	Significance	t Value	Significance
S.W.D.	1.081	N.S.	2.9989	$P < 0.025$
U.S.	0.768	N.S.	0.154	N.S.
EXS.	0.393	N.S.	1.652	N.S.
WAX	0.429	N.S.	1.024	N.S.
ICE	1.720	N.S.	0.708	N.S.

Data for individual subjects is contained in Table N of Appendix 4.

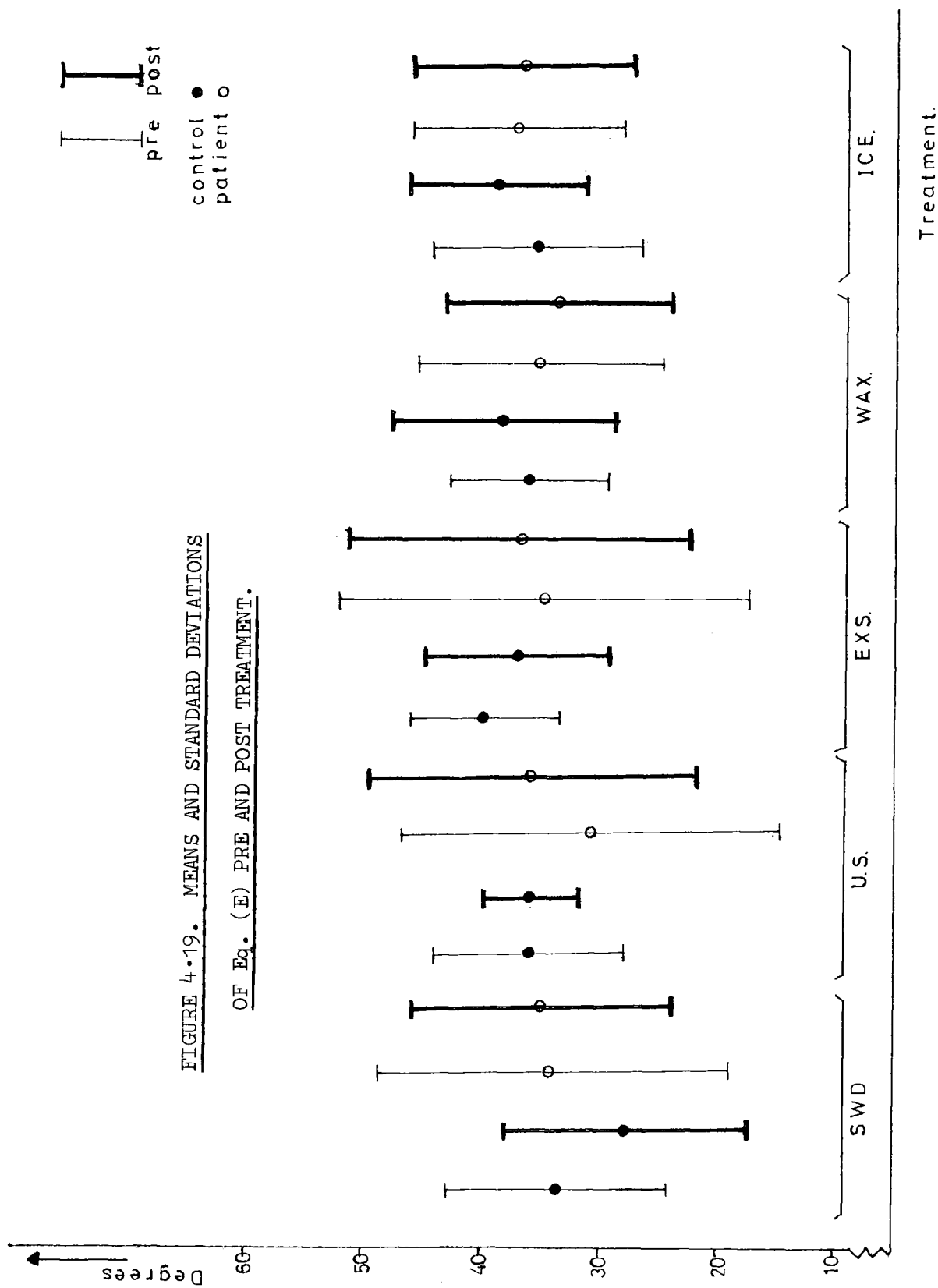

FIGURE 4-19. MEANS AND STANDARD DEVIATIONS
 OF Eq. (E) PRE AND POST TREATMENT.

TABLE 4-16 Eq. (E)

t VALUES AND SIGNIFICANCE LEVELS PRE AND POST TREATMENT IN THE
PATIENT AND CONTROL GROUPS

	Controls		Patients	
	t Value	Significance	t Value	Significance
S.W.D.	2.101	N.S.	0.1448	N.S.
U.S.	0.247	N.S.	1.9	N.S.
EXS.	0.795	N.S.	0.559	N.S.
WAX	1.070	N.S.	0.368	N.S.
ICE	1.160	N.S.	0.4382	N.S.

Data for individual subjects is contained in Table O of Appendix 4.

4.9 Other Parameters

4.9.1 Grip Strength

Figure 4.20 shows the means and standard deviations of grip strength in patients and controls prior to and following treatment.

Table 4.17 shows no significant difference within each group prior to and following treatment.

4.9.2 Limb Circumference

Slight differences were noted in the limb circumference measurements prior to and following treatment, although there was no significant difference in either patient or the control groups.

Table 4.18 and 4.19 show the means and standard deviations of the control and patient groups pre and post treatment.

4.9.3 Temperature

Short wave diathermy, ultrasound and paraffin wax produced a rise in temperature in both groups following treatment. Ice produced a lowering of temperature in both groups. A rise in temperature, significant at $P < 0.02$ was found in the control group following exercise but similar results were not found in the patient group.

Table 4.20 shows the t values and significance levels between pre and post treatment temperatures in patients and controls.

Raw data of various parameters are contained in Appendix 4.

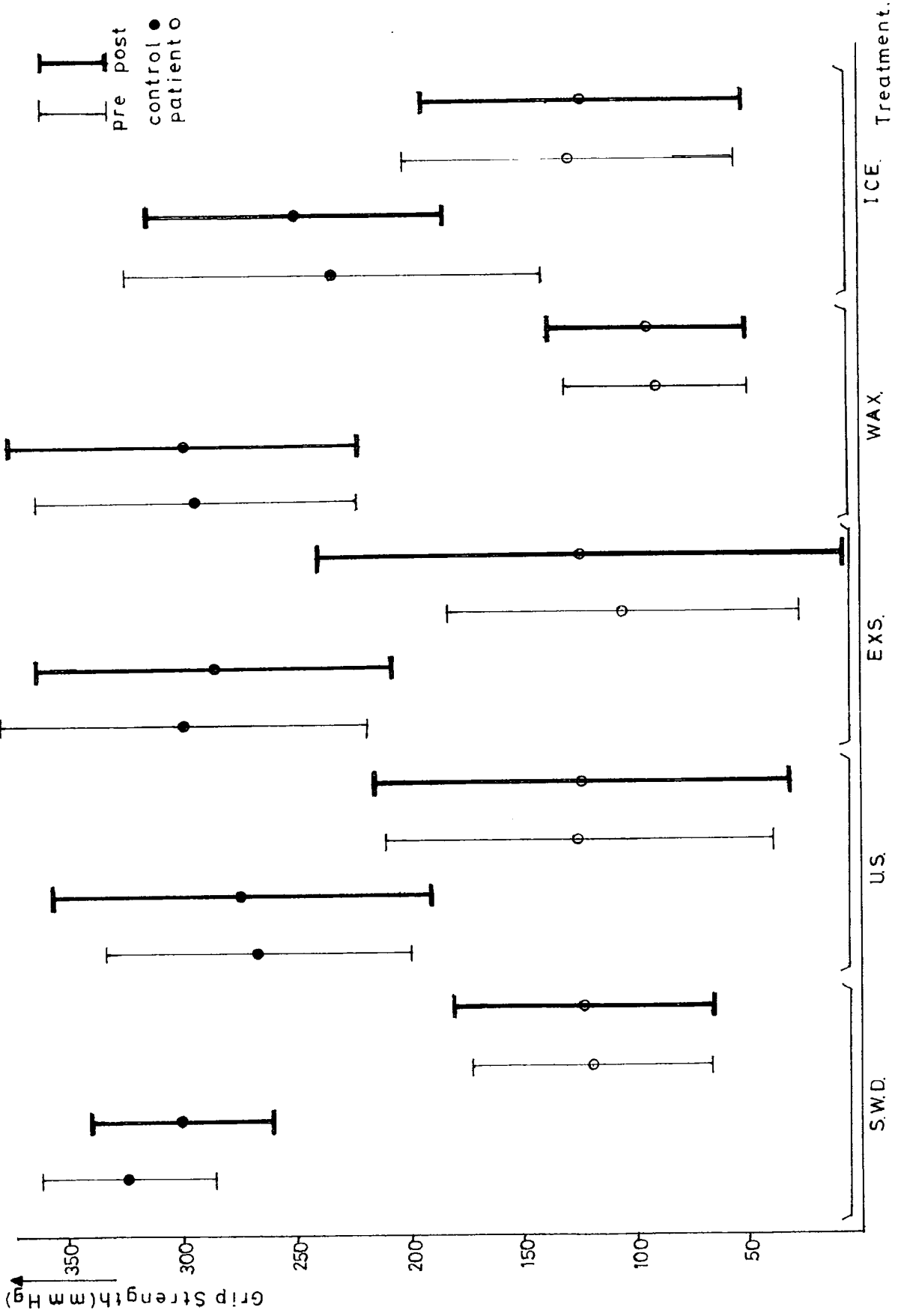

FIGURE 4•20. MEANS AND STANDARD DEVIATIONS OF GRIP STRENGTH PRE AND POST TREATMENT.

TABLE 4-17 GRIP STRENGTH

t VALUES AND SIGNIFICANCE LEVELS PRE AND POST TREATMENT IN THE
PATIENT AND CONTROL GROUPS

	Controls		Patients	
	t Value	Significance	t Value	Significance
S.W.D.	1.352	N.S.	0.374	N.S.
U.S.	0.518	N.S.	0.175	N.S.
EXS.	1.015	N.S.	1.148	N.S.
WAX	0.325	N.S.	0.7318	N.S.
ICE	0.117	N.S.	1.039	N.S.

Data for individual subjects is contained in Table P of Appendix 4.

TABLE 4.18 LIMB CIRCUMFERENCES
 MEANS AND STANDARD DEVIATIONS PRE AND POST TREATMENT
 IN THE CONTROL GROUP

		Pre (cm)	Post (cm)
S.W.D.	Wrist	16.05 ± 0.85	16.10 ± 0.80
	Forearm $\frac{1}{4}$	17.70 ± 1.12	17.85 ± 1.00
	Forearm $\frac{1}{2}$	23.00 ± 1.52	23.15 ± 1.42
	Forearm $\frac{3}{4}$	25.00 ± 1.18	25.15 ± 1.21
U.S.	Wrist	15.25 ± 0.90	15.56 ± 0.95
	Forearm $\frac{1}{4}$	16.88 ± 1.27	17.19 ± 1.39
	Forearm $\frac{1}{2}$	21.44 ± 1.93	21.50 ± 1.90
	Forearm $\frac{3}{4}$	23.50 ± 1.73	23.75 ± 1.64
EXS.	Wrist	15.78 ± 0.95	15.94 ± 0.93
	Forearm $\frac{1}{4}$	17.50 ± 1.51	17.83 ± 1.63
	Forearm $\frac{1}{2}$	22.72 ± 1.84	23.22 ± 2.02
	Forearm $\frac{3}{4}$	25.17 ± 1.91	25.56 ± 1.83
WAX	Wrist	15.50 ± 0.92	15.70 ± 0.87
	Forearm $\frac{1}{4}$	16.95 ± 1.67	17.30 ± 1.55
	Forearm $\frac{1}{2}$	22.35 ± 2.33	22.45 ± 2.32
	Forearm $\frac{3}{4}$	24.80 ± 2.05	25.0 ± 2.19
ICE	Wrist	15.50 ± 0.97	15.7 ± 0.95
	Forearm $\frac{1}{4}$	17.1 ± 1.34	17.35 ± 1.38
	Forearm $\frac{1}{2}$	21.95 ± 1.96	22.05 ± 1.94
	Forearm $\frac{3}{4}$	24.35 ± 1.88	24.45 ± 1.90

TABLE 4.19 LIMB CIRCUMFERENCES
 MEANS AND STANDARD DEVIATIONS PRE AND POST TREATMENT
 IN THE PATIENT GROUP

		Pre (cm)	Post (cm)
S.W.D.	Wrist	17.50 ± 1.56	17.75 ± 1.47
	Forearm $\frac{1}{4}$	17.88 ± 2.01	18.12 ± 1.98
	Forearm $\frac{1}{2}$	22.56 ± 2.71	22.56 ± 2.65
	Forearm $\frac{3}{4}$	25.50 ± 2.75	25.56 ± 2.65
U.S.	Wrist	17.42 ± 0.84	17.58 ± 0.89
	Forearm $\frac{1}{4}$	18.67 ± 1.21	18.92 ± 1.40
	Forearm $\frac{1}{2}$	23.00 ± 1.78	23.33 ± 2.11
	Forearm $\frac{3}{4}$	25.42 ± 1.95	25.33 ± 2.05
EXS.	Wrist	16.72 ± 1.58	16.61 ± 1.59
	Forearm $\frac{1}{4}$	17.22 ± 1.67	17.33 ± 1.70
	Forearm $\frac{1}{2}$	21.56 ± 2.1	21.94 ± 2.22
	Forearm $\frac{3}{4}$	24.44 ± 2.22	24.44 ± 2.22
WAX	Wrist	17.00 ± 1.43	17.30 ± 1.55
	Forearm $\frac{1}{4}$	18.20 ± 2.14	18.60 ± 2.20
	Forearm $\frac{1}{2}$	22.80 ± 2.69	22.85 ± 2.77
	Forearm $\frac{3}{4}$	25.00 ± 2.18	25.00 ± 2.17
ICE	Wrist	17.40 ± 1.58	17.30 ± 1.43
	Forearm $\frac{1}{4}$	18.18 ± 2.04	18.20 ± 1.95
	Forearm $\frac{1}{2}$	22.91 ± 2.87	22.73 ± 2.85
	Forearm $\frac{3}{4}$	25.91 ± 2.79	25.95 ± 3.01

TABLE 4.20.

t VALUE AND SIGNIFICANCE LEVELS BETWEEN PRE AND POST TREATMENT
SKIN TEMPERATURE IN THE PATIENT AND CONTROL GROUPS.

	Controls		Patients	
	t Value	Significance	t Value	Significance
S.W.D.	3.1282	$P < 0.01$	2.3015	$P < 0.05$
U.S.	3.2752	$P < 0.02$	3.0262	$P < 0.05$
EXS.	2.9883	$P < 0.02$	0.8682	N.S.
WAX	5.5383	$P < 0.0005$	3.8214	$P < 0.005$
ICE	8.4182	$P < 0.0005$	8.025	$P < 0.0005$

Data for individual subjects is contained in Table Q of Appendix 4.

CHAPTER FIVE

DISCUSSION

The present work was not intended to be a rheological study of joint stiffness but the results of the pilot study necessitated the use of rheological models to explain them. Long et al. (1964), Johns and Wright (1964) and more recently Thompson (1978) have attempted to explain joint stiffness in terms of rheological models. Thompson suggests that these models provide a framework to compare and analyse previous work and to visualise the response of a system. By starting with basic elements he builds up a model which he tested by experimentation. Thompson studied knee joint stiffness by cycling the human knee joint through small amplitude movements of 5 degrees at a frequency of 0.1 Hz. As a consequence there are some similarities with the present study.

5.1 Basic Elements

Elasticity (Hooke Element)

Elasticity may be linear or non-linear and is a property of an ideal solid. A model showing linear elasticity is shown in Figure 5.1(a). Stress is proportional to strain, or, displacement proportional to torque. Removal of the deforming force results in the elastic body returning to its original shape. Non-linear elasticity is exemplified by a set of elements placed in parallel as shown in Figure 5.1 (b).

Viscosity (Newtonian Element)

Viscosity is a property of a fluid. A linear relationship exists between the applied force and velocity. High viscosity

FIGURE 5.1. HOOKE ELEMENTS.

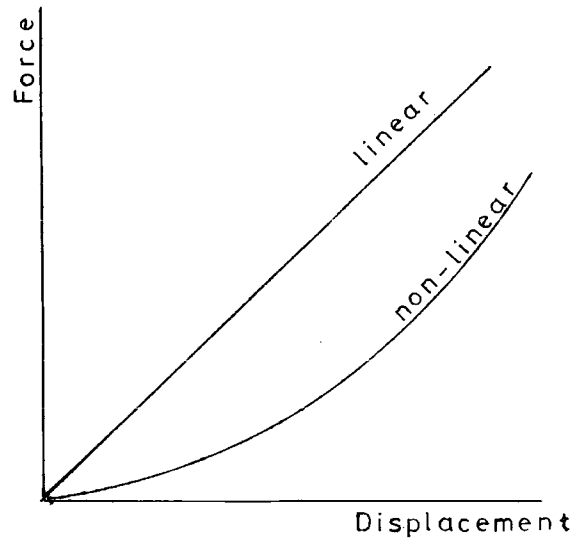
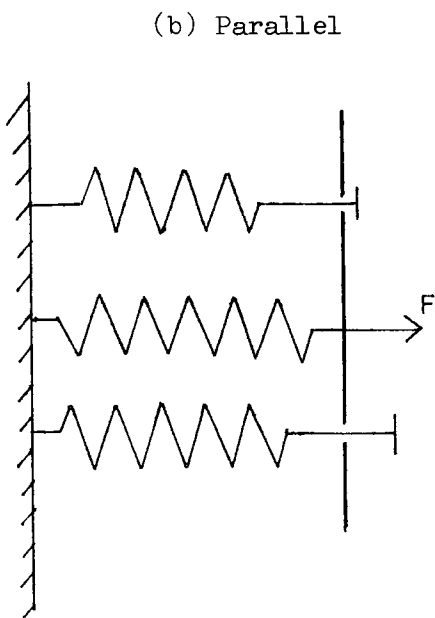
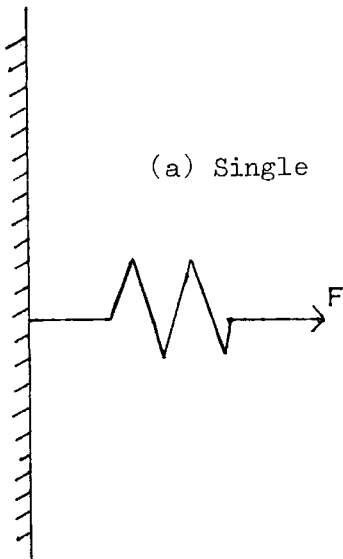

results in a steeper slope (Figure 5.2(a)). Non-linear viscosity can be exemplified by a set of parallel dashpots as shown in Figure 5.2 (b).

Friction and Plasticity

Friction and plasticity are evidenced by dissipated energy. Thompson (1978) noted that joint testing of the type in the present work does not allow a differentiation between frictional effects due to the articulating surfaces and the plastic effects of collagenous tissue. The two effects are grouped together on the understanding that any frictional effects will contribute to the plasticity measurement. The basic element is shown by a Coulomb element in Figure 5.3.

Inertia

Inertia is not discussed since the arthrograph in the present study was designed to eliminate inertial effects.

It was not within the realms of the present work to perform experiments to validate rheological models. However, the results of the pilot study suggest that an explanation is required to account for the differences in the stiffness characteristics. Differences in the hysteresis loops have been shown to occur according to the direction in which the joint is cycled, with those loops in the direction of extension below those in the direction of flexion. Thompson (1978) suggests that the elastic resistance and dissipated energy may be affected by the displacement history of the joint. He found that by recording a hysteresis loop at a position near

FIGURE 5.2. NEWTONIAN ELEMENTS.

(a) Single

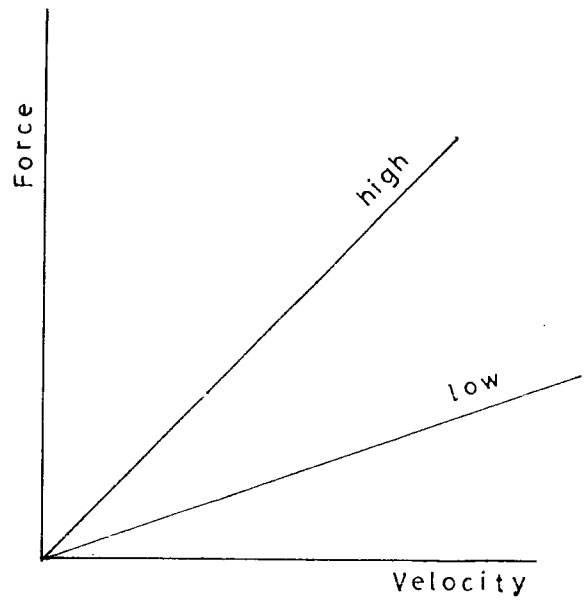
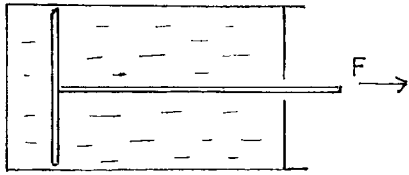

(b) Parallel

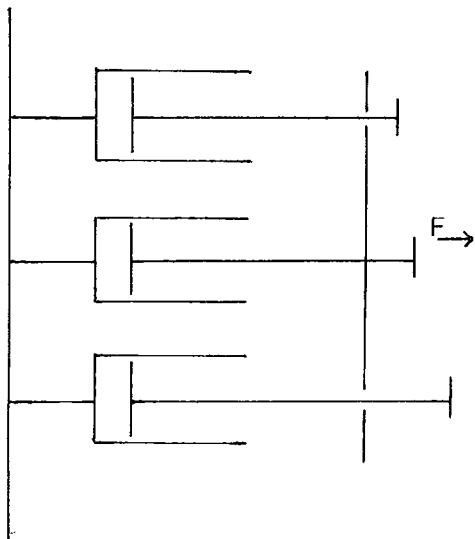
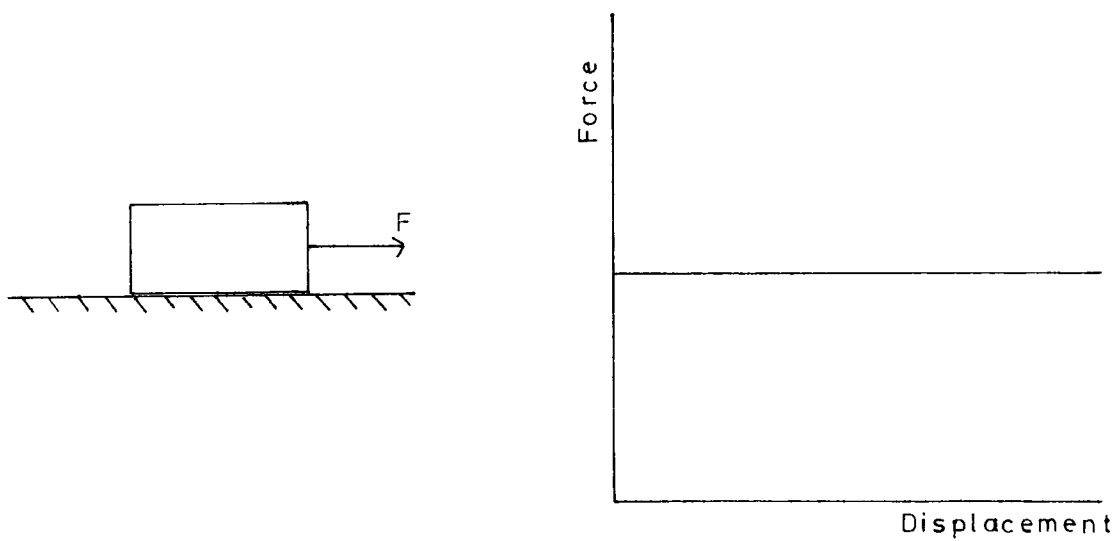

FIGURE 5.3. COULOMB ELEMENT.



equilibrium, before and after flexing the joint to the limit of range, provided slightly different characteristics. However, he did not pursue the experiments to produce complete sets of hysteresis loops in the direction of flexion and extension. He proposed the rheological model shown in Figure 5^{4(a)} to account for the stiffness characteristics in the knee joint. A Kelvin body (a Hooke and Newtonian element in parallel) is set in series with a further Hooke element. This set of elements is in parallel with a Coulomb element. Additional springs are added to account for increased elastic resistance at the limits of range. Although Thompson does not consider his model to be complete it is considered a basic framework upon which to base the analysis of data.

Viidik in 1968 provided a rheological model for collagen tissue. The proposed model was produced as a result of load - deformation studies on the anterior cruciate ligament of the rabbit. The experiments produced cyclic loading and unloading to 98.1 N and each successive cycle required a larger deformation to reach the required force. He states that the yield force increases with deformation and the action is irreversible. Included in the final model is a series of Coulomb elements connected by loose strings. A Newton element, set in parallel with the Coulomb elements, influences the force at each deformation but cannot be reversed. Figure 5^{4(b)} shows the model proposed by Viidik.

The model proposed by Thompson will account for the observed hysteresis loops in the direction of flexion from the equilibrium position towards full flexion, where one sees an increase in torques

FIGURE 5.4. PROPOSED RHEOLOGICAL MODELS.

(a) Model proposed by Thompson (1978).

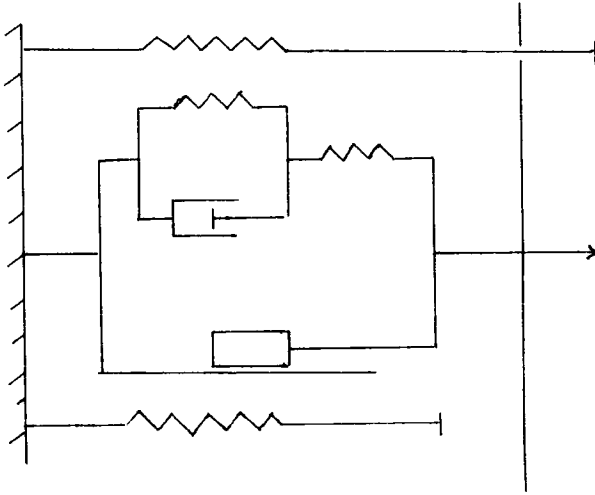

(b) Model proposed by Viidik (1968).

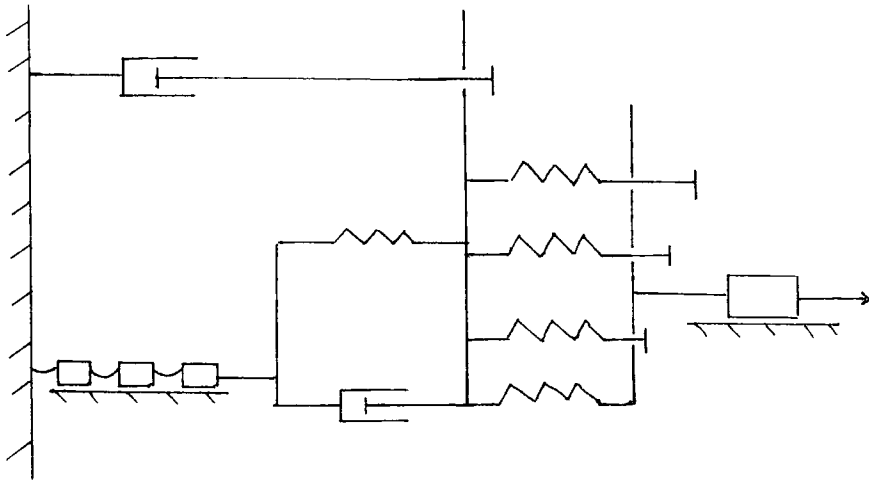

and dissipated energies. However, decreased torques and dissipated energies are produced during the extension cycles until the equilibrium position is reached. Beyond the equilibrium point, increases in torque and dissipated energies occur until the limit of extension is reached. The disparity between the present work and that of previous workers is to form the basis of further study though a combination of the Thompson and Viidik rheological models may account for the observations in the present study.

5.2 Circadian Variation of Stiffness Parameters

The results show a circadian variation in all the stiffness parameters analysed. Dissipated energy exhibited a maximum rise during the early hours of the morning. A smaller peak was evident in two female subjects in the evening and a similar peak occurred at midday in one male subject.

A variation in torque 20 (F) and torque 20 (E) was also evident. The peak of torque 20 (E) occurred two hours following the peak of torque 20 (F). These peaks were unrelated to alterations in the equilibrium positions. High values of torque were found in the morning. Backlund and Tiselius (1967) found evidence of increased stiffness in patients in the morning but could not reproduce similar results in normal subjects.

A circadian variation in grip strength (as measured by gripping an inflatable rubber bag encased in leather) has been described by Wright (1959) and Wright and Plunkett (1966). The lowest grip strength was recorded at 0400 hr; this was followed by a sharp rise. A negative correlation appears to occur between the circadian variation of grip strength as measured by Wright and dissipated energy as measured in the present study. Thompson (1978) also noted a diurnal variation of dissipated energy in his study of knee joints. Unfortunately, only patients were tested between the hours of rising and retiring and no normal subjects were tested, therefore direct comparisons cannot be made.

All biological measurements vary to some extent. Many follow

a circadian variation whereas others are related to night and day and are described as nycthemeral.

Temperature undergoes a circadian variation. Rectal temperature, recorded hourly, falls during the night and is minimal in the early hours of the morning, whereas temperature recorded from the tip of the middle finger shows a general reversal of this pattern. (Mills (1976) suggests that minimum body temperature is attained shortly after maximum skin temperature, at a time when heat loss is greatest). Wilkinson (1971) has noted a deep trough in oral body temperature during the early hours of the morning. The present study shows considerable variation between skin temperature and stiffness parameters.

Freemont-Smith et al. (1969) demonstrated a circadian rhythm of proximal interphalangeal joint circumference in patients with rheumatoid arthritis, with peak joint sizes between the hours 0700 and 0915.

Circadian variations have also been noted in the plasma concentrations of adrenal hormones and in their renal excretion. Cortisol shows peak plasma concentrations in the early morning though a reversal of the pattern may occur in night workers, when high plasma concentrations are found at about the time of starting work.

Wright (1959) studied the circadian variation of grip strength and found it paralleled the urinary output of 17 - ketosteroid.

Furthermore patients who had corticotrophin administered improved their grip strength and the circadian variation was abolished.

On the basis of the present study it is conjecture to assume causative relationships between circadian variations in stiffness parameters and circadian variations in other parameters. Further studies would have to be performed to investigate any of these relationships, though the close correlation between plasma cortisol levels and stiffness deserves further study.

5.3 Stiffness Parameters in Normal Subjects and Patients with Rheumatoid Arthritis

5.3.1 Dissipated Energy

Dissipated energy is greater in male than female subjects. Patients do not exhibit different dissipated energy characteristics to normal subjects. Thompson (1978) found lower dissipated energies in patients with rheumatoid arthritis compared with controls. His sample of rheumatoid patients was only 2 and he compared individual hysteresis loops at 4 positions, (between 60 degrees and 90 degrees in one patient and between 90 degrees and 120 degrees in the second patient), with the means of individual loops at the same positions in normal subjects.

In the present work the controls and patients were analysed over the same range of motion (4 degrees to 54 degrees) which would be a relatively free range of motion for normal subjects. At 54 degrees of flexion many patients were reaching the limit of their available range and as a consequence a higher than predicted value of dissipated energy was evident in this group. More significant differences between patients and controls may occur if comparisons of dissipated energies are made at ranges towards the limits of flexion and extension, in the region which Backlund and Tiselius (1967) describe as 'end-point stiffness'.

Neither the small positive nor negative correlation coefficients, in controls and patients respectively, achieved conventional statistical significance. This would confirm the work of Thompson (1978) which showed that dissipated energy is independent

of age. Torque 20 (F) and torque 20 (E) are positively correlated with dissipated energy but this relationship only achieved statistical significance in the control group. Further discussion of these points will be made later in this Chapter.

A positive correlation exists between dissipated energy and temperature in the patient group. Temperature increases with an acute inflammatory process and as such could be considered as a measure of the activity of the disease. The possibility arises that both the high value of dissipated energy and a high value of temperature may be a result of the disease process.

5.3.2 Torque 20 (F) and Torque 20 (E) (Resistive Torque)

Mean resistive torque is higher in patients than controls although the results are not statistically significant. Males and females exhibit no significant difference.

Absolute comparisons of these results with those of previous workers are difficult as different measures of the elastic response of joints have been used. Such et al. (1975) considered peak to peak values as a measure of the elastic response in knees, whereas Thompson (1978) also in knees, used the difference in mid-position torque at values between 50 degrees and 120 degrees of flexion as a measure of the elastic resistance. Wright and Johns (1961) and Backlund and Tiselius (1967) used the slopes of hysteresis loops as a measure of the elastic response of metacarpophalangeal joints. Each group of workers found that there was a sex difference in the elastic response of the joint tested, with females having a lower

response than males. Mortimer (1977) analysing the difference between the torques at two positions could find no support for a sex difference in this parameter.

The present work shows slightly higher resistive torques in male than female subjects but this is not statistically significant. A more detailed inspection of Thompson's results shows that mean torques at positions close to the equilibrium position show a small difference between male and female subjects, whereas as one moves further from the equilibrium position a greater mean difference becomes evident. The possibility arises that because the two torque parameters used in this study are within 20 degrees of the equilibrium position, significant sex differences are not apparent.

Torque 20 (F) has a statistically significant correlation with torque 20 (E) in both the patient and control groups. It may be anticipated that an increase in resistive torque in one direction is associated with an increase in the opposite direction.

Torque 20 (E) correlates with the equilibrium position in flexion in the patient group. A higher torque is associated with a correspondingly high equilibrium position. The control group, however, demonstrated a reversal of that trend with mainly negative correlations. Torque 20 (F) had a highly significant negative correlation. It is difficult to understand or comment upon the disparity between these results.

There is a trend towards a positive relationship between resistive torque and grip strength, although the relationship is

not as strong as that between elastic resistance and isometric quadriceps strength found by Thompson. The disparity may be attributed to the position at which absolute values of torque were recorded (i.e. at 20 degrees from the equilibrium positions), or to the different type of muscle contraction used to assess muscle strength. Thompson used an isometric contraction whereas the present work used an isotonic contraction.

Skin temperature and resistive torque show no significant correlation. The association between temperature and the dissipative components of stiffness have been previously discussed. Alterations in skin temperature will be discussed in the relevant sections.

5.3.3 Equilibrium Positions

The equilibrium position in any cycle depends upon the direction in which the joint is moving. Two positions are identified for each subject with the equilibrium position in the direction of flexion approximately 50 per cent of that in the direction of extension. Thompson (1978) compared the data of previous workers and obtained representative values for elastic torques and equilibrium positions from experimental reports. He stressed that previous authors did not attempt to provide average normal values and that wide differences were found. He calculated representative values for equilibrium positions as 30 degrees (Wright and Johns 1960), 25 degrees (Long et al. 1964) and 35 degrees (Backlund and Tiselius 1967).

The present work has shown that patients have slightly lower

mean equilibrium positions than normal subjects though the results are not statistically significant.

No significant difference could be found between the sexes in this parameter.

As could be predicted high correlation coefficients were obtained between the respective equilibrium positions in flexion and extension in each group.

A small negative correlation in each group was found between age and equilibrium position. The patient group exhibited positive correlations with grip strength, temperature and limb circumference measurements, whereas the control group exhibited small negative correlations with these parameters. There is no reason to expect a causal relationship between equilibrium position and these parameters and none of these associations reached significance.

5.4 Other Parameters

Grip strength is greater in male than female subjects. This was predictable in view of the larger muscle mass in male subjects. Soft tissue bulk (as measured by limb circumference) is also shown to be greater in male subjects.

Grip strength has a positive correlation with soft tissue bulk in each group with significance attributed to all sites of limb circumference measurement in the control group. The highest correlation coefficient is associated with the forearm $\frac{3}{4}$ measurement and only this level is of statistical significance in the patient group although the association is not as strong as the

control group. This site contains a higher proportion of muscle fibres than other levels of measurement. The effect of soft tissue bulk on grip strength is to be expected in that a greater mass of soft tissue reflects a greater amount of muscle tissue which would contribute to greater grip strength.

An association between grip strength, soft tissue bulk and dissipated energy can probably be predicted. A large number of muscle fibres would contribute to higher viscous and frictional losses as the fibres slide over one another and hence give a higher value for dissipated energy. This is certainly true in the control group where high correlation coefficients are exhibited between each of the parameters, grip strength, dissipated energy and soft tissue bulk. Thompson (1978) describes a similar high correlation coefficient between dissipated energy and thigh muscle size and between dissipated energy and quadriceps strength. Such et al. (1975), also demonstrated an increase of energy loss as thigh circumference increased.

The patients in the present study did not exhibit similar results. Grip strength has a statistically significant correlation with the forearm $\frac{3}{4}$ level. The small positive correlation coefficient between dissipated energy and grip strength and dissipated energy and soft tissue bulk in this group did not reach statistical significance.

Thompson (1978) studied a patient suffering with myopathy and found very low dissipated energy. This confirmed previous work

that indicated dissipated energy was mainly dependant upon muscle tissue (Haslock and Wright 1972). Patients with rheumatoid arthritis are often weak and may exhibit muscle atrophy as a result of disuse (Haslock et al. 1970). The muscles may undergo myositic changes which are manifested in muscle degeneration and interfibrillar oedema. The possibility arises that changes occurring in muscle tissue either as a consequence of pathology or disuse result in lower dissipated energies.

The present study, however, shows that dissipated energy does not differ between patients and controls, which suggests that in rheumatoid arthritis, changes other than muscular changes are responsible for the dissipated energy during motion.

A number of workers have suggested that the periarticular soft tissues are responsible for clinical joint stiffness (Radin et al. (1971), Cooke et al. (1976) and Radin and Paul (1972)). Unsworth et al. (1975), whilst investigating joint lubrication, reported that the coefficient of friction in a rheumatoid arthritic hip increased fifteenfold over that of normal hip joints which would make "a significant contribution to the total stiffness experienced".

Although firm conclusions cannot be made on the basis of the present evidence, the possibility arises that in rheumatoid arthritis dissipated energy results from a shift of emphasis from muscle bulk to more intimately associated soft tissue periarticular structures; including the capsule and its attendant ligaments and tendons, synovial membrane and cartilage.

Resistive torques and limb circumference show, at forearm $\frac{1}{2}$ and forearm $\frac{3}{4}$, no significant difference between the groups. However, a significant correlation exists between resistive torque and these limb circumference measurements in the patient group. Thompson (1978) found a high correlation between his elastic response parameter and thigh girth in normal subjects but did not reproduce the experiments with the patient group. Such et al. (1975) also noted a greater elastic response with increasing limb circumference. There is disparity between the results of the present study and those of previous workers although different parameters have been used to characterise the elastic response. The reasons for the correlations seen in the patient group are not clear though there would appear to be increasing evidence towards a predominant effect of soft tissue structures other than muscles in this group.

Skin temperature has a higher value in patients than in normal subjects. Patients with inflammatory conditions exhibit higher skin temperatures and temperature is often regarded as an indicator of disease activity. The higher temperatures shown by patients are thus to be expected.

Discussion of the correlation between temperature and dissipated energy has taken place. There are no other relevant associations between temperature and other parameters.

Mean limb circumference exhibited no significant difference in the forearm $\frac{1}{2}$ and forearm $\frac{3}{4}$ measurements between patients and controls. A significant difference was found between the two groups

at the wrist and forearm $\frac{1}{4}$ measurements. The patient group had the higher mean values. Patients with rheumatoid arthritis often shown signs and symptoms of disease activity in the joints and soft tissues surrounding the wrist, with oedema and synovial thickening. The synovial thickening not only affects the synovial membrane of the wrist joint but also the tendon sheaths of the muscles passing over the wrist. These factors could account for the increased limb circumference measurements at these sites.

5.5 The Effects of Physiotherapeutic Measures on Stiffness Parameters

The effects of heating, cooling and exercise have been analysed by various workers during investigations of joint stiffness. Limited work of the effects of these various modalities has been investigated at usual therapeutic dosages. Chapter 2 cites the major contributors and their work in this field of study.

The present study has shown that paraffin wax, ice and exercise have little effect on any of the stiffness parameters measured. The lack of significant change to heating by paraffin wax or cooling by ice packs is contrary to previous work on the effects of heat and cold on joint stiffness.

Previous work indicates that a reduction in stiffness follows heating of a joint, whereas an increase in stiffness results from cooling of the joint. Most work has been in relation to elastic stiffness parameters (Wright and Johns (1960), Wright and Plunkett (1966), Backlund and Tiselius (1967), Wright et al. (1971)). Some work has been involved with subjective assessment of stiffness (Kirk and Kersley (1968), Pegg and Littler (1969)) and others with changes in mobility (Loebl 1972). Few results are available with respect to heating and cooling on dissipated energy characteristics of stiffness. The present work has shown that short wave diathermy used at therapeutic dosages causes a significant decrease in the dissipated energy characteristics in the metacarpophalangeal joint of patients with rheumatoid arthritis.

Conductive heat in the form of paraffin wax baths has no

significant effect on the dissipated energy characteristics. This would suggest that heating of deeper placed structures is important in the reduction of stiffness. An increase in temperature will reduce the viscosity of synovial and tissue fluids though it is difficult to see how this would have any great effect in patients with rheumatoid arthritis. These patients, as a result of their condition, have a lowered viscosity of synovial fluid and further reduction would further impair its function as a lubricant. A decrease in the lubricating action of synovial fluid would lead to increased frictional wear of cartilage and hence to an increase in the dissipated energy characteristics of the joint.

The possible cause for decreased dissipated energy characteristics may be found in the periarticular structures of the joint whereby the heat causes a reduction in the viscous and frictional characteristics of these structures. The deep heating produced may reduce any vascular congestion in and around the joint and hence reduce the dissipated energy characteristics of the joint. Equally reduction of the viscosity of any soft tissue oedema would also result in lowered dissipated energy.

Further evidence for this is provided by the effect of ultrasound therapy on these characteristics of stiffness. Ultrasound was applied in a controlled temperature bath and pulsed at a 1:4 ratio. Any heating of the skin was considered to be due to the water temperature and, because of the pulsed nature of the ultrasound its effects were considered to be due to pressure variations rather than temperature variations. The pressure variations or 'micromassage effect' of ultrasound has an effect of increasing the permeability

of cell membranes which, in turn, reduces oedema. A reduction in any oedema in and around the metacarpophalangeal joint would reduce viscous resistance and hence result in lowered dissipated energies.

The effects of ice therapy on dissipated energy characteristics are difficult to understand. Apart from the studies which involved subjective assessment of cold therapy (Kirk and Kersley (1968) and Pegg and Littler (1969)) all other workers have shown an increase in stiffness following cooling. Hunter et al. (1952) suggests that a decrease in temperature results in increased viscosity of synovial fluid. This would cause an increase in the viscous stiffness of a joint. Other studies have concentrated on the elastic components of stiffness and have shown that elastic stiffness increases with cooling of a joint. In Chapter 4 the results of various treatments were given, Figure 4.15 shows the means and standard deviations of the various treatments on dissipated energy. The mean values of patients and controls did not vary to any great extent prior to and following treatment by ice. Some subjects showed increased dissipated energy whilst others showed decreased dissipated energy. Cooling causes an initial vasoconstriction followed by vasodilation. The present findings may be related in some way to the timing of these events. However, the disparity of these results does not allow firm conclusions to be reached and further studies need to be undertaken.

The results of a simple "warming up" exercise are also variable. Some subjects exhibited a decrease in dissipated energy whereas others exhibited an increase. All subjects were allowed to perform the exercise at their own pace. Some subjects worked maximally for a short period whereas others performed the exercise at a more leisurely speed. No attempt was made to standardise the position

of the arms whilst performing the exercise, as the intention was to simulate normal practise. Therefore some subjects rested their elbows on a table and their hands were in a position of elevation, hence aiding venous and lymphatic drainage from the hands. Other subjects rested their forearms on their thighs and consequently their hands were in a dependant position. On the basis of the present results it is difficult to draw conclusions on the effects of exercise on dissipated energy.

None of the therapeutic modalities utilised in this study produced significant changes to the resistive torques.

Johns and Wright (1962) using 'peak to peak' values of large amplitude hysteresis loops identified the major components of stiffness in the wrist joint of a cat, which they found had many similarities to the human metacarpophalangeal joint. In the mid-range of motion they found that the major contributors to stiffness were the capsule (47 per cent) and muscles (41 per cent). Thompson (1978) using a cadaveric knee with many of its muscles removed, showed muscle and fatty tissue gave a greater contribution, 70 to 80 per cent, to elastic stiffness than did the capsule.

The various therapeutic agents in the present study were directed at the metacarpophalangeal joint and as such could not be considered to have much effect on the muscle tissue in the forearm and therefore no effect on the elastic response of muscle. It is interesting to note that Wright et al. (1971) found that heating the thigh had no effect on the stiffness of the knee. On the basis of present information it would appear that the various forms of physiotherapy employed have no effect on the resistive torque

parameter used in this study.

Short wave diathermy produced a statistically significant alteration in the equilibrium position (F) in the patient group. A shift towards flexion occurred following this treatment. Alteration of the equilibrium position results from changes to the tissues on the flexor and extensor aspect of the joint. A shift in the equilibrium position towards flexion may result either from a reduction of tension in the structures on the extensor aspect or a reduction in compression of soft tissues on the flexor aspect or from a combination of both. The experimental work by Wright and Johns (1962) on the cats' wrist indicated that the flexor tendons were capable of compressing the muscle and so would contribute to the torque in flexion.

The short wave diathermy technique utilised would have affected all the periarticular joint structures between the electrodes. The degree of heating produced in each tissue would vary according to the fluid content of the tissue. It was anticipated that a change in the equilibrium position (F) would be associated with a corresponding change in the equilibrium position (E). Consequently it is difficult to understand a lack of significant change in the equilibrium position (E).

CHAPTER SIX

6.1 CONCLUSIONS

The horizontal finger arthrograph has enabled stiffness to be quantified in terms of dissipated energy, resistive torque and equilibrium position. The arthrograph is a suitable machine for monitoring differences in these parameters. It is portable and can be used for bedside monitoring of stiffness. The majority of subjects can readily relax during the testing procedure.

A circadian variation of stiffness has been noted. Normal subjects exhibit high values of dissipated energy and resistive torque in the early hours of the morning, although there is no subjective feeling of stiffness.

Small differences in the parameters used were found between normal subjects and a sample of patients suffering from rheumatoid arthritis though these differences did not reach statistical significance.

Correlation of the parameters obtained with the arthrograph with measurements of limb girth and grip strength has shown some differences between the control and patient groups.

Various forms of physiotherapy, applied in conventional ways to effect a reduction in stiffness, have been compared. Short wave diathermy and ultrasound effected a reduction in dissipated energy in the patient group. A shift in the equilibrium position also occurred following short wave diathermy in this group.

Results have been compared, where possible, with those of previous workers. However, some previous workers have tended to use arbitrary points of reference for stiffness parameters. Hence this study has been presented with the equilibrium position calculated for each subject and the absolute values of torque measured at a fixed distance from this position.

6.2 RECOMMENDATIONS FOR FURTHER WORK

The information that has been generated during this work could be subjected to further analysis. Analysis of one section of the overall cycle or even one hysteresis loop may provide adequate information to compare subjects or treatment. Further work is to be started in this field of study.

Further work on the effects of physiotherapy techniques needs to be undertaken. A logical extension of the present work would be to assess the effects of treatments directed at the muscles and soft tissues of the forearm. In the wider field of physiotherapy, the arthrograph could provide an assessment of the effects of treatment of neurological conditions and soft tissue injuries. It could also provide useful information on the effects of metacarpophalangeal joint prostheses on stiffness parameters.

The effect of drug therapy could be monitored and studies have been initiated to assess the effects of intra-articular and periarticular injections of corticosteroids.

It is hoped that a clearer understanding of subjective stiffness and its relationship with other symptoms, particularly pain, will result from further work with the horizontal arthrograph.

APPENDIX 1

SUBJECT DATA AND MEASUREMENT PROFORMA

NAME: HOSP. NO:

ADDRESS:

.....

TEL. NO: SEX: AGE:

CONTROL/PATIENT: DIAGNOSIS

SURGERY

DRUGS

CLINICAL FEATURES

EXT/FLEX. TENDON INVOLVEMENT

SWELLING: SOFT - Mild / Moderate / Severe

 BONY - Mild / Moderate / Severe

DATE OF TEST: TIME OF TEST:

PHYSICAL TREATMENT - NONE / S.W.D. / I.R. / WAX / U.S. / EXS. /

ICE

	PRE	POST
WRIST SIZE		
FOREARM $\frac{1}{4}$		
$\frac{1}{2}$		
$\frac{3}{4}$		
GRIP 1		
2		
3		
MEAN		
TEMPERATURE		
PAIN (Subjective)		
STIFFNESS (Subjective)		

APPENDIX 2

SHORT WAVE DIATHERMY

Short wave diathermy is a high frequency current operating at a frequency of 27.12 MHz with a wavelength of 11 metres. There are two methods of transferring the electromagnetic energy into the body in short wave diathermy. In one, the capacitance method, the part of the body to be treated is placed between two plate-like electrodes, energised by a high frequency voltage. The second method, inductance method, of transferring energy into the body is magnetic induction, where a coil is placed around the part to be treated and the alternating current in the coil results in an alternating magnetic field in the tissues.

The capacitance method of short wave diathermy was utilised in this study. The part to be treated becomes part of a resonant electrical circuit. A simple circuit of this nature consists of a capacitor and an inductor. Electrical energy from a power supply flows back and forth between the capacitor and inductor thus providing an alternating electric field (or current). The tissues are situated between the plates of the capacitor and as such become part of the dielectric of this capacitor. The alternating electric field causes ions in the tissues to move back and forth and as they do, acquire kinetic energy. Part of the kinetic energy is dissipated as heat as ions collide with the molecules of the tissues. The heat produced is proportional to the square of the current times a constant determined by the tissues. The greater the fluid content of the tissue, the less will be its resistance and the larger the current. A large proportion of the heating therefore occurs in muscle and blood vessels.

ULTRASOUND

Ultrasonic therapy is produced by converting electrical energy to mechanical energy by utilising the piezoelectric effect. Application of an oscillating voltage to a quartz crystal will produce a vibration of the crystal and thus produce sound waves. The transducer for converting electrical energy to mechanical energy has a natural frequency at which it will oscillate. The thinner the crystal the higher will be the frequency. Therapeutic ultrasonic transducers have a frequency of about 1 MHz.

Ultrasound is transmitted to the body by placing the vibrating crystal in close contact with the skin. Air is eliminated by using water or jelly as a couplant. The principal effects of ultrasonic therapy are temperature increase and pressure variations. Two methods of application can be used, either 'continuous' or 'pulsed'. The continuous application results in a temperature increase and pressure variations. The pulsed application has variable ratios of on/off phases. The off phase allows for dispersal of any heat produced during the on phase and is principally used for the effects of pressure variation. The present study used pulsed ultrasound at a 1:4 ratio (1 phase on, 4 phases off).

The ultrasonic waves, as with audible sound waves, produce mechanical motion and as the waves move through the body the particles in the tissues move back and forth, causing pressure increases (compressions) and decreases (rarefactions). Stretching of tissue occurs in the regions of compression and rarefaction and this has led to the term 'micromassage' to describe these effects.

PARAFFIN WAX

Paraffin wax utilises conductive heating. Heat is transferred by contact of warm molten wax. The part to be heated is either maintained immersed or, more commonly, repeatedly dipped in the heated wax. The latter method was utilised in this study and following the application of several coats of wax, the part treated was wrapped in towelling to provide insulation.

Skin temperature rises when it is in contact with a heat source. The degree of heating of underlying tissues depends upon the amount of heat dispersed by the circulation.

APPENDIX 3

TABLE A

DISSIPATED ENERGY IN LOOPS BETWEEN 4 DEGREES AND
54 DEGREES IN 6 MALE AND 41 FEMALE CONTROLS

	Dissipated Energy Nm/cycle Males N = 6	Dissipated Energy Nm/cycle Females N = 41
	0.0056	0.0082
	0.0187	0.0119
	0.0128	0.0112
	0.0150	0.0126
	0.0220	0.0169
	0.0153	0.0133
	<hr/>	0.0151
Mean	0.0149	0.0154
		0.0052
		0.0073
S.D.	0.0051	0.0187
		0.0133
		0.0078
		0.0079
		0.0123
		0.0109
		0.0086
		0.0107
		0.0064
		0.0092
		0.0126
		0.0111
		0.0104
		0.0102
		0.0050
		0.0145
		0.0084
		0.0091
		0.0075
		0.0100
		0.0147
		0.0111
		0.0117
		0.0096
		0.0150
		0.0122
		0.0094
		0.0126
		0.0199
		0.0097
		0.0171
		<hr/>
		Mean 0.0113
		S.D. 0.0034

TABLE B

DISSIPATED ENERGY IN LOOPS BETWEEN 4 DEGREES AND
54 DEGREES IN 13 MALE AND 24 FEMALE PATIENTS

	Dissipated Energy Nm/cycle Males N = 13	Dissipated Energy Nm/cycle Females N = 24
	0.0072	0.0093
	0.0088	0.0036
	0.0037	0.0081
	0.0148	0.0100
	0.0156	0.0044
	0.0154	0.0060
	0.0189	0.0104
	0.0171	0.0095
	0.0136	0.0105
	0.0196	0.0165
	0.0123	0.0122
	0.0165	0.0051
	0.0242	0.0103
		0.0158
		0.0116
Mean	0.0144	0.0128
		0.0103
S.D.	0.0053	0.0170
		0.0128
		0.0179
		0.0133
		0.0110
		0.0147
		0.0143
		Mean
		0.0111
		S.D.
		0.0039

TABLE D

TORQUE AT 20 DEGREES FROM THE EQUILIBRIUM POSITION IN THE
DIRECTION OF FLEXION IN 13 MALE AND 24 FEMALE PATIENTS

	Torque (Nm) Males N = 13	Torque (Nm) Females N = 24
	0.021	0.012
	0.009	0.017
	0.016	0.051
	0.002	0.003
	0.033	0.021
	0.024	0.014
	0.014	0.006
	0.010	0.010
	0.028	0.020
	0.009	0.017
	0.018	0.009
	0.014	0.013
	0.025	0.011
		0.021
		0.007
Mean	0.0172	0.01
		0.005
S.D.	0.0084	0.034
		0.008
		0.020
		0.021
		0.017
		0.019
		0.020
		Mean
		0.0161
		S.D.
		0.00999

TABLE E

TORQUE AT 20 DEGREES FROM THE EQUILIBRIUM POSITION IN THE
DIRECTION OF EXTENSION IN 6 MALE AND 35 FEMALE CONTROLS

	Torque (Nm) Males N = 6	Torque (Nm) Females N = 35
	- 0.013	- 0.008
	- 0.009	- 0.012
	- 0.006	- 0.005
	- 0.018	- 0.021
	- 0.018	- 0.014
	- 0.021	- 0.021
	<hr/>	- 0.010
Mean	- 0.0142	- 0.027
		- 0.012
S.D.	0.0053	- 0.007
		- 0.007
		- 0.012
		- 0.011
		- 0.006
		- 0.009
		- 0.015
		- 0.011
		- 0.011
		- 0.010
		- 0.013
		- 0.008
		- 0.013
		- 0.009
		- 0.007
		- 0.011
		- 0.012
		- 0.013
		- 0.008
		- 0.010
		- 0.012
		- 0.006
		- 0.012
		- 0.011
		- 0.014
		- 0.019
		<hr/>
		Mean - 0.0116
		S.D. 0.0046

TABLE F

TORQUE AT 20 DEGREES FROM THE EQUILIBRIUM POSITION IN THE
DIRECTION OF EXTENSION IN 13 MALE AND 17 FEMALE PATIENTS

	Torque (Nm) Males N = 13		Torque (Nm) Females N = 17
	- 0.018		- 0.017
	- 0.012		- 0.032
	- 0.017		- 0.003
	- 0.015		- 0.021
	- 0.012		- 0.009
	- 0.004		- 0.010
	- 0.010		- 0.010
	- 0.015		- 0.007
	- 0.016		- 0.007
	- 0.010		- 0.012
	- 0.015		- 0.034
	- 0.012		- 0.010
	- 0.022		- 0.011
			- 0.005
			- 0.009
Mean	- 0.0137		- 0.024
S.D.	0.0043		- 0.017
		Mean	- 0.014
		S.D.	0.0088

TABLE G
 EQUILIBRIUM POSITION IN THE DIRECTION OF FLEXION
 IN 6 MALE AND 39 FEMALE CONTROLS

	Equilibrium Position (degrees) Males N = 6	Equilibrium Position (degrees) Females N = 39
	22.0	20.5
	20.5	15.5
	15.5	18.5
	14.5	16.0
	23.0	8.5
	20.0	27.0
		9.0
		21.0
Mean	19.25	9.5
		28.0
S.D.	3.172	21.0
		11.0
		17.0
		14.5
		12.5
		31.0
		14.5
		18.5
		26.0
		21.5
		20.5
		21.0
		29.5
		13.5
		26.5
		8.0
		19.0
		13.5
		16.0
		7.0
		25.0
		17.0
		12.5
		16.0
		17.5
		21.0
		6.5
		20.0
		12.0
		Mean
		17.51
		S.D.
		6.309

TABLE H

EQUILIBRIUM POSITION IN THE DIRECTION OF FLEXION
IN 13 MALE AND 26 FEMALE PATIENTS

	Equilibrium Position (degrees) Males N = 13	Equilibrium Position (degrees) Females N = 26
	22.5	14.0
	17.5	17.5
	17.0	14.0
	14.0	8.5
	7.0	17.5
	14.5	7.5
	14.5	13.5
	16.0	17.0
	7.0	17.0
	17.0	12.5
	22.5	18.0
	6.5	10.0
	23.5	25.0
		23.5
		29.5
Mean	15.35	14.5
		26.0
S.D.	5.548	18.0
		13.5
		7.0
		20.5
		5.0
		13.0
		9.5
		6.0
		16.5
		Mean
		15.17
		S.D.
		6.169

TABLE I

EQUILIBRIUM POSITION IN THE DIRECTION OF EXTENSION
IN 6 MALE AND 38 FEMALE CONTROLS

	Equilibrium Position (degrees) Males N = 6	Equilibrium Position (degrees) Females N = 38
	45.5	32.5
	35.0	19.5
	33.5	31.5
	32.5	28.0
	46.5	25.0
	34.0	39.5
		24.0
		49.0
Mean	37.83	20.5
		54.0
S.D.	5.829	40.0
		33.0
		34.5
		37.0
		25.5
		43.5
		30.0
		31.5
		45.0
		43.5
		43.5
		31.5
		46.5
		20.5
		43.5
		29.5
		44.0
		32.5
		36.0
		44.5
		32.5
		43.0
		32.5
		38.0
		39.5
		49.0
		39.0
		29.5
		Mean
		35.84
		S.D.
		8.508

TABLE J

EQUILIBRIUM POSITION IN THE DIRECTION OF EXTENSION
IN 15 MALE AND 26 FEMALE PATIENTS

	Equilibrium Position (degrees) Males N = 15	Equilibrium Position (degrees) Females N = 26
	57.0	30.5
	41.5	27.0
	28.5	22.0
	37.5	49.0
	38.5	35.0
	58.5	28.0
	22.0	16.5
	23.5	51.0
	55.5	20.5
	32.0	39.0
	34.5	25.5
	49.5	49.0
	46.0	36.0
	25.0	41.5
	35.0	16.5
		58.0
		35.5
Mean	38.97	39.0
		9.0
S.D.	11.734	54.0
		11.0
		19.0
		21.0
		16.0
		32.0
		29.0
		Mean
		31.17
		S.D.
		13.345

APPENDIX 4

TABLE K
DISSIPATED ENERGY (Nm/cycle)
PRE AND POST TREATMENT

	Pre	Post
S.W.D.	0•0082	0•0097
	0•0119	0•0118
	0•0112	0•0108
	0•0169	0•0181
	0•0133	0•0101
	0•0151	0•0195
	0•0154	0•015
	0•0052	0•0057
	0•0056	0•0054
	0•0187	0•0194
U.S.	0•0145	0•015
	0•0084	0•0092
	0•0091	0•0083
	0•0075	0•0081
	0•0147	0•0147
	0•0111	0•018
	0•0117	0•0136
	0•0096	0•0091
WAX	0•0126	0•0101
	0•0107	0•0098
	0•0064	0•0099
	0•0153	0•0124
	0•0150	0•0125
	0•0122	0•0113
	0•0126	0•0117
	0•0199	0•0140
	0•0097	0•009
0•0171	0•0165	
EXS.	0•0092	0•0068
	0•0126	0•0139
	0•0111	0•0112
	0•0104	0•0118
	0•022	0•022
	0•0102	0•0099
	0•005	0•0043
	0•01	0•0094
0•0094	0•0145	
ICE	0•0127	0•0112
	0•015	0•0161
	0•0073	0•0080
	0•0187	0•0168
	0•0133	0•0124
	0•0078	0•0061
	0•0079	0•0129
	0•0123	0•0127
	0•0109	0•01
0•0085	0•0097	

TABLE K (cont)

DISSIPATED ENERGY (Nm/cycle)

PRE AND POST TREATMENT

PATIENTS

	Pre	Post
S.W.D.	0•0060	0•0038
	0•0104	0•0079
	0•0095	0•0072
	0•0105	0•0099
	0•0162	0•0133
	0•0154	0•016
	0•0189	0•019
	0•0171	0•0155
U.S.	0•0128	0•0089
	0•0103	0•0082
	0•017	0•0086
	0•0128	0•0095
	0•0242	0•0147
	0•0179	0•0162
EXS.	0•0165	0•0099
	0•0148	0•0146
	0•0136	0•0144
	0•0158	0•0145
	0•0116	0•0166
	0•0113	0•0098
	0•0109	0•0099
	0•0110	0•012
WAX	0•0093	0•0079
	0•0036	0•0037
	0•0081	0•0081
	0•0072	0•0082
	0•01	0•008
	0•0088	0•0075
	0•0037	0•006
	0•0044	0•0062
	0•0147	0•0138
	0•0143	0•0097
ICE	0•0122	0•0073
	0•0196	0•0245
	0•0123	0•0105
	0•0051	0•0066
	0•0103	0•0093
	0•0165	0•02

TABLE I
 TORQUE 20 (F) (Nm)
 PRE AND POST TREATMENT
 CONTROLS

	Pre	Post
S.W.D.	0.015	0.015
	0.014	0.012
	0.019	0.018
	0.018	0.018
	0.025	0.026
	0.023	0.018
	0.019	0.025
	0.013	0.014
	0.012	0.014
	0.016	0.012
U.S.	0.02	0.014
	0.008	0.013
	0.011	0.011
	0.009	0.008
	0.014	0.018
	0.01	-
	0.02	0.016
	0.013	0.011
EXS.	0.017	0.018
	0.004	0.012
	0.012	0.017
	0.011	0.01
	0.018	0.024
	0.012	0.011
	0.011	0.013
	0.013	0.012
	0.014	0.013
WAX	0.018	0.018
	0.014	0.012
	0.016	0.015
	0.007	0.008
	0.01	0.012
	0.015	0.019
	0.023	0.011
	0.01	0.011
	0.019	0.019
ICE	0.009	0.012
	0.021	0.018
	0.011	0.007
	0.011	0.025
	0.012	0.014
	0.013	0.011
	0.014	0.013
	0.012	0.012
	0.012	0.012
0.006	0.01	

TABLE L (cont)

TORQUE 20 (F) (Nm)

PRE AND POST TREATMENT

PATIENTS

	Pre	Post
S.W.D.	0.017	0.009
	0.01	0.016
	0.028	0.052
	0.009	0.014
	0.009	0.007
	0.013	0.009
	0.018	0.014
	0.014	0.017
	0.011	0.006
U.S.	0.01	0.01
	0.005	0.007
	0.034	0.017
	0.009	0.009
	0.025	0.018
	0.02	0.031
EXS.	0.02	0.013
	0.009	0.012
	0.014	0.02
	0.021	0.014
	0.007	0.03
	0.021	0.015
	0.028	0.03
	-	0.02
0.017	0.013	
WAX	0.012	0.017
	0.017	0.017
	0.051	0.085
	0.021	0.016
	0.003	0.008
	0.021	-
	0.019	0.022
	0.02	0.007
ICE	0.017	0.009
	0.01	0.016
	0.028	0.052
	0.009	0.014
	0.009	0.007
	0.013	0.009
	0.018	0.014
	0.014	0.017
0.011	0.006	

TABLE M
 TORQUE 20 (E) (Nm)
 PRE AND POST TREATMENT
 CONTROLS

	Pre	Post
S.W.D.	- 0.008	- 0.004
	- 0.012	- 0.011
	- 0.021	- 0.026
	- 0.014	-
	- 0.021	-
	- 0.01	- 0.009
	- 0.013	- 0.013
	- 0.009	-
U.S.	-	- 0.016
	- 0.013	- 0.011
	- 0.009	- 0.009
	- 0.007	- 0.007
	- 0.012	- 0.015
	- 0.013	- 0.017
	- 0.008	- 0.009
EKS.	- 0.015	- 0.013
	- 0.011	- 0.012
	- 0.011	- 0.013
	- 0.01	- 0.01
	- 0.018	-
	- 0.013	- 0.01
	- 0.008	- 0.014
	- 0.011	- 0.012
	- 0.006	- 0.007
WAX	- 0.005	- 0.006
	- 0.009	- 0.008
	- 0.021	- 0.018
	- 0.01	- 0.002
	- 0.012	- 0.01
	- 0.012	- 0.016
	- 0.011	- 0.008
	- 0.014	- 0.012
	- 0.019	- 0.025
ICE	- 0.006	- 0.008
	- 0.018	- 0.018
	-	- 0.034
	- 0.027	- 0.019
	- 0.012	- 0.011
	- 0.007	- 0.012
	- 0.007	- 0.019
	- 0.012	- 0.008
	- 0.011	- 0.007
- 0.006	- 0.004	

TABLE M (cont)
 TORQUE 20 (E) (Nm)
 PRE AND POST TREATMENT
 PATIENTS

	Pre	Post
S.W.D.	- 0.009	-
	-	- 0.01
	- 0.01	- 0.24
	- 0.012	- 0.011
	- 0.004	- 0.01
	-	- 0.024
	-	- 0.024
U.S.	- 0.01	- 0.007
	- 0.005	- 0.006
	- 0.009	- 0.002
	- 0.022	- 0.016
EXS.	-	- 0.014
	- 0.015	- 0.013
	- 0.01	- 0.006
	- 0.034	- 0.017
	-	- 0.007
	- 0.011	- 0.015
	-	- 0.018
- 0.030	-	
-	- 0.023	
WAX	- 0.017	-
	- 0.032	- 0.034
	- 0.018	- 0.034
	- 0.003	- 0.005
	- 0.012	- 0.012
	- 0.017	- 0.016
	- 0.021	- 0.019
	- 0.024	- 0.021
- 0.017	- 0.018	
ICE	- 0.01	- 0.014
	- 0.015	- 0.031
	- 0.016	- 0.031
	- 0.01	- 0.007
	- 0.007	- 0.011
	- 0.007	- 0.006
	- 0.015	- 0.01
	- 0.012	- 0.008
- 0.012	- 0.009	

TABLE N

Eq (F)

PRE AND POST TREATMENT

CONTROLS

	Pre	Post
S.W.D.	20.5	16.5
	15.5	10.5
	18.5	23.0
	8.5	24.5
	27.0	12.5
	9.0	12.0
	21.0	11.5
	22.0	15.0
	20.5	4.0
	U.S.	13.5
26.5		16.0
8.0		10.5
19.0		21.0
16.0		15.5
25.0		16.5
17.5		15.0
EXS.	18.5	15.0
	28.0	28.0
	21.5	30.0
	20.5	20.5
	23.0	9.5
	21.0	32.5
	29.5	14.0
	13.5	16.0
	17.0	16.5
WAX	16.0	14.0
	14.5	22.0
	20.0	20.0
	12.5	14.0
	16.0	16.0
	21.0	13.0
	6.5	16.0
	20.0	14.0
	12.0	17.0
ICE	15.5	24.5
	14.5	19.0
	9.5	14.0
	28.0	23.5
	21.0	21.5
	11.0	15.0
	17.0	16.5
	14.5	18.5
	12.5	15.0
	31.0	28.5

TABLE N (cont)

Eq (F)

PRE AND POST TREATMENT

PATIENTS

	Pre	Post
S.W.D.	7.5	9.0
	13.5	21.0
	17.0	18.5
	17.0	18.0
	14.0	17.0
	7.0	16.5
	14.5	17.0
U.S.	18.0	26.0
	13.5	15.5
	7.0	6.5
	20.5	14.0
	23.0	17.5
	5.0	5.5
EXS.	17.0	19.0
	17.5	15.0
	14.5	17.5
	29.5	23.5
	14.5	16.5
	26.0	37.0
	13.0	15.0
	21.5	26.5
	9.5	20.5
WAX	14.0	9.0
	17.5	16.5
	14.0	49.0
	22.5	19.5
	8.5	13.5
	17.5	21.5
	6.0	19.0
	16.5	8.5
ICE	12.5	12.0
	18.0	15.5
	16.0	13.0
	7.0	8.0
	17.0	23.5
	10.0	16.0
	25.0	39.0
	22.5	21.0
	6.5	9.0
	23.5	15.0

TABLE O

Eq. (E)

PRE AND POST TREATMENT

CONTROLS

	Pre	Post
S.W.D.	32.5	36.0
	19.5	10.0
	31.5	37.0
	25.0	25.5
	39.5	22.0
	24.0	21.0
	49.0	41.5
	45.5	38.5
	35.0	17.0
U.S.	20.5	32.0
	43.5	40.5
	29.5	31.0
	44.0	44.0
	36.0	35.5
	44.5	30.0
	32.5	32.5
EXS.	31.5	34.5
	45.0	45.0
	43.5	45.0
	43.5	46.5
	46.5	21.5
	31.5	41.0
	46.5	31.0
	32.5	33.5
	38.0	35.0
WAX	28.0	38.0
	30.0	33.5
	34.0	32.5
	43.0	57.0
	32.5	32.5
	39.5	34.0
	49.0	54.0
	39.0	34.0
	29.5	30.0
ICE	33.5	50.0
	32.5	42.5
	20.5	30.5
	54.0	39.5
	40.0	43.0
	33.0	25.5
	34.5	34.0
	37.0	43.5
	25.5	31.0
43.5	47.5	

Eq. (E)

PRE AND POST TREATMENT

PATIENTS

	Pre	Post
S.W.D.	28.0	16.5
	16.5	29.5
	51.0	30.5
	38.5	46.0
	58.5	49.0
	22.0	32.0
	23.5	40.0
U.S.	35.5	46.5
	39.0	38.5
	9.0	21.5
	54.0	51.0
	35.0	44.0
	11.0	12.5
EXS.	20.5	30.5
	37.5	39.5
	55.5	55.0
	41.5	37.5
	16.5	24.5
	58.0	70.5
	19.0	26.5
	59.0	31.0
	21.0	21.0
	16.0	30.0
WAX	30.5	16.0
	16.5	25.0
	22.0	37.0
	57.0	36.0
	49.0	30.5
	41.5	42.0
	28.5	53.0
	35.0	37.5
	32.0	30.0
	29.0	28.0
ICE	39.0	32.5
	32.0	34.5
	34.5	25.5
	49.5	47.5
	25.5	29.0
	49.0	55.0
	46.0	42.5
	25.0	27.5
	36.0	36.0

TABLE P
 MEAN GRIP STRENGTH (mm Hg)
 PRE AND POST TREATMENT
 CONTROLS

	Pre	Post
S.W.D.	373.3 270.0 286.6 353.3 360.0 300.0	373.3 300.0 250.0 306.6 296.6 280.0
U.S.	253.3 183.3 293.3 233.3 243.3 210.0 286.6 433.3	303.3 176.6 300.0 256.6 293.3 156.6 256.6 446.6
EXS.	313.3 286.6 193.3 393.3 300.0 210.0 183.3 446.6	363.3 256.6 223.3 313.3 280.0 166.6 170.0 436.6
WAX	410.0 276.6 236.6 323.3 363.3 356.6 190.0 176.6 286.6 303.3	436.6 280.0 320.0 426.6 300.0 270.0 186.6 203.3 266.6 293.3
ICE	246.6 403.3 323.3 146.6 160.0 190.0 160.0	300.0 336.6 300.0 236.6 200.0 243.3 130.0

TABLE P (cont)

MEAN GRIP STRENGTH (mm Hg)

PRE AND POST TREATMENT

PATIENTS

	Pre	Post
S.W.D.	160.0	126.6
	120.0	116.6
	63.3	60.0
	66.6	73.3
	70.0	73.3
	230.0	236.6
	136.6	193.3
	106.6	100.0
U.S.	100.0	96.6
	143.3	120.0
	40.0	43.3
	66.6	70.0
	300.0	323.3
	100.0	90.0
EXS.	63.3	80.0
	70.0	80.0
	260.0	266.6
	53.3	50.0
	100.0	93.3
	90.0	96.6
	56.6	50.0
	253.3	416.6
	50.0	46.6
	56.6	60.0
WAX	48.6	52.0
	90.0	98.0
	66.6	79.3
	85.0	64.6
	86.6	87.3
	186.6	206.6
	122.0	121.3
	117.6	118.6
	63.3	66.6
	50.0	46.6
ICE	40.0	40.0
	50.0	46.6
	110.0	110.0
	273.3	230.0
	243.3	270.0
	120.0	116.6
	70.0	63.3
	73.3	70.0
	190.0	153.3
	136.6	146.6
	103.3	96.6

TEMPERATURE

PRE AND POST TREATMENT

CONTROLS

	Pre	Post
S.W.D.	27.1	31.4
	30.7	28.0
	35.9	36.1
	28.0	29.5
	31.0	33.1
	32.1	35.3
	26.6	32.5
	32.0	33.7
	29.1	33.6
	27.2	33.3
U.S.	33.6	33.2
	30.6	33.8
	28.4	34.0
	26.7	31.2
	31.8	32.8
	31.4	33.7
	29.4	33.8
	34.4	34.4
EXS.	32.2	32.0
	26.9	27.7
	28.8	30.4
	30.9	32.7
	32.1	32.1
	31.1	31.7
	28.9	32.0
	26.4	30.7
	30.1	31.2
WAX	34.6	36.2
	27.8	32.8
	32.0	33.9
	26.5	33.1
	29.3	34.2
	33.4	35.6
	26.9	33.3
	30.5	33.3
	31.4	33.5
	33.6	35.2
ICE	32.4	15.2
	25.0	17.0
	32.4	21.2
	28.0	19.7
	25.2	20.1
	28.7	17.5
	30.3	24.5
	30.5	20.0
	28.8	16.7
	27.2	20.5

TEMPERATURE
PRE AND POST TREATMENT
PATIENTS

	Pre	Post
S.W.D.	32.7	34.5
	30.5	34.7
	32.3	34.6
	32.5	33.7
	34.8	35.6
	34.7	35.3
	30.5	35.9
	35.5	33.7
U.S.	31.9	33.9
	27.3	32.7
	33.7	34.8
	31.9	33.1
	32.7	33.7
	28.1	33.8
EXS.	33.5	33.2
	34.8	35.1
	34.7	35.0
	33.7	33.1
	33.8	34.3
	34.0	34.6
	34.2	34.4
WAX	34.4	34.9
	34.4	34.9
	30.6	34.4
	32.4	35.5
	32.8	35.7
	32.5	35.2
	33.8	35.6
	34.5	35.6
	35.3	34.9
	28.8	34.2
ICE	35.6	34.5
	35.2	25.1
	30.6	24.5
	33.7	22.6
	33.1	28.3
	31.8	24.4
	34.6	27.8
	32.5	23.2
	29.6	21.9
	33.0	24.5

REFERENCES

ABRAMSON, D. I., BELL, Y., REJAL, H., TUCK, S., BURNETT, C. and FLEISCHER, C. J. (1960). Changes in blood flow, oxygen uptake and tissue temperatures produced by therapeutic physical agents. II Effect of short wave diathermy. Americal Journal of Physical Medicine, 39, 87-95.

ABRAMSON, D. I., BURNETT, C., BELL, Y., TUCK, S., REJAL, H. and FLEISCHER, C. J. (1960). Changes in blood flow, oxygen uptake and tissue temperatures produced by therapeutic physical agents. I Effect of ultrasound. Americal Journal of Physical Medicine, 39, 51-62.

ASMUSSEN, E. and BØJE, O. (1945). Body temperature and capacity for work. Acta Physiologica Scandinavica, 10, 1-22.

BACKLUND, L. and TISELIUS, P. (1967). Objective measurement of joint stiffness in rheumatoid arthritis. Acta Rheumatologica Scandinavica, 13, 275-288.

BARCROFT, H. and EDHOLM, O. G. (1943). The effect of temperature on blood flow and deep temperature in the human forearm. Journal of Physiology, 102, 5-20.

BARNETT, C. H. and COBBOLD, A. F. (1962). Lubrication within living joints. Journal of Bone and Joint Surgery, 44B, 662-674.

BARNETT, C. H. and COBBOLD, A. F. (1968). Effects of age upon the mobility of human finger joints. Annals of the Rheumatic Diseases, 27, 175-177.

BEIGHTON, P. and HORAN, F. (1969). Orthopaedic aspects of the Ehlers-Danlos syndrome. Journal of Bone and Joint Surgery, 51B, 444-453.

BEIGHTON, P., SOLOMON, L. and SOSKOLNE, C. L. (1973). Articular mobility in an African population. Annals of the Rheumatic Diseases, 32, 413-418.

CARTER, C. and WILKINSON, J. (1964). Persistent joint laxity and congenital dislocation of the hip. Journal of Bone and Joint Surgery, 46B, 40-45.

COBB, S., WARREN, J., THOMPSON, D. and CIOCCO, A. (1954). The epidemiology of rheumatoid arthritis. Pennsylvania Medical Journal, 57, 37-39.

COOKE, A. F., DOWSON, D. and WRIGHT, V. (1976). Lubrication of synovial membrane. Annals of the Rheumatic Diseases, 35, 56-59.

ELLIS, F. and BUNDICK, W. (1956). Cutaneous elasticity and hyperelasticity. American Medical Association Archives of Dermatology, 74, 22-32.

FERRIS, B. G., FORSTER, R. E., PILLION, E. L. and CHRISTENSEN, W. R. (1947). Control of peripheral blood flow: responses in the human hand when extremities are warmed. American Journal of Physiology, 150, 304-314.

FREMONT-SMITH, K., HARTER, J. G. and HALBERG, F. (1969). Circadian rhythmicity of proximal interphalangeal (P I P) joint circumference in patients with rheumatoid arthritis. Arthritis and Rheumatism, 12, 294.

GODDARD, R., DOWSON, D., LONGFIELD, M. D. and WRIGHT, V. (1969). The measurement of stiffness in human joints. Rheologica Acta, 8, 229-234.

GRAHAM, R. and JENKINS, J. M. (1972). Joint hypermobility - asset or liability? Annals of the Rheumatic Diseases, 31, 109-111.

HARRIS, H. and JOSEPH, J. (1949). Variation in extension of the metacarpo-phalangeal and interphalangeal joints of the thumb. Journal of Bone and Joint Surgery, 31B, 547-559.

HASLOCK, D. I. and WRIGHT, V. (1972). A biomechanical approach to joint disease. Medicine, 1, 18-22.

HASLOCK, D. I., WRIGHT, V. and HARRIMAN, D. G. F. (1970). Neuromuscular disorders in rheumatoid arthritis. Quarterly Journal of Medicine, New Series, 39, 335-358.

HICKLIN, J. A., WIGHTON, R. J. and ROBINSON, F. J. (1968).

Measurement of finger stiffness. Annals of Physical Medicine, 9, 234-242.

HOLLANDER, J. L. and HORVATH, S. M. (1949). The influence of physical therapy procedures on the intra-articular temperature of normal and arthritic subjects. American Journal of the Medical Sciences, 218, 543-548.

HORVATH, S. M. and HOLLANDER, J. L. (1949). Intra-articular temperature as a measure of joint reaction. Journal of Clinical Investigation, 28, 469-473.

HUNTER, J., KERR, E. H. and WHILLANS, M. G. (1952). The relation between joint stiffness upon exposure to cold and the characteristics of synovial fluid. Canadian Journal of Medical Sciences, 30, 367-377.

HUNTER, J. and WHILLANS, M. G. (1951). A study of the effect of cold on joint temperature and mobility. Canadian Journal of Medical Sciences, 29, 255-262.

INGPEN, M. L. (1968). The quantitative measurement of joint changes in rheumatoid arthritis. Annals of Physical Medicine, 9, 322-327.

INGPEN, M. L. and HUME KENDALL, P. (1968). A simple apparatus for assessment of stiffness. Annals of Physical Medicine, 9, 203-205.

- JOBINS, B., BIRD, H. A. and WRIGHT, V. (1979). A joint hyperextensometer for the quantification of joint laxity. Engineering in Medicine, 8, 103-104.
- JOHNS, R. J. and WRIGHT, V. (1962). Relative importance of various tissues in joint stiffness. Journal of Applied Physiology, 17, 824-828.
- JOHNS, R. J. and WRIGHT, V. (1964). An analytical description of joint stiffness. Biorheology, 2, 87-95.
- KERSLAKE, D. McK. and COOPER, K. E. (1950). Vasodilation in the hand in response to heating the skin elsewhere. Clinical Science, 9, 31-47.
- KIRK, J. A. and KERSLEY, G. D. (1968). Heat and cold in the physical treatment of rheumatoid arthritis of the knee. Archives of Physical Medicine, 9, 270-274.
- LANSBURY, J. (1956). Quantitation of the activity of rheumatoid arthritis. American Journal of the Medical Sciences, 231, 616-621.
- LESS, M., KREWER, S. E. and EICKELBERG, W. W. (1977). Exercise effect on strength and range of motion of hand intrinsic muscles and joints. Archives of Physical Medicine and Rehabilitation, 58, 370-374.
- LOEBL, W. Y. (1972). The assessment of mobility of metacarpophalangeal joints. Rheumatology and Physical Medicine, 11, 365-379.

- LONG, C., THOMAS, D. and CROCHETIERE, W. J. (1964). Viscoelastic factors in hand control. Excerpta Medica International Congress Series, No. 107, 440-445.
- LOPEZ, B. (1978). The use of thermic modalities in rheumatic diseases. Wisconsin Medical Journal, 77, 70.
- MILLIS, M. B., MILLENDER, L. H. and NALEBUFF, E. A. (1976). Stiffness of the proximal interphalangeal joints in rheumatoid arthritis. Journal of Bone and Joint Surgery, 58A, 801-805.
- MILLS, J. N. (1976). Circadian rhythms in PASSMORE, R. and ROBSON, J. S. ed. A Companion to Medical Studies. Volume 1, 2nd edition, Blackwell Scientific Publications, Oxford, England.
- MORTIMER, R. G. (1977). Stiffness in the human metacarpophalangeal joint. A final years honours project. University of Durham.
- PEGG, S. M. H., LITTLER, T. R. and LITTLER, E. N. (1969). A trial of ice therapy and exercise in chronic arthritis. Physiotherapy, 55, 51-56.
- RADIN, E. L. and PAUL, I. L. (1972). A consolidated concept of joint lubrication. Journal of Bone and Joint Surgery, 54A, 607-616.
- RADIN, E. L., PAUL, I. L., SWANN, D. A. and SCHOTTSTAEDT, E. S. (1971). Lubrication of synovial membrane. Annals of the Rheumatic Diseases, 30, 322-325.

- RODDIE, I. C. and SHEPHERD, J. T. (1956). The blood flow through the hand during local heating, release of sympathetic vasomotor tone by indirect heating, and a combination of both. Journal of Physiology, 131, 657-664.
- ROPES, M. W., BENNETT, G. A., COBB, S., JACOX, R. and JESSAR, R. A. (1957). Proposed diagnostic criteria for rheumatoid arthritis. Annals of the Rheumatic Diseases, 16, 118-123.
- ROPES, M. W., BENNETT, G. A., COBB, S. JACOX, R. and JESSAR, R. A. (1959). 1958 revision of diagnostic criteria for rheumatoid arthritis. Arthritis and Rheumatism, 2, 16-20.
- SAVAGE, O. (1958). Criteria for measurement in chronic diseases. In Report of a Symposium on Clinical Trials. Pfizer, Kent.
- SCOTT, J. T. (1960). Morning stiffness in rheumatoid arthritis. Annals of the Rheumatic Diseases, 19, 361-368.
- SMITH, E. M., JOVINALL, C., BENDER, L. F. and PEARSON, J. R. (1966). Flexor forces and rheumatoid metacarpophalangeal deformity. Journal of the American Medical Association, 198, 150.
- SPEALMAN, C. R. (1945). Effect of ambient air temperature and of hand temperature on blood flow in hands. American Journal of Physiology, 145, 218-222.
- SUCH, C. H., UNSWORTH, A., WRIGHT, V. and DOWSON, D. (1975). Quantitative study of stiffness in the knee joint. Annals of the Rheumatic Diseases, 34, 286-291.

THOMPSON, D. T. (1978). A study of knee joint stiffness.

Ph.D. Thesis. University of Leeds.

THOMPSON, D. T., WRIGHT, V. and DOWSON, D. (1978). A new form of knee arthrograph for the study of stiffness. Engineering in Medicine, 7, 84-92.

TUCKER, K. (1978). Some aspects of post-traumatic elbow stiffness. Injury, 9, 216-220.

TUTTLE, W. W. and FITTS, L. (1944). The effect of heat produced by short wave diathermy on the activity of muscle. The Journal of Laboratory and Clinical Medicine, 29, 609-613.

UNSWORTH, A. and ALEXANDER, W. J. (1979). Dimensions of the metacarpo-phalangeal joint with particular reference to joint prostheses. Engineering in Medicine, 8, 75-80.

UNSWORTH, A., DOWSON, D. and WRIGHT, V. (1975). Some new evidence on human joint lubrication. Annals of the Rheumatic Diseases, 34, 277-285.

VERRIER, M., FALCONER, K. and CRAWFORD, J. S. (1977). A comparison of tissue temperature following two short wave diathermy techniques. Physiotherapy (CANADA), 29, 21-25.

VIIDIK, A. (1968). A rheological model for uncalcified parallel-fibred collagenous tissue. Journal of Biomechanics, 1, 3-11.

WILKINSON, R. (1971). Hours of work and the twenty-four-hour cycle of rest and activity, in WARR, P. B. ed. Psychology at Work. Harmondsworth, Penguin.

WRIGHT, V. (1959). Some observations on diurnal variation of grip. Clinical Science, 18. 17-23.

WRIGHT, V., DOWSON, D. and GODDARD, R. (1971). Rheological characteristics of human joints with particular reference to the knee. Rheologica Acta, 10, 61-66.

WRIGHT, V. and JOHNS, R. J. (1960a). Observations on the measurement of joint stiffness. Arthritis and Rheumatism, 3, 328-340.

WRIGHT, V. and JOHNS, R. J. (1960b). Physical factors concerned with the stiffness of normal and diseased joints. Bulletin of John Hopkins Hospital, 106, 215-231.

WRIGHT, V. and PLUNKETT, T. G. (1966). Scientific assessment of the results of physical treatment - measurement of stiffness. Annals of Physical Medicine, 8, 280-291.

ACKNOWLEDGEMENTS

I would like to express my thanks to the following people and organisations for their help, without whose help this work could not have been undertaken.

Dr. A. Unsworth, Ph.D. and Dr. D. I. Haslock, M.D. for their supervision, advice and encouragement.

My colleagues at Middlesbrough General Hospital and students of the South Teesside School of Physiotherapy, who acted as subjects for the experiments, particularly those students who were woken at two hourly intervals during the circadian variation studies.

Dr. D. R. L. Newton and Dr. D. I. Haslock for allowing access to patients and their documents.

A special thanks to Mrs. M. Cook, S.R.N. and Mrs. C. Kirlew, M.C.S.P. for allowing me the facilities of the ward and physiotherapy units of the Rheumatology Unit at West Lane Hospital, Middlesbrough.

My colleagues at the Bradford School of Physiotherapy for their support during the latter stages of the work.

The technical staff of the University of Durham for building the arthrograph.

Mr. K. Goult for producing the photographs.

The Department of Health and Social Security for their financial assistance.

Mrs. R. Davidson for her secretarial help during the draft stages of the thesis and Mrs. E. Hirst for typing the final manuscript.

My wife, Brenda, for her unselfishness, patience and understanding.

Finally, my grateful thanks to the many patients who kindly volunteered for the experiments.