



## Durham E-Theses

---

### *Synthetic and spectroscopic studies of some organotin(IV) complexes*

Clark, Helen

#### How to cite:

---

Clark, Helen (1986) *Synthetic and spectroscopic studies of some organotin(IV) complexes*, Durham theses, Durham University. Available at Durham E-Theses Online: <http://etheses.dur.ac.uk/7103/>

#### Use policy

---

The full-text may be used and/or reproduced, and given to third parties in any format or medium, without prior permission or charge, for personal research or study, educational, or not-for-profit purposes provided that:

- a full bibliographic reference is made to the original source
- a [link](#) is made to the metadata record in Durham E-Theses
- the full-text is not changed in any way

The full-text must not be sold in any format or medium without the formal permission of the copyright holders.

Please consult the [full Durham E-Theses policy](#) for further details.

SYNTHETIC AND SPECTROSCOPIC  
STUDIES  
OF SOME ORGANOTIN(IV) COMPLEXES

by

Helen Clark B.Sc.  
(Graduate Society)

A thesis submitted for the degree of  
Doctor of Philosophy  
in the University of Durham  
November 1986

The copyright of this thesis rests with the author.  
No quotation from it should be published without  
his prior written consent and information derived  
from it should be acknowledged.



23. APR. 1987

Thesis  
1986/CLA

Eight eights are eighty-one,

multiply by seven.

If its more, carry four

and take away eleven.

Nine nines are sixty four

multiply by three.

When its done, carry one

and then its time for tea.

A.A.Milne

### Acknowledgements

I would like to thank my supervisor, Dr. K. B. Dillon for his help, encouragement and advice throughout the course of this study.

Thanks are also due to Dr. P. J. Smith for Mossbauer work, Dr. J. Halfpenny for X-ray crystallography, Dr. A. Royston for help with NMR work and word processing, Dr. Angelika Sebald for NMR work and general advice, Mr. P. Lux for infra-red, Mr. N. Everall for Raman spectra, and Mr. R. Coult for analyses.

The sheepish remarks of Jimmy and the Lab. nineteenies are also acknowledged, as is the sustaining influence of Victoria, Elizabeth and camp followers.

Final thanks go to SERC for the maintenance award and to Mrs. Elizabeth Wood for much help with diagrams.

### Declaration

The work described in this thesis was carried out in the University of Durham between October 1983 and October 1986. This work has not been submitted, completely or in part, for a degree in this or any other university and is the original work of the author, except where acknowledged by reference.

### Abstract

$^{119}\text{Sn}$  NMR and IR data are presented for  $\text{Me}_2\text{SnX}_2$  ( $X = \text{Cl}, \text{NCS}, \text{N}_3, \text{NCO}$ ). Three series of mixed dimethyltin chloro-pseudohalide complexes  $(\text{Et}_4\text{N}^+)_2 \text{Me}_2\text{SnCl}_n \text{X}_{4-n}^{2-}$  ( $X = \text{NCS}, \text{N}_3$ , partial success obtained for  $X = \text{NCO}$ ) have been prepared from them, and IR, Mossbauer (determined by Dr. P. J. Smith) and  $^{119}\text{Sn}$  NMR data are presented for the first two series of complexes. The results show them to be formed discretely, to contain regular octahedral anions with linear trans Me-Sn-Me units, and to dissociate in solution. The crystal structure of  $(\text{Ph}_4\text{P}^+)_2 \text{Me}_2\text{Sn}(\text{N}_3)_4^{2-}$  (determined by Dr. J. Halfpenny) is also presented.

$\delta(^{119}\text{Sn})$  changes across the series in the opposite direction to that expected on the basis of substituent electronegativity. The change is tentatively ascribed to polarisability differences between Cl and pseudohalide ligands. A rough correlation between  $\delta(\text{mms}^{-1})$  and substituent electronegativity is observed, and the  $\Delta E_q$  values correlate fairly well with those expected on the basis of the additivity model.

The corresponding series of diphenyltin complexes has been prepared for  $X = \text{NCS}, \text{C}_2^+ \text{Ph}_2\text{Sn}(\text{NCS})_n \text{Cl}_{4-n}^{2-}$ , as has the series of five-coordinate complexes  $\text{Et}_4\text{N}^+ \text{Me}_2\text{Sn}(\text{NCS})_n \text{Cl}_{3-n}^-$  (except for  $\text{Me}_2\text{Sn}(\text{NCS})_3^-$ ). Mossbauer data for the former compounds again show that the anions take up a trans octahedral arrangement.

The dissociation of the dimethyltin tetrahalo/pseudohalo complexes  $(\text{Et}_4\text{N}^+)_2 \text{Me}_2\text{SnCl}_4^{2-}$ ,  $(\text{Pr}_4\text{N}^+)_2 \text{Me}_2\text{Sn}(\text{NCS})_4^{2-}$  and  $(\text{Et}_4\text{N}^+)_2 \text{Me}_2\text{Sn}(\text{N}_3)_4^{2-}$  has been investigated in acetonitrile solution by  $^{119}\text{Sn}$  NMR, and equilibrium constants for the



dissociation were derived. These show the tetra-azide complex to be considerably less dissociated in solution than are the chloride and thiocyanate complexes, although  $K$  is quite large for all three.

When the same reaction was investigated in DMSO solution, it was deduced that the solvent completely replaces two of the anionic ligands of the complex.

Addition of  $X^-$  to  $\text{Me}_2\text{SnCl}_3^-$  ( $X = \text{Cl}$ ),  $\text{Me}_2\text{SnCl}_2$  ( $X = \text{Cl}$ ) and  $\text{Me}_2\text{Sn}(\text{NCS})_2$  ( $X = \text{Cl}, \text{NCS}$ ) in acetonitrile has also been studied. Addition is observed in all cases, followed by substitution for  $\text{Me}_2\text{Sn}(\text{NCS})_2 + \text{Cl}^-$ , and the limiting shift of the appropriate six-coordinate complex is ultimately obtained.

Substitution reactions have been followed for the systems  $\text{Me}_2\text{Sn}(\text{NCS})_4^{2-} + \text{Cl}^-$  and  $\text{Me}_2\text{SnCl}_4^{2-} + \text{NCS}^-$  (both in acetonitrile). The reaction was found to be more facile in the former case.

The synthesis of some compounds containing hexacoordinate heterocyclic tin has been attempted, for testing as possible anti-cancer reagents. Preparation via ylide or dilithium reagents did not lead to useful products, but a series of bis(pyridine) or (bidentate pyridine ligand).1,1-dibromostannacyclohexanes has been successfully prepared. The  $^1\text{H}$ ,  $^{13}\text{C}$  and  $^{119}\text{Sn}$  NMR and infra-red data for these compounds are presented and discussed.



Abbreviations and symbols

Ps	pseudohalide	$\gamma$	magnetogyric
X	halide		ratio
L	donor ligand	$H_R, H_S$	field at the reference
Bz	benzyl		or sample nucleus,
Cy	cyclohexyl		respectively
phen	1,10-phenanthroline	e	magnitude of the
bipy	2,2'-bipyridyl		charge on an electron
py	pyridine	$\mu_0$	permiability of free
3,5-Cl <sub>2</sub> py	3,5-dichloropyridine		space
3-Clpy	3-chloropyridine	$\mu_B$	Bohr magneton
3,5-Me <sub>2</sub> py	3,5-dimethylpyridine	Q	nuclear quadrupole
Tpy	2,2',2''-terpyridyl		moment
pan	1-(2-pyridylazo)-2-naphtholate		
acac	acetylacetonate	q	electronic field
acet	acetone		gradient at the
DMSO	dimethylsulphoxide		nucleus
DMF	dimethylformamide	$I_z$	z component of the
HMPT } HMPA }	hexamethylphosphoric triamide		nuclear spin quantum number
THF	tetrahydrofuran	$Z_{eff}$	effective nuclear charge
s.m.	starting material	$(\Delta\nu)_{1/2}$	signal width at 1/2 ht
$x_n$	mole fraction of n	$B_0$	External applied field
$\chi_n$	electronegativity of n	$k_1$	rate of forward reaction
$\nu_0$	Larmor precession	$k_2$	rate of back reaction
	frequency	$\nu(X-Y)$	stretching vibration
		$\delta(X-Y)$	bending vibration
		$\rho(X-Y)$	rocking vibration

## INDEX

<u>CHAPTER 1: INTRODUCTION</u>	1
1 Organotin(IV) compounds	1
1.1 Structures	1
1.1.1 Four-coordinate compounds	1
1.1.2 Compounds of coordination number >4	2
1.1.3 Compounds of coordination number >6	6
1.2 Reactions	7
1.2.1 Nucleophilic substitution	7
1.3 Industrial uses	9
2 Area of work	10
2.1 Pseudohalide complexes	10
2.2 Dissociation studies of dimethyltin compounds	11
2.3 Synthesis of heterocycles	11
3 Nuclear magnetic resonance	13
3.1 General	13
3.1.1 $\delta$ values	13
3.1.2 Coupling constants	14
3.2 Proton and C-13 spectra	15
3.3 Sn-119 NMR	15
3.3.1 $\delta$ values	16
3.3.2 Empirical correlations of $\delta$ with structure	17
3.3.3 Coupling constants	19
3.3.4 Correlations of J with molecular structure	21
3.3.5 Mossbauer/NMR parameter correlations	22
4 Mossbauer spectroscopy	23

4.1 General	23
4.1.1 $\delta$ values	23
4.1.2 $\Delta E_q$ values	24
4.2 Relation of parameters to bonding and structure	25
4.2.1 $\delta$ values	25
4.2.2 $\Delta E_q$ values	25
4.2.2a Additivity model	26
4.2.2b Experimental parameters	27
5 Infra-red spectroscopy	30
5.1 Pseudohalide bands	30
5.2 Sn-X bands	31
5.3 Sn-C bands	32
5.4 Sn-Ph bands	33
<u>CHAPTER 2: EXPERIMENTAL</u>	35
1 Glove box techniques	35
2 Vacuum/nitrogen line	36
3 Chemicals and solvents	37
4 Elemental analysis	37
5 Infra-red spectra	39
6 NMR spectra (except $^1\text{H}$ )	39
7 $^1\text{H}$ NMR spectra	41
8 Mossbauer spectra	41
9 X-ray crystallography	41

CHAPTER 3: DIMETHYL AND DIPHENYLTIN THIOCYANATO-CHLORIDE COMPLEXES

	42
1 Introduction	42
2 Four-coordinate compounds	46
2.1 Infra-red data	46
2.2 $^{119}\text{Sn}$ chemical shift data	48
2.3 Coupling constants	49
2.4 Concentration dependence of $\delta$	50
2.5 Discussion	52
3 6-coordinate complexes	
$(\text{Et}_4\text{N}^+)_2 \text{Me}_2\text{Sn}(\text{NCS})_n \text{Cl}_{4-n}^{2-}$ (n = 0-4)	54
3.1 Infra-red data	54
3.2 $^{119}\text{Sn}$ chemical shift data	55
3.3 Coupling constants $^2J(^{119}\text{Sn}-\text{C}-^1\text{H})$	56
3.4 Concentration dependence of $\delta$	57
3.5 Mossbauer data	58
3.6 Discussion	59
4 Diphenyltin thiocyanato-chloride complexes	
$\text{C}_2^+ \text{Ph}_2\text{Sn}(\text{NCS})_n \text{Cl}_{4-n}^{2-}$	63
4.1 Infra-red data	64
4.2 $^{119}\text{Sn}$ NMR chemical shift data	65
4.3 Mossbauer data	66
4.4 Discussion	67
5 5-coordinate complexes $(\text{Et}_4\text{N}^+) \text{Me}_2\text{Sn}(\text{NCS})_n \text{Cl}_{3-n}^{2-}$	69
5.1 Infra-red data	69
5.2 $^{119}\text{Sn}$ chemical shift data	70
5.3 Discussion	71
6 Experimental	72

6.1 General	72
6.2 Preparation of 4-coordinate starting materials	73
6.3 Preparation of complexes	73

CHAPTER 4: MIXED DIMETHYLTIN CHLORIDE/PSEUDOHALIDE COMPLEXES

$(\text{Et}_4\text{N}^+)_2 \text{Me}_2\text{SnXCl}_{4-n}^{2-}$ X = AZIDE, CYANATE, CYANIDE	80
--	----

1 Introduction	80
2 Four-coordinate starting materials	83
2.1 Infra-red data	83
2.2 $^{119}\text{Sn}$ chemical shift data	84
2.3 Coupling constants	85
2.4 Discussion	85
3 6-coordinate dimethyltin azidochloride complexes	88
3.1 Complexes with tetra-phenylphosphonium cation	88
3.1.1 Infra-red data	88
3.1.2 $^{119}\text{Sn}$ chemical shift data	89
3.1.3 Crystal structure of $(\text{Ph}_4\text{P}^+)_2 \text{Me}_2\text{Sn}(\text{N}_3)_4^{2-}$	90
3.1.4 Discussion	91
3.2 Tetraethyl-ammonium complexes	92
3.2.1 Infra-red data	92
3.2.2 $^{119}\text{Sn}$ chemical shift data	94
3.2.3 Coupling constants	95
3.2.4 Mossbauer data	95
3.2.5 Discussion	96
4 6-coordinate dimethyltin cyanato-chloride complexes	102
4.1 Infra-red data	102
4.2 $^{119}\text{Sn}$ chemical shift data	103

4.3 Discussion	103
5 Attempted preparations of dimethyltin cyanide complexes	105
5.1 $\text{Me}_2\text{Sn}(\text{CN})_2$	105
5.2 6-coordinate complexes	105
6 Experimental	106
6.1 General	106
6.2 4-coordinate starting materials	107
6.3 Preparation of complexes	108
6.4 Preparation of dimethyltin cyanide complexes	109
6.4.1 $\text{Me}_2\text{Sn}(\text{CN})_2$	109
6.4.2 Complexes	110
6.5 Analytical results	111

CHAPTER 5:  $^{119}\text{Sn}$  NMR STUDIES OF SOME EQUILIBRIUM REACTIONS OF  
DIMETHYLTIN CHLORIDE AND PSEUDOHALIDE COMPLEXES 112

1 Introduction	112
2 Dissociation supression of 6-coordinate $\text{Me}_2\text{SnX}_4^{2-}$ complexes	114
2.1 Equilibrium constant determination	114
2.2 $(\text{Et}_4\text{N}^+)_2 \text{Me}_2\text{SnCl}_4^{2-} + \text{Et}_4\text{NCl} / \text{CH}_3\text{CN}$	119
2.3 $(\text{Pr}_4\text{N}^+)_2 \text{Me}_2\text{Sn}(\text{NCS})_4^{2-} + \text{Pr}_4\text{NNCS}$	
a in $\text{CH}_3\text{CN}$	120
b in DMSO	121
2.4 $(\text{Et}_4\text{N}^+)_2 \text{Me}_2\text{Sn}(\text{N}_3)_4^{2-} + \text{Et}_4\text{NN}_3 / \text{CH}_3\text{CN}$	122
2.5 Discussion	123
3 $(\text{Et}_4\text{N}^+) \text{Me}_2\text{SnCl}_3^- + \text{Et}_4\text{NCl} / \text{CH}_3\text{CN}$	128
4 Addition to four-coordinate compounds	129

4.1	$\text{Me}_2\text{SnCl}_2 + \text{Et}_4\text{NCl} / \text{CH}_3\text{CN}$	129
4.2	$\text{Me}_2\text{Sn}(\text{NCS})_2 + \text{Pr}_4\text{NNCS} / \text{CH}_3\text{CN}$	130
4.3	Discussion	130
5	Substitution reactions	132
5.1	$(\text{Bu}_4\text{P}^+)_2 \text{Me}_2\text{SnCl}_4^{2-} + \text{Pr}_4\text{NNCS}$	133
5.2	$(\text{Pr}_4\text{N}^+)_2 \text{Me}_2\text{Sn}(\text{NCS})_4^{2-} / \text{CH}_3\text{CN}$	134
5.3	Discussion	135
6	Substitution and addition reactions	138
6.1	$\text{Me}_2\text{Sn}(\text{NCS})_2 + \text{Et}_4\text{NCl} / \text{CH}_3\text{CN}$	138
7	Preparation of samples	142

## CHAPTER 6: SYNTHESIS OF SOME HETEROCYCLIC ORGANOTIN COMPLEXES

		143
1	Introduction	143
2	Attempted syntheses using Grignard, organolithium and phosphorous ylide reagents	146
2.1	Use of Grignard and organolithium reagents	146
2.2	Use of phosphorus ylide reagents	147
3	One step preparation of some 6-coordinate 1,1-dibromostannacyclohexane.pyridine base adducts	152
3.1	1,10-phenanthroline.1,1-dibromostannacyclohexane	153
3.1.1	Characterisation data	153
3.1.2	Conclusions	154
3.2	Bis(pyridine).1,1-dibromostannacyclohexane	156
3.2.1	Characterisation data	156
3.2.2	Conclusions	159
3.3	2,2'-bipyridyl.1,1-dibromostannacyclohexane	162
3.3.1	Characterisation data	162
3.3.2	Conclusions	164

3.4 Bis(3,5-dichloropyridine).1,1-dibromostannacyclohexane	165
3.4.1 Characterisation data	165
3.4.2 Conclusions	166
3.5 Bis(3,5-dimethylpyridine).1,1-dibromostannacyclohexane	167
3.5.1 Characterisation data	167
3.5.2 Conclusions	170
3.6 Bis(3-chloropyridine).1,1-dibromostannacyclohexane	171
3.6.1 Characterisation data	171
3.6.2 Conclusions	172
3.7 Discussion	173
4 Experimental	178
4.1 Preparative method for an $\alpha,\omega$ -diGrignard reagent	178
4.2 Distillation of $\text{Ph}_3\text{Sn}(\text{CH}_2)_5\text{SnPh}_3$	179
4.3 Preparation of an $\alpha,\omega$ -diorganolithium reagent	179
4.4 Synthesis of tin ylide complexes	181
4.4.1 Preparation of phosphonium salts	181
4.4.2 Preparation of ylide	182
4.4.3 Preparation of complex	183
4.5 Preparation of $\text{L}_2\cdot\text{Br}_2\text{Sn}(\text{CH}_2)_5$	183
4.6 Spectrometric conditions for $\text{L}_2\cdot\text{Br}_2\text{Sn}(\text{CH}_2)_5$	185
<u>CHAPTER 7: SUGGESTIONS FOR FURTHER WORK</u>	186
1 Dialkyltin halide/pseudohalide complexes	186
2 Study of equilibria	187
3 Synthesis of tin heterocycles	189
3.1 Tin ylide complexes	189
3.2 1,1-dibromostannacyclohexane complexes	190



3.3 Further development	192
3.3.1 Synthesis of Sn-C heterocycles	192
3.3.2 Use of bis(triorganostannyl)methanes	193
Bibliography	197
Appendix	i

CHAPTER ONEINTRODUCTION1 ORGANOTIN(IV) COMPOUNDS1.1 Structures (1)

The vast majority of organotin compounds contain Sn(IV), where tin employs its 4 ( $s^2 p^2$ ) valence shell electrons in 4 more or less equivalent  $sp^3$  hybridised tetrahedrally disposed orbitals.

Distortions from regular geometry are steric or electronic in origin.

1.1.1 Four coordinate compounds

The cases where this geometry applies are :-

1: Compounds of low Lewis acidity,

These compounds are four coordinate under all normal conditions.

eg.  $R_4Sn$  where R = alkyl, aryl, vinyl, allyl, and combinations thereof :-  $Me_4Sn$ ,  $Ph_4Sn$  are regular tetrahedra in the gas and liquid phases, and (for  $Me_4Sn$ ) in solution (2,3).

Organotin sulphur compounds are distorted tetrahedra even in solutions of strong donor solvent, eg bis triphenyltin sulphide (4), hexamethyltristannathiane (5) and organotin thioesters (6).

2: Compounds of significant Lewis acidity

There are certain circumstances where these compounds retain four-coordinate geometry.

a; Electron diffraction studies show that many organotin halides adopt a distorted tetrahedral structure in the gas phase eg.

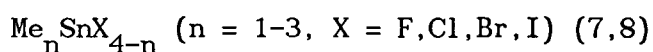

b; Some have weak enough interactions in the solid state to be disrupted by non-donor solvents, in which they are distorted



tetrahedra (9,10,11,12,13,).

c; Compounds with bulky groups can prevent any increase in coordination number eg tricyclohexyltin acetate.(14)

#### 1.1.2 Compounds of coordination number > 4

Tin compounds become significantly Lewis acidic when one of the R groups is replaced by an electron-withdrawing group. The inductive withdrawal of electron density that this causes increases the effective nuclear charge on tin. It is probable that d orbitals are deshielded, and their energy lowered sufficiently to allow them to accept electron density from other ligands.

The acceptor strength of the tin Lewis acid, and thus the coordination number of the resultant complex, increases with the number and electronegativity of the replacing groups, (and is dependent to some extent on the electronic nature of the R groups) although complexation can be restricted if R is bulky. The range of possible replacing groups and resultant complexes is very large, since tin forms stable bonds with most of the elements of the periodic table, especially those in the first row.

Increased coordination is in general achieved by :

1: Association in the solid state where the electronegative ligand bridges to the next tin atom, using one or more atoms.

(Please see sections 1.1.2a b and c.)

2: Complexation with Lewis bases

a; With neutral Lewis bases. Interactions between such bases and tin compounds have been observed in solution, and a large variety of the adducts so formed has been isolated as solids.

NMR is a good technique for solution studies of such

interactions due to the large changes in tin shifts and coupling constants that occur. For example, for methyl tin halides in various donor solvents, the shielding increase is taken as a measure of the relative strength of interaction, and a series (in order of increasing donor strength) is derived: acet < py < DMF < DMSO < HMPT (15).

A Lewis base can also be added to solutions of halide and the interactions studied. Solid adducts often precipitate from such solutions.

b: Salt formation with a charged Lewis base, eg.

$(\text{Et}_4\text{N}^+)_2 \text{Me}_2\text{SnCl}_4^{2-}$ ,  $\text{Et}_4\text{N}^+ \text{Me}_3\text{SnCl}_2^-$  etc. The size of cation necessary to stabilize the complex increases with the size of complex - thus  $\text{K}_2^+ \text{Me}_2\text{SnF}_4^{2-}$  has been isolated but only  $\text{Cs}_2^+ \text{Me}_2\text{SnCl}_4^{2-}$  is known, and tetra-alkyl ammonium or similar large cations are employed for larger complexes. (16)

3: Intramolecular coordination (solid state or solution): Extra coordination sites on the ligands are utilized. These may be in the R group eg. in estertin compounds (17), or in the X group, eg in trineophyltin nitrate, which is 5-coordinate in the solid state (18).

1.1.2a  $\text{R}_3\text{SnX}$  compounds accept one electron pair, forming five-coordinate complexes with a trigonal bipyramidal tin. The R groups occupy the equatorial sites and X and D (donor) the axial. Tin has been described as  $\text{sp}^3\text{d}$  hybridised, or as using  $\text{sp}^2$  orbitals to bond to R and the remaining p orbital in a 3-centre bond to X and D (19). 5-coordinate complexes are formed even if D is bidentate. Distortions from this description are common, eg. solid state association is found in  $\text{Me}_3\text{SnX}$  (X = F, NCS,  $\text{N}_3$  and CN) and  $\text{Ph}_3\text{SnNCO}$ . When X = F, the tin atom is 5 coordinate,

surrounded by 3 planar methyl groups and 2 non-linear asymmetric F-Sn...F bridges (20). The others have more distorted structures (21,22,23,24).

Other tin halides have much weaker interactions in the solid state, due to increased size and decreased electronegativity of the halogen (25,26,27).

Interaction with Lewis bases has been observed in solutions of  $\text{Me}_3\text{SnX}$  in DMSO, py etc. (12). Solid adducts of many mono- and bidentate donors have been isolated, both donor types giving 5-coordinate complexes (28,29), although  $\text{Ph}_3\text{SnNCS.phen}$  is thought to be octahedrally coordinated (30). Salts of charged Lewis bases have also been studied, and are also trigonal bipyramids, eg.  $\text{Me}_3\text{SnCl}_2^-$  (31),  $\text{Ph}_3\text{SnX}_2^-$  (32,33,34),  $\text{Me}_3\text{Sn(NCS)}_2^-$  (35).

Chelation via X is found in trineophyltin nitrate (18), and via R in (1) and (2) (36,37,38). Please see diagram 1.

1.1.2b  $\text{R}_2\text{SnX}_2$  compounds are known to form 5-coordinate trigonal bipyramidal complexes where one X group is equatorial. With a 1:2 ratio of monodentate ligand, or a 1:1 ratio of bidentate, an octahedral structure is produced, in which the tin is 6-coordinate, with trans R groups in most cases. The most common description of the bonding is  $\text{sp}^3\text{d}^2$  hybridisation, but sp Sn-R bonds and 2 3-centre Sn-X bonds (19) have also been postulated. This is the idealised structure - a large degree of distortion from octahedral geometry has been found, eg. solid state association:  $\text{Me}_2\text{SnF}_2$  has a regular octahedral structure (39). Its infinite 2-dimensional polymeric sheets consist of tin bonded to 2 linear Me groups and 4 linearly symmetrically bridging fluorines.

Fig. 1.1

Chelation in  $R_3SnX$

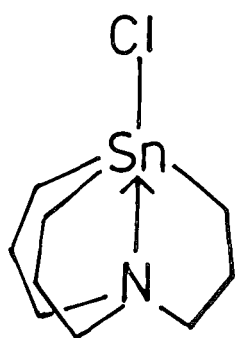

(1)

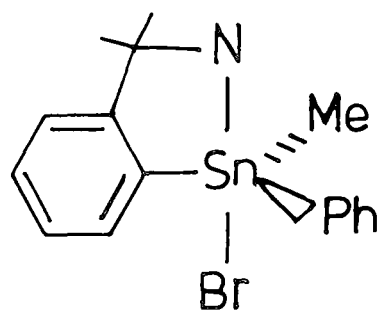

(2)

Dialkyltin dicarboxylates in neat liquid or solid states also have reasonably regular octahedral structures, but the polymers are chains, and the bridging is across the group (40,41).

Halides and pseudohalides show a greater degree of distortion;  $\text{Me}_2\text{Sn}(\text{CN})_2$  forms sheets like  $\text{Me}_2\text{SnF}_2$ , but here  $\text{Me-Sn-Me} = 148.7^\circ$  (42).  $\text{Me}_2\text{SnCl}_2$ ,  $\text{Et}_2\text{SnCl}_2$ ,  $\text{Et}_2\text{SnBr}_2$  and  $\text{Me}_2\text{Sn}(\text{NCS})_2$  have chain polymer structures, where  $\text{R-Sn-R}$  is very distorted (43,44,45,46). Interactions with Lewis bases: it has been observed via PMR that dimethyltin dihalides interact with donor solvents, the strength of the interaction varying with the strength of the donor, (11,47,48) and also when a Lewis base is added to a non-donor solution (49). Here, it has been shown by PMR and IR that dibutyltin compounds show weaker interactions than dimethyltin compounds, due to inductive and steric effects.

Many solid adducts with mono- and bidentate donors have been isolated and their structures found to conform fairly well to the "ideal" eg.  $\text{Me}_2\text{SnBr}_2 \cdot 2\text{py}$  (50),  $\text{Bz}_2\text{SnCl}_2 \cdot \text{bipy}$  (and others in this ref. (51)),  $\text{Ph}_2\text{Sn}(\text{NCS})_2 \cdot \text{bipy}$  (35) and  $\text{Ph}_2\text{SnI}_2 \cdot \text{PBI}^\dagger$  (51).

Salts formed by the addition of charged bases can be 5-coordinate eg.  $\text{Et}_4\text{N}^+ \text{Me}_2\text{SnCl}_3^-$ , (31) or, if 2 moles of donor are added, 6-coordinate - as in  $(\text{pyH}^+)_2 \text{Me}_2\text{SnCl}_4^{2-}$ ,  $(\text{Ph}_4\text{P}^+) \text{Me}_2\text{Sn}(\text{N}_3)_4^{2-}$ ,  $(\text{Et}_4\text{N}^+)_2 \text{Me}_2\text{Sn}(\text{NCS})_4^{2-}$  (2,52,35,). Mixed salts are also known, eg.  $(\text{Ph}_4\text{P}^+)_2 \text{Ph}_2\text{Sn}(\text{NCS})_2(\text{N}_3)_2^{2-}$  (52). Chelated structures: via R and X are found - eg. (3), and (4), in diagram 2 (17,53,54,19,55). Please see over.

PBI = 2-(2-pyridyl)benzimidazole

Fig. 1.2

Chelation in  $R_2SnX_2$

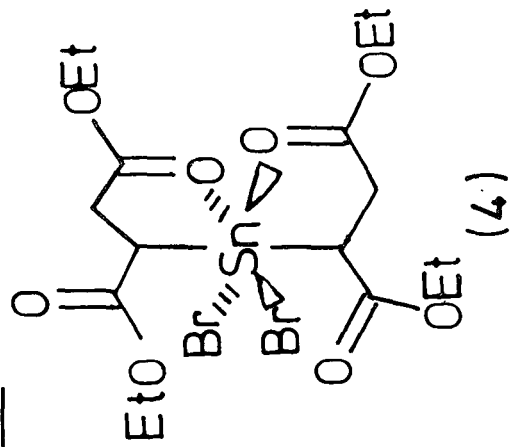
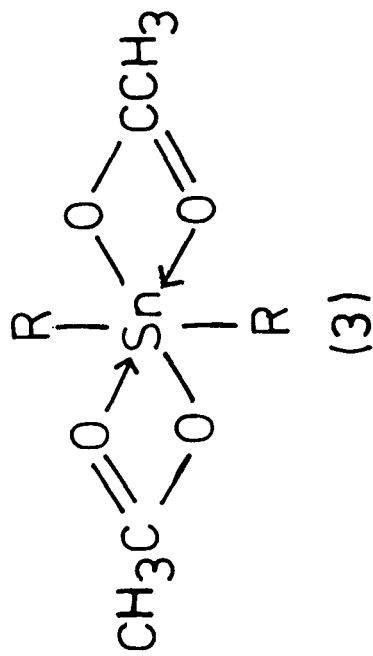



1.1.2c RSnX<sub>3</sub> compounds can form 5-coordinate, trigonal bipyramidal structures, but by far the majority of their compounds are octahedral, with the same hybridisation as before.

Solid state association is extensive for all the halides, the interaction being stronger here due to the larger number of X groups.

MeSnX<sub>3</sub> (X = F, Cl, Br, I) all have similar sheet polymeric structures to Me<sub>2</sub>SnF<sub>2</sub>, except that two X groups bridge, and one is terminal (taking the place of the Me group) (56).

Interactions with Lewis acids are similar to, but stronger than, those observed in dimethyltin dihalides, as they are in the solid state (11,47,48).

Complexes with neutral donors can be 5-coordinate eg. MeSnCl<sub>3</sub>.2,5-diaminonitrobenzene (15), or 6-coordinate eg. RSnX<sub>3</sub>.bipy (15), as can complexes with charged donors eg. Ph<sub>4</sub>As<sup>+</sup> MeSnCl<sub>4</sub><sup>-</sup> (58) and BuSnX<sub>n</sub>Y<sub>5-n</sub><sup>2-</sup> (57).

Chelated structures: some compounds with bulky substituents are restricted to trigonal bipyramidal coordination (17,59). (5 and 6 in diagram 3)

### 1.1.3 Compounds of coordination number > 6

These are found occasionally eg. in diorganotin compounds; the crystal structures of the 1:1 diphenyltin nitrate. Ph<sub>3</sub>PO (or Ph<sub>3</sub>AsO) adducts show them to be 7-coordinate pentagonal bipyramids (60,61), and the <sup>119</sup>Sn NMR shifts of Me<sub>2</sub>Sn(pan)(acac) and Me<sub>2</sub>Sn(NCS)<sub>2</sub>TPy (62) indicate a similar coordination for these compounds in solution.

In monoorganotin compounds MeSn(NO<sub>3</sub>)<sub>3</sub> has been shown to be 7-coordinate by X-ray crystallography (63) and BuSn(OCOMe)<sub>3</sub> and

Fig. 1.3

Chelation in  $R\text{SnX}_3$

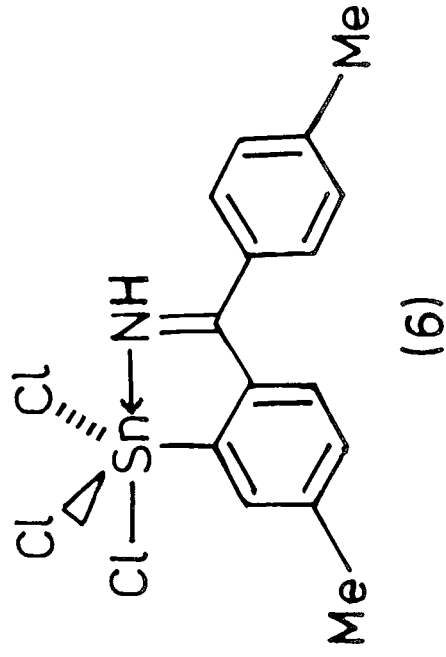
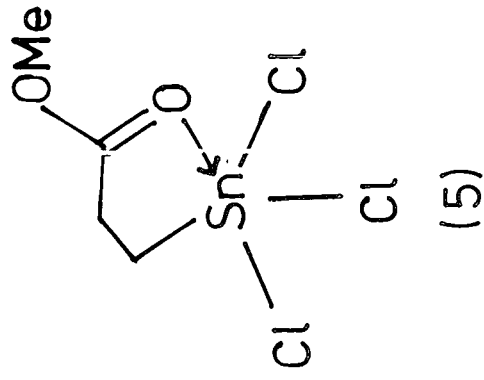

$\text{BuSn}(\text{OCOEt})_3$  have been assigned a pentagonal bipyramidal structure in solution from infra-red evidence (64).

Some 1:4 complexes have also been reported, eg.  $\text{PhSnCl}_3 \cdot (\text{morpholine})_4$  has been assigned an 8-coordinate structure from a Mossbauer study (65).

## 1.2 Reactions

Tetraorganotin compounds react by electrophilic substitution, the most important reagents being protic acids, metallic halides and halogens. Radical reactions of tin compounds are also known, although they are mostly restricted to alkyltin hydrides.

For  $\text{R}_n\text{SnX}_{4-n}$  compounds, the most important reactions are complexation, which has already been considered, and nucleophilic substitution (1).

### 1.2.1 Nucleophilic substitution

This is a very important route for making other compounds from the easily available organotin halides and oxides (or hydroxides). The presence of an anionic group makes two reaction mechanisms possible (66):-

a: by increasing the Lewis acidity enough to allow the formation of a 5-coordinate intermediate.

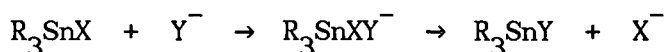

or b: by supplying a leaving group;

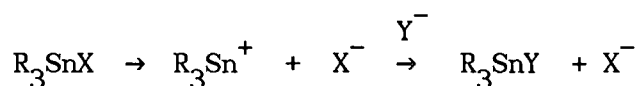

#### 1.2.1a Exchange reactions

If the substituting reagent is also an organotin compound an exchange process results. This is used to prepare compounds with mixed anionic groups (67,68,69) and is the most useful preparative

method for alkyltin halides from  $R_4Sn$  and  $SnX_4$  (70).

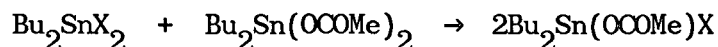
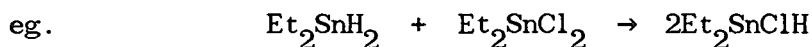

( X = Cl, Br )

Similar exchange processes are used with trimethylsilyl halides to prepare tin compounds (73,74).

### 1.2.1b Substitution

This is used to prepare a large range of compounds by employing differing nucleophiles. Reagents employed include;

water or alkali to give hydrated tin cations, oxides or hydroxides (75,76);

metal salts of carboxylates and alcohols, as well as

pseudohalides, to give alkyltin carboxylates, alkoxides and pseudohalides (68);

carbon nucleophiles, in the form of Grignard reagents or organolithiums, to give other organotin compounds. This is an important route in synthesis (75,76).

### 1.3 Industrial uses

Tin compounds have wide applications as selective toxins, for use against bacteria, fungi, insects and other organisms; their area of use depends on the structure of the compound (77,78,79,80).

Of particular relevance to this work is the discovery that dialkyltin compounds may act against cancer cells, presumably in a similar manner to octahedral cis-platinum(IV) complexes

$Pt(NH_3)_2Cl_4$ , since the active tin compounds are structurally very similar (81,82).

Their non-toxic uses are as plasticisers for PVC (the largest

single use at present), particularly in food wrappings, as some compounds show no mammalian toxicity, and to a small extent as homogeneous catalysts (83,84,85).

## 2 AREA OF WORK

2.1 Pseudohalide complexes The structure and behaviour of dimethyl tin dihalides have been studied by most available physical techniques, as have their complexes with neutral Lewis bases (19,86,87,88, and see section 1).

The areas of interest here are dimethyltin dipseudohalides and the charged complexes produced when they and the corresponding halides react with halide/pseudohalide ions. Although  $\text{Me}_2\text{SnX}_2$  ( $\text{X} = \text{CN}, \text{NCO}, \text{NCS}, \text{N}_3$ ), (42,45,89,90),  $\text{C}^+ \text{Me}_2\text{SnX}_3^-$  ( $\text{C} = \text{cation}, \text{X} = \text{Cl}, \text{Br}$ ) and  $\text{C}_2^+ \text{Me}_2\text{SnX}_4^{2-}$  ( $\text{C} = \text{cation}, \text{X} = \text{Cl}, \text{Br}, \text{NCS}, \text{N}_3$ ) (35,52,87,91,93) are known,  $^{119}\text{Sn}$  NMR data is not available for any of the diorganotin dipseudohalides, and only for very few ionic organotin halide complexes (93,95).

When  $\text{SnX}_6^{2-}$  and  $\text{SnY}_6^{2-}$  (with  $\text{NBu}_4^+$  or  $\text{PBu}_4^+$  cation) are mixed in solution, intermediate complexes  $\text{SnX}_n\text{Y}_{6-n}^{2-}$  are formed, with long enough lifetimes for their NMR signals to be observable (94). We find that if a similar experiment is performed with  $(\text{Et}_4\text{N}^+)_2 \text{Me}_2\text{SnCl}_4^{2-}$  and  $(\text{Pr}_4\text{N}^+)_2 \text{Me}_2\text{Sn}(\text{NCS})_4^{2-}$ , only one signal is observed, the position of which changes with the proportions of the components of the mixture, indicating the presence of a rapid exchange equilibrium on the NMR timescale.

We have therefore prepared and characterised the intermediate complexes  $(\text{Et}_4\text{N}^+)_2 \text{Me}_2\text{Sn}(\text{NCS})_n\text{Cl}_{4-n}^{2-}$  ( $n = 0-4$ , cation =  $(\text{Pr}_4\text{N}^+)$  when  $n = 4$ , for solubility reasons), to see if they can be formed as discrete compounds.

Information obtained by IR,  $^{119}\text{Sn}$  NMR ( $\delta$  and  $J$  parameters) and Mossbauer techniques show that they are indeed discrete compounds, and that they have the trans-octahedral structure typical of these

complexes (see section 1.1.2b).

Studies have been attempted on similar diphenyltin compounds, but yield less information - their PMR and IR spectra are more complex, and their insolubility makes  $^{119}\text{Sn}$  NMR data difficult to obtain.

Some of the analogous 5 coordinate complexes have been prepared, as have parallel complexes of other pseudohalides (CN,  $\text{N}_3$ , NCO), with varying degrees of success.

2.2 Dissociation: Tin complexes in solution dissociate to some extent, whether these are with neutral bases such as donor solvent (12,96,97), or with charged ions (16). The observed chemical shift is therefore the average of the signals from the tin containing components of the system.

Dissociation of several of the thiocyanate, chloride and azide complexes has been studied, in an attempt to obtain an estimate of the equilibrium constants involved, by observing the shift changes on successive addition of excess ligand to a solution of the complex in question.

Exchange and exchange/addition reactions have been similarly investigated by adding different pseudohalides to the solution of the complex.

2.3 Synthesis of heterocycles: Attempts have been made to synthesise compounds of possible anti-tumour activity (see section 1.3), utilizing rather more complex preparative techniques than those involved in the preceding sections.

We decided to attempt to make compounds where tin atoms are part of a ring, since the structure of a cyclic, octahedrally coordinate tin would be structurally interesting, as well as

having anti-tumour potential.

The approaches we made were;-

(a) Ylid type complexes; Schmidbauer et al. have produced many ylid-metal complexes (98) including some with coinage metals incorporated in an eight membered ring.

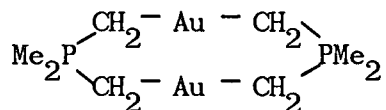

Some studies with tin have been reported (99,100), but the results of our attempts to make similar compounds gave high molecular weight, insoluble complexes of little practical use.

(b) Grignard/organolithium compounds; These have previously been used in various contexts (101,102,103) including synthesising stannacycloalkanes (75,76,104,105,106). The results we obtained were very inconclusive, however, possibly due to the high reactivity of the intermediates.

(c) Direct synthesis; Reactions of elemental tin with an organic halide can produce organotin halides, either with (107) or without (108) a catalyst. We have achieved some success by an adaptation of such a method (109), if in rather low yield. A series of complexes of the type  $(\text{CH}_2)_5\text{SnBr}_2 \cdot \text{L}_2$  (L = pyridine base) has been synthesised and characterised by IR, PMR,  $^{13}\text{C}$  and  $^{119}\text{Sn}$  NMR. The variation of  $\delta(^{119}\text{Sn})$  as a function of pKa (base) has been considered.

It is this last area where it is anticipated that future investigation will prove most fruitful.



### 3 NUCLEAR MAGNETIC RESONANCE

#### 3.1 General(110,111,112)

NMR spectroscopy measures the frequency of transitions between orientations of nuclear spins. In a nucleus of spin  $I$ , the allowed orientations are given by  $I_z$  - the  $z$  component of the spin - which can take values between  $-I$  and  $I$  in integral differences, hence giving  $2I+1$  orientations. The simplest case,  $I = 1/2$ , therefore has 2 orientations and one transition, the frequency of which is given by the Larmor equation:

$$\nu_0 = \frac{\gamma B_0}{2\pi}$$

It includes the magnitude of the external field because the  $I_z$  levels are degenerate in its absence ( $B_0$  effectively defines the  $z$  axis).

The usefulness of this technique to the chemist arises from the effect on this transition frequency of (a) the electron cloud surrounding the nucleus and (b) other magnetic spins in the molecule.

##### 3.1.1 $\delta$ values

The position of the resonance is affected by the shielding effect of the extra-nuclear electron cloud. The presence of  $B_0$  sets up motion of this cloud such that the field produced opposes  $B_0$  and is proportional to its magnitude. This is expressed in the Larmor equation as

$$\nu_0 = \frac{\gamma B_0 (1-\sigma)}{2\pi}$$

since the field at the nucleus is given by

$$B_{\text{eff}} = B_0 - B_0 \sigma \qquad \sigma = \text{shielding constant}$$

$\sigma$  is a tensor quantity that is measured absolutely only with difficulty. Instead changes in  $\sigma$  are measured with respect to a

common reference, in terms of a dimensionless quantity,  $\delta$ , (in ppm) defined as follows:

for sample  $\nu_S = \frac{\gamma B_0}{2\pi}(1-\sigma_S)$  and for reference  $\nu_R = \frac{\gamma B_0}{2\pi}(1-\sigma_R)$

so defining  $\delta = \frac{\nu_S - \nu_R}{\nu_R} \times 10^6 = \frac{\sigma_R - \sigma_S}{1 - \sigma_R} \times 10^6 = (\sigma_R - \sigma_S) \times 10^6$

since  $\sigma_R \ll 1$

Hence  $\delta$  is a direct measure of shielding differences and is independent of operating field strength.

It can also be defined in terms of field, where

$$\delta = (\sigma_R - \sigma_S) \times 10^6 = \frac{H_R - H_S}{H_R} \times 10^6$$

so as  $\sigma_S$  increases, the resonance frequency and  $\delta$  decrease, and the applied field increases.

(This is the definition adopted for  $\delta$ ; the expressions can and have been used with the opposite sign convention.)

### 3.1.2 Coupling constants

The multiplicity of the signal is affected by the presence of magnetic dipoles, since they have a (very small) effect on the energy levels of the orientations of the magnetic dipole.

Since the energy difference is so small, population differences between the states are negligible, and the possible transitions are observed with equal probability. The number of transitions is  $2nI+1$ , where  $n$  is the number of magnetically equivalent nuclei affecting the A resonance, and  $I$  is their nuclear spin. If there is more than one type of nucleus present, then the A resonance will be split by all of them. In first order cases the effect of each group of nuclei can be seen separately. They are of significant diagnostic value in all cases.

### 3.2 Proton and Carbon-13 Spectra

Proton NMR spectra of organotin compounds are useful for fingerprinting, and predicting general structure (29,74,75,113,114). They are also exceedingly good sources of tin-proton coupling constants (11,48,113,115,116) since, particularly in methyltin compounds, the resonance is one sharp singlet corresponding to at least three equivalent protons (and more often six or nine) bonded to magnetically inactive tin, flanked by satellites of 4.3 and 3.8% intensity, from  $^{119}\text{Sn}$  and  $^{117}\text{Sn}$ , respectively. The coupling can thus be easily identified, whereas in the tin spectrum, 4, 7, or 10 lines will be anticipated due to Sn-C-H coupling, and this may be further complicated by other nearby protons. If more complex organo-groups are bound to tin then identification of constants in  $^1\text{H}$  spectra may not be so easy, but usually valuable information can be obtained (117,55).

Carbon-13 spectra have been used in a similar manner (48,118,119),  $^1\text{J}(^{13}\text{C}-^{119}\text{Sn})$  being very sensitive to structural changes.

### 3.3 Tin-119 NMR (120)

Of the ten isotopes of tin, three have non-zero spin (all  $I = 1/2$ ). Of these,  $^{119}\text{Sn}$  is usually studied, due to its better sensitivity and abundance (relative to  $^1\text{H}$ , 0.052, making it approx. 25 times more sensitive than  $^{13}\text{C}$ ).

Older results have been obtained by double resonance techniques (12,121,122,123,124), but the advent of Fourier transform methods, together with the use of gated decoupling and polarization transfer techniques, have made NMR data much more accessible.

Chemical shift data is useful, since its range is very large - > 2000ppm - so small changes in structure have significant effects. Coupling constants also provide valuable structural information.

### 3.3.1 $\delta$ values (125)

The shielding in a nucleus is caused by several factors;-

$$\sigma = \sigma_{AA}^d + \sigma_{AA}^p + \sum_{A \neq B} \sigma_{AB} + \sigma_A^l + \sigma_m$$

(1)   (2)        (3)        (4)   (5)

(1)  $\sigma_{AA}^d$  is the diamagnetic, or Lamb term. It is due to the shielding effect produced by the movement of the electron cloud in the presence of a magnetic field. It is proportional to the density of the cloud, and is the dominant term for small nuclei, particularly  $^1\text{H}$ . For heavier nuclei, the majority of this effect is due to inner electrons, which are unaffected by chemical environment.

(3)  $\sum_{A \neq B} \sigma_{AB}$  is the effect of electronic circulation of other atoms, and is dependent on the magnetic anisotropy of these groups. The effect can be significant (120).

(4)  $\sigma_A$  is a ring current effect - ie. circulation of delocalised electrons. This again can be important for protons, since the shielding they receive is strongly dependent on their orientation with respect to the current.

(5)  $\sigma_m$  is the effect of the medium, which is rarely of great importance in tin shifts.

(2)  $\sigma_{AA}^p$  is the paramagnetic term - considered last, because it is the dominant contributor to the shielding of all nuclei except  $^1\text{H}$ . It arises from the restriction of electron circulation around the nucleus, and has the opposite sign to  $\sigma_{AA}^d$ .

A simplified expression for  $\sigma^p$  is

$$\sigma_p = \frac{-2e^2 h^2}{3m^2 c^2 \Delta E} (\langle r^{-3} \rangle_{np} Q_{np} + \langle r^{-3} \rangle_{nd} Q_{nd})$$

$\Delta E$  is the mean excitation energy for ground and excited states, for which little information is available.

$\langle r^{-3} \rangle_{np}, \langle r^{-3} \rangle_{nd}$  are the inverse cubes of the mean distances of the p and d electrons from the nucleus.

$Q_{np}, Q_{nd}$  are the amounts of electron imbalance in the valence p and d orbitals, hence the effect of the difference in substituent electronegativity on  $\delta$ .

The terms in this equation involve data that is difficult to obtain, hence it is more useful to consider empirical correlations with observed physical properties.

### 3.3.2 Empirical correlations of $\delta$ with structure

$\delta$  values for a large range of compounds have been obtained, (13,93,66,96,121,125), and the following trends have been recognised.

#### a Inductive effects

These produce a deshielding of the tin nucleus where other effects do not intervene, and where the electron-withdrawing group is distant from it (121,127,128). Where X is bonded to Sn,  $\sigma$  still decreases as  $\kappa_X$  increases (10,129), but as the number of X groups increases, a "sagging"  $\delta$  vs n curve results (121,129,130). The most likely explanation for this seems to be the p orbital imbalance term in the  $\sigma^p$  expression, which would be expected to be a maximum at n = 2. Sn is often, depending on R, most deshielded at this point.

b  $\pi$  bonding

This has been much discussed as an influence on  $\delta(^{119}\text{Sn})$  where groups with lone pairs, available  $\pi$  clouds, or d electrons are bound to Sn (whether 4- or 6- coordinate ) (121,124,122,115). Firm evidence is lacking as to whether  $\pi$  donation to vacant Sn 5d orbitals is the cause of the observed effect, and it is now thought that it is unlikely to be involved, especially since the effect of other factors, such as substituent polarisability, cannot be separated out (17,21,18,9).

c Bulky atom effects (93,125,126)

The presence of a bulky, polarizable group in the molecule produces a shielding effect. The mechanism causing this is unclear, the local (from X ) diamagnetic effect being an inadequate explanation. The mutual polarizability of such groups is now considered to be a major factor in determining  $^{119}\text{Sn}$  chemical shifts and coupling constants.

d Bond angles

Compressed angles give downfield shifts (128,132,133).

e Increase of coordination number

This is accompanied by a large upfield shift per increase that has proved diagnostically very useful, whether to show four coordination, (6,74,134) or greater (60,119,135,136,137, 138).

The origin of the effect is unclear. The increased electron density will increase the diamagnetic term, though this is not large enough to account for the size of the observed changes.  $Z_{\text{eff}}$  will decrease, which may affect the paramagnetic term via  $\langle r^{-3} \rangle$ , and rehybridisation, which will accompany complex formation, may decrease  $Q_{\text{np}}$ .

f Dissociation (12,93,10)

Some donor-acceptor complexes dissociate in solution, and an equilibrium is set up:

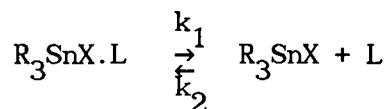

The observed chemical shift is an average, (weighted by mole fraction of tin-containing species present) and its value will be sensitive to concentration, and amount of added ligand.

Equilibrium constants and other thermodynamic parameters can be deduced from the behaviour of  $\delta$ .

$$\delta_{obs} = \delta_o(1-\alpha) + \delta_c\alpha \quad \text{where } \delta_o = \text{shift of uncomplexed species}$$

$$\delta_c = \text{shift of complexed species}$$

$$\alpha = \text{fraction of complex remaining}$$

Torochesnikov gives the expression for the equilibrium constant as

$$K = \frac{k_1}{k_2} = \frac{\delta_o^2(1-C) + \delta_c^2 - \delta_o\delta_c}{\delta_o(\delta_c - C\delta_o)} \quad C = \text{initial concn. complex}$$

3.3.3 J values (120)

The coupling constant is the magnitude of interaction between 2 nuclear spins, mediated by the electrons that bond them together - this may be over >1 bond, but the magnitude of the effect decreases rapidly as the number of bonds increases. (Non-bonded nuclei also interact, but this is generally averaged to zero by molecular motion.) The observed value is dependent on the magnetogyric ratios of the nuclei involved, so a reduced constant, K, is defined to compare the electronic effects in different constants;

$$K = J \cdot \frac{4\pi^2}{\gamma_A \gamma_B h}$$

K is a tensor property, but its anisotropy is usually averaged out in non-viscous liquids. It also has a sign, relative values of which can be measured by double resonance experiments (selective decoupling). Positive K implies that the energy state where the spins of A and B are antiparallel is stabilised.

Calculation of K from basic principles has proved difficult, and semi-empirical methods, involving sum over states and finite perturbation calculations, are generally used to make predictions.

In non-viscous liquids, K can be split into 3 components;

$$K_{AB} = K_{AB}^1 + K_{AB}^2 + K_{AB}^3 .$$

$K^1$  is due to the nuclear interactions, depicted by their  $\gamma$ 's and the field produced by their electrons, and is called the orbital term.

$K^2$  is due to interaction between nuclear and electronic dipoles and is hence called the dipolar term.

$K^3$  arises from electrons in orbitals having finite density at the nucleus and is called the contact term. It is generally agreed to dominate J for heavy nuclei.

A simplified expression for  $K^3$  is

$$K_{AB}^3 = -\frac{16\pi}{9} \cdot \mu_o \mu_B^o \cdot S_A^2(0) S_A^2(0) \Pi_{AB}$$

where  $S^2(0)$  is the electron density at the nucleus and  $\Pi_{AB}$  is the mutual polarisability of the valence orbitals on A and B.

J is therefore affected by the hybridisation of the atoms concerned, and by their electronegativity, an increase in which will increase the effective nuclear charge on tin, so increasing  $S^2(0)$ . Anionic groups also cause secondary rehybridisation of the



bonding orbitals (138), concentrating p electron density into the Sn-X bonds and s electron density into the Sn-C-H bonds.  $|J|$  will therefore increase.

### 3.3.4 Correlations between J and molecular structure

Relations between J and bond angles have been derived, particularly for  $^3J(A-X-X'-B)$  where a Karplus relation is observed between J and the dihedral angle between the two coupled nuclei.

$$J_{AB} = A\cos 2\phi + B\cos\phi + C \quad (A,B,C \text{ are experimental constants})$$

Such relations have been observed in  $^{119}\text{Sn-C-C-}^{13}\text{C}$  couplings (14).

The couplings of interest here are  $^2J(^{119}\text{Sn-C-H})$  and  $^1J(^{119}\text{Sn-}^{13}\text{C})$ :

A linear relationship between the two, when measured for the same series of compounds, has been observed (139,118), but it does not pass through the origin, indicating that there is a contribution to J from terms other than the contact term.

Relations between both constants and the s character of the Sn-C-H bonds has been postulated (10,118,134,135), and in some cases claimed to be linear (97,115). This is highly unlikely, but the magnitude of J can give a rough indication of the s character of the Sn-C-H bonds for closely related compounds. Over wider ranges the relationship breaks down. The polarisability term is thought to be more important than electron density changes although this could explain why J is dependent on (a) the number and electronegativity of groups bonded to Sn (97,140,141), and (b) the coordination number of the complex (4,116,121,97,). Inductive withdrawal of electrons by such groups will lead to increased nuclear charge and rehybridisation, giving increased s electron

density in the Sn-C-H sites in both cases.

Relationships between  $^1J(^{119}\text{Sn-C})$  and  $^2J(^{119}\text{Sn-C-}^1\text{H})$  and bond angles have been observed (118,132,140).  $J$  decreases with bond angle, due to the decreased  $s$  character in the compressed bond (144).

In solutions of dissociating complexes, the coupling is averaged between the values of the components of the equilibrium in the same way as are the chemical shifts.

### 3.3.5 Mossbauer / NMR parameter correlations

Correlations between  $\Delta E_q$  and  $\delta(^{119}\text{Sn})$  parameters have been observed (145). The relationship is due to the dependence of both terms on the  $p$ -orbital imbalance at the tin nucleus. Also,  $\delta(^1\text{H})$  correlates with isomer shift in some organotin compounds (146), because both terms reflect the Sn-C-H electronic environment.

## 4 MOSSBAUER SPECTROSCOPY

### 4.1 General (145,146,147)

The technique involves absorption of  $\gamma$ -rays by the sample, raising it to an excited nuclear state.

The  $\gamma$ -rays of appropriate energy are produced by excited nuclei of the same isotope decaying back to the ground state, produced in their turn by the much slower decay of an appropriate radioactive isotope (eg. for  $^{57}\text{Fe}$ , the isotope is  $^{57}\text{Co}$ ,  $t^{1/2} = 270$  days  $\rightarrow$   $^{57}\text{Fe}$ ,  $t^{1/2} = 10^{-7}$  s ). The technique is therefore limited to those nuclei with a reasonably stable parent radio-isotope, of which  $^{57}\text{Fe}$  and  $^{119}\text{Sn}$  are by far the most studied. Scanning a suitable frequency range is achieved by moving the source at a known rate, thus adding a Doppler shift to the frequency of the emitted radiation, according to the expression:

$$\Delta\nu = \nu v/c$$

$\Delta\nu$  = change in frequency

$\nu$  = original frequency

$v$  = rel. velocity of  
source and absorber

$c$  = velocity of radiation

$$(3 \times 10^8 \text{ ms}^{-1})$$

#### 4.1.1 $\delta$ Values

The technique is useful because the electronic environment of the sample affects its transition frequency. The Doppler shift added to the emitted radiation and therefore the relative velocity of the source necessary for resonance is thus directly proportional to this frequency change, and so is a direct reflection of the electronic differences between source and

absorber.

A standard reference compound is used ( $\text{BaSnO}_3$  for  $^{119}\text{Sn}$ ) and all shifts quoted relative to this. They are given the term chemical, or isomer, shift ( $\delta$ ) and are quoted in  $\text{mms}^{-1}$ .

$\delta$  is proportional to the s electron density at the nucleus - in effect the difference in electron density between source and absorber.

$$\delta = C \cdot \frac{\Delta R}{R_g} (\rho_s^2 - \rho_a^2)$$

$\rho^2$  = electron density at the nucleus

C = constant

$\Delta R/R_g$  is the difference in radius of the nucleus between ground and excited states as a ratio of the radius of the ground state - a constant for each isotope. For  $^{119}\text{Sn}$ , this is positive so  $\delta$  increases with electron density. For  $^{57}\text{Fe}$ , the reverse is true.

Differences in p and d density have an indirect influence on  $\delta$ , since the s wave function has a finite probability at greater distance from the nucleus than the p and d functions, so an increase in p or d density will therefore shield the s electrons.

#### 4.1.2 $\frac{\Delta E}{q}$ Values

In practise the resonance is often split, because of the interaction of the quadrupole moment of the nucleus, Q, (which is present because for most nuclei  $I > 1/2$  in either the ground or excited states) with the electronic field gradient, q, at the tin nucleus. The e.f.g. is caused by imbalance in orbital populations around tin, and reflects the difference in electron demand between the substituents.

The magnitude of the interaction is dependent on the angle made between the efg and the nucleus, i.e. on  $|I_z|$ . Hence for

$^{119}\text{Sn}$ , the ground state components,  $I_z = \pm 1/2$ , remain degenerate, and the excited state splits into 2 components,  $I_z = \pm 1/2$ ,  $I_z = \pm 3/2$ , so 2 transitions are observed, the difference between them being the quadrupole splitting,  $\Delta E_q$ .

$$\Delta E_q = 1/2 e^2 q Q (1 + \eta^2/3)^{1/2}$$

If a magnetic field is present, the degeneracy of the  $I_z$  levels is completely lifted and more transitions are observed.

## 4.2 Relation of parameters to bonding and structure

### 4.2.1 $\delta$ values

These vary with the total electron demand of the ligands, since this determines the s electron density at the central nucleus.

Correlations between  $\delta$  values and either Pauling or Mulliken electronegativities of attached ligands have been observed for  $\text{Sn}(\text{NCS})_n \text{X}_{4-n}$  ( $X = \text{Cl}, \text{Br}$ ),  $\text{SnCl}_n \text{Br}_{6-n}^{2-}$ , and  $\text{RSnX}_n \text{Y}_{5-n}^{2-}$  ( $X, Y = \text{F}, \text{Cl}, \text{Br}$ ,  $X \neq Y$ ;  $R = \text{Ph}, \text{Bu}$ ) (57, 148, 149, 150, 160).  $\delta$  decreases as the electronegativity of the halogen increases. Attempts have also been made to correlate  $\delta$  with the partial charge on the tin atom (151).  $\delta$  is found to decrease as the electron withdrawing ability of the organic group increases - eg. phenyl complexes have lower values than the corresponding methyl ones (40).

The effect of p and d orbital occupancy mentioned in section 4.1.1 is also observed, since  $\delta$  is lower for 5- and 6-coordinate compounds than for tetrahedral species (40).

### 4.2.2 $\Delta E_q$ Values (152)

$\Delta E_q$  is proportional to the efg tensor at the nucleus, since the quadrupolar moment is constant for each isotope.

This tensor measures the distortion from cubic symmetry in

each direction. If the axes are chosen appropriately, the matrix describing the efg is diagonalised, so that it is reduced to three components,  $V_{xx}$ ,  $V_{yy}$ , and  $V_{zz}$ .

$V_{zz} = eq = -$ the z component of the efg.

Also  $V_{xx} + V_{yy} + V_{zz} = 0$ , so only 2 parameters are independent.

These are defined as  $V_{zz}$  and  $\eta$  - the asymmetry parameter in the xy plane.

$$\eta = (V_{xx} - V_{yy}) / V_{zz}$$

If the axes are chosen such that  $|V_{zz}| \geq |V_{yy}| \geq |V_{xx}|$ , then

$$0 \leq \eta \leq 1$$

So  $\Delta E_q = 1/2 e V_{zz} Q (1 + \eta^2/3)^{1/2}$  is a direct measure of  $V_{zz}$  and  $\eta$  as a product of the quadrupolar moment. (With the axes chosen as above,  $(1 + \eta^2/3)^{1/2}$  is often close to 1 and so can be ignored in these cases.)

#### 4.2.2a Additivity model

The contribution to the field gradient from a point charge,  $e$ , can be expressed as follows:

$$V_{xx} = er^{-3}(3\sin^2\theta\cos^2\phi - 1)$$

$$V_{yy} = er^{-3}(3\sin^2\theta\sin^2\phi - 1)$$

$$V_{zz} = er^{-3}(3\cos^2\theta - 1) \text{ where } \theta \text{ and } \phi \text{ are polar coordinate}$$

angles

These expressions can be put to use if  $\Delta E_q$  is considered to be additive - i.e. it can be considered as the sum of independent components, one for each ligand.

##### (i) Point charge formalism

If each ligand is represented by [L] - a charge C at a distance r,- then the components of the efg can be expressed in terms of

[L]:

$$V_{xx} = e\Sigma_L[L](3\sin^2\theta\cos^2\phi - 1)$$

$$V_{yy} = e\Sigma_L[L](3\cos^2\theta\sin^2\phi - 1)$$

$$V_{zz} = e\Sigma_L[L](3\cos^2\theta - 1)$$

so expressions for expected values of  $V_{zz}$  for various structural types can be derived in terms of [L]. It is assumed that a value of [L] will hold for any compound of a given nucleus in a given valence state, e.g. Sn(IV).

Using [L] parameters is reasonable if  $\Delta E_q$  is considered to be dependent on  $\sigma$  effects only. In Sn(IV) compounds this seems to be the case.

Hence it can be shown, using these expressions, that:

$$V_{zz} = \{4[A] - 4[B]\} \quad \eta = 0 \quad \text{for trans } A_2SnB_4$$

$$V_{zz} = \{2[B] - 2[A]\} \quad \eta = 0 \quad \text{for cis } A_2SnB_4$$

So  $\Delta E_q \text{ trans} / \Delta E_q \text{ cis} = 2$  since the sign of  $\Delta E_q$  is not routinely determined. In practise for complexes of the type  $R_2SnX_4^{2-}$

$$\Delta E_q(\text{trans}) \simeq 4mms^{-1} \text{ and } \Delta E_q(\text{cis}) = 2mms^{-1}.$$

For a series of complexes  $R_2SnA_nB_{4-n}$ , assuming trans R, then

$$R_2SnA_4 \quad V_{zz} = \{4[R] - 4[A]\}e \quad \eta = 0 \text{ (as above)}$$

$$R_2SnA_3B \quad V_{zz} = \{4[R] - 3[A] - [B]\} \quad \eta \neq 0$$

$$R_2SnA_2B_2 \quad V_{zz} = \{4[R] - 2[A] - 2[B]\} \text{ cis A } \eta = 0$$

$$\text{trans A } \eta \neq 0$$

$$R_2SnAB_3 \quad V_{zz} = \{4[R] - [A] - 3[B]\} \quad \eta \neq 0$$

$$R_2SnB_4 \quad V_{zz} = \{4[R] - 4[B]\} \quad \eta = 0$$

and a constant difference of  $([A] - [B])$  is expected between each member of the series - assuming  $(1+\eta^2/3)^{1/2} \simeq 1$ .

(ii) Molecular orbital approaches (153)

Consideration of the action of the electric field gradient tensor on the wave function of a molecule  $ML_n$ , and the assumption as before that the total efg can be written as the sum of independent ligand contributions, (which works if the orbitals are equivalent) allows partial field gradient parameters to be assigned to a ligand. These values will hold if they are used for sets of equivalent orbitals, so values within octahedral and tetrahedral compounds can be compared, but  $[L]_{tet}$  is not necessarily the same as  $[L]_{oct}$ . For trigonal bipyramidal cases there are two sets of orbitals - the axial and the equatorial - so the situation is more complex here.

It is also evident that  $V_{zz}$  values are dependent on differences between ligands, so only values of the form  $[A]^{oct} - [B]^{oct}$  can be derived from  $\Delta E_q$  information.

Parameters predicted by both molecular orbital and point charge models are quite close, indicating that the assumptions made in both modes are valid.

4.2.2b Experimental parameters (147)

Experimental values of partial quadrupolar splittings  $(p.q.s.)_L$  can be derived from and applied to obtained  $\Delta E_q$  values, providing a separate value is used for each structural type ie.  $(p.q.s.)_L^{tet}$ ,  $(p.q.s.)_L^{oct}$  etc, where  $(p.q.s.)_L = 1/2e^2|Q|[L]$ .  
eg for a compound of the type  $R_2SnX_4^{2-}$ ,

$$\Delta E_q = 4(p.q.s.)_R^{oct} - 4(p.q.s.)_X^{oct}$$

Only differences between  $(p.q.s.)_L$  values are derivable from experimental data, so an arbitrary value of 0 is assigned to  $(p.q.s.)_X$  ( $X = F, Cl, Br$ , - differences between them are very



small), since they are commonly occurring ligands.

Values are then all calculated with respect to halogen - i.e.

$(p.q.s.)_L = 1/2e^2|Q|([L] - [X])$  and expected values for

$\Delta E_q(\text{complex})$  are calculated using the  $V_{zz}$  expressions.

Relevant values are (all for octahedral complexes, in  $\text{mms}^{-1}$ )

$$[\text{alkyl}] = -1.03$$

$$[\text{NCS}] = +0.07$$

$$[\text{Ph}] = -0.95$$

$$[\text{N}_3] = -0.13 \text{ (derived from}$$

(52))

N.B. (1) a general value for alkyl groups is used since, as with halogens, differences between their values are small.

(2) [alkyl] and [Ph] are negative because of the negative value of Q.

The effect of distortions from regular geometry has been considered with respect to both point charge (154) and molecular orbital models (153). They are found to be significant, particularly for cis-R complexes -  $\Delta E_q$  is found to increase smoothly with  $\hat{C}-\hat{Sn}-\hat{C}$  between cis and trans values.

The approximations used in this model mean an allowable error of 10-20%, or  $\approx 0.4 \text{ mms}^{-1}$ , between calculated and theoretical values. Unfortunately differences between halide and pseudohalide ligand effects are small  $[(p.q.s.)_{\text{NCS}}^{\text{oct}} = 0.07 \text{ mms}^{-1}]$ , so these will easily be masked by errors. Since our complexes are all of the same structural type, however, and we are looking at differences across the series, it is hoped that errors will cancel out to some extent.

## 5 INFRA-RED SPECTROSCOPY

This technique has been used here to decide the presence or absence of certain groups, and to make some structural assignments.

### 5.1 Pseudohalide bands

Assignments for ionic pseudihalides used here are (155,156):-

	$\nu_{as}$	$\nu_s$	$\delta$
KCN	2080	-	-
KNCS	2062	748	468, 478
$\cdot KN_3$	2041	1344	645
KNCO	2155	1282	630
		1202	

Of these, the asymmetric stretch is the most useful, due to its very high intensity. The given frequencies are generally altered somewhat by coordination.

In NCO and NCS the possibility of linkage isomerism arises, i.e. bonding may be via N or O/S (although the majority of organometallic cyanates are N-bonded). Tin compounds so far isolated have been assigned N-bonded structures on the basis of their IR spectra (155):-

	N-bonded ( $\text{cm}^{-1}$ )	O/S-bonded ( $\text{cm}^{-1}$ )
$\nu_{\text{as}}$	2050	2100
NCS $\nu_{\text{s}}$	860-780	720-690 (often weak)
$\delta$	1 band $\approx$ 480	>1 band $\approx$ 420
NCO $\nu_{\text{as}}$	2300-2200	2300-2200
$\nu_{\text{s}}$	1400	<1200

## 5.2 Sn-X bands

(i) X = pseudohalide; the frequencies are generally too low to be accessible, although they have been observed around  $400 \text{ cm}^{-1}$  for  $\text{Me}_3\text{SnX}$  (157).

(ii) X = Cl; the bands appear at  $300 - 200 \text{ cm}^{-1}$ , their frequencies decreasing with increased coordination number, (especially if charged complexes are formed) due to increasing ionicity and length of the bonds (31,158,159).

	$\nu$ (Sn-Cl) ( $\text{cm}^{-1}$ )	
$\text{Me}_2\text{SnCl}_2$	361, 356	cyclohexane solution
$\text{Me}_2\text{SnCl}_3^-$	313, 256, 242	Nujol mull
$\text{Me}_2\text{SnCl}_4^{2-}$	227	Nujol mull

In 5- or 6-coordinate complexes, the multiplicity of the bands is affected by the symmetry of the complex (159);

Structure	no. IR active Sn-X modes
cis-MX <sub>3</sub> R <sub>2</sub>	3
trans-MX <sub>3</sub> R <sub>2</sub>	1
cis-MX <sub>4</sub> R <sub>2</sub>	4
trans-MX <sub>4</sub> R <sub>2</sub>	1

cis-MX<sub>3</sub>R<sub>2</sub> refers to both possible cis-R trigonal bipyramidal isomers, since they both have the same number of infra-red active Sn-X stretches.

In accordance with this, Me<sub>2</sub>SnCl<sub>3</sub><sup>-</sup> is assigned a cis-Me structure and Me<sub>2</sub>SnCl<sub>4</sub><sup>2-</sup> a trans-Me structure from the given data.

### 5.3 Sn-C bonds

Again the number of the bands is affected by the geometry of the complex.

Structure	no. IR active Sn-C modes
cis-MX <sub>3</sub> R <sub>2</sub>	2
trans-MX <sub>3</sub> R <sub>2</sub>	1
cis-MX <sub>4</sub> R <sub>2</sub>	2
trans-MX <sub>4</sub> R <sub>2</sub>	1

As with the Sn-Cl modes, cis-MX<sub>3</sub>R<sub>2</sub> refers to either of the possible isomers.

The asymmetric stretch is active in all cases, whereas the symmetric stretch is only active for cis geometry.

The appearance of  $\nu_s$  Sn-C<sub>2</sub> is generally taken to indicate distortion from linearity of Sn(CH<sub>3</sub>)<sub>2</sub> groups, or from planarity of Sn(CH<sub>3</sub>)<sub>3</sub> groups (19).





For instance;

	$\nu$ Sn-C <sub>2</sub> (cm <sup>-1</sup> )	Structure
Me <sub>2</sub> SnCl <sub>2</sub>	560,542	highly dist O <sup>h</sup>
Me <sub>2</sub> SnCl <sub>3</sub> <sup>-</sup>	581,519 (573,518)	cis trig.bipy.
Me <sub>2</sub> SnCl <sub>4</sub> <sup>2-</sup>	580	trans O <sup>h</sup>
Me <sub>2</sub> Sn(NCS) <sub>4</sub> <sup>2-</sup>	587 (581)	trans O <sup>h</sup> (31,35,91,158,)

#### 5.4 Sn-Ph compounds

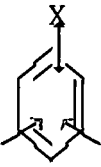
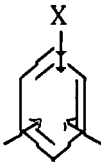
These compounds show spectra typical of substituted benzenes Ph-X.

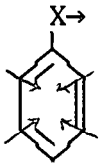
Of the 30 possible modes, 6 are X sensitive (t,u and x being the most) (156).

						
	q	r	y	t	u	x
Ph <sub>4</sub> Sn	1075	616	459 448	268 212	225	193 152
Ph <sub>2</sub> SnCl <sub>2</sub>	1069	614	442	273 235	213	180
Ph <sub>2</sub> SnCl <sub>3</sub> <sup>-</sup>	1065	672 660	454 446	285 235	217 204	182 152
Ph <sub>2</sub> SnCl <sub>4</sub> <sup>2-</sup>	1060	658	462	292 233	201	174

$\nu$  Sn-Cl occurs at comparable frequencies to those in alkyl tin halides, again decreasing in frequency on increased coordination.

	$\nu$ Sn-Cl )cm <sup>-1</sup> )	ref
$\text{Ph}_2\text{SnCl}_2$	360	(34)
$\text{Ph}_2\text{SnCl}_3^-$	330, 250	(158)
$\text{Ph}_2\text{SnCl}_4^{2-}$	267, 254, 237	(158)

Assignments and structural deductions made for new compounds are made by comparison with the appropriate data here.

CHAPTER TWOEXPERIMENTAL1 Glove box techniques

The main method used in the manipulation of air-sensitive materials was to handle them in an inert environment, provided by a glove box continuously purged with dry (molecular sieve column) nitrogen. Access to the box is gained via a large entry port, which is purged with nitrogen for 20-30 mins before opening from the inside, and a small "quick-entry" port, which is small enough to be purged by the outflow of  $N_2$  caused by pushing the gloves into the box. It was also fitted with a water pump to enable suction filtration to be carried out inside it, and contained a small stirrer motor, and an open dish of phosphorus pentoxide. The latter was to remove the last traces of moisture, or some of the solvent vapour that was produced via manipulations of solutions. It was replenished as it was used up.

The glove box was used to store air sensitive starting materials and products, or pre-dried materials (such as KBr for discs) and dried solvents. A supply of solvents ( $CHCl_3$ ,  $CH_2Cl_2$  and petroleum ether (30-40°C)), stored over 4A molecular sieve, were also kept here, together with all deuterated solvents used, for convenience in making up solution samples.

It was also used to carry out the following procedures routinely:-

a) measuring out reactants. A preweighed, purged sample bottle was taken into the box, an approximation to the correct amount of material added, the bottle sealed and the total weighed (outside the box). Corrections were made, if necessary, by addition or

removal of material in the box, and weighing repeated.

b) mulls and KBr discs for infra-red work. A supply of Nujol and a mortar and pestle were kept in the box, along with some oven dried KBr, so that all sample preparation can be carried out under  $N_2$ .

c) samples for analysis by microcombustion were made up in aluminium capsules, and sealed with a press. Those for analysis by atomic absorption or potentiometric titration were made up in gelatine capsules, the whole assembly being dissolved or combusted in the analytical process.

d) solution state samples for NMR work were made up in the box by addition of the solid sample to a preweighed tube and the sealed tube weighed. Solvent is added to the sample by syringe once it is taken back into the box. Samples were sealed by stopper and "Parafilm". Deuterated solvents are used for  $^1H$  and  $^{13}C$  NMR work.

( $D_6$ -DMSO,  $D_3$ -acetonitrile,  $D_6$ -acetone and  $CDCl_3$  were obtained from Aldrich chemical company in 99% isotopic purity. The first two contain 1% TMS. For spectrometric conditions, see section 6.)

Deuterium locking in  $^{119}Sn$  NMR work was provided where required in DMSO and  $CH_3CN$  solutions by making up the sample with 50% normal and 50% deuterated solvents. In other solvents, the lock was provided by addition of 0.25ml  $D_6$ -benzene (Aldrich, 99% isotopic purity).

## 2 Vacuum/Nitrogen line

Further handling of reacting systems was carried out by using a combined nitrogen/vacuum line manufactured in the departmental glass blowing facility, and designed such that a vessel can be opened to nitrogen or vacuum via the same outlet. The vacuum was provided by an Edwards "Speedivac" high vacuum pump, which was



protected from the line by two traps, cooled by liquid nitrogen. The line was also fitted with a mercury manometer.

This arrangement allows reactions and manipulations to be carried out easily and without exposing the system to the air.

The vacuum system was primarily used for drying of solids at elevated temperatures, sublimation, vacuum transfer of volatiles, suction filtration and removal of solvents from solutions.

### 3 Chemicals and solvents

Commercial grade starting materials were used without further purification, after the presence of impurities was discounted by the appropriate spectroscopic technique (IR,  $^1\text{H}$  NMR or  $^{119}\text{Sn}$  NMR). The following techniques were used for drying solvents:

- a) toluene was refluxed over sodium using benzophenone as an indicator. The presence of a deep blue colouration showed that all moisture had been removed, and the solvent was then distilled off. It was generally used immediately (after cooling).
- b) THF was dried in the same way, except that potassium was used instead of sodium. The solvent was stored and transferred under an atmosphere of dry nitrogen.
- c) diethyl ether was dried by the addition of sodium wire (produced freshly from a press) to the solvent at room temperature. Reaction was generally complete after approx. 1hr.
- d) acetonitrile was refluxed over  $\text{P}_2\text{O}_5$  for 1hr and then distilled off. On cooling, 4A molecular sieve was added.

#### 4 Elemental analysis

Percentages of C, H and N were determined as a laboratory service by microcombustion using a Perkin Elmer 240 Elemental analyser.

Reliability of values was found to be variable.

Determination of all other elements was performed by Mr. R. Coult.

Chlorine and Bromine:- the sample was combusted in a Schoniger oxygen flask, and the gases absorbed into alkaline peroxide. A sample of this solution was then titrated potentiometrically against N/100  $\text{AgNO}_3$  using Ag, AgCl electrodes in an acetone medium.

Sulphur:- the sample is combusted and gases dissolved as above, and the resultant solution was then titrated with N/100 barium perchlorate.

Phosphorus:-

first method - 20-30mg of sample was fused in a Ni bomb with 2g sodium peroxide. The fused melt was then dissolved in water acidified with c  $\text{HNO}_3$ , and made up to 100mls. Suitable aliquots were removed (10mls) and an ammonium molybdate/ammonium vanadate complexing reagent added. The intensity of the yellow colour so formed was measured at  $420\mu\text{m}$  using a Unicam SP500 spectrophotometer.

second method - 20-30mg of sample was digested with 2mls c  $\text{HClO}_4$  and 2mls  $\text{H}_2\text{SO}_4$  until it became clear and colourless. The digest was then made up to 100mls and treated as above.

Tin:- 10-20mg of sample was decomposed in aqua regia and made up to volume in water. The tin content of this solution was measured by atomic absorption using a Perkin Elmer 5000 spectrophotometer.

Lithium:- a sample of a solution containing lithium was added to water and acidified with c  $\text{HNO}_3$ . The lithium content of this

solution was then measured by atomic absorption, as above.

### 5 Infra-red spectra

These were obtained using Perkin Elmer 577 or 597 spectrophotometers, as Nujol mulls or as KBr discs.

### 6 NMR spectra (except $^1\text{H}$ )

$^{119}\text{Sn}$  NMR spectra were obtained using either of two instruments, both run in the Fourier transform mode. The first was constructed in the department by Dr. A. Royston. The probe takes tubes of 8.4mm external diameter, which are not spun. External  $\text{Me}_4\text{Sn}$  is used as a reference, with values to higher frequency of this being taken as positive. The spectrometer construction is shown in Fig 2.1, and uses a 1.4T Perkin Elmer R10 magnet, meaning that  $^{119}\text{Sn}$  resonances are sought around 22.37616MHz. The system is driven by a PDP/34 computer with 64K memory and RT11 operating system, with attachments as follows:-

oscilloscope for display;

2 x RX01 floppy disk drives;

HILOT (Houston Instruments) digital plotter;

pulse programmer;

DECWRITER LA36 keyboard.

The operating system allows user control of data acquisition and processing by setting variables. These allow specification of number of, length of and time between pulses, number of channels used in acquisition, width and position of spectral window with respect to  $\text{Me}_4\text{Sn}$ , and manipulation of F.I.D. curve once the appropriate number of scans have been accumulated. Once the F.I.D. curve is transformed, further parameters are used to phase

Figure 2.1

Multinuclear n.m.r. Spectrometer.

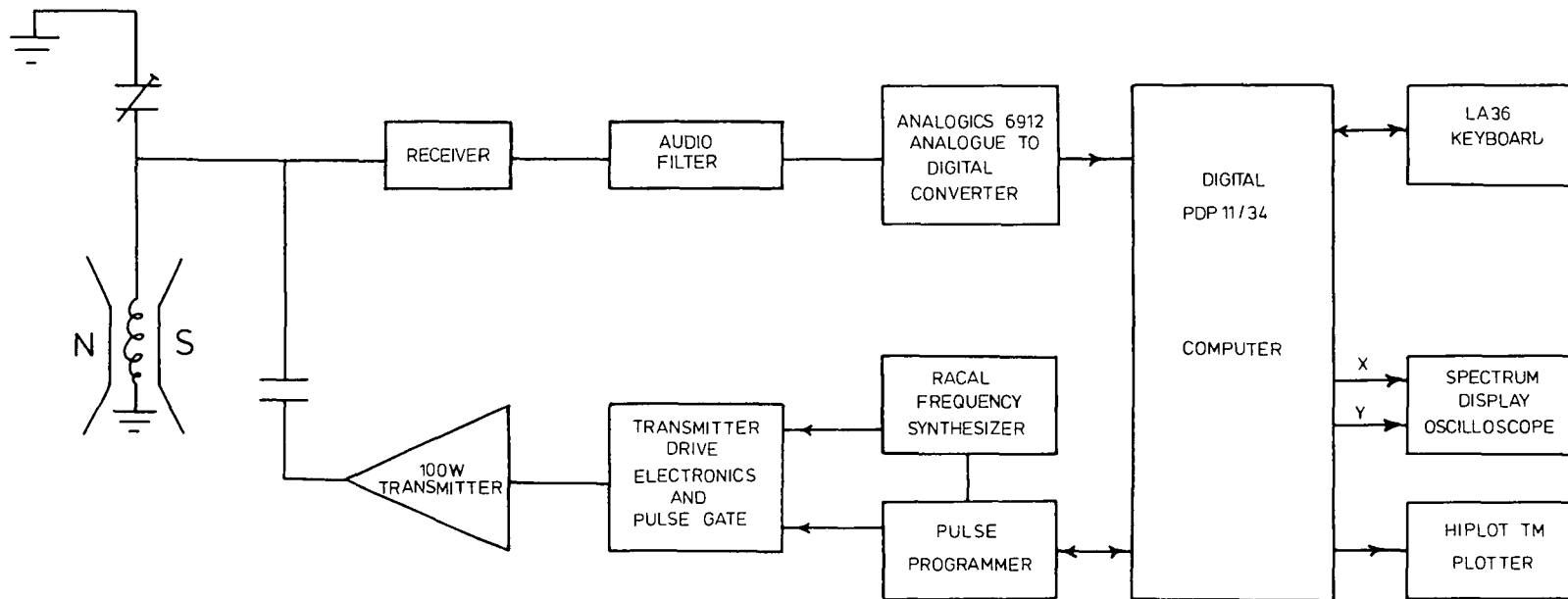

correct, measure and plot the resultant spectrum.

Accumulation times varied with the concentration of sample, being between 1/2hr and a weekend, most commonly overnight.

All the materials produced in this work contain nuclei coupled to tin, most commonly  $^2J(^1\text{H-C-}^{119}\text{Sn})$ , hence all the spectra are multiplets. If only the shift value of the system was required, conditions were chosen (large sweep width, small number of channels) such that the signal was produced in a relatively small number of channels, thus reducing the acquisition time, but rendering the observed value of the coupling constant meaningless, since signals in a multiplet are only separated by 2-3 channels, of width 30-40Hz (depending on conditions). This allowed relatively rapid pinpointing of the shift values, and coupling constants could then be obtained by using narrower sweep widths (2-5kHz) and a large (1024/2048) number of channels. Under a wide sweep width, the typical error on results was 3.5ppm.

This instrument was also used to obtain  $^{31}\text{P}$  spectra using the operating frequency of 24.2897MHz and external  $\text{H}_3\text{PO}_4$  as reference.

The second instrument is a Bruker AC-250 spectrometer, utilizing an Oxford Instruments superconducting 5.9T magnet, an Aspect 3000 minicomputer with BASF Winchester disk and floppy disk drive, a Watenabe Graphtec 4731 plotter and a 14 inch colour raster VDU. Operation is via Bruker Software DISB 861, and takes a very similar form to that described above, operating conditions being set by a series of parameters specified by two letter commands.

The probe takes 10mm external diameter tubes, spun at 20Hz, and has facilities for broad band and inverse gated decoupling. Field frequency stability is provided by a deuterium lock.

Shift values are referenced to the absolute frequency of  $^{119}\text{Sn}$  in  $\text{Me}_4\text{Sn}$  at this field strength (93.2760630MHz), and the same sign convention is used as before.

This machine, operating in the broad band proton decoupled mode, was also used to obtain  $^{13}\text{C}$  spectra (at 62.896MHz with respect to internal TMS, or solvent peak).

#### 7 $^1\text{H}$ NMR spectra

These were obtained either on the above instrument, at 250.133MHz, or in continuous wave mode at 60MHz, for more routine work, on a Hitachi-Perkin Elmer R24B, both with respect to internal TMS, taking the high frequency direction as positive.

#### 8 Mossbauer spectra

These were obtained by Dr. Peter Smith at the International Tin Research Institute. Data were obtained at 77K relative to  $\text{BaSnO}_3$ .

#### 9 X-Ray crystallography

Crystal structures were determined by Dr. J. Halfpenny at Napier College of Commerce and Technology, Edinburgh.

CHAPTER 3DIMETHYL AND DIPHENYLTIN THIOCYANATO-CHLORIDE COMPLEXES1 INTRODUCTION

In general, triorganotin compounds are more widely studied than are diorganotins, probably due to the application of the former in preparative organic/organometallic chemistry. The methyl and phenyl tin chlorides and thiocyanates are no exception, particularly regarding NMR data.  $^{119}\text{Sn}$  chemical shifts have been obtained in a wide variety of solvents for  $\text{Me}_3\text{SnX}$  and  $\text{Me}_2\text{SnX}_2$  ( $\text{X} = \text{Cl, Br}$ ) but the only thiocyanate study is a value of +60ppm in benzene or  $\text{CCl}_4$  for  $\text{Me}_3\text{SnNCS}$ . Phenyl compounds are less well studied,  $\text{Ph}_3\text{SnCl}$  and  $\text{Ph}_2\text{SnCl}_2$  chemical shifts having been recorded in benzene or methylene chloride, and no thiocyanate values being available (93,126).

Most of these compounds have however been studied by X-ray crystallography, the only exception being  $\text{Ph}_2\text{Sn}(\text{NCS})_2$  (22,25,26,43,45,46,161,162). The methyl compounds all have bridged polymeric structures, with tin taking up trigonal bipyramidal geometry in the trimethyl compounds, and a distorted structure intermediate between tetrahedral and trans octahedral in the dimethyl compounds. The phenyltin chlorides have discrete molecular, distorted tetrahedral structures due to the bulk of the aromatic group. In  $\text{Ph}_3\text{SnNCS}$  the increased Lewis acidity of tin caused by replacement of chloride by thiocyanate is enough to cause polymerisation, and tin takes up trigonal bipyramidal coordination.

These findings are backed up by Mossbauer data, which is

complete for the set of compounds under consideration (please see table below).

Mossbauer data for  $R_2SnX_2$  and  $R_3SnX$

(R = Me, Ph, X = Cl, NCS)

	$\delta$ (mms <sup>-1</sup> )	$\Delta E_q$ (mms <sup>-1</sup> )
$Me_2SnCl_2$	1.56	3.55
$Me_2Sn(NCS)_2$	1.48	3.87
$Me_3SnCl$	1.42	3.44
$Me_3SnNCS$	1.40	3.77
$Ph_2SnCl_2$	1.38	2.82
$Ph_2Sn(NCS)_2$	1.45	3.96
$Ph_3SnCl$	1.34	2.54
$Ph_3SnNCS$	1.35	3.50 (144,147)

Infra-red data for all these compounds have been presented, but are mostly confined to pseudohalide frequencies. Only for the methyltin chlorides are Sn-C stretching frequencies given (158).

	$\nu_{as}$ (cm <sup>-1</sup> )	$\nu_s$ (cm <sup>-1</sup> )
$Me_2SnCl_2$	560	542
$Me_3SnCl$	542	513

(run in cyclohexane solution)

Complexation of these compounds with neutral donors has been widely documented (eg. 9,15,19,30,31,33,35,163) but although complexation by a halide donor has been known since 1910 (164), this field has attracted rather less attention.  $Me_2SnCl_4^{2-}$  has been studied by NMR (95) Mossbauer (147), and IR (31), and has had its



crystal structure determined with various cations (87,92,165).

Data for dimethyltin thiocyanate complexes and diphenyltin anionic complexes are rather more scarce, although IR and Mossbauer parameters have been determined (16,19,29,32,34,35,90,91,166).

We wanted to look at the mixed pseudohalide/halide complexes, initially as isomers formed in solution, and subsequently, since they proved impossible to observe under such conditions, as discrete complexes, if they could be obtained. Some mixed halide/pseudohalide complexes have been previously synthesised, for study mainly by IR and Mossbauer techniques, eg.

$(\text{Ph}_4\text{As}^+)_2 \text{Ph}_2\text{Sn}(\text{NCS})_2(\text{N}_3)_2^{2-}$  and  $(\text{Ph}_4\text{As}^+) \text{Ph}_3\text{Sn}(\text{NCS})\text{N}_3^-$  (52),  
 $\text{Ph}_2\text{CySnXY}^-$ , and  $\text{Ph}_2\text{SnX}_2\text{Y}_2^{2-}$  (X, Y = Cl, Br), (167,168)  $\text{Ar}_3\text{SnXY}^-$  (X = Cl, Br, Y =  $\text{N}_3$ , NCS) (35) and  $\text{RSnX}_n\text{Y}_{5-n}^{2-}$  (R = Bu, Ph, X = F, Cl, Br) (169).

NMR data is confined to mixtures of inorganic tin halide and pseudohalide complexes (94,170-172). In these studies, mixtures of  $\text{SnX}_6^{2-}$  and  $\text{SnY}_6^{2-}$  yielded spectra in which signals for the intermediate complexes appeared - formed by exchange reactions - but these could not be isolated from the mixture. The shift and  $119/117\text{Sn}-^{14}\text{N}$  coupling constant of  $\text{Sn}(\text{NCS})_6^{2-}$  have also been determined (173).

We found that mixing  $(\text{Et}_4\text{N}^+)_2 \text{Me}_2\text{SnCl}_4^{2-}$  and  $(\text{Pr}_4\text{N}^+)_2 \text{Me}_2\text{Sn}(\text{NCS})_4^{2-}$  gave spectra containing only one signal, the position of which changed with the proportions of the mixture, indicating the presence of an exchange equilibrium that is fast on the NMR timescale.

The intermediate complexes should be formed during this process, so it was decided to attempt to make them discretely, and

investigate their structure. Also their NMR parameters would make a useful addition to the current  $^{119}\text{Sn}$  NMR literature, since little is available for this type of compound, and the variation across the series should make an interesting comparison with other series of compounds that have already been so studied.

2 FOUR-COORDINATE PSEUDOHALIDES\*2.1 Infra-red dataall values in  $\text{cm}^{-1}$ .

$\text{Me}_2\text{Sn}(\text{NCS})_2$	$\text{Me}_2\text{SnCl}_2$	lit. vals	assignment
2040vs, br		2088 vs	$\nu_{\text{as}}$ NCS
		2062 s	
965 w		965 w	
		846 w	$\nu_{\text{s}}$ NCS
805 br	800 s, vbr		$\rho_{\text{as}}$ $\text{CH}_3$
720 m	722 m		$\rho_{\text{s}}$ $\text{CH}_3$
572 m	569 m	560	$\nu_{\text{as}}$ $\text{Sn-C}_2$
515 m	518 m	542	$\nu_{\text{s}}$ $\text{Sn-C}_2$
480 m		483 m-w	$\delta$ NCS
459 m		459 m	
	280 s, br		( $\nu$ $\text{Sn-Cl}$ )

ref. (35) Lit. references are to  $\text{Me}_2\text{Sn}(\text{NCS})_2$  as a Nujol mull, excepting  $\nu\text{Sn-C}_2$  values, which refer to  $\text{Me}_2\text{SnCl}_2$  in cyclohexane solution (158).

(\* only nominally 4-coordinate)

$\text{Ph}_2\text{Sn}(\text{NCS})_2$	$\text{Ph}_2\text{SnCl}_2$	lit.vals	assignment
	3070 w		$\nu$ (C-H)
	3050 w		aromatic
2090 s,br			$\nu_{\text{as}}$ NCS
1065 w	1075 w	1069 w	q mode
1020 m	1021 m		
995	998		
935			
780			? $\nu_{\text{s}}$ NCS
730 d,m	729 m		
738			
690	695	614	r mode
	553		
	538		
	538		
468			$\delta$ NCS
459			+
449	449	442	y mode
	362	360	$\nu$ Sn-Cl
290	280	273	
+sh 280			t mode
245 m		235	

(non-labelled bands are probably non-mass dependent phenyl vibrations. lit. ref. (156))

2.2  $^{119}\text{Sn}$  NMR chemical shift data

A larger range of values is obtainable for  $\text{Me}_2\text{SnCl}_2$ , since it is sufficiently soluble in a greater range of solvents, particularly less polar ones.

solvent	$\delta \text{ Me}_2\text{SnCl}_2$	$\delta \text{ Me}_2\text{Sn}(\text{NCS})_2$
DMSO	-246.1	-375.6
$\text{PhNO}_2$	-116.9	
$\text{MeNO}_2$	-107.2	
MeOH	-94.3	-339.7
EtOH	-64.2	-317.2
$\text{CH}_3\text{CN}$	+33.2	-239.2
$\text{CH}_2\text{Cl}_2$	+138.6	

solvent	$\delta \text{ Ph}_2\text{SnCl}_2$	$\delta \text{ Ph}_2\text{Sn}(\text{NCS})_2$
EtOH	-198.8	-436.4
$\text{CH}_3\text{CN}$	-128.4	-359.4

(all values in ppm with respect to external  $\text{Me}_4\text{Sn}$ , and for saturated solutions. Lit. value for  $\text{Me}_2\text{SnCl}_2 / \text{CH}_2\text{Cl}_2$  (20 mole %)  $\delta = +137\text{ppm}$  (93))

### 2.3 Coupling constants

$^2J (^{119}\text{Sn}-\text{C}-^1\text{H})$  values were obtained for  $\text{Me}_2\text{SnCl}_2$  and  $\text{Me}_2\text{Sn}(\text{NCS})_2$  from  $^{119}\text{Sn}$  and  $^1\text{H}$  spectra.

The expected  $^{119}\text{Sn}$  signal is a 1:6:15:20:15:6:1 heptet. A pentet was usually observed, since the outer signals were of too low intensity to be distinguished from the noise.

solvent	$\text{Me}_2\text{SnCl}_2$			$\text{Me}_2\text{Sn}(\text{NCS})_2$		
	$^{119}\text{Sn}$	$^1\text{H}$	lit.	$^{119}\text{Sn}$	$^1\text{H}$	lit.
$\text{CH}_3\text{CN}$	83+5	80	81.2	93+5	92	
$\text{CHCl}_3$		68	69			
DMSO			114.8			115

lit. ref (174) in  $\text{CCl}_4$ , (11) in  $\text{CD}_3\text{CN}$  and DMSO.

#### 2.4 Concentration dependence of $\delta$

This was investigated in MeCN for  $\text{Me}_2\text{SnCl}_2$  and  $\text{Me}_2\text{Sn}(\text{NCS})_2$ , to see how variable the  $\delta$  values are over the concentration ranges used.

$\text{Me}_2\text{SnCl}_2$ : Quantity of sample = 0.168g = 0.763 mmol.

Volume (ml)	concn. (M)	shift (ppm)
0.5	1.53	33.2
0.6	1.27	33.2
0.8	0.95	33.2
1.0	0.76	31.4
1.2	0.64	31.4
1.4	0.55	36.7
2.0	0.32	33.2

Me<sub>2</sub>Sn(NCS)<sub>2</sub>: Quantity of sample = 0.348g = 1.313 mmol

Volume (ml)	concn. (M)	shift (-ppm)
0.7	1.84	233.9
0.9	1.43	233.9
1.1	1.17	233.9
1.3	0.99	233.9
1.5	0.76	242.7
1.7	0.76	242.7
1.9	0.68	233.9
2.1	0.61	234.4
2.3	0.56	240.9
2.5	0.51	239.2
2.9	0.44	239.2
3.5	0.37	242.7

It can be concluded from these results that any variation over the range of concentration used here is negligible - and masked by error produced by channel width.



## 2.5 Discussion

The infra-red data show that both thiocyanates are N-bonded, and both methyl compounds are highly distorted from linearity, as is known from their crystal structures (43,45). The discrepancy between the value observed for  $\nu_{as}$  NCS and the literature value is probably due to the broadness of this band.

The NMR shift and coupling constant data indicate that complexation is taking place in solutions of donor solvents, since  $|J|$  values increase, and  $\delta$  moves to lower frequencies. For  $\text{Me}_2\text{SnCl}_2$ , the range of data also indicates complexation, since such a spread of values for one compound could only be produced by direct chemical interaction. The donor strength of solvent towards  $\text{Me}_2\text{SnCl}_2$  decreases across the series  $\text{DMSO} > \text{PhNO}_2 > \text{CH}_3\text{NO}_2 > \text{MeOH} > \text{EtOH} > \text{CH}_3\text{CN}$  (assuming hexacoordination in all cases) since  $\delta$  will move further upfield as strength of donation increases. This is in general agreement with the results reported by Petrosyan et al. for methyl tin halides (15,115) ( $\text{DMSO} > \text{DMF} > \text{HMPT} > \text{py} > \text{DME} > \text{acet} > \text{THF} > \text{dioxan}$ ) although different solvents are used.

$\delta$  values for  $\text{Me}_2\text{Sn}(\text{NCS})_2$  are  $\approx 265$  ppm to lower frequency than for  $\text{Me}_2\text{SnCl}_2$ , and  $|J|$  values are  $\approx 10\text{Hz}$  larger. The higher shielding is contrary to expectations in view of the higher group electronegativity of NCS ( $\chi_{\text{NCS}}^* = 4.17$ , (121)  $\chi_{\text{Cl}}^* = 3.15$ , (175)). The observed result could be due to increased Lewis acidity of the Sn, resulting in stronger complexes. Also the larger size of the NCS group may increase its shielding effect.

The higher J value is probably because the higher electronegativity of the NCS group causes a greater degree of secondary rehybridisation (138), or because the group is more

polarisable than Cl.

The values for phenyl compounds are  $\simeq$  120 ppm to lower frequency than for the corresponding methyl compounds, in line with available literature values for triphenyl compounds (93,126). (This may be due to Lewis acidity effects, or to the greater size and polarisability of the phenyl group.)

The lower solubility of both thiocyanates indicates the presence of stronger interactions in the solid state, which is in line with a more acidic tin in these compounds.

The concentration dependence of  $\delta$  is negligible over the concentration range employed, hence the complexation equilibrium

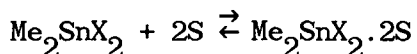

must be well over to the right hand side (hexa-coordination is assumed).

Other studies (10-12,96) of trimethyltinhalide-donor complexes have found concentration dependences for  $\delta$  and J. This is possibly because donor-acceptor interactions are weaker for these compounds, and they are significantly more soluble. Both these factors will swing the equilibrium position to the left, and then let it move progressively to the right as the acceptor concentration decreases.

3 6-COORDINATE COMPLEXES  $(Et_4N^+)_2 Me_2Sn(NCS)_n Cl_{4-n}^{2-}$  (n=0-4)3.1 Infra-red data(all values in  $cm^{-1}$ )

n =	4	4(*)	3	2	1	0	assignment
	2040	2045	2030	2040	2045		$\nu_{as}$ NCS
	1295vw		1295w	1295w	1300	1308m	
	1258vw	1258w					
				1215w			
	1170m		1170m	1172m	1172m	1181m	
	+sh1185						
						1118w	
	1050w			1058w	1070w	1078w	
	+sh1065		1055w	1032w	1050w		
		1030w		1026w	1022m	1030m	
	998m		998w	998m	995m	1005m	
	955m	965m	955vw	945w			
	785s	780m	780s	785s	785s	788s	
		750m		762m		+sh805	$\rho_{as} CH_3$
				735m			
	720m	720m	720m	720m	721m	721m	$\rho_s CH_3$
	578m	588m	578m	578m	575m	578m	$\nu_{as} Sn-C$
	470m	470m	470w	470w	470w		$\delta$ NCS
				235br	235br	235br	$\nu$ Sn-Cl

(assignments by comparison with (35,91), unassigned bands are probably cation bands)

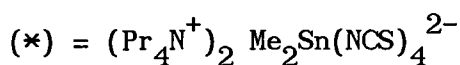

3.2  $^{119}\text{Sn}$  NMR shift data

Some difficulty was encountered in obtaining data for these compounds, due to their low solubility. This was in part overcome by using the  $\text{Pr}_4\text{N}^+$  cation for  $\text{Me}_2\text{Sn}(\text{NCS})_4^{2-}$  (since solubility decreases as n increases).

Anion	shift (-ppm) in	
	$\text{CH}_3\text{CN}$	DMSO
$\text{Me}_2\text{SnCl}_4^{2-}$	139.5	240.9
$\text{Me}_2\text{Sn}(\text{NCS})\text{Cl}_3^{2-}$	133.1	247.9
$\text{Me}_2\text{Sn}(\text{NCS})_2\text{Cl}_2^{2-}$	152.0	253.1
$\text{Me}_2\text{Sn}(\text{NCS})_3\text{Cl}^{2-}$	406.7	358.6
$\text{Me}_2\text{Sn}(\text{NCS})_4^{2-}$	416.0	387.1

Values are plotted graphically (please see graph opposite).

Expected values on the basis of a mixture of compounds are also plotted on the graph as fine lines.

Figure 3.1

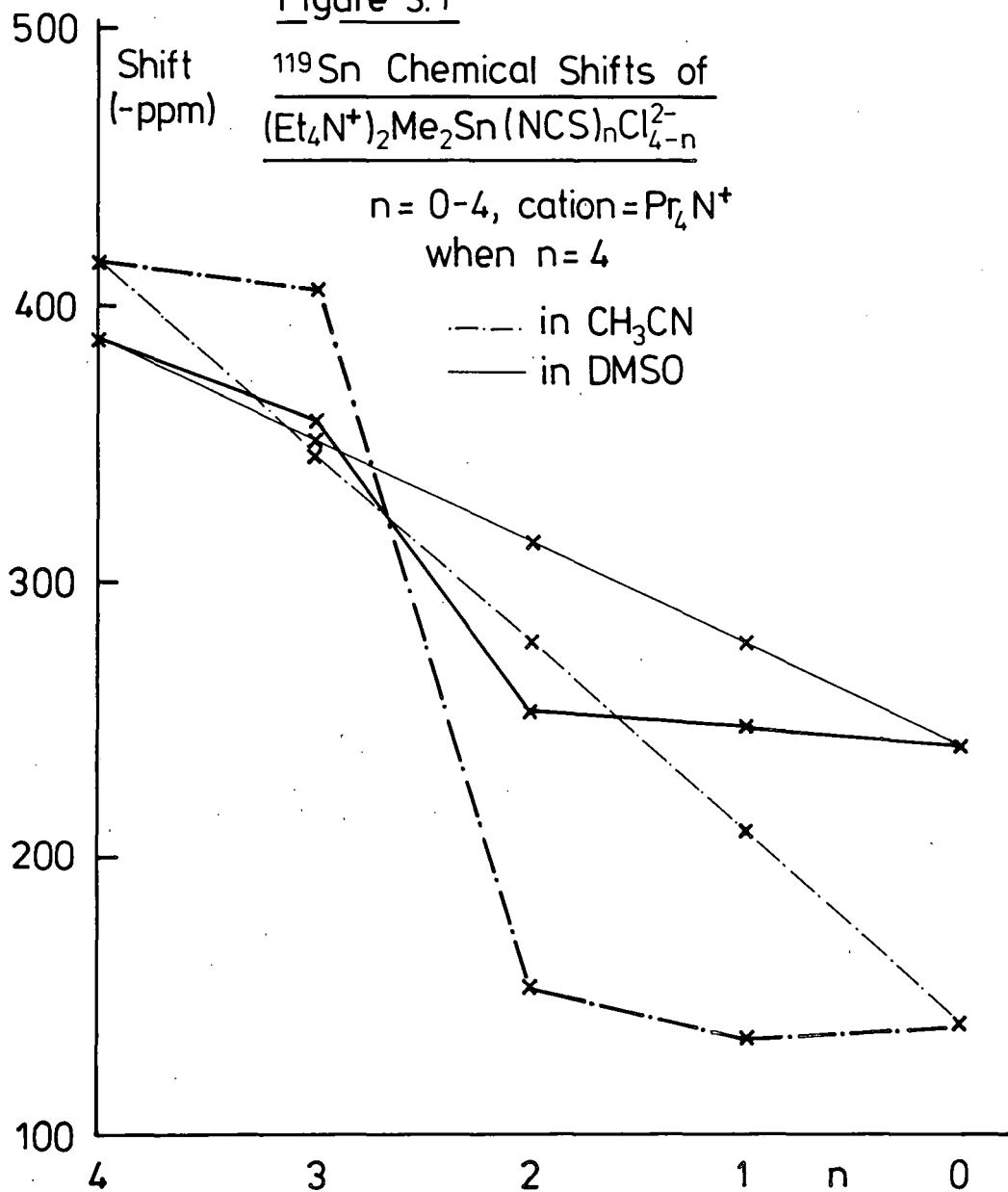

3.3 Coupling constants  $^2J(^{119}\text{Sn-C-}^1\text{H})$ 

Conditions as for 4-coordinate compounds. Error due to channel width  $\approx 4\text{Hz}$ .

from  $^{119}\text{Sn}$  NMR spectra;

Anion	$^2J$ in		$\bar{K}_{\text{ave}}$
	$\text{CH}_3\text{CN}$	DMSO	
$\text{Me}_2\text{SnCl}_4^{2-}$	96 $\pm$ 2	112 $\pm$ 10	3.15
$\text{Me}_2\text{Sn}(\text{NCS})\text{Cl}_3^{2-}$	93 $\pm$ 7		3.40
$\text{Me}_2\text{Sn}(\text{NCS})_2\text{Cl}_2^{2-}$	99 $\pm$ 6		3.66
$\text{Me}_2\text{Sn}(\text{NCS})_3\text{Cl}^{2-}$	117 $\pm$ 2		3.91
$\text{Me}_2\text{Sn}(\text{NCS})_4^{2-}$	115 $\pm$ 5		4.17

from PMR spectra;

Anion	$^2J$ in	
	$\text{CD}_3\text{CN}$	$\text{CDCl}_3$
$\text{Me}_2\text{SnCl}_4^{2-}$	94	89
$\text{Me}_2\text{Sn}(\text{NCS})_2\text{Cl}_2^{2-}$	98	
$\text{Me}_2\text{Sn}(\text{NCS})_3\text{Cl}^{2-}$	118	
$\text{Me}_2\text{Sn}(\text{NCS})_4^{2-}$	118	

Measuring errors on these values = 2 Hz

$^2J$  values are also plotted graphically against average substituent electronegativity - please see opposite.

Figure 3.2

Coupling constants  ${}^2J({}^{119}\text{Sn}-\text{C}-{}^1\text{H})$  of  
 $(\text{Et}_4\text{N}^+)_2\text{Me}_2\text{Sn}(\text{NCS})_n\text{Cl}_{4-n}^{2-}/\text{CH}_3\text{CN}$   
vs average ligand electronegativity  
 $n=0-4$  (cation =  $\text{Pr}_4\text{N}^+$  when  $n=4$ )

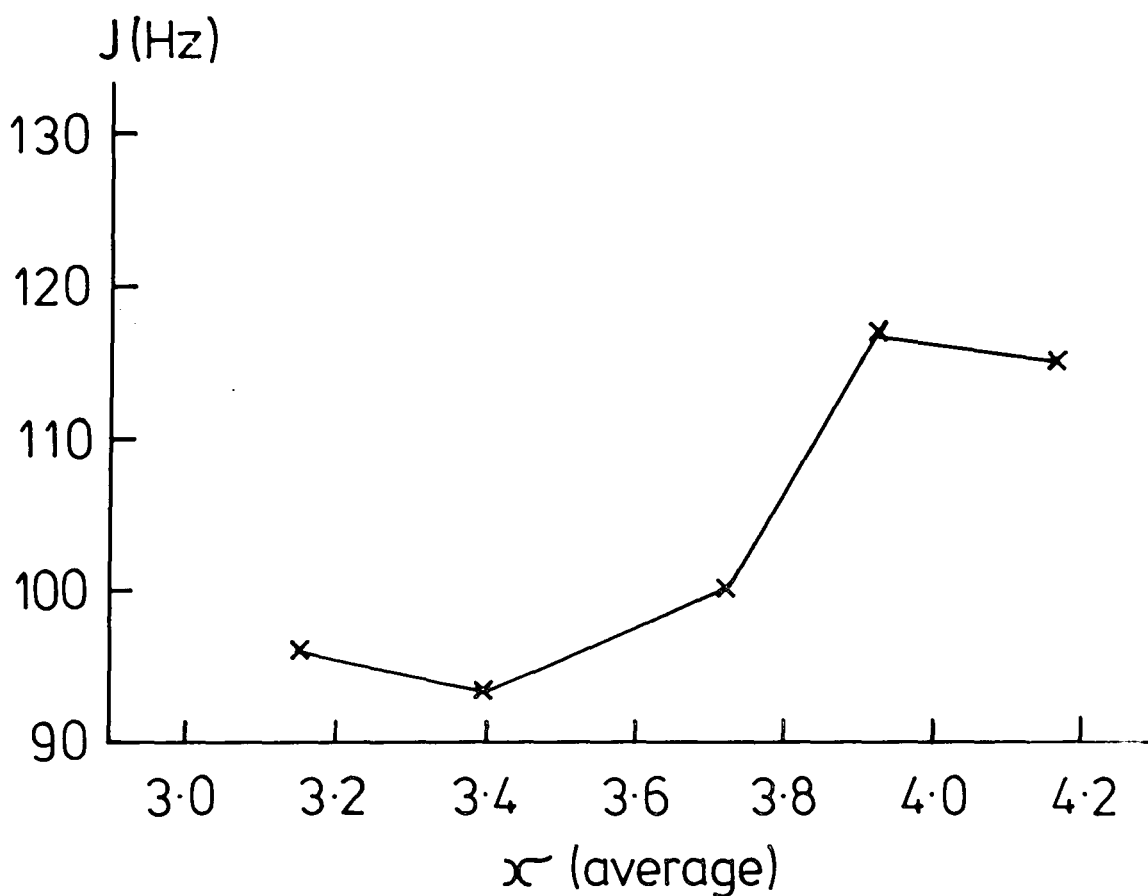

### 3.4 Concentration dependence of $\delta$

This was investigated for a solution of 0.1455g of  $(\text{Et}_4\text{N}^+)_2 \text{Me}_2\text{Sn}(\text{NCS})\text{Cl}_3^{2-}$  in  $\text{CH}_3\text{CN}$ , since this is one of the most soluble compounds, so giving a greater range of concentrations, and easily obtainable data.

Volume of $\text{CH}_3\text{CN}$ (ml)	concentration ( $\text{mol dm}^{-3}$ )	$\delta$ (-ppm)
1.0	0.25	133.49
1.2	0.21	128.36
1.4	0.18	128.36
1.6	0.16	123.22
1.8	0.14	128.36
2.0	0.13	123.23
3.0	0.085	129.18

Concentration dependence of  $\delta$  is therefore small over the range where a signal is observable.



3.5 Mossbauer data

Compound	$\delta$ ( $\text{mms}^{-1}$ )	$\Delta E_q$ ( $\text{mms}^{-1}$ )	$\Gamma_1$ ( $\text{mms}^{-1}$ )	$\Gamma_2$ ( $\text{mms}^{-1}$ )
$(\text{Pr}_4\text{N}^+)_2$ $\text{Me}_2\text{Sn}(\text{NCS})_4^{2-}$	1.32	4.50	0.96	0.99
$(\text{Et}_4\text{N}^+)_2$ $\text{Me}_2\text{Sn}(\text{NCS})_4^{2-}$	1.28	4.33	1.01	1.00
$(\text{Et}_4\text{N}^+)_2$ $\text{Me}_2\text{Sn}(\text{NCS})_3\text{Cl}^{2-}$	1.35	4.35	0.79	1.05
$(\text{Et}_4\text{N}^+)_2$ $\text{Me}_2\text{Sn}(\text{NCS})_2\text{Cl}_2^{2-}$	1.45	4.30	0.99	1.05
$(\text{Et}_4\text{N}^+)_2$ $\text{Me}_2\text{Sn}(\text{NCS})\text{Cl}_3^{2-}$	1.47	4.06	1.30	1.20
$(\text{Et}_4\text{N}^+)$ $\text{Me}_2\text{SnCl}_4^{2-}$	1.49	4.13	1.10	1.07
$(\text{Bu}_4\text{P}^+)_2$ $\text{Me}_2\text{SnCl}_4^{2-}$	1.46	4.10	1.03	1.07

Error on these values =  $0.03 \text{ mms}^{-1}$ .

Isomer shift is plotted against average substituent electronegativity - please see graph opposite.

Figure 3.3

Mossbauer isomer shifts vs average ligand electronegativity for  $(Et_4N^+)_2Me_2Sn(NCS)_nCl_{4-n}^{2-}$

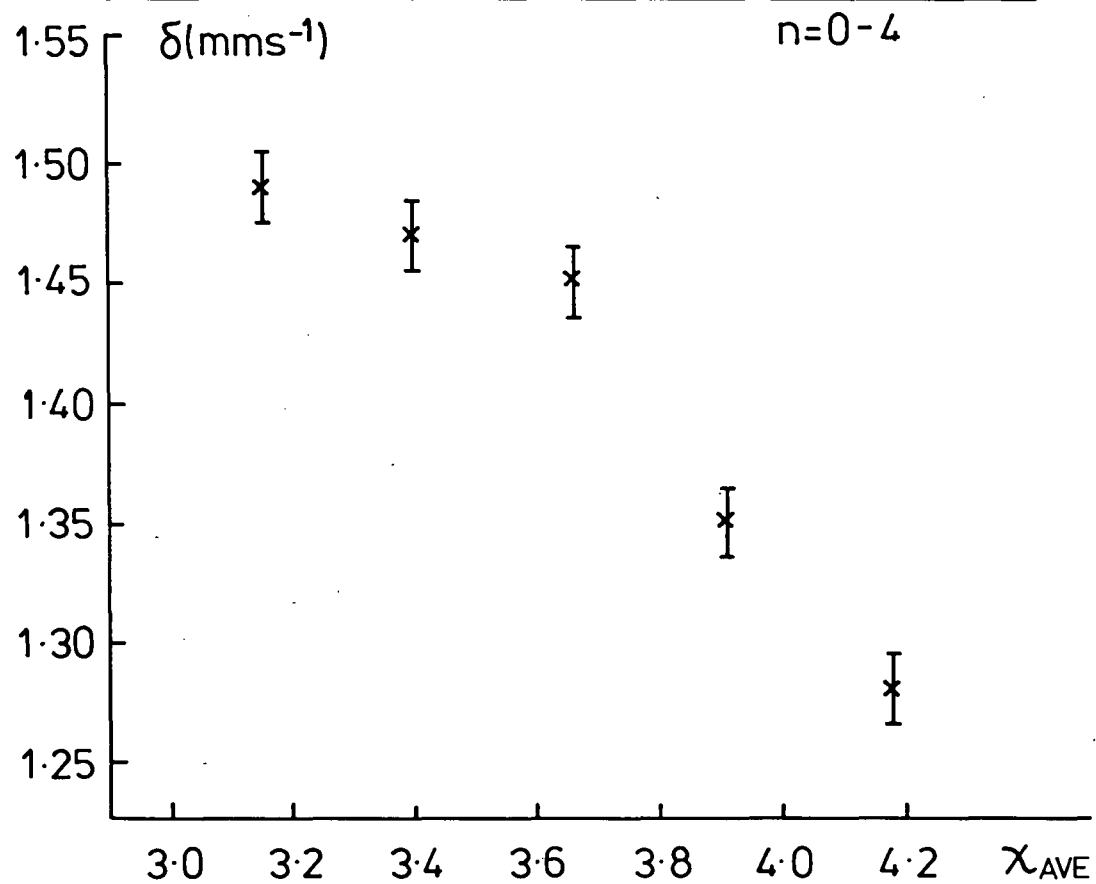

### 3.6 Discussion

The infra-red data show that the complexes contain N-bonded thiocyanate groups, like the four coordinate starting material, but with trans, linear Me-Sn-Me units. This is expected from previous studies of  $(\text{Et}_4\text{N}^+)_2 \text{Me}_2\text{Sn}(\text{NCS})_4^{2-}$  by infra-red, and of  $\text{Me}_2\text{SnCl}_4^{2-}$  with various cations by IR and X-ray crystallography (35,87,92).

The spectra do not show whether the intermediate complexes are mixtures or not, since similar spectra would be expected in either case.

NMR shift values are typical of 6 coordinate complexes (93,126). A rapidly exchanging mixture of two tin complexes would give an observed shift that varied linearly with the mole fraction of the tin containing components of the equilibrium. If the complexes prepared in this work are a mixture of the tetrachloride and tetrathiocyanate, then their shifts would follow this pattern. Since this is definitely not observed, it is likely that the intermediate complexes are formed discretely.

The values vary in the opposite direction to that expected on the basis of substituent electronegativity, as do those of the starting materials. Possible factors involved in causing this effect could be the larger size and polarisability of the NCS group, and stronger bonding than in the chloride, resulting in more electron donation to Sn, and shorter bond lengths.

There is a significant difference in the values obtained in the 2 solvents. On the face of it, this would not be expected for hexa-coordinate complexes, with no sites for direct complex - solvent bonds. (Hepta-coordination is known (63), but is highly

unlikely here). It is, however, known that many complexes are labile in solution, dissociating to the 5- (or even 4-) coordinate precursor, where the solvent can occupy the vacant sites. As previously mentioned, the observed shift will be an average over all the exchanging species, so the properties of the solvent will affect the observed shift. The flattening of the shift range in DMSO indicates that this solvent also affects the equilibrium position of the dissociation reaction, presumably due to its very strong donor ability. Looking at dissociating systems is therefore best done in a weakly or non-coordinating solvent, but with some of these complexes this is not possible.

Dissociation of these complexes is further discussed in chapter 5.

Coupling constants do show the expected increase with average electronegativity of ligand, even if this is rather irregular, and the values are in the expected range for 6-coordinate complexes (93,126). The irregularity is a further indication that the complexes are formed discretely, by the same argument as that employed for shift values; an exchanging mixture of  $\text{Me}_2\text{Sn}(\text{NCS})_4^{2-}$  and  $\text{Me}_2\text{SnCl}_4^{2-}$  would produce an observed value that varied linearly with the mole fractions of the components. Coupling constant differences between solvents can also be explained by involvement of solvent in the dissociation equilibrium, as with the  $\delta$  values. J values are well known to vary with solvent in 4-coordinate alkyltin halides (10,11,48,97,115,174,176).

The observed chemical shift concentration dependence is small, even for the relatively soluble complex used. This is probably because the solvent is always present in very large excess.

Mossbauer data show fairly conclusively that discrete complexes are formed, since results are obtained that could not be produced by a mixture of species.

Variation of values with cation is not expected, but is obviously significant in some cases ( $\text{Pr}_4\text{N}^+$  or  $\text{Et}_4\text{N}^+$  for  $\text{Me}_2\text{Sn}(\text{NCS})_4^{2-}$ ) so values are compared between complexes with the same cation -  $\text{Et}_4\text{N}^+$ .

$\delta$  values decreases irregularly as n increases, and therefore as  $\kappa_{\text{ave}}$  decreases. Since  $\delta$  depends on the s electron density at the nucleus, (see Ch.1 section 4.1.1), which will decrease as the electronegativity of the ligands increases, this is reasonable.  $\Delta E_q$  values are all around  $4 \text{ mms}^{-1}$ , confirming the supposition from the IR spectra that the complexes contain trans Me-Sn-Me units.

The values compare well with those expected on the basis of the additivity model, using Bancroft's derived  $(\text{pqs})_{\text{L}}$  values (Ch.1 section 4.2.2 and (147). Please see table).

<u>Values</u>	$(\text{pqs})_{\text{alkyl}} = - 1.03$
	$(\text{pqs})_{\text{NCS}} = + 0.07$

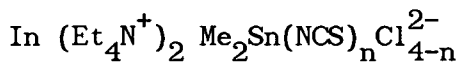

n	$\Delta E_q$ (expected)	$\Delta E_q$ (obtained)
4	4.40	4.33
3	4.33	4.35
2	4.26	4.30
1	4.19	4.06
0	4.12	4.13

In view of the approximations in the model, the only value that is a long way from the expected one is  $\Delta E_q$  for  $[(\text{Et}_4\text{N}^+)_2 \text{Me}_2\text{Sn}(\text{NCS})\text{Cl}_3^{2-}]$ . The model therefore applies reasonably well to these complexes, and they are definitely formed discretely in the solid state where they probably have fairly regular octahedral geometry, since distortions would affect the  $\Delta E_q$  values.

None of the techniques used can discriminate between the cis and trans halogen isomers of  $(\text{Et}_4\text{N}^+)_2 \text{Me}_2\text{Sn}(\text{NCS})_2 \text{Cl}_2^{2-}$ . This is left to X-ray crystallography.

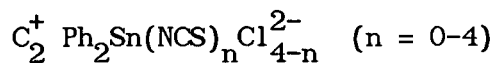
4 DIPHENYLTIN THIOCYANATOCHLORIDE COMPLEXES

NMR data for diphenyltin complexes is more difficult to obtain because these compounds are even less soluble than the dimethyltin analogues. Also, IR spectra are more complex, and due to the higher mass of the phenyl group, many of the bands of interest (eg.  $\nu_{Sn-C}$ ,  $\nu_{Sn-X}$ ) are of too low frequency to be detectable, hence less structural information is obtainable. For these reasons, data for these compounds is more limited, and particularly because of low solubility,  $^{119}Sn$  NMR data could not be obtained using the same cation or solvent as in the previous series, making comparisons between them rather indirect.

4.1 Infra-red data

For  $(\text{Bu}_4\text{P}^+)_2 \text{Ph}_2\text{Sn}(\text{NCS})_n \text{Cl}_{4-n}^{2-}$   $n = 1-4$ . All values in  $\text{cm}^{-1}$ .

n =        4                    3                    2                    1                    assignment

---

	2040 vs	2050s	2070vs	2080s	$\nu_{\text{as}}$ NCS
				1340w	
	1275w	1278vw		1282w	
	1261w	1262w		1265w	
	1222m	1228m	1225w	1223w	
+sh	1218	+sh 1220w			
	1180w	1182w	1182vw	1182vw	
	1149w	1152w	1150w	1150w	
	1089m-s	1090m	1092m	1092m	$\delta$ C-H
	1071m	1075m	1069m	1069m	q mode
			1050vw	1050vw	
	1021m, sh	1025w	1025w	1020w, sh	
	994m	995w	995w	995w	
	960m	964m	964m	965m	r mode
	901m-s	905m-s	905m-s	905m	$\Pi$ CH
			+sh 915	+sh 915	
			895	895	
	841m-w	845w	845w	845w	
	780	785			
	769 vw	772 vw		770 vw	
	758	760	760w		
			746w		
	735vs, sh	739s, sh	731s, sh	732s, sh	$\Pi$ CH



n =        4                3                2                1                assignment

718m-s        722                721m        +sh 721

+sh 712

692s, sh        698s, sh        691m, sh        692s, sh        r mode

660w                665vw

470m                475m-w        468                470w                 $\delta$  NCS +

458s, sh        462m, sh        460m                460m, sh        y mode

440

388vw

330vw

292s                296m                288w-m        289m                t mode

+sh 275

ref. (34)

#### 4.2 $^{119}\text{Sn}$ NMR chemical shift data

Anion	cation	solvent	shift(-ppm)
$\text{Ph}_2\text{Sn}(\text{NCS})_4^{2-}$	$\text{Bu}_4\text{P}^+$	$\text{CHCl}_3$	502.7
$\text{Ph}_2\text{Sn}(\text{NCS})_3\text{Cl}^{2-}$	$\text{Bu}_4\text{P}^+$	$\text{CHCl}_3$	376.1
$\text{Ph}_2\text{Sn}(\text{NCS})_2\text{Cl}_2^{2-}$	$\text{Bu}_4\text{P}^+$	$\text{CHCl}_3$	308.0
$\text{Ph}_2\text{Sn}(\text{NCS})\text{Cl}_3^{2-}$	$\text{Bu}_4\text{P}^+$	$\text{CHCl}_3$	273.1
$\text{Ph}_2\text{SnCl}_4^{2-}$	$\text{Pr}_4\text{N}^+$	$\text{CHCl}_3$	253.9
$\text{Ph}_2\text{SnCl}_4^{2-}$	$\text{PNP}^+$	$\text{MeCN}$	251.6
$\text{Ph}_2\text{SnCl}_4^{2-}$	$\text{Pe}_4\text{N}^+$	$\text{MeCN}$	270.7

Figure 3.4

$^{119}\text{Sn}$  chemical shifts of  
 $(\text{Bu}_4\text{P}^+)_2\text{Ph}_2\text{Sn}(\text{NCS})_n\text{Cl}_{4-n}^{2-}/\text{CHCl}_3$   
 $n=0-4$ , cation =  $\text{Pr}_4\text{N}^+$  when  $n=0$

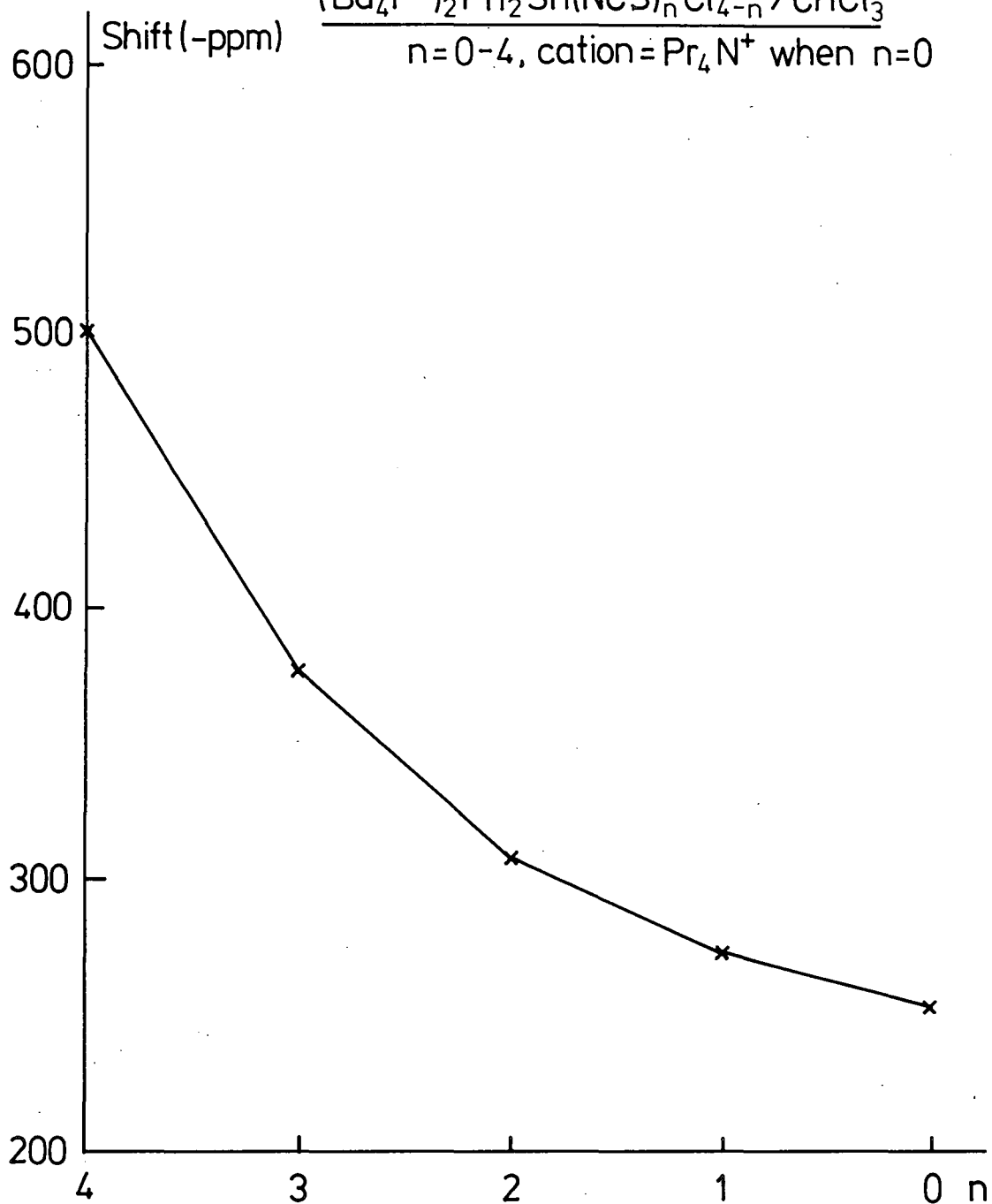

## 4.3 Mossbauer data

Compound	$\delta$ (mms <sup>-1</sup> )	$\Delta E_q$ (mms <sup>-1</sup> )	$\Gamma_1$ (mms <sup>-1</sup> )	$\Gamma_2$ (mms <sup>-1</sup> )
(Bu <sub>4</sub> P <sup>+</sup> ) <sub>2</sub> Ph <sub>2</sub> Sn(NCS) <sub>4</sub> <sup>2-</sup>	1.06	3.88	1.03	1.05
(Et <sub>4</sub> N <sup>+</sup> ) <sub>2</sub> Ph <sub>2</sub> Sn(NCS) <sub>4</sub> <sup>2-</sup>	1.09	3.87	1.00	1.04
(Et <sub>4</sub> N <sup>+</sup> ) <sub>2</sub> Ph <sub>2</sub> Sn(NCS) <sub>3</sub> Cl <sup>2-</sup>	1.12	3.49	1.23	1.18
(Et <sub>4</sub> N <sup>+</sup> ) <sub>2</sub> Ph <sub>2</sub> Sn(NCS) <sub>2</sub> Cl <sub>2</sub> <sup>2-</sup>	1.12	3.71	1.05	1.03
(Bu <sub>4</sub> P <sup>+</sup> ) <sub>2</sub> Ph <sub>2</sub> Sn(NCS)Cl <sub>3</sub> <sup>2-</sup>	1.21	3.56	1.03	1.05
(Et <sub>4</sub> N <sup>+</sup> ) <sub>2</sub> Ph <sub>2</sub> Sn(NCS)Cl <sub>3</sub> <sup>2-</sup>	1.23	3.51	1.13	1.09
(Bu <sub>4</sub> P <sup>+</sup> ) <sub>2</sub> Ph <sub>2</sub> SnCl <sub>4</sub> <sup>2-</sup>	1.31	3.59	0.98	0.98
(Et <sub>4</sub> N <sup>+</sup> ) <sub>2</sub> Ph <sub>2</sub> SnCl <sub>4</sub> <sup>2-</sup>	1.30	3.56	1.05	1.12

Error on these values = 0.03mms<sup>-1</sup>

Figure 3.5

Mossbauer isomer shifts vs average  
ligand electronegativity for  
 $(Et_4N^+)_2 / (Bu_4P^+)_2 Ph_2Sn(NCS)_n Cl_{4-n}$   
 $n=0-4$

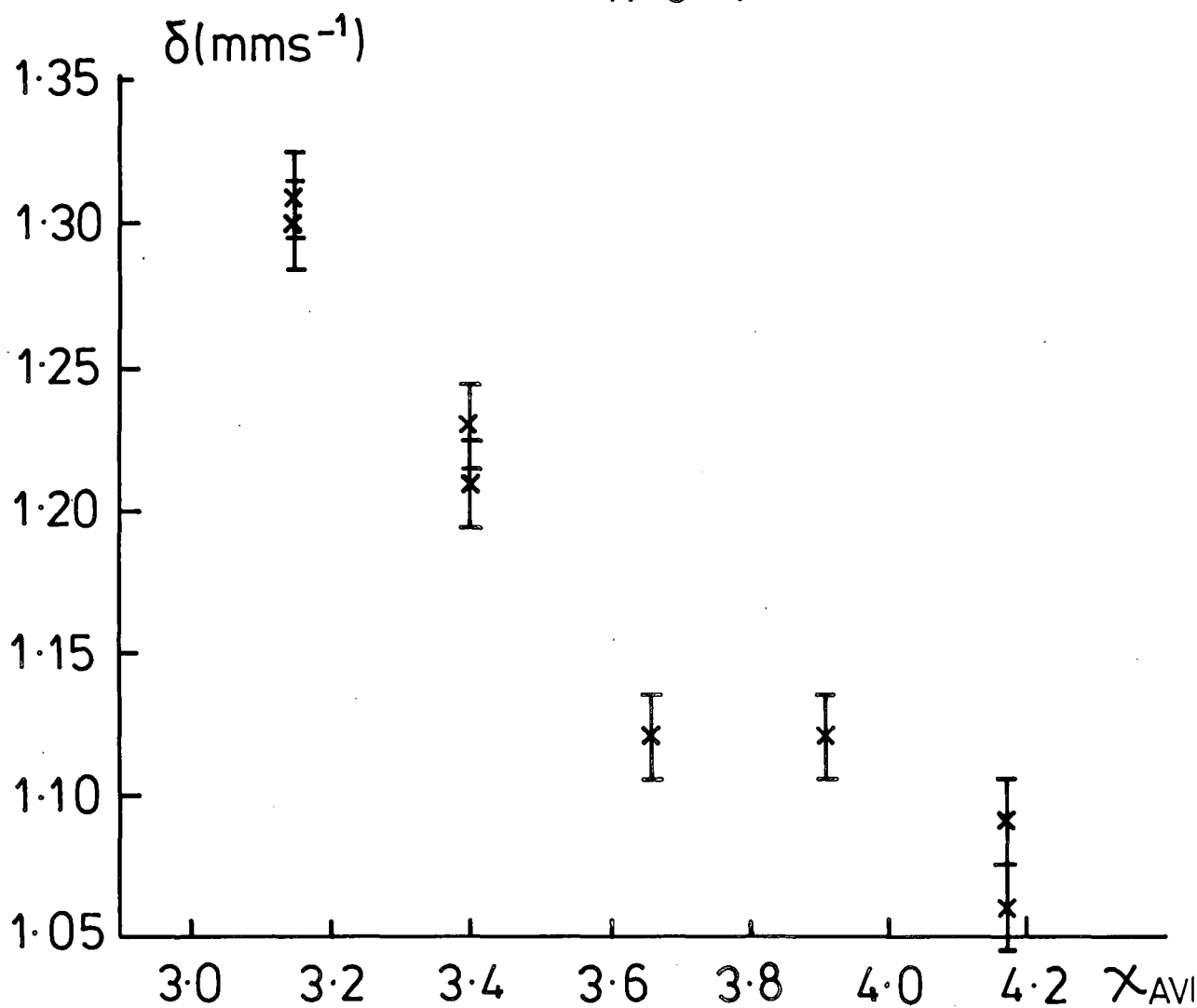

#### 4.4 Discussion

All that can be deduced with any certainty from the infra-red data are that the compounds contain [Ph-Sn] units, and N-bonded thiocyanate groups.

The  $^{119}\text{Sn}$  chemical shift data show a broadly similar trend to the dimethyltin complexes, but all the values are on average  $\approx$  100ppm to higher field. This is not expected on the basis of group electronegativity, ( $X_{\text{Ph}} = 2.49$ ,  $X_{\text{Me}} = 2.27$  (121,175)) but may be due to the greater bulk and polarisability of the phenyl group, and/or the increased Lewis acidity of the tin in these compounds. The decrease in shielding as n increases is much more regular for  $\text{Ph}_2\text{Sn}$  complexes, but the direction and amount of total change (275ppm for  $\text{Me}_2\text{Sn}$  complexes in MeCN, 249ppm for  $\text{Ph}_2\text{Sn}$  complexes in  $\text{CHCl}_3$  - DMSO not considered due to the probability of large solvent effects) is roughly the same in both cases, indicating that the same factors are changing in both series.

Mossbauer data show fairly conclusively that the complexes are obtained discretely and not as mixtures. The  $\delta$  values are lower than for methyl complexes. This is expected in view of the higher electronegativity of the phenyl group, but the difference ( $\approx 18\%$ ) is proportionally greater than the small difference in substituent electronegativity. The variation across the series is similar to the dimethyl compounds, but the amount of change in both cases ( $\approx 18\%$  again) is comparable to the substituent electronegativity difference.

$\Delta E_{\text{q}}$  values are also lower than in the dimethyl complexes, due to a reduction in electron density imbalance across the tin nucleus. The values are still nearer to  $4\text{mms}^{-1}$  than  $2\text{mms}^{-1}$ , so

these complexes also contain trans organic groups.

The values do not compare nearly so well with those expected on the basis of the point charge model as those of the dimethyl complexes. Agreement is better if a  $(pqs)_{Ph}$  value derived from our obtained value of  $\Delta E_q(\text{Ph}_2\text{SnCl}_4^{2-})$  is used, rather than Bancroft's value, but there is still considerable discrepancy. This is most probably caused by distortion from regular octahedral geometry.

$(pqs)_L$  values

$$(pqs)_{Ph} = - 0.95 \text{ mms}^{-1} \text{ (ref. 147)}$$

$$(pqs)_{Ph} = - 0.89 \text{ mms}^{-1} \text{ (derived)}$$

$$(pqs)_{NCS} = + 0.07 \text{ mms}^{-1} \text{ (ref. 147)}$$

$\Delta E_q$  values

Anion	Expected value using		Obtain
	Bancroft	derived val	
$\text{Ph}_2\text{Sn}(\text{NCS})_4^{2-}$	4.08	3.84	3.88
$\text{Ph}_2\text{Sn}(\text{NCS})_3\text{Cl}^{2-}$	4.01	3.77	3.49
$\text{Ph}_2\text{Sn}(\text{NCS})_2\text{Cl}_2^{2-}$	3.94	3.70	3.71
$\text{Ph}_2\text{Sn}(\text{NCS})\text{Cl}_3^{2-}$	3.87	3.63	3.51
$\text{Ph}_2\text{SnCl}_4^{2-}$	3.80	3.56	3.56

5 5-COORDINATE COMPLEXES (Et<sub>4</sub>N<sup>+</sup>) Me<sub>2</sub>Sn(NCS)<sub>n</sub>Cl<sub>3-n</sub><sup>2-</sup>

n = 0-3,

5.1 Infra-red data(all values in cm<sup>-1</sup>)

n = 0	1	2	assignment
	2040 vs	2040 s	$\nu_{as}$ NCS
	1300m	1300w-m	
	1260w	1258w	
1175m	1170m-s	1170m	
	+sh 1180	+sh 1180	
1070w	1068w	1068w	
1051w	1050w-m	1050w-m	
1035vw	1030w	1028w	
998m	998m-s	998m	
	950vw	950vw	
905vw	900vw		
790s, br	785vs	780vs	$\rho_s$ CH <sub>3</sub>
722m	720m	720m	$\rho_{as}$ CH <sub>3</sub>
562	562	574w	$\nu_{as}$ Sn-C <sub>2</sub>
570 d,m	568 d,m		
512w	510w	518m	$\nu_s$ Sn-C <sub>2</sub>

n =        0                1                2                assignment

---

	472m	474m	$\delta$ NCS
415vw		415vw	
315m	325m } 310s }	320m-s	$\nu$ Sn-Cl
240m-s	250m, br	250m, br	
ref. (42)			

### 5.2 $^{119}\text{Sn}$ NMR chemical shift data

Run in  $\text{CH}_3\text{CN}$  on  $\text{Et}_4\text{N}^+$  salts.

Anion	$\delta$ (-ppm)
$\text{Me}_2\text{Sn}(\text{NCS})_2\text{Cl}^-$	184.05
$\text{Me}_2\text{Sn}(\text{NCS})\text{Cl}_2^-$	161.21
$\text{Me}_2\text{SnCl}_3^-$	115.97



### 5.3 Discussion

The infra-red data again show that the ions contain N-bonded thiocyanate groups. The spectra show a greater degree of complexity than those of the 6-coordinate analogues; in the  $\nu$  Sn-C<sub>2</sub> region both  $\nu_{as}$  and  $\nu_s$  are visible, and  $\nu_{as}$  is sometimes split (in  $\text{Me}_2\text{SnCl}_3^-$  and  $\text{Me}_2\text{Sn}(\text{NCS})\text{Cl}_2^-$ ), indicating that the ions contain cis methyl groups, with some distortion from regular trigonal bipyramidal geometry. Two bands are visible in the  $\nu$  Sn-Cl region, but the lower one is rather broad, so could well contain both of the reported bands (ref.31 -  $\nu$  Sn-Cl at 315, 256 and  $242\text{cm}^{-1}$ ) in this range. This again indicates a trigonal bipyramidal arrangement with cis methyl groups.

<sup>119</sup>Sn chemical shifts are at much lower field than those of the 6-coordinate ions, which is expected, but the difference is quite large. This could possibly be due to dissociation.

We have no data that proves conclusively that these complexes are formed discretely, but it seems reasonable to assume that they are, on the basis of the findings for the 6-coordinate complexes.

The preparation of  $(\text{Pr}_4\text{N}^+) \text{Me}_2\text{Sn}(\text{NCS})_3^-$  was attempted, but on dissolving 1:1  $\text{Pr}_4\text{NNCS}$  and  $\text{Me}_2\text{Sn}(\text{NCS})_2$  in ethanol,  $(\text{Pr}_4\text{N}^+)_2 \text{Me}_2\text{Sn}(\text{NCS})_4^{2-}$  and  $\text{Me}_2\text{Sn}(\text{NCS})_2$  were formed.

## 6 EXPERIMENTAL

### 6.1 General

Amounts of reactants were measured out in the glove box, and weighed in air-tight containers, as were samples for Mossbauer and  $^{119}\text{Sn}$  NMR work.

All reactions were carried out under an atmosphere of dry nitrogen, to exclude atmospheric moisture.

The commercially obtained salts ( $\text{Et}_4\text{N}^+\text{NCS}^-$ ,  $\text{Et}_4\text{N}^+\text{Cl}^-$ ,  $\text{Pr}_4\text{N}^+\text{Cl}^-$ ,  $\text{Bu}_4\text{P}^+\text{Cl}^-$  and  $\text{Ph}_4\text{P}^+\text{Cl}^-$ ) were dried before use by dissolving the material in methanol, removing the solvent under vacuum, and then repeating the process with toluene. In the case of the very hygroscopic salts, this was followed by stirring for long periods in low boiling ( $30\text{--}40^\circ\text{C}$ ) petroleum ether, filtering off the solid from the suspension and pumping to dryness. Solids were then stored under nitrogen.

$\text{Pr}_4\text{N}^+$ ,  $\text{Bu}_4\text{P}^+$  and  $\text{Ph}_4\text{P}^+$  thiocyanates were prepared by double decomposition of the appropriate chloride with an excess of KNCS in ethanolic solution. The method used was the same as that given in the next section for  $\text{R}_2\text{Sn}(\text{NCS})_2$ , but using a molar ratio of approx 1.5 moles KNCS : 1 mole chloride.

PNPCL was prepared by Mr J.Lincoln, and  $(\text{Pe}_4\text{N}^+)_2 \text{Ph}_2\text{SnCl}_4^{2-}$  by Mr G.Hewitson.

## 6.2 Preparation of 4-coordinate compounds

Dimethyl and diphenyltin diisothiocyanates were prepared in ethanolic solution by double decomposition between KNCS and the appropriate chloride (177).

A slight excess over 2 molar equivalents of KNCS was dissolved in hot ethanol and a solution (in ethanol) of the chloride added, with stirring. A white precipitate of KCl appeared immediately, and then the solution was allowed to cool to room temperature and stirred for approx. 1 hr. After this time, the solids were filtered off and the volume of solvent reduced under vacuum until a precipitate of product was obtained. This was filtered off, washed with pet. ether (30-40°C) and dried. The product was used without further purification for preparation of complexes, or recrystallised from a mixture of toluene/methanol.

$\text{Me}_2\text{Sn}(\text{NCS})_2$  Expect C 18.14% H 2.28% N 10.57%

Obtain C 17.68% H 2.45% N 10.50%

$\text{Ph}_2\text{Sn}(\text{NCS})_2$  Expect C 42.13% H 5.05% N 7.02%

Obtain C 40.14% H 3.50% N 5.94%

## 6.3 Preparation of complexes

These were prepared by combining solutions of the appropriate ratio of tetraalkyl ammonium/phosphonium halide/pseudohalide with  $\text{R}_2\text{SnX}_2$ , in ethanol - or dichloromethane for the more soluble chlorides. Precipitation either occurred immediately for the thiocyanates, or on reduction in volume of solvent for chlorides.

Contamination of products by EtOH was discounted due to the absence of  $\nu$  O-H from their IR spectra.

Reaction mixtures

Complex	$R_2SnX_2$	ratio of halide	solvent
$(Et_4N^+)_2$ $Me_2SnCl_4^{2-}$	$Me_2SnCl_2$	2 $Et_4NCl$	$CH_2Cl_2$
$(Bu_4P^+)_2$ $Me_2SnCl_4^{2-}$	$Me_2SnCl_2$	2 $Bu_4PCl$	$CH_2Cl_2$
$(Et_4N^+)_2$ $Me_2Sn(NCS)Cl_3^{2-}$	$Me_2SnCl_2$	1 $Et_4NCl$ +1 $Et_4NNCS$	EtOH
$(Et_4N^+)_2$ $Me_2Sn(NCS)_2Cl_2^{2-}$	$Me_2SnCl_2$	2 $Et_4NNCS$	EtOH
$(Et_4N^+)_2$ $Me_2Sn(NCS)_3Cl^{2-}$	$Me_2Sn(NCS)_2$	1 $Et_4NNCS$ +1 $Et_4NCl$	EtOH
$(Et_4N^+)_2$ $Me_2Sn(NCS)_4^{2-}$	$Me_2Sn(NCS)_2$	2 $Et_4NNCS$	EtOH
$(Pr_4N^+)_2$ $Me_2Sn(NCS)_4^{2-}$	$Me_2Sn(NCS)_2$	2 $Pr_4NNCS$	EtOH

Complex	$R_2SnX_2$	halide	solvent
$(Et_4N^+)_2$ $Ph_2SnCl_4^{2-}$	$Ph_2SnCl_2$	2 $Et_4NCl$	$CH_2Cl_2$
$(Pr_4N^+)_2$ $Ph_2SnCl_4^{2-}$	$Ph_2SnCl_2$	2 $Pr_4NCl$	$CH_2Cl_2$
$(Bu_4P^+)_2$ $Ph_2SnCl_4^{2-}$	$Ph_2SnCl_2$	2 $Bu_4PCl$	$CH_2Cl_2$
$(PNP^+)_2$ $Ph_2SnCl_4^{2-}$	$Ph_2SnCl_2$	2 $PNPCl$	EtOH
$(Et_4N^+)_2$ $Ph_2Sn(NCS)Cl_3^{2-}$	$Ph_2SnCl_2$	1 $Et_4NCl$ +1 $Et_4NNCS$	EtOH
$(Bu_4P^+)_2$ $Ph_2Sn(NCS)Cl_3^{2-}$	$Ph_2SnCl_2$	1 $Bu_4PCl$ +1 $Bu_4PNCS$	EtOH
$(Et_4N^+)_2$ $Ph_2Sn(NCS)_2Cl_2^{2-}$	$Ph_2SnCl_2$	2 $Et_4NNCS$	EtOH
$(Bu_4P^+)_2$ $Ph_2Sn(NCS)_2Cl_2^{2-}$	$Ph_2SnCl_2$	2 $Bu_4PNCS$	EtOH
$(Et_4N^+)_2$ $Ph_2Sn(NCS)_3Cl^{2-}$	$Ph_2Sn(NCS)_2$	1 $Et_4NCl$ +1 $Et_4NNCS$	EtOH
$(Bu_4P^+)_2$ $Ph_2Sn(NCS)_3Cl^{2-}$	$Ph_2Sn(NCS)_2$	1 $Bu_4PCl$ +1 $Bu_4PNCS$	EtOH
$(Et_4N^+)_2$ $Ph_2Sn(NCS)_4^{2-}$	$Ph_2Sn(NCS)_2$	2 $Et_4NNCS$	EtOH
$(Bu_4P^+)_2$ $Ph_2Sn(NCS)_4^{2-}$	$Ph_2Sn(NCS)_2$	2 $Bu_4PNCS$	EtOH

Complex	$R_2SnX_2$	ratio of halide	solvent
$(Et_4N^+)$ $Me_2SnCl_3^-$	$Me_2SnCl_2$	1 $Et_4NCl$	$CH_2Cl_2$
$(Et_4N^+)$ $Me_2Sn(NCS)Cl_2^-$	$Me_2SnCl_2$	1 $Et_4NNCS$	EtOH
$(Et_4N^+)$ $Me_2Sn(NCS)_2Cl^-$	$Me_2Sn(NCS)_2$	1 $Et_4NCl$	EtOH

Analytical results

Complex	C	H	N
$(Et_4N^+)_2$ Expect	39.23	8.41	5.08
$Me_2SnCl_4^{2-}$ Obtain	39.18	10.06	4.95
$(Bu_4P^+)_2$ Expect	50.45	9.71	0
$Me_2SnCl_4^{2-}$ Obtain	48.14	9.64	0
$(Et_4N^+)_2$ Expect	39.78	8.08	7.32
$Me_2Sn(NCS)Cl_3^{2-}$ Obtain	37.00	7.87	6.76
$(Et_4N^+)_2$ Expect	40.28	7.78	9.40
$Me_2Sn(NCS)_2Cl_2^{2-}$ Obtain	39.63	7.91	9.12
$(Et_4N^+)_2$ Expect	40.75	7.49	11.31
$Me_2Sn(NCS)_3Cl^{2-}$ Obtain	39.32	8.04	10.24
$(Et_4N^+)_2$ Expect	41.18	7.23	13.10
$Me_2Sn(NCS)_4^{2-}$ Obtain	38.93	7.80	10.08
$(Pr_4N^+)_2$ Expect	47.80	8.29	11.15
$Me_2Sn(NCS)_4^{2-}$ Obtain	44.95	7.27	9.65

Complex	C	H	N
(Et <sub>4</sub> N <sup>+</sup> ) <sub>2</sub> Expect	49.81	7.46	4.15
Ph <sub>2</sub> SnCl <sub>4</sub> <sup>2-</sup> Obtain	51.22	8.41	4.21
(Pr <sub>4</sub> N <sup>+</sup> ) <sub>2</sub> Expect	54.77	8.43	3.55
Ph <sub>2</sub> SnCl <sub>4</sub> <sup>2-</sup> Obtain	49.18	7.00	2.21
(Bu <sub>4</sub> P <sup>+</sup> ) <sub>2</sub> Expect	56.61	8.85	0
Ph <sub>2</sub> SnCl <sub>4</sub> <sup>2-</sup> Obtain	58.79	8.66	0
(PNP <sup>+</sup> ) <sub>2</sub> Expect	61.62	4.73	0
Ph <sub>2</sub> SnCl <sub>4</sub> <sup>2-</sup> Obtain	61.46	3.81	0
(Et <sub>4</sub> N <sup>+</sup> ) <sub>2</sub> Expect	49.0	7.22	6.05
Ph <sub>2</sub> Sn(NCS)Cl <sub>3</sub> <sup>2-</sup> Obtain	48.2	7.47	6.84
(Bu <sub>4</sub> P <sup>+</sup> ) <sub>2</sub> Expect	56.52	8.64	1.46
Ph <sub>2</sub> Sn(NCS)Cl <sub>3</sub> <sup>2-</sup> Obtain	53.62	9.52	0.94
(Et <sub>4</sub> N <sup>+</sup> ) <sub>2</sub> Expect	51.3	7.17	7.97
Ph <sub>2</sub> Sn(NCS) <sub>2</sub> Cl <sub>2</sub> <sup>2-</sup> Obtain	53.8	7.98	8.43
(Bu <sub>4</sub> P <sup>+</sup> ) <sub>2</sub> Expect	56.44	8.44	2.86
Ph <sub>2</sub> Sn(NCS) <sub>2</sub> Cl <sub>2</sub> <sup>2-</sup> Obtain	53.91	10.33	1.87
(Et <sub>4</sub> N <sup>+</sup> ) <sub>2</sub> Expect	49.43	6.69	9.30
Ph <sub>2</sub> Sn(NCS) <sub>3</sub> Cl <sup>2-</sup> Obtain	44.04	5.65	6.82
(Bu <sub>4</sub> P <sup>+</sup> ) <sub>2</sub> Expect	56.21	8.06	4.10
Ph <sub>2</sub> Sn(NCS) <sub>3</sub> Cl <sup>2-</sup> Obtain	53.27	8.85	4.67
(Et <sub>4</sub> N <sup>+</sup> ) <sub>2</sub> Expect	50.19	6.58	10.98
Ph <sub>2</sub> Sn(NCS) <sub>4</sub> <sup>2-</sup> Obtain	47.72	6.42	9.98
(Et <sub>4</sub> N <sup>+</sup> ) <sub>2</sub> Expect	56.30	8.07	5.47
Ph <sub>2</sub> Sn(NCS) <sub>4</sub> <sup>2-</sup> Obtain	60.74	11.50	6.91



Complex		C	H	N
(Et <sub>4</sub> N <sup>+</sup> )	Expect	31.17	6.80	3.63
Me <sub>2</sub> SnCl <sub>3</sub> <sup>-</sup>	Obtain	32.44	8.01	4.13
(Et <sub>4</sub> N <sup>+</sup> )	Expect	32.38	6.42	6.87
Me <sub>2</sub> Sn(NCS)Cl <sub>2</sub> <sup>-</sup>	Obtain	33.13	6.59	6.74
(Et <sub>4</sub> N <sup>+</sup> )	Expect	33.47	6.09	9.70
Me <sub>2</sub> Sn(NCS) <sub>2</sub> Cl <sup>-</sup>	Obtain	30.83	8.54	7.02

## CHAPTER 4

MIXED DIMETHYLTIN CHLORIDE/PSEUDOHALIDE COMPLEXESPSEUDOHALIDE = AZIDE, CYANATE, CYANIDE1 INTRODUCTION

As with alkyltin halides and isothiocyanates, less structural information is available for dimethyltin azides, cyanates and cyanides than for trimethyltin derivatives.  $\text{Me}_2\text{Sn}(\text{CN})_2$  is the only crystal structure known out of this list (43), but the structures of  $\text{Me}_3\text{SnCN}$ ,  $\text{Me}_3\text{SnN}_3$  and  $\text{Ph}_3\text{SnNCO}$  have been determined (21,23,24) and show the compounds to be intermolecularly coordinated, with an approximately trigonal bipyramidal configuration about the tin atom.

$^{119}\text{Sn}$  NMR data is confined to trialkyltin compounds; shifts and  $^2J$  ( $^{119}\text{Sn}-\text{C}-^1\text{H}$ ) values in a variety of solvents are known for  $\text{Me}_3\text{SnN}_3$ ,  $\text{Me}_3\text{SnNCO}$  and  $\text{Bu}_3\text{SnCN}$  (13,126,174).  $\delta(^1\text{H})$  and  $^2J(^{119}\text{Sn}-\text{C}-^1\text{H})$  have been determined for  $\text{Me}_2\text{Sn}(\text{N}_3)_2$  in pyridine (174), the value of 94.5Hz for  $^2J$  indicating that complexation is taking place, as is expected in a donor solvent.

Infra-red (90,156,178) and Mossbauer data (144,147,178,179) have been more widely reported (please see below). The data do not include values for  $\nu_{\text{as}}$  and  $\nu_{\text{s}}$   $\text{Sn}-\text{C}_2$ , so no judgement can be made on the planarity or otherwise of the methyl groups. The low value of  $\nu_{\text{as}} \text{N}_3$  has been interpreted as showing extensive intermolecular coordination to be present (89).  $\nu \text{Sn}-\text{Ps}$  has been assigned for  $\text{Me}_3\text{SnN}_3$  and  $\text{Me}_3\text{SnNCO}$  at 462 and 400  $\text{cm}^{-1}$  respectively (157).

Infra-red data

Compound	$\nu_{as}$	$\nu_s$	$\delta$
$\text{Me}_3\text{SnN}_3$	2088	1286	660
$\text{Me}_3\text{SnNCO}$	2243	1375	618
$\text{Me}_3\text{SnCN}$	2163		
$\text{Me}_2\text{Sn}(\text{N}_3)_2$	2062	1278	660
$\text{Me}_2\text{Sn}(\text{NCO})_2$	2204		
$\text{Me}_2\text{Sn}(\text{CN})_2$	2174		

Mossbauer data

	$\delta$	$\Delta E_q$	ref.
$\text{Me}_3\text{SnN}_3$	1.43	3.67	179
	1.34	3.45	147
$\text{Me}_3\text{SnNCO}$	1.36	3.31	178
$\text{Me}_3\text{SnCN}$	1.35	3.10	147
	1.41	3.19	144
$\text{Me}_2\text{Sn}(\text{N}_3)_2$	1.29	2.84	178
	1.26	3.17	179
$\text{Me}_2\text{Sn}(\text{NCO})_2$	1.06	2.61	147

$\text{Me}_2\text{Sn}(\text{N}_3)_2$  and  $\text{Me}_2\text{Sn}(\text{NCO})_2$  have quadrupole splittings that are closer to the expected values for cis alkyl groups than for trans. On this basis, their structures have been assigned as distorted tetrahedral and monomeric in the solid state, in contrast to the conclusions from IR data (178,179).

Studies of anionic complexes of these pseudohalides have been

confined to azides, and mixed azido-thiocyanato or -halo complexes. The most extensive study is that of  $(\text{Ph}_4\text{As}^+)_2 \text{Me}_2\text{Sn}(\text{N}_3)_4^{2-}$ , which has been assigned a trans octahedral structure with linear Me-Sn-Me units on the basis of Mossbauer and IR evidence (52).

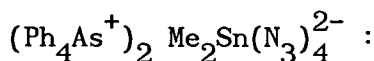

Mossbauer data

$$\delta = 1.23 \text{ mms}^{-1}, \quad \Delta E_q = 3.61 \text{ mms}^{-1}$$

$$\text{Infra-red } \nu_{\text{as}} \text{N}_3 = 2040 \text{ cm}^{-1}, \quad \nu_{\text{as}} \text{Sn-C}_2 = 555 \text{ cm}^{-1}$$

$$\nu_{\text{s}} \text{Sn-C}_2 = 497 \text{ cm}^{-1} \quad (\text{Raman band})$$

PMR (in methanol solution)

$$\delta = 0.75 \text{ ppm} \quad {}^2J = 88.5 \text{ Hz.}$$

Other complexes identified by IR and/or Mossbauer techniques are  $\text{Me}_4\text{N}^+$  and  $\text{Ph}_4\text{As}^+$  salts of  $\text{Ph}_3\text{Sn}(\text{N}_3)_2^-$ ,  $\text{Ph}_3\text{Sn}(\text{NCS})\text{N}_3^-$  and  $\text{Ph}_2\text{Sn}(\text{NCS})_2(\text{N}_3)_2^{2-}$  (52),  $(\text{Et}_4\text{N}^+) \text{Ph}_2\text{CySnXY}^-$  (X =  $\text{N}_3$ , Y = Cl, Br, NCS, X = NCS, Y = Br) and  $(\text{Et}_4\text{N}^+) \text{Ph}_3\text{SnXY}^-$  (X =  $\text{N}_3$ , NCS, Y = Cl, Br) (167, 169). The question of cis/trans isomerisation of pseudohalide in the 6-coordinate complex was not considered.

The aim of this study was therefore to supply information on the four-coordinate compounds and the mixed pseudohalo-chloride complexes produced from them, to prove the discrete existence (or otherwise) of the latter series of complexes, and perhaps make some comments on their structures.

2 FOUR-COORDINATE STARTING MATERIALS;  $\text{Me}_2\text{Sn}(\text{N}_3)_2$  and  $\text{Me}_2\text{Sn}(\text{NCO})_2$ 2.1 Infra-red data

All values in  $\text{cm}^{-1}$ . Ps = pseudohalide.

Spectra of both compounds appear very similar.

$\text{Me}_2\text{Sn}(\text{N}_3)_2$ (lit.)	$\text{Me}_2\text{Sn}(\text{NCO})_2$ (lit.)	assignment
2120 s	2210 vs	
2061 vs 2062	2180 vs 2204	$\nu_{\text{as}}$ Ps
1320 w		
	1305 w ?1375	$\nu_{\text{s}}$ NCO
1273 w 1278		$\nu_{\text{s}}$ $\text{N}_3$
	1258 vw	
1190 w	1195m	
1150 w	1150 w	
	1092 m	
1048 w-m	1058 m-s	
970 w	970 w	
	899 w-m	
780 m-s	780 m-s	$\rho_{\text{as}}$ $\text{CH}_3$
720 m	720 m	$\rho_{\text{s}}$ $\text{CH}_3$
640 s, sh 660		

$\text{Me}_2\text{Sn}(\text{N}_3)_2$ (lit.)	$\text{Me}_2\text{Sn}(\text{NCO})_2$ (lit.)	assignment
628 s,sh	618 m    618	$\delta$ Ps
589 m	590 m-s	
568 m	564 m-s	$\nu_{\text{as}}$ Sn-C <sub>2</sub>
518 w-m	521 m-s	$\nu_{\text{s}}$ Sn-C <sub>2</sub>
280 m	280 m-w	? $\nu$ Sn-PS

## 2.2 $^{119}\text{Sn}$ NMR chemical shifts

All run in DMSO, since their solubility is too low in other solvents to obtain a signal. Other values included for comparison.

Compound	$\delta$ (-ppm)	$\delta_{\text{ave}}$
$\text{Me}_2\text{SnCl}_2$	246.1	3.15
$\text{Me}_2\text{Sn}(\text{NCS})_2$	375.6	4.17
$\text{Me}_2\text{Sn}(\text{N}_3)_2$	330.1	4.42
$\text{Me}_2\text{Sn}(\text{NCO})_2$	305.4	4.46

### 2.3 Coupling Constants

Again, run in DMSO. Obtained from PMR spectra, with a measuring error of  $\pm 1$  Hz

Compound	$^2J$ (Hz)
$\text{Me}_2\text{SnCl}_2$	114.8*
$\text{Me}_2\text{Sn}(\text{NCS})_2$	115
$\text{Me}_2\text{Sn}(\text{NCO})_2$	107

\* from (21)

### 2.4 Discussion

The position of  $\nu_s$  NCO indicates that  $\text{Me}_2\text{Sn}(\text{NCO})_2$  is N-bonded, as is  $\text{Me}_3\text{Sn}(\text{NCO})$  and the majority of organometallic cyanates so far isolated (90). The presence of  $\nu_{as}$  and  $\nu_s$  Sn-C<sub>2</sub> in both spectra indicates that their solid state structures contain Me-Sn-Me units that are highly distorted from linearity. This is also the case in  $\text{Me}_2\text{SnCl}_2$  and  $\text{Me}_2\text{Sn}(\text{NCS})_2$ , the frequencies of the bands being comparable in all cases.

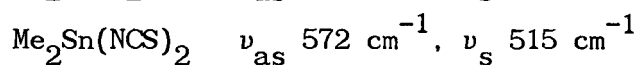

The azide and isocyanate compounds are highly insoluble, DMSO being the only solvent in which they are sufficiently soluble to give an NMR signal in a reasonable length of time. This indicates that strong intermolecular interactions are present in the solid state, as has been postulated by Thayer (15) on IR evidence, and

is also indicated by the short intermolecular distances in the structures of  $\text{Me}_3\text{SnN}_3$  and  $\text{Ph}_3\text{SnNCO}$  (23,24). The Mossbauer  $\Delta E_q$  values also indicate a bent Me-Sn-Me unit (nearly cis), but it is likely that the structures of the compounds are polymeric, with highly distorted octahedral configurations around the tin atom, rather than the tetrahedral monomers postulated by Cheng and Herber (179). Such a structure is found in  $\text{Me}_2\text{SnCl}_2$  (43) and  $\text{Me}_2\text{Sn}(\text{NCS})_2$  (45,46).

Chemical shift values are all at low frequency and in the expected range for 6-coordinate complexes (93,174), indicating that strong complexation is taking place in DMSO solution. No relationship is observed between  $\delta$  and substituent electronegativity, unlike the good linear correlation observed for  $\text{Me}_3\text{SnX}$  ( $X = \text{SiPh}_3, \text{H}, \text{CH}_3, \text{I}, \text{Br}, \text{Cl}$ ) (93). This shows that inductive withdrawal of electron density is not the dominant factor in determining the  $\delta$  value of these pseudohalides. It is possibly significant that tin is most shielded in  $\text{Me}_2\text{Sn}(\text{NCS})_2$ , which contains the heaviest and most polarisable pseudohalide. Size and polarisability of ligand are known to affect  $\delta$  (see Ch.1 Section 3.3.2), so this could be the cause of the higher shielding.

The Lewis acidity of the tin will also vary across the series, causing the strength of complexation to differ. This will also affect the shielding of the tin in the resultant complex.

$\text{Me}_2\text{Sn}(\text{N}_3)_2$  and  $\text{Me}_2\text{Sn}(\text{NCO})_2$  consistently gave low %N analysis figures, possibly due to incomplete or very rapid combustion of the compound during the analytical process. It seems definite, however, that the stated compounds were obtained in a reasonably



pure state, since tests for Cl on them were negative, the %C is reasonable for  $\text{Me}_2\text{Sn}(\text{NCO})_2$ , their IR spectra are in reasonable agreement with literature values and complexes of acceptable analysis were obtained when prepared from these compounds.

### 3 6-COORDINATE DIMETHYLTIN AZIDOCHLORIDE COMPLEXES

#### 3.1 Complexes with the tetraphenyl phosphonium cation

These complexes were prepared because of the applicability of the substitution method of Barbieri et al. (52). This did produce an excellent product in pure crystalline form, the crystal structure of which is presented in section 3.1.3.

It was found rather more difficult to obtain reasonable analytical results for the intermediate complexes, particularly  $(\text{Ph}_4\text{P}^+)_2 \text{Me}_2\text{Sn}(\text{N}_3)_3\text{Cl}^{2-}$  and  $\text{Me}_2\text{Sn}(\text{N}_3)\text{Cl}_3^{2-}$ , so no data for them are given.

##### 3.1.1 Infra-red data

All values in  $\text{cm}^{-1}$ .

n =            4                            2                            assignment

(KBr disc)

---

2035 s	2035 s	$\nu_{\text{as}} \text{N}_3$ (2040)
1584 w,br	1582 w br	k mode Ph
1479 w		
1432 m	Nujol	
1405 w		
1329 w-m	1328 w-m	?o mode Ph
1280 w	1280 w	$\nu_{\text{s}} \text{N}_3$
1220 vw		
1190 w	1185 w	
1160 w	1160 w	
1109 s	1109 s	q mode $\text{Ph}_4\text{P}^+$
	1069 w,br	
1028 vw	1025 w	

n = 4 2 assignment

(KBr disc)

---

996 m	995 w, sh	
760 m-s	760 m	f mode Ph and/or
725 s	724 s	$\rho$ CH
689 m-s	689 m-s	r mode $\text{Ph}_4\text{P}^+$ (687)
650 w	645 w	$\delta$ $\text{N}_3$ (660)
615w	615 w	
556 vw	556 vw	$\nu_{\text{as}}$ Sn-C <sub>2</sub> (555)
524 vs	524 s	y mode $\text{Ph}_4\text{P}^+$ (526)
	472 vw	
445 w	445 w	t mode $\text{Ph}_4\text{P}^+$ (454)
260 m, br	270 m, br	u mode $\text{Ph}_4\text{P}^+$ (283, 270)

### 3.1.2 $^{119}\text{Sn}$ chemical shift values

Run in DMSO due to low solubility.

Anion	d (-ppm)
$\text{Me}_2\text{Sn}(\text{N}_3)_4^{2-}$	331.7
$\text{Me}_2\text{Sn}(\text{N}_3)_2\text{Cl}_2^{2-}$	298.5

### 3.1.3 Crystal structure

(Please see over for structure)

The crystals are triclinic with unit cell parameters  $a = 12.38(1)$ ,  $b = 10.11(1)$ ,  $c = 11.44(1)\text{\AA}$ .  $\alpha = 123.1(1)^\circ$ ,  $\beta = 72.95(1)^\circ$ ,  $\gamma = 100.0(1)^\circ$ ,  $U = 1168.6\text{\AA}^3$  of space group  $P\bar{1}$ ,  $z = 2$ . The structure was obtained using  $\text{Mo-K}_\alpha$  radiation,  $\lambda = 0.7107\text{\AA}$ . 4059 independent reflections were collected, and the 3451 of these for which  $F > 3\sigma(F)$  were used to calculate the crystal structure.

There is a centre of symmetry at the tin atom.

#### Principle bond lengths and angles

Sn-N1 = 2.287 (3) all lengths in  $\text{\AA}$

Sn-N2 = 3.035 (4)

Sn-N4 = 2.250 (5)

Sn-N5 = 3.033 (6)

Sn-C25 = 2.134 (5)

N1-N2 = 1.187 (7)

N2-N2 = 1.136 (8)

N4-N5 = 1.178 (7)

N5-N6 = 1.150 (8)

$\widehat{\text{N1-Sn-N4}} = 88.7 (2)^\circ$

$\widehat{\text{N1-Sn-C25}} = 86.7 (2)^\circ$

$\widehat{\text{N4-Sn-C25}} = 91.6 (2)^\circ$

$\widehat{\text{Sn-N1-N2}} = 118.3 (3)^\circ$

$\widehat{\text{Sn-N4-N5}} = 121.3 (3)^\circ$

$\widehat{\text{N4-N5-N6}} = 178.3 (5)^\circ$

$\widehat{\text{N1-N2-N3}} = 177.8 (5)^\circ$

Fig.4.1 Crystal structure of  $(\text{Ph}_4\text{P}^+)_2\text{Me}_2\text{Sn}(\text{N}_3)_4^{2-}$

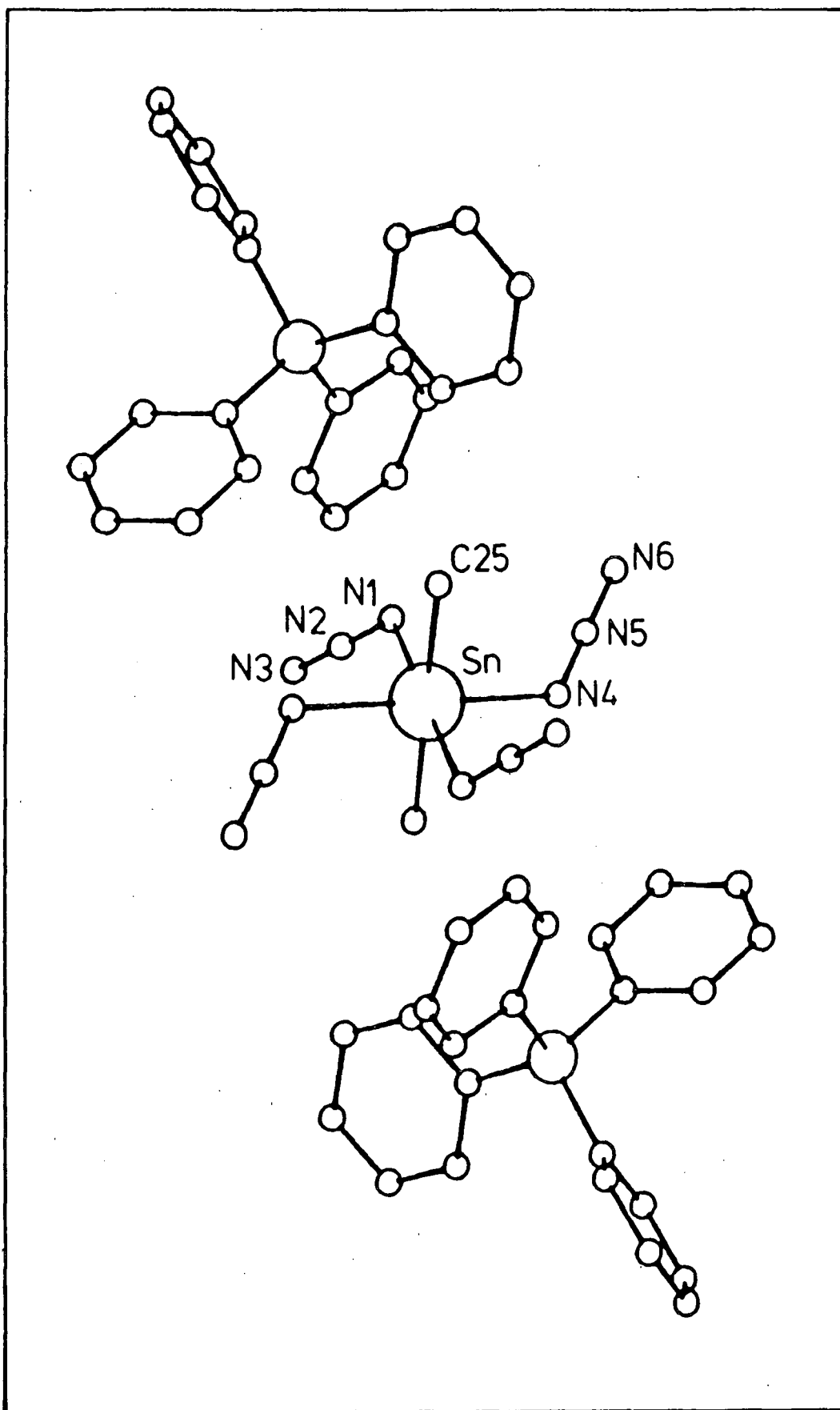
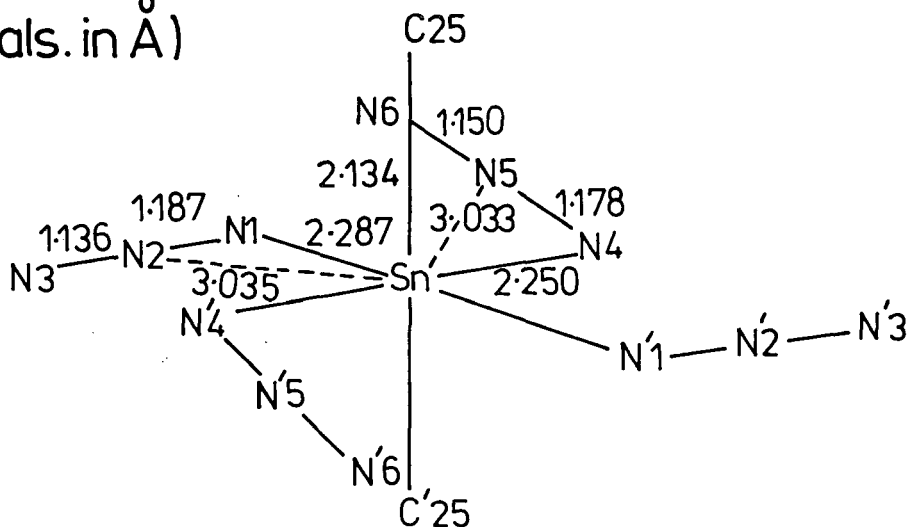

Fig. 4.2

Bond lengths and angles in the anion of  
 $(\text{Ph}_4\text{P}^+)_2\text{Me}_2\text{Sn}(\text{N}_3)_4^{2-}$

4.2a bond lengths  
 (all vals. in Å)



4.2b bond angles

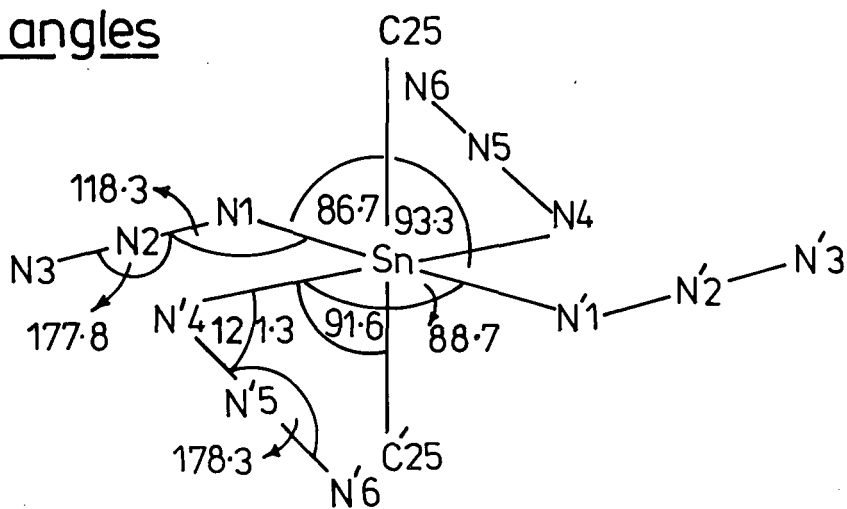

4.2c Arrangement of azide groups vertical section

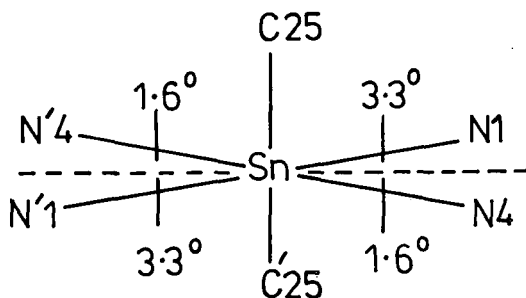

### 3.1.4 Discussion

The infra-red spectra of these compounds are all very similar and dominated by the vibrations of the  $(\text{Ph}_4\text{P}^+)$  cation - which, since the  $\text{R}_4\text{P}^+$  skeletal modes are very strong, and there are 8 phenyl groups per complex, is hardly surprising. The azide bands and  $\nu_{\text{as}} \text{Sn-C}_2$  are visible, however; their frequencies conform to those found by Barbieri et al. (52), and agree with their supposition of a regular octahedral anion with trans methyl groups. This is fully vindicated by the crystal structure where  $\widehat{\text{C-Sn-C}}$  is almost  $180^\circ$ , so distortions from ideal geometry are very small. The structure also shows that the  $\text{Sn-N}_3$  moiety is non-linear ( $\widehat{\text{Sn-N-N}} \simeq 120^\circ$ ), in common with other organometallic azides (89), and all the azide groups lie very close to the xy plane of the octahedron.

The  $\delta$  values for the series are in the expected range for 6-coordinate compounds in a solution of a strong donor solvent. Detailed discussion of trends will be confined to the values for  $(\text{Et}_4\text{N}^+)$  complexes, since they are more complete.

### 3.2 Tetraethylammonium complexes

Complexes were prepared with this cation for several reasons:-

1-their infra-red spectra would not be dominated by very strong cation bands;

2-their Mossbauer data would be directly comparable to that obtained for dimethyltin thiocyanatochloride complexes;

3-it was hoped that they would be soluble enough for  $^{119}\text{Sn}$  NMR data to be obtained in solvents other than DMSO;

4-since the R.M.M. of these complexes is lower than the previous set, the variation in, and absolute values of, the %N of the complex would be larger. Analytical results would therefore give a better indication of the degree of substitution.

Complexes with reasonable analytical purity were obtained, but none of them with sufficient crystallinity for crystal structure determination.

#### 3.2.1 Infra-red data

All values in  $\text{cm}^{-1}$

n = 4	3	2	1	assignment
2035s,br	2031s,br	2031s,br	2041vs	$\nu_{\text{as}} \text{N}_3$ (2040)
1320m	1320m-w	1330m	1335m	
1302w	1305vw	1302w	1310m	
1278m	1279w-m	1275m	1290m	$\nu_{\text{s}} \text{N}_3$ (1278)
1220w	1222w	1222w		
1180m	1180m	1181m-s	1181m-s	
+sh 1140	+sh 1140	+sh 1150		
1106	1115			



n = 4	3	2	1	assignment
1098 w, d				
1070w	1072	1072	1078	
1065w				
1020m	1020m	1025m	1025m-s	
998m-s	1000m	1002m	1005m-s	
890vw	890vw	890w	895w	
		805s		
	790s	790s	785s	$\rho_{as} \text{ CH}_3$
780s, br	782s	775s		
	755s			
720m-s	720m-s	720m-s	720m-s	$\rho_s \text{ CH}_3$
			685w	
658m-w			658m	$\delta \text{ N}_3$
648m	650m-s	650m-s		
612m-w	615m-w	612m-w	618m	
558m	558m	558m	570m	$\nu_{as} \text{ Sn-C}_2$
			540vw	
465w	465vw	465vw	475vw	
372w	390vw		390vw	
272s, br	260s, br	270s, br	278m, br	? $\nu \text{ Sn-N}_3$

Unlabelled bands are cation bands, since the spectra are very similar in appearance to those of  $\text{Et}_4\text{NCl}$  and of the other tetraethyl ammonium complexes.

The band that appears at  $\approx 270 \text{ cm}^{-1}$  was at first thought to be  $\nu \text{ Sn-Cl}$ , but this was discounted since it appears at  $\approx 235 \text{ cm}^{-1}$  in  $(\text{Et}_4\text{N}^+)_2 \text{Me}_2\text{SnCl}_4^{2-}$ . It is possible that it is  $\nu \text{ Sn-N}_3$  since this band is observable for  $\text{Me}_3\text{SnN}_3$  (157).

The spectra are much cleaner than the previous set in the area of interest - azide and  $\nu \text{ Sn-C}_2$  bands appear without overlap from cation bands.

### 3.2.2 $^{119}\text{Sn}$ Chemical shifts

Anion	shift in (-ppm)	
	DMSO	MeCN
$\text{Me}_2\text{SnCl}_4^{2-}$	240.9	139.5
$\text{Me}_2\text{Sn}(\text{N}_3)\text{Cl}_3^{2-}$	267.4	183.6
$\text{Me}_2\text{Sn}(\text{N}_3)_2\text{Cl}_2^{2-}$	289.4	235.4
$\text{Me}_2\text{Sn}(\text{N}_3)_3\text{Cl}^{2-}$	302.0	237.7
$\text{Me}_2\text{Sn}(\text{N}_3)_4^{2-}$	332.4	326.2

Please see opposite for a plot of these values. (Fig. 4. )

400  $\delta$ (-ppm)

Fig. 4.3.

$^{119}\text{Sn}$  chemical shifts of  
 $(\text{Et}_4\text{N}^+)_2\text{Me}_2\text{Sn}(\text{N}_3)_n\text{Cl}_{4-n}^{2-}$

— in  $\text{CH}_3\text{CN}$   
- - - in DMSO

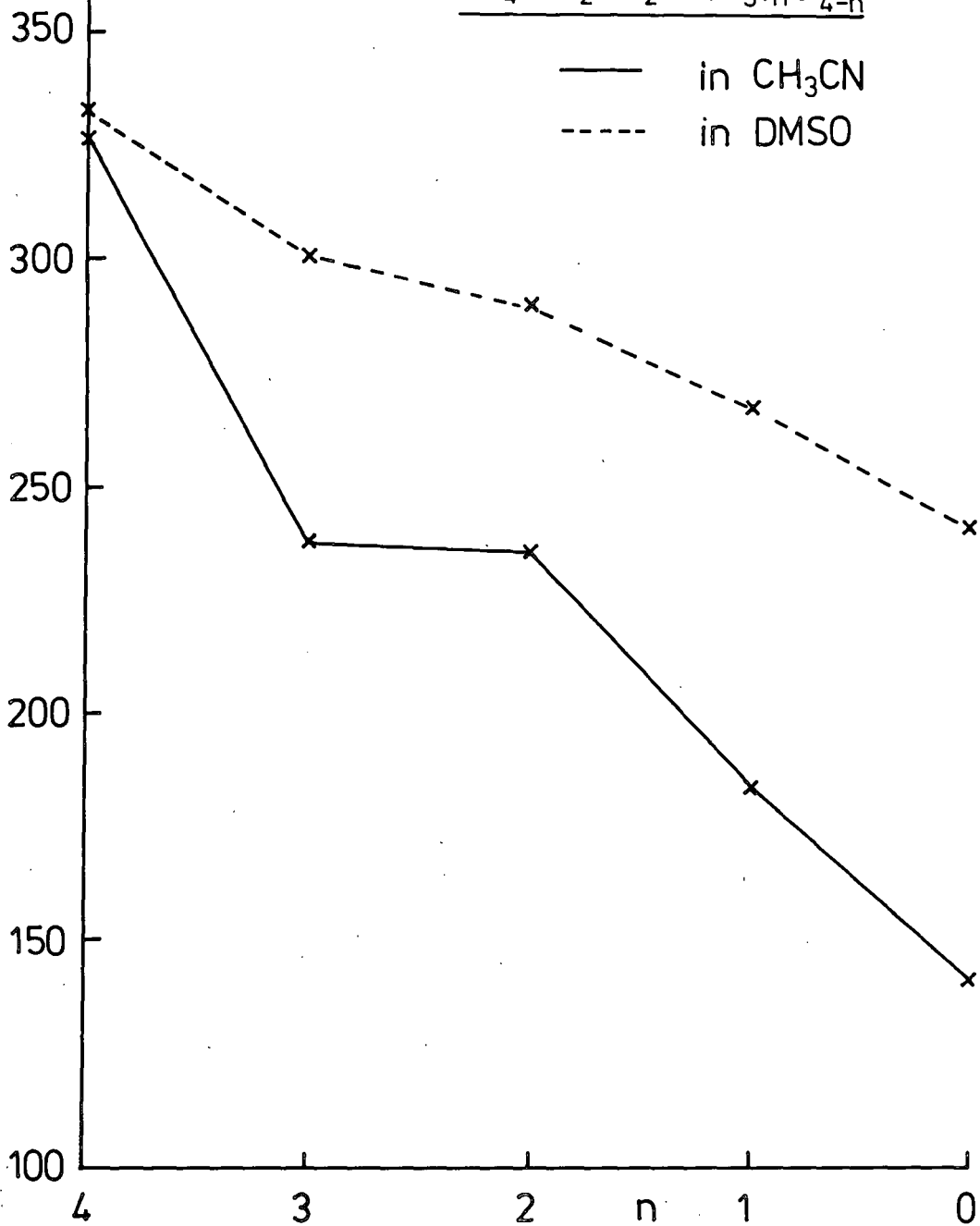

3.2.3  $^2J$  ( $^{119}\text{Sn-C-}^1\text{H}$ ) coupling constants

Anion	$^2J$ in (Hz)		$\kappa_{\text{ave}}$
	DMSO	MeCN	
$\text{Me}_2\text{SnCl}_4^{2-}$	112 $\pm$ 10	96 $\pm$ 2	3.15
$\text{Me}_2\text{Sn}(\text{N}_3)\text{Cl}_3^{2-}$	117 $\pm$ 5	105 $\pm$ 4	3.47
$\text{Me}_2\text{Sn}(\text{N}_3)_2\text{Cl}_2^{2-}$	117 $\pm$ 5	108 $\pm$ 4	3.79
$\text{Me}_2\text{Sn}(\text{N}_3)_3\text{Cl}^{2-}$	113 $\pm$ 3		4.10
$\text{Me}_2\text{Sn}(\text{N}_3)_4^{2-}$	113 $\pm$ 3	104 $\pm$ 4	4.42

## 3.2.4 Mossbauer data

Compound	$\delta$ ( $\text{mms}^{-1}$ )	$\Delta E_q$ ( $\text{mms}^{-1}$ )	$\Gamma_1$ ( $\text{mms}^{-1}$ )	$\Gamma_2$ ( $\text{mms}^{-1}$ )
$(\text{Et}_4\text{N}^+)_2$ $\text{Me}_2\text{SnCl}_4^{2-}$	1.49	4.13	1.10	1.07
$(\text{Et}_4\text{N}^+)_2$ $\text{Me}_2\text{Sn}(\text{N}_3)\text{Cl}_3^{2-}$	1.42	3.94	0.91	0.90
$(\text{Et}_4\text{N}^+)_2$ $\text{Me}_2\text{Sn}(\text{N}_3)_2\text{Cl}_2^{2-}$	1.34	3.82	0.84	0.83
$(\text{Et}_4\text{N}^+)_2$ $\text{Me}_2\text{Sn}(\text{N}_3)_3\text{Cl}^{2-}$	1.31	3.82	0.83	0.87
$(\text{Et}_4\text{N}^+)_2$ $\text{Me}_2\text{Sn}(\text{N}_3)_4^{2-}$	1.31	3.76	1.04	0.93

Error on these values =  $0.03 \text{ mms}^{-1}$ .

Fig. 4.4

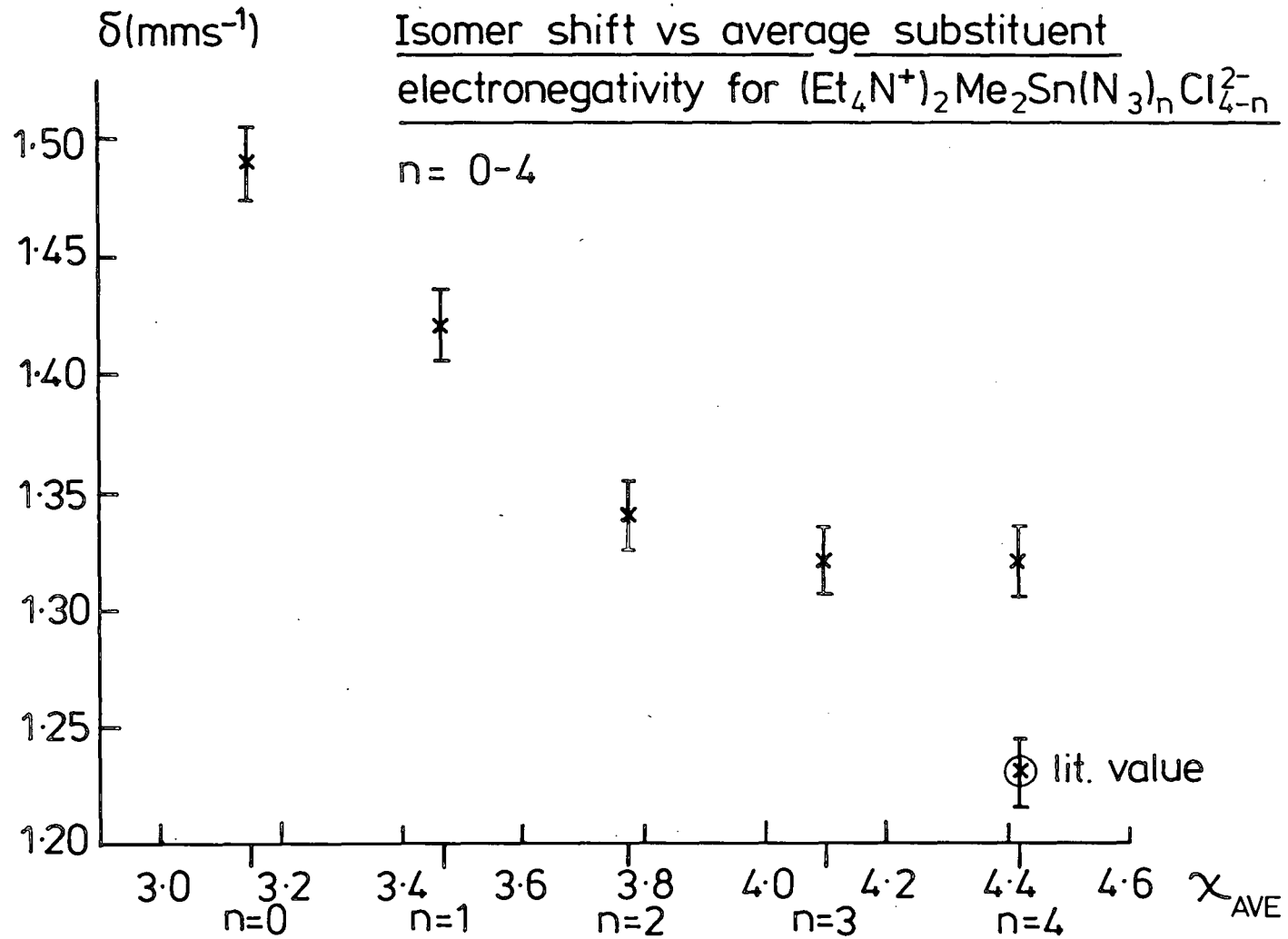

### 3.2.5 Discussion

Infra-red data show that the anions have linear trans Me-Sn-Me units, since  $\nu_{as} \text{Sn-C}_2$  appears in the same position as in the  $(\text{Ph}_4\text{P}^+)$  complexes and  $\nu_s$  is absent, so it seems likely that this part of the structure at least is the same.  $\text{Me}_2\text{Sn}(\text{N}_3)\text{Cl}_3^{2-}$  is different -  $\nu_{as} \text{Sn-C}_2$  is shifted  $12 \text{ cm}^{-1}$  to higher frequency from the others, and a very weak band appears at  $540 \text{ cm}^{-1}$ . This is rather high to be assigned as  $\nu_s \text{Sn-C}_2$ , (observed in the Raman spectrum at  $497 \text{ cm}^{-1}$  (52)) but indicates that some distortion may be present in this ion.

$^{119}\text{Sn}$  chemical shifts are in the range expected for 6-coordinate species, and move to lower frequency as average substituent electronegativity increases. ( $\chi_{\text{N}_3} = 4.42$ ,  $\chi_{\text{Cl}} = 3.15$  (175,121)).

The difference between values in different solvents is marked, and indicates that the complexes dissociate in solution. The strong influence of DMSO on the equilibrium is shown by the "flattening" of the curve across the series. It is likely that strong interactions take place here that alter the dissociation constants of the anions, particularly those containing more Cl - i.e.  $n = 0,1,2$  in  $\text{Me}_2\text{Sn}(\text{N}_3)_n\text{Cl}_{4-n}^{2-}$  - since the difference is greatest here.

The coupling constants indicate the same trend - the values are all higher in DMSO, and the difference across the series is only 5Hz (comparable in magnitude to the experimental error).

In MeCN there is an irregular increase in  $^2J$  with number of azide groups in the ion, although this totals only 12Hz. It is possible that this may be due to changes in bond character caused

by increased electronegativity of X, (which would give the Sn-X bonds more p character, and the Sn-C-H sites more s character. Thus, if J is dependent on  $S^2(0)$ , it would be expected to increase in magnitude), but the effect of differences in dissociation constants, due to changing the Lewis acidity of tin, is unknown, and may have a significant effect.

The values obtained for isomer shift and quadrupolar splitting of  $\text{Me}_2\text{Sn}(\text{N}_3)_4^{2-}$  differ considerably from those obtained by Barbieri et al. (52) for the  $\text{Ph}_4\text{As}^+$  complex.

$$\delta = 1.23 \text{ mms}^{-1}, \Delta E_q = 3.61 \text{ mms}^{-1} \quad \text{Ph}_4\text{As}^+ \text{ complex}$$

$$\delta = 1.31 \text{ mms}^{-1}, \Delta E_q = 3.76 \text{ mms}^{-1} \quad \text{Et}_4\text{N}^+ \text{ complex.}$$

This could be due to the difference in cation, since different values have been observed when the cation is changed in other six-coordinate complexes - please see Ch.3, section 3.3.5.

Barbieri's value is included on the plot of isomer shift vs. average substituent electronegativity. This shows a fairly regular decrease in  $\delta$  with increased  $\chi_{\text{ave}}$ , as is expected from the dependence of  $\delta$  on s electron density at the nucleus. Similar trends have previously been observed for complexes of neutral donors with mixed stannahalothiocyanates (148), for mixed stannic halide complexes and for alkyltin pentahalide complexes (150,182,157). The change in  $\delta$  across the series ( $\approx 12\%$ ) is rather less than the relative change in electronegativity of substituent (29%), showing that these values only indicate the direction of change in nuclear electron density and give no quantitative information.

$\Delta E_q$  values can be compared with those expected on the basis of the additivity model, using the following parameters;-

$$(\text{pqs})_{\text{Me}} = -1.03 \text{ mms}^{-1}, (\text{pqs})_{\text{N}_3} = -0.13 \text{ mms}^{-1}.$$

$\Delta E_q$  values

Anion	Expect (mms <sup>-1</sup> )	Obtain (mms <sup>-1</sup> )
$\text{Me}_2\text{SnCl}_4^{2-}$	4.12	4.13
$\text{Me}_2\text{Sn}(\text{N}_3)\text{Cl}_3^{2-}$	3.99	3.94
$\text{Me}_2\text{Sn}(\text{N}_3)_2\text{Cl}_2^{2-}$	3.86	3.82
$\text{Me}_2\text{Sn}(\text{N}_3)_3\text{Cl}^{2-}$	3.73	3.82
$\text{Me}_2\text{Sn}(\text{N}_3)_4^{2-}$	3.60	3.76

The agreement is not unreasonable, in view of the approximations in the model, and the experimental error in the obtained values. These show fairly conclusively that the mixed azido-chloride complexes are obtained discretely and not as mixtures in the solid state.

What is surprising is the consistent, if rather irregular, trend to lower  $\Delta E_q$  values with increasing number of azide groups in the anion, in spite of the high electronegativity of this group.

$\Delta E_q$  reflects the imbalance of charge across the Sn nucleus. The main factor in this imbalance here will be the difference in electron demand between the substituents along the Me-Sn-Me (z) axis and those in the plane occupied by the halide / pseudohalide groups (xy plane). This is expected to increase as the electron-withdrawing power of X, as reflected by its electronegativity, increases. On these grounds,  $\Delta E_q$  values for azides are expected to



be  $\approx$  5-6% higher than those for the thiocyanates. Instead they are  $\approx$  30% lower.

If the data for the dimethyltin azidochloride and isothiocyanato-chloride complexes are compared, the infra-red, Mossbauer and crystal structures indicate that both sets have fairly regular octahedral geometry with the expected trans-disposed methyl groups.

The chemical shift values for the complexes show a trend to increased shielding with increased n in both cases, in spite of the high electronegativity of both pseudohalides. Another common feature of the two series is the decreased range of shifts in DMSO, and the movement of values to lower frequency in this solvent, due to the effect on the dissociation of the complexes.

In  $(Et_4N^+)_2 Me_2SnX_n Cl_{4-n}^{2-}$ :

n	X = N <sub>3</sub>			X = NCS		
	$\delta$ (-ppm)		J (Hz)	$\delta$ (-ppm)		J (Hz)
	DMSO	CH <sub>3</sub> CN	CH <sub>3</sub> CN	DMSO	CH <sub>3</sub> CN	CH <sub>3</sub> CN
0	240.9	139.5	96	240.9	139.5	96
1	267.4	183.6	105	247.9	133.1	92.8
2	289.4	235.4	108	253.1	152.0	99
3	302.0	237.4		358.6	406.7	117
4	332.4	326.4	104	387.1	416.0	118

The range of shifts for the thiocyanate complexes is larger and less regular than for the azides, showing a very large change in shift between n = 2 and n = 3 (105.5ppm in DMSO and 254ppm in CH<sub>3</sub>CN).

Values of  $|^2J(^{119}Sn-C-^1H)|$  increase with increasing n across both

series, although the trend is rather irregular. Values for  $|^2J|$  in the thiocyanates are slightly larger than for the azides, which again could be an effect of the polarisability of the pseudohalide.

Previous studies of the change in shielding at tin as the substituents surrounding it are changed have revealed mainly that the situation is not simple, and the change that is observed depends heavily upon the nature of the substituent under consideration.

The following trends have been identified:-

- a) the shielding decreases as the symmetry of the molecule decreases, as predicted by the orbital occupancy term in  $\sigma_p$  (see Ch.1 section 3.3.1). This is observed for  $R_nSnX_{4-n}$  as  $n$  is changed, where  $X = Cl, Br, NMe_2, NEt_2, OR, SR, SeR, C_5H_5,$  or  $OBu$  (93).
- b) A correlation between the electron-withdrawing / releasing properties of the substituent is observed if the symmetry is kept reasonably constant - eg. if  $R$  is changed in  $R_nSnCl_{4-n}$  ( $n = 1-3$ , but kept constant as  $R$  is changed) and  $Me_3SnSR$ ,  $\delta$  moves to lower frequencies as the Taft  $\sigma^*$  constant decreases (93). In  $R_3SnX$  compounds, a good correlation is observed between the Pauling electronegativity of  $X$ , and  $\delta$ , shifts moving progressively to higher frequency as  $\chi_x$  increases (93).  $\delta$  values have also been found to correlate as expected with  $pK_a$ (parent acid) in organotin carboxylates, with electron-withdrawing ability of substituent in polysubstituted phenyltin compounds (128), and found to reflect the strength of interaction between  $SnX_4$  and ether donors in solution (119).
- c) If  $R$  is unsaturated, however, the opposite trend to the

expected variation with its electron-withdrawing ability is observed, the tin atom becoming progressively more shielded as  $n$  decreases in  $\text{Me}_n\text{SnR}_{4-n}$ . This is observed when  $R = \text{allyl, Ph, Bz, (13) and CH=CHR'}$  (the nature of  $R'$  has little effect on  $\delta$ ) (190). The effect is thought to be due to polarisability of the substituent.

The observed trend for the complexes presented in this work is closest to that in the third group, the tin atom becoming progressively more shielded as the degree of substitution of Cl for  $\text{NCS/N}_3$  increases. In common with this group of compounds, the substituents are also unsaturated, so it may be that polarisability effects are dominating  $\delta$  in dimethyltin azido- and thiocyanatochloride complexes.

No effect due to the lowering of symmetry in the complexes seems to be observed. This could be because the orbital imbalance caused by replacing Cl by  $\text{NCS/N}_3$  is not sufficiently large to override the polarisability effect. It must also be borne in mind that the shifts given are averages over a dissociation equilibrium, so detailed correlations with any property are not valid. This is also discussed in Ch.5.

In the Mossbauer data, the trends across the  $\delta$  values for the two series are very similar, showing that the effect on the nuclear electron density of the thiocyanate and azide ligands are, within the limits of error, the same, as was found by Barbieri (52).

In contrast, the two ligands have entirely opposite effects on the quadrupolar splitting value; increasing amounts of  $\text{NCS}^-$  in the ion increasing it, and increasing amounts of azide decreasing it.

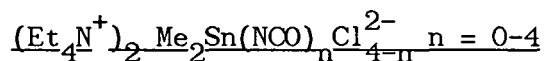

4 6-COORDINATE DIMETHYL TIN ISOCYANATO-CHLORIDE COMPLEXES4.1 Infra-red dataAll values in  $\text{cm}^{-1}$ 

n = 3	2	1	assignment
2180s, br	2190s, br	2160s, br	$\nu_{\text{as}}$ NCO
1305w	1310w	1305w	
1260w	1265w	1260w	$\nu_{\text{s}}$ NCO
+sh1185	1190m		
1175m	1175m	1180m-s	
1102w	1105m		
		1095w	
1065m		1065w-m	
		1049m	
1038m	1035w	1028m	
	1008m	1005m	
895vw	905w-m	890vw	
790s, br	790s, br	785s	$\rho_{\text{as}}$ $\text{CH}_3$
		760m-s	
742m		742m	
721m	725w-m	720m	$\delta_{\text{s}}$ $\text{CH}_3$
		650w	
621m	610m	620w	$\delta$ NCO
594m	570s, br		
564m	550m	570m-w	$\nu_{\text{as}}$ $\text{Sn-C}_2$
+sh575			

n = 3	2	1	assignment
521w	520w-m	518vw	$\nu_s$ Sn-C <sub>2</sub>
465w-m	470w, br		
270m, br	280w, br	280w, br	? $\nu$ SnNCO

#### 4.2 <sup>119</sup>Sn Chemical shift data

<u>Anion</u>	<u>solvent</u>	<u><math>\delta</math> (-ppm)</u>
Me <sub>2</sub> Sn(NCO)Cl <sub>3</sub> <sup>2-</sup>	CH <sub>3</sub> CN	247.7
Me <sub>2</sub> Sn(NCO) <sub>2</sub> Cl <sub>2</sub> <sup>2-</sup>	CHCl <sub>3</sub>	213.0
Me <sub>2</sub> Sn(NCO) <sub>3</sub> Cl <sup>2-</sup>	CH <sub>3</sub> CN	365.9
	DMSO	391.0

#### 4.3 Discussion

The infra-red data indicate that these complexes contain N-bonded cyanate groups, although the  $\nu_s$  value is rather low. The weak  $\nu_s$  (Sn-C<sub>2</sub>) band shows that some distortion may be present in these ions, but the geometry can still be described as trans octahedral.

The limited NMR chemical shift data that have been obtained *are* in the same region as for the analogous dimethyltin azido- and thiocyanatochloride complexes. The results also show the same trend to lower frequency values with increasing numbers of pseudohalogen groups in spite of high electronegativity ( $\delta_{\text{NCO}} = 4.46$ ).

The shielding by these ligands may be due to their larger size and higher polarizability; from the table below it can be seen that shielding increases as molecular weight of pseudohalide increases.

Chemical shifts of  $(Et_4N^+)_2Me_2SnX_4^{2-}$  and  $Me_2SnX_2$

X	$\delta(Me_2SnX_2)$ in DMSO	$\delta(Me_2SnX_4^{2-})$ in DMSO	$\delta(Me_2SnX_4^{2-})$ in MeCN	RMM
Cl	246.1	240.9	139.5	35.5
NCO	305.4			42
$N_3$	330.1	332.4	326.2	42
NCS	375.6	387.1	416.0	58

( $\delta$  values in -ppm)

Unfortunately the same trend is not observed for the intermediate complexes, but here the effect of preferential dissociation of ligands and differing degrees of dissociation will have a considerable effect.

## 5 ATTEMPTED PREPARATIONS OF DIMETHYL TIN CYANIDE COMPLEXES

### 5.1 Me<sub>2</sub>Sn(CN)<sub>2</sub>

Preparation of the 4-coordinate<sup>\*</sup> starting material was attempted by the double decomposition method previously used, but without success.

The best results were obtained from KCN/refluxing methanol -  $\nu(\text{CN})$  was visible in the IR spectrum of the product, and a  $^{119}\text{Sn}$  signal was obtained ( $\delta = -494\text{ppm}$  in MeOH, very poorly resolved). However, the IR corresponded badly to that obtained by Lorbeth et al. (180), and analytical results were very poor.

### 5.2 6-coordinate complexes

Preparation of  $\text{Me}_2\text{Sn}(\text{CN})_4^{2-}$  was attempted by substituting  $\text{CN}^-$  into  $\text{Me}_2\text{SnCl}_4^{2-}$ , since Sn-Cl bonds are weaker in the 6-coordinate complexes than in  $\text{Me}_2\text{SnCl}_2$ , so substitution should be easier. Preparation of both  $(\text{Bu}_4\text{P}^+)$  and  $(\text{Et}_4\text{N}^+)$  complexes were unsuccessful, producing uncharacterisable, sticky solids.

Finally the preparation of  $(\text{Bu}_4\text{P}^+)_2 \text{Me}_2\text{Sn}(\text{CN})_2\text{Cl}_2^{2-}$  was attempted by adding  $\text{Bu}_4\text{PCN}$  to  $\text{Me}_2\text{SnCl}_2$ . The product of this reaction was  $\text{Me}_2\text{SnCl}_2$  with impurities, indicating that  $\text{CN}^-$  does not add easily to tin and complexes are unstable. Hence, even if  $\text{Me}_2\text{Sn}(\text{CN})_2$  could be obtained in reasonable purity, it is unlikely that complexes could be prepared from it, or studied in solution.

The work of A. Marshall (170) supports these findings, since although inorganic tin cyano- complexes were observed (by  $^{119}\text{Sn}$  NMR) in  $\text{CH}_2\text{Cl}_2$  solution, salts containing the  $\text{Sn}(\text{CN})_6^{2-}$  ion could not be isolated.

\* nominally 4-coordinate

## 6 EXPERIMENTAL

### 6.1 General

Preparation of samples for Mossbauer,  $^{119}\text{Sn}$  NMR and IR work, as well as the measuring out of air-sensitive reactants, was carried out under an atmosphere of dry nitrogen.

$\text{Ph}_4\text{Cl}$ ,  $\text{Bu}_4\text{PCl}$ ,  $\text{Et}_4\text{NCl}$  and  $\text{Et}_4\text{NNCO}$  were obtained commercially. They were dried before use by the method described in Ch.3, section 6.1, and stored under dry nitrogen. Particular care had to be taken with  $\text{Et}_4\text{NNCO}$ , since in addition to being extremely hygroscopic, it is also light-sensitive, and must be stored in a light-excluding cover.

$\text{Et}_4\text{NN}_3$  was prepared by stirring  $\approx 30\text{mls}$  of  $\text{Et}_4\text{NCl}$  with  $\text{NaN}_3$  in hot methanol for 2-3 hrs, filtering off the solids that appeared on cooling, and reducing the volume of solvent to obtain a precipitate. Extraction into  $\text{CHCl}_3$  removed any  $\text{NaN}_3$  still present.

$\text{Ph}_4\text{PN}_3$  was similarly prepared, but ethanol was used as solvent, the reaction mixture filtered whilst hot, and crystals of  $\text{Ph}_4\text{PN}_3$  precipitated on cooling. Both azides were then dried under vacuum to remove traces of solvent.

The preparation of  $\text{Ph}_4\text{PNCO}$  was attempted by the same method, but we were unable to obtain full substitution. Also, this compound is more light-sensitive than  $\text{Et}_4\text{NNCO}$ , and darkens rapidly on standing.

$(\text{Et}_4\text{N}^+)_2 \text{Me}_2\text{SnCl}_4^{2-}$  and  $(\text{Bu}_4\text{P}^+)_2 \text{Me}_2\text{SnCl}_4^{2-}$  for cyanide substitution reactions were prepared by combining 6 mmols of  $\text{Me}_2\text{SnCl}_2$  and 12 mmols of  $\text{Bu}_4\text{PCl}/\text{Et}_4\text{NCl}$  in 30 mls  $\text{CH}_2\text{Cl}_2$ . Precipitation of product was obtained by dropwise addition of



petroleum ether (30-40°C).

$(\text{Bu}_4\text{P}^+)_2 \text{Me}_2\text{SnCl}_4^{2-}$  Expect 50.45%C 9.71%H

Obtain 48.14%C 9.64%H

$\delta (^{119}\text{Sn}) = -135.2 \text{ ppm}$

$(\text{Et}_4\text{N}^+)_2 \text{Me}_2\text{SnCl}_4^{2-}$  Expect 39.23%C 8.41%H 5.08%N

Obtain 39.18%C 10.06%H 4.61%N

$\delta (^{119}\text{Sn}) = -141.6 \text{ ppm}$

## 6.2 Preparation of 4-coordinate\* starting materials

### $\text{Me}_2\text{Sn}(\text{N}_3)_2$ and $\text{Me}_2\text{Sn}(\text{NCO})_2$

These were prepared by double decomposition between  $\text{NaN}_3$  or  $\text{NaNCO}$  and  $\text{Me}_2\text{SnCl}_2$

$\text{Me}_2\text{Sn}(\text{N}_3)_2$ : an excess of 2 molar equivalents of  $\text{NaN}_3$  was dissolved in MeOH, (heating was necessary to effect solution; EtOH and water were also tried as solvents, but methanol gave the best results.), and 1 molar equivalent of  $\text{Me}_2\text{SnCl}_2$  in methanol was added, under  $\text{N}_2$ , with stirring. After refluxing for 1-2 hrs the mixture was allowed to cool, the precipitate of NaCl and excess  $\text{NaN}_3$  filtered off, and the product obtained by reducing the volume of solvent, and isolating the precipitate.

$\text{Me}_2\text{Sn}(\text{NCO})_2$  was prepared as above, using  $\text{NaNCO}$  in MeOH (results not so good in EtOH). After filtering off the chloride precipitate, all the solvent was removed under vacuum and the product extracted into hot ethanol. This produced satisfactory Cl and C analyses.

$\text{Me}_2\text{Sn}(\text{N}_3)_2$  Expect 10.30%C 2.60%H 36.10%N 0%Cl

Obtain 9.01%C 2.24%H 25.19%N 0%Cl

$\text{Me}_2\text{Sn}(\text{NCO})_2$  Expect 20.64%C 2.46%H 12.03%N 0%Cl

Obtain 19.20%C 2.40%H 7.58%N 0%Cl

\* nominally 4-coordinate.

### 6.3 Preparation of complexes

6.3(a) By addition:- the intermediate complexes were prepared by adding the appropriate ratio of halide / pseudohalide to  $\text{Me}_2\text{SnX}_2$ . Ethanol was found to be the best solvent, as  $\text{Me}_2\text{Sn}(\text{N}_3)_2$  and  $\text{Me}_2\text{Sn}(\text{NCO})_2$  will dissolve in it at elevated temperatures. The exception was  $(\text{Et}_4\text{N}^+)_2 \text{Me}_2\text{Sn}(\text{NCO})\text{Cl}_3^{2-}$  which gave the best results when prepared in  $\text{CH}_2\text{Cl}_2$ .

$(\text{Et}_4\text{N}^+)_2 \text{Me}_2\text{Sn}(\text{NCO})_2\text{Cl}_2^{2-}$  was prepared by adding 2 equivalents of  $\text{Et}_4\text{NCl}$  to  $\text{Me}_2\text{Sn}(\text{NCO})_2$ . Attempts at adding  $\text{NCO}^-$  to  $\text{Me}_2\text{SnCl}_2$  were unsuccessful.

Precipitates of product were obtained by reducing the volume of solvent, and/or adding  $\approx 10$ -20 mls of non-polar solvent (usually toluene).

Analytical results are given at the end of section 6.4. Approximate scales of reaction were 5 mmols of  $\text{Me}_2\text{SnX}_2$  in 30-40 mls of solvent.

6.3(b) By substitution (52):-  $(\text{Ph}_4\text{P}^+)_2 \text{Me}_2\text{Sn}(\text{N}_3)_4^{2-}$  was prepared by refluxing 1.3 mmol  $\text{Me}_2\text{SnCl}_2$ , 2.6 mmols  $\text{Ph}_4\text{PN}_3$  and  $>3$  mmols  $\text{NaN}_3$  in 30-40 mls of dry MeCN. After  $\approx 3$  hrs, the mixture was filtered hot and the product obtained on cooling the precipitate to  $-20^\circ\text{C}$  for 4-5 hrs.

Crystals reprecipitated from DMSO solution in sufficient purity and crystallinity for crystal structure determination.

$(\text{Et}_4\text{N}^+)_2 \text{Me}_2\text{Sn}(\text{N}_3)_4^{2-}$  was prepared by refluxing 5 mmols  $\text{Me}_2\text{SnCl}_2$  with 10 mmols  $\text{Et}_4\text{NCl}$  and 30 mmols  $\text{NaN}_3$  in  $\approx 30$  mls dry MeCN. After removing the solids from the hot solution, the product was obtained by reducing the volume of solvent and cooling.

$(\text{Et}_4\text{N}^+)_2 \text{Me}_2\text{Sn}(\text{NCO})_4^{2-}$  could not be obtained by adaptations of

the above methods. Refluxing 5 mmols of  $\text{Me}_2\text{SnCl}_2$ , 10mmols of  $\text{Et}_4\text{NNCO}$  and a large excess of  $\text{NaNCO}$  in dry  $\text{MeCN}$  gave a reasonable yield of  $\text{Me}_2\text{Sn}(\text{NCO})_3\text{Cl}^{2-}$ . This is typical of the substitution behaviour of  $\text{NCO}^-$ .

#### 6.4 Preparation of dimethyltin cyanide compounds

##### 6.4.1 $\text{Me}_2\text{Sn}(\text{CN})_2$

Slightly more than 10 mmols  $\text{CN}^-$  and 5 mmols  $\text{Me}_2\text{SnCl}_2$  in approx. 50 mls solvent were used in all reactions.

KCN was used in  $\text{CH}_2\text{Cl}_2$ ,  $\text{EtOH}$  and  $\text{MeOH}$ . Both solids were added to the solvent and stirred for up to 24 hrs. Filtration and reduction in volume of solvent yielded unreacted starting material.

With  $\text{AgCN}$  and  $\text{Zn}(\text{CN})_2$  reactants were combined in  $\text{EtOH}$ , and, after long reaction times, similar isolation procedures yielded uncharacterisable products.

30 mls aqueous KCN was added to 30mls ethereal  $\text{Me}_2\text{SnCl}_2$  with stirring, according to the method of Cheng and Herber (10). The white solid precipitate that was produced appeared to be some form of dimethyl tin oxide.

When KCN was added to  $\approx 50$  mls  $\text{MeOH}$  and the solution heated until all the solid dissolved, and then  $\text{Me}_2\text{SnCl}_2$  / 10 mls  $\text{MeOH}$  was added, a white precipitate appeared, indicating that some reaction had occurred. The product that was isolated did show cyanide absorptions in the infra-red, but the rest of the spectrum and the analysis figures were very poor.

Analysis:	Expect	23.92%C	3.01%H	13.95%N
	Obtain	12.00%C	0.53%H	11.32%N

#### 6.4.2 6-coordinate complexes

The preparation of  $(\text{Et}_4\text{N}^+)_2 \text{Me}_2\text{Sn}(\text{CN})_4^{2-}$  and  $(\text{Bu}_4\text{P}^+)_2 \text{Me}_2\text{Sn}(\text{CN})_4^{2-}$  was attempted by substitution of  $\text{CN}^-$  into  $(\text{Et}_4\text{N}^+)_2 \text{Me}_2\text{SnCl}_4^{2-}$  and  $(\text{Bu}_4\text{P}^+)_2 \text{Me}_2\text{SnCl}_4^{2-}$  respectively.

0.5 mmols  $\text{Me}_2\text{SnCl}_4^{2-}$  was stirred in  $\approx 30$  mls of methanol with excess KCN for 3-4 hrs. A white precipitate appeared during this time, but filtering this off and reducing the volume of solvent yielded a sticky solid that analysed very poorly.

The preparation of  $(\text{Bu}_4\text{P}^+)_2 \text{Me}_2\text{Sn}(\text{CN})_2\text{Cl}_2^{2-}$  was attempted by combining 1.2 mmols of  $\text{Me}_2\text{SnCl}_2$  and 2.4 mmols of  $\text{Bu}_4\text{PCN}$  in  $\text{CH}_2\text{Cl}_2$  solution, reducing the volume of solvent and adding toluene to isolate the product.

The resulting solid showed no  $\nu(\text{CN})$  in the infra-red, bands in the same places as  $\nu_{\text{as}}$  and  $\nu_{\text{s}}$  Sn-C<sub>2</sub> of  $\text{Me}_2\text{SnCl}_2$ , and gave a  $^{119}\text{Sn}$  NMR signal at -45.4 ppm (cf  $\text{Me}_2\text{SnCl}_2$ , -33.2.ppm). This indicates that very little addition takes place, and virtually none persists in solution.

Analysis for  $(\text{Bu}_4\text{P}^+)_2 \text{Me}_2\text{Sn}(\text{CN})_4^{2-}$

Expect 59.14%C 10.19%H 7.26%N

Obtain 17.92%C 0.46%H 16.29%N

Complex		C	H	N	Cl
$(\text{Ph}_4\text{P}^+)_2$	Expect	61.12	4.72	8.55	
$\text{Me}_2\text{Sn}(\text{N}_3)_2\text{Cl}_2^{2-}$	Obtain	60.51	4.78	10.36	
$(\text{Ph}_4\text{P}^+)_2$	Expect	60.32	4.66	16.88	
$\text{Me}_2\text{Sn}(\text{N}_3)_4^{2-}$	Obtain	59.55	4.64	16.42	
$(\text{Et}_4\text{N}^+)_2$	Expect	38.76	8.31	12.55	
$\text{Me}_2\text{Sn}(\text{N}_3)\text{Cl}_3^{2-}$	Obtain	40.04	7.85	12.60	
$(\text{Et}_4\text{N}^+)_2$	Expect	38.37	8.22	19.86	
$\text{Me}_2\text{Sn}(\text{N}_3)_2\text{Cl}_2^{2-}$	Obtain	38.15	7.82	21.65	
$(\text{Et}_4\text{N}^+)_2$	Expect	37.88	8.12	26.99	
$\text{Me}_2\text{Sn}(\text{N}_3)_3\text{Cl}^{2-}$	Obtain	37.12	8.48	27.44	
$(\text{Et}_4\text{N}^+)_2$	Expect	37.44	8.03	33.96	0
$\text{Me}_2\text{Sn}(\text{N}_3)_4^{2-}$	Obtain	38.36	9.48	31.92	0
$(\text{Et}_4\text{N}^+)_2$	Expect	40.92	8.31	7.54	
$\text{Me}_2\text{Sn}(\text{NCO})\text{Cl}_3^{2-}$	Obtain	43.16	7.22	7.48	
$(\text{Et}_4\text{N}^+)_2$	Expect	42.09	8.12	9.82	12.6
$\text{Me}_2\text{Sn}(\text{NCO})_2\text{Cl}_2^{2-}$	Obtain	42.30	8.90	10.50	9.19
$(\text{Et}_4\text{N}^+)_2$	Expect	44.19	8.12	12.27	8.41
$\text{Me}_2\text{Sn}(\text{NCO})_3\text{Cl}^{2-}$	Obtain	37.5	9.1	8.03	5.77

## CHAPTER 5

<sup>119</sup>Sn NMR STUDIES OF SOME EQUILIBRIUM REACTIONS  
OF DIMETHYL TIN CHLORIDE AND PSEUDOHALIDE COMPLEXES

1 INTRODUCTION

The complexation of organotin compounds is very widely documented (15,16,30,35,48,183,184). It is also well known that such complexes are prone to dissociation in solution to a greater or lesser extent, and in the case of complexation with solvent, this can occur even in the presence of a large excess of donor (12,176,185-189).

NMR provides a useful method of quantifying such equilibria, since in the case where an equilibrium is fast enough to give signal averaging, the observed chemical shift is the average of those of the components of the equilibrium, weighted by their mole fractions.

$$\delta_{\text{obs}} = \delta_1 x_1 + \delta_2 x_2 \text{ etc.}$$

Knowledge of the chemical shifts of the species involved in the equilibrium can be used to obtain the relevant mole fractions, and hence the equilibrium constant. Alternatively, expressions such as that of Torochesnikov (12, given in Ch1 section 3.3.2) can be used to obtain K directly for dissociation equilibria. Thermodynamic data can then be derived from the temperature dependence of K.

In previous work the formation of organotin halide complexes has been observed in solution by <sup>119</sup>Sn NMR, from the chemical shift changes on the addition of successive portions of halide to the solution (95). The values move to lower frequency, consistent with addition, and tend to a limiting shift which corresponds to

that of the fully complexed species. In other words, the equilibrium is forced to the left because of the presence of excess ligand

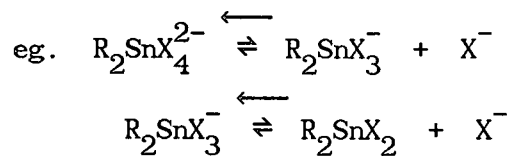

and the observed chemical shift is that of the complex only, since  $x(\text{uncomplexed})$  is very small.

In this work it was also observed that this limiting shift is at significantly lower frequency than the shift obtained when the complex is prepared discretely and redissolved, proving that ionic alkyltin halide complexes dissociate in solution.

## 2 DISSOCIATION SUPPRESSION OF 6-COORDINATE $\text{Me}_2\text{SnX}_4^{2-}$ COMPLEXES

(X = Cl, NCS,  $\text{N}_3$ )

Limiting shifts of these complexes were obtained in acetonitrile (DMSO was also used for  $\text{Me}_2\text{Sn}(\text{NCS})_4^{2-}$ , without success) by addition of successive amounts of halide/pseudohalide to a solution of the complex, and observing the resultant chemical shift changes. These values were then used to obtain an estimate of the dissociation constants of the complexes.

### 2.1 Equilibrium constant determination

The dissociation of the 6-coordinate salt can be represented as follows:-



Torchesnikov's formula cannot be applied here, since the shift of  $\text{Me}_2\text{SnX}_3^-$  cannot be determined directly. If the complex is prepared discretely and dissolved in acetonitrile, it dissociates to an unknown extent, so the observed shift for the solvated species is also an average. Also, the only 5-coordinate complex to be successfully prepared so far out of the ones involved here is  $\text{Me}_2\text{SnCl}_3^-$ .

An alternative expression, using only the known shift values and amount of added  $\text{X}^-$ , can be used to determine the mole fraction of complex.



It is derived as follows:-

For the equilibrium

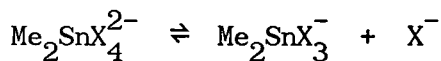

Concentrations are 1  $C(1-x)$        $Cx$        $Cx$

$$K = \frac{x^2 C}{1-x}$$

2  $C(1-y)$        $Cy$        $Cy+a$

$$K = \frac{Cy(y+a/C)}{1-y}$$

$$= \frac{Cy(y+N)}{1-y} \quad \text{where } N = a/C$$

All species are assumed to be solvated, due to the large excess of donor solvent that is present. Hence, all are 6-coordinate, although coordinated solvent is omitted from the expressions, for clarity.

1 At equilibrium, the equilibrium constant, K, is written in terms of the fraction of complex that dissociates, x, and the initial concentration of complex, C.

2 If  $\text{X}^-$  is added, of concentration "a" molar with respect to  $\text{X}^-$ , the system will take up a new equilibrium position to maintain K. N is the molar ratio of added  $\text{X}^-$  to initial amount of complex.

Since K is the same in both situations, then:-

$$\frac{x^2 C}{1-x} = \frac{Cy(y+N)}{1-y}$$

so  $x^2(1-y) = y(y+N)(1-x)$  (i)

The observed NMR signal in each case, since the equilibrium is relatively rapid, is the average of the signal of  $\text{Me}_2\text{SnX}_4^{2-}$  and  $\text{Me}_2\text{SnX}_3^-$ .

For situation 1       $\delta_o = \delta_1(1-x) + \delta_2x$  (ii)

and 2       $\delta'_o = \delta_1(1-y) + \delta_2y$  (iii)

Where  $\delta_o$ ,  $\delta'_o$  are the observed shifts,  $\delta_1 = \delta(\text{Me}_2\text{SnX}_4^{2-})$  and  $\delta_2 = \delta(\text{Me}_2\text{SnX}_3^-)$

Eliminating  $\delta_2$  between ii and iii gives

$$\frac{x}{y} = \frac{\delta_o - \delta_1(1-x)}{\delta'_o - \delta_1(1-y)}$$

which rearranges to

$$y = \frac{x(\delta'_o - \delta_1)}{(\delta_o - \delta_1)}$$

$$\text{or defining } \Lambda = \frac{(\delta'_o - \delta_1)}{(\delta_o - \delta_1)} \quad y = \Lambda x \quad (\text{iv})$$

Substituting this in (i) gives

$$x^2(1-\Lambda x) = \Lambda x(1-x)(\Lambda x + N)$$

which rearranges to

$$\Lambda x^2(1-\Lambda) + x(\Lambda^2 - N\Lambda - 1) + N\Lambda = 0 \quad (\text{v})$$

which is best solved by substituting numerical values for  $\Lambda$  and  $N$ .

The value of  $x$  thus obtained is then used to obtain  $K$ .

This treatment is an approximation, since it takes no account of the dissociation of  $\text{Me}_2\text{SnCl}_3^-$  that will occur on its formation. The amount of secondary dissociation will also be dependent on the concentration of added chloride, due to suppression effects. If  $N$  is chosen to be small, the amount of secondary dissociation will be approximately the same in both situations 1 and 2 and therefore errors in  $x$  will be minimised.

The only 5-coordinate species that has been isolated successfully is  $(\text{Et}_4\text{N}^+) \text{Me}_2\text{SnCl}_3^-$ . The chemical shift of this compound in  $\text{CH}_3\text{CN}$  is -116ppm. This shift corresponds to the system

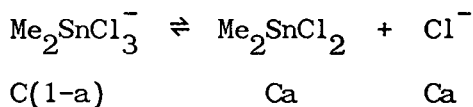

$$\delta_{\text{obs}} = \delta_i(1-a) + \delta_{ii}a \quad (\text{vi})$$

Where  $a$  = degree of dissociation

$\delta_{\text{obs}}$  = observed shift for  $\text{Me}_2\text{SnCl}_3^-$

$\delta_i$  = shift of  $\text{Me}_2\text{SnCl}_3^-$  (undissoc.)

$\delta_{ii}$  =  $\delta(\text{Me}_2\text{SnCl}_2)$

The full equilibrium for the dissociation of  $\text{Me}_2\text{SnCl}_4^{2-}$  is written:

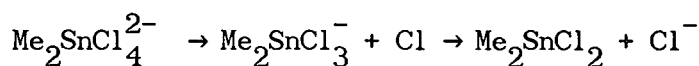

The amount of dissociation of  $\text{Me}_2\text{SnCl}_4^{2-}$  is



being the same as those considered previously.)

The  $\text{Me}_2\text{SnCl}_3^-$  so formed then dissociates:

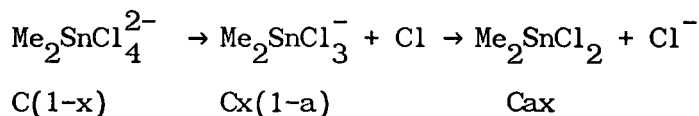

The observed shift for this system is therefore as follows:

$$\begin{aligned} \delta'_{\text{obs}} &= \delta_{iii}(1-x) + \delta_i x(1-a) + \delta_{ii} xa \quad (\text{vii}) \\ &= \delta_{iii}(1-x) + x[\delta_i(1-a) + \delta_{ii}a] \end{aligned}$$

which, by comparison with (vi) above, gives

$$\delta'_{\text{obs}} = \delta_{iii}(1-x) + \delta_{\text{obs}} x$$

where  $\delta_{iii}$  is the undissociated shift of  $\text{Me}_2\text{SnCl}_4^{2-}$  (-210 ppm from the graph).

All these values are known, so  $x$  can be determined.

$\delta'_{\text{obs}} = -139.5\text{ppm}$  and  $\delta_{\text{obs}} = -116\text{ppm}$  (these results are given in Ch3, section 3.2).

Substituting these values into the above equation gives  $x = 0.75$ , and  $K = 0.646 \text{ moldm}^{-3}$  indicating that  $\text{Me}_2\text{SnCl}_4^{2-}$  is 75% dissociated in acetonitrile solution.

[N.B. Coordination saturation by solvent is again assumed, although not expressed explicitly.]

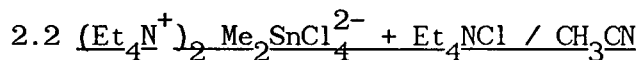

Initial amount of complex = 120mg in 0.7mls  $\text{CH}_3\text{CN}$

Hence  $C = 0.287\text{M}$

point no.	weight added (mg)	total equivs. $\text{Cl}^-$	shift (-ppm)
1	0	0	139.5
2	35.4	1.07	156.1
3	36.7	2.18	159.6
4	34.7	3.22	168.9
5	35.3	4.29	191.0
6	38.2	5.44	192.0
7	37.2	6.56	199.8
8	37.1	7.68	212.0
9	36.1	8.78	208.5

These figures are plotted in Fig. 5.1

The graph gives a limiting shift of approx. -210ppm

From the graph:

N	$\Delta$	x	$K(\text{mol dm}^{-3})$
0.1	0.968	0.702	0.475
0.2	0.936	0.695	0.455

Hence  $x = 0.698 \pm 0.004$  and  $K = 0.460 \pm 0.010 \text{ mol dm}^{-3}$  using this method.

Fig. 5.1

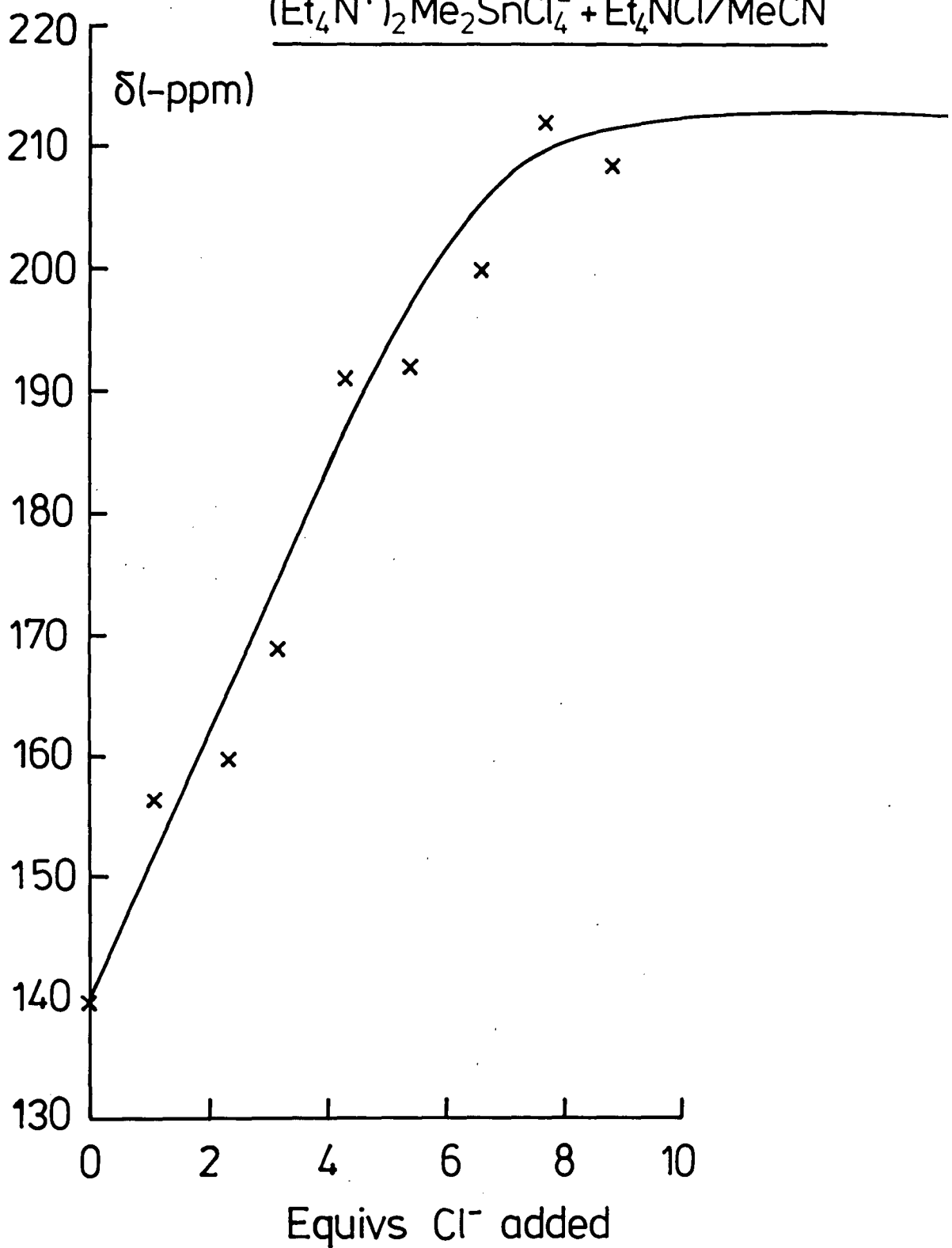
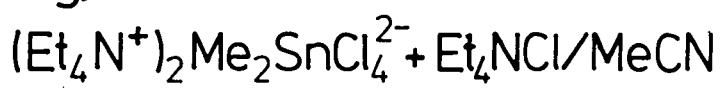

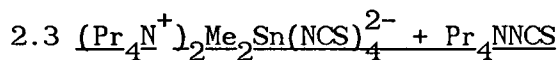

a: in  $\text{CH}_3\text{CN}$

Initial amount = 67.6mg in 0.7ml  $\text{CH}_3\text{CN}$

Hence C = 0.128M

point no.	weight added (mg)	total equivs. $\text{X}^-$	shift (-ppm)
1	0	0	416.0
2	24.5	1.12	430.2
3	24.5	2.24	437.1
4	42.6	4.18	461.6
5	44.0	6.19	472.1
6	45.0	8.24	473.8

These values are plotted in Fig. 5.2. Please see over. It gives a limiting shift of approx. -474ppm.

Taking values from the graph:-

N	$\Delta$	x	$K(\text{mol dm}^{-3})$
0.1	0.983	0.830	0.518
0.2	0.966	0.830	0.518
0.5	0.896	0.784	0.364

Hence  $x = 0.815 \pm 0.033$  and  $K = 0.467 \pm 0.103 \text{ mol dm}^{-3}$  by this method.

Fig. 5.2

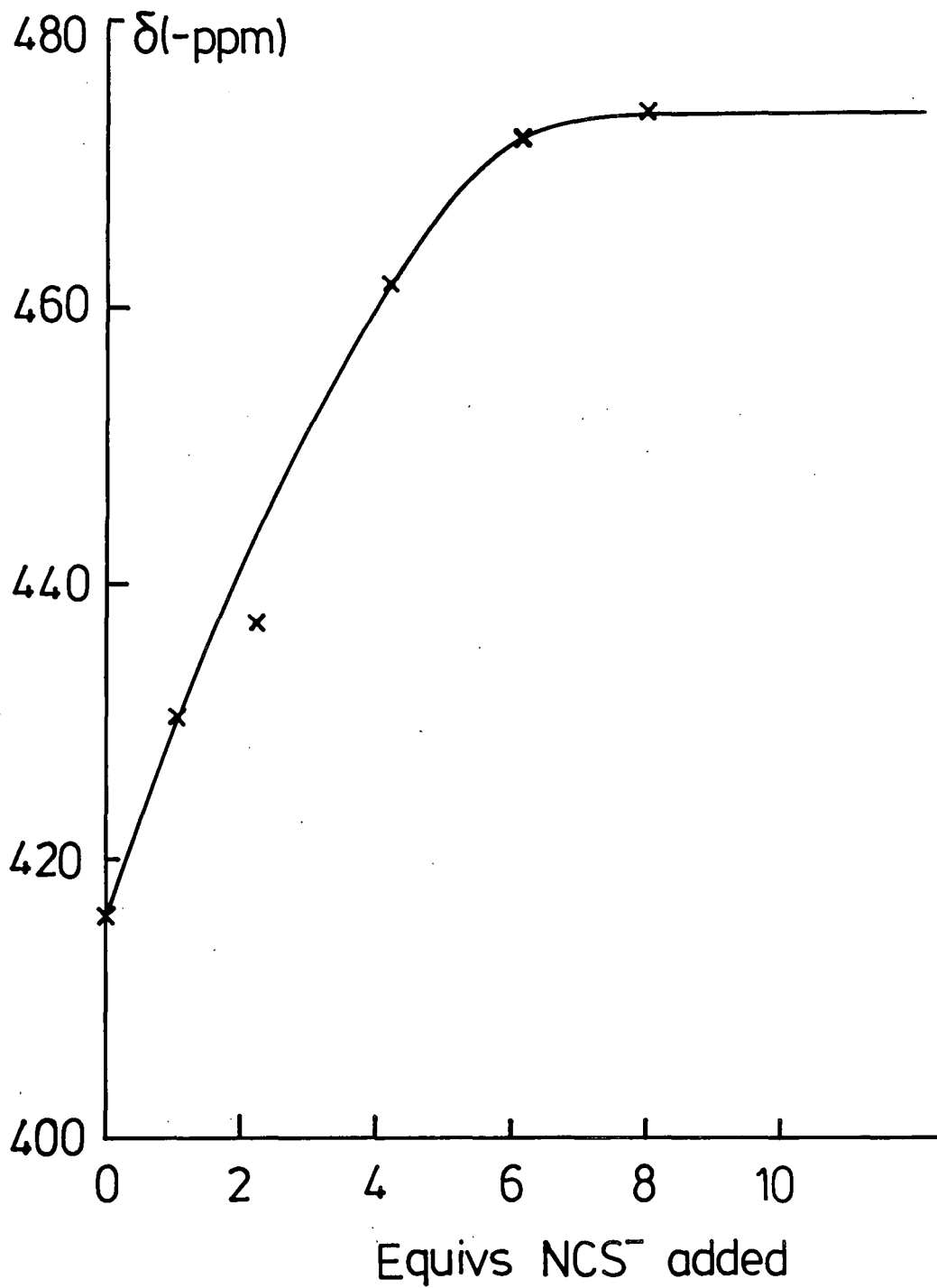



b: in DMSO

Initial amount = 139.7mg in 1ml DMSO. Hence C = 0.218M

point no.	weight added (mg)	total equivs. $X^-$	shift (-ppm)
1	0	0	387.1
2	20.2	0.49	385.3
3	29.5	1.21	378.3
4	64.6	2.78	390.6
5	64.0	4.34	394.8
6	30.3	5.08	393.1
7	68.4	6.66	382.6
8	78.1	8.56	381.8

These values are plotted in Fig.5.3. They show no systematic increase in  $\delta$ .

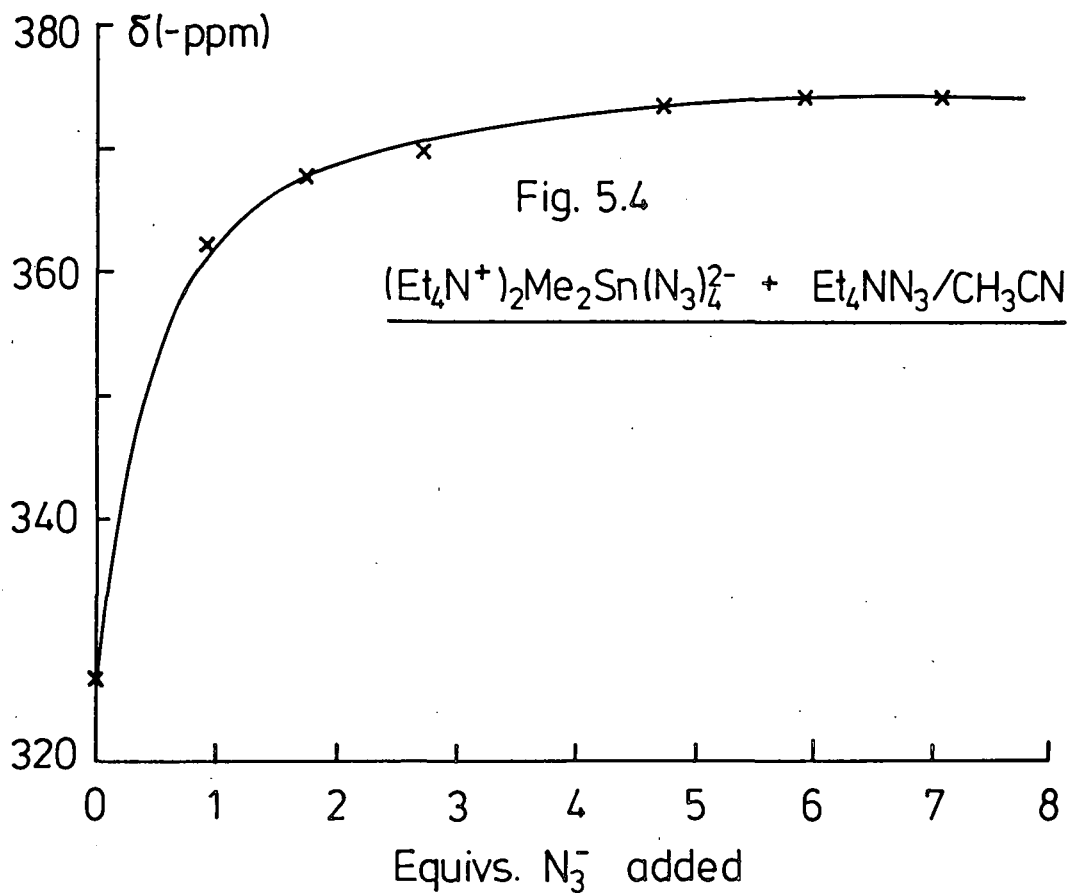
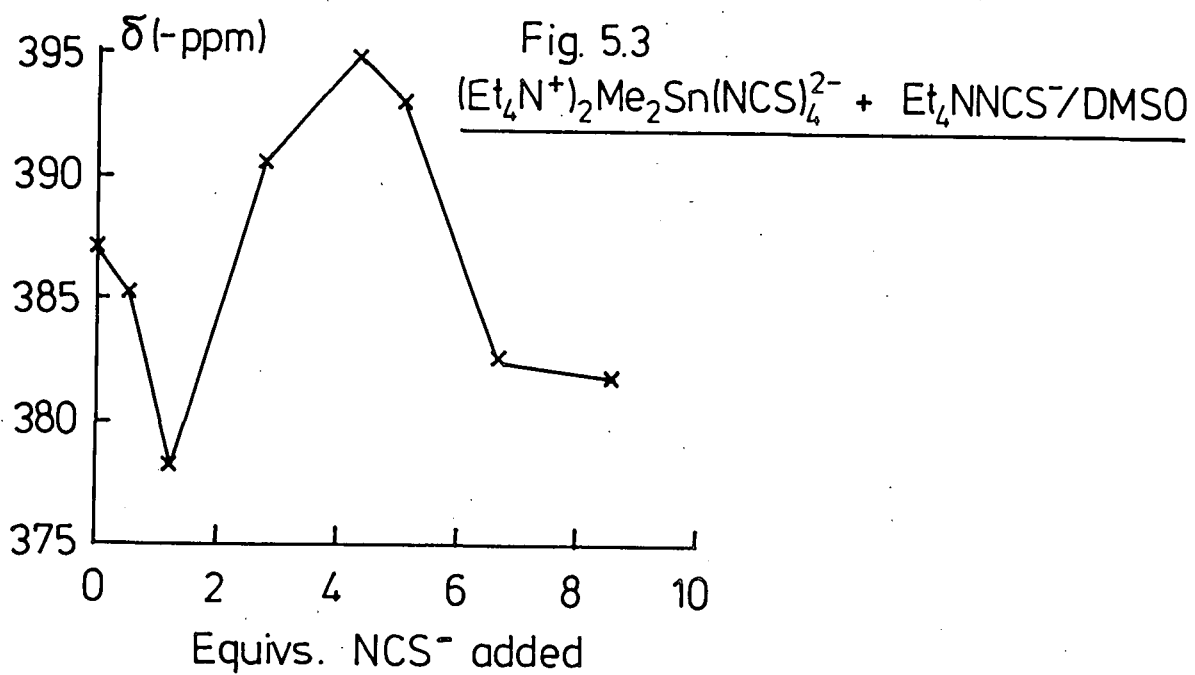

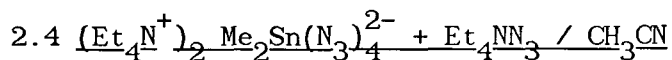

Initial amount = 214.7mg in 1ml  $\text{CH}_3\text{CN}$ . Hence  $C = 0.389\text{M}$

point no.	weight added (mg)	total equivs. $\text{X}^-$	shift (-ppm)
1	0	0	326.0
2	23.5	0.35	348.6
3	38.1	0.92	362.1
4	30.3	1.37	363.9
5	25.5	1.75	367.7
6	64.2	2.71	369.8
7	59.4	3.60	373.2
8	73.1	4.69	373.4
9	83.8	5.94	374.0
10	75.2	7.07	374.2

The plot of these values, Fig. 5.4, shows a systematic increase in shielding to a limiting value of  $\delta = -374\text{ppm}$ .

Taking values from the graph:-

N	$\Delta$	x	$K(\text{mol dm}^{-3})$
0.1	0.854	0.264	$3.69 \times 10^{-2}$
0.2	0.682	0.219	$2.39 \times 10^{-2}$
0.5	0.438	0.216	$2.31 \times 10^{-2}$

Hence  $x = 0.233 \pm 0.031$  and  $K = 2.80 \pm 0.89 \times 10^{-2} \text{ mol dm}^{-3}$ .

## 2.5 Discussion

The same shape of curve is produced in cases 2.2 (Fig. 5.1), 2.3a (Fig. 5.2) and 2.4 (Fig. 5.4), as was found by Hewitson for the addition of halide to alkyltin halides (95), and the limiting shift is observed after a comparable amount of halide has been added. The differences that occur can be attributed to solvent effects, the observed shift for the complex with no added halide, and the intermediate values, are all shifted to low frequency ( $\text{Me}_2\text{SnCl}_4^{2-}/\text{CH}_2\text{Cl}_2$ ,  $\delta = -128$  ppm;  $\text{Me}_2\text{SnCl}_4^{2-}/\text{CH}_3\text{CN}$ ,  $\delta = -139.5$  ppm). The values for the limiting shifts in the two solvents also are different;  $-210$ ppm in  $\text{CH}_3\text{CN}$  and  $-167$ ppm in  $\text{CH}_2\text{Cl}_2$  (95). It is not expected that solvent would make more than  $\approx 5$ ppm difference to these shifts, since it is not directly coordinated to the complex, so this difference is rather anomalous.

In the addition of chloride to  $\text{Me}_2\text{SnCl}_2$ , a plateau is observed before the final end point, which is attributed to the formation of  $\text{Me}_2\text{SnCl}_3^-$ . This is not observed in these graphs. The shift value of  $\text{Me}_2\text{SnCl}_4^{2-}$  in  $\text{CH}_2\text{Cl}_2$  is very close to this plateau, indicating that this complex is extensively dissociated in  $\text{CH}_2\text{Cl}_2$ . The value of  $x = 0.75$  (section 2.1) and  $x = 0.70$  (section 2.2) indicates that the tetrachloride is also considerably dissociated in  $\text{CH}_3\text{CN}$ , but not to such a large extent.

The effect of DMSO on the dissociation equilibrium is clearly demonstrated by the results in section 2.3b.

The strong donor character of this solvent is also shown by the effect it has on the parameters of other complexes presented here.  $\text{Me}_2\text{SnCl}_2$  and  $\text{Me}_2\text{Sn}(\text{NCS})_2$  have  $^{119}\text{Sn}$  chemical shifts that are significantly ( $\approx 280$  and  $\approx 150$ ppm respectively) to lower frequency

of the values in other (weaker) donor solvents.  $^2J$  is also larger in DMSO. This shows that very strong complexes are being formed, with considerable electron density donation onto the tin atom.

The range of shifts of dimethyltin azido and thiocyanato chloride complexes is reduced in DMSO, and the values are (mostly) moved to lower frequency. This indicates that DMSO has a very strong influence on the dissociation equilibria of these complexes.

This study shows that addition of  $\text{NCS}^-$  to a solution of  $\text{Me}_2\text{Sn}(\text{NCS})_4^{2-}$  in DMSO has virtually no effect on the equilibrium position of its dissociation. Table 2.3b and Fig. 5.3 show that the range of shifts observed over an 8-fold increase in amount of  $\text{NCS}^-$  present is only 16.5ppm, and the variation is totally non-systematic. This variation is not significant when compared with a channel width of  $\approx 5$ ppm.

The similarity of these values to that obtained for  $\text{Me}_2\text{Sn}(\text{NCS})_2$  in this solvent (-378.1ppm and -380.2ppm respectively) indicates that DMSO has replaced  $\text{NCS}^-$  in the coordination sphere, and since the shift changes little on further addition of  $\text{NCS}^-$ , this anion is not strong enough to displace DMSO, even when present in large excess. Parallel experiments were not performed with  $\text{Me}_2\text{SnCl}_4^{2-}$  and  $\text{Me}_2\text{Sn}(\text{N}_3)_4^{2-}$ , but the shift values of the 4- and 6-coordinate compounds indicates that a similar situation is involved.

X	$\delta(\text{Me}_2\text{SnX}_2)$ (-ppm)	$\delta(\text{Me}_2\text{SnX}_4^{2-})$ (-ppm)
Cl	246.1	241.6
NCS	378.1	380.2
$\text{N}_3$	330.1	332.4

Since  $\text{Me}_2\text{SnX}_4^{2-}$  is fully dissociated, it seems likely that the intermediate complexes will be also. If this is the case, the observed shift for each complex will be the average over the 4-coordinate species present, the relative amounts of which are statistically determined if DMSO completely and randomly replaces 2 of the anionic ligands in the complex.

(Complexation by 2 moles of DMSO is assumed for all the following 4-coordinate species.)

In DMSO therefore;

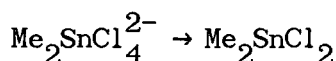

$$\delta_1 = \delta(\text{Me}_2\text{SnCl}_2)$$

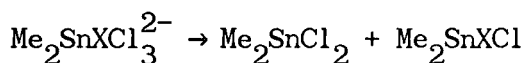

$$\delta_2 = 1/2 \delta(\text{Me}_2\text{SnCl}_2) + 1/2 \delta(\text{Me}_2\text{SnXCl})$$

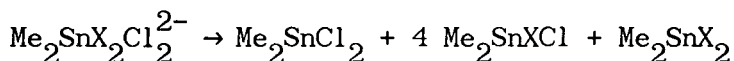

$$\delta_3 = 1/6 \delta(\text{Me}_2\text{SnCl}_2) + 2/3 \delta(\text{Me}_2\text{SnXCl}) + 1/6 \delta(\text{Me}_2\text{SnX}_2)$$

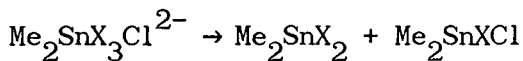

$$\delta_4 = 1/2 \delta(\text{Me}_2\text{SnX}_2) + 1/2 \delta(\text{Me}_2\text{SnXCl})$$

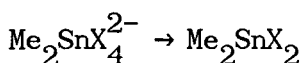

$$\delta_5 = \delta(\text{Me}_2\text{SnX}_2)$$

By using  $\delta(\text{Me}_2\text{SnXCl}) = 2\delta_2 - \delta_1$  to obtain a value for the shift of this species, the expected values for the intermediate 6-coordinate complexes on the basis of complete dissociation can be compared with those actually obtained.

		X = NCS	X = N <sub>3</sub>
(all values in -ppm)			
$\delta_1$		241.6	
$\delta_2$		247.9	267.4
$\delta_3$	Expect	272.75	291.1
	Obtain	253.1	289.4
$\delta_4$	Expect	316.2	312.8
	Obtain	358.6	302.0
$\delta_5$		378.1	332.4

The values obtained for azide complexes are close to those expected on the assumption of dissociation, so it seems likely that DMSO has completely replaced two of the anionic ligands in these complexes, although the shift value for  $\delta_4$  is slightly lower than anticipated, indicating that more chloride than expected may be formed.

In the case of the thiocyanate complexes, the shifts are in the same region as expected, but differences are significant. This indicates that some degree of complexation by  $\text{X}^-$  could be retained by these complexes in DMSO solution.

The values that are obtained for  $\text{K}(\text{Me}_2\text{SnCl}_4^{2-})$  from both treatments are the same, within the limits of the simplifications inherent in the derivation ( $K = 0.646 \text{ moldm}^{-3}$ ,  $x = 0.75$  using

$\delta(\text{Me}_2\text{SnCl}_3^-)$  and  $K = 0.475 \text{ mol dm}^{-3}$ ,  $x = 0.70$  using the derived equation). That both treatments agree indicates that the approximations made are reasonable, and the values give an acceptable estimate of the actual degree of dissociation.

If the values obtained for each complex are compared as shown below,

X	K	x at 0.25M
Cl	0.475	0.760
NCS	0.467	0.721
$\text{N}_3$	0.028	0.283

it is apparent that the chloride and thiocyanate complexes are both dissociated to approximately the same extent at comparable concentrations in acetonitrile, but the tetraazido-complex is only approx. 28% dissociated. This suggests that stronger bonds are formed in the latter.

If dimethyltin tetra-chloride and thiocyanate complexes are both dissociated to the same extent, then mixed chloro-thiocyanato complexes will lose  $\text{Cl}^-$  or  $\text{NCS}^-$  in equal proportions. Across the series, dissociation differences will be small, so the variation in chemical shift with changing n in  $(\text{Et}_4\text{N}^+)_2 \text{Me}_2\text{Sn}(\text{NCS})_n \text{Cl}_{4-n}^{2-}$  will be due to electronic effects only.

When  $(\text{Et}_4\text{N}^+)_2 \text{Me}_2\text{Sn}(\text{N}_3)_n \text{Cl}_{4-n}^{2-}$  is considered, as n increases the degree of dissociation will decrease, and  $\delta(\text{observed})$  will be closer to  $\delta(\text{Me}_2\text{Sn}(\text{N}_3)_4^{2-})$ . Also, chloride will be lost preferentially over azide in all cases, so the observed shifts will be moved to low frequency from where they would have been had dissociation effects been the same across the series. In other words the observed changes in  $\delta$  reflect dissociation as well as



electronic differences, with a tendency to bias the shifts to low frequency values.

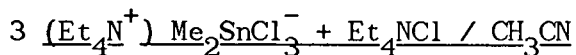

Initial weight = 92.0mg in 0.6mls  $\text{CH}_3\text{CN}$  Hence C = 0.398M

point no	total equivs $\text{Cl}^-$	shift (-ppm)
1	0	116.0
2	0.385	143.0
3	1.847	162.6
4	2.890	168.1
5	4.041	183.8
6	5.230	208.5
7	6.195	203.5
8	8.208	209.5

These values are plotted graphically in Fig. 5.5.

The graph tends to the same limit as that observed for  $\text{Me}_2\text{SnCl}_4^{2-}$ , indicating that this is the final product of the reaction. No plateau is observed for the discrete formation of  $\text{Me}_2\text{SnCl}_3^-$  (undissociated), so this shift remains unknown. Neither Torchesnikov's method nor the equation previously derived can be used, since the unknown shift in this situation is  $\delta_1$  - the shift of the undissociated complex. The extent of dissociation therefore cannot be obtained from the information available.

Fig 5.5

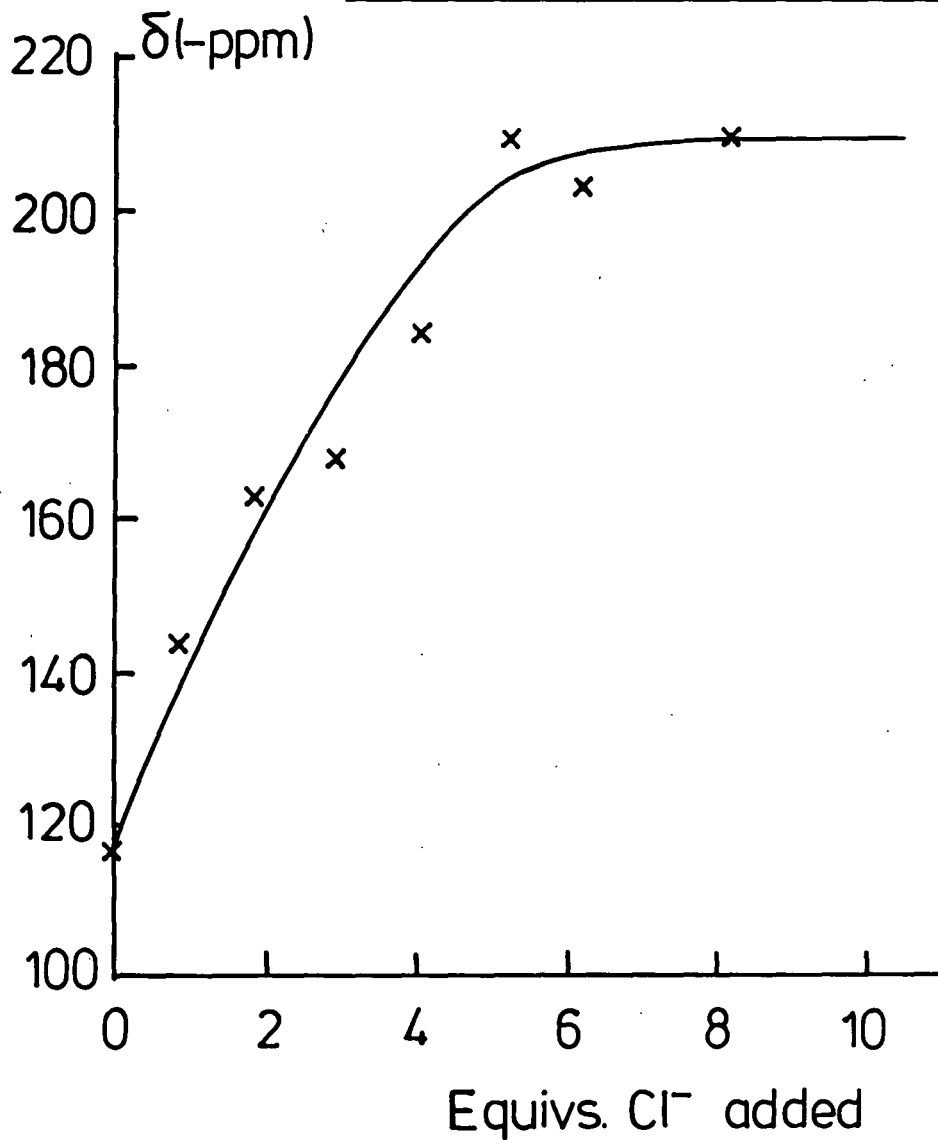
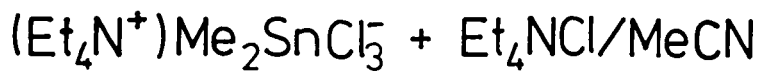

4 ADDITION TO 4-COORDINATE COMPLEXES4.1 Me<sub>2</sub>SnCl<sub>2</sub> + Et<sub>4</sub>NCl / CH<sub>3</sub>CNInitial amount = 144.6mg in 0.6mls CH<sub>3</sub>CN. C = 1.10M

point no.	total equivs Cl <sup>-</sup>	shift (-ppm)
1	0	-33.2
2	0.474	52.4
3	0.958	120.7
4	1.415	135.6
5	1.930	144.6
6	2.428	159.6
7	2.937	170.9
8	3.466	174.1
9	3.993	179.2
10	4.937	189.3
11	5.950	192.8
12	6.940	203.3
13	7.926	210.2

These figures are plotted in Fig. 5.6. Please see over.

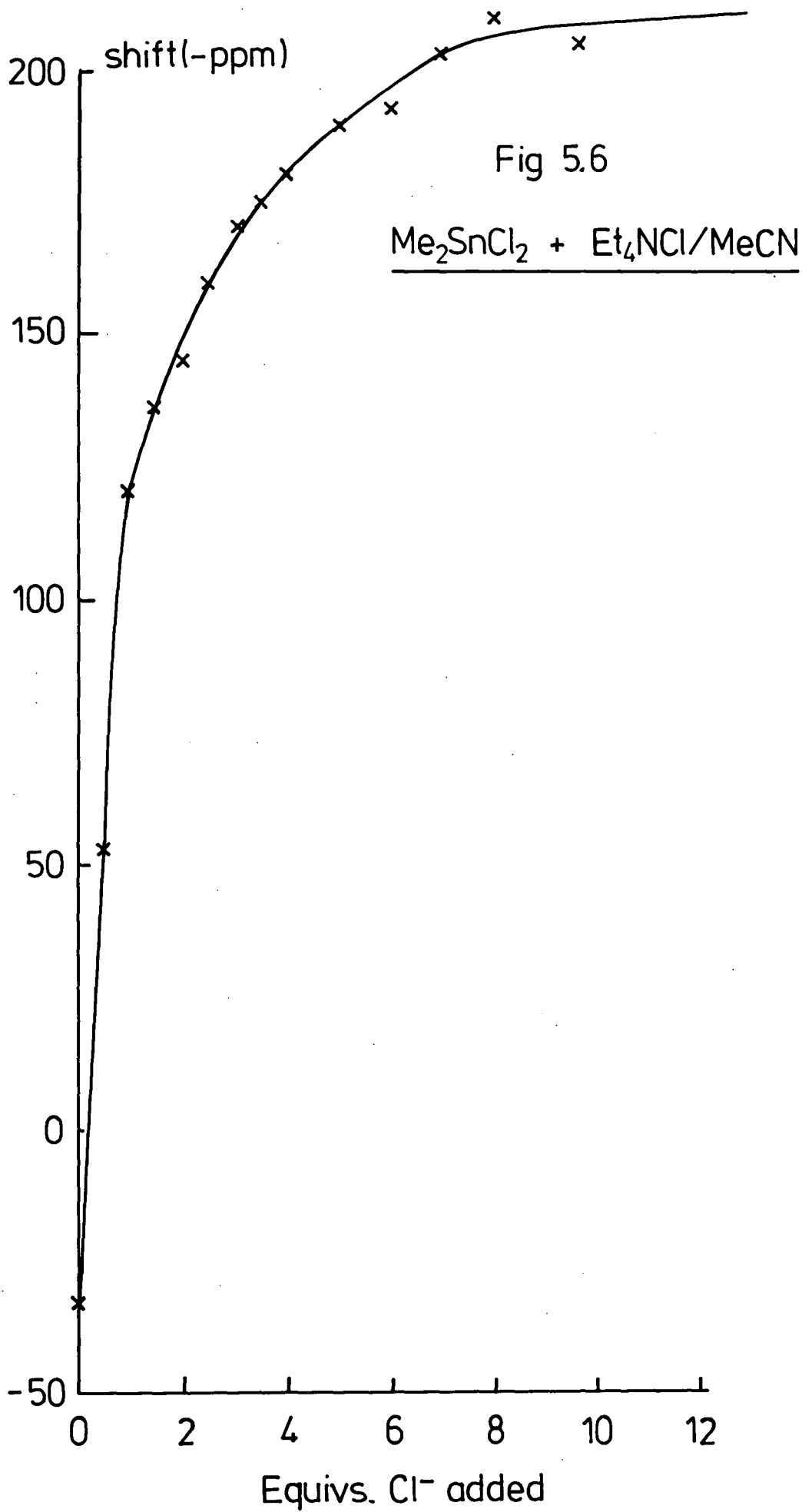

4.2  $\text{Me}_2\text{Sn}(\text{NCS})_2 + \text{Pr}_4\text{NNCS} / \text{CH}_3\text{CN}$ Initial amount = 81.9mg in 0.7mls  $\text{CH}_3\text{CN}$ . C = 0.441M

point no.	total equivs $\text{X}^-$	shift (-ppm)
1	0	239.1
2	0.800	239.9
3	1.300	284.9
4	1.889	360.4
5	2.534	389.7
6	2.604	376.9
7	3.104	400.4
8	3.648	411.6
9	5.833	449.4
10	6.851	451.2
11	8.585	468.8
12	10.332	461.6

These values are plotted in Fig. 5.7.

4.3 Discussion

The steepness of the initial part of the curve indicates that addition takes place fairly readily in solution.

In 4.1 and 4.2, no plateau is observed for the discrete formation of the 5 coordinate species, in contrast to Hewitson's results in  $\text{CH}_2\text{Cl}_2$ , where a shift for  $\text{Me}_2\text{SnCl}_3^-$  was obtained. This indicates that the formation of the five-coordinate complex does not go to completion before some six-coordinate complex is formed.

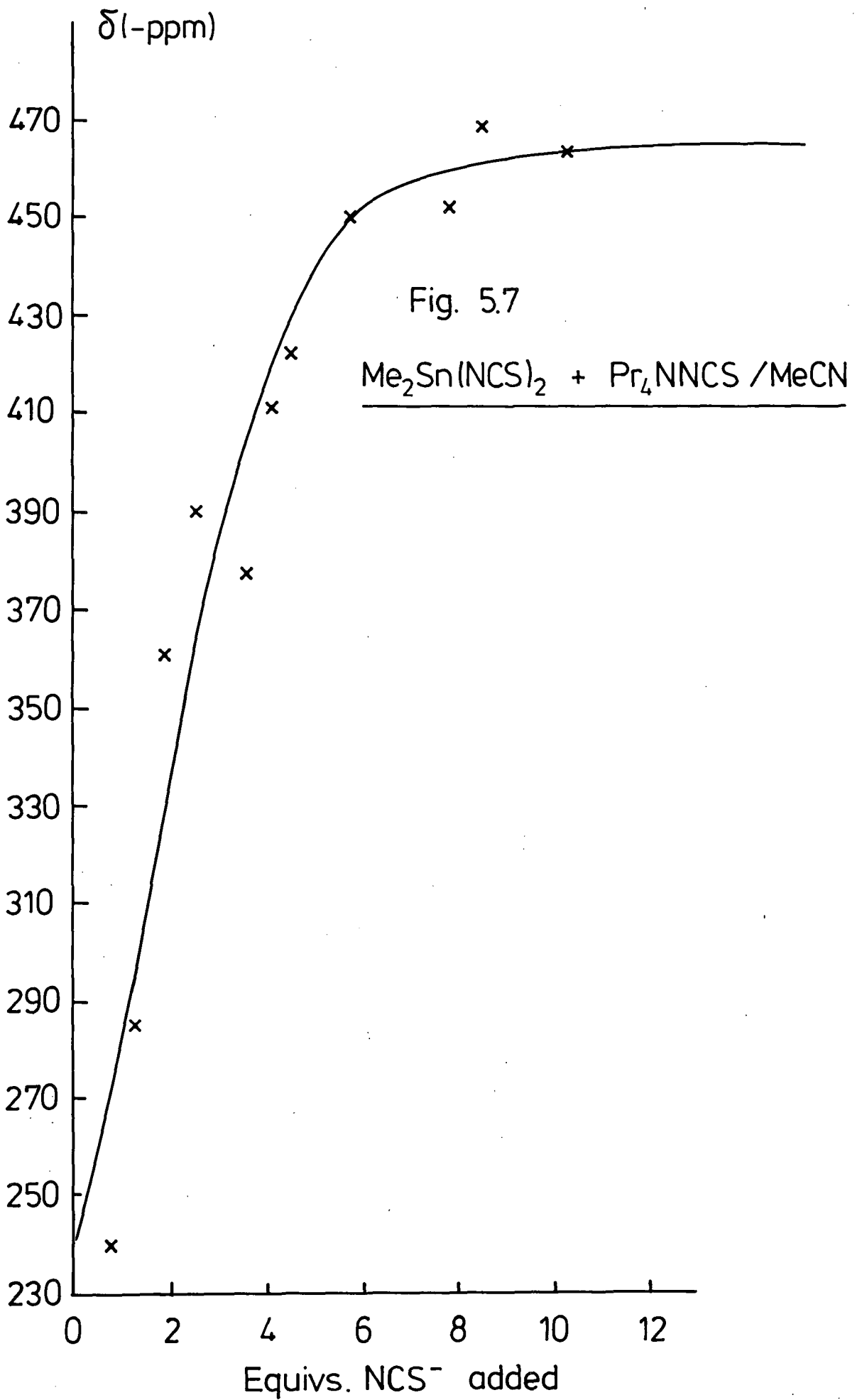

This situation was anticipated from the behaviour of the six-coordinate complexes in section 2, and is probably a solvent effect - the complexes are in fact six-coordinate at all stages, and the reaction is more accurately described as substitution with  $\text{Cl}^-$  substituting for MeCN.

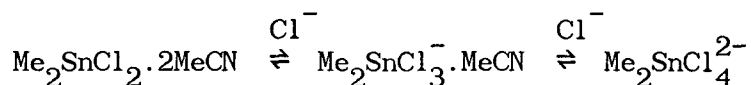

The difference in stability between the above complexes is likely to be less than for their non-solvated analogues, and hence the difference between stages in addition on the graph is much less clear-cut.

The solvent also moves the observed values of the shifts to lower frequency, due to complexation effects, and the limiting shift found here is to significantly lower frequency than that found in  $\text{CH}_2\text{Cl}_2$ . Solvent is not expected to make a major difference to this value, but the values of  $\delta(\text{limit})$  are the same whether the starting complex is 4, 5 or 6-coordinate, so they seem to be reliable.

The comparability of the limiting shifts obtained for chloride and thiocyanate complexes regardless of starting material indicates that complexation has been pushed to a maximum and dissociation has been more or less completely suppressed in all cases.

5 SUBSTITUTION REACTIONS

Since the 6-coordinate complexes are labile in solution, mixtures of the dimethyltin tetrathiocyanate and chloride complexes should undergo exchange. This is found to be the case, but unfortunately this exchange is rapid enough to give one signal that is an average over all the components of the equilibrium, meaning none of them can be seen discretely, unlike the inorganic ions  $\text{SnX}_6^{2-}$  where the intermediate complexes have long enough lifetimes for discrete NMR signals to be observable (94,171).

Shifts of mixtures of  $(\text{Et}_4\text{N}^+)_2 \text{Me}_2\text{SnCl}_4^{2-}$  and  
 $(\text{Pr}_4\text{N}^+)_2 \text{Me}_2\text{Sn}(\text{NCS})_4^{2-} / \text{MeCN}$

$\delta$ (-ppm)	mol % $\text{Me}_2\text{Sn}(\text{NCS})_4^{2-}$
128.4	18.8
159.2	32.1
195.1	49.8
340.6	72.9

Since all possible tri- and tetrahalo/pseudohalo-anions (hexa-coordination is assumed throughout, due to solvent coordination) have a probability of being formed, in proportions that depend on the relevant equilibrium constants and the initial amounts of complexes,

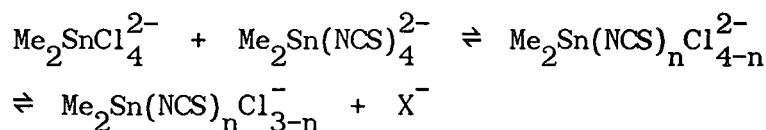

$\delta$  will be an average over around nine species, so no



meaningful analysis can easily be performed on the shift values of these mixtures.

The situation was simplified to study substitution effects. Successive amounts of  $Y^-$  were added to  $Me_2SnX_4^{2-}$  and resultant changes in  $\delta$  monitored.

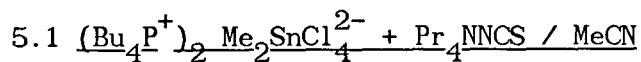

Initial amount = 137.0mg

point no.	weight added (mg)	total equivs $X^-$	shift (-ppm)
1	0	0	135.2
2	20.5	0.495	128.2
3	18.2	0.936	136.2
4	21.1	1.447	143.2
5	22.5	1.992	152.7
6	19.8	2.471	144.9
7	20.6	2.970	150.1
8	20.6	3.469	158.9
9	22.0	4.002	167.6
10	21.0	4.150	165.8
11	26.2	5.143	169.2
12	16.1	5.533	186.8
13	23.7	6.105	188.5

signal unobtainable on further addition of  $X^-$ .

These values are plotted in Fig. 5.8.

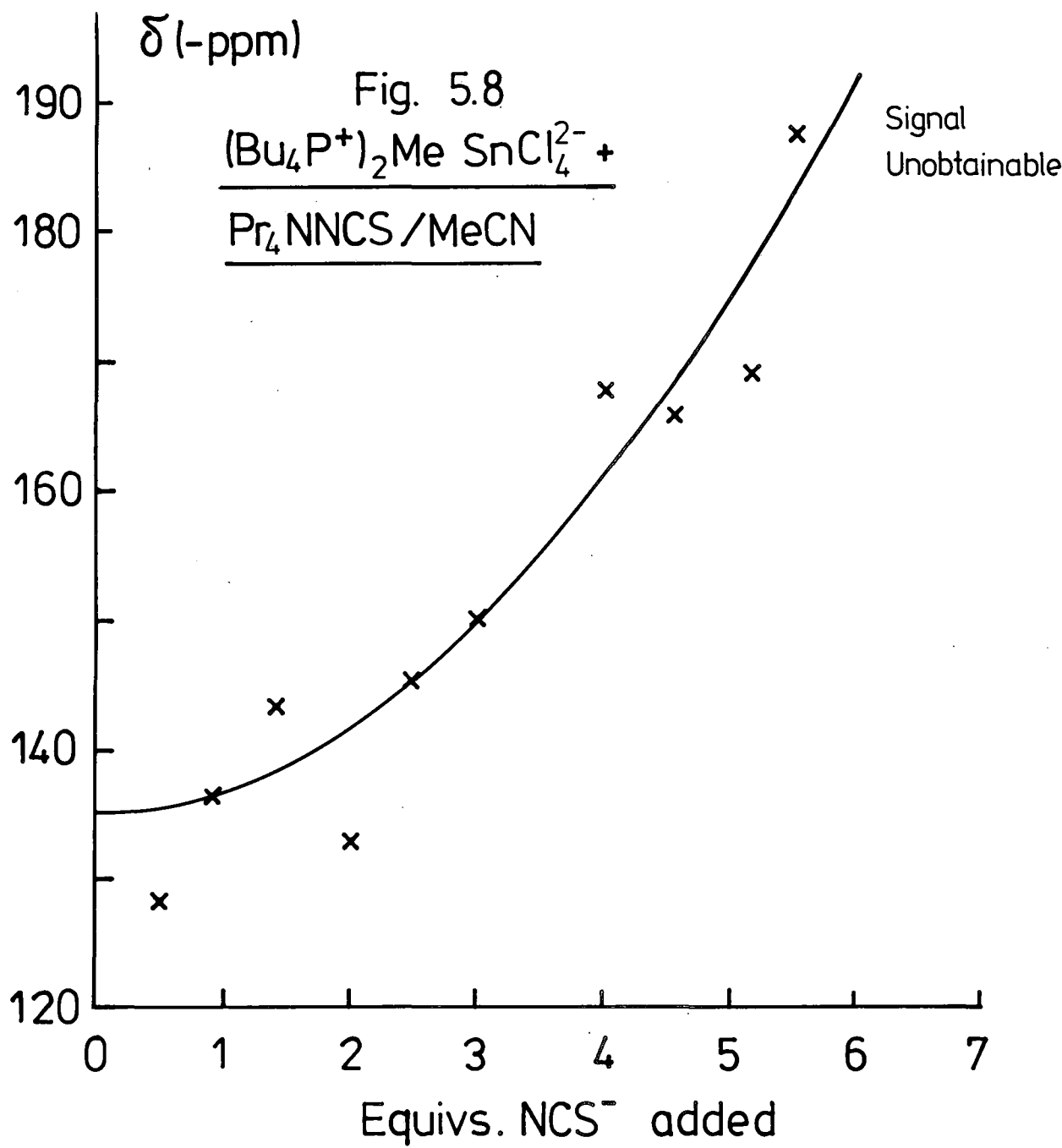

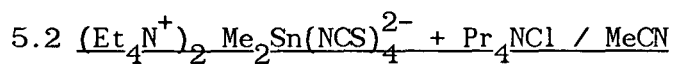

Initial amount = 73.1mg

point no.	weight added (mg)	total equivs. $\text{X}^-$	shift (-ppm)
1	0	0	416.0
2	14.5	0.67	340.4
3	9.6	1.12	282.2
4	11.7	1.66	225.2
5	10.2	2.14	195.5
6	10.4	2.62	162.4
7	10.6	3.11	157.1
8	7.2	3.45	155.4
9	8.2	3.83	150.1
10	9.5	4.27	141.1
11	15.1	4.97	143.2
12	12.6	5.56	143.2
13	11.0	6.07	143.2
14	18.2	6.91	148.4
15	10.4	7.40	157.1
16	10.9	7.89	157.1
17	12.3	8.45	160.4

Signal unobtainable on further addition of  $\text{X}^-$ .

These figures are plotted in Fig. 5.9.

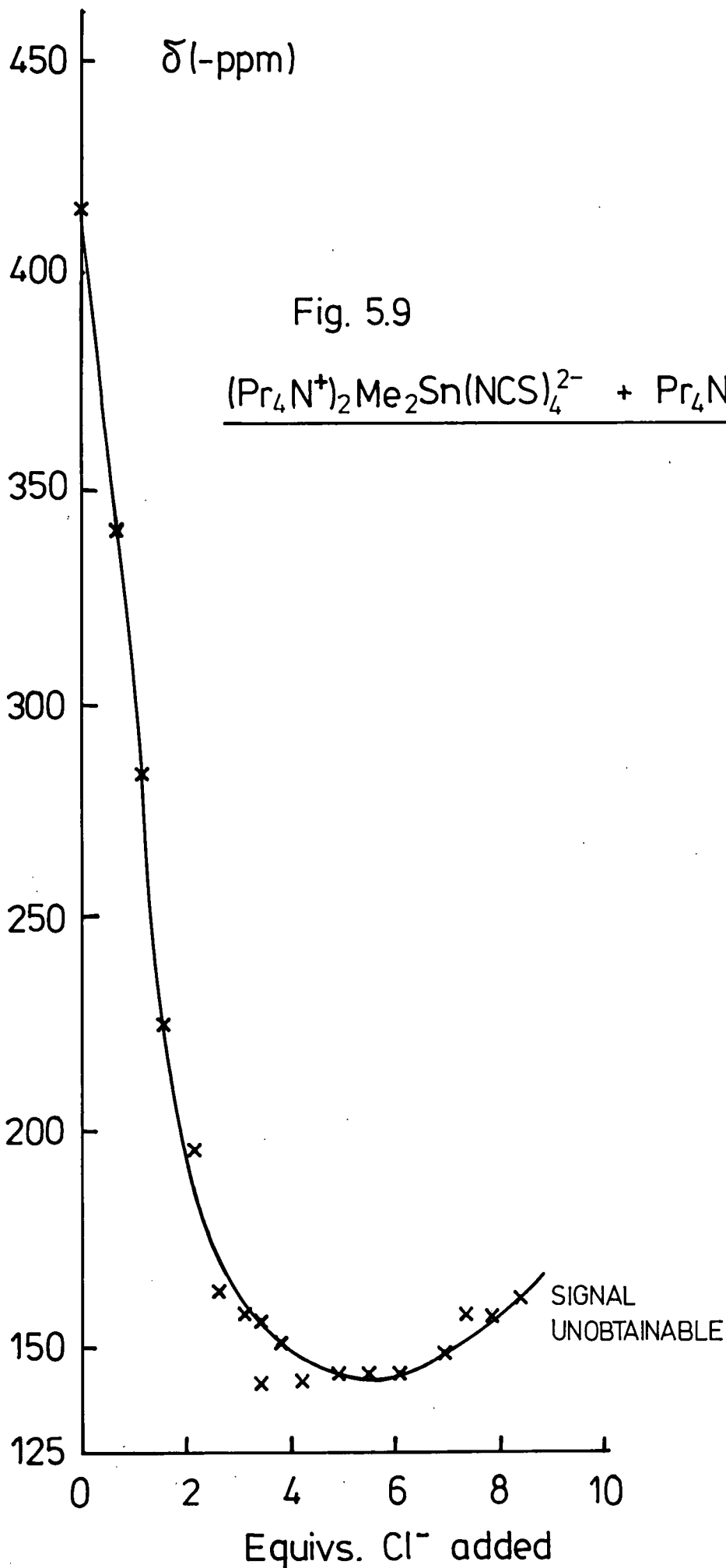

### 5.3 Discussion

If substitution occurs, the reaction can be written as follows

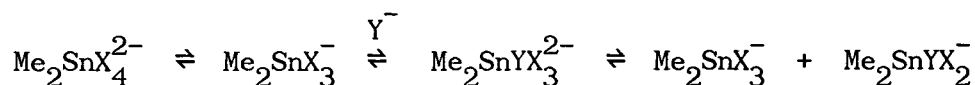

which is effectively the sum of the dissociation of  $\text{Me}_2\text{SnX}_4^{2-}$  and  $\text{Me}_2\text{SnYX}_3^{2-}$ , so  $\delta$  for such a system is the average of the observed shifts of these two complexes. As more  $\text{Y}^-$  is added, the formation of  $\text{Me}_2\text{SnY}_2\text{X}_2^{2-}$  etc. is anticipated.

Looking at the graphs, it can be seen that in both cases  $\delta$  changes with added anion in the direction expected from the shifts of the substitution products (ie.  $\delta$  moves towards  $\delta(\text{Me}_2\text{Sn}(\text{NCS})\text{Cl}_3^{2-})$  and  $\delta(\text{Me}_2\text{Sn}(\text{NCS})_2\text{Cl}_2^{2-})$  in 5.1, Fig. 5.8, and towards  $\delta(\text{Me}_2\text{Sn}(\text{NCS})_3\text{Cl}^{2-})$  and  $\delta(\text{Me}_2\text{Sn}(\text{NCS})_2\text{Cl}_2^{2-})$  in 5.2, Fig. 5.9).

The initial change in  $\delta$  is less dramatic in 5.1, but in considering this, the much smaller differences between the shift values of the complexes formed in substitution must be taken into account. The shift of  $\text{Me}_2\text{Sn}(\text{NCS})_2\text{Cl}_2^{2-}$  is reached after approx. 3 equivalents of  $\text{NCS}^-$  are added, so substitution is rather less than stoichiometric. A signal becomes unobtainable before the shift of  $\text{Me}_2\text{Sn}(\text{NCS})_3\text{Cl}^{2-}$  is reached, but since the values that are obtained are to significantly lower frequency than  $\delta(\text{Me}_2\text{Sn}(\text{NCS})_2\text{Cl}_2^{2-})$  (-152.1ppm) a proportion of  $\text{Me}_2\text{Sn}(\text{NCS})_3\text{Cl}^{2-}$  is likely to have been formed.

Hence after 6 equivalents of  $\text{NCS}^-$  have been added, the reaction mixture can probably be described as  $\text{Me}_2\text{Sn}(\text{NCS})_2\text{Cl}_2^{2-} + \text{Me}_2\text{Sn}(\text{NCS})_3\text{Cl}^{2-}$  (with appropriate dissociation products).

In 5.2, Fig. 5.9,  $\delta$  moves to higher frequency dramatically as  $\text{Cl}^-$  is added to the solution. After 1 equivalent the shift is at

higher frequency than the observed value for  $\text{Me}_2\text{Sn}(\text{NCS})_3\text{Cl}^{2-}$ , so further substitution must take place before stoichiometric formation of the monosubstituted product, indicating that replacement of the first  $\text{NCS}^-$  is extremely facile. After this point, the change in  $\delta$  slows down and  $\delta(\text{Me}_2\text{Sn}(\text{NCS})_2\text{Cl}_2^{2-})$  is reached after approx. 3.5 equivalents of  $\text{Cl}^-$  have been added - which is 0.5 equivalents more than was necessary to obtain this shift in system 5.1. The minimum of the graph is observed when 5.5 equivalents of  $\text{Cl}^-$  have been added. This represents the maximum substitution obtained, since after this point,  $\delta$  moves to lower frequency, showing that further addition of  $\text{Cl}^-$  causes dissociation suppression. The value obtained is 4ppm to lower frequency of the observed value for  $\delta(\text{Me}_2\text{SnCl}_4^{2-})$  so it is highly probable that full substitution has taken place. This would be confirmed if a limiting shift of approx. -210ppm could be obtained, but unfortunately the signal ceased to be observable before this point was reached.

The minimum of the graph is reached after 5.5 equivalents of  $\text{Cl}^-$  have been added. The addition of the corresponding amount of  $\text{NCS}^-$  in system 5.1 produces a chemical shift corresponding to a mixture of  $\text{Me}_2\text{Sn}(\text{NCS})_2\text{Cl}_2^{2-}$  and  $\text{Me}_2\text{Sn}(\text{NCS})_3\text{Cl}^{2-}$ . This indicates that substitution is easier in system 5.2, but this could be because  $\text{Cl}^-$  is a stronger substitution agent or because bonds are weaker in the  $\text{Me}_2\text{Sn}(\text{NCS})_4^{2-}$  ion. If this experiment was performed on both complexes using the same substituting anion - eg.  $\text{N}_3^-$  - it could be determined which of these two factors was causing the observed effect.

In conclusion, these experiments show that both complexes

undergo substitution of one ligand fairly readily, after which further substitution is more difficult. Full substitution is probably observed for  $\text{Me}_2\text{Sn}(\text{NCS})_4^{2-}$  but not for  $\text{Me}_2\text{SnCl}_4^{2-}$ , where partial substitution to  $\text{Me}_2\text{Sn}(\text{NCS})_3\text{Cl}^{2-}$  is probably occurring when a signal for the system ceases to be observable.

6 SUBSTITUTION AND ADDITION REACTIONS

If  $X^-$  is added to a solution of  $Me_2SnX_2$ , the only observable reaction is addition. Substitution is possible, but produces no overall change. If  $Y^-$  is added to a solution of  $Me_2SnX_2$ , then substitution or addition is possible. The following experiment was carried out to determine which occurs preferentially.

6.1  $Me_2Sn(NCS)_2 + Et_4NCl / MeCN$ 

Initial amount = 181.1mg

= 0.684 mmols

point no.	weight added (mg)	total equivs $Cl^-$	shift (-ppm)
1	0	0	239.0
2	25.4	0.900	192.8
3	21.1	1.086	193.0
4	27.9	1.332	185.8
5	22.8	1.533	161.4
6	27.1	1.772	154.4
7	28.0	2.019	147.4
8	30.7	2.290	150.9
9	24.3	2.505	152.7
10	27.9	2.751	151.9
11	27.0	2.989	156.1
12	28.5	3.241	161.4
13	30.8	3.513	163.8
14	28.2	3.762	175.3



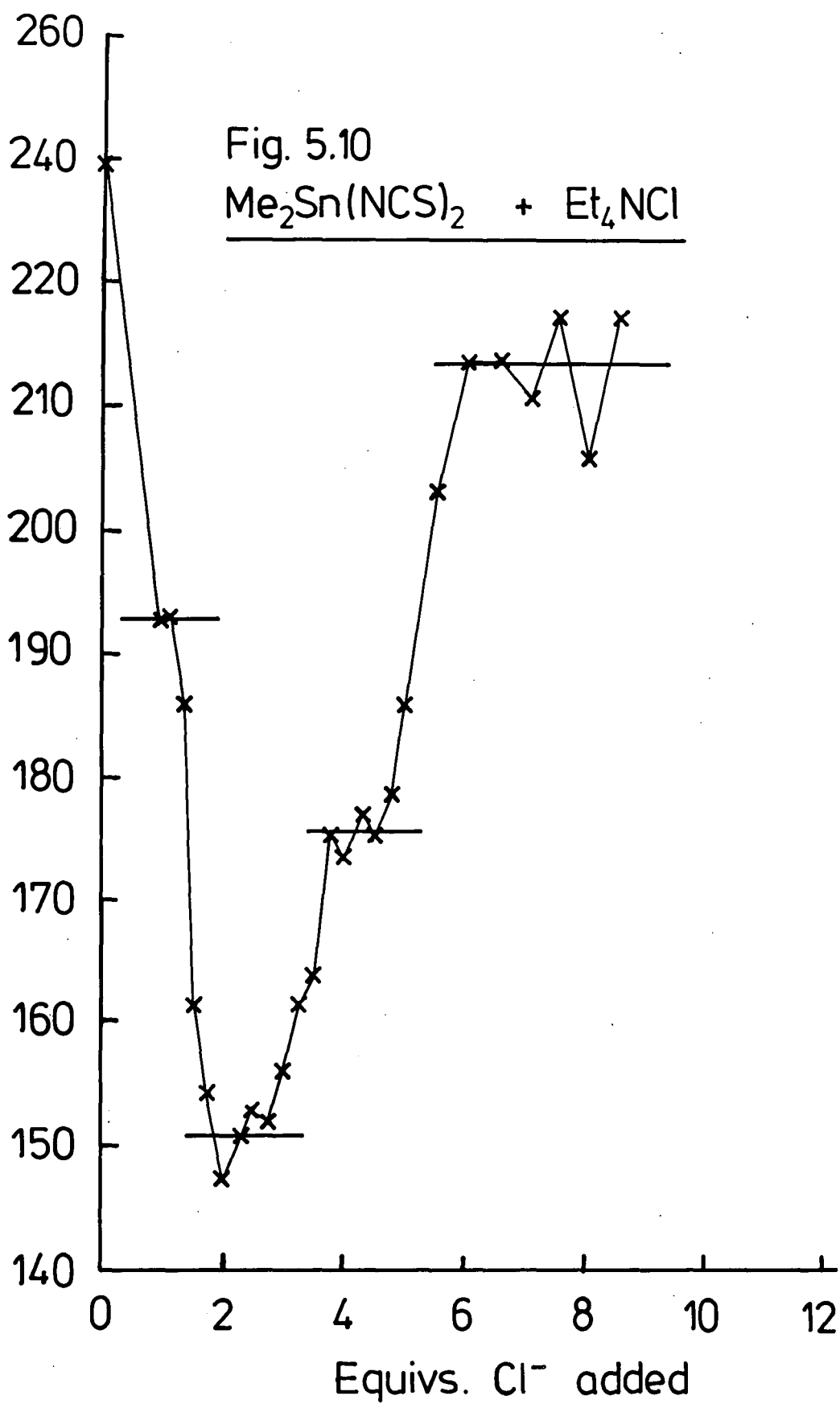

point no.	weight added (mg)	total equivs Cl <sup>-</sup>	shift (-ppm)
15	27.7	4.007	175.3
16	28.5	4.259	177.0
17	28.0	4.506	175.3
18	28.6	4.758	178.8
19	27.5	5.001	185.8
20	25.8	5.494	203.3
21	59.5	6.017	213.7
22	57.5	6.525	213.7
23	59.3	7.048	210.7
24	54.5	7.529	217.2
25	55.3	8.017	200.2
26	56.3	8.514	217.2

These values are plotted in Fig. 5.10.

$-\delta$  first dips to 193ppm. It then drops to a minimum at 151ppm, increases again to a stationary point at 176ppm and ends up at a new maximum of 214ppm.

The first point indicates that the main reaction is addition - this shift is reasonably close to that observed for  $\text{Me}_2\text{Sn}(\text{NCS})_2\text{Cl}^-$  (-193 vs. -184ppm). The second step is likely to be further addition of  $\text{Cl}^-$  to give  $\text{Me}_2\text{Sn}(\text{NCS})_2\text{Cl}_2^{2-}$  since the  $\delta$  value is very close to the value obtained for this complex (-152ppm for  $\text{Me}_2\text{Sn}(\text{NCS})_2\text{Cl}_2^{2-}$ , -151ppm observed minimum). Both these steps take place after stoichiometric amounts of chloride have been added, so

addition takes place readily.

The end point of the reaction is almost certainly  $\text{Me}_2\text{SnCl}_4^{2-}$ , which is formed and then undergoes dissociation suppression as more  $\text{Cl}^-$  is added, to give an end point at almost the same place as the observed limiting shift of  $\text{Me}_2\text{SnCl}_4^{2-}$  (-214ppm vs.  $\delta(\text{lim}) = -210\text{ppm}$ ).

The stationary point at -176ppm is rather more difficult to explain. It could correspond to an intermediate stage of substitution between  $\text{Me}_2\text{Sn}(\text{NCS})_2\text{Cl}_2^{2-}$  and  $\text{Me}_2\text{SnCl}_4^{2-}$ , but the observed shift here is at considerably lower frequency than that observed for  $\text{Me}_2\text{Sn}(\text{NCS})\text{Cl}_3^{2-}$  ( $\delta = -133\text{ppm}$ ). It could be that the dissociation of  $\text{Me}_2\text{Sn}(\text{NCS})_2\text{Cl}_2^{2-}$  is suppressed before substitution takes place. This is reasonable since the observed shift change is in the direction that is expected for this process, but when dissociation suppression has been studied alone, as in  $\text{Me}_2\text{SnCl}_4^{2-}$  and  $\text{Me}_2\text{Sn}(\text{NCS})_4^{2-}$ , 6 or 7 equivalents of  $\text{X}^-$  have to be added before the curve flattens off. The "limit" is observed here after only 2.5 equivalents have effectively been added to  $\text{Me}_2\text{Sn}(\text{NCS})_2\text{Cl}_2^{2-}$ .

This experiment does show that addition takes place preferentially when chloride is added to  $\text{Me}_2\text{Sn}(\text{NCS})_2$  in MeCN. When excess chloride is added, substitution takes place on the initially formed complex, and finally with greater excess of chloride, the dissociation of the last formed complex is suppressed and its limiting shift is observed.

This pattern of events is reasonable, since it is known that Sn-X bonds are weaker in 6-coordinate complexes than their 4-coordinate analogues (15). It would therefore be expected that substitution would be easier in the former compounds. Substitution

reactions are known to occur involving 4-coordinate compounds, eg. exchange reactions, where the substituting reagent is also an organotin reagent (6,69,71), and nucleophilic substitution reactions with organotin halides such as are used to prepare the four-coordinate dimethyltin psuedohalides used in this study (90,177).

## 7 PREPARATION OF SAMPLES

Organotin compounds and tetra-alkyl ammonium salts were prepared and/or purified by the methods decribed in Ch 3, section 6 and Ch 4, section 6.

$\text{CH}_3\text{CN}$  was dried as described in Ch 2, and DMSO was used as obtained, without further purification.

All samples were measured out under nitrogen (glove box) and weighed in air-tight containers. Solvents were added (again in the glove box) by 1ml syringe (accuracy  $\pm$  0.05ml).

CHAPTER 6SYNTHESIS OF SOME HETEROCYCLICORGANOTIN COMPLEXES1 INTRODUCTION

Tin compounds have long been used for their biological properties, but it is only recently that their antitumour potential has been investigated (191). Results show that those with the highest activity have very similar geometry to the widely applied six-coordinate cis-platinum complexes, the tin compounds having the advantage of a much lower nephrotoxicity. The essential stereochemical requirements for activity are two labile ligands that are mutually cis, along with two more stable bonds (81).

It was therefore considered potentially fruitful to synthesise complexes where the tin was incorporated into a ring (192). From the point of view of the antitumour potential considered above, the required geometry could be produced if tin were complexed with appropriate donors of a similar nature to 2,2'-bipyridyl and 1,10-phenanthroline, since these have proved previously successful. There is also the possibility of putting two active sites into the same molecule by producing a dimeric distannacycloalkane on further development of the method.

From a chemical point of view, incorporating octahedrally coordinated tin into a heterocycle would have interesting structural consequences, both for the bond angles and resultant degree of ring strain, and for the effect that this would have on the electronic environment of the tin.

Synthesis of tin-carbon heterocycles is not an extensively investigated field, in contrast to germacycloalkanes (106),

but the compounds do seem to be reasonably stable. They undergo the slow atmospheric oxidation (193) or hydrolysis (194) that seems to be a requirement in the anticancer compounds (82).

Grignard and alkyllithium methods have been applied to produce fairly low yields of monostannacycloalkanes (194,195), as has a disproportionation route developed by Bulten and Budding to produce dimethylstannacycloalkanes (76,196). Such compounds have been investigated by  $^1\text{H}$  NMR (197),  $^{13}\text{C}$  NMR,  $^{119}\text{Sn}$  NMR, X-ray crystallography (105), mass-spectroscopy (198), and infra-red (199). The 5- and 6- membered rings seem to be the most stable saturated derivatives - smaller rings have been reported, (106) including a trimethylsilyl substituted distannacyclobutane (200), but such compounds do not seem to be generally accessible.

The compounds that are produced are tetraorganotin of very low Lewis acidity, and hence in this state unsuitable for making complexes. It is known, however, that diphenylstannacyclohexanes will undergo substitution with bromine without ring cleavage, to give  $\text{Br}_2\text{Sn}(\text{CH}_2)_5$  (104). (In the corresponding dimethyl compound, reaction is primarily via ring cleavage, with a small amount of 1-methyl,1-bromostannacyclohexane being produced (202).) This last compound should form the required 6-coordinate complexes when reacted with a base. Reports of such compounds have appeared in the literature, but data are limited to analytical figures and a melting point (203,204).

Alternative routes that produce a  $\text{Br}_2\text{Sn}$  moiety incorporated into a ring without the need for the substitution step were also considered. If a phosphorous ylide is used as a carbon nucleophile, it is known that many stable metal-ylide complexes

can be obtained (205). The range of possible metals is very wide, such complexes having been produced with transition metals (206), lanthanides (207) and main group metals including silicon (98,208). It was hoped that these reactions could be extended to produce tin-ylide complexes, with the aim of producing compounds of a similar nature to the coinage metal 8-membered heterocyclic complexes developed by Schmidbaur et al. (209-12).

We also obtained some success from reacting tin metal with 1,5-dibromopentane (109), producing 1,1-dibromostannacyclohexane directly. As indicated in Ch.1 Section 2, such reactions have been used previously, the best example being the industrial preparation of  $\text{Bz}_2\text{SnCl}_2$  from tin and benzyl chloride (108).

## 2 ATTEMPTED SYNTHESSES USING GRIGNARD, ORGANOLITHIUM AND

### PHOSPHOROUS YLIDE REAGENTS

It was decided to attempt the synthesis of 1,1-diphenylstannacyclohexane, by the direct reaction of  $\text{Ph}_2\text{SnCl}_2$  with a Grignard or organolithium reagent, following Zimmer's method (194), and also to try and extend the disproportionation method (76,196) to making this compound. It was intended to produce 6-coordinated bromostannacycloalkane complexes by substitution with  $\text{Br}_2$ , followed by complexation.

#### 2.1 Use of Grignard and organolithium reagents

##### 2.1.1 Direct preparation of $\text{Ph}_2\text{Sn}(\text{CH}_2)_5$ :-

Small yields of mono- and distannacycloalkanes have been obtained via the reaction of a dialkyl/diaryltin dihalide with an  $\alpha,\omega$ -diGrignard or dilithium reagent, and the crystal structure of 1,1,6,6-tetraphenyl-1,6-distannacyclohexane has been presented (105,194,195).

When similar reactions using the diGrignard reagent derived from  $\text{Br}(\text{CH}_2)_5\text{Br}$  with  $\text{Ph}_2\text{SnCl}_2$  were attempted, only starting materials could be isolated.

##### 2.1.2 Preparation of $\text{Ph}_2\text{Sn}(\text{CH}_2)_5$ by disproportionation:-

Bulten and Budding have developed a method for the synthesis of dimethylstannacycloalkanes, utilising the disproportionation of an  $\alpha,\omega$ -bis(trimethylstanna)alkane, catalysed by  $\text{ZnCl}_2$ . The product is distilled off as it is formed, to prevent polymerisation (76,196).

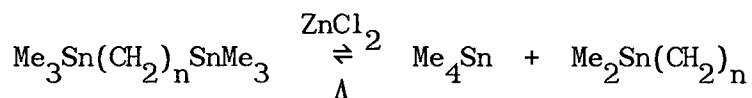

The low boiling point of  $\text{Me}_4\text{Sn}$  means it is lost during



distillation, so reversal of the reaction is prevented, and the product is produced clean.

1,5-bis(triphenylstanna)pentane was prepared by the Grignard method (see section 4.1), but attempted distillation of this compound produced an insoluble waxy solid that analysed badly and was assumed to be polymeric. The high molecular weight of the product and the high boiling point of  $\text{Ph}_4\text{Sn}$  ( $>420^\circ\text{C}$ ) presumably prevented the distillation of the product before polymerisation occurred.

Use of organolithium reagents:-

The preparation of the diorganolithium reagent  $\text{Li}(\text{CH}_2)_5\text{Li}$  was attempted using finely divided lithium metal and  $\text{Br}(\text{CH}_2)_5\text{Br}$ . Analysis of the solution after the solids had been filtered off indicated the presence of a reasonable yield of the reagent, but addition of  $\text{Ph}_3\text{SnCl}$  to this solution gave only starting material.

## 2.2 Use of phosphorous ylide reagents

Schmidbaur et al. have produced many ylide-metal complexes (209-212), but the only reported ones with tin that have any stability are methylene tris(dimethylamino)phosphorane-triphenyltin chloride by Yamamoto (100), and a complex with 2 moles of methylenetriphenyl-phosphorane by Seyferth (99). The latter complex was produced from a 1:1 reaction between  $\text{Ph}_3\text{P}=\text{CH}_2$  and  $\text{Me}_2\text{SnBr}_2$ , so it was anticipated that if  $\text{SnBr}_4$  was used as the acceptor, we would have the advantage of putting the required halogens straight into the molecule. Also, using a stronger Lewis acid would probably produce a stronger complex.

The preparation was first attempted using methylenetriphenyl-

phosphorane, and then with methylenemethyldiphenylphosphorane, this second acidic methyl group being necessary to bond to another tin and hopefully to cyclise.

The sequence of reactions used was:

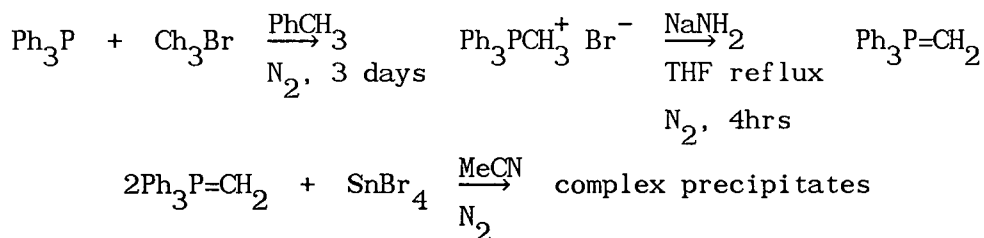

(Preparative methods and spectrometric results for intermediate products and analytical results for all products are given in section 4.4).

#### <sup>1</sup>H NMR spectra

Run in DMSO solution. They consist of 2 complex groups of peaks in the aromatic region and an aliphatic doublet.

Values for the centres of the peaks, together with  $\delta$  values for the intermediate products, are given below.

	$\text{Ph}_3\text{PCH}_3^+$		$\text{Ph}_3\text{P}(\text{CH}_3)_2^+$			
salt $\delta(\text{ppm})$	7.7	3.24	8.0	7.58	2.85	
ylide $\delta(\text{ppm})$	7.7	2.15		7.5	1.81	
product $\delta(\text{ppm})$	7.7	7.54	2.04	7.9	7.56	1.66
multiplicity	complex		2	complex		
J (Hz)	-	-	13.4	-	-	13.3
rel. intensity						
Expect	7.5 : 1		2.5 : 1			
Obtain	3.48: 1		1.36: 1			

$^{13}\text{C}$  NMR spectra of productsRun in  $\text{D}_6$  DMSO

assignment	$\text{Ph}_3\text{PCH}_3^+$		$\text{Ph}_2\text{P}(\text{CH}_3)_2^+$	
	$\delta$	$n_{\text{J}}(^{13}\text{C}-^{31}\text{P})$	$\delta$	$n_{\text{J}}(^{13}\text{C}-^{31}\text{P})$
Ph-P ( $\alpha$ C)	139.06	99	139.9	95.6
Ph-P ( $\bar{\text{p}}$ C)	135.39	-	135.4	5.3
Ph-P ( $\bar{\text{o}}$ C)	134.10	9.6	133.5	9.6
Ph-P ( $\bar{\text{m}}$ C)	132.50	11.6	132.4	12.2
$\text{CH}_2$ -P	19.86	72.9	21.7	70.2

 $^{31}\text{P}$  NMR spectra

	$\text{Ph}_3\text{PCH}_3^+$	$\text{Ph}_2\text{P}(\text{CH}_3)_2^+$
salt $\delta$ (ppm)	22.7	21.1
$\text{/CHCl}_3$		
product $\delta$ (ppm)	33.7	33.4
$\text{/DMSO}$		
multiplicity	?6	1 broad
J (Hz)	11.7	-

 $^{119}\text{Sn}$  NMR spectra

The spectra of both products in DMSO solution consist of a sharp singlet at  $-1275$  ppm, and a smaller one ( $\approx 36\%$  intensity) at  $-1016$  ppm.

Infra-red spectrum

The frequencies of the main mass-dependent phenyl modes (Whiffen notation, see Ch. 1, section 5.4) are given for the phosphonium

salts and the products, along with the  $\nu$ Sn-Br frequencies in  $\text{SnBr}_4$  and the products.

mode	$\text{Ph}_3\text{PCH}_3^+$		$\text{Ph}_2\text{P}(\text{CH}_3)_2^+$	
	salt	product	salt	product
q	1122	1128	1116	1132
		+sh 1140		
r	695	688	690	695
y	511	494	478	482
	+sh 518	505 } d	490 } d	
	495	+sh 484		
t	456	?490	446	445
			+ sh 450	
u	260	310	265	300
		300		
$\nu$ Sn-Br	s.m. 278	245		240
	+ sh 285	230		225

The anticipated reaction is

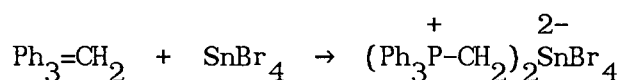

The spectrometric results for the product show that a reaction has occurred, and that the product is significantly different to the starting material. Infra-red evidence indicates that tin increases its coordination number, since  $\nu$ Sn-Br moves to lower frequency. The very low frequency values of the tin chemical shift, and the lack of any observation of tin couplings with the ylide group in the product, indicate that tin is 6-coordinate, and bonded to Br, but do not show that any organic groups are bonded, at least in DMSO solution. Analytical results are also unsatisfactory for the

required complex. The very high intensities of the P-CH<sub>2</sub> doublet indicate that this part of the molecule has undergone further reaction.

These reactions therefore do not produce products of the type we are aiming for, and it was decided that it would be more fruitful to explore other avenues of work.

### 3 ONE STEP PREPARATION OF SOME 6-COORDINATE

#### 1,1-DIBROMOSTANNACYCLOHEXANE.PYRIDINE BASE ADDUCTS

A series of monostannacyclohexanes has been prepared using the direct reaction between tin metal and 1,5-dibromopentane, catalysed by iodine and an amine (109).

The reaction as presented in the literature produces the 4-coordinate 1,1-dibromostannacyclohexane, which appears to be very air-sensitive (203). To prevent loss of product by decomposition during its isolation, its bis(pyridine) complex was prepared in situ by adding a solution of base to the reaction mixture after the solids were filtered off, since the coordinatively saturated compounds are known to be more stable and this is the required product in any case. The product then precipitated out as a yellow-orange solid (depending on base) in  $\approx$  20% yield.

The preparation of six such compounds has been attempted with different pyridine bases. The aim was to produce a series where the shielding of the tin atom differs because of the change in one factor only - here, the amount of electron density donated by the base, which is proportional to its pKa. The general bulk of these ligands is reasonably constant, so polarisability changes should be relatively small. These nitrogen bases are also incorporated into the tin complexes that have shown most promise as anti-cancer reagents (81,191).

The results for the individual bases are first discussed separately, and the general conclusions are presented in Section 3.7.

### 3.1 1,10-phenanthroline.1,1-dibromostannacyclohexane

This compound was prepared as an orange/red powder by the method given in section 4. It proved to be insoluble in all common solvents except DMSO, so all solution state NMR data were obtained in this solvent.

#### 3.1.1 Characterisation data

##### a $^1\text{H}$ NMR spectrum

The spectrum shows a group of peaks corresponding to 1,10-phenanthroline (9.24 - 7.91 ppm) and a group in the aliphatic region (2.54 - 0.91 ppm).

Please see diagrams of spectra (Fig. 6.1)

Peak centres (7 - 10 ppm)

phen/ $\text{CDCl}_3$   $\delta$  (ppm) 9.18 8.20 8.09 7.7

complex  $\delta$  (ppm) 9.24 8.67 8.54 8.43 8.11 7.94

##### b $^{13}\text{C}$ NMR spectrum

$^{13}\text{C}$  chemical shifts for 1,10-phen. $\text{Br}_2\text{Sn}(\text{CH}_2)_5$

and comparable compounds

100-150ppm

	C1/14	C3/12	C4/11	C5/10	C6/9	C7/8
$\delta(\text{phen})/\text{DMSO}$ ppm	149.9	145.6	123.3	136.15	126.6	128.5
$\delta(\text{complex})$ ppm	150.2	143.9	125.6	139.4	130.8	128.2

0-50ppm

$\delta(1,5\text{-dibromopentane})^*$	37.8	33.9	28.7			
$\delta(\text{Ph}_2\text{Sn}(\text{CH}_2)_4)/\text{CH}_2\text{Cl}_2$	32.3	10.7				(105)
$\delta(\text{Pr}_2\text{SnBr}_2)/\text{CH}_2\text{Cl}_2$	29.9	19.5	17.5			(214)
$\delta(\text{Bu}_2\text{SnCl}_2 \cdot \text{py}_2)/\text{CH}_2\text{Cl}_2$	38.4	28.4	26.0			(214)
$\delta(\text{complex})/\text{DMSO}$	36.1	29.8	23.2	22.8	15.1	

[\* Shift values for 1,5 dibromopentane are calculated by using the substituent effect of Br on the shifts of pentane (213)]

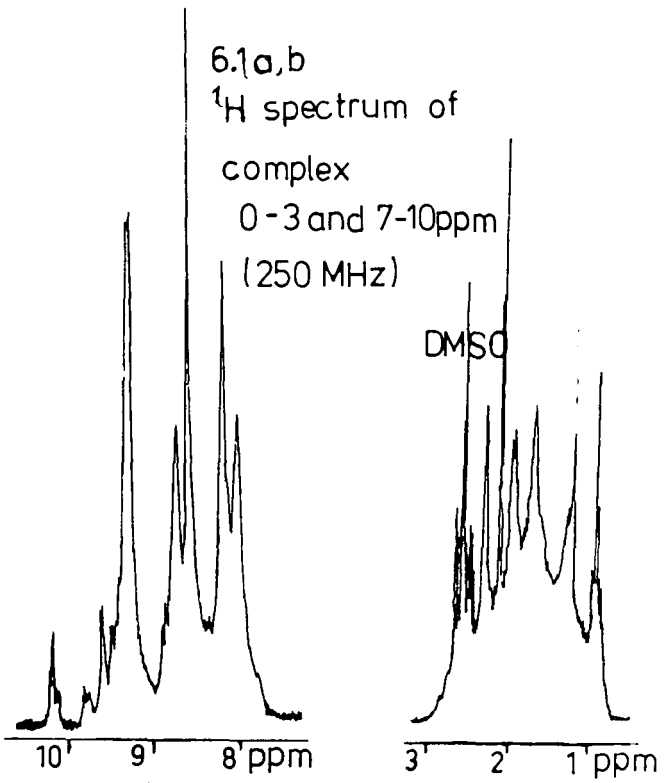
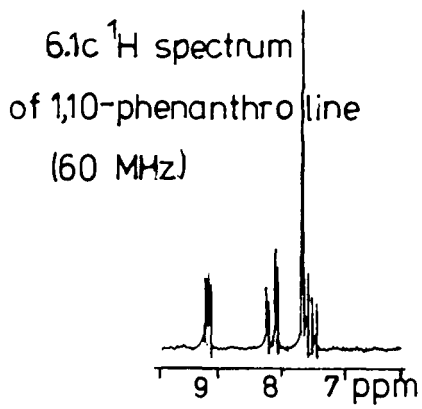
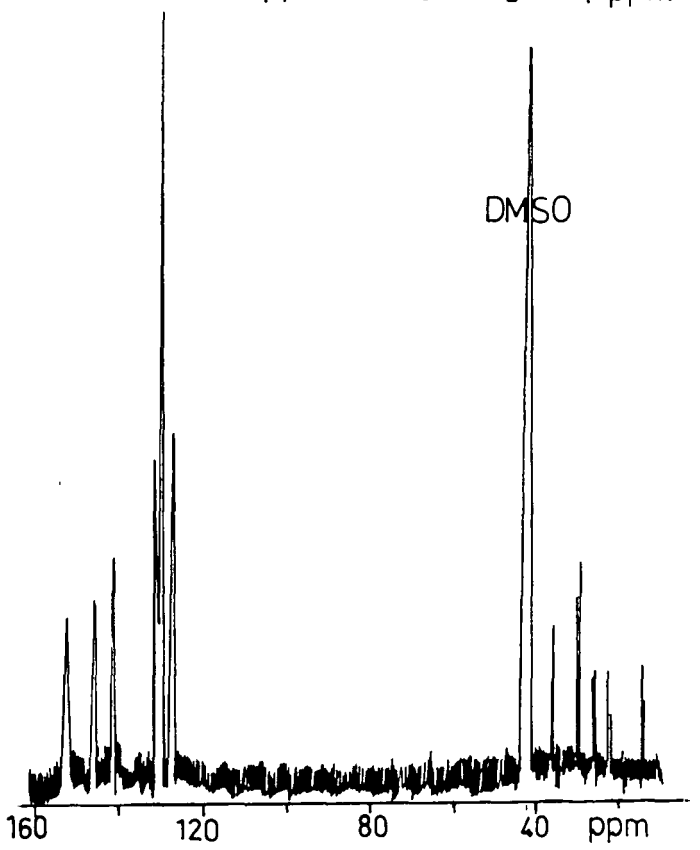

Fig 6.1  $^1\text{H}$  and  $^{13}\text{C}$   
spectra of  
phen. $\text{Br}_2\text{Sn}(\text{CH}_2)_5$

6.1d  $^{13}\text{C}$  spectrum  
of complex





c Infra-red spectrum

The Nujol mull spectrum of the product is not very informative, since the C-H vibrations are obscured, so the presence or absence of methyl groups cannot be determined.

Spectra of 1,10 phenanthroline

and 1,10-phen.Br<sub>2</sub>Sn(CH<sub>2</sub>)<sub>5</sub>, 900-600 cm<sup>-1</sup>

(all values in cm<sup>-1</sup>)

<u>1,10-phen</u>	<u>1,10-phen.Br<sub>2</sub>Sn(CH<sub>2</sub>)<sub>5</sub></u>
836	840
sh 852	852 d
810	795
779	sh 765
765	
731	730
sh 725	715
702	
619	640

d <sup>119</sup>Sn NMR spectrum

$\delta = -545.05$  ppm,  $(\Delta\nu)_{1/2} = 40$  Hz

3.1.2 Conclusions

The <sup>1</sup>H shift values and splittings of the free ligand are considerably different from those in the aromatic region of the <sup>1</sup>H spectrum of the product. This could be caused by complexation, due to alterations in electron density across the aromatic system, but the change in solvent will also affect the shifts. The differences are greatest for protons distant from the nitrogen (the low

frequency signals), whereas for complexation, a movement of the signal of the  $\bar{o}$  protons to higher frequency is expected, so it is likely that the solvent is causing the observed effect. This is confirmed by the  $^{13}\text{C}$  spectrum, since here the shift differences between free ligand and complex are extremely small.

The overall ratio of signal intensities is 1:1 aromatic : aliphatic. This is reasonably close to the expected ratio for the required product of 1:1.25, especially when it is considered that the solvent peak partially overlaps the rather broad aliphatic resonance, making precise integration ratios unobtainable. This complexity of signals also prevents any assignment of individual aliphatic peaks. It is also evident that the triplet peak observed at 3.45 ppm for  $\text{BrCH}_2(\text{CH}_2)_5\text{CH}_2\text{Br}$ , and starting material signals in the  $^{13}\text{C}$  spectrum, are absent, so reaction has occurred. The aliphatic regions of both spectra show values to lower frequency than appear in the starting material, again indicating that the C-Br bonds have been broken and that the  $\text{CH}_2$  groups are bonded to more electropositive species.

Splitting is observed for aliphatic peaks in the  $^{13}\text{C}$  spectrum, indicating the presence of conformational isomers. It is possibly the case that the large size and rigidity of phen. means that there is a large enough barrier to conformational changes for the individual conformations to have relatively long lifetimes (on the NMR timescale), giving separate signals.

The IR spectrum indicates that phen. is complexed in the solid state, since the band positions are altered in the product.

The  $^{119}\text{Sn}$  NMR signal is at low frequency for organometallic tin compounds, even when the shielding effect of the solvent is

considered, (values for dimethyltin halides and pseudohalides in DMSO are in the region -260 - -350ppm), so tin must be 6-coordinate in solution. The low value may also be due to the presence of Br in the coordination sphere, since this ligand is known to shield the tin nucleus because of its bulk (eg.  $\text{SnCl}_6^{2-}/\text{CH}_2\text{Cl}_2$   $\delta = -734.2$  ppm,  $\text{SnBr}_6^{2-}/\text{CH}_2\text{Cl}_2$   $\delta = -2075.5$  ppm (94,170) or  $\text{Me}_3\text{SnCl}$   $\delta = +164.2$  ppm,  $\text{Me}_3\text{SnBr}$   $\delta = +128$  ppm, both in benzene or  $\text{CHCl}_3$  (126)).

### 3.2 bis(pyridine).1,1-dibromostannacyclohexane

This yellow powder was prepared in 22% yield. As before, all solution state data were obtained in DMSO due to low solubility of product.

#### 3.2.1 Characterisation data

##### a $^1\text{H}$ NMR spectrum

The spectrum of pyridine (see Fig. 6.3) consists of three groups of peaks, the values for the centres of which are compared with the obtained values for the complex.

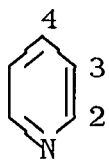

assignment	2	4	3			
$\delta(\text{py})/\text{CDCl}_3$ ppm	8.61	7.62	7.26			
$\delta(\text{complex})$ ppm	8.68	8.00	7.58	1.70	1.28	0.86
Relative intensity aromatic:aliphatic				Observed	1:1.62	
				Expected	1:1	

Fig 6.2  $^1\text{H}$  NMR spectra of  $(\text{py})_2\cdot\text{Br}_2\text{Sn}(\text{CH}_2)_5$

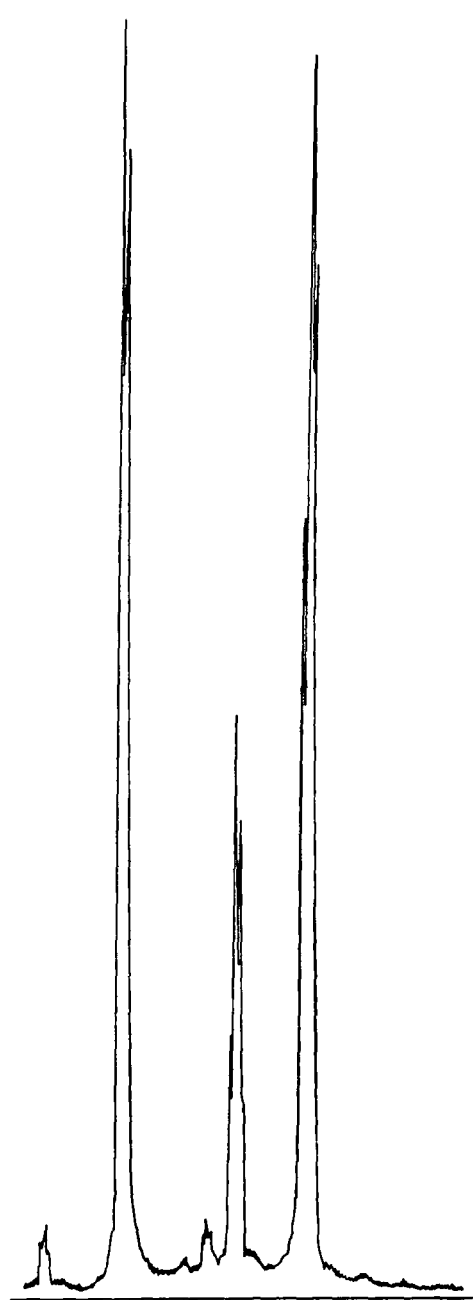

6.2b complex 6-9ppm  
(250 MHz)

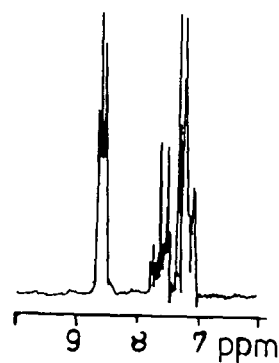

6.2a pyridine 6-10ppm (60MHz)

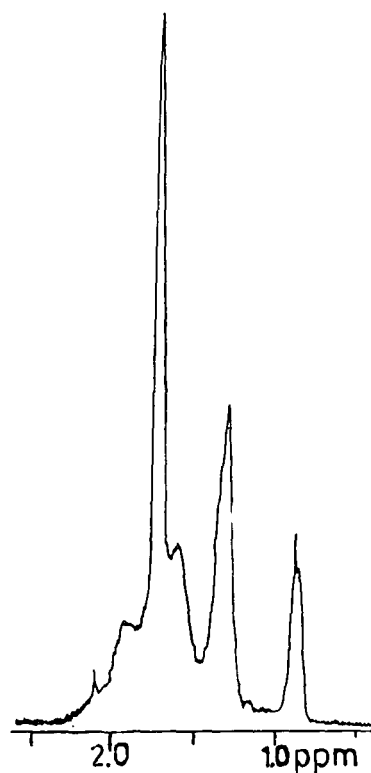

6.2c complex 0-3ppm  
(250 MHz)

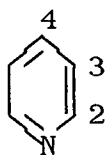
b  $^{13}\text{C}$  NMR spectrum

assignment	2	4	3				
$\delta(\text{py})^*$ ppm	150.2	135.9	123.9				
$\delta(\text{complex})$ ppm	146.2	140.9	125.5	36.1	26.0	21.8	14.0
$\delta(\text{Br}(\text{CH}_2)_5\text{Br})$ ppm				37.8	33.9	28.7	

(\*ref.215 in  $\text{CDCl}_3$ )

c IR spectrum

This was obtained as a Nujol mull, with CsI plates in order to see bands below  $400\text{ cm}^{-1}$ , and as a KBr disc to see C-H bands.

i  $\nu(\text{C-H})$  region

(see Fig. 6.3a)

The spectrum shows a series of bands from  $3106.7$  to  $3048.6\text{ cm}^{-1}$  attributable to pyridine, and three bands below  $3000\text{ cm}^{-1}$  due to  $\nu(\text{C-H})$  of the aliphatic part of the molecule.

$$\underline{\nu(\text{C-H}) \text{ of } \text{py}_2\cdot\text{Br}_2\text{Sn}(\text{CH}_2)_5 \text{ } 3000\text{-}2800\text{ cm}^{-1}}$$

	Expected values for		(216)
$\nu(\text{C-H})$ complex	$\nu(\text{C-H})$ methyl	$\nu(\text{C-H})$ methylene	
2955.7			
$\nu_{\text{as}}$ 2924.4	2962	2926	
$\nu_{\text{s}}$ 2854.5	2872	2853	

The observed values are very close to the expected ones for  $\nu\text{CH}_2$ , and none corresponds satisfactorily to Me group vibrations. The extra band at  $2955.7\text{ cm}^{-1}$  is possibly a  $\delta\text{CH}_2$  overtone.

Fig 6.3  
Infra-red spectra  
(KBr disc) of  
 $(py)_2Br_2Sn(CH_2)_5$

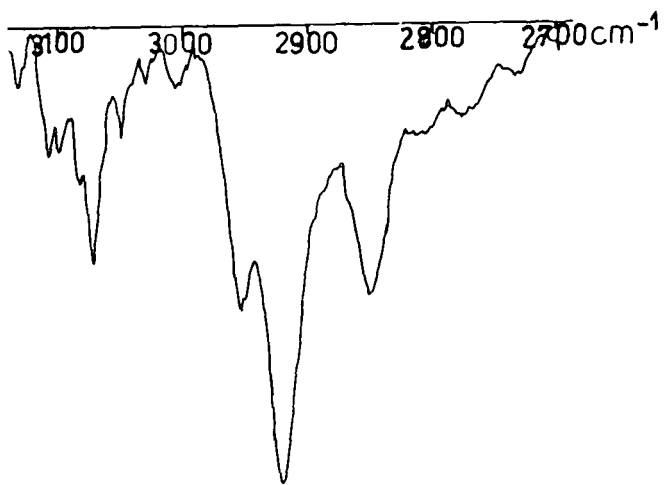

6.3a 3200-2700 $cm^{-1}$

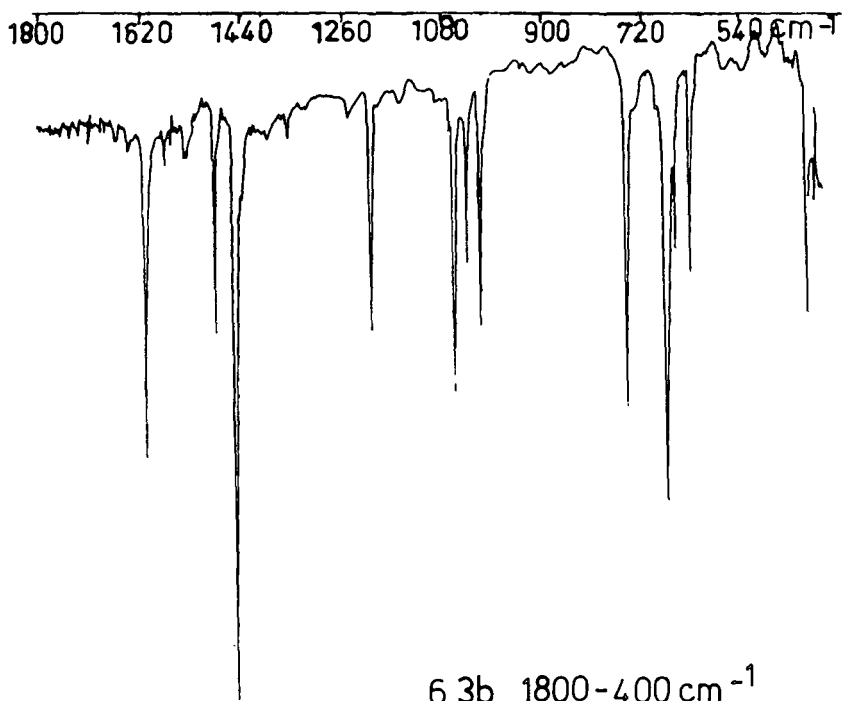

6.3b 1800-400  $cm^{-1}$

The  $\nu$ CH bands are fairly weak, (change in transmission  $\approx 16\%$ ), and the pyridine bands are strong and sharp ( $\approx 90\%$  change in transmission) so the  $\delta$ (C-H) bands are obliterated.

ii pyridine bands ( $1700-400 \text{ cm}^{-1}$ )

The pyridine group shows a series of strong sharp bands (broader in the liquid state) in the above range. The spectrum is shown in Fig. 6.3

<u>Complex</u>	<u>Pyridine</u>	<u>Complex</u>	<u>Pyridine</u> (vals. in $\text{cm}^{-1}$ )
1605.7 s, sh	1570 vs, br	1015.2 m	
	sh 1625		991 vs
1483.1 m, sh	1478 m-s		940 vw
1448.2 vs, sh	1430 s		880 w, br
	1370 vw	754.1 s, sh	745 vs
	1290 vw	683.0 s, sh	695 vs, br
1207.9 m, sh	1215 s	668.2 m, sh	
	1145 s	641.1 m, sh	
1061.1 m, sh	1068 s		602 s, sh
1037.8 m	1032 vs	431.0 m	405 m-s

iii Low frequency vibrations ( $400-200 \text{ cm}^{-1}$ )

The spectrum shows two resolvable bands in this region, at 250 and  $230 \text{ cm}^{-1}$ . These can be assigned to  $\nu$ Sn-Br by comparison with the observed shifts for alkyltin bromides (156).

d Raman spectrum

The Raman spectrum of this compound was the only one to be obtained successfully. Attempts to produce spectra of other complexes failed due to large amounts of fluorescence, or the compound burning in the beam.

Raman spectrum of  $\text{py}_2\cdot\text{Br}_2\text{Sn}(\text{CH}_2)_5$   
(all vals in  $\text{cm}^{-1}$ )

35	} lattice modes	651	
58			
106		1017	} ring breathing modes
		1041	
150	} Sn-Br mixed modes	1210	
196		1608	
?236(vw)		3080	} $\nu$ CH (py)
		sh 3076	
643			

e  $^{119}\text{Sn}$  NMR

$\delta = -521.2$  ppm,  $(\Delta\nu)_{1/2} 350$  Hz. This is very similar to the value for the product from the phen reaction.

3.2.2 Conclusions

The following general conclusions can be derived from the spectra:- The difference between observed values for free and complexed ligand signals in the proton spectrum are due to solvent changes rather than being evidence for complexation, since the changes are not in the right direction, and in the  $^{13}\text{C}$  spectrum, where the same solvent is used in both cases, the observed changes are very small. No  $^n\text{J}(^{119}\text{Sn}-^{13}\text{C})$  couplings were observed, due to the low solubility of the complexes.



In none of the methods used is there any evidence of unreacted bromide. In particular the triplet peak at 3.45ppm in its  $^1\text{H}$  spectrum ( $-\text{CH}_2\text{Br}$ ) is absent, indicating that the C-Br bonds have been broken. The signals that are observed in the aliphatic region of the  $^1\text{H}$  and  $^{13}\text{C}$  spectra conform reasonably well to values previously obtained for tin heterocycles (11,12), indicating that Br has been replaced by a relatively electropositive group. This is supported by the fact that no evidence for the presence of any other functional groups is found in any of the spectra.

There are five signals visible in the aliphatic region of the  $^{13}\text{C}$  spectrum, whereas three are normally expected for a 6-membered heterocycle (eg. piperidine (217)). Since the differences between the shifts are small, it may be that the presence of several coordination isomers at tin give rise to different carbon environments. This could also explain why the aliphatic signals in the  $^1\text{H}$  spectrum are so broad.

The infra-red spectrum shows that the ligand is present, and coordinated in the solid state, since the frequencies of the bands are altered in the complex, although previous reports indicate that the only significant changes in pyridine IR vibrational frequencies occur below  $650\text{ cm}^{-1}$  (156).

The tin-NMR spectrum shows the presence of a six-coordinate, highly shielded tin nucleus in DMSO solution. The value is not at low enough frequency for the tin to be in an inorganic ion, however, (eg.  $\text{SnBr}_6^{2-}$  in  $\text{CH}_2\text{Cl}_2$ ,  $\delta = -2075\text{ppm}$  (170)).

In particular for this compound, the intensities of the  $^1\text{H}$  signals for complexed pyridine are higher than expected. This result conflicts with the analytical figures, since a higher ratio

of pyridine to tin should result in much larger C and N figures than are obtained.

The other feature of this product is the smaller number of aliphatic signals in the  $^1\text{H}$  spectrum than in that of the preceding complex. This is probably due to the difference in rigidity between the two complexes - the presence of two pyridine rings will not constrain the proposed structure as much as 1,10-phenanthroline, so molecular motion will be less restricted in this instance.

The infra-red spectrum indicates that it is highly unlikely that Me groups are present. This is good evidence that the aliphatic part of the molecule is in the form of a ring, since chain formation would give methyl or other end groups, none of which are visible. The presence of more than one  $\nu\text{Sn-Br}$  indicates that two bromines are bonded to tin. This is supported by the analytical figures.

The Raman spectrum of pyridine is known to change significantly on its coordination to a metal, the two ring modes at 1031 and 991  $\text{cm}^{-1}$  being replaced by a strong band at  $\approx 1019 \text{ cm}^{-1}$  and a weaker one at  $\approx 1050 \text{ cm}^{-1}$  (156). This spectrum shows the expected changes clearly, and indicates that at least one pyridine ring is coordinated to tin in the solid state. It also shows that there is no uncoordinated pyridine present.

### 3.3 2,2'-bipyridyl.1,1-dibromostannacyclohexane

This compound was produced in 18% yield as a pale yellow powder.

All solution state data were obtained in DMSO.

#### 3.3.1 Characterisation data

##### a $^1\text{H}$ NMR spectrum

The spectrum of free bipyridyl (see Fig. 6.4a) consists of 4 groups of peaks, with complex splitting patterns. The shifts of the centres of these groups are used to compare with the spectrum of the complex.

##### $^1\text{H}$ spectrum of bipy and bipy.Br<sub>2</sub>Sn(CH<sub>2</sub>)<sub>5</sub>

bipy/CDCl<sub>3</sub>

$\delta$ (ppm)	8.69	8.42	7.75	7.2
multiplicity	2x2	2x2	3x2	complex

complex:

$\delta$ (ppm)	8.80	8.47	8.04	7.55	1.67	1.27	0.85
multiplicity	1	2	3	3			
J Hz	-	8	8	6			

Relative intensity aromatics:aliphatics                      Expect 1:1.25

Obtain 1:1.6

##### b $^{13}\text{C}$ NMR spectrum

bipy*	$\delta$ (ppm)	155.2	149.2	137.2	124.2	120.4	
complex	$\delta$ (ppm)	154.8	149.2	137.7	124.5	120.9	42.3
			35.2,34.3		25.7	21.7	13.95

\* ref. (218)

Both spectra obtained in DMSO solution.

Fig 6.4  $^1\text{H}$  NMR spectra of  $\text{bipy}.\text{Br}_2\text{Sn}(\text{CH}_2)_5$

6.4a 2,2'-bipyridyl

5-10ppm (60MHz)

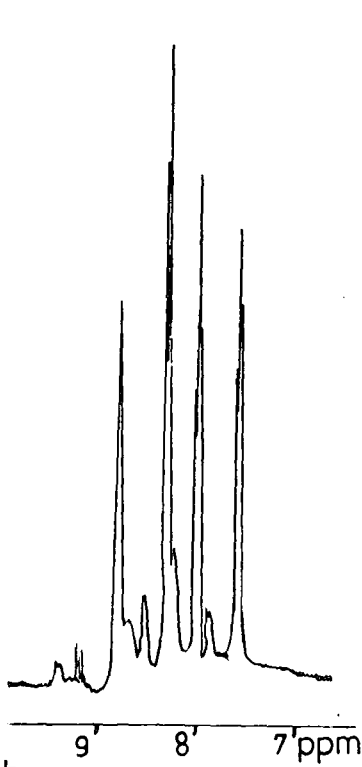
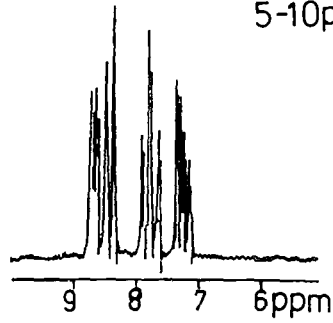

6.4 b

complex 7-10ppm  
(250 MHz)



6.4 c

complex 0-3ppm (250 MHz)

c Infra-red

Run as a Nujol mull with CsI plates, to see the low frequency vibrations, and as a KBr disc to see the C-H vibrations.

a  $\nu$ C-H region 3200-2800  $\text{cm}^{-1}$ 

Please see Fig. 6.5.

		<u>Band maxima (<math>\text{cm}^{-1}</math>)</u>	
Obtained		Expect	Expect
for complex		for $\text{CH}_3$	for $\text{CH}_2$ (216)
3109.4			
3075.0	aromatic		
3059.5	$\nu$ C-H		
3031.1	from bipy		
2952.8			
$\nu_{\text{as}}$ 2921.5		2962	2926
$\nu_{\text{s}}$ 2851.3		2872	2853

b Mid region; 1600-700  $\text{cm}^{-1}$ 

Shows a mixture of bipyridyl and aliphatic C-H bands. Please see Fig. 6.5.

<u>Complex</u>	<u>bipy</u>	<u>Complex</u>	<u>bipy</u>
1598.0		1317.9	
1576.0	1575 m	1249.0	1250 m
1566.0		1175.9	1158 w-m
1494.9		1158.7	1140 w
1475.0		1104.8	
1422.1		+ sh 1091.2	1090 m
+sh 1456.7		1062.5	1065 w
1419.4		+ sh 1071.1	

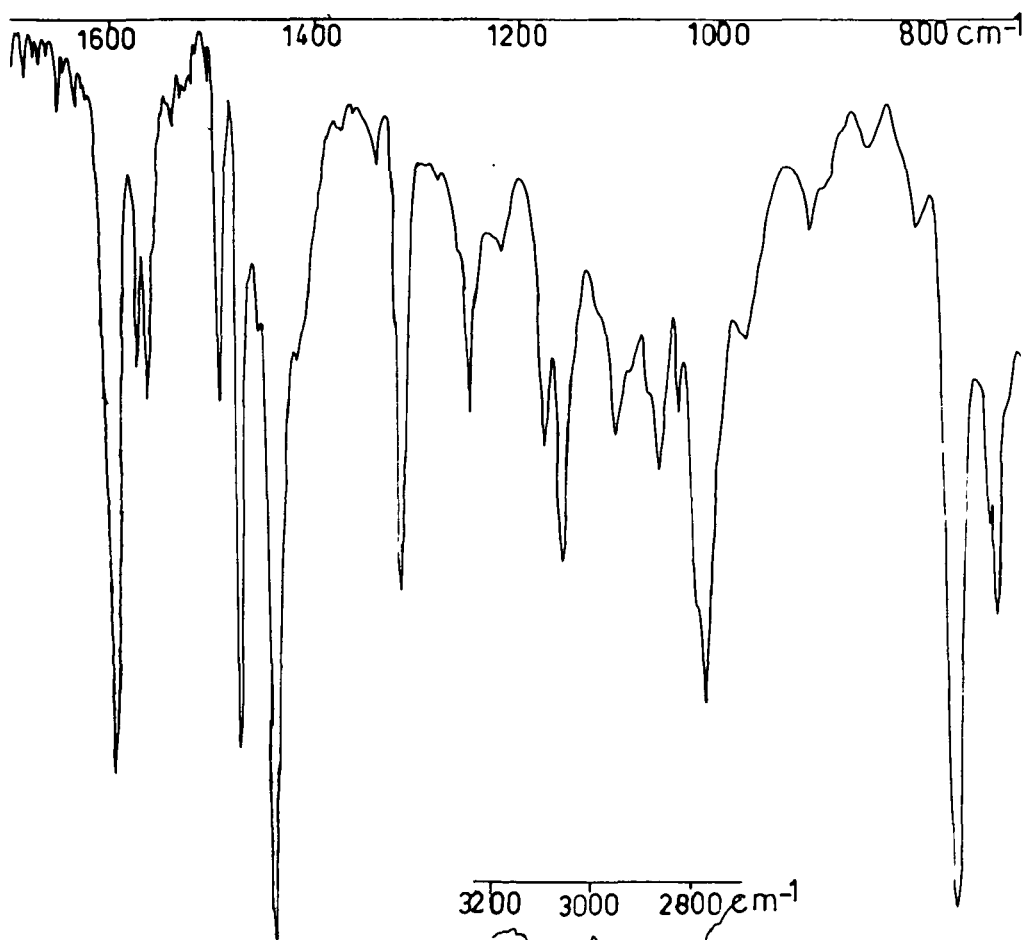

6.5a 1600-700 $\text{cm}^{-1}$

3200 3000 2800  $\text{cm}^{-1}$

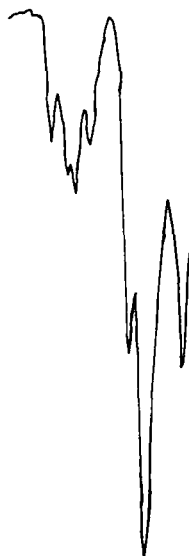

6.5b  
3200-2700  $\text{cm}^{-1}$

Fig 6.5 Infra-red spectra (KBr disc) of  $\text{bipy.Br}_2\text{Sn}(\text{CH}_2)_5$

<u>Complex</u>	<u>bipy</u>	<u>Complex</u>	<u>bipy</u>
1042.8	1042 m		896 w
1017.3		767.0	760 s
976.3	992 w-m	726.4	} d
		734.0	
c <u>Low frequency vibrations</u> 700 - 200 $\text{cm}^{-1}$			
<u>Band maxima (<math>\text{cm}^{-1}</math>)</u>		<u>Band maxima (<math>\text{cm}^{-1}</math>)</u>	
684		469	
650	cf. bipy 654 $\text{cm}^{-1}$	442	
+sh 657		414	cf. bipy 400 $\text{cm}^{-1}$
631	cf. bipy 620 $\text{cm}^{-1}$	265 vw	} $\nu\text{Sn-Br}$
		225 vbr	
584	} $\nu\text{Sn-C}$		
519			
491 br			

d  $^{119}\text{Sn}$  NMR spectrum

This gives a peak at  $\delta = -521.25$  ppm, the same as that obtained for the previous compound.

### 3.3.2 Conclusions

The general conclusions from section 3.2.2 also apply here, as do the deductions concerning absence of methyl groups and number of  $\nu\text{Sn-Br}$  bands in the infra-red, since the spectra of the two complexes are very similar in these regions.

The infra-red spectrum also shows two bands that are assigned as  $\nu\text{Sn-C}$ . They are  $\nu_{\text{as}} = 584 \text{ cm}^{-1}$ ,  $\nu_{\text{s}} = 519 \text{ cm}^{-1}$  these bands being the clearest in this region, and the values obtained agree with those of Hobbs and Tobias (91) for the tetra-bromide

complexes. Since two bands are observed, the  $\text{CH}_2\text{-Sn-CH}_2$  moiety must be considerably distorted from linearity, as would be expected if the organic group were constrained into a ring.

### 3.4 bis(3,5-dichloropyridine).1,1-dibromostannacyclohexane

The synthesis of this compound was attempted by the method given in section 4.5. Analytical results on the orange powder produced were unsatisfactory, and no  $^{13}\text{C}$  or  $^{119}\text{Sn}$  NMR results could be obtained, due to lack of pure material.

#### 3.4.1 Characterisation data

##### a $^1\text{H}$ NMR spectrum

Please see Fig. 6.5.

3,5-dichloropyridine/ $\text{CDCl}_3$

$\delta$  (ppm) 8.49 7.71

complex

$\delta$  (ppm) 8.98 8.59 2.43 2.07 1.64 1.50 1.24

Relative intensity, aromatic : aliphatic Expect 1 : 1.67

Obtain 1 : 1.95

##### b Infra-red spectrum

Run as a Nujol mull, using CsI plates.

$4000 - 1000 \text{ cm}^{-1}$

<u>Complex</u>	<u>3,5-Cl<sub>2</sub>py</u>	<u>Complex</u>	<u>3,5-Cl<sub>2</sub>py</u>
			(all vals. in $\text{cm}^{-1}$ )
3084 } w	3080 w,br	1200 w	1202 } d,w
3044 }			1212 }
1540 br	1540 w,br	1148 m,br	
1420 m	1410 m	+sh 1159	1130 w
1295 w	1292 w-m	1108 m-s	1108 } d,s
			}
1260 vw		1035 w-m	1035 m-s



Fig 6.6  $^1\text{H}$  NMR spectra of  $(3,5\text{-Cl}_2\text{py})_2\cdot\text{Br}_2\text{Sn}(\text{CH}_2)_5$

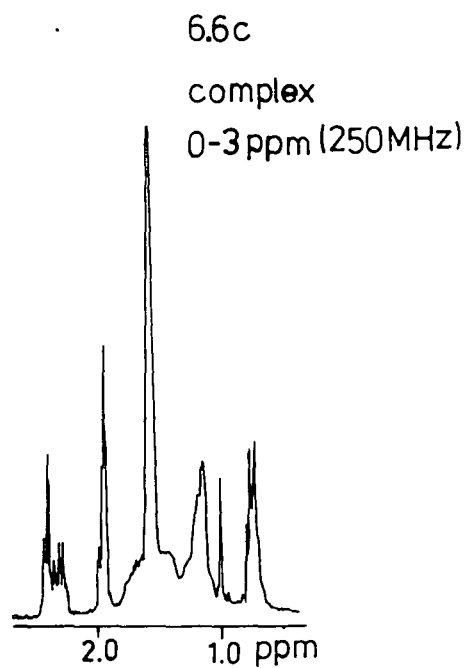
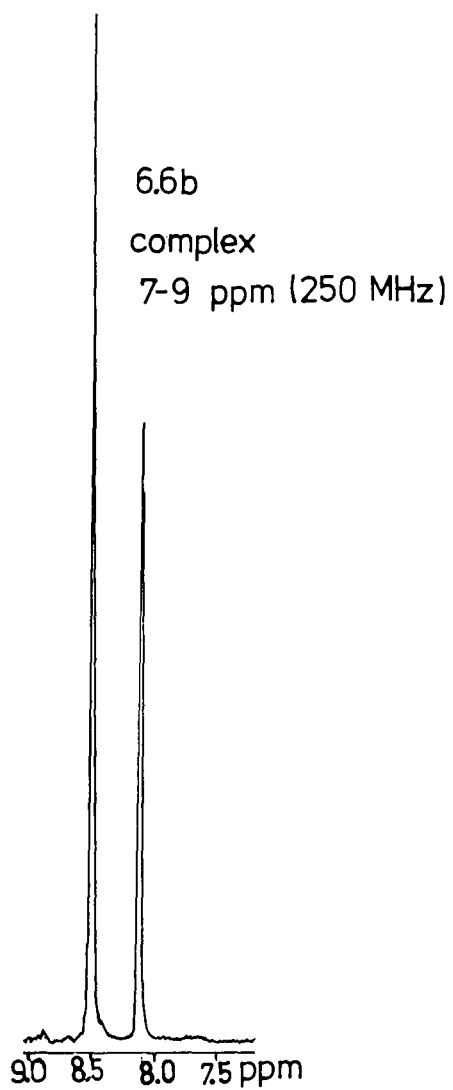
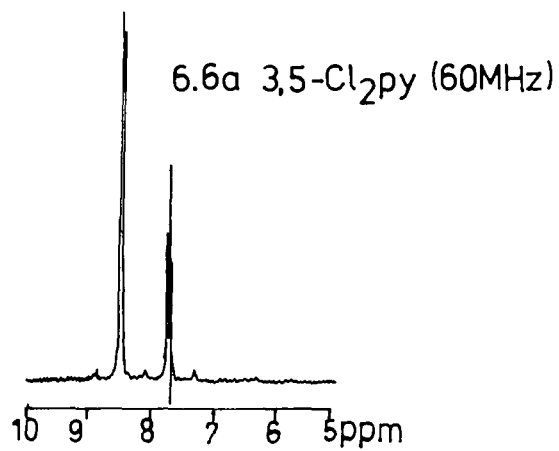

$$\underline{1000 - 200 \text{ cm}^{-1}}$$

<u>Complex</u>	<u>3,5-Cl<sub>2</sub>py</u>	<u>Complex</u>	<u>3,5-Cl<sub>2</sub>py</u>
1012 w	1012 m-s	671 s	685 m-s
980 m	935 w	+sh 682	650 } d,m 662 }
875 m	875 s	578 w	
850 w	840 w-m	478 w	
829 } d,m 814 }		450 vw	445 m
	810 s	392w	390m
759 vw		340 w	
750 s, sh		250-220 vs, br	
736 w	720 w, br		
712 w-m, sh		+sh 265	

### 3.4.2 Conclusions

The general conclusions from  $^1\text{H}$  spectra outlined in section 3.2.2 again apply here, but the peaks in the aliphatic region of this spectrum are not at such low frequencies as those of other products. These peaks are also more intense than expected for the required complex.

The infra-red spectrum of the product corresponds closely to that of the free ligand, indicating that interactions are weak in the solid state. The band at  $578 \text{ cm}^{-1}$  is assigned to  $\nu_{\text{as}} \text{Sn-C}_2$ , by comparison with other dimethyltin halide complexes (91). The presence of only one band indicates that the carbon residues are linear which is highly unlikely if a ring is formed.

The large band at  $250-225 \text{ cm}^{-1}$  is assigned as  $\nu_{\text{Sn-Br}}$ . The broadness of the peak means it may cover more than one band, so more than one bromine may be attached to tin.

It may be tentatively concluded that since this base is relatively weak ( $pK_a = 0.7$ ) it has not formed the strong 6-coordinate tin complex that is necessary to stabilise the heterocycle. It is possible that a polymeric species has been produced, since these compounds are often the undesirable by-products in other ring-forming reactions (eg. 105,194,196). This would also be consistent with the lack of other functional groups observed, and would allow the tin to take up the preferred trans arrangement of alkyl groups (which possibly accounts for the single  $\nu_{Sn-C}$  band observed in the IR).

### 3.5 bis(3,5-dimethylpyridine).1,1-dibromostannacyclohexane

This compound was prepared as a pale yellow powder in 21% yield. All solution state data were recorded in DMSO.

#### 3.5.1 Characterisation data

##### $^1H$ NMR spectrum

Please see Fig. 6.7.

3,5-dimethylpyridine /  $CDCl_3$

$\delta$ (ppm)	8.25	7.3	2.31
rel. intensity	2	1	6

$(3,5-Me_2py)_2 \cdot Br_2Sn(CH_2)_5$

$\delta$ (ppm)	8.44	7.81	2.35*	1.73	1.28	0.87
rel. intensity						

Expect	2	1	6	5
--------	---	---	---	---

Obtain	2.4	1	7.5	5
--------	-----	---	-----	---

\*This peak is probably more intense than expected because it covers the solvent residual peak ( $D_6$  DMSO,  $\delta = 2.52$  ppm). This also accounts for the presence of satellite peaks at its base.

Fig 6.7  $^1\text{H}$  NMR spectra of  $(3,5\text{-Me}_2\text{py})_2\cdot\text{Br}_2\text{Sn}(\text{CH}_2)_5$

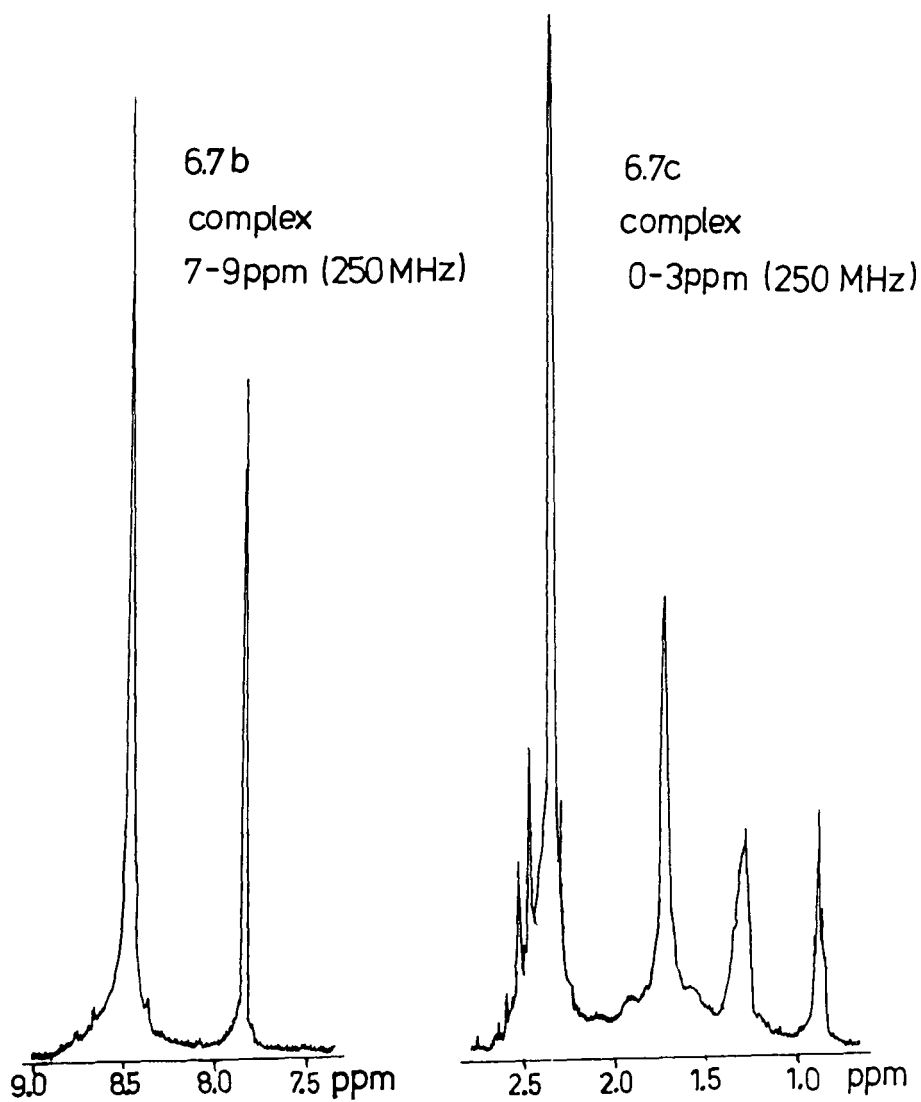
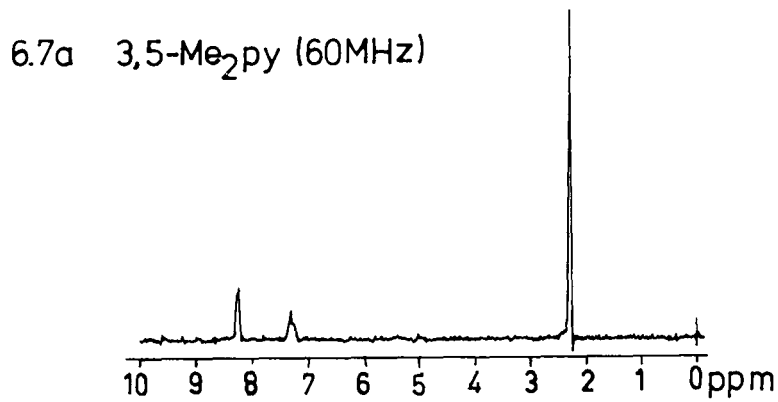

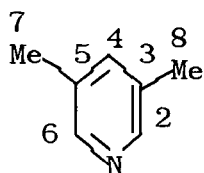
b  $^{13}\text{C}$  NMR spectrum

position      2      4      3

3,5-dimethylpyridine (neat) (219)

$\delta$  (ppm)    147.1    136.7    131.7

$(3,5\text{-Me}_2\text{py})_2\cdot\text{Br}_2\text{Sn}(\text{CH}_2)_5$

$\delta$  (ppm)    142.9    141.5    134.4    43.3    34.17    25.8    21.6

3,5-dimethylpyridine (46)    (Me - 8)

$\delta$  (ppm)                            17.5

$(3,5\text{-Me}_2\text{py})_2\cdot\text{Br}_2\text{Sn}(\text{CH}_2)_5$

$\delta$  (ppm)                            17.6    13.8

very

intense

Infra-red spectrum

Was run as a Nujol mull with CsI plates.

The presence of methyl groups in the pyridine ligand means that the C-H vibrations have no diagnostic value for this complex.

See Fig. 6.8.

<u>complex</u>	<u>Band maxima (cm<sup>-1</sup>)</u>		<u>3,5-Me<sub>2</sub>py</u>
	<u>3,5-Me<sub>2</sub>py</u>	<u>complex</u>	
	3010		1852 w, br
	2980 envelope		1775 w, br
	2975 vs		1630 m, br
	2738 m		

Fig 6.8 Infra-red spectrum of  $(3,5\text{-Me}_2\text{py})_2\text{Br}_2\text{Sn}(\text{CH}_2)_5$  ( $1700\text{-}700\text{ cm}^{-1}$ )

6.8a Spectrum of 3,5-Me<sub>2</sub>py

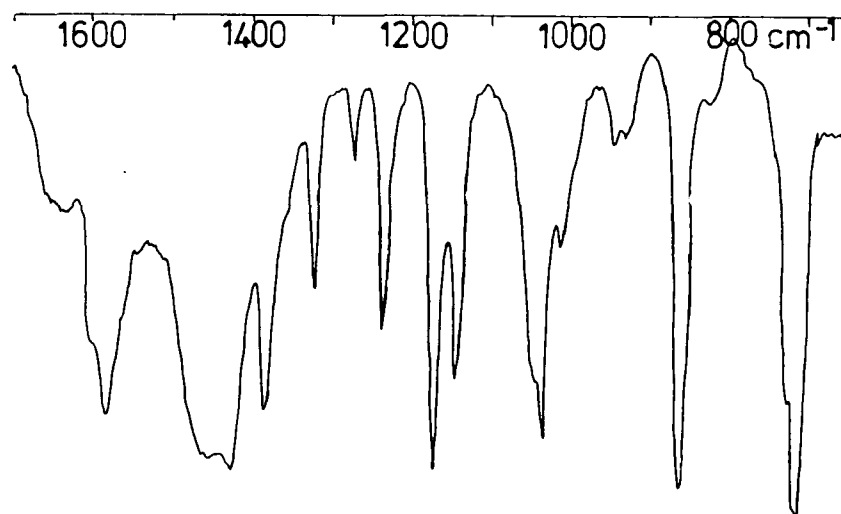

6.8b Spectrum of complex

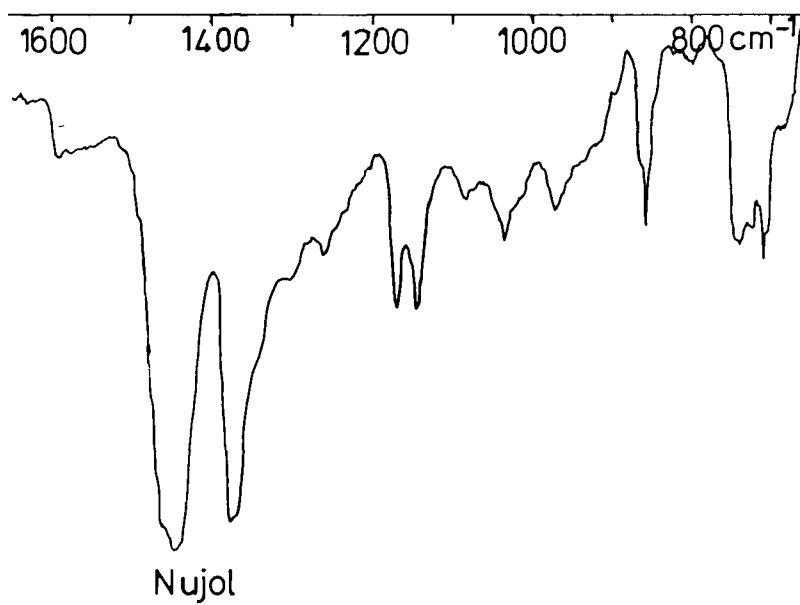

<u>Band maxima (cm<sup>-1</sup>)</u>			
<u>complex</u>	<u>3,5-Me<sub>2</sub>py</u>	<u>complex</u>	<u>3,5-Me<sub>2</sub>py</u>
1591 w,br	1579 s	855	860 vs
	1422 s	+sh 865 m-s	
	+ sh to 1460		825 w,br
	1380 s	745	
		738 } env.	712 vs
		722 } m-s	+sh 725
	1321 m	710 m-s	
1260 w	1271 w	+sh 705	
	1235 m-s		584 w
1170 m	1170 s		570 w
1145 m	1141 m-s	540 w	532 w
1082 w			+sh 540
1035 w-m	1035 m-s		518 w
	+sh 1045		430 w
	1012 w	395 w-m,br	395 w,br
970 w-m	945 } d		355 vw
	932 }		

The spectrum of the liquid sample is much stronger than that of the mull, so more detail is visible for these bands. The  $\nu$ C-H and  $\delta$ C-H bands are also visible for the ligand, whereas they are obscured by Nujol in the mull.

#### <sup>119</sup>Sn NMR spectrum

This consists of a signal at -521.5 ppm,  $(\Delta\nu)_{1/2} = 250$  Hz.

### 3.5.2 Conclusions

The general conclusions outlined in section 3.2.2 are again applicable to this product.

The shifts and intensities of the signals in the  $^1\text{H}$  spectrum are close to expected values for the required complex. The aliphatic region shows three broad peaks, in very similar positions to the first three products of this series. The broadness of the peaks could be due to several reasons - the viscosity of DMSO could slow down molecular motions in the system, or different isomers, having very similar proton environments, could be present, or some sort of exchange mechanism could be occurring. The true situation is likely to be a combination of these factors. Five aliphatic  $^{13}\text{C}$  signals are observed, so it is likely that several isomers are present. Also in the  $^{13}\text{C}$  spectrum, the signals from C2 and C4 are broadened due to interaction with the nitrogen. The signal from C3 is surprisingly intense for a tertiary carbon site.

The only conclusion that can be reached from the infra-red data is the general one that the ligand is coordinated in the solid state. No  $\nu\text{Sn-C}$  or  $\nu\text{Sn-Br}$  were observed, and the presence of methyl groups in the ligand means that the  $\nu\text{C-H}$  bands have no diagnostic value.



3.6 bis(3-chloropyridine).1,1-dibromostannacyclohexane

A small amount of product ( $\approx 10\%$ ) was obtained when the reaction was attempted using this base. Analytical results were unsatisfactory.

3.6.1 Characterisation dataa  $^1\text{H}$  NMR spectrum

Run in  $\text{D}_6$  DMSO

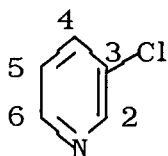

assignment	2	6	4	5			
	3-Clpy/ $\text{CDCl}_3$						
$\delta$ (ppm)	8.65	8.50	7.70	7.25			
	complex						
$\delta$ (ppm)	8.64	8.56	7.96	7.48	1.72	1.29	0.88
multiplicity	1	2	2	2x2	all broad singlets		
J (Hz)	-	4.4	8.0	8.1,4.7			

Intensity ratio aromatic : aliphatic    Expect 1 : 1.25

Obtain 1 : 4.63

The spectrum of the free ligand consists of four groups of peaks with complex splitting patterns. The values for the centres of these groups are given here, in comparison with those obtained for the complex.

 $^{13}\text{C}$  NMR spectrum

No aromatic peaks are visible, just a series of 6 peaks from 42.0 - 13.9 ppm.

### <sup>119</sup>Sn NMR spectrum

The spectrum of the obtained product consists of a broad signal centred at -232.4 ppm and a sharper one at -521.0 ppm.

#### 3.6.2 Conclusions

In the proton spectrum of this compound, the very low intensity of the aromatic peaks indicates that little complexation has occurred. These signals cannot be observed at all in the <sup>13</sup>C spectrum, and the <sup>119</sup>Sn spectrum also shows that the majority of the product is not as required, with a small proportion being the same as the rest of the series.

It is likely that once again the low base strength of the ligand has prevented the formation of a stable complex, as was the case with the 3,5-dichloropyridine ligand.

### 3.7 Discussion

If data that are not purely dependent on the nature of the pyridine ligand are compared for all complexes, it can be seen that the reaction has produced very similar results in all cases where there is supporting evidence for complexation.

#### $^{119}\text{Sn}$ NMR results for $\text{L}_2\cdot\text{Br}_2\text{Sn}(\text{CH}_2)_5$

	Ligand	pKa (47)	$\delta$ (ppm)
1	1,10-phenanthroline	4.9	-545.1
2	pyridine	5.2	-521.1
3	2,2'-bipyridine	4.4	-521.25
4	3,5-dichloropyridine	0.7	no signal
5	3,5-dimethylpyridine	6.15	-521.5
6	3-chloropyridine	2.8	(-521.0)
			-232.4

#### $^1\text{H}$ NMR shift values (0 -5 ppm) for $\text{L}_2\cdot\text{Br}_2\text{Sn}(\text{CH}_2)_5$

Ligand no.	$\delta$ (ppm)					
1	2.29	2.09	1.94	1.70	1.21	0.92
2				1.70	1.28	0.86
3				1.67	1.27	0.85
4	2.43	2.07	1.64	1.50	1.24	
5				1.73	1.28	0.88
6				1.73	1.29	0.88

$^{13}\text{C}$  NMR shift values (0-45 ppm) for  $\text{L}_2\cdot\text{Br}_2\text{Sn}(\text{CH}_2)_5$ 

Ligand no.	$\delta$ (ppm)					
1	36.1	35.15	29.8	27.1	23.2	15.1
2	36.1			26.0	21.8	14.0
3	42.3	35.2	34.3	25.7	21.7	13.95
4	no spectrum					
5	43.3	34.17		25.8	21.6	13.8
6	42.0	35.15	34.3	25.7	21.7	13.9

Complexes 4 and 6, where the product does not characterise well have different spectra. The ligands in these cases are both rather weak bases, so it would appear that this prevents them from forming stable complexes with tin. For the rest, the differences between results are small, and can mostly be attributed to differences in character of the ligands, so a series of general deductions can be made about the nature of these four complexes.

The absence of characteristic bands for the starting material shows that a reaction has occurred in which the C-Br bonds have been broken. The product that results is a tin-pyridine complex, since evidence for Sn-Br and Sn-py bonding has been found in IR and Raman spectra (where obtainable).

From the number of Sn-Br bands, the analytical ratios and the relative intensities of aromatic signals in the  $^1\text{H}$  spectra, it would seem that the stoichiometry of this part of the molecule is  $\text{SnBr}_2\text{py}_2$  or  $\text{SnBr}_2\text{L}$  (L = bidentate ligand), as expected.

The aliphatic part of the molecule also seems to be bonded to tin, since there is no evidence for other functional groups

replacing Br in the starting material, nor, from the infra-red  $\nu$ C-H frequencies, have they been replaced by H to form methyl groups. The  $^1\text{H}$  and  $^{13}\text{C}$  aliphatic shift values are as expected for ring compounds (11,12,36). It would therefore seem reasonable that a complex of the required form has indeed been produced. The assignment of two  $\nu$ Sn-C bands for complex 3 is evidence that the two carbons are mutually cis, as they would be in a ring. It is unfortunate that the strong pyridine bands obscure these bands in other complexes. More solid state data would be useful to demonstrate the cis nature of these carbons, Mossbauer spectra in particular.

From the broadness of the aliphatic  $^1\text{H}$  signals and the large number of  $^{13}\text{C}$  signals, it seems likely that a number of coordination isomers are present. This may make Mossbauer spectra complex and difficult to interpret.

In the first complex, with 1,10-phenanthroline, 5  $^1\text{H}$  signals from 0-5 ppm were observed, and in its  $^{13}\text{C}$  spectrum, the signals show fine splittings. Since this ligand is bulky and constrained to planarity, it will slow down the interconversion between rotational conformations that generally occur in solution at ambient temperatures. It is likely, therefore, that these closely spaced signals are due to the presence of conformational isomers with relatively long lifetimes.

The solution state tin shift for this complex is also at lower frequency than for the other three observed, so 1,10-phen seems to stay complexed in solution, at least to a small extent. This again is probably because the size and rigidity of the group prevents it

from being completely replaced by solvent.

Apart from when L = 1,10-phen, the  $^{119}\text{Sn}$  chemical shifts for these complexes are all the same. It is unlikely that ligands with such varying donor power (as demonstrated by their pKa values) would produce complexes with identical shielding environments at the metal. Since the  $^1\text{H}$  and  $^{13}\text{C}$  NMR spectra show little change in the signals of the ligand that are attributable to complexation, and DMSO is known to be a strong enough donor to replace electronegative groups in a complex (see Ch.5 section 2.5), it appears that substitution of the pyridine ligands has occurred here, and that the DMSO complexes are actually being observed in solution.

The evidence of Ch.4 section 3.2.5 and Ch.5 section 2.5 indicates that DMSO replaces two of the electronegative ligands in 6-coordinate complexes, but not more (otherwise the observed shifts for  $\text{Me}_2\text{SnX}_2$  would be much closer together, since the main species in solution would be solvated  $\text{Me}_2\text{Sn}^{2+}$ ). In this case, it seems that the species being observed in solution is  $(\text{CH}_2)_5\text{SnBr}_2 \cdot 2\text{DMSO}$ , in various isomeric forms. The low frequency of the shift is probably attributable to the retention of bromine in the coordination sphere, since it is known to shield tin nuclei (94,126,170).

Study of the isomers present in the solid state and of the geometry of the ring has not been possible using the information obtained. Further evidence, such as could be derivable from their Mossbauer or solid state  $^{13}\text{C}$  or  $^{119}\text{Sn}$  NMR spectra, would be useful to look at the state of coordination in these compounds.

Structural modifications, possibly achieved by changing the

nature of the donor, are also desirable to make the complexes soluble enough to be studied in a less disruptive solvent than DMSO.

4 EXPERIMENTAL4.1 Preparative method for an  $\alpha,\omega$ -diGrignard reagent (194,196)

An oven-dried, 11,3-necked round bottomed flask was fitted with a Claisen head (to attach an  $N_2$  inlet and reflux condenser), a paddle stirrer and 100ml dropping funnel. 3g of oven-dried Mg was introduced into the flask together with 30 mls dry THF and a crystal of  $I_2$ .  $3.4 \text{ cm}^3$  (5.7g, 25mmols) of the dibromide in 30 mls THF was added slowly over 1-1.5hrs, whilst the mixture was warmed.

The reaction was assumed to have commenced when the colour of the iodine disappeared and the solution went cloudy. Once this had happened, the stirrer was started, and the reaction was continued, with heating, for 2-3hrs. The mixture was then cooled, the solids filtered off and a solution of the appropriate chloride (in THF) added dropwise (1-1.5 hrs). After stirring overnight, the mixture was hydrolysed with 100mls  $NH_4Cl$  (satd. aqueous), the organic phase separated off and the aqueous phase washed twice with ether (Na dried). The combined organic phase and washings were then dried over  $MgSO_4$  and the solvent removed under vacuum, leaving in most cases a clear oil.

When  $Ph_2SnCl_2$  was used, addition of petroleum ether ( $30 - 40^\circ$ ) to the product caused the precipitation of a white solid which characterises as the starting material.

$Ph_3SnCl$  gave an oil which analyses as  $Ph_3Sn(CH_2)_5SnPh_3$ :

Analysis	Expect	61.09%C	5.00%H
	Obtain	61.15%C	5.77%H



$^1\text{H}$ NMR			
$\delta$ $\text{Ph}_3\text{SnCl}$ (ppm)	7.2		
$\delta$ $\text{Br}_2(\text{CH}_2)_5\text{Br}$ (ppm)		3.45	1.85
<u>Product</u>			
$\delta$ (ppm)	7.27	4.27	1.50
rel. int Expect	7.5	1	1.5
Obtain	7.95	1	2.2

#### 4.2 Distillation of $\text{Ph}_3\text{Sn}(\text{CH}_2)_5\text{SnPh}_3$ (196)

This compound was heated under vacuum, together with 20 mol% of  $\text{ZnCl}_2$ , in a B10 distillation apparatus, by Wood's metal bath (Bath temp.  $270\text{--}300^\circ\text{C}$ , column temp.  $200^\circ\text{C}$  or over. Heating tape was applied to the column to raise the temperature.). A small yield of clear liquid that solidified on cooling was obtained. It proved to analyse poorly and was insoluble in any available solvent, so it was assumed to be polymeric in nature.

Analysis for $\text{Ph}_2\text{Sn}(\text{CH}_2)_5$	Expect	59.52%C	5.58%H
	Obtain	67.18%C	4.41%H

#### 4.3 Preparation of an $\alpha,\omega$ -diorganolithium reagent (221)

Approx. 2.6 mls of Li metal and 25 mls of Na dried ether were introduced into an oven-dried, 3 necked, 500ml round bottomed flask, well purged with  $\text{N}_2$  and fitted with a dry ice/acetone condenser (with  $\text{N}_2$  purge), paddle stirrer and Claisen head to take a pressure equalising dropping funnel (with  $\text{N}_2$  purge) and thermometer. 6.7 mls (11.4g, 50mmols) of  $\text{Br}_2(\text{CH}_2)_5\text{Br}$  in 25mls of ether (Na dried) were then introduced into the dropping funnel,

and a few drops added to the flask. The ether was then heated to a steady reflux, and the remainder of the bromide added over a period of 1/2 hr. Reflux was then continued, with stirring, for a further 3-4hrs, after which time the reaction mix was allowed to cool, and the solids filtered off. 1ml of the solution was then abstracted by syringe for analysis.

A solution of the appropriate amount of  $\text{Ph}_3\text{SnCl}$  in 100mls toluene (Na dried) was then added dropwise, and the mixture stirred for  $\approx 2$  days, over which time a white precipitate appears. This was filtered off, and the solvent removed from the remaining solution to leave an oily liquid.

The proton NMR spectrum of the solid shows only aromatic signals, and that of the oil only aliphatic ones, so the materials produced are either the starting materials or their hydrolysis products.

<u>Analysis</u>	Expect for $\text{Ph}_3\text{Sn}(\text{CH}_2)_5\text{SnPh}_3$	61.09%C	5.00%H
	Obtain	42.55%C	5.70%H

Analysis of the organolithium reagent

The 1ml aliquot of reaction solution was added to 10ml EtOH, whereupon a white precipitate formed. This was then made up to 50mls by addition of distilled water (with more precipitation).

This sample was then quantitatively analysed by atomic absorption, after the precipitate was redissolved by acidification with  $\text{HNO}_3$ , showing approx. 30% yield of the reagent.

Typical analysis:

For a 100% yield of reagent, the solution is expected to contain 99.2mmols, 688.45mg Li, therefore a 1ml aliquot should contain 1.98 mmol, 13.77mg Li.

Obtain 0.717mmol, 4.98mg Li = 36.2% yield.

#### 4.4 Synthesis of tin-ylide complexes

##### 4.4.1 Preparation of phosphonium salts (222)

10g  $\text{Ph}_3\text{P}$  and 50mls toluene were added to a 100ml 2 necked round bottomed flask, purged with  $\text{N}_2$  and fitted with an air bleed. 3.5g  $\text{CH}_3\text{Br}$  was added to this mixture via the latter over 1/2 hr and it was then stirred for 2-3 days, during which time a dense white precipitate of product was obtained. This was then isolated and used for the next step without further purification.

[ $\text{CH}_3\text{Br}$  is measured out by volume (2.2mls) in a cold finger by vacuum transfer. The air bleed from the reaction flask was then attached to the neck of this vessel, and the bromide transfers as it warms up and vaporises.]

##### Analytical results

$\text{Ph}_3\text{PCH}_3^+$	Expect	63.88%C	5.08%H
	Obtain	65.00%C	4.95%H
$\text{Ph}_3\text{P}(\text{CH}_3)_2^+$	Expect	56.89%C	5.45%H
	Obtain	58.37%C	5.33%H

##### $^1\text{H}$ NMR

$\text{Ph}_3\text{PCH}_3^+ \text{Br}^-$			
$\delta$ (ppm)	7.7	3.24	(doublet, $J = 13\text{Hz}$ )
Rel. int. Expect	1	0.2	
Obtain	1	0.2	
$\text{Ph}_2\text{P}(\text{CH}_3)_2^+ \text{Br}^-$			
$\delta$ (ppm)	8.0	7.59	2.85 (doublet, $J = 14\text{Hz}$ )
Rel. int. Expect	1	0.6	
Obtain	1	0.61	

4.4.2 Preparation of ylide (223)

40 mmols  $\text{NaNH}_2$  (75% excess) were introduced into a 2 necked 100ml round bottomed flask, well purged with  $\text{N}_2$  and fitted with  $\text{N}_2$  inlet and reflux condenser. To this was added 60 mls pre-dried THF and 22 mmols phosphonium salt. (The latter was added in portions, over a period of 1/2 hr.) The mixture was then refluxed ( $60\text{--}70^\circ\text{C}$ , under  $\text{N}_2$ ) for 4-5 hrs, during which time it developed a bright yellow colouration and  $\text{NH}_3$  was evolved.

After cooling, the solids were filtered off and the solvent removed under vacuum, leaving  $\approx 10$  mmols of yellow solid. Since it is air sensitive, it is used immediately in the next step of the reaction.

 $^1\text{H}$  NMR

$\text{Ph}_3\text{P}=\text{CH}_2$  in  $\text{D}_6$  DMSO

$\delta$ (ppm)	7.70	2.15	(doublet, $J = 13.2$ Hz)
Rel. int. Expect	1	0.13	
Obtain	1	0.14	

$\text{Ph}_2\text{P}(\text{Me})\text{CH}_2$  in  $\text{CD}_3\text{CN}$

$\delta$ (ppm)	7.50	1.81	(doublet, $J = 13$ Hz)
Rel. int. Expect	1	0.5	
Obtain	1	0.55	

The spectrum of the second ylide shows only one aliphatic signal, so either a proton has been removed from both methyl groups, giving a diylide compound, or resonance is occurring between the possible forms of the monoylide, giving a product of the form

$\text{Ph}_2\text{P}^+\begin{matrix} \text{CH}_3 \\ \text{CH}_2 \end{matrix}$ . The integration ratio indicates that the latter is more

likely, but since these values are rarely very accurate, this is not certain.

#### 4.4.3 Formation of complex

MeCN solutions of  $\text{SnBr}_4$  and ylide were combined under  $\text{N}_2$  (glove box), with stirring. The white solid product precipitated almost immediately, and was filtered off, washed with pet. ether ( $30\text{--}40^\circ\text{C}$ ) and dried in vacuo to remove traces of solvent.

#### Analytical results

##### $\text{Ph}_3\text{P-CH}_2$ complex

Expect	46.06%C	3.06%H	0%N	6.25%P	11.98%Sn	32.26%Br
Obtain	37.00%C	3.38%H	0%N	5.43%P	13.06%Sn	32.16%Br

##### $\text{Ph}_2\text{MeP-CH}_2$ complex

Expect	38.30%C	3.49%H	0%N	7.15%P	13.69%Sn	36.87%Br
Obtain	28.81%C	2.69%H	0%N	7.08%P	13.59%Sn	38.43%Br

#### 4.5 Preparation of $\text{L}_2\cdot\text{Br}_2\text{Sn}(\text{CH}_2)_5$ or $\text{L}'\cdot\text{Br}_2\text{Sn}(\text{CH}_2)_5$ (109)

A mixture of 5.95g (50 mmols) tin powder, 11.4g (50 mmols)  $\text{Br}(\text{CH}_2)_5\text{Br}$ , 0.43g (5 mmols, 10 mole%) piperidine and 0.25g (2mmols 4 mole%)  $\text{I}_2$  in 25 mls decane was refluxed ( $160\text{--}180^\circ\text{C}$ ) for 5hrs with intermittent stirring in a 500ml 3-necked round bottomed flask, well purged with  $\text{N}_2$  and fitted with reflux condenser, paddle stirrer and  $\text{N}_2$  inlet and thermometer (connected via a Claisen head). During this period a strong yellow colour developed in the solution. The mixture was then cooled to room temperature, producing a waxy precipitate, which was redissolved by addition, by syringe, of 1:1 analar acetone and toluene (Na dried) totalling  $\approx 40$  mls. The solid tin residue was then filtered off, while the  $\text{N}_2$  purge was maintained, and  $\approx 35$  mmols of bidentate base, or  $\approx 70$  mmols of monodentate base (assuming 70% yield of heterocycle) in  $\approx 50$ mls acetone (quantity depending on solubility of the base) were

added dropwise over 1-1.5 hrs via a pressure equalising dropping funnel. Precipitation of product was almost immediate, and continued as the mixture was stirred overnight under N<sub>2</sub>. This precipitate was then isolated, and a further crop of product obtained on reduction in volume of solvent.

The product was recrystallised from ≈70 mls butan-2-one. This solvent is not ideal, since the products are only slightly soluble and, once dissolved, do not reprecipitate until the volume of solvent is reduced.

Analytical data for L<sub>2</sub>.Br<sub>2</sub>Sn(CH<sub>2</sub>)<sub>5</sub> or L'.Br<sub>2</sub>Sn(CH<sub>2</sub>)<sub>5</sub>

Ligand		C	H	N	Sn <sup>1</sup>	Br+Cl <sup>2</sup>
1,10-phenanthroline	Expect	38.61	3.43	5.30	22.44	30.22
	Obtain	39.47	3.52	5.43	14.85	30.62
pyridine	Expect	35.5	3.98	5.53	23.41	31.53
	Obtain	36.91	3.59	5.06	24.75	30.86
2,2'-bipyridine	Expect	35.69	3.59	5.55	23.51	31.66
	Obtain	31.90	4.06	4.43	24.31	33.12
3,5-dichloropyridine	Expect	27.95	2.50	4.35	18.41	46.79
	Obtain	20.6	1.49	3.13	16.03	49.25
3,5-dimethylpyridine	Expect	40.54	5.01	4.98	21.08	28.39
	Obtain	39.2	5.5	3.8		29.34
3,-chloropyridine	Expect	31.21	3.15	4.87	20.61	40.08
	Obtain	17.8	3.5	2.4	16.83	49.76

<sup>1</sup> Sn values only given where reliable data could be obtained.

<sup>2</sup> Total halogen percentages given.

#### 4.6 Spectrometric conditions for $L_2 \cdot Br_2 Sn(CH_2)_5$ or $L' \cdot Br_2 Sn(CH_2)_5$

Proton spectra: These were run in  $D_6$ DMSO solution, using internal TMS reference at 60 MHz on a Hitachi - Perkin Elmer R24B

spectrometer, and at 250MHz on the Bruker AC-250 spectrometer.

$^{13}C$  spectra: These were run in  $D_6$ DMSO using a deuterium lock and internal TMS reference, in the broad band proton decoupled mode.

Spectrometer frequency = 62.896 MHz on the Bruker AC-250 spectrometer.

$^{119}Sn$  spectra: These were run in DMSO (approx. 50%  $D_6$ DMSO) on the Bruker AC-250 at 93.27MHz, using the frequency of  $\delta(Me_4Sn) = 93.2760630$  MHz as an external reference, and a deuterium lock. The signal was accumulated in the broad band proton decoupled mode using rapid pulsing (relaxation delay = 0s) since the large width of the signals indicated that relaxation via dipole-dipole interaction with  $^1H$  is unlikely. Since this is the case, inverse gated pulsing to suppress NOE confers no benefits.

Infra-red KBr disc spectra: These were run in Fourier transform mode from 4000-400  $cm^{-1}$  using a Nicolet 60SX machine.

Raman spectra were run on a Cary 82 Raman spectrometer, at  $\lambda = 514.5nm$ , 50mW.

All other results were obtained by the general methods given in Ch.2.

## CHAPTER SEVEN

SUGGESTIONS FOR FURTHER WORK1 Dialkyltin halide/pseudohalide complexes

The crystal structures of  $(Et_4N^+)_2 Me_2Sn(NCS)_4^{2-}$  and  $(Et_4N^+)_2 Me_2Sn(NCS)_2Cl_2^{2-}$  are currently under investigation. In the latter, it is hoped that this will reveal whether the halogens take up a mutually cis or trans orientation (or both).

Further investigation into dimethyltin cyanide complexes does not seem to be worthwhile. The four-coordinate  $Me_2Sn(CN)_2$  can be made using HCN (224), but from available information (see Ch.4 and (170)) it seems unlikely that complexes can be obtained.

The dimethyltin cyanate complexes are worthy of further development, however. Since  $NCO^-$  is a weaker substitution agent than  $Cl^-$ , conditions need to be weighted in its favour for complexation to take place (ie. a large excess of cyanate needs to be used). The other possibility is to attempt the synthesis of the analogous bromide complexes, since  $Br^-$  is a weaker donor than  $Cl^-$ .

If dimethyltin azidothiocyanate complexes were prepared, their main feature of interest would be their quadrupolar splitting values.  $NCS^-$  causes an increase in  $\Delta E_q$  and  $N_3^-$  a decrease. If the additivity model holds and geometry of the complexes is reasonably regular, it is expected that the following trends would be obtained for  $(Et_4N^+)_2 Me_2Sn(NCS)_n(N_3)_{4-n}^{2-}$  :-



$n$	$\frac{\Delta E_q}{q} \text{ (mms}^{-1}\text{)}$
4	4.40
3	4.24
2	4.08
1	3.92
0	3.76

(From using the values  $(pqs)_{Alk} = -1.03 \text{ mms}^{-1}$ ,  $(pqs)_{NCS} = -0.07$ ,  $(pqs)_{N_3} = +0.09 \text{ mms}^{-1}$  (3). The last value is derived from  $\Delta E_q(\text{Me}_2\text{Sn}(\text{N}_3)_4^{2-})$  given in Ch4.)

The synthesis of the mixed complexes described in this work means that a wide variety of similar species could also be made. Extension of the method would be useful if ligands were used whose properties (such as polarisability, electron withdrawing abilities etc.) were well known. The variation in chemical shifts could therefore be compared with a given property with reasonable accuracy. This would mean looking at a system where dissociation was not extensive, although this may be difficult to achieve.

It may also be worthwhile preparing complexes with large inorganic cations in order to attempt to improve the solubility of these complexes, particularly in non-coordinating solvents. It may then be possible to obtain  $^1J(^{119}\text{Sn}-^{13}\text{C})$  coupling constants to compare with  $^2J(^{119}\text{Sn}-\text{C}-^1\text{H})$ .

## 2 Study of equilibria

The alternative to studying complexes that do not dissociate is to determine the shifts of the undissociated complexes by other means. The method used in this work of finding a limiting shift by

addition of excess ligand cannot be applied to the intermediate complexes since they would undergo substitution. Two other methods could be applied, however, namely variable temperature study of the solution, or determining the solid state shift.

Running the solution state spectrum at a low temperature would hopefully slow down the exchange equilibrium sufficiently for its components to have long enough lifetimes to give separate NMR signals. Hence, an equilibrium constant could be derived at any temperature - by the position of the average signal (at higher temperatures), or from the relative intensities of the separate signals (at low temperatures).

The problem with this approach is the low solubility of most of the complexes prepared, which would probably decrease with temperature, so it may be that very little of the complex remains in solution at the temperature under consideration. Also, relatively polar solvents are required, which are likely to freeze before the required temperature is reached (eg. mpt.  $\text{CH}_3\text{CN} = -45.7^\circ\text{C}$ ).

These problems would not be encountered with solid state work. Some attempts have already been made to obtain signals for these complexes, but only very broad (of the order of  $\approx 5000$  Hz) resonances were obtained, probably because of the large quadrupolar interactions with the nitrogens (or chlorines) that are present. The worst case is the tetra-azide complex, where there are twelve nitrogens surrounding the central tin atom.

The chemical shift information obtained from either of these means could then be used in conjunction with other parameters to determine what factors are causing the observed change in  $\delta$ .

A correlation between  $\delta$  and  $\Delta E_q$  values would indicate that p orbital population imbalance is important, as has been found for  $(R_3Sn)_2E$  (R = Me, Ph, E = S, Se, Te) (145).

UV/visible or photoelectron spectra could be used to look at the excitation energies.

Since  $\delta$  is itself an averaged property, this approach would still only lead to very generalised information. Comparisons with observed trends across other series would still be informative, however.

### 3 Synthesis of tin heterocycles

This is the area that provides the most scope for further development. Work could be done either in developing the ideas initiated in this study, or in new, related areas.

#### 3.1 Tin-ylide complexes

Work already done (99,100,225) indicates that tin-ylide complexes can be formed. The present study also shows that a reaction between  $SnBr_4$  and an ylide certainly occurs, even though the results are very ambiguous. Hence, it would probably be worthwhile repeating Seyferth's reaction of methylene triphenylphosphorane with trimethyltin bromide, since the resulting complex is likely to be soluble in less disruptive solvents than DMSO.  $^{119}Sn$  NMR characteristics of trimethyltin halides are well known (93,126) and an increase in the coordination number of tin (as is expected for the complex) would be clearly evident.

It may also be worthwhile trying different ylides, since Yamamoto (100) has found that methylene tris(dimethylamino)-phosphorane forms stable complexes with organotin compounds.

### 3.2 1,1-dibromostannacyclohexane complexes

Mossbauer results for these compounds would clearly indicate whether the organic groups on tin adopt cis or trans orientations, and hence give very good evidence for ring formation. The possible isomers would also be visible via their different  $\Delta E_q$  values (although this may complicate the spectra.). If cis alkyl groups are assumed the following isomers are possible:-

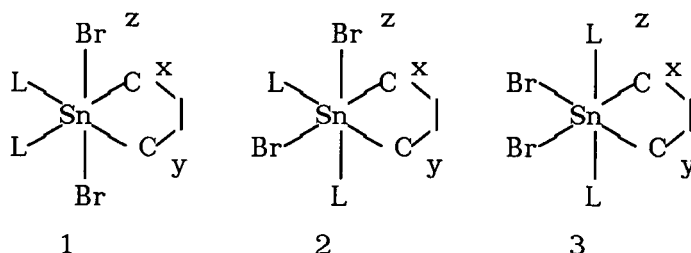

For a bidentate ligand, only isomers 1 and 2 are possible.

The ring is treated as being two separate alkyl groups, for simplicity.

L = donor ligand

Axes are chosen to maintain the ordering  $|V_{zz}| \geq |V_{yy}| \geq |V_{xx}|$ .

The formulae given in Ch.1 section 4.2.2 may then be applied to give the following expressions for the quadrupolar splittings of the isomers (assuming  $\Delta E_q \approx V_{zz}$ )

$$(1) \quad V_{zz} = -2\{[L] - [\text{Alk}]\} \quad \text{mms}^{-1}$$

$$(2) \quad V_{zz} = [L] - 2[\text{Alk}] \quad \text{mms}^{-1}$$

$$(3) \quad V_{zz} = 4[L] - 2[\text{Alk}] \quad \text{mms}^{-1}$$

since  $[\text{Br}] = 0 \text{ mms}^{-1}$ , by convention. Hence, these isomers are distinguishable by their  $\Delta E_q$  values.

If experimental parameters are substituted into these equations, expected values can then be obtained. Bancroft and Platt give the following parameters (147):-

$$\begin{aligned}(\text{pqs})_{\text{Alk}} &= -1.03 \text{ mms}^{-1} \\ 1/2(\text{pqs})_{\text{phen}} &= -0.04 \text{ mms}^{-1} \\ 1/2(\text{pqs})_{\text{bipy}} &= -0.08 \text{ mms}^{-1} \\ (\text{pqs})_{\text{py}} &= -0.10 \text{ mms}^{-1}\end{aligned}$$

which predict the following values for the quadrupolar splittings for the complexes.

	L			
isomer	phen.	bipy.	py.	
(1)	2.14	2.22	2.26	
(2)	2.02	1.98	1.96	
(3)	-	-	1.66	

(Only magnitudes of values are given, since the sign of  $\Delta E_q$  is not routinely determined.)

These values should be distinguishable. Deviation from expected values is likely to be primarily due to angle distortion, since values for cis-alkyl complexes seem particularly sensitive to this effect. This could indicate whether the presence of the ring is distorting the octahedral angle at tin, and opening it up to nearer the tetrahedral angle that is ideal for a 6-membered ring. In considering this, however, it must be borne in mind that it is uncertain how well the  $(\text{pqs})_{\text{Alk}}$  value applies to these rings, since no Mossbauer data have so far been recorded for such complexes, particularly those incorporating an octahedrally coordinated tin atom.

It may also be fruitful to alter the donor type to try and increase the solubility of the complex (which would mean that the procedure for isolating the product would need alteration).

$R_3P=O$  donors may be interesting, since this would give the possibility of observing  ${}^2J({}^{31}P-O-{}^{119}Sn)$ , via the spectra of both nuclei. ( ${}^2J({}^{119}Sn-{}^{119}Sn)$  coupling mediated through oxygen has been observed in the spectra of  $(R_3Sn)_2O$  (143,226) and the complexation of trialkyl tin halides with triphenylphosphine oxide (in benzene) has also been investigated by  ${}^{31}P$  NMR (227).

### 3.3 Further development

#### 3.3.1 Synthesis of Sn-C heterocycles

Azuma and Newcomb (75) have developed the synthesis of large di- and tetrastannacycloalkanes by brominating  $Ph_3Sn(CH_2)_5SnPh_3$ , and either reacting this with the appropriate  $\alpha,\omega$ -diGrignard reagent (scheme a), or by converting the dibromide to the dilithium reagent, and reacting this with the  $\alpha,\omega$ -dibromoalkane (scheme b).

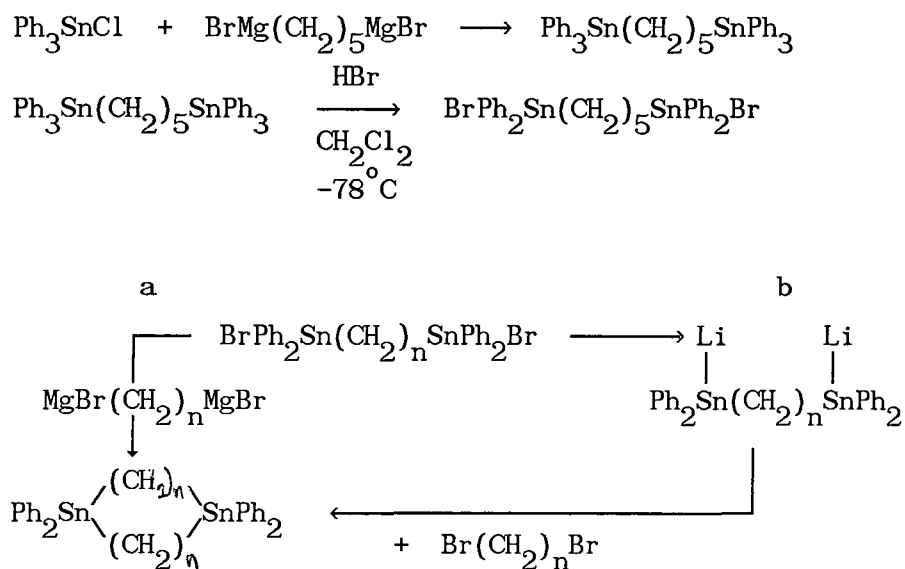

Scheme b proved more successful for small rings, although the yield of product from both routes was reduced by competing polymerisation reactions.

If either of these routes were followed, it should be possible to brominate the resultant heterocycle without ring cleavage. (The authors of this paper found that cleavage of Ph-Sn bonds was extremely facile in the initial  $\alpha,\omega$ -bis(triphenylstanna)-alkane, and if the reaction was carried out using  $\text{Br}_2/\text{CCl}_4$  at room temperature, the second phenyl group was removed almost as easily as the first.) This compound can then be complexed with suitable donors.

Unsaturated Sn-C heterocycles have been synthesised using alkynes. Stannacyclopentadiene is produced by treating 1,2-diphenylethyne with lithium, and adding  $\text{R}_2\text{SnCl}_2$ . Further synthesis of complex compounds has followed, but bromination of this unsaturated derivative proceeds via ring cleavage (106). Alternatively, stannaheptadiene has been produced (in low yield, due to competing polymerisation reactions) through reactions of an  $\alpha,\omega$ -dialkyne with a dialkyltin dihydride (106).

It may be possible to use these methods to synthesise rings and then saturate, or functionalise the double bonds, before attempting bromination reactions by similar procedures to those previously outlined.

### 3.3.2 Use of bis(triorganostannyl)methanes

Considerable use has been made recently of these compounds in synthetic organotin chemistry (228).

They are made by two methods, the first using the methylene diGrignard reagent developed by Bruin (229) and  $\text{Ph}_3\text{SnBr}$ , and the second involving the reaction of the super-nucleophilic reagent  $\text{Me}_3\text{Sn}^- \text{Na}^+$  with methylene chloride (230). (It may be that the latter is more effective, since its preparation is less complex.)

Once made, either  $(\text{Me}_3\text{Sn})_2\text{CH}_2$  or  $(\text{Ph}_3\text{Sn})_2\text{CH}_2$  can be halogenated (in contrast to the problems encountered in functionalising dimethylstannacyclohexane (202)). This is again achieved by two methods. Direct reaction with halogen or halogen halide produces  $(\text{XR}_2\text{Sn})_2\text{CH}_2$  and excess halogen with the phenyl compound gives  $(\text{Br}_2\text{RSn})_2\text{CH}_2$ , although Karol (230) reports that with the trimethyl compound, the major reaction pathway is via cleavage of the Sn-methylene bond, giving a mixture of methyltin bromides as products. In this work, the required product is obtained by reaction with the appropriate ratio of  $\text{SnCl}_4$ . Bis(trichloro-stannyl)methane cannot be obtained by this method, but if bis(trivinylstannyl)methane [ $\{(\text{CH}_2=\text{CH})_3\text{Sn}\}_2\text{CH}_2$ ] is prepared and reacted with excess  $\text{SnCl}_4$ , the higher reactivity of the vinyl group allows the fully substituted product to be produced. The reaction of  $\text{SnCl}_4$  with bis(triphenylstannyl) methane was not investigated.

Once halogenated, it is then possible to substitute X for other ligands. eg. if a carboxylate is used, the product undergoes intramolecular coordination (231).

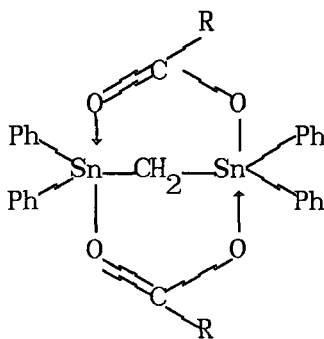

More complex intramolecular coordination is achieved by using a bidentate thiol ligand, to produce  $\text{CH}_2[\text{SnPh}\{(\text{SCH}_2\text{CH}_2)_2\text{NMe}\}]_2$  (232) where tin is coordinated to the two sulphurs and the nitrogen



(as well as the two organic groups) in an approximately trigonal bipyramidal arrangement.

Although studies have been made of the adducts of the original halides with DMSO and HMPA (230,233) and of the antitumour potential of the uncoordinated bis(halophenylstannyl)methanes (234), complexation of the bis(dihalophenylstannyl)methanes (which should produce bis-hexacoordinate tin complexes) has not yet been extensively investigated, nor has their antitumour potential. Use of pyridine bases (eg. phen, bipy etc.) is anticipated, since they are known to form strong complexes with tin (15) and are also present in compounds that have previously shown antitumour activity (81).

It would be interesting to investigate:-

- a) the geometry and isomerisation of the complexes formed, particularly since the presence of different coordination isomers in the same molecule should be clearly evident in the  $^{119}\text{Sn}$  NMR spectrum;
- b) the possibility of coordinating across both tin atoms by using bidentate ligands such as 2,2'-bipyridyl;
- c) whether coordination is restricted on either or both of the tin atoms by use of bulky ligands.

Most of the above should be easily demonstrated by  $^{119}\text{Sn}$  NMR, if suitable solvents could be found for the complexes, and they did not undergo extensive dissociation in solution.

The other use so far developed for the functionalised ditin compounds is for making heterocycles. The main development to date

is to dimerise the bis (halodialkylstanna)methane via a Wurtz type reaction with Na/liq.  $\text{NH}_3$ , thus producing 1,2,4,5-tetrastannacyclohexanes (235-7). Bruin reports a mixture of tin-containing rings from the direct reaction between  $\text{Me}_2\text{SnCl}_2$  and  $(\text{BrMg})_2\text{CH}_2$  (229).

Interesting as these molecules are as they stand, it would probably be of little use attempting to halogenate them, since ring cleavage would almost certainly be the main course of the reaction. Instead, reaction of the bis(halodiphenylstanna)methane with an  $\alpha,\omega$ -diGrignard reagent (with  $n \geq 4$  for reasonable stability (201)) should yield an asymmetric tetraphenyldistannacycloalkane of reasonable stability, hence bromination and complexation of this compound should be possible. The geometry, complexation properties and antitumour potential of these products could then be investigated.

BIBLIOGRAPHY

- 1 A.G.Davies, P.J.Smith, in *Comprehensive organometallic Chemistry* Vol 2, Ch 11. ed. G.Wilkinson, F.G.A.Stone, E.W. Abel Pergamon Press Ltd. 1982
- 2 J.A.Zubieta, J.J.Zuckerman ., *Prog.Inorg.Chem.*, 24 (1978) 251
- 3 P.A.Cusack, P.J.Smith, J.A.Donaldson, S.M.Grimes, *A Bibliography of X-ray crystal structures of organotin compounds*, I.T.R.I. 1978
- 4 F.W.B.Einstein, C.H.W.Jones, T.Jones, R.D.Sharma, *Can.J.Chem.*, 61 (1983) 2611
- 5 B.Menzebach, P.Bleckmann, *J.Organomet.Chem.*, 91 (1975) 291
- 6 S.J.Blunden, L.A.Hobbs, P.J.Smith, A.G.Davies, S.B.Teo, *J.Organomet. Chem.*, 282 (1985) 9
- 7 H.A.Skinner, L.E.Sutton, *Trans.Farad.Soc.*, 40 (1944) 164
- 8 H.Fujii, M.Kimura, *Bull.Chem.Soc.Japan.*, 44 (1971) 2643
- 9 I.Beattie, G.P.McQuillan, *J.Chem.Soc.*, (1963) 1519
- 10 B.K.Hunter, L.W.Reeves, *Can.J.Chem.*, 46 (1968) 1399
- 11 V.S.Petrosyan, N.S.Yashina, V.I.Bakhneutov, A.B.Permin, O.A.Reutov, *J.Organomet.Chem.*, 72 (1974) 71
- 12 V.N.Torochesnikov, *J.Organomet.Chem.*, 35 (1972) C25
- 13 P.J.Smith, L.Smith, *Inorg.Chim.Acta.Rev.*, 7 (1973) 11
- 14 N.W.Alcock, R.E.Timms, *J.Chem.Soc.*, (1968) 1876
- 15 V.S.Petrosyan, N.S.Yashina, O.A.Reutov, *Adv.Organomet.Chem.*, 14 (1976) 63
- 16 J.W.Nicholson, *Coord.Chem.Revs.*, 47 (1982) 263
- 17 P.G.Harrison, T.G.King, M.A.Healy, *J.Organomet.Chem.*, 182 (1979) 17
- 18 W.T.Reichle, *Inorg.Chem.*, 5 (1966) 87
- 19 R.Okawara, M.Wada, *Adv.Organomet.Chem.* 8 (1967) 137

- 20 H.C.Clark, R.J.O'Brien, J.Trotter, *J.Chem.Soc.*, (1964) 2332
- 21 E.O.Schlemper, D.Britton, *Inorg.Chem.*, 5 (1966) 507
- 22 R.A.Forder, G.Sheldrick, *J.Organomet.Chem.*, 21 (1970) 115
- 23 T.N.Tarkhova, E.V.Chuprunov, M.A.Simonov, N.N.Belov,  
*Sov.Phys.Crystallogr.*, 22 (1977) 571
- 24 R.A.Allmann, R.Hohlfeld, A.Waskowa, J.Lorberth,  
*J.Organomet.Chem.*, 192 (1982) 353
- 25 M.B.Hossain, J.L.Lefferts, K.C.Molloy, *Inorg.Chim.Acta.*, 36  
(1979) 2409
- 26 N.Bokii, Yu.T.Stuchkov, *Zh.Strukt.Khim.(Engl.Trans.)*, 9  
(1968) 633
- 27 H.Preut, F.Huber, *Acta.Cryst.*, B35 (1979) 744
- 28 L.A.Aslanov, V.M.Ionov, A.B.Permin, V.S.Petrosyan,  
*Zh.Strukt.Khim.(Engl.Trans.)*, 18 (1977) 884
- 29 A.C.Sau, L.A.Carpino, R.R.Holmes, *J.Organomet.Chem.*, 69  
(1980) 181
- 30 J.H.Holloway, G.P.McQuillan, D.S.Ross, *J.Chem.Soc.(A)*,  
(1969) 2505
- 31 J.P.Clark, C.J.Wilkins, *J.Chem.Soc.(A)*, (1966) 871
- 32 P.G.Harrison, K.Molloy, R.C.Phillips, P.J.Smith, A.J.Crowe,  
*J.Organomet.Chem.*, 160 (1978) 421
- 33 K.A.Elgebede, R.A.N.McLean, *J.Organomet.Chem.*, 69 (1974) 405
- 34 I.Wharf, J.Z.Lobos, M.Onyschuk, *Can.J.Chem.*, 48 (1970) 2787
- 35 M.Wada, R.Okawara, *J.Organomet.Chem.*, 8 (1967) 261
- 36 K.Jurkschat, A.Tzchach, J.Meunier-Piret, *J.Organomet.Chem.*,  
290 (1985) 285
- 37 G.van Koten, J.G.Noltes, *J.Organomet.Chem.*, 118 (1976) 183

- 38 G.van Koten, J.T.B.H.Jastrebski, J.G.Noltes, G.J.Verhoeck, A.L.Spek, *J.Chem.Soc.Dalton Trans.*, (1980) 1352
- 39 E.O.Schlemper, W.C.Hamilton, *Inorg.Chem.*, 5 (1966) 995
- 40 P.J.Smith, *Organomet.Chem.Revs.(A)*, 5 (1970) 373
- 41 A.K.Sawyer, H.G.Kuivila, *J.Org.Chem.*, 27 (1962) 610
- 42 J.Konnert, D.Britton, *Acta.Crystall.*, 328 (1970) 180
- 43 A.G.Davies, H.J.Milledge, D.C.Puxley, P.J.Smith, *J.Chem.Soc.(A)*, (1971) 2862
- 44 N.W.Alcock, J.F.Sawyer, *J.Chem.Soc.Dalton Trans.* (1977) 1090
- 45 Y.M.Chow, *Inorg.Chem.*, 9 (1970) 794
- 46 R.A.Forder, G.M.Sheldrick, *J.Organomet.Chem.*, 22 (1970) 611
- 47 V.S.Petrosyan, A.B.Permin, O.A.Reutov, *Mag.Res.Rel.Phenom.*, (1978) 501
- 48 V.S.Petrosyan, A.B.Permin, O.A.Reutov, *J.Mag.Res.*, 40 (1980) 511
- 49 J.Otera, T.Yano, K.Kusabe, *Bull.Chem.Soc.Japan*, 56 (1983) 1057
- 50 L.A.Aslanov, V.M.Ionov, A.B.Permin, V.S.Petrosyan, *Zh.Strukt.Khim.(Engl.Trans.)*, 19 (1978) 166
- 51 A.J.Crowe, P.J.Smith, *J.Organomet.Chem.*, 224 (1982) 223
- 52 R.Barbieri, N.Beratazzi, C.Tomarchio, R.H.Herber, *J.Organomet.Chem.* 84 (1975) 39
- 53 T.Kimura, *Bull.Chem.Soc.Japan*, 42 (1969) 2479
- 54 M.Yosida, *Bull.Chem.Soc.Japan*, 41 (1968) 1113
- 55 Y.Meada, *J.Organomet.Chem.*, 10 (1967) 247
- 56 L.E.Levchuk, J.R.Sams, F.Aukbe, *Inorg.Chem.*, 11 (1979) 43
- 57 L.A.Hobbs, P.J.Smith, *J.Organomet.Chem.*, 206 (1981) 59

- 58 M.Webster, K.R.Mudd, D.J.Taylor, *Inorg.Chim.Acta.*, 20 (1976)  
231
- 60 B.W.Fitzsimmons, *J.Chem.Soc.Chem.Comm.*, (1977) 215
- 61 M.Nardelli, C.Pelizzi, G.Pelizzi, *J.Chem.Soc.Dalton Trans.*,  
(1978) 131
- 62 M.Nardelli, C.Pelizzi, G.Pelizzi, *Inorg.Chim.Acta.*, 30 (1978)  
179
- 63 J.Otera, T.Hinoishi, R.Okawara, *J.Organomet.Chem.*, 202  
(1980) C93
- 64 G.S.Brownlee, A.Walker, S.C.Nyburg, J.T.Szymanski  
*Chem.Commun.*, (1971) 1073
- 65 B.A.Goodman, N.N.Greenwood, K.L.Jaura, K.K.Sharma,  
*J.Chem.Soc.(A)*, (1971) 1865
- 66 V.S.Petrosyan, *Prog,NMR Spectrosc.*, 11 (1977) 115
- 67 D.L.Anderson, *J.Chem.Soc.*, (1962) 2050
- 68 D.P.Gaur, G.Srivastava, R.C.Mehrotra, *J.Organomet.Chem.*, 63  
(1973) 221
- 69 A.D.Cohen, C.R.Dillard, *J.Organomet.Chem.*, 25 (1970) 421
- 70 K.A.Koseschow, *Berichte*, 66 (1933) 1661
- 71 D.A.Armitage, A.Tarassoli, *Inorg.Chem.*, 14 (1975) 1210
- 72 V.A.Chausov, *Zh.Obsch.Khim.*, 36 (1966) 952
- 73 R.C.Poller, *The Chemistry of Organotin compounds* Logos  
London 1971
- 74 S.J.Blunden, P.J.Smith, D.G.Gillies, *Inorg.Chim.Acta.*, 60  
(1982) 105
- 75 Y.Azuma, M.Newcomb, *Organometallics*, 3 (1984) 9
- 76 E.J.Bulten, H.A.Budding, *J.Organomet.Chem.*, 110 (1976) 167

- 77 G.J.M.van der Kerk, J.G.A.Luitjen, *J.Appl.Chem.*, 4 (1954) 314
- 78 M.H.Gitlitz, *Adv.Chem.Ser.*, 157 (1976) 167
- 79 B.Sugarman, *J.Med.Microbiol.* 13 (1980) 351
- 80 C.J.Evans, *Tin, its uses*, 110 (1976) 6
- 81 A.J.Crowe, P.J.Smith, G.Atassi, *Chem-biol.interactions*, 32 (1980) 171
- 82 F.Huber, G.Roge, L.Carl, G.Atassi, F.Spreffico, S.Filippeschi, R.Barbieri, A.Silvestri, E.Rivaroles, G.Ruisi, F.DiBianco, G.Alonzo, *J.Chem.Soc., Dalton Trans.*, (1985) 523
- 83 P.Klimsch, *Plastc.Kauc.*, 24 (1977) 380
- 84 G.Ayrey, B.C.Head, R.C.Poller, *J.Polymer Sci.*, (1975) 69
- 85 S.Karpel, *Tin, its uses*, (190) 1251
- 86 H.Fujiwara, F.Sakai, A.Kawamura, N.Shimuzu, Y.Sakasi, *Bull.Chem.Soc.Japan.*, 58 (1985) 2331
- 87 G.Matsubayashi, K.Ueyana, T.Tanaka, *J.Chem.Soc.Dalton*, (1985) 465
- 88 N.G.Bokii, Yu.T.Struchkov, *Zh.Strukt.Khim.(Engl.Trans.)*, 9 (1968) 465
- 89 J.S.Thayer, *Organomet.Chem. Rev.*, 1 (1966) 157
- 90 J.S.Thayer, R.West, *Adv.Organomet.Chem.*, 8 (1967) 169
- 91 C.W.Hobbs, R.S.Tobias, *Inorg.Chem.*, 9 (1970) 1037
- 92 F.A.K.Nasser, M.D.Hossain, D van der Helm, J.J.Zuckerman, *Inorg.Chem.*, 23 (1984) 606
- 93 P.J.Smith, A.P.Tupciauskas, *Annu Rep NMR Spectrosc.*, 9, (1978) 291
- 94 K.B.Dillon, A.Marshall, *J.Chem.Soc.(Dalton)*, (1984) 1245
- 95 G.Hewitson, *M.Sc.Thesis*, Durham University 1980

- 96 R.Hani, R.A.Geanangel, *Coord.Chem.Rev.*, 44 (1982) 229
- 97 V.S.Petrosyan, O.A.Reutov, *Pure Appl.Chem.*, 37 (1974) 147
- 98 H.Schmidbauer, *Acc.Chem.Res.*, 8 (1975) 62
- 99 D.Seyferth, S.O.Grim, *J.Am.Chem.Soc.*, 83 (1961) 1610
- 100 Y.Yamamoto, *Bull.Chem.Soc.Japan.*, 57 (1984) 43
- 101 S.Boue, M.Gielen, J.Nasieski, J.P.Lieutenant, R.Spielmann, *Bull.Chem.Soc.Belges.*, 78 (1969) 135
- 102 F.Glockling, *J.Chem.Soc.(Dalton)*, (1974) 2537
- 103 H.A.Meinema, *J.Organomet.Chem.*, 63 (1973) 243
- 104 F.J.Bayer, *Ph.D.Thesis*, (1964) Univ.New York Buffalo
- 105 A.G.Davies, M.W.Tse, J.D.Kennedy, W.McFarlane, G.S.Pyne, M.F.Ladd, D.C.Povey, *J.Chem.Soc.Perkin II*, (1981) 369
- 106 B.C.Pant, *J.Organomet.Chem.*, 66 (1974) 321
- 107 J.Murphy, R.S.Poller, *J.Organomet.Chem., Library*, 9 (1980) 189
- 108 K.Sisido, Y.Takeda, Z.Kimugawa, *J.Am.Chem.Soc.*, 83 (1961) 583
- 109 V.I.Shiryaev, E.M.Stepina, V.P.Kochergin, T.S.Kupstova, V.P.Mironov, *J.Gen.Chem.USSR*, 48 (1978) 2386
- 110 D.Shaw, *Fourier Transform NMR Spectroscopy* 2nd ed. Elsevier 1974
- 111 J.W.Akitt, *NMR & Chemistry* 2nd ed. Chapman & Hall 1984
- 112 E.D.Becker, *High Resolution NMR Spectroscopy: Theory & Applications* Academic Press 1980
- 113 S.J.Ruzicka, A.E.Merbach, *Inorg.Chim.Acta*, 22 (1977) 181
- 114 A.Zchunke, O.Mugge, M.Scheer, K.Jurkschat, A.Tzchach, *J.Crystal.Spectrosc.Res.*, 13 (1983) 201



- 115 J.R.Holmes, H.D.Kaeszi, *J.Am.Chem.Soc.*, 83 (1961) 3903
- 116 K.Kawakami, T.Tanaka, *J.Organomet.Chem.*, 49 (1973) 409
- 117 M.Gielen, M.de Clerq, B.de Poorter, *J.Organomet.Chem.*, 34 (1972) 305
- 118 H.G.Kuivila, J.L.Considine, R.H.Sharma, R.J.Mynott, *J.Organomet.Chem.*, 111 (1976) 179
- 119 S.J.Blunden, D.Searle, P.J.Smith, *Inorg.Chim.Acta*, 98 (1985) 185
- 120 R.K.Harris, B.E.Mann, *NMR & the Periodic Table*, Academic Press 1978
- 121 A.G.Davies, P.G.Harrison, J.D.Kennedy, T.N.Mitchell, R.J.Puddephatt, W.McFarlane, *J.Chem.Soc.(A)*, (1969) 1136
- 122 J.D.Kennedy, W.McFarlane, *J.Chem.Soc.(Perkin II)*, (1974) 146
- 123 W.McFarlane, J.C.Maire, M.Delmas, *J.Chem.Soc.(Dalton)*, (1972) 1862
- 124 E.V.van der Berghe, G.P.van der Kelen, *J.Organomet.Chem.*, 26 (1971) 207
- 125 J.D.Kennedy, W.McFarlane, *Rev.Si,Ge,Sn,Pb,Cmpnds.*, (1974) 235
- 126 B.Wrackmeyer, *Prog.NMR Spectrosc.*, 16 (1985) 73
- 127 W.Adcock, G.B.Kok, A.N.Abeywickrema, W.Kitching, G.M.Drew, A.Olszowy, I.Schott, *J.Am.Chem.Soc.*, 105 (1983) 290
- 128 H.J.Kroth, H.Schumann, H.G.Kuivila, C.D.Schaeffer, J.J.Zuckermann, *J.Am.Chem.Soc.*, 97 (1973) 1754
- 129 E.V.van der Berghe, G.P.van der Kelen, *J.Organomet.Chem.*, 59 (1973) 175
- 130 C.R.Lassigne, E.J.Wells, *Can.J.Chem.* 55 (1977) 927
- 131 W.H.J.de Beer *Spectrochim Acta* 37A (1981) 1099

- 132 J.D.Kennedy, W.McFarlane,G.S.Pyne, *Bull.Soc.Chim.Belges*, 84 (1975) 289
- 133 C.S.Frampton, R.M.G.Roberts, J.Silver, J.F.Warmsley, B.Yavari, *J.Chem.Soc.(Dalton)*, (1985) 169
- 134 S.J.Blunden, R.Hill, *Inorg.Chim.Acta*, L7 (1985) 98
- 135 J.Holecek, M.Nadvornik, K.Handlir, A.Lycka, *J.Organomet.Chem.*, 241 (1983) 177
- 136 M.Nadvornik, J,Holecek, K.Handlir, A.Lycka, *J.Organomet.Chem.*, 275 (1984) 43
- 137 J.Otera, *J.Organomet.Chem.*, 221 (1981) 57
- 138 H.A.Bent, *Chem.Rev.*, 61 (1961) 275
- 139 W.F.Howard, R.W.Crecely, W.H.Nelson, *Inorg.Chem.*, 24 (1985) 2204
- 140 L.E.Khoo, *Spectrosc.Lett.*, 13 (1980) 757
- 141 L.Verdonck, G.P.van der Kelen, *Ber.Bus.Physik.Chem.*, 69 (1965) 478
- 142 H.C.Clark, VK.Jain, R.C.Mehrotra, B.P.Singh, G.Srivastava, T.Birchall, *J.Organomet.Chem.*, 279 (1985) 385
- 143 T.P.Lockhart, W.F.Manders, F.E.Brinckmann, *J.Organomet.Chem.*, 286 (1985) 153
- 144 B.Gassenheimer, R.Herber, *Inorg.Chem.*, 8 (1969) 1120
- 145 C.N.Banwell, *Fundamentals of Molecular Spectroscopy* 2nd ed.McGraw Hill 1972
- 146 B.P.Staughan, S.Walker *Spectroscopy 1* 2nd ed. Chapman & Hall 1976
- 147 G.M.Bancroft, R.H.Platt, *Adv.Inorg.Chem.Radiochem.*, 15 (1972) 59
- 148 P.A.Cusack, B.N.Patel, *Inorg.Chim.Acta.*, 86 (1984) 1

- 149 A.G.Davies, L.Smith, P.J.Smith, *J.Organomet.Chem.*, 23 (1970) 135
- 150 R.H.Herber, H.S.Cheng, *Inorg.Chem.*, 8 (1969) 2145
- 151 R.Barbieri, A.Silvestri, *Inorg.Chim.Acta*, 47 (1981) 201
- 152 R.V.Parish, *Mossbauer Spectrosc.Appl.Inorg.Chem.*, (1984) 527
- 153 M.G.Clark, A.G Maddock, R.H.Platt, *J.Chem.Soc.Dalton Trans.*, (1972) 281
- 154 T.K.Sham, G.M.Bancroft, *Inorg.Chem.*, 14 (1975) 2281
- 155 K.Nakamoto, *Infra-red and Raman spectra of inorganic and coordination componds*. 3rd ed. Wiley Interscience 1978
- 156 E.Maslowsky, *Vibrational spectra of organometallic compounds* Wiley Interscience 1977
- 157 J.S.Thayer, D.P.Strommen, *J.Organomet.Chem.*, 5 (1966) 383
- 158 R.H.J.Clark, A.G.Davies, R.J.Puddephatt, *J.Chem.Soc.(A)*, (1968) 1828
- 159 M.K.Das, J.Buckle, P.G.Harrison, *Inorg.Chim.Acta*, 6 (1972) 17
- 160 C.A.Clausen, M.L.Good, *Inorg.Chem.*, 9 (1970) 817
- 161 P.T.Green, R.F.Bryan, *J.Chem.Soc.(A)*, (1971) 2549
- 162 A.M.Domingos, G.M.Sheldrick, *J.Organomet.Chem.*, 67 (1974) 257
- 163 A.J.Crowe, P.J.Smith, *J.Organomet.Chem.*, 224 (1982) 223
- 164 P.Pfeiffer, *Annalen.*, 376 (1910) 310
- 165 L.E.Smart, M.Webster, *J.Chem.Soc.Dalton Trans.*, (1976) 1924
- 166 A.Cassol, P.Portanova, R.Barbieri, *J.Inorg.Nucl.Chem.*, 27 (1965) 2275
- 167 S.N.Battacharya, P.Raj, M.Singh, *Ind.J.Chem.*, 18A (1979) 231
- 168 S.N.Battacharya, A.K.Saxena, *Ind.J.Chem.*, 18A (1979) 452
- 169 S.N.Battacharya, A.K.Saxena, *Ind.J.Chem.*, 19A (1980) 222

- 170 A.Marshall, *Ph.D Thesis* Durham University 1982
- 171 R.Colton, D.Dakternieks, C.A.Harvey, *Inorg.Chim.Acta*, 61 (1982) 1
- 172 P.A.W.Dean, D.F.Evans, *J.Chem.Soc.(A)*, (1968) 1154
- 173 S.J.Blunden, P.A.Cusack, D.G.Gillies *J.Mag.Res.*, 60 (1984) 114
- 174 V.S.Petrosyan, *Prog.NMR Spectrosc.*, 11 (1977) 115
- 175 R.T.Sanderson, *Chemical Periodicity* Reinhold Publishing Co., New York,
- 176 A.Lycka, J.Holecek, M.Nadvornik, K.Handlir, *J.Organomet.Chem.*, 280 (1985) 323
- 177 M.Wada, M.Nishino, R.Okawara, *J.Organomet.Chem.*, 3 (1965) 70
- 178 K.L.Leung, R.H.Herber, *Inorg.Chem.*, 10 (1971) 1020
- 179 H.S.Cheng, R.H.Herber, *Inorg.Chem.*, 9 (1970) 1686
- 180 J.Lorberth, *Chem.Ber.* 98 (1965) 1201
- 181 M.Birkhahn, *J.Organomet.Chem.*, 192 (1980) 47
- 182 C.Clausen, M.L.Good, *Inorg.Chem.*, 9 (1970) 817
- 183 H.Fujiwara, F.Sakai, Y.Mikawa, Y.Sasaki, *Bull.Chem.Soc.Japan.*, 58 (1985) 1741
- 184 R.Visalaski, V.K.Jain, S.K.Kulshreshtha, G.S.Rao *Inorg.Chim.Acta*, 118 (1986) 119
- 185 F.Sakai, H.Fujiwara, Y.Sasaki *J.Organomet.Chem.*, 310 (1986) 293
- 186 M.Oki, M.Ohira *Chem.Lettrs.*, (1982) 1267
- 187 J.L.Neito, A.M.Guiterrez, *Polyhedron*, 2 (1983) 987
- 188 H.Fujiwara, F.Sakai, Y.Sasaki, *J.Chem.Soc.Perkin II*, (1983)

- 189 H.Puff, E.Friedrichs, R.Hunt, R.Zimmer *J.Organomet.Chem.*, 259 (1983) 79
- 190 T.N.Mitchell *J.Organomet.Chem.*, 141 (1977) 289
- 191a A.J.Crowe, P.J.Smith, *Chem.Ind.*, (1980) 200  
b A.J.Crowe, P.J.Smith, ITRI Publication no. 583
- 192 K.D.Paull *Personal communication*
- 193 E.J.Bulten, H.A.Budding *J.Organomet.Chem.*, 166 (1979) 339  
23
- 194 H.Zimmer, C.W.Blewitt, A.Brakas *Tetrahedron Lettrs.*, 13 (1968) 1615
- 195 A.G.Davies, M-W.Tse, J.D.Kennedy, G.S.Pyne, M.F.C.Ladd, D.C.Povey *J.Chem.Soc.Chem.Comm.*, (1978) 791
- 196 E.J.Bulten, H.A.Budding *J.Organomet.Chem.*, 82 (1974) C13
- 197 M.Gielen, J.Topart, *J.Organomet.Chem.*, 81 (1974) 357
- 198 M.Gielen, J.Topart, *Bull.Soc.Chim.Belges.*, 83 (1974) 249
- 199 G.Davidovics, M.Guiliano, J.Chouteau, R.Ouaki, J.C.Maire *Spec.Acta*, 32A (1976) 301
- 200 D.Seyferth, J.L.Lefferts *J.Am.Chem.Soc.*, 9 (1974) 6237
- 201 R.West, E.G.Rochow *J.Org.Chem.*, 18 (1953) 1739
- 202 E.J.Bulten, H.A.Budding *J.Organomet.Chem.*, 155 (1978) 305
- 203 M.Devaud, P.Lepoussez *J.Chem.Res.*, 5 (1982) 1121
- 204 F.J.Bajer, H.W.Post, *J.Organomet.Chem.*, 11 (1968) 187
- 205 H.Schmidbaur *Pure Appl.Chem.*, 52 (1980) 1057
- 206 H.Schmidbaur, R.Franke *Inorg.Chim.Acta*, 13 (1975) 79
- 207 H.Schmidbaur *Angew.Chem.Int.Ed.Engl.*, 22 (1983) 907
- 208 N.E.Miller, *Inorg.Chem.*, 4 (1965) 1148
- 209 H.Schmidbaur J.R.Mandl, A.Franke, G.Huttner *Chem.Ber.*, 109 (1976) 466
- 210 H.Schmidbaur, A.Wohlleben, U.Schubert, R.Frank, G.Huttner *Chem.Ber.*, 110 (1977) 2751

- 211 H.Schmidbaur, R.Frank *Inorg.Chim.Acta*, 13 (1975) 85
- 212 H.Schmidbaur, R.Frank *Ang.Chem.Int.Ed.Engl.*, 12 (1973) 416
- 213 Bassler, Silverstein, Morrill *Spectrometric Identification of Organic Compounds* 4th Ed. Wiley
- 214 T.N.Mitchell *J.Organomet.Chem.*, 59 (1973) 189
- 215 R.J.Cushley, D.Naugler, C.Oritz *Can.J.Chem.*, 53 (1975) 3419
- 216 L..N.Bellamy *The Infra-red spectra of complex molecules* Vol.1 3rd ed. Chapman & Hall 1975
- 217 G.Ellis, R.G.Jones, *J.Chem.Soc.Perkin II*, (1972) 437
- 218 E.Breitmar, G.Haas, W.Voelter *Atlas of C-13 NMR Data* Heyden 1979 (no. 2435)
- 219 P.C.Lauterbur, *J.Chem.Phys.*, 43 (1965) 360
- 220 D.D.Permin *Dissociation constants of organic bases in aqueous solution* Butterworth
- 221 *Vogel's Textbook of Practical Organic Chemistry* 4th Ed. Longman 1978
- 222 U.Schollkopf *Angew.Chem.*, 71 (1959) 260
- 223 R.Koster, D.Simic, M.A.Grassberger *Leibigs Ann.Chem.*, 739 (1970) 211
- 224 J.Lorberth *Chem.Ber.*, 98 (1965) 1201
- 225 R.Saneti, R.K.Bansal, R.C.Mehrotra *J.Organomet.Chem.*, 303 (1986) 351
- 226 T.P.Lockhart *J.Organomet.Chem.*, 287 (1985) 179
- 227 J.N.Spencer, R.B.Belser, S.R.Moyer, R.E.Harris, M.A.DiStravalo, C.H.Yoder *Organometallics* 5 (1986) 118
- 228 M.Gielen, *Rev.Si Ge Sn Pb Compounds* 5 (1981) 1
- 229 J.W.Bruin, G.Schat, O.S.Akkerman, F.Bickelhaupt *J.Organomet.Chem.*, 288 (1985) 13
- 230 T.Karol *Organometallics* 2 (1983) 106

- 231 M.Gielen, K.Jurkschat *J.Organomet.Chem.*, 273 (1984) 303
- 232 R.Willem, M.Gielen, J.Meunier-Piret, M. van Meersche,  
K.Jurkschat, A.Tzschach *J.Organomet.Chem.*, 227 (1984) 335
- 233 M.Gielen *Bull.Soc.Chim.Belges*, 93 (1984) 379
- 234 M.Gielen, K.Jurkschat, G.Atassi *Bull.Soc.Chim.Belges*, 93  
(1984) 153
- 235 K.Jurkschat, M.Gielen *J.Organomet.Chem.*, 236 (1982) 69
- 236 J.Meunier-Piret, V. van Meersche, M.Gielen, K.Jurkschat  
*J.Organomet.Chem.*, 252 (1983) 289
- 237 H.Preut, P.Bleckmann, T.N.Mitchell, B.Fabisch *Acta,Cryst.*  
C40 (1984) 370

APPENDIX

The Board of studies in Chemistry requires that each postgraduate thesis contains an appendix listing;

a) all research colloquia, seminars, and lectures arranged by the Department of Chemistry during the period of the author's residence as a postgraduate student,

b) all research conferences attended and papers presented by the author during the period in which the research for the thesis was carried out;

c) details of the postgraduate induction course.

a) Research Colloquia, Seminars and Lectures.1983

(\* indicates those attended by the author)

- 5 October \* Prof. J. P. Maier (University of Basel, Switzerland), "*Recent approaches to spectroscopic characterisation of cations*".
- 12 October Dr C. W. McLeland (University of Port Elizabeth, Australia), "*Cyclisation of aryl alcohols through the intermediacy of alkoxy radicals and aryl radical cations*".
- 19 October Dr. N. W. Alcock (University of Warwick), "*Aryl Tellurium(IV) compounds, patterns of primary and secondary bonding*".
- 20 October \* Prof. R. B. Cundall (University of Salford), "*Explosives*".
- 26 October Dr. R. H. Friend (Cavendish Laboratory, University of Cambridge), "*Electronic properties of conjugated*



polymers".

- 3 November Dr. G. Richards (University of Oxford), "*Quantum pharmacology*".
- 10 November Dr. G. Thorpe (Sterling Organics), "*Applied chemistry and the pharmaceutical industry*".
- 24 November Prof. D. A. King (University Of Liverpool), "*Chemistry in two dimensions*".
- 30 November Prof. I. Cowie (University of Stirling), "*Molecular interpretation of non-relaxation processes in polymer glasses*".
- 1 December \* Dr. J. D. Coyle (The Open University), "*The problem with sunshine*".
- 14 December Prof. R. J. Donovan (University Of Edinburgh), "*Chemical and physical processes involving ion pair states of the halogen molecules*".

#### 1984

- 10 January Prof. R. Hester (university of York), "*Nano second laser spectroscopy of reaction intermediates*".
- 18 January \* Prof. R. K. Harris (University of East Anglia), "*Multi-nuclear solid state magnetic resonance*".
- 26 January Prof. T. L. Blundell (Birbeck College, London) "*Biological recognition: interactions of macromolecular surfaces*".
- 2 February N. B. H. Jonathon (University of Southampton), "*Photoelectron spectroscopy – a radical approach*".
- 8 February \* Dr. B. T. Heaton (University of Kent), "*Multi-nuclear n.m.r. studies*".
- 15 February Dr. R. M. Paton (University of Edinburgh),

*"Heterocyclic synthesis using nitrile sulphides"*.

- 16 February \* Prof. D. Phillips (The Royal Institution),  
*"Luminescence and the photochemistry— a light  
entertainment"*.
- 23 February Prof. F. G. A. Stone (University of Bristol), *"The use  
of the carbene and carbyne groups to synthesise metal  
clusters"*.
- 1 March Prof. A. J. Leadbetter (Rutherford Appleton  
Laboratories), *"Liquid crystals"*.
- 7 March Dr. R. T. Walker (University of Birmingham),  
*"Synthesis and biological properties of some  
5-substituted uracil derivatives; yet another example  
of serendipity in antiviral chemistry"*.
- 8 March Prof. D. Chapman (Royal Free Hospital School of  
Medicine, University of London), *"Phospholipids and  
biomembranes: basic structure and future techniques"*.
- 21 March Dr. P. Sherwood (University of Newcastle), *"X-Ray  
photoelectron spectroscopic studies of electrode and  
other surfaces"*.
- 23 March Dr. A. Ceulemans (Catholic University of Leuven), *"The  
development of field type models of bonding in  
molecular clusters"*;
- 28 March \* R. S. C. Centenary Lecture. Prof. H. Schmidbaur  
(Technical University of Munich F.R.G.), *"Ylides in  
the coordination sphere of metals; synthetic,  
structural, and theoretical aspects"*.
- 2 April Prof. K. O'Driscoll (University of Waterloo), *"Chain  
ending reactions in free radical polymerisations"*.

- 3 April Prof. C. H. Rochester (University of Dundee),  
*"Infrared studies of adsorption at the solid-liquid interface"*.
- 25 April Dr. R. M. Acheson (Department of Biochemistry,  
University of Oxford), *"Some heterocyclic detective stories"*.
- 27 April \* Dr. T. Albright (University of Houston), *"Sigmatropic rearrangements in organometallic chemistry"*.
- 14 May Prof. W. R. Dolbier Jr. (University of Florida),  
*"Cycloaddition reactions of fluorinated allenes"*.
- 16 May Dr. P. J. Garrett (University College, London),  
*"Syntheses with dilithiated vicinal diesters and carboximides"*.
- 31 May \* Dr. A. Haaland (University of Oslo), *"Electron diffraction studies of some organometallic compounds"*.
- 11 June Dr. J. B. Street (I.B.M. San Jose), *"Conducting polymers derived from pyrroles"*.
- 19 September Dr. C. Brown (I.B.M. San Jose), *"New superbase reactions-organic compounds"*.
- 21 September Dr. H. W. Gibson (Signal UOP Research Centre, Des Plaines, Illinois), *"Isomerisation of polyacetylene"*.
- 18 October Dr. N. Logan (University of Nottingham), *"N<sub>2</sub>O<sub>4</sub> and rocket fuels"*.
- 19 October Dr. A. Germain (Univeriste du Languedoc, Montpellier),  
*"Anodic oxidation of the perfluoro organic compounds in perfluoro sulphonic acids"*.
- 24 October \* Prof. R. K. Harris (University of Durham), *"N.m.r. of*

- solid polymers*".
- 1 November Prof. B. J. Aylett (Queen Mary College, University of London), "*Silicon-dead common or refined*".
- 7 November Dr. H. S. Munro (University of Durham), "*New information from E.S.C.A. data*".
- 7 November Prof. W. W. Porterfield (Hampden Sidney College, U.S.A.), "*There is no borane chemistry, only geometry*".
- 15 November Prof. B. T. Golding (University of Newcastle-upon-Tyne), "*The vitamin B<sub>12</sub> mystery*".
- 21 November Dr. W. J. Feast (University of Durham), "*A plain man's guide to polymeric organic metals*".
- 22 November Prof. D. T. Clark (I.C.I. New Science Group), "*Structure, bonding, reactivity and synthesis as revealed by E.S.C.A.*".
- 28 November \* Dr. T. A. Stephenson (University of Edinburgh), "*Some recent studies in platinum metal chemistry*".
- 29 November Prof. C. J. M. Sterling (University College of North Wales), "*Molecules taking the strain*".
- 6 December Prof. R. D. Chambers (University of Durham), "*The unusual world of fluorine chemistry*".

### 1985

- 24 January Dr. A. K. Covington (University of Newcastle-upon-Tyne), "*Chemistry with chips*".
- 31 January Dr. M. L. H. Green (University of Oxford), "*Naked atoms and negligee ligands*".
- 7 February Prof. A. Ledwith (Pilkington Brothers), "*Glass as a high technology material*".

- 13 February Dr. G. W. J Fleet (University of Oxford), "*Synthesis of some alkaloids from carbohydrates*".
- 14 February \* Dr. J. A. Salthouse (University of Manchester), "*Sun et Lumiere, (a chemical energy show)*".
- 19 February Dr. D. J. Mincher (University of Durham), "*Stereoselective syntheses of some novel anthracyclines related to the anti-cancer drug adriamycin and to the streptomycin antibiotics*".
- 21 February Prof. P. M. Maitlis F.R.S. (University of Sheffield), "*What use is rhodium*".
- 27 February Dr. R. E. Mulvey (University of Durham), "*Some unusual lithium complexes*".
- 7 March Dr. P. J. Rodgers (I.C.I. plc Agricultural Division, Billingham), "*Industrial polymers from bacteria*".
- 7 March Dr. P. W. Atkins (University of Oxford), "*Magnetic reactions*".
- 12 March \* Prof. K. J. Packer (BP Research Centre), "*N.m.r. investigations of the structure of solid polymers*".
- 14 March Prof. A. R. Katritzky FRS (University of Florida), "*Some adventures in heterocyclic chemistry*".
- 21 March Dr. M. Poliakoff (University of Nottingham), "*New methods for detecting organometallic intermediates in solution*".
- 28 March Prof. H. Ringsdorf (Organic Chemistry Institute, University of Mainz), "*Polymeric liposomes as models for biomembranes and cells*".
- 24 April Dr. M. C. Grosel (Bedford College, University of London), "*Hydroxypyridone dyes—bleachable one*".

- dimensional metals*".
- 1 May Dr. D. Parker (I.C.I. plc Petrochemicals and Plastics Division, Wilton), "*Applications of radioisotopes in industrial research*".
- 7 May Prof G. E. Coates (formerly of the University of Wyoming, U.S.A.), "*Chemical education in Britain and America: successes and deficiencies*".
- 8 May Prof. D. Tuck (University of Windsor, Ontario), "*Lower oxidation state chemistry of indium*".
- 8 May Prof. G. Williams (University College of Wales, Aberystwyth), "*Liquid crystalline polymers*".
- 9 May Prof. R. K. Harris (University of Durham), "*Chemistry in a spin*".
- 14 May \* Prof. J. Passmore (University of New Brunswick), "*The synthesis and characterisation of some novel selenium-iodine cations, aided by  $^{77}\text{Se}$  n.m.r. spectroscopy*".
- 15 May Dr. J. E. Packer (University of Auckland, New Zealand), "*Studies of free radical reactions in aqueous solution using ionising radiation*".
- 17 May Prof. I. D. Brown (Institute for Materials Research, M<sup>C</sup>Master University, Canada), "*Bond valence as a model for inorganic chemistry*".
- 21 May \* Dr. D. L. H. Williams (University of Durham), "*Chemistry in colour*".
- 22 May Dr. R. Grimmett (University of Otago, Dunedin, New Zealand), "*Some aspects of nucleophilic substitution in imidazoles*".
- 22 May Dr. M. Hudlicky (Virginia State University,

- Blacksburg), "*Preferential elimination of hydrogen fluoride from vicinal bromofluorocarbons*".
- 13 June Dr. D. Woollins (Imperial College, University of London), "*Metal-sulphur-nitrogen complexes*".
- 14 June Prof. Z. Rappoport (The Hebrew University, Jerusalem), "*The rich mechanistic world of nucleophilic vinylic substitution*".
- 19 June \* Dr. T. N. Mitchell (University of Dortmund), "*Some synthetic and n.m.r.-spectroscopic studies of organotin compounds*".
- 26 June Prof. G. Shaw (University of Bradford), "*Some synthetic studies in imidazole nucleosides and the antibiotic coformycin*".
- 12 July Dr. K. Laali (Hydrocarbon Research Institute, University of Southern California), "*Recent developments in superacid chemistry and mechanistic considerations in electrophilic aromatic substitutions; a progress report*".
- 13 September Dr. V. S. Palmer (University of Delhi), "*Enzyme Assisted ERC Synthesis*".
- 17 October Dr. C. J. Ludman (University of Durham), "*Some Thermochemical Aspects of Explosions*".
- 24 October Dr. J. Dewing (U. M. I. S. T.), "*Zeolites - Small Holes, Big Opportunities*".
- 30 October Dr. S. N. Whittleton (University of Durham), "*An Investigation of a Reaction Window*".
- 31 October \* Dr. P. Timms (University of Bristol), "*Some Chemistry of Fireworks*".

- 5 November Prof. M. J. O'Donnell (Indiana-Perdue University),  
*"New Methodology for the Synthesis of Amino Acids"*.
- 7 November \* Prof. G. Ertl (University of Munich), *"Heterogeneous  
Catalysis"*.
- 14 November Dr. S. G. Davies (University of Oxford), *"Chirality  
Control and Molecular Recognition"*.
- 20 November Dr. J. A. H. Macbride (Sunderland Polytechnic), *"A  
Heterocyclic Tour on a Distorted Tricycle -  
Biphenylene"*.
- 21 November Prof. K. H. Smith (University of Newcastle),  
*"Chemistry of Si-Al-O-N Engineering Ceramics"*.
- 28 November \* Dr. B. A. G. Clark (Kodak Ltd.), *"Chemistry and  
Principles of Colour Photography"*.
- 28 November Prof. D. J. Waddington (University of York),  
*"Resources for the Chemistry Teacher"*.

### 1986

- 15 January Prof. N. Sheppard (University of East Angla),  
*"Vibrational and Spectroscopic Determinations of the  
Structures of Molecules Chemisorbed on Metal  
Surfaces"*.
- 23 January Prof. Sir Jack Lewis (University of Cambridge), *"Some  
more Recent Aspects in the Cluster Chemistry of  
Ruthenium and Osmium Carbonyls"*.
- 29 January Dr. J. H. Clark (University of York), *"Novel Fluoride  
Ion Reagents"*.
- 30 January \* Dr. N. J. Phillips (University of Technology,  
Loughborough), *"Laser Holography"*.
- 12 February Dr. J. Yarwood (University of Durham), *"The Structure*



- of Water in Liquid Crystals*".
- 12 February Prof. O. S. Tee (Concordia University, Montreal),  
*"Bromination of Phenols"*.
- 13 February Prof. R. Grigg (Queens University, Belfast), *"Thermal  
Generation of 1,3-Dipoles"*.
- 19 February Prof. G. Procter (University of Salford), *"Approaches  
to the Synthesis of some Natural Products"*.
- 20 February \* Dr. C. J. F. Barnard (Johnson Matthey Group),  
*"Platinum Anti-Cancer Drug Development"*.
- 26 February Miss C. Till (University of Durham), *"ESCA and Optical  
Emission Studies of the Plasma Polymerisation of  
Perfluoroaromatics"*.
- 27 February \* Prof. R. K. Harris (University of Durham), *"The Magic  
of Solid State NMR"*.
- 5 March Dr. D. Hathaway (University of Durham), *"Herbicide  
Selectivity"*.
- 5 March Dr. D. M. Schroder (University of Edinburgh), *"Studies  
on Macrocyclic Complexes"*.
- 6 March Dr. B. Iddon (University of Salford), *"The Magic of  
Chemistry"*.
- 12 March Dr. J. M. Brown (University of Oxford), *"Chelate  
Control in Homogeneous Catalysis"*.
- 14 May Dr. P. R. R. Langridge-Smith (University of  
Cambridge), *"Naked Metal Clusters - Synthesis,  
Characterisation and Chemistry"*.
- 9 June Prof. R. Schmutzler (University of Braunschweig),  
*"Mixed Valence Diphosphorous Compounds"*.

23 June Prof. R. E. Wilde (Texas Technical University),  
"Molecular Dynamic Processes from Vibrational  
Bandshapes".

**b) Research conferences attended**

Graduate Symposium, Durham, April, 1984.

Graduate Symposium, Durham, April, 1985.

Graduate Symposium, Durham, April, 1986.

**c) Postgraduate Induction Course**

In each part of the course, the uses and limitations  
of the various services available were explained.

Departmental Organisation: - Dr. E. J. F. Ross.

Safety Matters: - Dr. M. R. Crampton.

Electrical Appliances and Infrared Spectroscopy: - (the late)

Mr. R. N. Brown.

Chromatography and Micro Analysis: - Mr. T. F. Holmes.

Atomic Absorption Spectrometry and Inorganic Analysis: -

Mr. R. Coult.

Library Facilities: - Mr. R. B. Woodward.

Mass Spectrometry: - Dr. M. Jones.

Nuclear Magnetic Resonance Spectroscopy: - Dr. R. S. Mathews.

Glassblowing Techniques: - Mr. R. Hart and Mr. G. Haswell.

