

Durham E-Theses

*Feasibility of extracting arsenic from industrially
polluted waters by the exploitation of two
arsenic-tolerant fungi*

Jackson, P

How to cite:

Jackson, P (1986) *Feasibility of extracting arsenic from industrially polluted waters by the exploitation of two arsenic-tolerant fungi*, Durham theses, Durham University. Available at Durham E-Theses
Online: <http://etheses.dur.ac.uk/7035/>

Use policy

The full-text may be used and/or reproduced, and given to third parties in any format or medium, without prior permission or charge, for personal research or study, educational, or not-for-profit purposes provided that:

- a full bibliographic reference is made to the original source
- a [link](#) is made to the metadata record in Durham E-Theses
- the full-text is not changed in any way

The full-text must not be sold in any format or medium without the formal permission of the copyright holders.

Please consult the [full Durham E-Theses policy](#) for further details.

Feasibility of extracting arsenic from industrially polluted
waters by the exploitation of two arsenic-tolerant fungi

A dissertation submitted in part for the degree of Master of Science
in the University of Durham.

The copyright of this thesis rests with the author.
No quotation from it should be published without
his prior written consent and information derived
from it should be acknowledged.

P. Jackson

Botany Department

August 1986



30 OCT 1992

ABSTRACT

The ability of two fungi (Scopulariopsis brevicaulis & Phaeolus schweinitzii) to accumulate arsenic (As) was investigated and the most tolerant species (S. brevicaulis) selected for further study. Growth on malt and Czapek-dox media was compared, together with the growth response to a change in medium concentration, pH, available light intensity, and the addition of arsenite, selenium, tellurium, and industrial effluent As. The maximum concentration (concn.) of arsenate tolerated by the fungus, was defined. An ability to grow in petri dishes, shake flasks and a chemostat was tested, to determine the potential of this fungus for large scale production. Swab samples were taken from As contaminated, industrial areas to detect the presence of microorganisms.

The potential uptake of As by mycelia growing in malt and floating on a 1 % glucose solution was monitored via the application of two As assays. Only mats of mycelia floating on glucose exhibited a significant decline in medium As concn.. A third test was employed to determine the amount of As taken up by the mycelia and showed more As present in fungi grown on malt than the floating mats. The use of this test to detect the volatile end product of As accumulation (trimethylarsine) did not yield any conclusive results.

Extracellular or intracellular enzymes involved in the uptake and volatilisation of As could not be found.

A change in medium viscosity, associated with growth in the presence of As, was found to be linked to qualitative rather than quantitative changes in medium components, by the use of biochemical tests, microscopic investigation and polyacrylamide gel electrophoresis.



In the light of it's reputation as a human pathogen, spores from S. brevicaulis were injected into mice and as no ill effects were observed, it is presumed that this isolate is not pathogenic for humans. Exposure to microwaves for longer than 10 min was found to inhibit growth, suggesting that microwave treatment is a quick method for the sterilisation of material contaminated with this species.

From the results provided by this study, the feasibility of applying a fungal biofilter to the extraction of As from industrial effluents is discussed and further lines of research outlined.

ABBREVIATIONS

kg	kilogramme	n	number of replicates
g	gramme	r	regression coefficient
mg	milligramme	wt	weight
µg	microgramme	V	volts
cm	centimetre	rev. min ⁻¹	revolutions per minute
mm	millimetre	SDS	sodium dodecyl sulphate
µm	micrometre	PB	phosphate buffer
nm	nanometre	PBS	phosphate buffered saline
l	litre	RTP	room temperature & pressure
ml	millilitre	ppm	parts per million
µl	microlitre	ppb	parts per billion
A _w	absorbance at w nm	v/w	volume for weight
h	hour	w/w	weight for weight
min	minute	Mr	molecular weight
s	second	M	molar
°C	degrees Celcius	mM	millimolar
no.	number	concn.	concentration
fig.	figure	dH ₂ O	distilled water
%	percent		

ACKNOWLEDGEMENTS

This project has relied upon the materials, experience and ideas given enthusiastically by my supervisors, Dr F. M. Dewey and Dr P. D. Turner, to whom I am most grateful. Research facilities in the Department of Botany were made available by Professor D. Boulter. It would also not have been possible without the continuous help and equipment provided by Mr G. Bainbridge, Mrs M. Snow, Mrs G. A. Walker and Mrs D. Hughes. For the photographs which appear in this project, my thanks go to Mr. P. Sidney, Dr. P. Gates and Dr N. Harris.

For particular items of equipment I wish to thank Professor D.C. Ellwood, Dr R. R. D. Croy, Mr J. Gilroy and Mr. J. W. Simon. An RM Nimbus X 16 microcomputer and Toshiba P 1351 printer were kindly provided by Dr B. Whitton for the typing of this dissertation. The support of my friends and colleagues throughout this project has been most welcome. Finally I am indebted to my family for providing the financial means and strong encouragement that made it all possible.

CONTENTS

	page
ABSTRACT	1
ABBREVIATIONS	3
ACKNOWLEDGEMENTS	4
CONTENTS	5
LIST OF TABLES	10
LIST OF FIGURES	10
1 INTRODUCTION	
1.1 General Introduction	13
1.2 Arsenic	13
1.21 Source and distribution	13
1.22 Production	16
1.23 Uses	16
1.24 Accumulation in the environment	19
1.25 Industrial exposure	21
1.26 As as a poison	22
1.27 Toxicity mechanisms	23
1.28 Detection methods	25
1.29 Disposal of As waste	27
1.3 Arsine	30
1.4 The Arsenic Cycle	31

1.5	Biological processing	34
1.51	Algae	34
1.52	Bacteria	35
1.53	Fungi	37
1.6	The fungi investigated	40
1.61	<u>Phaeolus schweinitzii</u>	41
1.62	<u>Scopulariopsis brevicaulis</u>	41
2	PROJECT AIMS	45
3	MATERIALS AND METHODS	46
3.1	Sources of biological material	46
3.2	Subculture techniques and growth in a variety of conditions	46
3.201	Subculture techniques	46
3.202	Growth of <u>S. brevicaulis</u> and <u>P. schweinitzii</u> with As	47
3.203	Dry weight determination	47
3.204	Growth on increasing malt concn.	47
3.205	Growth in the light and the dark	48
3.206	Growth at different values of medium pH	48
3.207	Growth in the presence of As (III), Se & Te	48
3.208	Growth on Czapek-Dox medium	48
3.209	Growth on malt medium with increasing concn. of As	49
3.210	Petri dish growth	50
3.211	Shake flask growth	50
3.212	Chemostat growth	50
3.3	Growth in industrial environments	54
3.31	Growth on realgar	54
3.32	Growth on industrial effluents	54
3.33	Swab sampling	54

3.4	Microscopic investigation	55
3.41	Morphology investigation	55
3.42	Surface polymer investigation	55
3.421	The periodic acid/Schiff's stain for carbohydrates	55
3.422	The nigrosin capsule stain	57
3.423	Fluorescent staining	57
3.424	Coccosic Blue staining	57
3.43	Immunofluorescence	57
3.44	Scanning electron microscopy	58
3.5	Testing for arsenic accumulation and trimethylarsine evolution	
3.51	The Mo/Va/HCl test for arsenic	58
3.52	Use of the indicator with malt medium	59
3.53	Following a reduction in medium As concn. during the growth of <u>S. brevicaulis</u>	60
3.54	Use of mycelial mats to accumulate As	60
3.55	Large scale mat experiments	61
3.56	The wet oxidation test for As	61
3.57	Determination of mycelial As uptake	64
3.58	Testing for trimethylarsine	65
3.6	Extra and intracellular enzymes	65
3.61	Extracellular, arsenic methylating enzymes	65
3.62	The release of cytosol enzymes	66
3.7	Quantitative analysis of an arsenic induced polymer	67
3.71	Detection of a change in protein levels	67
3.72	Detection of a change in carbohydrate levels	68
3.73	The acetone test for carbohydrates	69
3.74	PBS dialysis	69
3.8	Qualitative analysis of an arsenic induced polymer	70
3.81	SDS reducing gels	70
3.82	Non reducing gels	72
3.9	Spore pathogenicity and microwave sterilisation	74
3.91	Spore pathogenicity test	74
3.92	Microwave sterilisation of <u>S. brevicaulis</u>	74
3.921	The spore blot transfer test	74
3.922	Cellophane disc colony treatment	75

4	RESULTS	76
4.1	Growth in a variety of conditions	76
4.101	Growth on liquid and solid media with As	76
4.102	Dry weight determination	78
4.103	Growth on increasing malt concn.	78
4.104	Growth in the light and dark	79
4.105	Growth at different values of medium pH	79
4.106	Growth in the presence of As (III), Se & Te	82
4.107	Growth on Czapek-Dox medium	82
4.108	Growth on increasing malt medium concn. of As	83
4.109	Petri dish growth	84
4.110	Shake flask growth	89
4.111	Chemostat growth	92
4.2	Growth in industrial environments	94
4.21	Growth on realgar	94
4.22	Growth on industrial effluent	94
4.23	Swab sampling	94
4.3	Microscopic investigation	95
4.31	Surface polymer investigation	95
4.32	Immunofluorescence	102
4.33	Scanning electron microscopy	102
4.4	Testing for arsenic accumulation and trimethylarsine evolution	
4.41	Mo/Va/HCl calibration and spectra	107
4.42	Use of the Mo/Va/HCl test in the presence of 50 g l ⁻¹ malt	
4.43	The reduction in medium As concn. by actively growing mycelia	113
4.44	Use of mycelial mats to accumulate As	121
4.45	Large scale mat experiments	125
4.46	Comparison of the wet oxidation test with the Mo/Va/HCl test	130
4.47	Determination of mycelial As uptake	131
4.48	Testing for trimethylarsine	135
4.5	Extra and intracellular enzymes	135
4.51	Extracellular, As methylating enzymes	135
4.52	The release of cytosol enzymes	136

4.6	Quantitative analysis of an arsenic induced polymer	139
4.61	Detection of a change in protein levels	139
4.62	Detection of a change in carbohydrate levels	142
4.63	The acetone test for carbohydrates	146
4.64	PBS dialysis	146
4.7	Qualitative analysis of an arsenic induced polymer	146
4.71	SDS PAGE	146
4.72	Non reducing PAGE	149
4.8	Spore pathogenicity and microwave sterilisation	154
4.81	Spore pathogenicity test	154
4.82	Microwave sterilisation	154
5	DISCUSSION	156
6	CONCLUSIONS	164
7	SUMMARY	165
	APPENDICES	166
	LIST OF MATERIALS	178
	LIST OF EQUIPMENT	180
	REFERENCES	182

LIST OF TABLES

page

1.211.	Naturally occurring arsenic bearing minerals.	14
1.231.	Industrial uses of arsenic.	15
1.232.	Present day use of arsenic in medicines.	18
1.241.	Threshold limits for arsenic and some of it's compounds.	20
1.281.	Detection of arsenic and some of it's compounds.	26
1.41.	Bioaccumulation of arsenic in fresh and sea water.	32

LIST OF FIGURES

1.271.	The action of mono and dithiols on the arsonous acid blocked, enzyme thiol group.	24
1.291.	Oxidation/reduction of arsenic between aerobic and anaerobic environments.	29
1.41.	The inorganic chemistry of arsenic in natural water systems.	32
1.42.	Microbial mobilisation of arsenic throughout the environment.	33
1.511.	Arsenic transformation between photosynthetic and nonphotosynthetic organisms.	36
1.521.	Methanobacterial methylation of arsenic.	36
1.531.	Proposed mechanism for trimethylarsine production in <u>S brevicaulis</u> .	39
3.212.	Photograph of the chemostat whilst in operation.	53
3.411.	Sterile culture chamber.	56
3.561.	The wet oxidation apparatus.	63
3.571.	Arsine detection apparatus utilising $HgCl_2$	63

4.1051. Growth (dry weights) at different values of medium pH.	81
4.1091. Morphology of <u>S. brevicaulis</u> when grown in petri dishes.	86
4.1092. Morphology differences with and without arsenic.	86
4.1093. Natural logarithmic plot of growth in petri dishes.	88
4.1101. Natural logarithmic plot of growth in shake flasks.	88
4.1102. Undesired shake flask morphology.	91
4.1103. Expected shake flask morphology.	91
4.231. Swab sample isolate.	99
4.311. Arsenic grown mycelia stained with periodic acid/Schiff's reagent.	97
4.312. Nigrosin capsule staining.	97
4.313. Fluorescent staining of a sample of mycelia with calcofluor.	99
4.314. Light micrograph of the spore configuration of <u>S. brevicaulis</u> .	101
4.331. Scanning electron micrograph of <u>S. brevicaulis</u> .	104
4.332. Scanning electron micrograph of annellophores and conidia.	104
4.333. Close up of annellophores and conidia.	106
4.334. Close up of collapsed hyphae, annellophores and conidia.	106
4.411. A ₄₀₀ time course for Mo/Va/HCl.	109
4.412. Spectral scan of the Mo/Va/HCl indicator	109
4.413. Calibration curve for the Mo/Va/HCl test: As + distilled water.	112
4.421. Calibration curve for the Mo/Va/HCl test: As + 10 g l ⁻¹ malt.	112
4.431. Reduction in A ₄₀₀ readings, with 0 & 50 µg ml ⁻¹ As + 10 g l ⁻¹ malt.	116

4.432.	Reduction in A_{400} readings, with 100 & 200 $\mu\text{g dl}^{-1}$ As + 10 g l^{-1} malt.	116
4.433.	Reduction in A_{400} readings, with 0 & 50 $\mu\text{g dl}^{-1}$ As + 2 g l^{-1} malt.	120
4.434.	Reduction in A_{400} readings, with 100 & 200 $\mu\text{g dl}^{-1}$ As + 2 g l^{-1} malt.	120
4.441.	Reduction in arsenic concn. with a glass petri dish control & colony mats.	124
4.442.	Reduction in arsenic concn. with a glass petri dish control & arsenic induced colony mats.	124
4.451.	Reduction in arsenic concn. with a glass petri dish control & larger scale colony mats.	129
4.471.	Results of the arsine generation test.	134
4.472.	Further results of the arsine generation test.	134
4.521.	Monogenised mycelia.	138
4.522.	French press treated mycelia.	138
4.611.	Calibration curve for the protein assay.	141
4.621.	Calibration curve for the 1 st carbohydrate assay.	141
4.622.	Calibration curve for the 2 nd carbohydrate assay.	145
4.623.	Calibration curve for the 3 rd carbohydrate assay.	145
4.711.	Coomassie Blue stained gel.	148
4.712.	Lipopolysaccharide stained gel.	148
4.713.	Protein silver stained gel.	151
4.721.	Non reducing gel.	153

1. INTRODUCTION

1.1 General Introduction

Substances potentially toxic to humans are maintained at relatively low levels in the natural environment by biodegradation, bioaccumulation and metabolism. Industrial, agricultural or domestic addition of a toxic compound to the environmental load, results in an imbalance and possible dangerous accumulation due to the a) blocking of bioprocessing pathways b) disruption of synthesis/degradation equilibria.

This biotechnology project is concerned with environmental protection and rejuvenation by the use of organisms, known to process arsenic.

1.2 Arsenic

1.21 Source and distribution

Arsenic is widely distributed throughout the earth (5g per tonne) in 150 arsenic bearing, igneous (0.06 parts per million (ppm) to 113 ppm) and sedimentary rocks (0.1ppm to 2900 ppm) (Table 1.211). Weathering of these minerals produces arsenic trioxide (As_2O_3), arsenites and arsenates which may become transported to lakes and oceans. The arsenic concentration of fresh and ground water is on average below 50 parts per billion (ppb), whilst sea water contains 1 to 8 ppb arsenic and due to the high dilution rates involved is often seen as a safe disposal site. (Clayton & Clayton, 1981; Lederer & Fensterheim, 1981).

Table 1.211. Naturally occurring arsenic bearing minerals
(Carapella , 1978)

Name	Formula		
safforlite	CoAs	orpiment	As_2S_3
bellingite	FeAs_2	cobalite	CoAsS
niccolite	NiAs	enargite	Cu_3AsS_4
rammelsbergite	NiAs_2	arsenopyrite	FeAsS
sperrylite	PtAs_2	gersdorffite	NiAsS
realgar	AsS	glaucodot	(Co,Fe)AsS

Table 1.231. Industrial uses of arsenic (Clayton & Clayton, 1981;
Carapella , 1978)

Industry	Form	Use
Agrochemical	Mono - & disodium methyl arsonate	Herbicides
	Cacodylic acid	Herbicides
	Arsenic acid	Defoliant
	Sodium arsenite	Herbicides Sheep dips Weed control
Glass	Arsenic trioxide	Decolourising
		Fining
Lead	Arsenic trioxide	Battery grids
		Bearings
		Cables
Car	Arsenic trioxide	Antifreeze, rust inhibitor
Tanning	Sodium arsenite	Biocidal treatment
Wood preservative	Chromated copper arsenate	Active ingredient
	Fluorochrome arsenate phenol	Active ingredient
Semiconductor	Gallium & indium arsenide	Light emit. diodes
		Lasers, solar cells n - type dopant

1.22 Production

Most domestic arsenic is in the form of white As_2O_3 which concentrates in the flue dust of base metal ore smelters. Mexico, Sweden, France and the USSR are the main producers. The flue dust is reacted in the presence of a small amount of pyrite (to prevent arsenite formation), 90% to 95% crude material is recovered after it's passage through cooling chambers. Further resublimation results in a 99.9% pure product. Metallic arsenic is obtained by arsenopyrite and loellingite smelting at $650^{\circ}C$ to $700^{\circ}C$ in the absence of air (Clayton & Clayton, 1981). Due to the large amounts presently produced, As_2O_3 is not expensive as a raw material and environmental protection rather than material recycling will prove to be a more successful biotechnology target.

1.23 Uses

Arsenic has found major uses in many industries (Table 1.231), which inevitably requires safe disposal, or accumulates in the environment. The incentive for developing an effective means of disposal often originates from Government pressure, but as yet, arsenic has not been viewed as a potential hazard. Monosodium methylarsonate ($NaCH_3AsO(OH)_2$) is used extensively in cotton fields for the control of johnson and nutsedge grasses, the malic enzyme involved in CO_2 transport within C_4 plants is inhibited by methane arsonous acid ($CH_3As(OH)_2$) due to a reaction with organic sulphhydryl groups, resulting in a reduction of sucrose production and the build up of malic acid (Knowles & Benson, 1983).

The first organic arsenical was prepared in 1760 by Cadet de Gassicourt. In 1863 Bechamp produced an aromatic arsenical which became known as Atoxyl; having been shown to cure experimental trypanosomiasis, Ehrlich & Bertheim (1907) published its structure as sodium hydrogen p-aminophenylarsonate ($\text{pNH}_2\text{C}_6\text{H}_4\text{AsO}_3\text{HNa}$) and produced the arsenonanine derivative, Salvarsan, employed in the treatment of syphilis (Carapella, 1978).

A deduction of the mechanism of arsenic binding to proteins led Rudolph Peters and colleagues to a successful antidote to the vesicant war gas lewisite (2,3-dimercapto-1-propanol (ClCH=CHAsCl_2)) (Knowles & Benson 1983). Table 1.232 gives a list of present day arsenicals (Emsley, 1985).

Farmers using roxarsone (3-nitro-4 hydroxyphenylarsonic acid) in pig and poultry feed obtain an average increase in livestock weight of 3% and may continue the use of such an additive up to a few days before slaughter as the arsenic is rapidly excreted (Emsley, 1985).

Table 1.232. Present day use of As in medicines.

(Carapella , 1978)

Name	Use
Melarsen oxide	African trypanosomiasis
Melarsoprol	Trypanosomiasis
Carbasone *	Amoebic dysentery
Glycobiarsol	Amoebiasis & malaria
Tryparsanide *	African trypanosomiasis

* Causes optic atrophy and resistant strains are evolving, drugs without As are therefore preferable.

1.24 Accumulation in the environment.

Permissible threshold limits of arsenic in the environment have been formulated (Table 1.241) in response to this widespread incorporation of As into many products. As the arsenic contained in food is tightly bound and gets rapidly excreted, no concentration of As up the human food chain has been observed. The total amount of As derived from the tripolyphosphates of detergent powder is 1-2 tonnes per annum (Waste Management No.20, 1980). Pressure impregnated industrial wood preservatives, produced via the direct oxidation of As_2O_3 in the presence of a platinum catalyst, are chemically fixed, resulting in little or no release of As from treated wood or sawdust (Emsley, 1985). The concn. of As very close to a treated wood burning fire is one thousand times greater than the permitted threshold limit value, 20-90% of the arsenic being volatilised, this is one area in which the use of biological filters may prove profitable. Future treated wood disposal may reach 500 tonnes per annum (Waste Management No.20, 1980).

The use of phosphoric acid (36 ng As per kg of acid) in the manufacture of agricultural fertilisers results in an unnatural addition of As to the soil, although the annual quantities of As introduced are ten to one hundred times less than the natural background levels. The effect of soil As on plants depends on the soil type and presence of other metals, but 5 ng As per kg of soil can affect plant growth. For plants grown in As containing soil; the roots exhibited the highest As concn., intermediate levels were detected in the vegetative top growth, whilst the edible seeds and fruit contained the lowest levels. Soil microflora generate di- and trimethyl arsine which is insoluble and therefore not toxic to plants (Waste Management No.20, 1980)

Table 1.241. Threshold limits for As and some of its compounds
(Waste Management No.20, 1980)

Form	Level (as As)
As ₂ O ₃ production	0.05 ng m ⁻³
As ₂ O ₃ handling and use	0.25 ng m ⁻³
Calcium arsenate	1.0 ng m ⁻³
Lead arsenate	0.04 ng m ⁻³
AsH ₃	0.05 mg m ⁻³
As in food	1 mg kg ⁻¹
As in non alcoholic beverages	0.1 mg kg ⁻¹
As in alcoholic beverages	0.2 mg kg ⁻¹
As in food additives	3 mg kg ⁻¹
As in drinking water	0.05 mg l ⁻¹

1.25 Industrial exposure

Chiefly occurs by inhalation and ingestion, about four fifths of which remains for many months in the liver, abdominal viscera, bone, skin, hair and nails long after it has disappeared from the urine and faeces. A very small quantity is exhaled as trimethylarsine (Clayton & Clayton, 1981).

Groups of workers particularly at risk include those in insecticide formulation, forestry workers applying silvicides of cacodylic acid and the repair and cleaning of furnaces. It is in these environments that biological filters may find protective applications. Metallic As is essentially non-toxic, hence workers in the semi-conductor industries are not at risk. Although arsine (AsH_3) has no industrial applications, it is generated whenever reducing acids come into contact with As bearing materials and is highly toxic (Clayton & Clayton, 1981).

Prolonged exposure to the toxic forms of As has resulted in the following physiological disorders:

- i) Dermal effects - cutaneous lesions in workers handling As insecticides or in the copper ore smelting industry.
- ii) Mucous membrane defects - the As dust from copper smelters, forms arsenious acid when moistened, resulting in perforation of the nasal septum.
- iii) Gastrointestinal disorders - nausea and vomiting.
- iv) Peripheral neuritis - pain and burning in the affected limbs.
- v) Haemolytic aspects - symptoms disappear in 2 - 3 weeks.

(Clayton & Clayton, 1981).

1.26 As as a poison

White arsenic (As_2O_3) was popular with poisoners as it could not be detected before the days of forensic analysis. Famous users and purveyors of As as a poison include the Borgia family, Toffana of Sicily and Madame La Voison. The damp conditions prevailing in Napoleon's residence on St Helena may have encouraged fungal growth under the wall paper in his room, converting the arsenic containing pigment, Scheele's Green (copper hydrogen arsenite), to trimethylarsine which may have led to his death in 1821 (Emsley, 1985). A more recent case is that of the poisoning of a family in a Forest of Dean cottage (Challenger, 1945).

The reported acute toxicity level of As_2O_3 for laboratory animals varies from 8 to 500 mg As / kg body weight, aqueous As_2O_3 being approximately ten times more toxic than solid As_2O_3 . The smallest recorded fatal dose for humans is 130 mg, whilst 200 to 250 mg is enough to kill most people. Symptoms of a fatal dose include abdominal pain and vomiting usually within half an hour of ingestion, death follows 12 to 48 hours later. Although As_2O_3 was believed to be carcinogenic, it requires a respiratory irritant such as SO_2 , metal oxide fumes or cigarette smoke to elicit a response (Clayton & Clayton, 1981).

The limiting factor in the survival of arsenic poisoning is the liver's processing capability. A person with an average weight of about 70 kg contains approximately 10 mg As, which is continuously converted to dimethylarsinic acid ($(\text{CH}_3)_2\text{AsO}_2\text{H}$) and is passed out in the urine (Emsley, 1985).

1.27 Toxicity mechanisms

By 1909 Ehrlich showed that thiol groups were involved in As poisoning. The effectiveness of British Anti Lewisite (BAL) therapy was defined in 1953 by Gunsalus, who showed that the As mercaptide ring formed during the inactivation of the pyruvic dehydrogenase complex is cleaved by BAL SH groups to regenerate lipoic acid (Clayton & Clayton, 1981).

In terms of toxicity :

Arsonous acid	>	Arsenous acid	>	Arsenic acid
$HAs(OH_2)$		$As(OH)_3$		$AsO(OH)_3$
(+1)		(+3)		(+5)
Immediate		Delayed		
response		response		

Arsonous acid (Fig. 1.271) reacts with single SH group enzymes to form a binary complex (1), reaction with a monothiol yields a relatively stable ternary complex insensitive to further reaction (2). A dithiol allows the As group to bind to one SH group, whilst the other SH displaces the As (3), releasing an active enzyme (4) and a cyclic dithioester (5). Such a pathway explains why monothiols inhibit enzyme action and dithiols reactivate As blocked enzymes (Knowles & Benson, 1983).

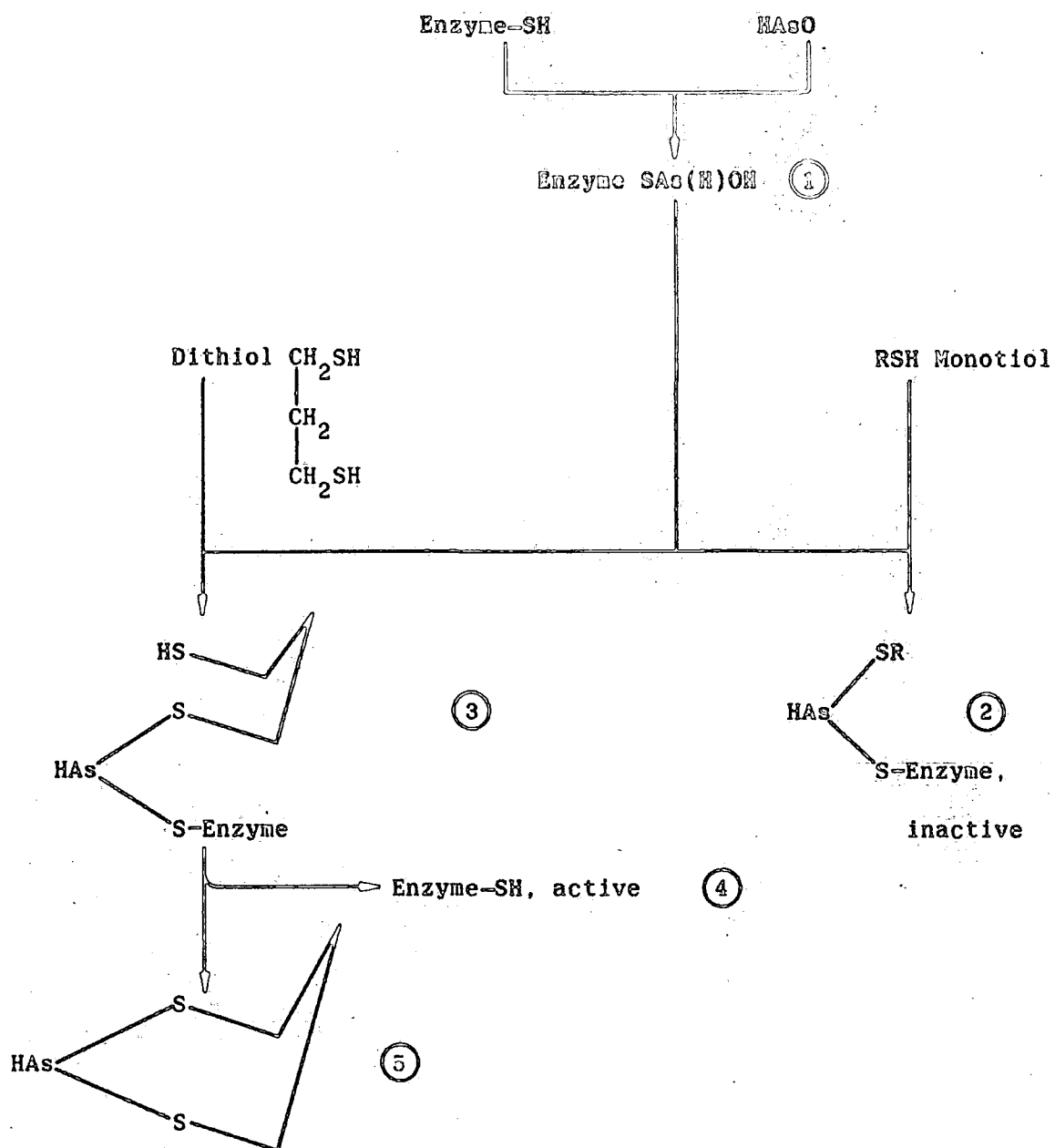

Figure 1.271. The action of mono and dithiols on the arsenous acid blocked, enzyme thiol group. (Knowles & Benson, 1983)

Pentavalent As, such as As_2O_5 competes with the phosphate ions involved in respiratory phosphorylation and is sixty times less toxic than trivalent As, whilst trimethylarsine is less toxic in food than in air (Ferguson & Gavis, 1972).

The production of thiosalt - metal complexes by fungi has been put forward as a detoxification mechanism (Wainwright & Grayston, 1983).

1.28 Detection Methods

A lack of forensic tests for As prompted John Marsh to devise a suitable procedure, samples of evidence were digested by heating in a strong acid and metallic zinc was added to generate arsine, which when passed through a heated glass tube formed a mirror of As on the cooler regions of the tube (Emsley, 1985). The Gutzeit test also relied upon arsine production but utilised mercuric chloride paper to indicate the presence of As (detection range = 0.04 to 1 μ g). A number of tests are presently available (Table 1.281)(Leder & Fensterheim, 1981).

Table 1.281. Detection of As and some of its compounds

(Lederer & Fensterheim, 1981)

Method	Detection limit (ppb)	Forms detected
Hydride generation & FAAS or GFASS	0.0005	Arsine
X - ray fluorescence	0.05	Various
GFASS	0.2	Total As content
Neutron activation analysis	< 1	Various
Molybdenum blue colourimetry	1	Arsenate & arsenite
Differential/sweep pulse - polarography	2 - 6	Arsenate & arsenite
Silver diethyldithiocarbamate	20	Methyl arsine
	10	Arsine
Interactively coupled Plasma Emission Spectrophotometry	10 - 80	Total As content
Heteropoly acid spectrophotometry	100	Various

FAAS = Flame Atomic Absorption Spectrophotometry

GFASS = Gas Furnace Atomic Absorption Spectrophotometry

Gas or High Performance Liquid Chromatography is used to fractionate samples with a mixture of As forms

1.29 Disposal of As waste.

About 9×10^6 tonnes of As bearing waste is disposed of per annum, in landfills (equivalent to 1,045 tonnes As) plus 10×10^6 tonnes per annum of domestic waste (100 tonnes As). Old tannery waste dumps are also a source of As pollution, resulting from the use of arsenic sulphides as depilatories and sodium arsenite as a raw hide preservative / biocidal compound.

In well aerated bioactive soils arsenate species occur as stable forms (H_3AsO_4 , $H_2AsO_4^-$, $HAsO_4^{2-}$) whilst under moderately reducing conditions arsenite species predominate (AsO_2^- , H_3AsO_3 , $H_2AsO_3^-$, $HAsO_3^{2-}$). When sulphide is present, As_2S_2 and As_2S_3 occur as stable solids and at pH values less than 5.5, $HAsS_2$ and AsS_2 are present. Stable elemental As has been detected under some conditions albeit with a low solubility. Although arsine may be formed under strongly reducing conditions, it is only slightly soluble and decomposes rapidly to As, on exposure to light and moisture. Landfill therefore generates further problems as a wide range of As forms occur, some more hazardous than others (Waste Management No.20, 1980).

Using elution of As from a lime - ferrous sulphate sludge, containing acidic arsenate, the mobility of anionic As was found to be low in soils with a high, clay content, hydrated oxide composition and surface area. The mobility of As increased in soils where the above parameters were low. (Waste Management No.20, 1980).

Landfill waste sites are subjected to absorption, desorption, oxidation, reduction and microbial degradation. Anaerobic bacteria produce short chain fatty acids and methylate As to dimethylarsine. Aerobic demethylating bacteria have also been isolated, such species could be of use in a mixed culture bioreactor where the As accumulating organism tends to generate arsine. (Fig. 1.291)(Waste Management No.20, 1980).

The observation that arsenate and arsenite form low solubility compounds when precipitated by metals has led to the development of a mixed lime - ferrous sulphate system, which can remove up to 99.99% of As in the range 2 to 14,000 mg/l. The main disadvantages of such a system are the large volumes of precipitant & extensive holding tanks required and the need to dispose of the precipitate. A biofilter is a more compact alternative and can operate continuously.

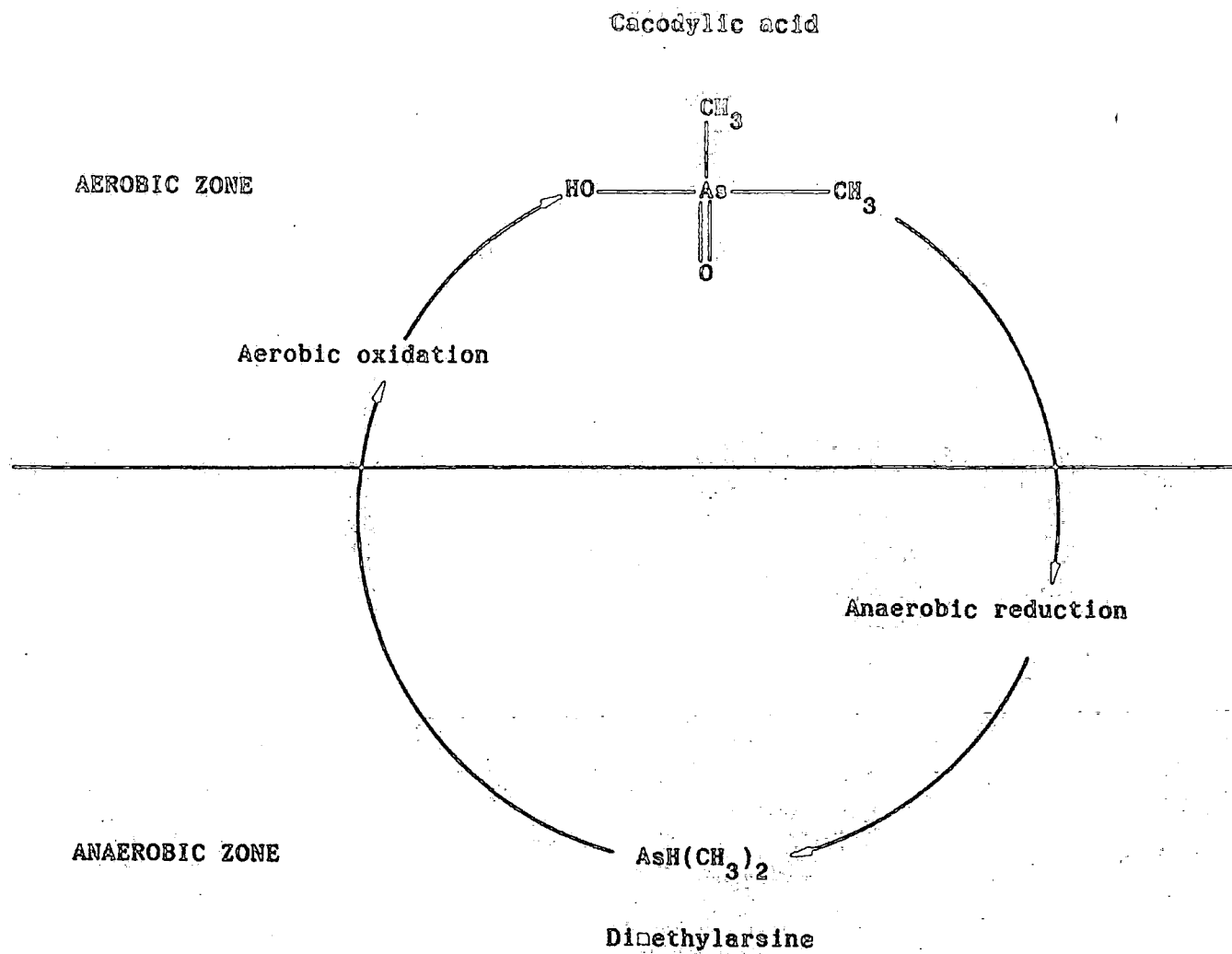

Figure 1.291. Oxidation /reduction of arsenic between aerobic and anaerobic environments (Waste Management No.20, 1980)

To determine the potential risk of As contamination of ground water flowing from a landfill site, a bore hole was excavated. The average As concn. of the bore hole water was 1.5×10^{-1} mg/l (only three times the maximum permitted levels for drinking water (World Health Authority proposed figure)). Thus controlled landfill of As offers little threat to ground water contamination. (Waste Management No.20, 1980).

Arsine generation is more of a potential danger, if arsenic bearing wastes come into contact with dilute mineral acids and metallic Fe, Cu, Zn or caustic alkali Al, and Zn. It is recommended that arsenic bearing wastes should be deposited at sites with a neutral pH. Once again it may prove feasible to screen the environment for organisms which accumulate this gas and use them as a biological filter.

Due to its abundance, the price of As_2O_3 is relatively low and thus recovery of low grade As_2O_3 from waste tips is not economically viable. But if present price trends continue (£30/tonne in 1973 rising to £300/tonne in 1979) biorecovery of As from waste producers may become attractive in the future (Waste Management No.20, 1980).

1.3 Arsine

Arsenic trihydride, or arsine, (AsH_3) is a colourless, flammable gas with a garlic like odour attributed to its tellurium content. Arsine is harmful in 1 to 20,000 dilutions, although blood transfusions and administration of dithiol ensures rapid recovery. Most damage arises from haemolysis, resulting in kidney damage and thus a marked rise in blood, nonprotein nitrogen levels. (Clayton & Clayton, 1981; Carapella, 1978).

It is now believed that arsine is not the reactive toxic form (Knowles & Benson, 1983), but is oxidised and tautomerised, before exerting a haemolytic action:

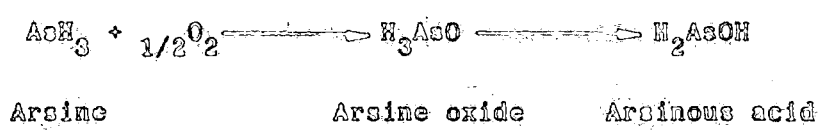

The recommended threshold limit value of arsine is 0.05 ppm (as As), the threshold odour of 0.5 ppm is therefore not a suitable warning level (Clayton & Clayton, 1981).

1.4 The Arsenic Cycle

The link between geochemical and biological As cycling occurs when arsenic contained in sediments is released into natural waterways. The form of As present depends on the pH and redox potential of the environment (Fig. 1.41). Such species accumulate to a much higher level in marine food chains than those of freshwater. (Table 1.41)

The metabolic activity of microorganisms plays a large part in the mobility of toxic materials within the environment, the process of methylation probably serving as a means of detoxification (Fig.1.42). Arsenic release has also been detected from orpiment, enargite and arsenopyrite, probably via the catalytic activity of autotrophic bacteria which are known to convert sulphide to sulphate and ferrous to ferric iron (Ferguson & Gavis, 1972; Wood, 1974)

Table 1.41. Bioaccumulation of As in fresh and sea water

(Ferguson & Gavis, 1972).

Environment	Level of As	Maximum accumulation factor from previous trophic level
Sea water	5×10^{-5} to 5×10^{-3} $\mu\text{g l}^{-1}$	-
Marine plants	1 to 12 kg^{-1}	2×10^3
Marine animals	0.1 to 50 kg^{-1}	4
Lobsters	200 kg^{-1}	4
Freshwater	1×10^{-2} mg l^{-1}	-
Freshwater fish	0.1 to 0.2 kg^{-1}	20

kg^{-1} values are dry weights

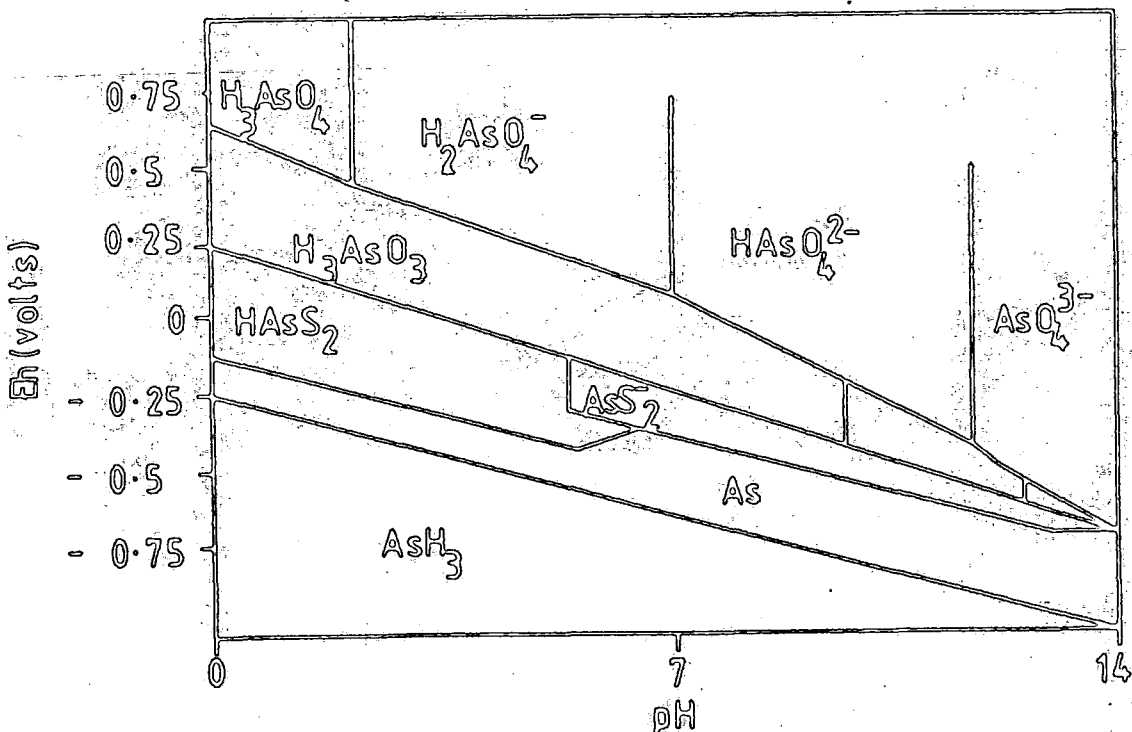

Figure 1.41. The inorganic chemistry of arsenic in natural water systems (Ferguson & Gavis, 1972)

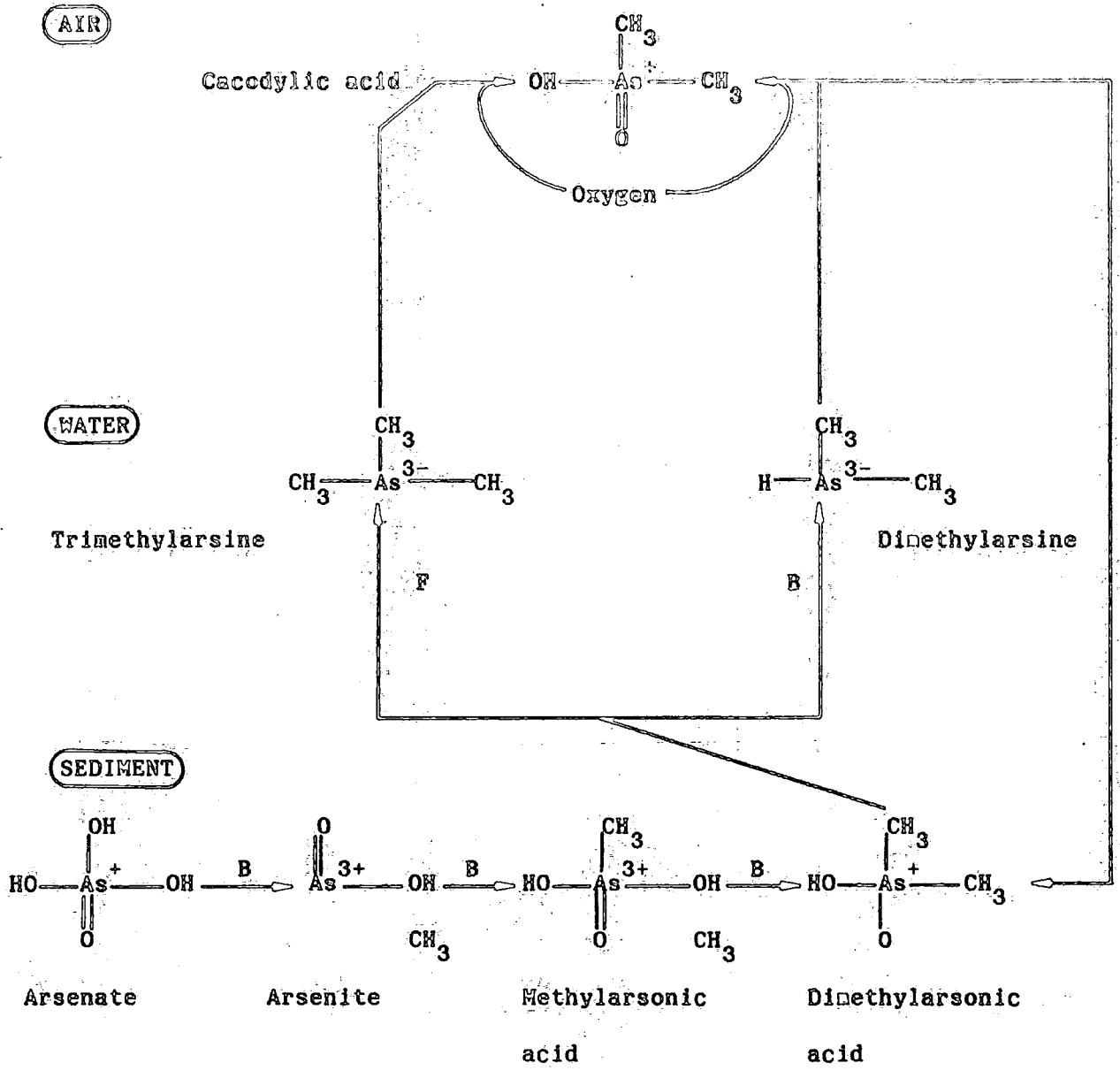

Figure 1.42. Microbial mobilisation of As throughout the environment
 B = Bacterial conversion F = Fungal conversion
 (Wood, 1974).

1.6 Biological processing

1.51 Algae

Algae may represent a significant reservoir of As in the marine environment because of their ability to concentrate As by up to one hundred times the extracellular levels. For the blue-green alga, Phormidium, Matsuto *et al* (1984) showed As (V) uptake from the environment, reduction in the tissues and rapid excretion as As (III). Weakly bound As, probably at it's mucilaginous surface, was excreted rapidly, whilst tightly bound As was released at a slower rate. For the marine alga Dunaliella sp. growth was inhibited by $3\ 000\ \text{mg As l}^{-1}$ (Yamaoka & Takimura, 1986).

Some species incorporate As into their own molecular constitution, Tetraselmis chui stores 0.5 % As in a phospholipid (Lederer & Fensterheim, 1981), whilst the brown kelp Eklonia radiata forms 2-hydroxy-3 sulphopropyl-5 deoxy-5-(dimethylarseno)furanoside. As Eklonia is the major organism that concentrates As in the coastal ecosystem, it may well be the source of As for organisms higher up the food chain, which convert As to arsenobetaine ($(\text{CH}_3)_3\text{As}^+\text{CH}_2\text{COO}^-$) (Edmonds & Francesconi, 1981).

A number of marine algae, when cultured in arsenate produced O-phosphatidyltrimethyl arsonium lactic acid and led Cooney, Mudda and Benson (1978) to the conclusion that this was a detoxification procedure with the potential for degradation in food chains.

Since vertebrate proteins avidly sequester and accumulate As (few detoxification pathways exist) Knowles and Benson (1983) suggest that aquatic plants take up As inadvertently, during their quest for phosphate. The giant clam Tridacna harbours symbiotic algae in it's mantle, which, it is believed, convert arsonous acid to phospholipid derivatives for membrane mediated excretion of the As. Reduced and detoxified forms of As may then be utilised as an energy source by bacteria (Fig. 1.511) (Knowles & Benson, 1983).

11.52 Bacteria

M^CBride & Wolfe (1971) utilised radioactive As to follow it's progress in Methanobacterium. Under anaerobic conditions with the methyl donor cobalamin ($\text{CH}_3\text{-B}_{12}$), H_2 , ATP and As, a garlic odour attributed to dimethylarsine accumulated in the reaction flasks (Fig. 1.521), whilst methylation was inhibited by the presence of methyl viologen, homocysteine, selenium and tellurium. Potential pollution hazards arise when the As pesticides, sodium methylarsenate and calcium/lead arsenate are leached into anaerobic, aquatic or terrestrial environments, and become converted to poisonous arsines. The small amount of As present in high phosphate detergents may get hydrogenated or methylated in anaerobic sewage sludge digesters (M^CBride & Wolfe, 1971).

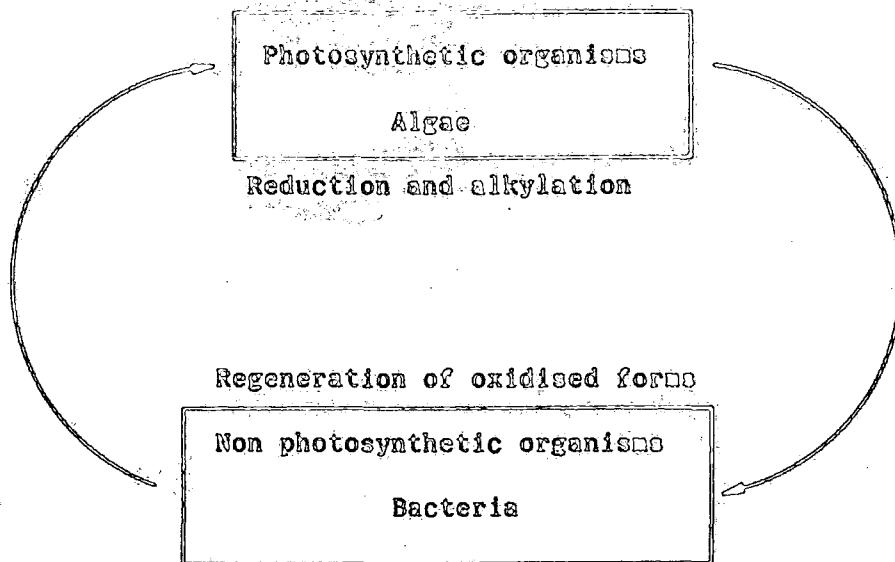

Figure 1.511. Arsenic transformation between photosynthetic & non photosynthetic organisms (Knowles & Benson, 1983)

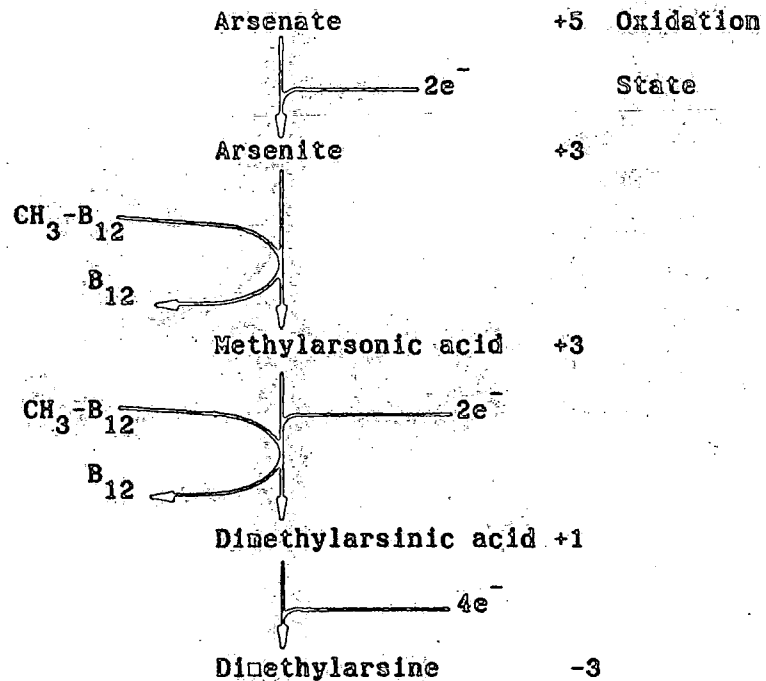

Figure 1.521. Methanobacterial methylation of arsenic

B_{12} = Betaine (M^CBride & Wolfe, 1971)

1.53 Fungi

Severe cases of As poisoning were reported in 1815, a garlic odour was noticed in rooms where arsenic poisoning had occurred (Gmelin, 1839) and that it was mould growing under the wallpaper which was responsible for the generation of arsine (Soldi, 1874). Preliminary experiments carried out in 1897 by Gosio utilising potato-mash containing arsenious oxide, evolved a garlic odour after colonisation by fungi and bacteria. Only the moulds were found to volatilise the arsenic i.e. Penicillium brevicaulis Saccardo (now named Scopulariopsis brevicaulis), Aspergillus glaucus, A. virens and Mucor mucedo. The gas was termed Gosio gas but incorrectly assumed to be diethylarsine ($(C_2H_5)_2AsH$) (Bignelli, 1901). It was not until 1932 that the gas was correctly identified as trimethylarsine ($(CH_3)_3As$) (Challenger, Higginbottom & Ellis, 1933). Scopulariopsis brevicaulis has also been observed to methylate the selenium and tellurium available in the growth medium, to dimethylselenide ($(CH_3)_2SeH$) and dimethyltelluride ($(CH_3)_2TeH$) (Rosenheim, 1902; Challenger & North, 1934; Bird & Challenger, 1939; Barks & Flemming, 1974). Because of these characteristics S. brevicaulis has been a popular organism for the study of biomethylation. The yeasts Saccharomyces cerevisiae, S. carlsbergensis and S. monacensis did not yield garlic odours when grown on metalloids (Challenger & Higginbottom, 1935), indicating that few species exhibit methylating capabilities.

Both acetic acid and formaldehyde have been intimated as essential initiators of methylation (Challenger, 1945), but Challenger and Higginbottom (1935) were unable to provide any evidence to support these models, and favour the transfer of methyl groups from a methylated donor such as choline or betaine (both molecules are present in fungi), because sodium selenite and sodium tellurite, when heated in the presence of betaine yielded dimethyl forms of both metalloids.

As methylarsonic acid, cacodylic acid and hydroxytrimethylarsonium nitrate produced arsine when present as substrates in broad cultures of S. brevicaulis a methyl donor was intimated (Figure 1.531) (Challengor, 1945).

Sinons (1941) studied the potential breakdown of choline during methylation. Total choline conversion was not observed and the author suggested that the formation of trimethylamine, other nitrogenous products or incorporation into mycelial phosphatides, had occurred.

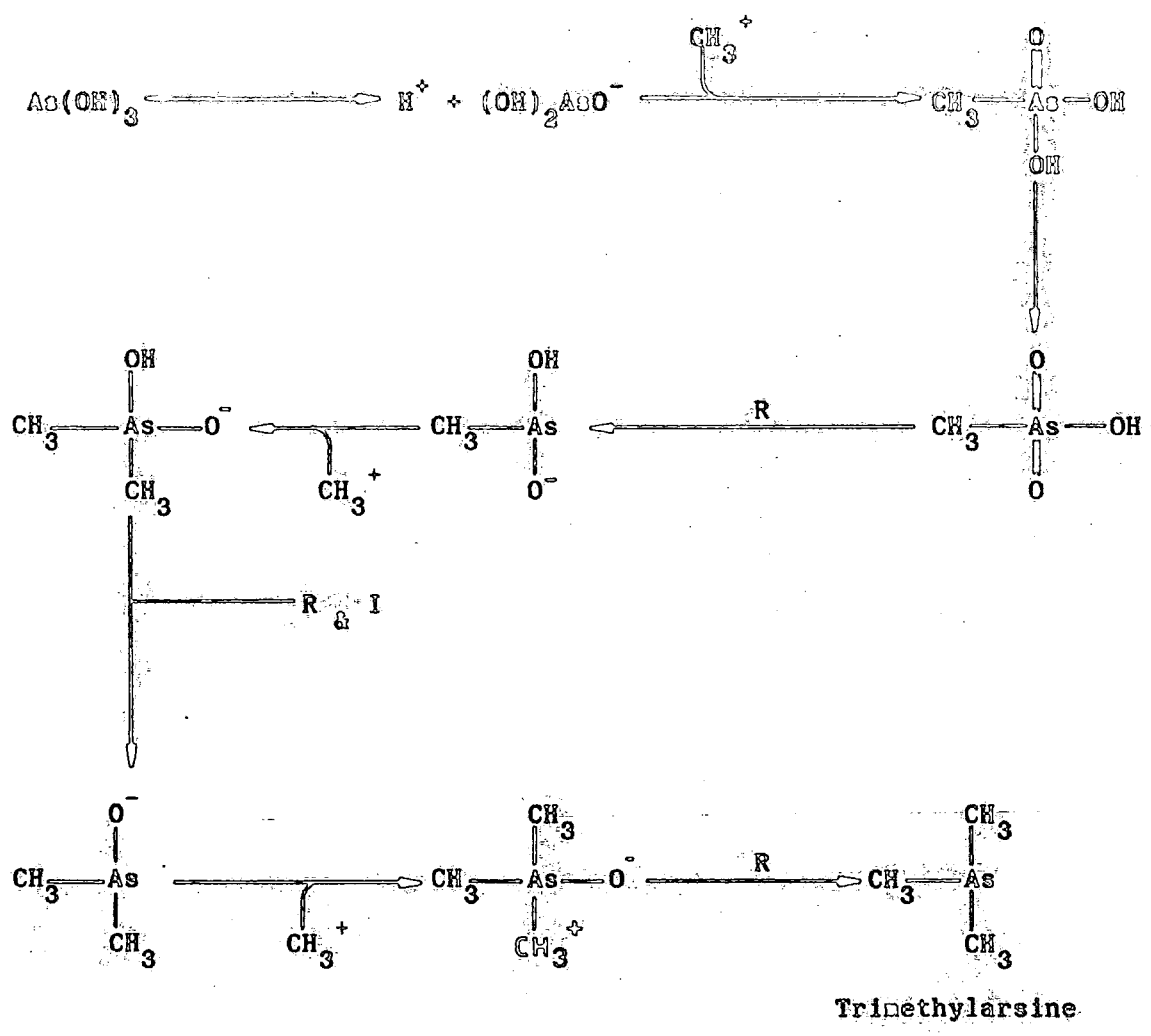

Figure 1.531. Proposed mechanism for trimethylarsine production in

Scopulariopsis brevicaulis

R = reduction I = isomerisation (Challenger, 1945).

Challenger, Lisle & Dransfield (1953), found methionine to be a more effective methyl donor than choline or betaine for As, Se & Te conversion. S. brevicaulis has been shown to cleave mono and disulphide bonds, resulting in methylthiol groups (Challenger & Charlton, 1946; Challenger & Lowther, 1950) and to generate aromatic ketones (Blink & Krivic, 1940). The formation of a poisonous gas is one of the major disadvantages associated with the use of fungi as biofilters.

Arsine production has been recorded in cultures of Trichophyton rubrum when grown on 1.5 mM to 1.6 mM arsenate, arsenite did not give rise to the evolution of a gas (Zussman, 1961).

A survey of recent literature on the subject of biological tolerance and accumulation of metalloids revealed studies by Stokes & Lindsay (1979) concerning copper in Penicillium ochro-chloron and selenium volatilisation by eight species of Mortierella (Zieve et al, 1985). Mainright & Grayston (1986) observed that Aspergillus niger & Trichoderma harzianum oxidised the sulphites of copper, lead and zinc (but not cadmium) to sulphates. No, up to date, articles were found concerning the response by fungi to the presence of arsenic in the growth medium.

1.6 The fungi investigated.

The tolerance of As by fungi has not been well documented and probably reflects the limited no. of species which can grow in it's presence. The two fungi selected for this project both grow on As: Phaeolus schweinitzii (Fr.) Pat. has been isolated from a mixed microflora, on a selective medium which contains Tanalith, a copper-chrome-arsenic wood preservative (Barrett, 1978). Whilst Scopulariopsis brevicaulis (Sacc.) Bainier has been associated with cases of arsine poisoning (Challenger, 1945), as a result of it's growth on substrates containing arsenic.

1.61 Phaeolus schweinitzii (Fr.) Pat.

(Classification No.: B32 (D.Barrett, personal communication))

A fungus which causes root- and butt-rot in a wide range of conifers in Europe & North America, resulting in the loss of timber. The most common mode of infection, in Britain, is through the roots. (Dewey, et al., 1984)

1.62 Scopulariopsis brevicaulis (Sacc.) Bainier

(Commonwealth Mycological Institute, Herbarium IMI No.: 273419)

Originally named Penicillium brevicaule by Saccardo in 1882 but reclassified as Scopulariopsis brevicaulis Bainier (1907) this species occurs mainly as a necrotic secondary infection on plants as well as being an animal parasite. It has also been isolated from a variety of environments: the desert soils of Saudi Arabia (Abdel-Hafez, 1981) and Egypt (Moubasher & Moustafa, 1970), from the Egyptian Peanut Arachis hypogaea (Moubasher, Abdel-Hafez, El Hissy & Hassan, 1980), canary seed, wheat grain, soya beans, ground nuts and hops (Morton & Smith, 1963), stored fodder (Scurti, Cantini & Colomb, 1969), fungal infections of chickens (Chute & O'Meara, 1958), birds nests, feathers and droppings (Hubalek, 1978), antarctic penguin colonies (Saez & Lesel, 1969). Also from domestic sewage treatment plants (Becker & Gardner Shaw, 1955), food stuffs (Burbianka & Stec, 1972; Henneberg & Kniefall, 1932) and marine environments (Dewey, Hunter-Blair & Banbury, 1984; Kohlmeier & Kohlmeier, 1979; Wright-Steele, 1967)

S brevicaulis is characterised by short conidiophores of one to three cells, each branch terminating in several annellophores (cylindrical & 3 - 4 μ m in diameter, 10 - 25 μ m long). The conidia are roughened on the surface, exhibit stem like points of attachment at their base and are borne as long chains (diameter = 5 - 7 μ m, see Fig. 4.334). Young conidia may

lack a roughened surface and solitary alicyriospores occasionally occur in place of the conidial chains. The hyphae are septate and measure 3 µm in diameter (Martin-Scott, 1954). Cole & Kendrick (1969) provide an explanation of how conidiogenesis progresses, utilising a culture chamber which ensured the production of long chains of conidia (Cole, Nag Raj & Kendrick, 1969). Further transmission and scanning electron micrographs were used to confirm the views obtained from light microscopy (Cole & Aldrich, 1971). Hannil (1971), recorded the presence of a spherical electron dense body which plugged the pore between conidia and conidiophores. Upon exposure to uranium acetate, radioactive sediment, fungicidal compounds and nystatin, S. brevicaulis responded with the production of enlarged annellophores and reduced conidiophores (Fassatiouva, 1972).

Colonies vary in colour from white through buff (the isolate used in this project) to black, which darken with age. When grown on malt agar at 24°C the colony diameter reaches 45 - 55 mm within 7 days, appearing white and translucent at first, then rapidly darkening. The narrow region of active growth at the colonies edge remains white. Growth on Czapek-Dox medium results in a much less dense mat of hyphae, and at a much slower rate. On all forms of media a few hemi-spherical growths occur which remain white in colour. At 5°C no growth occurs, at 18°C the spores present produce a single germ tube through the base of the spore and only rarely does a second apical tube appear. Raising the temperature to 24°C doubles the growth rate and induces sporulation, with the same growth rate at 30°C but an increase in the no. of spores. At 37°C only slight growth was detected (Morton & Smith, 1963). Dewey, Hunter-Blair & Banbury (1984) found that S. brevicaulis grew better on xylan or araban as sole sources of carbon, than on glucose and having been isolated from Philippine seaweed,

flourished in a saline medium (optimum growth occurred in 200 mM NaCl and conidia germinated in fresh sea water).

Onychomycosis, a chronic infection of the nail plate was first noted to involve S. brevicaulis by Brumpt & Langeron (1910), who designated the organism involved, S. brevicaulis var. hominis. A further 13 French cases were recorded in 1919 by Weil & Gaudin. The requirement for an initial infection site other than nails was noted by Rocca (1929). Muster & Paillard (1942) cultured S. brevicaulis from 3 cases of interdigital mycosis and one case of erythro-squamous patches occurring over the whole body. The growth and deep penetration of S. brevicaulis on a previously cleaned calves hoof was used by Blank (1951) to show that S. brevicaulis is the main cause of onychomycosis (also Schoenborn & Schmoranzner, 1970). Martin-Scott, (1954) described the keratin air channels formed by the invading fungus. Relatively recent cases have been reported in Berlin, Basel and Sydney (Gemeinhardt, 1972; Onsberg, 1980; Frey & Muir, 1981). The ability of S. brevicaulis to tolerate arsenic, invalidates the use of arsenic preparations as therapeutic agents for these skin infections (Kozłowska, 1956). In Parker ink stained, onychomycotic nail samples, it was possible to differentiate between infection by S. brevicaulis and the dermatophytes Trichophyton rubrum and T. metagrophytes (Fragner, 1969). Scopulariopsis has also been isolated from the skin of a dead body (Zach, 1939) and a pyodermatous plaque on the scalp of a Japanese boy (Tagani, 1970).

Injection of this fungus into mice (Mankowski, 1960) resulted in advanced amyloidosis of the spleen, liver and kidneys. Chronic infections were characterised by hyperplasia of the lymph nodes and formation of lymphoblastomas. The use of 1% glutaraldehyde as an antimycotic agent has been suggested (Dabrowa, Landau & Newcomer, 1972). Fungi isolated from Hawaii soil (Blunt & Baker, 1968) have been found to produce compounds

which exhibit antinycotic activity towards the human pathogen

S. brevicaulis.

The use of biological material in industrial surroundings must not create potential health hazards. As the isolate used in this project is a pathogen of seaweed and pathogenicity tests on mice proved negative (the mice survived exposure to S. brevicaulis spores) it is assumed not to exhibit any mycotic activity against humans. References to a human variety of this fungus (Brumpt & Langeron, 1910; Mankowski, 1960) indicate that not all S. brevicaulis isolates are onychomycotic.

An extracellular protease associated with S. brevicaulis has been noted to hydrolyse casein, haemaglobin, gelatin, fibrinogen, fibrin and the A and B insulin chains. Whilst low esterase activity was detected, little or no activity was observed for a variety of peptides, except poly-L-lysine and poly-L-glutamic acid (Singh & Vezina, 1971 & 1972; Yoshimura & Danno, 1964). The activity of extracellular carbohydrases has also been recorded (Dewey, Hunter-Blair & Banbury, 1984). Protease secretion is not a common phenomena amongst fungi and is present in S. brevicaulis because of it's high protein environment; human tissue.

2 PROJECT AIMS

The directive for this study was to investigate the ability of fungi (particularly *S. brevicaulis*) to extract and accumulate arsenic, for potential use in the recovery of arsenic from industrial wastes. To achieve these aims a number of experiments were outlined:

- i) Growth in a variety of environments
- ii) Testing the culture fluid for a reduction in As concn.
- iii) Testing the mycelia for As accumulation
- iv) Testing for arsine evolution
- v) Detection of As specific extra/intracellular enzymes
- vi) Blocking pathways which lead to the generation of arsine
- vii) Determining the metabolic requirements for As uptake
- viii) Ascertaining the pathogenicity of *S. brevicaulis*

Further points which arose during the course of this project were:

- i) Assessment of spore resistance to microwave treatment
- ii) Investigation of the change in culture fluid viscosity induced during growth in As.

3 MATERIALS AND METHODS

3.1 Sources of biological material.

The two fungi investigated were subcultured from the following isolates:

i) Phaeolus schweinitzii was isolated from infected soil by

D. Barrett

ii) Scopulariopsis brevicaulis derives from the Philippines, intimated as the cause of the disease " Ice-Ice " in the red seaweed Eucheuma (Dewey, Hunter-Blair & Banbury, 1984; Uyenco, 1981).

3.2 Subculture techniques and growth in a variety of conditions.

3.201 Subculture techniques

Unless stated otherwise, all cultures were grown in or on 20 ml of 50 g l⁻¹ malt (presterilised at 120°C, 1 bar for 20 minutes) in 8.5 cm diameter plastic petri dishes and incubated for ten days at 23 +/- 2°C. Solidified media contained 20 g l⁻¹ agar. All plates were poured in a sterile airflow hood and inoculated with a 4 mm diameter plug of culture grown on agar, cut with an ethanol flamed cork borer from the growing edge of each inoculum plate. All solutions (v/v or w/v) and dilutions were made up in distilled water unless described otherwise.

3.202 Growth of S. brevicaulis and P. schweinitzii with As.

To select the fastest grow^{er} and hence probably the fastest As accumulator, four replicates of the following treatments were inoculated with both species:

a) Liquid medi + 0, 7, 15 & 30 $\mu\text{g ml}^{-1}$ As (as $\text{Na}_2\text{HAsO}_4 \cdot 7\text{H}_2\text{O}$)

b) Solid medi + 0, 7, 15 & 30 $\mu\text{g ml}^{-1}$ As (as $\text{Na}_2\text{HAsO}_4 \cdot 7\text{H}_2\text{O}$)

One sterile disc of cellophane (preboiled in 1 g l^{-1}

Ethylenediaminetetraacetic acid) was placed on each solid plate to facilitate colony removal. Due to a lower growth rate and As tolerance (section, 3.209) exhibited by P. schweinitzii, only S. brevicaulis was used for the rest of these experiments.

3.203 Dry weight determination.

All mycelial samples were separated from the culture fluid by vacuum filtration through a Buchner funnel, containing a 9 cm disc of filter paper which had been pre-microwaved (10 or 20 minutes) and weighed. The inoculum plug was removed and the samples exposed to microwaves (700 watts) for 10 to 20 minutes (depending on the mass of mycelia present) until dry. To ensure exposure times were correct, a set of 5 samples of mycelia plus filter paper were weighed every 2 minutes of microwaving to check that mycelia which appeared dry, contained no residual moisture.

3.204 Growth on increasing malt concn.

To determine the most efficient malt concn. for growth, five replicates of the following malt concn. were set up with liquid and solid media:

10 g l^{-1} , 20 g l^{-1} , 50 g l^{-1} , 70 g l^{-1} & 100 g l^{-1}

Growth was determined from dry weights (liquid culture) or colony diameters: an average of two measurements taken at 90° to one another (solid culture).

3.205 Growth in the light and dark.

Five replicates of 50 g l^{-1} malt were inoculated and grown under a normal day/night photoperiod, whilst five more replicates of 50 g l^{-1} malt were inoculated and covered in a double layer of black polythene. All plates were incubated at room temperature for ten days.

3.206 Growth at different values of medium pH.

The pH growth range was assessed by changing the pH of two 500 ml bottles of 50 g l^{-1} malt sequentially, one pH unit either side of pH 5.0 (untreated value) using known volumes of 1 M NaOH or 1M HCl and a pH electrode and meter. Five liquid replicates were poured and inoculated for each pH value. Dry weights were ascertained ten days later, together with any change in pH.

3.207 Growth in the presence of As (III), Se & Te.

Five, 50 g l^{-1} liquid plates were poured with the following amounts of each compound, to form a $500 \text{ } \mu\text{g ml}^{-1}$ concn.:

	Mr	Weight added (mg)
sodium-m-arsenite	129.90	86.7
sodium tellurate	273.62	182.6
sodium selenate	369.10	246.3

3.208 Growth on Czapek-Dox medium (Dewey et al., 1984).

Investigation of an alternative medium: Ten liquid and ten solid Czapek-Dox plates were poured, containing:

- a) 100 mg KH_2PO_4 in 50 ml distilled water
plus
- b) 200 mg NaNO_3 + 50 mg $\text{MgSO}_4 \cdot 7\text{H}_2\text{O}$ + 50 mg KCl
+ 1 mg $\text{FeSO}_4 \cdot 7\text{H}_2\text{O}$ in 50 ml distilled water

Dry weights and colony diameters were measured.

3.209 Growth on malt medium with increasing concn. of As.

Two experiments were set up to determine the lethal As concn. for S. brevicaulis and P. schweinitzii utilising two liquid replicates for a 0 to 100 000 $\mu\text{g ml}^{-1}$ As concn. range and five liquid replicates of S. brevicaulis only, for a 0 to 40 000 $\mu\text{g ml}^{-1}$ As concn. range. The cultures were harvested ten days later and dry weights assessed:

$\text{Na}_2\text{HAsO}_4 \cdot 7\text{H}_2\text{O}$ added (mg 100 ml ⁻¹)		Effective As concn. ($\mu\text{g ml}^{-1}$)	
i)	0	0	ii) 0
	20.35	50	2 035
	40.70	100	4 070
	101	250	6 105
	203	500	8 140
	407	1000	10 175
	4 070	10 000	12 211
	20 352	50 000	14 246
	40 704	100 000	16 281

The following experiments were employed to assess the feasibility of growing this fungus on a larger scale:

3.210 Petri dish growth.

70 plates of 50 g l^{-1} malt were poured & inoculated and the dry weight of mycelia measured each day for 11 days after the date of inoculation, then at 12, 14 and 20 days.

3.211 Shake flask growth.

Conical flasks (100 ml) with 20 ml, 50 g l^{-1} malt plus sponge stoppers were autoclaved and inoculated when cool. The flasks were incubated at 23°C in two shaking water baths (140 strokes/minute) and the growth of mycelia in 4 flasks determined every two days. The contents of some flasks were sampled and subcultured onto solid plates of 50 g l^{-1} malt to check culture purity.

3.212 Chemostat growth.

Four litres of 50 g l^{-1} malt were made up in a 5 litre conical flask and connected with 5 mm diameter silicon tubing to a short length of 1 mm diameter silicon tubing for location under the rollers of a peristaltic pump. This media feed line was connected to a glass chemostat with 5 mm diameter silicon tubing. A second 5 l flask was connected to the chemostat media overflow outlet. Both the media feed and collection flasks had sponge stoppers, 10 ml glass pipette feed/delivery tubes and silicon tubing breather pipes fitted.

The fermenter was filled with 80 ml, 50 g l⁻¹ malt and a magnetic stirring bar added. A pair of sterilisable 0.45 µm Millipore filters were connected to all air inlets/outlets and wrapped in aluminium foil, then clamped prior to sterilisation to prevent moisture migration. The inoculum injection port was sealed with a suba seal rubber stopper and the ground glass collar lubricated with silicone vacuum grease. All tubing/tubing and glass/tubing connections were secured with plastic fasteners, the two media flasks calibrated in litres and the optional ports blocked off with rubber pipette bulbs. The whole assembly was autoclaved as usual and returned to the laboratory bench for attachment to the media feed peristaltic pump, air pump and magnetic stirrer.

A sterile 5 ml syringe and 60 mm hypodermic needle were used to repeatedly squirt 3 ml of sterilised 0.1M pH 8.0 phosphate buffer (2.8 ml 0.5M KH₂PO₄ + 32.4 ml 0.5M Na₂HPO₄ diluted to 500 ml at 25°C), across a culture surface to create a spore suspension of S. brevicaulis. One ml of this suspension was transferred to a bijou bottle for spore density assessment (section, 3.91) and 2 ml injected into the chemostat via the injection port. The fungus was grown in batch culture for 48 h to establish a reasonable growth rate, then the media pump was activated, delivering about 14 ml of media h⁻¹. The collection flask sample tube was used to sterily extract a 100 ml sample of shaken culture each day and a 20 ml subsample was used for dry weight determination. The pH of the sampled culture and the volume of medium fed per day were recorded. Culture samples were plated out on solid agar & culture vessels to check culture purity.

A magnetic stirring bar was added to the medium feed flask a few days after inoculation & the medium stirred at low speed to prevent particulate matter settling out (Fig. 3.212)

Fig. 3.212. Photograph of the chemostat whilst in operation.

1. Medium feed flask
2. Breather tube and air filters
3. Peristaltic pump
4. Air pump
5. Glass chemostat
6. Medium outflow port
7. Magnetic stirrer
8. Medium collection flask
9. Culture sample tube

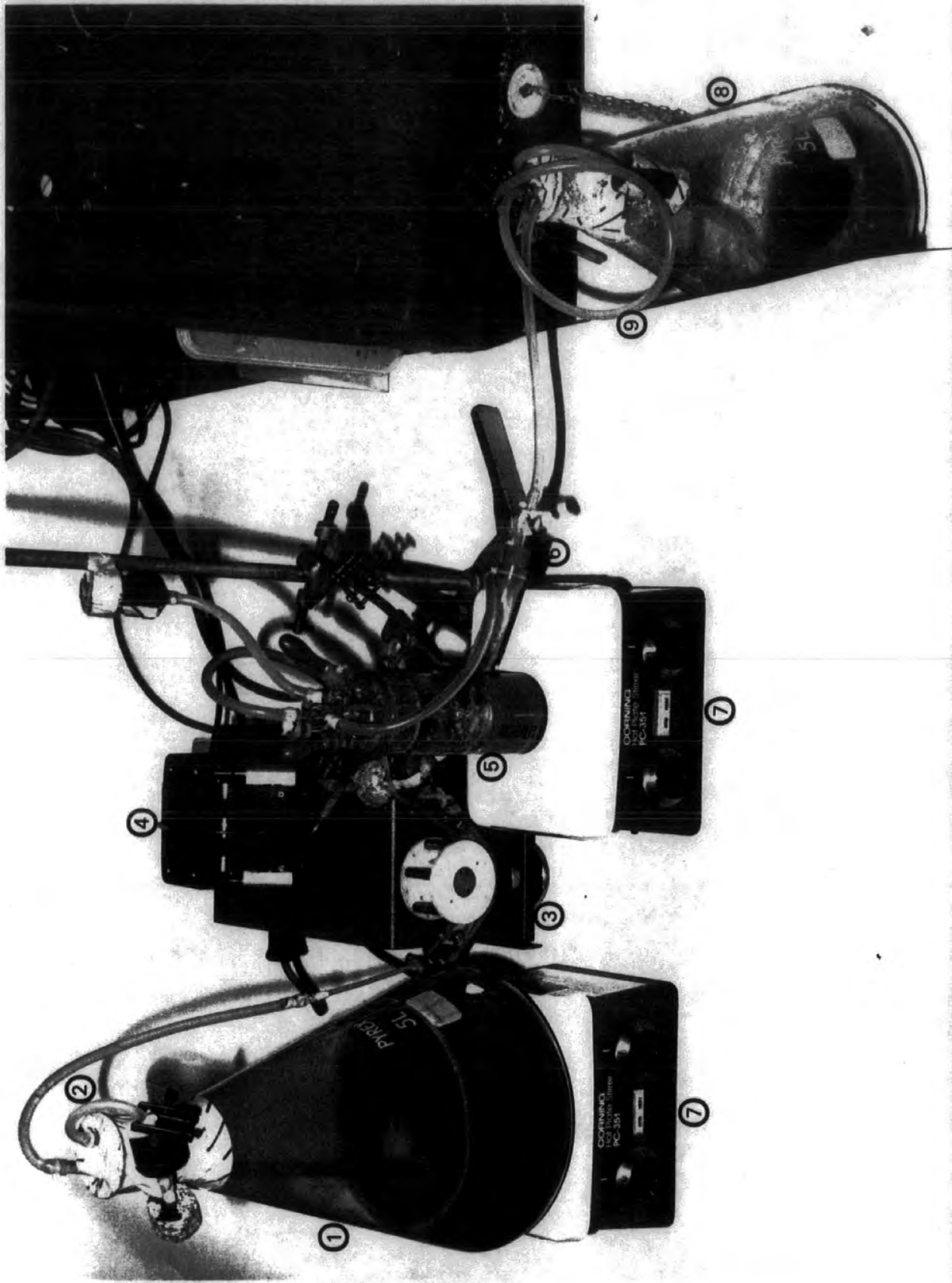

3.3 Growth in industrial environments.

Industrial sources of As were used to observe the response to an industrial contaminant:

3.31 Growth on realgar.

A sample of realgar (As₂S₃) provided by The Biological Products Division, ICI Billingham, UK was carefully crushed to a powder in a mortar and pestle. Three sets of 5, 20 ml, 50 g l⁻¹ malt plates had 50, 100 and 500 µg of realgar added to them plus 20 g l⁻¹ agar. Colony diameters were recorded ten days later.

3.32 Growth on industrial effluents.

Two sets of 5 plastic petri dishes were poured with 20 ml of two concn. of industrial As waste (20 µg ml⁻¹ & 100 000 µg ml⁻¹). High As concn. are disposed of by concn. , precipitation then landfill, whilst low As concn. wastes are diluted by disposal in the sea. Growth was assessed ten days later.

3.33 Swab sampling.

Eight sterile swabs, used to sample areas around a recycling plant, were sterily transferred to McCartney bottles containing 20 ml, 50 g l⁻¹ malt plus 100 µg ml⁻¹ As and vortexed for a short period to solubilise any microorganisms present. The swabs were placed on solid medium + 100 µg ml⁻¹ As and the liquid As inoculum transferred to petri dishes. All samples were screened every two days for the appearance of potential Scopulariopsis species.

3.4 Microscopic investigation.

Consult the list of equipment for the microscopes used. Black and white photographs were taken with a Nikon M-350 automatic exposure camera, on Ilford FP 4 or Kodak Technical Pan 2415 film and printed on Kodak paper. Colour photographs were shot with an Olympus OM 2 on Ilford HR 100 film.

3.41 Morphology investigation.

Culture chambers incubated at 23°C were used to view the sporulation structures of slide microcultures for identification purposes (Fig. 3.411)

3.42 Surface polymer investigation.

The possible induction of polymer production and export to the medium during growth on As, prompted the following tests:

3.421 The periodic acid/Schiff's stain for carbohydrates

(O'Brien & McCully, 1981)

The base of petri dishes containing hyphae grown in 500 µg ml⁻¹ As were used for this and the next test:

- i) The hyphae were exposed to 1% v/v periodic acid for 10 min
- ii) Washed in distilled water for 5 min
- iii) Exposed to Schiff's reagent for 30 min
- iv) Washed 3 X 2 min. in 0.5% w/v Na₂S₂O₅ in 1% v/v HCl
- v) Washed in distilled water for 5-10 min
- vi) Counterstained in hematoxylin

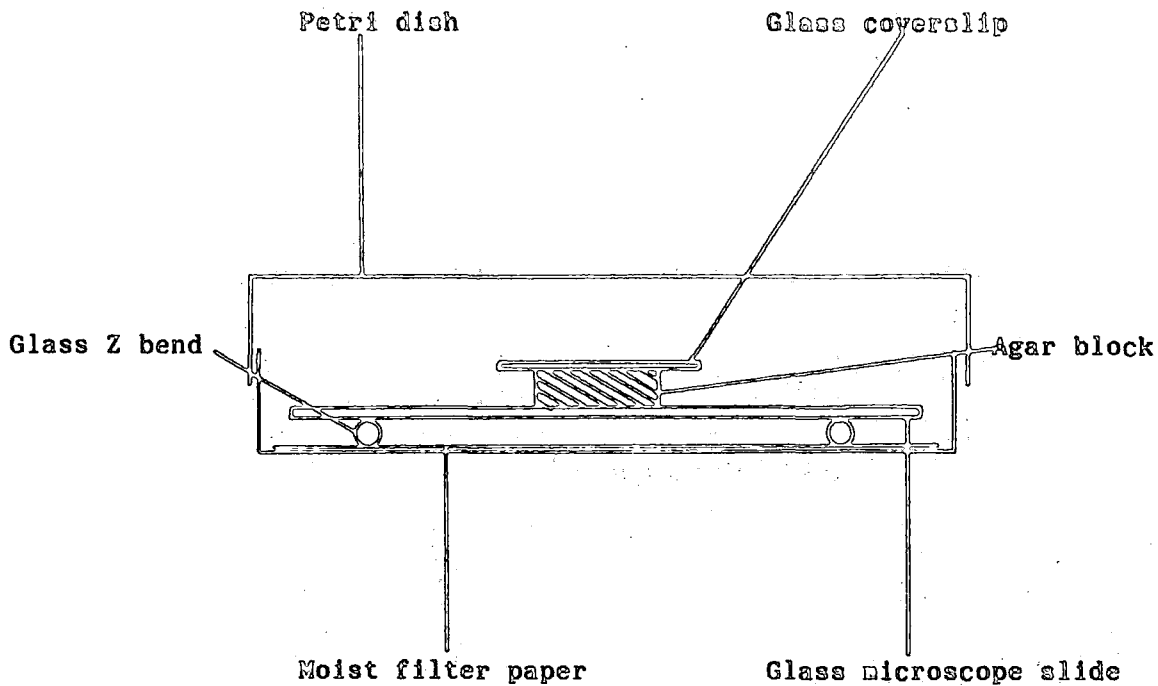

Fig. 3.411. Sterile culture chamber.

3.422 The nigrosin capsule stain (Dewey, 1982).

Used for the detection of an extracellular capsule:

- i) Stained for 30 s in safranin
- ii) Washed gently in distilled water & dried with blotting paper
- iii) The top half of the preparation was covered in nigrosin, using a glass slide spreader held at 45° , leaving the bottom half as a control
- iv) The sample was dried at room temperature and further counterstained with safranin.

3.423 Fluorescent staining (O'Brien & McCully, 1981).

Used for staining carbohydrates:

- i) Slides from culture vessels (section 3.41) were stained with 0.01% calcofluor for 1 min, then washed in distilled water.

3.424 Coomassie Blue staining.

For staining proteins:

- i) Further slides were exposed to Coomassie Blue for 30 min. (0.05% w/v Coomassie Blue, 50% v/v methanol, 7% v/v acetic acid)
- ii) Then destained in 50% v/v methanol, 7% v/v acetic acid.

3.43 Immunofluorescence (Dewey, Barrett, Vose & Lamb, 1984).

To search for mouse, anti-fungal antibodies potentially induced upon the injection of spores into mice:

- i) Slides of mycelia were fixed in ethanol/chloroform/formalin (6:3:1, v/v) for 3 min
- ii) Transferred to 95% v/v ethanol and left for 4 min
- iii) Washed with distilled water for 30 s and air dried

- iv) The fixed samples were divided in two (longitudinally) with a wax pencil line
- v) 20 μ l of spore-exposed antisera and preimmune anti sera diluted 0.1 & 0.05 X with PBS were added to the fixed samples
- vi) After 30 min exposure the slides were washed 3 X 5 min with PBS then exposed to anti mouse, fluorescein-isothiocyanate labelled anti-rabbit IgG serum, diluted 10 X with PBS and incubated for 30 min in closed petri dishes. Unbound fluorescent antibody was removed by washing 3 X in PBS
- vii) The mycelial preparation was fixed in 2 drops of 50:50 v/v glycerol: pH 8.4 PBS.

3.44 Scanning electron microscopy (SEM)

Culture samples were grown in humid culture chambers (section 3.41) with 20 mm X 20 mm squares of aluminium replacing the usual coverslips, to prevent charge build on the mycelia when placed under the electron beam. SEM images were recorded on Ilford FP 4 film and printed on Kodak paper.

3.5 Testing for arsenic accumulation & trimethylarsine evolution

To show that S. brevicaulis extracts As from the medium a number of tests were applied:

3.51 The molybdenum/vanadium/hydrochloric acid test for arsenic (Mo/Va/HCl test) (Gullstrom & Mellon, 1953).

This test is also sensitive to Si and other ions, so all the apparatus used was plastic.

- i) 25 g of sodium molybdate dihydrate ($\text{Na}_2\text{MoO}_4 \cdot 2\text{H}_2\text{O}$) were dissolved in 80 ml of distilled water and 4 g of sodium metavanadate (NaVO_3) were dissolved in 0.5M NaOH by vigorous shaking and neutralised with drops of 36% HCl, any remaining insoluble matter was discarded.
- ii) The two solutions were mixed forming a bright red/orange colour, 50 ml, 36% HCl were added, the acidified solution diluted to 250 ml and stored in a plastic bottle at 4°C in the dark, to prevent indicator photooxidation
- iii) The sample, solution:indicator ratio was always 10:1 v/v and the absorbance of the resulting yellow colour recorded at 400 nm
- iv) A spectral wavelength and time scan at 400 nm were taken to decide upon the appropriate sampling wavelength and time (from initial addition of indicator).

3.52 Use of the indicator with media.

Initial experiments worked well with water, but the constituents of the malt appeared to interfere with the detection of As; a no. of attempts were made to reduce such interference:

- i) Boiling the malt medium with 50% H_2SO_4 for 10 min
- ii) Incubation with 50% H_2SO_4 for 0, 5, 10, 20 & 30 min
- iii) Incubation with 4% oxalic acid (to reduce phosphate interference) for 15 min
- iv) Use of Czapek-Dox as the medium
- v) Dilution of the malt medium before adding the indicator

Option v) proved to be the most effective, so a 5 X dilution was used with the appropriate 5 X concn. of initial As addition. The acid nature of the indicator precipitated components of the malt, hence all samples were spun at $5\ 000\ \text{rev. min}^{-1}$ in a bench centrifuge and the particle free

supernatant used. Absorbance readings were made with 4 X plastic, 1 cm wide cuvettes and the variation in readings between them noted, when filled with distilled water.

The indicator solution was calibrated with a $500 \mu\text{g ml}^{-1}$ As standard in the range 0 to $40 \mu\text{g ml}^{-1}$ in $5 \mu\text{g ml}^{-1}$ increments. The total reaction volume was made up to either 5 or 2.5 ml with distilled water.

3.53 Following a reduction in medium arsenic concn. during the growth of S. brevicaulis

- i) Five replicates of 0, 50, 100 & $200 \mu\text{g ml}^{-1}$ As in $10 \text{ \& } 50 \text{ g l}^{-1}$ medium were poured and inoculated for 2, 4, 6, 8 & 10 day sampling periods after the date of inoculation (total no. of plates = 100)
- ii) The initial As concn. of the medium was assessed by the Mo/Va/HCl test
- iii) On each sample date the As concn. of the medium was determined and mycelial dry weights calculated.

3.54 Use of mycelial mats to accumulate arsenic.

To negate the problems of a change in medium optical density with growth, reduce interference from other ions and observe the uptake rates for mature mycelia:

- i) 20 ml of 10 g l^{-1} glucose in tap water was sterilised and its pH adjusted to 6.5 with 37% HCl
- ii) 500 and $1000 \mu\text{g ml}^{-1}$ As ($1.0176 \text{ \& } 2.035 \text{ g}$ of $\text{Na}_2\text{HAsO}_4 \cdot 7\text{H}_2\text{O}$ in 500 ml medium) were added
- iii) The following 12 day old samples were utilised:
 - a) Mycelia grown on 50 g l^{-1} malt
 - b) Heat treated mycelia (37°C for 5 days)

c) Mycelia grown on 50 g l^{-1} malt + $100 \text{ } \mu\text{g ml}^{-1}$ As

(for potential enzyme induction)

d) Control, glass petri dish (to prevent As adsorption to plastic or Cellophane)

A sampling notch was sterily cut at the edge of each disc with one mat per petri dish and 5 dishes per treatment

iv) 0.1 ml of medium (1% glucose) was sampled at 0, 2, 4 & 6 days after the date of inoculation and tested for As content with the Mo/Va/HCl test.

3.55 Large scale mat experiments.

To increase the amount of As being taken up, 14 cm diameter plastic petri dishes were set up with 10 g l^{-1} glucose + $100 \text{ } \mu\text{g ml}^{-1}$ As, 4 mycelial mats and a glass petri dish control. The glucose content of the medium was assessed 12 days later with the anthrone test (section 3.72). A second larger scale system was set up but with a low glucose concn., 0.1 g l^{-1} to observe the effect of glucose limitation.

3.56 The wet oxidation test for arsenic.

An alternative to the Mo/Va/HCl test this procedure is used in the analytical department at ICI Billingham with a detection range of 0 to 20 $\mu\text{g As}$:

- i) 1 ml of sample was boiled with 20 ml conc. HNO_3 down to 5 ml on a hot plate, then cooled
- ii) 10 ml nitric/perchloric acid (50:50 v/v) were added and heated to drive off the HNO_3 as white fumes. Heating was continued to dense fumes of perchloric acid, then immediately cooled
- iii) The sample was diluted with distilled water to yield an As concn. range of 0 to 20 μg

- iv) 6 ml, 50% H_2SO_4 were added to the digest and made up to 45 ml with distilled water
- v) 2 g KI + 2 ml stannous chloride reagent (40 g stannous chloride + 20 ml conc. HCl diluted to 100 ml with distilled water) were mixed well and stood for 5 min
- vi) The reagent was transferred to the arsine generator situated in a fume cupboard (Fig. 3.561)
- vii) 5 ml of silver diethyldithiocarbamate (DDTC) were pipetted carefully into the arsine trap, 10 g of zinc added and the stopper quickly fitted to the flask. All joints were sealed with silicone grease
- viii) The reaction was run for 45 min, or until the zinc had stopped producing gas bubbles
- ix) Any colour change in the DDTC indicator was detected at 540 nm.

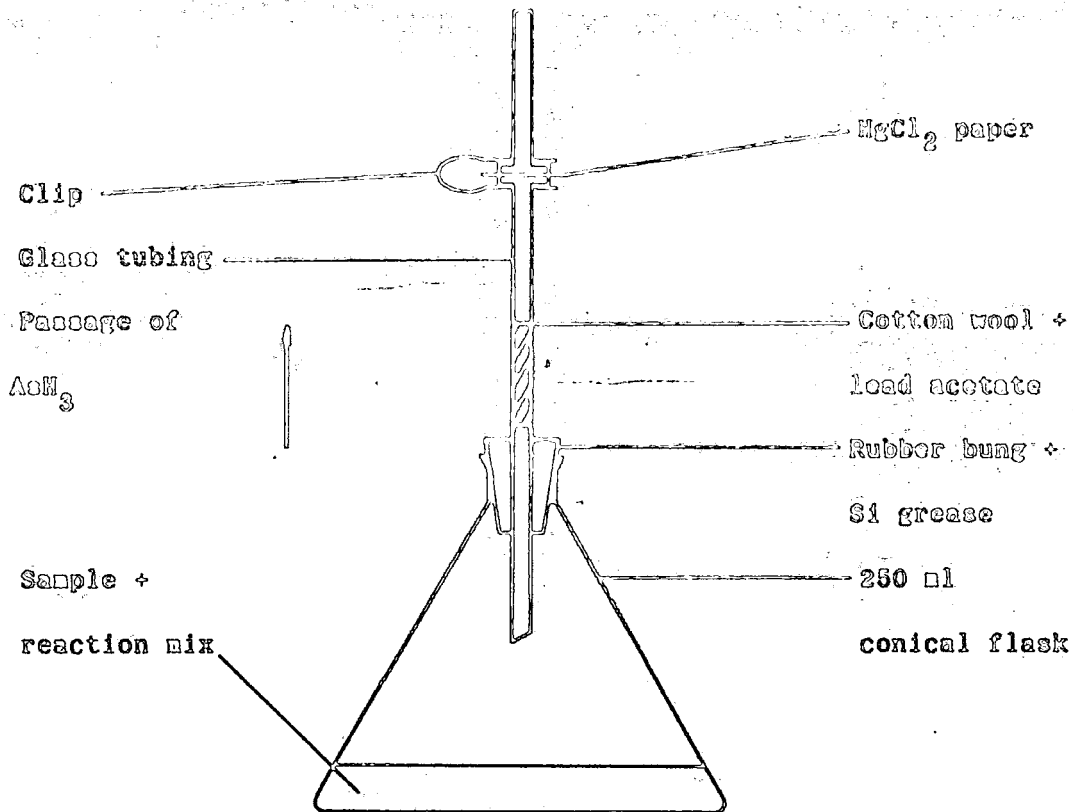

Fig. 3.571. Arsine detection apparatus, utilising $HgCl_2$.

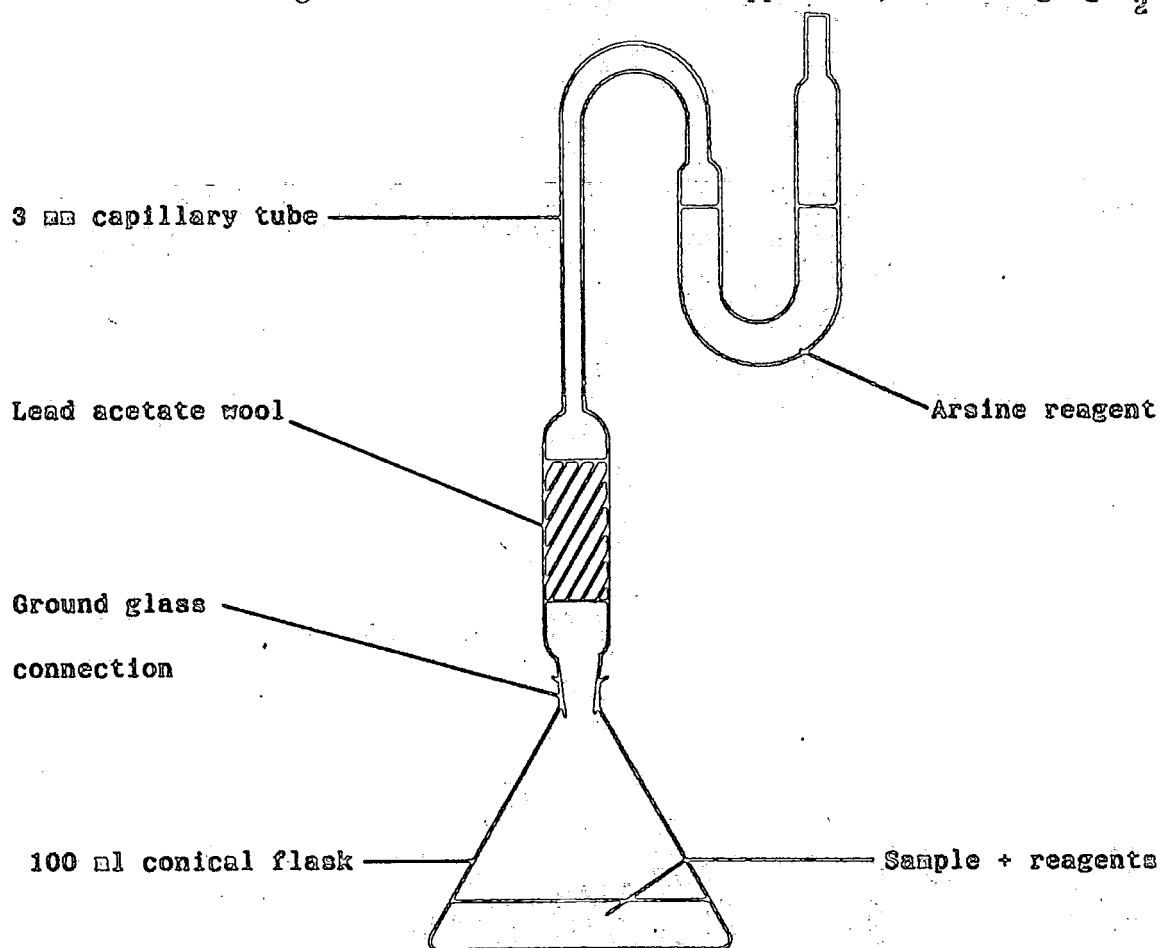

Fig. 3.561. The wet oxidation apparatus.

3.57 Determination of mycelial arsenic uptake

(British Pharmacopoeia, 1980)

- i) Mycelia grown with and without $500 \mu\text{g ml}^{-1}$ As were separated from the culture fluid by vacuum filtration and washed four times in distilled water.
- ii) A known wet weight of mycelia was transferred to a 250 ml conical flask, which was placed in a fume cupboard and 10 ml, 98% HCl + 50 ml distilled water were added
- iii) 0.5 g KI (reduces As (V) to As (III) by hydriodic acid production) plus 1 ml stannous chloride reagent (see 3.56 v)) were introduced
- iv) A small disc of filter paper (20 mm diameter) soaked in 1M HgCl_2 , then dried (& stored in the dark at 4°C to prevent photooxidation) was inserted between two glass tubes and secured. The lower glass tube was plugged with a short length of cotton wool soaked in 1M lead acetate to absorb any H_2S formed, which interferes with the test
- v) 5 g of Zn shot were quickly added to the reaction flask, which was stoppered with a rubber bung plus glass tubing (Fig. 3.571)
- vi) The reaction was run to completion with occasional shaking
- vii) Any As present is converted to arsine and forms a yellow brown spot on the HgCl_2 paper
- viii) Standard samples of 0, 5, 10, 15, 20, 250 & $500 \mu\text{g ml}^{-1}$ As were used to calibrate the system.

3.58 Testing for trimethylarsine.

The HgCl_2 test was employed to detect the arsine generated by

S. brevicaulis:

- i) Five replicate plates with and without $500 \mu\text{g ml}^{-1}$ As were inoculated and sealed in polythene bags (to contain any trimethyl arsine produced) with 3 HgCl_2 discs
- ii) The plates were incubated at 23°C and inspected regularly for signs of trimethylarsine production (spots which may form on the HgCl_2 paper).

3.6 Extra and intracellular enzymes.

3.61 Extracellular, arsenic methylating enzymes.

The culture fluid from As exposed mycelia was tested for the presence of methylating enzymes:

a)

- i) Three replicates of 25 ml, $200 \mu\text{g ml}^{-1}$ As grown culture medium were passed through a $0.45 \mu\text{m}$ liquid filter to which was sterily added 20 ml of malt plus $300 \mu\text{g ml}^{-1}$ As in a sponge stoppered conical flask
- ii) The reaction mix was shaken in a water bath at 23°C . One ml samples were extracted sterily at 0, 2, 4, 6, 8, 16, & 32 h after setting up the reaction and their As concn. determined with the Mo/Va/HCl test.

b)

- 1) 500 $\mu\text{g ml}^{-1}$ As was added to 3 replicates of 0.45 μm filtered *S. brevicaulis* As grown media in 25 ml sterile McCartney bottles plus one control with no As. The tubes were incubated at RTP for about 60 h
- ii) The As concn. of each tube was assessed by the wet oxidation procedure (section 3.56)

3.62 The release of cytosol enzymes.

A combination of homogenisation and French press pressure were employed to break open hyphae and release their cytosol enzymes:

- i) Shake flask grown mycelia were washed and resuspended in 50 ml pH 8.0, 50 mM phosphate buffer at 4°C and stored on ice. The material was homogenised in a 25 mm diameter glass/teflon homogeniser at 6 000 rev. min^{-1} to break down large mycelial clumps.
A sample of homogenate was viewed under the light microscope to check the efficiency of disruption (Fig. 4.521)
- ii) Two 25 ml samples of homogenate were passed through a 4°C precooled French press at 1 500 to 2 000 PSI and a sample viewed under the light microscope to ensure effective cell disruption (Fig. 4.522)
- iii) The resulting samples were centrifuged at 1 000 g force for 30 min at 2°C to remove the cell wall components and cell walls which constituted the first pellet (P1). The cytosol contents were released into the supernatant (S1)
- iv) A high speed spin of 30 000 g force at 2°C was carried out on 19 ml, S1 to remove cytosol organelles resulting in a second pellet (P2) and supernatant (S2)

- v) P1 & P2 were resuspended in 10 ml, pH 8.0, PB & 10 ml of S2 was utilised. Two, 5 ml samples of P1, P2 & S2 were transferred to M^CCartney bottles, 500 $\mu\text{g ml}^{-1}$ As added plus a control of 2 X 5 ml pH 8.0 PB + 500 $\mu\text{g ml}^{-1}$ As and incubated for 60 hours at RTP
- vi) The samples were spun at 30 000 g force to yield a clear supernatant, which was assessed for As content by the wet oxidation method (section 3.56)

3.7 Quantitative analysis of an arsenic induced polymer.

The observation that the viscosity of As containing medium increases when used as a growth substrate for *S. brevicaulis*, prompted a no. of tests to investigate the possibility of the production and release of a polymer in such an environment.

3.71 Detection of a change in protein levels.

The microLowry test was employed (Lowry et al, 1951 and adapted by H. Read, Northumbria Biologicals Ltd, unpublished)

- i) 50 ml of As and non As malt medium, associated mycelia and viscous polymer were frozen with liquid nitrogen in a 100 ml conical flask, dried under vacuum for about 24 h (lyophilised) and stored at 4^oC, sealed with parafilm
- ii) 8 mg bovine serum albumin ml^{-1} 0.1M, pH 8.0 PB was serially diluted to form the following protein standards:

8, 4, 2, 1, 0.5 & 0.25 $\mu\text{g ml}^{-1}$
- iii) 10 mg of each lyophilised sample was suspended in 100 μl 0.1M, pH 8.0 PB and serially diluted:

50, 25, 12.5, 6.25, 3.125 & 1.563 $\mu\text{g ml}^{-1}$

- iv) Solution A (24 parts 2% w/v Na_2CO_3 + 0.5 parts 0.5% w/v $\text{CuSO}_4 \cdot 5\text{H}_2\text{O}$ + 0.5 parts 1% w/v $\text{KNaC}_4\text{H}_6\text{O}_6 \cdot 4\text{H}_2\text{O}$, all dissolved in distilled water) and solution B (1% v/v Folin's reagent in distilled water) were made and stored with the protein standards & samples at 4°C
- iv) 20 μl of each standard & sample were pipetted into 5, flat bottomed, microtitration wells plus 200 μl of solution A, mixed well by pipette suction/expulsion and incubated at RTP for 10 min
- v) 20 μl of solution B was added and incubated for 30 min at RTP
- vi) The absorbance of the resulting blue colour was recorded at 492 nm with a microwell strip reader.

3.72 Detection of a change in carbohydrate levels.

The anthrone test for carbohydrates was utilised (Fairburn, 1953):

- i) 50 ml of 4°C distilled water was measured into a plastic container and 150 ml, 98% H_2SO_4 added carefully, cooled on ice then followed by 400 mg of anthrone
- ii) A 100 $\mu\text{g ml}^{-1}$ glucose standard was serially diluted:
100, 80, 60, 40, 20 & 0 $\mu\text{g ml}^{-1}$
- iii) Five replicates of 500 $\mu\text{g ml}^{-1}$ samples were diluted (section 3.71 iii))
- iv) 1.0 ml of the standards and samples were cooled on ice in glass test tubes and 5.0 ml anthrone indicator added & mixed well
- v) The tubes were heated in a boiling water bath for at least 15 min to develop and fix the yellow/green colours which were assessed for absorbance at 625 nm
- vi) Fresh standards and samples were made up for each determination.

3.73 The acetone test for carbohydrates.

Acetone will precipitate the carbohydrate in samples:

- i) 1 ml of the following samples were added to 10 ml 100% acetone & incubated at RTP for up to 24 h:
 - a) Culture filtrate with and without As
 - b) Mycelia grown with & without As, crushed in a mortar & pestle and resuspended: 1 g 10ml⁻¹ PB
 - c) Mycelia grown with & without As, spun down in PB and the resulting supernatant used
- ii) Any precipitate formed was spun down at 2 000 rev. min⁻¹ for 2 min.

3.74 PBS dialysis.

Dialysis against Na⁺ and Cl⁻ ions breaks up any negatively charged carbohydrate matrices:

- i) A 10 mm wide dialysis bag was boiled twice in 5 g 500ml⁻¹ NaHCO₃ then thoroughly washed in distilled water
- ii) 10 X PBS was made up in 500 ml distilled water (40 g NaCl + 5.75 g Na₂HPO₄ + 1 g KCl + 1 g KH₂PO₄)
- iii) Culture polymer was extracted from 3 X 20 ml, 500 µg ml⁻¹ As cultures and dialysed against 2 l, 1X PBS at 4°C on a magnetic stirrer for 48 h
- iv) The dialysed sample was lyophilised and the resulting powder compared with non dialysed, freeze dried samples.

3.8 Qualitative analysis of an arsenic induced polymer.

A change in the form, rather than quantities, of the medium components may occur during growth on As and was investigated by separation of the medium's constituents via polyacrylamide gel electrophoresis (PAGE), with (to detect differences in the no. of polypeptide subunits), and without (to observe complete proteins) sodium dodecyl sulphate (SDS)

+ β mercaptoethanol:

3.81 SDS reducing gels (Pharmacia, 1983).

- i) Sample preparation: 150 μ l, 100 mg ml⁻¹ samples (section 3.71) were added to 150 μ l sample buffer (1.21 g l⁻¹ TRIS + 0.29 g l⁻¹ EDTA + 1 % SDS + 5 % β mercaptoethanol: pH 8.0), boiled for 10 min and stored at 4°C
- ii) 10% running gel: 20 ml, 30:0.8 acrylamide:bisacrylamide + 15 ml, 1.5M pH 6.8 Tris HCl + 24.08 ml distilled water, degased then + 20 μ l tetramethylethylenediamine (TEMED) + 600 μ l 10% SDS + 300 μ l 10% ammonium persulphate (fresh), set in a gel mould under a layer of water
- iii) 5% stacking gel: 2 ml, 30:0.8 acrylamide:bisacrylamide + 3 ml, 0.5M pH 6.8 Tris HCl + 6.76 ml distilled water, degased then + 6 μ l TEMED + 0.12 ml 10% SDS + 200 μ l 10% ammonium persulphate (fresh) poured on top of the solidified running gel devoid of the settling water layer. A plastic, well forming comb was placed in the liquid gel, then allowed to set
- iv) Electrode buffer: 0.05M tris HCl + 0.2M glycine + 0.1% SDS, made up to 1 l was used for each gel run

- v) When the gel was set the comb was removed, the gel transferred to an electrophoresis tank and the wells loaded with known volumes of samples and Mr markers. 750 ml of running buffer was poured into the PAGE tank, 1 ml of bromophenol blue was added to the top reservoir and the samples run through the stacking gel for about 2 h at 60 V and for about 4 h at 120 V through the running gel
- vi) When the marker dye had run at least 3/4 of the length of the gel, the gel plates were prized apart and the gel clipped to mark the position of lane 1. The following staining procedures were employed to visualise the separated components:
- a) Coomassie Blue stain for proteins (for one half of a gel)
Stained for 45 min in 0.05% v/v Coomassie Blue + 50% v/v methanol + 7% v/v glacial acetic acid, then destained in 3-4 changes of 50% v/v methanol + 7% v/v glacial acetic acid.
- b) Lipopolysaccharide silver stain (Tsai & Frasch, 1982)
The gel was fixed overnight in 40% v/v ethanol + 5% v/v glacial acetic acid, then oxidised for 5 min in 40% v/v ethanol + 5% v/v glacial acetic acid + 0.7% v/v periodic acid
Washed 3 X in 500 - 1000 ml distilled water for 15 min each.
The water was drained off for 50 ml, fresh staining reagent (2 ml conc. NH_4OH + 28 ml 0.1M NaOH, titrated with fresh 20% w/v AgNO_3 to saturation (5 -10 ml)). Washed 3 X in 500 - 1000 ml distilled water then replaced with 200 ml of developer (50 mg citric acid + 0.5 ml, 37% v/v formaldehyde per litre of distilled water). The reaction was terminated by

washing in water and overstaining was corrected by the use of Coomassie Blue destain.

c) Silver stain for PAGE proteins (Morrisey, 1981)

The gel was prefixed in 50% v/v methanol + 10% v/v glacial acetic acid for 30 min then 5% v/v methanol + 10% glacial acetic acid for 30 min, using 100 ml of solution. 50 ml, 10% v/v glutaraldehyde fixed the gel in 30 min, which was then washed 4 times with distilled water in 2 h and soaked in $5\mu\text{g ml}^{-1}$ dithiothreitol for 30 min. This solution was replaced with 0.1% w/v AgNO_3 and incubated for 30 min. A small volume of water was used to rinse the gel, followed by two rapid washes in a small amount of developer (50 μl , 37% v/v formaldehyde in 100 ml, 3% w/v Na_2CO_3) then soaked in developer until the desired stain intensity was reached. Staining was halted by the direct addition of 5 ml, 2.3M citric acid.

3.82 Non reducing gels.

The gels were constructed as in section 3.81 but without the addition of β -mercaptoethanol, SDS or boiling of the sample. A non specific esterase stain was employed (Markert & Hunter, 1959):

- a) 1.5 ml of substrate (1% w/v α -naphthyl acetate in ethanol) was added to 90 ml, 0.1M pH 5.0 acetate buffer (14.8 ml, 0.2M glacial acetic acid + 35.2 ml 0.2M sodium acetate diluted to 100 ml). The gel was incubated in fresh assay buffer (without α -naphthyl substrate) at 4°C for longer than 2 min. Then incubated in fresh assay buffer plus substrate for 3-5 min.

Fresh assay buffer + substrate + 200 ng fast blue B stain per 90 ml buffer was employed until the desired staining intensity was reached (overnight if necessary). The stained gel was stored in 25 % methanol + 7 % glacial acetic acid.

3.9 Spore pathogenicity and microwave sterilisation.

3.91 Spore pathogenicity test

The isolate used for this project was tested for pathogenicity because of the reputation of S. brevicaulis as an onychomycotic agent. A sterile 1 ml syringe and hypodermic needle were used to continuously squirt 1 ml of PBS over the surface of an S. brevicaulis colony to generate a spore suspension. The density of suspended spores was recorded using a haemocytometer and light microscope, 0.3 ml was injected into the peritoneum of two mice. A higher spore density was achieved by spinning down the suspension in a bench centrifuge and resuspending in a smaller volume of PBS with the further addition of more centrifuged samples. The injected mice were observed for 3 months and remained healthy throughout this period; they were occasionally bled to gain antisera against the injected spores.

3.92 Microwave sterilisation of S. brevicaulis

The potentially lethal effects of microwave treatment were investigated:

3.921 The spore blot transfer test

- i) 12 sheets of 70 mm diameter Whatman filter paper were placed in a glass petri dish which was covered in silver foil and autoclaved, then dried in an oven over night
- ii) Spores were transferred to each filter paper disc by blotting them on the surface of a solid colony of S. brevicaulis and pairs of discs exposed to high power (700 W) microwaves for 0, 5, 10, 20, 30 & 45 min

- iii) The discs were transported to an air flow hood in sealed petri dishes and blotted onto the surface of fresh medium
- iv) Any spore germination and subsequent growth was recorded as an increase in colony diameter after incubation for ten days.

3.922 Cellophane disc colony treatment

- i) Five replicates of S. brevicaulis were grown on solid medium plus a sheet of Cellophane, until the colony reached a diameter of about 40 mm
- ii) The cellophane discs plus colonies were sterily removed from the medium's surface and microwaved (700 W) for the following periods: 0, 5, 10, 15, 20, 25 & 30 min
- iii) The microwaved discs were then sterily transferred to fresh solid medium, at this stage they were dry and mishapen but after two days exposure to the medium's moisture, the discs were sterily rearranged on the surface to form a flat sheet
- iv) Any growth after a further 8 days incubation, was detected by an increase in colony diameter.

4 RESULTS

All of the results in this section are averages of n no. of replicates, unless n = 1. For original data consult the appendices.

4.1 Growth in a variety of conditions.

4.101 Growth on liquid and solid medium, with arsenic.

The following wet and dry weights have been converted from mg of mycelia 20 ml^{-1} of medium to g l^{-1} :

a) Scopulariopsis brevicaulis

As concn. ($\mu\text{g ml}^{-1}$)	liquid medium			cd (mm)	solid medium		
	dry wt. (g l^{-1})	wet wt. (g l^{-1})	n		dry wt. (g l^{-1})	wet wt. (g l^{-1})	n
0	4.2	82.15	4	30.5	1.25	10.4	4
7.5	4.15	46.65	4	29	0.85	7.75	2
15	4.4	61.15	4	24.5	0.75	5.6	4
30	4.05	50.75	4	34.5	1.2	7.75	4

Growth characteristics: produces dense, buff coloured mycelia with a textured surface & white leading edges

b) Phaeolus schweinitzii

As concn. ($\mu\text{g ml}^{-1}$)	liquid medium			cd (mm)	solid medium		
	dry wt. (g l^{-1})	wet wt. (g l^{-1})	n		dry wt. (g l^{-1})	wet wt. (g l^{-1})	n
0	0.225	3.2	4	61.5	0.7	6.3	3
7.5	0.125	1.9	4	58	0.6	10.15	3
15	0.2	1.05	3	61	0.65	5.6	4
30	0.15	1.35	4	65.5	0.7	4.7	3

Growth characteristics: a thin, white, translucent mycelial mat is formed which evolves volatile odours & secretes a viscous fluid

where: wt. = weight, cd = colony diameter, n = no. of replicates

S. brevicaulis produces about 10 - 20 times more mycelial dry weight and grows as a denser colony than P. schweinitzii, and there is no growth response to the above As concn..

4.102 Dry weight determination.

The reduction in weight of mycelia during microwaving was followed:

Microwave duration (min)	Mycelial dry wt. (g l ⁻¹)	n
0	85.65	5
2	59.55	5
4	28.80	5
6	12.60	5
8	7.30	5
10	6.65	5
15	6.50	5

After ten min exposure to microwaves the samples looked dry and the above results show that little, further reduction in weight occurs.

4.103 Growth on increasing malt concentrations.

	Malt concn. (g l ⁻¹)					n
	10	20	50	70	100	
liquid medium dry wt. (g l ⁻¹)	4.15	8.55	20.20	43	634	5
solid medium cd (mm)	49.5	50	60	67	72.5	5

4.104 Growth in the light and the dark.

	cd (nm)	n
Light growth	55.8	5
Dark growth	47.7	5

4.105 Growth at different values of medium pH

Initial pH	1	2	3	4	5	6	n
Mycelia dry wt. (g l ⁻¹)	0	4.45	10.1	11.13	11.9	12.3	5
Final pH	1.5	1.8	2.5	3.0	3.0	3.5	
Initial pH	7	8	9	10	11	12	n
Mycelial dry wt. (g l ⁻¹)	11.7	9.85	°	8.25	17.95	17.3	5
Final pH	4.0	4.0	°	6.0	8.6	8.9	

° not determined

Fig. 4.1051. Growth (dry weights) at different values of medium pH.

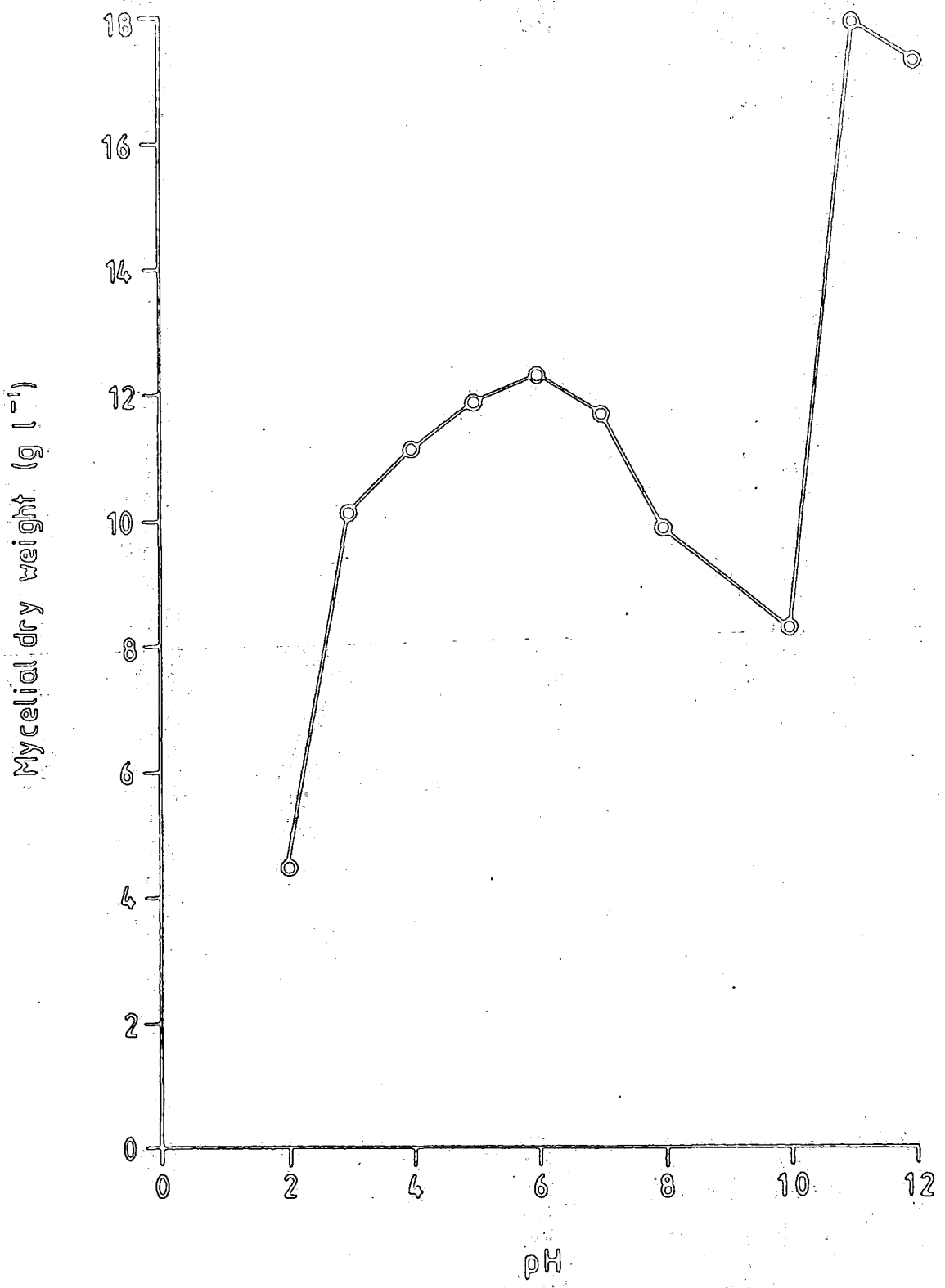

4.106 Growth in the presence of As (III), Se & Te.

Metalloid	Concn. ($\mu\text{g ml}^{-1}$)	Mycelial dry wt. (g l^{-1})	n
As (III)	500	16.1	5
Te	500	14.4	5
Se	500	No growth	5
	50	No growth	5

Growth in the presence of As (III) & Te is as strong as growth with As (V) (section 4.108).

4.107 Growth on Czapek-Dox medium.

	Initial pH	cd (mm)	Mycelial dry wt. (g l^{-1})	n
Solid medium	-	57	-	9
Liquid medium	6.1	-	2.05	10

Growth on this medium is thin and comparable with that of *P. schweinitzii*, although its components are controllable, malt is still a better medium.

4.108 Growth on malt medium with increasing concn. of arsenate.

Arsenic concn. ($\mu\text{g ml}^{-1}$)	<i>S. brevicaulis</i>		<i>P. schweinitzii</i>	
	Mycelial dry wt. (g l^{-1})	n	Mycelial dry wt. (g l^{-1})	n
0	13.05	5	2.5	2
50	11.10	2	2.45	2
100	23.65	2	-	-
250	16.55	2	-	-
500	15.50	2	-	-
1 000	11.55	2	-	-
5 000	11.60	5	§	§
10 000	9.15	5		
15 000	7.45	5		
20 000	6.85	5		
25 000	6.20	5		
30 000	6.60	5		
35 000	9.05	5		
40 000	7.05	5		
50 000	*	2		
100 000	**	2		

* = Very limited growth ** = No growth

§ = No further determinations carried out

4.109 Petri dish growth

The amount of growth in 20 ml of medium was determined each day, the dry weight of malt present in the first 4 days is significant with respect to the weight of mycelia and was subtracted from the mycelial dry weight. The specific growth rate constant, μ , was determined from a natural logarithmic plot of the data (Fig. 4.1093)

Days after inoculation	Mycelial dry wt. (g l ⁻¹)	ln dry wt.	n
1	0	0	5
2	0.3	-1.20	5
3	2.95	1.08	5
4	5.85	1.77	5
5	10.65	2.37	5
6	11.25	2.42	5
7	13.75	2.62	5
8	14.05	2.64	5
9	13.25	2.58	5
10	14.95	2.71	5
11	15.95	2.77	5
12	18.05	2.89	5
14	15.05	2.71	5
20	19.10	2.95	4

Dry weight of 20 ml, malt = 2 g l⁻¹

$$\mu = 0.025 \text{ h}^{-1}$$

Fig. 4.1091. Morphology of S. brevicaulis when grown in petri dishes.

Fig. 4.1092. Morphology differences with (a) and without (b) As.

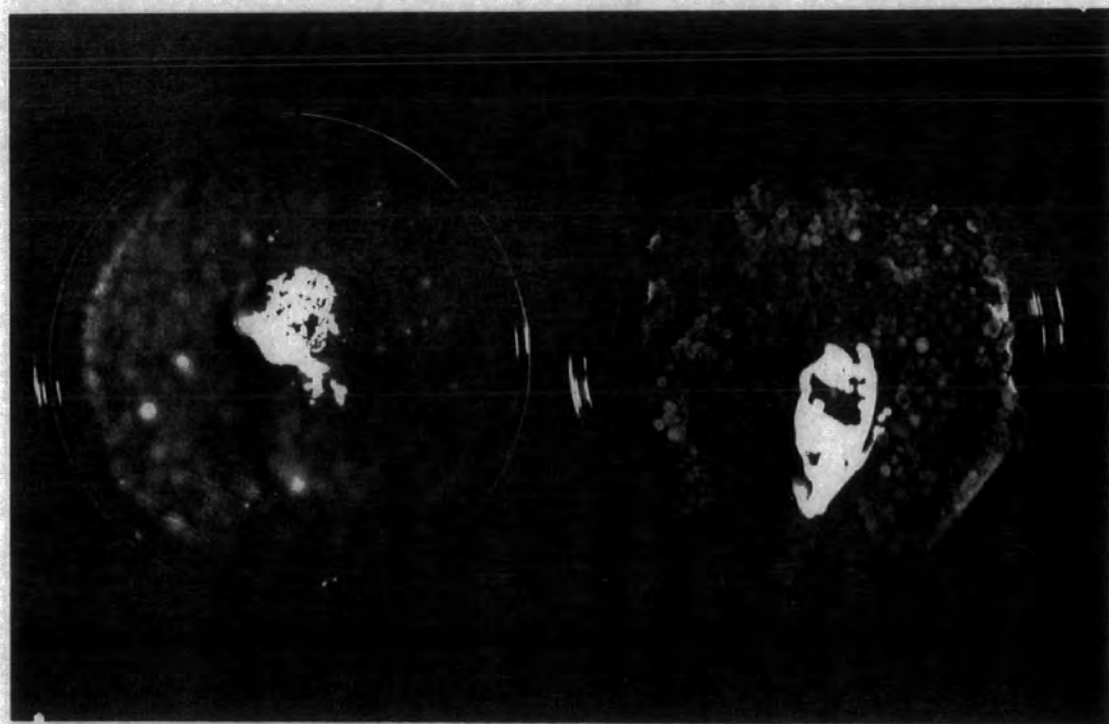
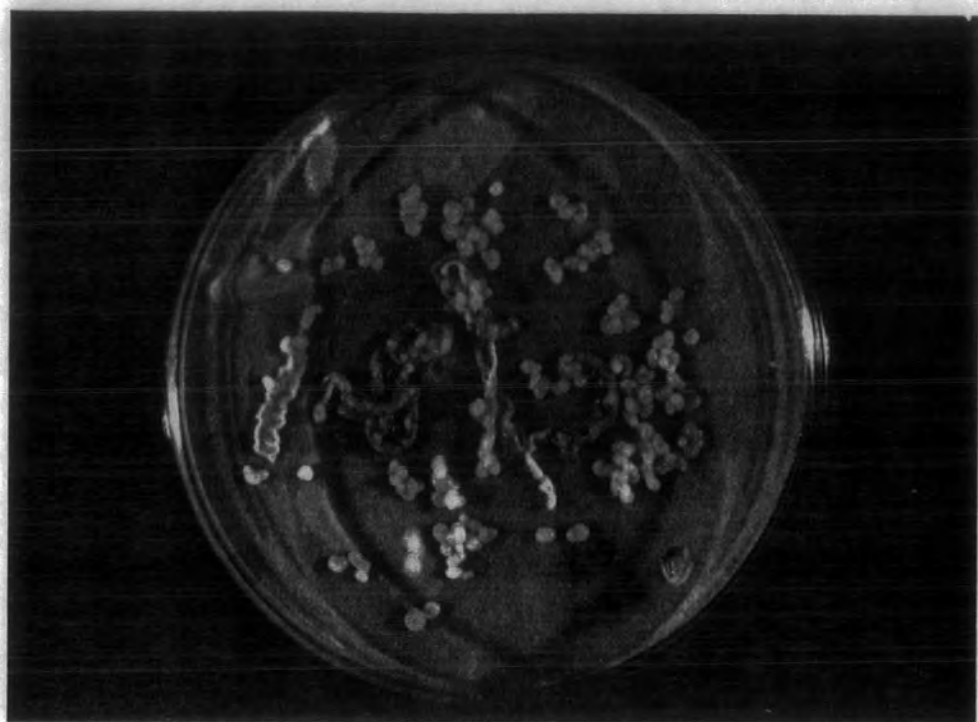

(a)

(b)

Fig. 4.1093. Natural logarithmic plot of growth in petri dishes

Fig. 4.1101. Natural logarithmic plot of growth in shake flasks.

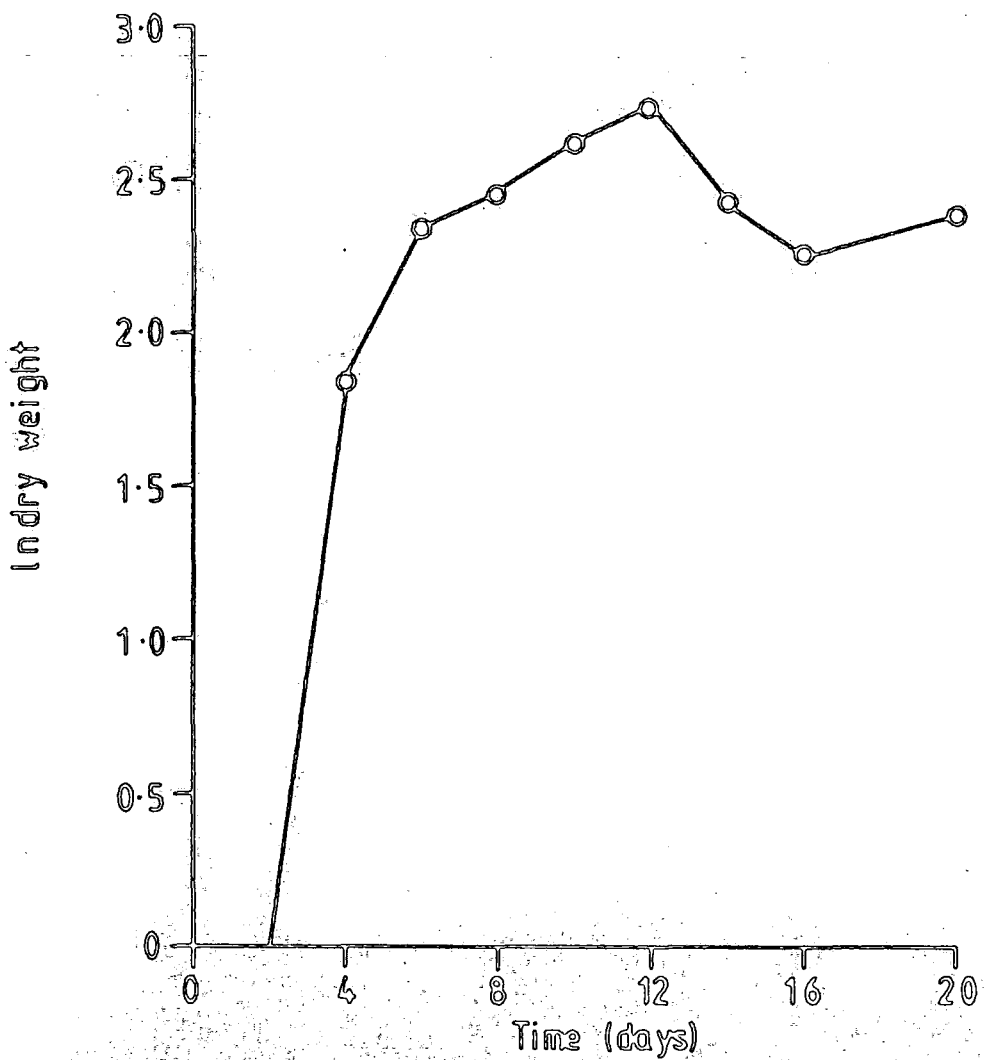
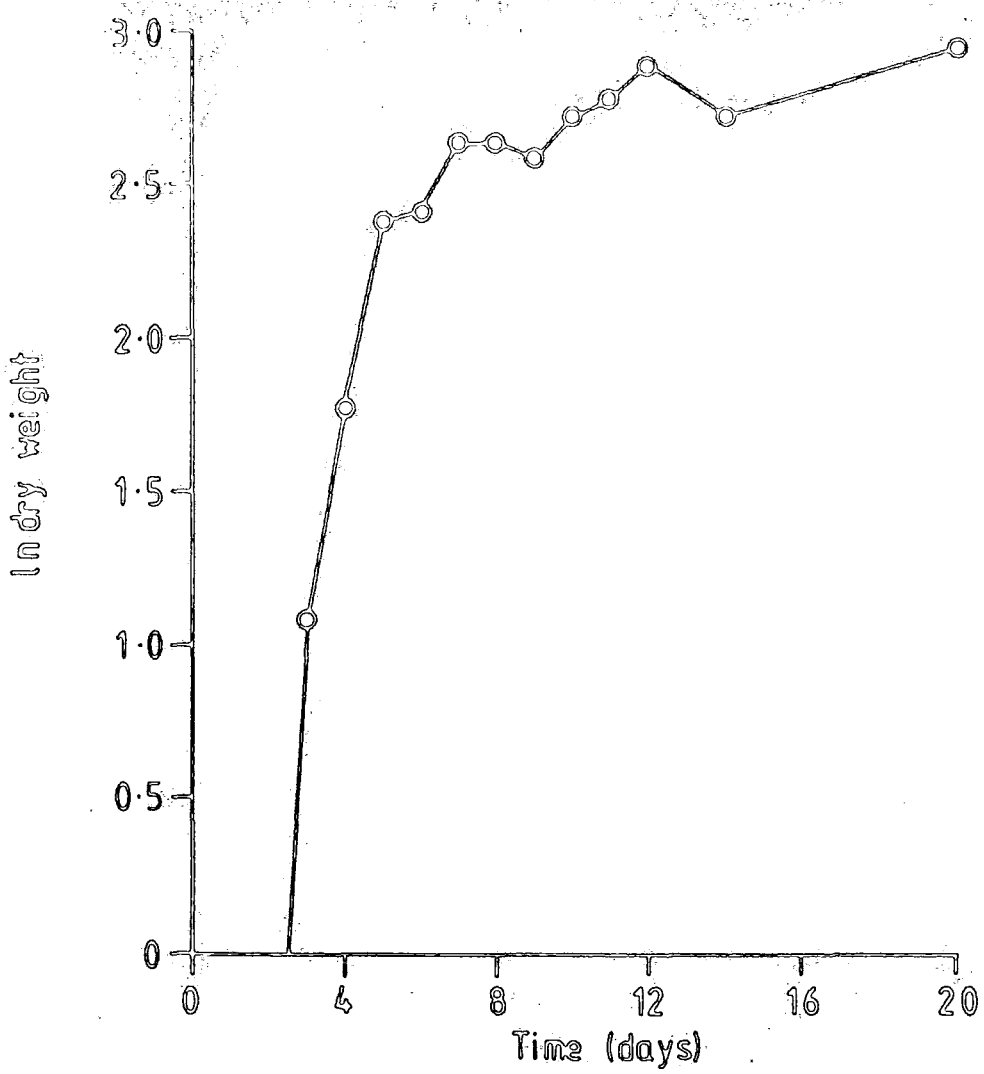

4.110 Shake flask growth

The introduction of aeration to 20 ml cultures does not increase the amount of growth, but would probably be required on a larger scale. The apparent reduction in biomass after 12 days is the result of typically large variations between samples. The specific growth rate constant, μ , was calculated from the following data via a natural logarithmic plot

(Fig. 4.1101). The purity of most shake flask cultures was maintained throughout the experiment.

Days after inoculation	Mycelial dry wt. (g l ⁻¹)	ln dry wt.	n
2	0.95	-0.05	4
4	6.30	1.84	4
6	10.35	2.34	4
8	11.65	2.45	4
10	13.60	2.61	4
12	15.50	2.74	4
14	11.35	2.43	3
16	9.50	2.25	4
20	10.75	2.38	3

$$\mu = 0.033 \text{ h}^{-1}$$

Fig. 4.1102. Undesired shake flask morphology.

Fig. 4.1103. Expected shake flask morphology

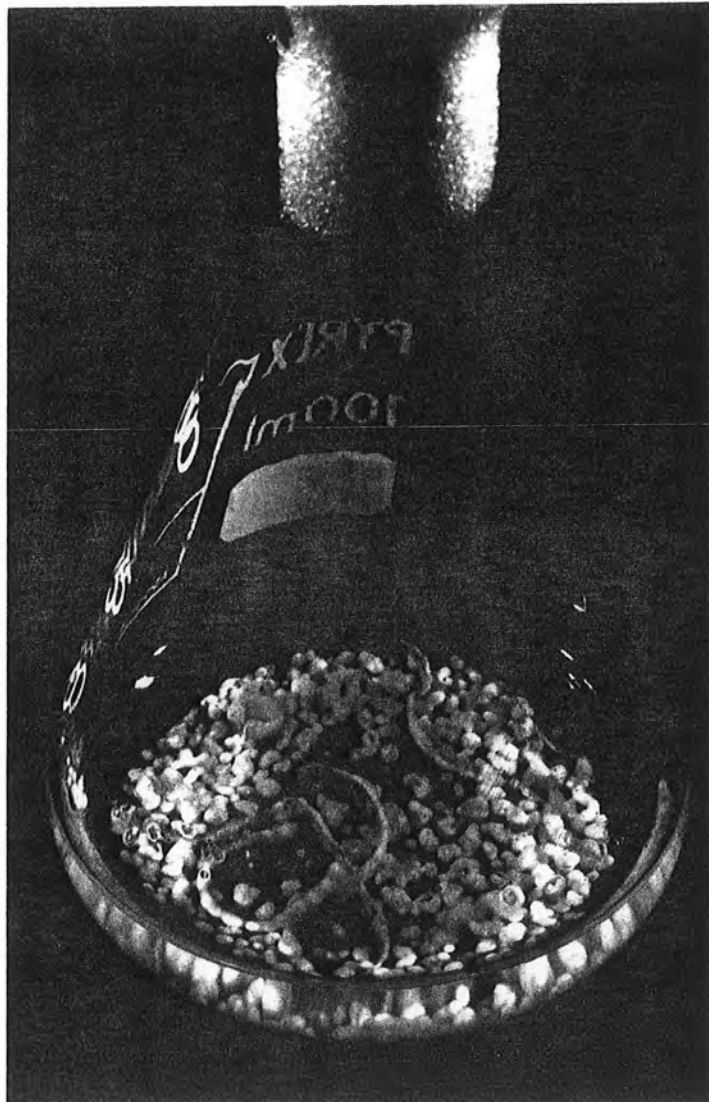

4.111 Chemostat growth.

a) Inoculum spore density.

Calculated from a haemocytometer estimation:

No. of spores counted in each 25 square grid = i) 76 ii) 71

Volume of each grid = 1×10^{-4} ml

$$\begin{aligned} \text{Average no. of spores ml}^{-1} &= (76 + 71 / 2) \\ &= 0.735 \times 10^6 \end{aligned}$$

2 ml were injected into the chemostat = 1.47×10^6 spores

b) Operational parameters.

Average mean generation time (time to double biomass), $t_d = 24$ h

$$\begin{aligned} \text{Specific growth rate (no. of doublings h}^{-1}\text{)}, \mu &= \log_e 2 / t_d \\ &= 0.693 / 24 \\ &= 0.029 \text{ h}^{-1} \end{aligned}$$

With steady state conditions dilution rate (D) = μ

Theoretical dilution rate = 0.029 h^{-1}

Peristaltic pump delivery rate = 0.014 l h^{-1}

Working volume of fermenter = 0.080 l

Actual dilution rate = 0.175 h^{-1}

Feedstock concn. = 50 g l^{-1}

Amount of media delivered = 0.7 g h^{-1}

$$= 16.8 \text{ g day}^{-1}$$

Typical rate of air delivery = $0.5 \text{ vol. air / vol. media / min}$

Chemostat working volume = 0.080 l

Thus typical air delivery rate = 0.040 l min^{-1}

Actual air delivery rate = 0.345 l min^{-1}

Steady state conditions were attained 3 days after inoculation:

after day 9 the medium feed flask became contaminated with *S. brevicaulis* and the medium outflow pH dropped to 4.9, so the run was terminated:

Days after inoculation	Mycelial dry wt. (g l ⁻¹)	Medium pH	Medium delivered (ml)
3	2.80	5.2	-
4	1.60	5.2	300
5	1.90	5.1	600
6	2.40	5.0	800
7	2.75	5.2	1 000
8	1.55	5.1	1 200
9	2.15	5.0	1 400

Average mycelial dry weight = 2.16 g l⁻¹

Theoretical productivity = D x average biomass

$$= 0.175 \times 2.16$$

$$= 0.378 \text{ g h}^{-1}$$

$$= 9.072 \text{ g day}^{-1}$$

Conversion efficiency = amount of biomass / unit weight of medium

$$= 9.072 / 16.8$$

$$= 54 \%$$

4.2 Growth in industrial environments.

4.21 Growth on realgar.

The presence of AsS in the medium did not reduce the amount of growth, the following colony diameters are comparable with those from untreated medium (section, 4.101):

	AsS concn. ($\mu\text{g ml}^{-1}$)			n
	50	100	500	
cd (mm)	39.9	44	34.4	5

4.22 Growth on industrial effluents.

Only a small amount of growth (and thus not assessed) was visible on the lower As concn. effluent, showing that a carbon source is required for growth.

4.23 Swab sampling.

3 samples revealed no growth on liquid or solid media, 2 samples produced buff coloured mycelia which were subcultured and identified as a species of Aspergillus (Fig. 4.231). One sample yielded a mixture of bacteria and fungi, whilst the last isolate contained a phycomycete. S. brevicaulis was not isolated from the plant, but the above isolates may prove useful sources of As processing material, which are adapted to that environment.

4.3 Microscopic investigation.

4.31 Surface polymer investigation.

a) periodic acid / Schiff's staining (Fig. 4.311).

The cell walls stained magenta indicating the presence of carbohydrates, whilst the extracellular spaces remained unstained providing evidence to show that carbohydrates are not released into the medium.

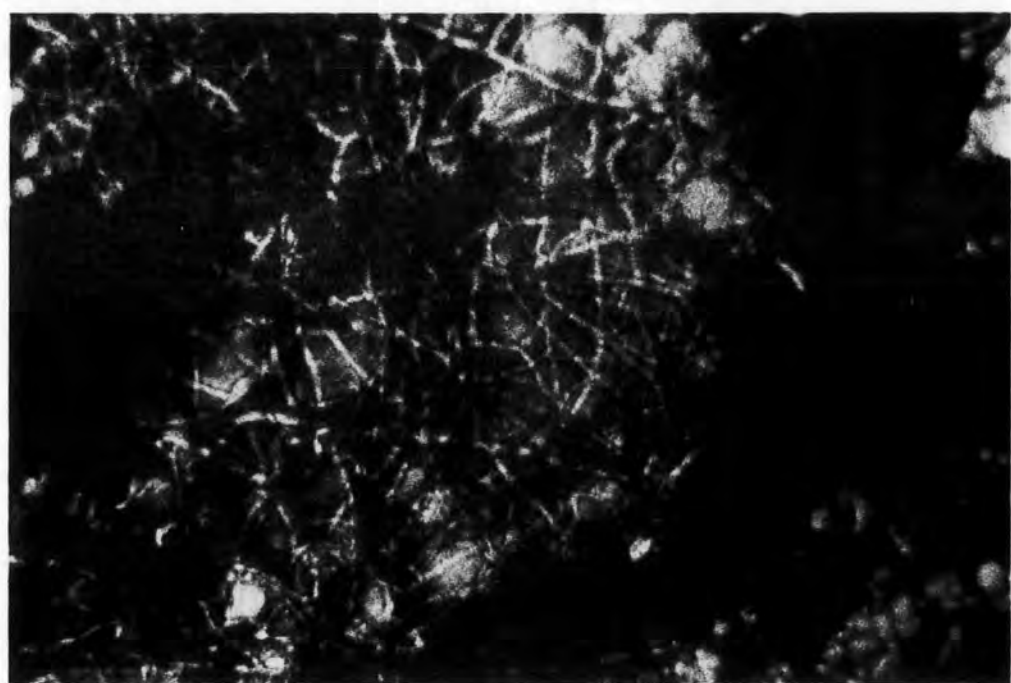
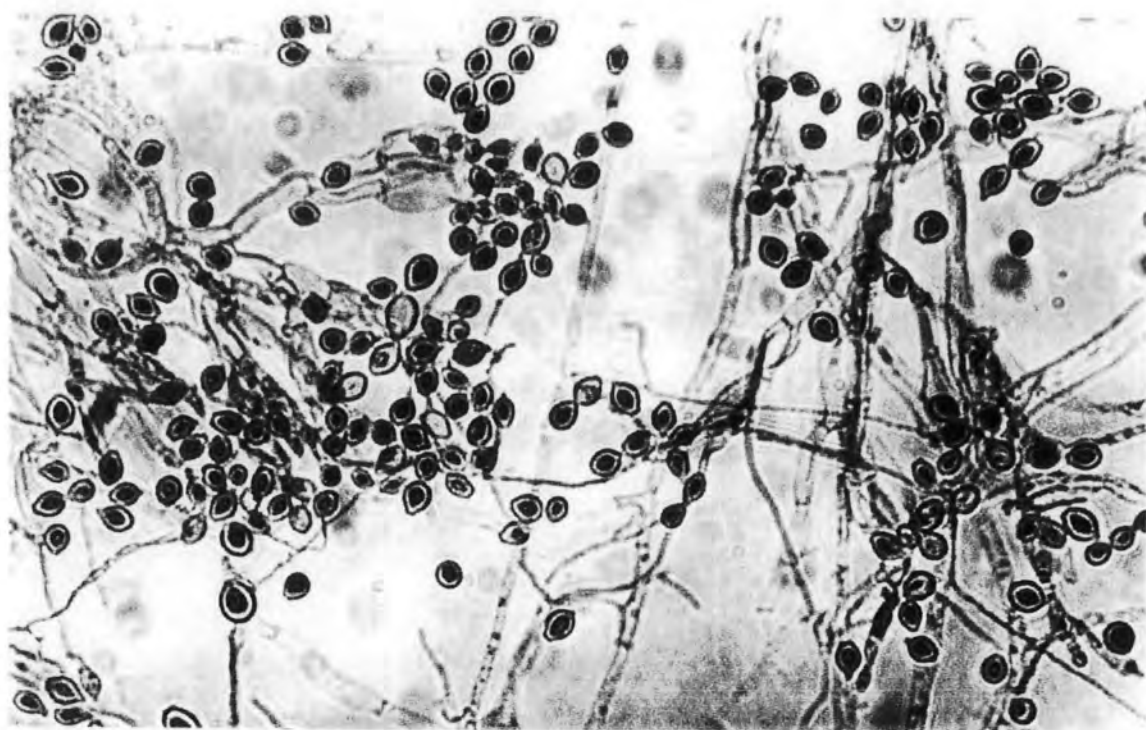

Fig. 4.311. As grown mycelia stained with periodic acid /
Schiff's reagent, magnification: X 650.

Fig. 4.312. Nigrosin capsule staining, magnification: X 650.

8

Fig. 4.313. Fluorescent staining of a sample of mycelia
with calcofluor, magnification: X 400

Fig. 4.231. Swab sample isolate, magnification: X 650

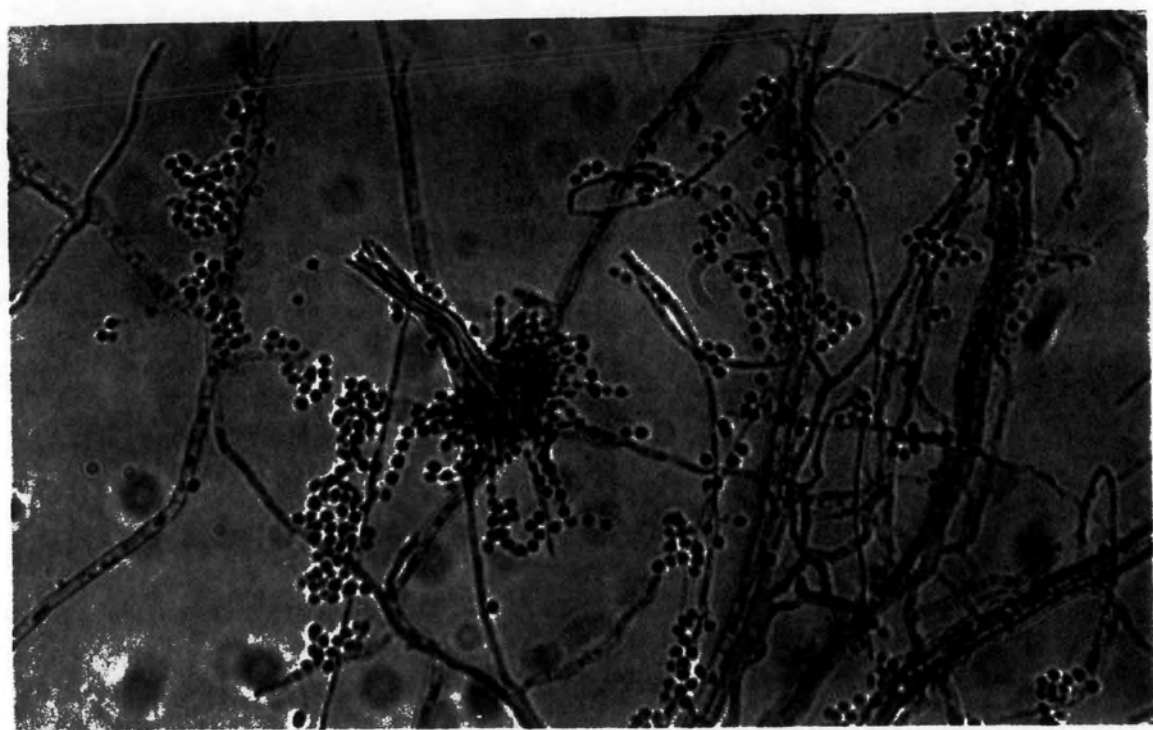
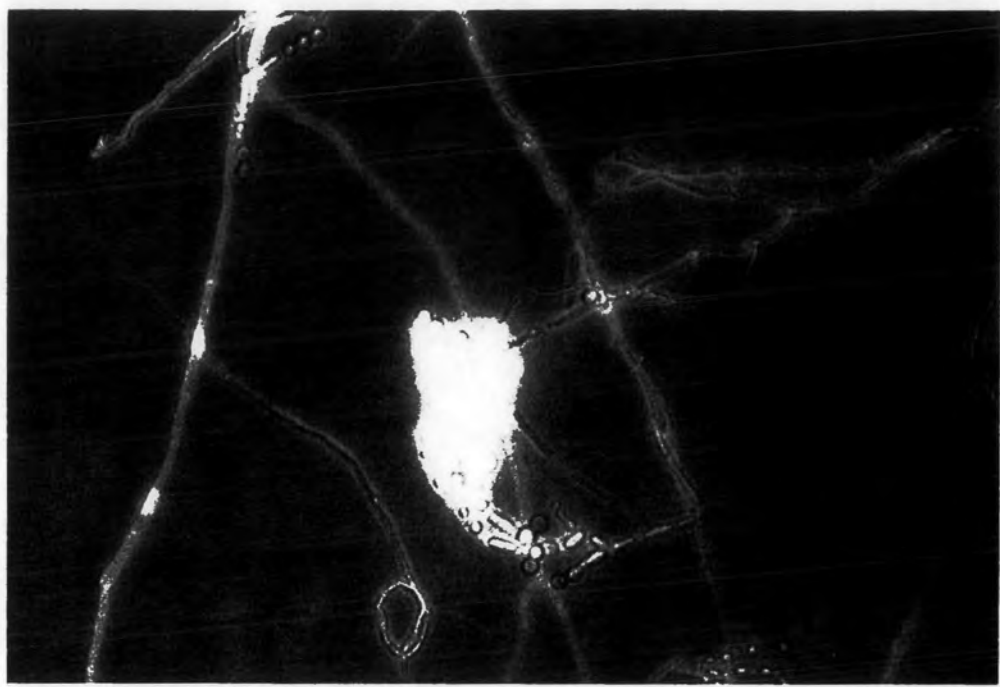

Fig. 4.314. Light micrograph of S. brevicaulis spore configuration



b) nigrosin capsule staining (Fig. 4.312)

The increase in medium viscosity may be accounted for by the formation of a capsule around the hyphae, but no translucent capsule region was seen between the negatively stained extracellular spaces (stained black) and the positively stained cytoplasm (stained red)

c) calcofluor (Fig. 4.313)

This compound stains materials with β 1-4, glucan linkages, ie cellulose. Only the hyphae fluoresced (especially at the growing hyphal tips) indicating that cellulose is not released into the media.

d) Coomassie Blue staining (no photograph taken)

No proteins were detected in the extracellular spaces, for once again the hyphae became stained, whilst the extracellular spaces remained unstained.

4.32 Immunofluorescence

Hyphal samples exposed to fluorescently labelled polyclonal antibodies did not fluoresce strongly and thus no photographs were taken.

4.33 Scanning electron microscopy.

Used to perform structural measurements and observe the behaviour of this species when placed, untreated, into the path of an electron beam. Without critical point drying the hyphae and anellophores collapse (Fig. 4.331 & 4.332), but the spores retain their structure, their roughened surface (Fig. 4.333 & 4.334) being a feature of this species.

Fig. 4.331. Scanning electron micrograph of S. brevicaulis.
magnification: X 375.

Fig. 4.332. Scanning electron micrograph of annellophores & conidia
magnification: X 750.



40μ

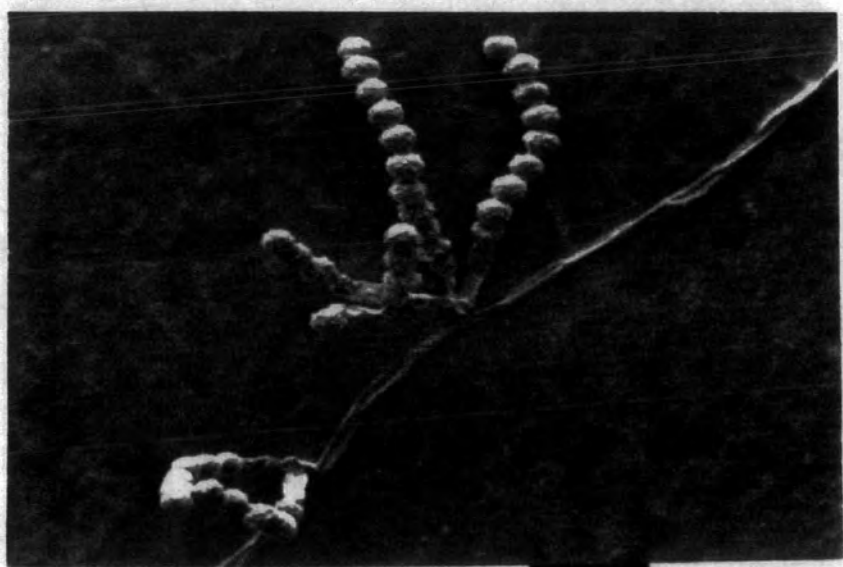

20μ

Fig. 4.333. Close up of annellophores & conidia,

magnification: X 1500.

Fig. 4.334. Close up of collapsed hyphae, annellophores & conidia,

magnification: X 1500.

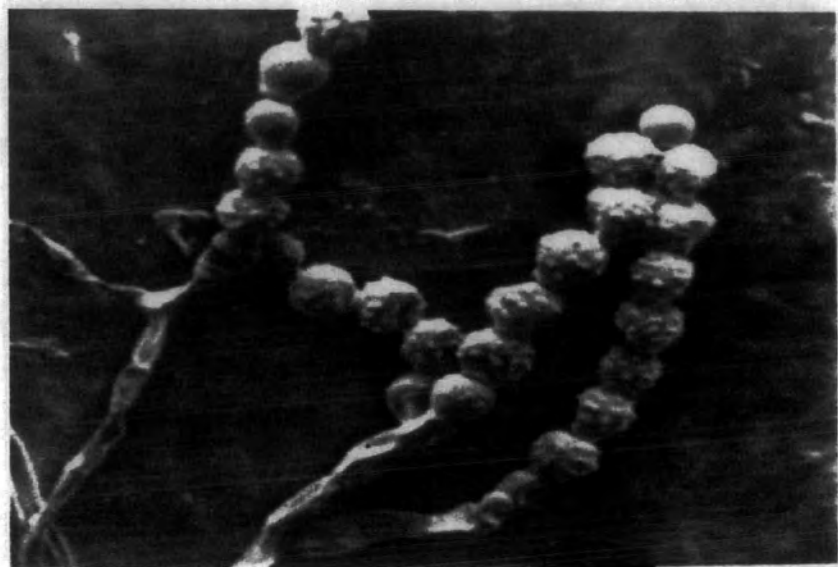

101

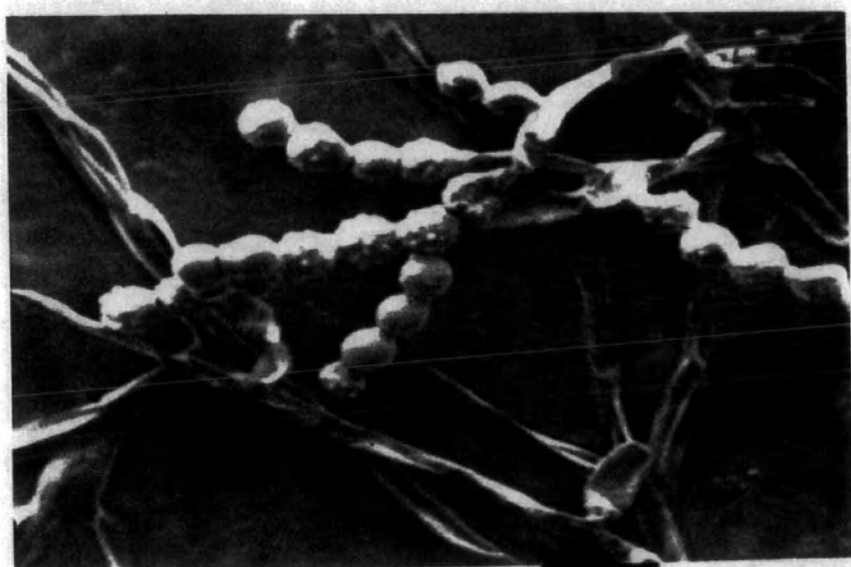

101

Micrograph measurements:

Structure	micrograph measurements [*]	reported measurements
	(μm)	(μm)
Hyphal diameter	2 - 3	3 - 5 ^{**}
Anellophore length	15 - 20	9 - 25 ^{**}
Anellophore diameter	3 - 4	3 - 4 ^{**}
Spore diameter	4 - 5	4.5 - 9 ^{***}
Length of spore chains	20	18 - 40 ^{***}

Maximum no. spores / chain = 10 (no. less than this probably represent broken chains)

^{*} calculated from (Figs. 4.331, 4.332, 4.333 & 4.334)

^{**} Morton & Smith (1963)

^{***} Martin-Scott (1954)

4.4 Testing for arsenic accumulation and trimethylarsine evolution.

4.41 Mo/Va/HCl calibration & spectra

Spectrophotometer wavelength and time scans for a $20 \mu\text{g ml}^{-1}$ As solution plus indicator were carried out to determine the best time & wavelength to use for this test (Fig. 4.411 & 4.412). As no absorption peak appeared in a scan from 350 - 450 nm, readings were taken at 400 nm. After 10 min reaction time the A_{400} readings stabilised, therefore values were recorded 10 min after addition of the indicator.

A $500 \mu\text{g ml}^{-1}$ As standard (0.814 g 400 ml^{-1} distilled water) was used to calibrate the As indicator solution:

Fig. 4.411. A_{400} time course for Mo/Va/HCl + $20 \mu\text{g ml}^{-1}$ As,

y axis: 10 mm = 0.1 absorbance units, x axis: 10 mm = 100 s.

Fig. 4.412. Spectral scan of the Mo/Va/HCl + $20 \mu\text{g ml}^{-1}$

y axis: 10 mm = 10 nm, x axis: 10 mm = 0.167 absorbance units

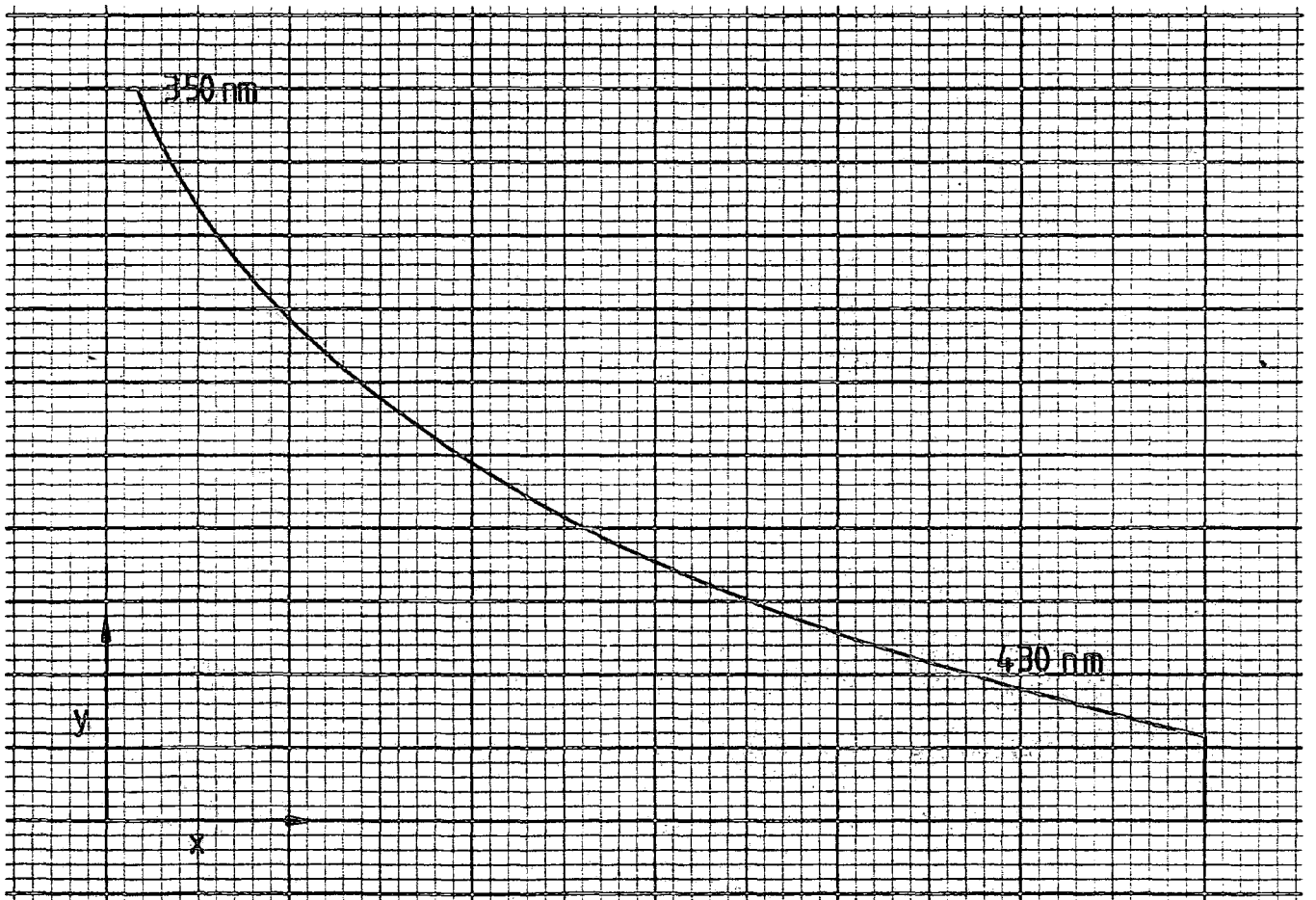
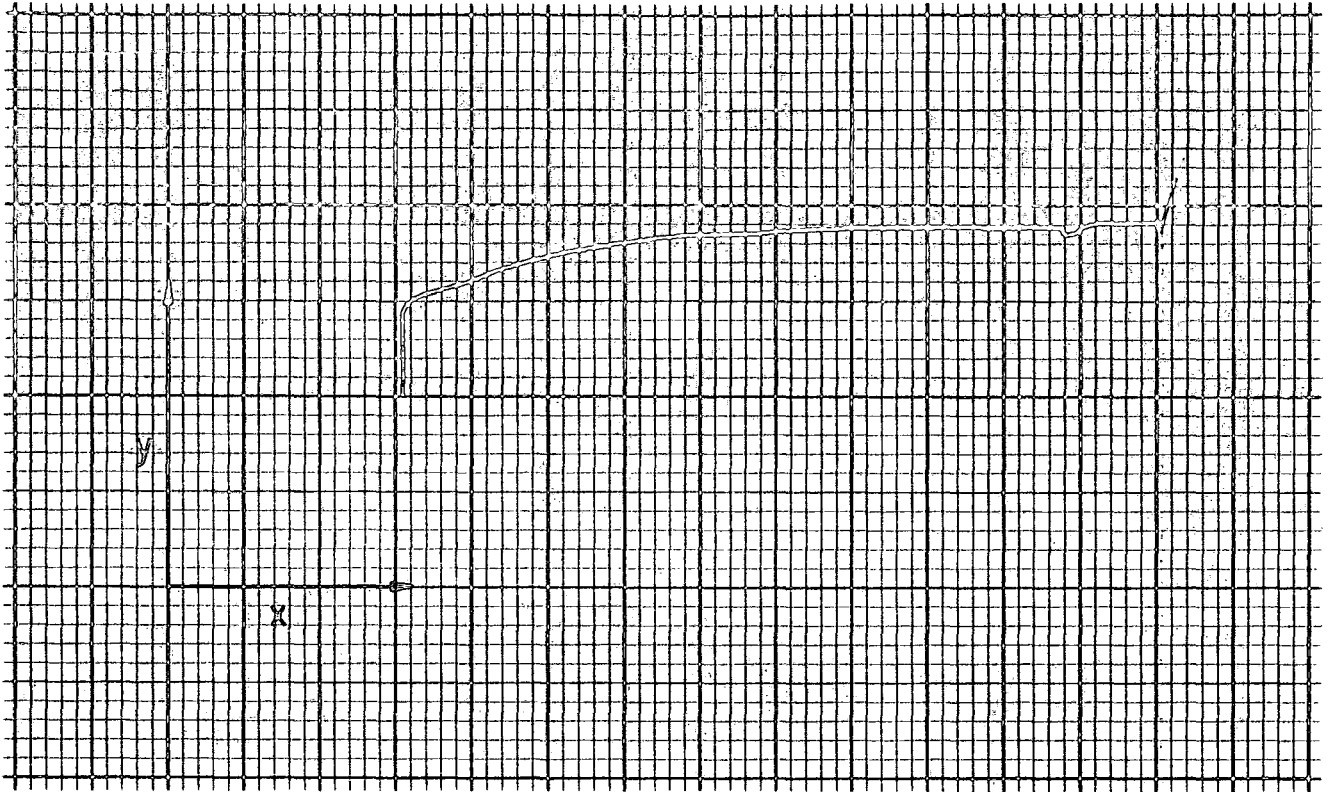

Total reaction volume = 30 ml indicator volume = 3 ml n = 5

As concn. ($\mu\text{g ml}^{-1}$)	Volume of As standard (ml)	Volume of dH_2O (ml)	A_{400}
0	0	27.0	0
10	0.6	26.4	0.202
20	1.2	25.8	0.375
30	1.8	25.2	0.689
40	2.4	24.6	0.760
50	3.0	24.0	1.076
60	3.6	23.4	1.278
70	4.2	22.8	1.465
80	4.8	22.2	1.628
90	5.4	21.6	1.733
100	6.0	21.0	1.855
110	6.6	20.4	1.917

Diluted indicator (0.1X) $A_{400} = 0.211$

Regression line for the As concn. range 0 - 80 $\mu\text{g ml}^{-1}$ (Fig.4.413):

$$y = 0.021 x - 0.005 \quad r = + 0.996$$

4.42 Use of the Mo/Va/HCl test in the presence of 50 g l^{-1} malt.

Addition of malt medium to the indicator changes it's sensitivity; thus further calibration is required:

Total reaction volume = 10 ml indicator volume = 1 ml

medium volume = 2 ml n = 2

11

Fig. 4.413. Calibration curve for the Mo/Va/HCl test:

As + distilled water.

Fig. 4.421. Calibration curve for the Mo/Va/HCl test: As + 10 g l⁻¹

malt.

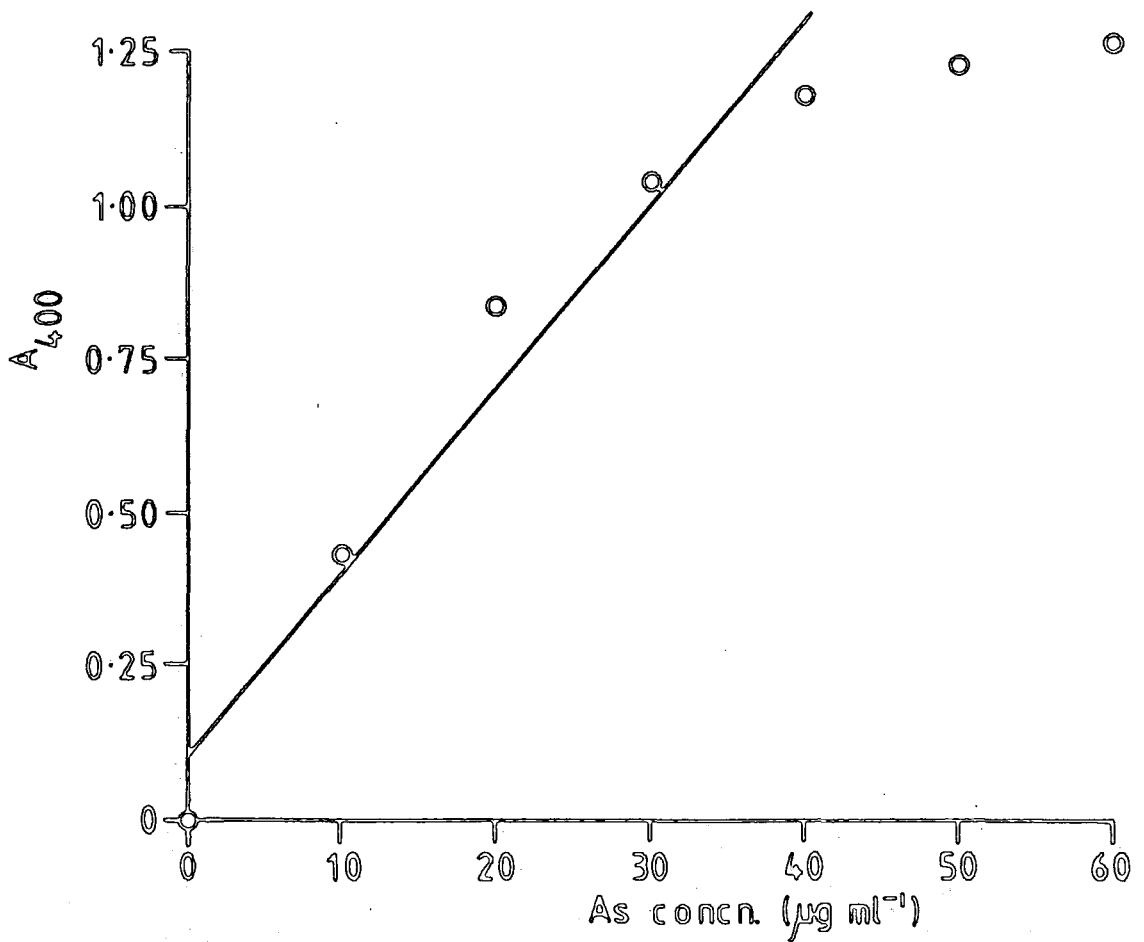
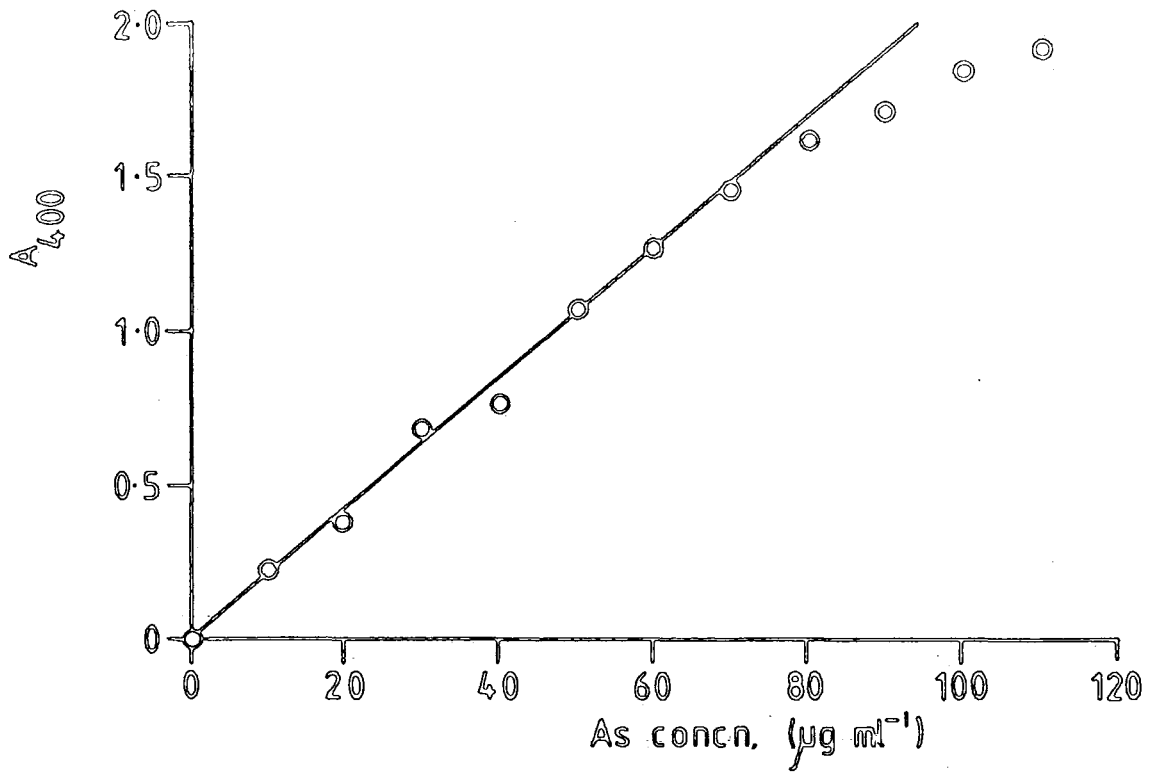

As concn. ($\mu\text{g ml}^{-1}$)	Volume of As standard (ml)	Volume of dH_2O (ml)	A_{400}
0	0	7.0	0
10	0.2	6.8	0.436
20	0.4	6.6	0.843
30	0.6	6.4	1.046
40	0.8	6.2	1.185
50	1.0	6.0	1.243
60	1.2	5.8	1.265

Diluted indicator (0.1X) $A_{400} = 0.095$

Regression line for the As concn. range 0 - 40 $\mu\text{g ml}^{-1}$ (Fig. 4.421)

$$y = 0.0298 x + 0.1060 \quad r = 0.9745$$

4.43 The reduction in medium As concn. by actively growing mycelia

1) 50 g l^{-1} malt

Arsenic concn. change. (see Figs. 4.431 & 4.432)

For all results in this section $n = 5$

Initial medium As concn. = 0 $\mu\text{g ml}^{-1}$		
Days after inoculation	mycelial dry wt. (g l^{-1})	A_{400}
0	-	1.114
2	1.85	1.011
4	8.30	0.513
6	11.65	0.334
8	12.05	0.346
10	16.5	0.321

Initial As concn. = 50 $\mu\text{g ml}^{-1}$

Days after inoculation	mycelial dry wt. (g l^{-1})	A_{400}
0	-	1.425
2	2.21	1.200
4	9.91	0.566
6	13.05	0.874
8	13.00	0.545
10	19.85	0.448

Initial As concn. = 100 $\mu\text{g ml}^{-1}$

Days after inoculation	mycelial dry wt. (g l^{-1})	A_{400}
0	-	1.660
2	2.15	1.260
4	9.71	0.433
6	15.35	0.787
8	14.50	0.616
10	17.20	0.566

Initial As concn. = 200 $\mu\text{g ml}^{-1}$

Days after inoculation	mycelial dry wt. (g l^{-1})	A_{400}
0	-	1.890
2	2.1	1.647
4	10.8	0.772
6	16.6	1.439
8	12.0	1.016
10	17.75	1.052

Fig. 4.521. Homogenised mycelia, magnification: X 650.

Fig. 4.522. French press treated mycelia: X 650.

b)

After 48 h incubation at RTP the following As contents, assessed by the wet oxidation method (section 3.56), were determined in samples originally containing $500 \mu\text{g ml}^{-1}$ As:

	As concn. ($\mu\text{g ml}^{-1}$)
Control (no As)	485
Culture filtrate I	435
Culture filtrate II	430

4.52 The release of cytosol enzymes

The cellular fractions incubated for 48 h with PB + $500 \mu\text{g ml}^{-1}$ As were assayed for possible As conversion with the wet oxidation test:

Sample	n	As concn. ($\mu\text{g ml}^{-1}$)
Control (no As)	2	450
1 st pellet	2	478
2 nd pellet	2	468
2 nd supernatant	2	478

4.48 Testing for trimethylarsine

After 20 days exposure both the control (no As) and the treatment ($500 \mu\text{g ml}^{-1}$) HgCl_2 paper turned brown at the edges, probably due to reagent ageing rather than trimethylarsine detection. As a garlic odour was evolved from the treatment plates, the HgCl_2 paper does not appear to detect $\text{As}(\text{CH}_3)_3$.

4.5 Extra and intracellular enzymes.

4.51 Extracellular As methylating enzymes

a)

The following A_{400} readings were taken for culture filtrate with $200 \mu\text{g ml}^{-1}$ As added:

Sampling time after As addition (h)	0	2	4	16	32
Filtrate + As, A_{400}	1.175	1.135	1.048	1.106	0.827
Effective As concn. ($\mu\text{g ml}^{-1}$)	209	189	144	174	29
Filtrate without As	0.847	0.847	0.924	0.836	0.767
Effective As concn. ($\mu\text{g ml}^{-1}$)	39	39	79	33	0

1.

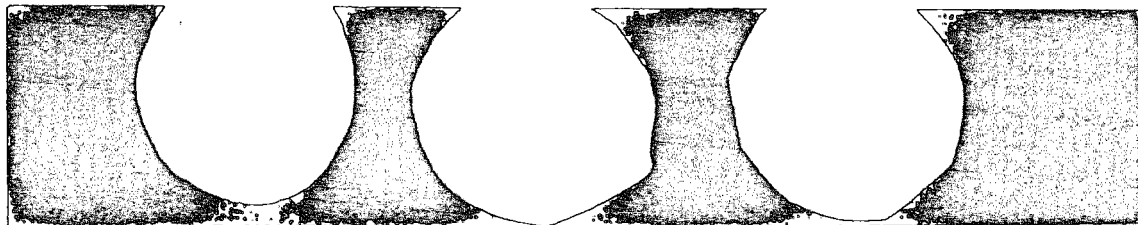

2.

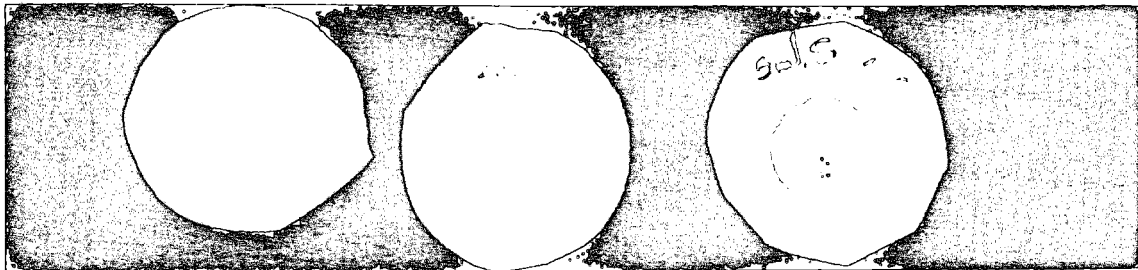

3.

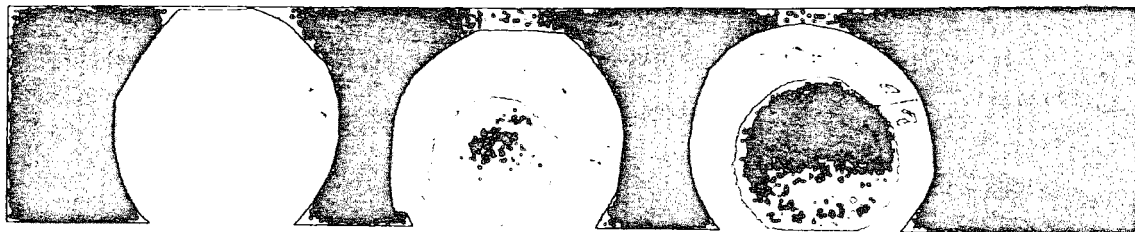

1.



2.

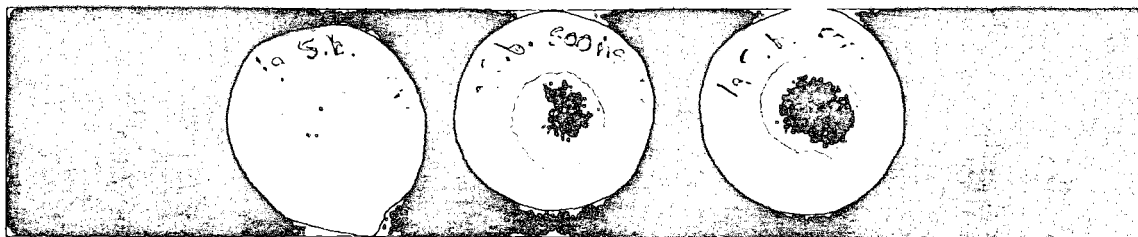

3.

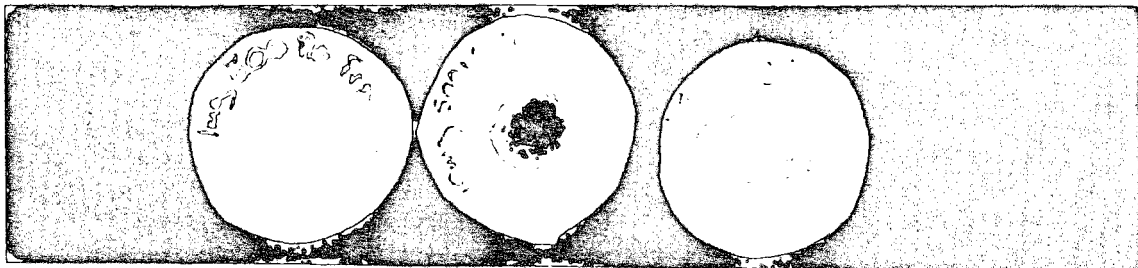

4.

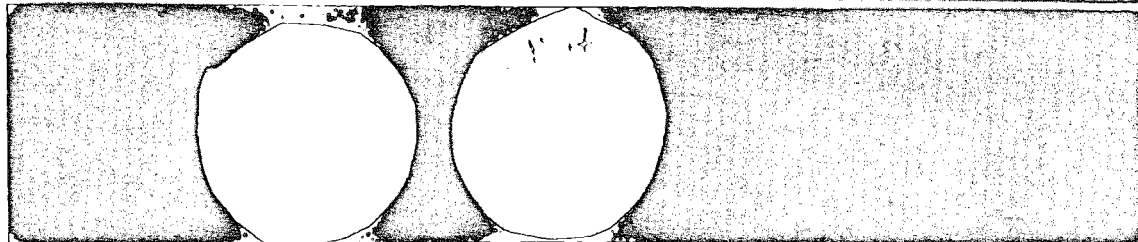

Fig. 4.471. Standards of the arsine generation test:

1. 0, 5 & 10 $\mu\text{g ml}^{-1}$ As
2. 15, 20 & 50 $\mu\text{g ml}^{-1}$ As
3. 100, 250 & 500 $\mu\text{g ml}^{-1}$ As.

Fig. 4.472. Results of samples used in the arsine generation test:

1. As content of mycelia grown without As
2. As content of mycelia grown on 500 $\mu\text{g ml}^{-1}$ As
3. As content of 1, 10 & 250 mg of freeze dried mycelia grown on 500 $\mu\text{g ml}^{-1}$ As.
4. As content of 1 g mycelial mat exposed to 500 $\mu\text{g ml}^{-1}$ As.

Type of mycelial sample	weight (ug)	Colour of HgCl_2 paper	Effective As concn. ($\mu\text{g ml}^{-1}$)
Grown without As	1000	no colour	0
Grown with 500 $\mu\text{g ml}^{-1}$ As	1000	light brown	> 50
Grown with 500 $\mu\text{g ml}^{-1}$ As	250	dark brown	> 500
& freeze dried	10	light brown	> 100
	1	light yellow	20
Mycelial mats with 500 $\mu\text{g ml}^{-1}$ As	1000	orange centre, yellow edge	15

Hence As accumulation levels are:

- i) Mycelia grown without As = 0 $\mu\text{g As mg}^{-1}$ mycelia
- ii) Mycelia grown with 500 $\mu\text{g ml}^{-1}$ As = > 0.5 $\mu\text{g As mg}^{-1}$ mycelia
- iii) Freeze dried mycelia + 500 $\mu\text{g ml}^{-1}$ As = > 2 $\mu\text{g As mg}^{-1}$ mycelia
- iv) Mycelial mats + 500 $\mu\text{g ml}^{-1}$ As = 0.015 $\mu\text{g As mg}^{-1}$ mycelia

4.47 Determination of mycelial As uptake.

a) As standards

The following volumes of a $10 \mu\text{g ml}^{-1}$ As standard were used to calibrate the detection procedure:

Volume of standard (ml)	Effective As concn. ($\mu\text{g ml}^{-1}$)	Colour of HgCl_2 paper
0	0	white
0.25	2.5	light yellow
0.5	5	yellow
1.0	10	dark yellow
1.5	15	orange centre, yellow edge
2.0	20	orange
25	250	light brown
50	500	dark brown

b) Mycelial samples

The As content of the following samples was determined by converting it to arsine and comparing the spot colour on HgCl_2 paper with the above standards:

4.46 Comparison of the ICI wet oxidation test with the Mo/Va/HCl test.

Samples of 5 % malt and 1 % glucose, with an original As concn. of $500 \mu\text{g ml}^{-1}$ were assayed over a period of 18 days by the wet oxidation test (carried out at ICI Billingham) and compared with results from the Mo/Va/HCl test:

Days after inoculation	As concn. ($\mu\text{g ml}^{-1}$)	
	wet oxidation test	Mo/Va/HCl test
a) 5 % malt		
3	565	741
6	498	790
9	637	699
12	600	588
18	495	346
b) 1 % glucose		
3	727	471
6	817	503
9	740	481
12	-	452
18	695	530

Values higher than the original As concn. of $500 \mu\text{g ml}^{-1}$ are probably the result of evaporation of liquid from the sampling tubes and thus concn. of the As present.

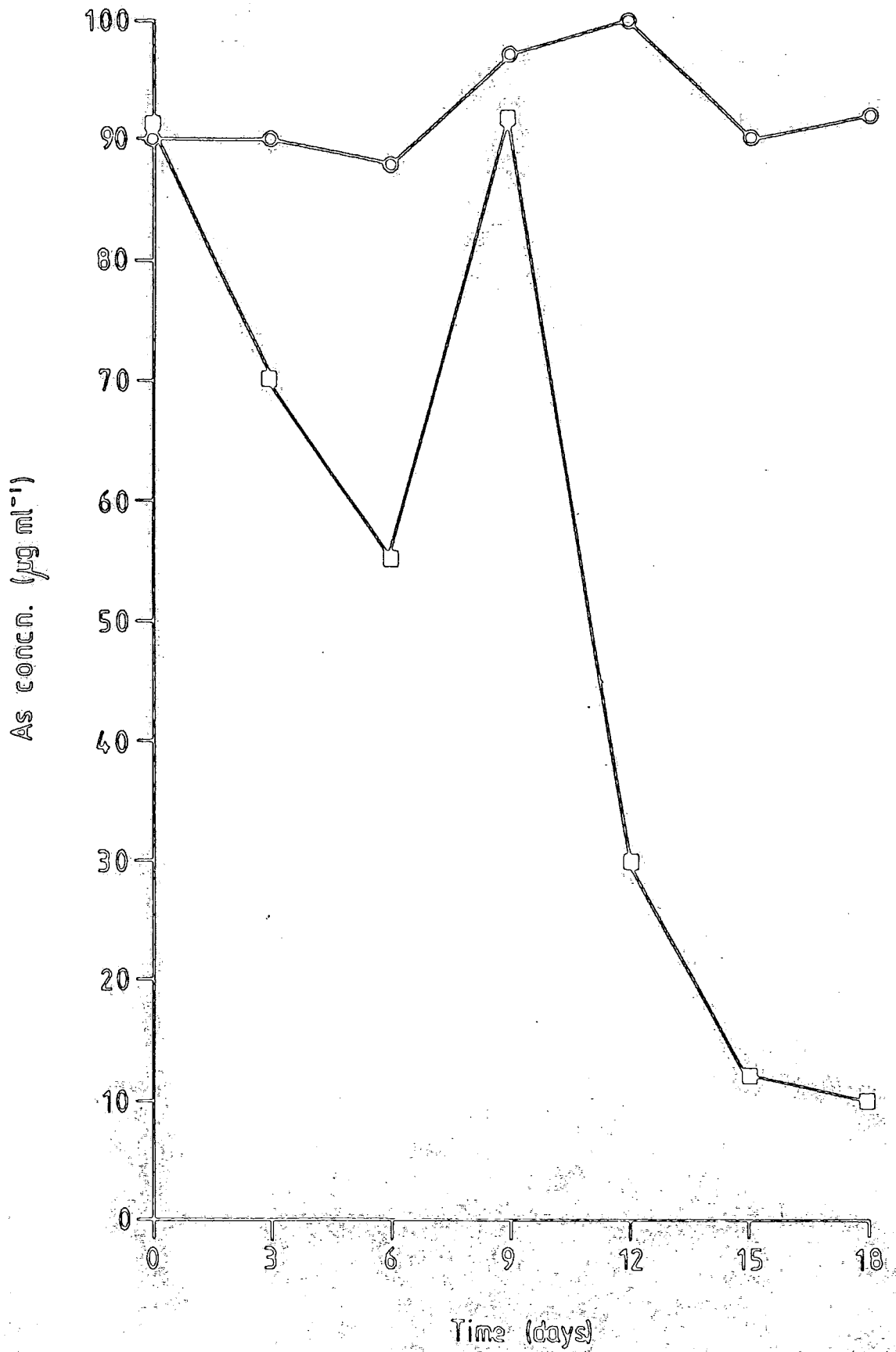

Fig. 4.451. Reduction in As concn.: glass petri dish control, 100 (○) $\mu\text{g ml}^{-1}$ and larger scale colony mats, 100 (□) $\mu\text{g ml}^{-1}$.

iii) As plates after 18 days incubation.

	A_{625}	Effective glucose concn. ($\mu\text{g ml}^{-1}$)
I	0.197	15
II	0.235	20
III	0.211	17
IV	0.299	29
V	0.194	15

c) As uptake on 0.01 % glucose.

Day		A_{400}	Effective As concn. ($\mu\text{g ml}^{-1}$)
0	I	0.883	84
	II	0.862	91
	III	0.847	87
10	I	0.775	62
	II	0.742	59
	III	0.763	64

b) Reduction in medium glucose concn.

i) Standardisation curve

Glucose concn. (mg ml^{-1})	A_{625}
0	0.077
20	0.224
40	0.380
60	0.545
80	0.692
100	0.774

Regression equation: $y = 0.072 x + 0.0877$ $r = + 0.996$

ii) Control

	A_{625}	Effective glucose concn. ($\mu\text{g ml}^{-1}$)
I	0.720	88
II	0.795	98
III	0.686	83
IV	0.708	86
V	0.690	83

d) As induced *S. brevicaulis* colonies plus Cellophane.

1 000 $\mu\text{g ml}^{-1}$ not determined.

Days after initiation	A_{400}	-	Effective As concn. ($\mu\text{g ml}^{-1}$)	-
0	1.303	-	464	-
1	1.346	-	469	-
2	1.209	-	408	-
4	1.093	-	339	-
8	0.976	-	270	-

4.45 Larger mycelial mats

a) Reduction in medium As concn.

Original As concn. = 100 $\mu\text{g ml}^{-1}$

Control = glass plate with no cellophane

Days after initiation	Treatment		Control	
	A_{400}	Effective As concn. ($\mu\text{g ml}^{-1}$)	A_{400}	Effective As concn. ($\mu\text{g ml}^{-1}$)
0	0.858	91	0.855	90
3	0.784	70	0.857	90
6	0.729	55	0.849	88
9	0.864	92	0.884	97
12	0.673	30	0.896	100
15	0.573	12	0.857	90
18	0.566	10	0.863	92

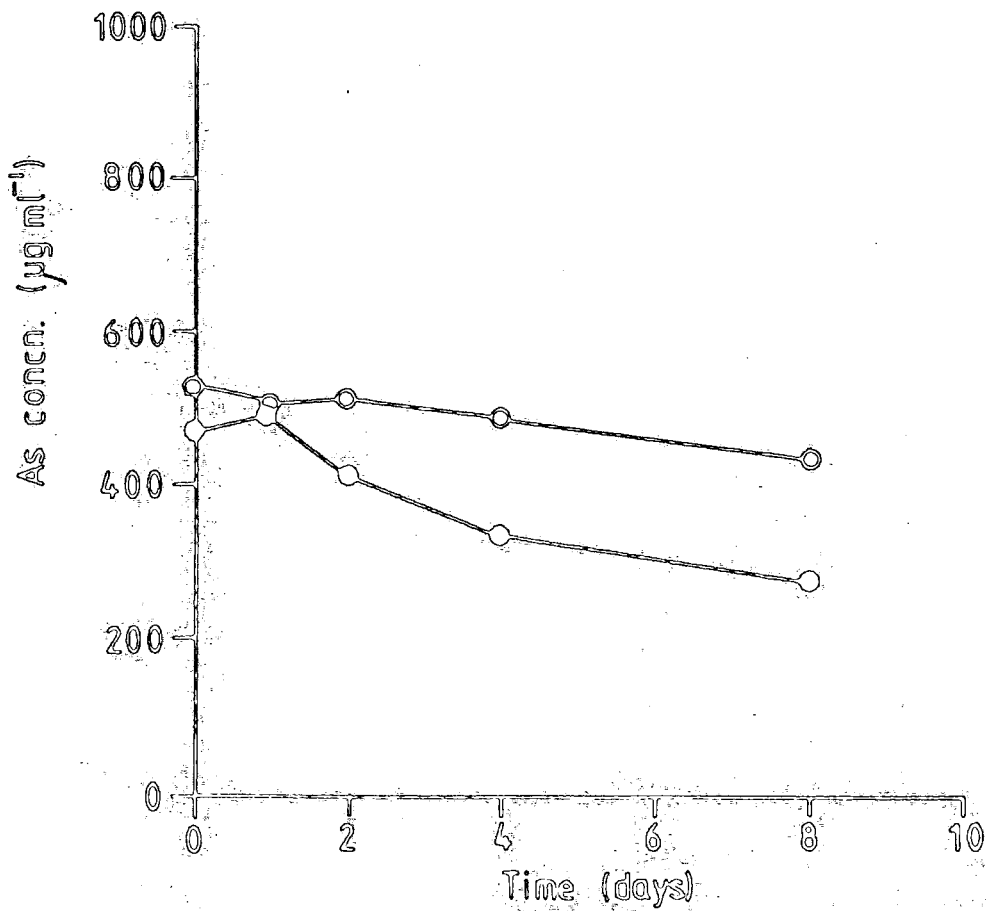
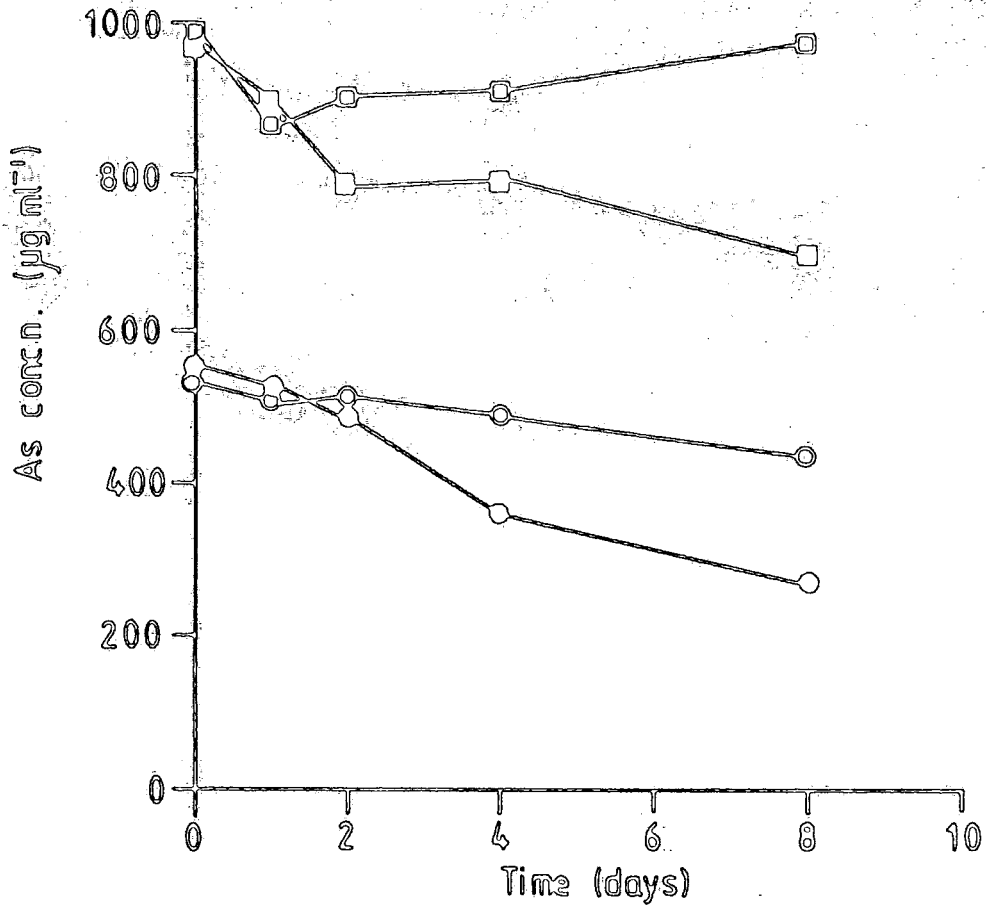

Fig. 4.441. Reduction in As concn.: glass petri dish control, 500 (○)
& 1000 (□) $\mu\text{g ml}^{-1}$ As and colony mats, 500 (○)
& 1000 (□) $\mu\text{g ml}^{-1}$ As.

Fig. 4.442. Reduction in As concn.: glass petri dish control, 500 (○)
 $\mu\text{g ml}^{-1}$ and As induced colony mats, 500 (○) $\mu\text{g ml}^{-1}$ As.

c) S. brevicaulis colonies plus Cellophane

Days after initiation	A_{400}		Effective A_0 concn. ($\mu\text{g ml}^{-1}$)	
	0	1.433	2.150	541
1	1.403	2.028	523	893
2	1.344	1.847	488	786
4	1.131	1.861	362	794
8	0.984	1.699	275	698

4.44 Use of mycelial mats to accumulate As.

For calibration curves see appendix 1.44

a) Glass petri dish control

For results in this section, original As concn. = 500 & 1 000 $\mu\text{g ml}^{-1}$

n = 5

Days after initiation	A_{400}		Effective As concn. ($\mu\text{g ml}^{-1}$)	
0	1.420	2.200	533	995
1	1.369	1.977	503	863
2	1.391	2.020	516	889
4	1.342	2.066	487	916
8	1.253	2.160	434	972

b) Plastic petri dish plus Cellophane controls

Days after initiation	A_{400}		Effective As concn. ($\mu\text{g ml}^{-1}$)	
0	1.381	2.170	510	978
1	1.350	2.054	492	909
2	1.177	2.101	389	937
4	1.281	2.043	451	902
8	1.373	2.177	505	982

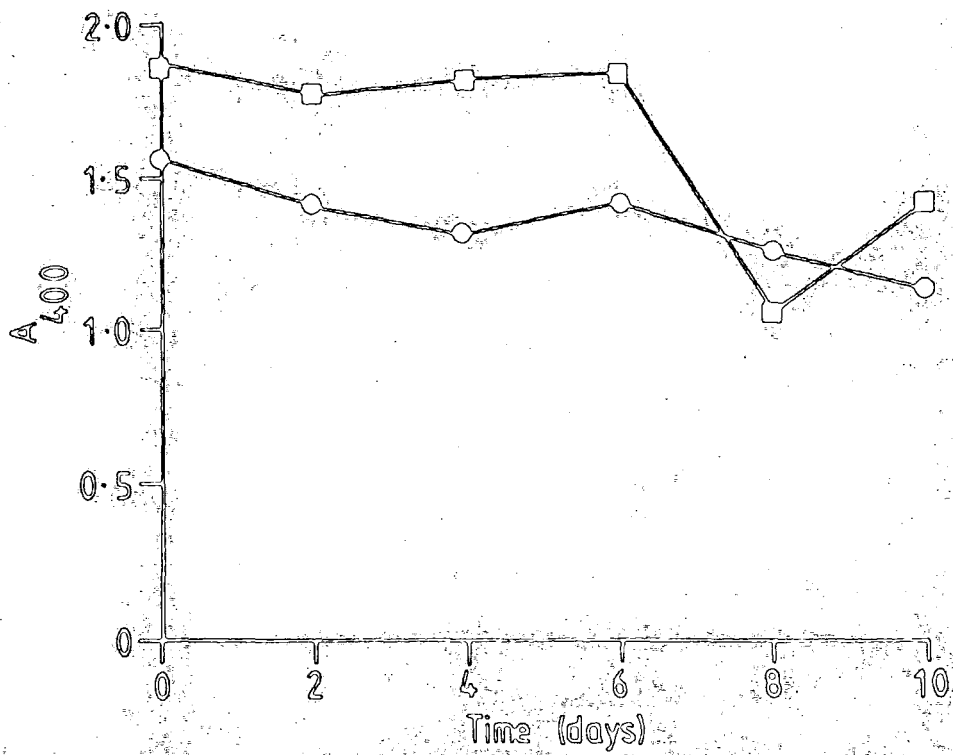
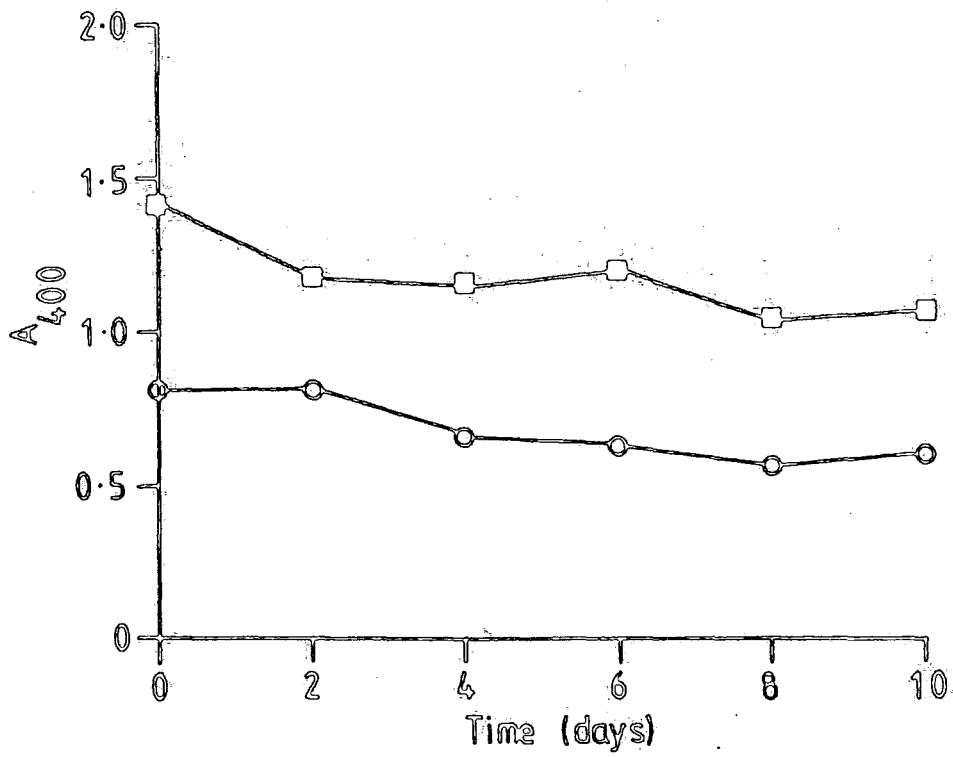

Fig. 4.433. Reduction in A_{400} readings with 0 (○) & 50 (□) $\mu\text{g ml}^{-1}$ As and 2 g l^{-1} malt.

Fig. 4.434. Reduction in A_{400} readings with 100 (○) & 200 (□) $\mu\text{g ml}^{-1}$ As and 2 g l^{-1} malt.

Initial As concn. = 100 $\mu\text{g ml}^{-1}$

Days after inoculation	mycelial dry wt. (g l^{-1})	A_{400}
0	-	1.560
2	0.95	1.436
4	1.20	1.326
6	2.75	1.421
8	3.15	1.251
10	3.45	1.134

Initial As concn. = 200 $\mu\text{g ml}^{-1}$

Days after inoculation	mycelial dry wt. (g l^{-1})	A_{400}
0	-	1.868
2	0.80	1.784
4	0.90	1.804
6	2.80	1.831
8	5.15	1.063
10	3.10	1.435

ii) 10 g l^{-1} malt

Initial As concn. = $0 \text{ } \mu\text{g ml}^{-1}$

Days after incubation	mycelial dry wt. (g l^{-1})	A_{400}
0	-	0.804
2	0.85	0.808
4	1.45	0.653
6	1.85	0.630
8	2.54	0.561
10	1.65	0.600

Initial As concn. = $50 \text{ } \mu\text{g ml}^{-1}$

Days after inoculation	mycelial dry wt. (g l^{-1})	A_{400}
0	-	1.430
2	0.85	1.168
4	1.30	1.153
6	2.40	1.186
8	3.75	1.049
10	3.10	1.062

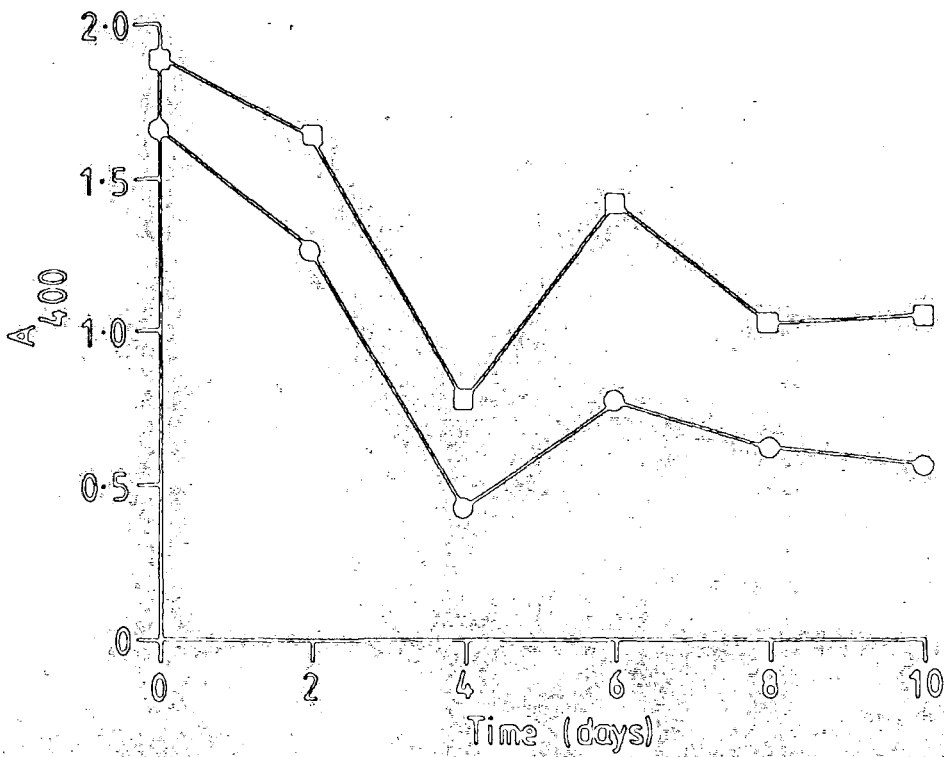
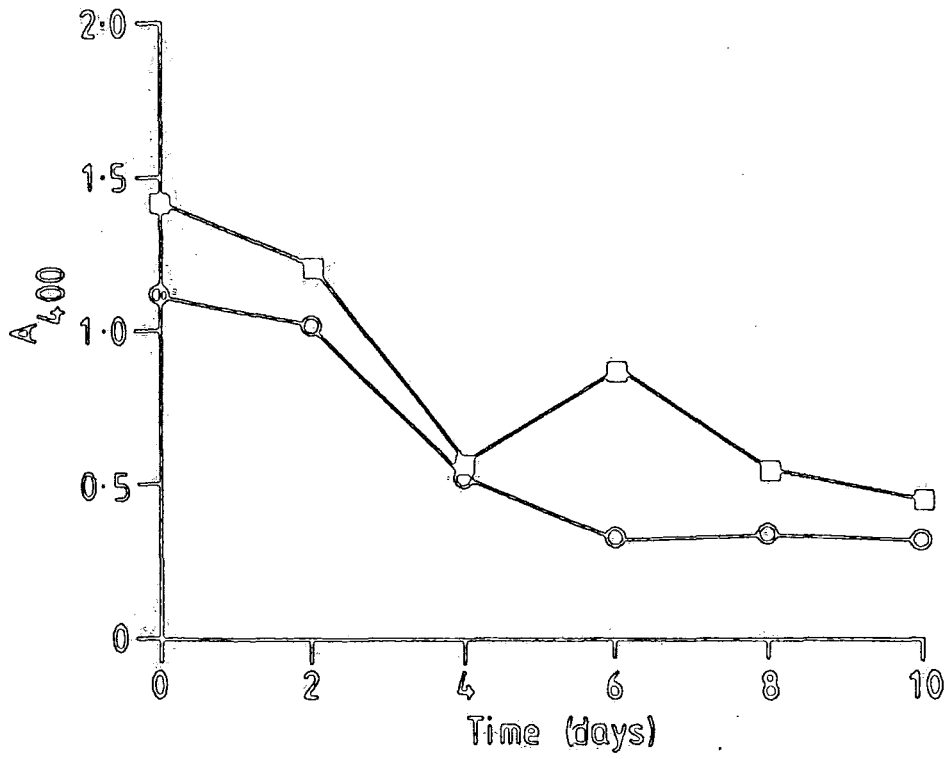
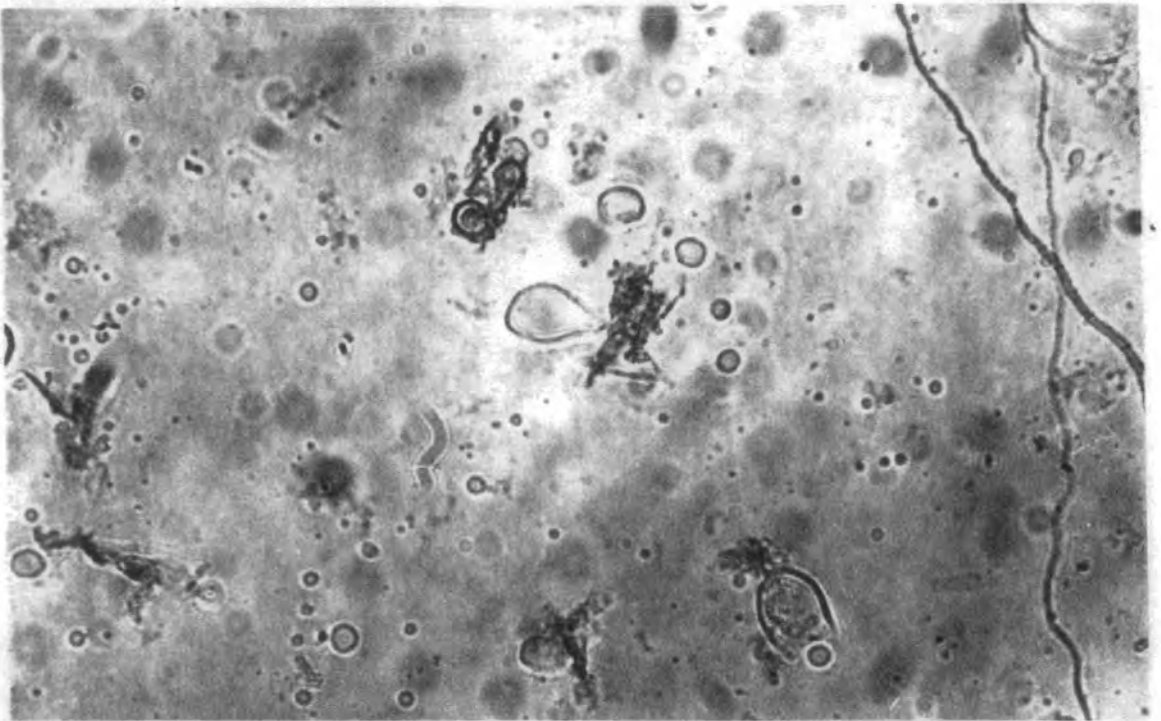
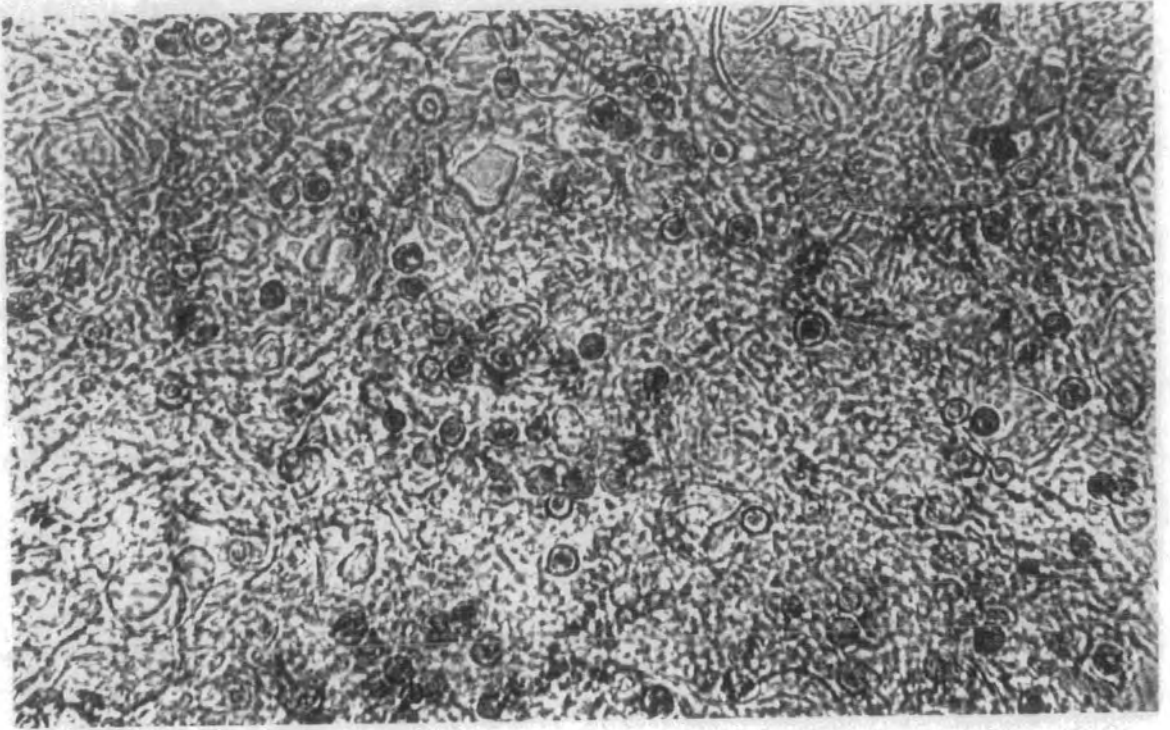

Fig. 4.431. Reduction in A_{400} readings with 0 (○) & 50 (□) $\mu\text{g ml}^{-1}$ As and 10 g l^{-1} malt.

Fig. 4.432. Reduction in A_{400} readings with 100 (○) & 200 (□) $\mu\text{g ml}^{-1}$ As and 10 g l^{-1} malt.



4.6 Quantitative analysis of an As induced polymer

4.61 Detection of a change in protein levels

a) Calibration curve, n = 5

Bovine serum albumin (mg ml ⁻¹)	8	4	2	1	0.5	0.25
A ₄₉₂	0.816	0.647	0.451	0.281	0.199	0.119

Regression equation in the range 2 - 0.25 mg ml⁻¹ (Fig. 4.611)

$$y = 0.137 x + 0.128 \quad r = +0.985$$

b) Samples, n = 5

Sample	concn. (mg ml ⁻¹)	A ₄₉₂	Effective protein content (mg ml ⁻¹)
Induced polymer	50	1.536	-
	25	0.901	-
	12.5	0.512	2.82
	6.25	0.268	1.03
	3.125	0.159	0.23
Control (no As)	50	1.442	-
	25	0.855	-
	12.5	0.471	2.51
	6.25	0.256	0.94
	3.125	0.149	0.16

Average protein content:

i) induced polymer = 0.157 mg mg⁻¹ polymer

ii) control = 0.142 mg mg⁻¹ culture filtrate

Fig. 4.611. Calibration curve for protein assay.

Fig. 4.621. Calibration curve for 1st carbohydrate assay.

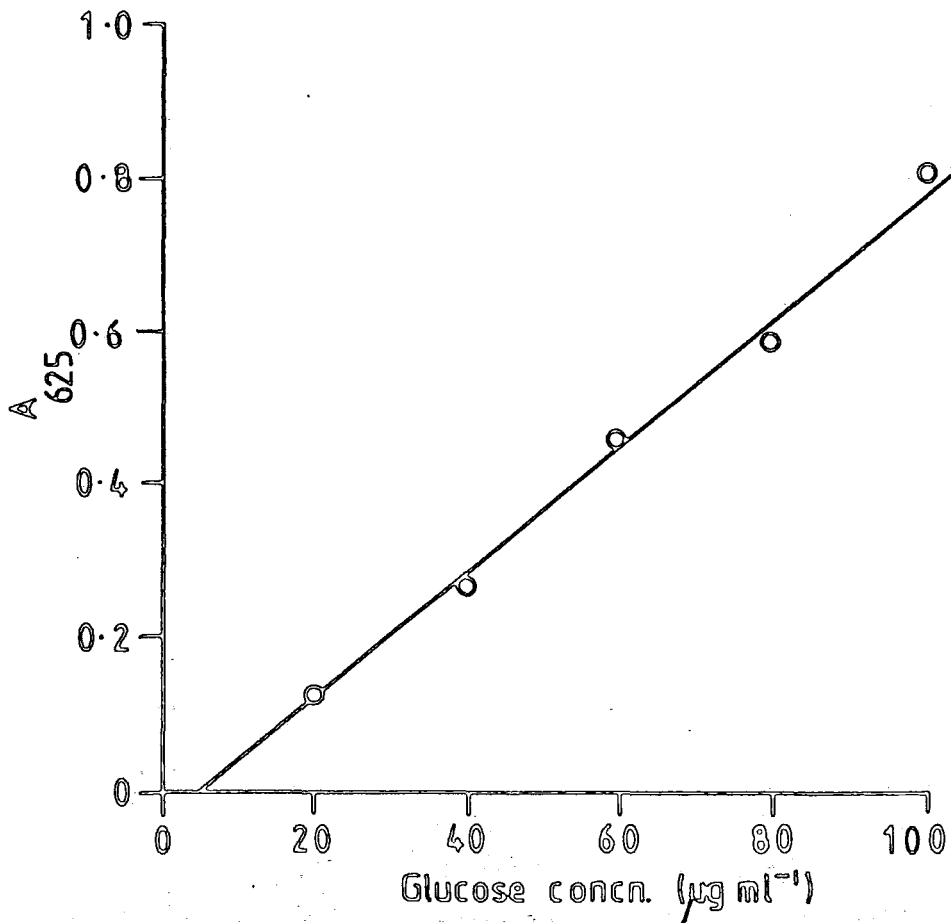
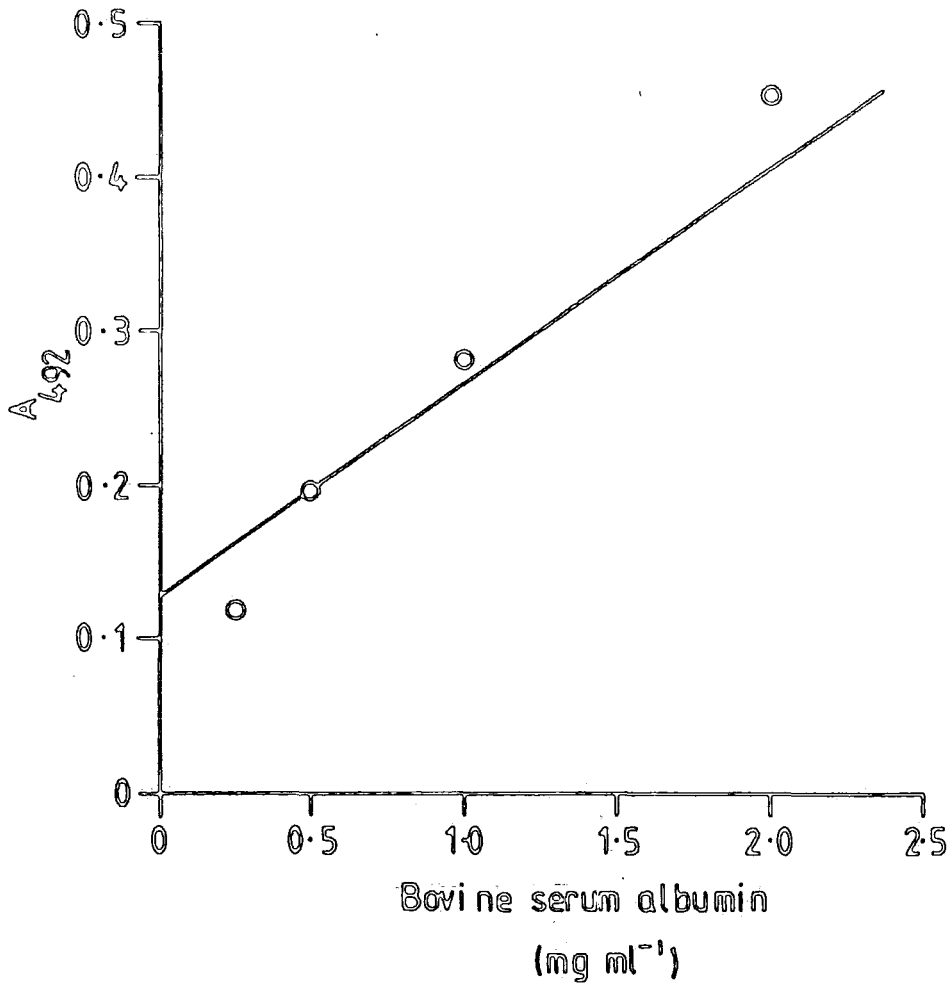

4.62 Detection of a change in carbohydrate levels

Three estimations of carbohydrate content were made, with new calibration curves for each assesment (see appendix 1.3)

Replicate	Calibration regression equation
I	$y = 0.0081 x - 0.0250$ $r = + 0.997$
II	$y = 0.0055 x - 0.0111$ $r = + 0.996$
III	$y = 0.0085 x + 0.0077$ $r = + 0.995$

Replicate	Sample concn. (mg ml ⁻¹)	A ₆₂₅	Effective carbohydrate content (mg dl ⁻¹)
I polymer	500	1.390	176
	250	0.687	88
	125	0.332	44
	62.5	0.132	20
control	500	1.225	155
	250	0.661	85
	125	0.320	43
	62.5	0.107	16
II polymer	500	0.939	171
	250	0.456	84
	125	0.184	35
	62.5	0.085	17
control	500	0.998	182
	250	0.424	78
	125	0.210	40
	62.5	0.070	15
III polymer	500	1.476	173
	250	0.762	90
	125	0.375	43
	62.5	0.240	27
control	500	1.300	152
	250	0.609	71
	125	0.284	33
	62.5	0.149	17

Average carbohydrate content from all 3 replicates:

- i) induced polymer = 0.341 mg mg⁻¹ polymer
 ii) control = 0.301 mg mg⁻¹ culture filtrate

64

Fig. 4.622. Calibration curve for 2nd carbohydrate assay.

Fig. 4.623. Calibration curve for 3rd carbohydrate assay.

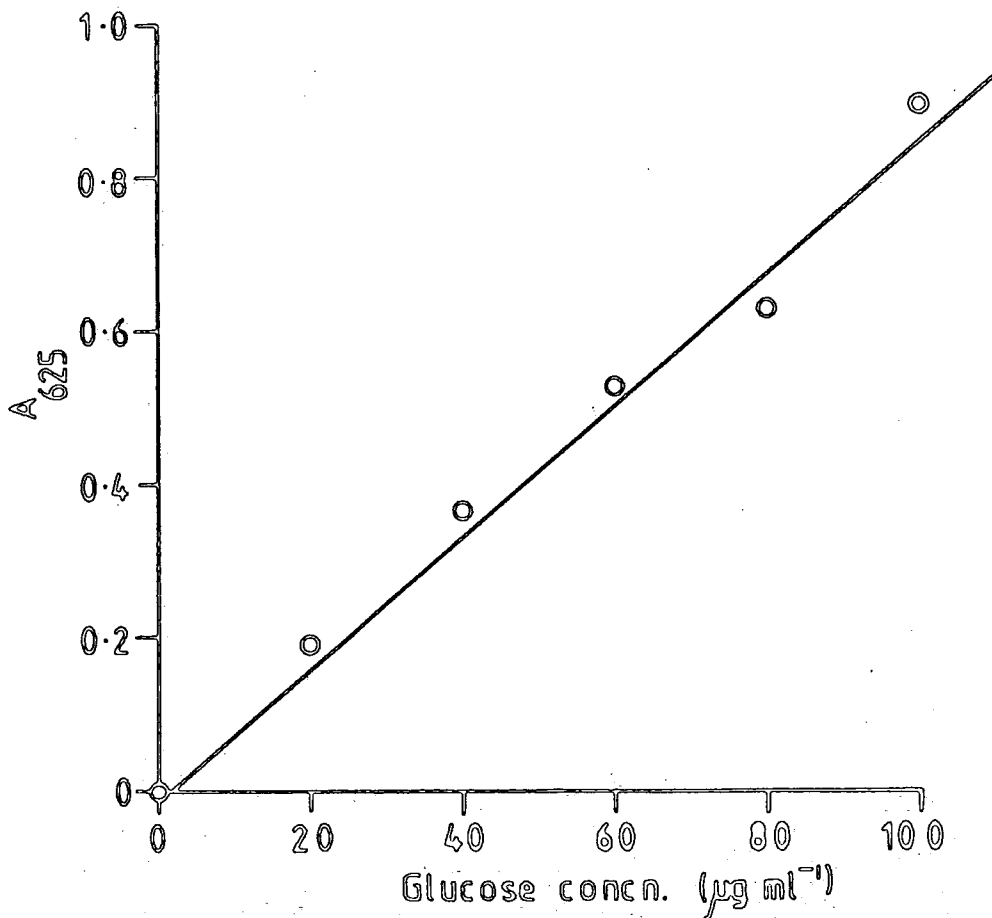
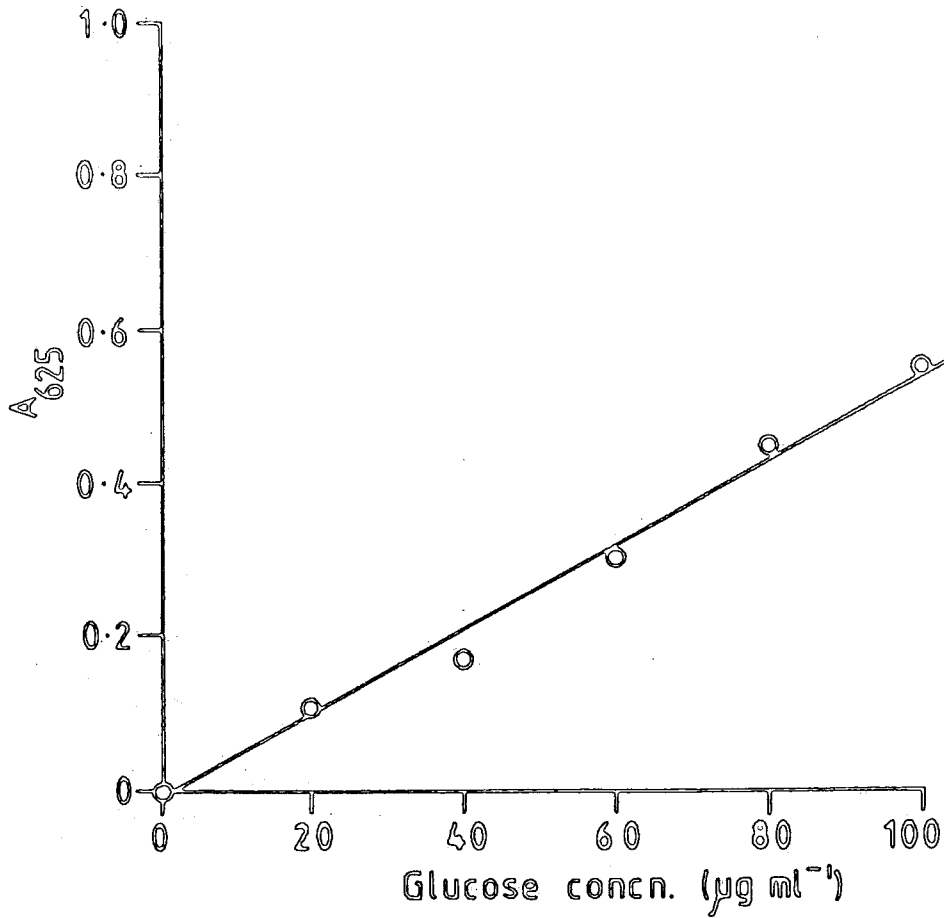

4.63 The acetone test for carbohydrates.

No significant precipitate was formed with any of the samples, hence no difference in carbohydrate content could be resolved.

4.64 PBS dialysis

Salt dialysis resulted in a lighter coloured and less crystalline freeze dried sample than undialysed mycelia, indicating that there is a difference in carbohydrate configuration between the induced polymer and untreated culture filtrate.

4.7 Qualitative Analysis of an As induced polymer

4.71 SDS PAGE

a) Coomassie Blue staining (Fig. 4.711)

Two broad bands formed (Mr 20 000 - 10 000 (Mr calculated from Appendix 3)) when freeze dried mycelia were run & stained with Coomassie Blue. No major difference between samples grown with and without As was observed and only faint bands occurred in the culture filtrate lanes.

b) Lipopolysaccharide silver staining (Fig. 4.712)

Culture filtrates with & without As separated into identical band patterns and therefore probably contain the same forms of lipopolysaccharide. A band with an approx. Mr of 36 000 was present for mycelia grown on As and absent for mycelia with no As (cannot be detected on photograph, but is visible if the original gel is back lit).

Fig. 4.711. Coomassie blue stained gel, clipped edges mark lane 1.

Lanes: 1.	Culture filtrate without As	- 80 μ l
2.	Culture filtrate with As	- 80 μ l
3.	Mycelia without As	- 80 μ l
4.	Mycelia with As	- 80 μ l
5.	Mr markers	- 20 μ l
6.	Mr markers	- 40 μ l

Fig. 4.712. Lipopolysaccharide stained gel.

Lanes: 1. & 2.	Mr markers	- 10 μ l
3.	Culture filtrate without As	- 80 μ l
4.	Mycelia without As	- 80 μ l
5.	As induced polymer	- 80 μ l
6.	Culture filtrate with As	- 80 μ l
7.	Mycelia with As	- 80 μ l
8. - 12.	as lanes 3. - 7.	
13. & 14.	Mr markers	- 10 μ l

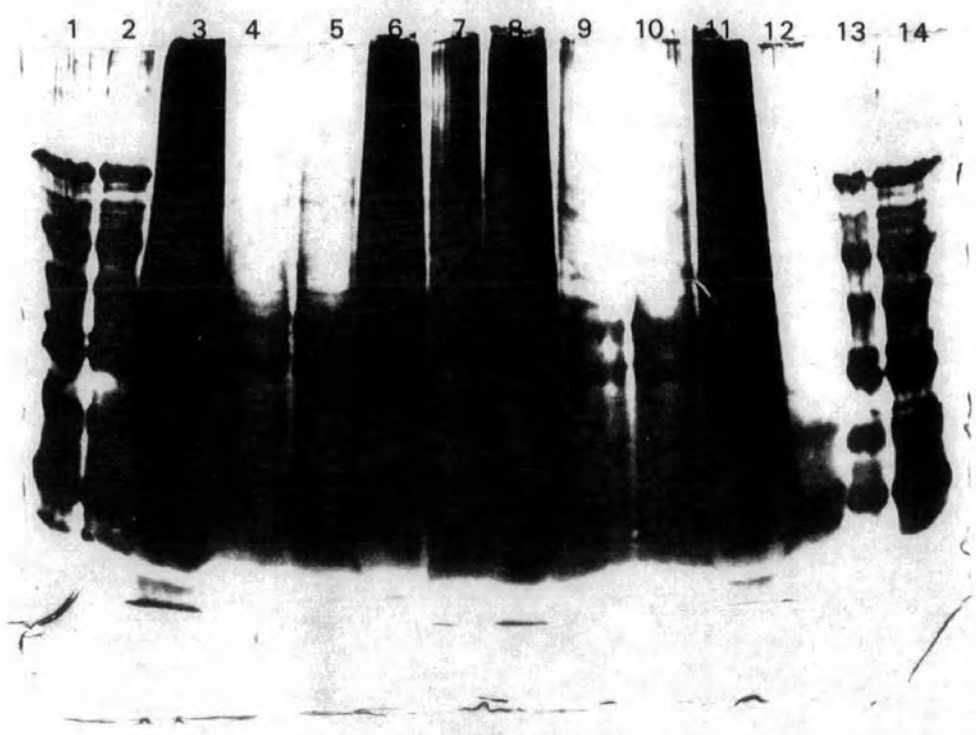
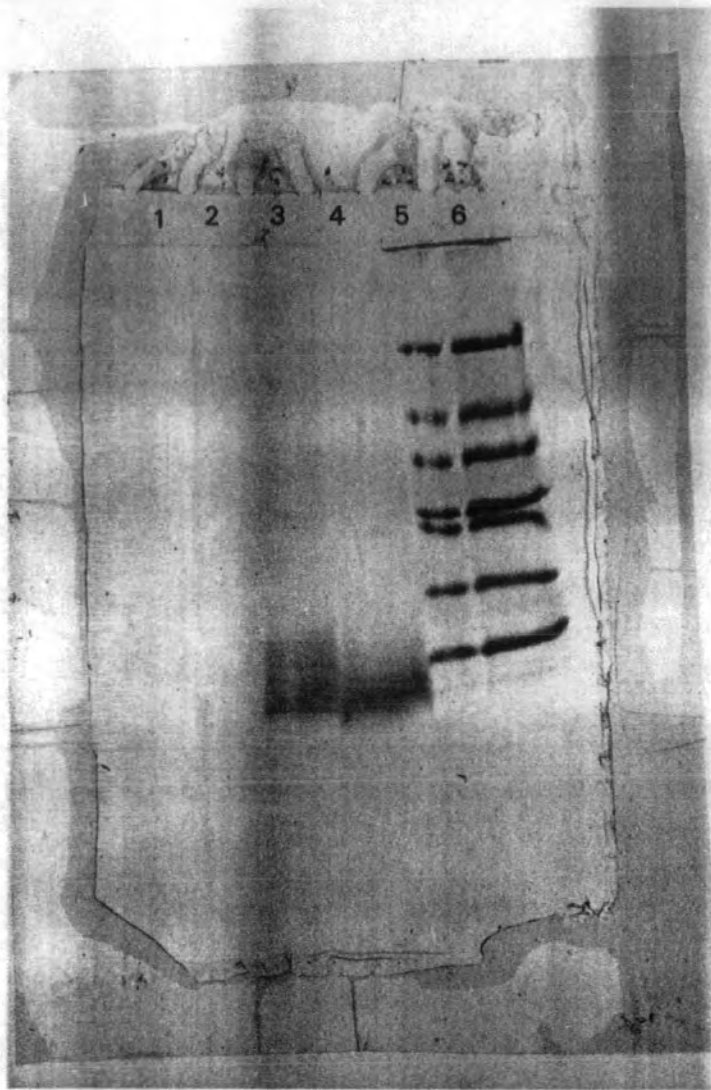

c) Protein silver stain (Fig. 4.713)

Culture filtrate without As separates out into a no. of bands, including a dark band of Mr 37 000 and a light band of Mr 35 000, such a band pattern is reversed for culture filtrate with As and the As induced polymer. The diffuse band of Mr 7 000 - 400 stains more strongly in the culture filtrate without As lane than in the other lanes, whilst bands of lipopolysaccharide appear at the base of the two As containing lanes (not visible in the photograph). Mycelia grown in the presence of As produces a much darker band of Mr 22 000 than samples grown without As.

4.72 Non reducing PAGE.

Non specific esterase activity was detected in samples of culture filtrate and mycelia without As. Two bands stained in the mycelial lane, whilst only one band was present in the culture filtrate. No activity was detected in As grown material.

Fig. 4.713. Protein silver stained gel.

Lanes: 1. Mr markers	- 10 μ l
2. Culture filtrate without As	- 80 μ l
3. Culture filtrate with As	- 80 μ l
4. As induced polymer	- 80 μ l
5. Mycelia without As	- 80 μ l
6. Mycelia with As	- 80 μ l

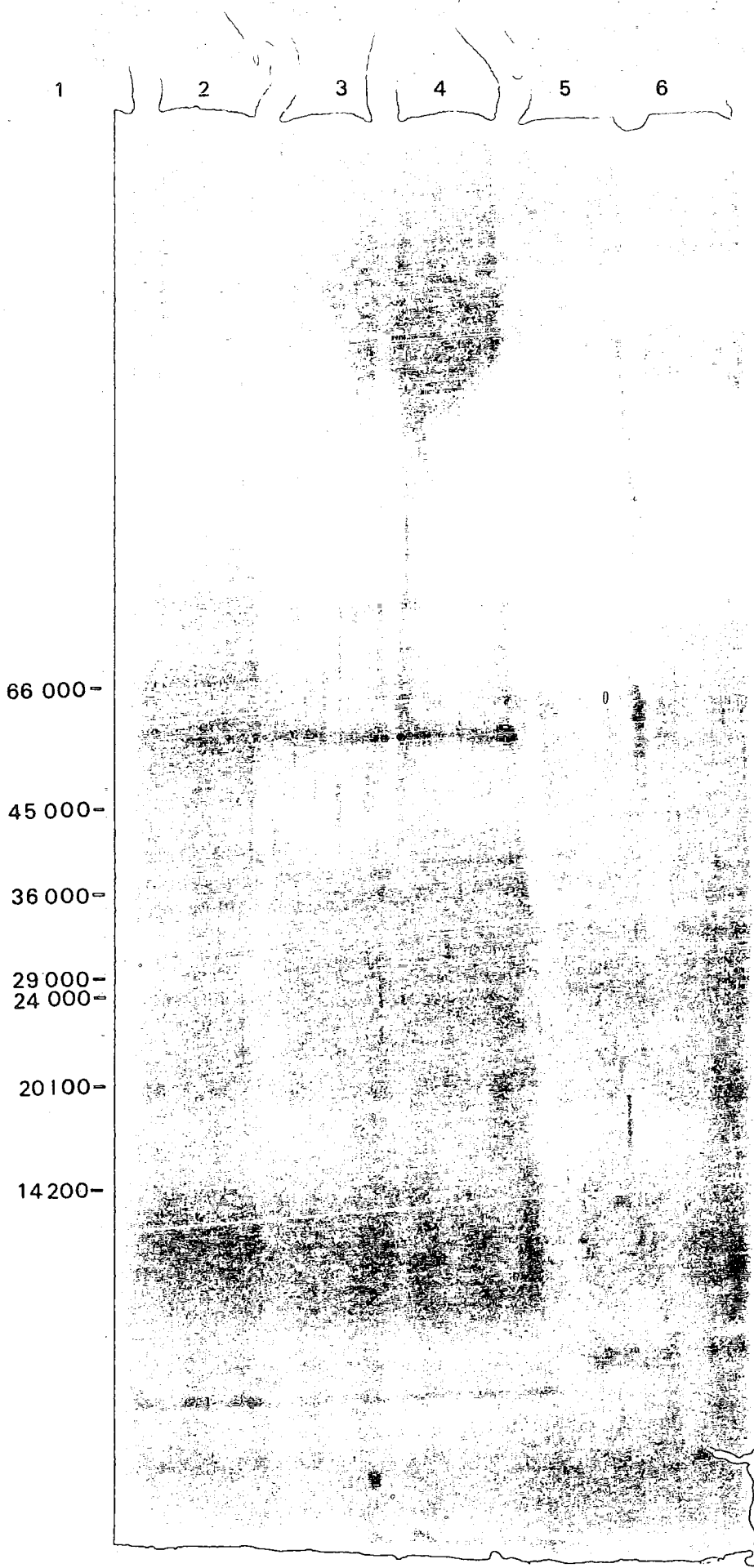

52

Fig. 4.721. Non reducing gel,

Lanes: 1. Blank

- 2. Culture filtrate without As - 80 μ l
- 3. Mycelia without As - 80 μ l
- 4. As induced polymer - 80 μ l
- 5. Culture filtrate with As - 80 μ l
- 6. Mycelia with As - 80 μ l

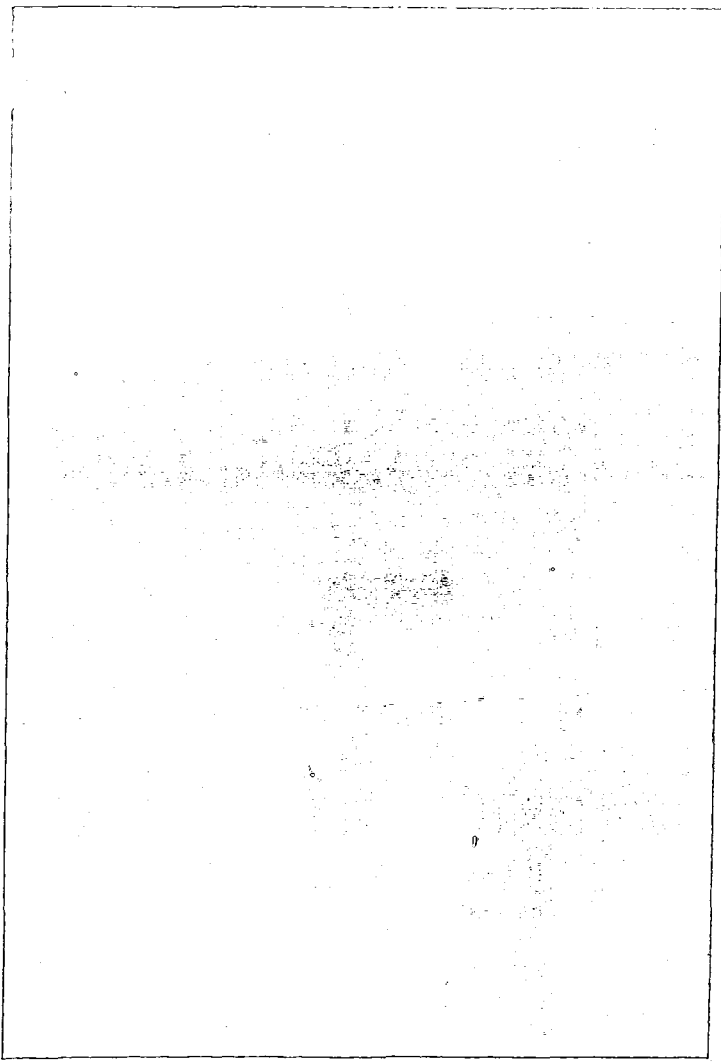

4.8 Spore investigation

4.81 Spore pathogenicity test.

a) No. of spores counted in each 25 square grid = i) 256 ii) 262
 Volume of each grid = 1×10^{-4} ml
 Thus, average no. of spores in suspension = 2.59×10^6 ml⁻¹
 0.3 ml of suspension was injected into the mice = 0.78×10^6 spores

b) No. of spores counted in each 25 square grid = i) 554 ii) 546
 Volume of each grid = 1×10^{-4} ml
 Average no. of spores in suspension = 5.5×10^6 ml⁻¹
 0.3 ml of suspension was injected into the mice = 1.65×10^6 spores

A sample of the spore suspensions created in this manner was plated out to check spore viability, after 12 days growth a thick mycelial mat formed and identified as S. brevicaulis by subculture in a growth chamber (section, 3.41). All of the injected mice showed no signs of suffering from the introduction of spores.

4.82 Microwave sterilisation

a) The spore blot transfer test:

Exposure time to microwaves (min)	0	5	10	20	30	45
Growth after transfer	+	+	-	-	-	-

+ = growth - = no growth

b) Cellophane disc colony treatment:

Exposure time to microwaves (min)	0	5	10	15	20	25
Increase in colony diameter (mm)	18	19	0	0	0	0
n	5	4	5	5	5	5

5 DISCUSSION

Petri dish dry weight figures vary considerably from one replicate to the next, probably due to the use of inocula in different metabolic states even though they were all taken from the same region of the colony. Fresh mycelia is reduced in weight by about 10 times during microwaving, resulting in biomass figures comparable with those published by Dewey *et al* (1984). Work on Phaeolus schweinitzii was discontinued after it exhibited a low growth rate and tolerance to As. The use of microwaves to dry mycelia until no moist areas remained, proved quick and reproducible. An increase in malt concn. leads to an increase in biomass, this response may be due to the extra carbon available or the higher osmotic pressure, but on a larger scale the economics and practicalities of using a high medium concn. would not prove feasible. Further experiments on cheap, local substrates should be carried out. S. brevicaulis does not require light for growth, the small difference between treatments reflecting the need for adequate ventilation of the plates, as those grown in the dark were enclosed.

The ability to grow at a wide range of medium pH values implies that it is suitable for use in a variety of industrial environments. More experiments with buffered media need to be carried out so that the pH remains constant throughout the growth period. No growth on 50 or 500 $\mu\text{g ml}^{-1}$ Se was noted even after 20 days incubation; as other workers have grown S. brevicaulis on Se (Challenger, 1945; Challenger, Lisle & Dransfield, 1953; Challenger & North, 1934) it is probably just this particular isolate which does not process Se.

Growth on As (III) is an useful attribute, as trivalent As is sixty times more poisonous than As (V) (Ferguson & Gavis, 1972), whilst growth on Te indicates it's use for industrial Te scrubbing. On this metalloid the hyphae were coloured green rather than the usual buff colour indicating Te uptake. Czapek-Dox did not provide a good medium for growth, although development of a defined medium is important to determine the limiting growth factors which influence growth.

A figure for the maximum As concn. which S. brevicaulis can tolerate is difficult to quote due to the variation in growth rate from one experiment to the next, growth appears to be stimulated in the region 50 - 1 000 $\mu\text{g ml}^{-1}$, but on concn. greater than 10 000 $\mu\text{g ml}^{-1}$ As, growth is suppressed and only very limited growth occurs on media containing greater than 50 000 $\mu\text{g ml}^{-1}$ (a high ppm tolerance figure for a biological system). No plate contamination was observed after 10 000 $\mu\text{g ml}^{-1}$ As, indicating that few species of fungi or bacteria can survive in a high As environment. Thus S. brevicaulis is suitable for use in industrial effluents with a wide range of As concn. The rate of growth in petri dishes tends towards zero after 20 days, either due to the physical restraint of volume or because of some other limiting factor such as nutrients or oxygen, further experiments are required to clarify this point. The amount of biomass generated in agitated media is comparable with that grown on the same volume in stationary petri dishes. Some shake flasks supported unusual growth forms (Fig. 4.1102), which on subculture proved to be pure cultures, these types may have been initiated from wall growth.

A chemostat was set up to observe the behaviour of *S. brevicaulis* in continuous culture and determine the potential for growth on a large scale for subsequent use as a biofilter. The rate of air flow was about ten times the usual value (0.040 l h^{-1}), due to the use of a fixed flow air pump and the need to inject the medium into the fermenter. The optimum rate of aeration and agitation for this species has yet to be determined.

Steady state conditions were attained with a dilution rate which was six times higher than the specific growth rate constant for petri dish and shake flask growth (due to the size of the peristaltic pump available), showing that growth is improved in chemostat culture. The continuous culture was maintained for about nine days indicating that this species can be grown on a commercial scale. The medium conversion efficiency (to biomass) was 54 % , this figure can be increased by running the chemostat at higher dilution rates. The shearing effect of the magnetic stirring bar maintained the diameter of mycelial pellets below 1 mm (pelleting is a problem in the fermentation of filamentous organisms) The pH of the medium remained relatively constant throughout the run period and the purity of the culture was maintained.

Wall growth was extensive due to:

- i) the medium being injected into the chemostat, splashing the wall with culture
- ii) a high malt concn.

resulting in eventual blocking of the outflow port. The feedstock flask became contaminated with fungal growth (which appeared to be S. brevicaulis), probably due to inconsistent flow of the medium and uneven peristaltic action (another reason for terminating the run). If the medium was filtered before sterilisation both of the above problems would have been alleviated.

Culture sampling should have been from the chemostat itself rather than the medium collection flask for a more accurate estimate of growth. A larger chemostat with comprehensive instrumentation (pH, temperature, agitation rate and pO_2 control) would provide much more information and bring this species one step nearer to growth on a commercial scale.

The presence of realgar in the growth medium did not have a detrimental effect and indicates the potential use of this species in the mining industry e.g. in gold refining where arsenopyrite contamination reduces yields. The thin growth on $20 \mu\text{g ml}^{-1}$ industrial effluent As shows that S. brevicaulis,

- i) requires an additional carbon source for growth
- ii) once supplemented, can grow in an industrial effluent

But as the ultimate aim is to produce a biofilter, the uptake and accumulation of As is more important than high growth rates in the presence of As. Large quantities of biomass can be generated in a separate reactor run under the conditions which optimise growth.

Swab samples from sources of industrial As proved that a variety of organisms can tolerate As.

Attempts to fluorescently label the hyphal surface were not successful probably because:

- i) the sample used, was in stationary phase
- ii) spores were injected into the peritoneum, rather than intravenously
- iii) the mice used to raise the antibodies, may not have found the spores particularly antigenic.

Monoclonal antibodies against the spores of S. brevicaulis would be most useful as markers to check sample purity and monitor the environment for biofilter leakage. Scanning electron microscopy provided good views of conidial structure, but as no critical point drying was employed the hyphae and annellophores collapsed.

The decision to use the Mo/Va/HCl test to monitor medium As concn. was based upon it's speed of determination and the large no. of samples which can be processed, compared with the wet oxidation procedure which takes 50 min to run and can only process a maximum of ten samples at any one time. Although initial standardisation experiments were successful (range with water = 0 - 80 $\mu\text{g ml}^{-1}$ and with 5 times diluted 50 g l^{-1} malt = 0 - 40 $\mu\text{g ml}^{-1}$), the change in malt absorbance during growth, interfered with that of the indicator absorbance and hence conversion to As concn. is not valid as changes in absorbance, reflect changes in malt, rather than As concn.. To overcome this problem a transparent glucose solution was used (to provide energy for the possible metabolic activity involved in As uptake) with mats of hyphae grown on Cellophane and a glass petri dish control to prevent the possible adsorption of As by plastic surfaces and Cellophane (although the Si present might have interfered with the indicator absorbance readings). The resulting decline in soluble As concn. with this protocol, prompted the design of a larger scale experiment, which showed a marked decline in medium As concn., whilst control plates exhibited a relatively stable As concn.. There is also a reduction in the medium's glucose concn. during incubation indicating that metabolic activity is associated with As accumulation. This belief is supported by the lack of As accumulation which occurs when the glucose concn. is low.

These experiments are only the start of the need to exhibit As uptake by this fungus and to enhance the rate of uptake as the present rate is slow (it takes up to 12 days for significant changes in As concn. to occur). Knowles & Benson (1983) have suggested that aquatic plants inadvertently take up As during phosphate scavenging in environments where the As concn. approaches that of available phosphate levels, the use of a glucose only medium may create the same type of environment and induce higher rates of As uptake.

Comparison of the wet oxidation procedure employed by ICI with the Mo/Va /HCl test provided variable results ,but neither test show any dramatic decline in the medium's As concn.; both tests exhibit the same sensitivity

The detection of As via AsH_3 generation proved to be the most conclusive test to demonstrate As uptake by S. brevicaulis, although the levels of As withheld by the mycelia are not high (in the range $0.5-5 \mu g As mg^{-1}$ mycelia) and the precise site of As accumulation needs further investigation (whether extracellular, cell wall bound or cytosolic). The mycelia on Cellophane discs also accumulated As and provide evidence that mycelial As content is not due to the formation of extracellular pockets of medium during growth but that the As is taken up from the medium, even across a Cellophane barrier. The amount of As accumulated is less than that for growing mycelia probably due to the relatively small surface area available for uptake and the barrier between the mycelia and the medium.

Although trimethylarsine was detected by it's garlic like odour from colonies grown on high As concn. the use of $HgCl_2$ indicator paper failed to show production of this form of As. Gas chromatography would be one method of volatile identification.

Thus although As uptake is known to occur, (for a 20 ml medium + 100 $\mu\text{g ml}^{-1}$ As about 1 500 $\mu\text{g As}$ is extracted over an 18 day period, whilst only 0.6 μg is accumulated by mycelia growing in 500 $\mu\text{g ml}^{-1}$ As for the same duration) due to the detectable evolution of $\text{As}(\text{CH}_3)_3$ it can only be observed after relatively long incubation periods (too long for industrial applications). Hence most of the medium As taken up, appears to be volatilised (probably a detoxification pathway) rather than accumulated; a reduction in the amount of As which is dealt with via methylation will either result in i) a favourable increase in the levels of accumulated As or ii) reduced growth on high medium As concn. This facet of the process being the main entry barrier for the production of an efficient biofilter.

In terms of achieving the project aims outlined in section 2, points i), ii), iii) & viii) were positively identified, aims iv) & v) yielded negative results, whilst points vi) & vii) remain to be investigated. All of these areas are central to the development of an efficient biofilter and require further lines of research:

- i) determination of the site of As accumulation
- ii) inhibition of the volatilisation process
- iii) selection of isolates with a high As processing capacity
- iv) defining the requirements for growth on a larger scale
- v) immobilisation of the mycelia for a continuous process
- vi) optimising the design & operation of a bioreactor
- vii) finding a use for the bioaccumulated As

6 CONCLUSIONS

This project has shown that S. brevicaulis tolerates a wide range of medium pH (2-12) and As concn. (0-40 000 $\mu\text{g ml}^{-1}$) and therefore has many industrial applications. Using two assays it was determined that the rate of As uptake is relatively slow, taking about 12 days before a significant reduction in medium As concn. occurs. More conclusive results were obtained from mycelia grown in As and mycelial mats on Cellophane, proving that As accumulation does occur. It has been found that this species also grows on As(III) & Te, but not Se and may once again prove to possess industrial potential. Successful chemostat growth and the tolerance of AsS were observed.

An increase in medium viscosity during growth in the presence of As is due to a change in the form of the medium's constituents rather than a change in their levels, as shown by PAGE. A pathogenicity test on mice failed to show any detrimental effects of this isolate on mammalian species and microwave treatment proved to be a quick and effective method of halting growth. Thus Scopulariopsis brevicaulis exhibits a number of exploitable characteristics and further work is necessary to enhance such attributes.

7 SUMMARY

Of the two species chosen for study, only one, S. brevicaulis was employed and the following characteristics were ascertained:

- i) It is capable of growth in a variety of "stressfull" environmental conditions.
- ii) The rate of uptake of As by mycelia and a concomitant decline in medium As concn. is slow, but detectable.
- iii) S. brevicaulis will grow successfully in chemostat culture and industrial environments.
- iv) No enzymic activity, associated with the uptake and volatilisation of As, was observed.
- v) The increase in medium viscosity during growth on As was linked to a change in the form, rather than total quantity of proteins/lipopolysaccharides present in the malt.
- vi) The spores from this isolate are not pathogenic for mice, but are inactivated after 10 min exposure to microwaves.

APPENDIX 1.

A1.44 Calibration curves for As concn. determination.

i) Mycellial mat accumulation:

Total volume = 5 ml indicator volume = 0.5 ml sample volume = 0.5 ml

ii) Larger mycellial mats:

Total volume = 2.5 ml indicator volume = 0.25 ml sample volume = 0.25 ml

iii) Extracellular As methylating enzymes:

Total volume = 5 ml indicator volume = 0.5 ml sample volume = 1 ml

As concn. ($\mu\text{g ml}^{-1}$)	A_{400}		
	i)	ii)	iii)
0	0.398	0.530	0.695
5	0.670	0.681	0.806
10	0.900	0.887	0.994
15	1.131	1.074	1.097
20	1.390	1.309	1.284
25	1.635	1.445	1.313
30	1.837	1.646	1.357
35	2.053	1.775	1.400
40	2.230	1.974	1.450

$$i) \quad y = 0.0462 x + 0.4368 \quad r = + 0.999$$

$$ii) \quad y = 0.0365 x + 0.5281 \quad r = + 0.998$$

$$iii) \quad y = 0.0192 x + 0.7722 \quad r = + 0.964$$

A1.62 Detection of a change in carbohydrate levels.

Glucose concn. ($\mu\text{g ml}^{-1}$)	A_{625}		
	i	ii	iii
0	0.000	0.000	0.000
20	0.126	0.112	0.193
40	0.277	0.186	0.365
60	0.461	0.300	0.503
80	0.590	0.448	0.636
100	0.814	0.553	0.894

APPENDIX 2.

Original Data

Roman numerals I - V indicate replicates

A2.101. Mycelial wet & dry weights for S. brevicaulis & P. schweinitziia) S. brevicaulis

As concn. ($\mu\text{g ml}^{-1}$)		liquid medium		cd (mm)	solid medium	
		dry wt. (mg)	wet wt. (mg)		dry wt. (mg)	wet wt. (mg)
0	I	182 [*]	6 570 [*]	25	140	14
	II			37	280	4
	III			31	216	23
	IV			-	195	21
7.5	I	70	710	29	156	12
	II	83	964	30	154	22
	III	98	1090	-	-	-
	IV	81	966	-	-	-
15	I	91	1957	28	152	17
	II	79	985	21	67	14
	III	87	981	-	106	12
	IV	93	971	-	124	16
30	I	95	1426	36	235	27
	II	72	448	33	130	23
	III	59	861	38	138	25
	IV	99	1326	32	117	21

bulked due to spillage

b) P. schweinitzii

0	I	4	25	57	137	10
	II	8	102	65	125	16
	III	2	110	62	117	16
	IV	4	18	-	-	-
7.5	I	4	85	63	270	16
	II	1	12	40	21	1
	III	4	28	64	319	20
	IV	1	30	-	-	-
15	I	5	22	63	89	12
	II	3	22	55	78	12
	III	4	20	61	119	14
	IV	-	-	65	160	14

30	I	6	36	67	102	17
	II	1	17	64	83	12
	III	1	32	66	96	14
	IV	4	22	-	-	-

- = irregular colony growth

A2.102 Duration of microwave treatment

Duration (min)	Mycelial weight (g)				
	I	II	III	IV	V
0	1.528	1.525	1.394	1.674	2.442
2	1.026	0.915	0.790	1.037	2.185
4	0.407	0.445	0.442	0.537	1.005
6	0.219	0.185	0.173	0.194	0.490
8	0.142	0.115	0.112	0.122	0.239
10	0.132	0.105	0.109	0.112	0.209
15	0.129	0.105	0.109	0.111	0.205

A2.103 Various malt concn. for liquid and solid media

		Malt concn. (g l ⁻¹)				
		10	20	50	70	100
a) liquid medium						
mycelial dry wt. (mg)	I	87	180	481	992	1212
	II	86	164	394	903	1405
	III	113	161	398	850	1270
	IV	77	194	335	701	1470
	V	56	258	416	885	983
b) solid medium						
colony diameter (mm)	I	50	52	61	65	75
	II	50	51	60	69	70
	III	48	48	59	65	69
	IV	50	50	62	68	72
	V	49	48	60	70	74

A2.104 Growth in the light and the dark.

	colony diameter (mm)				
	I	II	III	IV	V
Light growth	51	56	57	56	59
Dark growth	45	50	45	50	49

A2.105 Growth at different values of medium pH.

initial pH	mycelial dry weight (mg)				
	I	II	III	IV	V
1	-	-	-	-	-
2	86	48	94	111	105
3	202	199	212	194	203
4	209	216	247	225	233
5	192	252	233	266	247
6	245	224	240	239	281
7	214	223	209	265	260
8	213	191	173	210	199
10	191	268	114	150	101
11	364	399	404	284	345
12	421	424	252	286	-

A2.107 Growth on As(III), Te & Se

metal	mycelial dry wt. (mg)				
	I	II	III	IV	V
As(III)	317	308	322	321	341
Te	300	288	244	313	297

A2.108 Growth on Czapek-Dox medium

	I	II	III	IV	V	VI	VII	VIII	IX	X
liquid medium dry wt. (mg)	41	41	39	37	46	40	40	39	41	41
solid medium colony diameter (mm)	57	56	58	56	57	56	56	58	58	-

A2.109 Growth on increasing As concn.

As concn. ($\mu\text{g ml}^{-1}$)	mycelial dry wt. (mg)				
	I	II	III	IV	V
0	250	280	247	270	258
50	315	129	-	-	-
100	624	322	-	-	-
250	303	358	-	-	-
500	313	307	-	-	-
1 000	198	263	-	-	-
5 000	252	207	235	207	215
10 000	169	156	195	208	188
15 000	169	150	149	159	117
20 000	169	117	119	134	148
25 000	134	149	113	119	105
30 000	128	154	115	113	150
35 000	217	181	187	167	153
40 000	153	129	130	139	153

A2.110 Petri dish growth

days after inoculation	mycelial dry wt. (mg)				
	I	II	III	IV	V
1	55	47	48	58	51
2	50	55	40	44	43
3	76	88	99	122	112
4	193	150	175	149	118
5	170	207	231	232	224
6	211	230	246	218	222
7	230	323	222	299	303
8	304	315	278	276	231
9	247	243	288	265	284
10	300	292	290	305	312
11	284	315	330	320	347
12	373	353	368	348	364

A2.111 Shake flask growth

days after inoculation	mycelial dry wt.			
	I	II	III	IV
2	65	42	66	63
4	120	149	183	211
6	213	210	191	215
8	237	229	228	238
10	272	271	261	282
12	320	326	300	294
14	-	209	219	254
16	204	178	197	181
20	218	162	265	-

A2.210 Growth on realgar

As concn. ($\mu\text{g ml}^{-1}$)	colony diameter (mm)				
	I	II	III	IV	V
50	48	37	33	37	42
100	42	51	39	40	45
500	31	29	41	33	38

A2.41 Standardising the Mo/Va/HCl indicator

As concn. ($\mu\text{g ml}^{-1}$)	A_{400}				
	I	II	III	IV	V
0	0.213	0.209	0.210	0.210	0.215
10	0.199	0.206	0.196	0.199	0.211
20	0.373	0.373	0.371	0.378	0.381
30	0.695	0.677	0.678	0.697	0.700
40	0.758	0.750	0.749	0.770	0.771
50	1.063	1.059	1.067	1.092	1.100
60	1.261	1.263	1.266	1.296	1.306
70	1.454	1.446	1.449	1.490	1.487
80	1.623	1.615	1.620	1.637	1.646
90	1.730	1.726	1.727	1.733	1.747
100	1.848	1.849	1.854	1.860	1.863
110	1.913	1.905	1.910	1.925	1.932

A2.42 Use of the Mo/Va/HCl indicator with 50 g l^{-1} malt

As concn. ($\mu\text{g ml}^{-1}$)	A_{400}	
	I	II
0	0.000	0.000
10	0.304	0.568
20	0.912	0.774
30	1.050	1.042
40	1.168	1.201
50	1.234	1.252
60	1.243	1.287

A2.43 Monitoring the reduction in As concn. when in the presence of

S. brevicaulisa) = $0 \mu\text{g ml}^{-1}$ Asb) = $50 \mu\text{g ml}^{-1}$ Asc) = $100 \mu\text{g ml}^{-1}$ Asd) = $200 \mu\text{g ml}^{-1}$ As

i) 50 g l⁻¹ malt

	days after inoculation	mycelial dry wt. (mg)					A ₄₀₀				
		I	II	III	IV	V	I	II	III	IV	V
a)	0										
	2	35	40	38	36	36	0.837	1.053	1.107	0.997	1.062
	4	96	209	192	158	178	0.530	0.309	0.530	0.447	0.748
	6	133	248	243	273	270	0.366	0.324	0.447	0.286	0.297
	8	273	233	245	252	202	0.578	0.536	0.115	0.103	0.396
	10	309	303	307	367	362	0.635	0.149	0.168	0.594	0.105
	12	351	305	177	393	387	1.131	0.986	1.513	1.525	1.385
b)	0										
	2	56	44	32	46	43	1.227	1.167	1.340	1.216	1.089
	4	145	223	-	215	207	0.675	0.701	-	0.650	0.237
	6	199	258	285	279	286	0.954	0.540	0.946	0.996	0.932
	8	198	296	263	269	276	0.520	0.470	0.457	0.648	0.632
	10	408	397	376	391	412	0.114	0.607	0.470	0.551	0.498
	12	343	394	421	324	415	0.395	0.500	0.425	0.623	0.502
c)	0										
	2	45	47	47	42	36	1.130	1.170	1.190	1.533	1.277
	4	215	217	163	212	163	0.400	0.463	0.470	0.338	0.400
	6	310	300	308	316	303	0.605	0.800	0.759	0.879	0.894
	8	296	249	299	303	301	0.447	0.555	0.969	0.640	0.470
	10	324	326	357	344	368	0.426	0.656	0.608	0.636	0.505
	12	292	350	329	393	372	0.638	0.446	0.392	0.251	0.189
d)	0										
	2	41	44	45	32	46	1.530	1.680	1.669	1.725	1.630
	4	182	228	208	241	224	0.556	0.376	0.812	1.055	1.060
	6	310	326	324	326	374	1.468	1.540	1.520	1.300	1.370
	8	237	219	221	250	274	1.330	0.845	0.971	0.950	0.985
	10	387	295	400	305	387	1.526	0.895	0.822	0.987	1.030
	12	271	390	307	373	362	1.283	1.195	1.225	1.120	1.635

ii) 10 g l⁻¹ malt

	days after inoculation	mycelial dry wt. (mg)					A ₄₀₀				
		I	II	III	IV	V	I	II	III	IV	V
a)	0										
	2	23	22	9	15	15	0.843	0.814	0.792	0.802	0.787
	4	28	26	26	32	31	0.652	0.825	0.516	0.607	0.663
	6	48	25	34	39	40	0.667	0.619	0.628	0.614	0.623
	8	48	46	40	47	62	0.598	0.565	0.540	0.532	0.570
	10	25	31	36	35	38	0.716	0.580	0.564	0.568	0.570
	12	33	36	38	34	51	0.783	0.646	0.651	0.655	0.612
b)	0										
	2	10	14	22	21	17	0.198	0.235	0.127	0.147	0.134
	4	27	26	27	22	29	0.107	0.189	0.142	0.166	0.140
	6	50	48	49	50	44	0.187	0.183	0.138	0.227	0.197
	8	84	63	44	90	94	0.028	0.040	0.043	0.068	0.068
	10	87	83	72	63	50	0.050	0.060	0.065	0.042	0.093
	12	39	34	38	47	50	0.026	0.000	0.005	0.018	0.013
c)	0										
	2	27	12	20	16	18	0.465	0.363	0.480	0.475	0.396
	4	24	20	27	27	20	0.371	0.359	0.169	0.352	0.377
	6	52	57	53	54	59	0.460	0.396	0.398	0.443	0.407
	8	52	69	76	56	61	0.140	0.215	0.367	0.155	0.378
	10	62	60	68	72	81	0.156	0.092	0.121	0.147	0.153
	12	78	79	66	71	64	0.177	0.144	0.108	0.156	0.150
d)	0										
	2	19	12	13	17	19	0.660	0.824	0.794	0.780	0.860
	4	18	24	12	17	21	0.733	0.782	0.897	0.803	0.805
	6	58	55	59	54	54	0.728	0.843	0.995	0.777	0.810
	8	52	65	134	119	144	0.026	0.106	0.103	0.033	0.045
	10	56	62	70	62	60	0.524	0.378	0.460	0.360	0.453
	12	59	60	57	62	62	0.000	0.000	0.005	0.001	0.000

A2.44 Use of mycelial mats to accumulate As.

a) 500 $\mu\text{g ml}^{-1}$ As

	days after initial exposure				
	0	1	A_{600}	4	8
i) glass petri dish control					
I	1.439	1.466	1.488	1.422	1.326
II	1.455	1.373	1.438	1.365	1.240
III	1.400	1.373	1.340	1.350	1.235
IV	1.422	1.342	1.330	1.194	1.245
V	1.385	1.285	1.400	1.380	1.220
ii) plastic petri dish + Cellophane					
I	1.382	1.425	1.440	1.439	1.316
II	1.380	1.349	1.347	1.200	1.507
III	1.370	1.319	0.680	1.245	1.470
IV	1.392	1.350	1.297	1.253	1.293
V	1.380	1.305	1.122	1.270	1.280
iii) mycelial mats + Cellophane					
I	1.406	1.415	1.360	1.015	0.947
II	1.426	1.390	1.293	1.173	0.996
III	1.456	1.420	1.333	1.197	0.994
IV	1.424	1.390	1.412	1.133	0.997
V	1.455	1.400	1.324	1.139	0.988
iv) induced mycelial mats					
I	1.320	1.400	1.314	1.095	1.023
II	1.325	1.317	1.211	1.100	1.011
III	1.230	1.340	1.181	1.132	1.018
IV	1.320	1.320	1.189	1.147	0.980
V	1.317	1.355	1.148	0.990	0.850

b) 1 000 $\mu\text{g ml}^{-1}$ As

		A_{400}				
i) glass petri dish control						
I	2.120	2.028	2.044	2.048	2.101	
II	2.340	1.967	1.994	2.202	2.183	
III	2.120	1.953	1.980	2.000	2.120	
IV	2.322	1.983	2.000	2.004	2.188	
V	2.098	1.955	2.080	2.074	2.208	
ii) plastic petri dish + Cellophane						
I	2.180	2.029	2.125	2.030	2.240	
II	2.182	2.057	2.140	2.018	2.200	
III	2.165	2.056	2.080	2.080	2.146	
IV	2.130	2.108	2.070	2.045	2.172	
V	2.195	2.022	2.090	2.042	2.170	
iii) mycelial mat + Cellophane						
I	2.180	2.080	1.992	1.750	1.915	
II	2.188	2.080	1.979	1.727	1.994	
III	2.120	2.048	-	1.730	1.570	
IV	2.138	1.963	1.710	2.056	1.500	
V	2.120	1.967	1.705	2.043	1.514	
iv) induced mycelial mat - not determined						

A2.45 Larger mycelial mats

		days after initial exposure						
		0	3	6	9	12	15	18
a) 100 $\mu\text{g ml}^{-1}$ As								
		A_{400}						
I	0.903	0.768	0.772	0.882	0.646	0.571	0.599	
II	0.860	0.830	0.768	0.932	0.776	0.625	0.603	
III	0.845	0.763	0.746	0.780	0.555	0.546	0.514	
IV	0.820	0.760	0.693	0.818	0.600	0.527	0.522	
V	0.860	0.797	0.717	0.907	0.607	0.595	0.590	
b) control								
I	0.860	0.860	0.860	0.887	0.870	0.851	0.862	
II	0.850	0.853	0.857	0.891	0.900	0.878	0.868	
III	0.821	0.838	0.830	0.883	0.905	0.858	0.866	
IV	0.881	0.863	0.852	0.912	0.902	0.868	0.856	
V	0.863	0.870	0.847	0.846	0.902	0.828	0.860	

A2.51 Extracellular As methylating enzymes

		days after initial exposure				
		0	2	4	16	32
a) 200 $\mu\text{g ml}^{-1}$ As				A_{400}		
	I	1.173	1.162	1.044	1.054	0.802
	II	1.165	1.148	1.048	1.137	0.800
	III	1.187	1.096	1.053	1.126	0.897
b) control						
	I	0.850	0.846	0.949	0.834	0.721
	II	0.837	0.857	0.866	0.856	0.766
	III	0.853	0.839	0.957	0.819	0.813

APPENDIX 3

PAGE Mr markers:

Protein	Mr	Manufacturers Rf on an 11 % gel	Calculated Rf on a 10 % gel
Albumin, bovine	66 000	0.190	0.280
Albumin, egg	45 000	0.320	0.350
Glyceraldehyde-3- phosphate dehydrogenase	36 000	0.420	0.422
Carbonic anhydrase	29 000	0.480	0.533
Trypsinogen	24 000	0.560	0.583
Trypsin inhibitor (soya bean)	20 100	0.660	0.700
Lactalbumin	14 200	0.825	0.833

The calculated relative migration (Rf) values are higher than those of the manufacturer because the gel used was 1 % less concentrated.

LIST OF MATERIALS

All the chemicals used in this project were Analar grade from British Drug House Chemicals Ltd., Poole, except the following:

Material	grade	ref. no.	manufacturer
Acrylamide		A8887	Sigma Chemical Company, Poole Dorset, England.
Agar		MC 2	London Analytical & Bacteriological Media Ltd., Salford, England.
AgNO ₃	AR	S/1280	Fisons, Loughborough, Leicester, England.
α naphthyl acetate		N-8505	Sigma.
Bromophenol blue		20015	BDH.
Cellophane			BDH.
Citric acid	AR	C/8200	Fisons.
CuSO ₄ · 5H ₂ O	AR	C/8560	Fisons.
EDTA	EDS		Sigma.
Fast(Coomassie) blue		F 0500	Sigma.
RR salt			Sigma.
FeSO ₄ · 7H ₂ O			BDH.
Filter paper			Whatman Ltd. Maidstone, Kent.
FITC anti-rabbit IgG		F-1010	Sigma.
Glutaraldehyde	AR	G-8257	Sigma.
Glycine	AR	G/0800	Fisons.
HgCl ₂			BDH.

Material	grade	ref. no.	manufacturer
HNO ₃			BDH.
H ₂ SO ₄			BDH.
KCl	AR	P/4280	Fisons.
KH ₂ PO ₄			Fisons.
KI	AR	P/4800	Fisons.
KNaC ₄ H ₆ O ₆ ·4H ₂ O	AR	P/6880	Fisons.
Malt		L 39	Oxoid Ltd., Basingstoke Hampshire, England.
Mr marker kit		MWSDS-70L	Sigma.
Na ₂ AsO ₃		S-1631	Sigma.
Na ₂ CO ₃	AR	S/2920	Fisons.
NaCl	AR	P/3160	Fisons.
Na ₂ HAsO ₄ ·7H ₂ O			Sigma.
NaHCO ₃	AR	S/4240	Fisons.
Na ₂ HPO ₄	AR	S/4450	Fisons
Na ₂ SeO ₄ ·10H ₂ O			BDH.
Na ₂ TeO ₄ ·2H ₂ O			BDH.
N,N methylene bis acrylamide		M-7256	Sigma.
Perchloric acid	Aristar		BDH.
Silicone grease			Dow Chemical Company
Sodium lauryl sulphate	Primar	S/5202	Fisons.
Tris buffer	AR	T/3712	Fisons.
Trizma base	Reagent	T1503	Sigma.
Yeast extract			Oxoid.

LIST OF EQUIPMENT

Equipment	model	manufacturer
Analytical balance	U40	Oertling, Orpington, Kent.
Air pump	GP 580	Modcalf Bros. Ltd., Potters bar Hertfordsire, England.
Autoclave	2001	Rodwell, Basildon, Essex, England
Bench centrifuge	piccolo	Maeraeus Christ GMBH, Osterode W. Germany.
Centrifuge	8 X 50 rotor	MSE, Crawley Sussex, England.
Double beam spectrophotometer	UV 150 - 02	Shimadzu Corp., Kyoto, Japan.
Haemacytometer		Hawksley, England.
Hot plate & stirrer	PC-351	Corning, New York 14830 USA.
Incubator		Lab. Thermal Equipment Ltd., Greenfield, Oldham, England.
Laminar air flow hood		MDH Intermed, Andover, Hampshire, England.
Microtitration flat bottomed wells		Flow Labs, Irvine Scotland.
Microwave	EM 3145	Sanyo Electric Company Ltd., Osaka, Japan.
Light microscopes	M 75	Vickers, Haxby Road, York.
	Nikon diaphot	Nippon Kogaku K.K. Tokyo 100, Japan.
Peristaltic pump	108	LKB Products, Stockholm, Sweden.

Equipment	model	manufacturer
Petri dishes		Sterilin, Ashford, Middlesex, England.
pH electrode	7020	Electronic Instruments Ltd., Chertsey, Surrey, England.
Refrigerator		Lec International, Bognor Regis, England.
Scanning Electron Microscope	S 600	Cambridge Instruments, Cambridge, England.
Spectrophotometer	Biochrom Ultrospec 4050	LKB Products, Stockholm, Sweden.
Titretek Strip Reader		Flow Labs, Irvine , Scotland.
Top pan balance	TP41	Oertling, Orpington, Kent.

REFERENCES

- Abdel-Hafez, S. I. I. (1981). Halophytic fungi of desert soils of Saudi Arabia. *Mycopathologia* 75, 76-80.
- Bainier, G. (1907). *Mycothèque de l'École de Pharmacie*, XIV Scopulariopsis (Penicillium pro parte) genre nouveau de Mucedinea. *Bull. Soc. Mycol. Fr.*, 23, 98-105.
- Barkes, L. & Flanning, R. W. (1974). Production of dimethylselenide gas from inorganic selenium by eleven soil fungi. *Bulletin of Environmental Toxicology* 12, 308-311.
- Barrett, D. K. (1978). An improved selective medium for the isolation of Phaeolus schweinitzii. *Trans. Br. mycol. Soc.* 71 (3), 507-508.
- Becker, J. G. & Gardner Shaw, C. (1955). Fungi in domestic sewage treatment plants. *Microbiol.* 3 (3), 173-180.
- Bignelli, P. (1901). *Gazz. Chim. Ital.* 31 (i), 58.
- Bird, M. L. & Challenger, F. (1939). The formation of Organometalloid and similar compounds by microorganisms Part VII. Dimethyltelluride. *J. Chem. Soc.* 1939 (1), 163-168.
- Blink, M. & Krivic, H. (1940). Reichstoff bildung bei Schimmelpilzen. I Biologie der Reichstoff bildung und Orientierung neber den Chemismus einiger Pilzreichst offe. *Arch. Mikrobiol.* 11 (4) 391-405.
- Blank, F. (1951). Simultan-infection eines Fusses durch Scopulariopsis brevicaulis (Sacc.) Bain. var. hominis Brumpt et Langeron und Ctenomyces interdigitalis (Priestly) Langeron & Milochewitch. [Simultaneous infection of one foot by S. brevicaulis var. hominis and C. interdigitalis]. *Dermatologia* 102, 95-102.
- Blunt, F. L. & Baker, G. E. (1968). Antimycotic activity of fungi isolated from Hawaiian soils. *Mycologia* 60 (3), 559-570.
- British Pharmacopoeia (1980) Appendix VII, A85. Vol II HMSO.
- Brumpt, E. & Langeron, M. (1910). In *Brumpt's Precis de Parasitologie*, Ed. 1, 838-840. Paris.
- Burbianka, M. & Stec, E. (1972). Poraziene gryzbarni krajowych produktow zwynosciowych [Fungi contamination of the domestic foodstuffs]. *Rocz. Panstw. Zakl. Hig.* 23 (1), 41-47.
- Carapella, S. C. (1978). *Encyclopaedia of Chemical Technology* Vol. 3 Wiley-Interscience New York.
- Challenger, F. (1945). Biological methylation. *Chem. Rev.* 36, 315-355.

- Challenger, F. & Charlton, P. T. (1946). Studies on biological methylation. Part X. The fission of the mono- and disulphide links by moulds.
- Challenger, F. & Higginbottom, C. (1935). The production of trimethylarsine by Penicillium brevicaulis (Scopulariopsis brevicaulis). Biochem. Jour. 29, 1757-1778.
- Challenger, F.; Higginbottom, C. & Ellis, L. (1933). The formation of Organometalloid compounds by microorganisms. Part I. Trimethylarsine and Dimethylethylarsine. J. Chem. Soc. 1933 (1), 95-101.
- Challenger, F.; Lisle, D. B. & Dransfield, P. B. (1953). The study of mycological methylation with radioactive methyl donors or sources. Chem. and Indust. [London]. 1953 (6), 128-130.
- Challenger, F. & Lowther, A. G. (1950). Experiments on the mechanism of the formation of methyl thiol from S-methyl-L-cysteine in cultures of Scopulariopsis brevicaulis. Biochem. Jour. 46, 18-19.
- Challenger, F. & North, H. E. (1934). The production of Organometalloid compounds by microorganisms Part II. Dimethyl selenide. J. Chem. Soc. 1934, 68-71.
- Chute, H. L. & O'Meara, D. C. (1958). Experimental fungus infections in chickens. Avian. Dis. 2 (2), 154-166.
- Clayton, G. D. & Clayton, F. E. eds. (1981). Patty's Industrial Hygiene and Toxicology. 3rd Edition 2A, 1517-1530. Wiley-Interscience.
- Cole, G. T. & Aldrich, H. C. (1971). Ultrastructure of conidiogenesis in Scopulariopsis brevicaulis. Can. J. Bot. 49 (5), 745-755.
- Cole, G. T. & Kendrick, W. B. (1969). Conidium ontogeny in hyphomycetes. The annellophores of Scopulariopsis brevicaulis. Can. J. Bot. 47 (6), 925-929.
- Cole, G. T.; Nag Raj, T. R. & Kendrick, W. B. (1969). A simple technique for time lapse photomicrography of microfungi in plate culture. Mycologia 61, 726-736.
- Cooney, R. V.; Mumma, R. O. & Benson A. A. (1978). Arsoniumphospholipid in algae. Proc. Natl. Acad. Sci. USA 75, (9) 4262-4264.
- Dabrowa, N.; Landau, J. W. & Newcomer, V. D. (1972). Antifungal activity of glutaraldehyde in vitro. Arch. Dermatol. 105, (4), 555-557.
- Dewey, F. M. (1982). Microbiology Laboratory Manual.
- Dewey, F. M.; Hunter-Blair, C. M. & Banbury, G. H. (1984). Isolation of Scopulariopsis brevicaulis from Eucheuma striatum and it's ability

to degrade seaweeds and their soluble products.
Trans. Br. mycol. Soc. 83 (4), 621-629.

- Dewey, F. M.; Barrett, D. K.; Vose, I. R. & Lamb, C. J. (1984).
Immunofluorescence microscopy for the detection and identification
of propagules of Phaeolus schweinitzii in infested soil.
Phytopathology 74 (3), 291-296.
- Edmonds, J. S. & Francesconi, K. A. (1981). Arseno-sugars from brown kelp
(Ecklonia radiata) as intermediates in the cycling of arsenic in a
marine ecosystem. Nature 289, 602-604.
- Ehrlich, P. (1909). Ber. Dtsch. Chem. Ges. 42 (1), 17.
- Ehrlich, P. & Bertheim, A. (1907). Ber. Dtsch. Chem. Ges. 40, 3292.
- Emsley, J. (1985). Whatever happened to arsenic ?. New Scientist 19/26
December 1985, 10-14.
- Fairburn, N. J. (1953). A modified anthrone reagent.
Chem. and Indust. 1953, 86.
- Fassatiava, O. (1972). Morphological changes of conidiophores and mycelium
of some hyphomycetes. Folia Microbiol. 16 (6), 426-431.
- Ferguson, J. F. & Gavis, J. (1972). A review of the Arsenic Cycle in
natural waters. Water Research, Pergamon Press. 6, 1259-1274.
- Franger, P. (1969). Možnosti mikroskopického rozlišení
Scopulariopsis brevicaulis a dermatofyt u nehtech při onchomykozach.
[Possibilities of a microscopic differentiation between
Scopulariopsis brevicaulis and dermatophytes in nails in
onychomycoses]. Ceska Mycol 23 (1), 45-49.
- Frey, D. & Muir, D. B. (1981). Onychomycosis caused by Scopulariopsis
brevicaulis. Australas J. Dermatol. 22, 123-126.
- Gemeinhardt, H. (1972). Zur dermatophytenflora von Berlin (Hauptstadt der
DDR) in den Jahren 1961 bis 1970 [On the dermatophyte flora of Berlin
(Capital of East Germany) in the years 1961 to 1970.
Dermatol. Monatsschr. 158 (3), 209-214.
- Gmelin. (1839) Karlsruhe Zeitung.
- Gosio, B. (1897). Ber. 30, 1024.
- Gullstrom, D. K. & Mellon, M. G. (1953). Spectrophotometric determination
of arsenic and tungsten as mixed heteropoly acids.
Analytical Chemistry 25 (12), 1809-1812.

- Gunsalus, L. C. (1953). J. Cell Comp. Physiol. 41 (1), 113.
- Hamill, T. M. (1971). Fine structure of annellophores. I
Scopulariopsis brevicaulis and S. koningii. Amer. J. Bot.
58 (1), 88-97.
- Henneberg, & Kniefall, (1932). Über die Gruppe Scopulariopsis brevicaulis (= Penicillium brevicaule). Milchw. Forsch. 13 (6), 520-529.
- Hubalek, Z. (1978). Coincidence of fungal spp. associated with birds. Ecology 59, 438-442.
- Knowles, F. C. & Benson, A. (1983). The biochemistry of arsenic. Trends in Biochem. Sci. May 1983, 178-180.
- Kohlmeyer, J. & Kohlmeyer, E. (1979). Marine Mycology, The Higher Fungi. Academic Press. New York San Francisco London . p. 690.
- Kozłowska, D. (1956). Scopulariopsis brevicaulis w hodowli Trichomonas vaginalis. [Scopulariopsis brevicaulis in a T. vaginalis culture] Wiadomosci Parazytol 1956, 31-32.
- Lederer, W. H. & Fensterheim, R. J. (1981). Determination of arsenic and arsenic compounds in water supplies. Arsenic: Industrial, Biomedical, Environmental Perspectives. Proceedings of the Arsenic Symposium, Gaithersburg, Maryland. Van Nostrand Reinhold Environmental Engineering Series. Van Nostrand Reinhold Company.
- Lowry, O. H. ; Rosebrough, N. J. ; Farr, A. L. & Randall, R. J. (1951). Protein measurement with the folin phenol reagent. J. Biol. Chem. 193, 265-275.
- Mankowski, Z. T. (1960). Experimental pathogenicity of Scopulariopsis brevicaulis var. hominis in CFW mice. Fed. Proc. 19 (1), 392.
- Markert, C. L. & Hunter, R. L. (1959). The distribution of esterases in mouse tissue. J. Histochem. Cytochem. 1, 42-49.
- Martin-Scott, I. (1954). Onychomycosis caused by Scopulariopsis brevicaulis. Trans. Br. mycol. Soc. 37 (1), 38-43.
- Matsuto, S.; Kasuga, H.; Okumoto, H. & Takahashi, A. (1984). Accumulation of arsenic in blue-green alga, Phormidium sp. Comp. Biochem. Physiol. 78 (2), 377-382.
- ¹⁴C Bride, B. C. & Wolfe, R. S. (1971). Biosynthesis of dimethylarsine by Methanobacterium. Biochem. Jour. 10, 4312-4317.

- Morrisey, J. H. (1981). Silver stain for proteins in polyacrylamide gels a modified procedure with enhanced uniform activity. *Analyt. Biochem.* 117, 307-310.
- Morton, F. J. & Smith, G. (1963). The genera Scopulariopsis Bainier, Microascus Zukal and Doratomyces corda. Commonwealth Mycological Institute, Mycological Papers 66, 1-96.
- Moubasher, A. H.; Abdel-Hafez, S. I. I.; El-Hissy, F. T. & Hassan, S. K. M. (1980). Effect of temperature and moisture content on Egyptian peanut (Arachis hypogaea) seed-borne fungi. *Mycopathologia* 70, 49-54.
- Moubasher, A. H. & Moustafa, A. F. (1970). A survey of Egyptian soil fungi with special reference to Aspergillus, Penicillium and penicillium-related genera. *Trans. Br. mycol. Soc.* 54 (1) 35-44.
- Muster, I. & Paillard, R. (1942). Remarques sur le Scopulariopsis brevicaulis Bainier 1907, a propos de 4 cas dermatomycosé due au Scopulariopsis. *Dermatologica*. [Basel] 86, 271-283.
- O'Brien, T. P. & McCully, M. E. (1981). The study of plant structure principles and selected methods. Blackwell Scientific Publications. Oxford London Edinburgh Boston Melbourne.
- Onsberg, P. (1980). Scopulariopsis brevicaulis in nails. *Dermatologica* [Basel] 161, 259-264.
- Pharmacia Fine Chemicals. (1983). Polyacrylamide Gel Electrophoresis laboratory techniques. Box 175, S-75104 Uppsala 1, Sweden.
- Rocca, G. C. (1929). Un caso di onicomicosi da Scopulariopsis brevicaulis var. hominis (sin Penicillium brevicaulis var. hominis). [A case of onychomycosis from S. brevicaulis var. hominis (synonym P. brevicaulis var. hominis).] *Riv. Med* [Napoli] 6 (3), 59-60.
- Rosenheim, (1902). *Proc. Chem. Soc.* 1902, 138.
- Saez, H. & Lesel, R. (1969). Contribution a l'etude ecologie des milieux sub-antarctiques: I Champignons isoles chez des spheniciformes aux Iles Kerguelen. *Vie Milieu* 19 (1C) , 1-9.
- Schoenborn, C. & Schmoranzner, H. (1970). Untersuchungen neber Schimmelpilzinfektionen der Zehennaegel. [Examinations on mould fungus infections of the toe nail]. *Mykosen* 13 (5), 253-272.
- Scurti, J. C.; Cantini, G. & Colomb, B. (1969). Ricerche sui miceti di foraggi conservati e sulla loro tossitica. [Research on fungi of stored fodders and their toxicity.] *Allionia* [Turin] 14, 113-121.
- Selmi, (1874). *Ber* 7, 1642.

- Simmons, C. (1941). The behaviour of Scopulariopsis brevicaulis towards choline. *Biochem. Jour.* 35 (7), 749-754.
- Singh, K. & Vezina, C. (1971). An extracellular proteolytic enzyme from Scopulariopsis brevicaulis. I Purification & properties. *Can. J. Microbiol.* 17 (8), 1029-1042.
- Singh, K. & Vezina, C. (1972). An extracellular proteolytic enzyme from Scopulariopsis brevicaulis. II Hydrolysis of polyanino acids. *Can. J. Microbiol.* 18 (7), 1165-1167.
- Stokes, P. M. & Lindsay, J. E. (1979). Copper tolerance and accumulation in Penicillium ochro-chloron isolated from copper plating solution. *Mycologia* 71, 796-806.
- Tagani, H. (1970). Numerous multiple hairs. *Arch. Dermatol.* 102 (3), 309-312.
- Tsai, C. M. & Frasc, C. E. (1982). A sensitive silver stain for detecting lipopolysaccharides in polyacrylamide gels. *Analyt. Biochem.* 119, 115-119.
- Uyenco, F. R.; Saniel, L. S. & Jacinto, G. S. (1981). The "Ice-Ice" problem in seaweed farming. Xth International Seaweed Symposium. Gruyter.
- Wainright, M. & Grayston, S. J. (1983). Reduction in heavy metal toxicity towards fungi by addition to media of sodium thiosulphate and sodium tetrathionate. *Trans. Br. mycol. Soc.* 81 (3), 541-546.
- Wainright, M. & Grayston, S. J. (1986). Oxidation of heavy metal sulphides by Aspergillus niger and Trichoderma harzanium. *Trans. Br. mycol. Soc.* 86 (2), 269-272.
- Waste management paper No. 20 - Arsenic bearing wastes - A technical memorandum on recovery, treatment and disposal including a code of practice. HMSO 1980.
- Weil, E. P. & Gaudin, L. (1919). Contribution a l'etude des onychomycoses a Penicillium, a Scopulariopsis, a Sterigmatocystis, a Spicaria *Arch. Med. exp.* 28, 452-467.
- Wood, J. M. (1974). Biological cycles for toxic elements in the environment. *Science* 183, 1049-1052.
- Wright-Steele, C. (1967). Fungus populations in marine waters and coastal sands of the Hawaiian Line & Phoenix Islands. *Pacific Science* 21, 317-331.
- Yamaoka, Y. & Takimura, O. (1986). Marine algae resistant to inorganic arsenic. *Agr. Biol. Chem.* 50 (1), 185-186.

- Yoshimura, S. & Danno, G. (1964). Studies on Scopulariopsis brevicaulis proteinases. VI Crystallization and some properties of [alkaline] proteinase III. Agr. Biol. Chem. 28 (5), A23.
- Zach, F. (1939). Studien an Scopulariopsis - und Mastigocladium - Arten. Osterreich. bot. Zeitschr. 88 (3), 200-209.
- Zieve, R.; Ansell, P. J.; Young, T. W. K. & Peterson, P. J. (1985). Selenium volatilisation by Mortierella species. Trans. Br. mycol. Soc. 84 (1), 177-179.
- Zussman, R. A.; Vicher, E. E. & Lyon, I. (1961). Arsine production by Trichophyton rubrum. J. Bact. 81, 157.

