

Durham E-Theses

Synthetic and spectroscopic studies of some new organophosphorus (111) and (v) compounds

Ali, Rusmidah

How to cite:

Ali, Rusmidah (1987) *Synthetic and spectroscopic studies of some new organophosphorus (111) and (v) compounds*, Durham theses, Durham University. Available at Durham E-Theses Online:
<http://etheses.dur.ac.uk/6680/>

Use policy

The full-text may be used and/or reproduced, and given to third parties in any format or medium, without prior permission or charge, for personal research or study, educational, or not-for-profit purposes provided that:

- a full bibliographic reference is made to the original source
- a [link](#) is made to the metadata record in Durham E-Theses
- the full-text is not changed in any way

The full-text must not be sold in any format or medium without the formal permission of the copyright holders.

Please consult the [full Durham E-Theses policy](#) for further details.

**SYNTHETIC AND SPECTROSCOPIC STUDIES OF SOME NEW
ORGANOPHOSPHORUS (III) AND (V) COMPOUNDS.**

BY

RUSMIDAH ALI
(Graduate Society)

A thesis submitted for the degree of Doctor of Philosophy
in the University of Durham.

February 1987

The copyright of this thesis rests with the author.
No quotation from it should be published without
his prior written consent and information derived
from it should be acknowledged.



23 APR 1987

Thom
1987/AL1

To

My parents, Khairi and Haryani.

DECLARATION.

The work described in this thesis was carried out in the University of Durham between October 1983 and January 1987. This work has not been submitted, either completely or in part, for a degree in this or any other university and is the original work of the author except where acknowledged by reference.

Some aspects of this work have been published in the following papers:-

- 1) R. Ali and K.B. Dillon, *Polyhedron*, 5, 1197 (1986).
- 2) R. Ali and K.B. Dillon, *Phosphorus and Sulfur*, in press.

ACKNOWLEDGEMENT.

I would like to thank my supervisor, Dr. K.B. Dillon, for the continual help and encouragement during my stay, Dr A. Royston, for his guidance on n.m.r. spectrometer in the early stage of study, Dr. Jones for the mass spectra, Mr. R. Coult for numerous analyses he performed, Mrs. M. Cocks for C, H and N microanalyses and Mr. J. Lincoln for his great assistances in the initial stage of this work.

I would also like to thank Universiti Teknologi Malaysia for the maintenance award.

Finally, I would like to express my gratitude to my husband for his constant support and encouragement.

ABSTRACT

The acceptor properties of some halogenated organophosphorus (V) compounds towards chloride, pyridine, 2,2'-bipyridine and 1,10-phenanthroline have been investigated by means of ^{31}P n.m.r. spectroscopy. It was found that $\text{C}_6\text{F}_5\text{PCl}_4$ forms a six-coordinate anionic species $\text{C}_6\text{F}_5\text{PCl}_5^-$ with R_4NCl which dissociates in solution. CCl_3PCl_4 also show acceptor properties towards R_4NCl , but a stable adduct was only formed with Pr_4NCl in PhNO_2 , where no dissociation was observed. In CH_2Cl_2 , decomposition occurred in which CCl_3PCl_2 was detected. In contrast, $\text{C}_2\text{Cl}_5\text{PCl}_4$ only showed temporary formation of the adduct with Et_4NCl in CH_2Cl_2 , followed by decomposition, but it did not do so with R_4NCl ($\text{R}=\text{n-Pr}$, n-Bu or n-Pe) either in CH_2Cl_2 or PhNO_2 , where only decomposition products were observed. As expected, the higher members of the series R_2PCl_3 ($\text{R}=\text{C}_6\text{F}_5$ or CCl_3) and $(\text{C}_6\text{F}_5)_3\text{PCl}_2$ did not form adducts with R_4NCl , either in CH_2Cl_2 or PhNO_2 .

R_2PCl_4 ($\text{R}=\text{C}_6\text{F}_5$ or CCl_3) react with pyridine to give $\text{R}_2\text{PCl}_4\cdot\text{py}$, but no adduct was found with bidentate ligands (L). In contrast, the complexes $[\text{C}_2\text{Cl}_5\text{PCl}_3\text{L}]^+\text{Cl}^-$ were isolated. $\text{R}_2\text{PCl}_3^+\text{X}^-$ ($\text{R}=\text{C}_6\text{F}_5$ and CCl_3 ; $\text{X}=\text{SbCl}_6$ and BCl_4) also form adducts with L, giving six-coordinate cationic species $[\text{R}_2\text{PCl}_3\text{L}]^+\text{X}^-$ which exist in two isomeric forms in solution but only one isomer is dominant when the solid is isolated.

The ionic compound $[\text{C}_6\text{F}_5\text{PBr}_3][\text{BBr}_4]$ was isolated, but attempts to establish the chemical shift for the six-coordinate species with bidentate ligands L failed.

Organophosphorus (III) halides $(\text{C}_6\text{F}_5)_n\text{PCl}_{3-n}$ ($X=\text{Cl}, \text{Br}, n=1, 2$) and pseudohalides $(\text{C}_6\text{F}_5)_n\text{PX}_{3-n}$ ($X=\text{NCS}, n=1; X=\text{CN}, n=2$) show acceptor properties towards Y^- ($\text{Y}=\text{Cl}, \text{Br}, \text{I}$ and NCS) to form four-coordinate phosphoranides $[(\text{C}_6\text{F}_5)_n\text{PX}_{3-n}\text{Y}]^-$, which all proved to be very unstable. Substitution reactions occurred with CN^- or NCS^- for $(\text{C}_6\text{F}_5)_n\text{PX}_{3-n}$ ($X=\text{Cl}, \text{Br}$) and with CN^- for $\text{C}_6\text{F}_5\text{P}(\text{NCS})_2$. No acceptor properties were observed towards $\text{Cl}^-, \text{Br}^-, \text{I}^-, \text{CN}^-$ or NCS^- ions for CCl_3PCl_2 and $(\text{C}_6\text{F}_5)_2\text{PNCS}$, whereas the compounds $\text{RP}(\text{NCS})_2$, ($\text{R}=\text{Me}, \text{Et}$ or Ph) are thermally unstable and their Lewis acid behaviour could not be investigated.

Substitution reactions occurred between AgNCS and $\text{RPCl}_3^+\text{X}^-$ ($\text{R}=\text{Me}$ or $\text{Ph}, X=\text{SbCl}_6; \text{R}=\text{C}_6\text{F}_5, X=\text{SbCl}_6$ or BCl_4), giving $[\text{RPCl}_{3-n}(\text{NCS})_n]^+$ ($1 \leq n \leq 3$), but with AgCN only $\text{MePCl}_{3-n}(\text{CN})_n^+$ ($2 \leq n \leq 3$) were detected in solution. Reaction of $\text{C}_6\text{F}_5\text{PCl}_3^+\text{X}^-$ ($X=\text{SbCl}_6$ or BCl_4) with LiN_3 gave $[\text{C}_6\text{F}_5\text{PCl}_{3-n}(\text{N}_3)_n]^+\text{X}^-$ which were detected in solution only. In the $\text{C}_6\text{F}_5\text{PCl}_3\text{BCl}_4/\text{NCS}^-, \text{CN}^-$ and N_3^- systems, substitution also occurred at the BCl_4^- anion, and the $\text{BCl}_{4-n}\text{Y}_n^-$ species were detected in solution by means of ^{11}B n.m.r.

Decomposition occurred on addition of M^+NCS^- ($\text{M}=\text{Ag}$,

Li or Et₄N) to RPCl₄ or RPCl₅⁻ (R=Me, Ph or Et) solutions to give RPCl₂, RPSCl₂ and RPS(NCS)₂, while substitution occurred with [C₆F₅PCl₅]⁻ giving [C₆F₅PCl_{5-n}(NCS)_n]⁻ (n = 1 and 2), followed by decomposition to C₆F₅PCl₂, C₆F₅P(NCS)₂, C₆F₅PS(NCS)₂ and C₆F₅PS(CN)₂. Conversely, the cyano-derivatives [RPCl_{5-n}(CN)_n]⁻ (R=Et, 1 ≤ n ≤ 5; R=C₆F₅, 1 ≤ n ≤ 4 and R=CCl₃, 1 ≤ n ≤ 3) were detected in solution and the complexes [Pr₄N][EtP(CN)₅], [R₄N][C₆F₅PCl(CN)₄] (R=Et or Pr) and [Pr₄N][CCl₃PCl_{5-n}(CN)_n] (n=2 and 3) were isolated.

ABBREVIATIONS USED

- Et = Ethyl
Me = Methyl
Pr = Propyl
Bu = n-butyl, $n\text{-C}_3\text{H}_7$
Pe = n-pentyl, $n\text{-C}_5\text{H}_{11}$
X = halogen or pseudo-halogen
py = pyridine
bipy = 2,2'-bipyridine
phen = 1,10-phenanthroline
cat = catechyl

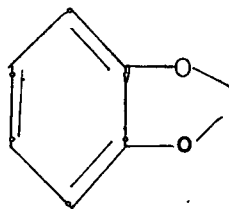

- R = any alkyl group

Miscellaneous

- n.m.r. = nuclear magnetic resonance
n.q.r. = nuclear quadrupole resonance
b.p. = boiling point
m.p. = melting point
 cm^{-1} = wave number
MHz = megahertz = $1 \times 10^{-6} \text{ sec}^{-1}$
p.p.m. = parts per million
T = Tesla

CONTENTS

| | Page No. |
|--|----------|
| CHAPTER 1 - INTRODUCTION | 1 |
| 1.1 Acceptor properties of phosphorus (V) compounds. | 1 |
| 1.2 Acceptor properties of phosphorus (III) compounds. | 4 |
| 1.3 Pseudohalide derivatives of five or six-coordinate phosphorus (V). | 6 10 |
| 1.4 Present work. | |
| CHAPTER 2 - EXPERIMENTAL. | 12 |
| 2.1 The dry box. | 12 |
| 2.2 Nuclear magnetic resonance spectroscopy. | 12 |
| 2.3 Other spectroscopic technique. | 14 |
| 2.4 Elemental analysis. | 15 |
| 2.5 Chemical and solvents. | 17 |
| 2.6 Starting material. | 17 |
| CHAPTER 3 - ACCEPTOR PROPERTIES OF PENTAFLUOROPHENYL PHOSPHORUS (V) COMPOUNDS. | 26 |
| 3.1 Acceptor properties of $C_6F_5PCl_4$ and related compounds. | 26 |
| 3.1.1 Introduction. | 26 |
| 3.1.2 The reaction of $C_6F_5PCl_4$ with other P(V) compounds. | 27 |
| 3.1.3 The reaction of $C_6F_5PCl_4$ with pyridine bases. | 29 |
| 3.1.4 Acceptor properties of $C_6F_5PCl_4$ | 31 |

| | |
|--|----|
| towards Cl^- ion. | |
| 3.1.5 Donor properties of $\text{C}_6\text{F}_5\text{PCl}_4$. | 33 |
| a) SbCl_5 | 33 |
| a(i) Acceptor properties of $\text{C}_6\text{F}_5\text{PCl}_3^-$ SbCl_6 towards bi- and uni-dentate pyridine bases. | 34 |
| b) BCl_3 | 37 |
| b(i) Acceptor properties towards bidentate ligands. | 40 |
| c) ICl_3 | 42 |
| d) AuCl_3 | 42 |
| 3.2 Acceptor properties of $(\text{C}_6\text{F}_5)_2\text{PCl}_3$ and related compounds. | 43 |
| 3.2.1 Introduction. | 43 |
| 3.2.2 Acceptor properties towards the Cl^- ion. | 45 |
| 3.2.3 Acceptor properties towards uni- and bidentate ligands. | 45 |
| 3.2.4 Donor properties. | 46 |
| a) SbCl_5 | 46 |
| a(i) Acceptor properties towards uni- and bidentate ligands. | 47 |
| b) BCl_3 | 50 |
| b(i) Acceptor properties towards uni- and bi-dentate ligands. | 50 |
| c) ICl_3 | 53 |
| 3.3 Acceptor properties of $(\text{C}_6\text{F}_5)_3\text{PCl}_2$ | 53 |

| | |
|---|----|
| and its derivatives. | |
| 3.3.1 Introduction. | 53 |
| 3.3.2 Acceptor properties towards Cl^- and other ligands. | 54 |
| 3.3.3 Donor properties towards Lewis acids. | 55 |
| a) SbCl_5 | 55 |
| b) BCl_3 | 57 |
| c) ICl_3 | 57 |
| 3.4 The acceptor properties of C_6F_5^- PBr_4 and its derivatives. | 58 |
| 3.4.1 Introduction. | 58 |
| 3.4.2 Acceptor properties towards uni- and bidentate ligands. | 60 |
| 3.4.3 The reaction of $\text{C}_6\text{F}_5\text{PBr}_4$ and BBr_3 | 62 |
| 3.4.4 Acceptor properties towards bidentate ligands. | 63 |
| 3.5 Summary. | 66 |
| 3.6 Experimental. | 67 |
| CHAPTER 4 - ACCEPTOR PROPERTIES OF TRICHLOROMETHYL- AND PENTACHLOROETHYLPHOSPHORUS (V). COMPOUNDS | 80 |
| 4.1 Acceptor properties of CCl_3PCl_4 and related compounds. | 80 |
| 4.1.1 Introduction. | 80 |
| 4.1.2 Acceptor properties towards Cl^- ion. | 83 |

| | Page no. |
|---|----------|
| 4.1.3 Reaction of CCl_3PCl_4 with Lewis acids. | 86 |
| a) SbCl_5 | 86 |
| a(i) Acceptor properties towards bidentate ligands. | 87 |
| b) BCl_3 | 88 |
| b(i) ^{35}Cl n.q.r. data. | 89 |
| b(ii) Reaction with bidentate ligands. | 90 |
| c) ICl_3 | 91 |
| 4.2 Acceptor properties of $(\text{CCl}_3)_2\text{PCl}_3$ and its derivatives. | 91 |
| 4.2.1 Introduction. | 91 |
| 4.2.2 Acceptor properties towards Cl^- ion. | 93 |
| 4.2.3 Acceptor properties towards bidentate ligands. | 93 |
| 4.2.4 Reaction with SbCl_5 . | 94 |
| 4.2.5 Other reactions | 98 |
| 4.3 Acceptor properties of $\text{C}_2\text{Cl}_5\text{PCl}_4$ and its derivatives. | 100 |
| 4.3.1 Introduction. | 100 |
| 4.3.2 Acceptor properties towards Cl^- ion. | 101 |
| 4.3.3 Acceptor properties towards bidentate ligands. | 103 |
| 4.3.4 Donor properties towards Lewis acids. | 105 |

| | Page no. |
|--------------------|----------|
| a) SbCl_5 | 105 |
| b) BCl_3 | 107 |
| c) ICl_3 | 108 |
| 4.4 Conclusion. | 109 |
| 4.5 Experimental. | 110 |

CHAPTER 5 - THE ACCEPTOR PROPERTIES OF ORGANOPHOSPHORUS

(111) COMPOUNDS.

| | |
|--|-----|
| 5.1 Thiocyanato-derivatives of organo-phosphorus (111) compounds. | 118 |
| 5.1.1 Introduction | 118 |
| 5.1.2 $\text{RP}(\text{NCS})_2$ (R=Me, Et, Ph and C_6F_5) and $(\text{C}_6\text{F}_5)_2\text{PNCS}$. | 119 |
| a) $\text{PhP}(\text{NCS})_2$. | 119 |
| b) $\text{MeP}(\text{NCS})_2$. | 121 |
| c) $\text{EtP}(\text{NCS})_2$. | 122 |
| d) $\text{C}_6\text{F}_5\text{P}(\text{NCS})_2$. | 123 |
| e) $(\text{C}_6\text{F}_5)_2\text{PNCS}$. | 125 |
| 5.2 Acceptor properties of organophosphorus halides. | 126 |
| 5.2.1 $\text{C}_6\text{F}_5\text{PCl}_2$. | 126 |
| a) Preparation of the compound. | 126 |
| b) $\text{C}_6\text{F}_5\text{PCl}_2/\text{Cl}^-$ system. | 127 |
| c) $\text{C}_6\text{F}_5\text{PCl}_2/\text{Br}^-$ " | 128 |
| d) $\text{C}_6\text{F}_5\text{PCl}_2/\text{I}^-$ " | 129 |
| e) $\text{C}_6\text{F}_5\text{PCl}_2/\dots \text{CN}^-$ and SCN^- system. | 130 |

| | Page no. |
|--|----------|
| 5.2.2 $C_6F_5PBr_2$. | 130 |
| a) Preparation of the compound. | 130 |
| b) $C_6F_5PBr_2/Br^-$ system. | 131 |
| c) $C_6F_5PBr_2/I^-$ system. | 132 |
| d) $C_6F_5PBr_2/Cl^-$, CN^- and SCN^- system. | 133 |
| 5.2.3 $C_6F_5PI_2$. | 134 |
| a) Preparation of the compound. | 134 |
| b) $C_6F_5PI_2/I^-$ system. | 135 |
| 5.2.4 CCl_3PCl_2 . | 137 |
| a) Preparation of the compound. | 137 |
| b) CCl_3PCl_2/Cl^- system. | 138 |
| c) CCl_3PCl_2/Br^- or I^- system. | 139 |
| d) CCl_3PCl_2/SCN^- or CN^- " | 139 |
| 5.2.5 $(C_6F_5)_2PCl$. | 139 |
| a) Preparation of the compound. | 139 |
| b) $(C_6F_5)_2PCl/Cl^-$ system. | 140 |
| c) $(C_6F_5)_2PCl/Br^-$ " | 143 |
| d) $(C_6F_5)_2PCl/I^-$ " | 144 |
| e) $(C_6F_5)_2PCl/SCN^-$ " | 145 |
| f) $(C_6F_5)_2PCl/CN^-$ " | 146 |
| 5.2.6 $(C_6F_5)_2PBr$. | 147 |
| a) Preparation of the compound. | 147 |
| b) $(C_6F_5)_2PBr/Cl^-$ system. | 148 |
| c) $(C_6F_5)_2PBr/Br^-$ " | 148 |
| d) $(C_6F_5)_2PBr/I^-$ " | 149 |
| e) $(C_6F_5)_2PBr/SCN^-$ " | 150 |
| f) $(C_6F_5)_2PBr/CN^-$ " | 151 |

| | Page no. |
|--|----------|
| 5.3 Acceptor properties of organo-phosphorus (III) pseudohalides. | 152 |
| 5.3.1 Acceptor properties of $RP(NCS)_2$ (R=Ph, Me and Et). | 152 |
| 5.3.2 Acceptor properties of $C_6F_5P(NCS)_2$. | 153 |
| a) $C_6F_5P(NCS)_2/Cl^-$ system. | 153 |
| b) $C_6F_5P(NCS)_2/Br^-$ " | 154 |
| c) $C_6F_5P(NCS)_2/I^-$ " | 155 |
| d) $C_6F_5P(NCS)_2/SCN^-$ " | 157 |
| e) $C_6F_5P(NCS)_2/CN^-$ " | 158 |
| f) Summary. | 159 |
| 5.3.3 $(C_6F_5)_2PCN$. | 160 |
| a) Introduction. | 160 |
| b) $(C_6F_5)_2PCN/Cl^-$ system. | 161 |
| c) $(C_6F_5)_2PCN/Br^-$ " | 162 |
| d) $(C_6F_5)_2PCN/I^-$ " | 163 |
| e) $(C_6F_5)_2PCN/SCN^-$ " | 164 |
| f) $(C_6F_5)_2PCN/CN^-$ " | 165 |
| 5.4 Conclusion. | 167 |
| 5.5 Experimental. | 169 |
| CHAPTER 6 - PSEUDOHALOGENO-DERIVATIVES OF ORGANO- PHOSPHORUS (V) COMPOUNDS. | 180 |
| 6.1 Azido-derivatives. | 180 |
| 6.1.1 Introduction. | 180 |
| 6.1.2 Azido-derivatives of $C_6F_5PCl_3^+X^-$ | 181 |
| 6.2 Thiocyanato-derivatives. | 185 |

| | Page no. |
|---|----------|
| 6.2.1 Introduction. | 185 |
| 6.2.2 Thiocyanato-derivatives of R^+PCl_3^- SbCl_6^- (R=C ₆ F ₅ , Me and Ph). | 186 |
| 6.2.3 Pairwise calculation. | 189 |
| 6.2.5 Attempts to synthesise $\text{R}^+\text{PCl}_{4-n}^-$ $(\text{NCS})_n^-$ (R=Me, Ph and C ₆ F ₅) | 195 |
| 6.2.6 Attempts to synthesise $\text{R}^+\text{PCl}_{5-n}^-$ $(\text{NCS})_n^-$ (R=Me, Ph and C ₆ F ₅). | 200 |
| 6.3 Cyano-derivatives of some organo- phosphorus (V) compounds. | 209 |
| 6.3.1 Introduction. | 209 |
| 6.3.2 Cyano-derivatives of R^+PCl_3^- SbCl_6^- (R=Me, Ph and C ₆ F ₅). | 210 |
| 6.4 Cyano-derivatives of $\text{R}'_4\text{NRPCl}_5$ (R=Et, R'=n-Pr; R=C ₆ F ₅ , R'=Et, or n-Pr; R=CCl ₃ , R'=n-Pr). | 213 |
| 6.4.1 Cyano-derivative of $\text{R}_4\text{NC}_6\text{F}_5\text{PCl}_5$ | 213 |
| a) Preparation of the complexes and discussion of the results. | 213 |
| b) Pairwise calculations | 219 |
| 6.4.2 Cyano-derivatives of $\text{Pr}_4\text{NEtPCl}_{5-n}(\text{CN})_n$ | 223 |
| a) Preparation of the complexes and discussion of the results. | 223 |
| b) Pairwise calculation. | 228 |

| | Page no. |
|---|----------|
| 6.4.3 Cyano-derivatives of $\text{Pr}_4\text{NCCl}_3\text{PCl}_5$. | 231 |
| a) Preparation of the complexes and discussion of the results. | 231 |
| b) Pairwise calculation. | 235 |
| 6.5 Experimental | 239 |
| | |
| CHAPTER 7 - 7.1 CONCLUSION AND DISCUSSION. | 246 |
| 7.2 Future work. | 250 |
| | |
| APPENDIX ONE | 253 |
| | |
| APPENDIX TWO | 259 |
| | |
| REFERENCES | 274 |

CHAPTER ONE

1.0 INTRODUCTION.

1.1 ACCEPTOR PROPERTIES OF PHOSPHORUS (V) COMPOUNDS.

Phosphorus (V) forms a series of halides which are similar to those of the heavier elements in the group, such as antimony and arsenic (1). Further investigation has shown that these compounds have a tendency to form adducts with Lewis acids and Lewis bases, for example SbCl_5Br^- (2), $\text{PCl}_5\cdot\text{pyridine}$ (3) and AsCl_6^- (4).

Beattie and co-workers (5,6) studied the stereochemistry of some addition compounds of the MCl_4^+ ion, in which the complexes $[\text{MCl}_4\text{phen}]^+[\text{SbCl}_6]^-$ (M=P, As or Sb) were isolated. This work has been extended by Dillon et al (7) and their results are in good agreement. In this work stable complexes with bidentate ligands, such as 2,2'-bipyridine and 1,10-phenanthroline, were isolated and for the pyridine complex in nitrobenzene, the following equilibrium occurred:

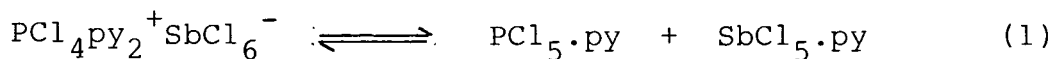

Both phosphorus species were detected by ^{31}P n.m.r. spectroscopy.



This research has been continued using organophosphorus (V) compounds such as RPX_4 ($\text{X}=\text{Cl}$, $\text{R}=\text{Ph}$, Et and Me) (8,9); $\text{X}=\text{Br}$, $\text{R}=\text{Ph}$ (10), $\text{R}_n\text{PCl}_{5-n}$ ($\text{R}=\text{Ph}$, Et and Me , $n=2$ and 3) (8), catPX_3 ($\text{X}=\text{Cl}$ (11) or Br (10)) and cat_2PX ($\text{X}=\text{Cl}$ (11) or Br (10)). Dillon et al (9,11) investigated the acceptor properties of the compounds $\text{PhPCl}_3^+\text{X}^-$ ($\text{X}=\text{SbCl}_6^-$ or PCl_6^-) (9), $[\text{catPCl}_2]^+[\text{SbCl}_6]^-$ and $[\text{cat}_2\text{P}]^+[\text{SbCl}_6]^-$ (11). A few derivatives of these compounds with neutral ligands (pyridine, 2,2'-bipyridine and 1,10-phenanthroline) were isolated, which have octahedral structures. As above, $[\text{PhPCl}_3]^-[\text{MCl}_6]$ reacted with pyridine to form the molecular species $\text{PhPCl}_4\cdot\text{py}$ and $\text{MCl}_5\cdot\text{py}$ ($\text{M}=\text{P}$ or Sb) (9). Beattie et al (12,13,14) had reported infrared and Raman spectra of $\text{PCl}_5\cdot\text{py}$ and found that it was undissociated in C_6H_6 or CH_3CN . Independent measurements of the ^{31}P n.m.r. chemical shift of PCl_5 in liquid pyridine are -234 (15), -228.0 and -224.7 ± 4.1 p.p.m. (solid) (3). $[\text{PhPCl}_3\text{L}']^+[\text{MCl}_6]^-$ ($\text{L}'=\text{bipy}$ or phen) are stable in solution and the cations exist in two isomeric forms, which can be detected by ^{31}P n.m.r. spectroscopy. In these studies, PhPCl_4 , catPCl_3 and cat_2PCl were also found to form six-coordinate anions with the chloride ion which were partially dissociated in solution.

Deng and Dillon (16) also investigated the acceptor properties of $\text{R}_n\text{PCl}_{5-n}$ ($n=1, 2$; $\text{R}=\text{Me}$, $1\leq n\leq 3$; $\text{R}=\text{Et}$) and their derivatives with Lewis acids (PCl_5 and SbCl_5) towards

Lewis bases (Cl^- , pyridine, 2,2'-bipyridine and 1,10-phenanthroline). Reaction only occurs with RPCl_4 and their derivatives, but not for the compounds with $n=2$ or 3. Several new compounds were isolated and characterised by elemental analysis, as well as ^{31}P n.m.r. spectroscopy. Dillon and Deng (10) also studied the acceptor properties of some organophosphorus (V) bromides, including $\text{PBr}_3(\text{cat})$, $\text{PBr}(\text{cat})_2$, PhPBr_4 and $[\text{PhPBr}_3]^+$, towards Lewis bases such as halide ions and pyridine bases. New compounds were isolated and characterised, including $[\text{RPBr}_{3-n}\text{L-L}][\text{BBr}_4]$ ($\text{R}=\text{Ph}$, $n=0$; $\text{R}=\text{cat}$, $n=1$; $\text{L-L}=2,2'$ -bipyridine or 1,10-phenanthroline).

Interesting results were obtained when $\text{R}_n\text{PCl}_{4-n}^+\text{X}^-$ ($0 \leq n \leq 1$; $\text{X}=\text{SbCl}_6$ or BCl_4) was reacted with some pseudo-halide salts. PCl_4^+ reacted with MNCS ($\text{M}=\text{Li}$ or Ag) in either acetonitrile or nitromethane to give $\text{SPCl}_{3-n}(\text{NCS})_n$ (17) while with MN_3 ($\text{M}=\text{Na}$ or Li) in nitromethane, a series of azido compounds, $\text{PCl}_{4-n}(\text{N}_3)_n^+$, ($0 \leq n \leq 4$) was formed (18). When 2,2'-bipyridine was added to a solution containing the ions $\text{PCl}_{4-n}(\text{N}_3)_n^+$, new resonances appeared at higher field, which were easily assigned to the six-coordinate species $[\text{PCl}_{4-n}(\text{N}_3)\text{bipy}]^+[\text{SbCl}_6]^-$ (19). A few organo-azido-phosphorus compounds $\text{RPCl}_{3-n}(\text{N}_3)_n^+$ ($\text{R}=\text{Me}$, Et and Ph ; $0 \leq n \leq 3$) were also identified in solution (20).

1.2 THE ACCEPTOR PROPERTIES OF PHOSPHORUS (III) COMPOUNDS.

A vast variety of organophosphorus (III) halides and dihalides has been described and a large volume of data is available including ^{31}P n.m.r. chemical shifts. In contrast only a few organophosphorus pseudohalides, R_2PX ; [$\text{X}=\text{NCS}$, NCO , CN or N_3 ; $\text{R}=\text{Ph}$, Et , C_6F_5 , Bu , Pr , CF_3 etc.) (21,22,23) and dipseudohalides, RPX_2 ; ($\text{R}=\text{Ph}$, Me , C_6F_5 , $\text{X}=\text{NCO}$, NCS and CN ; $\text{R}=\text{4-MeC}_6\text{H}_4$, $\text{X}=\text{NCS}$; $\text{R}=\text{Et}$, $\text{X}=\text{NCO}$) (23,24) have been reported, mainly in the nineteen sixties, but until recently no one had tried to investigate the acceptor properties of these compounds.

Recently (20,25) the acceptor properties of some organophosphorus (III) halides and pseudohalides have been investigated, in which $\text{RP}(\text{CN})_2\text{X}^-$; ($\text{R}=\text{Me}$, Ph , and Et ; $\text{X}=\text{Cl}$, Br , I or NCS) were isolated and their ^{31}P n.m.r. data recorded. The addition of cyanide ion to $\text{RP}(\text{CN})_2$ resulted in a reductive elimination to give $\text{RP}(\text{CN})^-$ and cyanogen (25). This phenomenon also occurred in the addition of CN^- ion to $\text{P}(\text{CN})_3$ which gave only $\text{P}(\text{CN})_2^-$ and cyanogen, a two-coordinate phosphorus (I) compound (26). $\text{PhP}(\text{CN})_2$ has also been reported to give a 1:1 adduct with chlorine, presumably the phosphorane $\text{PhP}(\text{CN})_2\text{Cl}_2$ (27), and with $\text{HCONMe}_2(\text{dma})$ to give 1:4 and 1:6 adducts $\text{PhP}(\text{CN})_2.\text{dma}_4$ or 6 respectively (28).

The addition of halides or pseudohalide salts to an

organophosphorus (III) dihalide such as MePCl_2 or PhPCl_2 failed to give an adduct, RPhCl_2X^- ($\text{R}=\text{Ph, Me or Et; X}=\text{I, Br, Cl or CN}$) (20), but some phosphorus (III) trihalides do show Lewis acid properties towards halides and pseudohalides (29). The acceptor properties of PX_3 ($\text{X}=\text{Cl, Br, CN or SCN}$) toward halides or pseudohalides X ($\text{X}=\text{Cl, Br, I, CN, SCN or NCO}$) have been studied, and several anionic derivatives (PX_4^-) have been obtained (29,30,31,32).

Boal and Ozin (33) have studied some thermally unstable complexes of group V trihalides with trimethylamine ($\text{PX}_3 \cdot \text{NMe}_3$; $\text{X}=\text{Cl, Br}$). These adducts were deduced to have pseudotrigonal bipyramidal molecular structures from vibrational spectra. Holmes and co-workers (34) isolated the PF_3 derivatives $\text{PF}_3 \cdot \text{NMe}_3$ and $\text{PF}_3 \cdot \text{NEt}_3$ as well as $\text{MePCl}_2 \cdot \text{NMe}_3$.

Adducts of PCl_3 and PBr_3 with pyridine and amides have also been reported but no structural data were given (35,36,37,38). P(NCS)_3 has been reported to form a well-defined 1:1 adduct with aniline (39). $\text{R}_4\text{N}^+\text{PBr}_4^-$ has been isolated from PBr_3 with an appropriate amount of tetraalkylammonium bromide (40). The structures of some hypervalent phosphorus (III) anions have also been determined by x-ray crystallography (31,32). This shows a ψ -trigonal bipyramidal structure for $[\text{P(CN)}_3\text{Cl}]^-$, PCl_4^- and $[\text{P(CN)}_2\text{Br}_2]^-$, an asymmetric dimeric structure for PBr_4^- , and a symmetric dimeric structure for $[\text{P(CN)}_3\text{Br}]^-$ and

$[\text{P}(\text{CN})_3\text{I}]^-$ with halogen bridges (31,32). Complexes of PCl_3 (3) and PI_3 (41) with pyridine have been detected by ^{31}P n.m.r. measurements and a four-coordinate anion has been identified by deprotonation of a hydridospirophosphorane (42). The infrared matrix isolation spectra of Cs^+PF_4^- and $\text{Cs}^+\text{PClF}_3^-$ ion pairs have also been reported (43).

1.3 PSEUDOHALIDE DERIVATIVES OF FIVE AND SIX-COORDINATE PHOSPHORUS (V).

The chemistry of phosphorus (V) pseudohalides has been little investigated, especially for the five-coordinate compounds. PCl_5 with small amounts of both lithium and sodium azide in PhNO_2 led only to the formation of phosphazenes $(\text{NPCl}_2)_n$, while with larger quantity of azides azido-substituted phosphonitrilic polymers were detected (29,44). Gall and Schuppen (45) performed vapour pressure measurements on the $\text{P}(\text{CN})_3$ - $(\text{CN})_2$ system which suggested the formation of $\text{P}(\text{CN})_5$, stable under a pressure of $(\text{CN})_2$. This was repeated by Dillon and Platt (17), who allowed cyanogen to condense into a tube containing $\text{P}(\text{CN})_3$ and the tube was sealed under vacuum. The ^{31}P n.m.r. showed the formation of $\text{P}(\text{CN})_5$ and $\text{P}(\text{CN})_4^+$. The cationic species is presumably formed from the following equilibrium:

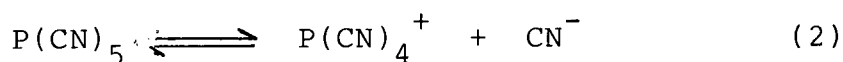

Attempts to produce $\text{PCl}_{5-n}(\text{CN})_n$ ($0 \leq n \leq 5$) species were made either by oxidation of phosphorus (III) compounds (PCl_3 or $\text{P}(\text{CN})_3$) or by direct substitution into PCl_5 , but only $\text{P}(\text{CN})_3$ oxidation with ClCN gave an adduct, as summarised below (29):

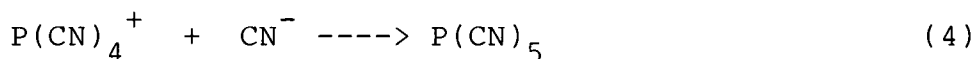
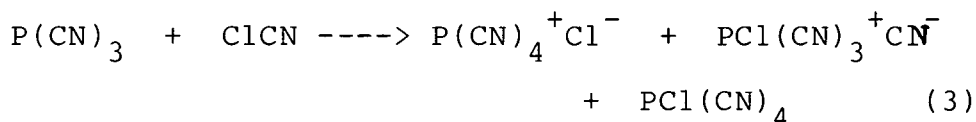

Attempted direct substitution of CN^- ion into PCl_5 in methylene chloride slowly produced PCl_3 . In PhNO_2 , resonances of the derivatives $\text{PCl}_4^+ \text{PCl}_{6-n}(\text{CN})_n^-$ ($0 \leq n \leq 3$) were observed, which slowly decomposed after several hours (29).

There is no reaction between $\text{P}(\text{NCS})_3 + (\text{SCN})_2$, but in the system $\text{PCl}_3 + (\text{SCN})_2$, a series of compounds, $\text{SPCl}_{3-n}(\text{NCS})_n$ formed which were identified by ^{31}P n.m.r., as well as $\text{PCl}_3(\text{NCS})^+$ (17). Attempted direct substitution into PCl_5 did not give any evidence to suggest the formation of mixed phosphoranes (29).

Attempts were also made to isolate cyanato-derivatives of PCl_5 (29), but POCl_3 and $\text{POCl}_2(\text{NCO})$ were usually formed. $\text{PCl}_4(\text{NCO})$ and $\text{PCl}_3(\text{NCO})_2$ were often identified in an early stage of the reaction but easily decomposed to POCl_3 or $\text{POCl}_2(\text{NCO})$ as the final product.

In contrast $\text{PCl}_5 \cdot \text{py}$ (3) and LiN_3 in liquid pyridine formed a series of complexes $\text{PCl}_{5-n}(\text{N}_3)_n \cdot \text{py}$ ($0 \leq n \leq 4$), which could be identified by means of ^{31}P n.m.r. spectroscopy (19). However, in CH_2Cl_2 , the decomposition of the complexes was quite rapid, as shown below (19):

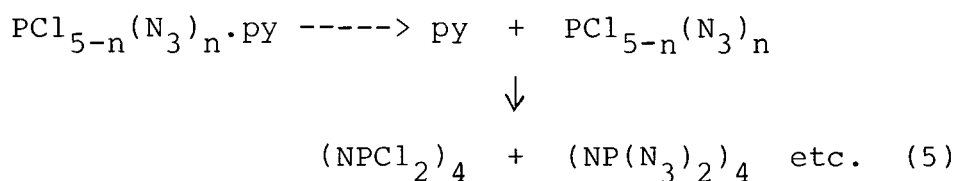

As has been mentioned in the above section, phosphorus (V) halides have a tendency to form six-coordinate complexes with suitable Lewis bases, (e.g. PCl_5/Cl^- or PF_5/F^-), but less has been published about their pseudo-halogeno-derivatives. New complexes $\text{K}^+[\text{PF}_n(\text{NCS})_{6-n}]^-$ ($3 \leq n \leq 5$) have been identified by ^{19}F and ^{31}P n.m.r. spectroscopy (46). Chevrier and Brownstein (47) studied the ^{19}F n.m.r. of the ions $\text{PF}_{6-n}(\text{X})_n^-$, ($\text{X} = \text{N}_3$, $0 \leq n \leq 3$; $\text{X} = \text{CN}$, $0 \leq n \leq 1$; $\text{X} = \text{SCN}$, $0 \leq n \leq 2$). The hexaazidophosphate ion has been prepared by the reaction of NaN_3 with PCl_5 in CH_3CN followed by addition of R_4NCl , R_4NN_3 or R_4PCl ($\text{R} = \text{alkyl group}$) to obtain the ion as its tetraalkylammonium or phosphonium salt (48,49). $\text{PCl}_4(\text{CN})_2^-$ has been prepared as a tetrachlorophosphonium salt by the reaction of PCl_5 with AgCN in CH_3CN (50), or as a tetraalkylammonium salt (51). The latter compound is more stable. PCl_5CN^- was synthesised by the reaction of PCl_5 with AgCN in a 2:1 ratio in

CH₃CN as the tetrachlorophosphonium salt (50).

Recently azido-derivatives of the type $[\text{PCl}_{6-n}(\text{N}_3)_n]^-$ (29,44) have been identified in solution by ³¹P n.m.r., and the structure of the single isomer formed preferentially in each case when n=2, 3, or 4 has been deduced from pairwise interactions (44). The cyano- and thiocyanato-derivatives $[\text{PX}_{6-n}(\text{Y})_n]^-$ (X=Cl, Y=CN; 0 ≤ n ≤ 4; X=Cl, Y=NCS; 0 ≤ n ≤ 6 (52); X=F, Y=CN, 0 ≤ n ≤ 4 (53); X=F, Y=NCS, 0 ≤ n ≤ 6 (54)), as well as derivatives of some chlorofluorophosphates of the type $\text{PFCl}_{5-n}(\text{Y})_n^-$ (Y=CN or N₃, 0 ≤ n ≤ 5), $\text{PF}_2\text{Cl}_{4-n}(\text{X})_n^-$ (X=CN, N₃ or NCS; 0 ≤ n ≤ 4) or $\text{PF}_3\text{Cl}_{3-n}(\text{X})_n^-$ (X=CN, N₃ or NCS; 0 ≤ n ≤ 3) (29,53,54) have also been identified in solution, and some of them have been isolated as salts with suitable large cations.

The thiocyanato-complexes were deduced to be N- rather than S-bonded from n.m.r. ($\text{K}^+[\text{PF}_n(\text{NCS})_{6-n}]^-$) or i.r. spectroscopy ($[\text{Pe}_4\text{N}][\text{P}(\text{NCS})_6]$) (46,52), indicating that phosphorus (V) behaves as a hard acid in this system.

Dillon and Platt (55) have identified the formation of N- or O-bonded cyanato-derivatives of hexachlorophosphate $\text{PCl}_{6-n}(\text{NCO})_n^-$ and $\text{PCl}_{6-n}(\text{OCN})_n^-$ (0 ≤ n ≤ 6), which were obtained in solution by different preparative routes.

This work has been extended to the organophosphorus (V) halide anions catPCl_4^- , $\text{cat}_2\text{PCl}_2^-$ (19), MePCl_5^- and Ph-

PCl_5^- (56,57). A few derivatives containing azide or cyanide ligands, comprising $\text{catPCl}_{4-n}(\text{N}_3)_n^-$ ($0 \leq n \leq 4$), $\text{cat}_2\text{PCl-N}_3^-$ (19) and $\text{RPCl}_{5-n}(\text{CN})_n^-$ ($\text{R}=\text{Ph}$, $0 \leq n \leq 3$; $\text{R}=\text{Me}$, $0 \leq n \leq 5$) (56,57) have been identified, but only $\text{MeP}(\text{CN})_5^-$ and $\text{PhP-Cl}_2(\text{CN})_3^-$ have been isolated pure (56,57).

1.4 PRESENT WORK.

Comparatively little was known about the acceptor properties of organophosphorus (III) compounds, as described above. Therefore in the present work the aim was to extend the investigations into the acceptor properties of organophosphorus (III) halides and pseudohalides towards halide and pseudohalide ions, and to investigate the best means of stabilising new phosphoranides. Starting materials were RPX_2 , ($\text{R}=\text{C}_6\text{F}_5$, $\text{X}=\text{Cl}$, Br , I and NCS ; $\text{R}=\text{CCl}_3$, $\text{X}=\text{Cl}$) and R_2PX ($\text{R}=\text{C}_6\text{F}_5$; $\text{X}=\text{Cl}$, Br , NCS and CN). The results of these studies are discussed in chapter 5, in which it was hoped that the introduction of electronegative groups such as C_6F_5 or CCl_3 on phosphorus would stabilise the anionic species without the necessity for cyanide ligands. Several novel phosphoranides with one or two organo-groups attached to phosphorus and no cyano group, as well as with cyano- and thiocyanato-groups present, have been isolated and characterised.

The identification of some new six-coordinate anionic organophosphorus (V) pseudohalogen-containing com-

pounds was also proposed, as well as four-coordinate cationic species, by the main technique of ^{31}P n.m.r. spectroscopy. In $\text{R}^+\text{PCl}_{5-n}\text{X}_n^-$ ($\text{X}=\text{CN}$, and NCS) systems, the main purpose was to examine the effect of the electronegative groups (C_6F_5 and CCl_3) on the substitution reaction ($\text{R}^+\text{PCl}_5^-/\text{X}^-$) and to make a comparison with the alkyl (CH_3 (55,56) and C_2H_5) and aryl systems (C_6H_5 (55,56)). This section is discussed in chapter 6. The cationic species were prepared by the reaction between R^+PCl_4 ($\text{R}=\text{C}_6\text{F}_5$, CCl_3 or C_2Cl_5), R_2^+PCl_3 ($\text{R}=\text{C}_6\text{F}_5$ and CCl_3) and R_3^+PCl_2 ($\text{R}=\text{C}_6\text{F}_5$) with an equimolar amount of MCl_3 ($\text{M}=\text{B}$, I or Au) or SbCl_5 in CH_2Cl_2 (chapters 3 and 4). The cations show acceptor properties towards neutral ligands such as 2,2'-bipyridine and 1,10-phenanthroline to form six-coordinate species, which may be observed in two isomeric structures by ^{31}P n.m.r.

Where compounds have been isolated, standard techniques such as elemental analysis and vibrational spectroscopy have been used to complete their characterisation.

CHAPTER TWO

2.0 EXPERIMENTAL.

2.1 THE DRY BOX.

All manipulations were carried out under an atmosphere of dry N_2 because nearly all the compounds were moisture-sensitive. All products containing phosphorus were stored in sealed containers under nitrogen and placed in a desiccator containing calcium chloride.

The dry box has two entry ports, a large and a small quick entry port. The large port was purged for 30 minutes before opening the inside window and the quick entry port was flushed with nitrogen by means of excess internal nitrogen pressure.

The water pump was connected to a filtration apparatus inside the box through dry $CaCl_2$ to absorb any water vapour diffused into the box. A large dish containing P_2O_5 was exposed in the box to remove any traces of moisture present in the box atmosphere.

2.2 NUCLEAR MAGNETIC RESONANCE SPECTROSCOPY.

The Fourier transform nuclear magnetic resonance spectrometer used in the earlier period of studies was con-

structed and programmed by Dr. A. Royston. The spectrometer employs a permanent magnet of field 1.4 T from a Perkin-Elmer R10 spectrometer and is controlled by a varian 620/L mini-computer. The ^{31}P resonance frequency is 24.29 MHz. The system stores and accumulates the free induction decay n.m.r. signal induced by a powerful R.F. pulse applied to a sample containing phosphorus. After completion of the required number of pulses, the computer processes the accumulated F.I.D.S to give a spectrum which is displayed on the oscilloscope. The sweep width could be varied from 40-800 p.p.m., and the origin could be altered so that ^{31}P resonances were observable in the range +400 to -1100 p.p.m.

A Fourier transform multinuclear spectrometer was also used in the later stage of studies, which included ^{31}P , ^{119}Sn , ^{11}B and ^{125}Te nuclei using different probes. The whole system was driven by a PDP 11/34 computer controlled from a keyboard. The computer program included facilities for free induction decay manipulation, phase correction of the spectra, measurement and tabulation of peaks, variation of pulse length and pulse intervals, and storage of the spectra. Chemical shifts were measured relative to an external 85% H_3PO_4 reference with the downfield direction taken as positive for ^{31}P spectra, while for ^{11}B n.m.r. $(\text{MeO})_3\text{B}$ was used as the external reference and the same sign convention was employed. The ^{11}B resonance frequency is 19.25 MHz for a field of 1.4 T. Literature data relative to $\text{BF}_3 \cdot \text{Et}_2\text{O}$ as external reference have been converted to

this scale using the experimental relationship:

$$\delta^{11}\text{B} (\text{B}(\text{OMe})_3) = \delta^{11}\text{B} (\text{BF}_3 \cdot \text{Et}_2\text{O}) - 18.75 \text{ p.p.m.} \quad (1)$$

Occasionally the samples were run on a Bruker-AC 250 high resolution nuclear magnetic resonance which employs a superconducting magnet of 5.9T field strength with 5 cm bore size for sample tubes up to 15 mm. The ^{31}P resonance frequency is 101.2 MHz and that of ^{11}B is 80.2 MHz. As for the two previous instruments, ^{31}P and ^{11}B chemical shifts were measured relative to 85% H_3PO_4 and $(\text{MeO})_3\text{B}$ respectively, with the downfield direction taken as positive.

2.3 OTHER SPECTROSCOPIC TECHNIQUES.

Infrared spectra of the solids and liquids were recorded on a Perkin-Elmer 457 or 577 instrument between caesium iodide plates, while for solutions, a KBr solution cell was used. For bromo- and chloro- compounds, the Nujol mulls or liquid smears were placed inside polythene discs to protect the plates from attack. The spectra were recorded in the range 4000 to 200 cm^{-1} .

^{35}Cl n.q.r. spectra were obtained from a commercial mid-range Decca spectrometer operating between 5 and 55MHz. The appropriate radiofrequency coil to give the correct frequency range was used, in which a 13 mm. outside

diameter glass container was placed. Spectra were recorded at 77K (liquid nitrogen), at 195K (acetone/cardice) and at room temperature.

2.4 ELEMENTAL ANALYSIS.

Carbon, hydrogen and nitrogen were determined by microcombustion with a Perkin-Elmer 240 instrument. The reliability of the instrument was variable.

Bromine and iodine were determined iodometrically following a Schöniger oxygen flask combustion of the compound.

Phosphorus and chlorine were determined by the following method. A Cl-containing sample weighed in a gelatine capsule was decomposed by fusing with sodium peroxide in a nickel Parr bomb. The residue was washed into a flask, acidified with concentrated nitric acid and made up to 100 mls. with distilled water. For phosphorus, a suitable aliquot was treated with ammonium molybdate/ammonium vanadate reagent and the absorbance was measured at $420\text{m}\mu$ using a unicam SP 500 spectrometer. Towards the end of the study, a new method was employed by weighing a sample (~10 mg), which was then digested in 3 mls each of concentrated sulphuric and perchloric acids to give a clear colourless solution. This solution was diluted to 50 mls, a suitable aliquot was removed and complexed with ammonium

molybdate/ammonium vanadate solution, and the absorbance was measured at $420\text{m}\mu$ as in the peroxide bomb fusion. Chlorine was determined by potentiometric titration against N/100 silver nitrate solution using Ag/AgCl electrodes in an acetone medium. About the same amount of benzoic acid was occasionally added to a compound containing no organic groups, such as CCl_3PCl_4 derivatives, in determining the chlorine content.

Sulphur was determined using an adaptation of the modified oxygen flask combustion (58).

Between 15 and 25 mg of sample was combusted in a 1 litre flask containing oxygen and 12 ml of dilute hydrogen peroxide solution. Capsules for air sensitive compounds were filled in a glove-box, being weighed before and after filling. The condensed vapours were washed out and made up to 100 mls, filtering if necessary. 5 or 10 mls sample were pipetted into a flask and 2 ml A.R. acetone, 4 drops of indicator (Sulfonazo 111) and 2 drops of N/100 barium perchlorate solution were added. The pink colour changed immediately to blue but was quickly restored by the addition of a further 1 ml of acetone. The titration could then be continued in the usual manner until a permanent blue colour was obtained.

Other elements such as boron, antimony and gold were determined by atomic absorption spectroscopy, using a

Perkin-Elmer 5000 atomic absorption spectrometer. Before samples were placed in the machine the following procedure was followed;

for antimony and gold: a sample of about 20 mg was digested in concentrated HNO_3 + HCl to give a clear solution in water;

for boron: a sample of about 10 mg was combusted in an oxygen flask containing 10 mls of dilute hydrogen peroxide solution.

2.5 CHEMICALS AND SOLVENTS.

All the chemicals and solvents were used from the best available commercial grades. Purification was carried out by recrystallisation for solids, and distillation for solvents, when necessary. For oxygen sensitive compounds, the solvent was degassed by pumping under vacuum, but without boiling, and let down to dry nitrogen, several times. Solvents for use in the glove box were dried using a grade 4A molecular sieve.

2.6 STARTING MATERIALS.

a) Anhydrous LiNCS.

This compound was prepared by the method of Lee(59).

LiOH.H₂O (8.4g, 0.02 moles) and NH₄NCS (15.2g, 0.2 moles) were mixed as solids with constant stirring and warming until the mixture was dissolved in the water produced by the reaction. The mixture was then heated under vacuum at 373K for 6 hours to remove H₂O and NH₃.

Analysis:

Found: C=17.66 N=20.48%.

Calculated: C=18.47 N=21.55%.

b) LiN₃ was purified by dissolving it in absolute ethanol and then evaporating to dryness in vacuo. Heating was continued at 328K for 6 hours to isolate dry LiN₃. All the azide waste was destroyed by treating it with sodium nitrite (NaNO₂) solution and acetic acid.

c) NH₄SCN was recrystallised from methanol and dried in vacuo for 6 hours.

d) All the tetraalkylammonium salts, R₄NCl (R=Et, n-Pr and n-Bu) were dried by heating to 420K in vacuo for 6-7 hours while Pe₄NCl was dried by heating to 370K in vacuo for 5 hours. Similarly Pr₄NBr and Pr₄NI were dried by heating to 373K for 5-7 hours in vacuo.

e) P(NCS)₃ was prepared in CH₂Cl₂ solution by adding NH₄SCN to a solution of PBr₃ with constant stirring until all the PBr₃ had reacted (³¹P for P(NCS)₃ = 85.4

p.p.m.). The solution was then filtered to remove NH_4Br and excess NH_4SCN . It was stored at 243K and used without further purification.

f) Preparation of $(\text{C}_6\text{F}_5)_n\text{PBr}_{3-n}$ ($n=1, 2$ or 3).

In a 3 litre three-necked flask fitted with mechanical stirrer, dropping funnel and CO_2 condenser were placed Mg turnings (3.88 g, 0.16 mmoles) and 350 mls anhydrous ether. Ethylene dibromide (5 mls) was added to the above solution as a catalyst. $\text{C}_6\text{F}_5\text{Br}$ (38.74 g, 0.16 mmoles) was placed in the dropping funnel and then 5 mls was added to the above solution. The reaction mixture was warmed gently with a hair drier until the reaction started (evolution of gas). The remainder of the $\text{C}_6\text{F}_5\text{Br}$ was then added dropwise to the reaction mixture. After addition was complete, the mixture was cooled to room temperature and stirred for 15 minutes before the excess Mg turnings were filtered off. This solution was then added to an equimolar solution of PBr_3 (42.24 g, 0.16 mmoles) in ether with cooling and stirring. The resulting brown solution was allowed to settle overnight and filtered under nitrogen. The ether was removed in vacuo and the dark brown oil was distilled in vacuo. The colourless liquid with boiling range 338-342K at 0.5 mm Hg was collected, and analysed as $\text{C}_6\text{F}_5\text{PBr}_2$.

Analysis:

Found: C=21.50 H=8.68 Br=44.43%.

Calculated: C=20.12 H=8.66 Br=44.66%.

The reaction is based on the following equations:

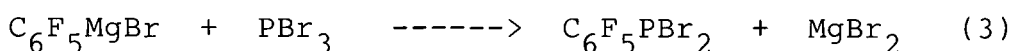
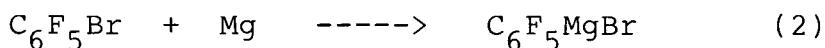

For $(\text{C}_6\text{F}_5)_2\text{PBr}$ and $(\text{C}_6\text{F}_5)_3\text{P}$, the above Grignard reaction was performed in 2:1 and 3:1 ratios respectively of the Grignard reagent to PBr_3 . $(\text{C}_6\text{F}_5)_2\text{PBr}$ was isolated as a colourless liquid with boiling range 385-387K at 0.5 mm Hg. Since it was a known compound, the analysis was not done and the ^{31}P n.m.r. was recorded at 11.4 p.p.m. in CH_2Cl_2 . $(\text{C}_6\text{F}_5)_3\text{P}$ was isolated as a white solid at >378K at 0.5 mm Hg. $(\text{C}_6\text{F}_5)_3\text{P}$ is a solid, m. pt. 389-390K.

(60), which always solidifies in the condenser, and this must be heated with a hair dryer to transfer the solid to the receiving flask. It was always contaminated with $\text{C}_6\text{F}_5\text{PBr}_2$ and $(\text{C}_6\text{F}_5)_2\text{PBr}$. Purification was carried out by washing it with low boiling petroleum ether.

Analysis:

Found: C=39.10 P=4.82%.

Calculated: C=40.60 P=5.83%.

g) Preparation of $\text{C}_6\text{F}_5\text{PI}_2$.

$\text{C}_6\text{F}_5\text{PBr}_2$ (1.65 g, 4.5 mmoles) was dissolved in $\text{CH}_2\text{-Cl}_2$. Dry LiI (1.24 g, 9.30 mmoles) was added to the above solution with constant stirring. The reaction mixture was left stirring overnight and then the LiBr was filtered off.

Evaporation of the solvent gave $C_6F_5PI_2$ as a brown liquid.

Analysis:

Found: C=16.07 P=7.57 I=56.06%.

Calculated: C=15.94 P=6.86 I=56.18%.

h) Preparation of $(C_6F_5)_nPCl_{3-n}$ (n=1 and 2).

$C_6F_5PBr_2$ (2.03 g, 5.7 mmoles) was diluted in CH_2Cl_2 and dry Et_4NCl (1.90 g, 11.5 mmoles) was added with constant stirring until only one ^{31}P n.m.r. signal at 135.5 ± 1 p.p.m. could be observed. The solvent was removed in vacuo and then the $C_6F_5PCl_2$ was extracted from Et_4NBr with low boiling petroleum ether. Evaporation of this solvent gave $C_6F_5PCl_2$ as a colourless liquid.

Analysis:

Found: C=27.33 P=red colour Cl=21.67%.

Calculated: C=26.77 P=11.52 Cl=26.39%.

When the above preparation was repeated using $(C_6F_5)_2PBr$ (2.50 g, 5.62 mmoles) and Et_4NCl (0.95 g, 5.74 mmoles), a colourless liquid was isolated, identified as $(C_6F_5)_2PCl$.

Analysis:

Found: C=35.03 P=7.00 Cl=7.10%.

Calculated: C=36.04 P=7.76 Cl=8.88%.

i) Preparation of $(C_6F_5)_nPCl_{5-n}$ (n = 1, 2 or 3).

$C_6F_5PCl_2$ (1.50 g, 5.58 mmoles) was dissolved in CH_2Cl_2 (30 mls) and dry Cl_2 gas was allowed to pass through

this solution with constant stirring until a greenish yellow solution formed. The solvent and excess Cl_2 were removed in vacuo to isolate a colourless liquid, $\text{C}_6\text{F}_5\text{PCl}_4$.

Analysis:

Found: C=20.11 P=10.48 Cl=38.24%.

Calculated: C=21.18 P=9.11 Cl=41.76%.

$(\text{C}_6\text{F}_5)_2\text{PCl}_3$ was isolated as a white solid from the action of chlorine on $(\text{C}_6\text{F}_5)_2\text{PCl}$ in a similar reaction.

Analysis:

Found: C=31.14 P=5.92 Cl=19.40%.

Calculated: C=30.60 P=6.59 Cl=22.63%.

$(\text{C}_6\text{F}_5)_3\text{PCl}_2$ was isolated as a white solid from the action of Cl_2 on $(\text{C}_6\text{F}_5)_3\text{P}$.

Analysis:

Found: C=35.87 P=4.54 Cl=9.14%.

Calculated: C=35.82 P=5.14 Cl=11.77%.

j) Preparation of $(\text{CCl}_3)_n\text{PCl}_{5-n}$ ($n=1, 2$).

These compounds were prepared by an adaptation of the method of Quin and Rolston (61).

MePCl_4 (0.78 g, 4.15 mmoles) was added to either CH_2Cl_2 or CCl_4 (~150 mls), and the mixture was warmed to 343-353K until all the solid had dissolved. Dry Cl_2 gas was allowed to flow in excess at a slow rate until a greenish yellow solution formed. The solvent and excess Cl_2 gas

were removed in vacuo to isolate a fine white solid, which analysed as CCl_3PCl_4 .

Analysis:

Found: C=4.51 P=9.52 Cl=83.81%.

Calculated: C=4.12 P=10.63 Cl=85.25%.

$(\text{CCl}_3)_2\text{PCl}_3$ was prepared by a similar method from Me_2PCl_3 . In this case, the starting material was only partly soluble in CH_2Cl_2 and CCl_4 , therefore the Cl_2 gas was allowed to flow into the slurry of Me_2PCl_3 until the greenish yellow clear solution formed. $(\text{CCl}_3)_2\text{PCl}_3$ was isolated as a fine white solid.

Analysis:

Found: C=6.46 P=6.83 Cl=83.20%.

Calculated: C=6.41 P=8.26 Cl=85.30%.

k) Preparation of $\text{R}_n\text{PCl}_{5-n}$ (R=Me, Et; n=1, 2).

RPCl_4 (R=Me, Et) were prepared by chlorination of RPCl_2 (R=Et, Me) in CH_2Cl_2 , as described for $\text{C}_6\text{F}_5\text{PCl}_4$, but the solution was cooled at 273K. Me_2PCl_3 was prepared by the method of Baumgartner (62) as described below:

Tetramethyldiphosphinedisulphide, $(\text{Me}_2\text{PS})_2$ (4.34 g, 0.02 mmoles) was dissolved in 300 mls CCl_4 and then a slow stream of dry chlorine was passed through this solution with constant stirring, until it was saturated. The mixture was then boiled in the dark by covering the flask and the condenser with aluminium foil until the solution

went red. The white precipitate which had formed was then filtered off, washed with CCl_4 and low boiling petroleum ether and dried in vacuo to produce a fine white solid.

Analysis:

Found: C=13.9 H=2.0 P=18.05 Cl=63.44%.

Calculated: C=14.33 H=3.58 P=18.51 Cl=63.58%.

1) Preparation of $\text{RPS}(\text{NCS})_2$ (R=Me and Ph).

These compounds were prepared by the method of Sowerby (63), as described below:

PhPSCl_2 was diluted in CH_3CN , and a 2:1 molar ratio of dry NH_4SCN was added to the above solution with constant stirring. The mixture was allowed to stir for 30 minutes before the ^{31}P n.m.r. was checked, to give one signal at 35.5 p.p.m. $\text{MePS}(\text{NCS})_2$, similarly prepared, gave one ^{31}P signal at 43.6 p.p.m. The NH_4Cl was filtered off and the solvent was removed in vacuo to isolate the product.

m) Preparation of $\text{PhPO}(\text{NCS})_2$.

Liquid PhPOCl_2 (1.38 g, 7.05 mmoles) was diluted in CH_2Cl_2 . Solid AgSCN (2.62 g, 15.8 mmoles) was added with constant stirring. The reaction mixture was allowed to stir overnight before the silver salts were filtered off. The solvent was then evaporated from the filtrate to yield a yellow liquid.

Analysis:

Found: C=39.75 H=1.70 N=10.73 P=11.87 S=27.50%.

Calculated: C=40.0 H=2.08 N=11.67 P=12.92 S=26.67%.

n) Preparation of CCl_3PCl_2 .

CCl_3PCl_4 (1.33 g, 4.56 mmoles) was dissolved in CH_2Cl_2 and warmed to 308K on a water bath. MeOPCl_2 (0.62 g, 4.56 mmoles) was then added to the above solution with constant stirring. After 30 minutes the solvent was removed to give a white solid.

Analysis:

Found: C=5.61 Cl=78.9% P=red colour.

Calculated: C=5.44 Cl=80.50 P=14.66%.

CHAPTER THREE

THE ACCEPTOR PROPERTIES OF PENTAFLUOROPHENYL- PHOSPHORUS (V) COMPOUNDS.

3.1 THE ACCEPTOR PROPERTIES OF $C_6F_5PCl_4$ AND RELATED COMPOUNDS.

3.1.1 INTRODUCTION.

$C_6F_5PCl_4$ was first reported by Fild et al (64). It was synthesized by chlorination of $C_6F_5PCl_2$, and the ^{31}P n.m.r. shift of -70.9 p.p.m. in CH_2Cl_2/CD_2Cl_2 (50:50) suggested that it had a five-coordinate molecular structure. The ^{35}Cl n.q.r. at 77K was also recorded to give a signal for ^{35}Cl equatorial at 34.4 MHz and one for ^{35}Cl axial at 27.1 MHz, in a 3:1 relative intensity. In this work, the compound was prepared by direct chlorination of $C_6F_5PCl_2$ in methylene chloride at room temperature, and the product was obtained as a colourless liquid after removal of the solvent. The ^{31}P n.m.r. gave a signal at -70.9 p.p.m. in methylene chloride, in excellent agreement with the reported value. The i.r. data is recorded in table 3.3. Recently Dillon and Lincoln (65) have reinvestigated its ^{35}Cl n.q.r. at 77K, but they observed three equally intense signals at 34.480, 34.380 and 34.290 MHz, identified as due to equatorial chlorines, while the signal at 27.1 MHz could not be observed (64). A fourth

equally intense signal was also found at 25.300 MHz, ascribed to the axial chlorine. The most probable explanation for this discrepancy is that the signal seen by Fild et al (64) at 27.1 MHz is the ^{37}Cl resonance from the equatorial chlorines, the frequency of which when calculated from the ^{35}Cl resonance at 34.4 MHz is 27.1 MHz. The isotopic ratio for $^{35}\text{Cl}:^{37}\text{Cl}$ is 3.07:1; in excellent agreement with Fild's intensity ratio. At 195K, four weak equally intense signals were also observed, with the average frequency for the equatorial chlorines at 33.92 MHz, confirming the structure of $\text{C}_6\text{F}_5\text{PCl}_4$ at 77 and 195K as ψ -trigonal bipyramidal with the electronegative C_6F_5 group occupying an axial position.

3.1.2 THE REACTION OF (PENTAFLUOROPHENYL)TETRA- CHLOROPHOSPHORANE WITH OTHER PHOSPHORUS (V) COMPOUNDS (RPCl_4 AND PCl_5 ; R=Me AND Ph).

All these compounds are capable of forming complexes with other metal halides which are themselves potential Lewis acids, eg; $\text{C}_6\text{F}_5\text{PCl}_3\text{BCl}_4$ or $\text{PhPCl}_3\text{SbCl}_6$, but they are good chloride acceptors in the absence of competing reactions, forming chlorophosphate anions (9,16). An investigation to determine whether $\text{C}_6\text{F}_5\text{PCl}_4$ or the other phosphorus (V) compound is the stronger chloride ion acceptor was carried out by mixing the two corresponding solutions in either methylene chloride or nitrobenzene in an n.m.r. tube, and recording the ^{31}P n.m.r. spectrum of

the mixture.

When $C_6F_5PCl_4$ was mixed with $MePCl_4$ in a 1:1 ratio, in CH_2Cl_2 , no change in the ^{31}P n.m.r. peak positions ascribed to the individual compounds was observed, with signals at -40.6 ($MePCl_4$) (16) and -70.9 ($C_6F_5PCl_4$) p.p.m., as compared with the shifts recorded for these compounds separately in methylene chloride, i.e. -38.7 and -70.9 p.p.m. respectively. In $PhNO_2$, a 1:1 mixture gave signals at -35.5 ($MePCl_4$) and 70.9 p.p.m. ($C_6F_5PCl_4$). The reaction was expected to give $MePCl_3^+$ (~120 p.p.m.) and $C_6F_5PCl_5^-$ (~-240 p.p.m.), since a consideration of inductive effects suggests that $C_6F_5PCl_4$ should be the stronger chloride acceptor. The bulk of the C_6F_5 group could impose a steric effect, however, which would reduce the acceptor ability of the compound towards the chloride ion, and it appears that these two compounds have the same acceptor ability in this case.

When $PhPCl_4$ was used, a similar spectrum was observed in which the signals for $C_6F_5PCl_4$ (-70.9) and $PhPCl_4$ (-45.3 p.p.m.) were seen in the mixture. This reaction was similarly expected to give $PhPCl_3^+$ (~103 p.p.m.) and $C_6F_5PCl_5^-$ (~-240 p.p.m.) since the C_6F_5 group is more electronegative than C_6H_5 , thus increasing the acceptor ability toward the chloride ion. The most probable explanation for the above result is again greater steric hindrance by C_6F_5 , so that overall the acceptor

abilities of the compounds are comparable.

Surprisingly, a similar result was obtained with PCl_5 , which is known to be a better chloride ion acceptor than PhPCl_4 (9) or MePCl_4 (16). The ^{31}P n.m.r. spectrum was recorded to give signals at -70.9 ($\text{C}_6\text{F}_5\text{PCl}_4$) and -80.8 p.p.m. (PCl_5). Hence no reaction to form ionic products appeared to take place under the conditions used.

3.1.3 THE REACTION OF $\text{C}_6\text{F}_5\text{PCl}_4$ WITH PYRIDINE BASES.

As soon as liquid pyridine was added to a $\text{C}_6\text{F}_5\text{PCl}_4$ solution in methylene chloride, a white precipitate immediately formed which turned black when left overnight in the spectrometer. No ^{31}P n.m.r. signal was observed, presumably due to the insolubility of the product in this solvent. When more solvent was added a yellow solution was formed, which gave a signal at -75.8 p.p.m., ascribed to the starting material. When a 1:1 ratio reaction was performed in methylene chloride, a yellowish solid was isolated which gave a signal at -75.8 p.p.m. when redissolved in methylene chloride. Its solid state spectrum gave signals at 8.2 and -75.8 p.p.m. (equal intensity), identified as $\text{C}_6\text{F}_5\text{PO}(\text{OH})_2$ and $\text{C}_6\text{F}_5\text{PCl}_4$ respectively. The solid melted to give a greenish liquid at the spectrometer operating temperature (307.2K). The analyses were poor for the expected compound $\text{C}_6\text{F}_5\text{PCl}_4\cdot\text{py}$, (found: $\text{C}=33.25$ $\text{H}=1.89$ $\text{N}=4.29$ $\text{P}=5.66$ $\text{Cl}=16.24\%$; required: $\text{C}=31.50$ $\text{H}=1.19$ $\text{N}=3.34$

$P=7.40$ $Cl=33.89\%$). When the reaction was repeated using dry pyridine, the solid isolated gave very good C, H and N analyses but the phosphorus and chlorine were slightly low ($C=31.96$, $H=1.40$, $N=3.31$, $P=4.86$, $Cl=28.10\%$). Its ^{31}P n.m.r. in nitrobenzene only showed signals at 135.5 p.p.m., ascribed to $C_6F_5PCl_2$, and 9.6 p.p.m ($C_6F_5PO(OH)_2$), so that decomposition probably occurred in solution. In a qualitative reaction, resonances in the six-coordinate region were detected when $C_6F_5PCl_4$ was treated with excess liquid pyridine in nitrobenzene. The shifts were measured as -192.8 and -201.0 p.p.m., ascribed either to two (out of three) possible isomers of $[C_6F_5PCl_3py_2]^+Cl^-$ (as described in section 3.1.5 a(i)), or to the two isomers of the neutral adduct $C_6F_5PCl_4 \cdot py$ (py cis or trans to the C_6F_5 group), but these signals were not detected from the solid isolated from a 1:1 ratio reaction. From an independent experiment between $C_6F_5PCl_3SbCl_6$ and pyridine, the results show that $[C_6F_5PCl_3py_2]^+$ gives a resonance at -178.9 p.p.m. Hence this supports the suggestion that neutral species were formed in the above reaction. Configurations cannot be readily assigned in this instance by the pairwise method (66) because the $C_6F_5:py$ term is not known.

When 1,10-phenanthroline or 2,2'-bipyridine were added to a solution of $C_6F_5PCl_4$ in either CH_2Cl_2 or $PhNO_2$, no six-coordinate species was detected. On many occasions only one signal at -70.8 p.p.m. was observed, assigned to $C_6F_5PCl_4$. Therefore no attempt was made to isolate a 1:1

Table 3.1: Shifts found in $C_6F_5PCl_4/Et_4NCl$ system in CH_2Cl_2 .

| Molar ratio $C_6F_5PCl_4/Et_4NCl$ | $\delta^{31}P$ | % association of $C_6F_5PCl_5^-$ |
|---|----------------|----------------------------------|
| 1:0.75 | -104 | 19.6 |
| 1:1.75 | -148 | 45.6 |
| 1:2.75 | -185.6 | 67.8 |
| 1:4.0 | -215.8 | 85.7 |
| 1:5.0 | -230.0 | 94.1 |
| 1:6.0 | -237.0 | 98.2 |
| 1:7.0 | -240.0 | 100.0 |
| $\delta(C_6F_5PCl_4) = -70.9$ p.p.m. | | |
| $\delta(C_6F_5PCl_5^-) = -240.0$ p.p.m. | | |

Table 3.2: Degree of association for $PhPCl_4/Et_4NCl$ system in CH_2Cl_2 .

| Molar ratio $PhPCl_4:Et_4NCl$ | $\delta^{31}P$ | % association of $PhPCl_5^-$ |
|---|----------------|------------------------------|
| 1:0.75 | -61.5 | 11.8 |
| 1:1.75 | -89.0 | 28.9 |
| 1:2.75 | -114.0 | 44.5 |
| 1:4.0 | -145.0 | 63.8 |
| 1:5.0 | -163.5 | 75.4 |
| 1:6.0 | -172.0 | 80.7 |
| 1:7.0 | -174.5 | 82.2 |
| 1:8.0 | -175.0 | 82.5 |
| $\delta(PhPCl_4) = -42.6$ p.p.m. | | |
| $\delta(PhPCl_5^-) = -203.0$ p.p.m. (9) | | |

adduct.

3.1.4 ACCEPTOR PROPERTIES OF $C_6F_5PCl_4$ TOWARDS Cl^- IONS.

When Et_4NCl was added to a $C_6F_5PCl_4$ solution in methylene chloride, the ^{31}P n.m.r. signal of the starting material moved upfield to a limiting shift of -240 p.p.m. (see fig.3.1). The results are listed in table 3.1. When stoichiometric amounts of $C_6F_5PCl_4$ and Cl^- ion are present, $C_6F_5PCl_5^-$ is incompletely formed and exchanges rapidly with free $C_6F_5PCl_4$. The degree of association at each molar ratio has been calculated, and is included in table 3.1. In comparison, the degree of association of $PhPCl_4/Et_4NCl$ in the same solvent is less, as shown in table 3.2. A 1:1 molar ratio reaction between $C_6F_5PCl_4$ and Et_4NCl gave a wet yellowish solid, which turned to a fine white solid after being treated with low boiling point petroleum ether. The elemental analyses showed very high carbon, hydrogen and nitrogen, so the product was presumably a mixture of the adduct and Et_4NCl , therefore no ^{31}P n.m.r. spectrum was recorded.

The above reaction was repeated using Pr_4NCl , and after removal of the solvent, a yellowish solid was isolated. Before the solution was evaporated to dryness, the ^{31}P n.m.r. was recorded and showed an intense signal at -103.3 p.p.m. and a weak signal at 9.81 p.p.m. When this

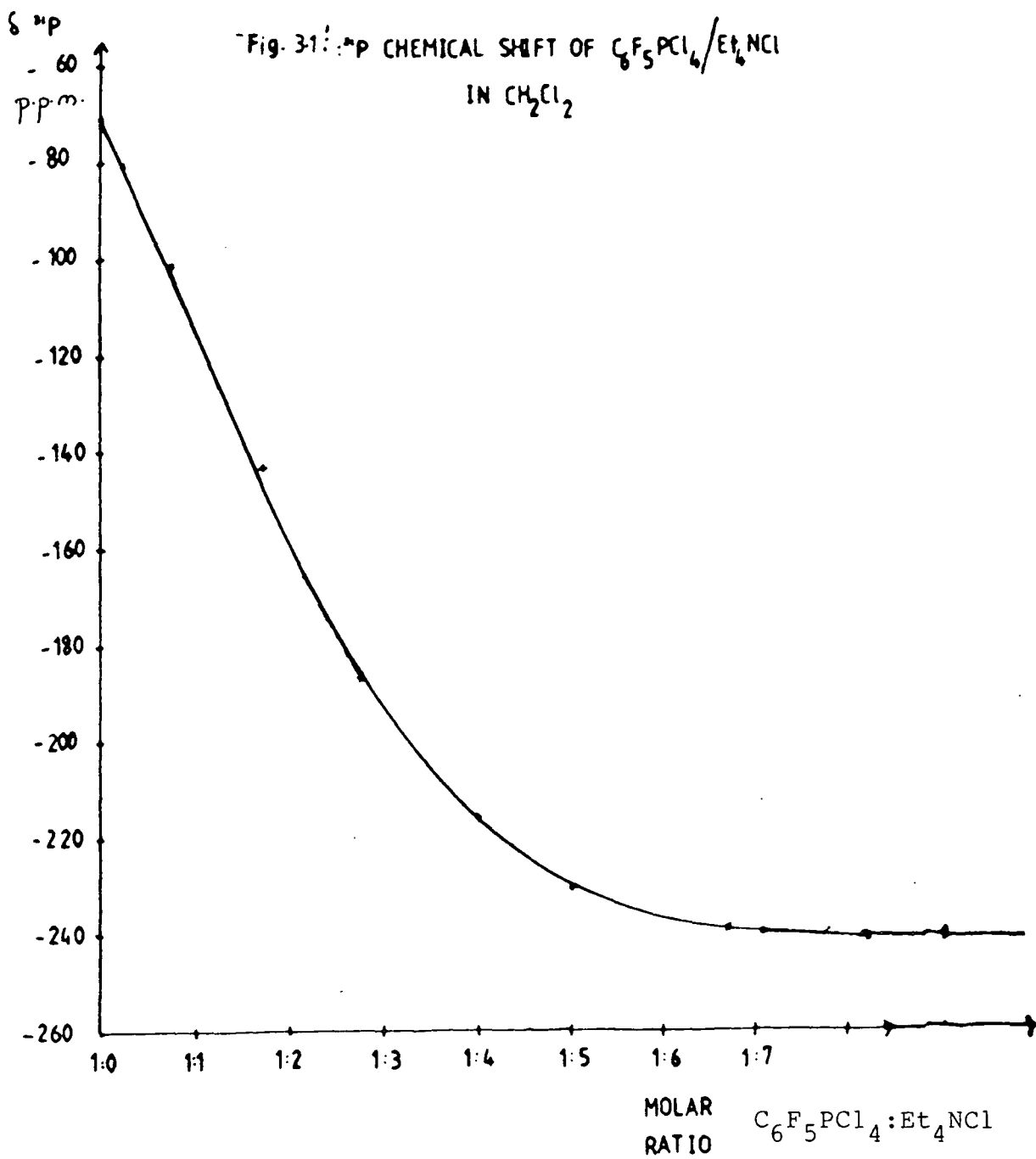

solid was redissolved in methylene chloride, the only signal was at 9.81 p.p.m., possibly due to $C_6F_5PO(OH)_2$. In nitrobenzene, its ^{31}P n.m.r. spectrum showed a signal at -183.4 p.p.m., indicating that it is partly dissociated in this solvent. In the solid state spectrum, a broad signal was observed in the six-coordinate region, but it was not reproducible. Two other signals were observed at 37.1 p.p.m. ($C_6F_5POCl_2$, weak), and 11.4 p.p.m. ($C_6F_5PO(OH)_2$, strong).

An attempt was made to wash this solid with low boiling petroleum ether, but this method only washed out all the organophosphorus compound, leaving behind a white solid, identified as Pr_4NCl . This was confirmed from the ^{31}P n.m.r. spectrum of the filtrate, in which three signals were observed at 35.5 p.p.m. ($C_6F_5POCl_2$, weak), 8.2 p.p.m. ($C_6F_5PO(OH)_2$, strong) and -70.0 p.p.m. ($C_6F_5PCl_4$, medium). Surprisingly the elemental analyses were reasonable for the expected compound, $Pr_4NC_6F_5PCl_5$ and the infrared spectrum showed the particular features expected for a six-coordinate chlorophosphorus (V) anion, with a broad band with maximum measured at 420 cm^{-1} (see table 3.3). The results may be compared with those for related complexes such as $Et_4NMePCl_5$, $n-(C_5H_{11})_4NEtPCl_5$ and $n-Pr_4NPhPCl_5$ (9,16).

Fig. 32: ^{31}P n.m.r. SPECTRA OF $\text{C}_8\text{F}_5\text{PCL}_3\text{MgCl}_8$

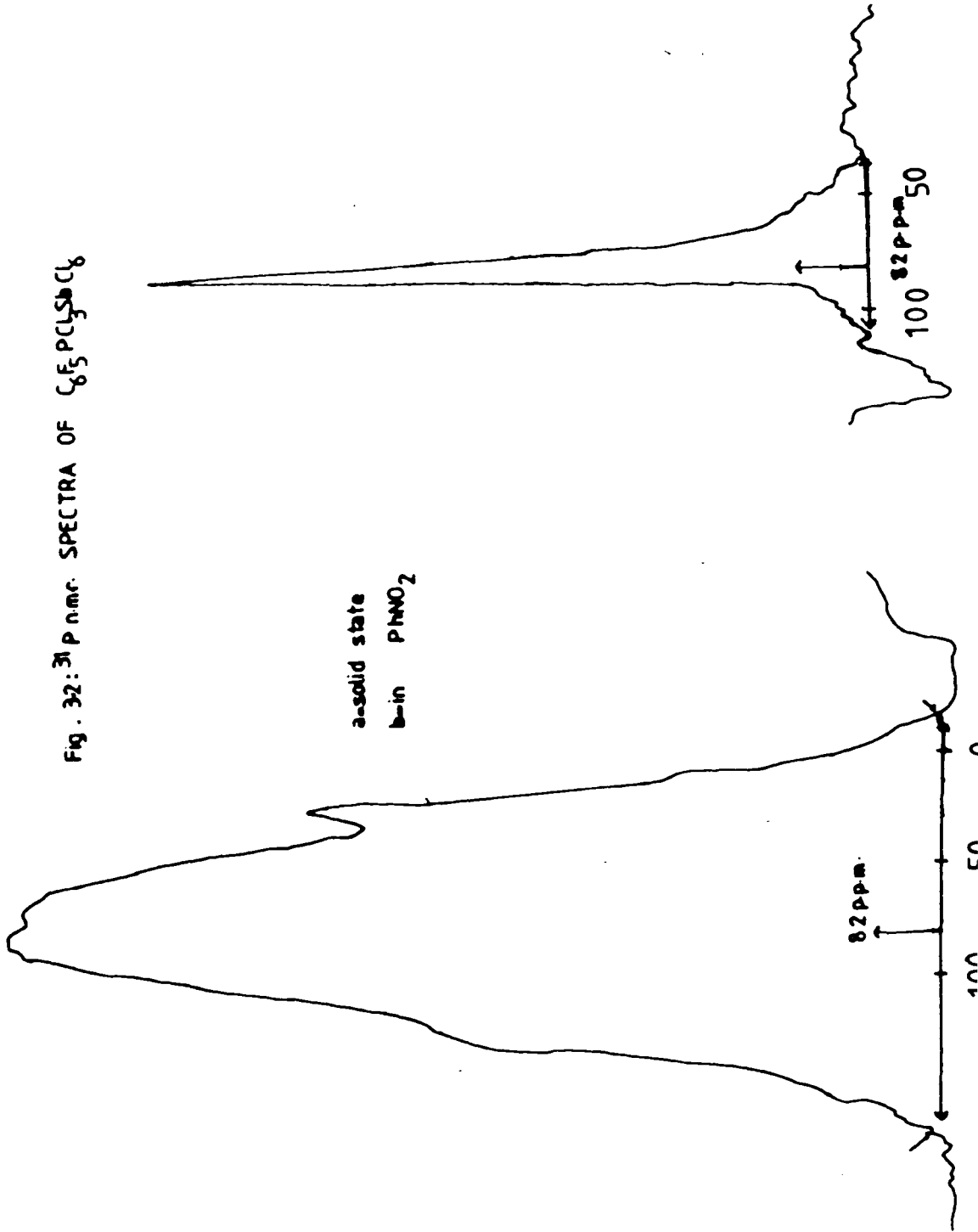

3.1.5 DONOR PROPERTIES OF $C_6F_5PCl_4$.

a) $SbCl_5$

Antimony (V) chloride is a stronger chloride acceptor than phosphorus (V) chloride, therefore the reaction between $C_6F_5PCl_4$ and $SbCl_5$ was expected to give the ionic species $[C_6F_5PCl_3]^+[SbCl_6]^-$ in solution. In a 1:1 ratio reaction, a grey solid was precipitated as soon as the antimony pentachloride was added to a solution of $C_6F_5PCl_4$ in methylene chloride. Its solid state spectrum gave a broad signal with the maximum measured at 82.2 p.p.m. (see fig.3.2). In nitrobenzene or nitromethane a peak at 82.2 p.p.m. was similarly observed. This evidence shows the presence of the four-coordinate phosphorus (V) cation $[C_6F_5PCl_3]^+$. Other organophosphorus (V) compounds, $RPCl_4$ ($R=Ph, Me, Et$ etc) also form the same type of ion with $SbCl_5$ (9,16).

The infrared spectrum was quite similar to that of the parent compound, except for the bands below 400 cm^{-1} (Table 3.3). It exhibited a broad absorption band at 335 cm^{-1} , easily assigned as an $SbCl_6^-$ band (13). The elemental analyses were reasonable for the expected compound, $[C_6F_5PCl_3][SbCl_6]$.

The ^{35}Cl n.q.r. spectrum was recorded at 77K and showed four slightly different environments for chlorines

Table 3.3: Infrared spectral data for $C_6F_5PCl_4$ and its derivatives.

| Compound | i.r. bands (800-200) cm^{-1} |
|---------------------|---|
| $C_6F_5PCl_4$ | 760m, 635m, 595s, 575m, 550s, 495m, 475m, 445m, 420s, 345w, 320m. |
| $C_6F_5PCl_3SbCl_6$ | 775m, 745sh, 655s, 620w, 590s, 560s, 480m, 405w, 375m, 335vs, br* 285w. |
| $C_6F_5PCl_3BCl_4$ | 775s, 645br*, 615s, 560s, 480m, 460w, 405m, 380m, 325s, 275w, 245s, 215s. |
| $C_6F_5PCl_3ICl_4$ | 800m, 765m, 655sh, 635m, 585m, 565s, 550s, 490w, 450w, 405m, 370w, 340w, 320w, 290sh, 260br*. |
| $C_6F_5PCl_3AuCl_4$ | 770w, 650s, 635s, 610w, 588s, 568m, 558m, 410w, 363s*, 320m. |
| $Pr_4NC_6F_5PCl_5$ | 800m, 630m, 585m, 570s, 550s, 490s, 450sh, 425s, br, 405s, 355s, 260br. |

* counter-ion

bonded to phosphorus in the lattice. Signals at 31.475(1), 31.600(2), 31.825(1) and 32.150(2) MHz were measured (relative intensities indicated in brackets). No signals were obtained either at cardiac or room temperature for these chlorines. No signals were detected for SbCl_6^- in the region below 28 MHz, either at 77K, 195K or room temperature. The SbCl_6^- ion at 77K gives average ^{35}Cl resonances for $[\text{Ph}_n\text{PCl}_{4-n}]^+$ at 24.95 (1 line), 24.47 (4 lines) and 25.48 (3 lines) MHz for $n=1, 2$ and 3 respectively (67), while in $\text{Et}_4\text{NSbCl}_6$ 4 lines (average 24.48 MHz) and in NOSbCl_6 6 lines (average 23.60 MHz) were observed (68). Hence this anion often gives a complex multiplet of lines (68,69), making the individual intensities weak, so that it is sometimes very difficult to detect, as for the present sample.

a(i) ACCEPTOR PROPERTIES OF $\text{C}_6\text{F}_5\text{PCl}_3\text{SbCl}_6$ TOWARDS BI- AND UNI-DENTATE PYRIDINE BASES.

This complex showed acceptor properties towards Lewis bases such as 2,2'-bipyridine and 1,10-phenanthroline. When a small amount of 2,2'-bipyridine was added to a solution of $\text{C}_6\text{F}_5\text{PCl}_3\text{SbCl}_6$, two new signals in the six-coordinate region were observed, at -177.3 and -188.6 p.p.m. This showed that the compound exists in two isomeric form, with N cis and trans to the C_6F_5^- group as below:

Table 3.4: Infrared data for the six-coordinate complexes $C_6F_5PCl_3L^+$ (800-200) cm^{-1} .

| Compound | i.r. bands (800-200) cm^{-1} . |
|-------------------------------------|---|
| $C_6F_5PCl_3$ bipySbCl ₆ | 770m, 765m, 755m, 710s, 665m, 650m, 630m, 580w, 520s, 505sh, 495s, 465m, 425s, 335vs,br*, 270w. |
| $C_6F_5PCl_3$ phenSbCl ₆ | 792w, 750w, 705sh, 655w, 630w, 590w, 555w, 493s, 465m, 445w, 425m, 345s,br*. |
| $C_6F_5PCl_3$ bipyBCl ₄ | 790sh, 760s, 665br*, 645sh, 635sh, 590m, 565m, 550s, 485w, 405m, 340m, 315m. |
| $C_6F_5PCl_3$ phenBCl ₄ | 770w, 695sh, 665sh,br*, 590w, 545m, 490m, 460m, 340m,br. |

*counter-ion



These signals disappeared with the addition of more bipyridine to the solution, which caused precipitation. A 1:1:1 molar ratio reaction between $\text{C}_6\text{F}_5\text{PCl}_4$, 2,2'-bipyridine and SbCl_5 gave a yellowish solid, which was analysed to give reasonable values for the expected compound, $[\text{C}_6\text{F}_5\text{PCl}_3\text{bipy}]\text{SbCl}_6$. When this solid was redissolved in nitrobenzene, only a single signal at -190.2 p.p.m. was observed. This evidence suggests that only one isomer is formed preferentially in the 1:1:1 ratio reaction. Attempts to obtain a solid state spectrum were unsuccessful.

The infrared spectrum was slightly different from that of the four-coordinate compound, because of the presence of 2,2'-bipyridine in the molecule (see table 3.3 and 3.4).

When dry 1,10-phenanthroline was added to a slurry of $\text{C}_6\text{F}_5\text{PCl}_3\text{SbCl}_6$ in methylene chloride, a yellow solution resulted and then after about 10 minutes stirring, a precipitate formed. Evaporation of this mixture gave a creamy solid. Its ^{31}P n.m.r. spectrum in nitrobenzene solution gave one signal at -190.2 p.p.m. After one week, reinvestigation of this solution only gave a signal at 4.91 p.p.m., probably due to the hydrolysis product, $\text{C}_6\text{F}_5\text{PO-}$

(OH)₂. Its i.r. frequencies are listed in table 3.4. The ³¹P n.m.r. data showed that, as for the bipy complex, only one isomer was formed in a 1:1 ratio reaction of C₆F₅PCl₃SbCl₆ and phen. The elemental analyses were quite reasonable for the expected compound C₆F₅PCl₃phenSbCl₆. The solid state ³¹P spectrum was not obtained.

Since cis isomers usually have higher field shifts than trans, (18,53), the resonances at -177.3 and -188.6 p.p.m. in the bipy system may be tentatively assigned to structures 11 and 1 respectively. In view of the similarity in shift between the higher field peak and the single resonance observed in the phen system, the latter may also arise from the cis isomer, although direct proof is lacking.

A deep yellow solution formed after the addition of pyridine to a solution of C₆F₅PCl₃SbCl₆ in nitrobenzene. The ³¹P n.m.r. showed a signal at -178.9 p.p.m., which disappeared after the formation of solid in the tube. This result suggests that C₆F₅PCl₃py₂SbCl₆ is probably formed, but is not stable, easily turning to C₆F₅PCl₄.py and SbCl₅.py as below. Similar behaviour has been observed in the RPCl₃py₂⁺SbCl₆⁻ systems (R=Cl, Ph or Me) (7,9,16).

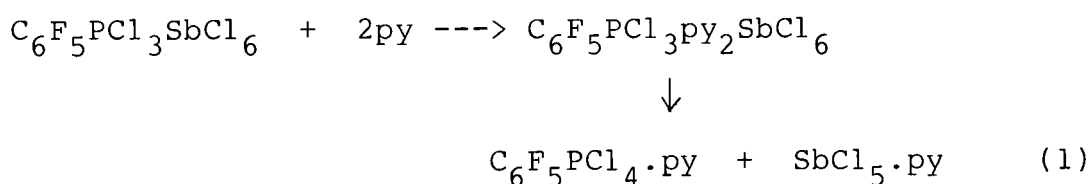

This signal could also be due to formation of the six-coordinate complex, $C_6F_5PCl_4 \cdot py$, generated from the rearrangement process of $C_6F_5PCl_3py_2SbCl_6$. This appears unlikely, however, in view of the shift data for $C_6F_5PCl_4 \cdot py$ (section 3.1.3). $C_6F_5PCl_3py_2^+$ can exist in three isomeric forms but the results indicate either preferential formation of one isomer, or rapid exchange between them as shown below:

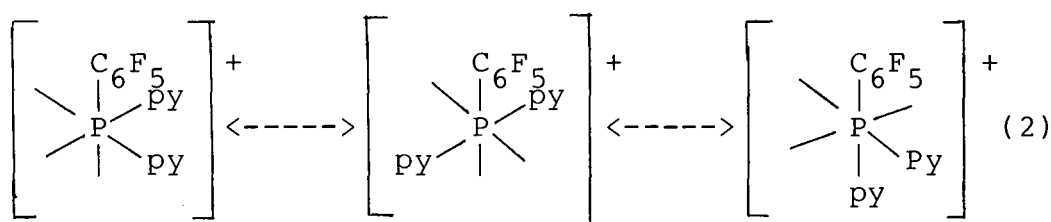

When the reaction was carried out in a 1:2 ratio of $C_6F_5PCl_3SbCl_6$ and py in methylene chloride, a yellowish solution formed. A yellowish solid was isolated after evaporation. The analysis was not good for the expected compound, $C_6F_5PCl_3py_2SbCl_6$, possibly due to a mixture of species present (see experimental section). No ^{31}P n.m.r. was recorded.

b) BCl_3 .

The adduct of $C_6F_5PCl_4$ with boron trichloride was readily prepared by allowing boron trichloride gas to flow into a $C_6F_5PCl_4$ solution, in which the fine white solid formed immediately after the reaction occurred. This solid was soluble in polar solvents such as nitrobenzene and

nitromethane, and solutions in both solvents gave ^{31}P n.m.r. peaks at 82.2 p.p.m. and ^{11}B n.m.r. peak at -10.65 p.p.m., in good agreement with the reported value for the BCl_4^- ion (70,71). Its solid state ^{31}P spectrum consisted of a broad signal with maximum measured at 82.2 p.p.m., quite similar to that of the antimony compound above. The elemental analyses were very good for the expected compound, $\text{C}_6\text{F}_5\text{PCl}_3\text{BCl}_4$.

Exposure to the air generated a new signal at 8.2 p.p.m., suspected to be $\text{C}_6\text{F}_5\text{PO}(\text{OH})_2$, the final product of hydrolysis. This signal was present in most of the reactions of the phosphorus (V) compound.

The infrared spectrum was recorded as a Nujol mull, and was very similar to that of the parent compound except for the bands below 650 cm^{-1} . The compound exhibits a broad band with the maximum measured at 645 cm^{-1} , which is easily assigned as a BCl_4^- band (72). This band is rather low in frequency compared with some other phosphorus (V) compounds containing the BCl_4^- ion (67,73), where it was observed in the region $660\text{-}700\text{ cm}^{-1}$, but it is higher than the tetrabromoborate frequencies in NH_4BBr_4 (586 and 607) cm^{-1} (72) and R_4NBr_4 (R=Me or Et) (585 cm^{-1}) (74).

The ^{35}Cl n.q.r. spectrum which was recorded at 77K exhibited 3 equally intense signals at 31.146, 32.175, and 32.448 MHz for the chlorines in the $\text{C}_6\text{F}_5\text{PCl}_3^+$ ion. This

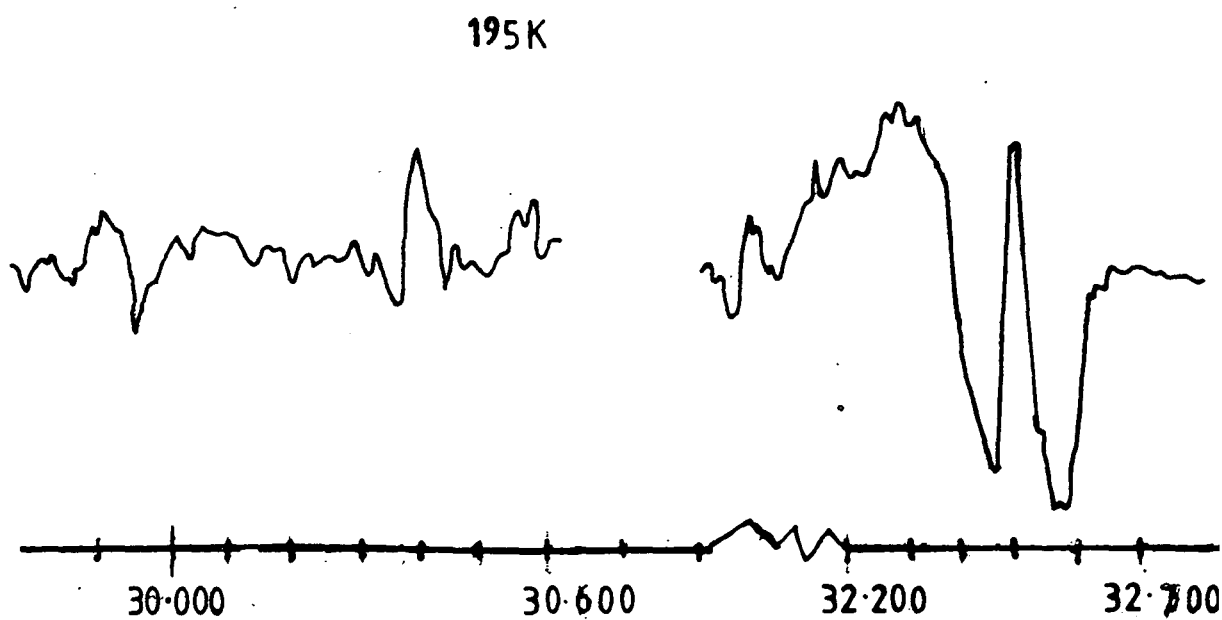
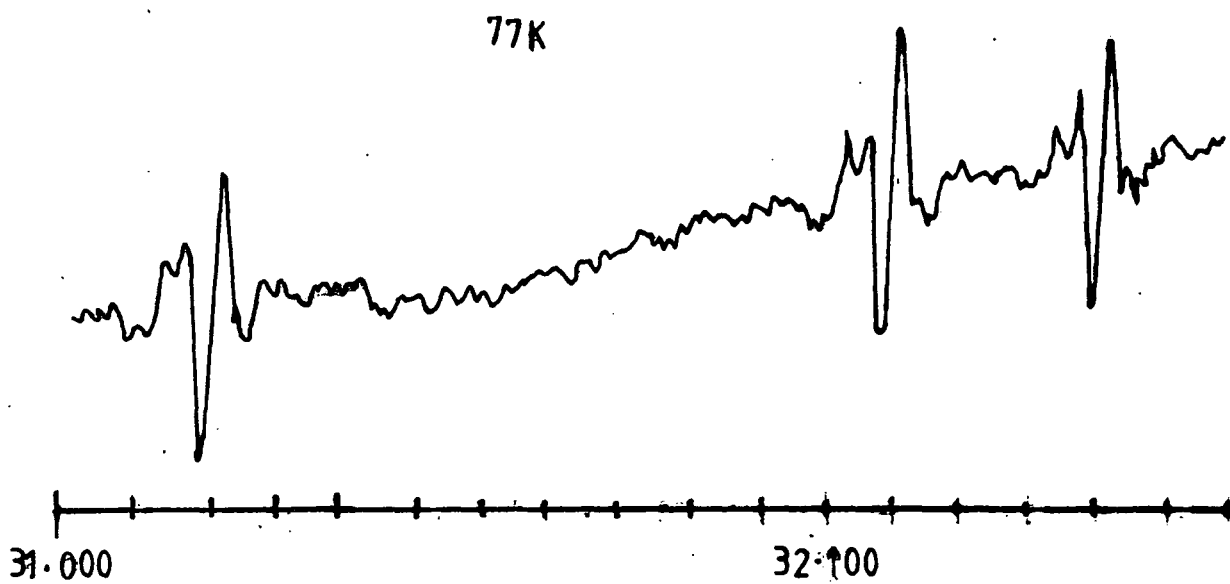
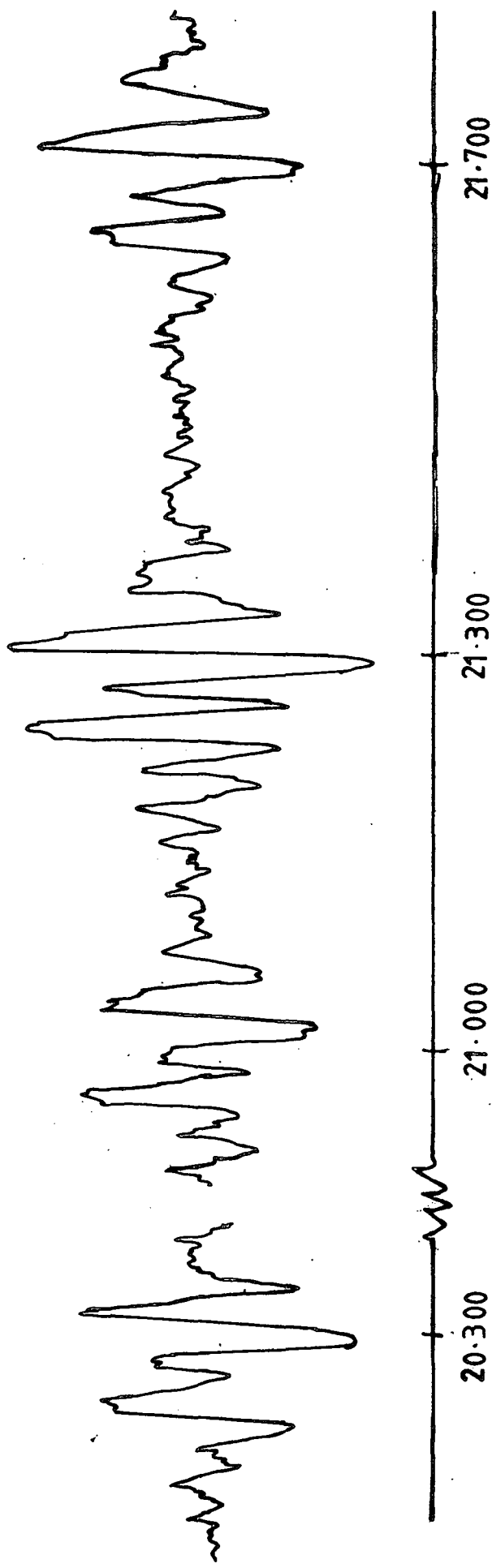

Fig. 3.3 : ^{35}Cl n.q.r. spectra for $\text{C}_6\text{F}_5\text{PCl}_3^+$ in $\text{C}_6\text{F}_5\text{PCl}_3 \text{BCl}_4$

result indicates that all three chlorines in the $\sqrt{3}$ -tetrahedral structure are crystallographically non-equivalent, therefore three separate resonances were observed. In contrast, at 195K, only two inequivalent signals were seen with frequencies measured at 30.400 and 32.500 MHz (the latter twice the intensity of the former, see fig.3.3). It seems that on increasing the temperature the 31.146 MHz signal at 77K appears at lower frequency as stated above, while only one signal with double intensity occurs in the higher frequency region, slightly higher in frequency than the two resonances observed at 77K. This phenomenon is unusual, since normally the n.q.r. frequency decreases with increase in temperature, because in most cases the increasing amplitudes of molecular thermal motions have a partial averaging effect on the electric field gradient. No resonance was observed at room temperature.

In the lower frequency region, four equally intense signals were obtained at 20.236, 21.010, 21.300, and 21.675 MHz, ascribed to the four chlorine atoms present in the tetrahedral BCl_4^- ion at 77K. Similarly, four equivalent signals were observed at 195K with slightly lower frequencies measured at 19.988, 20.775, 20.950 and 21.230 MHz (see fig.3.4). Again no signal was observed at room temperature. These results also show that the four chlorines in the BCl_4^- ion are crystallographically non-equivalent.

77K



195K

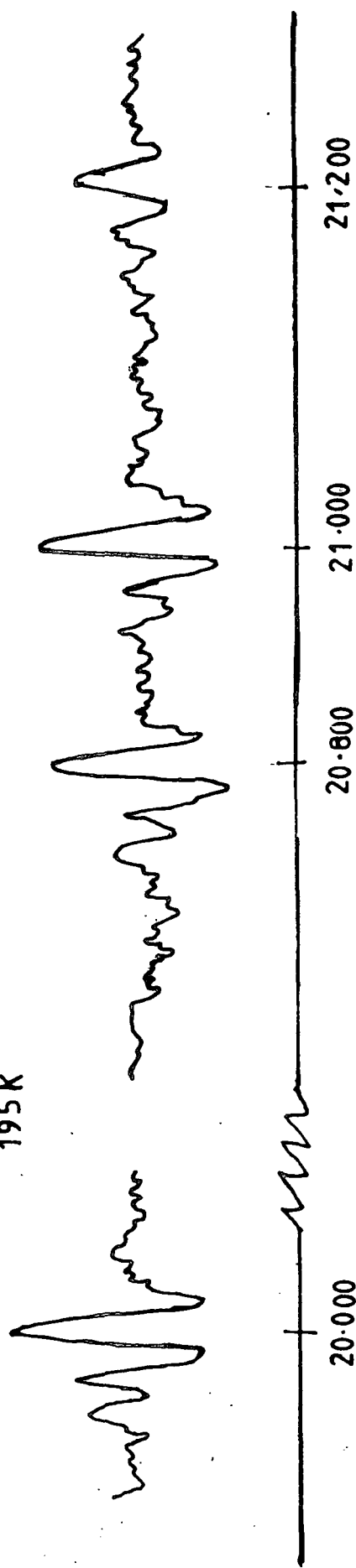

Fig. 34: ^{35}Cl n.q.r. spectra for BCl_4^- in $\text{C}_6\text{F}_5\text{PCl}_3\text{BCl}_4$

b(i) ACCEPTOR PROPERTIES TOWARDS BIDENTATE LIGANDS.

a) 2,2'-Bipyridine.

Like the antimony compound which was described in an earlier section, $C_6F_5PCl_3BCl_4$ showed acceptor properties toward bidentate ligands such as 2,2'-bipyridine and 1,10-phenanthroline to form six-coordinate cations (see sec.3.1.5). The acceptor properties were studied by ^{31}P n.m.r. spectroscopy.

When a small amount of 2,2'-bipyridine was added to a $C_6F_5PCl_3BCl_4$ solution in nitrobenzene, two new signals were observed in the six-coordinate region at -180.6 and -190.2 p.p.m., showing the presence of two isomeric structures. The addition of more bipyridine caused precipitation, and these two signals could not be detected. In a 1:1:1 ratio reaction of $C_6F_5PCl_4:2,2'$ -bipyridine: BCl_3 in methylene chloride, the adduct was isolated from the filtrate. The ^{31}P n.m.r., which was recorded before isolation of the product, exhibited the above two signals. Attempts to record a solid state spectrum failed. When the product was redissolved in $PhNO_2$, only one signal at -182.2 p.p.m. was observed. This result suggests that in this case, the trans isomer is more stable because the redissolved compound gives a shift in agreement with the lower of the two signals.

The elemental analyses were reasonable for the expected compound, but rather low in nitrogen, presumably because the ligand was not completely burned during combustion.

The i.r. spectrum (Nujol mull) was slightly different from that of the four-coordinate phosphorus (V) cation. The ligand bands can be assigned by comparing these two spectra. The BCl_4^- band was observed as a broad signal with the maximum measured at 665 cm^{-1} , superimposed with one of the ligand bands (see table 3.4).

b) 1,10-Phenanthroline.

When dry 1,10-phenanthroline was added to a slurry of $\text{C}_6\text{F}_5\text{PCl}_3\text{BCl}_4$ in methylene chloride, a yellow solution formed, which precipitated immediately a yellowish solid. This was isolated by evaporating the solvent to dryness. The solid was only slightly soluble in polar solvents. In nitrobenzene, a signal at -186.2 p.p.m. was observed, but in an attempted solid state spectrum, signals at 6.5 and -8.2 p.p.m. were detected, probably due to hydrolysis products from a trace of moisture in the tube. The above solution gave an ^{11}B n.m.r. peak at -12.2 p.p.m., in good agreement with the result for $\text{C}_6\text{F}_5\text{PCl}_3^+\text{BCl}_4^-$, and reported values for the BCl_4^- ion (70,71). No ^{35}Cl n.q.r. spectrum was recorded due to insufficient solid obtained from the above preparation. The i.r. data are tabulated in

table 3.4.

As for the bipy compound, the elemental analyses were quite reasonable for the expected compound, $C_6F_5PCl_3-phen^+BCl_4^-$.

c) ICl_3 .

An orange solution formed when ICl_3 was added to a solution of $C_6F_5PCl_4$ in methylene chloride. After removal of the solvent, a wet solid formed which was treated with low boiling point petroleum ether to isolate a fine yellow solid. When this solid was redissolved in nitrobenzene and in methylene chloride, signals at 77.5 p.p.m. and 38.4 p.p.m. (partial conversion to $C_6F_5PCl_4$ and ICl_3) respectively were observed. The analyses were reasonable for the expected compound, $C_6F_5PCl_3ICl_4$.

The infrared spectrum which was recorded as a Nujol mull exhibited an ICl_4^- band at 260 cm^{-1} , in good agreement with the reported value (20). The other bands below 800 cm^{-1} are listed in table 3.3. The solid melted in the range 327-329K. No ^{35}Cl n.q.r. signal was observed from 33 to 15 MHz at 77, 195 and 298K.

d) $AuCl_3$.

$C_6F_5PCl_3AuCl_4$ was prepared by reacting an equimolar

amount of $C_6F_5PCl_4$ and $AuCl_3$. After 2 hours, the reaction mixture was filtered to remove any impurities and the compound was isolated from the filtrate as a greenish yellow solid. When the solid was redissolved in nitrobenzene and methylene chloride, the signal was observed in the same position as for other $C_6F_5PCl_3^+$ cations, at 82.2 p.p.m. Its solid state ^{31}P spectrum showed a broad signal with the maximum at 88.7 p.p.m. The carbon and phosphorus analyses were very good for the expected compound, $C_6F_5PCl_3AuCl_4$, but the chlorine and gold were quite low (20.69% and 20.50% respectively). The analysis was repeated, and gave very high gold (33.3%) but the chlorine was increased by 12%. These results show that the measurements were variable. When it was repeated for the third time it gave even higher gold (38.95%) and 32.7% chlorine. No ^{35}Cl n.q.r. signal was detected in the range 15-33 MHz at 77, 195 and 298K.

The infrared spectrum showed a strong $AuCl_4^-$ band at 363 cm^{-1} (75). The other bands are listed in table 3.3.

3.2 THE ACCEPTOR PROPERTIES OF $(C_6F_5)_2PCl_3$ AND RELATED COMPOUNDS.

3.2.1 INTRODUCTION.

The compound $(C_6F_5)_2PCl_3$ was first reported by Ang and Miller (76), and was prepared by chlorination of

Table 3.5: Infrared data for $(C_6F_5)_2PCl_3$ and its derivatives below 800 cm^{-1} .

| Compound | i.r. bands ($800-200$) cm^{-1} |
|-------------------------|---|
| $(C_6F_5)_2PCl_3$ | 770m, 760m, 645sh, 640s, 595s, 570s, 540s, 500m, 490m, 460s, 450sh, 442s, 410sh, 395s, 370s, 345s, 320m, 305m, 270w. |
| $(C_6F_5)_2PCl_2SbCl_6$ | 780w, 765w, 650m, 625w, 605m, 595w, 580m, 550w, 535m, 495w, 475w, 435s, 348s, br*, 280w. |
| $(C_6F_5)_2PCl_2BCl_4$ | 770m, 670m, br*, 655w, 650m, 620m, 595w, 535w, 445w, 435m, 410w, 340m. |
| $(C_6F_5)_2PCl_2ICl_4$ | 645s, 640s, 625w, 605m, 593s, 580s, 535s, 500w, 460s, 438s, 348m, 340m, 320w, 290m, 250s, br*. |

* counter-ions

$(C_6F_5)_2P-P(C_6F_5)_2$ according to the following reaction:-

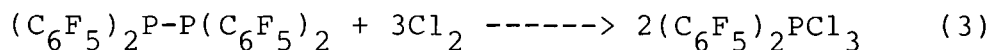

The compound was isolated as a solid, melting point 373K with decomposition. No ^{31}P n.m.r. and ^{35}Cl n.q.r. data were reported in this work. Fild et al. (64) reprepared this compound by the same method. Its ^{31}P n.m.r. spectrum consisted of a signal at -80.0 p.p.m. and its ^{35}Cl n.q.r. spectrum at 77K gave one signal at 35.58 MHz., ascribed to equatorial chlorines (64). In this work the compound was prepared from $(C_6F_5)_2PCl$ (see section 2.6f) by direct chlorination in methylene chloride and isolated as a fine white solid after removal of the solvent. Its ^{31}P n.m.r. in either nitrobenzene or methylene chloride consisted of a single resonance at -80.7 p.p.m., in good agreement with the reported value (64). No signal was observed in the solid state spectrum, as expected for five-coordinate species such as $(C_6F_5)_2PCl_3$. Its ^{31}P n.m.r. data indicate that this compound exists as a molecular species in solution with a ψ -trigonal bipyramidal structure like $C_6F_5PCl_4$. Its ^{35}Cl n.q.r. signal was measured at 35.355 MHz at 77K for equatorial chlorines, in good agreement with the data of Fild et al. (64), indicating that both C_6F_5 groups go axial. No resonance was observed at cardiac or room temperature. The elemental analysis was reasonable for the expected compound and its i.r. data are recorded in table 3.5.

3.2.2 ACCEPTOR PROPERTIES TOWARDS THE Cl^- ION.

Similar to Et_2PCl_3 , $(\text{C}_6\text{F}_5)_2\text{PCl}_3$ does not show acceptor properties towards the chloride ion, either using Et_4NCl in methylene chloride or Pr_4NCl in nitrobenzene. No change in colour was observed, and the ^{31}P n.m.r. gave only a signal at -80.7 p.p.m. ascribed to $(\text{C}_6\text{F}_5)_2\text{PCl}_3$.

3.2.3 ACCEPTOR PROPERTIES TOWARDS UNI- AND BI-DENTATE LIGANDS.

When three drops of pyridine were added to $(\text{C}_6\text{F}_5)_2\text{PCl}_3$ in methylene chloride, no solid formed and the colour of the solution remained the same (a homogenous clear solution). The ^{31}P n.m.r. consisted of a strong signal at -79.1 p.p.m., identified as the starting material, and a weak signal at 4.9 p.p.m., ascribed to the hydrolysis product $(\text{C}_6\text{F}_5)_2\text{PO}(\text{OH})$. When this solution was left on the machine overnight, the colour turned pinkish, but the peak positions remained unchanged. In solution, $(\text{C}_6\text{F}_5)_2\text{PCl}_3$ exists as a molecular species because the signal appears in the five-coordinate region, so if the reaction occurred with pyridine, only one molecule would be capable of coordination with this compound to form a six-coordinate molecular species. This would be expected to give a higher field signal. It is also possible that two pyridines could coordinate to phosphorus and one

chlorine could be displaced to form $(C_6F_5)_2PCl_2PY_2^+Cl^-$, which should also give a higher field resonance. The results show clearly that coordination did not occur in this system. Similarly no reaction occurred when phen or bipy ligands were added to a solution of $(C_6F_5)_2PCl_3$ either in CH_2Cl_2 or $PhNO_2$, where in both cases only the parent signal at -80.7 p.p.m. was detected.

3.2.4 DONOR PROPERTIES.

a) $SbCl_5$.

A grey solid immediately formed after neat $SbCl_5$ was added to a solution of $(C_6F_5)_2PCl_3$ in methylene chloride in a 1:1 ratio reaction. As for other similar types of compounds this solid was only soluble in a polar solvent such as nitrobenzene or nitromethane. In nitrobenzene, its ^{31}P n.m.r. consisted of a signal at 64.6 while in CH_3NO_2 a signal at 64.2 p.p.m. was measured, due to the presence of the $(C_6F_5)_2PCl_2^+$ cation in solution. A broad peak with the maximum measured at 66.2 p.p.m. was obtained from its solid state spectrum.

The elemental analyses were very good for the expected compound, $(C_6F_5)_2PCl_2SbCl_6$, confirming its formation (see experimental section). The infrared spectrum which was recorded as a Nujol mull exhibited a strong, broad band, with maximum at 348 cm^{-1} , identified as the $SbCl_6^-$

anion band, in good agreement with results for $[\text{C}_6\text{F}_5\text{PCl}_3]\text{SbCl}_6$ (see section 3.1.5). Other bands below 800 cm^{-1} are listed in table 3.5.

a(i) ACCEPTOR PROPERTIES TOWARDS UNI- AND BIDENTATE LIGANDS.

When a small amount of 1,10-phenanthroline was added to a solution of $(\text{C}_6\text{F}_5)_2\text{PCl}_2\text{SbCl}_6$ in PhNO_2 , a higher field signal measured at -80.4 p.p.m. was observed. With more phenanthroline, a precipitate formed and the ^{31}P n.m.r. remained the same. This resonance is in the same position as for $(\text{C}_6\text{F}_5)_2\text{PCl}_3$ and very low for the expected compound if coordination occurs, $[(\text{C}_6\text{F}_5)_2\text{PCl}_2\text{phen}][\text{SbCl}_6]$. In a 1:1 ratio reaction, a fine greenish solid was isolated, and its elemental analyses were reasonable for the expected six-coordinate compound. When it was redissolved in either PhNO_2 or CH_3NO_2 , however, only a signal at -80.4 p.p.m. was detected. No solid state n.m.r. spectrum was recorded after 29,600 scans. This signal was assigned to $(\text{C}_6\text{F}_5)_2\text{PCl}_3$ rather than to the six-coordinate complex because the individual signal of $(\text{C}_6\text{F}_5)_2\text{PCl}_3$ is also at -80.7 p.p.m. in CH_2Cl_2 .

These results suggest that the compound isolated is probably a genuine six-coordinate species but is not stable in solution, easily converting to $(\text{C}_6\text{F}_5)_2\text{PCl}_3$ and SbCl_5 . phen as below:-

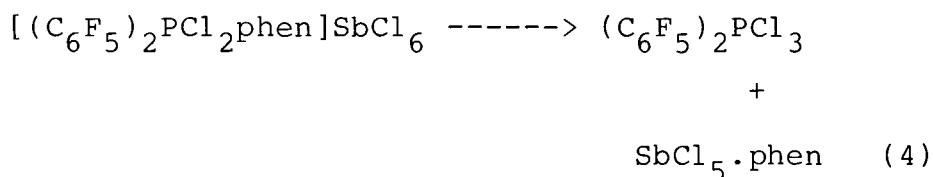

The infrared spectrum of the compound isolated strongly supports its formulation as $[(C_6F_5)_2PCl_2phen]^+SbCl_6^-$, because the bands below 400 cm^{-1} for $(C_6F_5)_2PCl_3$ were not present (see appendix, spectra 11 and 14). For example $(C_6F_5)_2PCl_3$ exhibits strong bands at 345, 370, 395 and 410 cm^{-1} but these were not found in this spectrum. If $SbCl_5 \cdot phen$ was present in the above solid it should give a medium intensity band at 409 cm^{-1} , as found in $2SbCl_5 \cdot phen$ (77), but this was not detected in this complex. It is not possible to make comparison for the $SbCl_6^-$ ion since $SbCl_5 \cdot phen$ will probably have the ionic structure $[SbCl_4phen]^+Cl^-$, which would also give an Sb-Cl stretching band in the same region (77). This deduction is supported by the result obtained from the BCl_3 -phen system, where ^{11}B n.m.r. indicates a 1:1 complex of $BCl_3 \cdot phen$.

When bipy was used instead of phen, similar results were obtained. Only one signal at -80.9 p.p.m. was recorded, ascribed to $(C_6F_5)_2PCl_3$, in nitrobenzene. No solid ^{31}P n.m.r. was obtained from the solid isolated from a 1:1 reaction. The elemental analysis was slightly high in carbon and low in chlorine for the expected compound, $[(C_6F_5)_2PCl_2bipy]^+SbCl_6^-$ (section 3.6), but was reasonable

for the other elements analysed.

In a qualitative reaction, a yellow solution formed when liquid pyridine was added to a solution of $(C_6F_5)_2PCl_2SbCl_6$ in $PhNO_2$, and its ^{31}P n.m.r. gave resonances at 6.4 p.p.m. ($(C_6F_5)_2PO(OH)$) and -78.8 p.p.m., assigned to $(C_6F_5)_2PCl_3$. The equation below is probably followed:

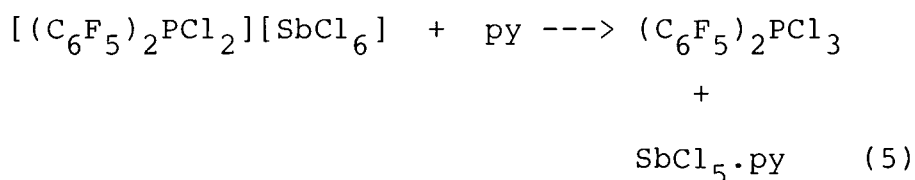

Reeve (78) similarly found that no six-coordinate species was formed by $[Ph_2PCl_2]^+PCl_6^-$, either with bipy or phen. Furthermore, Deng (20) found that $R_2PCl_2^+X^-$ ($R=Me, Et$; $X=SbCl_6$ or BCl_4) do not show acceptor properties towards py, bipy and phen.

The above results suggest that $(C_6F_5)_2PCl_2^+$ is a better acceptor than $R_2PCl_2^+$ ($R=Ph, Me$ or Et), in keeping with the greater electron-withdrawing ability of the C_6F_5 groups, but that even so the complexes formed by bidentate ligands are unstable in solution, and readily undergo conversion to more stable species.

b) BCl_3 .

$(\text{C}_6\text{F}_5)_2\text{PCl}_2\text{BCl}_4$ was synthesized by the reaction of $(\text{C}_6\text{F}_5)_2\text{PCl}_3$ with BCl_3 gas at room temperature under a dry nitrogen atmosphere. As soon as the BCl_3 gas was allowed to flow through the $(\text{C}_6\text{F}_5)_2\text{PCl}_3$ solution in methylene chloride, a white precipitate formed. The compound was isolated after filtration as a fine white solid. A peak at 62.7 p.p.m. was observed when its ^{31}P n.m.r. was recorded in nitrobenzene, and a signal at -11.2 p.p.m. for ^{11}B n.m.r., in good agreement with other tetrachloroborates in this work and with literature data for the BCl_4^- ion (70,71).

Carbon, chlorine and boron analyses were reasonable for the expected compound, $(\text{C}_6\text{F}_5)_2\text{PCl}_2\text{BCl}_4$. The phosphorus analysis gave a red colouration at the first attempt, but a reasonable value was obtained when the analysis was repeated. The i.r. spectrum showed a medium band at 640 cm^{-1} , assigned to BCl_4^- (72).

b(i) ACCEPTOR PROPERTIES TOWARDS UNI- AND BIDENTATE LIGANDS.

Similar properties to those of the SbCl_6^- salt were observed when $(\text{C}_6\text{F}_5)_2\text{PCl}_2\text{BCl}_4$ was reacted with phen or bipy. A precipitate was formed when solid phen was added to a solution of $(\text{C}_6\text{F}_5)_2\text{PCl}_2\text{BCl}_4$ in nitrobenzene, and a

resonance was seen at -80.9 p.p.m., ascribed to $(C_6F_5)_2PCl_3$. No six-coordinate species was detected in solution. When a 1:1 ratio reaction was performed in CH_2Cl_2 a pinkish solid was isolated. Its ^{31}P n.m.r. spectrum consisted of a resonance at -80.4 p.p.m. in $PhNO_2$, assigned to $(C_6F_5)_2PCl_3$. The elemental analyses of the solid were reasonable for the six-coordinate species $(C_6F_5)_2PCl_2phenBCl_4$. The i.r. data are listed in table 3.6. Again, the prominent stretching bands in the i.r. spectrum of $(C_6F_5)_2PCl_3$ were not present in this spectrum, suggesting that the solid is a genuine six-coordinate species, $[(C_6F_5)_2PCl_2phen]BCl_4$, but that it decomposes in solution to give $(C_6F_5)_2PCl_3$ and $BCl_3.phen$ similar to the behaviour of the hexachloroantimonate. When ^{11}B n.m.r. was used to detect the anionic species, a resonance at -10.1 p.p.m. was recorded in $PhNO_2$. This shift is quite low for the BCl_4^- ion, which normally gives a signal between -11.0 and -12.5 p.p.m. (70,71). This result indicates that the solution contained $[BCl_2phen]^+Cl^-$ rather than $[BCl_2phen][BCl_4]$, which should give two resonances at -10.3 and -11.2 p.p.m. for the cationic and anionic species respectively (20). When bipy was used in a qualitative reaction, a strong signal measured at -80.4 p.p.m. was observed in $PhNO_2$ solution, ascribed to $(C_6F_5)_2PCl_3$. The solution gave a resonance for ^{11}B at -10.1 p.p.m., assigned to $[BCl_2bipy]^+$ (20). In a 1:1 ratio reaction, a yellowish solid was

Table 3.6: Infrared data for the six-coordinate species $(C_6F_5)_2PCl_2X^+Y^-$.

| Compound | i.r. bands (800-200) cm^{-1} |
|-----------------------------|---|
| $(C_6F_5)_2PCl_2phenSbCl_6$ | 765m, 645m, 615w, 600m, 585m, 570w, 530s, 455m, 430m, 340s, br*. |
| $(C_6F_5)_2PCl_2phenBCl_4$ | 760w, 655m, br*, 635m, br, 585s, 560m, 530s, 450s, 435m, 390s, 335m, 315w. |
| $(C_6F_5)_2PCl_2bipySbCl_6$ | 760s, 640s, 620m, 600m, 590m, 580w, 545s, 535s, 515sh, 475m, 465m, 435m, 345s, br*. |
| $(C_6F_5)_2PCl_2bipyBCl_4$ | 760s, 690sh, 630m, br*, 585m, 550m, 530s, 450m, 435m, 390m, 340m. |

* counter-ions.

isolated. Its ^{31}P n.m.r. in nitrobenzene exhibited a resonance at -80.4 p.p.m., ascribed to $(\text{C}_6\text{F}_5)_2\text{PCl}_3$, and its ^{11}B n.m.r. showed a signal at -12.2 p.p.m., probably also due to $[\text{BCl}_2\text{bipy}]^+$ in a slightly different environment. In this case the chlorine analysis was very good but the rest of the analyses, except for boron which was high, were rather lower than the calculated values (see experimental section).

Its i.r. spectrum supported the above assignment, since the BCl_4^- stretching band was measured at 630 cm^{-1} (medium broad) and the characteristic bands for $(\text{C}_6\text{F}_5)_2\text{PCl}_3$ were absent (the rest of the data are listed in table 3.6).

The results obtained from these reactions of $(\text{C}_6\text{F}_5)_2\text{PCl}_2^+$ salts with phen and bipy showed that coordination could occur giving the six-coordinate complexes, which were unstable in solution, and easily rearranged to the molecular species as below:

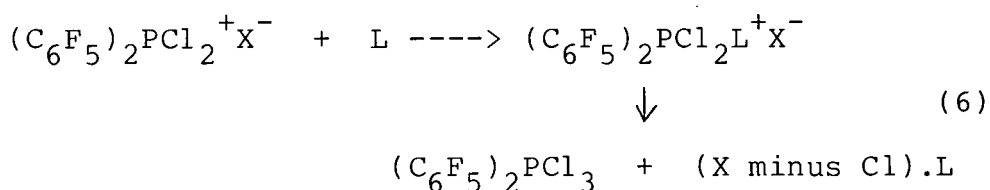

L=bipy or phen.

X= BCl_4 or SbCl_6 .

c) ICl_3 .

As soon as solid ICl_3 was added to a solution of $(\text{C}_6\text{F}_5)_2\text{PCl}_3$ in CH_2Cl_2 , a yellow precipitate formed, which was isolated as a yellow solid after filtration. When this solid was redissolved in nitromethane, its ^{31}P n.m.r. spectrum showed a peak at 62.9 p.p.m. Its solid state n.m.r. spectrum was not obtained because the solid turned dark red at the machine operating temperature, and only a signal at 6.5 p.p.m. was recorded, ascribed to the hydrolysis product $(\text{C}_6\text{F}_5)_2\text{PO}(\text{OH})$. The analysis was reasonable for the expected compound $[(\text{C}_6\text{F}_5)_2\text{PCl}_2][\text{ICl}_4]$ and the i.r. spectrum showed a band at 250 cm^{-1} assigned to I-Cl stretching vibration of the ICl_4^- ion (20).

3.3 THE ACCEPTOR PROPERTIES OF $(\text{C}_6\text{F}_5)_3\text{PCl}_2$ AND ITS DERIVATIVES.

3.3.1 INTRODUCTION.

$(\text{C}_6\text{F}_5)_3\text{PCl}_2$ was first reported by Emeleus and Miller (79), and was prepared by chlorination of solid $(\text{C}_6\text{F}_5)_3\text{P}$. This is a slow reaction, which takes place over a period of a day. A ^{31}P n.m.r. signal at -104.7 p.p.m. in benzene was reported (79).

In the present work, the above reaction was repeated in CH_2Cl_2 . After chlorine gas was passed for a

few minutes into a solution of $(C_6F_5)_3P$, a white precipitate formed which was isolated after removal of the solvent. $(C_6F_5)_3PCl_2$ dissolved in CH_2Cl_2 gave a ^{31}P n.m.r. resonance at -106.4 p.p.m, while in $PhNO_2$ a signal at -104.5 p.p.m. was detected. The starting material $(C_6F_5)_3P$ was isolated impure from a Grignard reaction, and was contaminated with $(C_6F_5)_2PBr$. Purification was carried out by extracting $(C_6F_5)_2PBr$ with low boiling petroleum ether, leaving behind as a pure white solid $(C_6F_5)_3P$. Its ^{31}P n.m.r. shift in CH_2Cl_2 was recorded at -75.5 p.p.m., in good agreement with the value reported by Fild et al (64).

3.3.2 ACCEPTOR PROPERTIES TOWARDS THE CHLORIDE ION AND OTHER LIGANDS.

$(C_6F_5)_3PCl_2$ does not show acceptor properties towards the chloride ion. When Et_4NCl was added to a solution of $(C_6F_5)_3PCl_2$ in CH_2Cl_2 , only one signal at -106.4 p.p.m. was recorded, assigned to $(C_6F_5)_3PCl_2$. With more Et_4NCl , the spectrum was unchanged, thus confirming its lack of acceptor properties towards chloride ion. R_3PCl_2 (R=Me, Et and Ph) also show no acceptor properties towards chloride ion (20).

When pyridine, 1,10-phenanthroline and 2,2'-bipyridine were separately added to a solution of $(C_6F_5)_3PCl_2$ in CH_2Cl_2 and the ^{31}P n.m.r. spectrum recorded, no higher field resonance in the six-coordinate region was observed,

just the signal from the starting material at -106.4 p.p.m. Hence this compound has no acceptor properties towards these ligands.

3.3.3 DONOR PROPERTIES TOWARDS LEWIS ACIDS.

a) SbCl_5 .

$(\text{C}_6\text{F}_5)_3\text{PCl}_2$ reacts readily with the strong Lewis acid SbCl_5 in CH_2Cl_2 . As soon as SbCl_5 was added to a solution of $(\text{C}_6\text{F}_5)_3\text{PCl}_2$ in CH_2Cl_2 , a grey precipitate formed which was isolated after filtration. It gave a resonance at 27.3 p.p.m. in nitrobenzene. As expected, no solid state spectrum was obtained even after 30,000 scans, probably due to the size of the cationic species which contains three C_6F_5 groups and could also be affected by ^{19}F coupling, although this does not seem to affect the solution spectra. The i.r. spectrum (Nujol mull) exhibited a strong broad band at 350 cm^{-1} , assigned to an SbCl_6^- stretching vibration. The elemental analyses were reasonable for the ionic compound $(\text{C}_6\text{F}_5)_3\text{PClSbCl}_6$.

When 1,10-phenanthroline was added to a solution of $(\text{C}_6\text{F}_5)_3\text{PClSbCl}_6$ in PhNO_2 , only one signal at -9.7 p.p.m. was observed. This signal was very low for the six-coordinate species $(\text{C}_6\text{F}_5)_3\text{PClphen}^+$, which was expected to give a resonance between -150 and -180 p.p.m. The shift is reasonable for $(\text{C}_6\text{F}_5)_3\text{PO}$ which normally resonates

Table 3.7: Infrared data for $(C_6F_5)_3PCl_2$ and its derivatives (800-200 cm^{-1}).

| Compounds | i.r. data |
|---------------------------|--|
| $(C_6F_5)_3PCl_2$ | 765s, 755m, 640sh, 630s, 585s, 530s, 460sh, 440s, 360sh, 340s, 310s, 280sh. |
| $(C_6F_5)_3PClSbCl_6$ | 765s, 630s, 600s, 585s, 460sh, 445s, 435s, 350s,br*, 340sh, 310m, 280w. |
| $(C_6F_5)_3PClBCl_4$ | 775s, 760w, (690, 670)s,br*, 640s, 610s, 590m, 530s, 450s, 440s, 410w, 400w, 340s, 320m. |
| $(C_6F_5)_3PClICl_4$ | 765s, 630s, 610s, 590s, 530s, 450s, 440s, 400w, 380w, 340s, 320m, 260s,br*. |
| $(C_6F_5)_3PClphenSbCl_6$ | 765m, 630w, 580w, 530s, 455m, 440W, 340s,br*. |

* counter- ions

at -8.2 p.p.m. (79), but this species was unlikely to form since all the manipulations were carried out in a dry N₂ atmosphere and the ligand was dry. In a 1:1 ratio reaction, a yellowish solid was isolated. When it was redissolved in PhNO₂ or CH₃NO₂, single signals at -9.7 and -8.0 p.p.m. respectively were recorded. In CH₃CN, a peak at -8.0 p.p.m. was obtained. The analysis was quite good for the compound (C₆F₅)₃PClphenSbCl₆, but the ³¹P n.m.r. data are very low for the expected six-coordinate cationic species. From these results, a real possibility is that in a more polar solvent there is an equilibrium between the ionic (δ 27) and covalent (δ -106) forms:

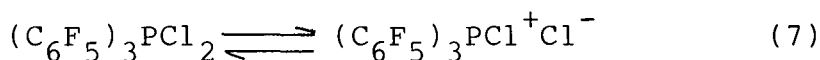

Hence if the six-coordinate complex is formed, decomposition will still give this equation:

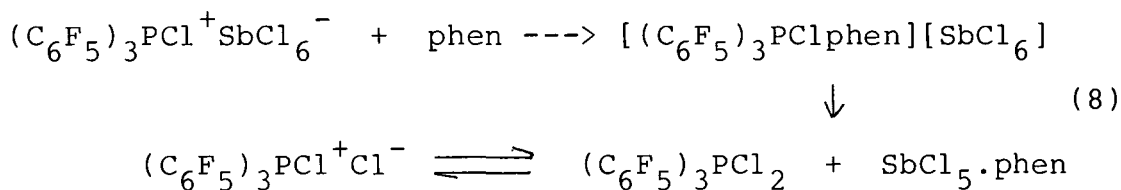

The solid isolated is probably genuine [(C₆F₅)₃PClphen]-[SbCl₆]. This statement is supported by the i.r. data (table 3.7), which showed different bands from these expected for a mixture of (C₆F₅)₃PCl₂ and SbCl₅·phen. For instance, SbCl₅·phen exhibited a medium intensity band at 409 cm⁻¹ as found in 2SbCl₅·phen (77), but this was not

detected in this complex. Furthermore, $(C_6F_5)_3PCl_2$ showed several strong bands below 650 cm^{-1} , whereas the complex only showed two strong bands in this region, at 530 and 340 $(SbCl_6^-)\text{ cm}^{-1}$.

b) BCl_3 .

The complex $(C_6F_5)_3PClBCl_4$ was prepared by a similar method to that used to synthesize the other two members of the series (see section 3.1.5b). In the first attempt, the solid isolated gave signals at 31.2 (weak), -8.2 (medium) and -103.5 (strong) p.p.m., showing that the reaction had not gone to completion. These signals were identified as $(C_6F_5)_3PCl^+$, $(C_6F_5)_3PO$ and $(C_6F_5)_3PCl_2$ respectively. The reaction was repeated by allowing the BCl_3 gas to flow in excess, to ensure that it went to completion. The solid isolated gave a $\delta^{31}P$ resonance at 14.5 p.p.m. when redissolved in $PhNO_2$, and at -12.2 p.p.m. for ^{11}B n.m.r. The ^{31}P n.m.r. shift was slightly high compared with the results for $(C_6F_5)_2PClSbCl_6$ and $(C_6F_5)_3PClICl_4$, but variation of ^{31}P for cationic species with the counter-ion is well-known (80,81). No attempt was made to investigate its acceptor properties towards pyridine, 1,10-phenanthroline or 2,2'-bipyridine.

c) ICl_3 .

$(C_6F_5)_3PClICl_4$ was prepared by adding an equimolar

amount of solid ICl_3 to a solution of $(\text{C}_6\text{F}_5)_3\text{PCl}_2$ in CH_2Cl_2 . After the addition of the solid was completed, an orange solution formed which gave a yellow precipitate after a few minutes stirring. The yellow solid isolated gave no solid state ^{31}P n.m.r. after 26,000 scans but when it was redissolved in CH_3NO_2 , a signal at 25.7 p.p.m. was recorded, assigned to the $(\text{C}_6\text{F}_5)_3\text{PCl}^+$ cation, with another weaker signal at -8.0 p.p.m. ($(\text{C}_6\text{F}_5)_3\text{PO}$). The i.r. spectrum (Nujol mull) exhibited a strong broad band at 260 cm^{-1} , assigned to the anionic species ICl_4^- (20). The elemental analyses were very good for the expected compound $(\text{C}_6\text{F}_5)_3\text{PClICl}_4$.

3.4 THE ACCEPTOR PROPERTIES OF $\text{C}_6\text{F}_5\text{PBr}_4$ AND ITS DERIVATIVES.

3.4.1 INTRODUCTION.

Several organobromophosphoranes such as PhPBr_4 (10, 78,82), cat_2PBr (10) and catPBr_3 (10,83) are known and their ^{31}P n.m.r. spectra have been established. Pentafluorophenyl-tetrabromophosphorane, $\text{C}_6\text{F}_5\text{PBr}_4$, has not yet been reported in the literature. In this work, it was prepared by the reaction of liquid bromine and $\text{C}_6\text{F}_5\text{PBr}_2$ in a 1:1 ratio, under an inert atmosphere. In 25% oleum, signals at -25.8 (strong), 8.2 (weak) and 37.1 p.p.m. (weak) were observed, ascribed to $\text{C}_6\text{F}_5\text{PBr}_3^+$, $\text{C}_6\text{F}_5\text{P}(\text{OH})_3^+$ and $\text{C}_6\text{F}_5\text{PBr}(\text{OH})_2^+$ respectively (84). Its solid state

spectrum which was recorded after 17,100 scans showed a strong signal at -42.0 p.p.m. which was assigned as $C_6F_5PBr_3^+$, with two other weaker signals at -16.2 p.p.m. (presumably $C_6F_5POBr_2$) and 111.3 p.p.m. ($C_6F_5PBr_2$). This result supports the ionic structure $C_6F_5PBr_3^+Br^-$ for the compound.

In common solvents such as CH_2Cl_2 and $PhNO_2$, decomposition occurred, and only a signal at 111.3 p.p.m. ascribed to $C_6F_5PBr_2$ was observed. In $PhNO_2$, this signal appeared at 93.5 p.p.m., a few p.p.m. to higher field than usually observed, probably due to the presence of the Br^- ion in solution which leads to the formation of the $C_6F_5PBr_3^-$ ion (section 5.2.2).

When the solid was redissolved in liquid bromine, two signals similar to a doublet and measured at -29.1 and -30.7 p.p.m. were recorded. The presence of the bromine should favour the formation of the ionic species $C_6F_5PBr_3^+$. The two signals observed are probably due to this cation associated with different counter-ions such as Br^- and Br_3^- .

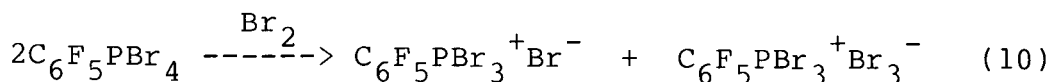
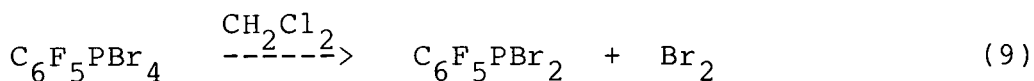

The liberation of Br_2 in CH_2Cl_2 could be seen by the brown colour both of the solution and above the solution around the n.m.r. tube, which disappeared after one day leaving a

clear yellow solution. The ^{31}P n.m.r. at this stage gave a signal at 8.2 p.p.m., identified as $\text{C}_6\text{F}_5\text{PO}(\text{OH})_2$, presumably due to a faulty n.m.r. tube cap which allowed moisture to enter.

The above results were compared with those for the compound $\text{C}_6\text{F}_5\text{PCl}_2\text{Br}_2$ which was prepared in a 1:1 ratio reaction between $\text{C}_6\text{F}_5\text{PCl}_2$ and Br_2 (84). It was found that a mixture of $\text{C}_6\text{F}_5\text{PBr}_{(3-n)}\text{Cl}_n^+$ ($0 \leq n \leq 3$) ions was present in 25% oleum. The $\text{C}_6\text{F}_5\text{PBr}_3^+$ ion was detected in the same position as for $\text{C}_6\text{F}_5\text{PBr}_3^+\text{Br}^-$ in this solvent, as mentioned above.

All the above results indicate that in solution the ionic structure $\text{C}_6\text{F}_5\text{PBr}_3^+\text{Br}^-$ is preferred rather than a molecular structure, just as for PhPBr_4 (10).

3.4.2 ACCEPTOR PROPERTIES TOWARDS UNI- AND BIDENTATE LIGANDS.

An attempt to isolate $\text{C}_6\text{F}_5\text{PBr}_3\text{pyBr}$ failed, due to the decomposition which took place in preference to the addition reaction. When $\text{C}_6\text{F}_5\text{PBr}_4$ was dissolved in neat pyridine, a brown clear solution formed and Br_2 gas was emitted from the mixture. The ^{31}P n.m.r. spectrum gave a sharp signal at 106.8 p.p.m., with weaker signals at 82.2 (difficult to assign) and -42.0 p.p.m. (which could be $\text{C}_6\text{F}_5\text{PBr}_3^+$, or the five-coordinate species with only one

pyridine bonded to phosphorus). A greenish brown precipitate formed in the n.m.r. tube. The peak at 106.8 p.p.m. was rather high for $C_6F_5PBr_2$ (111.3), and in this case, coordination of pyridine probably occurred to give $C_6F_5PBr_2 \cdot py$, similar to the behaviour of $PhPBr_4$ (10), as shown below:

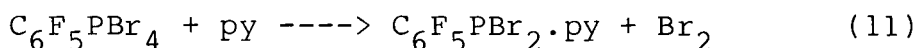

It is also probable that Br_2 would react further with pyridine to give $Br_2 \cdot py$.

When 2,2'-bipyridine was added to a slurry of $C_6F_5PBr_4$ in a small amount of CH_2Cl_2 , a yellow solid was immediately formed. The yellow solid isolated gave signals at 111.3 (weak, $C_6F_5PBr_2$), -21.0 (strong) and -42.0 p.p.m. (strong) when it was redissolved in $PhNO_2$. The last two signals were very low to be assigned to the six-coordinate species $C_6F_5PBr_3 \text{ bipy}^+ Br^-$, so presumably this compound dissociates in solution to give the $C_6F_5PBr_3^+$ ion, as shown by the signal at -42.0 p.p.m. The signal at -21.0 p.p.m. was very difficult to assign but it could be $C_6F_5POBr_2$ as impurity in the solid isolated. In CH_2Cl_2 , signals were measured at 111.3 (strong), -21.0 (medium) and -42.0 p.p.m. (medium), indicating that decomposition occurred more rapidly in this solvent.

Fig. 35: ^{31}P nmr SOLID STATE SPECTRA OF a & b

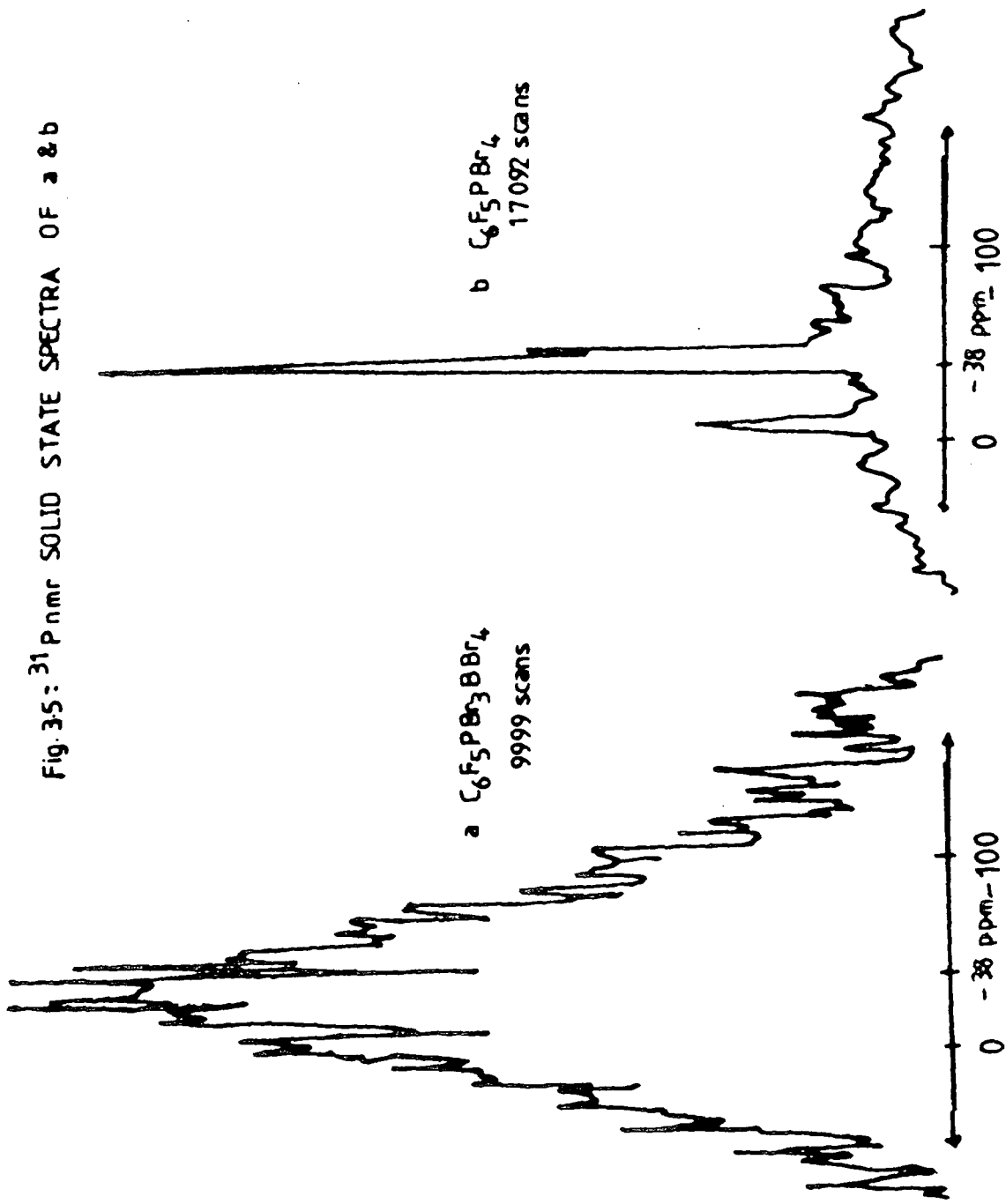

The elemental analysis was as expected for $[\text{C}_6\text{F}_5\text{PBr}_3\text{bipy}]^+[\text{Br}]^-$ and its i.r. data is tabulated in table 3.8. It appeared to be a genuine complex rather than a mixture of $\text{C}_6\text{F}_5\text{PBr}_4$ and bipy, because it exhibited two i.r. bands at 560 and 545 cm^{-1} which were not detected in the spectra of either $\text{C}_6\text{F}_5\text{PBr}_4$ or bipy. Moreover, the stretching bands in the $800\text{ to }250\text{ cm}^{-1}$ region are weaker than those bands in $\text{C}_6\text{F}_5\text{PBr}_4$. Two medium bands at 605 and 385 cm^{-1} were seen in the bipy spectrum, but they were not detected in the above spectrum. These data strongly support the formation of the complex $[\text{C}_6\text{F}_5\text{PBr}_3\text{bipy}]^+\text{Br}^-$.

3.4.3 THE REACTION OF $\text{C}_6\text{F}_5\text{PBr}_4$ AND BBr_3 .

As in the other reactions involving phosphorus (V) compounds and BX_3 ($\text{X}=\text{Cl}$ or Br), a white precipitate was immediately formed after the addition of BBr_3 to a slurry of $\text{C}_6\text{F}_5\text{PBr}_4$ in a small amount of CH_2Cl_2 . In PhNO_2 , the ^{31}P n.m.r. spectrum gave a signal at 21.1 p.p.m., suggesting that dissociation occurred to give $\text{C}_6\text{F}_5\text{PBr}_2$ which then formed a complex with BBr_3 to give $\text{C}_6\text{F}_5\text{PBr}_2\cdot\text{BBr}_3$. This deduction was checked independently by treating $\text{C}_6\text{F}_5\text{PBr}_2$ with BBr_3 in PhNO_2 . A new signal was observed at 22.5 p.p.m., assigned to the $\text{C}_6\text{F}_5\text{PBr}_2\cdot\text{BBr}_3$ complex. Solid formed at the bottom of the tube but no attempt was made to isolate this solid. The solid state ^{31}P n.m.r. spectrum of $\text{C}_6\text{F}_5\text{PBr}_3^+\text{Br}_4^-$ gave a broad signal with the maximum measured at -38.0 p.p.m. (see fig. 3.5), assigned to the

$C_6F_5PBr_3^+$ ion, with another sharp signal at 108.0 p.p.m. (possibly $C_6F_5PBr_3^-$). The ^{11}B n.m.r. spectrum of the nitrobenzene solution exhibited a peak at -40.6 p.p.m. assigned to BBr_4^- , in good agreement with the value for this ion in $Me_3PBrBBR_4$ (δ -39.4 p.p.m.) (20).

In liquid Br_2 , a ^{31}P n.m.r. signal at -25.8 p.p.m. was observed, due to the presence of the $C_6F_5PBr_3^+$ ion.

The elemental analysis was reasonable for the expected compound $C_6F_5PBr_3BBR_4$ and the i.r. data is tabulated in table 3.8.

3.4.4 ACCEPTOR PROPERTIES TOWARDS BIDENTATE LIGANDS.

When bipy was added to a slurry of $C_6F_5PBr_3BBR_4$ in CH_2Cl_2 , the deep yellow colour turned to a pale solution and after a few minutes a yellow precipitate was formed. A yellow solid was isolated after the solvent was removed in vacuo. Its ^{31}P n.m.r. in $PhNO_2$ exhibited signals at 111.3 (strong, $C_6F_5PBr_2$) and -42.0 p.p.m. (medium, $C_6F_5PBr_3^+$). The ^{11}B n.m.r. spectrum of this solution consisted of a single peak at -19.8 p.p.m., which was probably due to $BBr_2bipy^+Br^-$ (20). As soon as solvent was added to the above sample, a brown solution formed which turned to a clear solution after 2 days. No signal was obtained after 10,000 scans for the solid state ^{31}P n.m.r. spectrum, and

its i.r. spectrum could not be obtained because it did not form a mull.

The elemental analysis was slightly high in carbon and the bromine content was rather low (see experimental section). The above results support the initial formation of the complex $[\text{C}_6\text{F}_5\text{PBr}_3\text{bipy}]^+\text{BBr}_4^-$, followed by decomposition in solution, (equation 12), rather than immediate decomposition, (equation 13). If the latter process occurred, the isolation procedure should remove Br_2 and leave a sticky mixture of $\text{C}_6\text{F}_5\text{PBr}_2$ (a liquid) and $\text{BBr}_2\text{phen}^+\text{Br}^-$. The isolation of a yellow solid, and the observation of a brown colour in solution, clearly favour the reaction path shown in equation 12. The occurrence of a small amount of decomposition of the starting material, (equation 13), cannot be entirely discounted, however, since $\text{C}_6\text{F}_5\text{PBr}_3\text{BBr}_4$ is unstable in solution.

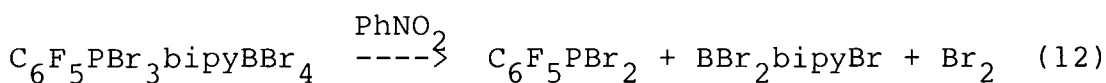

or

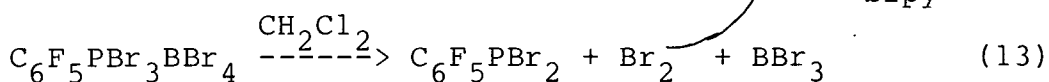

When the reaction was repeated using 1,10-phenanthroline, similar results were obtained; the ^{31}P n.m.r. spectrum in PhNO_2 only exhibited a signal at 111.3 p.p.m. ($\text{C}_6\text{F}_5\text{PBr}_2$) and the ^{11}B n.m.r. spectrum showed a single resonance at -18.8 p.p.m., presumably due to $\text{BBr}_2\text{phen}^+\text{Br}^-$. The elemental analysis of the compound isolated again

showed a slightly high carbon and a correspondingly low bromine content. If the reaction (13) above occurred before the addition of the ligand, then no adduct containing the six-coordinate cation could be isolated, so an alternative method of preparing this species was tried by reversing the addition of the reactants. 1,10-Phenanthroline was dissolved in a small amount of CH_2Cl_2 and solid $\text{C}_6\text{F}_5\text{PBr}_3\text{BBr}_4$ was added to the above solution with constant stirring. As soon as the solid was added, its yellowish colour turned to a deeper yellow. The C, H and N analyses of the solid isolated were as expected for a mixture of $\text{BBr}_2\text{phenBr}$ and $\text{C}_6\text{F}_5\text{PBr}_3\text{phenBBr}_4$, and no ^{31}P n.m.r. spectrum was recorded, but its ^{11}B n.m.r. spectrum showed a resonance at -18.8 p.p.m., ascribed to $\text{BBr}_2\text{phen}^+$. In this system the results are rather more ambiguous than in the bipy reaction, but do support the formation of at least some of the complex $[(\text{C}_6\text{F}_5\text{PBr}_3\text{phen})^+\text{BBr}_4^-]$. No information could be obtained from its i.r. spectrum because it did not form a mull. The table below shows the i.r. data for $\text{C}_6\text{F}_5\text{PBr}_4$ and its derivatives.

Table 3.8: I.r. data for $C_6F_5PBr_4$ and its derivatives below 800 cm^{-1} .

| Compound | i.r. data ($800-200$) cm^{-1} |
|------------------------------|---|
| $C_6F_5PBr_4$ | 753sh, 638m, 630m, 540w, 525s, 495s, 460s, 445w, 423m, 405w, 380w, 345w, 325m. |
| $[C_6F_5PBr_3\text{bipy}]Br$ | 760s, 638w, 620s, 590w, 560w, 545w, 525s, 495s, 470w, 460m, 435w, 420m, 405m, 380w, 320w. |
| $[C_6F_5PBr_3][BBr_4]$ | 765w, 652m, (625, 605, 560)*s,br, 528m, 515sh, 510s, 432s, 405w, 345m, 325w, 305w. |

* counter-ion.

3.5 SUMMARY.

The phosphoranes $(C_6F_5)_nPCl_{5-n}$ show donor properties towards Lewis acids to form four-coordinate cations, which were easily isolated as salts from the reaction mixtures. $[(C_6F_5)_nPCl_{4-n}][X]$ ($X=SbCl_6^-$ and BCl_4^- $1 \leq n \leq 2$) show acceptor properties towards bidentate ligands such as 2,2'-bipyridine and 1,10-phenanthroline, to form six-coordinate cations which exist in two isomeric forms. Attempts to establish the chemical shift for $(C_6F_5)_2PCl_2L^+X^-$ ($L=bipy$ or phen, $X=SbCl_6^-$ or BCl_4^-) failed; only the phosphorane signal was detected in solution, even though the analysis and i.r. data show that these complexes were genuine. $[(C_6F_5)_3PCl-L][SbCl_6]$ also gave reasonable elemental analysis and i.r.

spectra, but the ^{31}P n.m.r. solution signals were very low to be assigned to six-coordinate cationic species, showing that these, too, were unstable in solution.

$\text{C}_6\text{F}_5\text{PCl}_4$ also exhibits acceptor properties towards the chloride ion to form a six-coordinate anion, but the other members of the series, $(\text{C}_6\text{F}_5)_n\text{PCl}_{5-n}$ ($2 \leq n \leq 3$) show no acceptor properties towards this ligand.

$\text{C}_6\text{F}_5\text{PBr}_4$ shows acceptor properties towards 2,2'-bipyridine, but attempts to establish the chemical shift of the complex were unsuccessful. On many occasions only decomposition products were detected. $\text{C}_6\text{F}_5\text{PBr}_3\text{BBr}_4$ formed unstable adducts with either bipy or phen, and no six-coordinate species were detected in solution.

3.6 EXPERIMENTAL.

1. The preparation of $\text{C}_6\text{F}_5\text{PCl}_3\text{SbCl}_6$.

$\text{C}_6\text{F}_5\text{PCl}_4$ (0.71 g, 2.08 mmoles) was dissolved in a small quantity of CH_2Cl_2 (3-4 mls). An equimolar amount of SbCl_5 (0.3 mls, 2.08 mmoles) was added to the above solution with constant stirring. The solution was allowed to stir for 15 minutes to allow reaction to go to completion. The solid was filtered off and washed with CH_2Cl_2 to isolate a fine grey solid; 70% yield.

Analysis:

Found: C=12.40 P=4.51 Cl=49.00 Sb=20.18%.

Calculated: C=11.30 P=4.85 Cl=49.98 Sb=19.04%.

2. The preparation of $C_6F_5PCl_3BCl_4$.

$C_6F_5PCl_4$ (1.13 g, 3.32 mmoles) in CH_2Cl_2 was placed in a two-necked round-bottomed flask which was connected to a schlenk tube containing liquid BCl_3 under vacuum. The gas was allowed to flow into the flask with constant stirring until a white solid formed. The solvent and an excess of BCl_3 were removed in vacuo to isolate a fine white solid which was washed with low boiling point petroleum ether (30-40^o) to give a 95% yield.

Analysis:

Found: C=16.73 Cl=54.23 P=6.30 B=2.12%.

Calculated: C=15.74 Cl=54.34 P=6.78 B=2.36%.

3. The preparation of $C_6F_5PCl_3ICl_4$.

$C_6F_5PCl_4$ (0.70 g, 2.06 mmoles) was dissolved in a small amount of CH_2Cl_2 . A solution of ICl_3 (0.49 g, 2.09 mmoles) in the same solvent was added dropwise to the above solution with constant stirring. The solvent was removed in vacuo to give a yellow solid which was washed with low boiling point petroleum ether to give a 75% yield.

Analysis:

Found: C=13.87 P=4.93 Cl=43.40 I=22.60%.

Calculated: C=12.56 P=5.41 Cl=43.34 I=22.13%.

4. The preparation of $C_6F_5PCl_3AuCl_4$.

$C_6F_5PCl_4$ (0.68 g, 2.00 mmoles) was dissolved in CH_2Cl_2 . $AuCl_3$ (0.64 g, 2.1 mmoles) was added to the above solution with constant stirring. Methylene chloride was added until all the solid disappeared. The reaction mixture was allowed to stir for 2 hours, filtered off and evaporation of the filtrate gave a greenish-yellow solid in 75% yield.

Analysis:

Found: C=11.47 P=4.34 Cl=33.00 Au=33.33%.

Calculated: C=11.20 P=4.82 Cl=38.62 Au=30.61%.

5. The preparation of $C_6F_5PCl_4 \cdot py$.

A. $C_6F_5PCl_4$ (0.52 g, 1.53 mmoles) was dissolved in CH_2Cl_2 . C_5H_5N (0.15 g, 1.90 mmoles) was added dropwise and the reaction mixture was allowed to stir for a while. The precipitate was filtered off to isolate a grey solid.

Analysis:

Found: C=33.25 H=1.89 N=4.29 P=5.66 Cl=16.24%.

Calculated: C=31.50 H=1.20 N=3.34 P=7.40 Cl=33.89%.

B. The reaction was repeated using an excess of C_5H_5N to give a grey solid, which analysed as the 1:1 adduct.

Analysis:

Found: C=31.96 H=1.40 N=3.31 P=4.86 Cl=28.10%.

Calculated: C=31.50 H=1.20 N=3.34 P=7.40 Cl=33.89%.

6. The preparation of $\text{Pr}_4\text{NC}_6\text{F}_5\text{PCl}_5$.

A. $\text{C}_6\text{F}_5\text{PCl}_4$ (0.68 g, 2.0 mmoles) was dissolved in a small quantity of CH_2Cl_2 . Dry Pr_4NCl (0.47 g, 2.12 mmoles) in the same solvent was added to the above solution with constant stirring. The reaction mixture was allowed to stir for 10 minutes before being evaporated to dryness. The product was dried in vacuo to isolate a yellowish solid in 75% yield.

Analysis:

Found: C=39.65 N=1.75 H=5.89 Cl=32.10 P=5.16%.

Calculated: C=38.47 N=2.49 H=5.00 Cl=31.61 P=5.52%.

B. When the reaction was repeated with Et_4NCl , a sticky solid was formed which gave only a mixture of the adduct and Et_4NCl after being treated with low boiling point petroleum ether.

Analysis:

Found: C=45.83 H=10.10 N=6.93%.

Et_4NCl requires: C=58.01 H=12.08 N=8.46%.

$\text{Et}_4\text{NC}_6\text{F}_5\text{PCl}_5$ requires: C=33.23 H=3.96 N=2.80%.

7. The preparation of $\text{C}_6\text{F}_5\text{PCl}_3\text{bipySbCl}_6$.

$\text{C}_6\text{F}_5\text{PCl}_4$ (0.44 g, 1.29 mmoles) and 2,2'-bipyridine (0.20 g, 1.30 mmoles) were separately dissolved in CH_2Cl_2 and both solutions were mixed with constant stirring. Then SbCl_5 (0.39 g, 1.30 mmoles) was added dropwise to the above mixture, which was allowed to stir for a while. The solid was filtered off and washed with low boiling point petrole-

um ether (30-40^o) to isolate a yellowish solid, 65% yield.

Analysis:

Found: C=22.37 H=0.90 N=1.10 P=4.53 Cl=40.03 Sb=15.69%.

Calculated: C=24.18 H=1.01 N=3.52 P=3.90 Cl=40.17

Sb=15.30%.

8. The preparation of $C_6F_5PCl_3bipyBCl_4$.

$C_6F_5PCl_4$ (0.39 g, 1.15 mmoles) and 2,2'-bipyridine (0.17 g, 1.10 mmoles) were separately dissolved in CH_2Cl_2 and both solutions were mixed with constant stirring. The reaction mixture was allowed to stir for 10 minutes and then BCl_3 gas was allowed to flow with constant stirring until the reaction was completed. The reaction mixture was filtered to remove the $C_6F_5PCl_3BCl_4$ formed and the filtrate was evaporated to dryness to give a yellowish solid, 45% yield.

Analysis:

Found: C=31.70 H=1.37 N=2.46 Cl=38.10 P=5.52 B=1.90%.

Calculated: C=31.30 H=1.30 N=4.56 Cl=40.51 P=5.05 B=1.76%.

9. The preparation of $C_6F_5PCl_3phenSbCl_6$.

A solution of 1,10-phenanthroline (0.09g, 0.49 mmoles) in CH_2Cl_2 was added to a slurry of $C_6F_5PCl_3SbCl_6$ (0.32g, 0.48mmoles) in the same solvent, with constant stirring. The slurry disappeared as soon as the ligand was added and then after a few minutes stirring, a precipitate formed. The solid was filtered off and washed with petroleum ether (30-40^o).

Analysis:

Found: C=26.37 H=0.86 N=2.00 Cl=34.4 P=3.20 Sb=15.14%.

Calculated: C=26.36 H=0.98 N=3.42 Cl=39.4 P=3.78 Sb=14.8%.

10. The preparation of $C_6F_5PCl_3phenBCl_4$.

The above reaction was repeated using 1,10-phenanthroline (0.12g, 0.67mmole) and $C_6F_5PCl_3BCl_4$ (0.29g, 0.63mmole). Evaporation of the solvent gave a yellowish solid.

Analysis:

Found: C=33.10 H=1.51 N=4.44 Cl=38.61 P=4.44 B= 1.60%.

Calculated: C=33.88 H=1.24 N=4.39 Cl=38.98 P=4.86 B=1.70%.

11. Attempted preparation of $C_6F_5PCl_3py_2SbCl_6$.

$C_6F_5PCl_3SbCl_6$ (0.52 g, 0.82 mmoles) was dissolved in CH_2Cl_2 and then liquid pyridine (0.13 g, 1.65 mmoles) was added to the above solution with constant stirring. The reaction mixture was allowed to stir for 20 minutes before the solvent was removed in vacuo to isolate a yellow solid.

Analysis:

Found: C=21.87 H=3.07 N=2.66 P=2.76 Cl=48.37 Sb=22.70%.

Calculated: C=24.08 H=1.25 N=3.51 P=3.89 Cl=40.08

Sb=15.27%.

12. The preparation of $(C_6F_5)_2PCl_2SbCl_6$.

$(C_6F_5)_2PCl_3$ (0.46 g, 0.96 mmoles) was dissolved in CH_2Cl_2 . $SbCl_5$ (0.28 g, 0.94 mmoles) was added dropwise into the above solution. The reaction mixture was allowed

to stir for 20 minutes before the grey solid was filtered off, washed thoroughly with low boiling point petroleum ether and isolated in 75% yield.

Analysis:

Found: C=18.71 P=4.02 Cl=36.90 Sb=15.83%.

Calculated: C=18.74 P=4.20 Cl=35.60 Sb=15.39%.

13. The preparation of $(C_6F_5)_2PCl_2BCl_4$.

$(C_6F_5)_2PCl_3$ (0.60 g, 1.27 mmoles) was dissolved in CH_2Cl_2 and then BCl_3 gas was allowed to flow through this solution for 5 minutes with constant stirring until the solid formed. The reaction mixture was allowed to stir for another 15 minutes for the reaction to go to completion. The solid was filtered off and dried in vacuo.

Analysis:

Found: C=25.50 Cl=36.30 P=5.60 B=1.90%.

Calculated: C=24.49 Cl=36.23 P=5.27 B=1.84%.

14. The preparation of $(C_6F_5)_2PCl_2ICl_4$.

$(C_6F_5)_2PCl_3$ (1.32g, 2.80 mmoles) was dissolved in CH_2Cl_2 . Solid ICl_3 (0.65g, 2.78 mmoles) was added to the above solution with constant stirring. The reaction mixture was allowed to stir for 20 minutes before the precipitate was filtered off and washed with CH_2Cl_2 and petroleum ether.

Analysis:-

Found: C=20.30 P=4.08 Cl=29.69 I=18.80%.

Calculated: C=20.44 P=4.40 Cl=30.24 I=18.02%.

15. The preparation of $(C_6F_5)_2PCl_2phenSbCl_6$.

$(C_6F_5)_2PCl_2SbCl_6$ (0.58g, 0.75mmoles) was dissolved in CH_2Cl_2 . A solution of 1,10-phenanthroline (0.139g, 0.75mmoles) in the same solvent was added dropwise to the above slurry with constant stirring. The reaction mixture was allowed to stir for 30 minutes before the solvent was removed in vacuo.

Analysis:-

Found: C=30.30 H=1.00 N=2.36 P=2.65 Cl=28.37 Sb=12.47%.

Calculated: C=30.32 H=0.84 N=2.95 P=3.26 Cl=29.90

Sb=12.82%.

16. The preparation of $(C_6F_5)_2PCl_2phenBCl_4$.

$(C_6F_5)_2PCl_2BCl_4$ (0.39g, 0.67mmoles) was treated with 1,10-phenanthroline (0.12g, 0.67 mmoles) by a similar method to that used to synthesise $(C_6F_5)_2PCl_2phenSbCl_6$.

Analysis:-

Found: C=38.69 H=1.37 N=2.86 P=4.08 Cl=27.31 B=1.89%.

Calculated: C=37.50 H=1.04 N=3.65 P=4.04 Cl=27.73 B=1.38%.

BCl_3 .phen requires: C=48.44 H=2.69 N=9.42 Cl=35.82 B=3.63%.

17. Attempts to synthesise $(C_6F_5)_2PCl_2bipyBCl_4$.

$(C_6F_5)_2PCl_2BCl_4$ (0.33g, 0.56mmoles) was suspended in CH_2Cl_2 . 2,2'-Bipyridine (0.087g, 0.60 mmoles) in CH_2Cl_2 was added dropwise with constant stirring. This reaction mixture was allowed to stir for one hour before the solvent was evaporated to dryness to yield an orange solid.

Analysis:-

Found: C=31.27 H=1.21 N=2.26 P=2.39 Cl=28.35 B=2.44%.

Calculated: C=35.48 H=1.08 N=3.76 P=4.17 Cl=28.63 B=1.45%.

$\text{BCl}_3 \cdot \text{bipy}$ requires: C=43.90 H=2.93 N=10.25 Cl=38.97

B=3.95%.

$(\text{C}_6\text{F}_5)_2\text{PCl}_3$ requires: C=30.60 P=6.59 Cl=22.63%.

18. Attempts to synthesise $(\text{C}_6\text{F}_5)_2\text{PCl}_2\text{bipySbCl}_6$.

The above reaction was repeated using $(\text{C}_6\text{F}_5)_2\text{PCl}_2\text{SbCl}_6$ (0.50g, 0.65 mmoles) and 2-2'-bipyridine (0.10g, 0.64 mmoles). A yellow solid was isolated.

Analysis:-

Found: C=32.09 H=1.12 N=2.95 P=2.80 Cl=27.38 Sb=12.88%.

Calculated: C=28.52 H=1.08 N=3.02 P=3.35 Cl=30.68

Sb=13.16%.

19. The preparation of $(\text{C}_6\text{F}_5)_3\text{PClSbCl}_6$.

$(\text{C}_6\text{F}_5)_3\text{PCl}_2$ (0.97 g, 1.61 mmoles) was dissolved in a small amount of CH_2Cl_2 . An equimolar amount of SbCl_5 (0.48 g, 1.62 mmoles) was added dropwise with constant stirring. The reaction mixture was allowed to stir for 10 minutes to complete the reaction before the grey solid was filtered, washed thoroughly with CH_2Cl_2 and dried in an inert N_2 atmosphere.

Analysis:

Found: C=24.40 P=2.99 Cl=26.37 Sb=12.70%.

Calculated: C=23.94 P=3.44 Cl=27.54 Sb=13.50%.

20. The preparation of $(C_6F_5)_3PClBCl_4$.

$(C_6F_5)_3PCl_2$ (0.94 g, 1.65 mmoles) was dissolved in CH_2Cl_2 . BCl_3 gas was allowed to flow into the above solution until a white precipitate was formed. The solid was filtered and washed thoroughly with CH_2Cl_2 to yield a fine white solid.

Analysis:

Found: C=31.07 P=3.16 Cl=24.14 B=2.07%.

Calculated: C=30.00 P=4.30 Cl=24.64 B=1.50%.

21. The preparation of $(C_6F_5)_3PClICl_4$.

$(C_6F_5)_3PCl_2$ (0.57 g, 0.95 mmoles) was dissolved in CH_2Cl_2 . Solid ICl_3 (0.25 g, 1.0 mmoles) was added to the above solution with constant stirring until a yellow precipitate was formed. The solid was filtered, washed with low boiling petroleum ether and dried in an inert N_2 atmosphere. The solid was stored in the freezer to avoid decomposition.

Analysis:

Found: C=26.36 P=3.59 Cl=22.83 I=15.34%.

Calculated: C=25.82 P=3.71 Cl=21.22 I=15.17%.

22. Attempt to prepare $(C_6F_5)_3PClphenSbCl_6$.

$(C_6F_5)_3PClSbCl_6$ (0.24 g, 0.27 mmoles) was suspended in CH_2Cl_2 . 1,10-Phenanthroline (0.05 g, 0.27 mmoles) was then added to the above solution with constant stirring.

The mixture was allowed to stir for 20 minutes before the solvent was evaporated in vacuo, to isolate a greenish solid.

Analysis:

Found: C=30.71 H=0.36 N=1.00 P=3.03 Cl=21.68 Sb=10.78%.

Calculated: C=33.26 H=0.74 N=2.59 P=2.86 Cl=22.96

Sb=11.25%.

23. The preparation of $C_6F_5PBr_4$.

$C_6F_5PBr_2$ (5.26 g, 1.14 mmoles) was diluted in CH_2Cl_2 . An excess of Br_2 (3.57 g, 2.20 mmoles) was added dropwise to the above solution with constant stirring. The suspension was allowed to stir for 30 minutes and then the solid was filtered off, washed with CH_2Cl_2 and dried in vacuo, to yield a fine orange solid.

Analysis:

Found: C=13.41 P=5.85 Br=61.69%.

Calculated: C=13.91 P=5.42 Br=61.75%.

24. The preparation of $C_6F_5PBr_3bipyBr$.

$C_6F_5PBr_4$ (0.62 g, 1.20 mmoles) was dissolved in a small amount of CH_2Cl_2 . 2,2'-Bipyridine (0.18 g, 1.20 mmoles) was added to the above slurry with constant stirring. The reaction mixture was allowed to stir for 30 minutes before the solid was filtered off and the filtrate was evaporated to dryness to give a yellow solid.

Analysis:

Found: C=30.39 H=1.22 N=3.48 P=4.16 Br=46.92%.

Calculated: C=28.50 H=1.19 N=4.16 P=4.60 Br=47.43%.

25. The preparation of $C_6F_5PBr_3BBr_4$.

BBr_3 (0.63 g, 2.51 mmoles) was added dropwise to a slurry of $C_6F_5PBr_4$ (1.20 g, 2.51 mmoles) in CH_2Cl_2 . The solution was allowed to stir for 20 minutes before being evaporated to dryness. The product was washed with petroleum ether to isolate a fine white solid.

Analysis:

Found: C=10.17 P=4.34 Br=69.50 B=1.73%.

Calculated: C=9.37 P=4.04 Br=72.82 B=1.41%.

26. Attempt to prepare $C_6F_5PBr_3bipyBBr_4$.

$C_6F_5PBr_3BBr_4$ (0.67 g, 0.87 mmoles) was dissolved in CH_2Cl_2 . 2,2'-Bipyridine (0.15 g, 0.90 mmoles) was added to the above slurry with constant stirring. The reaction mixture was allowed to stir for 30 minutes before evaporation to dryness to isolate a fine yellow solid.

Analysis:

Found: C=23.75 H=1.62 N=2.82 P=2.79 B=1.38 Br=53.5%.

Calculated: C=20.77 H=0.87 N=3.03 P=3.35 B=1.17 Br=60.51%.

27. Attempt to prepare $C_6F_5PBr_3phenBBr_4$.

A. $C_6F_5PBr_3BBr_4$ (0.53 g, 0.69 mmoles) was dissolved in CH_2Cl_2 . 1,10-Phenanthroline (0.53 g, 0.69 mmoles) was added to the above slurry with constant

stirring. The reaction mixture was allowed to stir for 30 minutes and then evaporated to dryness to isolate a fine yellow solid.

Analysis:

Found: C=26.00 H=1.70 N=2.55 P=2.93 Br=48.15 B=1.23%.

Calculated: C=22.78 H=0.84 N=2.95 P=3.27 Br=58.98 B=1.14%.

B. Reversed reaction; 1,10-Phenanthroline (0.09 g, 0.50 mmoles) was dissolved in a small quantity of CH_2Cl_2 . Solid $\text{C}_6\text{F}_5\text{PBr}_3\text{BBr}_4$ (0.38 g, 0.50 mmoles) was added to the above solution with constant stirring. The reaction mixture was allowed to stir for 30 minutes before the solvent was removed in vacuo, and the solid product was washed with low boiling petroleum ether. It analysed as a mixture.

Analysis:

Found: C=30.99 H=1.80 N=4.52 P=2.97 Br=52.10 B=1.56%.

$\text{C}_6\text{F}_5\text{PBr}_3\text{phenBBr}_4$ requires: C=22.78 H=0.84 N=2.95 P=3.27
Br=58.98 B=1.14%.

$\text{BBr}_2\text{phenBr}$ requires: C=33.49 H=1.86 N=6.51 Br=55.65
B=2.51%.

CHAPTER FOUR

THE ACCEPTOR PROPERTIES OF ORGANOCHLORO- PHOSPHORUS (V) COMPOUNDS.

4.1 ACCEPTOR PROPERTIES OF CCl_3PCl_4 AND RELATED COMPOUNDS.

4.1.1 INTRODUCTION.

CCl_3PCl_4 is a well-known compound, and is prepared by direct chlorination of CCl_3PCl_2 . The starting material was first made by Perner and Henglein (85) by heating white phosphorus and carbon tetrachloride in a sealed tube at high temperature ($>373\text{K}$). At lower temperature (298K) it tends to give more red phosphorus (22%) than CCl_3PCl_2 (4.5%). As in other sealed tube reactions, the yield was very low and several side products were isolated, including red phosphorus, PCl_3 , C_2Cl_6 and a polymer $(\text{CCl}_2)_n$.

The above compound can also be prepared from a reduction of the phosphonium salt $[\text{CCl}_3\text{PCl}_3][\text{AlCl}_4]$ (86) with methylphosphorodichloridite (MeOPCl_2), as in the equation below:

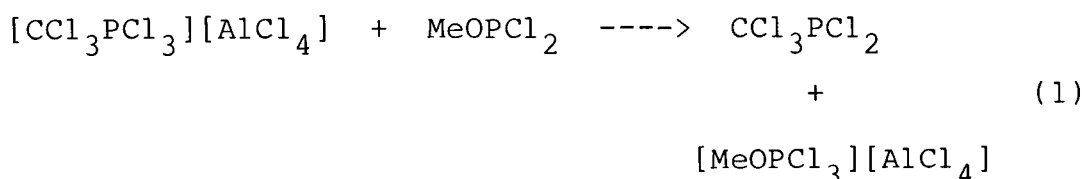

The phosphonium salt was synthesised by direct combination of its constituents, CCl_4 , PCl_3 and freshly sublimed AlCl_3 (87,88). The ^{31}P n.m.r. signal of CCl_3PCl_2 was recorded at 148.6 p.p.m. in CCl_4 (86).

When the second method was repeated in equimolar amount of its constituents (88) (PCl_3 , CCl_4 , AlCl_3 and MeO-PCl_2), the ^{31}P n.m.r. spectrum after the reaction had been completed showed several signals measured at 149 (weak), 102.9 (weak, $\text{CCl}_3\text{PCl}_3^+$), 70.8 (weak) and 32.2 p.p.m. (strong, $\text{CCl}_3\text{POCl}_2$). The signal at 149.0 p.p.m. was assigned as CCl_3PCl_2 . After evaporation in vacuo, only one signal at 33.8 p.p.m. ($\text{CCl}_3\text{POCl}_2$) was observed. The oxidation product was isolated rather than CCl_3PCl_2 , possibly indicating that MeOPCl_2 was contaminated with MeOH which could affect the product. In the second attempt, pure MeOPCl_2 was used but the resultant solution also showed the $\text{CCl}_3\text{POCl}_2$ signal as a major product, therefore the above reaction was abandoned, due to the low yield of the required compound CCl_3PCl_2 and the time consumed in the above preparation.

Quin and Rolston (61) employed a different approach to prepare CCl_3PCl_4 . MePCl_2 as starting material was converted to MePCl_4 by direct chlorination at freezing temperature in phenylphosphinic dichloride as a solvent. The slurry of tetrachloromethylphosphorane was warmed at 333K,

and then an excess amount of chlorine gas was added in a period of three hours. The slurry was stirred at 328-333K under 100-150 mm Hg pressure to remove hydrogen chloride and excess chlorine. In this report, CCl_3PCl_4 was not isolated. It was directly reduced to CCl_3PCl_2 by MeOPCl_2 .

This method was performed in methylene chloride with a slight modification, in which the resultant white slurry was heated at 333-343K until it all dissolved, before the chlorine gas was allowed to pass into the above solution. The reaction was continued to saturation (clear yellowish solution) to ensure that substitution was complete. The ^{31}P n.m.r. spectrum of this solution exhibited only one signal at -19.9 p.p.m. assigned to CCl_3PCl_4 , in good agreement with the reported values of -18.6, -19.8 and -20.1 p.p.m. in C_6H_6 , PhNO_2 and MeNO_2 respectively (89). This indicated that the reaction had been completed. After the solvent was removed in vacuo, a fine white solid was isolated. Its solid state spectrum was recorded to give a resonance at 32.2 p.p.m., again in good agreement with the Russian value of 33.2 p.p.m. (89).

Russian workers (89,90) have studied the ^{35}Cl n.q.r. spectrum of this compound, which gave signals at 39.689(3) MHz (δCCl_3^-), and at 28.250(1) and 31.952(3) MHz for (P-Cl) axial and equatorial respectively, at 77K. The CCl_3 mobility in the crystal of CCl_3PCl_4 was studied by n.q.r., using temperature dependence measurements of both

the resonance frequencies and the spin-lattice relaxation times for ^{35}Cl nuclei (90). Dmitriev et al (89) have also isolated the 1:1 derivative of CCl_3PCl_4 with the Lewis acid SbCl_5 , which gave ^{31}P n.m.r. signals at 103.9 and 103.3 p.p.m. in nitrobenzene and nitromethane respectively. It was prepared in CCl_4 by adding a 5% molar excess of SbCl_5 to a CCl_3PCl_4 solution. The crystalline precipitate formed was filtered off, washed with CCl_4 and dried in vacuo. No ^{35}Cl n.q.r. data were reported. The compound was formulated as $\text{CCl}_3\text{PCl}_3^+\text{SbCl}_6^-$ on the basis of the n.m.r. results.

4.1.2 ACCEPTOR PROPERTIES TOWARDS THE Cl^- ION.

CCl_3PCl_4 shows no acceptor properties towards tetraethylammonium chloride either in methylene chloride or nitrobenzene. When Et_4NCl was added to a solution of CCl_3PCl_4 in either PhNO_2 or CH_2Cl_2 , no shift movement was observed, the only signal being at -20.9 p.p.m., assigned to CCl_3PCl_4 . When Pr_4NCl was used in PhNO_2 solution, however, a new signal in the six-coordinate region was observed at -194.6 p.p.m. When more Pr_4NCl was added, the signal at -20.9 declined but the intensity of the six-coordinate signal increased. This resonance was assigned to the six-coordinate anion $\text{CCl}_3\text{PCl}_5^-$. With an excess of Pr_4NCl , only one signal at -196.2 p.p.m was measured. This signal was not detected when the reaction was carried out in CH_2Cl_2 , and only the resonance of the starting material

was apparent, indicating that no adduct formation occurred in this solvent. The acceptor properties of this compound towards Cl^- had also been observed by Russian workers (91). They deduced from u.v. spectra that the addition of Me_4NCl or Bu_3PCl_2 to CCl_3PCl_4 in either $\text{C}_2\text{H}_4\text{Cl}_2$ or CH_3CN gives a small amount of $\text{CCl}_3\text{PCl}_5^-$ ion.

When the reaction was carried out in a 1:1 ratio in PhNO_2 , a signal at -197.8 p.p.m. was recorded before the solvent was removed. Attempts to isolate the adduct failed since the solvent was very difficult to remove and always gave the oxidation product, $\text{CCl}_3\text{POCl}_2$ (28.9 p.p.m.). When the solvent was removed by vacuum distillation, a creamy solid was isolated, but its ^{31}P n.m.r. spectrum in PhNO_2 only gave a signal at -298.3 p.p.m., assigned to PCl_6^- . It seems that heating tends to break the P-C bond in $\text{CCl}_3\text{-PCl}_5^-$, but the mechanism of this reaction is not clear at present. CCl_3PCl_4 was found to be decomposed at 398K to CCl_4 and PCl_3 (92). Nixon (93) also performed a heat treatment reaction on CCl_3PCl_4 in a sealed tube. After heating at 413K for 19 hours, the liquid product isolated was identified by i.r. spectroscopy as a mixture of PCl_3 and CCl_4 .

No other solvent was suitable for this reaction. In CH_3NO_2 , only one signal at 32.2 p.p.m. was observed, even before the addition of the chloride salt. In acetonitrile, decomposition occurred as soon as the Pr_4NCl

was added. The ^{31}P n.m.r. spectrum showed only a signal at 149.6 p.p.m., ascribed to CCl_3PCl_2 , when more Pr_4NCl was added.

CCl_3PCl_4 showed no acceptor properties towards 1,10-phenanthroline and 2,2'-bipyridine, either in nitrobenzene or methylene chloride. In both cases, only the signal of the parent compound was apparent. When liquid pyridine was added to a solution of CCl_3PCl_4 in methylene chloride, its ^{31}P n.m.r. spectrum showed resonances at 32.2 ($\text{CCl}_3\text{POCl}_2$) and -46.6 p.p.m., probably the six-coordinate species $\text{CCl}_3\text{PCl}_4\cdot\text{py}$ which was partly dissociated in solution. When the reaction was performed in a 1:1 molar ratio, a grey solid was isolated after the solvent was evaporated to dryness. The ^{31}P n.m.r. spectrum which was recorded in nitrobenzene showed a broad signal at -39.0 p.p.m., with a sharper signal at 31.9 p.p.m. ($\text{CCl}_3\text{POCl}_2$). Surprisingly the elemental analyses of this solid were reasonable for the expected compound, $\text{CCl}_3\text{PCl}_4\cdot\text{py}$. Therefore the signals detected at -39.0 and -46.6 p.p.m. seem to be genuinely due to $\text{CCl}_3\text{PCl}_4\cdot\text{py}$, the shift being dependent on the concentration of pyridine in the solution.

This phenomenon has also been observed by Ramirez et al (94) in spiro-pentaoxyphosphorane adducts with pyridine. The higher the ratio of pyridine to the adduct, the higher the negative value of the ^{31}P n.m.r. shift. No solid ^{31}P n.m.r. spectrum was obtained even after 30,000 scans.

Table 4.1: Infrared data for CCl_3PCl_4 and its derivatives.

| Compound | i.r. data $800-200\text{ cm}^{-1}$ |
|---|---|
| CCl_3PCl_4 | 790s, 760m, 590s, 565s, 545m, 520s, 455s, 430w, 400m, 370m, 355m, 345m, 310w. |
| $\text{CCl}_3\text{PCl}_3\text{BCl}_4$ | 800s, 650s, br*, 590s, 535s, 440w, 370m, 315s, 235m. |
| $\text{CCl}_3\text{PCl}_3\text{ICl}_4$ | 790s, 650s, br, 590m, 560w, 535s, 450w, 365w, 315m, 240s, br. |
| $\text{CCl}_3\text{PCl}_3\text{SbCl}_6$ | 790s, 660s, 590w, 535s, 340s, br*, 315s. |

* counter-ion

Table 4.2: Infrared data for six-coordinate cationic species.

| Compound | i.r. data $800-200\text{ cm}^{-1}$ |
|---|---|
| $\text{CCl}_3\text{PCl}_3\text{phenSbCl}_6$ | 790w, 770m, 745s, 705s, 590m, 543s, 515w, 490s, 475s, 455sh, 435s, 420m, 380m, 340s, br*. |
| $\text{CCl}_3\text{PCl}_3\text{bipySbCl}_6$ | 790m, 775s, 760s, 665w, 650w, 590w, 540sh, 505s, 490s, 455s, 440w, 425s, 380m, 340s, br*. |

* counter-ion.

4.1.3 REACTION OF CCl_3PCl_4 WITH LEWIS ACIDS.

a) SbCl_5 .

Like the other organophosphorus (V) compounds, CCl_3PCl_4 reacted readily with SbCl_5 to give the ionic species $\text{CCl}_3\text{PCl}_3^+\text{SbCl}_6^-$. As soon as liquid SbCl_5 was added to the solution of CCl_3PCl_4 in methylene chloride, a grey precipitate formed which was easily isolated by filtration. Its ^{31}P n.m.r. spectrum in nitrobenzene showed a resonance at 104.5 p.p.m., in good agreement with the Russian data, in which its shift was established as 103.9 p.p.m. in nitrobenzene and 103.3 p.p.m. in nitromethane (89). Its solid state n.m.r. spectrum after 1552 pulses gave a very sharp signal measured at 99.7 p.p.m. The elemental analyses were satisfactory for the expected compound, $\text{CCl}_3\text{PCl}_3^-\text{SbCl}_6$, but the addition of an approximately equal amount of benzoic acid was necessary to obtain a reasonable chlorine result, due to the absence of an organic group in the molecule to help the combustion.

Its i.r. spectrum in a Nujol mull exhibited a strong sharp band at 340 cm^{-1} , assigned to the SbCl_6^- ion. The other bands between 800 and 200 cm^{-1} are listed in table 4.1. No ^{35}Cl n.q.r. resonance was detected between 45-15 MHz, covering the C- Cl_3 , P-Cl and Sb-Cl regions at 77, 195 or 298K.

a(i) ACCEPTOR PROPERTIES TOWARDS BIDENTATE
LIGANDS.

When a small amount of dry 1,10-phenanthroline was added to a solution of $\text{CCl}_3\text{PCl}_3\text{SbCl}_6$ in nitrobenzene, new resonances were observed at 147.0 and -127.0 p.p.m., ascribed to CCl_3PCl_2 and $[\text{CCl}_3\text{PCl}_3\text{phen}][\text{SbCl}_6]$. This result indicated that decomposition occurred to some extent to give phosphorus (III) species, together with the six-coordinate phosphorus (V) cation. A 1:1 molar ratio reaction gave a yellow solution after solid phen was added to a slurry of $\text{CCl}_3\text{PCl}_3\text{SbCl}_6$ in methylene chloride, which soon precipitated a solid product. Evaporation of the solvent gave a yellow solid which analysed as the six-coordinate complex, $[\text{CCl}_3\text{PCl}_3\text{phen}][\text{SbCl}_6]$. Its ^{31}P n.m.r. spectrum in nitrobenzene showed a sharp signal measured at -132.2 p.p.m. This complex can exist in two isomeric forms, cis and trans (see section 3.2.4), and therefore should give two signals in the six-coordinate region if both isomers are present. The above n.m.r. data suggested that only one isomer is dominant. Its i.r. spectrum showed a broad signal at 340 cm^{-1} (SbCl_6^-) as well as some ligand bands; the frequencies are listed in table 4.2. When the solution containing the above complex was exposed to the air, a signal at 33.0 p.p.m. was measured, ascribed to $\text{CCl}_3\text{POCl}_2$.

When 2,2'-bipyridine was added to a slurry of CCl_3-

$\text{PCl}_3\text{SbCl}_6$ with constant stirring, a yellow solution formed which immediately precipitated a yellow solid. When this solid was redissolved in nitrobenzene, a resonance at -131.9 p.p.m. was observed, ascribed to the six-coordinate species $[\text{CCl}_3\text{PCl}_3\text{bipy}][\text{SbCl}_6]$. No solid n.m.r. spectrum was obtainable. The elemental analysis was reasonable for the expected compound, confirming the formation of the species. The i.r. spectrum showed the expected bands for the ligand and the counter-ion SbCl_6^- (table 4.2). As in the phen reaction, only one of the two possible isomeric cations appears to form preferentially.

b) BCl_3 .

The complex $\text{CCl}_3\text{PCl}_3\text{BCl}_4$ was prepared by dissolving solid CCl_3PCl_4 in methylene chloride and allowing BCl_3 gas to pass through this solution until a white precipitate formed. The white solid which was isolated gave a ^{31}P n.m.r. resonance at 105.2 p.p.m. in nitrobenzene, in good agreement with the value for the hexa-chloroantimonate salt (89). The ^{11}B n.m.r. spectrum of this solution gave a very sharp peak at -11.2 p.p.m., assigned to the anionic species BCl_4^- , in excellent agreement with data from Deng (20), and other independent researchers (70,71,95). Its solid state ^{31}P and ^{11}B n.m.r. spectra gave sharp signals measured at 102.9 and -10.1 p.p.m. respectively. The elemental analysis was reasonable for the expected compound $[\text{CCl}_3\text{PCl}_3][\text{BCl}_4]$. Benzoic acid was added to promote combustion in

detecting the chlorine, but the result was still rather low. Its i.r. spectrum (Nujol mull) exhibited a broad band at 650 cm^{-1} , assigned to the BCl_4^- ion, and other bands are listed in table 4.1.

b(i) ^{35}Cl N.Q.R. DATA.

$[\text{CCl}_3\text{PCl}_3][\text{BCl}_4]$ gave beautiful signals in the ^{35}Cl n.q.r. spectrometer. At 77K, all three different types of chlorine were detected. The CCl_3 group exhibited three equally intense signals at 41.330, 41.480 and 41.645 MHz, indicating that all three chlorines are not crystallographically equivalent and consequently have slightly different resonance frequencies. All the resonances appeared in the right region for the trichloromethyl group, which is normally between 38-42 MHz (96). No resonance was detected either at 193K or at room temperature for the CCl_3 group.

Two strong signals were observed at 31.600 and 31.950 MHz in a 2:1 intensity ratio at 77K. These signals were assigned to chlorine bonded to phosphorus. The above results indicate that two of the three chlorines in the tetrahedral structure of the $[\text{CCl}_3\text{PCl}_3]^+$ ion are crystallographically equivalent at this temperature. As for the CCl_3 group, no resonance was detected either at 193K or at room temperature.

The BCl_4^- ion always resonates in the lower frequ-

Fig. 4.1: ^{35}Cl n.q.r. spectra for $\text{CCl}_3\text{PCl}_3\text{BCl}_4$ at 77K

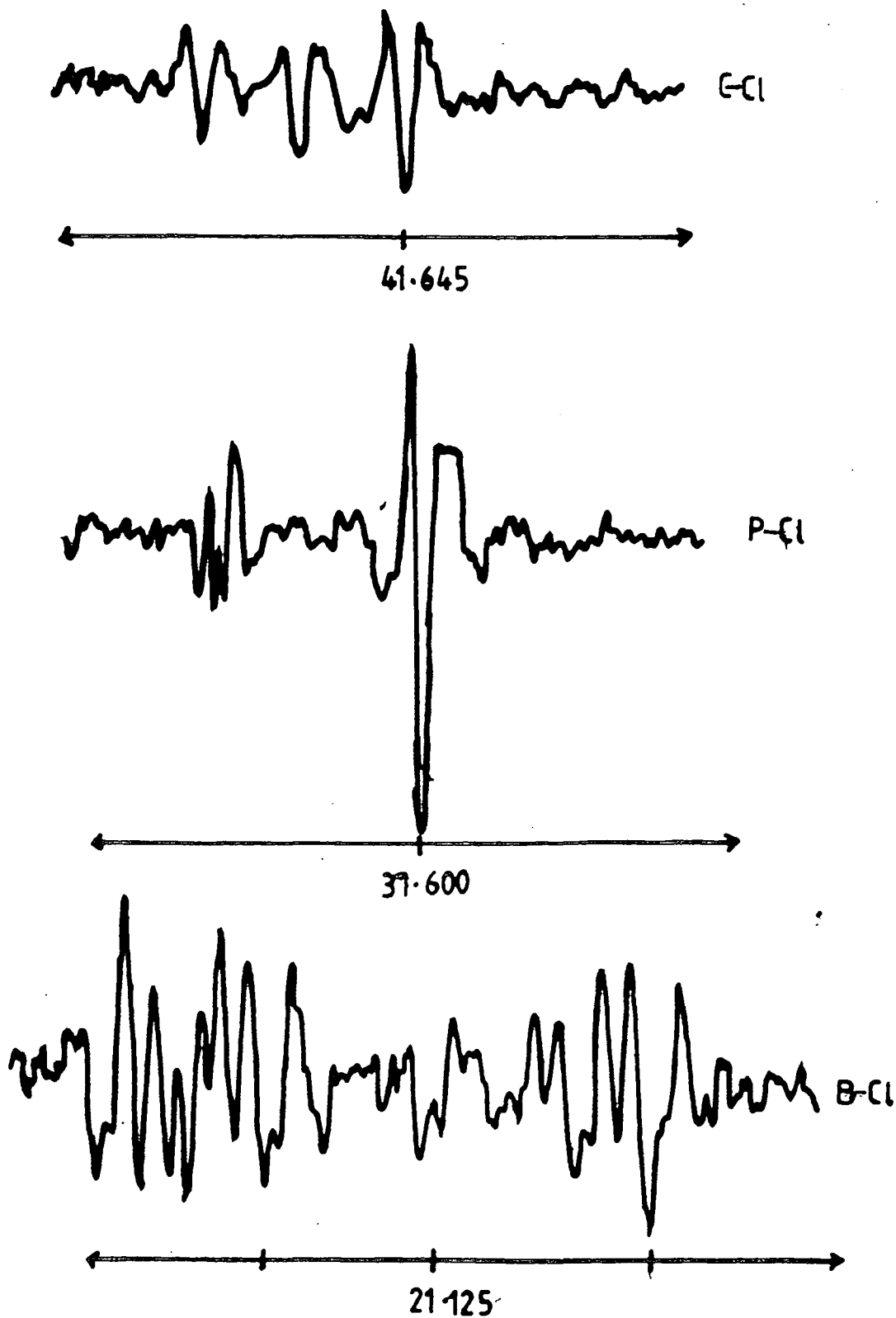

ency region. For this particular sample, four equivalent strong signals were observed, measured at 20.825, 20.925, 21.367 and 21.550 MHz at 77K (see figure 4.1). These results suggest that either all four chlorines are inequivalent in a slightly distorted tetrahedral structure, or there could be more than one molecule in the unit cell. When the spectrum was recorded at 193K, two equivalent medium intensity signals at 20.850 and 22.375 MHz were observed. No signal was detected at room temperature.

b(ii) REACTION WITH BIDENTATE LIGANDS.

No adduct was isolated with either 1,10-phenanthroline or 2,2'-bipyridine. On many occasions only one signal at -19.3 p.p.m. was discerned, ascribed to CCl_3PCl_4 . When dry phen was added to a slurry of $\text{CCl}_3\text{PCl}_3\text{BCl}_4$ in methylene chloride, a yellow solution formed in which a few minutes later a precipitate appeared. A yellow solid isolated after evaporation gave very low carbon and nitrogen analyses as well as for phosphorus and chlorine (see section 4.5). A similar reaction was carried out with bipy, in which only one signal at -20.9 p.p.m. was detected before evaporation, indicating that CCl_3PCl_4 was present in solution. The ^{11}B n.m.r. spectrum of the solution gave a resonance at -10.1 p.p.m., ascribed to $\text{BCl}_3\cdot\text{bipy}$ (20). Due to the above results, no 1:1 ratio product was isolated. The results suggest that the reaction probably follows equation 3 rather than 2 as shown below:

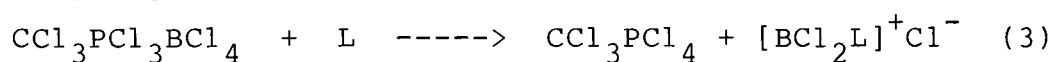
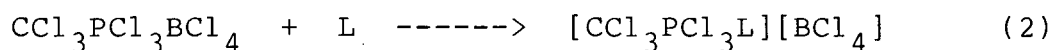

L=bipy or phen.

c) ICl_3 .

When an equimolar amount of solid iodine trichloride was added to a solution of CCl_3PCl_4 in methylene chloride, a yellow precipitate immediately formed, which was isolated by filtration. Like the other ICl_3 derivatives, it was unstable at room temperature, easily melting to an orange liquid. Its ^{31}P n.m.r. spectrum in nitrobenzene exhibited a resonance at 96.5 p.p.m., but its solid state spectrum exhibited a broad signal with maximum measured at 86.9 p.p.m. and a shoulder peak at 77.2 p.p.m., slightly to higher field of the solution resonance. The elemental analyses were reasonable for the expected compound $\text{CCl}_3\text{PCl}_3\text{-ICl}_4$. Its i.r. spectrum showed a broad band measured at 260 cm^{-1} , ascribed to an ICl_4^- vibration.

4.2 ACCEPTOR PROPERTIES OF $(\text{CCl}_3)_2\text{PCl}_3$ AND ITS DERIVATIVES.

4.2.1 INTRODUCTION.

This compound was first reported by Reinhardt et al (97); in their preparation tetramethyldiphosphine disulphide was suspended in CCl_4 and then heated under reflux for

one hour under ultra violet (uv) light. The mixture was then chlorinated for six hours to give a solution of $(\text{CCl}_3)_2\text{PCl}_3$. No ^{31}P n.m.r. data was reported in this paper. Later, Kozlov (98) reported a new method of synthesizing this compound by allowing chlorine to pass slowly into a solution of $(\text{ClCH}_2)_3\text{P}$ in CCl_4 at 273-278K until a yellowish colour appeared. The temperature of the reaction mixture was gradually raised, first to 293K and then to 333K and chlorination continued until no more HCl came off. The compound was isolated as colourless prisms, m.p. 465-466K. Dmitriev et al (89) reported the ^{31}P n.m.r. and ^{35}Cl n.q.r. data for this compound. In nitrobenzene it gave a ^{31}P shift of 29.3 p.p.m., while in benzene a signal at 31.3 p.p.m. was recorded. There were two ^{35}Cl resonances for $\nu(\text{CCl}_3)$, measured at 39.749(3) and 39.609(3) MHz, and only one at 29.458(3) for $\nu(\text{P-Cl})$ MHz at 77K.

It is stable to air and moisture, and is not hydrolysed even by boiling water, although aqueous ethanolic sodium hydroxide converts it to bis(trichloromethyl)phosphinic acid (99). At its decomposition point, it breaks down largely, but not entirely, to hexachloroethane and phosphorus trichloride (99).

In the present work, the compound was prepared by chlorination of Me_2PCl_3 as the starting material (see section 2.6.j). Me_2PCl_3 was prepared as reported by Baumgartner et al (62). The white solid which was isolated

was partially soluble in nitrobenzene giving a ^{31}P n.m.r. signal at 29.0 p.p.m. In methylene chloride, a resonance at 32.2 p.p.m. was recorded, in good agreement with the value of Dmitriev et al (89). Its solid state ^{31}P n.m.r. was recorded to give a signal at 33.8 p.p.m. (quite sharp), indicating that it has a molecular structure in both the solid state and solution. Its infrared data are given in table 4.3, and the elemental analyses were reasonable for the expected compound.

4.2.2 ACCEPTOR PROPERTIES TOWARDS Cl^- ION.

$(\text{CCl}_3)_2\text{PCl}_3$ shows no acceptor properties towards chloride ion either in nitrobenzene or methylene chloride. When Et_4NCl was added to a solution of $(\text{CCl}_3)_2\text{PCl}_3$ either in CH_2Cl_2 or PhNO_2 , no upfield movement of the parent signal was observed. With more Et_4NCl added, the spectrum remained the same, confirming that no adduct was formed in this solution. When Pr_4NCl was used, the same observation was made, therefore no six-coordinate anionic species was formed. This behaviour was also found by Sergienko et al (91).

4.2.3 ACCEPTOR PROPERTIES TOWARDS BIDENTATE LIGANDS.

When a small amount of 1,10-phenanthroline was added to a solution of $(\text{CCl}_3)_2\text{PCl}_3$ either in methylene chlori-

de or nitrobenzene, a pinkish solution formed, and the ^{31}P n.m.r. showed the parent signal at 28.9 p.p.m. only. With more phen added, no precipitate was formed and the ^{31}P n.m.r. spectrum was unchanged, showing that no six-coordinate species $[(\text{CCl}_3)_3\text{PCl}_2\text{phen}]^+\text{Cl}^-$ was formed. Due to this result, no attempt was made to isolate an adduct with 2,2'-bipyridine.

When $(\text{CCl}_3)_2\text{PCl}_3$ was added to neat pyridine, the ^{31}P n.m.r. spectrum of the solution gave a signal at 28.9 p.p.m., from the starting material, so no coordination with uni- or bidentate ligands was observed. The solubility of the compound is very poor in most solvents, which makes the investigation of its properties more difficult.

4.2.4 REACTION WITH SbCl_5 .

When an equimolar amount of antimony pentachloride was added to a solution of $(\text{CCl}_3)_2\text{PCl}_3$ in methylene chloride, a white precipitate immediately formed, which was filtered off and, after washing with methylene chloride, a white solid was isolated. It was first prepared by Dmitriev et al (89) by using a 5% excess of SbCl_5 to $(\text{CCl}_3)_2\text{PCl}_3$ in CCl_4 . Its ^{31}P n.m.r. shift in PhNO_2 and CH_3NO_2 were recorded at 148.9 and 148.4 p.p.m. respectively, and no solid state ^{31}P n.m.r. or ^{35}Cl n.q.r. data were reported in this paper. In the present work, a chemical shift at 149.0 p.p.m. was recorded in nitrobenzene, but in

the solid state an asymmetrical broad signal between 155 and 30 p.p.m. was seen, with the maximum measured at 75.6 p.p.m. Rearrangement could possibly occur to some extent in the solid state to give the phosphorane (δ 33.9), but it is not possible to draw definite conclusions from this rather poor quality spectrum, even after 32,000 pulses. The infrared spectrum showed a broad sharp signal at 336 cm^{-1} , assigned to the SbCl_6^- counter-ion. The elemental analyses were good for the expected compound $(\text{CCl}_3)_2\text{PCl}_2\text{SbCl}_6$. No ^{35}Cl n.q.r. signal was detected between 43 and 15 MHz at 77, 195 or 298K.

When a small amount of 1,10-phenanthroline was added to a solution of $(\text{CCl}_3)_2\text{PCl}_2\text{SbCl}_6$ in nitrobenzene, a brown clear solution formed. Its ^{31}P n.m.r. spectrum exhibited two signals, measured at 35.4 (medium strong) and 32.2 p.p.m. (strong). With more phen added, a precipitate formed which reduced the intensity of the new signals. More precipitate formed when an excess of phen was added to this solution and again reduced the intensity of these two signals. No six-coordinate species was detected in this qualitative reaction. These two signals were probably from $(\text{CCl}_3)_2\text{PCl}_3$, which has three possible isomers as shown below:

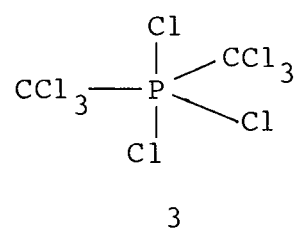
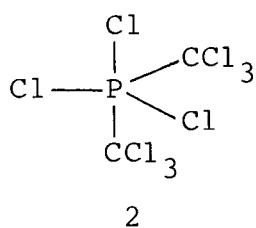
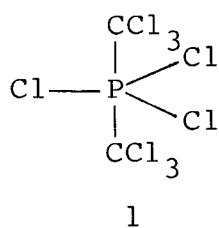

The above result suggests that two isomers were formed, probably isomers 1 and 2 which have at least one of the more electronegative CCl_3 groups axial. The signal at 32.2 p.p.m. is for isomer 1 and that at 35.4 p.p.m. is assigned to isomer 2. Isomer 1 is expected to be more stable than 2, and was the only product obtained by direct chlorination. In this reaction, isomer 2 was probably formed in addition because the phosphorane was obtained from pseudotetrahedral $(\text{CCl}_3)_2\text{PCl}_2^+$ which could lead to an equatorial CCl_3 group.

In a 1:1 molar ratio reaction, when solid phen was added to a slurry of $(\text{CCl}_3)_2\text{PCl}_2\text{SbCl}_6$ in methylene chloride, a yellowish suspension formed which gave a yellow solid. This solid readily turned to orange in the box. Its ^{31}P n.m.r. spectrum in nitrobenzene only showed one signal at 30.9 p.p.m., ascribed to the most stable isomer of $(\text{CCl}_3)_2\text{PCl}_3$. No coordination occurred in this compound to give the six-coordinate species $[(\text{CCl}_3)_2\text{PCl}_2\text{phen}][\text{SbCl}_6]$. This was supported by the elemental analysis which gave very low carbon and nitrogen content, (found: C=13.75 H=1.50 N=1.74%; calculated: C=19.68 H=0.94 N=3.28%; $\text{SbCl}_5\cdot\text{phen}$ requires: C=30.03 H=1.67 N=5.84%). From these results, the solid formed in the above reaction is probably a mixture of

[SbCl₅.phen] (6) and (CCl₃)₂PCl₃, but containing an excess of the phosphorane. A similar reaction to that shown in equation (4) was observed between (C₆F₅)₂PCl₂SbCl₆ and phen (section 3.2.4).

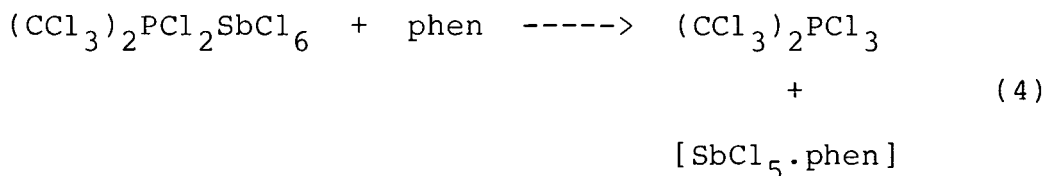

When a small amount of 2,2'-bipyridine was added to a solution of (CCl₃)₂PCl₂SbCl₆ in PhNO₂, two upfield signals were detected, measured at 30.3 (strong) and 14.5 p.p.m. (strong). The signal at 30.3 p.p.m. was assigned to (CCl₃)₂PCl₃ and the peak at 14.5 p.p.m. is probably from impurities. Again, no coordination occurred with bipy, therefore no attempt was made to isolate a 1:1 ratio adduct. Table 4.3 below shows the infrared data for (CCl₃)₂PCl₃ and (CCl₃)₂PCl₂SbCl₆.

Table 4.3: Infrared data for (CCl₃)₂PCl₃ and its derivative.

| Compound | i.r. data 800-200 cm ⁻¹ . |
|---|--------------------------------------|
| (CCl ₃) ₂ PCl ₃ | 785s, 550s,br, 445s, 370s. |
| (CCl ₃) ₂ PCl ₂ SbCl ₆ | 765m, 665s, 575s, 480s, 340s,br*. |

* counter-ion.

4.2.5 OTHER REACTIONS.

When a 1:1 ratio reaction between $(\text{CCl}_3)_2\text{PCl}_3$ and ICl_3 was carried out, a white solid was isolated after stirring the mixture for half an hour. The dark red filtrate gave a sticky pinkish solid after evaporation of the solvent, which turned to a white solid after washing with CH_2Cl_2 . Both solids gave ^{31}P n.m.r. signals at 29.9 p.p.m. in nitrobenzene, indicating that no reaction occurred. This signal is assigned to $(\text{CCl}_3)_2\text{PCl}_3$.

A similar result was obtained when BCl_3 gas was allowed to flow into a solution of $(\text{CCl}_3)_2\text{PCl}_3$ in CH_2Cl_2 . Evaporation of the solvent only gave a white solid which analysed as $(\text{CCl}_3)_2\text{PCl}_3$. These results indicate that a strong Lewis acid such as SbCl_5 is needed to pull a chlorine from the phosphorus atom and form the cationic species $[(\text{CCl}_3)_2\text{PCl}_2]^+$. Hence the presence of the two electronegative trichloromethyl groups on the phosphorus atom strengthens the P-Cl bonds, thus stabilizing the molecule. This conclusion was supported by Dmitriev et al (89), who found that electronegative trichloromethyl groups occupying axial positions raised the stability of the trigonal bipyramid, in comparison with phenyl groups, relative to that of the cationic form.

The compound was also stable toward reducing agents such as MeOPCl_2 (methylphosphorodichloridite). When MeOPCl_2

was added to a $(\text{CCl}_3)_2\text{PCl}_3$ solution in CH_2Cl_2 at 303K and the mixture stirred for a few hours, its ^{31}P n.m.r. spectrum showed signals at 181.0 and 33.9 p.p.m., ascribed to MeOPCl_2 and $(\text{CCl}_3)_2\text{PCl}_3$ respectively. Conversely, CCl_3PCl_4 is reduced to CCl_3PCl_2 by the same reagent under the same conditions (see section 2.5.4). This result supports the enhanced stability of the phosphorane $(\text{CCl}_3)_2\text{PCl}_3$.

In another attempt to prepare $(\text{CCl}_3)_2\text{PCl}$, which has not been reported in the literature, $[(\text{CCl}_3)_2\text{PCl}_2]\text{AlCl}_4$ was synthesized, with a view to reducing it with the Al/KCl reagent used by Komkov et al (100). In a qualitative reaction, when solid AlCl_3 was added to a solution of $(\text{CCl}_3)_2\text{PCl}_3$ in CH_2Cl_2 , a clear yellow solution formed which later precipitated. The ^{31}P n.m.r. signal of this slurry gave only one signal at 149.6 p.p.m., assigned to the cation of the $[(\text{CCl}_3)_2\text{PCl}_2][\text{AlCl}_4]$ species.

When the reaction was performed in a 1:1 ratio, no precipitate formed when freshly sublimed AlCl_3 was added. When the reaction mixture was left stirring for an hour, the solution turned red and finally a brown suspension was observed after stirring was continued for 3 hours. The solid isolated gave a very low carbon content (found: C=1.4%; required: C=4.72%). Its ^{31}P n.m.r. spectrum in CH_2Cl_2 showed several signals in the lower field region which were very difficult to assign. The strongest signal was at 126.0 p.p.m. Other signals were measured at 139.2

(medium), 131.3 (weak), 129.6 (strong), 125.2 (strong), 124.7 (strong), 108.0 (strong), 102.7 (medium), 101.1 (weak), 87.4 (weak), 50.0 (weak) and 35.8 p.p.m. (weak). This reaction was therefore not investigated further as a preparative route.

4.3 ACCEPTOR PROPERTIES OF $C_2Cl_5PCl_4$ AND ITS DERIVATIVES.

4.3.1 INTRODUCTION.

No literature data is available so far for $C_2Cl_5PCl_4$. In the present work, it was prepared by direct substitution between the hydrogens in $EtPCl_4$ and chlorine gas. The reaction was carried out at 343-353K until a saturated yellow solution formed. The product was isolated as a white solid which gave a ^{31}P n.m.r. signal at -19.3 p.p.m. in $PhNO_2$ and at -17.7 p.p.m. in methylene chloride. Its solid state n.m.r. spectrum was very complicated, containing several signals measured at 146.3 ($C_2Cl_5PCl_2$, medium), 116.8 ($C_2Cl_5PCl_3^+$, strong broad), 38.6 ($C_2Cl_5POCl_2$, medium) and one other signal at 51.5 p.p.m. (strong) which was very difficult to assign. This result indicated that the compound decomposed while the spectrum was being recorded, and the data suggest that it has a molecular structure in CH_2Cl_2 and $PhNO_2$ but may be ionic in the solid state. When the solid was left in the box for a long time, its solid state ^{31}P n.m.r. spectrum showed several signals measured

at 220.3 (weak, PCl_3), 144.7 (strong, $\text{C}_2\text{Cl}_5\text{PCl}_2$), 112.6 (medium broad, $\text{C}_2\text{Cl}_5\text{PCl}_3^+$), 49.9 (medium), 38.6 (medium, $\text{C}_2\text{Cl}_5\text{POCl}_2$), 1.6 (weak, $\text{C}_2\text{Cl}_5\text{PO}(\text{OH})_2$) and -295.9 p.p.m. (medium broad, PCl_6^-). This spectrum indicates that the compound is unstable, easily decomposing to give the phosphorus (III) species $\text{C}_2\text{Cl}_5\text{PCl}_2$ as well as PCl_3 which involves breaking the P-C bond. The mechanism is unknown. This type of decomposition has also been observed by Frank (99) for trichloromethyl phosphorus compounds. $(\text{CCl}_3)_2\text{PCl}_3$ decomposed to CCl_3CCl_3 and PCl_3 while CCl_3PCl_4 gave CCl_4 and PCl_3 (99).

The elemental analysis was reasonable for the expected compound as well as for its other derivatives, supporting the view that the compound isolated was pure. Its i.r. frequencies ($800\text{-}200\text{ cm}^{-1}$) are listed in table 4.4.

4.3.2 ACCEPTOR PROPERTIES TOWARDS THE Cl^- ION.

When a small amount of Et_4NCl was added to a solution of $\text{C}_2\text{Cl}_5\text{PCl}_4$ in nitrobenzene ($\delta^{31}\text{P}$ -19.3 p.p.m.), a new signal at 146.3 p.p.m. was detected as well as the parent signal. This signal was identified as $\text{C}_2\text{Cl}_5\text{PCl}_2$, showing that decomposition to phosphorus (III) was occurring. With more chloride added, only one signal at 146.3 p.p.m. was observed. There was no evidence for formation of the six-coordinate adduct $[\text{C}_2\text{Cl}_5\text{PCl}_5]^-$. When the reaction was performed in CH_2Cl_2 , a new signal at -168.9 p.p.m. was re-



corded, but it disappeared with the addition of more chloride, with the appearance of lower field region resonances at 148.0 (strong, $C_2Cl_5PCl_2$), 40.2 (weak, $C_2Cl_5POCl_2$) and -3.2 p.p.m. (weak, probably $C_2Cl_5PO(OH)_2$). The signal at -168.9 p.p.m. probably arises from temporary formation of $[C_2Cl_5PCl_5]^-$, which is unstable, and readily decomposes to give $C_2Cl_5PCl_2$. Furthermore, this signal appeared in the range -160 ± 10 p.p.m. predicted for $C_2Cl_5PCl_5^-$ by using the correlation between the ^{31}P chemical shift differences between A^+ and $AX(\Delta 1)$, and between A^+ and $AX_2^-(\Delta 2)$ (101), where A^+ is a phosphonium ion and X is an ionic ligand. This calculation supports the suggestion that the signal at -168.9 p.p.m. is due to the genuine six-coordinate species $C_2Cl_5PCl_5^-$. Pr_4NCl gave only decomposition products, either in methylene chloride or nitrobenzene. After addition of a small amount of this salt, signals at 149.5 ($C_2Cl_5PCl_2$), 40.2 ($C_2Cl_5POCl_2$) and -17.5 p.p.m. ($C_2Cl_5PCl_4$), with a strong signal at -298.7 p.p.m., were observed. With more salt added, only signals at 149.5, 40.2 and -298.7 p.p.m. were detected. The signal at -298.7 p.p.m. was assigned to the $[PCl_6]^-$ ion but again it is not clear how it is formed, since no PCl_5 was used in this system. If it is from $C_2Cl_5PCl_4$, the mechanism involves breaking the P-C bond, which was also observed by Frank (99). $ClCH_2POCl_2$ and $(Cl(CH_2))_2POCl$ react smoothly and quantitatively with PCl_5 at 368-373K, giving among other products CCl_4 and phosphorus (III) fragments containing one less P-C bond; PCl_3 and CCl_3PCl_2 respectively. Kozlov and Gaidamaka (98) pre-

pared $(\text{CCl}_3)_2\text{PCl}_3$ by chlorination of $(\text{ClCH}_2)_3\text{P}$ in carbon tetrachloride, again requiring the cleavage of one P-C bond.

When dry $n\text{-Bu}_4\text{NCl}$ was added to a solution of $\text{C}_2\text{Cl}_5\text{-PCl}_4$ in nitrobenzene, only signals at 146.3 ($\text{C}_2\text{Cl}_5\text{PCl}_2$), 40.2 ($\text{C}_2\text{Cl}_5\text{POCl}_2$) and 3.21 p.p.m. ($\text{C}_2\text{Cl}_5\text{PO}(\text{OH})_2$) were observed. No resonance for PCl_6^- was detected, but when Pe_4NCl was used, peaks at -8.0 (possibly $\text{C}_2\text{Cl}_5\text{PCl}_4$) and -297.5 p.p.m. (PCl_6^-) were discerned. No sign of the decomposition product ($\text{C}_2\text{Cl}_5\text{PCl}_2$ 149.7 p.p.m.) was detected. It seems that decomposition occurs more rapidly than the addition reaction to form a six-coordinate anionic species, therefore no attempt was made to isolate a 1:1 ratio adduct.

4.3.3 ACCEPTOR PROPERTIES TOWARDS BIDENTATE LIGANDS.

In a qualitative reaction, when 1,10-phenanthroline was added to a solution of $\text{C}_2\text{Cl}_5\text{PCl}_4$ in methylene chloride, a pink solution formed which immediately precipitated. The ^{31}P n.m.r. spectrum of this suspension only gave resonances at 146.3 ($\text{C}_2\text{Cl}_5\text{PCl}_2$, medium) and 53.1 p.p.m. (weak, not easily assignable). No six-coordinate species was detected, probably due to insolubility of the product in this solvent. A 1:1 ratio reaction between $\text{C}_2\text{Cl}_5\text{PCl}_4$:phen was performed in the same solvent. As soon as 1,10-phenanthroline was added, a yellowish solution formed which then immedia-

tely precipitated. While stirring, the suspension turned to pinkish. Filtration gave a white solid. It was fairly insoluble in nitrobenzene from which only a very weak signal at -138.5 p.p.m. was detected, assigned to $C_2Cl_5PCl_3$ -phenCl. No solid state n.m.r. signal was apparent after 41,000 pulses. This solid gave very good carbon, hydrogen and nitrogen analyses but the phosphorus was slightly high (7.68%) and the chlorine was slightly low (53.15%). When the analysis was repeated by adding boric acid the chlorine content was quite reasonable for the expected compound while the phosphorus was improved (see section 4.5). Its infrared spectrum was recorded as a Nujol mull and the bands are listed in table 4.4.

When 2,2'-bipyridine was used, a precipitate formed immediately after solid bipy was added to a slurry of $C_2Cl_5PCl_4$ in methylene chloride. As for the phen reaction, a pink solution formed while stirring. A yellowish solid was isolated after filtration. Unfortunately no ^{31}P n.m.r. signal was obtained either in solution or in the solid state. The product was insoluble in all common solvents. As for the phen analogue, the carbon, hydrogen, nitrogen and phosphorus analyses were reasonable for the expected compound, $C_2Cl_5PCl_3$ bipyCl, but the chlorine content was low, even after the addition of boric acid. The infrared data (Nujol mull) are presented in table 4.4.

4.3.4 DONOR PROPERTIES TOWARDS LEWIS ACIDS.

a) SbCl_5 .

As soon as liquid antimony pentachloride was added to a solution of $\text{C}_2\text{Cl}_5\text{PCl}_4$ in methylene chloride, a grey precipitate formed which was isolated after filtration. Its ^{31}P n.m.r. spectrum in nitrobenzene gave a resonance at 112.4 p.p.m., due to the cationic species $[\text{C}_2\text{Cl}_5\text{PCl}_3]^+[\text{SbCl}_6]^-$. Its solid state ^{31}P n.m.r. gave a broad signal with the maximum measured at 109.4 p.p.m., in good agreement with the solution data.

The elemental analyses were reasonable for the expected compound and its infrared absorptions (Nujol mull) are listed in table 4.4. It exhibited a strong broad band at 340 cm^{-1} assigned to the SbCl_6^- stretching vibration, in good agreement with the reported value (5,6,102).

When 1,10-phenanthroline was added to a solution of $\text{C}_2\text{Cl}_5\text{PCl}_3\text{SbCl}_6$ in nitrobenzene, new signals were discerned in the higher field region, measured at 40.8 ($\text{C}_2\text{Cl}_5\text{POCl}_2$) and -135.5 p.p.m. (strong), showing that coordination occurs at the phosphorus atom forming a six-coordinate complex $[\text{C}_2\text{Cl}_5\text{PCl}_3\text{phen}][\text{SbCl}_6]$, as discussed in chapter 3. This compound should give two isomeric forms, with the C_2Cl_5 group trans to Cl or to N, but it seems that only one isomer is dominant. It is not certain which isomer is present but

if steric interactions are considered, the trans isomer (C_2Cl_5 trans to N) is perhaps more likely to form, because it is less sterically hindered than the cis isomer (C_2Cl_5 trans to Cl).

In a 1:1 ratio reaction, as soon as phen was added to a slurry of $C_2Cl_5PCl_3SbCl_6$ in CH_2Cl_2 , a precipitate formed. A yellow solid was isolated after evaporation in vacuo but the elemental analyses diverged from the expected values for $[C_2Cl_5PCl_3phen][SbCl_6]$. Its ^{31}P n.m.r. in nitrobenzene gave signals at 112.5 (weak), 40.8 (strong, $C_2Cl_5-POCl_2$) and -135.5 p.p.m. (strong). The resonances at 112.5 and -135.5 p.p.m. are assigned to $[C_2Cl_5PCl_3]^+$ and $[C_2Cl_5-PCl_3phen]^+$ respectively. This indicates that some of the starting material had not reacted, so the reaction cannot be performed quantitatively in this way.

When the reaction was carried out with $C_2Cl_5PCl_3-SbCl_6$ and 2,2'-bipyridine, a creamy suspension was immediately formed as soon as bipy was added. The precipitate was filtered off to isolate a creamy solid. No solid state ^{31}P n.m.r. resonance was detected after 215,256 pulses, as well as no solution signals in $PhNO_2$ and CH_3CN . The elemental analyses gave a very low phosphorus content and poor results for other elements. The product could be a mixture containing $SbCl_5.bipy$ as well as $[C_2Cl_5PCl_3bipy]SbCl_6$, although the C, H and N analyses were lower than expected for this possibility (see section 4.5). This reaction was not

investigated further. It seems probable in view of the results of the phen reaction and those for bipy with $C_2Cl_5P-Cl_4$ that complex formation does take place, but direct evidence for the species $[C_2Cl_5PCl_3bipy]^+SbCl_6^-$ is lacking.

b) BCl_3 .

When excess BCl_3 gas was allowed to flow into a slurry of $C_2Cl_5PCl_4$ in CH_2Cl_2 , a white precipitate formed after a few minutes stirring. A white solid was isolated after the solvent was removed in vacuo. When this solid was redissolved in $PhNO_2$, signals at 112.1 (strong, $C_2Cl_5-PCl_3^+$), 87.7 (medium), 80.2 (weak) and 41.1 p.p.m. (weak, $C_2Cl_5POCl_2$) were discerned. The other two signals were very difficult to assign since the reaction is not straightforward. After treatment with CH_2Cl_2 , its solid state ^{31}P n.m.r. spectrum exhibited a broad band with maxima measured at 109.4 and 93.3 p.p.m., but when it was redissolved in $PhNO_2$, three signals were observed at 220.2 (weak, PCl_3), 112.6 (strong, $C_2Cl_5PCl_3^+$) and 83.3 p.p.m. (medium), the assignment of the last signal being unknown. Its ^{11}B n.m.r. resonance was detected at -12.2 p.p.m., indicating that the BCl_4^- ion is present in this solution. It seems that decomposition of this product also involves breaking the P-C bond to give PCl_3 as a minor product.

As expected from the n.m.r. data, the elemental analysis was poor for the expected compound, $C_2Cl_5PCl_3BCl_4$,

therefore no attempt was made to isolate any adduct with bidentate ligands such as 1,10-phenanthroline and 2,2'-bipyridine.

c) ICl_3 .

A fine yellow solid was isolated from a 1:1 ratio reaction between $\text{C}_2\text{Cl}_5\text{PCl}_4$ and ICl_3 in CH_2Cl_2 . Like the other ICl_4^- salts prepared in this work, it was unstable at room temperature and easily turned to a dark orange liquid, so it should be kept at low temperature. Its solid state ^{31}P n.m.r. spectrum exhibited a strong broad peak with the maximum measured at 112.6 p.p.m. Before evaporation a signal at 109.5 p.p.m. was detected but when the yellow solid was dissolved in PhNO_2 , the peak position was measured as 112.6 p.p.m. The elemental analyses were reasonable except that the phosphorus content was rather high and the chlorine content was low, even after benzoic acid was added to promote the combustion. Its infrared spectrum (Nujol mull) showed a broad ICl_4^- band at 250 cm^{-1} , and the rest of the signals below 800 cm^{-1} are listed in table 4.4.

Table 4.4: Infrared data for $C_2Cl_5PCl_4$ and its derivatives.

| Compound | i.r. bands ($800-200\text{ cm}^{-1}$). |
|-----------------------------|---|
| $C_2Cl_5PCl_4$ | 785w, 655m,br, 595s, 560s, 555sh, 505s, 440sh, 420s, 390m, 350m. |
| $C_2Cl_5PCl_3SbCl_6$ | 650s,br, 565s, 465m, 340s,br,*. |
| $C_2Cl_5PCl_3ICl_4$ | 750sh, 650s,br, 590m, 465m, 385w, 335m, 250s,br*. |
| $C_2Cl_5PCl_3\text{bipyCl}$ | 760s, 650w, 620m, 610m, 590m, 540w, 440s,br, 340m. |
| $C_2Cl_5PCl_3\text{phenCl}$ | 770w, 750s, 705s, 655m, 620m, 540s, 525m, 505sh, 500s, 480s, 465sh, 440s,br, 415sh, 350m, 290w. |

* counter-ion

4.4 CONCLUSION.

The acceptor properties of CCl_3PCl_4 are greater than those of $(CCl_3)_2PCl_3$, since more derivatives were formed with the former compound than the latter. For example, CCl_3PCl_4 formed a six-coordinate anionic species with the chloride ion and cationic species with bidentate ligands, $[CCl_3PCl_3L]^+$ (L=bipy or phen), but $(CCl_3)_2PCl_3$ does not do so. The other chlorinated compound $C_2Cl_5PCl_4$ showed properties intermediate between those of CCl_3PCl_4 and $(CCl_3)_2PCl_3$. Six-coordinate cationic species $[C_2Cl_5PCl_3L]^+Cl^-$ (L=bipy or phen) were isolated, but $C_2Cl_5PCl_4$ showed only

weak acceptor properties towards the chloride ion, and decomposition usually occurred instead.

In comparison, the acceptor properties of the phosphoranes containing chlorinated organo-groups (CCl_3 or C_2Cl_5) are less than those with C_6F_5 groups present, as well as those of compounds containing methyl, ethyl and phenyl groups (9,16). No six-coordinate species was observed with phen or bipy and $\text{CCl}_3\text{PCl}_3\text{BCl}_4$, but $\text{C}_6\text{F}_5\text{PCl}_3\text{L}^+\text{BCl}_4^-$ (L=bipy or phen) were isolated. Moreover, several cationic species were isolated with $(\text{C}_6\text{F}_5)_2\text{PCl}_3$, but only $(\text{CCl}_3)_2\text{P-Cl}_2\text{SbCl}_6$ was formed, showing that a stronger Lewis acid is needed to remove one chlorine from $(\text{CCl}_3)_2\text{PCl}_3$.

CCl_3PCl_4 and $(\text{CCl}_3)_2\text{PCl}_3$ have a molecular structure, both in solution and in the solid state. In contrast, $\text{C}_2\text{Cl}_5\text{PCl}_4$ exists in a molecular form in solution but may be ionic in the solid state.

4.5 EXPERIMENTAL.

1) Preparation of $\text{CCl}_3\text{PCl}_3\text{SbCl}_6$.

CCl_3PCl_4 (0.80 g, 2.74 mmoles) was dissolved in CH_2Cl_2 . SbCl_5 (0.82 g, 2.74 mmoles) was added dropwise with constant stirring. The reaction mixture was allowed to stir for 10 minutes before the precipitate was filtered off and washed twice with CH_2Cl_2 . The solid was dried in an atmosphere of N_2 .

Analysis:

Found: C=2.60 P=4.69 Cl=70.42 Sb=19.77%.

Calculated: C=2.03 P=5.25 Cl=72.11 Sb=20.63%.

2) Preparation of $\text{CCl}_3\text{PCl}_3\text{BCl}_4$.

CCl_3PCl_4 (0.90 g, 3.09 mmoles) was dissolved in CH_2Cl_2 . BCl_3 gas was allowed to flow, with constant stirring, until a white precipitate was formed. The reaction mixture was stirred for another 10 minutes before the precipitate was filtered off and washed with CH_2Cl_2 to remove any hydrolysis product.

Analysis:

Found: C=3.61 Cl=80.4 P=7.28 B=2.75%.

Calculated: C=2.94 Cl=86.84 P=7.58 B=2.65%.

3) Preparation of $\text{CCl}_3\text{PCl}_3\text{ICl}_4$.

CCl_3PCl_4 (1.14 g, 3.91 mmoles) was dissolved in CH_2Cl_2 . ICl_3 (0.91 g, 3.90 mmoles) was added to the above solution with constant stirring. The yellow precipitate which formed immediately after mixing was filtered off, washed with CH_2Cl_2 and then dried under a dry N_2 atmosphere.

Analysis:

Found: C=2.38 Cl=66.96 P=5.64 I=25.33%.

Calculated: C=2.29 Cl=67.63 P=5.91 I=24.18%.

4) Preparation of $\text{CCl}_3\text{PCl}_3\text{phenSbCl}_6$.

$\text{CCl}_3\text{PCl}_3\text{SbCl}_6$ (0.36 g, 0.64 mmoles) was suspen-

ded in CH_2Cl_2 . 1,10-Phenanthroline (0.11 g, 0.60 mmoles) was added to the above slurry with stirring. The yellow solution which formed immediately precipitated a yellow solid. The solvent was evaporated to dryness and the solid isolated was washed with low boiling petroleum ether and dried under an N_2 atmosphere.

Analysis:

Found: C=21.87 H=1.94 N=3.19 P=2.89 Cl=51.71

Sb=13.20%.

Calculated: C=20.25 H=1.05 N=3.63 P=4.02 Cl=55.25

Sb=15.80%.

5) Preparation of $\text{CCl}_3\text{PCl}_3\text{bipySbCl}_6$.

$\text{CCl}_3\text{PCl}_3\text{SbCl}_6$ (1.29 g, 2.18 mmoles) was dissolved in CH_2Cl_2 . 2,2'-Bipyridine (0.34 g, 2.18 mmoles) was added to the above slurry with constant stirring. The reaction mixture was allowed to stir for an hour before the solvent was evaporated to dryness, and the product was washed with low boiling petroleum ether.

Analysis:

Found: C=18.80 H=1.34 N=2.76 P=3.09 Cl=53.13 Sb=19.20%.

Calculated: C=17.70 H=1.35 N=3.75 P=4.15 Cl=56.73

Sb=16.32%.

6) Attempted preparation of $\text{CCl}_3\text{PCl}_3\text{phenBCl}_4$.

$\text{CCl}_3\text{PCl}_3\text{BCl}_4$ (0.33 g, 0.81 mmoles) was suspended in CH_2Cl_2 . 1,10-Phenanthroline (0.14 g, 0.80 mmoles) was added to the above slurry with constant stirring. The yellow

solution which formed immediately precipitated a yellow solid. Evaporation of the solvent in vacuo gave a yellowish solid, which analysed as a mixture.

Analysis:

Found: C=16.86 H=0.78 N=1.88 P=3.27 Cl=52.2 B=1.78%.

Calculated: C=26.51 H=1.37 N=4.75 P=5.26 Cl=60.27 B=1.84%.

CCl_3PCl_4 requires: C=4.12 P=10.63 Cl=85.25%.

BCl_3 .phen requires: C=48.45 H=2.71 N=9.41 Cl=35.80 B=3.63%.

7) Preparation of CCl_3PCl_4 .py.

CCl_3PCl_4 (1.02 g, 3.50 mmoles) was dissolved in methylene chloride. Liquid pyridine (0.28 g, 3.54 mmoles) was added dropwise with constant stirring, and stirring was then continued for 30 minutes. The solvent was evaporated to dryness to isolate a greyish solid.

Analysis:

Found: C=21.27 H=2.13 N=2.79 P=6.42 Cl=63.60%.

Calculated: C=19.43 H=1.35 N=3.78 P=8.37 Cl=67.07%.

8) Preparation of $(\text{CCl}_3)_2\text{PCl}_2\text{SbCl}_6$.

$(\text{CCl}_3)_2\text{PCl}_3$ (0.80 g, 2.14 mmoles) was dissolved in CH_2Cl_2 . SbCl_5 (0.64 g, 2.14 mmoles) was added dropwise with constant stirring. The reaction mixture was stirred for a further 10 minutes to allow the reaction to go to completion. The precipitate formed was filtered off, and washed with CH_2Cl_2 and low boiling petroleum ether to isolate a white solid.

Analysis:

Found: C=4.17 P=4.41 Cl=68.62 Sb=18.40%.

Calculated: C=3.57 P=4.60 Cl=73.76 Sb=18.07%.

9) Attempts to prepare $(\text{CCl}_3)_2\text{PCl}_2\text{BCl}_4$.

$(\text{CCl}_3)_2\text{PCl}_3$ (1.13 g, 3.02 mmoles) was dissolved in CH_2Cl_2 . BCl_3 gas was allowed to flow into the solution with constant stirring until a white precipitate formed. The solvent was evaporated in vacuo to isolate a fine white solid. It analysed as $(\text{CCl}_3)_2\text{PCl}_3$.

Analysis:

Found: C=10.45 P=6.64 Cl=81.80 B=0.24%.

Calculated: C=4.88 P=6.30 Cl=86.62 B=2.20%.

$(\text{CCl}_3)_2\text{PCl}_3$ requires: C=6.41 P=8.26 Cl=85.30%.

10) Preparation of $\text{C}_2\text{Cl}_5\text{PCl}_4$.

EtPCl_4 (2.0 g, 9.90 mmoles) was dissolved in CCl_4 and warmed to 343-353K until a clear solution formed. Dry Cl_2 gas was passed through this solution at a slow rate with constant stirring until a saturated greenish solution formed. The solvent was removed in vacuo and the solid was washed twice with low boiling petroleum ether.

Analysis:

Found: C=6.20 P=9.08 Cl=72.2%.

Calculated: C=6.41 P=8.28 Cl=85.31%.

11) Preparation of $[\text{C}_2\text{Cl}_5\text{PCl}_3][\text{SbCl}_6]$.

$\text{C}_2\text{Cl}_5\text{PCl}_4$ (1.50 g, 4.00 mmoles) was dissolved in

CH_2Cl_2 . SbCl_5 (1.20 g, 4.01 mmoles) was added to the above solution with constant stirring. After a few minutes stirring, the solvent was evaporated to dryness to isolate a grey solid.

Analysis:

Found: C=4.30 P=4.70 Cl=74.32 Sb=18.0%.

Calculated: C=3.57 P=4.60 Cl=73.76 Sb=18.07%.

12) Attempts to prepare $\text{C}_2\text{Cl}_5\text{PCl}_3\text{BCl}_4$.

$\text{C}_2\text{Cl}_5\text{PCl}_4$ (1.30 g, 3.47 mmoles) was suspended in CH_2Cl_2 . Excess BCl_3 gas was allowed to flow into the above slurry with constant stirring until a precipitate formed. The solvent was removed in vacuo to isolate a grey solid.

Analysis:

Found: C=5.70 P=7.51 Cl=78.31 B=3.93%.

Calculated: C=4.88 P=6.30 Cl=86.62 B=2.20%.

13) Preparation of $\text{C}_2\text{Cl}_5\text{PCl}_3\text{ICl}_4$.

$\text{C}_2\text{Cl}_5\text{PCl}_4$ (0.89 g, 2.38 mmoles) was dissolved in CH_2Cl_2 . Solid ICl_3 (0.56 g, 2.40 mmoles) was added to the above solution with constant stirring. The reaction mixture was allowed to stir for 15 minutes before the solvent was removed in vacuo to isolate a fine yellow solid.

Analysis:

Found: C=4.40 P=7.33 Cl=56.95 I=21.42%.

Calculated: C=3.95 P=5.10 Cl=70.08 I=20.88%.

14) Preparation of $C_2Cl_5PCl_3phenCl$.

$C_2Cl_5PCl_4$ (0.96 g, 2.56 mmoles) was dissolved in CH_2Cl_2 . 1,10-Phenanthroline (0.46 g, 2.55 mmoles) was added to the above solution with constant stirring. After a few minutes stirring, the precipitate formed was filtered off and the solid was washed thoroughly with CH_2Cl_2 to isolate a fine white solid.

Analysis:

Found: C=30.40 H=1.20 N=5.10 P=7.12 Cl=59.19%.

Calculated: C=30.29 H=1.44 N=5.05 P=5.59 Cl=57.60%.

15) Preparation of $C_2Cl_5PCl_3bipyCl$.

When solid 2,2'-bipyridine (0.40 g, 2.56 mmoles) was added to a slurry of $C_2Cl_5PCl_4$ (0.96 g, 2.56 mmoles) in CH_2Cl_2 , a precipitate formed. After a few minutes stirring, a pinkish solution formed. A yellowish solid was isolated after the solvent was removed in vacuo.

Analysis:

Found: C=28.10 H=1.80 N=6.00 P=5.35 Cl=51.00%.

Calculated: C=27.08 H=1.89 N=5.26 P=5.82 Cl=59.95%.

16) Attempt to prepare $C_2Cl_5PCl_3bipySbCl_6$.

$C_2Cl_5PCl_3SbCl_6$ (0.70 g, 1.04 mmoles) was suspended in CH_2Cl_2 . 2,2'-Bipyridine (0.16 g, 1.02 mmoles) was added to the above slurry with constant stirring. The reaction mixture was allowed to stir for an hour before the precipitate was filtered off and washed with methylene chloride to isolate a creamy solid.

Analysis:

Found: C=14.70 H=0.70 N=2.90 P=0.59 Cl=48.92 Sb=19.68%.

Calculated: C=17.33 H=1.21 N=3.37 P=3.73 Cl=59.71

Sb=14.65%.

SbCl₅.bipy requires: C=26.27 H=2.20 N=6.13 Cl=38.77

Sb=26.63%.

17) Attempt to prepare C₂Cl₅P-Cl₃phenSbCl₆.

When the above reaction was repeated with C₂Cl₅P-Cl₃SbCl₆ (0.44 g, 0.65 mmoles) and 1,10-phenanthroline (0.12 g, 0.67 mmoles) a yellowish solid was isolated.

Analysis:

Found: C=16.70 H=1.20 N=2.20 P=2.41 Cl=48.89 Sb=9.84%.

Calculated: C=19.67 H=0.94 N=3.28 P=3.63 Cl=58.20

Sb=14.27%.

CHAPTER FIVE

ACCEPTOR PROPERTIES OF ORGANOPHOSPHORUS (111) COMPOUNDS.

5.1 THIOCYANATO-DERIVATIVES OF ORGANO- PHOSPHORUS (111) COMPOUNDS.

5.1.1 INTRODUCTION.

Several thiocyanato-derivatives of phosphorus (111) compounds have been reported, such as $RP(NCS)_2$ ($R=Ph$ (27,103,104,105), Me (24), C_6F_5 (22,23) and $4-MeC_6H_4$ (103)) and $R_2P(NCS)$ ($R=Ph$ (105), or C_6F_5 (22,23)). ^{31}P n.m.r shifts were quoted as shown in table 5.1.

Table 5.1: $\delta^{31}P$ (p.p.m) for $RP(NCS)_2$ and $R_2P(NCS)$.

| R | $\delta^{31}P$ (p.p.m) | solvent | ref |
|--------------|------------------------|----------------------|-----|
| Ph | 33.0 | not stated | 105 |
| Me | 37.9 | liquid | 24 |
| C_6F_5 | 62.2 | C_6H_6 or $CHCl_3$ | 22 |
| $(C_6F_5)_2$ | 12.4 | C_6H_6 or $CHCl_3$ | 22 |

Most of the thiocyanato compounds were thermally unstable and decomposed readily to give either thiophosphoryl compounds (22) or polymeric materials, as shown in

equations (1) and (2) respectively.

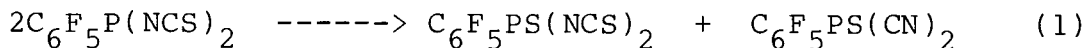

or

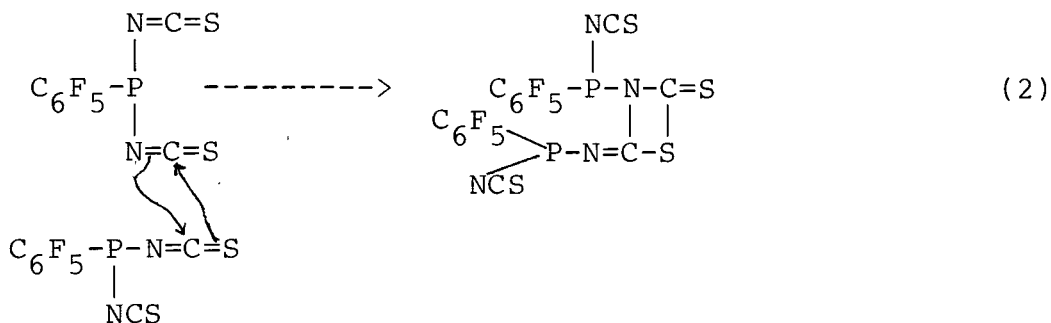

and so on...

The ^{31}P n.m.r data for the phenyl and methyl compounds were found to be unreliable, therefore in the present work new ^{31}P n.m.r shifts for several compounds have been recorded.

5.1.2 $\text{RP}(\text{NCS})_2$ (R=Ph, Me, Et or C_6F_5) and $(\text{C}_6\text{F}_5)_2\text{PNCS}$.

a) $\text{PhP}(\text{NCS})_2$.

When AgSCN was added to a solution of Ph_2PCl_2 in methylene chloride, two new signals at 117.7 and 88.7 p.p.m were discerned, assigned to $\text{PhPCl}(\text{NCS})$ and $\text{PhP}(\text{NCS})_2$ respectively. The 1:2 molar ratio reaction of $\text{Ph}_2\text{PCl}_2:\text{AgSCN}$ gave a yellow liquid which analysed as $\text{PhP}(\text{NCS})_2$

(experimental section). Its ^{31}P n.m.r in CH_2Cl_2 gave only one signal at 88.7 p.p.m, confirming the completion of reaction. The infrared spectrum of the yellow liquid showed a broad band with maxima at 2050 and 1950 cm^{-1} , which was assigned as the NCS asymmetric stretching band. This band appeared in the same region as for $\text{P}(\text{NCS})_3$ and $\text{PO}(\text{NCS})_3$ (63,106,107), as well as for $\text{MeP}(\text{NCS})_2$ (24). These bands were rather low in frequency for SCN stretching vibrations, which usually appear as strong bands between 2200 and 2150 cm^{-1} (107). Hence it was concluded that the NCS groups were bonded through nitrogen in $\text{PhP}(\text{NCS})_2$.

The liquid was very unstable at room temperature, and easily turned to a dark brown viscous liquid, containing very low percentages of carbon, nitrogen and sulphur (Found: C=33.30, H=3.17, N=9.60, S=14.25%; Required: C=42.86, H=2.23, N=12.50, S=28.57%).

In contrast, Russian workers (105) have reported the chemical shift of $\text{PhP}(\text{NCS})_2$ as 33.0 p.p.m but the preparative method seemed unusual in view of its properties. The compound was prepared by heating trimethylsilyl isothiocyanate (Me_3SiNCS) with PhPCl_2 (2:1) for 2-3 hours at 373-423K, which yielded 20% of $\text{PhP}(\text{NCS})_2$ after liberation of Me_3SiCl . When the preparation was repeated using PhPCl_2 and $\text{Me}_3\text{Si}(\text{NCS})$ (in a 1:2 ratio), and the mixture was heated at 373-423K under reflux for two hours, this resulted in an orange solution which turned darker after 3/4 hour reflux.

The ^{31}P n.m.r of this solution gave four signals at 106 p.p.m (probably $\text{PhPCl}(\text{NCS})$, 54 p.p.m (probably polymeric material), 37.0 p.p.m (PhPOCl_2) and -16.0 p.p.m ($\text{PhPO}(\text{NCS})_2$). This result suggests that the Russian workers probably only recorded the spectrum of the oxidation product, PhPOCl_2 ($\delta^{31}\text{P}=34\pm 0.5$ p.p.m. (20, 31)), rather than that of $\text{PhP}(\text{NCS})_2$.

b) $\text{MeP}(\text{NCS})_2$.

This compound was first reported by Maier (24), who performed a similar experiment as the Russian workers using MePBr_2 and $\text{Hg}(\text{NCS})_2$ in carbon tetrachloride. The reaction mixture was stirred under reflux for 8 hours. After that the mercury salt was removed by filtration and fractional distillation of the filtrate gave $\text{MeP}(\text{NCS})_2$; its ^{31}P shift was recorded at 37.9 p.p.m. When the reaction was repeated using MePCl_2 and AgSCN in CH_2Cl_2 , a small amount of AgSCN gave a new signal at 141.8 p.p.m, assigned as the intermediate ($\text{MePCl}(\text{NCS})$). The addition of more AgSCN generated a new signal at 103.3 p.p.m, ascribed to $\text{MeP}(\text{NCS})_2$, with the disappearance of the two former signals. An excess of AgSCN only gave one signal at 103.3 p.p.m, confirming the formation of this thiocyanato-compound. When a 1:2 ratio reaction of $\text{MePCl}_2:\text{AgSCN}$ was carried out in methylene chloride, after 30 minutes the white solution turned to yellow and the ^{31}P n.m.r was recorded to give one signal at 106.3 p.p.m. Evaporation

of the yellow solution after filtration gave a yellow liquid. This liquid was very unstable, easily turning to a viscous brownish-red colour while being purged in the port of the glove box. The elemental analysis, which was carried out immediately after preparation, gave reasonable values for the expected compound $\text{MeP}(\text{NCS})_2$ (see experimental section).

The infrared spectrum, which was recorded in methylene chloride, exhibited a broad band between $2150\text{-}1800\text{ cm}^{-1}$. The viscous liquid turned to a black solid after being left in the glove box for a month.

c) $\text{EtP}(\text{NCS})_2$.

No one had reported the preparation of this compound before. When a similar reaction was carried out using $\text{EtP}(\text{NCS})_2$ and AgSCN , two signals were observed upfield from the starting material, measured at 150.0 and 112.9 p.p.m, and assigned as $\text{EtP}(\text{NCS})$ and $\text{EtP}(\text{NCS})_2$ respectively. A 1:2 ratio reaction of $\text{EtP}(\text{NCS})_2:\text{AgSCN}$ gave a liquid, which analysed as $\text{EtP}(\text{NCS})_2$. Its ^{31}P n.m.r spectra in nitrobenzene or methylene chloride showed one resonance at 112.6 p.p.m. The infrared spectrum showed a strong broad band between $2100\text{-}1900\text{ cm}^{-1}$, indicating that the thiocyanate groups in this compound also bond through nitrogen rather than sulphur.

d) $C_6F_5P(NCS)_2$.

This compound was prepared by reacting $C_6F_5PBr_2$ with AgNCS in methylene chloride. After one hour, one signal at 61.3 p.p.m. was recorded from the reaction mixture, in good agreement with the published data (22). In a qualitative reaction, the intermediate signal was observed at 79.1 p.p.m. ($C_6F_5PBr(NCS)$), which disappeared with the addition of more AgSCN. The reaction product was isolated as a yellow liquid. This liquid was quite stable at room temperature for several hours, unlike the other thiocyanato-derivatives of phosphorus (III) compounds $RP(NCS)_2$, (R=Ph, Et or Me). The infrared spectrum of the isolated yellow liquid exhibited a strong band with maxima measured at 2050 and 1940 cm^{-1} , assigned as an NCS asymmetric vibration, because the band is rather low in wave number for the SCN band which always appears at 2230 to 2100 cm^{-1} (107). In a qualitative reaction, the addition of a small amount of AgSCN to $C_6F_5PCl_2$ in CH_2Cl_2 gave a yellowish colour, and the ^{31}P n.m.r. showed a strong signal at 135.5 ($C_6F_5PCl_2$) with a weak peak at 90.4 p.p.m. ($C_6F_5PCl(NCS)$). The addition of more AgSCN increased the intensity of the second signal while the signal at 135.5 p.p.m. decreased. An excess of silver salt only gave one signal at 61.2 p.p.m., assigned to the complete substitution product $C_6F_5P(NCS)_2$. No quantitative reaction was performed.

Fild et al (23) prepared $C_6F_5P(NCS)_2$ by refluxing

$C_6F_5PCl_2$ with AgSCN in benzene or acetonitrile for several hours. The silver halide was filtered off and the filtrate was distilled to isolate the product as a liquid. When Fild's method was followed using acetonitrile as a solvent, the solution mixture turned red-brown and the ^{31}P n.m.r. gave three signals at -12.0, -22.0 and -30.0 p.p.m., probably due to polymeric materials. No expected signal at 61.3 p.p.m. was observed, therefore this reaction was not reproducible.

Fild discovered that further heating of this compound led to a mixture of two substances which could not be separated by distillation and gave higher field ^{31}P signals at 7.0 and -40.0 p.p.m. (22). These were deduced to arise from $C_6F_5P(S)(NCS)_2$, and $C_6F_5P(S)(CN)_2$ respectively. In support of this hypothesis a chemical shift of 6.8 p.p.m. was measured for $C_6F_5P(S)(NCS)_2$, but the cyano-compound could not be isolated pure (22). Table 5.2 below shows the collected ^{31}P n.m.r. chemical shifts for organophosphorus (III) thiocyanates and their intermediates in methylene chloride.

Table 5.2: ^{31}P n.m.r. shifts (p.p.m.) for some organophosphorus (III) thiocyanates.

| Compound | RPX_2 (1) | $\text{RPX}(\text{NCS})$ (2) | $\text{RP}(\text{NCS})_2$ (3) | $\Delta(1-3)$ |
|----------------------------|--------------------|------------------------------|-------------------------------|---------------|
| CH_3 | 192.6 | 141.8 | 103.3 | 89.3 |
| C_2H_5 | 199.8 | 150.0 | 112.9 | 86.9 |
| C_6H_5 | 161.3 | 117.7 | 88.7 | 72.6 |
| C_6F_5 | 135.6 | 90.4 | 61.2 | 74.4 |
| C_6F_5 (a) | 111.3 | 79.1 | 61.2 | 49.9 |

a, X=Br; in all other cases X=Cl.

In the above table, the differences in the chemical shift values ($\Delta\delta$) for the starting material (RPhCl_2) and the fully substituted thiocyanate compounds ($\text{RP}(\text{NCS})_2$) are slightly larger for aliphatic than aromatic R groups, but are quite similar for R=Me or Et, and for R=Ph or C_6F_5 . There is a striking discrepancy, however, between the present results and literature data for $\text{PhP}(\text{NCS})_2$ (δ 33.0 p.p.m.) (105) and $\text{MeP}(\text{NCS})_2$ (δ 37.9 p.p.m.) (24). It thus seems probable that the signals reported previously for $\text{MeP}(\text{NCS})_2$ (24) and $\text{PhP}(\text{NCS})_2$ (105) may be due to one of the corresponding decomposition products, possibly $\text{RP}(\text{S})(\text{NCS})_2$ (R=Me or Ph), or to an oxidation product RPOCl_2 of the starting chloride.

e) $(\text{C}_6\text{F}_5)_2\text{PNCS}$.

This compound was first reported by Fild et al

(22,23). It was prepared by a similar method to that used for $C_6F_5P(NCS)_2$. Its ^{31}P n.m.r. shift was recorded at 12.4 p.p.m. in C_6H_6 and $CHCl_3$. In this work, it was prepared by reacting $(C_6F_5)_2PBr$ with $AgSCN$ in 1:1 molar ratio. After filtration of the $AgBr$, the filtrate gave a yellow liquid when the solvent was removed in vacuo. Its ^{31}P n.m.r. in CH_2Cl_2 gave one signal at 9.8 p.p.m. The elemental analysis was reasonable for the expected compound and its i.r. spectrum exhibited a broad band between 1950 and 2050 cm^{-1} , assigned to the NCS asymmetric stretching vibration.

5.2 ACCEPTOR PROPERTIES OF ORGANOPHOSPHORUS HALIDES.

5.2.1 $C_6F_5PCl_2$.

a) PREPARATION OF THE COMPOUND.

This compound was prepared by the same method as $(C_6F_5)_2PCl$ (see section 5.2.4), but from $C_6F_5PBr_2$ with a 1:2 ratio of the reagents, equation 3:-

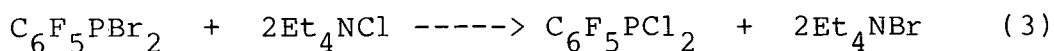

It was isolated as a colourless liquid when the solvent was removed in vacuo (see section 2.6.h). Its ^{31}P n.m.r. spectrum in CH_2Cl_2 showed a signal at 135.6 p.p.m., assigned to $C_6F_5PCl_2$. The intermediate signal was observed at

δ_{31P}
(P.P.m.)

Fig.51: ^{31}P CHEMICAL SHIFTS FOR $C_6F_5PX_2 / Pr_4NX$ IN CH_2Cl_2

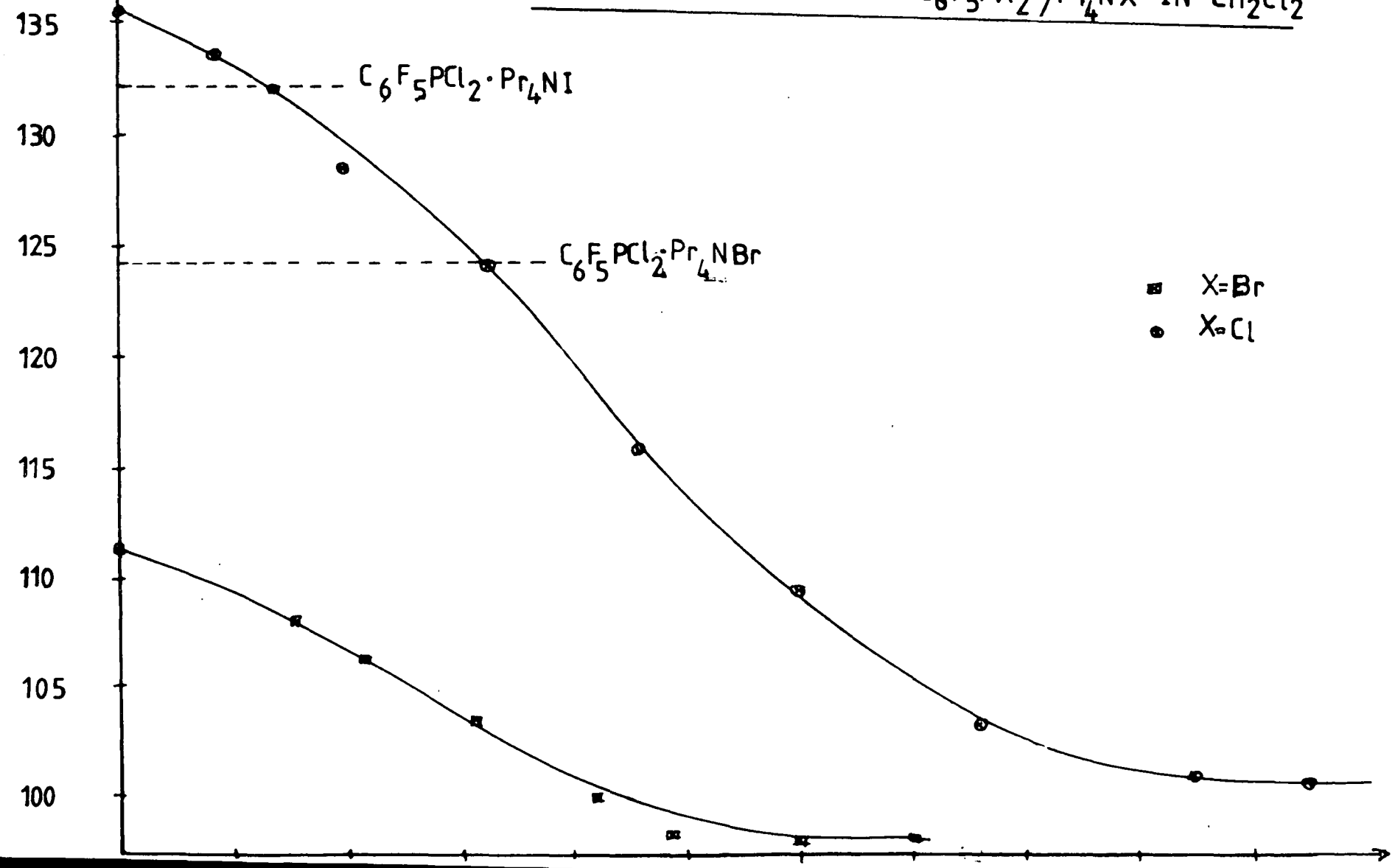

124.2 p.p.m. when a qualitative reaction was carried out between the above reagents. $C_6F_5PCl_2$ is a known compound (108,109,110), reported as a liquid, boiling range 312-314K at 0.1 mm Hg (108) or 345-347K at 21 mm Hg (108). Its ^{31}P n.m.r. shift has been measured as 137.0 p.p.m. (108) and 136.7 p.p.m. (108). The ^{19}F n.m.r. has also been studied previously (108,111).

b) $C_6F_5PCl_2/Cl^-$ SYSTEM.

The introduction of electronegative atoms into the phenyl group will make the phosphorus atom more electropositive, therefore increasing its acceptor properties towards halide ions, compared with $C_6H_5PCl_2$ which showed no acceptor ability (20). The limiting shift was established as 100.0 p.p.m. (figure 5.1) when Pr_4NCl was used as the reactant (see table 5.5). When Et_4NCl was used, a limiting shift of 109.3 p.p.m. was recorded while with Pe_4NCl , a value of 96.5 p.p.m. was established.

When a 1:1 ratio reaction was carried out using $C_6F_5PCl_2:Et_4NCl$, a signal at 130.6 p.p.m. was recorded, probably due to partial formation of the $C_6F_5PCl_3^-$ ion. After a few hours, new peaks at 24.0, 1.6 and -14.0 p.p.m. were observed, possibly from the oxidation product $C_6F_5POCl_2$ and the hydrolysis product $C_6F_5PO(OH)_2$ for the first two signals, but the third signal could not be readily assigned. A sticky solid was isolated from this

reaction but surprisingly, the analysis showed a very good carbon value while the phosphorus and chlorine were very low for the expected compound, $[\text{Et}_4\text{N}][\text{C}_6\text{F}_5\text{PCl}_3]$ (found: C=38.18 H=6.31 N=3.81 P=3.96 Cl=18.5%; calculated: C=38.67 H=4.60 N=3.22 P=7.13 Cl=24.55%). When the reaction was performed with Pr_4NCl , a wet solid formed and its ^{31}P n.m.r. spectrum in nitrobenzene consisted of a signal at 124.2 p.p.m. The analyses showed that the material isolated was a mixture, containing mainly the adduct (found: C=50.87 H=10.09 N=3.83; required: C=44.04 H=5.71 N=2.85%, for Pr_4NCl : C=65.01 H=12.64 N=6.32%). There is thus clear evidence for the formation of the $\text{C}_6\text{F}_5\text{PCl}_3^-$ ion in solution, but it has not so far been isolated as a solid in a pure state with a suitable large cation.

c) $\text{C}_6\text{F}_5\text{PCl}_2/\text{Br}^-$ SYSTEM.

When a small amount of Pr_4NBr was added to a solution of $\text{C}_6\text{F}_5\text{PCl}_2$ in methylene chloride, the signal moved upfield to a limiting shift of 124.2 p.p.m. with an excess of Pr_4NBr (figure 5.1). When the reaction was carried out in a 1:1 ratio, a white sticky solid was isolated after the solvent was removed, suggesting that it was a mixture of $\text{C}_6\text{F}_5\text{PCl}_2$ and Pr_4NBr . The analysis strongly supported this assumption (found: C=43.93 H=7.53 N=3.63 P=4.11%; calculated: C=40.37 H=5.23 N=2.62 P=5.79%; Pr_4NBr requires: C=54.16 H=10.53 N=5.27 Br=30.04%). The halogen content could not be determined separately. When this

solid was redissolved in methylene chloride, a signal at 131.5 p.p.m. was observed. No infrared spectrum was recorded due to the properties of this solid, which did not form a mull and partly dissociated in solution. Again, there is thus clear evidence for the formation of the $C_6F_5PCl_2Br^-$ ion in solution, but it has not so far been isolated as a solid in a pure state with a suitable cation.

d) $C_6F_5PCl_2/I^-$ SYSTEM.

When Pr_4NI was added qualitatively to a solution of $C_6F_5PCl_2$ in methylene chloride, a yellow solution formed and an upfield movement of the chemical shift was observed. A limiting shift of 132.2 p.p.m. was established when an excess of Pr_4NI was added (figure 5.1). When a 1:1 ratio reaction was performed in the same solvent, a yellow solid was isolated. Its ^{31}P n.m.r. spectrum in $PhNO_2$ consisted of a single peak at 131.9 p.p.m. Before evaporation, the signal was measured at 132.2 p.p.m. This difference was presumably due to the concentration of the solution. The analysis was reasonable for the expected compound $[Pr_4N]-[C_6F_5PCl_2I]$, thus confirming the formation of this adduct. Its infrared spectrum (Nujol mull) was very similar to that of the parent compound.

In contrast (20), $RPCl_2$ ($R=Me, Et$ and Ph) do not show any acceptor properties toward Cl^- , Br^- and I^- ions but $(C_6F_5)_2PCl$ (see section 5.2.4) showed acceptor properties,

and several adducts with Cl^- , Br^- and I^- salts have been isolated.

e) $\text{C}_6\text{F}_5\text{PCl}_2/\text{CN}^-$ or SCN^- SYSTEM.

Substitution occurred when the pseudohalide ions SCN^- and CN^- were added to $\text{C}_6\text{F}_5\text{PCl}_2$. When Et_4NSCN was used, a new signal at 92.0 p.p.m. was observed, assigned to the intermediate, $\text{C}_6\text{F}_5\text{P}(\text{NCS})$, and an excess of the SCN^- salt gave one signal at 58.0 p.p.m. ($\text{C}_6\text{F}_5\text{P}(\text{NCS})_2$). Addition of Et_4NCN to a $\text{C}_6\text{F}_5\text{PCl}_2$ solution in CH_2Cl_2 gave a new signal at -116.0 p.p.m., identified as $\text{C}_6\text{F}_5\text{P}(\text{CN})_2$; the same signal was observed when AgCN was reacted with $\text{C}_6\text{F}_5\text{PCl}_2$.

5.2.2 $\text{C}_6\text{F}_5\text{PBr}_2$.

a) PREPARATION OF THE COMPOUND.

$\text{C}_6\text{F}_5\text{PBr}_2$ is a known compound (76,79,112,113), and was prepared by a Grignard reaction as below:

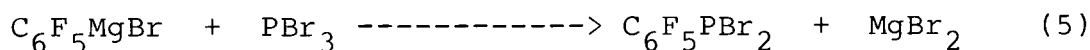
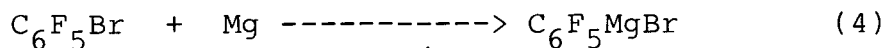

It was reported as a liquid, boiling range 338-342K at 0.5 mm Hg (112) and its ^{31}P n.m.r. signal was observed at 113.5 p.p.m. (110). In the present work, a similar preparation

was performed in which a colourless liquid was isolated from vacuum distillation. Its ^{31}P n.m.r. in CH_2Cl_2 gave a signal at 111.3 p.p.m., in good agreement with the reported value (110). Its infrared spectrum (liquid) was very similar to literature data (114).

b) $\text{C}_6\text{F}_5\text{PBr}_2/\text{Br}^-$ SYSTEM.

When a small amount of Pr_4NBr was added to a solution of $\text{C}_6\text{F}_5\text{PBr}_2$ in CH_2Cl_2 , the chemical shift moved upfield to a limiting value of 98.3 p.p.m. (see fig 5.1). Similarly, a limiting shift of 99.7 p.p.m. was reached with He_4NBr . A 1:1 ratio reaction with Pr_4NBr was carried out in the same solvent, and yielded a wet solid, the analysis of which was far from that of the expected compound, since it contained very low bromine (found: C=37.83 H=6.78 N=2.23 P=5.07 Br=19.52%; required: C=34.63 H=4.49 N=2.24 P=4.97 Br=38.43%). Its solid state n.m.r. spectrum exhibited a strong signal at 117.0 p.p.m. and in PhNO_2 a signal at 111.3 p.p.m. was observed. These two resonances are probably due to the starting material, $\text{C}_6\text{F}_5\text{PBr}_2$, since it gave a signal at 112.0 p.p.m. in PhNO_2 .

When the reaction was repeated in acetonitrile, a yellowish sticky solid was isolated. The analysis showed a very high carbon content (C=40.79 H=5.50 N=2.82%) but the bromine percentage was increased (32.02%). These results were reasonable for the adduct with three moles of CH_3CN

except for the N content which was low. This formula requires C=38.57 H=4.96 N=7.50 and Br=32.10%. Pr_4NBr requires: C=54.16 H=10.53 N=5.27 Br=30.04% and $\text{C}_6\text{F}_5\text{PBr}_2$ requires: C=20.12 Br=44.16%. Attempted phosphorus analysis gave a red colouration. These analyses suggested the possible formation of $[\text{Pr}_4\text{N}][\text{C}_6\text{F}_5\text{PBr}_3].3\text{CH}_3\text{CN}$, but were far from conclusive.

c) $\text{C}_6\text{F}_5\text{PBr}_2/\text{I}^-$ SYSTEM.

When tetrapropylammonium iodide was used instead of Pr_4NBr , a limiting shift of 90.0 p.p.m. was recorded. According to the normal limiting shift order, $\text{C}_6\text{F}_5\text{PBr}_3^- > \text{C}_6\text{F}_5\text{PBr}_2\text{I}^-$, therefore from the above results it appears that one of them must be in error. From the data in section 5.2.4 for the $(\text{C}_6\text{F}_5)_2\text{PBr}$ compound, the limiting shift for $\text{C}_6\text{F}_5\text{PBr}_3^-$ appears to be incorrect because the difference between the shift of the starting material and the limiting shift is only 12.9 p.p.m., compared with 52.2 p.p.m. for the $(\text{C}_6\text{F}_5)_2\text{PBr}$ derivative. It is therefore probable that adduct formation was incomplete from a 1:1 ratio reaction of $\text{C}_6\text{F}_5\text{PBr}_2$ and Pr_4NBr , and that the limiting shift was not reached, even when an excess of Br^- ions was used (Fig. 5.1). These results suggest that the adduct with I^- is more stable than that with Br^- .

When a 1:1 ratio reaction was carried out between $\text{C}_6\text{F}_5\text{PBr}_2$ and Pr_4NI , a reddish liquid was isolated after the

solvent was removed. It turned to a red solid when left in the box for one day, and then a white solid was obtained when it was left over the weekend. This behaviour is probably due to the instability of the adduct at room temperature. Its ^{31}P n.m.r. in PhNO_2 showed several peaks, measured at 106.2 (strong, adduct), 51.5 (weak), 8.0 (weak) and -10.3 p.p.m. (weak), which were very difficult to assign, therefore no elemental analysis was carried out for this solid.

When the reaction was repeated and the product analysed immediately after preparation, the results were quite reasonable for the expected compound $[\text{Pr}_4\text{N}][\text{C}_6\text{F}_5\text{PBr}_2\text{I}]$ except that the bromine content was still low. Its ^{31}P n.m.r. spectrum gave signals at 109.3 (strong, adduct) and 117.4 p.p.m. (strong, $\text{C}_6\text{F}_5\text{PBr}_2$). These results suggest that the adduct $[\text{Pr}_4\text{N}][\text{C}_6\text{F}_5\text{PBr}_2\text{I}]$ had been obtained. Its i.r. spectrum could not be recorded because it did not form a mull.

d) $\text{C}_6\text{F}_5\text{PBr}_2/\text{Cl}^-$, CN^- AND SCN^- SYSTEMS.

As for the chloro-analogue, substitution occurred when Et_4NCN and Et_4NSCN were added to $\text{C}_6\text{F}_5\text{PBr}_2$. New signals at -32.6 (weak), assigned to $\text{C}_6\text{F}_5\text{PBr}(\text{CN})$, and -112.8 p.p.m. (strong) were observed in a dark brown solution when Et_4NCN was the reagent. The second signal was ascribed to the fully-substituted cyano-compound, $\text{C}_6\text{F}_5\text{P}(\text{CN})_2$. When

Et_4NSCN was used, two signals were observed at 77.5 (weak, $\text{C}_6\text{F}_5\text{PBr(NCS)}$) and 61.3 p.p.m., assigned to $\text{C}_6\text{F}_5\text{P(NCS)}_2$. Substitution also took place when Et_4NCl was added to the above solution, giving $\text{C}_6\text{F}_5\text{PBrCl}$ (124.2 p.p.m.) as an intermediate and $\text{C}_6\text{F}_5\text{PCl}_2$ (135.5 p.p.m.). This reaction was used to prepare $\text{C}_6\text{F}_5\text{PCl}_2$, since it was very difficult to isolate directly from the Grignard reaction of $\text{C}_6\text{F}_5\text{MgCl}$ and PCl_3 .

5.2.3 $\text{C}_6\text{F}_5\text{PI}_2$

a) PREPARATION OF THE COMPOUND.

This compound was first reported by Cowley and Pinnell, and was synthesised by HI cleavage of $\text{C}_6\text{F}_5\text{P}[\text{N}((\text{CH}_3)_2)_2]_2$ (112). Since then, however, no one has recorded its ^{31}P n.m.r. data. In this work, this compound was prepared in a different way. $\text{C}_6\text{F}_5\text{PBr}_2$ was reacted with LiI in a more than 1:2 ratio in methylene chloride and the reaction mixture was allowed to stir overnight, until only one signal at 32.4 p.p.m. was observed. The lithium salt was removed by filtration and evaporation of the filtrate gave a brown liquid. The analysis was reasonable for the formula, $\text{C}_6\text{F}_5\text{PI}_2$ (see section 2.6.g). When a 1:1 ratio reaction was performed, a weak signal at 79.0 p.p.m. and a strong signal at 32.4 p.p.m. were recorded. The weak signal was assigned to the intermediate $\text{C}_6\text{F}_5\text{PIBr}$.

b) $C_6F_5PI_2/I^-$ SYSTEM.

Attempts to establish a limiting shift for addition of I^- to $C_6F_5PI_2$ failed. On many occasions, signals at -125.5 and -135.5 p.p.m. were observed when Pr_4NI was added to a $C_6F_5PI_2$ solution in methylene chloride, which were not easily assignable. To make sure that these signals were not from the hydrolysis product because of the presence of water in the box or in the I^- salt, one drop of water was added to a $C_6F_5PI_2$ solution which showed only one signal at 32.4 p.p.m. The new signals which appeared were not at the same positions as the two signals above, but a doublet was seen with components at -104.3 and -112.9 p.p.m. ($\delta^{31}P$ -108.6 p.p.m.), with J_{P-H} 209 Hz. This signal was assigned to the hydrolysis product C_6F_5POHI , which is expected to have a four-coordinate phosphorus (V) structure as shown below:

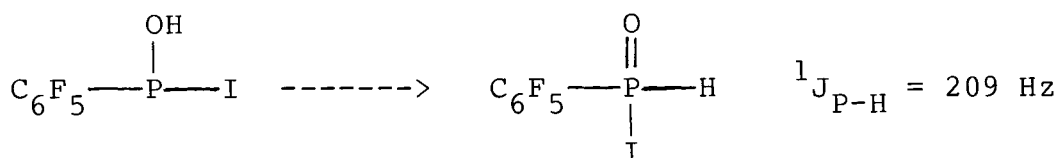

Confirmation of the above structure was obtained by recording its 1H n.m.r. in CD_2Cl_2 . Two equivalent signals were measured at 3.5 and 6.75 p.p.m. (δ 5.12 p.p.m.), ${}^1J_{H-P}$ 195 Hz. When more water was added to the above solution, new ${}^{31}P$ signals at -178.0 (strong) and -182.2 p.p.m. (medium)

were observed, with another signal in the lower field region at 3.3 p.p.m., probably due to $C_6F_5PO(OH)_2$. The two higher field signals were very difficult to identify. If the second substitution occurred it should give $C_6F_5P(O)(H)(OH)$ which would again give a doublet. The shift would probably be lower, however, with no iodine on phosphorus. Therefore the signals that appeared when Pr_4NI was added to $C_6F_5PI_2$ in solution were probably not from the addition product, but could be due to the presence of two isomers of the P-P compound below:

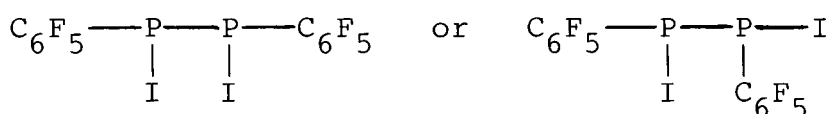

This deduction was supported by the result obtained when R_4NI was reacted with PI_3 (115). The reaction of PI_3 with a tetraalkylammonium iodide in non-polar solvents led to the formation of P_2I_4 and R_4NI_3 , as below:

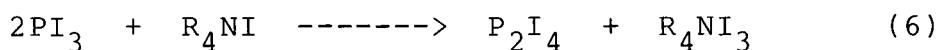

There was no evidence for the formation of the PI_4^- ion in this system. From this evidence the following reaction probably occurs with $C_6F_5PI_2$:

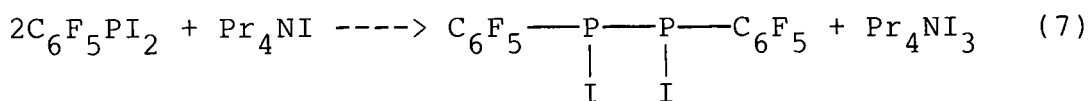

A third isomer is theoretically possible, i.e., $(C_6F_5)_2P-$

PI₂, but this is unlikely because it would involve migration of a C₆F₅ group. It would give a ³¹P spectrum of two sets of doublets, since the phosphorus atoms would be magnetically inequivalent.

5.2.4 CCl₃PCl₂.

a) PREPARATION OF THE COMPOUND.

This compound was prepared from MePCl₂ by modification of the method of Quin and Rolston (61) (see chapter 2) as below:

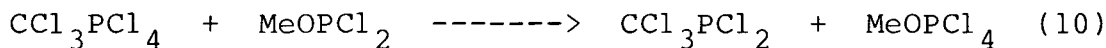
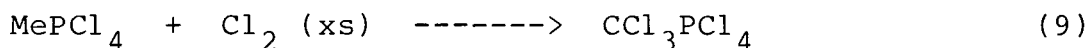
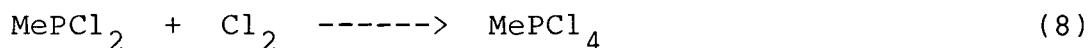

In this method, MePCl₂ was oxidized to MePCl₄, which was then converted to CCl₃PCl₄ with an excess of chlorine in either methylene chloride or carbon tetrachloride solution. Reduction followed in the third stage using methylphosphorodichloridite (MeOPCl₂) to isolate CCl₃PCl₂, which gave a ³¹P shift at 149.6 p.p.m. in CH₂Cl₂. MeOPCl₄ is unstable, easily decomposing to give MeCl and POCl₃ which can be removed from the reaction mixture.

Schmutzler and Fild (86) synthesised this compound

from its salt, $[\text{CCl}_3\text{PCl}_3][\text{AlCl}_4]$ which was reduced to CCl_3PCl_2 by the same reagent as above. When this procedure was attempted, only a small amount of CCl_3PCl_2 was obtained compared with the quantity of starting material used. Frank (99) prepared this compound as shown in the following equation:

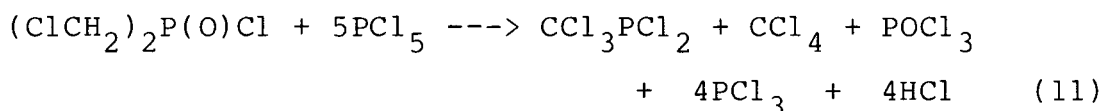

The carbon-containing fragments, CCl_3PCl_2 and CCl_4 , were isolated in 87% and 48% yields respectively (99).

In earlier years, Perner and Henglein (85) performed a simple reaction using white phosphorus and carbon tetrachloride which were exposed to γ -radiation. Red phosphorus was the main product at room temperature, but its yield rapidly decreased at higher temperature, while the reverse was true for CCl_3PCl_2 .

b) $\text{CCl}_3\text{PCl}_2/\text{Cl}^-$ SYSTEM.

When a small amount of Et_4NCl was added to a solution of CCl_3PCl_2 in CH_2Cl_2 , no movement of the parent signal was observed. Only one signal at 149.7 p.p.m. for CCl_3PCl_2 was detected. With more Et_4NCl , the same position of peak was observed, confirming that CCl_3PCl_2 shows no acceptor properties towards the Cl^- ion.

c) $\text{CCl}_3\text{PCl}_2/\text{Br}^-$ OR I^- SYSTEMS.

Similarly, no adduct was formed when Pr_4NBr or Pr_4NI was added to a solution of CCl_3PCl_2 in CH_2Cl_2 . Only one signal at 149.7 ± 0.2 p.p.m. was detected, assigned to CCl_3PCl_2 .

d) $\text{CCl}_3\text{PCl}_2/\text{SCN}^-$ OR CN^- SYSTEMS.

In this instance, no addition or substitution products were detected when Et_4NSCN or Et_4NCN were added to a solution of CCl_3PCl_2 in CH_2Cl_2 . In both cases, only the signal at 149.7 p.p.m. was observed, ascribed to CCl_3PCl_2 .

5.2.5 $(\text{C}_6\text{F}_5)_2\text{PCl}$.

a) PREPARATION OF THE COMPOUND.

This compound was prepared by substitution into $(\text{C}_6\text{F}_5)_2\text{PBr}$ by Et_4NCl in the following reaction:

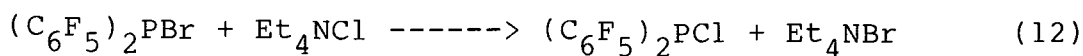

The methylene chloride solvent was removed in vacuo, and the solid was then treated with petroleum ether (30-40°) so

that the tetraethylammonium salt could be removed by filtration, as for $C_6F_5PCl_2$ (see section 5.2.1). The filtrate gave a ^{31}P signal at 37.1 p.p.m., in good agreement with the reported value (110). A colourless liquid was isolated after the solvent was removed in vacuo. The elemental analysis was reasonable for the expected compound, $(C_6F_5)_2PCl$ (see section 2.6.h). The infrared spectrum was recorded, as shown in table 5.3. The compound was isolated as a colourless liquid, boiling point 363-365K at 0.5 mm Hg, when it was prepared by a Grignard reaction as below:

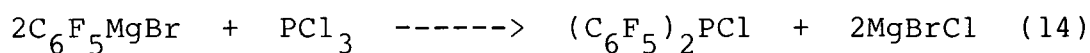
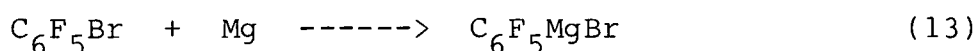

This method was unsuccessful since the product isolated was a mixture, with $(C_6F_5)_2PBr$ as the major component, and $C_6F_5PBr_2$ and $(C_6F_5)_2PCl$ as minor constituents. This mixture was very difficult to separate, especially $(C_6F_5)_2PBr$ and $(C_6F_5)_2PCl$ which have very close boiling points (76). On some occasions the above reaction did not give $(C_6F_5)_2PCl$, and a mixture of the other two products was isolated.

b) $(C_6F_5)_2PCl/Cl^-$ SYSTEM.

$(C_6F_5)_2PCl$ shows acceptor properties towards the chloride ion, since the addition of a small amount of

Et_4NCl to a solution of $(\text{C}_6\text{F}_5)_2\text{PCl}$ in methylene chloride moved the signal upfield. An excess of the Cl^- salt gave a limiting shift at -24.2 p.p.m. A 1:1 ratio reaction of $(\text{C}_6\text{F}_5)_2\text{PCl}:\text{Et}_4\text{NCl}$ in the same solvent gave a sticky yellowish solid. The ^{31}P n.m.r. spectrum of this solid in nitrobenzene gave only one signal at -19.5 p.p.m. This signal is about 5 p.p.m. away from the limiting shift, indicating that the compound is slightly dissociated in this solvent. When this solution was re-investigated the next day, various other signals were observed, showing that the compound had decomposed. The strongest peak was at -6.5 p.p.m., probably from the oxidised hydrolysis product $(\text{C}_6\text{F}_5)_2\text{PO}(\text{OH})$. The other peaks were at 9.5 (weak), -14.5 (weak), -62.9 (medium), -79.1 (weak), and a possible doublet with resonances at -137.1 (medium) and -146.7 p.p.m. (medium), δ -141.9 p.p.m., $^1\text{J}_{\text{P-H}}$ 233 Hz, and could not be readily assigned. The last two signals could be from the hydrolysis product $(\text{C}_6\text{F}_5)_2\text{P}(\text{OH})$, which would then probably rearrange to $(\text{C}_6\text{F}_5)_2\text{P}(\text{O})(\text{H})$, giving a doublet spectrum. To check this hypothesis, a solution of $(\text{C}_6\text{F}_5)_2\text{PCl}$ in CH_2Cl_2 was treated with one drop of water and the ^{31}P n.m.r. was recorded immediately, giving a doublet signal measured at -137.1 and -147.7 p.p.m., (δ -142.4 p.p.m., $^1\text{J}_{\text{P-H}}$ 257 Hz) ascribed to $(\text{C}_6\text{F}_5)_2\text{P}(\text{O})(\text{H})$. No ^1H n.m.r. signal was obtainable when one drop of water was added to a solution of $(\text{C}_6\text{F}_5)_2\text{PCl}$ in CD_2Cl_2 . These signals were also observed in other derivatives as described subsequently. The solid state n.m.r. of the adduct gave

signals at 25.8 p.p.m. (strong, sharp) and -8.2 p.p.m. (possibly $(C_6F_5)_2PO(OH)$) with the same intensity. This result suggests that the compound may be unstable in the solid state.

The elemental analyses, which were carried out immediately after the adduct was prepared, confirmed that the product was $[Et_4N][C_6F_5)_2PCl_2]$. The infrared spectrum was slightly different from that of the starting material (see table 5.3).

In contrast, the organophosphorus dihalides $RPCl_2$ ($R=Me$ and Ph) did not show acceptor properties toward halides (Cl , Br or I) or the pseudohalide CN (20). The first member of this series $C_6F_5PCl_2$ shows acceptor properties toward halide (section 5.2.1), but attempts to isolate a 1:1 ratio product were unsuccessful, except with iodide.

When the above reaction was repeated using Pr_4NCl , the limiting shift was established at -25.6 p.p.m. A 1:1 ratio reaction also gave a sticky yellowish solid. Before evaporation the ^{31}P n.m.r. consisted of a signal at 32.0 p.p.m. from the starting material, but when the solid was dissolved in nitrobenzene, a signal at -11.4 p.p.m. was observed, due to partial dissociation of the $[Pr_4N][C_6F_5)_2PCl_2]$ complex.

The analysis confirmed the formation of this adduct, and its infrared spectrum was very similar to that of the Et_4NCl derivative (table 5.3).

In contrast, when the reaction was repeated with the bigger cation Pe_4NCl , a limiting shift of -41.8 p.p.m. was established, showing that the limiting shift is dependent on the size of the cation.

c) $(\text{C}_6\text{F}_5)_2\text{PCl}/\text{Br}^-$ SYSTEM.

In a qualitative reaction, the addition of a small quantity of solid Pr_4NBr moved the $(\text{C}_6\text{F}_5)_2\text{PCl}$ peak upfield. An excess of Pr_4NBr gave the limiting shift as -6.3 p.p.m. When the reaction was carried out with He_4NBr , a limiting shift of -27.0 p.p.m. was established. A 1:1 ratio reaction of $(\text{C}_6\text{F}_5)_2\text{PCl}:\text{Pr}_4\text{NBr}$ in methylene chloride gave a yellowish solution and a sticky solid was isolated after the solvent was removed in vacuo. Before evaporation, a signal at 34.0 p.p.m. was measured, but when the solid was redissolved in nitrobenzene, only one peak at 11.4 p.p.m. was observed, indicating that the compound is partly dissociated in solution. No solid state ^{31}P n.m.r. shift was recorded.

The elemental analysis, which was carried out immediately after preparation, gave very good values for carbon, hydrogen, nitrogen and phosphorus for the expected

compound, $[\text{Pr}_4\text{N}][(\text{C}_6\text{F}_5)_2\text{PClBr}]$ but no bromine was detected and the chlorine was reasonable for $[\text{Pr}_4\text{N}][(\text{C}_6\text{F}_5)_2\text{PCl}_2]$. (Found: C=44.16 H=4.26 N=1.74 P=4.41 Br=0.0 Cl=10.21%; required: C=43.22 H=4.20 N=2.10 P=4.65 Cl=5.33 Br = 11.99%; $[\text{Pr}_4\text{N}][(\text{C}_6\text{F}_5)_2\text{PCl}_2]$ requires: C=46.30 H=4.50 N=2.25 P=4.98 and Cl=11.41%). After this result, the reaction was repeated but the analysis was still the same, with 10.6% chlorine detected. When a bromine test was carried out, this indicated that bromine was present. Furthermore the total halogen detected in both samples was reasonable for the expected compound, but the two could not be detected separately (for example, in 62.2 mg of sample in 10 mls solution, Br (11.99%) and Cl (5.33%) should each give a titre of 0.93 mls AgNO_3 , giving a total of 1.86 mls Ag^+ . The titre obtained was 1.79 mls, indicating that the compound is $[\text{Pr}_4\text{N}][(\text{C}_6\text{F}_5)_2\text{PClBr}]$. The infrared spectrum was not recorded because the compound did not form a mull, and it is partly dissociated in solution.

d) $(\text{C}_6\text{F}_5)_2\text{PCl}/\text{I}^-$ SYSTEM.

As expected for this system, the addition of Pr_4NI to $(\text{C}_6\text{F}_5)_2\text{PCl}$ in methylene chloride only gave a very small upfield movement of the signal, to a limiting shift of 29.5 p.p.m. In a 1:1 ratio reaction, the addition of the iodide gave a yellow solution which immediately changed to brown. Evaporation of this solution gave a yellow solid. In CH_2Cl_2 the ^{31}P n.m.r. showed a signal at 30.7 p.p.m., but

when the solid was redissolved in nitrobenzene, a signal at 32.3 p.p.m. was observed. The difference between these two values may have been due to the concentration of the solution prepared, or to a different degrees of dissociation in the two solvents.

The adduct was unstable, becoming darker after a few days, and new solution peaks were discerned at 4.9, -133.4 and -143.5 p.p.m. (doublet, δ -138.5 p.p.m., $^1J_{P-H}$ 245 Hz). Solid state n.m.r. gave several signals, with the strongest measured at 34.0 p.p.m. and weaker resonances at 1.6, -138.7 and -148.4 p.p.m. (doublet, δ 143.6 p.p.m., $^1J_{P-H}$ 236 Hz). At the machine temperature, the yellow solid became orange-black, showing that the compound was thermally unstable. The peak at 34.0 p.p.m. was probably due to the adduct, even though the shift was lower than in the solution spectra, and the higher field signals were presumably due to $(C_6F_5)_2P(O)(H)$ which gives a doublet (see section 5.2.4 b).

The elemental analyses, which were carried out soon after preparation, were very good for the expected compound $[Pr_4N][(C_6F_5)_2PClI]$. The infrared spectrum (Nujol mull) is similar to those of the other derivatives (table 5.3).

e) $(C_6F_5)_2PCl/SCN^-$ SYSTEM.

Substitution occurred when Et_4NSCN was added to a

$C_6F_5PCl_2$ solution in methylene chloride to give $C_6F_5P(NCS)_2$, and $(C_6F_5)_2PCl$ behaved similarly. When a small amount of Et_4NSCN was added to a solution of $(C_6F_5)_2PCl$ in methylene chloride, a yellow solution formed and the ^{31}P n.m.r. showed an upfield movement of the signal (δ 25.7 p.p.m.) relative to that of the starting material, attributed to exchange. With more Et_4NSCN added, a signal at 9.8 p.p.m. was established, ascribed to the formation of $(C_6F_5)_2P(NCS)$ as for the bromo-analogue.

Like other thiocyanate compounds, this solution was thermally unstable, and turned dark brown when left in the box for a long time. Similarly its ^{31}P n.m.r. spectrum in nitrobenzene when reinvestigated after one day exhibited several peaks measured at -6.5 (strong), -24.2 (weak) and -56.5 p.p.m. (weak). These peaks could not be readily assigned, and were probably due to oxidation and/or polymerisation products.

f) $(C_6F_5)_2PCl/CN^-$ SYSTEM.

$(C_6F_5)_2PCl$ possibly showed some acceptor properties with a small amount of Et_4NCN , since the signal moved upfield about 2 p.p.m. When more Et_4NCN was added, a dark brown solution formed and the ^{31}P n.m.r. gave signals at 27.5 (weak) and -96.7 p.p.m. (strong). The latter signal was assigned to $(C_6F_5)_2PCN$ (section 5.3.3).

Table 5.3: I.r. data for $(C_6F_5)_2PCl$ and its derivatives (800-200 cm^{-1}).

| Compound | i.r. bands (800-200 cm^{-1}) |
|----------------------------|--|
| $(C_6F_5)_2PCl$ | 770m, 640s, 630s, 590s, 550m, 510s, 500s, 450m, 425s, 400s, 330s, 320s, 280w. |
| $[Et_4N][(C_6F_5)_2PCl_2]$ | 640ms, 590m, 535s, 523s, 510s, 490w, 480w, 450s, 430s, 395ms, 345m, 330s, 318s, 285w. |
| $[Pr_4N][(C_6F_5)_2PClI]$ | 750sh, 640s, 595m, 550m, 535s, 515s, 500m, 480w, 460w, 450w, 425m, 400s, 325s, 320s, 285w. |

5.2.6 $(C_6F_5)_2PBr$.

a) PREPARATION OF THE COMPOUND.

This compound was prepared directly from a Grignard reaction as below:

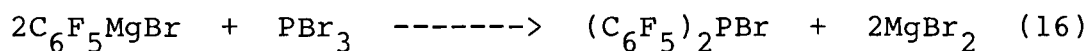
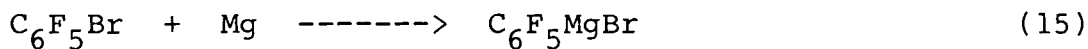

It is a well-known compound (110,116) and its ^{31}P n.m.r. chemical shift was reported by Fild and co-workers (110) as 13.0 p.p.m. as a liquid. In the above preparation the chemical shift was measured as 11.4 p.p.m. It was isolated

as a colourless liquid boiling at 363-367K at 0.5 mm Hg. Its i.r. spectrum is recorded in table 5.4.

b) $(C_6F_5)_2PBr/Cl^-$ SYSTEM.

$(C_6F_5)_2PBr$ does not show acceptor properties towards the chloride ion; instead, a substitution reaction occurred to give the chloro-derivative of this compound, $(C_6F_5)_2PCl$. When Et_4NCl was added to $(C_6F_5)_2PBr$ in CH_2Cl_2 , a new signal at 37.1 p.p.m. was observed, assigned as $(C_6F_5)_2PCl$. This was expected since the chloride ion forms stronger bonds to phosphorus than the bromide ion, so it can easily replace the latter to form the chloro-derivative. As has been mentioned before, this reaction was used to prepare $(C_6F_5)_2PCl$.

c) $(C_6F_5)_2PBr/Br^-$ SYSTEM.

$(C_6F_5)_2PBr$ shows acceptor properties towards the bromide ion to form a four-coordinate anionic species. When Pr_4NBr was added to a $(C_6F_5)_2PBr$ solution in methylene chloride, the chemical shift moved upfield to a limiting value of -30.7 p.p.m. with an excess of Pr_4NBr . This is ascribed to the presence of the $(C_6F_5)_2PBr_2^-$ ion. In a 1:1 ratio reaction, a yellow solution formed when Pr_4NBr was added to a solution of $(C_6F_5)_2PBr$ in the same solvent. A yellow viscous liquid was isolated, which gave only one signal at 6.5 p.p.m. when it was redissolved in methylene

chloride. Like other derivatives of this kind, this compound was unstable. Several peaks other than that of the adduct were observed on an overnight run, measured at -3.3 (strong), -133.2 (weak), -145.1 (weak) as well as the signal at 6.5 p.p.m. (strong, almost the same intensity as the peak at -3.3 p.p.m.). The signals at -133.5 and -143.1 p.p.m. were probably from the hydrolysis product $(C_6F_5)_2P(O)H$, arising from P-H coupling in the molecule (doublet, δ^{31P} -138.3 p.p.m., $^1J_{P-H}$ 233 Hz).

The analyses which were carried out immediately after preparation were reasonable for the expected compound, $[Pr_4N][(C_6F_5)_2PBr_2]$. The infrared spectrum was recorded as a neat liquid; the frequencies are listed in table 5.4.

d) $(C_6F_5)_2PBr/I^-$ SYSTEM.

When Pr_4NI was added to a solution of $(C_6F_5)_2PBr$ in methylene chloride, the single peak moved upfield until the limiting shift of -16.2 p.p.m. was reached, ascribed to the $(C_6F_5)_2PBrI^-$ ion. A red solid was isolated from a 1:1 ratio reaction of $(C_6F_5)_2PBr:Pr_4NI$ in methylene chloride. Its solid state n.m.r. spectrum showed a broad signal with the peak maximum measured at 0.0 p.p.m., with other weaker signals at -133.8 and -143.5 p.p.m. This broad signal is probably from the adduct, while the small signals arise from the hydrolysis product $(C_6F_5)_2P(O)H$ (doublet, δ -138.7

p.p.m., $^1J_{\text{P-H}}$ 236 Hz). In methylene chloride only one signal was observed at 3.3 p.p.m., indicating that the adduct is partially dissociated in this solvent.

The elemental analyses which were performed immediately after the sample was prepared confirmed the formulated compound, $[\text{Pr}_4\text{N}][(\text{C}_6\text{F}_5)_2\text{PBrI}]$. Its infrared data are recorded in table 5.4

e) $(\text{C}_6\text{F}_5)_2\text{PBr}/\text{SCN}^-$ SYSTEM.

When a small amount of Et_4NSCN was added to a solution of $(\text{C}_6\text{F}_5)_2\text{PBr}$ in methylene chloride, no change in colour was observed and the ^{31}P n.m.r. spectrum showed no movement of the signal (11.4 p.p.m.). When more SCN^- was added, the colour turned to yellow and the ^{31}P n.m.r. showed a signal at 9.8 p.p.m. Finally, the colour became dark red and the signal was located at 6.5 p.p.m. From this qualitative study, it was presumed that a substitution reaction had occurred rather than an addition because the movement of the signal was too small to be considered as due to the addition product. If the addition product had formed, it was expected to give a limiting shift between those of the bromide (-30.7) and the iodide adducts (-16.2 p.p.m., see table 5.5), therefore no attempt was made to isolate a 1:1 adduct.

f) $(C_6F_5)_2PBr/CN^-$ SYSTEM.

Vigorous reaction occurred when a small amount of Et_4NCN was added to a solution of $(C_6F_5)_2PBr$ in methylene chloride. This solution was put aside for the reaction to subside before its ^{31}P n.m.r. was recorded. A new signal at -95.1 p.p.m. was discerned and the colour of the solution became dark brown. Finally only one signal at -95.1 p.p.m. was observed when more Et_4NCN was added. This signal was assigned as $(C_6F_5)_2PCN$ (the substitution product). Tables 5.4 and 5.5 below show respectively the i.r. data for $(C_6F_5)_2PBr$ and its derivatives, and the limiting shifts for the phosphoranides derived from the organophosphorus (III) halides.

Table 5.4: Infrared data for $(C_6F_5)_2PBr$ derivatives.

| Compound | i.r. data ($800-200\text{ cm}^{-1}$). |
|----------------------------|--|
| $(C_6F_5)_2PBr$ | 765w, 630m, 585w, 540w, 505s, 470w, 445w, 415s, 390m, 370w, 325s. |
| $[Pr_4N][(C_6F_5)_2PBr_2]$ | 795s, 640m, 628m, 590m, 545w, 525s, 515s, 450sh, 430s, 395s, 332s, 320sh. |
| $[Pr_4N][(C_6F_5)_2PBrI]$ | 750sh, 640s, 593m, 565w, 550w, 535w, 515s, 480w, 455m, 430s, 395m, 330m, 315m. |

Table 5.5: Limiting shifts ($\delta^{31}\text{P}$ p.p.m.) for RPX_2 and R_2PX adducts (X=Cl or Br).

| Compound | $\delta^{31}\text{P}$ (p.p.m.). | | | | |
|-------------------------------------|-------------------------------------|-----------|-----------|-----|----|
| | Cl | Br | I | NCS | CN |
| $\text{C}_6\text{F}_5\text{PX}_2$ | | | | | |
| X=Cl (135.5) | 109.3(Et) 100.0(Pr) | 124.2(Pr) | 132.2(Pr) | S | S |
| X=Br (111.2) | S | 98.3(Pr)? | 90.0(Pr)? | S | S |
| $(\text{C}_6\text{F}_5)_2\text{PX}$ | | | | | |
| X=Cl (37.1) | -24.2(Et) -25.6(Pr) -41.8(Pe) | -6.3(Pr) | 29.5(Pr) | S | S |
| X=Br (11.4) | S | -30.7(Pr) | -16.2(Pr) | S | S |

S = Substitution

5.3 ACCEPTOR PROPERTIES OF ORGANOPHOSPHORUS (111) PSEUDOHALIDES.

5.3.1 ACCEPTOR PROPERTIES OF $\text{RP}(\text{NCS})_2$ (R=Ph, Et and Me) AND $(\text{C}_6\text{F}_5)_2(\text{NCS})$.

Attempts to isolate any derivatives of the compounds $\text{RP}(\text{NCS})_2$, (R=Ph, Et and Me), with halides and pseudohalides failed, because of the instability of the thiocyanate compound. These compounds were thermally very unstable. On several occasions the compounds polymerised or decomposed during the isolation. They turned to a red

brown colour from yellow when the solvent was removed, and the ^{31}P n.m.r. then showed more than one signal (section 5.1.2).

Conversely, $(\text{C}_6\text{F}_5)_2\text{PNCS}$ is quite stable at room temperature. It was isolated as a yellow liquid from a 1:>1 ratio reaction between $(\text{C}_6\text{F}_5)_2\text{PBr}$ and AgSCN , as stated in section 5.1.3. When a small amount of R_4NX ($\text{R}=\text{Et}, \text{Pr}$; $\text{X}=\text{Cl}, \text{Br}$ or I) was added to a solution of $(\text{C}_6\text{F}_5)_2\text{PNCS}$ in either CH_2Cl_2 or PhNO_2 , no upfield movement of the parent signal was observed. Generally only one signal at 9.8 p.p.m. was detected, assigned to $(\text{C}_6\text{F}_5)_2\text{PNCS}$. Therefore no attempt was made to isolate any adduct of this compound since no acceptor properties were apparent. Substitution occurred when Et_4NCN was added to a solution of $(\text{C}_6\text{F}_5)_2\text{PNCS}$ in CH_2Cl_2 . A new signal measured at -93.7 p.p.m. was observed, assigned to $(\text{C}_6\text{F}_5)_2\text{P}(\text{CN})$.

5.3.2 Acceptor properties of $\text{C}_6\text{F}_5\text{P}(\text{NCS})_2$.

The acceptor properties of $\text{C}_6\text{F}_5\text{P}(\text{NCS})_2$ were studied by ^{31}P n.m.r. spectroscopy. It was found to act as a Lewis acid towards halides and pseudohalides, as detailed below.

a) $\text{C}_6\text{F}_5\text{P}(\text{NCS})_2/\text{Cl}^-$ SYSTEM.

In a similar way to $\text{PhP}(\text{CN})_2$, $\text{C}_6\text{F}_5\text{P}(\text{NCS})_2$ shows a tendency with chloride ion to form a four-coordinate phos-

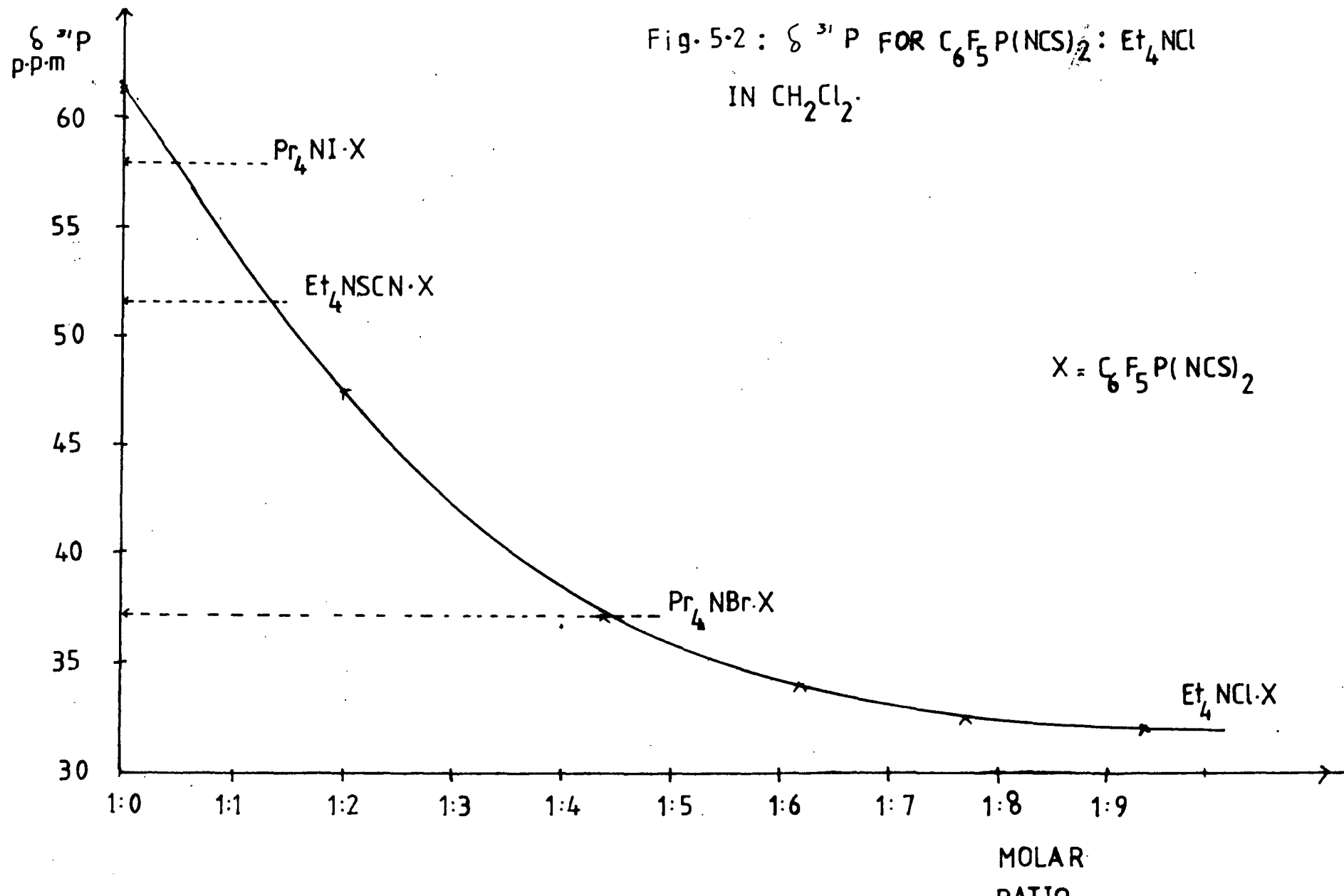

phorus (III) anion. When Et_4NCl was added to a solution of $\text{C}_6\text{F}_5\text{P}(\text{NCS})_2$ in methylene chloride, the signal moved upfield to a limiting shift of 32.5 p.p.m., as shown in figure 5.2, ascribed to the presence of the $\text{C}_6\text{F}_5\text{P}(\text{NCS})_2\text{Cl}^-$ ion. The 1:1 ratio reaction gave an orange sticky solid after being treated with low-boiling petroleum ether. The analyses were reasonable for the expected compound, $[\text{Et}_4\text{N}][\text{C}_6\text{F}_5\text{P}(\text{NCS})_2\text{Cl}]$, even though it tended to decompose when left for a long time either in the fridge or at room temperature, when the colour turned to dark red.

When Pr_4NCl was used, a brown sticky oil formed and the elemental analyses were reasonable for the expected formula $[\text{Pr}_4\text{N}][\text{C}_6\text{F}_5\text{P}(\text{NCS})_2\text{Cl}]$. Its ^{31}P n.m.r. in nitrobenzene consisted of a signal at 48.4 p.p.m., therefore dissociation occurs to some extent in this solvent. The i.r. spectrum in CH_2Cl_2 was recorded, and exhibited a very strong NCS stretching band with maxima at 2025 and 1975 cm^{-1} . The absorption bands below 1800 cm^{-1} were similar to those of the starting material (see table 5.6). The difference between the limiting shift and that of the starting material (δ 29 p.p.m.) is in good agreement with Deng's work (20,117) on the $\text{PhP}(\text{CN})_2/\text{Cl}^-$ system, as well as the $\text{C}_6\text{F}_5\text{P}(\text{CN})_2/\text{Cl}^-$ system, where the differences are 28 and 42 p.p.m. respectively.

Table 5.6: I.r data (800-200 cm^{-1}) for $\text{C}_6\text{F}_5\text{PBr}_2$,
 $\text{C}_6\text{F}_5\text{P}(\text{NCS})_2$ and its derivatives
as Nujol mulls.

| Compound | NCS band | other bands. |
|---|-----------------------|--|
| $\text{C}_6\text{F}_5\text{PBr}_2$ | - | 615m, 575s, 495m, 435s, 410s, 395s, 370m, 355sh, 310s, 300sh. |
| $\text{C}_6\text{F}_5\text{P}(\text{NCS})_2$ | 2010, 1940 (s, br) | 765m, 635s, 580m, 550br, 510s, 475w, 450m, 395m, 340s, 310m, 275w. |
| $\text{Pr}_4\text{NC}_6\text{F}_5\text{P}(\text{NCS})_2\text{Cl}^*$ | 2025, 1975 (s, br) | (800-640)br, 630m, 585w, 545w, 505w, 485w, 455m. |
| $\text{Pr}_4\text{NC}_6\text{F}_5\text{P}(\text{NCS})_2\text{Br}^*$ | 2000, 1960 (s, br) | (800-640)br, 635w, 585m, 545m, 505m, 475w, 455m. |
| $\text{Pr}_4\text{NC}_6\text{F}_5\text{P}(\text{NCS})_2\text{I}$ | 2010, 1940 (s, br) | 775s, 635s, 585m, 550br, 510s, 475w, 460s, 395s, 340s, 310w. |
| $\text{Et}_4\text{NC}_6\text{F}_5\text{P}(\text{NCS})_3$ | 2005, 1960 (s, br) | 765w, 635m, 585w, 550br, 510m, 475w, 460m, 395m, 340m, 310w. |

* in CH_2Cl_2

b) $C_6F_5P(NCS)_2/Br^-$ SYSTEM.

A deep yellow solution formed when Pr_4NBr was added to the thiocyanate solution in methylene chloride, and the signal moved upfield. An excess of Pr_4NBr gave a limiting shift at 37.1 p.p.m., which was in the expected direction for formation of the adduct. As for the chloride, a viscous yellow liquid was isolated from a 1:1 molar ratio reaction. Its ^{31}P n.m.r. spectrum in nitrobenzene exhibited a signal at 45.3 p.p.m.; likewise a value of 53.3 p.p.m. was obtained in CH_2Cl_2 . Hence dissociation occurs in both solvents, but is more extensive in CH_2Cl_2 . The infrared spectrum in methylene chloride was very similar to that of the chloride ion adduct, showing strong NCS bands at 2000 and 1960 cm^{-1} . Elemental analyses, which were carried out one day after the compound was prepared, showed that it had already decomposed. This could be seen by its ^{31}P n.m.r. which contained a few signals between 2.1 and 26 p.p.m., together with the adduct signal at 45.3 p.p.m. The reaction was repeated, and the analyses carried out immediately after preparation show very reasonable values for the expected adduct $[Et_4N][C_6F_5P(NCS)_2Br]$. Moreover its ^{31}P n.m.r. spectrum gave only one signal at 43.8 p.p.m. in nitrobenzene.

c) $C_6F_5P(NCS)_2/I^-$ SYSTEM.

As in the above reaction, the addition of Pr_4NI in

a 1:1 ratio to a solution of $C_6F_5P(NCS)_2$ in CH_2Cl_2 gave a deep yellow solution, which finally turned to orange. A yellow solid was isolated when the solvent was removed in vacuo. The limiting shift was recorded at 58.0 p.p.m. when a large excess of Pr_4NI was added. When the solid was redissolved in nitrobenzene, only one signal was observed at 58.0 p.p.m., and it occurred at 62.9 p.p.m. in methylene chloride. Its solid state n.m.r. gave a very strong sharp signal at 59.5 p.p.m. as in a liquid or solution spectrum, rather than a broad signal which is usually observed in a solid state spectrum, presumably because it is fairly mobile at the spectrometer operating temperature. No signal was observed when this sample was re-examined after three weeks. When a melting point measurement was carried out, at 338K the yellow solid turned red and at 383K it became a black sticky oil.

The elemental analyses were reasonable for the expected compound, $[Pr_4N][C_6F_5P(NCS)_2I]$, and its infrared spectrum which was recorded as a Nujol mull was very similar to those of the other thiocyanato-derivatives. The asymmetric NCS vibration was observed as a broad band with maxima at 2010 and 1960 cm^{-1} (see table 5.6).

Attempts were made to recrystallise this solid for X-ray crystallography, but on several occasions only the Pr_4NI salt was isolated. For instance a saturated solution in CH_2Cl_2 , when placed in the fridge, only gave white-red

crystals, analysing as a mixture of the adduct and Pr_4NI : (Found: C=41.90, H=7.64, N=4.39, P=3.59%; Pr_4NI requires: C=46.0, H=8.95, N=4.47%; $[\text{Pr}_4\text{N}][\text{C}_6\text{F}_5\text{P}(\text{NCS})_2\text{I}]$ requires: C=38.28, H=4.47, N=6.70, P=4.94%). Fine yellow crystals were isolated from a saturated solution of $[\text{Pr}_4\text{N}][\text{C}_6\text{F}_5\text{P}(\text{NCS})_2\text{I}]$ in acetonitrile. The analyses again indicated a mixture of Pr_4NI and the adduct. (Found: C=41.48, H=6.77, N=4.12, P=1.05, I=29.30%). These failures are probably due to the instability of the adduct in solution, which easily dissociates to its components, the less soluble one then crystallising out on cooling. Attempts to obtain crystals suitable for X-ray study were therefore abandoned.

d) $\text{C}_6\text{F}_5\text{P}(\text{NCS})_2/\text{SCN}^-$ SYSTEM.

In a qualitative reaction between $\text{C}_6\text{F}_5\text{P}(\text{NCS})_2$ and Et_4NSCN , the limiting shift was recorded at 51.6 p.p.m., lying between those of the $\text{C}_6\text{F}_5\text{P}(\text{NCS})_2\text{Br}^-$ and $\text{C}_6\text{F}_5\text{P}(\text{NCS})_2\text{I}^-$ ions. These results are in the same sequence as for $\text{C}_6\text{F}_5\text{P}(\text{CN})_2$ with Cl^- , Br^- , I^- and NCS^- ions (56,117). An orange solution from a 1:1 ratio reaction gave a red wet solid. Its ^{31}P n.m.r. in nitrobenzene consisted of a peak at 56.5 p.p.m. A solid state spectrum gave a broad signal with a maximum at 58.0 p.p.m., and a weak signal at 4.7 p.p.m. The main signal at 58.0 p.p.m. could be from the adduct, and the signal at 4.7 p.p.m. could be from decomposition or polymerisation. The red solid turned to a sticky red oil in the machine.

The elemental analysis was quite reasonable for the expected compound, confirming that $[\text{Et}_4\text{N}][\text{C}_6\text{F}_5\text{P}(\text{NCS})_3]$ had been formed (experimental section). The infrared spectrum (Nujol mull) exhibited a broad NCS band between 2010 and 1940 cm^{-1} , similar to that of the parent compound.

e) $\text{C}_6\text{F}_5\text{P}(\text{NCS})_2/\text{CN}^-$ SYSTEM.

It is well-known from transition metal systems that the CN^- ion is a more powerful ligand than SCN^- or NCS^- ions, and this principle can be applied in this system. Therefore in the reaction between $\text{C}_6\text{F}_5\text{P}(\text{NCS})_2$ and Et_4NCN , an attempt to isolate a four-coordinate phosphorus (III) compound containing the ion $\text{C}_6\text{F}_5\text{P}(\text{NCS})_2\text{CN}^-$ was not successful. In a qualitative reaction, the addition of a small quantity of Et_4NCN generated a new signal at -16.5 p.p.m., assigned to $\text{C}_6\text{F}_5\text{P}(\text{NCS})(\text{CN})$, or to an exchanging peak between this species and $\text{C}_6\text{F}_5\text{P}(\text{NCS})_2$. The addition of more CN^- to the solution gave a new signal at -127.0 p.p.m. and moved the former signal to -25.0 p.p.m. An excess of CN^- increased the intensity of the higher field signal (-127.0 p.p.m.) and moved it 3 p.p.m. upfield. The higher field signal was assigned as the $\text{C}_6\text{F}_5\text{P}(\text{CN})_2(\text{NCS})^-$ ion, rather than to $\text{C}_6\text{F}_5\text{P}(\text{CN})_2$, from the shift value. Formation of this phosphoranide was not unexpected, since NCS^- ions would be present in solution. An attempt to isolate this species was made by reacting $\text{C}_6\text{F}_5\text{P}(\text{CN})_2$ and Et_4NCSN in a

1:1 molar ratio, resulting in an orange liquid after the solvent was removed. Its ^{31}P n.m.r. in methylene chloride was recorded at -125.8 p.p.m., while the limiting shift achieved for this ion was -135.5 p.p.m. The limiting shift obtained by Deng and Dillon (117) was -136.0 p.p.m. The elemental analyses were quite reasonable for the expected compound $[\text{Et}_4\text{N}][\text{C}_6\text{F}_5\text{P}(\text{CN})_2(\text{SCN})]$ (experimental section).

The formation of $[\text{Et}_4\text{N}][\text{C}_6\text{F}_5\text{P}(\text{CN})_3]$ is very unlikely since $\text{P}(\text{CN})_4^-$ (26) and $\text{RP}(\text{CN})_3^-$ (R=Ph, Me or Et) (56,117) are not stable, easily decomposing to give RPCN^- and cyanogen, and no signal assignable to this species was observed in the spectrum.

The reaction was repeated using AgCN instead of $\text{Et}_4\text{N}^+\text{CN}^-$. The addition of a small amount of CN^- gave two new signals at -12.9 p.p.m. ($\text{C}_6\text{F}_5\text{P}(\text{CN})(\text{NCS})$) and -116 p.p.m. ($\text{C}_6\text{F}_5\text{P}(\text{CN})_2$), ~ 3 p.p.m. away from the usual value of -112.9 p.p.m. (117). Attempts to isolate the intermediate by reacting in a 1:1 ratio were unsuccessful. This gave two signals at -12.9 (weak) and -114.6 p.p.m. (very strong). Therefore from these results substitution occurs, rather than addition, as below:

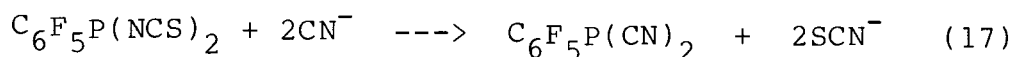

The infrared data for all the derivatives are listed in table 5.6.

f) SUMMARY.

$C_6F_5P(NCS)_2$ is quite stable at room temperature, and forms four-coordinate phosphorus (III) anions, in which the limiting shifts follow the sequence:

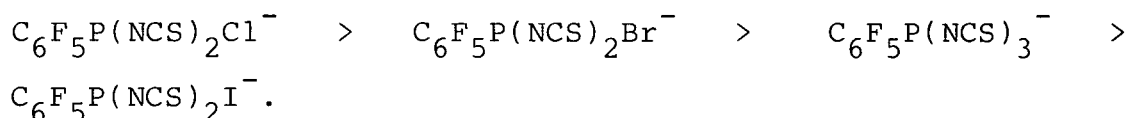

When cyanide ion is used, which bonds more strongly than the NCS^- ion, substitution occurs rather than formation of the addition product. Almost all the adducts were quite stable in the fridge but easily decomposed at room temperature. Furthermore, they are less stable than the starting material because they give poor elemental analyses when left overnight in the box, unlike $C_6F_5P(NCS)_2$.

5.3.3 $(C_6F_5)_2P(CN)$.

a) INTRODUCTION.

Bis(pentafluorophenyl)cyanophosphine was prepared by the addition of an equimolar amount of silver cyanide to a solution of $(C_6F_5)_2PCl$ in methylene chloride, with constant stirring, which was continued for an hour. It was isolated as a creamy solid after scratching the flask

Table 5.7: Infrared data for $(C_6F_5)_2PCN$ and its derivatives below 800 cm^{-1} .

| Compound | CN band | ($800-200\text{ cm}^{-1}$). |
|-----------------------------|---------|--|
| $(C_6F_5)_2PCN$ | 2180w | 760s, 640s, 615br, 585m, 540m, 513s, 500sh, 475w, 445sh, 430s, 395m, 350w, 310s, 280sh. |
| $[Pr_4N][(C_6F_5)_2P(CN)I]$ | 2180m | 750s, 645s, 610m, 585w, 513s, 500sh, 450sh, 435m, 400w, 360w, 310s, 280w. |

Table 5.8: The limiting shifts (p.p.m.) of the cyano-derivatives.

| Compound | X | | | | Ref |
|-----------------|--------|--------|--------|--------|-----------|
| | Cl | Br | I | NCS | |
| $RP(CN)_2X^-$ | | | | | |
| Me | -101.3 | -98.4 | -90.4 | -92.0 | 14 |
| Et | -77.1 | -70.9 | -66.2 | -66.2 | 14 |
| Ph | -103.3 | -90.4 | -77.5 | -83.8 | 14 |
| C_6F_5 | -158.0 | -143.5 | -128.9 | -135.5 | 117 |
| $(C_6F_5)_2PCN$ | -112.9 | -101.6 | -95.1 | -98.4 | This work |

containing the liquid of $(C_6F_5)_2PCN$ with a spatula. It was first reported by Fild and co-workers (23) from the reaction of $AgCN$ with $(C_6F_5)_2PX$ ($X=Cl$ or Br) in either benzene or acetonitrile, followed by refluxing for several hours. $(C_6F_5)_2PCN$ in this preparation was isolated by sublimation; its melting point was reported as 335K and the ^{31}P chemical shift was measured as -100.2 p.p.m. (solvent either C_6H_6 or $CHCl_3$) (22).

In contrast, in this work the chemical shift was recorded at -93.5 p.p.m., either in methylene chloride or nitrobenzene. The elemental analyses were reasonable for $(C_6F_5)_2PCN$, and the infrared spectrum showed a weak CN stretching band at 2180 cm^{-1} (see table 5.7).

b) $(C_6F_5)_2PCN/Cl^-$ SYSTEM.

In a qualitative reaction, the addition of a tetra-alkylammonium chloride (R_4NCl , $R=Et$ or Pr) to a solution of $(C_6F_5)_2PCN$ in either methylene chloride or nitrobenzene moved the chemical shift upfield to a limiting shift of -112.9 p.p.m., ascribed to the formation of the four-coordinate anion $(C_6F_5)_2P(CN)Cl^-$. In a 1:1 ratio reaction with Et_4NCl , a sticky solid was isolated even after treatment with low-boiling petroleum ether. The ^{31}P n.m.r. gave only one signal at -95.1 p.p.m. in methylene chloride, showing that the adduct was partly dissociated in solution as below:

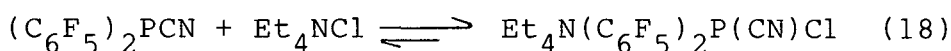

In nitrobenzene a signal at -99.7 p.p.m. was obtained, showing that greater association occurs in polar solvents.

This compound was very unstable; a new signal at 9.8 p.p.m. was observed when the solution was reinvestigated the next day, therefore the analysis had to be carried out immediately after preparation to give reasonable values. From the analyses, the compound $\text{Et}_4\text{N}(\text{C}_6\text{F}_5)_2\text{P}(\text{CN})\text{Cl}$ had been isolated. The infrared spectrum could not be recorded because this adduct did not form a mull and partly dissociated in solution. $\text{C}_6\text{F}_5\text{P}(\text{CN})_2$ (56,117) also shows acceptor properties towards the chloride ion, but the difference between the limiting shift and that of the starting material is twice as big as for the present compound (117).

c) $(\text{C}_6\text{F}_5)_2\text{PCN}/\text{Br}^-$ SYSTEM.

The addition of a tetraalkylammonium bromide to a $(\text{C}_6\text{F}_5)_2\text{PCN}$ solution in methylene chloride gave a yellowish solution, in which the chemical shift moved upfield. With an excess of the Br^- salt, the limiting shift of -101.6 p.p.m. was reached, which was smaller than that for Cl^- , as expected for the less electronegative ion. When the reac-

tion was carried out in a 1:1 ratio of $(C_6F_5)_2PCN:Pr_4NBr$ the ^{31}P n.m.r. gave only one signal at -97.0 p.p.m. before the solvent was removed, showing that the compound is partially dissociated in solution. Evaporation to dryness gave a sticky yellow liquid which when dissolved in nitrobenzene gave a ^{31}P signal at -97.8 p.p.m., similarly showing that dissociation was occurring.

Like the chloride adduct, it was very unstable; after one day the analysis gave a very low nitrogen content, and this evidence was supported by the appearance of several signals downfield from the adduct signal, so the analysis again had to be carried out immediately after preparation. As for the chloride adduct, the i.r. spectrum was not recorded, because of the same problem. From the analysis the phosphoranide salt $[Et_4N][(C_6F_5)_2P(CN)Br]$ had indeed been isolated.

d) $(C_6F_5)_2PCN/I^-$ SYSTEM.

Iodine is a less electronegative ion than bromine and chlorine, so the addition of a tetraalkylammonium iodide to the $(C_6F_5)_2PCN$ solution in methylene chloride only gave a very small movement of the chemical shift. An excess of I^- gave the limiting shift at -95.1 p.p.m., ascribed to the presence of the $(C_6F_5)_2P(CN)I^-$ ion.

A 1:1 ratio reaction with Pr_4NI gave a white solid

in 90% yield, in which the ^{31}P n.m.r. spectrum for the reaction mixture before evaporation gave a signal at -94.0 p.p.m. When the white solid was redissolved in PhNO_2 , a signal at -95.0 p.p.m. was measured. This solid was very unstable. It turned to a deep yellow in the machine during an overnight run and several sharp signals were measured at -1.6, (probably $(\text{C}_6\text{F}_5)_2\text{PO}(\text{OH})$), -96.4 (the adduct), and two signals at -137.1 and -146.7 p.p.m. These two signals could be a doublet from $(\text{C}_6\text{F}_5)_2\text{PHO}$, formed by hydrolysis, followed by the usual P (III) \rightarrow P (V) rearrangement:

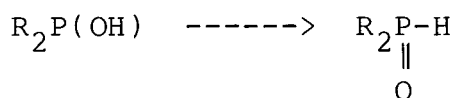

In that case $\delta^{31}\text{P} = -141.9$ p.p.m. and $^1\text{J}_{\text{P-H}} = 233$ Hz.

The elemental analysis is consistent for the adduct, $[\text{Pr}_4\text{N}][(\text{C}_6\text{F}_5)_2\text{P}(\text{CN})\text{I}]$. The infrared spectrum was recorded in the solid state, and was very similar to that of the other adducts. The CN band appeared at 2180 cm^{-1} as a weak feature.

e) $(\text{C}_6\text{F}_5)_2\text{PCN}/\text{SCN}^-$ SYSTEM.

Like the first member of the pentafluorophenyl series, $\text{C}_6\text{F}_5\text{P}(\text{CN})_2$, $(\text{C}_6\text{F}_5)_2\text{PCN}$ shows acceptor properties towards the SCN^- ion. The addition of Et_4NSCN to a solution of $(\text{C}_6\text{F}_5)_2\text{PCN}$ in methylene chloride gave an upfield movement, to a limiting shift of -98.4 p.p.m. with an excess of

SCN⁻. The limiting shift was found at the normal position, lying between those of the bromide and iodide adducts (see table 5.8).

In a 1:1 ratio reaction, a yellowish solid was isolated, for which the analyses were reasonable for the adduct, [Et₄N][(C₆F₅)₂P(CN)(SCN)]. A ³¹P shift of -95.7 p.p.m. was recorded before the solvent was removed, and -96.7 p.p.m. when the solid was redissolved in PhNO₂. When this solution was re-observed after one day, two other signals at -11.4 (sharp) and -21.8 p.p.m. (weak) were discerned, with the adduct signal at -96.7 p.p.m. Its solid state n.m.r. spectrum was not obtained since this solid melted at the machine operating temperature to give a reddish-orange material and two strong signals at -100.0 and -11.4 p.p.m. were observed. The solid was also unstable at room temperature, since a deep yellow colour became apparent when it was left in the glove box for a long time, therefore it should be kept in the freezer.

The compound did not completely form a mull in Nujol, so that the i.r. stretching bands below 800 cm⁻¹ were not easily seen. The asymmetric stretch of the NCS group was measured as a medium strong broad band with the maximum at 2030 cm⁻¹, showing that the compound is bonded through N rather than S. The CN stretching band was not observable because it usually appeared as a weak feature around 2100-2200 cm⁻¹, so it probably lay under the broad

NCS band.

f) $(C_6F_5)_2PCN/CN^-$ SYSTEM.

As soon as Et_4NCN was added to a $(C_6F_5)_2PCN$ solution in methylene chloride, an orange colour formed which then turned to a reddish-black solution. The ^{31}P n.m.r. of this solution showed several signals, measured at 132.4 (medium), 74.2 (medium), 11.4 (weak), -12.9 (strong), -27.5 (weak) and -74.2 p.p.m. (strong). No adduct signal was observed since all the signals appeared downfield from that of the starting material at -93.7 p.p.m. These signals could not readily be assigned. After the solution was left overnight in the closed tube at room temperature, the signals at 132.4 and 74.2 p.p.m. had disappeared and new medium intensity signals were discerned at 34.0, 4.9, -35.5 and -56.5 p.p.m. The addition of more Et_4NCN only gave strong signals at -1.6, -12.9 and -21.1 p.p.m. The reaction appeared to be very complicated, so no attempt was made to isolate a 1:1 reaction product.

In contrast, reductive elimination occurred for the following compounds, $RP(CN)_2$ (R=Me, Et and Ph) (20,56) and $P(CN)_3$ (26) in which the salt containing $RP(CN)^-$ was isolated and cyanogen was evolved as shown below:

Table 5.9: Chemical shifts for $(C_6F_5)_2P(H)(O)$
obtained from $(C_6F_5)_2PX_2^-$ or $(C_6F_5)_2PXY^-$
systems (p.p.m.).

| Species decomposing (hydrolysing) | Shift | separation | δ | J(Hz) |
|--------------------------------------|----------------|------------|----------|-------|
| $(C_6F_5)_2PCl_2^-$ (soln) | -137.1, -146.7 | 9.6 | -141.9 | 233 |
| $(C_6F_5)_2PClI^-$ (soln) | -133.4, -143.5 | 10.1 | -138.5 | 245 |
| " (solid) | -138.7, -148.4 | 9.7 | -143.5 | 236 |
| $(C_6F_5)_2PBr_2^-$ (soln) | -133.5, -143.1 | 9.6 | -138.3 | 233 |
| $(C_6F_5)_2PBrI^-$ (soln) | -133.8, -143.5 | 9.7 | -138.7 | 236 |
| " (solid) | -133.8, -143.5 | 9.7 | -138.7 | 236 |
| $(C_6F_5)_2PCNI^-$ (soln) | -137.1, -146.7 | 9.6 | -141.9 | 233 |
| $(C_6F_5)_2PCN(SCN)^-$ (soln) | -133.8, -143.5 | 9.7 | -138.7 | 236 |

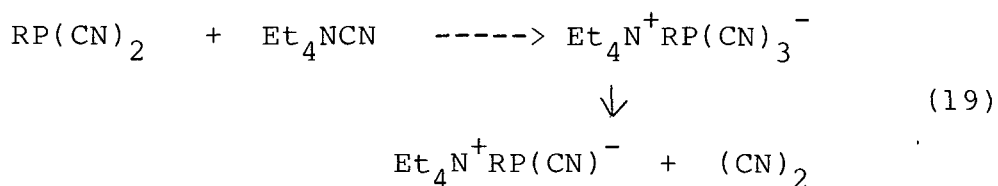

When $(\text{C}_6\text{F}_5)_2\text{PCN}$ is used as a starting material, a possible product is $\text{Et}_4\text{N}^+(\text{C}_6\text{F}_5)_2\text{P}^-$, which could produce the signal at 132.4 p.p.m. Table 5.7 lists the infrared data for $(\text{C}_6\text{F}_5)_2\text{PCN}$ and its derivatives.

5.4 CONCLUSION.

Several organophosphorus (111) compounds have been shown to possess acceptor properties toward halides X ($\text{X}=\text{Cl}^-$, Br^- or I^-) and the pseudohalide NCS^- , in addition to the cyanides RP(CN)_2 ($\text{R}=\text{Ph}$, Me , Et or C_6F_5) (20,56). These include RPX_2 ($\text{X}=\text{Cl}$ or Br ; $\text{R}=\text{C}_6\text{F}_5$), but for these compounds attempts to isolate the adducts in a pure state failed, except $\text{C}_6\text{F}_5\text{PX}_2\text{I}^-$ ($\text{X}=\text{Cl}$ or Br), and $\text{X}=\text{NCS}$, $\text{R}=\text{C}_6\text{F}_5$.

Some compounds containing two organo-groups of the type R_2PX ($\text{X}=\text{Cl}$, Br and CN ; $\text{R}=\text{C}_6\text{F}_5$) also show similar behaviour. Most of the phosphoranides isolated were unstable, easily hydrolysing to give $(\text{C}_6\text{F}_5)_2\text{P(H)(O)}$, as shown by a doublet at higher field with consistent $^1\text{J}_{\text{P-H}}$ values (table 5.9). Nevertheless these are the first simple phosphoranides to be prepared with two organo-substituents on phosphorus (118).

For $\text{C}_6\text{F}_5\text{P(CN)}_2$ and $(\text{C}_6\text{F}_5)_2\text{PCN}$ it was found that the

acceptor properties of these compounds follow the sequence below:

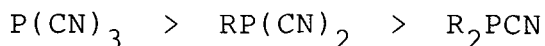

Within the above sequence, the acceptor properties of the compounds are reduced by the presence of electron-supplying groups such as Me or t-Bu, but increased by introducing electron-withdrawing groups such as C₆F₅ into RP(CN)₂, since this will increase the electropositive character of the phosphorus atom for nucleophilic addition.

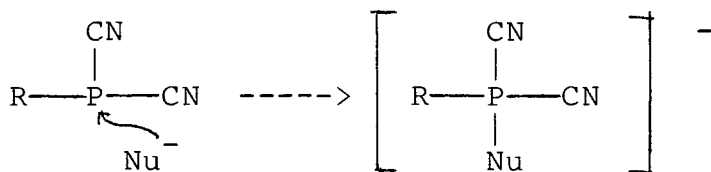

Furthermore CN⁻ itself is a strongly electron-withdrawing group, thus increasing the possibility of the formation of the addition product. RP(CN)₂ (R=Et, Me and Ph) also possess acceptor properties toward the halides X (X=Cl, Br and I) and pseudohalide NCS (20) but the reaction of RP(CN)₂ with CN⁻ involves reductive elimination to give RPCN⁻ and cyanogen.

There are two basic possible structures for anionic four-coordinate species, either monomeric and ψ -trigonal-bipyramidal or dimeric ψ -octahedral (31,32). The crystal structure of PhP(CN)₂Cl⁻ (as its Et₄N⁺ salt) shows that it is monomeric, similar to PCl₄⁻ (56), with a very long P-Cl axial bond.

RPhCl_2 (R=Ph and Me), $t\text{-BuP}(\text{CN})_2$, R_2PCN (R=Me and Ph), $(\text{C}_6\text{F}_5)_2\text{PNCS}$ and CCl_3PCl_2 did not show any tendency to form adducts with the above-mentioned ligands.

In general, the limiting shifts of the four-coordinate phosphorus (III) anions follow the sequence:

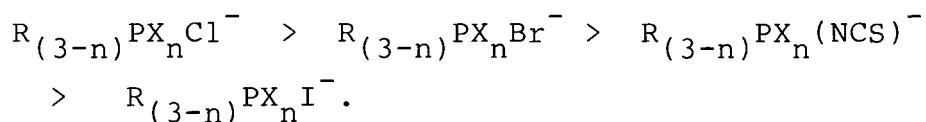

$n=1$ and 2 ; $\text{R}=\text{C}_6\text{F}_5$; $\text{X}=\text{halide}$ or pseudohalide.

A similar sequence has been observed in the phosphoranides $\text{RP}(\text{CN})_2\text{X}^-$ (R=Me, Et, Ph or C_6F_5 ; X=Cl, Br, I, NCS) (20,56,117).

5.5 EXPERIMENTAL.

1) Preparation of $\text{PhP}(\text{NCS})_2$.

PhPCl_2 (0.99 g, 5.53 mmoles) was dissolved in CH_2Cl_2 . An excess of AgSCN (2.40 g, 14.46 mmoles) was added to the solution with constant stirring. The reaction mixture was allowed to stir for two hours for completion of the reaction. The excess AgSCN and AgCl were removed by filtration. The filtrate was evaporated to dryness to isolate a yellow liquid which was stored under nitrogen in the fridge.

Analysis:

Found: C=41.20 H=2.24 N=8.48 P=13.76 S=27.54%.

Calculated: C=42.86 H=2.23 N=12.50 P=13.84 S=28.57%.

2) Preparation of $\text{MeP}(\text{NCS})_2$.

When the reaction above was repeated using $\text{MeP}(\text{NCS})_2$ (0.73 g, 6.20 mmoles) and AgSCN (2.32 g, 13.9 mmoles) which were stirred for 1 hour, a yellow liquid was isolated, and it was analysed immediately.

Analysis:

Found: C=23.20 H=1.74 N=15.94 S=39.99 P=19.26%.

Calculated: C=22.20 H=1.85 N=17.28 S=39.51 P=19.14%.

3) Preparation of $\text{EtP}(\text{NCS})_2$.

The above reaction was repeated using $\text{EtP}(\text{NCS})_2$ (0.90 g, 4.46 mmoles) and AgSCN (2.03 g, 12.27 mmoles) which were stirred for 2-3 hours. Evaporation gave a yellow liquid.

Analysis:

Found: C=28.50 H=3.00 N=15.30 S=35.73 P=16.90%.

Calculated: C=27.27 H=2.90 N=15.91 S=36.36 P=17.61%.

4) Preparation of $\text{C}_6\text{F}_5\text{P}(\text{NCS})_2$.

The above reaction was repeated using $\text{C}_6\text{F}_5\text{P}(\text{NCS})_2$ (4.50 g, 12.6 mmoles) and AgSCN (5.02 g, 30.24 mmoles) which were stirred for 2-3 hours. The product was isolated as above as a yellow liquid.

Analysis:

Found: C=30.62 N=7.17 P=10.51 S=19.42%.

Calculated: C=30.57 N=8.92 P=9.87 S=20.38%.

5) Preparation of $(C_6F_5)_2PNCS$.

When the above reaction was repeated using $(C_6F_5)_2^-PBr$ (0.70 g, 1.57 mmoles) and AgSCN (0.40 g, 2.41 mmoles) which were stirred for 2-3 hours, a yellow liquid was isolated after removal of the solvent.

Analysis:

Found: C=36.17 N=2.17 P=6.35%.

Calculated: C=37.77 N=3.39 P=7.51%.

6) Attempt to synthesise $[Et_4N][C_6F_5PCl_3]$.

$C_6F_5PCl_2$ (0.61 g, 2.27 mmoles) was dissolved in CH_2Cl_2 . A solution of Et_4NCl (0.38 g, 2.29 mmoles) in the same solvent was added to the above solution with constant stirring. The reaction mixture was allowed to stir for 15 minutes and then the solvent was removed in vacuo to isolate a yellowish solid.

Analysis:

Found: C=38.13 H=6.31 N=3.13 P=5.84 Cl=18.50%.

Calculated: C=38.67 H=4.60 N=3.22 P=7.13 Cl=24.51%.

7) Attempt to synthesise $[Pr_4N][C_6F_5PCl_2Br]$.

$C_6F_5PCl_2$ (0.52 g, 1.93 mmoles) was diluted in CH_2Cl_2 . Solid Pr_4NBr (0.51 g, 1.92 mmoles) was added to the above solution with constant stirring. The reaction

was allowed to stir for one hour, before being evaporated to dryness to isolate a wet solid.

Analysis:

Found: C=43.93 H=7.53 N=3.63 P=4.11%.

Calculated: C=40.37 H=5.23 N=2.62 P=5.79%.

8) Preparation of $[\text{Pr}_4\text{N}][\text{C}_6\text{F}_5\text{PCl}_2\text{I}]$.

$\text{C}_6\text{F}_5\text{PCl}_2$ (0.32 g, 1.09 mmol) was dissolved in CH_2Cl_2 . Solid Pr_4NI (0.35 g, 1.06 mmol) was added to the above solution with constant stirring. After 10 minutes stirring the solvent was removed in vacuo to isolate a yellow solid.

Analysis:

Found: C=39.55 H=6.28 N=2.35 P=4.71 Cl=11.53 I=22.17%.

Calculated: C=37.11 H=4.81 N=2.41 P=5.33 Cl=12.2 I=21.80%.

9) Attempts to synthesise $[\text{Pr}_4\text{N}][\text{C}_6\text{F}_5\text{PBr}_3]$.

a) $\text{C}_6\text{F}_5\text{PBr}_2$ (0.92 g, 2.57 mmol) was diluted in CH_2Cl_2 . Pr_4NBr (0.68 g, 2.56 mmol) in the same solvent was added to the above solution with constant stirring. The reaction mixture was allowed to stir for half an hour before being evaporated to dryness to isolate a wet yellowish solid.

Analysis:

Found: C=38.11 H=5.56 N=2.28 P=5.07 Br=19.52%.

Calculated: C=34.63 H=4.49 N=2.24 P=4.97 Br=38.43%.

b) When the above reaction was performed in CH_3CN ,

a yellowish sticky solid was isolated.

Analysis:

Found: C=40.79 H=5.50 N=2.83 P=red colour Br=32.02%.

Calculated: C=34.63 H=4.49 N=2.24 P=4.97 Br=38.43%.

10) Preparation of $[\text{Pr}_4\text{N}][\text{C}_6\text{F}_5\text{PBr}_2\text{I}]$.

$\text{C}_6\text{F}_5\text{PBr}_2$ (0.47 g, 1.31 mmoles) was dissolved in CH_2Cl_2 . Solid Pr_4NI (0.41 g, 1.31 mmoles) was added to the above solution with constant stirring. The reaction mixture was allowed to stir for a while before the solvent was evaporated to dryness to isolate a reddish liquid.

Analysis:

Found: C=34.13 H=6.79 N=1.69 P=3.88 Br=11.28 I=16.67%.

Calculated: C=32.20 H=4.17 N=2.09 P=4.62 Br=23.82 I=18.92%.

11) Preparation of $[\text{Et}_4\text{N}][(\text{C}_6\text{F}_5)_2\text{PCl}_2]$.

$(\text{C}_6\text{F}_5)_2\text{PCl}$ (0.70 g, 1.75 mmoles) was dissolved in a small quantity of methylene chloride. Et_4NCl (0.30 g, 1.80 mmoles) was added to the above solution with constant stirring. The mixture was allowed to stir for 10 minutes before the solution was evaporated to dryness to isolate the $(\text{C}_6\text{F}_5)_2\text{PCl} \cdot \text{Et}_4\text{NCl}$ adduct as a sticky yellowish solid.

Analysis:

Found: C=43.0 H=4.27 N=2.20 P=5.15 Cl=11.48%.

Calculated: C=42.4 H=3.53 N=2.47 P=5.48 Cl=12.54%.

12) Preparation of $[\text{Pr}_4\text{N}][(\text{C}_6\text{F}_5)_2\text{PCl}_2]$.

When the above reaction was repeated using

$(C_6F_5)_2PCl$ (0.86 g, 2.15 mmoles) with Pr_4NCl (0.5 g, 2.25 mmoles), a sticky solid formed when the solvent was removed in vacuo.

Analysis:

Found: C=44.20 H=4.30 N=1.74 P=4.41 Cl=10.21%.

Calculated: C=46.30 H=4.50 N=2.25 P=4.98 Cl=11.41%.

13) Preparation of $[Pr_4N][(C_6F_5)_2PClBr]$.

Similarly to the above reaction, $(C_6F_5)_2PCl$ (0.86 g, 2.15 mmoles) and Pr_4NBr (0.57 g, 2.14 mmoles) gave a sticky solid when the reaction mixture was evaporated to dryness in vacuo.

Analysis:

Found: C=44.16 H=4.26 N=1.94 P=4.48% Halogens see section 5.2.5c.

Calculated: C=43.22 H=4.20 N=2.10 P=4.65 Br=11.99 Cl=5.33%.

14) Preparation of $[Pr_4N][(C_6F_5)_2PClI]$.

When a similar reaction was carried out using $(C_6F_5)_2PCl$ (0.70 g, 1.75 mmoles) and Pr_4NI (0.56 g, 1.79 mmoles), a brown solution formed. Evaporation of this solution gave a yellow solid.

Analysis:

Found: C=40.89 H=3.99 N=1.37 P=4.12 Cl=5.24 I=21.4%.

Calculated: C=40.36 H=3.92 N=1.96 P=4.34 Cl=4.98 I=17.79%.

15) Preparation of $[Pr_4N][(C_6F_5)_2PBr_2]$.

$(C_6F_5)_2PBr$ (0.63 g, 1.42 mmoles) was dissolved in

methylene chloride. Solid Pr_4NBr (0.39 g, 1.47 mmoles) was added to the above solution with constant stirring. The reaction mixture was stirred for 20 minutes before the solvent was removed in vacuo to isolate a yellow viscous liquid which was analysed immediately.

Analysis:

Found: C=40.35 H=5.45 N=1.52 P=3.76 Br=24.93%.

Calculated: C=40.52 H=3.94 N=1.97 P=4.36 Br=22.50%.

16) Preparation of $[\text{Pr}_4\text{N}][(\text{C}_6\text{F}_5)_2\text{PBrI}]$.

The reaction was carried out similarly to the preparation of the bromide analogue using $(\text{C}_6\text{F}_5)_2\text{PBr}$ (0.71 g, 1.60 mmoles) and Pr_4NI (0.51 g, 1.63 mmoles). Evaporation of the reddish-brown solution in vacuo gave a red solid.

Analysis:

Found: C=36.50 H=4.74 N=1.30 P=3.88 Br=11.80 I=17.49%.

Calculated: C=38.00 H=3.69 N=1.85 P=4.09 Br=10.54 I=16.80%.

17) Preparation of $[\text{Pr}_4\text{N}][\text{C}_6\text{F}_5\text{P}(\text{NCS})_2\text{Cl}]$.

$\text{C}_6\text{F}_5\text{P}(\text{NCS})_2$ (0.62 g, 1.97 mmoles) was dissolved in methylene chloride. An equimolar amount of Pr_4NCl (0.46 g, 2.07 mmoles) in the same solvent was added to the above solution with stirring. The mixture was allowed to stir for 20 minutes and evaporated to dryness to isolate a brown sticky oil. Attempts to isolate a solid failed since treatment with petroleum ether (30-40^o) only gave Pr_4NCl .

Analysis:

Found: C=45.04 H=5.63 N=6.81 P=5.80 Cl=6.63 S=11.29%..

Calculated: C=44.82 H=5.23 N=7.84 P=4.82 Cl= 6.35 S=11.95%.

When the above reaction was repeated using Et_4NCl (0.07 g, 0.45 mmoles) and $\text{C}_6\text{F}_5\text{P}(\text{NCS})_2$ (0.14 g, 0.45 mmoles), it yielded a sticky orange solid.

Analysis:

Found: C= 41.68 H=4.57 N=7.70 P=6.03 S=12.00 Cl=7.10%.

Calculated: C=40.07 H=4.17 N=8.76 P=6.47 S= 13.35 Cl=7.40%.

18) Preparation of $[\text{Pr}_4\text{N}][\text{C}_6\text{F}_5\text{P}(\text{NCS})_2\text{Br}]$.

The above reaction was repeated using $\text{C}_6\text{F}_5\text{P}(\text{NCS})_2$ (0.22 g, 0.70 mmoles) and Pr_4NBr (0.19 g, 0.71 mmoles), to give a sticky orange liquid.

Analysis:

Found: C=40.36 H=5.77 N=6.00 Br=16.55 P=4.50 S=9.50%.

Calculated: C=41.38 H=4.83 N=7.24 Br=13.79 P=5.34 S=11.00%.

19) Preparation of $[\text{Pr}_4\text{N}][\text{C}_6\text{F}_5\text{P}(\text{NCS})_2\text{I}]$.

The reaction above was repeated using $\text{C}_6\text{F}_5\text{P}(\text{NCS})_2$ (1.73 g, 5.50 mmoles) and Pr_4NI (1.72 g, 5.50 mmoles); a deep yellow solution was obtained which finally turned orange. Evaporation to dryness gave a yellow solid, in 91% yield.

Analysis:

Found: C=37.63 H=4.47 N=6.20 P=5.33 S=10.23 I=21.00%.

Calculated: C=38.28 H=4.47 N=6.70 P=4.94 S=10.21 I=20.30%.

20) Preparation of $[\text{Et}_4\text{N}][\text{C}_6\text{F}_5\text{P}(\text{NCS})_3]$.

When the above reaction was repeated with $\text{C}_6\text{F}_5\text{P}(\text{NCS})_2$ (0.35 g, 1.11 mmoles) and Et_4NSCN (0.21 g, 1.12 mmoles), a sticky orange oil was produced which turned to a red sticky solid.

Analysis:

Found: C=41.63 H=5.34 N=9.90 P=6.30 S=19.64%.

Calculated: C=40.64 H=4.00 N=11.60 P=6.20 S=19.12%.

21) Preparation of $[\text{Et}_4\text{N}][\text{C}_6\text{F}_5\text{P}(\text{CN})_2(\text{NCS})]$.

$\text{C}_6\text{F}_5\text{P}(\text{CN})_2$ (0.51 g, 2.04 mmoles) was dissolved in methylene chloride. Et_4NSCN (0.38 g, 2.03 mmoles) was added to the above solution and the mixture was allowed to stir for a while before being evaporated to dryness. An orange liquid was isolated.

Analysis:

Found: C=43.23 H=4.84 N=10.30%.

Calculated: C=46.54 H=4.56 N=12.78%.

22) Preparation of $[\text{Et}_4\text{N}][(\text{C}_6\text{F}_5)_2\text{P}(\text{CN})\text{Cl}]$.

$(\text{C}_6\text{F}_5)_2\text{PCN}$ (0.34 g, 0.87 mmoles) was dissolved in methylene chloride. An equimolar amount of Et_4NCl (0.14 g, 0.85 mmoles) was added to the above solution. The yellowish solution was allowed to stir for 10 minutes before being evaporated to dryness to isolate a sticky yellowish solid. Attempts to isolate a dry solid failed when it was treated with petroleum ether (30-40°).

Analysis:

Found: C=46.97 H=3.37 N=4.00 P=4.82 Cl=7.81%.

Calculated: C=45.28 H=3.59 N=5.03 P=5.57 Cl=6.40%.

23) Preparation of $[\text{Pr}_4\text{N}][(\text{C}_6\text{F}_5)_2\text{P}(\text{CN})\text{Br}]$.

The reaction above was repeated using $(\text{C}_6\text{F}_5)_2\text{PCN}$ (0.23 g, 0.59 mmoles) and Pr_4NBr (0.16 g, 0.60 mmoles) to give a yellowish sticky liquid after removal of the solvent in vacuo. Similarly, no solid formed after treatment with low boiling petroleum ether.

Analysis:

Found: C=49.76 H=4.21 N=4.13 P=4.16 Br=12.25%.

Calculated: C=45.67 H=4.26 N=4.26 P=4.72 Br=12.16%.

24) Preparation of $[\text{Pr}_4\text{N}][(\text{C}_6\text{F}_5)_2\text{P}(\text{CN})\text{I}]$.

When a similar reaction to the above was carried out using $(\text{C}_6\text{F}_5)_2\text{PCN}$ (0.36 g, 0.92 mmoles) and Pr_4NI (0.29 g, 0.93 mmoles), a white solid was isolated when the solvent was evaporated to dryness.

Analysis:

Found: C=41.44 H=4.45 N=3.60 P=4.32 I=17.90%.

Calculated: C=42.61 H=3.98 N=3.96 P=4.40 I=18.03%.

25) Preparation of $[\text{Et}_4\text{N}][(\text{C}_6\text{F}_5)_2\text{PCN}(\text{NCS})]$.

A similar reaction was performed with $(\text{C}_6\text{F}_5)_2\text{PCN}$ (0.35 g, 0.90 mmoles) and Et_4NSCN (0.18 g, 0.95 mmoles), in which after evaporation to dryness a yellowish solid was isolated in 80% yield.

Analysis:

Found: C=44.60 H=3.52 N=4.40 P=5.61%.

Calculated: C=45.60 H=3.45 N=7.25 P=5.35%.

CHAPTER SIX

PSEUDOHALOGENO-DERIVATIVES OF ORGANOPHOSPHORUS (V) COMPOUNDS.

6.1 AZIDO-DERIVATIVES.

6.1.1 INTRODUCTION.

Until recently mixed azido-halogenophosphorus compounds were not well known, although several fully-substituted azido-derivatives of organophosphorus compounds had been described (119). Herring (120) studied polymeric phosphazenes of the type $(\text{Br}_2\text{PN})_n$, $(\text{C}_6\text{H}_5\text{ClPN})_n$ and $((\text{C}_6\text{H}_5)_2\text{PN})_n$ which were synthesised by reacting NaN_3 with the corresponding trivalent phosphorus halides at specific temperatures. Furthermore, photolysis with ultraviolet light of hydrogen azide (HN_3) dissolved in phosphorus trichloride between 195 and 206K gave a viscous liquid which was identified as $(\text{P}_5\text{N}_8\text{Cl}_9)_4$ (121). No direct evidence for the formation of mixed azido-phosphorus (III) substituted compounds was found in either case. In 1978, Dillon et al (122) reported the identification of some mixed azido-halogeno-species and their decomposition products.

As for the phosphorus (III) compounds, little was known about mixed azido-halogeno phosphorus (V) derivatives

until recently. Dillon et al (44) have identified the complete series of azidochloro-phosphates $\text{PCl}_{6-n}(\text{N}_3)_n^-$ in solution by ^{31}P n.m.r. spectroscopy. Deng (20,56,57) extended the study to species with an organo-group attached to phosphorus such as RPCl_5^- salts, (R=Et, Me and Ph), but only decomposition products were identified in solution. Thus replacement of chlorine by an organo-group seems to enhance the decomposition of the azido-anions, as compared with the relative kinetic stability of the hexaazido-phosphate ion and its precursors, $\text{PCl}_{6-n}(\text{N}_3)_n^-$ ($0 \leq n \leq 5$).

The azido-containing cations of the types $(\text{CH}_3)_{4-n}\text{P}(\text{N}_3)_n^+$ (123), $(\text{C}_6\text{H}_5)_{4-n}\text{P}(\text{N}_3)_n^+$ ($0 \leq n \leq 4$) (124), $\text{RPCl}_{3-n}(\text{N}_3)_n^+$, ($0 \leq n \leq 3$), (R=Me or Ph (19,20) or Et (20)) and $\text{R}_2\text{PCl}_{2-n}(\text{N}_3)_n^+$, $0 \leq n \leq 2$, (R=Me or Et) (20) have been identified in solution and their ^{31}P n.m.r. chemical shifts recorded.

6.1.2 AZIDO-DERIVATIVES OF $\text{C}_6\text{F}_5\text{PCl}_3^+\text{X}^-$ (X= SbCl_6 or BCl_4).

When LiN_3 was added to a solution of either $\text{C}_6\text{F}_5\text{PCl}_3\text{BCl}_4$ or $\text{C}_6\text{F}_5\text{PCl}_3\text{SbCl}_6$ in nitrobenzene, an upfield signal was discerned, measured at 56.5 p.p.m. The addition of more LiN_3 gave three other signals, at 45.3 and 29.1 (weak) and 17.1 p.p.m. (strong). Finally a very strong signal at 17.1 p.p.m. was observed, together with weaker signals at 4.9 and 0.0 p.p.m. The first three signals were assigned

Table 6.1: $\delta^{31}\text{P}$ (p.p.m.) for the azido-derivatives of $\text{C}_6\text{F}_5\text{PCl}_{3-n}(\text{N}_3)_n^+$.

| n | δ obs | δ calc. (1) | δ calc. (2) |
|---|--------------|--------------------|--------------------|
| 0 | 82.2 | 82.2 | 82.2 |
| 1 | 56.5 | 56.5 | 65.3 |
| 2 | 45.3 | 38.0 | 46.8 |
| 3 | 29.1 | 29.1 | 29.1 |

Note:

| Term | δ calc. (1) | δ calc. (2) |
|-----------------------------------|---|---|
| $\text{C}_6\text{F}_5:\text{Cl}$ | 13.70 ($\text{C}_6\text{F}_5\text{PCl}_3^+$) | 13.70 ($\text{C}_6\text{F}_5\text{PCl}_3^+$) |
| $\text{Cl}:\text{Cl}$ | 14.52 (PCl_4^+) | 14.52 (PCl_4^+) |
| $\text{N}_3:\text{N}_3$ | 1.90 ($\text{P}(\text{N}_3)_4^+$) | 1.90 ($\text{P}(\text{N}_3)_4^+$) |
| $\text{C}_6\text{F}_5:\text{N}_3$ | 7.80 ($\text{C}_6\text{F}_5\text{P}(\text{N}_3)_3^+$) | 7.80 ($\text{C}_6\text{F}_5\text{P}(\text{N}_3)_3^+$) |
| $\text{N}_3:\text{Cl}$ | 3.39 ($\text{C}_6\text{F}_5\text{PCl}_2(\text{N}_3)^+$) | 7.78 ($\text{PCl}_3(\text{N}_3)^+$) |

Table 6.2: ^{11}B n.m.r. data for $\text{BCl}_{4-n}(\text{N}_3)_n^-$ derivatives (p.p.m.).

| n | δ obs(1) | δ obs(2) | δ calc(1) | δ calc(2) |
|---|-----------------|-----------------|------------------|------------------|
| 0 | -12.2 | -12.2 | -12.17 | -12.17 |
| 1 | -15.2 | -15.2 | -15.21 | -15.21 |
| 2 | -18.8 | -18.5 | -18.76 | -18.67 |
| 3 | - | - | -22.83 | -22.56 |
| 4 | -26.9 | - | -27.42 | -26.88 |

Note:

1= $\text{C}_6\text{F}_5\text{PCl}_3\text{BCl}_4$ in CH_3NO_2 solution

2= Et_4NBCl_4 " " "

as the azido-derivatives $C_6F_5PCl_{3-n}(N_3)_n^+$, ($1 \leq n \leq 3$), (Table 6.1) and the other three signals are probably from decomposition products. From analysis of the spectra, decomposition appeared to be more rapid than the substitution itself to give the fully substituted azido-derivative $C_6F_5P(N_3)_3^+$, since the decomposition product at 17.1 p.p.m. was observed as a strong signal, compared with the $C_6F_5P(N_3)_3^+$ signal at 29.1 p.p.m. which was relatively weak. After one week, the solution spectrum was re-recorded to give two equivalent strong signals measured at 6.5 and 0.0 p.p.m. The signal at 6.5 p.p.m. is probably from the same compound as the signal at 4.9 p.p.m. above. Attempts to obtain only one signal at 29.1 p.p.m. failed since always the decomposition products were detected before complete substitution occurred. The above reaction became vigorous after the sample was placed in the machine, therefore it needed to be allowed to subside before more LiN_3 was added. The assignments of the azido-derivatives agree well with those of Deng for other $[RP(N_3)_nCl_{3-n}]^+$ species (20).

The values calculated from both sets of data are not in good numerical agreement with the observed shifts for $n=2$ (1) or $n=1$ (2). Nevertheless the assignments seem unambiguous.

Attempts were made to prepare some six-coordinate derivatives of these species, but were not successful. When

a solution of $C_6F_5PCl_3BCl_4$ and LiN_3 in $PhNO_2$ or $MeNO_2$ which gave two equivalent signals (either $n=0$ and 1 , $n=1$ and 2 or $n=2$ and 3) was treated with dry bipyridine, a precipitate formed and the two signals disappeared. No signal in the six-coordinate region was observed. No reaction occurred when $C_6F_5PCl_3bipySbCl_6$ was treated with a small amount of LiN_3 . When more LiN_3 was added and the sample left running overnight, the only signal observed, apart from the parent signal at -190.2 p.p.m., was one at 0.0 p.p.m., probably due to either a hydrolysis or decomposition product. PCl_4bipy^+ also does not react with LiN_3 to form an azido-derivative (19).

In contrast, Dillon et al (19) have reported several six-coordinate species of the type $PCl_{4-n}(N_3)_n bipy^+ X^-$, ($0 \leq n \leq 4$) which were studied in solution only.

When $C_6F_5PCl_3BCl_4$ was used as a reactant, the alternative method of ^{11}B n.m.r. was used to follow the behaviour of the anion with the changing of the cation. $C_6F_5PCl_3BCl_4$ gave one ^{11}B n.m.r. signal at -12.2 p.p.m., relative to $(MeO)_3B$ as the external reference, in good agreement with the literature value of -11.1 p.p.m. (70,71). Not surprisingly, substitution also occurred at the BCl_4^- anion, and upfield signals were observed when LiN_3 was added to $C_6F_5PCl_3BCl_4$ in either nitrobenzene or nitromethane. When a small amount of LiN_3 was used, a new signal measured at -15.2 p.p.m. was observed, assigned as

the $\text{BCl}_3(\text{N}_3)^-$ ion. The addition of more LiN_3 generated two more signals, measured at -18.8 $[\text{BCl}_2(\text{N}_3)_2]^-$ and -26.9 p.p.m. $[\text{B}(\text{N}_3)_4]^-$ respectively. No signal was observed for the third substitution product, $[\text{BCl}(\text{N}_3)_3]^-$. These signals are in good agreement with the calculated values as shown in table 6.2.

Preparation of the substituted species by reaction of LiN_3 with Et_4NBCl_4 was also attempted, but in this case reaction stopped at $n=2$ (Table 6.2). This behaviour may be due to increased stability of the azido-substituted anions with $\text{C}_6\text{F}_5\text{PCl}_3^+$ as the cation. These studies were performed in solution only because isolation of the solid might tend to give an explosion.

Pairwise calculation in set (1) was carried out using the values of $\text{Cl}:\text{Cl}=-2.03$ from BCl_4^- , $\text{N}_3:\text{Cl}=-3.04$ from $\text{BCl}_3(\text{N}_3)^-$ and $\text{N}_3:\text{N}_3=-4.57$ p.p.m. from $\text{BCl}_2(\text{N}_3)_2^-$. In set (2), the reaction was assumed to go to completion. Therefore the $\text{N}_3:\text{N}_3$ term was calculated as -4.48 p.p.m. while $\text{N}_3:\text{Cl}$ was taken as -3.04 p.p.m. from $\text{BCl}_3(\text{N}_3)^-$. From these values, the second derivative gave a theoretical shift of -18.67 p.p.m. and the results confirmed that the third signal was not observed (see table 6.2).

6.2 THIOCYANATO-DERIVATIVES.

6.2.1 INTRODUCTION.

Even less has been published on thiocyanato-derivatives of 5- or 6-coordinate phosphorus (V) compounds compared with cyano- and azido-compounds. This type of compound has only been investigated recently. Platt (29) attempted an oxidation reaction between $P(NCS)_3$ and $(SCN)_2$ in methylene chloride, but no reaction seemed to occur from the ^{31}P n.m.r. spectrum.

In the system of $(PCl_3 + (SCN)_2)$, a series of compounds $PSCl_{3-n}(NCS)_n$ was formed as well as the $PCl_3(NCS)^+$ ion. The identification of these compounds was accomplished by means of ^{31}P n.m.r. spectroscopy. No reaction occurred when $AgSCN$ was added directly to PCl_5 (29). New species $K^+[PF_{6-n}(NCS)_n]^-$ ($1 \leq n \leq 3$) have been identified by ^{19}F and ^{31}P n.m.r. spectroscopy (46). Chevrier and Brownstein (47) studied the fluorine n.m.r. of the compounds formulated as $PF_{6-n}(SCN)_n^-$, ($0 \leq n \leq 2$)

Dillon and Platt (29,52,54) have studied thiocyanate compounds of the type $[PX_{6-n}(NCS)_n]^-$ ($X=Cl$ or F , $0 \leq n \leq 6$), as well as some chlorofluorophosphate derivatives of the type $[PF_3Cl_{3-n}(NCS)_n]^-$ ($0 \leq n \leq 3$). These thiocyanato complexes were deduced to be N- rather than S-bonded from ^{31}P n.m.r. (46) or vibrational (i.r. or Raman) spectroscopy (52),

indicating that phosphorus (V) behaves as a hard acid in this system.

6.2.2 THIOCYANATO-DERIVATIVES OF $\text{RPhCl}_3^+\text{SbCl}_6^-$.

When the compounds $\text{RPhCl}_3\text{SbCl}_6$ (R=Me or Ph) and $\text{C}_6\text{F}_5\text{PCl}_3\text{BCl}_4$ were treated with a thiocyanate salt (AgSCN, $\text{Hg}(\text{SCN})_2$ or LiNCS) in nitrobenzene, upfield resonances from the starting material were observed which are assigned and tabulated in table 6.3. $\text{MePhCl}_3\text{SbCl}_6$ and AgSCN in PhNO_2 gave a yellow solution, the ^{31}P n.m.r. of which was recorded to give signals at 96.7 (weak), 66.2 (strong) and 45.3 (medium) p.p.m. These three resonances were assigned as the first, second and third substitution products in the formula, $\text{MePhCl}_{3-n}(\text{NCS})_n^+$ ($1 \leq n \leq 3$). When more AgSCN was added to the above solution, other new signals at 25.8 and -8.2 p.p.m. were observed, presumably the hydrolysis products $\text{MePOCl}(\text{NCS})$ and $\text{MePO}(\text{NCS})_2$ respectively (105), with increased intensity of the signals at 66.2 and 45.3 p.p.m.

The introduction of $\text{Hg}(\text{SCN})_2$ into a solution of $\text{PhPhCl}_3\text{SbCl}_6$ in PhNO_2 generated new signals measured at 79.1 (medium), 50.0 (strong) and 37.1 (medium) p.p.m. The addition of more $\text{Hg}(\text{SCN})_2$ to the above solution increased the intensity of the third signal and the first signal declined. These three signals were ascribed to $\text{PhPhCl}_2(\text{NCS})^+$, $\text{PhPhCl}(\text{NCS})_2^+$ and $\text{PhP}(\text{NCS})_3^+$ respectively.

Other than these peaks, a signal at 10.4 ± 1 p.p.m. was always present as soon as $\text{Hg}(\text{SCN})_2$ was added, which increased with the addition of more $\text{Hg}(\text{SCN})_2$. This is presumably due to $\text{PhPOCl}(\text{NCS})$, which was observed at 8.2 p.p.m. when PhPOCl_2 was treated with AgSCN in CH_2Cl_2 .

When $\text{C}_6\text{F}_5\text{PCl}_3\text{BCl}_4$ was treated with a small amount of AgSCN in nitromethane, a weak signal at 56.5 p.p.m. and two other strong signals at 27.5 and 8.2 p.p.m. were discerned. The addition of more AgSCN to the same solution increased the strength of the signal at 8.2 p.p.m., with the appearance of another strong signal at -11.4 and medium intensity signals at -17.8, -38.7 and -45.3 p.p.m. In this stage, decomposition occurred since a $\text{C}_6\text{F}_5\text{PCl}_2$ signal was also observed at 135.5 p.p.m. The intensity of the last two signals (-38.7 and -45.3) p.p.m. increased with the addition of more AgSCN but the signal at 8.2 p.p.m. was unchanged. The first three resonances above were assigned as $\text{C}_6\text{F}_5\text{PCl}_{3-n}(\text{NCS})_n^+$, ($1 \leq n \leq 3$) respectively. The rest of the signals observed are probably due to polymeric material, since most phosphorus thiocyanato-compounds have a tendency to form polymers (29) and are unstable as shown below:

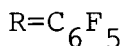
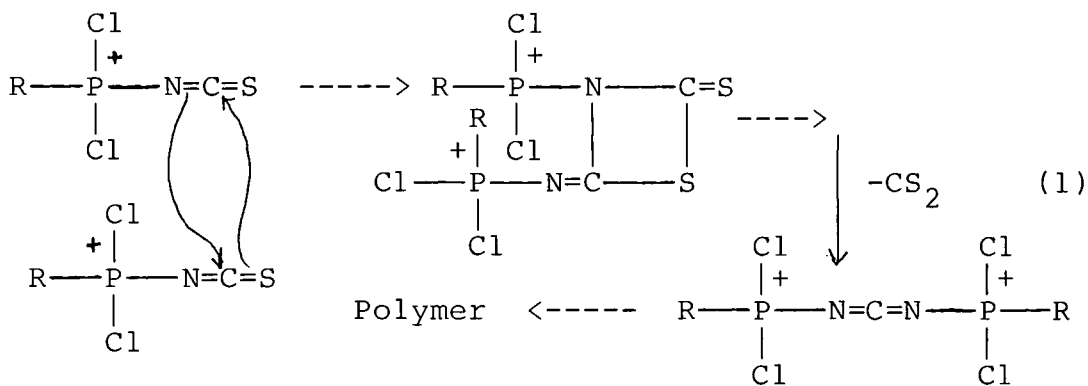

Dillon and Platt identified CS_2 (from its gas phase i.r. spectrum) in the decomposition products of the $\text{P}(\text{NCS})_6^-$ ion at room temperature (52). It is also possible that some of these signals were from cyano-derivatives formed by rearrangement of the thiocyanato-compounds, similar to reactions observed by Platt (29) and Fild (22). This possibility was strongly supported by the spectrum obtained when this solution (which was kept in the fridge) was reinvestigated after 2 days, when signals at 61.8 ($\text{C}_6\text{F}_5\text{P}(\text{NCS})_2$), 6.0 ($\text{C}_6\text{F}_5\text{PS}(\text{NCS})_2$) and -38.7 p.p.m. ($\text{C}_6\text{F}_5\text{PS}(\text{CN})_2$) were observed, together with other weaker signals at -22.4, -29.9 and -33.0 p.p.m. due to the polymeric material. These spectra confirmed the instability of the thiocyanato-compounds (29).

When $\text{Hg}(\text{SCN})_2$ was used, the resonance from the first substitute was not detected. A strong signal at 29.1 p.p.m., and medium intensity signals at 9.8 and -13.4 ± 2 p.p.m. were recorded, assigned as $\text{C}_6\text{F}_5\text{P}(\text{NCS})_2^+$, $\text{C}_6\text{F}_5\text{P}(\text{NCS})_3^+$ and $\text{C}_6\text{F}_5\text{PO}(\text{NCS})_2$ respectively. The addition of more $\text{Hg}(\text{SCN})_2$ only increased the intensity of the

Table 6.3: ^{31}P n.m.r. data for $\text{RPCl}_{3-n}(\text{NCS})_n^+$ (R= Me, Ph and C_6F_5) derivatives in PhNO_2 .

| δ_{obs} (p.p.m.) | Assignment | δ_{calc} (1) (p.p.m.) | δ_{calc} (2) (p.p.m.) |
|-----------------------------------|--|--|--|
| 120.9 | MePCl_3^+ | 120.9 | 120.9 |
| 96.7 | $\text{MePCl}_2(\text{NCS})^+$ | 91.4 | 91.5 |
| 66.2 | $\text{MePCl}(\text{NCS})_2^+$ | 66.2 | 66.3 |
| 45.3 | $\text{MeP}(\text{NCS})_3^+$ | 45.2 | 45.3 |
| 103.3 | PhPCl_3^+ | 103.3 | 103.3 |
| 79.1 | $\text{PhPCl}_2(\text{NCS})^+$ | 74.5 | 77.0 |
| 50.0 | $\text{PhPCl}(\text{NCS})_2^+$ | 50.0 | 54.9 |
| 37.1 | $\text{PhP}(\text{NCS})_3^+$ | 29.9 | 37.1 |
| 82.2 | $\text{C}_6\text{F}_5\text{PCl}_3^+$ | 82.2 | 82.2 |
| 56.5 | $\text{C}_6\text{F}_5\text{PCl}_2(\text{NCS})^+$ | 53.0 | 53.9 |
| 27.5 | $\text{C}_6\text{F}_5\text{PCl}(\text{NCS})_2^+$ | 27.5 | 29.3 |
| 8.2 | $\text{C}_6\text{F}_5\text{P}(\text{NCS})_3^+$ | 5.6 | 8.3 |

Table 6.4: ^{11}B n.m.r. data for $\text{BCl}_{4-n}(\text{NCS})_n^-$ derivatives in CH_3NO_2 (p.p.m.).

| Ion | δ_{obs} | δ_{calc} (1) | δ_{calc} (2) |
|--------------------------------|-----------------------|----------------------------|----------------------------|
| BCl_4^- | -12.2 | -12.2 | -12.2 |
| $\text{BCl}_3(\text{NCS})^-$ | -19.8 | -19.8 | -19.8 |
| $\text{BCl}_2(\text{NCS})_2^-$ | -25.9 | -26.4 | -26.3 |
| $\text{BCl}(\text{NCS})_3^-$ | -31.9 | -32.0 | -31.7 |
| $\text{B}(\text{NCS})_4^-$ | -36.0 | -36.4 | -36.0 |

signal at -13.4 ± 2 p.p.m. and generated a new signal at -38.7 p.p.m., ascribed to $C_6F_5PS(CN)_2$.

All the above thiocyanato-derivatives are probably bonded through nitrogen rather than sulphur, similar to the six-coordinate fluoro-thiocyanato-derivatives (54). This conclusion is supported by the results obtained from a 2:3 molar ratio reaction between $C_6F_5PCl_3BCl_4$ and $Hg(SCN)_2$ in which the i.r. spectrum of the product in $PhNO_2$ showed a broad NCS band with the maxima measured at 2095 and 1905 cm^{-1} . Its ^{31}P n.m.r. spectrum showed 2 signals at 29.1 and 9.8 p.p.m., due to the presence of $C_6F_5PCl(NCS)_2^+$ and $C_6F_5P(NCS)_3^+$.

Using the pairwise calculation method, (66) all the theoretical values of ^{31}P n.m.r. shifts for tetrahedral species can be calculated, as shown in table 6.3. (Details are given in section 6.2.3). Attempts to isolate the thiocyanato-derivatives were not carried out because of the poor solubility of the starting material in methylene chloride and the unstable nature of these compounds, as described above.

6.2.3 PAIRWISE CALCULATIONS.

1) R=Me

In the above calculation, the Cl:Cl term was taken

as 14.5 p.p.m. from the shift of $\text{PCl}_4^+\text{SbCl}_6^-$ (17). This gives the Me:Cl term as 25.8 p.p.m., from the value for MePCl_3^+ . The Cl:NCS and NCS:NCS terms were taken as 3.6 and -3.0(3) p.p.m. from data for other four-coordinate phosphorus (V) systems, (17,29) enabling the Me:NCS term to be evaluated as 18.1 p.p.m. from the shift for $\text{MePCl}(\text{NCS})_2^+$. The shifts for $\text{MePCl}_2(\text{NCS})^+$ and $\text{MeP}(\text{NCS})_3^+$ were then calculated as 91.4 and 45.3 p.p.m. respectively, as shown in column 1 of table 6.3.

Alternatively the Me:NCS term may be derived from the shift of $\text{MeP}(\text{NCS})_3^+$ as 18.13 p.p.m., giving values of 91.5 and 66.3 p.p.m. for the first and second substitutes (column 2). The numerical agreement is less good for $\text{MePCl}_2(\text{NCS})^+$ than for the other species, but there seems little doubt about the peak assignments.

11) R=Ph

A similar treatment applied to the thiocyanato-derivatives of PhPCl_3^+ gives a Ph:Cl term of 19.95 p.p.m. from the shift of $\text{PhPCl}_3^+\text{SbCl}_6^-$. If the Ph:NCS term is taken from the shift of $\text{PhPCl}(\text{NCS})_2^+$ as 12.95 p.p.m., the calculated values for $\text{PhPCl}_2(\text{NCS})^+$ and $\text{PhP}(\text{NCS})_3^+$ are 74.5 and 29.9 p.p.m. respectively (column 1). When the Ph:NCS term is derived as 15.4 p.p.m. from the shift for $\text{PhP}(\text{NCS})_3^+$, the calculated values are 77.0 and 54.9 p.p.m. for $\text{PhPCl}_2(\text{NCS})^+$ and $\text{PhPCl}(\text{NCS})_2^+$ respectively (column 2).

Although the agreement is again moderate, the assignments are straightforward.

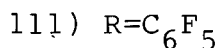

Since the starting material here was $C_6F_5PCl_3^+BCl_4^-$, the Cl:Cl value was taken as 13.9 p.p.m. from the shift of the PCl_4^+ ion (17,29). This gives the $C_6F_5:Cl$ term as 13.5 p.p.m. from the shift of $C_6F_5PCl_3^+BCl_4^-$. The values in column 1 were derived by taking the $C_6F_5:NCS$ term as 4.9 p.p.m. from the shift of $C_6F_5PCl(NCS)_2^+$. Those in column 2 used the value of 5.8 p.p.m. for this term from the shift of $C_6F_5P(NCS)_3^+$. All other terms were used as in the previous systems. The numerical agreement is quite reasonable in this case, and again supports the assignments made in the above table.

When $C_6F_5PCl_3BCl_4$ was used as the starting material, an alternative study was carried out by ^{11}B n.m.r. to investigate the behaviour of the anionic species towards the addition of the thiocyanate salt. The starting material gave one ^{11}B n.m.r. signal at -12.2 p.p.m. in nitromethane, in excellent agreement with the values reported by Landesman (70) and Dillon et al (71).

New signals upfield from the starting material were observed when $AgSCN$ was added to the solution of $C_6F_5PCl_3BCl_4$ in nitromethane. When a small amount of $AgSCN$

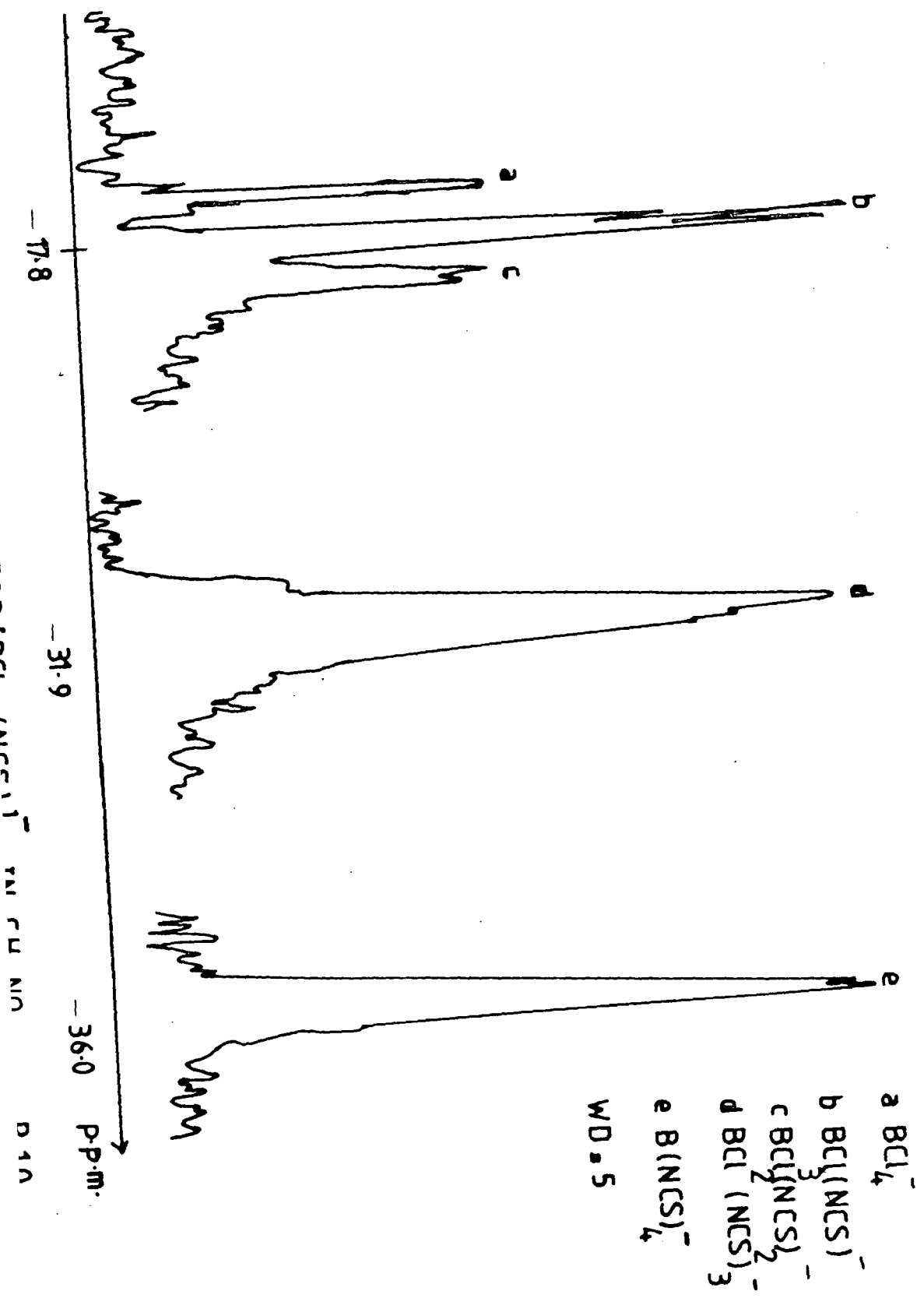

was introduced into the above solution, a new signal at -19.8 p.p.m. was discerned, assigned as the first derivative $\text{BCl}_3(\text{NCS})^-$. This signal split into three peaks with almost the same intensity measured at -18.3, -19.8 and -20.8 p.p.m. with more AgSCN (see fig. 6.1). When more of the SCN^- salt was added, two other signals were observed at -25.9 and -31.9 p.p.m., in which the first signal also split into three peaks at -24.9, -25.9 and -27.4 p.p.m. when the intensity was increased, similar to the behaviour of the first substitute. These signals were identified as $\text{BCl}_2(\text{NCS})_2^-$ and $\text{BCl}(\text{NCS})_3^-$ respectively. Finally, an excess of the SCN^- salt gave a peak at -36.0 p.p.m., which was superimposed on the signal at -31.9 p.p.m. because both signals are broad. When more SCN^- was added, however, it caused the disappearance of the signal at -31.9 and the only resonance was at -36.0 p.p.m. which appeared to be split into two components with the same intensity on a 5 MHz sweep width. This signal was ascribed to the fully-substituted tetrathiocyanatoborate, $\text{B}(\text{NCS})_4^-$ (see fig 6.1). This shift is in excellent agreement with the value reported by Binder (125) for the compound $[(\text{SCN})_3\text{P}:\text{NP}(\text{NCS})_3][\text{B}(\text{NCS})_4]$ ($\delta = -36.5$ p.p.m.), which was prepared by reaction of NH_4SCN with $[\text{Cl}_3\text{P}:\text{NPCl}_3][\text{BCl}_4]$ in methylene chloride. When the ^{31}P n.m.r. spectrum was recorded for the above solution, a signal at -38.7 p.p.m. was obtained, possibly due to $\text{C}_6\text{F}_5\text{P}(\text{S})(\text{CN})_2$, formed as described previously. From the above investigation, it is probable that the fully-substituted compound, $\text{C}_6\text{F}_5\text{P}(\text{NCS})_3^-$

$B(NCS)_4$ is formed, but it is unstable, and easily reverts to decomposition and/or polymerisation products.

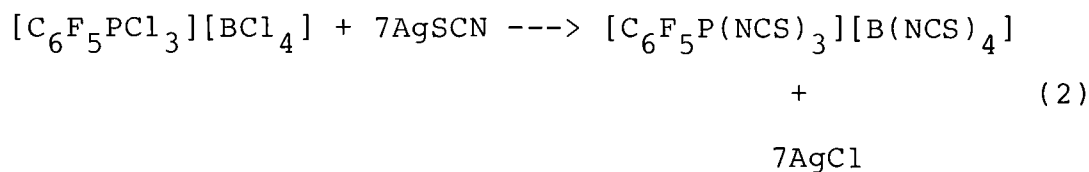

The thiocyanate groups are probably bonded through nitrogen, as in Binder's compound (125) or in $BX_{3-n}(NCS)_n$; X=Br or Cl (126). Table 6.4 shows the ^{11}B chemical shift data for the $[C_6F_5PCl_3][BCl_4]$ and AgSCN system in $MeNO_2$.

Pairwise calculation was carried out using the following values:

1) Set 1

The Cl:Cl term was taken as -2.03 p.p.m. from the BCl_4^- value of -12.17 p.p.m., while the Cl:NCS and NCS:NCS terms were taken as -4.57 and -6.06 p.p.m. from the values of $BCl_3(NCS)^-$ and $BCl(NCS)_3^-$ respectively. Therefore the second and fourth derivatives are calculated to give signals at -26.37 and -36.36 p.p.m., as shown in column 1 of table 6.4. These assumptions gave good agreement for the fully-substituted ion, but slightly less so for the second derivative.



Fig. 6.2

^{10}B N.m.r. spectrum for $\text{BCl}_{4-n}(\text{NCS})_n^-$ ions in CD_3NO_2

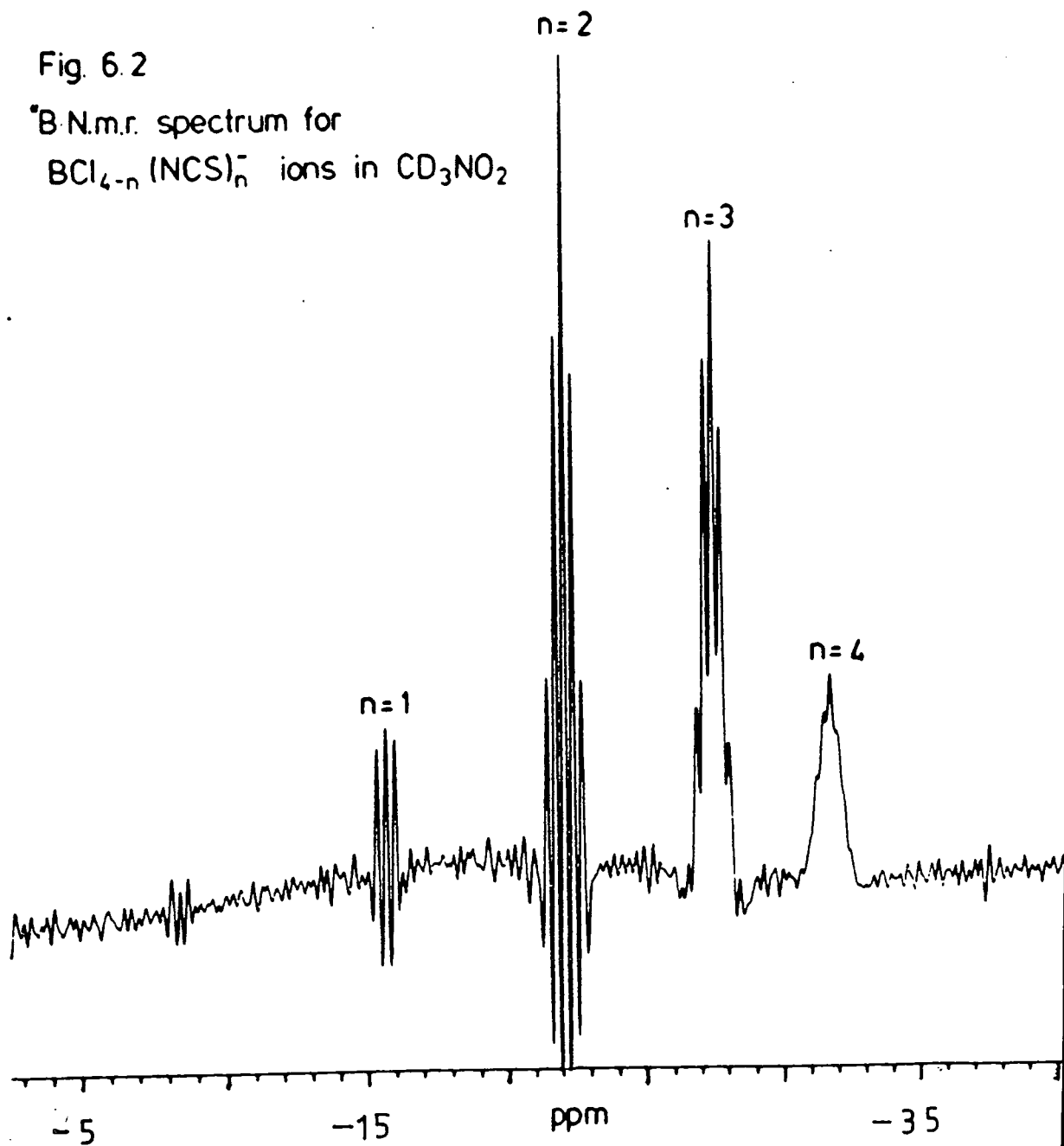

2) Set 2

Alternatively, these values can be calculated by assuming that the signal at -36.0 p.p.m. is from $\text{B}(\text{NCS})_4^-$, so that the NCS:NCS term can be derived as -6.00 p.p.m. The Cl:Cl term was taken as -2.03 p.p.m. from the BCl_4^- value of -12.17 p.p.m. Therefore the Cl:NCS term can be calculated as -4.57 p.p.m. from the $\text{BCl}_3(\text{NCS})^-$ value of -19.8 p.p.m. In this case, the shifts for the second and third derivatives are calculated as -26.31 and -31.71 p.p.m. respectively. These assumptions give slightly better values compared with set 1.

The splitting of the signals observed in this series could arise from $^{11}\text{B}-^{14}\text{N}$ coupling, therefore observation was continued on the high resolution multinuclear spectrometer, type Bruker CD 250, as described in chapter 2. When a solution of $\text{C}_6\text{F}_5\text{PCl}_3\text{BCl}_4$ with a small amount of AgSCN in CD_3NO_2 was placed in this machine, a singlet peak at -9.2 and a 1:1:1 triplet with the components measured at -16.4, -16.8 and -17.1 p.p.m. were observed. These signals were assigned to BCl_4^- and $\text{BCl}_3(\text{NCS})^-$ ions respectively. The coupling constant $^1J_{\text{B-N}}$ was measured as 25.4 Hz (see fig. 6.2). With more AgSCN added to this solution, the parent signal reduced in intensity while the triplet signal increased, with the appearance of the second substituted signal, $\text{BCl}_2(\text{NCS})_2^-$, as a pentet with a coupling constant $^1J_{\text{B-N}}$ 25.7 Hz. These signals were

measured at -22.2, -22.7, -23.2 -23.5 and -24.0 p.p.m. Furthermore, with more AgSCN added, the third substitution product $\text{BCl}(\text{NCS})_3^-$ was discerned as a septet, as shown in figure 6.2, with $^1J_{\text{B-N}}$ 24.6 Hz. It was very difficult to obtain the coupling constant for the $\text{B}(\text{NCS})_4^-$ ion, which is predicted to give nine lines because of ^{11}B - ^{14}N coupling. The resolution become worse as n increased (see fig 6.2). This was presumably caused by the build up of the AgCl and any excess of AgSCN in the tube, which made the signal broad. When the silver salts were filtered, the filtrate did not give any ^{11}B n.m.r. signal. The shifts in general appeared to be slightly to lower field in the deuterated solvent.

Recently, $\text{Et}_4\text{NB}(\text{NCS})_4$ has been isolated from the reaction of Et_4NBCl_4 and an excess of KNCS in CH_2Cl_2 . It gave an ^{11}B shift in CD_2Cl_2 at -36.2 p.p.m. (9 lines, $^1J_{\text{B-N}}$ 23.2 Hz) (127).

6.2.5 ATTEMPTS TO SYNTHESISE $\text{RCl}_{4-n}(\text{NCS})_n$ (R=Me, Ph AND C_6F_5).

Similarly to the behaviour of PCl_5 (29), attempts to make compounds of the above type by direct substitution into RCl_4 (R=Me, Et and C_6F_5) were unsuccessful. In general only decomposition products were detected in solution. PhPCl_4 reacted rapidly with AgSCN, Et_4NSCN or LiNCS in CH_2Cl_2 to give yellow solutions. The ^{31}P n.m.r. spectrum

from the AgSCN reaction showed four new signals at 162.7, 75.8, 35.5 and 29.1 p.p.m., as well as the starting material signal at -45.3 p.p.m. The first three of these were assigned as PhPCl_2 , PhPSCl_2 and PhPS(NCS)_2 respectively, while the signal at 29.1 p.p.m. could be the hydrolysis product, PhPOCl_2 , since it was weaker than the others. (See fig. 6.3). No signal for PhPSCl(NCS) was detected.

The addition of more AgSCN to such a solution only increased the intensity of all the signals except for that of the starting material, and caused the appearance of another signal measured at 0.0 p.p.m., while the colour changed to orange. This signal (0.0 p.p.m.) is probably due to the hydrolysis product PhPO(OH)_2 formed by traces of water present in the tube. It is possible that the compound $\text{PhPCl}_3(\text{NCS})$ is formed initially, but is unstable and follows the PCl_5 decomposition pattern (29), as below:

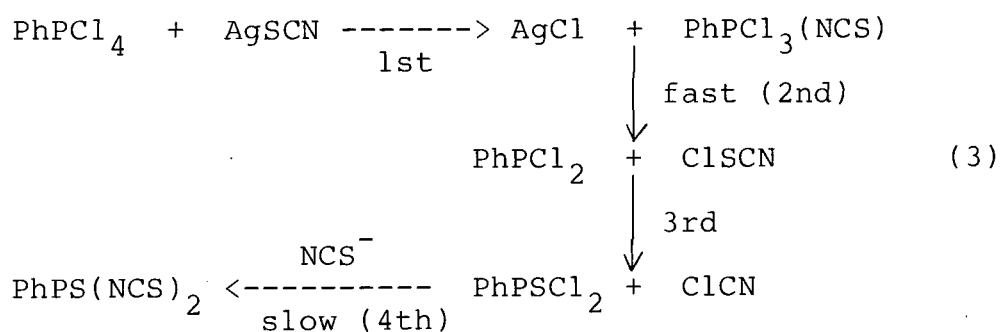

The decomposition occurred very fast, therefore $\text{PhPCl}_3(\text{NCS})$ was not detected in the ^{31}P n.m.r. spectrum. When Et_4NCSN was used, the same pattern of ^{31}P n.m.r.

signals was recorded, but the resonance for the starting material moved upfield because of the presence of the Cl^- ion in solution.

To confirm the above assignments, PhPSCl_2 was reacted with NH_4SCN in an attempt to prepare PhPS(NCS)_2 (63). As soon as NH_4SCN was added to a solution of PhPSCl_2 in acetonitrile, a white precipitate of NH_4Cl was formed; the ^{31}P n.m.r. spectrum showed signals at 53.3 (weak) assigned to PhPSCl(NCS) , and 35.5 (strong) p.p.m. due to PhPS(NCS)_2 , with a medium intensity signal at 75.8 p.p.m. from the starting material, PhPSCl_2 . When more NH_4SCN was added, only one signal at 35.5 p.p.m. was obtained, showing the complete substitution of PhPSCl_2 . Unfortunately, there is no literature ^{31}P value for PhPS(NCS)_2 , even though it is a known compound and its i.r. data have been established (63).

Treatment of PhPSCl_2 with AgSCN or Hg(SCN)_2 in CH_2Cl_2 gave very slow reactions, in which after seven days only weak signals at 54.6 (PhPSCl(SCN)) and 37.1 p.p.m. (PhPS(SCN)_2) were recorded. In contrast, no reaction occurred with Me_3SiSCN . These results confirm that the signal at 35.5 p.p.m. in the reaction of PhPCl_4 with AgSCN is from PhPS(SCN)_2 , and that at 75.8 p.p.m. is due to PhPSCl_2 .

MePCl_4 gave a similar result when treated with

AgSCN in CH_2Cl_2 . No five-coordinate phosphorus (V) thiocyanate species was detected, and only decomposition products were observed. This reaction gave a yellow solution, the ^{31}P n.m.r. of which showed several signals measured as 193.5 (medium), 82.2 (strong), 59.6 (weak), 43.6 (strong) and 40.4 p.p.m. (weak). These signals were easily assigned as MePCl_2 , MePSCl_2 , MePSCl(NCS) , MePS(NCS)_2 and MePOCl_2 respectively. MePOCl_2 normally gives a signal at 42.6 p.p.m., but in this solution the resonance at 40.4 p.p.m. rather than that at 43.6 p.p.m. was assigned to this species because it was weaker than the others. After two weeks, only signals at 79.9 (strong), 35.0 (medium) and 29.1 p.p.m. (weak) were observed. This showed that MePSCl_2 is quite stable in solution for some time. The last two signals were not easy to assign but were probably due to polymeric material.

When MePSCl_2 was reacted with NH_4SCN , signals at 62.2 (MePSCl(NCS)) and 43.6 p.p.m. (MePS(NCS)_2) were observed, with a white precipitate at the bottom of the tube. These two values support the above assignments.

When $\text{C}_6\text{F}_5\text{PCl}_4$ was used as a starting material, signals at 137.1, 9.8 and -69.5 p.p.m. were observed when a small amount of AgSCN was added to a solution of the compound in CH_2Cl_2 . These signals were identified as $\text{C}_6\text{F}_5\text{PCl}_2$, $\text{C}_6\text{F}_5\text{PO(OH)}_2$ and $\text{C}_6\text{F}_5\text{PCl}_4$ respectively. When more AgSCN was added, the intensity of the signal from the starting

material decreased while the other two signals increased in intensity, and two new weak signals were detected at 33.9 ($C_6F_5POCl_2$) and -4.9 p.p.m. These results show that the decomposition pattern (3) for this compound stops at the second step in which $C_6F_5PCl_2$ is produced, but no further reaction occurs between $C_6F_5PCl_2$ and $ClSCN$ to give $C_6F_5PSCl_2$ which normally gives a signal at 30.0 p.p.m. (128). Consequently, no thiophosphoryl derivatives were detected in this system.

These results show that attempts to isolate thiocyanato-derivatives of phosphorus (V), $RPCl_{4-n}(NCS)_n$ ($1 \leq n \leq 4$) were unsuccessful, due to the instability of these compounds under the experimental conditions. However, Burski et al (129) have prepared a few five-coordinate phosphorus (V) thiocyanato-compounds via both oxidative addition of thiocyanogen and ligand substitution, as in the following equations:

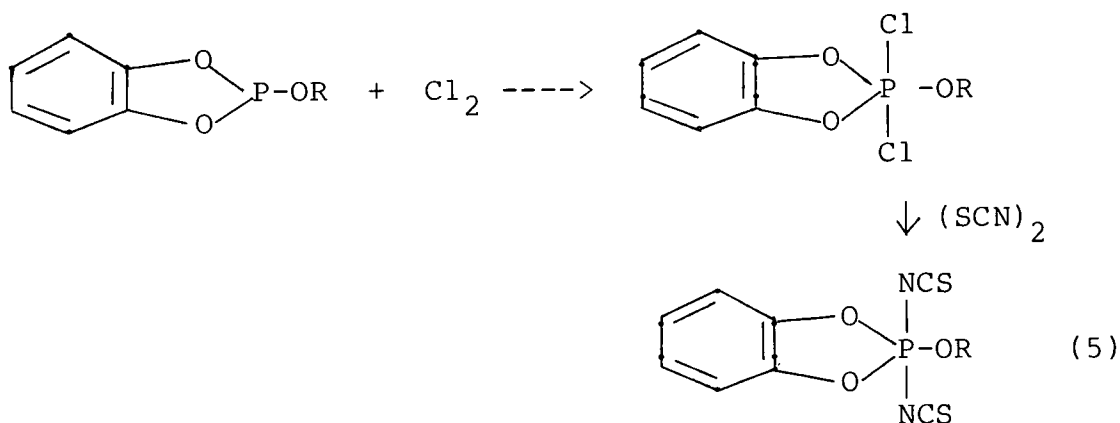
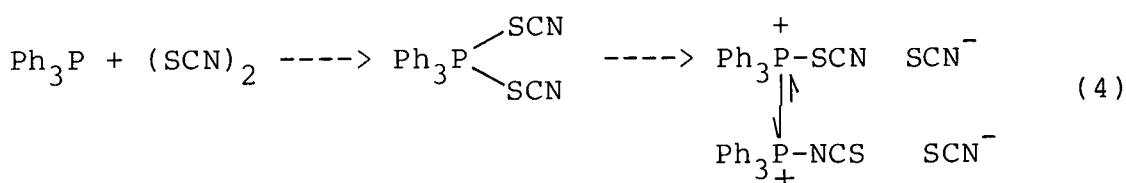

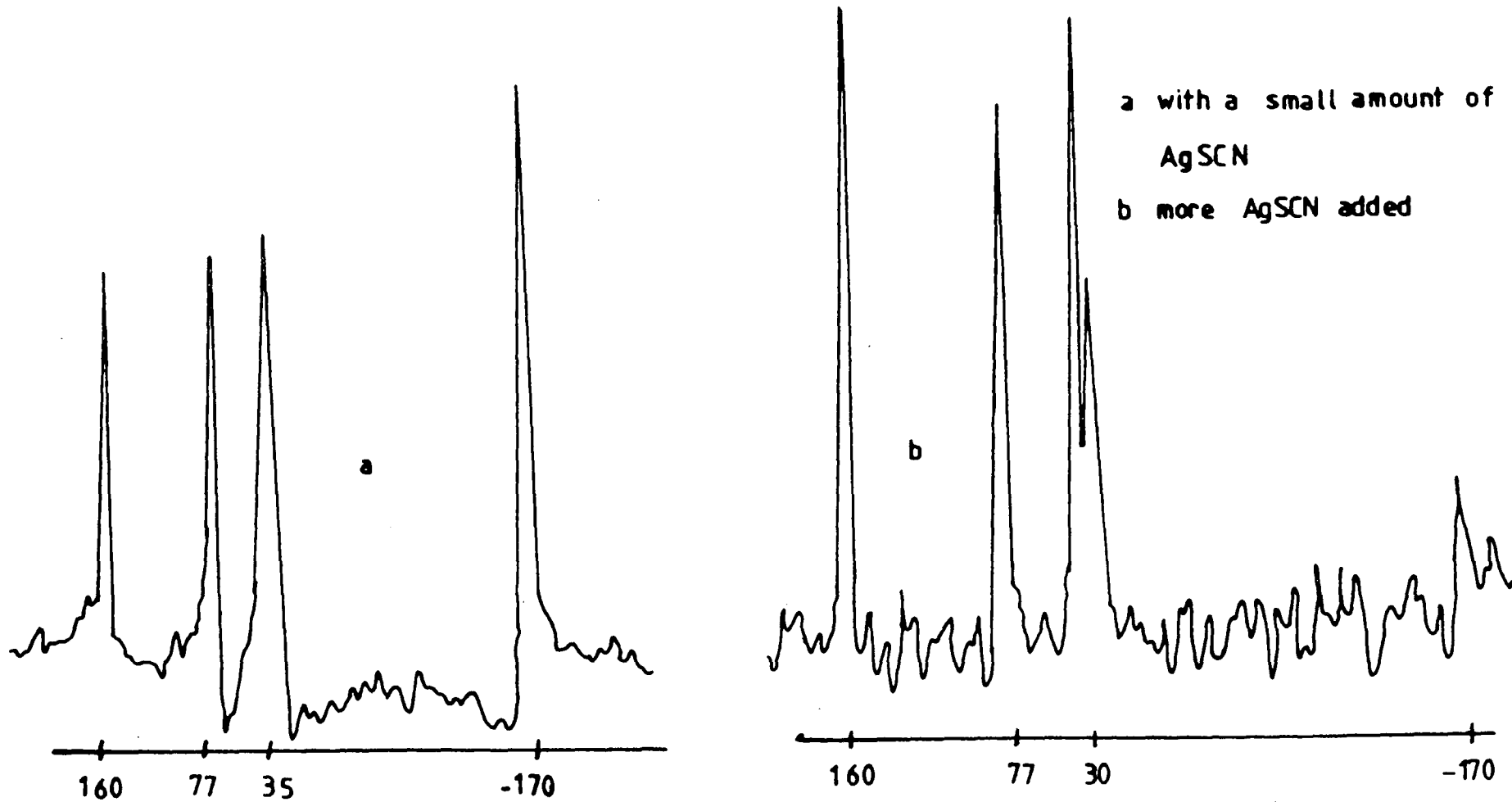

Fig. 6.3: ^{31}P NMR SPECTRA FOR $\text{Et}_3\text{NPhPCL}_2 / \text{SCN}^-$ SYSTEM

The shifts (p.p.m.) of $C_6H_4O_2P(NCS)_2OR$ were $R=Et$, -77; $R=t-Bu$, -41; $R=t-BuCH_2$, -76, while $[Ph_3PNCS][SCN]$ gave a signal at 39 p.p.m. The isothiocyanato phosphonium salts and phosphoranes were only identified spectroscopically.

6.2.6 ATTEMPTS TO SYNTHESISE $RPCl_{5-n}(NCS)_n^-$
($R=Me, Ph, C_6F_5$ and CCl_3).

a) $Et_4NPhPCl_5$.

As for the five-coordinate compounds, attempts to prepare six-coordinate phosphorus (V) anions containing the SCN^- ion were unsuccessful, probably due to their instability at room temperature. Several attempts using different thiocyanate salts ($AgSCN$, NH_4SCN , $LiSCN$ or Et_4NCSN) only gave a series of decomposition products, as described subsequently.

When $Et_4NPhPCl_5$ was used as the starting material in CH_2Cl_2 (this solution was prepared by the addition of Et_4NCl to a $PhPCl_4$ solution until the limiting shift at -173.0 p.p.m. was reached), the addition of a metal thiocyanate only gave signals at 161.3, 77.3, 35.5 and 28.6 p.p.m. (see fig. 6.3). The peak at 161.3 p.p.m. was easily assigned as $PhPCl_2$. The assignment of the other signals was less straightforward, but it seemed probable that this species would follow a similar decomposition pattern to that proposed in section 6.2.5:-

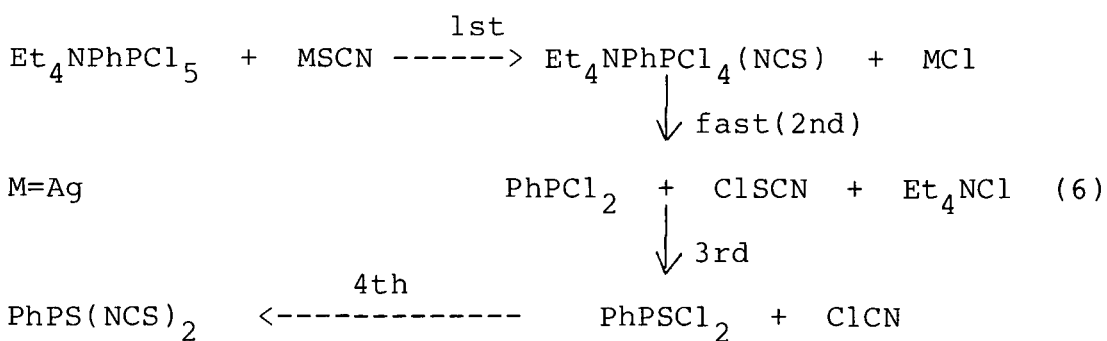

Therefore the signal at 77.3 p.p.m. was assigned as PhPSCl_2 and the signal at 35.5 p.p.m. to PhPS(NCS)_2 . The other peak at 28.6 p.p.m. is thought to be from PhPOCl_2 , due to traces of water in the tube, although the S-bonded isomer PhPS(SCN)_2 cannot be entirely discounted. No evidence has been found for bonding of thiocyanate through S to phosphorus (V) species, however, except for $[\text{Ph}_3\text{PSCN}][\text{SCN}]$ which easily converted to $[\text{Ph}_3\text{PNCS}][\text{SCN}]$ (129). Surprisingly, no signal was detected for PhP(NCS)_2 , the shift of which has been established independently as 88.7 p.p.m. (see table 5.2) (130). Direct substitution only gives N-bonded species. It seems that PhPCl_2 does not react with the excess of NCS^- ions present in the tube, but PhPSCl_2 does so. In direct substitution into PhPSCl_2 (sect. 6.2.5) and PhPCl_2 (sect. 5.1) by AgSCN , PhPCl_2 was found to react faster than PhPSCl_2 , therefore it is just possible that the signal at 77.3 p.p.m. could be due to the S-bonded species PhP(SCN)Cl while the signal at 28.6 p.p.m. could then be for PhP(SCN)_2 and that at 35.5 p.p.m. for PhPOCl_2 , so that the decomposition stops at stage 2.

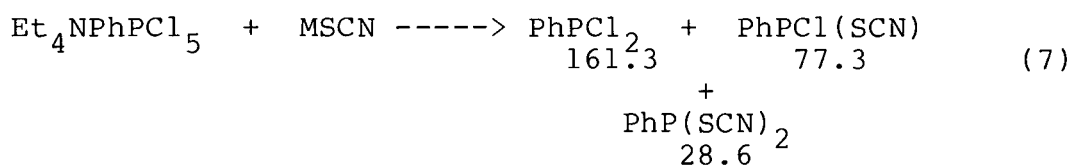

(M=Ag⁺, Li⁺, NH₄⁺ or Et₄N⁺)

When the reaction was repeated using P(NCS)₃, an exchange reaction occurred in which most of the signals from the final products were very similar to those from the AgSCN reaction. These signals were assigned as below:-

Hypothesis a :-

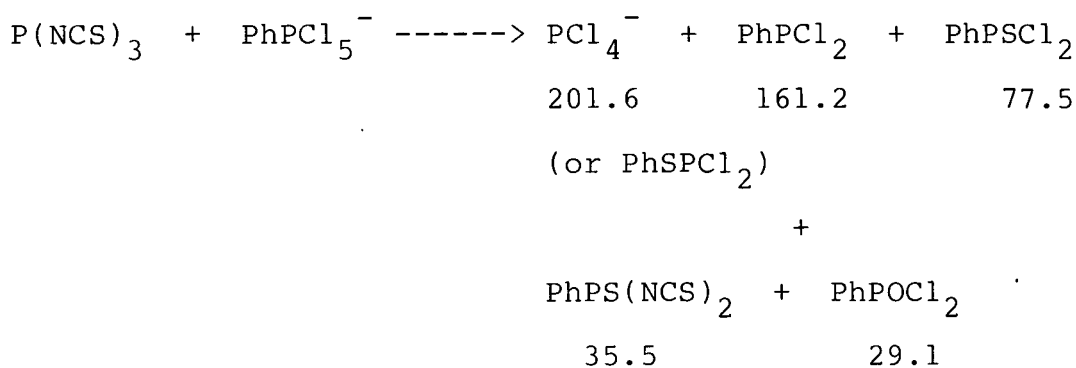

Hypothesis b :-

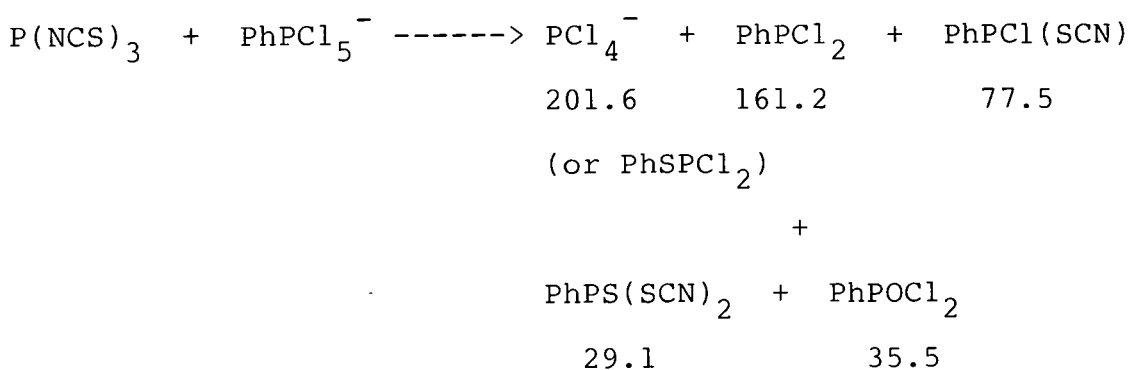

When a small amount of P(NCS)₃ was used, two other signals were observed at 152.0 p.p.m. (PCl₂(NCS)) and 112.0 p.p.m. (PCl(NCS)₂), as well as a PCl₃ resonance at 211 p.p.m.

The addition of more P(NCS)_3 moved this signal (PCl_3) upfield, as high as 201.6 p.p.m. This shift is rather high compared with the reported data for PCl_3 (131), and may arise either from PCl_4^- formation since the Cl^- ion in the mixture may tend to coordinate to PCl_3 , or from the $\text{PCl}_3\text{-NCS}^-$ system (29). Alternatively, the signal at 201.6 p.p.m. could be PhPSCl_2 if insertion occurs at the Ph-P bond as below:-

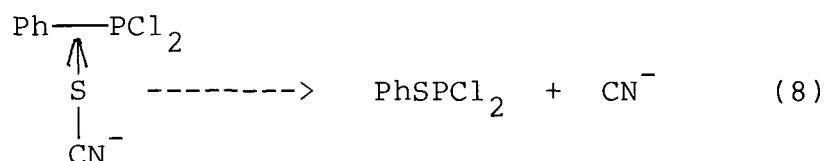

This signal is close to the reported value of 204.2 p.p.m. (131). Like the methyl analogue, this compound will isomerize to give PhP(S)Cl_2 in an Arbuzov rearrangement (132-5).

Several signals were seen and the spectrum was complicated when solid $\text{Et}_4\text{NPhPCl}_5$ was directly added to a P(NCS)_3 solution. A strong signal was observed at -12.0 p.p.m., possibly from PhPO(NCS)_2 , although this appears rather unlikely at first sight, because when PhPOCl_2 was reacted with AgSCN in methylene chloride, the substitution was only completed after overnight stirring, giving a peak at -16.2 p.p.m. The analysis for the yellow liquid isolated was good for the expected compound PhPO(NCS)_2 (see chapter 2). An intermediate signal for PhPOCl(NCS) was recorded at 8.2 p.p.m.

When freshly-made PhP(NCS)_2 was used instead of P(NCS)_3 , this reaction gave a spectrum similar to the spectra obtained using different SCN^- salts. These results show that $\text{PhPCl}_{5-n}(\text{NCS})_n^-$ ($1 \leq n \leq 5$) ions, if present, are not stable and decompose to give phosphorus (III) compounds, which may then undergo further reaction or rearrangement.

b) $\text{Et}_4\text{NMePCl}_5$.

The addition of AgSCN to a solution of $\text{Et}_4\text{NMePCl}_5$ (after the limiting shift was reached) gave new signals measured at 206.4, 195.3, 83.8 and 45.3 p.p.m. Hence the decomposition follows equation 6; the signal at 195.3 p.p.m. was assigned to MePCl_2 while resonances at 83.8 and 45.3 p.p.m. were assigned to MePSCl_2 and MePS(NCS)_2 respectively. The signal at 206.4 p.p.m. is presumably either from MeSPCl_2 , resulting from the sulphur insertion reaction, or from PCl_4^- . The latter seems unlikely in this system since a P-C bond would need to be broken to give PCl_4^- . The detection of MeSPCl_2 strongly supports the conclusion that the decomposition follows equation 6. This compound could rearrange to give MePSCl_2 as below, by the Arbuzov reaction (132-5).

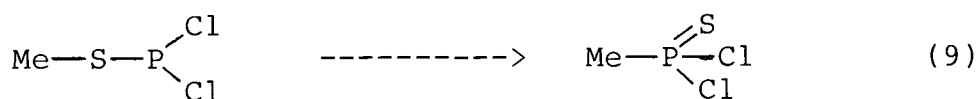

The addition of more AgSCN only increased the intensity of

these signals until all the starting material had reacted. The resonances for MePCl_2 , MePSCl_2 and MeSPCl_2 then started to decline while the intensity of the signal at 45.3 p.p.m. increased when more AgSCN was added. After 21 days, when the solution was reinvestigated, only signals at 83.8 (medium) and 45.1 p.p.m. (strong) were observed, which showed that these compounds were reasonably stable when kept in the fridge.

c) $\text{Et}_4\text{NC}_6\text{F}_5\text{PCl}_5$.

i) Results and discussion.

$\text{Et}_4\text{NC}_6\text{F}_5\text{PCl}_5$ gave a signal upfield from that of the starting material (-240.0 p.p.m.) when a small amount of AgSCN was added in methylene chloride solution, at -260.2 ± 1 p.p.m., with other signals at 135.5 ($\text{C}_6\text{F}_5\text{PCl}_2$) and -11.4 p.p.m. ($\text{C}_6\text{F}_5\text{PO}(\text{OH})_2$). The addition of more AgSCN to the above solution increased the intensity of these signals relative to that of $\text{C}_6\text{F}_5\text{PCl}_5^-$ and gave another resonance at -254.8 p.p.m., but the signal at 135.5 p.p.m. moved upfield to 114.6 p.p.m. Due to the excess of Et_4NCl , $\text{C}_6\text{F}_5\text{PCl}_2$ shows acceptor properties to form $\text{C}_6\text{F}_5\text{PCl}_3^-$ which has a limiting shift of 100.9 p.p.m. (see chapter 5), thus accounting for the upfield movement of the resonance originally at 135.5 p.p.m. The addition of more AgSCN caused the disappearance of the signals in the higher field region and increased the intensity of the decomposition

product resonance at 114.6 p.p.m., as well as generating a new resonance at 35.5 p.p.m. ($C_6F_5POCl_2$) and weaker signals at 61.7 ($C_6F_5P(NCS)_2$), 8.6 ($C_6F_5PS(NCS)_2$), -16.2 ($C_6F_5PO(NCS)_2$) and -38.7 p.p.m. ($C_6F_5PS(CN)_2$). The assignments for the new signals are largely based on the results of Fild for $C_6F_5P(NCS)_2$, which was found to be unstable and readily converted to $C_6F_5PS(NCS)_2$ and $C_6F_5PS(CN)_2$. These compounds were detected at 6.8 and -40 p.p.m. in the ^{31}P n.m.r. spectrum respectively (22).

ii) PAIRWISE CALCULATIONS ON THE $C_6F_5P(NCS)_{5-n}Cl_n^-$ SYSTEM.

The assignments of the six-coordinate thiocyanato-complexes above are based on pairwise calculations. In this system, the first substitution may give two isomeric forms, cis- and trans- $C_6F_5PCl_4(NCS)^-$. For the trans-isomer, there is no $C_6F_5:NCS$ term, therefore the chemical shift for this isomer can be calculated as -229.1 p.p.m., using the $NCS:Cl$, $Cl:Cl$ and $NCS:NCS$ terms of -22.13, -24.85 and -21.81 p.p.m. respectively, taken from the $PCl_{6-n}(NCS)_n^-$ system (52). The $C_6F_5:Cl$ term is taken as -10.3 p.p.m., from the limiting shift of $C_6F_5PCl_5^-$ of -240.0 p.p.m. The calculated value (-229.1) is well below the shift of the first substitute signal observed at -260.2 p.p.m. This signal may thus be reasonably assigned to the cis-isomer, enabling the $C_6F_5:NCS$ term to be evaluated as -38.66 p.p.m. By using the above values, the calculated

Table 6.5: ^{31}P n.m.r. data predicted from pairwise interactions for $\text{C}_6\text{F}_5\text{PCl}_{5-n}(\text{NCS})_n^-$ ions

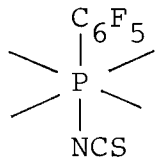
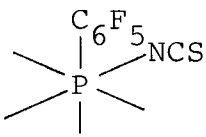
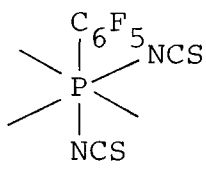
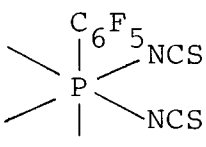
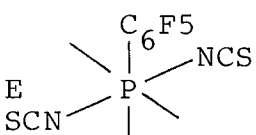
| ion | calculated $\delta^{31}\text{P}$ (p.p.m.) | | experimental $\delta^{31}\text{P}$ (p.p.m.) |
|--|---|--------|---|
| | 1 | 2 | |
| A  | -229.1 | -229.1 | - |
| B  | -260.2 | -254.8 | -260.2 |
| C  | -251.7 | -246.3 | -254.8 |
| D  | -282.8 | -272.0 | - |
| E  | -280.4 | -269.6 | - |

chemical shifts for all the possible mono- and di-thiocyanato-derivatives are listed in column 1 of table 6.5. The signal at -254.8 p.p.m. may then be assigned to isomer C of the disubstituted compound. In column 2, if the signal at -254.8 p.p.m. is ascribed to $\text{cis-C}_6\text{F}_5\text{PCl}_4(\text{NCS})^-$, the $\text{C}_6\text{F}_5:\text{NCS}$ term is evaluated as -33.26 p.p.m. On this basis, however, there is no reasonable assignment for the signal at -260.2 p.p.m. According to these results, the first assumption fits better both numerically and chemically, so that the pattern of substitution is as shown below:

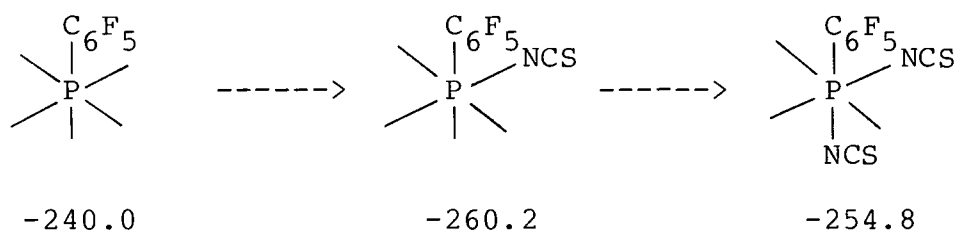

Formation of the cis isomer in the first stage of substitution is also more probable statistically.

d) $\text{Pr}_4\text{NCCl}_3\text{PCl}_5$.

In contrast, $\text{Pr}_4\text{NCCl}_3\text{PCl}_5$ with AgSCN in PhNO_2 gave only CCl_3PCl_2 (148.0 p.p.m.). When AgSCN was added to a $\text{Pr}_4\text{NCCl}_3\text{PCl}_5$ solution in PhNO_2 , (which gave a signal at -196.2 p.p.m.), only one peak at 148.0 p.p.m. was observed, assigned to CCl_3PCl_2 . The addition of more AgSCN caused no immediate change in the spectrum. After two weeks when the

solution was reinvestigated, three other weak signals measured at 75.6, 32.2 and 9.6 p.p.m. were detected, probably due to $\text{CCl}_3\text{PSCl}_2$, $\text{CCl}_3\text{PS}(\text{NCS})_2$ and a polymerisation or hydrolysis product respectively. These results show that the decomposition from $\text{Pr}_4\text{NCCl}_3\text{PCl}_4(\text{NCS})$ to CCl_3PCl_2 occurs very quickly, but the third and fourth stages are very slow compared with the other compounds (R=Me, Ph and C_6F_5).

Among all the four ions RPCl_5^- (R=Me, Ph, CCl_3 and C_6F_5), only the first thiocyanato-derivatives of $\text{C}_6\text{F}_5\text{PCl}_5^-$ were detected in solution. These results suggest that the six-coordinate organophosphorus thiocyanato-species may be stabilised to some extent by introducing electronegative atoms into the phenyl group, although no such stability was found for the electronegative alkyl group CCl_3 .

In contrast, Dillon and Platt (52,54) have reported the full range of thiocyanato-derivatives of $\text{PX}_{6-n}(\text{NCS})_n^-$ (X=Cl and F; $0 \leq n \leq 6$) in solution, and the isolation of compounds containing the ions $\text{P}(\text{NCS})_6^-$, $\text{PF}_5(\text{NCS})^-$ or $\text{mer-PF}_3(\text{NCS})_3^-$ as thermally unstable solids. Therefore the introduction of an organo-group into a six-coordinate phosphorus (V) anion seems to enhance the decomposition of the thiocyanato-derivatives as compared with the relative stability of the hexa-thiocyanato-phosphate ion (29).

6.3 CYANO-DERIVATIVES OF SOME ORGANOPHOSPHORUS (V) COMPOUNDS.

6.3.1 INTRODUCTION.

Several methods of introducing cyano-groups into phosphorus (V) compounds have been reported, as shown below (29,51):

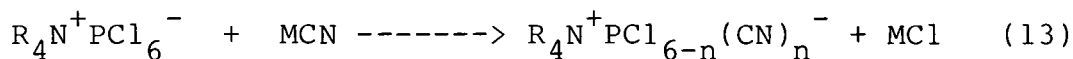
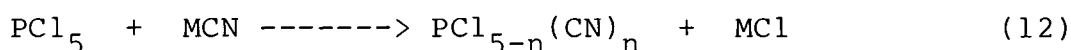
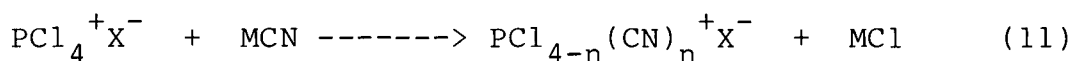

In the second method, when the reaction was carried out in CH_3CN anionic chlorocyanophosphates (V) were obtained, (51) presumably due to the reaction of PCl_5 with solvent to give hexachlorophosphate (136) as shown below:

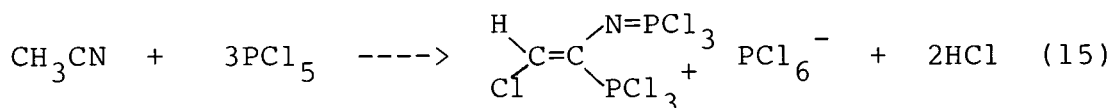

Chevrier and Brownstein (47) prepared $\text{PF}_5(\text{CN})^-$ by reacting PF_5 with cyanide ion. Dillon and Platt (53) have reported the preparation of six-coordinate anions of the types $\text{PF}_{6-n}(\text{CN})_n^-$ ($1 \leq n \leq 4$) and $\text{PF}_3\text{Cl}_{3-n}(\text{CN})_n^-$ ($1 \leq n \leq 3$) by

a variety of routes. Reaction of PF_5 with Et_4NCN in methylene chloride gave $\text{PF}_5(\text{CN})^-$ and PF_6^- , while PF_3Cl_2 under similar conditions yielded an isomeric mixture of $\text{PF}_3\text{Cl}_2(\text{CN})^-$ ions. The compounds $\text{Et}_4\text{NPF}_3\text{Cl}_{3-n}(\text{CN})_n$ ($1 \leq n \leq 2$) have been isolated and their ^{31}P n.m.r. spectra recorded. The cationic species $[\text{PBr}_{4-x-y}\text{Cl}_x(\text{CN})_y]^+$ ($0 \leq x \leq 4$; $0 \leq y \leq 4$) have also been reported (17). Deng (20,56-7) has extended this research by introducing an organo-group into the phosphorus (V) compound and several complexes of the types $\text{RCl}_{5-n}(\text{CN})_n^-$; $\text{R}=\text{Me}$, $0 \leq n \leq 5$ and $\text{R}=\text{Ph}$; $0 \leq n \leq 3$ have been identified in solution. $[\text{Et}_4\text{N}][\text{PhPCl}_2(\text{CN})_3]$ and $[\text{Et}_4\text{N}][\text{Me-P}(\text{CN})_5]$ have been isolated and their ^{31}P n.m.r. recorded (20,56-7).

6.3.2 CYANO-DERIVATIVES OF RCl_3^+X^- ($\text{R}=\text{Me}$, Ph AND C_6F_5 ; $\text{X}=\text{SbCl}_6$ AND BCl_4).

When silver cyanide was added to a solution of $\text{MePCl}_3\text{SbCl}_6$ in nitromethane, upfield signals were observed in the ^{31}P n.m.r., measured at 62.9, 46.7 and 16.2 p.p.m. The signals were assigned as $\text{MePCl}(\text{CN})_2^+$, $\text{MeP}(\text{CN})_3^+$ and $\text{MePOCl}(\text{CN})$ (20) respectively. This assignment was based on comparison with the azido-analogues (20,19). The possibility of the signal at 46.7 p.p.m. being due to MePOCl_2 cannot be entirely discounted, however. The first substitute, $\text{MePCl}_2(\text{CN})^+$, was not observed in the above experiment, but is expected to give a signal between those of MePCl_3^+ and $\text{MePCl}(\text{CN})_2^+$.

Table 6.6: $\delta^{31}\text{P}$ (p.p.m.) for $\text{MePCl}_{3-n}(\text{CN})^+$ derivatives.

| Compound | δ obs | δ calc 1 |
|-------------------------------|--------------|-----------------|
| MePCl_3^+ | 120.9 | 120.9 |
| $\text{MePCl}_2(\text{CN})^+$ | - | 89.3 |
| $\text{MePCl}(\text{CN})_2^+$ | 62.9 | 62.9 |
| $\text{MeP}(\text{CN})_3^+$ | 46.7 | 41.6 |

Table 6.7: $\delta^{11}\text{B}$ (p.p.m.) for $\text{C}_6\text{F}_5\text{PCl}_3^+\text{BCl}_{4-n}(\text{CN})_n^-$ derivatives.

| n | δ obs 1 | δ obs 2 | δ cal 1 | δ calc 2 |
|---|----------------|----------------|----------------|-----------------|
| 0 | -10.7 | -12.2 | -10.68 | -10.68 |
| 1 | - | -14.2 | -13.89 | -14.19 |
| 2 | -17.8 | -18.3 | -17.75 | -18.25 |
| 3 | -21.8 | -22.3 | -22.26 | -22.86 |
| 4 | -27.4 | - | -27.42 | -28.02 |

a=AgCN/CH₃NO₂

b=Zn(CN)₂/PhNO₂

Calc. 1: Cl:Cl=-1.78 p.p.m. from BCl_4^- (-10.65 p.p.m.).

CN:CN=-4.57 " " $\text{B}(\text{CN})_4^-$.

CN:Cl=-2.85 " " $\text{BCl}_2(\text{CN})_2^-$.

Calc. 2: Cl:Cl=-1.78 " " BCl_4^- .

CN:CN=-4.67 " " $\text{BCl}_2(\text{CN})_2^-$.

CN:Cl=-2.95 " " $\text{BCl}_3(\text{CN})^-$.

An attempt to isolate the fully-substituted cyano-compound $\text{MeP}(\text{CN})_3^+\text{SbCl}_6^-$ failed. When an excess of AgCN was added to a solution of $\text{MeP}(\text{CN})_3\text{SbCl}_6$ in PhNO_2 , which was stirred overnight, the mixture only gave a broad signal with the maximum measured at 37.8 p.p.m. After the solvent was removed by vacuum distillation, a brown sticky liquid was isolated, which gave resonances superimposed on each other at 35.4 (medium), 25.7 (strong) and 17.7 (medium) p.p.m. No $\text{MeP}(\text{CN})_3^+$ signal was observed, so presumably it was thermally unstable, possibly decomposing to give the signals at 35.4 and 25.7 p.p.m. These deductions were supported by the elemental analysis which gave a slightly high carbon and hydrogen content but a very low nitrogen content. (Found: C=12.30, H=3.20, N=3.70%; calculated: C=10.46, H=0.65, N=9.16%).

The pairwise calculated values are listed in table 6.6. In set 1, CN:CN was taken as -6.98 p.p.m. from the $\text{P}(\text{CN})_4^+$ shift of 41.9 p.p.m. (29). The Cl:CN term was derived from $\text{PCl}_3(\text{CN})^+$ as 0.86 p.p.m. and Cl:Cl was taken as -13.87 p.p.m. from PCl_4^+ (17,29). From the $\text{MeP}(\text{CN})_3^+$ shift of 120.9 p.p.m., the Me:Cl term can be calculated as 26.43 p.p.m. If $\text{MeP}(\text{CN})_2^+$ is assumed to give the signal at 62.9 p.p.m., the Me:CN term can be calculated as 20.86 p.p.m., enabling the shifts of the first and third substitutes to be calculated as 89.3 and 41.6 p.p.m. respectively.

The calculated value for $n=3$ is a few p.p.m. away from the observed value, while no comparison can be made for $n=1$ because this signal was not observed in the above experiment.

In contrast, $C_6F_5PCl_3BCl_4$ or $PhPCl_3SbCl_6$ did not give new signals when a small amount of AgCN was added to their solutions in either nitromethane or nitrobenzene. With more AgCN added, only one signal at 14.5 and 38.7 p.p.m. for $C_6F_5PCl_3^+$ and $PhPCl_3^+$ respectively was observed, possibly due to the decomposition products $C_6F_5POCl(CN)$ and $PhPOCl_2$. These results were unexpected, so an investigation on the anion was carried out, using a $C_6F_5PCl_3BCl_4$ solution in nitromethane as the reactant. When a small amount of AgCN was added to this solution and the ^{11}B n.m.r. was immediately recorded, new signals upfield from that of the starting material were observed, at -17.8 and -21.8 p.p.m. With an excess of AgCN, only one signal at -27.4 p.p.m. was detected. These signals were assigned to $BCl_2(CN)_2^-$, $BCl(CN)_3^-$ and $B(CN)_4^-$ respectively, in good agreement with the values of Landesman and Williams (70). The first derivative, $BCl_3(CN)^-$ was not identified in this system, but a signal was observed when $Zn(CN)_2$ was used as the reagent in nitrobenzene solution. In this system, the reaction stops at $n=3$ only. The ^{31}P n.m.r. spectrum of this solution was recorded, but it only gave one signal at 14.5 p.p.m. Table 6.7 shows the ^{11}B n.m.r. chemical shifts for

$C_6F_5PCl_3^+BCl_{4-n}(CN)_n^-$ derivatives.

From the above calculation, set 1 gives better overall agreement with the experimental results than set 2.

6.4.0 CYANO-DERIVATIVES OF R'_4NRPCl_5 (R=Et,
R'=n-Pr; R=C₆F₅, R'=Et or n-Pr;
R=CCl₃, R'=n-Pr).

6.4.1 CYANO-DERIVATIVES OF $R_4NC_6F_5PCl_5$ (R=Et
OR n-Pr).

a) PREPARATION OF THE COMPLEXES AND DISCUSSION
OF THE RESULTS.

The introduction of AgCN into a solution of $Pr_4NC_6F_5PCl_5$ in methylene chloride gave several signals upfield from that of the parent compound. In a qualitative reaction, Pr_4NCl was added to a $C_6F_5PCl_4$ solution in methylene chloride until the limiting shift was reached, measured at -240.0 p.p.m. (see fig. 3.1). When a small amount of AgCN was added to this solution, no change in colour was observed but the ^{31}P n.m.r. spectrum showed a new signal at -277.3 p.p.m., assigned as one of the isomers of $Pr_4N^+C_6F_5PCl_4(CN)^-$. This result showed that a substitution reaction had occurred between the halogen and the cyanide. The addition of more AgCN to this solution gave an orange colour, and the ^{31}P n.m.r. spectrum showed

three other new signals at -303.0, -307.0 and -315.9 p.p.m. These signals were attributed to the presence of the three isomers of the second substitution product, where $n=2$ in the formula $C_6F_5PCl_{5-n}(CN)_n^-$. These assignments were strongly supported by the appearance of another four signals when more AgCN was added to the above solution, measured at -328.8, -332.0, -338.6 and -341.6 p.p.m. These signals were assigned to the presence of three isomers for $n=3$, and only one isomer for $n=4$ in the above formulation. An excess of AgCN only gave a strong signal at -341.6 p.p.m., and it was believed that the substitution had stopped at $n=4$. To prove this assignment, quantitative reactions were carried out in 1:2, 1:3 and 1:5 ratios as described subsequently.

When a 5:1 ratio reaction of AgCN:Pr₄NC₆F₅PCl₅ in methylene chloride was carried out, after an hour a purple suspension had formed. After filtration to remove silver salts and evaporation to dryness in vacuo, a fine white solid was isolated. The ³¹P n.m.r. spectrum was recorded before evaporation to give a signal at -340.0 p.p.m., but when the white solid was redissolved in PhNO₂, a strong signal at -341.6 p.p.m. was observed. Its solid state n.m.r. spectrum showed a broad signal with the maximum measured at -341.0 p.p.m. The carbon and nitrogen analyses of this solid suggested that the compound was the 3:1 product, $C_6F_5PCl_2(CN)_3^-$ rather than the 4:1 or 5:1 ions, but the phosphorus, hydrogen and chlorine analyses were

reasonable for the 4:1 ratio product. (Found: C=47.82, H=5.43, N=9.13, P=5.87, Cl=5.50%; required for 3:1 product: C=47.28, H=5.25, N=10.51, P=5.82, Cl=13.32%; required for 4:1 product: C=50.43, H=5.35, N=13.37, P=5.92, Cl=6.78%; required for 5:1 product: C=53.70, H=5.45, N=16.34, P=6.03, Cl=0.0%).

This apparent anomaly was probably due to the stability of one of the CN groups attached to phosphorus, which was not completely combusted during the analysis. To test the stability of the compound, the solution containing the above material was exposed to the air overnight and the ^{31}P n.m.r. spectrum was recorded the next day. Not surprisingly, no other signal was observed in the lower field region. Even after five drops of water were added to this solution, the spectrum showed the same signal at -341.6 p.p.m. This evidence shows that the four CN groups attached to phosphorus prevent attack on the molecule to give a hydrolysis product, such as $\text{C}_6\text{F}_5\text{PO}(\text{CN})_2$, $\text{C}_6\text{F}_5\text{PO}(\text{CN})-\text{(OH)}$ or $\text{C}_6\text{F}_5\text{PO}(\text{OH})_2$, on the assumption that Cl would hydrolyse more readily than CN.

These properties are presumably due to the effects of the CN groups, which are the highest in the spectrochemical series of all the common ligands, therefore the separation between the t_{2g} and e_g orbitals in the complex is expected to be larger than for other ligands (29,52). As a result the vacant 3d t_{2g} orbitals on phosphorus will be

Table 6.8: $\delta^{31}\text{P}$ (p.p.m.) for

| $[\text{Pr}_4\text{N}][\text{C}_6\text{F}_5\text{PCl}_{5-n}(\text{CN})_n]$ in CH_2Cl_2 . | | | | | |
|--|--------|--------|---------|---------|--------|
| n | 0 | 1 | 2 | 3 | 4 |
| δ | -240.0 | -277.3 | -303.0a | -328.8* | -341.6 |
| | | | -307.0 | -332.0 | |
| | | | -315.9* | -338.6a | |

a: identified in a qualitative reaction.

*: more abundant isomer.

Table 6.9: Infrared data for $\text{R}_4\text{N}[\text{C}_6\text{F}_5\text{PCl}_{5-n}(\text{CN})_n]$ in the region (800-200) cm^{-1} .

| Compound | i.r. data |
|---|---|
| $\text{Pr}_4\text{NC}_6\text{F}_5\text{PCl}_5$ | 800m, 630m, 485m, 570s, 550s, 490s, 450sh, 420s,br, 405s, 355s. |
| $\text{Pr}_4\text{NC}_6\text{F}_5\text{PCl}_3(\text{CN})_2$ | 765m, 760w, 750m, 655sh, 645m, 640sh, 595s, 570s, 555s, 515s, 475s, 450sh, 440sh, 430 , 419sh, 390m, 370s, 340s, 280sh. |
| $\text{Pr}_4\text{NC}_6\text{F}_5\text{PCl}_2(\text{CN})_3$ | 765m, 758m, 640s, 610sh, 593s, 570s, 520m, 490s, 465w, 445sh, 440m, 420m, 370w, 340w, 320w, 305w. |
| $\text{Pr}_4\text{NC}_6\text{F}_5\text{PCl}(\text{CN})_4$ (5:1) | 765m, 760m, 645s, 610s, 595s, 570s, 540m, 482m, 460w, 440m, 340sh, 330m. |
| $\text{Et}_4\text{NC}_6\text{F}_5\text{PCl}(\text{CN})_4^*$ (>5:1 ratio) | 545s, 520w, 500m, 485m, 468s, 450s, 393s. |

*: recorded in CH_2Cl_2 solution (KBr cell); others were recorded as Nujol mulls using CsI/polythene plates.

lowered in energy, enabling them to take part in π bonding by donation from a filled orbital on a CN or Cl group. This effect will strengthen the P-X bonds toward hydrolysis, as observed above. On this basis, the identification of the solid was made from the phosphorus and chlorine analyses which were reasonable for the 4:1 ratio product $[\text{Pr}_4\text{N}][\text{C}_6\text{F}_5\text{PCl}(\text{CN})_4]$.

The infrared spectrum was recorded as a Nujol mull and the CN stretch was observed as a medium intensity band at 2180 cm^{-1} . The rest of the bands are listed in table 6.9.

Confirmation of the above conclusion was achieved by repeating the experiment, using a salt of a different cation. Instead of Pr_4NCl , Et_4NCl was used, and an excess of AgCN was added to a solution of $[\text{Et}_4\text{N}][\text{C}_6\text{F}_5\text{PCl}_5]$. After the reaction mixture was allowed to stir overnight, a pink solution formed. Its ^{31}P n.m.r. spectrum showed one signal at -340.0 p.p.m. The reaction is summarised below:

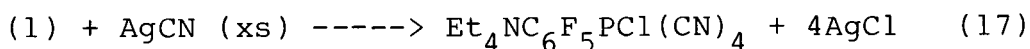
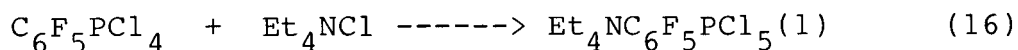

A dark red solid was isolated from this reaction, which gave a signal at -341.7 p.p.m. in PhNO_2 . It, too, was stable to hydrolysis and after five drops of water had been added to this solution the spectrum remained unchanged.

The elemental analyses were reasonable for a 4:1 compound rather than 3:1, thus confirming that the compound is $[\text{Et}_4\text{N}][\text{C}_6\text{F}_5\text{PCl}(\text{CN})_4]$. The mass spectrum of this product was also recorded. No information was obtained on electron impact bombardment, probably due to the ionic nature of the compound. When fast atomic bombardment (FAB) was applied to this sample, which was dissolved in 2,2'-thiodiethanol (TDE), a non-volatile solvent, a molecular ion with m/e 467 was observed as a weak signal. This peak was assigned to the $[\text{Et}_4\text{N}][\text{C}_6\text{F}_5\text{PCl}(\text{CN})_4]$ molecular ion. The fragmentation pattern for $\text{C}_6\text{F}_5\text{PCl}(\text{CN})_4^-$ was very difficult to study since it was superimposed on the solvent fragmentation pattern as well as that of the cationic species.

Deng (20,56,57) performed a similar experiment using $\text{Et}_4\text{NPhPCl}_5$ as the starting material. He found that the substitution stopped at $n=3$ and the compound $\text{Et}_4\text{NPhPCl}_2(\text{CN})_3$ was isolated from both 5:1 and 3:1 ratio reactions of $\text{AgCN}:\text{Et}_4\text{NPhPCl}_5$. From these results, it appears that the fluorine substituents in the benzene ring activate the phosphorus atom towards further substitution. This could be due to steric effects; C_6F_5 is larger than C_6H_5 , hence formation of the six-coordinate species could be hindered and dissociation of it favoured. In this system, substitution reaction are expected to proceed via 5- rather than 7-coordinate intermediates, i.e. via dissociation. While a more electronegative group makes the phosphorus more positive, thus strengthening the bonding in the six-coordi-

nate anion and making it resistant to substitution (cf Ph or CCl_3 vs Me or Et), the presence of a bulky group such as C_6F_5 may expedite the loss of the sixth ligand necessary to give further substitution.

Similarly, Dillon and Platt (52) isolated the mer-isomer of $[\text{PCl}_3(\text{CN})_3]^-$ from the isomeric mixture obtained from 4:1 and 6:1 ratios of $\text{AgCN}:\text{PCl}_6^-$. Both isomers of $[\text{PCl}_3(\text{CN})_3]^-$ were very resistant to further substitution or hydrolysis, although $\text{trans-}[\text{PCl}_2(\text{CN})_4]^-$ was identified in one fortuitous reaction between Et_4NPCl_6 and the excess of AgCN used to prepare $\text{mer-}[\text{PCl}_3(\text{CN})_3]^-$ (52). The elemental analyses of this product indicated that $[\text{PCl}_2(\text{CN})_4]^-$ ions were present. The great stability of $[\text{PCl}_3(\text{CN})_3]^-$ has been rationalised in a similar manner to that described above for $[\text{C}_6\text{F}_5\text{PCl}(\text{CN})_4]^-$.

An approximately 2:1 ratio reaction of $\text{AgCN}:\text{Pr}_4\text{N-C}_6\text{F}_5\text{PCl}_5$ afforded both $[\text{C}_6\text{F}_5\text{PCl}_3(\text{CN})_2]^-$ and $[\text{C}_6\text{F}_5\text{PCl}_2(\text{CN})_3]^-$ ions in the same solvent. The ^{31}P n.m.r. of the product in PhNO_2 showed signals at -311.1 and -317.5 p.p.m., assigned to two isomers of $[\text{C}_6\text{F}_5\text{PCl}_3(\text{CN})_2]^-$ as the major components, with two other signals at -328.8 and -332.0 p.p.m., assigned to isomers of $[\text{C}_6\text{F}_5\text{PCl}_2(\text{CN})_3]^-$. No evidence for $[\text{C}_6\text{F}_5\text{PCl}_4(\text{CN})]^-$ was obtained, because the amount of AgCN added was in slight excess of the quantity required for a 2:1 reaction (see experimental section).

Similarly a 3:1 ratio reaction of AgCN: $C_6F_5PCl_5^-$ gave a mixture of $[C_6F_5PCl_2(CN)_3]^-$ and $[C_6F_5PCl(CN)_4]^-$, for which signals were found at -328.8 and -332.0 p.p.m. as major products, together with a weak signal at -340.0 p.p.m., due to the slight excess of AgCN used. It therefore seems highly improbable that the pure 3:1 and 2:1 compounds can be isolated. Table 6.8 shows the cyano-derivatives of $[Pr_4N][C_6F_5PCl_{5-n}(CN)_n]$ and their ^{31}P n.m.r. data.

The analyses of the 2:1 and 3:1 products both gave rather low chlorine, presumably due to the mixture as mentioned above (see expt. sect.). Their infrared spectra which were recorded as Nujol mulls exhibited a medium intensity broad CN band at 2180 cm^{-1} , except for $[Et_4N][C_6F_5PCl(CN)_4]$, the spectrum of which was recorded in CH_2Cl_2 . A sharp strong band was observed at 2180 cm^{-1} , with other weaker absorptions at 2150, 2130 and 2030 cm^{-1} . Other bands below 800 cm^{-1} are recorded in table 6.9.

b) PAIRWISE CALCULATIONS.

^{31}P chemical shifts of the derivatives $[C_6F_5PCl_{5-n}(CN)_n]^-$ can be calculated via the approximation of pairwise additivity, according to the method of Vladimiroff and Malinowski (66). In an octahedral species, there are 12 cis interactions between the different ligands which

Table 6.10: $\delta^{31}\text{P}$ (p.p.m.) data calculated from pairwise interactions for $[\text{C}_6\text{F}_5\text{PCl}_{5-n}(\text{CN})_n]^-$ ions.

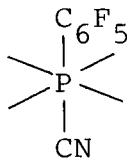
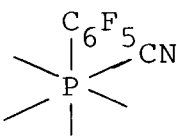
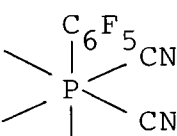
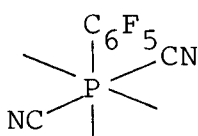
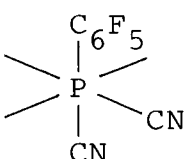
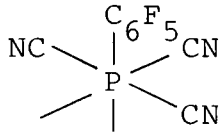
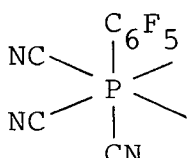
| ion | calculated $\delta^{31}\text{P}$ | | | Expt. $\delta^{31}\text{P}$ | |
|-----|---|--------|--------|--------------------------------|--------|
| | 1 | 2 | 3 | | |
| A |  | -249.6 | -249.6 | -249.6 | - |
| B |  | -277.3 | -258.5 | -274.3 | -277.3 |
| C |  | -322.0 | -284.4 | -315.9 | -315.9 |
| D |  | -314.6 | -277.0 | -308.5 | -307.0 |
| E |  | -294.0 | -275.2 | -291.0 | -303.0 |
| F |  | -366.6 | -310.2 | -357.5 | -338.6 |
| G |  | -346.0 | -308.4 | -340.0 | -332.0 |

| | | | | | |
|---|--|--------|--------|--------|---------|
| H | | -338.7 | -301.1 | -332.6 | -328.8* |
| I | | -418.6 | -343.4 | -406.5 | - |
| J | | -398.0 | -341.6 | -388.9 | -341.6 |

* most abundant isomer

surround the central atom. If in the compound under investigation there are three different ligands, C_6F_5 , Cl and CN, and only one C_6F_5 group, five possible types of interaction are possible between the three different unidentate ligands, denoted as A (C_6F_5), B and C respectively (A:B, A:C, B:B, B:C and C:C). In $trans-C_6F_5PCl_4(CN)^-$, however, there are only three types of interactions, i.e. Cl:Cl, $C_6F_5:Cl$, and CN:Cl. The Cl:Cl term was calculated from the well-known chemical shift of PCl_6^- as -24.85 p.p.m., on the assumption that terms can be transferred from one octahedral complex to another. The $C_6F_5:Cl$ term was similarly evaluated as -10.3 p.p.m. from the limiting shift of $C_6F_5PCl_5^-$ at -240.0 p.p.m. and the CN:Cl term was taken as -27.19 p.p.m. from the $PCl_{6-n}(CN)_n^-$ series (52). From these three values, the chemical shift for the trans isomer of $C_6F_5PCl_4(CN)^-$ can be calculated as -249.4 p.p.m. The observed spectrum did not show a signal close to this value, suggesting that no trans isomer was formed. This evidence is in good agreement with the statistical pattern, which predicts the formation of only 20% of the trans isomer compared with 80% of the cis isomer (see fig. 6.4). If the first signal observed is assigned to the cis isomer, the $C_6F_5:CN$ term can be evaluated as -40.58 p.p.m. and if the CN:CN term is taken as -36.88 p.p.m. from the $PCl_{6-n}(CN)_n^-$ series (52), the shifts for all possible isomeric forms can be calculated, as shown in column 1 of table 6.10.

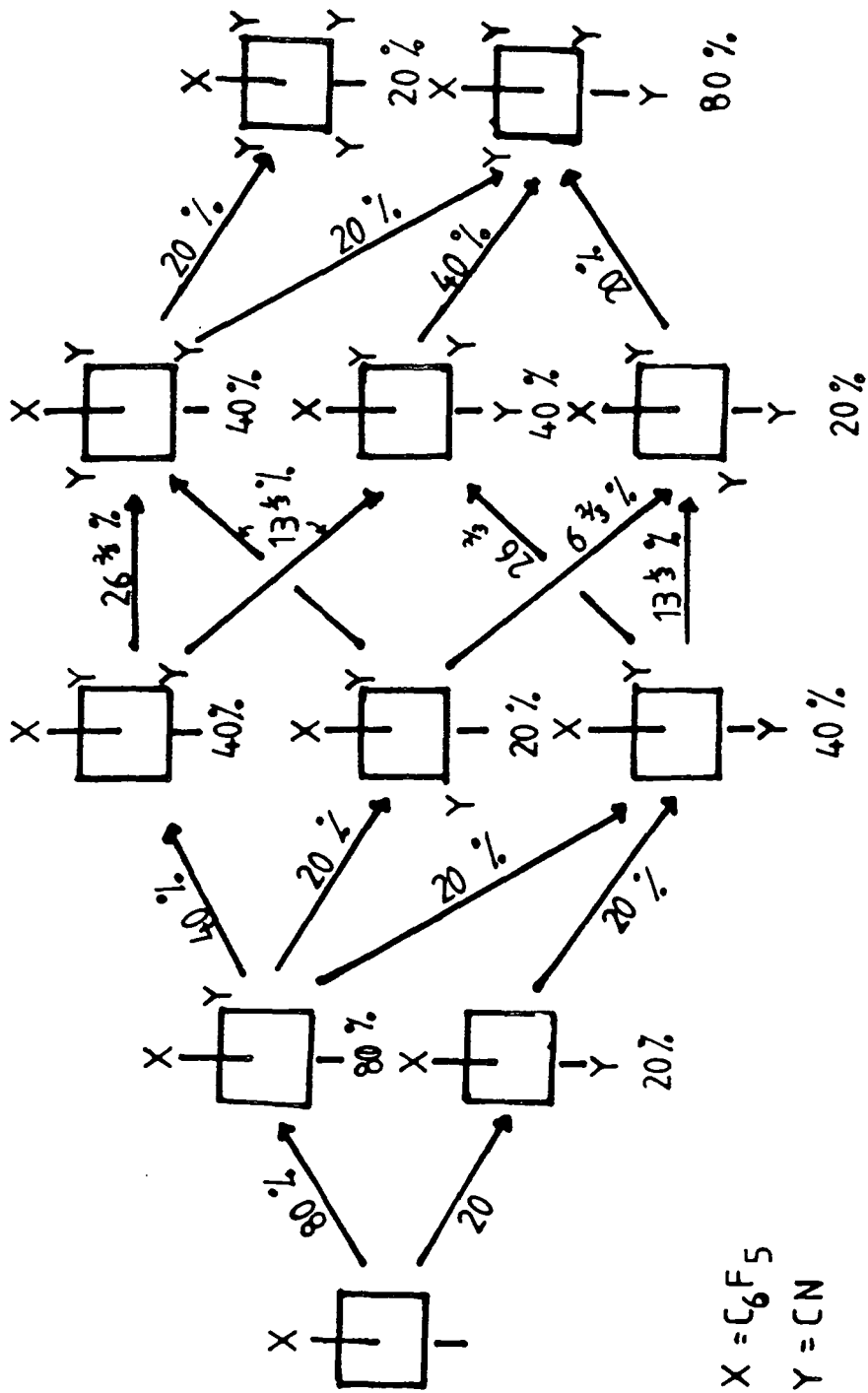

Fig. 6.4 : STATISTICAL PATTERN OF SUBSTITUTION IN THE $C_6F_5PCl_5/CN^-$ SYSTEM

If the $C_6F_5:CN$ term is taken from the most probable isomer present for $C_6F_5PCl(CN)_4^-$ i.e. the cis isomer, it can be calculated as -21.78 p.p.m. and column 2 gives all the chemical shifts calculated on this basis. If this term is derived as -37.55 p.p.m. from the shift of the most abundant isomer of $[C_6F_5PCl_3(CN)_2]^-$ which is taken as the one with both CN groups cis to each other and to the C_6F_5 group, the values in column 3 result.

As expected, the calculated values are not in good agreement with the observed values. This has also been observed for the $PCl_{6-n}(CN)_n^-$ series and for the fluoro-analogues containing the cyano-group (52,53), as well as for the complexes $RPCl_{5-n}(CN)_n^-$; $R=Me$, $0 \leq n \leq 5$ and $R=Ph$, $0 \leq n \leq 3$ (20,56,57). The discrepancies may arise from distortion of the (assumed) regular octahedral geometry. From the above data, set 1 diverges from the experimental values with increasing n , and set 2 gives poor agreement for low values of n . Set 3 is better than set 1, but still diverges for higher values of n . Despite the poor numerical agreement, isomeric configurations can be assigned. The mono-substituted cyano-compound appears to be cis rather than trans, as expected statistically. Only one isomer was detected for $n=4$, and this is probably the cis isomer (J) which is favoured statistically and has a numerically lower (less negative) calculated shift. Furthermore, since all 3 isomers of $C_6F_5P(CN)_3Cl_2^-$ are seen, J is the only possible single product for

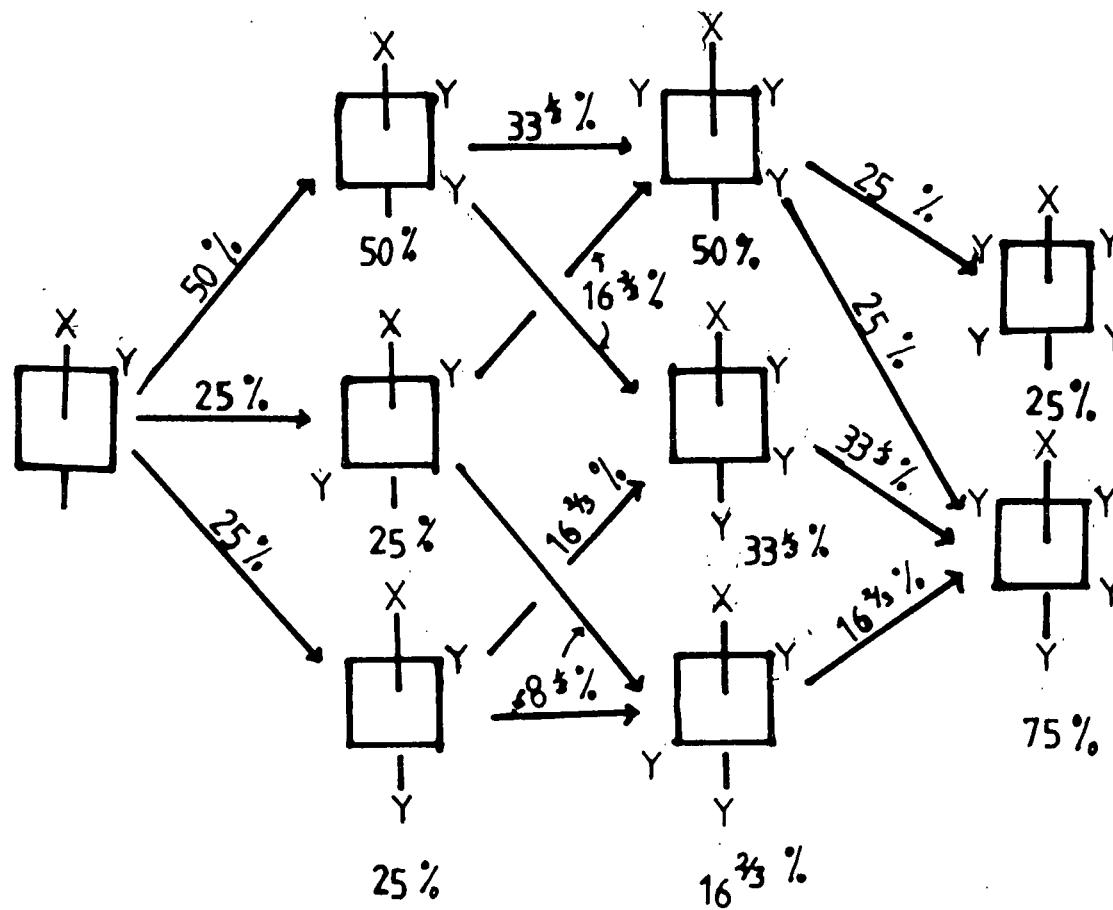

Fig. 6.5: STATISTICAL PATTERN DERIVED FROM EXPERIMENTAL DATA FOR $[C_6F_5PCl_4(CN)]^-$.

$C_6F_5P(CN)_4Cl^-$ without ligand rearrangement. The configurations for the isomers when $n=2$ and 3 are assigned as shown in table 6.10.

In $C_6F_5PCl_3(CN)_2^-$ and $C_6F_5PCl_2(CN)_3^-$, all three isomeric forms can be detected from the substitution reaction, but their resonances are not equal in intensity. For the second substitution product, the more abundant isomer is assigned the structure with 2 CN groups in the equatorial plane, cis to each other, rather than either of the other possibilities. In contrast, after further substitution to give 3 CN groups, the more abundant isomer seems to be the least probable (20%) statistically on the basis of the shifts, with 2 CN groups trans to each other and the third trans to the C_6F_5 group. The statistical pattern can be revised as shown in fig. 6.5 if it is assumed that $cis-[C_6F_5PCl_4(CN)]^-$ is formed exclusively, as observed experimentally. This diagram predicts that isomer C from table 6.10 should be the most abundant, in agreement with the pairwise calculations, but predicts that isomer F should be more abundant than G or H, which is not in accordance with the assignments in the table. Hence it is probable that either C_6F_5 , or CN, or both, may exert directing effects on the position of substitution in these complexes, and that the statistical predictions will not be followed exactly. This deduction is supported by the observation of only one isomer for $[C_6F_5PCl(CN)_4]^-$, even though this one is favoured statistically.

6.4.2 CYANO-DERIVATIVES OF $\text{Pr}_4\text{NEtPCl}_{5-n}(\text{CN})_n$.

a) PREPARATION OF THE COMPLEXES AND DISCUSSION OF THE RESULTS.

EtPCl_4 was prepared by chlorination of EtPCl_2 ; the reaction flask was placed in an ice bath to prevent the formation of Et_2PCl_3 ($\delta^{31}\text{P}/\text{CH}_2\text{Cl}_2=146.7$ p.p.m.), from the scrambling reaction when the heat of the reaction was increased. On several occasions, if the reaction was performed at room temperature, only one signal at 146.7 p.p.m. was observed, assigned to Et_2PCl_3 . EtPCl_4 in nitrobenzene gave a ^{31}P n.m.r. resonance at 35.5 p.p.m., but in methylene chloride a signal at 11.4 p.p.m. was recorded. The chemical shift in nitrobenzene is in good agreement with the reported value (16,20), but in methylene chloride the shift is quite low compared with the reported value of -24.2 p.p.m. (16,20), presumably due to the equilibrium between the ionic structure $\text{EtPCl}_3^+\text{Cl}^-$ and the molecular structure EtPCl_4 . The ionic species is likely to form readily in the presence of excess chlorine or any traces of HCl in the solution. Deng (16,20) has studied the acceptor properties of this compound towards Pe_4NCl and Et_4NCl , but only the tetra-n-pentylammonium derivative could be isolated (16,20). In this work, Pr_4NCl was introduced into the solution of EtPCl_4 in methylene chloride, and a limiting shift of -160.0 p.p.m. was recorded. EtPCl_4 also showed acceptor properties towards a

chloride of a larger cation, $\text{Ph}_3\text{PNPPh}_3^+$, (PNP), since addition of this salt moved the parent signal upfield, but the limiting shift could not be obtained because of the strong PNP signal compared with that of EtPcl_4 . These results indicated that $\text{X}^+\text{EtPcl}_5^-$ ($\text{X}=\text{PNP}$ or Pr_4N) could also be formed.

To extend the study of pseudohalide-derivatives of six-coordinate phosphorus anions, AgCN was added to a solution of $\text{Pr}_4\text{NEtPcl}_5$ in methylene chloride (this solution was prepared by adding Pr_4NCl to EtPcl_4 in methylene chloride until the limiting shift was reached). With a small amount of AgCN , a new signal at -206.5 p.p.m. was discerned, ascribed to the first substitution product, the $\text{EtPcl}_4(\text{CN})^-$ ion. The addition of more AgCN increased the intensity of this signal and generated two other signals, at -243.5 (strong) and -246.6 p.p.m. (strong). These two new signals were assigned to two of the three isomers possible for the second substitute, $\text{EtPcl}_3(\text{CN})_2^-$. When more cyanide was added to this solution, the parent signal disappeared and the first signal was reduced in intensity, with three other signals discerned, measured at -275.7 , -295.6 and -296.6 p.p.m. (the latter two with similar intensities). These signals were assigned as one isomer of $\text{EtPcl}_2(\text{CN})_3^-$ and the two isomers of $\text{EtPcl}(\text{CN})_4^-$ respectively, by analogy with the methyl derivatives (20,56,57). An excess of AgCN only gave one signal at -309.2 p.p.m., suggesting that the substitution goes to completion to form

EtP(CN)_5^- , similar to the behaviour of MeP(CN)_5^- .

When the reaction was carried out with an excess (>5:1) of AgCN and the mixture was stirred overnight, a creamy solid was isolated; before evaporation to dryness, the ^{31}P n.m.r. spectrum of the solution was recorded to give a signal at -306.2 p.p.m. The same signal was observed when the solid was redissolved in nitrobenzene, indicating that the ion was not dissociated in solution.

The elemental analyses of this product for C and N were lower than expected for EtP(CN)_5^- . In contrast, the phosphorus and chlorine analyses were reasonable for the 5:1 product, since no chlorine was found in the solid isolated. The same problem has been observed for $[\text{Pr}_4\text{N}][\text{C}_6\text{F}_5\text{P(CN)}_4]$ which was discussed in the previous section, as well as for $[\text{Et}_4\text{N}][\text{MeP(CN)}_5]$ (20,56,57). These properties are believed to be caused by two of the CN groups in the complex being resistant toward combustion during the analyses. To check the stability of this species, the solution containing the above solid was exposed to the atmosphere overnight and the ^{31}P n.m.r. spectrum was recorded the next day. It was confirmed that the stability of the compound was not affected by atmospheric moisture, since the same signal at -306.2 p.p.m. was observed. Even when it was treated with 5 drops of water, no signal for the probable hydrolysis product, EtPO(CN)_2 ($\delta^{31}\text{P}$ -54.9 p.p.m. (20)) was observed. These properties are presumably

due to the effects of the CN groups, which are the highest in the spectrochemical series of all the common ligands. The separation between the 3d t_{2g} and e_g orbitals on phosphorus is therefore expected to be larger than for other ligands, as discussed in the previous section for $C_6F_5PCl(CN)_4^-$ (52). As a result, the vacant 3d t_{2g} orbitals will be lowered in energy, enabling them to take part in P-CN π bonding by donation from a filled orbital on a CN group. This effect will strengthen the P-CN bond toward hydrolysis, as observed above. The identification of the solid was made from the phosphorus and chlorine analyses, which were reasonable for the 5:1 ratio product. When $R=C_6F_5$ in $[RCl_5]^-$ rather than Et (in the previous section), the substitution stopped at $n=4$. This result is probably due to electronic effects from C_6F_5 which hinder further substitution, as well as the strengthening of the P-Cl bond effected by the CN groups attached to phosphorus.

The infrared spectrum which was recorded as a Nujol mull exhibited a medium intensity CN band at 2180 cm^{-1} , and other bands below 800 cm^{-1} are listed in table 6.12.

When the above reaction was performed in a 3:1 ratio, an orange solid was isolated after treatment of the reaction mixture with low-boiling petroleum ether. This solid was contaminated by the 2:1 ratio product, $EtPCl_3^-(CN)_2^-$ and the 4:1 ratio product, $EtPCl(CN)_4^-$. This was shown by its ^{31}P n.m.r. spectrum, either in methylene

Table 6.11: $\delta^{31}\text{P}$ (p.p.m.) for $[\text{Pr}_4\text{N}]-$
 $[\text{EtPCl}_{5-n}(\text{CN})_n]$ in CH_2Cl_2 .

| n | 0 | 1 | 2 | 3 | 4 | 5 |
|-----------------------|--------|--------|--------|--------|--------|--------|
| $\delta^{31}\text{P}$ | -160.0 | -206.5 | -243.5 | -275.7 | -293.6 | -306.2 |
| | | | -246.6 | | -296.6 | |

Table 6.12: Infrared data for $[\text{Pr}_4\text{N}][\text{EtPCl}_{5-n}(\text{CN})_n]$
 derivatives below 800 cm^{-1} .

| Compound | i.r. data (cm^{-1}) | |
|--|--------------------------------|---|
| | CN | (800-200) |
| $[\text{Pr}_4\text{N}][\text{EtPCl}_2(\text{CN})_3]$ | 2170 (m,br) | 755sh, 695sh, 580m,br, 535m,br, 485m,s, 465sh, 455sh, 430m,s, 375br,s 295m,s. |
| $[\text{Pr}_4\text{N}][\text{EtP}(\text{CN})_5]$ | 2180 (m, s) | 605s, 580m,br, 530w, 505m, 425s, 405w, 390w, 380m, 360m, 340w, 330m, 320w, 305s, 285m. |

chloride or nitrobenzene, in which signals at -244.9 (strong), assigned as one of the isomers of $\text{EtPCl}_3(\text{CN})_2^-$, -277.4 (strong) for $\text{EtPCl}_2(\text{CN})_3^-$ as the major product, and a weak resonance measured at -294.4 p.p.m. assigned to one isomer of the $\text{EtPCl}(\text{CN})_4^-$ ion, were seen. When this solution was left on the bench with the lid opened for one day, all the signals in the six-coordinate region disappeared and a new signal at 34.7 p.p.m. was discerned, probably the hydrolysis product EtPOClCN . This indicated that the derivatives $\text{EtPCl}_{5-n}(\text{CN})_n^-$, ($0 \leq n \leq 4$), were not stable to hydrolysis. Because of the mixture obtained from the 3:1 reaction, attempts to isolate $[\text{Pr}_4\text{N}][\text{EtPCl}_{5-n}(\text{CN})_n]$ ($n=1, 2$ and 4) were not made. Table 6.11 shows the ^{31}P n.m.r. chemical shifts for $[\text{Pr}_4\text{N}][\text{EtPCl}_{5-n}(\text{CN})_n]$ derivatives.

Table 6.11 shows that not all the possible isomers for $n=1, 2$ and 3 were detected in the reaction between AgCN and EtPCl_5^- . For $n=1$, only one isomer of the two possible ones was observed. Statistically, the cis isomer is more probable since its formation is four times more likely than the trans isomer, but for $n=4$ both isomers were present. Again two out of three isomers were detected for $n=2$ but only one for $n=3$.

The overall values of the ^{31}P n.m.r. chemical shifts for EtPCl_5^- and its cyano-derivatives ($n=1$ to 5) are lower than the values recorded by Deng (20,56,57) for $\text{MePCl}_{5-n}(\text{CN})_n^-$ ($1 \leq n \leq 5$), but this is not surprising since

the limiting shift of EtPCl_5^- is lower (less negative) than that of MePCl_5^- . There are marked similarities with the MePCl_5^- system (20,56,57), apart from $n=2$ where only one isomer was seen in the latter. Table 6.12 shows the i.r. data for $[\text{Pr}_4\text{N}][\text{EtPCl}_{5-n}(\text{CN})_n]$ derivatives.

b) PAIRWISE CALCULATIONS.

By following the method of Vladimiroff and Malinowski (66), the ^{31}P chemical shifts of these derivatives, $\text{EtPCl}_{5-n}(\text{CN})_n^-$, can be calculated via the approximation of pairwise additivity as mentioned before (see sect. 6.4.1 b). In this system, only five possible types of interaction are involved, $\text{Et}:\text{Cl}$, $\text{Cl}:\text{Cl}$, $\text{Et}:\text{CN}$, $\text{CN}:\text{Cl}$ and $\text{CN}:\text{CN}$. From the limiting shift value of -160.0 p.p.m., the $\text{Et}:\text{Cl}$ term can be calculated as 9.7 p.p.m. If the $\text{Cl}:\text{Cl}$, $\text{Cl}:\text{CN}$ and $\text{CN}:\text{CN}$ terms are taken from the $\text{PCl}_{6-n}(\text{CN})_n^-$ series (52) as -24.85 , -27.19 and -36.88 p.p.m. respectively, only the $\text{Et}:\text{CN}$ term is unknown. The mono-cyano complex exists in two isomeric forms, cis and trans. For the trans isomer, there is no $\text{Et}:\text{CN}$ term, therefore the chemical shift can be calculated as -169.4 p.p.m. The observed signal at -206.5 p.p.m. is thus assumed to be due to the cis isomer, enabling the $\text{Et}:\text{CN}$ term to be evaluated as -29.78 p.p.m.. From these values, the shifts for all the other possible isomers may then be calculated as shown in column 1. It is apparent from the table that the calculated values are not in good agreement for higher values of n . These results

Table 6.13: $\delta^{31}\text{P}$ (p.p.m.) predicted from pairwise interactions for $[\text{EtPCl}_{5-n}(\text{CN})_n]^-$ ions.

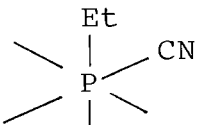
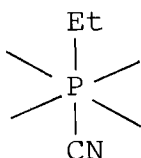
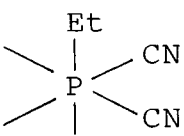
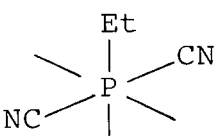
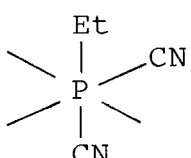
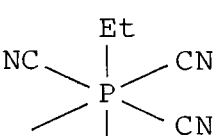
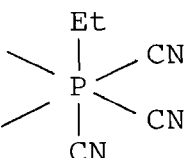
| Ion | calculated $\delta^{31}\text{P}$ | | | experimental $\delta^{31}\text{P}$ |
|--|----------------------------------|--------|--------|------------------------------------|
| | 1 | 2 | 3 | |
| A  | -206.5 | -206.5 | -203.8 | -206.5 |
| B  | -169.4 | -196.4 | -196.4 | - |
| C  | -260.4 | -233.4 | -226.0 | -246.6 |
| D  | -253.0 | -226.0 | -220.7 | -243.5 |
| E  | -223.2 | -223.2 | -218.5 | - |
| F  | -314.2 | -260.2 | -248.1 | -275.7 |
| G  | -284.4 | -257.4 | -246.0 | - |

| | | | | | |
|---|--|--------|--------|--------|--------|
| H | | -277.1 | -250.1 | -240.7 | - |
| I | | -375.4 | -294.4 | -275.6 | -296.6 |
| J | | -345.6 | -291.6 | -273.4 | -293.6 |
| K | | -414.2 | -333.2 | -306.2 | -306.2 |

were not unexpected, since big discrepancies between observed and calculated values occur also for $\text{RPCl}_{5-n}(\text{CN})_n^-$; $\text{R}=\text{C}_6\text{F}_5$ (see sect. 6.4.1), Ph or Me (20,56,57), and to a lesser extent in the $\text{PCl}_{6-n}(\text{CN})_n^-$ series (52).

In this instance, the true limiting shift of EtPCl_5^- may not have been reached, since the ion is known to be unstable (16,137). It was therefore calculated from the difference between the shifts of the cationic species EtPCl_3^+ ($^{31}\text{P}=129$ p.p.m.) and that of the phosphorane EtPCl_4 ($^{31}\text{P}=-24$ p.p.m.) (16). By using the correlation between the ^{31}P chemical shift differences between A^+ and AX ($\Delta 1$), and between A^+ and AX_2^- ($\Delta 2$), where A^+ is a phosphonium ion and X is an ionic ligand (as mentioned in section 4.3.2) (101), the revised limiting shift was calculated as -187 p.p.m. This gives the Et:Cl term as 2.95 p.p.m.

In column 2, the calculation was made using the values from column 1, except for the values of Et:Cl, which was taken as 2.95 p.p.m., and Et:CN, taken from the shift of $\text{cis-EtPCl}_4(\text{CN})^-$ as -9.53 p.p.m.

Column 3 is calculated using the new Et:Cl term as in column 2, and CN:CN as -34.84 p.p.m. from $\text{MeP}(\text{CN})_5^-$ (20,57), hence the Et:CN term is derived from the shift of $\text{EtP}(\text{CN})_5^-$ as -6.87 p.p.m. The Cl:Cl and CN:Cl terms are identical to those used in columns 1 and 2.

Column 2 give the best overall agreement, although the numerical discrepancies are quite marked in some cases. Nevertheless some structural conclusion can be drawn. For $n=2$, only two isomers were seen, and these are assigned structures C and D (Table 6.13), since the pairwise calculations always give more negative values for these species than for E.

According to the statistical pattern of substitution in the $\text{EtPCl}_5^-/\text{CN}^-$ system (see fig.6.4), the isomers A ($n=1$); C, D ($n=2$); F, G ($n=3$); J ($n=4$) and K ($n=5$) are more likely to form. The experimental data showed that this pattern was not followed. Since only one isomer was detected for $n=1$, the statistical pattern can be revised as in fig. 6.5, which gives C as more likely to form than isomers D and E for $n=2$. The pairwise calculations support the formation of isomers C and D but not E as indicated above (even though isomers D and E have the same probability of forming). Furthermore, for $n=3$, only the most probable isomer (F) was detected. Although the statistical pattern is not followed, the observation of F as the only isomer makes chemical sense by substitution into C and D, which do not have CN trans to Et. Both isomers of $\text{EtP}(\text{CN})_4\text{Cl}^-$ were detected, and structures are assigned as shown in table 6.13, so the pattern of substitution derived from the experimental data is shown in Fig. 6.6. The **divergence** of the observed data from the

statistical pattern is possibly caused by directive effects from either the ethyl group, or the cyano-groups once the substitution has started, as observed in other $\text{RPCl}_{5-n}(\text{CN})_n^-$ systems (R=Ph or Me (56,57), C_6F_5 or CCl_3 (this work)).

Fig.6.6: Pattern of substitution in the $[\text{EtPCl}_{5-n}(\text{CN})_n]^-$ system derived from experimental data.

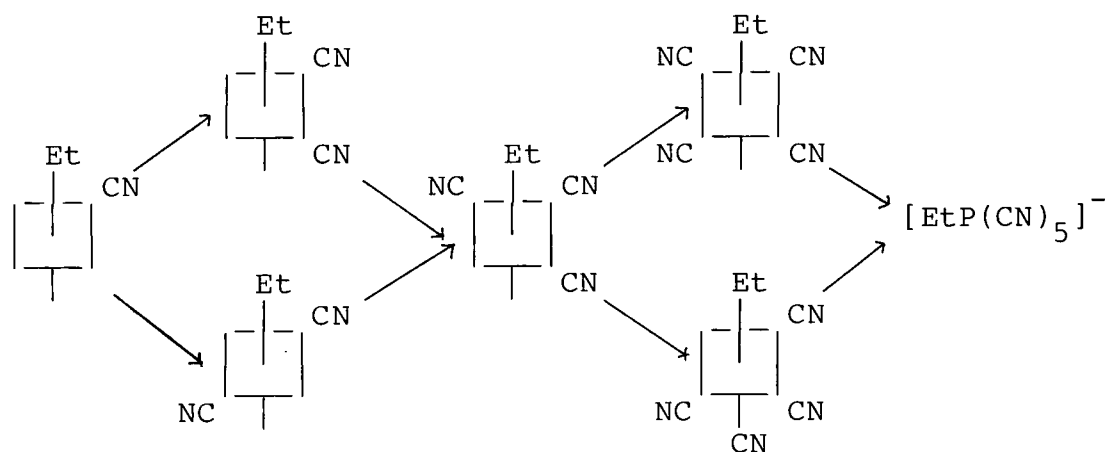

6.4.3 CYANO-DERIVATIVES OF $[\text{Pr}_4\text{N}][\text{CCl}_3\text{PCl}_5]$.

a) PREPARATION OF THE COMPLEXES AND DISCUSSION OF THE RESULTS.

Successive small amounts of AgCN were added to a concentrated solution of $[\text{Pr}_4\text{N}][\text{CCl}_3\text{PCl}_5]$ (prepared by adding Pr_4NCl to a solution of CCl_3PCl_4 in PhNO_2 until only one signal at -196.6 p.p.m. was obtained), and the ^{31}P

Table 6.14 : $\delta^{31}\text{P}$ (p.p.m.) for $[\text{CCl}_3\text{PCl}_{5-n}(\text{CN})_n]$ ions in PhNO_2 solution.

| n | 0 | 1 | 2 | 3 |
|-----------------------|--------|--------|---------|---------|
| $\delta^{31}\text{P}$ | -196.6 | -210.7 | -241.2* | -258.9* |
| | | -221.9 | -243.6a | -261.3 |
| | | | -249.3 | -262.9 |

* : more abundant isomer

a : see text

Table 6.15 : Infrared data for CCl_3PCl_4 and its cyano-derivatives in the 800-200 cm^{-1} region.

| Compound | CN | other bands (cm^{-1}). |
|--|----------------|--|
| $[\text{Pr}_4\text{N}][\text{CCl}_3\text{PCl}_3(\text{CN})_2]$ | 2180 (w,br) | 775s,br, 760s, 570 550s,br, 490s, 470s, 445sh, 420s,br, 365w, 340s, 290m, 265m, 255 |
| $[\text{Pr}_4\text{N}][\text{CCl}_3\text{PCl}_2(\text{CN})_3]$ | 2020w | 770sh, 755sh, 625m, |
| (from 1:3 ratio reaction) | 2180m 2310w | 570sh, 555s, 530m, 510w, 490s, 455m, 425 400m, 360w, 345m, 315 290m. |
| $[\text{Pr}_4\text{N}][\text{CCl}_3\text{PCl}_2(\text{CN})_3]$ | 2020w | 780sh, 620sh, 575sh, |
| (from reaction with | 2180m | 550s,b, 550m, 485m, |
| excess AgCN) | 2300w | 450m, 415w, 390m, 365 345w, 315m, 295w. |

n.m.r. spectrum was recorded after each addition. Resonances upfield from the $\text{CCl}_3\text{PCl}_5^-$ signal were observed, together with those of decomposition products CCl_3PCl_2 (149.6 p.p.m., medium) and $\text{CCl}_3\text{P}(\text{CN})_2$ (-90.1 p.p.m., weak). The new signals were recorded and assigned as in table 6.14.

In a qualitative reaction, the two signals at -243.6 and -261.3 p.p.m. were not observed on a 20 MHz (823 p.p.m.) sweep width. These were only detected on a 10 MHz sweep width in both the qualitative and quantitative reactions. The above results showed that all the possible isomers for $n=1, 2$ and 3 were present in the solution. For $n=1$, both signals had the same intensity, indicating that the two isomers were present in approximately equal amounts. For the $[\text{CCl}_3\text{PCl}_3(\text{CN})_2]^-$ ion, however, the isomer which gives a signal at -241.2 p.p.m. was much more abundant than the two other isomers, which showed very weak signals. Similarly, for the species with three CN groups present, the isomer which gives a resonance at -258.9 p.p.m. was more abundant than the other two isomers. No further signals were observed when excess AgCN was added to the above solution.

The above assignment was based on the analyses obtained from quantitative reactions. In a 1:1 ratio reaction, signals were observed at -19.3 p.p.m. (weak, starting material), -212.3 (medium) and -223.5 (medium),

assigned to $[\text{CCl}_3\text{PCl}_4(\text{CN})]^-$, and at -241.2 (strong) and -249.3 (weak) p.p.m., ascribed to two of the isomers of the $[\text{CCl}_3\text{PCl}_3(\text{CN})_2]^-$ ion. No attempt was made to isolate the product because of the various mixed chlorocyanides present in the solution.

When the reaction was performed in a 1:2 ratio, only signals at -239.2 (strong) and -247.7 p.p.m. (weak) were obtained. These signals were ascribed to two of the isomers of the $[\text{CCl}_3\text{PCl}_3(\text{CN})_2]^-$ ion. When the solvent (PhNO_2) was removed by vacuum distillation and the residue treated with low boiling petroleum ether, a creamy solid was isolated, which analysed as $[\text{Pr}_4\text{N}][\text{CCl}_3\text{PCl}_3(\text{CN})_2]$. Signals at -239.6 (strong) and -247.7 p.p.m. (weak) were observed when this solid was redissolved in nitrobenzene or methylene chloride. Its i.r. spectrum showed a weak broad absorption band at 2180 cm^{-1} , assigned to $\text{C}\equiv\text{N}$ stretching vibrations.

Attempts to isolate a complete substitution product $[\text{Pr}_4\text{N}][\text{CCl}_3\text{P}(\text{CN})_5]$, failed. The reaction with excess AgCN (> 5:1) in nitrobenzene gave a creamy solid which analysed as $[\text{Pr}_4\text{N}][\text{CCl}_3\text{PCl}_2(\text{CN})_3]$. The analyses were reasonable for the compound with three CN groups attached to phosphorus. Its i.r. spectrum which was recorded as a Nujol mull showed three absorption bands in the $\text{C}\equiv\text{N}$ region, measured at 2020, 2180 and 2300 cm^{-1} . When this solid was redissolved in nitrobenzene, signals at -258.9 (~44%),

-261.3 (~28%) and -262.9 (~28% of intensity) p.p.m. were detected, assigned to the three possible isomers of $[\text{CCl}_3\text{PCl}_2(\text{CN})_3]^-$. When this solution was exposed to the laboratory atmosphere for three hours, no change in the position of the resonances was observed, indicating that the compound is air stable.

When the reaction was performed in a 1:3 $\text{CCl}_3\text{PCl}_5^-:\text{AgCN}$ ratio, and the mixture was stirred for three hours, a creamy solid was isolated after the solvent was distilled off in vacuo. Before the solvent was removed, the ^{31}P n.m.r. spectrum was recorded and showed signals at -259.7 and -263.7 p.p.m. These two signals were also obtained when the creamy solid was redissolved in nitrobenzene. The solid state ^{31}P n.m.r. spectrum exhibited signals at -258.1 and -262.1 p.p.m., presumably from the presence of the same isomers in all cases. No resonance from the third isomer was detected from the 3:1 ratio reaction.

The analyses were very good for the expected compound, except for the nitrogen which was slightly low (see experimental section). The i.r. spectrum (Nujol mull) showed a medium strong, sharp absorption at 2180 cm^{-1} and weak bands at 2310 and 2020 cm^{-1} , assigned to $\text{C}\equiv\text{N}$ stretching vibrations. The other bands from $800\text{--}200\text{ cm}^{-1}$ are listed in table 6.15.

Table 6.16 : $\delta^{31}\text{P}$ (p.p.m.) predicted from pairwise interactions for $[\text{CCl}_3\text{PCl}_{5-n}(\text{CN})_n]^-$ ions.

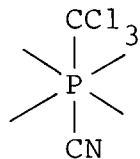
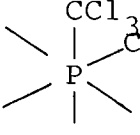
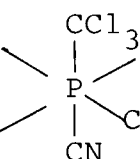
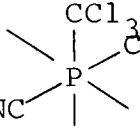
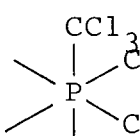
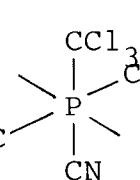
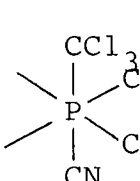
| No | Ion | $\delta^{31}\text{P}$ calc. | | | | $\delta^{31}\text{P}$ Exp |
|----|---|-----------------------------|--------|--------|--------|---------------------------|
| | | 1 | 2 | 3 | 4 | |
| A |  | -206.0 | -206.0 | -206.0 | -206.0 | -210.7 |
| B |  | -221.9 | -215.7 | -214.1 | -217.3 | -221.9 |
| C |  | -238.6 | -232.4 | -230.8 | -234.0 | -241.2* |
| D |  | -247.2 | -234.8 | -231.5 | -237.9 | -243.6 |
| E |  | -254.6 | -242.2 | -238.9 | -245.3 | -249.3 |
| F |  | -271.3 | -258.9 | -255.6 | -262.0 | -258.9* |
| G |  | -278.6 | -266.2 | -263.0 | -269.4 | -261.3 |

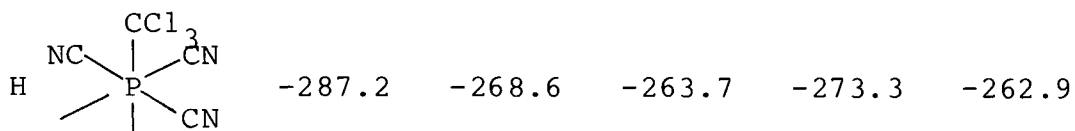

* more abundant isomer

- 1 $\text{CCl}_3:\text{CN} = -17.73$ p.p.m. (from shift of B)
- 2 $\text{CCl}_3:\text{CN} = -11.53$ p.p.m. (from shift of most abundant isomer of $[\text{CCl}_3\text{P}(\text{CN})_3\text{Cl}_2]^-$)
- 3 $\text{CCl}_3:\text{CN} = -9.90$ p.p.p. (from weighted average for isomers of $[\text{CCl}_3\text{P}(\text{CN})_3\text{Cl}_2]^-$)
- 4 $\text{CCl}_3:\text{CN} = -13.10$ p.p.m. (from weighted average for all species)

This solid was also resistant to hydrolysis. When two drops of water were added to the above solution, only the same two signals were observed. Hydrolysis only became apparent after two days, as shown by the solution ^{31}P n.m.r. spectrum.

b) PAIRWISE CALCULATIONS.

The ^{31}P chemical shift values calculated from the approximation of pairwise additivity according to the method of Vladimiroff and Malinowski (66) are given in the table 6.16.

In the above table, the values in column 1 were obtained on the basis of the following assumptions. For both isomers of $[\text{CCl}_3\text{PCl}_4(\text{CN})]^-$ there are no more than four types of interactions involved, i.e. Cl:Cl, $\text{CCl}_3:\text{Cl}$, CN:Cl and $\text{CCl}_3:\text{CN}$. The Cl:Cl and CN:Cl terms were calculated from the shifts of PCl_6^- and $[\text{PCl}_{6-n}(\text{CN})_n]^-$ as -24.85 and -27.19 p.p.m. respectively (52). The $\text{CCl}_3:\text{Cl}$ term was then evaluated as 0.55 p.p.m. from the limiting shift of $[\text{CCl}_3\text{PCl}_5]^-$ (-196.6 p.p.m.). For the isomer of $[\text{CCl}_3\text{PCl}_4(\text{CN})]^-$ with the CN group trans to CCl_3 , there are no $\text{CCl}_3:\text{CN}$ interactions, and its chemical shift can be calculated as -206.0 p.p.m., in reasonable agreement with the peak observed at 210.7 p.p.m. The signal at -221.9 p.p.m. may therefore be assigned to the cis isomer, enabling the $\text{CCl}_3:\text{Cl}$ term to be evaluated as -17.73 p.p.m.

If the CN:CN term is taken as -36.88 p.p.m. from the $[\text{PCl}_{6-n}(\text{CN})_n]^-$ series (52), the shifts for all the other possible isomers may be calculated, as shown in column 1 of table 6.16.

It is apparent that the calculated values are not in good agreement with the observed values, particularly for $n=3$. This is not too surprising, since similar discrepancies have been observed previously by Dillon and Platt (52) in the $[\text{PCl}_{6-n}(\text{CN})_n]^-$ series, and in related fluoro-system with cyanide ligands present (53), as well as by Deng and Dillon in the $[\text{RPCl}_{5-n}(\text{CN})_n]^-$ series ($\text{R}=\text{Ph}$, $1 \leq n \leq 3$ and $\text{R}=\text{Me}$, $1 \leq n \leq 5$) (20,56,57). These differences may arise from distortion of the regular octahedral structure.

In the second calculation, the $\text{CCl}_3:\text{CN}$ term was derived as -11.53 p.p.m. from the experimental value of -258.9 p.p.m. for the shift of the most abundant isomer of $[\text{CCl}_3\text{PCl}_2(\text{CN})_3]^-$, which was assumed to have the structure with a CN group trans to CCl_3 , and the other two cyano-groups trans to each other, since this isomer has the calculated shift at lowest field in all cases. The shifts calculated on this basis and using the Cl:Cl, CN:Cl and CN:CN terms from the $[\text{PCl}_{6-n}(\text{CN})_n]^-$ series are given in column 2.

Values in column 3 were derived by taking the weighted average for the $\text{CCl}_3:\text{CN}$ term as -9.90 p.p.m. from

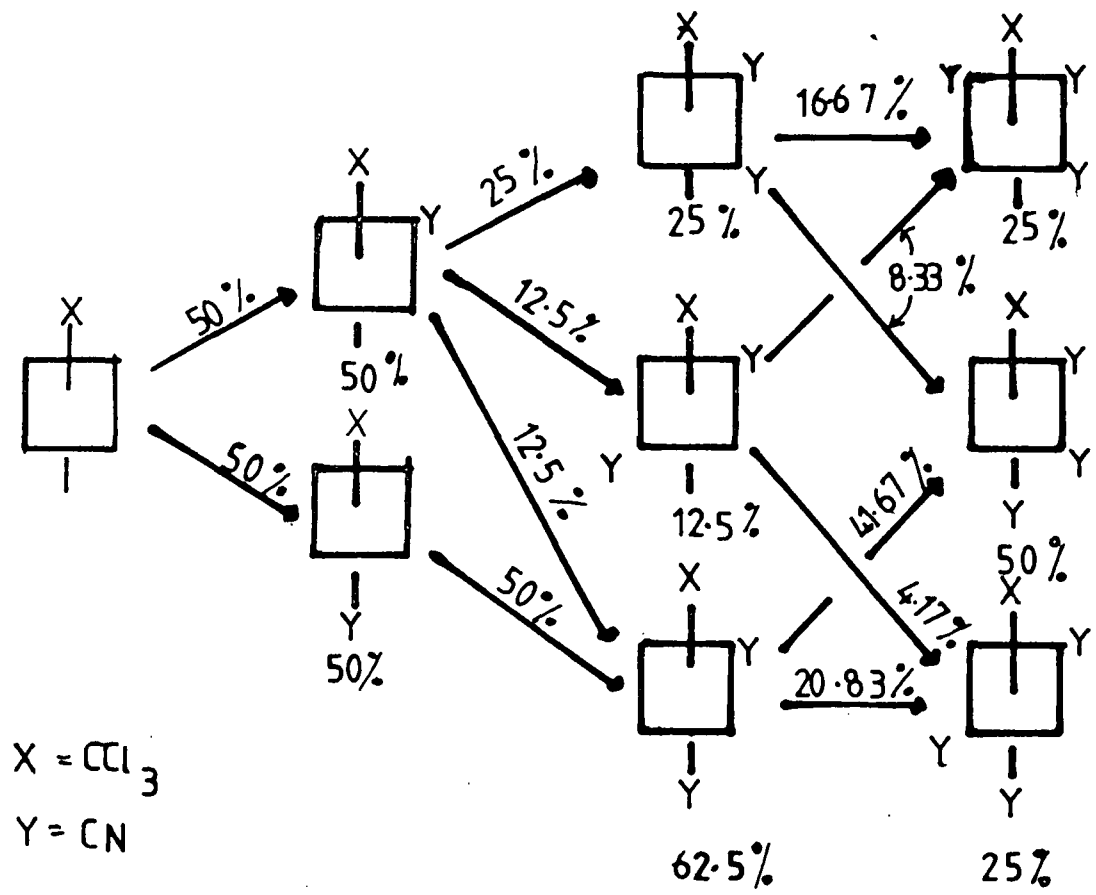

Fig. 6.7 STATISTICAL PATTERN OF SUBSTITUTION IN THE $[\text{CCl}_3\text{PCl}_{5-n}(\text{CN})_n]^-$ DERIVED FROM EXPERIMENTAL DATA.

the shifts of the three isomers of $[\text{CCl}_3\text{PCl}_2(\text{CN})_3]^-$, and those in column 4 from the weighted average for the $\text{CCl}_3:\text{CN}$ term as -13.10 p.p.m. for all species with $\text{CCl}_3:\text{CN}$ interactions.

None of these assumptions gave very good values for the chemical shifts of the expected isomers. In column 1, the theoretical values are quite reasonable for $n=1$ and 2 but give poorer agreement for $n=3$. Similarly, when the values were calculated by deriving the $\text{CCl}_3:\text{CN}$ term from the experimental shifts of the $[(\text{CCl}_3)\text{P}(\text{CN})_3\text{Cl}_2]^-$ ions, reasonable shifts resulted for these isomers but the values did not fit as well for $n=1$ and 2. Nevertheless some structural deductions may be made from the results, as shown in table 6.16.

Experimental data showed that all the possible isomers for $[\text{CCl}_3\text{PCl}_{5-n}(\text{CN})_n]^-$, ($1 \leq n \leq 3$) were present. The results obtained did not follow the statistical pattern of substitution shown in fig. 6.4 with $X=\text{CCl}_3$. The cis isomer of $[\text{CCl}_3\text{PCl}_4(\text{CN})]^-$ is four times more likely to be formed than the trans isomer, but from the observed data both isomers were present, in almost the same quantities. Not surprisingly, deviations from this statistical pattern were also apparent for the species with more cyano-groups present. A new statistical diagram was therefore derived (fig. 6.7), on the assumption of equal quantities of the isomers of $[\text{CCl}_3\text{P}(\text{CN})\text{Cl}_4]^-$ being formed. The experimental

results for $[\text{CCl}_3\text{P}(\text{CN})_2\text{Cl}_3]^-$ were now in good agreement with these predictions. The most abundant isomer is expected to be the one with a CN group trans to CCl_3 , in accordance with the assignment in table 6.16, while the experimental data also showed that the signal at -249.3 p.p.m. was slightly larger than the signal at -243.6 p.p.m., again as expected from the statistical treatment.

All three isomers of $[\text{CCl}_3\text{PCl}_2(\text{CN})_3]^-$ were observed, with the species giving a signal at -258.9 p.p.m. being more abundant. This ion is assigned structure F in table 6.16, with one CN group trans to the CCl_3 group and the other two cyanide substituents trans to each other. This does not agree with the statistical prediction that structure G should be more abundant, but seems entirely reasonable when electronic effects are considered. Both CCl_3 and CN are more electronegative than Cl, and may thus reasonably be expected to take up trans positions in the coordination polyhedron when substitution by CN^- into $[\text{CCl}_3\text{PCl}_5]^-$ takes place. In practice, this effect is seen, but does not occur exclusively since the cis isomer is formed in approximately equal amounts. Nevertheless the statistical pattern favouring the cis isomer is distorted. When the second substitution takes place, both statistical (based on 50:50 cis:trans $[\text{CCl}_3\text{PCl}_4(\text{CN})]^-$) and electronic effects favour the formation of structure C, and this is indeed found to be the most abundant isomer. For further substitution into C, however, the electronic effects will

tend to favour trans substitution by the third cyano-group, giving structure F, since this will keep the electronegative cyano-groups as far apart as possible, while statistics favour structure G. The experimental results suggest that electronic effects are again important, as in the first substitution, and that the kind of statistical distribution found, for example, in chlorobromostannates (IV) $[\text{SnBr}_{6-n}\text{Cl}_n]^{2-}$ (138,139), does not occur in the present system.

6.5 EXPERIMENTAL.

In the following reactions, all the solvents used were degassed on the vacuum line to remove any oxygen present and stored over molecular sieve. Tetraalkylammonium salts were dried as mentioned in chapter 2.

1) Azido-derivatives of $\text{R}\text{PCl}_3^+\text{X}^-$.

All manipulations were carried out inside the glove box. A small amount of the compound under investigation $\text{R}\text{PCl}_3^+\text{X}^-$ ($\text{R}=\text{Me}$ or Ph , $\text{X}=\text{SbCl}_6$ and $\text{R}=\text{C}_6\text{F}_5$, $\text{X}=\text{BCl}_4$ or SbCl_6) was placed in the n.m.r. tube and a limited quantity of solvent was added, followed by cautious addition of the LiN_3 . Vigorous reactions were allowed to subside before sealing the tube and recording the ^{31}P or ^{11}B n.m.r. spectra. $\text{C}_6\text{F}_5\text{PCl}_3\text{BCl}_4$ and $\text{C}_6\text{F}_5\text{PCl}_3\text{SbCl}_6$ were prepared as mentioned in the previous chapter. Et_4NBCl_4 was prepared by reacting a solution of Et_4NCl in CH_2Cl_2 with BCl_3 gas, which was allowed to flow into the flask for ten minutes.

Analysis (found: C=33.95, H=7.80, N=3.82%; required: C=33.97, H=7.13, N=4.95%). The azide waste was destroyed by treatment with sodium nitrite (NaNO_2) solution and acetic acid.

2) Thiocyanato-derivatives of $\text{RPCl}_3^+\text{X}^-$.

$\text{RPCl}_3^+\text{X}^-$; (R=Me and Ph, X= SbCl_6 and R= C_6F_5 ; X= SbCl_6 and BCl_4) were placed in the n.m.r. tube and a small amount of PhNO_2 or MeNO_2 was added, followed by the addition of $\text{Ag}(\text{SCN})$ or $\text{Hg}(\text{SCN})_2$. The reaction was followed by recording the ^{31}P and/or ^{11}B n.m.r. spectra. All the solutions prepared were stored in the fridge to minimise polymerisation or decomposition.

3) Cyano-derivatives of $\text{RPCl}_3^+\text{X}^-$.

A small amount of the compound $\text{RPCl}_3^+\text{X}^-$ (R=Me and Ph, X= SbCl_6 ; R= C_6F_5 , X= BCl_4 or SbCl_6) was placed in the n.m.r. tube and a limited quantity of PhNO_2 or CH_3NO_2 was added, followed by cautious addition of the AgCN . The ^{31}P and ^{11}B n.m.r. spectra of the solution were recorded immediately after each addition of silver salt until the reaction was completed.

4) Thiocyanato-derivatives of $\text{Et}_4\text{N}^+\text{C}_6\text{F}_5\text{PCl}_5^-$.

$\text{C}_6\text{F}_5\text{PCl}_{5-n}(\text{NCS})_n^-$ ($1 \leq n \leq 2$) were studied in solution only. $\text{Et}_4\text{N}^+\text{C}_6\text{F}_5\text{PCl}_5^-$ (which was prepared by adding Et_4NCl to $\text{C}_6\text{F}_5\text{PCl}_4$ until the limiting shift was reached) was treated with a small amount of AgSCN in CH_2Cl_2 . Its ^{31}P n.m.r. was

recorded immediately after the solution was prepared. The reaction was continued until no further change in the ^{31}P spectrum was observed.

5) Preparation of $[\text{Pr}_4\text{N}][\text{C}_6\text{F}_5\text{PCl}(\text{CN})_4]$.

$[\text{Pr}_4\text{N}][\text{C}_6\text{F}_5\text{PCl}_5]$ (0.39 g, 0.70 mmoles) was dissolved in a small amount of CH_2Cl_2 . AgCN (0.47 g, 3.51 mmoles) was added to the above solution with constant stirring. The mixture was allowed to stir for 3 hours before the silver salts were filtered off. The filtrate was then evaporated to dryness to isolate a fine creamy solid, in 80% yield, which analysed as a 1:4 product.

Analysis:

Found: C=47.82 H=5.43 N=9.13 P=5.87 Cl=5.50%.

Calculated: C=50.43 H=5.35 N=13.37 P=5.92 Cl=6.78%.

6) Attempted preparation of $[\text{Pr}_4\text{N}][\text{C}_6\text{F}_5\text{PCl}_3(\text{CN})_2]$.

$[\text{Pr}_4\text{N}][\text{C}_6\text{F}_5\text{PCl}_5]$ (0.54 g, 0.96 mmoles) was dissolved in a small amount of methylene chloride. An equivalent amount of AgCN (0.27 g, 2.02 mmoles) was added to the above solution with constant stirring. The reaction mixture was allowed to stir for 2 hours during which the suspension turned purple. The silver salts were filtered off and the filtrate was evaporated to dryness to isolate a fine white solid. It analysed as a mixture of the 1:2 and 1:3 products.

Analysis :

Found: C=43.27 H=5.66 N=6.13 P=6.30 Cl=16.48%.

Calculated: C=44.24 H=5.16 N=7.74 P=5.71 Cl=19.63%, for 1:2 complex.

7) Attempted preparation of $[\text{Pr}_4\text{N}][\text{C}_6\text{F}_5\text{PCl}_2(\text{CN})_3]$.

The above reaction was repeated using $[\text{Pr}_4\text{N}][\text{C}_6\text{F}_5\text{PCl}_5]$ (0.66 g, 1.18 mmoles) and AgCN (0.50 g, 3.73 mmoles). After evaporation to dryness, a fine greyish solid was isolated.

Analysis:

Found: C=44.73 H=5.56 N=8.10 P=5.56 Cl=10.0%.

Calculated: C=47.28 H=5.25 N=10.51 P=5.82 Cl=13.32%.

8) Attempted preparation of $[\text{Et}_4\text{N}][\text{C}_6\text{F}_5\text{P}(\text{CN})_5]$.

$\text{C}_6\text{F}_5\text{PCl}_4$ (0.86 g, 2.53 mmoles) was dissolved in a small quantity of methylene chloride. An equimolar amount of Et_4NCl (0.44 g, 2.66 mmoles) was added to the above solution. The reaction mixture was allowed to stir for 30 minutes and then an excess of AgCN (2.49 g, 18.60 mmoles) was added to this mixture, which was allowed to stir overnight. The ^{31}P n.m.r. spectrum was then recorded to give one signal at -340.0 p.p.m. The silver salts were removed by filtration and the pink solution was evaporated to dryness to isolate a sticky red liquid which turned to a red solid in the box. This solid analysed as the 1:4 product, in 72% yield.

Analysis:

Found: C=45.3 H=3.80 N=12.80 P=5.14 Cl=7.47%.

Calculated: C=46.15 H=4.27 N=14.96 P=6.62 Cl=7.59%.

9) Preparation of $[\text{Pr}_4\text{N}][\text{EtP}\text{Cl}_5]$.

EtPCl_4 (0.44 g, 2.18 mmoles) was dissolved in a small quantity of CH_2Cl_2 . Pr_4NCl (0.49 g, 2.28 mmoles) in the same solvent was added to the above solution with constant stirring. The reaction mixture was allowed to stir for 30 minutes before evaporation to dryness to yield a white solid. The solid was not washed with petroleum ether (30-40^o) since it would give the starting materials.

Analysis:

Found: C=42.28 H=9.37 N=2.86 P=7.05 Cl=40.68%.

Calculated: C=39.67 H=7.79 N=3.31 P=7.32 Cl=41.91%.

10) Preparation of $[\text{Pr}_4\text{N}][\text{EtP}(\text{CN})_5]$.

EtPCl_4 (0.48 g, 2.38 mmoles) was dissolved in a small amount of methylene chloride and then Pr_4NCl (0.53 g, 2.40 mmoles) was added to the above solution with constant stirring. The reagents were allowed to stir for one hour before AgCN (2.5 g, 18.7 mmoles) was added, and the mixture was then left to stir overnight. The ^{31}P n.m.r. was recorded, giving one signal only at -306.2 p.p.m., before the silver salts were filtered off. The filtrate was evaporated to dryness to isolate a yellowish solid, in 70% yield.

Analysis:

Found: C=53.76 H=8.55 N=16.34 P=6.64 Cl=0.0%.

Calculated: C=60.64 H=8.78 N=22.34 P=8.24 Cl=0.0%.

11) Preparation of $[\text{Pr}_4\text{N}][\text{CCl}_3\text{PCl}_3(\text{CN})_2]$.

CCl_3PCl_4 (0.80 g, 2.74 mmoles) was dissolved in nitrobenzene and Pr_4NCl (0.61 g, 2.75 mmoles) was added to the above solution with constant stirring. The solution was allowed to stir for 20 minutes, and its ^{31}P n.m.r. spectrum was recorded to yield a single peak at -196.6 p.p.m. AgCN (0.73 g, 5.37 mmoles) was then added. The reaction mixture was allowed to stir for two hours before the AgCl was filtered off, and the filtrate was distilled in vacuo to remove PhNO_2 . The remaining liquid was treated with low boiling petroleum ether and decanted four times to remove any excess PhNO_2 . This treatment gave a creamy solid.

Analysis:

Found: C=36.42 H=5.32 N=7.23 P=5.56 Cl=38.70%.

Calculated: C=36.44 H=5.67 N=8.50 P=6.28 Cl=43.12%.

12) Preparation of $[\text{Pr}_4\text{N}][\text{CCl}_3\text{PCl}_2(\text{CN})_3]$.

The above preparation was followed using CCl_3PCl_4 (0.86 g, 2.95 mmoles), Pr_4NCl (0.65 g, 2.94 mmoles) and AgCN (1.19 g, 8.89 mmoles) to isolate a creamy solid.

Analysis:

Found: C=40.81 H=6.50 N=9.17 P=5.92 Cl=35.96%.

Calculated: C=39.63 H=5.78 N=11.56 P=6.40 Cl=36.64%.

13) Attempted preparation of $[\text{Pr}_4\text{N}][\text{CCl}_3\text{P}(\text{CN})_5]$.

The above procedure was followed using CCl_3PCl_4 (1.76 g, 6.03 mmoles), Pr_4NCl (1.34 g, 6.05 mmoles) and AgCN (4.90 g, 36.06 mmoles) to yield a creamy solid, which analysed approximately as $[\text{Pr}_4\text{N}][\text{CCl}_3\text{PCl}_2(\text{CN})_3]$.

Analysis:

Found: C=39.60 H=5.98 N=10.60 P=5.91 Cl=34.70%.

Calculated: C=39.63 H=5.78 N=11.56 P=6.40 Cl=36.64%.

CHAPTER 7

7.1 CONCLUSION AND DISCUSSION.

The organophosphoranes which contain electronegative groups, $C_6F_5PCl_4$ and CCl_3PCl_4 , have been shown to possess acceptor properties towards chloride ion and pyridine to form the six-coordinate species $RPCl_5^-$ and $RPCl_4 \cdot py$ respectively. $C_6F_5PCl_5^-$ was found to dissociate to some extent in solution. The degree of association is greater than that of $PhPCl_5^-$ in CH_2Cl_2 , but $CCl_3PCl_5^-$ shows no dissociation in $PhNO_2$, indicating that the first compound is less stable than the latter compound as shown below:

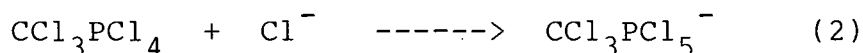
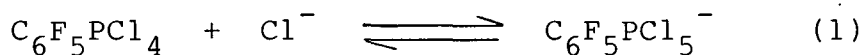

As has been found for the alkyl-substituted phosphoranes $RPCl_4$, (R= Me and Et) (20) and for $PhPCl_4$ (78), the introduction of more than one organo-group into the compound, R_nPCl_{4-n} , reduces the acceptor properties of the compound to such an extent that no adducts with Lewis bases can be detected. This behaviour presumably results from the inductive effects of the R groups. In the case of $C_2Cl_5PCl_4$, decomposition occurred on introducing the tetraalkylammonium salt R_4NCl either in CH_2Cl_2 or $PhNO_2$, giving $C_2Cl_5PCl_2$, except with Et_4NCl in CH_2Cl_2 which

showed temporary formation of the adduct, but for CCl_3PCl_4 decomposition only occurred in CH_2Cl_2 .

The phosphoranes $\text{R}_n\text{PCl}_{5-n}$ react readily with Lewis acids to form the ionic species $[\text{R}_n\text{PCl}_{4-n}][\text{X}]$; ($\text{X}=\text{SbCl}_6^-$, BCl_4^- and ICl_4^- ; $\text{R}=\text{C}_6\text{F}_5$, $1 \leq n \leq 3$; $\text{R}=\text{CCl}_3$, $n=1$; and $\text{X}=\text{SbCl}_6^-$ and ICl_4^- , $\text{R}=\text{C}_2\text{Cl}_5$, $n=1$), but for $(\text{CCl}_3)_2\text{PCl}_3$, only the compound with SbCl_5 was isolated, indicating that only a strong Lewis acid is able to pull one chlorine from this phosphorane. A few six-coordinate species were detected by reacting these ionic compounds with bidentate ligands L (1,10-phenanthroline and 2,2'-bipyridine). These exist in two isomeric forms (cis and trans) in solution as $[\text{R}_n\text{PCl}_{4-n}\text{L}][\text{Y}]$; ($\text{R}=\text{C}_6\text{F}_5$, $\text{Y}=\text{SbCl}_6^-$ and BCl_4^- , $n=1$; $\text{R}=\text{C}_6\text{F}_5$, $\text{Y}=\text{SbCl}_6^-$, $n=2$; $\text{R}=\text{CCl}_3$, $\text{Y}=\text{SbCl}_6^-$, $n=1$), but only one isomer appears to be dominant in the solid isolated.

Acceptor properties of some organophosphorus (III) halides and pseudohalides have been investigated. The compounds $(\text{C}_6\text{F}_5)_n\text{PX}_{3-n}$ ($\text{X}=\text{Cl}$ or Br ; $1 \leq n \leq 2$) and $(\text{C}_6\text{F}_5)_n\text{PX}_{3-n}$ ($\text{X}=\text{NCS}$, $n=1$; $\text{X}=\text{CN}$, $n=2$) exhibited acceptor properties while CCl_3PCl_2 , $(\text{C}_6\text{F}_5)_2\text{PNCS}$ and $\text{RP}(\text{NCS})_2$, ($\text{R}=\text{Me}$, Et and Ph) show no acceptor ability toward halides and pseudohalides, either in CH_2Cl_2 or PhNO_2 . The derivatives with two C_6F_5 groups present are the first simple phosphoranides to be prepared with two organic groups on phosphorus. The thiocyanato-phosphines with no C_6F_5 groups present are thermally unstable and decompose on isolation, therefore it is

impossible to isolate any adducts with halides or pseudohalides (118), even though several derivatives were successfully isolated from $C_6F_5P(NCS)_2$. Substitution occurred rather than addition when Et_4NCN or Et_4NNCS was reacted with $(C_6F_5)_nPX_{3-n}$ ($X=Cl$ or Br , $1 \leq n \leq 2$). The $(C_6F_5)_2PCN/CN^-$ system may undergo reductive elimination, like the $PhP(CN)_2/CN^-$ (20) or $P(CN)_3/CN^-$ systems (26), to give $[(C_6F_5)_2P]^-$ and cyanogen, although the reaction seems complicated in this case.

An investigation has also been performed into substitution reactions in the ionic species $RPCl_3^+X^-$ ($X = SbCl_6^-$ or BCl_4^-). $RPCl_{3-n}X_n^+SbCl_6^-$ ($R=Me, Ph, \text{ or } C_6F_5, X=NCS^-, 1 \leq n \leq 3; R=C_6F_5, X=N_3^-, 1 \leq n \leq 3; R=Me, X=CN^-, 2 \leq n \leq 3$) and $C_6F_5PCl_3^+BCl_{4-n}X_n^-$ ($X=CN^-, N_3^-$ and $NCS^-, 1 \leq n \leq 4$) were identified in solution by reacting the compounds with the corresponding pseudohalide salt. Most of the compounds under investigation were unstable, therefore all attempts to isolate any of the species failed. The identification of the species was carried out by using ^{31}P (or ^{11}B where appropriate) n.m.r. spectroscopy, and comparing the results with those for the methyl and phenyl analogues (20,29).

Stepwise addition of thiocyanate salts (Et_4NSCN , $LiNCS$ and $AgNCS$) to a solution of an organophosphorane $RPCl_4$ ($R=Ph, Me$ and C_6F_5) or to the organophosphate ions $RPCl_5^-$ ($R=Ph$ and Me), yielded only the decomposition

products RCl_2 , RSCl_2 and $\text{RPS}(\text{NCS})_2$, whereas with $\text{C}_6\text{F}_5\text{PCl}_5^-$, substitution occurred in which the complexes $\text{C}_6\text{F}_5\text{PCl}_{5-n}(\text{NCS})_n^-$, ($1 \leq n \leq 2$) were detected in solution, followed by rapid decomposition giving $\text{C}_6\text{F}_5\text{PCl}_2$, $\text{C}_6\text{F}_5\text{P}(\text{NCS})_2$, $\text{C}_6\text{F}_5\text{PS}(\text{NCS})_2$ and $\text{C}_6\text{F}_5\text{PS}(\text{CN})_2$.

In contrast, substitution occurred to some extent with AgCN and several compounds were isolated pure. The complexes $\text{RCl}_{5-n}(\text{CN})_n^-$; ($\text{R}=\text{C}_6\text{F}_5$, $1 \leq n \leq 4$; $\text{R}=\text{Et}$, $1 \leq n \leq 5$ and $\text{R}=\text{CCl}_3$, $1 \leq n \leq 3$) were detected in solution but only $\text{C}_6\text{F}_5\text{P}(\text{CN})_4\text{Cl}^-$, $\text{EtP}(\text{CN})_5^-$, $\text{CCl}_3\text{P}(\text{CN})_2\text{Cl}_3^-$ and $\text{CCl}_3\text{P}(\text{CN})_3\text{Cl}_2^-$ were isolated pure as salts with suitable large cations. These results show that in alkyl systems the introduction of electronegative atoms into the organic group limits the extent of substitution, while it promotes further reaction in aryl systems. This behaviour is probably caused by inductive effects in the alkyl systems, where electron-withdrawing groups do not favour nucleophilic substitution at phosphorus, but the susceptibility of $\text{C}_6\text{F}_5\text{P}(\text{CN})_3\text{Cl}_2^-$ to further substitution, unlike $\text{C}_6\text{H}_5\text{P}(\text{CN})_3\text{Cl}_2^-$, may arise from a steric effect of the bulky C_6F_5 group, which may destabilise the six-coordinate anion. Attempts to isolate the intermediate species for $\text{RCl}_{5-n}(\text{CN})_n^-$; ($\text{R}=\text{C}_6\text{F}_5$ and Et) failed; usually a mixture of products was isolated. Similar behaviour has been found previously in the C_6H_5 and Me derivatives (20,56-7).

In all cases, the compounds were identified by

means of ^{31}P n.m.r. spectroscopy and, for isolable compounds, elemental analyses, i.r. and sometimes ^{35}Cl n.q.r. spectroscopy were used for final structural proof.

7.2 FUTURE WORK.

So far little is known concerning the acceptor properties of organophosphorus (III) halides and pseudohalides. Further investigations are desirable for other compounds with electronegative organo-groups present, such as RPX_2 ($\text{R}=\text{CF}_3$ and C_2Cl_5 ; $\text{X}=\text{Cl}, \text{Br}, \text{I}, \text{CN}$ and NCS) and the analogous R_2PX series. Alternative methods of synthesising $\text{CCl}_3\text{P}(\text{CN})_2$ might also be worth pursuing, (eg. chlorination of $\text{MeP}(\text{CN})_2$, although this could lead to the phosphorane $\text{CCl}_3\text{P}(\text{CN})_2\text{Cl}_2$ or even to CCl_3PCl_2 by loss of cyanogen), and if this compound could be isolated, the acceptor properties could be investigated towards halides and pseudohalides.

It would also be interesting to study the acceptor properties of CF_3PX_4 ($\text{X} = \text{Cl}$ or Br) towards Lewis bases such as halide ions and uni- or bidentate pyridines, and those of its ionic derivative CF_3PX_3^+ towards uni- and bidentate ligands such as 2,2'-bipyridine and 1,10-phenanthroline, to see whether isomeric six-coordinate cationic species can be prepared. Substitution of NCO^- , NCS^- and CN^- into the $\text{CF}_3\text{PCl}_5^-$ anion, if it can be synthesised, can be investigated and compared with the results obtained for the cyano- and thiocyanato-derivatives in this work.

Furthermore the acceptor properties of organophosphorus (V) species RBr_4 or $\text{RPCl}_{4-n}\text{Br}_n$ ($\text{R}=\text{C}_6\text{F}_5$, CCl_3 or C_2Cl_5) towards chloride or bromide could be studied, and,

if the adduct is isolable, its reactions with pseudohalides (NCS^- , CN^- and NCO^-) could also be investigated.

It would also be interesting to react some of the phosphorus (V) acceptors with different bidentate ligands, such as $\text{Ph}_2\text{PCH}_2\text{CH}_2\text{PPh}_2$, instead of bipy or phen, to see whether they will complex with "soft" as well as "hard" bases.

APPENDIX ONE

INFRARED SPECTRA.

Index to the spectra.

1. $\text{PhP}(\text{NCS})_2$ (liquid).
2. $\text{EtP}(\text{NCS})_2$ "
3. $\text{C}_6\text{F}_5\text{P}(\text{NCS})_2$ "
4. $\text{Et}_4\text{NC}_6\text{F}_5\text{P}(\text{NCS})_3$ (Nujol Mull).
5. $\text{Pr}_4\text{NC}_6\text{F}_5\text{P}(\text{NCS})_2\text{I}$ "
6. $\text{C}_6\text{F}_5\text{PCl}_4$ "
7. $\text{Pr}_4\text{NC}_6\text{F}_5\text{PCl}_5$ "
8. $\text{C}_6\text{F}_5\text{PCl}_3\text{BCl}_4$ "
9. $\text{C}_6\text{F}_5\text{PCl}_3\text{bipySbCl}_6$ "
10. $\text{C}_6\text{F}_5\text{PCl}_3\text{phenSbCl}_6$ "
11. $(\text{C}_6\text{F}_5)_2\text{PCl}_3$ "
12. $(\text{C}_6\text{F}_5)_2\text{PCl}_2\text{SbCl}_6$ "
13. $(\text{C}_6\text{F}_5)_2\text{PCl}_2\text{ICl}_4$ "
14. $(\text{C}_6\text{F}_5)_2\text{PCl}_2\text{phenSbCl}_6$ "
15. $\text{CCl}_3\text{PCl}_3\text{BCl}_4$ "
16. $\text{CCl}_3\text{PCl}_3\text{phenSbCl}_6$ "
17. $\text{C}_2\text{Cl}_5\text{PCl}_4$ "
18. $\text{C}_2\text{Cl}_5\text{PCl}_3\text{phenCl}$ "
19. $\text{Pr}_4\text{NC}_6\text{F}_5\text{PCl}(\text{CN})_4$ "
20. $\text{Et}_4\text{NC}_6\text{F}_5\text{PCl}(\text{CN})_4$ (in CH_2Cl_2)
21. $\text{Pr}_4\text{NCCl}_3\text{PCl}_3(\text{CN})_2$ "
22. $\text{Pr}_4\text{NCCl}_3\text{PCl}_2(\text{CN})_3$ "

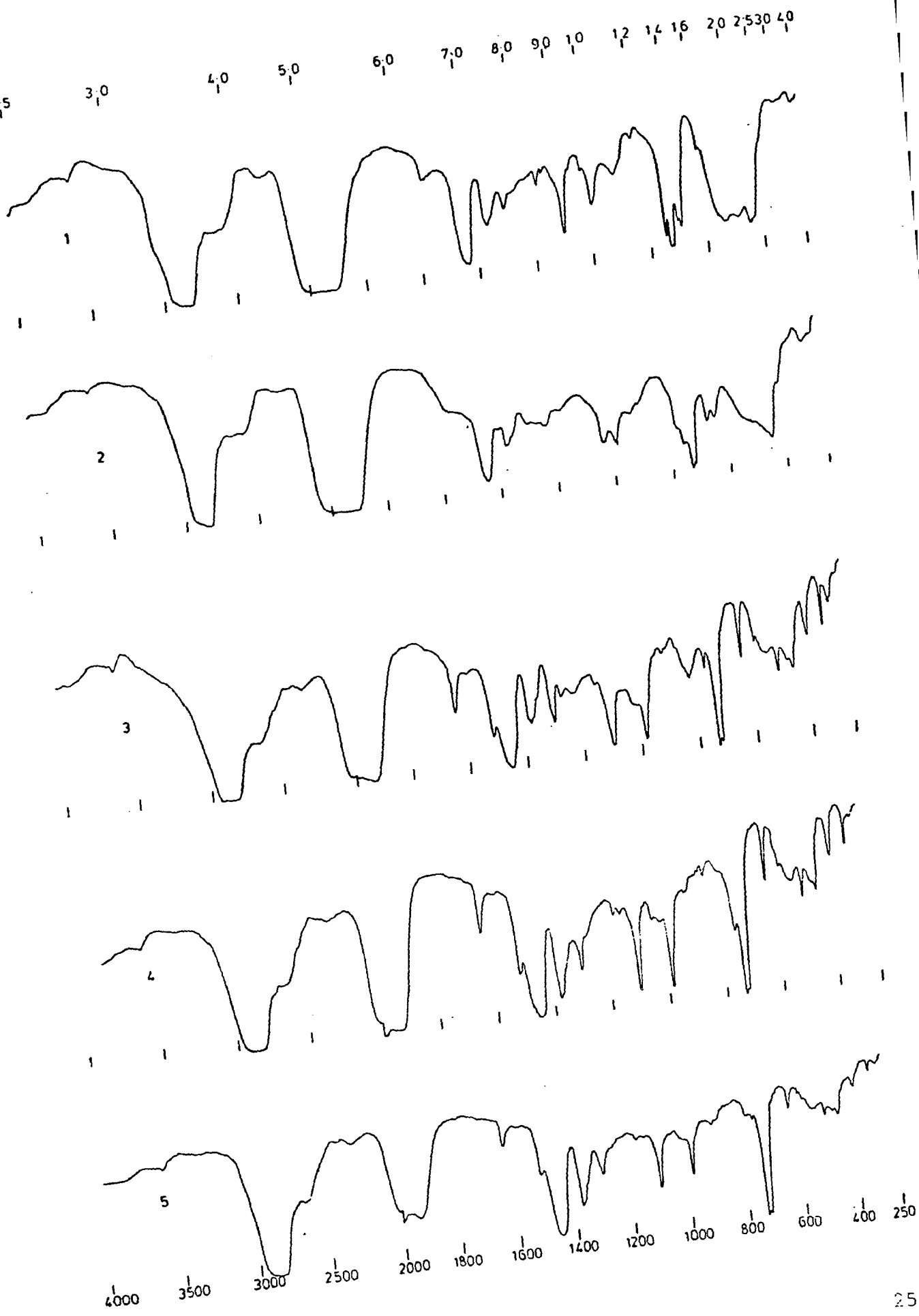

25 MICRONS 30

40

50

60

70

80

90

10

12

14

16

20

25

30 40

6

7

8

9

10

4000
3500
3000
WAVENUMBER (CM⁻¹)

2500

2000

1800

1000

1400

1200

1000

800

600

400

250

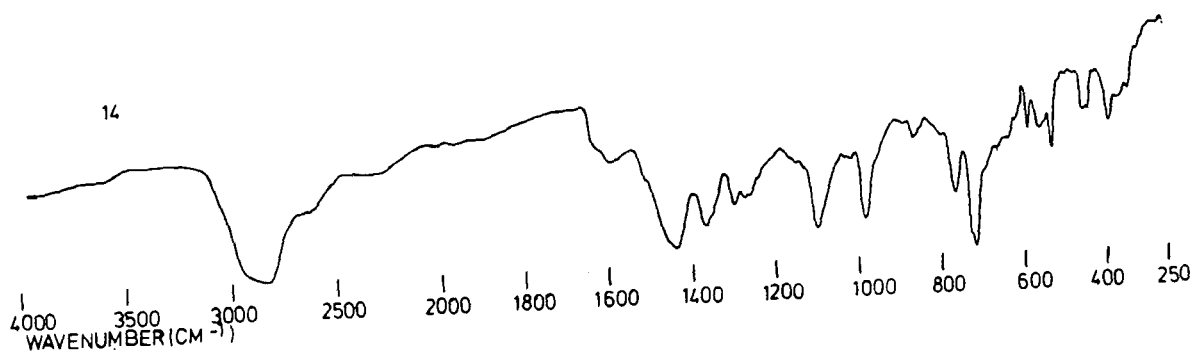
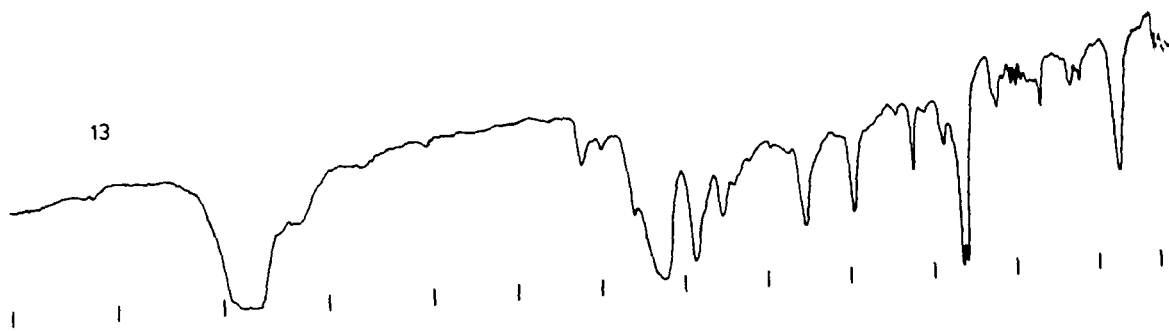
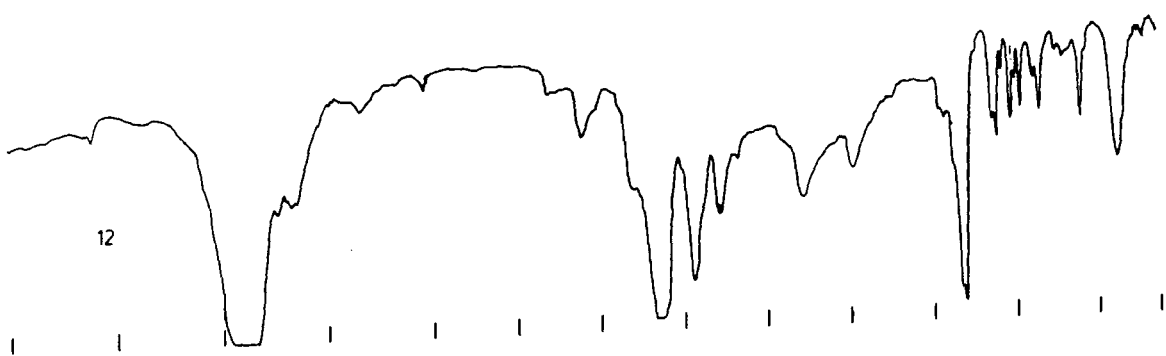
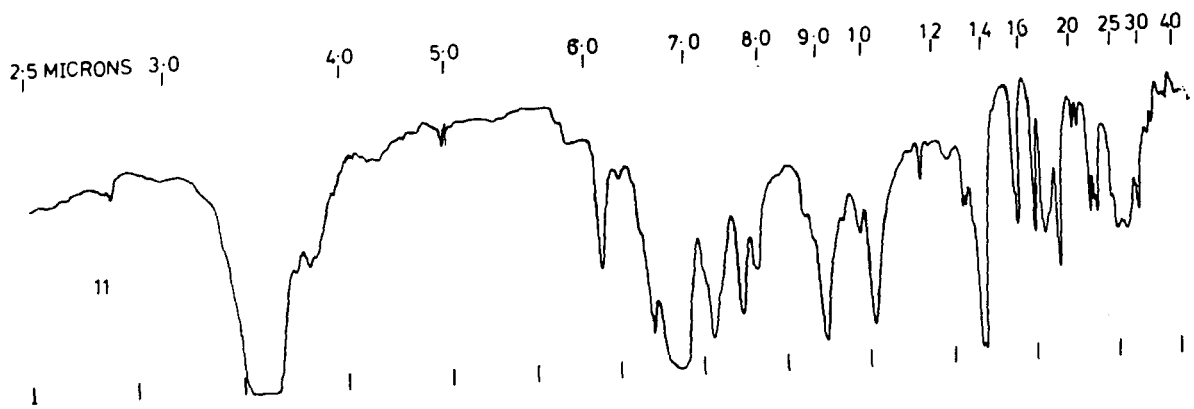

2.5 MICRONS 3.0 4.0 5.0 6.0 7.0 8.0 9.0 10 12 14 16 18 20 25 30 40

15

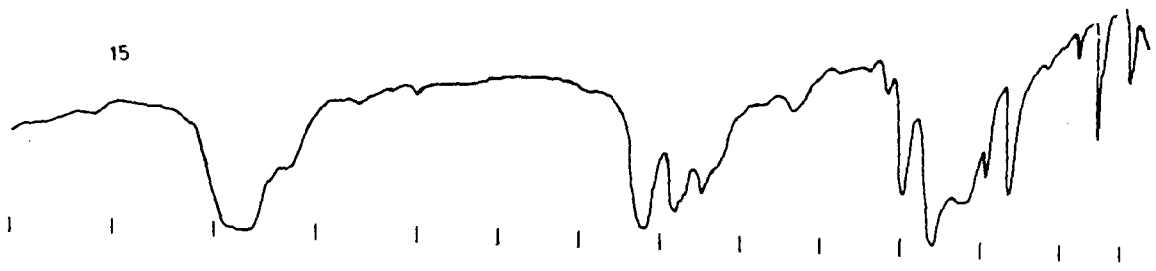

16

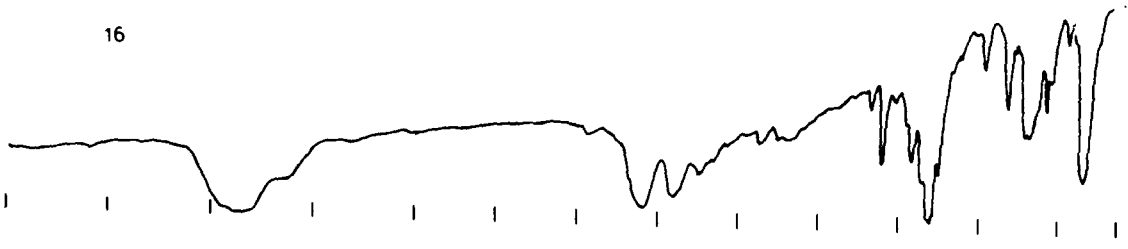

17

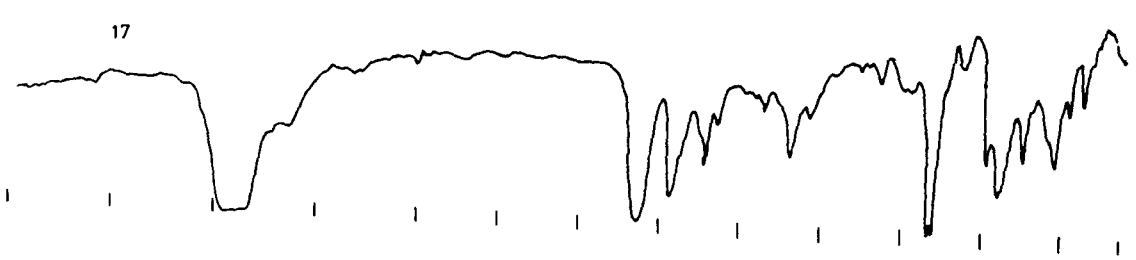

18

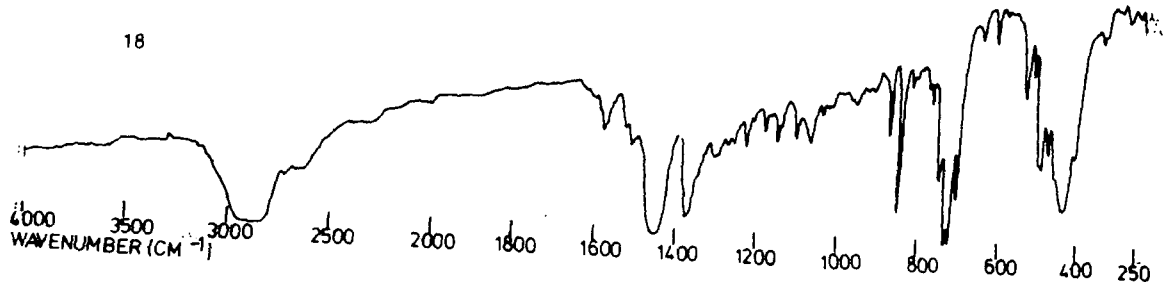

4000
3500
3000
WAVENUMBER (CM⁻¹)

2500 2000 1800 1600 1400 1200 1000 800 600 400 250

2.5 MICRONS 30

40

50

60

70

80

90

10

12

14

16

20

25

30

40

19

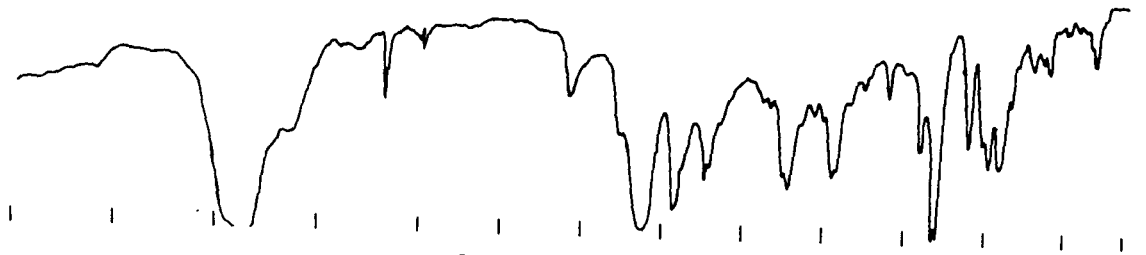

20

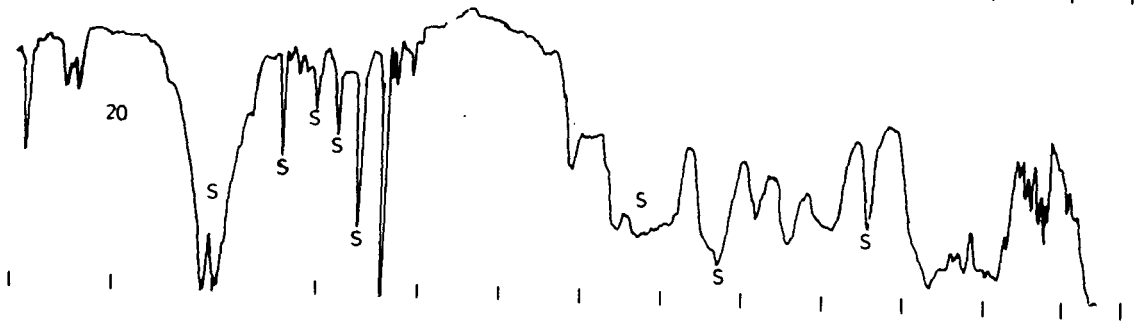

21



22

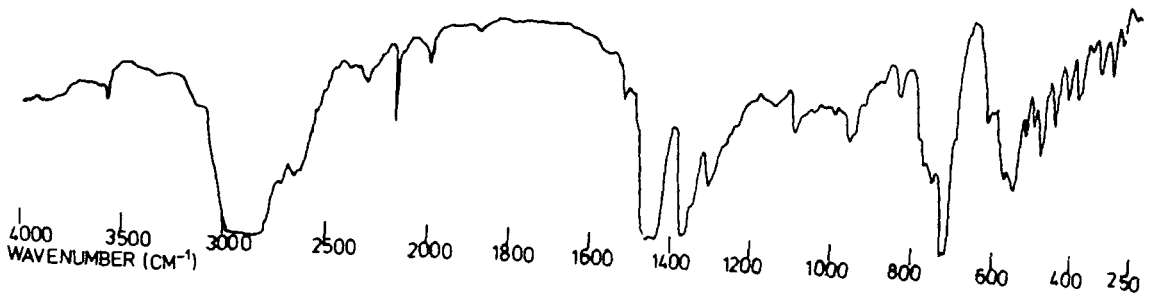

APPENDIX TWO

Departmental colloquia and first-year induction course for post-graduates. The colloquia marked (*) were the ones attended by the author.

1) University of Durham chemistry colloquia:

Academic year 1983-1984

- 5 October* Prof. J.P. Maier (Basel, Switzerland)
"Recent approaches to spectroscopic characterization of cations"
- 12 October* Dr. C.W. McLeland (Port Elizabeth, Australia)
"Cyclization of aryl alcohols through the intermediacy of alkoxy radicals and aryl radical cations"
- 19 October* Dr. N.W. Alcock (Warwick)
"Aryl tellurium (IV) compounds, patterns of primary and secondary bonding"
- 26 October* Dr. R.H. Friend (Cavendish, Cambridge)
"Electronic properties of conjugated polymers"
- 30 November* Prof. I.M.G. Cowie (Stirling)
"Molecular interpretation of non-relaxation processes in polymer glasses"
- 2 December Dr. G.M. Brooke (Durham)
"The fate of the ortho-fluorine in 3,3-sigmatropic reactions involving polyfluoro-aryl and -hetero-aryl systems"

- 14 December Prof. R.J. Donovan (Edinburgh)
 "Chemical and physical processes involving
 the ion-pair states of the halogen molecules"
- 10 January* Prof. R. Hester (York)
 "Nanosecond Laser Spectroscopy of Reaction
 Intermediates"
- 18 January* Prof. R.K. Harris (UEA)
 "Multi-nuclear solid state magnetic
 resonance"
- 8 February* Dr. B.T. Heaton (Kent)
 Multi-nuclear NMR studies"
- 15 February* Dr. R.M. Paton (Edinburgh)
 "Heterocyclic Syntheses using Nitrile
 Sulphides"
- 7 March* Dr. R.T. Walker (Birmingham)
 "Synthesis and Biological Properties of some
 5-substituted Uracil Derivatives; yet another
 example of serendipity in Anti-viral
 Chemotherapy"
- 21 March Dr. P. Sherwood (Newcastle)
 "X-ray photoelectron spectroscopic studies of
 electrode and other surfaces"
- 21 March Dr. G. Beamson (Durham/Kratos)
 "EXAFS: General principles and Applications"
- 23 March* Dr. A. Ceulemans (Leuven)
 "The development of Field-Type models of the
 Bonding in Molecular Clusters"

- 2 April Prof. K. O'Driscoll (Waterloo)
 "Chain Ending reaction in Free Radical Polymerisation"
- 3 April* Prof. C.H. Rochester (Dundee)
 "Infrared Studies of Adsorption at the solid-liquid Interface"
- 25 April Dr. R.M. Acheson (Biochemistry, Oxford)
 "Some Heterocyclic Detective Stories"
- 27 April Dr. T. Albright (Houston, U.S.A.)
 "Sigmatropic Rearrangements in Organometallic Chemistry"
- 14 May Prof. W.R. Dolbier (Florida, U.S.A.)
 "Cycloaddition Reactions of Fluorinated Allenes"
- 16 May Dr. P.J. Garratt (UCL)
 "Synthesis with Dilithiated Vicinal Diesters and Carboximides"
- 22 May Prof. F.C. de Schryver (Leuven)
 "The use of Luminescence in the study of micellar aggregates" and "Configurational and Conformational control in excited state complex formation"
- 23 May Prof. M. Tada (Waseda, Japan)
 "Photochemistry of Dicyanopyrazine Derivatives"
- 31 May* Dr. A. Haaland (Oslo)
 "Electron Diffraction Studies of some

- organo-metallic compounds"
- 11 June Dr. J.B. Street (IBM, California)
"Conducting Polymers derived from Pyrroles"
- 19 September Dr. C. Brown (IBM, California)
"New Superbase reactions with organic
compounds"
- 21 September Dr. H.W. Gibson (Signal OUP, Illinois)
"Isomerization of Polyacetylene"
- Academic year 1984-1985
- 19 October Dr. A. Germain (Languedoc, Montpellier)
"Anodic oxidation of Perfluoro Organic
Compounds in Perfluoroalkane Sulphonic Acids"
- 24 October* Prof. R.K. Harris (Durham)
"N.M.R. of Solid Polymers"
- 28 October Dr. R. Snaith (Strathclyde)
"Exploring Lithium Chemistry: Novel
Structures, Bonding and Reagents"
- 7 November Prof. W.W. Porterfield (Hamden-Sydney
College, U.S.A.)
"There is no Borane Chemistry (only Geometry)"
- 7 November Dr. H.S. Munro (Durham)
"New Information from ESCA Data"
- 21 November Mr. N. Everall (Durham)
"Picosecond Pulsed Laser Raman Spectroscopy"
- 27 November Dr. W.J. Feast (Durham)
"A Plain Man's Guide to Polymeric Organic
Metals"

- 28 November Dr. T.A. Stephenson (Edinburgh)
 "Some recent studies in Platinum Metal
 Chemistry"
- 12 December* Dr. K.B. Dillon (Durham)
 "³¹P n.m.r. Studies of some Anionic
 Phosphorus Complexes"
- 11 January Emeritus Prof. H. Suschitzky (Salford)
 "Fruitful Fissions of Benzofuroxanes and
 Isobenzimidazoles (umpolung of
 o-phenylenediamine)"
- 13 February Dr. G.W.J. Flett (Oxford)
 "Synthesis of some Alkaloids from
 Carbohydrates"
- 19 February Dr. D.J. Mincher (Durham)
 "Stereoselective Synthesis of some novel
 Anthra-cyclinones related to the anti-cancer
 drug Andriamycin and to the Steffimycin
 Antibiotics"
- 27 February Dr. R.E. Mulvey (Durham)
 "Some unusual Lithium Complexes"
- 6 March Dr. P.J. Kocienski (Leeds)
 "Some Synthetic Applications of
 Silicon-Mediated Annulation Reaction"
- 7 March Dr. P.J. Rodgers (I.C.I. plc. Agricultural
 Division, Billingham)
 "Industrial Polymers from Bacteria"

- 12 March* Prof. K.J. Packer (B.P. Ltd./East Anglia)
 "N.M.R. Investigation of the Structure of Solid Polymers"
- 14 March Prof. A.R. Katritzky F.R.S. (Florida)
 "Some Advantures in Heterocyclic Chemistry"
- 20 March* Dr. M. Poliakoff (Nottingham)
 "New Methods for detecting Organometallic Intermediates in Solution"
- 28 March Prof. H. Ringsdorf (Mainz)
 "Polymeric Liposomes as Models for Biomembranes and Cells"
- 24 April Dr. M.C. Grossel (Bedford College, London)
 "Hydroxypyridone dyes-Bleachable one-dimensional Metals?"
- 25 April Major S.A. Shackelford (U.S. Air Force)
 "In Situ Mechanistic Studies on Condensed Phase Thermochemical Reaction Processes; Deuterium Isotope Effects in HMX Decomposition, Explosives and Combustion"
- 1 May Dr. D. Parker (I.C.I. plc., Petrochemical and Plastics Division, Wilton)
 "Applications of Radioisotopes in Industrial research"
- 7 May Prof. G.E. Coates (formerly of University of Wyoming, U.S.A.)
 "Chemical Education in England and Amarica: Successes and Deficiencies"

- 8 May Prof. D. Tuck (Windsor, Ontario)
"Lower oxidation State Chemistry of Indium"
- 8 May Prof. G. Williams (U.C.W. Aberystwyth)
"Liquid Crystalline Polymers"
- 9 May* Prof. R.K. Harris (Durham)
"Chemistry in a Spin: Nuclear Magnetic Resonance"
- 14 May Prof. J. Passmore (New Brunswick, U.S.A.)
"The Synthesis and Characterisation of some Novel Selenium-Iodine Cations, aided by ^{77}Se N.M.R. Spectroscopy"
- 15 May* Dr. J.E. Packer (Auckland, New Zealand)
"Studies of Free Radical Reactions in aqueous solution using Ionising Radiation"
- 17 May Prof. I.D. Brown (McMaster University, Canada)
"Bond Valence as a Model for Inorganic Chemistry"
- 21 May Dr. D.L.H. Williams (Durham)
"Chemistry in Colour"
- 22 May Dr. M. Hudlicky (Blacksburg, U.S.A.)
"Preferential Elimination of Hydrogen Fluoride from Vicinal Bromofluorocompounds"
- 22 May Dr. R. Grimmett (Otago, New Zealand)
"Some Aspects of Nucleophilic Substitution in Imidazoles"

- 4 June Dr. P.S. Belton (Food Research Institute,
Norwich)
"Analytical Photoacoustic Spectroscopy"
- 13 June Dr. D. Woolins (Imperial College, London)
"Metal-Sulphur-Nitrogen Complexes"
- 14 June Prof. Z. Rappoport (Hebrew University,
Jerusalem)
"The Rich Mechanistic World of Nucleophilic
Cinylic Substitution"
- 19 June Dr. T.N. Mitchell (Dortmund)
"Some Synthetic and N.M.R.-Spectroscopic
Studies of Organotin Compounds"
- 26 June Prof. G. Shaw (Bradford)
"Synthetic Studies on Imidazole Nucleosides
and the Antibiotic Coformycin"
- 12 July Dr. K. Laali (Hydrocarbon Research
Institute, University of southern California)
"Recent Developments in Superacid Chemistry
and Mechanistic Considerations in
Electrophilic Aromatic Substitutions; a
Progress Report"
- Academic year 1985-1986
- 13 September* Dr. V.S. Parmar (University of Delhi)
"Enzyme Assisted ERC Synthesis"
- 30 October Dr. S.N. Whittleton (University of Durham),
"An Investigation of a Reaction Window"

- 5 November Prof. M.J. O'Donnell (Indiana-Purdue University)
 "New Methodology for the Synthesis of Amino acids"
- 20 November Dr. J.A.H. MacBride (Sunderland Polytechnic),
 "A Heterocyclic Tour on a Distorted Tricycle-Biphenylene"
- 28 November Prof. D.J. Waddington (University of York),
 "Resources for the Chemistry teacher"
- 15 January Prof. N. Sheppard (University of East Anglia),
 "Vibrational and Spectroscopic Determinations of the Structures of Molecules Chemisorbed on Metal Surfaces"
- 29 January Dr. J.H. Clark (University of York),
 "Novel Fluoride Ion Reagents"
- 12 February Prof. O.S. Tee (Concordia University, Montreal),
 "Bromination of Phenols"
- 12 February Dr. J. Yarwood (University of Durham),
 "The Structure of Water in Liquid crystals"
- 19 February Prof. G. Procter (University of Salford),
 "Approaches to the Synthesis of some Natural products"
- 26 February Miss C. Till (University of Durham),
 "ESCA and Optical Emission Studies of the Plasma Polymerisation of Perfluoroaromatics"

- 5 March Dr. D. Hathway (University of Durham),
"Herbicide Selectivity"
- 12 March Dr. J.M. Brown (University of Oxford),
"Chelate Control in Homogeneous Catalysis"
- 14 May Dr. P.R.R. Langridge-Smith (University of
Edinburgh),
"Naked Metal Cluster - Synthesis, Charac-
terisation and Chemistry"
- 9 June* Prof. R. Schmutzler (University of
Braunschweig),
"Mixed Valence Diphosphorous Compounds"
- 23 June* Prof. R.E. Wilde (Texas Technical
University),
"Molecular Dynamic Processes from
Vibrational Bandshapes"

2) Durham University Chemical Society Lectures:

Academic year 1983-1984

- 20 October* Prof. R.B. Cundall (salford)
"Explosives"
- 3 November Dr. G. Richards (Oxford)
"Quantum Pharmacology"
- 10 November Prof. J.H. Ridd (U.C.L.)
"Ipso-Attack in Electrophilic Aromatic
Substitution"
- 17 November Dr. J. Harrison (Sterling Organic)
"Applied Chemistry and the Pharmaceutical

- Industry" (Joint Lecture with the Society of
Chemical Industry)
- 24 November Prof. D.A. King (Liverpool)
"Chemistry in 2-Dimensions"
- 1 December Dr. J.D. Coyle (The Open University)
"The Problem with Sunshine"
- 26 January Prof. T.L. Blundell (Birkbeck College,
London)
"Biological Recognition: Interactions of
Macro-molecular surfaces"
- 2 February* Prof. N.B.H. Jonathan (Southampton)
"Photoelectron Spectroscopy - A Radical
Approach"
- 23 February Prof. F.G.A. Stone F.R.S. (Bristol)
"The Use of Carbene and Carbyne Groups to
Synthesise Metal Clusters" (The Waddington
Memorial Lecture)
- 1 March* Prof. A.J. Leadbetter (Rutherford Appleton
Labs)
"Liquid Crystals"
- 8 March Prof. D. Chapman (Royal Free Hospital School
of Medicine, London)
"Phospholipids and Biomembranes, Basic
science and Future Technique"
- 28 March Prof. H. Schmidbaur (Munich, F.R.G.)
"Ylides in Coordination Sphere of Metal:
Synthetic, structural and Theoretical

- Aspects" (R.S.C. Centenary Lecture)
- 12 June* Prof. D. Phillips (The Royal Institution)
 "Luminescence and Photochemistry - A Light
 Entertainment"
- Academic year 1984-1985
- 13 October* Dr. N. Logan (Nottingham)
 "N₂O₄ and Rocket Fuels"
- 23 October Dr. W.J. Feast (Durham)
 "Syntheses of Conjugated Polymers. How and
 Why?"
- 8 November Prof. B.J. Aylett (Queen Mary College,
 London)
 "Silicon - Dead Common or Refined?"
- 15 November Prof. B.T. Golding (Newcastle-upon-Tyne)
 "The Vitamine B12 Mystery"
- 22 November Prof. D.T. Clark (I.C.I. New Science group)
 "Structure, Bonding, Reactivity and
 Synthesis as Revealed by ESCA" (R.S.C.
 Tilden Lecture)
- 29 November Prof. C.J.M. Stirling (University College of
 North Wales)
 "Molecules taking the strain"
- 6 December Prof. R.D. Chambers (Durham)
 "The Unusual World of Fluorine"
- 24 January Dr. A.K. Covington (Newcastle-upon-Tyne)
 "Chemistry with Chips"

- 31 January Dr. M.L.H. Green (Oxford)
"Naked Atoms and Negligee Ligands"
- 7 February* Prof. A. Ledwith (Pilkington Bros.)
"Glass as a High Technology Material" (Joint
lecture with the Society of Chemical
Industry)
- 14 February Dr. J.A. Salthouse (Manchester)
"Son et Lumiere"
- 21 February Prof. P.M. Maitlis, F.R.S. (Sheffield)
"What Use is Rhodium?"
- 7 March Dr. P.W. Atkins (Oxford)
"Magnetic Reactions"

Academic year 1985-1986

- 17 October Dr. C.J. Ludman (University of Durham),
"Some Thermochemical aspects of Explosions"
(A Demonstration Lecture)
- 24 October Dr. J. Dewing (U.M.I.S.T.),
"Zeolites-Small Holes, Big Opportunities"
- 31 October Dr. P. Timms (University of Bristol),
"Some Chemistry of Fireworks"
(A Demonstration Lecture)
- 7 November Prof. G. Ertl (University of Munich),
"Heterogeneous Catalysis"
(R.S.C. Centenary Lecture)

- 14 November Dr. S.G. Davies (University of Oxford),
"Chirality Control and Molecular
Recognition"
- 21 November Prof. K.H. Jack, F.R.S. (University of
Newcastle/Tyne),
"Chemistry of Si-Al-O-N Engineering
Ceramics" (Joint Lecture with the Society of
Chemical Industry)
- 28 November Dr. B.A.J. Clark (Research Division, Kodak
Ltd),
"Chemistry and Principles of colour
Photography"
- 23 January Prof. Sir Jack Lewis, F.R.S. (University of
Cambridge),
"Some More Recent Aspects in the Cluster
Chemistry of Ruthenium and Osmium Carbonyls"
(The Waddington Memorial Lecture)
- 30 January Dr. N.J. Phillips, (University of
Technology, Loughborough),
"Laser Holography"
- 13 February Prof. R. Grigg (Queen's University,
Belfast),
"Thermal Generation of 1,3-Dipoles"
(R.S.C. Tilden Lecture)
- 20 February DR. C.J.F. Barnard, (Johnson Matthey Group,
"Platinum Anti-Cancer Drug Development -
From Serendipity to Science"

27 February* Prof. R.K. Harris, (University of Durham),
"The Magic of Solid State N.M.R."
6 June Dr. B. Iddon (University of Salford),
"The Magic of Chemistry"
(A Demonstration Lecture)

* Lectures attended.

3. First year induction course.

Series of lectures arranged by the department for the benefit of the post-graduate students.

| | |
|---|------------------------------------|
| Department organisation | Dr. E.J.F. Ross |
| Safety matters | Dr. M.R. Crampton |
| Electrical appliances and infrared spectroscopy | Mr. R.N. Brown |
| Chromatography, high-pressure work and microanalysis | Mr. T.F. Holmes |
| Atomic absorptiometry and inorganic analysis | Mr. R.Coult |
| Library facilities | Mr. J.A. Wintrip |
| Mass spectrometry | Dr. M. Jones |
| Nuclear magnetic resonance spectroscopy | Dr.R.S. Matthews |
| Glass blowing technique | Mr. R. Hart and Mr. G. Hasswell |

REFERENCES.

1. M. Webster, Chem. Rev. 66, 87 (1966).
2. C.J. Adams and A.J. Downs, J. Inorg. Nucl. Chem. 34, 1829 (1972).
3. K.B. Dillon, R.N. Reeve and T.C. Waddington, J.C.S. Dalton, 1410 (1977).
4. C.D. Schmulbach, Inorg. Chem. 4, 1232 (1965).
5. I.R. Beattie, K. Livingston and M. Webster, J. Chem. Soc., 7421 (1965).
6. I.R. Beattie and M. Webster, J. Chem. Soc. (A), 2166 (1968).
7. K.B. Dillon, R.N. Reeve and T.C. Waddington, J.C.S. Dalton, 2382 (1977).
8. K.B. Dillon, R.J. Lynch, R.N. Reeve and T.C. Waddington, J.C.S. Dalton, 1243 (1976).
9. K.B. Dillon, R.N. Reeve and T.C. Waddington, J.C.S. Dalton, 1318 (1978).
10. R.M.K. Deng and K.B. Dillon, J.C.S. Dalton, 1917 (1984).
11. K.B. Dillon, R.N. Reeve and T.C. Waddington, J.C.S. Dalton, 1465 (1978).
12. I.R. Beattie and M. Webster, J. Chem. Soc. 1731 (1961)
13. I.R. Beattie and M. Webster, J. Chem. Soc. 38 (1963).
14. I.R. Beattie, T.R. Gilson and G.A. Ozin, J. Chem. Soc. (A), 2772 (1968).
15. H.P. Latscha, Z. Naturforsch, B23, 139 (1968).

16. R.M.K. Deng and K.B. Dillon, J.C.S. Dalton, 1911 (1984).
17. K.B. Dillon and A.W.G. Platt, Polyhedron, 2, 641 (1983).
18. K.B. Dillon, A.W.G. Platt and T.C. Waddington, J.C.S. Dalton, 1036 (1980).
19. K.B. Dillon, A.W.G. Platt and T.C. Waddington, J.C.S. Dalton, 2292 (1981).
20. R.M.K. Deng, Ph.D. Thesis, Durham (1981).
21. F.W. Bennett, H.J. Emeleus and R.N. Haszeldine, J. Chem. Soc, 1565 (1953).
22. M. Fild, Z. Naturforsch, 23b, 604 (1968).
23. M. Fild, O. Glemser and I. Hollenberg, Naturwiss, 53, 130 (1966).
24. L. Maier, Helv. Chim. Acta, 46, 2667 (1963).
25. R.M.K. Deng and K.B. Dillon, J.C.S. Chem. Comm., 1170 (1981).
26. A. Schmidpeter and F. Zwaschka, Angew. Chem. Internat. Edn., 16, 704 (1977).
27. A. Michaelis, Justus Liebigs Ann. Chem. 293, 193 (1896).
28. P.G. Kirk and T.D. Smith, J. Chem. Soc. (A), 2190 (1969).
29. A.W.G. Platt, Ph.D. Thesis, Durham (1980).
30. A. Schmidpeter and F. Zwaschka, Angew. Chem. Internat. Edn., 18, 411 (1979).

31. W.S. Sheldrick, A. Schmidpeter, F. Zwaschka, K.B. Dillon, A.W.G. Platt and T.C. Waddington, *J.C.S. Dalton*, 413 (1981).
32. K.B. Dillon, A.W.G. Platt, A. Schmidpeter, F. Zwaschka, and W.S. Sheldrick, *Z. Anorg. Allg. Chem.*, 488, 7 (1982).
33. D.H. Boal and G.A. Ozin, *J.C.S. Dalton*, 1824 (1972).
34. R.P. Holmes and R.P. Wagner, *Inorg. Chem.*, 2, 384 (1963).
35. A.R. Katrizky, F.J. Swinbourne and B. Ternai, *J. Chem. Soc. (B)*, 235 (1966).
36. R.G. Makitra, M.S. Makuruk and M.N. Didych, *J. Gen. Chem. U.S.S.R.*, 42, 1872 (1972).
37. R.C. Paul, M.L. Seghal and S.L. Chadha, *Indian J. Chem.*, 7, 623 (1969).
38. R.C. Paul, M.L. Seghal and S.L. Chadha, *J. Indian Chem. Soc.*, 407, 1071 (1970).
39. A.E. Dixon, *J. Chem. Soc.*, 85, 350 (1904).
40. K.B. Dillon and T.C. Waddington, *Chem. Comm.*, 1317 (1969).
41. M.P. Nisbet, Ph.D. Thesis, Durham (1976).
42. I. Granoth and J.C. Martin, *J. Am. Chem. Soc.*, 100, 7434 (1978).
43. P. Wermer and B.S. Ault, *Inorg. Chem.*, 20, 970 (1981).
44. K.B. Dillon, A.W.G. Platt and T.C. Waddington, *J.C.S. Chem. Comm.*, 889 (1979).

45. H. Gall and J. Schuppen, *Chem. Ber.* 63, 482 (1930).
46. E.G. Il'in, A.P. Nazarov, M.N. Shcherbakova and Yu A. Buslaev, *Doklady Akad. Nauk S.S.S.R.*, 250, 367 (1980).
47. P.J. Chevrier and S. Brownstein, *J. Inorg. Nucl. Chem.*, 42, 1397 (1980).
48. P. Volgnandt and A. Schmidt, *Z. Anorg. Allg. Chem.*, 425, 189 (1976).
49. H.W. Roesky, *Angew. Chem. Internat. Edn.*, 6, 637 (1967).
50. J.R. Walther, M.Sc. Thesis, Ohio State, (1963).
51. H.W. Roesky, *Angew. Chem. Internat. Edn.*, 6, 363 (1967).
52. K.B. Dillon and A.W.G. Platt, *J.C.S. Dalton*, 1199 (1982).
53. K.B. Dillon and A.W.G. Platt, *J.C.S. Chem. Comm.*, 1089 (1983).
54. K.B. Dillon and A.W.G. Platt, *J.C.S. Dalton*, 1159 (1983).
55. K.B. Dillon and A.W.G. Platt, *Phosphorus Sulfur*, 299 (1984).
56. R.M.K. Deng, K.B. Dillon and A.W.G. Platt, *Phosphorus Sulfur*, 18, 93 (1983).
57. R.M.K. Deng and K.B. Dillon, *J.C.S. (Dalton)*, 1843 (1986).
58. B. Budesinsky, *Anal. Chem.* 37, 1159 (1965).
59. D.A. Lee, *Inorg. Chem.*, 3, 289 (1964).
60. L.A. Wall, R.E. Donadio and W.J. Pummer, *J. Am. Chem.*

- Soc., 82, 4846 (1960).
61. L.D. Quin and C.H. Rolston, J. Am. Chem. Soc., 1693 (1958).
 62. R. Baumgartner, W. Sawodny and J. Goubeau, Z. Anorg. Allg. Chem. 333, 171 (1964).
 63. D.B. Sowerby, J. Inorg. Nucl. Chem., 22, 205 (1961).
 64. M. Fild, R. Kurpat and T. Stankiewicz, Z. Anorg. Allg. Chem., 439, 145 (1978).
 65. K.B. Dillon and J. Lincoln, Polyhedron, 4, 1333 (1985).
 66. T. Vladimiroff and E.R. Malinowski, J. Chem. Phys. 46, 1830 (1967).
 67. K.B. Dillon, R.J. Lynch, R.N. Reeve and T.C. Waddington, J.C.S. (Dalton), 1243 (1976).
 68. J.V. Lorenzo and R.F. Schneider, Inorg. Chem. 6, 766 (1967).
 69. R.J. Lynch and T.C. Waddington, Advance in n.q.r. Spectroscopy, Vol. 1, Ed. J.A.S. Smith, Heyden and Son, 1974, page 37.
 70. H. Landesman and R.E. Williams, J. Am. Chem. Soc., 83, 2663 (1961).
 71. K.B. Dillon and T.C. Waddington, Spectrochim. Acta, A30, 1873 (1974).
 72. W. Kynaston, B.E. Larcombe and H.S. Turner, J. Chem. Soc., 1772 (1960).
 73. K.B. Dillon, T.C. Waddington and D. Younger, J.C.S. (Dalton), 790 (1975).
 74. T.C. Waddington and J.A. White, Proc. Chem. Soc. 85

- (1960).
75. G.E. Coates and C. Parkin, *J. Chem. Soc.*, 421 (1961).
 76. H.G. Ang and J.M. Miller, *Chem. and Ind.*, 944 (1966).
 77. M. Webster and M.J. Deveney, *J. Chem. Soc. (A)*, 2166 (1968).
 78. R.N. Reeve, Ph.D. Thesis, Durham (1975).
 79. H.J. Emeleus and J.M. Miller, *J. Inorg. Nucl. Chem.*, 28, 662 (1966).
 80. K.B. Dillon and P.N. Gates, *J.C.S., Chem. Comm.*, 348 (1972).
 81. K.B. Dillon, M.P. Nisbet and T.C. Waddington, *Polyhedron*, 1, 123 (1982).
 82. M.P. Nisbet, Ph.D. Thesis (1976).
 83. H. Gross, J. Gloede, E. Eichhorn, C. Richter and D. Krake, *East German Patent.*, 50605 1966, *Chem. Abs.*, 67, 32468h (1967).
 84. J. Lovell, Personal communication.
 85. V.D. Perner and A. Henglein, *Z. Naturforsch.*, 17b, 703 (1962).
 86. R. Schmutzler and M. Fild, *Inorg. Synthesis*, 12, 290 (1970).
 87. A.M. Kinnear and E.A. Perren, *J. Chem. Soc.*, 3437 (1952).
 88. K.C. Kennard and C.S. Hamilton, *Org. Synthesis*, 4, 950 (1963).
 89. V.I. Dmitriev, E.S. Kozlov, V.B. Timokhin, L.G. Dubenko and A.V. Kalabina, *J. Gen. Chem. U.S.S.R.*, 50, 1799 (1980).

90. I.A. Kyuntsel, V.A. Mokeeva, G.B. Soifer, and I.G. Shaposhnikov, *J. Mag. Res.*, 32, 403 (1978).
91. L.M. Sergienko, G.V. Ratovskii, E.S. Koslov and V.I. Dmitriev, *Zh. Obsch. Khim.*, 51, 494 (1981).
92. A. Ya Yakubovich and V.A. Ginsberg, *Zh. Obsch. Khim.*, 24, 1465 (1954).
93. J.F. Nixon, *J. Inorg. Nucl. Chem.*, 27, 1281 (1965).
94. F. Ramirez, V.A.V. Prasad, and J.F. Marecek, *J. Am. Chem. Soc.*, 96, 7269 (1974).
95. H. Steinberg and A.L. McCloskey, *Progress in Boron Chemistry*, McMillan Co., N.Y. 1974.
96. E.S. Kozlov, S.N. Gaidamaka, I.A. Kyuntsel, V.A. Mokeeva and G.B. Soifer, *J. Gen. Chem., U.S.S.R.*, 47, 930 (1977).
97. H. Reinhardt, D. Banchi and D. Molle, *Chem. Ber.*, 90, 1656 (1957).
98. E.S. Kozlov and S.N. Gaidamaka, *J. Gen. Chem., U.S.S.R.*, 39, 902 (1969).
99. A.W. Frank, *Can. J. Chem.*, 46, 3573 (1968).
100. I.P. Komkov, K.U. Karomanov and S.Z. Ivin, *J. Gen. Chem. U.S.S.R.*, 28, 2992 (1958).
101. K.B. Dillon and R.N. Reeve, *Polyhedron*, 4, 1533 (1985).
102. I.R. Beattie, K. Livingston and T. Gilson, *J. Chem. Soc. (A)*, 1 (1968).
103. A. Michaelis, *Justus Liebigs Ann. Chem.*, 294, 1 (1896).
104. H.H. Anderson, *J. Am. Chem. Soc.*, 75, 1576 (1953).
105. A.N. Pudovik, G.V. Romanov and T. Ya. Stepanova, *J.*

- Gen. Chem. U.S.S.R., 49 , 1248 (1979).
106. J. Goubeau and J. Reyhing, Z. Anorg. Chem., 294, 96 (1958).
107. K. Oba, F Watari and K. Aida, Spectrochim. Acta, 23A, 1515 (1967).
108. M.G. Barlow, M. Green, R.N. Haszeldine and H.G. Hegson, J. Chem. Soc. (B), 1025 (1966).
109. M.G. Barlow, M. Green, R.N. Haszeldine and H.G. Hegson, J. Chem. Soc. (C), 1592 (1966).
110. M. Fild, O. Glemser and I. Hollenberg, Z. Naturforsch, 21b, 920 (1966).
111. M.G. Hogben and W.A.G. Graham, J. Am. Chem. Soc., 91, 283 (1969).
112. A.H. Cowley and R.P. Pinnell, J. Am. Chem. Soc., 88, 4533 (1966).
113. D.D. Magnelli, G. Tesi, J.U. Lowe Jr and W.E. Mc. Quiston, Inorg. Chem., 5, 457 (1966).
114. M. Fild, I. Hollenberg and O. Glemser, Z. Naturforsch, 22b, 248 (1967).
115. K.B. Dillon and M.G.C. Dillon, unpublished work.
116. J.M. Miller, J. Chem. Soc. (A), 828 (1967).
117. R.M.K. Deng and K.B. Dillon, unpublished work.
118. R. Ali and K.B. Dillon, Phosphorus and Sulfur, in press.
119. R.K. Bunting and C.D. Schmulbach, Inorg. Chem., 5, 533 (1966).
120. D.L. Herring, Chem. and Ind., 717 (1960).
121. R.J.W. Cremlyn and D.H. Wakeford, Topics Phosphorus

- Chem., 8, 1 (1976).
122. K.B. Dillon, A.W.G. Platt and T.C. Waddington, Inorg. Nucl. Chem. Lett. 14, 511 (1978).
 123. A. Schmidt, Chem. Ber. 103, 3923 (1970).
 124. W. Buder and A Schmidt, Chem. Ber. 106, 3812 (1973).
 125. Z.H. Binder, Z. Anorg. Allgem. Chem. 383(3), 279 (1971).
 126. J Dazord, H Mongest and H. Atchekzai, Can. J. Chem., 54, 2135 (1976)
 127. K.B. Dillon, unpublished work.
 128. M. Fild and T. Stankiewicz, Z. Naturforsch, 29b, 206 (1974).
 129. J. Burski, J. Kieszkowski, J. Michalski, M. Pakalski and A. Skowronska, Tetrahedron, 39, 4175 (1983).
 130. R. Ali and K.B. Dillon, Polyhedron, 5, 1197 (1986).
 131. M.M. Crutchfield, C.H. Dungan, J.H. Letcher, V. Mark and J.R. Van Wazer, Topics in Phosphorus Chem., 5, (1967).
 132. A.B. Burg and K. Gosling, J. Amer. Chem. Soc., 87, 2113 (1965).
 133. A.E. Arbuzov and K.V.N. Nikoronov, Zh. Obsch. Khim., 18, 2008 (1948).
 134. T.R.B. Jones, J.M. Miller and M. Fild, Org. Mass. Spectroscopy, 12, 317 (1977).
 135. R.G. Harvey and E.R. De Sombre, Topics in Phosphorus Chemistry, 1, 57 (1964).
 136. H.P. Latscha, W. Weber and M. Becke-Goehring, Z. Anorg. Chem. 367, 40 (1969).

137. C.M. Sergienko, G.V. Ratovskii, V.I. Dmitriev and
B.V. Timokhin, *Zh. Obsch. Khim.*, 51, 495 (1981).
138. A. Marshall, Ph.D. Thesis, Durham (1982).
139. K.B. Dillon and A. Marshall, *J.C.S. Dalton*, 1245
(1984).

