



Durham E-Theses

New routes to novel oeganofluorine compounds

Fuss, Robert W.

How to cite:

Fuss, Robert W. (1989) *New routes to novel oeganofluorine compounds*, Durham theses, Durham University. Available at Durham E-Theses Online: <http://etheses.dur.ac.uk/6504/>

Use policy

The full-text may be used and/or reproduced, and given to third parties in any format or medium, without prior permission or charge, for personal research or study, educational, or not-for-profit purposes provided that:

- a full bibliographic reference is made to the original source
- a [link](#) is made to the metadata record in Durham E-Theses
- the full-text is not changed in any way

The full-text must not be sold in any format or medium without the formal permission of the copyright holders.

Please consult the [full Durham E-Theses policy](#) for further details.

NEW ROUTES TO NOVEL ORGANOFLOURINE COMPOUNDS

by

Diplom-Chemiker
Robert W. Fuss
Van Mildert College

The copyright of this thesis rests with the author.
No quotation from it should be published without
his prior written consent and information derived
from it should be acknowledged.

A Thesis submitted for the degree of
Doctor of Philosophy
of the University of Durham
December 1989



25 JUN 1990

Für ewig

Denn was der Mensch in seinen Erdenschränken
Von hohem Glück mit Götternamen nennt,
Die Harmonie der Treue, die kein Wanken,
Der Freundschaft, die nicht Zweifelsorge kennt;
Das Licht, das Weisen nur zu einsamen Gedanken,
Das Dichtern nur in schönen Bildern brennt,
Das hatt' ich all in meinen besten Stunden
In ihr entdeckt und es für mich gefunden.

Goethe

Meiner lieben Petra gewidmet...

MEMORANDUM

The work described in this thesis was carried out at the Universities of Durham, United Kingdom, and at Universität-Gesamthochschule Duisburg, Duisburg, West-Germany, between January 1987 and December 1989. This work has not been submitted for any other degree and is the original work of the author except where acknowledged by reference.

A C K N O W L E D G E M E N T S

I would like to express my thanks to Professor R.D. Chambers for his invaluable advice and encouragement throughout the course of this work.

My thanks also to Professor P. Sartori, Universität-Gesamthochschule Duisburg, for his help and advice with the electrochemical fluorination part of this work.

I am indebted to Drs M. Jones and R. Matthews for running numerous mass spectra and n.m.r. spectra, respectively, and their friendly and helpful discussions while interpreting the data.

I would also like to thank Dr. A. Royston for his support while familiarizing me with the use of the computer facilities.

My special thanks to Mr. T. Holmes and all members of lab. 115/117 who made my stay in Durham so interesting and special thanks for tuition on 'useful' English words.

Last, but by no means least my thanks also to the staff of the Chemistry Department, too numerous to be listed, for their splendid help.

Financial support by the European Community is gratefully acknowledged.

A B S T R A C T

Use of the carbon hydrogen bond as a functional group in free radical addition reactions to fluorinated olefins has been studied. Using cyclic ethers a detailed investigation of the products obtained revealed that not only carbon hydrogen bonds α to oxygen but also the β and γ carbon hydrogen bonds reacted.

Employing hydrocarbons, clean free radical addition reactions initiated by either γ rays or peroxides were observed. Whereas aliphatic hydrocarbons gave reasonable yields, cyclic hydrocarbons gave nearly complete conversions. Some modifications of polyethylene using fluorinated olefins and fluorinated ketones proved successful.

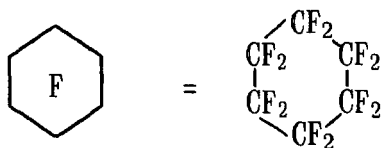
Free radical reactions of tributyltin hydride with fluoro-olefins gave quantitative yields of new tributyl fluoroalkyltin compounds.

Employing partly fluorinated ethers, amines and hydrocarbons exhaustive fluorinations using two different techniques were carried out. Photofluorination gave good yields of the corresponding perfluorinated compounds and a new apparatus, making this technique more generally applicable was designed.

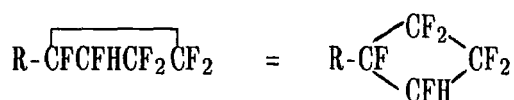
Electrochemical fluorination also gave remarkably good yields of perfluorinated products. This demonstrated the suitability of partly fluorinated compounds for further fluorination to perfluorinated derivatives by these techniques.

N O M E N C L A T U R E

A capital F in a ring or before a chemical structure and the prefix 'perfluoro' denoted that all the ring or the other structure and all unmarked substituents are bonded to fluorine.



For easier writing the following way of illustrating a ring system has been used:



List of Abbreviations

D.T.B.P.	Di-tert-Butyl-Peroxide
D.B.P.	Di-Benzoyl-Peroxide
PE	Polyethylene
ESCA	Electron Spectroscopy for Chemical Analysis
TFE	Tetrafluoroethylene
HFP	Hexafluoropropene
FEP	Copolymer of TFE and HFP
PTFE	Polytetrafluoroethylene
E.C.F.	Electrochemical Fluorination
Ah	Ampere hour
AIBN	Azobisisobutyronitrile

C O N T E N T S

CHAPTER ONE	Some free radical additions of hydrocarbons and derivatives to fluoro-olefins and fluoro-ketones	1
I.A.	Introduction	1
	1. Ethers and amines	1
	2. Hydrocarbons	2
	i) Reactions with fluoro-olefins	2
	ii) Mechanism	2
	a) Aliphatic hydrocarbons	3
	b) Partly fluorinated aliphatic hydrocarbons	6
	c) Unsaturated aliphatic hydrocarbons	7
	d) Cyclic hydrocarbons	9
	g) Free radical reactions of fluoro-ketones with saturated substrates	13
I.B.	Polymer modifications	16
	a) Hexafluoropropene	16
	b) Perfluoro-ketones	16
I.C.	Summary	17
I.D.	Result and Discussion	18
I.E.	Free radical addition of cyclic ethers to hexafluoropropene	18
	1. Mono-adducts	18
	a) Oxolane	18
	b) Oxane	19
	c) Effect of the interaction of CFH groups in hexafluoropropene side chains with heteroatoms	22
	2. Di-adducts	24
	a) Oxolane	24
	b) Oxane	26
I.F.	Stereoelectronic effects on hydrogen abstraction	27
I.G.	Free radical additions of hydrocarbons to hexafluoropropene	29
	1. Cyclic hydrocarbons	29
	a) Cyclohexane	29
	b) Cyclopentane	31
	c) Cyclopropane	32
	d) Cyclohexene	32

	e) 1,5-cyclo-octadiene	33
	f) Decalin	33
	2. Aliphatic hydrocarbons	34
	a) Methane	34
	b) Propane	35
	c) 2-Methyl propane	35
	d) n-Butane	36
	e) 2-Methylbutane	39
	f) n-Hexane	40
I.H.	1. Competition experiments	43
	2. Conclusions	45
	a) Cyclohexane or cyclopentane competition reactions with n-hexane	45
	b) Cyclohexane and cyclopentane competition reaction	46
	c) Cyclohexane and oxane competition reaction	46
	d) Oxolane and 2-(2H-hexafluoropropyl)oxolane competition reaction	46
I.I.	Free radical additions of hydrocarbons to hexafluoroacetone	46
	a) Cyclohexane	46
I.K.	Polymer modifications	47
	a) Polymer modifications using hexafluoropropene	47
	b) Polymer modification using hexafluoroacetone	48
I.L.	Summary and conclusions	50
CHAPTER TWO Some free radical additions of organotin and organoditin compounds to fluorinated olefins		52
II.A.	Introduction	52
II.B.	Organotin hydrides and dihydrides	52
	1. Free radical addition reactions of organotin hydrides to fluoro-olefins	53
	i) Mechanism	53
	ii) Reactions	53
	2. Some free radical addition reactions of organotin dihydrides to fluoro-olefins	55
II.C.	Free radical addition reactions of organoditin compounds to fluoro-olefins	56
	i) Mechanism	57

ii) Reactions	58
II.D. Perfluorovinyltin compounds	60
II.E. Some reactions of organotin compounds containing a polyfluoro side chain	61
II.F. Result and Discussion	
Free radical addition reactions of n-tributyltin hydride and organosilicon compounds to fluoro-olefins	63
1. Introduction	63
II.G. Tributyltin hydride addition reactions to fluoro-olefins	63
a) 1,1-difluoroethylene	64
b) Trifluoroethylene	64
c) Chlorotrifluoroethylene	65
d) Hexafluoropropene	66
e) 2H-pentafluoropropene	67
f) Hexafluoro-2-butyne	67
g) Hexafluorocyclobutene	68
II.H. Reaction of organosilicon compounds with hexafluoropropene	70
II.I. Summary and conclusions	72
II.K. Outlook	73
CHAPTER THREE Direct fluorination (Photofluorination)	74
III.A. Introduction	74
1. Thermochemistry of direct fluorinations	74
2. Steric factors in direct fluorination	76
3. Kinetic control of the reactions of elemental fluorine	76
III.B. Selective fluorinations using elemental fluorine	78
III.C. Liquid phase direct fluorination	79
III.D. Solid state direct fluorination	82
1. Aerosol direct fluorination	82
2. LaMar direct fluorination	85
III.E. Result and Discussion	89
1. Strategy	89
2. Apparatus	89
3. Characterisations	90
4. Direct fluorinations	92

a)	Partly fluorinated aliphatic ether	92
b)	Partly fluorinated di-ethers	93
c)	Partly fluorinated cyclic ethers	94
d)	Partly fluorinated cyclic di-ethers	94
e)	Partly fluorinated tertiary amine	96
f)	Partly fluorinated aliphatic ketone	97
g)	Partly fluorinated cyclic tertiary amine	97
h)	Partly fluorinated cyclic hydrocarbons	97
III.F.	Summary and conclusion	98
CHAPTER FOUR Electrochemical fluorination		99
IV.A.	Introduction	99
IV.B.	Perfluorinated ethers	102
1.	General properties and applications	102
2.	Perfluorinated aliphatic ethers by E.C.F.	104
3.	Perfluorinated cyclic ethers by electrochemical fluorination	107
4.	E.C.F. of cyclic ethers	107
5.	E.C.F. of carboxylic acids and derivatives thereof	109
IV.C.	Result and Discussion	113
1.	Starting materials	113
2.	Electrochemical fluorination conditions	114
3.	Calculation of the theoretically needed current	114
4.	Work up procedure	115
IV.D.	Electrochemical fluorinations	116
1.	Aliphatic mono-ethers	116
a)	Di-(2,2,3,4,4,4-hexafluoro-1-methylbutyl)ether	116
2.	Cyclic mono-ethers	117
a)	2-(2H-hexafluoropropyl)oxolane (<u>1</u>)	117
b)	2,x-bis-(2H-hexafluoropropyl)oxolane (x= 3,4,5) (<u>5</u>)(<u>6</u>)(<u>7</u>)	117
c)	x,y-bis-(2H-hexafluoropropyl)oxane (<u>8</u>)-(13)	119
3.	Cyclic diether	120
a)	2-(2H-hexafluoropropyl)-1,4-dioxan	120
b)	2,x-bis-(2H-hexafluoropropyl)-1,4-dioxan (x= 3,5,6)	120
4.	Tertiary cyclic amines	121
a)	N-(2,2,3,4,4,4-hexafluorobutyl)-x-	

	(2H-hexafluoropropyl)piperidine (x= 2,3,4)	121
5.	Ketones	122
	a) 3,3,4,5,5,5-hexafluoropent-2-on	122
EXPERIMENTAL		
INSTRUMENTATION AND REAGENTS		124
CHAPTER FIVE EXPERIMENTAL TO CHAPTER ONE		125
V.A.	GENERAL PROCEDURE	125
	1. γ -Ray Initiated Reactions	125
	2. Peroxide Initiated Reactions	125
V.B.	SYNTHESIS Free Radical Additions of Hydrocarbons to Hexafluoropropene	126
	1. Cyclic hydrocarbons	126
	a) Cyclohexane	126
	b) Cyclopentane	126
	c) Cyclopropane	127
	d) Cyclohexene	127
	e) 1,5-cyclo-octadiene	127
	f) Decalin	127
	2. Aliphatic hydrocarbons	127
	a) Methane	127
	b) Propane	128
	c) 2-Methylpropane	128
	d) n-Butane	128
	e) 2-Methyl butane	129
	f) n-Hexane	129
V.C.	Competition experiments	130
V.D.	Free Radical Additions of Hydrocarbons to Hexafluoroacetone	130
	a) Cyclohexane	130
V.E.	Polymer modification Free Radical Additions of Polyethylene to Fluorinated Compounds	131
	a) Hexafluoropropene	131
	b) Hexafluoroacetone	131
CHAPTER SIX EXPERIMENTAL TO CHAPTER TWO		132

VI.A.	GENERAL PROCEDURE	132
	1. γ -Ray Induced Reactions	132
	2. Peroxide Initiated Reactions	132
	3. Work up and characterisation	132
VI.B.	SYNTHESES Reactions of n-tributyltin hydride with	
	a) 1,1-difluoroethylene	133
	b) Trifluoroethylene	133
	c) Chlorotrifluoroethylene	133
	d) Hexafluoropropene	134
	e) 2H-pentafluoropropene	134
	f) Hexafluoro-2-butyne	134
	g) Perfluorocyclobutene	134
CHAPTER SEVEN EXPERIMENTAL TO CHAPTER THREE		136
VII.A.	Photofluorination	136
	1. General procedure	136
	a) Di-(2,2,3,4,4,4-hexafluoro-1-methylbutyl)ether	137
	b) 2,4,7-tris-(2H-hexafluoropropyl)ethyleneglycol diethylether	137
	c) 2-(1,1,2,3,3,3-hexafluoropropyl)-1,4-dioxan	137
	d) 2,x-bis(1,1,2,3,3,3-hexafluoropropyl)-1,4-dioxan (x= 3,5,6)	137
	e) 2,3,5-tris(1,1,2,3,3,3-hexafluoropropyl)- 1,4-dioxan and 2,3,5,6-tetrakis(1,1,2,3,3,3- hexafluoropropyl)-1,4-dioxan	138
	f) 1,x-bis(1,1,2,3,3,3-hexafluoropropyl)cyclohexane (x= 2,3,4) (18) (19) (20)	138
	g) 2-(2H-hexafluoropropyl)oxolane (1)	139
	h) 3,3,4,5,5,5-hexafluoropent-2-on	139
	i) Tris-(2,2,3,4,4,4-hexafluoro-1-methylbutyl)- amine	139
CHAPTER EIGHT EXPERIMENTAL TO CHAPTER FOUR		140
VIII.	ELECTROCHEMICAL FLUORINATIONS	140
	1. Apparatus	140
	2. General procedure	142
	3. Experiments	143
	a) Di-(2,2,3,4,4,4-hexafluoro-1-methylbutyl)ether	143

b)	2-(2H-hexafluoropropyl)oxolane (<u>1</u>)	143
c)	2,x-bis-(2H-hexafluoropropyl)oxolane (x= 3,4,5) (<u>5</u>) (<u>6</u>) (<u>7</u>)	144
d)	x,y-bis-(2H-hexafluoropropyl)oxane (x= 2,3) (y= 3,4,5,6) (<u>8</u>) (<u>9</u>) (<u>10</u>) (<u>11</u>) (<u>12</u>) (<u>13</u>)	145
e)	2-(2H-hexafluoropropyl)-1,4-dioxan	145
f)	2,x-bis-(2H-hexafluoropropyl)-1,4-dioxan (x= 3,4,5)	145
g)	N-(2,2,3,4,4,4-hexafluorobutyl)-x- (2H-hexafluoropropyl)piperidine (x= 2,3,4)	146
h)	3,3,4,5,5,5-hexafluoropent-2-on	146
APPENDIX 1	NUCLEARMAGNETIC RESONANCE SPECTRA	148
APPENDIX 2	INFRARED SPECTRA	184
APPENDIX 3	MASS SPECTRA	193
APPENDIX 4	COLLOQUIA AND CONFERENCES	236
REFERENCES		245

CHAPTER ONE

**SOME FREE RADICAL ADDITIONS OF HYDROCARBONS AND DERIVATIVES
TO FLUORO-OLEFINS AND FLUORO-KETONES**

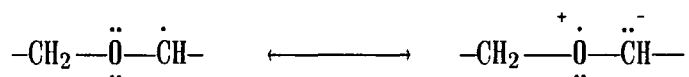
CHAPTER ONE

SOME FREE RADICAL ADDITIONS OF HYDROCARBONS AND DERIVATIVES TO FLUORO-OLEFINS AND FLUORO-KETONES

I.A. INTRODUCTION

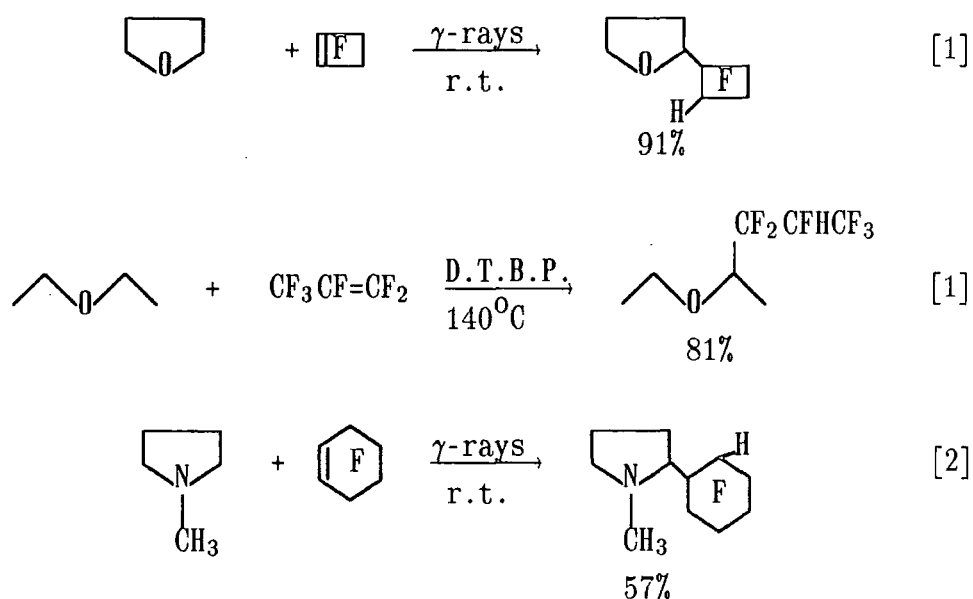
1. Ethers and amines

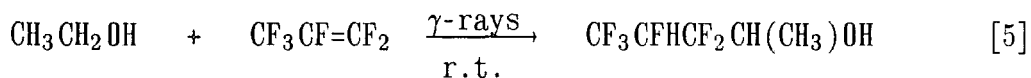
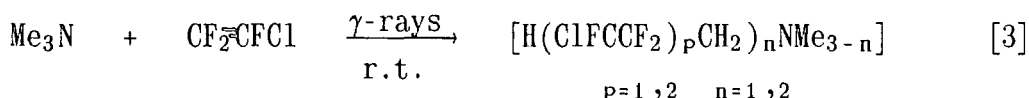
The use of a carbon-hydrogen bond as a functional group in free radical addition reactions to fluoro-olefins has already been described elsewhere¹⁻⁴. The reacting C-H bonds were contained in ethers or amines. In these compounds a radical formed on a carbon atom adjacent to the heteroatom was stabilized by interaction of the radical centre with the lone pair electrons, thus lowering the overall energy of the system.



This stabilisation and subsequent formation of a nucleophilic radical is considered the main driving force for successful nucleophilic radical additions to fluoro-olefins, which are, of course, electrophilic. Some examples are given in table 1.1.

Table 1.1. *Some additions of ethers and amines to fluoro-olefins*





Free radical addition reactions of hydrocarbon compounds to fluoro ketones¹⁹, fluoro-olefins in general^{12,14} and hexafluoropropene in particular^{9,15} have also been described.

2. Hydrocarbons

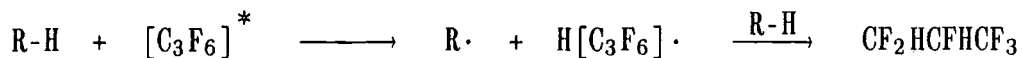
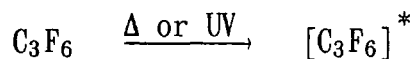
i) Reactions with fluoro-olefins

ii) Mechanism

Additions of the fluoro-olefins to hydrocarbons were initiated either thermally⁷ (*via* thermally excited hexafluoropropene) or by use of ultra violet irradiation⁸ (Scheme 1.1.). The conversions of these reactions, which were accompanied by formation of other products than the addition products, were generally low.

Scheme 1.1. *Radical chain mechanism initiated by hydrogen atom abstraction by excited hexafluoropropene*

Initiation:



Propagation:

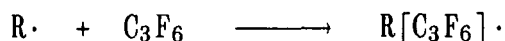
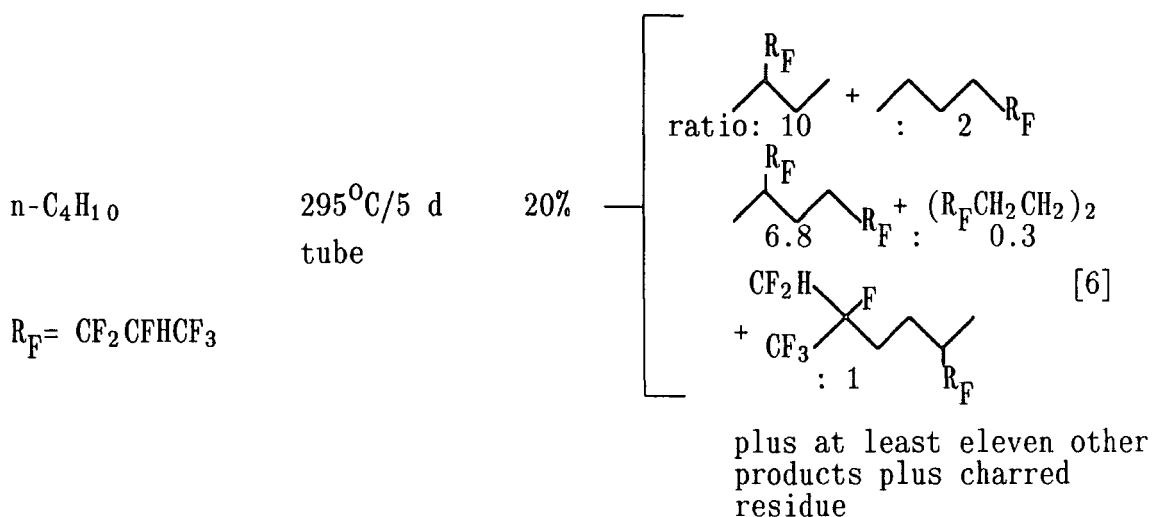


Table 1.2. *Aliphatic hydrocarbon hexafluoropropene adducts*¹
(No peroxides were employed)

Hydrocarbon	Conditions	Recovered ² hexafluoro- propene	Products (yields, %) ^a	Ref.
C ₂ H ₆	300°C/4 d pyrex ampoule	46%	CH ₃ CH ₂ -R _F	[7]
C ₃ H ₈	295°C/4 d pyrex ampoule	32%	(CH ₃) ₂ CH-R _F	[7]
C ₃ H ₈	UV, 40-60°C 24 h, silica ampoule	80%	(CH ₃) ₂ CH-R _F	[8]
i-C ₄ H ₁₀	295°C/4 d	30%	(CH ₃) ₃ C-R _F 11%	[7]
i-C ₄ H ₁₀	UV, 40-60°C 24 h, silica ampoule	71%	(CH ₃) ₃ C-R _F 19.7%	[8]

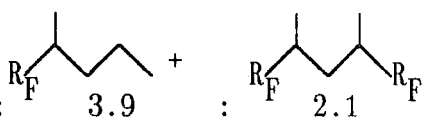
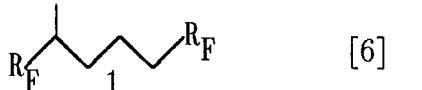
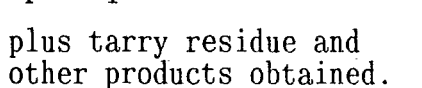


¹ Only the products obtained from addition reactions of hexafluoropropene to the parent hydrocarbon compound are listed.

² A three times molar excess of hydrocarbon was used throughout!

n-C ₄ H ₁₀	UV, 40-60°C 24 h, silica tube	85%	products as above [6] ratio: 39:7:11:0.3:1 plus other products
----------------------------------	-------------------------------------	-----	--

n-C ₄ H ₁₀	D.T.B.P. (2mol%) 130°C, 70 h pyrex tube	60%	products as above [6] ratio: 18:1:40:0.6:3
----------------------------------	--	-----	---

n-C ₅ H ₁₂	300°C/5 d autoclave	22%	ratio:  +  :  3.9 : 2.1 1 [6]
----------------------------------	------------------------	-----	--

R_F = CF₂CFHCF₃

plus tarry residue and other products obtained.

^aWhere possible the yields given were calculated by the author under consideration of the conversions of the reactions. The yields quoted in the literature were based on the obtained product mixtures.

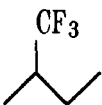
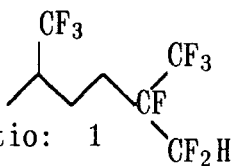
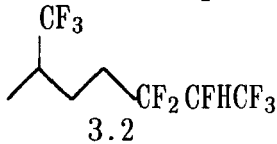

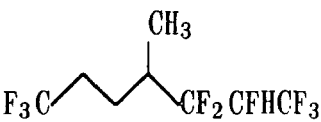
The reactions carried out under thermal conditions, usually *ca.* 300°C for 3 to 5 days not only afforded the desired addition products but also gave rise to considerable side reactions caused mainly by thermal degradation. The products obtained from this process then reacted again with hexafluoropropene thus leading to very complex product mixtures. Formation of tarry residues was also always observed. Table 1.2. reveals a different product distribution for thermal and UV irradiated reactions compared to peroxide initiated reactions. The former ones predominantly formed the mono-adducts whereas the latter one yielded the di-adducts as main product.

b) Partly fluorinated aliphatic hydrocarbons

Partly fluorinated non-cyclic starting materials such as 2-trifluoromethylbutane and 1,1,1-trifluoropentane have also been used to undergo free radical addition reactions to hexafluoropropene¹⁰. Again, thermal conditions were used (292°C) and a number of products were obtained, but only the addition products shall be discussed here. The products are given in table 1.3.

The trifluoromethyl group has a comparable electron withdrawing -I effect to that of a C₃HF₆ group¹⁰. The latter one was found to have a strong deactivating influence on the reactivities of C-H bonds in the α - or β -positions to the polyfluoro group⁶. Since a trifluoromethyl group is less bulky it should sterically hinder reaction at the α - or β -C-H bonds to a lesser extent. However, as the products obtained reveal (table 1.3.), deactivation of the α - and β -C-H bonds in 2-trifluoromethylbutane and 1,1,1-trifluoropentane was caused by the -I effect of the fluoroalkyl groups and steric effects are relatively unimportant. These results are in good agreement with previously reported deactivations of the α - and β -C-H bonds in 1,1,1-trifluoropentane toward abstraction by chlorine¹¹.

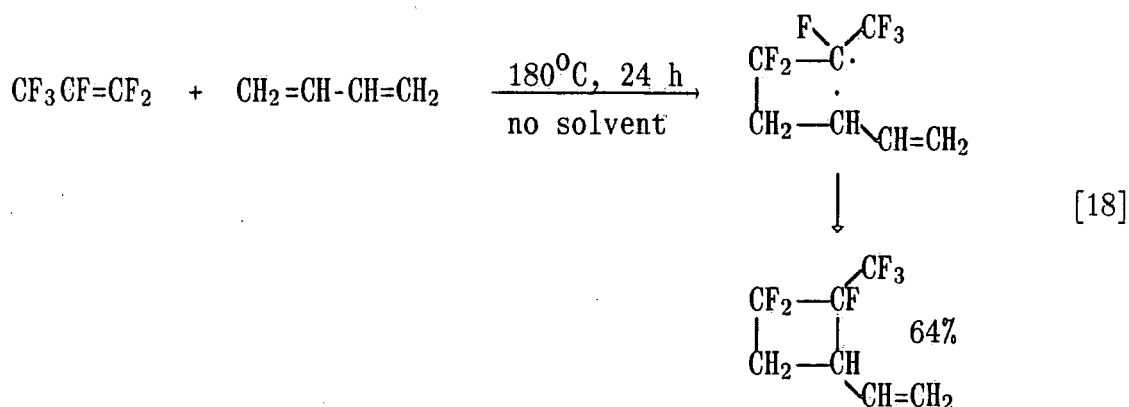
Table 1.3. *Reactions of fluorine containing non-cyclic hydrocarbons with hexafluoropropene (no peroxides were used)*

Hydrocarbon	Conditions	Products	Ref.
	280°C/4 d	ratio: 1   3.2	[10]
	295°C/4 d		[10]

c) Unsaturated aliphatic hydrocarbons

The thermal reaction (380°C) of hexafluoropropene with hydrocarbon olefins can give three different types of products, namely 1,1,2-trifluoro-2-trifluoromethyl-cyclobutanes (scheme 1.3.), hexafluoropropene adducts of the type $R_1R_2C=CR_3CH_2CF_2CFHCF_3$ (e.g. $R_1=R_2=R_3=H$; scheme 1.4.) and 1,1,2-trifluoro-2-trifluoromethylcyclopentanes (scheme 1.5.). Formation of the cyclobutanes involves short lived singlet di-radical intermediates in which bond rotation competes with cyclisation. The major, and often exclusive product, is formed *via* the most stable diradical intermediate¹².

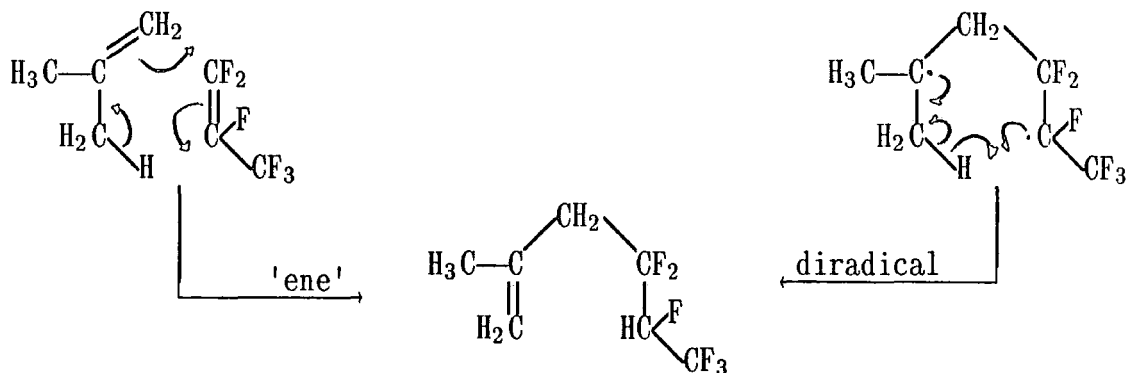
Scheme 1.3. *Thermal cycloaddition of hexafluoropropene to olefins*¹⁸
(no peroxides were used).



Cis- and trans-1,2-disubstituted cyclobutanes were formed and the isomers were obtained in a *ca.* 1:1 ratio. This was explained on the basis of free rotation in the diradical intermediates giving an equal probability for closure to cis- or trans-structures. Haszeldine *et al.*¹³ reported also formation of cis and trans cyclobutanes in a *ca.* 1:1 ratio in reactions employing hexafluoropropene and terminal alkenes such as for example prop-2-enylbenzene or 2,3-dimethylbut-1-ene despite the bulk of the groups attached. However, with non-terminal olefins, noticeable deviations from the *ca.* 1:1 ratios was observed¹³. Thus, for example, 2-methylbut-2-ene gave a cis to trans ratio of *ca.* 1:3. The results indicated that 1,3-steric interactions in the diradical were important and the major isomer was found to be formed in each case in which the CF_3 group and the 3-substituent were trans.

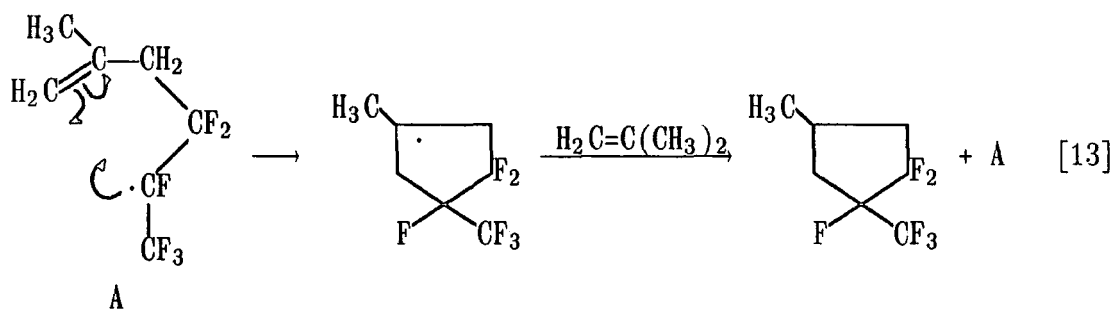
Formation of $R_1R_2C=CR_3CH_2CF_2CFHCF_3$ products was claimed to proceed either *via* an allylic radical generated by proton abstraction by thermally excited hexafluoropropene or by a concerted 'ene' mechanism (scheme 1.4.).

Scheme 1.4. *Concerted 'ene' and diradical mechanism for the formation of hexafluoropropene/olefin adducts¹³ under thermal reaction conditions (no peroxides were used).*



The formation of cyclopentanes was proposed¹² to arise *via* cyclisation of a radical as shown in scheme 1.5.

Scheme 1.5. *Proposed cyclisation reaction for cyclopentanes¹³ under thermal reaction conditions (no peroxides were used).*




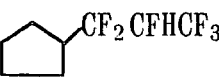

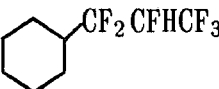

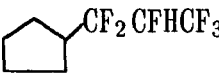

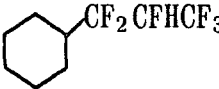

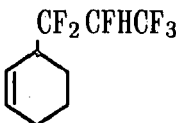


In addition to the three types of products just discussed additional products arising from breakdown reactions were also obtained. Cyclopentanes were not always produced and, if obtained, usually in very small amounts. Allylic insertion products were formed in slightly larger amounts than cyclopentanes but the major products were the cyclobutanes. The conversion of the reactions were usually between 2 and 50% and temperatures used varied from 180°C to 360°C and reaction times from 0.5 to 28 days.

d) Cyclic hydrocarbons

Saturated and unsaturated cyclic hydrocarbon systems as well as alkylbenzenes have been reported to undergo reaction with hexafluoropropene, again, under drastic thermal conditions^{7,9,13}. However, reactions of cyclopentane and cyclohexane have also been carried out under UV irradiation⁸. Both, thermal and UV irradiation reactions were carried out with similar conversions as reported for aliphatic hydrocarbons with hexafluoropropene under identical conditions and are listed in table 1.4. The yields quoted in the literature were based on consumption of hexafluoropropene with not always mentioning the amount of recovered hexafluoropropene, thus they are not listed. Additional products formed were not mentioned in the patent literature^{7,8} but their formation cannot be excluded.

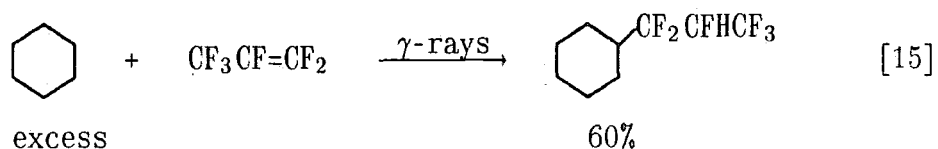
Table 1.4. *Reactions of saturated and unsaturated cyclic hydrocarbons with hexafluoropropene (no peroxides were used).*

Hydrocarbon	Conditions	Recovered ³ hexafluoro- propene	Products (yields) ^a	Ref.
	310°C/4 d	87%		[7]
	290°C/2 d	not given		[7]
	280°C/3 d	40%		[7]
	UV, 40-60°C 60 h	50%		[8]
	UV, 40-60°C 24 h	40%		[8]
	320°C/4 d	4%		[8]

^a The yields quoted in the literature were based on the obtained product mixtures without consideration of the conversion, thus they were not considered here.

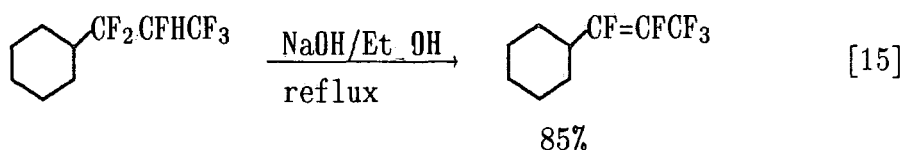
A different approach with intention of kinetic studies was chosen by Russian workers¹⁵. They reacted a 3:2 excess of cyclohexane with hexafluoropropene under γ -ray irradiation at various temperatures (20°C, 25°C, 81°C; 10-14 Mrad).

³ A three times molar excess of hydrocarbon was used throughout!

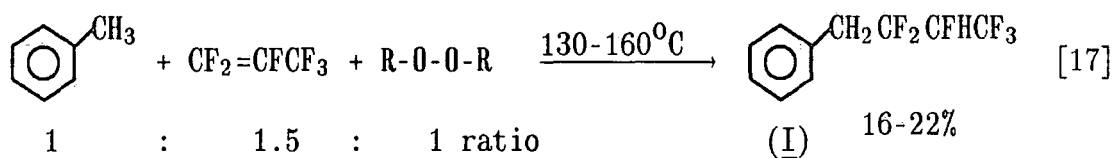


In this clean reaction no additional products, e.g. di-adducts, were reported. The reaction was found to become partly inhibited by water and completely so by benzene or iodine.

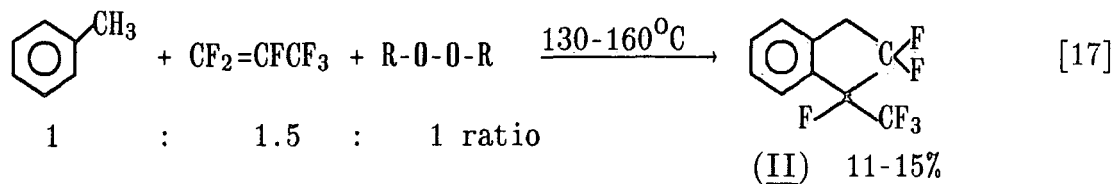
The mono-adduct obtained could be dehydrofluorinated while refluxing in an alcoholic solution of sodium hydroxide.



Some reactions involving alkylbenzenes and chemical initiation are listed in table 1.5. Here, not only the expected additions products like (I), e.g.



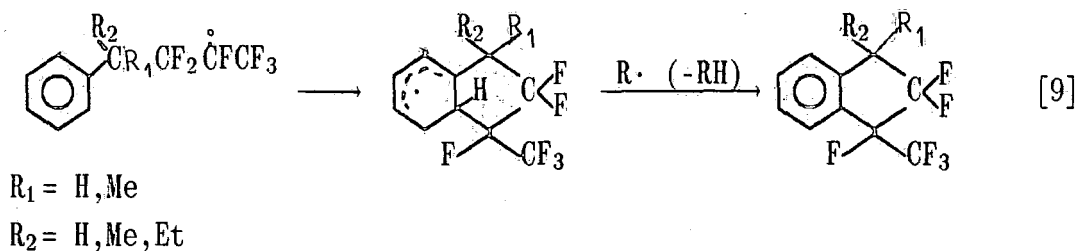
were formed but also indans (II), e.g.



were found.

The formation of indans may be explained as shown in scheme 1.6.

Scheme 1.6. Proposed indan formation by 1,5 cyclisation

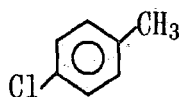


A number of additional products were also described resulting from breakdown or elimination and rearrangement reactions but will not be considered here.

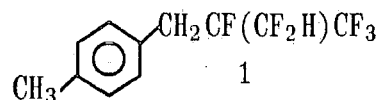
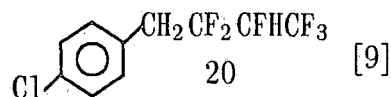
Table 1.5. Alkylbenzene addition products with hexafluoropropene under thermal reaction conditions (no peroxides were used).

Hydrocarbon	Conditions	Recovered hexafluoropropene ⁴	Products (ratios)	Ref.
	pyrex tube 280°C/3 d	65%	80 1.5 1.5 1 5 1.5 1	[9]

⁴ A three times molar excess of hydrocarbon was used throughout!



pyrex tube
250°C/3 d 30%



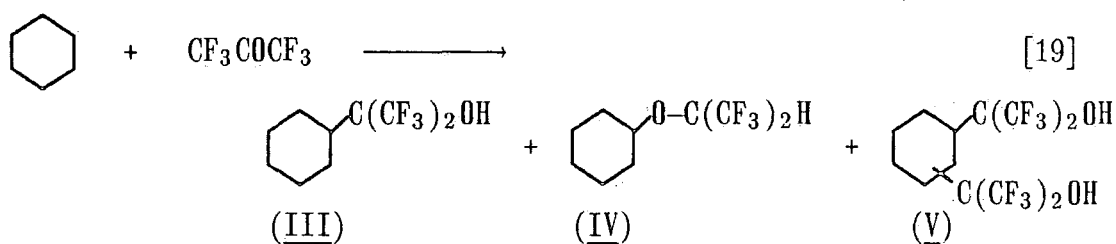
plus four additional
products

As can be seen in table 1.5. in addition to low conversions a large number of products (in the first example at least nine) were formed. Although the major (expected) addition product was obtained a number of undesired side reactions took place which very probably were caused by the drastic conditions employed.

g) Free radical reactions of fluoro-ketones with saturated substrates

Fluoro-ketones are characterized by the electron withdrawing inductive effect (-I) exerted by highly electronegative fluoroalkyl groups. This results in a weakly polarized, electron-deficient carbonyl function, direct evidence for which is the shift of a carbonyl absorption to shorter than normal wavelengths in the infrared²⁰. The electronic arrangement of the carbonyl function in fluoro-ketones more closely resembles the double bond of weakly polarized olefins than it does the carbonyl group in normal hydrocarbon ketones, and fluoro-ketones may therefore undergo free-radical reactions more readily than their hydrocarbon counterparts¹⁹.

Reactions of free radicals (e.g. t-butoxyl radicals) with hexafluoroacetone yielded fluorinated radicals with the odd electron on either the carbon or oxygen as intermediates prior to addition to e.g. saturated hydrocarbons. Thus, for example, cyclohexane gave in free radical addition to hexafluoroacetone a mixture of an alcohol (III), an ether (IV) and a diol (V)

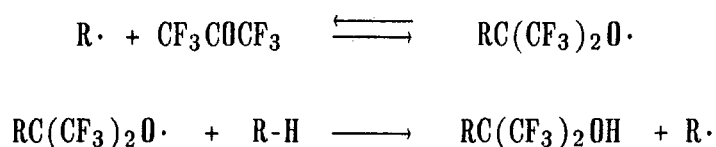


The ratio between the above products was found dependent on the reaction temperature. Yields and reaction conditions are listed below in table 1.6.

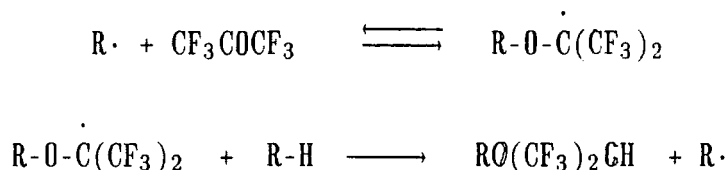
Table 1.6. *Reaction of cyclohexane with hexafluoroacetone*¹⁹.

Initiator	Temperature (°C)	Relative amounts (%)		Yields (%)	
		(III)	(IV)	(III) + (IV)	(V)
UV	-10	100	0	69	14
D.B.P.	80	95	5	60	7-14
D.T.B.P.	135	83	17	73	17
C ₆ H ₅ C(CH ₃) ₂ OOH	200	55	45	20	

The product ratios (C vs. O alkylation) in free radical reactions with fluoro-ketones depend¹⁹ upon the over-all energy relationship between the paired C-alkylation sequence



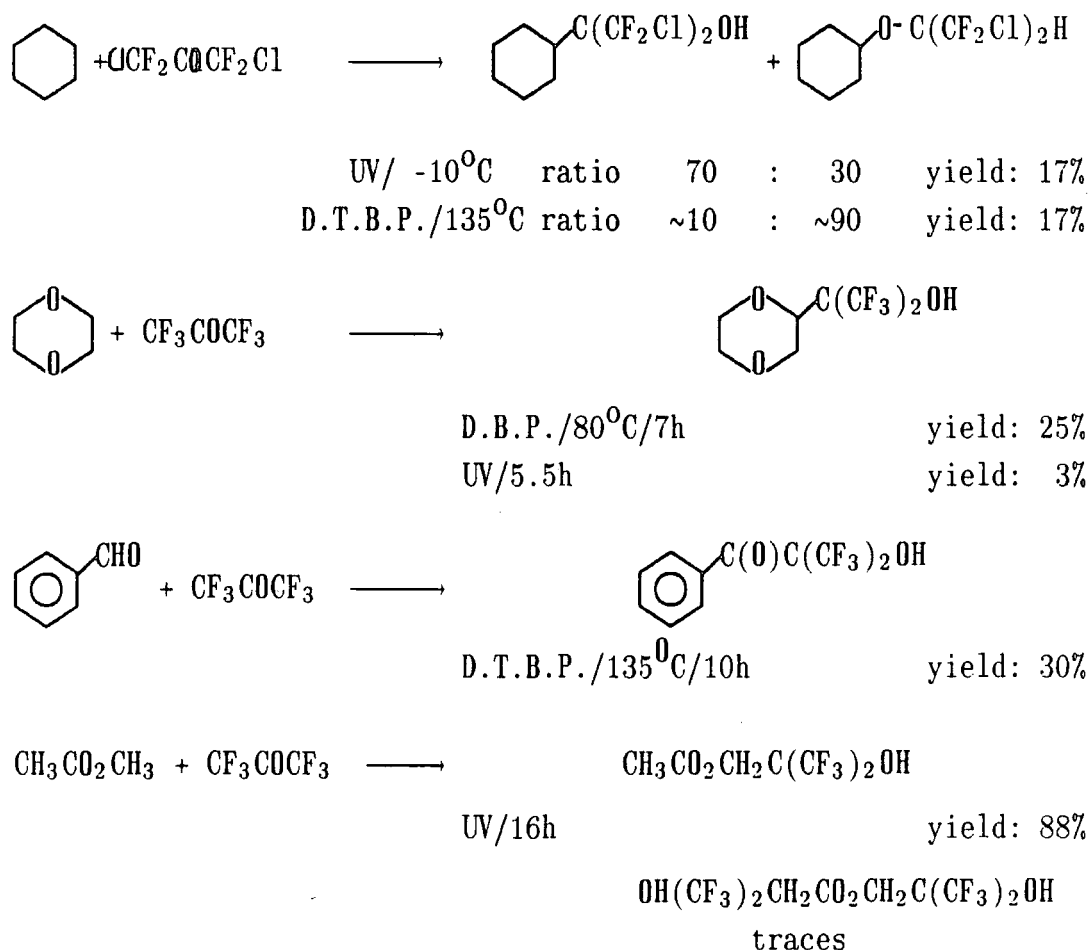
and the paired O-alkylation sequence,

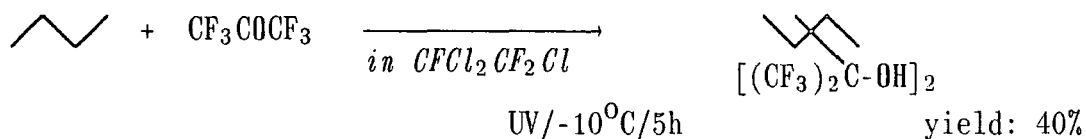


Any significant energy difference will result in a product derived from the most favourable of the two competing reactions. Thus, hydrogen abstraction which was found to be the rate determining step becomes more competitive by the O-alkylated radical at higher temperatures, yielding more of the ether product at higher temperatures as shown in table 1.6.

Some free radical reactions of polyfluoro-ketones are given in table 1.7.

Table 1.7. Some free radical additions of polyfluorinated ketones¹⁹.





I.B. Polymer modifications

a) Hexafluoropropene

Hexafluoropropene was reacted with a number of polymers involving, for example polyethylene, Nylon 6 and cotton under thermal and UV irradiation conditions⁸. Generally, a small amount of hexafluoropropene was incorporated into the polymeric material; thus, for example irradiating a thin film of polyethylene in a silica ampoule under 8 atm pressure of hexafluoropropene with UV light for 72 hours gave a compound containing 4.2% fluorine. An enhancement of the photochemical hexafluoropropene insertion was observed at elevated temperatures (100°C)⁸. However, this modification of the polyethylene film resulted already in a noticeable change of surface properties⁸. Using thermal conditions (290°C, 14 d, 80 atm of hexafluoropropene pressure) the incorporation of 50% hexafluoropropene into the polyethylene sample was reported⁸ giving rise to a viscous liquid. Other experiments⁸ involving reaction times of one day, 260-290°C and 80 atm of hexafluoropropene pressure gave solid polymer material with a hexafluoropropene content of 1-14%.

b) Perfluoro-ketones

Hexafluoroacetone can directly be co-polymerized with ethylene in a free radical way to give an alternating hexafluoroacetone/ethylene copolymer^{21,22}. Reactions of perfluoro ketones under free radical conditions with polymeric substrates e.g. polyethylene, gave net insertion of the fluoro-ketone into a polymer carbon-hydrogen bond¹⁹. These reactions were carried out using benzene as solvent. Table 1.8. lists some examples. The properties of the polymeric products were quite different, the crystallinity was greatly reduced while acidity and an ability to hydrogen bond are markedly developed.

Table 1.8. *Reactions of fluorocarbonyl compounds and polymers*¹⁹.

Polymer	Fluorocarbonyl compound	Initiator Temperature (°C)	Product analysis (%)
polyethylene	hexafluoroacetone	none/135	F: none
polyethylene <i>linear</i>	hexafluoroacetone	D.T.B.P./135	F: 30.67
polyethylene purified from above reaction	hexafluoroacetone	D.T.B.P./135	F: 40.62
polyethylene	(CF ₃ CF ₂ CF ₂) ₂ CO	D.T.B.P./135	F: 1.1
polyethylene	CF ₃ CF ₂ CF ₂ CHO·H ₂ O	D.T.B.P./135	F: 4.6

I.C. Summary

In summary, the thermal or UV irradiated reactions of hydrocarbons with hexafluoropropene were found to give modest conversions and complex product mixtures (except the γ -ray induced reaction). Although a separation and characterisation of these products was successfully carried out the use of these reactions for synthetic use can be seen as unfavourable. A different picture arises from the γ -ray induced reaction which in a clean reaction was found to give good yields of a single product. This reaction is well suitable for synthesis.

As far as the modification of polymers is concerned, a limited introduction of hexafluoropropene into the polymer (or its surface) could be achieved. Free radical additions of hexafluoroacetone to polyethylene proved successful and up to 40% fluorine could be introduced into the polymeric material.

I.D. Result and Discussion

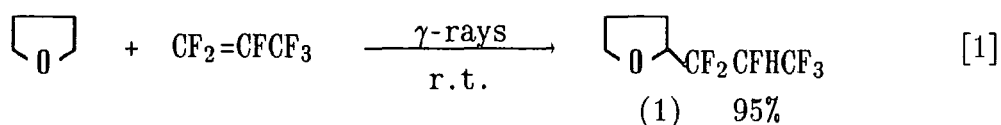
Free radical reactions of cyclic and acyclic ethers have been carried out as described elsewhere¹. These products were then used to undergo exhaustive fluorination as will be described in Chapters 3 and 4. Analysis of these perfluorinated products showed that a mixture was obtained which consisted of structural isomers. Therefore a re-examination of the synthesis of the partly fluorinated starting materials has been carried out and it was found that not only the expected products as described previously were obtained¹ but also isomers.

I.E. Free radical addition of cyclic ethers to hexafluoropropene

1. Mono-adducts

a) Oxolane

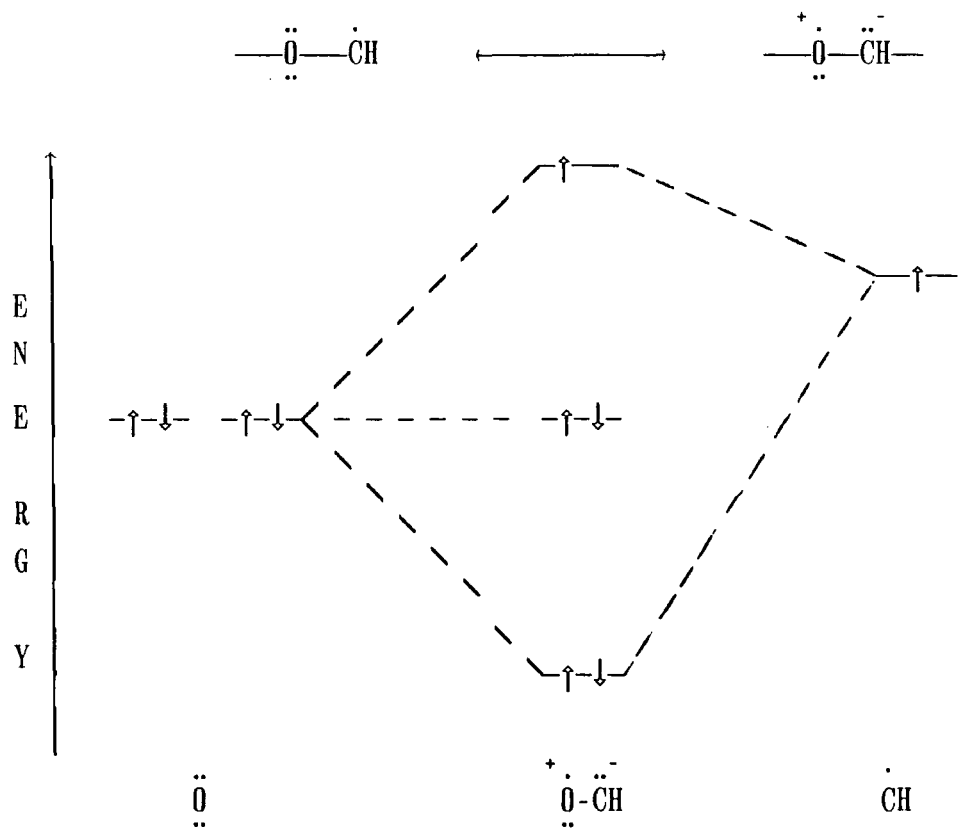
The reaction of oxolane with hexafluoropropene yielded the expected mono-adduct in good yields.



Analysis by capillary g.l.c. gave two peaks of identical intensity caused by the presence of two diastereomers. The molecular ion $M^+ = 222$ was observed in mass spectrometry and loss of the side chain leading to an intact ring fragment at $m/z = 71$ gave the base peak ($M^+ - \text{CF}_2\text{CFHCF}_3$). The nuclear magnetic resonance data clearly confirmed the already described compound (1).

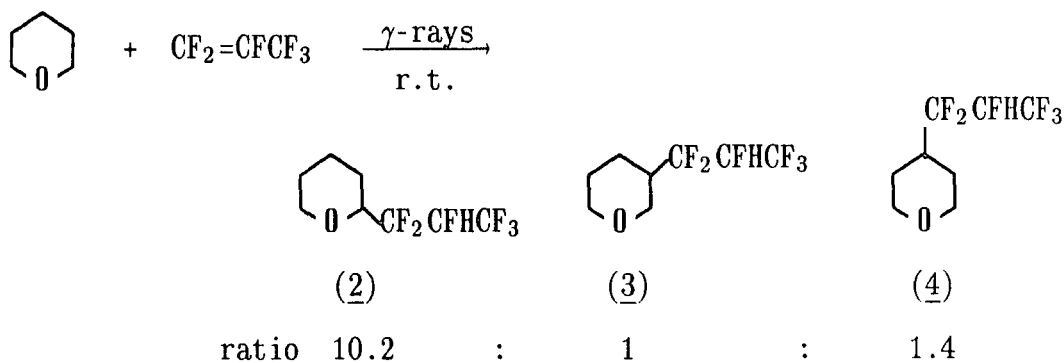
From the theoretical point of view the exclusive formation of (1) was expected since a carbon radical adjacent to a heteroatom is stabilized by interaction with the lone pairs of the heteroatom. This interaction lowers the energy of the system, as shown in figure 1.1., and consequently stabilizes the radical. This nucleophilic radical then adds to the fluoro-olefin and thus produces (1) after the adduct radical has been trapped.

Figure 1.1 Interaction of a radical SOMO and adjacent heteroatom lone pairs



b) Oxane

However, employing oxane in the reaction with hexafluoropropene yielded not only the expected mono-adduct arising from addition to the α -position. The total conversion of that reaction was 93%.



The expected main product was isomer (2) but also additions of hexafluoropropene to the β - and γ -positions leading to isomers (3) and

(4), respectively, were possible.

The obtained products which could not be separated were investigated by g.l.c.-m.s. and both, proton and fluorine n.m.r. spectroscopy. A number of confirmatory observations for structures (2), (3) and (4) may be made from analysis of the various spectral data.

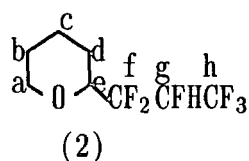
On g.l.c. analysis three peaks were obtained, the first and the second peak were each resolved into two components and the third peak was a single one. Examination by g.l.c.-m.s., electron impact mode, gave the molecular ion ($M^+ = 236$) for each of these peaks.

The breakdown pattern for the first double peak gave $m/z = 85$ [$(M - CF_2CFHCF_3)^+$] as base peak. This represented formation of the intact ring fragment by loss of the polyfluorinated side chain. The same fragmentation pattern was observed in the case of 2-hexafluoropropyl-oxolane (1), thus the first double peak, caused by the two possible diastereomers, was assigned to (2).

The second double peak and the third single peak which gave similar breakdown patterns, showed $m/z = 55$ as base peak caused by fragmentation of the ring. This demonstrated that loss of the side chain was not the preferred breakdown when the side chain was bonded in the β - and γ -position, respectively. The second peak which was resolved into two components was assigned to (3) which consisted of two diastereomers and the single third peak to (4) which does not form diastereomers.

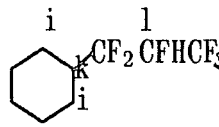
Confirmatory evidence also arose from the chemical shifts obtained from the product mixture. In the proton n.m.r. spectrum a distinction between $-O-C(R_F)H-CH_2-$, $-O-CH_2-C(R_F)H-$ and $-O-CH_2-CH_2-CH(R_F)H-$ groups was possible ($R_F = CF_2CFHCF_3$).

By direct comparison of chemical shifts with (1) which contained only one structural isomer it was possible to assign the resonances belonging to the major isomer (2) ($-O-C(R_F)H-CH_2-$).

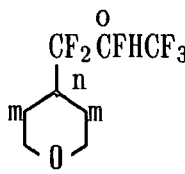


shift (ppm)	assign- ment
1.58	b, c, d
3.43	a
4.01	e
5.37	g

In order to establish the methylene group resonances adjacent to the tertiary carbon in isomer (4), comparison with 1,1,2,3,3,3-hexafluoropropylcyclohexane (17) which, of course, only existed as one structural isomer was useful.

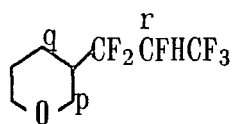
 (17)	<table border="0"> <thead> <tr> <th style="text-align: left;">shift</th> <th style="text-align: left;">assign- ment</th> </tr> </thead> <tbody> <tr> <td style="border-top: 1px solid black;">1.96</td> <td style="border-top: 1px solid black;">i,k</td> </tr> <tr> <td>4.78</td> <td>l</td> </tr> </tbody> </table>	shift	assign- ment	1.96	i,k	4.78	l
shift	assign- ment						
1.96	i,k						
4.78	l						

The resonances for the methylene groups adjacent to the carbon carrying the side chain as well as the tertiary proton were found just under 2.00 ppm. A similar resonance was observed in the oxane product mixture. Assignments for isomer (4), as far as they were not overlapping with (2), are given below.

 (4)	<table border="0"> <thead> <tr> <th style="text-align: left;">shift (ppm)</th> <th style="text-align: left;">assign- ment</th> </tr> </thead> <tbody> <tr> <td style="border-top: 1px solid black;">1.96</td> <td style="border-top: 1px solid black;">m,n</td> </tr> <tr> <td>4.86</td> <td>o</td> </tr> </tbody> </table>	shift (ppm)	assign- ment	1.96	m,n	4.86	o
shift (ppm)	assign- ment						
1.96	m,n						
4.86	o						

The CFH group of all isomers, which were overlapping, formed a triplet type system of multiplets. The least intense multiplet of that triplet will be one half of the expected doublet of multiplets arising from CFH in the two least abundant isomers, i.e. (3) and/or (4). The chemical shift thus obtained (4.86 ppm) was in good agreement with the chemical shift (4.78 ppm) obtained in (17).

Isomer (3) contained a methylene group which was adjacent to two electronegative groups (-O-CH₂-C(R_F)H-). Thus the chemical shift for that methylene group (p) should be further down field than for an O-CH₂ group but should also be further up field than the tertiary proton attached to the carbon carrying the fluorinated side chain. The corresponding resonance was observed and assignments for (3) are given below as far as they were separately obtainable (not overlapping with the other isomers).

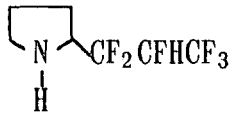
	shift (ppm)	assign- ment
(3)	2.32	q
	3.68	p
	4.86	r

In the fluorine n.m.r. spectrum four separate doublets (two major ones and two minor ones) were obtained for the CFH groups. For isomer (2) two doublets were expected (see below) and one each for isomers (3) and (4). The two major CFH resonances (-215.6 ppm and -220.7 ppm, respectively) were assigned to the major isomer (2). Integration for the two minor ones gave a 1.4 : 1 ratio. This was the same ratio previously calculated on the basis of the integrated g.l.c. peaks. Thus the observed resonances at -212.8 ppm and -213.6 ppm were assigned to (3) and (4), respectively. Comparison with (17), previously used to assign the methylene groups in (4), showed that the CFH resonance in (17) was also found at -213.6 ppm. This was further proof for the validity of the assignments made above.

c) Effect of the interaction of CFH groups in hexafluoropropene side chains with heteroatoms

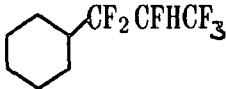
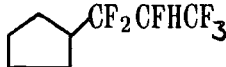
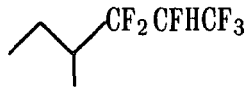
An interesting general phenomenon was observed from resonances of the CFH groups in ^{19}F n.m.r.. It was noted that adducts of hexafluoropropene with heterocyclic compounds such as cyclic ethers e.g. (1) or (2) and secondary and tertiary cyclic and aliphatic amines gave rise to two CFH doublets being typically some 4.5 - 5.5 ppm apart. Also two different CF_3 resonances were observed being separated by some 0.3 - 0.5 ppm. In aliphatic ether/hexafluoropropene adducts the same effect was noted but the separation of the two doublets was only in the magnitude of just over 2 ppm. Table 1.6. lists some examples.

Table 1.6. *Examples for the occurrence of two different CFH and two CF₃ resonances in heteroatom containing molecules.*

	CHF (ppm)	CF ₃ (ppm)	
	$\delta_{\text{F}} = -214.7$ $\delta_{\text{F}} = -218.3$	-75.5 -75.7	[23]
Et ₂ N-CH(CH ₃)CF ₂ CFHCF ₃	$\delta_{\text{F}} = -212.4$ $\delta_{\text{F}} = -217.9$	-74.2 -74.5	[2]
Et-O-CH(CH ₃)CF ₂ CFHCF ₃	$\delta_{\text{F}} = -215.7$ $\delta_{\text{F}} = -218.5$	-74.4 -74.6	[1]

In contrast, compounds (17) or (21) did not exhibit this type of behaviour (see table 1.7.). Here only one doublet for the CFH group and one CF₃ resonance was observed.

Table 1.7. *Examples for the occurrence of one CFH and one CF₃ resonance in hydrocarbon compounds.*

	CFH (ppm)	CF ₃ (ppm)
 (17)	$\delta_{\text{F}} = -212.3$	-74.7
 (21)	$\delta_{\text{F}} = -209.5$	-72.9
 (28)	$\delta_{\text{F}} = -211.8$	-74.6

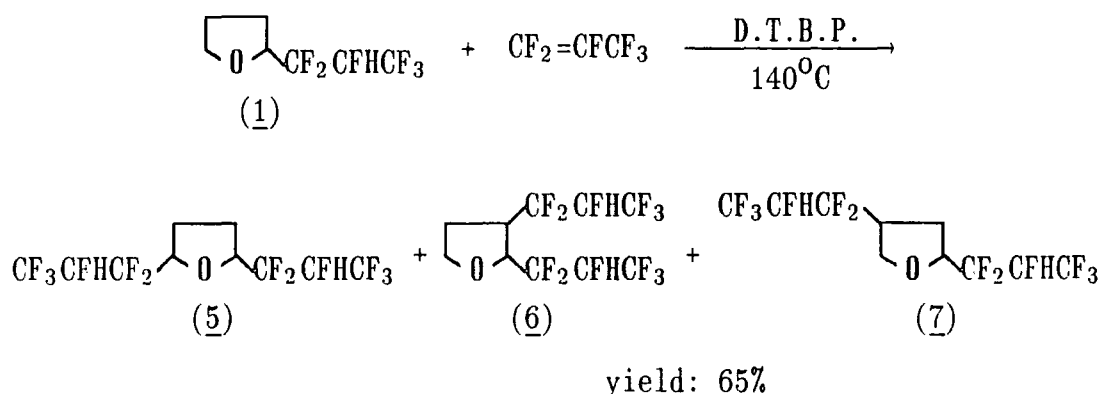
Formation of two diastereomers caused by the second chiral centre, which was not in the polyfluorinated side chain, was found not to be the reason for the appearance of two CFH and two CF₃ resonances, since (28), which also contains a second chiral centre did not give two CFH and CF₃ resonances, respectively. It is thought, therefore, that a hydrogen-bonding between the CFH proton and the heteroatom caused this phenomenon. In the case of (3) where the CFH group was too far remote to interact with the heteroatom only one CFH and one CF₃ resonance was observed. This phenomenon might, therefore, be used as a probe for locating 2H-hexafluoropropyl side chains in compounds containing heteroatoms, since the interaction between the CFH group (as shown below) was only possible, when the side chain was attached in the α-position to the heteroatom.



2. Di-adducts

a) Oxolane

Reacting (1) with hexafluoropropene under chemical initiation conditions (di-*t*-butyl-peroxide, D.T.B.P.) at 140°C yielded the di-adducts.



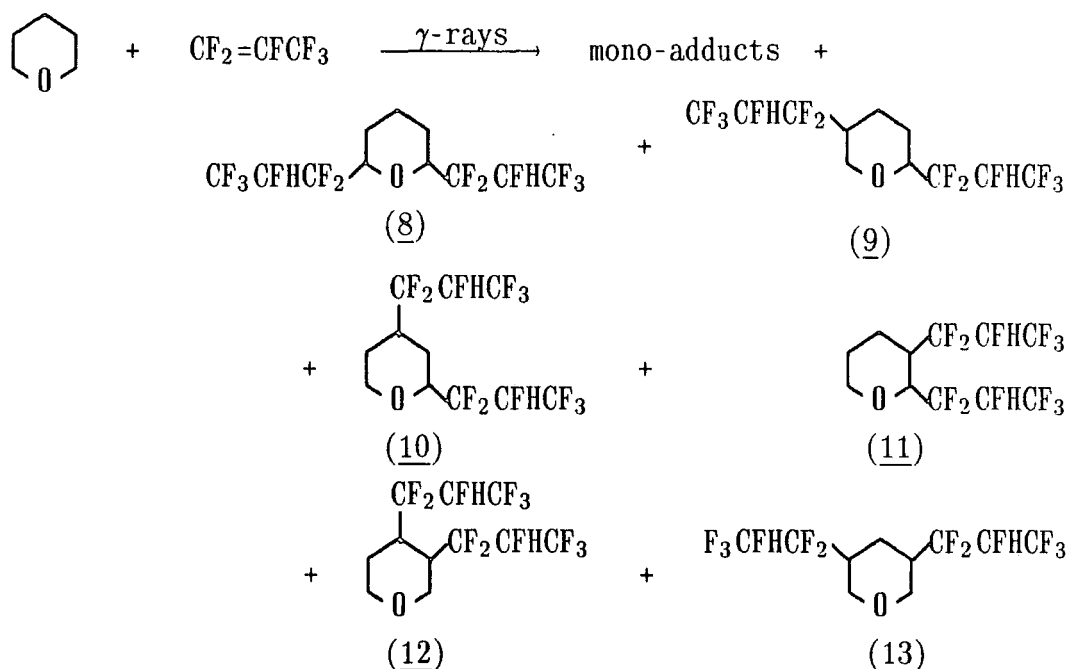
Analysis by g.l.c. gave five product peaks with a 11.4 : 2.3 : 1.2 : 2.3 : 1.0 ratio (with increasing retention times). Investigation by

g.l.c.-m.s. gave the molecular ion minus one $[M-1=37]^{+}$ for all peaks thus demonstrating that they were isomers. No further separation was possible. Although stereo isomers (cis and trans isomers) are resolved on g.l.c., the number of peaks obtained was too large to be accounted for by stereo isomers of the expected major product (5). Therefore structural isomers such as (6) and (7) must also have been produced. No structural information could be deduced from the breakdown patterns in mass spectrometry. The proton n.m.r. spectrum clearly showed a major product which was assigned structure (5) since it consisted of a symmetrical multiplet for the two methylene groups, a triplet-type multiplet for the two tertiary protons and a doublet of multiplets for the CFH group. An absorption corresponding to a O-CH₂ group was observed but was too broad to be integrated. However, the O-CH₂ resonance indicated that the other two compounds were possibly (6) and (7).

The fluorine n.m.r. spectrum gave four CF₃ resonances, the two major ones clearly must include (5). The CF₂ region consisted of a number of AB-systems which could not be assigned to any particular structure. The CFH region gave four separate doublets, two major and two minor ones. The two major ones (ratio 1:1) must include (5). The two minor ones (ratio 1:1) were likely to be caused by the two different β -side chains of isomers (6) and (7). Lack of interaction with the oxygen atom, not possible for a CFH group when the side chain was not in the α -position, gave rise to only one resonance for each of the two β -side chains whereas the α -side chain CFH resonances were expected to overlap with the ones of isomer (5). Thus, the ratio between (5) and (6) plus (7) was calculated to *ca.* 85 : 15. No distinction between isomers (6) and (7) could be made. The perfluorination (see Chapter 4) confirmed the minor isomers. Here, CF₂-O resonances were observed in the fluorine n.m.r. spectrum and the same ratio for the major to the minor isomers (*ca.* 85:15) as found in the starting material was observed. Still, no distinction between the two minor isomers was possible.

b) Oxane

The reaction of oxolane with hexafluoropropene not only yielded the mono-adducts but also the di-adducts.



A minimum of six major g.l.c. peaks plus additional smaller peaks were obtained for the di-adducts which could not be separated. In mass spectrometry (electron impact mode) the molecular ion ($M^+ = 386$) for all peaks were obtained. The number of peaks was too large to be accounted for by stereo isomers (cis and trans isomers) of the expected product (8). Considering that the mono-adducts were already a mixture of all possible structural isomers (and, of course, stereo isomers), the maximum possible number of structural di-adduct isomers was 6 with each forming theoretically 16 stereo isomers. Although symmetry elements reduce the actual number of isomers the mixture was too complex to positively identify any structural isomers. The breakdown patterns obtained in g.l.c.-m.s. were very similar for all peaks and thus, no structural information could be obtained. In the proton n.m.r. spectrum only broad multiplets were obtained but the presence of O-CH₂ resonances was clearly visible. A separate integration was not possible due to overlap. The 19-fluorine n.m.r. spectrum gave a number of peaks in the CF₃ region and various AB-systems in the CF₂ region. The CFH region gave seven doublets consisting of two major ones and five smaller ones. The two major ones (ratio $\approx 1 : 1$) were identical with

the ones observed in (2), thus they were assigned to include (8). No further assignments were possible.

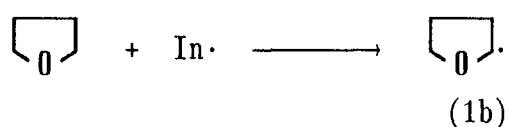
After perfluorination (see Chapter 4) the fluorine n.m.r. spectrum confirmed the presence of CF₂-O groups but still no assignments were possible.

In summary, detailed investigation into the products of the reaction of oxolane and oxane with hexafluoropropene gave the following results. The reaction of oxolane with hexafluoropropene gave exclusively the expected mono-adduct (1). Further reaction of (1) with hexafluoropropene lead to formation of the expected di-adduct (5) but also addition of hexafluoropropene to the β-positions leading to (6) and (7) was observed (15%).

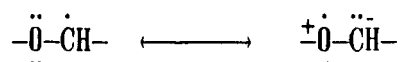
Employing oxane in the same reaction α-, β- and γ- isomers were all produced. Formation of the di-adduct was even less selective. The product mixture could not be separated and no structural isomers could be positively identified.

I.F. Stereoelectronic effects on hydrogen abstraction

These findings might be explained as follows. The generation of radical (1b) was achieved by hydrogen abstraction e.g. by t-butoxyl radicals from the parent ether.



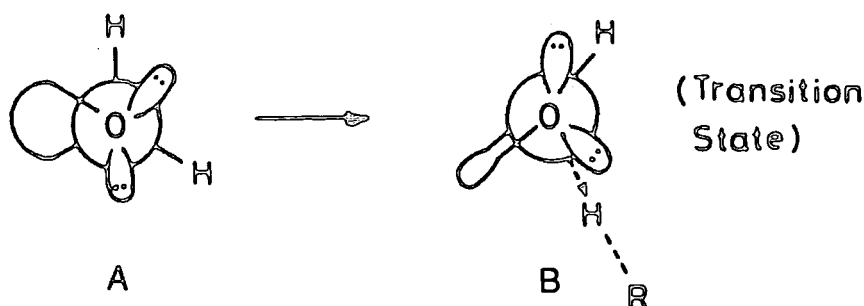
Stereoelectronic effects in hydrogen atom abstraction from cyclic ethers have been described in the literature²⁴. Homolytic C-H bond fission is favoured when the bond undergoing cleavage can assume coplanarity with an adjacent occupied non bonding orbital. Chambers *et al.*²⁷ described the reduction in reactivity from a five to a six membered cyclic ether and demonstrated the influence of stereo electronic effects on the reactivity in a free radical process. The activating influence of oxygen on the formation of a radical at an adjacent site may be represented as follows:



The interaction of an electron pair on oxygen with the orbital containing the odd electron is crucial and, therefore, subject to conformational effects.

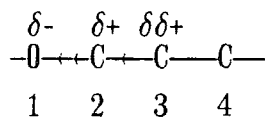
Flexing of a 5-membered ring is associated only with a very small energy change, whereas a significant barrier exists to eclipsing in a 6-membered ring²⁸. The stereochemistry of oxygen non-bonding pairs is less clear. Recent theoretical²⁵ and experimental²⁶ studies suggest that the electron pairs are non-equivalent, one being more 2p-like, and a better donor than the other non-bonding pair, which is more sp^2 -like and a poorer donor. While recognising this distinction, like other authors²⁹, Chambers *et al.*²⁷ adopted the approximation of representing them as equivalent and the oxygen as a tetrahedral. This approximation is shown in Figure 1.1. and is an alternative to the other extreme of regarding one as a 2p orbital and the other ones an sp^2 orbital.

Figure 1.1. *The oxygen lone pairs of oxane in relation to the adjacent C-H bonds in the ground and transition state in an approximation*

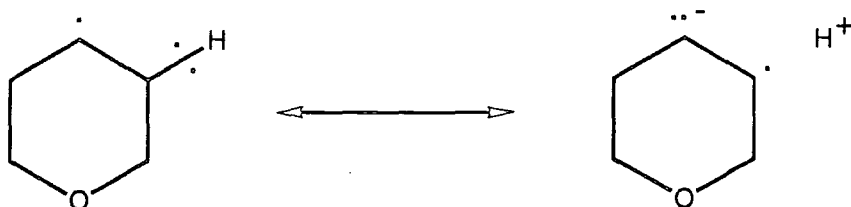


In the transition state leading to the radical derived from these cyclic ethers, the activating effect of adjacent oxygen will depend on the energy requirement for each ring to produce an essential eclipsing interaction between an electron pair on the ether oxygen and the breaking C-H bond. This change (A \rightarrow B) for a 6-membered ring is illustrated in Figure 1.1. Thus, the greater reactivity of a 5-membered ring simply reflects the low energy barrier to attain the favourable conformation B in comparison with that of a 6-membered ring. As a consequence of that, the 5-membered ring is very selective (exclusive addition to the 2-position) whereas in the 6-membered ring additions to other positions, preferentially to the 4-position, can occur. The 4-position might be preferred due to the decrease in

polarity at this position caused by the oxygen electron withdrawing effect (-I), e.g.,



However, additions to the 3-positions have also been detected, although to a lesser extent (the 4-position was found nearly 3 times more reactive than the 3-position). The generated radicals at the 3- or 4-position could be stabilized by hyperconjugation, e.g.,



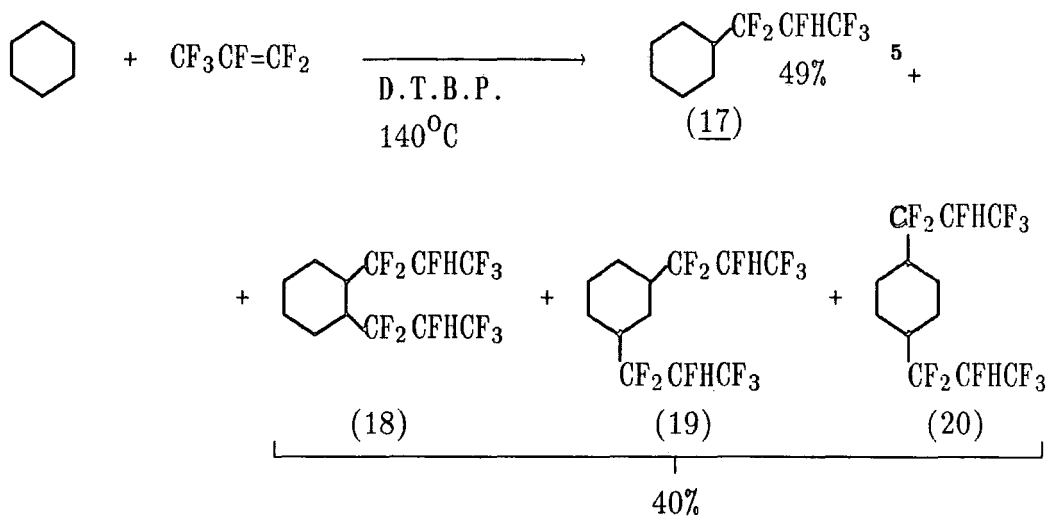
As for the di-adducts the electron withdrawing polyfluoro side chain causes a reduced availability of the oxygen lone pair electrons. Thus stereoelectronic weakening of the α -C-H bond should be reduced. Consequently radical formation in the other positions becomes competitive thus leading to not exclusive α -addition products.

I.G. Free radical additions of hydrocarbons to hexafluoropropene

1. Cyclic hydrocarbons

a) Cyclohexane

Since not only the C-H bonds α to oxygen were found to react, cyclohexane was used to undergo chemically initiated free radical addition to hexafluoropropene.



The conversion of the reaction was >90% based on recovered cyclohexane. Compound (17) was found identical with previously reported data¹⁵. In g.l.c.-m.s., five major peaks (ratio of 1.7 : 3.8 : 2.1 : 3.3 : 1 (with increasing retention time)) which all gave the same highest mass ($M - 20$)⁺ = 364 were observed and thus identified as di-adducts. Since isomer (20) crystallized out it was possible to characterize it separately. No distinction between isomers (18) and (19) was possible since they could not be separated. In addition, g.l.c.-m.s. suggested that higher adducts were also formed (*ca.* 5% by g.l.c.) but these were not further investigated.

Using γ -ray initiation similar conversions and product distributions were observed. In the literature¹⁵ employing a deficiency of hexafluoropropene a γ -ray reaction has been reported yielding 60% of (17) but no formation of di-adducts was stated.

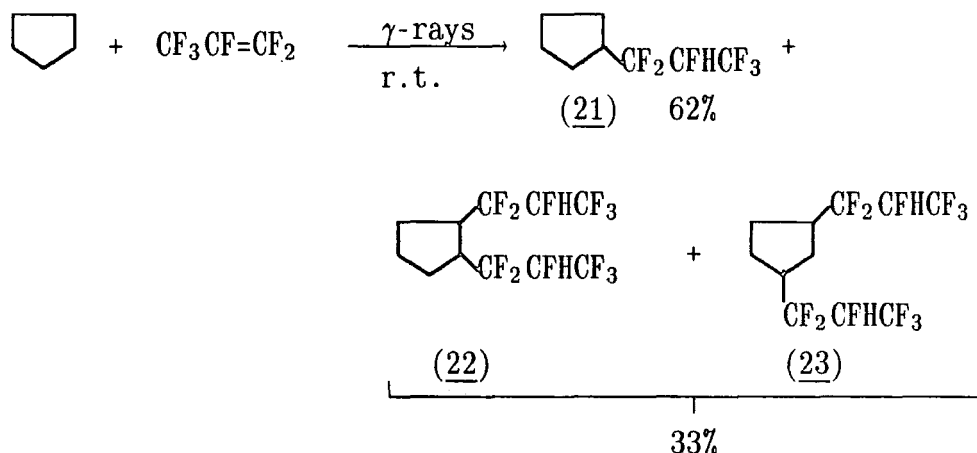
Using azobisisobutyronitrile (AIBN) as initiator resulted in recovery of the starting materials. Since the addition reaction using cyclohexane and hexafluoropropene was successful at room temperature while employing γ -rays the temperature should have no significant influence for the proceeding of the reaction. Thus, the cage effect of AIBN might have inhibited the reaction³¹. This was demonstrated in a reaction using di-benzoyl-peroxide (D.B.P.) at 80°C where the expected addition products were obtained.

⁵ The percentages quoted are overall yields based on the starting material which was in deficiency (usually the hydrocarbon compound).

This result demonstrated the readiness with which a hydrocarbon compound can undergo free radical addition reactions to hexafluoropropene. Thus, a number of aliphatic and cyclic hydrocarbons were employed to undergo reaction with hexafluoropropene.

b) Cyclopentane

Cyclopentane was used in a γ -ray induced addition reaction with hexafluoropropene.

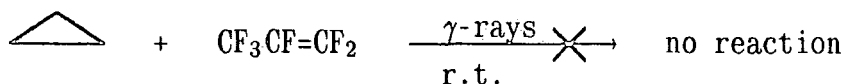


The conversion was found to be >95% based on cyclopentane. The product mixture was separated into the mono- and di-adducts and the latter ones could not be further separated. Compound (21) was clearly identified by its m.s. and n.m.r. data.

Analysis by g.l.c.-m.s. gave six peaks (ratio 1.8 : 1.3 : 2.7 : 2.2 : 1.8 : 1) all possessing the same highest mass ($M - 20$)⁺ = 350. Thus more than one structural di-adduct must have been formed. However, no distinction between possible isomers (22) and (23) was possible. The ¹⁹F n.m.r. gave a singlet for the CF₃ groups, a multiplet for the CF₂ groups and a broad resonance for the CFH group which was resolved.

c) Cyclopropane

Using cyclopropane and hexafluoropropene in a γ -ray initiated experiment resulted in the recovery of the starting materials.

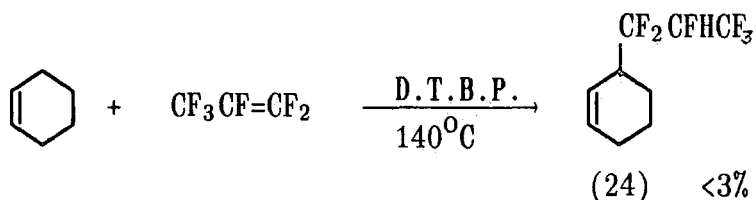


The explanation for this result can be deduced from the unusual nature of cyclopropane³². The cyclopropyl radical, in contrast to other cyclic or acyclic radicals, exists in a bent σ radical^{33,6}. In general σ radicals are more electrophilic than π radicals³⁴ e.g. cyclohexyl radical, and it has been shown³⁵ that the cyclopropyl radical is the least nucleophilic of the cycloalkyl radicals.

Thus, the low nucleophilicity of the cyclopropyl σ radical could explain the low reactivity toward addition of hexafluoropropene.

d) Cyclohexene

An unsaturated system, cyclohexene, was added to hexafluoropropene.



In repeated experiments only a very low conversion (less than 5%) was achieved. The product obtained was analysed by g.l.c.-m.s. and found complex. The major compound gave a peak which was resolved into two components and was only identified by its molecular ion $M^+ = 232$ to be (24). Isolation from the mixture proved unsuccessful thus no further analysis could be carried out.

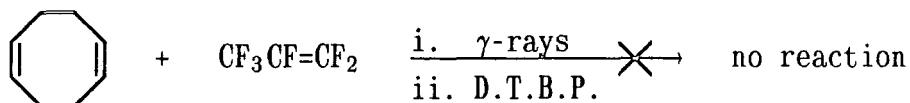
The very low or non reactivity observed in reactions employing unsaturated cyclic hydrocarbons was caused by formation of allylic radicals which are stabilized by interaction with the adjacent π

⁶ The term σ radical is applied to those radicals in which the electron occupies a hybridized orbital and a π radical to those in which the electron occupies a p-orbital. See also ref. 32.

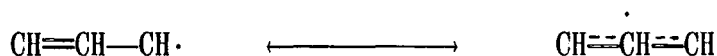
orbital, thus making the radicals more electrophilic. A further example is the experiment involving 1,5-cyclo-octadiene.

e) 1,5-cyclo-octadiene

The experiment employing 1,5-cyclo-octadiene was carried out using both, γ -ray and chemical initiation.

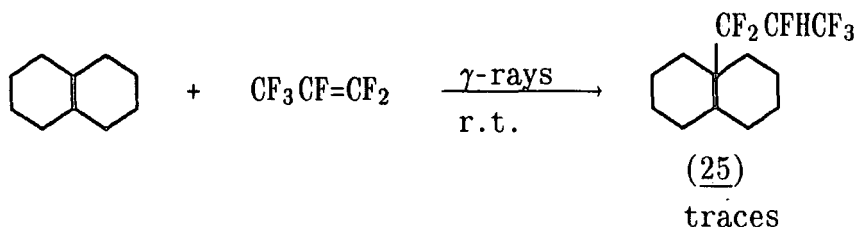


Employing γ -rays at room temperature no reaction took place. Since the starting materials were not miscible prior to reaction and still two layers were obtained after irradiation with γ -rays a rocking furnace was used for the chemically initiated reaction but still no reaction occurred.



f) Decalin

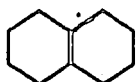
Separate reactions employing cis and trans decalin in the free radical addition reaction to hexafluoropropene were carried out.



In both cases only traces of a mono-addition product were found by g.l.c.-m.s. analysis due to formation of the molecular ion $M^+ = 288$. Since the starting materials were not miscible an experiment employing acetone as solvent was carried out. This improved the situation slightly and analysis by g.l.c.-m.s. detected not only some mono-adducts but also some higher adducts. However, since the conversion was so low (5-7%) and the product mixture complex no further investigations were carried out. Since some reaction was observed, employing higher

temperatures (e.g. peroxides at 140°C) it is expected to improve the conversion of the reaction.

The low reactivity observed for decalin may also be explained by steric hindrance due to formation of the most stable tertiary radical (25b).



(25b)

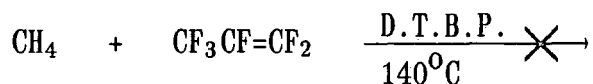
The same reason might be used for the unsuccessful reactions of hexafluoropropene and ethyl cyclohexane and isopropyl cyclohexane, respectively. Here in γ -ray induced reactions minute amounts of addition products were detected by g.l.c.-m.s. The reactions were not investigated further. That steric reasons were important and not only the stability of a tertiary radical will be demonstrated below; there a tertiary radical was found to react in good yields.

2. Aliphatic hydrocarbons

A series of strait chain and branched aliphatic hydrocarbons were employed in the free radical addition reaction with hexafluoropropene.

a) Methane

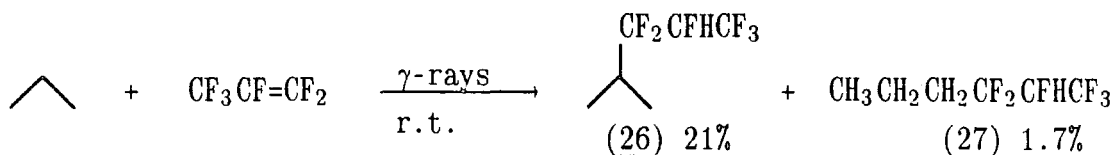
Using methane the simplest hydrocarbon compound, in the chemically initiated reaction with hexafluoropropene proved unsuccessful.



Although some liquid product was obtained analysis revealed it consisted of an extremely complex mixture and investigation by g.l.c.-m.s. gave no indication of formation of the desired addition product.

b) Propane

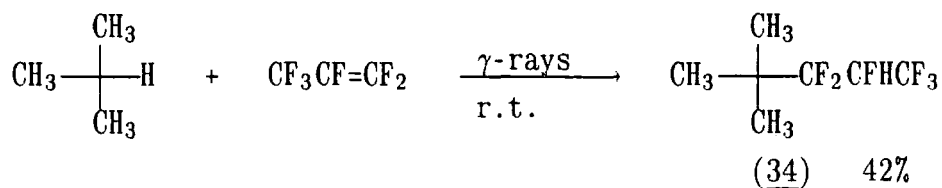
Employing propane in the γ -ray induced addition reaction to hexafluoropropene proved successful.



The reaction which had a conversion of 30%, gave the mono-adducts (26) and (27) which could not be separated. Although excess hexafluoropropene was employed no higher adducts were detected. The structure of (26) was confirmed by proton n.m.r. Less than 5% of the product obtained consisted of isomer (27) which was also identified by its proton n.m.r. spectrum. The fluorine n.m.r. spectrum confirmed the two structural isomers by showing two sets of resonances common for a 2H-hexafluoropropyl group. Using electron impact mode in mass spectrometry, the two isomers showed a different breakdown pattern, for compound (26) the molecular ion minus 19 [(M-F)⁺ = 175] was the highest peak obtained. Loss of the polyfluoro side chain leading to m/z = 43 formed the base peak. Isomer (27), however, gave m/z = 193 as the highest peak, which was the molecular ion minus one [(M-H)⁺ = 193] followed by two losses of 20 mass units implying a dehydrofluorination process took place (m/z = 193 $\xrightarrow{-\text{HF}}$ m/z = 173 $\xrightarrow{-\text{HF}}$ m/z = 153). The base peak was observed at m/z = 57 which represented a C₄H₇ unit.

c) 2-Methylpropane

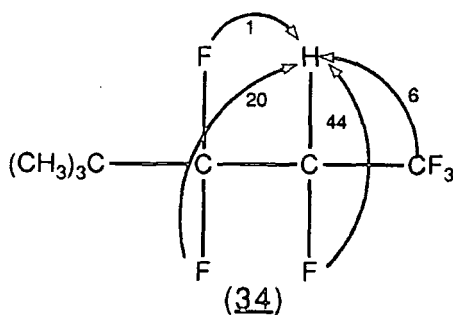
In a γ -ray induced free radical reaction 2-methylpropane was reacted with hexafluoropropene.



A single product was obtained originating from reaction of a *tertiary* radical. The conversion of this reaction was found to be 42%.

Compound (34) was clearly confirmed by mass spectrometry [$(M - \text{CH}_3)^+ = 193$] and its proton n.m.r. spectrum. A distinct splitting pattern was observed in the proton n.m.r. for the CFH group which gave a doublet of doublets of quartets of doublets (ddqd). Usually a doublet of multiplets with $^2J_{\text{H-F}} = 44$ Hz and smaller coupling constants in the magnitude between *ca.* 1 - 14 Hz, which cannot be resolved separately due to overlap, were obtained for a CFH group. In (34), however, it was found that a slight change in the intra molecular dihedral $\text{CF}_2\text{-CH}$ angle, probably caused by steric requirements resulted in a change of coupling constants which reduced the overlap and made it possible to spot the couplings separately. The assignment is given in Figure 1.2. .

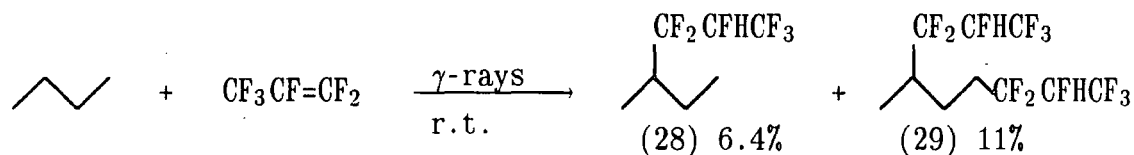
Figure 1.2. Coupling constants for the CFH group in (34)



Coupling constants in Hz

d) n-Butane

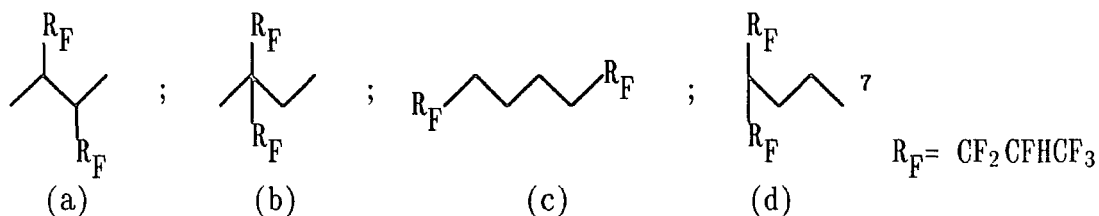
The next homologue n-butane was employed in the addition reaction with hexafluoropropene induced by γ -rays.



The conversion of this reaction was found to be 18%. Separation was carried out by analytical g.l.c. The mono-adduct (28) consisted of only one structural isomer and no product arising from addition to a terminal carbon was observed. The structure of (28) was clearly shown by its proton n.m.r. spectrum. Investigation of (28) by mass spectroscopy gave the molecular ion minus 21 [$(M - \text{HF-H})^+ = 187$].

In mass spectral analysis compound (29) gave a molecular ion minus 35 [$(M - \text{CH}_3 - \text{HF})^+ = 323$]. The structure of (29) was determined by use of ^{13}C n.m.r. spectroscopy. Here, in the region typical for carbons

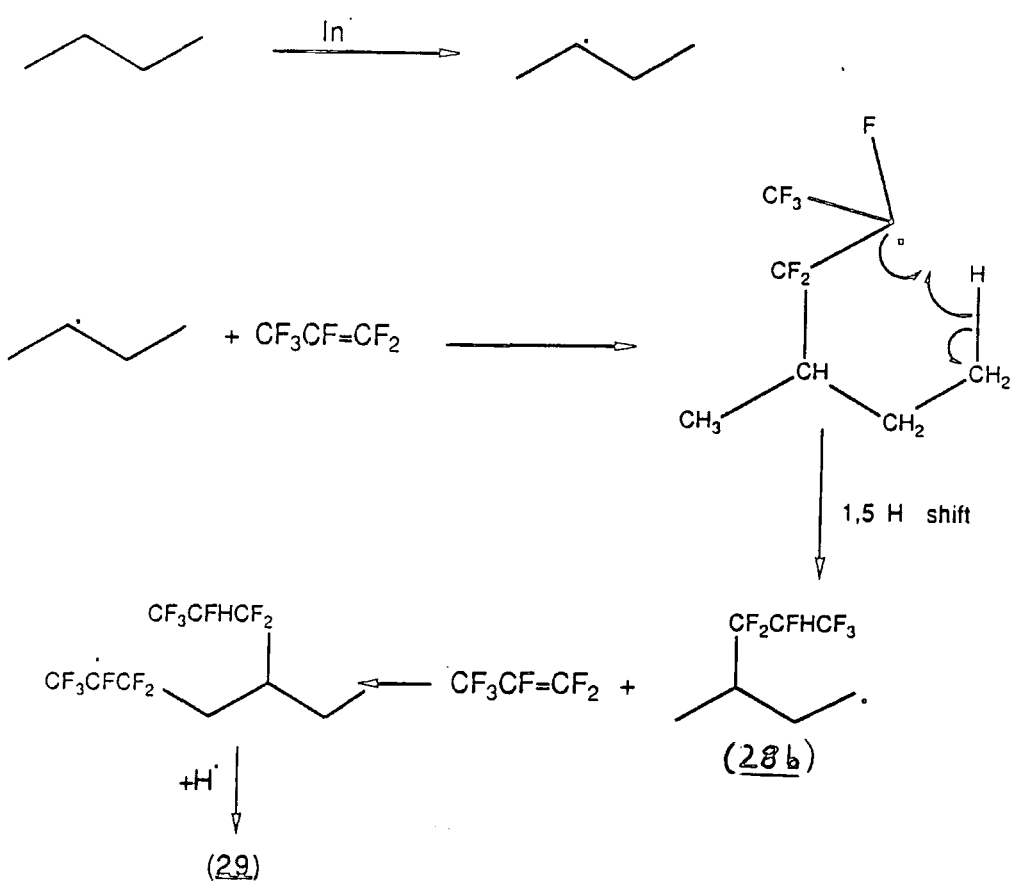
bonded to hydrogen (0 ppm \rightarrow ca. 50 ppm) four resonances being clearly separated by ca. 5 to 8 ppm and of roughly the same intensity were obtained. Thus, the following structures could be excluded:



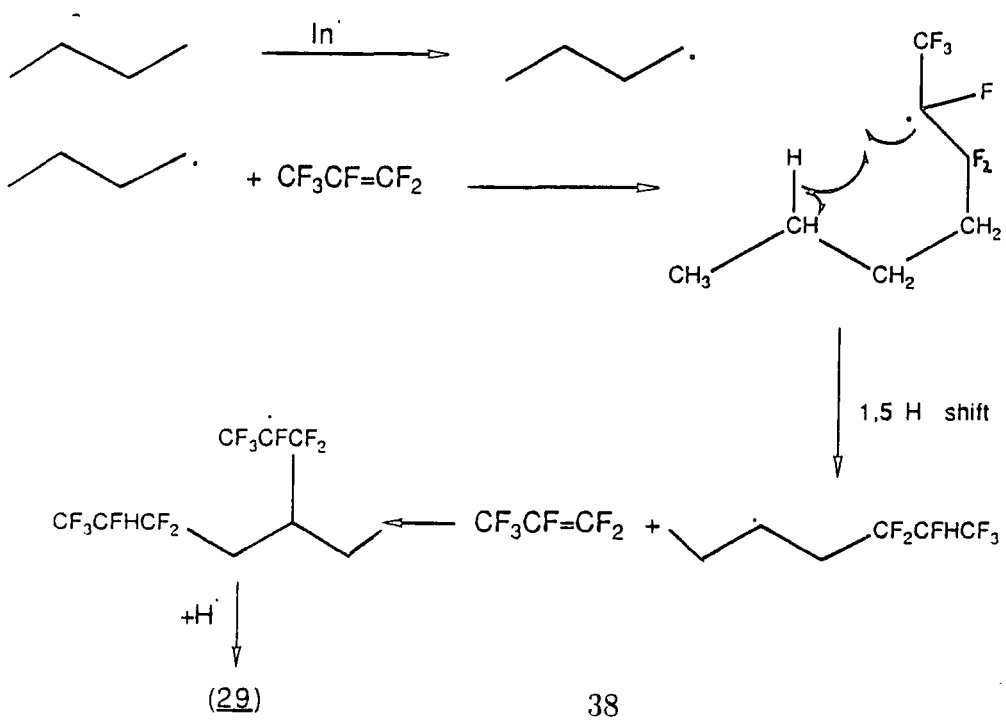
In structures (a) and (c) each molecule would have only two different carbons attached to hydrogen(s), structure (b) has only 3 carbon atoms bonded to hydrogens plus a quaternary carbon, whereas (d) does possess four different carbons bonded to hydrogen(s). The quaternary carbon (b) due to its relaxation time would only be spotted in form of a small (weak) resonance (under the conditions the spectrum was recorded). The proton n.m.r. spectrum obtained for the di-adduct could not confirm product (d) but the proposed isomer (29).

As can be seen from the yields the di-adduct was produced in much greater quantities than the mono-adduct, which would be expected to be the major product. This finding demonstrated that the formation of the di-adduct was likely to proceed via a 1,5-hydrogen shift (1,5H \sim) to give radical (28b) which underwent further addition reaction to hexafluoropropene before being trapped.

⁷ The formation of di-adducts carrying the two polyfluorinated side chains at the *same* carbon atom could not be demonstrated in any reaction.



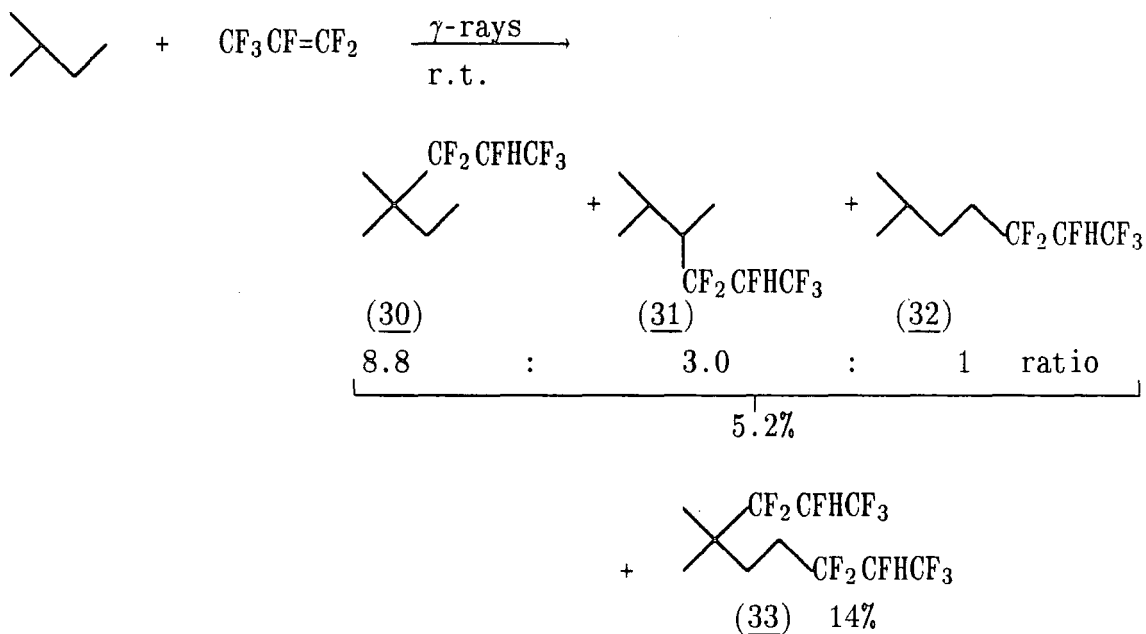
A different way could also be postulated:



But, firstly, formation of the most stable radical (secondary > primary) would be expected. Secondly, the mono-addition product obtained in the reaction of n-butane with hexafluoropropene was found to be exclusively compound (28). Nevertheless, the latter reaction pathway cannot be completely dismissed, since reaction of propane with hexafluoropropene demonstrated, that formation of a long chain mono-adduct (27) was possible.

e) 2-Methylbutane

A branched butane derivative, 2-methylbutane, was employed in the addition reaction with hexafluoropropene initiated by γ -rays. A number of products were obtained in this reaction which had a conversion of 20%.



The mono- and di-adducts were separated by analytical g.l.c. The mono-adducts which could not be separated any further were investigated by g.l.c.-m.s. and n.m.r. spectroscopy. A number of confirmatory observations for structures (30), (31) and (32) may be made from analysis of the various spectral data. On g.l.c. analysis three peaks were obtained with the second peak being resolved into two components. Analysis by mass spectrometry gave for all peaks $(M - \text{CH}_3)^+ = 207$ as highest mass. Major fragmentation for the first peak was loss of the polyfluorinated side chain leading to $m/z = 71$ $[(M - \text{CF}_2\text{CFHCF}_3)^+]$, the intact parent hydrocarbon, as base peak. Since the g.l.c. peak was not

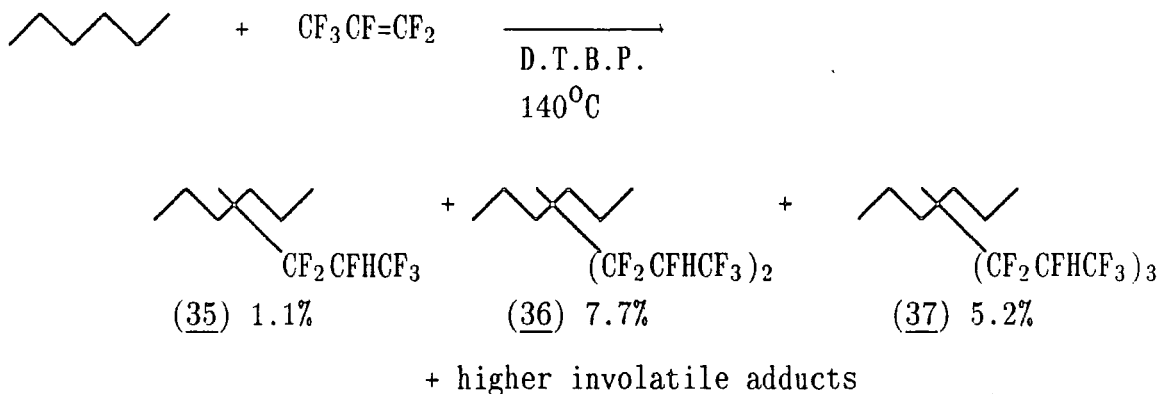
resolved into two components it was assigned to isomer (30). The second, and only double peak gave also $m/z=71$ [$(M-CF_2CFHCF_3)^+$] as base peak but since it was resolved into two diastereoisomers, it was assigned to isomer (31). The last and smallest g.l.c. peak gave $m/z=57$ [$(M-CH_2CF_2CFHCF_3)^+$] as the base peak. This fragment must come from a molecule where the 2H-hexafluoropropyl group was added to a methyl group. Since the g.l.c. peak was not resolved into two diastereoisomers only addition to the 4-position in the parent hydrocarbon compound could have occurred. Thus the third peak was assigned to (32).

Confirmatory evidence also arose from the chemical shifts obtained from the product mixture. The methyl groups were all found to overlap in the proton n.m.r. spectrum. However, the methylene group in (30) was clearly visible. The two tertiary protons in (31) gave rise to a broad peak which also was clearly distinguishable. The abundance of (32) was too low to be detected separately by n.m.r. spectroscopy, especially since all its resonances were overlapping with (30) and (31).

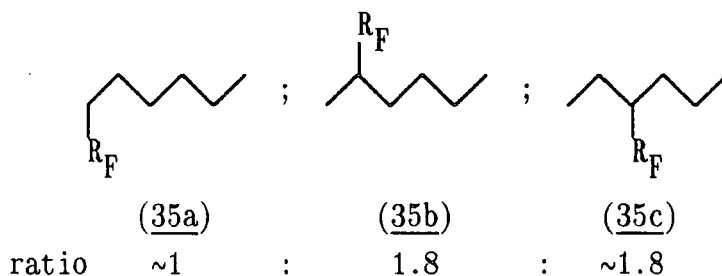
As well as mono-adducts, di-adducts were produced, again as the major product. The g.l.c. trace gave one large single peak and g.l.c.-m.s. showed $m/z=337$ ($M-HF-CH_3$)⁺ as highest peak. Since the g.l.c. peak was not resolved into two components it was assigned (33) which was the only di-adduct which did not form stereo isomers. Minute amounts of other di-adducts (less than 2%) were also detected but not investigated further. The proton n.m.r. spectrum gave a broad singlet for the two methyl groups and two separate multiplets (ratio 1:1) for the two methylene groups.

f) n-Hexane

Both, chemical and γ -ray induced reactions were carried out using n-hexane in the free radical addition reaction to hexafluoropropene. No major differences in either product formation or distribution were observed.



The conversion of this reaction was found to be 14% based on recovered n-hexane. Volatile and small amounts of involatile products were obtained. Separation of the volatile products by analytical g.l.c. gave the mono-, di- and tri-adducts, all of which could not be separated further. Analysis of the mono-adducts by g.l.c. gave three peaks, two of which were resolved into two components. Mass spectrometry gave the molecular ion ($M^+ = 236$) for each of these peaks. Three structural isomers were possible,



and isomers (35b) and (35c) both contain an additional chiral centre which gave rise to formation of diastereomers. However, the m.s.-breakdown pattern for the two double peaks were very similar and thus no assignment concerning structures (35b) and (35c) could be made. The only single peak obtained was assigned (35a) since here no diastereomers can be produced. Thus, the formation of all possible isomers was demonstrated. No structural information concerning any particular isomer was obtainable from the proton n.m.r. spectrum but the integration ratio for the CFH groups and the remaining protons was consistent. Analysis of the di- and tri- adducts by g.l.c. gave a number of overlapping g.l.c. peaks and investigation by g.l.c.-m.s. established the molecular ion $M^+ = 386$ and $M^+ = 536$, respectively. The number of possible structural di- and tri-adducts was 9 and 10, respectively, if there is only one polyfluoro side chain per carbon

atom. Mass spectral data for the breakdown pattern were too similar to be conclusive and thus no structural information concerning any particular structure was obtainable. However, the great number of overlapping g.l.c. peaks suggested that all isomers were produced. Investigations by proton and fluorine n.m.r. spectroscopy did not reveal any information concerning any particular structure, however, integration of the proton spectrum gave the correct ratio for the CFH and remaining protons.

The involatile residue was analysed by elemental analysis and was found to contain some 62% fluorine, 36% carbon and 2% hydrogen. It was therefore concluded that this material consisted of adducts higher than the tri-adducts.

As already mentioned in the case of n-butane, higher adducts than the mono-adducts were predominantly obtained. This findings were further support that the reaction proceeded via a 1,5 hydrogen shift. Once the mono-adduct radical was formed the rearrangement was the most favourable reaction pathway rather than chain transfer by proton abstraction.

I.H.1. Competition experiments

Employing cyclohexane, cyclopentane and n-hexane competition experiments were carried out in order to establish if cyclic systems were exceptional in their reactivity (towards hexafluoropropene) and that aliphatic hydrocarbons were less reactive and thus leading to low conversions as observed.





The competition experiments were carried out using both γ -ray and chemical initiations in order to also establish if any heat dependence of the reaction occurred. The competition experiments were designed and conducted as follows:

An equimolar mixture of hydrocarbons was reacted with a 0.15 molar ratio of hexafluoropropene. Prior to reaction a sample was taken from the equimolar hydrocarbon mixture and analysed by g.l.c. (capillary, temperature controlled) and their relative peak areas obtained were calculated by use of an electronic integrator. Thus, a ratio between the hydrocarbons was obtained representing a known equimolar mixture. This way external errors, e.g. different response factors to the detector, were excluded. On completion the product mixture was analysed by the same method (using the same equipment and conditions) and the results obtained were directly compared with the analysis results prior to reaction. Usually no hexafluoropropene was recovered. The results are given in Table 1.2.







It was noted that n-hexane (commercial) contained at least two impurities (*ca.* 8% by g.l.c.) the major one of which gave a molecular ion $M^+ = 84$ which was found to be n-hexene. This, of course, meant that an inhibitor was present since allylic radicals (see earlier) were produced. Since an inhibitor would inhibit both addition to a cyclic compound and aliphatic compound the results obtained were still valid.

Table 1.2. Competition reactions between cyclic and acyclic hydrocarbons in addition reactions to hexafluoropropene



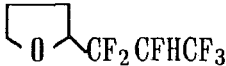

a) Di-tert-butyl-peroxide reactions at 140°C

Hydrocarbons	ratio		overall ratio	ratio per carbon
	prior reaction	after (%)		
	48.56	32.14	1	0.17
	48.42	31.99		
	44.13	12.01	1	0.2
	48.46	16.05		

b) γ -ray induced reactions at room temperature ⁸

Hydrocarbons	ratio		overall ratio	ratio per carbon
	prior reaction	after (%)		
	48.56	11.7	1	0.17
	48.42	10.5		
	44.60	38.81	1	0.2
	47.09	38.50		
	52.61	30.83	1.026	0.17
	46.19	27.78		

⁸ In reactions marked with an asterix (*) some hexafluoropropene has been recovered.

Hydrocarbons	ratio		overall ratio	ratio per carbon
	prior reaction	after (%)		
	58.92	44.38	1.048	0.21
	41.08	29.50		
	67.51	76.51	did not react	
	31.49	22.56	reacted exclusively	

The products formed were mainly the mono-adducts for the cyclic systems and di- and higher adducts for n-hexane.

2. Conclusions

a) Cyclohexane or cyclopentane competition reactions with n-hexane

The results obtained clearly indicate the following points: Firstly, no significant differences in reactivity can be stated for cyclic and aliphatic systems. Secondly, low conversions, e.g. as found in the reaction of n-hexane with hexafluoropropene, do not necessarily mean low reactivity of the substrate. Either an equilibrium process may cause a low conversion, or, as demonstrated here, the presence of a trace of an inhibitor of free radical reactions can result in a false assessment of reactivity. A competition reaction therefore demonstrated if the latter point is the reason for low conversions, since now both reagents are inhibited from further reactions. Thirdly, an increase in temperature was found to increase the conversion but not change significantly the product distribution.

b) Cyclohexane and cyclopentane competition reaction

The reaction showed no big differences in reactivity of either substrate toward hexafluoropropene. The slightly higher reactivity of cyclopentane possibly arises from the fact that the ring strain in cyclopentane (6.3 kcal/mol) is greater than in cyclohexane (0.2 kcal/mol)³⁰. Formation of a radical releases the ring strain and thus formation of a cyclopentyl radical should be preferred. However, at room temperature this effect, as demonstrated here, was too small to give rise to significantly different reactivities.

c) Cyclohexane and oxane competition reaction

The competition reaction of oxane and cyclohexane did not reveal any significant differences in reactivity. Both compounds formed radicals possessing a similar nucleophilicity. Although it was expected that due to the interaction of the oxygen lone pairs a oxanyl radical would be more favourable the results indicated that this was not the case.

d) Oxolane and 2-(2H-hexafluoropropyl)oxolane competition reaction

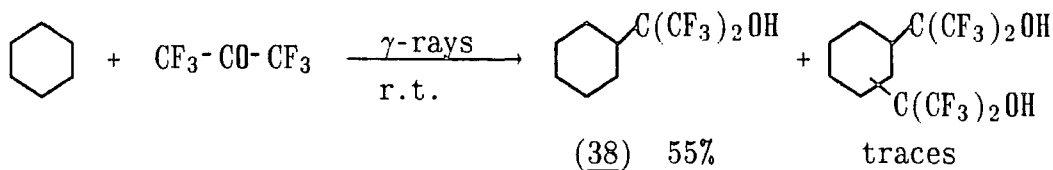
A different picture arose for this competition reaction. Here the oxolanyl radical, as expected, was much more reactive than the 2-(2H-hexafluoropropyl)oxolanyl radical thus formation of (1) was the exclusive reaction. No formation of di-adducts was observed.

I.I. Free radical additions of hydrocarbons to hexafluoroacetone

a) Cyclohexane

A reaction employing hexafluoroacetone and cyclohexane was carried out.

However, γ -rays were used to initiate the reaction, whereas the reported¹⁹ reactions involved the use of UV or peroxide initiation.

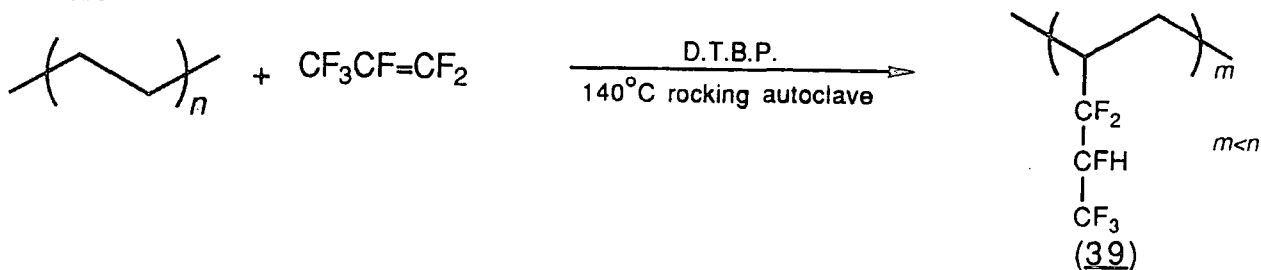


The reaction (conversion: 68%) yielded the alcohol (38). Only traces of the diol were spotted by g.l.c.-m.s. giving $m/z = 397$ [$(M - F)^+$], and no indication of formation of a previously reported ether compound could be found. The conversion based on recovered cyclohexane was found to be 68%. The molecular ion ($M^+ = 250, 2.49\%$) was obtained and major breakdown was loss of the fluorine containing side chain forming $m/z = 83$ as base peak. The infrared spectrum gave a broad OH peak, a medium C-H and a strong C-F absorption. The fluorine n.m.r. consisted of one singlet for the two identical CF_3 groups and a broad proton n.m.r. resonance at 2.93 ppm was found to disappear after a D_2O shake (OH-proton).

I.K. Polymer modifications

a) Polymer modifications using hexafluoropropene

Since small chain hydrocarbons, e.g. n-hexane were shown to react with hexafluoropropene while chemically initiated, polyethylene (PE) should also react. However, polyethylene is a solid material and in order to obtain a large surface a solvent had to be used. Polyethylene can be dissolved in toluene or benzene at elevated temperatures (*ca.* $80^\circ C$). Employing benzene as solvent polyethylene was reacted with hexafluoropropene at $140^\circ C$ using D.T.B.P. as initiator in a rocking autoclave.



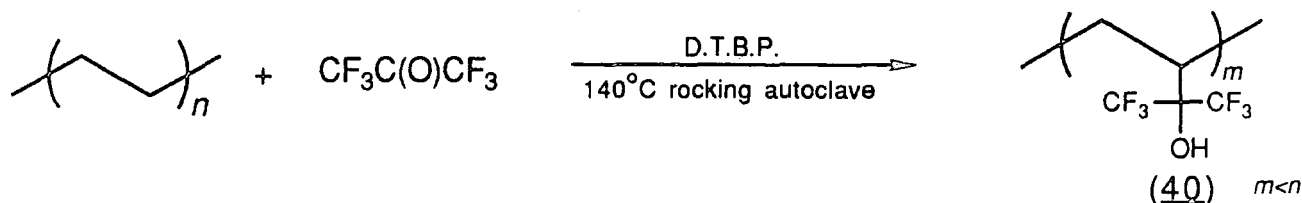
After removal of excess hexafluoropropene a viscous, sticky (honey like) liquid material was obtained. The conversion based on recovered hexafluoropropene was >90%. Analysis by proton and fluorine n.m.r. confirmed the structure of (39). Only a slightly higher relative ratio than 3:1 obtained in proton n.m.r. integrations indicated that not exactly one molecule of hexafluoropropene per methylene unit has been added. Investigation by infrared spectroscopy revealed the presence of benzene as well as non aromatic C-H and strong C-F absorptions. Elemental analysis (after removal of the solvent) gave for (39) 59.5% fluorine, 3.1% hydrogen and 37.4% carbon. One hexafluoropropyl group per ethylene unit in the molecule would require 64.0% fluorine, 2.3% hydrogen and 39.7% carbon. From these analytical data a hexafluoropropyl to ethylene ratio of 10 : 11 was calculated for (39). This was in good agreement with the previously found integration ratio in the proton n.m.r. spectrum for (39).

Applying reduced pressure, a sample of the material foamed and a colourless liquid (benzene) was removed. After all solvent was removed the material sank together and formed a non-sticky glass like slightly yellowish compound.

Pouring some benzene containing material onto a watch glass and applying gentle heating (hair dryer) the solvent evaporated and a flexible non-sticky film was obtained. It was also possible to draw threads from the solvent containing material. As soon as the solvent was evaporated the threads obtained were non-sticky. At room temperature (39) was easily soluble in acetone and acetonitrile (or a mixture thereof) and less easy in 2,2,2-trifluoroethanol but is was not re-soluble in benzene.

b) Polymer modification using hexafluoroacetone

Polyethylene, using benzene as solvent, was reacted with hexafluoroacetone in a chemically initiated reaction at 140°C.

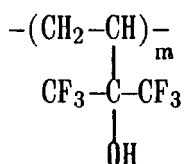


On completion volatile material was removed and a flexible solid rubber-like material was obtained. The conversion based on recovered hexafluoroacetone was calculated to roughly 50%. The surface, which was not covered by the walls of the autoclave was uneven and covered with a layer of clods of elastomeric material whereas underneath that layer dense homogeneous rubber material was obtained. Analysis of the top layer material which still contained some benzene, by infrared spectroscopy gave a broad OH-peak, aliphatic C-H and strong C-F absorptions. The infrared spectrum of the dense bottom layer material was less resolved but found to be principally the same as the top layer. Remaining solvent was removed under vacuum over a period of 3 to 4 days. Elemental analysis was carried out on each of the two layers and the data are given in table 1.4.

Table 1.4. *Elemental analysis data for (40)*

element	top layer (%)	bottom layer (%) (solid rubber)
Carbon	34.6	63.4
Hydrogen	2.85	9.7
Fluorine	51.5	24.6

Addition of one hexafluoroacetone group per ethylene unit required carbon 30.9%, hydrogen 2.1% and fluorine 58.5%.



Assuming the top layer consisted only of the alcohol suggested above, calculation gave that one hexafluoroacetone group was introduced per 1.16 methylene units.

Since a suitable solvent at room temperature was not found analysis by nuclear magnetic resonance could not be carried out. At present further detailed investigations are in progress in order to fully characterize the obtained products.

I.L. Summary and conclusions

Initiated by γ -rays or peroxides free radical additions of hexafluoropropene to cyclic and acyclic hydrocarbons gave clean reactions. The products formed, mono-, di- and higher adducts, could be separated. Structural isomers were also obtained but here a separation was not possible. The yields for the cyclic hydrocarbons are nearly quantitative whereas aliphatic hydrocarbons gave conversions between 14 and 42%. However, only addition products were obtained and not complex mixtures as reported in the literature for thermally or UV initiated reactions. This makes these reactions despite sometimes low conversions synthetically useful. Compared to the reported thermal and UV initiated reactions the yields obtained were at least the same and often higher. Furthermore, reaction times are generally much shorter than the reported ones, especially compared to the thermal reactions.

Two preliminary experiments demonstrated the modification of a hydrocarbon polymer was possible. Benzene, which did not inhibit the free radical addition process, appeared to be an ideal solvent. Compound (39) was clearly characterized and its properties arising from a content of nearly 60% fluorine will make it a good candidate for industrial application e.g. for use as coatings for fiber glasses and such like. Furthermore, due to its solubility in acetonitrile exhaustive fluorination by direct fluorination will provide access to a perfluoropentane polymer which could not be obtained by other methods.

The products obtained in the reaction of polyethylene with hexafluoroacetone exhibited an elastomeric behaviour. Although the structure has not yet been fully determined, it was considered likely that cross linking had occurred. The resulting flexible polymer was found to be insoluble in a number of standard solvents. These preliminary investigations are not complete and further research is being carried out at present. Optimisation of the reaction conditions, e.g. use of a stirred autoclave is expected to result in formation of a single homogeneous product containing more polyfluoro groups (e.g. as many as the top layer did).

The most important fact is already clearly highlighted: modification of

hydrocarbon polymers by means of free radical addition reactions with fluorine containing unsaturated systems e.g. fluoro-olefins or fluoro-carbonyls was found to proceed with high conversions thus leading to novel highly fluorine containing polymers with a potentially wide range of applications.

CHAPTER TWO

SOME FREE RADICAL ADDITIONS OF ORGANOTIN AND ORGANODITIN COMPOUNDS TO FLUORINATED OLEFINS

CHAPTER TWO

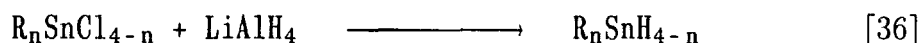
SOME FREE RADICAL ADDITIONS OF ORGANOTIN AND ORGANODITIN COMPOUNDS TO FLUORINATED OLEFINS

II.A. INTRODUCTION

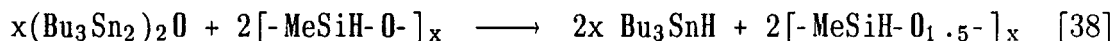
In the decade beginning at the early 1960's a number of studies involving the formation of tin-fluorocarbon bonds were carried out. Tin compounds such as organotin hydrides⁴⁵, dihydrides^{39,46} and organoditins⁴⁷ were reacted under free radical conditions with fluoro-olefins.

II.B. Organotin hydrides and dihydrides

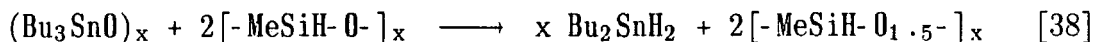
Organotin hydrides are important reagents in synthetic and mechanistic organic studies involving free radical intermediates. In 1947 after the discovery of lithium aluminium hydride, organotin hydrides became readily accessible through the reduction of organotin chlorides to the corresponding organotin hydrides.



This reaction still is the most commonly used one for synthesis of organotin hydrides³⁷. A widely used tin hydride, n-butyltin hydride can be obtained while reducing the corresponding tin oxide with poly(methylhydrosiloxane).



Using the same technique n-dibutyltin dihydride is afforded according to the following equation.

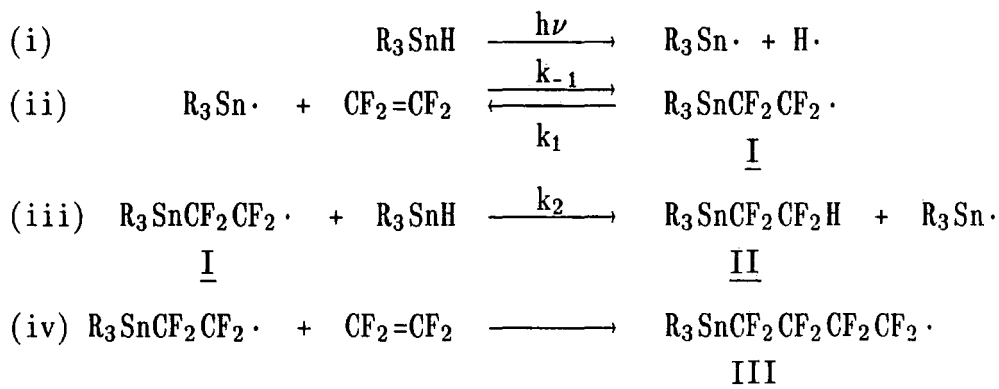


1. Free radical addition reactions of organotin hydrides to fluoro olefins

i) Mechanism

The mechanism of the free addition reaction is given in scheme 2.1. Catalyzed by free radical initiator (e.g. AIBN, UV-irradiation, γ -rays) the tin-hydrogen bond is homolytically cleaved (eq. i). The addition of the tin radical $R_3Sn\cdot$ to the double bond of the olefin (eq. ii) was found to be reversible⁴¹ with k_{-1} being much greater than k_2 (eq. iii). The direction of the addition of the organotin hydride is therefore thermodynamically controlled. Products of reaction (iv) which leads to oligomerisation of the olefin were never obtained no matter how large the excess of the olefin used was⁴². Thus showing the readiness of chain transfer by tin hydride, or, in other words, the great ability of tin hydrides to trap product radical I and thus regenerating the tin radical. In fact, the use of e.g. n-tributyltin hydride as a trap for adduct radicals has recently been described by Giese⁴⁴.

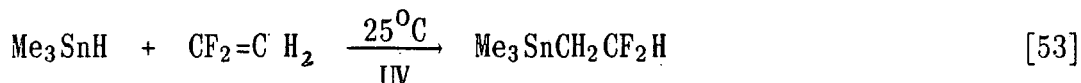
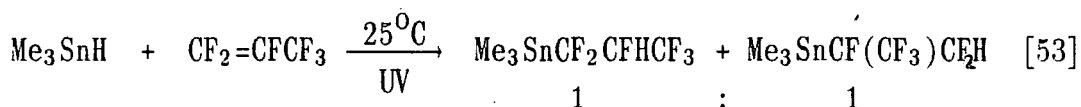
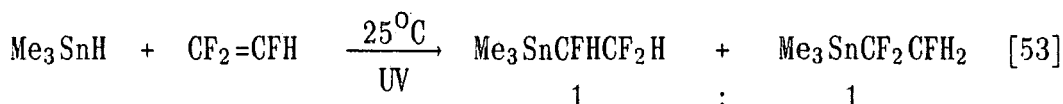
Scheme 2.1. *Free radical mechanism for addition reaction of tin hydrides to fluoro-olefins*



ii) Reactions

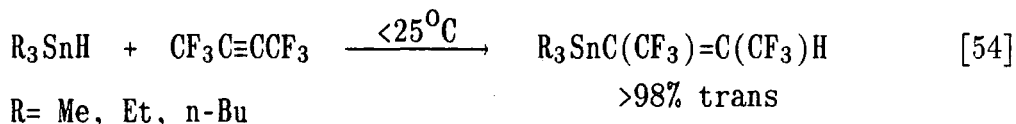
Using trimethyltin hydride the addition to fluoro-olefins yielded usually stable products which could be isolated and characterized.

In the reaction of hexafluoropropene and trifluoroethylene each olefin gave two possible isomers in roughly the same quantities, whereas the reaction of 1,1-difluoroethylene yielded only one isomer⁵³.



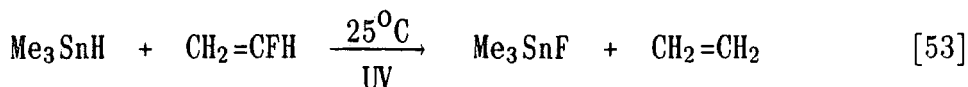
Rather surprising is the non-selectivity reported for the addition of the organotin radical ($\text{R}_3\text{Sn}\cdot$) to trifluoroethylene and hexafluoropropene. Due to the nucleophilic character of $\text{R}_3\text{Sn}\cdot$ predominant attack at the CFH side in trifluoroethylene and the CF_2 side in hexafluoropropene would have been expected. However, a great selectivity is reported for the reaction with 1,1-difluoroethylene which exclusively yielded the expected product.

The reaction of organotin hydrides with perfluoro-2-butyne⁵⁴ gave nearly exclusively (>98%) the trans-product. The reaction was exothermic and occurred immediately on mixing the reagents at temperatures below 20°C .



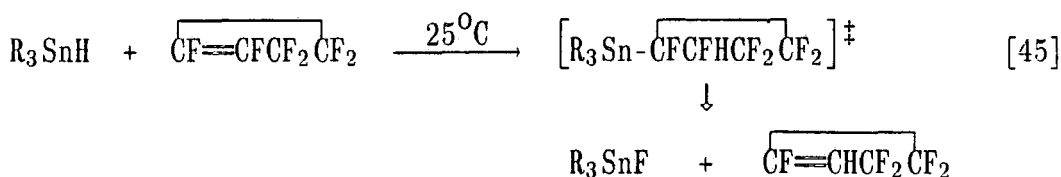
These products are stable and have been fully characterized by Cullen *et al*⁵⁴.

Only trimethyltin fluoride and ethylene could be isolated in the reaction of trimethyltin hydride with vinyl fluoride⁵³.



Perfluorocyclobutene was reacted without any initiation with trimethyl- and triethyltin hydride⁵⁵. In both cases the addition products were

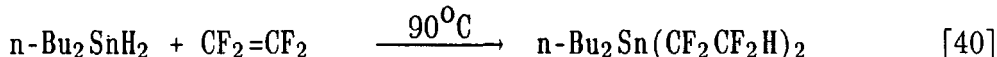
observed by ^1H n.m.r. but only the decomposition products organotin fluoride and 1H-pentafluorobutene were isolated.



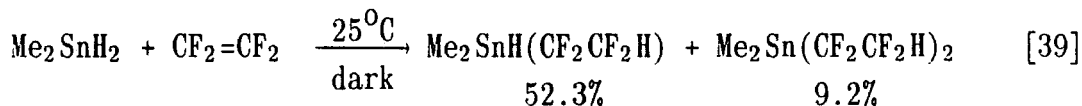
It is interesting to note that the same reaction with silanes or germanes yielded stable addition products⁴⁵.

2. Some free radical addition reactions of organotin dihydrides to fluoro-olefins

The free radical addition reaction of organotin dihydrides to fluoro-olefins were studied in the early 1960's by Clark *et al.*³⁹ and later by Cullen *et al.*⁴⁵. Prior to that only one publication by Krespan and Engelhardt⁴⁰ in 1958 reported the successful thermal addition of tetrafluoroethylene to dibutyltin dihydride.



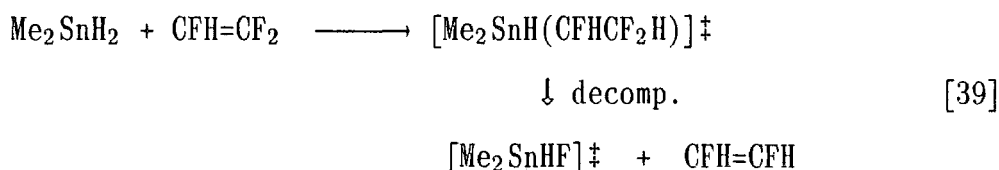
Dimethyltin dihydride was reacted⁴⁹ with several fluoro-olefins such as tetrafluoroethylene, trifluoroethylene, 1,1-difluoroethylene and bromotrifluoroethylene. Only in the first case, reaction with tetrafluoroethylene, stable addition products were obtained.



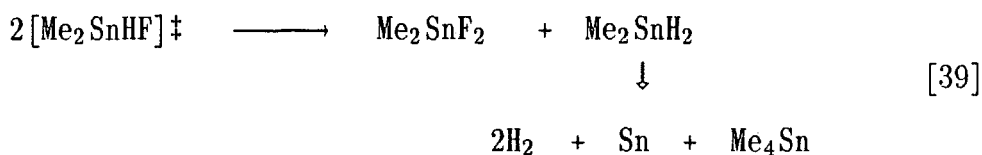
This result is somewhat different to the one reported by Krespan and Engelhardt⁴⁰ who observed exclusive formation of the di-adduct at 90°C.

The latter three olefins (trifluoroethylene, 1,1-difluoroethylene and

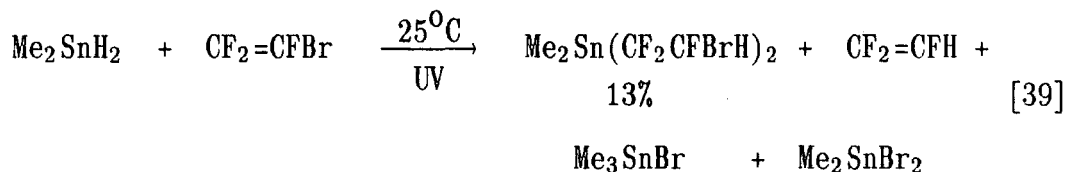
bromotrifluoroethylene) yielded products thought to be the decomposition products from an unstable dihydride-fluoro-olefin adduct.



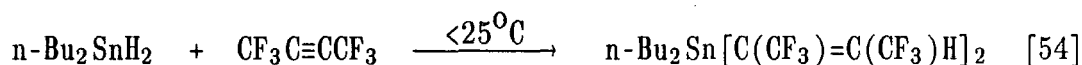
Thus, 1,2-difluoroethylene is obtained and the produced dimethyltin hydrofluoride is thought to rearrange to give dimethyltin difluoride and the decomposition products of dimethyltin dihydride³⁹.



In the case of the bromotrifluoroethylene a small quantity of the di-adduct was obtained together with the usual decomposition products.



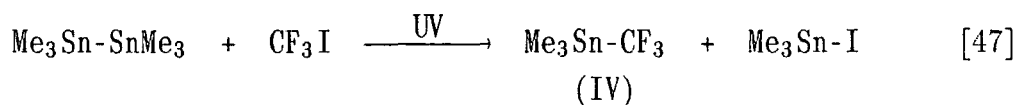
The reaction of n-dibutyltin dihydride with perfluoro-2-butyne⁵⁴ yielded exclusively the di-adduct. The exothermic reaction occurred immediately on mixing the reagents below 20°C and was quantitative.



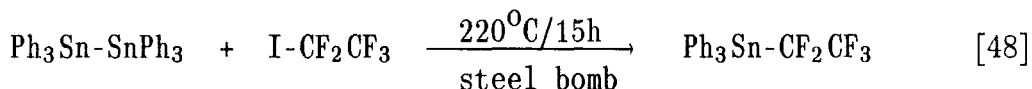
II.C. Free radical addition reactions of organoditin compounds to fluoro-olefins

A different approach made use of the reactivity of the tin-tin bond in compounds like hexamethylditin ($\text{Me}_3\text{Sn-SnMe}_3$). Chambers *et al.*⁴⁷ for

example, reacted hexamethylditin with trifluoromethyl iodide and obtained *via* a free radical mechanism an organotin-fluorocarbon compound (IV).



Generally the use of perfluoroiodides in this type of reaction grants access to a variety of organotin-fluorocarbon compounds⁴⁸.



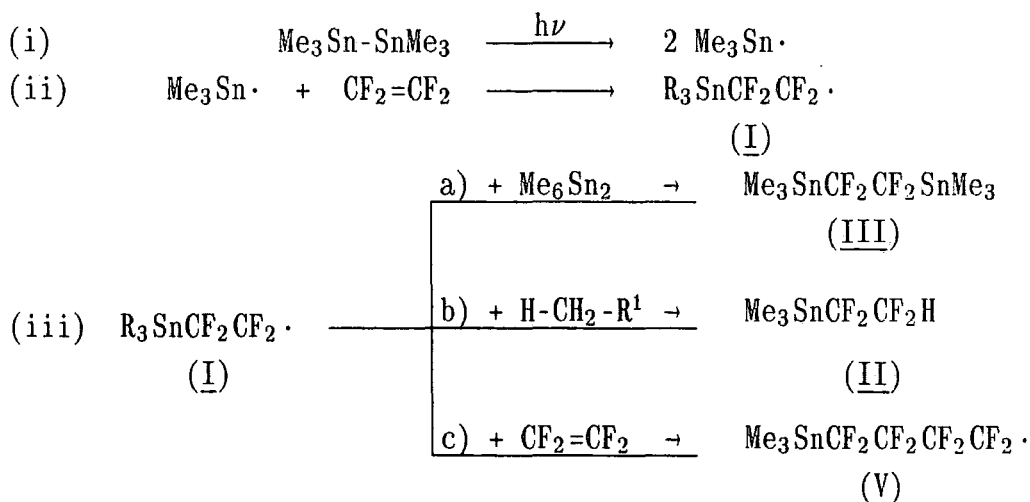
i) Mechanism

The mechanism of the reactions involving organoditin compounds is similar to the one of organotin hydrides and dihydrides described in scheme 2.1. However, adduct radical (I), since it is not exclusively trapped like in the organotin hydride reactions, can undergo three different types of reactions, namely

- a) reaction with another organoditin molecule,
- b) abstraction of a proton (e.g. from a methyl group), and
- c) reaction with another olefin molecule.

Reaction c, of course, will finally be terminated by either reaction a or b. Scheme 2.2. demonstrates the reaction mechanism.

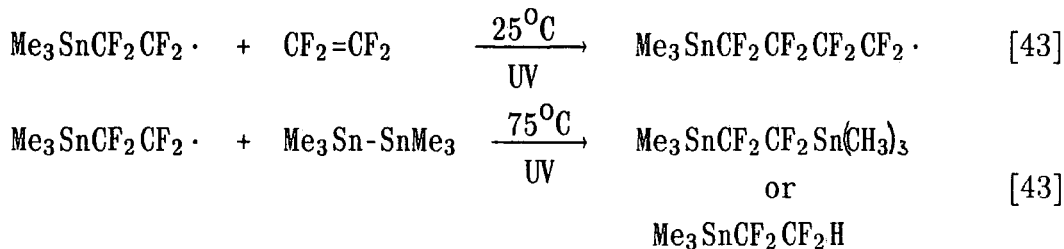
Scheme 2.2. Free radical reaction mechanism for organoditin compounds to fluoro-olefins



Thus more products are formed in an organoditin reaction than in a tin hydride reaction. Here oligomerisation products (reaction c) and insertion products (reaction a) are additionally obtained.

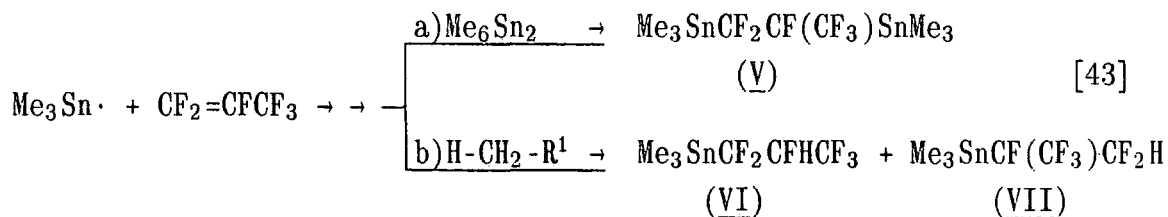
ii) Reactions

Clark *at al.*⁴³ observed the formation of products arising from reaction c while using tetrafluoroethylene. With increasing temperatures a preferential formation of products arising from reactions a and b was observed.



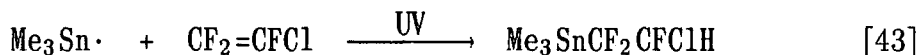
The higher proportion of olefin in the gas phase at 25°C is assumed to favour reaction c whereas at 75°C a higher vapor pressure of hexamethylditin will increase reactions a and b⁴³.

Perfluoropropene gave only mono-adducts arising from reactions a and b and from its two possible isomeric forms (VI) and (VII) only isomer (VI) was observed.



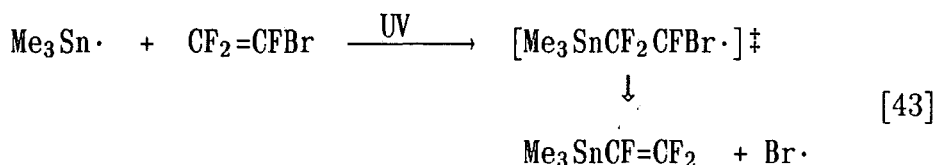
This latter fact demonstrates the nucleophilic character of the $\text{Me}_3\text{Sn}\cdot$ radical and the sensitivity of hexafluoropropene towards nucleophilic attack occurring exclusively at the $\text{CF}_2=$ group⁵⁵. Reaction of hexamethylditin with trifluoroethylene and 1,1-difluoroethylene demonstrated again the nucleophilicity of the $\text{R}_3\text{Sn}\cdot$ radical leading to predominant addition to the CFH and CH_2 group, respectively. The same type of product mixture as in the reaction of tetrafluoroethylene with hexamethylditin were obtained⁴³.

In the reaction of hexamethylditin with chlorotrifluoroethylene only products arising from reaction b (hydrogen abstraction) were observed.



The orientation of the radical attack is due to the different stabilities of radicals $\text{R}_3\text{SnCF}_2\text{CFCl}\cdot > \text{R}_3\text{SnCFClCF}_2\cdot$ because of the powerful stabilizing effect of the chlorine atom⁵⁶.

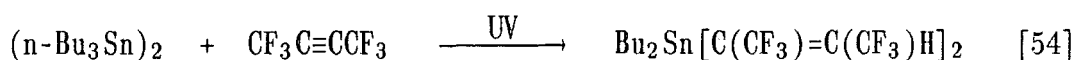
Perfluorovinyltrimethyltin was obtained in the reaction of bromotrifluoroethylene with hexamethylditin.



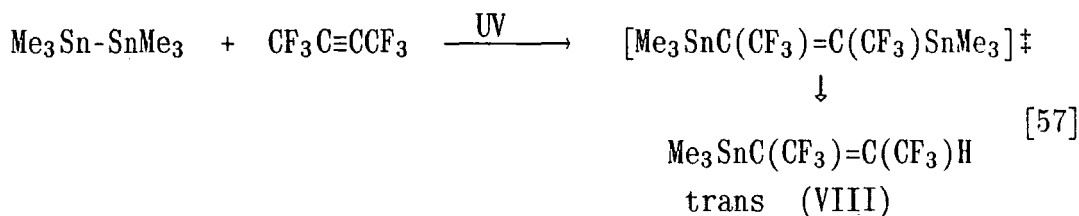
This is consistent with the ease of formation of a bromine radical under UV-irradiation reported elsewhere^{55,56}.

Cullen *et al.*⁵⁷ reacted hexabutyltin with hexafluoro-2-butyne and obtained a complex product mixture from which only dibutyl bis(1,1,1,4,4,4-hexafluoro-2-but-2-enyl)tin could be isolated. This

product was apparently identical with the one obtained in the reaction of dibutyltin dihydride and hexafluoro-2-butyne by the same workers.



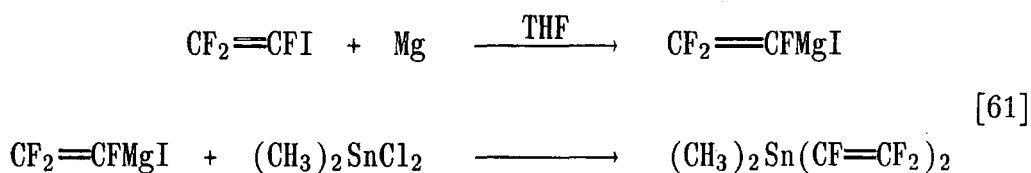
Reaction of hexamethylditin with hexafluoro-2-butyne gave an unstable insertion product which decomposed to give among other products trimethylperfluoro(2H,1-methyl)prop-1-ene (VIII).



II.D. Perfluorovinyltin compounds

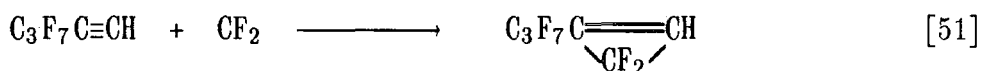
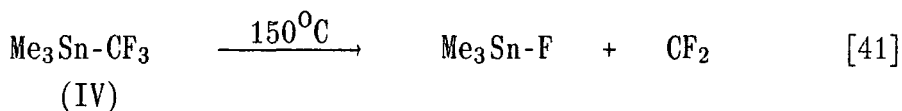
Although perfluorovinyltin compounds^{61,62} are not derived from organotin hydrides or organotin compounds their synthesis shall briefly be mentioned since their behaviour towards cleavage reactions (see 2.3.) is different to the one observed by fluoroalkyltin compounds.

Perfluorovinyltin compounds are derived by a Grignard reaction of e.g. perfluorovinyl magnesium iodide with dialkyltin dichlorides.



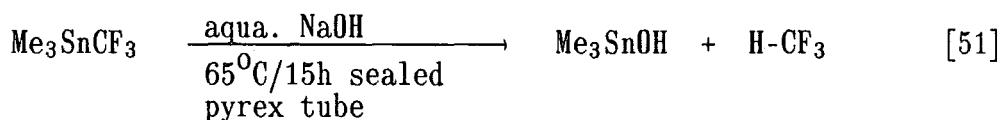
II.E. Some reactions of organotin compounds containing a polyfluoro side chain

On pyrolysis Clark and Willis⁴⁹ found (IV) to produce a difluorocarbene and addition to C=C double bonds and C≡C triple bonds yielded cyclopropanes⁵⁰ and cyclopropenes⁵¹, respectively.

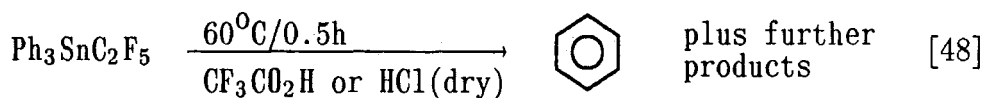


No other tin compounds were found to act as a carbene source by an investigation lead by Cullen *et al*⁵².

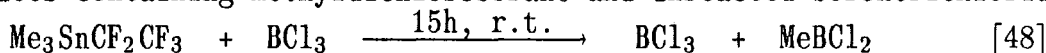
The perfluoroalkyl group is quantitatively removed by base from perfluoroalkyltin compounds.



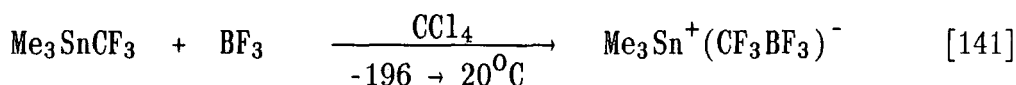
but treatment with electrophilic reagents lead to preferential cleavage of alkyl or aryl groups and not formation of the corresponding polyfluoroalkane.



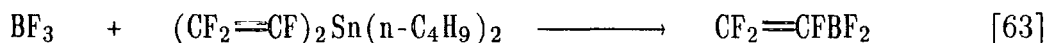
The reaction of the strong Lewis acid borontrichloride with trimethyl(pentafluoroethyl)tin gave rise to a mixture of volatile products containing methyldichloroborane and unreacted borontrichloride.



Employing trimethyltrifluoromethyltin in the reaction with borontrifluoride Chambers *et al.* observed formation of a 1:1 adduct.



This was in direct contrast to perfluorovinylalkyltin compounds which gave with borontrifluoride or borontrichloride the desired fluorovinylboron fluorides and chlorides, respectively.



On treatment of perfluorovinylalkyltin compounds with acid preferentially perfluorovinyl groups were cleaved. This behaviour (reactions with e.g. borontrifluoride and acid cleavage, respectively) was attributed to hybridization differences resulting in a higher or lower electron density at a particular carbon atom. In the perfluorovinyltin compounds the perfluorogroup is bonded to tin through a carbon atom which is sp^2 hybridized, not sp^3 as in the perfluoroalkyl derivatives. The presence of a filled p_π -orbital in the perfluorovinyl derivatives apparently is sufficient to attract the attacking electrophilic reagent⁴⁸.

II.F. Result and Discussion

FREE RADICAL ADDITION REACTIONS OF N-TRIBUTYLTIN HYDRIDE AND ORGANOSILICON COMPOUNDS TO FLUORO-OLEFINS

1. INTRODUCTION

Using γ -rays at room temperature for initiation of free radical conditions has great advantages of supplying very mild reaction conditions and heat sensitive adducts can be obtained. Thus, reacting n-tributyltin hydrides with fluoro-olefins yielded adducts being stable at room temperature in very good yields. Some decomposition products (e.g. tributyltin fluoride) are usually obtained but so minute that they can be considered irrelevant. In certain cases chemical initiation using peroxides e.g. benzoyl peroxide has proved successful, too. However, elevated temperatures and use of peroxides can cause a different product distribution as will be shown in the reaction of n-tributyltin hydride with chlorotrifluoroethylene where a side reaction was found to occur more readily in the chemically initiated reaction. Since the γ -ray irradiation reactions were carried out at room temperature elevated temperatures alone might cause the side reaction to occur more readily. But principally the same reaction products are obtained using either initiation technique.

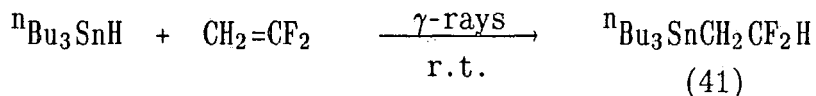
Although similar products as the ones obtained have already been postulated as unstable intermediates³⁹ we now have been able to synthesize and characterize them by means of ^1H -, ^{13}C -, ^{19}F -, and ^{119}Sn -nuclear magnetic resonance spectroscopy as well as by infrared spectroscopy.

II.G. Tributyltin hydride reactions to fluoro-olefins

n-Tributyltin hydride was reacted with a number of fluoro-olefins and complete conversion of the hydride was achieved using a stoichiometric excess of the fluoro-olefins.

a) 1,1-difluoroethylene

Using 1,1-difluoroethylene as olefin the addition occurred exclusively at the CH₂= side thus yielding (41) quantitatively.

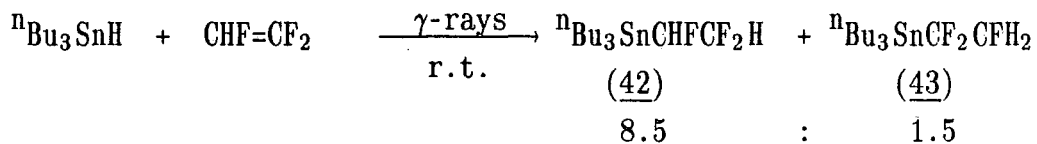


The ¹⁹F-n.m.r. spectrum gave a doublet of triplets for the CF₂H group with the largest coupling constant being J_{F-H} = 60 Hz for the geminal hydrogen and fluorines. The proton n.m.r. spectrum gave a triplet of triplets for the CF₂H group and the proton-fluorine coupling was again found to be J_{H-F} = 60 Hz. The ¹¹⁹Sn n.m.r. consisted of a singlet. A summary of the tin data is given in table 2.1. and table 2.2. lists the main bands observed in the infrared spectrum.

b) Trifluoroethylene

with trifluoroethylene

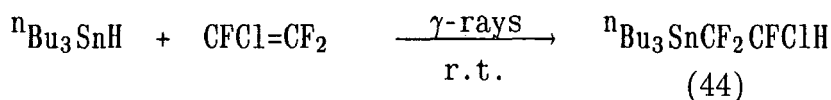
Reacting n-tributyltin hydride gave a mixture of products consisting of compounds (42) and (43) in a 8.5 : 1.5 ratio. Again the nucleophilic tin radical showed a great selectivity towards the direction of attack.



The ¹⁹F n.m.r. spectrum for compound (42) revealed an AB-system for the CF₂H fluorines with a fine structure caused by the geminal proton. The CFH group gave rise to a doublet (J_{F-H} = 47 Hz). The proton spectrum showed a doublet of doublets of doublets of doublets for the CFH-proton and a triplet of doublets for the CF₂H-proton. The ¹¹⁹Sn n.m.r. spectrum consisted of a doublet. Under this doublet the expected triplet for the minor compound (43) was observed but only one line of that triplet was visible. Thus the data given in table 2.1. for compound (43) are an approximate value. The major bands of the infrared spectrum for (42) are listed in table 2.2.

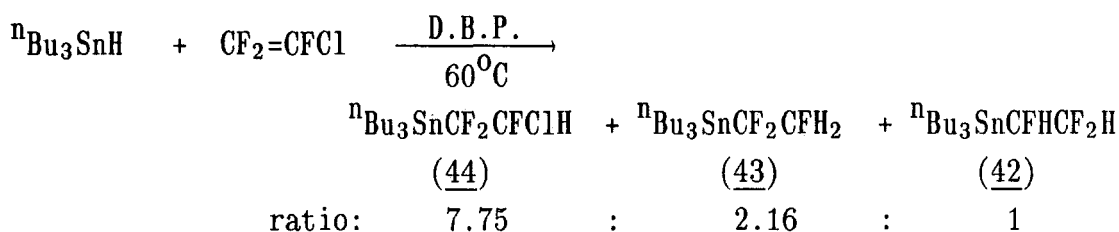
c) Chlorotrifluoroethylene

Employing chlorotrifluoroethylene in the γ -ray induced reaction with n-tributyltin hydride produced very selectively the adduct arising from an attack of the tin radical at the CF_2 side. As already mentioned in the introduction the chlorine atom exhibits a massive stabilizing influence on the intermediate radical ($\text{R}_3\text{SnCF}_2\text{CFC1}\cdot > \text{R}_3\text{SnCFC1CF}_2\cdot$). This reaction was accompanied by formation of a small amount of reduction products (see below).



The ${}^{19}\text{F}$ n.m.r. spectrum showed a doublet for the CFHCl group with a fluorine-proton coupling constant of $J_{\text{F-H}} = 50$ Hz. Each line of the AB-system obtained for the CF_2 group was accompanied by the tin-satellites ($J_{\text{F-Sn}} = 211$ Hz). The proton n.m.r. spectrum gave a doublet of multiplets for the CFH group with the largest coupling constant being $J_{\text{H-F}} = 50$ Hz. The ${}^{119}\text{Sn}$ n.m.r. spectrum gave a triplet with a tin-fluorine coupling $J_{\text{Sn-F}} = 211$ Hz. Data from the infrared spectrum are listed in table 2.2.

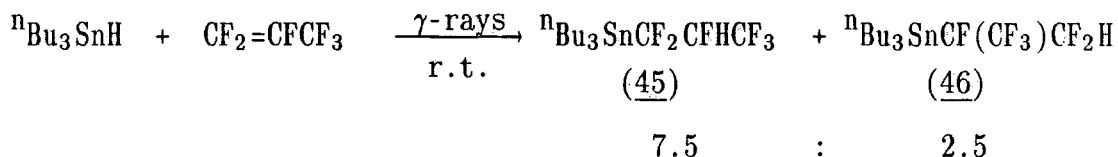
Using dibenzoyl peroxide (D.B.P.) at 60°C as initiator not only adduct (44) was obtained but two further products were produced. Organotin hydrides do not only form nucleophilic radicals which undergo addition reactions but also can act as reducing agents and thus reducing the adduct obtained to give compounds (43) and (42).



Compounds (43) and (42) were identified on comparison with compounds derived from the reaction of n-tributyltin hydride with trifluoroethylene in a non-ambiguous way.

d) Hexafluoropropene

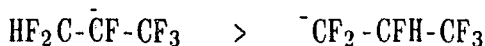
Upon irradiation hexafluoropropene gave while reacting with n-tributyltin hydride two addition products. These products arose from attack of the nucleophilic tin radical either at the terminal side of the double bond and or at the centre carbon. Attack at the more electropositive CF₂= side lead to formation of the major product (45) which was formed in a 7.5 : 2.5 ratio in comparison with product (46).



Analysis of (45) by ¹⁹F n.m.r. spectroscopy gave an AB-system for the CF₂ group and each line was accompanied by tin satellites (J_{F-Sn} = 210 Hz). A singlet was obtained for the CF₃ group and a doublet showing the geminal fluorine-proton coupling (J_{F-H} = 45 Hz) for the CFH group. The proton n.m.r. spectrum gave a doublet of multiplets for the CFH group with the largest coupling constant being J_{H-F} = 45 Hz. The tin n.m.r. showed a triplet caused by the adjacent CF₂ group (J_{Sn-F} = 215 Hz). Compound (46) showed singlets for the CF₃ group and the CF group, respectively. The CF₂H group formed an AB-system with each line being split into a doublet by the geminal proton (J_{F-H} = 42 Hz). The proton n.m.r. spectrum showed a doublet of multiplets for the CF₂H group (J_{H-F} = 42 Hz). Surprisingly no separate ¹¹⁹Sn resonance was observed for compound (46) in a mixture with (45). Since the tin atom was now bonded to a tertiary carbon compared with compound (45) which was bonded to a secondary carbon this should have given rise to a distinctly different chemical shift for the tin. However, no separate resonance was observed.

A mixture containing (45) and (46) was stored in a refrigerator. After a six month period it was found that basically all of compound (46) had been decomposed, presumably by hydrolysis. This can be interpreted by

means of an carbanionic reaction with compound (46) forming a more stable secondary carbanion compared with a primary carbanion which would be obtained from compound (45).



e) 2H-pentafluoropropene

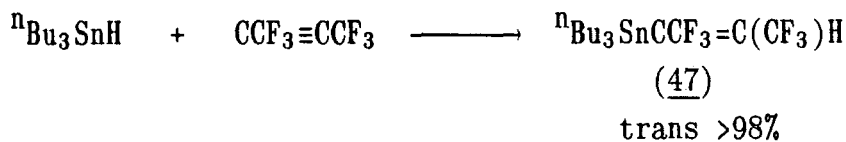
A very low conversion was achieved reacting 2H-pentafluoropropene with n-tributyltin hydride. The reason could be the instability of the adduct radical formed. Thus only small amount of (54) was produced accompanied by formation of some tributyltin fluoride.



Characterisation by ^{19}F n.m.r. spectroscopy gave a singlet for the CF_3 group and a doublet of AB-systems for the CF_2 group. The proton spectrum showed a multiplet for the CH_2 group. The ^{119}Sn n.m.r. spectrum the observed resonance was rather weak and consisted of a singlet with a fine structure so that the expected triplet can be assumed.

f) Hexafluoro-2-butyne

Quantitative reaction of n-tributyltin hydride with hexafluoro-2-butyne occurred to give compound (47). Investigation by ^{19}F n.m.r. spectroscopy and comparison with literature data⁵⁴ revealed that the obtained product was the trans adduct and no indication of the cis adduct was obtained.

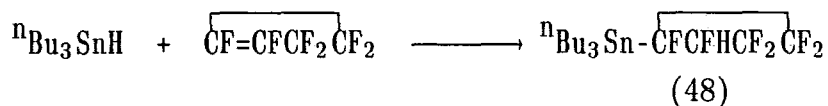


The fluorine n.m.r. spectrum gave two singlets for the two different CF_3 groups and the proton n.m.r. spectrum showed a multiplet for the CH

group. The ^{119}Sn n.m.r. consisted of a singlet (table 2.1.). Table 2.2. contains the major absorption bands observed in the infrared spectrum for (47).

g) Hexafluorocyclobutene

Hexafluorocyclobutene reacted with n-tributyltin hydride under γ -ray irradiation affording adduct (48).



Two types of AB-systems were observed in the fluorine n.m.r. spectrum for the two different CF_2 groups. The CFH group showed a doublet with a typical geminal proton-fluorine coupling constant ($J_{\text{F-H}} = 56$ Hz). The tertiary fluorine gave a singlet and was flanked by the tin satellites ($J_{\text{F-Sn}} = 165$ Hz). The proton n.m.r. spectrum consisted of a doublet of multiplets for the CFH group with the largest coupling constant being $J_{\text{H-F}} = 56$ Hz. A doublet ($J_{\text{Sn-F}} = 165$ Hz) was obtained in the ^{119}Sn n.m.r. spectrum (table 2.1.). The infrared data are given in table 2.2.

Table 2.1. ¹¹⁹Tin n.m.r. data

Compound	Shift ^a		Coupling Constant (Hz)		
			J _{119Sn-19F}	J _{119Sn-13C}	
ⁿ Bu ₃ Sn-CH ₂ CF ₂ H	(41)	-16.5	s		
ⁿ Bu ₃ Sn-CFHCF ₂ H <i>major 85%</i>	(42)	-29.1	d	180	289
ⁿ Bu ₃ Sn-CF ₂ CFH ₂ <i>minor 15%</i>	(43)	-30.6	t <i>calculated</i>	234	
ⁿ Bu ₃ Sn-CF ₂ -CFC1H	(44)	-17.4	t	211	329
ⁿ Bu ₃ Sn-CF ₂ CFHCF ₃	(45)	-13.1	t	215	
ⁿ Bu ₃ Sn-CF(CF ₂ H)CF ₃	(46)	no data		210 ± 5	
ⁿ Bu ₃ Sn-C(CF ₃)=C(CF ₃)H <i>trans > 98%</i>	(47)	-23.7	s	none	355
ⁿ Bu ₃ Sn- $\overline{\text{CFCFHCF}_2\text{CF}_2}$	(48)	+5.5	d	165	332
ⁿ Bu ₃ Sn-CF ₂ -CH ₂ -CF ₃	(54)	-3.9	s <i>broad</i>		

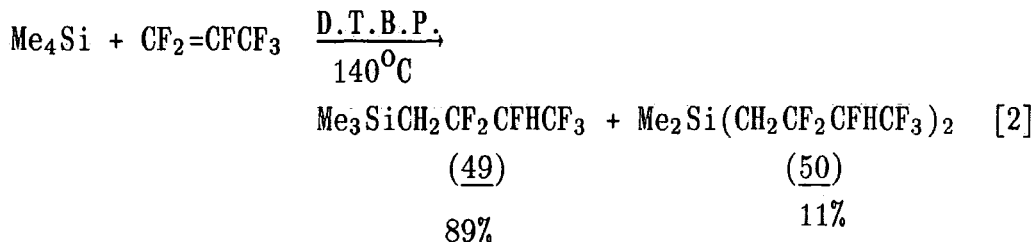
^aExternal Standard Me₄Sn.

Table 2.2. *Infrared spectra (major absorptions only)*

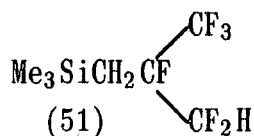
Compound (R= n-Bu ₃ Sn)	wave numbers (cm ⁻¹)
R-CH ₂ CF ₂ H	(41) 1462, 1425, 1375, 1358, 1185, 1130, 1105, 1070, 995, 958, 928.
R-CFHCF ₂ H	(42) 1463, 1378, 1355, 1182, 1125, 1065, 1002, 952.
R-CF ₂ CFC1H	(44) 1458, 1375, 1332, 1315, 1252, 1140, 1065, 1005, 960.
R-CF ₂ CFHCF ₃	(45) 1468, 1380, 1285, 1200, 1168, 1092, 1048, 1005.
R-C(CF ₃)=C(CF ₃)H	(47) 1468, 1379, 1330, 1295, 1245, 1138, 1073.
R- <u>CFCFHCF₂CF₂</u>	(48) 1467, 1420, 1389, 1328, 1272, 1232, 1175, 1090, 1077, 1017, 998, 950.

II.H. Reaction of organosilicon compounds with hexafluoropropene

A reaction which has been described elsewhere² was carried out involving the use of tetramethylsilane and hexafluoropropene. Employing excess tetramethylsilane the mono- and di-adducts were produced.



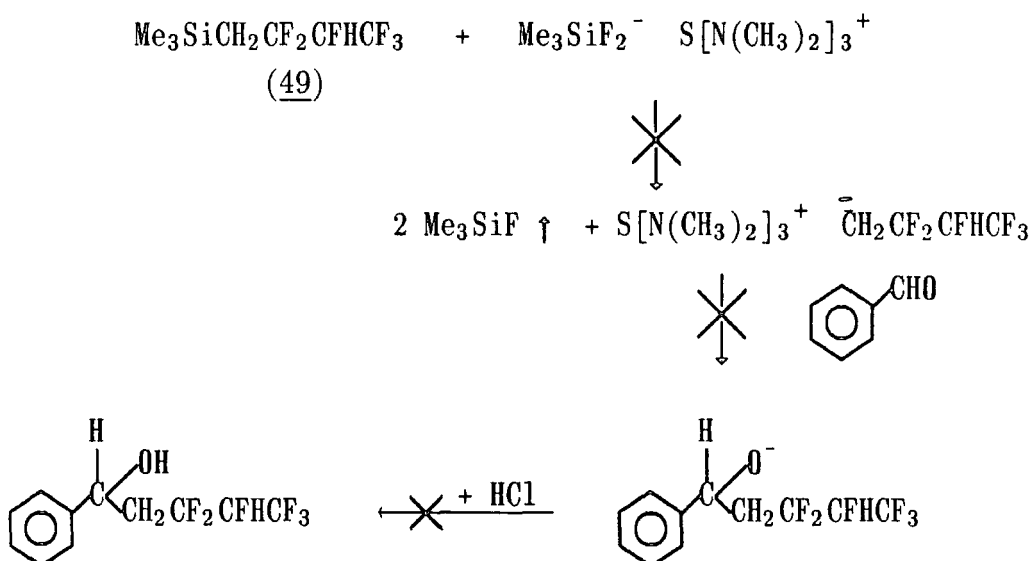
These compounds are stable and can be distilled without any decomposition. A structural isomer of adduct (49), adduct (51), arising from attack at the central carbon atom in hexafluoropropene, was also produced.



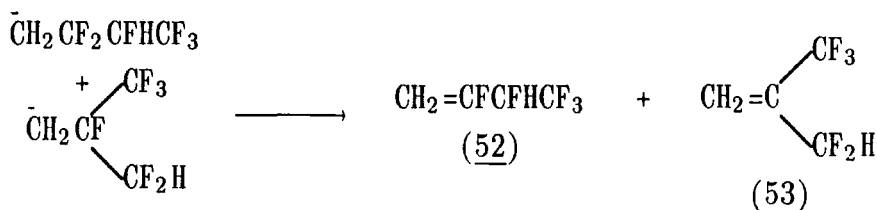
This type of addition to hexafluoropropene has been observed in cases where the nucleophilic character of the radical has been reduced by

attached electron-withdrawing substituents⁵⁹ (e.g. electron back donation from the radical p-orbital to an empty silicon d-orbital).

Reacting a mixture of the mono-adducts (49) and (51) with the fluoride ion source TASF [tris(dimethylamino)sulfur(trimethylsilyl)difluoride, $(\text{Me}_3\text{SiF}_2^- \text{S}[\text{N}(\text{CH}_3)_2]_3^+)$]⁵⁸ was attempted, in order to generate the corresponding carbanion by means of a fluoride ion (base) induced displacement at silicon. TASF, having a non-metal counter ion was used since a metal counter ion (e.g. Cs^+) induces the decomposition of the carbenoid species, while forming a metal halogen bond. The absence of a metal counter ion should eliminate these interactions, and the carbenoid species may then undergo synthetically useful reactions before decomposition.



However, the reaction did not yield the carbanion addition product. The intermediate carbanion decomposed very readily by elimination of F^- to give of (52) and (53),

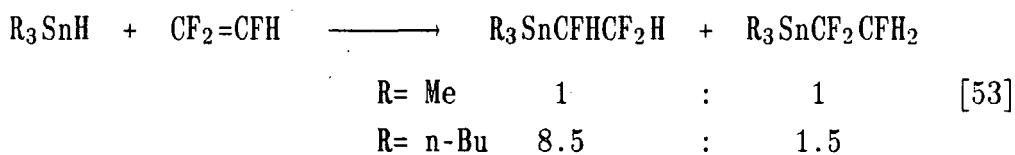


even at low temperature (-60°C). The identity of the products obtained

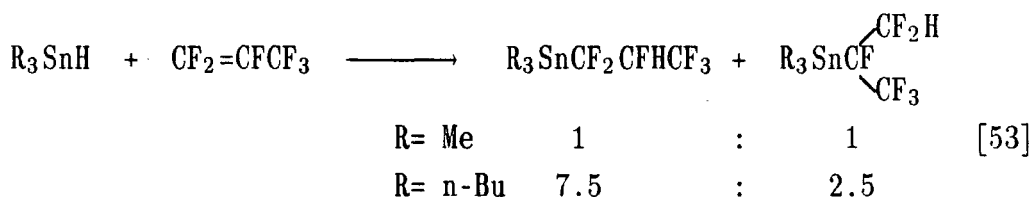
was confirmed by comparison with previously described samples elsewhere²³.

II.I. Summary and conclusions

The addition reactions of n-tributyltin hydride to fluoro-olefins showed a great selectivity towards the side of attack. This selectivity of the electrophile is influenced by the type of organic groups R attached to tin. If the groups are all methyl groups no selectivity has been reported⁵³ for the addition reaction to trifluoroethylene. If the groups R, however, are n-butyl groups, we found an 8.5 : 1.5 excess of the expected addition product.



A similar result was obtained in the case of hexafluoropropene.



However, reactions involving 1,1-difluoroethylene gave in both cases R= Me⁴³ and R= n-Bu exclusively the expected products.

The reaction of chlorotrifluoroethylene has been reported previously and the tin radicals used were generated by homolytic fission of a tin-tin bond. We generated the organotin radicals from an organotin hydride and consequently observed a side reaction which was caused by the organotin hydride acting as a reducing agent. Thus, reduction products were formed and could be identified. Use of different sources of organotin radicals therefore has a great influence of the products formed. In all cases of using organotin hydrides no indications for higher adducts arising from oligomerisation reactions were found. This demonstrated the great ability of n-tributyltin hydride to act as a chain transfer agent.

II.K. Outlook

The obtained tin compounds containing a polyfluorinated side chain may be used for reactions involving the formation of carbanions generated by fluoride ion induced displacement at tin using TASF as fluoride ion source. This reaction would lead to formation of a carbanion where the negative charge would be located at a carbon atom carrying two fluorine atoms. Thus, it is expected to be more stable than the one obtained in the reaction of (49) with TASF, which gave a carbanion with the negative charge located at a methylene group⁶⁰ (this was found to be unstable and elimination of F⁻ under formation of polyfluoro olefins was observed). The so produced polyfluoro carbanion could then be added to systems like benzaldehyde thus giving after appropriate work up rise to fluorine containing alcohols.

CHAPTER THREE

DIRECT FLUORINATION (PHOTOFLUORINATION)

CHAPTER THREE

Direct fluorination (Photofluorination)

III.A. Introduction

The process of direct fluorination⁶⁴ involves use of diluted or undiluted elemental fluorine in order to achieve partial or complete fluorination (exchange of hydrogen for fluorine) of organic or inorganic materials.

This chapter only deals with processes to achieve complete fluorination (perfluorination) and selective partial fluorinations⁶⁵⁻⁶⁸ utilizing elemental fluorine will only be mentioned briefly.

The basic problem while using elemental fluorine is the enormous heat of reaction which can lead to extensive fragmentation and even combustions⁶⁹. The rate of reaction must be slowed down so that the energy liberated from the reaction may be absorbed or carried away. Thus kinetics and thermodynamics shall be considered first.

1. Thermochemistry of direct fluorinations

The direct fluorination process proceeds via a free radical mechanism and table 3.1. list the thermodynamic data for steps in the fluorination of methane.

Table 3.1. *Thermodynamic Data⁷⁰ for Steps in Fluorination of CH₄^a*

Step	Reaction	ΔH_{298K} kcal/mol	ΔG_{298K} kcal/mol
Initiation	1a $F_2 \rightarrow 2 F\cdot$	+ 37.7	+ 29.55
	1b $F_2 + RH \rightarrow R\cdot + HF + F\cdot$	+ 3.9	- 5.84
Propagation	2a $RH + F\cdot \rightarrow R\cdot + HF$	- 33.8	- 36.215
	2b $R\cdot + F_2 \rightarrow RF + F\cdot$	- 69.1	- 68.1
Termination	3a $R\cdot + F\cdot \rightarrow RF$	-106.8	- 97.5
	3b $R\cdot + R\cdot \rightarrow R-R$	- 83.8	- 70.3
Overall reaction	$R-H + F_2 \rightarrow R-F + HF$	-102.9	-103.9

^aBased on JANAF Table data for CH₄.

The overall heat of reaction for the fluorination process ($\Delta G_{298} = -103.4$ kcal/mol) is exothermic enough to cleave a carbon-carbon single bond which has an average energy of 84 - 88 kcal/mol. Table 3.1., however, reveals that each single step of the free radical mechanism does not liberate enough energy to destroy a C-C bond except for the termination step 3a (combination of radical R· with atomic fluorine, $R\cdot + F\cdot \rightarrow R-F$, $\Delta G_{298} = -97.5$ kcal/mol).

Any successful fluorination process must minimize the chances of this amount of energy (84 - 88 kcal/mol) being appropriately localized and available per C-C bond in order to preserve the carbon-carbon skeleton and avoid fragmentation. In table 3.2. thermodynamic data for fragmentation of ethane are listed.

Table 3.2. *Thermodynamic Data⁷⁰ for Fragmentation of Ethane^a*

Step	Reaction	ΔH_{298K} kcal/mol	ΔG_{298K} kcal/mol
1	$R_3C-CR_3 + F_2 \rightarrow 2 R_3C-F$	- 63.6	- 63.2
2	$R_3C-CR_3 + 2F\cdot \rightarrow 2 R_3C-F$	- 82.4	- 77.9

^a Based on JANAF Table data for C_2H_6 .

Attention should be drawn to the fact that two possible initiation steps (1b and the combination of 1a and 2a) are possible. Step 1b in which a fluorine molecule reacts with a hydrocarbon molecule to yield an alkylradical, hydrogen fluoride and a fluorine atom was postulated by Miller⁷¹⁻⁷³ on the basis of reaction products. This step is important from the point of minimizing the population of fluorine radicals. This process is exothermic at room temperature ($\Delta G_{298} = -5.84$ kcal/mol) although the enthalpy is slightly positive ($\Delta H_{298} = +3.9$ kcal/mol). Although this step has not been proved by means of spectroscopic methods the fact that fluorine reacts with hydrocarbons at a significant rate in the dark at $-78^\circ C$ is an indication that step 1b is a significant step and may have very little or no activation energy at room temperature⁷⁰. At atmospheric pressure and 298 K fluorine is less than 1% dissociated and at 598 K 4.6% dissociation of molecular fluorine has been calculated

from an equilibrium calculation⁷⁰. Therefore only 1% of the collisions at room temperature would result in reaction if step 1a were the only important initiation step.

2. Steric factors in direct fluorination

Initially most of the collisions of fluorine molecules with hydrocarbons or aromatic compounds are likely to occur at a hydrogen site or at a π -bond site. Once fluorine carbon bonds have begun to form the carbon skeleton is somewhat sterically protected by the sheath of fluorine atoms. The non-bonding electron cloud of the attached fluorine atoms would tend to repel some of the incident fluorine molecules as they approach the carbon skeleton. This reduces the number of effective collisions, making it possible to increase the total number of collisions and still not accelerate the reaction rate as the reaction proceeds towards completion.

This sheath of fluorine atoms explains the greater success (commonly reported in the literature) when the hydrocarbon to be fluorinated is partially fluorinated in advance (by some other process or is perchlorinated).

3. Kinetic control of the reactions of elemental fluorine

The initial stages of reaction are most critical and nearly all the fragmentation occurs at this time. Employing low but slowly increasing fluorine concentrations rather than a constant relatively high fluorine concentration from the very beginning has been considered much more promising⁷⁰.

Molecular relaxation processes such as vibration or rotational relaxation and thermal conduction make it possible to dissipate energy released during fluorination. Therefore in the initial stages of fluorination it is advantageous to reduce the probability of more than one reaction site on the same molecule or adjacent molecules in a crystal, such that relaxation processes distribute the energy more widely over the molecules and fragmentation is avoided (very low elemental fluorine concentration at the beginning of fluorination). A very low initial concentration of elemental fluorine as used for example in the LaMar process⁷⁰ or the aerosol technique⁷⁸, greatly

decreases the probability of simultaneous fluorine collisions on the same molecules or on adjacent reaction sites. Reactant molecules, as they become more highly fluorinated are able to withstand more and more fluorine collisions without decomposition because sites are sterically protected by fluorine. Such carbon-fluorine sites collisions are non-reactive and therefore the fluorine concentration may be increased as the reaction proceeds to obtain a practical rate of reaction.

In summary, the following points from the foregoing discussion may highlight the important facts to be considered while carrying out direct fluorinations:

- 1) small atomic fluorine population is desired
- 2) rapid dissipation of heat of reaction
- 3) small number of reactive fluorine-hydrocarbon collisions
- 4) reduced (low) mobility of hydrocarbon intermediate radicals
(avoid step 3a in table 3.1.).

These four points reflect a general solution of the problems arising from direct fluorinations employing elemental fluorine.

Various types of process have been developed to perfluorinate organic and inorganic compounds. These processes may be distinguished between those where the compound to be fluorinated is in the liquid phase and those where it is in the solid state.

These two processes, which will be discussed in due course, shall be briefly characterized.

The liquid phase direct fluorination process is usually carried out in an inert solvent^{74,75} and is mainly characterized by a small number of reactive fluorine-hydrocarbon collisions (point 3). The number of reactive fluorine-hydrocarbon collisions is given by the concentration of hydrocarbon material in the inert solvent with the concentration of elemental fluorine being constant. When the reaction occurs, the heat of reaction is automatically dissipated by the solvent. A small atomic fluorine population is automatically obtained (low number of reactive collisions) and mobility of the intermediate hydrocarbon radical (avoiding step 3a) is not important on pure statistical grounds (likelihood of a collision of R· with F· is very low when the concentration of F· is low). The temperatures used range from -75°C to +120°C. Non-fluorinated as well as partly fluorinated starting materials can be employed.

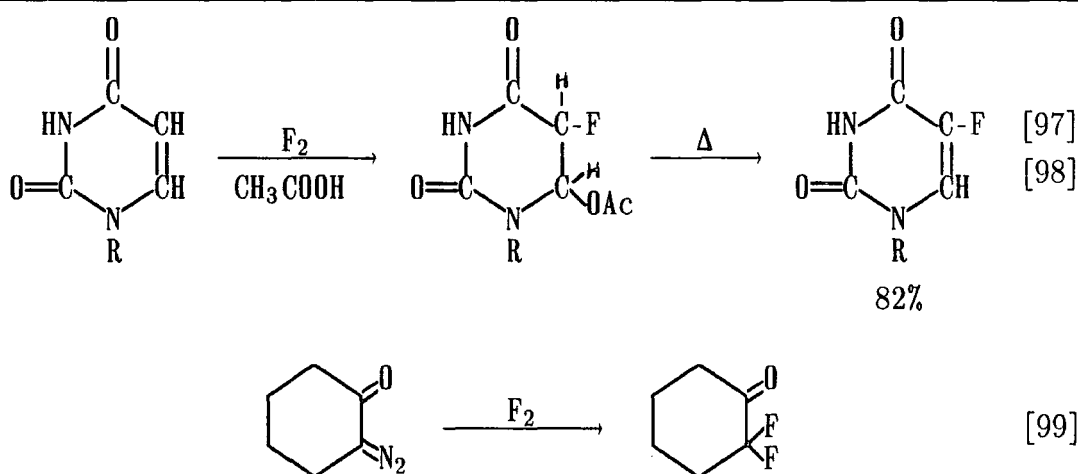
The solid state direct fluorination processes (LaMar^{76,77} (Lagow and Margrave); Aerosol fluorination⁷⁸ (Adcock *et al.*)) puts equal priority on each of the four points. Initially very low temperatures are applied (down to -210°C). The solid hydrocarbon material to be fluorinated is either in a stationary (LaMar⁷⁶) or in a flexible (Aerosol fluorination⁷⁸) phase. Low starting concentrations of elemental fluorine are used and the conditions are changed (higher elemental fluorine concentration, higher temperature) as the reaction proceeds. Mostly non-fluorinated starting materials are used.

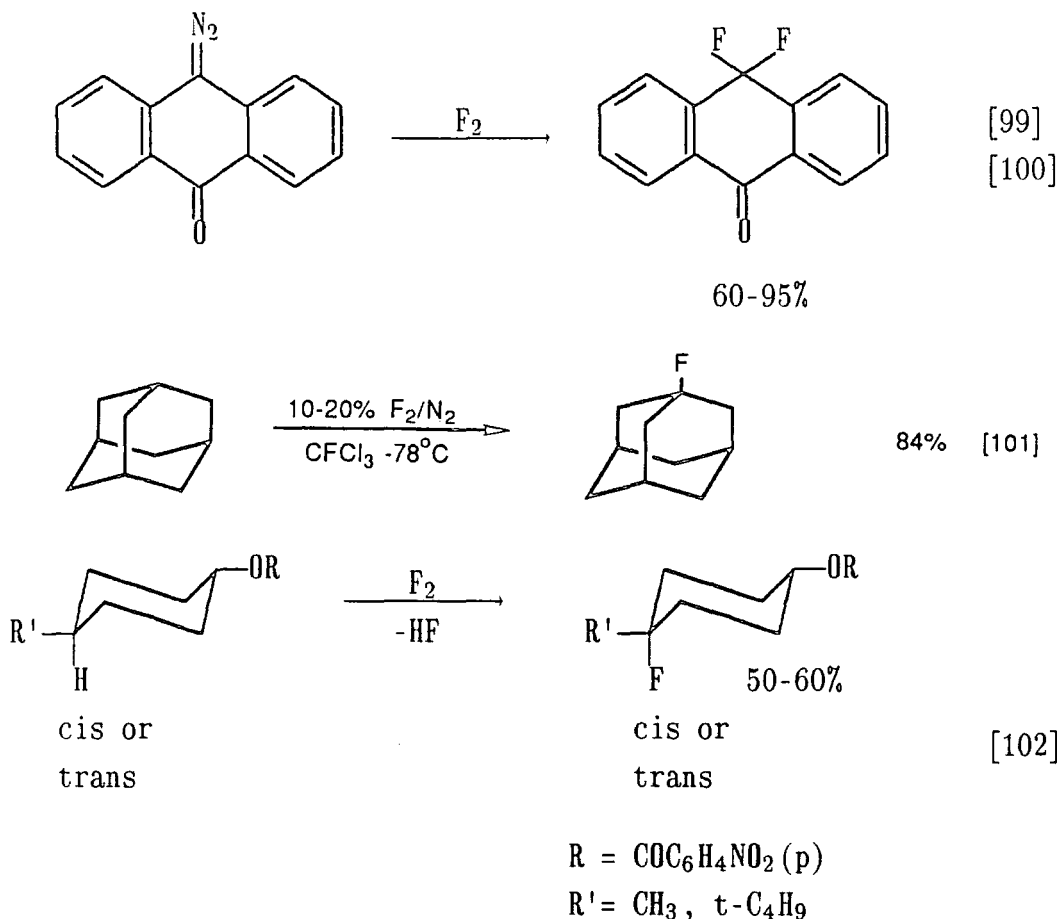
Before discussing the methods to achieve exhaustive fluorination a brief summary of selective fluorinations utilizing elemental fluorine should be given.

III.B. Selective fluorinations using elemental fluorine

Functionalizing or modifying organic and inorganic compounds employing elemental fluorine has become more and more important in recent years. A number of publications⁶⁵⁻⁶⁸ are dealing with this type of direct fluorination and only a few examples are given here to demonstrate the excellent results obtained.

Table 3.3. *Some selective fluorination reactions.*





III.C. Liquid phase direct fluorination

The reaction is carried out in an inert solvent and the material to be fluorinated is fed slowly into the reactor and is stirred vigorously to achieve a rapid dilution by the solvent. Partly fluorinated or non-fluorinated starting materials are employed.

Sherer⁷⁵ *et al.* use temperatures preferentially between -30°C to 25°C and employ FC12 (perfluoro hexane) or F-113

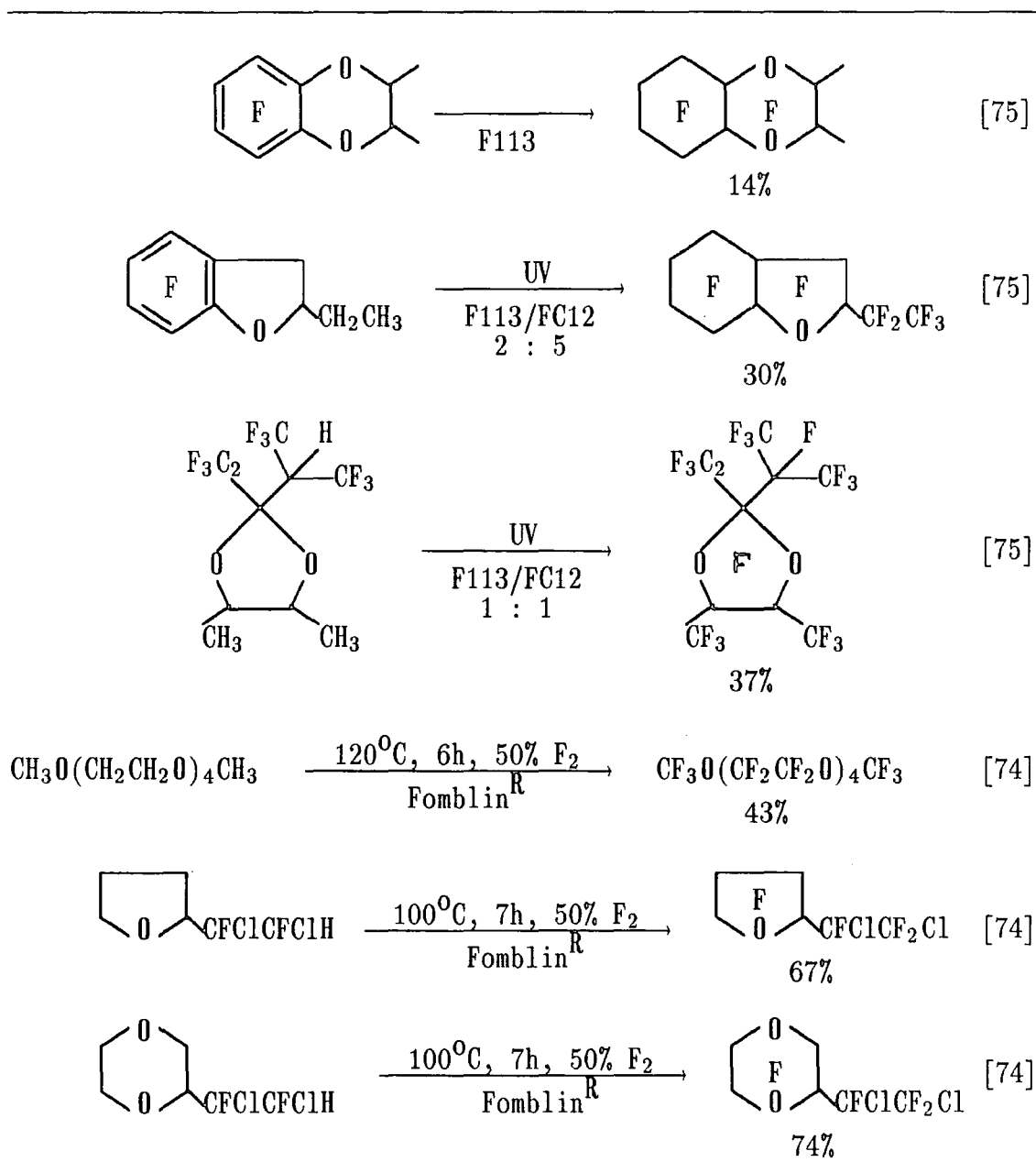
(1,1,2-trichloro-1,2,2-trifluoro-ethane) or a mixture thereof as reaction medium. Diluted or undiluted elemental fluorine is employed and UV-irradiation (240-330 nm wave length) is used to initiate fluorinated atom chains if spontaneous initiation is not sufficient rapid. The yields achieved range between 14 to 38%.

Moggi⁷⁴ *et al.* charge the reactor with Fomblin^R and KF (HF scavenger), heat it to 100 - 120°C and purge it with a 50% elemental fluorine in nitrogen flow for 20 min. In a constant flow rate the material to be fluorinated is fed into the reactor and products are collected in a cold

trap. Partly fluorinated materials being a side product are again fed into the reactor. The yields obtained are between 43 and 74%.

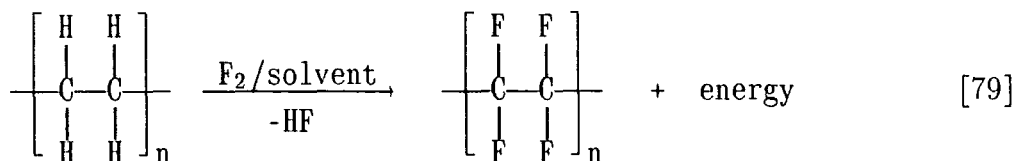
Table 3.4. lists some of the compounds synthesized by the above techniques.

Table 3.4. *Some liquid fluorination reactions.*



A different type of liquid phase fluorination is used to perfluorinate the surface of artifacts⁷⁸⁻⁸⁰. Here an inert solvent such as Flutec^R or Fomblin^R is saturated with a blend of fluorine and nitrogen. The

liquid then is pressed into the container to be fluorinated (if the inside was meant to be fluorinated) or the container is dipped into the liquid (if the outer surface was meant to be fluorinated). After the process is complete the container is flushed with nitrogen and remaining solvent is removed. Thus e.g. PE-surfaces are perfluorinated to give a layer of $\text{CF}_2\text{-CF}_2$ or, if the fluorination is not complete, $\text{CF}_2\text{-CH}_2$, CFHCFH or CFH-CH_2 groups are obtained and analysis is carried out using ESCA techniques.



This process enhances the properties of the artifact dramatically mainly stopping the diffusion of organic compounds through the artifact due to the formation of a blocking layer.

III.D. Solid state direct fluorination

Two different techniques are used employing diluted or undiluted elemental fluorine at low temperatures to achieve perfluorination. Their basic difference is that one process is continuous (Aerosol direct fluorination⁷⁸) and the other one is static (LaMar⁷⁰).

1. Aerosol direct fluorination⁷⁸

The aerosol direct fluorination system as shown in figure 3.1. is designed to produce a controlled continuous stream of aerosol particulates. Highly dispersed NaF particles are sublimed (850⁰C) into helium carrier gas which is then cooled to near -196⁰C. A second gas stream carrying hydrocarbon vapor is mixed with the first gas stream and the hydrocarbon vapor condenses onto the NaF particles thus forming a mobile solid phase of organic material. These particles pass through the reactor (tube) and conditions such as temperature and elemental fluorine concentration can be changed along the tube due to additional gas inlets and different cooling stages. Thus, a low temperature and low elemental fluorine concentration exists at the entrance of the reactor tube (beginning of the reaction) where the initial fluorination takes place (stage 1). A high reactant surface area promotes uniform attack by fluorine on all reactant molecules and low temperature reduces the vigour of reaction by an overall reduction in kinetic energy and by limiting the number of radical chain initiations. Heat dissipation may be achieved by cooled helium carrier gas and the crystalline matrix which also reduces hydrocarbon radical recombination acts as an energy sink to dissipate reaction energies. Once the molecule contains some fluorine (it is then more resistant towards elemental fluorine), the conditions (higher temperature, higher elemental fluorine concentration) can be changed (stage 2). Several different stages creating different conditions may be added if required. Finally, a photochemical reaction stage is added to activate the elemental fluorine and increase the contact time in order to complete fluorination. The products obtained also contain partly fluorinated compounds and the yield of perfluorinated products vary between 30-57%. The scale of the these reactions are within the range of 5-6 mmol of non-fluorinated starting materials and reaction times are over periods of 3-5 hours. Some results are listed in table 3.5.

Table 3.5. Some aerosol direct fluorination products.



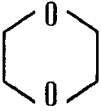
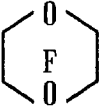
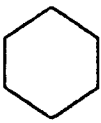

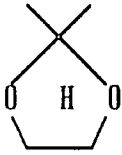
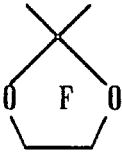
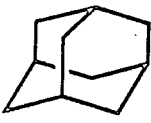
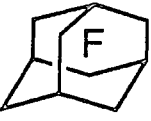
	$\xrightarrow[\text{UV}]{\text{F}_2/\text{N}_2}$	F- 	[78]
		38%	
	$\xrightarrow[\text{UV}]{\text{F}_2/\text{N}_2}$		[78]
		57%	
	$\xrightarrow[\text{UV}]{\text{F}_2/\text{N}_2}$		[78]
		30%	
	$\xrightarrow[\text{UV}]{\text{F}_2/\text{N}_2}$		[78]
		51%	
	$\xrightarrow[\text{UV}]{\text{F}_2/\text{N}_2}$		28% [81]
$\text{CH}_3(\text{O}-\text{CH}_2\text{CH}_2)_n-\text{OCH}_3$	$\xrightarrow[\text{UV}]{\text{F}_2/\text{N}_2}$	$\text{CF}_3(\text{O}-\text{CF}_2\text{CF}_2)_n-\text{OCF}_3$	[82]
		n= 1 36%	
		n= 2 22%	
		n= 3 30%	
		n= 4 15%	

Figure 3.1. *Aerosol direct fluorination apparatus*⁷⁸

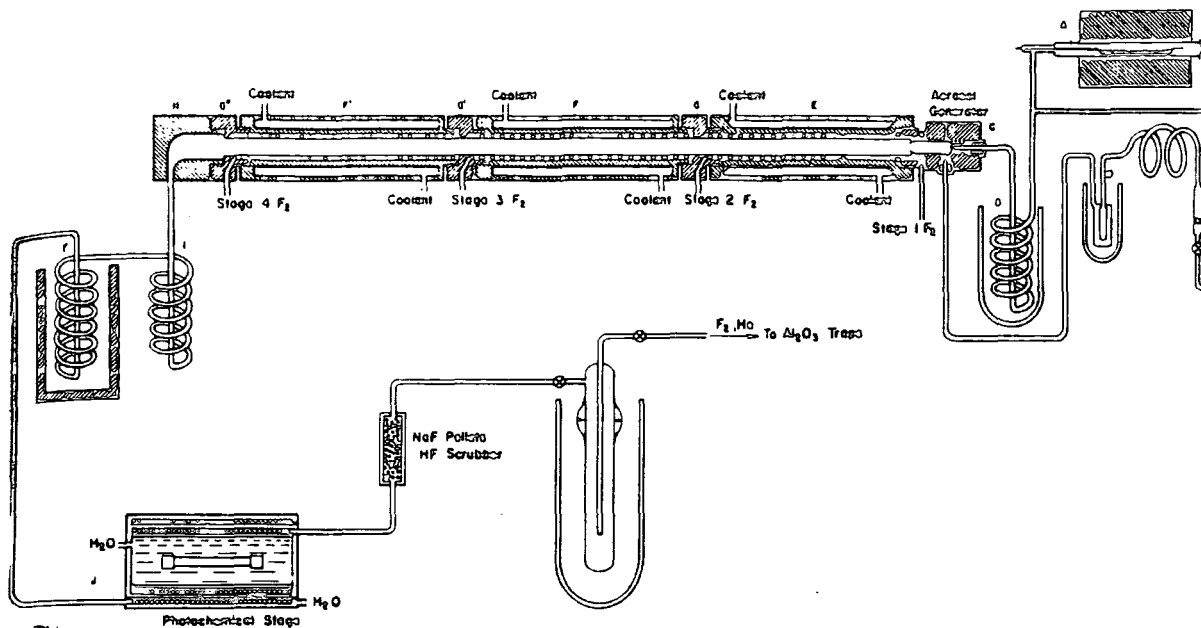
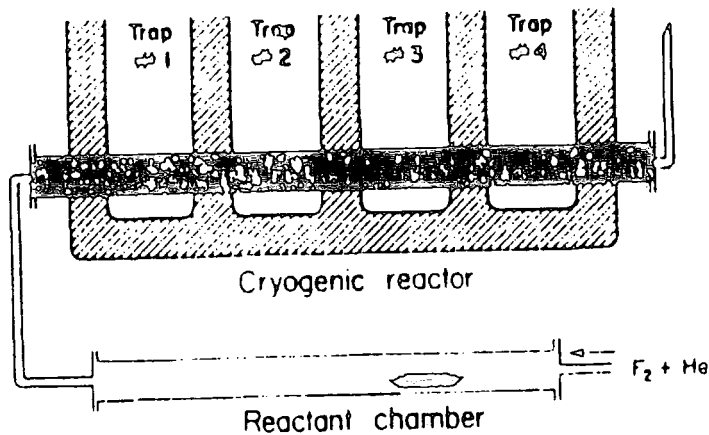


Figure 3.2. *LaMar direct fluorination apparatus*⁷⁰

Cryogenic reactor system





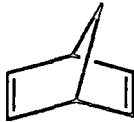
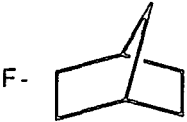
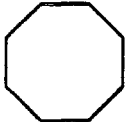

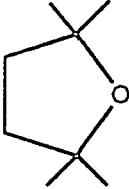
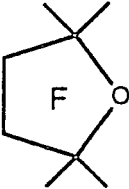
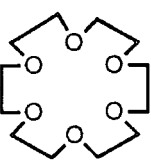
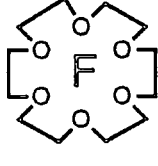
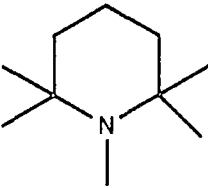
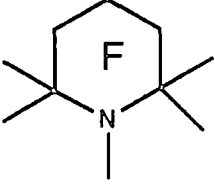
2. LaMar direct fluorination

This technique is again a low temperature technique which realizes all four points mentioned as essential for a successful fluorination at the same time.

The cryogenic reactor system as shown in figure 3.2. consists of a nickel or Monel^R reactant chamber in which solid or liquid reactants are placed in a nickel or Monel^R boat. When solid samples are to be fluorinated it is essential to grind the hydrocarbon starting material to a particle size of less than 100 mesh so that the elemental fluorine is able to diffuse into the centre of the particles to react. Use of larger particles result in an unfluorinated core of hydrocarbon material in the centre of the particle.

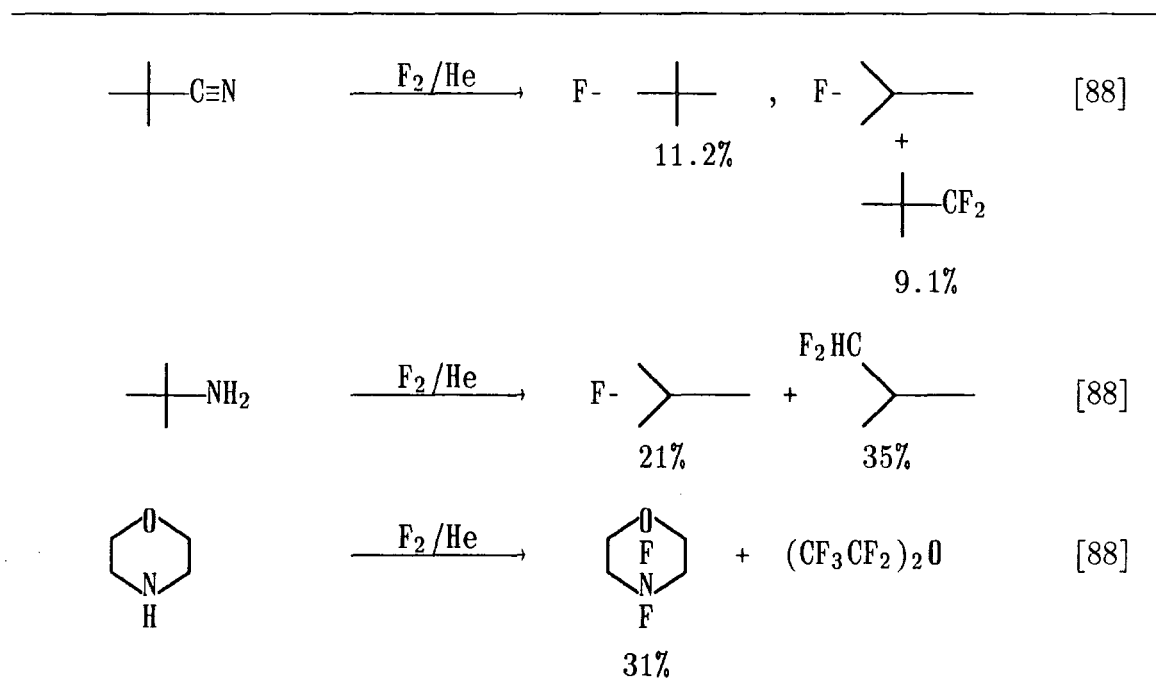
The cryogenic reactor is enclosed by a stainless steel cold box and consists of a nickel tube tightly packed with fluorinated copper turnings and is divided into several zones. Generally the method for introducing compounds into the cryogenic reactor is as follows: the vapor of the reactant being placed in the nickel boat in the reactant chamber is carried by helium carrier gas into the first zone of the cryogenic reactor which is cooled to the temperature needed to freeze the reactant. The individual zones of the cryogenic reactor can be cooled to any temperature between 0°C (ice) and -150°C (using a liquid nitrogen temperature controller) or heated for reactions with polymers (e.g. polypropylene oxide). Fluorination is started by introducing elemental fluorine into the helium carrier gas stream. The reactant is vaporized slowly down the reactor by successive warming and cooling of zones. The more highly fluorinated material is more volatile than the partially fluorinated material and moves through the zones more quickly, thus providing a fresh surface for further fluorination. Finally, the products which consist of a mixture of fully and partly fluorinated compounds are trapped outside the reactor in a series of cold traps at different temperatures. The scale of reaction lies usually between 4-15 mmol (0.4-4.1 g starting material) and reaction times are between 4 and 26 days the average being 13 days. The yields range from 3.5-45% (or 0.077-2.48 g) and are usually well below 25%. Table 3.6. lists some examples.

Table 3.6. Some products obtained by LaMar technique.

			Yield	Ref.
$\begin{array}{c} \text{CH}_3 \\ \\ \text{CH}_3 - \text{C} - \text{CH}_3 \\ \\ \text{CH}_3 \end{array}$	$\xrightarrow[-78^\circ\text{C}]{\text{F}_2/\text{He}}$	$\begin{array}{c} \text{CF}_3 \\ \\ \text{CF}_3 - \text{C} - \text{CF}_3 \\ \\ \text{CF}_3 \end{array}$	10.4%	[83]
$\begin{array}{c} \text{CH}_3 \quad \quad \text{CH}_3 \\ \quad \quad \\ \text{CH}_3 - \text{C} - \text{CH}_2 - \text{C} - \text{CH}_3 \\ \quad \quad \\ \text{CH}_3 \quad \quad \text{CH}_3 \end{array}$	$\xrightarrow[-78^\circ\text{C}]{\text{F}_2/\text{He}}$	$\begin{array}{c} \text{CF}_3 \quad \quad \text{CF}_3 \\ \quad \quad \\ \text{CF}_3 - \text{C} - \text{CF}_2 - \text{C} - \text{CF}_3 \\ \quad \quad \\ \text{CF}_3 \quad \quad \text{CF}_3 \end{array}$	14%	[85]
	$\xrightarrow[-78^\circ\text{C}]{\text{F}_2/\text{He}}$		12.2%	[84]
	$\xrightarrow[-78^\circ\text{C}]{\text{F}_2/\text{He}}$		8.2%	[84]
	$\xrightarrow[-78^\circ\text{C}]{\text{F}_2/\text{He}}$		6.2%	[84]
	$\xrightarrow[-120^\circ\text{C to rt}]{\text{F}_2/\text{He}}$		45%	[87]
	$\xrightarrow[-78^\circ\text{C to } +60^\circ\text{C}]{\text{F}_2/\text{He}}$		33.5%	[86]
	$\xrightarrow[-78^\circ\text{C to } +25^\circ\text{C}]{\text{F}_2/\text{He}}$		19.5%	[87]
$\begin{array}{c} \text{CH}_3 \\ \\ \text{CH}_3 - \text{C} - \text{CH}_2 - \text{O} - \text{C}_6\text{H}_5 \\ \\ \text{CH}_3 \end{array}$	$\xrightarrow[-78^\circ\text{C to } +60^\circ\text{C}]{\text{F}_2/\text{He}}$	$\begin{array}{c} \text{CF}_3 \\ \\ \text{CF}_3 - \text{C} - \text{CF}_2 - \text{O} - \text{C}_6\text{H}_4\text{F} \\ \\ \text{CF}_3 \end{array}$	6%	[87]

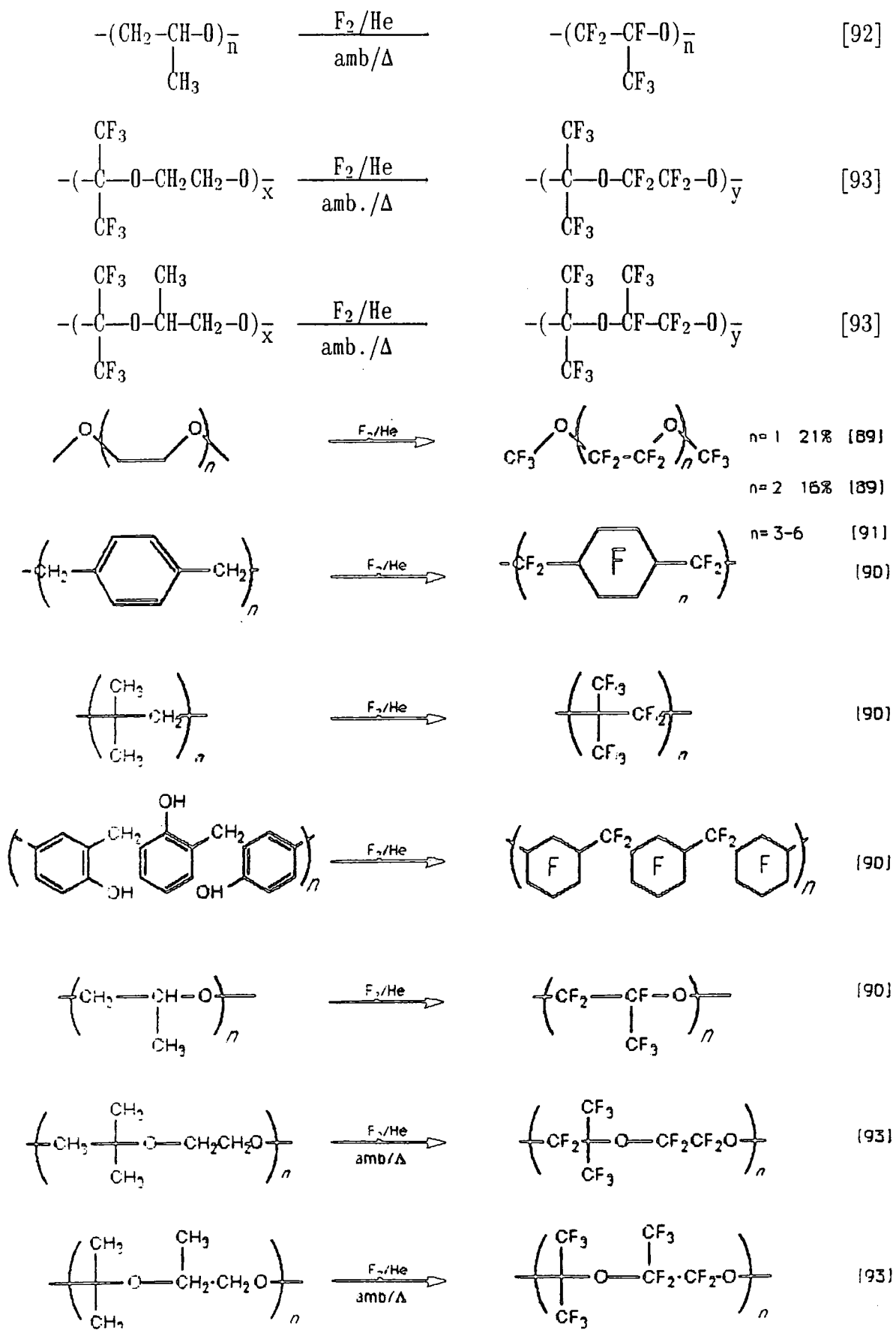
The use of nitrogen compounds as precursors⁸⁸ to branched fluorocarbons by direct fluorination was also investigated. Here, side reactions and radical dissociation substantially interfered with a "successful" fluorination although valuable products were obtained. Table 3.7. lists some of the reactions.

Table 3.7. *Perfluoro compounds from nitrogen precursors.*



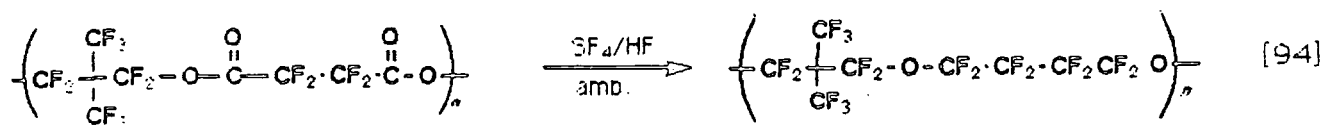
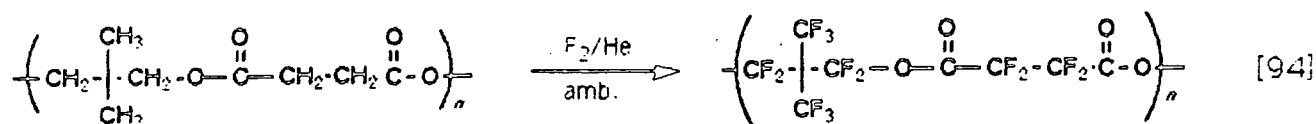
Employing the LaMar technique polymers have been perfluorinated on similar scales mentioned earlier. Some examples are given in table 3.8.

Table 3.8. Perfluoropolymers derived by LaMar technique.



An interesting approach to obtain perfluoro polyethers is the fluorination of linear hydrocarbon polyester⁹⁴ followed by conversion to polyethers using SF₄ as selective fluorinating agent. The advantage of this technique includes synthesis of carbon chains in the polymer backbone longer than two carbon atoms (not possible with vinyl-epoxides), synthesis of unsymmetrical co-polymers such as A-O-B, alternating perfluoro co-polymers and excess to highly branched perfluoro-polyether systems. The general scheme of these reactions is demonstrated in table 3.9. by an example .

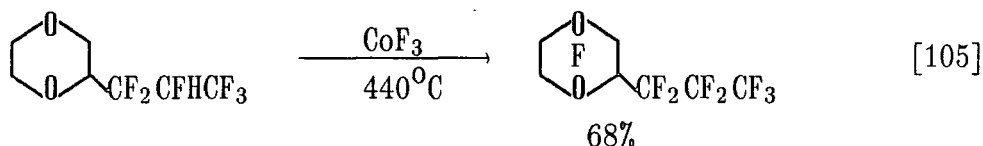
Table 3.9. *Perfluoro polyethers from polyesters.*



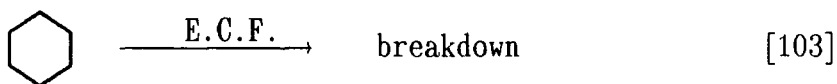
III.E. Result and Discussion

1. Strategy

Exhaustive fluorination using cobalt trifluoride or the electrochemical fluorination technique has shown that partial fluorinated materials are well suitable as starting materials for these processes. Chambers *et al.*¹⁰⁵ reported the successful fluorination of partly fluorinated ethers over cobalt trifluoride at 440°C. The yields of the desired perfluorinated compounds were good (60 - 70%) and no extensive breakdown was observed.



Employing electrochemical fluorination good yields were also reported¹⁰³ while using partial fluorinated starting materials. Not only improved partial fluorination prior to exhaustive fluorination the yields of perfluorinated products but it enabled in some cases reactions to succeed which otherwise had failed.



We now wanted to investigate if the direct fluorination technique could be employed successfully for exhaustive fluorination of partly fluorinated starting materials such as cyclic and acyclic ethers and di-ethers as well as hydrocarbons.

2. Apparatus

Preliminary results indicated that these compounds were stable towards

direct fluorination, and in fact application of elemental fluorine (50% in nitrogen) did not achieve the desired perfluorination even at elevated temperatures. Therefore UV-irradiation was employed to increase the concentration of atomic fluorine in order to achieve a reasonable rate of reaction. Under these conditions (50% F₂/N₂ and UV-irradiation) perfluorination was achieved at room temperature. The initial reactions were carried out in quartz apparatus but etching due to HF formation limited the lifetime of these apparatus and even led to complete loss of the experiment once the glass became too thin and broke. The new re-designed apparatus used throughout the experiments is shown in diagram 3.3. The photofluorination apparatus, as developed in our laboratories, consisted of three main parts,

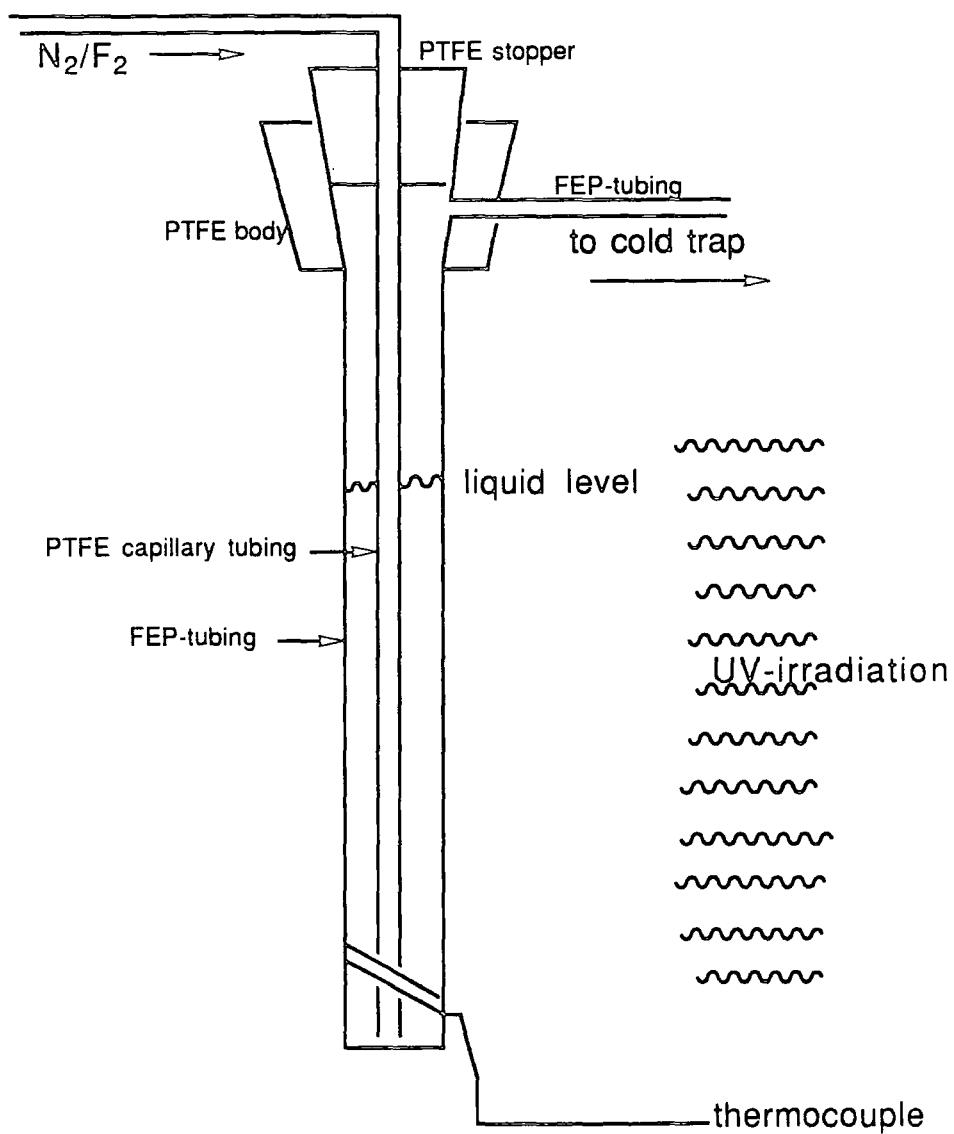
- a) the fluorination chamber,
- b) the UV-irradiation source and
- c) the cooling or heating device.

The apparatus was located in an isolated fumes hood to avoid UV-irradiation to escape from the area. The use of FEP (a co-polymer of hexafluoropropene and tetrafluoroethylene) proved extremely successful. The chamber was filled with the reactant and no solvent was used. PTFE tubing leading to the bottom of the chamber was used to bubble the gas mixture (F₂ in N₂) through the partly fluorinated liquid starting material. The outlet consisted of a FEP tubing connected to a cold trap (dry ice) and lead through a fluorine and hydrogen fluoride scrubber into the fumes hood. A UV-lamp provided the necessary UV-irradiation and employing a fan the temperature was kept at room temperature. A thermocouple attached to the end of the fluorination chamber enabled us to monitor the temperature. Using additional equipment other temperatures can be achieved by surrounding the reaction chamber with a quartz cooler and employing suitable liquids (e.g. water) the reaction might be cooled or heated as required.

3. Characterisations

For characterisation of the material obtained besides ¹⁹F n.m.r. spectroscopy, infrared spectroscopy and elemental analysis, mass spectrometry proved very successful. Using the negative ion spectroscopy technique the molecular ion was obtained, indicating that

Figure 3.3. *Direct fluorination apparatus as developed in our laboratories.*

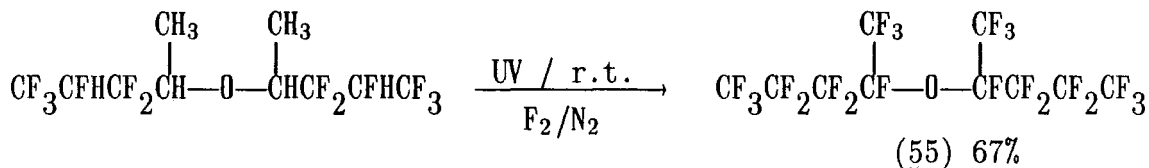


the parent compound was still intact and no fragmentation had taken place. Very useful information was obtained employing the electron impact technique, too. Usually no molecular ion was observed here, but valuable information about the breakdown of the compound under investigation was gathered. Typical fragmentation pattern, e.g. complete loss of a side chain or formation of a distinct fragment, gave further proof about the structural integrity of the products. Thus, a combination of both negative ion and electron impact technique finalized the structural analysis of the reaction products. The starting materials were synthesized as described in Chapter 1 or elsewhere^{1,96}.

4. Direct fluorinations

a) Partly fluorinated aliphatic ether

Di-(2,2,3,4,4,4-hexafluoro-1-methylbutyl)ether was photofluorinated at room temperature using the above described apparatus.

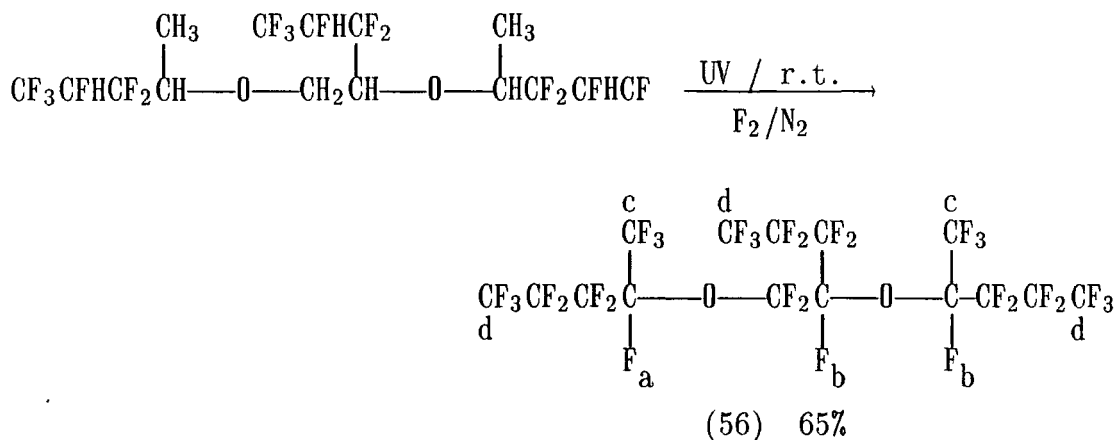


Comparison of ¹⁹F n.m.r. and elemental analysis data with already reported data⁹⁵ established the desired product.

Perfluoro-di-(1-methylbutyl) ether (55) was obtained in much better yield than the one reported using cobalt trifluoride⁹⁵. This demonstrated that direct fluorination conducted in a much less sophisticated apparatus than the CoF₃ apparatus was a well suitable process for the synthesis of perfluorinated compounds with similar efficiency.

b) Partly fluorinated di-ethers

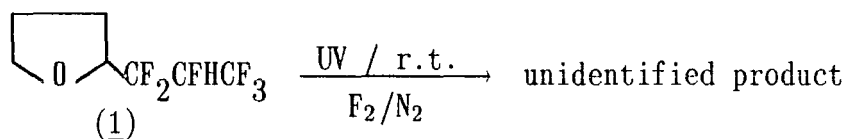
Employing the ethyleneglycol diethylether/hexafluoropropene 1:3 adduct photofluorination was successfully carried out yielding the corresponding perfluorinated compound in good yields.



The ^{19}F n.m.r. spectrum for (56) was of particular interest. Three separate resonances were observed for the CF_3 groups (c) bonded to the chiral centre. The other CF_3 groups (d) gave rise to one singlet. The CF_2 groups gave a system of overlapping AB systems in the usual area (-120 to -129 ppm). The tertiary fluorines were observed giving resonances at -134.4 and -135.5 ppm for fluorines b and at -143.2 ppm for fluorine a. This demonstrated that tertiary fluorines can be shifted down field towards or into the CF_2 region in compounds like (56). Therefore this compound serves as a model compound for perfluoro polyethers where, as demonstrated here, the chemical shift of tertiary fluorines are shifted into the CF_2 region and can therefore not always be spotted separately. Synthesis of perfluorinated polyethers are successfully carried out in our laboratories¹⁰⁴.

c) Partly fluorinated cyclic ethers

Attempts were made to photofluorinate 2-(2H-hexafluoropropyl)oxolane (1).

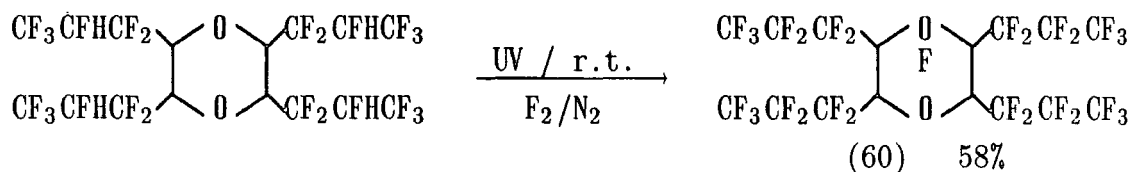
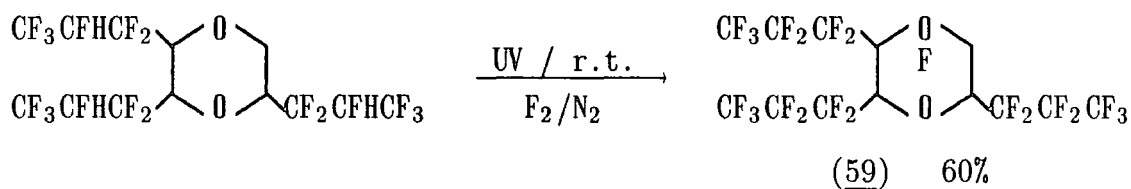
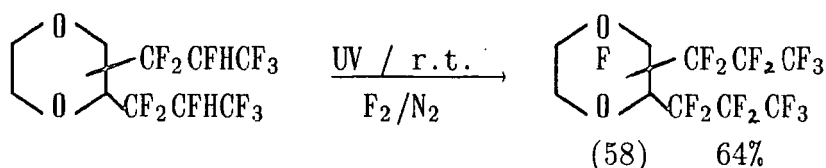
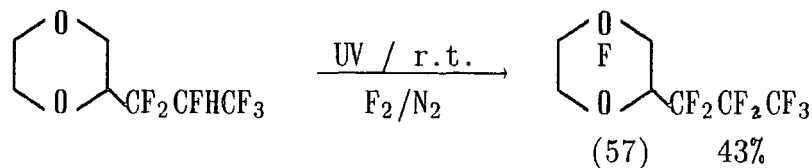


Repeated experiments even under very mild conditions (very low elemental fluorine concentration over a long period of time) usually not required for such partly fluorinated starting materials, did not yield the desired perfluorinated product. A significant loss of starting material occurred and a perfluorinated highly viscous colourless liquid was always produced. The integration ratios observed in ^{19}F n.m.r. spectrum for $\text{CF}_2/\text{CF} : \text{CF}_3/\text{O}-\text{CF}_2$ and elemental analysis were just slightly out as required for the perfluoro-2-propyloxolane (64). Since no carbonyl absorption was observed in the infrared spectrum a ring opening process (leading to the formation of a carbonyl function) can be excluded. Usually high viscosity is caused by strong hydrogen bonding of remaining protons with fluorine⁹⁶, but in this case the presence of any hydrogen atoms had proved negative. Thus an increased molecular weight was likely to have caused the viscosity implying that some type of oligomerisation and/or cross linking must have taken place during the photochemical fluorination. At present work is under way to identify the structure of this product.

d) Partly fluorinated cyclic di-ethers

The mono-, di-, tri- and tetra-adducts of 1,4-dioxan and

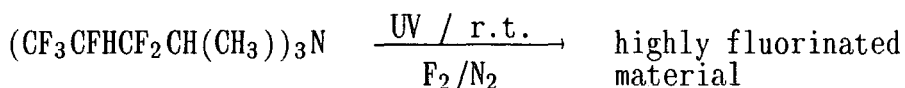
hexafluoropropene have been photofluorinated successfully.



The di-adduct consisted of all possible structural and diastereo isomers which could not be separated. After photofluorination the product obtained showed a simpler g.l.c. trace than the starting material (capillary g.l.c., 40°C isothermal) since now the retention times of all isomers were virtually identical and two close peaks with a distinct fine structure were obtained. Analysis by g.l.c.-m.s. showed an identical breakdown pattern for all isomers produced. The tri- and tetra-adduct starting material were only obtained as a complex mixture and were separated after photofluorination by preparative g.l.c. and their yields estimated by capillary g.l.c.

e) Partly fluorinated tertiary amine

Employing tris-(2,2,3,4,4,4-hexafluoro-1-methylbutyl)amine photofluorination was carried out.



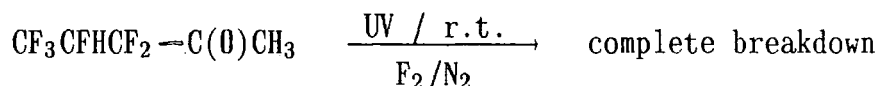
The direct fluorination gave only a highly fluorinated material which still contained some hydrogen even after prolonged fluorination. Elemental analysis did detect some hydrogen and spectroscopic analysis by ^1H n.m.r. and infrared spectra confirmed their presence. The ^{19}F n.m.r. spectrum did not show the expected chemical shift at $\delta_{\text{F}} = -210$ ppm for a CFH group. However, at $\delta_{\text{F}} = -152$ ppm some resonances (CFH_2) were observed. Tertiary fluorine resonances are not observed separately, in fact, their presence can not be positively stated. Like in the di-ether system of ethyleneglycol diethylether/hexafluoropropene 1:3 adduct (56) they are expected to be shifted into the CF_2 region. The ^1H n.m.r. spectrum showed a peculiar feature in that the resonance for CFH groups usually became broader and broader as fluorination proceeded and disappeared eventually into the baseline. Here, the ^1H n.m.r. spectrum showed an increasingly sharper resonance in the region of $\delta_{\text{H}} = 4.7$ to 4.9 ppm. Mass spectrometry did not give a molecular ion for the expected perfluorinated compound.

The reason for not achieving complete fluorination may be due to steric hindrance. All protons to be substituted are located in the "centre" of the molecule. Therefore intense hydrogen bonding between these protons and the surrounding fluorine made it difficult to substitute the remaining protons (see also reference 96, p. 89). The complete absence of any CFH group indicated the complete fluorination of the side chains. Usually it is expected that this proton in the hexafluoropropyl side chain is the last one to be exchanged. Here, however, we find the presence of CFH_2 groups which only could arise from the former methyl groups. The substitution of the tertiary hydrogen can not be proved definitively. If substituted the fluorine resonance will appear within the CF_2 region, if not, the chemical shift observed in the ^1H n.m.r. $\delta_{\text{H}} = 4.7$ to 4.9 ppm could well be attributed to a tertiary proton in such an

electron withdrawing surrounding as well as for the two protons bonded to the same carbon as a fluorine atom (CFH₂ group).

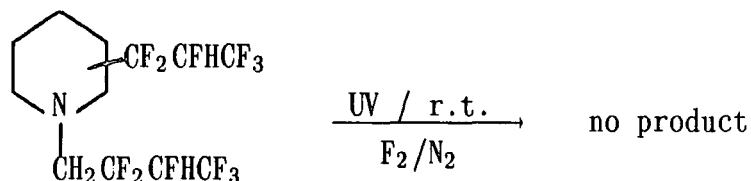
f) Partly fluorinated aliphatic ketone

The ketone employed was not stable enough to undergo photofluorination and resulted in a complete breakdown of the molecule.



g) Partly fluorinated cyclic tertiary amine

A mixture of structural isomers of the N-methyl piperidine/hexafluoropropene di-adducts was employed in this reaction.

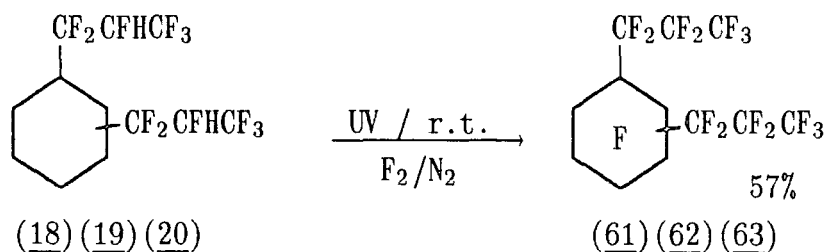


Although a considerable loss of organic material was observed some highly fluorinated material was obtained being not perfluorinated nor containing any trace of the desired perfluorinated product (g.l.c.-m.s.). Breakdown products were trapped and consisted of a complex mixture of fluorine containing compounds. No further investigations were carried out into the nature of these products.

h) Partly fluorinated cyclic hydrocarbons

A mixture of structural isomers of the cyclohexane/hexafluoropropene

di-adducts, 1,x-bis(1,1,2,3,3,3-hexafluoro-propyl)cyclohexane (x= 2,3,4) (18),(19),(20), was employed for photofluorination.



The desired perfluorinated products (61), (62) and (63) were obtained in good yields. Due to close retention times on g.l.c. (capillary, 40°C isothermal) the perfluorinated di-adducts could not be separated. This reaction, therefore, is an example, that our technique is also suitable for photofluorination of partly fluorinated hydrocarbons. G.l.c.-m.s. revealed only a trace of perfluoro-propyl-cyclohexane (1:1 adduct), obviously resulting from breakdown.

III.F. Summary and conclusion

Our approach can be seen as a development taking the liquid phase direct fluorination technique further making it more easy to handle and more generally accessible. Here treatment of partly fluorinated starting materials at room temperature with diluted elemental fluorine gave good yields of perfluorinated compounds. The main characteristics of this process was a small number of reactive fluorine-hydrocarbon collisions (point 3). Through a large surface kept at room temperature rapid dissipation of heat was realised. A low atomic fluorine population combined with a low number of reactive fluorine-hydrocarbon collisions resulted in an even lower rate of reaction, therefore UV-irradiation was employed to increase the number of atomic fluorine in order to achieve a reasonable rate of reaction. The intermediate radicals produced were partly fluorinated and therefore point 4 became obsolete.

Partly fluorinated cyclic and acyclic ethers and di-ethers as well as partly fluorinated cyclic hydrocarbons were successfully photofluorinated. Attempts to perfluorinate a partly fluorinated tertiary amine resulted in a highly fluorinated product. An aliphatic ketone gave complete breakdown upon the reaction conditions used.

CHAPTER FOUR

ELECTROCHEMICAL FLUORINATION

CHAPTER FOUR

Electrochemical fluorination

IV.A. Introduction

The electrochemical fluorination process (E.C.F.) as invented by Simons¹⁰⁶ is one of the most widely used techniques for synthesis of perfluorinated materials¹⁰¹⁻¹¹¹.

The so-called Simons cell, for electrolysis, consists of a stainless steel body with lid which is fitted with a package of usually nickel electrodes¹³² (cathodes can be made of iron but anodes must be nickel or nickel alloy (Monel^R) to achieve perfluorination).

The cell filled with anhydrous hydrogen fluoride and organic material (<15% w/w) is electrolyzed by application of 4-6 V potential difference. Voltages above 10 V certainly result in release of elemental fluorine and lead to extensive destruction of organic material and anodes. On completion perfluorinated material being insoluble in hydrogen fluoride separates out and is removed through a valve at the bottom of the cell.

The mechanism of the process is not clear yet. Tatlow¹⁰⁹ points out that higher valency nickel fluorides NiF₃ or NiF₄ are unlikely to be involved in the E.C.F. process since the electrode potential for the reaction



must be higher than to liberate fluorine. Fluorine is not liberated during a normal E.C.F. process.

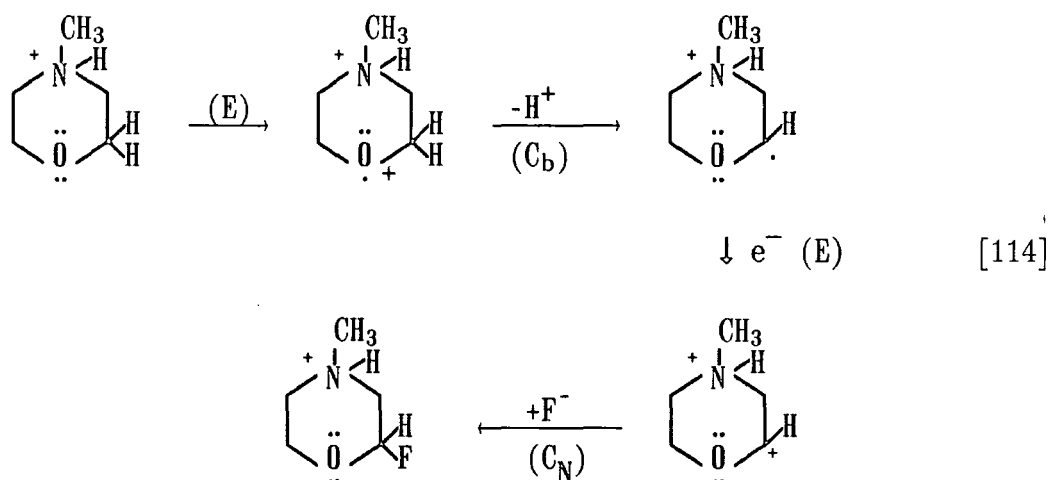
Some functional groups are often retained in E.C.F. but are lost in other processes (high valency metal fluorides e.g. CoF₃, AgF₂, etc. and elemental fluorine). It has been suggested¹¹² that a loose complex of nickel difluoride and atomic or molecular fluorine might be formed and the fluorination would take place between this complex and the substrate, possibly also adsorbed on the nickel fluoride.

A different mechanism, the so-called EC_bEC_N-mechanism, which was earlier proposed by Burdon¹¹³ *et al.* has been further investigated by

Gambaretto¹¹⁴ *et al.* (scheme 4.1.). This four stage mechanism involves in the first stage (E) the adsorption of the organic molecule on the anode where it undergoes an electrochemical oxidation to the corresponding radical cation. A second stage (C_b) follows during which the saturated organic compound generally eliminates a proton. The radical formed in this manner is then oxidized to the corresponding cation in stage three (E), which reacts with a fluoride ion (fourth stage, C_N).

According to this mechanism the oxidation of the fluoride anions to radical and a non-ionic origin of the C-F bond are excluded.

Scheme 4.1. EC_bEC_N mechanism suggested for E.C.F.

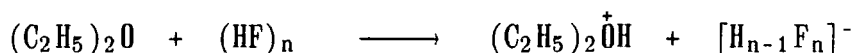
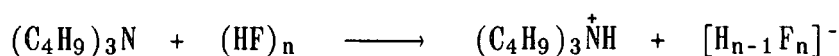


Through E.C.F. compounds are available which would not be obtainable on other routes or only with great difficulty. As mentioned already functional groups such as COF and SO₂F are retained.

Limitations of the process are characterized through the following points:

- The organic material must be soluble in hydrogen fluoride; this is the case, when it contains protonizable groups e.g.

R_1-O-R_2 , $\begin{matrix} R_1 \\ \diagup \\ C=O \\ \diagdown \\ R_2 \end{matrix}$, R_3N etc. which then form a solution of 'onium species which exhibit high electrical conductivity.



In contrast, hydrocarbon species are only 2% soluble in hydrogen fluoride.

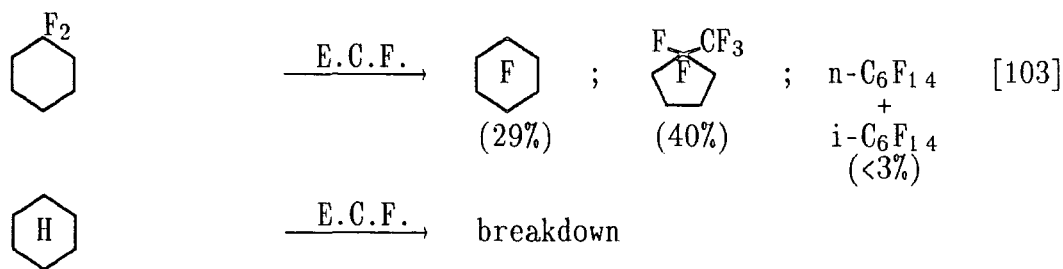
- Unsaturated sites become saturated (including aromatics) and polymerisation which lead to a rapid resinification of the electrodes can occur.
- Whereas C-Cl bonds are often retained C-I and C-Br bonds are always substituted by fluorine.
- Compounds containing sulphur in the oxidation states S(II) or S(IV) are oxidized to give S(VI) compounds.
- Single bonds of O, N, S, Cl, Br, I, Si, and P split with fluorination even more readily than C-C bonds.
- The fission of C-C bonds occurs leading to breakdown of the starting material.
- Yields are variable but usually quite low.

Despite these limitations E.C.F. provides a very useful method for the synthesis of novel compounds exhibiting remarkable properties.

Progress has been made employing partly fluorinated starting materials¹⁰³. Introducing CF₂ or CF₃ groups prior to E.C.F. gave much improved yields and in some cases a fluorination was made possible which previously only resulted in complete breakdown. Table 4.1. demonstrates the stabilizing effect of fluorine being in the molecule prior to E.C.F..

Table 4.1. *Stabilizing effect of fluorine in molecules used for E.C.F.*

$n\text{-C}_4\text{H}_9\text{CF}_2\text{CH}_3$	$\xrightarrow{\text{E.C.F.}}$	$n\text{-C}_6\text{F}_{14}$ (62%)	+	$\text{C}_n\text{F}_{2n+2}$ $n=1-5$	[103]
$n\text{-C}_6\text{H}_{14}$	$\xrightarrow{\text{E.C.F.}}$	$n\text{-C}_6\text{F}_{14}$ (22%)			[103]



IV.B. Perfluorinated ethers

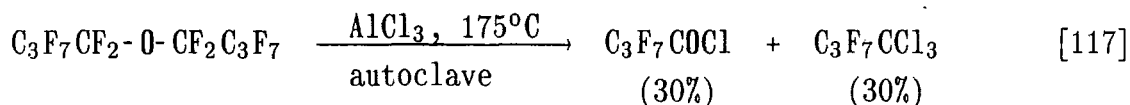
1. General properties and applications¹¹⁰

Perfluorinated ether are non-polar, odourless, practically non-toxic and non-flammable compounds. They also have great thermal stability (equivalent to perfluoroalkanes when heated in stainless steel).

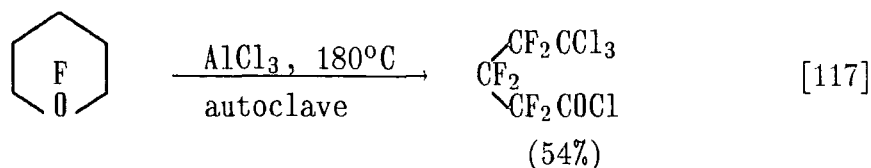
However, this stability depends greatly on the material of the container. Perfluoroethers are considerably more volatile than their hydrocarbon analogous. They boil very close to perfluoroalkanes having the same number of carbon atoms (*cf.* $(n\text{-C}_4\text{H}_9)_2\text{O}$ b.p. 142°C ; $(n\text{-C}_4\text{F}_9)_2\text{O}$ b.p. 102°C ; $n\text{-C}_8\text{F}_{18}$ b.p. 103°C). By contrast they freeze at lower temperatures than the corresponding perfluoroalkanes, owing to the increased molecular flexibility conferred by the ether linkage (*cf.* $(\text{C}_6\text{F}_{13})_2\text{O}$ m.p. -90°C ; $\text{C}_{12}\text{F}_{26}$ m.p. $+42^\circ\text{C}$)¹¹⁵.

Since perfluoroethers lack basicity normally associated with hydrocarbon ethers, they are unaffected e.g. by hydriodic acid and do not form addition compounds with boron trifluoride.

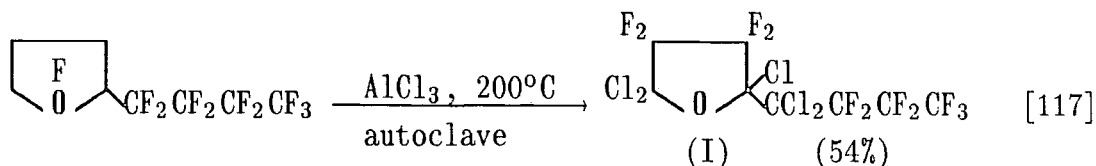
However, AlCl_3 replaces α -fluorine by chlorine and thereby can affect C-O bond cleavage at elevated temperatures¹¹⁶, e.g.



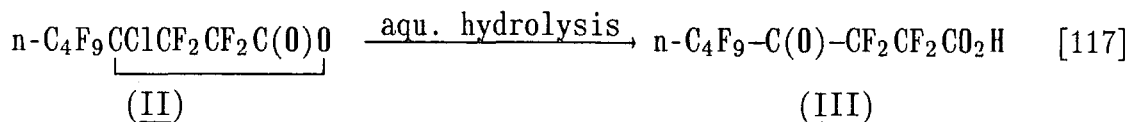
Cyclic perfluoroethers containing no perfluoroalkyl substituent in the α -position undergo ring-opening when heated with AlCl_3 to yield (ω, ω, ω -trichloro-alkanoyl)chlorides, e.g.



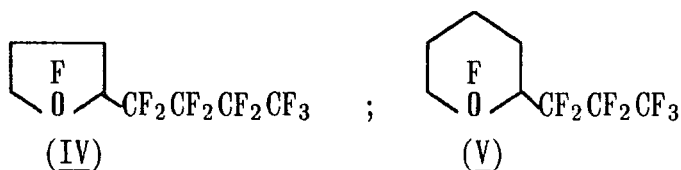
whereas when an α -perfluoroalkyl group is present, the α -fluorine atoms are replaced by chlorine and the ether link remains intact, e.g.



Hydrolysis with hot fuming sulfuric acid, of the trichloro-ether (I), yield the lactone (II), which on aqueous hydrolysis gives the keto-acid (III):



Due to their thermal stability and relative chemical inertness, perfluoroethers (sometimes along with perfluoroamines) can be used for a variety of purposes (e.g. lubrication). Their most dramatic use has been as blood substitutes. The 3M Company marketed a mixture of mainly perfluoro-(2-n-butyl)oxolane (IV) and perfluoro-(2-n-propyl)oxane (V) under the trade name FC^R-75.

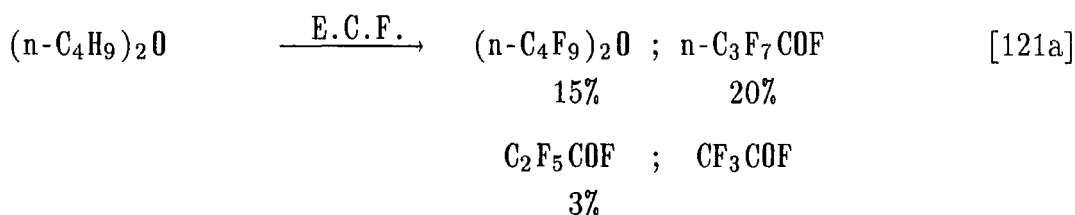
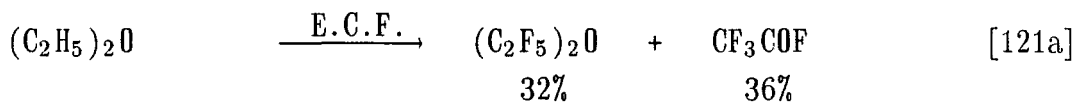


These compounds (FLUORINERTS) have played an important role in the development of blood substitutes and organ preservation media of the fluorocarbon class. In 1966 Collan and Clark¹¹⁸ found that mice could breath liquid FC^R-75 containing dissolved oxygen and survive. More recently¹¹⁹ a medical team from St. Christophers Hospital For Children in Philadelphia had inflated the lungs of a premature baby with a liquid perfluorocarbon which consisted of perfluoro-oxane-derivatives. After a 15 min session of breathing the liquid, the infant lived for 19 hours.

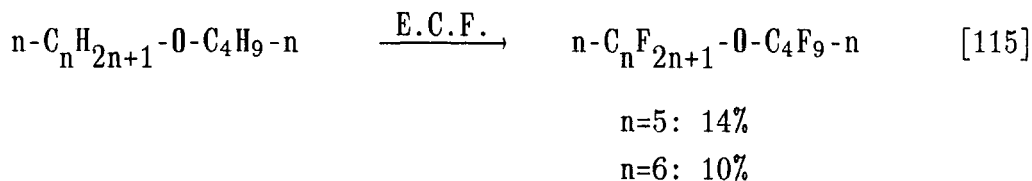
These compounds not only dissolve oxygen in a liquid but will also adsorb carbon dioxide and carry it out the lungs.

2. Perfluorinated aliphatic ethers by E.C.F.

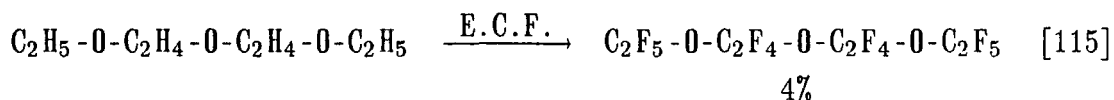
Electrolysis of dialkyl ethers gives poor yields^{1,20} of the perfluorinated product. Mainly breakdown occurs due to extensive C-O bond fission,



coupled with the usual problem of increase in C-C cleavage with increasing molecular weight.









Fluorination of polyethers was also carried out.



Aminoalkyl ethers have been fluorinated^{1,2} and the goal was to combine the favourable yields of trialkylamine fluorinations with the properties of ethers. Several dialkylamines and alkylene units were combined in a variety of diamino mono-ethers, diamino di-ethers, and monoamino mono-ethers. Some examples are given in table 4.2.

Table 4.2. Some examples of E.C.F. of aminoalkyl ethers.

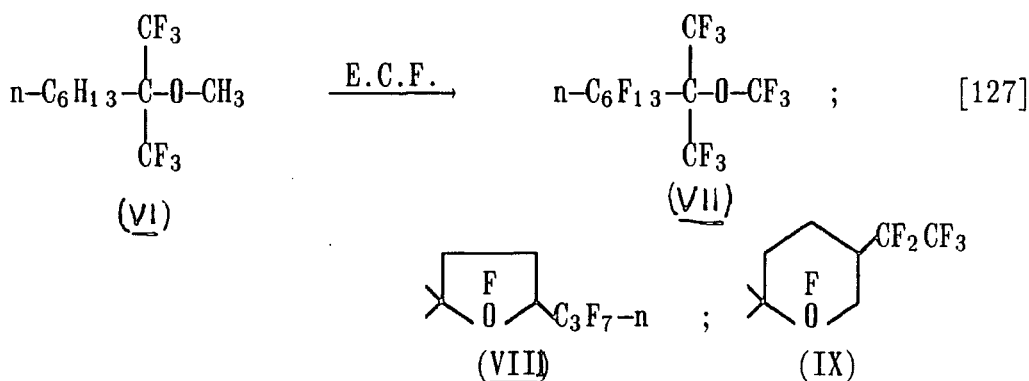
$(C_2H_5)_2N-(CH_2)_4-O-(CH_2)_4-N(C_2H_5)_2$	$\xrightarrow{\text{E.C.F.}}$	$(C_2F_5)_2N-(CF_2)_4-O-(CF_2)_4-N(C_2F_5)_2$	[122]
		19%	
 N-(CH ₂) ₂ O(CH ₂)N(C ₃ H ₇) ₂	$\xrightarrow{\text{E.C.F.}}$	 N-(CF ₂) ₂ O(CF ₂)N(C ₃ F ₇) ₂	[122]
		14%	
 N-(CH ₂) ₂ -O-(CH ₂) ₃ -O-(CH ₂) ₂ -N 	$\xrightarrow{\text{E.C.F.}}$	 N-(CF ₂) ₂ -O-(CF ₂) ₃ -O-(CF ₂) ₂ -N 	[122]
		4%	
$CH_3CH_2CH_2-O-CH_2CH_2N(C_3H_7)_2$	$\xrightarrow{\text{E.C.F.}}$	$CF_3CF_2CF_2-O-CF_2CF_2N(C_3F_7)_2$	[122]
		15%	

In electrochemical fluorination of aliphatic chlorine containing ethers¹⁹ a chlorine bonded to an α -carbon atom in the ethers was readily removed during the process whilst a chlorine bonded to the β -carbon atom was retained to yield β -chlorinated polyfluoroethers. Table 4.3. gives some examples of these experiments which gave very low yields of mostly well under 15% of chlorine containing polyfluoroethers.

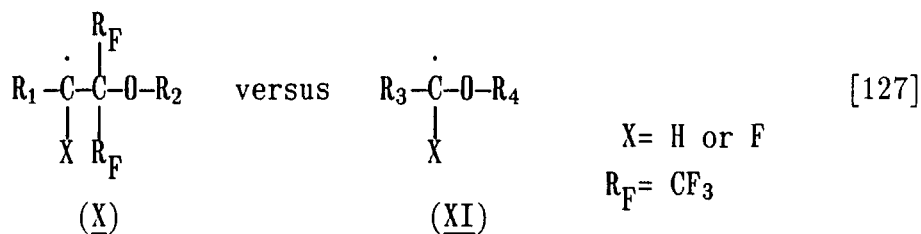
Table 4.3. E.C.F. of aliphatic chlorine containing ethers¹²³

Compound	products % (among others)			
	$CF_3OC_2F_5$	$CF_3OCF_2CClF_2$	$CF_3OCF_2CCl_2F$	$CF_3OCF_2CCl_3$
$CH_3OCH_2CCl_3$	2.3	8.3	7.9	1.0
$CH_3OCHClCCl_3$	4.4	4.8	13.5	3.0
$CH_3OCCl_2CCl_3$	1.5	1.8	2.9	
$CH_3OCCl=CCl_2$	7.6	15.0	28.9	
$CH_3OCH=CCl_2$	3.5	8.6	4.8	

The use of partly fluorinated substrates as precursors for total fluorination was found to give better yields compared with non-fluorine containing starting materials^{103,124-126}. Yokoyama¹²⁷ *et al.* used 2-methyl-1,1,1-trifluoro-2-(F-methyl)octane (VI) and obtained a 27% yield of the perfluorinated product. As by-products 5- and 6-membered cyclic ethers were obtained and it was claimed that this was the first time cyclic ethers have been generated from aliphatic ethers during E.C.F. and their proposed mechanism is outlined in Scheme 4.2.

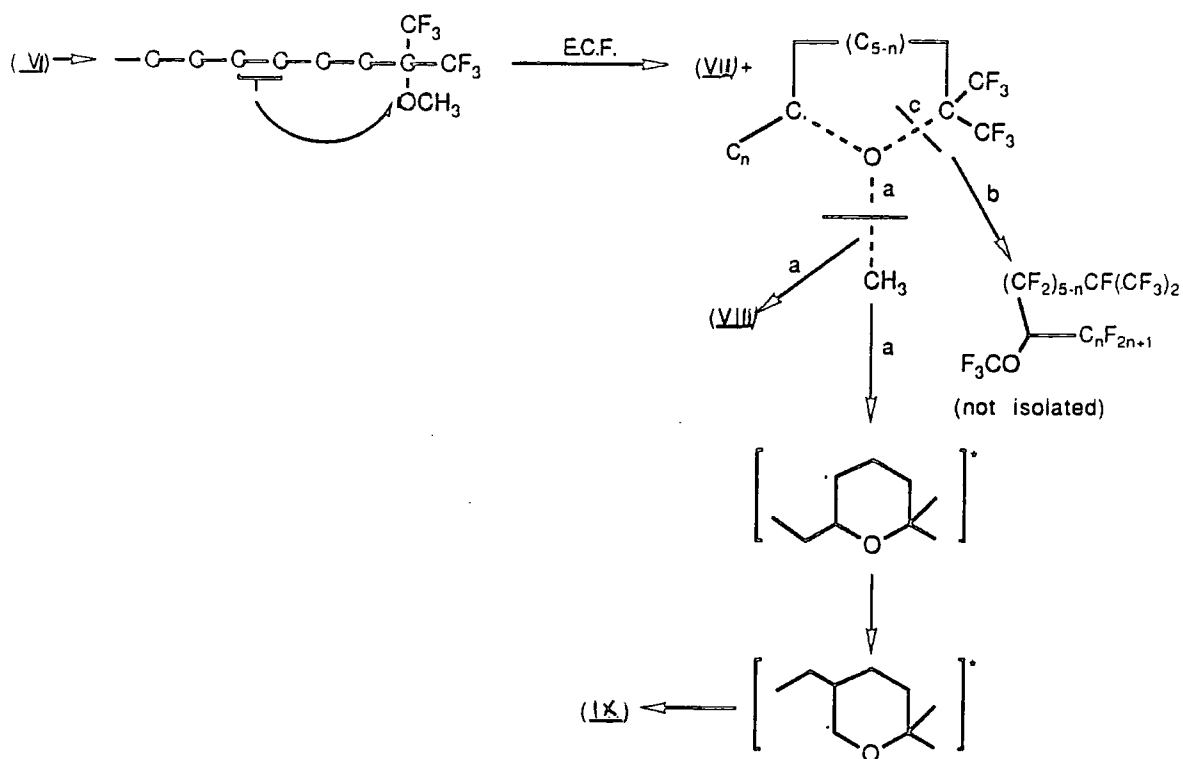


Furthermore, no significant fluorocarbon fraction was found, indicating very little breakdown of the ether bond of $(\text{CF}_3)_2\text{C-O}$, which was already blocked by CF_3 -groups prior to E.C.F. Therefore, formation of a radical adjacent to oxygen was hindered resulting in a protection of the ether linkage.



Note: Radical (X) tends to give RCOF to a greater extent compared to (XI).

Scheme 4.2. Proposed mechanism for the formation of the products obtained in E.C.F. employing partly fluorinated starting materials outlined by Yokoyama (see above)



3. Perfluorinated cyclic ethers by electrochemical fluorination

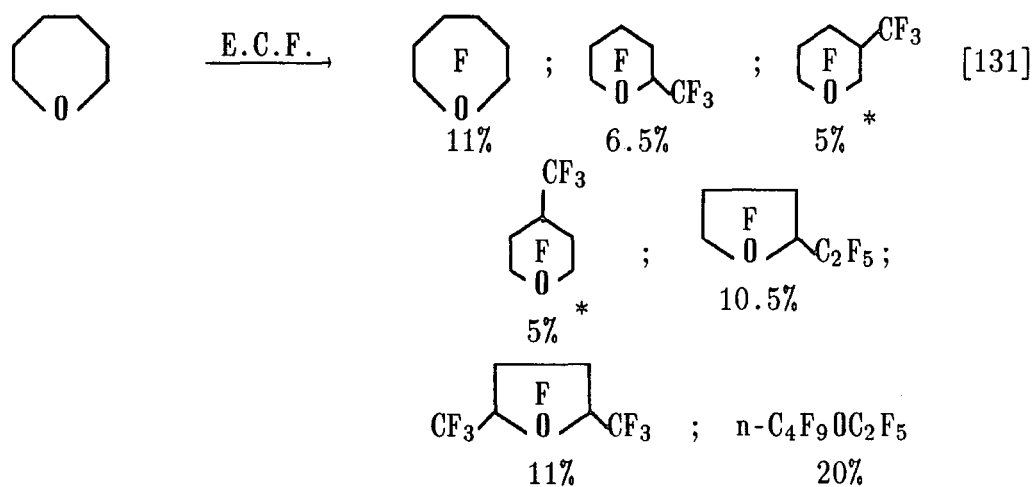
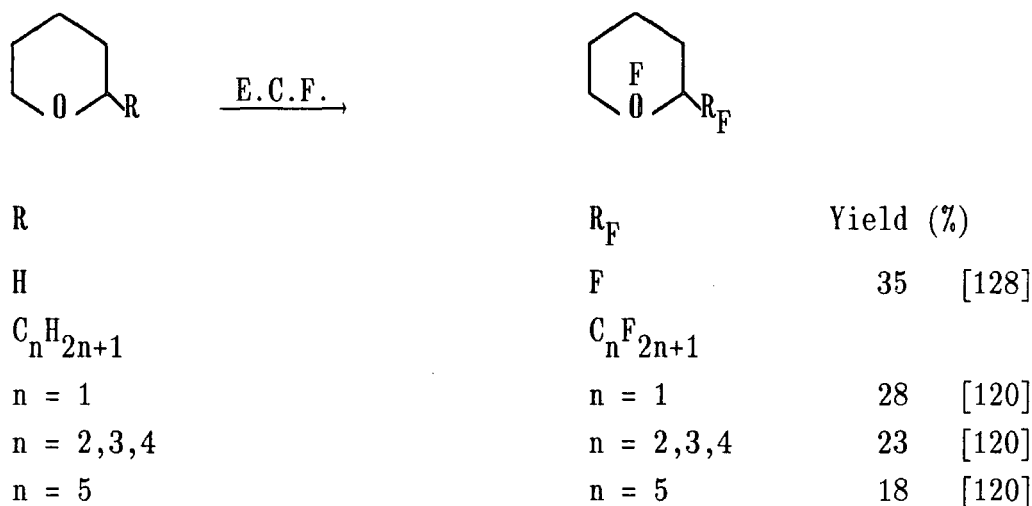
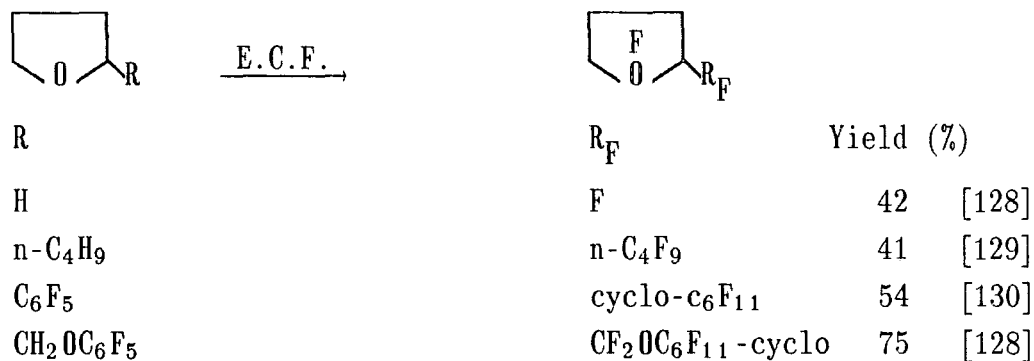
Principally two ways of obtaining perfluoro cyclic ethers are possible:

- E.C.F. of parent cyclic ethers,
- E.C.F. of carboxylic acids and derivatives derived there from, e.g. acid chlorides. with a minimum number of three carbon atoms.

4. E.C.F. of cyclic ethers

Table 4.4. summarizes some results from reactions employing cyclic ethers as starting materials. Again introduction of fluorinated groups into the molecule prior to exhaustive fluorination resulted in much higher yields compared with non-fluorine containing starting materials.

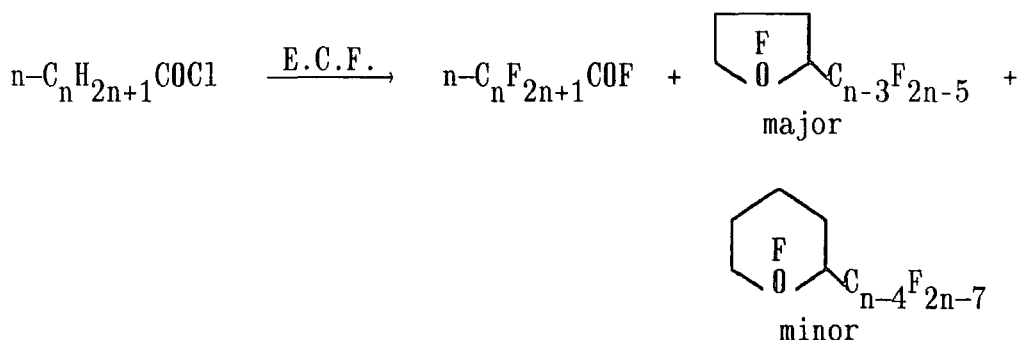
Table 4.4. Some electrochemical fluorinations of cyclic ethers



* These compounds formed a mixture and were only assigned by n.m.r.

5. E.C.F. of carboxylic acids and derivatives thereof

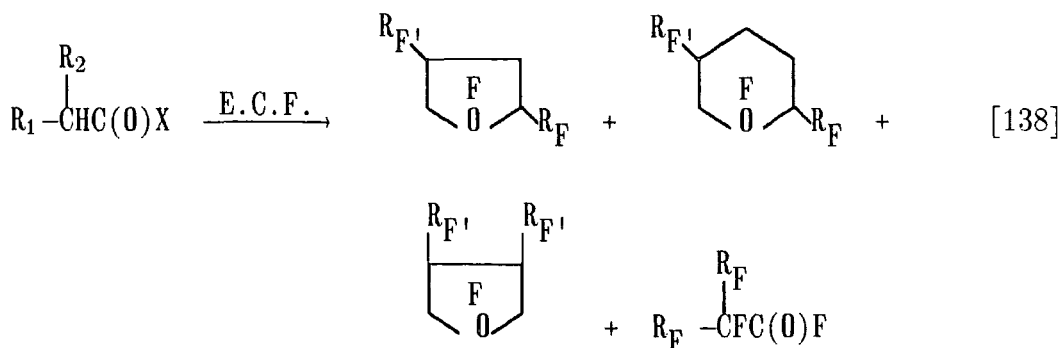
Electrolyzing carboxylic acids or derivatives such as acid chlorides and esters not only yield the perfluorinated starting material but also cyclic ethers. These are formed through a cyclisation process during E.C.F. The mechanism involved had already been outlined in scheme 4.2.



	Yield %	Yield %	
n	acid fluoride	ethers	
5	15	24	[133]
6	11	26	[133]
7	10 - 14	20 - 32	[134]

This phenomenon of cyclisation during E.C.F. was soon used by 3M Company. E.C.F. of actanoic acid or its chloride afforded a mixture containing perfluoro-(2-n-propyloxane) which were used as blood substituents (see above).

Employing α -alkyl substituted carboxylic acids or their derivatives (chlorides or esters) gave substituted perfluorocyclic ethers some of which had not been accessible previously, e.g. perfluoro-2,4-dialkyloxolanes. One of the reasons for this were synthetic difficulties of making the corresponding acyclic ethers as raw materials.



X = Cl; OCH₃

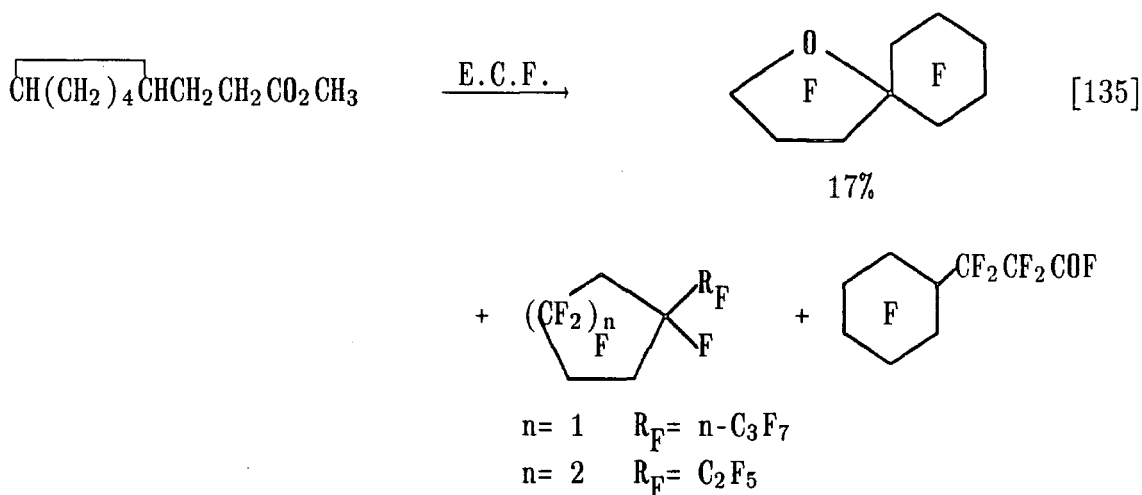
R_F = e.g. n-C₃F₇

R_F' = CF₃

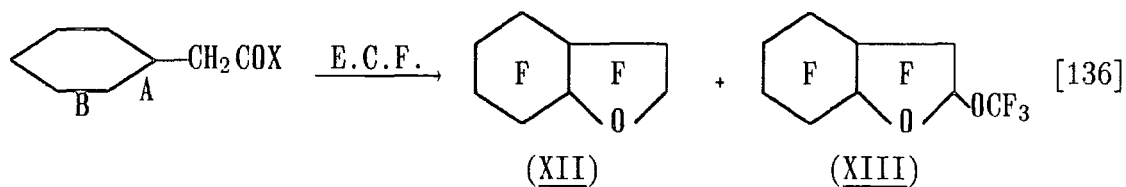
R₁ = e.g. n-C₃H₇

R₂ = e.g. CH₃

Spiro ethers have been obtained when cyclic carboxylic derivatives were used, e.g.



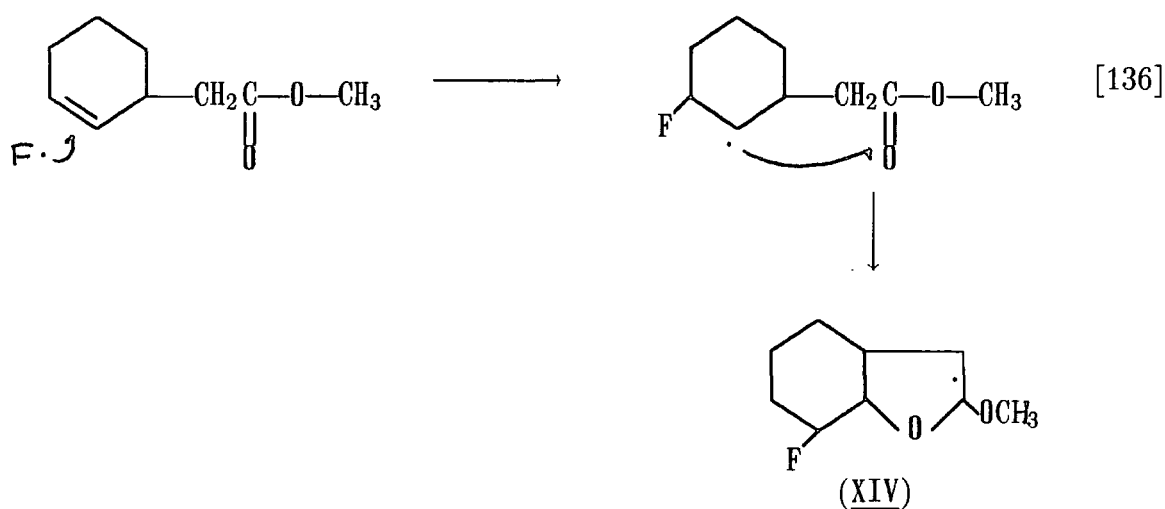
Perfluoro-bicyclic ethers have been obtained when the methyl ester of cyclohexylacetic acid as starting material rather than its acid chloride was used. Introduction of an endocyclic double bond at the 1- or preferable 2-position increased the yield of the expected fused ring ethers.



X	(XII)	(XIII)
Cl	7%	-
O-CH ₃	12%	4%
O-CH ₃ A= C=C	13%	6%
O-CH ₃ B= C=C	19%	9%

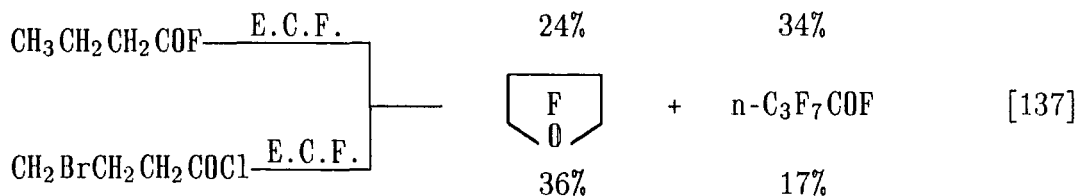
Perfluoro-7-oxa-bicyclo[4,3,0]nonane (XII) was the major product and was accompanied by perfluoro-8-methoxy-7-oxa-bicyclo[4,3,0]nonane (XIII). The reaction is expected to proceed as indicated in scheme 4.3. Formation of resonance-stabilized intermediate radicals of type (XIV) is believed to provide a driving force for ring-closure in these electrocyclic synthesis.

Scheme 4.3. *Proposed mechanism for formation of bi-cyclic ethers*

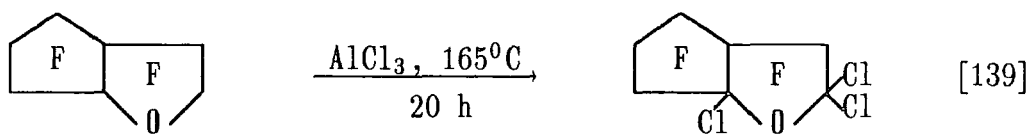


Attempts to optimize ether formation during E.C.F. of straight compounds have led to the discovery of the favourable effect of a γ -bromine

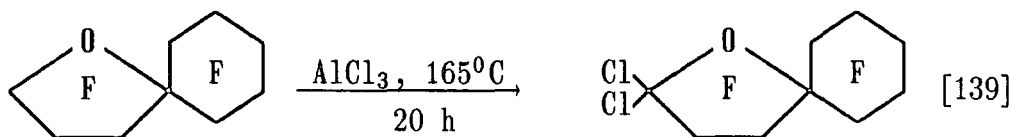
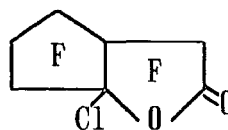
substituent, e.g.



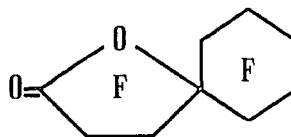
The reaction of perfluoro bicyclic ethers and perfluoro spiroethers with anhydrous aluminium chloride as well as some hydrolytic reactions of α, α, α' -trichlorinated and α, α -dichlorinated products with fuming sulfuric acid to give the corresponding lactones were carried out¹³⁹;



fuming
H₂SO₄



fuming
H₂SO₄



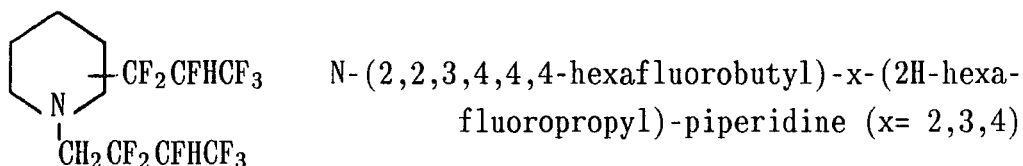
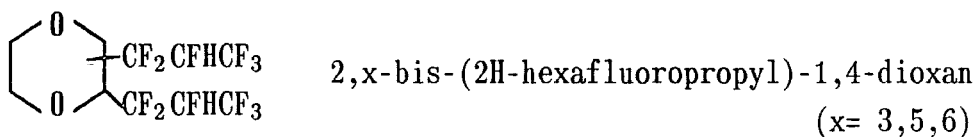
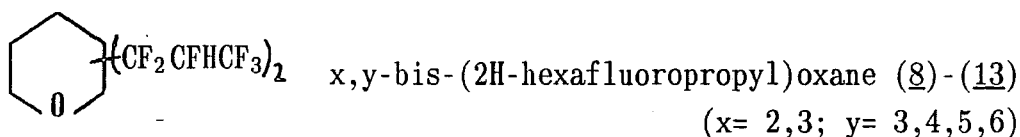
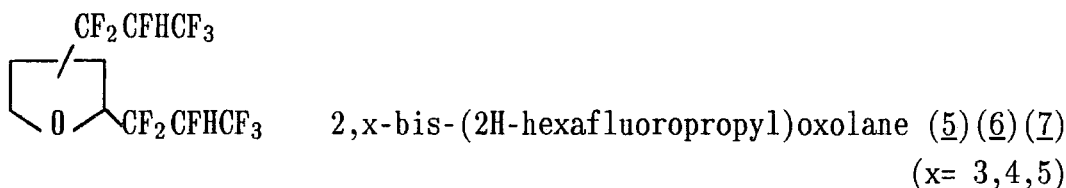
IV.C. Result and Discussion

The electrochemical fluorination experiments were carried out in the laboratories of Professor P. Sartori at Universität-Gesamthochschule-Duisburg in Duisburg, West-Germany, and in collaboration with Alan P. Swales.

1. Starting materials

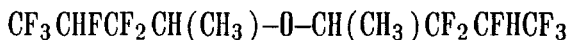
The materials chosen were cyclic and acyclic mono- and di-ethers, tertiary cyclic amines and a ketone.

The synthesis of the starting materials has been described in Chapter 1. It has to be remembered that the following di-adducts consisted of a mixture of possible isomers:



which can not be separated.

However, the employed di-(2,2,3,4,4,4-hexafluoro-1-methyl-butyl)ether consisted of only one isomer (and, of course, diastereoisomers).



2. Electrochemical fluorination conditions

The number of variable parameters for a given electrochemical fluorination cell with a fitted set of electrodes is limited to the following major ones:

- cell temperature
- cell voltage
- concentration of organic material.

The literature offers a wide range of conditions which have been successfully applied^{106,107}. Typical conditions are a potential difference between 4.0-6.0 V, a cell temperature between 0-20°C, and a concentration of organic material <15% by weight.

Each compound requires a unique set of conditions to give optimum results. These can only be obtained through a number of trial runs. Therefore a standard set of conditions had to be chosen and all reactions were carried out under roughly the same conditions. These conditions were:

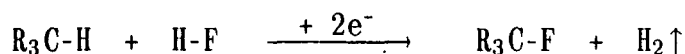
Concentration	cell voltage*	cell temperature
8-12% (w/w)	5.5 V	0°C

* at the beginning, if the resulting current was too high (>12 V) the voltage was temporarily reduced to 4.5 V.

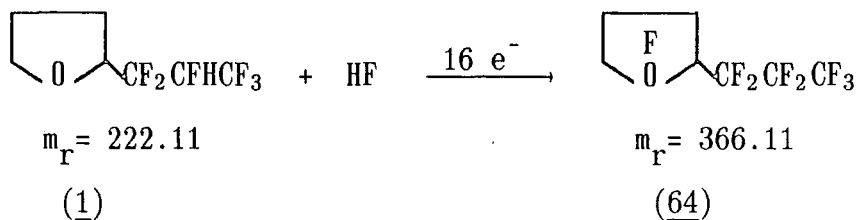
The exact conditions used including recovered organic material are given at the relevant place. The reactions were terminated after at least 110% of the theoretically needed current had been passed the cell.

3. Calculation of the theoretically needed current

The overall reaction during electrochemical fluorination is expressed in the following equation:



As an example the calculation of the theoretically needed current for the electrochemical fluorination of 2-(2H-hexafluoropropyl)oxolane (1) is described :



There are eight C-H bonds to be converted into C-F bonds. Since each bond contains 2 e⁻ the total number of e⁻ needed is 16 per molecule.

Charge	mass of compound	number of required e ⁻ for fluorination	Faraday constant
	m	n	F
$Q =$	$\frac{\text{relative mol mass of compound}}{\mu}$		

$$Q = \frac{92.72 \text{ g} \cdot 16 \cdot 96,490 \text{ As mol}^{-1}}{222.11 \text{ g mol}^{-1}}$$

$$Q = 644,320.73 \text{ As}$$

$$Q = 178.978 \text{ Ah}$$

Thus, the theoretically needed current to achieve perfluorination of 2-(2H-hexafluoropropyl)oxolane is 178.978 Ah.

4. Work up procedure

On completion of the electrolysis (a minimum of 110% of the theoretically need current had been passed the cell) organic material which had separated from the hydrogen fluoride was removed through the bottom valve of the cell (for cell details see Chapter 8). Trapped in polyethylene-bottles (PE-bottles) and kept at -78⁰C the cell sludge was decanted and excess hydrogen fluoride poured off. The organic material was then pipetted off (PE-pipette) and thus separated from remaining

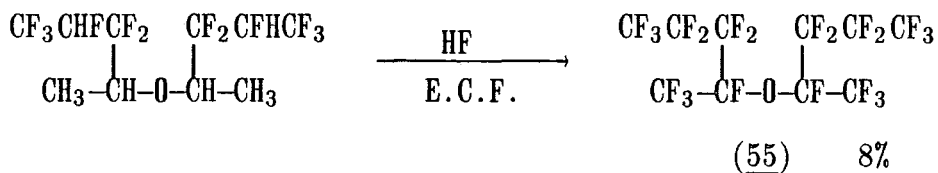
hydrogen fluoride and cell sludge. After addition and neutralisation with anhydrous potassium fluoride usual separation and characterisation processes (distillation, g.l.c., n.m.r., g.l.c.-m.s., i.r.) were carried out.

VI.D. Electrochemical fluorinations

1. Aliphatic mono-ethers

a) Di-(2,2,3,4,4,4-hexafluoro-1-methylbutyl)ether

The reaction was carried out using the conditions listed below.



Concentration	cell voltage	cell temperature	recovered organic material
9.3%	5.5 V	0°C	25%

Some small amounts of volatiles ($\approx 1\%$) were trapped but not investigated further. The recovered organic material consisted of perfluorinated and partly fluorinated material in similar amounts. Comparison with previously characterised material (Chapter 3) established the desired product in low yields.

2. Cyclic mono-ethers

a) 2-(2H-hexafluoropropyl)oxolane (1)

The fluorination was carried out employing the conditions listed below.



Concentration	cell voltage	cell temperature	recovered organic material
11.2%	4.5 V	0°C	50%

Some volatiles (~ 4%) were trapped in cold traps but not investigated any further. After separation from the cell drainings and neutralisation with potassium fluoride g.l.c. analysis revealed that perfluoro-2-propyloxolane (64) was obtained which required no further purification.

b) 2,x-bis-(2H-hexafluoropropyl)oxolane (x= 3,4,5) (5)(6)(7)

Two runs were carried out employing a mixture of structural isomers as detailed in Chapter 1. The electrochemical perfluorination was achieved employing the conditions listed in table 4.5.:

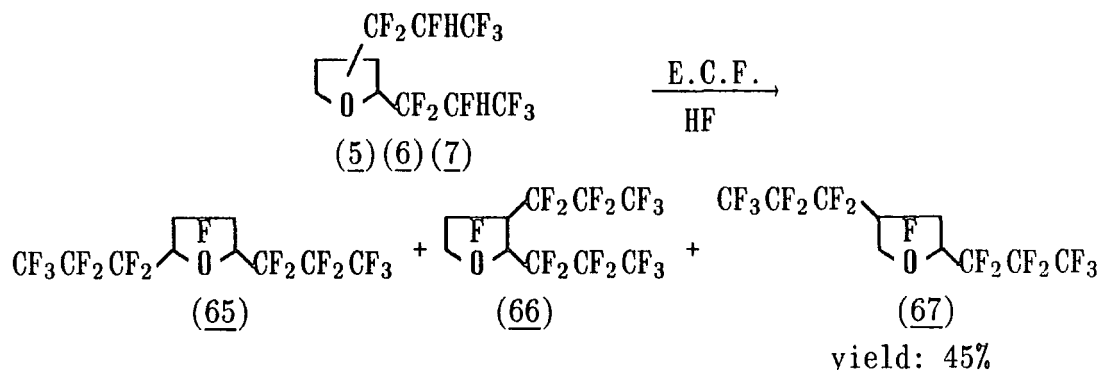
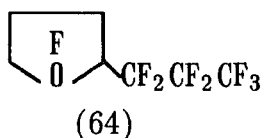


Table 4.5. *Conditions used for electrochemical fluorination of*
(5) (6) (7)

Run	Concentration	cell voltage	cell temperature	recovered organic material
I	10.2%	5.5 V	5-6°C	49.5%
II	10.2%	5.5 V	0°C	59.6%

The temperature was the only variable. However, this does not mean that a decreased temperature resulted in a better yield since the same hydrogen fluoride was used in both runs. Saturation effects therefore have to be taken into account. Analysis by g.l.c.-m.s. (negative ionisation mode) gave three peaks (ratio 14.7 : 1 : 1) and all possessed the same highest mass ($M = 516$). Their breakdown examined in daughter ion mode, however, was significantly different. Whereas the first peak showed the loss of a side chain as major breakdown ($m/z = 347, 100\%$), the other two peaks gave loss of a CF_2-O unit [$(M-66)^- = 450$] as major breakdown. Comparison with (64) under the same conditions showed that given the possibility of elimination of either a side chain or a neutral CF_2-O unit the latter took place.

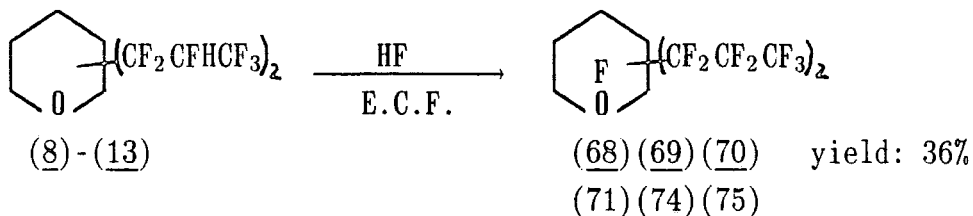


This demonstrated that a CF_2-O group was present in the molecule and since the g.l.c. ratio for the perfluorinated compounds (14), (15) and (16) was found identical with the one obtained earlier from the calculation of the integral heights of the CFH groups in compounds (5), (6) and (7) a rearrangement during fluorination can be excluded. The fluorine n.m.r. spectrum confirmed the presence of CF_2-O groups having a chemical shift very much different from a CF_2 group not adjacent to a heteroatom ($CF_2O = -75 \rightarrow -85$ ppm; $CF_2 = -105 \rightarrow -135$ ppm), however, no distinction between (66) and (67) was possible.

As a breakdown product perfluoro-2-propyloxolane (64) (14% of the recovered material by g.l.c.) was identified.

c) α, γ -bis-(2H-hexafluoropropyl)oxane ($x = 2, 3$) ($y = 3, 4, 5, 6$) (8)-(13)

A mixture of structural isomers (8) - (13) as detailed in Chapter 1, was perfluorinated using the conditions listed below.



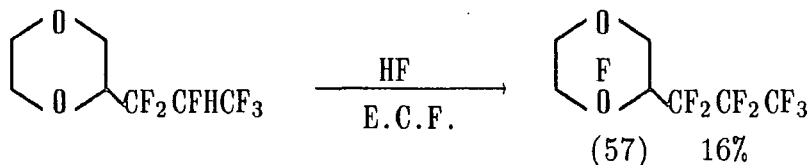
Concentration	cell voltage	cell temperature	recovered organic material
6%	5.5V	0°C	41%

No volatiles were collected in this reaction. Analysis by g.l.c. gave at least four major compounds in a ratio of roughly 1 : 3.2 : 1.4 : 3.4. Using negative ionisation mass spectrometry the same highest mass were obtained for all peaks ($M^- = 566$). A separation of isomers was not possible. Further investigations employing daughter-ion mass spectrometry revealed that loss of one side chain leading to $m/z = 397$ ($M^- - \text{CF}_2\text{CF}_2\text{CF}_3$) was the predominant breakdown for all components. No further information concerning any particular isomer could be deduced. Investigation by fluorine n.m.r. spectroscopy gave a very complex spectrum but revealed the presence of O-CF₂ groups.

3. Cyclic di-ether

a) 2-(2H-hexafluoropropyl)-1,4-dioxan

Using the conditions listed below perfluorination of 2-(2H-hexafluoropropyl)-1,4-dioxan was achieved.

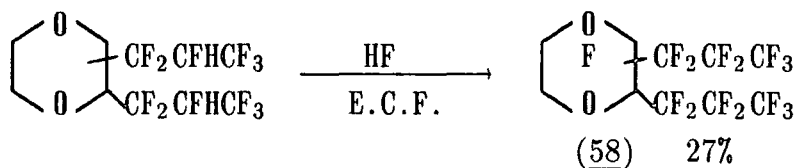


Concentration	cell voltage	cell temperature	recovered organic material
11.2%	4.75 V	0°C	24.3%

Some 16% of organic material was trapped in cold traps. Although it was not possible to fully characterize this material under the given circumstances investigation by gas phase i.r. was carried out. Absorption at ν 1800 cm^{-1} (CO), ν_{max} 1250 and 1150 cm^{-1} (CF) were observed. The absence of C-H vibrations (below 3000 cm^{-1}) indicated perfluorinated breakdown products which included some ring opening products. Comparison of the recovered organic material from the cell with previously characterized material (Chapter 3) gave the desired perfluoro-2-propyl-1,4-dioxan (57).

b) 2,x-bis-(2H-hexafluoropropyl)-1,4-dioxan (x= 3,5,6)

A mixture of structural isomers was employed in this reaction and the exact conditions used to achieve perfluorination are listed below.



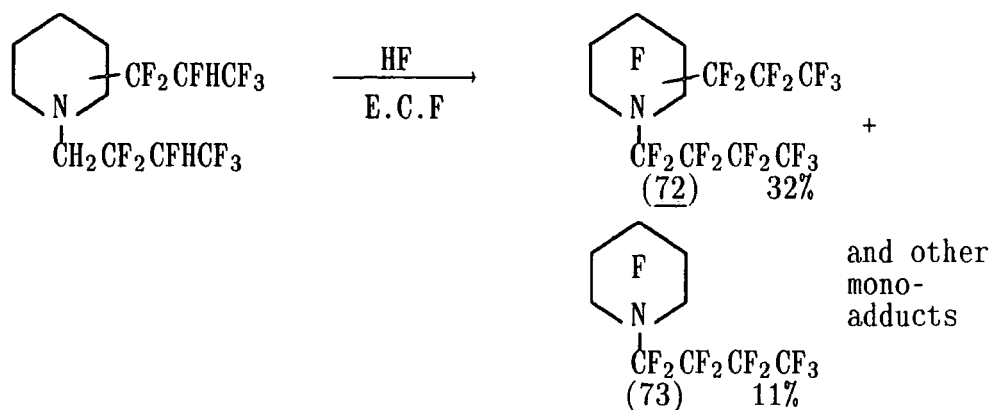
Concentration	cell voltage	cell temperature	recovered organic material
ca. 8.0%	5.5 V	0°C	41%

No volatiles were obtained in this run. After work up the recovered material showed three major peaks in an isothermal g.l.c. analysis. All peaks possessed a fine structure. An isolation of a single compound was not possible. The first compound with the shortest retention time was identified as the breakdown product perfluoro-2-propyl-1,4-dioxan (57). In a mass spectrometric analysis the molecular ion (M^+ = 532) was obtained for the remaining two g.l.c. peaks. Further characterisation confirmed that the desired perfluorination of the mixture gave perfluoro-2,x-dipropyl-1,4-dioxan (x= 3,5,6) (58). No statement can be made concerning the perfluorinated structural isomers since a separation was not possible due to very close retention times. The partly fluorinated starting material gave rise to at least six peaks of different intensities in g.l.c. but a separation was not possible.

4. Tertiary cyclic amines

a) N-(2,2,3,4,4,4-hexafluorobutyl)-x-(2H-hexafluoropropyl)-piperidine (x= 2,3,4)

The exact conditions employed to perfluorinate the structural isomers of N-methyl-pyrrolidine and hexafluoropropene are given below.



Concentration	cell voltage	cell temperature	recovered organic material
8.1%	4.4 V	0°C	49.5%

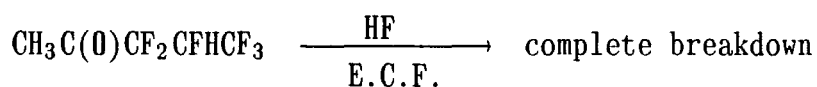
Some low boiling material was trapped in cold traps but not investigated. Analysis by capillary g.l.c.-m.s. revealed that perfluorinated mono and di-adducts were obtained the former one being the product of a breakdown reaction. The mono-adducts could only be identified by their molecular ions (M^- , 483, 100%).

Perfluoro-N-butyl-piperidine (73) was identified through its significant breakdown pattern. Complete loss of the perfluoro-butyl-side-chain gave the intact perfluorinated ring m/z 264 (M^- - $CF_2CF_2CF_2CF_3$, 40). This was not observed in any other case. The di-adducts consisted of a number of isomers and were identified by their molecular ions (M^- , 633, 100%). A separation of any isomer was not possible. An n.m.r. sample obtained through analytical g.l.c. (10% SE 30) gave such a complex ^{19}F n.m.r. spectrum that no identification of any isomer was possible.

5. Ketones

a) 3,3,4,5,5,5-hexafluoropent-2-on

The ketone was attempted to fluorinated using the conditions listed below.



Concentration	cell voltage	cell temperature	recovered [*] organic material
12.2%	4.5 V	0°C	21.2%

* trapped in cold traps

No organic material could be regained from the cell. All recovered organic material was trapped in the cold traps. Analysis by infrared spectroscopy showed the presence of carbon-hydrogen bonds (below 3000 cm^{-1}) and the carbonyl vibration was missing. Capillary g.l.c. revealed numerous peaks and analysis by g.l.c.-m.s. did not give any indication that the desired product was formed. A complete breakdown of the ketone during electrochemical fluorination took place and numerous products which still contained hydrogen were obtained. No further investigation was carried out.

INSTRUMENTATION AND REAGENTS

Instrumentation

Gas liquid chromatographic (g.l.c.) analyses were carried out using a Hewlett-Packard 5890A gas chromatograph fitted with a 25 m cross-linked methyl silicone capillary column (time programmed, temperature controlled). Analytical gas liquid chromatography was carried out on a Varian Aerograph Model 920 (catharometer detector) gas chromatograph using a column (5 m) packed with 10% silicone elastomer 30 on chemosorb P (column 10% SE 30).

Fractional distillation of product mixtures was carried out using Fischer-Spaltrohr MMS 225 and HMS 500, small and large concentric tube systems.

Melting and boiling points were determined at atmospheric pressure unless otherwise stated and are uncorrected. Boiling points were recorded during fractional distillation.

Carbon, hydrogen and nitrogen analyses were obtained using a Perkin-Elmer 240 Elemental Analyser or a Carlo Erba 1106 Elemental Analyser. Analyses for halogens were performed as described in the literature¹⁴⁰.

Infrared (i.r.) spectra were recorded on either a Perkin-Elmer 577 or 1310 Grating Spectrophotometer using conventional techniques.

Proton (¹H), carbon (¹³C), fluorine (¹⁹F) and tin (¹¹⁹Sn) n.m.r. spectra were recorded on a Bruker AC250 spectrometer operating at 250 MHz, 62.8 MHz, 235.3 MHz and 93.3 MHz, respectively.

G.l.c.-mass spectra were recorded on a VG 7070E spectrometer linked to a Hewlett-Packard 5790A gas chromatograph fitted with a 25 m cross-linked methyl silicone capillary column.

Reagents

In general all chemical were used a received from suppliers. If different qualities were available always the highest ones were used. Polyethylene powder (spectroscopic grade) (m.p. 130-145⁰C) was used for modification experiments.

Diethyl ether was dried over sodium wire. Oxolane was dried over sodium wire and stored and handled under a nitrogen atmosphere.

Fluoroalkenes were either available within this laboratory or were prepared by technical staff.

CHAPTER FIVE

EXPERIMENTAL TO CHAPTER ONE

CHAPTER FIVE

EXPERIMENTAL TO CHAPTER ONE

V.A. GENERAL PROCEDURE

1. γ -Ray Initiated Reactions

Solid and/or liquid reagents were introduced into a Pyrex Carius tube ($V \approx 100$ ml) and several times degassed. Any gaseous reagents were then transferred into the tube using common vacuum line techniques. Frozen down to liquid air temperature the Carius tube was sealed under vacuum. Placed in a metal sleeve, the tube was allowed to warm up to room temperature in a secure place. Transferred to the γ -ray irradiation chamber the reactions were irradiated, unless otherwise stated, with a total dose of *ca.* 10 Mrad at room temperature. The tube was opened while the contents were frozen to liquid air temperature and any gaseous species were transferred under vacuum.

2. Peroxide Initiated Reactions

Without exception all peroxide initiated reactions were carried out employing autoclaves ($V \approx 165$ ml) fitted with a valve secured by a bursting disk. Charged as described above the autoclave was transferred to the high pressure facilities in a liquid air dewar. Still frozen the autoclave was fitted into a rocking furnace and connected to a catch pot. Warmed up the reaction was started. After the reaction was finished the autoclave was allowed to cool to room temperature. Frozen down to liquid air temperature the autoclave valve was opened and any gaseous species were transferred under vacuum.

Free Radical Additions of Hydrocarbons to Hexafluoropropene1. Cyclic hydrocarbonsa) Cyclohexane

An autoclave charged with a mixture of i.r. grade cyclohexane (8.2 g, 0.098 mol), hexafluoropropene (24.4 g, 0.176 mol) and di-tert-butyl-peroxide (0.55 g, 3.8 mmol) was rocked at 140°C for 24 h. Excess olefin (3.8 g) was removed and a turbid liquid (29.7 g) obtained. Distillation gave 1,1,2,3,3,3-hexafluoropropylcyclohexane (17) (10.5 g, 49%); b.p. 155°C; (Found: C, 46.3; H, 5.1; F, 49.1; M^+ , 234. $C_9H_{12}F_6$ requires C, 46.15; H, 5.1; F, 48.7%; M , 234); i.r. spectrum 12; n.m.r. spectrum 13; mass spectrum 8; and 1,x-bis-(1,1,2,3,3,3-hexafluoropropyl)cyclohexane (x= 2,3,4) (18), (19), (20) (14.8 g, 40%); b.p. 105°C/15mm Hg; (Found: C, 37.4; H, 3.0; F, 59.1; , 364. $C_{12}H_{12}F_{12}$ requires C, 37.5; H, 3.1; F, 59.4%; M , 364); i.r. spectrum 13; n.m.r. spectrum 14; mass spectrum 9. From the latter mixture 1,4-bis-(1,1,2,3,3,3-hexafluoropropyl)cyclohexane (20) crystallized out on standing over night; m.p. 84°C; i.r. spectrum 14; n.m.r. spectrum 15; mass spectrum 10.

b) Cyclopentane

A miscible mixture of cyclopentane (3.9 g, 0.056 mol) and hexafluoropropene (16.7 g, 0.111 mol) was irradiated with γ -rays at room temperature. Excess olefin (6.0 g) was removed and liquid material (14.5 g) was obtained. Distillation gave 1,1,2,3,3,3-hexafluoropropylcyclopentane (21) (8.0 g, 62%); b.p. 102°C; (Found: C, 43.7; H, 4.5; F, 52.3; ($M - 1$)⁺, 219. $C_8H_{10}F_6$ requires C, 43.6; H, 4.55; F, 51.8%; M , 220); i.r. spectrum 10; n.m.r. spectrum 11; mass spectrum 11; and 1,x-bis-(1,1,2,3,3,3-hexafluoropropyl)cyclopentane (x= 2,3) (22) (23) (6.5g, 33%); b.p. 80°C/5mm Hg; (Found: C, 36.0; H, 2.7; F, 62.0; ($M - 20$)⁺, 350. $C_{11}H_{12}F_{12}$ requires C, 35.7; H, 2.7; F, 61.6%; M , 370); i.r. spectrum 11; n.m.r. spectrum 12; mass spectrum 12.

c) Cyclopropane

A miscible mixture of cyclopropane (4.2 g, 0.1 mol) and hexafluoropropene (30.0 g, 0.2 mol) was irradiated with γ -rays at room temperature. No reaction had taken place and all starting materials were recovered.

d) Cyclohexene

A mixture of cyclohexene (8.2 g, 0.1 mol), hexafluoropropene (30.8g, 0.205 mol) and di-tert-butyl-peroxide (0.5 g, 3 mmol) was rocked at 140°C for 24 h. Nearly all starting materials were recovered and only a trace of 3-(1,1,2,3,3,3-hexafluoropropyl)cyclohex-1-ene (24) was shown by mass spectrometry. (Found: M^+ , 232. $C_9H_{10}F_6$ requires M , 232); mass spectrum 13.

e) 1,5-cyclo-octadiene

A mixture of 1,5 cyclo-octadiene (5.0 g, 0.046 mol) and hexafluoropropene (14.8 g, 0.999 mol) were irradiated with γ -rays at room temperature. No reaction took place and all starting materials were recovered.

f) Decalin

A mixture of cis-decalin (6.9 g, 0.05 mol), hexafluoropropene (15.0 g, 0.1 mol) and molecular sieve dried acetone (8 ml) was irradiated with γ -rays at room temperature. Nearly all hexafluoropropene was recovered and analysis of the liquid material by g.l.c.-m.s. gave traces of 9-(1,1,2,3,3,3-hexafluoro)decalin (25); (Found: M^+ , 288. $C_{10}H_{18}F_6$ requires M , 288); mass spectrum 14.

2. Aliphatic hydrocarbons

a) Methane

A 250 ml autoclave charged with di-tert-butyl-peroxide (1.0 g, 6.8 mmol) and fitted with a pressure gauge was pressurized to 700 psi with methane (the equivalent of 0.5 mol methane). Frozen to liquid air temperature the autoclave was charged with hexafluoropropene (75.0 g, 0.5 mol). After being rocked 24 h at 140°C the autoclave was cooled to -78°C and unreacted methane removed. Warmed up to ice/salt temperature (-21°C) unreacted hexafluoropropene was removed. Some liquid material (~3 ml) was obtained and analysis by g.l.c.-m.s. gave a complex mixture and no indication for formation of 1,1,1,2,3,3-hexafluorobutane or such like could be found.

b) n-Propane

A mixture of n-propane (4.0 g, 0.09 mol) and hexafluoropropene (27.3 g, 0.18 mol) was irradiated with γ -rays at room temperature. Volatiles were removed and liquid material (5.3 g) was obtained. Analysis gave 4-methyl-1,1,1,2,3,3-hexafluorobutane (26) (21%, calculated by g.l.c. under consideration of the conversion); (Found: C, 36.9; H, 3.9; F, 58.3; ($M - 19$)⁺, 175. C₆H₈F₆ requires C, 37.1; H, 4.1; F, 58.8; M , 194); i.r. spectrum 1; n.m.r. spectrum 2; and 1,1,1,2,3,3-hexafluorohexane (27) (1.7%, calculated by g.l.c. under consideration of the conversion); (Found: ($M - 1$)⁺, 193. C₆H₈F₆ requires M^+ , 194); n.m.r. spectrum 1; mass spectrum 16.

c) 2-Methylpropane

A mixture of 2-methylpropane (5.8 g, 0.1 mol) and hexafluoropropene (30.0 g, 0.2 mol) was irradiated with γ -rays at room temperature. After removal of the volatiles (26.5 g) liquid material (8.8 g) was obtained. Analysis gave 4,4-dimethyl-1,1,1,2,3,3-hexafluoropentane (34) (8.8 g, 42%); (Found: C, 40.1; H, 4.5; F, 54.4; ($M - 15$)⁺, 193. C₇H₁₀F₆ requires C, 40.4; H, 4.8; F, 54.8%; M , 208); i.r. spectrum 2; n.m.r. spectrum 3; mass spectrum 17.

d) n-Butane

A mixture of n-butane (5.8 g, 0.1 mol) and hexafluoropropene (30.0 g,

0.2 mol) was irradiated with γ -rays at room temperature. After removal of the volatiles (29.8 g) liquid material (5.4 g) was obtained. Separation by analytical g.l.c. (10% SE 30, 120°C) gave 4-methyl-1,1,1,2,3,3-hexafluorohexane (28) (6.4%, calculated by g.l.c. under consideration of the conversion); (Found: C, 40.1; H, 4.4; F, 54.7; ($M - 21$)⁺, 187. $C_7H_{10}F_6$ requires C, 40.3; H, 4.8; F, 54.8%; M , 208); i.r. spectrum 3; n.m.r. spectrum 4; mass spectrum 18; and 4-methyl-1,1,1,2,3,3,7,7,8,9,9,9-dodecafluorononane (29) (11%, calculated by g.l.c. under consideration of the conversion); (Found: C, 33.6; H, 2.5; F, 64.1; ($M - 35$)⁺, 323. $C_{10}H_{10}F_{12}$ requires C, 33.5; H, 2.8; F, 63.7%; M , 358); i.r. spectrum 4; n.m.r. spectrum 5; mass spectrum 19.

e) 2-Methylbutane

A mixture of 2-methylbutane (7.2 g, 0.1 mol) and hexafluoropropene (30.0 g, 0.2 mol) was irradiated with γ -rays at room temperature. Volatiles (26.4 g) were removed and liquid material (9.9 g) was obtained. Separation by analytical g.l.c. (10% SE 30, 130°C) gave a mixture of 4,4-dimethyl-1,1,1,2,3,3-hexafluorohexane (30) (Found: ($M - 15$)⁺, 207. $C_8H_{12}F_6$ requires M , 222); i.r. spectrum 5; n.m.r. spectrum 6; mass spectrum 20; and 4,5-dimethyl-1,1,1,2,3,3-hexafluorohexane (31) (Found: ($M - 35$)⁺, 187. $C_8H_{12}F_6$ requires M , 222); mass spectrum 21; and 6-methyl-1,1,1,2,3,3-hexafluoroheptane (32) (Found ($M - 15$)⁺, 207. $C_8H_{12}F_6$ requires M , 222); mass spectrum 22; (5.2 %, all together, by g.l.c., calculated under consideration of the conversion) and 4,4-dimethyl-1,1,1,2,3,3,7,7,8,9,9,9-dodecafluorononane (33) (14% by g.l.c., calculated under consideration of the conversion); (Found: C, 35.2; H, 3.15; F, 61.6; ($M - 35$)⁺, 337. $C_{11}H_{12}F_{12}$ requires C, 35.5; H, 3.2; F, 61.3%; M , 372); i.r. spectrum 6; n.m.r. spectrum 7; mass spectrum 23.

f) n-Hexane

A mixture of n-hexane (8.6 g, 0.1 mol), hexafluoropropene (30.0 g, 0.2 mol) and di-tert-butyl-peroxide (0.6 g, 4.0 mmol) was reacted in a rocking autoclave at 140°C for 24 h. Removal of excess hexafluoropropene (23.3 g) and unreacted hexane (6.8 g) gave a viscous

material (6.5 g). Transfer under vacuum of the viscous material gave an involatile residue (0.5 g). Separation of the volatile product mixture by analytical g.l.c. (10% SE 30, 130°C) gave a mixture of hexafluoropropene/n-hexane mono-adducts (35) (1.1% by g.l.c., calculated under consideration of the conversion); (Found: ($M - 40$)⁺, 196. C₉H₁₄F₆ requires M , 236); i.r. spectrum 7; n.m.r. spectrum 8; mass spectrum 24; and a mixture of hexafluoropropene/n-hexane di-adducts (36) (7.7% by g.l.c., calculated under consideration of the conversion); (Found: C, 37.6; H, 3.6; F, 58.8; ($M - 40$)⁺, 346. C₁₂H₁₄F₁₂ requires C, 37.3; H, 3.6; F, 59.1%; M , 386); i.r. spectrum 8; n.m.r. spectrum 9; mass spectrum 25; and a mixture of hexafluoropropene/n-hexane tri-adducts (37) (5.2% by g.l.c., calculated under consideration of the conversion); (Found: C, 33.3; H, 2.4; F, 63.3; ($M - 40$)⁺, 496. C₁₅H₁₄F₁₈ requires C, 33.6; H, 2.6; F, 63.8%; M , 536); i.r. spectrum 9; n.m.r. spectrum 10; mass spectrum 26. The residue was found to contain C, 35; H, 2.05; F, 61.4% and was expected to be a mixture of higher hexafluoropropene/n-hexane adducts.

V.C. Competition experiments

All competition experiments were conducted in the same way. A typical example is the following: A sample (0.1 ml) for g.l.c. analysis was taken from a mixture of cyclohexane (8.6 g, 0.1 mol) and n-hexane (8.4 g, 0.1 mol). Then hexafluoropropene (4.5 g, 0.03 mol) was added and the mixture was either irradiated with γ -rays at room temperature or di-tert-butyl-peroxide (0.5 g, 3.4 mmol) was added and the reaction was rocked at 140°C for 24 h. The obtained liquid was analysed by g.l.c.

V.D. Free Radical Additions of Hydrocarbons to Hexafluoroacetone

a) Cyclohexane

A mixture of cyclohexane (5.0 g, 0.06 mol) and hexafluoroacetone (19.7 g, 0.12 mol) which was not miscible prior to reaction was irradiated with γ -rays at room temperature. Excess volatiles (10.8 g) were removed and a liquid (12.5 g) was obtained. Analysis gave 1,1,1-trifluoro-2-(F-methyl)-2-hydroxyethylcyclohexane (38) (55% by g.l.c., under consideration of the conversion of the reaction); (Found:

C, 43.3; H, 4.7; F, 45.4; $(M + 1)^+ = 251$ (c.i.). $C_9H_{12}F_6O$ requires C, 43.2; H, 4.8; F, 45.6; M , 250); i.r. spectrum 15; n.m.r. spectrum 16; mass spectrum 27.

V.E. Polymer modification

Free Radical Additions of Polyethylene to Fluorinated Compounds

a) Hexafluoropropene

A mixture of i.r. grade polyethylene powder (8.7 g, 0.31 mol) and di-tert-butyl-peroxide (1.25 g, 8.6 mmol) was charged into a nickel autoclave ($V \approx 165$ ml), then benzene (20 ml) and hexafluoropropene (72.2 g, 0.48 mol) were condensed into the autoclave and the reaction was rocked at $140^\circ C$ for 24 h. Excess hexafluoropropene (30.8 g, 0.2 mol) was removed and a highly viscous liquid obtained. After removal of solvent analysis gave a hexafluoropropene/polyethylene polymer (39) (10 hexafluoropropyl groups per 11 methylene units) (>90% conversion) (Found: C, 37.4; H, 3.1; F, 59.5. $C_5H_4F_6$ would require C, 33.7; H, 2.25; F, 64.0%); i.r. spectrum 16; n.m.r. spectrum 16.

b) Hexafluoroacetone

A mixture of spectroscopic grade polyethylene powder (8.2 g, 0.29 mol) and di-tert-butyl-peroxide (1.25 g, 8.6 mmol) was charged into a nickel autoclave ($V \approx 165$ ml), then benzene (20 ml) and hexafluoroacetone (81.2 g, 0.49 mol) were transferred under vacuum into the autoclave. After rocking at $140^\circ C$ for 24 h excess hexafluoroacetone (57.5 g) and some benzene (5.1 g) were removed. A material consisting of a homogeneous dense basis and the top layer which was covered with clods of elastomeric material was obtained. Solvent was removed under reduced pressure (3-4 days) and elemental analysis gave for the top layer: C, 34.6; H, 2.85; F, 51.5%; i.r. spectrum 17; and for the bottom layer: C, 63.4; H, 9.7; F, 24.6%. The structure of these materials is not known.

CHAPTER SIX

EXPERIMENTAL TO CHAPTER TWO

CHAPTER SIX

EXPERIMENTAL TO CHAPTER TWO

VI.A. GENERAL PROCEDURE

1. γ -Ray Induced Reactions

The reactions were usually carried out in a Carius-tube or an autoclave (if the vapor pressure of the olefin was too high to allow use of a Carius tube) and the same procedures applied as described in chapter 5. Work up was carried out as described in chapter 5. Again, 10 Mrad of irradiation were applied.

2. Peroxide Initiated Reactions

Peroxide induced reactions were carried out using the same procedures described in Chapter 5.

3. Work up and characterisation

Characterization was achieved using infrared spectroscopy and nuclear magnetic resonance spectroscopy for all relevant nuclei. Due to contamination problems arising from the presence of tin within the molecule no mass spectra were recorded. Elemental analysis were attempted repeatedly, however, due to breakdown reactions during analysis the results obtained for fluorine, carbon and hydrogen were always the ones expected for tributyltin fluoride. Analysis for tin proved unsuccessful, too. Here analysis of the same sample gave no reproducible results and deviations of more than 40% for identical samples were obtained. Thus, no elemental analysis data were obtained. Only use of atomic absorption spectroscopy (AAS) in the case of chlorine containing compounds lead to correct analytical data.

VI.B. SYNTHESES

Reactions of n-tributyltin hydride with

a) 1,1-difluoroethylene

An autoclave containing a mixture of n-tributyltin hydride (5.0 g, 0.017 mol) and 1,1-difluoroethylene (4.0 g, 0.0625 mol) was irradiated with γ -rays at room temperature. Excess olefin (3.0 g) was removed and filtration of the turbid liquid gave n-tributyl(2,2-difluoroethyl)tin (41) (4.2 g); i.r. spectrum 18; n.m.r. spectrum 18. The filtered residue (1.2 g) was analyzed to give n-tributyltin fluoride (Found: C, 46.6; H, 8.8; F, 5.9; Sn, 40.1. $C_{12}H_{27}FSn$ requires C, 46.7; H, 8.75; F, 6.2; Sn, 38.4%); m.p. 268°C.

b) Trifluoroethylene

In an autoclave a mixture of n-tributyltin hydride (6.5 g, 0.022 mol) and trifluoroethylene (4.4 g, 0.054 mol) was irradiated with γ -rays at room temperature. Excess olefin (2.5 g) was removed and filtration of the turbid liquid (6.5 g) gave n-tributyl(1,2,2-trifluoroethyl)tin (42) (85% by ^{19}F n.m.r.); i.r. spectrum 19; n.m.r. spectrum 19; and n-tributyl(1,1,2-trifluoroethyl)tin (43) (15% by ^{19}F n.m.r.); decomp. \approx 135°C; n.m.r. spectrum 20. The solid residue (1.5 g) was found to be n-tributyltin fluoride.

c) Chlorotrifluoroethylene

In a Carius-tube a mixture of n-tributyltin hydride (10.0 g, 0.034 mol) and chlorotrifluoroethylene (5.6 g, 0.048 mol) was irradiated with γ -rays at room temperature. Excess olefin (1.5 g) was removed and the turbid liquid (12.7 g) gave on filtration n-tributyl(2-chloro-1,1,2-trifluoroethyl)tin (44), b.p. 179°C. (Found: Cl, 8.2. $C_{14}H_{27}ClSn$ requires Cl, 8.7%); i.r. spectrum 20; n.m.r. spectrum 21. The solid material obtained (1.2 g) was identified as n-tributyltin fluoride.

d) Hexafluoropropene

In a Carius-tube a mixture of n-tributyltin hydride (3.8 g, 0.013 mol) and hexafluoropropene (2.9 g, 0.019 mol) was irradiated with γ -rays at room temperature. Excess olefin (0.9 g) was removed and the turbid liquid obtained gave after filtration

n-tributyl(1,1,2,3,3,3-hexafluoropropyl)tin (45) (75% by ^{19}F n.m.r.); i.r. spectrum 21; n.m.r. spectrum 22; and n-tributyl(1-fluoro-1-(F-methyl)-2,2-difluoroethyl)tin (46) (25% by ^{19}F n.m.r.); decomp. 230°C ; n.m.r. spectrum 23.

e) 2H-pentafluoropropene

In an autoclave a mixture of n-tributyltin hydride (10.2 g, 0.035 mol), 2H-pentafluoropropene (9.3 g, 0.07 mol) and di-t-butyl-peroxide (0.7 g, 0.005 mol) was reacted at 140°C in a rocking furnace for 24 hours.

Gaseous products (0.8 g) were recovered and consisted mainly of unreacted 2H-pentafluoropropene. Liquid turbid material obtained (11.0 g) contained after filtration mainly unreacted n-tributyltin hydride and traces of n-tributyl(1,1,3,3,3-pentafluoropropyl)tin (54) ($\approx 5\%$ by proton n.m.r.); n.m.r. spectrum 24.

f) Hexafluoro-2-butyne

In a Carius-tube n-tributyltin hydride (10.0 g, 0.034 mol) and hexafluoro-2-butyne were irradiated with γ -rays at room temperature. The reagents were not miscible prior to reaction. On completion excess olefin (2.1 g) was removed. After filtration of the cloudy liquid analysis gave n-tributyl(1-(F-methyl)-3,3,3-trifluoroprop-1-enyl)tin (47) ($>98\%$ trans by ^1H n.m.r.); i.r. spectrum 22; n.m.r. spectrum 25.

g) Perfluorocyclobutene

In a Carius-tube n-tributyltin hydride (10.5 g, 0.036 mol) and F-cyclobutene (15.0 g, 0.093 mol) were irradiated at room temperature with γ -rays. The starting materials were not miscible prior to reaction. Excess olefin (8.9 g) was removed and the turbid liquid

obtained (15.4 g) gave after filtration n-tributyl(F-2H-cyclobutyl)tin
(48); decomp. $<80^{\circ}\text{C}$; i.r. spectrum 23; n.m.r. spectrum 26.

CHAPTER SEVEN

EXPERIMENTAL TO CHAPTER THREE

CHAPTER SEVEN

EXPERIMENTAL TO CHAPTER THREE

VII.A. Photofluorination

The starting materials used for the photofluorination experiments were synthesized as outlined in chapter 1 or elsewhere⁴⁰. The apparatus used has already been described in chapter 2. The fluorination chamber was made of FEP tubing (36 cm, O.D. 0.25 in) sealed at the bottom. The capillary tubing used to bubble the gas mixture (F_2 in N_2) had an inner diameter of 0.012 in. UV-irradiation was achieved by use of a medium pressure mercury arc UV-lamp, 1000 W, fitted with a time counter device. The temperature was monitored by a thermocouple attached to the bottom of the fluorination chamber and was kept at room temperature at all times by use of a fan. Throughout the experiments no additional equipment (e.g. condenser surrounding the fluorination chamber to achieve different temperatures) was used to regulate the temperature. The outlet consisted of a FEP tubing connected to a cold trap (dry ice) and lead through a fluorine and hydrogen fluoride scrubber into the fumes hood.

1. General procedure

The reaction chamber was charged up to half (volume of reactant *ca.* 2-3 ml) with liquid organic material to become photofluorinated. A gas flow yielding separate small bubbles was employed. Under UV-irradiation and cooling to room temperature the gas stream was checked from time to time and regulated manually. Elemental fluorine (50% in nitrogen) (commercially) was diluted as needed with nitrogen and pressurized into a cylinder (*ca.* 1000 ml) which was then connected to the reaction chamber. Once the cylinder was empty (after *ca.* 24 h) the concentration was changed or maintained. The end of the reactions was indicated by the liquid becoming very mobile and was checked by i.r. or 1H . n.m.r.. The product obtained was neutralized with anhydrous KF and analyzed. Cold trap material if trapped was usually minute and not investigated.

a) Di-(2,2,3,4,4,4-hexafluoro-1-methylbutyl)ether

Di-(2,2,3,4,4,4-hexafluoro-1-methylbutyl)ether (4.6 g, 0.012 mol) was placed in the direct fluorination apparatus and under UV-irradiation the following elemental fluorine concentrations in nitrogen were used: 25% for 36 h and 50% for 74 h. Analysis of the obtained colourless liquid gave perfluoro-di-(1-methylbutyl)ether (55) (4.4 g, 67%). (Found: C, 21.5; F, 75.9; M^+ -19, 535. $C_{10}F_{22}O$ requires C, 21.7; F, 75.45%; M , 554); i.r. spectrum 24; n.m.r. spectrum 27; mass spectrum 28.

b) 2,4,7-tris-(2H-hexafluoropropyl)ethyleneglycol diethylether

2,4,7-tris-(2H-hexafluoropropyl)ethyleneglycol diethylether (4.3 g, 7.5 mmol) was treated with elemental fluorine diluted with nitrogen under UV irradiation at room temperature as follows: 5% F_2 in N_2 for 12 h, 15% F_2 in N_2 for 12 h, 25% F_2 in N_2 for 12 h, and 50% F_2 for 96 h. Analysis of the obtained liquid gave perfluoro-5,8-dioxa-4,9-dimethyl-6-propyldodecan (56) (3.1 g, 50%). (Found: C, 22.3; F, 74.4; M^- , 820. $C_{15}F_{32}O_3$ requires C, 21.95; F, 74,15%; M , 820); i.r. spectrum 25; n.m.r. spectrum 28; mass spectrum 29.

c) 2-(1,1,2,3,3,3-hexafluoropropyl)-1,4-dioxan

2-(1,1,2,3,3,3-hexafluoropropyl)-1,4-dioxan (3.9 g, 0.016 mol) was treated with elemental fluorine diluted with nitrogen under UV-irradiation at room temperature as follows: 5% F_2 in N_2 for 46 h, 10% F_2 in N_2 for 48 h, 25% F_2 in N_2 for 48 h, and 50% F_2 in N_2 for 48 h. Within the first 20 h of the reaction the colourless liquid became yellowish brown but turned colourless again after another 15 h and stayed colourless thereafter. Analysis gave perfluoro-2-propyl-1,4-dioxan (57) (2.6 g, 43%). (Found: C, 21.7; F, 69.05; M^- , 382. $C_7F_{14}O_2$ requires C, 22.0; F, 69.6%; M , 382); i.r. spectrum 26; n.m.r. spectrum 32; mass spectrum 30.

d) 2,x-bis(1,1,2,3,3,3-hexafluoropropyl)-1,4-dioxan (x= 3,5,6)

2,x-bis(1,1,2,3,3,3-hexafluoropropyl)-1,4-dioxan (x=3,5,6) (3.8 g, 9.7

mmol) was fluorinated with elemental fluorine diluted with nitrogen at room temperature as follows: 10% F₂ in N₂ for 22 h, 25% F₂ in N₂ for 24 h, and 50% F₂ in N₂ for 24 h. Analysis of the colourless very mobile liquid gave perfluoro-2,x-dipropyl-1,4-dioxan (58) (x= 3,5,6) (3.3 g, 64%). (Found: C, 22.7; F, 71.1; M^- , 532. C₁₀F₂₀O₂ requires C, 22.55; F, 71.4%; M , 532); i.r. spectrum 27; n.m.r. spectrum 33; mass spectrum 31.

- e) 2,3,5-tris(1,1,2,3,3,3-hexafluoropropyl)-1,4-dioxan and 2,3,5,6-tetrakis(1,1,2,3,3,3-hexafluoropropyl)-1,4-dioxan

A mixture containing of

2,3,5-tris(1,1,2,3,3,3-hexafluoropropyl)-1,4-dioxan and 2,3,5,6-tetrakis(1,1,2,3,3,3-hexafluoropropyl)-1,4-dioxan (3.2 g, 5.0 mmol) was fluorinated with elemental fluorine diluted with nitrogen at room temperature under UV-irradiation as follows: 25% F₂ in N₂ for 48 h and 50% F₂ in N₂ for 60 h. Separation by analytical g.l.c. (10% SE 30, 110°C) gave perfluoro-2,3,5-tripropyl-1,4-dioxan (59) (60%, estimated by g.l.c.), (Found: C, 22.6; F, 72.4; M^- , 682. C₁₃F₂₆O₂ requires C, 22.9; F, 72.4%; M , 682); i.r. spectrum 28; n.m.r. spectrum 34; mass spectrum 32; and perfluoro-2,3,5,6-tetrapropyl-1,4-dioxan (60) (58%, estimated by g.l.c.). (Found: C, 23.0; F, 72.2; M^- , 832. C₁₆F₃₂O₂ requires C, 23.1; F, 73.1%; M , 832); i.r. spectrum 29; n.m.r. spectrum 35; mass spectrum 33.

- f) 1,x-bis(1,1,2,3,3,3-hexafluoropropyl)cyclohexane (x= 2,3,4)
(18) (19) (20)

A mixture of compounds (18), (19) and (20) (3.8 g, 0.01 mol) was fluorinated employing elemental fluorine diluted with N₂ at room temperature and under UV-irradiation as follows: 5% F₂ in N₂ for 46 h, 10% F₂ in N₂ for 48 h, 25% F₂ in N₂ for 50 h, and 50% F₂ in N₂ for 46 h. Analysis of the colourless liquid gave perfluoro-1,x-dipropylcyclohexane (x= 2,3,4) (61) (62) (63) (3.5 g, 58%). (Found: C, 24.3; F, 75.4; M^+ -19, 581. C₁₂F₂₄ requires C, 24.0; F, 76.0%; M , 600); i.r. spectrum 30; n.m.r. spectrum 37; mass spectrum 34.

g) 2-(2H-hexafluoropropyl)oxolane (1)

2-(2H-hexafluoropropyl)oxolane (1) (2.8 g, 0.0126 mol) was photofluorinated with elemental fluorine diluted with nitrogen at room temperature as follows: 5% F₂ in N₂ for 36 h, 10% F₂ in N₂ for 72 h, 25% F₂ in N₂ for 72 h, and 50% F₂ in N₂ for 48 h. Colourless highly viscous material (0.8 g) was obtained. Comparison with previously characterized material (Chapter 8) showed that the desired product was not formed.

h) 3,3,4,5,5,5-hexafluoropent-2-on

3,3,4,5,5,5-Hexafluoropent-2-on (3.4 g, 5 mmol) was photofluorinated with elemental fluorine diluted with nitrogen at room temperature as follows: 25% F₂ in N₂ for 60 h and 50% F₂ in N₂ for 60 h. Recovered material (1.0 g) consisted of a complex product mixture which did not contain any of the desired product (by g.l.c.-m.s. analysis).

i) Tris-(2,2,3,4,4,4-hexafluoro-1-methylbutyl)amine

Tris-(2,2,3,4,4,4-hexafluoro-1-methylbutyl)amine (4.2 g, 7.65 mmol) was photofluorinated at room temperature and 50% fluorine in nitrogen was used for 86 hours. The colourless liquid still contained protons* thus fluorination was continued at elevated temperatures (50°C) for 24 h. Analysis gave that the products obtained still contained protons and no further investigation of the products obtained was carried out.

* by ¹H-n.m.r.

CHAPTER EIGHT

EXPERIMENTAL TO CHAPTER FOUR

CHAPTER EIGHT

EXPERIMENTAL TO CHAPTER FOUR

VIII. ELECTROCHEMICAL FLUORINATIONS

The electrochemical fluorination experiments described here were conducted in the laboratories of Prof. P. Sartori at Universität-Gesamthochschule-Duisburg, Duisburg, West-Germany, and also in collaboration with Alan P. Swales.

1. Apparatus

The electrochemical fluorination experiments were carried out in the apparatus shown in diagram 8.1. The 1170 ml cell shown in detail in diagram consisted of a conical stainless steel body with an outlet valve at the bottom. The cell itself was surrounded by a cooling jacket. A transparent tube fitted to the outside of the cell enabled a constant monitoring of the liquid colour and level in the cell. The electrodes consisted of a pack of nickel plates and possessed a total surface area of 3588 cm². They were fitted to the lid and were isolated with a PTFE gasket. The lid itself was screwed onto the body and sealed with a PTFE seal. A Claisen tube was fitted between the top of the cell and condenser, thus enabling to charge the assembled cell through the side arm which was sealed with a 3-way-valve. From the top of the metal condenser FEP tubing was leading to two PE-cold traps (V ≈ 200 ml) cooled with dry ice. A third trap was fitted with a saturated sodium thiosulfate solution (Na₂S₂O₃) and a fourth one with a *ca.* 15% potassium iodide solution. Finally the tube led into the ventilation system.

Sodium thiosulfate chemically destroys hydrogen fluoride thus avoiding an escape into the ventilation system. While acidifying with dilute acids sodium thiosulfate reacts to give colloidal sulphur.

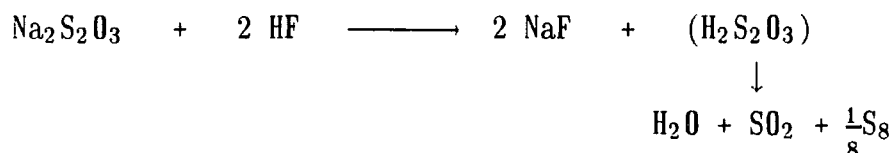
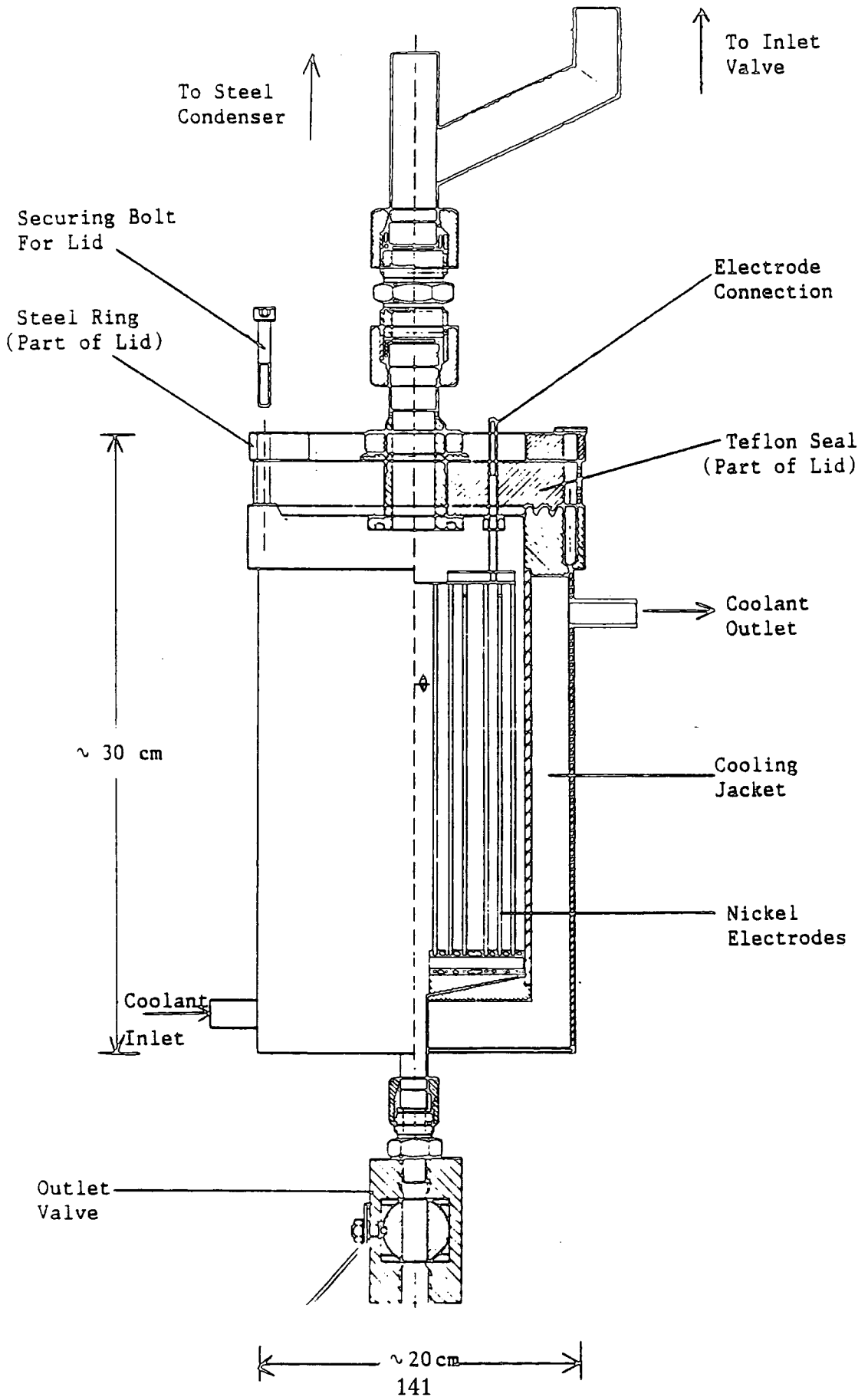
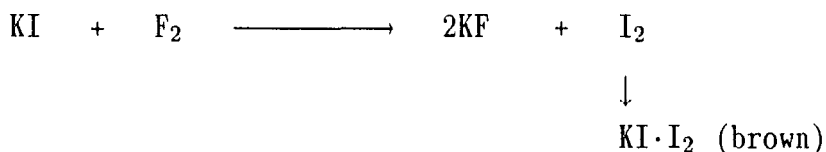


Diagram 8.1. *Electrochemical fluorination cell.*



The presence of fluorine can be checked in the last trap.



Potassium iodide dissolves iodine with brown colour to give KI·I₂.

The current was supplied by a direct current (DC) generator which had additional facilities to count the ampere minutes used as well as the duration time of the electrolysis. The potential difference was measured by a voltmeter across the electrode connections on top of the cell lid. The potential difference applied was regulated manually by means of increasing or decreasing the current. Within limits of *ca.* ± 0.3 V the potential difference chosen remained constant. Consequently the current changed accordingly once the conductivity within the cell had changed. Within the first hours of every run care was taken that the current did not exceed a reasonable limit of ~ 12 A. If so, the potential difference was decreased.

All pieces of equipment used (except the voltmeter) were designed and build by Universität-Gesamthochschule-Duisburg.

2. General procedure

Prior to the experiments the electrodes had to be conditioned if the cell had not been used for quite some time. This was achieved by electrolyzing commercial hydrogen fluoride until the current had reached a constant level. Then the hydrogen fluoride was disposed off and the cell refilled with fresh hydrogen fluoride. Theoretically, a complete non-conductivity indicated the end of the drying process. This, however, was not achieved in practice. Therefore, hydrogen fluoride conducting a constant and low current (min. 6 hours, ≤ 1 A) was considered dry.

After fresh hydrogen fluoride had been dried the cell was charged with the material to be electrolyzed. A wide necked PE-bottle (V ~ 250 ml) fitted with a top, contained the organic material. From the bottom through the top a tube leading out of the PE-bottle was fitted to the

inlet valve at the Claisen-tube. A second tube was pressurising the PE-bottle with argon gas. That way the liquid material was transferred into the cell.

Electrolysis was maintained until a minimum of 110% of the calculated current necessary for complete fluorination had been passed.

Volatile products were collected in cold traps. Organic material which separated from the hydrogen fluoride was run off the bottom of the cell (cell drainings). After being separated from cell sludge and excess hydrogen fluoride the organic material was neutralized with anhydrous potassium fluoride and analyzed.

Conductivity additives were not used throughout the experiments. The current density always laid between 20 and 30 mA/cm².

3. ELECTROCHEMICAL FLUORINATIONS

a) Di-(2,2,3,4,4,4-hexafluoro-1-methylbutyl)ether

A solution of di-(2,2,3,4,4,4-hexafluoro-1-methylbutyl) ether (89.6 g, 0.24 mol) in electrochemically dried hydrogen fluoride (960 g) was electrolyzed by application of a potential difference of 5.5 V at a cell temperature of 0°C. The reaction was terminated after 46 h 35 min when 145.22 Ah (113% of the theoretically needed current) had been passed the cell. Only minor amounts of volatiles were collected and not investigated any further. Analysis of the recovered organic material (32.5 g) gave perfluoro-di-(1-methylbutyl)ether (55) (32% of the recovered organic material by g.l.c.) and was found identical with previously characterized material (Chapter 7). Some 62% of the recovered organic material was found to be a complex mixture of not fully fluorinated material and was not investigated further.

b) 2-(2H-hexafluoropropyl)oxolane (1)

A solution of (1) (101.0 g, 0.455 mol) in electrochemically dried hydrogen fluoride (898 g) was electrolyzed by application of a cell voltage of 4.5 V at 0°C cell temperature. After 69 h 17 min 144% of the theoretically needed current had been passed the cell and the reaction terminated. Some volatiles (~ 7.0 g) were collected in cold traps but not investigated. After work up recovered organic material

(83.5 g) gave perfluoro-2-propyloxolane (64), (83.5 g, 50%); b.p. 79°C; (Found: C, 22.8; F, 73.0; M^- , 366. $C_7F_{14}O$ requires C, 22.95; F, 72.7%; M , 366); i.r. spectrum 31, n.m.r. spectrum 29, mass spectrum 35.

c) 2,x-bis-(2H-hexafluoropropyl)oxolane (x= 3,4,5) (5)(6)(7)

Run I:

A solution containing of a mixture of (5), (6) and (7) (102.0 g, 0.274 mol) in electrochemically dried hydrogen fluoride (1000 g) was electrolyzed by application of 5.5 V potential difference at 5-6°C cell temperature. Only minor amounts of volatile material were obtained (<0.5 g) and not investigated.

Initial g.l.c. analysis of the recovered organic material (70.0 g) showed it to be of very similar composition to the recovered organic material from run II and so these materials were combined before further analysis.

Run II:

The same hydrogen fluoride as in run I was used. A solution of (5)(6)(7) (100.0 g, 0.296 mol) and re-used hydrogen fluoride (*ca.* 1000 g) was electrolyzed at 5.5 V potential difference at a cell temperature of 0°C. Small amounts of volatiles were trapped (<0.5 g) and not investigated any further. Initial g.l.c. analysis of the recovered organic material (82.7 g) showed it to be of very similar composition as run I and so they were combined. Preparative g.l.c. (column 10% SE 30, 70°C) of this combined material gave perfluoro-2,x-dipropyloxolane (x= 3,4,5) (65)(66)(67), (85% of the recovered organic material by g.l.c.); b.p. 123°C; (Found: C, 23.5; F, 73.9; M^- , 516. $C_{10}F_{20}O$ requires C, 23.3; F, 73.6%; M , 516); i.r. spectrum 32; n.m.r. spectrum 30; mass spectrum 36.

Other minor products were detected by g.l.c. but only perfluoro-2-propyloxolane (64) (13% of recovered organic material by g.l.c.) was positively identified (comparison with previously characterised material, Chapter 7).

d) x,y-bis-(2H-hexafluoropropyl)oxane (x= 2,3)(y= 3,4,5,6)
(8)(9)(10)(11)(12)(13)

A solution of (8), (9), (10), (11), (12) and (13) (50.0 g, 0.13 mol) in electrochemically dried hydrogen fluoride (800 g) was electrolyzed by application of a potential difference of 5.5 V and a cell temperature of 0°C. Volatile products were not obtained in this experiment.

Separation by preparative g.l.c. (column 10% SE 30, 70°C) of a sample of the recovered organic material (30.5 g; 41%) gave

perfluoro-x,y-dipropyloxane (x= 2,3) (y= 3,4,5,6) (68), (69), (70), (71), (74) and (75) (87% of recovered organic material by g.l.c.); (Found: C, 23.0; F, 74.4; M^+ , 566. $C_{11}F_{22}O$ requires C, 23.3; F, 73.85%; M , 566); i.r. spectrum 33; n.m.r. spectrum 31; mass spectrum 39.

As a breakdown product perfluoro-x-propyloxane (x= 2,3,4) (14), (15), (16) (10% of recovered organic material by g.l.c.) was identified by means of mass spectral data (Found: M^+ , 416. $C_8F_{16}O$ requires M , 416); mass spectrum 38.

e) 2-(2H-hexafluoropropyl)-1,4-dioxan

A solution of 2-(2H-hexafluoropropyl)-1,4-dioxan (89.5 g, 0.376 mol) in electrochemically dried hydrogen fluoride (835 g) was electrolyzed at a potential difference of 4.75 V and a cell temperature of 0°C. The reaction was terminated after 45 h 57 min when 208.88 Ah (129.5% of the theoretically needed current) had been passed the cell. Volatile material (23.0 g; 16%) was collected in cold traps and could only be investigated by gas phase infrared spectroscopy. Due to carbonyl absorptions ring opened products were assumed among these products which were perfluorinated (absence of C-H vibrations (below 3000 cm^{-2})). Analysis of the recovered organic material (34.9 g; 24.3%) gave perfluoro-2-propyl-1,4-dioxan (57) (66% of the recovered organic material by g.l.c.) on comparison with previously characterized material (Chapter 7).

f) 2,x-bis-(2H-hexafluoropropyl)-1,4-dioxan (x= 3,4,5)

A solution of 2,x-bis-(2H-hexafluoropropyl)-1,4-dioxan (x= 3,4,5) (65.0 g, 0.167 mol) in electrochemically dried hydrogen fluoride (800 g) was

rough electrolyzed for 24 h 17 min when 92.29 Ah (128.5% of the theoretically needed current) had been passed^x the cell. A potential difference of 5.5 V at 0°C cell temperature had been applied. No volatiles were collected in this experiment. Analysis of the recovered organic material (36.5 g; 41%) gave perfluoro-2,x-dipropyl-1,4-dioxan (x= 3,5,6) (58) (66.5% of the recovered organic material by g.l.c.) on comparison with previously characterized material (Chapter 7).

g) N-(2,2,3,4,4,4-hexafluorobutyl)-x-(2H-hexafluoropropyl) piperidine (x= 2,3,4)

A solution of

N-(2,2,3,4,4,4-hexafluorobutyl)-x-(2H-hexafluoropropyl)piperidine (x= 2,3,4) (40.5 g, 0.102 mol) in electrochemically dried hydrogen fluoride (498 g) was electrolyzed at a potential difference of 4.4 V and a cell temperature of 0°C. The reaction was terminated after 69 h 55 min when 124.79 Ah (176% of the theoretically needed current) had been passed the cell. Some volatile material (≈ 1.5 g) was collected but not investigated any further. Analysis of the recovered organic material (31.8 g; 50%) gave perfluoro-N-butyl-x-propylpiperidine (x= 2,3,4) (72) (64% of the recovered organic material by g.l.c.). An analytical g.l.c. sample (column 10% SE 30, 80°C) was used for characterisation. (Found: C, 22.9; F, 74.5; N, 2.4; M^- , 633. $C_{12}F_{25}N$ requires C, 22.75; F, 75.0; N, 2.2%; M , 633); i.r. spectrum 34; n.m.r spectrum 36; mass spectrum 40.

As a breakdown product perfluoro-N-butylpiperidine (73) and other mono-adducts were identified by g.l.c.-m.s. (Found: M^- , 483. $C_9F_{19}N$ requires M , 483); mass spectrum 41.

h) 3,3,4,5,5,5-hexafluoropent-2-on

A solution of 3,3,4,5,5,5-hexafluoropent-2-on (103.8 g, 0.535 mol) in electrochemically dried hydrogen fluoride (850 g) was electrolyzed at a potential difference of 4.5 V at 0°C cell temperature. The reaction was terminated after 43 h 56 min when 152.79 Ah (133% of the theoretically needed current) had been passed. Only volatile materials (30.2 g; 21.2%) which still contained hydrogen were recovered from the cold traps. Further analysis showed that no perfluoropent-2-on was

produced and only a complex mixture of numerous compounds was obtained which was not investigated any further.

APPENDIX 1

NUCLEAR MAGNETIC RESONANCE SPECTRA

APPENDIX 1

NUCLEAR MAGNETIC RESONANCE SPECTRA

1. 1,1,1,2,3,3-hexafluorohexane (27)
2. 4-methyl-1,1,1,2,3,3-hexafluoropentane (26)
3. 4,4-dimethyl-1,1,1,2,3,3-hexafluoropentane (34)
4. 4-methyl-1,1,1,2,3,3-hexafluorohexane (28)
5. 4-methyl-1,1,1,2,3,3,7,7,8,9,9,9-dodecafluorononane (29)
6. 4,4-dimethyl-1,1,1,2,3,3-hexafluorohexane (30)
7. 4,4-dimethyl-1,1,1,2,3,3,7,7,8,9,9,9-dodecafluorononane (33)
8. Mixture of n-hexane/hexafluoropropene mono-adducts (35)
9. Mixture of n-hexane/hexafluoropropene di-adducts (36)
10. Mixture of n-hexane/hexafluoropropene tri-adducts (37)
11. 1,1,2,3,3,3-hexafluoropropylcyclohexane (21)
12. Mixture of bis-1,x-(1,1,2,3,3,3-hexafluoropropyl)cyclopentane (x= 2,3) (22) (23)
13. 1,1,2,3,3,3-hexafluoropropylcyclohexane (17)
14. Mixture of bis-1,x-(1,1,2,3,3,3-hexafluoropropyl)cyclohexane (x= 2,3,4) (18) (19) (20)
15. Bis-1,4-(1,1,2,3,3,3-hexafluoropropylcyclohexane (20)
16. 1,1,1-trifluoro-2-(F-methyl)-2-hydroxycyclohexane (38)
17. Hexafluoropropene/polyethylene-polymer (39)
18. n-tributyl(2,2-difluoroethyl)tin (41)
19. n-tributyl(1,2,2-trifluoroethyl)tin (42)
20. n-tributyl(1,1,2-trifluoroethyl)tin (43)
21. n-tributyl(2-chloro-1,1,2-trifluoroethyl)tin (44)
22. n-tributyl(1,1,2,3,3,3-hexafluoropropyl)tin (45)
23. n-tributyl(1-fluoro-1-(F-methyl)-2,2-difluoroethyl)tin (46)
24. n-tributyl(1,1,3,3,3-pentafluoropropyl)tin (54)
25. n-tributyl(1-(F-methyl)-3,3,3-trifluoroprop-1-enyl)tin (47)
26. n-tributyl(F-2H-cyclobutyl)tin (48)
27. Perfluoro-di-(1-methyl-butyl)ether (55)
28. Perfluoro-5,8-dioxa-4,9-dimethyl-6-propyldodecan (56)
29. Perfluoro-2-propyloxolane (64)
30. Perfluoro-2,5-dipropyloxolane (65)
31. Mixture of perfluoro-x,y-dipropyloxane (x= 2,3; y= 3,4,5) (68) (69) (70) (71) (74) (75)
32. Perfluoro-2-propyl-1,4-dioxan (57)
33. Mixture of perfluoro-2,x-dipropyl-1,4-dioxan (x= 3,5,6) (58)

34. Perfluoro-2,3,5-tripropyl-1,4-dioxan (59)
35. Perfluoro-2,3,5,6-tetrapropyl-1,4-dioxan (60)
36. Perfluoro-N-butyl-x-propylpiperidine (x= 2,3,4) (72)
37. Perfluoro-1,x-dipropylcyclohexane (x= 2,3,4) (61)(62)(63)

Unless otherwise stated, proton, fluorine and tin spectra were recorded of neat samples.

For proton spectra, chemical shifts are quoted in ppm relative to external tetramethylsilane with downfield shifts positive. For fluorine spectra chemical shifts are quoted in ppm relative to external trichlorofluoromethane with upfield shifts negative. For tin spectra chemical shifts are quoted in ppm relative to neat external tetramethyltin with downfield shift positive.

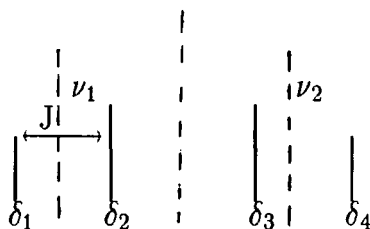
Carbon spectra were recorded from samples being dissolved in deuterio-chloroform with one percent tetramethylsilane (CDCl₃/1%TMS) with chemical shifts quoted in ppm relative to internal TMS with downfield shift positive.

For the splitting patterns of the n.m.r resonances the following abbreviations are used:

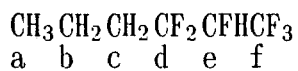
- s = singlet
- d = doublet
- t = triplet
- q = quartet
- m = multiplet

For an AB system, chemical shifts are quoted as the 'centre of gravity' or $\pm \Delta\nu/2$ from the mid-point of the pattern, calculated from:

$$(\delta_1 - \delta_3) = (\delta_2 - \delta_4) = \sqrt{(\Delta\nu)^2 + J^2}$$

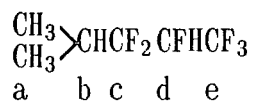


1. 1,1,1,2,3,3-hexafluorohexane (27)



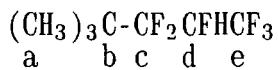
Chemical Shift (ppm)	Multiplicity	Coupling Constant (Hz)	Relative Intensity	Assignment
¹ H				
0.81	m		3	a
1.43	m		2	b
1.81	m		2	c
4.43	d of m	² J _{H-F} = 40	1	e
¹⁹ F				
-68.3	s		3	f
-108.3	A of AB	J = 268	2	d
-111.4	B of AB	J = 268		
-211.2	d	J = 40	1	e

2. 4-methyl-1,1,1,2,3,3-hexafluoropentane (26)



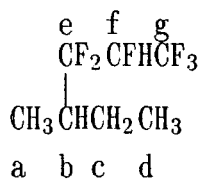
Chemical Shift (ppm)	Multiplicity	Coupling Constant (Hz)	Relative Intensity	Assignment
^1H				
1.10	s <i>broad</i>		6	a
2.13	m		1	b
4.57	m		1	d
^{19}F				
-74.9	s		3	e
-117.9	A of AB	J= 265	2	c
-122.0	B of AB	J= 266		
-212.3	d	J= 36	1	d

3. 4,4-dimethyl-1,1,1,2,3,3-hexafluoropentane (34)



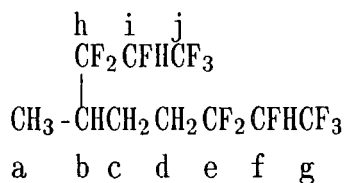
Chemical Shift (ppm)	Multiplicity	Coupling Constant (Hz)	Relative Intensity	Assignment
¹ H				
1.16	s		9	a
4.93	d of m	J= 39	1	d
¹⁹ F				
-75.5	s		3	e
-118.6	A of AB	J= 271	2	c
-126.7	B of AB	J= 271		
-207.6	d	J= 39	1	d

4. 4-methyl-1,1,1,2,3,3-hexafluorohexane (28)



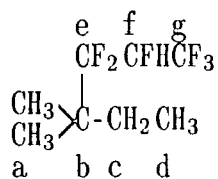
Chemical Shift (ppm)	Multiplicity	Coupling Constant (Hz)	Relative Intensity	Assignment
^1H				
0.97	t		3	a
1.12	t		3	d
1.30	m		1	c
1.73	m		1	b
2.06	m		1	b
4.84	d of m	J= 44	1	f
^{19}F				
-74.6	s		3	g
-116.4	A of AB - d	J= 266; J= 210	2	e
-119.3	B of AB - d	J= 266; J= 163		
-211.8	s <i>broad</i>		1	f

5. 4-methyl-1,1,1,2,3,3,7,7,8,9,9,9-dodecafluorononane (29)



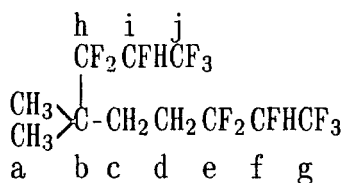
Chemical Shift (ppm)	Multiplicity	Coupling Constant (Hz)	Relative Intensity	Assignment
^1H				
1.08	s		3	a
1.52	m		1	b
1.99	m		4	c,d
4.76	m		2	f,i
^{13}C broad band proton decoupled				
11.3	s			a
22.7	s			c
32.9	s			d
36.7	s			b
84.2	m			f,h
118.6 - } 134.6 }	m			e,h, g,j
^{19}F				
-74.7 -75.0	s } s }		3	g,j
-107.7 -111.9 -115.8 -120.3 -116.4	A of AB B of AB - d A of AB B of AB s	J= 269 J= 269; J= 130 } J= 273 } J= 271 }	2	e,h
-210.6 -211.7	s <i>broad</i> d	J= 45 }	1	f,i

6. 4,4-dimethyl-1,1,1,2,3,3-hexafluorohexane (30)



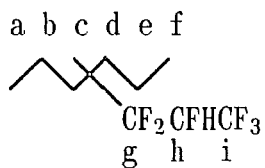
Chemical Shift (ppm)	Multiplicity	Coupling Constant (Hz)	Relative Intensity	Assignment
^1H				
0.88	s <i>broad</i>		3	d
0.97	s <i>broad</i>		6	a
1.45	s <i>broad</i>		2	c
4.76	m		1	f
^{19}F				
-74.4	s		3	g
-116.6	A of AB	J= 269	2	e
-123.9	B of AB	J= 266		
-206.6	d		1	f

7. 4,4-dimethyl-1,1,1,2,3,3,7,7,8,9,9,9-dodecafluorononane (33)



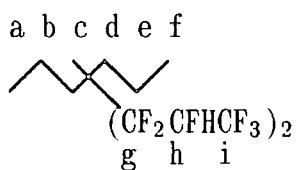
Chemical Shift (ppm)	Multiplicity	Coupling Constant (Hz)	Relative Intensity	Assignment
^1H				
1.03	s <i>broad</i>		3	a
1.68	s <i>broad</i>		1	c
1.96	m		1	d
4.78	m		1	i, f
^{13}C <i>broad band proton decoupled</i>				
20.8	s			a
27.1	s			c or d
27.5	s			c or d
40.4	m			b
84.4	m			f, i
119.2	m			g, j
120.2	m			e, h
^{19}F				
-74.4	s		3	g or i
-74.9	s		3	g or i
-108.3	A of AB	J= 271	2	e or h
-112.2	B of AB	J= 270		
-115.9	A of AB	J= 275	2	e or h
-122.8	B of AB	J= 273		
-207.0	d	J= 41	1	f or i
-210.6	d	J= 40	1	f or i

8. Mixture of n-hexane/hexafluoropropene mono-adducts (35)



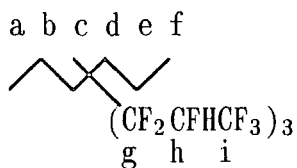
Chemical Shift (ppm)	Multiplicity	Coupling Constant (Hz)	Relative Intensity	Assignment
^1H				
0.92	m		13	a, b, c, d, e, f
1.09	m			
1.28	m			
1.60	m			
1.93	m			
4.47	m		1	h
^{19}F				
-74.7	s		3	i
-74.9	s			
-108.2	A of AB		2	g
-111.3	B of AB			
-117.1	m			
-210.9	s		1	h
-211.8	s			

9. Mixture of n-hexane/hexafluoropropene di-adducts (36)



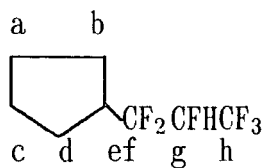
Chemical Shift (ppm)	Multiplicity	Coupling Constant (Hz)	Relative Intensity	Assignment
¹ H				
1.14	m		6	a, b, c, d, e, f
1.21	m			
1.72	m			
2.22	m			
4.83	m		2	h
¹⁹ F				
-74.8	s		3	i
-117.3	m		2	g
-210.8	s <i>broad</i>		1	h
-211.9	s			

10. Mixture of n-hexane/hexafluoropropene tri-adducts (37)



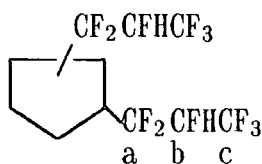
Chemical Shift (ppm)	Multiplicity	Coupling Constant (Hz)	Relative Intensity	Assignment
¹ H				
1.19	m		11	a,b,c d,e,f
1.46	m			
1.74	m			
1.89	m			
2.19	m			
4.90	m		3	h
¹⁹ F				
-74.7	s		3	i
-75.2	s			
-77.9	s			
-113.9	m			g
-210.6	s <i>broad</i>		1	h
-211.4	s <i>broad</i>			

11. 1,1,2,3,3,3-hexafluoropropylcyclopentane(21)



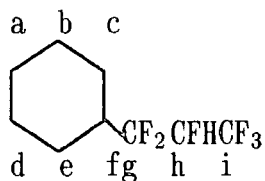
Chemical Shift (ppm)	Multiplicity	Coupling Constant (Hz)	Relative Intensity	Assignment
^1H				
1.55	m		8	a, b, c, d
2.40	m		1	e
4.59	d of m		1	g
^{19}F				
-72.9	s		3	h
-112.4	A of AB	J= 265	2	f
-116.8	B of AB	J= 265		
-209.5	s <i>broad</i>		1	g

12. Mixture of bis-1,x-(1,1,2,3,3,3-hexafluoropropyl)cyclopentane
 (x= 2,3) (22) (23)



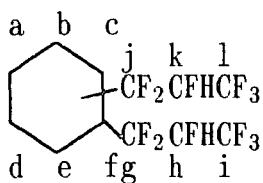
Chemical Shift (ppm)	Multiplicity	Coupling Constant (Hz)	Relative Intensity	Assignment	
¹ H					
1.13 1.57 1.77 1.93	} <i>overlapping multiplets</i>		3	CH ₂	
2.07		m		1	CH
4.77		d of m	J= 45	1	b
¹⁹ F					
-72.9	s		3	c	
-112.8	m		2	a	
-208.0 -209.1	d s <i>broad</i> }		1	b	

13. 1,1,2,3,3,3-hexafluoropropylcyclohexane (17)



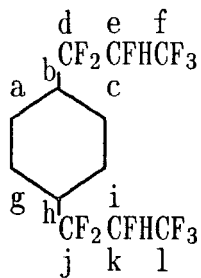
Chemical Shift (ppm)	Multiplicity	Coupling Constant (Hz)	Relative Intensity	Assignment
^1H				
1.26	m		11	a, b, c, d, e, f
1.84	m			
4.84	d of m	J= 43	1	h
^{19}F				
-74.7	s		3	i
-118.9	A of AB	J= 268	2	g
-120.3	B of AB	J= 281		
-212.3	d	J= 43	1	h

14. Mixture of bis-1,x-(1,1,2,3,3,3-hexafluoropropyl)cyclohexane
 (x= 2,3,4) (18) (19) (20)



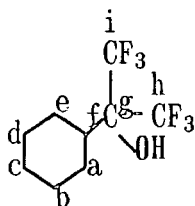
Chemical Shift (ppm)	Multiplicity	Coupling Constant (Hz)	Relative Intensity	Assignment
^1H				
1.27	m		5	a,b,c,
2.01	m }			d,e,f
4.85	d of m	J= 44	1	h,k
^{19}F				
-74.7	s		3	i,l
-116.2	m		2	g,j
-211.4	m		1	h,k

15. Bis-1,4-(1,1,2,3,3,3-hexafluoropropyl)cyclohexane (20)



Chemical Shift (ppm)	Multiplicity	Coupling Constant (Hz)	Relative Intensity	Assignment
^1H				
1.35	m		5	a,b,c, g,h,i
1.98	m }			
4.77	d of m	J= 44	1	e,k
^{19}F				
-74.5	s		3	f,l
-117.4	A of AB	J= 270	2	d,j
-118.9	B of AB	J= 271 }		
-211.5	d	J= 44	1	e,k

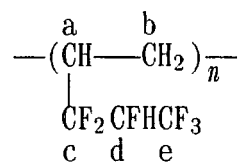
16. 1,1,1-trifluoro-2-(F-methyl)-2-hydroxycyclohexane (38)



Chemical Shift (ppm)	Multiplicity	Coupling Constant (Hz)	Relative Intensity	Assignment
¹ H				
1.35	m		6	b, c, d
1.99	m		5	a, e, f
2.94	s <i>broad</i>		1	g ¹
¹⁹ F				
-74.6	s			i, h

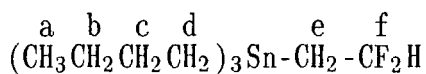
¹ Peak disappeared after shaking with D₂O.

17. Hexafluoropropene/polyethylene-polymer (39)



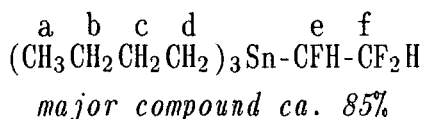
Chemical Shift (ppm)	Multiplicity	Coupling Constant (Hz)	Relative Intensity	Assignment
<i>Solvent: d₆-acetone/d₃-acetonitrile</i>				
¹ H				
1.0 - 2.5	m <i>broad</i>		3	a, b
~5.1	m <i>broad</i>		1	d
¹⁹ F				
-74.6	s <i>broad</i>		3	e
-114.4	m <i>broad</i>		2	c
-211.5	s <i>broad</i>		1	d

18. n-tributyl(2,2-difluoroethyl)tin (41)



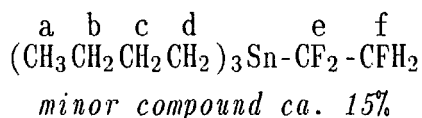
Chemical Shift (ppm)	Multiplicity	Coupling Constant (Hz)	Relative Intensity	Assignment
¹ H				
0.91	m		29	a,b,c, d,e
0.94	m			
1.33	m			
1.55	m			
6.02	t of t	J = 60	1	f
¹⁹ F				
-96.5	d of t	J _{gem} = 60 J _{vic} = 47		f
¹³ C				
10.2	s			d
14.1	s			a
16.8	s			e
28.1	s			b or c
29.6	s			b or c
119.2	t	J = 238		f
¹¹⁹ Sn				
-16.5	s			

19. n-tributyl(1,2,2-trifluoroethyl)tin (42)



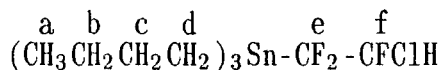
Chemical Shift (ppm)	Multiplicity	Coupling Constant (Hz)	Relative Intensity	Assignment
¹ H				
0.83	t	J= 7	9	d
1.02	m		6	a
1.27	m		6	b or c
1.51	m		6	b or c
4.92	dddd	J= 46 J= 28 J= 13.5 J= 2	1	e
5.98	tdd	J= 53 J= 9.5 J= 2	1	f
¹³ C (<i>broad band proton decoupled</i>)				
9.3	s	Sn satellites J= 289		d
13.4	s			a
27.4	s			b or c
28.9	s			b or c
91.6	d of t	J _{C-F_{gem}} = 193 J _{C-F_{vic}} = 38		e
116.8	t of d	J _{C-F_{gem}} = 240 J _{C-F_{vic}} = 27		f
¹⁹ F				
-117.1	A of AB - t	J= 287	2	f
-123.9	B of AB - t	J= 38 J= 287 J= 40		
-237.4	d	J= 35		
¹¹⁹ Sn (<i>broad band proton decoupled</i>)				
-29.1	d	J= 180		

20. n-tributyl(1,1,2-trifluoroethyl)tin (43)



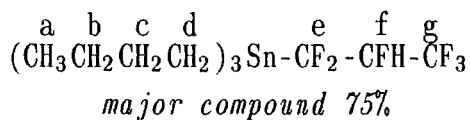
Chemical Shift (ppm)	Multiplicity	Coupling Constant (Hz)	Relative Intensity	Assignment
¹ H				
0.83	t			d
1.02	m			a
1.27	m			b or c
1.51	m			b or c
4.30	d of t	J= 48 J= 17		f
¹⁹ F				
-108.7	s	Sn satellites J= 234	2	e
-229.1	t	J= 42	1	f
¹¹⁹ Sn (<i>broad band proton decoupled</i>) (<i>only one line of an expected triplet visible; data are calculated</i>)				
30.6	t	J= 234		

21. n-tributyl(2-chloro-1,1,2-trifluoroethyl)tin (44)



Chemical Shift (ppm)	Multiplicity	Coupling Constant (Hz)	Relative Intensity	Assignment
¹ H				
-0.15	t	J= 7	9	a
0.11	m		6	d
0.33	m		6	c
0.52	m		6	b
4.89	d of m	J= 50 J= 8	1	f
¹³ C (<i>broad band proton decoupled</i>)				
10.4	s	Sn satellites J= 329		d
13.4	s			a
27.3	s			b or c
27.9	s			b or c
101.0	d of t	J= 243		f
129.2	d <i>broad</i>	J= 154		e
¹⁹ F				
-105.9	A of AB	J= 321 J _{Sn-F} = 207	2	e
-113.1	B of AB	J= 321 J _{Sn-F} = 211		
-146.9	d	J= 47	1	f
¹¹⁹ Sn (<i>broad band proton decoupled</i>)				
-17.4	t	J _{¹¹⁹Sn-F} = 211		

22. n-tributyl(1,1,2,3,3,3-hexafluoropropyl)tin (45)



Chemical Shift (ppm)	Multiplicity	Coupling Constant (Hz)	Relative Intensity	Assignment
----------------------	--------------	------------------------	--------------------	------------

¹H

0.69	t	J= 9	9	a
0.99	m		6	d
1.17	m		6	c
1.32	m		6	b
4.64	d of m	² J ₂₋₃ = 45.4 ³ J ₄₋₃ = 6.5 ³ J ₃₋₁ = 6.5	1	f

¹³C (*broad band proton decoupled*)

9.6	s			d
12.6	s			a
26.7	s			b or c
28.0	s			b or c
89.0	d of m	J= 156		f
121.0	d of q	J= 281		g
130.7	t of d	J= 293 J= 53		e

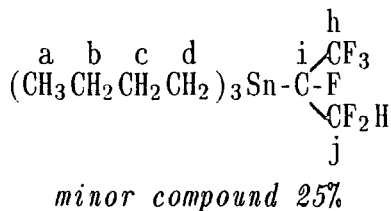
¹⁹F

-75.2	s		3	g
-106.6	A of AB	J= 343	2	e
-113.7	B of AB	J _{Sn-F} = 210 J = 344 J _{Sn-F} = 207		
-204.7 -209.1	d s	J = 37.3		

¹¹⁹Sn (*broad band proton decoupled*)

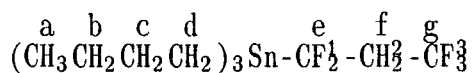
-13.1	t	J _{¹¹⁹Sn-F} = 215		
-------	---	---------------------------------------	--	--

23. n-tributyl(1-fluoro-1-(F-methyl)-2,2-difluoroethyl)tin (46)



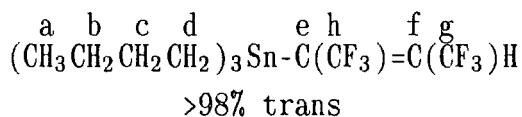
Chemical Shift (ppm)	Multiplicity	Coupling Constant (Hz)	Relative Intensity	Assignment
¹H				
0.69	t	J= 9	9	a
0.99	m		6	d
1.17	m		6	c
1.32	m		6	b
5.7	ddd	J= 52 J= 8	1	i
¹³C (broad band proton decoupled)				
9.6	s			d
12.6	s			a
26.7	s			b or c
28.0	s			b or c
98.0	m			i
113.8	t of d	J= 244 J= 26		j
130.7	m			h
¹⁹F				
-73.4	s		3	h
-120.3	A of AB - d	J= 307	2	j
-124.2	B of AB - d	J= 54		
		J= 311 J= 54		
-209.4	s	Sn satellites J= 210	1	i

24. n-tributyl(1,1,3,3,3-pentafluoropropyl)tin (54)



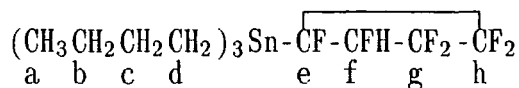
Chemical Shift (ppm)	Multiplicity	Coupling Constant (Hz)	Relative Intensity	Assignment
^{19}F				
-56.5	s		3	g
-102.8	A of AB - d	J= 309	2	e
		$J_{\text{Sn-F}^-}$		
		${}^3J_{1-2} = 59$		
-113.1	B of AB - d	J= 306		
		$J_{\text{Sn-F}^-}$		
		${}^3J_{1-2} = 56$		
^{119}Sn (<i>broad band proton decoupled</i>)				
-3.9	s <i>broad</i>			

25. n-tributyl(1-(F-methyl)-3,3,3-trifluoroprop-1-enyl)tin (47)



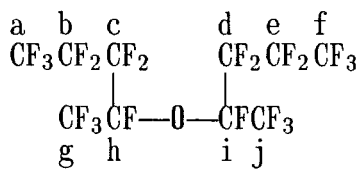
Chemical Shift (ppm)	Multiplicity	Coupling Constant (Hz)	Relative Intensity	Assignment
¹ H				
0.68	t	J= 7	9	a
0.93	m		6	d
1.12	m		6	c
1.29	m		6	b
6.53	m		1	f
¹³ C (<i>broad band proton decoupled</i>)				
10.8	s	tin satellites J _{Sn-C} = 355		d
12.4	s			a
26.5	s			b or c
28.0	s			b or c
122.4	q <i>broad</i>	J= 268.1		g or h
125.6	q <i>broad</i>	J= 273.9		g or h
132.1	s <i>broad</i>			f
147.1	m			e
¹⁹ F				
-62.9	s		1	g or h
-63.3	s		1	g or h
¹¹⁹ Sn (<i>broad band proton decoupled</i>)				
-23.7	s			

26. n-tributyl(F-2H-cyclobutyl)tin (48)



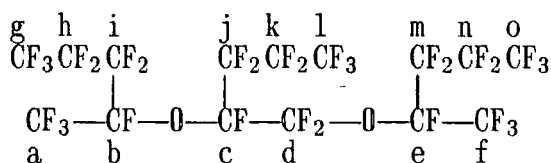
Chemical Shift (ppm)	Multiplicity	Coupling Constant (Hz)	Relative Intensity	Assignment
^1H				
0.66	t	J= 7	9	a
0.94	m		6	d
1.05	m		6	c
1.28	m		6	b
4.87	d of m	$^2\text{J}= 56$	1	f
^{13}C (<i>broad band decoupled</i>)				
10.7	s	tin satellites $\text{J}_{\text{Sn}-\text{C}}= 332$		d
12.8	s			a
26.9	s			b or c
28.3	s			b or c
93.0	d	$\text{J}_{\text{C}-\text{F}}= 220$		f
101.4	d of t	$\text{J}_{\text{C}-\text{F}}= 241$		e
112.4	t	$\text{J}_{\text{C}-\text{F}}= 297$		g or h
114.3	t	$\text{J}_{\text{C}-\text{F}}= 282$		g or h
^{19}F				
-108.4 } -130.4 }	A of AB B of AB	J= 225	2	g or h
-121.4 } -129.8 }	A of AB B of AB	J= 227	2	g or h
-191.2	d	$^2\text{J}_{\text{F}-\text{H}}= 56$	1	f
-195.9	s	Sn satellites J= 165	1	e
^{119}Sn				
5.5	d	J= 164		

27. Perfluoro-di-(1-methyl-butyl)ether (55)



Chemical Shift (ppm)	Multiplicity	Coupling Constant (Hz)	Relative Intensity	Assignment
¹⁹ F				
-79.60	s		6	g, j
-80.97	s			
-83.83	s		6	a, f
-126.19	m		8	b, c, d, e
-136.16	s		2	h, i
-136.93	s			

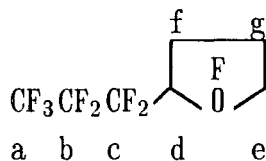
28. Perfluoro-5,8-dioxa-4,9-dimethyl-6-propyldodecan (56)



Chemical Shift (ppm)	Multiplicity	Coupling Constant (Hz)	Relative Intensity	Assignment
¹⁹ F				
* -77.5	m		1	d
-79.35	s broad		6	a, f
-80.24	s broad			
-81.03	s broad			
-83.64	s broad		9	i, l, o
-124.89	m		12	g, h j, k m, n
-135.22	s broad		2	b, c
-142.89	s broad		1	e

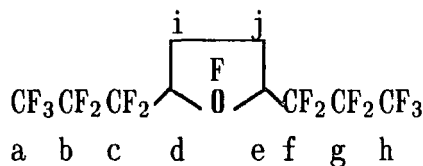
* part of an expected AB system; partial integral only accounts for one half of that system. The second half is expected under the broad singlets for the various CF₃ groups since the total integral for that region accounts for a total of 17 (9+6+2).

29. Perfluoro-2-propyloxolane (64)



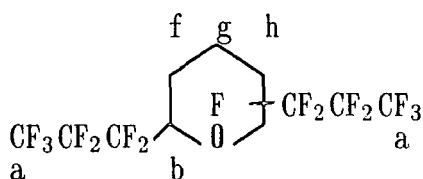
Chemical Shift (ppm)	Multiplicity	Coupling Constant (Hz)	Relative Intensity	Assignment
^{19}F				
-83.82	s		3	a
-84.88	A of AB	J= 132	2	e
-87.33	B of AB	J= 129		
-126.6	m		8	b, c, f, g
-138.89	s		1	d
-139.98	s			

30. Perfluoro-2,5-dipropyloxolane (65)



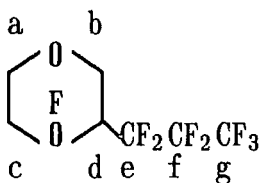
Chemical Shift (ppm)	Multiplicity	Coupling Constant (Hz)	Relative Intensity	Assignment
^{19}F				
-83.99	s		6	a, h
-126.03	m		12	b, c, f, g, i, j
-133.08	s		2	d, e
-134.17	s			
-134.76	s			
-135.86	s			

31. Mixture of perfluoro-x,y-dipropyloxane (x= 2,3; y= 3,4,5)
 (68) (69) (70) (71) (74) (75)



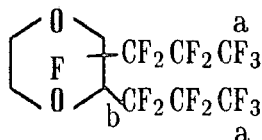
Chemical Shift (ppm)	Multiplicity	Coupling Constant (Hz)	Relative Intensity	Assignment
^{19}F				
-83.5 } -83.9 }	s			a
-70.3 - -83.0	m			O-CF ₂
-115.4 - -144.7	-			CF ₂ /b
-179.3 - -190.3	m			CF

32. Perfluoro-2-propyl-1,4-dioxan (57)



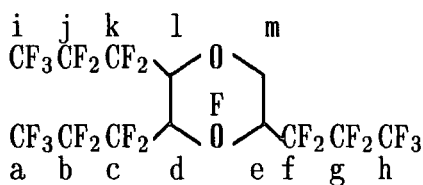
Chemical Shift (ppm)	Multiplicity	Coupling Constant (Hz)	Relative Intensity	Assignment
^{19}F				
-83.4	s		3	g
-84.7	m		5	d, e, f
-126.6	m		6	a, b, c

33. Mixture of perfluoro-2,x-dipropyl-1,4-dioxan (x= 3,5,6) (58)



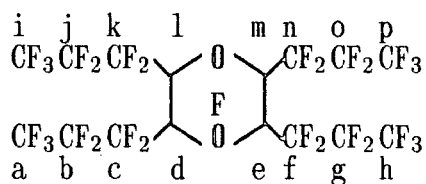
Chemical Shift (ppm)	Multiplicity	Coupling Constant (Hz)	Relative Intensity	Assignment
^{19}F				
-83.9	s		3	a
-81.5	m		2	O-CF ₂
-127.3	m		5	CF ₂ / b

34. Perfluoro-2,3,5-tripropyl-1,4-dioxan (59)



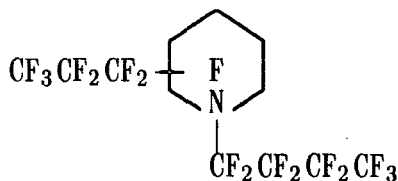
Chemical Shift (ppm)	Multiplicity	Coupling Constant (Hz)	Relative Intensity	Assignment
^{19}F				
-81.83	A of AB	J= 156.5	2	m
-84.73	B of AB	J= 157.2		
-83.99	s		9	a, h, i
-127.31	m			b, c, d, e, f, g, j, k, l

35. Perfluoro-2,3,5,6-tetrapropyl-1,4-dioxan (60)



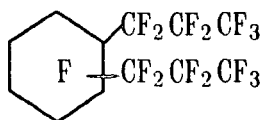
Chemical Shift (ppm)	Multiplicity	Coupling Constant (Hz)	Relative Intensity	Assignment
^{19}F -81.16	s		3	a, h, i, p
-124.25	m		5	b, c, d, e, f, g, j, k, l, m, n, o

36. Perfluoro-N-butyl-x-propylpiperidine (x= 2,3,4) (72)



Chemical Shift (ppm)	Multiplicity	Coupling Constant (Hz)	Relative Intensity	Assignment
^{19}F -48.0 - -52.0 -73.0 - -82.0 -84.5 - -85.9 -91.3 - -93.0 -109.0 - -144.0 -153.0	} <i>unassigned series of peaks</i>		19	
-83.5 -83.9		s s }	6	CF ₃

37. Perfluoro-1,x-dipropylcyclohexane (x= 2,3,4) (61)(62)(63)



Chemical Shift (ppm)	Multiplicity	Coupling Constant (Hz)	Relative Intensity	Assignment
^{19}F				
-83.6	s		9	f, l
-114.4 - -128.1	series of peaks		8	a, b, d, e, g, h, i, k
-186.6	m		1	c, i

APPENDIX 2

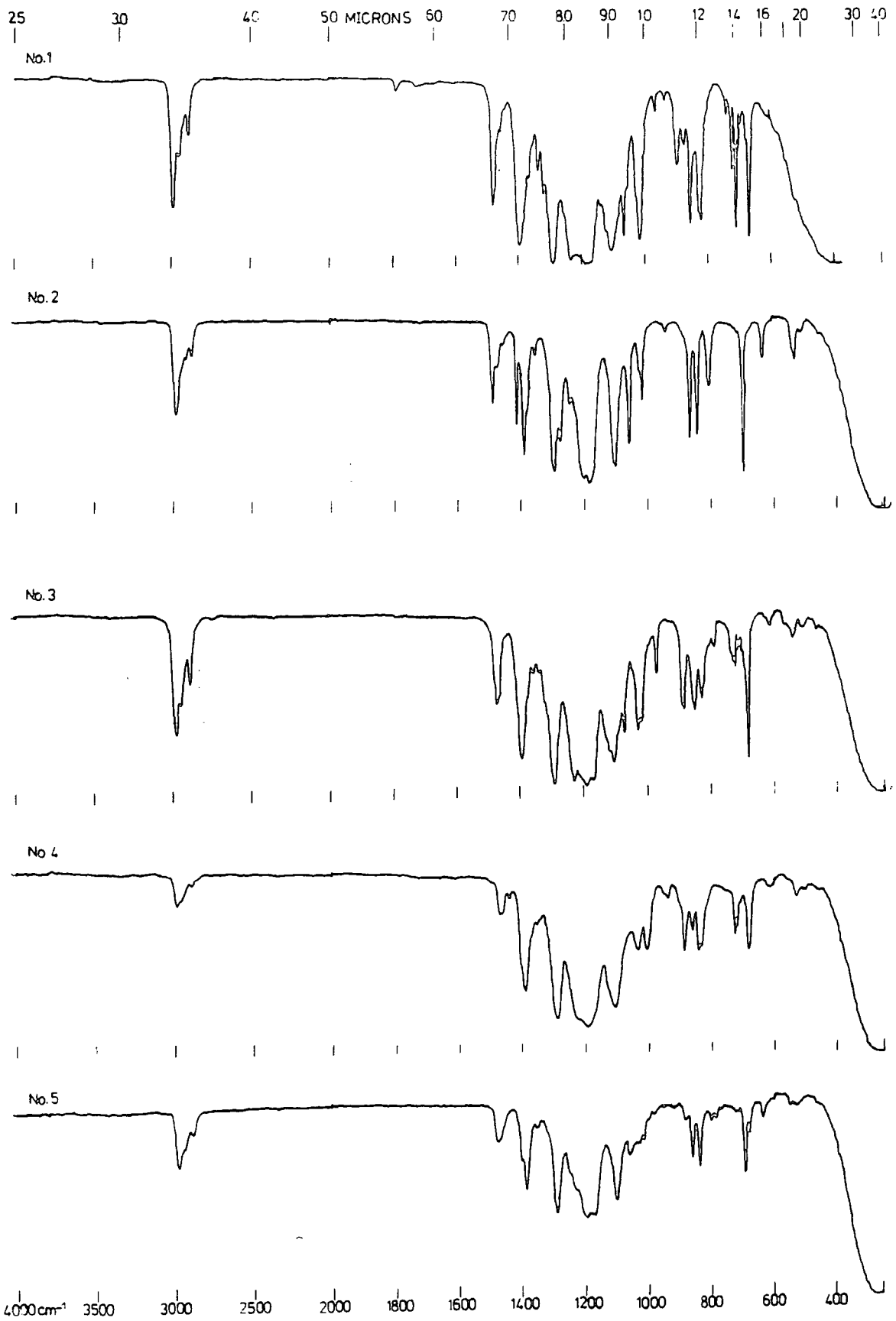
INFRARED SPECTRA

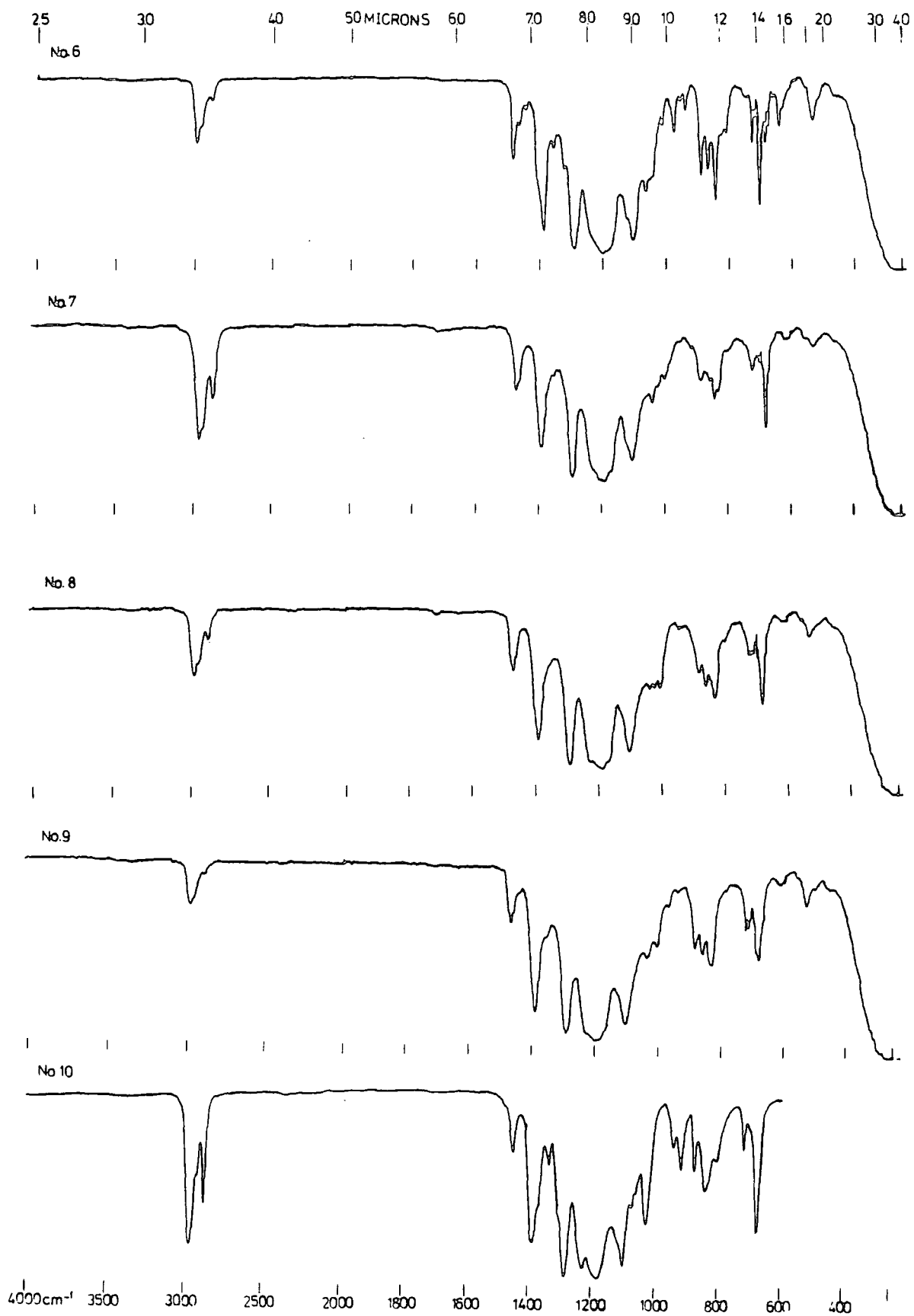
APPENDIX 2

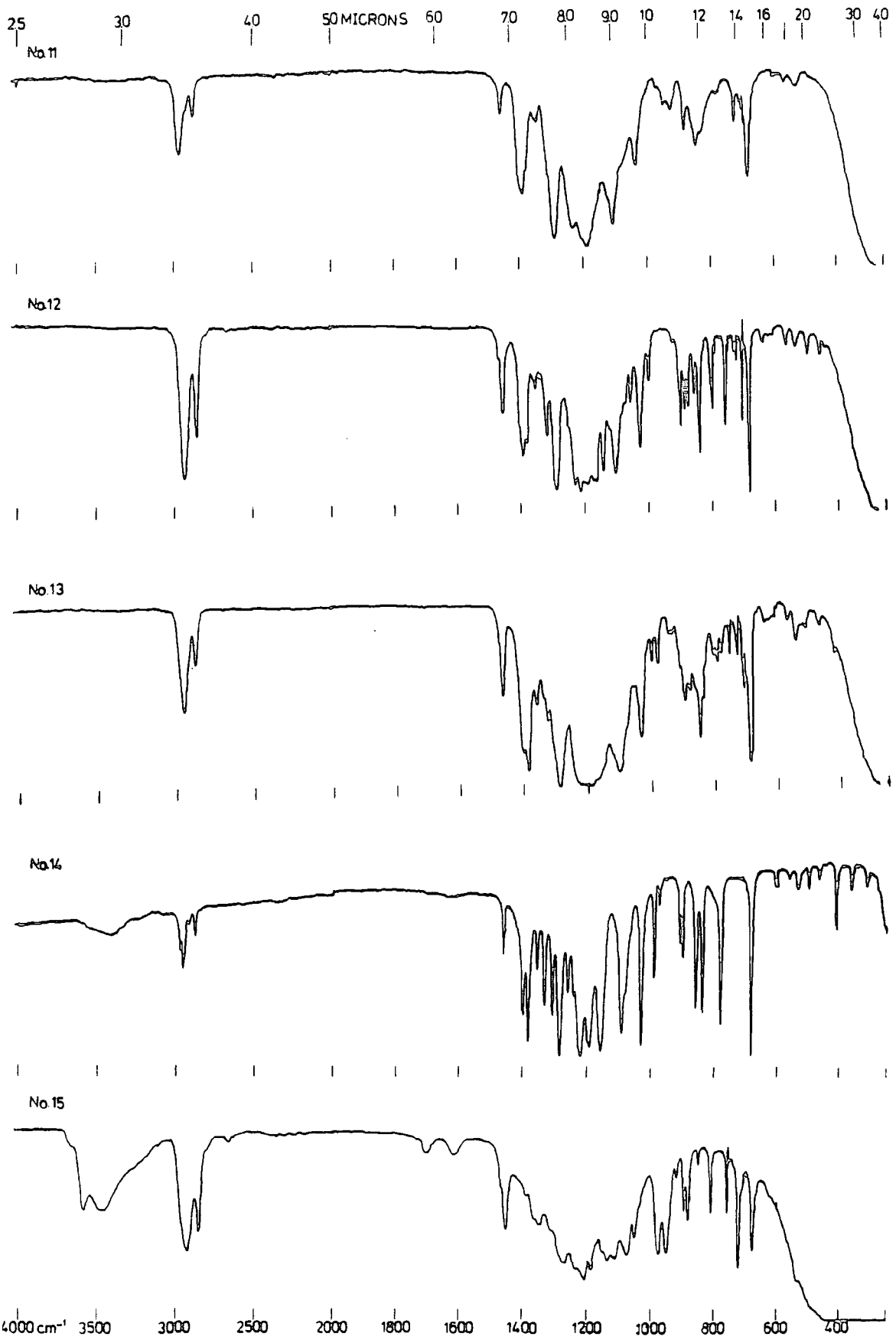
INFRARED SPECTRA

1. 4-methyl-1,1,1,2,3,3-hexafluorobutane (26)
2. 4,4-dimethyl-1,1,1,2,3,3-hexafluoropentane (34)
3. 4-methyl-1,1,1,2,3,3-hexafluorohexane (28)
4. 4-methyl-1,1,1,2,3,3,7,7,8,9,9,9-dodecafluorononane (29)
5. Mixture of 4,4-dimethyl-1,1,1,2,3,3-hexafluorohexane (30),
4,5-dimethyl-1,1,1,2,3,3-hexafluorohexane (31) and
6-methyl-1,1,1,2,3,3-hexafluoropentane (32)
6. 4,4-dimethyl-1,1,1,2,3,3,7,7,8,9,9,9-dodecafluorononane (33)
7. Mixture of hexafluoropropene/n-hexane mono-adducts (35)
8. Mixture of hexafluoropropene/n-hexane di-adducts (36)
9. Mixture of hexafluoropropene/n-hexane tri-adducts (37)
10. 1,1,2,3,3,3-hexafluoropropylcyclopentane (21)
11. 1,x-bis-(1,1,2,3,3,3-hexafluoropropyl)cyclopentane (x= 2,3)
(22) (23)
12. 1,1,2,3,3,3-hexafluoropropylcyclohexane (17)
13. 1,x-bis-(1,1,2,3,3,3-hexafluoropropyl)cyclohexane (x=2,3,4)
(18), (19), (20)
14. 1,4-bis-(1,1,2,3,3,3-hexafluoropropyl)cyclohexane (20)
15. 1,1,1-trifluoro-2-(F-methyl)-2-hydroxyethylcyclohexane (38)
16. hexafluoropropene/polyethylene polymer (39)
17. hexafluoroacetone/polyethylene polymer (40)
18. n-tributyl(2,2-difluoroethyl)tin (41)
19. Mixture of n-tributyl(1,2,2-trifluoroethyl)tin (42) and
n-tributyl(1,1,2-trifluoroethyl)tin (43)
20. n-tributyl(2-chloro-1,1,2-trifluoroethyl)tin (44)
21. Mixture of n-tributyl(1,1,2,3,3,3-hexafluoropropyl)tin (45)
n-tributyl(1-fluoro-1-(F-methyl)-2,2-difluoroethyl)tin (46)
22. n-tributyl(1-(F-methyl)-3,3,3-trifluoroprop-1-enyl)tin (47)
23. n-tributyl(F-2H-cyclobutyl)tin (48)
24. Perfluoro-di-(1-methyl-butyl)ether (55)
25. Perfluoro-5,8-dioxa-4,9-dimethyl-6-propyldodecan (56)
26. Perfluoro-2-propyl-1,4-dioxan (57)
27. Perfluoro-2,x-dipropyl-1,4-dioxan (58)
28. Perfluoro-2,3,5-tripropyl-1,4-dioxan (59)
29. Perfluoro-2,3,5,6-tetrapropyl-1,4-dioxan (60)
30. Perfluoro-1,x-dipropylcyclohexane (61) (62) (63)

31. Perfluoro-2-propyloxolane (64)
32. Perfluoro-2,x-dipropyloxolane (x= 3,4,5) (65) (66) (67)
33. Perfluoro-x,y-dipropyloxane (x= 2,3) (y= 3,4,5,6)
(68) (69) (70) (71) (74) (75)
34. Perfluoro-N-butyl-x-propylpiperidine (x= 2,3,4) (72)

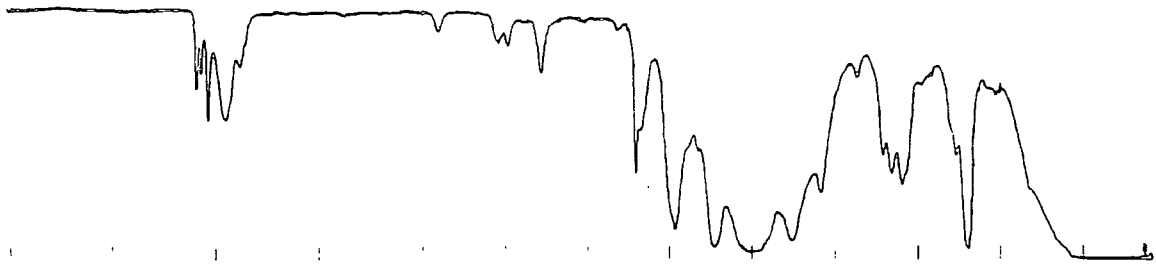




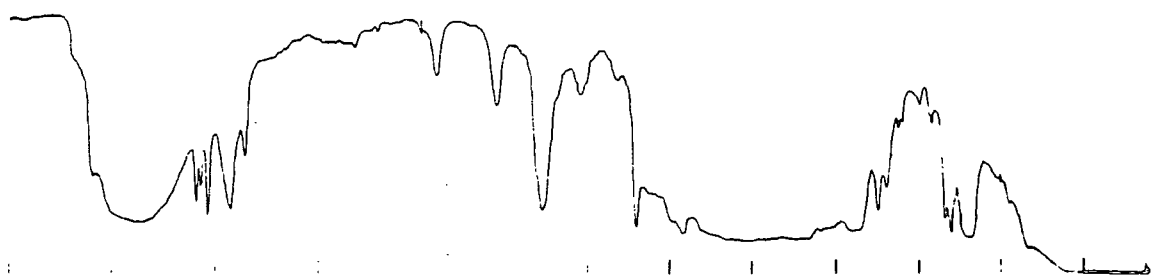


25 30 40 50 MICRONS 60 70 80 90 10 12 14 16 20 30 40

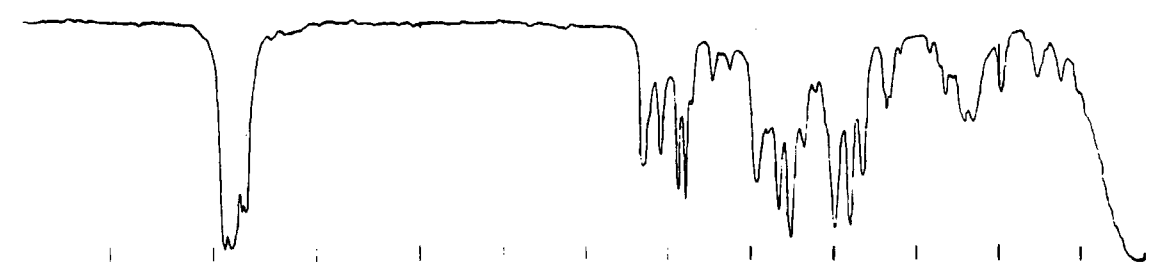
No. 16



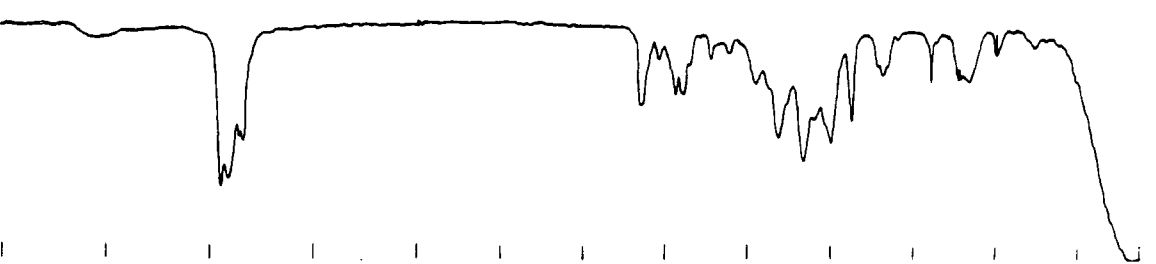
No. 17



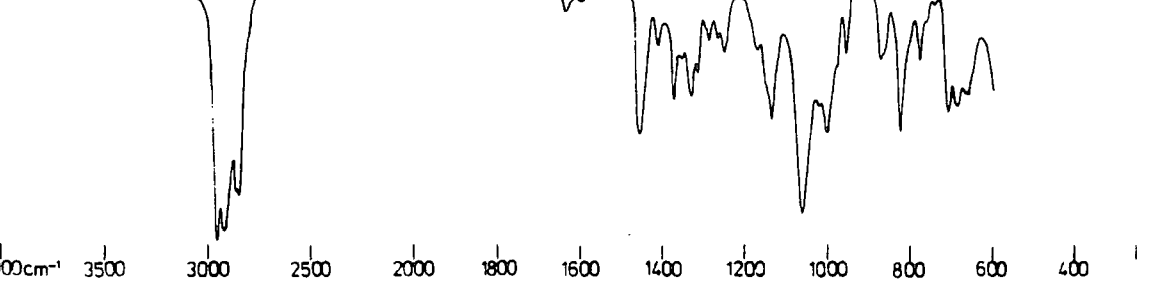
No. 18



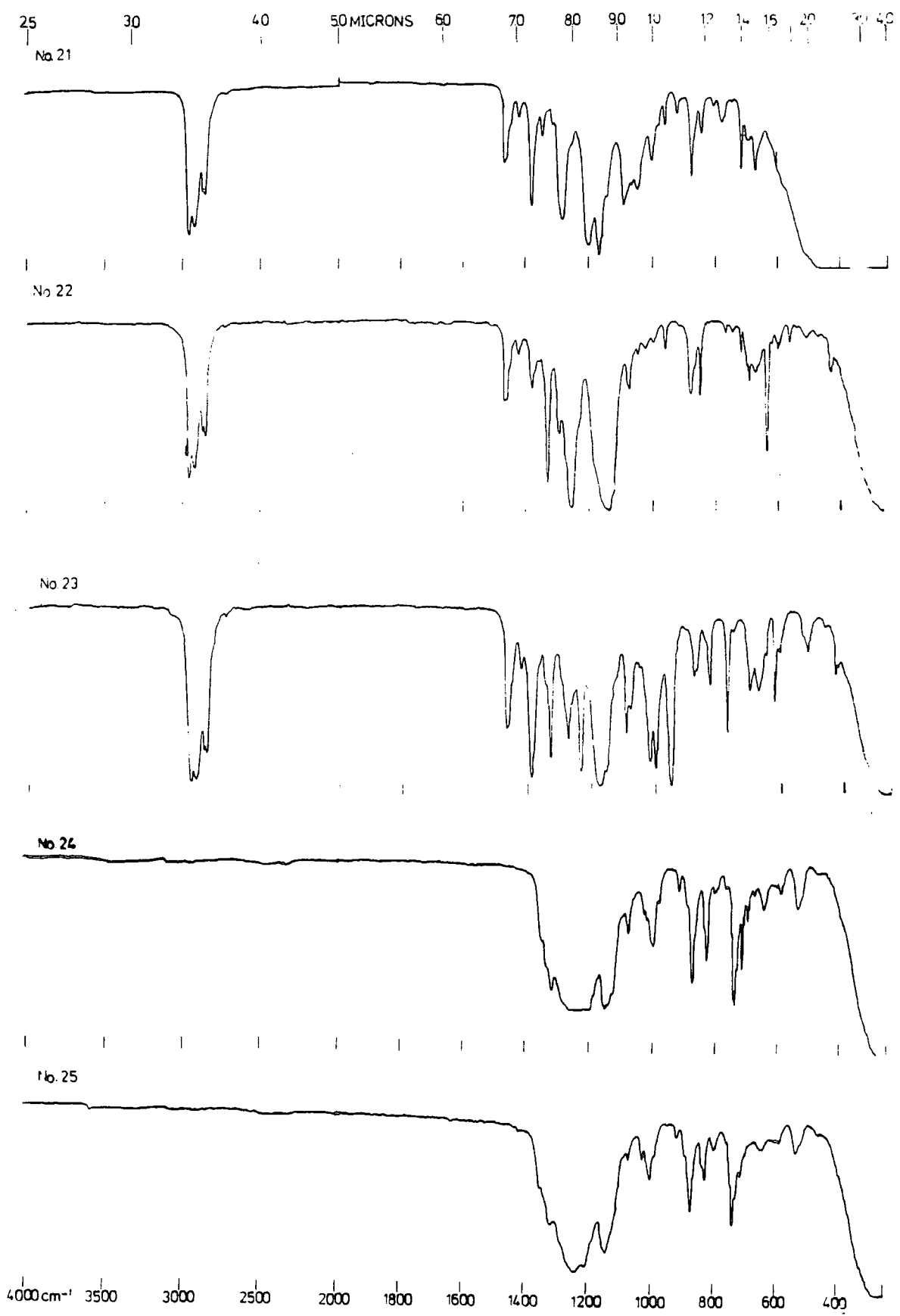
No. 19

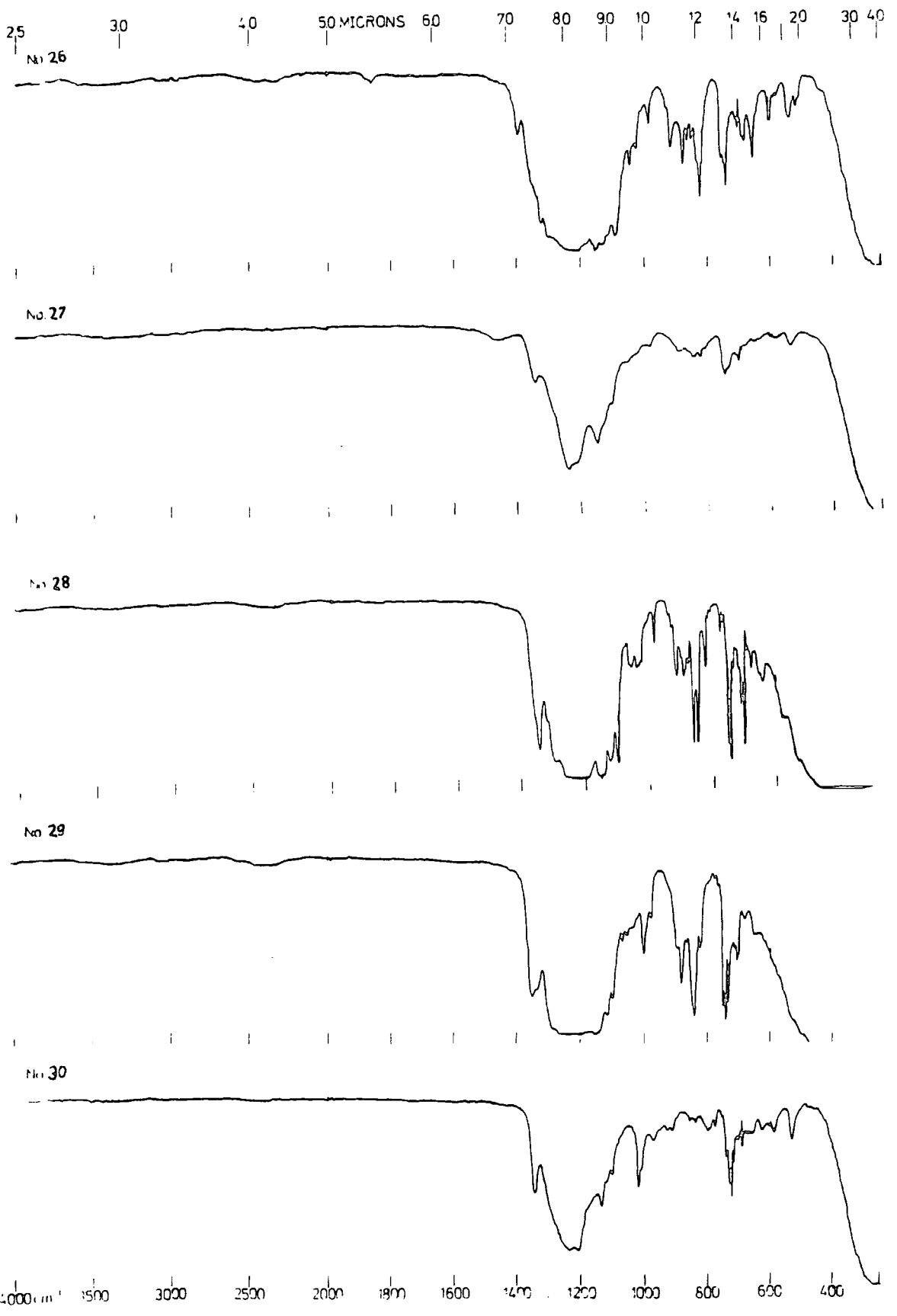


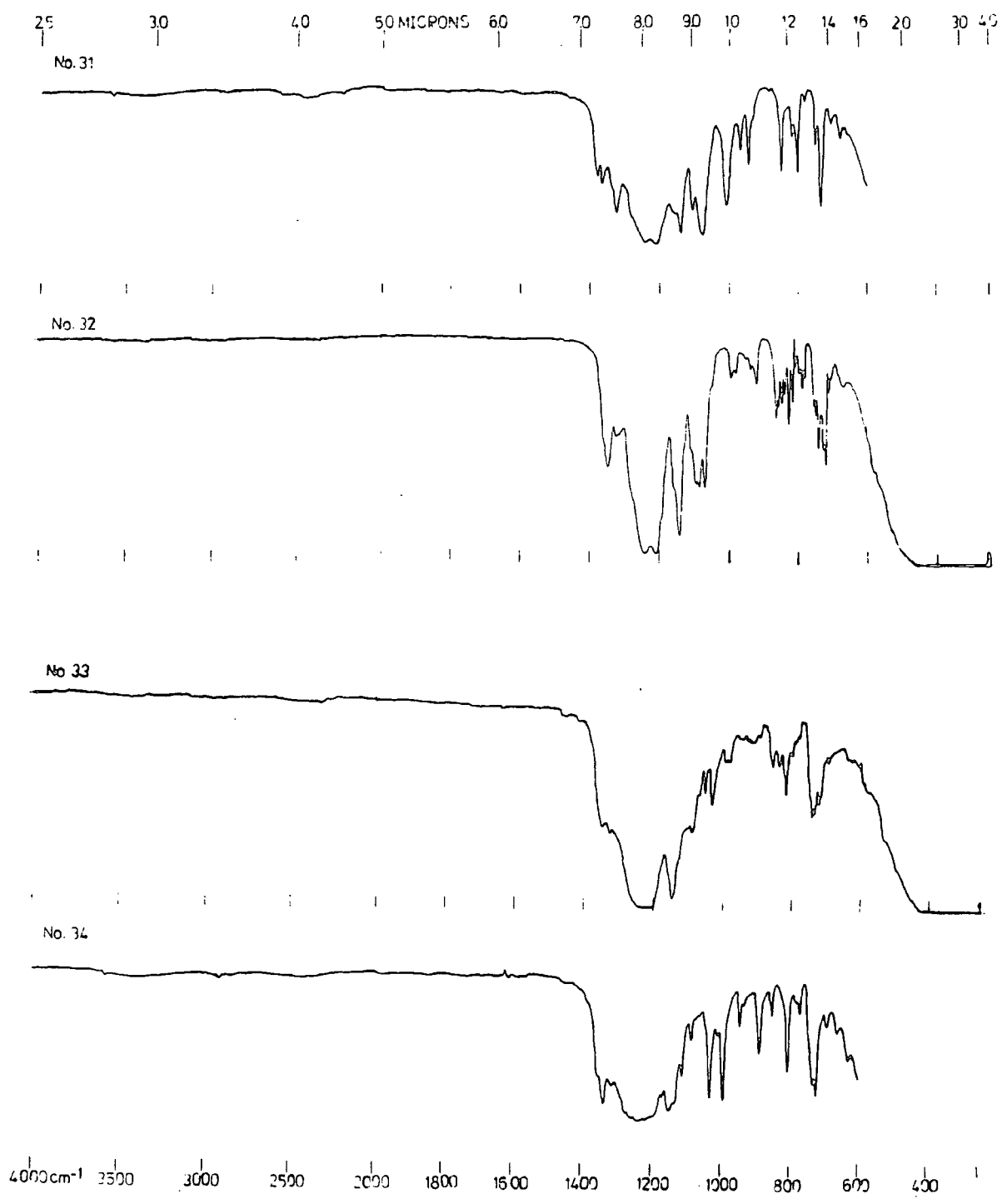
No. 20



4000cm⁻¹ 3500 3000 2500 2000 1800 1600 1400 1200 1000 800 600 400







APPENDIX 3

MASS SPECTROMETRY DATA

APPENDIX 3

MASS SPECTROMETRY DATA

1. 2-hexafluoropropyloxolane (1)
2. 2-hexafluoropropyloxane (2)
3. 3-hexafluoropropyloxane (3)
4. 4-hexafluoropropyloxane (4)
5. 2,5-bis-hexafluoropropyloxolane (5)
6. 2,x-bis-hexafluoropropyloxolane (6) (7)
7. x,y-bis-hexafluoropropyloxane (8) (9) (10) (11) (12) (13)
8. 1,1,2,3,3,3-hexafluoropropylcyclohexane (17)
9. 1,x-bis-(1,1,2,3,3,3-hexafluoropropyl)cyclohexane (x= 2,3,4) (18)
(19) (20)
10. 1,4-bis-(1,1,2,3,3,3-hexafluoropropyl)cyclohexane (20)
11. 1,1,2,3,3,3-hexafluoropropylcyclopentane (21)
12. 1,x-bis-(1,1,2,3,3,3-hexafluoropropyl)cyclopentane (x= 2,3)
(22) (23)
13. 3-(1,1,2,3,3,3-hexafluoropropyl)cyclohex-1-ene (24)
14. 9-(1,1,2,3,3,3-hexafluoro)decalin (25)
15. 4-methyl-1,1,1,2,3,3-hexafluoropentane (26)
16. 1,1,1,2,3,3-hexafluorohexane (27)
17. 4,4-dimethyl-1,1,1,2,3,3-hexafluoropentane (34)
18. 4-methyl-1,1,1,2,3,3-hexafluorohexane (28)
19. 4-methyl-1,1,1,2,3,3,7,7,8,9,9,9-dodecafluorononane (29)
20. 4,4-dimethyl-1,1,1,2,3,3-hexafluorohexane (30)
21. 4,5-dimethyl-1,1,1,2,3,3-hexafluorohexane (31)
22. 6-methyl-1,1,1,2,3,3-hexafluoroheptane (32)
23. 4,4-dimethyl-1,1,1,2,3,3,7,7,8,9,9,9-dodecafluorononane (33)
24. Hexafluoropropene/n-hexane mono-adducts (35)
25. Hexafluoropropene/n-hexane di-adducts (36)
26. Hexafluoropropene/n-hexane tri-adducts (37)
27. 1,1,1-trifluoro-2-(F-methyl)-2-hydroxyethylcyclohexane (38)
28. Perfluoro-di-(1-methyl-butyl)ether (55)
29. Perfluoro-5,8-dioxa-4,9-dimethyl-6-propyldodecan (56)
30. Perfluoro-2-propyl-1,4-dioxan (57)
31. Perfluoro-2,x-dipropyl-1,4-dioxan (58) (x= 3,5,6)
32. Perfluoro-2,3,5-tripropyl-1,4-dioxan (59)
33. Perfluoro-2,3,5,6-tetrapropyl-1,4-dioxan (60)
34. Perfluoro-1,x-dipropylcyclohexane (x= 2,3,4) (61) (62) (63)

35. Perfluoro-2-propyloxolane (64)
36. Perfluoro-2,5-dipropyloxolane (65)
37. Perfluoro-2,x-dipropyloxolane (x= 3,4) (66)(67)
38. Perfluoro-x-propyloxane (x= 2,3,4) (14)(15)(16)
39. Perfluoro-x,y-dipropyloxane (x= 2,3) (y= 3,4,5,6) (68)(69)(70)(71)
(74)(75)
40. Perfluoro-N-butyl-x-propylpiperidine (x= 2,3,4) (72)
41. Perfluoro-N-methyl-piperidine/hexafluoropropene mono-adducts (73)

Note:

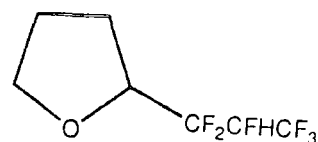
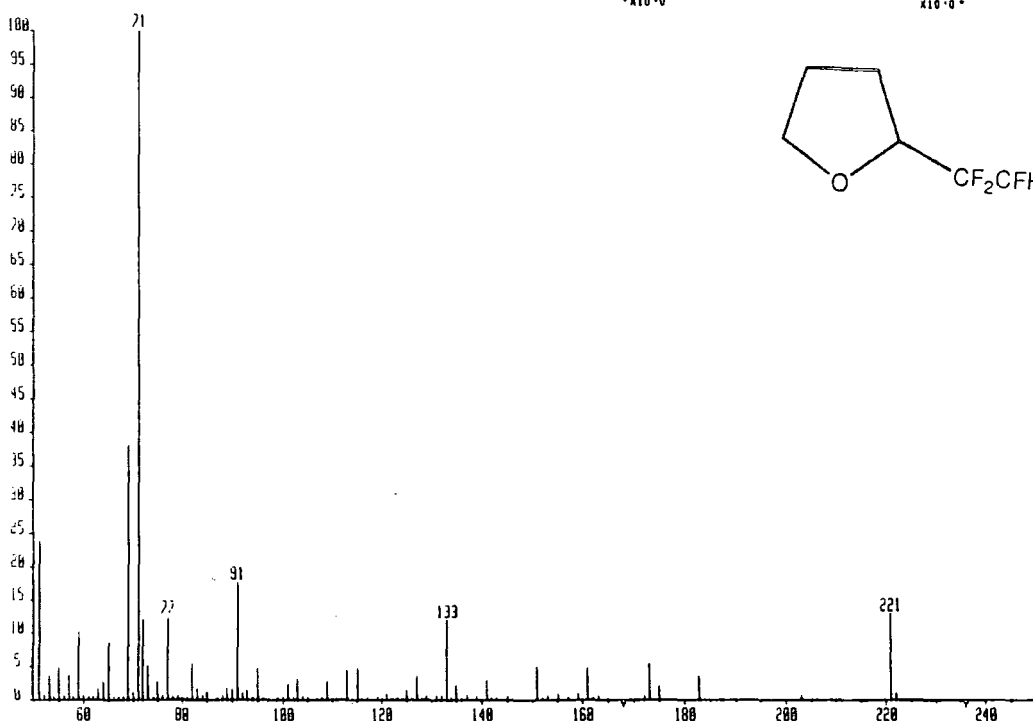
In the data list the following letters occur:

- F: the mass given was obtained from a split peak;
- O: the peak was overloaded (above 100%);
- F0: the peak was overloaded and split.

1. 2-hexafluoropropylloxolane (1)

RI1000344 x1 0gd=339 22-NOV-09 15 3:0 04 50 70E EI+
 Bp#-0 I=100 Ha=223 TIC=221516000 Acnt Sys FOOT
 FR3 0.1ASEC GC= 77⁰ Cal PFK15MOV *x10⁻⁰

HR 65534000
 RASS 71
 x10⁻⁰



Mass	% Base	121.06	0.84
51.02	23.76	125.06	1.29
52.04	0.58	127.05	3.54
53.05	3.55	129.04	0.51
55.06	4.76	131.02	0.67
56.04	0.54	133.05	11.81
57.03	3.61	135.08	2.17
59.05	9.95	137.06	0.66
63.03	1.59	140.04	0.03
64.03	2.57	141.03	2.94
65.04	8.55	142.03	0.11
69.01	38.01	143.05	0.20
70.04	1.13	145.04	0.48
71.08	100.00	146.06	0.07
72.07	12.03	147.06	0.07
73.06	5.07	150.05	0.04
75.02	2.55	151.03	4.82
76.03	0.54	152.02	0.09
77.04	12.49	153.07	0.47
78.04	0.51	155.07	0.84
79.04	0.65	157.04	0.09
82.03	5.23	159.06	0.84
83.04	1.55	160.05	0.04
84.06	0.52	161.04	4.71
85.07	1.05	162.05	0.18
88.04	0.55	163.07	0.54
89.04	1.72	165.06	0.09
90.05	1.65	172.07	0.06
91.06	17.59	173.07	0.54
92.06	0.87	174.07	0.03
93.03	1.44	175.06	0.19
95.04	4.48	177.07	0.04
101.05	2.25	183.09	0.35
103.06	2.98	185.07	0.02
109.05	2.68	203.12	0.06
113.03	4.44	219.05	0.03
115.07	4.73	221.07	1.29
		222.09	0.09
		223.11	0.05

2. 2-hexafluoropropylloxane (2)

RF13104350 x1 0gd=419 16-MAY-89 11:40:05:27 70E

E1+

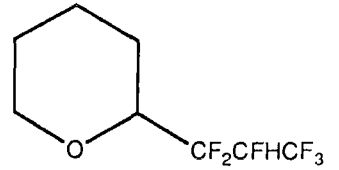
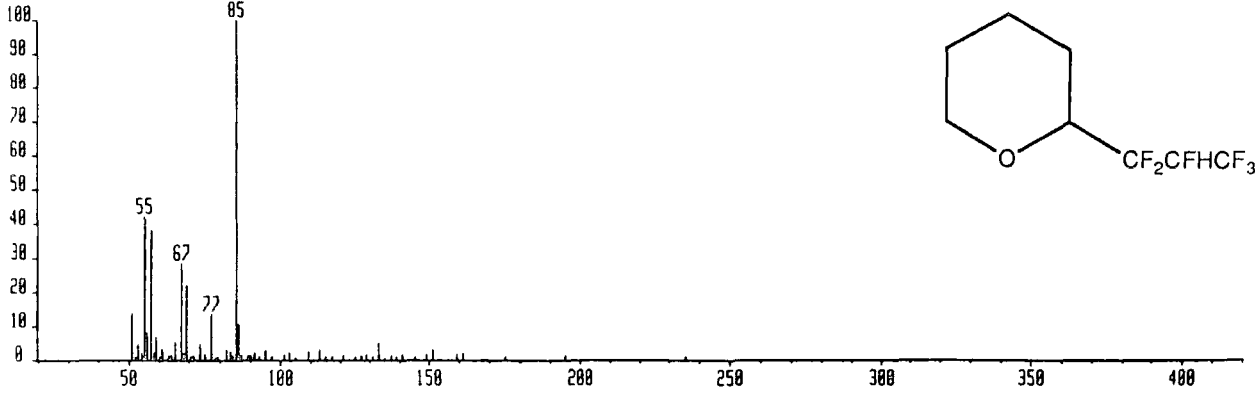
0pA=0 I=10v Ha=236 TIC=247085000

Acnt:

Sys: FOOT

HRR: 65534000
RASS: 05

GC= 95° Cal: PFK104



51.12	13.56	127.03	1.25
52.14	0.83	129.10	1.39
53.15	4.37	131.06	0.62
54.16	2.11	132.07	0.44
55.16	41.93	133.08	4.74
56.16	7.93	135.11	0.53
57.17	37.77	137.10	1.15
58.17	1.74	139.09	0.68
59.13	6.33	141.10	1.32
60.13	0.60	145.11	0.71
61.14	2.72	147.13	0.33
63.10	1.00	149.14	1.35
64.10	1.08	151.09	2.80
65.11	5.11	155.10	0.44
66.12	0.42	157.12	0.35
67.13	28.26	159.12	1.37
68.12	1.66	161.10	1.89
69.07	21.61	167.14	0.33
70.09	0.57	175.13	0.74
71.10	1.16	177.15	0.37
73.11	4.18	189.15	0.35
74.10	0.39	195.14	0.95
75.07	1.51	197.16	0.50
76.07	0.39	199.16	0.44
77.08	13.16	235.16	0.64
78.08	0.53		
79.08	0.57		
81.07	0.50		
82.06	2.86		
83.09	2.23		
84.10	1.08		
85.15	100.00		
86.12	10.18		
87.12	1.32		
88.07	0.32		
89.08	0.98		
90.08	0.98		
91.08	1.64		
93.07	0.78		
94.07	0.30		
95.08	2.37		
97.10	0.84		
99.10	0.33		
101.08	1.43		
103.10	1.84		
104.11	0.38		
105.12	0.52		
109.10	2.20		
110.08	2.86		

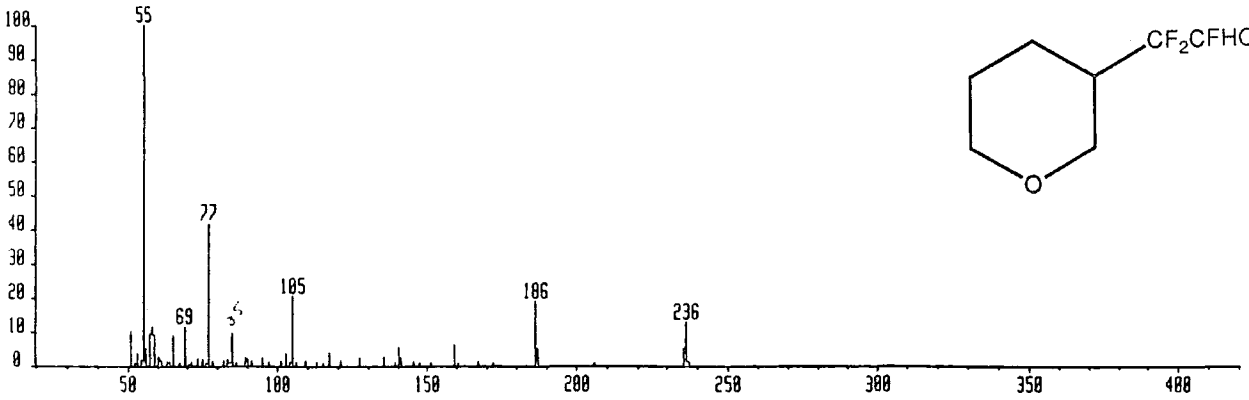
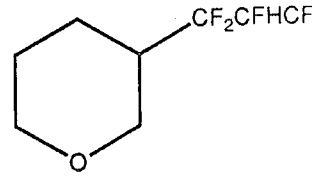
Hm= 236

below printout threshold

3. 3-hexafluoropropylloxane (3)

RF1310464o x1 Bgd=468 16-MAY-89 11:4:08:49 78E EI+
 BpA=8 I=2.7v Ha=237 TIC=63214000 Acnt: Sys:FOOT
 GC= 99° Cal:PFK184

HAR: 174918
 AASS:

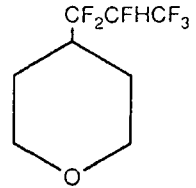
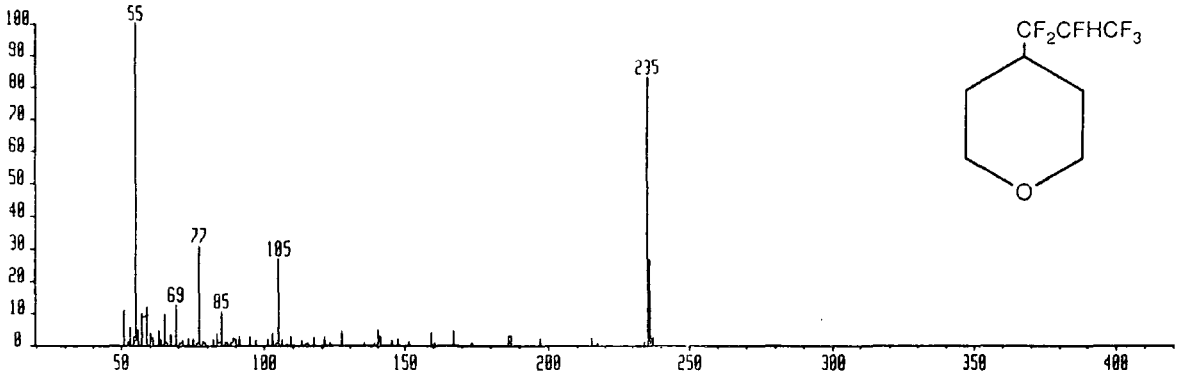


Mass	% Base		
51.12	10.04	106.12	1.11
52.14	0.72	107.08	0.31
53.15	3.57	108.08	0.47
54.16	1.66	109.10	1.29
55.16	100.00	113.07	1.13
56.16	4.87	115.10	0.56
57.13	9.12	117.11	3.85
58.14	11.55	119.06	0.35
59.13	9.10	121.08	1.38
60.14	2.37	123.10	0.46
61.14	1.59	127.08	2.02
63.11	0.91	135.13	2.50
64.10	0.99	139.09	0.90
65.10	9.06	140.10	5.41
66.11	0.46	141.11	2.05
67.13	0.82	145.10	1.04
69.06	11.26	147.12	0.58
70.08	0.51	151.09	0.74
71.10	1.01		
73.11	1.98	159.11	5.98
75.06	1.73	160.12	0.86
76.07	0.54	167.14	1.02
77.08	41.64	172.13	0.77
78.08	1.29	186.15	19.04
81.07	0.38	187.16	5.15
82.05	1.45	205.14	0.45
83.09	1.92	206.15	0.56
84.10	0.83	235.15	5.04
85.10	9.14	236.15	12.99
86.10	0.77	237.16	1.23
87.11	0.49		
88.07	0.40		
89.08	2.06		
90.08	1.93		
91.09	1.28		
95.07	2.18		
97.10	1.02		
101.08	1.29		
102.09	0.31		
103.10	3.63		
104.11	1.09		
105.12	20.43		

4. 4-hexafluoropropylloxane (4)

RF13184770 xi Bqd=471 16-ARY-09 11:40:05 59 78E EI
 BpA=0 I=5.3v Ha=230 TIC=165501000 Acnt: Sys FOOT
 GC= 101^o Cat PFK104

NRR: 3472800
 RRS: 55



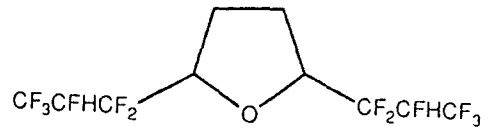
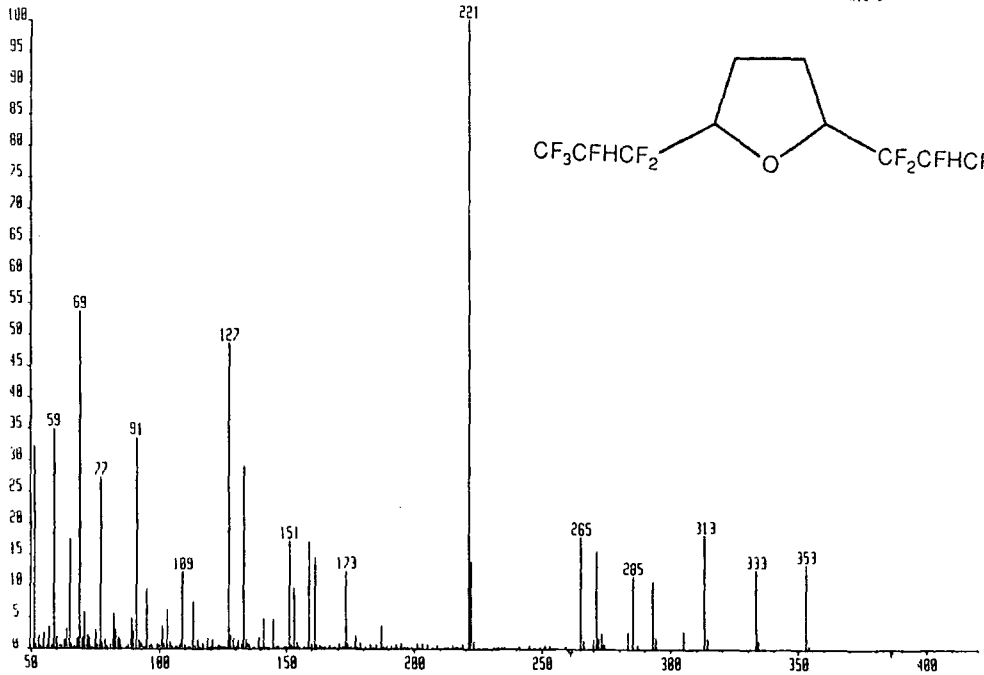
Mass	% Base		
51.12	10.83	105.12	26.66
52.14	0.92	106.12	1.43
53.15	5.31	108.09	0.51
54.16	2.37	109.10	2.36
55.16	100.00	113.07	1.34
56.16	4.69	114.10	0.53
57.14	9.81	115.10	0.80
58.14	8.76	117.11	2.64
59.13	11.93	119.06	0.43
60.13	3.73	121.08	2.44
61.14	2.12	123.10	0.66
63.11	4.21	127.09	4.29
64.10	1.39	128.10	0.41
65.10	9.61	129.09	0.41
66.12	0.57	133.09	0.33
67.13	3.09	135.12	0.55
69.06	12.64	139.10	0.79
69.14	5.81	140.10	4.50
70.10	0.75	141.11	2.57
71.09	1.47	145.10	1.34
72.10	0.34	147.13	1.63
73.11	2.27	149.13	0.34
75.06	1.79	151.09	0.91
76.07	0.71	153.12	0.33
77.08	30.73	159.11	3.78
78.08	1.15	160.12	0.66
79.09	0.60	167.15	4.23
81.07	0.34	168.15	0.43
82.06	1.62	171.12	0.32
83.09	3.45	172.13	0.33
84.09	0.72	173.14	0.56
85.11	10.49	186.15	2.87
86.11	0.85	187.16	2.71
87.11	0.85	197.14	1.81
88.07	0.56	206.14	0.33
89.08	2.00	215.16	2.27
90.08	1.81	217.16	0.60
91.09	2.58	234.21	1.21
95.08	2.58	235.15	83.16
96.09	0.37	236.16	26.96
97.10	1.17	237.16	2.08
98.11	0.37		
101.08	1.84		
103.10	3.47		
104.10	0.80		

5. 2,5-bis-hexafluoropropylloxolane (5)

RF1000476 x1 Bgd:465 22-NOV-89 15 3-0 06 42 78E
 BpA=0 l=10 Ha=371 TIC:413463008 Acnt
 FR3 0.1RSEC GC= 95°

EI-
 Sys FOOT
 Cal PFK15HOW
 *x10⁻⁶

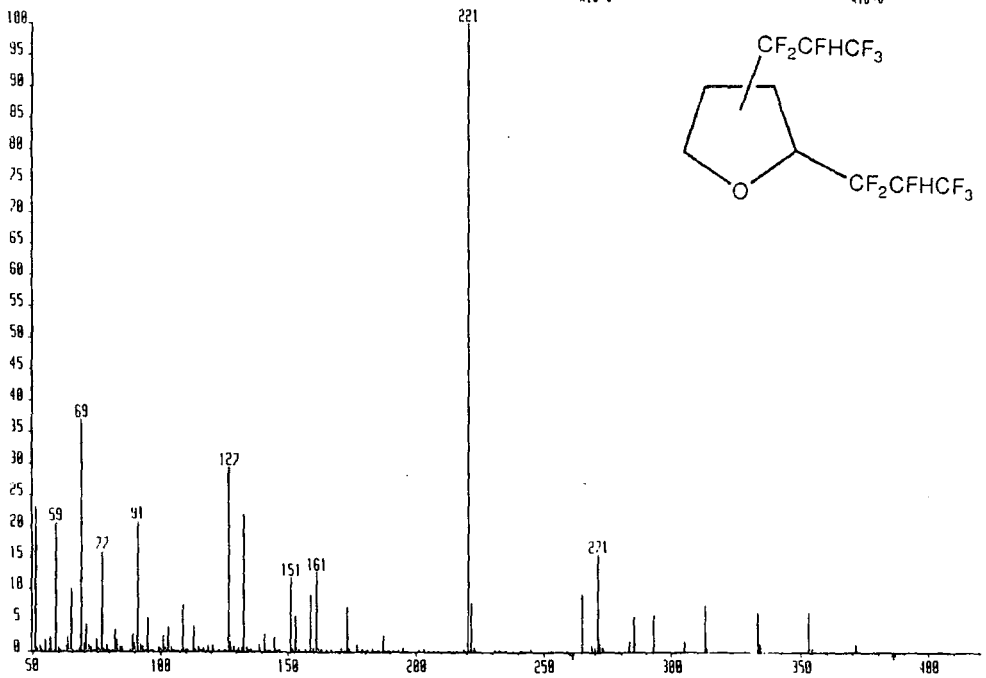
NHR 655340U
 MASS 22
 x10⁻⁶



Mass	% Base	100.02	0.51	221.10	100.00	FO
51.01	32.15	101.03	3.55	222.07	13.82	F
52.03	0.57	102.04	0.82	223.07	1.04	
53.05	1.95	103.05	6.00	245.04	0.51	
55.03	2.44	104.06	1.06	251.07	0.40	
56.03	0.53	108.03	0.63	253.06	0.35	
57.02	3.37	109.04	11.98	254.12	0.05	
59.04	34.89	113.02	7.50	259.05	0.11	
60.04	1.75	115.04	1.35	265.05	1.77	
63.02	1.36	117.03	0.71	266.05	0.13	
64.02	3.07	119.04	1.47	267.12	0.03	
65.03	17.32	121.04	1.37	270.07	0.15	
66.03	0.53	123.05	0.50	271.06	1.54	
68.03	1.49	127.04	48.51	272.05	0.14	
69.00	53.61	128.04	2.00	273.05	0.25	
70.03	1.72	129.02	1.54	274.09	0.06	
71.03	5.83	131.02	1.21	274.48	0.06	
72.05	2.19	132.02	0.66	274.68	0.03	
73.04	1.61	133.04	28.91	274.99	0.03	
75.01	2.89	134.04	1.31	283.10	0.25	
76.02	0.54	134.34	0.74	285.06	1.13	
77.03	27.14	135.39	0.59	286.09	0.04	
78.03	0.90	139.04	1.61	287.05	0.06	
79.02	1.38	141.01	4.70	292.68	0.03	
81.03	0.58	145.03	4.60	293.05	1.06	
82.01	5.43	151.01	17.03	294.07	0.17	
83.03	2.89	153.05	9.35	294.42	0.03	
84.05	1.66	154.04	0.84	303.13	0.04	
85.05	1.31	159.04	16.99	305.06	0.28	
88.03	0.64	160.05	0.79	313.06	1.80	
89.03	4.65	161.02	14.41	314.07	0.16	
90.04	2.55	162.03	0.60	333.07	1.24	
91.04	33.56	171.05	0.72	334.07	0.12	
92.05	1.33	173.05	12.05	353.07	1.33	
93.02	0.94	174.06	0.78	354.06	0.05	
95.02	9.34	177.04	1.98	355.14	0.03	
97.04	0.56	179.04	0.85	371.12	0.03	
99.04	0.83	183.04	0.53			
		185.06	0.63			
		187.04	3.68			

6. 2,x-bis-hexafluoropropylloxolane (6)(7)

RF10000514* x1 Bgd=511 22-NOV-89 15 3-8 07 14 78E E1-
 OpA=0 I=6.6v Ha=371 TIC=186248000 Acnt Sys FOOT HHR 4309
 RA3 0.1RSEC GC= 181^o Cal PFK15HOW *x10⁻⁶ RASS



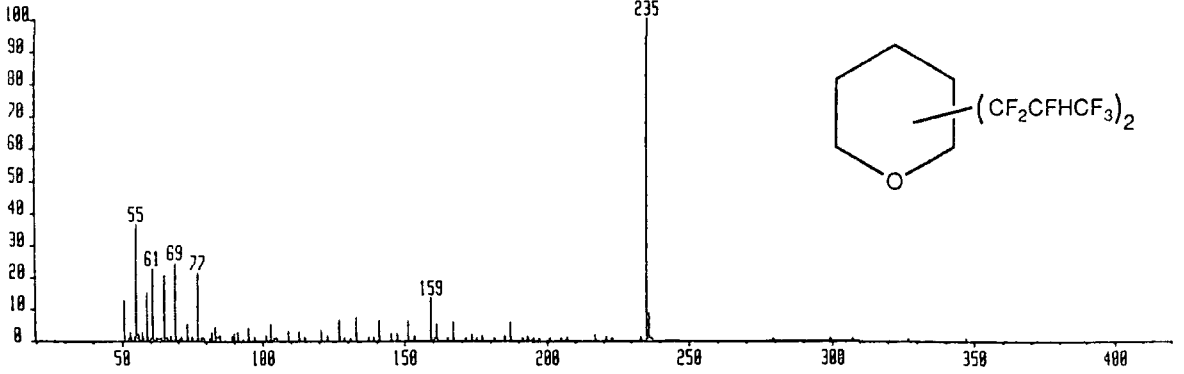
Mass	% Base	115.04	0.85	221.05	100.00
51.01	23.08	117.03	0.53	222.06	7.69
53.04	0.95	119.04	1.11	223.05	0.54
55.02	1.83	121.04	1.03	251.04	0.05
57.02	2.23	127.03	29.28	253.07	0.18
59.03	20.41	128.03	1.45	259.07	0.09
60.03	0.65	129.02	0.71	265.05	0.91
63.01	0.93	131.01	0.66	269.02	0.08
64.02	2.22	132.02	0.54	270.10	0.06
65.02	9.96	133.03	21.93	271.06	1.55
68.03	0.68	134.03	0.82	272.08	0.12
69.00	36.83	139.03	1.00	273.07	0.07
70.03	1.15	141.01	2.70	283.11	0.17
71.03	4.26	145.01	2.27	285.06	0.55
72.04	1.01	151.00	11.59	293.05	0.59
73.04	0.76	153.04	5.65	305.09	0.16
75.01	1.94	159.03	8.92	313.05	0.75
77.02	15.84	160.04	0.51	313.99	0.06
79.02	1.08	161.01	12.53	314.15	0.04
82.01	3.53	162.02	0.52	333.05	0.64
83.03	1.87	173.05	7.15	334.06	0.12
84.04	0.83	177.03	1.12	353.07	0.63
85.06	0.72	179.04	0.52	354.12	0.08
89.03	2.67	187.03	2.60	371.11	0.11
90.03	1.55	195.02	0.55		
91.04	20.83				
92.05	1.01				
93.02	0.81				
95.02	5.24				
99.03	0.60				
101.03	2.44				
102.04	0.54				
103.05	3.83				
104.05	0.73				
109.03	7.39				
113.01	4.10				

7. x,y-bis-hexafluoropropylxane (8)(9)(10)(11)(12)(13)

RF1310581e x1 Bgd=576 16-MAY-89 11:40:07:17 78E
 SpA=0 I=3.8v Ha=384 TIC=107066000

Acnt: EI+
 GC= 114° Sys: FOOT
 Cal: PFK104

HAR: 24640000
 RAS: 235

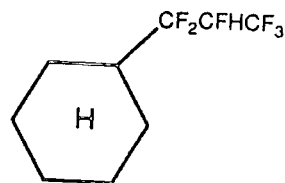
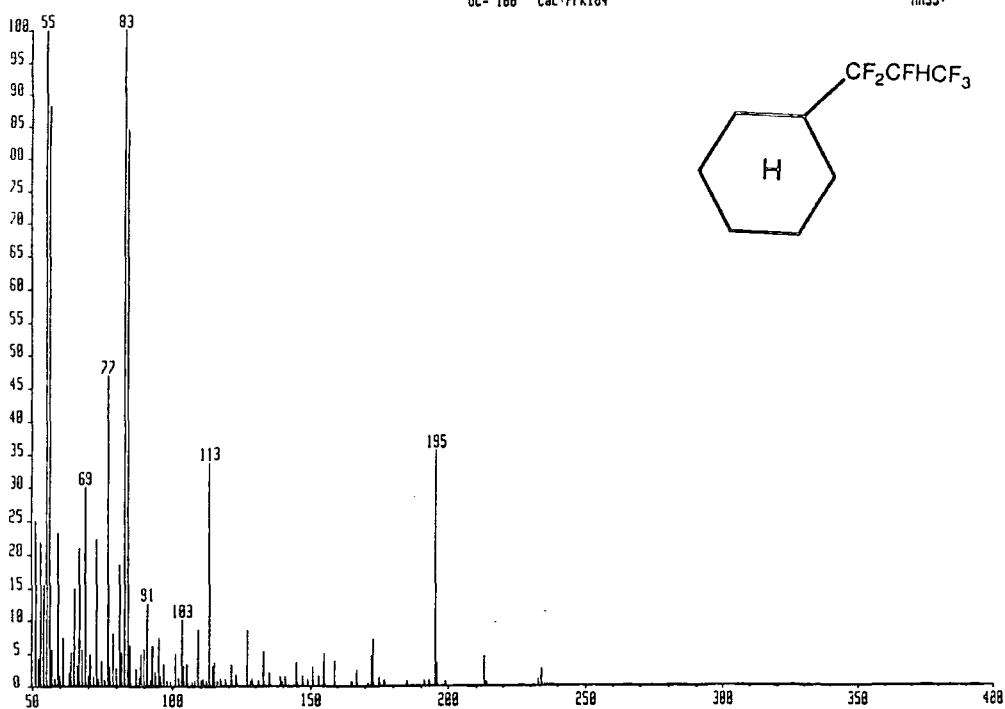


Mass	% Base	235.52	0.15
172.13	0.41	235.61	0.12
173.13	1.75	236.15	0.51
175.12	0.85	237.15	0.74
177.13	1.49	239.09	0.12
178.14	0.15	247.15	0.15
179.07	0.13	259.15	0.35
179.14	0.22	267.17	0.35
181.13	0.87	279.17	0.67
183.14	0.22	285.12	0.12
185.14	1.36	285.17	0.11
186.14	0.27	287.16	0.35
187.16	5.54	299.17	0.54
188.16	0.38	307.17	0.87
189.13	0.15	327.17	0.89
191.13	0.72	329.19	0.18
193.12	1.03	347.18	0.79
195.14	0.84	367.17	0.14
196.15	0.14	384.09	0.14
196.85	0.15		
197.13	0.87		
199.15	0.22		
200.18	0.11		
200.45	0.22		
200.72	0.19		
201.13	0.61		
203.14	0.27		
205.14	0.74		
206.19	0.12		
207.12	0.92		
209.13	0.22		
215.15	0.45		
217.15	1.98		
218.18	0.19		
219.15	0.35		
221.15	0.91		
223.16	0.54		
227.14	0.15		
233.14	0.53		
233.92	0.12		
234.13	0.32		
235.15	100.00		

8. 1,1,2,3,3,3-hexafluoropropylcyclohexane (17)

RF1261563 x1 Bgd=547 24-APR-89 13:30:07:09 70E EI+
 OpA=0 I=10v Ha=234 TIC=634384000 Acnt: Sys:FOOT
 GC=100° Cal:PFK184

HHR: 65534000
 MASS: 03



Mass	% Base	81.93	3.26 F	193.47	0.06
51.05	24.87	82.01	5.02 F	193.51	0.05
52.07	4.16	82.90	4.79 F	193.68	0.04
53.07	21.81	83.06	100.00 FO	193.76	0.06
54.07	15.36 F	84.02	84.51 F	193.97	0.15
55.00	3.93 F	85.00	6.05	194.96	35.35
55.07	100.00 O	86.99	2.59	195.42	0.06
56.08	88.22	87.96	1.19	195.44	0.04
57.04	5.46 F	88.96	4.74	195.49	0.07
57.09	3.72 F	89.97	5.66	195.71	0.11
58.04	1.05	90.98	12.61	195.97	3.40
59.04	23.12	93.00	6.05	196.95	0.21
60.04	1.54	94.00	2.13	198.94	0.53
61.05	7.22	94.95	7.28	199.99	0.07
63.02	1.93	95.99	1.52	203.90	0.09
64.01	5.11	96.98	3.24	204.91	0.29
65.01	14.84	100.95	4.84	205.87	0.06
66.03	3.05	101.96	1.13	210.90	0.04
67.03	20.93	102.59	0.05	212.26	0.02
68.03	5.48	102.70	0.05	212.70	0.05
68.97	29.90 F	102.75	0.05	212.94	4.41
69.04	5.15 F	102.76	0.05	213.94	0.64
69.99	1.51	102.86	0.12	214.87	0.04
70.99	4.71	102.97	10.13	214.94	0.11
72.00	1.32	108.96	8.66	216.91	0.12
73.00	22.21	109.97	0.95	217.96	0.05
74.00	1.08	110.89	0.05	230.93	0.12
74.97	3.75	110.99	1.01	232.94	1.01
76.97	46.88	113.00	33.70	233.95	2.59
77.98	2.88			234.96	0.18
79.00	7.93				

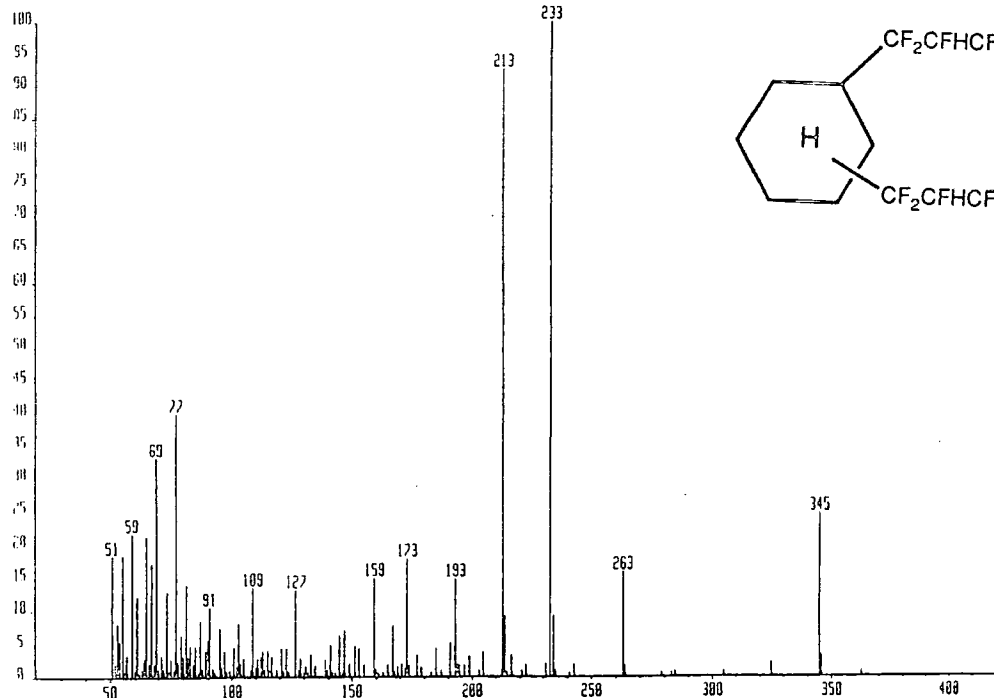
9. 1,x-bis-(1,1,2,3,3,3-hexafluoropropyl)cyclohexane (x= 2,3,4) (18)

(19) (20)

PF12431406 x1 0gd=399 21-APR-89 12 1-0 05-06 78E
 UpN-U 1=6.0v Ha=300 TIC=370406016

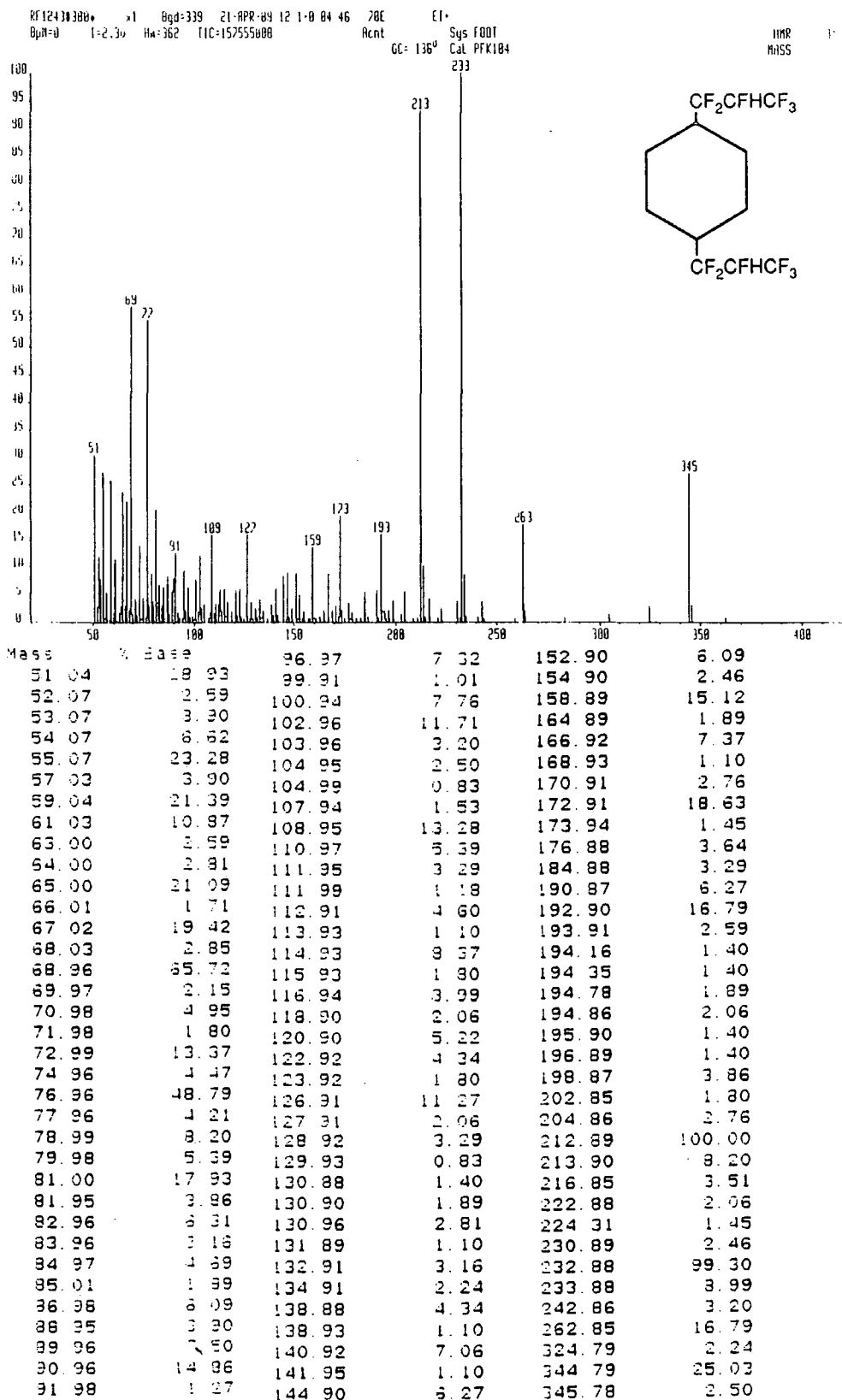
GC= 140° E1-
 Sys:FOOT
 Cal:PFK104

HMR: 44000000
 MASS: 233



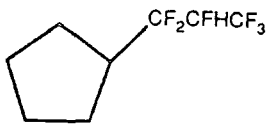
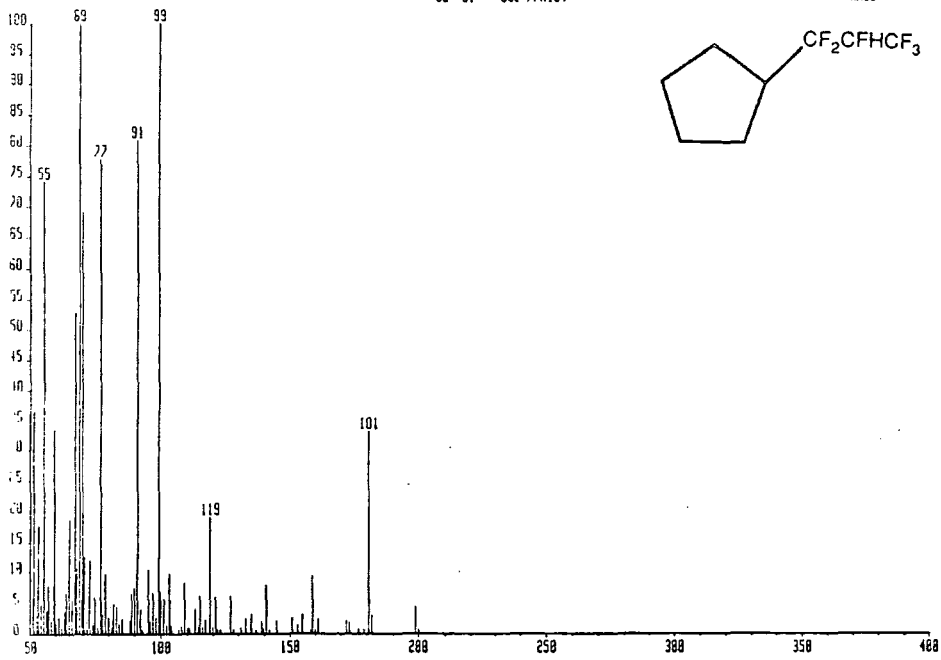
Mass	% Base				
51.04	18.20	86.99	8.51	192.92	14.68
52.06	1.88	87.95	1.23	212.92	92.65 F
53.07	8.02	88.95	3.85	213.92	8.98
54.07	5.32	89.96	5.42	214.91	0.52
55.08	18.39	90.97	10.39	215.98	0.08
57.03	3.24	91.98	1.18	216.23	0.05
59.04	21.56	94.94	7.20	216.90	3.29
61.05	12.01	95.96	1.27	217.90	0.26
63.01	1.02	96.97	3.86	218.91	0.35
64.00	2.70	100.94	4.46	220.87	0.94
65.01	21.13	101.82	0.08	221.86	0.10
66.02	1.85	101.84	0.08	222.90	1.77
67.03	17.10	101.95	1.53	232.69	1.29 F
68.03	1.81	102.85	0.13	232.92	100.00 F
68.96	33.06	102.96	8.07	233.49	0.07
70.99	3.08	103.45	0.07	233.57	0.08
71.99	1.01	103.87	0.07	233.67	0.15
73.00	12.78	103.96	1.93	233.92	9.24
74.96	2.53	104.46	0.05	233.92	
76.96	39.83	104.97	2.60	262.88	15.65
77.98	2.16	105.95	0.15	344.82	24.50
78.99	6.24	106.94	0.36	345.51	0.10
80.00	3.02	107.00	0.07	345.82	3.16
81.00	13.73	107.94	0.83	346.80	0.10
81.93	2.94	108.84	0.16	362.79	0.85
82.01	1.82	108.95	13.27	363.77	0.20
82.96	4.58	126.91	13.03	364.79	0.11
83.97	1.81	158.91	14.82	380.77	0.15
84.97	4.53	172.93	17.72		

10. 1,4-bis-(1,1,2,3,3,3-hexafluoropropyl)cyclohexane (20)



11. 1,1,2,3,3,3-hexafluoropropylcyclopentane (21)

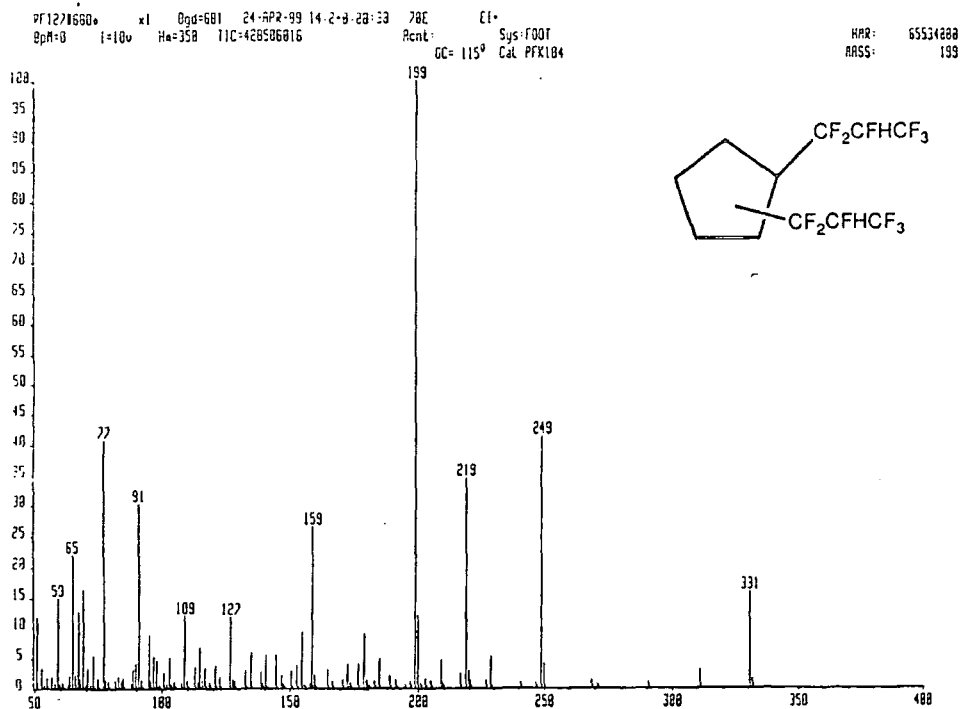
PF1271422* x1 89d=402 24-APR-89 14:20:85:17 70E C1-
 Op1=0 1=10v Hn=210 TIC=665321824 Acnt: Sys=FOOT
 GC= 81⁹ Cal=PFK184 HR: 65534888
 RAS: 99



Mass	% Base		
87.97			2.02
51.06	36.44		6.59
52.03	2.97		7.52
53.09	17.68		80.69
54.09	4.71		3.98
55.09	74.09		10.35
56.09	3.65		1.89
57.05	7.84		6.61
58.05	2.05		2.56 F
59.06	33.48		100.00 FO
60.06	1.65	100.01	6.86
61.06	2.67	118.99	18.91
63.03	3.52	180.98	33.06
64.02	6.65	181.32	0.05
65.03	18.65	181.35	0.04
66.05	5.45	181.42	0.07
67.05	52.77	181.53	0.07
68.04	10.62 F	181.65	0.06
69.09	100.00 FO	182.00	2.96
70.05	69.08	183.01	0.09
71.02	12.58	184.96	0.29
72.02	1.91	190.93	0.07
73.02	12.03	191.94	0.18
74.02	1.28	196.93	0.12
74.98	5.98	198.96	4.23
75.99	1.08	199.97	0.54
76.99	77.64	200.97	0.15
78.00	3.09	204.96	0.12
79.02	9.71	216.95	0.05
80.02	2.70	216.98	0.05
81.95	4.84 F	218.97	0.15
82.98	4.45 F		
84.00	1.58		
85.01	2.36		

12. 1,x-bis-(1,1,2,3,3,3-hexafluoropropyl)cyclopentane (x= 2,3)

(22) (23)

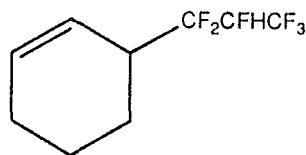
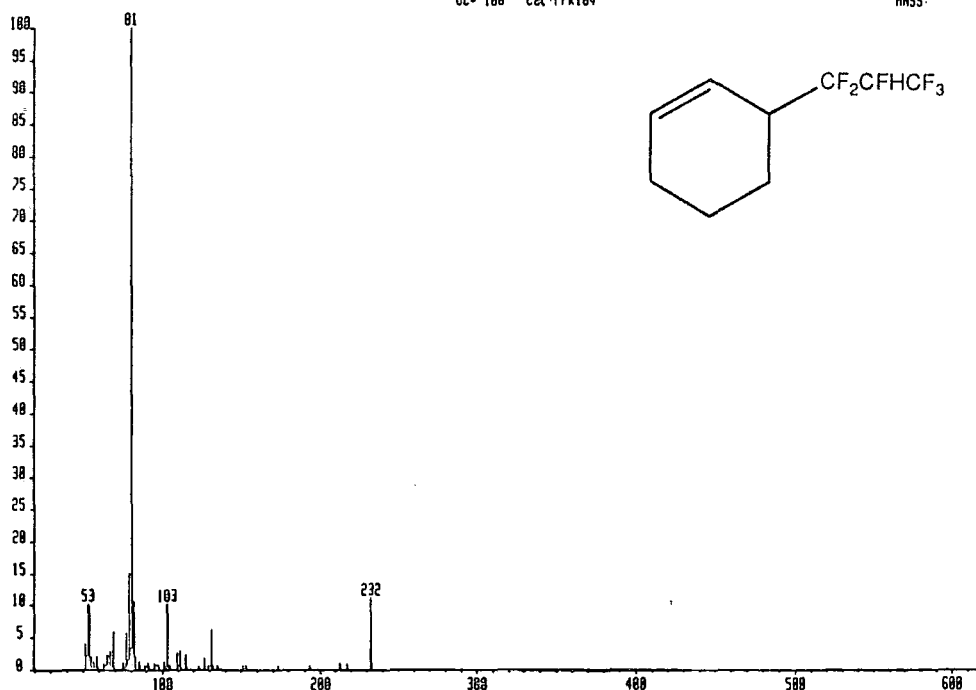


Mass	% Base	Mass	% Base
51.05	11.64	101.97	0.68
53.08	3.24	102.88	0.05
55.09	1.63	102.98	5.07
57.05	1.90	103.98	0.52
59.05	14.80	104.99	1.09
64.02	2.09	105.99	0.13
65.02	22.00	106.96	0.23
66.04	2.27	107.96	0.69
67.04	12.56	108.85	0.10
68.05	1.47	108.97	11.79
68.98	16.37	126.94	11.77
71.00	3.33	158.94	26.41
73.01	5.52	198.76	1.35 F
74.97	1.68	198.95	100.00 FO
76.98	40.68	199.49	0.09
77.99	1.37	199.73	0.19
79.00	1.02	199.95	11.92
81.96	1.38	218.94	34.31 F
82.98	1.91	248.92	41.17
83.98	1.10	330.90	15.77
84.99	1.70	331.17	0.04
88.97	3.10	331.90	1.54
89.98	4.16	332.89	0.11
90.98	30.29	348.86	0.40
91.99	1.32	350.85	0.05
94.96	8.79		
95.98	1.12		
96.99	5.22		
98.00	4.58		
100.97	2.53		

13. 3-(1,1,2,3,3,3-hexafluoropropyl)cyclohex-1-ene (24)

RF13205670 xl Bgd=551 4-MAY-89 08:50:07:86 78E E1+
 BpA=0 l=10v Ha=233 TIC=167613088 Acnt: GC= 100° Sys:FOOT
 Cal: PFK104

HRR: 65534088
 RNS: 81

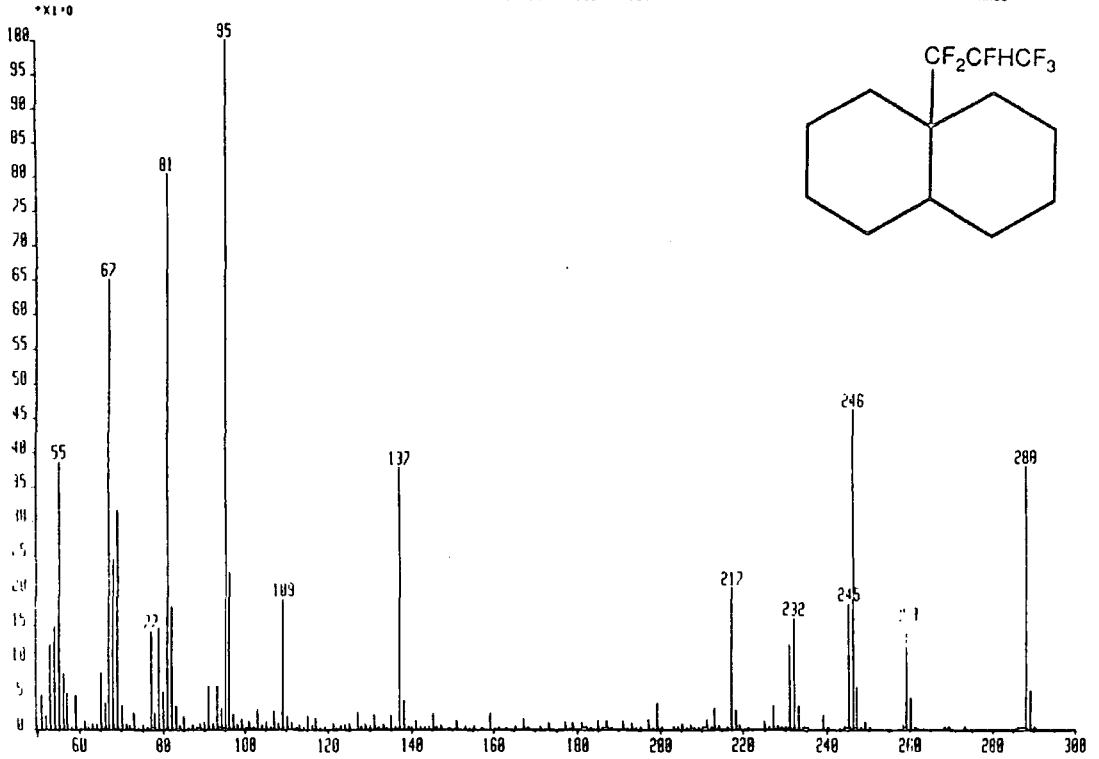


Mass	% Base			
51.11	3.02	F	204.07	0.40
51.13	3.93	F	211.09	0.07
52.13	2.11		212.10	0.09
53.14	10.07		213.11	1.03
54.14	9.71		214.12	0.07
55.15	1.90		217.08	0.94
57.11	1.20		218.09	0.10
59.11	1.89		231.09	0.39
65.10	2.27		231.88	0.07
66.11	1.91		232.09	11.10
67.11	2.78		233.09	1.03
69.05	5.82			
77.06	5.69			
78.08	1.53			
79.09	14.89			
80.09	3.22			
81.03	1.42			
81.10	100.00	O		
82.10	10.58			
83.06	1.93			
85.08	1.21			
101.06	1.15			
103.07	10.03			
109.08	2.50			
111.10	2.85			
115.07	2.20			
127.06	1.85			
131.09	6.01			

14. 9-(1,1,2,3,3,3-hexafluoro)decalin (25)

RF144018280 x1 8gd=1019 17-ARY-89 10:3:0:12:54 78E EI+
 Bp#=# I=4.8v No=290 TIC=230140888 Acnt: Sys=FOOT
 GC= 167^o Cat: PFK104

HAR: 2651580
 MASS: 9

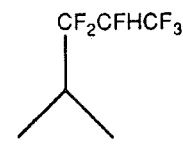
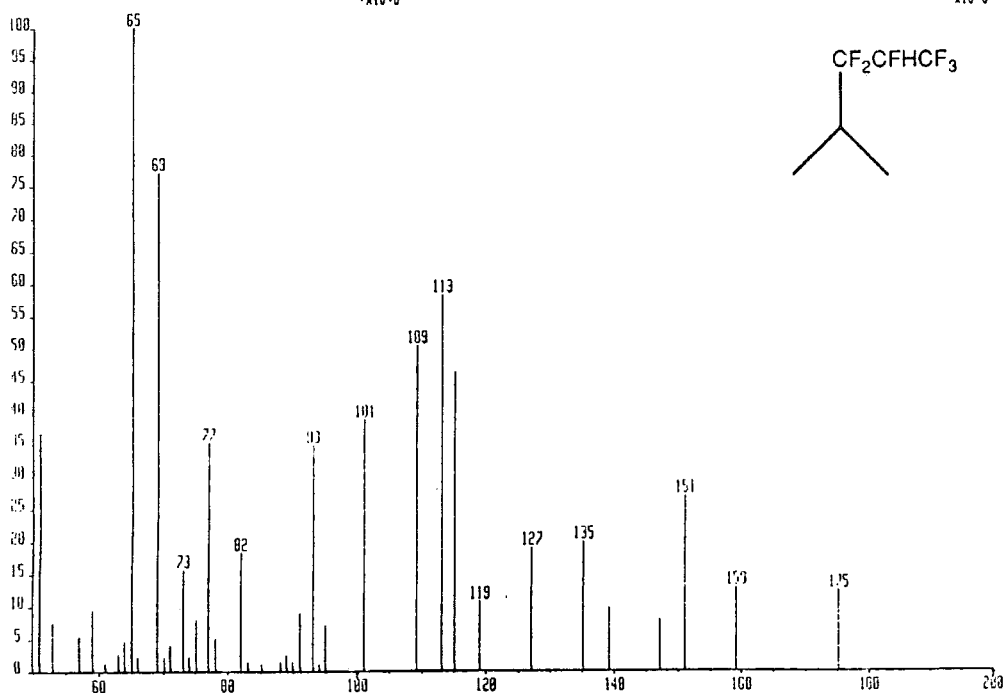


Mass	% Base	109.19	18.70	211.20	1.40
51.14	4.79	110.18	1.88	213.21	3.02
52.16	2.04	111.16	0.87	214.20	0.45
53.17	12.13	113.12	0.69	216.18	0.31
54.17	14.75	114.13	0.31	217.19	20.27
55.18	38.68	115.13	2.01	219.21	2.66
56.18	8.08	116.13	0.63	219.22	0.57
57.16	5.09	117.14	1.61	225.23	1.09
58.19	0.30			227.24	3.28
59.15	4.79	119.14	0.35	228.26	0.38
60.16	0.31	121.12	0.84	230.21	0.35
61.16	1.17	123.14	0.63	231.22	12.00
63.13	0.81	124.16	0.75	232.22	15.91
64.12	0.79	125.16	0.84	233.23	3.30
65.13	8.21	127.12	2.49	239.23	1.93
66.14	3.93	128.13	0.51	244.21	0.45
67.14	64.96	129.14	0.69	245.21	18.09
68.15	24.59	130.16	0.42	246.22	46.28
69.08	7.37	131.15	2.18	247.23	6.12
69.16	31.46	132.15	0.31	248.24	0.32
70.16	3.27	133.13	0.69		
71.15	0.82	135.20	1.92	259.25	15.21
72.12	0.45	137.24	37.74	260.26	4.43
73.13	2.44	138.24	4.05	261.26	0.35
75.10	0.60	139.17	0.30	268.30	0.30
77.11	14.12	141.16	1.15	269.29	0.32
78.12	2.50	144.18	2.26	273.29	0.43
79.13	14.55	147.19	0.63	287.32	0.32
80.13	5.44	151.12	1.23	288.30	38.03
81.14	80.44	153.15	0.49	289.31	5.51
82.15	17.76	155.17	0.55	290.29	0.35
83.14	3.27	159.15	2.26		
84.13	0.55	165.16	0.43		
85.12	1.78	167.23	1.53		
87.14	0.67	171.16	0.38		
89.10	0.91	173.18	0.93		
90.11	1.11	177.17	0.99		
91.13	6.24	179.18	0.91		
92.14	0.91	181.20	0.91		
93.15	6.22	185.19	1.23		
93.65	0.32	187.24	1.23		
94.16	3.13	191.19	1.03		
95.17	100.00	193.20	0.87		
96.17	12.59	197.18	1.35		
97.16	1.11	199.20	3.85		

15. 4-methyl-1,1,1,2,3,3-hexafluoropentane (26)

RF163V1162* x1 Dgd=155 21-JUN-89 10:30:02:01 78C C1+
 Opn=0 I=346aw Hn=175 TIC=9669000 Rent: Sys:FOOT
 FA3 0.1RSEC GC= 49° Cal:PK156

HPR: 2263000
 MASS 65
 x10.0



Mass	% Base		
50.99	36.67	94.15	1.01
53.03	7.40	95.10	7.01
57.02	5.24	101.11	3.88
59.04	9.34	109.14	5.02
61.07	1.23	113.10	5.82
63.03	2.56	115.14	4.63
64.04	4.50	119.13	1.06
65.05	100.00	127.14	1.90
66.06	2.07	135.17	1.98
69.04	77.08	139.15	0.97
70.06	1.98	147.18	0.79
71.08	3.88	151.15	2.69
73.11	15.65	159.19	1.28
74.11	2.12	175.26	1.23
75.06	7.84		
77.08	35.13		
78.09	5.07		
82.08	18.11		
83.10	1.41		
85.12	0.93		
88.10	1.32		
89.10	2.38		
90.11	1.37		
91.12	8.95		
93.14	34.64		

16. 1,1,1,2,3,3-hexafluorohexane (27)

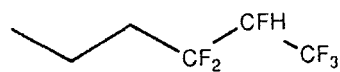
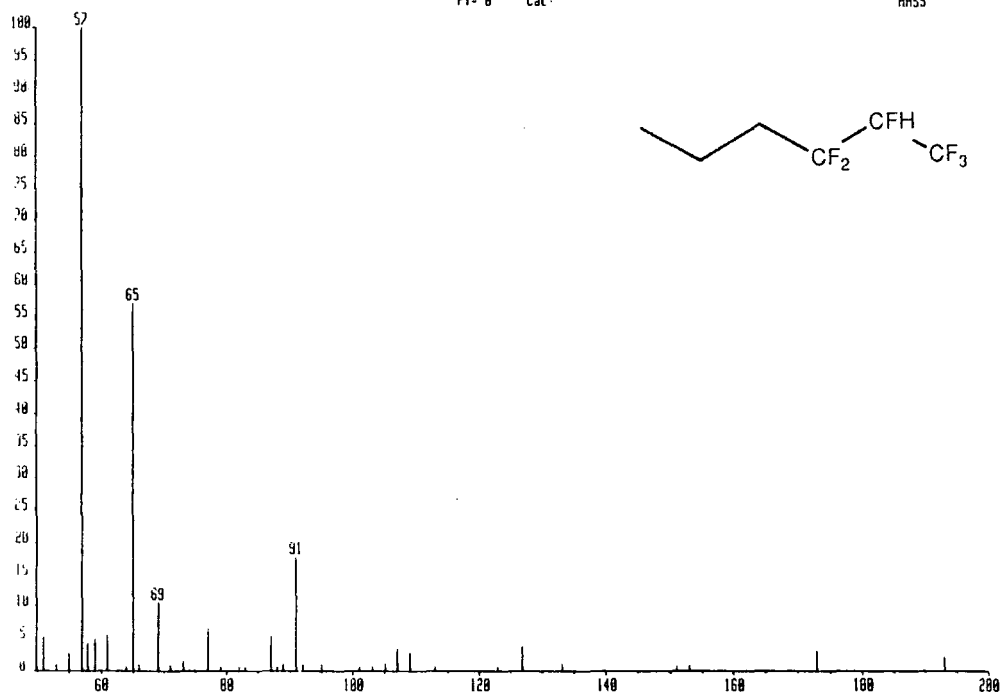
RI 63V111 x1000 0g0-1
 OpR=0 I=10v Ha=194 TIC:254161

-0 00 00

Acnt Sys
 Pf= 0° Cat

HRR
 HRSS

65514
 57

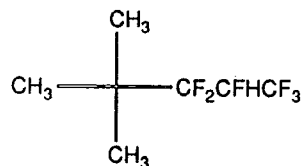
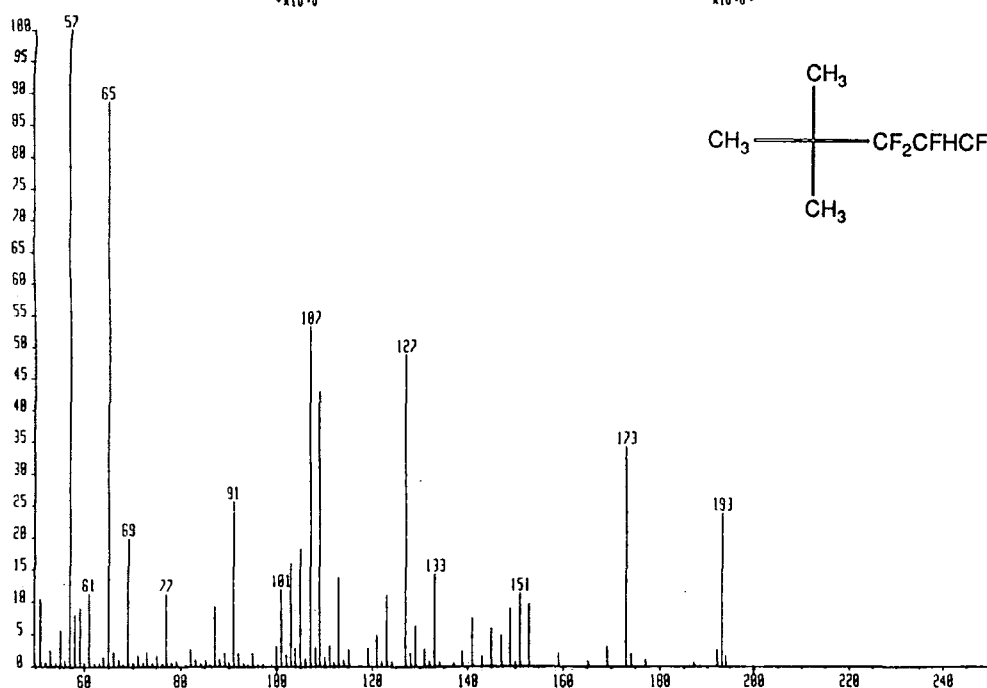


Mass	% Base	77.03	6.59
27.03	5.90	79.05	0.58
28.02	2.18	82.01	0.58
29.05	30.43	83.04	0.50
32.00	0.63	87.07	5.34
39.03	8.45	88.06	0.53
40.04	1.02	89.03	1.10
41.05	40.95	91.04	17.78
42.05	1.91	92.05	1.02
43.06	2.06	95.02	1.22
47.04	41.74	101.03	0.59
48.04	0.69	103.05	0.96
51.02	5.31	105.06	0.98
53.05	1.04	107.08	3.38
55.07	2.79	109.03	2.75
57.00	100.00	113.01	0.80
58.08	4.14	123.06	0.50
59.04	4.96	127.02	3.64
61.06	5.53	133.03	0.97
64.02	0.54	151.01	0.53
65.03	57.07	153.03	0.67
66.04	1.06	173.04	2.89
69.01	10.51	193.04	2.11
71.04	0.75		
73.06	1.39		
77.02	0.77		

17. 4,4-dimethyl-1,1,1,2,3,3-hexafluoropentane (34)

RF15401926 x1 8gd=185 6-JUN-89 14:28 82:24 78E E1+
 BpR=8 I=18v Ha=194 TIC=242582888 Rcnt: Sys FOOT
 GC= 63° Cal: PFK184

HRR 65534888
 ARSS 57

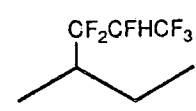
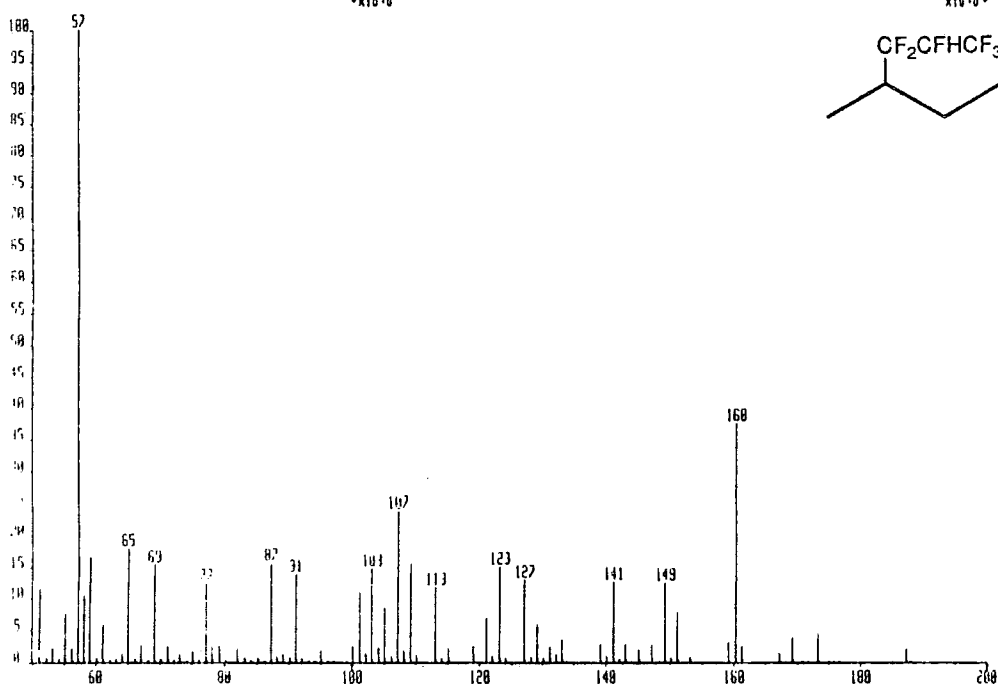


Mass	% Base				
51.13	10.27	83.08	0.94	141.13	0.74
52.14	0.47	84.09	0.36	145.10	0.57
53.15	2.43	85.10	0.76	147.12	0.47
54.16	0.33	87.12	9.08	149.16	0.89
55.16	5.51	88.11	0.99	151.10	1.12
56.16	0.98	89.08	1.91	153.13	0.96
57.19	100.00	90.09	0.64	159.12	0.20
58.18	7.94	91.10	25.54	169.18	0.30
59.13	8.97	92.10	2.04	173.16	3.40
60.13	0.47	93.07	0.32	174.16	0.20
61.14	11.28	95.08	1.93	192.16	0.24
62.13	0.36	100.06	0.30	193.17	2.38
63.10	0.49	101.08	1.18		
64.10	1.42	103.11	1.60		
65.11	88.68	104.11	0.27		
66.10	2.09	105.13	1.82		
67.13	0.89	107.14	5.33		
69.06	19.84	108.13	0.29		
70.08	0.40	109.10	4.28		
71.10	1.69	111.12	0.30		
72.10	0.41	113.08	1.36		
73.11	2.16	115.10	0.24		
74.11	0.25	119.07	0.28		
75.07	1.71	121.09	0.47		
76.08	0.30	123.10	1.08		
77.08	11.04	127.09	4.88		
78.08	0.45	129.11	0.62		
79.09	0.78	131.06	0.26		
81.06	0.20	133.10	1.43		
82.06	2.58	139.11	0.23		

18. 4-methyl-1,1,1,2,3,3-hexafluorohexane (28)

RF1561218* x1 Bgd=202 6-JUN-89 11 4*8 02:37 20E C1+
 RpR=8 l=18u Ha=187 TIC=186632008 Rcont: Sys F001
 GC= 65° Cal PFK104

HHR 65534008
 RASS x10.0 57

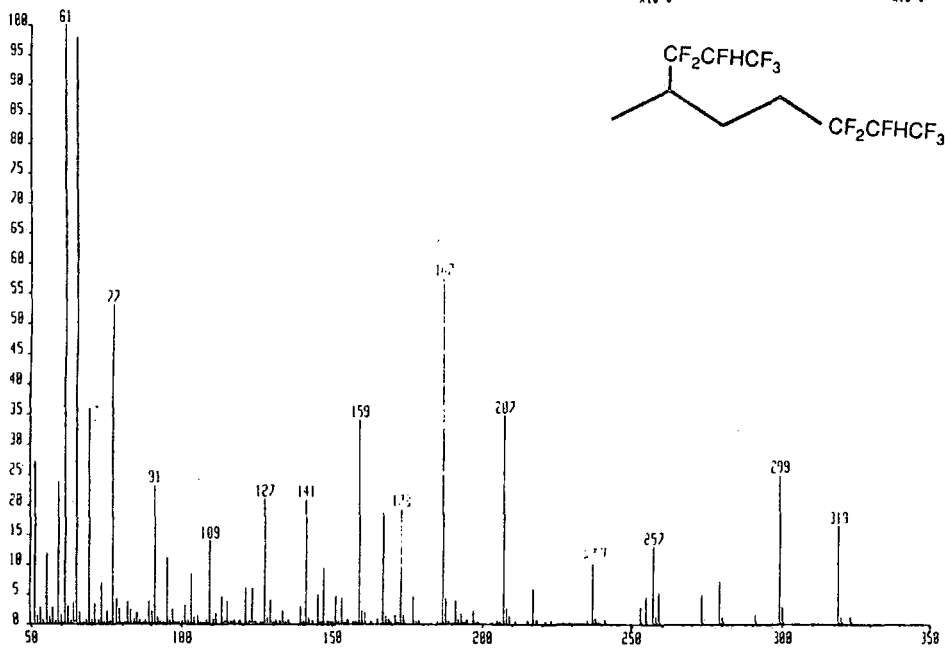


Mass	% Base				
51.16	11.65	97.17	15.61	151.17	0.78
52.18	0.57	88.16	0.89	159.20	0.30
53.19	2.05	89.14	1.19	160.21	3.74
54.20	0.39	90.15	0.79	161.22	0.24
55.20	7.57	91.15	13.73	169.25	0.38
56.21	2.19	92.16	0.66	173.23	0.44
57.23	100.00	93.12	0.20	187.26	0.20
58.22	10.34	95.13	1.75		
59.17	16.58	100.12	0.24		
60.18	0.68	101.14	1.08		
61.19	5.80	103.16	1.46		
63.15	0.46	104.17	0.23		
64.14	1.22	105.18	0.84		
65.15	17.90	107.20	2.38		
66.15	0.39	109.17	1.54		
67.18	2.58	113.14	1.17		
69.11	15.36	115.16	0.21		
70.13	0.42	119.14	0.24		
71.14	2.37	121.15	0.68		
72.15	0.35	123.17	1.50		
73.16	1.15	127.15	1.29		
75.12	1.68	129.18	0.57		
76.12	0.34	131.13	0.22		
77.13	12.23	133.17	0.35		
78.13	2.49	139.17	0.27		
79.14	2.46	141.19	1.25		
92.11	2.11	143.21	0.28		
93.13	0.71	145.18	0.20		
94.15	0.20	147.20	0.25		
95.15	0.74	149.23	1.25		

19. 4-methyl-1,1,1,2,3,3,7,7,8,9,9,9-dodecafluorononane (29)

RF15614330 x1 Bgd=419 6-JUN-89 11:40 05:25 JMC [1+
 BpH=0 I=3.0v Hn=323 TIC=200243000 Acnl Sys FOOT
 iC= 33° Cal: PFK104

HRR 24526000
 ARSS 61
 x10.0*

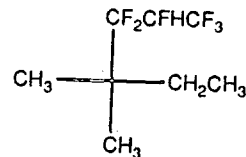
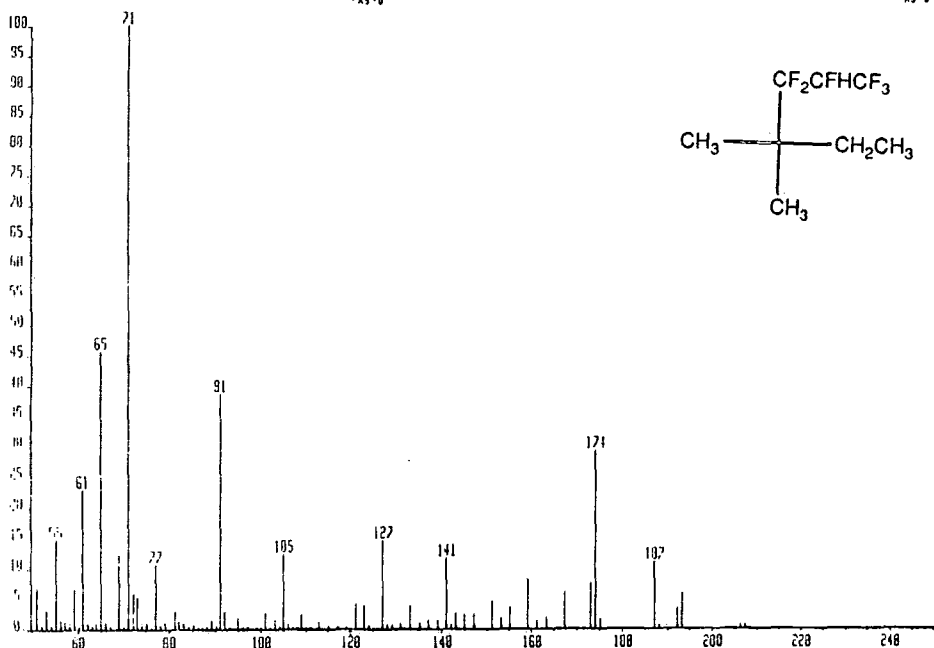


Mass	% Base	109.16	13.88	167.23	18.58
51.16	27.18	110.17	0.74	168.24	1.26
52.18	1.33	111.18	1.72	169.21	0.78
53.19	2.76	113.14	4.55	171.21	1.39
54.20	0.60	127.15	20.86	173.23	19.21
55.20	11.65	128.16	1.04	174.23	1.30
56.21	1.24	129.17	3.97	177.21	4.69
57.16	2.76	130.18	0.22	178.22	0.26
58.17	0.46	131.13	0.55	179.22	0.61
59.17	23.76	132.15	0.39	185.24	0.50
60.18	1.48	133.16	2.08	187.25	57.43
61.18	100.00	135.19	0.68	188.25	4.26
62.19	2.99	139.17	2.81	189.22	0.38
63.15	0.59	140.18	0.39	191.23	3.85
64.14	3.41	141.19	20.86	207.25	34.74
65.01	0.20	142.20	1.11	208.25	2.55
65.15	97.86	143.21	0.66	217.25	5.98
66.15	2.03	145.17	4.84	218.25	0.61
68.14	0.55	146.18	0.28	221.23	0.24
69.11	35.71	147.19	9.37	223.24	0.46
70.13	0.74	148.21	0.45	235.25	0.46
71.14	3.31	149.38	0.35	237.26	9.97
72.15	0.55	150.17	0.25	238.27	0.85
73.16	6.75	151.17	4.63	241.25	0.59
74.16	0.36	152.18	0.28	253.25	0.28
75.12	2.11	153.20	4.31	255.26	0.45
76.12	0.48	154.20	0.22	257.27	1.31
77.13	53.02	155.22	0.74	259.24	0.53
91.15	23.19	157.18	0.24	273.27	0.48
92.16	1.03	158.18	0.26	279.28	0.71
93.12	0.32	159.19	33.88	299.28	2.48
160.20		160.20	2.16		

20. 4,4-dimethyl-1,1,1,2,3,3-hexafluorohexane (30)

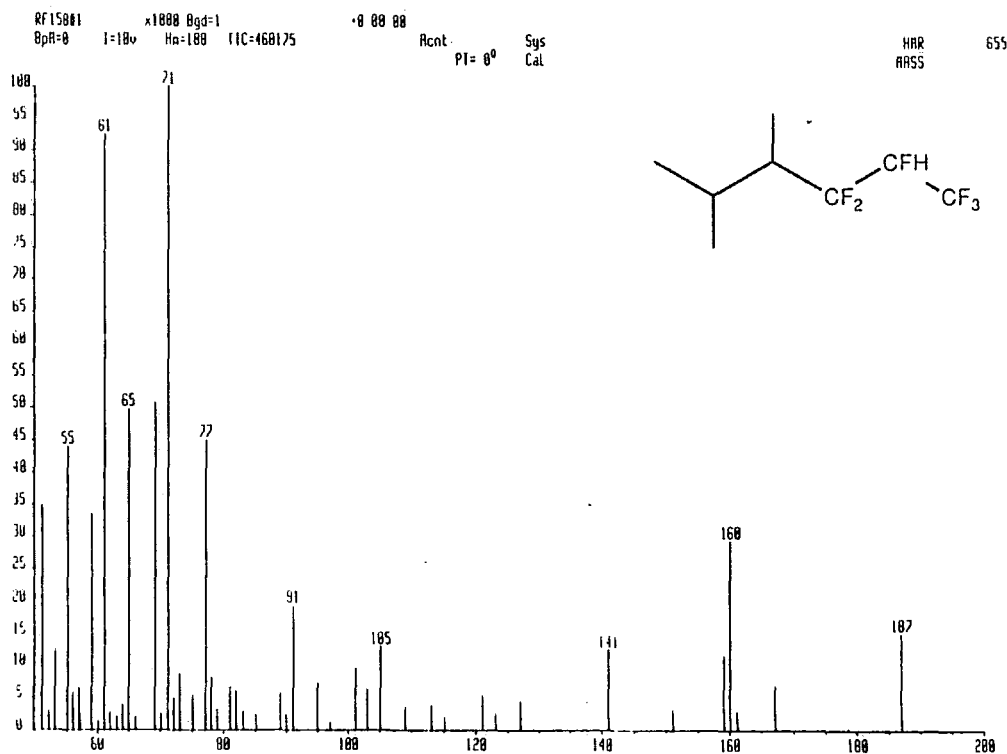
FF1504292+ x1 8gg=285 5-JUN-89 12:4:0:03:39 78C EI+
 Dgm=0 I=5.4u Ha=287 TIC=122782888 Acnt: GC= 75° Sys:FOOT Cal:PFK104

HRR: 35150888
 RASS: 71
 XS=0*



Mass	% Base				
51.15	6.65	82.09	1.16	143.17	0.48
52.16	0.53	83.11	0.87	145.13	0.46
53.17	3.03	84.12	0.35	147.15	0.45
54.18	0.49	85.13	0.73	151.12	0.92
55.19	14.66	87.14	0.22	153.15	0.34
56.19	1.30	88.10	0.31	155.17	0.70
57.16	1.34	89.11	1.35	159.15	1.65
58.15	0.25	90.11	0.49	161.17	0.25
59.15	6.55	91.12	38.67	163.20	0.36
60.16	0.33	92.13	2.87	167.18	1.19
61.16	22.92	95.10	1.71	173.18	1.50
62.16	0.73	97.13	0.32	174.19	5.78
63.13	0.34	101.15	2.55	175.19	0.32
64.12	0.95	102.15	0.21	187.19	2.18
65.13	45.61	103.13	1.46	192.18	0.66
66.13	1.12	104.14	0.30	193.19	1.16
67.15	0.34	105.15	12.31		
69.09	12.18	106.16	0.80		
69.16	1.03	109.13	2.39		
70.14	0.32	113.10	1.03		
71.18	100.00	115.12	0.39		
72.18	5.71	117.14	0.34		
73.13	5.08	119.12	0.21		
74.13	0.43	121.11	0.82		
75.11	0.83	123.13	0.77		
76.10	0.22	127.11	2.92		
77.10	10.54	133.13	0.75		
78.11	0.40	137.16	0.28		
79.12	1.04	139.13	0.28		
81.15	3.01	141.14	2.31		

21. 4,5-dimethyl-1,1,1,2,3,3-hexafluorohexane (31)

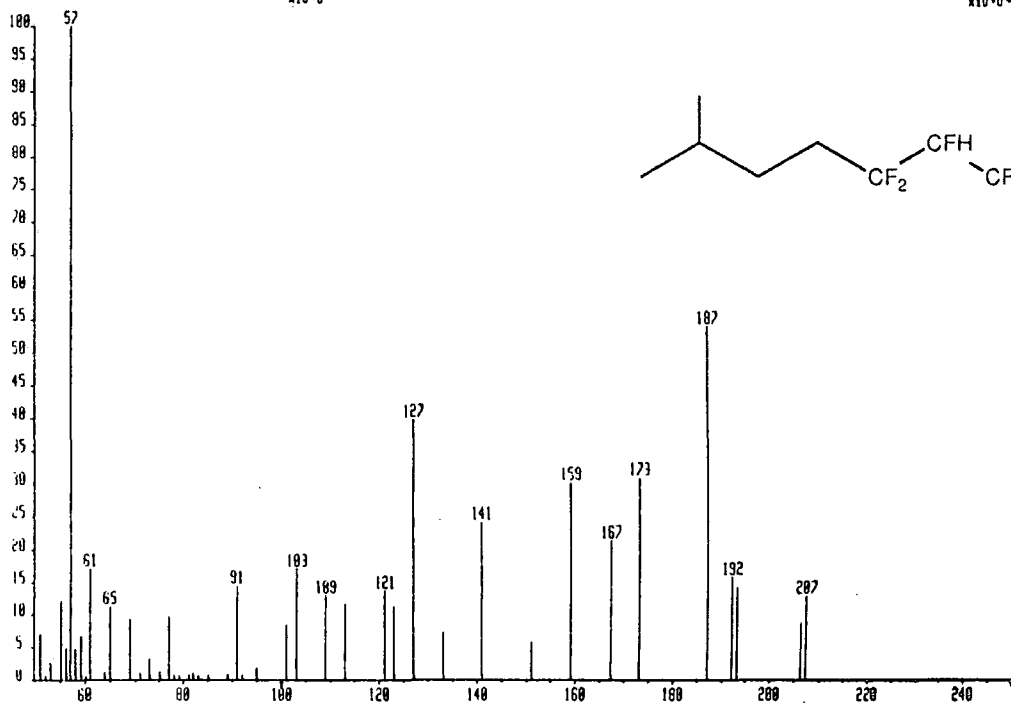


Mass	% Base		
51.14	34.78	31.14	6.69
52.17	2.89	82.09	5.97
53.17	12.48	83.10	2.83
55.18	44.06	85.12	2.41
56.19	5.85	89.10	5.85
57.14	6.45	90.11	2.41
57.19	1.99	91.12	19.35
57.20	2.41	95.10	7.23
59.15	33.57	97.10	1.14
60.15	1.39	101.15	9.46
61.16	92.59	103.13	6.27
62.16	2.71	105.14	12.96
63.13	1.99	109.13	3.56
64.12	3.92	113.10	3.92
65.12	49.73	115.12	1.99
66.13	1.99	121.11	5.30
69.09	50.81	121.17	1.63
70.16	2.35	123.12	2.53
71.17	100.00	127.11	4.40
72.15	4.88	141.14	12.48
73.13	8.62	151.12	3.13
75.09	5.36	159.14	11.51
77.10	44.98	160.15	29.48
78.11	8.26	161.15	2.83
79.11	3.07	167.17	6.81
		187.19	15.13

22. 6-methyl-1,1,1,2,3,3-hexafluoroheptane (32)

Kf1584258 v1 8pd=255 6-JUN-89 12:4:0.03:14 78C E1
 BpR=8 I=865w Ho=207 TIC=14289889 Acnt: Sys:FOOT Cal:PFK104

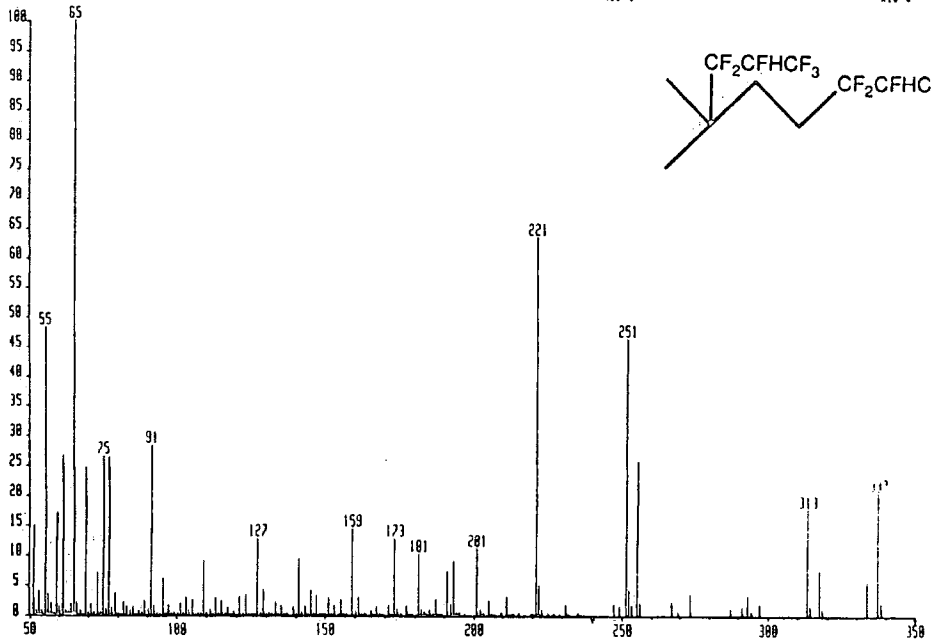
WGT: 56730
 MASS: *10.0*



Mass	% Base		
51.14	6.93	92.11	0.37
52.17	0.58	92.13	0.62
53.17	2.52	95.10	1.83
55.19	12.29	101.13	0.83
56.19	4.81	103.13	1.69
57.19	100.00	109.13	1.29
58.20	4.78	113.10	1.15
59.15	6.68	121.14	1.36
60.16	0.44	123.12	1.13
61.16	16.94	127.10	3.97
64.12	1.18	133.12	0.72
65.12	11.16	141.14	2.41
69.09	9.18	151.12	0.58
71.12	0.99	159.14	3.01
73.13	3.05	167.18	2.13
75.13	1.18	173.17	3.08
77.10	9.75	187.18	5.41
78.12	0.58	192.16	1.57
79.11	0.58	193.18	1.43
79.13	0.58	206.18	0.86
81.13	0.38	207.18	1.29
81.15	0.72		
82.08	0.86		
83.11	0.62		
83.12	0.44		
85.12	0.56		
89.10	0.65		
89.12	0.76		
91.12	14.33		

23. 4,4-dimethyl-1,1,1,2,3,3,7,7,8,9,9,9-dodecafluorononane (33)

RF1501545a xl 8gd=508 6-JUN-89 12:40 86 58 78E E1+
 RpA=8 I=6.4u Ha=338 TIC=268531888 Rcnt: Sys FOOT GC= 187° Cal: PFK184
 HRR 41648846
 RASS 55
 *x10⁻⁶
 x10⁻⁶

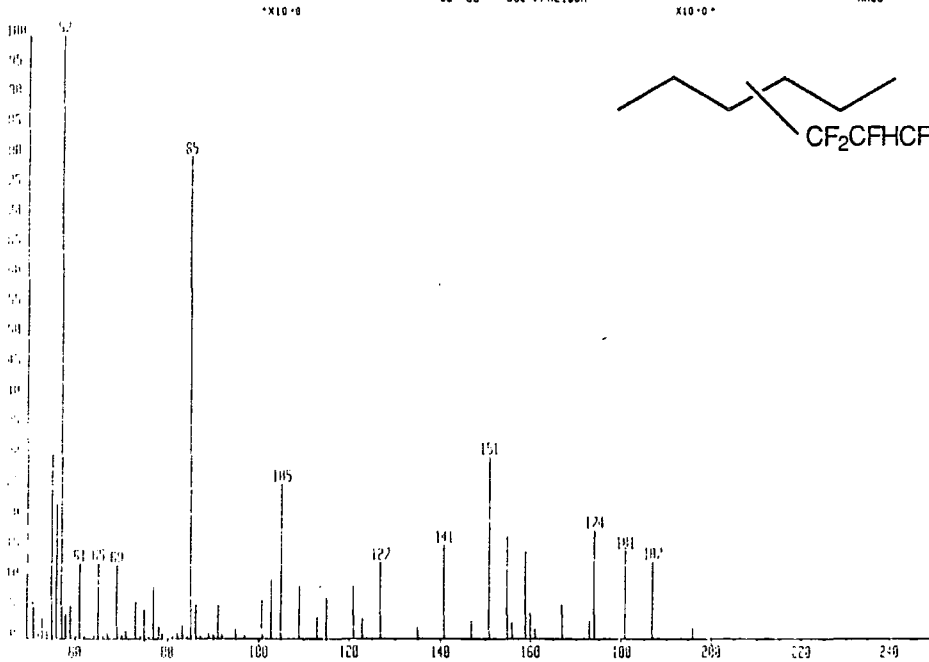


Mass	% Base				
51.15	14.79	127.11	12.70	201.21	11.12
52.16	0.72	128.12	0.52	202.22	0.85
53.18	3.92	129.13	4.24	203.18	0.23
54.18	0.79	130.14	0.21	205.19	2.37
55.19	48.20	131.10	0.46	209.18	0.50
56.19	3.37	132.12	0.22	211.19	3.03
57.14	1.95	133.13	2.10	215.17	0.49
58.15	0.30	135.15	1.57	221.24	63.41
59.16	16.93	137.16	0.34	222.23	4.96
60.16	1.31	139.13	1.33	223.20	0.92
61.17	26.61	141.15	9.34	225.20	0.25
62.16	0.79	142.17	0.62	227.18	0.27
63.13	0.45	143.18	1.52	231.21	1.84
64.13	1.83	145.14	4.03	235.18	0.48
65.13	100.00	146.16	0.27	251.23	4.64
66.13	2.07	147.16	3.26	252.24	0.42
67.16	0.77	151.13	2.83	255.20	2.58
69.09	24.62	153.16	1.65	257.21	0.23
69.17	4.79	155.17	2.63	273.22	0.34
70.13	0.39	159.16	14.33	293.22	0.31
71.13	1.80	160.17	0.75	313.23	1.77
72.13	0.45	161.19	3.02	317.21	0.75
73.14	6.92	162.19	0.21	333.25	0.56
74.13	0.43	163.16	0.27	337.22	2.06
75.15	26.45	165.16	0.76		
76.14	1.11	167.19	1.46		
77.11	26.34	171.17	1.60		
91.13	28.28	173.19	12.70		
92.13	1.52	174.19	1.00		
93.12	0.23	177.17	1.64		
95.11	6.01	179.19	0.21		
		181.21	10.10		

24. Hexafluoropropene/n-hexane mono-adducts (35)

01434413 x1 8gd:403 27-JUN-89 15:38:05:47 78C C1+
 1=1.6v In=156 TIC=36786888 Reat: GC= 86° Sys FOOT Cal PFK21JUN

HRB: 1022080
 ARSS: 57

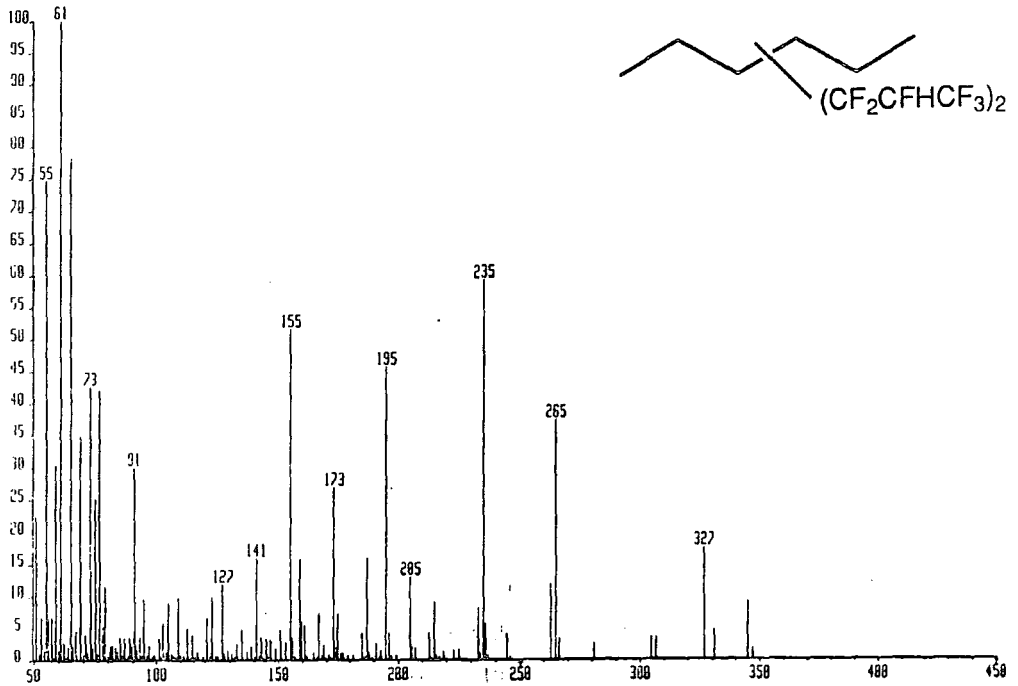


Mass	% Base
50.97	6.11
53.00	3.15
54.01	1.04
55.02	30.26
56.02	22.14
57.03	100.00
58.03	4.01
58.99	5.37
61.00	12.45
64.99	12.35
68.96	12.09
70.99	1.20
73.00	6.13
75.00	4.82
76.97	9.64
77.99	1.95
83.02	2.10
85.05	79.92
86.05	5.60
90.98	5.41
94.99	1.54
104.98	2.54
126.94	1.26
140.94	1.54
150.90	2.98
154.96	1.70
158.93	1.44
173.95	1.72
180.91	1.46
186.93	1.27
193.03	0.15

25. Hexafluoropropene/n-hexane di-adducts (36)

RF14316671 x1 0gd=659 27-JUN-89 15:30:09:20 70C
 OpA=0 l=1.4v Ha=346 TIC=95455088 Rcnt: GC= 122° Cat: PFK21JUN
 *x10⁻⁶

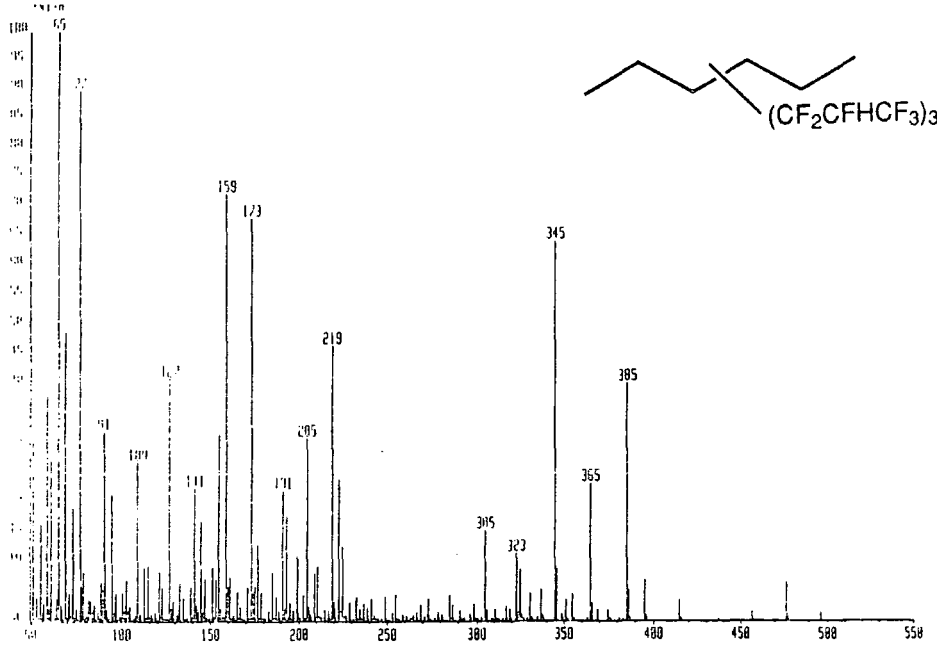
HAR: 9194888
 ARSS: 61
 x10⁻⁶



Mass	% Base				
102.97				5.60	212.96
50.97	22.29			8.77	214.97
53.00	3.43			9.60	232.95
55.01	74.82			4.81	234.95
57.02	3.33			3.73	235.97
59.04	3.71			6.55	244.94
61.00	100.00			9.68	264.93
62.01	2.71			11.70	
64.98	78.16			2.25	
67.01	4.37			4.76	
68.95	34.66	F		15.70	
69.03	5.03	F		3.37	
70.98	3.95			3.11	
72.99	3.95			2.98	
75.01	42.38			4.49	
76.97	25.03			2.57	
77.98	41.91			51.40	
78.98	5.20			3.30	
81.02	11.57			15.64	
81.96	2.19			5.34	
84.99	2.25			5.30	
87.00	3.27			7.13	
88.97	3.40			2.13	
89.97	3.40			26.64	
90.98	2.14			7.07	
92.99	29.92			4.15	
94.95	3.28			15.68	
96.97	9.60			2.46	
100.95	2.19			45.52	
	3.22			4.10	
				12.71	

26. Hexafluoropropene/n-hexane tri-adducts (37)

RF1411284 x1 8yd=278 27-JUN-89 15:30:18:58 28C C1+
 Op:n=1 l=1.7u Hw=496 TIC=163349888 Acnt: Sys:FOOT HNR: 1897288
 GC= 138° Cal:PFK21JUN MASS: 65

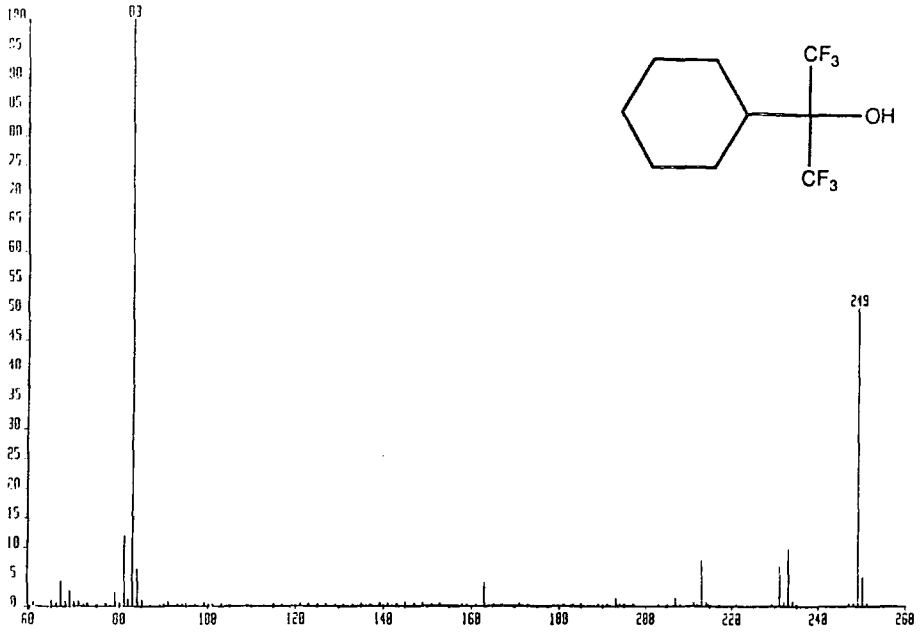


Mass	% Base	104.99	2.40	190.93	22.01
50.97	33.07	108.95	26.62	192.95	17.61
53.00	3.99	112.93	8.88	194.92	2.96
55.02	18.18	114.95	9.26	198.96	10.71
56.99	3.01	120.95	8.36	202.93	4.30
59.99	37.89	122.97	5.58	204.95	30.62
60.00	2.63	126.94	40.88	205.95	2.34
61.01	26.97	127.95	2.09	208.92	8.04
63.97	3.95	128.95	3.33	210.93	9.11
64.98	100.00	132.94	6.71	218.94	46.37
65.99	2.83	134.97	3.98	219.95	3.25
67.01	2.06	138.94	5.61	222.91	23.84
68.95	48.78	140.94	22.20	224.92	12.49
70.98	4.76	141.95	2.63	304.86	15.16
73.00	19.05	144.92	16.73	316.83	2.36
74.98	2.15	146.93	7.09	322.83	11.15
76.97	89.61	150.91	9.01	324.88	8.46
77.98	5.76	152.94	6.92	330.89	4.49
78.99	8.12	154.96	31.42	336.86	5.19
81.95	3.42	158.93	72.04	344.87	63.92
82.97	3.40	159.94	5.78	345.97	8.65
85.00	2.51	160.94	7.27	350.89	3.55
88.97	6.37	164.93	4.78	354.87	4.39
89.97	5.29	166.95	2.23	364.87	23.09
90.98	31.78	170.92	5.73	365.87	2.84
91.98	2.00	172.93	67.95	384.88	39.93
94.95	21.36	173.94	4.98	385.88	5.16
96.97	4.55	174.95	5.76	394.87	6.79
100.95	4.65	176.91	12.69	414.79	3.50
102.97	6.76	178.94	4.73	456.88	1.47
		184.94	8.19	476.85	6.30
				477.87	1.21

27. 1,1,1-trifluoro-2-(F-methyl)-2-hydroxyethylcyclohexane (38)

GC= 100° Cal= PFK21JUH

HR: 33066888
MS: 83

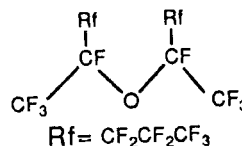
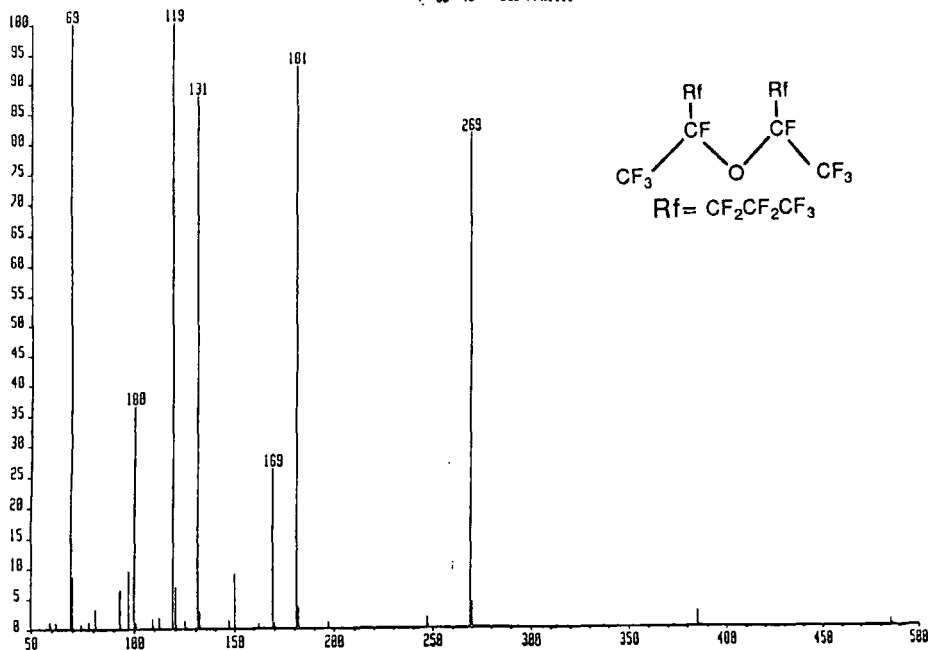


Mass	% Base	Mass	% Base
61.06	0.30	163.10	2.02
65.04	0.43	193.12	0.73
66.05	0.21	207.08	0.71
67.06	2.16	211.11	0.26
68.07	0.35	213.12	3.90
69.06	1.35	214.12	0.32
70.08	0.29	231.11	3.43
71.08	0.36	232.13	0.30
73.05	0.21	233.12	4.95
77.04	0.21	234.14	0.42
79.07	1.16	249.11	25.98
80.07	0.22	250.12	2.49
81.08	6.10	251.12	0.18
82.08	0.58		
83.10	51.68		
84.10	3.23		
85.10	0.44		
91.06	0.39		
95.06	0.17		
99.08	0.22		
115.05	0.26		
123.08	0.18		
139.06	0.24		
141.07	0.19		
143.09	0.18		
145.04	0.28		
147.06	0.19		
149.08	0.23		

28. Perfluoro-di-(1-methyl-butyl)ether (55)

RF99197* x1 8gd=95 24-NOV-88 16:40:01:43 78E EI*
 BpH=0 I=10v He=486 TIC=417875808 Acnt: GC= 48° Sys:FOOT Cal:PFK1111

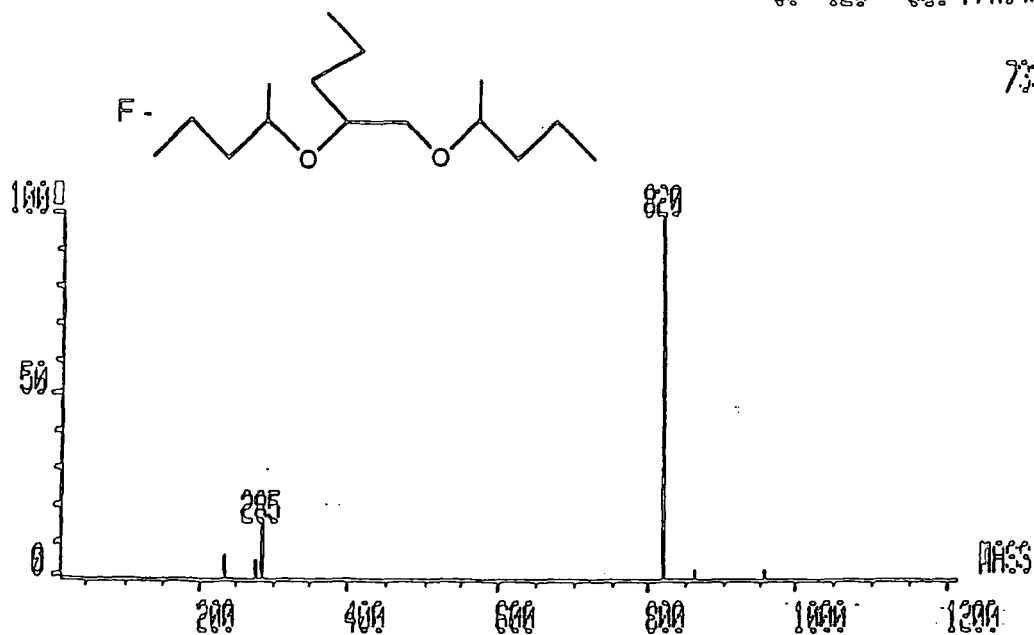
HAR: 65534888
 MASS: 119



Mass	% Base	264.52	0.05
29.03	1.88	265.51	0.05
31.00	10.60	265.78	0.03
46.98	3.84	265.83	0.07
49.98	3.72	265.91	0.06
59.04	1.05	265.95	0.05
68.89	3.83	265.98	0.06
68.98	100.00 0	266.43	0.05
69.99	8.41	266.54	0.05
80.98	3.14	266.73	0.08
92.99	6.38	266.91	0.05
96.98	9.45	266.97	0.09
99.98	36.47	267.09	0.06
108.98	1.42	269.06	81.51
111.98	1.66	269.52	0.06
119.02	100.00 0	269.75	0.05
119.99	6.66	269.81	0.04
124.99	1.13	270.06	4.07
130.99	87.63	271.07	0.16
132.00	2.69	297.05	0.03
146.98	1.25	347.10	0.13
149.98	8.87	363.15	0.08
169.00	26.01	366.12	0.05
181.00	92.86	395.15	2.42
182.01	3.42	386.15	0.18
247.04	1.61	397.19	0.14
250.05	0.05	485.27	0.99
259.03	0.05	486.25	0.10
262.55	0.08		

29. Perfluoro-5,8-dioxa-4,9-dimethyl-6-propyldodecan (56)

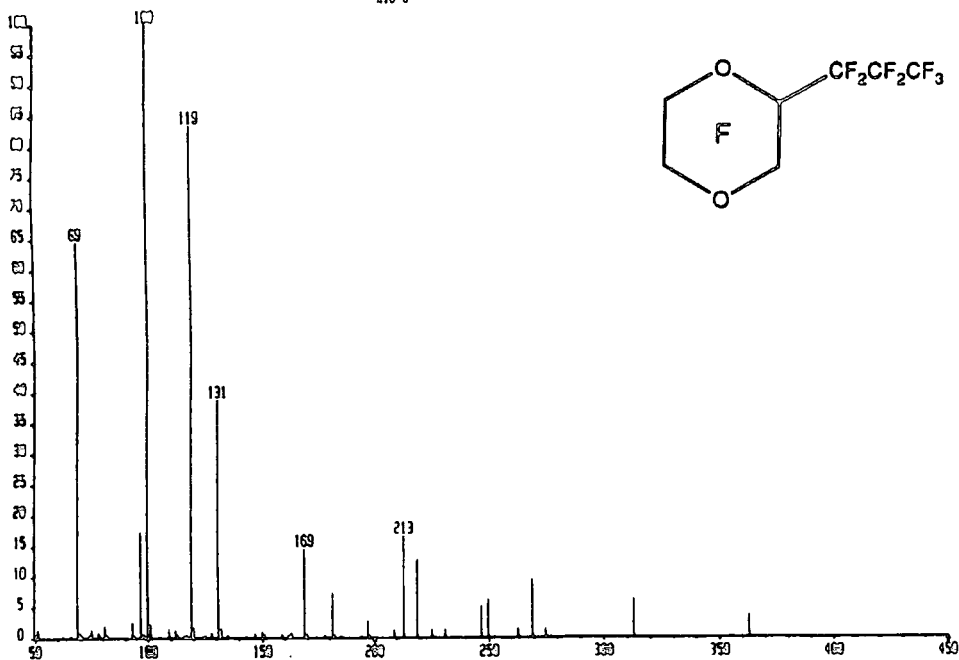
RF13#134 x1 Agd=35 17-DEC-87 14:40:03:15 70E EI-
 EpM=0 I=111mV Hi=355 TIC=963000 Acnt: Sys:FOOT
 GC=1200 Cal:PFK14NEG 1.0
 73300E



MASS	X BASE
235.00	5.06
235.05	4.09
275.03	3.41
285.03	13.76
286.04	2.05
819.99	100.00
841.13	1.23
959.89	1.36

30. Perfluoro-2-propyl-1,4-dioxan (57)

71821103 11-0-0 01 22 116-1719
 476300 110-0*

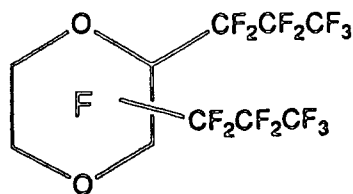
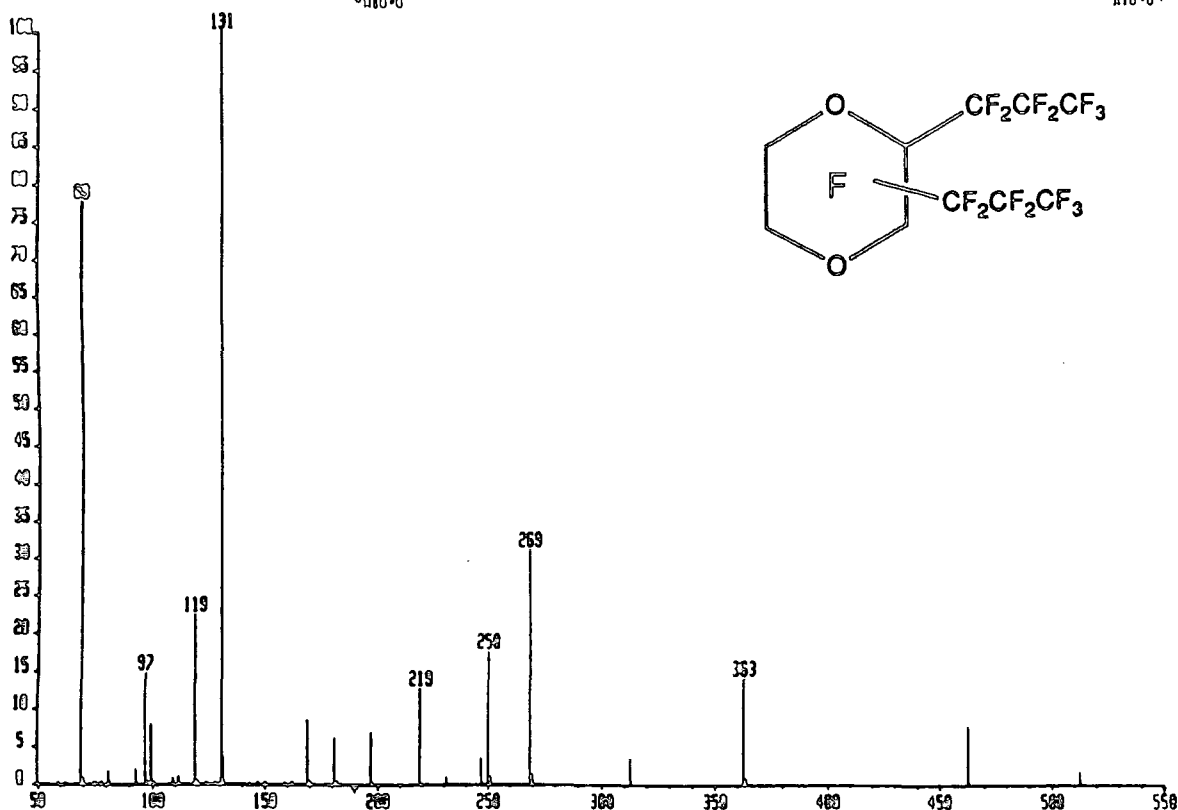


Mass	% Base	Mass	% Base
51.08	1.17	130.82	0.29
62.04	0.19	130.95	38.72
66.02	0.16	131.95	1.34
68.93	0.49	134.94	0.37
69.00	64.58	142.96	0.19
70.01	0.70	146.95	0.55
74.00	0.25	149.95	0.95
74.99	1.22	150.96	0.50
77.98	0.83	158.94	0.41
78.99	0.13	161.95	0.37
80.98	1.88	162.94	0.75
81.98	0.36	168.94	14.46
92.98	2.47	169.95	0.41
93.98	0.14	177.94	0.26
96.88	0.13	180.94	7.33
96.97	17.24	181.94	0.28
97.97	0.40	184.92	0.15
99.86	0.77	193.91	0.12
99.97	100.00	196.90	2.67
100.98	2.05	197.91	0.12
108.97	1.30	208.92	0.12
111.97	1.07	212.91	1.65
112.97	0.29	218.92	1.28
115.95	0.27	224.92	0.12
116.95	0.26	230.93	0.12
118.82	0.63	246.89	0.51
118.94	83.67	249.89	0.61
119.95	1.64	262.89	0.14
123.95	0.12	268.89	0.94
124.94	0.12	274.88	0.14
127.94	0.70	312.85	0.62
		362.80	0.34

31. Perfluoro-2,x-dipropyl-1,4-dioxan (58) (x= 3,5,6)

1230133 #1 03-133 4-27-02 10:00:01:04 EI
 1=0.20 1=512 TIC=14331700 Scan: 400 Sys: F007
 GC= 400 Ctl: F71104

54054000
 131
 #10.0*



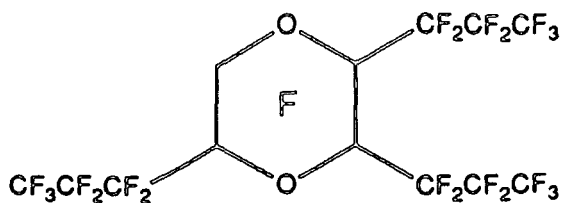
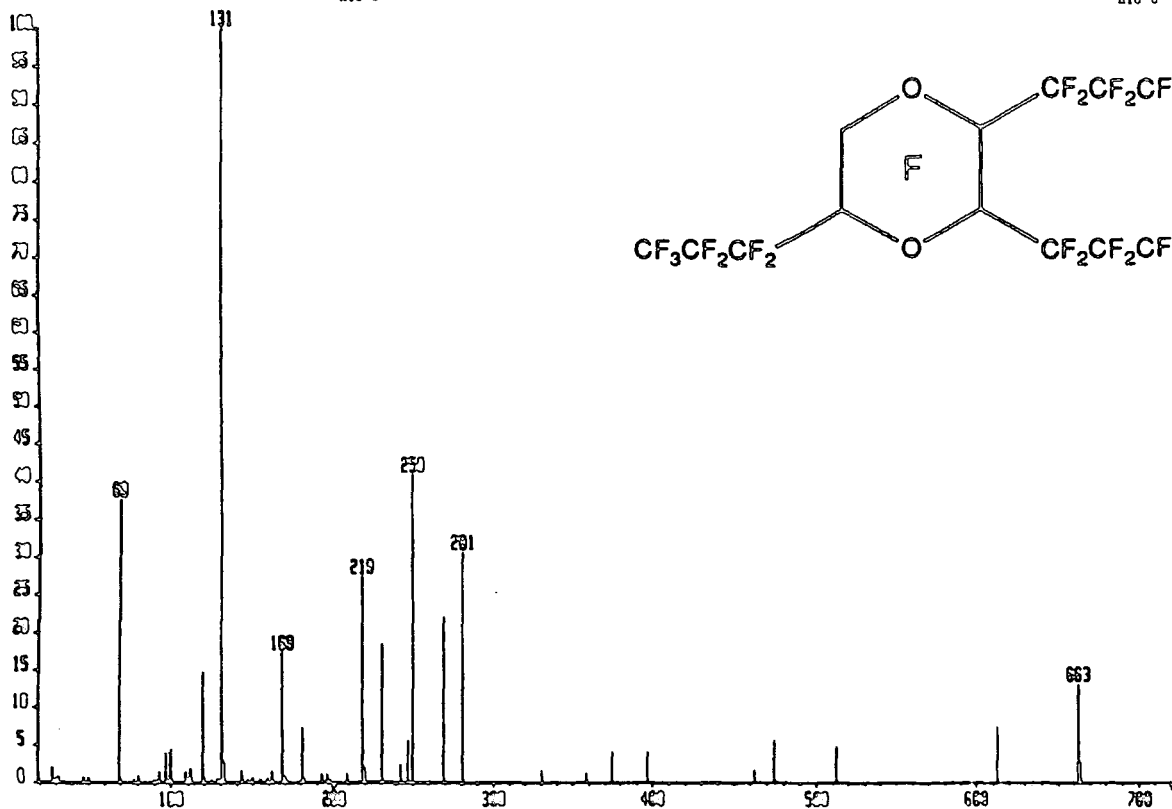
Mass	% Base	131.94	3.51
59.09	0.22	131.94	3.51
62.03	0.16	142.95	0.14
68.92	0.61	146.94	0.23
68.99	77.67	149.94	0.32
70.00	0.75	158.93	0.21
73.99	0.12	161.94	0.36
77.97	0.31	168.93	8.45
80.97	1.63	169.93	0.31
92.97	1.97	180.92	6.10
96.87	0.10	181.93	0.28
96.96	14.76	196.89	0.68
97.96	0.29	218.90	1.27
99.96	7.89	246.87	0.34
100.96	0.18	249.87	1.76
108.96	0.77	250.89	0.11
111.96	1.08	268.87	3.10
118.82	0.16	269.87	0.12
118.93	22.37	312.83	0.36
119.94	0.43	362.77	1.41
123.94	0.12	462.66	0.77
127.93	0.17	512.58	0.17
130.77	0.80		
130.93	100.00		

32. Perfluoro-2,3,5-tripropyl-1,4-dioxan (59)

15:30:03.02
 1=3.46
 TIC=925220
 110.0

El.
 S: FE01
 C: F7R

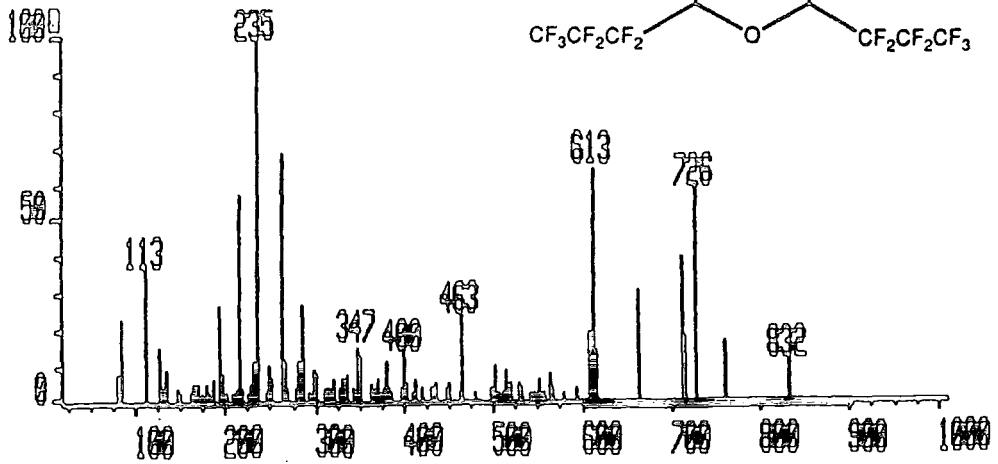
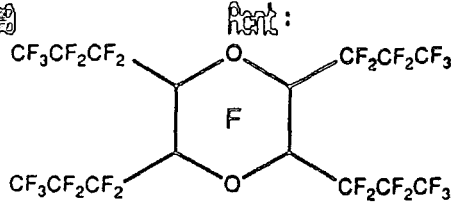
2227000
 131
 110.0



Mass	% Base	Mass	% Base
28 01	1.84	268.90	2.20
68 99	37.44	280.89	3.06
92 98	1.31	330.93	0.15
96 97	3.80	358.81	0.11
99 98	4.25	374.83	0.40
108 97	1.23	396.83	0.40
111 97	1.64	462.70	0.16
118 96	14.55	474.77	0.54
130 96	100.00	512.78	0.47
131 96	2.63	612.75	0.74
142 95	1.36	663.06	1.31
161 94	1.44	664.13	0.26
168 93	17.17		
180 91	7.05		
208 90	0.11		
218 90	2.73		
219 89	0.18		
219 96	0.18		
230 90	1.83		
242 92	0.22		
246 88	0.55		
249 88	4.07		

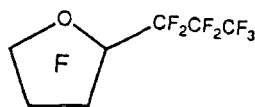
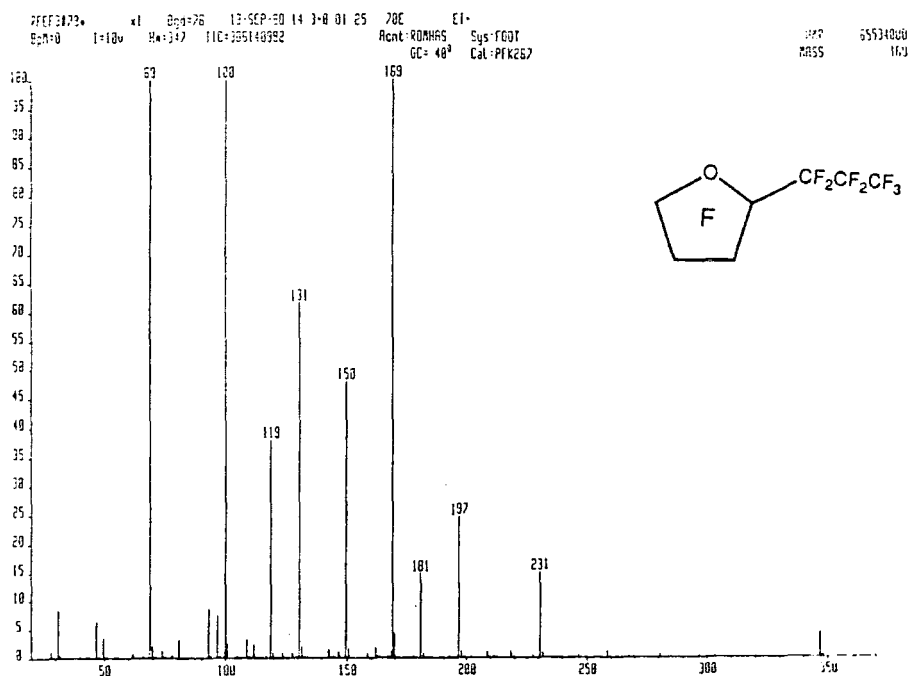
33. Perfluoro-2,3,5,6-tetrapropyl-1,4-dioxan (60)

RT=235.065 x1 Ag=248 15-NOV-00 16:30:04:43 782 C1-
 I=346.0 V=0.32 TIC=1733929



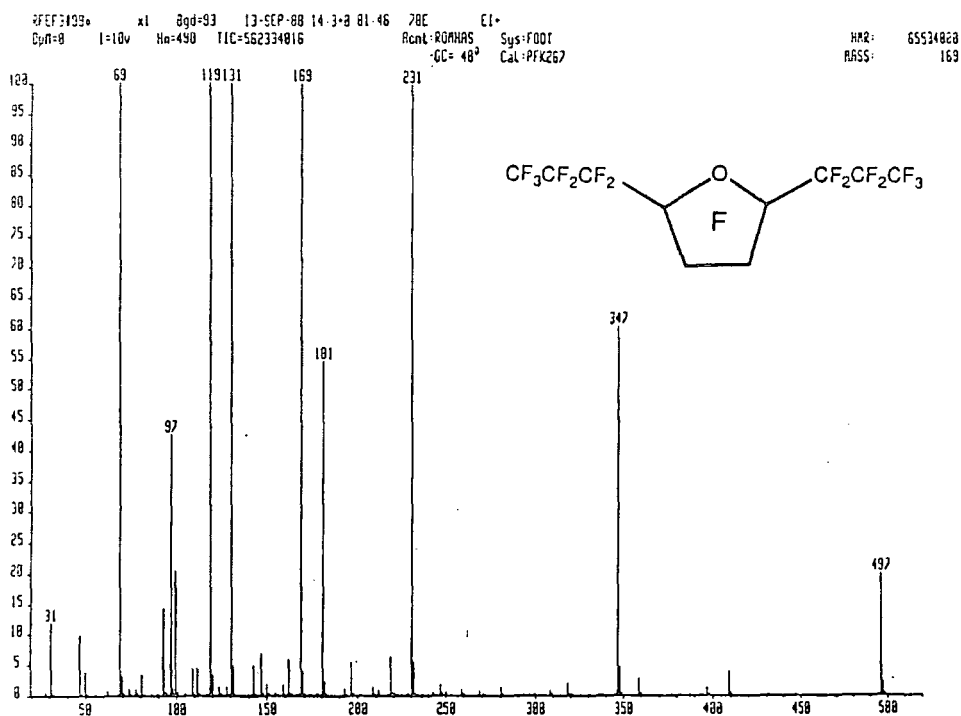
Mass	% Base	269	10	2	20	429	19	2	11
78	93	6	08	278	09	3	08	431	19
80	92	6	61	281	11	10	66	435	19
85	00	21	23	285	10	25	64	447	19
113	01	36	21	297	12	7	67	450	23
126	94	14	36	300	12	6	61	463	20
128	06	2	20	309	14	3	08	464	21
135	03	8	02	312	14	3	08	497	30
147	02	3	08	313	11	2	82	500	24
163	04	4	14	316	12	2	91	513	24
169	05	4	14	319	14	4	85	519	27
178	05	3	79	328	17	2	03	529	25
185	05	5	46	331	14	4	85	532	34
193	05	25	81	335	13	6	48	550	28
194	06	2	73	343	14	2	11	563	27
197	04	6	61	347	14	14	71	566	35
213	08	2	20	350	14	12	07	594	34
216	07	55	95	351	13	3	61	607	33
217	07	2	82	362	15	2	20	611	22
219	08	2	82	363	16	3	61	613	35
228	09	4	32	366	19	2	07	614	34
231	08	10	66	369	17	5	73	663	32
235	08	100	00	378	15	2	20	713	40
236	09	3	52	379	15	9	96	714	46
247	08	8	37	381	18	2	95	726	38
250	08	4	49	397	19	2	20	727	35
262	10	4	93	400	18	13	13	760	51
263	09	67	58	401	20	3	83	832	47
264	11	3	08	412	18	4	76		
266	10	9	78	413	19	2	82		
				419	19	2	11		

35. Perfluoro-2-propyloxolane (64)



Mass	% Base	Mass	% Base	Mass	% Base
30.90	8.33	167.18	0.03	218.66	0.96
46.86	6.19	167.21	0.05	227.65	0.24
49.86	3.39	167.23	0.05	230.30	0.05
68.76	1.37	167.29	0.06	230.42	0.13
68.82	100.00 0	167.37	0.05	230.65	14.93
69.82	1.86	167.48	0.08	231.65	0.77
80.80	3.18	168.54	1.10	246.65	0.35
92.78	8.52	168.69	100.00 0	258.67	1.01
96.78	7.36	168.84	0.06	259.67	0.08
99.77	100.00 0	168.91	0.04	280.63	0.43
100.77	2.43	168.96	0.03	296.61	0.09
108.76	3.04	169.06	0.05	346.62	4.25
111.75	2.19	169.56	0.03	347.62	0.31
118.75	37.92	169.70	4.11		
130.74	61.64	170.71	0.06		
131.74	1.84	177.68	0.20		
142.72	1.34	180.41	0.03		
149.71	48.05	180.51	0.12		
150.72	1.55	180.68	14.70		
154.71	0.07	181.69	0.57		
158.69	0.62	182.71	0.05		
161.70	1.62	192.68	0.17		
162.66	0.07	196.01	0.03		
162.70	0.10	196.45	0.22		
163.69	0.03	196.67	24.66		
165.69	0.04	197.67	1.10		
166.89	0.05	198.67	0.06		
166.99	0.03	208.65	0.91		
167.10	0.06	209.66	0.06		
167.12	0.05	211.66	0.11		

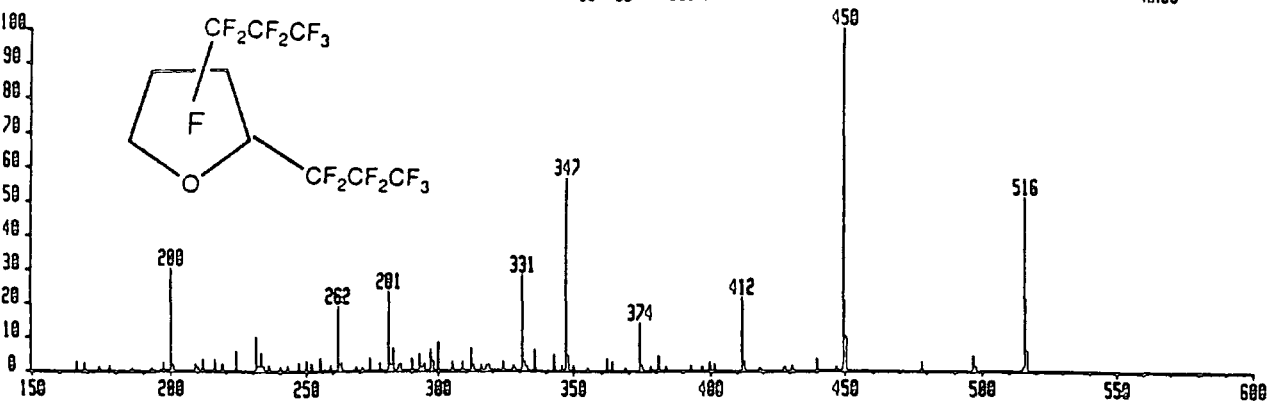
36. Perfluoro-2,5-dipropyloxolane (65)



Mass	% Base				
30.90	11.90	170.70	0.16	344.62	0.02
46.86	9.80	173.70	0.08	344.77	0.05
49.86	3.63	177.68	0.12	344.98	0.05
68.76	2.40	178.31	0.03	345.18	0.08
68.82	100.00	179.65	0.04	346.08	0.53
69.82	2.98	180.01	0.05	346.60	60.22
73.81	1.00	180.68	54.49	347.27	0.06
77.80	1.07	196.51	0.04	347.61	4.52
80.80	3.26	196.67	5.31	348.62	0.30
92.78	14.29	197.67	0.21	358.64	2.60
96.77	42.56	201.67	0.04	359.66	0.24
97.78	1.03	208.66	1.36	377.72	0.17
99.77	20.47	209.67	0.07	380.70	0.06
108.75	4.26	211.66	0.72	396.78	1.16
111.76	4.41	218.48	0.05	397.77	0.16
118.64	1.13	218.66	6.21	408.81	3.89
118.75	100.00	219.66	0.25	409.81	0.41
119.75	3.16	220.65	0.15	430.73	0.08
123.74	1.32	227.66	0.08	446.70	0.13
127.74	1.39	228.41	0.04	458.71	0.04
130.62	1.17	228.65	0.07	495.02	0.03
130.73	100.00	228.71	0.05	495.26	0.04
131.74	4.72	228.84	0.05	495.97	0.22
142.72	4.96	228.95	0.05	496.66	19.90 F
146.71	6.88	228.98	0.05	497.67	2.06 F
161.70	5.71	229.01	0.05	498.11	0.03
168.54	0.96	229.15	0.06	498.23	0.05
168.70	100.00	230.45	0.85	498.66	0.17
168.86	0.06	230.66	99.66		
169.50	0.04	231.44	0.05		
169.70	3.84	231.66	5.30		

37. Perfluoro-2,x-dipropylloxolane (x= 3,4) (66)(67)

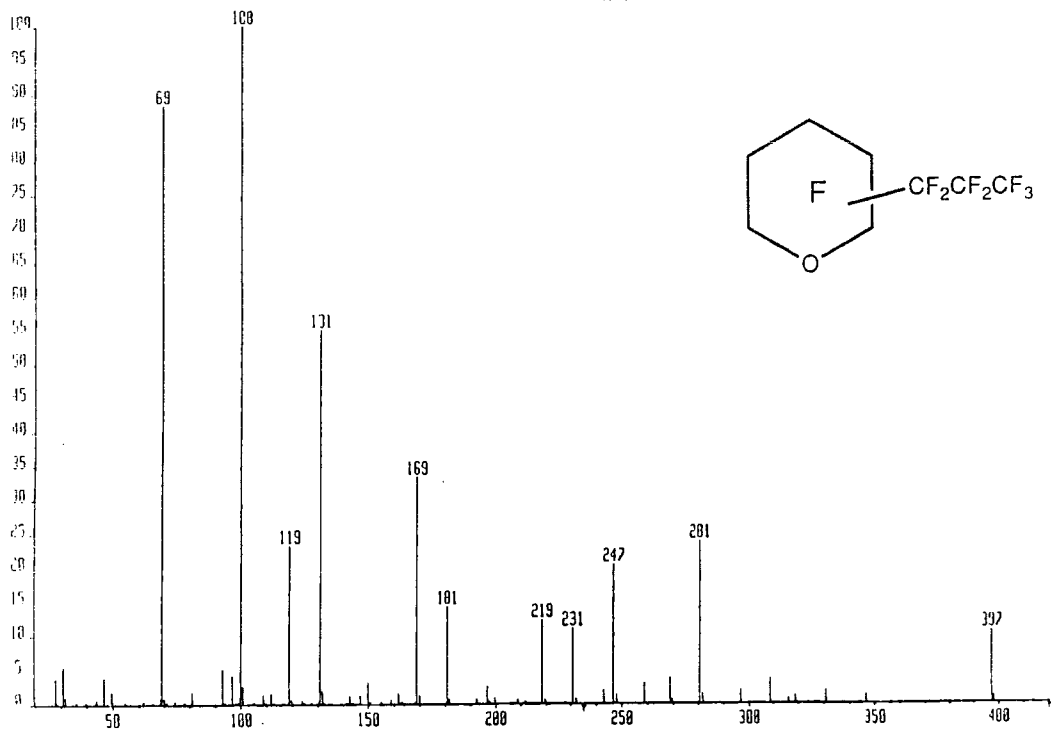
RFFEF2H0219o x1 8gd=211 17-JRH-09 13:0:0:01:59 78E Cl-
 BpH=0 I=459av Ha=516 TIC=17428888 Acnt: Sys:FC0Y
 GC= 35° C2L: PFK171H HRR: 3888888
 MASS: 450



Mass	% Mass	Mass	% Mass	Mass	% Mass
165.92	2.33	284.90	1.06	346.85	56.58
168.94	2.19	289.90	1.80	347.87	4.36
173.94	1.03	289.90	3.19	349.80	1.26
177.90	1.26	292.89	4.65	349.97	0.93
177.96	1.26	293.88	0.86	354.94	0.73
185.97	0.73	294.87	1.80	361.82	3.72
192.94	0.86	296.87	6.05	362.02	1.00
196.91	2.06	297.87	2.66	363.84	2.33
196.97	1.40	299.88	8.05	368.77	0.86
199.93	30.15	304.90	2.33	373.83	13.90
200.94	1.40	308.88	2.59	374.70	1.26
208.91	1.73	311.87	6.32	374.78	1.26
209.94	0.73	312.81	0.86	374.94	1.26
211.92	3.16	312.94	1.26	377.91	0.93
215.91	3.39	319.85	1.60	380.83	4.19
218.90	1.66			383.80	1.00
219.01	0.73	319.97	0.73	383.88	0.76
223.92	9.55	316.01	0.86	392.71	1.26
230.92	9.91	317.83	0.73	392.81	1.13
231.95	1.00	317.91	1.26	396.78	1.13
232.91	9.12	317.96	1.26	399.85	2.59
233.88	1.06	318.81	1.93	401.81	1.66
235.90	1.26	323.85	2.46	411.81	21.28
239.85	0.73	323.99	0.73	412.80	2.66
239.98	1.20	327.85	1.60	418.72	0.60
242.91	1.26	327.98	0.86	427.74	0.73
243.01	1.60	330.86	27.86	427.88	1.00
246.93	2.13	331.86	2.49	430.65	1.26
249.94	2.76	332.73	0.86	430.80	1.00
251.93	1.80	332.91	1.13	430.91	1.13
254.92	3.52	339.86	6.12	439.83	3.13
258.88	1.26	342.84	4.49	446.75	1.13
261.90	19.08	343.76	1.26	449.26	1.66
262.86	2.13			449.81	100.00
262.97	1.43			450.80	9.77
268.84	1.00			477.82	2.66
268.88	1.00			496.79	4.45
268.97	1.00			497.68	1.00
270.93	0.80			514.89	0.73
273.89	3.72			515.13	1.00
277.90	2.19			515.26	0.86
280.89	23.07			515.76	51.00
281.90	1.53			516.76	5.83
282.89	6.58				
284.82	1.26				

38. Perfluoro-x-propyloxane (x= 2,3,4) (14)(15)(16)

PERF1104 x1 Dgd=02 13-SEP-00 11:10:01:30 78C EI+
 Cp=0 I=10v In=397 TIC=263736800 Acnt:RUMHRS Sys:FOOT
 GC= 40° Cal:PFK267
 *X10.0
 HMR: 65524.00
 MASS 130
 x10.0

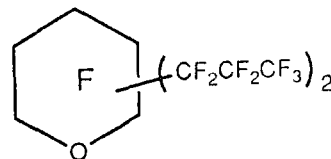
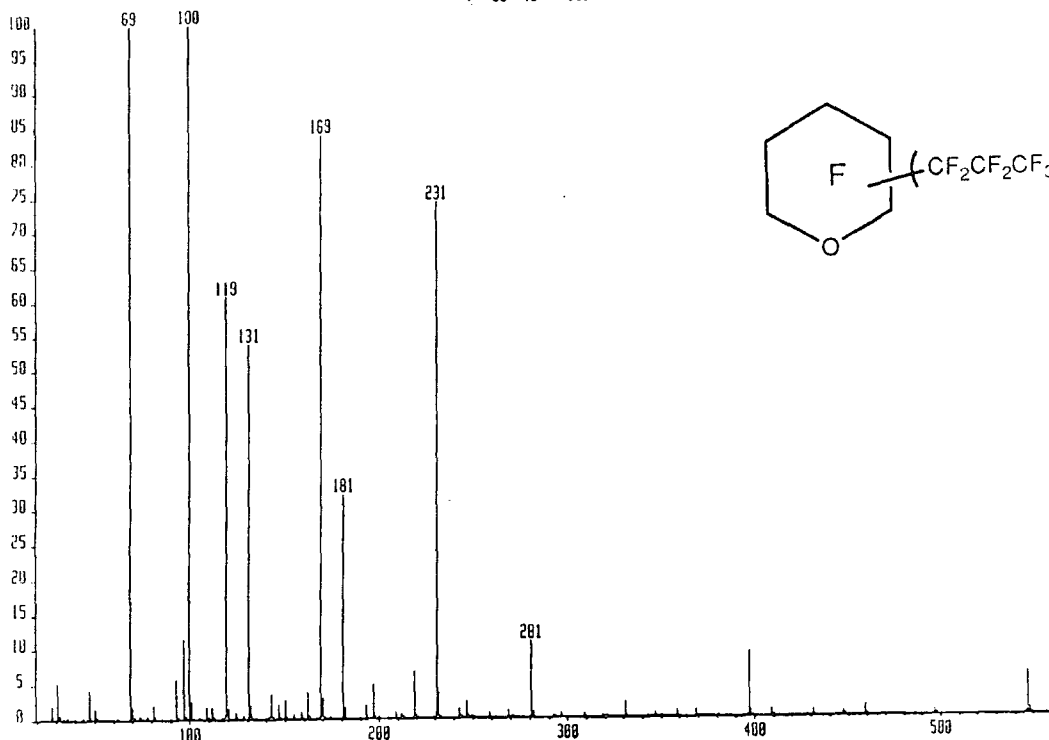


Mass	% Base		
27.93	3.69	169.77	1.05
30.92	5.37	180.56	0.13
46.89	3.79	180.74	14.15
49.90	1.66	181.74	0.58
68.86	88.40	192.75	0.60
80.85	1.73	196.74	2.47
92.83	5.05	197.75	0.09
96.82	4.04	199.74	0.71
99.82	100.00	208.74	0.44
100.82	2.49	211.74	0.14
108.81	1.25	218.51	0.10
111.81	1.31	218.73	12.11
118.81	23.24	219.74	0.48
130.79	55.06	227.74	0.06
131.80	1.79	230.50	0.09
142.78	1.10	230.74	10.89
149.78	3.09	396.87	1.05
150.78	0.14	397.88	0.10
154.77	0.13		
158.77	0.52		
161.77	1.37		
162.78	0.14		
168.06	0.05		
168.21	0.05		
168.33	0.05		
168.38	0.03		
168.41	0.03		
168.57	0.29		

39. Perfluoro-x,y-dipropylloxane (x= 2,3) (y= 3,4,5,6) (68)(69)(70)(71)
(74)(75)

RF40120* x1 Bgd=105 13-SEP-80 11:10:02:00 70E EI+
OpM=0 I=10v Ha=548 TIC=420816016 Acnt:ROAHAS Sys:FOOT
GC= 40^o Cal:PFK267

HAR: 65534000
PASS: 108



Mass	% Base		
27.93	1.71	230.75	74.44
30.92	5.04	231.76	3.99
46.89	3.94	242.76	1.12
49.90	1.32	246.75	2.29
68.80	1.25	280.75	10.87
68.86	100.00 0	330.75	2.13
69.87	1.70	396.91	8.99
80.85	1.82	458.85	1.27
92.83	5.59	546.86	5.96
96.83	11.33	547.85	0.76
99.83	100.00 0		
100.83	2.41		
108.82	1.69		
111.82	1.61		
118.81	60.72		
119.82	1.28		
130.80	53.80		
131.81	1.79		
142.79	3.35		
146.78	1.81		
149.79	2.58		
161.77	3.72		
168.77	83.96		
169.77	2.77		
180.75	32.01		
181.75	1.45		
192.76	1.83		
196.76	4.79		
218.75	6.54		

40. Perfluoro-N-butyl-x-propylpiperidine (x= 2,3,4) (72)

PFEBN1249o x1 8qd=181 13-JAN-89 15:28:04:14 70C Cl-
 Dpn=633 l=1.3v Ha=635 TIC=27534888 Acnt: Sys:FOOT
 GC= 35° Cat:PFK812R

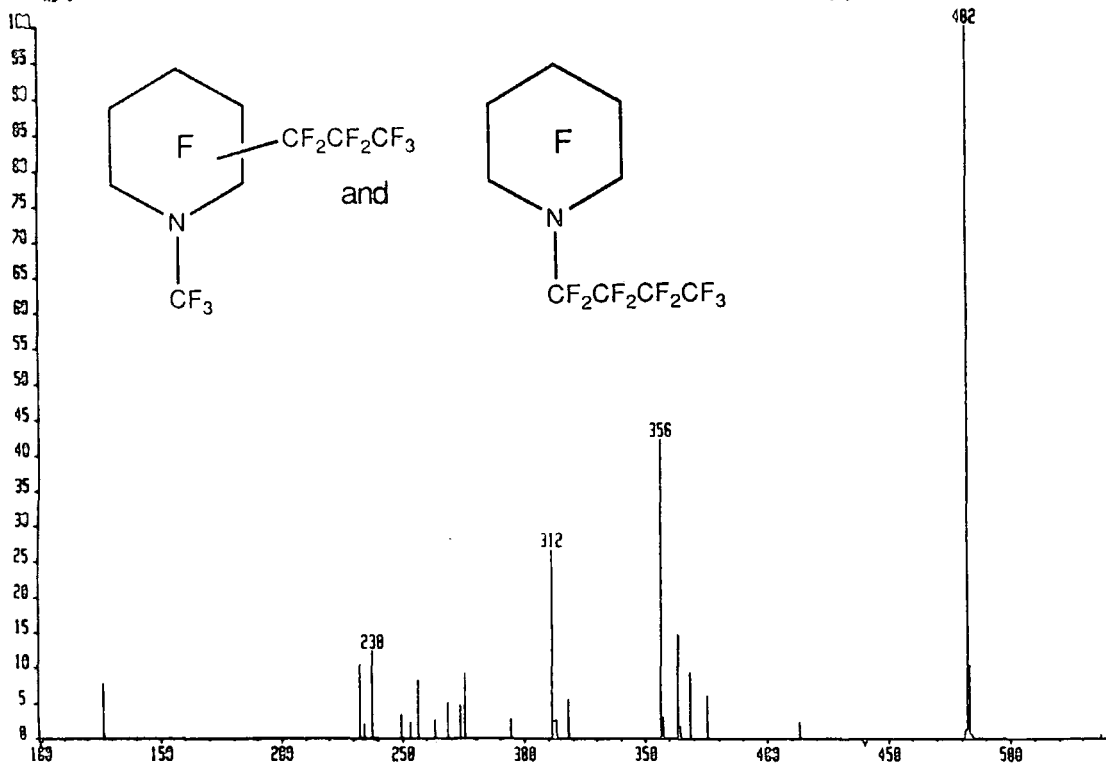
HRR: 8718888
 MASS: 633



Mass	% Base				
126.72	6.50	332.52	3.92	463.35	35.82
186.72	2.32	337.50	0.55	464.36	3.23
206.68	0.41	349.48	0.85	468.35	1.47
206.72	0.39	356.48	2.92	475.34	0.99
211.67	0.44	357.48	0.30	494.29	0.37
223.65	0.28	361.45	0.57	494.39	0.45
225.65	0.57	365.45	0.31	496.32	0.44
225.70	0.30	368.45	0.34	496.40	0.39
234.68	0.48	368.51	0.44	506.33	0.95
237.66	0.31	375.44	8.94	511.37	0.34
242.63	0.60	376.45	0.76	513.32	2.45
244.64	0.62	380.44	2.32	518.35	0.99
249.63	0.67	382.43	5.39	525.32	1.09
256.63	0.57	383.40	0.44	534.28	1.65
260.63	0.39	384.42	0.21	534.47	0.44
261.61	0.92	387.45	1.03	556.28	3.42
263.61	1.31	392.45	0.40	557.31	0.34
273.59	0.85	394.43	6.55	557.42	0.25
275.59	1.19	395.44	0.89	563.27	1.90
280.59	0.89	406.41	1.73	572.27	6.26
282.58	1.35	413.40	2.41	573.27	0.99
287.57	0.45	418.34	0.25	593.79	0.45
292.58	0.22	425.39	7.09	594.30	31.87
294.56	3.76	426.39	0.76	595.29	3.92
295.57	0.34	430.40	1.00	613.27	0.89
299.55	2.23	437.37	1.49	614.26	0.81
311.53	3.79	444.38	1.65	631.07	0.25
313.53	5.16			631.17	0.26
314.54	0.25			632.24	100.00
315.52	0.39			633.26	12.80
318.52	1.28			634.27	0.94

41. Perfluoro-N-methyl-piperidine/hexafluoropropene mono-adducts (73)

#FFFC301 x1663 Bgd=1 -0:00:00 Rcnt: Sys: Cl- HR: 65534
 Exp=0 I=10v H=538 TIC=97931 PT= 0° Cal: MASS 482



Mass	% Base
126.72	1.56
232.65	2.05
234.65	0.32
237.64	2.45
249.62	0.67
253.62	0.46
256.62	1.65
263.61	0.51
266.59	0.99
273.59	0.93
275.59	1.81
294.55	0.55
311.52	5.29
312.51	0.49
313.52	0.51
318.52	1.10
356.48	8.43
357.47	0.59
363.46	2.91
364.45	0.33
368.45	1.86
375.45	1.21
413.40	0.44
481.69	1.15
482.32	100.00 0
483.33	10.16
484.32	0.47
537.28	0.44

APPENDIX 4

RESEARCH COLLOQUIA, SEMINARS, LECTURES AND CONFERENCES

APPENDIX 4

RESEARCH COLLOQUIA, SEMINARS, LECTURES AND CONFERENCES

The Board of Studies in Chemistry requires that each postgraduate research thesis contains an appendix listing:

- (A) all research colloquia, seminars and lectures arranged by the Department of Chemistry during the period of the author's residence as a postgraduate student;
- (B) lectures organised by Durham University Chemical Society;
- (C) all research conferences attended and papers presented by the author during the period when research for the thesis was carried out;
- (D) details of the postgraduate induction course.

(A) Research colloquia, seminars and lectures organised by
Durham University Chemistry Department, 1987-1989

(those attended are marked *)

- 28.1.87 Dr. W. Clegg (University of Newcastle-upon-Tyne),
'Carboxylate Complexes of Zinc: Charting a
Structural Jungle'.
- 4.2.87 Prof. A. Thomson (University of East Anglia),
'Metalloproteins and Magneto-optics'.
- 11.2.87 Dr. T. Shepherd (University of Durham), 'Pteridine
Natural Products: Synthesis and Use in
Chemotherapy'.
- 17.2.87 Prof. E.H. Wong (University of New Hampshire,
U.S.A.), 'Symmetrical Shapes from Molecules to Art
and Nature'.
- 4.3.87 Dr. R. Newman (University of Oxford), 'Change and
Decay: A Carbon-13 CP/MAS NMR Study of
Humification and Coalification Processes'.
- 11.3.87 Dr. R.D. Cannon (University of East Anglia),
'Electron Transfer in Polynuclear Complexes'.
- 17.3.87 Prof. R.F. Hudson (University of Kent), 'Aspects of
Organophosphorus Chemistry'.
- 18.3.87 Prof. R.F. Hudson (University of Kent), 'Homolytic
Rearrangements of Free Radical Stability'.
- 6.5.87 Dr. R. Bartsch (University of Sussex), 'Low
Co-ordinated Phosphorus Compounds'.
- 7.5.87 Dr. M. Harmer (I.C.I. Chemicals & Polymer Group),
'The Role of Organometallics in Advanced
Materials'.
- 11.5.87 Prof. S. Pasykiewicz (Technical University,
Warsaw), 'Thermal Decomposition of Methyl Copper
and its Reactions with Trialkylaluminium'.
- 27.5.87 Dr. R.M. Blackburn (University of Sheffield),
'Phosphonates as Analogues of Biological Phosphate
Esters'.
- 24.6.87 Prof. S.M. Roberts (University of Exeter),
'Synthesis of Novel Antiviral Agents'.
- 26.6.87 Dr. C. Krespan (E.I. Dupont de Nemours), 'Nickel
(0) and Iron (0) as Reagents in Organofluorine
Chemistry'.
- 4.11.87 Mrs. M. Mapletoft (Durham Chemistry Teachers'
Centre), 'Salters' Chemistry'.

- 19.11.87 Dr. J. Davidson (Herriot-Watt University), 'Metal Promoted Oligomerisation Reactions of Alkynes'.
- 10.12.87 Dr.C.J. Ludman (University of Durham), 'Explosives'.
- 16.12.87 Mr. R.M. Swart (I.C.I.), 'The Interaction of Chemicals with Lipid Bilayers'.
- 16.3.88 Mr. L. Bossons (Durham Chemistry Teachers' Centre), 'GSCE Practical Assessment'.
- 7.4.88 Prof. M.P. Hartshorn (University of Canterbury, New Zealand), 'Aspects of Ipso-Nitration'.
- 13.4.88 Mrs. E. Roberts (SATRO Officer for Sunderland), Talk - Durham Chemistry Teachers' Centre, 'Links Between Industry and Schools'.
- 18.4.88 Prof. C.A. Nieto de Castro (University of Lisbon and Imperial College), 'Transport Properties of Non-polar Fluids'.
- 19.4.88 Graduate Chemists (Northeast Polytechnics and Universities), R.S.C. Graduate Symposium.
- 25.4.88 Prof. D. Birchall (I.C.I Advanced Materials), 'Environmental Chemistry of Aluminium'.
- 27.4.88 Dr. J.A. Robinson (University of Southampton), 'Aspects of Antibiotic Biosynthesis'.
- 27.4.88 Dr. R. Richardson (University of Bristol), 'X-Ray Diffraction from Spread Monolayers'.
- 28.4.88* Prof. A. Pines (University of California, Berkeley, U.S.A.), 'Some Magnetic Moments'.
- 11.5.88* Dr. W.A. McDonald (I.C.I. Wilton), 'Liquid Crystal Polymers'.
- 11.5.88 Dr. J. Sodeau (University of East Anglia), Durham Chemistry Teachers' Centre Lecture, 'Spray Cans, Smog and Society'.
- 8.6.88 Prof. J.-P. Majoral (Universite Paul Sabatier), 'Stabilisation by Complexation of Short-Lived Phosphorus Species'.
- 29.6.88* Prof. G.A. Olah (University of Southern California), 'New Aspects of Hydrocarbon Chemistry'.
- 18.10.88 Dr. J. Dingwall (Ciba Geigy), 'Phosphorus-containing Amino Acids: Biologically Active Natural and Unnatural Products'.
- 18.10.88 Mr. F. Bollen (Durham Chemistry Teachers' Centre),

'The Use of SATIS in the classroom'.

- 18.10.88* Dr. C.J. Ludman (Durham University), 'The Energetics of Explosives' .
- 9.11.88 Dr. G. Singh (Teesside Polytechnic), 'Towards Third Generation Anti-Leukaemics'.
- 16.11.88 Dr. K.A. McLauchlan (University of Oxford), 'The Effect of Magnetic Fields on Chemical Reactions'.
- 2.12.88 Dr. G. Hardgrove (St. Olaf College, U.S.A.), 'Polymers in the Physical Chemistry Laboratory'.
- 9.12.88 Dr. C. Jäger (Friedrich-Schiller Universität, GDR), 'NMR investigations of Fast Ion Conductors of the NASICON Type'.
- 14.12.88 Dr. C. Mortimer (Durham University Teachers' Centre), 'The Hindenberg Disaster - An Excuse for Some Experiments'
- 25.1.89* Dr. L. Harwood (University of Oxford), 'Synthetic Approaches to Phorbols Via Intramolecular Furan Diels-Alder Reactions: Chemistry Under Pressure
- 1.2.89 Mr. T. Cressey and Mr. D. Waters (Durham Chemistry Teachers' Centre), 'GCSE Chemistry 1988: A Coroner's Report'.
- 13.2.89 Prof. R.R. Schrock (M.I.T.), 'Recent Advances in Living Metathesis' .
- 15.2.89 Dr. A.R. Butler (St. Andrews University), 'Cancer in Linxiam: The Chemical Dimension'.
- 22.2.89 Dr. G. MacDougall (Edinburgh University), 'Vibrational Spectroscopy of Model Catalytic Systems'.
- 1.3.89 Dr. R.J. Errington (University of Newcastle-upon-Tyne), 'Polymetalate Assembly in Organic Solvents'.
- 9.3.89 Dr. I. Marko (Sheffield University), 'Catalytic Asymmetric Osmylation of Olefins'.
- 14.3.89 Mr. P. Revell (Durham Chemistry Teachers' Centre), 'Implementing Broad and Balanced Science 11-16'.
- 15.3.89 Dr. R. Aveyard (University of Hull), 'Surfactants at your Surface'.
- 20.4.89 Dr. M. Casey (University of Salford), 'Sulphoxides in Stereoselective Synthesis'.
- 27.4.89* Dr. D. Crich (University College London), 'Some Novel Uses of Free Radicals in Organic Synthesis'.

- 3.5.89 Mr. A. Ashman (Durham Chemistry Teachers' Centre), 'The Chemical Aspects of the National Curriculum'.
- 3.5.89* Dr. P.C.B. Page (University of Liverpool), 'Stereocontrol of Organic Reactions Using 1,3-dithiane-1-oxides'.
- 10.5.89 Prof. P.B. Wells (Hull University), 'Catalyst Characterisation and Activity'.
- 11.5.89 Dr. J. Frey (Southampton University), 'Spectroscopy of the Reaction Path: Photodissociation Raman Spectra of NOCl'.
- 16.5.89 Dr. R. Stibr (Czechoslovak Academy of Sciences), 'Recent Developments in the Chemistry of Intermediate-Sited Carboranes'.
- 17.5.89 Dr. C.J. Moody (Imperial College), 'Reactive Intermediates in Heterocyclic Synthesis'.
- 23.5.89 Prof. P. Paetzold (Aachen), 'Iminoboranes $\text{XB}\equiv\text{NR}$: Inorganic Acetylenes ?'.
- 14.6.89 Dr. M.E. Jones (Durham Chemistry Teachers' Centre), 'GCSE and A-level Chemistry 1989'.
- 15.6.89* Prof. J. Pola (Czechoslovak Academy of Sciences), 'Carbon Dioxide Laser Induced Chemical Reactions - New Pathways in Gas-Phase Chemistry'.
- 28.6.89 Dr. M.E. Jones (Durham Chemistry Teachers' Centre), 'GCSE and A-level Chemistry 1989'.
- 11.7.89 Dr. D. Nicholls (Durham Chemistry Teachers' Centre), 'Liquid Air Demonstration'.
- 18.9.89 Dr. I. Hemer and Dr. Olda Paleta (Technical University of Prague), 'Aspects of Fluorinated Alkenes'.
- 11.10.89 Dr. N. Kenning (University of Durham), 'Infrared reflection spectroscopy from metal surfaces'.
- 1.11.89 Dr. J.P.S. Badyal (Durham), 'Breakthroughs in heterogeneous catalysis'.
- 10.11.89* Prof. J. Bercaw (California Institute of Technology), 'Synthetic and mechanistic approaches to Ziegler-Natta polymerization of olefins'.

(B) Lectures organised by Durham University Chemical Society 1986-1989

(those attended are marked *)

- 22.1.87 Prof. R.H. Ottewill (University of Bristol),
'Colloid Science: A Challenging Subject'.
- 5.2.87* Dr. P. Hubberstey (University of Nottingham),
'Demonstration Lecture on Various Aspects of
Alkali Metal Chemistry'.
- 12.2.87* Dr. D. Brown (I.C.I. Billingham), 'Industrial
Polymers from Bacteria'.
- 19.2.87* Dr. M. Jarman (Institute of Cancer Research), 'The
Design of Anti-Cancer Drugs'.
- 5.3.87 Prof. S.V. Ley (Imperial College), 'Fact and
Fantasy in Organic Synthesis'.
- 9.3.87* Prof. F.G. Bordwell (Northeastern University,
U.S.A.), 'Carbon Anions, Radicals, Radical Anions
and Radical Cations'.
- 12.3.87 Dr. E.M. Goodger (Cranfield Institute of
Technology), 'Alternative Fuels for Transport'.
- 15.10.87* Dr. M.J. Winter (University of Sheffield),
'Pyrotechnics'.
- 22.10.87* Prof. G.W. Gray (University of Hull), 'Liquid
Crystals and their Applications'.
- 29.10.87* Mrs. S. van Rose (Geological Museum), 'Chemistry
of Volcanoes'.
- 5.11.87* Dr. A.R. Butler (University of St. Andrews),
'Chinese Alchemy'.
- 12.11.87* Prof. D. Seebach (E.T.H. Zurich), 'From Synthetic
Methods to Mechanistic Insight'.
- 19.11.87 Prof. P.G. Sammes (Smith, Kline and French),
'Chemical Aspects of Drug Development'.
- 26.11.87 Dr. D.H. Williams (University of Cambridge),
'Molecular Recognition'.
- 3.12.87* Dr. J. Howard (I.C.I. Wilton), 'Liquid Crystal
Polymers'.
- 21.1.88* Dr. F. Palmer (University of Nottingham),

'Luminescence'.

- 28.1.88* Dr. A. Cairns-Smith (University of Glasgow), 'Clay Minerals and the Origin of Life'.
- 11.2.88 Prof. J.J. Turner (University of Nottingham), 'Catching Organometallic Intermediates'.
- 18.2.88* Dr. K. Borer (University of Durham Industrial Research Laboratories), 'The Brighton Bomb - A Forensic Science View'.
- 25.2.88 Prof. A. Underhill, (University of Bangor), 'Molecular Electronics'.
- 3.3.88 Prof. W.A.G. Graham (University of Alberta, Canada), 'Rhodium and Iridium Complexes in the Activation of Carbon-Hydrogen Bonds'.
- 6.10.88* Prof. R. Schmutzler (Technische Universität Braunschweig), 'Fluorophosphines Revisited - New Contributions to an Old Theme'.
- 21.10.88* Prof. P. von Rague Schleyer (Universität Nürnberg-Erlangen), 'The Fruitful Interplay Between Calculational and Experimental Chemistry'.
- 27.10.88* Prof. W.C. Rees (Imperial College), 'Some Very Heterocyclic Compounds'.
- 10.11.88* Prof. J.I.G. Cadogan (B.P. Research), 'From Pure Science to Profit'.
- 24.11.88* Dr. R.W. Walker and Dr. R.R. Baldwin (University of Hull), 'Combustion - Some Burning Problems'.
- 1.12.88* Dr. R. Snaith (University of Cambridge), 'Egyptian Mummies - What, Where, Why and How ?'
- 26.1.89* Prof. K.R. Jennings (University of Warwick), 'Chemistry of the Masses'.
- 2.2.89* Prof. L.D. Hall (Addenbrookes' Hospital), 'NMR - A Window to the Human Body'.
- 9.2.89* Prof. J. Baldwin (University of Oxford), '??'.
- 16.2.89* Prof. J.B. Aylett (Queen Mary College), 'Silicon-based Chips: The Chemists Contribution'.
- 23.2.89* Dr. B.F.G. Johnson (University of Cambridge), 'The Binary Carbonyls'.
- 17.10.89* Dr. F. Palmer (University of Nottingham),

'Thunder and Lightning'.

- 25.10.89 Prof. C. Floriani (Lausanne), 'Molecular Aggregates - A Bridge between Homogeneous and Heterogeneous Systems'.
- 9.11.89* Prof. N.N. Greenwood (University of Leeds), 'Novel Cluster Geometries in Metalloborane Chemistry'.
- 16.11.89* Dr. D. Parker (University of Durham), 'Macrocycles, Drug and Rock 'n' Roll'.
- 30.11.89* Dr. M.N. Hughes (King's College), 'A Bug's Eye View of the Periodic Table'.
- 07.12.89 Dr. A. Butler (St. Andrew's), 'The Discovery of Penicillin - Facts and Fancies'

(C) Research Conferences attended

Graduate Symposium
Durham, April 1987.

R.S.C. Perkin Division, One-Day Meeting,
Newcastle, 15 September 1987.

Gesellschaft Deutscher Chemiker, Fachtagung Elektrochemie
Frankfurt am Main, October 1987.

21st Sheffield Symposium on "Modern Aspects of Stereochemistry", Sheffield, 16 December 1987.

Graduate Symposium,
Durham, April 1988.

Graduate Symposium,
Durham, April 1989

9th European Symposium on Fluorine Chemistry, Leicester,
September 1989

(D) First year induction course, October 1987

This course consists of a series of one hour lectures on the services available in the department.

1. Departmental organisation.
2. Safety matters.
3. Electrical appliances and infra-red spectroscopy.
4. Chromatography and microanalysis.
5. Atomic absorptiometry and inorganic analysis.
6. Library facilities.
7. Mass spectroscopy.
8. Nuclear magnetic resonance spectroscopy.
9. Glassblowing technique.

REFERENCES

REFERENCES

1. B. Grievson, Ph.D. Thesis, Durham University, 1983.
2. S.L. Jones, Ph.D. Thesis, Durham University, 1987.
3. F. Liska and V. Kubelka,
Coll. Czech. Chem. Commun., 1972, 37, 1381.
4. R. D. Chambers, Interscience Monographs on Organic Chemistry,
Ed. G.Olah, "Fluorine in Organic Chemistry", John Wiley and Sons,
New York, 1973.
5. R.N. Haszeldine, R. Rowland, R.P. Sheppard, and A.E. Tipping,
J. Fluorine Chem., 1985, 28, 291.
6. T. Davies, R.N. Haszeldine, R. Rowland, and A.E. Tipping,
J. Chem. Soc. Perkin Trans. 1, 1983, 109.
7. R.N. Haszeldine and R. Rowland, US Pat. 3,917,725 (1975).
8. R.N. Haszeldine and R. Rowland, US Pat. 3,816,286 (1974).
9. R.N. Haszeldine, A.J. Mitchinson, R. Rowland, and A.E. Tipping,
J. Chem. Soc. Perkin Trans. 1, 1976, 517.
10. T. Davies, R.N. Haszeldine, and A.E. Tipping,
J. Chem. Soc. Perkin Trans. 1, 1983, 1343.
11. H. Singh and J.M. Tedder, *J. Chem. Soc.*, 1964, 4737.
12. P.D. Bartlett, L.K. Montgemery, and B. Seidel, *J. Am. Chem. Soc.*,
1964, 86, 616; L.K. Montgomery, K. Schueller, and P.D. Bartlett,
ibid., 1964, 86, 622; P.D. Bartlett and L.K. Montgomery, *ibid.*,
1964, 86, 628.
13. R.N. Haszeldine, C.M. Raynor, and A.E. Tipping,
J. Chem. Soc. Perkin Trans. 1, 1982, 2219.
14. J.D. Roberts and C.M. Sharts in "Organic Reactions", Vol. 12,
John Wiley and Sons, Inc., New York, N.Y., 1962, p. 1.
15. A.T. Podkhalyuzin and M.P. Nazorova,
Khim. Uys Energ., 1979, 13, 130.
16. R.N. Haszeldine, C. M Raynor, and A.E. Tipping,
J. Chem. Soc. Perkin Trans. 1, 1983, 2801.
17. H. Kimoto, H. Muramatsu, and K. Inukai, *Chem. Letters*, 1974, 791.
18. McBee, Hsu, Pierce, and Roberts, *J. Am. Chem. Soc.*, 1955, 77, 915.
19. E.G. Howard, P.B. Sargeant, and C.G. Krespan,
J. Am. Chem. Soc., 1967, 89, 1422.
20. a) L.J. Bellamy and R.L. Williams, *J. Chem. Soc.*, 1957, 4294;
b) M. Stacey, J.C. Tatlow, and A.G. Sharpe,
Adv. Fluorine Chem., 1963, 3, 1; c) *ibid.*, 1965, 4, 284.
21. Y. Tabata, W. Ito, K. Oshima, and Y. Yamamoto,

- Adv. Chem. Ser.*, 1973, 129, 190.
22. H. Masubayashi, Y. Chatani, H. Tadokora, Y. Tabata, and W. Ito, *Polymer Journal (Japan)*, 1977, 9, 145.
 23. A.P. Swales, Ph.D. Thesis, Durham, 1989.
 24. A.J. Kirby in *Reactivity and Structure Concepts in Organic Chemistry* 15, "The anomeric effect and related stereoelectronic effects at oxygen"; Springer-Verlag, Berlin, 1983.
 25. S. David, O. Einstein, W.J. Hehre, L. Salem, and R. Hoffmann, *J. Am. Chem. Soc.*, 1973, 95, 3806.
 26. A.D. Sweigart, *J. Chem. Educ.*, 1973, 50, 322.
 27. R.D. Chambers and B. Grievson, *J. Chem. Soc. Perkin Trans. 1*, 1985, 2215.
 28. M. Hanack, 'Conformation Theory, Organic Chemistry - a Series of Monographs', Vol. 3, Academic Press, New York, 1965.
 29. P. Deslongchamps, 'Stereoelectronic Effects in Organic Chemistry', Pergamon Press, Oxford, 1983.
 30. S. W. Benson, "Thermochemical Kinetics"; Wiley, New York, 1978.
 31. D.C. Nonhebel, J.M. Tedder, and J.C. Walton, "Radicals"; Cambridge University Press, 1979, p. 113.
 32. H.M. Walborsky, *Tetrahedron*, 1981, 37, 1625.
 33. R.W. Fessenden and R.H. Schuler, *J. Chem. Phys.*, 1963, 43, 2704; *ibid.*, 1963, 39, 2147.
 34. J.M. Hay, "Reactive Free Radicals"; Academic Press, New York, 1974.
 35. A. Clerici, F. Minisci, and O. Porta, *J. Chem. Soc. Perkin II.*, 1699 (1974).
 36. A.E. Finhold, A.C. Bond, Jr., K.E. Wilzbach, and H.I. Schlesinger, *J. Am. Chem. Soc.*, 1947, 69, 2692.
 37. G.J.M. van der Kerk, J.G. Noltes, and J.G.A. Luijten, *J. Appl. Chem.*, 1957, 7, 366.
 38. K. Hayashi, J. Iyoda, and I. Shiihara, *J. Organometal. Chem.*, 1967, 10, 81.
 39. H.C. Clark, S.G. Furnival, and J.T. Kwon, *Can. J. Chem.*, 1963, 41, 2889.
 40. C.G. Krespan and V.A. Engelhardt, *J. Org. Chem.*, 1958, 23, 1565.
 41. H.G. Kuivila and R. Sommer, *J. Am. Chem. Soc.*, 1967, 89, 5616.
 42. H.C. Clark and J.T. Kwon, *Can. J. Chem.*, 1964, 42, 1288.
 43. H.C. Clark, J.D. Cotton, and J.H. Tsai, *Can. J. Chem.*, 1966, 44, 903.
 44. B. Giese, in *Organic Chemistry Series*, Ed. J.E. Baldwin, Vol. 5, "Radicals in Organic Synthesis", Pergamon Press, Oxford, 1986,

p. 56, and references therein.

45. W.R. Cullen and G.E. Styan, *J. Organometal. Chem.*, 1966, 3, 633.
46. H.C. Clark and J.T. Kwon, *Can. J. Chem.*, 1964, 42, 1288.
47. R.D. Chambers, H.C. Clark, and C.J. Willis,
Chem. Ind. (London), 1960, 76.
48. H.D. Kaesz, J.R. Phillips, and F.G.A. Stone,
J. Am. Chem. Soc., 1960, 82, 6228.
49. H.C. Clark and C.J. Willis, *J. Am. Chem. Soc.*, 1960, 82, 1888.
50. W.R. Cullen and W.R. Leeder, *J. Inorg. Chem.*, 1966, 5, 1004.
51. W.R. Cullen and M.C. Waldman, *Can. J. Chem.*, 1969, 47, 3093.
52. W.R. Cullen, J.R. Sams, and M.C. Waldman,
Inorg. Chem., 1970, 9, 1682.
53. M. Akhtar and H.C. Clark, *Can. J. Chem.*, 1969, 47, 3753.
54. W.R. Cullen and G.E. Styan, *J. Organometal. Chem.*, 1966, 6, 117.
55. G.M. Burch, H. Goldwhite, and R.M. Haszeldine,
J. Chem. Soc., 1963, 1083.
56. R.N. Haszeldine and B.R. Steele, *J. Chem. Soc.*, 1957, 2800.
57. W.R. Cullen, D.S. Dawson, and G.E. Styan,
J. Organometal. Chem., 1965, 3, 406.
58. W.J. Middleton, U.S. Patent 3,940,402 (1976).
59. as ref. 23, p. 56 and references quoted.
60. Personal communication R.D. Chambers and G. Olah.
61. D. Seyferth, G. Raab, and K.A. Brändle,
J. Org. Chem., 1961, 26, 2934.
62. H.D. Kaesz, S.L. Stafford, and F.G.A. Stone,
J. Am. Chem. Soc., 1960, 82, 6232.
63. F.E. Brinckman and F.G.A. Stone, *J. Am. Chem. Soc.*, 1960, 82, 6218.
64. J.M. Tedder, *Adv. Fluorine Chem.*, 1961, 2, 104
65. A. Haas and M. Lieb, *CHIMINA*, 1985, 39, (5), 134
66. H. Vypel, *CHIMINA*, 1985, 39, (5), 305
67. M.R.C. Gerstenberger and A. Haas, *Angew. Chem. Int. Ed. Engl.*,
1981, 20, 647.
68. S. Rozen and C. Gail, *J. Fluorine Chem.*, 1985, 27, 143.
69. A.M. Lovelace, D.A. Ranch, and W. Postelneck, "Aliphatic Fluorine
Compounds", Reinhold., New York, 1958, p. 20.
70. R.J. Lagow and J.L. Margrave, *Prog. Inorg. Chem.*, 1979, 26, 161.
71. W.T. Miller, Jr., S.D. Koch, Jr., and F.W. McLafferty, *J. Am. Chem.
Soc.*, 1956, 78, 4992.
72. W.T. Miller, Jr. and A.C. Dittman, *J. Am. Chem. Soc.*, 1956, 78,
2793.

73. W.T. Miller, Jr. and S.D. Koch, *J. Am. Chem. Soc.*, 1957, 79, 3084.
74. S.Modena, P. Calini, G. Gregorio, and G. Moggi, *J. Fluorine Chem.*, 1988, 40, 349.
75. E.P. Appl. 0 190 393 (02.08.1895) (to The Green Cross Corp., Japan).
76. R.J. Lagow and J.L. Margrave, *Proc. Nati. Acac. Sic. USA*, 1970, 67, (4), 8A.
77. R.J. Lagow and J.L. Margrave, *Chem. Eng. News*, 1970, 40, 40.
78. J.L. Adcock, K. Horita, and E.B. Renk, *J. Am. Chem. Soc.*, 1981, 103, 6937.
79. C. Bliefert, H.-M. Boldhaus, F. Erdt, and M. Hoffmann, *Kunststoffe*, 1986, 76, (3), 235.
80. C. Bliefert, "Lösungsfluorierung (off line)", in: VDI (Hrsg.), Sperrschichtbildung bei Kunststoff-Hohlkörpern. Düsseldorf: VDI-Verlag, 1986.
81. J.L. Adcock and M.L. Robin, *J. Org. Chem.*, 1983, 48, 3128.
82. J.L. Adcock and M.L. Cherry, *J. Fluorine Chem.*, 1985, 30, 343.
83. R.J. Lagow and N.J. Maraschin, *Inorg. Chem.*, 1973, 12, (6), 1458.
84. R.J. Lagow, G. Jarvinen, L.H. Davis, D. Catsikis, and N.J. Marashin, *J. Am. Chem. Soc.*, 1975, 97, 513.
85. R.J. Lagow and L.A. Shimp, *J. Org. Chem.*, 1977, 42, 3437.
86. R.J. Lagow, W.I. Bailey, Jr., and W.-H. Lin, *Chem. Commun.*, 1985, 1350.
87. R.J. Lagow, D.F. Persico, H.-N. Huang, and L.C. Clark, Jr., *J. Org. Chem.*, 1988, 53, 78.
88. J.L. Adcock, B.D. Catsikis, J.W. Thompson, and R.J. Lagow, *J. Fluorine Chem.*, 1976, 7, 197.
89. J.L. Adcock and R.J. Lagow, *J. Org. Chem.*, 1973, 38, 3617.
90. A.J. Otsuka and R.J. Lagow, *J. Fluorine Chem.*, 1974, 4, 371.
91. G.E. Gerhardt and R.J. Lagow, *J. Org. Chem.*, 1978, 43, 4505.
92. G.E. Gerhardt and R.J. Lagow, *J. Chem. Soc., Perkin 1*, 1981, 1321.
93. D.F. Persico and R.J. Lagow, *Macromolecules*, 1985, 18, 1383.
94. D.F. Persico, G.E. Gerhardt, and R.J. Lagow, *J. Am. Chem. Soc.*, 1985, 107, 1197.
95. R.D. Chambers, B. Grievson, F.G. Drakesmith, and R.L. Powell, *J. Fluorine Chem.*, 1985, 29, 323.
96. P. Telford, Ph.D. Thesis, Durham University, 1986.
97. D. Cech and A. Holy, *Collect. Czech. Chem. Commun.*, 1976, 41, 3335.
98. A. Haas and D. Kortmann, *Chem. Ber.*, 1981, 114, 1176.
99. T.B. Patrick, J.J. Scheibel, and G.L. Cantrell, *J. Org. Chem.*,

- 1981, 46, 3917.
100. T.B. Patrick, and P.A. Flory, *J. Fluorine Chem.*, 1985, 25, 157.
 101. D.H.R. Barton, R.H. Hesse, R.E. Machwell, M.M. Pechet, and H.T. Toh, *J. Am. Chem. Soc.*, 1976, 98, 3034.
 102. S. Rozen, C. Gal, and Y. Faust, *J. Am. Chem. Soc.*, 1980, 102, 6860.
 103. M. Sander and W. Blöchl, *Chem.-Ing.-Tech.*, 1965, 37, 7;
Ger. Pat. 1 119 262 (1962); UK Pat. 879 057 (1961) (to Saline Ludwigshalle).
 104. R.D. Chambers and M.W.H. West, unpublished results.
 105. R.D. Chambers and B. Grievson, *J. Fluorine Chem.*, 1985, 25, 523.
 106. J.H. Simons, US Pat. 2,500,388 (1950) (to 3M).
 107. J.H. Simons in "Fluorine Chemistry", ed. J.H. Simons, Academic Press, New York, 1950, Vol. 1, p.414.
 108. J.H. Simons and T.J. Brice in "Fluorine Chemistry", ed. J.H. Simons, Academic Press, New York, 1954, Vol. 2, p.340.
 109. J. Burdon and J.C. Tatlow, *Adv. Fluorine Chem.*, 1960, 1, 129.
 110. T. Abe and S. Nagase in "Preparation, Properties and Industrial Applications of Organofluorine Compounds", ed. R.E. Banks, Ellis Harwood, Chichester, 1982, p.235.
 111. E. Hollitzer and P. Sartori, *Chem.-Ing.-Tech.*, 1986, 58, Nr. 1, 31.
 112. R.D. Dresdner and J.A. Young, *J. Am. Chem. Soc.*, 1954, 81, 514.
 113. J. Burdon, I.W. Parsons, and J.C. Tatlow, *Tetrahedron*, 1972, 28, 43.
 114. G. P. Gambaretto, M. Napoli, L. Conte, A. Scipioni, and R. Armelli, *J. Fluorine Chem.*, 1985, 27, 149.
 115. T. Abe, E. Hayashi, H. Baba, K. Kodaira, and S. Nagase, *J. Fluorine Chem.*, 1980, 15, 353.
 116. R.E. Banks, "Fluorocarbons and Their Derivatives", MacDonald, London, 1970, (2nd edn.).
 117. G.V.D. Tiers, *J. Am. Chem. Soc.*, 1955, 77, 4837, 6703,6704;
see also: T. Abe and S. Nagase, *J. Fluorine Chem.*, 1978, 12, 359.
 118. L.C. Clark and F. Gollan, *Science*, 1966, 152, 1756.
 119. *New Scientist*, (12.08.1989), No. 1677, 29.
 120. J.H. Simons, US Pat. 2,519,983 (1950) (to 3M).
 121. a) S. Nagase, H. Baba, and R. Kojima, *Kogyo Kagaku Zasshi*, 1962, 65, 1183; b) H. Kiaski, S. Mabuchi, and T. Sakomura, *Deuki Kagaku*, 1966, 34, 24.
 122. G.G.I. Moore, J.C. Hansen, T.M. Barrett, J.E. Waddell, K.M. Jewell, T.A. Kestner, and R.M. Payfer, *J. Fluorine Chem.*, 1986, 32, 41.

123. K. Okazaki, S. Nagase, H. Baba, and K. Kodaira, *J. Fluorine Chem.*, 1974, 4, 387.
124. N. Yabinin, I. Kolenko, L. Pushkina, V. Kollegov, and B. Lundin, *Zh. Org. Khim.*, 1969, 39, 2716.
125. V. Plashkin, S. Mertsalov, V. Kollegov, and S. Sokolov, *Zh. Org. Khim.*, 1970, 6, 1006.
126. M. Yonekura, S. Nagase, H. Baba, K. Kodaira, and T. Abe, *Bull. Chem. Soc. Jpn.*, 1976, 49, 1113.
127. T. Ono, Y. Inoue, L. Fukaya, Y. Arakawa, Y. Naito, and K. Yokoyama, *J. Fluorine Chem.*, 1985, 27, 333.
128. E.A. Kauck and J.H. Simons, US Pat. 2,594,272 (1952) (to 3M).
129. N.A. Ryabinin, I.P. Kolenko, and B.N. Lundin, *Zhur. Obshchei. Khim.*, 1967, 37, 1229.
130. N.A. Ryabinin, I.P. Kolenko, L.N. Pushkina, V.F. Kollegov, and B.N. Lundin, *Zhur. Obshchei. Khim.*, 1969, 39, 2716.
131. T. Abe and S. Nagase, *J. Fluorine Chem.*, 1979, 13, 519.
132. F.G. Drakesmith and D.A. Hughes, *J. Fluorine Chem.*, 1986, 32, 103.
133. Experiments by J. Murray (ICI) which are cited by A.J. Rudge, in "Industrial Electrochemical Process", ed. A.T. Kuhn, Elsevier, Amsterdam, 1971, p. 77.
134. E.A. Kauck and J.H. Simons, US Pat. 2,644,823 (1953) (to 3M); Brit. Pat. 718,318 (1954) (to 3M).
135. T. Abe, E. Hayashi, H. Baba, and S. Nagase, *Chem.-Letters*, 1980, 121.
136. T. Abe, E. Hayashi, H. Baba, and S. Nagase, *J. Fluorine Chem.*, 1984, 25, 419; see also: T. Abe, H. Baba, E. Hayashi, and S. Nagase, *J. Fluorine Chem.*, 1983, 23, 123.
137. UK Pat. 1,007,288 (1965) (to 3M).
138. T. Abe, K. Kodaira, H. Baba, and S. Nagase, *J. Fluorine Chem.*, 1978, 12, 1.
139. T. Abe, E. Hayashi, H. Baba, and S. Nagase, *J. Fluorine Chem.*, 1984, 26, 295.
140. R.E. Banks, F. Cuthbertson, and W.K.R. Musgrave, *Anal. Chim. Acta.*, 1955, 13, 442.
141. R.D. Chambers, H.C. Clark, and C.J. Willis, *J. Am. Chem. Soc.*, 1960, 82, 5298.

