



Durham E-Theses

The synthesis of poly(sulphur nitride) and some novel 4-phenyl-1,2,3,5-dithiadiazolium compounds

Wait, Simon Timothy

How to cite:

Wait, Simon Timothy (1989) *The synthesis of poly(sulphur nitride) and some novel 4-phenyl-1,2,3,5-dithiadiazolium compounds*, Durham theses, Durham University. Available at Durham E-Theses Online: <http://etheses.dur.ac.uk/6481/>

Use policy

The full-text may be used and/or reproduced, and given to third parties in any format or medium, without prior permission or charge, for personal research or study, educational, or not-for-profit purposes provided that:

- a full bibliographic reference is made to the original source
- a [link](#) is made to the metadata record in Durham E-Theses
- the full-text is not changed in any way

The full-text must not be sold in any format or medium without the formal permission of the copyright holders.

Please consult the [full Durham E-Theses policy](#) for further details.

THE SYNTHESIS OF POLY(SULPHUR NITRIDE) AND SOME NOVEL
4-PHENYL-1,2,3,5-DITHIADIAZOLIUM COMPOUNDS.

Simon Timothy Wait

The copyright of this thesis rests with the author.
No quotation from it should be published without
his prior written consent and information derived
from it should be acknowledged.

A thesis submitted for the degree of Ph.D. to the
University of Durham.

April 1989



25 APR 1991

To my mother

ACKNOWLEDGEMENTS

I would first of all like to thank my supervisor, Dr. A.J. Banister for his continual support and endless enthusiasm. I would also like to thank Dr. Z.V. Hauptman, without whose excellent technical and practical skills, as well as many other attributes, this work would not have been possible.

Special thanks are due to P. Nicholson, for his crystal growth advice, and to Dr. D. Walbridge and the ICI Paints division, for the funding. I also wish to thank Dr. W. Clegg (University of Newcastle) for solving all the excellent crystal structures, Dr. L.H Sutcliffe (Royal Bedford and Holloway New College, London) for running all the e.s.r. spectra, and H. Ancelin (University of Durham) for running the (SN)_x thin film spectra.

Thanks also to Dr. A. Royston, for teaching me to use the word processor on which this thesis is typed, and to Ian Gorrell, Wendy Gill, Michael Hansford, Jeremy Rawson, Anthony Luke, Phil Coates and Mark Briscoe for friendship and support, and finally to all the technical staff at the University of Durham for an excellent service.

MEMORANDUM

The work in this thesis was carried out by me in the Chemistry Department of Durham University between October 1985 and December 1988. I declare that the work has not been submitted previously for a degree at this or any other university. This thesis is my original work, except when acknowledged by reference. The copyright of this thesis rests with the author. No quotation from it should be published without his written consent and information derived from it should be acknowledged. Material from this thesis has been or will be included in the following publications:

- a) "Novel S-N Ring Contractions using Dithiadiazoles; The Synthesis and X-ray Crystal Structures of $[\text{Ph}\overline{\text{CNSSN}}][\text{S}_3\text{N}_2]\text{Cl}$ and $[[\text{Ph}\overline{\text{CNSSN}}]_2\text{Cl}][\text{S}_3\text{N}_3]$, A.J. Banister, W. Clegg, Z.V. Hauptman, A. Luke, and S.T. Wait, J. Chem. Soc., Chem Commun., 1989, 351.
- b) "Direct Insertion of a Nitrogen Atom into the S-S bond of a 1,2,3,5-Dithiadiazole Ring in a D.C. Nitrogen Glow Discharge, and X-ray Crystal Structure of 4-Methyl-1,2,3,5-Dithiadiazole, A.J. Banister, W. Clegg, M.I. Hansford, Z.V. Hauptman, and S.T. Wait, in press.
- c) The Synthesis, X-ray Crystal and Electronic Structure of 4-phenyl-1,2,3,5-Dithiadiazolium Trithiatriazinide, $[\text{Ph}\overline{\text{CNSSN}}][\text{S}_3\text{N}_3]$, A.J. Banister, W. Clegg, Z.V. Hauptman, K.A. Jorgenson, and S.T. Wait, in preparation.

The Synthesis of Poly(Sulphur Nitride) and Some Novel
4-Phenyl-1,2,3,5-Dithiadiazolium Salts

S.T. Wait, Ph.D., University of Durham, April 1989

ABSTRACT

$[S_5N_5]Cl$ has been reacted with a wide variety of reducing agents leading to a new non-explosive route to high quality powdered $(SN)_x$. Data collected from these reductions has led to a new mechanistic proposal for the formation of the powdered polymer. The vacuum thermolysis of $[S_5N_5]Cl$ with Li_3N produced S_2N_2 in low yield.

The new supporting electrolyte, $[Bu_4N]AsF_6$, was prepared, and has a greater scanning window in SO_2 compared with any others previously reported. $S_5N_5AsF_6$ has been produced in high purity and is much less moisture and oxygen sensitive than any other $S_5N_5^+$ salts previously prepared. The new supporting electrolyte, $[Bu_4N]AsF_6$, in conjunction with $[Bu_4N]BF_4$, was used to study the electrochemistry of $S_5N_5AsF_6$, $[SN]AsF_6$, $[S_4N_3]BF_4$, S_2N_2 and $[PhCN_2S_2][S_3N_3]$ by cyclic voltammetry. Electroreduction of both $S_5N_5AsF_6$ and $[SN]AsF_6$ produced conducting forms of $(SN)_x$ containing AsF_6^- , the latter product having a molecular formula of approximately $S_5N_5AsF_6$. Exhaustive electrolysis of $[S_5N_5]BF_4$ showed the breakdown of BF_4^- anion, producing BF_3 , which was seen as the $CH_3CN \cdot BF_3$ adduct, and F^- which reacted with the solvent, SO_2 , to produce SO_2F_2 ; the $S_4N_4 \cdot SO_3$ adduct was also produced.

Reduction of $[S_5N_5]Cl$ by $(PhCN_2S_2)_2$ produced $[[PhCN_2S_2]_2Cl][S_3N_3]$, (I), in CH_3CN and $[PhCN_2S_2][S_3N_3]$, (II), in pentane. Reduction of $[S_4N_3]Cl$ by $(PhCN_2S_2)_2$ in CH_3CN produced $[PhCN_2S_2][S_3N_2]Cl$, (III). X-ray structure determination has given accurate structures for all three compounds. (I), (II) and (III) were all successfully prepared in high yields. Large crystals of (II) were prepared from the reaction between $[S_5N_5]AlCl_4$ and $(PhCN_2S_2)_2$ in SO_2 , and were shown to contain some free $[PhCN_2S_2]^+$ monomers by e.s.r. spectroscopy. When vapours of $(SN)_x$ and $(PhCN_2S_2)_2$ were mixed together (II) was produced adding further evidence for $S_3N_3^+$ being the major vapour phase species of $(SN)_x$. Another e.s.r. active species, $[PhCN_2S_2]_2Cl$ (IV), was produced from the solid state reaction between $\frac{1}{2}(PhCN_2S_2)_2$ and $[PhCN_2S_2]Cl$. (I), (II), (III) and (IV) were all subjected to a low temperature D.C. nitrogen plasma, producing $(PhCN_3S_2)_2$, except for (IV) which decomposed to form $[PhCN_2S_2]Cl$ and a black non-conductive polymer.

TABLE OF CONTENTS

	<u>Page</u>
Chapter 1 General Introduction	1
1.1 Historical background	1
1.2 A synthetic overview of (SN) _x	2
1.3 The 4-phenyl-1,2,3,5-dithiadiazolium/ole system; a brief overview	5
1.4 An overview of my thesis	7
References	9
Chapter 2 General Experimental Techniques	12
2.1 General techniques	12
2.1 More specialised techniques	14
2.3 Electrochemical techniques	15
2.4 Sulphur-Nitrogen starting materials	21
2.5 Other starting materials	25
2.6 Miscellaneous reagents	26
2.7 Solvents	29
References	30
Chapter 3 Some Reductions of [S₅N₅]Cl in an Attempt to prepare powdered (SN)_x	32
3.1 Introduction	32
3.2 Results and Discussion	35
3.2.1 Chemical reductions of [S ₅ N ₅]Cl	35
a) Reduction by Fe in SO ₂	35
b) Reduction by Zn in SO ₂	36
c) Reduction by Ag in CH ₃ CN	36
d) Reduction by [Me ₄ N]N ₃ in CH ₃ CN	36
e) Reduction by (Me ₃ SiCO ₂) ₂ in CH ₃ CN	37

	<u>Page</u>
f) Reduction by Ph_3Sb in CH_3CN	37
g) Reduction by Ph_3Sb in SO_2	38
h) Reduction by Ph_3Sb and Me_3SiN_3 in CH_3CN	38
i) Reduction by Ph_3Sb with Seed $(\text{SN})_x$	39
3.2.2 Vacuum thermolysis of $[\text{S}_5\text{N}_5]\text{Cl}$ and LiN_3	50
3.3 Conclusions	50
3.4 Experimental	51
3.4.1 Chemical reductions of $[\text{S}_5\text{N}_5]\text{Cl}$	51
a) Reduction by Fe in SO_2	51
b) Reduction by Zn in SO_2	52
c) Reduction by Ag in CH_3CN	52
d) Reduction by $[\text{Me}_4\text{N}]\text{N}_3$ in CH_3CN	53
e) Reduction by $(\text{Me}_3\text{SiCO}_2)_2$ in CH_3CN	54
f) Reduction by Ph_3Sb in CH_3CN	54
g) Reduction by Ph_3Sb in SO_2	55
h) Reduction by Ph_3Sb and Me_3SiN_3 in CH_3CN	56
i) Reduction by Ph_3Sb with Seed $(\text{SN})_x$	56
3.4.2 Vacuum thermolysis of $[\text{S}_5\text{N}_5]\text{Cl}$ and LiN_3	57
References	59

Chapter 4 An Electrochemical study of some Sulphur- Nitrogen Compounds	62
4.1 Introduction	62
4.2 Results and Discussion	65
4.2.1 The Preparation of $[\text{Bu}_4\text{N}]\text{AsF}_6$	65
4.2.2 The Preparation of $\text{S}_5\text{N}_5\text{AsF}_6$	67
4.2.3 Cyclic voltammetric studies on $[\text{SN}]\text{AsF}_6$	
a) In liquid SO_2	68
b) In acetonitrile	70

	<u>Page</u>
4.2.4 Cyclic voltammetric study on S ₅ N ₅ AsF ₆ in CH ₃ CN	72
4.2.5 Cyclic voltammetric study on [S ₄ N ₃]BF ₄ in CH ₃ CN	75
4.2.6 Cyclic voltammetric study on S ₂ N ₂ in CH ₃ CN	78
4.2.7 Cyclic voltammetric study on [Ph $\overline{\text{CNSSN}}$][S ₃ N ₃] in CH ₃ CN	83
4.2.8 Potentiostatic electrolysis of [SN]AsF ₆ in SO ₂	86
4.2.9 Potentiostatic electrolysis of S ₅ N ₅ AsF ₆ in CH ₃ CN	89
4.2.10 Potentiostatic electrolysis of [S ₅ N ₅]BF ₄ in SO ₂	90
4.2.11 Immersion deposition of (SN) _x from S ₅ N ₅ AsF ₆ in CH ₃ CN	93
4.3 Conclusions	96
4.4 Experimental	97
4.4.1 The Preparation of [Bu ₄ N]AsF ₆	97
4.4.2 The Preparation of S ₅ N ₅ AsF ₆	98
4.4.3 Cyclic voltammetric studies on [SN]AsF ₆	
a) In liquid SO ₂	98
b) In acetonitrile	99
4.4.4 Cyclic voltammetric study on S ₅ N ₅ AsF ₆ in CH ₃ CN	99
4.4.5 Cyclic voltammetric study on [S ₄ N ₃]BF ₄ in CH ₃ CN	100
4.4.6 Cyclic voltammetric study on S ₂ N ₂ in CH ₃ CN	100

	<u>Page</u>
4.4.7 Cyclic voltammetric study on $[\overline{\text{PhCNSSN}}][\text{S}_3\text{N}_3]$ in CH_3CN	100
4.4.8 Potentiostatic electrolysis of $[\text{SN}]\text{AsF}_6$ in SO_2	101
4.4.9 Potentiostatic electrolysis of $\text{S}_5\text{N}_5\text{AsF}_6$ in CH_3CN	102
4.4.10 Potentiostatic electrolysis of $[\text{S}_5\text{N}_5]\text{BF}_4$ in SO_2	103
4.4.11 Immersion deposition of $(\text{SN})_x$ from $\text{S}_5\text{N}_5\text{AsF}_6$ in CH_3CN	104
References	105

Chapter 5 The Preparation and Crystal Structures of some Novel Dithiadiazolium Salts

5.1 Introduction	108
5.2 Results and Discussion	113
5.2.1 Crystal growth and structure of $[[\overline{\text{PhCNSSN}}]_2\text{Cl}][\text{S}_3\text{N}_3]$	113
5.2.2 Preparation of $[[\overline{\text{PhCNSSN}}]_2\text{Cl}][\text{S}_3\text{N}_3]$	128
5.2.3 Extraction of $[[\overline{\text{PhCNSSN}}]_2\text{Cl}][\text{S}_3\text{N}_3]$	128
5.2.4 Vacuum thermolysis of $[[\overline{\text{PhCNSSN}}]_2\text{Cl}][\text{S}_3\text{N}_3]$	129
5.2.5 Crystal growth and structure of $[\overline{\text{PhCNSSN}}][\text{S}_3\text{N}_2]\text{Cl}$	129
5.2.6 Preparation of $[\overline{\text{PhCNSSN}}][\text{S}_3\text{N}_2]\text{Cl}$	140
5.2.7 Extraction of $[\overline{\text{PhCNSSN}}][\text{S}_3\text{N}_2]\text{Cl}$	140
5.2.8 Crystal growth and structure of $[\overline{\text{PhCNSSN}}][\text{S}_3\text{N}_3]$	141
5.2.9 Preparation of $[\overline{\text{PhCNSSN}}][\text{S}_3\text{N}_3]$	149

	Page
a) Reaction of $[\text{PhCNSSN}][\text{AsF}_6]$ with $[\text{Pr}_4\text{N}][\text{S}_3\text{N}_3]$ in CH_3CN	149
b) Reaction of $[\text{S}_5\text{N}_5]\text{Cl}$ with $(\text{PhCNSSN})_2$ in SO_2	150
c) Reaction of $[\text{S}_5\text{N}_5]\text{AlCl}_4$ with $(\text{PhCNSSN})_2$ in CH_3CN	150
d) Mixing vapours of $(\text{SN})_x$ and $(\text{PhCNSSN})_2$	151
5.2.10 Reaction of $[\text{PhCNSSN}][\text{AsF}_6]$ with $[\text{Pr}_4\text{N}][\text{S}_3\text{N}_3]$ in CH_2Cl_2	153
5.2.11 Preparation of $[\text{PhCNSSN}]_2\text{Cl}$	155
5.2.12 Extraction of $[\text{PhCNSSN}]_2\text{Cl}$	155
5.2.13 Reaction in a DC nitrogen plasma of	157
a) $[\text{PhCNSSN}][\text{S}_3\text{N}_3]$	157
b) $[[\text{PhCNSSN}]_2\text{Cl}][\text{S}_3\text{N}_3]$	159
c) $[\text{PhCNSSN}][\text{S}_3\text{N}_2]\text{Cl}$	159
d) $[\text{PhCNSSN}]_2\text{Cl}$	159
5.3 Conclusions	160
5.4 Experimental	161
5.4.1 Crystal growth of $[[\text{PhCNSSN}]_2\text{Cl}][\text{S}_3\text{N}_3]$	161
5.4.2 Preparation of $[[\text{PhCNSSN}]_2\text{Cl}][\text{S}_3\text{N}_3]$	161
5.4.3 Extraction of $[[\text{PhCNSSN}]_2\text{Cl}][\text{S}_3\text{N}_3]$	162
5.4.4 Vacuum thermolysis of $[[\text{PhCNSSN}]_2\text{Cl}][\text{S}_3\text{N}_3]$	163
5.4.5 Crystal growth of $[\text{PhCNSSN}][\text{S}_3\text{N}_2]\text{Cl}$	163
5.4.6 Preparation of $[\text{PhCNSSN}][\text{S}_3\text{N}_2]\text{Cl}$	164
5.4.7 Extraction of $[\text{PhCNSSN}][\text{S}_3\text{N}_2]\text{Cl}$	165
5.4.8 Crystal growth of $[\text{PhCNSSN}][\text{S}_3\text{N}_3]$	165
5.4.9 Preparation of $[\text{PhCNSSN}][\text{S}_3\text{N}_3]$ by	
a) Reaction of $[\text{PhCNSSN}][\text{AsF}_6]$ with $[\text{Pr}_4\text{N}][\text{S}_3\text{N}_3]$ in CH_3CN	165

	<u>Page</u>
b) Reaction of $[\text{S}_5\text{N}_5]\text{Cl}$ with $(\overline{\text{PhCNSSN}})_2$ in SO_2	166
c) Reaction of $[\text{S}_5\text{N}_5]\text{AlCl}_4$ with $(\overline{\text{PhCNSSN}})_2$ in CH_3CN	167
d) Mixing vapours of $(\text{SN})_x$ and $(\overline{\text{PhCNSSN}})_2$	167
5.4.10 Reaction of $[\overline{\text{PhCNSSN}}][\text{AsF}_6]$ with $[\text{Pr}_4\text{N}][\text{S}_3\text{N}_3]$ in CH_2Cl_2	168
5.4.11 Preparation of $[\overline{\text{PhCNSSN}}]_2\text{Cl}$	168
5.4.12 Extraction of $[\overline{\text{PhCNSSN}}]_2\text{Cl}$	169
5.4.13 Reaction in a DC nitrogen plasma of	169
a) $[\overline{\text{PhCNSSN}}][\text{S}_3\text{N}_3]$	169
b) $[[\overline{\text{PhCNSSN}}]_2\text{Cl}][\text{S}_3\text{N}_3]$	170
c) $[\overline{\text{PhCNSSN}}][\text{S}_3\text{N}_2]\text{Cl}$	170
d) $[\overline{\text{PhCNSSN}}]_2\text{Cl}$	171
References	172
Appendix	175

LIST OF TABLES

<u>Table</u>		<u>Page</u>
3.1	Reaction yields of (SN) _x for different solvent compositions	40
5.1	A list of R-1,2,3,5-CN ₂ S ₂ ⁺ X ⁻ compounds and their references	109
5.2	Crystal data, bond lengths and angles for $[[\text{PhCNSSN}]_2\text{Cl}][\text{S}_3\text{N}_3]$	115
5.3	Anisotropic thermal parameters ($\text{\AA} \times 10^3$) for $[[\text{PhCNSSN}]_2\text{Cl}][\text{S}_3\text{N}_3]$.	116
5.4	The atomic coordinates ($\times 10^4$) and isotropic thermal parameters ($\text{\AA}^2 \times 10^3$) for the hydrogen atoms	116
5.5	Atomic Coordinates ($\times 10^4$) for $[[\text{PhCNSSN}]_2\text{Cl}][\text{S}_3\text{N}_3]$	117
5.6	Calculated and observed angle for the planes in a crystal of $[[\text{PhCNSSN}]_2\text{Cl}][\text{S}_3\text{N}_3]$	122
5.7	Crystal data, bond lengths and angles for $[\text{PhCNSSN}][\text{S}_3\text{N}_2]\text{Cl}$	131
5.8	The Atomic co-ordinates ($\times 10^4$) and isotropic thermal parameters ($\text{\AA}^2 \times 10^3$) for the hydrogen atoms	131
5.9	Atomic Coordinates ($\times 10^4$) for $[\text{PhCNSSN}][\text{S}_3\text{N}_2]\text{Cl}$	132
5.10	Anisotropic thermal parameters ($\text{\AA} \times 10^3$) for $[\text{PhCNSSN}][\text{S}_3\text{N}_3]$	132
5.11	Crystal data, bond lengths and angles for $[\text{PhCNSSN}][\text{S}_3\text{N}_3]$	142
5.12	The Atomic co-ordinates ($\times 10^4$) and isotropic thermal parameters ($\text{\AA}^2 \times 10^3$) for the hydrogen atoms	142
5.13	The atomic co-ordinates ($\times 10^4$) for $[\text{PhCNSSN}][\text{S}_3\text{N}_3]$	143
5.14	Anisotropic thermal parameters ($\text{\AA} \times 10^3$) for $[\text{PhCNSSN}][\text{S}_3\text{N}_3]$	143

LIST OF FIGURES

<u>Figure</u>		<u>Page</u>
2.1	The "dog"	16
2.2	The "closed extractor"	17
2.3	The plasma tube used for small scale reactions	18
2.4	The reference electrode	20
2.5	Three limbed undivided cell (typically used for cyclic voltammetry)	22
2.6	Breakdown of the modified Swagelock glass to metal connector	22
3.1	Yield of powdered $(\text{SN})_x$ vs. SO_2 solvent percentage	41
3.2	A wide scan core-level photoelectron spectrum of vacuum deposited $(\text{SN})_x$ on a glass substrate showing the presence of C, N, S, O and Si environments	45
3.3	A close up around the oxygen binding energy showing the presence of an Sb environment in vacuum deposited $(\text{SN})_x$	46
3.4	FT infra-red spectrum from a thin film of $(\text{SN})_x$ coated onto a KRS-5 crystal	47
3.5	FT infra-red spectrum of the same sample from figure 3.4 after 70 hours in a hygostat, showing partial hydrolysis of the layer	48
4.1	$[\text{Bu}_4\text{N}]\text{AsF}_6$ background cyclic voltammogram in SO_2 at $+20^\circ\text{C}$	66
4.2	$[\text{Bu}_4\text{N}]\text{AsF}_6$ background cyclic voltammogram in CH_3CN at $+20^\circ\text{C}$	66
4.3	D.S.C. trace of $\text{S}_5\text{N}_5\text{AsF}_6$	69
4.4	Cyclic voltammogram of $[\text{SN}]\text{AsF}_6$ in SO_2 at -32°C	71
4.5	Cyclic voltammogram of $[\text{SN}]\text{AsF}_6$ in CH_3CN at -32°C	71

<u>Figure</u>		<u>Page</u>
4.6a	Cyclic voltammogram of $S_5N_5AsF_6$ in CH_3CN at $-30^\circ C$	73
4.6b	Cyclic voltammogram of $S_5N_5AsF_6$ in CH_3CN at $-30^\circ C$ after holding the potential P for 3 minutes followed by scanning in the positive direction	73
4.7	Background cyclic voltammogram of $[Bu_4N]AsF_6$ in SO_2 at $+20^\circ C$ using an $(SN)_x$ electrode	76
4.8	Cyclic voltammogram of $[S_4N_3]BF_4$ in CH_3CN at $-20^\circ C$	77
4.9	Cyclic voltammogram of $[S_4N_3]BF_4$ in CH_3CN at $+20^\circ C$	77
4.10	Cyclic voltammogram of S_2N_2 in CH_3CN at $+16^\circ C$	81
4.11	Cyclic voltammogram of $[Ph\overline{CNSSN}][S_3N_3]$ in CH_3CN at $+20^\circ C$	84
4.12	D.S.C. trace of $(S_5N_5AsF_6)_x$ produced from the electrolysis of $[SN]AsF_6$ in SO_2	87
4.13	Gas phase spectrum of the products from the exhaustive reduction of $[S_5N_5]BF_4$ in liquid SO_2	92
5.1	$[[Ph\overline{CNSSN}]_2Cl][S_3N_3]$ - the asymmetric unit	118
5.2	The new planar cation, $[Ph\overline{CNSSN}]_2Cl$	119
5.3	The unit cell for $[[Ph\overline{CNSSN}]_2Cl][S_3N_3]$ showing the parallel rings	120
5.4	The predominant habit of the $[[Ph\overline{CNSSN}]_2Cl][S_3N_3]$ crystal	123
5.5	Perpendicular projection of the $(00\bar{1})$ plane in $[[Ph\overline{CNSSN}]_2Cl][S_3N_3]$.	124
5.6	Perpendicular projection of the $(\bar{2}30)$ plane in $[[Ph\overline{CNSSN}]_2Cl][S_3N_3]$.	125
5.7	Perpendicular projection of the $(0\bar{5}4)$ plane in $[[Ph\overline{CNSSN}]_2Cl][S_3N_3]$.	126
5.8	$[Ph\overline{CNSSN}][S_3N_2]Cl$ - the asymmetric unit.	133
5.9	The four nearest sulphur atoms to the chloride ion in $[Ph\overline{CNSSN}][S_3N_2]Cl$.	134

<u>Figure</u>		<u>Page</u>
5.10	The weaker secondary interactions between two adjacent $[\text{PhCNSSN}][\text{S}_3\text{N}_2]\text{Cl}$ molecules.	135
5.11	The unit cell of $[\text{PhCNSSN}][\text{S}_3\text{N}_2]\text{Cl}$	137
5.12	$[\text{PhCNSSN}][\text{S}_3\text{N}_3]$ - the asymmetric unit	144
5.13	The ABBA stacking arrangement in $[\text{PhCNSSN}][\text{S}_3\text{N}_3]$	145
5.14	A projection down the S_3N_3^- plane of $[\text{PhCNSSN}][\text{S}_3\text{N}_3]$	146
5.15	The close proximity of the S(5 & 3) atoms in the S_3N_3^- ring to the sulphurs in the CN_2S_2 ring	147
5.16	The unit cell of $[\text{PhCNSSN}][\text{S}_3\text{N}_3]$ showing the parallel rings	148
5.17a	The e.s.r spectrum from a single crystal of $[\text{PhCNSSN}][\text{S}_3\text{N}_3]$	152
5.17b	The e.s.r. spectrum taken at 90° to a) showing the orientation dependence of the crystal	152
5.18	The e.s.r. spectrum of crystalline $[\text{PhCNSSN}]_2\text{Cl}$	156
5.19	A projection along the crystallographic a axis showing the tunnels (2.6\AA diameter) through the $[\text{PhCNSSN}][\text{S}_3\text{N}_3]$ lattice	158

LIST OF SCHEMES

<u>Scheme</u>		<u>Page</u>
4.1	Reaction mechanisms inferred from the cyclic voltammetry data obtained from $[\text{S}_4\text{N}_3]\text{BF}_4$	79
4.2	Reaction mechanisms inferred from the cyclic voltammetry data obtained from S_2N_2	82
4.3	Reaction mechanisms inferred from the cyclic voltammetry data obtained from $[\text{Ph}\overline{\text{CNSSN}}][\text{S}_3\text{N}_3]$	85
4.4	A summary of reactions that occurred when $[\text{S}_5\text{N}_5]\text{BF}_4$ was exhaustively electroreduced	91
4.5	A proposed mechanism for the formation of SO_3 from the electrolysis of SO_2	94
5.1	Some possible reaction mechanisms for the formation of $[[\text{Ph}\overline{\text{CNSSN}}]_2\text{Cl}][\text{S}_3\text{N}_3]$	127
5.2	Some possible reaction mechanisms for the formation of $[\text{Ph}\overline{\text{CNSSN}}]_2\text{Cl}][\text{S}_3\text{N}_2]\text{Cl}$	139

CHAPTER 1

General Introduction

1.1 Historical Developments:

S_4N_4 was the first binary sulphur-nitrogen compound to be prepared and is one of the most studied inorganic heterocycles. It has continually stimulated new experiments and this has led to the introduction of several new ideas about structure, bonding and reactivity.¹ However it was the published work of Dr. Becke-Goehring, some of which was concerned with $(SN)_x$, which created much of the interest in sulphur-nitrogen chemistry today.²

More recently the discovery of the superconducting properties of $(SN)_x$ ³ led to increased activity in the sulphur-nitrogen field; $(SN)_x$ was first prepared in 1910 by Burt⁴ but its exciting metallic properties were not discovered until *ca.* 50 years later.^{2a} Indeed it is one of the few sulphur-nitrogen compounds whose properties are such that it might have commercial applications. Light weight batteries,⁵ light emitting diodes⁶ and solar cells⁷ are the three areas in which $(SN)_x$ has the greatest "potential".

The proposal by Hoffmann *et al*⁸ that a polymer made up of (-C-N-S-N)- repeating units would have conducting properties superior to those of $(SN)_x$ prompted investigations into the synthesis of possible precursors and this has given rise to a wide variety of C/N/S heterocycles⁹⁻¹⁵, including the dithiadiazoles.

Further evidence for the recent growth and interest in sulphur-nitrogen chemistry is provided by the comprehensive range of review articles which have been published in the last ten years.^{1, 16-25} Among

the most useful for me was the "Gmelin Handbook of Inorganic Chemistry"¹⁹ which surveys S(VI)-N and S(IV)-N cyclic compounds and S/N/C heterocycles.

1.2 (SN)_x; A Synthetic Overview:

a) "Classical" (SN)_x. The physical properties of (SN)_x have been well reviewed²⁶ and those relevant to the work discussed in this thesis are highlighted in the introductions to chapters 3 and 4. It is these exiting properties which have led to the search for "better" synthetic preparations of (SN)_x.

Initially all (SN)_x was prepared from the solid state polymerisation of S₂N₂,²⁷ which itself is prepared by the cracking of S₄N₄ over hot silver wool. Material prepared in this way is known as "classical" (SN)_x. It is crystalline (although full of defects),²⁶ stable up to 210°C, very pure and easily vacuum sublimed to produce high quality thin films of the polymer.

The explosive nature of S₂N₂²⁸⁻³¹ and S₄N₄³², however, has meant that a scale up of the synthesis could not be safely achieved and this has put a high price on the "classical" polymer. A rough estimate of the cost of synthesis by A.J. Banister and Z.V. Hauptman,³³ puts it at £1,000,000 per kilogram or £1,000 per gram which, after losses associated with coating, would put the price of potential electrical devices out of the market compared to others which are already commercially available.

Many other preparative routes to the "classical" (SN)_x precursor, S₂N₂, have been found. Vacuum thermolysis of the S₄N₄ adducts, CuBr·S₄N₄ (180°C)³⁴ and BeCl₂·S₄N₄ (80°C),³⁵ and of Ph₃As=N-S₃N₃ (135°C)³⁶ all produced S₂N₂. A recycling process was also developed³⁷

where the reaction of a powdered mixture of $S_2N_2 \cdot 2AlCl_3$ and S_4N_4 , in a 2:5 molar ratio, at $80^\circ C$ in high vacuum (*ca.* 10^{-5} torr) resulted in the formation of S_2N_2 in a 39% yield. Pyrolysis of $[S_4N_3]Cl$ alone,³⁸ or through silver wool,³⁹ produced S_2N_2 which in the latter case gave a 55% yield.

So far all the reactions described above use either S_4N_4 or S_2N_2 , or a mixture of both. This has meant high cost $(SN)_x$ and so other preparations were sought in an attempt to produce a high quality product which could be safely scaled up (i.e. avoiding the use of potentially explosive S_4N_4 and S_2N_2) and hence bring the cost down.

b) "Plasma" $(SN)_x$. Plasma deposition of $(SN)_x$ layers directly on to substrates⁴⁰⁻⁴² has been studied and in two of the three cases it does not require the use of S_4N_4 . Formation of $(SN)_x$ in this way was first reported by W.L. Jolly⁴⁰ in 1965 when atomic nitrogen was reacted with a variety of divalent sulphur compounds (H_2S , CS_2 , OCS , S_8 , S_2Cl_2 , SCl_2). $(SN)_x$ was produced in most cases but in low yields and the purity of the product was never stated.

More recently thin films were directly deposited on to non-conductive and semi-conductive substrates⁴¹ from a plasma glow-discharge decomposition of H_2S in a partial vacuum containing NH_3 or N_2 . Indeed this process was felt to be so important that it was patented.

$(SN)_x$ was also obtained, in a 50% yield, from S_4N_4 in a radio frequency glow-discharge containing helium.⁴² However this development involves the sublimation of S_4N_4 at $70-80^\circ C$; a potentially hazardous operation.

c) "Electrochemical" $(\text{SN})_x$. Electrochemical synthesis of $(\text{SN})_x$ from the reduction of SN cations has also proved to be a useful preparation of thin films directly on to conducting substrates.

"Electrochemical" $(\text{SN})_x$ was first prepared by Banister *et al*⁴³ from the reductions of $[\text{S}_5\text{N}_5]\text{Cl}$, $[\text{S}_5\text{N}_5]\text{FeCl}_4$ and $[\text{S}_5\text{N}_5]\text{AlCl}_4$ in liquid SO_2 at a platinum electrode. Shortly afterwards Fritz *et al*⁴⁴ published a similar synthesis from the electroreduction of $[\text{S}_5\text{N}_5]\text{FeCl}_4$ in CH_2Cl_2 . A.G. Kendrick⁴⁵ also showed that reduction of S_4N_3^+ in CH_3CN produced $(\text{SN})_x$ although the product was never fully characterised.

More recently a comprehensive study on the preparation and mechanism^{of formation} of "electrochemical" $(\text{SN})_x$ from the reductions of $[\text{S}_5\text{N}_5]\text{Cl}$ and $[\text{S}_5\text{N}_5]\text{BF}_4$ has been published.⁴⁶ Although all four electrochemical references discuss the synthesis of $(\text{SN})_x$, studies on its potential for electrical devices in the form of thin films have not been performed.

d) "Powdered" $(\text{SN})_x$. Powdered $(\text{SN})_x$ was initially⁴⁷ and is still⁴⁸ produced from the reduction of N/S/Cl compounds in solution by azides. The first⁴⁷ $(\text{SN})_x$ powder was prepared from the reduction of $(\text{NSCl})_3$, $\text{S}_3\text{N}_2\text{Cl}_2$ or $\text{S}_3\text{N}_2\text{Cl}$ by Me_3SiN_3 at -15°C in CH_3CN . However, inadequate purification procedures (extraction by CCl_4 , CS_2 and formic acid) led to the powders being highly unstable, decomposing under dry nitrogen within one week. Such powders were therefore highly unsuitable for thin film preparation by vacuum deposition.

An improved synthesis⁴⁸ from $(\text{NSCl})_3$ and Me_3SiN_3 in CH_3CN at -18°C has been reported in which the powdered polymer is simply purified by extraction with liquid SO_2 . This preparation was used to produce gram quantities of the polymer and such samples were suitable for vacuum

deposition although much of the $(SN)_x$ was lost, by decomposition, as S_4N_4 .

It can therefore be seen that significant development towards safer and cheaper preparations of $(SN)_x$ have been made. Indeed the plasma and electrochemical preparations deposit thin layers directly on to substrates which are most likely to be of importance to the electronics industry.

1.3 The 4-Phenyl-1,2,3,5-Dithiadiazolium/ole System; A brief overview.

Chapter 5 is exclusively concerned with the 4-phenyl-1,2,3,5-dithiadiazolium/ole ring and so I have chosen these particular compounds for discussion. A general overview of all the dithiadiazolium/oles is given in the introduction of chapter 5.

4-Phenyl-1,2,3,5-dithiadiazolium chloride $[\text{Ph}\overline{\text{CNSSN}}]\text{Cl}$, (I), is an orange non-volatile solid which was first prepared in 1977 by Banister *et al*⁴⁹ from the reaction between $(\text{NSCl})_3$ and PhCN . The X-ray crystal structure, which was not fully published until 1988,⁵⁰ showed it to be the first example of an aromatic 5 membered carbon-nitrogen-sulphur ring containing only one carbon atom. It was later prepared⁵¹ more conveniently (*ca.* 16g batches) from the reaction between NH_4Cl , SCl_2 and PhCN .

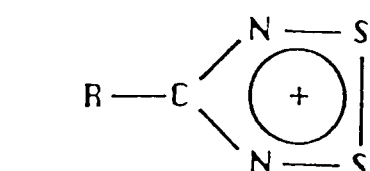

(I)

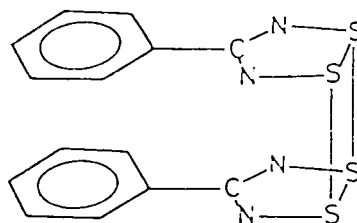

(II)

4-Phenyl-1,2,3,5-dithiadiazole dimer $(\text{Ph}\overline{\text{CNSSN}})_2$ (II), was prepared⁵² two years later from the reduction of $[\text{Ph}\overline{\text{CNSSN}}]\text{Cl}$ by sodium thiocyanate in refluxing 1,2-methoxyethane. The use of Zn/Cu couple⁵³ as a reducing agent at room temperature, followed by sublimation (80°C, 10^{-1} mmHg, 10h, cold finger 10-15°C) to yield dichroic, purple-green crystals of $(\text{Ph}\overline{\text{CNSSN}})_2$ proved to be a more convenient synthesis. The X-ray crystal structure⁵² (II) showed that the two half-molecules are bonded together in each dimer through weak S...S bonds (3.112Å). The two halves are nearly parallel in a *cis* arrangement and are twisted with respect to each other by *ca.* 6.8°C.⁵⁴

From the geometry of the ring, and from the S-N and N-C bond lengths, it was suggested that the CN_2S_2 groups were 6π -electron Hückel rings,⁵² in which each S donates two electrons, C and N one electron, linked by the two long S...S bonds. The positive charges on each ring are compensated by two electrons delocalised through the four sulphur atoms. It has, however, been shown more recently, by *ab initio* calculation,⁵⁵ that much of this "two electron" charge is found on the more electronegative nitrogen atoms and not exclusively on the four sulphurs as originally thought.

A solution esr spectrum of $(\text{Ph}\overline{\text{CNSSN}})_2$ in perdeuterotoluene⁵⁶ showed the presence of the $[\text{Ph}\overline{\text{CNSSN}}]^\cdot$ stable free radical giving a simple 1:2:3:2:1 quintet from two equivalent nitrogen nuclei, and it was shown that above *ca.* 250K almost no dimer was present (i.e. the solution consisted only of $[\text{Ph}\overline{\text{CNSSN}}]^\cdot$ monomers). In the solid state there are less free radicals present but the esr still shows an intense, though ill-resolved spectrum.

In a D.C. nitrogen glow discharge, $(\text{Ph}\overline{\text{CNSSN}})_2$ undergoes a particularly novel ring expansion⁵⁷ producing $(\text{PhCN}_3\text{S}_2)_2$, the "plasma

product", by insertion of one nitrogen atom into the S-S bond of each CN_2S_2 ring. Further work has shown⁵⁸ that dithiadiazoliums, with large polarisable anions such as Br^- and I^- , also react to produce $(\text{PhCN}_3\text{S}_2)_2$, although $[\text{Ph}\overline{\text{CNSSN}}]\text{Cl}$ is unaffected. Another requirement for reaction to occur seems to be the presence of lattice channels which are large enough to allow the nitrogen to reach the reactive sites.

1.4 An Overview of this Thesis:

Chapter 3 describes the preparation of "powdered" $(\text{SN})_x$ from the reduction of $[\text{S}_5\text{N}_5]\text{Cl}$ by Ph_3Sb with "seed" $(\text{SN})_x$. The reduction of $[\text{S}_5\text{N}_5]\text{Cl}$ by Ph_3Sb , and a small quantity of Me_3SiN_3 , as well as other less productive reductions (e.g. by metals and ionic azides), helps to give an insight into the mechanism of formation of the powdered polymer.

Chapter 4 deals with the electrochemical synthesis of $(\text{SN})_x$ by electroreduction of S_5N_5^+ and the attempted preparation from the electroreduction of SN^+ . $[\text{S}_5\text{N}_5]\text{AsF}_6$ proved to be a valuable starting material for electrosynthesis of $(\text{SN})_x$ as it was more stable to hydrolysis or oxidation than any other previously prepared S_5N_5^+ salt. The preparation of the new supporting electrolyte $[\text{Bu}_4\text{N}]\text{AsF}_6$ allowed the cyclic voltammetry of SN^+ to be studied for the first time in CH_3CN and SO_2 . Subsequent electroreduction of SN^+ produced the known polymer, $(\text{S}_5\text{N}_5\text{AsF}_6)_x$, which was shown to be conducting. Cyclic voltammetric studies on $[\text{S}_5\text{N}_5]\text{AsF}_6$, $[\text{S}_4\text{N}_3]\text{BF}_4$ were carried out in order to shed further light on to the reaction mechanism for the formation of $(\text{SN})_x$.

The attempted preparation of powdered $(\text{SN})_x$ from the reduction of $[\text{S}_5\text{N}_5]\text{Cl}$ by $(\text{Ph}\overline{\text{CNSSN}})_2$ in CH_3CN led to the discovery of $[[\text{Ph}\overline{\text{CNSSN}}]_2\text{Cl}][\text{S}_3\text{N}_3]$, and in pentane $[\text{Ph}\overline{\text{CNSSN}}][\text{S}_3\text{N}_3]$ was produced. Both crystal structures were solved and are discussed. Similar reduction of

$[S_4N_3]Cl$ in CH_3CN produced $[Ph\overline{CNSSN}][S_3N_2]Cl$ whose structure is also discussed. Larger scale preparative routes to all three compounds have been devised. The solid state reaction between $(Ph\overline{CNSSN})_2$ and $[Ph\overline{CNSSN}]Cl$ produced another new compound, $[Ph\overline{CNSSN}]_2Cl$ whose structure has not been determined. The mixing together of the vapours from $(Ph\overline{CNSSN})_2$ and $(SN)_x$ produced $[Ph\overline{CNSSN}][S_3N_3]$, and adds further evidence to the controversy as to which species is present in $(SN)_x$ vapour.

REFERENCES

1. H.G. Heal, "The Inorganic Heterocyclic Chemistry of Sulphur, Nitrogen, and Phosphorus", Academic, London 1980, pp. 1/127, 98/165.
2. (a) M. Goehring, *Q. Rev. Chem. Soc.*, 1956, 10, 437.
(b) M. Goehring in "Scientia Chimica", 9, Berlin, 1957.
(c) M. Goehring, "Ergebnisse and Probleme der Chemie der Schwefel-Stickstoffverbindungen", Akademie Verlag, Berlin, 1957.
(d) M. Becke-Goehring in "Progr. Inorg. Chem.", 1, F.A. Cotton, Ed., Wiley, New York, N.Y., 1959.
(e) M. Becke-Goehring, *Adv. Inorg. Chem. Radiochem.*, 1960, 2, 169.
(f) M. Becke-Goehring and E. Fluck in "Devolp. in Inorg. Nitr. Chem.", C.B. Colburn, Ed., Elsevier, Amsterdam, 1, 1966, 150.
3. V.V. Walatka, M.M. Labes, J.H. Peterson, *Phys. Rev. Lett.*, 1973, 31, 1139.
4. F.P. Burt, *J. Chem. Soc.*, 1171, 1910.
5. a) Hitachi Maxell ltd., J.P. 58,46,574/1983.
b) Asahi Chemical Industry Co., J.P. 58,93,177/1983.
c) Asahi Chemical Industry Co., J.P. 58,93,164/1983.
d) J. Badoz, M. Bardin, C. Bernard, M. Herlem, G. Robert, and A. Thiebault, E.P. Appl. 97,078/1983.
e) Asahi Chemical Industry Co., J.P. 58,197,677/1983.
f) Asahi Chemical Industry Co., J.P. 58,204,478/1983.
g) Allied Corp., J.P. 59,49,155,1982.
6. A.E. Thomas, J. Woods, and Z.V. Hauptman, *J. Phys. D: Appl. Phys.*, 1983, 16, 1123.
7. J.S. Harris, M.J. Cohen, H.M. Manasevit, and S.W. Zehr, *Energy Res. Abs.*, 1984, 9(3); no. 4534 ca: 100; 203814.
8. M.H. Whangbo, R. Hoffmann, and R.B. Woodward, *Proc. R. Soc. London, Ser. A*, 1979, 366, 23.
9. I. Earnest, W. Holick, G. Rihs, D. Schomburg, G. Shoham, D. Wenkert, and R.B. Woodward, *J. Am. Chem. Soc.*, 1981, 103, 1540.
10. S.T.A.K. Daley, C.W. Rees, and D.J. Williams, *J. Chem. Soc., Chem Commun.*, 1984, 55 and 57.
11. R. Jones, J.L Morris, C.W. Rees, and D.J. Williams, *J. Chem. Soc., Chem Commun.*, 1985, 1654.
12. H. Koenig and R.T. Oakley, *J. Chem. Soc., Chem Commun.*, 1983, 73.
13. P.J. Hayes, R.T. Oakley, A.W. Cordes, and W.T. Pennington, *J. Am. Chem. Soc.*, 1985, 107, 1346.
14. J.L. Morris, C.W. Rees, and D.J. Rigg, *J. Chem. Soc., Chem Commun.*, 1985, 396.

15. R.T. Boeré, A.W. Cordes, and R.T. Oakley, *J. Chem. Soc., Chem Commun.*, 1985, 929.
16. O. Glemser and R. Mews, *Angew. Chem. Int. Ed.*, 1980, 19, 883.
17. R. Glieter, *Angew. Chem. Int. Ed.*, 1981, 20, 444.
18. T. Chivers and R.T. Oakley, *Topics Curr. Chem.*, 1982, 102, 883.
19. "Gmelin Handbook of Inorganic Chemistry", 8th Ed., Sulphur-Nitrogen Compounds, Parts 1-4, Springer-Verlag, Berlin, 1984.
20. (a) T. Chivers, *Acc. Chem. Res.*, 1984, 17, 166.
(b) T. Chivers, *Chem. Rev.*, 1985, 85, 341.
21. G.K. MacLean, Ph.D. Thesis, University of New Brunswick, N.B., 1984.
22. N.N. Greenwood and A. Earnshaw, "Chemistry of the Elements", Pergamon Press, New York, 1984.
23. J.L. Morris and C.W. Rees, *Chem. Soc. Rev.*, 1986, 15, 1.
24. A.R. Katritzky and A.J. Boulton, Eds., "Advances in Heterocyclic Chemistry", Vols. 1-35, Academic Press, New York, 1953-1988.
25. R.T. Oakley, "Progress in Inorganic Chemistry", 36, Wiley, New York, 1988, 299.
26. M.M. Labes, P. Love, and L.F. Nichols, *Chemical Reviews*, 1979, 79, 1.
27. R.L. Patton, Ph.D. Thesis, University of California, Berkeley, 1969.
28. M. Goehring and D. Voigt, *Naturwissenschaften*, 1953, 40, 482.
29. M. Goehring and D. Voigt, *Z. Anorg. Allg. Chem.*, 1956, 285, 181.
30. M. Becke-Goehring, *Progr. Inorg. Chem.*, 1959, 1, 207.
31. M. Becke-Goehring, *Sulphur Inst. J.*, 1966, 2, 2.
32. M. Villena-Blanco, UCRL-11081, 1963, 1.
33. A.J. Banister, and Z.V. Hauptman, personal communication.
34. U. Thewalt and B. Muller, *Z. Naturforsch.*, 1982, 37b, 829.
35. H.W. Roesky, J. Anhaus, and W.S. Sheldrick, *Inorg. Chem.*, 1984, 23, 75.
36. T. Chivers, A.W. Cordes, R.T. Oakley, and P.N. Swepston, *Inorg. Chem.*, 1981, 20, 2376.
37. H.W. Roesky and J. Anhaus, *Chem. Ber.*, 1982, 115, 3682.
38. S.C. Peake and A.J. Downs, *J. Chem. Soc. Dalton Trans.*, 1974, 859.

39. R.W.H. Small, A.J. Banister, and Z.V. Hauptman, *J. Chem. Soc. Dalton Trans.*, 1980, 731.
40. J.J. Smith and W.L. Jolly, *Inorg. Chem.*, 1965, 4, 1006.
41. S.R. Ovshinsky and A. Madan, G.P. Appl. 3004009/1980.
42. M.W.R. Witt, W.I. Bailey, and R.J. Lagow, *J. Am. Chem. Soc.*, 1983, 105, 1668.
43. A.J. Banister, Z.V. Hauptman, and A.G. Kendrick, *J. Chem. Soc., Chem. Commun.*, 1983, 1016.
44. H.P. Fritz and R. Bruchhaus, *Z. Naturforsch.*, 1983, 38b, 1375.
45. A.G. Kendrick, Ph.D. Thesis, University of Durham, 1986.
46. A.J. Banister, Z.V. Hauptman, J. Passmore, and R.W.H. Small, *J. Chem. Soc. Dalton Trans.*, 1986, 915.
47. F.A. Kennett, G.K. MacLean, J. Passmore, and M.N. Rao, *J. Chem. Soc. Dalton Trans.*, 1982, 851.
48. A.J. Banister, Z.V. Hauptman, J. Passmore, C. Wong, and P.S. White, *J. Chem. Soc. Dalton Trans.*, 1986, 2371.
49. G.G. Alange, A.J. Banister, B. Bell, and P.W. Millen, *Inorg. Nucl. Chem. Letters*, 1977, 13, 143.
50. A. Hazell and R.G. Hazell, *Acta Cryst.*, 1988, C44, 1807.
51. G.G. Alange, A.J. Banister, B. Bell, and P.W. Millen, *J. Chem. Soc. Perkin*, 1979, 1192.
52. A. Vegas, A. Pérez-Salazar, A.J. Banister, and R.G. Hey, *J. Chem. Soc. Dalton Trans.*, 1979, 1812.
53. A.J. Banister, N.R.M. Smith, and R.G. Hey, *J. Chem. Soc. Dalton Trans.*, 1984, 1379.
54. Letter from A. Vegas to A.J. Banister.
55. K.A. Jorgenson, personal communication.
56. S.A. Fairhurst, K.M. Johns, L.H. Sutcliffe, K.F. Preston, A.J. Banister, Z.V. Hauptman, and J. Passmore, *J. Chem. Soc. Dalton Trans.*, 1986, 1465.
57. A.J. Banister, M.I. Hansford, and Z.V. Hauptman, *J. Chem. Soc., Chem. Commun.*, 1987, 63.
58. A.J. Banister, M.I. Hansford, Z.V. Hauptman, and S.T. Wait, in press.

CHAPTER 2

General Experimental Techniques

2.1 General Techniques:

a) **The dry box.** Nearly all the compounds which I prepared were moisture or oxygen sensitive, or were hygroscopic, so manipulations were carried out under an atmosphere of dry nitrogen in a pressure regulated Vacuum Atmospheres glove box (Type HE43-2) fitted with an HE-493 Dri-Train.

b) **Bench manipulations.** All manipulations of moisture or oxygen sensitive and hygroscopic materials, or distillations of solvents, were carried out under an atmosphere of departmental nitrogen (dried by passing through a P_4O_{10} tower), or *in vacuo*.

c) **Infra-red spectra.** These were recorded as Nujol mulls between KBr plates, unless otherwise stated, on a Perkin-Elmer 477 or 577 grating spectrometer. Gas phase spectra were recorded using a passivated stainless steel cell fitted with AgCl windows.

Spectra of thin layer of $(SN)_x$ were recorded on a Mattson Sirius 100 Fourier Transform infra-red spectrometer with a resolution of 1cm^{-1} . The thin layer was deposited onto a 3 x 25 x 10mm ATR KRS-5 crystal (thallium iodide - thallium bromide) and 500 scans were co-added in order to improve the signal to noise ratio.

d) **Mass spectra.** Mass spectra were recorded using a VG Analytical 7070E spectrometer using the electron impact (EI) method.

e) Raman spectra. These were recorded on a Cary 82 instrument using a Spectra Physics Model 164 Argon Ion laser at 519.5nm.

f) Nuclear magnetic resonance spectra. NMR of ^{19}F and ^{11}B were recorded using a Brüker AC 250 machine.

g) Elemental analysis. C/H/N analyses were carried out on a Carlo Erba 1106 elemental analyser. Fluorine was determined by overnight fusion with potassium metal in a bomb, followed by passing the solution through an ion exchange column and titrating against aqueous NaOH (by Mrs M. Cocks, University of Durham, chemistry department).

Sulphur was determined as sulphate and chlorine determined as chloride, following oxygen flask combustion, by titration against barium perchlorate and silver nitrate respectively. Arsenic was determined by decomposition in acid and the concentration measured by atomic absorption spectrophotometry (by Mrs Y. Dostal, University of Durham, chemistry department).

h) Glassware. All glassware was oven dried at *ca.* 100°C for a minimum of 30 minutes. For highly moisture sensitive compounds (e.g. [SN]AsF₆) glassware was dried by an oxygen/gas hand torch or in an oven at *ca.* 450°C.

i) The metal vacuum line. A metal vacuum line, previously described,¹ was used for manipulation of SO₂.

j) Temperature regulation. Temperatures as low as -40°C could be maintained by the use of a Haake F3 digital bath circulator filled with

alcohol. Temperature above 25°C were obtained by the use of an oil bath, heating tapes or a transparent resistance heater.

k) X-ray oscillation photographs. X-ray photographs were recorded using a Nonius integrating Weissenburg goniometer with a Phillips X-ray generator Type PW 1009 130, fitted with an X-ray tube with a Cu anode and Ni filter, at 42KV and 16mA. The image was recorded using Agfa-Gevaert Osray X-ray film.

l) X-ray structure determination. X-ray structure determination was carried out at Newcastle University by Dr. W. Clegg on a Siemens AED2 diffractometer with a graphite monochromator using MoK α radiation ($\lambda = 0.71073\text{\AA}$). ω/θ scan mode was used for data collection, with appropriately chosen scan width and time. Programs (SHELTXL and local software) were run on a Data General Model 30 computer.

m) Differential scanning calorimetry (D.S.C.). D.S.C. traces were recorded using a Mettler FPS0 control unit coupled to a Mettler FPS5 thermal analysis cell and a Fisons y-t chart recorder. Samples were hermetically sealed in aluminium capsules by cold welding.

n) X-ray photoelectron spectroscopy (e.s.c.a.). These were recorded on a Kratos ES300 spectrometer using MgK α (1253.6eV) radiation.

2.2 More specialised techniques:

a) The dog. This has previously been described.² It is a two bulbed vessel, with each bulb being surmounted by a J. Young tap and

separated by a medium porosity glass frit (figure 2.1).

b) **The closed extractor.** This has previously been described.³ It is based on the soxhlet extraction system where the solvent is heated and the vapour condensed by means of a cold water jacket onto the material to be extracted (figure 2.2).

c) **The plasma tube.** This has previously been described.⁴ A self-explanatory diagram of the tube is shown in figure 2.3. Compounds were transferred to the plasma tube in a glove box. The tube was found suitable for exploratory reactions and for small scale synthesis, as high current densities could be maintained. Generally, a current of approximately 2mA was used requiring 900-1000 volts across the electrodes. The flow rate of nitrogen through the tube was maintained at approximately $70 \text{ torr cm}^3 \text{ S}^{-1}$ by balancing the bleed rate with the pumping speed. Reaction temperatures could be varied from 35°C (the temperature at which the tube operates) to 250°C by the use of a transparent resistance heater. After reaction the tube was let down to nitrogen and quickly transferred into the glove box.

2.3 Electrochemical Techniques:

The reference and other electrodes, electrochemical cells and the modified Swagelock connectors were all designed by Z.V. Hauptman (Durham University, chemistry department).

a) **Current source.** A constant current (potentiostatic) was maintained by a Ministat precision potentiostat supplied by H.G. Thompson Associates (Newcastle upon Tyne).

Figure 2.1 The "Dog".

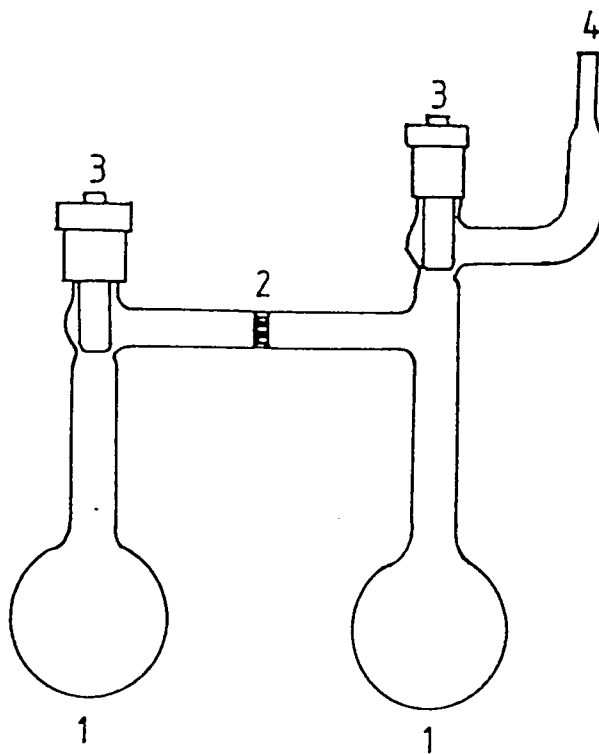

1. Reaction bulb.
2. Glass sinter (usually porosity grade 3).
3. J. Young teftlon tap.
4. $\frac{1}{4}$ " ground glass.

Figure 2.2 The "closed extractor".

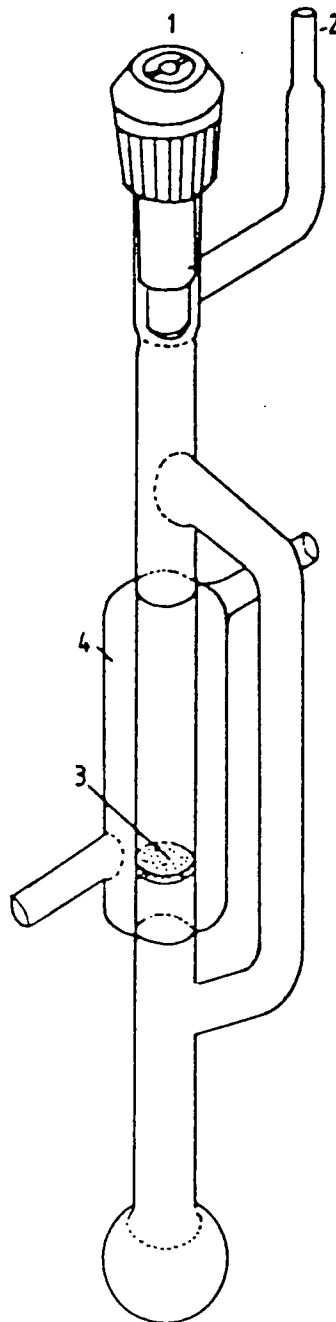

1. J. Young teflon tap.
2. $\frac{1}{4}$ " Ground glass.
3. Glass sinter (usually porosity grade 3).
4. Cooling jacket.

Figure 2.3 The plasma tube used for small scale reactions.

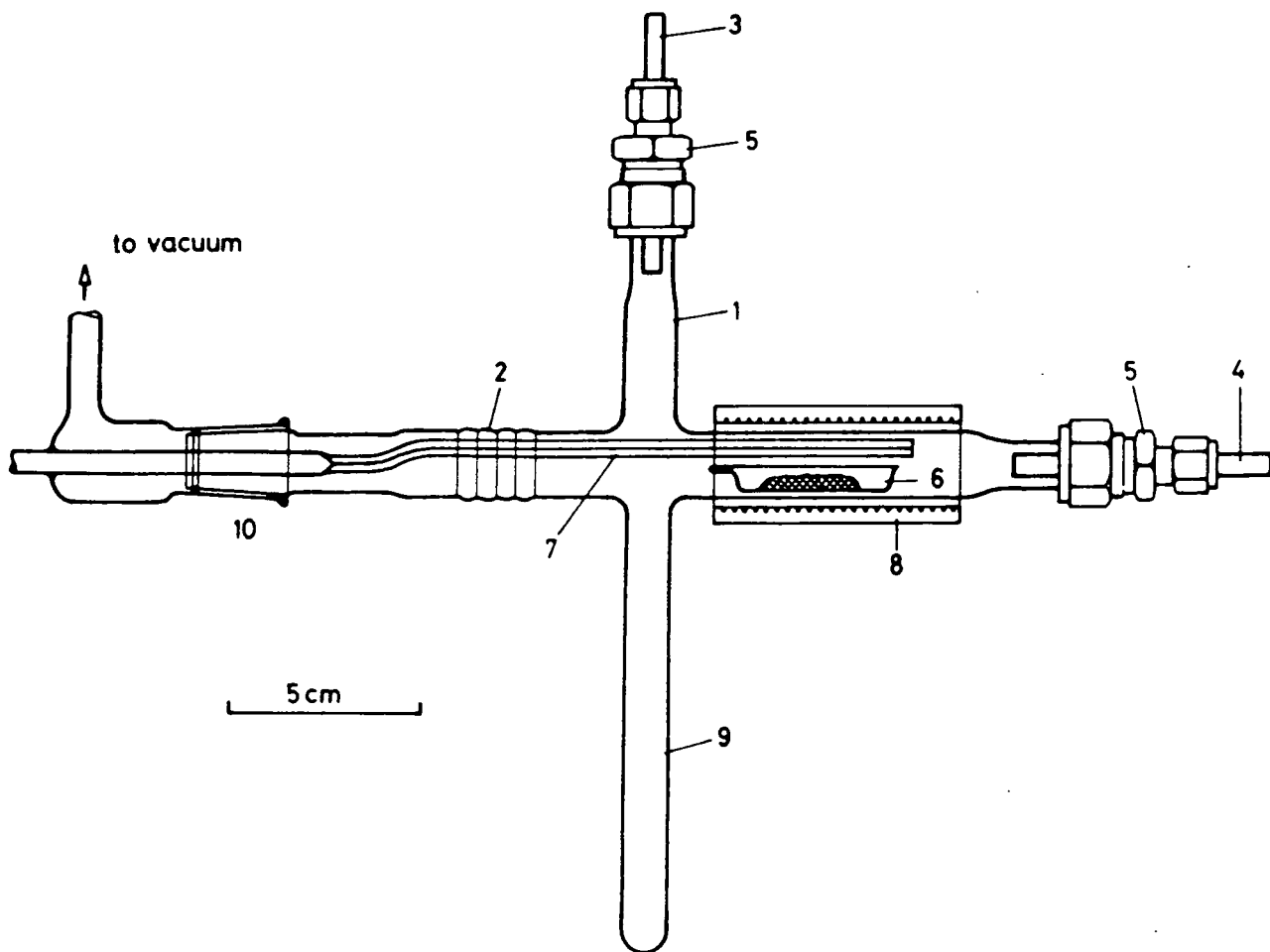

1. Quarts discharge tube.
2. Pyrex to quartz graded joint.
3. Anode.
4. Cathode.
5. Demountable vacuum feed through (adapted swagelock $\frac{1}{2}$ " to $\frac{1}{4}$ " reducing union).
6. Quartz boat.
7. *Ca.* 1mm bore capillary.
8. Transparent resistance heater.
9. Volatiles trap.
10. Young's greaseless joint.

57

b) **Cyclic voltammetry.** Cyclic voltammograms were recorded using a BioAnalytical Systems potential wave generator (type CV-113) and a Linseis x-y recorder (type LY 17100).

c) **Reference electrode.** The reference electrode is of the Ag/Ag^+ type and is similar in design and properties to one already published.¹ The new electrode (figure 2.4) is similar to the earlier version in that both hold a constant potential for many months and that the potential is dependant on the room temperature and not the temperature of the solution that it is in. However the new design (designed by Z.V. Hauptman) incorporates a J. Young tap at the apex of the electrode which has major advantages over its predecessor. Both can be used under pressure (e.g in liquid SO_2) as there are no compressible gas bubbles which would allow the "probed solution" to flow into the electrode. However, in time, gas bubbles do build up but these are simply removed in the new electrode, by opening the Young tap and allowing the bubble to escape, the space being filled by solution in the reservoir (the old electrode would have had to be broken open and refilled by a long and laborious process). The silver metal is also easily cleaned in the new electrode, by simply unscrewing it from the tap and gently polishing it. This also means that metals other than silver can easily be used.

d) **Other electrodes.** Cyclic voltammetry was carried out using a working electrode, designed by Z.V. Hauptman, consisting of a polished platinum disk mounted in FEP tubing and connected to a $\frac{1}{4}$ inch steel bar. An $(\text{SN})_x$ single crystal electrode was also used. This consisted of a crystal mounted in FEP tubing and connected to a $\frac{1}{4}$ inch steel bar. The $(\text{SN})_x$ electrode was polished each time before use on a soft cloth with a

Figure 2.4 The reference electrode.

1. PTFE stem of Young's greaseless tap.
2. Turning knob of Young's greaseless tap.
3. Stainless steel (or monel) rod, eighth inch diameter, with 5BA thread on both ends tightly fitting into the central bore in the PTFE stem.
4. Metal electrode (e.g. silver) screwed onto the central rod.
5. Knife edge machined on the flat end of 4 (to achieve a tight seal).
6. Brass ring around PTFE stem (to prevent yielding through axial compression).
7. "O" ring in conical groove machined in the top of the PTFE stem.
8. Washer.
9. 5BA nuts.
10. Soldering eyelet.
11. Side arm of Young's greaseless tap ended with a $\frac{1}{4}$ O.D. tube for swagelock connection.
12. Pyrex sinter porosity grade 4.
13. See 11.
14. $\frac{1}{4}$ " O.D. section for air-tight mounting (using the swagelock connector).

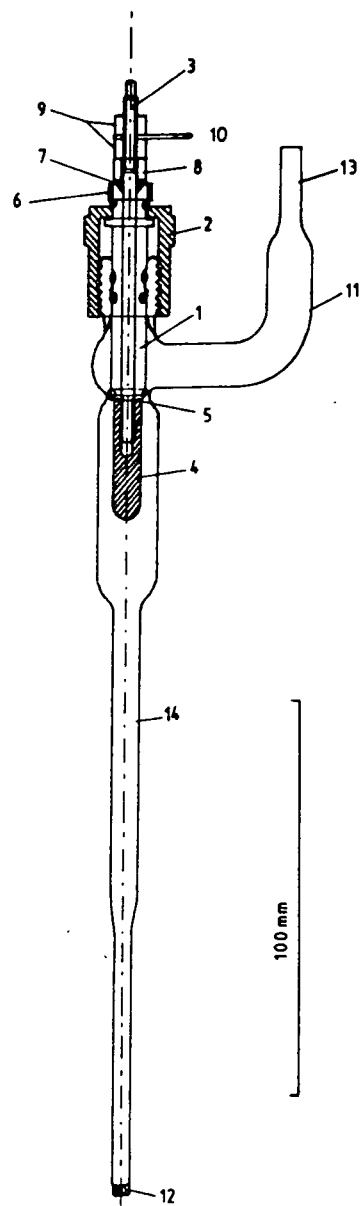

small amount of gamma alumina powder and then sonicated in absolute alcohol. When not in use it was kept in a sealable tube under dry nitrogen.

For bulk electrolysis a platinum sheet, gripped in platinum jaws, was used; the auxiliary electrode being made of coiled platinum wire. Both electrodes were heated to red hot temperature before use.

e) **Electrochemical cells.** Cyclic voltammetry was carried out in a three limbed undivided cell (figure 2.5), the bulb having a volume of *ca.* 15ml. For bulk preparations a three limbed divided cell was used. Two sizes were available depending on the scale required, of volumes 40 or 9cm³.

f) **Glass to metal connections.** Modified Swagelok joints (figure 2.6) were used to ensure a vacuum/pressure tight glass to metal seal. These were modified by reversal of the back ferrule with insertion of a PTFE "O" ring between the two ferrules. The back of each ferrule was also machined to give them a concave face which grips the "O" ring in place more satisfactorily.

2.4 Sulphur-Nitrogen Starting Materials:

a) S_4N_4 was prepared⁵ from the reaction between S_2Cl_2 and NH_3 according to the literature method.

b) $S_3N_2Cl_2$ was prepared⁶ from the reaction between NH_4Cl , S_2Cl_2 and sulphur according to the literature method.

Figures 2.5 and 2.6 Three limbed undivided electrochemical cell (typically used for cyclic voltammetry) and the breakdown of the modified Swagelok glass to metal connector.

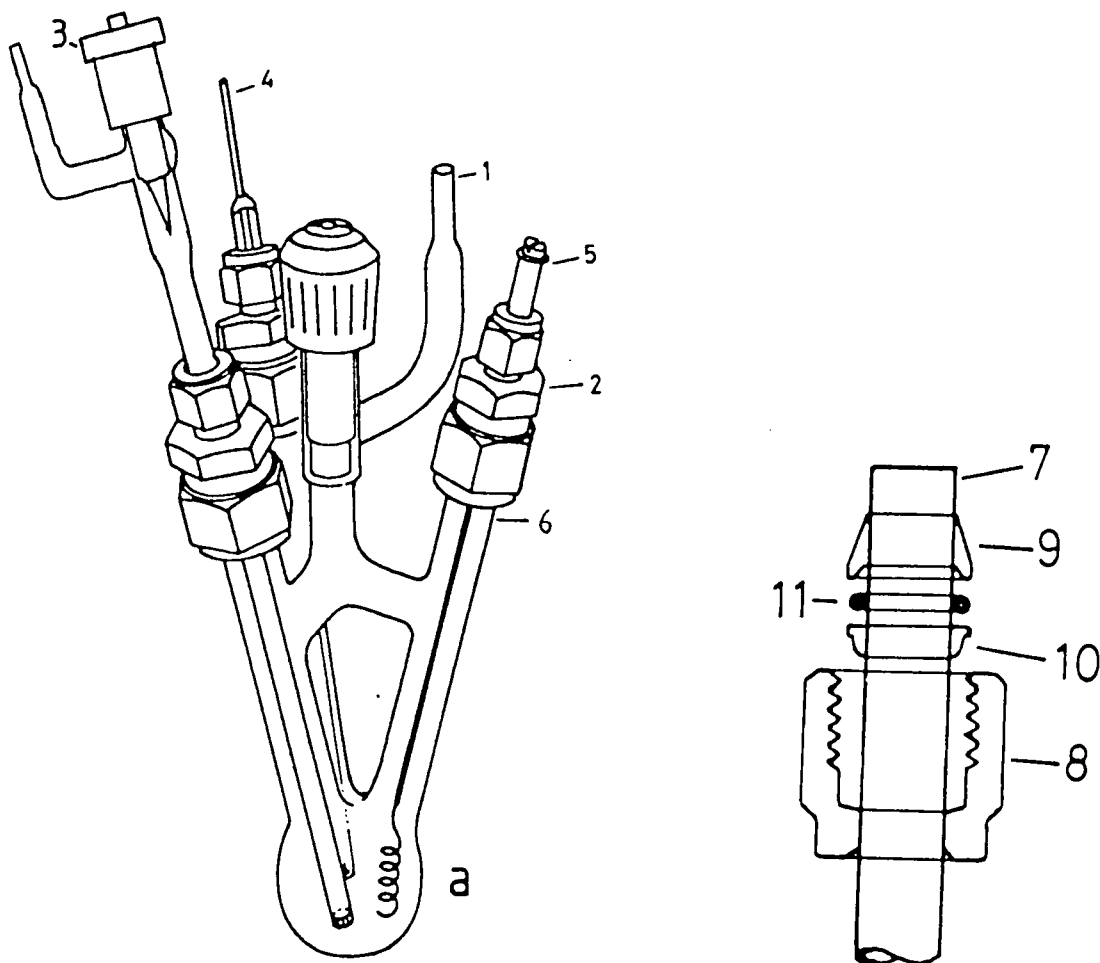

1. $\frac{1}{4}$ " Ground glass.
2. Swagelok $\frac{1}{2}$ " to $\frac{1}{4}$ " reducing union.
3. Reference electrode.
4. Micro electrode (usually platinum).
5. Auxiliary electrode (platinum).
6. $\frac{1}{2}$ " Ground glass.
7. Same as 6.
8. Compression nut.
9. Front ferrule.
10. Back ferrule (reversed).
11. PTFE "O" ring.

c) $(\text{NSCl})_3$ was prepared⁶ according to the method of Jolly and Maguire from the reaction between $\text{S}_3\text{N}_2\text{Cl}_2$ and Cl_2 although the product, which was used in the preparation of $[\text{S}_5\text{N}_5]\text{AlCl}_4$, was considered to be pure enough such that recrystallisation was unnecessary.

d) $[\text{SN}]\text{AsF}_6$ was prepared⁷ from the reaction between $(\text{NSCl})_3$ and AgAsF_6 in SO_2 according to the literature method.

e) $\overset{\text{Cl}}{\text{S}_3\text{N}_2\text{FeCl}_4}$ was prepared⁸ from the reaction between $\text{S}_3\text{N}_2\text{Cl}_2$ and FeCl_3 in SOCl_2 according to the literature method.

f) $[\text{S}_4\text{N}_3]\text{Cl}$ was prepared⁶ from the reaction between $\text{S}_3\text{N}_2\text{Cl}_2$ and SCL_2 in CCl_4 according to the literature method.

g) $[\text{S}_4\text{N}_3]\text{BF}_4$ was prepared by A.G. Kendrick¹ from the reaction between $[\text{S}_4\text{N}_3]\text{Cl}$ and 40% BF_4 according to the literature method.

h) $[\text{S}_5\text{N}_5]\text{AlCl}_4$ was prepared⁹ from the reaction between $(\text{NSCl})_3$, S_4N_4 and AlCl_3 in SOCl_2 according to the literature method.

i) $[\text{S}_5\text{N}_5]\text{Cl}$ was prepared¹⁰ from the reaction between $[\text{S}_5\text{N}_5]\text{AlCl}_4$ and THF according to the literature method.

j) $[\text{S}_5\text{N}_5]\text{BF}_4$ was prepared¹⁰ from the reaction between $[\text{S}_5\text{N}_5]\text{Cl}$ and 40% HBF_4 according to literature methods.

k) $[\text{Pr}_4\text{N}]\text{S}_3\text{N}_3$ was prepared¹¹ according to the literature method with slight modification. S_4N_4 (1.160g, 6.32mmol), $[\text{Pr}_4\text{N}]\text{N}_3$ (1.200g, 5.26mmol) and a Teflon coated magnetic stirrer bar were placed in a two necked round bottomed flask. Ethanol (30ml) was added and the mixture stirred for 24 hours after which time there was a bright yellow precipitate and a red solution. Under a counter flow of dry nitrogen, n-pentane (150ml) was added to the solution, the solid filtered off, washed with n-pentane (3 x 50ml) and extracted in a closed extractor for two days to give a yellow powder identified by infra-red spectroscopy as $[\text{Pr}_4\text{N}]\text{S}_3\text{N}_3$.

l) $[\text{PhCNSSN}]\text{Cl}$ was prepared¹² from the reaction between NH_4Cl , SCl_2 and PhCN according to the literature method.

m) $[\text{PhCNSSN}]\text{AsF}_6$ was prepared by M.I. Hansford¹³ according to the following method. $[\text{PhCNSSN}]\text{Cl}$ (1.000g, 3.766mmol), AgAsF_6 (1.118, 3.766mmol) and a Teflon coated magnetic stirrer bar were placed in one bulb of a dog. SO_2 (10ml) was condensed onto the mixture using an acetone/dry ice bath at -78°C and the mixture warmed to room temperature with vigorous stirring. Almost immediately a white precipitate and a bright orange solution were formed. After 24 hours the mixture was filtered and the white precipitate washed with back distilled SO_2 (3 x 10ml) and the solvent removed to reveal a bright orange solid and a white powder (AgCl), which darkened on exposure to light. The orange solid was identified by infra-red spectroscopy and elemental analysis as $[\text{PhCNSSN}][\text{AsF}_6]$.

Yield = 1.35g (97%), ν_{max} = 1549(m), 1500(m), 1395(s), 1297(w), 1202(w), 1185(m sh), 1160(m), 1148(m sh), 1070(w), 1030(m), 1002(w),

928(m), 915(m), 846(m), 789(m sh), 785(m), 692(vs), 555(m), 400(vs).
Analysis found: C, 22.4; H, 1.37; N, 7.7; S, 17.5; As, 20.0; F, 31.2%.
[PhCNSSN][AsF₆] requires: C, 22.7; H, 1.35; N, 7.6; S, 17.3; As, 20.3;
F, 30.8%.

n) (PhCNSSN)₂ was prepared¹² from the reduction of [PhCNSSN]Cl by Zn/Cu couple in THF according to the literature method.

2.5 Other starting materials:

a) Arsenic pentafluoride, AsF₅. This was prepared¹ from the reaction between lumps of arsenic metal and gaseous fluorine according to the literature method.

b) Silver hexafluoroarsenate, AgAsF₆. This was prepared¹ from the reaction between AsF₅ and silver powder according to literature methods.

c) Tetrapropylammonium azide, ((C₃H₇)₄N)N₃. This was first prepared by T. Chivers¹¹ and involved the use of ion exchange columns. The more convenient preparation¹⁴ of these azides, which is described below, was devised by C.J. Ludman (University of Durham, chemistry department).

When a solution of AgNO₃ (2.000g, 11.76mmol, 20ml H₂O) was added to a solution of NaN₃ (0.765g, 11.76mmol, 20ml H₂O) a white precipitate of AgN₃ immediately formed. The solution was filtered and the silver azide washed liberally with water (1 litre). N.B. The silver azide must be kept moist and on the frit at all times as in the dry state it is highly explosive. The minimum quantity of aqueous ammonia (50:50) needed to fully dissolve the azide was added and the solution filtered into a

clean flask. A solution of $(C_3H_7)_4NI$ (3.863g, 11.76mmol) in 50:50 water:ethanol was added to the azide and immediately a yellow precipitate of silver iodide formed which was filtered off. The solvent was removed by rotary evaporation and the white product dried *in vacuo* at 50°C for three hours.

d) Tetramethylammonium azide, $[Me_4N]N_3$. This was prepared¹⁴ as in 2.5c above from the reaction between $AgNO_3$, NaN_3 and $[Me_4N]I$.

e) Trimethylsilyloxalate, $(Me_3SiCO_2)_2$. This was prepared¹⁵ from the reaction between $H_2C_2O_4$ and Me_3SiCl in toluene according to the literature method.

2.6 Miscellaneous Reagents:

a) Aluminium, Al. This was supplied by B.D.H. and used directly from the bottle.

b) Iron, Fe. This was supplied by Aldrich and used directly from the bottle.

c) Zinc, Zn. This was supplied by Aldrich and used directly from the bottle.

d) Silver, Ag. This was supplied by B.D.H. and used directly from the bottle.

e) Sulphur di-chloride, SCl_2 . This was supplied by Hopkin and Williams and used directly from the bottle.

f) Di-sulphur di-chloride, S_2Cl_2 . This was supplied by Hopkin and Williams and used directly from the bottle.

g) Sulphur, S_8 . This was supplied by B.D.H. and used directly from the bottle.

h) Ammonium chloride, NH_4Cl . This was supplied by Aldrich and dried in an oven at $100^\circ C$ before use.

i) Benzonitrile, $PhCN$. This was supplied by Aldrich and used directly from the bottle.

j) Chlorine, Cl_2 . This was supplied by Matheson and was used from the cylinder and dried through a P_4O_{10} tower.

k) Aluminium trichloride, $AlCl_3$. This was prepared as a pure white powder by passing HCl gas over very pure aluminium wire.

l) Iron trichloride, $FeCl_3$. This was prepared as a pure green powder by passing Cl_2 gas over very pure iron powder.

m) Sodium azide, NaN_3 . This was supplied by Aldrich and used directly from the bottle.

n) Tetrapropylammonium iodide, $(C_3H_7)_4NI$. This was supplied by Aldrich and used directly from the bottle.

o) Silver nitrate, AgNO_3 . This was supplied by Aldrich and used directly from the bottle.

p) Tetrabutylammonium hydrogensulphate, $[(\text{C}_4\text{H}_9)_4\text{N}]\text{HSO}_4$. This was supplied by Labkemi and used directly from the bottle.

q) Sodium tetrafluoroborate, NaBF_4 . This was supplied by Ventron and used directly from the bottle.

r) Lithium hexafluoroarsenate, LiAsF_6 . This was supplied by Alpha and used directly from the bottle.

s) Arsenic, As . This was supplied by Ventron and used directly from the bottle.

t) Fluorine, F_2 . This was supplied by Mathews as a 50:50 mixture with nitrogen and used directly from the cylinder.

u) Trimethylsilylazide, Me_3SiN_3 . This was supplied by Aldrich and stored under nitrogen in a J. Young tap sealed flask.

v) Triphenylstibine, Ph_3Sb . This was supplied by Aldrich and used directly from the bottle.

w) Oxalic Acid, $\text{H}_2\text{C}_2\text{O}_4$. This was supplied by Aldrich and used directly from the bottle.

x) Trimethylsilylchloride, Me_3SiCl . This was supplied by Aldrich and used directly from the bottle.

y) Lithium aluminiumhydride, LiAlH_4 . This was supplied by Aldrich and used directly from the bottle.

2.7 Solvents:

a) Sulphur dioxide, SO_2 . This was supplied by B.D.H. and distilled off P_4O_{10} and stored over CaH_2 .

b) Acetonitrile, CH_3CN . This was supplied by Aldrich as HPLC grade and dried by distillation off CaH_2 . The dry acetonitrile was stored under nitrogen in a pyrex bulb fitted with a J. Young tap.

c) Solvents dried with sodium wire. These were benzene, pentane, toluene and 1,4 dioxane.

d) Tetrahydrofuran, $\text{C}_4\text{H}_8\text{O}$. This was initially distilled off KOH and finally distilled off CaH_2 .

e) Absolute ethanol, $\text{C}_2\text{H}_5\text{OH}$. This was dried by distillation off magnesium shavings and a small quantity of CCl_4 catalyst.

f) Thionyl chloride, SOCl_2 . This was distilled off triphenylphosphite (10% by weight) in an apparatus fitted with Teflon sleeves and stored in the dark under dry nitrogen in a pyrex bulb fitted with a J. Youngs tap.

g) Methylene chloride, CH_2Cl_2 . This was distilled off lithium aluminiumhydride and stored under dry nitrogen in a pyrex bulb fitted with a J. Young tap.

REFERENCES

1. A.G. Kendrick, Ph.D. Thesis, University of Durham, 1986.
2. R.G. Hey, Ph.D. Thesis, University of Durham, 1980.
3. R.W.H. Small, A.J. Banister, and Z.V. Hauptman, *J. Chem. Soc. Dalton Trans.*, 1984, 1377.
4. A.J. Banister, W. Clegg, M.I. Hansford, Z.V. Hauptman, and S.T. Wait, in press.
5. M. Villena-Blanco, W.L. Jolly, *Inorg. Synth.*, 1977, 9, 98.
6. W.L. Jolly and K.D. Maguire, *Inorg. Synth.*, 1967, 9, 102.
7. A. Apblett, A.J. Banister, D. Biron, A.G. Kendrick, J. Passmore, M. Schriver, and M. Stojanac, *Inorg. Chem.*, 1986, 25, 4451.
8. A.J. Banister, P.J. Dainty, *J. Chem. Soc. Dalton Trans.*, 1972, 2658.
9. A.J. Banister, H.G. Clarke, *Inorg. Synth.*, 1977, 17, 188.
10. A.J. Banister, Z.V. Hauptman, and A.G. Kendrick, *J. Chem. Soc. Dalton Trans.*, 1987, 915.
11. J. Bojes and T. Chivers, *Inorg. Chem.*, 1978, 17, 318.
12. A.J. Banister, N.R.M. Smith, and R.G. Hey, *J. Chem. Soc. Perkin Trans. I*, 1983, 1181.
13. M.I. Hansford, personal communication.
14. C. Ludman, personal communication.
15. G. Schott and G. Henneberg, *Z. Anorg. Allg. Chem.*, 1963, 228.

CHAPTER 3

Some Reductions of $[S_5N_5]Cl$ in an Attempt to Prepare Powdered $(SN)_x$.

3.1 INTRODUCTION

Poly(sulphur nitride), $(SN)_x$, is the first example of a polymeric metal. It was first prepared in 1910 by Burt¹ as a thin blue film by vacuum sublimation of S_4N_4 through hot silver gauze. It was not until 1953 that S_2N_2 ,² the intermediate in the formation of $(SN)_x$, was isolated by Becke-Goehring and co-workers. Cleavage of S_4N_4 vapour on heated silver wool is thought to occur in two stages.³ Firstly, S_4N_4 reacts with the silver in a nearly complete decomposition:

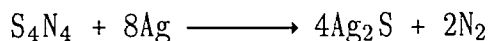

Secondly, the Ag_2S catalyses the thermal splitting producing S_2N_2 :

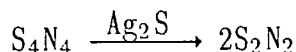

S_2N_2 is a white volatile solid³ which is indefinitely stable at $-197^\circ C$ but undergoes solid state polymerisation above $0^\circ C$ to produce "classical" $(SN)_x$; completion of this process normally takes six to eight weeks.

The major drawback to the "classical" route is the explosive nature of the materials involved. S_4N_4 is a high explosive which is easily detonated⁴ when subjected to percussion, friction or sudden heating to

above 100°C. Its sensitivity to shock and heat increases with purity making purification a hazardous task. Unfortunately very pure S_4N_4 is required in the "classical" preparation to avoid impurities such as S_4N_2 , which are produced from the reaction between sulphur and S_2N_2 .

Similarly S_2N_2 , when recrystallised from ether, has been known to detonate when warmed to 30°C, forming elemental sulphur and nitrogen. Such crystals are also sensitive to mechanical shock and detonate violently when an attempt is made to grind them.⁵⁻⁸ No explosions have been reported when S_2N_2 is completely free from organic solvent.^{3,9}

"Classical" $(SN)_x$ has some extraordinary electrical properties. Considerable interest has been shown in its "normal state" conductivity,¹⁰⁻¹² and its superconductivity^{13,14} below 0.3K. Many groups observed typical single crystal room temperature conductivities of between *ca.* 1000 and 3000 Scm^{-1} with increases at liquid helium temperatures by a factor of *ca.* 200 to 250.

Much of the interest in $(SN)_x$ has been due to its electrical properties and the ease of producing thin layers which has resulted in a range of applications such as in light emitting diodes,¹⁵ solar cells¹⁶ and batteries.¹⁷⁻²³ These applications, as well as the electrochemical preparations of $(SN)_x$, are discussed further in Chapter 4.

Due to the explosive nature of S_4N_4 ,⁴ which is used in the preparation of "classical" $(SN)_x$, several alternative methods have been developed.²⁴⁻²⁶ However these methods still rely on the intermediate S_2N_2 for the preparation of $(SN)_x$. $[S_4N_3]Cl$ has been used as an alternative to S_4N_4 ²⁷ in the preparation of "classical" $(SN)_x$, by heating at 130°C and passing the vapours through silver wool, which gives S_2N_2 as the major product. Thermolysis of $Ph_3As=NS_3N_3$ has also been shown to produce S_2N_2 .²⁸

Other methods of preparing $(\text{SN})_x$ include the slow decomposition of S_4N_2 ²⁹ at -10°C for three to four weeks, and by low pressure plasma reactions (of S_4N_4 ³⁰ vapour or $\text{H}_2\text{S}/\text{NH}_3$ ³¹ or $\text{H}_2\text{S}/\text{N}_2$ ³²).

The preparation of powdered polymer from the chemical reduction of $(\text{NSCl})_3$ by SiMe_3N_3 ³³ has proved to be the most convenient and safest route to gram quantities of $(\text{SN})_x$.

Such powders were first prepared from the reduction of $(\text{NSCl})_3$, $\text{S}_3\text{N}_2\text{Cl}_2$ or $\text{S}_3\text{N}_2\text{Cl}$ by excess Me_3SiN_3 at -15°C in acetonitrile.³⁴ The polymer was also prepared from the reaction between $(\text{NSCl})_3$ and excess NaN_3 in acetonitrile, or from the reaction between CsN_3 and $\text{S}_2\text{N}[\text{AsF}_6]$ in SO_2 . The $(\text{SN})_x$ prepared from these routes was purified by tedious extractions with CCl_4 , CS_2 and formic acid, but even after such careful cleaning, $(\text{SN})_x$ prepared from $\text{S}_3\text{N}_2\text{Cl}_2$ had up to 7% silicon impurities. The use of formic acid also caused problems in that extracted $(\text{SN})_x$ samples proved to be highly unstable, decomposing after only one week when stored under dry nitrogen.

More recently an improved synthesis and purification of powdered $(\text{SN})_x$ was reported.³³ Gram quantities were prepared from the reaction between $(\text{NSCl})_3$ and Me_3SiN_3 (molar ratio 1:7.5) in acetonitrile, followed by liquid SO_2 extraction of impurities. SO_2 , unlike formic acid, does not degrade the powdered $(\text{SN})_x$ but efficiently extracts all the impurities present. Samples were, however, readily converted to S_4N_4 in an infra-red beam as shown by repeated runs using a sample in a KBr disc. The powders were suitable for the preparation of thin layers of $(\text{SN})_x$ by vacuum sublimation onto a glass substrate, producing golden layers.

3.2 RESULTS AND DISCUSSION

3.2.1 Chemical Reductions of $[S_5N_5]Cl$:

a) Reduction by Fe in SO_2 . Prior to this work reduction of $(NSCl)_3$ by Me_3SiN_3 ³³ was the best method for producing reasonable quality powdered $(SN)_x$. However, the polymer samples were photosensitive and contained appreciable amounts of silicon impurity. $[S_5N_5]Cl$ was therefore chosen as a potential starting material for production of powdered $(SN)_x$ (by various reductions) due to its highly favourable $SN:Cl$ ratio (5:1) compared to $(NSCl)_3$ (1:1); hence the product might be less contaminated by the reducing agent.

$[S_5N_5]Cl$ had previously been shown to be a good starting material for the preparation of "good quality" powdered $(SN)_x$ ³⁵ by reduction with Me_3SiN_3 , although the polymer was never fully characterised. However due to the poisonous and explosive nature of azides³⁶ a wide variety of other reducing agents were chosen in the hope of preparing good quality powdered $(SN)_x$ from $[S_5N_5]Cl$ by safe means.

$[S_5N_5]Cl$ was reacted in SO_2 with excess iron powder and stirred for one day with the aim of producing powdered $(SN)_x$. The soluble products were separated from the insolubles and identified as mainly S_4N_4 with a small quantity of unreacted $S_5N_5^+$ (equation 3.1).

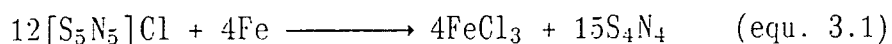

The insoluble products were placed in a sublimator and heated *in vacuo* in order to check if any powdered $(SN)_x$ was present. No sublimate was observed on the cold finger, demonstrating that $(SN)_x$ was not present.

b) Reduction by Zn in SO₂. [S₅N₅]Cl was treated (24 hours) in SO₂ with an excess of powdered zinc. The product was identified as mainly S₄N₄ (equation 3.2) with a small amount of unreacted S₅N₅⁺.

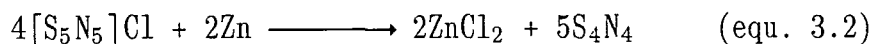

As in 3.2.1a, attempted vacuum sublimation of the insoluble products showed no evidence for the presence of powdered (SN)_x.

c) Reduction by Ag in CH₃CN. [S₅N₅]Cl was reacted with excess silver powder in acetonitrile and the mixture stirred for 24 hours. The infra-red spectrum of the products showed that [S₅N₅]Cl was indeed reduced by silver powder producing S₄N₄ (equation 3.3), with no evidence for powdered (SN)_x formation.

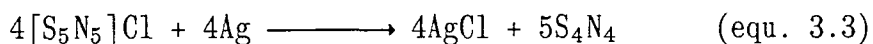

Much of the starting material, [S₅N₅]Cl, remained unreacted even though there was a nearly two fold excess of silver powder, presumably due to the very low solubility of both starting materials in acetonitrile.³⁷

d) Reduction by [Me₄N]N₃ in CH₃CN. [Me₄N]N₃ reacted with [S₅N₅]Cl producing a mixture of S₄N₄, S₄N₅⁻ and S₃N₃⁻ with the evolution of nitrogen gas. The various light coloured products and the absence of any infra-red peaks corresponding to the polymer indicated that (SN)_x was not a product of the reaction.

The reaction of S_4N_4 with alkali metal or tetraalkylammonium azides in ethanol has previously³⁸ been shown to produce either the tetrasulphur pentanitride anion, $S_4N_5^-$ (Li^+ , Na^+ , K^+), the trisulphur trinitride anion, $S_3N_3^-$ (Cs^+ , Me_4N^+ , Et_4N^+ , $n-Pr_4N^+$, $n-Bu_4N^+$), or a mixture of $S_4N_5^-$ and $S_3N_3^-$ (Rb^+). It can therefore be concluded that the initial reaction between $S_5N_5^+$ and Me_3SiN_3 produces S_4N_4 (cf. 2.1a-c) which is subsequently further reduced by the azide to produce a mixture of $S_4N_5^-$ and $S_3N_3^-$.

e) Reduction by $(Me_3SiCO_2)_2$ in CH_3CN . $[S_5N_5]Cl$ and $(Me_3SiCO_2)_2$ were reacted together in acetonitrile for 48 hours in an attempt to prepare powdered $(SN)_x$ by reduction of the $S_5N_5^+$ according to equation 3.4 below.

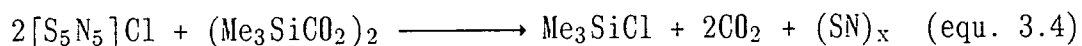

No reaction was observed; the infra-red spectrum showed only starting materials.

f) Reduction by Ph_3Sb in CH_3CN . Ph_3Sb has previously been used as a reducing/dechlorinating agent.³⁹ It is particularly useful in dechlorination reactions, as the product, Ph_3SbCl_2 ,⁴⁰ is a yellow volatile liquid which is easily separated from non-volatile products by pumping. Ph_3Sb did indeed reduce/dechlorinate $[S_5N_5]Cl$ producing Ph_3SbCl_2 (yellow volatile in the cold trap), S_4N_4 and a small quantity of powdered $(SN)_x$ (3.5% yield).

g) Reduction by Ph_3Sb in SO_2 . As in the previous reaction, 3.2.1f, reduction of $[\text{S}_5\text{N}_5]\text{Cl}$ by Ph_3Sb in SO_2 produced Ph_3SbCl_2 (yellow volatile in the cold trap), S_4N_4 and a small quantity of powdered $(\text{SN})_x$ (5.8% yield).

h) Reduction by Ph_3Sb and Me_3SiN_3 in CH_3CN . $[\text{S}_5\text{N}_5]\text{Cl}$ was reacted with Ph_3Sb and Me_3SiN_3 , and the reaction mixture stirred for 24 hours at 0°C . 4.38mg of Me_3SiN_3 was used in the reaction and this would produce only 8.74mg of $(\text{SN})_x$ for a theoretical 100% yield. The total mass of powdered $(\text{SN})_x$ recovered was 36mg, so at least 27.2mg of the $(\text{SN})_x$ was produced from the reduction of $[\text{S}_5\text{N}_5]\text{Cl}$ by Ph_3Sb . The reduction of $[\text{S}_5\text{N}_5]\text{Cl}$ by Ph_3Sb alone would produce only 4.5mg of product (*cf.* section 3.2.1f) suggesting that a slightly unusual mechanism has occurred.

The reaction mechanism for the formation of powdered $(\text{SN})_x$ from the reduction of $(\text{NSCl})_3$ by Me_3SiN_3 ³⁴ is complex. The fact that Si was found in the polymer opens up the possibility that chain growth was initiated at a $\text{Me}_3\text{Si-}$ site. Once such a chain was initiated, propagation could be maintained by the addition of "SN" units produced from the reduction of the S_5N_5^+ . Without such a growth site the propagating "SN" units presumably react to produce S_4N_4 as in the reduction of $[\text{S}_5\text{N}_5]\text{Cl}$ by metals (*cf.* section 3.2.1a-c).

When S_5N_5^+ is reduced the $\text{S}_5\text{N}_5^\cdot$ radical is produced. This has been shown by cyclic voltammetry (section 4.2.4), to decay with the formation of cyclic $\text{S}_3\text{N}_3^\cdot$. S_4N_4 is always present as a byproduct and is presumably formed from the reaction of the remaining S_2N_2 portion. This is probably linear rather than cyclic as the known S_2N_2 (cyclic) has not been observed in such solution reductions.

In the reduction of $[\text{S}_5\text{N}_5]\text{Cl}$ by Ph_3Sb only small yields of $(\text{SN})_x$

were observed (<6%) compared with *ca.* 50% when Me_3SiN_3 is used. This is possibly due to the lower Sb-S/N bond energies ($\text{Sb-N} = <335\text{KJmol}^{-1}$, $\text{Sb-S} = <226\text{KJmol}^{-1}$) compared to those for Si-S/N ($\text{Si-N} = 335\text{KJmol}^{-1}$, $\text{Si-S} = 226\text{KJmol}^{-1}$).

Therefore in this reaction, where both Ph_3Sb and Me_3SiN_3 are used together, the Me_3SiN_3 is acting as the chain initiator, hence small quantities have a major effect, and the Ph_3Sb is producing the propagating $\text{S}_3\text{N}_3\cdot$ (i.e yields of $(\text{SN})_x$ must be less than 60%) unit from the reduction of the $[\text{S}_5\text{N}_5]\text{Cl}$.

i) **Reduction by Ph_3Sb with Seed $(\text{SN})_x$.** Powdered $(\text{SN})_x$ was added to the reaction mixture in the hope that it would provide initiation sites in a similar fashion to $\text{Me}_3\text{Si-}$ above (*cf.* section 3.2.1h). This was indeed the case as yields increased from <6% without seed $(\text{SN})_x$ up to *ca.* 50% with seed $(\text{SN})_x$.

In each reaction a total volume of 15ml of solvent was used, which was either pure CH_3CN or SO_2 , or a mixture of the two. All the seed $(\text{SN})_x$ was produced in one batch from the reduction of $[\text{S}_5\text{N}_5]\text{Cl}$ by Me_3SiN_3 .

The reaction numbers are tabulated in three sections (table 3.1), 1-11, 12-13, and 14-17. Each section represents a set of reactions carried out using the same batch of dry acetonitrile. The graphical representation of reactions 1-11 (figure 3.1) shows a maximum yield at an SO_2 volume percentage of *ca.* 15.5% with a minimum at *ca.* 63.3%. The yields were within experimental error of one another where only one solvent was present (i.e. SO_2 volume percentage = 0 or 100%).

Many factors such as the solubility of $[\text{S}_5\text{N}_5]\text{Cl}$ and the stability of intermediate species in $\text{SO}_2/\text{CH}_3\text{CN}$, and the homogeneity of the mixture

Table 3.1 Reaction yields of (SN)_x for different solvent compositions.

REACTION NUMBER	VOLUME OF (ml)		YIELD OF (SN) _x %
	SO ₂	CH ₃ CN	
1	15	-	35.8
2	15	-	29.2
3	10.93	4.07	14.6
4	7.40	7.60	17.7
5	5.01	9.99	33.9
6	3.99	11.01	38.1
7	3.13	11.87	45.4
8	2.64	12.36	45.0
9	2.33	12.67	49.3
10	1.78	13.22	40.8
11	1.42	13.58	35.4
12	2.11	12.89	31.9
13	2.15	12.85	30.2
14	2.16	12.84	50.0
15	2.16	12.84	53.9
16	-	15	45.0
17	-	10	46.6

Figure 3.1 Yield of powdered $(SN)_x$ vs. SO_2 volume percentage.

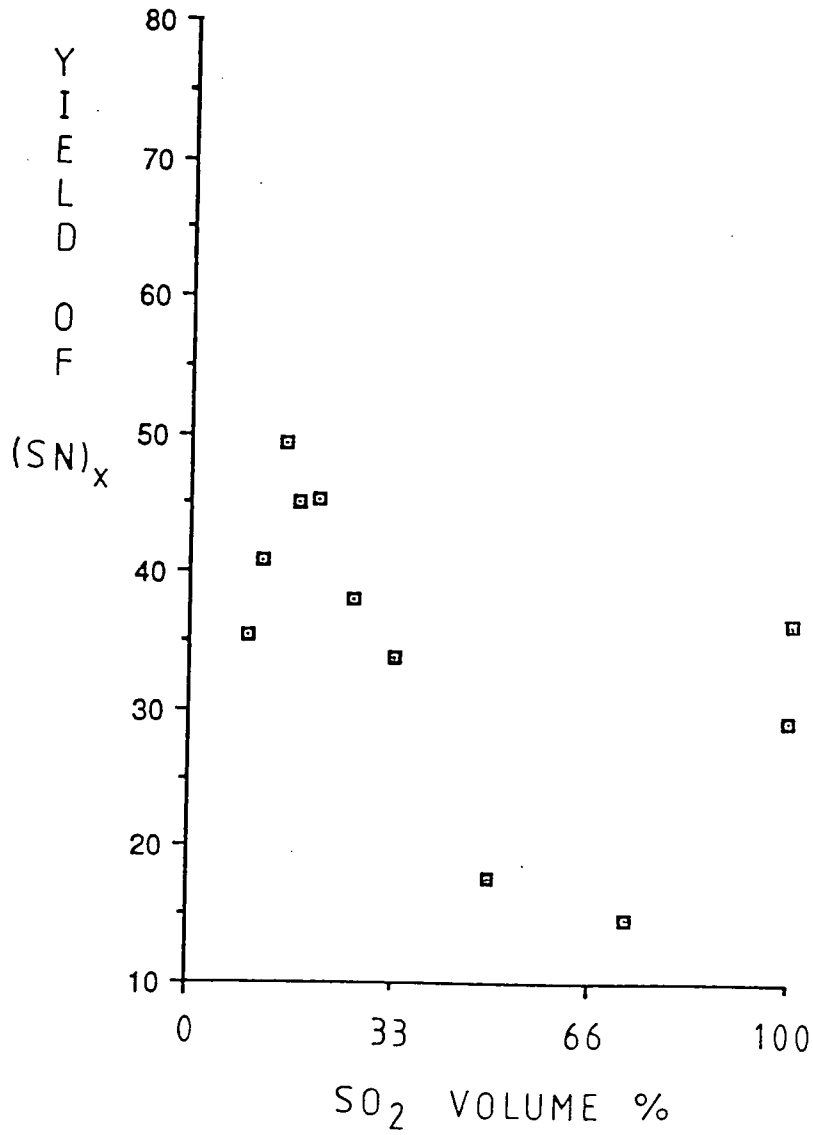

must be taken into account when considering possible explanations for such a result. $[S_5N_5]Cl$ is almost insoluble in pure acetonitrile and, therefore, much of the reduction by the soluble Ph_3Sb will take place on the surface of the $[S_5N_5]Cl$ where there are no initiation sites for chain growth. This will lead to the production of S_4N_4 as in reductions by metals (*cf.* section 3.2.1a-c). However as the SO_2 volume percentage is increased the yield increases because (i) more $[S_5N_5]Cl$ will be solubilised ($[S_5N_5]Cl$ is highly soluble in SO_2) increasing the chance of the reactive propagating unit reaching the surface of the seed $(SN)_x$ and (ii) there will be a lower $[S_5N_5]Cl$ surface area on which the reduction can take place with production of S_4N_4 .

At *ca.* 15.5% volume of SO_2 the direction of the curve reverses to a downward trend in yield. This is presumably the point at which the concentration of intermediates and $S_5N_5^+$ in solution are such that internal reactions occur producing S_4N_4 , as for example in equations 3.5 and 3.6 below.

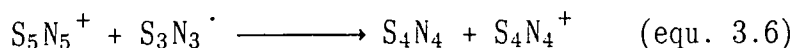
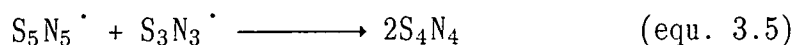

This downward trend continues over an SO_2 percentage volume range of *ca.* 15.5-63.3% due to the increase in solubility of $[S_5N_5]Cl$ and hence an increase in the concentration of the intermediates.

At *ca.* 63.3% volume of SO_2 the trend again changes to an upward one in percentage yield terms. SO_2 is known to stabilise free radicals⁴¹⁻⁴⁴ and so the reactive chain propagating units, thought to be $S_3N_3^\cdot$ (*cf.* section 3.2.1h), are less likely to react with other species and

hence are more likely to find an $(SN)_x$ initiation site or an already established chain to grow on. It must be stressed that the above explanation for such a complex set of variables is highly speculative.

After reaction 11 a new batch of acetonitrile from the same winchester was dried and distilled. The yields for the next two reactions, 12 and 13, were *ca.* 15% below corresponding yields in section 1. Suspecting that the acetonitrile might not be dry a new batch from the same winchester was dried and distilled. Reactions 14 and 15 show a rise in yield, increasing to *ca.* 5% above expectations from section 1.

It would therefore appear, that since the only variable was the acetonitrile, the reaction yields must be sensitive to moisture. A similar hypothesis has been reported previously;³⁴ "It is possible that an impurity in the acetonitrile (e.g. water) may play a role in $(SN)_x$ formation". Reactions 16 and 17 simply show that the total volume of solvent used appears to have little effect on the yield.

The powdered $(SN)_x$ produced was of good quality. A KBr disc of the product showed no decomposition to S_4N_4 in an infra-red beam. Such decomposition had previously been observed³³ in our lab for $(SN)_x$ produced from the reduction of $(NSCl)_3$ by Me_3SiN_3 . A typical D.S.C. trace showed slow decomposition of the product to S_4N_4 between 90-130°C, followed by decomposition of the S_4N_4 between 150-210°C.

Analyses of the samples showed no trends and were fairly consistent with nitrogen being *ca.* 28.6% (the calculated value is 30.4%). Unfortunately sulphur analyses were unreliable as the rapid combustion of the polymer in an oxygen flask caused spluttering of the sample (i.e. it sprayed out from the crucible) resulting in uncombusted sulphur and hence inaccurate analysis.

Powdered $(SN)_x$ produced from a typical reaction was coated onto a glass substrate for ESCA analysis, and onto a KRS-5 ATR crystal (TlBr-TlI) for FT infra-red spectroscopy. Since adhesion and stability of $(SN)_x$ are much affected by the quality of the underlying support, the glass slides (65 x 16 x 1mm) were freshly cleaned (using a proprietary surfactant, MICRO in an ultrasonic bath, follow by rinses with dilute HCl and distilled water) and the KRS-5 crystal was carefully polished (using gamma alumina on a fine cloth with a few drops of absolute ethanol, followed by heating *in vacuo* at 120°C for eight hours).

A wide scan core-level photoelectron spectrum of the vacuum deposited $(SN)_x$ film (figure 3.2) showed five types of atom (O, N, C, S, Si). A closer look at the area near the oxygen binding energy revealed a low intensity peak for antimony (figure 3.3). The ratios of the atoms on the surface were C: N: S: O: Si: Sb = 100: 134: 167: 24: 17: 1. Silicone oil invariably contaminates the surface of the sample as it is very mobile in a high vacuum system. This will have affected the Si:O:C ratios although some silicon would be present anyway due to the seed $(SN)_x$ which was prepared from Me_3SiN_3 . Most importantly the spectrum shows a weak peak for antimony, indicating that a small amount of the Ph_3Sb is present, presumably at the $(SN)_x$ chain ends.

The S:N ratio was 1:1.25 which is similar to one previously reported.³³ However the golden colour of the thin film suggests much higher quality $(SN)_x$ than such a ratio above, as colour is very much dependent on quality. The carbon content is high, some being due to silicone oil discussed earlier, but presumably the Me groups on Me_3Si and Ph groups on Ph_3Sb contribute as well.

A similar golden film on a KRS-5 crystal produced an excellent FT infra-red spectrum (figure 3.4) which was identical to a previously

Figure 3.2 Wide scan core-level photoelectron spectrum of vacuum deposited $(SN)_x$ on a glass substrate showing the presence of C, N, S, O, and Si environments.

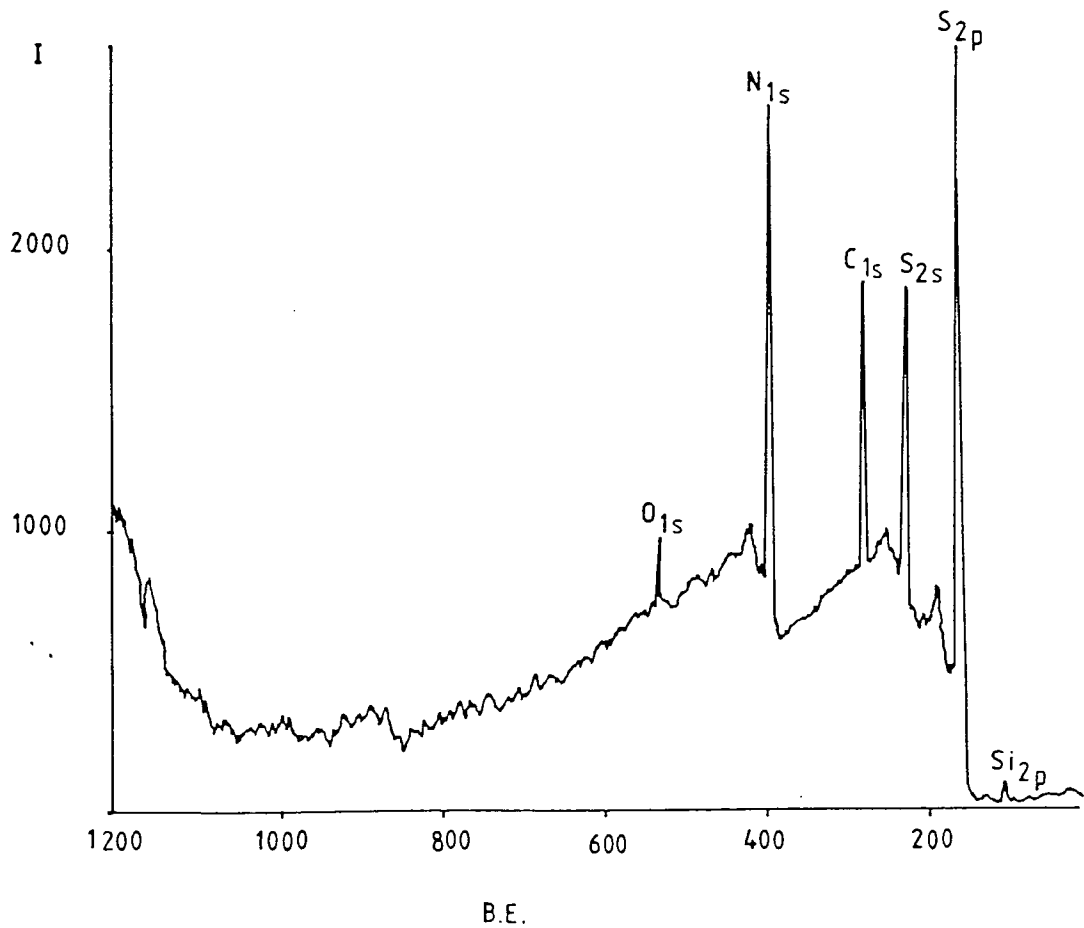

Figure 3.3 A close up around the oxygen binding energy showing the presence of an Sb environment in vacuum deposited $(\text{SN})_x$.

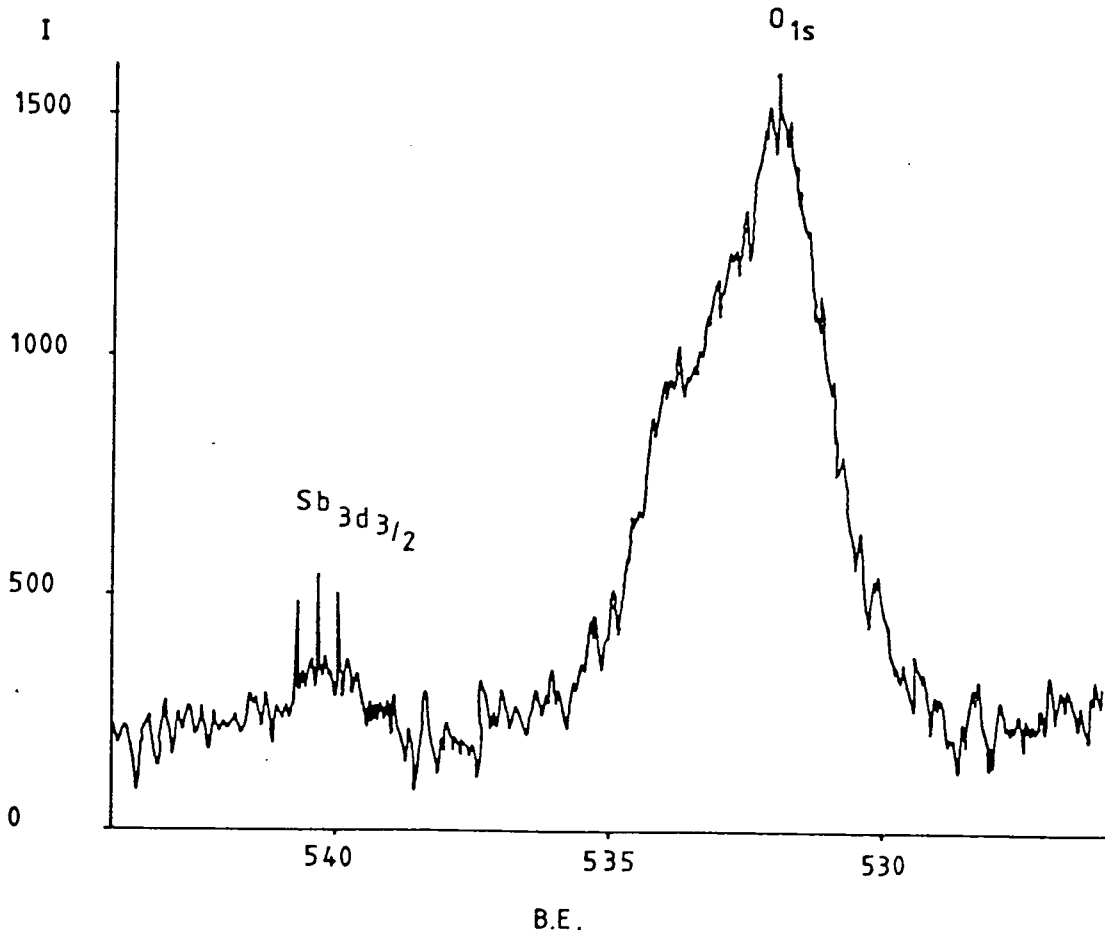

Figure 3.4 FT infra-red spectrum from a thin film of $(\text{SN})_x$ coated onto a KRS-5 crystal.

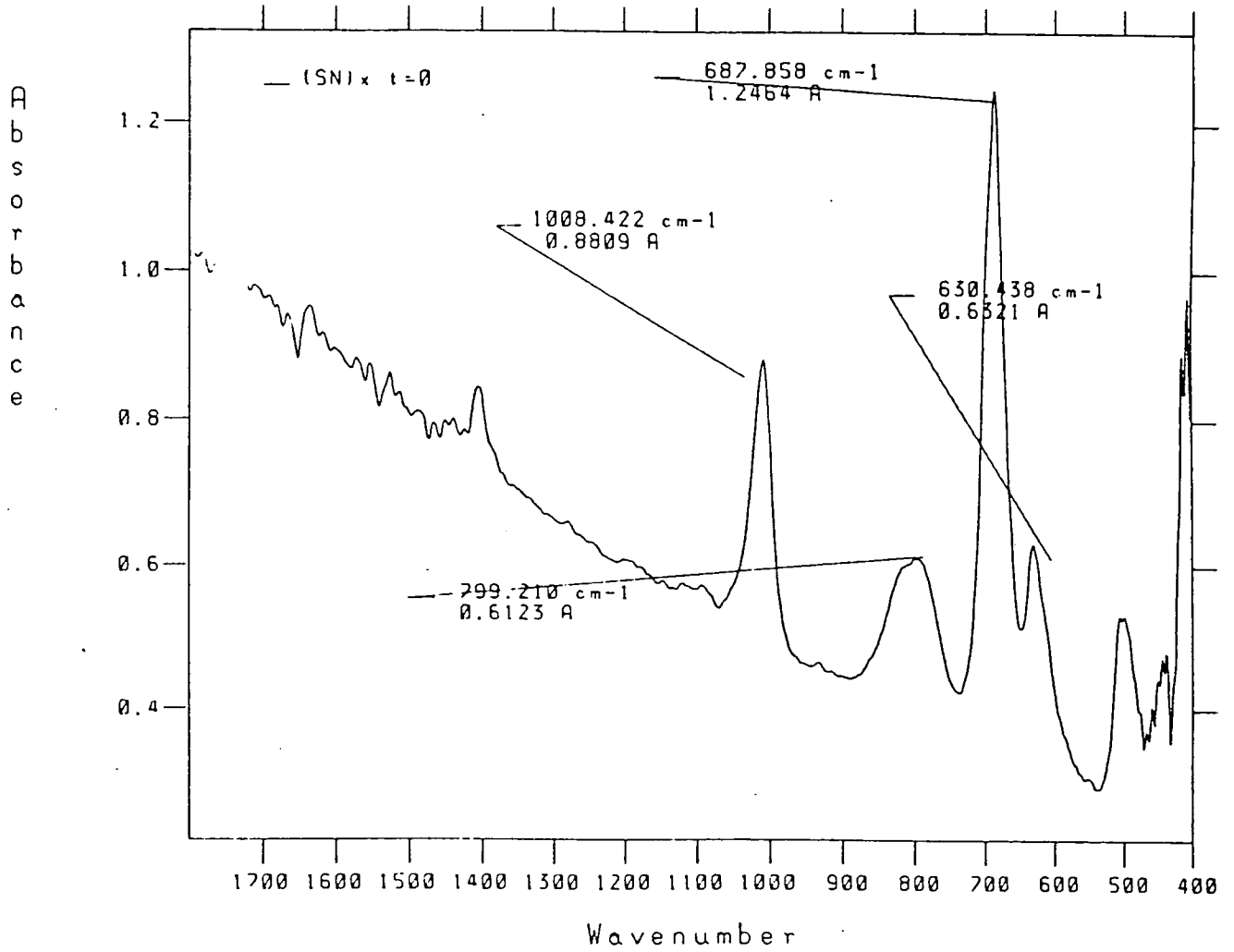
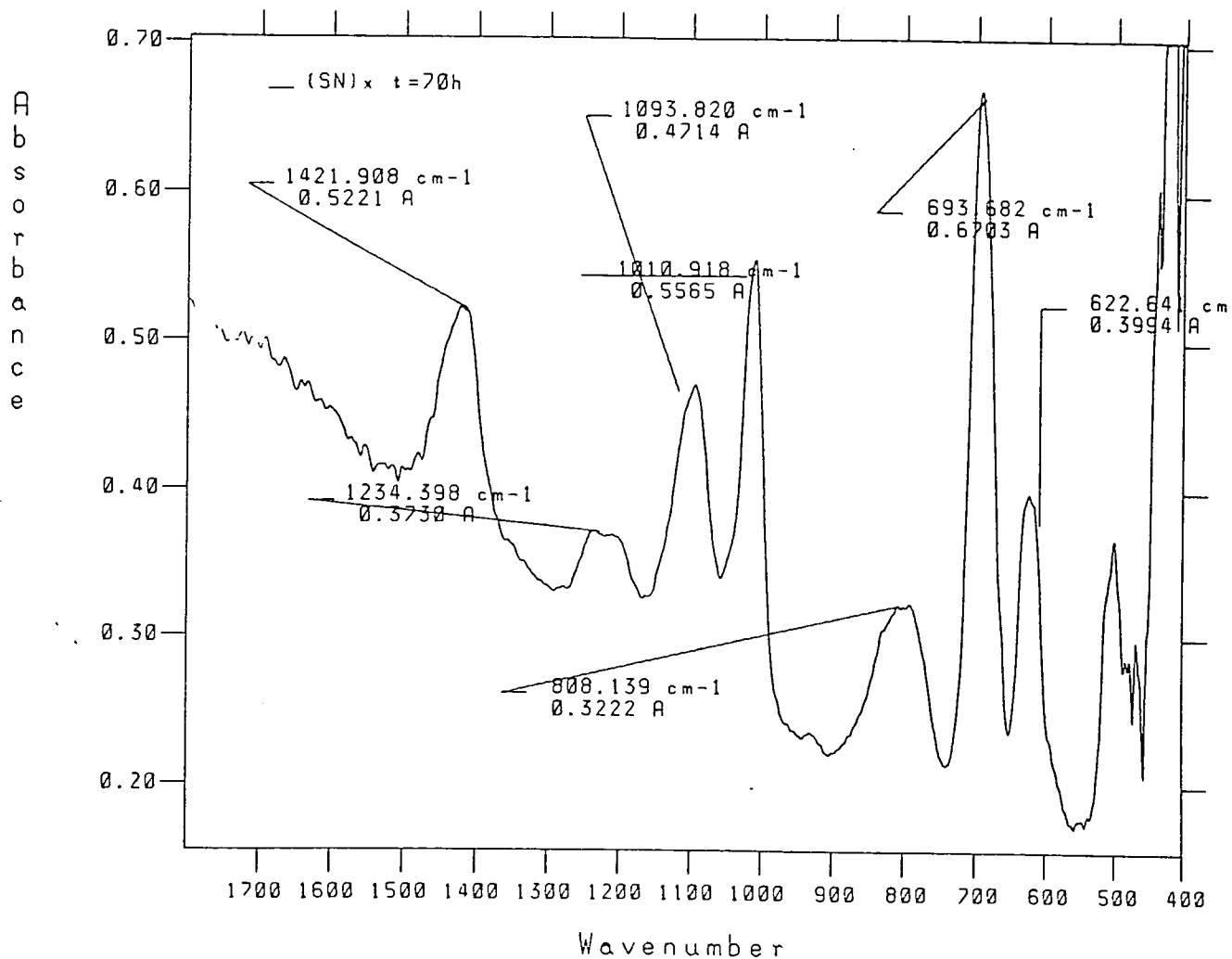

Figure 3.5 FT infrared spectrum of the same sample from figure 3.4 after 70 hours in a hygrostat, showing partial hydrolysis of the layer.



reported spectrum.⁴⁵ There were no peaks corresponding to S_4N_4 or other impurities.

This thin film was then placed in an NH_4Cl/H_2O hygostat⁴⁶ for 70 hours and the infra-red spectrum repeated in order to study the stability of the layer in damp aerobic conditions. Figure 3.5 shows the change in the infra-red peaks as a result of hydrolysis; The peaks due to $(SN)_x$ are reduced in intensity and three new absorptions have appeared:-

(i) $1422cm^{-1} : \nu_2 (NH_4^+)$

(ii) $1234cm^{-1} : \nu_3 (S=O)$

(iii) $1094cm^{-1} : \nu_4 (SO_4^{2-})$

Peaks (i) and (iii) were assigned to $(NH_4)_2SO_4$ ⁴⁷, and their intensity increased as the $(SN)_x$ slowly hydrolysed. Peak (ii) was assigned to an S=O absorption but was not due to $(NH_4)_2SO_4$. Its intensity was constant throughout the hydrolysis and on completion of this process it disappeared, suggesting that it was an intermediate in the formation of $(NH_4)_2SO_4$, probably associated with hydrolysis at the chain ends. The films were $<0.5\mu m$ thick and so it is hardly surprising that hydrolysis has occurred as even "classical" $(SN)_x$ crystals and thin layers have been shown to hydrolyse slowly.⁴⁸ The spectra were run, and the peaks assigned, by H. Ancelin (University of Durham, chemistry department).

During one of the vacuum sublimations of powdered $(SN)_x$, delicate crystals of $(SN)_x$ were produced in the powder. They were observed, under an optical microscope, to consist of highly reflective golden fibrous crystals which were dendritic in appearance. Indeed they were similar to the more compact "classical" $(SN)_x$. A similar result has

previously been reported³³ although, as in my experiments, it was never successfully repeated.

3.2.2 The Vacuum Thermolysis of $[S_5N_5]Cl$ and LiN_3 :

When $[S_5N_5]Cl$ and Li_3N were placed together in a sublimator and heated at *ca.* 100°C under high vacuum (*ca.* 2×10^{-6} torr) a reduction occurred which produced nitrogen (as demonstrated by the aerial activity of the mixture in the tube and the lowering of the vacuum), S_2N_2 and an unidentified compound as shown in equation 3.7.

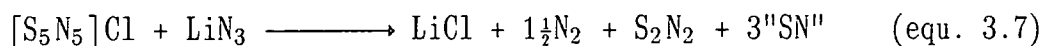

The unidentified orange/yellow compound was thought to be a mixture of S_4N_4 , $(NSCl)_3$, and $[S_4N_3]Cl$, all of which have been produced from the vacuum thermolysis of $[S_5N_5]Cl$, previously reported.³⁵

All previous solution reductions of $[S_5N_5]Cl$ have shown no signs of S_2N_2 production but it is thought that S_3N_3 is the main building block in the formation of powdered $(SN)_x$ (*cf.* section 4.2.1h). This is produced from the decomposition of the S_5N_5 with the formation of S_4N_4 [from $S_2N_2(1in)$] as a by-product. However, *in vacuo* it is possible that the $S_2N_2(1in)$ has time to cyclise and hence it is seen in the cold trap as the white cyclic volatile solid, S_2N_2 .

3.3 CONCLUSIONS

A simple, safe (i.e. non-azide) synthesis for the production of powdered $(SN)_x$ has been devised from the reduction of $[S_5N_5]Cl$ by Ph_3Sb with seed $(SN)_x$. Powdered $(SN)_x$ was also produced from the reaction between $[S_5N_5]Cl$ and Ph_3Sb with a tiny quantity of Me_3SiN_3 . In the

absence of Me_3SiN_3 yields were greatly reduced, suggesting that Me_3Si behaves as a chain initiation site. Once such a growth site exists, propagation continues by addition of "SN" units produced from the straightforward reduction of the $[\text{S}_5\text{N}_5]\text{Cl}$.

The need for chain growth sites explains why reduction by metals and ionic azides produces only S_4N_4 , and why the yield is high in the presence of seed $(\text{SN})_x$.

The use of mixed solvents increases yields from *ca.* 35% to *ca.* 54% and emphasizes the importance of solubility of $[\text{S}_5\text{N}_5]\text{Cl}$, and the stability and concentration of intermediates in such solvent systems.

The highest recorded yield so far was 54%, and so it is probable that S_3N_3 is the intermediate species responsible for chain growth. If such a unit were the major product then yields could not expect to exceed 60%.

Further work might involve the testing of different reducing agents with $[\text{S}_5\text{N}_5]\text{Cl}$ in the presence of varying amounts ^{of} seed $(\text{SN})_x$, with the aim of optimising yield and purity.

3.4 EXPERIMENTAL

3.4.1 Chemical Reductions of $[\text{S}_5\text{N}_5]\text{Cl}$:

a) Reduction by Fe in SO_2 . $[\text{S}_5\text{N}_5]\text{Cl}$ (0.050g, 0.188mmol) and iron powder (0.520g, 9.28mmol) were placed together, with a teflon stirrer bar, in one bulb of a dog (*cf.* section 2.2a). SO_2 (*ca.* 10ml) was condensed onto the reaction mixture at -197°C . The yellow reaction mixture slowly turned brown on warming up to room temperature and was stirred continuously for 12 hours. The mixture was filtered and the solid residue washed with back distilled SO_2 (3 x 10ml). Removal of the

SO₂ revealed a grey powder (insoluble) and a red/orange/brown mixture (soluble).

The grey powder was then placed in a sublimator, with a cold finger at -197°C, and heated at 135°C under high vacuum (*ca.* 10⁻⁵ torr). No sublimate was observed.

The solubles were identified by infra-red spectroscopy as S₅N₅⁺ and S₄N₄, $\nu_{\max} = 1162(w)^a$, $1100(w)^a$, $928(s)^b$, $720(m)^b$, $700(s)^b$, $551(s)^b$; a = S₅N₅⁺, b = S₄N₄.

b) Reduction by Zn in SO₂. [S₅N₅]Cl (0.050g, 0.188mmol) and zinc powder (0.600g, 9.23mmol) were placed together, with a teflon stirrer bar, in one bulb of a dog. SO₂ (*ca.* 10ml) was condensed on to the reaction mixture at -197°C. The yellow reaction mixture slowly turned brown on warming up to room temperature and was stirred continuously for 12 hours. The mixture was filtered and the solid residue washed with back distilled SO₂ (3 x 10ml). Removal of the SO₂ revealed a grey powder (insoluble) and a red/orange/brown mixture (soluble).

The grey powder was then placed in a sublimator, with a cold finger at -197°C, and heated at 135°C under high vacuum (*ca.* 10⁻⁵ torr). No sublimate was observed.

The solubles were identified by infra-red spectroscopy as S₅N₅⁺ and S₄N₄, $\nu_{\max} = 1162(w)^a$, $1100(w)^a$, $928(s)^b$, $720(m)^b$, $700(s)^b$, $551(s)^b$; a = S₅N₅⁺, b = S₄N₄.

c) Reduction by Ag in CH₃CN. [S₅N₅]Cl (0.150g, 0.565mmol) and silver powder (0.100g, 0.926mmol) were placed together, with a teflon stirrer bar, in one bulb of a dog. Acetonitrile (15ml) was syringed in and the reaction mixture stirred for 24 hours during which time the

solution turned from very pale pink to orange. The mixture was filtered and the insoluble product washed with back distilled CH_3CN (3 x 15ml). Removal of the solvent by pumping revealed an orange compound (soluble) and a white/red mixture (insoluble).

The red/white product was identified by infra-red spectroscopy as unreacted $[\text{S}_5\text{N}_5]\text{Cl}$ (it also presumably contained Ag and AgCl).

The orange solid was identified by infra-red spectroscopy as S_4N_4 , $\nu_{\text{max}} = 930(\text{s}), 770(\text{w}), 730(\text{m}), 701(\text{s}), 623(\text{w}), 552(\text{s}), 530(\text{w})$.

d) Reduction by $[\text{Me}_4\text{N}]\text{N}_3$ in CH_3CN . $[\text{S}_5\text{N}_5]\text{Cl}$ (0.150g, 0.565mmol) and $[\text{Me}_4\text{N}]\text{N}_3$ (0.100g, 0.86mmol) were placed together, with a teflon coated magnetic stirrer bar, in one bulb of a dog. Acetonitrile (13ml) was added and the mixture stirred. Almost immediately a small amount of a colourless gas was evolved (presumably nitrogen) and the reaction mixture turned brown. The reaction mixture was stirred for twelve hours, the final solution being burgundy in colour. The mixture was then filtered, and the solid residue washed with back distilled acetonitrile (3 x 13ml) and the solvent removed by pumping.

Examination of the solids under an optical microscope (x30) revealed that the microcrystalline soluble products in bulb (a) were red, orange and white in colour while the insoluble products in bulb (b) were white and yellow in colour. Diethyl ether (6ml) was added to bulb (a) to give a pale yellow solution, and the mixture was filtered. Bulb (a) was then washed four times in an identical fashion with back distilled diethyl ether.

The compounds in bulb (a) were identified by infra-red spectroscopy as $[\text{Me}_4\text{N}]\text{S}_4\text{N}_5$ and $[\text{Me}_4\text{N}]\text{S}_3\text{N}_3$, $\nu_{\text{max}} = 1405(\text{w})^{\text{a}}, 1265(\text{m}), 1225(\text{m}), 1089(\text{m}), 1040(\text{w}), 1020(\text{m}), 980(\text{m}), 950(\text{s})^{\text{a,b}}, 915(\text{s})^{\text{c}}, 810(\text{w}), 772(\text{w})$,

746(m)^c, 725(m)^a, 682(m)^c, 641(m)^b, 604(m)^c, 547(w sh), 538(m sh), 527(m)^c, 500(w)^c, 460(m)^a, 432(w)^c. a = Me₄N⁺, b = S₃N₃⁻ and c = S₄N₅⁻.

The compounds in bulb (b) were identified by infra-red spectroscopy as mainly S₄N₄ with a small amount of Me₄N⁺, ν_{\max} = 952(m)^a, 928(s)^b, 769(w)^b, 760(w)^b, 720(m)^b, 700(s)^b, 548(s)^b. a = Me₄N⁺ and b = S₄N₄.

e) Reduction by (Me₃SiCO₂)₂ in CH₃CN. [S₅N₅]Cl (0.100g, 0.377mmol) and trimethylsilyl oxalate, (Me₃SiCO₂)₂, (0.060g, 0.256mmol) were placed together, with a teflon stirrer bar, in one bulb of a dog. Acetonitrile (15ml) was added and the reaction mixture stirred for 48 hours. During this time there was no observable reaction and the infra-red spectrum of the mixture after 48 hours showed only starting materials.

f) Reduction by Ph₃Sb in CH₃CN. [S₅N₅]Cl (0.100g, 0.377mmol) and Ph₃Sb (0.067g, 0.190mmol) were placed together, with a teflon coated magnetic stirrer bar, in one bulb of a dog. Acetonitrile (15ml) was added and the reaction mixture stirred for 24 hours, resulting in a yellow solution containing a very fine black precipitate which could not be separated by filtration through a No.3 glass sinter. The solvent was removed by pumping (the solvent in the cold trap had a distinct yellow colouration, presumably due to Ph₃SbCl₂) and the solid placed in a closed extractor and extracted overnight with SO₂. On removal of the SO₂ a small amount of an insoluble black powder remained on the frit (presumably (SN)_x) and a dirty yellow solid in the bulb.

The black powder was not identified, as the very small quantity (ca. 3 mg) was lost, due to static in the glove box, while trying to transfer it into an agate pestle and mortar in order to take an infra-red spectrum. However, its colour and its insolubility in CH₃CN

and SO_2 suggested that it was $(\text{SN})_x$. Yield of $(\text{SN})_x = ca. 3\text{mg}$ (4.5%)

The dirty yellow soluble residue was identified by infra-red spectroscopy as a mixture of S_4N_4 and Ph_3Sb , $\nu_{\text{max}} = 1574(\text{w})^a$, $1439(\text{m})^a$, $1332(\text{w})^a$, $1305(\text{w})^a$, $1260(\text{w})^a$, $1180(\text{w})^a$, $1100(\text{m})^a$, $1063(\text{s})^a$, $1022(\text{m})^a$, $1000(\text{s})^a$, $930(\text{m})^b$, $735(\text{s})^a$, $703(\text{m})^b$, $550(\text{m})^b$, $459(\text{m})^a$. $a = \text{Ph}_3\text{Sb}$ and $b = \text{S}_4\text{N}_4$.

g) Reduction by Ph_3Sb in SO_2 . $[\text{S}_5\text{N}_5]\text{Cl}$ (0.100g, 0.377mmol) and Ph_3Sb (0.067g, 0.190mmol) were placed, together with a teflon coated magnetic stirrer bar, in one bulb of a dog. SO_2 (*ca.* 10ml) was condensed onto the reaction mixture at -197°C , warmed to room temperature and stirred for 24 hours, resulting in a yellow solution containing a very fine black precipitate which could not be separated by filtration through a No.3 glass sinter. The solvent was removed by pumping (the solvent in the cold trap had a distinct yellow colouration, presumably due to Ph_3SbCl_2) and the solid placed in a closed extractor and extracted overnight with SO_2 . On removal of the SO_2 a small amount of an insoluble black powder remained on the frit (presumably $(\text{SN})_x$) and a dirty yellow solid in the bulb.

The black powder was identified by infra-red spectroscopy as mainly $(\text{SN})_x$ with a small amount of S_4N_4 impurity. Yield = *ca.* 5mg (5.8%), $\nu_{\text{max}} = 1300(\text{vw})^a$, $1165(\text{w br})^a$, $1020(\text{w br})^a$, $938(\text{vw})^b$, $835(\text{w br})^a$, $700(\text{m br})^a$, $635(\text{w})^a$, $552(\text{w})^b$, $505(\text{w br})^a$. $a = (\text{SN})_x$ and $b = \text{S}_4\text{N}_4$.

The solubles were identified by infra-red spectroscopy as a mixture of S_4N_4 and Ph_3Sb , $\nu_{\text{max}} = 1576(\text{w})^a$, $1438(\text{m})^a$, $1330(\text{w})^a$, $1260(\text{w})^a$, $1180(\text{w})^a$, $1101(\text{m})^a$, $1065(\text{s})^a$, $1021(\text{m})^a$, $1000(\text{s})^a$, $931(\text{m})^b$, $735(\text{s})^a$, $703(\text{m})^b$, $551(\text{m})^b$, $459(\text{m})^a$. $a = \text{Ph}_3\text{Sb}$ and $b = \text{S}_4\text{N}_4$.

h) Reduction by Ph_3Sb and Me_3SiN_3 in CH_3CN . $[\text{S}_5\text{N}_5]\text{Cl}$ (0.150g, 0.565mmol) and Ph_3Sb (0.100g, 0.29mmol) were placed together, with a teflon coated magnetic stirrer bar, in one bulb of a dog. Acetonitrile (15ml) and Me_3SiN_3 (0.00438g, 0.038mmol) were syringed in and the reaction mixture stirred at 0°C for 24 hours, during which time the solution changed in colour from colourless \rightarrow brown \rightarrow deep red \rightarrow yellow with the formation of a black precipitate. The solvent was removed by pumping and the dirty black solid washed by extraction with SO_2 in a closed extractor overnight to reveal a black powder on the frit and a dirty brown solid in the extractor bulb.

The black powder was identified by infra-red spectroscopy as $(\text{SN})_x$. Yield = 36mg (27%), $\nu_{\text{max}} = 1222(\text{w br}), 1150(\text{w}), 1001(\text{m br}), 935(\text{w}), 580(\text{w br}), 690(\text{s br}), 627(\text{w}), 500(\text{m br})$.

The dirty brown solid was identified by infra-red spectroscopy as a mixture of S_4N_4 and Ph_3Sb , $\nu_{\text{max}} = 1055(\text{w br})^a, 1020(\text{w})^a, 996(\text{m})^a, 928(\text{s})^b, 768(\text{w})^a, 730(\text{s})^a, 700(\text{s})^{a,b}, 683(\text{s})^?, 550(\text{s})^b, 457(\text{s})^a$. $a = \text{Ph}_3\text{Sb}$ and $b = \text{S}_4\text{N}_4$.

i) Reduction by Ph_3Sb in $\text{CH}_3\text{CN}/\text{SO}_2$ with Seed $(\text{SN})_x$. In a typical reaction $[\text{S}_5\text{N}_5]\text{Cl}$ (0.300g, 1.13mmol) and powdered $(\text{SN})_x$ (0.040g prepared from the reaction between $[\text{S}_5\text{N}_5]\text{Cl}$ and Me_3SiN_3 in acetonitrile at -18°C) were placed in one bulb of a dog, together with a teflon coated magnetic stirrer bar. Ph_3Sb (0.200g, 0.567mmol) was placed in the other bulb. SO_2 (y ml, calculated by weight) was condensed on to the Ph_3Sb at -197°C and that arm of the dog sealed off by the use of the J. Young tap. Acetonitrile (15 - y ml, calculated by weight; excess was removed by pumping) was added to the other arm of the dog and the system frozen and evacuated. Both arms were then warmed up to room temperature and the

Ph₃Sb solution transferred into the acetonitrile solution and the mixture stirred at -18°C for 24 hours. During this time the solution changed from very pale pink to yellow and more (SN)_x appeared to precipitate. The solvent was removed by pumping (the solvent had a distinct yellow colouration in the cold trap presumably due to Ph₃SbCl₂) and the solid residue placed in a closed extractor and extracted with SO₂ for 24 hours to reveal a black powder on the glass sinter and a dirty yellow powder in the extractor bulb.

The black powder (*cf.* table 3.1 for yields) was identified by infra-red spectroscopy as (SN)_x, $\nu_{\max} = 1310(\text{w br}), 1015(\text{w br}), 940(\text{vw}), 690(\text{m br}), 630(\text{w}), 510(\text{w sh}), 500(\text{w})$. Typical Analysis: found N, 28.6%; (SN)_x requires 30.4%. D.S.C. showed; peak (v_{vw}) 90-130°C, peak (vs) 150-210°C.

The solubles were identified by infra-red spectroscopy as a mixture of Ph₃Sb and S₄N₄, $\nu_{\max} = 1310(\text{w})^{\text{a}}, 1160(\text{w})^{\text{b}}, 1067(\text{w})^{\text{a}}, 1057(\text{w})^{\text{a}}, 1020(\text{w})^{\text{a}}, 1000(\text{m})^{\text{a}}, 930(\text{m})^{\text{b}}, 770(\text{w})^{\text{b}}, 738(\text{s sh})^{\text{a}}, 731(\text{s})^{\text{a}}, 704(\text{m})^{\text{b}}, 687(\text{m})^{\text{?}}, 617(\text{w})^{\text{b}}, 550(\text{m})^{\text{b}}, 463(\text{m sh})^{\text{a}}, 455(\text{m})^{\text{a}}$. a = Ph₃Sb and b = S₄N₄

3.4.2 The Vacuum Thermolysis of [S₅N₅]Cl and Li₃N:

Li₃N (0.110g, 3.16mmol) was carefully ground together with [S₅N₅]Cl (0.200g, 0.75mmol) in an agate pestle and mortar, and the mixture placed in a sublimator under nitrogen. The sublimator was evacuated and the apparatus degassed until a vacuum of *ca.* 2×10^{-6} torr was achieved. A safety screen was placed in front of the apparatus and the mixture gently heated to 100°C using a thermostated oil bath. After only a few minutes the vacuum decreased to *ca.* 10^{-4} torr and the reaction mixture became aeri-ally agitated (*i.e.* the mixture flew around the tube, presumably due to the release of nitrogen gas). After half an hour a

yellow ring (above the oil level) had formed in the glass tube and the cold finger (*ca.* -197°C) was red/brown in colour. When a small pad of cotton wool soaked in liquid nitrogen was placed on the outside glass of the sublimer, a white volatile solid, thought to be S_2N_2 , condensed on the glass wall. On warming back to room temperature the white solid disappeared.

After $1\frac{1}{2}$ hours no further reaction appeared to be occurring and the vacuum had recovered to *ca.* 10^{-6} torr. The cold finger was slowly warmed up to room temperature (the cold finger went black in colour) and the volatiles transferred into a U-tube, which could be sealed at both ends by greased high vacuum taps, at -197°C . The U-tube, which contained a small amount of a dirty white solid, was then isolated and placed in a fridge at 0°C in an attempt to grow crystals of S_2N_2 . After three days in the fridge all the dirty white compound had migrated into (or reacted with) the grease, turning it black and leaving a yellow residue on the glass wall.

WARNING: When $[\text{S}_5\text{N}_5]\text{Cl}$ (0.050g, 0.188mmol) was mixed with Li_3N (0.020g, 0.574mmol) in a 250ml round bottomed flask with no solvent present, and the mixture stirred by accident, it detonated violently.

REFERENCES

1. F.P. Burt, *J. Chem. Soc.*, 1910, 1171.
2. M. Goehring, *Q. Rev. Chem. Soc.*, 1956, 10, 437
3. R.L. Patton, Ph.D. Thesis, University of California, Berkeley, 1969.
4. M. Villena-Blanco, UCRL-11081, 1963, 1.
5. M. Goehring and D. Voigt, *Naturwissenschaften*, 1953, 40, 482.
6. M. Goehring and D. Voigt, *Z. Anorg. Allg. Chem.*, 1956, 285, 181.
7. M. Becke-Goehring, *Progr. Inorg. Chem.*, 1959, 1, 207.
8. M. Becke-Goehring, *Sulphur Inst. J.*, 1966, 2, 2.
9. C.M. Mikulski, P.J. Russo, M.S. Saran, A.G. MacDiarmid, A.F. Garito, and A.J. Heeger, *J. Am. Chem. Soc.*, 1975, 97, 6358.
10. V.V. Walatka, M.M. Labes, J.H. Perlstein, *Phys. Rev. Lett.*, 1973, 31, 1139.
11. C. Hsu and M.M. Labes, *J. Chem. Phys.*, 1974, 61, 4640.
12. R.L. Greene, P.M. Grant, and G.B. Street, *Phys. Rev. Lett.*, 1975, 34, 89.
13. R.L. Greene, G.B. Street, and L.J. Suter, *Phys. Rev. Lett.*, 1975, 34, 577.
14. G.B. Street, H. Arnal, W.D. Gill, P.M. Grant, and R.L. Greene, *Mater. Res. Bull.*, 1975, 10, 872.
15. A.E. Thomas, J. Woods, and Z.V. Hauptman, *J. Phys. D: Appl. Phys.*, 1983, 16, 1123.
16. J.S. Harris, M.J. Cohen, H.M. Manasevit, and S.W. Zehr, *Energy Res. Abs.*, 1984, 9(3); no. 4534 ca: 100; 203814.
17. Hitachi Maxell ltd., J.P. 58,46,574/1983.
18. Asahi Chemical Industry Co., J.P. 58,93,177/1983.
19. Asahi Chemical Industry Co., J.P. 58,93,164/1983.
20. J. Badoz, M. Bardin, C. Bernard, M. Herlem, G. Robert, and A. Thiebault, E.P. Appl. 97,078/1983.
21. Asahi Chemical Industry Co., J.P. 58,197,677/1983.
22. Asahi Chemical Industry Co., J.P. 58,204,478/1983.

23. Allied Corp., J.P. 59,49,155,1982.
24. U. Thewalt and B. Müller, *Z. Naturforsch*, 1982, 37b, 828.
25. S.C. Peake and A.J. Downs, *J. Chem. Soc. Dalton Trans.*, 1974, 859.
26. H.W. Roesky, J. Anhaus, *Chem. Ber.*, 1982, 115, 3682.
27. A.J. Banister and Z.V. Hauptman, *J. Chem. Soc. Dalton Trans.*, 1980, 731.
28. T. Chivers, A.W. Cordes, R.T. Oakley, and P.N. Swepston, *Inorg. Chem.*, 1981, 20, 2376.
29. R.W.H. Small, A.J. Banister, and Z.V. Hauptman, *J. Chem. Soc. Dalton Trans.*, 1981, 2188.
30. M.W.R. Witt, W.I. Bailey, and R.J. Lawow, *J. Am. Chem. Soc.*, 1983, 105, 1668.
31. J.J. Smith and W.L. Jolly, *Inorg. Chem.*, 1965, 4, 1006.
32. S.R. Ovshinsky and A. Madan, G. P. Appl. 3004009/1980; *Chem. Abs.*, 1980, 93, P160058.
33. A.J. Banister, Z.V. Hauptman, J. Passmore, C. Wong, and P.S. White, *J. Chem. Soc. Dalton Trans.*, 1986, 2371.
34. F.A. Kennett, G.K. MacLean, J. Passmore, and M.N. Rao, *J. Chem. Soc. Dalton Trans.*, 1982, 851.
35. A.G. Kendrick, Ph.D. Thesis, University of Durham, 1986.
36. N. Irving Sax, "Dangerous Properties of Industrial Materials", 5th Edition, Litton Educational Publishing, 1979.
37. A.J. Banister, Z.V. Hauptman and R.W.H. Small, *J. Chem. Soc. Dalton Trans.*, 1987, 915.
38. J. Bojes and T. Chivers, *Inorg. Chem.*, 1978, 17, 318.
39. W.V.F. Brooks, N. Burford, J. Passmore, M.J. Schriver, and L.H. Sutcliffe, *J. Chem. Soc., Chem Commun.*, 1987, 66.
40. L.A. Harrah, M.T. Ryan, and C.Tamborski, *Spectrochim. Acta*, 18, 21.
41. L.F. Audrieth and J. Kleinberg, "Non-Aqueous Solvents", John Wiley and Sons, New York, N.Y., 1953.
42. G. Jander, "Die Chemie in Wasserähnlichen Lösungsmitteln", Springer-Verlag, Berlin, 1949.
43. J.M. Markowitz, Ph.D. Thesis, University of Michigan, 1985.
44. K. Cruse, *2.Electrochem.*, 1940, 46, 571.

45. J.W. Wacklin, G.B. Street, W.D. Gill, *J. Chem. Phys.*, 1979, 70, 2425
46. W.L. Jolly, "The Synthesis and Characterisation of Inorganic Compounds", Prentice-Hall Inc., New Jersey, 1970.
47. L.J. Bellamy, "The Infra-red spectra of Complex Molecules", Vol 1, Chapman and Hall, 1975, 387.
48. L.F. Nichols and M.M. Labes, unpublished results.

CHAPTER 4

An Electrochemical Study of some Sulphur-Nitrogen Compounds

4.1 INTRODUCTION

Much of the interest in poly(sulphur nitride) is due to the electrical properties of thin layers.^{1,2} When $(\text{SN})_x$ or $(\text{SNBr}_{0.4})_x$ films are deposited on semiconductor substrates, they have interesting interfacial properties, e.g. for improving efficiency of solar cells³ and light emitting diodes.⁴ In a GaAs/ $(\text{SN})_x$ solar cell,³ open circuit voltages greater than 0.7 volts were observed; 40% more than in conventional GaAs/gold cells. Thin layers of $(\text{SN})_x$ deposited on ZnS⁴ have been used to fabricate blue light emitting diodes which have a quantum efficiency for the blue high energy emission, 100 x that of the corresponding devices fabricated with gold. The patenting of new lightweight, high output batteries,⁵⁻¹¹ often with a wide temperature operating range, has been frequent in Japanese work. In these novel batteries the $(\text{SN})_x$, which is often halogenated, is deposited as thin layers onto a substrate and used as the cathode.

Traditionally thin films have been produced by vacuum sublimation of $(\text{SN})_x$, at temperatures greater than 135°C, onto substrates such as Mylar,¹² Teflon,¹³ polyethene and quartz. Indeed this was felt so important that the vapour deposition method was patented.¹³

More recently thin films of $(\text{SN})_x$ have been prepared by the electroreduction of S_5N_5^+ salts. The first reported synthesis¹⁴ of electrochemical $(\text{SN})_x$ was from the reduction of $[\text{S}_5\text{N}_5]\text{Cl}$ in liquid SO_2 . Reduction of the AlCl_4^- and FeCl_4^- salts¹⁵ also produced comparable layers of $(\text{SN})_x$. However $[\text{S}_5\text{N}_5]\text{AlCl}_4$ decomposes slightly in CH_3CN due

to complexation of the AlCl_3 with CH_3CN producing a little $[\text{S}_5\text{N}_5]\text{Cl}$, and in $[\text{S}_5\text{N}_5]\text{FeCl}_4$ the reduction of the FeCl_4^- might contaminate the $(\text{SN})_x$ produced. It has also been shown that solutions of $[\text{S}_5\text{N}_5]\text{Cl}$ in SO_2 are metastable,¹⁶ decomposing to produce a wide variety of products. It was, therefore, felt important to find an anion that should be (i) electrochemically inactive (ii) should contain no metallic species and (iii) be stable and soluble in a variety of solvents. The BF_4^- anion fulfilled all these criteria and was easily prepared from the reaction between $[\text{S}_5\text{N}_5]\text{Cl}$ and HBF_4 solution.¹⁶ Electroreduction of this salt produced good quality layers of $(\text{SN})_x$ which could be vacuum-deposited onto a glass substrate.

There has also been considerable interest in the properties of crystalline $(\text{SN})_x$ which have been well reviewed.¹⁷ However, due to the nature of the polymerisation process from S_2N_2 ,¹⁸ a perfect single crystal has never been obtained and therefore physical measurements are not entirely accurate. Indeed if a single crystal could be prepared many results, such as T_c ,¹⁹ the temperature at which $(\text{SN})_x$ becomes a superconductor, might be improved upon.

When $[\text{S}_5\text{N}_5]\text{Cl}$ was electroreduced in SO_2 ¹⁶ and the $(\text{SN})_x$ product examined under an electron microscope, small crystallites of $10\mu\text{m}$ average size (and a very few needles,^(optical microscope) up to 0.5mm in length) could be seen stacked in zig-zag chains arranged at right angles to the electrode surface. These findings have led to further investigations into the mechanism of electrochemical formation of $(\text{SN})_x$ in the hope that better methods of electrocrystallisation could be found.

Cyclic voltammetry¹⁶ has been the major tool used to elucidate the mechanism of $(\text{SN})_x$ formation from S_5N_5^+ salts. Studies on $[\text{S}_5\text{N}_5]\text{Cl}$ in SO_2 , using $[\text{Bu}_4\text{N}]\text{BF}_4$ as supporting electrolyte, show a peak at

$E_{p/2}^{\text{red}} = +0.34\text{V}$ (this potential, and all subsequent values are converted to the S.C.E. scale), which was assigned to the reduction of S_5N_5^+ to $\text{S}_5\text{N}_5^\cdot$, with cathodic breakdown of SO_2 occurring at $E_{p/2}^{\text{red}} = -0.16\text{V}$. A large peak at $E_{p/2}^{\text{oxd}} = +1.32\text{V}$ was assigned to the oxidation of Cl^- , with anodic breakdown of BF_4^- occurring at ca. $E_{p/2}^{\text{oxd}} = +2.5\text{V}$, presumably with formation of BF_3 and SO_2F_2 . A small oxidation peak at $E_{p/2}^{\text{oxd}} = +1.08\text{V}$ was assigned unambiguously to the breakdown of $(\text{SN})_x$ which has previously been reported to occur at $+1.0\text{V}$.

Cyclic voltammetric studies were also carried out on a solution of $[\text{S}_5\text{N}_5]\text{BF}_4$ in acetonitrile¹⁶ in order to study more negative potentials, as both CH_3CN and BF_4^- are recognised to be particularly electro-inert. As for $[\text{S}_5\text{N}_5]\text{Cl}$ and $[\text{S}_5\text{N}_5]\text{FeCl}_4$ ¹⁵ the first reduction peak was assigned to the reduction of the S_5N_5^+ ion ($E_{p/2}^{\text{red}} = +0.46\text{V}$). The second peak ($E_{p/2}^{\text{red}} = -0.08\text{V}$) was shown to be temperature dependant; at room temperature it is present only as a weak, broad feature but at lower temperatures the peak becomes progressively sharper and more intense until at -18.5°C it was the same height as the S_5N_5^+ reduction peak. This second peak was assigned to the reduction of a short lived neutral species produced by the fragmentation of the $\text{S}_5\text{N}_5^\cdot$ radical; peaks assigned to S_4N_4 were also present.

This cyclic voltammetry data, together with $(\text{SN})_x$ current yields in the region of 40-50%, suggest that the $\text{S}_5\text{N}_5^\cdot$ radical either (i) ring-opens to form $(\text{SN})_x$ or (ii) cleaves to form cyclic $\text{S}_3\text{N}_3^\cdot$ radical and linear S_2N_2 (cyclic S_2N_2 , which is stable below 0°C , was not seen).

An extensive study on the electrochemistry of the S_3N_3^- ion has been carried out.^{20,21} Polarography showed three successive anodic waves at -0.25 , $+0.81$ and 1.4 volts. It might, therefore, be thought that oxidation of the S_3N_3^- ion to the radical results in the formation

of $(\text{SN})_x$. However, potentiostatic oxidation at 0.0V produced S_4N_4 in ca. 90%^{yield} with no evidence of $(\text{SN})_x$, although the S_3N_3^- ion has been chemically oxidised²² by COCl_2 producing good quality $(\text{SN})_x$ in 22% yield.

Fritz *et al*²³ have shown by cyclic voltammetry that the oxidation of S_3N_3^- in CH_2Cl_2 is almost reversible with a recognisable oxidation peak at $E_p = +0.21\text{V}$ and a reduction peak at $E_p = +0.13\text{V}$. They also studied the cyclic voltammetry of $[\text{SN}]\text{SbCl}_6$ which clearly showed the non-reversible reduction of SN^+ ($E_p^{\text{red}} = +0.76\text{V}$) in trifluoroacetic acid (the only solvent which gave a stable solution of $[\text{SN}]\text{SbCl}_6$).

If the mechanism of $(\text{SN})_x$ growth from S_5N_5^+ salts and the dissolution of $(\text{SN})_x$ could be further elucidated then the possibility of growing better layers and single crystals would be greatly increased.

4.2 RESULTS AND DISCUSSION

4.2.1 The Preparation of $[\text{Bu}_4\text{N}]\text{AsF}_6$:

This new supporting electrolyte was required in order to study the electrochemistry of AsF_6^- salts of S/N cations such as SN^+ and S_5N_5^+ . It was prepared by the addition of equimolar quantities of aqueous $[\text{Bu}_4\text{N}]\text{HSO}_4$ and LiAsF_6 (both are highly soluble in water), the white $[\text{Bu}_4\text{N}]\text{AsF}_6$ (highly insoluble in water) precipitating out. The crude solid was filtered off, liberally washed with water and dried in air. This was then dissolved in the minimum quantity of acetonitrile, and water added to precipitate the product which was dried *in vacuo* at 60°C .

A background cyclic voltammogram of the supporting electrolyte in SO_2 and CH_3CN (figures 4.1 and 4.2) showed an almost flat trace indicating the high purity of the compound. In SO_2 the cathodic cut off

Figure 4.1 $[\text{Bu}_4\text{N}]\text{AsF}_6$ background cyclic voltammogram in SO_2 at $+20^\circ\text{C}$.

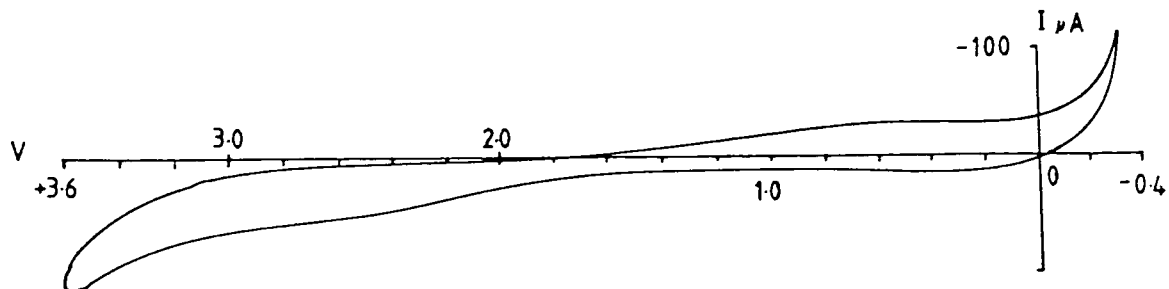
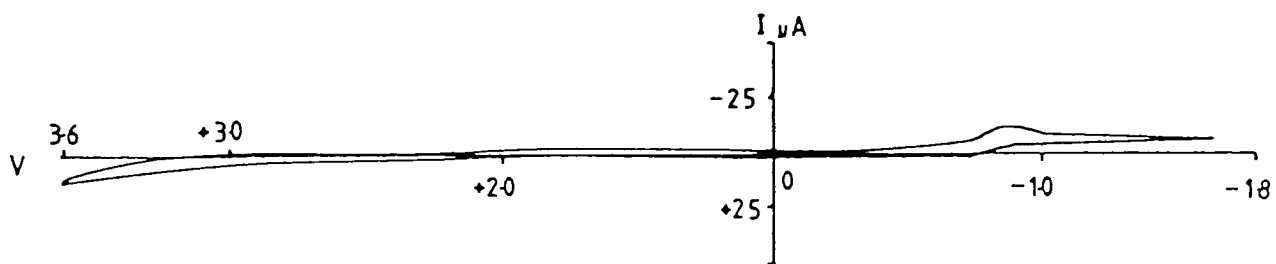

Figure 4.2 $[\text{Bu}_4\text{N}]\text{AsF}_6$ background cyclic voltammogram in CH_3CN at $+20^\circ\text{C}$.



point, due to the reduction of SO_2 ^{24,25} producing $\text{SO}_2^{\cdot-}$, occurred at *ca.* -0.4V and the anodic cut off, due to the breakdown of AsF_6^- , was at *ca.* +3.6V. $[\text{Bu}_4\text{N}]\text{AsF}_6$ has a greater, and therefore superior, scanning range compared to other supporting electrolytes such as $[\text{Bu}_4\text{N}]\text{ClO}_4$ (+3.4V) and $[\text{Bu}_4\text{N}]\text{BF}_4/\text{PF}_6$ (+3.3V - not *ca.* +4V as suggested in this papers conclusion).²⁶

Independently, and unknown to our laboratory, Bard and coworkers²⁷ also synthesised $[\text{Bu}_4\text{N}]\text{AsF}_6$ from a similar reaction between $[\text{Bu}_4\text{N}]\text{Br}$ and LiAsF_6 in water followed by recrystallisation (x 2) of the crude solid from hot ethyl acetate and diethyl ether. In SO_2 they reported cathodic breakdown at *ca.* -0.7V and anodic breakdown at *ca.* +4.7V. This greater range, compared with our product, can be attributed to i) a purer product (recrystallised twice) and ii) the use of purer SO_2 (passed through P_4O_{10} , conc. H_2SO_4 and a Woelm B-super 1 Alumina (Woelm Phara) column packed on glass wool).

4.2.2 The Preparation of $\text{S}_5\text{N}_5\text{AsF}_6$:

$\text{S}_5\text{N}_5\text{AsF}_6$ was prepared by the addition of a slight excess of fresh $[\text{S}_5\text{N}_5]\text{Cl}$ to AgAsF_6 (1.1:1) in SO_2 , the white AgCl precipitating out almost immediately. In order for the reaction to go to completion, the reaction mixture was stirred for at least 12 hours; this also allowed the AgCl to agglomerate, thus enabling an effective filtration of the orange solution containing the $\text{S}_5\text{N}_5\text{AsF}_6$. On removal of the SO_2 an orange solid remained which was heated *in vacuo* to remove the excess $[\text{S}_5\text{N}_5]\text{Cl}$. The final product was identified by elemental analysis and infrared spectroscopy as $\text{S}_5\text{N}_5\text{AsF}_6$.

$\text{S}_5\text{N}_5\text{AsF}_6$ had previously been prepared²⁸ from the reaction between equimolar quantities of $[\text{S}_5\text{N}_5]\text{Cl}$ and AgAsF_6 in SO_2 for 2 hours. However

our new work has shown that under such reaction conditions silver impurities contaminate the $S_5N_5AsF_6$. Such impurities result from incomplete reaction in two hours which is further encouraged by the use of equimolar quantities of the starting materials.

The thermal stability of $S_5N_5AsF_6$ (D.S.C. shows decomposition starting at *ca.* 150°C [figure 4.3]) allows the less thermally stable $[S_5N_5]Cl$ (D.S.C. shows decomposition starting at *ca.* 100°C) to be removed by heating *in vacuo* at 100°C, resulting in a very pure product.

$S_5N_5AsF_6$ is the most stable $S_5N_5^+$ salt known. Samples were only very slightly moisture sensitive and could be handled in the atmosphere (e.g. to charge a cell) for several minutes with negligible decomposition. The acetonitrile solution used for immersion deposition of $(SN)_x$ (*cf.* section 4.4.11) was stable (e.g. $(SN)_x$ could still be produced) for at least two weeks under conditions in which $[S_5N_5]BF_4$ decomposed in two days. This therefore makes $S_5N_5AsF_6$ a highly suitable compound for the preparation of $(SN)_x$ by electroreduction.

4.2.3 Cyclic Voltammetric Studies of $[SN]AsF_6$:

a) In liquid SO_2 . Liquid SO_2 was seldom used as a solvent²⁹ for electrochemical studies until the 1970's. Early work was hampered³⁰ by the lack of a good supporting electrolyte and a stable reference electrode. In 1970 Miller and Mayeda³¹ reported that the use of tetraalkylammonium salts as supporting electrolytes in SO_2 gave reasonable conductivities and that 9,10-diphenylanthracene could be oxidised reversibly to a stable cation radical. More recently $[Bu_4N]AsF_6$ was reported²⁷ to have a scanning range from -0.7 to +4.7V (vs. S.C.E.) in SO_2 , thus being the most effective supporting electrolyte so far for work in SO_2 .

Figure 4.3 D.S.C. trace of $S_5N_5AsF_6$.

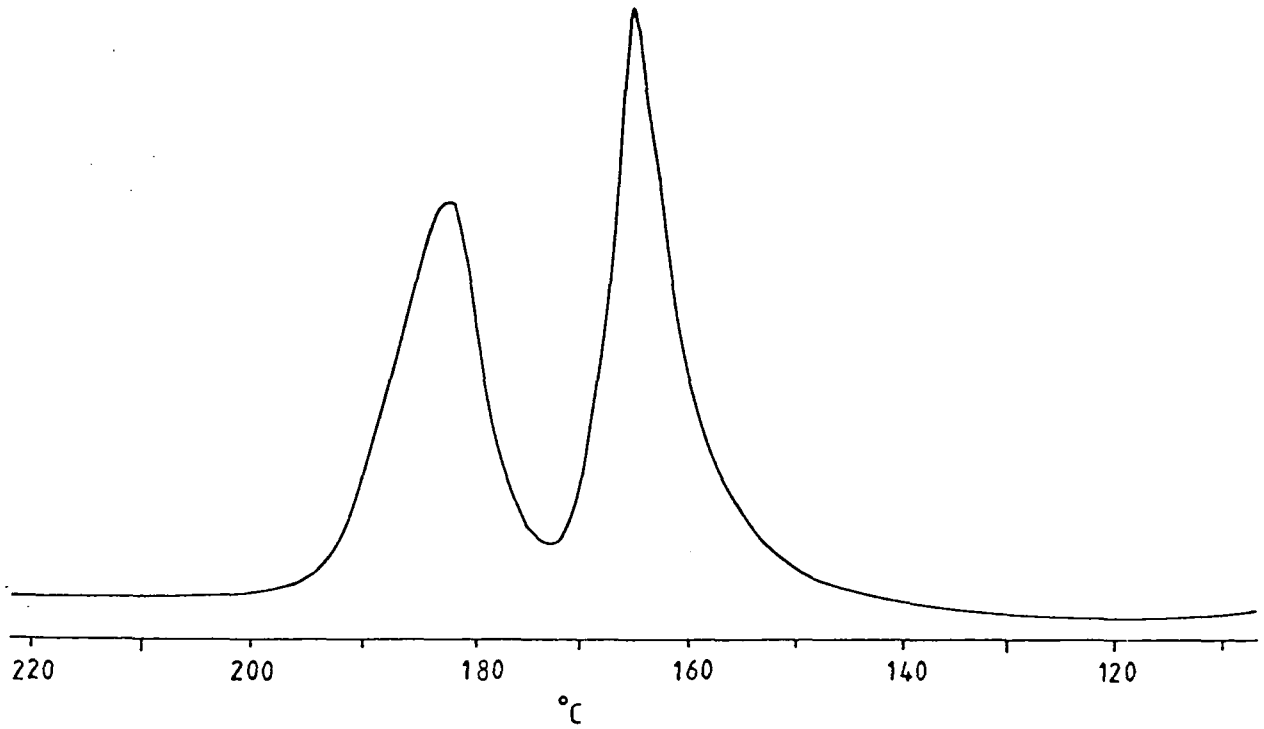

$[\text{Bu}_4\text{N}]\text{AsF}_6$, the supporting electrolyte, was chosen for this work as the anion is identical to the anion present in the electroactive compound to be studied, $[\text{SN}]\text{AsF}_6$. In cyclic voltammetry³² it is usual to use at least a 100 fold molar excess of supporting electrolyte to the electroactive material. This is to reduce migration of the electroactive species to the electrode, as diffusion is the mode of mass transport required in cyclic voltammetric studies. Since the use of a 0.1 molar solution would only require 3.01mg of $[\text{SN}]\text{AsF}_6$, and SN^+ is highly moisture sensitive, it was decided to add a greater quantity in order that some SN^+ would still remain after the inevitable hydrolysis.

Figure 4.4 shows a typical cyclic voltammogram of SN^+ at -32°C . The reduction peak 1 ($E_{p-2}^{\text{red}} = 1.26$ volts) and the oxidation peak 3 were assigned to the reversible reduction of SN^+ to SN^\cdot . This reversibility is highly temperature dependant. At low temperatures peak 3 is a weak feature and as the temperature is raised it weakens further until at 0°C it is absent. This can be rationalised by looking at the highly reactive nature of the SN^\cdot radical which is more likely to be stabilised at lower temperatures. On warming the solution from -32°C to room temperature over a period of one hour, peak 1 reduces in amplitude until it is absent, presumably due to hydrolysis. Reduction peak 2 ($E_{p-2}^{\text{red}} = +0.42\text{V}$) was temperature independent and could not be unambiguously assigned. Cathodic breakdown occurred at *ca.* 0.04V and was assigned to the reduction of SO_2 .^{24, 25} Anodic breakdown occurred at *ca.* 3.2 volts and was assigned to the oxidation of AsF_6^- , presumably with the formation of AsF_5 and F^\cdot .

b) In acetonitrile. In order to study the electrochemistry of SN^+ in an electrochemically inert solvent,³³ and hence be able to look at

Figure 4.4 Cyclic voltammogram of $[\text{SN}]\text{AsF}_6$ in SO_2 at -32°C .

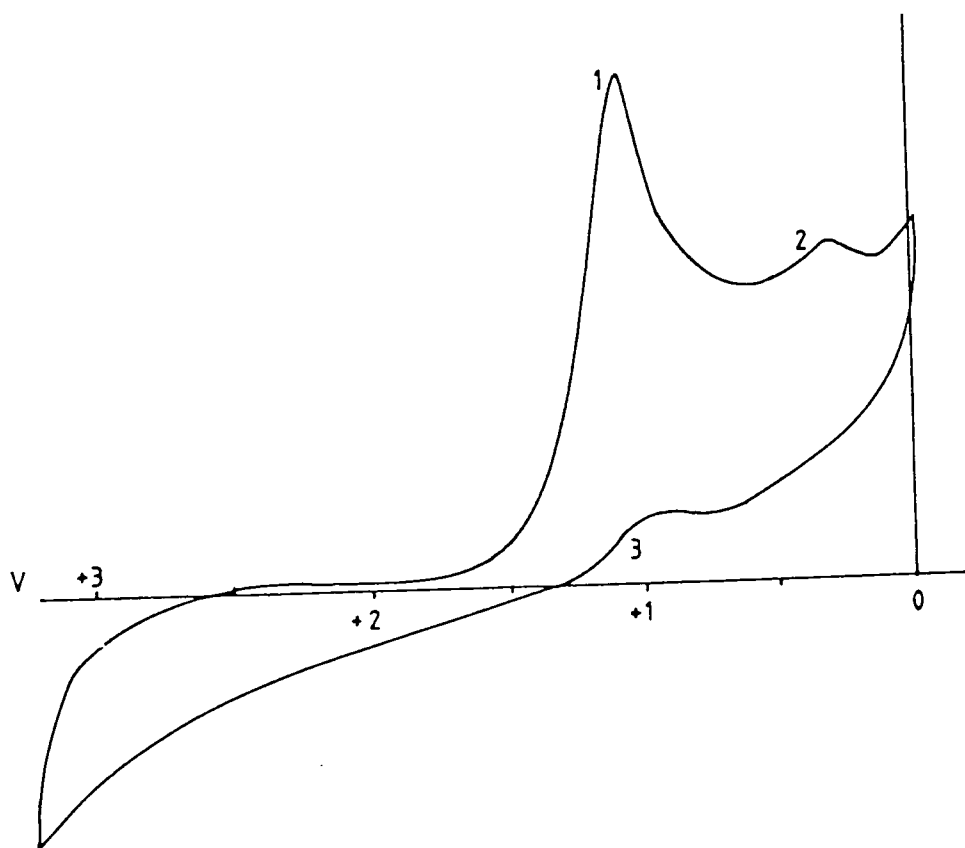
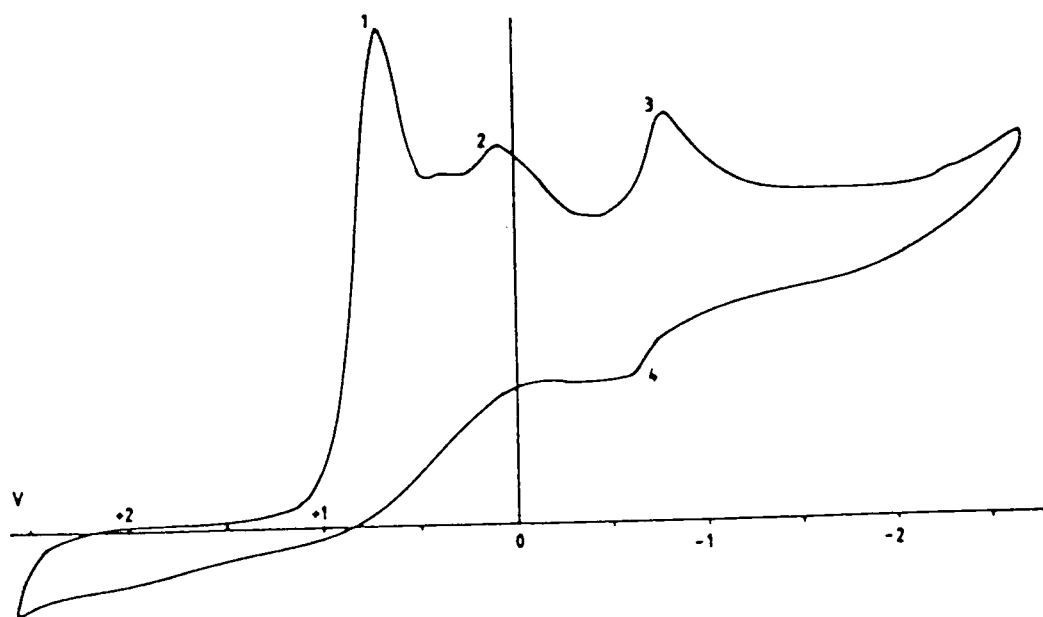

Figure 4.5 Cyclic voltammogram of $[\text{SN}]\text{AsF}_6$ in CH_3CN at -30°C .



the reduction of species produced from the SN^\cdot radical, a cyclic voltammetric study of $[\text{SN}]\text{AsF}_6$ in acetonitrile was undertaken. A typical cyclic voltammogram is illustrated in figure 4.5.

Peak 1 ($E_{p/2}^{\text{red}} = +0.83$ volts) was assigned to the reduction of the SN^+ ion (in SO_2 $E_{p/2}^{\text{red}} = 1.26$ volts), although in this system no corresponding oxidation peak is observed and hence the process is irreversible (unlike a) above). From the $E_{p/2}^{\text{red}}$ potentials it can be seen that SN^+ is more easily reduced in SO_2 than in acetonitrile. This implies that SO_2 is a better electron donating solvent than acetonitrile, hence making the reduction of SN^+ in SO_2 easier. SO_2 is also known to stabilise free radicals³⁴⁻³⁷ thus making the reduction of SN^+ in SO_2 easier. As in SO_2 , the height of the SN^+ reduction peak rapidly diminishes as the solution is warmed up, probably due to the increased rate of hydrolysis at higher temperatures.

Peak 2 has not yet been unambiguously assigned but could be the reduction of a hydrolysis product. The reduction peak 3 ($E_{p/2}^{\text{red}} = -0.68\text{V}$) and the oxidation peak 4 were assigned to the reversible reduction of S_4N_4 ²¹ to the radical anion, $\text{S}_4\text{N}_4^{\cdot-}$. S_4N_4 could be produced from the "tetramerisation" of SN^\cdot .

4.2.4 Cyclic Voltammetric Study on $\text{S}_5\text{N}_5\text{AsF}_6$ in CH_3CN :

The electrochemistry of $[\text{S}_5\text{N}_5]\text{Cl}$ and $[\text{S}_5\text{N}_5]\text{BF}_4$ has previously been studied¹⁶ by our group using cyclic voltammetry. Both salts clearly show the reduction of the S_5N_5^+ ion presumably with the formation of the $\text{S}_5\text{N}_5^\cdot$ radical. When $\text{S}_5\text{N}_5\text{AsF}_6$ was studied the characteristic S_5N_5^+ reduction peak was again observed. A typical cyclic voltammogram of $\text{S}_5\text{N}_5\text{AsF}_6$ in acetonitrile at -30°C is illustrated in figure 4.6a.

Peak 1 ($E_{p/2}^{\text{red}} = +0.06\text{V}$) was assigned to the reduction of S_5N_5^+ to

Figure 4.6 a) Cyclic voltammogram of $S_5N_5AsF_6$ in CH_3CN at $-30^\circ C$.

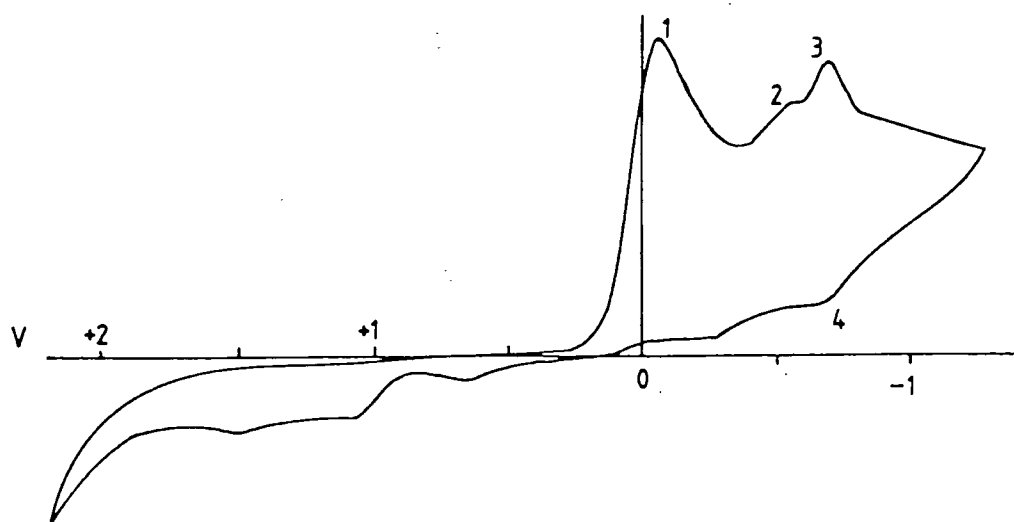

b) Cyclic voltammogram of $S_5N_5AsF_6$ in CH_3CN at $-30^\circ C$ after holding at potential P for 3 minutes followed by scanning in the positive direction.

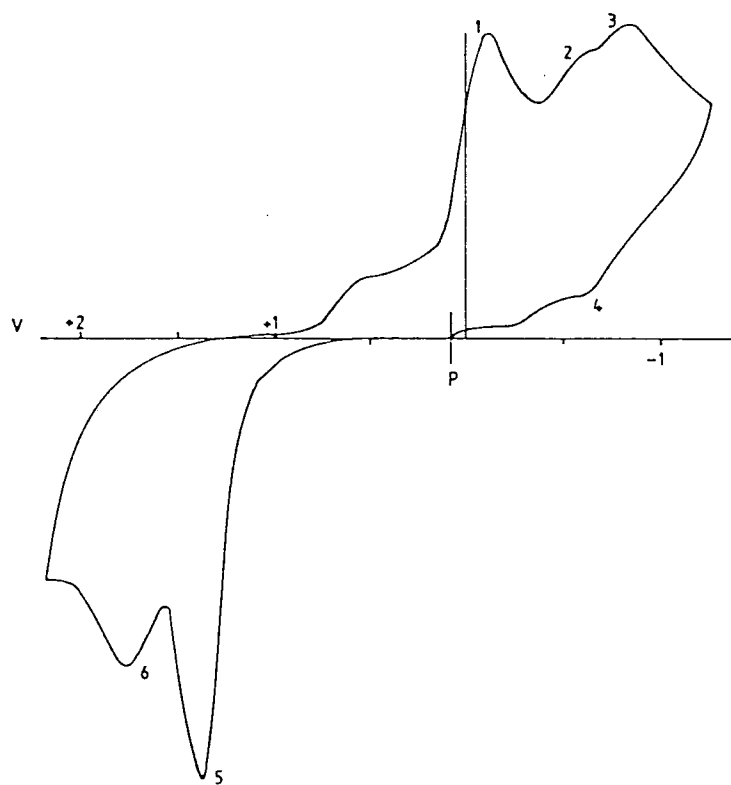

the $S_5N_5^{\cdot}$ radical. This peak is at a more negative potential compared to other $S_5N_5^+$ salts such as BF_4^- ($E_{p/2}^{red} = +0.23V$ at $0^\circ C$ in CH_3CN) and Cl^- ($E_{p/2}^{red} = +0.34V$ at $3^\circ C$ in SO_2), due to the harder AsF_6^- anion donating very little charge into the $S_5N_5^+$ ring.

Previous cyclic voltammetric studies on $[S_5N_5]BF_4$ showed the presence of a short lived species which was thought to be the $S_3N_3^{\cdot}$ radical ($E_{p/2}^{red} = -0.19V$) produced from the breakdown of the $S_5N_5^{\cdot}$ radical. Shortly afterwards Fritz *et al*²³ showed the reversible reduction of $S_3N_3^{\cdot}$ to $S_3N_3^-$ in CH_2Cl_2 to occur at *ca.* $E_p^{red} = +0.13V$ and one can speculate that this is the same short lived species produced from the breakdown of the $S_5N_5^{\cdot}$ radical produced above. For $S_5N_5AsF_6$ such an $S_3N_3^{\cdot}$ radical reduction peak would be hidden underneath that of the $S_5N_5^+$ reduction peak.

The reduction peaks 2 and 3 ($E_{p/2}^{red} = -0.42$ and $-0.60V$ respectively) and the oxidation peak 4 may all be assigned to the reversible reduction of S_4N_4 .²¹ Peak 2 corresponds to the pre-wave observed by Chivers and Hojo in their polarographic study of S_4N_4 . The other oxidation peaks are very poorly defined and are probably associated with products produced from the breakdown of the $S_5N_5^{\cdot}$ radical.

Two new peaks (5 and 6) were observed (figure 4.6b) at *ca.* $+1.25$ and $+1.50V$ when the potential was held at $+0.08V$ for 3 minutes and then scanned in the positive direction. These may correspond to the anodic breakdown of SN oligomers produced from the electroreduction of the $S_5N_5^+$ cation. Previous reports³⁸ have suggested anodic breakdown of $(SN)_x$ electrodes occurring at *ca.* $+1.0V$, although our own research has shown that under aprotic conditions $(SN)_x$ behaves as a precious metal, being stable at voltages where the supporting electrolyte (e.g.

[Bu₄N]AsF₆) breaks down (figure 4.7). The new oxidation peaks are therefore unlikely to be associated with the breakdown of high chain length (SN)_x but are likely to be due to lower chain length oligomers.

4.2.5 Cyclic voltammetric Study of [S₄N₃]BF₄ in CH₃CN:

The electrochemistry of S₅N₅⁺ salts has been studied previously, in our laboratory¹⁶ and elsewhere,¹⁵ involving both cyclic voltammetry and bulk electrolysis. A preliminary study²⁷ on the electroreduction of S₄N₃⁺ produced (SN)_x, S₄N₂ and S₄N₄, but it was thought that small traces of silver (an impurity in the [S₄N₃]BF₄ used) could have catalysed the reaction, thus accounting for the "somewhat complicated nature of the products".²⁷ It was therefore important (so as to understand the reaction mechanism) to study the cyclic voltammetry of pure [S₄N₃]BF₄ in acetonitrile. Figure 4.8 shows a typical cyclic voltammogram obtained at -20°C.

Peak 1 (E_{p/2}^{red} = +0.24V) was assigned to the reduction of the S₄N₃⁺ cation, presumably with the formation of the S₄N₃[·] radical. There is no corresponding oxidation peak and hence the process is irreversible. Peak 2 (E_{p/2}^{red} = +0.04V) is approximately half the amplitude of peak 1, independent of the temperature and is probably the reduction of a species produced from the fragmentation of the S₄N₃[·] radical (see next paragraph). Peak 3 was assigned to the reduction of S₄N₄²⁺ to S₄N₄^{·-} and is reversible.

Peak 4 (E_{p/2}^{oxd} = +0.07) was assigned²³ to the oxidation of S₃N₃^{·-} and its half wave potential is very close to that of peak 2 (E_{p/2}^{red} = 0.04V). It is therefore probable that peak 2 corresponds to the known reversible reduction of the S₃N₃^{·-} radical to S₃N₃⁻, thus peaks 2 and 4 are a reversible pair.

Figure 4.7 Background cyclic voltammogram of $[\text{Bu}_4\text{N}]\text{AsF}_6$ in SO_2 at $+20^\circ\text{C}$ using an $(\text{SN})_x$ electrode.

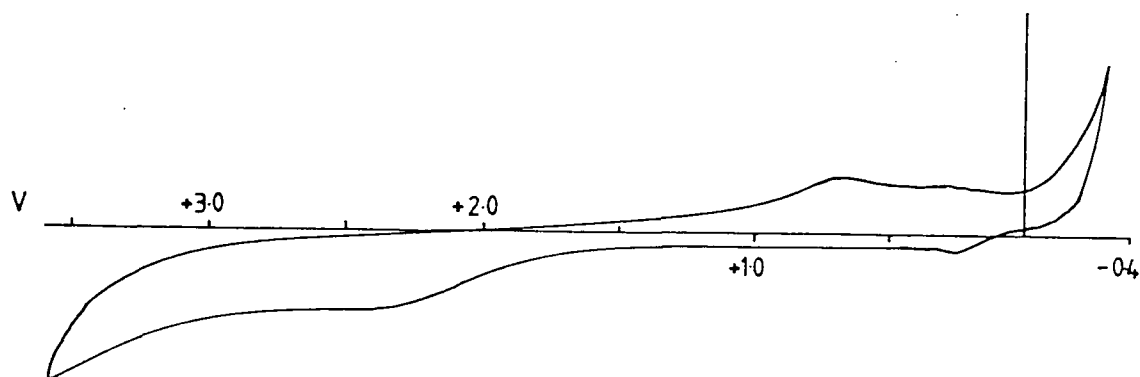

Figure 4.8 Cyclic voltammogram of $[S_4N_3]BF_4$ in CH_3CN at $-20^\circ C$.

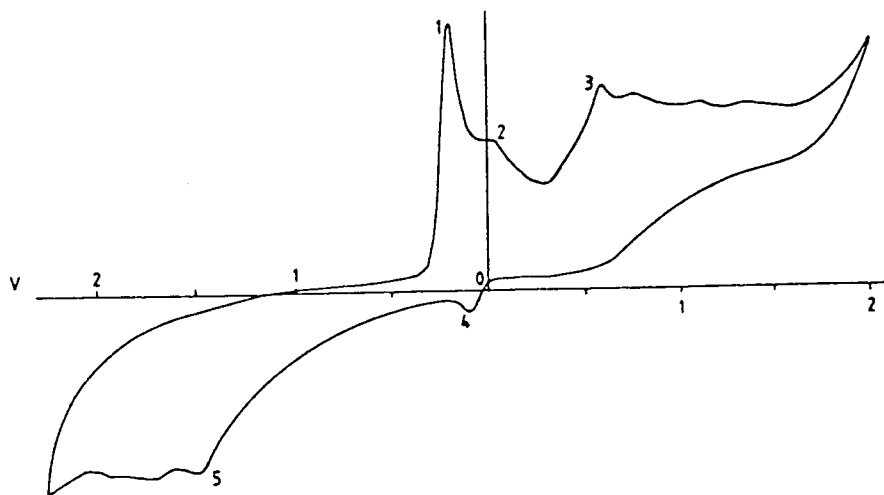
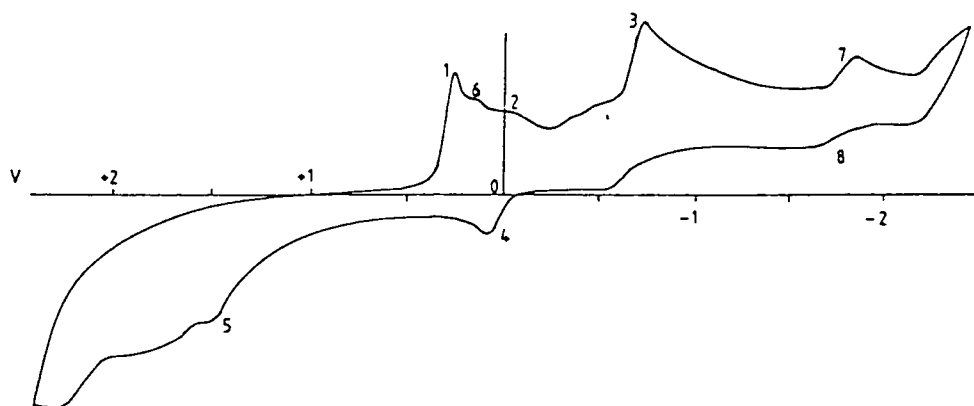

Figure 4.9 Cyclic voltammogram of $[S_4N_3]BF_4$ in CH_3CN at $+20^\circ C$.



Peak 5 was not part of such a pair and could not be unambiguously assigned. When a small cycle was carried out, such that the reduction potential of the $S_4N_3^+$ was not reached, peak 5 disappeared, *i.e.* peak 5 was due to the oxidation of a product from the breakdown of the $S_4N_3^\cdot$ radical. The overall set of reactions inferred from the cyclic voltammetry data at -20°C is summarised in scheme 4.1.

The $S_4N_3^+$ ion is discharged to form the transient $S_4N_3^\cdot$ radical (peak 1). This cleaves to produce $S_3N_3^\cdot$ and sulphur, although other lower yielding products may be formed. This reactive $S_3N_3^\cdot$ radical may either be reduced at the electrode producing the $S_3N_3^-$ anion (peak 2) or react further to produce S_4N_4 which itself can be reduced reversibly (peak 3). The $S_3N_3^-$ produced, both from the reduction of the $S_3N_3^\cdot$ radical and from the reduction of S_4N_4 ,²¹ is readily oxidised (peak 4) to reform the transient $S_3N_3^\cdot$ radical.

A typical cyclic voltammogram at $+20^\circ\text{C}$ (figure 4.9) shows the appearance of peaks 6, 7 and 8 ($E_{p-2}^{\text{red}} = +0.18\text{V}$, $E_{p-2}^{\text{red}} = -1.8$ and $E_{p-2}^{\text{oxd}} = -1.8\text{V}$ respectively) which could not be unambiguously assigned. It is quite probable though that at higher temperatures the transient $S_4N_3^\cdot$ radical cleaves to produce a greater range of products which could account for the three extra peaks at $+20^\circ\text{C}$ (compared with -20°C). These new peaks may well be due to S_4N_2 or $S_3N_2^{+\cdot}$, which have been observed when $S_4N_3^+$ is electrochemically (S_4N_2)³¹ or chemically (S_4N_2 and $S_3N_2^{+\cdot}$ *cf.* section 5.3.5) reduced.

4.2.6 Cyclic Voltammetric Study of S_2N_2 in CH_3CN :

Addition of CH_3CN to S_2N_2 at -17°C produced a colourless solution over excess S_2N_2 . On warming to 17°C all the S_2N_2 dissolved and the solution remained colourless. It is well known that in the solid state

Scheme 4.1 Reaction mechanisms inferred from the cyclic voltammetry data obtained from $[\text{S}_4\text{N}_3]\text{BF}_4$.

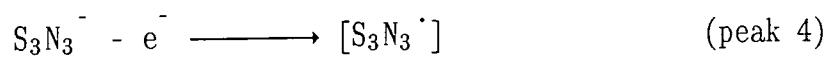
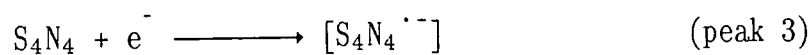
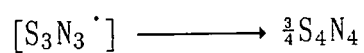
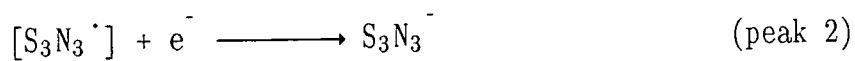
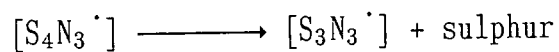
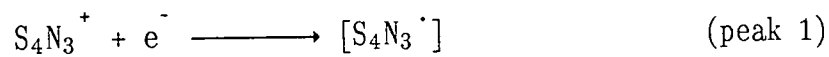

S_2N_2 polymerises³⁹ producing "classical" $(SN)_x$ although in solution⁴⁰ it is described as being more stable. Figure 4.10 shows a typical cyclic voltammogram of S_2N_2 , the peaks being numbered in order of appearance. Peak 1 ($E_{p-2}^{red} = -0.84V$) was assigned to the reduction of S_2N_2 presumably with the formation of $S_2N_2^{\cdot-}$. Peak 2 is a very weak feature and was assigned to the known oxidation of $S_4N_4^{\cdot-}$ to S_4N_4 .²¹ Peak 3 ($E_{p-2}^{oxd} = +0.07 V$) was assigned to the oxidation of $S_3N_3^-$ to $S_3N_3^{\cdot}$,²³ and on the second scan peak 4 ($E_{p-2}^{red} = -0.56 V$) appears which was assigned to the reduction of S_4N_4 .²⁴

This data provides a valuable insight into the solution and electrochemistry of S_2N_2 . A summary of the reactions is shown in scheme 4.2.

Electron rich sulphur/nitrogen aromatics⁴¹ have been shown to have low energy π^* molecular orbitals enabling such heterocycles to accommodate the additional electron into a π type orbital with ease and hence reduction of S_2N_2 (peak 1) readily occurs at $-0.84 V$ producing $S_2N_2^{\cdot-}$.

Peak 2 was assigned to the oxidation of $S_4N_4^{\cdot-}$. The initial cycle showed no peak corresponding to the reduction of S_4N_4 and hence dimerisation of S_2N_2 has not occurred at room temperature. Other workers have reported⁴² that solutions of S_2N_2 near room temperature yellow immediately (S_4N_4) and dark flakes of $(SN)_x$ gradually precipitate out in the presence of water. The radical anion (peak 2) must therefore have been produced from the reaction between $S_2N_2^{\cdot-}$ and S_2N_2 . $S_3N_3^-$ which is produced by decay²¹ of the radical anion $S_4N_4^{\cdot-}$ is seen as peak 3, its oxidation ultimately producing S_4N_4 which shows up on the second cycle as peak 4.

Figure 4.10 Cyclic voltammogram of S_2N_2 in CH_3CN at $+16^\circ C$.

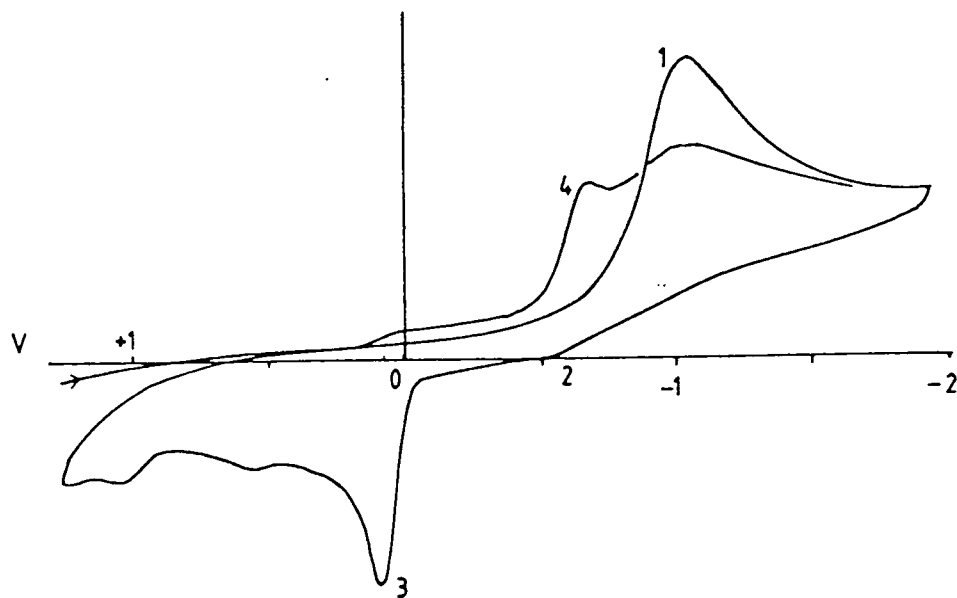

Scheme 4.2 Reaction mechanisms inferred from the cyclic voltammetry data obtained from S_2N_2 .

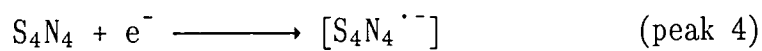
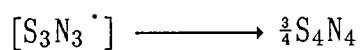
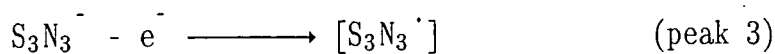
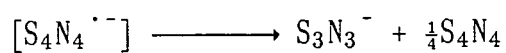
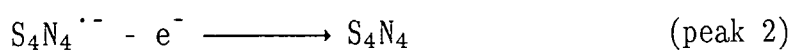
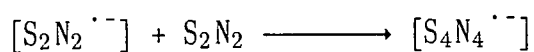
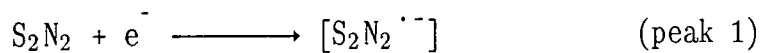

4.2.7 Cyclic Voltammetric Study of $[\text{PhCNSSN}][\text{S}_3\text{N}_3]$ in CH_3CN :

$[\text{PhCNSSN}][\text{S}_3\text{N}_3]$ (*cf.* section 5.4.7 and figure 5.12) is practically insoluble in acetonitrile making reduction or oxidation for electrochemical synthesis impossible, although large enough quantities could be dissolved in order to study its electrochemistry using cyclic voltammetry. A typical cyclic voltammogram is shown in figure 4.11.

The reduction peak 1 ($E_{p-2}^{\text{red}} = +0.58$) and the oxidation peak 8 ($E_{p-2}^{\text{oxd}} = +0.56\text{V}$) were assigned to the reversible reduction⁴³ of $[\text{PhCNSSN}]^+$. This reversible pair of peaks, corresponding to the reduction of $[\text{PhCNSSN}]^+$ to $[\text{PhCNSSN}]^\cdot$ and its reoxidation back to $[\text{PhCNSSN}]^+$, has previously been shown to occur reversibly at *ca.* +0.6V for $[\text{PhCNSSN}]\text{Cl}$.⁴³ The reduction peak 4 ($E_{p-2}^{\text{red}} = -0.84\text{V}$) and the corresponding oxidation peak 5 ($E_{p-2}^{\text{oxd}} = -0.87\text{V}$) were assigned to the reversible reduction of the $[\text{PhCNSSN}]^\cdot$ radical producing the $[\text{PhCNSSN}]^-$ anion. The oxidation peak corresponds to the oxidation of the anion back to the neutral radical, $[\text{PhCNSSN}]^\cdot$.

The reduction peak 2 ($E_{p-2}^{\text{red}} = +0.04\text{V}$) and the oxidation peak 7 ($E_{p-2}^{\text{oxd}} = 0.00\text{V}$) were assigned²³ to the reversible reduction of $\text{S}_3\text{N}_3^\cdot$. A previous study by Fritz *et al* on an S_3N_3^- salt in CH_2Cl_2 shows a similar reversible pair; the oxidation peak ($E_{\frac{1}{2}}^{\text{oxdn}} = +0.21\text{V}$) was assigned by them to the oxidation of S_3N_3^- to $\text{S}_3\text{N}_3^\cdot$ and the reduction peak ($E_{\frac{1}{2}}^{\text{red}} = +0.13\text{V}$) was assigned to the reduction of $\text{S}_3\text{N}_3^\cdot$ back to S_3N_3^- .

The reduction peak 3 ($E_{p-2}^{\text{red}} = -0.62\text{V}$) and the oxidation peak 6 were assigned²¹ to the reversible reduction of S_4N_4 . This produces $\text{S}_4\text{N}_4^{\cdot-}$ which is subsequently oxidised to S_4N_4 as previously observed by Chivers and Hojo. The S_4N_4 is probably produced from the breakdown of the $\text{S}_3\text{N}_3^\cdot$ radical. The overall reaction scheme is shown in scheme 4.3.

Figure 4.11 Cyclic voltammogram of $[\text{PhCNSSN}]^+[\text{S}_3\text{N}_3]^-$ in CH_3CN at $+20^\circ\text{C}$.

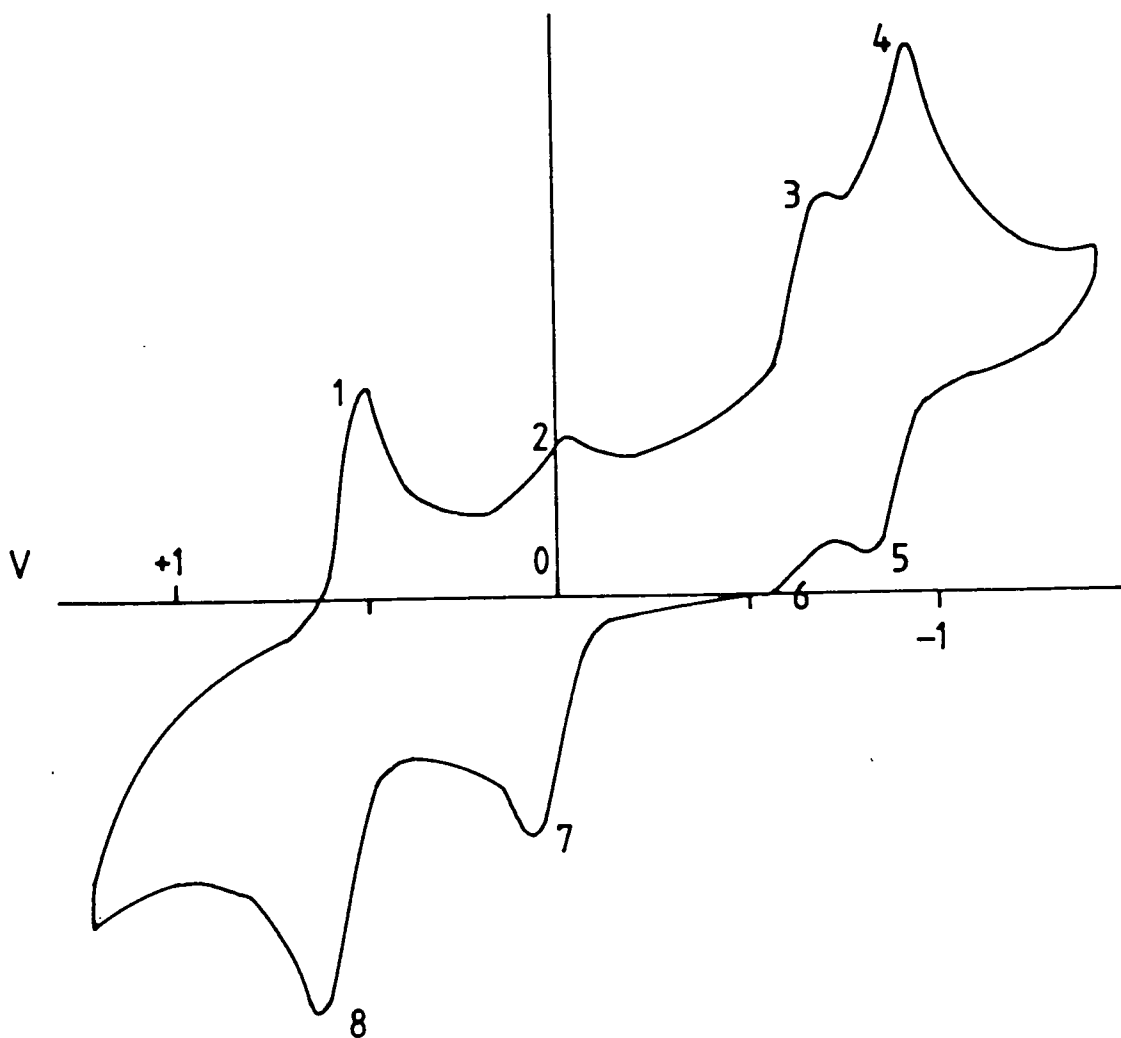

Scheme 4.3 Reaction mechanisms inferred from the cyclic voltammetry data obtained from $[\text{PhCNSSN}]^+[\text{S}_3\text{N}_3]^-$.

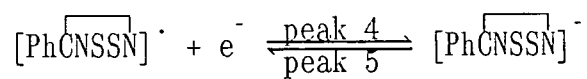
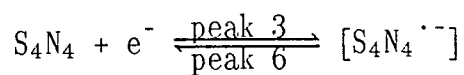
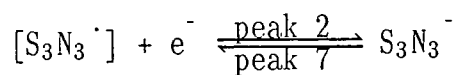
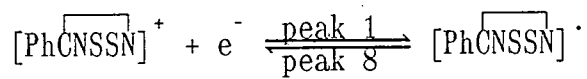

4.2.8 Potentiostatic Electrolysis of $[\text{SN}]\text{AsF}_6$ in SO_2 :

SN^+ is easily reduced as shown by cyclic voltammetry, producing the smallest possible SN^\cdot radical building block (*cf.* section 4.2.3). When other SN cations such as S_5N_5^+ and S_4N_3^+ are electroreduced,²⁷ $(\text{SN})_x$ is produced in an amorphous state although some crystallinity on the micro scale has been reported.¹⁶ Electroreduction of SN^+ was therefore chosen as a potential method of growing crystalline $(\text{SN})_x$ as the chain would hopefully be built up from the smallest possible unit, the SN^\cdot radical.

A two compartment cell without background supporting electrolyte was chosen to test the viability of SN^+ electroreduction as a synthetic route to $(\text{SN})_x$. Electroreduction on shiny platinum of a 0.12molar solution of $[\text{SN}]\text{AsF}_6$ in SO_2 produced a loosely adhering black/bronze solid on the electrode. The product was then thoroughly washed with SO_2 in a closed extractor for one day and approximately identified by chemical analysis as $(\text{S}_5\text{N}_5\text{AsF}_6)_x$. A well mulled sample (at normal concentration) did not give an infrared spectrum suggesting that the product was polymeric.

The product from the reduction of $[\text{SN}]\text{AsF}_6$ can be described as "ionic" $(\text{SN})_x$, with one in every five SN units in the chain having a positive charge and being associated with an AsF_6^- anion. The product from the reduction of $\text{S}_5\text{N}_5\text{AsF}_6$ (*cf.* section 4.2.9) is less "ionic" than the above, having only one positive site on the chain per 50 units.

D.S.C. measurements (figure 4.12) on the $(\text{S}_5\text{N}_5\text{AsF}_6)_x$ polymer showed initial decomposition between 97-143°C followed by two sharper decompositions at 152-182°C and 182-210°C. When the measurements were interrupted at 143°C and the aluminium capsule cracked open, an orange powder was present which was identified by infrared spectroscopy as $\text{S}_5\text{N}_5\text{AsF}_6$ (*cf.* section 4.4.2). The two further peaks were assigned to

Figure 4.12 D.S.C. trace of $(S_5N_5AsF_6)_x$ produced from the electrolysis of $[SN]AsF_6$ in SO_2 .

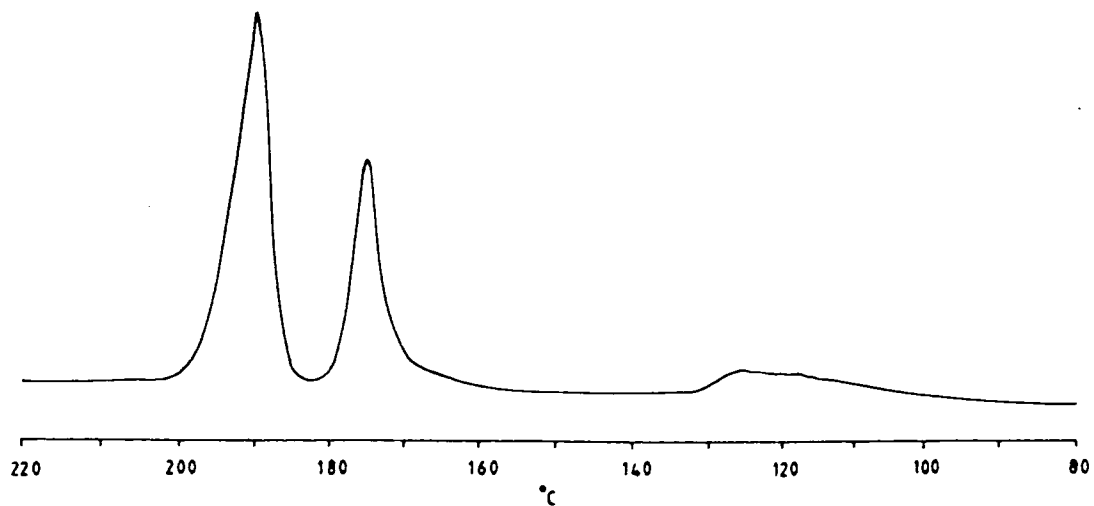

the decomposition of $S_5N_5AsF_6$ (cf. section 4.4.2), producing S_4N_4 followed by decomposition of the S_4N_4 itself.

Examination of the purified product under the optical microscope (x40) showed that the structure was not microcrystalline, but consisted of many "cauliflower" shapes, although there were a very few tiny facets which were lustrous and golden.

When compressed under 10kbar pressure, a coppery metallic tablet was produced with a density of 2.23gcm^{-3} , compared⁴⁴ with 2.30gcm^{-3} for classical β -phase $(SN)_x$. The tablet had a conductivity of *ca.* $6 \times 10^{-2}\text{Scm}^{-1}$ compared to the much higher conductivity⁴⁵ of *ca.* 600Scm^{-1} for a typical crystal of classical $(SN)_x$. Electrochemically prepared samples of $(SN)_x$ from $[S_5N_5]BF_4$ and $S_5N_5AsF_6$ (cf. section 4.2.9) had conductivities of *ca.* 0.5Scm^{-1} and *ca.* 0.15Scm^{-1} respectively. From these data it can be seen that the more "ionic" the $(SN)_x$, the lower the conductivity.

It has been shown⁴⁶ in organic polymers such as polyacetylene that the more simple the polymeric backbone structure, the higher the electrical conductivity that can be obtained. Chain branching, substitution and cross-linking all seem to decrease the electrical conductivity that can be obtained. This also appears true for electrochemical $(SN)_x$; the more AsF_6^- associated with the chain, the lower the conductivity.

A similar compound was produced in 1976 by Mews⁴⁷ when an SN^+ unit was inserted into S_4N_4 in SO_2 . This black insoluble product was characterised as $(S_5N_5AsF_6)_x$. The infrared spectrum contained two strong bands at 700cm^{-1} ($\nu_3 AsF_6^-$) and 880cm^{-1} (br) which suggested to Mews a polymeric material and the $(SN):AsF_6$ ratio could be varied by changing the stoichiometry of the reactants. It was not noted that the

product was conducting.

The reaction mechanism involved in the electrochemical formation of our $(S_5N_5AsF_6)_x$ polymer is probably similar to that in the chemical preparation by Mews,⁴⁷ in that, ultimately, it is the reaction between S_4N_4 and $[SN]AsF_6$. The S_4N_4 is produced from the oligomerisation of the SN radicals produced from the reduction of SN^+ . S_4N_4 can be clearly seen as a reduction product from SN^+ in the cyclic voltammogram of $[SN]AsF_6$ (*cf.* section 4.2.3b).

4.2.9 Potentiostatic Electrolysis of $S_5N_5AsF_6$ in CH_3CN :

The low moisture and oxygen sensitivity of $S_5N_5AsF_6$ (*cf.* section 4.2.2) made this material an ideal candidate for the easy formation of $(SN)_x$ (ionic or otherwise) by electroreduction. Cells could be charged by weighing the $S_5N_5AsF_6$ in an open atmosphere.

In order to test the viability of $S_5N_5AsF_6$ electroreduction to produce $(SN)_x$ a three electrode, two compartment cell was used. Electrolysis on shiny platinum of a 0.07 molar acetonitrile solution in this cell yielded a bronzy polymer which loosely adhered to the platinum cathode. S_4N_4 , which was the major co-product, was recovered by sublimation from the residue after solvent removal.

After exhaustive extraction with SO_2 the bronzy product was characterised by elemental analysis as $(SN)_x$ with a small amount of inherent AsF_6^- , amounting to one AsF_6^- per fifty SN units. However, this small amount of "impurity" did not alter the X-ray powder photograph which showed a conventional β -phase $(SN)_x$ spectrum.⁴⁴ The X-ray lines were few and broad suggesting at best a slightly microcrystalline material. Conductivities are discussed above in section 4.2.8.

4.2.10 Potentiostatic electrolysis of $[S_5N_5]BF_4$ in SO_2 :

Potentiostatic electrolysis of $[S_5N_5]BF_4$ has previously¹⁶ been carried out using a 0.1 molar $LiClO_4/MeCN$ solution which on reduction at 0.0 volts produced a bronze coloured compact layer of $(SN)_x$. When a 0.077 molar solution of $[S_5N_5]BF_4$ in SO_2 was exhaustively reduced at 0.0 volts, $(SN)_x$ was similarly produced. The electrolysis was allowed to proceed until 268 coulombs had passed through the system in order to completely exhaust the $[S_5N_5]BF_4$ such that the yield of $(SN)_x$ could be calculated (theoretical for 1.01mmol = 97 coulombs). When the SO_2 was removed and the vapours passed through a U-tube at 0°C a colourless diamond-like crystalline solid condensed out which, in a sealed tube, was easily sublimed at 35°C to give well formed crystals. These were identified by mass spectroscopy and NMR⁴⁸ as the known adduct $CH_3CN \cdot BF_3$.⁴⁹

At first it might seem highly surprising that a reaction carried out in liquid SO_2 might produce an acetonitrile adduct but it was evident that over such a relatively long time period the reference electrode (Ag/Ag^+ in CH_3CN) had leaked. It also follows that Ag^+ must also have leaked out with the acetonitrile and this would have been reduced to Ag metal at 0.0 volts, mildly contaminating the $(SN)_x$.

The BF_3 produced from the anodic breakdown of BF_4^- (*cf.* scheme 4.4), which is known to occur at *ca.* +2.6 volts,¹⁶ reacted with the acetonitrile from the reference electrode producing $CH_3CN \cdot BF_3$. Excess BF_3 can be clearly seen in the gas phase spectrum⁵⁰ (figure 4.13). The highly reactive free fluorine produced from the anodic breakdown of BF_4^- quickly reacted with SO_2 producing SO_2F_2 , and with CH_3CN producing HF which will further react with glass producing SiF_4 ; both SO_2F_2 and SiF_4 can be clearly seen in the gas phase spectrum (figure 4.13).^{50, 51}

Scheme 4.4 A summary of reactions that occurred when $[\text{S}_5\text{N}_5]\text{BF}_4$ was exhaustively electroreduced.

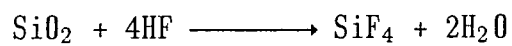
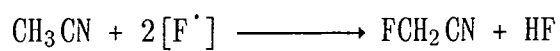
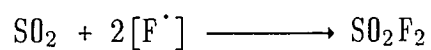
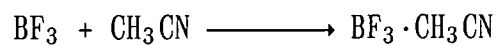
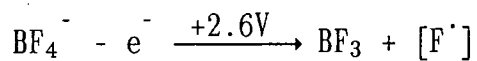
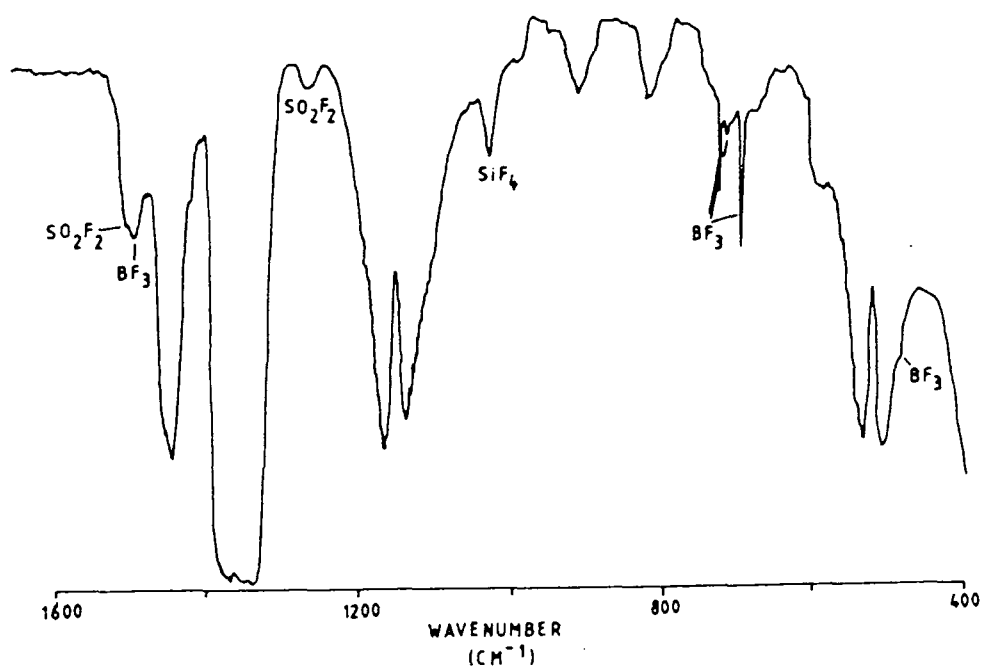

Figure 4.13 Gas phase spectrum of the products from the exhaustive reduction of $[S_5N_5]BF_4$ in liquid SO_2 .



Crystals of $S_4N_4 \cdot SO_3^{52}$ were isolated, after removal of the SO_2 , by washing the residue with hexane and ethanol. These red crystals were found on the surface of the working electrode and identified by single crystal X-ray analysis. Such crystals are probably produced from the reaction between S_4N_4 and SO_3 .

S_4N_4 has previously been produced²⁷ from the reaction between $[S_5N_5]Cl$ and BF_3 , via the $[S_5N_5]Cl \cdot BF_3$ intermediate. A similar intermediate is unlikely to occur from the reaction between $[S_5N_5]BF_4$ and BF_3 and so S_4N_4 is probably produced from the breakdown of the $S_5N_5 \cdot$ radical.

Knittel studied²⁵ the products from the electrochemical reduction of SO_2 by UV-Vis spectroscopy. His proposed reactions are summarised in scheme 4.5, and show how SO_3 might be produced.

The initial reduction produces the $SO_2^{\cdot -}$ radical anion which reacts with SO_2 producing the blue intermediate, $S_2O_4^{\cdot -}$. This further reacts with $SO_2^{\cdot -}$ in an equilibrium to produce red $S_3O_6^{2-}$ which can decay yielding SO_3^{2-} and SO . SO_3^{2-} is then oxidised at the anode in a two electron transfer to produce SO_3 which reacts with S_4N_4 , produced as a product from the electroreduction of $S_5N_5^+$, forming the adduct $S_4N_4 \cdot SO_3$.

4.2.11 Immersion deposition of $(SN)_x$ from $S_5N_5AsF_6$ in CH_3CN :

In the past, thin layers of $(SN)_x$ have been produced from electrochemical reduction of S/N cations such as $S_5N_5^+$ and $S_4N_3^+$,²⁷ or from the vacuum deposition of good quality $(SN)_x$ vapour.^{12,13} However when a clean strip of zinc or cadmium was immersed into a solution of 0.1 molar $S_5N_5AsF_6$ in acetonitrile, which is the most stable $S_5N_5^+$ salt to moisture and oxygen (*cf.* section 4.2.2), a thin patchy deposit of blue $(SN)_x$ grew on the surface of the metal.

Scheme 4.5 A proposed mechanism for the formation of SO_3 from the electrolysis of SO_2 .

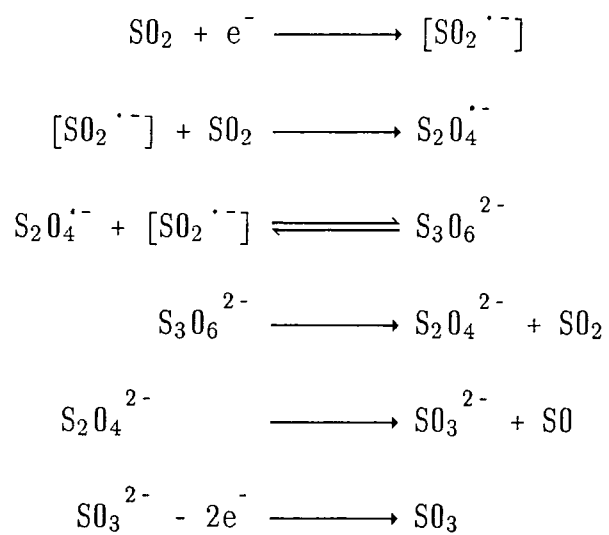

Such effects are well known.⁵³ For example, if zinc is placed in a copper sulphate bath, copper is deposited rapidly on the zinc, because the zinc potential is so negative that zinc transfers electrons to the copper ions, converting them to metal, while zinc dissolves ($Zn + Cu^{2+} \rightarrow Zn^{2+} + Cu$). These *immersion* or *displacement deposits* are usually spongy and black with a lack of adhesion.

A similar effect occurred when Zn was dipped into a solution of $S_5N_5^+$ in acetonitrile. The zinc potential ($E^0 = -0.763V$ in aqueous solution vs. the standard hydrogen electrode) is more negative than the $S_5N_5^+$ potential ($E^0 = +0.3V$ vs. the standard hydrogen electrode) and so electrons from the zinc are transferred to the $S_5N_5^+$, reducing it and producing $(SN)_x$ as shown in equation 4.1 below.

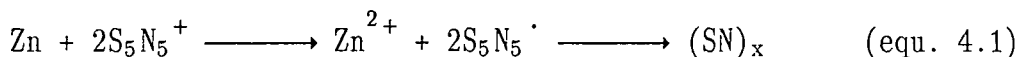

However zinc ions are continuously leaving the surface of the electrode and disrupting the growing $(SN)_x$ layer, causing a patchy, poor quality porous surface. Similarly the potential of Cd/Cd^{2+} ($E^0 = -0.403V$ in aqueous solution vs. the standard hydrogen electrode) is more negative than that of $S_5N_5^+$ and so the same poor quality $(SN)_x$ layer is produced from the reduction of the $S_5N_5^+$ ion.

In an attempt to grow a thicker and more uniform layer of $(SN)_x$ an electrically connected Zn/Au couple was dipped into a similar solution of $S_5N_5AsF_6$. Almost immediately a uniform bronzy layer of $(SN)_x$, which appeared to be pin-hole free and well adhered, grew on the surface of the gold. As described above, the zinc metal ^{loses} electrons into the solution causing an electron deficiency, not only at the surface of the zinc but at the surface of the electrically connected gold as well.

97

$S_5N_5^+$ is then reduced at the surface of the gold, but unlike the zinc, no atoms are lost into the solution and hence the coating is pin-hole free and of much higher quality.

4.3 CONCLUSIONS

Electrochemical reduction of $[SN]AsF_6$ proved to be a new method for synthesising $(S_5N_5AsF_6)_x$ which has now been shown to be conductive. Similar electroreduction of $S_5N_5AsF_6$ also produced a conducting form of $(SN)_x$ with a molecular formula $([S_{50}N_{50}]AsF_6)$. These new forms of "ionic" $(SN)_x$ are less conductive than metallic $(SN)_x$ previously prepared by the electroreduction of $[S_5N_5]BF_4$ and $[S_5N_5]Cl$.

The preparation of $[Bu_4N]AsF_6$ has made cyclic voltammetry of AsF_6^- salts more practical with a greater scanning window compared with other supporting electrolytes. Cyclic voltammetric studies on $[SN]AsF_6$ have clarified the mechanism for the formation of $(S_5N_5AsF_6)_x$ from the electroreduction of SN^+ . Similar studies on $[Ph\overline{CNSSN}][S_3N_3]$, $[S_4N_3]BF_4$ and $[S_5N_5]BF_4$ have clearly shown the formation of the known $S_3N_3^{\cdot-}$ radical. The latter two compounds produced $(SN)_x$ when electroreduced, suggesting that $S_3N_3^{\cdot-}$ is the basic building block in the formation of metallic $(SN)_x$. As yet the oxidation of $S_3N_3^{\cdot-}$ has produced only S_4N_4 , but if $S_3N_3^{\cdot-}$ is responsible for the growth of $(SN)_x$ chains then further studies on the oxidation of other $S_3N_3^{\cdot-}$ salts should be carried out in a variety of solvents.

Lastly, and most importantly, the development of the new anion, AsF_6^- , for $S_5N_5^+$ has led to an almost moisture and oxygen stable compound. Quantities of $S_5N_5AsF_6$ can be handled in a normal atmosphere for periods of up to a few minutes with negligible decomposition. Samples in a desiccator are stable for a much greater length of time,

possibly as long as a year or two. Good quality *immersion deposits* of $(\text{SN})_x$ can be formed on the surface of gold (and potentially other precious metals), electrically connected to zinc, when such a couple is dipped into a solution of $\text{S}_5\text{N}_5\text{AsF}_6$ in acetonitrile. This new "electrodeless" development, complimented by the highly stable $\text{S}_5\text{N}_5\text{AsF}_6$ solution, could have far reaching consequences for the electronics industry in devices such as solar cells and light emitting diodes.

4.4 EXPERIMENTAL SECTION

A general description of electrochemical cells and electrodes is given in Chapter 2.

4.4.1 The Preparation of $[\text{Bu}_4\text{N}]\text{AsF}_6$:

A solution of $[\text{Bu}_4\text{N}]\text{HSO}_4$ (3.46g, 10.21mmol, 100ml H_2O) was added, with vigorous stirring, to LiAsF_6 (2.00g, 10.21 mmol) dissolved in 100ml of distilled water. On mixing a white precipitate immediately formed, which was filtered and washed liberally with water (2 litres). The product was roughly dried in air, dissolved in the minimum quantity of acetonitrile and precipitated out by addition of water (1 litre). After filtration the white crystalline product was dried for three hours *in vacuo* at 60°C .

Yield of $[\text{Bu}_4\text{N}]\text{AsF}_6$ = 3.58g (81%), ν_{max} = 1049(w), 1361(w), 1350(w), 1322(w), 1276(w), 1245(w), 1184(w sh), 1166(w), 1131(w), 1113(w), 1071(w), 1038(w), 1015(w), 993(w), 932(w), 885(m), 818(w sh), 810(w sh), 795(w sh), 743(m sh), 700(vs), 600(w), 575(w), 537(w), 495(w), 469(w), 405(vs). Analysis found C, 44.32; H, 8.39; N, 3.44; As, 17.87; F, 25.92; $[\text{Bu}_4\text{N}]\text{AsF}_6$ requires C, 44.55; H, 8.35; N, 3.25; As, 17.40; F, 26.45%.

4.4.2 The Preparation of $S_5N_5AsF_6$:

$[S_5N_5]Cl$ (0.500g, 1.88mmol) and $AgAsF_6$ (0.520g, 1.75mmol) were placed, together with a Teflon coated magnetic stirrer bar, in one bulb of a dog (*cf.* section 2.2a). SO_2 (*ca.* 10ml) was condensed into the bulb at $-78^\circ C$, using an acetone/dry ice bath, and the mixture warmed to room temperature with stirring. Almost immediately a white precipitate and an orange solution were formed. After 24 hours the mixture was filtered and the white precipitate washed with back distilled SO_2 (3 x 10ml). Removal of the solvent revealed an orange solid and a white powder ($AgCl$), which darkened on exposure to light. The orange solid was then heated in vacuo ($<10^{-3}$ torr) at $100^\circ C$ for three hours with a small amount of another orange crystalline compound subliming out and being identified as S_4N_4 by infrared spectroscopy. The final product was identified by infrared spectroscopy (nujol mull using CsI plates) and elemental analysis as $S_5N_5AsF_6$.

Yield = 0.652g (89%), $\nu_{max} = 1262(w)$, 1176(s br), 1140(s br), 1600(w), 1020(w), 970(w), 815(w), 800(w sh), 700(vs), 681(s sh), 620(w), 578(m), 540(m), 405(vs), 327(m). Analysis found As, 18.18; S, 38.17; N, 16.55; F, 27.36; $S_5N_5AsF_6$ requires As, 17.87; S, 38.24; N, 16.70; F, 27.20%. D.S.C. showed, peak(s) $140-183^\circ C$, peak(m) $183-210^\circ C$. X-ray powder photograph ($CuK\alpha$) showed, 3.13(w), 3.33(w), 3.72(m br), 4.05(w), 4.35(w)Å.

4.4.3 Cyclic Voltammetric Study of $[SN]AsF_6$:

a) in SO_2 . $[Bu_4N]AsF_6$ (0.560g, 1.30mmol) was placed, together with $[SN]AsF_6$ (0.0076g, 0.0032mmol) in a three limbed undivided cell (*cf.* figure 2.5) equipped with modified Swagelock compression fittings (*cf.* figure 2.6). A platinum disc microelectrode and a coiled platinum wire

counter-electrode were introduced through two of the limbs and the third was sealed with a $\frac{1}{4}$ inch O.D. glass plug. SO_2 (ca. 13ml) was condensed into the cell (resulting in a pale yellow solution) at -78°C , using an acetone/dry ice bath, warmed up to 0°C , and against a counter flow of dry nitrogen, the Ag/Ag^+ reference electrode was inserted in place of the glass plug. Cyclic voltammograms were then obtained using the control box and an x-y recorder.

b) in CH_3CN . $[\text{Bu}_4\text{N}]\text{AsF}_6$ (0.560g, 1.30mmol) was placed, together with $[\text{SN}]\text{AsF}_6$ (0.0091g, 0.039mmol) in a three limbed undivided cell equipped with modified Swagelock compression fittings. A platinum disc microelectrode and a coiled platinum wire counter-electrode were introduced through two of the limbs. Acetonitrile (13ml) was syringed into the cell (resulting in a pale yellow solution) and the Ag/Ag^+ reference electrode inserted into the third limb, against a counter flow of dry nitrogen. Cyclic voltammograms were then obtained using the control box and an x-y recorder.

4.4.4 Cyclic Voltammetric Study of $\text{S}_5\text{N}_5\text{AsF}_6$ in CH_3CN :

$[\text{Bu}_4\text{N}]\text{AsF}_6$ (0.560g, 1.30mmol) was placed, together with $\text{S}_5\text{N}_5\text{AsF}_6$ (0.0055g, 0.013mmol) in a three limbed undivided cell equipped with modified Swagelock compression fittings. A platinum disc microelectrode and a coiled platinum wire counter-electrode were introduced through two of the limbs. Acetonitrile (13ml) was syringed into the cell (resulting in a yellow solution) and the Ag/Ag^+ reference electrode inserted into the third limb against a counter flow of dry nitrogen. Cyclic voltammograms were then obtained using the control box and an x-y recorder.

4.4.5 Cyclic Voltammetric Study of $[S_4N_3]BF_4$ in CH_3CN :

$[Bu_4N]BF_4$ (0.430g, 1.36mmol) was placed, together with $[S_4N_3]BF_4$ (0.0058g, 0.023mmol) in a three limbed undivided cell equipped with modified Swagelock compression fittings. A platinum disc microelectrode and a coiled platinum wire counter-electrode were introduced through two of the limbs. Acetonitrile (13ml) was syringed into the cell (resulting in a yellow solution) and the Ag/Ag^+ reference electrode inserted into the third limb, against a counter flow of dry nitrogen. Cyclic voltammograms were then obtained using the control box and an x-y recorder.

4.4.6 Cyclic Voltammetric Study of S_2N_2 in CH_3CN :

$[Bu_4N]BF_4$ (0.410g, 1.30mmol) was placed, together with S_2N_2 (ca. 0.005g - freshly prepared by cracking S_4N_4 through hot silver wool) in a three limbed undivided cell equipped with modified Swagelock compression fittings. A platinum disc microelectrode and a coiled platinum wire counter electrode were introduced through two of the limbs. Acetonitrile (13ml) was syringed into the cell (resulting in a colourless solution containing a few $(SN)_x$ husks) and the Ag/Ag^+ reference electrode inserted into the third limb, against a counter flow of dry nitrogen. Cyclic voltammograms were then obtained using the control box and an x-y recorder.

4.4.7 Cyclic Voltammetric Study of $[Ph\overline{CNSSN}][S_3N_3]$ in CH_3CN :

$[Bu_4N]AsF_6$ (0.560g, 1.30mmol) was placed, together with $[Ph\overline{CNSSN}][S_3N_3]$ (0.0041g, 0.013mmol) in a three limbed undivided cell equipped with modified Swagelock compression fittings. A platinum disc microelectrode and a coiled platinum wire counter-electrode were

introduced through two of the limbs. Acetonitrile (13ml) was syringed into the cell (resulting in a green solution) and the Ag/Ag^+ reference electrode inserted into the third limb, against a counter flow of dry nitrogen. Cyclic voltammograms were then obtained using the control box and an x-y recorder.

4.4.8 Potentiostatic Electrolysis of $[\text{SN}]\text{AsF}_6$ in SO_2 :

A three-electrode, two compartment cell equipped with modified Swagelock compression fittings was used. The Ag/Ag^+ reference electrode and working electrode (Pt sheet, area = 0.9mm^2) were separated from the counter electrode (Pt coil) by a porous glass frit. $[\text{SN}]\text{AsF}_6$ (0.140g, 0.595mmol in the two electrode compartment; 0.120g, 0.51mmol in the other) was placed in the cell and SO_2 (ca. 9ml) was condensed in at -78°C using an acetone/dry ice bath. The cell was warmed up and maintained at 0°C . The electrodes were connected to a potentiostatic current source and a potential of +0.469V (vs. S.C.E.) was maintained at the working electrode for 2 hours 45 minutes passing a total charge of 38.48 coulombs.

The initial pale yellow solution turned black after passing current for only a few minutes and after 2 hours 45 minutes removal of the working electrode revealed a black powdery layer on the surface of the platinum which was continuously extracted with SO_2 in a closed extractor for one day. The black layer peeled off on removal of the SO_2 revealing a compact bronzy layer. The product was characterised by elemental analysis, mass spectroscopy, D.S.C., X-ray powder photo and infra-red spectroscopy and shown to be $(\text{S}_{4.3}\text{N}_{4.8})\text{AsF}_6.12$.

Bronzy layer of $(\text{SN})_x$. Analysis found S, 34.51; N, 16.97; F, 29.1; As, 19.16; $(\text{S}_5\text{N}_5\text{AsF}_6)_x$ requires S, 38.24; N, 16.70; F, 27.20;



As, 17.87%. Mass spectroscopy showed, m/e 184 (7.25) $S_4N_4^+$, 138 (16.15) $S_3N_3^+$, 132 (10.94) AsF_3^+ , 113 (42.63) AsF_2^+ , 94 (5.90) AsF^+ , 92 (30.59) $S_2N_2^+$. D.S.C. showed, peak(w br) 97-143°C, peak(m) 152-182°C, peak(s) 182-210°C. X-ray powder photograph ($CuK\alpha$) showed, 3.13(w), 3.33(w), 3.72(m br), 4.05(w), 4.35(w)Å.

4.4.9 Potentiostatic Electrolysis of $S_5N_5AsF_6$ in CH_3CN :

A three-electrode, two compartment cell equipped with modified Swagelock compression fittings was used. The Ag/Ag^+ reference electrode and working electrode (Pt sheet, area = 0.9mm^2) were separated from the counter electrode (Pt coil) by a porous glass frit. $S_5N_5AsF_6$ (0.135g, 0.322mmol in the two electrode compartment; 0.116g, 0.277mmol in the other) was placed in the cell and acetonitrile (*ca.* 9ml) syringed in. The electrodes were connected to a potentiostatic current source and a potential of +0.055V (vs. S.C.E.) was maintained at the working electrode for 1 hour 50 minutes passing a total charge of 57.02 coulombs.

Removal of the working electrode revealed a black powdery layer on the surface of the platinum which was continuously extracted with SO_2 in a closed extractor for one day. On removal of the SO_2 the black layer peeled off the electrode, revealing a compact bronzy layer. This was characterised as β -phase $(SN)_x$ by elemental analysis and X-ray powder photography. When the dirty orange residue in the cell was heated in vacuo ($<10^{-3}$ torr) at 80°C after removal of the solvent an orange solid, identified as S_4N_4 , sublimed out.

Bronzy $(SN)_x$. Analysis found N, 28.93; S, 63.19; As, 2.99; F, 4.89; $(SN)_x$ requires N, 30.40; S, 69.60%. D.S.C. showed, peak(w br) 94-143°C, peak(s) 155-210°C. X-ray powder photograph showed, 2.88(m),

3.25(s br), 3.42(w)Å.

4.4.10 Potentiostatic Electrolysis of $[S_5N_5]BF_4$ in CH_3CN :

$[S_5N_5]BF_4$ (0.320g, 1.00mmol) was placed in a three limbed undivided cell equipped with modified Swagelock compression fittings. A platinum sheet working electrode and a coiled platinum wire counter-electrode were introduced through two of the limbs and the third was sealed with a $\frac{1}{4}$ inch O.D. glass plug. SO_2 (ca. 13ml) was condensed into the cell at $-78^\circ C$, using an acetone/dry ice bath, warmed up to $0^\circ C$, and against a counter flow of dry nitrogen, the Ag/Ag^+ reference electrode was inserted in place of the glass plug. $[S_5N_5]BF_4$ was potentiostatically reduced at 0 volts (vs. S.C.E.) electrode for $15\frac{1}{2}$ hours with a total current of 268 coulombs passing through the system, the colour of the solution changing from orange \rightarrow brown \rightarrow red over this period. The reference electrode was removed, replaced by a $\frac{1}{4}$ inch glass plug and the SO_2 allowed to evaporate through the J.Young tap. The cell was then pumped on for 10 minutes and volatile diamond-like crystals collected in a sealable cold trap at $0^\circ C$. These were shown by mass spectroscopy and $^{19}F/^{11}B$ NMR to be $CH_3CN \cdot BF_3$. Removal of the working electrode and crude washing with ethanol showed a golden/black powdery layer of $(SN)_x$ interspersed by a few red crystals which were shown by X-ray crystallography to be $S_4N_4 \cdot SO_3$.

$CH_3CN \cdot BF_3$: Mass spectroscopy; m/e 49.96 (2.03) HBF_2^+ , 41.00 (9.04) CH_3CN^+ . NMR; ^{19}F singlet $-139.27ppm$, ^{11}B singlet $0.764ppm$. Gas phase spectrum $\nu_{max} = 1510(m)^a$, $1500(m)^b$, $1200(s)^b$, $1025(s)^c$, $721(m)^a$, $432(m)^a$; $a = BF_3$, $b = SO_2F_2$, $c = SiF_4$.

4.4.11 Immersion Deposition of $(SN)_x$ from $S_5N_5AsF_6$ in CH_3CN :

When Zn or Cd was dipped into a 0.1 molar acetonitrile solution of $S_5N_5AsF_6$, a thin blue patchy/porous layer of $(SN)_x$ formed on the surface of the metal (Zn or Cd) within a few minutes. When an electrically connected Zn/Au couple was dipped into a similar solution a uniform bronzy layer of $(SN)_x$ formed on the precious metal within 30 seconds.

REFERENCES

1. F. de la Cruz and H.J. Stolz, *Solid State Commun.*, 1976, 20, 241.
2. R.J. Soulen and D.B. Utton, *Solid State Commun.*, 1977, 21, 105.
3. J.S. Harris, M.J. Cohen, H.M. Manasevit, and S.W. Zehr, *Energy Res. Abstr.*, 1984, 9(3); no. 4534 ca: 100; 203814.
4. A.E. Thomas, J. Woods, and Z.V. Hauptman, *J. Phys. D: Appl. Phys.*, 1983, 16, 1123.
5. Hitachi Maxell ltd., J.P. 58,46,574/1983.
6. Asahi Chemical Industry Co., J.P. 58,93,177/1983.
7. Asahi Chemical Industry Co., J.P. 58,93,164/1983.
8. J. Badoz, M. Bardin, C. Bernard, M. Herlem, G. Robert, and A. Thiebault, E.P. Appl. 97,078/1983.
9. Asahi Chemical Industry Co., J.P. 58,197,677/1983.
10. Asahi Chemical Industry Co., J.P. 58,204,478/1983.
11. Allied Corp., J.P. 59,49,155,1982.
12. A.A. Bright, M.J. Cohen, A.F. Garito, A.J. Heeger, C.M. Mikulski, and A.G. MacDiarmid, *Appl. Phys. Lett.*, 1975, 26, 612.
13. R.J. Nowak, Ph.D. Thesis, University of Cincinnati, 1977.
14. A.J. Banister, Z.V. Hauptman, and A.G. Kendrick, *J. Chem. Soc., Chem Commun.*, 1983, 1016.
15. H.P. Fritz, and R. Bruchhaus, *Z. Naturforsch.*, 1983, 38b, 1375.
16. A.J. Banister, Z.V. Hauptman, A.G. Kendrick, R.W.H. Small, *J. Chem. Soc. Dalton Trans.*, 1982, 915.
17. M.M. Labes, P. Love, and L.F. Nichols, *Chemical Reviews*, 1979, 79.
18. R.H. Baughman and R.R. Chance, *J. Polymer Science, Polymer Phy. Ed.*, 1976, 14, 2019.
19. R.L. Greene, G.B. Street, L.J. Suter, *Phys. Rev. Lett.*, 1975, 34, 577.

20. J. Bojes, T. Chivers, I. Drummond, and G. MacLean, *Inorg. Chem.*, 1978, 17, 3668.
21. T. Chivers, M. Hojo, *Inorg. Chem.*, 1984, 23, 1526.
22. T. Chivers and M.N.S. Rao, *Can. J. Chem.*, 1983, 61, 1957.
23. H.P. Fritz, R. Bruchhaus, R. Mews, H.V. Höfs, *Z. Anorg. Allg. Chem.*, 1985, 525, 214.
24. P. Castellonese and P.C. Lacaze, *C.R. Acad. Sci.*, 1972, 274, 2050.
25. D. Knittel, *J. Electroanal. Chem.*, 1985, 195, 345.
26. J.G. Gaiello, P.R. Sharp, and A.J. Bard, *J. Am. Chem. Soc.*, 1982, 104, 6373.
27. E. Garcia, J. Kwak, and A.J. Bard, *Inorg. Chem.*, 1988, 27, 4377.
28. A.G. Kendrick, Ph.D. Thesis, University of Durham, 1986.
29. D.F. Burrow, "Chem. of Non-Aqueous Solvents", Langowski, New York, 3, 137, (1966).
30. P.J. Elving, J.M. Markowitz, I. Rosenthal, *J. Phys. Chem.*, 1961, 65, 680.
31. L.L. Miller, E.A. Mayeda, *J. Am. Chem. Soc.*, 1970, 92, 5818.
32. J.T. Maloy, *J. Chemical Education*, 1983, 60, 285.
33. M.M. Beizer, "Organic Electrochemistry", Dekker, New York, 1973.
34. L.F. Audrieth and J. Kleinberg, "Non-Aqueous Solvents", John Wiley and Sons, New York, N.Y., 1953.
35. G. Jander, "Die Chemie in Wasserähnlichen Lösungsmitteln", Springer-Verlag, Berlin, 1949.
36. J.M. Markowitz, Ph.D. Thesis, University of Michigan, 1985.
37. K. Cruse, *2. Electrochem.*, 1940, 46, 571.
38. R.J. Nowak, C.J. Loyal, and D.C. Weber, *J. Electroanal. Chem.*, 1983, 143, 413.
39. C.M. Mikulski, P.J. Russo, M.S. Saran, A.G. MacDiarmid, A.F. Garito, A.J. Heeger, *J. Am. Chem. Soc.*, 1975, 97, 6358.
40. M. Becke-Goehring, *Progr. Inorg. Chem.*, 1959, 1, 207.
41. T. Chivers, *Acc. Chem. Res.*, 1984, 17, 166.
42. J. Bragin, M.V. Evans, *J. Chem. Phys.*, 1969, 51, 268.
43. M. Hansford, personal communication.

44. T. Chivers, A.W. Cordes, R.T. Oakley, *Inorg. Chem.*, 1981, 20, 2376.
45. R.L. Greene, P.M. Grant, G.B. Street, *Phys. Rev. Lett.*, 1975, 34, 89.
46. T.A. Skotheim, "Handbook of Conducting Polymers", 1986, 1, 494
47. R. Mews, *Angew. Chem. Int. Ed. Engl.*, 1976, 15, 691.
48. Yu.A. Buslaev, V.V. Evsikov, and Yu.V. Kokunov, *Koord. Khim.*, 1979, 5, 639.
49. A.W. Laubengayer and D.S. Sears, *J. Am. Chem. Soc.*, 1945, 67, 164.
50. G. Herzberg, "Infrared and Raman Spectra of Polyatomic Molecules", D. Van Nostrand Company, Inc., Volume II, 1962, New York.
51. K. Nakamoto, "Infrared and Raman Spectra of Inorganic and Coordination Compounds", John Wiley and Sons, fourth Ed., New York.
52. A. Gieren, B. Dedeever, H.W. Roesky, N. Amin, O. Peterson, *Z. Anorg. Allg. Chem.*, 1978, 440, 119.
53. F.A. Lowenheim, "Modern Electroplating", John Wiley and Sons, third Ed., 1974, 6.

CHAPTER 5

The Preparation and Crystal Structures of some
Novel Dithiadiazolium Salts

5.1 INTRODUCTION

The dithiadiazolium ring system was first prepared in 1977¹ from the reaction of $(\text{NSCl})_3$ with various nitriles, RCN ($\text{R} = \text{CCl}_3, \text{Bu}^t, \text{Ph}$), to give 1,2,3,5-dithiadiazolium chlorides (I). Later, in 1981, the 1,3,2,4 isomer (II) was prepared² from the reaction between S_4N_4 , Br_2 , and CS_2 at room temperature.

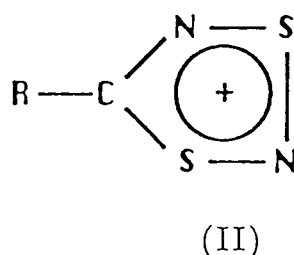
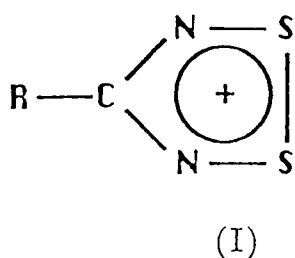

Most of the earlier work centred around the chemistry of the 1,2,3,5 cation with the substituents at position 4 and the associated anions varying enormously (see table 5.1). $(\text{NSCl})_3$ has been the most commonly used starting material in the preparation of this isomer, readily reacting with nitriles^{1, 3-5}, azines⁶, and tetrachloroethene to produce a series of brightly coloured cations in a wide range of yields (12 → 92%). However, SCl_2 is a more accessible starting material than $(\text{NSCl})_3$, reacting with ammonium salts and nitriles, or directly with amidinium salts⁵ to produce a more convenient synthesis of the 1,2,3,5 cation. More esoteric preparations include the reaction of SCl_2 with

Table 5.1 A list of 4-R-1,2,3,5-CN₂S₂⁺X⁻ compounds and their references.

R	X ⁻	REFERENCE No.
Cl	Cl, AsF ₆ , SbCl ₆ , $\frac{1}{2}$ SnCl ₆ ²⁻ , SO ₃ F, Br	7,4
Br	Br, Cl	7,4
CF ₃ , CCl ₃ , Me, CMe ₃	Cl	1,3,5,13,14,18
Ph	Cl, SbCl ₆ , CF ₃ SO ₃ , N(SO ₂ F), PF ₆ , BF ₄	14,6,20,5,15,1
Ph	FeCl ₄ , Br, NCS	20
Bu ^t	AsF ₆ , Cl	6,5
<i>p</i> -ClC ₆ H ₄	Cl	20
CF ₃	Cl	4,3
F	Cl, AsF ₆ , Br	14

NCNSF₂ (N-cyanosulphur difluoride imide) and Me₃SiNCNSiMe₃ (bis(trimethylsilyl)carbodiimide)⁷ and the reaction of sodium azide with RCN(NSCl)₂⁸ to produce ClCN₂S₂Cl and Et₂N-CN₂S₂Cl respectively.

Very few examples of the 1,3,2,4 isomer were reported² until the advent of the linear sulphur nitrogen synthon, S₂N⁺, which was first reported in 1978⁹ as the SbCl₆⁻ salt, but later prepared in much higher yield as the AsF₆⁻ salt¹⁰. [S₂N]AsF₆ was first reacted¹¹ with acetonitrile to give colourless 5-methyl-1,3,2,4-dithiadiazolium hexafluoroarsenate(v) via a symmetry allowed cycloaddition. The reaction of S₂N[AsF₆] with other nitriles has been reported, resulting in varying substituents at position 5 (R = CF₃, I, Bu^t)^{12,13}.

Much of the interest in the dithiadiazolium system is due to the easy reduction, of both isomers, to form dithiadiazoles (III and IV),

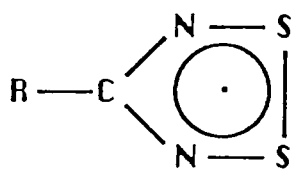

(III)

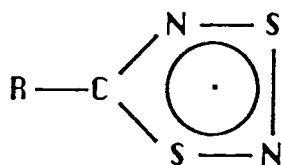

(IV)

many of which exist as stable free radicals. The reduction of [PhCNSSN]Cl by sodium thiocyanate¹⁴ gave the 4-phenyl-1,2,3,5-dithiadiazole dimer, (PhCNSSN)₂ (V), which was the first example of such compounds. The structure of the dimer shows two identical PhCNSSN units bonded together through two weak S...S bonds in a *cis* configuration. The short (mean) CN₂S₂ ring distances and their coplanarity suggest that the rings are aromatic with one electron pair delocalised at the four sulphur atoms, although much of the charge is on the more electronegative nitrogen atoms. It was later shown by esr that

solutions of the phenyl dimer contained "persistent free radicals"¹⁵. The solution spectrum of $(\text{Ph}\overline{\text{CNSSN}})_2$ showed a simple 1:2:3:2:1 quintet¹⁶ due to the interaction of an unpaired electron with two equivalent nitrogen nuclei, and in solutions above 250K almost no dimer was present. Appreciable amounts of radicals are also present in the solid due to the reversible dissociation of the dimer, and the powder esr shows an intense but ill resolved spectrum.

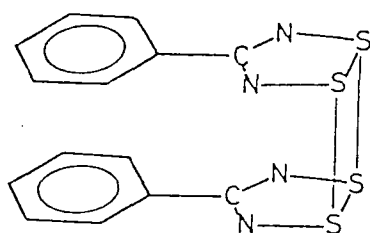

(V)

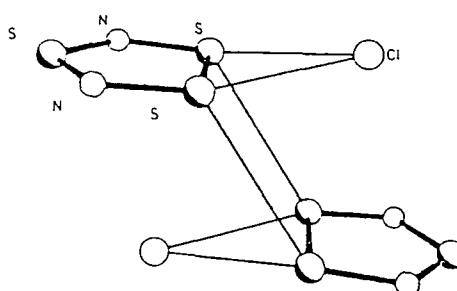

(VI)

A variety of derivatives of (III) ($R = \text{CH}_3, \text{CF}_3, \text{I}, \text{Bu}^t$) and (IV) ($R = \text{CH}_3, \text{I}, \text{Ph}, \text{F}, \text{Cl}, \text{Br}, \text{CF}_3, \text{Bu}^t$)^{7, 12-14} have been reported, all of which show high esr activity in solution. Of the two isomers, the 1,3,2,4 compounds are the less thermodynamically stable, having a tendency to rearrange thermally¹² or photochemically¹³ to the 1,2,3,5 isomer. As a consequence the known but thermally unstable compounds $\text{CF}_3\overline{\text{CNSSN}}\cdot$ and $\overline{\text{ICNNSNS}}\cdot$ have never been isolated but their rearrangement has been followed by esr spectroscopy showing the initial three line signal decaying into a five line pattern. The majority of the dithiadiazoles are diamagnetic solids but a few are deeply coloured paramagnetic liquids [(III) ($R = \text{Bu}^t, \text{CH}_3$) and (IV) ($R = \text{Bu}^t, \text{CF}_3$)] further exemplifying the existence of stable free monomers in the pure state.

There are very few reports of the dithiadiazole ring system itself taking part in reactions¹⁷⁻¹⁹ but one particularly novel reaction occurs when the 4-phenyl-1,2,3,5-dithiadiazole dimer, $(\text{Ph}\overline{\text{CNSSN}})_2$, reacts with "active nitrogen" in a low pressure nitrogen plasma at 45°C. Each dithiadiazole ring undergoes a ring expansion incorporating one nitrogen atom into each disulphide bond producing the six membered ring "plasma product", $(\text{PhCN}_3\text{S}_2)_2$.¹⁷

Dithiadiazoliums and dithiadiazoles, RCN_2S_2^+ and $\text{RCN}_2\text{S}_2^\cdot$, are isoelectronic with $\text{S}_3\text{N}_2^{2+}$ and $\text{S}_3\text{N}_2^{\cdot+}$ respectively²⁰. The neutral compound S_3N_2 has been shown by a Hückel MO scheme and Hund's rules to have a triplet ground state, thus being unstable²¹, and hence there is very little evidence for its existence²².

The radical cation $\text{S}_3\text{N}_2^{\cdot+}$ exists almost entirely as the dimer $[\text{S}_3\text{N}_2]_2^{2+}$ in salts with various anions²³⁻²⁵. The dimer, $(\text{S}_3\text{N}_2\text{Cl})_2$ (VI), has a novel structure consisting of two identical, planar $\text{S}_3\text{N}_2^{\cdot+}$ cations²⁶ linked to each other in a pronounced chair conformation by two long bonds between pairs of sulphur atoms. $\text{S}_3\text{N}_2[\text{AsF}_6]$ is the only reported compound to exist as a stable monomeric entity²¹.

Esr measurements have shown that the solid dimer, $(\text{S}_3\text{N}_2\text{Cl})_2$, contains "appreciable amounts" of the radical monomer and a well resolved spectrum was obtained by examining a frozen solution of ^{15}N labelled $(\text{S}_3\text{N}_2\text{Cl})_2$ in D_2SO_4 ¹⁶. $(\text{S}_3\text{N}_2\text{Cl})_2$ is conveniently prepared from $\text{S}_3\text{N}_2\text{Cl}_2$ by controlled slow dechlorination with SO_2 ²⁷. $\text{S}_3\text{N}_2\text{Cl}^+\text{Cl}^-$ itself can be prepared by the reaction of granular NH_4Cl , S_2Cl_2 and S_8 in a 3:2:1 ratio²⁸. Many anions associated with $\text{S}_3\text{N}_2\text{Cl}^+$, other than Cl^- , are known including sulphonic acid derivatives²⁹⁻³⁰ and chlorometallates³⁰⁻³².

Prior to my own work there had been no examples of CN_2S_2 compounds associated with other S/N anions such as in $[\text{PhCNSSN}][\text{S}_3\text{N}_3]$. A wide variety of other S_3N_3^- compounds are known; the alkali metal³³⁻³⁴ and tetraalkylammonium salts³⁵ among the most common. These brightly coloured salts are prepared from the reaction of the metal or tetraalkylammonium azide with S_4N_4 in ethanol.

X-ray diffraction of $(n\text{-C}_4\text{H}_9)_4\text{N}[\text{S}_3\text{N}_3]^{36}$ shows that the S_3N_3^- anion is a six membered, essentially planar ring. *Ab initio* Hartree-Fock-Slater SCF calculations³⁶ show that (i) the planar configuration is of lower energy than alternative chair or boat conformations and that (ii) as predicted by Banister³⁷ the ground-state electronic structure is a 10π system with a net of 2π electrons distributed over the six S-N bonds of the ring.

The following results describe the formation and reactions of some novel dithiadiazolium compounds.

5.2 RESULTS AND DISCUSSION

5.2.1 Crystal growth and structure of $[[\text{PhCNSSN}]_2\text{Cl}][\text{S}_3\text{N}_3]$:

Dechlorination and reduction of $[\text{S}_5\text{N}_5]\text{Cl}$ by $(\text{PhCNSSN})_2$ produced an insoluble, non-conductive, green reflective, microcrystalline solid. The soluble products were shown by infra-red spectroscopy to be S_4N_4 , $[\text{PhCNSSN}]\text{Cl}$ and the then unknown compound $[\text{PhCNSSN}]_2\text{Cl}$ (*cf.* section 5.2.11). Attempts at purifying the residual green solid by extraction with various solvents (C_6H_6 , CH_3CN and SO_2) failed as the compound decomposed producing a wide range of products. The impure solid also decomposed slowly in the glove box; after one month, previously

undetectable amounts of S_4N_4 could be clearly seen in the infra-red spectrum.

Due to the apparent instability of the unknown compound, X-ray diffraction on a single crystal was chosen as the best possible method of identification. Crystals of a suitable size were grown by allowing a saturated solution of $(\text{Ph}\overline{\text{CNSSN}})_2$, in acetonitrile, to slowly diffuse through a No. 3 glass sinter into a saturated solution of $[\text{S}_5\text{N}_5]\text{Cl}$ above excess $[\text{S}_5\text{N}_5]\text{Cl}$. In this way the number of nucleation sites would be reduced and the size of the crystallites would increase. These conditions were achieved by the use of a inverted "dog" (*cf.* section 2.2a). After one week large golden crystals up to 10mm long were growing out of the solid $[\text{S}_5\text{N}_5]\text{Cl}$, and many black needle clusters of $[\overline{\text{PhCNSSN}}]_2\text{Cl}$ could be seen in the other compartment. The golden crystals were discovered to be relatively air stable, only tarnishing after approximately one hour in air. They were picked and mounted (in 0.5 and 0.7mm glass Lindemann capillaries) in air. The first crystal picked (0.2 x 0.4 x 0.7mm) was shown by an X-ray oscillation photograph to be a single crystal and was submitted for full X-ray structure determination; the results of this analysis are shown in tables 5.2-5 and in figures 5.1-3.

The analysis shows the new planar cation $[[\overline{\text{PhCNSSN}}]_2\text{Cl}]^+$ and the known S_3N_3^- anion.³³⁻³⁵ The asymmetric unit (figure 5.1) shows the almost planar S_3N_3^- sandwiched between two CN_2S_2 rings in a parallel arrangement. There are significant S...S interactions (table 5.2) between the CN_2S_2 and S_3N_3 rings, the mean length being 3.056Å compared with 3.109Å between rings in $(\overline{\text{PhCNSSN}})_2$.

The bond lengths and angles for the CN_2S_2^+ and S_3N_3^- rings in $[[\overline{\text{PhCNSSN}}]_2\text{Cl}][\text{S}_3\text{N}_3]$ are comparable, within experimental error, to those

Table 5.2 Crystal data, bond lengths and angles for

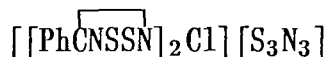

Crystal data: $\text{C}_{14}\text{H}_{10}\text{N}_7\text{S}_7\text{Cl}$, $M_r = 536.2$

Triclinic, Space Group $\overline{P1}$

$a = 9.509(2)$, $b = 10.641(2)$, $c = 12.187(3)\text{\AA}$, $\alpha = 98.29(1)$,

$\beta = 107.61(1)$, $\gamma = 112.081(1)^\circ$, $V = 1041.7\text{\AA}^3$, $Z = 2$,

$R = 0.083$ for 2836 reflections with $F > 4\sigma_c(F)$ and $2\theta \leq 50^\circ$.

Bond lengths (\AA) and bond angles($^\circ$)

S(11)-S(12)	2.340(1)	S(11)-N(11)	1.597(3)
S(12)-N(12)	1.611(3)	N(11)-C(11)	1.359(5)
N(12)-C(11)	1.329(3)	C(11)-C(12)	1.469(4)
C(12)-C(13)	1.391(7)	C(12)-C(17)	1.389(5)
C(13)-C(14)	1.396(6)	C(14)-C(15)	1.362(8)
C(15)-C(16)	1.380(11)	C(16)-C(17)	1.377(5)
S(21)-S(22)	2.047(1)	S(21)-N(21)	1.607(3)
S(22)-N(22)	1.606(3)	N(21)-C(21)	1.340(5)
N(22)-C(21)	1.344(3)	C(21)-C(22)	1.482(5)
C(22)-C(23)	1.384(5)	C(22)-C(27)	1.399(4)
C(23)-C(24)	1.380(7)	C(24)-C(25)	1.369(5)
C(25)-C(26)	1.375(7)	C(26)-C(27)	1.384(6)
S(31)-N(31)	1.587(4)	S(31)-N(32)	1.597(4)
S(32)-N(32)	1.615(3)	S(32)-N(33)	1.590(4)
S(33)-N(31)	1.603(3)	S(33)-N(33)	1.593(4)
S(21')-Cl	3.082(2)	S(22')-Cl	2.897(2)
S(11)-Cl	2.964(2)	S(12)-Cl	2.903(2)
S(31)-S(22)	3.002	S(32)-S(11)	2.929
S(33)-S(12)	3.263	S(33)-S(21)	3.032
S(12)-S(11)-N(11)	95.7(1)	S(11)-S(12)-N(12)	94.6(1)
S(11)-N(11)-C(11)	114.7(2)	S(12)-N(12)-C(11)	115.6(3)
N(11)-C(11)-N(12)	119.4(3)	N(11)-C(11)-C(12)	120.2(2)
N(12)-C(11)-C(12)	120.4(3)	C(11)-C(12)-C(13)	119.9(3)
C(11)-C(12)-C(13)	119.8(4)	C(13)-C(12)-C(17)	120.2(3)
C(12)-C(13)-C(14)	118.6(4)	C(13)-C(14)-C(15)	120.4(7)
C(14)-C(15)-C(16)	121.3(5)	C(15)-C(16)-C(17)	119.2(4)
C(12)-C(17)-C(16)	120.3(5)	S(22)-S(21)-N(21)	94.8(1)
S(21)-S(22)-N(22)	95.1(1)	S(21)-N(21)-C(21)	115.1(2)
S(22)-N(22)-C(21)	114.8(3)	N(21)-C(21)-N(22)	120.1(3)
N(21)-C(21)-C(22)	120.4(2)	N(22)-C(21)-C(22)	119.4(3)
C(21)-C(22)-C(23)	119.5(2)	C(21)-C(22)-C(27)	121.1(3)
C(23)-C(22)-C(27)	119.4(3)	C(22)-C(23)-C(24)	120.4(3)
C(23)-C(24)-C(25)	120.3(4)	C(24)-C(25)-C(26)	119.9(5)
C(25)-C(26)-C(27)	121.0(3)	C(22)-C(27)-C(26)	119.0(4)
N(31)-S(31)-N(32)	116.2(2)	N(32)-S(32)-N(33)	116.1(2)
N(31)-S(33)-N(33)	114.8(2)	S(31)-N(31)-S(33)	124.9(3)
S(31)-N(32)-S(32)	122.9(2)	S(32)-N(33)-S(33)	124.9(2)

Table 5.3 Anisotropic thermal parameters ($\text{\AA}^2 \times 10^3$) for $[[\text{PhCNSSN}]_2\text{Cl}][\text{S}_3\text{N}_3]$. The anisotropic temperature factor exponent takes the form $-2\pi^2(h^2a^*U_{11} + \dots + 2hka^*b^*U_{12})$

Atom	U_{11}	U_{22}	U_{33}	U_{23}	U_{13}	U_{12}
S(11)	48(1)	49(1)	52(1)	25(1)	31(1)	27(1)
S(12)	38(1)	44(1)	48(1)	20(1)	14(1)	16(1)
N(11)	47(1)	41(1)	44(1)	15(1)	21(1)	22(1)
N(12)	45(1)	42(1)	44(1)	22(1)	21(1)	19(1)
C(11)	40(1)	35(1)	43(2)	16(1)	19(1)	21(1)
C(12)	40(2)	33(1)	61(2)	21(1)	22(1)	21(1)
C(13)	54(2)	61(2)	82(3)	42(2)	39(2)	32(2)
C(14)	82(3)	80(3)	144(5)	74(3)	80(4)	52(3)
C(15)	47(2)	49(2)	175(6)	40(3)	47(3)	19(2)
C(16)	45(2)	41(2)	125(4)	9(2)	13(2)	14(2)
C(17)	49(2)	44(2)	72(2)	9(2)	15(2)	20(2)
S(21)	53(1)	47(1)	55(1)	22(1)	32(1)	26(1)
S(22)	36(1)	51(1)	60(1)	25(1)	19(1)	22(1)
N(21)	47(1)	41(1)	50(2)	17(1)	24(1)	22(1)
N(22)	40(1)	47(1)	52(2)	23(1)	16(1)	23(1)
C(21)	43(2)	39(1)	46(2)	19(1)	20(1)	26(1)
C(22)	46(2)	37(1)	53(2)	19(1)	26(1)	25(1)
C(23)	59(2)	55(2)	49(2)	20(2)	25(2)	23(2)
C(24)	77(3)	69(2)	62(2)	32(2)	41(2)	31(2)
C(25)	71(2)	57(2)	93(3)	36(2)	53(2)	31(2)
C(26)	49(2)	48(2)	76(2)	18(2)	27(2)	19(2)
C(27)	47(2)	46(2)	57(2)	20(2)	23(2)	24(1)
S(31)	38(1)	46(1)	88(1)	23(1)	10(1)	15(1)
S(32)	67(1)	58(1)	93(1)	48(1)	55(1)	37(1)
S(33)	78(1)	63(1)	51(1)	22(1)	22(1)	47(1)
N(31)	72(2)	66(2)	103(3)	59(2)	64(2)	50(2)
N(32)	83(2)	69(2)	48(2)	23(2)	20(2)	50(2)
N(33)	37(1)	42(2)	91(2)	7(2)	13(1)	20(1)
Cl	50(1)	67(1)	94(1)	33(1)	40(1)	17(1)

Table 5.4 The atomic coordinates ($\times 10^4$) and isotropic thermal parameters ($\text{\AA}^2 \times 10^3$) for the hydrogen atoms

Atom	x	y	z	U
H(13)	3828	6620	589	69
H(14)	6408	8463	920	100
H(15)	8388	9627	2850	106
H(16)	7881	9025	4508	94
H(17)	5318	7238	4213	70
H(23)	2720	-1087	4814	64
H(24)	865	-2603	5474	78
H(25)	-1729	-4292	4099	78
H(26)	-2478	-4485	2054	69
H(27)	-664	-2962	1362	57

Table 5.5 Atomic Coordinates ($\times 10^4$) for $[[\text{PhCNSSN}]_2\text{Cl}][\text{S}_3\text{N}_3]$

<u>Atom</u>	<u>x</u>	<u>y</u>	<u>z</u>
S(11)	579(1)	4150(1)	2842(1)
S(12)	-122(1)	3734(1)	1027(1)
N(11)	2386(3)	5364(3)	3169(2)
N(12)	1597(3)	4916(3)	1099(2)
C(11)	2732(4)	5648(3)	2203(3)
C(12)	4339(4)	6766(3)	2379(3)
C(13)	4648(5)	7115(4)	1391(4)
C(14)	6167(6)	8200(5)	1590(6)
C(15)	7342(6)	8886(5)	2728(7)
C(16)	7046(5)	8538(4)	3711(5)
C(17)	5539(4)	7481(4)	3534(4)
S(21)	3563(1)	-43(1)	1150(1)
S(22)	5110(1)	1017(1)	2911(1)
N(21)	2102(3)	-1093(3)	1455(2)
C(21)	2420(4)	-912(3)	2630(3)
C(22)	1218(4)	-1872(3)	3032(3)
C(23)	1651(5)	-1780(4)	4242(3)
C(24)	555(5)	-2677(5)	4632(4)
C(25)	-970(5)	-3672(4)	3824(4)
C(26)	-1411(5)	-3789(4)	2618(4)
C(27)	-341(4)	-2887(4)	2204(3)
S(31)	4392(1)	3538(1)	3046(1)
S(32)	1251(1)	1684(1)	2887(1)
S(33)	1853(1)	1850(1)	771(1)
N(31)	3665(4)	3063(4)	1618(3)
N(32)	3137(4)	2849(4)	3656(3)
N(33)	710(3)	1206(3)	1467(3)
Cl	-2922(1)	2050(1)	1538(1)

Figure 5.1 $[[\text{PhCNSSN}]_2\text{Cl}][\text{S}_3\text{N}_3]$ - the asymmetric unit.

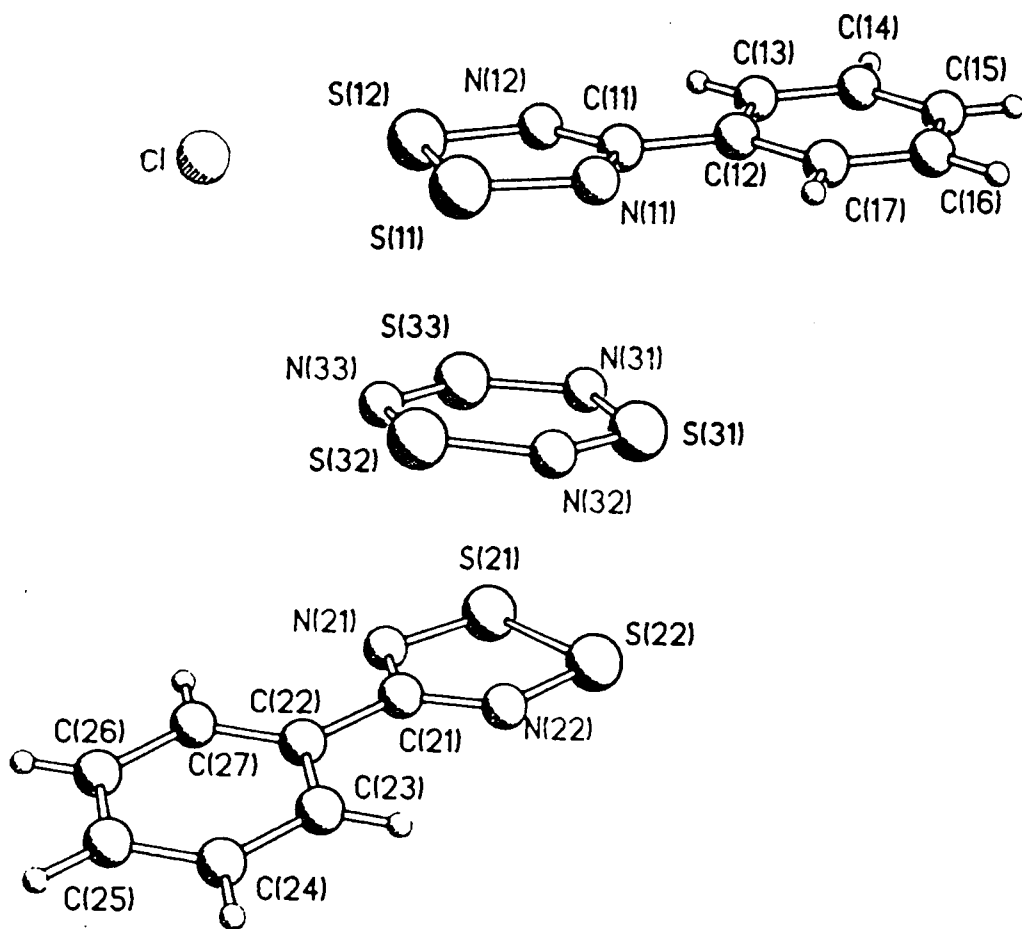

Figure 5.2 The new planar cation, $[\text{PhCNSSN}]_2\text{Cl}^+$.

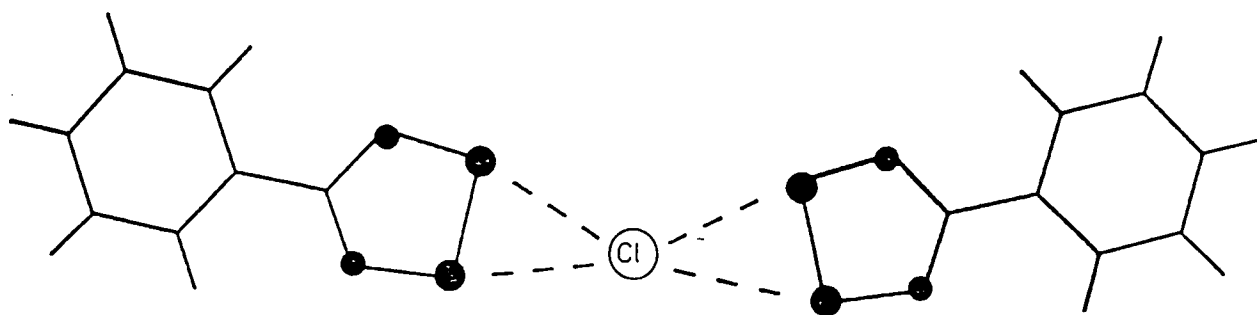
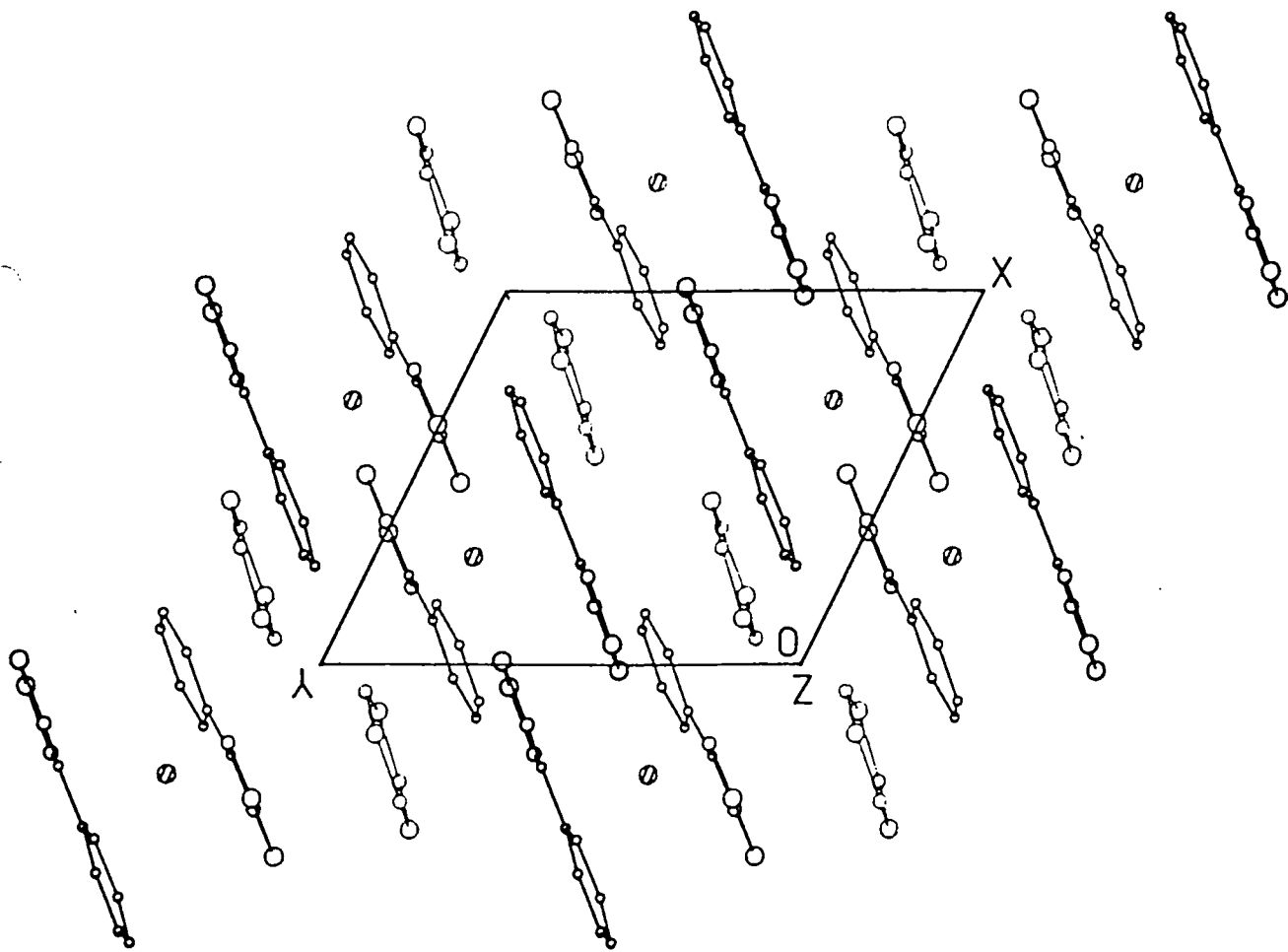

Figure 5.3 The unit cell for $[[\text{PhCNSSN}]_2\text{Cl}][\text{S}_3\text{N}_3]$ showing the parallel rings.



found in $[\text{PhCNSSN}]\text{Cl}^{38}$ and $[\text{tBu}_4\text{N}]\text{S}_3\text{N}_3^{36}$. The new $[\text{PhCNSSN}]_2\text{Cl}^+$ cation (figure 5.2) is planar and slightly bent with the chloride weakly bonded to the four sulphurs in the two CN_2S_2 rings. The mean S-Cl distance in the cation is 2.962\AA compared with the slightly shorter distance of 2.906\AA in $[\text{PhCNSSN}]\text{Cl}$. These slightly weaker S-Cl "bonds" in the $[\text{PhCNSSN}]_2\text{Cl}^+$ cation are not surprising, as the chloride is interacting with four sulphurs compared with just two in $[\text{PhCNSSN}]\text{Cl}$. All the rings are parallel to each other in the crystal lattice and this can be clearly seen in figure 5.3. which shows the unit cell containing two asymmetric units.

A well formed single crystal was studied in an optical goniometer and the angles between facets measured. By studying the crystal data on a computer, using the "PLUTO" program, the exact angle between planes could be calculated and matched up with the observed angles; hence the predominant crystal habit of $[[\text{PhCNSSN}]_2\text{Cl}][\text{S}_3\text{N}_3]$ could be found. The calculated and observed angles, and the corresponding planes are shown in table 5.6.

The predominant crystal habit and the projections perpendicular to the $(00\bar{1})$, $(\bar{2}30)$ and $(0\bar{5}4)$ planes are illustrated in figures 5.4-7. From the predominant crystal habit (figure 5.4) it can be seen that the smallest facet was on the $(\bar{2}30)$ plane, which is also the most densely populated plane (figure 5.6). This is expected as crystals tend to grow fastest on the most densely populated plane.

The proposed mechanism for the formation of $[[\text{PhCNSSN}]_2\text{Cl}][\text{S}_3\text{N}_3]$ (scheme 5.1) involves a two step reduction with a ring contraction after the first step. A dithiadiazole monomer reduces the S_5N_5^+ ring, in a one electron transfer, to the cyclic $\text{S}_5\text{N}_5^\cdot$ radical, the $[\text{PhCNSSN}]^\cdot$ being oxidised to $[\text{PhCNSSN}]\text{Cl}$. $[\text{PhCNSSN}]\text{Cl}$ will further react with the excess

Table 5.6 Calculated and observed angles for the planes in a crystal of $[[\text{PhCNSN}]_2\text{Cl}][\text{S}_3\text{N}_3]$.

Crystal Planes	Angles ($^\circ$)	
	Calculated	Observed
$(00\bar{1})/(0\bar{5}4)$	68.02	67.2(2)
$(00\bar{1})/(\bar{2}30)$	90.67	90.0(5)
$(0\bar{5}4)/(\bar{2}30)$	132.3	132.5(5)

Figure 5.4 The predominant habit of the $[[\text{Ph}\overline{\text{CNSSN}}]_2\text{Cl}][\text{S}_3\text{N}_3]$ crystal.

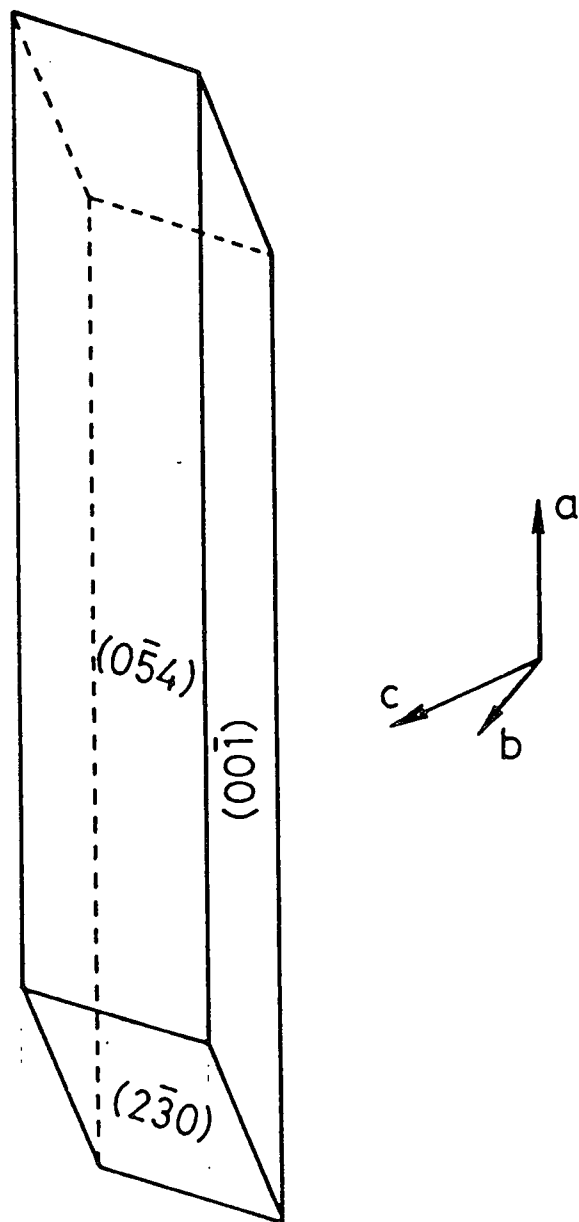

Figure 5.5 Perpendicular projection of the $(00\bar{1})$ plane in $[[\text{PhCNSSN}]_2\text{Cl}][\text{S}_3\text{N}_3]$.

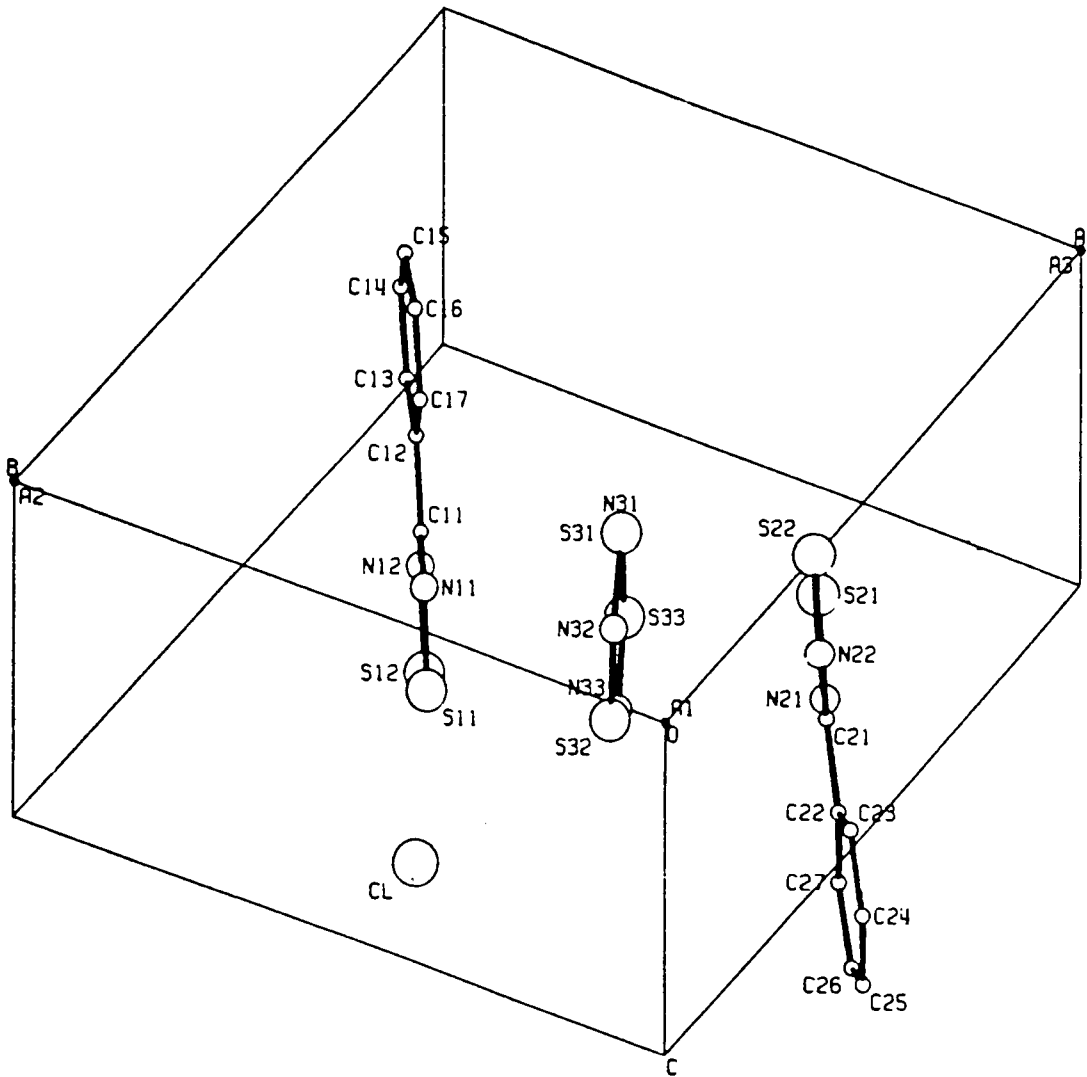

Figure 5.6 Perpendicular projection of the $(\bar{2}30)$ plane in $[[\text{PhCNSN}]_2\text{Cl}][\text{S}_3\text{N}_3]$.

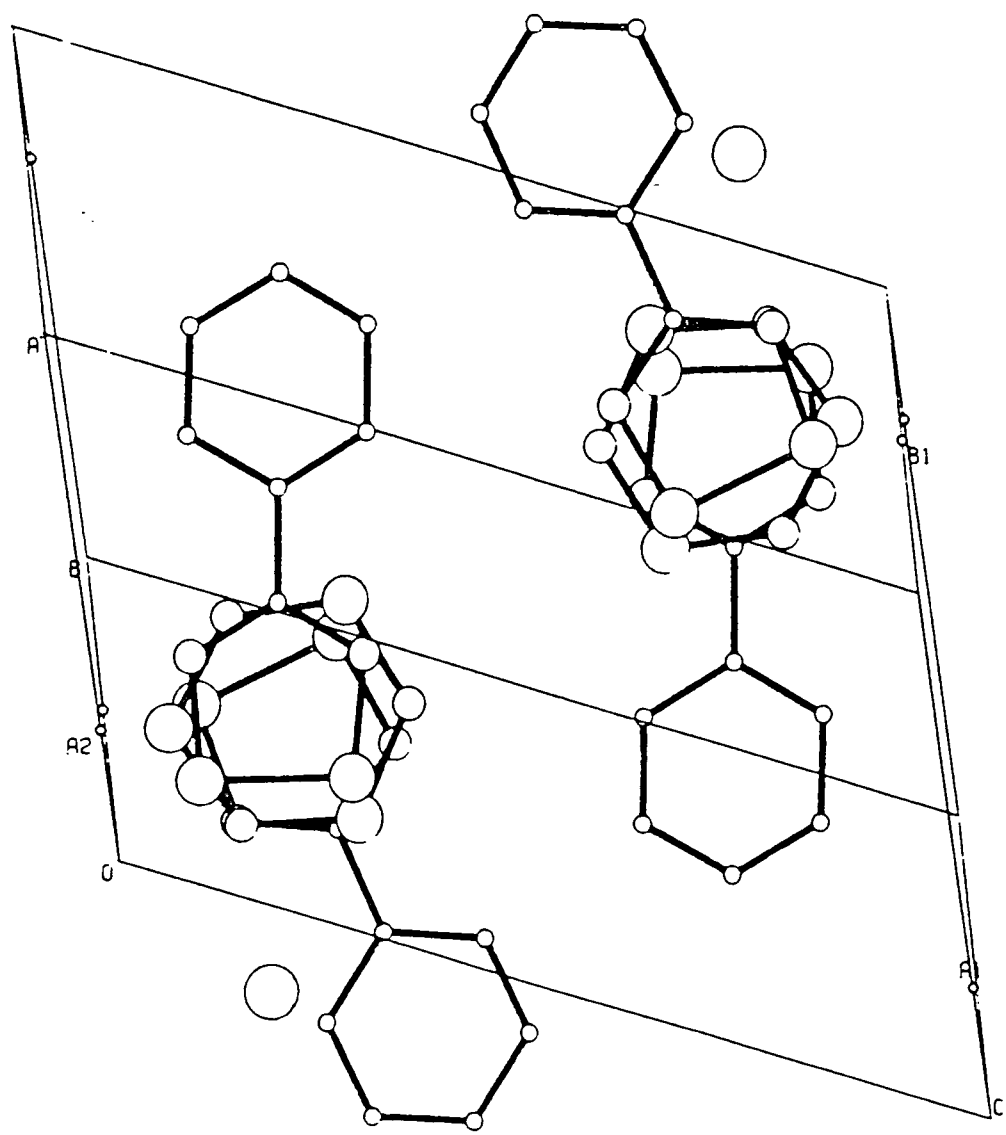
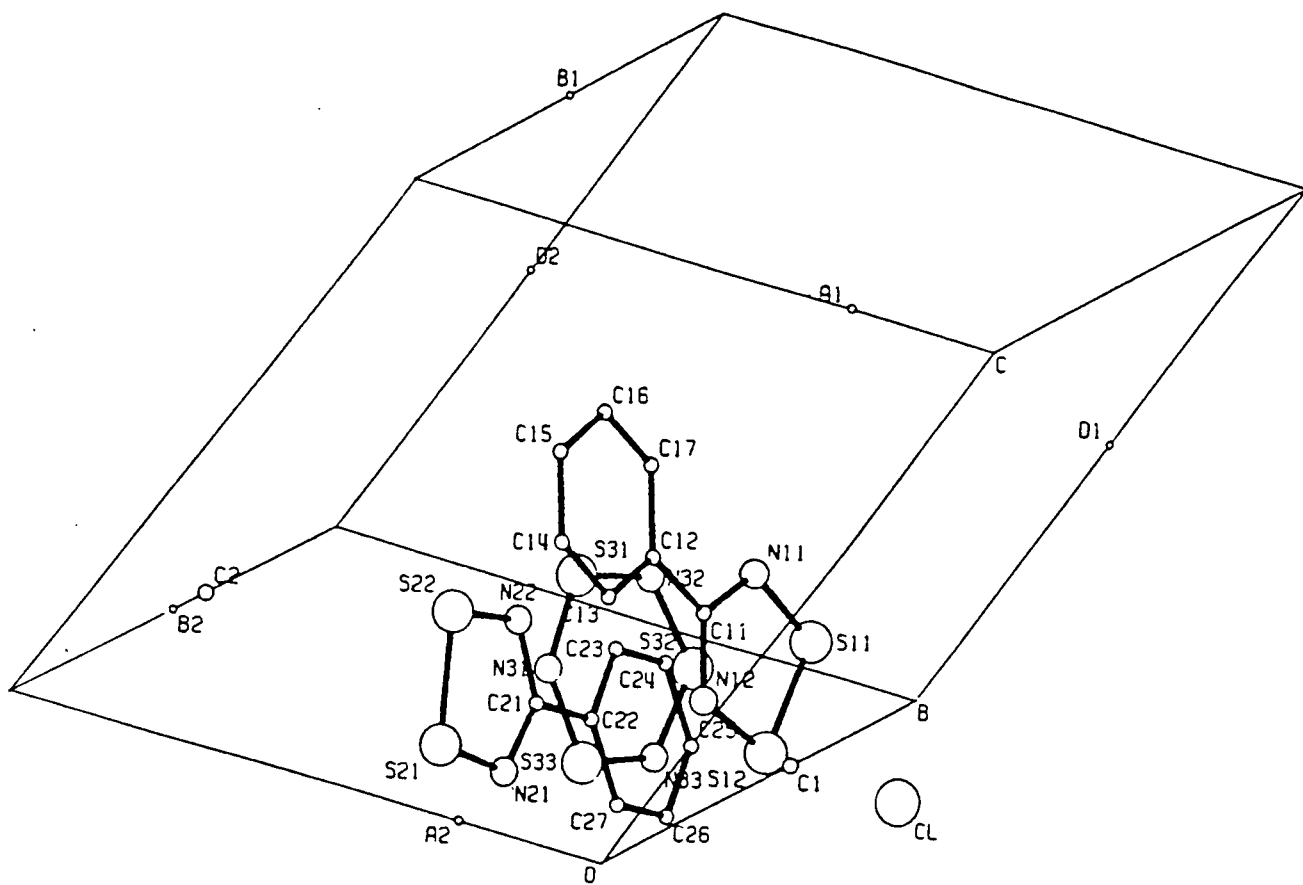
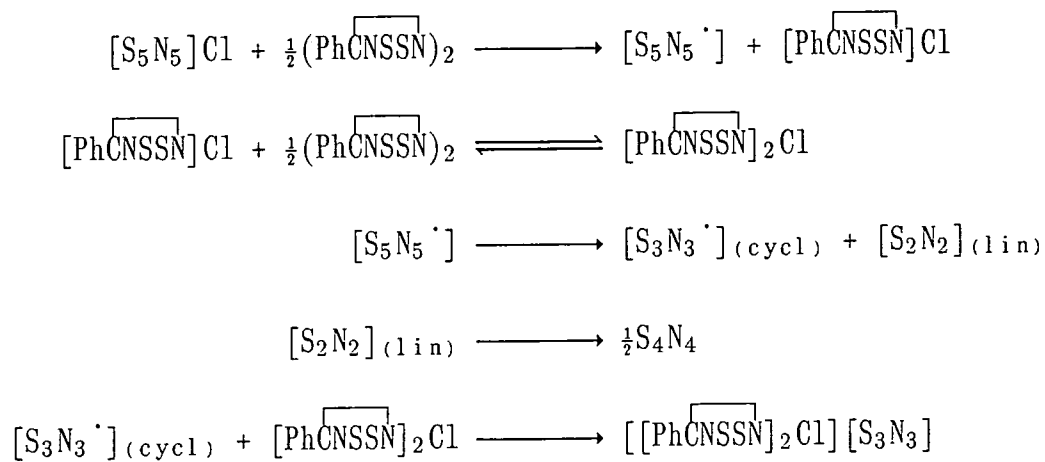

Figure 5.7 Perpendicular projection of the $(0\bar{5}4)$ plane in $[[\text{PhCNSSN}]_2\text{Cl}][\text{S}_3\text{N}_3]$.



Scheme 5.1 Some possible reaction mechanisms for the formation of $[[\text{Ph}\overline{\text{CNSSN}}]_2\text{Cl}][\text{S}_3\text{N}_3]$.



$(\text{Ph}\overline{\text{CNSSN}})_2$ in an equilibrium to form $[\text{Ph}\overline{\text{CNSSN}}]_2\text{Cl}$ (*cf.* section 5.2.12). A previous electrochemical study³⁹ on the reduction of $[\text{S}_5\text{N}_5]\text{Cl}$ postulated that the $\text{S}_5\text{N}_5^\cdot$ radical is produced, cleaving to form linear S_2N_2 and cyclic $\text{S}_3\text{N}_3^\cdot$. This is consistent with my products, linear S_2N_2 dimerising to produce S_4N_4 , and cyclic $\text{S}_3\text{N}_3^\cdot$ being further reduced by $[\text{Ph}\overline{\text{CNSSN}}]_2\text{Cl}$, in a one electron transfer, producing $[[\text{Ph}\overline{\text{CNSSN}}]_2\text{Cl}][\text{S}_3\text{N}_3]$.

5.2.2 Preparation of $[[\text{Ph}\overline{\text{CNSSN}}]_2\text{Cl}][\text{S}_3\text{N}_3]$:

The reaction of $[\text{S}_5\text{N}_5]\text{Cl}$ with excess (1:1.2) $(\text{Ph}\overline{\text{CNSSN}})_2$ in acetonitrile produced a golden microcrystalline solid which was sparingly soluble in acetonitrile. The volume of solvent used in the reaction was very important as (i) the use of too much reduced the yield and (ii) the use of too little allowed S_4N_4 , which could not be separated from the product, to crystallise out. The slight excess of $(\text{Ph}\overline{\text{CNSSN}})_2$ was needed to ensure that no unreacted $[\text{S}_5\text{N}_5]\text{Cl}$ remained, which, like S_4N_4 , was impossible to separate from the final product. Elemental analysis, infra-red and mass spectroscopy data were all consistent with the formula $[[\text{Ph}\overline{\text{CNSSN}}]_2\text{Cl}][\text{S}_3\text{N}_3]$. D.S.C. measurements showed a minor decomposition at 138°C followed by a major decomposition at 148°C; smaller, broader decomposition peaks occurred at 161°C and 177°C.

5.2.3 Extraction of $[[\text{Ph}\overline{\text{CNSSN}}]_2\text{Cl}][\text{S}_3\text{N}_3]$:

Extraction of pure $[[\text{Ph}\overline{\text{CNSSN}}]_2\text{Cl}][\text{S}_3\text{N}_3]$ with acetonitrile produced many golden crystals of $[[\text{Ph}\overline{\text{CNSSN}}]_2\text{Cl}][\text{S}_3\text{N}_3]$ (up to 0.7mm long) and a small amount of a dirty brown solid. The infra-red spectrum of this mixture showed $[[\text{Ph}\overline{\text{CNSSN}}]_2\text{Cl}][\text{S}_3\text{N}_3]$ to be the major product. However,

some new weak intensity peaks showed that minor decomposition of the starting material had occurred producing $[\text{PhCNSSN}]_2\text{Cl}$, $[\text{PhCNSSN}]\text{Cl}$ and S_4N_4 although their low intensity made exact identification impossible.

5.2.4 Vacuum thermolysis of $[[\text{PhCNSSN}]_2\text{Cl}][\text{S}_3\text{N}_3]$:

When $[[\text{PhCNSSN}]_2\text{Cl}][\text{S}_3\text{N}_3]$ was heated at 60°C in a simple sublimation apparatus with a cold finger at -20°C under high vacuum (*ca.* 10^{-5} torr), $[\text{PhCNSSN}]\text{Cl}$ and $[\text{PhCNSSN}][\text{S}_3\text{N}_3]$ were produced as in equation 5.1 below.

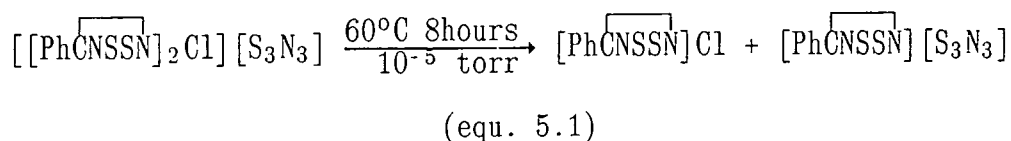

$[\text{PhCNSSN}][\text{S}_3\text{N}_3]$ was easily sublimed at 60°C and collected on a cold finger. $[\text{PhCNSSN}]\text{Cl}$ is much less volatile than $[\text{PhCNSSN}][\text{S}_3\text{N}_3]$ and so remained as the residue allowing complete separation.

It is unsurprising that under the strenuous condition of heat and high vacuum the original compound, $[[\text{PhCNSSN}]_2\text{Cl}][\text{S}_3\text{N}_3]$, decomposed producing $[\text{PhCNSSN}]\text{Cl}$ and $[\text{PhCNSSN}][\text{S}_3\text{N}_3]$. The mean S...Cl distance in the new planar cation, $[[\text{PhCNSSN}]_2\text{Cl}]^+$, is 2.960\AA showing only weak bonding, whilst the asymmetric unit (figure 5.1) shows that the spatial arrangement of the CN_2S_2 and S_3N_3 rings is very similar to that in the compound $[\text{PhCNSSN}][\text{S}_3\text{N}_3]$ (figure 5.12). Hence the starting material readily decomposed into its two "potential" halves.

5.2.5 Crystal growth and structure of $[\text{PhCNSSN}][\text{S}_3\text{N}_2]\text{Cl}$:

Slow diffusion of $(\text{PhCNSSN})_2$ onto $[\text{S}_4\text{N}_3]\text{Cl}$ in acetonitrile, in a typical crystal growth experiment (*cf.* section 5.2.1), produced a few

small highly reflective green platelets of $[\text{PhCNSSN}][\text{S}_3\text{N}_2]\text{Cl}$, which grew on the solid $[\text{S}_4\text{N}_3]\text{Cl}$, and many large black needle clusters of $[\text{PhCNSSN}]_2\text{Cl}$.

Crystals of both $[\text{PhCNSSN}][\text{S}_3\text{N}_2]\text{Cl}$ and $[\text{PhCNSSN}]_2\text{Cl}$ were surprisingly air stable. A small platelet of $[\text{PhCNSSN}][\text{S}_3\text{N}_2]\text{Cl}$ immersed in a droplet of tap water kept its mirror appearance for 15 minutes and a needle of $[\text{PhCNSSN}]_2\text{Cl}$ was stable in air for at least a day. Crystals of both were therefore picked in air and mounted in glass Lindemann capillaries. The first green crystal picked (0.37 x 0.48 x 0.04mm) was shown by an X-ray oscillation photograph to be a single crystal and was submitted for a full X-ray structure determination. The results of the analysis are shown in tables 5.7-10 and figures 5.8-11.

A single crystal of $[\text{PhCNSSN}]_2\text{Cl}$ was not found as all the crystals were split or too long. Due to fragility, when a long crystal was cut it resulted in splitting.

The asymmetric unit of $[\text{PhCNSSN}][\text{S}_3\text{N}_2]\text{Cl}$ (figure 5.8) shows the CN_2S_2 ring bonded to the S_3N_2 ring by the four disulphide sulphurs in a *cis* arrangement. The two rings are not parallel but are inclined at 26.2° to each other. The chloride ion is weakly bonded to all four disulphide sulphurs but is slightly closer to those in the S_3N_2 ring than the CN_2S_2 ring (*cf.* table 5.7) suggesting a greater positive charge on the S_3N_2 ring. The full chloride environment is shown in figure 5.9, the other $\text{S}\dots\text{Cl}$ distances being $>3.4\text{\AA}$.

Figure 5.10 shows the weaker secondary interactions between two adjacent $[\text{PhCNSSN}][\text{S}_3\text{N}_2]\text{Cl}$ molecules, which are very weakly "bonded" through the disulphide sulphurs of the adjacent S_3N_2 rings ($d_{\text{s}\dots\text{s}} = 3.522\text{\AA}$). The sulphur bonding between the CN_2S_2 and S_3N_2 rings is, however, much more significant, the mean $\text{S}\dots\text{S}$ bond length being

Table 5.7 Crystal data, bond lengths and angles for $[\text{PhCNSSN}][\text{S}_3\text{N}_2]\text{Cl}$ Crystal data: $\text{C}_7\text{H}_5\text{N}_4\text{S}_5\text{Cl}$, $M_r = 340.9$ Monoclinic, Space Group $\text{P2}_1\text{c}$ $a = 9.452(2)$, $b = 14.995(3)$, $c = 9.716(2)\text{\AA}$, $\beta = 114.07(1)$ $V = 1257.3\text{\AA}^3$, $Z = 4$, $R = 0.0493$ for 2566 reflections with $F > 4\sigma_c(F)$ and $2\theta \leq 25^\circ$.Bond lengths (\AA) and angles ($^\circ$)

$\text{S}(11)-\text{S}(12)$	2.055(2)	$\text{S}(11)-\text{N}(11)$	1.618(5)
$\text{S}(12)-\text{N}(12)$	1.613(5)	$\text{N}(11)-\text{C}(11)$	1.339(6)
$\text{N}(12)-\text{C}(11)$	1.340(6)	$\text{C}(11)-\text{C}(12)$	1.490(8)
$\text{C}(12)-\text{C}(13)$	1.369(7)	$\text{C}(12)-\text{C}(17)$	1.385(7)
$\text{C}(13)-\text{C}(14)$	1.399(9)	$\text{C}(14)-\text{C}(15)$	1.373(8)
$\text{C}(15)-\text{C}(16)$	1.391(8)	$\text{C}(16)-\text{C}(17)$	1.388(10)
$\text{S}(21)-\text{S}(22)$	2.152(2)	$\text{S}(21)-\text{N}(22)$	1.632(5)
$\text{S}(22)-\text{N}(21)$	1.632(5)	$\text{S}(23)-\text{N}(21)$	1.570(5)
$\text{S}(23)-\text{N}(22)$	1.556(5)	$\text{S}(11)-\text{S}(21)$	2.864(2)
$\text{S}(12)-\text{S}(22)$	2.812(2)	$\text{S}(21a)-\text{S}(22)$	3.522(2)
$\text{S}(22a)-\text{S}(21)$	3.522(2)	$\text{S}(11)-\text{Cl}$	3.134(3)
$\text{S}(12)-\text{Cl}$	3.100(3)	$\text{S}(21)-\text{Cl}$	2.907(3)
$\text{S}(22)-\text{Cl}$	2.954(3)		
$\text{S}(12)-\text{S}(11)-\text{N}(11)$	95.1(2)	$\text{S}(11)-\text{S}(12)-\text{N}(12)$	94.6(1)
$\text{S}(11)-\text{N}(11)-\text{C}(11)$	114.5(4)	$\text{S}(12)-\text{N}(12)-\text{C}(11)$	115.1(3)
$\text{N}(11)-\text{C}(11)-\text{N}(12)$	120.6(5)	$\text{N}(11)-\text{C}(11)-\text{C}(12)$	120.1(4)
$\text{N}(12)-\text{C}(11)-\text{C}(12)$	119.2(4)	$\text{C}(11)-\text{C}(12)-\text{C}(13)$	120.3(4)
$\text{C}(11)-\text{C}(12)-\text{C}(17)$	118.7(5)	$\text{C}(13)-\text{C}(12)-\text{C}(17)$	121.0(6)
$\text{C}(12)-\text{C}(13)-\text{C}(14)$	119.7(5)	$\text{C}(13)-\text{C}(14)-\text{C}(15)$	119.5(5)
$\text{C}(14)-\text{C}(15)-\text{C}(16)$	120.9(6)	$\text{C}(15)-\text{C}(16)-\text{C}(17)$	119.2(5)
$\text{C}(12)-\text{C}(17)-\text{C}(16)$	119.7(5)	$\text{S}(22)-\text{S}(21)-\text{N}(22)$	96.6(2)
$\text{S}(21)-\text{S}(22)-\text{N}(21)$	96.8(2)	$\text{N}(21)-\text{S}(23)-\text{N}(22)$	108.2(3)
$\text{S}(22)-\text{N}(21)-\text{S}(23)$	118.9(3)	$\text{S}(21)-\text{N}(22)-\text{S}(23)$	119.4(3)

Table 5.8 The Atomic co-ordinates ($\times 10^4$) and isotropic thermal parameters ($\text{\AA}^2 \times 10^3$) for the hydrogen atoms

Atom	x	y	z	U
H(13)	2662	5891	3721	48
H(14)	3895	6883	2677	54
H(15)	6249	7457	4266	53
H(16)	7436	7032	6882	53
H(17)	6173	6069	7925	46

Table 5.9 Atomic Coordinates ($\times 10^4$) for $[\text{PhCNSSN}][\text{S}_3\text{N}_2]\text{Cl}$

Atom	x	y	z
S(11)	1613(1)	4161(1)	6519(1)
S(12)	3473(1)	4211(1)	8592(1)
N(11)	2250(5)	4877(3)	5655(5)
N(12)	4370(5)	4917(3)	7995(5)
C(11)	3611(6)	5209(3)	6542(5)
C(12)	4331(5)	5876(3)	5890(6)
C(13)	3639(6)	6123(3)	4365(6)
C(14)	4366(7)	6712(3)	3746(6)
C(15)	5755(7)	7048(4)	4687(7)
C(16)	6456(7)	6804(4)	6239(7)
C(17)	5720(6)	6226(3)	6847(7)
S(21)	-17(1)	5247(1)	7803(1)
S(22)	1988(1)	5324(1)	9918(1)
S(23)	1456(2)	6854(1)	8154(2)
N(21)	2479(5)	6330(3)	9655(6)
N(22)	103(5)	6246(3)	7179(6)
Cl	778(2)	3493(1)	9211(2)

Table 5.10 Anisotropic thermal parameters ($\text{\AA}^2 \times 10^3$) for $[\text{PhCNSSN}][\text{S}_3\text{N}_3]$
The anisotropic temperature factor exponent takes the form $-2\pi^2(h^2 a^{*2} U_{11} + \dots + 2hka^*b^*U_{12})$

Atom	U_{11}	U_{22}	U_{33}	U_{23}	U_{13}	U_{12}
S(11)	38(1)	45(1)	34(1)	-3(1)	16(1)	-11(1)
S(12)	35(1)	42(1)	34(1)	6(1)	17(1)	0(1)
N(11)	36(3)	42(3)	30(2)	-3(2)	13(2)	-4(2)
N(12)	27(2)	40(2)	33(2)	5(2)	9(2)	0(2)
C(11)	33(3)	27(2)	35(2)	0(2)	20(2)	0(2)
C(12)	31(3)	35(2)	38(3)	-2(2)	21(2)	6(2)
C(13)	36(3)	44(3)	36(3)	-2(2)	16(2)	-2(2)
C(14)	66(4)	37(3)	37(3)	0(2)	27(3)	-3(3)
C(15)	60(4)	35(3)	54(3)	1(2)	39(3)	-3(3)
C(16)	38(3)	39(3)	64(4)	-5(3)	28(3)	-6(2)
C(17)	38(3)	37(3)	41(3)	0(2)	17(2)	4(2)
S(21)	29(1)	45(1)	38(1)	1(1)	15(1)	-5(1)
S(22)	33(1)	48(1)	29(1)	1(1)	14(1)	0(1)
S(23)	51(1)	46(1)	61(2)	9(1)	1(1)	-9(1)
N(21)	39(3)	50(3)	50(3)	-2(2)	11(2)	-8(2)
N(22)	32(3)	49(3)	49(3)	4(2)	5(2)	-7(2)
Cl	44(1)	41(1)	54(1)	2(1)	28(1)	-3(1)

Figure 5.8 $[\text{PhCNSSN}][\text{S}_3\text{N}_2]\text{Cl}$ - the asymmetric unit.

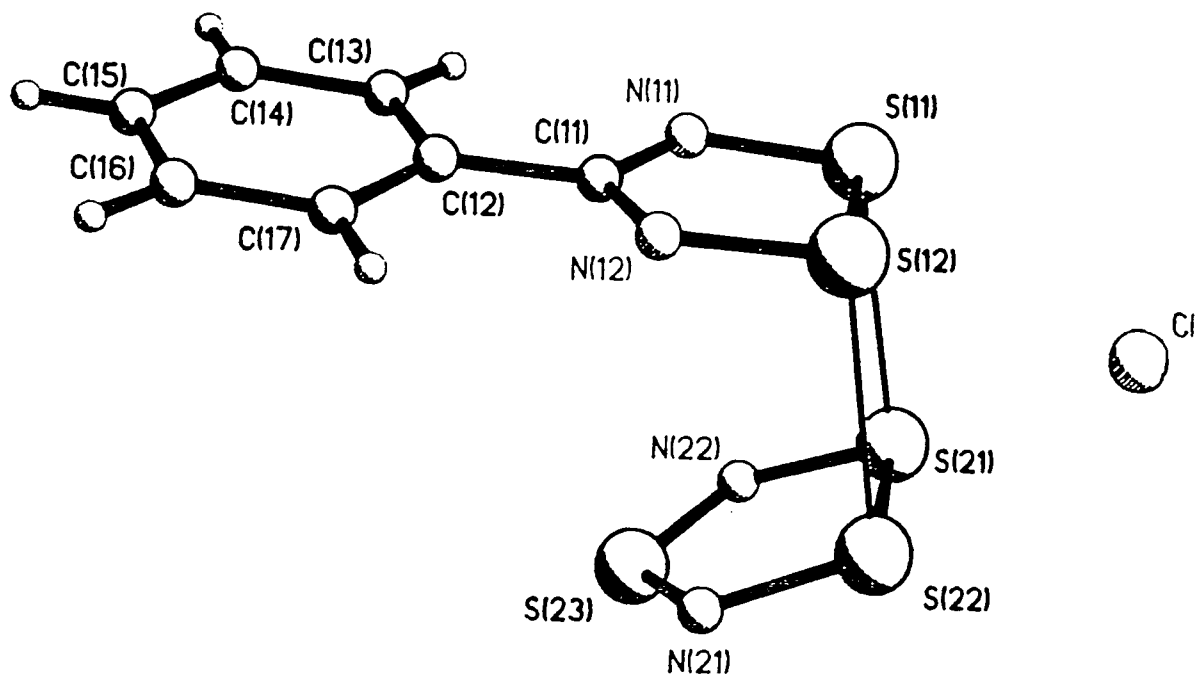

Figure 5.9 The four nearest sulphur atoms to the chloride ion in $[\text{PhCNSSN}][\text{S}_3\text{N}_2]\text{Cl}$.

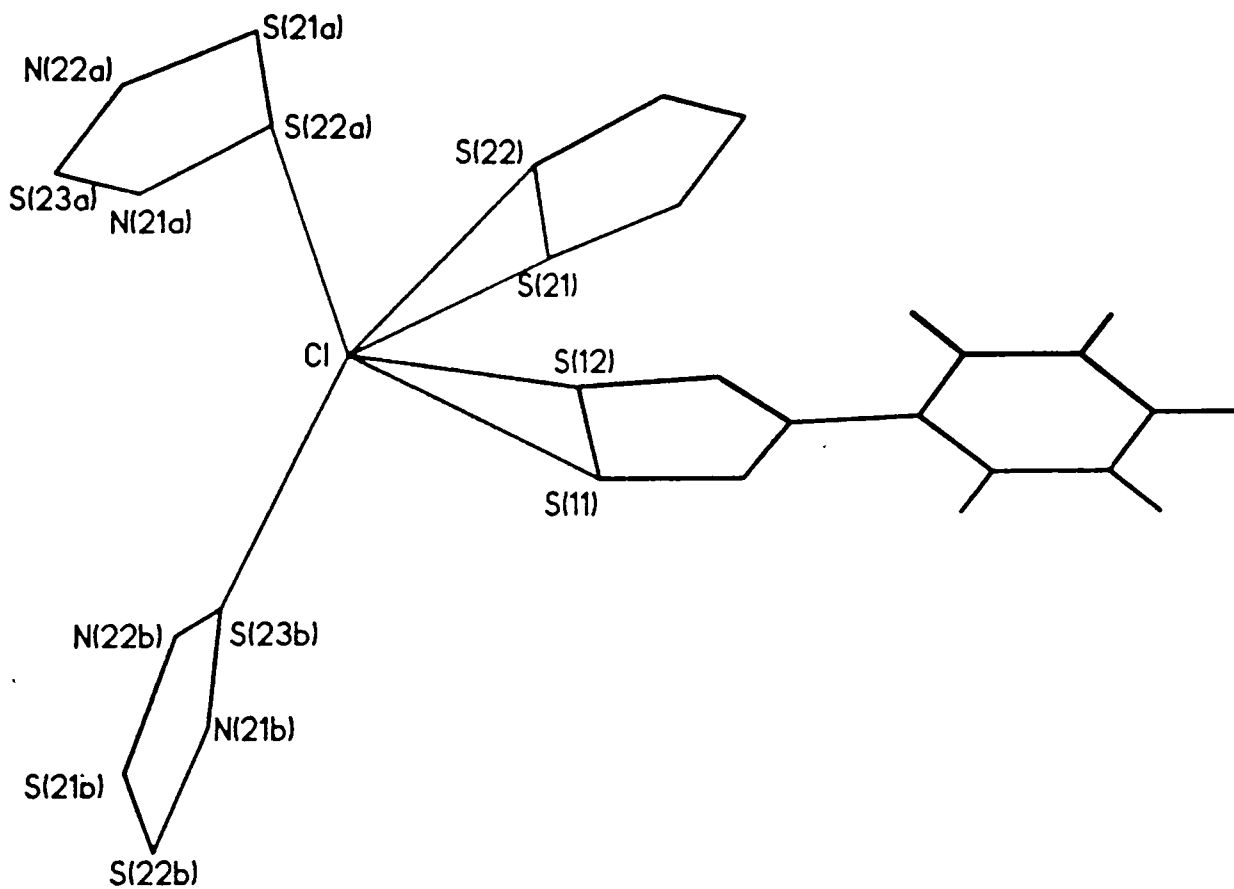
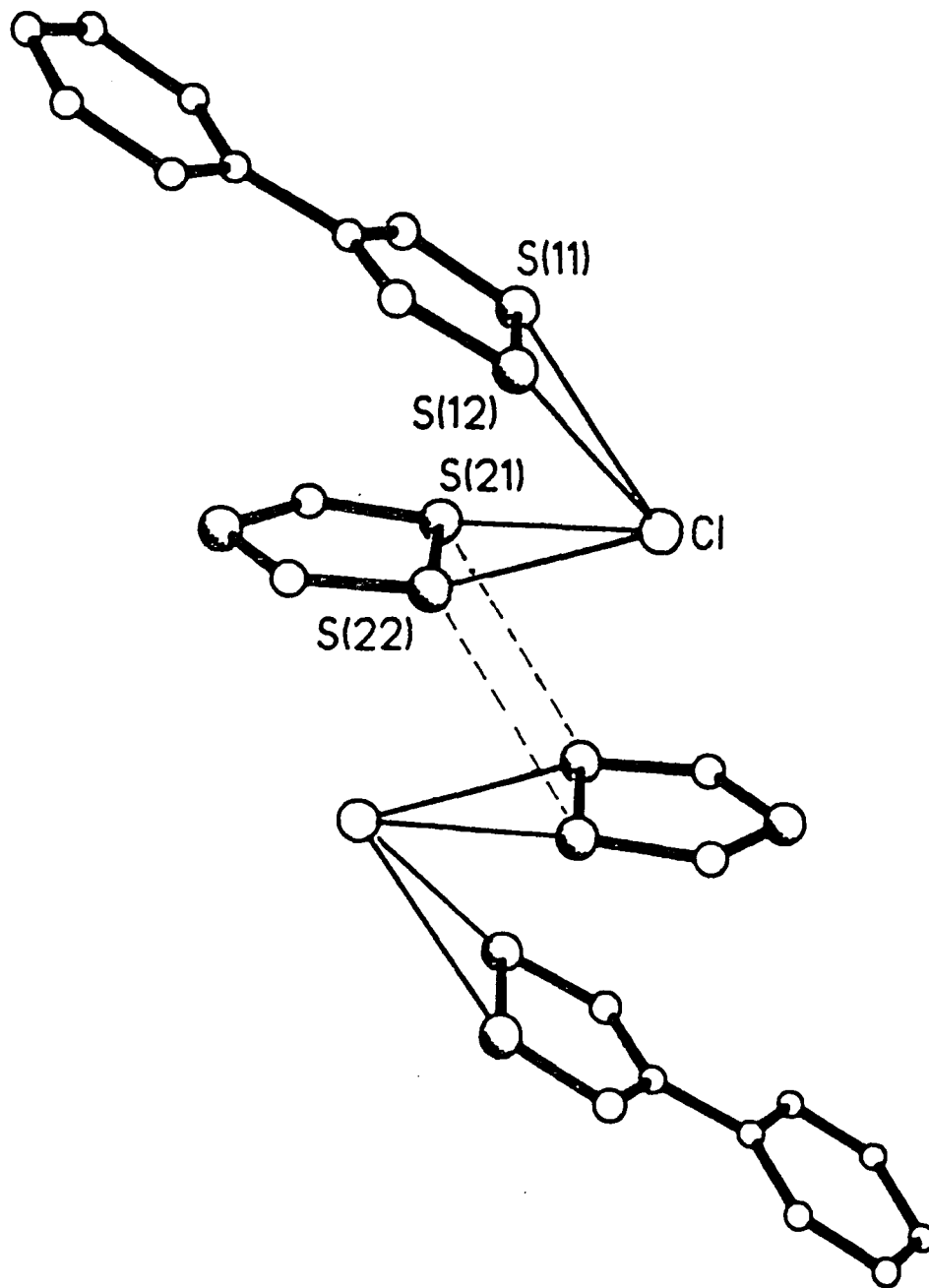

Figure 5.10 The weaker secondary interactions between two adjacent $[\text{PhCNSSN}][\text{S}_3\text{N}_2]\text{Cl}$ molecules.



2.838(2)Å (*cf.* 3.109(5)Å in $(\text{Ph}\overline{\text{CNSSN}})_2$)¹⁴. A projection along the z axis (figure 5.11) shows four molecules per unit cell.

S-S bonds lengths in both $[\text{Ph}\overline{\text{CNSSN}}]^\cdot$ and $\text{S}_3\text{N}_2^{\cdot+}$ are particularly sensitive to the removal of charge since the HOMO is antibonding w.r.t. the S-S bond. Therefore to construct a clearer picture of the relative charge distribution between the two rings of $[\text{Ph}\overline{\text{CNSSN}}]^\cdot$ and $\text{S}_3\text{N}_2^{\cdot+}$, comparisons of the S-S bond lengths were made with $[\text{Ph}\overline{\text{CNSSN}}]\text{Cl}$,³⁸ $(\text{Ph}\overline{\text{CNSSN}})_2$ ¹⁴ and $(\text{S}_3\text{N}_2\text{Cl})_2$.²⁶

The S_3N_2 S-S bond length in $[\text{Ph}\overline{\text{CNSSN}}][\text{S}_3\text{N}_2]\text{Cl}$ is slightly longer than in $(\text{S}_3\text{N}_2\text{Cl})_2$, suggesting that more electron donation into the ring HOMO has occurred (antibonding w.r.t. S-S). In response to the slightly lower positive charge on the $\text{S}_3\text{N}_2^{\cdot+}$ ring, the Cl^- ion moves further away ($d_{\text{S}\dots\text{Cl}} = 2.931(3)\text{Å}$ compared with $2.850(2)\text{Å}$ in $(\text{S}_3\text{N}_2\text{Cl})_2$) and towards the very slightly positive $[\text{Ph}\overline{\text{CNSSN}}]^\cdot$ ring. The idea of a slight positive charge on the $[\text{Ph}\overline{\text{CNSSN}}]^\cdot$ ring is further reinforced by the intermediate S-S distance in the CN_2S_2 ring [$2.055(2)\text{Å}$] compared with $[\text{Ph}\overline{\text{CNSSN}}]^+$ (1.991Å) and $(\text{Ph}\overline{\text{CNSSN}})_2$ [$2.089(5)\text{Å}$].

Consequently the molecule can be thought of as $[\text{Ph}\overline{\text{CNSSN}}]^{\cdot\delta+}$ radical bonded through the disulphide sulphurs to an $\text{S}_3\text{N}_2^{\cdot(1-\delta+)}$ radical cation with an associated Cl^- anion, i.e. $[\text{Ph}\overline{\text{CNSSN}}]^{\cdot\delta+}[\text{S}_3\text{N}_2^{\cdot(1-\delta+)}\text{Cl}^-]$ where Δ is probably less than 0.5.

However, the two "radicals" are associated by electron charge approximately delocalised at the four sulphur atoms, a bonding picture reinforced by the absence of an esr signal. The fact that the majority of the positive charge exists on the S_3N_2 ring, can be explained by (i) the lower reduction potential of $[\text{Ph}\overline{\text{CNSSN}}][\text{AsF}_6]$ (0.61 Volts)⁴⁰ compared with $[\text{S}_3\text{N}_2][\text{AsF}_6]$ (1.52 Volts)⁴⁰ and (ii) the known instability²¹ of the neutral S_3N_2 species.

Figure 5.11 The unit cell of $[\overline{\text{PhCNSSN}}][\text{S}_3\text{N}_2]\text{Cl}$

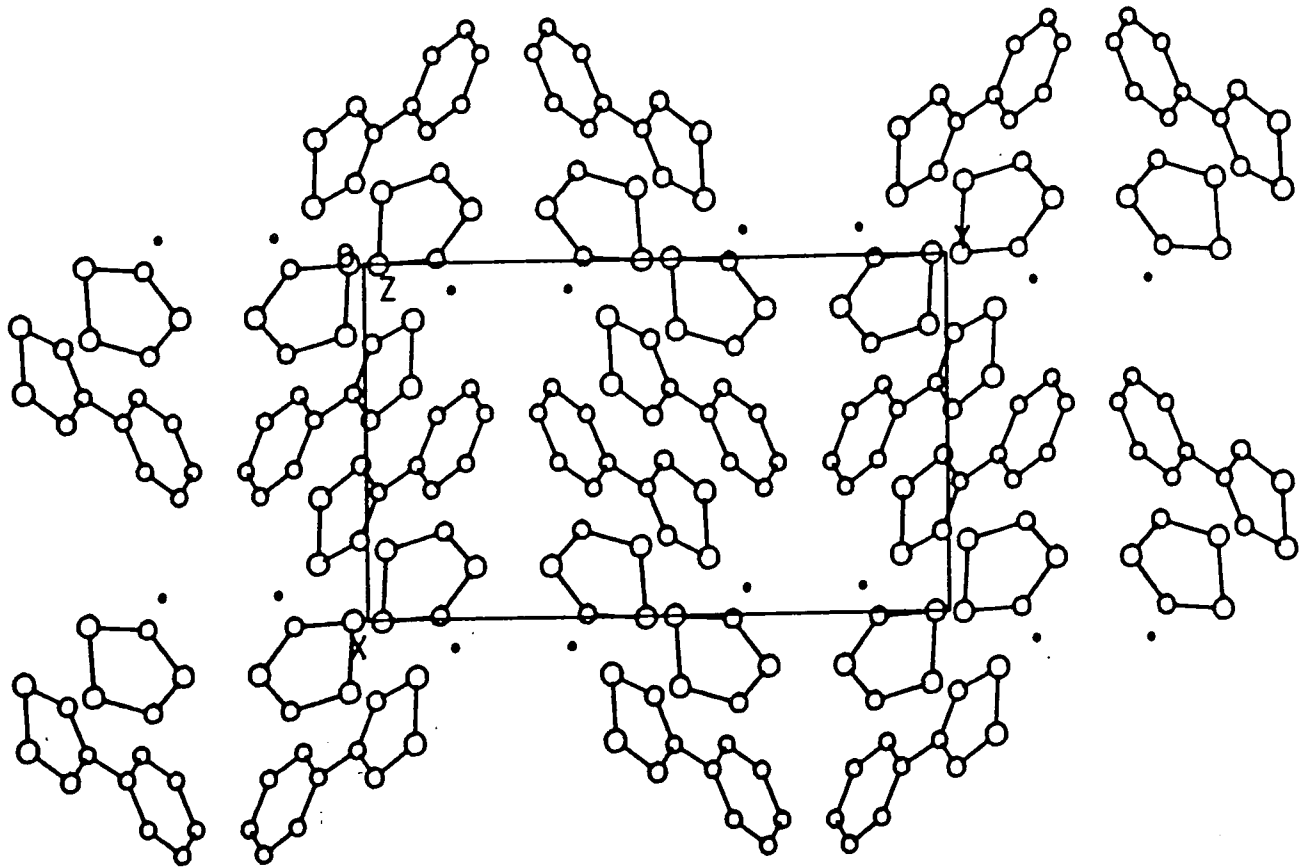

The reaction mechanism for the formation of $[\text{PhCNSSN}][\text{S}_3\text{N}_2]\text{Cl}$ is very difficult to predict as it probably involves short lived, low concentration radicals (hence the wide range of products). Exact yields of each product could not be obtained but $[\text{PhCNSSN}]_2\text{Cl}$, $[\text{PhCNSSN}]\text{Cl}$, S_8 and S_4N_4 were the major products, the minor products being $[\text{PhCNSSN}][\text{S}_3\text{N}_2]\text{Cl}$ and S_4N_2 . The wide range of products are probably obtained from the breakdown of the $[\text{S}_4\text{N}_3\cdot]$ radical which was formed from the reduction of $[\text{S}_4\text{N}_3]\text{Cl}$ by $(\text{PhCNSSN})_2$, with co-formation of $[\text{PhCNSSN}]\text{Cl}$. This highly reactive radical initially decomposes by ring opening of the weak S-S bond; MNDO calculations (carried out by our laboratory) have shown that the LUMO in S_4N_3^+ is antibonding w.r.t. S-S. Scheme 5.2 shows some possible reactions in the mechanism of formation of these products.

Cyclic voltammetry on an S_4N_3^+ salt at room temperature (*cf.* section 4.2.5) showed that $[\text{S}_4\text{N}_3\cdot]$ splits mainly into $[\text{S}_3\text{N}_3\cdot]$, presumably with the formation of sulphur. Other smaller peaks could be seen which may well have corresponded to $\text{S}_3\text{N}_2^{+\cdot}$ and S_4N_2 observed above. Similar reductions of $[\text{S}_4\text{N}_3]\text{Cl}$ ⁴¹ and other S/N/Cl⁴² species have also been shown to produce S_4N_2 although mechanistic interpretations were not put forward.

The mechanism for the formation of $[\text{PhCNSSN}][\text{S}_3\text{N}_2]\text{Cl}$ is highly speculative but it is possible that the cyclic $[\text{S}_3\text{N}_2\cdot]$ radical was produced from the breakdown of $[\text{S}_4\text{N}_3\cdot]$, further reacting with $[\text{PhCNSSN}]\text{Cl}$ to produce $[\text{PhCNSSN}][\text{S}_3\text{N}_2]\text{Cl}$. Both $[\text{SN}\cdot]$ and $[\text{S}_3\text{N}_3\cdot]$ are unstable and will react to produce S_4N_4 which was a major product. $[\text{PhCNSSN}]_2\text{Cl}$ was produced from the reaction between $[\text{PhCNSSN}]\text{Cl}$ and $(\text{PhCNSSN})_2$ (*cf.* section 5.2.11).

Scheme 5.2 Some possible reaction mechanisms for the formation of $[\text{Ph}\overline{\text{CNSSN}}][\text{S}_3\text{N}_2]\text{Cl}$.

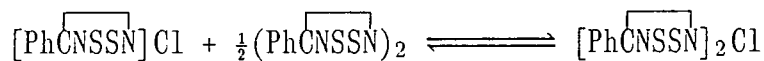
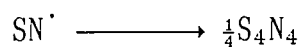
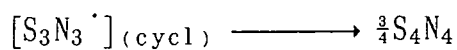
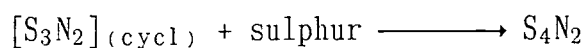
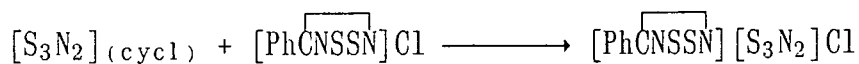
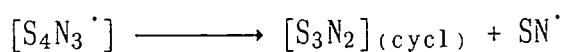
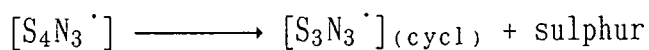
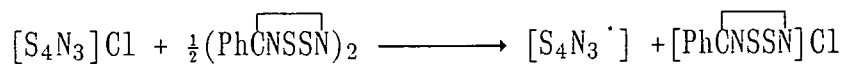

The major question remaining is why, if $S_3N_3^{\cdot}$ and $[\overline{\text{PhCNSSN}}]_2\text{Cl}$ are produced, is $[[\overline{\text{PhCNSSN}}]_2\text{Cl}][S_3N_3]$ not (*cf.* section 5.2.1)?

5.2.6 Preparation of $[\overline{\text{PhCNSSN}}][S_3N_2]\text{Cl}$:

Previous reports^{43,44} have shown that the $S_3N_2Cl^+$ ion is easily reduced to S_3N_2Cl . Consequently when $[S_3N_2Cl][FeCl_4]$ was reduced by an equimolar quantity of $(\overline{\text{PhCNSSN}})_2$ (equations 5.2-5.4 below) $[\overline{\text{PhCNSSN}}][S_3N_2]\text{Cl}$ was produced in 56% yield.

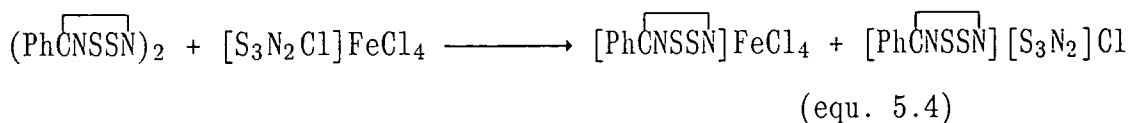
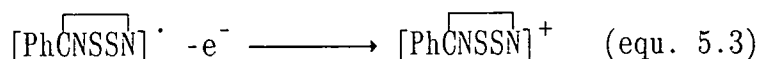
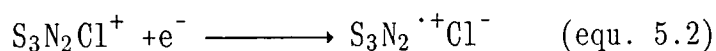

5.2.7 Extraction of $[\overline{\text{PhCNSSN}}][S_3N_2]\text{Cl}$:

The product $[\overline{\text{PhCNSSN}}][S_3N_2]\text{Cl}$, which is readily precipitated in acetonitrile from the equimolar reaction between $(\overline{\text{PhCNSSN}})_2$ and $[S_3N_2Cl]FeCl_4$ (*cf.* section 5.2.6), was purified by continuous extraction with acetonitrile. Extraction of only 0.040g of pure $[\overline{\text{PhCNSSN}}][S_3N_2]\text{Cl}$ took 3 days to complete, the original compound decomposing to $[\overline{\text{PhCNSSN}}]Cl$, S_4N_4 and sulphur. Such a decomposition is not easily explained but it can be seen in equations 5.5-7, below and overleaf, that in solution $[\overline{\text{PhCNSSN}}][S_3N_2]\text{Cl}$ acts as a redox system.

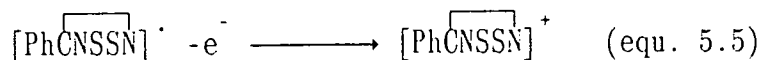

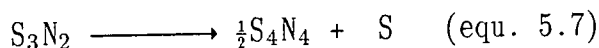
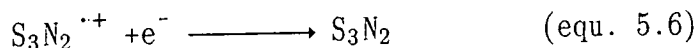

One must therefore conclude that in solution the $[\text{Ph}\overline{\text{CNSSN}}]\text{S}_3\text{N}_2^{2+}$ ion is thermodynamically unstable, decomposing as above, and that it is only due to its low solubility (i.e. a kinetic effect) that $[\text{Ph}\overline{\text{CNSSN}}][\text{S}_3\text{N}_2]\text{Cl}$ is produced.

5.2.8 Crystal growth and structure of $[\text{Ph}\overline{\text{CNSSN}}][\text{S}_3\text{N}_3]$:

Green platelets of $[\text{Ph}\overline{\text{CNSSN}}][\text{S}_3\text{N}_3]$ were formed, while attempting to grow large golden crystals of $[[\text{Ph}\overline{\text{CNSSN}}]_2\text{Cl}][\text{S}_3\text{N}_3]$, by the reaction of $[\text{S}_5\text{N}_5]\text{Cl}$ and $(\text{Ph}\overline{\text{CNSSN}})_2$ in pentane in a typical crystal growth experiment. After one month a very few gold crystals could be seen on the surface of the $[\text{S}_5\text{N}_5]\text{Cl}$, sparingly interspersed by green platelets. The green platelets were stable in an open atmosphere for many hours, and crystals for X-ray examination were therefore picked in air. The first crystal picked (0.04 x 0.15 x 0.40mm) was shown by an X-ray oscillation photograph to be a single crystal and was submitted for a full X-ray structure determination. The results of this analysis are shown in tables 5.11-14 and figures 5.12-16.

The asymmetric unit (figure 5.12) shows the S_3N_3 ring directly below the CN_2S_2 ring, the two planar halves being almost parallel at an angle of only 6.8° to one another. There is significant bonding between the sulphurs in the CN_2S_2 ring and the sulphurs (5 & 3) in the S_3N_3 ring, the S...S bond length being $2.9055(3)\text{\AA}$ (cf. $3.109(5)\text{\AA}$ in $(\text{Ph}\overline{\text{CNSSN}})_2$).¹⁴ In contrast, there is very little S...S interaction between adjacent CN_2S_2 rings ($d_{s\dots s} > 3.5\text{\AA}$) as seen from the side in an

Table 5.11 Crystal data, bond lengths and angles for $[\text{PhCNSSN}][\text{S}_3\text{N}_3]$ Crystal data: $\text{C}_7\text{H}_5\text{N}_5\text{S}_5$, $M_r = 319.45$ Triclinic, Space Group $\bar{P}1$ $a = 6.113(1)$, $b = 8.661(1)$, $c = 12.124(2)\text{\AA}$, $\alpha = 86.29(1)$ $\beta = 76.50(1)$, $\gamma = 70.18(1)^\circ$, $V = 587.12\text{\AA}^3$, $Z = 2$, $R = 0.0340$ for 2881 reflections with $F > 4\sigma_c(F)$ and $2\theta \geq 50^\circ$.Bond Lengths (\AA) and angles ($^\circ$)

$\text{C}(1)-\text{C}(2)$	1.471(5)	$\text{C}(1)-\text{N}(1)$	1.349(6)
$\text{C}(1)-\text{N}(2)$	1.338(5)	$\text{C}(2)-\text{C}(3)$	1.392(6)
$\text{C}(2)-\text{C}(7)$	1.394(7)	$\text{C}(3)-\text{C}(4)$	1.376(6)
$\text{C}(4)-\text{C}(5)$	1.370(7)	$\text{C}(5)-\text{C}(6)$	1.386(7)
$\text{C}(6)-\text{C}(7)$	1.373(6)	$\text{N}(1)-\text{S}(1)$	1.611(3)
$\text{N}(2)-\text{S}(2)$	1.619(3)	$\text{S}(1)-\text{S}(2)$	2.064(2)
$\text{N}(3)-\text{S}(3)$	1.623(4)	$\text{N}(3)-\text{S}(5)$	1.616(4)
$\text{S}(3)-\text{N}(4)$	1.574(4)	$\text{N}(4)-\text{S}(4)$	1.630(4)
$\text{S}(4)-\text{N}(5)$	1.636(4)	$\text{N}(5)-\text{S}(5)$	1.564(4)
$\text{C}(2)-\text{C}(1)-\text{N}(1)$	119.4(4)	$\text{C}(2)-\text{C}(1)-\text{N}(2)$	119.9(4)
$\text{N}(1)-\text{C}(1)-\text{N}(2)$	120.8(3)	$\text{C}(1)-\text{C}(2)-\text{C}(3)$	119.7(4)
$\text{C}(1)-\text{C}(2)-\text{C}(7)$	121.3(4)	$\text{C}(3)-\text{C}(2)-\text{C}(7)$	119.0(4)
$\text{C}(2)-\text{C}(3)-\text{C}(4)$	120.2(4)	$\text{C}(3)-\text{C}(4)-\text{C}(5)$	120.7(4)
$\text{C}(4)-\text{C}(5)-\text{C}(6)$	119.4(4)	$\text{C}(5)-\text{C}(6)-\text{C}(7)$	120.7(5)
$\text{C}(2)-\text{C}(7)-\text{C}(6)$	119.9(4)	$\text{C}(1)-\text{N}(1)-\text{S}(1)$	114.8(3)
$\text{C}(1)-\text{N}(2)-\text{S}(2)$	114.8(3)	$\text{N}(1)-\text{S}(1)-\text{S}(2)$	94.9(2)
$\text{N}(2)-\text{S}(2)-\text{S}(1)$	94.8(1)	$\text{S}(3)-\text{N}(5)-\text{S}(5)$	122.6(2)
$\text{N}(3)-\text{S}(3)-\text{N}(4)$	116.1(2)	$\text{S}(3)-\text{N}(4)-\text{S}(4)$	125.5(3)
$\text{N}(4)-\text{S}(4)-\text{N}(5)$	113.4(2)	$\text{S}(4)-\text{N}(5)-\text{S}(5)$	125.2(3)
$\text{N}(3)-\text{S}(5)-\text{N}(5)$	116.7(2)		

Table 5.12 The atomic co-ordinates ($\times 10^4$) and isotropic thermal parameters ($\text{\AA}^2 \times 10^3$) for the hydrogen atoms

Atom	x	y	z	U
H(3)	7902	6640	2260	48
H(4)	6709	8390	809	58
H(5)	3698	8206	3	57
H(6)	1759	6308	705	57
H(7)	2843	4594	2187	51

Table 5.13 The atomic co-ordinates ($\times 10^4$) for $[\text{PhCNSN}][\text{S}_3\text{N}_3]$

Atom	\bar{x}	\bar{y}	\bar{z}
C(1)	6264(6)	4343(4)	3285(3)
C(2)	5490(6)	5443(4)	2370(3)
C(3)	6629(7)	6574(5)	1948(3)
C(4)	5935(7)	7599(5)	1085(4)
C(5)	4153(7)	7501(5)	614(3)
C(6)	3012(7)	6377(5)	1030(4)
C(7)	3656(7)	5360(5)	1901(3)
N(1)	8168(6)	4373(4)	3652(3)
N(2)	5076(5)	3328(4)	3743(3)
S(1)	8850(2)	3108(1)	4652(1)
S(2)	6117(2)	2183(1)	4739(1)
N(3)	11035(5)	-536(4)	3609(3)
S(3)	8779(2)	-571(1)	3134(1)
N(4)	8343(6)	457(4)	2039(3)
S(4)	9829(2)	1641(1)	1417(1)
N(5)	11962(6)	1639(4)	2019(3)
S(5)	12520(2)	684(1)	3116(1)

Table 5.14 Anisotropic thermal parameters ($\text{\AA}^2 \times 10^3$) for $[\text{PhCNSN}][\text{S}_3\text{N}_3]$
The anisotropic temperature factor exponent takes the form $-2\pi(h^2 a^{*2} U_{11} + \dots + 2hka^* b^* U_{12})$

Atom	U_{11}	U_{22}	U_{33}	U_{23}	U_{13}	U_{12}
C(1)	31(2)	27(2)	39(2)	-2(2)	-5(2)	-6(2)
C(2)	32(2)	31(2)	35(2)	-2(2)	-3(2)	-7(2)
C(3)	39(2)	40(2)	44(2)	5(2)	-10(2)	-14(2)
C(4)	53(3)	40(2)	53(3)	4(2)	-2(2)	-22(2)
C(5)	48(2)	41(2)	44(2)	10(2)	-13(2)	-4(2)
C(6)	41(2)	52(3)	56(3)	12(2)	-24(2)	-15(2)
C(7)	37(2)	43(2)	51(3)	14(2)	-16(2)	-16(2)
N(1)	46(2)	32(2)	47(2)	3(2)	-20(2)	-15(2)
N(2)	32(2)	37(2)	47(2)	9(2)	-10(1)	-9(1)
S(1)	52(1)	39(1)	45(1)	2(1)	-23(1)	-12(1)
S(2)	39(1)	42(1)	39(1)	8(1)	-4(1)	-9(1)
N(3)	37(2)	35(2)	41(2)	10(2)	-13(1)	-12(1)
S(3)	40(1)	42(1)	54(1)	0(1)	-11(1)	-21(1)
N(4)	40(2)	59(2)	53(2)	-6(2)	-20(2)	-18(2)
S(4)	48(1)	59(1)	38(1)	8(1)	-13(1)	-12(1)
N(5)	42(2)	54(2)	50(2)	12(2)	-3(2)	-21(2)
S(5)	29(1)	47(1)	53(1)	5(1)	-15(1)	-14(1)

Figure 5.12 $[\overline{\text{PhCNSSN}}][\text{S}_3\text{N}_3]$ - the asymmetric unit.

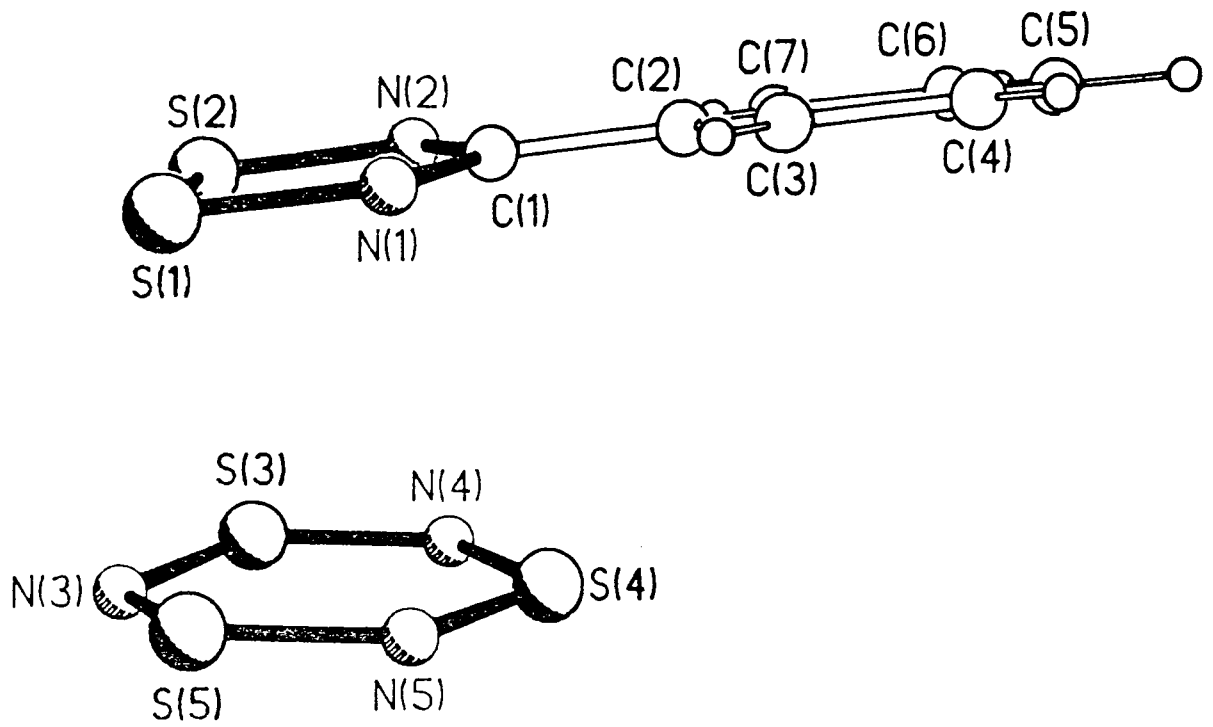

Figure 5.13 The ABBA stacking arrangement in $[\text{Ph}\overline{\text{CNSSN}}][\text{S}_3\text{N}_3]$.

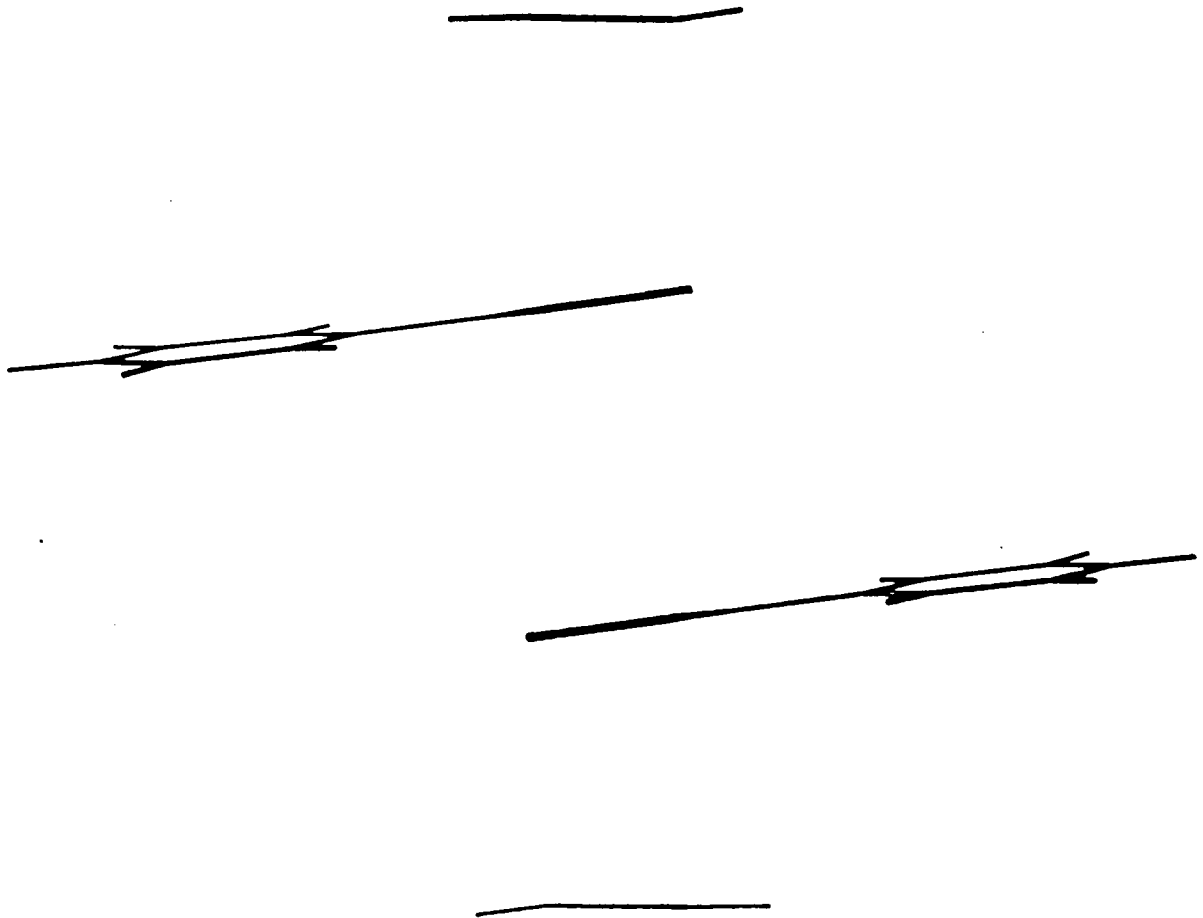

Figure 5.14 A projection down the $S_3N_3^-$ plane of $[\overline{\text{PhCNSSN}}][S_3N_3]$

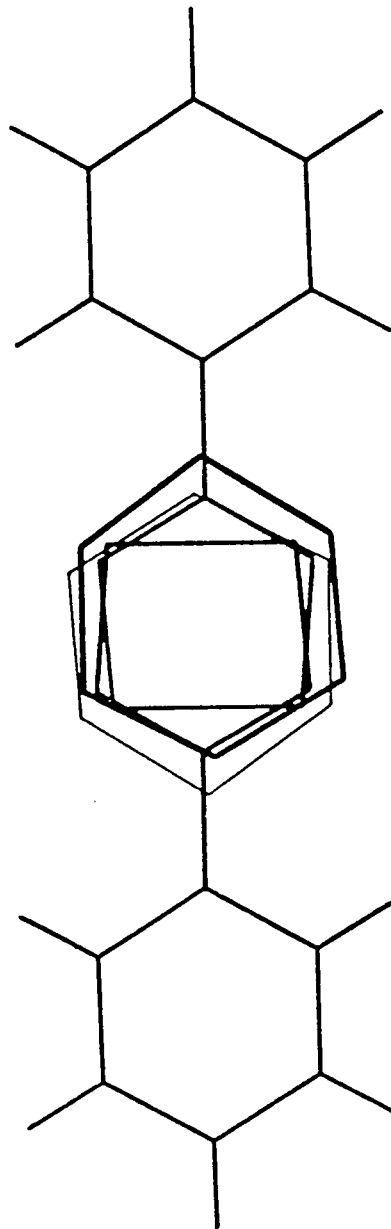

Figure 5.15 The close proximity of the S(5 & 3) atoms in the $S_3N_3^-$ ring to the sulphurs in the CN_2S_2 ring.

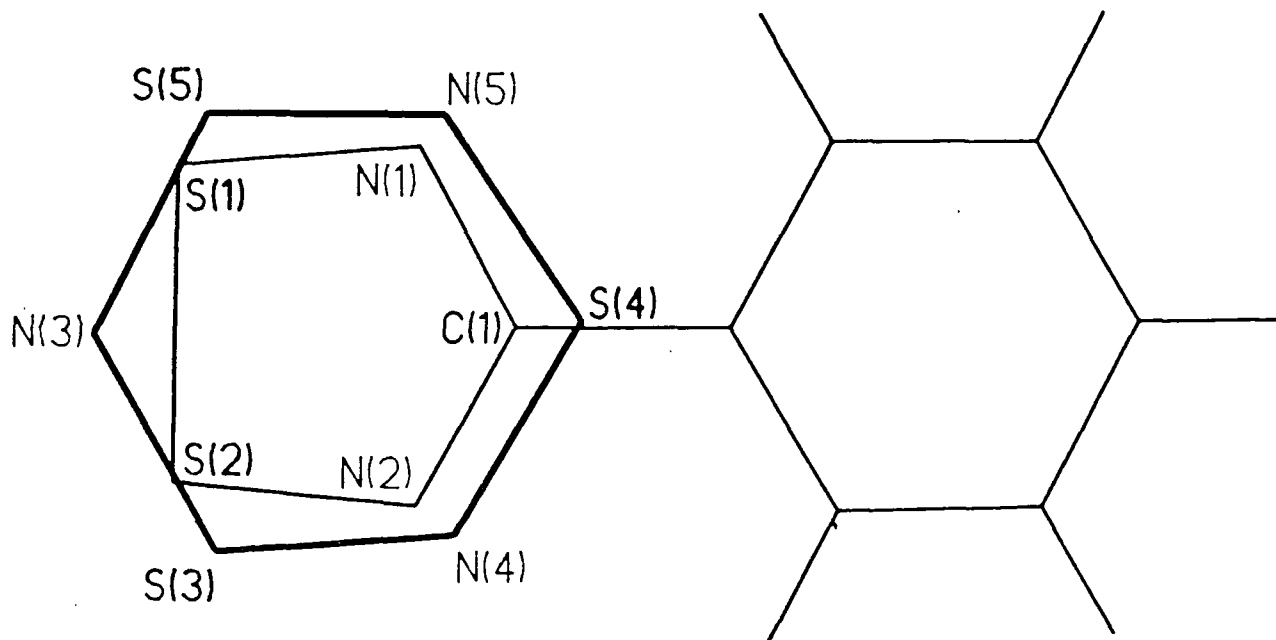
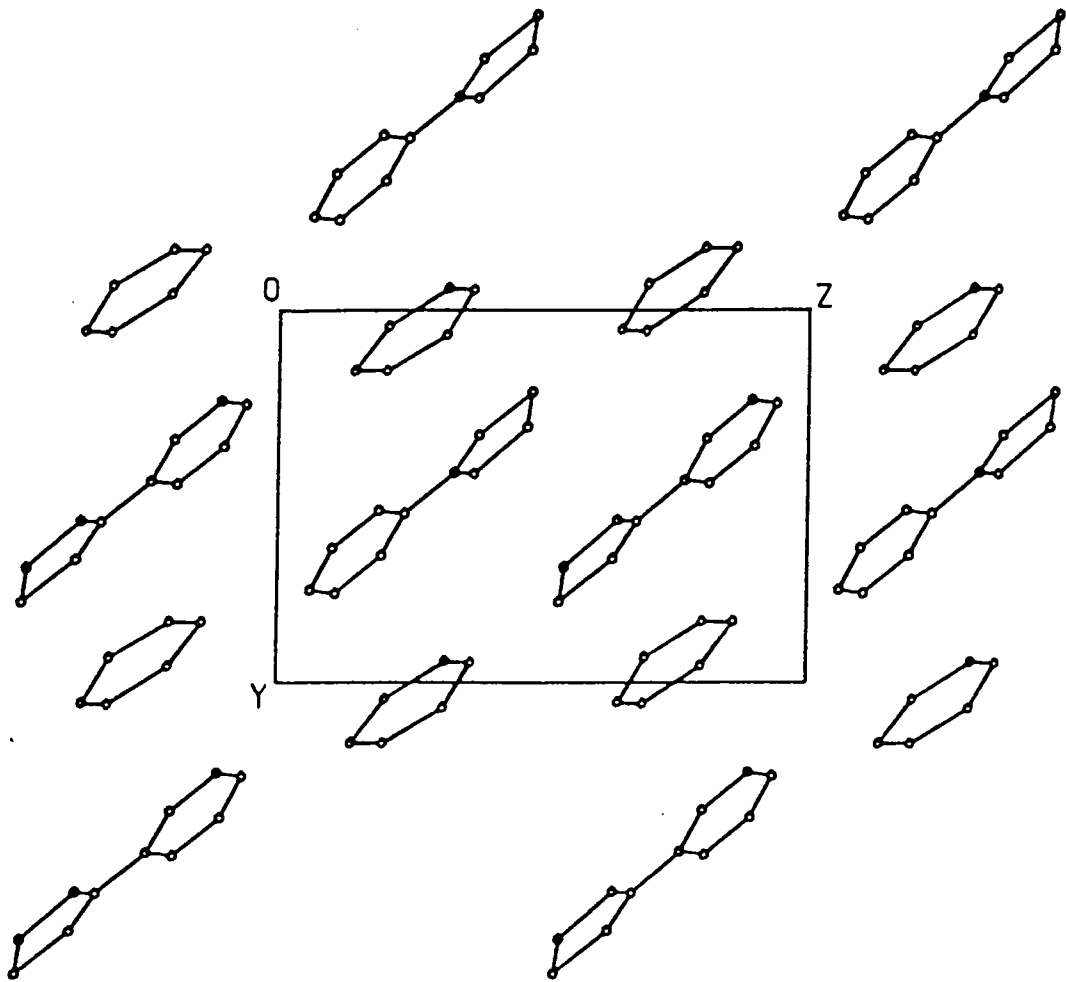

Figure 5.16 The unit cell of $[\text{PhCNSSN}]^+[\text{S}_3\text{N}_3]^-$ showing the parallel rings.



ABBA stacking arrangement (figure 5.13). The same arrangement of molecules can be seen, projected down the S_3N_3 plane in figure 5.14. Figure 5.15 shows the close proximity of the sulphur atoms in the CN_2S_2 ring to those relevant in the S_3N_3 ring. As in $[[\text{Ph}\overline{\text{CNSSN}}]_2\text{Cl}][\text{S}_3\text{N}_3]$ (*cf.* section 5.2.1), the unit cell shows the molecules packed in a parallel arrangement containing two molecules per unit cell (figure 5.16).

The differences in the $S_3N_3^-$ anion parameters for $[\text{Bu}^t_4\text{N}]\text{S}_3\text{N}_3$ ($R = 0.097$)³⁶ and $[\text{Ph}\overline{\text{CNSSN}}][\text{S}_3\text{N}_3]$ ($R = 0.034$) are within X-ray crystallographic errors. The bonding in the $CN_2S_2^+$ ring is also similar to other known CN_2S_2 rings;³⁸ the S-S bond length of $2.064(2)\text{\AA}$, which is intermediate between $(\text{Ph}\overline{\text{CNSSN}})_2$ ($2.089(5)\text{\AA}$) and in $[\text{Ph}\overline{\text{CNSSN}}]\text{Cl}$ (1.991\AA), suggests that there is substantial electron donation from the $S_3N_3^-$ ring into the $CN_2S_2^+$ ring.

The earlier reaction between $[\text{S}_5\text{N}_5]\text{Cl}$ and $(\text{Ph}\overline{\text{CNSSN}})_2$ in CH_3CN (*cf.* section 5.2.1) produced $[[\text{Ph}\overline{\text{CNSSN}}]_2\text{Cl}][\text{S}_3\text{N}_3]$ with no evidence of $[\text{Ph}\overline{\text{CNSSN}}][\text{S}_3\text{N}_3]$. However, when the solvent was changed to pentane both compounds were produced. Although the solubility of these compounds has not yet been studied, it could be clearly seen from the almost colourless solution, that both were almost insoluble in pentane. Hence, the kinetic factor of solubility must be competing with the product that is the most thermodynamically stable; in this case balancing to produce both $[\text{Ph}\overline{\text{CNSSN}}][\text{S}_3\text{N}_3]$ and $[[\text{Ph}\overline{\text{CNSSN}}]_2\text{Cl}][\text{S}_3\text{N}_3]$.

5.2.9 Preparation of $[\text{Ph}\overline{\text{CNSSN}}][\text{S}_3\text{N}_3]$:

a) Reaction of $[\text{Ph}\overline{\text{CNSSN}}][\text{AsF}_6]$ with $[\text{Pr}_4\text{N}][\text{S}_3\text{N}_3]$ in CH_3CN . $[\text{Ph}\overline{\text{CNSSN}}][\text{S}_3\text{N}_3]$ is relatively insoluble in acetonitrile and was therefore easily prepared by precipitation from the stoichiometric

metathesis of $[\overline{\text{PhCNSSN}}]\text{AsF}_6$ and $[\text{Pr}_4\text{N}][\text{S}_3\text{N}_3]$; the other product $[\text{Pr}_4\text{N}]\text{AsF}_6$, which is readily soluble in acetonitrile, remained in solution. After crude cleaning with acetonitrile, the green product was sublimed at 70°C under high vacuum (*ca.* 10^{-6} torr) and collected on a cold finger at -20°C . There was a small amount of a grey residue, identified by infra-red spectroscopy as $[\text{Pr}_4\text{N}]\text{AsF}_6$. The green sublimate was identified by infra-red spectroscopy, elemental analysis and mass spectroscopy as $[\overline{\text{PhCNSSN}}][\text{S}_3\text{N}_3]$. D.S.C. measurements showed melting at 130°C followed by slow decomposition at 148°C .

b) Reaction of $[\text{S}_5\text{N}_5]\text{Cl}$ with $(\overline{\text{PhCNSSN}})_2$ in SO_2 . The reaction between $[\text{S}_5\text{N}_5]\text{Cl}$ and $(\overline{\text{PhCNSSN}})_2$ produced $[[\overline{\text{PhCNSSN}}]_2\text{Cl}][\text{S}_3\text{N}_3]$ in acetonitrile and both $[[\overline{\text{PhCNSSN}}]_2\text{Cl}][\text{S}_3\text{N}_3]$ and $[\overline{\text{PhCNSSN}}][\text{S}_3\text{N}_3]$ in pentane. In SO_2 only $[\overline{\text{PhCNSSN}}][\text{S}_3\text{N}_3]$ was produced in *ca.* 56% yield (a small amount of an unidentified yellow impurity was also present). It has been shown previously that $[\text{S}_5\text{N}_5]\text{Cl}$ is soluble in SO_2 due to the interaction of the solvent with the chloride ion producing the chlorosulphite, SO_2Cl^- , ion.⁴⁵ Hence we are really looking at the reaction between $(\overline{\text{PhCNSSN}})_2$ and $[\text{S}_5\text{N}_5]\text{SO}_2\text{Cl}$. The initial product, $[\overline{\text{PhCNSSN}}]\text{SO}_2\text{Cl}$, will not react with $(\overline{\text{PhCNSSN}})_2$ producing $[\overline{\text{PhCNSSN}}]_2\text{SO}_2\text{Cl}$ (*cf.* $[\overline{\text{PhCNSSN}}]_2\text{Cl}$ section 5.2.11) as the larger SO_2Cl^- ion will be less able to coordinate to both $[\overline{\text{PhCNSSN}}]^+$ ions thus avoiding precipitation of $[[\overline{\text{PhCNSSN}}]_2\text{SO}_2\text{Cl}][\text{S}_3\text{N}_3]$.

c) Reaction of $[\text{S}_5\text{N}_5][\text{AlCl}_4]$ with $(\overline{\text{PhCNSSN}})_2$ in CH_3CN . $[\text{S}_5\text{N}_5]\text{AlCl}_4$ was reacted with $(\overline{\text{PhCNSSN}})_2$ in acetonitrile, in a typical crystal growth experiment, in an attempt to find new routes to synthesise crystals of $[\overline{\text{PhCNSSN}}][\text{S}_3\text{N}_3]$. After one week the products were isolated and

identified by infra-red spectroscopy as $[\text{PhCNSSN}][\text{S}_3\text{N}_3]$, S_4N_4 and $[\text{PhCNSSN}]\text{AlCl}_4$. As for the reaction between $[\text{S}_5\text{N}_5]\text{SO}_2\text{Cl}$ and $(\text{PhCNSSN})_2$ (cf. section 5.2.9b), the AlCl_4^- is too large to coordinate with two $[\text{PhCNSSN}]^+$ ions thus avoiding precipitation of $[[\text{PhCNSSN}]_2\text{AlCl}_4][\text{S}_3\text{N}_3]$.

The $[\text{PhCNSSN}][\text{S}_3\text{N}_3]$ crystals produced were large (up to 2mm in length) and well formed. Although $[\text{PhCNSSN}]^+$ and S_3N_3^- are electron pair species (6π and 10π respectively), samples of $[\text{PhCNSSN}][\text{S}_3\text{N}_3]$ showed a strong powder esr signal (figure 5.17) typical for that of $(\text{PhCNSSN})_2$ (i.e. ill resolved).¹⁶ This does not appear to be due to contamination as single crystal measurements show the spectra to be orientation dependent. The presence of such a signal is more likely to originate from crystal defects which could produce small amounts of monomeric $[\text{PhCNSSN}]^{\cdot}$. A detailed ^{e.s.f.} single crystal study is in progress and the results will be reported later.

d) **Mixing vapours of $(\text{SN})_x$ and $(\text{PhCNSSN})_2$** . There has been much interest in the vapour species volatilised from $(\text{SN})_x$, with earlier workers suggesting linear $(\text{SN})_4$ as the predominant species.²² Irrespective of more recent studies, doubts still remain as to which species hold the key role in the polymer formation. Lau *et al*⁴⁶ showed by HeI photoelectron spectroscopy and *in situ* mass spectrometry, that the vapour above $(\text{SN})_x$ *in vacuo* at 130-150°C is comprised mainly of $\text{S}_3\text{N}_3^{\cdot}$ radicals. Ab initio calculation further showed that this $\text{S}_3\text{N}_3^{\cdot}$ radical is most likely to be in the configuration of a planar ring. Besenyeyi *et al*⁴⁷ suggest a different mechanism in which $(\text{SN})_2$ and SN species assume the role of the main building blocks in $(\text{SN})_x$ formation. On this basis it was thought that $(\text{SN})_x$ vapour might react with $(\text{PhCNSSN})_2$ vapour producing $[\text{PhCNSSN}][\text{S}_3\text{N}_3]$ as shown in equation 5.8

Figure 5.17 a) The e.s.r. spectrum from a single crystal of $[\text{PhCNSSN}]^+[\text{S}_3\text{N}_3]^-$.

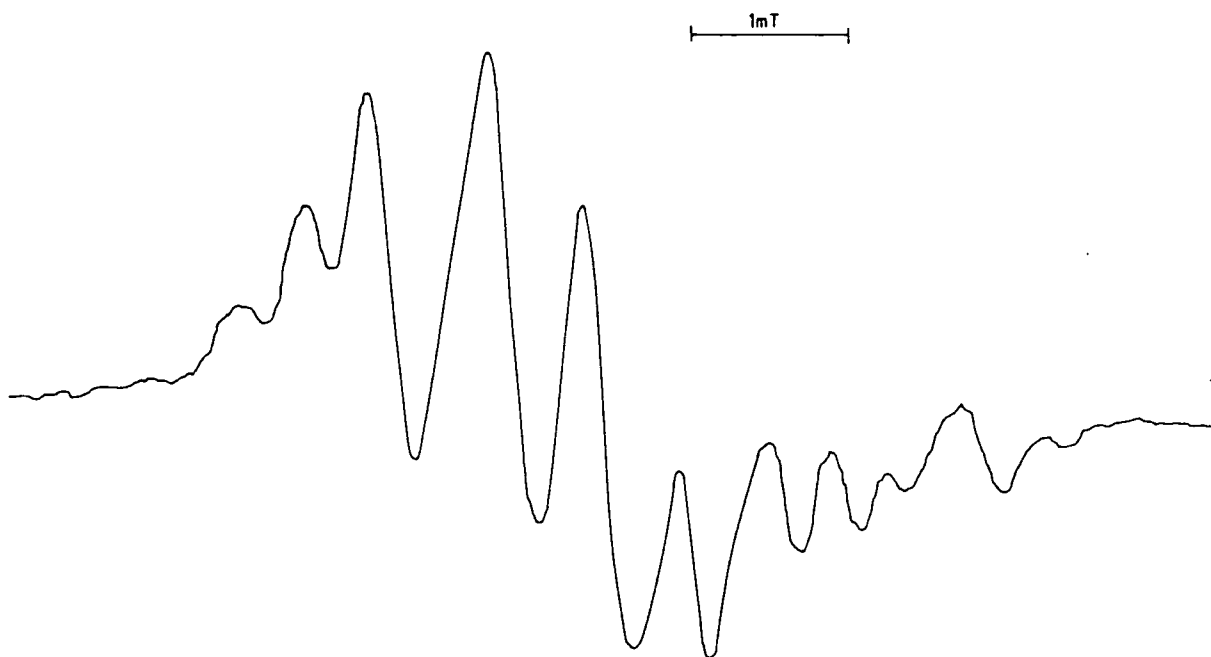

b) The e.s.r. spectrum taken at 90° to a) showing the orientation dependence of the crystal.

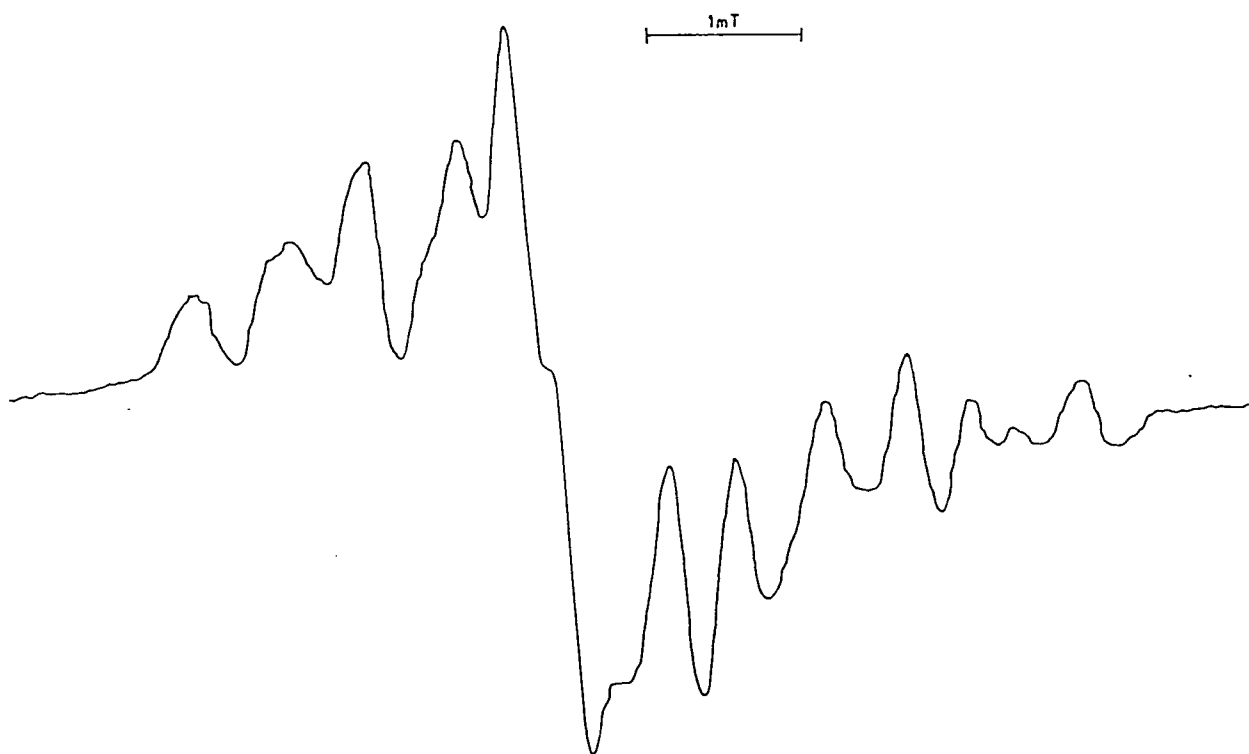

below.

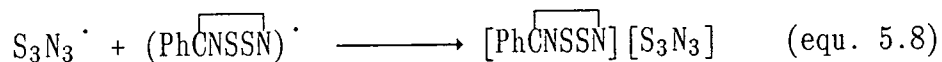

Indeed when the vapours of $(SN)_x$ (heated at 160°C) and $(\overline{\text{PhCNSSN}})_2$ (heated at 50°C) were mixed together at 160°C through quartz wool *in vacuo* (3×10^{-6} torr), and the products collected on a cold finger at -196°C , $[\overline{\text{PhCNSSN}}][S_3N_3]$ and S_4N_4 (often produced when $(SN)_x$ is vacuum sublimed) were produced with some unreacted $(\overline{\text{PhCNSSN}})_2$ and $(SN)_x$. The source temperatures for $(\overline{\text{PhCNSSN}})_2$ and $(SN)_x$ were chosen so as to obtain a favourable ratio of the mass flow of both components; the purpose of the quartz wool was to enhance mixing and frequency of collisions. Only small amounts of $[\overline{\text{PhCNSSN}}][S_3N_3]$ were produced in the absence of quartz wool, the other materials on the cold finger being starting materials.

Although this result adds much weight towards the existence of cyclic $S_3N_3 \cdot$ in the vapour phase, it is not entirely conclusive as SN monomer and $(SN)_2$ could be the vapour species which react with one another to produce $S_3N_3 \cdot$, hence the higher yield when the mean path length is increased by the incorporation of the quartz wool. It is less likely however that linear $(SN)_4$ could cyclise and eject an SN unit producing cyclic $S_3N_3 \cdot$.

5.2.10 Reaction of $[\overline{\text{PhCNSSN}}]AsF_6$ with $[\text{Pr}_4N]S_3N_3$ in CH_2Cl_2 :

The reaction between $[\overline{\text{PhCNSSN}}]AsF_6$ and $[\text{Pr}_4N]S_3N_3$ in acetonitrile (*cf.* section 5.2.9a) produced a green precipitate of $[\overline{\text{PhCNSSN}}][S_3N_3]$ in 56% yield; in a typical crystal growth experiment using CH_2Cl_2 as the solvent, S_4N_4 , $(\overline{\text{PhCNSSN}})_2$ and $[\text{Pr}_4N]AsF_6$ were produced. Clearly in CH_2Cl_2 a redox reaction is occurring as shown in equations 5.9-11

below.

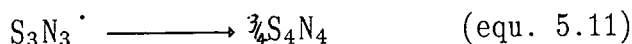
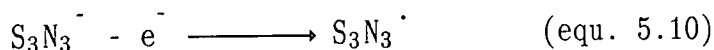
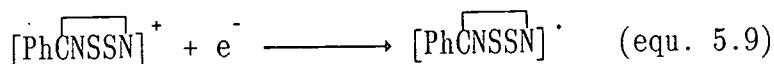

The reversible reduction of $[\text{Ph}\overline{\text{CNSSN}}]^+$ to $[\text{Ph}\overline{\text{CNSSN}}]^\cdot$ has been shown to occur at *ca.* +0.6V (w.r.t. S.C.E.)⁴⁰ in acetonitrile. Fritz *et al* showed⁴⁸ the reversible reduction of $\text{S}_3\text{N}_3^\cdot$ to S_3N_3^- to occur at *ca.* +0.17V. Looking at the half cell equations (equation 5.12-14 below) it can be seen that the overall emf of reaction is *ca.*+0.43V.

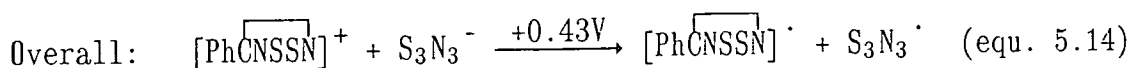
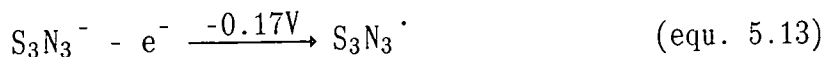
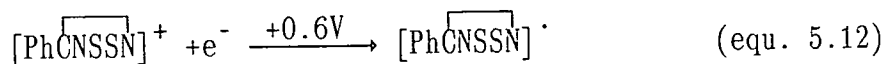

Since $\Delta G = -nFE_{\text{rxn}}$ and the emf is positive (+0.43V), ΔG will be negative showing thermodynamically that the reaction will be spontaneous. Presumably in acetonitrile the low solubility of $[\text{Ph}\overline{\text{CNSSN}}][\text{S}_3\text{N}_3]$ is such that this kinetic effect overrides the thermodynamic effect suggesting that $[\text{Ph}\overline{\text{CNSSN}}][\text{S}_3\text{N}_3]$ is more soluble in CH_2Cl_2 than in acetonitrile.

5.2.11 Preparation of $[\text{PhCNSSN}]_2\text{Cl}$:

When $(\text{PhCNSSN})_2$ and $[\text{PhCNSSN}]\text{Cl}$ were thoroughly ground together in a 1:2 molar ratio, and heated at 156°C under a blanket of nitrogen, a brown solid was formed which was shown by elemental analysis, infra-red spectroscopy and mass spectroscopy to be $[\text{PhCNSSN}]_2\text{Cl}$ (equation 5.15).

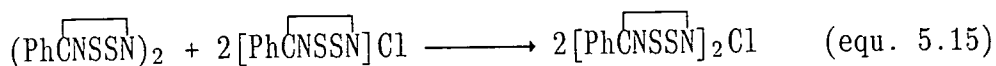

The reaction occurs in a quantitative yield as shown by the absence of starting material peaks in the infra-red spectrum of the product. A similar compound, $(\text{CF}_3\text{CN}_2\text{S}_2)_3\text{Cl}$, was reported by Mews⁴ which consisted of a central Cl^- surrounded by three $\text{CF}_3\text{CN}_2\text{S}_2$ units.

The solid esr spectrum (figure 5.18) showed a single intense broad peak, which was not orientation dependant in a single crystal, indicating the presence of a relatively mobile radical. This new compound can be thought of as a mixture of $[\text{PhCNSSN}]^+\text{Cl}^-$ and $(\text{PhCNSSN})^\cdot$, the electron probably swapping between CN_2S_2 rings in each molecule giving a resonance structure of $[\text{PhCNSSN}^{\frac{1}{2}+\frac{1}{2}}]_2\text{Cl}^-$. Similarly the compound produced by Mews gave an esr spectrum.⁴

5.2.12 Extraction of $[\text{PhCNSSN}]_2\text{Cl}$:

When $[\text{PhCNSSN}]_2\text{Cl}$ was extracted for one hour with acetonitrile, and the solvent removed, a dirty yellow solid remained on the frit and a brown compound in the bulb. The dirty yellow compound was shown by infra-red spectroscopy to be $[\text{PhCNSSN}]\text{Cl}$. In solution there would appear to be an equilibrium (equation 5.16 overleaf) between $[\text{PhCNSSN}]_2\text{Cl}$ and the two starting materials, $[\text{PhCNSSN}]\text{Cl}$ and $(\text{PhCNSSN})_2$; indeed in many crystal growth reactions between $(\text{PhCNSSN})_2$ and S/N/

Figure 5.18 The e.s.r. spectrum of crystalline $[\text{Ph}\overline{\text{CNSSN}}]_2\text{Cl}$.

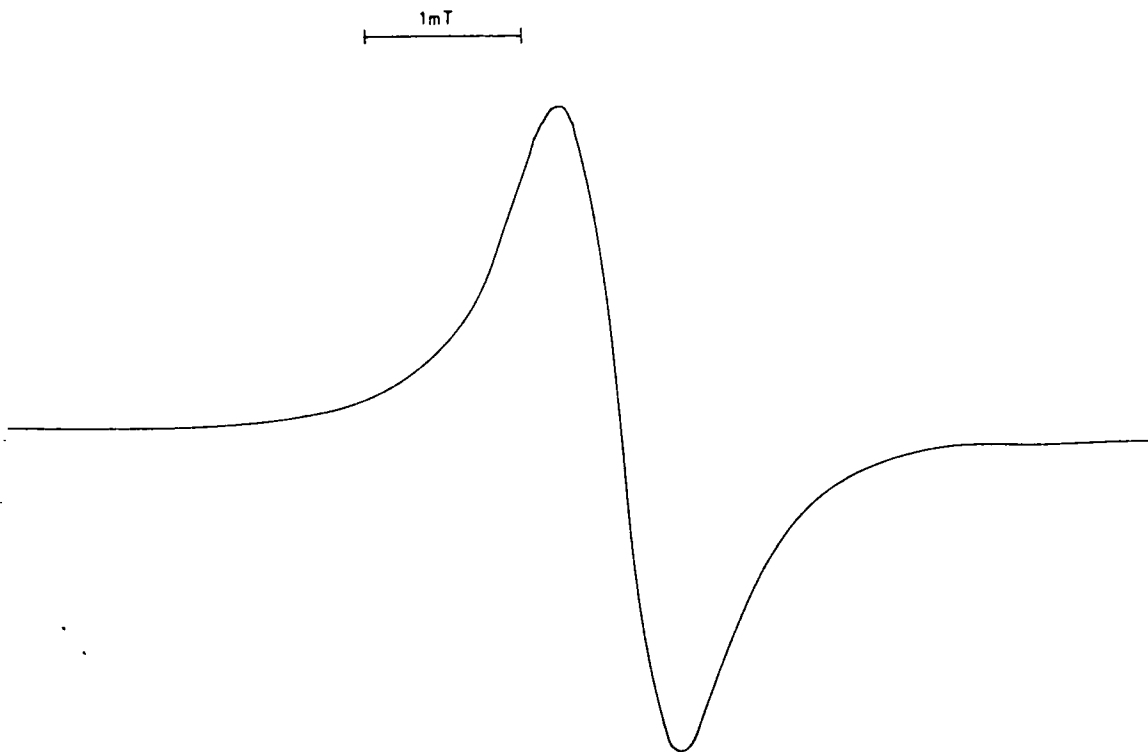

chlorides all three compounds could be seen individually.

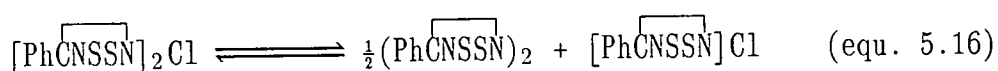

In the solid state this equilibrium is well over to the left hand side, as shown by the lack of infra-red absorptions corresponding to the species on the right hand side. In solution, however, the lower solubility of $[\text{Ph}\overline{\text{CNSSN}}]\text{Cl}$, compared with $(\text{Ph}\overline{\text{CNSSN}})_2$, allows the more soluble $(\text{Ph}\overline{\text{CNSSN}})_2$ to be extracted creating an excess of relatively insoluble $[\text{Ph}\overline{\text{CNSSN}}]\text{Cl}$ which remains on the frit.

5.2.13 Reaction in a DC nitrogen plasma of:

a) $[\text{Ph}\overline{\text{CNSSN}}][\text{S}_3\text{N}_3]$. The unique insertion of atomic nitrogen, generated in a DC plasma, into the disulphide link of a five membered 1,2,3,5-dithiadiazole, RCN_2S_2 ($\text{R} = \text{Ph}, \text{p-ClPh}$), has previously been reported.¹⁷ More recently it has been shown that some dithiadiazoliums, $[\text{RCN}_2\text{S}_2]^+\text{X}^-$ ($\text{R} = \text{Ph}, \text{p-ClPh}, \text{X} = \text{I}^-, \text{Br}^-$), will also react¹⁸ with the formation of $(\text{Ar}\overline{\text{CNSSN}})_2$ and the release of the corresponding neutral halogen. The mechanism of the nitrogen insertion reactions involving dithiadiazolium salts is uncertain, although it has been shown that larger more polarisable anions, such as I^- and Br^- , promote the reaction. It has also been shown that large holes¹⁸ running through the lattice in $(\text{Ph}\overline{\text{CNSSN}})_2$ (3.5Å in diameter) allow the atomic nitrogen to approach the reaction sites. Such channels, although only 2.6Å in diameter, are also present in $[\text{Ph}\overline{\text{CNSSN}}][\text{S}_3\text{N}_3]$ adjacent to the S-S bonds of the CN_2S_2 ring and run approximately along the crystallographic a axis (figure 5.19). It is hardly surprising therefore that reaction occurs, producing $(\text{Ph}\overline{\text{CN}_3\text{S}_2})_2$, since the S_3N_3^- anion is large and

Figure 5.19 A projection along the crystallographic a axis showing the tunnels (2.6Å diameter) through the $[\text{PhCNSSN}][\text{S}_3\text{N}_3]$ lattice.

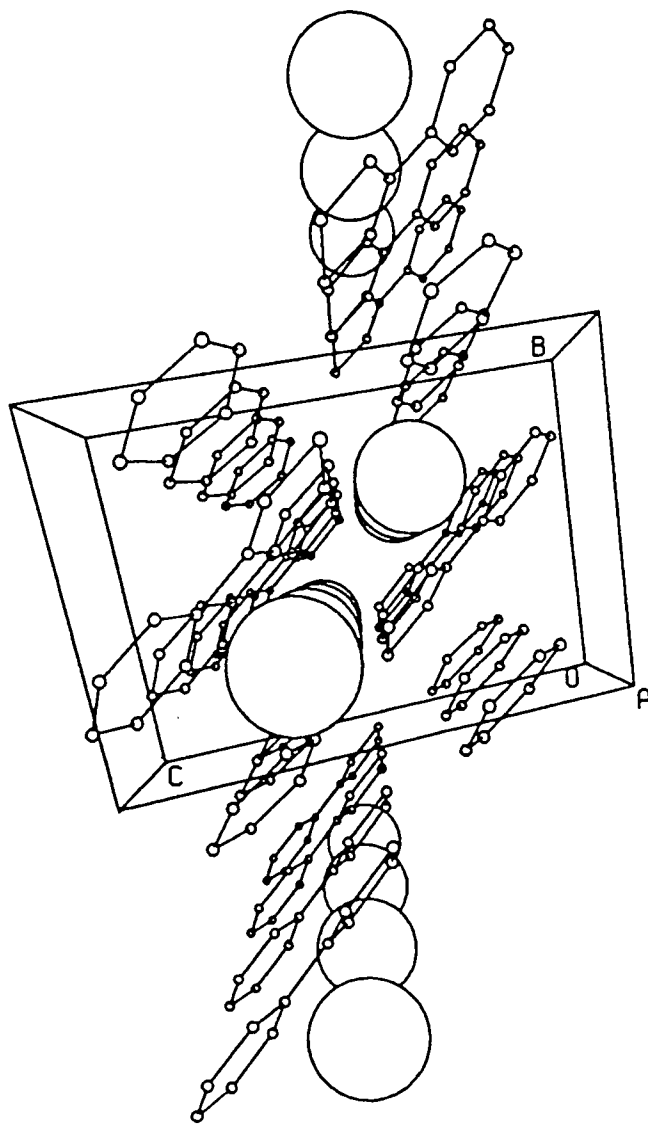

polarisable and that large channels can be seen running through the crystal lattice. No other S/N material was detected and so it must be assumed that the S_3N_3 was incorporated in the brown polymer also produced.

b) $[\overline{[PhCNSSN]}_2Cl][S_3N_3]$. Similarly $[\overline{[PhCNSSN]}_2Cl][S_3N_3]$ produced $(PhCN_3S_2)_2$ and $[\overline{[PhCNSSN]}]Cl$ in the plasma. Structurally $[\overline{[PhCNSSN]}_2Cl][S_3N_3]$ consists of a $[\overline{[PhCNSSN]}]Cl$ portion weakly bonded, through S...Cl bonds, to a $[\overline{[PhCNSSN]}][S_3N_3]$ unit. Under the strenuous conditions of heat and vacuum the molecule decomposes to produce $[\overline{[PhCNSSN]}]Cl$ and $[\overline{[PhCNSSN]}][S_3N_3]$ (*cf.* section 5.2.4). The conditions in a nitrogen plasma are also quite strenuous so it is likely that $[\overline{[PhCNSSN]}_2Cl][S_3N_3]$ decomposed in the same fashion as above; $[\overline{[PhCNSSN]}][S_3N_3]$ producing $(PhCN_3S_2)_2$ and a brown polymer, and $[\overline{[PhCNSSN]}]Cl$ remaining unreacted.

c) $[\overline{[PhCNSSN]}][S_3N_2]Cl$. $[\overline{[PhCNSSN]}][S_3N_2]Cl$ reacted producing $(PhCN_3S_2)_2$ and a dark brown polymer which presumably originated from the S_3N_2Cl portion which was otherwise not seen. The CN_2S_2 ring in $[\overline{[PhCNSSN]}][S_3N_2]Cl$ is radical in character and the whole molecule is similar in configuration to $(\overline{[PhCNSSN]})_2$ (which reacts readily in a nitrogen plasma), so it is unsurprising that the reaction occurs.

d) $[\overline{[PhCNSSN]}_2]Cl$. $[\overline{[PhCNSSN]}_2]Cl$ also reacted, but at $100^\circ C$ (the other three all reacting at *ca.* $35^\circ C$) producing $[\overline{[PhCNSSN]}]Cl$ and a brown polymer. $[\overline{[PhCNSSN]}_2]Cl$ was shown to decompose at $100^\circ C$ *in vacuo* producing $(\overline{[PhCNSSN]})_2$ and $[\overline{[PhCNSSN]}]Cl$. At such high temperature in a nitrogen plasma $(\overline{[PhCNSSN]})_2$ produces only polymer and $[\overline{[PhCNSSN]}]Cl$ will

remain unreacted.

5.3 CONCLUSIONS

The reactions of the dithiadiazole dimer $(\text{Ph}\overline{\text{CNSSN}})_2$ with the two known SN cations S_5N_5^+ and S_4N_3^+ have produced three new dithiadiazolium salts by novel ring contractions. These are $[(\text{Ph}\overline{\text{CNSSN}})_2\text{Cl}][\text{S}_3\text{N}_3]$ (I), $[\text{Ph}\overline{\text{CNSSN}}][\text{S}_3\text{N}_2]\text{Cl}$ (II) and $[\text{Ph}\overline{\text{CNSSN}}][\text{S}_3\text{N}_3]$ (III). S_5N_5^+ (to produce I and III) and S_4N_3^+ (to produce II) were ring contracted to produce S_3N_3^- and S_3N_2^+ respectively. Higher yield routes to all three compounds have now been devised, yielding analytically pure products.

The crystal structures of all three compounds have been solved. In each structure there are considerable S...S secondary interactions between the CN_2S_2 rings and the other SN rings. These interactions affect the bond lengths in the individual rings to such an extent that the distribution of charge between each ring can be roughly assessed, e.g. whether it is +, radical, $\delta+$etc.

Compound (I) easily crystallises as large (up to 1cm) golden elongated prisms. Although they appear to be highly metallic no conduction has been observed. Perhaps the use of a different R group and/or a different halogen might give rise to conduction in the crystal.

Crystals of compound (III) have been shown to be esr active with an orientation dependency. The levels of free radical are such that it is a perfect compound in which to study the $[\text{Ph}\overline{\text{CNSSN}}]^\cdot$ radical in a single crystal. This is being followed up in Canada (by Dr.K. Preston) and should lead to some exciting results.

Another new dithiadiazolium, $[\text{Ph}\overline{\text{CNSSN}}]_2\text{Cl}$, was also prepared although a good single crystal could not be found. This compound is interesting in that it was prepared by the mechanical grinding of

$\frac{1}{2}(\text{Ph}\overline{\text{CNSSN}})_2$ with $[\text{Ph}\overline{\text{CNSSN}}]\text{Cl}$, producing a grey powder which was highly esr active. Perhaps if the R group on the dithiadiazole $(\text{RCN}_2\text{S}_2)_2$, and the R_1 group on the dithiadiazolium $[\text{R}_1\text{CN}_2\text{S}_2]\text{Cl}$ were different, and the product reduced, a mixed dimer could be produced $(\text{RCN}_2\text{S}_2^\cdot)(\text{R}_1\text{CN}_2\text{S}_2^\cdot)$.

The next, and most obvious, step is to prepare a whole range of derivatives by using a variety of R groups. This could lead to changes in the crystal structure and hence the properties of such new compounds.

5.4 EXPERIMENTAL

5.4.1 Crystal Growth of $[[\text{Ph}\overline{\text{CNSSN}}]_2\text{Cl}][\text{S}_3\text{N}_3]$:

$[\text{S}_5\text{N}_5]\text{Cl}$ (0.200g, 0.75mmol) was placed in one bulb of a dog with $(\text{Ph}\overline{\text{CNSSN}})_2$ (0.150g, 0.41mmol) in the other bulb. Acetonitrile (8ml) was added to each side. Inversion of the reaction vessel allowed the solutions to mix by slow diffusion through a medium porosity glass sinter. Removal of the brown solution (by syringe and pumping) yielded many large golden crystals, a few orange crystals of $[\text{Ph}\overline{\text{CNSSN}}]\text{Cl}$ and S_4N_4 , and some black needles of $[\text{Ph}\overline{\text{CNSSN}}]_2\text{Cl}$.

The golden crystals were identified by X-ray single crystal analysis and infra-red spectroscopy as $[[\text{Ph}\overline{\text{CNSSN}}]_2\text{Cl}][\text{S}_3\text{N}_3]$, $\nu_{\text{max}} = 1595(\text{w})$, $1400(\text{m})$, $1181(\text{m})$, $1173(\text{w})$, $1137(\text{m})$, $1022(\text{m})$, $946(\text{m br})$, $925(\text{sh})$, $905(\text{s})$, $875(\text{m})$, $811(\text{vs})$, $769(\text{m})$, $682(\text{s})$, $662(\text{m})$, $543(\text{m})$, $495(\text{sh})$, $482(\text{m})$. Esr inactive.

5.4.2 Preparation of $[[\text{Ph}\overline{\text{CNSSN}}]_2\text{Cl}][\text{S}_3\text{N}_3]$:

$[\text{S}_5\text{N}_5]\text{Cl}$ (0.375g, 1.41mmol) and $(\text{Ph}\overline{\text{CNSSN}})_2$ (0.625g, 1.73mmol) were placed together, with a teflon coated stirrer bar, in a 250ml round bottomed flask. Acetonitrile (55ml) was added and the reaction mixture

stirred. After 24 hours the solution was red and there was a golden precipitate. The mixture was filtered, the golden solid washed with acetonitrile (3 x 10ml) and the solvent removed by pumping.

The golden solid was identified by infra-red spectroscopy as $[[\text{PhCNSSN}]_2\text{Cl}][\text{S}_3\text{N}_3]$. Yield = 0.441g (56%), $\nu_{\text{max}} = 1596(\text{w})$, 1405(w sh), 1184(w), 1175(w), 1140(m), 1027(w), 945(m br), 925(w sh), 906(m), 891(w sh), 878(w), 871(w sh), 813(s), 770(w), 720(w), 693(w), 682(m), 675(w sh), 666(m), 541(m), 495(w), 483(w), 470(w sh). Analysis: found C, 31.32; H, 1.91; N, 17.96; S, 40.06; Cl, 7.30%; $[[\text{PhCNSSN}]_2\text{Cl}][\text{S}_3\text{N}_3]$ requires C, 31.31; H, 1.86; N, 18.26; S, 41.75; Cl, 6.62%. Mass spectroscopy (EI) showed m/e; 181 (100%) $[\text{PhCNSSN}]^+$, 138 (9.8%) S_3N_3^+ . D.S.C. showed; peak(w) 138-145°C, trough(w) 145-148°C, peak(s) 148-160°C, peak(m) 160-175°C, peak(m) 175-250°C.

5.4.3 Extraction of $[[\text{PhCNSSN}]_2\text{Cl}][\text{S}_3\text{N}_3]$:

$[[\text{PhCNSSN}]_2\text{Cl}][\text{S}_3\text{N}_3]$ (0.040g, 0.117mmol) was placed in a closed extractor and extracted to completion by acetonitrile. Removal of the solvent revealed many golden crystals and a small amount of a dirty brown solid. The infra-red spectrum showed $[[\text{PhCNSSN}]_2\text{Cl}][\text{S}_3\text{N}_3]$ to be the major product with traces of S_4N_4 , $[\text{PhCNSSN}]\text{Cl}$ and/or $[\text{PhCNSSN}]_2\text{Cl}$.

$\nu_{\text{max}} = 1595(\text{w})^{\text{a}}$, 1400(w)^a, 1175(w)^a, 1137(m)^a, 1023(m)^a, 948(m)^a, 925(m sh)^a, 875(m)^a, 840(w)^b, 812(s)^a, 780(w)^a, 770(w)^a, 720(w)^a, 698(w sh)^b, 692(w sh)^b, 683(m)^a, 663(m)^a, 550(w)^b, 542(m)^a, 495(w sh)^a, 482(w)^a, 478(w)^b, 468(w)^a, 455(vw)^a. a = $[[\text{PhCNSSN}]_2\text{Cl}][\text{S}_3\text{N}_3]$, b = S_4N_4 and/or $[\text{PhCNSSN}]\text{Cl}/[\text{PhCNSSN}]_2\text{Cl}$.

5.4.4 Vacuum Thermolysis of $[\overline{\text{PhCNSSN}}]_2\text{Cl} [\text{S}_3\text{N}_3]$:

$[\overline{\text{PhCNSSN}}]_2\text{Cl} [\text{S}_3\text{N}_3]$ (0.100g, 0.186mmol) was heated at 60°C under high vacuum ($>10^{-5}$ torr) and the volatile product collected on a cold finger at 0°C. After 8 hours the cold finger was dark green and an orange residue remained at the bottom of the sublimator. The residue and the product on the cold finger were identified by infra-red spectroscopy as $\overline{\text{PhCNSSN}}\text{Cl}$ and $\overline{\text{PhCNSSN}} [\text{S}_3\text{N}_3]$ respectively.

Yield of $\overline{\text{PhCNSSN}}\text{Cl}$ = 0.038g (93%), ν_{max} = 1601(m), 1439(s), 1295(w), 1150(m), 1029(w), 923(m), 895(m), 849(s), 797(w), 784(m), 700(s), 550(s). Yield of $\overline{\text{PhCNSSN}} [\text{S}_3\text{N}_3]$ = 0.051g (86%), ν_{max} = 1594(w), 1241(w), 1184(m), 1148(m), 1078(w br), 1029(m), 990(m br), 926(w), 908(m), 854(m), 844(w sh), 806(s), 776(s), 726(w), 700(m), 687(m), 664(m), 648(s), 603(m), 550(w), 536(w), 458(w).

5.4.5 Crystal Growth of $\overline{\text{PhCNSSN}} [\text{S}_3\text{N}_2]\text{Cl}$:

$\text{S}_4\text{N}_3\text{Cl}$ (0.100g, 0.487mmol) was placed in one bulb of a dog with $(\overline{\text{PhCNSSN}})_2$ (0.088g, 0.243mmol) in the other bulb. Acetonitrile (8ml) was added to each side. Inversion of the reaction vessel allowed the solutions to mix by slow diffusion, over a period of one week, through a medium porosity glass sinter. Removal of the brown solution (by syringe and pumping) revealed many orange (S_4N_4 and $\overline{\text{PhCNSSN}}\text{Cl}$) and black crystals ($[\overline{\text{PhCNSSN}}]_2\text{Cl}$) interspersed by a very small number of shiny green platelets, and a faint white haze on the glass (sulphur). A small amount of a deep red compound was collected in the cold trap and identified by its typical colour and iodine like smell as S_4N_2 . The green platelets were identified by X-ray single crystal analysis and infra-red spectroscopy as $\overline{\text{PhCNSSN}} [\text{S}_3\text{N}_2]\text{Cl}$.

Infra-red spectrum of $[\text{PhCNSSN}][\text{S}_3\text{N}_2]\text{Cl}$ showed $\nu_{\text{max}} = 1250(\text{w})$, 1167(w), 1142(w), 1025(w), 987(w), 941(m), 910(m), 862(m), 818(s), 810(sh), 790(m), 722(w), 705(s), 697(s), 578(w), 538(m). Esr inactive.

Infra-red spectrum of $[\text{PhCNSSN}]_2\text{Cl}$ showed $\nu_{\text{max}} = 1667(\text{w br})$, 1595(w), 1214(w), 1175(w), 1169(w), 1158(w), 1144(m), 1025(m), 1018(w), 1000(w), 935(w), 923(w), 909(m), 901(m), 895(w), 876(w), 855(w), 832(m), 803(s), 781(m), 773(m), 720(w), 694(m), 688(m), 675(w), 665(m), 536(m), 521(w), 486(w), 468(s). Esr active.

5.4.6 Preparation of $[\text{PhCNSSN}][\text{S}_3\text{N}_2]\text{Cl}$:

$[\text{S}_3\text{N}_2\text{Cl}][\text{FeCl}_4]$ (0.300g, 0.84mmol) and $(\text{PhCNSSN})_2$ (0.300g, 0.83mmol) were placed together, with a teflon coated stirrer bar, in one bulb of a dog. Acetonitrile (10ml) was added and immediately a dark green precipitate was formed. The mixture was stirred for one day, the brown solution filtered and the green precipitate washed with back distilled CH_3CN (3 x 10ml). The solvent was removed by pumping to give a brown sticky tar and a crude green solid which was extracted in a closed extractor with acetonitrile for one day.

Yield of $[\text{PhCNSSN}][\text{S}_3\text{N}_2]\text{Cl} = 158\text{mg}$. (56%), $\nu_{\text{max}} = 1250(\text{w})$, 1167(w), 1142(w), 1025(w), 987(w), 941(m), 910(m), 862(m), 818(s), 810(sh), 790(m), 722(w), 705(s), 697(s), 578(w), 538(m). Analysis: found C, 24.00; N, 16.47; H, 1.36; S, 46.40; Cl, 11.33%; $[\text{PhCNSSN}][\text{S}_3\text{N}_2]\text{Cl}$ requires C, 24.67; N, 16.45; H, 1.47; S, 46.98; Cl, 10.47%. D.S.C. showed; peak(s) 138-154°C, peak(w) 154-173°C, peak(m) 173-220°C. Mass spectroscopy (EI) showed m/e; 181 (98%) $[\text{PhCNSSN}]^+$, 149 (14%) PhCN_2S^+ , 135 (37%) PhCNS^+ , 124 (6%) S_3N_2^+ , 92 (9%) S_2N_2^+ .

5.4.7 Extraction of $[\text{PhCNSSN}][\text{S}_3\text{N}_2]\text{Cl}$:

$[\text{PhCNSSN}][\text{S}_3\text{N}_2]\text{Cl}$ (0.040g, 0.117mmol) was placed in a closed extractor and extracted for three days to completion by CH_3CN . A dirty green solid and a white haze (sulphur) remained on removal of the solvent by pumping.

Infra-red spectroscopy showed the mixture to be S_4N_4 and $[\text{PhCNSSN}]\text{Cl}$, $\nu_{\text{max}} = 1596(\text{w})^{\text{a}}$, $1400(\text{m})^{\text{a}}$, $1150(\text{w br})^{\text{a}}$, $1030(\text{w})^{\text{a}}$, $923(\text{m})^{\text{b}}$, $891(\text{m})^{\text{a}}$, $843(\text{m})^{\text{a}}$, $810(\text{w})$, $780(\text{w})$, $720(\text{w})^{\text{b}}$, $695(\text{s})^{\text{b}}$, $548(\text{s})^{\text{b}}$. $\text{a} = [\text{PhCNSSN}]\text{Cl}$, $\text{b} = \text{S}_4\text{N}_4$.

5.4.8 Crystal growth of $[\text{PhCNSSN}][\text{S}_3\text{N}_3]$:

$[\text{S}_5\text{N}_5]\text{Cl}$ (0.200g, 0.75mmol) was placed in one bulb of a dog with $(\text{PhCNSSN})_2$ (0.150, 0.41) in the other bulb. Pentane (2 x 8ml) was added to each side. Inversion of the reaction vessel allowed the two solutions to mix by slow diffusion through a medium porosity glass sinter. After one month the yellow solution was removed (by syringe followed by pumping) to reveal, in the $[\text{S}_5\text{N}_5]\text{Cl}$ compartment, a dirty red powder ($[\text{S}_5\text{N}_5]\text{Cl}$) with a few gold $[[\text{PhCNSSN}]_2\text{Cl}][\text{S}_3\text{N}_3]$ crystals and a very few green platelets on the surface. The green platelets were identified by X-ray single crystal analysis as $[\text{PhCNSSN}][\text{S}_3\text{N}_3]$.

5.4.9 Preparation of $[\text{PhCNSSN}][\text{S}_3\text{N}_3]$:

a) Reaction of $[\text{PhCNSSN}][\text{AsF}_6]$ with $[\text{Pr}_4\text{N}][\text{S}_3\text{N}_3]$ in CH_3CN . $[\text{PhCNSSN}][\text{AsF}_6]$ (0.114g, 0.308mmol) and $[\text{Pr}_4\text{N}][\text{S}_3\text{N}_3]$ (0.100g, 0.320mmol) were placed together, with a teflon coated stirrer bar, in one bulb of a dog. On addition of acetonitrile (10ml) a deep red solution and a dark green precipitate formed. After stirring for 1 day the now pale red solution was filtered off and the solvent removed by pumping to give a

dirty red solid which was identified by infra-red spectra as $[\text{Pr}_4\text{N}][\text{AsF}_6]$. The crude green solid was then sublimed (70°C , 4×10^{-6} torr) and the product collected on a cold finger at -20°C .

Yield of $[\text{PhCNSSN}][\text{S}_3\text{N}_3] = 0.099\text{g}$ (57%), $\nu_{\text{max}} = 1595(\text{w})$, $1240(\text{w})$, $1184(\text{m})$, $1147(\text{m})$, $1078(\text{wbr})$, $1028(\text{m})$, $990(\text{m br})$, $927(\text{w})$, $908(\text{m})$, $853(\text{m})$, $844(\text{w sh})$, $806(\text{s})$, $775(\text{s})$, $726(\text{w})$, $700(\text{m})$, $687(\text{m})$, $663(\text{m})$, $648(\text{s})$, $605(\text{m})$, $550(\text{w})$, $535(\text{w})$, $458(\text{w})$. Analysis: found C, 26.40; N, 22.09; H, 1.52; S, 50.07%; $[\text{PhCNSSN}][\text{S}_3\text{N}_3]$ requires C, 26.33; N, 21.94; H, 1.56; S, 50.16%. D.S.C. showed; trough(w) $125-140^\circ\text{C}$, peak(s br) $140-205^\circ\text{C}$. Mass spectrum (EI) showed m/e; 181 (100%) $[\text{PhCNSSN}]^+$, 138 (9.81%) S_3N_3 .

b) Reaction of $[\text{S}_5\text{N}_5]\text{Cl}$ and $[\text{PhCNSSN}]_2$ in SO_2 . $[\text{S}_5\text{N}_5]\text{Cl}$ (0.200g, 0.75mmol) and $(\text{PhCNSSN})_2$ (0.136g, 0.38mmol) were placed, together with a teflon coated magnetic stirrer bar, in one bulb of a dog. SO_2 (ca. 10ml) was condensed onto the reaction mixture at liquid N_2 temperature. On warming to room temperature an immediate reaction occurred giving a deep red solution which was stirred at room temperature for 24 h. The mixture was filtered and the SO_2 removed to yield a green solid contaminated by a small amount of a yellow compound. Acetonitrile (5ml) was added (in an attempt to remove the yellow impurity), the solid product filtered, washed with back distilled acetonitrile (2 x 5ml), and finally the solvent was removed by pumping. A small amount of yellow impurity still remained. The soluble products were shown by infra-red spectroscopy to be a mixture of S_4N_4 and $[\text{PhCNSSN}]\text{Cl}$.

Yield of $[\text{PhCNSSN}][\text{S}_3\text{N}_3] = \text{ca. } 0.101\text{g}$ (56%), $\nu_{\text{max}} = 1594(\text{vw})$, $1400(\text{w})$, $1242(\text{w})$, $1181(\text{m})$, $1141(\text{m br})$, $1021(\text{m})$, $986(\text{w br})$, $925(\text{w})$, $905(\text{m})$, $851(\text{m})$, $800(\text{s})$, $720(\text{m})$, $719(\text{w})$, $694(\text{m})$, $681(\text{m})$, $657(\text{m})$, $640(\text{m})$, $600(\text{w})$, $530(\text{m})$, $455(\text{w})$.

c) Reaction of $[\text{S}_5\text{N}_5]\text{AlCl}_4$ and $(\text{Ph}\overline{\text{CNSSN}})_2$ in CH_3CN . $[\text{S}_5\text{N}_5]\text{AlCl}_4$ (0.165g, 0.41mmol) was placed in one bulb of a dog with $(\text{Ph}\overline{\text{CNSSN}})_2$ (0.150g, 0.41mmol) in the other bulb. Acetonitrile (2 x 8ml) was added and the dog inverted in a typical crystal growth experiment. After a few minutes the solution in the dimer compartment was deep red. After two days there were many shiny green platelets interspersed by a few yellow crystals in the dimer compartment. The mixture was filtered, washed with back distilled CH_3CN (2 x 5ml) and the solvent removed by pumping. Infra-red spectroscopy showed the orange solubles to be a mixture of $[\text{Ph}\overline{\text{CNSSN}}]\text{AlCl}_4$ and S_4N_4 , and the green crystals to be $[\text{Ph}\overline{\text{CNSSN}}][\text{S}_3\text{N}_3]$.

Yield of $[\text{Ph}\overline{\text{CNSSN}}][\text{S}_3\text{N}_3]$ = ca. 21mg (16%), ν_{max} = 1595(w), 1240(w), 1184(m), 1147(m), 1078(w br), 1028(m), 990(mbr), 927(w), 908(m), 853(m), 844(w sh), 806(s), 775(s), 726(w), 700(m), 687(m), 663(m), 648(s), 605(m), 550(w), 535(w), 458(w).

d) Mixing vapours of $(\text{SN})_x$ and $(\text{Ph}\overline{\text{CNSSN}})_2$. Vapours of $(\text{SN})_x$ (ca. 0.042g, 0.913mmol at 160°C) and $(\text{Ph}\overline{\text{CNSSN}})_2$ (0.022g, 0.061mmol at 50°C) were mixed together through quartz wool under high vacuum (3×10^{-6} torr) at 160°C. The product was collected on a cold finger at -196°C and resublimed at 70°C to separate the excess $(\text{SN})_x$ from the green product which was identified by infra-red spectrum as a mixture of $[\text{Ph}\overline{\text{CNSSN}}][\text{S}_3\text{N}_3]$, S_4N_4 and $(\text{Ph}\overline{\text{CNSSN}})_2$.

ν_{max} = 1597(w)^a, 1322(vw)^a, 1242(w)^a, 1187(m)^a, 1158(w sh)^a, 1144(m)^a, 1101(vw)^a, 1077(w)^a, 1025(m)^a, 990(m)^a, 928(s)^b, 906(m)^a, 803(s)^a, 778(m)^c, 770(s)^a, 726(m)^a, 706(s sh)^a, 698(s)^b, 682(m)^c, 658(m)^a, 644(m)^a, 605(w)^a, 550(s)^b, 530(m)^a, 510(w)^c, 457(w)^a. a = $[\text{Ph}\overline{\text{CNSSN}}][\text{S}_3\text{N}_3]$, b = S_4N_4 , c = $(\text{Ph}\overline{\text{CNSSN}})_2$.

5.4.10 Reaction of $[\text{PhCNSSN}][\text{AsF}_6]$ and $[\text{Pr}_4\text{N}][\text{S}_3\text{N}_3]$ in CH_2Cl_2 :

$[\text{Pr}_4\text{N}][\text{S}_3\text{N}_3]$ (0.100g, 0.309mmol) was placed in one bulb of a dog with $[\text{PhCNSSN}][\text{AsF}_6]$ (0.116g, 0.314mmol) in the other bulb. CH_2Cl_2 (2 x 9ml) was added to each side and the dog inverted in a typical crystal growth experiment. After one day the solution in both compartments was deep red and there were a few orange crystals on the walls. The mixture was filtered and the solvent removed by pumping to yield a red/brown solid. This was shown by infra-red spectroscopy to be a mixture of S_4N_4 , $[\text{PhCNSSN}]_2$ and $[\text{Pr}_4\text{N}][\text{AsF}_6]$.

Infra-red Spectrum of the mixture, $\nu_{\text{max}} = 1600(\text{w})^{\text{a}}$, $1402(\text{w})^{\text{a}}$, $1261(\text{w})^{\text{a}}$, $1242(\text{w})^{\text{a}}$, $1229(\text{w})^{\text{a}}$, $1188(\text{w})^{\text{a}}$, $1140(\text{w})^{\text{a}}$, $1078(\text{w})^{\text{a}}$, $1040(\text{w})^{\text{a}}$, $1025(\text{w})^{\text{a}}$, $987(\text{w})^{\text{a}}$, $968(\text{w})^{\text{a}}$, $928(\text{m})^{\text{b}}$, $900(\text{w})^{\text{a}}$, $850(\text{w})^{\text{a}}$, $846(\text{w})^{\text{a}}$, $805(\text{m})^{\text{a}}$, $778(\text{m})^{\text{a}}$, $770(\text{m})^{\text{a}}$, $752(\text{w})^{\text{b}}$, $726(\text{m sh})^{\text{b}}$, $710(\text{s sh})^{\text{c}}$, $698(\text{s})^{\text{c}}$, $690(\text{s})^{\text{b}}$, $685(\text{s})^{\text{a}}$, $652(\text{m})^{\text{a}}$, $552(\text{s})^{\text{c}}$, $512(\text{m})^{\text{a}}$, $402(\text{s})^{\text{b}}$. $\text{a} = [\text{PhCNSSN}]_2$, $\text{b} = [\text{Pr}_4\text{N}][\text{AsF}_6]$, $\text{c} = \text{S}_4\text{N}_4$.

5.4.11 Preparation of $[\text{PhCNSSN}]_2\text{Cl}$:

$(\text{PhCNSSN})_2$ (0.100g, 0.276mmol) was ground together with $[\text{PhCNSSN}]\text{Cl}$ (0.1196g, 0.552mmol) in an agate pestle and mortar. Initially the mixture was observed to be sticky but on persistent grinding a brown powder resulted which was heated at 156°C for 15 minutes under a blanket of nitrogen to produce $[\text{PhCNSSN}]_2\text{Cl}$.

Yield = (100%), $\nu_{\text{max}} = 1600(\text{w br})$, $1395(\text{s sh})$, $1260(\text{w})$, $1213(\text{w})$, $1177(\text{m})$, $1130(\text{s})$, $1070(\text{w})$, $1024(\text{m})$, $1000(\text{vw})$, $939(\text{w})$, $925(\text{w})$, $911(\text{m})$, $902(\text{m})$, $879(\text{m})$, $856(\text{w})$, $832(\text{m})$, $807(\text{s})$, $782(\text{s})$, $772(\text{s})$, $696(\text{s sh})$, $689(\text{s})$, $676(\text{m})$, $667(\text{m})$, $662(\text{m sh})$, $650(\text{m sh})$, $540(\text{m})$, $525(\text{m})$, $489(\text{w})$, $470(\text{s})$. Analysis: found C, 42.55; N, 14.12; H, 2.58; S, 33.18%; $[\text{PhCNSSN}]_2\text{Cl}$ requires C, 42.26; N, 14.08; H, 2.52; S, 32.12%.

D.S.C. showed; trough(w br) 135-158°C, peak(s) 158-187°C. Mass spectrum (EI) showed m/e; 181 (100%) $[\text{PhCNSSN}]^+$. Esr active.

5.4.12 Extraction of $[\text{PhCNSSN}]_2\text{Cl}$:

$[\text{PhCNSSN}]_2\text{Cl}$ (0.100g, 0.25mmol) was placed in a closed extractor and extracted for one hour with acetonitrile. Removal of the solvent, by pumping, revealed a dirty yellow solid on the frit and a dirty brown solid in the bulb. Infra-red spectroscopy showed the yellow compound to be $[\text{PhCNSSN}]\text{Cl}$ and the brown compound to be mainly $(\text{PhCNSSN})_2$ with a small amount of $[\text{PhCNSSN}]\text{Cl}/[\text{PhCNSSN}]_2\text{Cl}$.

Yellow $[\text{PhCNSSN}]\text{Cl}$ showed $\nu_{\text{max}} = 1322(\text{w}), 1279(\text{w}), 1221(\text{w}), 1132(\text{m}), 1072(\text{w}), 1021(\text{w}), 919(\text{w}), 897(\text{w}), 834(\text{w}), 800(\text{m}), 781(\text{s}), 676(\text{s}), 721(\text{m}), 680(\text{s}), 650(\text{s}), 510(\text{m})$.

Brown mixture showed $\nu_{\text{max}} = 1595(\text{w})^{\text{a}}, 1395(\text{s})^{\text{a}}, 1345(\text{w})^{\text{a}}, 1320(\text{m})^{\text{a}}, 1292(\text{w})^{\text{a}}, 1210(\text{w})^{\text{a}}, 1170(\text{w})^{\text{a}}, 1150(\text{w})^{\text{a}}, 1137(\text{m})^{\text{ab}}, 1070(\text{w})^{\text{a}}, 1028(\text{m})^{\text{a}}, 1000(\text{w})^{\text{a}}, 921(\text{m})^{\text{a}}, 893(\text{s})^{\text{a}}, 845(\text{s})^{\text{a}}, 802(\text{w})^{\text{b}}, 785(\text{s})^{\text{ab}}, 720(\text{w})^{\text{a}}, 700(\text{s})^{\text{a}}, 690(\text{m sh})^{\text{a}}, 678(\text{vw})^{\text{b}}, 580(\text{m})^{\text{a}}, 520(\text{m})^{\text{a}}, 466(\text{w})^{\text{b}}$. $\text{a} = (\text{PhCNSSN})_2$, $\text{b} = [\text{PhCNSSN}]\text{Cl}/[\text{PhCNSSN}]_2\text{Cl}$.

5.4.13 Reaction in a DC nitrogen plasma of:

a) $[\text{PhCNSSN}][\text{S}_3\text{N}_3]$. Green $[\text{PhCNSSN}][\text{S}_3\text{N}_3]$ (0.010g, 0.031mmol) was acted on by a nitrogen plasma at *ca.* 35°C with a current of 0.8mA. After 3 hours the product was a light brown powder partially covered in a dark brown polymer.

Infra-red spectroscopy showed the product to be a mixture of starting material and $(\text{PhCN}_3\text{S}_2)_2$, $\nu_{\text{max}} = 1596(\text{w})^{\text{a}}, 1390(\text{m sh})^{\text{b}}, 1340(\text{s})^{\text{b}}, 1244(\text{w})^{\text{a}}, 1182(\text{m})^{\text{a}}, 1166(\text{w})^{\text{b}}, 1143(\text{m})^{\text{a}}, 1023(\text{m})^{\text{a}}, 990(\text{m br})^{\text{a}}, 905(\text{m})^{\text{a}}, 895(\text{m})^{\text{b}}, 852(\text{m br})^{\text{a}}, 802(\text{s})^{\text{a}}, 785(\text{w})^{\text{b}}, 771(\text{s})^{\text{a}}, 763(\text{w sh})^{\text{b}}$,

697(m)^a, 691(w sh)^a, 681(s)^a, 670(w)^b, 662(m)^a, 657(m)^b, 644(m)^a, 605(w)^a, 532(m)^b, 489(w)^b, 451(m)^a. a = $[\overline{\text{PhCNSSN}}][\text{S}_3\text{N}_3]$, b = $(\text{PhCN}_3\text{S}_2)_2$.

b) $[[\overline{\text{PhCNSSN}}]_2\text{Cl}][\text{S}_3\text{N}_3]$. Gold $[[\overline{\text{PhCNSSN}}]_2\text{Cl}][\text{S}_3\text{N}_3]$ (0.015g, 0.028mmol) was acted on by a nitrogen plasma at *ca.* 35°C with a current of 2.0mA. After 45 minutes the product was a light brown powder partially covered in a dark brown polymer.

Infra-red spectroscopy showed the product to be a mixture of starting materials, $(\text{PhCN}_3\text{S}_2)_2$ and $[\overline{\text{PhCNSSN}}]\text{Cl}$, $\nu_{\text{max}} = 1595(\text{w})^a$, 1400(m sh)^a, 1340(s)^b, 1290(w)^b, 1178(w)^a, 1163(w)^b, 1139(m)^a, 1022(m)^{ab}, 943(m br)^a, 921(w sh)^a, 905(s)^a, 895(s)^b, 877(w)^a, 844(w)^c, 810(s)^a, 785(m)^b, 772(m)^a, 700(m sh)^b, 697(m)^a, 680(s)^b, 667(m)^a, 550(vw)^c, 542(w)^a, 495(w sh)^b, 485(w br)^a, 452(w)^b. a = $[[\overline{\text{PhCNSSN}}]_2\text{Cl}][\text{S}_3\text{N}_3]$, b = $(\text{PhCN}_3\text{S}_2)_2$, c = $[\overline{\text{PhCNSSN}}]\text{Cl}$.

c) $[\overline{\text{PhCNSSN}}][\text{S}_3\text{N}_2]\text{Cl}$. Green coloured $[\overline{\text{PhCNSSN}}][\text{S}_3\text{N}_2]\text{Cl}$ (0.012g, 0.035mmol) was acted on by a nitrogen plasma at *ca.* 35°C with a current of 1.8mA. After 1 hour the product was a light brown powder partially covered in a dark brown polymer.

Infra-red spectroscopy showed the product to be a mixture of starting material and $(\text{PhCN}_3\text{S}_2)_2$, $\nu_{\text{max}} = 1596(\text{w})^a$, 1392(w sh)^b, 1344(s)^b, 1250(w br)^a, 1189(w)^b, 1179(w)^b, 1165(m)^b, 1151(w)^a, 1140(m)^a, 1068(w)^a, 1023(m)^{ab}, 984(m)^a, 934(s)^a, 930(w sh)^b, 905(s)^a, 895(s)^b, 860(s)^a, 852(w)^a, 815(s)^a, 787(s)^a, 772(m)^b, 767(w)^a, 700(s)^a, 692(s)^a, 688(s sh)^a, 680(s sh)^b, 671(m)^b, 615(w)^a, 575(w)^a, 533(m)^a, 490(w)^b, 469(w)^a, 450(m)^b, 435(m)^a. a = $[\overline{\text{PhCNSSN}}][\text{S}_3\text{N}_2]\text{Cl}$, b = $(\text{PhCN}_3\text{S}_2)_2$.

d) $[\text{Ph}\overline{\text{CNSSN}}]_2\text{Cl}$. $[\text{Ph}\overline{\text{CNSSN}}]_2\text{Cl}$ (0.015g, 0.038mmol) was acted on by a nitrogen plasma. No reaction occurred until 100°C when very quickly a black polymer coated the sample and the glass of the sample holder. The solid product was dirty yellow in colour and was identified by infra-red spectroscopy as $[\text{Ph}\overline{\text{CNSSN}}]\text{Cl}$, $\nu_{\text{max}} = 1320(\text{w}), 1280(\text{w}), 1220(\text{w}), 1132(\text{m}), 1072(\text{w}), 1020(\text{w}), 920(\text{w}), 897(\text{w}), 835(\text{w}), 802(\text{m}), 781(\text{s}), 676(\text{s}), 720(\text{m}), 680(\text{s}), 652(\text{s}), 510(\text{m})$.

REFERENCES

1. G.G. Alange, A.J. Banister, B. Bell, and P.W. Millen, *Inorg. Nucl. Chem. Letters*, 1977, 13, 143.
2. G. Wolmershäuser, C. Kruger and Y. Tsay, *Chem. Ber.*, 1982, 115, 1126.
3. H. Höfs, G. Hartmann, R. Mews and G.M. Sheldrick, *Angew. Chem. Int. Ed. Engl.*, 1984, 23, 988.
4. H. Höfs, J.W. Bats, R. Gleiter, G. Hartmann, R. Mews, M. Eckert-Maksic, H. Oberhammer and G.M. Sheldrick, *Chem. Ber.*, 1985, 118, 3781.
5. G.G. Alange, A. J. Banister, B. Bell, and P.W. Millen, *J. Chem. Soc. Perkin*, 1979, 1192.
6. H.W. Roesky and T. Müller, *Chem. Ber.*, 1978, 111, 2960.
7. H. Höfs, R. Mews, W. Clegg, M. Noltemeyer, M. Schmidt and G.M. Sheldrick, *Chem. Ber.*, 1983, 116, 416.
8. T. Chivers, F. Edelmann, J.F. Richardson, N.R.M. Smith, O. Treu and M. Trsic, *Inorg. Chem.*, 1986, 25, 2119.
9. R. Faggiani, R.J. Gillespie, C.J. Lock and J.D. Tyrer, *Inorg. Chem.*, 1978, 17, 2975.
10. A.J. Banister, R.G. Hey, J.K. MacLean and J. Passmore, *Inorg. Chem.*, 1982, 21, 1679.
11. G.K. MacLean, J. Passmore, M.N. Sudheendra Rao, M.J. Schriver and P. S. White, *J. Chem. Soc. Dalton Trans.*, 1985, 1405.
12. N. Burford, J. Passmore and M.J. Schriver, *J. Chem. Soc., Chem Commun.*, 1986, 140.
13. W.V.F. Brooks, N. Burford, J. Passmore, M.J. Schriver and L.H. Sutcliffe, *J. Chem. Soc., Chem Commun.*, 1987, 69.
14. A. Vegas, A. Pérez-Salazar, A.J. Banister, R.G. Hey, *J. Chem. Soc. Dalton*, 1979, 1812.
15. L.N. Markovski, O.M. Polumbrik, V.S. Talanov and Yu. G. Shermolovich, *Tetrahedron Letters*, 1982, 23, 761.
16. S.A. Fairhurst, K.M. Johnson, L.H. Sutcliffe, K.F. Preston, A.J. Banister, Z.V. Hauptman and J. Passmore, *J. Chem. Soc. Dalton Trans.*, 1986, 1465.
17. A.J. Banister, M.I. Hansford and Z.V. Hauptman, *J. Chem. Soc., Chem Commun.*, 1987, 63.
18. A.J. Banister, W. Clegg, M.I. Hansford, Z.V. Hauptman and S.T. Wait, in press.

19. A.J. Banister, I.B. Gorrell, W. Clegg, and K.A. Jorgenson, in press.
20. A.J. Banister, N.R.M. Smith and R.G. Hey, *J. Chem. Soc. Dalton Trans. 1*, 1983, 1181.
21. R. Gleiter, R. Bartetzko and P. Hofmann, *Z. Naturforsch.*, 1980, 35b, 1166.
22. R.D. Smith, J.R. Wyatt, J.J. DeCorpo, F.E. Saalfeld, H.J. Moran and A.G. MacDiarmid, *J. Am. Chem. Soc.*, 1977, 99, 1726.
23. R.J. Gillespie, J.P. Kent and J.F. Sawyer, *Inorg. Chem.*, 1981, 20, 3784.
24. R.C. Paul, R.P. Sharma and R.D. Verma, *Indian J. Chem.*, 1974, 12, 418.
25. U. Thewalt and M. Burger, *Z. Naturforsch.*, 1981, 36b, 293.
26. A.J. Banister, H.G. Clark, I. Raynat and H.M.N. Shearer, *Inorg. Nucl. Chem. Letters*, 1974, 10, 647.
27. R.W.H. Small, A.J. Banister and Z.V. Hauptman, *J. Chem. Soc. Dalton Trans.*, 1984, 1377.
28. W.L. Jolly and K.D. Maguire, *Inorg. Syn.*, 1967, 9, 102.
29. R.C. Paul, P. Kapoor, R. Kapoor and R.D. Verma, *J. Inorg. Nuc. Chem.*, 1978, 40, 2001.
30. H.W. Roesky and M. Dietl, *Chem. Ber.*, 1973, 106, 3101.
31. W. Isenberg, N.K. Homsy, J. Anhaus, H.W. Roesky and G.M. Sheldrick, *Z. Naturforsch.*, 1983, 38b, 808.
32. A.J. Banister, and P.J. Dainty, *J. Chem. Soc. Dalton Trans.*, 1972, 2658.
33. J. Bojes and T. Chivers, *Inorg. Chem.*, 1978, 17, 318.
34. J. Bojes, T. Chivers, J. Drummond and G. MacLean, *Inorg. Chem.*, 1978, 17, 3668.
35. J. Bojes and T. Chivers, *J. Chem. Soc., Chem Commun.*, 1977, 453.
36. J. Bojes, T. Chivers, W.G. Laidlaw and M. Trsic, *J. Am. Chem. Soc.*, 1979, 101, 4517.
37. A.J. Banister, *Nature (London) Phys. Sci.*, 1972, 92, 237.
38. A. Hazell and R.G. Hazell, *Acta. Cryst.*, 1988, 44C, 1807.
39. A.J. Banister, Z.V. Hauptman, A.G. Kendrick, and R.W.H. Small, *J. Chem. Soc. Dalton Trans.*, 1987, 915.
40. M.I. Hansford, personal communication.

41. R.W.H. Small, A.J. Banister, and Z.V. Hauptman, *J. Chem. Soc. Dalton Trans.*, 1981, 2188.
42. A.J. Banister, A.J. Fielder, R.G. Hey, and N.R.M. Smith, *J. Chem. Soc. Dalton Trans.*, 1980, 1457.
43. H. Vincent, Y. Monteil, and M.P. Berthet, *Z. Anorg. Allg. Chem.*, 1980, 471, 233.
44. A.J. Banister, H.G. Clarke, I Rayment, and M.M. Shearer, *Inorg. Nucl. Chem. Letters*, 1974, 10, 647.
45. D.F. Burrow, *Inorg. Chem.*, 1972, 11, 573.
46. W.M. Lau, N.P.C. Westwood, and M.H. Palmer, *J. Am. Chem. Soc.*, 1986, 108, 3229.
47. E. Besenyei, G.K. Eigendorf, and D.C. Frost, *Inorg. Chem.*, 1986, 25, 4404.
48. H.P. Fritz, R. Bruchhaus, R. Mews, and H.V. Höfs, *Z. Anorg. Allg. Chem.*, 1985, 525, 214.

APPENDIX

DEPARTMENT COLLOQUIA AND DURHAM UNIVERSITY CHEMICAL SOCIETY
(D.U.C.S.) LECTURES

- 13.9.85 Dr. V.S. Parmar (University of Delhi), "Enzyme Assisted ERC Synthesis".
- 17.10.85* Dr. C.J. Ludman (University of Durham), "Some Thermochemical Aspects of Explosions".
- 30.10.85 Dr. S.N. Whittleton (University of Durham), "An investigation of a Reaction Window".
- 31.10.85* Dr. P. Timms (University of Bristol), "Some Chemistry of Fireworks".
- 5.11.85 Prof. M.J. O'Donnell (Indiana-Purdue University), "New Methodology for the Synthesis of Amino Acids".
- 7.11.85* Prof. G. Ertl (University of Munich), "Heterogeneous Catalysis".
- 20.11.85 Dr. J.A.H. McBride (Sunderland Polytechnic), "A Heterocyclic Tour on a Distorted Tricycle - Biphenylene".
- 21.11.85* Prof. K.H. Jack (University of Newcastle), "Chemistry of Si-Al-O-N Engineering Ceramics".
- 24.11.85 Dr. J. Dewing (U.M.I.S.T.), "Zeolites - Small Holes, Big Opportunities".
- 28.11.85 Prof. D.J. Waddington (University of York), "Resources for the Chemistry Teacher".
- 28.11.85 Dr. S.G. Davies, (University of Oxford), "Chirality Control and Molecular Recognition".
- 28.11.85* Dr. B.A.J. Clark (Kodak Ltd.), "Chemistry and Principles of Colour Photography".
- 15.1.86 Prof. N. Sheppard (University of East Anglia), "Vibrational and Spectroscopic Determinations of the Structures of Molecules Chemisorbed on Metal Surfaces".
- 23.1.86 Prof. Sir J. Lewis (University of Cambridge), "Some more Recent Aspects in the Cluster Chemistry of Ruthenium and Osmium Carbonyls".
- 29.1.86 Dr. J.H. Clark (University of York), "Novel Fluoride Ion Reagents".
- 30.1.86 Dr. N.J. Phillips (University of Technology, Loughborough), "Laser Holography".

- 12.2.86* Dr. J. Yarwood (University of Durham), "The Structure of Water in Liquid Crystals".
- 12.2.86 Prof. O.S. Tee (Concordia University, Montreal), "Bromination of Phenols".
- 13.2.86 Prof. R. Grigg (Queens University, Belfast), "Thermal Generation of 1,3-Dipoles".
- 19.2.86 Prof. G. Procter (University of Salford), "Approaches to the Synthesis of some Natural Products".
- 20.2.86* Dr. C.J.F. Barnard (Johnson Matthey Group), "Platinum Anti-Cancer Drug Development".
- 26.2.86 Miss C. Till (University of Durham), "ESCA and Optical Emission Studies of the Plasma Polymerisation of Perfluoroaromatics".
- 27.2.86 Prof. R.K. Harris (University of Durham), "The Magic of Solid State NMR".
- 5.3.86 Dr. M. Schroeder (University of Edinburgh), "Studies on Macrocyclic Complexes".
- 5.3.86 Dr. D. Hathaway (University of Durham), "Herbicide Selectivity".
- 6.3.86* Dr. B. Iddon (University of Salford), "The Magic of Chemistry".
- 12.3.86 Dr. J.M. Brown, "Chelate Control in Homogenous Catalysis".
- 14.5.86 Dr. P.P.R. Langridge-Smith (University of Edinburgh), "Naked Metal Clusters - Synthesis, Characterisation and Chemistry".
- 9.6.86 Prof. R. Schmutzler (University of Braunschweig), "Mixed Valence Diphosphorus Compounds".
- 23.6.86 Prof. R.E. Wilde (Texas Technical University), "Molecular Dynamic Processes from Vibrational Bandshapes".
- 16.10.86* Prof. N.N. Greenwood (University of Leeds), "Glorious Gaffes in Chemistry".
- 29.10.86 Prof. E.H. Wong (University Of New Hampshire, U.S.A.), "Coordination Chemistry of P-O-P Ligands".
- 5.11.86 Prof. D. Döpp (University of Duisburg), "Cyclo-additions and Cyclo-reversions Involving Captodative Alkenes".
- 6.11.86* Dr. R.M. Scowston (University of Hull), "From Myth and Magic to Modern Medicine".
- 13.11.86 Prof. Sir G. Allen (Unilever Research), "Biotechnology and the Future of the Chemical Industry".

- 20.11.86 Dr. A. Milne and Mr. S. Christie (International Paints), "Chemical Serendipity - A Real Life Case Study".
- 23.11.86* Prof. H.W. Kroto (University of Sussex), "Chemistry in Stars, Between Stars and in the Laboratory".
- 26.11.86 Dr. N.D.S. Canning (University of Durham), "Surface Adsorption Studies of Relevance to Heterogeneous Ammonia Synthesis".
- 27.11.86* Prof. R.L. Williams (Metropolitan Police Forensic Science), "Science and Crime".
- 3.12.86 Dr. J. Miller (Dupont Central Research, U.S.A.), "Molecular Ferromagnets; Chemistry and Physical Properties".
- 8.12.86 Prof. T. Dorfmüller (University of Bielefeld), "Rotational Dynamics in Liquids and Polymers".
- 22.1.87 Prof. R.H. Ottewill (University of Bristol), "Colloid Science a Challenging Subject".
- 28.1.87* Dr. W. Clegg (University of Newcastle-upon-Tyne), "Carboxylate Complexes of Zinc; Charting a Structural Jungle".
- 2.2.87 Prof. A. Thompson (University of East Anglia), "Metalloproteins and Magneto-optics".
- 5.2.87* Dr. P. Hubbersley (University of Nottingham), "Demonstration Lecture on Various Aspects of Alkali Metal Chemistry".
- 11.2.87 Dr. T. Shepherd (University of Durham), "Pteridine Natural Products; Synthesis and Use in Chemotherapy".
- 12.2.87 Dr. P.J. Rodgers (I.C.I. Billingham), "Industrial Polymers from Bacteria".
- 17.2.87 Prof. E.H. Wong (University of New Hampshire, U.S.A.), "Symmetrical Shapes from Molecules to Art and Nature".
- 19.2.87* Dr. M. Jarman (Institute of Cancer Research), "The Design of Anti Cancer Drugs".
- 4.3.87 Dr. R. Newman (University of Oxford), "Change and Decay: A Carbon-13 CP/MAS Study of Humification and Coalification Processes".
- 5.3.87 Prof. S.V. Ley (Imperial College), "Fact and Fantasy in Organic Synthesis".
- 15.3.87 Prof. R.F. Hudson (University of Kent), "Homolytic Rearrangements of Free Radical Stability".
- 17.3.87 Prof. R.F. Hudson (University of Kent), "Aspects of Organophosphorus Chemistry".

- 6.5.87 Dr. R. Bartsch (University of Sussex), "Low Co-ordinated Phosphorus Compounds".
- 7.5.87 Dr. M. Harmer (I.C.I. Chemicals and Polymer Group), "The Role of Organometallics in Advanced Materials".
- 9.5.87 Prof. F.G. Bordwell (Northeastern University, U.S.A.), "Carbon Anions, Radicals, Radical Anions and Radical Cations".
- 11.5.87 Prof. S. Pasynkiewicz (Technical University, Warsaw), "Thermal Decomposition of Methyl Copper and its Reactions with Trialkylaluminium".
- 11.5.87 Dr. R.D. Cannon (University of East Anglia), "Electron Transfer in Polynuclear Complexes".
- 12.5.87* Dr. E.M. Goodger (Cranfield Institute of Technology), "Alternative Fuels for Transport".
- 24.5.87 Prof. S.M. Roberts (University of Exeter), "Synthesis of Novel Antiviral Agents".
- 26.5.87 Dr. C. Krespan (E.I. Dupont de Nemours), "Nickel(0) and Iron(0) as Reagents in Organofluorine Chemistry".
- 27.5.87 Dr. M. Blackburn (University of Sheffield), "Phosphonates as Analogues of Biological Phosphate".
- 15.10.87* Dr. M.J. Winter (University of Sheffield), "Pyrotechnics (Demonstration Lecture)".
- 22.10.87* Prof. G.W. Gray (University of Belfast), "Liquid Crystals and their Applications".
- 3.11.87 Dr. J. Howard (I.C.I. Wilton), "Chemistry of Non-Equilibrium Processes".
- 4.11.87 Mrs. C. Mapletoft ((Durham Chemistry Teacher's Centre), "Salter's Chemistry".
- 5.11.87 Dr. A.R. Butler (University of St. Andrews), "Chinese Alchemy".
- 19.11.87 Prof. P.G. Seebach (E.T.H. Zurich), "From Synthetic Methods to Mechanistic Insight".
- 23.11.87 Dr. J. Davidson (Herriot-Watt University), "Metal Promoted Oligomerisation Reactions of Alkynes".
- 26.11.87 Dr. D.H. Williams (University of Cambridge), "Molecular Recognition".
- 29.11.87* Mrs. E. van Rose (Geological Museum), "Chemistry of Volcanoes".
- 10.12.87* Dr. C.J. Ludman (University of Durham), "Explosives".

- 16.12.87 Mr. R.M. Swart (I.C.I.), "The Interaction of Chemicals with Lipid Bilayers".
- 21.1.88* Dr. F. Palmer (University of Nottingham), "Luminescence (Demonstration Lecture)".
- 28.1.88 Dr. A. Cairns-Smith (Glasgow University), "Clay Minerals and the Origin of Life".
- 11.2.88 Prof. J.J. Turner (University of Nottingham), "Catching Organometallic Intermediates".
- 18.2.88 Dr. K. Borer (University of Durham Industrial Research Labs.), "The Brighton Bomb - A Forensic Science View".
- 25.2.88 Prof. A. Underhill (University of Bangor), "Molecular Electronics".
- 3.3.88 Prof. W.A.G. Graham (University of Alberta, Canada), "Rhodium and Iridium Complexes in the Activation of Carbon-Hydrogen Bonds".
- 7.3.88 Mr. P. Lacey (Durham Chemistry Teacher's Centre), "Double Award Science".
- 16.3.88 L. Bossons (Durham Chemistry Teacher's Centre), "GCSE Practical Assessment".
- 7.4.88 Prof. M.P. Hartshorn (University of Canterbury, New Zealand), "Aspects of Ipso-Nitration".
- 13.4.88 Mrs. E. Roberts (SASTRO Officer for Sunderland), "Talk - Durham Chemistry Teacher's Centre - "Links Between Industry and Schools".
- 19.4.88* Graduate Chemists (Northeast Polytechnics and Universities), "R.S.C. Graduate Symposium".
- 25.4.88 Prof. D. Birchall (I.C.I. Advanced Materials), "Environmental Chemistry of Aluminium".
- 27.4.88 Dr. R. Richardson (University of Bristol), "X-Ray Diffraction from Spread Monolayers".
- 27.4.88 Dr. J.A. Robinson (University of Southampton), "Aspects of Antibiotic Biosynthesis".
- 28.4.88 Prof. A. Pines (University of California, Berkeley, U.S.A.), "Some Magnetic Moments".
- 11.5.88 Dr. J. Sodeau (University of East Anglia), "Durham Chemistry Teacher's Centre Lecture: "Spray Cans, Smog and Society"".
- 11.5.88* Dr. W.A. McDonald (I.C.I. Wilton), "Liquid Crystal Polymers".

- 18.5.88 Prof. C.A. Nieto de Castro (University of Lisbon and Imperial College), "Transport Problems of Non-Polar Fluids".
- 8.6.88 Prof. J.P. Majoral (University Paul Sabatier), "Stabilisation by Complexation of Short-lived Phosphorus Species".
- 29.6.88 Prof. G.A. Olah (University of Southern California), "New Aspects of Hydrocarbon Chemistry".
- 6.7.88 Prof. H.F. Koch (Ithaca College, U.S.A.), "Does the E2 Mechanism Occur in Solution?".
- 29.7.88 Dr. M.E. Jones (Durham Chemistry Teacher's Centre), "GCSE Chemistry Post-mortem".
- 29.7.88 Dr. M.E. Jones (Durham Chemistry Teacher's Centre), "GCSE Chemistry A Level Post-mortem".

* Indicates the lectures and colloquia that I have attended.

RESEARCH CONFERENCES ATTENDED

The Annual General Meeting of the American Chemical Society, Denver, Colorado, April 1986.

WORKSHOPS ATTENDED

Electrochemical Workshop, Sussex University, March 1987.

FIRST YEAR INDUCTION COURSE

The course consists of a series of one hour lectures, explaining the uses and limitations of the various services available in the Department.

1. Departmental Organisation - Dr. E.J.F. Ross.
2. Safety Matters - Dr. M.R. Crampton.
3. Electrical appliances and infrared spectroscopy.
4. Chromatography and microanalysis - Mr. T.F. Holmes.
5. Atomic adsorptiometry and inorganic analysis - Mr. R. Coult.
6. Library Facilities - Mr. R.B. Woodward.
7. Mass Spectroscopy - Dr. M. Jones.
8. Nuclear Magnetic Resonance Spectroscopy - Dr. R.S. Matthews.
9. Glass blowing techniques - Mr. R. Hart and Mr. G. Haswell.

