



Durham E-Theses

Neutral Currents Beyond The Standard Model

Shaheen, Matloob H.

How to cite:

Shaheen, Matloob H. (1988) *Neutral Currents Beyond The Standard Model*, Durham theses, Durham University. Available at Durham E-Theses Online: <http://etheses.dur.ac.uk/6334/>

Use policy

The full-text may be used and/or reproduced, and given to third parties in any format or medium, without prior permission or charge, for personal research or study, educational, or not-for-profit purposes provided that:

- a full bibliographic reference is made to the original source
- a [link](#) is made to the metadata record in Durham E-Theses
- the full-text is not changed in any way

The full-text must not be sold in any format or medium without the formal permission of the copyright holders.

Please consult the [full Durham E-Theses policy](#) for further details.

Neutral Currents Beyond The Standard Model

by

Matloob H. Shaheen

**Thesis submitted for the Degree of
Doctor of Philosophy
at the
University of Durham**

**Department of Mathematical Sciences
University of Durham
Science Laboratories
South Road
Durham DH1 3LE, England.**

March, 1988

The copyright of this thesis rests with the author.
No quotation from it should be published without
his prior written consent and information derived
from it should be acknowledged.



10. MAY 1988

DEDICATED TO

My parents (late),

Mrs. Taseem A. Shaheen

and Mudasser Shaheen

Declaration

The work presented in this thesis has been carried out in the Department of Mathematical Sciences at the University of Durham under the Supervision of Professor E.J. Squires between November 1985 and February 1988. The author duly declares that this work has not been submitted previously for any degree in this or any other University.

Most of Chapters 1, 2, 4 and 7 are review; the work described in Chapters 3, 5 and 6 is claimed as original except where otherwise indicated.

The copyright of this thesis entirely rests with the author and any quotation from it is not allowed to be published without his prior permission.

Acknowledgements

I owe a great debt of gratitude to my Supervisor, Professor E.J. Squires for his encouragement, unreserved attention, helpful discussion, guidance and critical comments. I have benefited enormously from his perceptive insights and ideas on the subject. I sincerely remain grateful to him.

The preparation and completion of this thesis has been aided by the co-operation and contribution of a number of people. Hence, special thanks are due to Dr. W.J. Stirling and Professor A.D. Martin, who generously shared with me their valuable time and insight that were crucial to the completion of this study. I am deeply indebted to the many friends both here in Durham and back home in Pakistan, for the personal and moral support extended to me. The full co-operation of one of my friends, Mr. D. Seigwart in proof reading the thesis has been of inestimable value. I also wish to express my sincere gratitude to Mrs. M.A. Chipchase, who typed the thesis with great care and patience.

Finally, but most importantly, the financial assistance rendered to me by the Ministry of Education, Government of Pakistan, during the full period of my studies here is gratefully acknowledge.

Abstract

The electroweak standard model (Salam-Weinberg) is well known to be a satisfactory and consistent theoretical description of all the experimental data we have obtained so far. In this thesis, we discuss possible phenomenology which goes beyond the standard model, with particular emphasis on the neutral current effects. First of all, the left-right symmetric extension of the standard model is discussed and we find limits on its parameters. We show that this model cannot explain certain newly reported and highly speculative events at the CERN collider [3], which in principle could be caused by the decay into two W 's of a new heavy Z . We then discuss composite models where there is a strong expectation that there should be two neutral Z 's of similar mass. We study the effects of these on neutral current phenomenology and show that in general the extra Z would be very hard to detect. A comparison of our model with a particular superstring model [6] is also made.

CONTENTS

	Page
Introduction	1
CHAPTER 1 The Standard Model	5
1.1 Introduction	5
1.2 Gauge theories	6
1.3 Local gauge symmetry in QED	6
1.4 Local gauge symmetry in QCD	9
1.5 Higgs mechanism	12
1.6 Salam-Weinberg model	16
1.7 Test of the Salam-Weinberg model	21 A
I Neutral current effects in $e^-e^+ \rightarrow \mu^-\mu^+$	24
II Electron-neutrino (antineutrino) elastic scattering	26
III Neutrino-nucleon scattering	28
CHAPTER 2 Left-right Symmetric Extension of the S.W. Model	32
2.1 Introduction	32
2.2 Mass matrix and eigenvalues for charged vector bosons	33
2.3 Some experimental evidences of M_W R	39
CHAPTER 3 The Possible Heavy $Z' \rightarrow W^-W^+$ Events at the CERN Collider	43
3.1 Introduction	43
3.2 Neutral currents in the left-right symmetric model	45
3.3 Production cross-section of Z'	

	3.4	The decay of Z'	52
	3.5	Branching ratio	54
CHAPTER	4	Composite Models	56
	4.1	Motivation	56
	4.2	The rishon model	58
	4.8	Problems	62
CHAPTER	5	The Simple Two Z 's Model	65
	5.1	Mass matrix and diagonalization formula	65
	5.2	The couplings of the vector bosons	72
	5.3	Both Z 's within experimental peak	77
	5.4	Two adjacent Z peaks	85
	5.5	Can the second Z explain the CERN $W+2$ Jet events?	89
CHAPTER	6	The Three Z 's Model	93
	6.1	Mass matrix, diagonalization formula and the new couplings of the vector bosons	93
	6.2	Two Z 's within the experimental peak	97
	6.3	Two adjacent Z peaks	105
	6.4	Can the higher Z be the new CERN events?	115
CHAPTER	7	The Superstring Models	120
	7.1	Introduction	120
	7.2	Why the string theory has an extra $U(1)$.	121
	7.3	The comparison with the string predictions	128

CHAPTER 8	Summary	131
REFERENCES		135
Figure Captions		138

INTRODUCTION

It is by now well established that the "standard model", based on the group $SU(3) \times SU(2) \times U(1)$ is compatible with all, confirmed, experimental data. In particular, the Salam-Weinberg sector, in which the Higgs mechanism is used to break the $SU(2) \times U(1)$, agrees with all weak and electromagnetic phenomenology. Thus Chapter 1 is specially designed to review and discuss the history and success of the standard model in all possible neutral currents dynamics. There it will be explicitly seen that the electroweak component of the standard model is fairly able to explain all the, so far, obtained and confirmed experimental data. However, this success does not necessarily mean that the model is correct at the fundamental level; it could instead be an approximation to something very different, with the experimental errors concealing higher order correction terms.

One obvious alternative model, which has been studied previously, is the left-right symmetric model based on the group $SU(2)_L \times SU(2)_R \times U(1)$ [1,2] for the electroweak interactions. This model clearly requires a modified Higgs mechanism which gives a mass to the gauge bosons associated with both $SU(2)$ factors. Provided the mass of the right-handed boson is much greater than that of the left-handed boson, this model gives similar "low energy" results to the standard model. Therefore, Chapter 2 is mainly aimed to review the current situation of the L-R symmetric model in detail. There it will be seen that present available



experimental data requires $M_{W_R} \geq 400$ GeV.

Although, as noted above, there is no confirmed evidence for effects outside the standard model, there are some unconfirmed "events" which might be relevant to our discussion. In particular there are two reported events[3] which might be caused by a heavy Z' decaying into two W 's. In Chapter 3 we shall study whether these events, if real, might be explained in terms of L-R symmetric model.

A much more basic alternative to the standard model is to assume that the quarks, leptons and gauge bosons of the weak interactions (W^\pm and Z^0) are composite objects, in which the fundamental particles (preons) are bound by some new, presumably gauge, interaction. This interaction is often referred to as quantum hypercolour dynamics (QHCD). By analogy with what happens in QCD the preons and the QHCD gauge bosons are assumed to be confined, so that only hypercolour singlets are seen. The observed weak interactions are residual (Van der Waal type) forces which arise in a similar way to the way in which nuclear forces arise from QCD. Actually, the original application of the Higgs mechanism, by Weinberg, was to nuclear forces and the ρ and ω were assumed to be gauge bosons. This idea was, of course, killed with the development of QCD, when it was realised that the ρ and ω were composite, and nuclear forces were not fundamental. What is being suggested here is that something similar might happen in the case of Salam-Weinberg model. The phenomenological success of this model would then

be understood as being due to the fact that even an "effective", low-energy, Lagrangian would be renormalisable, so that it would have to look like a Higgs broken gauge theory, at least up to the energy where composite effects become important. Therefore, Chapter 4 discusses the composite models in details.

There is, however, one possible difference between this type of theory and the Salam-Weinberg model. Since the photon is a massless particle, it seems natural to assume that it really is a genuine gauge boson. (The basic interactions could then be all unbroken gauge theories: QHCD, QCD, and electromagnetism.) This almost certainly means that the effective theory will contain two U(1) factors, because we expect the composite state to include an isotriplet (W and one neutral) and an isosinglet (cf. the ρ and ω). Thus the theory will have 3 neutral vector bosons, or 4 if we consider the L-R symmetric version.

Chapters 5 and 6 deal with this model. Since there is no obvious origin of parity violation in composite models, we study the L-R symmetric case in general. However, in Chapter 5 we restrict our discussion to the case where M_{W_R} is very heavy so that the right-handed SU(2) is irrelevant.

Some other fashionable models, which require extra gauge bosons, are the superstring-inspired models. In these models the current experimental limits on the mass of the new neutral gauge bosons from low-energy neutral current experiments and from the $p\bar{p}$ CERN collider are rather weak [4,5]. We compare these results with the extended

electroweak theory in Chapter 7. There we equally notice that our analysis reasonably agree with the analysis made in superstring models [6].

Finally, Chapter 8 is simply devoted to a summary of the major results presented in this thesis.

CHAPTER 1

The Standard Model

1.1 Introduction

The history of attempts to unify the weak and electromagnetic interaction is very long and probably can be regarded as beginning with the work of E. Fermi [7] in 1934. The standard $SU(2) \times U(1)$ model, proposed and established by Salam-Weinberg to unify the electromagnetic and weak interaction correctly predicted weak neutral currents as well as the existence and properties of W^\pm , Z bosons. This model, theoretically, was suggested first by S. Glashow [8] in 1961 and in more detail by S. Weinberg [9] in 1967 and finally, by A. Salam [10] in 1968 in a variety of situations but still remained experimentally unconfirmed. In 1973 [11] its first prediction was confirmed when people obtained experimental neutral current data which precisely matched with the theoretical prediction made by Salam and Weinberg earlier. Later, in 1983, the W^\pm and Z bosons were seen at the CERN [12,13,14,15]. Before going into the detailed study of the Salam-Weinberg model, we shall briefly discuss in a general way, gauge theories and the Higgs mechanism.

1.2 Gauge theories

Nature has provided us with two kinds of symmetry principles, i.e. local symmetry principles and global symmetry principles. Theories which are based on local symmetry principles are called gauge theories. Einstein also made use of these symmetry principles and by considering the symmetry under general co-ordinates transformations he was led to the general theory of relativity, i.e. the theory of the gravitational interaction. Since the gravitational interaction is not relevant to our research work, we need not to discuss it in the following sections, but it is universally agreed that the theory of gravitational interaction is a theory of exchange of massless gravitons. Thus the present belief is that all particle interactions, currently known and regarded as fundamental, may be described by gauge theories. In the next section we describe the simplest such theory.

1.3 Local gauge symmetry in QED.

Here we begin our discussion by writing down the free Lagrangian for a Dirac particle

$$L = \bar{\psi} (i \gamma^\mu \partial_\mu - m) \psi \quad (1.3.1)$$

where "m" is the mass of the Dirac particle and ψ is the

field associated with it. We use the notation

$$\bar{\psi} = \psi^\dagger \gamma^0 \quad (1.3.2)$$

Now we consider transforming the complex field, describing an electron in space and time, according to:

$$\psi(x) \rightarrow \psi'(x) = e^{i\alpha(x)} \psi(x) \quad (1.3.3)$$

where $\alpha(x)$ is real and depends upon space and time. A Lagrangian that remains invariant under the above phase transformation is said to possess a local gauge symmetry. It is easy to see that the second term appearing in equation (1.3.1) is unchanged by the local phase transformation as given in equation (1.3.2). However the first term changes according to:

$$\bar{\psi}' \not{\partial} \psi' = \bar{\psi} \not{\partial} \psi + i \bar{\psi} \not{\partial} \alpha(x) \psi \quad (1.3.4)$$

The extra term in equation (1.3.3) breaks local gauge invariance. Note that if $\alpha(x)$ is constant this term is zero implying that equation (1.3.1) is invariant under global phase transformation. If we demand that the Lagrangian should be invariant under the above local phase transformation, then we naturally must look for a modified Lagrangian so that we can get rid of the second term appearing in equation (1.3.3). In order to find this modification we need to introduce a vector field A_μ with some

transformation properties such that the Lagrangian becomes automatically invariant. For this purpose the covariant form of the derivative, D_μ , is constructed [16]:

$$\partial_\mu \rightarrow D_\mu = \partial_\mu - ieA_\mu \quad (1.3.5)$$

where the vector field A_μ transforms as

$$A_\mu \rightarrow A_\mu + \frac{1}{e} \partial_\mu \alpha \quad (1.3.6)$$

Then the transformation (1.3.5) is used to obtain the symmetry of the Lagrangian under the local gauge transformation. The invariant Lagrangian is

$$\begin{aligned} L &= \bar{\psi}(i \gamma_\mu D^\mu - m) \psi \\ &= \bar{\psi}(i \gamma^\mu \partial_\mu - m)\psi + e \bar{\psi} \gamma^\mu \psi A_\mu \end{aligned} \quad (1.3.7)$$

Thus equation (1.3.7) shows that in order to demand the invariance of the L under local gauge transformations, we are naturally forced to introduce a vector field A_μ that couples to the Dirac particle in precisely the same way as the photon field. Now if this newly introduced vector field, A_μ , is considered to be the physical photon field then we need to add its K.E term in the Lagrangian (1.3.7).

The invariance of L requires that the K.E term is also invariant under (1.3.6). In this regard, the K.E term only

could involve the anti-symmetric field tensor $F_{\mu\nu}$ defined by

$$F_{\mu\nu} = \partial_\mu A_\nu - \partial_\nu A_\mu \quad (1.3.8)$$

Thus the complete invariant Lagrangian under the local phase transformation for QED attains the final form as:

$$L = \bar{\psi} (i\gamma^\mu \partial_\mu - m) \psi + e \bar{\psi} \gamma^\mu \psi A_\mu - \frac{F_{\mu\nu} F^{\mu\nu}}{4} \quad (1.3.9)$$

It is very important to note that a mass term of the form $\frac{m^2}{2} A_\mu A^\mu$ for the newly introduced vector field A_μ is not compatible with the gauge invariance and hence is not allowed in the Lagrangian (1.3.9). Hence the local gauge symmetry requires the photon to be massless. Now it is quite clear that the phase difference will always be created whenever the phase is changed locally and this phase difference could easily be detected unless otherwise it is compensated ^{for} in some way. The interesting result is that it seems as if the photon field was simply introduced just to cancel the phase difference that was developed due to the local gauge transformation and then subsequently to preserve the local gauge symmetry.

1.4 Local Gauge Symmetry in QCD

Quarks are fermions which carry a colour label

q_i , $i = 1, 2, 3$. Thus the Lagrangian for a free quark is

$$L = \sum_{j=1}^3 \bar{q}_j (i \gamma^\mu \partial_\mu - m) q_j \quad (1.4.1)$$

where for simplicity we consider only one flavour of quark. Now we consider the effect on L if the quark field is transformed under the most general local gauge transformation which mixes the quarks

$$\begin{aligned} q(x) \rightarrow U q(x) &= e^{i \alpha_a(x) T_a} q(x) \\ &\simeq (1 + i \alpha_a(x) T_a) q(x) \end{aligned} \quad (1.4.2)$$

where U is a special unitary 3×3 matrix, i.e. $\det U = 1$ and $\alpha_a(x)$ are the group parameters. T_a with $a = 1, 2, \dots, 8$ are the generators and they satisfy the algebra

$$[T_a, T_b] = i f_{abc} T_c \quad (1.4.3)$$

where the f_{abc} are called the structure constants of the group $SU(3)$.

In the last line of equation (1.4.2) we have expanded using the assumption that the $\alpha_a(x)$ are very small. The derivative of equation (1.4.2) gives

$$\partial_\mu q'(x) = (1 + i \alpha_a(x) T_a) \partial_\mu q(x) + i T_a q(x) \partial_\mu \alpha^a(x) \quad (1.4.4)$$

which shows that the second term appearing on the right hand side of equation (1.4.4) destroys the invariance of the Lagrangian (1.4.1). So we need then to introduce light gauge field G_μ^a to obtain a covariant derivative such that the invariance of L is preserved automatically. By making the replacement

$$\partial_\mu \rightarrow D_\mu = \partial_\mu + igT_a G_\mu^a \quad (1.4.5)$$

where every gauge field G_μ^a transforms as

$$G_\mu^a \rightarrow G_\mu^a - \frac{1}{g} \partial_\mu \alpha^a(x) \quad (1.4.6)$$

the equation (1.4.1) becomes:

$$L = \bar{q}(i \gamma^\mu \partial_\mu - m)q - g(\bar{q} \gamma^\mu T_a q) G_\mu^a \quad (1.4.7)$$

This equation (1.4.7) is the QCD analogue of QED (1.3.6). Because the generators T_a do not commute (equation (1.4.3)) this is an example of a non-Abelian gauge theory. To preserve invariance of L we require that the gauge fields G_μ^a be transformed according to:

$$G_\mu^a \rightarrow G_\mu^a - \frac{1}{g} \partial_\mu \alpha^a(x) - f_{abc} \alpha^b(x) G_\mu^c \quad (1.4.8)$$

If G_μ^a are regarded as the physical coloured gauge fields then the invariant K.E. terms corresponding to these fields

are naturally required to be added in the Lagrangian (1.4.7). Therefore the complete gauge invariant QCD Lagrangian for interacting coloured quarks q and vector gluons G_μ with coupling g is then achieved as

$$L = \bar{q}(i\gamma^\mu \partial_\mu - m)q - g(\bar{q}\gamma^\mu T_a q)G_\mu^a - \frac{1}{4} G_{\mu\nu}^a G_a^{\mu\nu} \quad (1.4.9)$$

where the field strength tensor is defined by

$$G_{\mu\nu}^a = \partial_\mu G_\nu^a - \partial_\nu G_\mu^a - gG_\mu^b G_\nu^c f_{abc} \quad (1.4.10)$$

Thus our arbitrariness in mixing the three quark colour fields, locally, requires eight vector gluon fields to be introduced in order to compensate all the possible transformations. Because an extra term appears in the field strength tensor defined in equation (1.4.10), the K.E. term in equation (1.4.9) now includes the kinetic part and an induced self-interaction between the three and four colour vector gluons. Finally, if we look at the invariant Lagrangian (1.4.9), we see that the mass terms $\frac{m^2}{2} G_\mu^a G_a^\mu$, as for the photon in Q.E.D, are forbidden, implying that the gluons are also massless.

1.5 Higgs Mechanism

The important message of the last section is that in

gauge theories the forces are vector-like and of infinite range, i.e. they correspond to exchange of massless, spin-one particles. It is easy to see that if we added a mass term for the vector bosons then the gauge invariance of the Lagrangian would be lost.

There is therefore a serious difficulty in applying these ideas to weak interactions which appear to be mediated by massive vector bosons. (Indeed these vector particles are so massive that at present energies the interaction appears as a point-like fermion interaction, although it is known that this cannot be the true interaction because it is not renormalizable).

The solution to this problem lies in the fact that it is possible to break the gauge invariance through spontaneous symmetry breaking in such a way that the renormalizability property remains true. In such a broken symmetry the gauge bosons in general acquire mass. To explain how this happens we consider the charged meson which is associated with complex scalar field ϕ described by the Lagrangian

$$L = \frac{1}{2} (\partial_\mu \phi)^* (\partial^\mu \phi) - \frac{\mu^2}{2} \phi \cdot \phi^* - \frac{\lambda}{4} (\phi \cdot \phi^*)^2 \quad (1.5.1)$$

Under $\phi \rightarrow \phi e^{i\alpha}$ transformation, L has a U(1) global gauge symmetry. Now suppose $\mu^2 < 0$ and $\lambda > 0$ then the potential

$$V(\phi) = \frac{\mu^2}{2} \phi \cdot \phi^* + \frac{\lambda}{4} (\phi \cdot \phi^*)^2 \quad (1.5.2)$$

has a minimum at

$$\phi \cdot \phi^* = -\frac{\mu^2}{\lambda} = v^2 \quad (1.5.3)$$

and this minimum potential corresponds to the ground state or vacuum (i.e. no particles).

$$|\langle \phi \rangle|^2 = -\frac{\mu^2}{\lambda} = v^2 \neq 0 \quad (1.5.4)$$

Since, however, equation (1.5.3) only determines the magnitude of $|\phi|$ the vacuum is degenerate. When we choose a particular $\langle \phi \rangle$ satisfying equation (1.5.4) we automatically break the symmetry. We translate the field ϕ to a true ground state in terms of new η, ξ by replacing

$\phi(x) = \frac{1}{\sqrt{2}} (v + \eta(x) + i\xi(x))$ in equation (1.5.1) and we get

$$\begin{aligned} \mathcal{L}' = \frac{1}{2} (\partial_\mu \xi)^2 + \frac{1}{2} (\partial_\mu \eta)^2 - \frac{1}{2} \mu^2 \eta^2 - \frac{1}{2} \lambda v^2 \eta^2 + \text{cubic and quartic} \\ \text{terms in } \eta, \xi \end{aligned} \quad (1.5.5)$$

The first term of equation (1.5.5) is the K.E. part for the ξ field and is seen to be massless. The third term of this equation is a mass term for η -field. Thus the theory now describes two scalar particles; one is massless and the

other having a mass. The appearance of a massless particle when a global symmetry is broken is a very general phenomena - such particles are called "Goldstone bosons". At first sight the addition of other unobserved massless states suggests that this mechanism of symmetry breaking causes further problems with gauge theories. However, when we apply the method to a theory possessing a local symmetry it turns out that the massless scalars are not physical states (they can be eliminated by suitable choice of gauge) and their degrees of freedom provide the extra degrees of freedom for the gauge bosons which become massive.

Instead of ∂_μ we use D_μ defined by

$$D_\mu = \partial_\mu - i e A_\mu \quad (1.3.4)$$

where the gauge field transforms as

$$A_\mu \rightarrow A_\mu + \frac{1}{ev} \partial_\mu \theta \quad (1.5.6)$$

and

$$\phi \rightarrow \sqrt{\frac{1}{2}}(v + h(x)) e^{i \theta(x)/v} \quad (1.5.7)$$

The gauge invariant lagrangian can then be written as:

$$L = (\partial^\mu + i e A^\mu) \phi^* (\partial_\mu - i e A_\mu) \phi - \mu^2 \phi^* \phi - \lambda (\phi^* \phi)^2 - \frac{1}{4} F_{\mu\nu} F^{\mu\nu} \quad (1.5.8)$$

where $F_{\mu\nu} F^{\mu\nu}$ term is purely K.E part for the gauge field A_μ . We take $\mu^2 < 0$ since we are interested to generate the masses by spontaneously symmetry breaking

$$L = \frac{1}{2} (\partial_\mu h)^2 - \lambda v^2 h^2 + \frac{1}{2} e^2 v^2 A_\mu^2 - \lambda v h^3 - \frac{1}{4} \lambda h^4 + \frac{1}{2} e^2 A_\mu^2 h^2 + v e^2 A_\mu^2 g - \frac{1}{4} F_{\mu\nu} F^{\mu\nu} \quad (1.5.9)$$

This Lagrangian contains two interacting massive particles, a vector gauge boson A_μ and a massive scalar h , which is called a "Higgs particle". Here the vector boson A_μ has eaten up the unwanted "Goldstone boson" and hence becomes massive. This kind of mechanism is called the "Higgs mechanism" and is the result of a spontaneously broken local symmetry.

1.6 Salam-Weinberg Model

We have seen in the previous section that the Higgs mechanism is responsible for generating the masses of the vector bosons which mediate the weak interaction. In the electroweak $SU(2) \times U(1)$ model, there will be four vector bosons, three (W^\pm, Z^0) associated with the weak interaction

and one (the photon) with the electromagnetic interaction. Therefore in this section we will make use of the Higgs mechanism in such a way that the W^\pm , Z bosons become massive but the photon remains massless. In order to do this, we first construct the Lagrangian for $SU(2)$ local gauge invariance.

We begin with the simplest form of such a Lagrangian

$$L = (\partial_\mu \phi)^\dagger (\partial^\mu \phi) - V(\phi) \quad (1.6.1)$$

where ϕ is a complex scalar doublet of an $SU(2)$ group and can be written

$$\phi = \frac{1}{\sqrt{2}} \begin{bmatrix} \phi_1 + i \phi_2 \\ \phi_3 + i \phi_4 \end{bmatrix} \quad (1.6.2)$$

where ϕ_1 , etc. are real scalar fields.

The self-interaction potential is given by

$$V(\phi) = \mu^2 \phi^\dagger \phi + \lambda (\phi^\dagger \phi)^2 \quad (1.6.3)$$

Since in the weak interaction there are three generators corresponding to the $SU(2)$ group, we will require three gauge fields to associate with these generators. Thus we replace ∂_μ by the covariant derivative as:

$$\partial_\mu \rightarrow D_\mu = \partial_\mu + i g \frac{\tau_a}{2} W_\mu^a \quad (1.6.4)$$

where $a = 1, 2, 3$.

Under $\phi'(x) = (1 + \alpha(x) \cdot \tau/2) \phi(x)$ gauge transformation, the three gauge fields, corresponding to an SU(2) group, transform as

$$W_\mu \rightarrow W_\mu - \partial_\mu \alpha - \alpha \times W_\mu \quad (1.6.5)$$

and the gauge invariant Lagrangian (1.6.1) attains the form given below

$$L = (\partial_\mu \phi + i g \frac{\tau_a}{2} W_\mu^a \phi)^\dagger (\partial^\mu \phi + i g \frac{\tau_a}{2} W_\mu^a \phi) - \frac{1}{4} W_{\mu\nu}^a \cdot W^{\mu\nu a} \quad (1.6.6)$$

The last term in equation (1.6.6) represents the K.E. and self-coupling of the gauge fields W_μ and is given by

$$W_{\mu\nu}^a = \underbrace{\partial_\mu W_\nu^a - \partial_\nu W_\mu^a}_{\text{K.E. Term}} - \underbrace{g W_\mu^a \times W_\nu^a}_{\text{self-coupling term}} \quad (1.6.7)$$

As we are interested in the case $\mu^2 < 0$ and $\lambda > 0$ so the potential (1.6.3) becomes

$$V(\phi) = \frac{\mu^2}{2} (\phi_1^2 + \phi_2^2 + \phi_3^2 + \phi_4^2) + \frac{\lambda}{4} (\phi_1^2 + \phi_2^2 + \phi_3^2 + \phi_4^2)^2 \quad (1.6.8)$$

Making use of a particular choice, say, at $\phi_1 = \phi_2 = \phi_4 = 0$, the minimum potential then becomes at

$$\phi_3^2 = -\frac{\mu^2}{\lambda} = v^2 \quad (1.6.9)$$

Therefore the complex scalar doublet ϕ , at this minimum potential, attains the form:

$$\phi_0 = \frac{1}{\sqrt{2}} \begin{pmatrix} 0 \\ v \end{pmatrix} \quad (1.6.10)$$

When we extend the range of gauge symmetry from SU(2) to SU(2) x U(1) then the gauge invariant Lagrangian can be written as:

$$L_1 = (D_\mu \phi)^\dagger (D^\mu \phi) - V(\phi) \quad (1.6.11)$$

$$\text{with } D_\mu \phi = \left(\partial_\mu - i \frac{g_T}{2} \cdot W_\mu - i \frac{g_Y}{2} B_\mu \right) \phi \quad (1.6.12)$$

where Y and B_μ are the weak hypercharge operator and the U(1) gauge vector field respectively. Making use of the expectation value ϕ_0 from equation (1.6.10) for $\phi(x)$ with $Y=1$, the Lagrangian becomes

$$L_1 = \left| \left(\partial_\mu - i g \frac{\tau}{2} \cdot W_\mu - i \frac{g'}{2} B_\mu \right) \phi \right|^2 - V(\phi) \quad (1.6.13)$$

The relevant mass term from equation (1.6.12) for the gauge bosons is given by

$$\begin{aligned}
&= \frac{1}{8} \left| \begin{bmatrix} gW_\mu^3 + g'B_\mu & g(W_\mu^1 - i W_\mu^2) \\ g(W_\mu^1 + i W_\mu^2) & -gW_\mu^3 + g'B_\mu \end{bmatrix} \begin{bmatrix} 0 \\ v \end{bmatrix} \right|^2 \\
&= \frac{v^2}{8} [g^2 W^+ W^- + |gW_\mu^3 - g'B_\mu|^2 + 0 |g'W_\mu^3 + gB_\mu|^2] \quad (1.6.14)
\end{aligned}$$

where we have substituted

$$W^\pm = \frac{W^1 \mp i W^2}{\sqrt{2}} \quad (1.6.15)$$

When we compare the first term of equation (1.6.13) with the K.E. of the charged vector bosons ($\frac{1}{2} M^2 W^+ W^-$), we find that

$$M_W = \frac{1}{2} g v \quad (1.6.16)$$

Hence the terms inside the small brackets of equation (1.6.14) are the physical fields and are orthogonal to each other. Now when we compare these terms with $\frac{M_Z^2}{2} Z_\mu^2$ and $\frac{M_A^2}{2} A_\mu^2$ and find that, after normalisation of the fields:

$$A_\mu = \frac{g' W_\mu^3 + g B_\mu}{(g^2 + g'^2)^{\frac{1}{2}}}, \text{ with } M_A = 0 \quad (1.6.17)$$

$$Z_\mu = \frac{g W_\mu^3 - g' B_\mu}{(g^2 + g'^2)^{\frac{1}{2}}}, \text{ with } M_Z = \frac{v}{2} ((g^2 + g'^2)^{\frac{1}{2}}) \quad (1.6.18)$$

Where W^\pm are two massive charged gauge bosons, A_μ is the photon and Z a neutral massive gauge boson. Now if we define $g'/g = \tan \theta_W$ then an alternative form of these physical fields becomes as

$$A_\mu = \cos \theta_W B_\mu + \sin \theta_W W_\mu^3 \quad (1.6.19)$$

$$Z_\mu = -\sin \theta_W B_\mu + \cos \theta_W W_\mu^3 \quad (1.6.20)$$

where θ_W is the Weinberg mixing angle. Using equation (1.6.16) and (1.6.18) we can more easily obtain the well known Weinberg mass relationship:

$$M_Z^2 = \frac{M_W^2}{1 - \sin^2 \theta_W} \quad (1.6.21)$$

To calculate the interactions of the fermions we use the covariant derivative (1.6.4) in the kinetic energy term (1.3.1) and hence obtain

$$-\bar{\psi} (i \gamma^\mu (g \tau_a W_\mu^a + g' \frac{Y}{2} B_\mu)) \psi \quad (1.6.22)$$

for the left-handed fermions doublets $\begin{pmatrix} \nu_e \\ e \end{pmatrix}$ etc., and

$$-\bar{e}_R (i \gamma^\mu g' \frac{Y}{2} B_\mu) e_R \quad (1.6.23)$$

for the right-handed singlet. Then using (1.6.17), (1.6.18)

and (1.6.22), and $\psi = \begin{pmatrix} \nu_{eL} \\ e_L \end{pmatrix}$ and $Y = -1$, we obtain the

following couplings to W^\pm , Z and γ

$$\begin{aligned}
 & : - \frac{ig}{\cos \theta_W} \bar{\nu}_{eL} \gamma^\mu \nu_{eL} Z_\mu - \frac{ig}{\sqrt{2}} \bar{\nu}_{eL} \gamma^\mu e_L W_\mu^+ \\
 & - \frac{ig}{\sqrt{2}} \bar{e}_L \gamma^\mu e_L W_\mu^- + ig \sin \theta_W \bar{e}_L \gamma^\mu e_L A_\mu \\
 & + \frac{ig \cos 2\theta_W}{\cos \theta_W} \bar{e}_L \gamma^\mu e_L Z_\mu \quad (1.6.24)
 \end{aligned}$$

Similarly the right-handed fermions singlets (e.g. electron e_R) couplings to γ and Z are found to be

$$: - ig \sin \theta_W \bar{e}_R \gamma^\mu e_R A_\mu + ig \tan \theta_W \bar{e}_R \gamma^\mu e_R Z_\mu . \quad (1.6.25)$$

Note that the coupling of the right-handed electron to the photon is the same as for left-handed thereby giving the required conservation of parity in electromagnetic interactions. On the other hand the right-handed electron couples to Z differently to the left-handed electron.

By putting together two of the vertices in (1.6.24) we can calculate the effective four-fermion weak coupling constant due to the exchange of the W meson (see 1.7 below).

1.7 Test of the Salam-Weinberg model

After having established the structure of the standard model (S-W) we find that there are parameters which directly

effect the phenomenology of weak and electromagnetic effects. These are two coupling constants (g, g') and a mass term. The constants g and g' represent the coupling strength of the vector bosons to the weak isospin and hypercharge currents respectively and the fundamental interactions for such couplings are shown in Figure (1). One constant is given (to a very high accuracy) by e , so effectively we have two constants M_W (the mass of the charged vector bosons) and θ_W (the mixing angle). These are related by:

$$G_F = \frac{\alpha\pi}{\sqrt{2}M_W^2 \sin^2\theta_W} \text{ (the Fermi weak interaction coupling constant)} \quad (1.7.1)$$

where $\alpha = \frac{e^2}{4\pi}$ (fine Structure Constant) (1.7.2)

We shall now see how it is possible to fit all the data with these two parameters. Historically neutral current measurements (see below) were used to obtain a value of $\sin^2\theta_W$ and equation (1.7.1) was then used to predict M_W and M_Z through the relation

$$M_Z^2 = \frac{M_W^2}{1 - \sin^2\theta_W} \quad (1.6.21)$$

These predictions were confirmed at CERN in 1983 [12,13,14,15]. The current values for the W and Z masses determined by UA1 and UA2, as reported by Di Lella[17] are:

$$\begin{aligned}
M_W &= 83.1 \pm 1.3(\text{stat}) \pm 3(\text{Syst.}) \text{ GeV} && \text{UA1} \\
M_Z &= 93.0 \pm 1.6(\text{stat}) \pm 3(\text{syst.}) \text{ GeV} && \text{UA1} \\
M_W &= 81.2 \pm 1.1(\text{stat}) \pm 1.3(\text{syst.}) \text{ GeV} && \text{UA2} \\
M_Z &= 92.5 \pm 1.3(\text{stat.}) \pm 1.5(\text{syst.}) \text{ GeV} && \text{UA2}
\end{aligned}$$

(1.7.3)

It is important to note that to calculate $\text{Sin}^2\theta_W$, using equation (1.6.21), from the above data we have ignored, for simplicity, the systematic error. By doing this the Weinberg angle is predicted to be

$$\text{Sin}^2\theta_W = 0.21 \pm 0.07 \quad (1.7.4)$$

as shown in Figure (4).

Using the numerical value of $G_\mu = 1.6638 \times 10^{-5} \text{ GeV}^{-2}$, which has been reported recently from the μ -decay process[18], and the masses of the W listed in equation (1.7.3), the equation (1.7.1) rightly determines the values for $\text{Sin}^2\theta_W$ as follows:

$$\text{Sin}^2\theta_W = 0.206 \pm 0.011 \quad (1.7.5)$$

This is also plotted in Figure (4).

We now turn to the neutral current data to see how well

they agree with these values of $\sin^2\theta_W$ given in equations (1.7.4) and (1.7.5).

I Neutral current effects in $e^+e^- \rightarrow \mu^-\mu^+$

In this regard the high energy e^+e^- beam colliders provide a useful testing ground for electroweak interference effects. The e^+e^- annihilations could be obtained either through electromagnetic (γ) or weak neutral current (Z) interactions as pictured, e.g. in Figure (2). But in our current discussion we assume that the neutral current interaction occurs by exchange of a Z-boson and a γ -boson with their standard couplings given in ref. [16]. By making use of the Feynman rules, the amplitudes for γ and Z corresponding to the diagrams in Figure (2) are:

$$M_\gamma = -\frac{e^2}{k^2} (\bar{\mu}\gamma^\nu\mu)(\bar{e}\gamma_\nu e) \quad (1.7.6)$$

$$M_Z = \frac{-g^2}{4 \cos^2\theta_W} [\bar{\mu}\gamma^\nu(c_V^\mu - c_A^\mu\gamma^5)\mu] \frac{g_{\nu\sigma} - k_\nu k_\sigma / M_Z^2}{k^2 - M_Z^2} [\bar{e}\gamma^\sigma(c_V^e - c_A^e\gamma^5)e] \quad (1.7.7)$$

where "K" is the four-momentum which is carried by γ or Z and $k^2 = \hat{S}$ (i.e. the c. of m. energy).

By assuming electron-muon universality i.e. $c_i^e = c_i^\mu = c_i$, we find that the differential cross-section for $e^+e^- \rightarrow \mu^+\mu^-$ process is given by [19]

$$\frac{d\sigma}{d\Omega} = \frac{\alpha^2}{4S} [R_{\mu\mu} (1 + \cos^2\theta) + B \cos\theta] \quad (1.7.8)$$

where

$$R_{\mu\mu} = 1 + 2 c_V X + X^2 (c_V^2 + c_A^2) \quad (1.7.9)$$

and

$$B = 4 c_A^2 X + 8 c_V^2 c_A^2 X^2 \quad (1.7.10)$$

The c_V and c_A are the vector and axial vector weak charges of the electron and muon. They are expressed in the standard model as:

$$c_V = -\frac{1}{2} + 2 \sin^2\theta_W \quad (1.7.11)$$

$$c_A = -\frac{1}{2} \quad (1.7.12)$$

By ignoring the width of the Z when compared to its mass, X is expressed entirely in terms of electroweak mixing gauge and the Z-boson mass as

$$X = \hat{S}/(4\sin^2\theta_W\cos^2\theta_W (\hat{S}-M^2)) \quad (1.7.13)$$

Now the integrated forward-backward asymmetry is given by [20]

$$A_{\mu\mu} \approx c_A^2 C / (3 + c^2) \quad (1.7.14)$$

Here we have neglected all the terms which are very much smaller than unity. Now by substituting the exactly known values for α and G_F [18] and the values for $\sin^2\theta_W$ [20] in equations (1.7.1) and (1.6.21), we find $M_Z = 90.4$ GeV. The mass of the Z is increased to 93.8 ± 2.4 GeV if the currently best known values of the parameters are used [21,22]. It is however, clear that the mass of Z is sensitive to θ_W and M_W free parameters.

The minimum and maximum forward-backward charge asymmetries in the standard model at $\hat{S} = 1798$ GeV² are predicted $A = -26.1\%$ and $A = -14.2\%$ corresponding to $\sin^2\theta_W = 0.103$ and $\sin^2\theta_W = 0.217$ respectively. Therefore the predicted asymmetries, using $M_Z = 93.8$ GeV are in good agreement with the currently obtained data [20]. The consistency between the Weinberg angle obtained from this process and the others is pictured in Figure (4).

II Electron-neutrino (antineutrino) elastic scattering

If electron-neutrino elastic scattering proceeds via the

Z exchange then the invariant amplitude for this neutral current can be written as

$$M^{NC}(\nu\bar{e} \rightarrow \nu\bar{e}) = \frac{G}{\sqrt{2}}(\bar{\nu}\gamma^\mu(1-\gamma_5)\nu)(\bar{e}\gamma_\mu(c_V-c_A\gamma_5)e) \quad (1.7.16)$$

It may, however, be noted that in equation (1.7.11) we have used the fact that the four momentum transfer q is such that $q^2 \ll M_Z^2$. By using the electron-muon universality assumption and the procedure outlined in ref. [16], the total cross sections for $\nu_\mu\bar{e} \rightarrow \nu_\mu\bar{e}$ and $\bar{\nu}_\mu e \rightarrow \bar{\nu}_\mu e$ reactions are obtained given below:

$$\sigma(\nu) = \frac{G^2 \hat{S}}{3\pi} [c_V^2 + c_V c_A + c_A^2] \quad (1.7.17)$$

$$\sigma(\bar{\nu}) = \frac{G^2 \hat{S}}{3\pi} [c_V^2 - c_V c_A + c_A^2] \quad (1.7.18)$$

Therefore, the ratio R of the cross sections for muon-neutrino and muon-antineutrino scattering on electrons is absolutely described by a single electroweak mixing angle θ_W parameter

$$R = \frac{\sigma(\nu)}{\sigma(\bar{\nu})} = 3 \frac{(1-4 \sin^2\theta_W + (16/3) \sin^2\theta_W)}{(1-4 \sin^2\theta_W + 16 \sin^4\theta_W)} \quad (1.7.19)$$

The latest experimental result of Ref.[23] is in good agreement with the prediction of the standard model for

$$\sin^2 \theta_W = 0.209 \pm 0.029 \pm 0.013 \quad (1.7.20)$$

which is shown in Figure (4).

III Neutrino-Nucleon Scattering

When the Z (weak neutral particle) is exchanged in a quasielastic scattering of the neutrino (antineutrino) from the nucleon then the inclusive differential cross section for such a process, phenomenologically shown in Figure (3), is written as

$$\begin{aligned} \frac{d^2\sigma}{dx dy} (\nu N \rightarrow \nu X) = \frac{G^2 \hat{S}}{2\pi} [& (g_L^u)^2 + (g_L^d)^2 Q(x) + (g_L^d)^2 + (g_L^u)^2 \bar{Q}(x) (1-y) \\ & + (g_R^u)^2 + (g_R^d)^2 Q(x) (1-y)^2 + (g_R^u)^2 + (g_R^d)^2 \bar{Q}(x)] \end{aligned} \quad (1.7.21)$$

where

$$\begin{aligned} g_L^u &= \frac{1}{2} - \frac{2}{3} \sin^2 \theta_W, \quad g_L^d = -\frac{1}{2} + \frac{1}{3} \sin^2 \theta_W, \\ g_R^u &= -\frac{2}{3} \sin^2 \theta_W \quad \text{and} \quad g_R^d = \frac{1}{3} \sin^2 \theta_W \end{aligned} \quad (1.7.22)$$

Integrating equation (1.7.21) over x, y and defining

$$\bar{Q} = \int x \bar{Q}(x) dx = \int x [\bar{u}(x) + \bar{d}(x)] dx \quad (1.7.23)$$

and

$$Q = \int x Q(x) dx = \int x [u(x) + d(x)] dx \quad (1.7.24)$$

we get

$$\begin{aligned} \sigma_V(\text{NC}) = \frac{G^2 \hat{S}}{2\pi} [(gu_L^2 + gd_L^2) Q + \frac{(G\bar{u}_L^2 + g\bar{d}_L^2)}{3} \bar{Q} + \frac{(gu_R^2 + gd_R^2)}{3} Q \\ + (g\bar{u}_R^2 + g\bar{d}_R^2) \bar{Q}] \quad (1.7.25) \end{aligned}$$

$$\begin{aligned} \sigma_{\bar{V}}(\text{NC}) = \frac{G^2 \hat{S}}{2\pi} [(g\bar{u}_L^2 + g\bar{d}_L^2) \bar{Q} + \frac{(gu_R^2 + gd_R^2)}{3} Q + \frac{(g\bar{u}_R^2 + g\bar{d}_R^2) \bar{Q}}{3} \\ + (gu_R^2 + gd_R^2) Q] \quad (1.7.26) \end{aligned}$$

But for charge currents we have

$$\sigma_V(\text{CC}) = \frac{G^2 \hat{S}}{2\pi} \left(Q + \frac{\bar{Q}}{3} \right) \quad (1.7.27)$$

$$\sigma_{\bar{V}}(\text{CC}) = \frac{G^2 \hat{S}}{2\pi} \left(\bar{Q} + \frac{Q}{3} \right) \quad (1.7.28)$$

So an isoscalar target with equal number of u and d quarks yields:

$$R = \frac{\sigma_V(NC)}{\sigma_V(CC)} = g_{u_L}^2 + g_{d_L}^2 + R_{CC} (g_{u_R}^2 + g_{d_R}^2) \quad (1.7.29)$$

where
$$R_{CC} = \frac{\sigma_{\bar{V}}(CC)}{\sigma_V(CC)} \quad (1.7.30)$$

and
$$\bar{R} = \frac{\sigma_{\bar{V}}(NC)}{\sigma_{\bar{V}}(CC)} = g_{u_L}^2 + g_{d_L}^2 + \frac{1}{R_{CC}} (g_{u_R}^2 + g_{d_R}^2) \quad (1.7.31)$$

Thus from equations (1.7.29) and (1.7.31) we obtain

$$g_{u_L}^2 + g_{d_L}^2 = \frac{R - \bar{R} R_{CC}^2}{1 - R_{CC}^2} = \frac{1}{2} - \sin^2 \theta_W + \frac{5}{9} \sin^4 \theta_W \quad (1.7.32)$$

and

$$g_{u_R}^2 + g_{d_R}^2 = \frac{(R - \bar{R}) R_{CC}}{R_{CC}^2 - 1} = \frac{5}{9} \sin^4 \theta_W \quad (1.7.33)$$

The values for R , \bar{R} and R_{CC} have been experimentally determined and they are [24]

$$R = 0.320 \pm 0.010 \quad (1.7.34)$$

$$\bar{R} = 0.277 \pm 0.020 \quad (1.7.35)$$

and

$$R_{CC} = 0.498 \pm 0.019 \quad (1.7.36)$$

Using the above results in the context of the standard model, the electroweak mixing angle can easily be obtained

$$\sin^2\theta_W = 0.23 \pm 0.023 \quad (1.7.37)$$

This is shown in Figure (4).

In summary we can safely say that the agreement between five different ways of determining $\sin^2\theta_W$ shown clearly in the Figure (4), gives strong support to the validity of the Salam-Weinberg model. If such a model is the low-energy limit of a different model (e.g. a L-R symmetric model) then the corrections resulting from the extra terms must be small, at least in the experiments discussed above. Similarly other models must explain the above agreement - it is hardly satisfactory to regard it as "accidental".

CHAPTER 2

Left-right Symmetric Extension of the S-W Model

2.1 Introduction

We have studied in the previous chapter the simplest renormalisable theory of weak interaction in which the coupling between the weak currents is mediated by massive intermediate vector bosons, since a four-fermion point interaction is not-allowed. In this chapter we discuss a left-right symmetric extension of this theory based on the group $SU(2)_L \times SU(2)_R \times U(1)$. Here the basic Lagrangian preserves parity and the observed breakdown of parity in weak interactions comes from the spontaneous symmetry breakdown, i.e. from the same mechanism that gives mass to the W and Z.

In order to have one-to-one correspondence in the $SU(2)_L \times SU(2)_R \times U(1)$ gauge theory, there must be the doubled number of charged gauge bosons (W_L^+ and W_R^+) as compared to the standard theory (W^+) and also the doubled number of massive neutral gauge bosons (i.e. two against one in the standard theory). In other words, there exists two kinds of intermediate vector bosons; one associated with (V-A) current is called the left-handed vector boson (W_L) and the other associated with (V + A) current is termed as the right-handed vector boson (W_R).

In the mid seventies, Pati, Salam and Mohapatra [1,2] discussed a completely left-right symmetric theory in which both left-handed and right-handed fermions participate in β decay. The (V-A) character of the observed interaction was a natural consequence of the suppression of right-handed (V+A) gauge currents which in turn was due to the right-handed charged vector boson W_R being heavier than W_L .

In a unified gauge theory of weak and electromagnetic interaction, the left-handed (V-A) currents and the right-handed (V+A) currents together produce a situation in which the parity is conserved in electromagnetic interactions and is violated in weak interactions in good agreement with the experimental result. It is explicitly shown by Sanjanovic [25] that the prediction of both the minimal left-right and the standard gauge theories are indistinguishable even with finite M_{W_R} both in the realm of charged and neutral currents at sufficiently low-energies. These gauge theories phenomenologically would definitely be different at higher energies.

2.2 Mass matrix and eigenvalues for charged vector bosons

The left-right symmetric gauge theory based on the group $SU(2)_L \times SU(2)_R \times U(1)$ has three sets of vectors, T_L , T_R and Y corresponding to the three sub-groups. The electric charge operator in this theory is defined as:

$$Q = T_{3L} + T_{3R} + \frac{Y}{2} \quad (2.2.1)$$

Left-right symmetry of the Lagrangian requires the equality of the $SU(2)_L$ and $SU(2)_R$ coupling constants, i.e. $g_L = g_R = g$. The left (right)-handed fermions are assigned to doublets under $T_L(T_R)$. In order to produce fermionic masses we will need the following Higgs multiplets

$$\Phi = \begin{bmatrix} \phi_1^0 & \phi_1^+ \\ \phi_2^- & \phi_2^0 \end{bmatrix} \quad (2.2.2)$$

with $SU(2)_L \times SU(2)_R \times U(1)$ quantum numbers

$$\Phi = \left(\frac{1}{2}, \frac{1}{2}, 0 \right) \quad (2.2.3)$$

i.e. Φ is a doublet under both $SU(2)$ groups and has zero hypercharge. Bosons will acquire mass when the symmetry is broken spontaneously by giving non-zero expectation value to the Higgs fields. The most general expectation value of consistent with preserving the electromagnetic gauge invariance is of the form:

$$\langle \Phi \rangle = \frac{1}{\sqrt{2}} \begin{bmatrix} k & 0 \\ 0 & k' \end{bmatrix} \quad (2.2.4)$$

After this first step, the symmetry is broken down to $U(1) \times U(1)$, i.e. there are now two massless neutral vector bosons. In order to have only one massless neutral vector

boson, the photon, in the theory we are required to break down the symmetry further down to U(1). For this purpose, we would obviously need more Higgs multiplets. The simplest choice is just to introduce two Higgs doublets:

$$X_L = \begin{pmatrix} X_L^+ \\ X_L^0 \end{pmatrix}, \quad X_R = \begin{pmatrix} X_R^+ \\ X_R^0 \end{pmatrix} \quad (2.2.5)$$

which are assigned the following quantum numbers:

$$X_L = (\frac{1}{2}, 0, 1), \quad X_R = (0, \frac{1}{2}, 1) \quad (2.2.6)$$

Therefore, the total Lagrangian for the X_L , X_R and ϕ Higgs scalar fields can be written as

$$L = (D_\mu X_L)^\dagger (D^\mu X_L) + (D_\mu X_R)^\dagger (D^\mu X_R) + \text{tr} (D^\mu \Phi)^\dagger D_\mu \Phi - V(X_L, X_R, \Phi) \quad (2.2.7)$$

where the general form of the Higgs potential $V(X_L, X_R, \phi)$ in the left-right symmetry is then given by:

$$\begin{aligned} V = & -\mu_1^2 \text{tr} \phi^\dagger \phi + \lambda_1 (\text{tr} \phi^\dagger \phi)^2 + \lambda_2 \text{tr} \phi^\dagger \phi \phi^\dagger \phi + \frac{1}{2} \lambda_3 (\text{tr} \phi^\dagger \tilde{\phi} + \text{tr} \tilde{\phi}^\dagger \phi)^2 \\ & + \frac{1}{2} \lambda_4 (\text{tr} \phi^\dagger \tilde{\phi} - \text{tr} \tilde{\phi}^\dagger \phi)^2 + \lambda_5 \text{tr} \phi^\dagger \phi \tilde{\phi}^\dagger \tilde{\phi} + \frac{1}{2} \lambda_6 [\text{tr} \phi^\dagger \tilde{\phi} \phi^\dagger \tilde{\phi} + \text{h.c.}] \\ & - \mu_2^2 (X_L^\dagger X_L + X_R^\dagger X_R) + \rho_1 [(X_L^\dagger X_L)^2 + (X_R^\dagger X_R)^2] + \rho_2 X_L^\dagger X_L X_R^\dagger X_R \\ & + \alpha_1 \text{tr} \phi^\dagger \phi (X_L^\dagger X_L + X_R^\dagger X_R) + \alpha_2 (X_L^\dagger \phi \phi^\dagger X_L + X_R^\dagger \phi \phi^\dagger X_R) \\ & + \alpha'_2 (X_L^\dagger \tilde{\phi} \tilde{\phi}^\dagger X_L + X_R^\dagger \tilde{\phi}^\dagger \tilde{\phi} X_R). \end{aligned} \quad (2.2.8)$$

where $\tilde{\phi}$ is defined by:

$$\tilde{\phi} = \tau_2 \phi^* \tau_2 = (\frac{1}{2}, \frac{1}{2}, 0) \quad (2.2.9)$$

Sanjanovic has explicitly shown [3] that one of the particular solutions for the minimum of this potential has the expectation values for the left-right handed Higgs scalar doublets, provided the gauge symmetry is broken, as under:

$$\langle X_L \rangle = 0, \quad \langle X_R \rangle = \frac{1}{\sqrt{2}} \begin{pmatrix} 0 \\ v \end{pmatrix} \quad (2.2.10)$$

$$\langle \tilde{\phi} \rangle = \frac{1}{\sqrt{2}} \begin{bmatrix} k & 0 \\ 0 & k' \end{bmatrix} \quad (2.2.4)$$

We shall choose $v > k, k'$, thus ensuring that the mass of the right-handed charged vector boson is greater than the mass of the left-handed charged vector bosons, which suppresses the right-handed charged current interactions at low-energies. However, under the parity operation the Higgs fields transform as:

$$X_L \leftrightarrow X_R, \quad \phi \leftrightarrow \phi^+ \quad \text{and} \quad \tilde{\phi} \leftrightarrow \tilde{\phi}^+ \quad (2.2.11)$$

Therefore the K.E. part of the Lagrangian defined in (2.2.8) for the scalar fields X_L, X_R and ϕ can then easily be written:

$$L = (D_\mu X_L)^\dagger D^\mu X_L + (D_\mu X_R)^\dagger D^\mu X_R + \text{tr} (D_\mu \phi)^\dagger D^\mu \phi, \quad (2.2.12)$$

where

$$\begin{aligned} D_\mu X_L &= \partial_\mu X_L - \frac{1}{2} i g \tau \cdot W_L X_L, \\ D_\mu X_R &= \partial_\mu X_R - \frac{1}{2} i g \tau \cdot W_R X_R, \\ D_\mu \phi &= \partial_\mu \phi - \frac{1}{2} i g (\tau \cdot W_L \phi - \phi^\dagger \cdot W_R) \end{aligned} \quad (2.2.13)$$

and the τ 's are the Pauli Spin matrices

$$\begin{aligned} \tau_1 &= \begin{bmatrix} 0 & 1 \\ 1 & 0 \end{bmatrix} \\ \tau_2 &= \begin{bmatrix} 0 & -i \\ i & 0 \end{bmatrix} \\ \tau_3 &= \begin{bmatrix} 1 & 0 \\ 0 & -1 \end{bmatrix} \end{aligned} \quad (2.2.14)$$

Now the relevant mass term of $D_\mu X_R$ is found:

$$(D_\mu X_R) = \frac{-ig}{2} \begin{bmatrix} W_{R1} & -i W_{R2} \\ & 0 \end{bmatrix} \quad (2.2.15)$$

where we used the fact:

$$W_R^\pm = \frac{1}{\sqrt{2}} (W_{R_1} \mp iW_{R_2}) \quad (2.2.16)$$

Thus

$$(D_\mu X_R)^\dagger (D^\mu X_R) = \frac{v^2 g^2}{4} (W_R^- W_R^+) \quad (2.2.17)$$

Similarly considering the mass term of $D_\mu \Phi$ for charged vector bosons we find

$$(D_\mu \Phi)^\dagger (D^\mu \Phi) = \frac{g^2}{4} \begin{bmatrix} k^2 W_L^+ W_L^- - kk' W_L^+ W_R^- - kk' W_R^+ W_L^- & 0 \\ +k'^2 W_R^+ W_R^- & k'^2 W_L^- W_L^+ - kk' W_L^- W_R^+ \\ 0 & -kk' W_R^- W_L^+ + k^2 W_R^- W_R^+ \end{bmatrix}$$

So

$$\text{tr}((D_\mu \Phi)^\dagger (D^\mu \Phi)) = \frac{g^2}{4} \begin{bmatrix} k^2 W_L^+ W_L^- - kk' W_L^+ W_R^- - kk' W_R^+ W_L^- + k'^2 W_R^+ W_R^- \\ +k'^2 W_L^- W_L^+ - kk' W_L^- W_R^+ - kk' W_R^- W_L^+ + k^2 W_R^- W_R^+ \end{bmatrix} \quad (2.2.18)$$

By replacing the values of $(D_\mu X_R)^\dagger (D^\mu X_R)$ and $\text{tr}(D_\mu \Phi)^\dagger (D^\mu \Phi)$ from equations (2.2.17) and (2.2.18) respectively in equation (2.2.12) the gauge particles of the theory are then conveniently represented by the matrix:

$$\begin{matrix} 2 \\ M = \end{matrix} \begin{matrix} W_L^- \\ W_R^- \end{matrix} \begin{vmatrix} W_L^+ & W_R^+ \\ \Sigma & \frac{-g^2 kk'}{2} \\ \frac{-g^2 kk'}{2} & \Sigma + \Lambda \end{vmatrix} \quad (2.2.19)$$

$$\text{where } \Lambda = \frac{g^2 v^2}{4} \quad \text{and} \quad \Sigma = \frac{g^2}{4} (k^2 + k'^2) \quad (2.2.20)$$

To make $W_R > W_L$, we choose $v^2 \gg k^2, k'^2$. In this limit the eigenstates of equation (2.2.19) are then immediately found (using the characteristic equation i.e. $\det (M - \lambda I) = 0$) as follows

$$M_{W_L}^2 = \frac{g^2}{4} (k^2 + k'^2) \quad (2.2.21)$$

$$M_{W_R}^2 = \frac{g^2}{4} (k^2 + k'^2 + v^2) \quad (2.2.22)$$

2.3 Some experimental evidences of M_{W_R}

In the preceding section we have assumed that the right-handed charged vector boson is heavier than the left-handed charged vector boson, in order to preserve the well established (V-A) character of the observed weak interaction at low-energies. The obvious question that arises is how small, M_{W_R} can be without violating the experimental data. This lower limit has been increased as the now highly sensitive and well designed machines are being used for

measurements. The effective current-current Lagrangian for the weak interactions at sufficiently low transfer of momentum is [26] given by

$$L_W = \frac{G_1}{\sqrt{2}} J_{(V-A)} J^{(V-A)*} + \frac{G_2}{\sqrt{2}} J_{(V+A)} J^{(V+A)*} \quad (2.3.1)$$

where G_1 and G_2 are the left-handed and right-handed Fermi coupling constants respectively and are defined as follows:

$$\frac{G_1}{\sqrt{2}} = \frac{4\pi g^2}{M_{W_L}^2}, \quad \frac{G_2}{\sqrt{2}} = \frac{4\pi g^2}{M_{W_R}^2} \quad (2.3.2)$$

and $J^{(V-A)}$ and $J^{(V+A)}$ are the left-handed and right-handed charge currents respectively. It is important to note that the interference effects of the (V-A) and (V+A) currents are not appearing in equation (2.3.1), because at higher energies these two currents behave almost independently. By knowing the relationship between G_1 and G_2 experimentally one can easily determine the mass of the right-handed charged vector boson. The integral probability of the negative muon-decay into one electron and two neutrinos (when both the (V+A) and (V-A) currents are considered to be involved in together) yields [26]:

$$W = \frac{M_\mu^5 G^2}{384\pi^3} [1 + a_1 (\xi_\mu \eta) + a_2 (\xi_e \eta) + a_3 (\xi_\mu \eta) (\xi_e \eta) + a_4 [(\xi_\mu \xi_e) - (\xi_\mu \eta) (\xi_e \eta)]] \quad (2.3.3)$$

with

$$G = (G_1^2 + G_2^2)^{\frac{1}{2}}, \quad a_1 = \frac{-1}{3} \left(1 - 2 \frac{G_2^2}{G^2}\right), \quad a_2 = -\left(1 - 2 \frac{G_2^2}{G^2}\right) \\ = 10^{-5}/M_n^2.$$

$$a_3 = \frac{1}{3}, \quad a_4 \cong 4 \frac{G_2}{3G} \quad (2.3.4)$$

Here a_1 is the electron asymmetry co-efficient, a_2 is the longitudinal polarisation coefficient, the coefficient a_3 gives the correlation of longitudinal polarisation and asymmetry, a_4 is the co-efficient of T- and P- even transverse electron polarisation in a plane determined by ξ_μ and η . Using the experimental value [27] determined for the electron asymmetry coefficient a_1 , the equation (2.3.4) clearly gives the following relation:

$$G_2 < 0.121 G_1 \quad (2.3.5)$$

From equations (2.3.2) and (2.3.5) we obtain:

$$M_{W_R}^2 \geq 8M_{W_L}^2 \quad (2.3.6)$$

The currently best known values for the mass of the M_{W_L} listed in equation (1.7.3) immediately yields the mass of the M_{W_R} as follows

$$M_{W_R} \geq 235 \text{ Gev.} \quad (2.3.7)$$

The first comprehensive study of the experimental constraints on left-right symmetric theories, from the low energy charged-current sector, was made by Beg et al [28]. There they concluded from their analysis that $M_{W_R} \geq 220 \text{ GeV}$ approximately in agreement with equation (2.3.7). later some

improved constraints on the mass scale of the right-handed currents, determined experimentally in μ^+ -decay were reported by Carr et al. [29] where they predicted from their experimental analysis that $M_{W_R} \geq 380$ GeV at 90% confidence level. The latest constraint on the mass of the right-handed currents has been placed by Stoker et al. [30] by making use of muon-spin-rotation technique in μ^+ -decay experiment. In this experimental study they conclude and set a lower limit on $M_{W_R} \geq 400$ GeV.

CHAPTER 3

The Possible Heavy Z' $\rightarrow W^-W^+$ Events at the CERN Collider

3.1 Introduction

In the first chapter we have explicitly discussed and analysed the standard Glashow-Weinberg-Salam (GWS) model of electroweak interactions, based on the gauge group $SU(2)_L \times U(1)_Y$. There, we have seen that this model has achieved great successes in describing all the neutral current processes and in correctly predicting the masses of the W^- and Z^- vector bosons. This standard model does not, at the present time, conflict with any confirmed experimental data.

In this chapter we shall discuss two possible events observed at the CERN $P\bar{P}$ collider which appear to be hard to explain within the standard models and which might therefore indicate "new" physics. We shall see whether the $L \times R$ symmetric model of the second chapter offers a way of explaining these events (should they be confirmed).

The unusual events were seen by the UAI group [3]. Basically, what they observed was a high transverse momentum distribution for ($W \rightarrow e\nu$ and $\rightarrow \mu\nu$) events in $P\bar{P}$ collider experiment shown in Figure (5). It is quite obvious from the figure that there is a continuous event population up to

$p_t^W \sim 40 \text{ GeV}/c$. There are also two events which are absolutely isolated from the rest at much higher values of p_t^W . The solid curve in this figure gives the expected p_t^W distribution for W 's produced directly from the QCD calculations of Ref. [31] with structure functions modified to take into account selection biases and detector smearing effects. These two events were actually seen, one at $p_t^W \sim 66 \text{ GeV}/c$ and the other at $p_t^W \sim 89 \text{ GeV}/c$. In each of the $W \rightarrow e\nu$ and $W \rightarrow \mu\nu$ samples the event with the largest W transverse momentum contains two jets and, further, that the jet-jet mass is of order M_W . For both events, the overall invariant mass of the W -jet-jet system is in the $245 \rightarrow 270 \text{ GeV}/c^2$ range. These events are therefore kinematically consistent with an apparent WW pair production. The expected WW pair production from the electroweak process is a factor ~ 10 below the present experimental results [32]. This new experimental data require $M_{WW} > 240 \text{ GeV}$. In summary, these events are interesting because they appear to be just outside the expectation of the standard model. At present, however, there is no clear understanding of what they represent. Various authors have different speculations about these newly seen events. For example, Stirling and Kleiss [33] consider the possibility that the W^+W^- pair are produced in the decay of a heavy "Z'" with mass in the range of $250 \rightarrow 300 \text{ GeV}/c^2$. The UA1 group [3] have also put a lower mass limit (90% cl) of $166 \text{ GeV}/c^2$ on a hypothetical heavy "Z'" with a standard (3%) branching ratio into e^+e^- .

We shall now consider the possibility that these events are actually the production of the heavy "Z'" (associated with the $SU(2)_R$) and its subsequent decay into two W's.

3.2 Neutral currents in the left-right symmetric model

From equations (2.2.4), (2.2.12) and (2.2.13) we obtain the mass matrix for the neutral gauge bosons (in the minimal low energy effective theory) as follows:

$$\langle i | M^2 | j \rangle = \begin{bmatrix} \Sigma & -\Sigma & 0 \\ -\Sigma & \Sigma + \Lambda & -\alpha\Lambda \\ 0 & -\alpha\Lambda & \alpha^2\Lambda \end{bmatrix} \quad (3.2.1)$$

where $\alpha = g_1/g$ (3.2.2)

The eigenvalues of this matrix are simply determined by making use of the characteristic equation i.e. $\det. (M - \lambda I) = 0$, where the λ 's are three $(\text{mass})^2$ eigen values associated with the photon (γ), the light massive observed vector boson (Z) and a heavy vector boson (Z'). Thus the eigenvalue spectrum becomes

$$\begin{aligned} \lambda_1 &= 0 \\ \lambda_2 &= \frac{\Sigma(1+2\alpha^2)}{1+\alpha^2} - \frac{\Sigma^2}{\Lambda} \frac{(1+2\alpha^2)}{(1+\alpha^2)^3} \\ \lambda_3 &= \Lambda(1+\alpha^2) + \frac{\Sigma}{1+\alpha^2} \end{aligned} \quad (3.2.3)$$

where we have ignored terms $O(\frac{\Sigma^2}{\Lambda^2})$ in λ_2 and λ_3 . In order to diagonalize the matrix (3.2.1) we introduce the states $|n\rangle$

$$|n\rangle = \sum_i |i\rangle \langle i|n\rangle \quad (3.2.4)$$

where

$$\langle i|n\rangle = \begin{bmatrix} \sin\theta_W & \cos\theta_W & -\frac{\Sigma}{\Lambda} \frac{(\cos 2\theta_W)^{3/2}}{\cos^3\theta_W} \\ \sin\theta_W & \frac{-\sin^2\theta_W}{\cos\theta_W} \left(1 - \frac{\Sigma(\cos 2\theta_W)^2}{\Lambda \sin^2\theta_W \cos^4\theta_W}\right) & \frac{(\cos 2\theta_W)^{1/2}}{\cos\theta_W} \left(1 + \frac{\Sigma \sin^2\theta_W \cos 2\theta_W}{\Lambda \cos^4\theta_W}\right) \\ (\cos 2\theta_W)^{1/2} & -\tan\theta_W (\cos 2\theta_W)^{1/2} \left(1 + \frac{\Sigma}{\Lambda} \frac{(\cos 2\theta_W)}{\cos^4\theta_W}\right) & -\tan\theta_W \left(1 - \frac{\Sigma}{\Lambda} \frac{(\cos 2\theta_W)^2}{\cos^4\theta_W}\right) \end{bmatrix} \quad (3.2.5)$$

$$\text{with } \sin^2\theta_W = \frac{\alpha^2}{1+2\alpha^2} \quad (3.2.6)$$

In the basis $|n\rangle$ we find:

$$\langle n|M^2|m\rangle = \sum_{i,j} \langle n|i\rangle \langle i|M^2|j\rangle \langle j|m\rangle$$

$$= \begin{bmatrix} 0 & & 0 \\ 0 & \Sigma \left(\frac{1}{\cos\theta_W}\right)^2 - \frac{\Sigma^2}{\Lambda} \frac{(\cos 2\theta_W)^2}{(\cos\theta_W)^6} & 0 \\ 0 & 0 & \frac{\Sigma \cos 2\theta_W}{(\cos\theta_W)^2} + \Lambda \frac{\cos^2\theta_W}{\cos 2\theta_W} \end{bmatrix} \quad (3.2.7)$$

Now to calculate the couplings of these states to the fermions we simply require

$$\langle i | = \sum_n \langle i | n \rangle \langle n | \quad (3.2.8)$$

where the states $\langle n |$, correspond to the photon $\langle \gamma |$, the standard neutral vector boson $\langle Z |$ and a very heavy neutral vector boson $\langle Z' |$, while the states $\langle i |$ are associated to the left-handed charged vector boson $\langle W_L |$, the right-handed charged vector boson $\langle W_R |$ and an hypercharge state $\langle B |$.

Therefore

$$\begin{bmatrix} W_L \\ W_R \\ B \end{bmatrix} = \begin{bmatrix} \sin\theta_W & \cos\theta_W & -\frac{\Sigma}{\Lambda} \frac{(\cos 2\theta_W)^{3/2}}{(\cos\theta_W)^3} \\ \sin\theta_W & \frac{-\sin^2\theta_W}{\cos\theta_W} \left(1 - \frac{\Sigma}{\Lambda} \frac{(\cos 2\theta_W)^2}{\cos^4\theta_W \sin^2\theta_W}\right) & \frac{(\cos 2\theta_W)^{1/2}}{\cos\theta_W} \left(1 - \frac{\Sigma}{\Lambda} \frac{\sin^2\theta_W \cos 2\theta_W}{(\cos\theta_W)^4}\right) \\ (\cos 2\theta_W)^{1/2} & -\tan\theta_W (\cos 2\theta_W)^{1/2} \left(1 + \frac{\Sigma}{\Lambda} \frac{\cos 2\theta_W}{\cos^4\theta_W}\right) & -\tan\theta_W \left(1 - \frac{\Sigma}{\Lambda} \frac{(\cos 2\theta_W)^2}{(\cos\theta_W)^4}\right) \end{bmatrix} \begin{bmatrix} \gamma \\ Z \\ Z' \end{bmatrix}$$

$$= \begin{bmatrix} \sin\theta_W \gamma & + \cos\theta_W Z & -\frac{\Sigma}{\Lambda} \frac{(\cos 2\theta_W)^{3/2}}{(\cos\theta_W)^3} Z' \\ \sin\theta_W \gamma & -\frac{\sin^2\theta_W}{\cos\theta_W} \left(1 - \frac{\Sigma}{\Lambda} \frac{(\cos 2\theta_W)^2}{\cos^4\theta_W \sin^2\theta_W}\right) Z & + \frac{(\cos 2\theta_W)^{1/2}}{\cos\theta_W} \left(1 + \frac{\Sigma}{\Lambda} \frac{\sin^2\theta_W \cos 2\theta_W}{(\cos\theta_W)^4}\right) Z' \\ (\cos 2\theta_W)^{1/2} \gamma & -\tan\theta_W (\cos 2\theta_W)^{1/2} \left(1 + \frac{\Sigma}{\Lambda} \frac{\cos 2\theta_W}{\cos^4\theta_W}\right) Z & -\tan\theta_W \left(1 - \frac{\Sigma}{\Lambda} \frac{(\cos 2\theta_W)^2}{(\cos\theta_W)^4}\right) Z' \end{bmatrix} \quad (3.2.9)$$

Since the couplings in general are defined by the relation:

$$: g T_{3L} W_L + g T_{3R} W_R + g_1 B \frac{Y_1}{2} \quad (3.2.10)$$

Thus the expected photon coupling becomes:

$$: g \sin\theta_W Q$$

where Q is defined in (2.2.1).

The Z coupling therefore attains the form:

$$: \frac{g}{\cos\theta_W} (T_{3L} - \sin^2\theta_W Q) + O\left(\frac{\Sigma}{\Lambda}\right) \quad (3.2.11)$$

and similarly the Z' coupling is found to be:

$$: \frac{-g}{2 \cos\theta_W (\cos 2\theta_W)^{1/2}} (c_V - c_{A'} \gamma_5) + O\left(\frac{\Sigma}{\Lambda}\right) \quad (3.2.12)$$

where $c_V = T_3 - 2\sin^2\theta_W Q$

and $c_{A'} = -T_3 \cos\theta_W \quad (3.2.13)$

We note that, to the zero order of $(\frac{\Sigma}{\Lambda})$, the Z has exactly the same coupling as in the standard model. We shall consider the $(\frac{\Sigma}{\Lambda})$ correction further in Chapter 6.

Since we are particularly concerned to compute the production cross-section of the heavy Z' and its subsequent

decay into two W_L 's, we also need to calculate the couplings of the Z' to the left-handed light massive charged vector bosons which are due to the gauge coupling between $3W_L$ particles and the fact that Z contains an admixture of W_L^0 . This coupling is (from equation 3.2.5) given by:

$$: - K g \cos \theta_W \quad (3.2.14)$$

where the suppression factor K is given by

$$K = \frac{(\cos 2\theta_W)^{3/2}}{(\cos \theta_W)^4} \frac{\Sigma}{\Lambda} \quad (3.2.15)$$

and " $g \cos \theta_W$ " is the standard model coupling of the Z to the left-handed massive charged vector bosons.

3.3 Production cross-section of "Z'" in $P\bar{P}$ collider

The production of weak intermediate vector bosons of very large masses at the CERN $P\bar{P}$ collider [12,13,14] provides a direct test of the Drell-Yan mechanism [34] assuming of course that the couplings are as given by the standard model. In this section we shall briefly discuss the kinematics of the Drell-Yan process and then find the production cross-section of the heavy " Z' " boson.

Consider a proton and antiproton with four momenta P_1 and P_2 respectively, which collide at total centre-of-mass energy squared " \hat{S} " to produce a vector boson of momentum,

"q". The diagram for a "Z'" boson produced by $P\bar{P}$ collision is shown in Figure (6). For the high energies we are considering the Mandelstam variable " \hat{S} " becomes:

$$\begin{aligned}\hat{S} &\equiv (P_1 + P_2)^2 \\ &\equiv 2P_1 \cdot P_2\end{aligned}\quad (3.3.1)$$

According to the parton model, the production of the boson proceeds via the interaction of a parton of momentum p_1 in proton with a parton of momentum p_2 in antiproton. Further if x_1 is the fraction of momentum carried by parton in proton and x_2 is the fraction of momentum carried by parton in antiproton then:

$$p_1 = x_1 P_1 \quad (3.3.2)$$

$$p_2 = x_2 P_2 \quad (3.3.3)$$

and

$$\begin{aligned}q^2 = M_Z^2 &= (P_1 + P_2)^2 \\ &= (x_1 P_1 + x_2 P_2)^2 \\ &\equiv x_1 x_2 \hat{S}\end{aligned}\quad (3.3.4)$$

Using the "Z'" coupling to fermions determined (neglecting the effect of $O(\frac{\Sigma}{\Lambda})$) in section (3.2), the invariant

production cross-section of "Z'" in $P\bar{P}$ reaction attains the form [35]:

$$\sigma(P\bar{P} \rightarrow ZX) = \frac{K_1^2 \pi^2 \alpha}{\sin^2 \theta_W \cos^2 \theta_W} \frac{1}{3} \sum_q \int_0^1 dx_1 \int_0^1 dx_2 [f_{\bar{p}}^{\bar{q}}(x_1) f_p^q(x_2) + f_p^q(x_1) f_{\bar{p}}^{\bar{q}}(x_2)] \times (c_V^2 + c_A^2) \delta(x_1 x_2 \hat{S} - M_{Z'}^2) \quad (3.3.5)$$

where

$$K_1 = \frac{1}{(\cos 2\theta_W)^{\frac{1}{2}}} \quad (3.3.6)$$

is the suppression factor which comes due to the "Z'" coupling.

Moreover $f_{\pm}^{q_{\pm}}(x)$ are the structure functions of the proton and antiproton respectively and they represent the distributions of quarks (anti-quarks) in the parent hadrons. The factor $\frac{1}{3}$ accounts for the fact that all three colours of q and \bar{q} occur with equal probability but only a q and \bar{q} of the same colour can annihilate to form a colourless boson. We note that (3.3.5) differs from the corresponding expression for Z production because of the factor K_1 and also because of the mass dependence which occurs in the δ - function.

The numerical values of the cross-section for the Z' production in $P\bar{P}$ mechanism, at its various masses, have been calculated from equation (3.3.5) and are drawn in Figure

(8). These calculations use the structure functions $f(x)$ given by E. Eichten et al. [37] and we are indebted to James Stirling who has performed the necessary computations.

Figure (8) clearly indicates that the total cross-section decreases by increasing the mass of the heavy Z' . We have also determined the ratio of the cross-section of the heavy Z' and the conventional Z , which is well shown in Figure (9) as a function of $M_{Z'}$.

3.4 The decay of "Z'"

Since, in our L-R symmetric extension of the standard model, the heavier neutral "Z'" particle is a spin one gauge boson, there must be three helicity states associated with it, $\pm 1, 0$. We estimate the decay of "Z'" into two W_L 's by taking a frame of reference in which "Z'" is at rest. In this frame the polarisation vector $\epsilon_\mu(p)$ for the gauge bosons shown in Figure (7) are given by:

$$\begin{array}{llll}
 \lambda & , & \epsilon_{\mu}^{W_L^+}(P_1) & , & \epsilon_{\mu}^{W_L^-}(P_2) & , & \epsilon_{\mu}^{Z'}(P_3) \\
 0 & , & \frac{1}{M_{W_L}}(P, 0, 0, E) & , & \frac{1}{M_{W_L}}(-P, 0, 0, E) & , & (0, 0, 0, 1) \\
 +1 & , & \frac{-1}{\sqrt{2}}(0, 1, i, 0) & , & \frac{-1}{\sqrt{2}}(0, 1, i, 0) & , & \frac{-1}{\sqrt{2}}(0, 1, i, 0) \\
 -1 & , & \frac{1}{\sqrt{2}}(0, 1, -i, 0) & , & \frac{1}{\sqrt{2}}(0, 1, -i, 0) & , & \frac{1}{\sqrt{2}}(0, 1, -i, 0)
 \end{array}$$

where λ 's are the helicity states and P 's represent the momenta of the vector bosons. Now using the "Z'" couplings to the vector bosons determined in Section (3.2) and working in the frame mentioned above we immediately find the invariant amplitude, for the process pictured in the Figure (7), [36] as

$$M = K g \cos\theta_W \epsilon_\nu^*(P_1) \epsilon_\lambda^*(P_2) [g_{\nu\lambda}(P_2 - P_1)_\mu - g_{\lambda\mu}(P_3 + P_2)_\nu + g_{\mu\nu}(P_3 + P_1)_\lambda] \epsilon_\mu(P_3) \quad (3.4.2)$$

The suppression factor K obviously gives the difference between the heavy "Z'" and the usual light Z (for which $K = 1$). Then after some straightforward and tedious mathematical calculations, the decay width of "Z'" into $W_L^- W_L^+$ becomes [33] as follows:

$$\Gamma(Z' \rightarrow W_L^- W_L^+) = K^2 \frac{\alpha \cot^2 \theta_W}{48} M_{Z'}(X)^{-3} (X^2 - 4)^{3/2} (X^4 + 20X^2 + 12) \quad (3.4.3)$$

where we have used $X = \frac{M_{Z'}}{M_{W_L}}$ (3.4.4)

Similarly the decay width of heavy "Z'" into $f\bar{f}$ attains the simplest form given below

$$\Gamma(Z' \rightarrow f\bar{f}) = \frac{K_1^2 g^2 M_{Z'}^2}{48 \pi \cos^2 \theta_W} [(c_V^f)^2 + (c_A^f)^2] \quad (3.4.5)$$

where K_1 , c_V and c_A are already well defined in Sections

(3.2) and (3.3). The notations f and \bar{f} represent fermion and antifermion respectively.

3.5 Branching ratio

The experimental results with which we wish to compare our predictions are concerned with possible events leading to pairs $W_L W_L$. In order to find how many of these pairs our model predicts will be seen we need to know how often the Z' decays into this mode. This is given by the branching ratio which is the ratio of the decay width of the Z' into a particular channel and the total width of the Z' into all possible channel including the $Z' \rightarrow W_L^- W_L^+$ mode. Thus

$$\text{B.R}(Z' \rightarrow W_L^- W_L^+) = \frac{\Gamma(Z' \rightarrow W_L^- W_L^+)}{\Gamma(Z' \rightarrow \sum_{\text{all}} f\bar{f} + W_L^- W_L^+)} \quad (3.5.1)$$

Then making use of the equations (3.4.4) and (3.4.6), the branching ratios of the fermions and W_L bosons have been determined and finally graphed in Figure (10). This Figure clearly indicates that increasing the mass of the Z' does not noticeably effect the branching ratios of the fermions like the standard model, whereas the branching ratios of the W_L bosons increase reasonably. The reason is very simple and obvious from the fact that the coupling strength of the Z' to W_L boson is effectively suppressed by a factor K that mainly depends on the M_{W_R} .

Now to find the number of Z' to be decayed into $W_L^- W_L^+$ pairs, we really require to calculate the number of the standard Z 's produced. These are well computed in Chapter 5 which are approximately 975 events. Then the number of Z' decayed into $W_L^- W_L^+$ events can be easily found by the relation

$$N_{Z'} = \text{No. of } Z \text{ (produced)} \times \text{Ratio of } \left(\frac{Z'}{Z}\right) \text{ cross-section}$$

$$\times \frac{\Gamma(Z' \rightarrow W_L^- W_L^+)}{\Gamma(Z' \rightarrow \sum_{\text{all}} f \bar{f} + W_L^- W_L^+)} \quad (3.5.2)$$

Since the ratio of $\left(\frac{Z'}{Z}\right)$ cross-section (see Figure 9) is 0.022 at $M_{Z'} = 200$ GeV, and the branching ratio of $W_L^- W_L^+$ pairs (see Figure 10) again at $M_{Z'} = 200$ GeV becomes approximately 0.002.

Thus our current model predicts

$$\begin{aligned} N_{Z'} &= 975 \times 0.0922 \times 0.002 \\ &\approx 0.043 \text{ events} \end{aligned} \quad (3.5.3)$$

which are, certainly, much smaller as compared to the experimental data [3]. Also notice that the number of Z' events to be seen can be further increased by lowering the mass of the right-handed vector boson (W_R) from 300 GeV to a reasonably acceptable value.

Composite Models

4.1 Motivation

The whole physical world around us is full of objects composed of so called "matter". In their sizes, appearances and properties they are very different. To find a simple and elegant way of understanding and explaining this amazing variety of objects as being made from some basic constituents has long been an aim of thinking man. The collective efforts of various scientists, at different ages, to explore the structure of matter have revealed a sequence of layers; molecule, atom, nucleus, nucleon and quark, each of which has eventually turned out to be composite, i.e. to conceal some further substructure. At the present stage of our understanding we have reached the level of quarks and leptons. Should we go further?

Early suggestions that quarks and leptons might have composite structure were made by Chang [38], Massam and Zichichi [39]. At present there are not very compelling reasons for believing in any substructure of quarks and leptons, but the probable discovery of six types of quarks, each appearing in three colours, and the existence of six types of leptons naturally raises the possibility that these particles are not the point-like building blocks of matter but are constructed from a simpler set. Moreover the

observed similarity between the properties of quarks and leptons suggests that both kinds of particles should be constructed from the same fundamental objects. The hypothetical new particles, the building blocks of quarks and leptons, are usually referred to by the generic name "preons".

The $SU(3)_C \times SU(2)_W \times U(1)_Y$ standard model provides a good description of the experimental world at the current level of accuracy, but still it has naively failed to explain why quarks and leptons are so identical in their weak interaction properties, both occurring in $SU(2)_L$ weak isospin doublets. Also it does not explain why the sum of electric charges of quarks and leptons in each "generation" vanishes (e.g. u, d, ν_e, e) i.e.

$$3(Q_u + Q_d) + Q_e + Q_{\nu_e} = 3\left(\frac{2}{3} - \frac{1}{3}\right)e - e + 0 = 0 \quad (4.1)$$

The large number of particles appearing in the $SU(3)_C \times SU(2)_W \times U(1)_Y$ standard model, the Higgs mechanism and three generations of fermions, each containing two leptons and two flavours of three coloured quarks, is a problem of substantial difficulty and has not as yet been clearly understood if all of them are really fundamental particles.

The final motivation is much more speculative. The masses of three generations, the Higgs particle mass, the mixing of quarks and leptons, and the gauge couplings include actually a large number of arbitrary parameters which are not all predicted by the standard model. The value of any new

model should lie in predicting most or all of these parameters. It is, however, expected that these difficulties and problems might be resolved if quarks and leptons are composed out of a common set of some fundamental particles. The short range force (intermediate vector bosons exchange) in the standard model could then be considered as a residual effect of some new unbroken gauge theory.

There are various arguments which suggest that any likely substructure may be observed only at extremely short distances and corresponding large energies. The well-known evidence for the "point-like" status of leptons and quarks clearly shows that such a substructure must correspond to distances well below 10^{-18} cm. The present limit on the proton's life time requires, for a simple class of models, distances below 10^{-29} cm or momenta somewhere above 10^{15} GeV.[40]. This tighter limit is, however, model dependent.

4.2 The rishon model

Using the above reasoning mentioned in Section (4.1), various models have been proposed all suggesting that quarks and leptons are composite particles. In this section we wish to explicitly discuss the rishon model. The model is clearly simple and extremely economic. In the rishon model, it is postulated [41,42] that quarks and leptons as well as gauge bosons are composite particles. This model in fact consists of only two fundamental massless spin 1/2 building

blocks, called T-rishon and V-rishon with charges of $\frac{1}{3}e$ and 0 respectively, and with SU(3) hypercolour and SU(3) colour assignments listed in table (1). The simplest composite fermions can be constructed from three rishons or three antirishons which are hypercolour confined and cannot be directly observed experimentally. The hypercolour scale Λ_H is substantially larger than the ordinary colour scale, i.e. $\Lambda_H \gg \Lambda_C$. All composite objects are hypercolour singlets and are therefore "observable" below the hypercolour scale Λ_H . The light hypercolour singlet combinations are

$$e^+ = (TTT), \quad u = (TTV), \quad \bar{d} = (TVV), \quad \nu = (VVV) \quad (4.2)$$

together with their antiparticles

$$e = (\bar{T}\bar{T}\bar{T}), \quad \bar{u} = (\bar{T}\bar{T}\bar{V}), \quad d = (\bar{T}\bar{V}\bar{V}), \quad \bar{\nu} = (\bar{V}\bar{V}\bar{V}) \quad (4.3)$$

Thus we can achieve all generations of quarks and leptons having the correct charge and colour properties so far we have seen. The major advantage of this model is that the neutrality of matter is satisfied automatically since, for instance,

$$\text{Hydrogen atom} = ep = euud = (\bar{T}\bar{T}\bar{T})(TTV)(TTV)(\bar{T}\bar{V}\bar{V}) \quad (4.4)$$

has no net charge as the total number of T-rishons and V-rishons vanish. It is also very clear from the above equation (4.4) that the rishon model describes the Universe

as the particle-antiparticle symmetric object. Since the hypercoloured rishons are not free fermions and are rather confined in leptons inside a radius of order Λ_H^{-1} , the two hypercolourless leptons will interact with each other by short range residual hypercolour forces. These are analogous exactly to the hadronic forces among two colourless hadrons containing coloured quarks. If we consider the hypergluon massless particle which is responsible for the binding of the fundamental rishons, the complete list of fundamental particles includes rishons, antirishons, hypergluons, gluons and photons which are, of course, not too many when compared to the particles appearing in the $SU(3)_C \times SU(2)_W \times U(1)_Y$ standard model. Furthermore, all these particles are massless so mass parameters and fundamental scalar particles, like Higgs scalar, do not exist at all. Therefore, the rishon model has really reduced the number of both the fundamental particles and the parameters to a reasonably acceptable level.

Until now we have not discussed the weak interactions in the content of the rishon model. Since the fundamental unit of electric charge is $e/3$ so the W^\pm cannot act between single rishon states. In fact, the simplest boson with the quantum numbers of $W^- (Q = -1, B-L = 0)$ can be carried by multirishon exchanges as shown in Figure (11) and correspond to a state of the form:

$$W^- = (\bar{T}\bar{T}\bar{V}\bar{V}\bar{V}) \quad (4.5)$$

Similarly

$$W^+ = (TTTVVV) \quad (4.6)$$

When W^- singlet state acts on a fermion that consists of three rishons, it produces a state of three antirishons, for example,

$$W^- |TTT\rangle = |\bar{V}\bar{V}\bar{V}\rangle = |\bar{\nu}_e\rangle, \quad W^- |VTT\rangle = |\bar{T}\bar{V}\bar{V}\rangle = |d\rangle \quad (4.7)$$

Thus W^- hypercolour singlet changes $e^+ \rightarrow \bar{\nu}_e$, $u \rightarrow d$, $\bar{d} \rightarrow \bar{u}$ and $\nu_e \rightarrow e$ as desired. Similarly the W^+ boson can easily transform the hypercolour singlets $\bar{\nu}_e \rightarrow e^+$, $d \rightarrow u$, $\bar{u} \rightarrow \bar{d}$ and $e \rightarrow \nu_e$. The neutral hypercolour singlet mediated in weak interactions is expressed in terms of charged T-rishons and neutral V-rishon as follows:

$$W^0 = \frac{1}{\sqrt{2}} (TTT\bar{T}\bar{T}\bar{T} - VVV\bar{V}\bar{V}\bar{V}) \quad (4.8)$$

Since it must couple symmetrically to T's and V's. The reason for these vector mesons (hypercolour singlets) to be lighter than any of the other mesons constructed from these combinations of rishons is still very much unclear. Note also that the theory starts out as left-right symmetric so it is necessary that the coupling to composite Higgs fields must break then this symmetry. How and why this

happens is a problem for composite models.

Equation (4.8) suggests a new and important feature of composite models. In addition to the weak SU(2), spin 1 vector particle [W^\pm , W^0] there ought also to be a weak SU(2), spin 0 vector particle.

$$B^0 = \frac{1}{\sqrt{2}} [TTTTT\bar{T} + VVVV\bar{V}] \quad (4.9)$$

Compare the ρ and ω of the quark model:

$$\rho = \frac{1}{\sqrt{2}} [u\bar{u} - d\bar{d}] \quad (4.10)$$

$$\omega = \frac{1}{\sqrt{2}} [u\bar{u} + d\bar{d}] \quad (4.11)$$

We expect that, at least in some approximation these states will be degenerate in mass (again as with the ρ and ω). Thus composite models might be expected to give an additional neutral vector boson. The effect of this will be discussed in the next few chapters.

4.3 Problems

In the preceding section we have explicitly discussed the rishon model (the most economic model) as the minimal possible scheme. In this model it is simply assumed that all quarks, leptons and massive vector bosons as well as all scalar particles are composite of a small set of new

fundamental building blocks. All properties of fermions and bosons are assumed to be consequence of the properties of the same set of elementary constituents; in particular, the standard model is expected to be derived as low-energy phenomenology. In other words, at energies well below Λ_H , the Lagrangian must possess all ingredients of a local gauge theory. Despite the success of the rishon model in reproducing and generating the correct spectrum of quarks and leptons as well as vector bosons, it still remains unexplained, why we observe only composite states like rrr or $\bar{r}\bar{r}\bar{r}$ but not, for example, $rr\bar{r}$? The second major problem of the rishon model (discussed in the previous section) is the requirement for light composite vector bosons that correspond to an approximate gauge symmetry of the energy well below Λ_H Lagrangian. This problem in fact seems to be an extremely interesting current issue disregarding the model. In QCD, all composite fermions acquired masses of order Λ_C (or more) at the expense of the spontaneously broken chiral symmetry. On the other hand, the rishons composite model of fermions which is basically based on hyperdynamics, suggests some degree of unbroken chiral symmetry, and this obviously generates massless quarks and leptons well below Λ_H . This might lead to some fundamental difference between the chiral symmetry breaking in QCD and the composite model. Unfortunately, the reason for this difference is not satisfactorily understood yet. Finally, the unusual assumption regarding the existence of a large v.e.v. for $rr\bar{r}$ (or $rrr\bar{r}\bar{r}$) states with small (or zero) v.e.v for $r\bar{r}$ states

is naturally unjustified and is considered to be an important problem of the rishon composite model presently. Despite the various difficulties of the rishon model, it still may remain a realistic candidate for the correct theory provided the problem of chiral symmetry is proved entirely different from that of ordinary QCD.

The Simple Two Z's Model

5.1 Mass matrix and diagonalisation formula

In this chapter we shall follow the ideas of the previous chapters and assume that the observed weak interactions are residual effects of an unbroken hypercolour gauge interaction. The effective Lagrangian, which describes the intermediate vector bosons mediating the weak interaction, will be renormalizable so it must have the structure of a Higgs-broken gauge theory. In order to agree with experiment we have to assume the existence of the appropriate set of light (i.e. compared to the hypercolour scale) vector particles. As we have noted it is natural that in addition to the zero charge members of the $SU(2)$ multiplets there should be a composite $U(1)$ vector boson. Thus the effective Lagrangian will be invariant under a local group:

$$G = SU(2)_L \times SU(2)_R \times U(1) \times U(1) \qquad (5.1.1)$$

where the other $U(1)$ factor refers to an "elementary" vector field. Following the discussion of the second Chapter, we assume that the couplings associated with the gauge groups $SU(2)_L$ and $SU(2)_R$ are equal. Hence the model under discussion has coupling constants g, g, g_1, g_2 corresponding

to each factor in equation (5.1.1). For the electromagnetic charge operator we can take

$$Q = T_{3L} + T_{3R} + \frac{Y_1}{2} \quad (5.1.2)$$

where Y_1 and Y_2 are the hypercharge associated with the two $U(1)$ factors. Note that there is no loss of generality in putting just Y_1 in equation (5.1.2). The minimal set of Higgs scalars required to break L-R symmetric model down to $U(1)$ of electromagnetism, and to give masses to the quarks and leptons, has been explicitly discussed by Mohapatra and Sanjanovic [43]. But in our model, because of the extra $U(1)$, we need an additional Higgs scalar which is basically obtained by assuming that there are two Higgs triplets with different couplings. The following set of Higgs scalars has been used in our subsequent work:

$$\begin{aligned} \Phi &= \left(\frac{1}{2}, \frac{1}{2}, 0, 0 \right) \\ X^1 &= (1, 0, 2, 2) \\ X_L^2 &= (1, 0, 2, -2) \\ X_R^1 &= (0, 1, 2, 2) \\ X_R^2 &= (0, 1, 2, -2) \end{aligned} \quad (5.1.3)$$

Up to this point we certainly have a completely L-R symmetric theory. This L-R symmetric theory is broken by assuming that only the right-handed X states possess a vacuum expectation value. Thus considering equation (5.1.2) as an exact quantum number, we can conveniently write:

$$\begin{aligned}
 \langle \Phi \rangle &= \frac{1}{\sqrt{2}} \begin{pmatrix} k & 0 \\ 0 & k' \end{pmatrix} \\
 \langle X_R^1 \rangle &= \frac{1}{\sqrt{2}} \begin{bmatrix} 0 \\ 0 \\ v \end{bmatrix}, \quad \langle X_R^2 \rangle = \frac{1}{\sqrt{2}} \begin{bmatrix} 0 \\ 0 \\ w \end{bmatrix} \\
 \langle X_L^1 \rangle &= \langle X_L^2 \rangle = 0
 \end{aligned} \tag{5.1.4}$$

Then by making use of the equations (2.2.12), (2.2.13) and (5.1.4), the following mass matrices both for the charged and neutral gauge bosons involved in the theory are obtained:

$$\langle i | M^+ | j \rangle = \begin{bmatrix} \Sigma & -\frac{1}{2} g^2 k' k \\ -\frac{1}{2} g^2 k' k & \Sigma + \Lambda \end{bmatrix} \tag{5.1.5}$$

$$\langle i | M | j \rangle = \begin{bmatrix} \Sigma & -\Sigma & 0 & 0 \\ -\Sigma & \Sigma + \Lambda & -\alpha \Lambda & -\beta(\Lambda - \Delta) \\ 0 & -\alpha \Lambda & \alpha^2 \Lambda & \alpha \beta(\Lambda - \Delta) \\ 0 & -\beta(\Lambda - \Delta) & \alpha \beta(\Lambda - \Delta) & \beta^2 \Lambda \end{bmatrix} \tag{5.1.6}$$

where the states $|i\rangle$ are $|W_{3L}\rangle$, $|W_{3R}\rangle$, $|B_1\rangle$ and

$|B_2\rangle$, and where

$$\begin{aligned}\Sigma &= \frac{g^2}{4} (k^2 + k'^2) = M_{WL}^2 \\ \Lambda &= \frac{g^2}{4} (v^2 + w^2) = M_{WR}^2 \\ \Delta &= \frac{g^2 w^2}{2}, \quad \alpha = \frac{g_1}{g}, \quad \beta = \frac{g_2}{g}\end{aligned}\quad (5.1.7)$$

In this chapter we shall take Λ very large so that the right-handed $SU(2)$ has no effect. To diagonalize the neutral mass matrix we just diagonalize that part of it which remains when we ignore Σ :

$$\langle i | M^2 | j \rangle = \begin{bmatrix} \Lambda & -\alpha\Lambda & -\beta' \Lambda \\ -\alpha\Lambda & \alpha^2 \Lambda & \alpha\beta' \Lambda \\ -\beta' \Lambda & \alpha\beta' \Lambda & \beta^2 \Lambda \end{bmatrix} \quad (5.1.8)$$

Here we have defined:

$$\beta' = \frac{\beta(\Lambda - \Delta)}{\Lambda} \quad (5.1.9)$$

The characteristic equation yields the following eigenvalue spectrum ($\lambda\Lambda$) for the mass matrix in equation (5.1.8). Where

$$\begin{aligned}\lambda &= 0, \\ \lambda_1 &= \frac{1 + \alpha^2 + \beta^2}{2} - \frac{1}{2} [(1 + \alpha^2 + \beta^2)^2 - 4(\beta^2 - \beta'^2)(1 + \alpha^2)]^{\frac{1}{2}}\end{aligned}$$

and

$$\lambda_2 = \frac{1+\alpha^2+\beta^2}{2} + \frac{1}{2} [(1+\alpha^2+\beta^2)^2 - 4(\beta^2-\beta'^2)(1+\alpha^2)]^{\frac{1}{2}} \quad (5.1.10)$$

Now we recall that we wish to take Λ very large - in fact we shall consider the limit $\Lambda \rightarrow \infty$. However, we want our model to have 3 neutral vector particles of finite mass (the photon, the standard Z_1 and a new Z_2). Thus one of the above eigenvalues, say $\lambda_1 \Lambda$, must remain finite as $\Lambda \rightarrow \infty$. This clearly requires:

$$\beta^2 - \beta'^2 \sim \frac{1}{\Lambda} \quad (5.1.11)$$

Hence we can expand equation (5.1.10) and write

$$\begin{aligned} \lambda_0 &= 0 \\ \lambda_1 &= \frac{(\beta^2 - \beta'^2)(1 + \alpha^2)}{(1 + \alpha^2 + \beta^2)} \\ \lambda_2 &= (1 + \alpha^2 + \beta^2) \end{aligned} \quad (5.1.12)$$

The diagonalization of the matrix given in equation (5.1.8) can be completed just by introducing the states $|n\rangle$:

$$|n\rangle = \sum_i |i\rangle \langle i|n\rangle \quad (5.1.13)$$

where

$$\langle i | n \rangle = \begin{bmatrix} 1 & 0 & 0 & 0 \\ 0 & s & cS & cC \\ 0 & c & -sS & -sC \\ 0 & 0 & c & -s \end{bmatrix} \quad (5.1.14)$$

with

$$\begin{aligned} s^2 &= \frac{\alpha^2}{1+\alpha^2}, & c^2 &= \frac{1}{1+\alpha^2} \\ s^2 &= \frac{\beta'^2}{1+\alpha^2+\beta'^2}, & c^2 &= \frac{1+\alpha^2}{1+\alpha^2+\beta'^2} \end{aligned} \quad (5.1.15)$$

(in the $\Lambda \rightarrow \infty$ approximation).

In the $|n\rangle$ basis, the full mass matrix (5.1.6) is obtained as follows

$$\langle n | M^2 | m \rangle = \sum_{i,j} \langle n | i \rangle \langle i | M^2 | j \rangle \langle j | m \rangle$$

$$= \begin{bmatrix} \Sigma & -s\Sigma & -cS\Sigma & -cC\Sigma \\ -s\Sigma & s^2\Sigma & scS\Sigma & scC\Sigma \\ -cS\Sigma & scS\Sigma & c^2s^2\Sigma+\lambda_1 & c^2CS\Sigma \\ -cC\Sigma & scC\Sigma & c^2SC\Sigma & c^2C^2\Sigma+\lambda_2\Lambda \end{bmatrix} \quad (5.1.16)$$

As expected this matrix is diagonal provided $\Sigma = 0$.

Since $(\lambda_2 \Lambda)$ becomes infinite as Λ goes to infinity we can ignore the off-diagonal terms of the fourth row and column and just diagonalize the top left 3 x 3 mass matrix of equation (5.1.16):

$$\frac{\langle n | \tilde{M}^2 | m \rangle}{\Sigma} = \begin{bmatrix} 1 & -s & -cS \\ -s & s^2 & scS \\ -cS & scS & c^2s^2 + K \end{bmatrix} \quad (5.1.17)$$

where

$$\frac{\lambda_1 \Lambda}{\Sigma} = \frac{(\beta^2 - \beta'^2)(1 + \alpha^2)}{(1 + \alpha^2 + \beta^2)} \frac{\Lambda}{\Sigma} = K \quad (5.1.18)$$

The eigenvalue spectrum of mass matrix (5.1.17) is then determined, by making use of the characteristic equation, to be

$$\begin{aligned} \lambda'_0 &= 0 \\ \lambda'_{1,2} &= \Sigma \left(\frac{1}{2} (1 + s^2 + K + c^2s^2) \mp \frac{1}{2} [(1 + s^2 + K + c^2s^2)^2 - 4K(1 + s^2)] \right)^{1/2} \end{aligned} \quad (5.1.19)$$

where the λ 's are three mass squared eigenvalues associated with the photon and the two massive neutral vector bosons M_Z . Further K , S and s are the only free parameters. Now if we define

$$\bar{\lambda}_1 = \frac{M_{Z1}^2}{\Sigma} \quad \text{and} \quad \bar{\lambda}_2 = \frac{M_{Z2}^2}{\Sigma} \quad (5.1.20)$$

then we have

$$\begin{aligned}\bar{\lambda}_0 &= 0 \\ \bar{\lambda}_{1,2} &= \frac{1+s^2+K+c^2S^2}{2} \mp \frac{1}{2}[(K-(1+s^2)+c^2S^2)^2+4c^2S^2(1+s^2)]^{1/2}\end{aligned}\quad (5.1.21)$$

5.2 The couplings of the vector bosons

In order to calculate the couplings of the vector bosons we need eigenstates which diagonalize the mass matrix (5.1.17), i.e.

$$\langle n|r\rangle = \begin{bmatrix} \sin\theta_W & \cos\theta_W S' & \cos\theta_W C' \\ \cos\theta_W & -\sin\theta_W S' & -\sin\theta_W C' \\ 0 & C' & -S' \end{bmatrix} \quad (5.2.1)$$

where the Weinberg angle is defined by

$$\sin^2\theta_W = \frac{g_1^2}{g^2+2g_1^2} \quad (5.2.2)$$

The constants C' and S' appearing in equation (5.2.1) are expressed in terms of known $(\bar{\lambda}_1, \bar{\lambda}_2)$ parameters by using the eigenvalue equation i.e.

$$\langle n|M|m\rangle \langle m|r\rangle = \lambda \langle n|r\rangle$$

$$\begin{bmatrix} 1 & -s & -cS \\ -s & s^2 & scS \\ -cS & scS & c^2S^2+K \end{bmatrix} \begin{bmatrix} \sin\theta_W & \cos\theta_W S' & \cos\theta_W C' \\ \cos\theta_W & -\sin\theta_W S' & -\sin\theta_W C' \\ 0 & C' & -S' \end{bmatrix} = \begin{bmatrix} \sin\theta_W & \cos\theta_W S' & \cos\theta_W C' \\ \cos\theta_W & -\sin\theta_W S' & -\sin\theta_W C' \\ 0 & C' & -S' \end{bmatrix}$$

$$\begin{bmatrix} \sin\theta_W - scos\theta_W & \cos\theta_W S' + s\sin\theta_W S' - cS C' & \cos\theta_W C' + s\sin\theta_W C' + cC S' \\ -s\sin\theta_W + s^2 \cos\theta_W & -scos\theta_W S' - s^2 \sin\theta_W S' + csS C' & -scos\theta_W C' - s^2 \sin\theta_W C' - scS S' \\ -cS\sin\theta_W + scS\cos\theta_W & -cS S' \cos\theta_W - scS S' \sin\theta_W + C'(c^2S^2+K) & -cS C' \cos\theta_W - scS C' \sin\theta_W - S'(c^2S^2+K) \end{bmatrix} = \begin{bmatrix} \\ \\ \end{bmatrix}$$

This equation (5.2.3) then yields

$$\begin{aligned} T'^2 &= \left(\frac{S'}{C'}\right)^2 = \frac{c^2 S^2}{(\cos\theta_W(1-\bar{\lambda}_1) + s \sin\theta_W)^2} \\ &= \frac{c^2 c'^2 S^2}{(1 - c'^2 \bar{\lambda}_1)^2} \end{aligned} \tag{5.2.4}$$

$$\text{where } c'^2 = 1/(1 + s^2) \tag{5.2.5}$$

To find the value of "S²" in terms of $\bar{\lambda}_1, \bar{\lambda}_2$, we begin with

equation (5.1.21) as follows

$$\begin{aligned}\bar{\lambda}_1 + \bar{\lambda}_2 &= 1 + s^2 + K + c^2 s^2 \\ &= 1 + s^2 + \frac{\lambda_1 \Lambda}{\Sigma} c^2 s^2\end{aligned}\quad (5.2.6)$$

and $\bar{\lambda}_1 \cdot \bar{\lambda}_2 = K(1 + s^2)$

$$\begin{aligned}\frac{\lambda_1 \lambda_2}{1+s^2} &= K \\ \frac{\bar{\lambda}_1 \bar{\lambda}_2}{1+s^2} &= \frac{\lambda_1 \Lambda}{\Sigma}\end{aligned}\quad (5.2.7)$$

Thus equations (5.2.6) and (5.2.7) simultaneously give

$$s^2 = \frac{(\bar{\lambda}_1 c'^2 - 1)(1 - c'^2 \bar{\lambda}_2)}{c^2 c'^2} \quad (5.2.8)$$

Substituting this into equation (5.2.4) then gives:

$$T'^2 = \frac{(\bar{\lambda}_2 c'^2 - 1)}{(1 - c'^2 \bar{\lambda}_1)} \quad (5.2.9)$$

Then by using the relation $s'^2 + c'^2 = 1$, we immediately find that

$$s'^2 = \frac{T'^2}{1+T'^2} = \frac{(c'^2 \bar{\lambda}_2 - 1)}{c'^2 (\bar{\lambda}_2 - \bar{\lambda}_1)} \quad (5.2.10)$$

and

$$c'^2 = \frac{1}{1+T'^2} = \frac{1 - c'^2 \bar{\lambda}_1}{c'^2 (\bar{\lambda}_2 - \bar{\lambda}_1)} \quad (5.2.11)$$

After having determined the constants involved in equation

(5.2.1) in terms of known parameters, we shall now calculate the couplings of the neutral gauge vector bosons. For this purpose we find first:

$$\langle i | r \rangle = \sum_i \langle i | n \rangle \langle n | r \rangle$$

$$= \begin{bmatrix} 1 & 0 & 0 & 0 \\ 0 & s & cS & cC \\ 0 & c & -sS & -sC \\ 0 & 0 & C & -S \end{bmatrix} \begin{bmatrix} \sin\theta_W & \cos\theta_W S' & \cos\theta_W C' & 0 \\ \cos\theta_W & -\sin\theta_W S' & -\sin\theta_W C' & 0 \\ 0 & C' & -S' & 0 \\ 0 & 0 & 0 & 1 \end{bmatrix}$$

$$= \begin{bmatrix} \sin\theta_W & \cos\theta_W S' & \cos\theta_W C' & 0 \\ s\sin\theta_W & -s\sin\theta_W S' + cSC' & -s\sin\theta_W C' - cSS' & cC \\ c\cos\theta_W & -c\sin\theta_W S' - sSC' & -c\sin\theta_W C' + sSS' & -sC \\ 0 & C' & -S' & -S \end{bmatrix}$$

(5.2.12)

The eigenstates $\langle i |$ corresponding to the order of factors in

equation (5.1.1) are given by:

$$\langle i | = \sum_r \langle i | r \rangle \langle r |$$

$$\begin{bmatrix} W_L \\ W_R \\ B_1 \\ B_2 \end{bmatrix} = \begin{bmatrix} \sin\theta_W & \cos\theta_W S' & \cos\theta_W C' & 0 \\ s\cos\theta_W & -s\sin\theta_W S' + cS C' & -s\sin\theta_W C' - cS S' & cC \\ c\cos\theta_W & -c\sin\theta_W S' - sS C' & -c\sin\theta_W C' + sS S' & -sC \\ 0 & C C' & -S C' & -S \end{bmatrix} \begin{bmatrix} \gamma \\ Z_1 \\ Z_2 \\ Z_3 \end{bmatrix}$$

$$\begin{bmatrix} W_L \\ W_R \\ B_1 \\ B_2 \end{bmatrix} = \begin{bmatrix} \sin\theta_W \gamma + \cos\theta_W S' Z_1 & +\cos\theta_W C' Z_2 & + 0 Z_3 \\ s\cos\theta_W \gamma + (-s\sin\theta_W S' + cS C') Z_1 & +(-s\sin\theta_W C' - cS S') Z_2 & + cC Z_3 \\ c\cos\theta_W \gamma + (-c\sin\theta_W S' - sS C') Z_1 & +(-c\sin\theta_W C' + sS S') Z_2 & - sC Z_3 \\ 0 \cdot \gamma + C C' Z_1 & -S C' Z_2 & - S Z_3 \end{bmatrix} \quad (5.2.13)$$

Then making use of the general definition of the couplings given in equation (3.2.12), we find that the photon coupling becomes:

$$\begin{aligned} \gamma &: g (T_{3L} + T_{3R} + \frac{Y_1}{2}) \sin\theta_W \\ &: g \sin\theta_W Q \end{aligned} \quad (5.2.14)$$

[Here we have used $cg_1 = sg$ and $Q = T_{3L} + T_{3R} + \frac{Y_1}{2}$]

As expected for the electromagnetic interactions.

The Z_1 coupling is then obtained as follows

$$z_1: \frac{gS'}{\cos\theta_W} [T_{3L} - \sin^2\theta_W Q] + g c'CS [T_{3R} - \alpha^2 \frac{Y_1}{2} + (1+\alpha^2) \frac{Y_2}{2}] \quad (5.2.15)$$

and finally the Z_2 coupling has the form:

$$z_2: \frac{gC'}{\cos\theta_W} [T_{3L} - \sin^2\theta_W Q] - gcSS' [T_{3R} - \alpha^2 \frac{Y_1}{2} + (1+\alpha^2) \frac{Y_2}{2}] \quad (5.2.16)$$

5.3 Both Z's within experimental peak

The composite model of Section (4.2) clearly suggests that there are two Z particles of approximately equal mass. Since there is no evidence for two Z's in the mass distribution of Z events, it is natural to assume that both Z's appear in the same experimental peak i.e. that the mass difference $|M_{Z_2} - M_{Z_1}|$ is less than the experimental uncertainty, which is about 2.6 Gev [44]. In this section we shall explore the consequences of this assumption. For this purpose we start with the experimentally known values of M_W^2/M_Z^2 and $\sin^2\theta_W$ which are given by [3,45].

$$\frac{M_W^2}{M_Z^2} = 0.777 \pm 0.02, \quad \sin^2\theta_W = 0.23 \pm 0.007 \quad (5.3.1)$$

Substituting $K = B + 1 + s^2$ into equation (5.1.21) then clearly gives

$$\bar{\lambda}_{1,2} = 1 + s^2 + \frac{B+c^2S^2}{2} \mp \frac{1}{2} [(B+c^2S^2)^2 + 4c^2S^2(1+s^2)]^{1/2} \quad (5.3.2)$$

We recall, from section (5.1), that B and S are given in terms of the original parameters by

$$B = \frac{(\beta^2 - \beta'^2) \Lambda}{(1 + \alpha^2 + \beta^2) \Sigma} - \frac{(1 + 2\alpha^2)}{1 + \alpha^2} \quad (5.3.3)$$

$$S = \frac{\beta'}{(1 + \alpha^2 + \beta^2)^{\frac{1}{2}}}$$

Clearly we can regard B and S as our new independent parameters. Since we have

$$M_{Z_2}^2 - M_{Z_1}^2 = (M_{Z_2} + M_{Z_1})(M_{Z_2} - M_{Z_1}) \leq 200 \text{ GeV}^2$$

$$\frac{M_{Z_2}^2 - M_{Z_1}^2}{M_W^2} \leq \frac{200}{10000} \leq \frac{1}{50}$$

$$\text{So } [(B + c^2 S^2)^2 + 4c^2 S^2(1 + S^2)]^{\frac{1}{2}} \leq \frac{1}{50}$$

which implies that:

$$B^2 + 2c^2 S^2 B + c^4 S^4 + 4c^2 S^2(1 + S^2) \leq \frac{1}{2500}$$

(5.3.4)

Thus both B^2 and S^2 are small $\leq 1/2500$, so we can ignore BS^2 and S^4 terms in the square root. Then working only to first order in B and S we get:

$$\bar{\lambda}_{1,2} = 1 + s^2 + \frac{B}{2} \mp \frac{1}{2} [B^2 + 4c^2 S^2(1 + S^2)]^{\frac{1}{2}} \quad (5.3.5)$$

Now if E_1 and E_2 are considered as the minimum and maximum

values of $\frac{M_{Z_1}^2}{M_W^2}$ and $\frac{M_{Z_2}^2}{M_W^2}$ which can, of course, be numerically determined from the equation (5.3.1), then equation (5.3.5) immediately gives:

$$s^2 = \frac{1}{c^2(1+s^2)} [(E_2 - (1+s^2))^2 - B(E_2 - (1+s^2))] \quad (5.3.6)$$

and

$$s^2 = \frac{1}{c^2(1+s^2)} [((1+s^2) - E_1)^2 + B((1+s^2) - E_1)] \quad (5.3.7)$$

Using $\sin^2 \theta_W = 0.23$ clearly produces

$$1+s^2 = 1.299, E_1 = 1.255 \text{ and } E_2 = 1.321 \quad (5.3.8)$$

The relationship between B and S, from equations (5.3.6) and (5.3.7) are shown in Figure (12a). The shaded area in this figure indicates the possible allowed region of the two Z's contribution. The standard model, of course, is included in this region at, for instance, $S = 0, B \neq 0$. Our prime concern here is to explore the area where both Z's are contributing. In this regard the maximum contribution is most likely to be shared by the two massive neutral gauge bosons at the points where the two different lines arising from the equations (5.3.6) and (5.3.7) intersect each other. It is probably worth noticing that different values of $\sin^2 \theta_W$

give different intersecting positions as shown in Figures (12b,c). But, from Figure (12a), we choose

$$B = - 0.022, S = \pm 0.033$$

and $\sin^2\theta_W = 0.23$ (5.3.9)

Then by using these values we get

$$\bar{\lambda}_1 = 1.28, \quad \bar{\lambda}_2 = 1.34 \quad (5.3.10)$$

which subsequently yield

$$s'^2 = 0.669, \quad c'^2 = 0.331 \quad (5.3.11)$$

We shall now test the consequences of the two Z's in the neutrino-electron elastic scattering process (Figure (13)) which is believed to be a sensitive and accurate probe of the fundamental features of the standard electroweak theory. The couplings of these two massive neutral vector bosons to the fermions in the region $S = B \neq 0$ can be rewritten as follows

$$Z_1: \frac{gS'}{2\cos\theta_W} [c_V - c_A\gamma_5] + \frac{gA}{2\cos\theta_W} [c_V - c_A'\gamma_5] \quad (5.3.12)$$

Here we have ignored the (unknown) Y_2 term and have used

$$\begin{aligned} \frac{Y_1}{2} &= Q - T_{3L} - T_{3R} \\ c_V &= T_3 - 2 \sin^2 \theta_W Q, \quad c_A = T_3 \\ c_{A'} &= -T_3 \cos 2\theta_W, \quad A = \frac{CS'}{(\cos 2\theta_W)^{\frac{1}{2}}} \end{aligned} \quad (5.3.13)$$

Alternatively equation (5.3.12) is written by:

$$Z_1: \frac{g}{2\cos\theta_W} [(S' c_L + A c_L') (1-\gamma_5) + (S' c_R + A c_R') (1+\gamma_5)] \quad (5.3.14)$$

where we have further defined:

$$\begin{aligned} c_L &= \frac{c_V + c_A}{2}, \quad c_R = \frac{c_V - c_A}{2} \\ c_L' &= \frac{c_V + c_{A'}}{2}, \quad c_R' = \frac{c_V - c_{A'}}{2} \end{aligned} \quad (5.3.15)$$

Similarly, the Z_2 coupling has the form:

$$Z_2: \frac{g}{2\cos\theta_W} [(C' c_L - H c_L') (1-\gamma_5) + (C' c_R - H c_R') (1+\gamma_5)] \quad (5.3.16)$$

with

$$H = \frac{SS'}{(\cos 2\theta_W)^{\frac{1}{2}}} \quad (5.3.17)$$

Now the amplitude due to the two Z 's exchange in $\nu e \rightarrow \nu e$ reaction can then immediately be written by:

$$M_{Z_1+Z_2}(\nu) = \frac{g^2}{8\cos^2\theta_W M_{Z_1}} \left[2 [A'\bar{\nu}(k')\gamma_\mu(1-\gamma_5)\nu(k)\bar{e}(p')\gamma^\mu(1-\gamma_5)e(p) + H'\bar{\nu}(k')\gamma_\mu(1-\gamma_5)\nu(k)\bar{e}(p')\gamma^\mu(1+\gamma_5)e(p)] \right] \quad (5.3.18)$$

where

$$A' = (\hat{S} + A\sin^2\theta_W) (\hat{C}'_L + Ac'_L) + (\hat{C}'_L - Hc'_L) (C' - H\sin^2\theta_W) \frac{M_{Z_1}^2}{M_{Z_2}^2} \quad (5.3.19)$$

and

$$H' = (\hat{S} + A\sin^2\theta_W) (\hat{C}'_R + Ac'_R) + (\hat{C}'_R - Hc'_R) (C' - H\sin^2\theta_W) \frac{M_{Z_1}^2}{M_{Z_2}^2}$$

Here we have assumed that the neutrinos in the experiment are purely left-handed. Thus the differential cross-section in the neutral current $\nu e \rightarrow \nu e$ process becomes:

$$\frac{d\sigma(\nu)}{dy} = \frac{g^4 \hat{S}}{32\pi\cos^4\theta_W M_{Z_1}^4} [A'^2 + (1-y^2)H'^2] \quad (5.3.20)$$

where \hat{S} is called the c. of m. squared-energy.

Integration over y from $0 \rightarrow 1$ obviously produces the total cross-section as follows

$$\sigma_{Z_1+Z_2}(\nu) = \frac{g^4 \hat{S}}{32\pi\cos^4\theta_W M_{Z_1}^4} \left[A'^2 + \frac{H'^2}{3} \right] \quad (5.3.21)$$

On substituting the values of A' and H' from the equation (5.3.19) into equation (5.3.21) and also making use of the expansions

$$\frac{1}{M_{Z_{1,2}}^4} = \frac{1}{M_Z^4} \left[1 - 2 \left(\frac{M_{Z_{1,2}}^2 - M_Z^2}{M_Z^2} \right) \right] \quad (5.3.22)$$

we get

$$\sigma_{Z_1+Z_2}(\nu) = \frac{G^2 \hat{S}}{\pi} \left[P' + \frac{2 \sin^2 \theta_W Q' S^2}{\cos 2\theta_W} - \frac{2(M_{Z_2}^2 - M_{Z_1}^2)}{M_Z^2} \left(P' + \frac{2 \sin^2 \theta_W S^2 Q'}{\cos 2\theta_W} \right) - \frac{2(M_{Z_2}^2 - M_{Z_1}^2)}{M_Z^2} \left(P' C' + \frac{\sin^2 \theta_W S^2 Q'}{\cos 2\theta_W} - \frac{S S C'}{(\cos 2\theta_W)^{1/2}} (P' \sin^2 \theta_W + Q') \right) \right] \quad (5.3.23)$$

where

$$P' = c_L^2 + \frac{c_R^2}{3} = \frac{c_V^2 + c_A^2 + c_V c_A}{3} = \frac{16 \sin^4 \theta_W - 12 \sin^2 \theta_W + 3}{12}$$

$$Q' = c_L c_{L'} + \frac{c_R c_{R'}}{3} = \frac{2 c_V^2 + c_V c_A' + c_A c_V + 2 c_A c_A'}{6}$$

$$= \frac{28 \sin^4 \theta_W - 17 \sin^2 \theta_W - \cos^2 \theta_W (3 - 4 \sin^2 \theta_W) + 3}{24}$$

(5.3.24)

and G is the usual weak interaction Fermi coupling constant. Also note that we have ignored the terms which come from the higher order of S^2 . Replacing $(M_{Z_2}^2 - M_{Z_1}^2)$ and $(M_{Z_2}^2 - M_{Z_1}^2)$ in terms of known B and S then gives the total cross-section as follows:

$$\begin{aligned}
\sigma_{Z_1+Z_2}(\nu) &= \sigma_{s.m.}(\nu) \left[1 + \frac{2\sin^2\theta_W S^2 \hat{M}}{\cos 2\theta_W} - 2\cos^2\theta_W \left(B^2 + \frac{4\cos 2\theta_W S^2 \right)^{\frac{1}{2}} - B \right] x \\
& \left(1 + \frac{2\sin^2\theta_W S^2 \hat{M}}{\cos 2\theta_W} \right) - 2\cos^2\theta_W \left(B^2 + \frac{4\cos 2\theta_W S^2 \right)^{\frac{1}{2}} x \\
& \left(C'^2 + \frac{\sin^2\theta_W S^2 \hat{M}}{\cos 2\theta_W} - \frac{\hat{S}CS(\sin^2\theta_W + \hat{M})}{(\cos 2\theta_W)^{\frac{1}{2}}} \right) \quad (5.3.25)
\end{aligned}$$

where we have defined

$$\sigma_{s.m.}(\nu) = \frac{G^2 \hat{S} P'}{\pi} \quad \text{and} \quad \hat{M} = \frac{Q'}{P'} \quad (5.3.26)$$

Thus substituting the values of S' , C' , S and B computed earlier yields the total cross-section numerically to be:

$$\sigma_{Z_1+Z_2}(\nu) = \sigma_{s.m.}(\nu) [1 - 0.103] \quad (5.2.27)$$

This clearly shows that the contributions of the two Z 's do not contradict the standard model prediction [46] provided that these two Z 's are constrained to be within the experimentally observed peak.

Finally, it is of interest to use our results to find the relationship between the original parameters β and β' , and to this end we merely make use of the equation (5.3.3). The values of the parameters B and S given in equation (5.3.9) can easily be shown to lead to

$$\beta^2 \sim 100 \beta'^2 \quad (5.2.28)$$

5.4 Two adjacent Z peaks

Our composite model seems to predict the existence of two Z's close together in mass. In the previous section we considered the possibility that they are so close that they both lie in the same peak, and have not been seen as two peaks because of their width and the experimental resolution. This required $\Delta M_Z \lesssim 1$ Gev. In this section we will consider the possibility that the observed peak is due to the lowest Z (the Z_1) and that the other lies a small distance above, but is too small to have been observed. As we shall see the required small coupling is predicted by the theory. We begin with equation (5.3.2)

$$M_{Z_{1,2}}^2 = M_Z^2 + \frac{M_W^2}{2} [B \mp (B^2 + 4c^2(1+s^2)S^2)^{1/2}] \quad (5.4.1)$$

where

$$M_Z^2 = \Sigma (1 + s^2) = \frac{M_W^2}{\cos^2 \theta_W} \quad (5.4.2)$$

Since experimentally $|M_Z - M_{Z_1}| \leq 2.6$ Gev and we wish $|M_{Z_2} - M_Z|$ to be much greater than this, we must have $B^2 > 4c^2(1+s^2)S^2$. Hence we can expand the square root and obtain:

$$\begin{aligned} M_{Z_1}^2 &= M_Z^2 + \frac{M_W^2 B}{2} - \frac{M_W^2 B}{2} \left(1 + \frac{2c^2(1+s^2)S^2}{B^2}\right) \\ &= M_Z^2 - \frac{M_W^2 c^2(1+s^2)S^2}{B} \end{aligned} \quad (5.4.3)$$

and similarly

$$M_{Z_2}^2 = M_Z^2 + M_W^2 + \frac{M_W^2 c^2 (1+s^2) S^2}{B} \quad (5.4.4)$$

Adding equations (5.4.3) and (5.4.4) then yields

$$B = \left(\frac{M_{Z_1}^2 + M_{Z_2}^2 - 2 M_Z^2}{M_W^2} \right) \quad (5.4.5)$$

and

$$S^2 = \frac{(M_Z^2 - M_{Z_1}^2)(M_{Z_1}^2 + M_{Z_2}^2 - 2M_Z^2)}{c^2 (1+s^2) M_W^4} \quad (5.4.6)$$

Thus the parameters arising in the equation (5.2.1) attain the simple form given below

$$c'^2 = \frac{M_Z^2 - M_{Z_1}^2}{M_{Z_2}^2 - M_{Z_1}^2} \quad (5.4.7)$$

$$s'^2 = \frac{M_{Z_2}^2 - M_Z^2}{M_{Z_2}^2 - M_{Z_1}^2} \quad (5.4.8)$$

Our next step is actually to compute the number of Z_2 events expected to be observed using the coupling listed in equation (5.2.16). For this purpose we merely make use of the leading terms of the couplings of the two Z 's and ignore the rest as they are not very much important at this stage. Under this approximation the ratio of the (couplings)² of these Z 's is determined as

$$R = \left(\frac{C'}{S'}\right)^2 \quad (5.4.9)$$

But the number of Z_2 and Z_1 events are related by:

$$\begin{aligned} \frac{N_{Z_2}}{N_{Z_1}} &= \frac{\text{Production rate of } Z_2}{\text{Production rate of } Z_1} \\ &= R \cdot R' \end{aligned} \quad (5.4.10)$$

where R' is the ratio of the kinematic factors of the two Z 's. Since the Z_1 and Z_2 masses are roughly equal the kinematic factors ratio can be taken to be 1 (see next section). On substituting the values of C' and S' from equations (5.4.7) and (5.4.8) into equation (5.4.10) we finally find:

$$N_{Z_2} = N_{Z_1} \left(\frac{M_{Z_2}^2 - M_{Z_1}^2}{M_{Z_2}^2 - M_Z^2} \right) \quad (5.4.11)$$

As we have assumed that Z_2 lies outside the observed peak and $M_{Z_2} > M_Z$ while $M_{Z_1} \sim M_Z$. Therefore the number of Z_2 events are suppressed by the number which really depends upon the M_{Z_2} . Using the experimental possible values for M_Z [44], the number of Z_2 events against its various masses are calculated and graphed in Figure (14a).

Since experimentally ~ 50 Z_1 's have been seen and no Z_2 's. We require this ratio to be $< 5\%$. Hence the model allows

$$M_{Z_2} > 110 \text{ Gev.}$$

if we take $|M_Z - M_{Z_1}| = 1 \text{ GeV}$. If $|M_Z - M_{Z_1}|$ is less than this, then even smaller values of M_{Z_2} are allowed (see Figures (14b,c)). We can also calculate the contribution of Z_2 to neutral current processes. For example the process $\nu + e \rightarrow \nu + e$ attains the form of the cross section, in terms of masses of the Z's under discussion, as follows

$$\begin{aligned} \sigma_{Z_1+Z_2}(\nu) = \sigma_{\text{s.m.}}(\nu) & \left[1 + \frac{2\sin^2\theta_W S^{2\hat{M}}}{\cos 2\theta_W} - 2 \frac{(M_Z^2 - M_{Z_1}^2)}{M_Z^2} \right. \\ & - 4 \frac{(M_Z^2 - M_{Z_1}^2) \sin^2\theta_W S^{2\hat{M}}}{M_Z^2 \cos 2\theta_W} - 2C' \frac{(M_{Z_2}^2 - M_{Z_1}^2)}{M_Z^2} \\ & \left. - 2 \frac{(M_{Z_2}^2 - M_{Z_1}^2) \sin^2\theta_W S^{2\hat{M}}}{M_Z^2 \cos 2\theta_W} + \frac{2(M_{Z_2}^2 - M_{Z_1}^2) S' C' (\sin^2\theta_W + \hat{M})}{M_Z^2 (\cos 2\theta_W)^{1/2}} \right] \end{aligned}$$

(5.4.12)

Note that in deriving equation (5.4.12) we have used the couplings of the two Z's which are given in equations (5.2.15) and (5.2.16). Then by fixing, from the experimental data [2],

$$\begin{aligned} M_{Z_1} &= 91.1 \text{ GeV.}, & M_Z &= 92.1 \text{ GeV.}, \\ M_{Z_2} &= 110 \text{ GeV.}, & M_W &= 80.1 \text{ GeV} \text{ and } \sin^2\theta_W = 0.23 \end{aligned}$$

(5.4.13)

we obtain

$$\frac{\sigma(v)}{Z_1+Z_2} = \frac{\sigma(v)}{\text{s.m}} [1 - 0.27] \quad (5.4.14)$$

which clearly indicates that although the Z_2 contribution is higher as compared to the previously calculated cross-section, it is still less than the error in the experimental values [46]. This is because of its weak coupling to the fermions, and so it is not seen experimentally.

We now again find the status of the original parameters β and β' . This time, as is clear from the equations (5.4.5) and (5.4.6), the parameters B and S are $M_{Z_{1,2}}$ dependent. Using the values given above, in equation (5.4.13), the following approximate relationship between β' and β is found

$$\beta^2 \cong 8\beta'^2 \quad (5.4.15).$$

5.5 Can the second Z explain the CERN W+2Jet events?

In the previous section we have assumed that the second Z has a mass close to the first Z_1 and we have seen that whether it lies within the experimental Z-peak or just outside it, there is no conflict with experiment since the departures from the standard model phenomenology are small. In this section we shall again take seriously the W+2Jet

events (discussed earlier in Chapter 3) which appear to lie outside the standard model and see whether they might be caused by the second Z. Clearly this requires that we take $M_{Z_2} \sim 200-300$ Gev. It is apparent from equation (5.4.7) that

$$C' = 0.06, 0.04 \quad (5.5.1)$$

which is very small. Hence the second part of the expression for the coupling in (5.2.5) and similarly the first part of (5.2.16) can be ignored. Then the Z's couplings become

$$Z_1 : \frac{gS'}{2\cos\theta_W} (c_V - c_A \gamma_5) \quad (5.5.2)$$

$$Z_2 : \frac{gSS'}{2\cos W} (\cos 2\theta_W)^{-\frac{1}{2}} (c_V - c_A' \gamma_5) \quad (5.5.3)$$

where c_V , c_A and c_A' have the same definition as given in (5.3.13). Thus by choosing

$$\begin{aligned} \sin^2\theta_W &= .23, M_Z = 92.1 \text{ Gev} \\ M_{Z_1} &= 91.5 \text{ Gev and } M_{Z_2} = 200-300 \text{ Gev} \end{aligned} \quad (5.5.4)$$

equation (5.4.6) gives

$$S = 0.31, 0.49 \quad (5.5.5)$$

Now if we just consider the left-right handed u and d valance quarks and their anti-quarks confined inside the proton (anti-proton), the ratio of the couplings squared of the two

Z exchange in $P\bar{P}$ inelastic process is given by

$$R = \frac{4[(u_R\bar{u}_R)^2 + (u_L\bar{u}_L)^2]^2 + (d_R\bar{d}_R)^2 + (d_L\bar{d}_L)^2}{4[(u_R\bar{u}_R)^2 + (u_L\bar{u}_L)^2] + (d_R\bar{d}_R)^2 + (d_L\bar{d}_L)^2} \left| \begin{array}{l} Z_2 \\ Z_1 \end{array} \right. \quad (5.5.6)$$

Using the values of S determined in equation (5.5.5) and the couplings of the two Z given in equations (5.5.2) and (5.5.3) at $\sin^2\theta_W = 0.23$, this ratio is computed as follows:

$$R \cong 0.01, 0.05 \quad (5.5.7)$$

i.e. due to the couplings given in equations (5.5.2) and (5.5.3) the Z_2 events are suppressed by factors $\sim 1/100, 1/20$ at $M_{Z_2} = 200-300$ Gev respectively.

There is in addition a kinematic effect due to the difference in the masses (see chapter 3). This obviously gives an extra suppression factor (R') of about 0.04, 0.002 for $M_{Z_2} = 200-300$ Gev at c. of m. energy $\sqrt{\hat{S}} = 630$ Gev.

We know that the number of Z_1 produced in $P\bar{P}$ inelastic phenomenology are related by the expression:

$$N_{Z_1}(\text{produced}) = N_{Z_1}(\text{seen}) \cdot \frac{\Gamma_{Z_1}^{\text{tot.}}}{\Gamma(Z_1 \rightarrow e^+e^-, \mu^+\mu^-)} \quad (5.5.8)$$

Since only ~ 50 Z_1 's have been experimentally observed and the total width of Z_1 is ~ 3.1 Gev [3,44]. Then the width of $Z_1 \rightarrow e^+e^-, \mu^+\mu^-$ pairs is estimated to be ~ 0.18 Gev. Therefore

the total number of Z_1 produced become:

$$N_{Z_1} \text{ (produced)} \cong 975 \text{ events.} \quad (5.5.9)$$

Thus we have the prediction

$$\begin{aligned} \frac{N_{Z_2} \text{ (produced)}}{N_{Z_1} \text{ (produced)}} &= R R' \\ &\cong 0.004, 0.0001 \end{aligned} \quad (5.5.10)$$

at $M_{Z_2} = 200-300 \text{ Gev}$ respectively.

$$\text{Hence } N_{Z_2} \text{ (produced)} \cong 0.4, 0.1 \text{ events.} \quad (5.5.11)$$

Surely, even if they all are decayed in to $W_L^+ W_L^-$ (which they would not), this cannot explain the events seen at the CERN.

The Three Z's Model

6.1 Mass matrix, diagonalization formula and the new couplings of the vector bosons

In the previous chapter we have discussed the possible effects of a second Z^0 due to compositeness. The calculations have been made under the assumption that there are no effects due to the right-handed $SU(2)$ couplings, i.e. we have taken W_R^\pm to have infinite mass.

However, as we saw in Chapter 2, the phenomenology of the charged current sector allows a W_R^\pm with a mass greater than about 400 Gev. In this chapter we shall therefore combine the effects of an extra Z^0 and the effects due to a large, but finite, value for $M_{W_R} \sim 400$ Gev.

Using the result of equation (5.1.16), the neutral mass-matrix in the basis of the states $|r\rangle$ defined by

$$|r\rangle = |n\rangle \langle n|r\rangle$$

$$\text{for } n,r = 1,2,3 \qquad (6.1.1)$$

and for $|r = 4\rangle = |n = 4\rangle$

where $\langle n|r\rangle$ is defined by equation (5.2.1), becomes

$$\langle r|M^2|\ell\rangle = \sum_{n,m} \langle r|n\rangle \langle n|M^2|m\rangle \langle m|\ell\rangle$$

$$= \begin{bmatrix} \sin \theta_W & \cos \theta_W & 0 & 0 \\ \cos \theta_W S' & -\sin \theta_W S' & C' & 0 \\ \cos \theta_W C' & -\sin \theta_W C' & -S' & 0 \\ 0 & 0 & 0 & 1 \end{bmatrix} \begin{bmatrix} \Sigma & -\Sigma s & -\Sigma cS & -\Sigma cC \\ -\Sigma s & \Sigma s^2 & \Sigma scS & scC\Sigma \\ -\Sigma cS & \Sigma scS & \Sigma (c^2 S^2 + \lambda_1 \frac{\Lambda}{\Sigma}) & c^2 CS\Sigma \\ -\Sigma cC & \Sigma scC & \Sigma c^2 CS & \Sigma (c^2 C^2 + \lambda_2 \frac{\Lambda}{\Sigma}) \end{bmatrix}$$

$$\begin{bmatrix} \sin \theta_W & \cos \theta_W S' & \cos \theta_W C' & 0 \\ \cos \theta_W & -\sin \theta_W S' & -\sin \theta_W C' & 0 \\ 0 & C' & -S' & 0 \\ 0 & 0 & 0 & 1 \end{bmatrix}$$

$$= \begin{bmatrix} 0 & 0 & 0 & 0 \\ 0 & \bar{\lambda}_1 & 0 & -cc'(1+s^2)S'C + c^2 SCC' \\ 0 & 0 & \bar{\lambda}_2 & -cc'(1+s^2)CC' - c^2 SCS' \\ 0 & -cc'(1+s^2)S'C + c^2 SCC' & -cc'(1+s^2)CC' - c^2 SCS' & c^2 C^2 + \lambda_2 \frac{\Lambda}{\Sigma} \end{bmatrix}$$

(6.1.2)

Previously we were able to neglect the off-diagonal terms because they were negligible compared to the difference between $\bar{\lambda}_2$ and $\lambda_2 \frac{\Lambda}{\Sigma}$. Now we shall include the effect of these terms by lowest order in perturbation theory. Since, according to the equations (5.2.8), (5.2.10) and (5.2.11), S

is $\sim (\bar{\lambda}_2 - \bar{\lambda}_1)$ which is small so we can put $S = 0$ and $C = 1$ in the off-diagonal terms of equation (6.1.2). Thus by considering the eigenvalue equation

$$\langle r | M^2 | \ell \rangle \langle \ell | p \rangle = \lambda_p \langle r | p \rangle$$

$$\text{where } p = 0, 1, 2, 3, \quad (6.1.3)$$

the following eigenvalue spectrum is obtained:

$$\begin{aligned} \bar{\lambda}_1 &\cong \bar{\lambda}_1 - \frac{(c'^2 - s'^2) S'^2 \Sigma}{c'^4 (\lambda_2 \Lambda - M_{Z_1}^2)} \\ \bar{\lambda}_2 &\cong \bar{\lambda}_2 - \frac{(c'^2 - s'^2) C'^2 \Sigma}{c'^4 (\lambda_2 \Lambda - M_{Z_2}^2)} \\ \bar{\lambda}_3 &\cong \lambda_2 \frac{\Lambda}{\Sigma} \end{aligned}$$

$$(6.1.4)$$

Similarly, the corrected eigenstates, by perturbation theory [47], are given by

$$|r\rangle_{\text{corrected}} = |r\rangle + \sum_{\ell \neq r} \frac{|\ell\rangle \langle \ell | M^2 | r\rangle}{E_r - E_\ell} \quad (6.1.5)$$

So the photon's new state is given by

$$|\gamma\rangle = |1'\rangle = |1\rangle \quad (6.1.6)$$

Therefore, the photon's new coupling remains unchanged and is given by:

$$\gamma : g \sin\theta_W Q \quad (5.2.14)$$

The new Z_1 state is also determined as:

$$|Z_1\rangle = |\dot{2}\rangle = |2\rangle + |4\rangle \frac{(-cc' (1+s^2) S' \Sigma)}{(M_{Z_1}^2 - \lambda_2 \Lambda)} \quad (6.1.7)$$

Thus the new Z_1 coupling becomes:

$$Z_1 : g \frac{S'}{\cos\theta_W} [T_{3L} - \sin^2\theta_W Q] + gc' S [T_{3R} - \alpha^2 \frac{Y_1}{2} + (1+\alpha^2) \frac{Y_2}{2}]$$

$$+ \frac{+gc^2 C' S \Sigma}{\cos\theta_W} \frac{[T_{3R} - \alpha^2 \frac{Y_1}{2} - \beta^2 \frac{Y_2}{2}]}{(\lambda_2 \Lambda - M_{Z_1}^2)} \quad (6.1.8)$$

Similarly the Z_2 state is given by

$$|Z_2\rangle = |3'\rangle = |3\rangle + |4\rangle \frac{(-cc' (1+s^2) C' \Sigma)}{(M_{Z_2}^2 - \lambda_2 \Lambda)} \quad (6.1.9)$$

and this clearly gives the new Z_2 coupling as:

$$Z_2 : \frac{gC'}{\cos\theta_W} [T_{3L} - \sin^2\theta_W Q] - gc' S [T_{3R} - \alpha^2 \frac{Y_1}{2} - (1+\alpha^2) \frac{Y_2}{2}]$$

$$+ \frac{gc^2 C' C \Sigma}{\cos\theta_W} \frac{[T_{3R} - \alpha^2 \frac{Y_1}{2} - \alpha^2 \frac{Y_2}{2}]}{(\lambda_2 \Lambda - M_{Z_2}^2)} \quad (6.1.10)$$

Finally the Z_3 state has the form given below

$$|Z_3\rangle = |4'\rangle = |4\rangle + |2\rangle \frac{(-cc'(1+s^2)S'\Sigma)}{(\lambda_2\Lambda - M_{Z_1}^2)} \quad (6.1.11)$$

Hence the new Z_3 coupling becomes:

$$\begin{aligned} Z_3 : & gcC [T_{3R} - \alpha^2 \frac{Y_2}{2} - \beta^2 \frac{Y_2}{2}] - \frac{gcS'^2 [T_{3L} - \sin^2\theta_W Q] \Sigma}{\cos^2\theta_W (\lambda_2\Lambda - M_{Z_1}^2)} \\ & - \frac{gc^2 SCS' [T_{3R} - \alpha^2 \frac{Y_1}{2} + (1+\alpha^2) \frac{Y_2}{2}] \Sigma}{\cos\theta_W (\lambda_2\Lambda - M_{Z_1}^2)} \end{aligned} \quad (6.1.12)$$

6.2 Two Z's within the experimental peak

In Section (5.3) we have seen the effects of the extra Z which has approximately the same mass as the standard Z. Here we basically intend to find the consequences of the extra Z when the additional term which appears due to the presence of the right-handed vector boson, is also taken into account. Using the equation (6.1.4), we have

$$\bar{\lambda}_1 = (1+s^2) + \frac{B}{2} - \frac{1}{2} (B^2 + 4c^2 S^2 (1+s^2))^{\frac{1}{2}} - \frac{(c'^2 - s'^2) S'^2 \Sigma}{c'^4 (\lambda_2 \Lambda - M_{Z_1}^2)} \quad (6.2.1)$$

and

$$\bar{\lambda}_2 = (1+s^2) + \frac{B}{2} + \frac{1}{2} (B^2 + 4c^2 S^2 (1+s^2))^{\frac{1}{2}} - \frac{(c'^2 - s'^2) C'^2 \Sigma}{c'^4 (\lambda_2 \Lambda - M_{Z_2}^2)} \quad (6.2.2)$$

Now making use of

$$S'^2 = \frac{(c'^2 \bar{\lambda}_2 - 1)}{c'^2 (\bar{\lambda}_2 - \bar{\lambda}_1)} = \frac{1}{2} \frac{[B + [B^2 + 4c^2 S^2 (1+s^2)]^{\frac{1}{2}}]}{[B^2 + 4c^2 S^2 (1+s^2)]^{\frac{1}{2}}} \quad (6.2.3)$$

$$c'^2 = \frac{(1-c'^2\bar{\lambda}_1)}{c'^2(\bar{\lambda}_2-\bar{\lambda}_1)} = \frac{1}{2} \frac{[(B^2+4c'^2s^2(1+s^2)]^{\frac{1}{2}}-B]}{[B^2+4c'^2s^2(1+s^2)]^{\frac{1}{2}}} \quad (6.2.4)$$

$$\text{and } \lambda_2 \cong (1+\alpha^2) = 1/c^2 \quad (6.2.5)$$

we finally find that

$$\bar{\lambda}_1 = (1+s^2) + B/2 - \hat{Q}/2 - \mu/2(B/\hat{Q} + 1) \quad (6.2.6)$$

and

$$\bar{\lambda}_2 = (1+s^2) + B/2 + \hat{Q}/2 - \mu/2(1 - B/\hat{Q}) \quad (6.2.7)$$

where

$$\mu = \frac{(c'^2-s'^2)^2}{c'^6(\Lambda-c'^2M_{Z_1}^2)} \quad \text{and } \hat{Q} = [B^2+(4c'^2s^2(1+s^2))]^{\frac{1}{2}} \quad (6.2.8)$$

Equations (6.2.6) and (6.2.7) simultaneously yield the following constraints:

$$\begin{aligned} \text{(i)} \quad B &\leq \frac{(2(1+s^2) - 2\bar{\lambda}_1 - \mu)\hat{Q} - \hat{Q}^2}{(\mu - \hat{Q})} \quad , \mu > \hat{Q} \\ B &\geq \frac{(2(1+s^2) - 2\bar{\lambda}_1 - \mu)\hat{Q} - \hat{Q}^2}{(\mu - \hat{Q})} \quad , \mu < \hat{Q} \end{aligned} \quad (6.2.9)$$

and

$$(ii) \quad B \leq \frac{(2\bar{\lambda}_2 - 2(1+s^2)+\mu)\hat{Q} - \hat{Q}^2}{(\hat{Q} + \mu)} \quad (6.2.10)$$

and

$$(iii) \quad |B| < \hat{Q} \quad (6.2.11)$$

We now calculate the range of values which are consistent with the experimental limits [45]:

$$1.126 < \bar{\lambda}_1 < \bar{\lambda}_2 < 1.32 \quad (6.2.12)$$

These are shown on the various graphs which give allowed values of B and \hat{Q} at different values of μ which of course depends upon the mass of the right-handed vector gauge boson.

The shaded area in each Figure (15a, 16a, 17a), represents the required region which satisfies all the three conditions mentioned above. The sharp changes occur when

$$\begin{aligned} -2\bar{\lambda}_1 + 2(1+s^2) - \mu &= 2\bar{\lambda}_2 - 2(1+s^2) + \mu \\ \mu &= 2(1+s^2) - (\bar{\lambda}_1 + \bar{\lambda}_2) \end{aligned} \quad (6.2.13)$$

and also when

$$\begin{aligned}
-2 \bar{\lambda}_1 + 2(1 + s^2) - \mu &= \mu \\
\mu &= (1 + s^2) - \bar{\lambda}_1
\end{aligned}
\tag{6.2.14}$$

It is interesting to note that increasing the value of the μ tends to decrease the volume of the enclosed shaded region, i.e. gives a smaller range of allowed values of the \hat{Q} and B parameters (see Figures 16a, 17a). Note that large μ corresponds to small mass of the right-handed gauge boson M_{W_R} . From equation (6.2.8) i.e.

$$s^2 = \frac{(\hat{Q}^2 - B^2)}{4c^2(1+s^2)}
\tag{6.2.8}$$

it is obvious that the higher value of " \hat{Q} " yields the higher value of "S" while keeping the Weinberg angle ' θ_W ' to be fixed from the experimental data. The typical value of μ that gives the highest value of \hat{Q} and reasonably small value of B, is 0.04 which results at $M_{W_R} \approx 300$ Gev and $\sin^2 \theta_W = 0.23$. Thus, the translation of the maximally enclosed region in B and \hat{Q} plane into the S and B plane (see Figure 17b), gives

$$S = \pm 0.026, B = 0.018
\tag{6.2.15}$$

and

$$s'^2 = 0.673, c'^2 = 0.327
\tag{5.3.16}$$

which are clearly not very much different as compared to the

values found earlier in Section (5.3) i.e.

$$S = \pm 0.033; B = - 0.022 \quad (5.3.9)$$

$$\text{and } S'^2 = 0.669; C'^2 = 0.331 \quad (5.3.11)$$

Thus, provided that the right-handed vector bosons are reasonably heavy, the calculations of this section do not suggest any significant changes in the neutral current data provided two Z's remain within the experimentally observed peak.

Now in order to see the effects of the additional terms appearing in the expressions (6.1.8) and (6.1.10), we simply try to find the formula for the total cross-section in the neutral current ($\nu_e \rightarrow \nu_e$) process. Before doing that, we first rewrite the equations (6.1.8) and (6.1.10) as follows

$$\begin{aligned} Z_1: & \frac{gS'}{2\cos\theta_W} [(c_V - c_A \gamma_5)] + \frac{g\bar{A}}{2\cos\theta_W} [c_V - c'_A \gamma_5] \\ & = \frac{g}{2\cos\theta_W} [(S' c_L + A c'_L) (1 - \gamma_5) + (S' c_R + \bar{A} c'_R) (1 + \gamma_5)] \end{aligned} \quad (6.2.17)$$

where

$$\bar{A} = \frac{SC'}{(\cos 2\theta_W)^{\frac{1}{2}}} (1 + \bar{\mu}), \quad \bar{\mu} = \frac{c^3 CS \Sigma}{\cos\theta_W (\Lambda - M_{Z_1}^2 c^2) CS} \quad (6.2.18)$$



Similarly

$$\begin{aligned}
 z_2 &: \frac{g\dot{C}}{2\cos\theta_W} (c_V - c_A \gamma_5) - \frac{g\bar{H}}{2\cos\theta_W} (c_V - c_A \gamma_5) \\
 &: \frac{g}{2\cos\theta_W} [(C' c_L - \bar{H} c_L') (1 - \gamma_5) + (C' c_R - \bar{H} c_R') (1 + \gamma_5)]
 \end{aligned} \tag{6.2.19}$$

where

$$\bar{H} = \frac{SS'(1-\bar{\mu})}{(\cos 2\theta_W)^{\frac{1}{2}}}, \quad \bar{\mu} = \frac{c^3 C C \Sigma}{\cos\theta_W (\Lambda - M_{Z_2}^2 c^2) SS'} \tag{6.2.20}$$

Thus the total amplitude due to the exchange of two Z's with new coupling strengths given in equations (6.2.17) and (6.2.19) becomes:

$$\begin{aligned}
 M_{(Z_1+Z_2)} &= \frac{g^2}{8\cos 2\theta_W M_{Z_1}^4} [\bar{A}\bar{v}(k) \gamma_\mu (1-\gamma_5) v(k) \bar{e}(p) \gamma^\mu (1-\gamma_5) e(p) \\
 &\quad + \bar{H}\bar{v}(k) \gamma_\mu (1-\gamma_5) v(k) \bar{e}(p) \gamma^\mu (1+\gamma_5) e(p)]
 \end{aligned} \tag{6.2.21}$$

where

$$\bar{A} = (S' + \bar{A} \sin^2\theta_W) (S' c_L + \bar{A} c_L') + (C' c_L - \bar{H} c_L') (C' - \bar{H} \sin^2\theta_W) \tag{6.2.22}$$

and

$$\bar{H} = (S' + \bar{A} \sin^2 \theta_W) (S' c_R + \bar{A} c_R) + (C' c_R - \bar{H} c_R) (C' - \bar{H} \sin^2 \theta_W) \quad (6.2.23)$$

$$\frac{M_{Z_1}^2}{M_{Z_2}^2}$$

and also where $k(k')$ and $p(p')$ represent the four vector momenta of the incoming (outgoing) particles (see Figure 13). Thus the total cross-section obtains the form

$$\sigma(v)_{(Z_1+Z_2)} = \frac{g^4 \hat{S}}{32 \pi \cos^4 \theta_W M_{Z_1}^4} \left[\bar{A}^2 + \frac{\bar{H}^2}{3} \right] \quad (6.2.24)$$

Therefore, on substituting the values of \bar{A} and \bar{H} from the equations (6.2.22) and (6.2.23) and also making use of the expansion given in equation (5.3.22), we finally get:

$$\begin{aligned} \sigma(v)_{(Z_1+Z_2)} =_{s.m.} & \left[1 + \frac{2 \sin^2 \theta_W \hat{M}}{\cos 2\theta_W} S_+^2 + \frac{\hat{S} C (\dot{\bar{\mu}} + \dot{\bar{\mu}}) \hat{M}}{(\cos 2\theta_W)^{\frac{1}{2}}} + 2 \frac{\hat{S} C \sin^2 \theta_W (\dot{\bar{\mu}} + \dot{\bar{\mu}}) \hat{M} S^2}{(\cos 2\theta_W)^{3/2}} \right. \\ & + \frac{2 \hat{S} C \sin^2 \theta_W (\dot{\bar{\mu}} + \dot{\bar{\mu}})}{(\cos 2\theta_W)^{\frac{1}{2}}} + \frac{4 \sin^2 \theta_W S}{\cos 2\theta_W} (\dot{\bar{\mu}} C^2 + \dot{\bar{\mu}} S^2 (C^2 - S^2)) \hat{M} \\ & - \frac{2 (M_{Z_2}^2 - M_{Z_1}^2)}{M_Z^2} \left[C^2 + \frac{\sin^2 \theta_W \hat{M} S^2}{\cos 2\theta_W} - \frac{\hat{S} C S (\sin^2 \theta_W + \hat{M})}{(\cos 2\theta_W)^{\frac{1}{2}}} \right. \\ & + \frac{\hat{S} C}{(\cos 2\theta_W)^{\frac{1}{2}}} [\dot{\bar{\mu}} (2C^2 + S^2) + C^2 \dot{\bar{\mu}}] [\sin^2 \theta_W + \hat{M}] \\ & + \frac{\sin^4 \theta_W \hat{C} S^2}{(\cos 2\theta_W)^{3/2}} [4 \dot{\bar{\mu}} S^2 + S^2 \dot{\bar{\mu}} - 2 \dot{\bar{\mu}} C^2 + C^2 \dot{\bar{\mu}}] \hat{M} \\ & \left. - \frac{\sin^2 \theta_W S}{\cos 2\theta_W} [2 \dot{\bar{\mu}} C^2 - 2 \dot{\bar{\mu}} S^2 (3C^2 + S^2)] \right] \end{aligned}$$

$$\begin{aligned}
& -2 \frac{(M_Z^2 - M_{Z_1}^2)}{M_Z^2} \left[1 + \frac{2 \sin^2 \theta_W S^2 \hat{M}}{\cos 2\theta_W} + 2 \frac{\dot{S}'(\dot{\bar{\mu}} + \dot{\bar{\mu}}) \hat{M}}{(\cos 2\theta_W)^{1/2}} + 2 \frac{\dot{S}' C S^2 \sin^4 \theta_W (\dot{\bar{\mu}} + \dot{\bar{\mu}}) \hat{M}}{(\cos 2\theta_W)^{3/2}} \right. \\
& \left. + \frac{4 \sin^2 \theta_W S}{(\cos 2\theta_W)} [\dot{\bar{\mu}} C^2 + \dot{\bar{\mu}} S^2 (C^2 - S^2)] \hat{M} \right]
\end{aligned}$$

(6.2.25)

where

$$\dot{\bar{\mu}} = \bar{\mu} S = \frac{(\cos 2\theta_W)^{3/2} M_{W_L}^2 \dot{S} C}{(M_{W_R}^2 - M_{Z_1}^2 \frac{\cos 2\theta_W}{\cos^2 \theta_W}) \cos^4 \theta_W C'}$$

(6.2.26)

and

$$\dot{\bar{\mu}} = \bar{\mu} S = \frac{(\cos 2\theta_W)^{3/2} M_{W_L}^2}{\cos^4 \theta_W (M_{W_R}^2 - M_{Z_2}^2 \frac{\cos 2\theta_W}{\cos^2 \theta_W})} \left(\frac{C C'}{S'} \right)$$

(6.2.27)

Now after making use of the computed values of the parameters involved in the formula (6.2.25), the numerical value of the total cross-section is approximately estimated as follows:

$$\sigma_{Z_1+Z_2}(\nu) = \sigma_{s.m.}(\nu) [1 - 0.140]$$

(6.2.28)

This seems to be about 4 per cent different from the earlier

calculation done in Chapter (5) i.e.

$$\frac{\sigma(\nu)}{Z_1+Z_2} = \frac{\sigma(\nu)}{s.m} [1 - 0.103] \quad (5.3.27)$$

Moreover, this calculation also indicates that the contributions of two Z's still lie well within the experimentally observed errors.

6.3 Two adjacent Z peaks

From the discussion and calculations of the last section we have concluded that even the presence of the reasonably heavy charged M_{W_R} (the right-handed vector boson) does not impose any particular restriction provided that the two Z's are considered to be within the observed peak. In this section we are going to discuss the possibility that the Z_1 still remains within the peak while the second Z lies outside the observed peak. We wish to see what the model predicts about whether this second Z is likely to have been seen, or whether, as in Section (5.4), its coupling is always sufficiently weak for it not to have been seen. We begin with the equations

$$\bar{\lambda}_1 = (1 + s^2) + B/2 - \hat{Q}/2 - \mu (1 + B/\hat{Q})/2 \quad (6.2.6)$$

and

$$\bar{\lambda}_2 = (1 + s^2) + B/2 + \hat{Q}/2 - \mu(1 - B/\hat{Q})/2 \quad (6.2.7)$$

If we define

$$d_{1/2} = (1 + s^2) - \bar{\lambda}_1 \quad (6.3.1)$$

$$\text{and } d_{2/2} = \bar{\lambda}_2 - (1 + s^2) \quad (6.3.2)$$

then we have

$$d_1 = \hat{Q} - B + \mu B/\hat{Q} + \mu \quad (6.3.3)$$

$$\text{and } d_2 = \hat{Q} + B + \mu B/\hat{Q} - \mu \quad (6.3.4)$$

We note that $\frac{d_1}{2}$ and $\frac{d_2}{2}$ are the deviations from the Salam-Weinberg values $\frac{2}{2}$ and, since $\hat{Q} > B$

$$d_1 > 0 \quad (6.3.5)$$

First, we shall suppose that Z_2 , the heaviest of the pair of Z particles, is the one which lies outside the observed peak.

Thus

$$d_2 > d_1 \quad (6.3.6)$$

Subtractions and additions of the equations (6.3.3) and

(6.3.4) yield

$$B = (d_2 - d_1)/2 + \mu \quad (6.3.7)$$

$$\text{and } \hat{Q}^2 - (d_2 + d_1)\hat{Q}/2 + \mu B = 0 \quad (6.3.8)$$

respectively. The equation (6.3.8) gives the roots:

$$\hat{Q} = (d_2 + d_1)/4 \pm \left[\frac{(d_2 + d_1)^2}{16} - \mu B \right]^{1/2} \quad (6.3.9)$$

It is obvious from this equation that \hat{Q} only exists if

$$\frac{(d_2 + d_1)^2}{16} > \mu B$$

or

$$\frac{(d_2 + d_1)^2}{16} > \mu^2 + \mu (d_2 - d_1)/2 \quad (6.3.10)$$

Roots are

$$\mu = - \frac{(d_2 - d_1)}{4} \pm \frac{1}{2} \left[\frac{(d_2 - d_1)^2}{4} + \frac{(d_2 + d_1)^2}{4} \right]^{1/2} \quad (6.3.11)$$

Since $d_2 > d_1$, so \hat{Q} exists provided

$$\mu < 1/4 (2d_2^2 + 2d_1^2)^{1/2} - 1/4 (d_2 - d_1) \quad (6.3.12)$$

[It is important to note that the condition mentioned in (6.3.6) gives $B > 0$ (using equation (6.3.7))].

Then the condition $B < Q$ certainly implies that

$$1/4(d_2 + d_1) \pm \left[\frac{(d_2+d_1)^2}{16} - \mu B \right]^{1/2} > \frac{1}{2} (d_2-d_1) + \mu$$

or

$$\pm \left[\frac{(d_2+d_1)^2}{16} - \mu B \right]^{1/2} > d_2/4 - 3d_1/4 + \mu \quad (6.3.13)$$

Suppose that the right-hand side of (6.3.13) is +ve i.e. if

$$d_2/4 - 3d_1/4 + \mu > 0 \quad (6.3.14)$$

Then we definitely need the +ve root, so we need

$$\frac{(d_2+d_1)^2}{16} - \mu B > (1/4 d_2 - 3d_1/4 + \mu)^2 \quad (6.3.15)$$

or [using equation (6.3.7)]

$$16 \mu \left(\frac{1}{2}(d_2-d_1) + \mu \right) < (d_2 + d_1)^2 - (d_2 - 3d_1 + 4\mu)^2$$

$$\boxed{\mu < d_1/2} \quad (6.3.16)$$

We could also take the +ve root even if (6.3.14) is not satisfied, i.e. if

$$\boxed{\mu < 3d_1/4 - d_2/4} \quad (6.3.17)$$

Normally (6.3.16) will imply (6.3.17).

If we take the -ve root then we must have

$$\mu < 3d_{1/4} - d_{2/4} \quad (6.3.18)$$

and also (from 6.3.12)

$$1/16 (d_2 + d_1)^2 - \mu B < (3d_{1/4} - d_{2/4} - \mu)^2 \quad (6.3.19)$$

which implies (again from equation (6.3.7)) that

$$1/16 (d_2 + d_1)^2 - (3d_{1/4} - d_{2/4} - \mu)^2 < \mu \frac{(d_2 - d_1 + \mu)}{2}$$

$$\mu > d_{1/2}$$

(6.3.20).

But (6.3.17) and (6.3.18) are only compatible if

$$3d_{1/4} - d_{2/4} > d_{1/2} \quad \text{i.e. if}$$

$$d_1 > d_2 \quad (6.3.21)$$

which we have already excluded, so the -ve root is irrelevant here. Thus (6.3.16) is the only required condition. Then the expressions (6.3.7), (6.3.8) and (6.3.16) can be written in terms of the original parameters in equations (6.2.6) and (6.2.8) as follows

$$B = \bar{\lambda}_1 + \bar{\lambda}_2 - 2(1 + s^2) + \mu \quad (6.3.22)$$

$$\hat{Q} = (\bar{\lambda}_2 - \bar{\lambda}_1) / 2 + 1/2 [(\bar{\lambda}_2 - \bar{\lambda}_1)^2 - 4\mu B]^{1/2} \quad (6.3.23)$$

and

$$\mu < (1 + s^2) - \bar{\lambda}_1$$

or

$$\bar{\lambda}_1 < (1 + s^2) - \mu \quad (6.3.24)$$

If $\hat{Q} = B$

$$\text{Then } \bar{\lambda}_1 \text{ max} = (1 + s^2) - \mu \quad (6.3.25)$$

The Weinberg angle $\sin^2 \theta_W$ is known from the neutral current data [44] , and is given by

$$\sin^2 \theta_W = 0.232 \pm 0.007 \quad (6.3.26)$$

so $(1 + s^2)$ can be calculated from the relations (3.2.2), (5.1.16) and (5.2.2):

$$(1 + s^2) = 1/(1 - \sin^2 \theta_W) \quad (6.3.27)$$

Thus after fixing the numerical value of the parameter $(1 + s^2)$ to be 1.322, the relationship between $\bar{\lambda}_1 \text{ max}$ and μ is shown in Figure (18), which clearly indicates that increasing the value of μ tends to decrease the size of the allowed region for $\bar{\lambda}_1$.

Our next main concern is actually to find the connection between the mass of the Z_2 and the number of Z_2 events. In order to compute the number of Z_2 events expected to be

observed, we merely take the leading terms appearing in the equations (6.1.8) and (6.1.10). So the number of Z_2 events are simply related by the expression given below:

$$\bar{N}_{Z_2} = N_{Z_1} \left(\frac{C'}{S'}\right)^2 \quad (6.3.28)$$

Substituting the values of C'^2 and S'^2 from the equations (6.2.3) and (6.2.4) then yields

$$\bar{N}_{Z_2} = \left(\frac{\hat{Q}-B}{\hat{Q}+B}\right) N_{Z_1} \quad (6.3.29)$$

After fixing the $\bar{\lambda}_1 = \frac{M_{Z_1}^2}{M_W^2} = 1.277$ (from the graph (18)) which naturally fixes $M_{Z_1} = 90.5$ Gev., the values of B and \hat{Q} are determined from the equations (6.3.21) and (6.3.22) at the particular values of M_{Z_2} and μ . Since μ is restricted not to go beyond its limiting values, i.e. 0.045, so the relationship between the Z_2 events and its mass is graphed in Figure (19) under the constraint that $\hat{Q} > B$ at the various possible values of μ . It is obvious and interesting to note, from the Figure (19), that increasing the values of both μ and M_{Z_2} suppress the number of Z_2 events to be seen. Since it has been mentioned earlier in this section that increasing the value of μ tends to decrease the range of the allowed region. Thus by fixing $\bar{\lambda}_1 = 1.262$ which again fixes $M_{Z_1} = 90.0$ Gev, the maximum value of the permitted range of μ becomes 0.06. After having done this, the plot between M_{Z_2} and the number of Z_2 events, at all possible values of μ , is

sketched (see Figure (20)) under the condition that $\hat{Q} > B$. It is very much clear from the Figures (19,20) that increasing the value of M_{Z_1} also causes to decrease the number of Z_2 events.

Figure (20) also shows that the probability of seeing the second peak decreases with $M_{Z_2}^2$ and $M_{W_R}^2$ (which is inversely proportional to μ). For the largest permitted value of μ (0.04 corresponding to $M_{W_R} = 300$ Gev) the number of Z_2 's is 5% of the number of Z_1 's provided $M_{Z_2} \geq 105$ Gev.

In the previous chapter, where we only considered $\mu = 0$ (see Section 5.4) we have explicitly seen that the probability of the number of Z_2 events being less than 5% of the number of Z_1 events requires $M_{Z_2} \geq 110$ Gev provided that $|M_{Z_2} - M_{Z_1}| = 1$ Gev, but if $|M_{Z_2} - M_{Z_1}| = 2.1$ Gev (less than the experimentally observed uncertainty) then it occurs at $M_{Z_2} \geq 126$ Gev (see Figure (20)).

Thus from the discussion of this section we could easily conclude that, in the presence of the reasonably heavy right-handed charged vector boson, the range of the permitted Z_2 masses starts just outside the observed peak, but in the absence of the intermediate right-handed charged vector boson this range begins considerably higher beyond the peak.

We now try to see the effect of the Z_2 contribution to the neutral current process ($\nu e \rightarrow \nu e$) by fixing

$$\begin{aligned}
 M_{Z_1} &= 90.0 \text{ Gev}, \quad M_Z = 92.1 \text{ Gev} \\
 M_{Z_2} &= 105.0 \text{ Gev}, \quad M_{W_L} = 80.1 \text{ Gev} \\
 \mu &= 0.04 \text{ and } \sin^2 \theta_W = 0.23
 \end{aligned}
 \tag{6.3.30}$$

Substituting these values in the equation (6.2.24) gives

$$\frac{\sigma(v)}{Z_1+Z_2} = \frac{\sigma(v)}{\text{s.m.}} [1 - 0.343] \quad (6.3.31)$$

which is still less than the experimental uncertainty [46]. Although the cross-section computed in equation (6.3.31) does not appear to go beyond the experimental value, but it seems to be improved by about 6% as compared to the cross section at $\mu = 0.0$ (see Section 5.4).

We now consider the opposite assumption, namely that the observed peak corresponds to the higher mass Z . Thus the Z_1 lies out of the peak and the Z_2 is inside the peak. In this case if we take $d_1 > d_2$ and $d_2 > 0$ then the -ve root of equation (6.3.8), which requires

$$\mu > d_{1/2} \quad (6.3.20)$$

or

$$\mu > (1 + s^2) - \bar{\lambda}_1 \quad (6.3.32)$$

cannot be ruled out. Fixing $M_{Z_1} = 88$ Gev and $M_{Z_2} = 93$ Gev then yield $\mu = 0.12$ at $B < \hat{Q}$, which after substituting in equations (6.3.21) and (6.3.22) gives $B = 0.04$ and $\hat{Q} = 0.06$. Therefore, the number of \bar{N}_{Z_1} , defined by the relation

$$\begin{aligned} \bar{N}_{Z_1} &= \bar{N}_{Z_2} \left(\frac{S'}{C'}\right)^2 \\ &= \bar{N}_{Z_2} \left(\frac{B+\hat{Q}}{\hat{Q}-B}\right) \end{aligned} \quad (6.3.33)$$

are computed to be ~ 250 events. Thus contrary to our assumption, more Z_1 than Z_2 are produced. \bar{N}_{Z_2} represents the number of experimentally observed events.

If we now assume that $M_{Z_2'}$, which lies inside the peak, is less than the standard M_Z i.e. $M_{Z_2'} < M_Z$, then clearly $d_1 > 0$ and $d_2 < 0$. Thus

$$B > 0 \quad (6.3.34)$$

requires

$$1/2 (d_2 - d_1) + \mu > 0 \quad (6.3.35)$$

or

$$\mu > 2(1 + s^2) - (\bar{\lambda}_1 - \bar{\lambda}_2) \quad (6.3.36)$$

Then by fixing $M_{Z_2} = 91.0$ Gev and $M_{Z_1} = 88$ Gev we have

$$\mu = 0.15 \quad (6.3.37)$$

and $B < \hat{Q}$ which subsequently gives $B = 0.01$ and $\hat{Q} = 0.03$. Notice that the value of μ given in (6.3.37) produces (from (6.2.8)) $M_{W_R} \approx 180$ Gev. Thus equation (6.3.33) gives

$$\bar{N}_{Z_1} = 100 \text{ events} \quad (6.3.38)$$

which are still too many.

6.4 Can the higher Z be the new CERN events?

In the simple two Z's model (see Chapter 5) we saw that because of the small number of Z_2 produced, we were unable to see the partial decay width of Z_2 into $W_L^- W_L^+$ events. There we also ignored the extra correction term arising from the presence of the right-handed vector bosons. In this section we shall try to study the possibility that there are two Z's within the experimental peak and that the higher Z (200-300 Gev) is responsible for the new events, possibly seen at the CERN $P\bar{P}$ collider [3]. We also notice that the two Z's have the same masses and nearly equal in magnitude to the mass of the standard Z, but their coupling strength is obviously different from each other as well as the standard model's Z. Since we have seen in section (6.2) that the numerical value of "S" is very small so the couplings of these Z's to the fermions finally become (see Section (6.1))

$$Z_1: \frac{gS'}{2\cos\theta_W} (c_V - c_A'\gamma_5) + \frac{gS\Sigma \cos 2\theta_W}{2\cos^5\theta_W (\Lambda - M_{Z_1}^2)} \frac{(c_V - c_A'\gamma_5)}{\cos^2\theta_W} \quad (6.4.1)$$

$$z_2 = \frac{gC'}{2\cos\theta_W} (c_V - c_A \gamma_5) + \frac{gC' \cos 2\theta_W (c_V - c_A \gamma_5)}{2\cos^5\theta_W (\Lambda - M_{Z_1}^2 \frac{\cos 2\theta_W}{\cos^2\theta_W})} \quad (6.4.2)$$

and

$$z_3 = \frac{g(c_V - c_A \gamma_5)}{2\cos\theta_W (\cos 2\theta_W)^{1/2}} - \frac{gS^2 \Sigma (\cos 2\theta_W)^{3/2} (c_V - c_A \gamma_5)}{2\cos^5\theta_W (\Lambda - M_{Z_1}^2 \frac{\cos 2\theta_W}{\cos^2\theta_W})} \quad (6.4.3)$$

where we have used $M_{Z_2}^2 = M_{Z_1}^2$.

Assuming that the dominant contributions come from the valence quarks inside the proton and anti-proton then the ratio of the production cross-section for the two Z's in $P\bar{P}$ inelastic collision is given by the expression

$$R = \frac{4 \left[(u_R \bar{u}_R)^2 + (u_L \bar{u}_L)^2 \right] + (d_R \bar{d}_R)^2 + (d_L \bar{d}_L)^2 \Big|_{Z_3}}{4 \left[u_{aR}^2 + u_{aL}^2 \right] + d_{aR}^2 + d_{aL}^2} \quad (6.4.4)$$

where we have defined

$$u_{aR} = (u_R \bar{u}_R)_{Z_1} + (u_R \bar{u}_R)_{Z_2}$$

$$u_{aL} = (u_L \bar{u}_L)_{Z_1} + (u_L \bar{u}_L)_{Z_2}$$

$$d_{aR} = (d_R \bar{d}_R)_{Z_1} + (d_R \bar{d}_R)_{Z_2}$$

$$d_{aL} = (d_L \bar{d}_L)_{Z_1} + (d_L \bar{d}_L)_{Z_2}$$

(6.4.5)

Substituting the values of s'^2 and c'^2 from (6.2) and $M_{W_R} = 300$ Gev, $M_{Z_1} = 92.0$ Gev $M_{W_L} = 80.1$ Gev and $\sin^2 \theta_W = 0.23$ into the equations (6.4.1), (6.4.2) and (6.4.3), this ratio is determined to be

$$R \approx 0.82$$

(6.4.6)

Because of the difference in the masses of the two Z's, the kinematic effect gives a suppression factor (R') of about 0.04 and 0.002 for $M_{Z_2} = 200 - 300$ Gev respectively (see Chapter 3). Thus the number of Z_3 produced are estimated as follows:

$$\begin{aligned} N_{Z_3} &= N_{Z_1} (R.R') \\ &= 975 (0.82) (0.04) (M_{Z_2} = 200 \text{ Gev}) . \\ &\approx 32 \text{ events} \end{aligned}$$

(6.4.7)

Obviously not all of these decay into $W_L^- W_L^+$ pairs. Thus we need to calculate the branching ratio for this decay, which requires the coupling strength of the Z_3 to the left-handed W's. Thus the second part of the expression (6.4.3) is the only term which mixes the left-right handed and hypercharge

vector bosons. From this term the following coupling of the Z_3 to the light W has been obtained

$$:K g \cos \theta_W \quad (6.4.8)$$

$$\text{where } K = \frac{(\cos 2\theta_W)^{3/2} \Sigma}{\cos^4 \theta_W (\Lambda - M_{Z_1}^2 \frac{\cos 2\theta_W}{\cos^2 \theta_W})} \quad (6.4.9)$$

With this coupling the decay rate of the Z_3 into $W_L^+ W_L^-$ is computed as [33]

$$\Gamma(Z_3 \rightarrow W_L^+ W_L^-) = \frac{K^2 \alpha \cot^2 \theta_W M_{Z_3}}{48} x^{-3} (x^2 - 4)^{3/2} (x^4 + 20x^2 + 12) \quad (6.4.10)$$

where

$$x = \frac{M_{Z_3}}{M_{W_L}} \quad (6.4.11)$$

Thus, after making use of the already described values of the quantities involved in equation (6.4.10), the partial decay width of Z_3 is numerically estimated to be 0.01 Gev at $M_{Z_3} = 200$ Gev. This width can be further increased to 0.054 Gev by replacing $M_{Z_3} = 300$ Gev.

Following the coupling of the Z_3 to the fermions calculated in Chapter 3, the branching ratio into $W_L^+ W_L^-$, defined by the expression

$$\text{B.R} = \frac{\Gamma(Z_3 \rightarrow W_L^+ W_L^-)}{\Gamma(Z_3 \rightarrow \sum_i^{\text{all}} f_i \bar{f}_i + W_L^+ W_L^-)} \quad (6.4.12)$$

is thus determined to be ~ 0.002 at $M_{Z_3} = 200$ Gev and $M_{W_R} = 300$ Gev. Then the number of $Z_3 \longrightarrow W_L^+ W_L^-$ observed events become.

$$\begin{aligned}
 N_{Z_3} \text{ (observed)} &= N_{Z_3} \text{ (produced)} \cdot \text{B.R.}(Z_3 \rightarrow WW) \\
 &\approx 0.1 \text{ events.} \qquad \qquad \qquad (6.4.13)
 \end{aligned}$$

Since experimentally two events have been observed [44] and our predicted rates do not seem to have much effect. The main reason for such a small effect is due to the weaker coupling strength of the Z_3 into $W_L^- W_L^+$ decay and this can be reasonably improved by decreasing the mass of the right-handed charged vector boson from 300 Gev to 200 Gev.

CHAPTER 7

The Superstring Models

7.1 Introduction

There has recently been much activity associated with the suggestion that 'particles' are not point-like objects but instead are one-dimensional, extended objects, "strings" [48,49]. One of the strongest reasons for believing this idea is that the ultra-violet divergent infinities of point field-theory are removed, so with strings it naturally seems to be possible to construct a finite theory of gravity. Point field theories however, are inconsistent with gravity since the quantum theory of gravity is not renormalizable.

Various string theories which seem to be reasonably promising candidates are being much studied and discussed. The most satisfactory and consistent string theory is the so called 'heterotic' superstring[50]. This is a closed string associated with the gauge group $E_8 \times E_8$ - such a group is selected from the essential requirement of anomaly cancellation. The heterotic string is initially defined in a space-time of ten-dimensions and one of the current big problems of string theory is to understand how six of these dimensions 'compactify' to leave four-physical space-time dimensions.

The low-energy effective theory in four-dimensions is the massless sector containing the ground state of the string

and the lowest (massless) modes of the compact six-dimensional manifold. Other excited states are expected to have mass 0 (M_{planck}) and to be irrelevant to "physics". The theory is necessarily required to have $N = 1$ supersymmetry down to energies ~ 1 Tev and it can be shown that this requires the manifold to have $SU(3)$ holonomy with the spin connection identified with a certain subset of the gauge connection. This requires embedding the $SU(3)$ holonomy group within a $SU(3)$ subgroup of one of the E_8 factors. The symmetry is thus automatically broken to $E_6 \times E_8$ gauge group.

We assume that the physical states are singlets of the E_8 factor and are in the adjoint representation of the E_6 . The problem then arises as to how this E_6 can be broken down to the standard model (or something similar). It is known from general consideration of Grand Unified Theories (GUT) that such a breaking must occur at an energy $\sim 10^{15}$ Gev or a little less than the planck mass ($\sim 10^{19}$ Gev). Thus it is natural to suppose that it occurs at the compactification scale.

7.2 Why the string theory has an extra $U(1)$

As we saw in the previous section the most natural compactification scheme for the heterotic string breaks the original $E_8 \times E_8$ group down to $E_6 \times E_8$. Although the E_6 factor is satisfactory as a Grand-Unified Group it has to be broken at a high energy, i.e. around the compactification scale. The question then arises as to how we can arrange for the

compactification to yield a suitable subgroup (e.g. the standard model) of E_6 rather than E_6 itself.

One possibility occurs if the 6-dimensional compact manifold, K , is not simply connected. This can always be arranged, starting from a simply connected manifold, by identifying points which are related by a suitable group operations. As a simple example if we start with a flat two-dimensional Euclidean space, described by co-ordinates x and y , which is simply connected, and identify points

x and $x + 1$

y and $y + 1$

Then we construct a torus which is not simply connected (see Figure 21). The line AB in Figure (21b) is a closed-loop which cannot be reduced to a point, thereby showing that the torus is not simply connected.

In general the method involves finding some discrete symmetry group F and identifying points on the manifold

x and fx

where f is any element of F . In order not to destroy the smooth properties of the manifold it is important that F acts "freely", i.e. x is never the same point as fx .

The idea of using this method to break the symmetry is that, instead of requiring of any physical field,

$$\psi(fx) = \psi(x) \quad (7.2.1)$$

we postulate

$$\psi(fx) = U_f(x) \quad (7.2.2)$$

where U_f is an element of E_6 , i.e. we require that on going round any non-contractible loop the field does not change apart from a specific gauge transformation.

We now make the successive use of equation (7.2.2) to show that, for any f, f' that are the elements of the discrete symmetry group F ,

$$\begin{aligned} U_f U_{f'} \psi(x) &= U_f \psi(f'x) \\ &= \psi(ff'x) \\ &= U_{ff'} \psi(x) \end{aligned} \quad (7.2.3)$$

or

$$U_{ff'} = U_f U_{f'} \quad (7.2.4)$$

It follows that the set of U_f 's form a (discrete) group and therefore that we must embed the group F into some discrete subgroup of E_6 . The gauge group E_6 is then broken into the group that commutes with all elements of this discrete subgroup.

An alternative way of describing this method of symmetry

breaking is through the idea of "Wilson loops". According to this technique, if γ is any non-contractible loop in a manifold K (which is not simply connected), starting and ending at some point x , then the "Wilson line" given by

$$U_\gamma = P \exp \oint_\gamma A \cdot dx \quad (7.2.5)$$

is essentially a gauge covariant. Here both A and U_γ are associated with E_6 -group and they represent the gauge field and an element of the group respectively. Also note that P denotes the path ordering.

Now if we take two loops γ and γ' , drawn in Figure (21c), the product loop $\gamma\gamma'$ is defined by

$$U_{\gamma\gamma'} = P \exp \oint_{\gamma\gamma'} A \cdot dx = (P \exp \oint_\gamma A \cdot dx) (P \exp \oint_{\gamma'} A \cdot dx) \quad (7.2.6)$$

Since E_6 is an abelian group, thus the equation (7.2.6) reduces to

$$U_{\gamma\gamma'} = U_\gamma \cdot U_{\gamma'} \quad (7.2.7)$$

which is analogous to (7.2.4) and describes a homomorphism mapping the fundamental group into E_6 . As the Wilson lines are taken to be not simply connected, the E_6 gauge field strength $F_{ij} = 0$ merely indicates that we can set gauge field A_i to zero by a non-single valued gauge transformation and

such kind of transformation in fact will introduce a "twist" in the boundary conditions that are obeyed by the charged fields. Thus symmetry breaking by Wilson lines is in fact the same as that produced by (7.2.2).

We now turn to the problem of determining the possible E_6 breaking that can be obtained by this mechanism. We first note that E_6 contains a maximal subgroup $SU(3) \times SU(3) \times SU(3)$. It is natural to suppose that one of these is the colour group and that the others represent "weak-interactions" on L, R fermions, i.e. we can write the subgroup as $SU(3)_C \times SU(3)_L \times SU(3)_R$. Thus we expect that the elements U_f will commute with $SU(3)_C$ and break $SU(3)_L$ down to $SU(2)_L$.

Consider for simplicity the case where the group formed by the U_f is a cyclic group, generated by a single element U which satisfies $U^n = 1$. Then, the above condition means that we can write U in the form

$$U = \begin{bmatrix} \alpha & & \\ & \alpha & \\ & & \alpha \end{bmatrix} \times \begin{bmatrix} \beta & & \\ & \beta & \\ & & \beta^{-2} \end{bmatrix} \times \begin{bmatrix} \gamma & & \\ & \delta & \\ & & \epsilon \end{bmatrix} \quad (7.2.8)$$

where we have diagonalized the $SU(3)_R$ part. Since we require U to belong to $SU(3)_C \times SU(3)_L \times SU(3)_R$ we require $\alpha^3 = \gamma\delta\epsilon = 1$. Also the condition $U^n = 1$ requires that $\alpha, \beta, \gamma, \delta, \epsilon$ are all n th roots of unity. For general values of the parameters that satisfy these conditions the subgroup of E_6 that commutes with the U is $SU(3)_C \times SU(2)_L \times U(1) \times U(1) \times U(1)$ where the three $U(1)$'s are, a diagonal matrix of $SU(2)_L$ of the form $\begin{bmatrix} a & & \\ & a & \\ & & b \end{bmatrix}$ and the two diagonal elements of $SU(3)_R$.

Thus we obtain the standard model plus 2 extra $U(1)$ factors. Of course for special values of the parameters we obtain a larger unbroken group, e.g. if $\gamma = \delta$ we obtain an unbroken $SU(2)_R$ so that we have a LXR symmetric model.

To obtain a smaller unbroken symmetry we consider the case of the non-abelian flux breaking of E_6 at the compactification scale, then it can be shown that the smallest subgroup becomes $SU(3)_C \times SU(2)_L \times U(1) \times U(1)$ which obviously has rank 5. This is the unique minimum possible extension of the standard model at low-energies in the superstring.

Thus, it seems natural to propose that if E_6 is broken by Wilson loops, there must be at least an additional $U(1)$ gauge interaction in the theory. This is a "prediction" of this class of string modes, and it is one of very few such predictions that have been obtained from the superstring. (It should be noted however, that there have recently been obtained consistent string models which do not have it).

7.3 The comparison with the string model predictions

We have explicitly discussed in the preceding section how the existence of two Z 's in the superstring theory seems to be natural provided the E_6 gauge group is broken down to some subgroup by Wilson loops. The interesting question of whether these two Z 's are similar to those in the composite, or significantly different, will be considered in this

section.

One immediate difference is that in the string theory there is no reason why the two Z's should have [51] similar masses, whereas, as we have seen, in the composite model there is a strong preference for this e.g. in the same way that the ρ and ω have almost equal masses. We shall indeed see below that such equality seems to be impossible in the string.

We now try briefly to compare the structure of our composite model explicitly described in Chapter 5 with the string theory. For the latter we use the careful discussion of Ref. [6]. If we recall our equation (5.1.21) we can easily find that

$$M_{Z_1}^2 + M_{Z_2}^2 = M_Z^2 + \left(\lambda \frac{\Lambda}{\Sigma} + c^2 S^2 \right) M_W^2 \quad (7.3.1)$$

$$M_{Z_1}^2 \cdot M_{Z_2}^2 = M_Z^2 \lambda \frac{\Lambda}{\Sigma} M_W^2 \quad (7.3.2)$$

Substituting $\lambda \frac{\Lambda}{\Sigma} = B + (1+s^2)$ into the above equations immediately yields

$$M_{Z_1}^2 + M_{Z_2}^2 = M_Z^2 + M_Z^2 + (B + c^2 S^2) M_W^2 \quad (7.3.3)$$

$$M_{Z_1}^2 \cdot M_{Z_2}^2 = M_Z^2 (M_Z^2 + (B + c^2 S^2) M_W^2) - M_Z^2 c^2 S^2 M_W^2 \quad (7.3.4)$$

In order to compare with the notations of the model being discussed in Ref. [6] we write these equations as

$$M_{Z_1}^2 + M_{Z_2}^2 = M_Z^2 + \hat{B} \quad (7.3.5)$$

and

$$M_{Z_1}^2 \cdot M_{Z_2}^2 = M_Z^2 B - \hat{C} \quad (7.3.6)$$

where

$$\hat{B} = M_Z^2 + (B + c^2 S^2) M_W^2 \quad (7.3.7)$$

and

$$\hat{C} = M_Z c S M_W \quad (7.3.8)$$

Equations (7.3.5) and (7.3.6) are identical to 5a and 5b of Ref. [6] except the quantities \hat{B} and \hat{C} are denoted by B and C and M_{Z_1} and M_{Z_2} are denoted by M_2 and M_3 .

In our model of course \hat{B} and \hat{C} are free parameters, subject only to the restrictions arising from the fact that S and B are all non-zero and further $\hat{Q} \geq B$ (see chapter 6). However, in the string model as used in Ref. [6] C seems to be at least partially determined.

The string restriction on C means that reasonable values of M_{Z_1} ($\equiv M_2$) require that M_{Z_2} ($\equiv M_3$) is bounded below (see Figure (22)). For a given value of M_2 Figure (22) shows that M_3 can be precisely determined. Also note that the string does not even allow $M_{Z_1} \approx M_{Z_2}$. While our model seems to be

entirely free from such restrictions. We have more degree of freedom in choosing the M_{Z_2} . In our model when the mass of the second Z is fixed from the experiment then the rate is too small.

The probability of observing the decay of the extra neutral gauge boson, which is being predicted in our composite model as well as in string model, into W^-W^+ vector bosons also seems relevant to be nicely compared. In string theory, the heavy new Z_3 couples to W-pairs through its coupling with standard Z^0 and is $\tilde{g}_1 c_W s_3$, where $\tilde{g}_1 c_W$ is the standard Z^0 coupling and s_3 the $Z^0 Z_3$ mixing. There they have shown that the present experiment limits require $s_3 < 0.1$ for $M_3 = 250$ Gev. They have further shown that the Z_3 coming from an E_6 -superstring-inspired model is unable to yield the presently needed cross-section.

On the other hand, we have well determined that the coupling of the new Z_3 to W-pairs has similar pattern as in string model and is $K g \cos \theta_W$, where $g \cos \theta_W$ is the standard Z coupling and K the ZZ_3 mixing given by

$$K = \frac{(\cos 2\theta_W)^{3/2} \Sigma}{\cos^4 \theta_W \left(\Lambda - \frac{M_{Z_1}^2 \cos 2\theta_W}{\cos^2 \theta_W} \right)} \quad (6.4.9)$$

However, the numerical value of the suppression factor K is computed to be ~ 0.08 at $M_{WR} = 250$ Gev and can be further increased by decreasing the mass of the right-handed vector

boson and vice-versa.

Thus, from the discussion of this section one could easily see that our composite model much studied in Chapters 5 and 6, and the string model well explained in Ref. [6] seem to be fairly consistent and both are, at present, unable to explain the current (speculative) experimental data discussed in Ref. [3].

CHAPTER 8

Summary

The unification of all natural forces has long been the prime and ultimate aim of many scientists. The process was begun by Maxwell, but it was Einstein who first conceived the idea of a complete unification. The various attempts to unify the electromagnetic and weak interactions successfully led to the establishment of the so called "Salam-Weinberg" electroweak standard model. We have explicitly seen how gauge theories and the Higgs mechanism play their individual role in the development of the standard model. In Chapter 1 we have mainly reviewed the Salam-Weinberg model and have seen how it is in agreement with all so far known phenomenology. However, this consistency of the electroweak standard model does not necessarily mean that the model can be regarded as correct at a deeper, more fundamental, level.

A detailed review of the left-right symmetric model, which is the most natural extension of the standard model, and is based on the group $SU(2)_L \times SU(2)_R \times U(1)$ for the electroweak interactions has been carefully made in Chapter 2. There we have clearly observed that the Higgs mechanism, which in fact provides the masses to the intermediate vector bosons, has to be modified. We have further seen that in order to preserve the low-energy phenomenology, the right-handed massive charged vector bosons (W_R) associated with $SU(2)_R$ factor must be much heavier than the experimentally

confirmed left-handed light massive charged vector bosons (W_L). To give a strong support to this assumption some experimental constraints on the mass of W_R have been briefly presented and it is seen that the latest available data requires $M_{W_R} \geq 400$ Gev.

Although the analysis of Chapter 1 clearly shows that there is no confirmed experimental evidence that lies beyond the Salam-Weinberg model, there have recently been some unconfirmed events [3] which have obviously spread various speculations about their nature. We have explicitly discussed them in the context of the extended left-right symmetric version of the electroweak standard model in Chapter 3. We have tried to explain the events as being due to the decay of the additional hypothetical neutral vector boson (Z') in the LxR symmetric model, thereby roughly fixing $M_{Z'} \sim 200$ Gev. In order to do this we have, first, derived the mass matrix for vector bosons and then using that mass matrix we have determined the corresponding mass eigenvalue spectrum and finally the coupling of the expected new Z' to the fermions. The coupling of the Z' to the W_L 's is found to be dependent on M_{W_R} . For reasonable values, it is highly suppressed, by a factor we call K , and the number of Z' decays predicted is much less than that required to explain the speculative experimental prediction [3].

Another class of models, which also predict the existence of two neutral vector bosons, are the composite models. The simplest and economic rishon model has been

reviewed in Chapter 4. An important feature of this model is that the two Z 's are expected to have closely similar masses. In Chapter 5 we have explicitly computed the couplings of the vector bosons in the framework of the composite model and have also discussed (under the assumption that the mass of the W_R is infinite) the various possible values for the masses of the two Z 's. Considering them both to be present within the experimentally observed peak we have found a range of acceptable parameters and shown that for this range the usual fits of the standard model to the cross-section obtained in $(\nu e \rightarrow \nu e)$ neutral current data is not affected. The possibility of one Z to be within the experimental peak and the other Z just outside the standard model, also does not conflict with the observed data because the weak coupling of the extra Z , means that it would be unlikely to have been seen. Then we consider the possibility of what happens if one of the Z 's is the 'standard one' with $M_{Z_1} \approx M_Z$ (the central value of the observed standard model prediction) and M_{Z_2} is sufficiently far away from the standard model, to allow it to explain the unconfirmed CERN events. However, we again find that the number of Z_2 's produced is too small to explain the data.

Then, we essentially combine the two models by taking into account the effects which come from the presence of the heavy right-handed vector bosons with a large but finite mass. We have carefully reconsidered all the possibilities regarding the masses and other dynamics of the Z 's. Again we do not find any obvious disagreements with the experimental

predictions. With regard to explaining the extra events we find that the number of hypothetical Z's produced is large but their probability of decaying into W-pairs has been estimated and is $\sim 1/20$ times less than that required to explain the events.

Finally, we have made a comparison of our model predictions with those of superstring (which in some forms at least also predicts the extra Z). There we have well seen that both models have similar structures and predictions. The constraints on the parameters given in the particular string model we study [6] are different from the expected in the composite model, in particular the string does not have any natural reason for requiring the two Z's to have similar masses.

The conclusions of this thesis can be briefly summarized in the following way:

(1) Presently available experimental methods do not distinguish a 2Z model from the standard model provided either that the mass separation is less than the width of the Z peak, or, if the separation is somewhat larger, provided that one of the Z's remains in the peak. These results apply even when a L x R symmetrical model, with an acceptable mass for W_R , is used.

(2) A modest improvement (from about 50% error to about 5%) in the accuracy of $\nu_e - e^-$ scattering data would enable further restrictions to be placed on the parameters of our models and maybe even to reveal evidence for the extra Z.

(3) With any combination of parameters a two Z, L x R symmetrical model, predicts a maximum "new Z \rightarrow 2W" rate which is at least an order of magnitude too small to explain the unconfirmed "non-standard" CERN events.

REFERENCES

- [1] J.C. Pati and A. Salam, Phys. Rev. D10 (1974) 275.
- [2] R.N. Mohapatra and J.C. Pati, Phys. Rev. D11 (1975) 566, 2558.
- [3] D. Denegri et al. (UA1 Collaboration), CERN-Saclay, preprint. DphPE 86-26 (1986).
- [4] J.L. Rosner, Comm. Nucl. Part. Phys. 14 (1985) 229 and 15 (1986) 195;
S.M. Barr, Phys. Rev. Lett . 55 (1985) 2778;
V. Barger, N.G. Deshpande and K. Whisnant, Phys. Rev. Lett. (1986) 30;
L.S. Durkin and P. Langacker, Phys. Lett . 166B (1986) 436;
D. London and J.L. Rosner, EFI Preprint 86-22 (1986);
G. Costa, J. Ellis, G.L. Fogli, D.V. Nanopoulos and F. Zwirner, CERN preprint, in preparation.
- [5] F. del Aguila, G.A. Blair, M. Daniel and G.G. Ross, CERN preprint TH. 4376/86 (1986).
- [6] F. del Aguila, M. Quiros and F. Zwirner, CERN preprint TH. 4506/86 (1986).
- [7] E. Fermi, Z. Phys. 88, 161 (1934).
- [8] S.L. Glashow, Nucl. Phys. 22, 579 (1961).
- [9] S. Weinberg, Phys. Rev. Lett. 19,1264 (1967).
- [10] A. Salam, In: Elementary Particle Theory, Proceedings of 8th Nobel Symps. (Almquist and Wiksell, Stockholm) p.369 (1968).
- [11] F.J. Hasert et al., Phys. Lett. 46B, 138 (1973).
- [12] UA1 Collaboration, G. Armison et al., Phys. Lett. 122B, 103 (1983).
- [13] UA2 Collaboration, M. Banner et al., Phys. Lett. 122B, 476 (1983).
- [14] UA1 Collaboration, G. Arnison et al., Phys. Lett. 125B, 398 (1983).

- [15] UA1 Collaboration, G. Arnison et al., Phys. Lett. 129B, 273 (1983).
- [16] F. Halzen and A.D. Martin, Quarks and Leptons: An Introductory Course in Modern Particle Physics (John Wiley and Sons, 1984).
- [17] L. Di Lella, Proceedings of the International Euro Physics Conference on High Energy Physics, Bari, 1985.
- [18] A. Sirlin, Phys. Rev. D29, 89 (1984).
- [19] R. Budney, Phys. Lett. 55B, 227 (1975).
- [20] W. Bartel et al., Z. Phys. C. 26, 507 (1985).
- [21] W.J. Marciano in p.80: 1983 International Symps. on Leptons and Photons Interactions at High Energies, Carnell University, ed. D.G. Cassel, D.L. Kreinick, 1983.
- [22] R.W. Brown et al., Phys. Rev. Lett. 52, 1192 (1984).
- [23] L.A. Ahrens et al., Phys. Rev. Lett. 54, 18 (1985).
- [24] M. Jonker et al., Phys. Lett. 99B, 265 (1981).
- [25] G. Sanjanovic, Nucl. Phys., 153B, 334 (1979).
- [26] E.M. Lipmanov, Sovt. J. Nucl. Phys. 6, 395 (1968).
- [27] I.I. Gurevich et al., Phys. Lett. 11, 185 (1964).
- [28] M.A.B. Beg et al., Phys. Rev. Lett. 38, 1252 (1977).
- [29] J. Carr et al., Phys. Rev. Lett. 51, 627 (1983).
- [30] D.P. Stoker et al., Phys. Rev. Lett. 54, 1887 (1985).
- [31] (a) G. Altarelli, R.K. Ellis, M. Rreco and G. Martinelli, Nucl. Phys. B246 (1984) 12;
 (b) G. Altarelli, R.K. Ellis and G. Martinelli, Z. Phys. C., Particles and Fields, 27 (1985) 617.
- [32] G. Arnisona et al., (UA1 Collaboration) Phys. Lett. 134B (1984) 469; 147B (1984) 241; 155B (1985) 442.
- [33] R. Kleiss and W.J. Stirling, CERN preprint TH-4490/86 (1986).
- [34] S. Drell and T.M. Yan, Phys. Rev. Lett. 25 (1970) 316; Ann. of Phys. 66 (1971) 578.

- [35] P.D.B. Collins and A.D. Martin, *Hadron Interactions* (Adam Hilger, Bristol, 1984).
- [36] I.J.R. Aitchison and A.J. Hey, *Gauge Theories in Particle Physics* (Adam Hilger, Bristol, 1982).
- [37] E. Eichten et al., *Rev. Mod. Phys.* 56 (1984) 599.
- [38] C.K. Chang, *Phys. Rev.* D5, 950 (1972).
- [39] T. Massam and A. Zichichi, *Nuovo Cim.* 43, 227 (1966).
- [40] H. Georgi, H.R. Quinn and S. Weinberg, *Phys. Rev. Lett.* 33, 451 (1974).
- [41] H. Harari, *Phys. Lett.* 86B, 83 (1979).
- [42] M.A. Shupe, *Phys. Lett.* 86B, 87 (1979).
- [43] R.N. Mohapatra and G. Senjanovic, *Phys. Rev. Lett.* 44 (1980) 912.
- [44] UA2 Collaboration, presented by S. Loucatos at the 6th topical Workshop on Proton-antiproton Collider Physics, Aachen, July 1986.
- [45] A.D. Martin, R.G. Roberts and W.J. Stirling, preprint RAL-87-002.
- [46] R.C. Allen et al., *Phys. Rev. Lett.* 55 (1985), 2401.
- [47] R.H. Dicke and J.P. Witke, *Introducton to Quantum Mechanics* (Addison-Wesley, 1980).
- [48] J.H. Schwarz, *Phys. Reports* 89 (1982) 223.
- [49] M.B. Green and J.H. Schwarz, *Phys. Lett.* 149B (1984) 117.
- [50] D.J. Gross et al., *Phys. Rev. Lett.* 54 (1985) 502; *Nucl. Phys.* B256 (1985) 253, B267 (1986), 75.
- [51] E. Witten, *Nucl. Phys.* B258 (1985) 75.

Figure captions

- (1) The vector boson couplings to the weak isospin and hypercharge currents.
- (2) Electromagnetic and weak contributions to $e^+e^- \longrightarrow \mu^+\mu^-$ process.
- (3) Neutrino nuclear inclusive neutral current interaction.
- (4) The Weinberg mixing angle obtained from the various neutral current phenomenology.
- (5) Experimental W-transverse momentum distribution for $W \rightarrow e\nu$ and $\rightarrow \mu\nu$. Events having at least one jet are shown shaded. The solid curve line is the QCD prediction [31], modified for selection and apparatus smearing effects.
- (6) The Drell-Yan mechanism for Z' production.
- (7) The decaying of the Z' into W^+W^- pairs.
- (8) The cross-section of the Z' exchanged in $P\bar{P}$ inelastic collision vs. its masses at the c. of m. energy $\sqrt{\hat{S}} = 546$ and 630 GeV.
- (9) The ratio of the (Z'/Z) cross-sections vs. the masses of the Z' at the c. of m. energy $\sqrt{\hat{S}} = 546$ and 630 GeV.
- (10) The branching ratio of the Z' decays into various possible channels vs. its masses.
- (11) The weak process $de^+ \longrightarrow u\bar{\nu}$ in the rishon model, mediated by $W^- = \bar{T}\bar{T}V\bar{V}\bar{V}$ exchange.
- (12) Allowed region in the (B,S) plane at various values of $\sin^2\theta_W$. The shaded area in each case represents the permitted range favoured by our model.

- (13) Neutral current $\nu e \rightarrow \nu e$ weak interaction.
- (14) The number of Z_2 events against its masses when
- $|M_Z - M_{Z_1}| = 1 \text{ GeV.}$
 - $|M_Z - M_{Z_1}| = 0.6 \text{ GeV.}$
 - $|M_Z - M_{Z_1}| = 0.4 \text{ GeV.}$
- (15) (a) The shaded region is the required area in the (B, \hat{Q}) plane at $B = \hat{Q}$ and at $\mu = 0.025$.
- (b) The translation of the above (B, \hat{Q}) plane into the (B, S) plane at $\mu = 0.025$.
- (16) (a) The shaded region is the required area in the (B, \hat{Q}) plane restricted at $B = \hat{Q}$ at $\mu = 0.03$.
- (b) The translation of the above (B, \hat{Q}) plane into the (B, S) plane at $\mu = 0.03$.
- (17) (a) The shaded region is the required area in the (B, \hat{Q}) plane at $B = \hat{Q}$ at $\mu = 0.04$.
- (b) The translation of the above (B, \hat{Q}) plane into the (B, S) plane at $\mu = 0.04$.
- (18) The ratio of the (M_Z^2/M_W^2) vs. the various values of μ is drawn. Shaded area represents the allowed region favoured by our model.
- (19) The number of Z_2 events vs. its different masses are depicted by fixing $M_{Z_1} = 90.5 \text{ GeV}$ and $M_Z = 92.1 \text{ GeV}$. The lines corresponding to $\mu = 0.0, 0.02$ and 0.04 are shown.
- (20) The number of Z_2 events against its various masses are depicted by fixing $M_{Z_1} = 90.0 \text{ GeV}$ and $M_Z = 92.1 \text{ GeV}$. The lines corresponding to $\mu = 0.0, 0.02, 0.04$ and 0.05 are shown.

- (21) (a) The construction of the two torus points A, B and C are regarded as the same points.
- (b) This is an alternative way of looking at the Figure (21a).
- (c) Two non-contractible loops γ and γ' are multiplied and this gives the multiplicative law defined in the fundamental group in the manifold K.
- (22) Allowed region in the (M_2, M_3) plane for the model (c) Ref. [6]. M_Z^0 is fixed by taking $M_W = 81.8$ GeV, while M_2 is varied according to the Figure (1) of Ref. [6].

Table 1

The Rishon Model

Rishon	Spin(\hbar)	Charge(e)	Hypercolour	Colour
T	$\frac{1}{2}$	$\frac{1}{2}$	3	3
V	$\frac{1}{2}$	0	3	$\bar{3}$

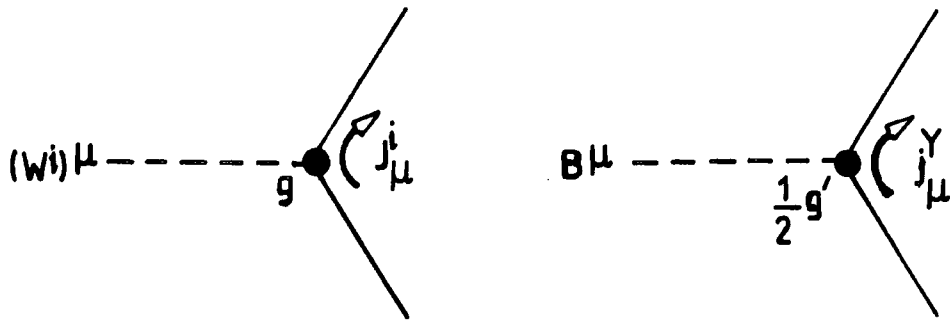

Fig.(1)

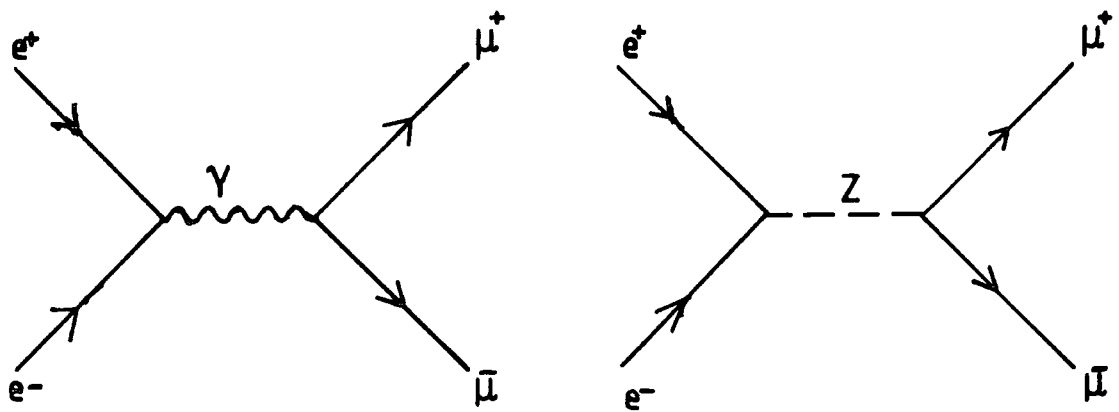

Fig.(2)

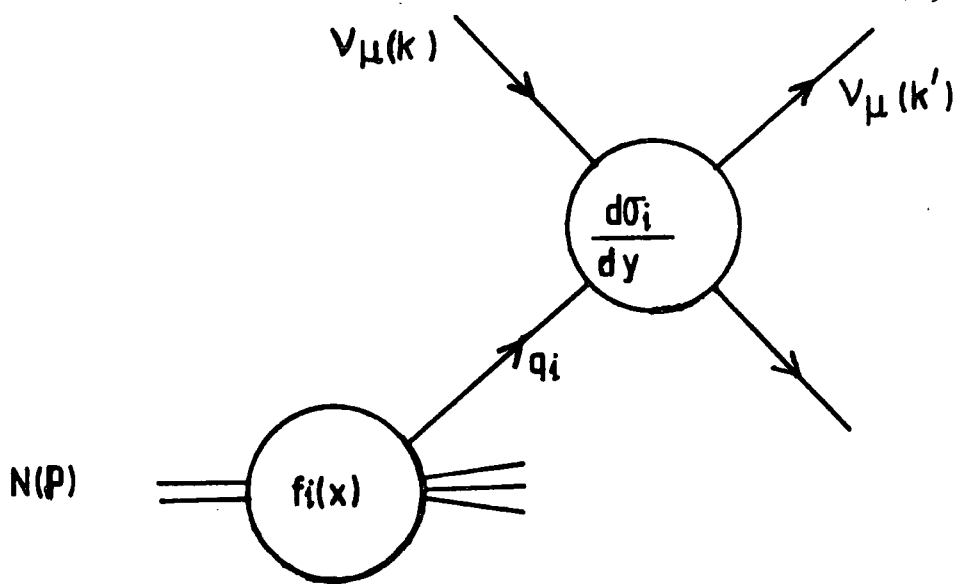

Fig.(3)

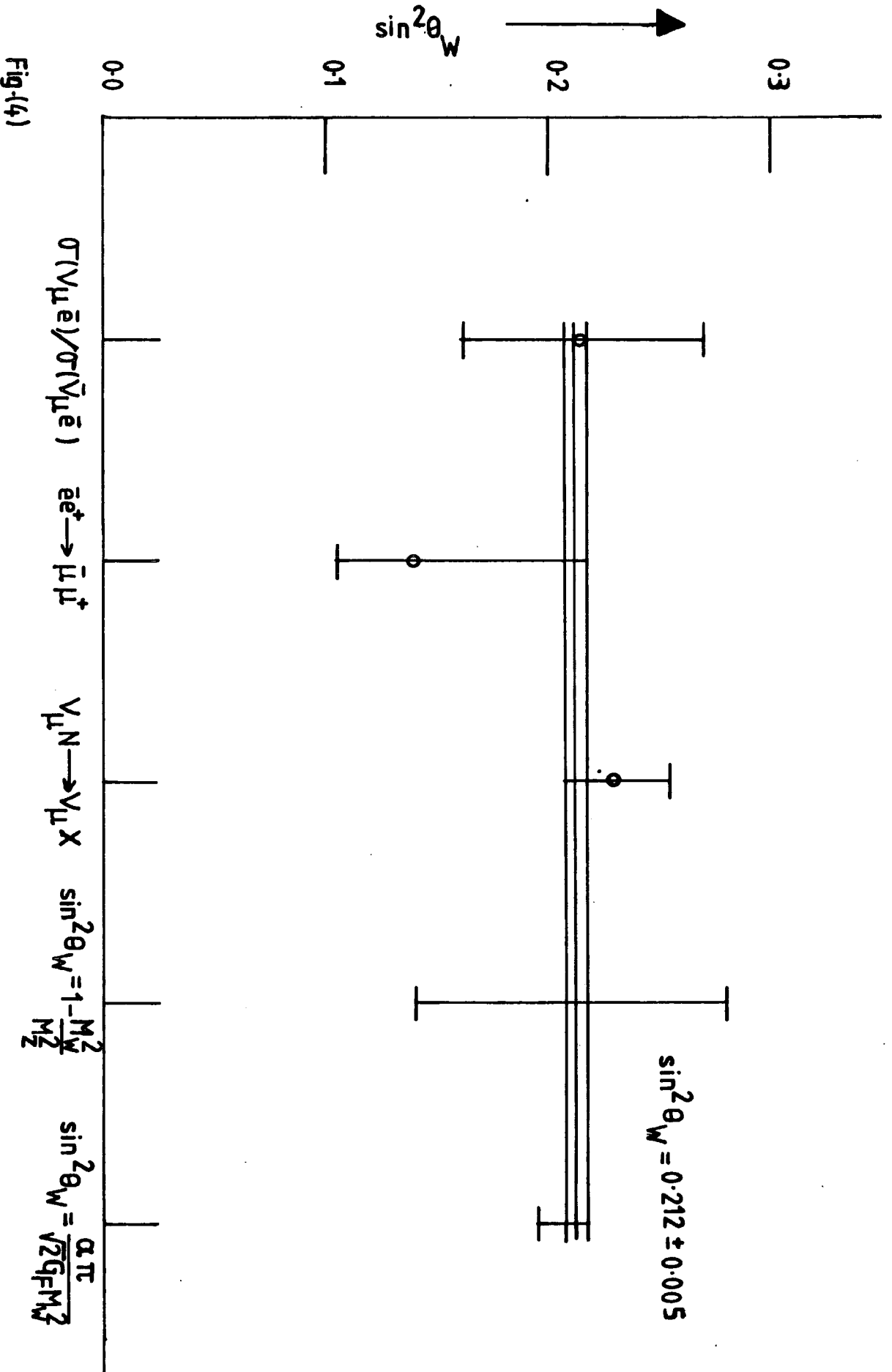

Fig.(4)

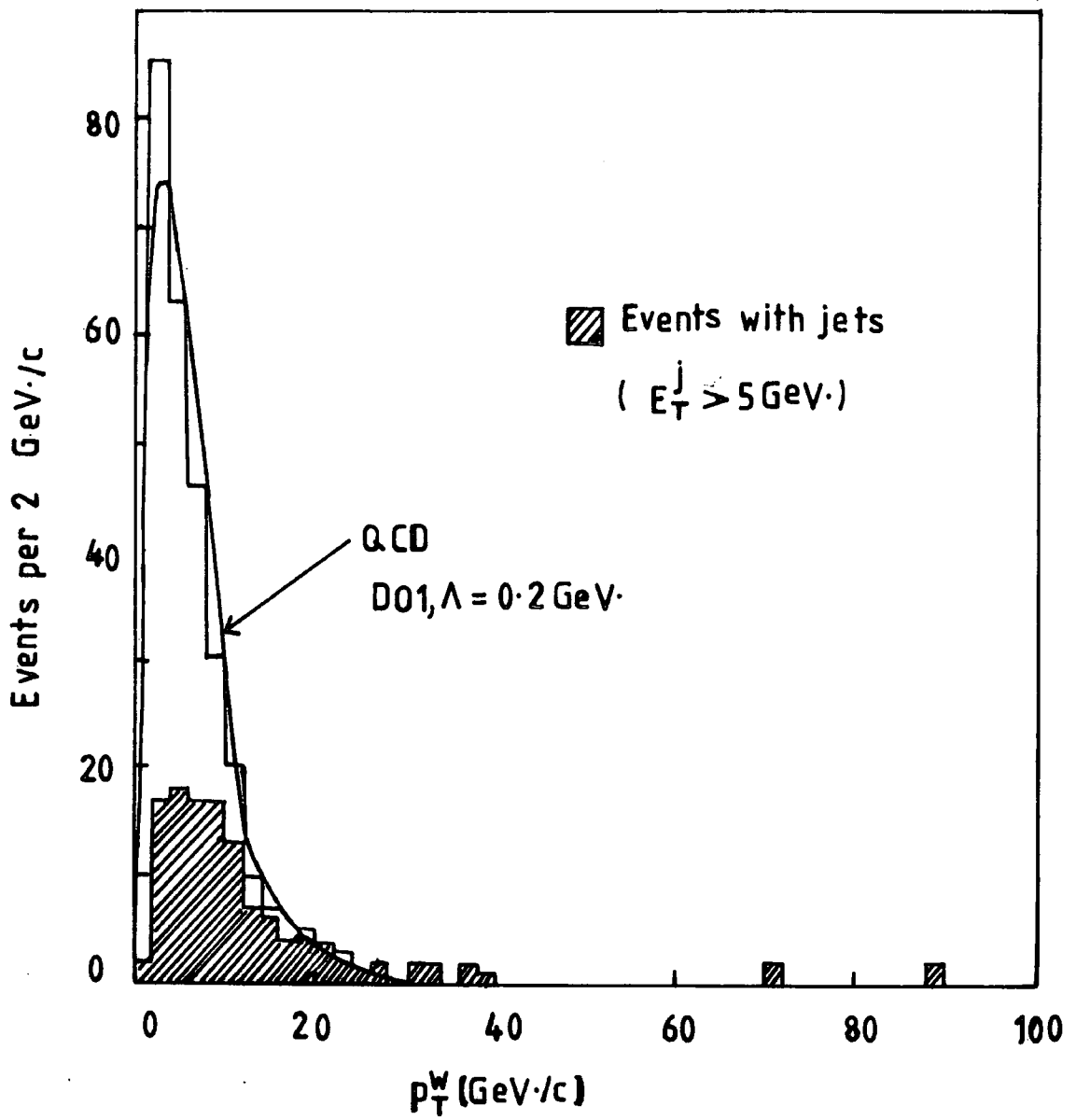

Fig.(5)

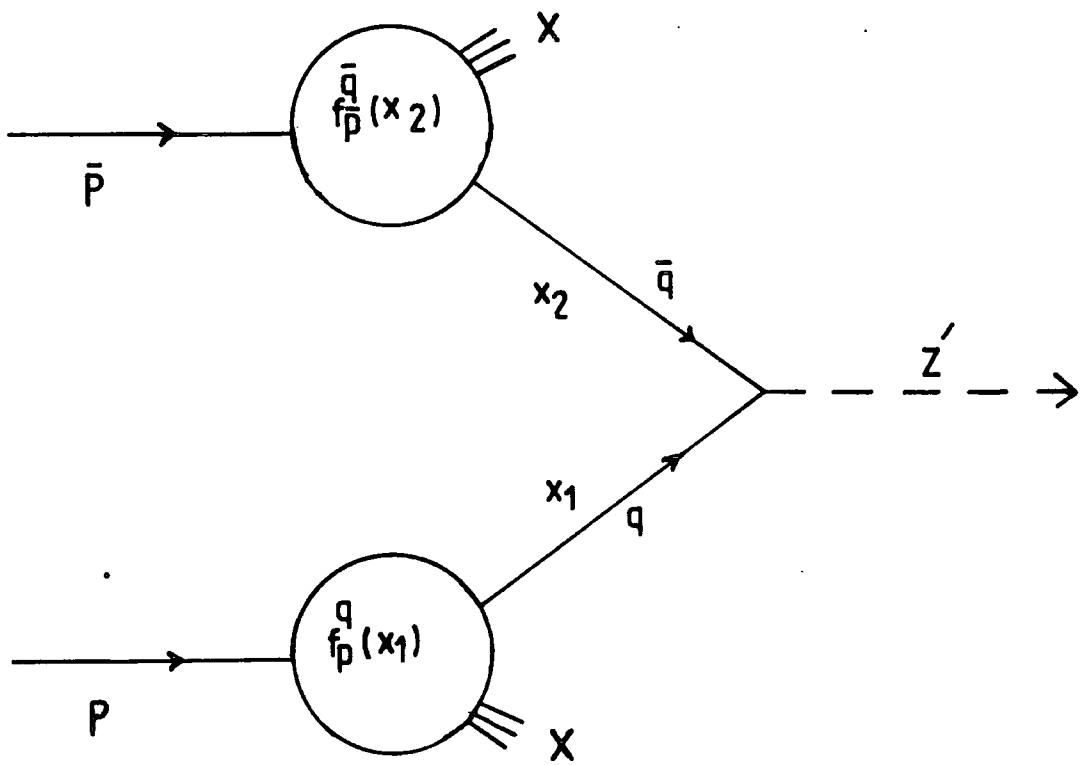

Fig.(6)

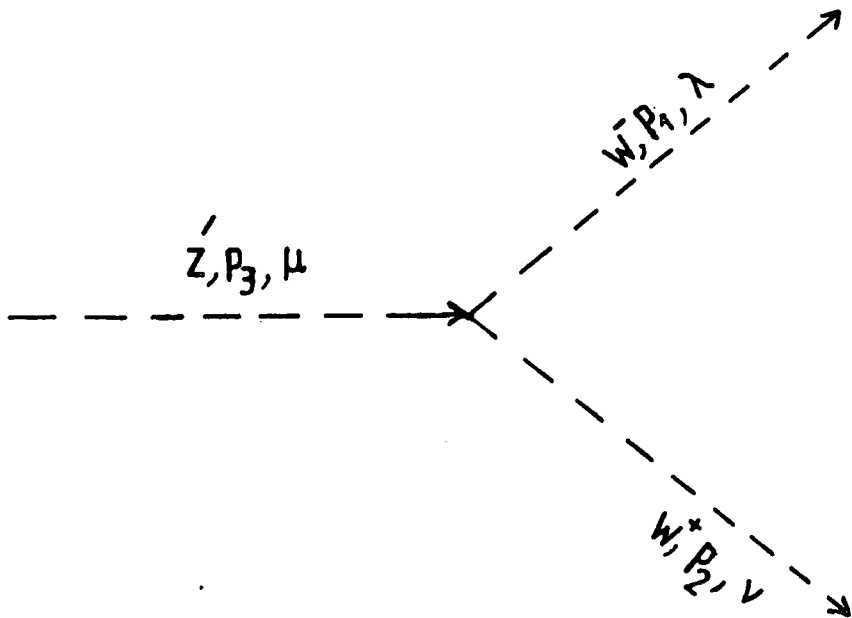

Fig.(7)

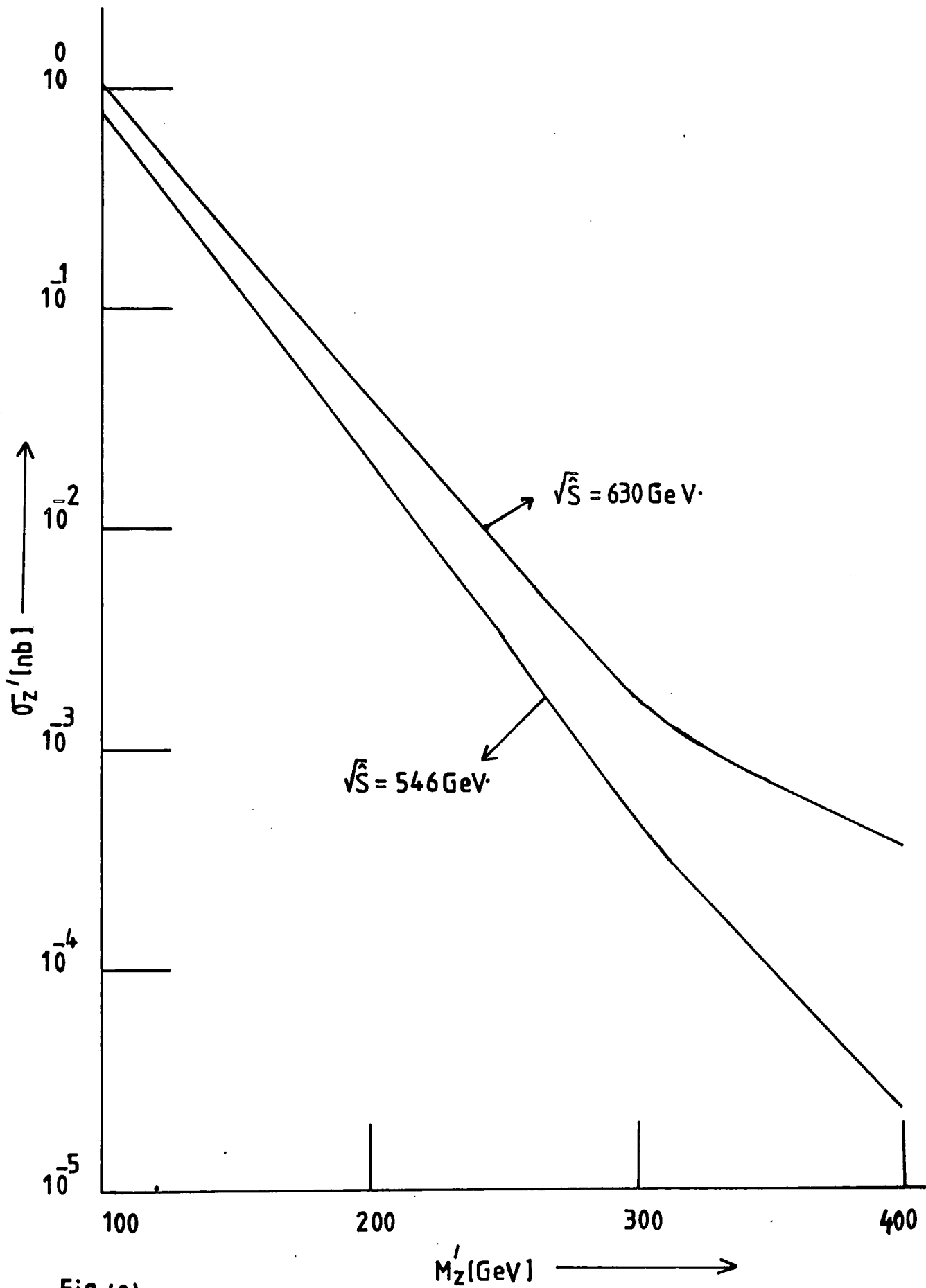

Fig.(8)

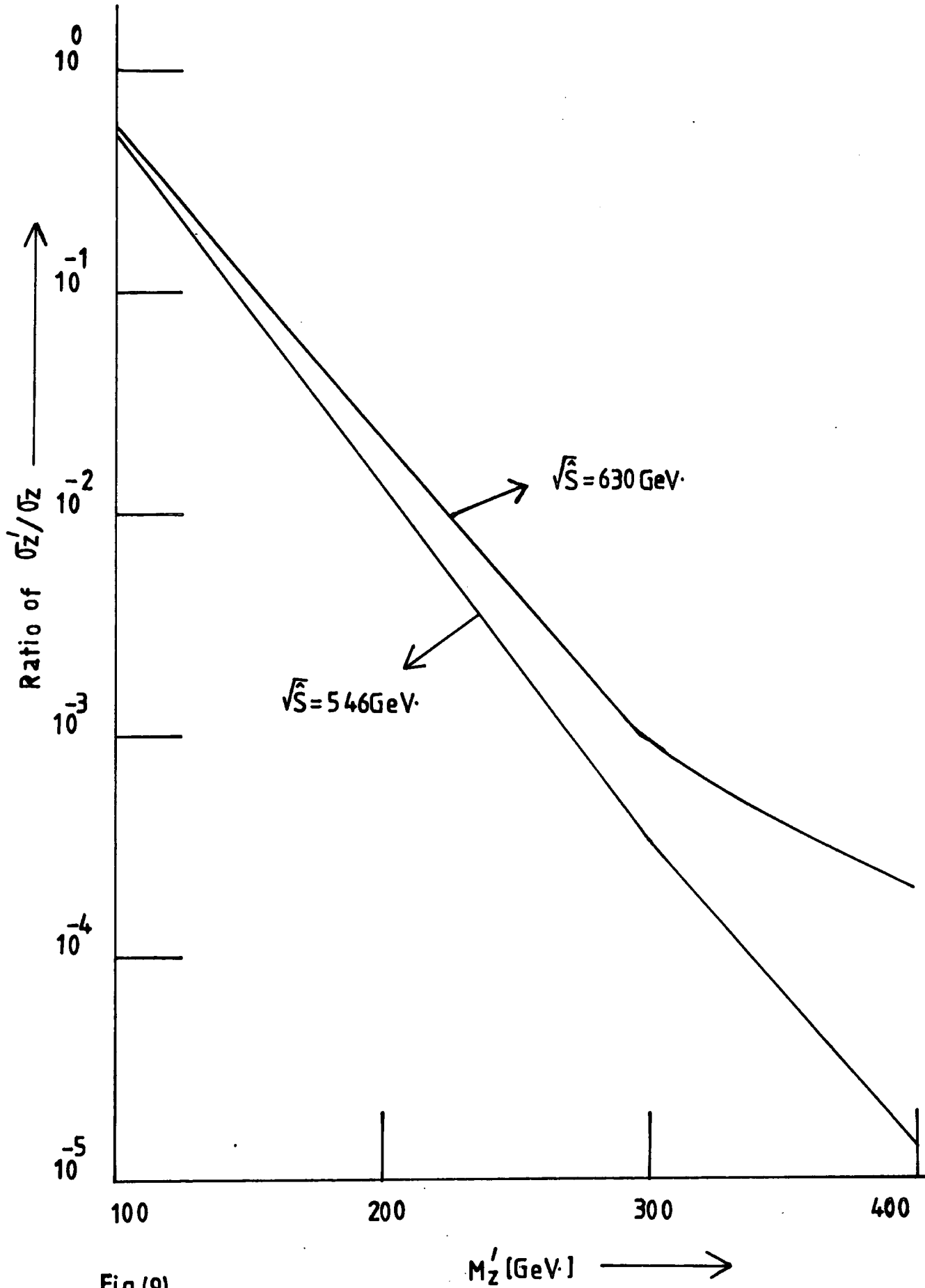

Fig.(9)

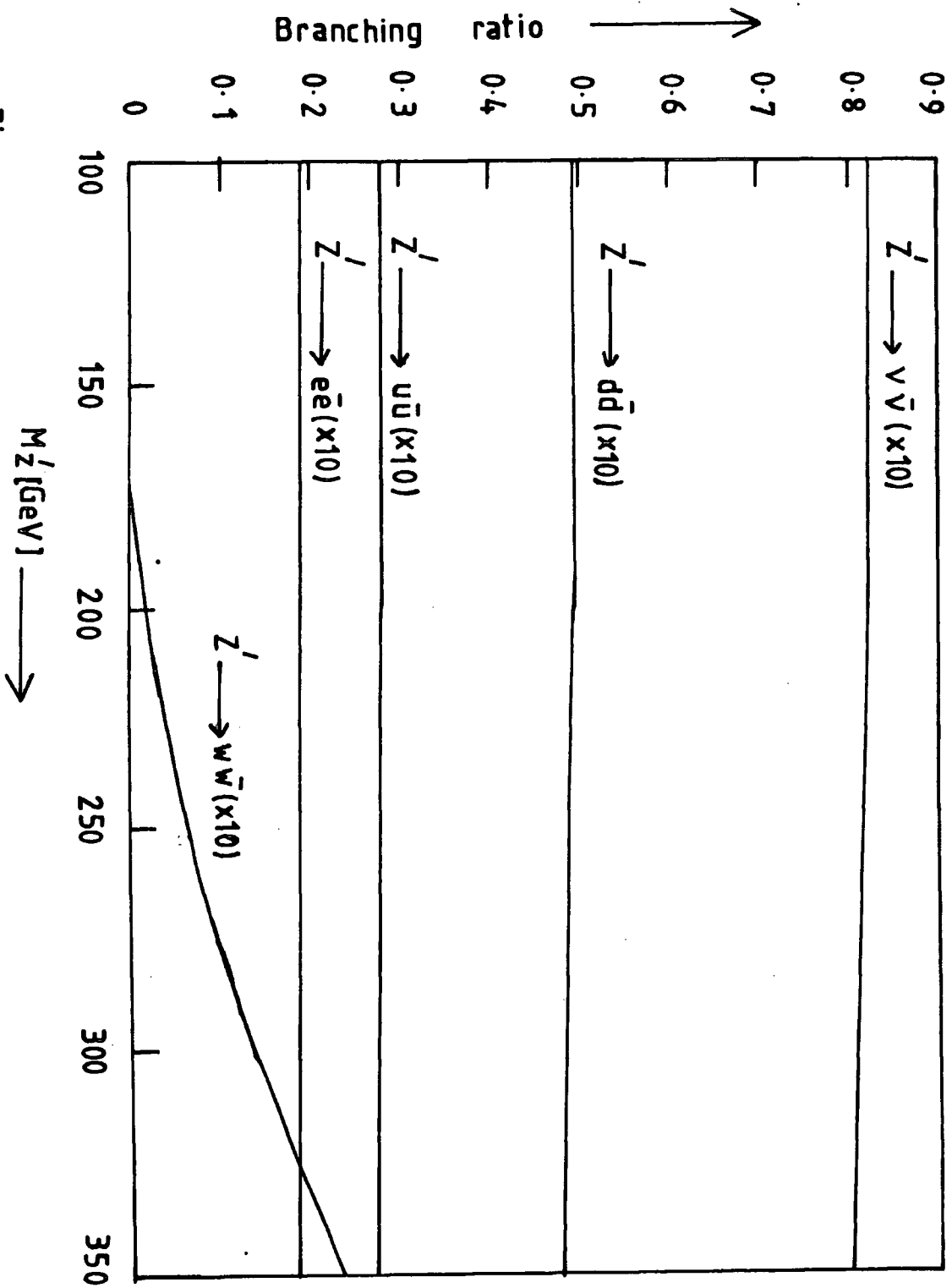

Fig.(10)

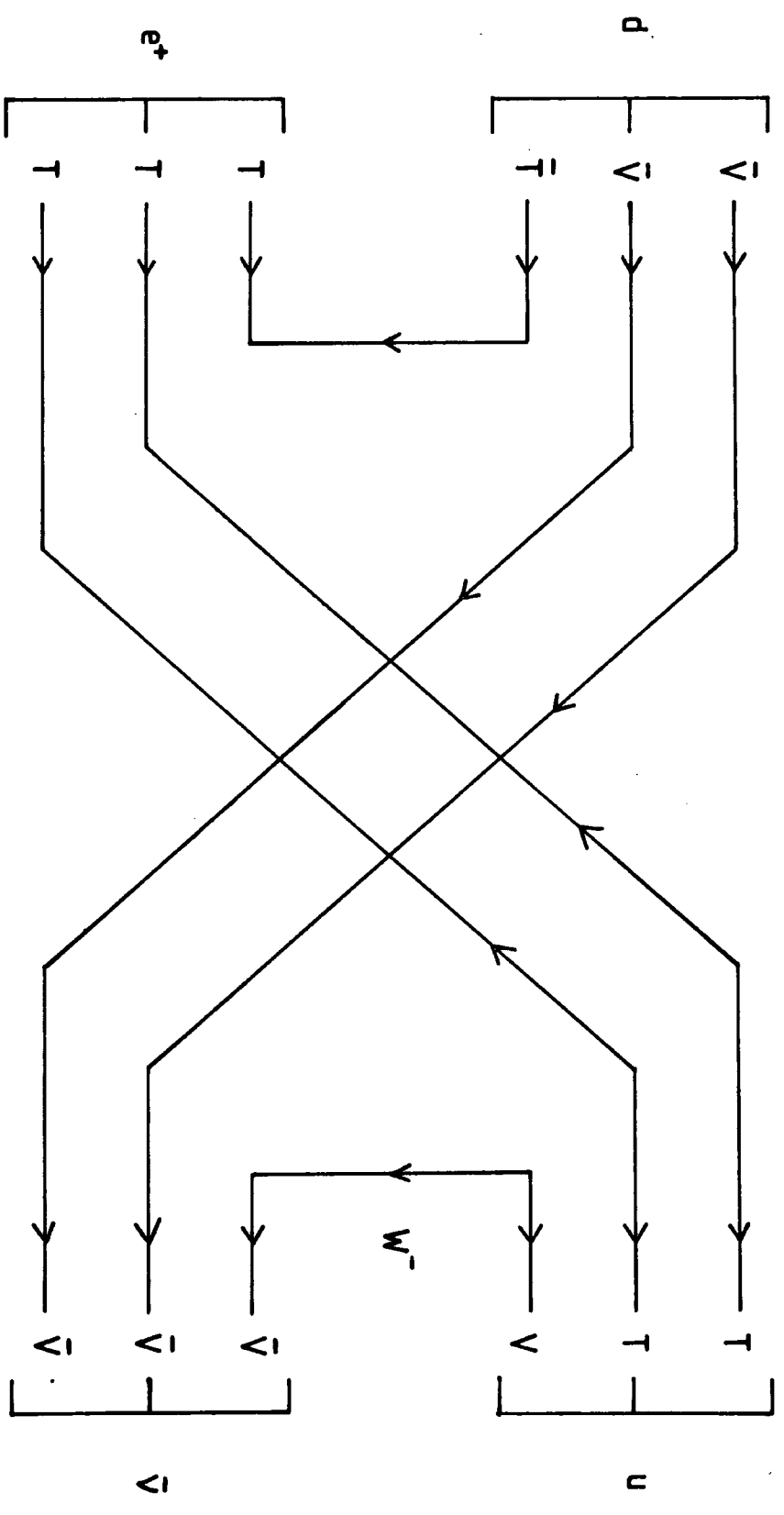
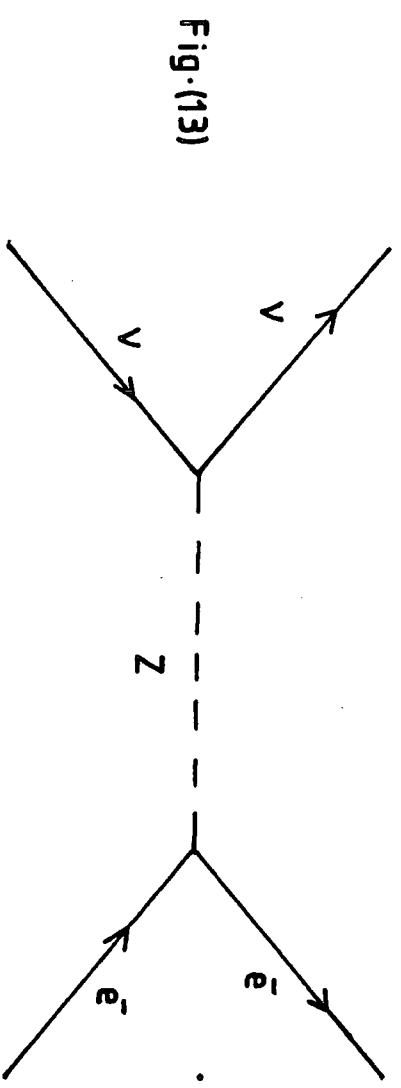
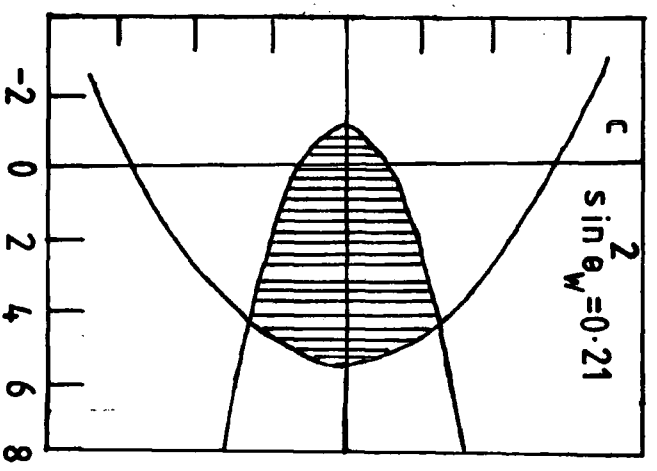
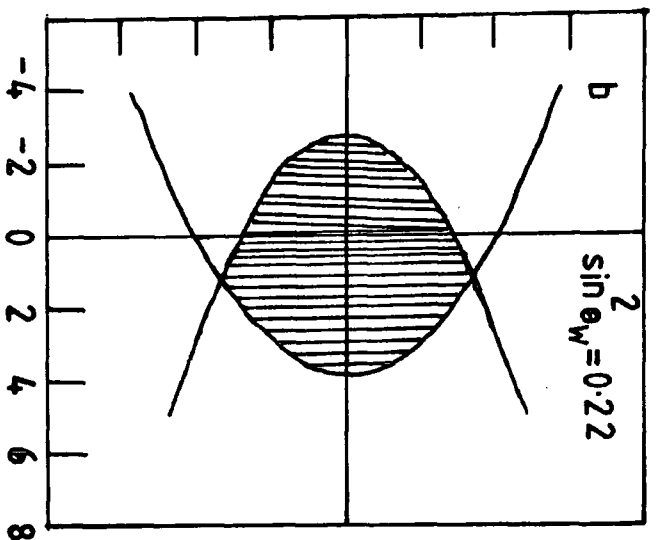
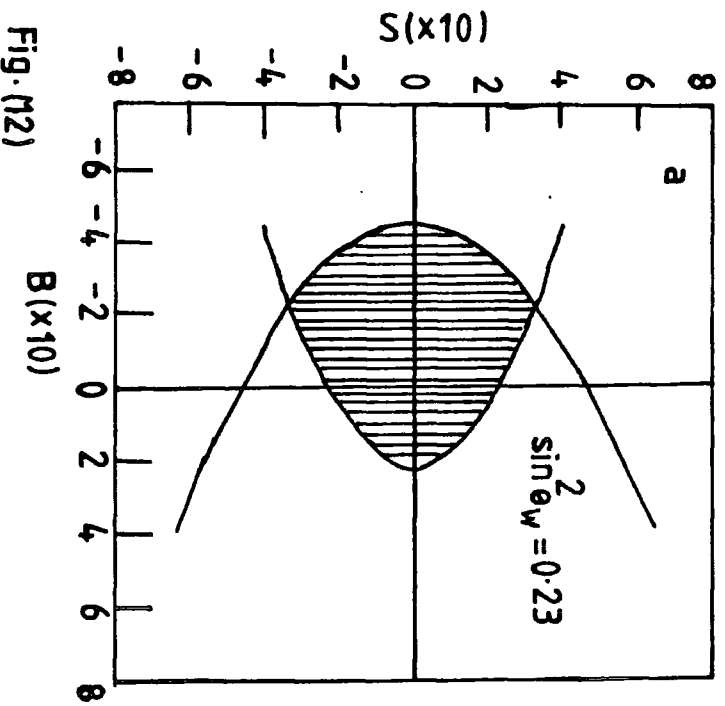

Fig.(11)



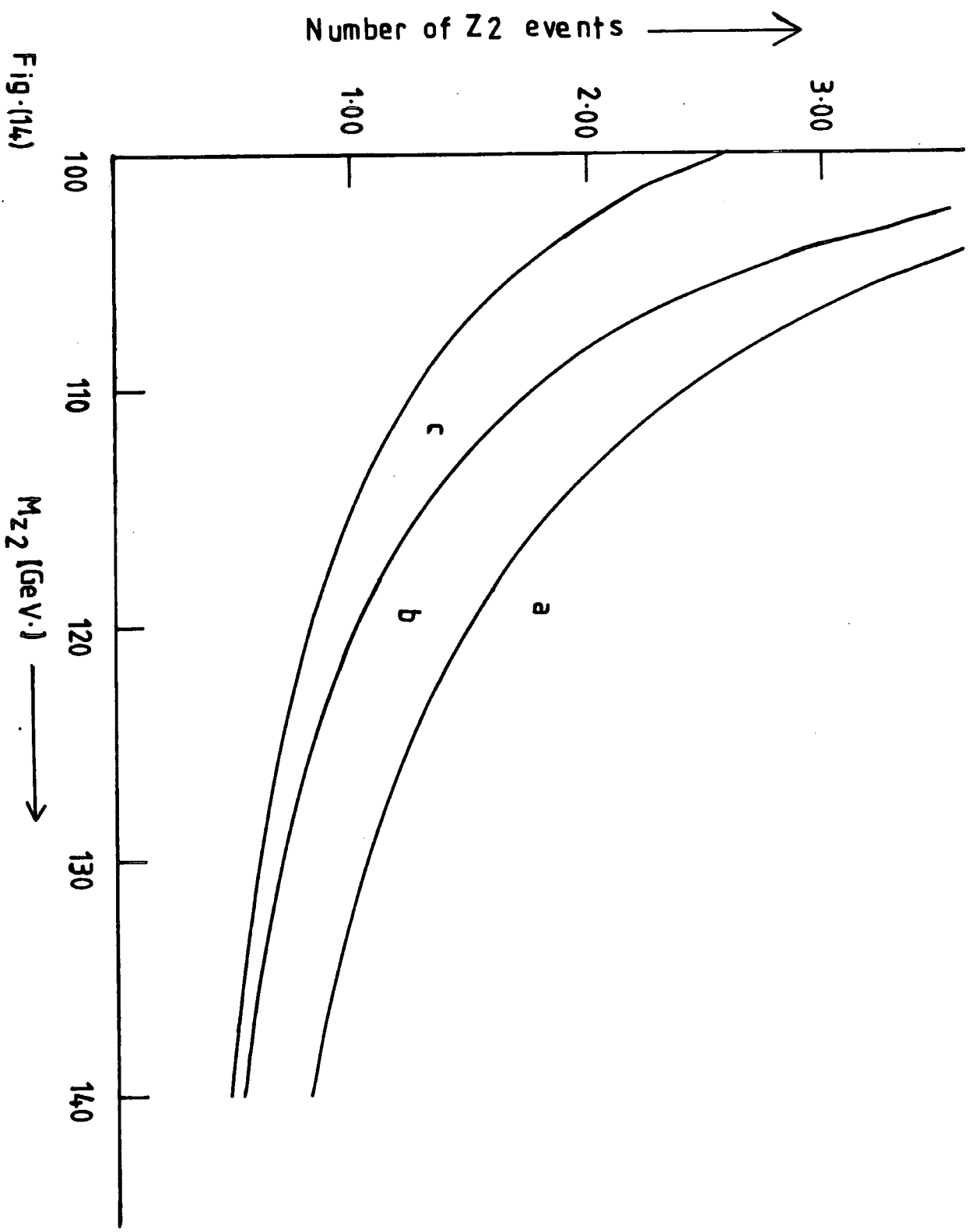

Fig. (14)

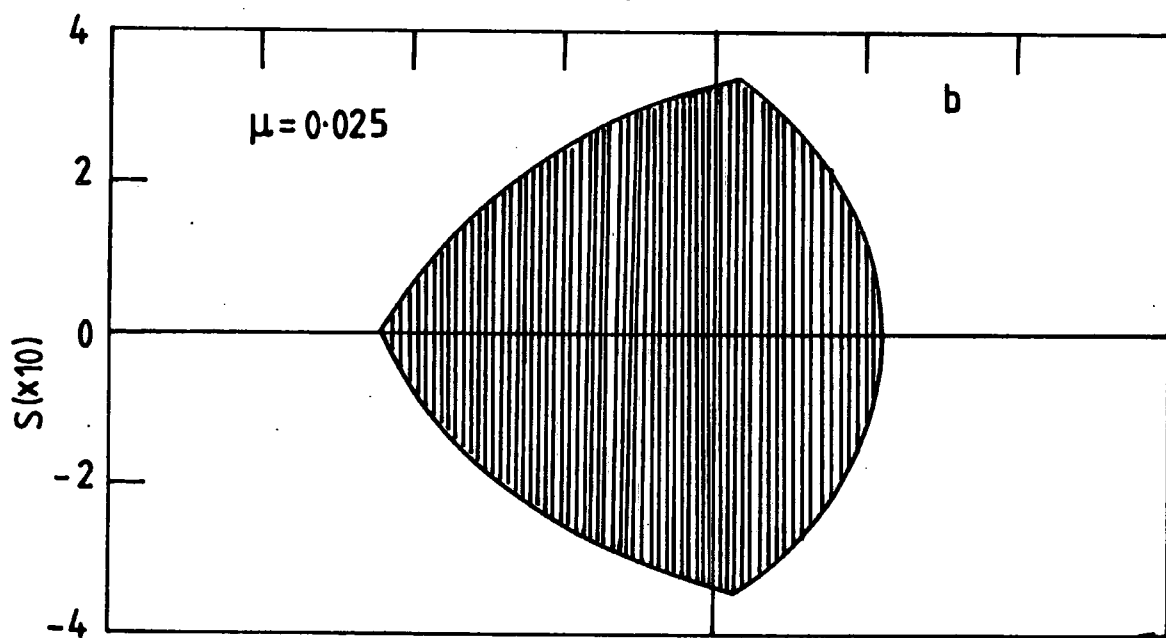
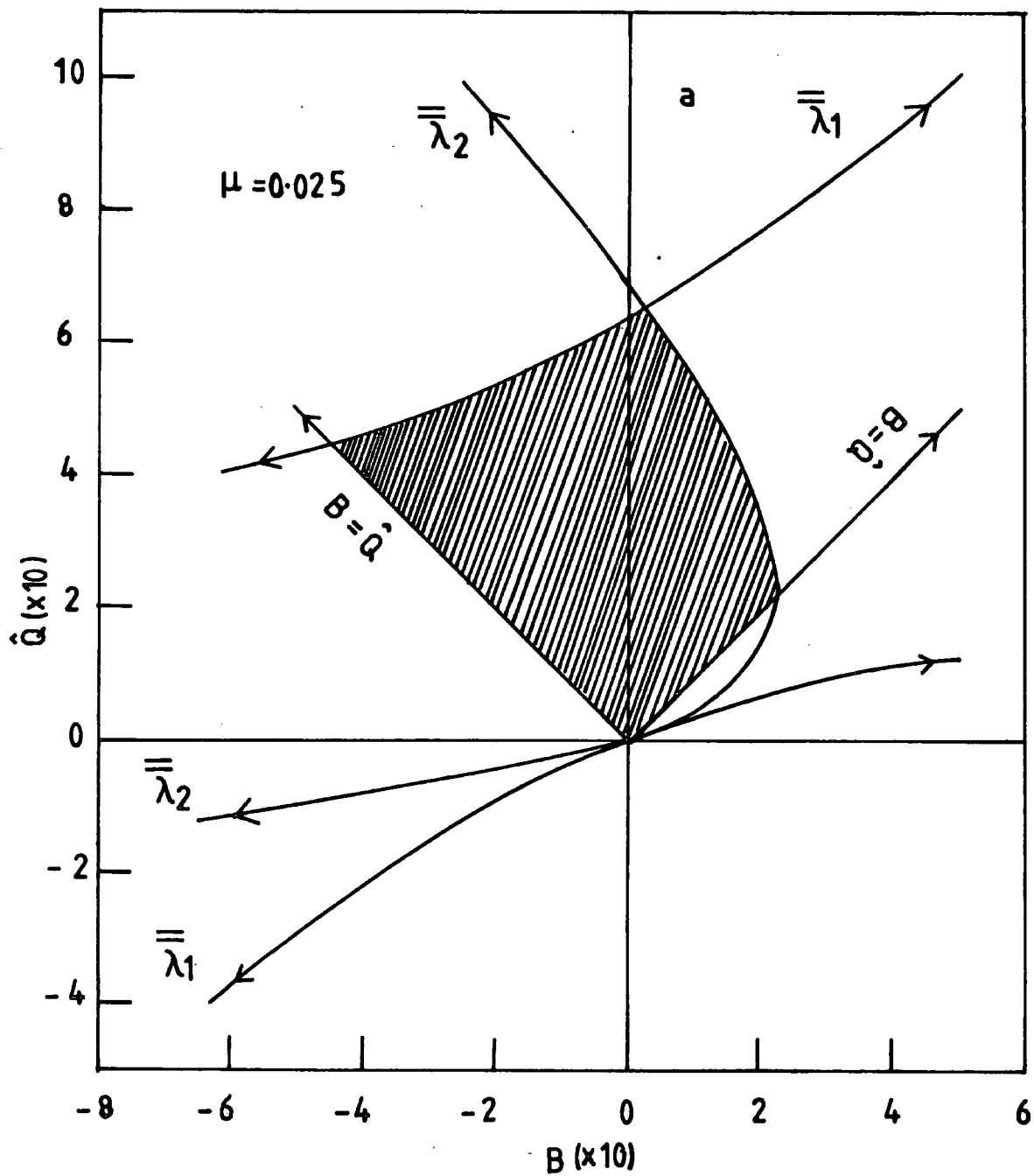

Fig. (15)

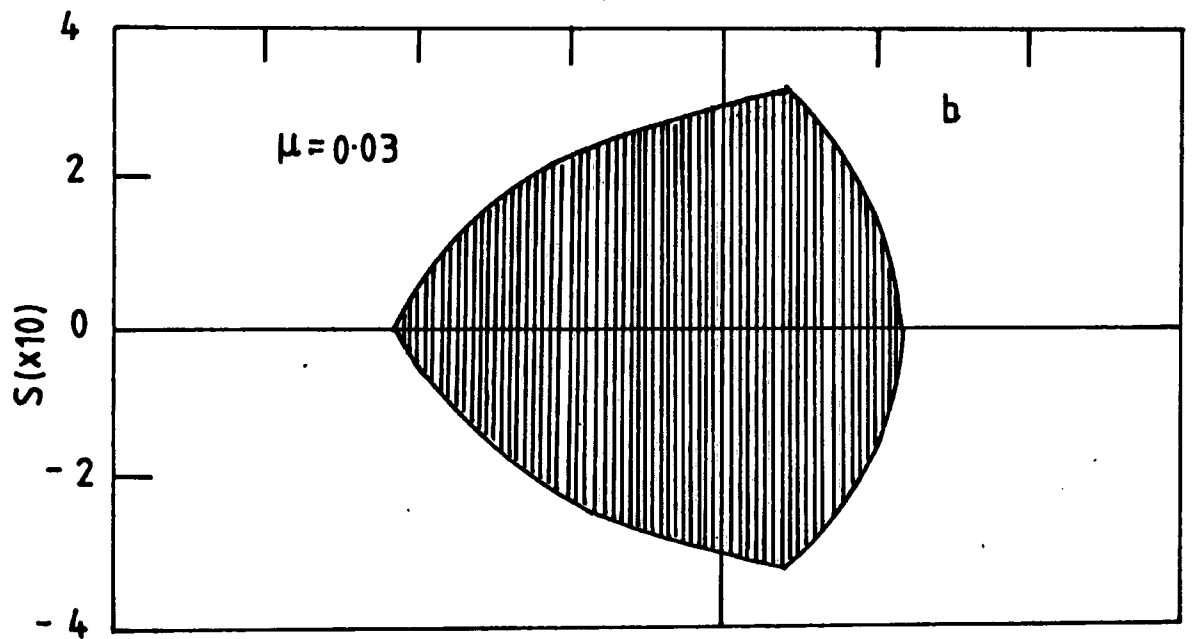
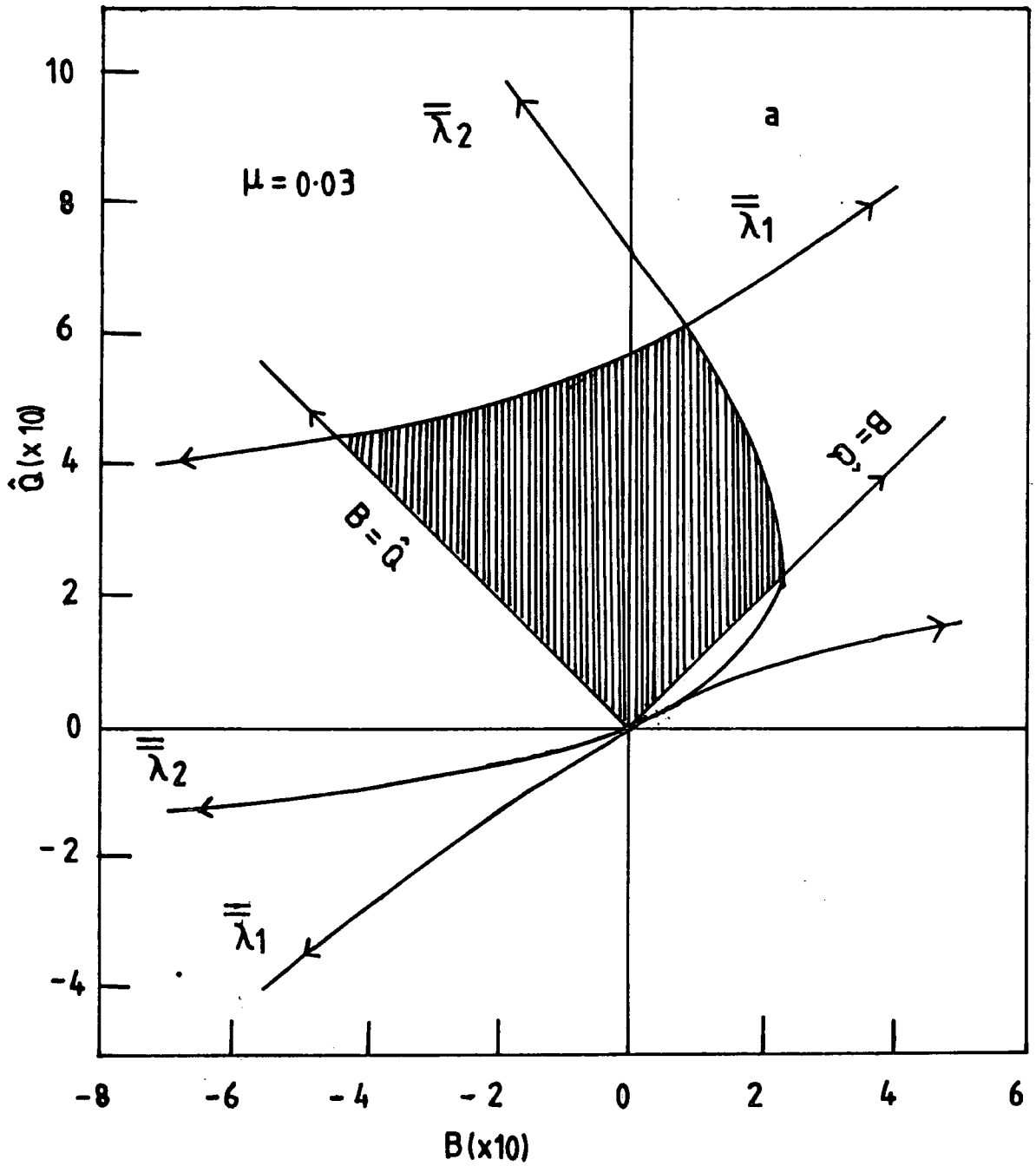

Fig.(16)

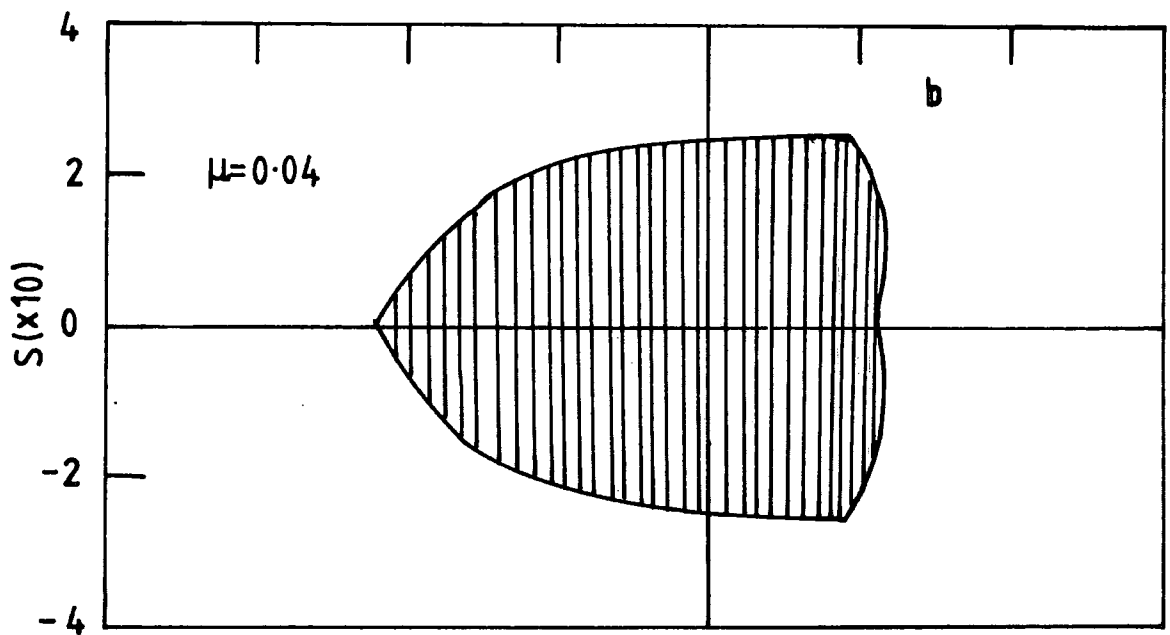
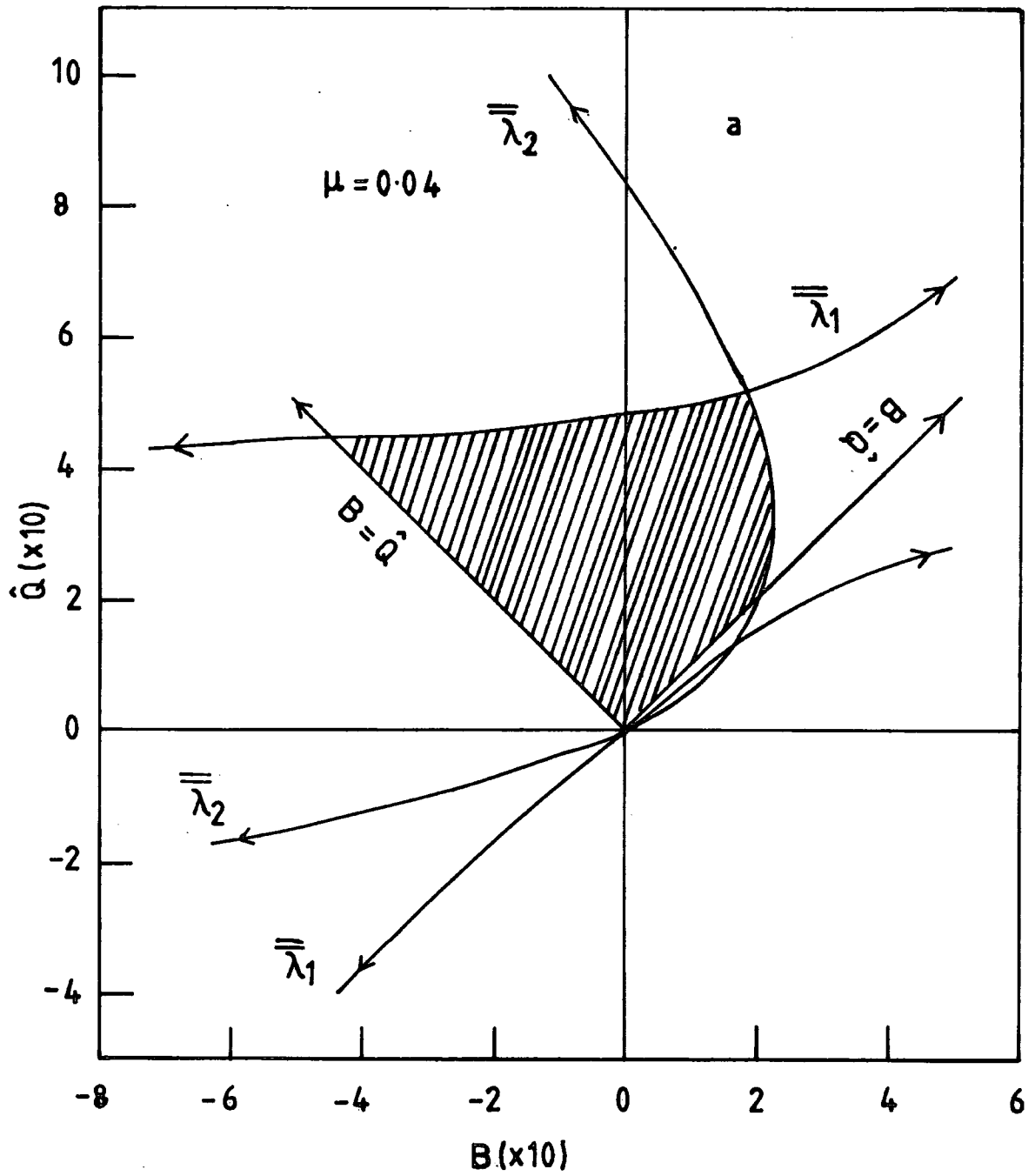

Fig.(17)

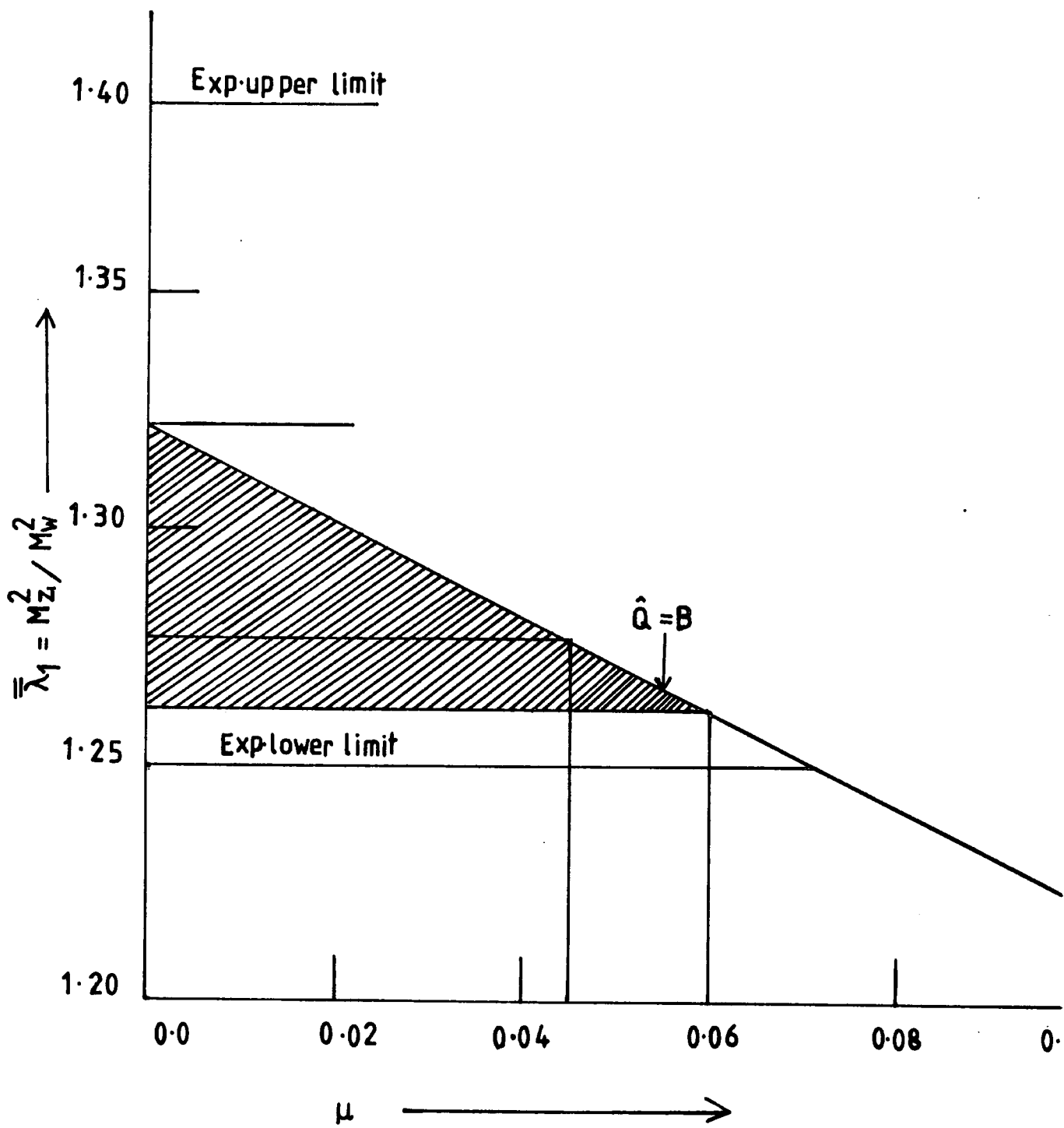

Fig. (10)

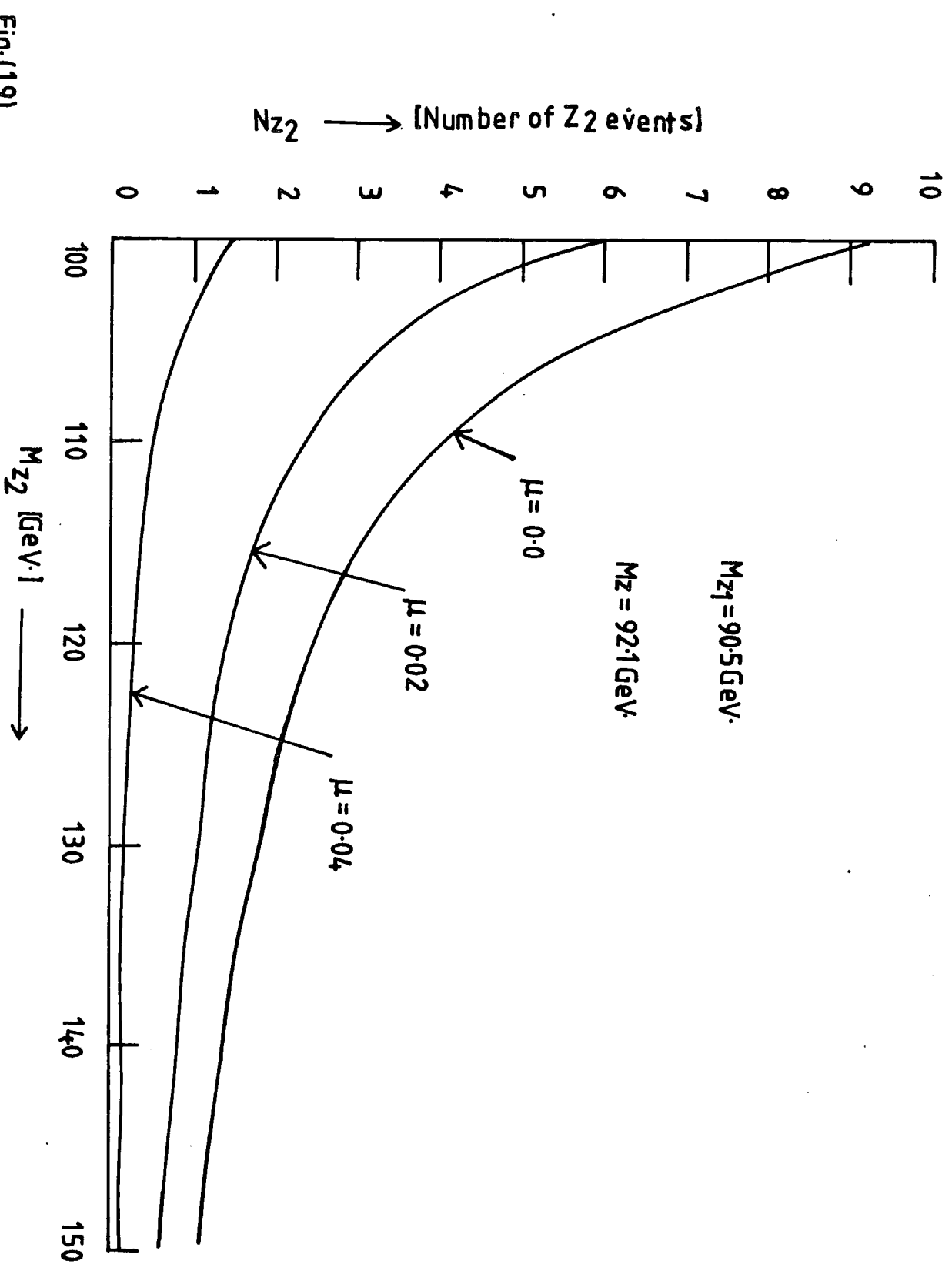

Fig.(19)

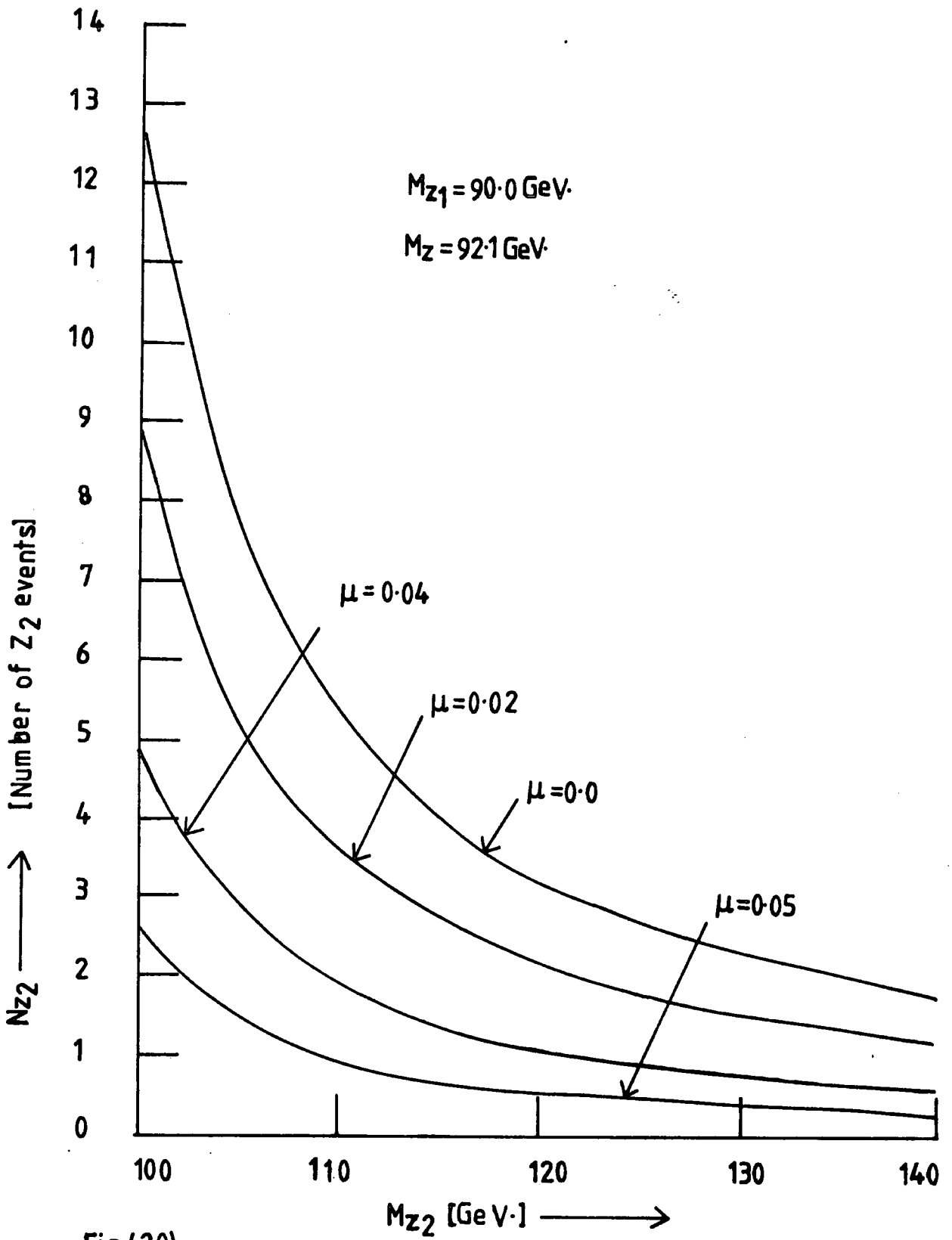

Fig.(20)

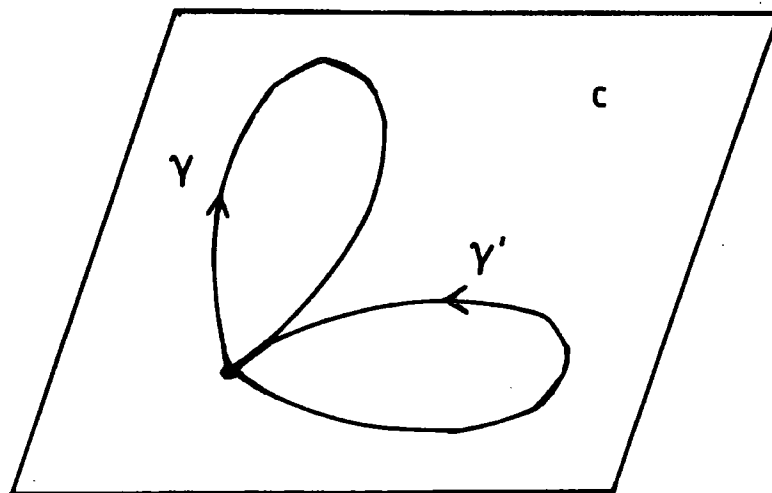
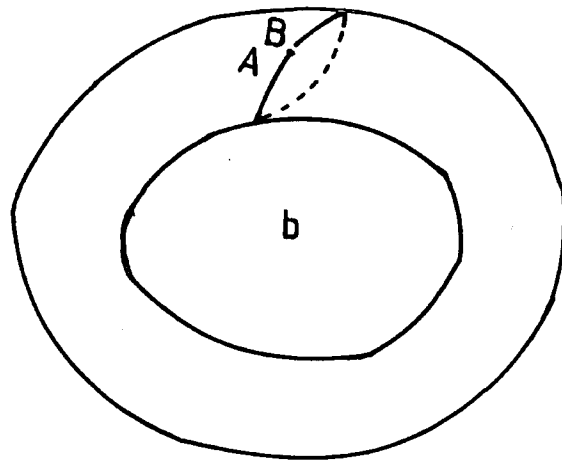
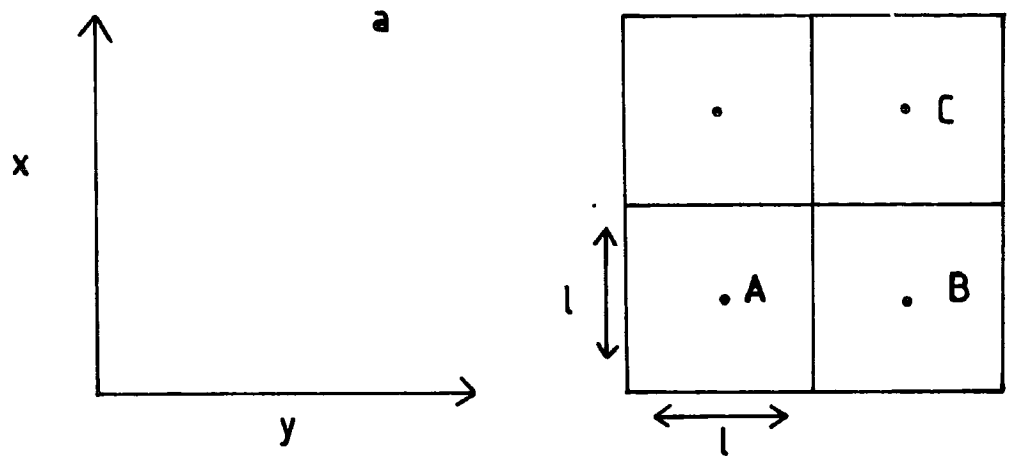

Fig.(21)

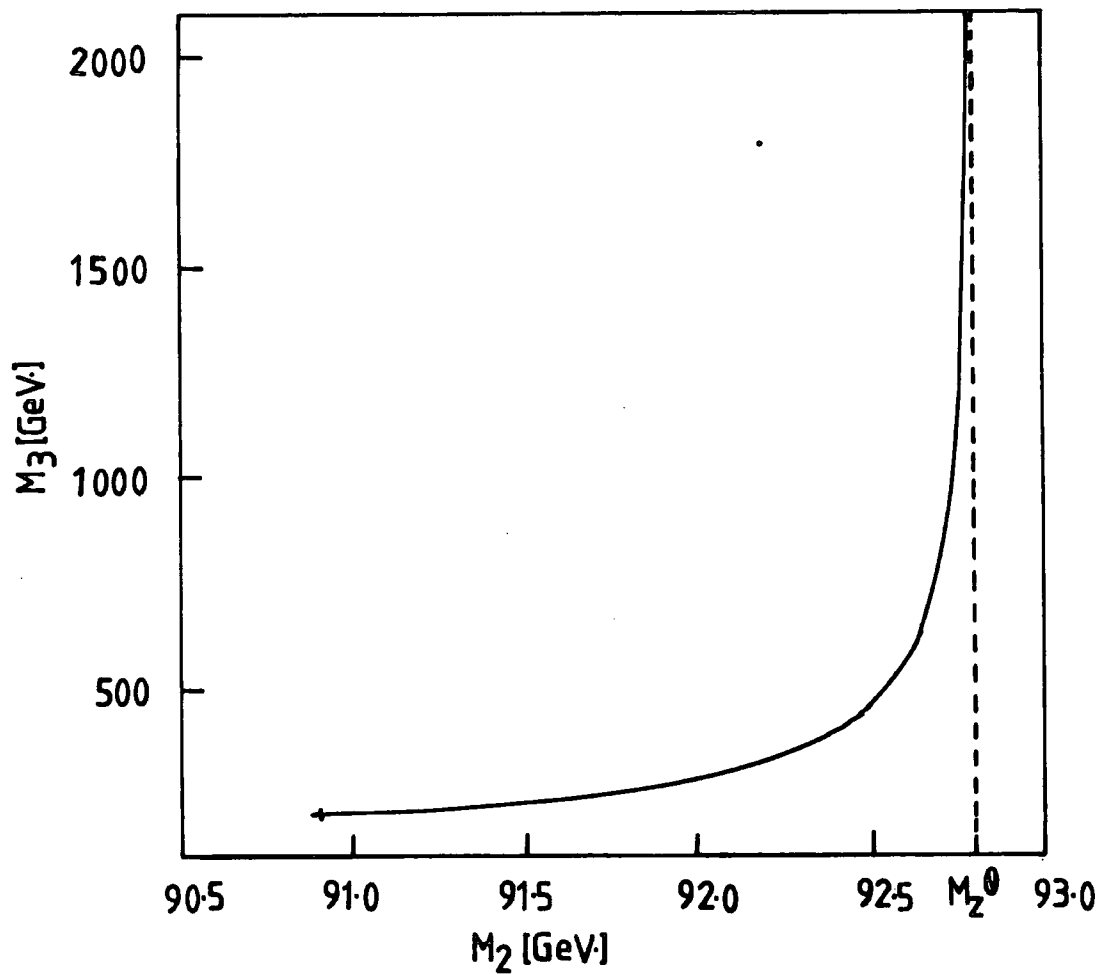

Fig. (22)

