



# Durham E-Theses

---

## *The latency of target elicited saccadic eye movements*

Wenban-Smith, M.G.

### How to cite:

---

Wenban-Smith, M.G. (1990) *The latency of target elicited saccadic eye movements*, Durham theses, Durham University. Available at Durham E-Theses Online: <http://etheses.dur.ac.uk/6260/>

### Use policy

---

The full-text may be used and/or reproduced, and given to third parties in any format or medium, without prior permission or charge, for personal research or study, educational, or not-for-profit purposes provided that:

- a full bibliographic reference is made to the original source
- a [link](#) is made to the metadata record in Durham E-Theses
- the full-text is not changed in any way

The full-text must not be sold in any format or medium without the formal permission of the copyright holders.

Please consult the [full Durham E-Theses policy](#) for further details.

The copyright of this thesis rests with the author.  
No quotation from it should be published without  
his prior written consent and information derived  
from it should be acknowledged. .

**THE LATENCY OF TARGET ELICITED SACCADIC EYE  
MOVEMENTS**

**THESIS SUBMITTED FOR THE DEGREE OF M.SC.  
UNIVERSITY OF DURHAM**

Department of Psychology

**M.G.WENBAN-SMITH**

**JULY 1990**



**21 MAR 1991**

# The Latency of Target Elicited Saccadic Eye Movements.

M.G.Wenban-Smith.

In 1967 M.G.Saslow found that latencies of target elicited saccades were significantly reduced when the target onset was preceded shortly by the offset of a fixation point (Saslow, 1967). This result has subsequently been replicated by various authors, and has provided the basis for a number of investigations into the properties of the mechanisms of saccadic control.

In 1983 B. Fischer and R. Boch reported the discovery of a second effect. Using the same basic experimental methods and using monkeys as subjects, they found a population of saccades with extremely short reaction times in addition to the general reduction in saccade latencies previously reported. They termed this population 'express saccades' (Fischer and Boch, 1983).

Various models have been proposed to explain both the reduction in saccade latencies reported by Saslow, and the occurrence of 'express saccades' reported by Fischer et al. This thesis provides an explicit, quantitative framework against which these models can be compared.

Although the phenomenon of express saccades has been well established for monkeys, the evidence for their occurrence in humans appears less convincing. This thesis tests in a rigorous manner for a population of saccades in humans equivalent to the express saccades found for monkeys.

Chapter One reviews the experimental factors that affect the latencies of target elicited saccades. The validity of the 'when/where' distinction in models of saccadic control is discussed in Chapter Two. In Chapter Three the reduction in saccade latencies found by Saslow, and express saccades, are discussed in greater detail together with models proposed in explanation. The fourth chapter gives the rationale for experiments designed to test these models, and in Chapter Five these experiments are described and their results and implications for models of saccadic latency are discussed. Conclusions to the thesis are given in Chapter Six.

## CONTENTS.

Introduction. . . . .	1
Chapter One: Experimental factors affecting saccade latency.	
Stimulus luminance and contrast . . . . .	3
Stimulus wavelength . . . . .	4
Spatial frequency of stimulus . . . . .	5
Temporal frequency of stimulus. . . . .	6
Target eccentricity . . . . .	6
Size of target set . . . . .	7
Target features . . . . .	8
The influence of the fixation point . . . . .	10
The gap/overlap paradigm . . . . .	11
Chapter Two: The distinction between ‘when’ and ‘where’ in saccade programming. . . . .	15
Chapter Three: Theories of latency reduction in the gap/overlap paradigm.	
Anticipatory saccades . . . . .	24
Visual effect of fixation point . . . . .	25
Explanations discussed by Saslow (1967) . . . . .	27
The warning effect of fixation point offset . . . . .	27
The preparation model . . . . .	29
The facilitation model . . . . .	34
Express saccades . . . . .	37
Chapter Four: Rationale for the experiments. . . . .	43

## Chapter Five: The experiments:

### Experiment One: Randomised gaps and overlaps.

Method . . . . .	45
Results . . . . .	52
Discussion . . . . .	64

### Experiment Two: The Effects of Practice.

Method . . . . .	66
Results . . . . .	67

### Experiment Three: Blocked gaps and overlaps.

Method . . . . .	69
Results . . . . .	73
Discussion . . . . .	74
The preparation model . . . . .	79
The facilitation model . . . . .	82

Chapter Six: Conclusions. . . . .	86
-----------------------------------	----

## Appendix.

1. Stimulus presentation . . . . .	88
2. Data Acquisition . . . . .	90
3. Calibration of timing . . . . .	91
4. Calibration of eye movement amplitudes . . . . .	92
5. Saccade detection . . . . .	93
6. Discarding 'bad' data . . . . .	94

References. . . . .	95
---------------------	----

## LIST OF FIGURES AND TABLES.

### Chapter One.

Figure 1.	Saccade latencies in the gap/overlap paradigm	. . . . .	11
2.	Bimodal latency distribution of saccades	. . . . .	13
3.	Occurrence of express saccades	. . . . .	14

### Chapter Two.

Figure 4.	The 'Amplitude Transition Function'	. . . . .	18
-----------	-------------------------------------	-----------	----

### Chapter Three.

Figure 5.	Target and fixation point timing in gap/overlap paradigm	. . . . .	30
6.	The 'preparation' model	. . . . .	32

### Chapter Five: Experiment one.

Table 1.	Stimulus parameters used for the experiments	. . . . .	44
Figure 7.	The stimulus arrangement	. . . . .	46
8.	The experimental set up	. . . . .	48
9.	Anticipatory saccades	. . . . .	50
10.	Correct and incorrect saccade latencies	. . . . .	51
11.	Saccade latency distributions	. . . . .	53
12.	Mean saccade latencies in different gap conditions	. . . . .	54
13.	Latency distributions for different gap conditions	. . . . .	56, 57
14.	Relationship between mean latency and standard deviation	. . . . .	60
Table 2.	Correlations of standard deviations with other measurements	. . . . .	61

15.	Latency distribution of 'fast' saccades . . . . .	63
-----	---	----

Chapter Five: Experiment Two.

Figure 16.	Change in mean saccade latency with practice. . . . .	68
------------	---	----

Chapter Five: Experiment Three.

Figure 17.	Correct and incorrect saccade latencies . . . . .	70
------------	---	----

18.	Mean saccade latencies for different gap conditions . . . . .	71
-----	---	----

19.	Comparison between blocked and randomised gap conditions . . . . .	72
-----	---	----

Table 3.	Correlations of standard deviations with other measurements . . . . .	74
----------	--	----

Figure 20.	Simplified representation of latency reduction in gap/overlap paradigm . . . . .	75
------------	---	----

21.	Fitted slopes to blocked data . . . . .	76,77
-----	---	-------

Table 4.	Values of fitted slope for each subject . . . . .	78
----------	---	----

Figure 22.	Average latency reduction in gap/overlap paradigm. . . . .	78
------------	--	----

23.	Predictions of preparation model . . . . .	81
-----	--	----

Appendix.

Figure 24.	Time course of phosphor fading. . . . .	88
------------	---	----

25.	Definitions of stimulus offset and target onset . . . . .	90
-----	---	----

26.	Calibration of timing . . . . .	91
-----	---------------------------------	----

27.	Calibration of amplitude . . . . .	92
-----	------------------------------------	----

28.	Blink artifact . . . . .	96
-----	--------------------------	----

## DECLARATION.

I declare that the work in this thesis is my own and has not been submitted for any other degree.

## STATEMENT OF COPYRIGHT.

The copyright of this thesis rests with the author. No quotation from it should be published without his prior written consent and information derived from it should be acknowledged.



## ACKNOWLEDGEMENTS.

I would like to thank my supervisor Dr. John Findlay, without whose continued support, encouragement and patience I would have been unable to complete this thesis.

I am grateful to all the technicians who have been involved with the preparation and maintenance of the equipment used for this research, specifically Neil Corr, Arthur Perry, Ray Cookson, and Chris Mullaney, and to Malcolm Rolling for preparation of the photographic illustrations.

I am eternally grateful for the time and patience of those who acted as subjects for this research; Dr. John Findlay, Dibs Hellowell, Ala Hola, Bob Kentridge, Fiona Parry and Garry Wilson.

Finally I would like to thank Bob Kentridge for good advice and timely encouragement.

## INTRODUCTION.

Detailed analysis of the vast amount of information available from light in the environment is a mammoth task. Given that there are constraints on brain size and so on the number of neurons available to make the analysis, and constraints on the time in which the analysis has to be made, there is likely to be a trade off between the extent of the visual environment that receives processing, and the complexity of the processing that takes place. One way of making efficient use of the available resources is to make detailed analysis of only a small area, and direct this high capability analysis towards areas of the environment that are most relevant to the organism at a particular point in time. This approach can be seen in the design of the primate eye. High acuity visual analysis is only made of the small area of the environment focussed onto the fovea where cell density is greatest, but analysis in the periphery as well as information from other sources allows the fovea to be directed very rapidly to new areas of interest. Primate visual perception thus involves successive fixations, interspersed by rapid eye movements from one fixation to the next. Each fixation lasts approximately 250-400 msec, and the eye movement in between takes about 20-60 msec depending on the size of the movement. These brief, fast eye movements are known as saccades.

Saccades are made in a variety of circumstances. When a person scans a scene it may feel as though the eyes move smoothly between points of interest, but the movement in fact consists of successive fixations and saccades. Similarly, when a person reads text the eyes do not scan the sentences smoothly, but make saccades from one fixation to another. A

somewhat different situation is when a person tries to keep the eyes stationary with respect to the head, in the presence of a visual stimulus moving across the retina. In this situation the pattern of eye movements is generally made up of two components - a smooth component by which the eyes track the movement of the stimulus across the retina, and a fast, saccadic component by which the eye maintains its position with respect to the head over time.

Another situation in which saccadic eye movements can be elicited is when a novel stimulus such as a sudden movement or noise occurs. As part of a general orienting response a saccade is made that brings the eyes to foveate in the direction of the stimulation. In the laboratory orienting saccades of this sort can be elicited by the presentation of a visual stimulus, with the instruction to the subject to fixate the stimulus as soon as possible when it appears. Saccades of this kind have become known as 'target elicited saccades'. The delay between the presentation of the target and the occurrence of the saccade is referred to as 'saccadic latency'.

The aim of this thesis is to investigate the factors that determine saccadic latency, and to relate these factors to more general models of the control of saccade elicitation.

## CHAPTER ONE: Experimental factors affecting saccade latency.

Investigations of the psychophysics of saccadic control have often distinguished between those aspects of control involved in determining the amplitude and direction of a planned saccade, often referred to as 'where' processes, and those aspects involved in the control of saccade timing, referred to as 'when' processes. The distinction is used as a framework in this section, and the justification for such a distinction is discussed in detail in the Chapter Two (pp. 15-24).

A wide variety of variables affect saccade latency. These factors can be divided into visual aspects of the target stimulus and background, and factors that provide information that may allow a subject to predict the timing and/or position at which a target is likely to appear. In general it has been found that factors concerning the appearance of the target have relatively little effect on saccadic latency, whereas factors that make the timing of target appearance predictable have a much greater effect. Without knowledge of the details of the saccadic control processes it makes sense initially to describe these effects atheoretically.

### Stimulus luminance and contrast.

The effects of stimulus luminance and contrast have been considered in a number of studies. The common finding is that with target stimuli close to threshold luminance, saccadic latency increases in a manner quantitatively similar to the effects predicted by the sensitivity of the rods and cones at those levels (eg Doma & Hallett, 1988). The contrast threshold

for the occurrence of saccades is also as predicted by the temporal summation profile of the retina at the particular level of background luminance and stimulus contrast (van Asten et al., 1988). For manual reaction times performance is affected by the relative rod/cone density at the retinal position stimulated when low luminance stimuli are used, and manual reaction time is at a minimum where rod density is greatest (Rains, 1963). For photopic stimuli reaction time is fastest at the fovea. Thus saccadic as well as manual latencies are affected by the luminance and contrast of the target when these are near the threshold. However for stimuli well above foveal threshold these factors have little effect and are no longer significant in determining probability of saccade elicitation or saccade latency to stimuli at a particular retinal location (Findlay, 1983).

#### Stimulus wavelength.

Saccade elicitation and saccade latency at low levels of luminance are affected by stimulus chromaticity in a manner suggesting independent performance of the rods and cones (Doma and Hallett, 1988). Van Asten et al. show that the contrast threshold for isoluminant targets decreases with increasing stimulus duration in the same way for saccadic elicitation as for psychophysical detection. In general they found isoluminant targets of the same contrast relative to saccadic threshold as isochromatic targets elicited saccades 25 msec later. This 25 msec delay was also evident in the 'averaging onset time' for double step presentations of isoluminant targets (see p. 18 for discussion of double step paradigm), though there was no difference in the duration of averaging. The results suggest that isoluminant targets are associated with a 25 msec afferent delay prior to entering the process determining target position, though

it is pointed out that the comparison of isoluminant and isochromatic stimuli in terms of units relative to their respective contrast thresholds does not ensure that two targets defined as having the same relative contrasts are necessarily equivalent in terms of salience. It is possible that 'salience' increases more rapidly with increasing contrast for isochromatic as opposed to isoluminant stimuli.

### Spatial Frequency of Stimulus.

A number of studies have looked at the effects of the spatial frequency (sf) of stimuli on the latencies of various types of response. Lupp et al. (1976) found that manual reaction times increased by around 100 msec when the spatial frequency of stimulation was increased from 1.0 to 16 cycles/degree. Parker and Salzen (1977) showed a very similar increase in the latency of visual evoked potentials. However using a method designed to match relative perceptual latency a much smaller effect, showing an increase of 21 msec over a range from 0.5 to 9.0 c/deg, was found (Parker and Dutch, 1987). The effects of spatial frequency have also been considered in the elicitation of saccades. Deubel et al. (1989) showed an increase in saccade latency of 60 msec when the major sf component of a single target was increased from 3.8 to 15.2 c/degree, although no attempt was made to control for relative contrast. Qualitatively similar results were found by Zetzsche et al. (1984) who used spatially and temporally modulated sf targets, and found latency differences of between 50 and 100 msec associated with a spatial frequency increase from 0.5 to 7.0 cycles/degree. These studies all show that low sf targets trigger a saccade faster than high sf targets, suggesting that the 'when' system may be more sensitive to low than high sf stimulation.

A number of studies have shown that a similar difference is likely to be significant in terms of the spatial processing of target position - the 'where' process. When latencies are held approximately constant, high sf targets have less influence than low sf targets in determining the spatial average of target position in the global effect (Deubel et al. 1989, Zetsche et al. 1984) and more recently evidence has been found showing that high sf information gains more influence in the calculation of saccade goal at a later time than low sf information. However no direct study has yet considered the latency of onset of averaging as opposed to the duration of averaging for different sf components using the double step paradigm, which would allow the differentiation of 'afferent' processing delays from sf specific computational differences within the putative spatiotemporal translator.

### Temporal Frequency.

Although some of the major afferent pathways to the superior colliculus are made up predominantly of cells known to be highly sensitive to temporal frequency information, the effects of temporal frequency components on saccadic or manual reaction times do not seem to have been studied.

### Target Eccentricity.

Findlay (1983) reviewed the results of 11 published studies relating saccade latency to saccadic eccentricity, demonstrating the common finding that for single targets varying the eccentricity between 1 and 15 degrees has

no effect on saccadic latency. One study (Wyman & Steinman, 1973) found an increase in latency for saccades to targets at less than 1 degree eccentricity, and most studies found an increase in latency for saccades to targets presented beyond 20 degrees. For very low luminance targets the relative density of rods and cones became a significant factor, and saccade latencies varied with eccentricity corresponding to the change in rod/cone density. However for supra-threshold stimuli, over the normal range of saccade amplitudes there is no simple effect of target eccentricity on saccade latency.

There is however a major effect of target eccentricity on determination of target selection, when targets are presented simultaneously on both sides of the fixation position. In this situation saccade direction is strongly biased to the nearer target (Findlay, 1980). This does not seem to be due only to the decrease in cortical magnification factor at larger eccentricities, as the decrease in relative salience remained far greater than could be accounted for simply by increasing the size of the more eccentric target to the cortically equivalent area.

#### Size of Target Set.

Saslow (1967a) investigated the effect of varying the predictability of target position using sets of 2, 4 or 8 possible positions for target presentation, and found no effect of set size on saccadic latency. In the study it was however possible that the fixation point offset could have been used as the cue for saccade elicitation, and might have decreased an effect of set size. Targets were only presented along the horizontal axis, which might



also have tended to reduce any effect. Heywood and Churcher (1980) repeated the experiment using a two dimensional stimulus array with set sizes varying from one choice to sixteen, and no cuing by fixation point. Apart from an unsurprising increase in the probability of anticipatory saccades in the single target condition, they found no effect of increased set size on saccade latencies.

These results strongly suggest that saccade elicitation is a process occurring in parallel across the whole visual field. This may not seem surprising in view of the simplicity of target identification against a homogeneous background. However for targets defined by 'higher level' characteristics the situation might be different, as suggested by Treisman's findings that are consistent with a degree of serial processing in visual search for such targets (eg Treisman and Gelade, 1980). In addition it is quite possible that differences between serial and parallel type search strategies would interact with target eccentricity.

### Target Features.

The question of which features define the 'target' as opposed to the background has rarely been addressed. The majority of investigations into saccade timing and amplitudes have used very simple stimuli - commonly the brightening of a light emitting diode or the occurrence of a bright or coloured patch against a dark or uniformly lit background. In these experiments it is assumed that the separation of target from background is computationally trivial - perhaps because the visual system accomplishes the task so easily. Only occasionally have the processes that might be involved in target extraction been studied. The

experiments of Zetzsche et al. (1984) have been mentioned in the section concerning spatial frequency elements of the targets.

Deubel et al. (1989) presented textured targets defined either by their increased luminance compared to a textured background, or by a difference in the orientation of the texture elements. The latencies of saccades to the targets in both cases were increased by the presence of the background, by about 20 msec when the target was defined by the orientation of the texture elements, and by about 25 msec when the target was defined by the luminance of the texture elements. It was assumed that these increases were due to an increase in the time associated with processing the targets. In the procedure used in the experiment the background and target elements were presented simultaneously, and so the temporal cuing for target onset was the same whether or not the background was present, and whether the target was defined by luminance or texture. Thus the signal that elicited the saccade had to be related to the identification of the target rather than to the overall timing of the experimental set up. This might appear inconsistent with the idea that saccade latency is determined by the first cue that triggers the saccade, and that saccade goal is determined by whatever the state of the 'where' process when the saccade is triggered. However it may be that sudden stimulation of the whole visual field can be treated as a special case, not directly comparable to the provision of a simple 'when' cue, or that such a method of presentation is similar to the situation in which targets are presented simultaneously on both sides of the fixation position, in which case saccade latency is considerably increased. There is also evidence that visual stimulation at the point of fixation tends to increase saccade latency to a target subsequently appearing in the periphery (see discussion of Ross and

Ross, 1980, below).

### The influence of the fixation point.

The experiments discussed above have concentrated on the aspects of saccade latency and amplitude that might be accounted for by properties of the target stimulus. This discussion has thus for the most part avoided other elements of the experimental design that are likely to influence saccade timing. Most importantly these include experiments manipulating the temporal relationships between available cues and designated targets.

In many studies of saccadic control a trial begins with the appearance of a fixation point which the subject is asked to foveate. This is convenient for two major reasons. Firstly the presence of the fixation point means that the direction of the subject's gaze is known at the beginning of the trial. This allows the experimenter to present target stimuli at known retinal eccentricities simply by varying the position of the target with respect to the fixation point. Secondly, the appearance of the fixation point can be used to tell the subject that the trial is about to begin and so warn the subject to try and avoid blinking, coughing, or making other eye movements that might interfere with the normal reaction to the stimulus.

With the presentation of the target stimulus the fixation stimulus may be simultaneously removed. It was Saslow in 1967 who pointed out that fixation point offset and target onset in fact constitute independent events, the relative timing of which could well have significant effects on saccade latency. The occurrence of fixation point offset may have significant effects

on the latency of saccades, either as a warning allowing the preparation of saccadic processes, or as an additional visual stimulus that might interfere with the programming of the saccade to the target.

The Gap/Overlap paradigm.

Saslow (1967) varied the timing of fixation point offset with respect to target onset, and measured saccadic latency with respect to the target onset. Fixation point offset could either precede (gap condition), coincide with (simultaneous condition), or follow (overlap condition) target onset. Saslow found that a gap between fixation point offset and target onset led

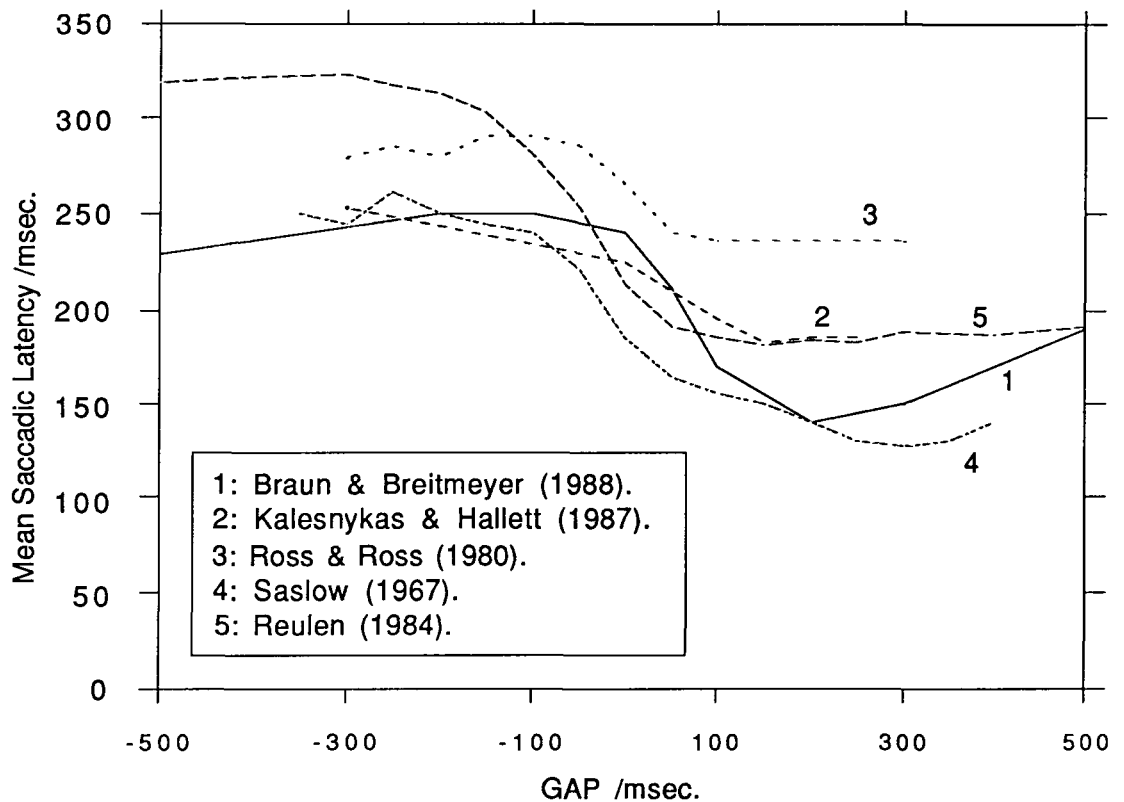

Figure 1. Mean saccadic latencies recorded using the Gap/Overlap method of target presentation. Negative Gap values represent overlap presentations.

to shorter saccade latencies, and an overlap to longer latencies, with simultaneous presentations having an intermediate effect. In Saslow's original study saccades made with overlaps greater than 150 msec resulted in saccade latencies of about 240 msec and saccades made with gaps of greater than 250 msec gave saccade latencies of about 130 msec. For intermediate gaps/overlaps latencies changed monotonically, with a latency of 195 msec when fixation offset and target onset were simultaneous. The same basic procedure has been used by a number of authors since Saslow, and their results are summarised in figure 1. Although the values of mean latency for each gap condition seem to vary considerably between different studies, and there is large intersubject variability (eg Reulen, 1984a), the latency reduction in various gap conditions has been consistently replicated.

More recently a second phenomenon of latency reduction associated with use of the gap condition has been reported.

Fischer and Boch (Fischer and Boch, 1983) used the gap paradigm to study the latency of target elicited saccades in the monkey. In addition to the expected decrease in saccade latencies as the gap length was increased, they reported the occurrence of an additional and discrete population of extremely short latency saccades that could occur when the gap exceeded about 150 msec. This population had latencies with a mean of around 70 msec, clearly separated from the population whose mean latency was about 150 msec (see figure 2, adapted from Fischer and Boch, 1983). They called these extremely short latency saccades 'Express Saccades'.

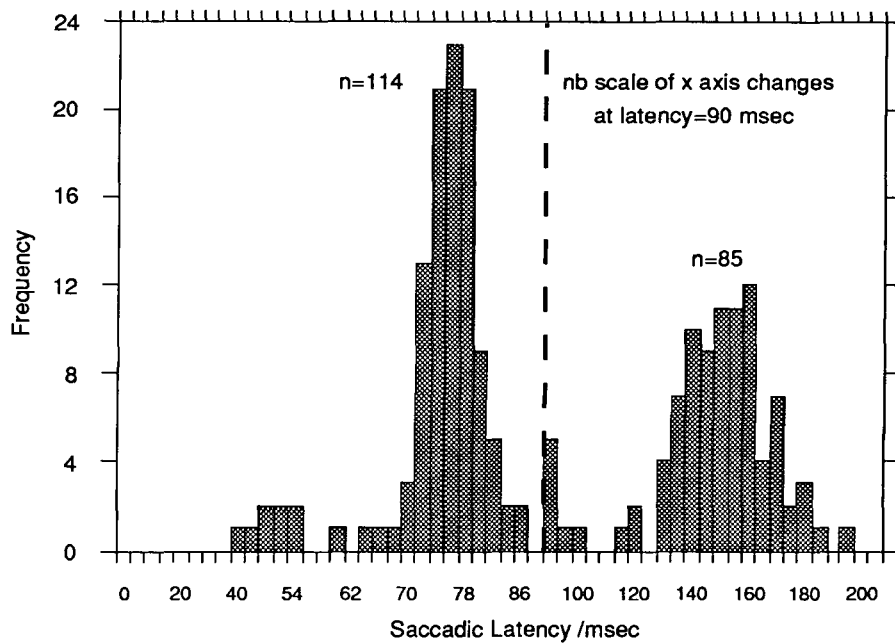

Figure 2. Bimodal distribution 'fast regular' and 'express' saccades. Figure taken from Fischer and Boch (1983). Below 90 msecs. the scale is non-linear.

There are therefore two phenomena of decreased saccadic latencies associated with the gap condition. The first of these, following Fischer's terminology, is the reduction in 'regular' saccade latency, from the normal latencies observed when there is no warning as to the timing of target onset, to the 'fast regular' latencies observed when target onset is preceded, or very closely followed, by fixation point offset. The second phenomenon is the occurrence of a separate population of extremely short latency saccades, separated from the 'fast regular' population, occurring usually with gaps greater than 150 msecs. These phenomena are shown in figure 3, adapted from Fischer and Boch (1983). Various hypotheses that might account for these findings are discussed in more detail in Chapter Three.

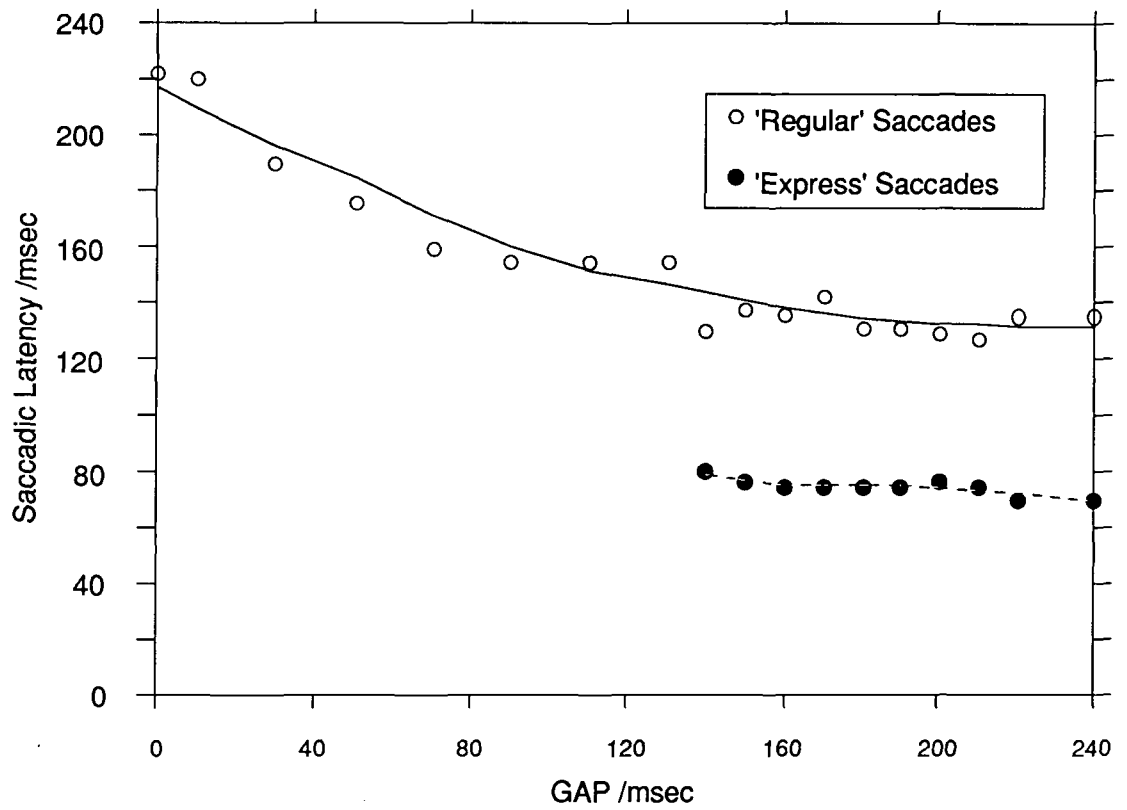

Figure 3. The occurrence of 'Express' Saccades in the Gap condition for a monkey. The diagram is adapted from Fischer and Boch (1983).

## CHAPTER TWO: The distinction between 'when' and 'where' in saccade programming.

A distinction has been made in the previous chapter between aspects of saccadic control associated with saccade timing - 'when', and aspects of control associated with programming saccade amplitude and direction - 'where'. Although this distinction is convenient for discussing different aspects of saccadic programming, it is not necessarily clear to what extent 'when' and 'where' represent a real division in the neural mechanisms underlying saccadic control. The distinction between 'when' and 'where' processes can for example be made at different levels, and it is important to consider which level is appropriate as a model of the functioning of particular aspects of the neural mechanisms of control.

At the highest level such a distinction is the necessary corollary of an ability to exert any control over saccade timing. Humans can make voluntary saccades and voluntarily suppress or delay saccades. There is no necessary connection between the determination of saccade goal and the control of saccade timing other than the logically trivial one that an initial direction for the saccade must have been calculated before the saccade can begin. At the descriptive level of the overall functioning of the saccadic system a clear distinction can therefore be made between 'when' and 'where'. The type of 'when' process involved is the decision to make an eye movement, which can be treated as being entirely independent of the processes involved in defining the goal of the movement.

At the lowest level one can also separate 'when' from 'where'.



Physiologists working on models of saccadic control (for review see Fuchs et al., 1985) generally assign omnipause neurons (OPNs) the role of controlling the timing of saccade occurrence, and burst cells the role of coding saccade goal. Burst cells fire a pulse of activity preceding saccade occurrence, the duration of which corresponds to the duration of the saccade. Omnipause cells tonically inhibit burst units, but are briefly inhibited prior to a saccade, thereby releasing the burst cells to fire a signal which may code saccade direction and amplitude. The separation between functioning of omnipause and burst cells seems to correspond to a separation between 'when' and 'where' processing. However, at this level the decision to make the saccade may already have been taken, leaving only the control of the saccadic plant still to be determined. This type of 'when' process may not be so much a decision as a part of the automatic processes involved in determining saccade dynamics once a decision has been made.

The relationship between 'when' and 'where' at the level of controlled decision, and 'when' and 'where' at the level of control of saccadic plant is not clear. One function of the saccadic system is to orient the eyes towards parts of the environment in which a sudden change has taken place, and in this situation the stimulus has an important role in determining the decision to make a saccade, as well as in defining the goal of the elicited saccade. It is at this kind of intermediate level that much of the experimental work involved in developing the ideas of 'when' and 'where' has taken place, and at this level it is necessary to distinguish between two types of when/where organisation, one in which the when/where elements are closely linked, and one in which they are independent. These different models of when/where organisation are the

implicit basis for the different models of saccadic control elaborated in Chapter Three.

For one type of organisation the decision to make a saccade is initiated by the occurrence of the target, but once initiated there is delay before the goal of the saccade is defined by a representation of the visual stimulation. The representation of the target at the time the saccade is triggered and the representation of the target at the time the saccade goal is defined are not identical. It would be possible to imagine independent structures involved in determining when to make the saccade and where to make it to. Thus the initiation of the saccade, and the exact definition of saccade goal are independent, and a strong distinction between 'when' and 'where' processes is maintained.

Alternatively, a single representation of the visual stimulation could define the saccade goal and once defined as the goal, this representation itself could initiate the saccade. In this case the initiation of the saccade is entirely dependent on the previous definition of saccade goal, and so there is no opportunity for that definition to change once the saccade has been initiated. The 'where' signal itself determines the 'when' signal, and they cannot be considered as distinct.

What then is the evidence for the distinction between 'when' and 'where' processes, and what is the nature of the distinction?

Becker and Jürgens (1979) investigated the control of saccade amplitude and timing using a double step paradigm (figure 4). Subjects were instructed to make a saccade to a single target that appeared on the

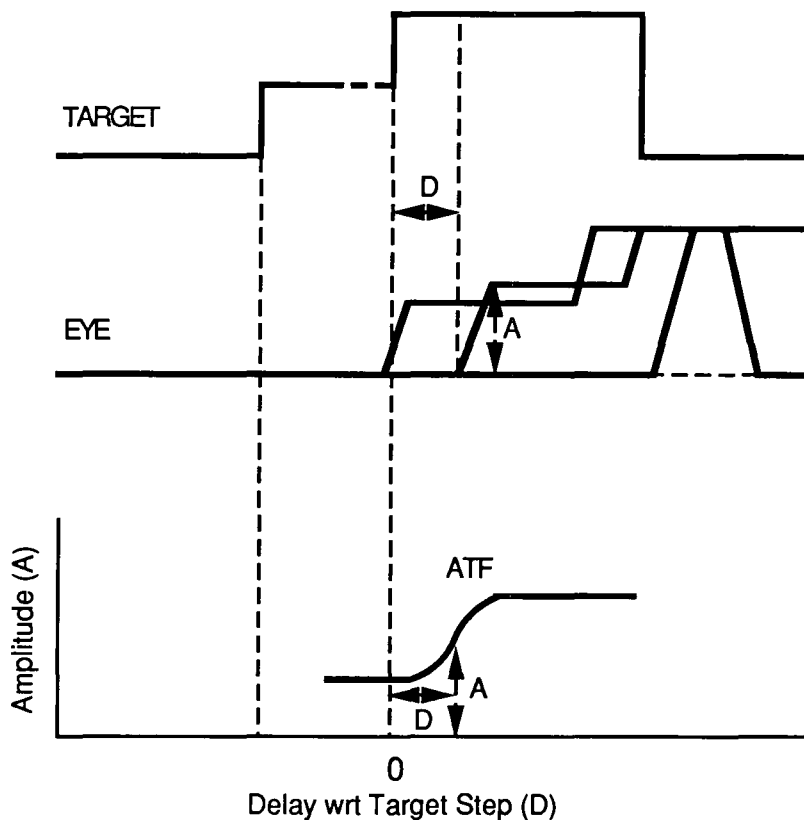

Figure 4. The experimental method used by Becker and Jürgens. Target position is shown at the top, change in eye position immediately below. The 'Amplitude Transition Function' (ATF), showing the change in saccadic amplitude (A) as the delay between target step and saccade (D) changes is shown at the bottom.

horizontal meridian and which, after a brief but unpredictable delay stepped to a second position, either further away from the fixation point (continuation trial), or back towards the fixation point (reversal trial). When the target step precedes a saccade towards the initial target position it can potentially influence the amplitude and/or timing of that saccade. Becker and Jürgens found that the amplitude of such a saccade depended closely on the interval between the target step and the occurrence of the saccade. For reversal trials, if the step preceded the initial saccade by less than 80 msecs the eye responded to the two target positions sequentially, making a saccade first to the early target position, and then after an interval to the later position. If the step occurred more than 190 msecs

before the saccade, the saccade was made to the later position. At intermediate intervals the saccade amplitude showed a gradual transition from the earlier to the later position, depending on the duration of the interval since the target step. This change in amplitude was referred to as the Amplitude Transition Function (ATF) (figure 4).

Becker and Jürgens interpreted these results in terms of the separation of the 'saccadic decision element' and the 'computation of response amplitude'. In their model the 'decision element' included a directional (left/right) decision, and so a bidirectional aspect of 'where' was included in the determination of 'when'. They proposed that the 'where' process consisted of a continually modified representation of saccade goal containing a spatio-temporal average of target position integrated over some time window. This representation was accessed when a trigger signal from the 'when' processing occurred. This trigger was provided by the initial target movement. Because of variation in the timing of the subsequent target step, and natural variability in the timing of the 'when' signal, the 'where' process was accessed at different times relative to the occurrence of the step, and hence the goal defined by the spatiotemporal average of the preceding visual stimulation varied between the position of the target after the initial movement and the position of the target following the step. They argued that because the 'when' signal was not tightly coupled to the state of the 'where' processor, there was no reason to believe that the timing of the 'when' signal was itself determined by the state of the 'where' processor.

A second source of evidence for the independence of the 'when' signal from the 'where' processor would be that the timing of saccades,

once triggered, was not affected by subsequent changes to the 'where' processor. This would mean that the latency distributions for first saccades of intermediate amplitudes on the amplitude transition function should be identical to the distributions for first saccades to single targets. The latencies would thus depend on the amplitude of the initial target position, so long as the eccentricity of the further target position was greater than 20 degrees from the fixation position (Findlay, 1983, and see p.6). Intermediate amplitude saccades produced by the target stepping from a far to a near position should have longer latencies than similar amplitude saccades produced by a single target appearing at an intermediate position, and these in turn should have longer latencies than saccades produced by a target stepping from a near to a far position. Latency data of this kind are not however published.

The proposal of Becker and Jürgens has been further investigated by presenting targets that made directional steps in two dimensions (eg Findlay and Harris, 1984; Aslin and Shea, 1987). The general finding has been that in these circumstances the direction of the saccade is intermediate to the direction of the earlier and later target positions, and that an 'angular transition function' equivalent to the amplitude transition function can be measured. On the basis of the exact parameters of amplitude and angular transition functions measured when a target step involves changes of both amplitude and direction Aslin & Shea proposed that different processes were involved in the calculation of angle and amplitude of saccade goal. The differences in the respective transition functions are however small, and it is not clear that they cannot be accounted for by inaccuracies in their calculation due to the small number of transitional data points. A simpler and physiologically more

plausible hypothesis is that a temporospatial average of target position takes place on the basis of a two-dimensional representation of visual space, rather than separate extraction of target direction and target eccentricity, followed by their separate averaging integration. The results would therefore be consistent with Becker and Jürgens proposal of independent 'when' processing providing the trigger to access a 'where' representation.

There are however some difficulties for their interpretation. The first is demonstrated by the case of saccades to targets that step across the midline, when responses are bimodal rather than showing an ATF. Becker and Jürgens proposed on account of this that a directional decision was associated with the 'when' process rather than the 'where' process, but this possibility seems unlikely in view of the results of experiments studying saccades to stepped targets in two dimensions. Such bimodality might however be expected if there were reciprocal inhibition between contralateral centres at some level of saccade programming. There is some neurophysiological evidence that this is the case (Highstein et al. (1976). Contralateral inhibition at the level of the oculomotor nuclei would prevent saccades averaging simultaneous left/right stimulation, or allow preparation of a saccade to one side to inhibit preparation of a saccade to the opposite side. In addition some OPNs may be directionally sensitive (Keller, 1974), which suggests some directional independence in saccadic programming.

A second difficulty is the demonstration by van Gisbergen et al. (1987) of saccade trajectories whose direction is modified during the saccade. The initial saccade direction is towards the early target position, but the trajectory curves and the saccade end point is at the position to which the

target has stepped. Curved trajectories were previously demonstrated by Findlay and Harris (1984), but occurred rarely. Van Gisbergen et al. increased the probability of their occurrence by eliciting large saccades (thus of long duration), and using large angular steps (45 degrees). They also showed that the saccadic velocity profiles of curved saccades commonly showed two peaks, consistent with the notion that the curves were produced by the overlap of two separately planned saccades. Similar saccade profiles occur occasionally when for instance an anticipatory saccade appears to be overlapped by a goal directed saccade to a target in the same direction (Fischer and Ramsperger, 1986).

On the face of it, these findings are at odds with the proposal that intermediate saccades are a single planned response to an intermediate representation of a stepped stimulus. However the results are compatible with the idea of spatio-temporal integration over a limited area. For instance the proposed temporal role of OPNs is to limit the extent of the temporal window over which integration of the firing of neurons occurs in the translation from a spatial representation to a saccadic vector. A group of cells such as the OPNs could then perform the equivalent task in the spatial domain, limiting the spatial extent of the integration of target position. If a target steps to a second position after a short interval then it would inhibit these cells at two different locations in the representation of target position. If the fields of inhibition caused by the neural excitation of the target at two positions overlap, then the integration of target position would occur over the area covered by the joint fields. However if the target steps to a position such that there is no overlap of the fields of inhibition, then two separate saccade vectors will be calculated independently, at slightly different times due to the delay of the step, and

these two saccade vectors will overlap in the movement of the eyes. Such a model depends on OPNs or similar cells with spatially limited fields of influence. Although spatially limited fields for OPNs have not been reported, they haven't been monitored for the large target steps separated both horizontally and vertically which seem to be necessary to induce this performance.

### Conclusion.

In general then the results of double step experiments seem to support the idea that saccade direction and amplitude - where - can be treated separately from the control of saccade elicitation - when. This interpretation therefore provides the framework within which models of factors affecting saccade latency will be subsequently considered.

In particular this means that the investigation of saccade latency is primarily an investigation of factors affecting the triggering mechanism of the saccadic system. If the trigger for saccade occurrence can occur independently of the particular state of the 'where' processor, then there is the possibility that factors other than the occurrence of a 'target' stimulus will be able to affect the trigger signal, and these factors will have significant effects on the timing of saccades. Furthermore time dependent aspects of the process of target localisation are not expected to affect saccade latency unless those aspects also affect the process of saccade triggering.



### CHAPTER THREE: Theories of latency reduction in the gap/overlap paradigm.

In Chapter One the effects of varying the timing of fixation point offset with respect to target onset, on the latency of target elicited saccades were introduced. Two phenomena were outlined. The first was a general reduction in saccade latency when target onset was preceded by, or very shortly followed by, fixation point offset. This is referred to as a reduction from 'regular' to 'fast regular' saccade latencies. The second was the occurrence of an additional population of extremely short latency saccades discovered by Fischer & Boch (1983) in the monkey, and referred to as 'express' saccades.

Various explanations have been proposed to account for these effects on saccade latency. The purpose of this chapter is to consider these explanations, and where possible to extend them to make further predictions about the behaviour of saccade latencies in the gap/overlap paradigm.

#### Anticipatory saccades.

One possibility for a decrease in saccade latency in the gap paradigm that has to be considered is that the latency reduction is due not to a particularly fast response to the target's appearance, but to a motor program elicited prior to the target appearance. In other words the saccades are anticipatory rather than goal directed. To eliminate this possibility it is essential to ensure that target position is not predictable. Since it has been shown that target set size has no influence on saccade latency (Heywood

and Churcher, 1980, and see p.7), the simplest technique is to vary target position randomly between the left and right of the fixation point. In this condition the probability that a saccade is made in the correct direction gives a criterion to determine whether saccades are target elicited or anticipatory (eg Kalesnykas and Hallett, 1987). When target position is randomised in this way the reduction in saccadic latency cannot be due to the occurrence of anticipatory saccades whose direction has been planned prior to the target's appearance.

#### Visual effect of fixation point.

Another possible explanation for the reduction in saccade latency in gap conditions, is that rather than there being a latency advantage associated with fixation offset, there is a positive disadvantage caused by the presence of the fixation point in the overlap conditions.

The simplest experiment to investigate the possibility that static visual aspects of the fixation point's presence might increase saccade latency is to compare the cases where no information about the timing of the target's appearance is available, with the fixation point either absent or present. Reulen (1984 b) made this comparison and showed that in either case the latencies of saccades are the same, a result replicated by Mayfrank et al. (1987). Thus it can be concluded that static visual effects of the fixation point are not significant in determining saccade latency.

This is not to say that the type of visual stimulus used as fixation point is immaterial. Ross and Ross (1980) compared the effects of fixation point offset with the effects of fixation point onset as a temporal cue for target

onset. They distinguished between two effects. Fixation point onset shortly before the appearance of the target caused an increase of up to 40 msec in the subsequent saccadic latency to the target, resulting in latencies greater than for the case where no cue at all was provided. However when the gap between fixation point onset and target onset was increased there was a reduction in subsequent saccade latency, similar to the reduction found for fixation offset. They concluded that the sudden appearance of a visual stimulus at the point of fixation interfered with processes involved in making a saccade to the peripheral target, but that this interference wore off over a period of several hundred milliseconds leaving a latency advantage over the no cue condition, as is found for fixation offset.

Cue onset and cue offset therefore have significantly different effects on the saccadic system. In light of the above results it would seem that these effects are the result of dynamic differences between fixation onset and the fixation offset. The saccadic system differentiates between the removal of a stimulus at the point of fixation, and the occurrence of a novel stimulus at the point of fixation. It does not seem to be affected by static stimulation due to the presence or absence of a fixation point.

These results also suggest that the simplest way to study the effects of temporal cuing by the fixation point is to use fixation point offset rather than onset as the cue. Although Ross & Ross's work was thirteen years later, this was the technique adopted by Saslow (1967), and subsequent workers.

### Explanations discussed by Saslow (1967).

Saslow (1967) discussed various hypotheses that might account for a reduction in saccade latency in the gap conditions. He rejected the idea that the presence of the fixation stimulus might cause a decrease in the signal strength of the target stimulus. This would in any case be inconsistent with the later finding that saccade latencies are similar in conditions of very long overlaps and conditions in the absence of any fixation stimulus (Reulen, 1984b).

For the same reason the proposal that the presence of the fixation stimulus increases the number of corrective saccades, and that the refractoriness of the saccadic system following a corrective saccade therefore increases the mean latency of subsequent target directed saccades can also be rejected. The idea that keeping the gap time constant within a block of trials made target onset temporally predictable and so allowed 'temporal pacing' was also rejected, on the grounds that randomising gap durations within a block had no effect on the gap advantage.

### The warning effect of fixation point offset.

Saslow also considered the possibility that the gap advantage was due to the warning effect of stimulus offset. He rejected this hypothesis on the grounds that if the advantage were a warning effect it would only occur for gaps greater than about 50 msecs, as is the case in manual reaction time experiments. Ross and Ross (1980) point out that this is not necessarily true. Studies of perceptual latency show that a stimulus offset may be perceived up to 25 msecs before a stimulus onset (Lewis et al.,

1972), and this could lead to a warning advantage from a cue that physically, though not perceptually, followed target onset. It is still a difficulty for a warning hypothesis to account for a latency reduction for saccades associated with overlaps of around 150 msec, as some of the results presented in figure 1 would seem to suggest.

The idea that a temporal warning allows a subject to prepare some aspect of saccadic control begs the question of which aspect of control the warning affects, and how the advantage occurs. Two types of advantage can be considered. The first is that the occurrence of a warning stimulus initiates some necessary, covert part of the procedure in which fixation changes from fixation stimulus to target stimulus. This covert process could include 'disengagement of fixation' and/or 'disengagement of covert attention', both of which have been considered to be involved in the operation of the saccadic system. This type of model is subsequently referred to as the 'preparation model'.

The second is that the warning changes the state of the system so that some or all of the procedure of change of fixation can occur at a faster rate than previously. A model of this kind was proposed by Reulen (Reulen, 1984a), and referred to as the 'facilitation model'.

Either of these models can be applied, with certain assumptions, to the data presented in figure 1. Both models are also concise enough to allow a quantitative comparison of their predictions. Reulen provided such a treatment of the facilitation model, but no similar work seems to have been applied to the preparation model. In this thesis such a treatment is given, based on the framework of figure 5.

### The Preparation Model.

The possibilities of the preparation model can be considered within the framework provided by the distinction between 'when' and 'where' processes, in relation to the order of events that lead to target elicited saccades with and without a temporal warning.

In the case of no warning, the appearance of the target is the single event that must trigger all the processes leading to saccade elicitation. The simplest proposal is that the appearance of the target (after an afferent delay) allows the computation of target position and also triggers any necessary, covert processes required before a saccade can occur. Once these covert processes are complete the 'where' processor is accessed, and a saccade elicited to whatever goal is defined by its state at that time. Following an efferent delay the saccade occurs and its latency can be measured.

In the gap situation it is assumed that the subject is looking at the fixation point at the start of the trial. With fixation point offset (again after some afferent delay) the 'when' signal can be triggered and covert processes can proceed, before the target has even appeared. When the target does appear there is an afferent delay followed by computation of target position before the saccade can occur. Thus in the gap situation, because certain covert processes can be carried out prior to the target appearance the gap condition will allow shorter saccadic latencies.

There is a major difficulty with this description, which occurs when the gap is long enough to allow the completion of any covert processes,

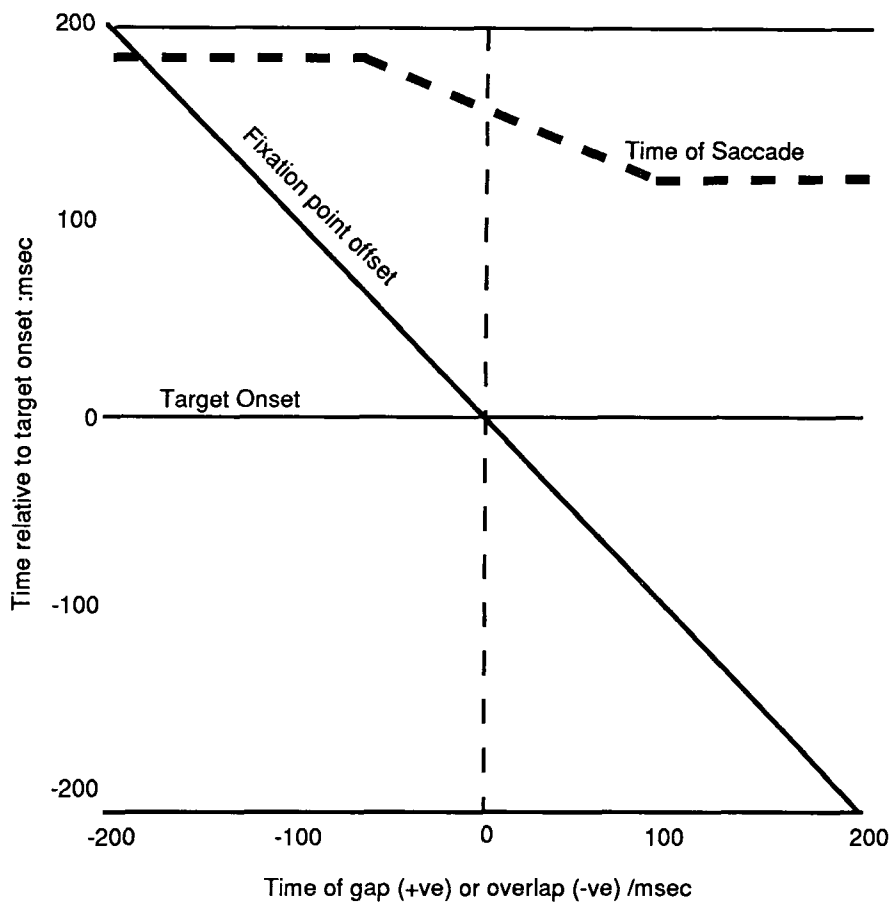

Figure 5. Graphical representation of Target Onset, Fixation Offset, and consequent saccade latencies for different conditions of Gap or Overlap.

prior to the target appearance. In such a case, a saccade should be triggered, but the representation of the visual scene by which saccade goal is defined is not stimulated by any target. In this case either a saccade will occur to whatever goal is defined by noise in the system, or the system must have a mechanism by which no saccade occurs unless there is some threshold level of stimulation. Experimental results provide some evidence for both possibilities. It is a common finding that with longer gaps anticipatory saccades, uncorrelated to the direction of the subsequent target, do occur. Their occurrence is consistent with the idea that a saccade has been triggered with the goal undefined by visual stimulation.

However it is more often the case that no saccade occurs until after the target has appeared. If the framework of 'when' and 'where' is used, then it has to be modified by the proposal that despite the occurrence of the 'when' signal a saccade will not usually occur unless there is some current stimulation of the 'where' processor.

The 'preparation' explanation then makes certain basic assumptions. The overall saccadic latency will include an afferent delay (Aff-T) for the target stimulation to reach the saccadic control system, and an efferent delay (Eff) for the programmed saccade to pass through the oculomotor neurons and finally cause the eye to move. In between these two necessary processes it is assumed there are only two types of process - preparatory (Prep) and target dependent (Targ). Preparatory processes are any processes that are independent of target location and which may therefore occur before target onset. Target determined processes are any processes that depend on the presence of the target. Following the argument of the previous paragraph, it is further assumed that before a saccade can occur the target dependent processes must have been completed. Saccadic latency is limited by the earliest time at which both target dependent and target independent processes can be completed. Then, following a necessary efferent delay, the saccade occurs. The results of this model are shown in figure 6.

For long overlaps, equivalent to no warning, all the processes necessary for change of fixation are initiated by the occurrence of the target. Thus the overall saccadic latency consists of  $\text{Aff-T} + (\text{Prep or Targ}) + \text{Eff}$ . It is assumed that preparatory and target determined processes proceed simultaneously, and so the overall latency will be



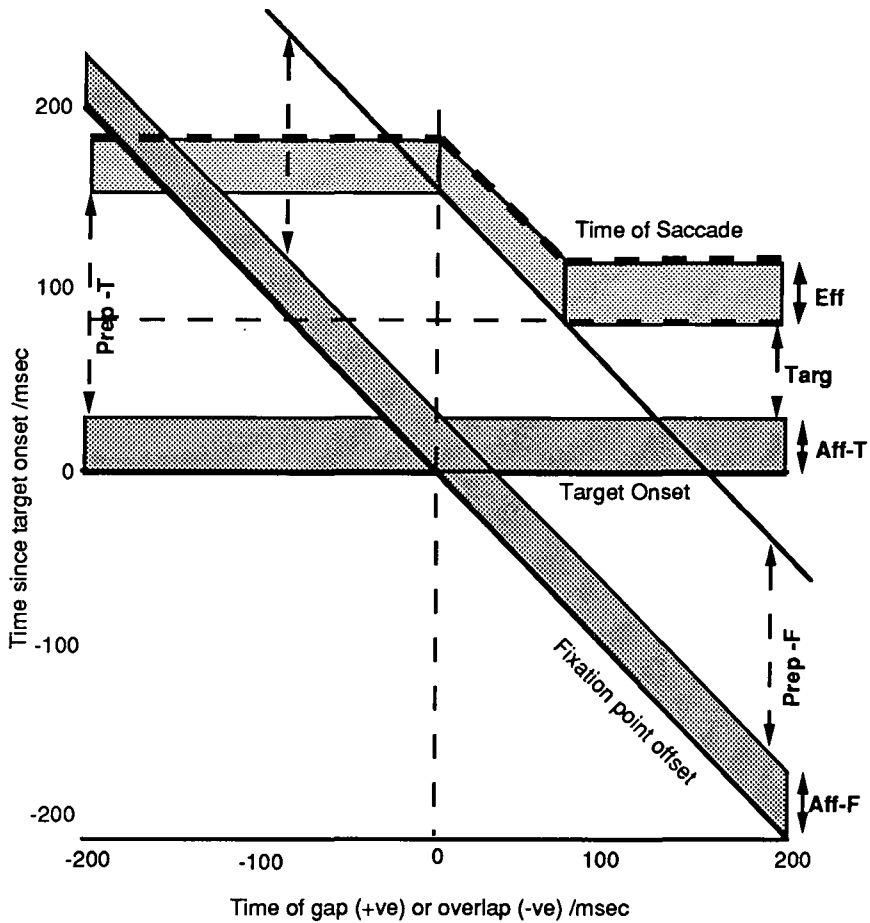

Figure 6. Diagram showing the time course of processes assumed in the 'preparation' model, and consequent saccade latencies for different Gap/Overlap conditions. Afferent delay of Target onset (Aff-T), Afferent delay of Fixation offset (Aff-F), Efferent Delay (Eff), Target dependent processing (Targ), Preparatory processes elicited by target (Prep-T), and Preparatory processes elicited by Fixation offset (Prep-F) are shown. Saccade occurrence is represented by the heavy dashed line.

determined by whichever of Prep and Targ is the longer. Thus the overall saccadic latency consists of  $Aff-T + (Prep \text{ or } Targ) + Eff$ . For long gaps it is assumed that all the target independent processes can be completed before the onset of the target, and so the saccadic latency will consist only of  $Aff-T + Targ + Eff$ . In between these two extremes latency is determined by whichever process is the limiting factor for the particular gap condition.

This highly simplified model of the processes of saccade generation allows certain predictions to be made that are general to any type of preparation model. The first is that, as shown in the diagram, the model predicts that the advantage of the gap condition will become effective only for gaps greater than 0. This follows from the assumption that aff-F + prep is the same as aff-T + prep, but contrasts with the experimental results that the advantage begins when fixation point offset follows target onset with some overlap. As discussed earlier however it may be the case that aff-T is as much as 25 msec slower than aff-F. A faster aff-F would mean that the point at which the advantage begins is shifted an equal amount towards the overlap conditions.

Potentially a more significant difficulty is the prediction of the model that the slope of the gap advantage should have a gradient of -1. This prediction springs from the essence of the model, that a 20 msec warning allows certain time limiting processes to begin 20 msec earlier, and so to reduce the overall latency correspondingly. The gradients of the data presented in figure 2 however are closer to -0.6.

One factor that would tend to soften the slope is that for small gaps or overlaps the preparatory processes could be controlled either by fixation offset or by target onset. If these processes are independent and contain some random variable element there would be a latency advantage when their timing overlapped, since whichever process finished soonest would trigger the saccade. A quantitative estimate of this advantage can be gained by considering the standard deviations of the latency data, and such a treatment is given in the results section. Alternatively fixation offset and target onset might affect the 'when'

signal additively, independently adding weight to a probabilistic threshold device, and again this would tend to decrease latencies when the two signals overlapped. Since the most effective overlap in either case would occur when the two signals reached the 'when' process simultaneously, their effect would be to extend the start of the slope further towards the overlap conditions, and in doing so to decrease the overall gradient of the slope.

The expected gradient of the slope from a preparation model would therefore be somewhat less than the initial estimate of -1, though quantitative predictions depend on the precise nature of the processes involved in triggering the 'when' signal, and on the variability associated with latency in different gap/overlap conditions.

#### The Facilitation Model.

The use of a facilitation model departs from many of the assumptions of separate 'when' and 'where' processing. The model assumes that the saccadic system can be in one of two states, either a fast processing state, or a regular processing state. A warning stimulus allows the system to switch from the regular to the fast state, and the saccade occurs when processing is complete. The sooner a cue for the switch occurs, the greater the proportion of processing that can be carried out in the fast state, and so the shorter the latency of the saccade. Thus the model is more like the simultaneous when/where processor discussed earlier (see p. 17), since the decision to make a saccade is limited by the completion of the 'where' process.

The switch may be considered equivalent to entering a state of readiness, and though there may be a delay between the occurrence of the cue and the occurrence of the switch, it is assumed that the switch itself takes a negligible amount of time. A formal treatment of a model of this type is provided by Reulen (1984 a), and is presented here in a simplified form. As for the preparation model, the facilitation model needs to provide explanations for the onset of a latency advantage for short overlaps, and for the slope of the advantage as the gap increases.

The onset of latency advantage is determined by the delay between fixation offset and the switch into the fast processing state. If this delay is shorter than the time taken to process the saccade at the regular processing speed, then a latency advantage will occur, as a part of the processing can then be carried out at the faster rate.

The gradient of the slope is determined by the degree of facilitation that occurs. The gradient can be used to give an estimate of the advantage of fast processing over regular processing. The way in which this estimate is determined, and the further assumptions that have to be made are given in the quantitative treatment of the results in Chapter Six.

How can one separate the predictions of increased speed of where processing, from disengagement of fixation?

One can argue that when target position is very easily calculated, it will be difficult to increase the speed of its processing because the speed is already at a ceiling, and in such circumstances it is unlikely that any increased processing capability will have much effect. Thus the increased

processing theory would predict little or no effect of the gap when targets are easily processed, and an increasing effect as targets require more processing. If saccade latency is considered a measure of the speed of the where processing, then the finding that for stimuli well above threshold increasing contrast has little effect on saccade latency (Wenban-Smith, Lennie & Cameron, unpublished data), suggests that for these stimuli processing time is already minimal, and so the prediction of increased where processing is that in this situation the gap will give no latency advantage. This is not however the case.

A further problem with the facilitation model is that it requires a mechanism by which the 'where' processor assesses when to trigger the saccade. The processor has no access to a veridical model of the 'completion of localisation', and so it is not clear on what basis the assessment can be made. The advantage of the preparation model is that the trigger is controlled independently of any assessment of localisation, and is based on what could be a very low level set of criteria.

In addition the warning gives a subject no additional information by which localisation of the target should become easier, so the same process of localisation has to be completed with or without warning. If the criterion for completed localisation is not affected, then it is hard to see why a system which can run equally effectively at a fast rate or a slow rate should ever run at the slow rate.

Thus the most likely explanation for decreased saccade latency in the gap condition may be that the temporal cue provided by fixation point offset allows the anticipatory occurrence of processes necessary for a saccade to be

elicited, but that are not related to the calculation of saccade metrics.

The models are not mutually exclusive. It is quite possible that there is an advantage both in faster processing following a warning, and an advantage in starting certain processes before the target appears. If this were the case the advantages of the two models would be additive, and this would make the slope correspondingly steeper.

Finally, neither model as stated predicts the occurrence of a separate population of express saccades. Express saccades occur in addition to the latency decrease from regular to fast regular saccades, and require an additional explanation.

#### Express Saccades.

The discovery of such a discrete population suggests that in the case of express saccades an additional mechanism of saccadic control is being revealed. When the monkey is allowed a warning of more than 150 msec its saccadic system can change from a state in which the mean saccadic latency is around 140 msec, to a state in which the mean saccadic latency is around 70 msec. As the gap increases from 150 to 250 msec the probability of achieving this 'express state' increases, and so the probability of making an express saccade increases.

Fischer and Boch initially failed to find a similar bimodal distribution of latencies when humans were used as subjects in a similar experimental procedure, but in 1984 Fischer and Ramsperger reported finding a bimodal distribution of latencies for saccades in humans - an

'express' population with a mean latency of around 115 msec, and a normal population with a mean latency around 155 msec, although the express peak did vary for different subjects between 115 and 135 msec (Fischer and Ramsperger, 1984).

The essential characteristic of express saccades is that they occur as a separated population to the regular saccades. There is no transition of intermediate latencies between the fast regular and express saccades. Explanations in terms of preparation induced by fixation offset, or a sudden change in processing rate induced by fixation offset do not predict the occurrence of such a sudden change in saccade latency. As discussed above the preparation model predicts a steady reduction in saccade latency as the gap increases, with a slope of -1. The facilitation model also predicts a steady reduction in latency, with a slope dependent of the increase in processing rate when the facilitation occurs. Although this would predict bimodality if the gradient of the slope became steep enough to resemble a step, in order to achieve such a steep slope the facilitated processing rate would have to tend towards an infinitely fast rate, an assumption which is physiologically and computationally implausible. A different kind of explanation is required.

One approach might be to consider that two separate processes of saccade elicitation are at work. The 'regular' process usually operates, involving the triggering of a 'when' signal, subsequent access of the 'where' processor, and control of the saccade. In certain situations an alternative process bypasses the 'when' signal, producing earlier saccades. This might be imagined as an 'express when'. The difficulty with this proposition is that the limiting factor of saccade latency in the fast regular condition has

been assumed to be the earliest time at which afferent delays associated with the target produce enough stimulation for any goal directed saccade to occur. A 'fast when' signal would lead to these 'express' saccades occurring for shorter gaps, but wouldn't create any further lowering of the minimum latency below that of fast regular saccades.

A second approach is to consider an alternative 'where' process, that allows the early occurrence of a goal directed saccade. According to this approach, when the warning exceeds a certain duration a different 'where' process can be accessed. This kind of approach was originally considered by Fischer and Boch, in terms of the possibility of parallel cortical and subcortical visual pathways to the superior colliculus.

The anatomy of the saccadic system suggests the possibility of parallel pathways. Afferent neurons from the retina and primary visual cortex synapse in the superficial layers, and afferents from extrastriate visual cortex, parietal cortex and the frontal eye fields all synapse in the deeper layers of the superior colliculus. Extensive work suggests that the deeper layers of the superior colliculus have a central role in the control of saccades (see Sparks & Hartwich-Young, 1989 for a recent review), however it remains an open question as to whether the superficial layers have any major functional connections with the deeper layers.

An alternative pair of parallel routes to the saccadic plant are the extrastriate and frontal eye field pathways, lesion studies demonstrating that either can function in the absence of the other (Mohler & Wurtz, 1977).

Fischer and Boch proposed that express saccades could represent the



use of a model of target localisation based on information derived from the direct retino-collicular path, in contrast to regular saccades for which target localisation was based on the longer cortical path. This model would predict the kind of results reported.

If this were the case it would make express saccades an extremely interesting phenomenon, in that they would provide psychophysical evidence for a neuroanatomical pathway connecting the superficial and deep layers of the superior colliculus, a pathway that has yet to be positively identified by anatomical or physiological techniques. They would in addition provide a tool by which the performance of this pathway could be assessed.

More recently Fischer and Breitmeyer (1987) discuss express saccades in terms of the saccadic system occurring in either an 'engaged' or a 'disengaged' state. With practice or cueing a subject can disengage fixation prior to target appearance without eliciting a saccade. When this happens and the target subsequently appears an express saccade results. The difficulty with such a model in explaining express saccades is that it is a model of the 'preparation' type. As discussed above such a model predicts that when disengagement is cued, for instance by the offset of a fixation point, saccade latency is reduced by the same extent as the amount of warning given. Without further assumptions the model does not predict the occurrence of a sudden change from one latency population to another. The engaged/disengaged proposal could therefore be applied to the reduction from 'regular' to 'fast regular' saccade latencies, but provides no explanation for the bimodality of 'express' saccades.

There are however a number of important practical details that have to be considered before the finding of express saccades can be accepted. As mentioned previously, it is essential when considering saccadic latencies to ensure that anticipatory saccades can be eliminated from the data. The simplest method of ensuring this is to randomise the position of the target. In collecting the data shown in figures 2 and 3 this procedure was not followed. The target location was always predictable within a block of trials. This means that the latencies could simply represent the ability of the monkey to move its eyes very fast to a predetermined location in order to collect its reward. Thus express saccades could be target elicited but not necessarily goal directed, and would therefore demonstrate a different phenomenon.

Bearing this in mind, it is interesting that one of the two monkeys from which data were collected made express saccades that consistently fell short of the target, and so required corrective saccades after an additional 50-250 msec. This suggests that at least for that particular monkey, the process of programming saccade goal was not behaving in a normal manner.

The results of experiments designed to clearly demonstrate express saccades in humans by varying gap length and presenting data equivalent to figures 2 and 3 have not been presented. When gap length was constant however, and target direction randomised between left and right, the mean saccade latency for 'express' saccades was 120 msec compared to the 'express' saccade latencies of 70 msec for monkeys (Fischer & Ramsperger, 1984). Finally, with a peak 'fast regular' saccade latency of 160 msec and a mean 'express' saccade latency of 120 msec, the argument that the peaks represent

a truly bimodal distribution of latencies requires rigorous testing. In view of the direct comparisons being made between express saccades in the monkey and express saccades in man it seems to be important to establish that they do in fact represent the same phenomenon. Because of the potential significance of the study of express saccades in generating new models of the control of the saccadic system, and their possible use as evidence of parallel pathways for saccadic control it also seems to be important to be important to establish the way in which they may be distinguished from the well known 'fast regular' saccades.

## CHAPTER FOUR: Rationale for the experiments.

The aim of this work therefore is twofold: firstly to collect the basic data in support of the proposition that express saccades occur in man, and are equivalent to the express saccades reported for monkeys: secondly to relate the data collected using the Gap/Overlap paradigm, in a quantitative way to the models of saccadic control that have been proposed to account for the findings in gap and overlap conditions in humans.

Although recent work (eg Braun and Breitmeyer, 1987) suggests that a gap between fixation point offset and target onset may not be a necessary condition for the occurrence of 'express' saccades, it never the less remains the simplest and most easily controlled method for their elicitation. The gap/overlap paradigm is therefore the method of presentation used in this investigation.

The predictions follow the early work by Fischer. As gap length is increased it is expected that mean saccadic latency will fall. At some point it is expected that the short latency population will split into separable populations of 'fast regular' and 'express' saccades. In humans the mean latencies of these two populations may be close together and so not easily distinguishable from the distribution of a single population. It would nevertheless be the case that the variance of the data should increase as the split is reached. In analysing the results therefore particular attention will be paid to the distribution of the data as the mean latency decreases.

As discussed in Chapter One there are many aspects of stimulus presentation that may have significant effects on saccade latencies. For this

reason it is important to specify the details of the conditions used in these experiments. These are presented in the table below. Further technical details are presented in the technical section at the end of the thesis.



DESCRIPTION OF STIMULUS	FIXATION POINT	TARGET	BACKGROUND
FEATURES			
SIZE :deg	0.75	0.75 -	-
LUMINANCE :candelas/m2	69	69	19
MICHELSON CONTRAST	0.57	0.57	-
WAVELENGTH	P31 Phosphor		
SIZE OF TARGET SET	-	2	-
TARGET ECCENTRICITY :deg	-	+/- 4	-
CONDITIONS OF PRESENTATION	Dimly lit room, photopic levels of luminance		

Table 1. Description of stimulus parameters for experiments. Further details of the conditions of stimulus presentation and timing are presented in the technical appendix.

## CHAPTER FIVE: The experiments.

### EXPERIMENT ONE.

#### Method.

#### Subjects.

In the initial experiment the author and two other members of the Psychology Dept. were used as subjects. The author (MWS, male, 24 yrs) and one subject (JMF, male, 47 yrs) were aware of the purpose of the experiment, the other subject (ALA, female, 29 yrs) was unfamiliar with the precise nature of the experiment.

#### Stimuli and Procedure.

Stimuli were presented on a Phillips TP-200 monochrome monitor, controlled by a BBC microcomputer. Care was taken to ensure that the stimuli could be changed within a single raster scan.

Subjects were seated in a dimly lit room with the monitor at a distance of 83cm, and their heads stabilised by use of a dental bite. Throughout the experiment the background luminance of the monitor was 19 candelas/m<sup>2</sup>. The luminance of the target stimulus was 69 candelas/m<sup>2</sup>.

#### Stimulus presentation.

Each trial began with the appearance of a fixation point in the form

of a small dot surrounded by a circle (radius 0.75 degrees). The fixation point remained on for a period varied randomly between 1 and 1.5 seconds in approximately 160 millisecond steps. This was to ensure that there was no accurate information from fixation point onset that would help predict the timing of target onset. The target stimulus consisted of a small square (side 0.75 degrees). Target onset either preceded fixation offset (overlap condition) or followed fixation offset after a pause (gap condition) (see figure 7). Within an experimental session subjects received trials of either the gap condition or the overlap condition, but never mixed. Each experimental session consisted of 4 blocks of 64 trials. Within

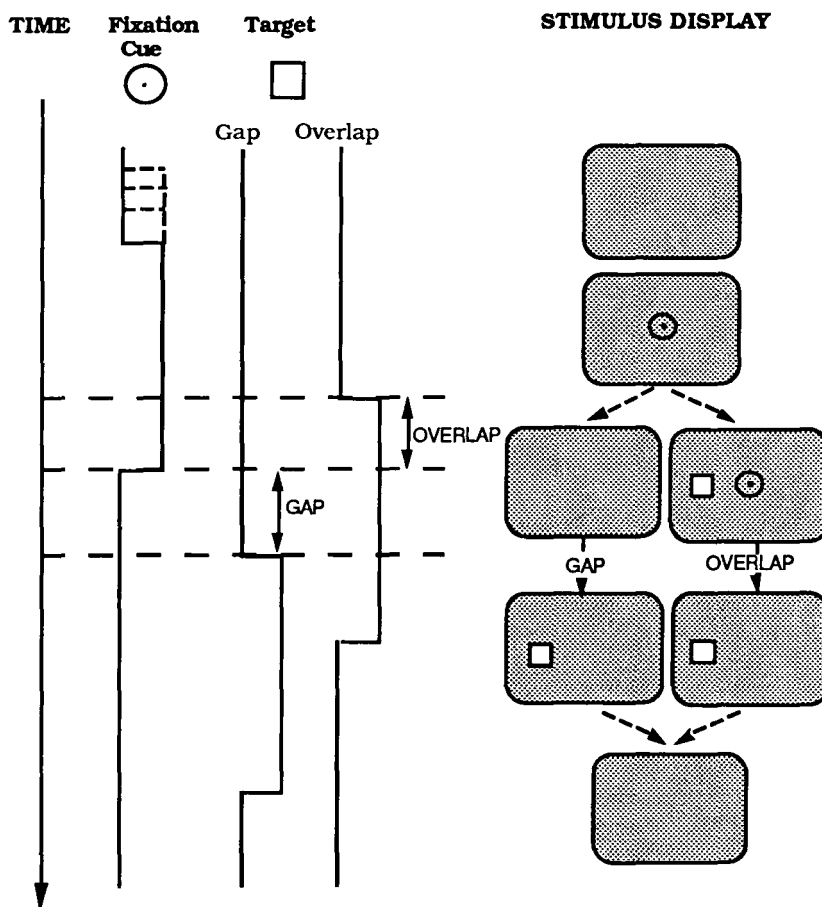

Figure 7. The time course of the stimulus display presented to subjects. Fixation duration varied between 1 and 1.5 secs.

a block the gap or overlap was varied between 0 and 300 msec in 20 msec steps, and for each gap or overlap the target was presented twice on each side of the fixation point. The order of presentation was randomised within every block of trials. Thus neither the position nor the timing of stimulus presentation was predictable. A block lasted about 5 minutes, and a complete session under 30 minutes.

Subjects were provided with a hand held response key and initiated each trial by pressing the key. They were encouraged to respond as fast as possible once a trial was initiated, but were told they could pause between trials if they wished. Subjects were instructed to fixate the dot in the centre of the fixation point until the target appeared, and then to make an eye movement to the target as fast as possible. They were warned that the duration the fixation point remained on would vary, and that they would sometimes be aware of a gap between fixation point offset and target onset, and so it was possible they might make eye movements in the wrong direction in anticipation of the target's appearance. They were told not to worry if this happened, and that it was better to make fast responses that were occasionally wrong than to make an effort to ensure that responses were always correct.

#### Data Acquisition.

Horizontal eye movements were recorded using a method based on the infrared reflectometry technique of Stark & Sandberg described by Young & Sheena (Young & Sheena, 1975). The analogue signal was sampled and digitised every 2.3 msec, and the data recorded onto disc. Recording was initiated at the moment of stimulus presentation, and continued for



1.5 seconds. These records were later analysed using a program that determined saccade onset by finding a threshold deviation of eye position calculated from the calibration procedure. The computed onset was visually inspected to ensure that the program had not picked up noise on

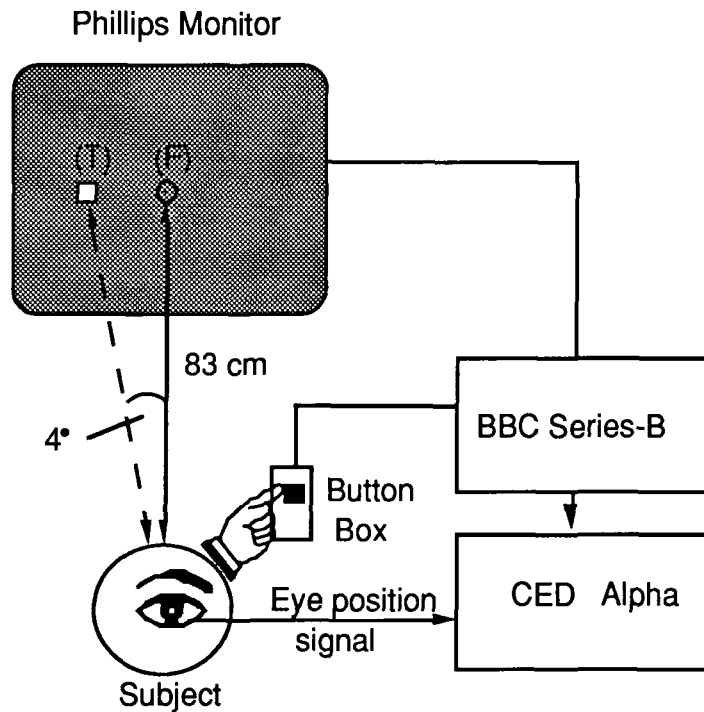

Figure 8. The experimental set up.

the record, and to ensure that the record was not contaminated with artifacts due to blinks etc. Details of data acquisition, calibration of the timing and calibration of saccade amplitudes are provided in the technical section of this thesis. Figure 8. is a diagram of the experimental set up.

#### Initial Analysis of Data.

After analysis of the calibration records the trial records were inspected. Data were discarded if the record of the saccade was not clear for any of the

reasons described above. At this stage 3.5% of trials were discarded. Initial eye position, saccade latency, saccade amplitude and peak saccadic velocity were then recorded for further analysis.

As Kalesnykas and Hallett (1987) pointed out, in analysing the results of experiments using a gap paradigm it is essential to have a method of eliminating anticipatory saccades from the latency records. Initial inspection shows that anticipatory saccades can appear very similar to normal saccades. When the latency of these saccades is as low as 20-30 msec, it can be safely assumed that they are not target guided (figure 9). However a short latency cut off cannot be used as a general criterion by which to eliminate anticipatory saccades, as it is specifically short latency saccades that are of interest.

If target position is predictable, then it is quite impossible to eliminate all anticipatory saccades from the records, as the characteristics of anticipatory saccades are not sufficiently distinct to allow their accurate identification. However if target direction is unpredictable, then it is an easy matter to determine whether saccades of a particular latency are consistently guided in the direction of the target or not. Previous studies conclude that the computation of target position is made in parallel over the visual field, so there is no reason to suppose that there will be an additional aspect of latency associated with the uncertainty of target direction. The latency distributions of saccades made in the correct and incorrect directions for the three subjects are shown in figure 10. From the latency distributions it was found that no incorrect saccade was made for any subject with a latency greater than 78 msec. Subsequently all saccades with a latency less than 80 msec have been eliminated from

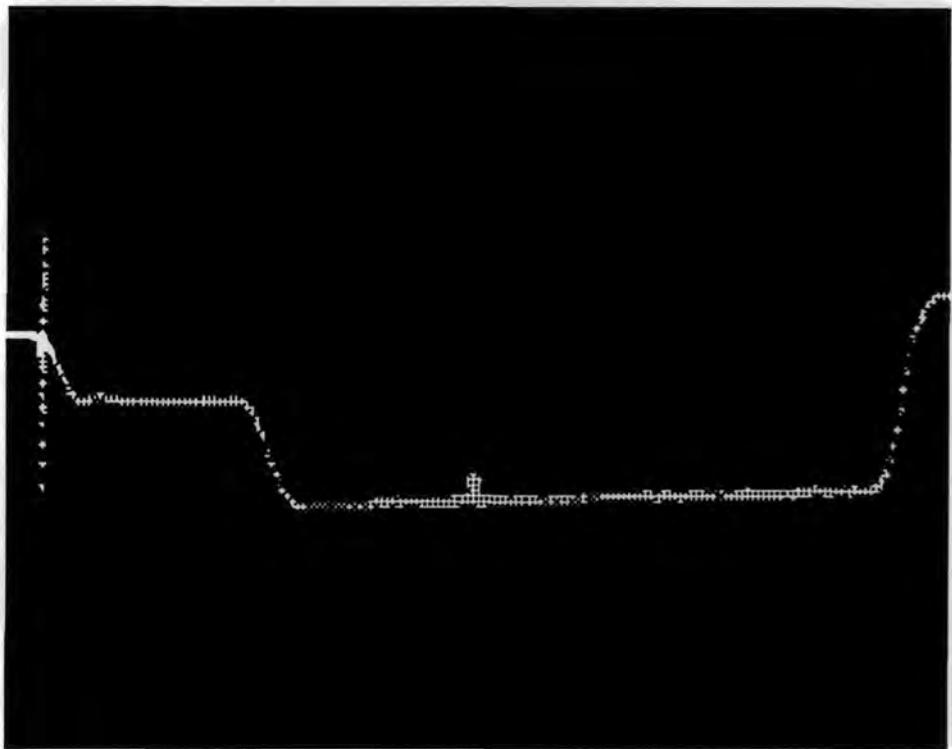
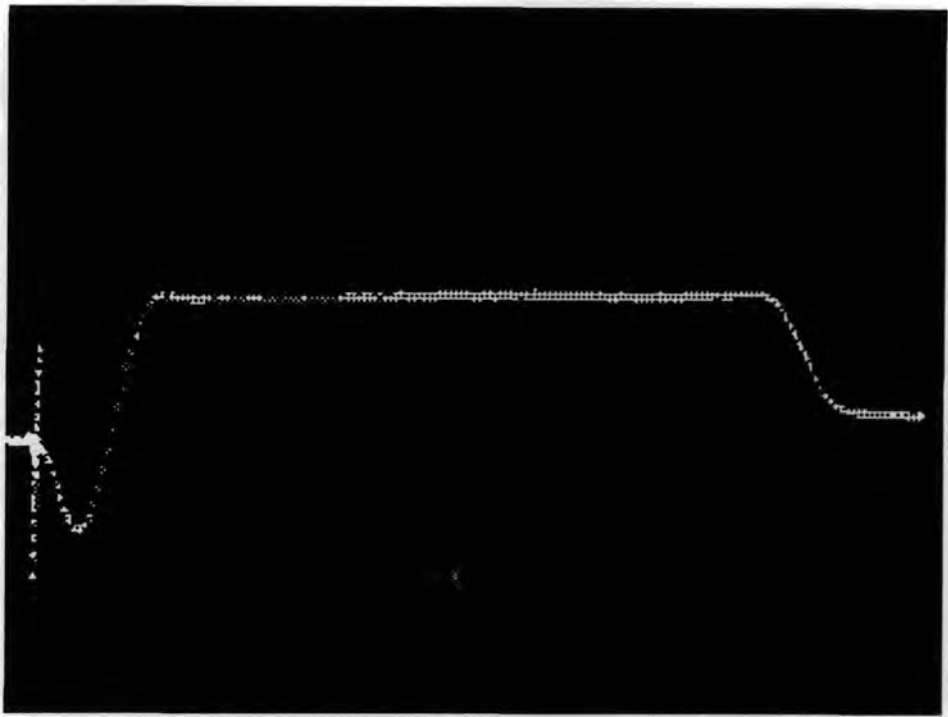

Figure 9. Two anticipatory saccades. The first overlapped by a corrective saccade in the opposite direction, the second in the correct direction but undershooting the position of the target.

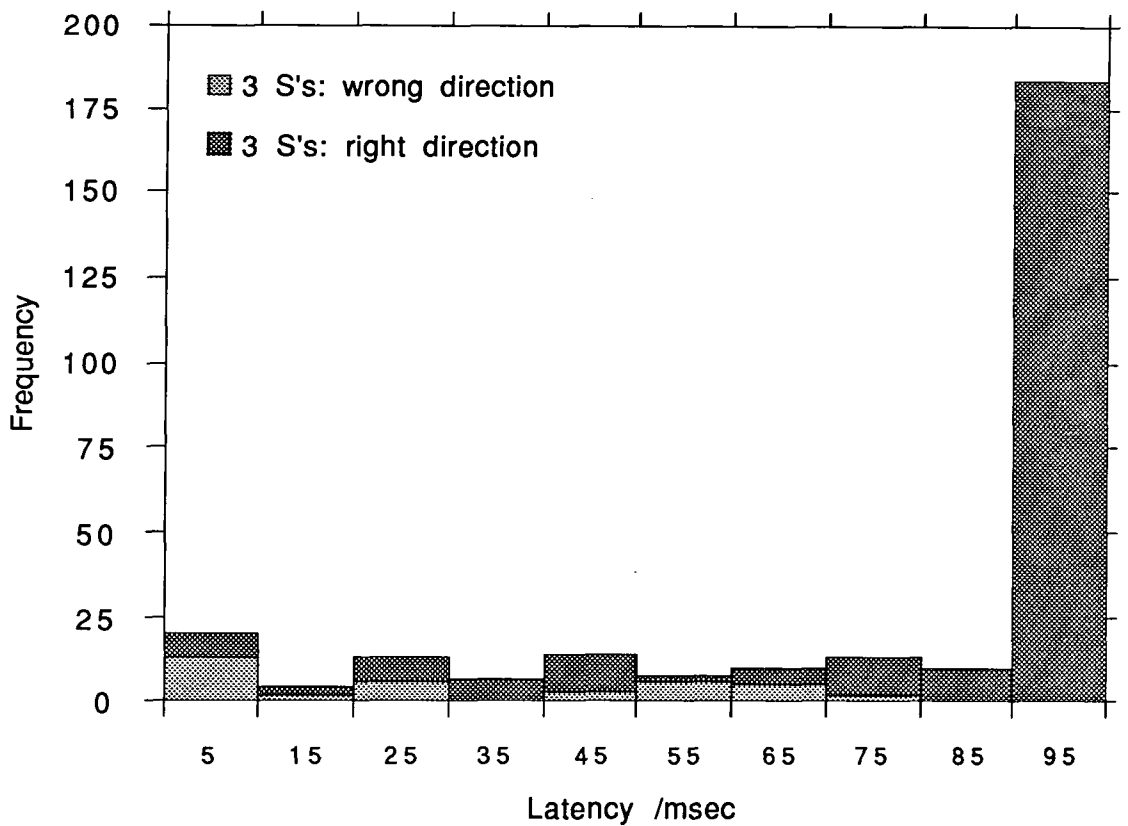

Figure 10. Initial part of latency distribution from Experiment 1., showing the proportions of correct and incorrect saccades for the three subjects.

further analysis.

A second problem introduced by the occurrence of anticipatory saccades is that the anticipatory saccade could occur before eye position began to be recorded. This might affect the latency as well as affecting the amplitude of the subsequent corrective saccade. The procedure of eliminating saccades for which initial eye position deviates excessively from the mean could not be used reliably because of the variation in the signal for initial eye position due to movements of the spectacles with respect to the head, rather than movement within a particular trial due to eye movement itself. The procedure used therefore was to discard saccades with outlying amplitudes. The justification for this was that if an

anticipatory saccade is made it will move the eye either towards or away from the target position, and so the subsequent corrective saccade will either be of substantially increased or substantially decreased amplitude. Two methods of removing outliers were considered. The first, to eliminate outliers from the line of regression of amplitude against latency was rejected because there was no a priori reason to suppose any relationship between amplitude and latency, and it was thought possible that outliers might in fact cluster towards the centre of the latency distribution, and so be less likely to be eliminated. For this reason outliers were defined simply as having amplitudes greater than 2 standard deviations from the mean amplitude for each experimental block. This method is not guaranteed to remove all corrective saccades. However the likely frequency of corrective saccades could be deduced from the frequency of known anticipatory saccades in the recorded data, and it was found that the method of eliminating outliers removed more saccades than would have been expected to be corrective. It is hoped therefore that very few corrective saccades remain within the data.

In total the removal of anticipatory saccades, and of saccades of outlying amplitudes led to the elimination of a further 7.5% of the available data. The remaining records were then analysed further.

### Results.

The latency distributions for the three subjects are shown for gap and overlap conditions combined in Fig 11. For subjects JMF and MWS the distributions are clearly bimodal. However it should be emphasised that these data are for all conditions of gap and overlap

combined. If there is a transition between short latency saccades in most gap conditions, and long latency saccades in most overlap conditions then bimodality is to be expected.

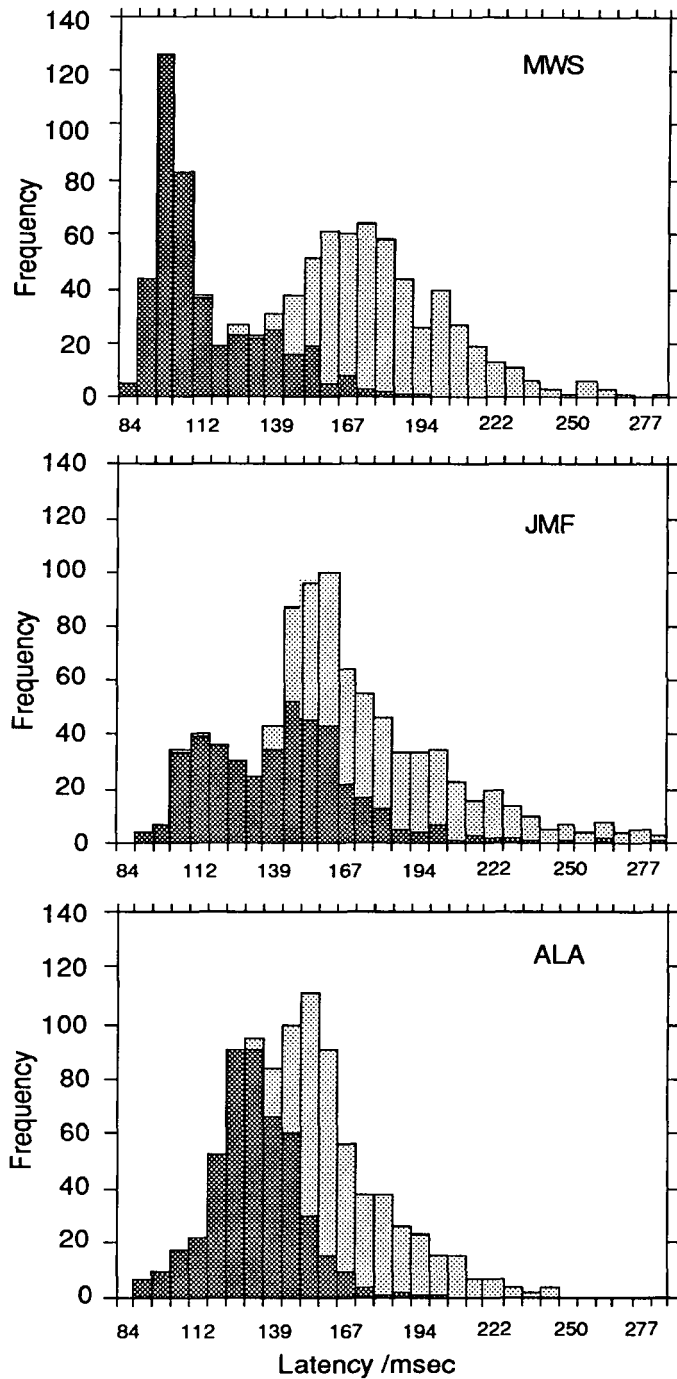

Figure 11. Latency distributions of saccades in gap (dark fill) and overlap (lighter fill) conditions.

Figure 12. shows the mean saccadic latency for each condition of gap or overlap for all three subjects. The lines between the scattered points are the results of an iterative smoothing function averaging latency before and after each plotted point. As expected from the work of other authors (see figure 1) there is a transition from longer latency saccades in the overlap conditions to shorter latency saccades in the gap conditions, and this is likely to account for the overall bimodal distribution of saccade latencies when gap and overlap conditions are combined. It is worth noting that the mean latencies to the

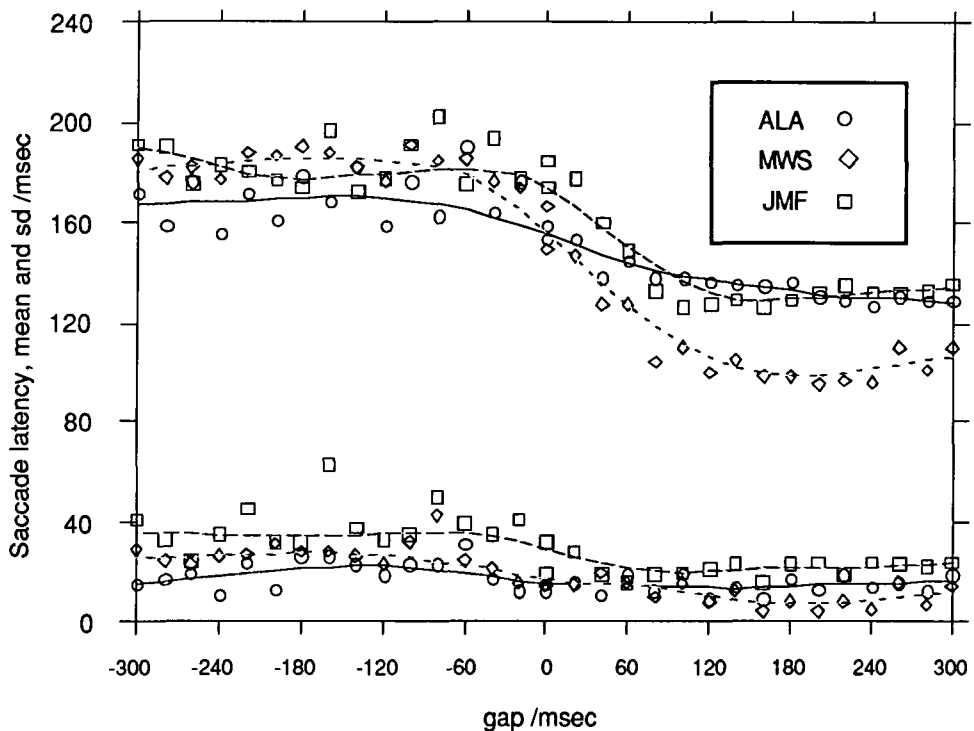

Figure 12. Means and standard deviations of saccades latencies for each of the gap and overlap conditions presented. The higher lines represent means, the lower lines standard deviations.

right of the graph are well within the range of 'express' latencies described by Fischer & Ramsperger. (1986) for different subjects. The mean of the longer latency saccades is between the reported 'regular' and 'fast

regular' latencies (see p.13).

It is not entirely clear then from these data whether the slower latency saccades are part of the 'regular' distribution, and the faster saccades 'express' saccades, or whether all the saccades are regular saccades, and 'express' saccades are not present.

Both possibilities can be considered. If the two populations of saccades shown in figure 11 represent 'regular' and 'express' saccades, and the decrease in mean saccade latency represents a shift from one population to the other, then those gap conditions that lead to saccades with intermediate mean latencies should be composed of a mixture of saccades from the 'regular' and 'express' populations. If this is the case then the standard deviations of the saccades collected in these intermediate gap conditions should be significantly greater than the standard deviations of saccades collected from gap conditions leading to only either 'regular' or 'express' saccades.

On the other hand if the intermediate latencies represent the expected transition from 'regular' to 'fast regular' saccades, then express saccades should occur for the same gap conditions that lead to 'fast regular' saccades, and the 'fast regular' population should be inspected more closely for bimodality.

The same data are therefore presented in terms of the latency distributions for each gap/overlap condition (Fig 13). The data are presented in the form of a colour-coded representation of a 3-dimensional plot, in which the y-axis represents saccade latency, the x-axis represents the



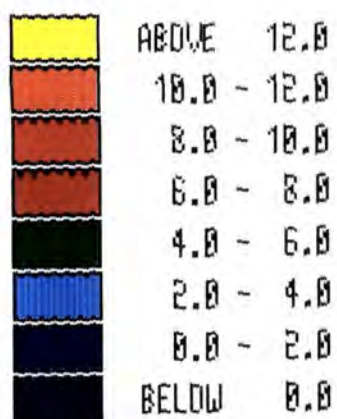
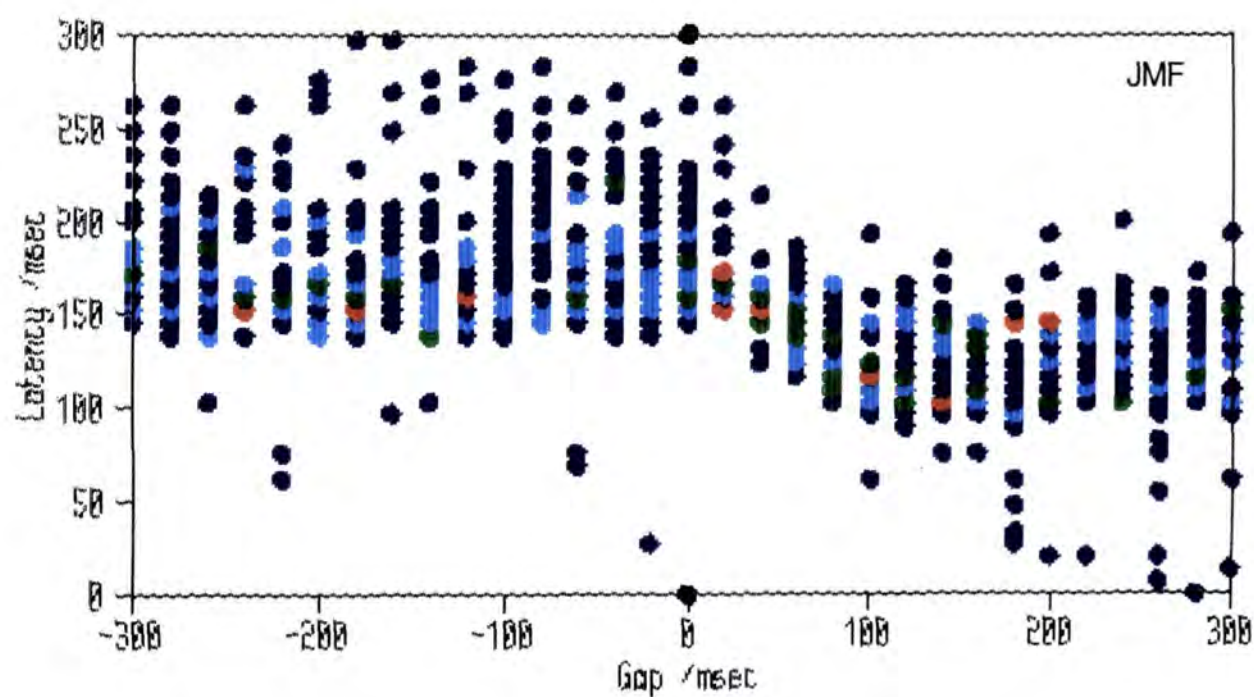
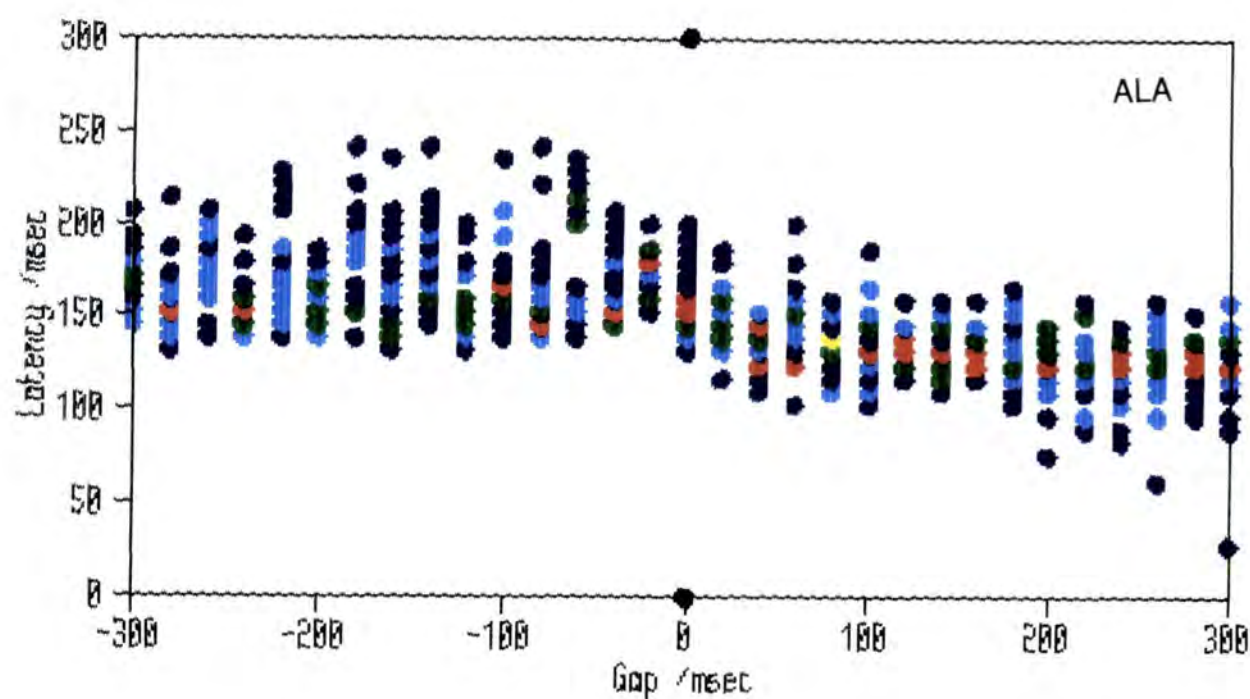

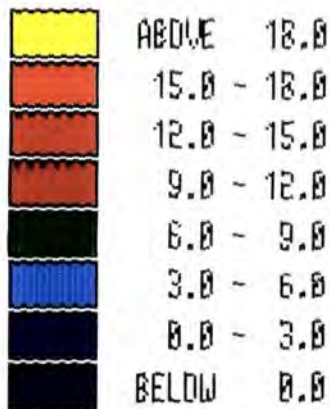
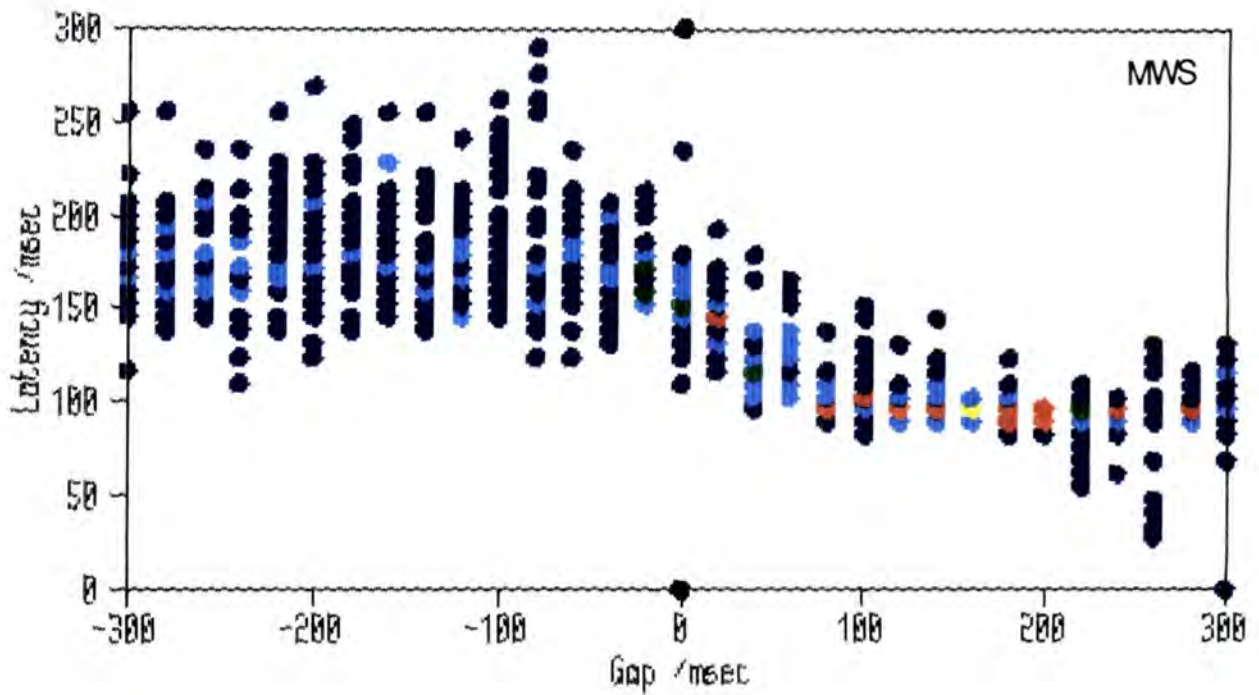

Figure 13. The latency distributions for the three subjects. Gap condition is represented on the x-axis, latency of the y-axis, and colour represents frequency. The figures show for each subject the change in the latency distributions of saccades produced in each gap condition. As the gap duration increases towards the left of the each figure, the saccade latencies decrease.

condition of gap/overlap, and colour represents the frequency distribution of the saccades in each condition. In order to test whether the intermediate gap condition populations showed any signs of bimodality it was decided to study the relationship between the mean latency in each condition and the standard deviation of the mean for the condition. If bimodality occurs for intermediate mean latencies, then those mean latencies will correlate with high standard deviations.

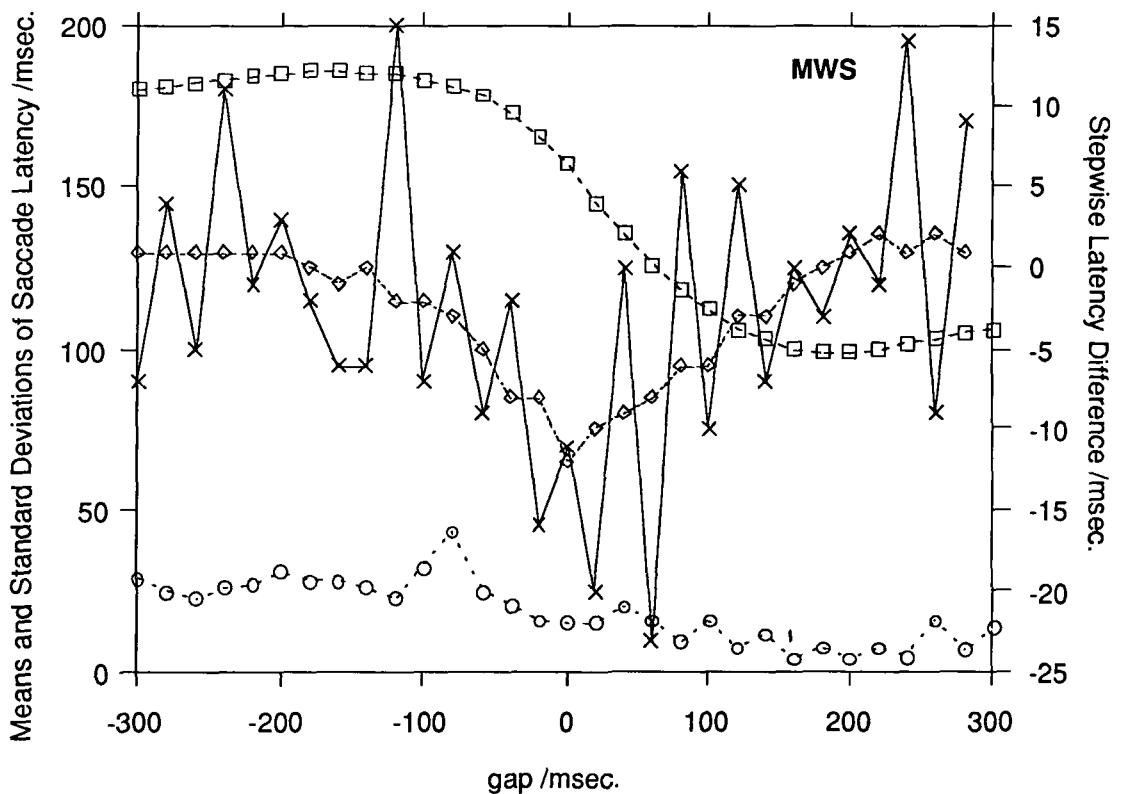

Figure 14a. Showing the effect of the smoothing operation on the function of stepwise latency differences. The squares represent the smoothed data and the circles the standard deviations of these data. The crosses and diamonds show the stepwise latency differences before (crosses), and after (diamonds), the smoothing operation.

In order to make such a comparison it was necessary to derive a quantitative measure of the position of a particular mean latency on the slope of changing latency with gap. The measure used was termed the

'stepwise latency difference'. For each subject a curve was fitted to the scatter of points representing mean latency in each condition, using the weighted fit smoothing function of the kaleidagraph<sup>©</sup> software package. The parameters of the weighting function were chosen by eye, and the same smoothing parameters then applied to the results for each subject. Using this smoothed line, the latency difference for each 20 msec change in gap/overlap was determined. The amplitude of this stepwise latency difference corresponded to the position of the mean latency value on the slope. The smoothing operation was required to lessen the effect of noise in the stepwise latency difference function. Figure 14a shows this function before and after smoothing. The effect of smoothing is to reduce the noise and so increase the chance of finding a significant correlation between the stepwise latency difference and amplitude of the standard deviation. These results are shown for each subject in Fig 14. For two subjects the transition between latencies is clearly marked by the increase in latency difference between different conditions. For the third subject the transition itself is less clear, and consequently the latency differences are smaller.

An analysis of the regression of standard deviation against latency difference was then made (table 2). As can be seen from the table the results were non-significant for all subjects, and indeed the slopes were in the opposite direction to the predictions of bimodality. However from inspection of the figures it appeared that there was a correlation between the size of the standard deviation and the mean latency, irrespective of the change in latency, and it was therefore possible that this effect was swamping an underlying correlation between standard deviation and mean

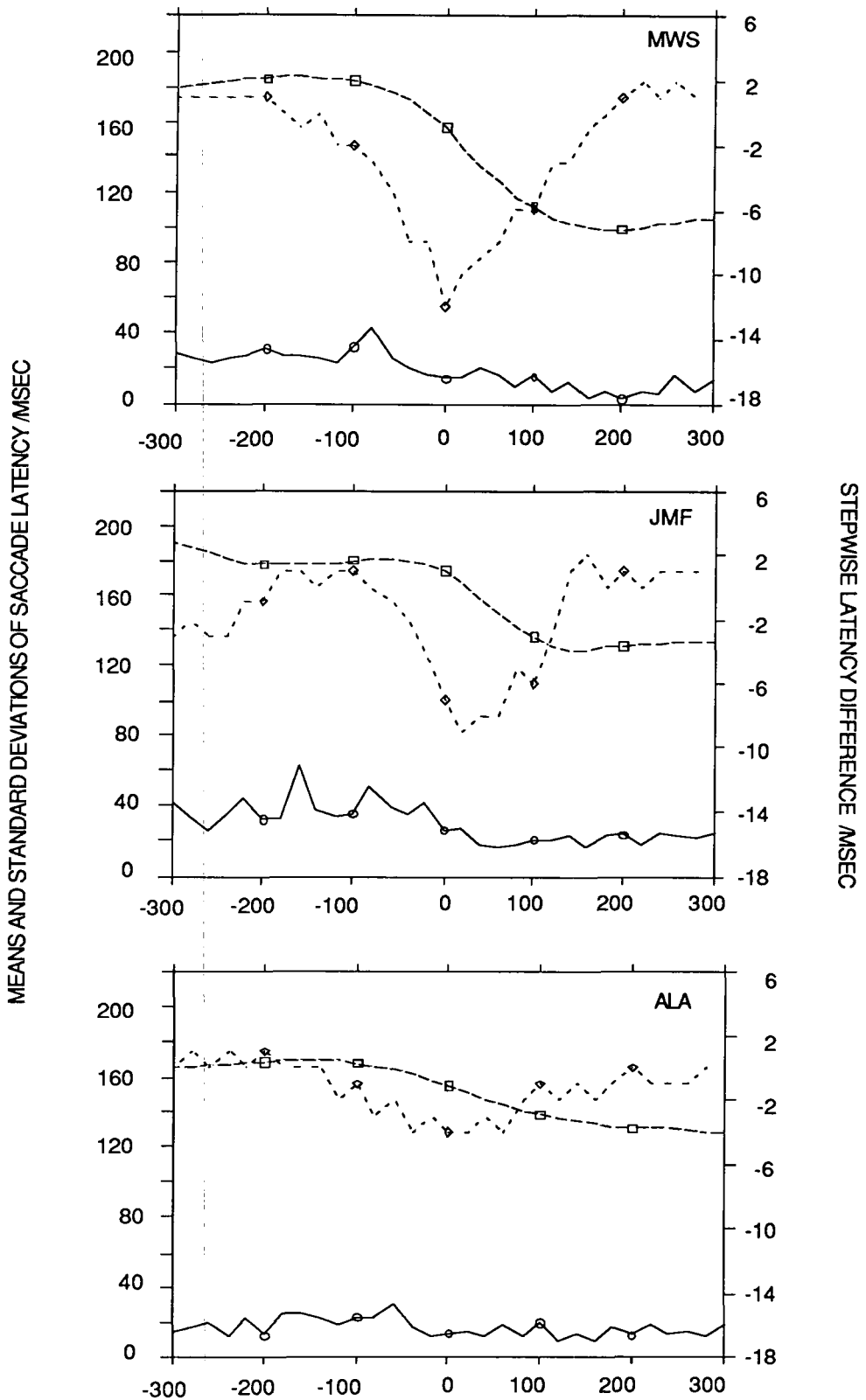

Figure 14. The relationship between mean latency (squares), stepwise latency difference between different gap conditions (diamonds), and standard deviation of saccade latency (circles).

latency within the transitional area. An analysis of regression between standard deviation and mean latency showed a significant result for all three of the subjects. The standard deviations were therefore recalculated using the regression line to remove the expected variance due to the mean latencies. The residual of the standard deviations was then compared to the difference of latencies. The regression was non-significant except for subject MWS, but again the slope itself was in the opposite direction to that predicted for bimodal intermediate distributions.

	ALA slope= r= N=	JMF slope= r= N=	MWS slope= r= N=
Standard Deviation with step-size	.36 .10 30	.16 .07 30	.85 .25 30
Standard Deviation with Latency	.16 .48 *	.23 .88 *	.34 .72 *
Standard Deviation with Resid. step-size	.56 .18 30	.16 .14 30	1.18 .50 *

\* = significant at p=.05

Table 2. Correlations of standard deviation with stepwise latency difference, and with latency, for data shown in figure 13.

The second possibility, that the transition from longer latency to shorter latency saccades is the expected transition from 'regular' to 'fast regular' saccades was therefore also tested. The smoothed data for saccade latencies were used to find the point at which the transition from 'regular' to 'fast regular' saccades was finished for each subject. Saccades collected using gap conditions greater than these values were then combined, and their latency distributions studied for signs of bimodality. For two subjects (ALA and MWS) saccades collected with gaps greater than 180 msec were

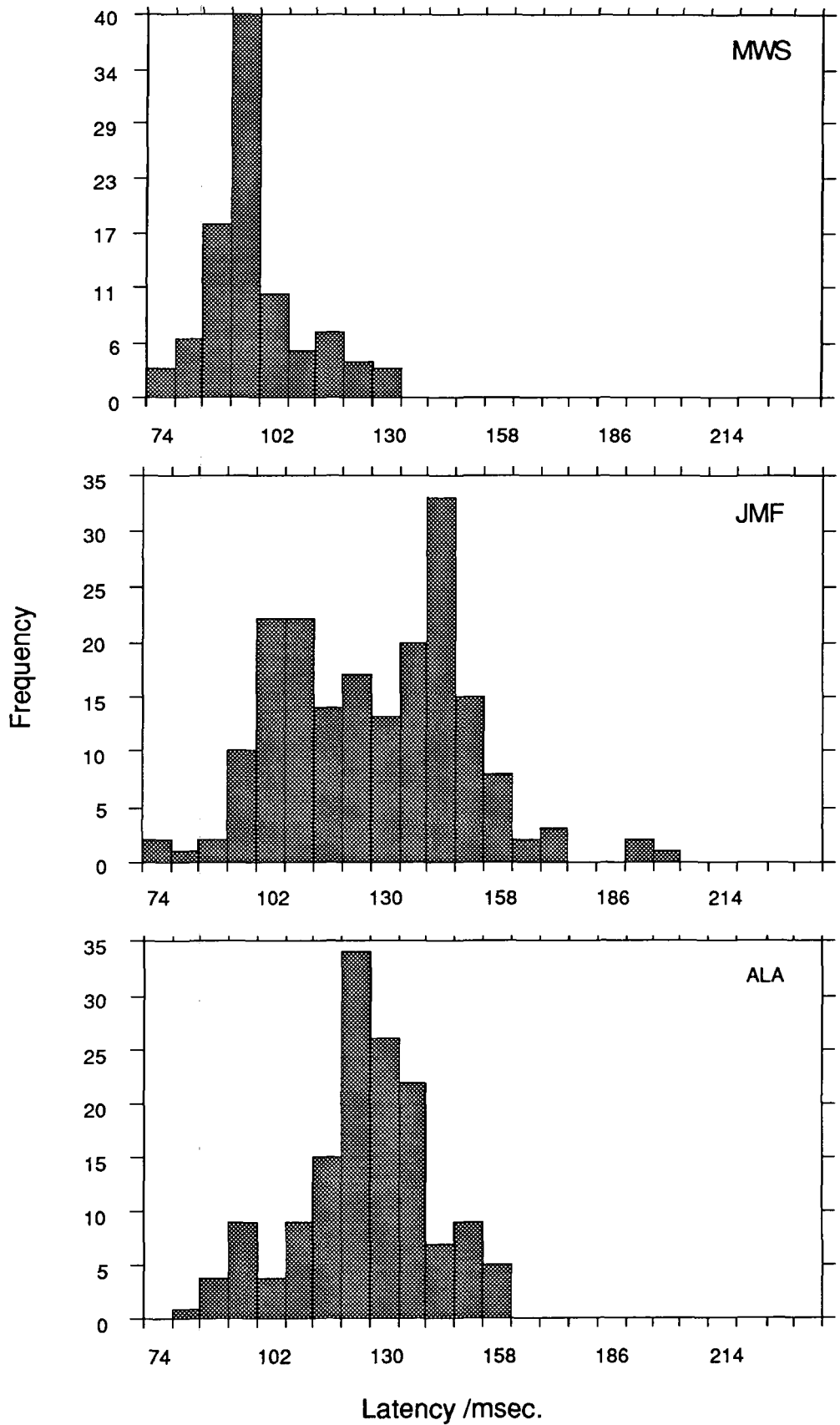

Figure 15. Latency distributions of fast saccades.

## Discussion.

The results of these three subjects reveal little evidence to support the view that express saccades form a distinct population of very low latency saccades in human beings. All the evidence was in fact consistent with a steady decrease in latency depending on the amount of time given as warning.

There are however a number of criticisms that can be made. Firstly the number of subjects was low, and for one of the subjects there was little evidence that saccades of express latencies were in fact being made at all. In addition to this the two subjects who did show 'express' latency saccades both knew the purpose of the experiment, and it could be argued that this in some way distorted their results.

Secondly, experiments that have found clearly bimodal saccade latency distributions have used blocks of stimulus presentations for which the gap remained constant. When the gap is varied unpredictably during a block of trials the fixation point offset gives an indication of the expected time of target appearance, but does not predict it exactly. When the gap is of a single duration for a block of trials the timing of target appearance is entirely predictable from fixation point offset. It was considered possible that this difference in the methods of presentation might account for the differences in results.

Comparison of these results with Saslow's shows many similarities in the general shape of the curve of reduction in saccade latency with increasing gap. The major difference is that for all conditions the mean



latencies collected here are considerably lower than those collected by Saslow, or other authors. The difference seems to be greater for the overlap conditions than for the gap conditions. One possibility is that the low mean latencies found in this experiment were due to the high degree of practice of the subjects. Saslow collected data from experimentally naive subjects over 5 days. His presentations were balanced to remove any effects of learning from comparisons between data for different conditions of gap or overlap, but if improvement did occur between different days this would be expected to raise all the means by a similar amount when the data from different days were combined.

It was therefore considered useful to look at the effects of practice and of blocked as opposed to mixed gap/overlap trials.

## EXPERIMENT TWO: EFFECTS OF PRACTICE.

### Aims.

The mean latencies for large gaps in the previous experiment were between 110msecs and 130 msecs. These latencies are somewhat shorter than the latencies reported by Saslow for equivalent conditions. One possible explanation for the difference is that the subjects used in this experiment were practised, whereas the subjects used by Saslow were unpractised at the start of the experiment. It was possible that by using practised subjects the mean latency was reduced. The aim of the second experiment was to test for the effects of practice on the latency of saccades in the gap paradigm.

### Method.

#### Subjects.

The subjects were two members of the Psychology Department. Neither had been involved previously with eye movement experiments, and neither was aware of the details of this experiment. Subjects were female, aged 25 and 27.

#### Stimuli and Procedure.

Stimuli and procedure were the same as for the previous experiment, with the difference that on each day 4 blocks of gap condition trials were presented, rather than alternate blocks of gap and overlap condition trials. Subjects were requested to move their eyes to the target as fast as possible

when the target appeared and not to worry about occasional mistakes. On the first day subjects were given 10 practice trials to demonstrate the task, and were given practice on the calibration procedure. The session was repeated at the same time of day on four consecutive days.

#### Data acquisition and analysis.

Data acquisition and analysis were identical to that described for the previous experiment.

#### Results.

Plots of mean saccade latency and the standard deviations of saccade latency for each day are shown in figure 16. For both subjects there is considerable improvement in the speed of response from the first day to the last. The improvement is present for every gap condition, with a mean of 33 msec for one subject and 23 msec for the other. The standard deviations of the data also decreased considerably from the first day to the last, by 13 msec and 14 msec respectively.

The improvement with practice appeared across all the gap conditions, although the gap on a particular trial was unpredictable. The practise advantage cannot therefore be due to learning the particular gap that is expected and 'pacing' the response. It could be due to better use of fixation point offset as a trigger for the saccadic processes, or more general practise effects. The results do suggest that the generally low latencies found in the previous experiment could in part be due to the high degree of practise of the subjects.

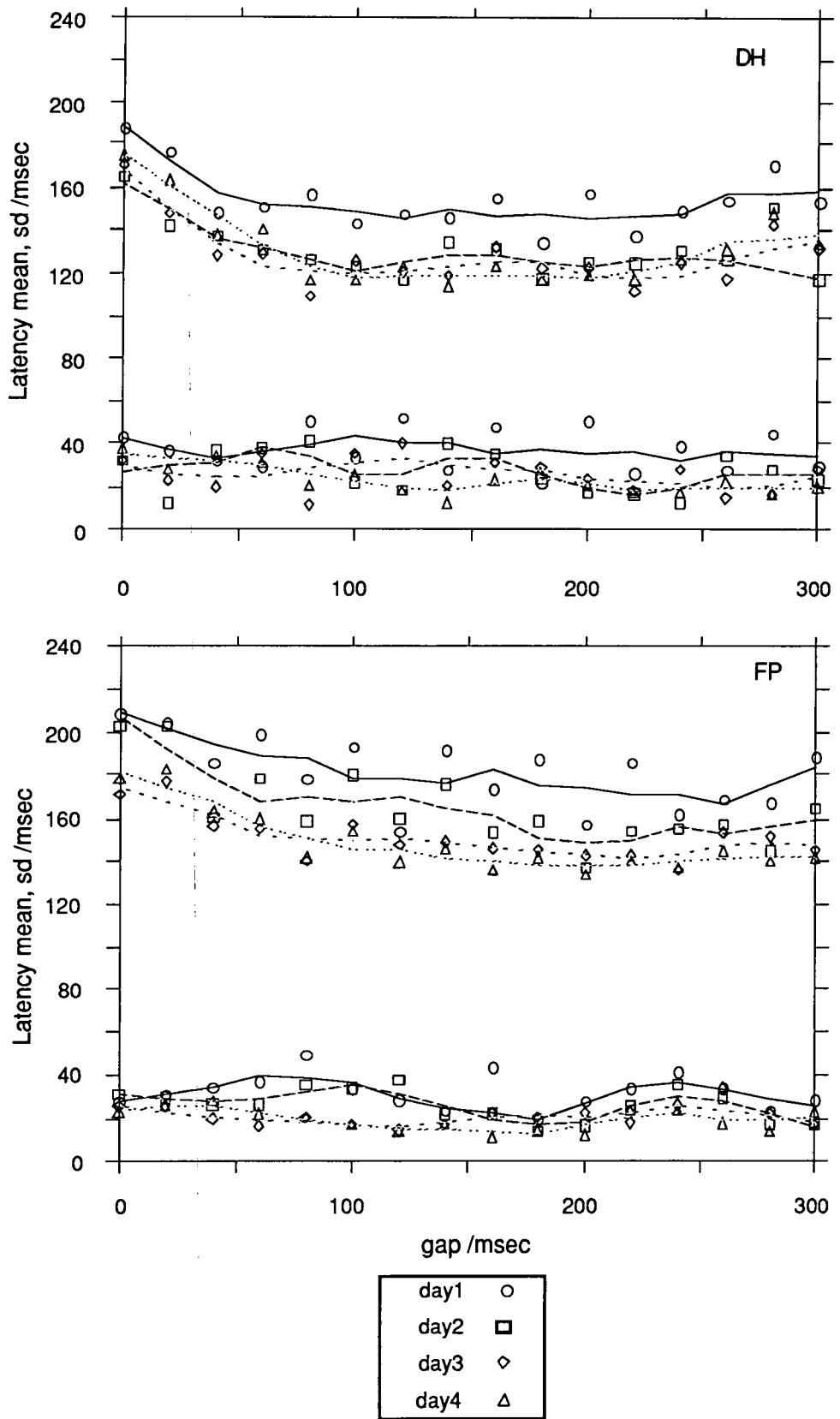

Figure 16. Change in mean saccadic latency for naive subjects over four days.

### EXPERIMENT THREE: Blocked trials.

#### Aims.

A possible explanation for the failure to find 'express' saccades in the first experiment is that the gap conditions for particular trials were mixed, whereas for many of the experiments for which 'express' saccades have been reported the trials have been in blocks of a single gap length. The experiment was therefore repeated using blocks of trials of the same gap length.

#### Method.

#### Subjects.

Subjects were six members of the Psychology Dept. having had varying degrees of experience of fast saccade experiments. Three (MWS, JMF, ALA), were the same subjects used in the first experiment, and a fourth (RK, male, 29 yrs) had been used previously as a subject in very similar experiments. DH was the same subject used as a naive subject, and GW (male, 24 yrs) had not previously taken part in eye movement experiments.

Stimuli and general procedure were the same as for the previous experiment. However trials of the same gap length were presented in a single block rather than mixed randomly within a block. The time of target onset was unpredictable from fixation onset on account of the randomised timing of onset with respect to target appearance. Blocks

consisted of 96 trials with direction randomised between 4 degrees to the left and right of the fixation point. Gap length was varied in 20 msec steps from an overlap of 100 msec to a gap of 120 msec, with the inclusion of additional blocks of 200 msec gap and overlap. The order of presentation of blocks was randomised for each subject. For each subject seven blocks were presented on the first day, and the remaining seven on the second day.

Data acquisition and analysis were the same as for the previous experiment. Out of a total of 8064 trials for all six subjects 347 (4%) were discarded at the initial stage of analysis on account of unclear records. For one recording session particular difficulty was encountered collecting good quality eye movement records, and for this session alone 165 (25%) of the available saccades were rejected.

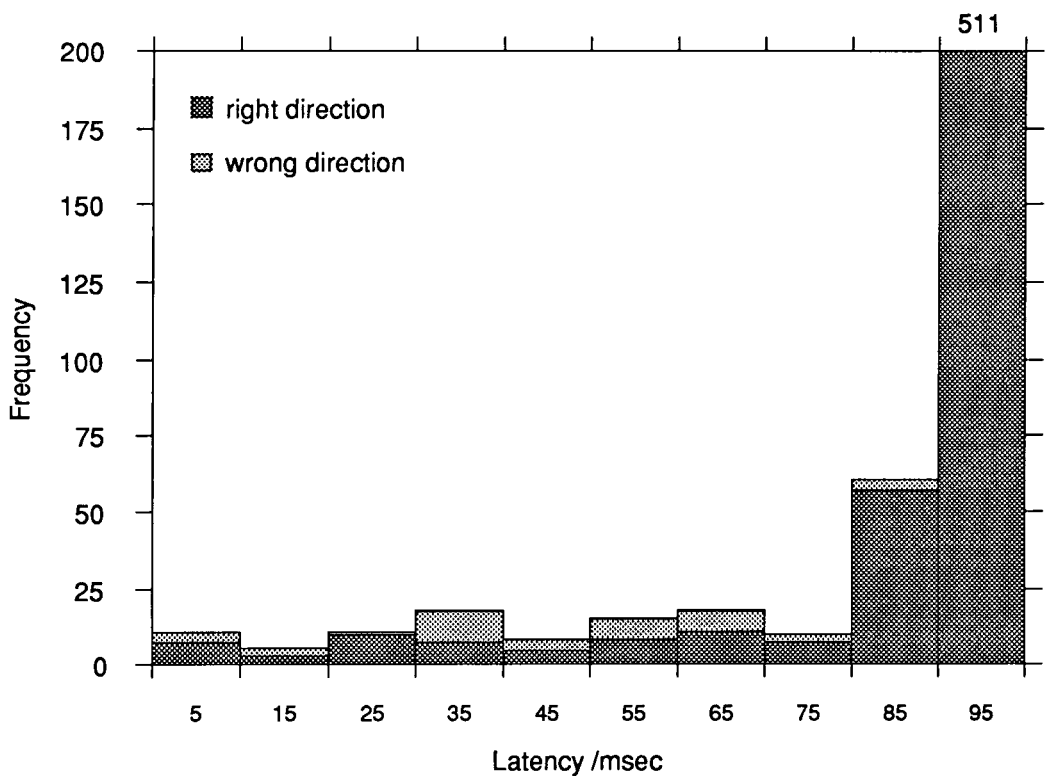

Figure 17. Initial part of latency distribution from Experiment Three, showing proportions of correct and incorrect saccades for six subjects.

The remaining saccades were then analysed in terms of their direction with respect to the target, and the results for the six subjects combined shown in figure 17. On the basis of this analysis saccades with latencies less than 82 msec were rejected on the grounds that they were not target directed. Saccades with latencies greater than 300 msec were also rejected. This led to the removal of 133 saccades (2%) from further analysis. Finally saccades with amplitudes greater than two standard deviations from the mean amplitude for each subject for each block were rejected, a total of another 291 saccades (4%). To summarise, of the maximum of 8064 trials 771 (10%) were rejected from the final analysis.

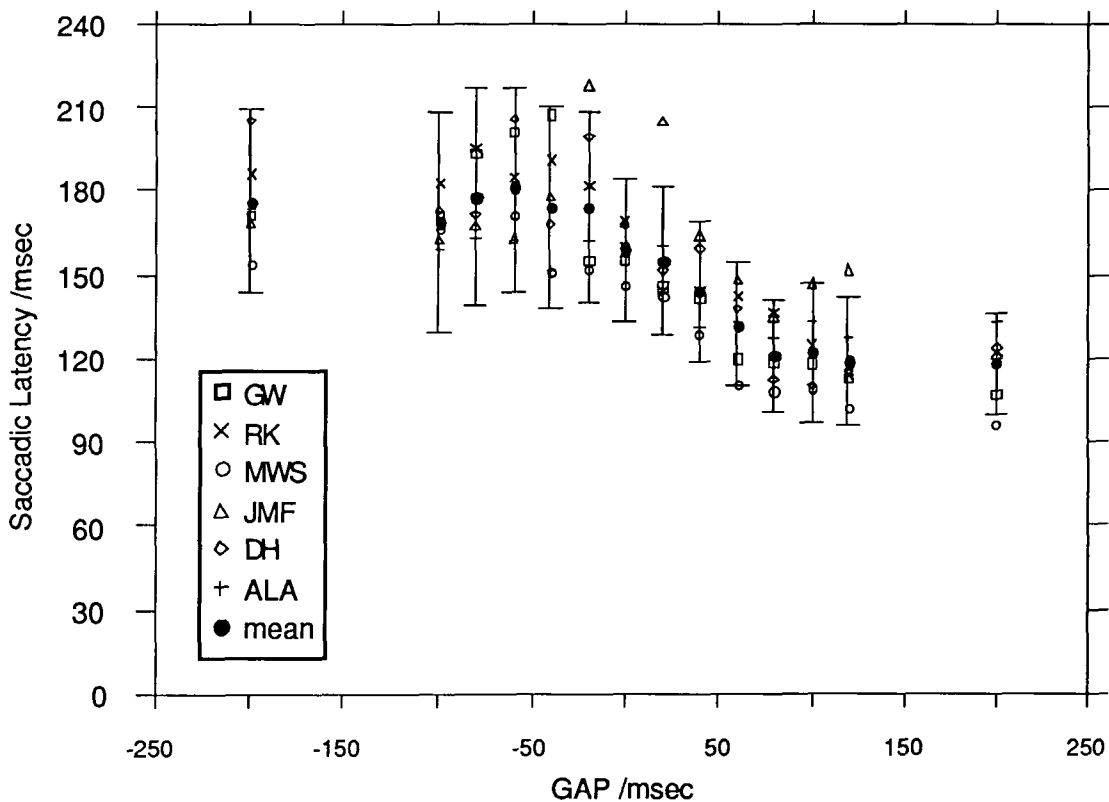

Figure 18. Mean latencies for saccades in each gap condition for six subjects. The error bars represent the mean of the standard deviations for all subjects.

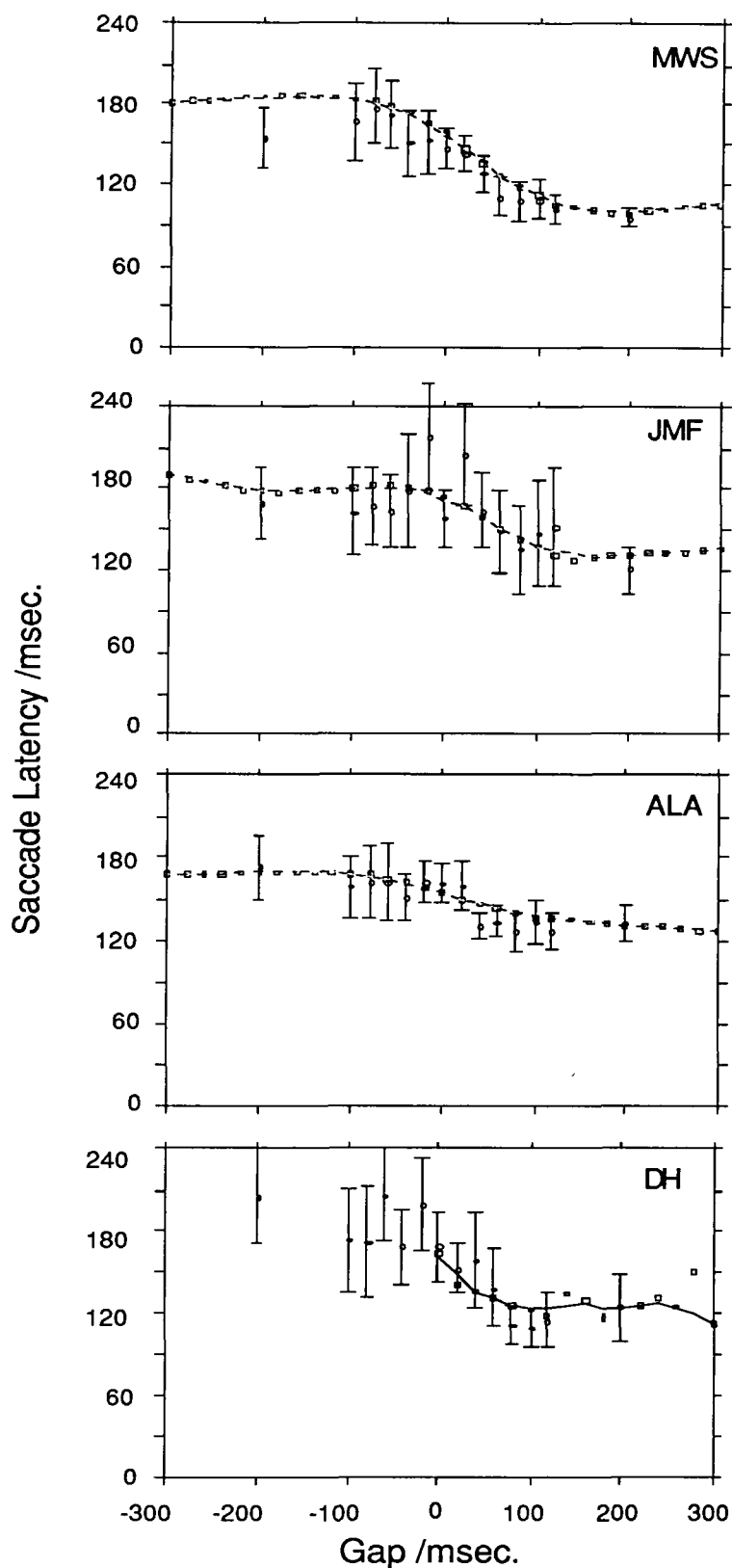

Figure 19. Mean saccade latencies collected using blocks of trials of identical gap conditions (circles), compared to mean latencies previously collected using randomly mixed gap conditions (dashed lines). Error bars show standard deviations.



## Results.

Figure 18 shows the mean saccadic latency for each gap for the six subjects.

In figure 19 the data for 4 subjects are compared to data previously collected for those subjects. In general the results are similar. The largest difference appears in the data of JMF, and in particular for the data collected during a session in which eye movement recording was poor. It is therefore possible that the difference is due to poor recording of data rather than an increase in the actual latency of eye movements for the blocked presentations. The data for this subject were not therefore used in the following analysis.

In the same way as for the previous data a smoothed fit of the results was constructed, and an estimate of the gradient of the slope found using the latency decrease between consecutive gaps. To ascertain that the latency decrease involved a steady change in the mean rather than a crossing over from one mean to another, the relationship of standard deviation to slope was assessed. As in the previous experiment there was a significant relationship between latency and standard deviation, and so this effect was first removed. An analysis of the residual values of standard deviations with the stepsize was then carried out, and the results shown in table 3.

For four of the five subjects analysed the relationship between standard deviation and stepsize is in the opposite direction to that predicted by a transfer of the mean between two separate populations.

For one subject the slope is in the correct direction, but is non significant.

	Standard Deviation with Latency			Residual of Standard Deviation with Step-size		
	slope=	r=	N=	slope=	r=	N=
MWS	.26	.88*	12	.52	.60*	12
GW	.34	.84*	12	.26	.20	12
DH	.28	.76*	12	-.12	.09	12
RK	.60	.89*	12	1.37	.66*	12
ALA	.30	.67*	12	.74	.35	12

\*=p<0.05

Table 3. Correlations of standard deviation with latency, and with step size, for the data collected in experiment three.

### Discussion.

The basic results of the gap/overlap paradigm have been known for over 20 years, and their implications for proposals relating to the role of attention in the control of eye movements have long been recognised. However rigorous comparison of the data with the predictions of the proposed models is rarely made (an exception is Reulen (1984)). It is the purpose of this chapter to make such a comparison, and to use the data acquired in the course of the experiments in a qualitative consideration of models of saccadic control.

The data were therefore combined to try and establish an averaged performance for all six subjects. Figure 18 shows the results for all subjects combined with the measure of variation given as the mean standard

deviation for each subject at the gap length specified. One problem with this treatment is that if the slopes of individual subjects do not coincide, they will tend to average out at the beginning and end, and so produce a longer, flatter averaged slope that might not reflect the individual data.

The data have therefore been combined in a second way, by extracting significant points from each graph and taking an average of each of these to produce an overall average graph shape. For the sake of simplicity it has been assumed that each individual result consists of two flat sections connected by a straight slope (figure 20).

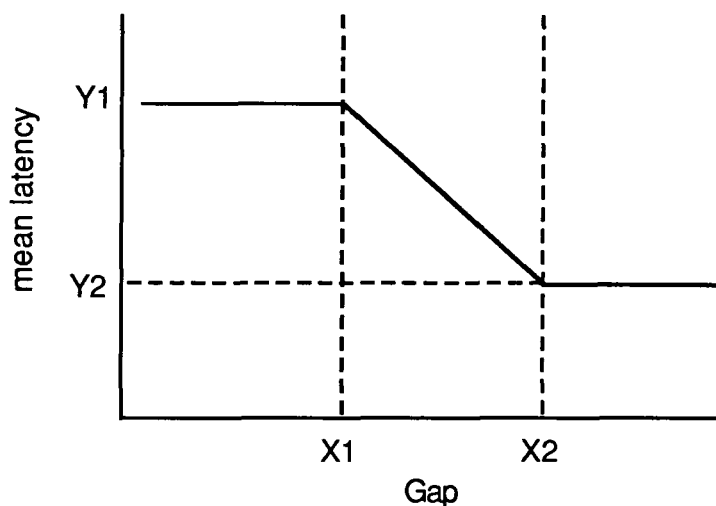
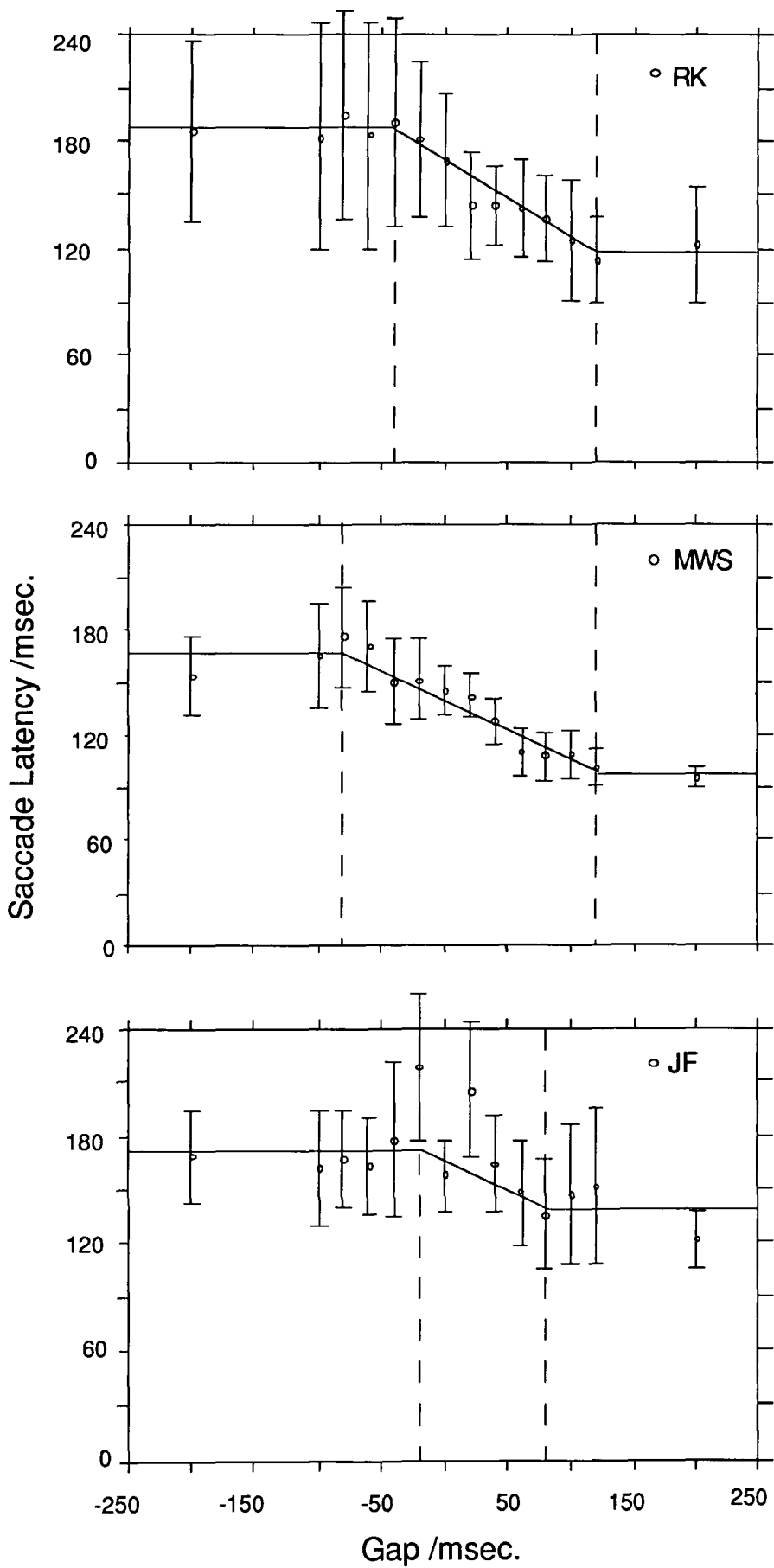
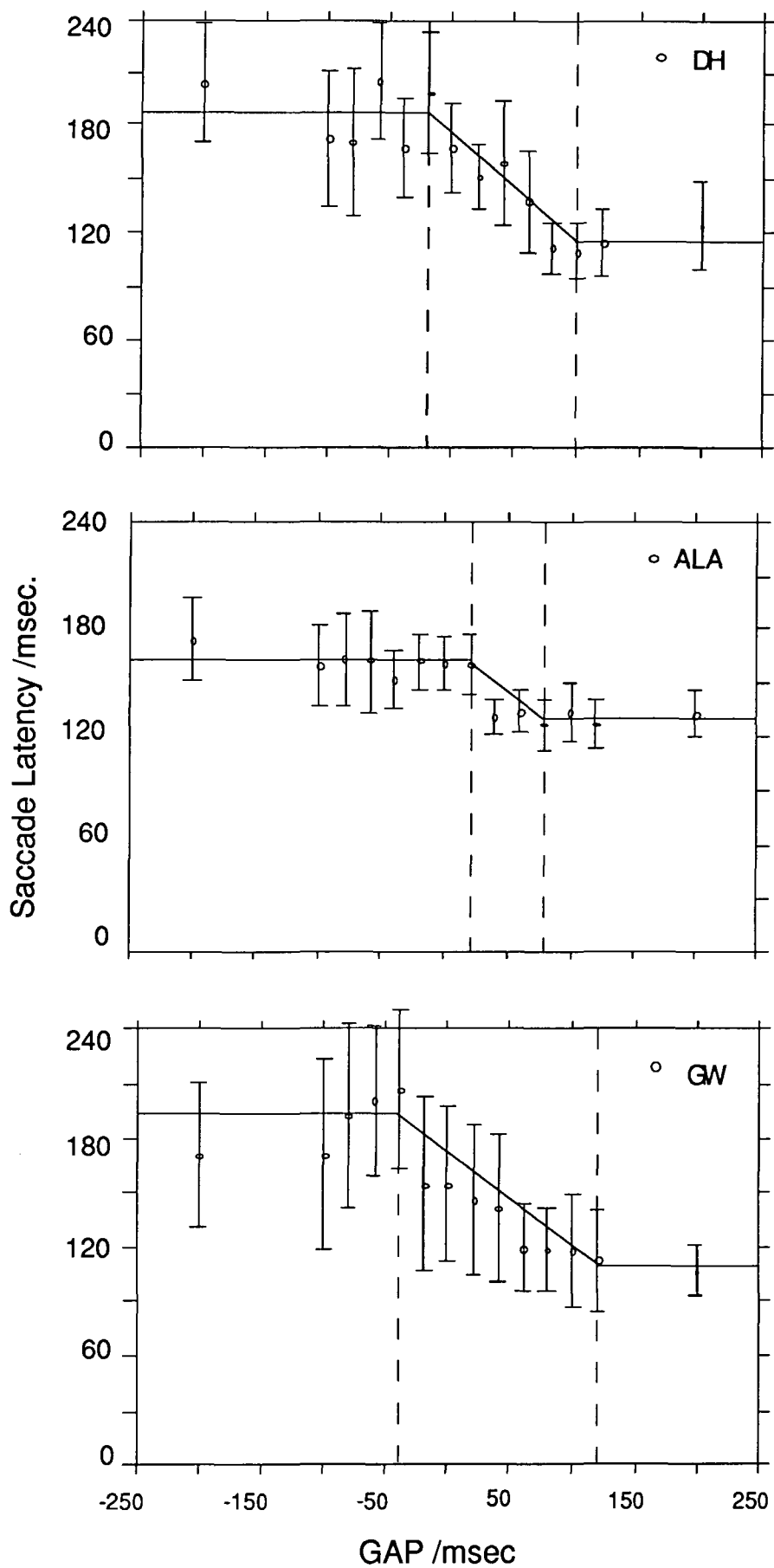

Figure 20.

For each subject the beginning and end of the slope (X1 and X2) have been judged by eye. An average of all the Y values prior to X1 has been calculated to represent Y1, and an average of all the Y values subsequent to X2 calculated to represent Y2. The graph has then been constructed to connect (X1,Y1) and (X2,Y2). The graphs for each subject are shown in figure 21, and the values of X1,Y1,X2 and Y2 presented in table 4. A mean has been taken of each value to produce a graph of the averaged data. This graph is subsequently referred to in the discussion of the results (figure 22).





(on previous pages) Figure 21. Means and standard deviations of saccade latencies for individual subjects, with fitted slopes as described in the text.

	X1	X2	Y1	Y2	slope
MWS	-60	120	167	99	-0.38
GW	-40	120	189	110	-0.49
DH	-20	100	187	116	-0.51
RK	-40	120	188	118	-0.44
ALA	20	80	162	130	-0.53
JMF	-20	80	173	138	-0.35
mean	-27	103	178	119	-0.45

Table 4. Values of X1, X2, Y1 and Y2 taken from data presented in figure 21, and gradient of slope calculated with these data.

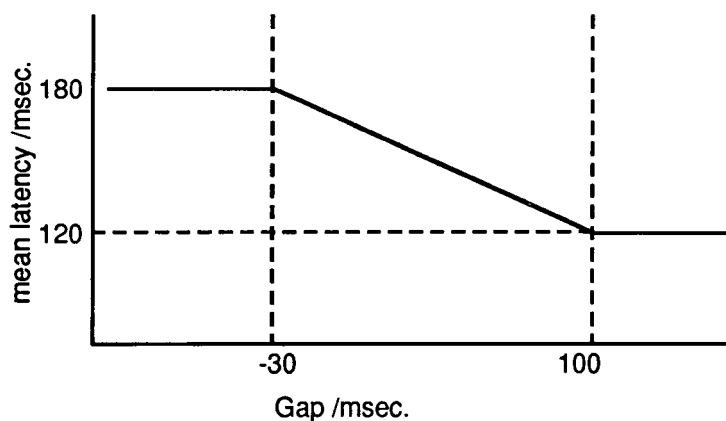

Figure 22. Slope of reduction in 'regular' saccade latency, using mean values from table 4.

### The Preparation Model.

The preparation model assumes that saccadic latency is composed of efferent and afferent delays, a delay associated with triggering, which may be target independent, and a delay associated with determining the coordinates of the saccade, which is target dependent. The model proposes that the latency advantage occurring in the gap conditions is due to the triggering signal being given by the fixation point offset, before the target actually appears.

Becker and Jürgens (1979) found that for double step experiments the minimum time at which a change in target position could affect saccade programming was 70 msec, and used this as an estimate of efferent and afferent delay. Smit and van Gisbergen (1989), used a different method and gave an estimate of 50 msec. For the purposes of this discussion an estimate of 60 msec is used. So far as the model is concerned it is not necessary initially to distinguish between efferent and afferent contributions to this delay.

Using this estimate, and the minimum saccadic latency in the gap condition of 120 msec found by experiment, an estimate of 60 msec is found for the additional time necessary to calculate target position and to trigger the saccade (Targ).

Using the same estimate for combined efferent and afferent delays, and assuming that preparation and target dependent processes are separate, the mean saccadic latency in the overlap condition allows the preparation time to be calculated as 180 (Total Latency) - 60 (efferent +

afferent delay) = 120 msec.

As discussed in Chapter Three, there are two features of the slope that require explanation; its gradient, and the overlap at which it starts. The simplest preparation model would predict the first gap advantage to occur with the first gap, and a slope of the advantage of -1. These results however show the gap advantage first appearing with an overlap of 30 msec, and having a mean gradient for six subjects of -0.45, or -0.5 if it is calculated from the mean values of X1, Y1, X2 and Y2 for each subject.

Two proposals can account for an advantage occurring for short overlap conditions. Firstly, if the afferent delay due to fixation offset is shorter than that due to target onset, then the preparation model predicts an advantage occurring at an overlap of the same time as the difference between the afferent delays. This difference might be as much as 25 msec.

Secondly, if saccade elicitation can be triggered by fixation offset *or* target onset, and if these signals are independent, then there is a reduction in predicted latency when the signals overlap because it is always the earlier of the signals that will in fact trigger the saccade.

A qualitative estimate of this advantage can be gained by considering the standard deviations of the latency data. For longer overlaps the mean standard deviation of latency is 40 msec. This consists of the variation in timing of Prep, plus variations in timing of Eff + Aff. For longer gaps the mean standard deviation is reduced to 20 msec. This consists of variation in timing of Targ, plus variations in timing of Eff + Aff. If one arbitrarily assigns a sd of 10 msec to Eff + Aff, then the variation due to Prep is 30



msecs. If two independent probabilistic processes occur simultaneously, then the probability that either one or the other is complete at a given time can be found using probability theory. Assuming a normal distribution of latencies for both processes, then if the two run simultaneously the mean latency is expected to be reduced

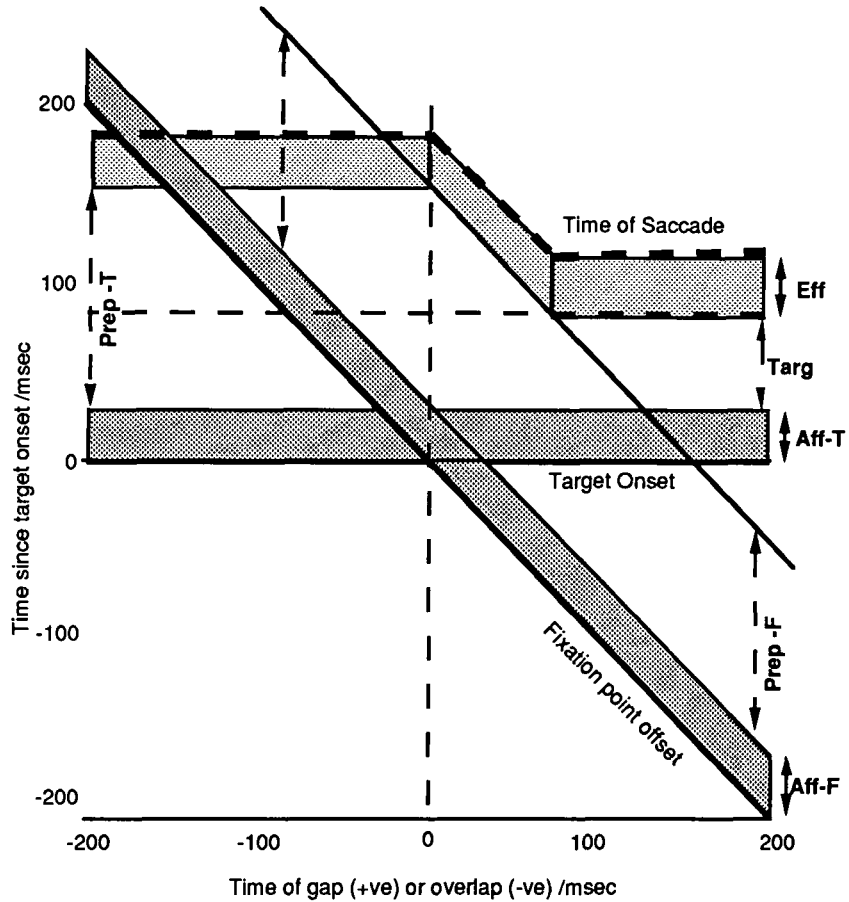

Figure 23. The predictions of the 'preparation' model, assuming afferent delay due to fixation offset is the same as the afferent delay due to target onset.

by approximately a third of the standard deviation, or 10 msecs. As the gap or overlap increases the advantage of running two processes simultaneously decreases. The effect of this simultaneous triggering is therefore rather small, shifting the onset of gap advantage about 10 msecs earlier, but in combination with an advantage of afferent processing of

fixation offset over target onset the observed gap advantage occurring for overlaps of 20 - 40 msec does not seem impossible to explain.

Despite the likelihood that the expected gradient of the slope would be somewhat less than the initial estimate of -1, it is not clear that the additional factors taken into account would be able to reduce it to the experimentally determined value of -0.5, and so the slope remains a difficulty for the 'preparation' model.

One possibility is that the particularly low slope is the result of using mean values for saccade latency for each gap condition for each subject. If it is difficult always to make use of the cue of fixation offset effectively, then this mean consists of some saccades of the optimum minimum latency possible, and others that are slower than the optimum. If minimum values were used, then the lowest latency for the gap conditions would be closer to 105 msec, and the slope correspondingly increased. There is a similar difficulty associated with using the overlap values. The assumption for these is that the triggering process is always elicited by the first available stimulus. A subject can however guess the likely time of onset, and begin the triggering process in the absence of a cue. An attempt was made to prevent this by randomising the duration for which the fixation point remained on, but it is possible an advantage was not eliminated.

### The Facilitation Model.

If the facilitation model is considered, then the gradient of the slope gives an estimate of the advantage of fast processing over regular processing. When all processing is carried out at the regular rate saccade

latency is 180 msec. The start of the slope marks the point at which the first effects of fast processing become apparent, and the end of the slope the point at which the maximum amount of processing is carried out at the fast rate. For the facilitation model no particular account needs to be taken of efferent or afferent delays. The important issue is whether or not a particular source of delay is open to facilitation. Initially it will be assumed that all sources of delay can be facilitated, and that the facilitatory effects are the same wherever they occur.

The 'facilitation' model can then be used to analyse the results in more detail. The first piece of information is derived from the length of overlap that still gives a latency advantage. The data give a value of 30 msec. This is the point at which the advantage of fast processing first becomes apparent, and so provides information about the delay before the system switches from the regular state to the fast state. For the values found here this would be  $180 \text{ msec} - 30 \text{ msec} = 150 \text{ msec}$ . In other words, 150 msec after fixation offset the system switches into the fast processing state, and thereafter all processing is carried out in the fast mode. This delay therefore makes a further prediction, that the range of gap lengths that gives a gap advantage will also be 150 msec. This prediction follows from the point at which time of fixation offset + 150 msec (delay before state change), overlaps the afferent delay of the target (assumed to be zero). After this time there is no additional advantage in greater gap lengths, because all the processing is already carried out in fast mode.

With these figures, for all processing at the regular rate, the overall latency is 180 msec. With all processing at the fast rate overall latency is 120

msecs. Thus the ratio of fast:regular processing rates is  $180:120 = 3:2$ . At this rate the gradient of the slope would be  $60/150$ , very close to the experimental value.

However this is assuming that all processing that can occur is open to facilitation. If there is any efferent or afferent delay that cannot be speeded up, and this would seem to be physiologically necessary at the saccadic plant, then this will affect the model. If there is an efferent delay, then the estimate of switch delay has to be reduced, the predicted range of gap values for which there would be a fast processing advantage will be reduced, there will be a corresponding increase in the proposed ratio of fast:regular processing and an increase in the gradient of the slope.

For instance, if 20 msecs of efferent delay is not open to facilitation, then the estimate for switch delay is reduced by 20 msecs, and the point at which maximal gap advantage is gained is shifted 20 msecs to the left.

Similarly, if there is 20 msecs of unaffordable afferent delay for the target the point at which maximal advantage is gained will be shifted 20 msecs to the left. If the same estimates for efferent and afferent delay are used as for the preparation model, and if these delays are not open to facilitation, then the extent of the slope would be reduced to 90 msecs, and would have gradient of -0.9.

Thus if realistic assumptions are made about the likely occurrence of delays, then either model predicts a steeper gradient than that observed.

The two models are not mutually exclusive. It is quite possible that

there is an advantage both in faster processing following a warning, and an advantage in starting certain processes before the target appears. If this were the case the advantages of the two models would be additive, and this would make the slope correspondingly steeper. This therefore seems unlikely, as the problem with both models is to explain the shallowness of the observed slope.

## CHAPTER SIX: Conclusions.

It has been the aim of this thesis to consider the predictions of some of the models proposed to account for saccade latencies in various conditions of gap or overlap with a visual cue, and to compare these predictions with the experimental results of such presentations.

Although the experimental technique has been used on many previous occasions, and many of the basic findings have been previously published, it is only recently that the phenomenon of express saccades has been reported. It was possible that previous work had not observed such saccades because their unusual short latencies led to the assumption that they were anticipatory, and they had thus been excluded from analysis. In this work particular care was taken to look for such express saccades, and relate their occurrence to the data previously published using similar techniques.

Using the techniques described, no evidence for the existence of such a population of express saccades was found. Saccades with short latencies, similar to the latencies previously described as 'express' were observed, but these were found to be part of a continuous distribution of saccade latencies, and not part of a separable population of saccades.

Furthermore, it is not clear that a physiologically plausible model of saccadic processing, of the type described by Fischer et al. would in fact lead to the prediction of a separable population of express saccades.

It is the conclusion of this thesis that in humans at least there is no

separable population that can be described as 'express' saccades. The data collected by other workers of express saccades in monkeys would therefore seem to relate to a phenomenon not found in humans. If this is the case then attempts to relate such saccades to models of attention or saccadic processing in humans will fail. It is therefore suggested that before such models are further developed, and before more work on the occurrence of express saccades in monkeys is pursued, it is essential to repeat work of the type described in this thesis, and either replicate the occurrence of express saccades in humans in a convincing way, or confirm their non-existence.

## APPENDIX.

### 1. Stimulus presentation.

The stimuli were presented on a Phillips TP-200 monochrome monitor with phosphor P-31. Because of the use of this phosphor the fading image of the fixation point was clearly visible some time after it had been turned off. (see fig 24 for photo of time course of fading). This problem was overcome by using a lit background brighter than the fading image. The luminance of the stimuli and background was measured using an SEI exposure photometer. Background luminance was 19 candelas/m<sup>2</sup>, and fixation point and target luminance was 69 candelas/m<sup>2</sup>, giving a Michelson contrast between stimuli and background of 0.58.

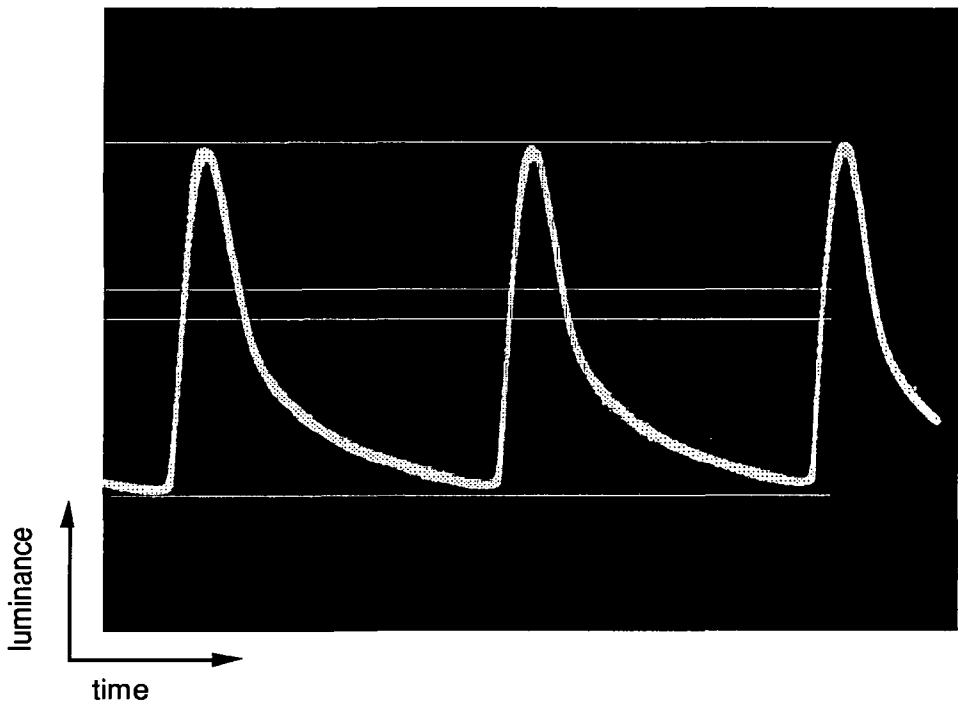

Figure 24. Time course of stimulus offset. The peaks are 20 msec apart.



The timing of stimulus presentation was controlled using a BBC series B microcomputer. The difficulty of accurate timing using the centisecond clock was overcome by using the screen synchronisation command to control the presentation. This meant that gap and overlap durations were determined in units of the refresh rate of the screen, specified as 20 milliseconds. The accuracy of this specification was later checked.

The timing of targets and fixation points are measured as if onset and offset were immediate, and as if the stimuli were steady light sources. In fact offset was not immediate due to the fade time of the phosphor. This has been measured, and the phosphor luminance due to the target fades to the same luminance as the background after 2 msec (figure 24). Rise time to the same level took approximately 1 msec.

Because the stimuli are presented using a raster scan with a 20 msec refresh rate they are not steady light sources, but have a frequency of 50 Hz. This creates difficulties in terms of the definition of gap and overlap lengths. The definitions used for this thesis are shown in figure 25. Together with the effect of fixation stimulus fade time this means that the presentation defined as simultaneous fixation offset and target onset in fact represents an overlap of 3 msec. This amount of time can therefore be added onto the overlap durations, and taken off the gap durations. In the final analysis however all latencies have been rounded to the nearest 10 msec, and so this discrepancy is not significant.

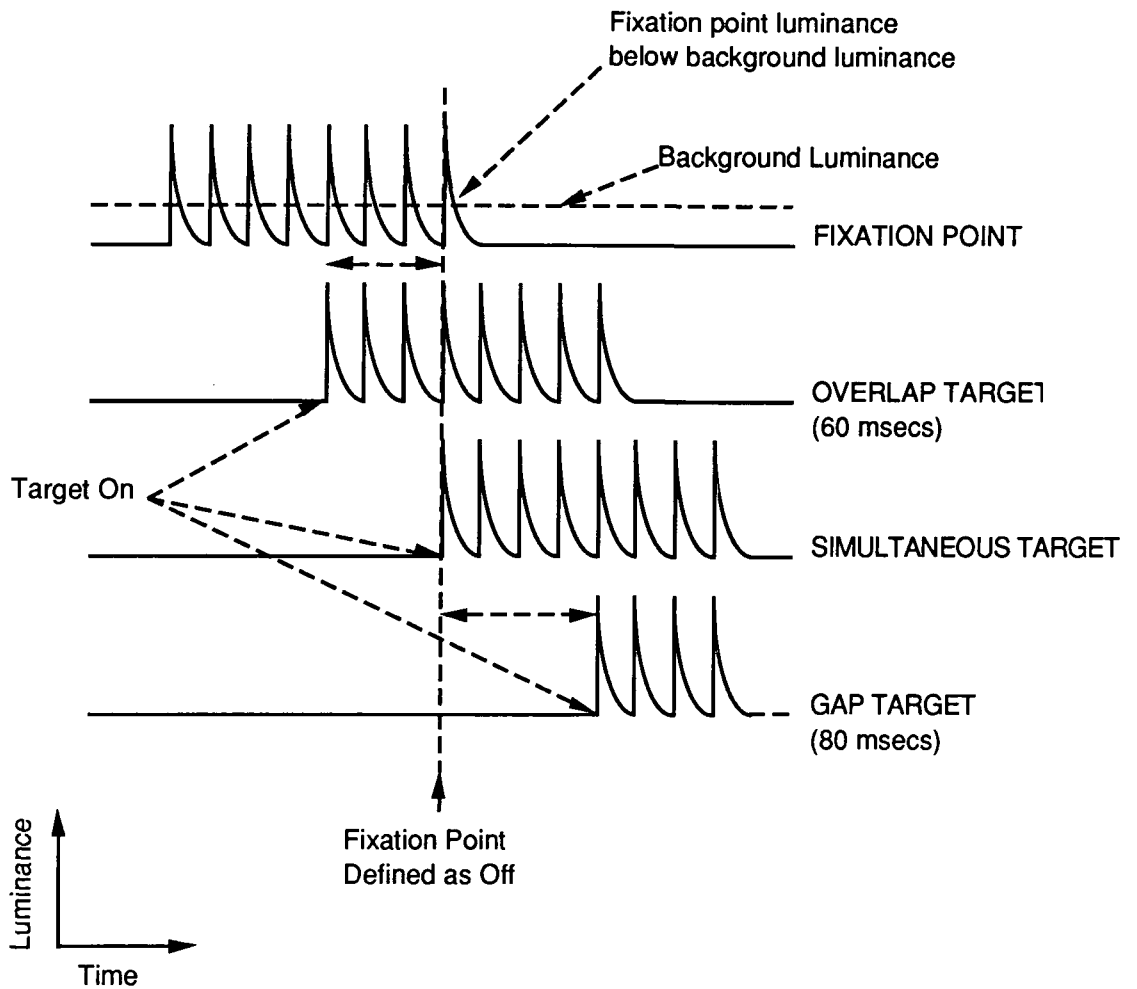

Figure 25. The definitions of Stimulus Onset and Fixation Offset.

## 2. Data Acquisition.

Eye movements were measured using an infrared reflectometry technique described in detail elsewhere (see Young & Sheena, 1975). The equipment used in these experiments was the EM 130 eye movement monitor unit from ACS Applied Research Developments Ltd. The unit provided an analogue signal representing eye position. This signal was digitised and recorded using a Cambridge Electronic Design Alpha computer with 502 interface. The ADC conversion took 10  $\mu$ secs/point, and

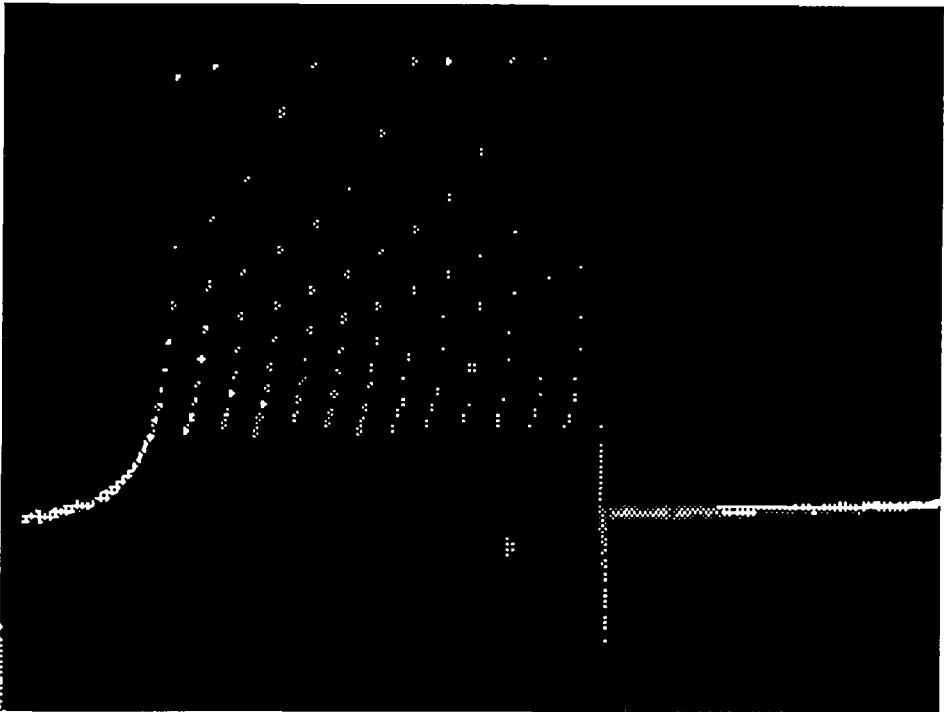

Figure 26. The recording of the BBC screen refresh rate, used to calibrate the timing routine

the acquisition time  $6 \mu\text{secs/point}$ , giving an overall acquisition rate of approximately 65 KHz.

### 3. Calibration of timing.

The refresh rate of the BBC monitor is specified as 20 msec. This was tested using an RCS 32 MHz counter timer, and found to be 19.97 msec (99.85% specification). The timing routine of the CED alpha was calibrated by recording the photometric response to the BBC screen (figure 26). It was found that data were recorded every 2.3 msec, rather than every 2 msec as desired. The error was traced to the delay associated with resetting the timer clock at the beginning of each timing sequence. The results presented have all been corrected for this discrepancy.

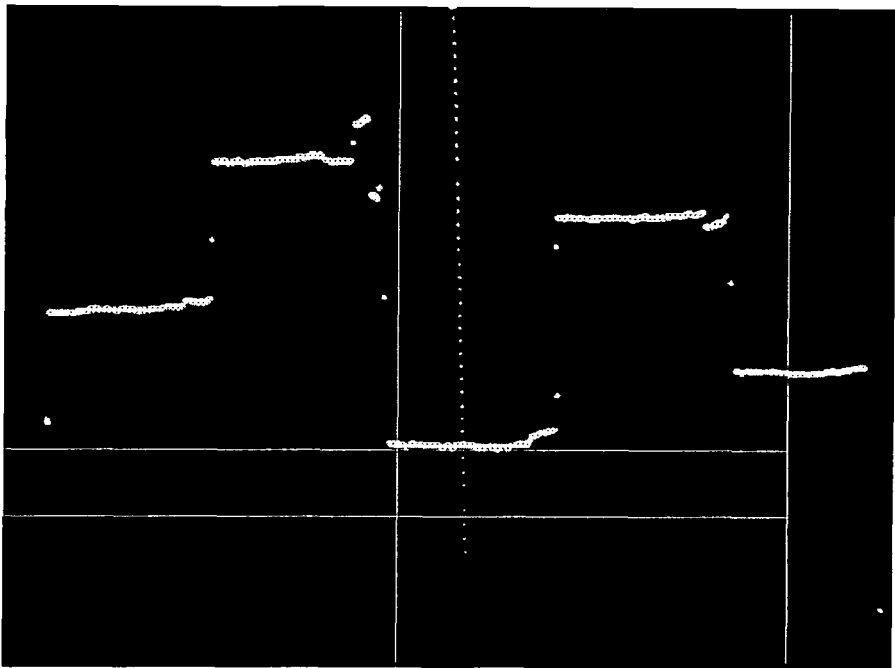

Figure 27. Example of calibration record.

#### 4. Calibration of eye movement amplitudes.

A stimulus identical to the fixation stimulus was shown in 5 positions; centrally, and at 4 and 2 degrees to the right and left of centre. The subject began a calibration by pressing a response button. The display went blank, and then a single fixation stimulus appeared once in each of the five positions in a random order, remaining there for 1.5 seconds. The subject was instructed to fixate the central spot of the stimulus at each of the five positions, and maintain as steady a fixation as possible. Eye position was sampled every 10 msecs, and saved on disc for later analysis. An example of such a record is given in fig. 27.

The calibration procedure was carried out at the beginning and end of every experimental session, and between every experimental block. Records contaminated by blinks were repeated.

The records were then analysed in a semi automated procedure. For each record a cursor was positioned at a flat part of the record for each fixation position, so as to avoid areas where the subject was refixating. The mean value of the eye position signal  $\pm 50$  msec of this time was determined and recorded. The amplitude of the record at each of the 5 fixation positions was recorded, and hence the change in amplitude of the eye position signal for each 2 degree step calculated. This procedure was repeated for each calibration within an experimental session. The mean values for each step for the whole session were then calculated and used to calibrate the eye movement records for the session. It was assumed that the relationship between eye movement and signal was linear. For accurate measurements of eye position over time this assumption may not be justified, but for repeated measurements of eye movement from the same central position over a range of  $\pm 4$  degrees this is a reasonable approximation. Results of the calibration procedure were stored for use in the subsequent saccade detection program.

#### 5. Saccade detection.

Following amplitude calibration by the method described above the data collected were analysed in a semi-automated fashion using a saccade detection program. For each consecutive data point  $N$ , the amplitude difference between  $N$  and  $N+2$  was calculated. If this failed to exceed a preset threshold based on the results of the amplitude calibration, then the program looked at the next point on the record. If the difference between  $N$  and  $N+2$  exceeded the threshold then the program looked at the difference between  $N$  and  $N+1$ . If the difference between  $N$  and  $N+1$  exceeded a quarter of the threshold, then the beginning of the saccade was

determined as the latency of the data point N, else the saccade beginning was determined as the latency of the data point N+1.

When the program detected a saccade a cursor was printed at the calculated onset, to allow a visual inspection of the record. If it was decided that the program had correctly identified saccade onset, then saccade latency was recorded. Eye position 46 msec later was used to determine saccade amplitude. For saccades of the amplitudes involved in this study saccade duration is around 30 msec. Saccade amplitude and maximum saccade velocity were calculated and recorded.

Saccade onset as determined by the computer program was accepted unless it was judged that a small eye movement had been missed by the program, or that the program had identified noise on the record as the start of a saccade. The exact criterion for distinguishing an unusual glitch due to noise from an unusually small eye movement was arbitrary. The number of times that such a decision had to be made however was small. The tendency was to err on the side of accepting noise, on the basis that if it was really noise then the directions of the 'saccades' would be unrelated to the direction of the target, and these could thus be excluded at a later stage of the analysis. Actual target position for the trial was not known at this stage.

#### 6. Discarding 'bad' data.

Using the infrared reflectometry technique there are various sources of noise that can interfere with the proper recording of eye position.

i) Noise. The amount of noise on the recording varied for different subjects, probably depending on how well adjusted the spectacles were with respect to the subject's eyes. The difficulty of adjusting spectacles was not trivial, in that it could be difficult to position the infrared emitter/detectors close to the eye depending on the shape of the subject's skull and nose. For the best recordings the noise represented  $\pm 0.2$  degrees. For the worst recordings it might be as high as  $\pm 0.5$  degrees, associated with a corresponding difficulty in reliably identifying saccade onset.

ii) The signal provided by the eye movement monitor is essentially the movement of the eye with respect to the spectacles. The desired recording is of angular eye movement with respect to the fixation point. The two are equivalent only so long as the head is stationary with respect to the fixation point, and the spectacles are stationary with respect to the head. To try and eliminate head movements subjects were fitted with individual dental bites that were clamped to a firm metal support throughout the experiment. The spectacles were fitted as firmly as possible, and stuck to the bridge of the nose with a small amount of blutac<sup>®</sup>. Neither of these procedures can be guaranteed to eliminate changes in the eye movement signal due to head or spectacle movements during the course of the experiment. However it was considered that such extraneous sources of change in the signal would operate over a different time scale to saccadic eye movements, and so although the signal for central eye position might be expected to change during the course of the experiment, this should not cause excessive error in the record for any individual saccade. Trials for which the record was not clearly due to an eye movement were discarded from the analysis.

iii) A similar conclusion can be drawn from the results of DC drift occurring during an experiment.

iv) Potentially a more serious problem can be caused by changes in the position of the eyelids during an experiment. A simple blink is easily distinguished (see figure 28), and records with blinks discarded. However the problem of drooping eyelids is less easily combated. If the eyelid position

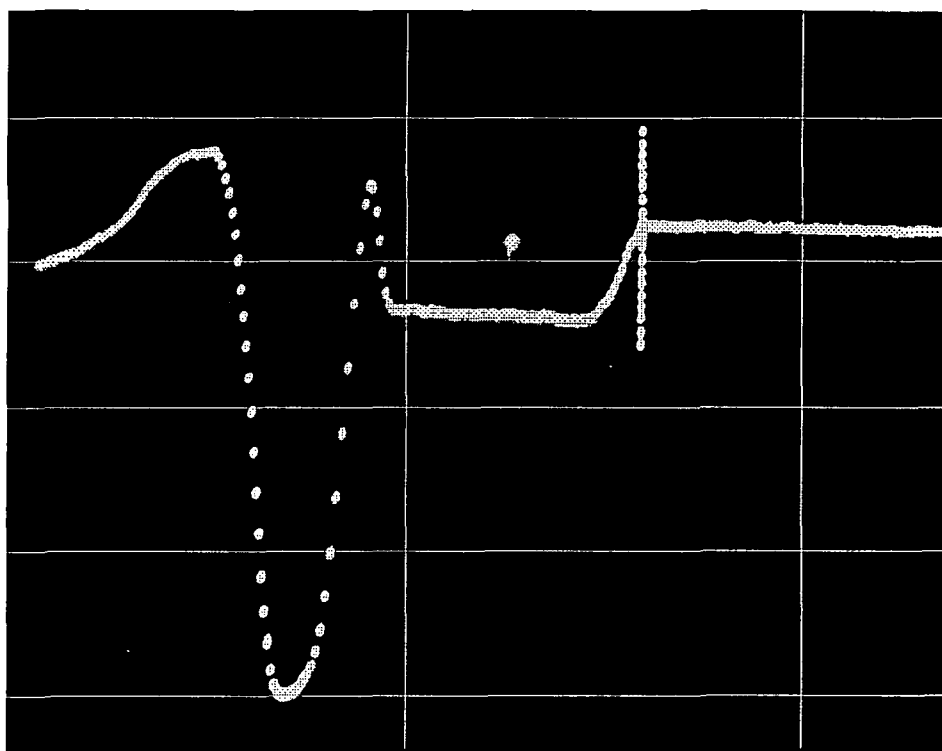

Figure 28. Example of a record contaminated by the occurrence of a blink.

changes, then both the signal during fixation, and the gain of the signal during the eye movement can be distorted. Eyelid position can change inadvertently or when the subject begins to feel drowsy. When it is



considered that the subject is seated comfortably in a warm, dimly lit room and is asked to carry out a dull and repetitive task requiring little concentration it is not surprising that the eyelids may occasionally droop. There is little remedy for this, beyond ensuring that experimental sessions are not inordinately long, and asking the subjects to cooperate so far as possible. It was hoped that by breaking a session into short blocks interspersed by calibrations the tendency to fall asleep would be minimised. For the longer experiments subjects were given a break half way through and asked to take a short walk in the corridor.

So long as these sources of error do not simulate the occurrence of saccades their major effect will be on the data concerning saccade amplitude, rather than saccade latency. Even when these data are distorted by changes in gain or offset of the eye position signal, the data relating to saccade onset should be relatively unaffected. Trials were however discarded when there was any sign of instability during the fixation prior to the saccade or during the period immediately following the saccade.

For all subjects in all sessions bar one, less than 5% of the data were discarded due to noisy or dirty records. In the total course of the experiments this was less than 5% of the trials.

## REFERENCES.

- Aslin, R.N., Shea, S.L. (1987). The Amplitude and Angle of Saccades to Double-Step Target Displacements. *Vision Research* 27:1925-1942.
- Becker, W., Jürgens, R. (1979). An Analysis of the Saccadic System by Means of Double Step Stimuli. *Vision Research* 19:967-983.
- Braun, D., Breitmeyer, B.G. (1988). Relationship Between Directed Visual Attention and Saccadic Reaction Times. *Experimental Brain Research* 73:546-552.
- Deubel, H., Findlay, J., Jacobs, A.M., Brogan, D. (1989). Saccadic Eye Movements to Targets Defined by Structure Differences. In *'Eye Movement Research: Physiological and Psychological Aspects'*, eds Luer, G., Lass, U., Shallo-Hoffmann, J. Toronto: Hogrefe.
- Doma, H., Hallett, P.E. (1988). Rod-Cone Dependence of Saccadic Eye-Movement Latency in a Foveating Task. *Vision Research* 28:899-913.
- Findlay, J.M. (1980). The Visual Stimulus for Saccadic Eye Movements in Human Observers. *Perception* 9:7-20.
- Findlay, J.M. (1983). Visual Information Processing for Saccadic Eye Movements. Chapter 16 in *'Spatially Oriented Behavior'*, eds Hein, A., Jeannerod, M. New York: Springer-Verlag.

- Findlay, J.M., Harris, L.R. (1984). Small Saccades to Double-Stepped Targets Moving in Two Dimensions. In *'Theoretical and Applied Aspects of Eye Movement Research'*, eds Gale, A.G., Johnson, F. North-Holland: Elsevier.
- Fischer, B. (1987). The Preparation of Visually Guided Saccades. *Rev. Physiol. Biochem. Pharmacol.* **106**:1-35.
- Fischer, B., Boch, R. (1983). Saccadic Eye Movements After Extremely Short Reaction Times in the Monkey. *Brain Research* **260**:21-26.
- Fischer, B., Breitmeyer, B. (1987). Mechanisms of Visual Attention Revealed by Saccadic Eye Movements. *Neuropsychologia* **25**:73-83.
- Fischer, B., Ramsperger, E. (1984). Human Express Saccades: Extremely Short Reaction Times of Goal Directed Eye Movements. *Experimental Brain Research* **57**:191-195.
- Fischer, B., Ramsperger, E. (1986). Human Express Saccades: Effects of Randomization and Daily Practice. *Experimental Brain Research* **64**:569-578.
- Fuchs, A.F., Kaneko, C.R.S., Scudder, C.A. (1985). Brainstem Control of Saccadic Eye Movements. *Annual Review of Neuroscience* **8**:307-337.
- Heywood, S., Churcher, J. (1980). Structure of the Visual Array and Saccadic Latency: Implications for Oculomotor Control. *Quarterly Journal of Experimental Psychology* **32**:335-341.

Highstein, S.M., Maekawa, K., Steinacker, A., Cohen, B. (1976). Synaptic input from the pontine reticular nuclei to abducens motoneurons and internuclear neurons. *Brain Research* **112**:162-167.

Kalesnykas, R.P., Hallett, P.E. (1987). The Differentiation of Visually Guided and Anticipatory Saccades in Gap and Overlap Paradigms. *Experimental Brain Research* **68**:115-121.

Keller, E.L. (1974). Participation of Medial Pontine Reticular Formation in Eye Movement Generation in Monkey. *Journal of Neurophysiology* **37**:316-331.

Lewis, J.H., Dunlap, W.P., Matteson, H.H. (1972). Perceptual Latency as a function of Stimulus Onset and Offset and Retinal Location. *Vision Research* **12**:1725-1732.

Lupp, U., Hauske, G., Wolf, W. (1976). Perceptual Latencies to Sinusoidal Gratings. *Vision Research* **16**:969-972.

Luschei, E.S., Fuchs, A.F. (1972). Activity of Brain Stem Neurons During Eye Movements of Alert Monkeys. *Journal of Neurophysiology* **35**:445-461.

Mohler, C.W., Wurtz, R.H. (1977). Role of Striate Cortex and Superior Colliculus in Visual Guidance of Saccadic Eye Movements in Monkey. *J. Neurophysiology* **40**: 74-94.

Mayfrank, L., Kimmig, H., Fischer, B. (1987). The Role of Attention in the Preparation of Visually Guided Saccadic Eye Movements in Man. In *'Eye Movements: From Physiology to Cognition'* eds O'Regan, J.K., Levy-Schoen, A. North Holland: Elsevier.

Parker, D.M., Dutch, S. (1987). Perceptual Latency and Spatial Frequency. *Vision Research* 27:1279-1283.

Parker, D.M., Salzen, E.A. (1977). Latency Changes in the Human Visual Evoked Response to Sinusoidal Gratings. *Vision Research* 17:1201-1204.

Rains, J.D. (1963). Signal Luminance and Position Effects in Human Reaction Time. *Vision Research* 3:239-251.

Reulen, J.P.H. (1984a). Latency of Visually Evoked Saccadic Eye Movements. I. Saccadic Latency and the Facilitation Model. *Biological Cybernetics* 50:251-262.

Reulen, J.P.H. (1984b). Latency of Visually Evoked Saccadic Eye Movements. II. Temporal Properties of the Facilitation Mechanism. *Biological Cybernetics* 50:263-271.

Ross, E.R., Ross, S.M. (1980). Saccade Latency and Warning Signals: Stimulus Onset, Offset, and Change as Warning Events. *Perception and Psychophysics* 27:251-257.



Saslow, M.G. (1967a). Effects of Components of Displacement-Step Stimuli Upon Latency for Saccadic Eye Movement. *Journal of the Optical Society of America* 57:1024-1029.

Saslow, M.G. (1967b). Latency for Saccadic Eye Movement. *Journal of the Optical Society of America* 57:1030-1032.

Smit, A.C., Van Gisbergen, J.A.M. (1989). A Short-Latency Transition in Saccade Dynamics During Square-Wave Tracking and its Significance for the Differentiation of Visually-Guided and Predictive Saccades. *Experimental Brain Research* 76:64-74.

Sparks, D.L., and Hartwich-Young, R. (1989). The deep layers of the superior colliculus. In *'The Neurobiology of Saccadic Eye Movements.'* eds Wurtz, R.H., Goldberg, M.E. North Holland: Elsevier.

Treisman, A.M., and Gelade, G. (1980). A Feature Integration Theory of Attention. *Cognitive Psychology* 12:97-136.

Van Asten, W.N.J.C., Gielen, C.C.A.M., De Winkel, M.E.M. (1988). The Effect of Isoluminant and Isochromatic Stimuli on Latency and Amplitude of Saccades. *Vision Research* 28:827-840.

Van Gisbergen, J.A.M., Van Opstal, A.J., Roebroek, J.G.H. (1987). Stimulus-Induced Midflight Modification of Saccade Trajectories. In *'Eye Movements: From Physiology to Cognition'* eds O'Regan, J.K., Levy-Schoen, A. North Holland: Elsevier.

Wyman, D., Steinman, R.M. (1983). Latency Characteristics of Small Saccades. *Vision Research* 13:2173-2176.

Young, R.L., Sheena, D. (1975). Eye-Movement Measurement Techniques. *American Psychologist* 30:315-330.

Zetsche, C., Kurzinger, G., Deubel, H., Elsner, T. (1984). Similar Mechanisms of Visual Processing in Perception and Oculomotor Control. Paper presented at the 7th ECVP, Cambridge. Abstract published in *Perception* 13:A6.

