



Durham E-Theses

Automated lay-up of composite blades

Jarvis, Simon D.H.

How to cite:

Jarvis, Simon D.H. (1992) *Automated lay-up of composite blades*, Durham theses, Durham University. Available at Durham E-Theses Online: <http://etheses.dur.ac.uk/6167/>

Use policy

The full-text may be used and/or reproduced, and given to third parties in any format or medium, without prior permission or charge, for personal research or study, educational, or not-for-profit purposes provided that:

- a full bibliographic reference is made to the original source
- a [link](#) is made to the metadata record in Durham E-Theses
- the full-text is not changed in any way

The full-text must not be sold in any format or medium without the formal permission of the copyright holders.

Please consult the [full Durham E-Theses policy](#) for further details.

The copyright of this thesis rests with the author.
No quotation from it should be published without
his prior written consent and information derived
from it should be acknowledged.

AUTOMATED LAY-UP OF COMPOSITE BLADES

by

SIMON D.H. JARVIS

(Dowty Aerospace Propellers)

March 1992

THE INFORMATION AND DATA PROVIDED HEREIN IS PROPRIETARY TO
DOWTY AEROSPACE GLOUCESTER LIMITED, TRADING AS DOWTY
AEROSPACE PROPELLERS. NO RIGHTS OR LICENCE ARE GRANTED TO THE
RECIPIENT TO USE, DISCLOSE, COPY, REPRODUCE, PUBLISH OR
COMMUNICATE BY ANY MEANS PART OR ALL OF THIS THESIS AND/OR
THE PROPRIETARY MATTER CONTAINED HEREIN WITHOUT THE PRIOR
WRITTEN CONSENT OF DOWTY AEROSPACE GLOUCESTER LIMITED,
TRADING AS DOWTY AEROSPACE PROPELLERS.

Thesis submitted for the degree of
Master of Science at the University of Durham
The School of Engineering and Applied Science
University of Durham



10 JUL 1992

To Alison

Through my secondment to Durham we met and to You I dedicate
my long awaited Thesis.

ABSTRACT

"Automated Lay-Up of Composite Blades" describes the Author's contribution to a joint research project between Dowty Aerospace Propellers and the University of Durham into the automated lay-up of complex, three dimensional carbon fibre composite propfan blade preforms. The emphasis of the highly applied Project, now continuing at Brunel University, has been to develop an operational research demonstrator cell.

The existing manual lay-up techniques employed by Dowty have been reviewed and a new methodology devised which can be far more easily automated. To implement the new methodology, a specialized lay-up station has been developed along with a practical prototype vacuum gripper technology capable of manipulating the range of large, complex, flexible and easily distorted plies required for propfan preform manufacture.

Both the gripper technology and the Lay-Up Station have been successfully tested, the latter in an industrial environment to manufacture "real life" propfan blades.

DOWTY AEROSPACE PROPELLERS

Dowty Aerospace Propellers (referred to as "Dowty" in the Thesis) is a wholly owned subsidiary of Dowty Aerospace Gloucester Ltd., part of the Dowty Group Plc. The Company, occupying an 85,000 sq ft main site, designs, develops and manufactures a range of all composite bladed advanced technology propeller systems for turboprop and propfan aircraft as well as hovercraft. Product applications include the SAAB 2000, SAAB 340, ITPN N-250, Fokker 50, Textron Bell LCAC and Textron C-7. Dowty Aerospace Propellers has an annual turnover of around £30 million.

ACKNOWLEDGEMENTS

I would like to express my gratitude to the many people at Durham and Dowty who have freely given their enthusiastic help and support in carrying out this work.

My special thanks go to both Roger Little and Brian Blackburn (School of Engineering workshops) whose skills and sound practical advice have been invaluable both to the Project and in teaching me the high value of concurrent engineering.

I am also indebted to Alison Clayton for her continuous and often highly assertive encouragement.

LIST OF CONTENTS

CHAPTER I INTRODUCTION

- 1.1 The Case for Research, 2
- 1.2 Scope and Objectives of the Research Programme, 8
- 1.3 The Thesis, 12

CHAPTER II TECHNICAL BACKGROUND

- 2.1 Dowty Aerospace Propellers and Fibre Reinforced Composites, 15
- 2.2 Fibre Composite Materials for Propeller Blades, 18
- 2.3 Propfan Structure, 20
- 2.4 Propfan Manufacture, 27
- 2.5 The Case for Automating the Lay-Up

of Propfan Blade Preforms, 35

2.6 Automated Manufacture, 39

CHAPTER III FABRIC HANDLING CHARACTERISTICS

3.1 Fabric Properties, 49

3.2 Interlaminar Bonding Characteristics
, 65

3.3 Ply Shape and Size, 68

3.4 Chapter Conclusions, 76

CHAPTER IV A NEW LAY-UP TECHNIQUE DESIGNED FOR AUTOMATION

4.1 Aerofoil and Root Lay-Up, 77

4.2 Root Forming, 80

4.3 Aerofoil Forming, 90

6.5 Industrial Performance Trails, 151

6.6 Conclusions, 177

CHAPTER VII HANDLING DEVICES

7.1 Functional Requirements, 181

7.2 Gripper Types, 183

7.3 Flat Grippers, 203

7.4 Flat Vacuum Grippers, 206

7.5 Prototype (Half Size) Flat Vacuum
Gripper, 219

7.6 A Full Size Gripper for the
Integrated Research Cell, 239

CHAPTER VIII CONCLUSIONS AND RECOMMENDATIONS FOR FURTHER WORK

8.1 Conclusions, 247

8.2	Recommendations for Further Work,
	256

APPENDIX I THE PROFAN

APPENDIX II DRIVE CHAIN CALCULATIONS

A2.1	Force and Torque Relationships, vii
A2.2	Velocity and Angular Velocity Relationships, viii
A2.3	Resolution and Angular Resolution Relationships, x
A2.4	Calculations, x

APPENDIX III LAY-UP STATION CAPABILITY ANALYSIS

A3.1	Theoretical Background, xvi
A3.2	Gap Dimension Results and Capability Analysis, xix

APPENDIX IV VACUUM PUMP SPECIFICATION

LIST OF FIGURES

- Fig 2-1 Propfan Blade and Cross Sections
- Fig 2-2 Typical Layer Profile
- Fig 2-3 Butted Plies Making Up a Single Preform Layer
- Fig 2-4 Sequence of Operations in Existing Propfan Manufacturing Process
- Fig 2-5 Cross Sectional Diagram of Assembled Preform Root
- Fig 2-6 Proportions of Manpower Input per Task
- Fig 3-1(a) Cantilevered Sample Carrying (w) Weight per Unit Length
- Fig 3-1(b) Sample Fixed Horizontally at each End Carrying (w) Weight per Unit Length
- Fig 3-2(a) Neutral Axis for Homogeneous Material
- Fig 3-2(b) Neutral Axis in Composite Fabric

- Fig 3-3(a) Deflection under Own Weight - Cantilevered
Unidirectional Fabric
- Fig 3-3(b) Deflection under Own Weight - Cantilevered
Woven Fabric
- Fig 3-3(c) Deflection under Own Weight - Fabric Fixed
Horizontally at Each End
- Fig 3-4 Porosity Measurement Apparatus
- Fig 3-5 Air Flow through Fabric for a Range of Carbon
(and Glass) Fibre Fabrics
- Fig 3-6 Successive Layer Profiles
- Fig 3-7 The Five Basic Geometrical Ply Families
- Fig 4-1 Main Functional Elements of a Propfan Blade
Preform
- Fig 4-2 Rolling End Effector Path to Form Root
Geometry over a Hanging Type Jig
- Fig 4-3 Hinged Flat Gripper Operation

Fig 4-4 Twin Roller Variation

Fig 4-5 Lay-Up Surface Action

Fig 4-6 Combined Lay-Up / Root Forming Table Operation

Fig 5-1 Dual Fabric Automated Cutting Station

Fig 5-2 Summary of New Lay-Up Process and Related
Functions

Fig 6-1 Root Tab Geometry

Fig 6-2 Affect of Error in Actual Length of Root
Geometry

Fig 6-3 The Theoretical Cosine Wrinkle

Fig 6-4 Wrinkle Amplitude v. Excess Fabric Length (Gap
Error) for Given Wrinkle Lengths

Fig 6-5 Accuracy and Repeatability

Fig 6-6 Root Tab Buckling as Lay-Up Surface Gap is
Reduced

- Fig 6-7 Simulated Root Tab Pack for Compression Testing
- Fig 6-8 Compression Test Results
- Fig 6-9 The Lay-Up Station
- Fig 6-10 Lay-Up Table Surfaces
- Fig 6-11 Arrangement of Linear Bearings
- Fig 6-12 Drive Chain
- Fig 6-13 Comparative Holding Forces of Vacuum Hold Down Method Using a Variety of Wet and Dry Emery Cloth Materials to Improve Coefficient of Friction between Lay-Up Surfaces and the Blade Preform
- Fig 6-14 Layout of Vacuum Nozzles
- Fig 6-15 Vacuum System Pipework Configuration
- Fig 6-16 Vacuum Level Control Valve
- Fig 6-17 Simultaneous lay-Up and Tacking (Tacked Zones)

- Fig 6-18 Force Application to Induce Downward Buckling
of Each Root Tab
- Fig 6-19(a) Root Gap Error (E_0) {Trial I}
- Fig 6-19(b) Statistical Distribution of Error (E_0) {Trial
I}
- Fig 6-20 Region Corresponding to fabric Across Root Gap
- Fig 6-21 New Position for Vacuum Bag Connectors on
Heat-Vacuum Consolidation Jig
- Fig 6-22 Position of Dial Indicators
- Fig 6-23(a) Root Gap Errors (E_e) {Trial II}
- Fig 6-23(b) Statistical Distribution of Errors (E_e)
{Trial II}
- Fig 6-24 New Consolidation Jig
- Fig 6-25 True Root Geometry
- Fig 6-26(a) Root Gap Errors (E_e) {Trial III}

- Fig 6-26(b) Statistical Distribution of Errors (E_e)
{Trial III}
- Fig 7-1(a) 0° Unidirectional Ply Cut into Strips for
Handling
- Fig 7-1(b) $\pm 45^\circ$ Unidirectional Ply Cut into Strips for
Handling (Strip across Root Tab Shown Only)
- Fig 7-2 Basic Principle of a Cylindrical Gripper Head
- Fig 7-3 Governing Equation for Vacuum or Electrostatic
Attachment
- Fig 7-4 Example of a Single Row Nozzle Configuration
for Picking a Typical Test Ply
- Fig 7-5 Zone Liable to Ruck during Rolling
- Fig 7-6 Conceptual Roller Gripper for Handling Propfan
Plies
- Fig 7-7 Progressive Two Stage Gripper Pre-Prototype
- Fig 7-8 Progressive Two Stage Pick-Up
- Fig 7-9 Rucking on Progressive Pick-Up along Weft Axis

Fig 7-10 Simplified Example of Interacting Nozzle
 Pattern Principle

Fig 7-11 Test Board and Frame

Fig 7-12 Half Size Flat Gripper

Fig 7-13(a) Possible Valve Positions - On Board

Fig 7-13(b) Possible Valve Positions - Remote

Fig 7-14 Air Flow Control Valve

Fig 7-15 Typical "Just Cut" Ply Nested in Waste Fabric

Fig 7-16 Framework of Full Sized Gripper

Fig 7-17 Modular Vacuum Nozzle Carrier Bar

Fig A2-1 Drive Chain

Fig A2-2 Stepper Motor Characteristics

LIST OF PLATES

- Plate 1-1 Propfan Engine
- Plate 1-2 Propfan Blade
- Plate 2-1 Hinged Hanging Jig
- Plate 6-1 Lay-Up Station
- Plate 6-2 Consolidated Prefrom (Showing Root when
Folded)
- Plate 6-3 Preform Root During Lay-Up (Trials II & III)
- Plate 6-4 Cross Section of Root Manufactured via Lay-Up
Station (Trial II)
- Plate 6-5 Cross Section of Root Manufactured via Lay-Up
Station (Trial III)
- Plate 7-1 Half Size Prototype Flat Gripper
- Plate 7-2 Vacuum Tubes Connected to Nozzles on Gripper
Plate
- Plate 7-3 On Board Air Flow Control Valves in Situ

Plate 7-4

Full Scale Gripper awaiting Fitment of Vacuum
Tubing

C H A P T E R I

I N T R O D U C T I O N

CHAPTER I

INTRODUCTION

In January 1989, Dowty Aerospace Gloucester Ltd. and the University of Durham initiated a joint applied research project, "Automated Manufacture of High Performance Components". The Project, supported by the Application of Computers in Manufacturing Engineering (A.C.M.E) Directorate of the Science and Engineering Research Council (S.E.R.C.), was set up to investigate techniques for automating the lay-up of high performance composite propeller blades for aeroengines. The project was specifically aimed at addressing the automation of propfan type propeller blade manufacture, but it was hoped that the knowledge gained would offer important wider based spin-offs of benefit to composite blade manufacture in general. "Automated Lay-Up of Composite Blades" documents the Author's contribution to the research work during the first eighteen months of the Project programme.

Chapter I of the Thesis explains the justification for the Project in terms of the current state of manufacturing

technology and the implications of a potentially large new market for composite blades. The scope and aims of the Project are then defined as is the scope and format of the following Chapters.

1.1 The Case for Research

1.1.1 Advancement of Manufacturing Technology

The first reinforced plastics were produced at the beginning of this century. It was, however, during World War II that the technical progress in the science of these materials can really said to have started to gather momentum. Since the early pioneering days, considerable research effort has been channelled, worldwide, into the development of high performance fibre reinforced plastic (FRP) composites. The reward to the aerospace industry has been advanced materials and impressive component design techniques. Commonly, however, corresponding advanced manufacturing technology has been slow to evolve and many key operations remain labour intensive.

At a time when the exploitation of fibre composite aircraft

components is increasing, aggressive market competition in the aerospace manufacturing industry has placed an ever growing requirement on companies to provide outstandingly high quality, often complex products at low cost. Consequently, major aerospace engineering companies have been compelled to look seriously at ways of optimizing their manufacturing techniques. In such an environment it is quite necessary to question reliance on labour intensive methods in composites manufacturing and a number of aerospace engineering companies are consequently embracing automation.

Dowty has itself recognized processes within its composite propeller manufacturing facility which remain highly labour intensive. The two most significant of these are manual carbon/glass fibre fabric ply cutting and subsequent manual ply lay-up to produce multi-layer fibre preforms prior to resin impregnation. With existing comparatively low volume demand for propellers, it has been difficult to financially justify automating these operations despite the scrap rate and labour costs associated with manual methods, although the lay-up of the skin layers of some blades can now be successfully replaced by a braiding process. Unfortunately, braiding is not suitable for all propeller blade aerofoil designs.

1.1.2 A New Market for Composite Propeller Blades.

Until recently, the application of propeller based engines including the *turboprop* (Appendix I) has been confined to comparatively slow low thrust aircraft due to performance limitations of the propeller. The market for Dowty composite propeller blades has, therefore, been restricted to relatively short haul commuter airliners, executive aircraft and transports. Faster medium and long distance aircraft have been almost predominantly powered by turbofans such as the Rolls-Royce RB211.

By radically redesigning the propeller, some aeroengine manufacturers have now devised a high thrust propellered jet engine, the *propfan* (plate 1-1 and Appendix I), which is well suited as a power plant for higher speed aircraft. The innovative designs exploit a comparatively thin, wide and short blade (plate 1-2) with a distinctively swept scythe like shape.

The propfan engine has a significant advantage over the turbofan, which it can match in speed and altitude, in that it has a much improved specific fuel consumption equating to

a 15% saving for long haul and 30% for medium haul flights with no compromise in the speed (Appendix I). The benefits of improved fuel consumption can be used to provide the aircraft operator with a competitive advantage through the reduction of running costs and, since aircraft will need to carry less fuel, additional useful payload capacity. It is hoped that these attractive advantages will persuade operators and aircraft designers to switch from turbofans to propfans, opening up a new market for composite propellers.

The potential future demand for propfan blades is unusually large. This is due to the number of aircraft that could

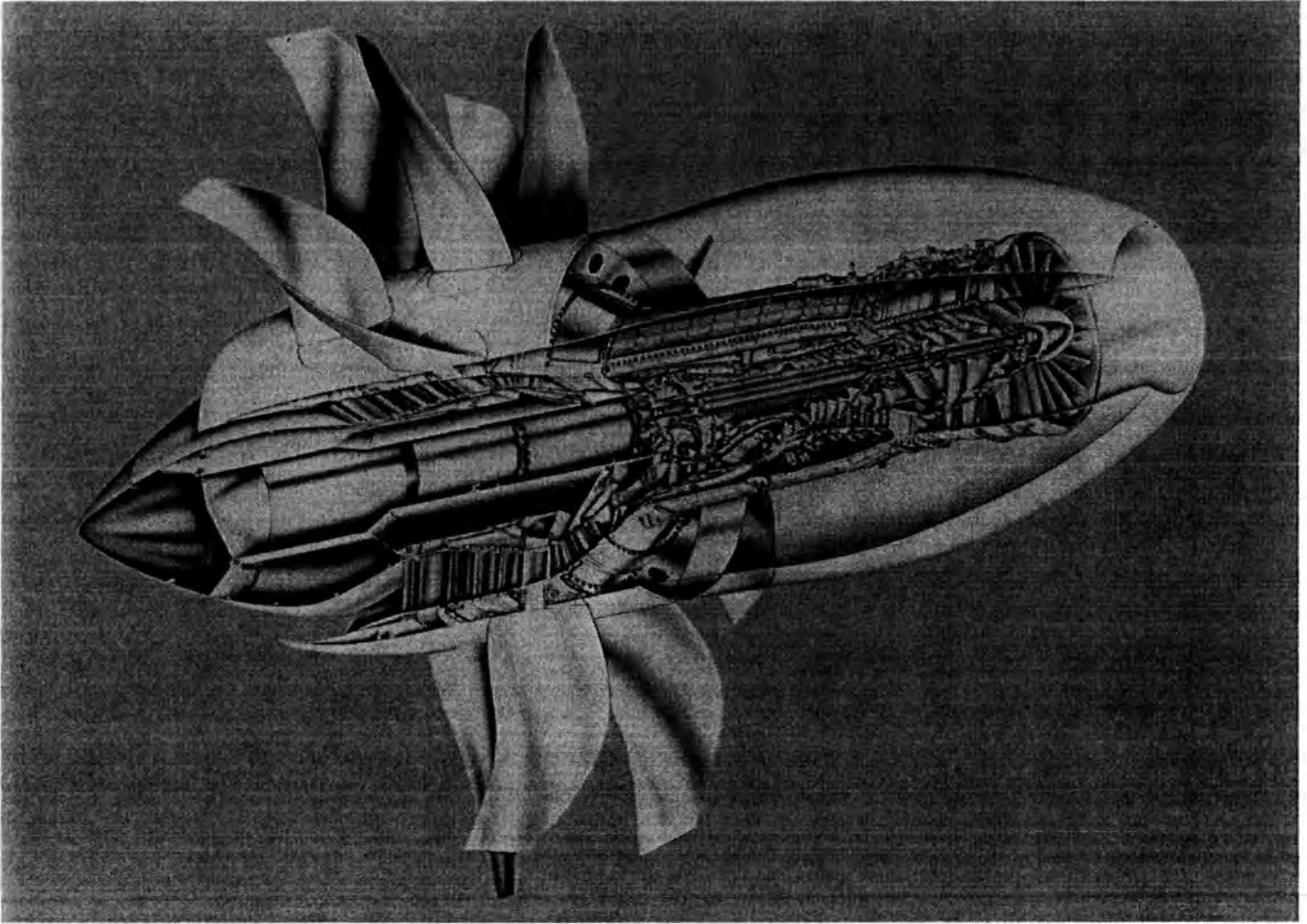

Plate 1-1. Propfan Engine

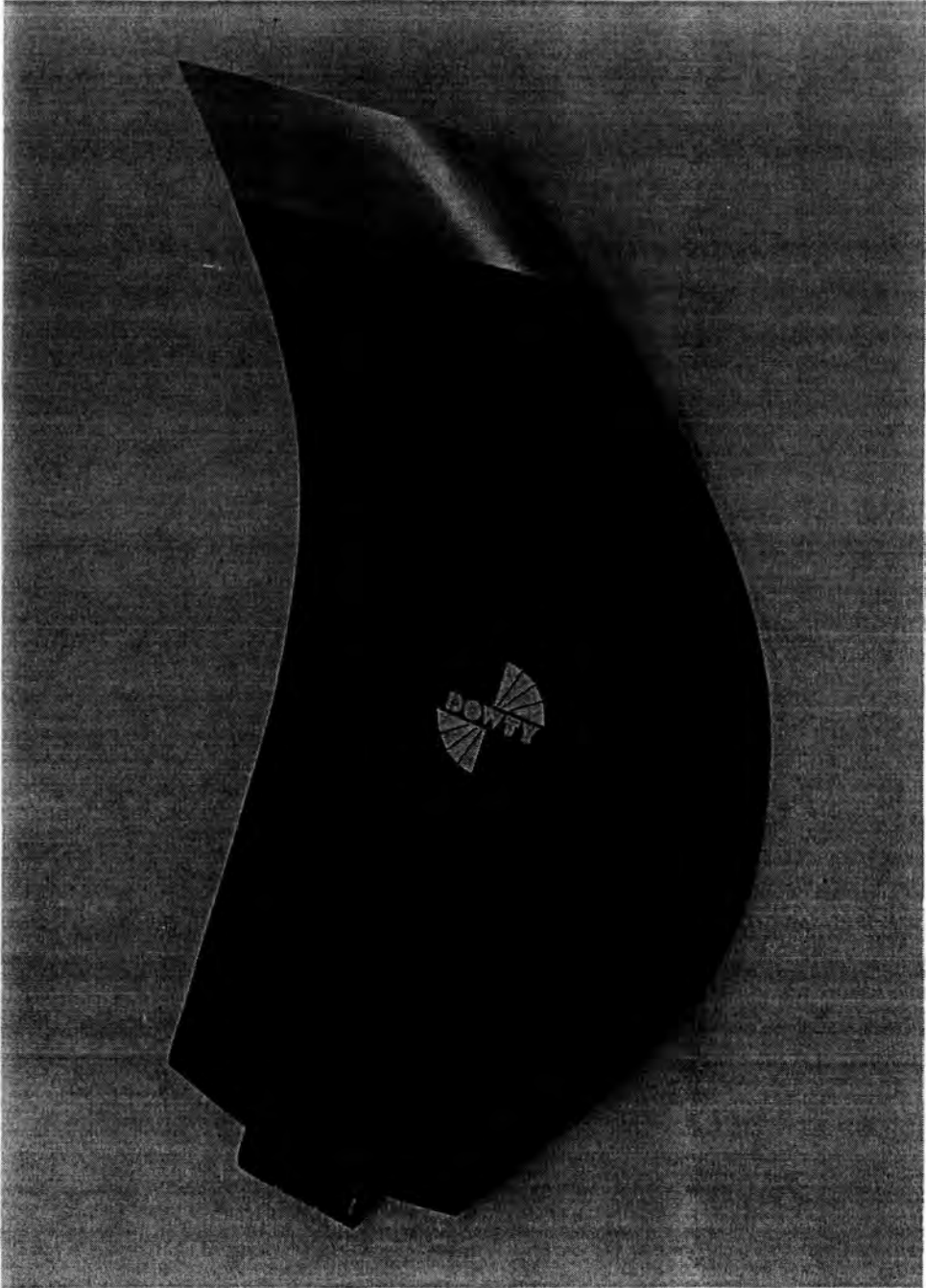

Plate 1-2. Propfan Blade

eventually be fitted with propfan engines and also to the number of blades required per aircraft set (typically between thirty and forty for an engine with contra rotating blades). The production runs are likely to be far higher volume than usually expected with conventional propeller blades.

Dowty has already been involved with the manufacture of propfan blades for demonstrator propfan aircraft. With its experience and proven record in the field of advanced technology turboprop propellers, the Company is in a particularly strong position to become a premier supplier of large numbers of propfan blades, particularly if the manufacturing process is optimized.

1.2 Scope and Objectives of the Research Programme

The prime objective of the Project is to research new process techniques and corresponding technologies, finally combining these into an integrated research demonstrator cell for the automated lay-up of fibre composite propeller blades. Special emphasis has been placed on propfan manufacture in line with the arguments above.

The scope of the Project has confined the research effort to developing automated lay-up only and does not attempt to develop other operations in the manufacturing process such as ply cutting. Automated cutting, it will be argued, is essential for successful automated lay-up, but not specifically researched because the technology has already been subject to commercial development by machine manufacturers; they are in the best position to develop a system to suit any new requirements associated with automating lay-up.

The Project strategy has been to divide the research effort into three phases. Phase I is concerned with analysis of the existing process and formulation of a new lay-up strategy. The second phase concentrates on the research and initial development of enabling techniques and technologies to form functional modules. Phase three aims to integrate all the enabling technologies to create the Research Demonstrator Cell.

The formulation of a new process strategy has been aimed at redesigning the existing high dexterity manual lay-up process to make it as easy as possible to automate. In this way, the Project's chances of success have been enhanced.

To realize the aims of the new strategy a number of core enabling technologies have been and are being developed. The first has been a novel lay-up station to facilitate the new process strategy. The next stage has been to research the practicality of alternative ply handling device options to support the Lay-up Station. It is has also been necessary to develop an automated means of tacking successive plies together to prevent ply disturbance and fibre wash during the resin impregnation stage of manufacture.

These core technologies must be successfully operated in an imperfect (real) environment and they must be controlled in a sensory open-loop manner. Supplementary enabling technologies must, then, be developed to monitor, interpret and ultimately control cell operation. Standard sensory devices such as position encoders and transducers have a significant role to play, but a complex computer vision system to accurately monitor ply position during lay-up and carry out inspection tasks is also essential. The development of a suitable computer vision system thus forms a major part of the Project.

The Phase III Demonstrator Cell is intended to act as a

research test bed and a proof of concept demonstrator from which a fully optimized manufacturing system can be developed.

The Project structure can be summarized as:

Phase I

- * A review of component design and existing manufacturing methods;
- * The development of a new manufacturing process more suited to automation.

Phase II

- * Research into Enabling Technology Modules:
 - Lay-Up Station
 - Handling Devices
 - Heat Bonding Devices
 - Sensor Systems
 - Computer Vision Systems

* Module Testing

Phase III

* Integration of Enabling Technologies to form
the Research Demonstrator Cell

1.3 The Thesis

1.3.1 Scope of the Thesis

This Thesis describes the portion of the first eighteen months of the Project work carried out by the Author in the capacity of the Project Team's seconded member from industry. The scope of this work covered the initial study of the existing manufacturing process (predominantly through practical "hands-on" composite shop experience), design of a new process more suited to automation, and applied research into the specialized Lay-up Station and ply handling devices

as part of Phase II of the Project.

1.3.2 Thesis Format

"Automated Lay-up of Composite Blades" has been set out in a way which follows the formulation of initial concepts through research and necessary development to the manufacture and testing of working prototypes.

Chapter II begins by providing adequate background material which aims to arm the reader with sufficient specialist understanding to appreciate the technical implications of the subsequent narrative. The third chapter supplements this with a generalized discussion on the handling characteristics of the fabrics which will be automatically manipulated.

Chapter IV proposes the new, automation orientated, lay-up method. This is discussed in relation to the rest of the manufacturing process in the subsequent Chapter.

The sixth chapter is dedicated to describing and discussing the development and trial of the Lay-Up Station. It will be clear that the successful operation of this station defines the operating parameters for the handling device discussed in Chapter VII.

The Thesis is completed by the Author's research conclusions and recommendations for some further work in continuing research programme.

C H A P T E R I I

T E C H N I C A L B A C K G R O U N D

CHAPTER II

TECHNICAL BACKGROUND

Chapter II sets out the Project's technical background. It aims to provide a brief historical perspective of Dowty's involvement with fibre reinforced plastics, a description of the construction of fibre composite propfan blades, and an overview of current manufacturing techniques. The potential for automation is also considered.

2.1 Dowty Aerospace Gloucester and Fibre Reinforced Composites - A Techno Historical Perspective.

Fibre reinforced composites are by no means a new technology. Early man, for example, was familiar with the benefits of incorporating straw with mud and clay to form a resilient composite building material. Timber, another fibre reinforced material, has been exploited by man for thousands of years and was, quite literally, a natural choice for early aircraft designers looking for a light weight structural medium for building propeller blades.

The strength and stiffness of wood are largely unidirectional; its grain must be strategically aligned so as to efficiently bear static and dynamic loading. The use of natural wood for propellers, therefore, had structural limitations. By laminating wooden plies and strategically aligning the grain of each layer, it was possible to produce a composite fibre reinforced material with controllable properties to accommodate complex aerodynamic loading. This was the principal adopted for the first propeller blades manufactured by the Company, then known as Rotol Airscrews Ltd. The propellers produced by Rotol for the legendary Spitfires and Hurricanes of World War II exemplified laminated wood type construction.

The early wood based composite used in these propellers exhibited, by modern standards, a poor strength to weight ratio and aluminium alloys subsequently became the preeminent propeller material. Magnesium and hollow steel propeller blades were also manufactured.

Aluminium alloys represented a step forward in strength for a given weight and permitted the use of thinner, higher efficiency aerofoils. Aluminium alloy propellers have served

the aircraft industry well and are still manufactured for numerous applications.

As high performance fibre reinforced plastics emerged, Dowty was quick to realize that the characteristics of these new materials were well suited to the needs of propeller design.

The Company, by then Dowty Rotol Ltd., began work on fibre reinforced plastic composite propeller blade technology in the mid 1960s with the first blades being developed not for aircraft but rather for hovercraft operating in severe air-sea environments[1]. By the end of the 1960s, sophisticated glass and carbon fibre reinforced composite aircraft propeller blades were being manufactured. These offered an extremely long fatigue life, high damage tolerance along with ease of repair, low mass, high strength and control over the modes / frequencies of resonance.

Today, Dowty has a proven record in the design and manufacture of a range of high performance fibre composite propellers. Aircraft which exploit the benefits of Dowty composite blades include the SAAB 340, the SAAB 2000, the Piper Cheyenne, and the Fokker F-50.

2.2 Fibre Composite Materials for Propeller Blades

Both carbon and glass fibres are in common use in aerospace for plastics reinforcement. Some common forms available are: continuous fibre tows; fabrics (both dry and pre-impregnated with resin); and chopped strand matting.

Continuous fibre, in basic form, is presented as a yarn or "tow" which is a continuous bundle of several thousand fibre filaments. Continuous fibre tows, usually supplied on bobbins, can be used to create fibre reinforcement preforms by such means as filament winding, knitting, or braiding.

Continuous fibre tows can, alternatively, be supplied ready woven into a fabric which can be subsequently cut into plies and laid up to generate a reinforcement preform. Such fabrics have a "warp" (which is the collective name for tows running the length of the fabric) interwoven with a "weft" (which is the collective name for the tows or individual fibres running across the width of the fabric). Two types of weave can be generated by using different yarns for the warp and weft. If the weft consists of reinforcement yarn (similar to that in the warp) the fabric is said to be "woven" and will exhibit bidirectional properties. On the other hand, if the

weft consists of a fine yarn (in comparison with the warp tows) the fabric is said to be "unidirectional". Both woven and unidirectional fabrics are available in a range of thicknesses (typically between 0.1mm to 1.25mm).

Carbon and glass fibre fabrics are available in both dry and resin pre-impregnated ("prepreg") forms. Dry reinforcement fabrics must be subsequently resin impregnated in a mould tool to produce a composite matrix of structural use. With pre-impregnated fabrics, no further resin impregnation is required and the finished structure is produced by compression at temperature in an autoclave. Prepreg fabric must be kept refrigerated prior to use to prevent premature curing.

Chopped strand matt is made from continuous fibres which have been cut into short lengths (typically between 25mm and 75mm), deposited randomly and then tacked together with a suitable chemical binder. This type of matting has a comparatively low structural performance, but is cheap and has multidirectional properties.

A combination of reinforcement materials are used to build up the structure of a traditional propeller blade. Dry woven

and unidirectional carbon fabric are used to produce the blade spar; dry woven glass fabric is used in the skin; and glass fibre chopped strand matting is employed at the blade tip[11].

Propfans are far more highly stressed than traditional blades and require the exclusive use of high modulus carbon fibre fabrics in both dry unidirectional and dry woven forms. The woven fabric comprises carbon warp tows interwoven with identical weft tows (appended sample). Each tow contains around 12 thousand continuous carbon fibre filaments. The unidirectional fabric comprises similar warp tows but these are interwoven with low melting point (typically 130°C) thermoplastic polyester threads (appended sample). Thermoplastic weft filaments have been introduced to allow dry laminates to be temporarily tacked or "heat bonded" together during lay-up to produce a stable preform which can be subsequently loaded into a mould and impregnated with resin.

2.3 Propfan Structure.

It is useful, for the purposes of description to consider the

structure of a propfan blade (figure 2-1) in terms of its two functional elements: the aerofoil (which generates thrust); and the root (which retains the aerofoil to the propeller hub).

The aerofoil is essentially a thin, gently curved aerodynamic composite shell encapsulating a low density polyurethane foam core. The aerofoil is designed to withstand "centrifugal" forces, due to high speed rotation, and both dynamic bending and twisting moments associated with thrust generation. The two faces of the aerofoil shell are known as the "pitch" and "camber" faces.

The root is essentially a "U"-shaped composite shell with a titanium core (figure 2-5). During operation, it must reliably transmit the high dynamic stresses set up in the aerofoil.

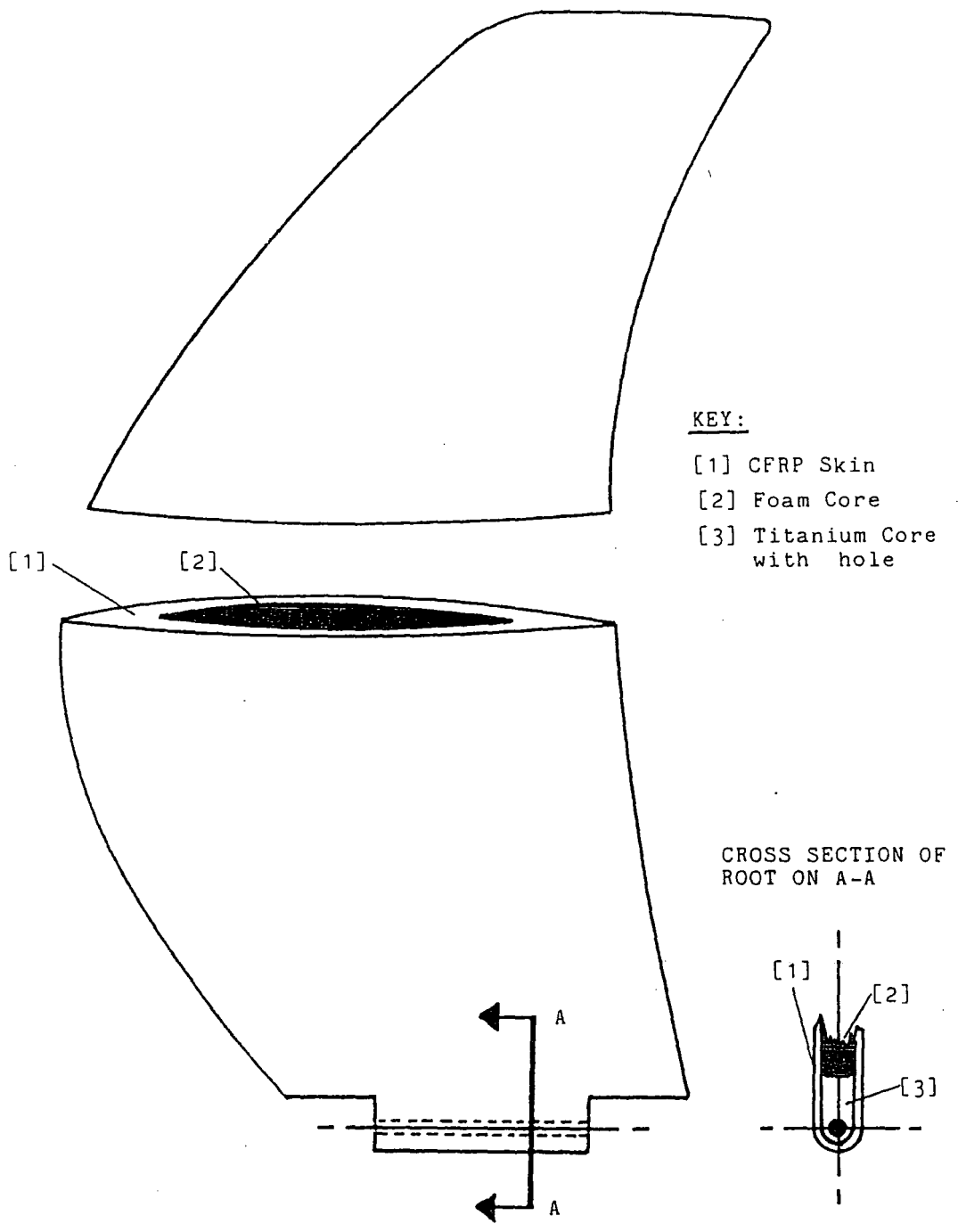

Figure 2-1. Propfan Blade and Cross Sections

The fibre reinforcement in propfan blades consists of fabric plies built around a foam core. Typically, a propfan reinforcement preform is made up of over twenty successive layers most of which have been laid-up such that they wrap from the aerofoil camber face, around the root to the pitch face.

A typical layer profile (figure 2-2) comprises of two "bat wing" like areas which become the aerofoil laminae in the completed preform, and a rectangular "tab" which when folded becomes lamina within the root. Although each preform layer has a similar shaped profile, their sizes are graduated such that they contour progressively outwards towards the outer surface of the folded preform.

Each layer within the preform is, in turn, made up of either one single ply or three individual plies butted (or "spliced") end to end (figure 2-3). In any given layer, each ply has a specific warp orientation (0° , $+45^\circ$, -45° or 90° to the lay-up axis) and can be cut from either unidirectional or woven fabric depending upon the blade designer's specification. It is, then, possible to have a mix of warp orientations and fabrics within any layer.

The purpose of using several plies of a different orientation to form a single layer is to provide an effective means of reinforcement cross bracing between layers in order to balance the blade's torsional and Young's moduli. The two moduli are important because they control both the torsional and longitudinal frequencies of vibration and the blades strength in each axis. Unidirectional fabric plies with 0° fibre orientation provide a high Young's modulus and, therefore, bending stiffness, as well as high axial strength. Unidirectional and woven fabrics placed at $+45^\circ$ or -45° provide a high torsional modulus. Unidirectional fabric at 90° is used to impart transverse strength. The reinforcement around the root is primarily highly loaded in tension during flight and so the fibre orientation in this area is thus predominantly at 0° to the lay-up axis; the dominant orientation provides high strength around the root geometry (for this reason, it is particularly important that the root reinforcement fabric is wrinkle free).

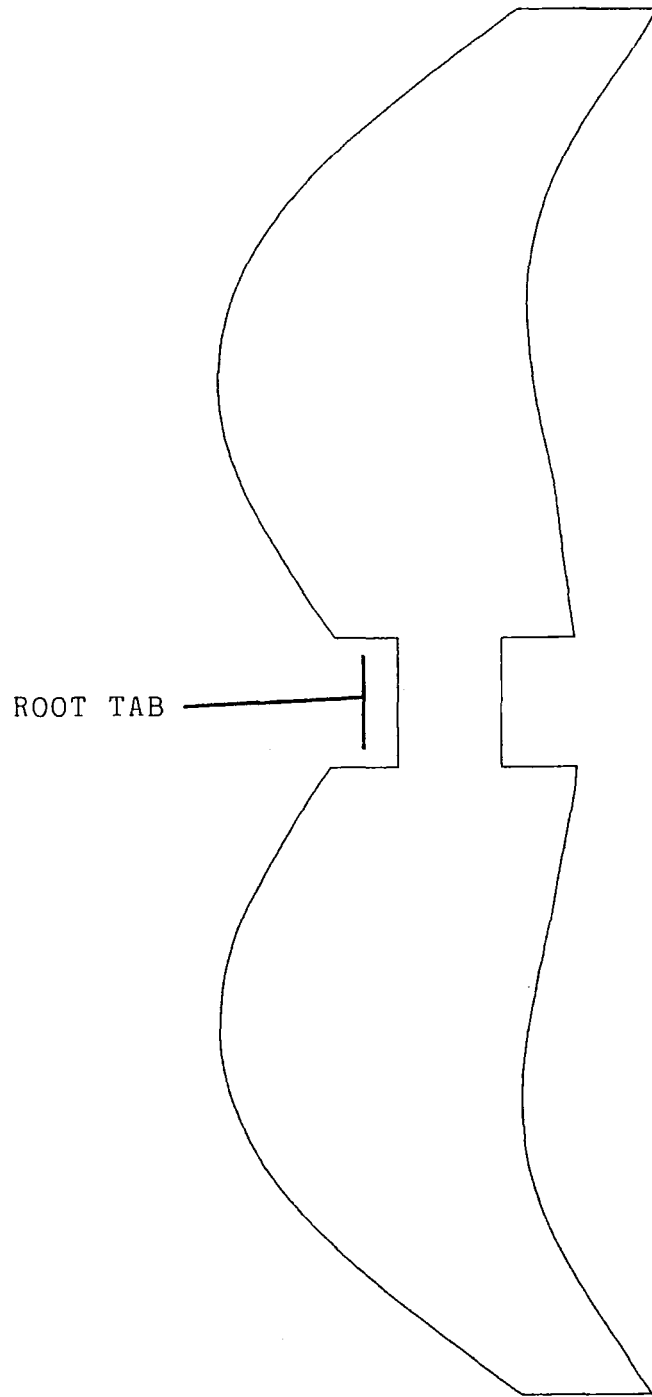

Figure 2-2. Typical Layer Profile

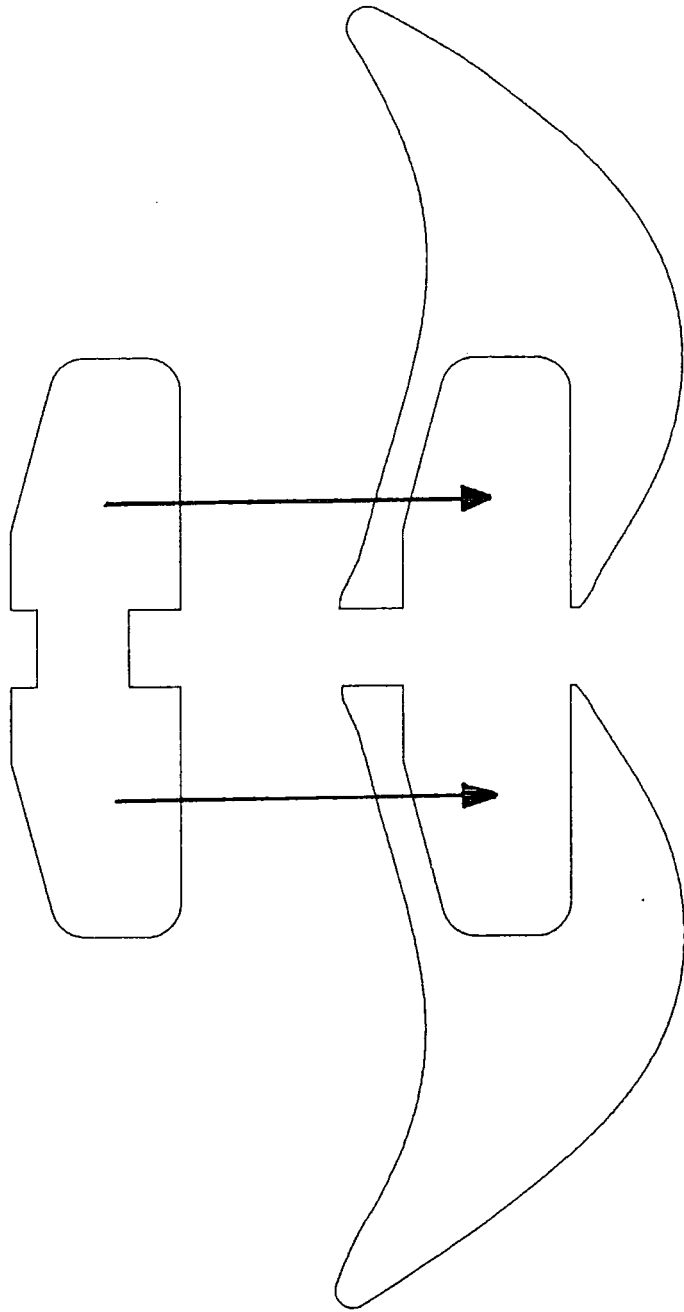

Figure 2-3. Butted Plies Making Up a Single Preform Layer

2.4 Propfan Manufacture

Composite blade manufacturing processes have undergone evolutionary change since production of composite propeller blades began at Dowty in the mid 1960s. The production methods used have, however, generally remained highly intensive in skilled labour.

There has in recent years been some success with braiding propeller blade skins, whereby the skin layers are braided from continuous yarns onto a previously manufactured, lightweight polyurethane foam core and carbon fibre spar former. The technique is likely to take an increasing role in propeller blade manufacture since it can rapidly, economically and reliably produce a very high performance preform. Braiding cannot, however, achieve the sharp preform edges required for propfan blades.

The existing Dowty method of propfan preform manufacture is based on manual lay-up of hand cut plies onto a specialized vertical jig. The manufacturing sequence (figure 2-4) is outlined below.

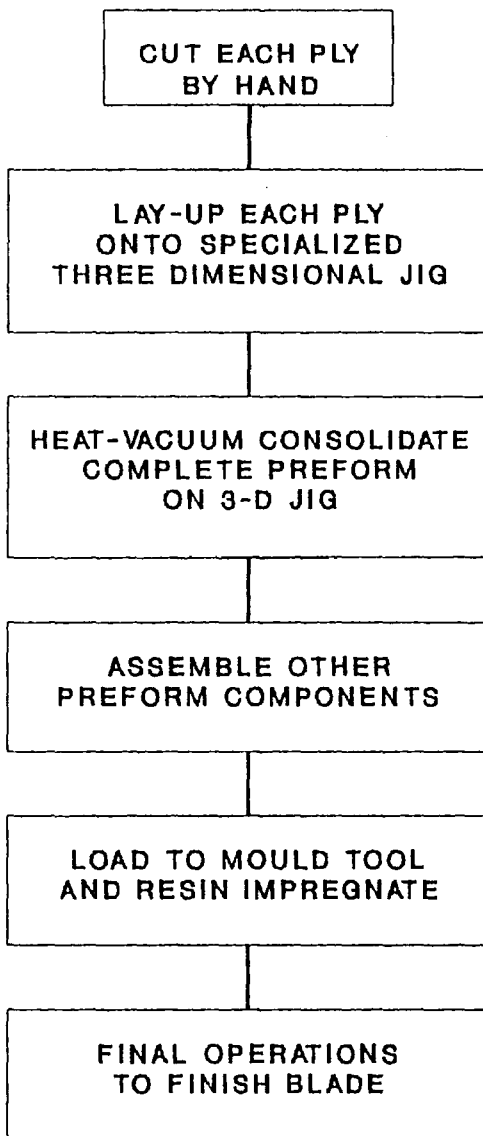

Figure 2-4. Sequence of Operations in Existing Propfan Manufacturing Process

a) Ply Cutting

Ply cutting is carried out by hand using a surgical scalpel and a set of profile templates. The process is slow and produces ply profiles of varying quality.

b) Lay-up on Jig

Each cut ply is laid up sequentially, layer by layer, over a specialized vertical jig. Two types of jig have been used to produce preforms. An earlier type, the "vertical hanging jig", was under trial at Dowty when the Project work at Durham began. The jig produced a preform with flat aerofoils; these were intended to be formed to their required contours within the mould tool during resin impregnation. In practice, this gave poor results because the stiff consolidated preform did not match the shape of the mould cavity and consequently tended to be unevenly crushed as the mould was closed. The vertical hanging jig was consequently superseded by the "hinged hanging jig" (plate 2-1) which produced a mouldable, ready contoured blade preform.

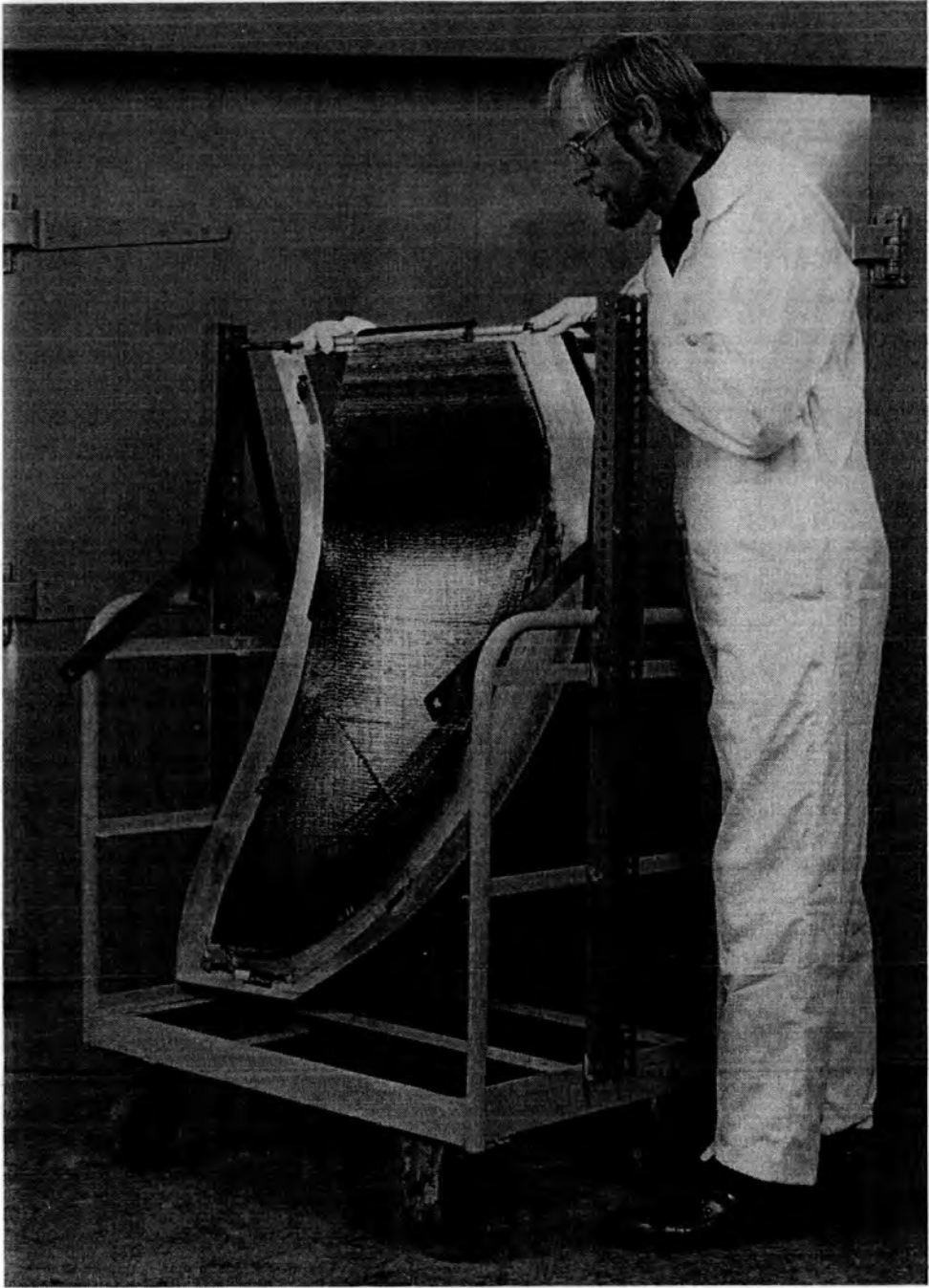

Plate 2-1. Hinged Hanging Jig

i) Lay-up on the vertical hanging jig

The early vertical hanging jig technique was to manually build up successive layers over the jig such that: the aerofoil faces were built up on each flat side of the jig; and the root geometry was generated over the root forming apparatus at top of the jig. Where layers were made up of a root tabbed ply and two outer spliced plies (figure 2-3) the tabbed ply was laid-up first and hand smoothed over the root former before being heat bonded to the layer below. The spliced plies were then bonded in place at each side of the jig, so that they butted up to the appropriate edges of the tabbed ply. When preform lay-up was complete, the root former could be raised or lowered (in relation to the rest of the jig) to tension the root and thus reduce the chance of wrinkle formation.

To guarantee a wrinkle free preform root, great care had to be taken to evenly tension and smooth the root tab layers around the root former. Since this was a manual operation, the amount of tensioning and degree of smoothing were not, however, fully controllable.

ii) Lay-up on the hinged hanging jig

The hinged hanging jig differs from its predecessor in that its sides are contoured to the required curvature of the blade aerofoil and are hinged at their apex (plate 2-1).

The procedure for manual ply placement is essentially the same as that used with the vertical hanging jig. At each layer, however, the sides of the jig are successively lowered by a specified angle so that they are almost horizontal for the first layer but vertical when the final layer is laid-up. The hinging action is intended to progressively tension the laid-up root tabs so avoiding wrinkles.

c) Heat-Vacuum Consolidation

After the completion of lay-up, the preform is sealed in a vacuum bag in situ on the jig. The jig is then transferred to an oven so that the preform can be subjected to a heat-vacuum process which compresses the structure for a specified period and heat bonds the constituent dry fibre layers together into a consolidated formed pack ready for assembly prior to injection.

d) Assembly

Once the consolidated preform has been removed from its parent jig, it is ready to be assembled along with the additional components which will be contained in the resin impregnated blade. These components are a polyurethane foam core and a titanium root insert which are both positioned within the preform (figure 2-5).

Two small outer preforms are finally heat bonded to the outer surface of the main preform, just below the root. The outer preforms are the width of the root lug and extend only 125mm down the aerofoil (figure 2-1). These small preforms are simply and cost effectively manufactured by hand and are not considered here as part of the automated lay-up operation.

f) Load into Mould and Resin Impregnate

The assembled preform is loaded into the cold female half of a press mounted mould tool, which is then closed by bringing the other half into position. The mould tool is then heated over a period of several hours. Once the mould and preform have reached the required temperature, the mould cavity is evacuated and hot resin is forced in under pressure at a

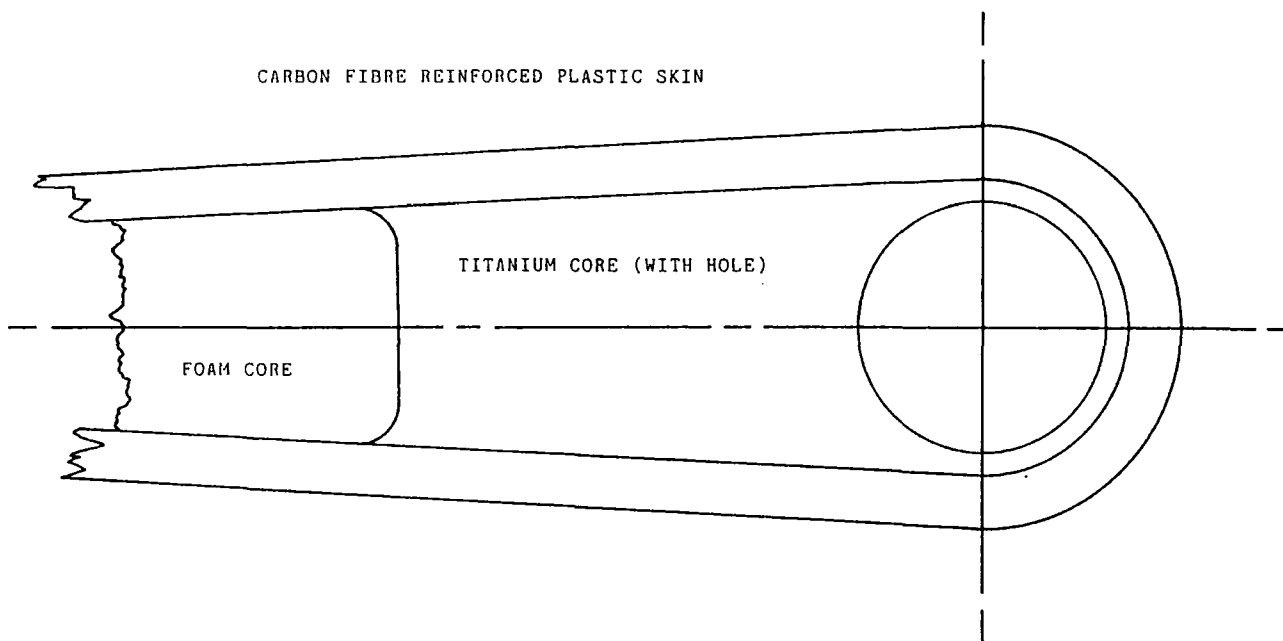

Figure 2-5. Cross Sectional Diagram of Assembled Preform Root

metered rate; this is known as "resin transfer moulding" or "RTM". On completion of RTM, the impregnated blade is cured in the mould for a set period under controlled conditions.

g) Final Operations

A number of operations follow RTM to finish the product. These can be summarized as: deflash blade edges to remove mould lines; machine slots in root as required to fit hub; fit root bushes; robotically spray blade surfaces with polyurethane coating; fit leading edge protection; paint; and finally balance and test.

2.5 The Case for Automating the Lay-Up of Propfan Blade Preforms

The potential production levels for propfan blades are significantly higher than those presently associated with conventional propeller blades (section 1.1.2). This is due to the number of aircraft that could be fitted with propfans and also to the comparatively large number of blades (typically around 36) which would make up each aircraft set.

Although lay-up is only part of the full manufacturing routing, it is a major contributor to the total labour requirement. A comparison of manpower input associated with each task stage of the existing manufacturing process (figure 2-6), based on initial Dowty estimates, shows the dominance of both the lay-up and cutting stages which combined represent some 40% of the total labour requirement. Since the automation of propfan blade lay-up is taken to include robotic ply collection from an automated cutting table, it will allow the both of these automated functions to be integrated. The potential labour cost saving with large production runs could be considerable[2].

Lay-up can also be a significant contributor to scrap costs, since operator error at this stage can lead to structural faults within the moulded blade. Two of the typical defects that could result from operator error are:

i) Incomplete Resin Impregnation

Poorly positioned plies can cause excessive local thickness within a preform. When the preform is moulded the excessive bulk will be compressed, packing the fabric layers too tightly for complete resin impregnation to take place; this

results in a dry (resin starved) area.

ii) Wrinkles

Poor lay-up in the root can cause the fabric running around the root to wrinkle. If such wrinkles remain in the root through resin impregnation, they will act as stress concentrations in the final blade. Since the root is highly loaded, such stress concentrations cannot be tolerated.

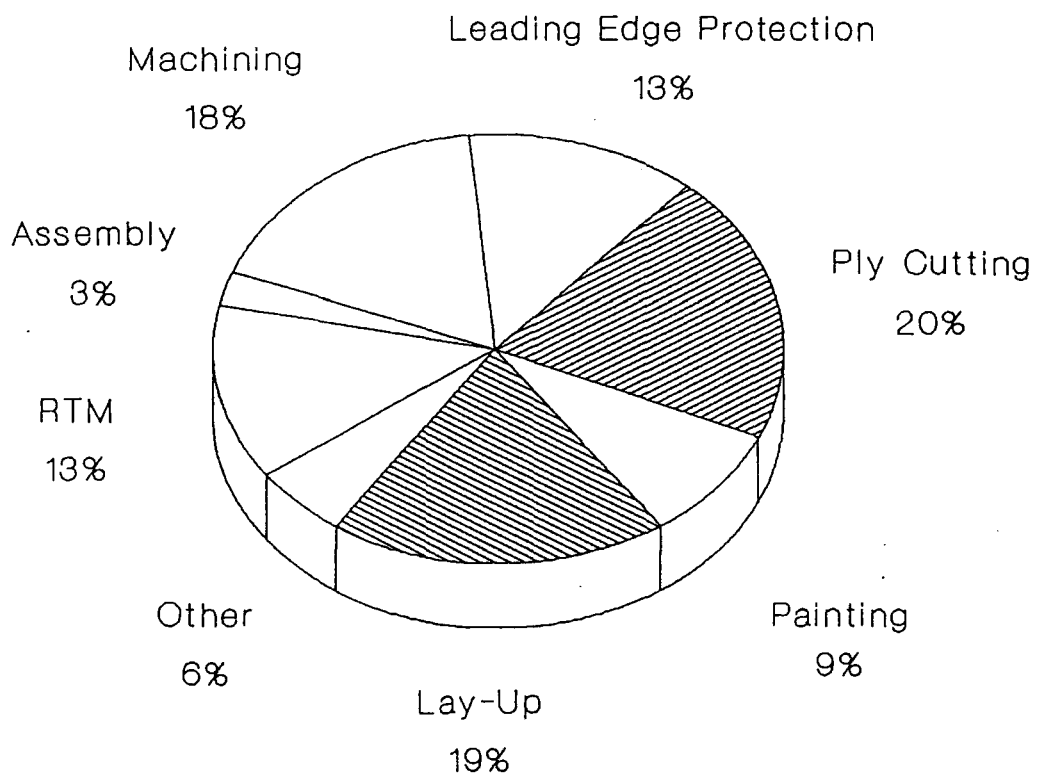

Figure 2-6. Proportions of Manpower Input Per Task

Faults, such as these, can usually only be detected after the blade has been released from RTM and cannot be rectified by rework. The associated scrap cost can, therefore, be high. Automation of lay-up should minimize the occurrence of preform faults by guaranteeing repeatably accurate lay-up, thereby reducing scrap rates and, therefore, production costs. It is also possible that the structural quality of finished blades could be consistently higher.

2.6 Automated Manufacture

Section 2.4 and 2.5 discussed existing manual manufacturing methods for producing propfan preforms at Dowty and argued the case for automation. In this section the selection of an appropriate general automation approach is considered.

2.6.1 Automated Techniques for Producing Reinforcement Preforms

A number of techniques have been developed in industry to automate the manufacture of reinforcement preforms for composite components. Each technique serves a particular niche. Automation techniques include: filament winding;

braiding; knitting; automated lamination; and hybrids[18]. This section argues that automated lamination is most appropriate for propfan preform manufacture.

Filament winding is suitable for generating simple or complex preform geometries by winding continuous fibre tow around an appropriate mandrel[3,4,5,6,7]. Braiding, which is already in use at Dowty to manufacture conventional type blade skin preforms, is particularly suited to the manufacture of structures with a rounded cross section[8,9]. Knitting is usually used to produce flat preforms and sheets, but moderately complex three dimensional preforms have been created[10,11]. Automated lamination is a viable method of manufacturing a wide range of laminar, solid, or shell preforms.

Neither filament winding nor braiding are appropriate techniques in propfan manufacture. The main obstacle to their effective application is that winding is not effective around sharp edges. Filament winding would also be very slow.

It is possible that knitting could be a technically viable method of producing the required preform. The geometry of the propfan preform including its "U"-shaped root would, however, necessitate the use of an extremely complex robotic knitting

machine. Such a machine would be extremely expensive to design and develop and is beyond the practicalities of the existing technology; the method would also be comparatively slow.

Automated lamination, by contrast is ideally suited to propfan preform manufacture, since sharp edged structures can be simply built up by appropriately contouring successive laminates. The process is also likely to be rapid.

2.6.2 Automated Lamination

Automated lamination can take one of two generic forms, automatic tape laying and automatic ply lay-up (operated in conjunction with automatic ply cutting). This section describes the two approaches of which ply lay-up is selected as most appropriate. It also argues that the results of known previous research into automated ply lay-up are not generally applicable to the automated manufacture of Dowty propfan blade preforms.

i) Tape laying versus ply lay-up

Automatic tape laying involves precision placement of a

series of narrow strips of composite fabric or "tape", typically around 75mm in width, from a specialized multi-axis numerically controlled robot mounted tape dispensing head. Tape laying machines are commercially available from several companies such as Alcoa/Goldsworthy and Cincinnati Milacron but have a high capital cost.

Tape laying is most economical when used to manufacture large preforms with an approximately rectangular profile (e.g. aircraft panels) which can be manufactured from tapes with minimum material wastage. Tape laying of plies with the profiles used in propfan manufacture would generate large quantities of costly waste. Moreover, the existing technology is only applicable to prepreg fabrics which can in effect be handled as "double sided sticky tapes".

Automated ply (or "broadgoods") lay-up is by contrast a means by which whole pre-cut plies can be robotically picked from an economically nested set of plies at a cutting station, transported and finally laid-up either directly into a mould tool or as an intermediate preform pack which can subsequently be transferred to a mould. This approach was considered to be most appropriate for automating propfan preform manufacture.

ii) Research into automated ply lay-up

A number of industrial and academic institutions have previously entered into research and development programmes aimed at automating ply handling [12, 13, 14, 15, 16, 17, 18]. Programmes have been almost exclusively been targeted at the manufacture of aircraft fuselage panels, control surfaces, stiffeners, and wing / fin skins. These products are predominantly made from prepreg laminates with relatively simple, approximately rectangular profiles. Consequently the systems are not optimized for handling complex profiled plies cut from dry reinforcement fabrics.

The core of automated ply handling systems is almost invariably a robot mounted handling device or gripper. Gripper design varies according to the generic application and no universal solution is known to exist. The factors which affect gripper design (ply size, ply shape, the range of shapes to be handled, the characteristics of the fabric being handled and the shape of the former into which the plies are to be laid) in the Dowty application are such that previously developed automation technologies are inappropriate.

2.6.3 Automated Cutting

Precisely cut undistorted plies are a prerequisite of successful automated lay-up. Since manual cutting methods are unreliable in these respects, a form of mechanised cutting is necessary. There are four mechanized techniques for automated composites cutting: by water jet; by laser; by computer controlled knife; and by press cutting using suitable dies.

Water jet cutting is not an acceptable method of cutting dry carbon or glass fibre fabric because of the high risk of moisture contaminating.

Cutter press systems can produce high quality undistorted plies and are relatively inexpensive. They do, however, require a series of dedicated cutter boards and are thus inflexibility to changes in ply profile or nest pattern. Automation of a cutter press system would also require the adoption of a mechanised cutter board handling system.

Gantry mounted laser cutting and mechanised knife systems are highly flexible, accurate and can be comparatively easily configured for fully automatic operation. These types of cutter systems are consequently attractive partners for

automated lay-up.

This Chapter has described Dowty Aerospace Propeller's association with fibre reinforced plastics and how these composite materials are used in the manufacture of new technology propfan propeller blades. The existing manufacturing process and the need for automation have been described. Of the alternative automation strategies subsequently described, automated lay-up has been selected as most likely to succeed; this option is pursued in the remaining Chapters.

REFERENCES

- [1] McCarthy, R., "Fifteen Years Experience with Composite Propeller Blades.", European Chapter SAMPE Intercontinental Conference - Advanced Technology in Materials Engineering, Cannes, France 12-14 Jan 1981.

- [2] Jarvis, S.D.H., "Fan Blade Lay-Up and Wrap Automation Programme - An Initial Justification", Dowty Aerospace Gloucester Ltd. internal report, January 1988.
- [3] Smith, E.A., (Edited by), *Carbon Fibres*, Morgan-Grampian Publishers Ltd., 1970.
- [4] Middleton, V., et al, "Developments in Non-Axisymmetric Filament Winding", Proceedings of Automated Composites '88, Netherlands 1988.
- [5] Lloyd-Thomas, D.G., et al, "Asymmetric Filament Winding", Proceedings of Automated Composites '88, Netherlands, 1988.
- [6] Parmar, M., and Boyce, G.S., "Development of a Volume Production Technique for the Manufacture of Complex Shaped Components in Continuous Fibre Composites", Proceedings of Automated Composites 88 (The Plastics and Rubber Institute) Noordwijkerhout, Netherlands, September 26-28, 1988.
- [7] Lubin, G., (Editor), *Handbook of Fiberglass and Advanced Plastics Composites*, Robert E. Krieger Publishing

Company, New York, 1975.

- [8] Ajibade, F., "Braided Structures - Successful Marriage of Textile and Composite Technology", Automated Composite '88.
- [9] Yokoyama, A., et al, " A New Braiding Process - Robotised Braiding Mechanism", Proceedings of the 10th International European Chapter Conference of SAMPE, Birmingham, July 11-13, 1989.
- [10] Leonard, L., "Speciality Fabrics: The promise of near-net-shape preforms", Advanced Composites, May/ June 1989.
- [11] Williams, D., "New Knitting Methods Offer Continuous Structures", Advanced Composites Engineering, Summer 1987.
- [12] Sarh, B., "Principle Tests for the Automated Production of the Airbus Fin Assembly with Fibre Composite Materials," 29th. National SAMPE Symposium, April 3-5, 1984.

- [13] Stone, K.L., "Automation in Composites Processing", 29th. National SAMPE Symposium, April 3-5, 1984.
- [14] Coad, C.L, Werner, S.M., and Dharan, C.K.H., "Design of a Composite Four-Axis Robot for Prepreg Layup.", SAMPE Journal, Jan/Feb 1985.
- [15] Johnson, D.G., and Hill, J.J., "A Sensory Gripper for Composite Handling.", Proceeding of the 4th. International Conference on Robot Vision and Sensory Controls, 1984.
- [16] Anon, "Composites and Robotics: Pushing Technology Forward.", Robotics Today, Fall 1980.
- [17] Bubeck, K.B., "Advanced Composites Handling Application.", Proceedings of the 13th. International Symposium on Industrial Robots, Chicago, April 18-21, 1983.
- [18] Goldsworthy, W.B., "Tow, Tape and Broadgoods in Automated Layup.", Proceedings of Automated Composites 88 (The Plastics and Rubber Institute), Noordwijkerhout, Netherlands, September 26-28, 1988.

C H A P T E R I I I

F A B R I C H A N D L I N G C H A R A C T E R I S T I C S

CHAPTER III

FABRIC HANDLING CHARACTERISTICS

An essential precursor to the design of an automated fabric handling system is the development of an understanding of the relevant characteristics of the materials to be manipulated. These characteristics are a function of both fabric properties and the form in which the fabric is presented.

This chapter discusses the characteristics of the fabric that will be handled by the automated lay-up cell.

3.1 Fabric Properties

The dominant fabric properties affecting the design of handling system for lay-up automation were identified as: weave stability (i.e. susceptibility to distortion in the x-y plane); flexural rigidity; susceptibility to forms of weave damage; the mass per unit area. Air porosity was also of interest since the initial grippers have been based on vacuum pick-up (Chapter VII).

3.1.1 Weave Instability

Fabric distortion during ply handling is undesirable since it alters the ply's profile rendering it impossible to correctly position during placement. The severity of potential distortion depends upon the forces applied to the fabric during handling and the weave type.

Carbon fibres have a very high modulus of elasticity (typically 380 GPa) and, therefore, fabrics cannot significantly deform through pure tension in the direction of fibre orientation. That is the warp axis for unidirectional fabric (appended sample) and both the warp and weft axes for woven fabric (appended sample). In the case of the unidirectional fabric, the thermoplastic weft filaments behave elastically allowing temporary deformation to occur across the fabric width. Elastic deformation does not cause a problem as long as the handling technique allows full elastic recovery to occur when the ply is laid down.

Distortion of ply profiles can occur in both woven and unidirectional fabrics when they are subjected to shear in the x,y plane. In the case of the unidirectional fabric the individual fibre tows are relatively firmly interlocked by

the thermoplastic weft fibres heat bonded to them. Consequently, the unidirectional fabric has a reasonable shear modulus. Within the woven material, however, the interlock between the carbon warp and carbon weft toes is purely frictional. Their intersections, therefore, act as near pin joints so that pronounced deformation occurs under very low applied shear loading. The gripper device, intended for both fabrics, must, therefore, apply minimal shear forces during handling operations and ideally no shear forces at all.

3.1.2 Flexural Rigidity

Since dry fibre reinforcement panels are inherently flexible, adequate support must be provided across the fabric surface during handling.

To complicate matters, the fabric flexibility varies according to the axis across which it is measured. The greatest flexural rigidity always follows the main fibre axis or axes (appended samples).

Unidirectional fabric exhibits its greatest stiffness along

the 0° (warp) axis. It has, however, virtually no stiffness at all in the weft axis which is supported only by highly flexible thermoplastic weft filaments. Woven fabric, however, exhibits a level of stiffness along both its 0° and its 90° since it has two fibre axes.

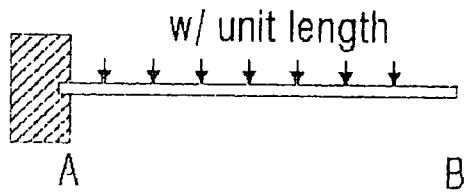

Deflection at B: $v = wL^4/8EI$

Figure 3-1 (a). Cantilevered Sample Carrying (w) Weight per Unit Length

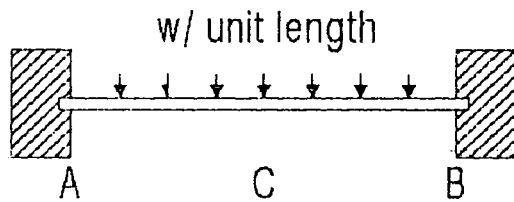

Deflection at C: $v = wL^4/384EI$

Figure 3-1 (b). Sample Fixed Horizontally at each End Carrying (w) Weight per Unit Length

The affect of bending moments on homogenous materials is a known science. Standard case deflection formulae^[1] (figures 3-2 (a) and (b)) relate directly to Young's modulus of elasticity (E), a material constant, the second moment of area (I) and length (L) of the section being bent. The derivation of these formulae depends upon the argument that for any bending section there is a neutral axis above which there is tensile stress (causing strain) and below which there is compressive stress (causing compression). Along the neutral axis (figure 3-2(a)) there is no resultant stress and so no strain.

Normal bending theory cannot, however, be applied to dry fibre reinforcement because the fabric is made up of a large number of bundled but discrete fibres. During bending, filaments towards the outer surface are in tension while filaments towards the lower surface are in compression. In tension, carbon fibres have a high Young's modulus, but in compression each fibre, not yet supported by a resin matrix and having a small moment of area, is easily buckled. The effective neutral axis is consequently at the tension surface of the fabric (Figure 3-2 (b)). The flexural rigidity is thus extremely difficult to predict and depends on method of loading as well as the severity of bending curvature.

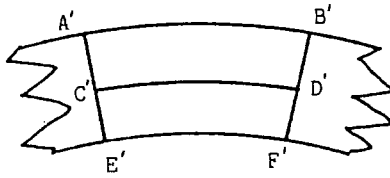
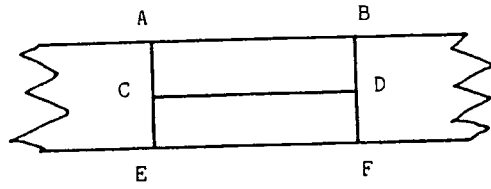

$$A'B' > AB = CD = EF = C'D' > E'F'$$

Figure 3-2 (a). Neutral Axis for Homogeneous Material.

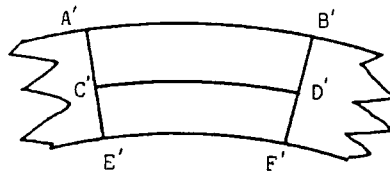
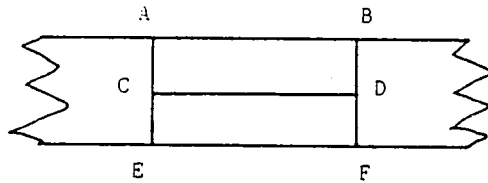

$$AB = CD = EF = A'B' > C'D' > E'F'$$

Figure 3-2 (b). Neutral Axis in Composite Fabric

A further complication is the initial time dependence of deflection which is particularly noticeable in the woven fabric but is also apparent unidirectional fabric. This creep behaviour appears to be the result of slow progressive buckling of the compressed fibres below the neutral axis in the unidirectional fabric. With the woven material it is due to both slow buckling and fibre slippage within the fabric weave. The creep is only a permanent deformation in the sense that the fabric must be physically flattened to return it to its original state.

Given the arguments above, it has been useful to empirically record values for deflection under own mass for the woven and unidirectional fabrics under cantilever and horizontally fixed at each end conditions (figures 3-3 (a), (b) and (c)).

3.1.3 Susceptibility to Weave Damage

Dry fibre fabrics can suffer from three types of weave damage during handling, all of which will reduce the performance of the completed component.

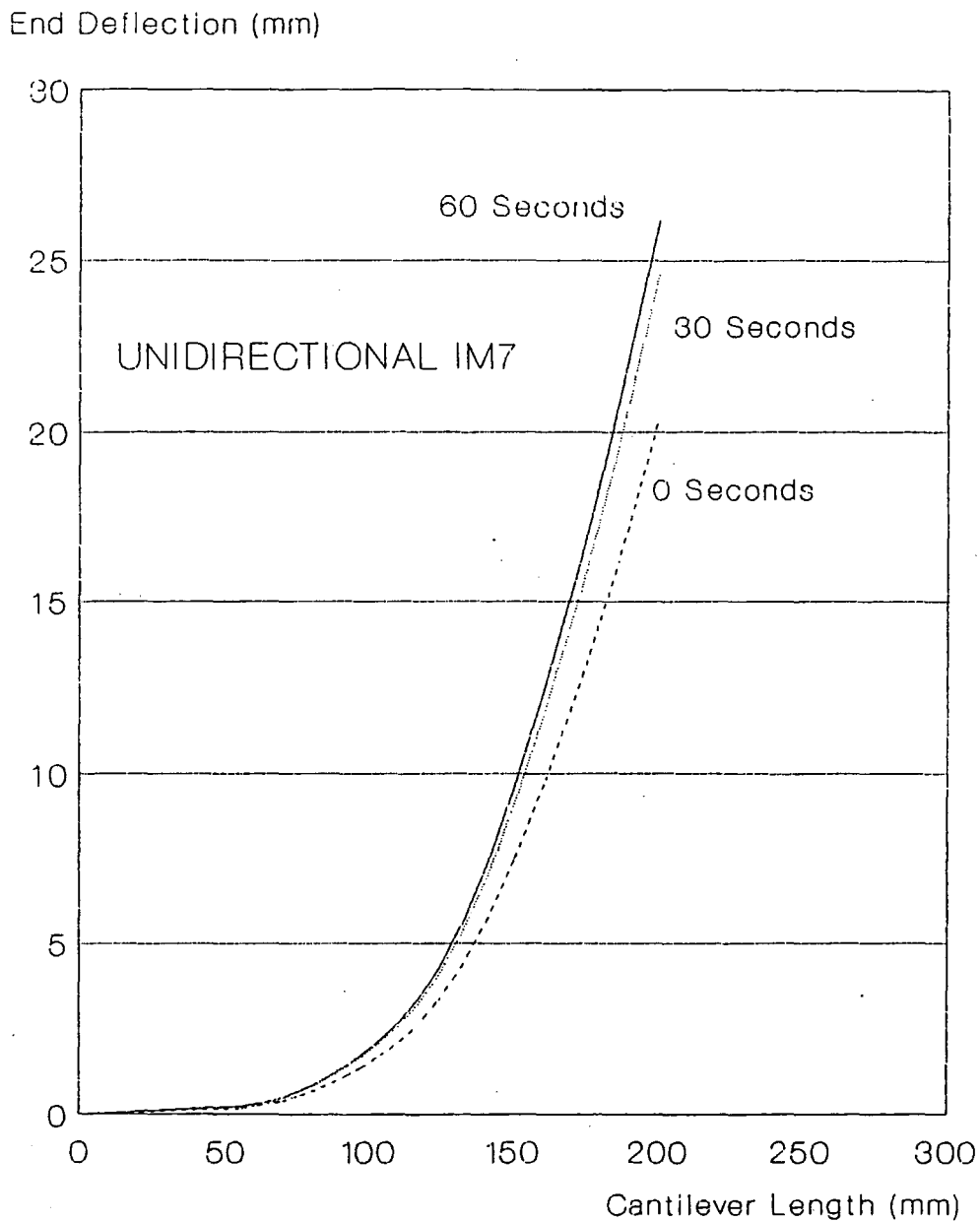

Figure 3-3(a). Deflection under Own Weight - Cantilevered Unidirectional Fabric

{Note that a gradual creep was recorded which stabilized within sixty seconds.}

End Deflection (mm)

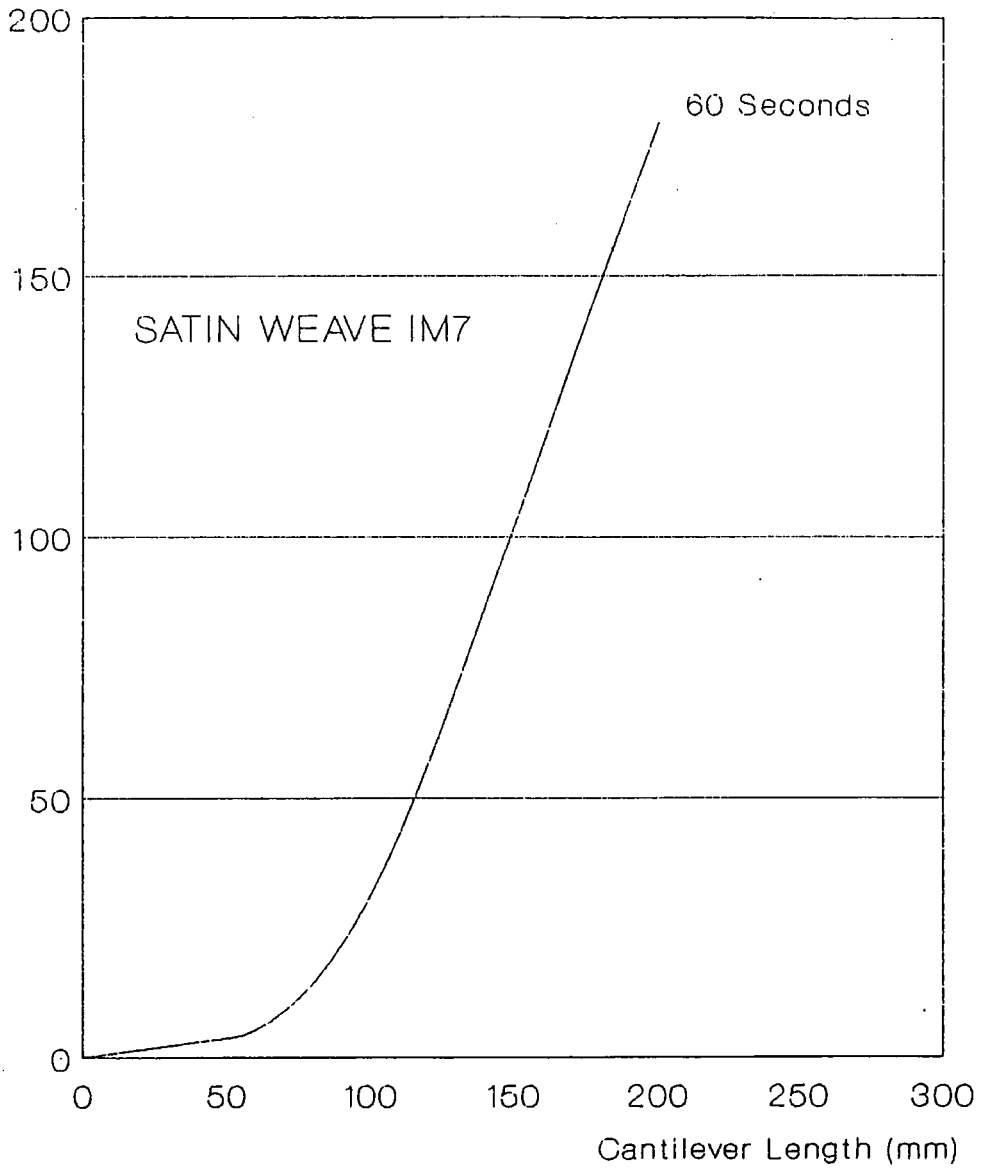

Figure 3-3(b). Deflection under Own Weight - Cantilevered Woven Fabric

{Note: creep was detected but was too rapid to record. Stability was reached within sixty seconds.}

Mid Point Deflection (mm)

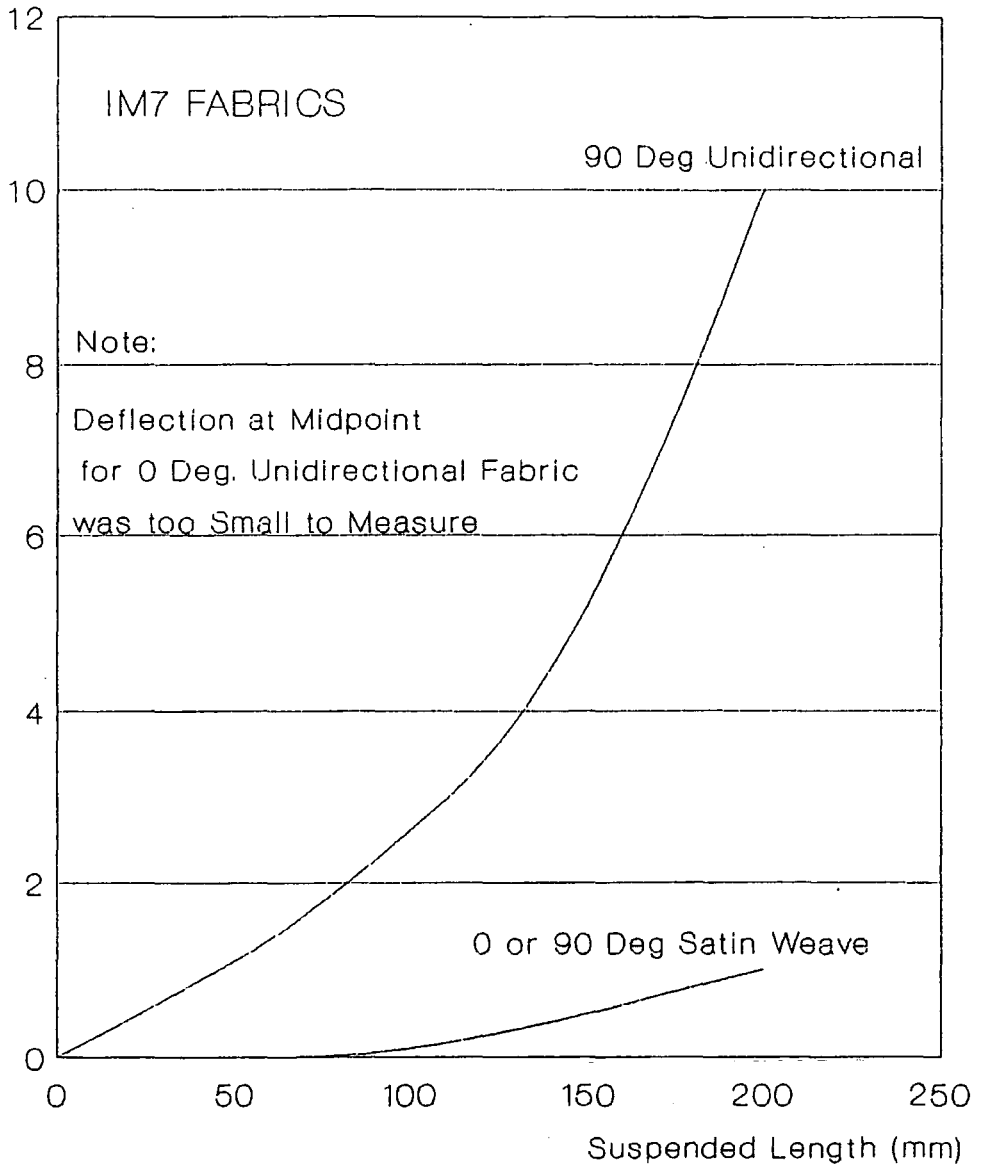

Figure 3-3(c). Deflection under Own Weight - Fabric Fixed Horizontally at Each End

{Note: no creep was detectable.}

i) Fibre Damage

Fibre filaments can be scored or broken thus reducing the performance of the parent tow.

ii) Tow Misalignment

Individual tows can be forced out of alignment within the weave pattern which, if severe, will cause a laminar stress concentration in the moulded blade. This is particularly likely with woven fabric because of the poor physical interlock between the warp and weft tows.

iii) Edge Definition

Dry composite fabrics, unlike prepregs, are prone to severe fraying such that whole tows can can tease from a ply edge. Again this is particularly the case with the woven fabric, where the individual tows of fabric are held by loose frictional interlocks at weave crossover points. Unidirectional fabric is less prone to fraying because each individual tow is linked to its neighbour by thermoplastic weft filaments. Individual filaments within each tow can, however, fray causing poor ply edge definition in both woven and

unidirectional fabrics.

The initial quality of ply edges after cutting is dependant on the cutting method. Traditional hand cutting by knife and template tends to induce some fraying depending on the skill of the operator and edge quality normally can be expected to deteriorate with subsequent manual handling. Automated cutting with an ultrasonic knife can generally only better skilled manual cutting if the cutting parameters such as frequency of reciprocation / oscillation (cutting speed) and cutting feed rate are optimized. The reason for this is that the travel and reciprocation of the knife can cause the individual tows / filaments to snag and be pulled away from the fabric. The affect is most significant when the line of cut is at a slight angle to direction of the tows within the fabric. Cuts across tows are far cleaner.

Automated laser cutting can generate a very high quality of cut since the fabric structure is not subjected to cutting forces. Laser cutting can cause slight filament oxidation/fusion at the ply edge, but if the phenomena is controlled it can help to prevent fraying during subsequent handling. Poorly controlled filament oxidation can lead to the build up of a fused / oxidized edge lip standing proud of

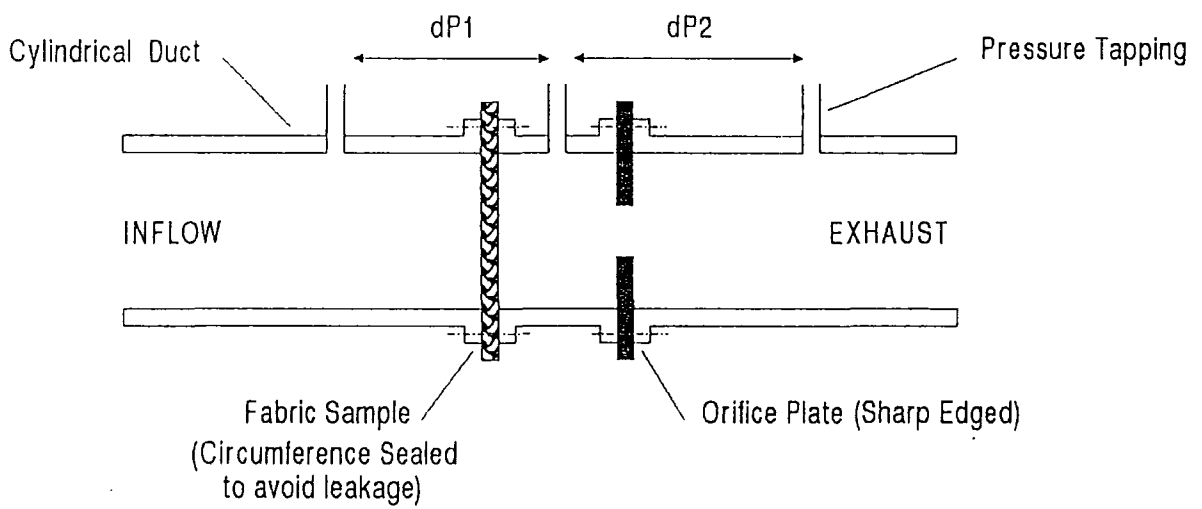

- 1) Pressure drop across fabric is $dP1$
- 2) Flow rate through fabric is a function of $dP2$

Figure 3-4. Porosity Measurement Apparatus

Flow Rate (Cm/h) per square mm of Fabric

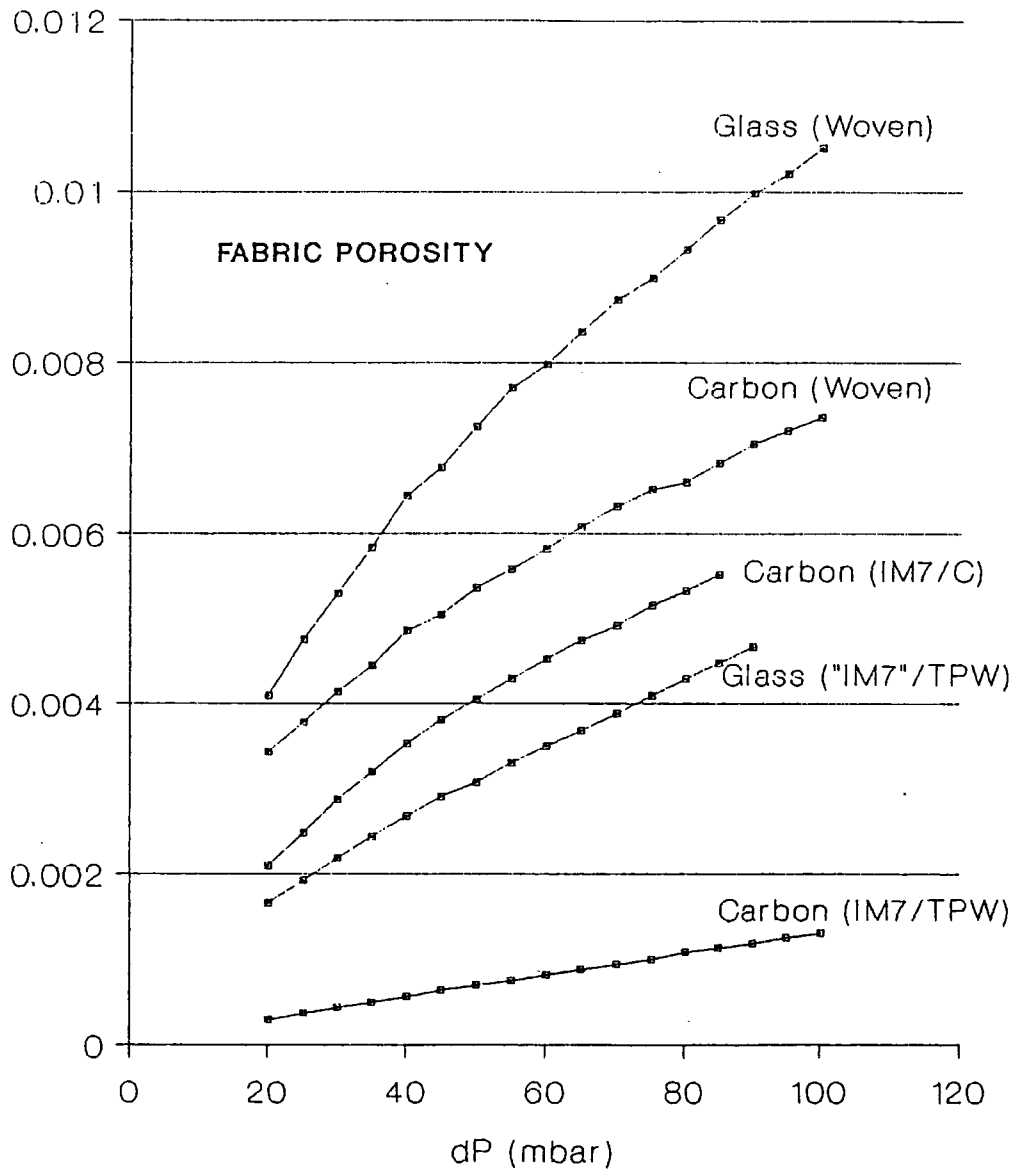

Figure 3-5. Air Flow through Fabric for a Range of Carbon (and Glass) Fibre Fabrics.

the surrounding material and this would form unacceptable ridges in the finished preform.

3.1.4 Porosity

The dry carbon fabrics considered in the Project do not carry a non porous backing film as do most dry and pre-impregnated composite fabrics. In vacuum type handling, therefore, the level of porosity of the fabric is significant.

Fabric porosity ("air permeability"), is a measure of the air flow rate through a given unit area of fabric for a given pressure difference across the fabrics surfaces. Porosity values are of particular interest when vacuum gripping techniques are being considered, (as will be the case in this thesis (Chapter VII)), since they dictate the requirements of the system vacuum pump.

The method used to measure fabric porosity was to draw air through samples held in a circular orifice plate apparatus (figure 3-4) and measure the flow rate for a given pressure difference or range of differences across the fabric surfaces (figure 3-5).

3.2 Interlaminar Bonding Characteristics

Unidirectional fabrics presently used in the manufacture of propfan blade preforms have a interwoven thermoplastic weft, which becomes sticky when heated and can be used to tack subsequent preform layers prior to resin impregnation. Adequate tacking can only be achieved if suitable conditions of bonding pressure, temperature and duration are met.

Woven fabric has no thermoplastic weft and must always be tacked between pairs of unidirectional plies.

3.3 A Comparison with Prepreg

The majority of automated ply handling systems developed to-date have been targeted for use with prepreg fabrics. The handling properties of prepregs are somewhat different to those of dry fibre fabrics. It is, therefore, useful to compare the two sister materials to indicate why the automated equipment for handling dry fibre fabrics will differ from those used for prepregs.

a) Flexural Rigidity

In the case of unidirectional fabrics, the warp axis stiffness of comparable weave dry and prepreg fabrics are of similar magnitude. The stiffness in the weft axis is, however, far higher for prepregs due to the supportive affect of its backing film and to the fibre-resin-fibre bond between adjacent warp filaments. Dry composite fabric, therefore, requires far greater cross weft support during handling. Similar arguments apply to woven fabrics.

b) Ply Distortion

Prepreg backing film also acts to stabilize the fabric weave such that plies are almost impossible to distort in the x,y. For this reason, gripper design for robotic handling of prepregs is not so concerned with avoiding the application of shear forces to plies during handling.

c) Fibre / Weave Damage

Prepreg fabric is far more difficult to damage during handling since it is, for the most part, protected by backing film. The support provided by the backing as well as the way

in which adjacent fibres are held together by resin also acts to make automated cutting of prepregs far simpler and extremely precise, producing clean cut highly stable edges.

d) Porosity

If the plies are to be held by a vacuum gripper, prepregs have an advantage in that their backing films are non porous. The required vacuum flow rate within the system is consequently negligible when compared to that required for handling the dry fabrics considered in the Thesis.

e) Lay-up Stage Interlaminar Tacking

Prepreg materials tack together on contact. This is an advantage in the sense that interlaminar bonding prior to consolidation (debulking) is a simple matter of pressing a handled ply onto the previous layer. The bonding apparatus for dry thermoplastic weft fabrics must combine pressure with controlled heating capability.

It can be seen from the above arguments that dry fabrics, which are an essential part of the Dowty propfan blade, are far more difficult to handle automatically than comparable

prepregs and this places greater demands on the capabilities of the handling system which must be employed.

3.3 Ply Shape and Size

The problems associated with the handling characteristics of dry fabrics are compounded by the size and geometry of the plies which make up a propfan blade preform. The exact size and nature of the plies depends on the design of a particular propfan blade but, for the representative propfan blade targeted in the Project the ply attributes can be set down as follows:

Each preform comprises of around forty different plies. The ply size ranges from around 635mm x 180mm to over 2100mm x 750mm. The outer profile of each layer or laminate is similar in shape but of a progressively larger size working from the inner layers towards the outer layers; the effect is somewhat similar to the successive contour lines shown on the map of a hill (figure 3-6).

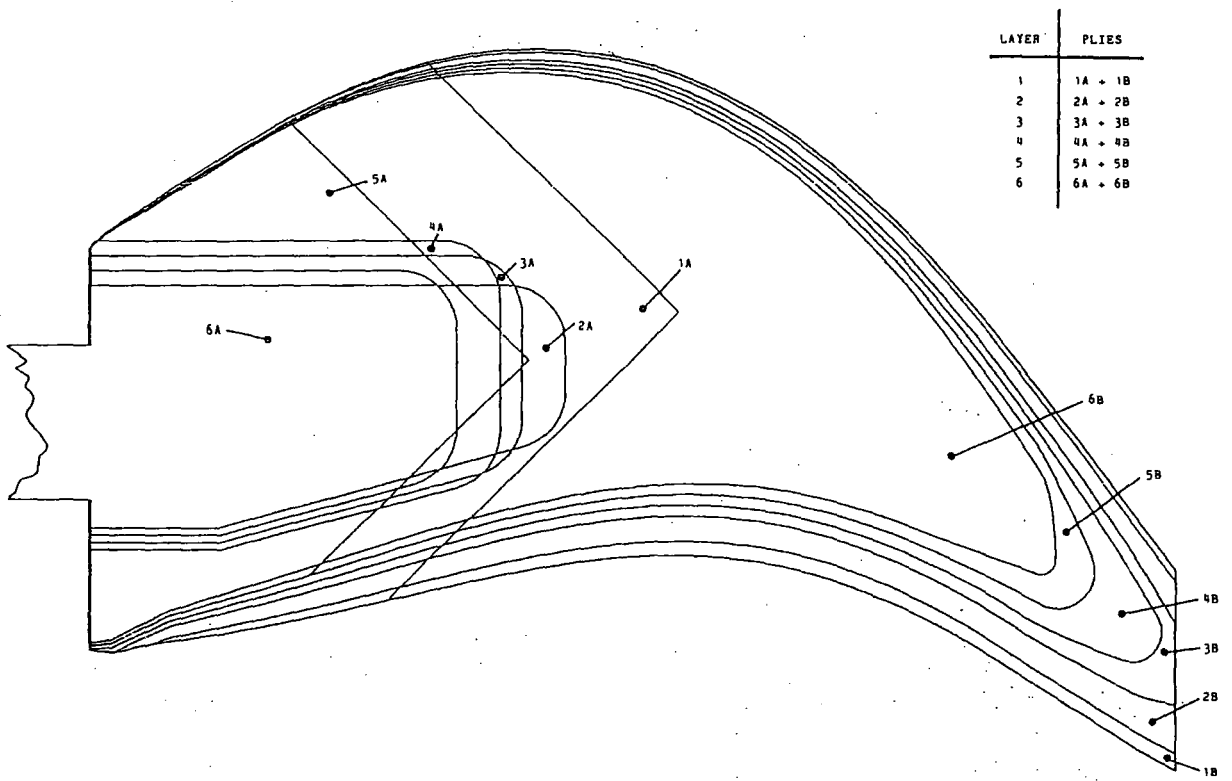

{For clarity, only six layers are depicted}

Figure 3-6. Successive Layer Profiles

In any layer, each spliced ply has a required fibre orientation (0° , 90° , $+45^\circ$ or -45°) and is cut from a specific fabric, either woven or unidirectional. The geometry of each spliced ply is dictated by two factors, the outer contour of the layer (laminate) to which the ply belongs and the way in which the ply is spliced within its parent layer to provide the different fibre orientations required (section 2.3). Ply geometries can be grouped into geometrical families, each consisting of similar shaped profiles of graduated sizes (figure 3-7).

It is particularly difficult to handle plies whose geometrical features include the long thin projected areas. In the worse cases, the projection may be as narrow as 50mm and have a length of over 500mm. Such features are extremely easy to distort especially if the ply fabric is i) woven or ii) unidirectional with the warp axis perpendicular to the length of the projection.

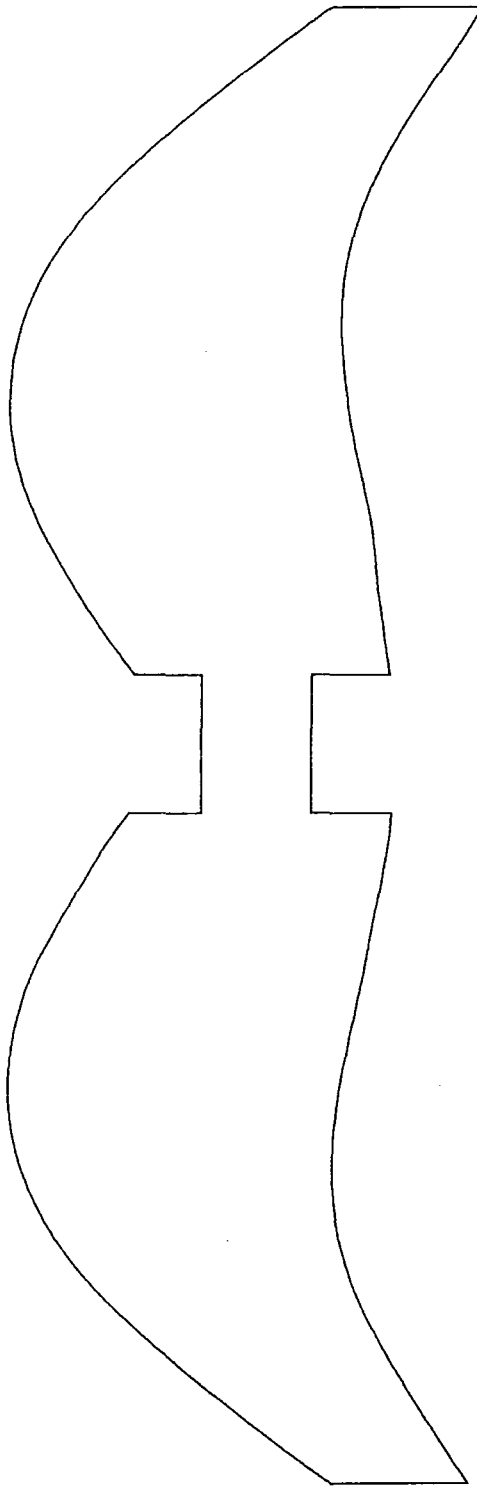

Figure 3-7(a). Geometrical Ply Family

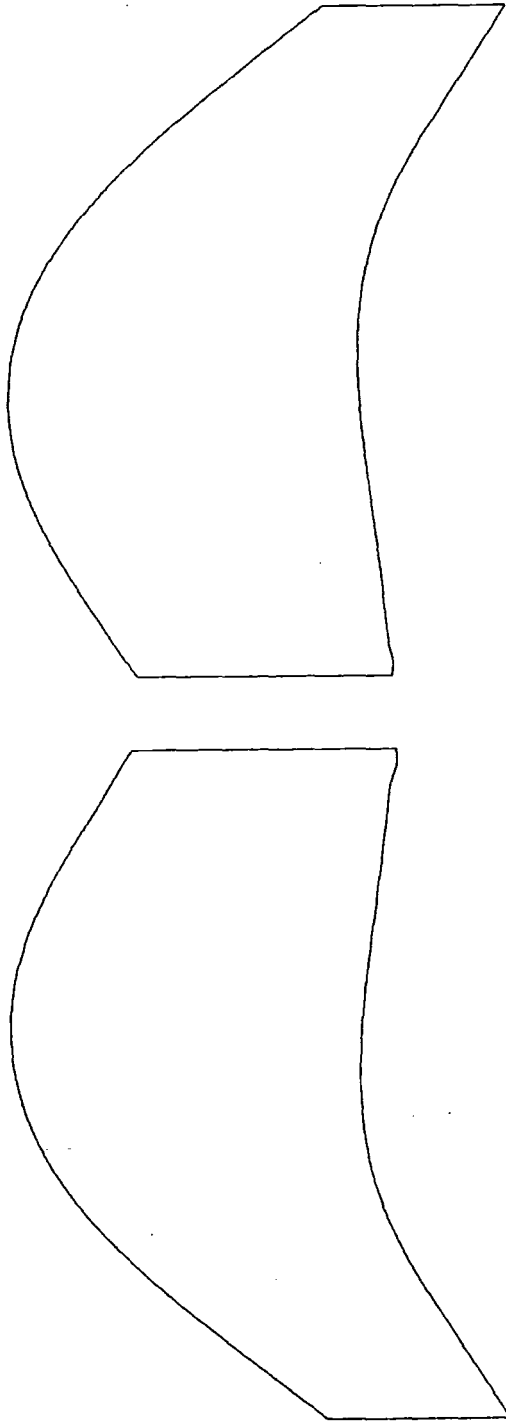

Figure 3-7(b). Geometrical Ply Family

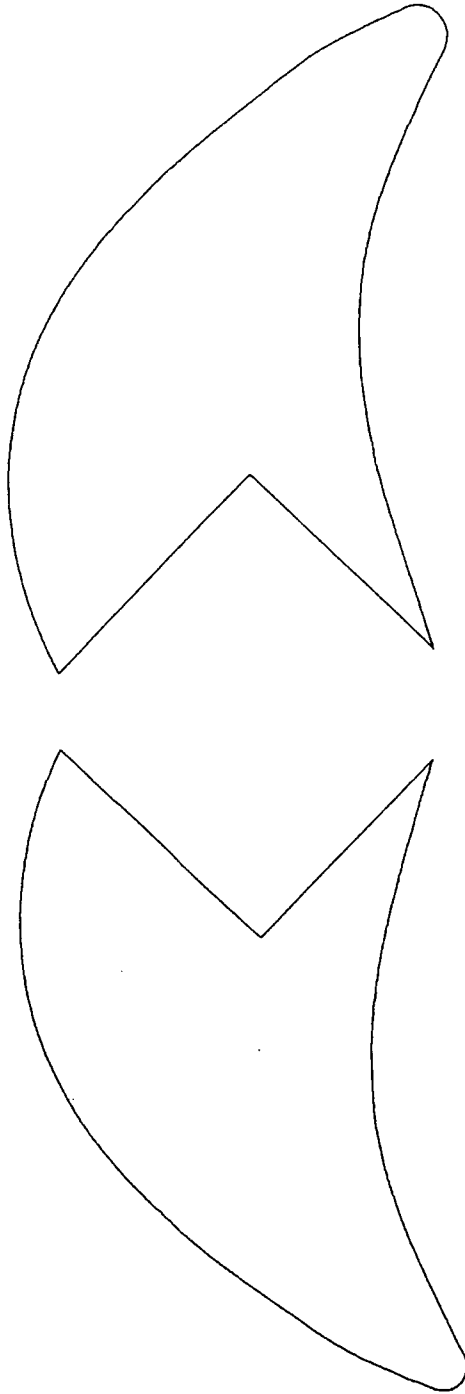

Figure 3-7(c). Geometrical Ply Family

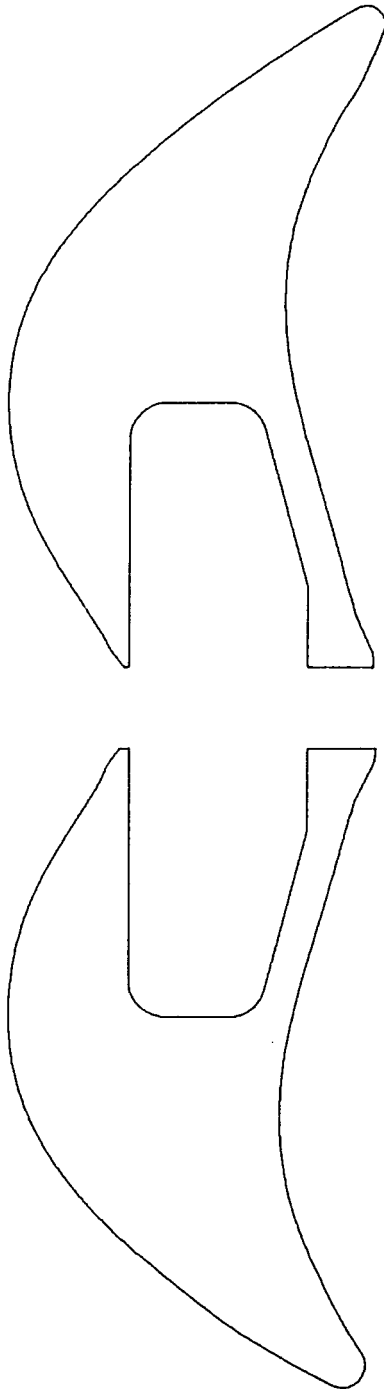

Figure 3-7(d). Geometrical Ply Family

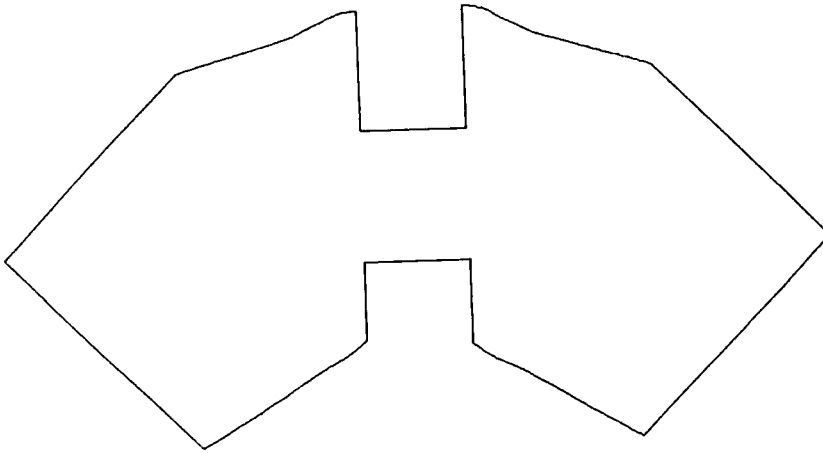

Figure 3-7(e). Geometrical Ply Family

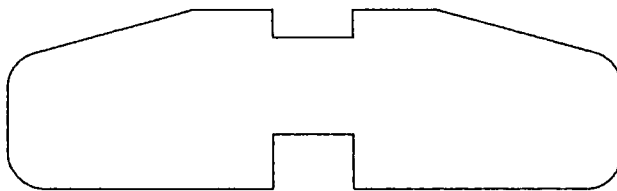

Figure 3-7(f). Geometrical Ply Family

3.4 Chapter Conclusions

Chapter III has described the characteristics which dictate the ease with which propfan plies can be handled. It has been argued that the dry fabrics used by Dowty, both woven and unidirectional, are far more difficult to handle than prepregs since they are particularly flimsy and readily distorted or damaged. The difficulty is further increased by the range and complexity of the plies which make up a propfan preform set.

REFERENCES

- [1] Benham, P.P., and Warnock, F.V., *Mechanics of Solids and Structures*, Pitman Books Ltd., London, 1976.

C H A P T E R I V

A N E W L A Y - U P T E C H N I Q U E
D E S I G N E D F O R A U T O M A T I O N

CHAPTER IV

A NEW LAY-UP TECHNIQUE DESIGNED FOR AUTOMATION

The present manufacturing techniques for lay-up of dry fibre propfan preforms demand a high level of human dexterity. Although the complexities of ply manipulation can be dealt with during manual lay-up, they make the existing technique extremely difficult to automate. It has, therefore, been essential to devise a new lay-up technique which is far easier to automate in order to allow a viable handling system to be developed.

4.1 Aerofoil and Root Lay-Up

It has been useful to consider propfan blade lay-up as comprising two functions: aerofoil formation and root formation. Aerofoil formation generates the pitch and camber faces of the preform, both characterised by a gentle axial curvature and a root to tip twist. Root formation, by contrast, has to generate the severe curvature necessary to produce the required "U"-shaped geometry. During manual lay-up both of these features are formed simultaneously. The

new technique adopted must be able to efficiently and reliably produce the root and aerofoil features whilst being simple and cost effective to automate.

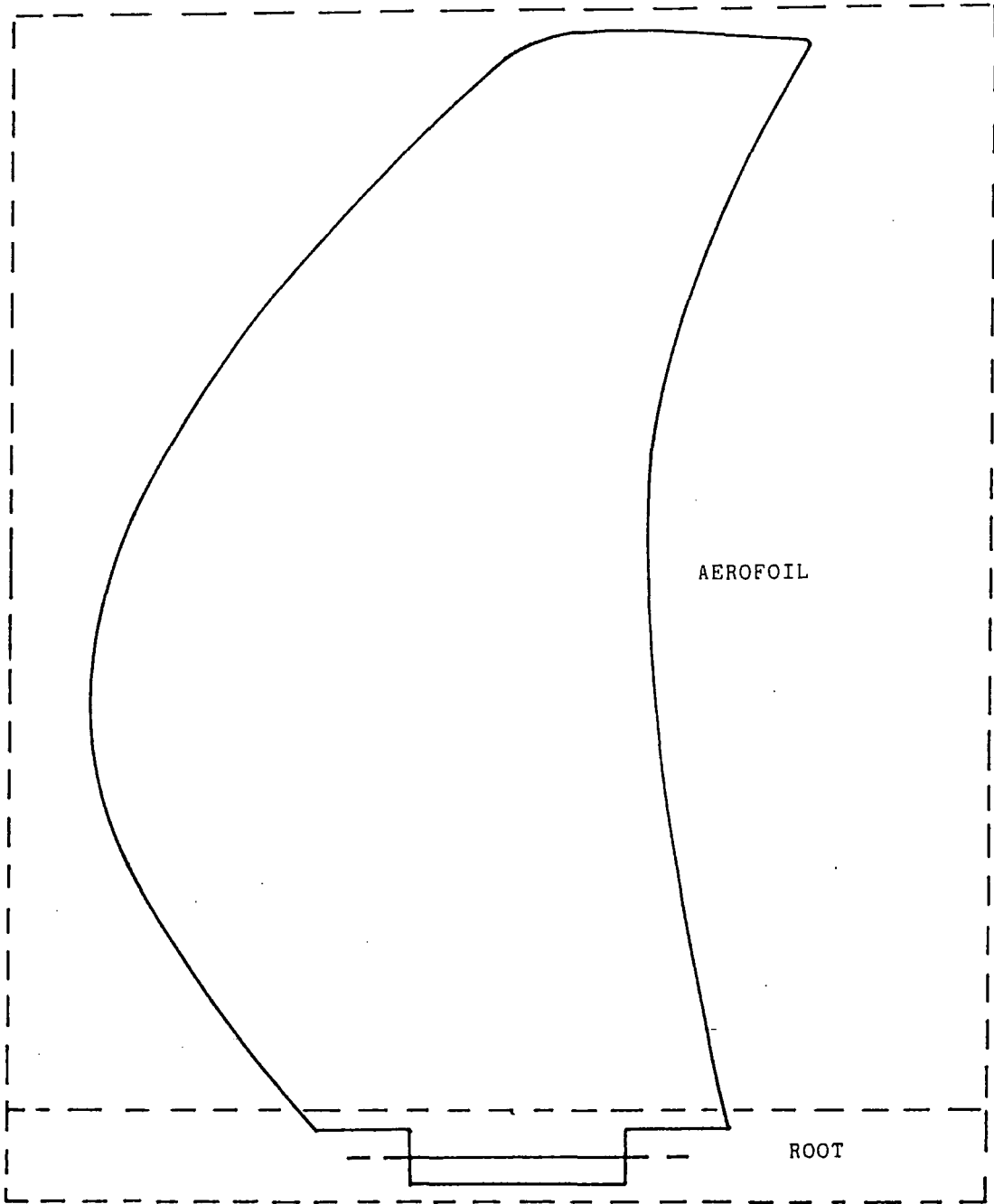

Figure 4-1. Main Functional Elements of a Propfan Blade Preform.

4.2 Root Forming

It is of vital importance during the generation of the preform root geometry that the potential formation of wrinkles in individual root tab layers is avoided. Such wrinkles occur when individual root tabs are laid-up either too tightly or too loosely (section 2.4). The existing technique relies on evenly tensioning each tab during lay-up to avoid the problem.

The first two lay-up concepts considered attempted to imitate the existing manual lay-up including the tensioning requirement. The third concept, however, moved radically away from the existing approach to achieve the simplification necessary for ease of automation.

4.2.1 Complex Path End Effector/ Hanging Jig Method

The Complex Path End Effector Concept was based on the utilization of the manual hanging jig (section 2.4(b)) to facilitate automated lay-up. The approach was to exploit a specialized gripper travelling around the jig surface to deposit each ply progressively, starting at one side of the jig, working up and over the root former and finally

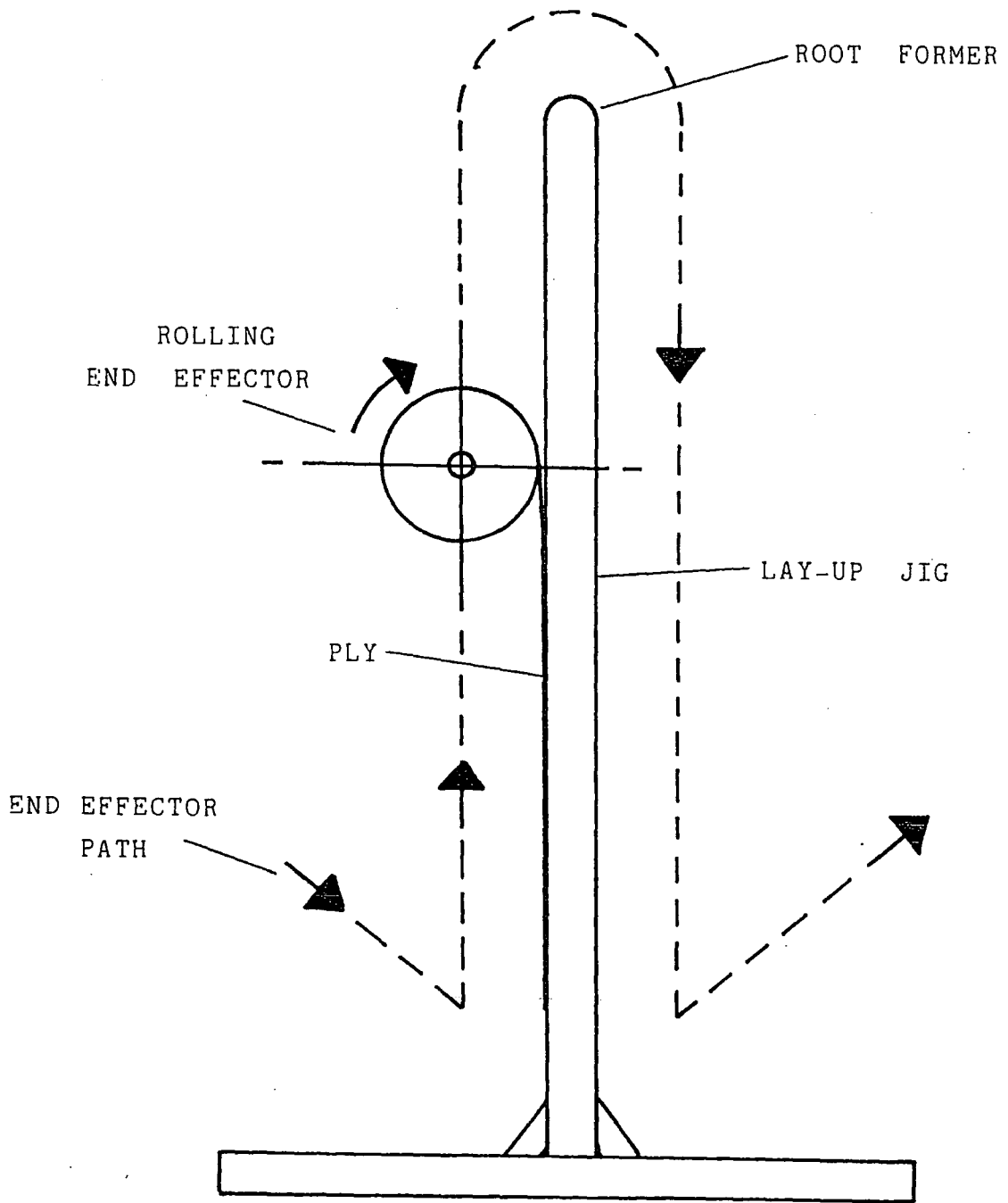

Figure 4-2. Rolling End Effector Path to Form Root Geometry Over a Hanging Type Jig.

completing the cycle at the base of the opposite side. A rolling type gripper would have been the most suitable candidate for an end effector (figure 4-2).

In order to ensure that plies could not slip during lay-up, it would have been necessary to tack each ply down as it left the surface of the gripper roller and was laid onto the jig. In practice, this would have had to have been achieved by means of a following heated roller. Heating the gripper drum would simply have heat bonded the coiled ply to itself. Heating the hanging jig would have prevented the re-solidification of the thermoplastic weft of plies already laid down.

The gripper drum's linear and rotary actuation would have had to have been precisely controlled to achieve consistently tensioned accurate lay-up at the preform root and accurate ply positioning. Furthermore, the Lay-Up Jig would have to have flat (non contoured) aerofoil surfaces, necessitating subsequent consolidation of the completed preform to the required three dimensional curvature.

4.2.2 Hinging End Effector/ Hanging Jig Method

The Hinged End Effector Concept was also based around a vertical type jig but was modelled on the use of a flat type gripper. The flat gripper would have had a centrally hinged section across which root tabs would have been supported (figure 4-3).

For the lay-up of plies with a root tab the operating sequence would have been: i) picked up ply and transfer it to a point just above the jig; ii) lowered gripper such that the root tab touches the top of the jig; iii) hinge down gripper arms such that the entire ply comes into contact with the jig; iv) finally, heat tack ply into place. The sequence would have been similar for spliced layers, but these would have been carried individually on the gripper arms.

The required wrinkle free formation of the root geometry would have been dependant on tensioning each root tab by applying a controlled downward force on the gripper as its arms were brought into lay-up position.

A possible variation of this concept would be to use two rolling grippers working in unison (figure 4-4).

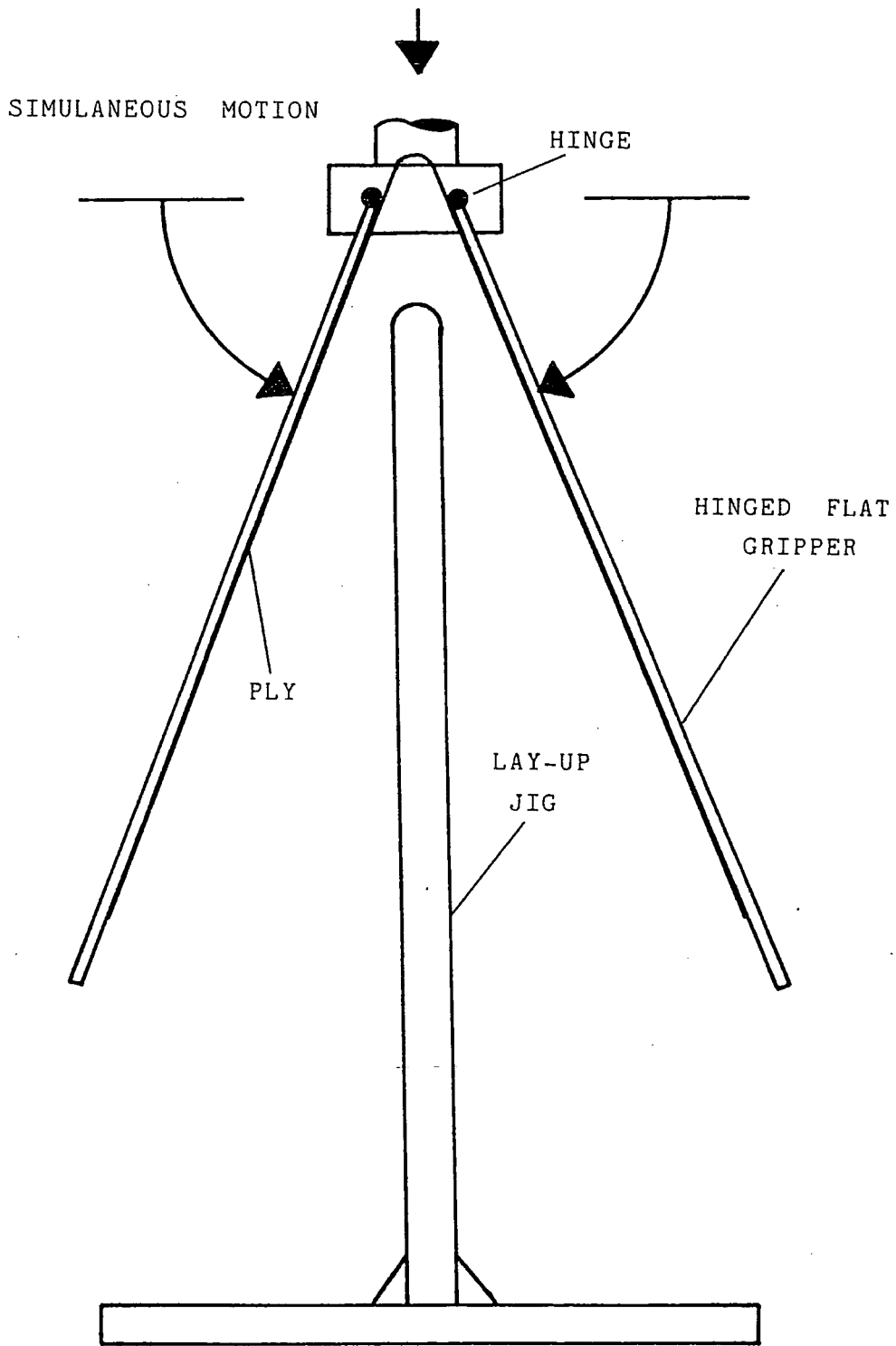
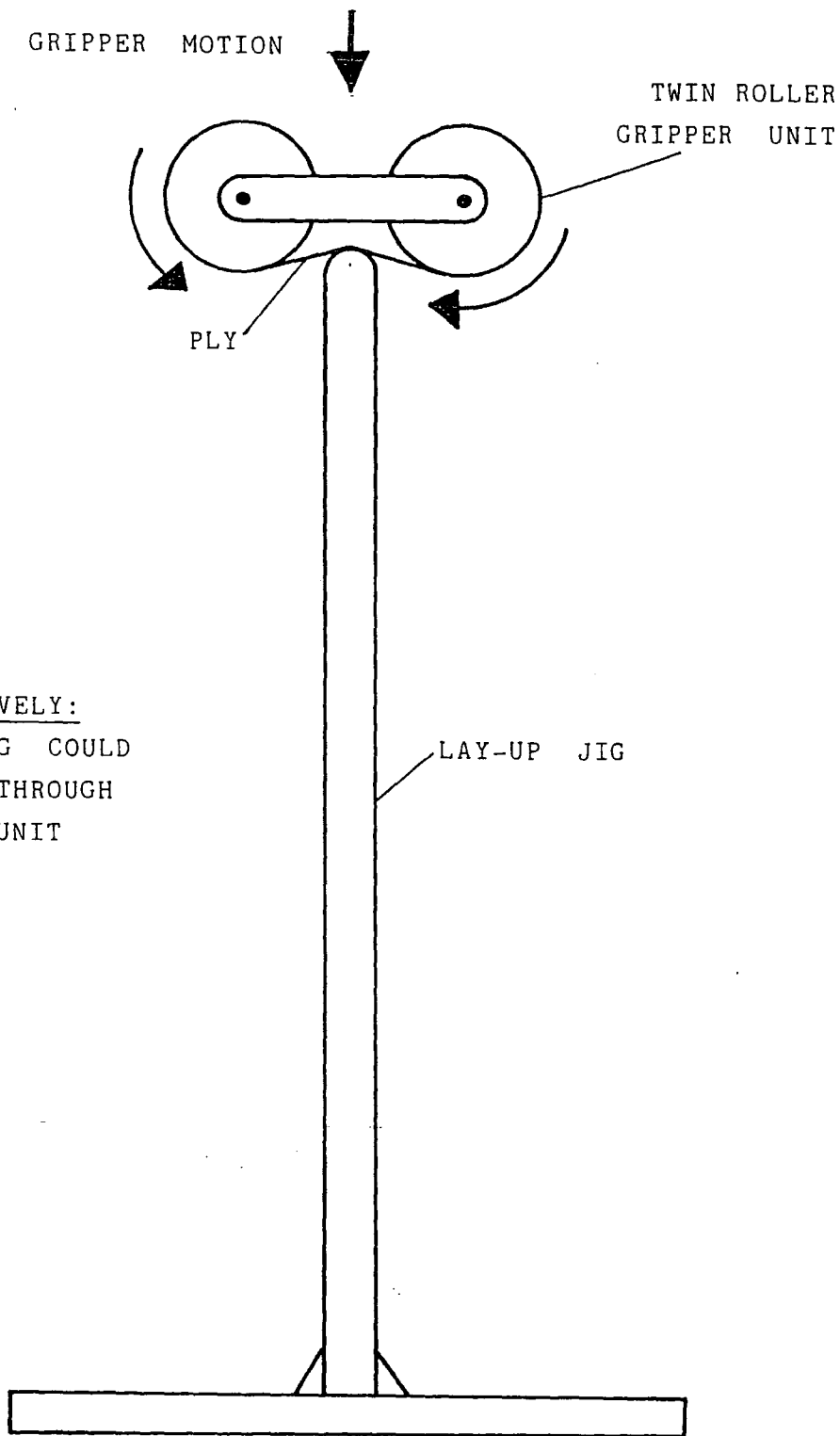

Figure 4-3. Hinged Flat Gripper Operation



ALTERNATIVELY:
 LAY-UP JIG COULD
 MOVE UP THROUGH
 GRIPPER UNIT

Figure 4-4. Twin Roller Variation

4.2.3 Horizontal Combined Lay-Up and Root Forming Table

The conceptual approaches discussed in sections 4.2.1 and 4.2.2 would have necessitated the employment of inherently complex handling devices attempting to imitate the manual method of draping plies over a vertical jig. A concept which aimed to simplify the handling requirements by avoiding mimicing the traditional technique was to replace the vertical lay-up jig with a novel horizontal lay-up station. The concept depended upon the development of special equipment allowing the entire preform to be laid up horizontally, layer by layer, with the completed preform being subsequently folded to its required form. It was this concept which was selected as being best suited to simplifying the task of automating lay-up since it permitted the use of a relatively simple gripper mechanism.

The envisaged station comprised of two separate lay-up surfaces, either flat or contoured, placed end to end; these were intended to support the preform's pitch and camber aerofoil faces. The gap between these surfaces could be varied by moving either or both surfaces (figure 4-5). Lay-up would be carried out by placing each layer sequentially onto the lay-up surfaces so that while each aerofoil face rested

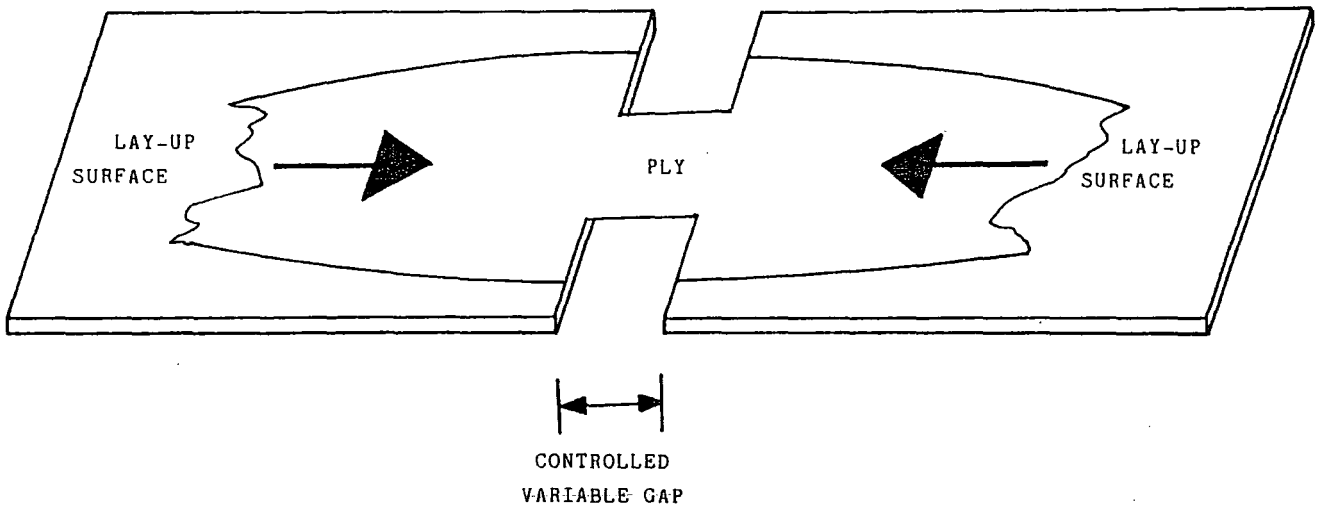

Figure 4-5. Lay-up Surface Action

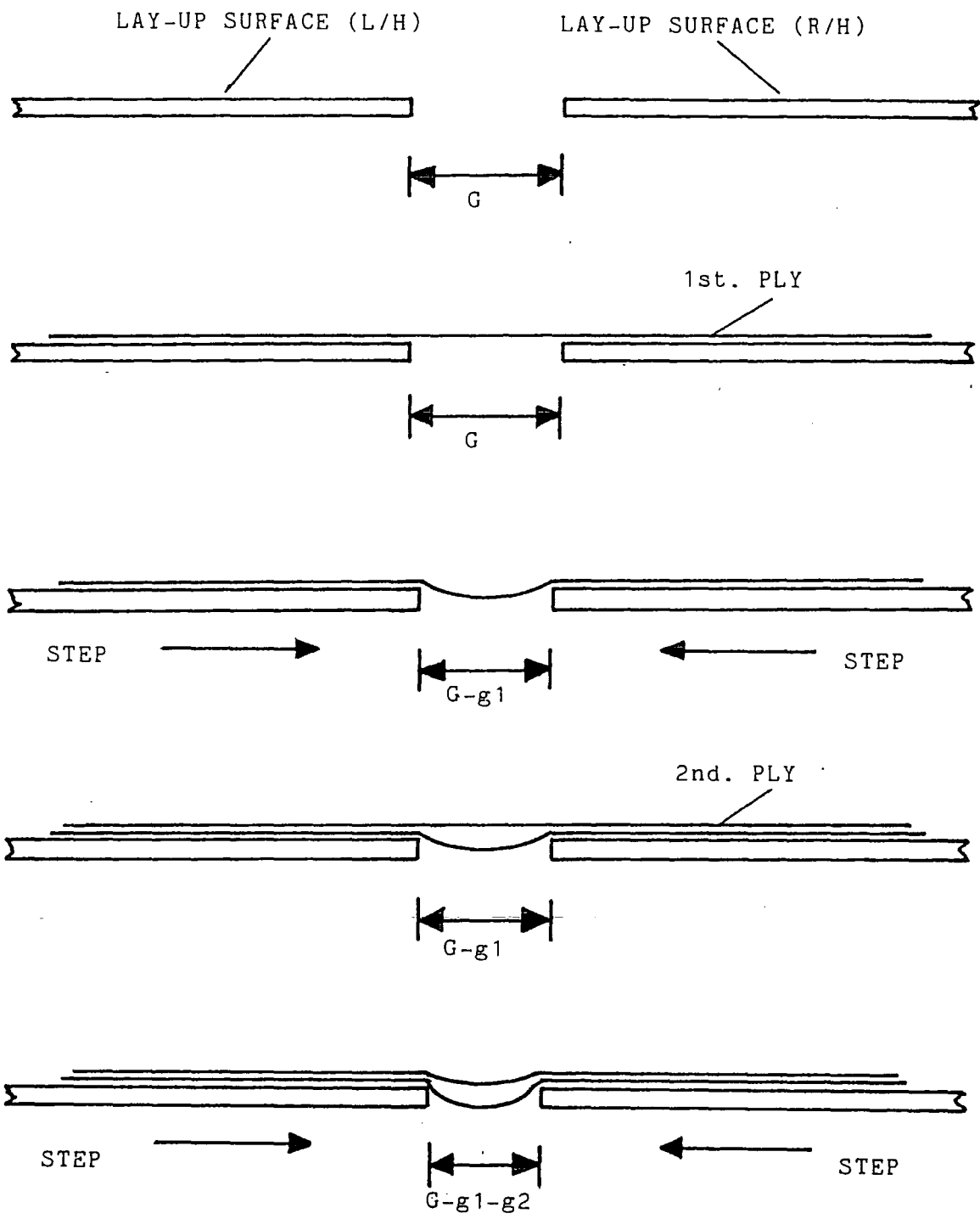

Figure 4-6. Combined Lay-Up/Root Forming Table Operation

on its respective surfaces, the root tab would span the gap between the two.

The operation of the station (figure 4-6) was based on the principle that the correct length of each root tab depends on its radius of curvature within the root geometry when the preform is subsequently folded to its final form.

The proposed sequence of operations was:

- a) The gap is set to an initial value (G) corresponding to a calculated value for the round the root tab length of the outer root layer which is the first to be laid down.
- b) The first layer is robotically placed down onto the table with its root tab spanning the initial set gap (G).
- c) The gap width is reduced by a calculated amount (g_1) corresponding to the difference in required round the root tab length between successive layers, such that the first layer root tab bows down into the gap ($G - g_1$).
- d) The second ply is now robotically laid in place on top

of the first layer with its root tab now spanning the gap ($G - g_1$).

e) The gap width is again reduced, this time to the required width ($G - g_1 - g_2$) for the third ply root tab, such that the second ply root tab bows down into the root gap.

f) The procedure continues, as above, until all the plies have been laid-up and a flat reinforcement preform has been produced.

g) The preform is subsequently removed from the Lay-up Station. It can now be folded over an existing hanging jig for consolidation (it is unlikely that there would be any cost benefit in automating this final operation since it should be possible to achieve quickly, simply, accurately and reliably by hand).

4.3 Aerofoil Forming

Whatever the cutting system employed, plies must be picked up flat, and then transferred, either directly or indirectly, to

the lay-up station. The aerofoil, however, has a gentle curvature, twist and bow (section 4.1) all of which must be imparted to the preform before it can be moulded.

Two approaches have been considered to achieve the required three dimensional form. The first is to lay-up the preform flat and generate curvature, twist and bow during pre RTM stage consolidation (section 2.4(c)). The second is to lay-up directly onto contoured lay-up surfaces which correspond exactly in shape to the pitch and camber faces of the moulded blade, such that subsequent aerofoil face forming is unnecessary.

If lay-up into a curved former were to be adopted, it would necessitate the 3-D manipulation of each ply to the required curvature during the handling sequence. Such a task could potentially be achieved by one of two methods; either the shape of the manipulator could be adapted or plies could be released from a small distance above the former and allowed to settle onto the blade former's curvature. Each method would need to take into account the largest ply envelope (2.1m X 0.75m).

Adaption of gripper shape during robotic operation would be

extremely difficult and inevitably add weight, complexity and cost to the design. Dropping plies onto a contoured surface, on the other hand, is undesirable because the difference in height between the highest and lowest points on such a surface would be as great as 120mm. This would present three risks: i) the entire ply might be displaced laterally reducing lay-up accuracy; ii) some ply profile features are highly distortable (section 3.3) and would, therefore, be extremely vulnerable during free fall; iii) there may be a tendency for fabric to flip up or tuck under itself during fall, especially where the ply edge is only supported by highly flexible thermoplastic weft filaments.

The adoption of a flat lay-up technique was recognised as offering the advantage over contoured lay-up that the manipulator could be of a simpler design. The approach hinges, however, on the practicality of post forming the flat pack of tacked together plies to the required 3-D form. Work carried out by Northrop[1] has found that this could be a viable technique for prepregs but depended on the both number of layers in the pack and severity of the contours to which it is being post formed. Such a post forming operation could be combined with the existing heat-vacuum consolidation operation.

In line with the general policy of exploiting design simplicity where possible, flat lay-up with post forming was adopted as the principal approach to be initially researched and developed.

REFERENCES

- [1] Bettner, T.J., "Fabrication of Aircraft Components Using Preplied Broadgoods Layed-Up in the Flat and Subsequently Formed; Cost Benefits and Resource Utilization Enhancements.", 14th. National SAMPE Technical Conference, October 12-14, 1982.

C H A P T E R V

P R O C E S S I N T E G R A T I O N

CHAPTER V

PROCESS INTEGRATION

Chapter IV discussed the selection of a conceptual methodology for automated lay-up and root forming of carbon fibre reinforced propfan blades. Before the concept could be developed into a working technique, however, the effect of altering the method of lay-up on both upstream and downstream operations needed to be understood.

The product of automated lay-up, a consolidated preform, was intended to be identical to that produced through the manual approach. Downstream operations will consequently be unaffected except for the expanded role of the post lay-up consolidation operation which will be relied upon to impart twist, bow and curvature to the flat preform removed from the Lay-up Station.

The only operation upstream of lay-up is that of ply cutting. The interface between these operations is of great importance and it is this interface which is considered first in this Chapter.

5.1 The Ply Cutting to Lay-up Interface

Ply cutting was not specifically included within the terms of reference of the Project, but its interface with the lay-up process is important because it has a major affect on the conditions under which the handling device (Chapter VII) must operate.

The cutting system will present cut plies which must be collected by the handling device and transferred to the Lay-up Station for lamination. It was recognized that transfer could either be direct or via an intermediate buffer storage station. Any of the cutting systems already outlined (section 2.6.3) could, moreover, cut plies either on a single fabric layer depth basis or from a pack of fabric several layers deep.

Sections 5.1.1, 5.1.2 and 5.1.3 consider single and multi-layer ply cutting and evaluate the viability of buffer storage between cutting and lay-up. The likely interface is subsequently defined and the effects on handling device design criteria are discussed.

5.1.1 Single Layer and Multi-Layer Ply Cutting

Multi-layer ply cutting was considered useful because of its potential to increase cutter system output. There are, however, a number of factors which weigh against the adoption of multi-layer cutting for use in conjunction with automated lay-up.

a) Waste Fabric Disposal

When nested plies are removed from a sheet of fabric, small irregular shaped waste fabric pieces are inevitably left behind. With single ply cutting, a cutting table conveyor may be exploited to allow waste to simply drop off the conveyor as it is indexed. The principle does not, however, apply to multi-layer cutting since waste fabric must be removed piece by piece to leave the layer below clear for gripper access; manual waste removal methods would have to be applied since such an operation would be extremely difficult to automate. If manual intervention is to be avoided single ply cutting must, then, be adopted.

b) Edge Entanglement

Another severe problem with multi-layer ply cutting is the risk of edge entanglements (or in the case of laser cutting edge fusion) between plies on different layers. Any significant edge entanglements would make automated ply off-load impractical.

c) Bed Length

Single layer ply cutting can be carried out on short bed length cutting system. This is possible because as soon as the first few plies have been cut and off-loaded, the table conveyer can be indexed to draw fresh fabric onto the table allowing subsequent plies to be cut. The multi-layer technique would require a far longer bed since the entire nest length would have to be accommodated on the bed at the same time. This would allow all the plies in the nest to be peeled away and the waste disposed of before the duplicate nest cut out of the lower layer of fabric is handled. It would only be possible to avoid a full nest bed length if a ply buffer storage system were adopted (section 5.1.2). The ply handling system would thus have to operate over a considerably larger area, increasing the cost of robotic

equipment and enlarging the floor area required to accommodate the manufacturing cell.

d) Cycle Times

Increased cutter system throughput has been cited as the main advantage of multi-layer cutting. The cutting operation is, however, likely to be considerably quicker than lay-up and, therefore, this increased throughput would cause a bottleneck at the Lay-up Station. A benefit would only be realized if there were to be sufficient product demand to justify the adoption of two lay-up cells so that material flow could be balanced.

The arguments put forward in section 5.1.1 point to single layer depth ply cutting as the most appropriate for the application considered.

5.1.2 Buffer Storage

Instead of transferring plies directly to the Lay-up Station it is possible that an intermediate buffer storage system could be adopted, the advantages and disadvantages of which are discussed in parts (b) and (c) of this section. Such a

system between automated cutting and lay-up stations would itself need to be automated since manual intervention between cutting and lay-up would: i) partially cancel the labour savings realized through automating lay-up and more importantly; and ii) introduce an extra risk of ply distortion which could render automated handling at the lay-up stage near impossible. Automation would not only have to encompass a buffer magazine mechanization, but also an extra handling system to service the increased handling requirement.

a) Types of Buffer Storage

A buffer storage system between cutting and lay-up could work in one of two ways. Either stacks of like plies could be stored in a multi-ply magazine or alternatively they could be buffered as blade kits, each kit containing all the plies necessary to lay-up one complete blade preform. In either case the storage could be in carousels to minimize demand on floor space.

Pure kitting of parts would involve the stacking of consecutive plies. This method of buffering offers a space saving over buffer storing in multiples of identical plies,

since, with kitting, the number of storage units is equal only to the number of complete kits in the buffer. Kitting also only requires intermittent buffer system actuation because the carousel moves just twice for each kit, once during loading and again during unloading.

Two factors make kitting of propfan preform component plies difficult. The first factor is layer splicing (section 2.4). The second, described below, relates to the order of stacking.

As will be seen in Chapter VI, it is necessary to lay-up the largest layer first and work through to the smallest. The stacking order at the buffer station must, therefore, put the largest layer top most so that it can be unloaded first (the principle is somewhat akin to loading a cargo ship where the goods to be unloaded first must be loaded last). The problem this presents is that the edges of larger layers will tend to drape over the layers below such that each ply is no longer flat. It will, therefore, be difficult to pick up using either the flat or roller type grippers which will be discussed in Chapter VII.

Given the arguments above, buffer storage of stacks of like

parts was considered to have the greatest potential in this application; the principle of kitting was rejected.

b) Benefits of Buffer Storage

There are several potential benefits to be gained from the adoption of a buffer system:

i) Reduction of the effect of individual breakdowns.

If either the cutting station or the lay-up station were to breakdown, the entire manufacturing process would normally have to stop. This would, of course, waste valuable production time. If, however, a buffer store was inserted between the two operations the cutting station could be out of operation, be it for a limited period, without starving the Lay-up Station.

ii) Accommodation of variability in cycle times.

In some flow lines, cycle times at individual stations can be highly variable. A buffer can be used in such a situation to smooth out the flow to the next station and, therefore, avoid bottlenecks.



The two stations considered here will be automated and random variations in cycle times should be minimal. There will, however, be predictable ply to ply variations in the cutting cycle due to the significant difference in perimeter lengths and profile characteristics of individual plies. The lay-up operation is, however, most likely to be slower than cutting and there will be a natural time buffer between the operations.

iii) Dual-fabric cutting.

Both unidirectional and woven fabrics are at present used in the manufacture of propfan blades; the cutting station must process both. In terms of materials flow this poses a potential problem since conventional cutting systems will only handle one fabric type at any one time. Because of this, fabrics might have to be switched regularly during the manufacturing operation.

A possible solution would be to buffer store cut plies between the cutting and the lay-up operations. In this way the cutter could run for set periods cutting appropriate plies from one fabric and then for another period cutting from the other fabric. This would allow non stop production

since the lay-up cell would be able to draw necessary plies from the buffer in either material as required.

An alternative solution would be to arrange the cutting system so that two different fabrics are available for cutting at any one time. The simplest form of this would be to employ two separate cutting stations one for each fabric. A more cost effective solution, however, might be to configure a single system for simultaneous dual fabric operation (figure 5-1).

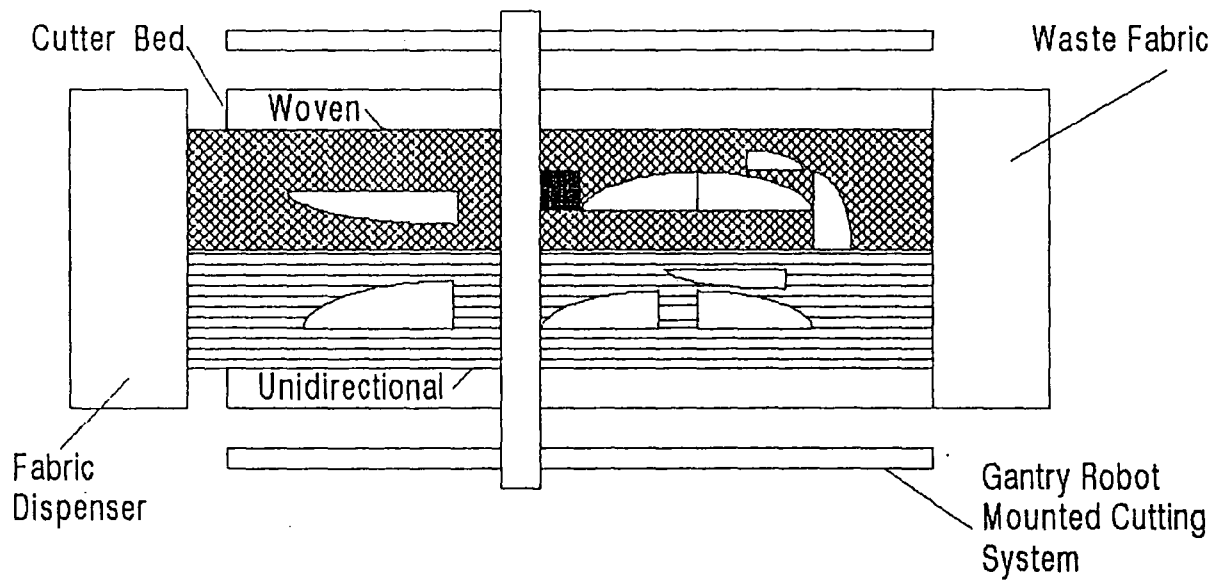

Figure 5-1. Dual Fabric Automated Cutting Station

iv) Tolerance to ply rejection during cutting.

It is possible that occasionally a ply will be miss cut and consequently rejected. Under this circumstance either the ply would have to be re-cut, which would require a real time alteration to the nesting pattern, or the cutting operation could continue unaltered simply adding plies to the buffer store; over long periods the buffer imbalance could be rectified by cutting a special run of plies. Without buffer storage a real time nesting capability would be necessary to ensure smooth running of the automated system.

c) The Disadvantages of Buffer Storage

Weighed against the benefits of buffer storage are:

i) Capital cost

There are two elements to the potentially high capital cost of a buffer storage system. The first is the actual cost of the automated storage system which would include automated racking and monitoring/control hardware. In addition to this, an extra robotic handling system would be necessary so that the lay-up handling system could continue to operate

simultaneously.

ii) Consequences of system failure

One of the reasons stated for buffer storage was as a protection against the effects of cutter system breakdown. The inclusion of a buffer system could, however, be counterproductive in that it itself could breakdown and halt the manufacturing process. It could, however, be argued that the buffer could be by passed in such a situation.

iii) Chance of ply damage

As discussed in Chapter III, dry composite fabrics are very susceptible to damage and distortion during handling. Minimum handling is, therefore, advisable. Buffer storage would effectively double the amount of handling since each ply would have to go through two pick and place operations.

iv) Work in progress costs

Storage of work in progress within a manufacturing process must, by definition, increase the total inventory cost tied up in that process. The value of stored plies would

predominantly be material cost equating to a few thousand pounds if, for example, ten preform sets were to be held.

v) Floor space

Floor space is almost always at a premium in an industrial environment. Buffer storage would by necessity increase the floor space required by the automated system reducing its overall benefit, even if a carousel were to be employed.

d) Conclusions on the Use of Buffer Storage

In conclusion, there are a large number of arguments for and against the use of a buffer storage system between cutting and lay-up. In balance, however, the disadvantages have a great adverse affect on the automation technologies that must be developed and the advantages offered are either minimal or can be gained through less troublesome means. The use of buffer storage at this stage of the manufacturing process was, therefore, rejected. The handling operation will be on a just-in-time basis, whereby a ply is removed from a fresh cut nest and then transferred to the lay-up station for immediate placement.

5.2 Design Consequences.

Section 5.1 concluded that the cutting system should operate through single ply depth cutting with cut plies transferred to the cutting system on a just-in-time basis. Consequently, criteria for the design of handling devices will be based on this mode of operation.

- i) The gripper unit must be able to pick each successive ply from a single layer depth nest of plies leaving surrounding waste and other nested plies undisturbed.
- ii) It must transfer each ply directly to the preform lay-up station for immediate lay-up.

A buffer free manufacturing process affects the specification of the cutting system. It must be highly reliable, offering continuous production with minimal down time, since the lay-up cell will not be able to operate without an uninterrupted supply of cut plies. It must be capable of real time re-nesting in case a ply is rejected. Finally, it must be capable of processing two fabric types simultaneously.

5.3 The Lay-up to Consolidation Interface.

The required product of the heat-vacuum consolidation process is a densely packed preform with the required root and contoured blade geometry. In manual lay-up, the preform was constructed to shape on a curved former which is part of the lay-up jig and then consolidated in situ. The new lay-up technique differs in that it generates a flat preform with a root section in which the layers are not initially tacked together. Consequently, the embryonic preform must be removed from the Lay-up Station to be folded and draped over a suitable consolidation former; a modified version of the existing manual lay-up was seen as being the appropriate hardware for this operation. The consolidation process must then be relied upon to compact and heat bond the root layers whilst forming the aerofoil face curvatures.

5.4 The New Lay-Up Process Summarized

To conclude this chapter, the planned format of the new lay-up process is summarized in flow chart form (figure 5-2).

Plies would be automatically cut out in a nested format

intended to minimize fabric wastage. The cutting operation was intended to be continuous, except during ply pick up when there would be a significant risk of collision between the cutting head and the gripper unit.

Each picked ply would be transferred immediately to the Lay-up Station and laid flat. Since accuracy and ply quality must be assured at each placement, it is essential that transfer involves a computer vision based inspection cycle.

On completion of lay-up, the resultant flat preform (with each layer tacked together) would be removed to one of several intermediate off-load station ready for manual transfer to the consolidation jig. It was envisaged that each preform would be transported automatically to an off-load station so that manual intervention need not be synchronized with the lay-up cycle.

{Note: The automation of ply tacking during lay-up, another important consideration, is part of the Research Team's work, but is not within the scope of this thesis.}

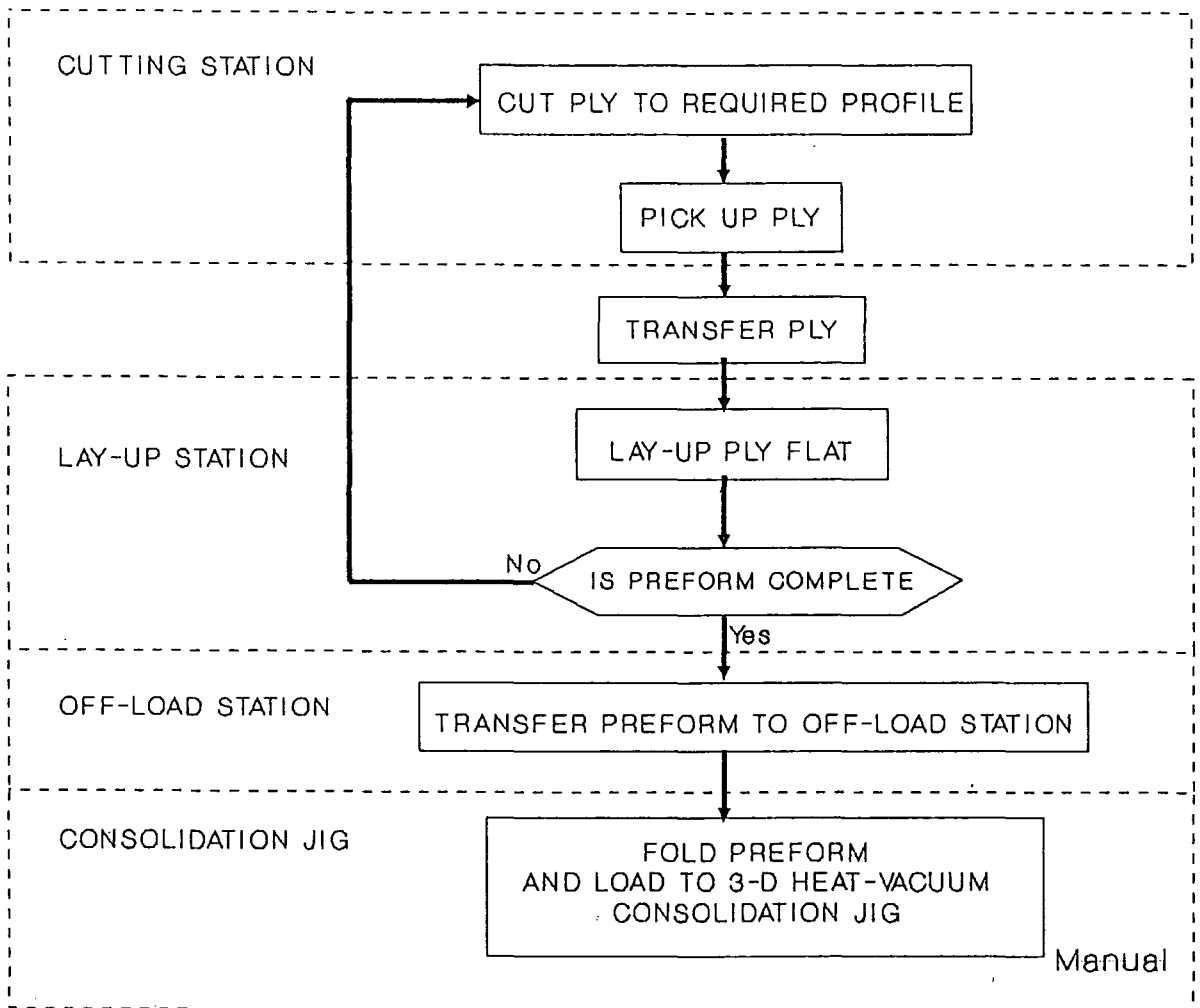

Figure 5-2. Summary of New Lay-up Process and Related Functions

C H A P T E R V I

L A Y - U P S T A T I O N

CHAPTER VI

LAY-UP STATION

Chapters IV and V discussed the formulation of a lay-up process suitable for automation. The new process is, however, dependant on the exploitation of a suitable lay-up station and it is this chapter which focuses on that technology.

6.1 Theoretical Background

The Lay-Up Station was intended to serve a dual role. The first was to provide a mechanism for the accurate, reliable control of the root tab length necessary for successful root forming, whilst the second was to provide a stable solid surface onto which robotic lay-up could take place. This section covers the theoretical background the system design.

6.1.1 Gap Width

The new root forming technique required each layer with a root tab to be laid across the correct gap between the two

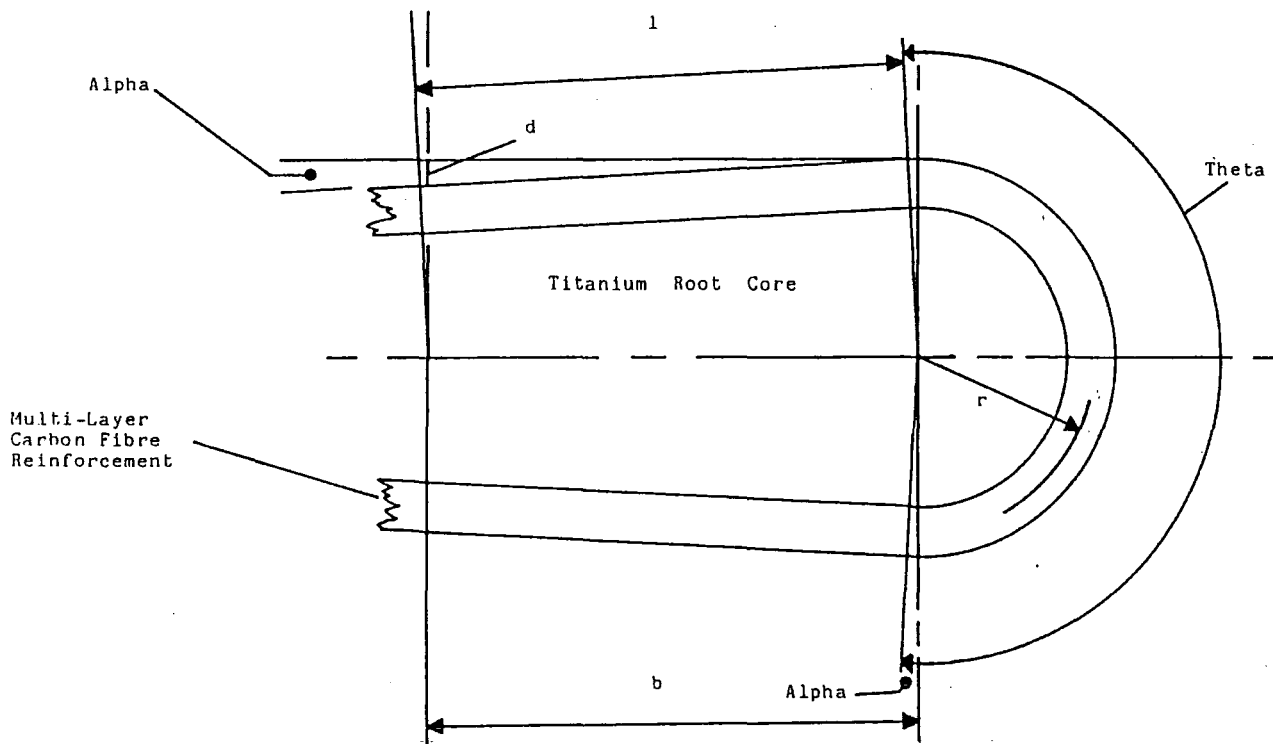

("Theta" = θ ; "Alpha" = α)

Figure 6-1. Root Tab Geometry

lay-up surfaces. The gap width appropriate to each layer could be found mathematically by considering the cross section of the folded root geometry (figure 6-1).

The correct gap width is equal to the length (s) of the root tab given by the formula:

$$s = r\theta + 2l,$$

Where θ is in radians and r is the radius of curvature of that ply root tab when the preform is folded (r refers to the radius of the neutral axis which, for this type of fabric, is assumed to be its outer surface).

θ is given by: $\theta = \pi + 2\alpha$

And: $\alpha = \tan^{-1}(d/b)$, (figure 6-2)

Therefore: $s = r(\pi + 2\tan^{-1}(d/b))$, (II)

It can also be seen that the difference between the root tab arc length of successive layers is:

$$s_1 - s_2 = (r_1 - r_2)(\pi + 2\tan^{-1}(d/b)),$$

But: $r_1 - r_2 = t$, (where t is ply thickness)

Therefore: $s_1 - s_2 = t(\Pi + 2 \tan^{-1}(d/b))$, (III)

This is the theoretical table closure step required for each root tab layer if all layers have the same thickness.

6.1.2 Required Motion

It was appreciated that the lay-up gap could either be varied by moving one lay-up surface alone (while the other's position remained fixed) or by moving both surfaces simultaneously. The actuation of only one lay-up surface is advantageous in terms of its ease of actuation and the more precise gap accuracies that could be achieved. It had the disadvantage, however, that the root gap centre line translates each time the gap is altered. Although it was known that this could have been accommodated during automated lay-up by correspondingly translating the robot co-ordinate system, it was not originally clear whether other auxiliary devices would be able to practically function about a travelling centre line. For the sake of research flexibility, it was, therefore, decided that both lay-up surfaces should be moved simultaneously on the basis that the system could

later be easily adapted to single surface movement at a later date if appropriate.

The required gap decrement for each successive root tab would be small and so the required speed of closure, given the time available while the gripper travels to collect the next ply, could be very low indeed.

6.1.3 Accuracy

The formation of a structurally acceptable propfan type root depends upon careful lay-up of root tabs of each laminate. Each root tab should follow its required "U"-shaped path smoothly to avoid the formation of wrinkles (section 2.4).

Manual propfan preform lay-up methods have invariably depended upon evenly controlled tensioning of each tab as it is laid around the root geometry. The new concept, however, relies upon highly accurate control of individual effective root tab lengths and, therefore, the lay-up surface gap to form the desired wrinkle free geometry in the folded preform. Too great a root gap for a given layer will cause an excess of fabric in that layer, such that when the preform is folded, the loose fabric will ruck forming one or more

root tab wrinkles. Too short a root tab implies that adjacent layers will have a comparative excess of fabric which must buckle during folding; the short tab cannot stretch significantly because of the high modulus of carbon fibre. Indeed, it is the difference in root tab length error between the tighter and the looser root tabs which will induce wrinkling in the latter and dictate the severity of root zone stress concentration.

The precise overall length of the completed root lug in the moulded blade (figure 6-2) is not in itself critical, but rather the change in the root tab length at each successive layer step. A small error in overall preform root lug length will mean that the carbon reinforcement in the blade aerofoil will be slightly displaced (figure 6-2). If the overall length is too short, the preform will be tight in the mould and this may cause local resin starvation. Conversely, too long an overall length will deprive blade edge near the root of reinforcement. So long as overall length error is small (nominally ± 0.025 "), it will cause no problems in manufacture.

Ideally, the acceptable table gap accuracy should be found by relating the gap error to the severity of wrinkle formation,

which should then be related to its effect on the blade's impact strength. Unfortunately, no data has been available relating wrinkle severity to reduction in impact strength and it has been necessary to make a subjective judgement about the maximum wrinkle severity acceptable. A model has, however, been formulated to attempt to theoretically relate gap error to the potential degree of wrinkle formation.

a) Mathematical Model:

Wrinkles have a characteristic, amplitude and geometry. The model assumes that a pure wrinkle can be represented as a full cosine wave form (figure 6-3). The model also assumes a worse case condition that any excess fabric is concentrated into a single wrinkle. This is the most severe scenario in terms of stress concentration.

The excess material or gap error is equal to the difference between the length of the wrinkle (L) and its cosine perimeter (s) both measured around the arc of the root tab when folded. The relation between the cosine perimeter and the cosine amplitude (a) can be found mathematically as derived below:

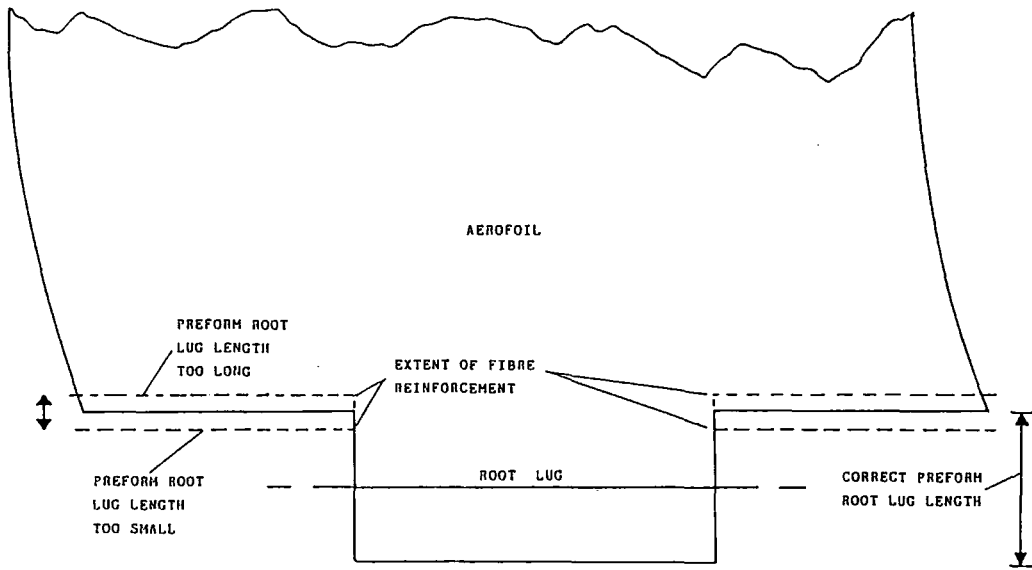

Figure 6-2. Effect of Error in Actual Length of Root Geometry

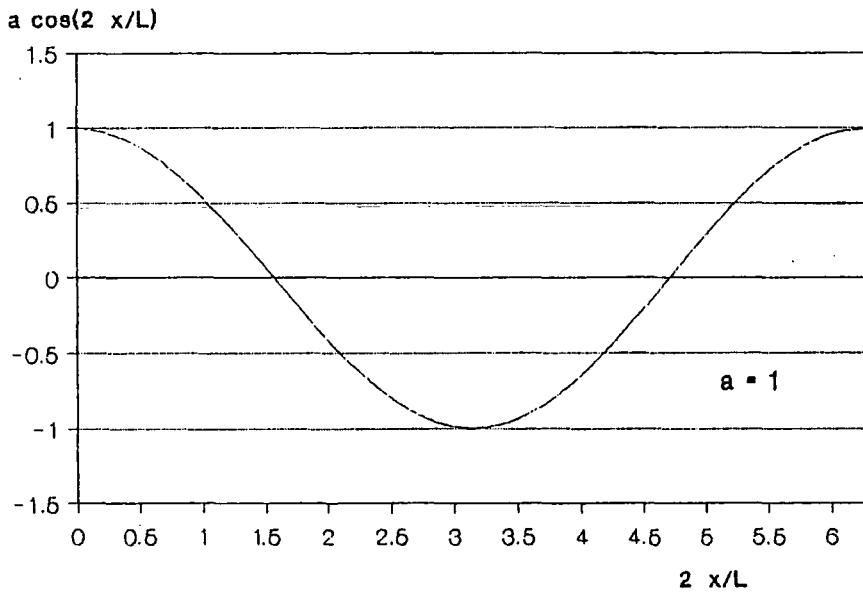

Figure 6-3. The Theoretical Cosine Wrinkle

To establish the perimeter of any curve an equation can be written relating δs , δx and δy :

$$(\delta s)^2 = (\delta x)^2 + (\delta y)^2, \text{ (I).}$$

From (I):

$$(\delta s/\delta x)^2 = (\delta y/\delta x)^2 + 1,$$

Therefore in the limit:

$$ds = (1 + (dy/dx)^2)^{1/2} dx,$$

And so:

$$s = \int (1 + (dy/dx)^2)^{1/2} dx, \text{ (II)}$$

But, where a is the cosine amplitude (which is half the wrinkle amplitude):

$$y = a \cos \alpha,$$

and with α in radians, where:

$$\alpha = (2\pi x/L),$$

Now:

$$dy/dx = - a(2\pi/L) \sin(2\pi x/L)$$

Therefore:

$$s = (1 + (-a(2\pi/L)\sin(2\pi x/L))^2)^{1/2} dx$$

{integrated between the limits $x=0$ and $x=L$ }

This may be most simply solved computer-numerically by employing the Trapezoidal Rule[1].

b) Discussion and Implications

The mathematical model assumes single wrinkle formation. In practice, however, the excess material may form into one, two or more wrinkles, so that the wrinkling affect can be concentrated at one location or distributed. If wrinkling is distributed, stress concentration is reduced and impact strength will be less affected. The model can, then, be said to represent the "worst case".

Another complicating factor is that wrinkling in adjacent layers will tend to interact, such that the resultant wrinkling can no longer be represented as a pure cosine; it will be complex and irregular.

Furthermore, it is impractical to predict wrinkle length since a ruck can be squeezed to virtually any dimension. The

model must, therefore, relate wrinkle amplitude to gap error for a spectrum of possible wrinkle lengths. Since the stress concentrating severity of a wrinkle is both a function of its length and amplitude, a long wrinkle with a given amplitude has a less significant stress concentrating affect than a sharp short wrinkle with an identical amplitude; the "worse case" analysis must then concentrate on short wrinkle lengths.

The theoretical values of wrinkle amplitude versus excess fabric length (which corresponds to lay-up station gap error) was calculated for assumed wrinkle lengths of 2.5mm, 5.0mm, 7.5mm and 10.0mm (figures 6-4 (a), (b), (c), and (d)). In each case small amounts of excess fabric can be seen to form comparatively high amplitude wrinkles especially where, perhaps surprisingly, the wrinkle length is long. If a wrinkle is squeezed into a shorter length, the wrinkle amplitude will in fact decrease. The stress concentration affect will, however, increase since more acute radii of curvature are generated.

A gap width tolerance of ± 0.05 mm (0.002 ") was selected as a practical target given, the known capabilities of moderate cost linear encoders and the limited severity of the worse

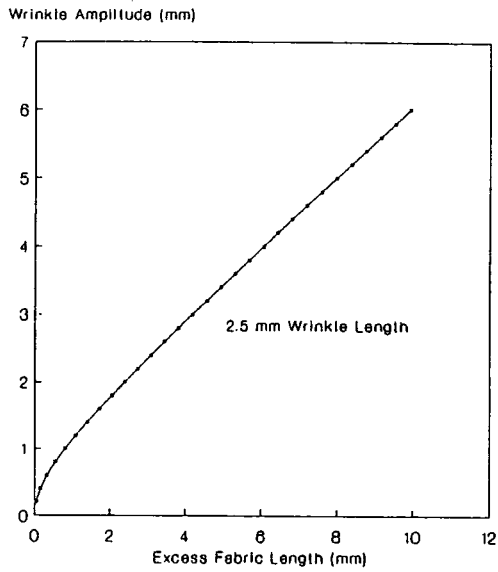

Figure 6-4(a). Wrinkle Amplitude v. Excess Fabric Length (Gap Error) for 2.5mm Wrinkle Length.

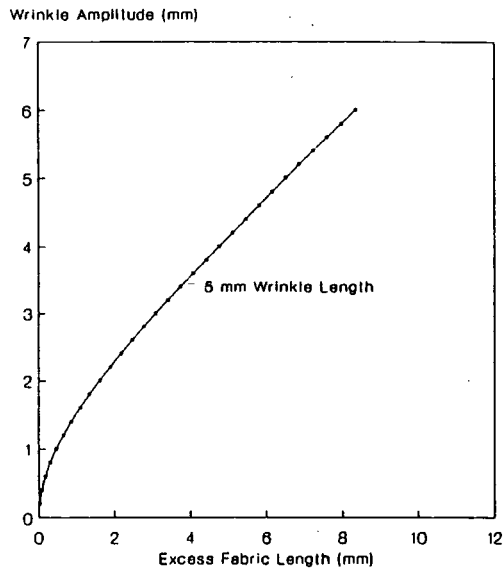

Figure 6-4(b). Wrinkle Amplitude v. Excess Fabric Length (Gap Error) for 5.0mm Wrinkle Length.

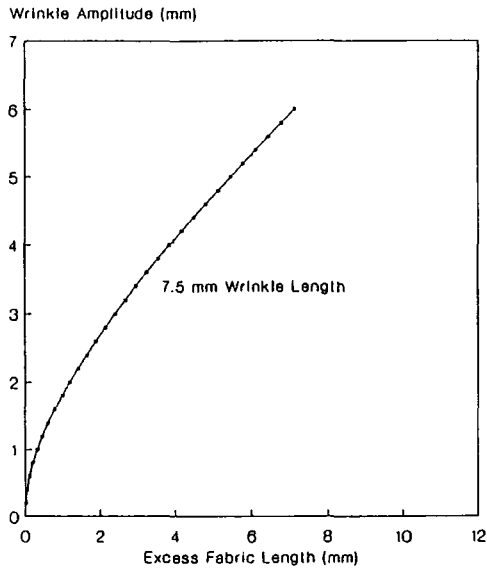

Figure 6-4(c). Wrinkle Amplitude v. Excess Fabric Length (Gap Error) for 7.5mm Wrinkle Lengths.

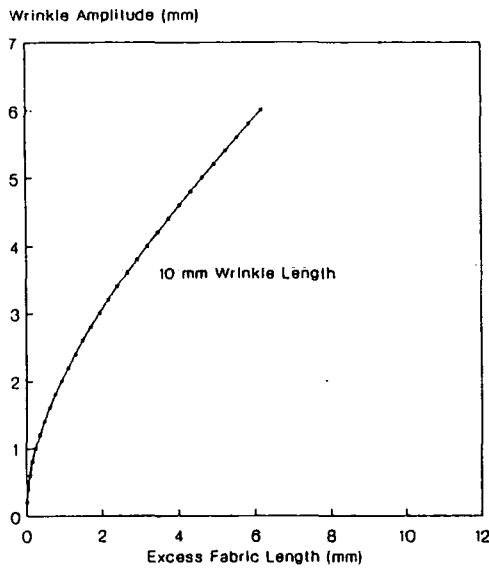

Figure 6-4(d). Wrinkle Amplitude v. Excess Fabric Length (Gap Error) for 10.0mm Wrinkle Lengths.

case wrinkles that could theoretically be generated. The target accuracy equates to a maximum allowable difference between the tightest and loosest tabs of 0.10 mm (0.004").

It was intended from the outset, that the control of gap width would be a closed loop operation (section 6.3.3). It was known, therefore, that the control resolution (CR)[2] would have to apply to the lay-up surface actuation, the associated feedback device and the system controller. A comparatively poor resolution in any of these interdependent devices would act as a weak link in the control chain and the required accuracy performance could not be achieved.

The required accuracy can be defined as[2] (figure 6-5):

$$\text{Accuracy} = \text{CR}/2 + 3(\text{std. deviations of mechanical error})$$

Making the assumption that mechanical error is negligible, the required control resolution would be twice the value of required accuracy:

$$\text{CR} = 2(0.05\text{mm}) = 0.1\text{mm}$$

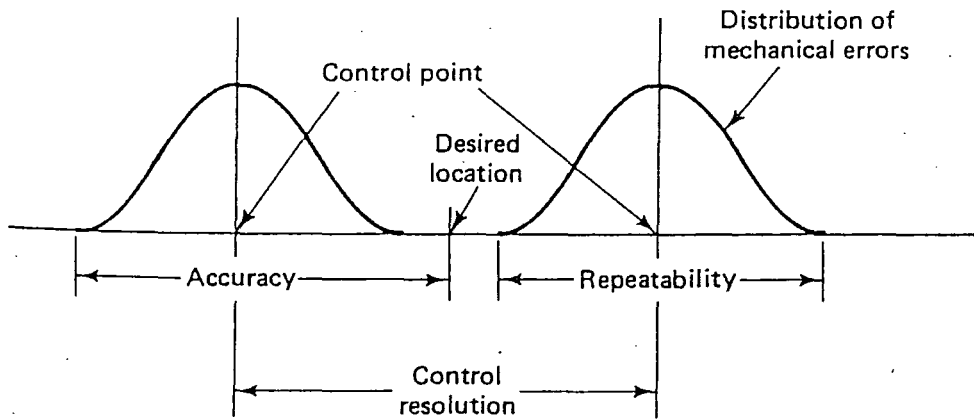

Figure 6-5. Accuracy and Repeatability[2]

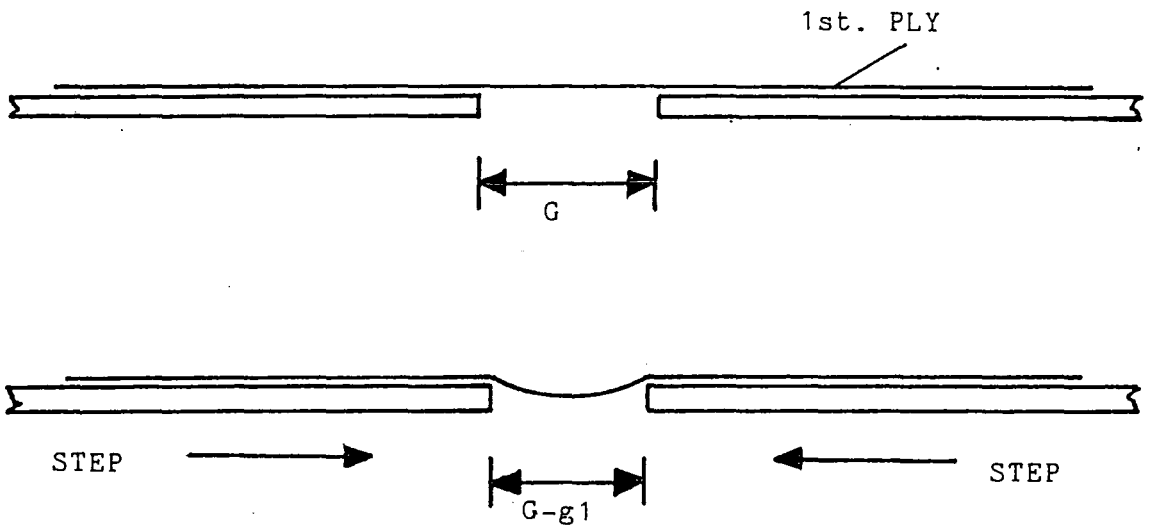

Figure 6-6. Root Tab Buckling as Lay-up Surface Gap is Reduced

6.1.4 Required Closing / Holding Force.

At each successive step reduction in the lay-up gap width, the root tabs already in position across the gap must be buckled downwards (figure 6-6). The table drive mechanism must exert sufficient driving / holding force to oppose the compressive force required to initiate and sustain the buckling action. The plies must also be firmly held to the table surface to prevent them from slipping; even slight slippage would cause the technique to fail.

The resistance of ply tabs to compression has been quantified empirically by monitoring a simulated pack (figure 6-7) of root tabs under compressive loading in a standard compression testing machine. The pack was intended to represent the root area of an almost fully laid up blade with one final layer to be applied. It thus represented the conditions under which the system would have to successfully apply the greatest compressive force.

The results of this test (figure 6-8) indicated that for a typical root geometry with 17 root tab layers the maximum required compressive force for a nominal 10mm gap decrease (far in excess of any gap decrease which would be applied in

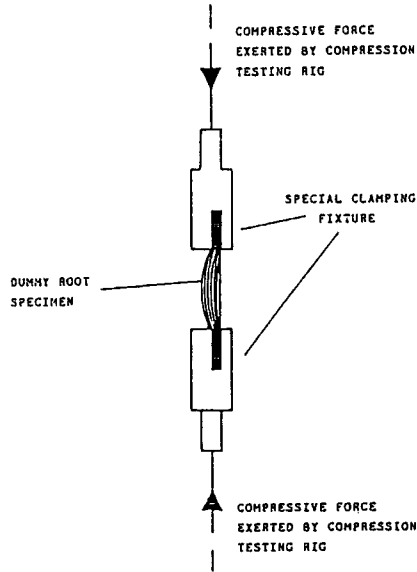

Figure 6-7. Simulated Root Tab Pack for Compression Testing

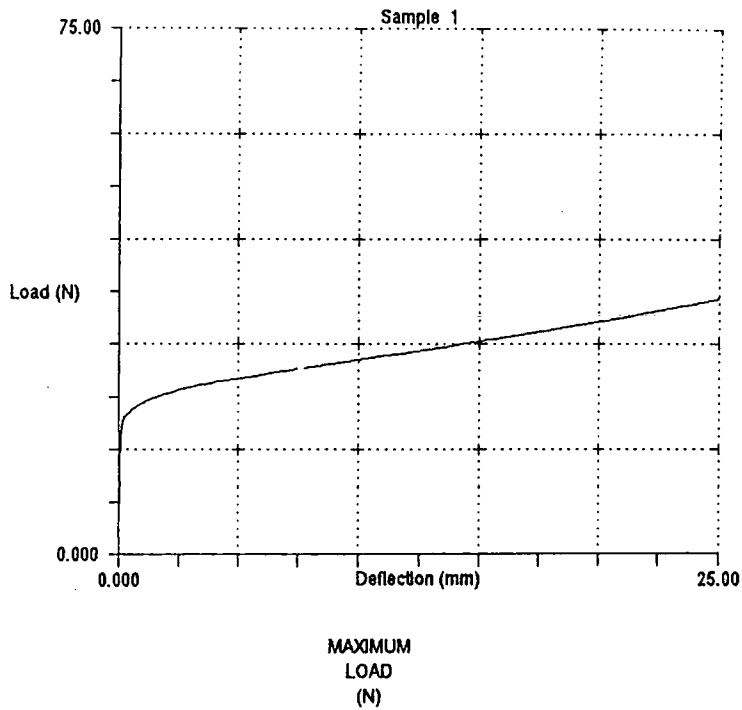

Figure 6-8. Compression Test Results

practice) of 30N for a typical 150mm width root tab.

6.2 Design

The theoretical basis for the root forming technique and technology have been covered and attention may now focus on the practical design of the Lay-up Station (figure 6-9 and plate 6-1). For descriptive purposes, the table is divided into three subsystems: i) the lay-up tables; ii) actuation and control; and iii) preform hold-down. These are described in sections 6.2.1, 6.2.2 and 6.4 respectively.

6.2.1 Lay-Up Tables

The Lay-up Station design has been developed around two almost identical lay-up tables placed end to end (figure 6-9). Each table comprises: a separate sub-frame; a separate main frame, which is mounted on top of the sub-frame; and a lay-up surface mounted by means of linear bearings to the main frame. The two sub-frames are connected by four heavy gauge steel plates. The modular nature of the main and sub-frames allows the tables to be easily dismantled for ease of modification and transportation between research and

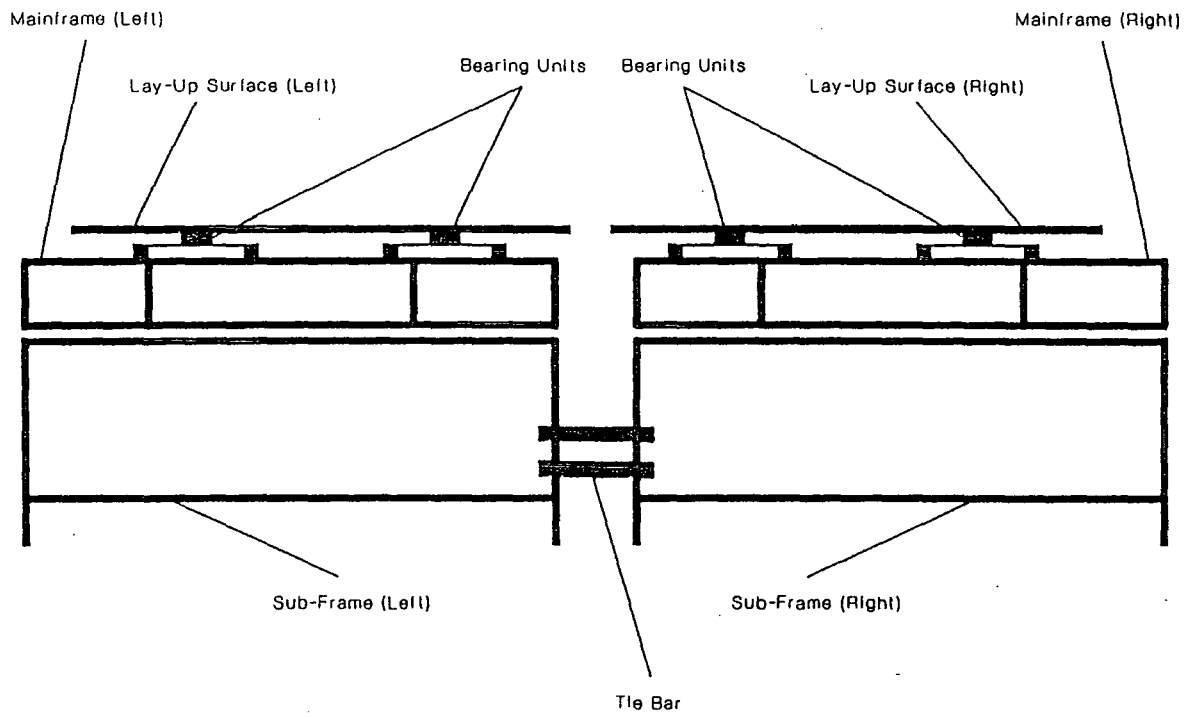

Figure 6-9. The Lay-Up Station

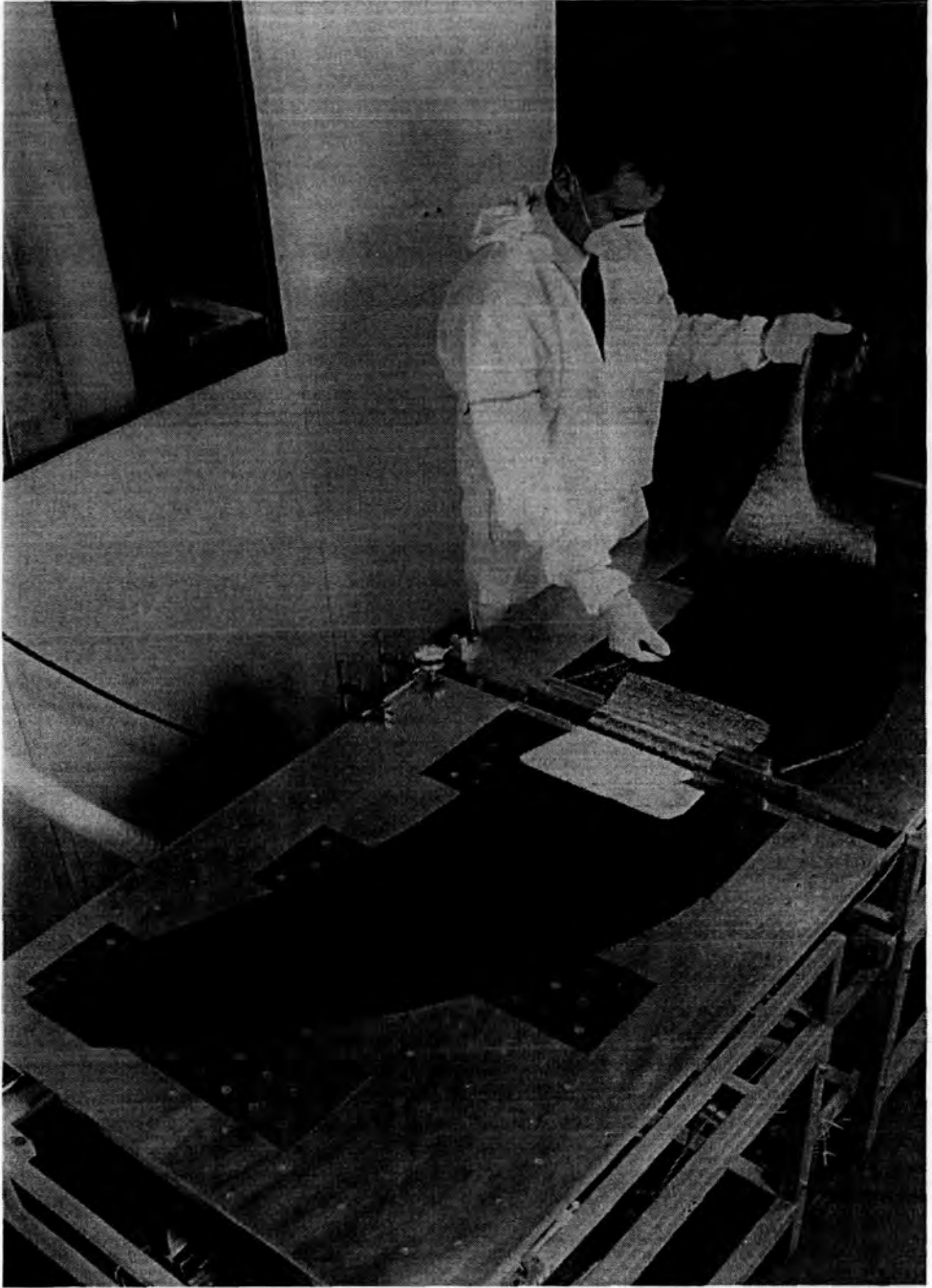

Plate 6-1. Lay-Up Station

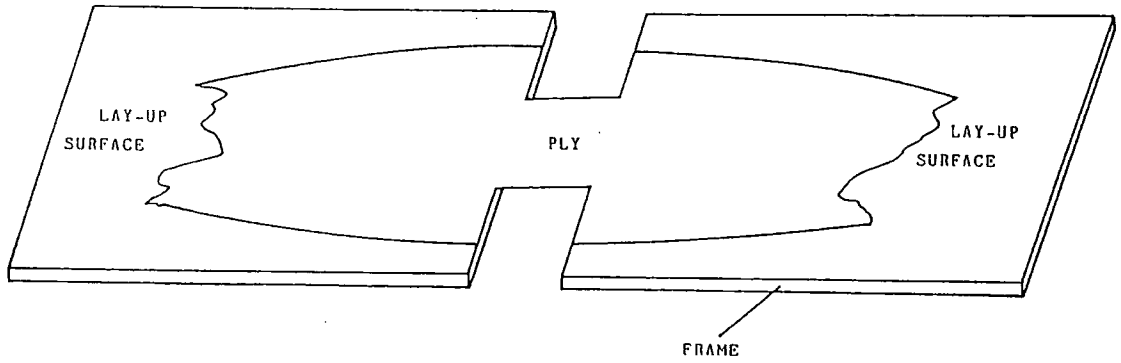

Figure 6-10. Lay-Up Table Surfaces

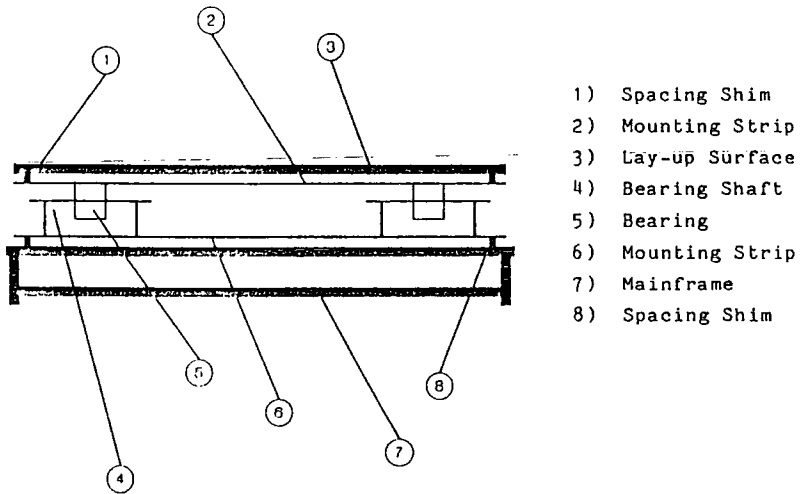

Figure 6-11. Arrangement of Linear Bearings

industrial environments.

The main and sub frames, fabricated from steel square section, are straightforward and do not warrant detailed description. It is useful, however, to examine the design of the lay-up surfaces.

The purpose of the lay-up surfaces is to provide a stable flat bed onto which plies can be accurately laid. Lay-up surface rigidity is provided by means of a stiff steel framework, onto which a flat 3mm thickness aluminium plate has been fastened (figure 6-10). The framework of each surface slides on four 50mm long linear bearing units mounted on separate 250mm X 16mm diameter shafts, allowing a total possible travel of 200mm per surface (figure 6-11). Short rather than full half table length bearing shafts have been exploited to provide maximum rigidity.

6.2.2 Drive, Transmission and Control

The function of the drive, transmission and control subsystem is to accurately position the lay-up surfaces and maintain the required holding torque, once the correct gap dimension is achieved. The speed of operation of the system is not

critical since the cycle time for handling the next ply while gap closure takes place is comparatively long (estimated at a minimum of 15 seconds); also the change in gap for each step is small (less than 1mm). The requirements for high accuracy / resolution and high torque, but at very low operating speed, can be met simultaneously by exploiting a high gear ratio between the motor and the final linear drive.

6.2.2 (a) Transmission

The adopted design achieved rotary-to-linear motion at a high gear ratio (figure 6-12). The lay-up surfaces are driven synchronously by common linear steel braced timing belts on each side of the Station. A high gear ratio is achieved by actuating the linear belt drive pulley axle through a reduction gearbox connected to a reduction timing pulley chain.

The starting point for deriving the necessary overall gear ratio was the required linear resolution at the lay-up gap, compared to the angular resolution at the motor. It was known that linear resolution would have to be less than or equal to the control resolution (section 6.1.3). Angular resolution is a property of the motor (section 6.2.2(b)).

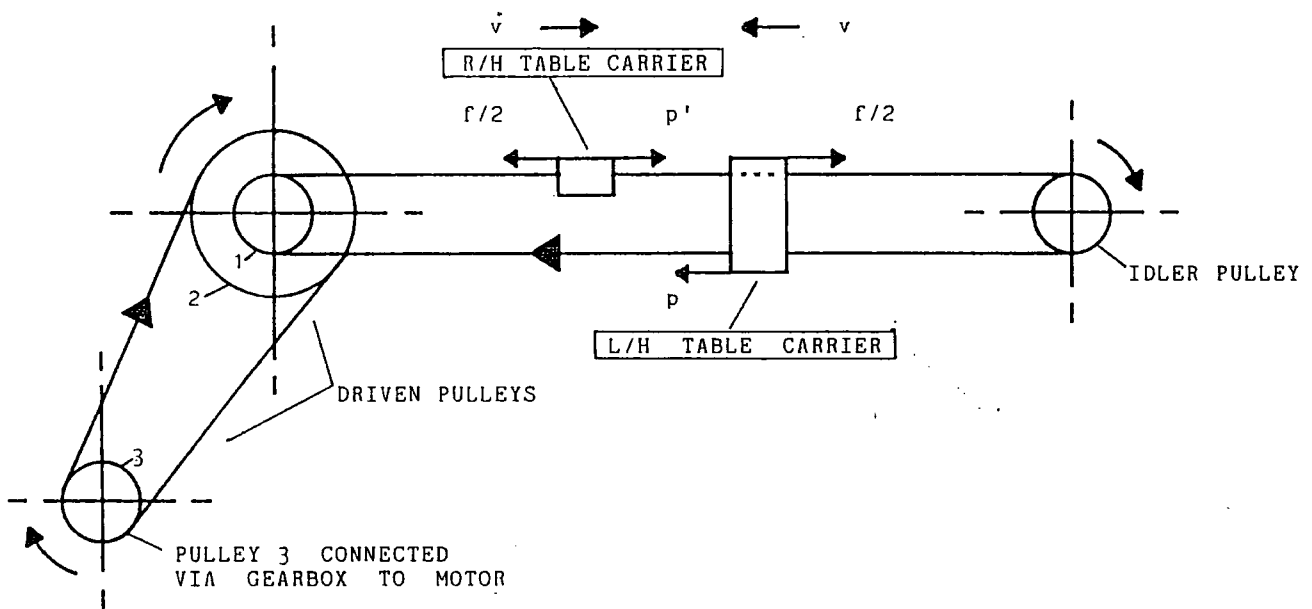

Figure 6-12. Drive Chain

For commonly available stepper motors, the minimum angular increment is 1.8° equating to a "half step". The required linear resolution at the gap was defined as 0.1mm (section 6.1.3). An equation can be derived relating the two values (Appendix II: equation (X)).

The equation is:

$$e_m \text{ (radians)} = n(e/2r_1)(N_2/N_3)$$

Or

$$e = 2r_1 e_m (N_3/N_2) / n$$

Where e , the linear resolution is finer than or equal to the control resolution, CR.

$$e < CR = 0.1\text{mm}$$

The accuracy of the drive chain is also affected by potential backlash within the timing belts and any gearboxes employed. The timing belts were selected on the basis of having a very high modulus of elasticity so minimizing the potential for belt stretch. It is known, however, that the stepper motor gearbox (figure 6-12) would have a significant internal backlash (typically of around 1° according to manufacturers).

It was consequently decided that in order to minimize inherent gearbox backlash the pulley ratio, N_3/N_2 , should be high.

6.2.2 (b) Motor Selection

A range of electric drive options were considered and of these a stepper type motor was considered to be ideal. One of the most important advantages of stepper motors is their direct compatibility with digital control techniques; this makes them simple to interface with a PC based control structure. A number of other advantages were also important: i) their holding force is high; ii) they can be stalled without overheating (this is significant if, for example, the transmission becomes jammed or the table is obstructed); iii) they have a rugged construction providing an extended maintenance free life; and iii) in the event of a short circuit, they move one step and hold compared, for example, with a servomotor which will run away until a mechanical or electrical stop is reached (such a runaway condition would severely damage the preform being laid up)[³]. The general disadvantage of stepper motors, their low power output and limited torque at speed, is not important because of the low speed requirement and the use of a high gearing ratio.

6.2.2 (c) Control Strategy

In principle, a stepper motor can be operated reliably in an open loop manner because the digital input is converted into discrete angular steps at the motor. Two factors, however, dictated the use of a closed loop control system. The first was that should the system become obstructed, the control system must be alerted. If not, it would continue to send impulses to the motor, which would miss step causing a discrepancy between perceived and actual position. The second was that even if the stepper motor has operated correctly in response to controller, the lay-up surfaces may not have moved as required because of transmission slippage or backlash. Since accuracy must be guaranteed, a closed-loop control strategy was, therefore, adopted.

In order to accurately monitor the root gap dimension during each gap reduction for closed loop control, a linear transducer was fitted across the lay-up gap. The direct measurement of the gap dimension was considered important, because it ensures that any drive system error can be recognised by the controller. Ideally, the transducer unit would be fitted centrally, since there will inevitably be some misalignment between the gap edges of the two lay-up

surfaces due to the small, but significant play in the linear bearings. Since the root tabs were intended to buckle down into this area, however, space was limited and it was necessary, on the research lay-up station, to install the encoder to one side of the table.

The control operation can be described as follows:

- i) With the lay-up surfaces initially parked, the linear transducer reads the actual gap dimension;
- ii) The difference between the reading and the required starting gap is then calculated and output to the stepper motor as a train of corrective impulses;
- iii) The stepper motor rotates through this required number of steps to implement the correction;
- iv) On completion of the impulse sequence, the encoder rereads the gap dimension. If there is a gap error within its resolution the corrective cycle repeats.
- v) The control sequence continues until no error is apparent. At this point the gap should be accurate within the resolution of the linear encoder and the

lay-up surfaces can be mechanically locked to prevent further unwanted movement.

6.3 Preform Hold Down

The Lay-up Station drive system exerts significant closure forces of a magnitude necessary to buckle down the individual tabs making up the root section during automated lay-up. The system cannot, however, perform its task unless those forces can be effectively transmitted from the lay-up surfaces through the preform to the individual root tabs. To achieve this, the preform must be held positively, during the entire preform lay-up cycle, to the lay-up surfaces to avoid any possibility of slippage.

6.3.1 Selection of Holding Methodology

Several techniques for holding preforms to the lay-up surface were considered. These were: mechanical clamping, needle gripper, vacuum hold down and electrostatic attraction. The possibility of mechanical clamping was ruled out immediately because the clamping equipment would clearly obstruct the robotic gripper path. Needle gripping was found to be

inappropriate since the fabric tended to slip slightly through the needles before a positive weave-needle interlock could be achieved (section 7.3). Both vacuum and electrostatic techniques were, however, considered technically feasible. Initial attention was, however, focused on the vacuum option, since there was some early concern over the safety and reliability implications of using a large electrostatic system in an environment sensitive to strong electrical fields and contaminated with stray carbon fibre dust and filaments.

6.3.2 Design Background

The governing equation for the resultant horizontal frictional force (F) on each side of the preform during lay-up is:

$$F = \mu R$$

Where μ is the coefficient of friction between the ply fabric surface and the lay-up surface and R is the vertical vacuum induced force applied to the fabric. Clearly, the higher the coefficient of friction between the lay-up surface and the bottom most ply, the firmer the grip for a given vacuum.

Unfortunately, both the plate aluminium of the lay-up surfaces and carbon fibre fabric are smooth, so the coefficient of friction is low. To increase μ , the use of a lay-up surface layer of abrasive paper or "Emery cloth" was investigated and found to improve the situation markedly. The test results (figure 6-13) indicated that the coarser the abrasive grain, the higher the achievable holding force for a given gauge vacuum.

Abrasive paper would not be an ideal medium in production application, since grit grains would tend to come away causing preform contamination. To minimize the risk of contamination at the prototype phase, a finer grain "wet and dry" abrasive paper with relatively secure grit grains was exploited. Similar, but more durable, materials designed as nonslip surfaces, rather than abrasives, are available and will be more appropriate for the fully developed production version of the Lay-up Station.

Since each successive ply is tacked securely into place on the preform pack, every ply within the preform will be retained in position, so long as the bottom most layer is not allowed to slip.

Comparative Holding Force

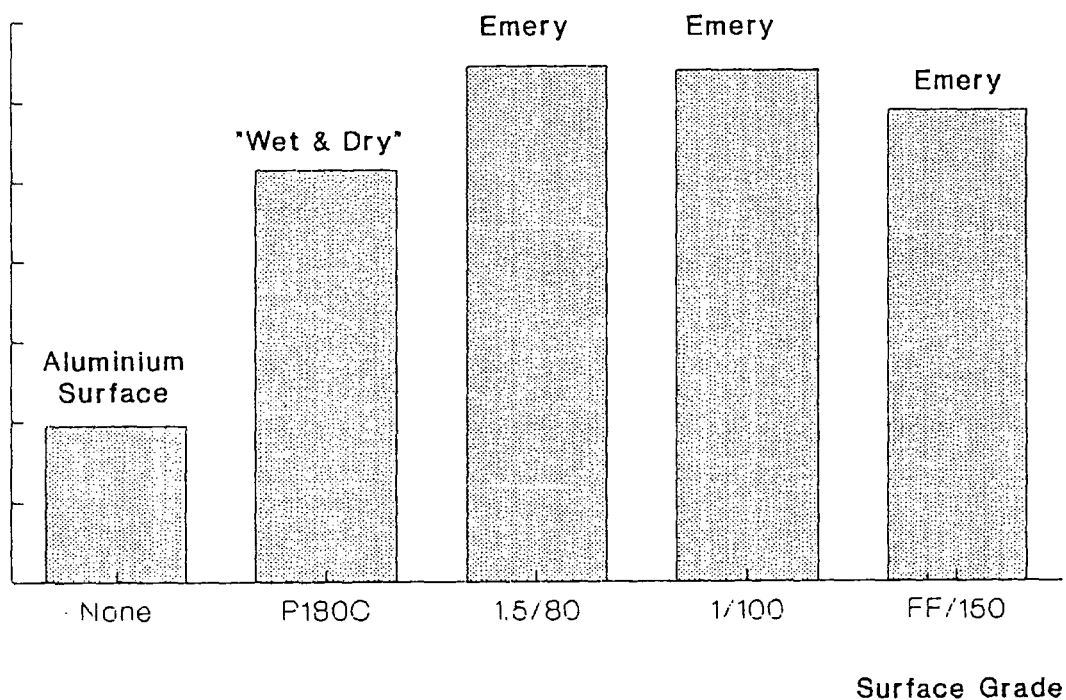

[N.B. Holding Force Values are Relative only]

Figure 6-13. Comparative Holding Forces of Vacuum Hold Down Method Using a Variety of "Wet & Dry" Emery Cloth Materials to Improve the Coefficient of Friction between the Lay-Up Surfaces and the Blade Preform

6.3.3 Hold Down System Configuration.

The vacuum hold down system was designed to provide an effective means of firmly holding each side of the preform to the corresponding lay-up surface.

The design exploits the structure of the framework by enclosing and sealing the natural cavities below each lay-up surface (figure 6-14). The three vacuum cavities per table are interconnected by means of short flexible hoses (figure 6-15). The central cavity of both tables is in turn connected to a single, floor mounted flow control manifold unit connected directly to a vacuum pump.

Vacuum nozzles are set out in three zones per table corresponding to the three vacuum cavities below each surface (figure 6-14). The zone nearest to the root gap is the primary anti-slippage means and consequently has the greatest nozzle density giving a high hold down force. The middle and outer blocks have a lower nozzle density since their prime role is to prevent lateral preform movement during robotic lay-up.

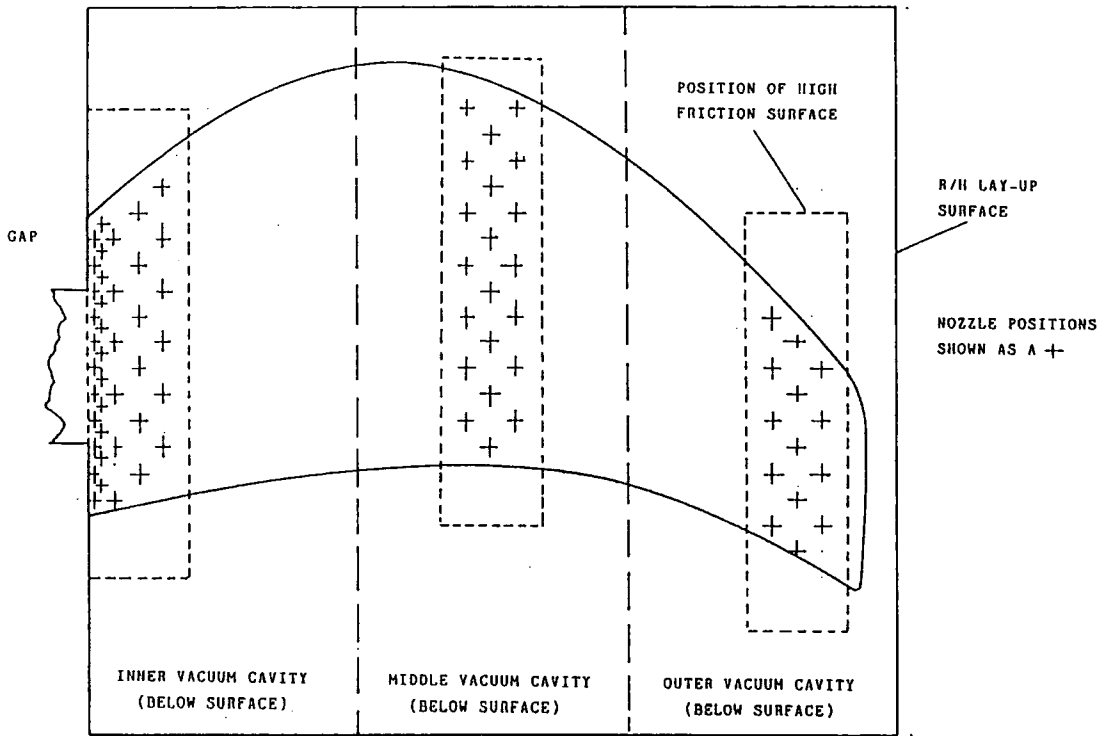

Figure 6-14. Layout of Vacuum Nozzles

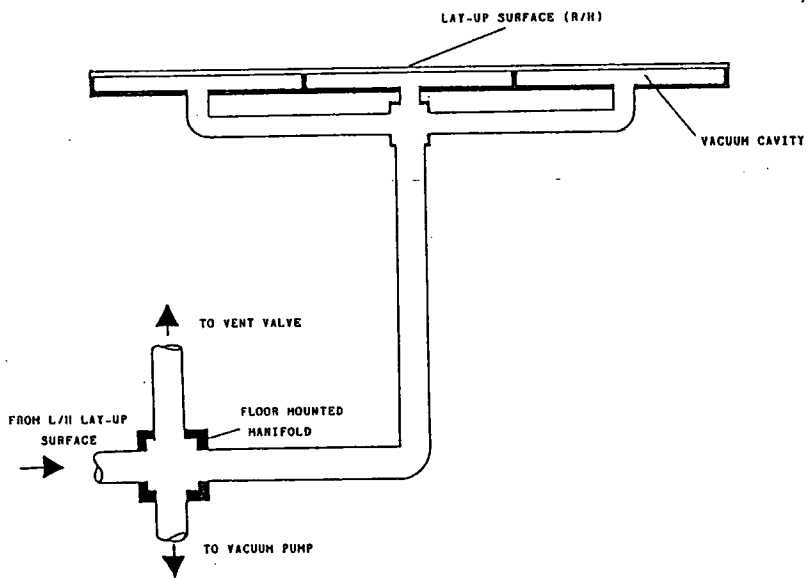

Figure 6-15. Vacuum System Pipework Configuration

6.3.4 Vacuum Pump Selection

Due to the semi-porous nature of carbon fibre fabrics (Chapter III) a significant air flow is induced when a vacuum is applied at the lay-up surfaces. Although the flow rate for a given gauge vacuum level could be calculated theoretically, it is difficult to establish an accurate equation to represent the particular flow conditions. Empirical test results have consequently been employed. The test data (Appendix IV), when compared with manufacturers pump performance charts (vacuum level versus flow rate), indicated that a 3 KW Bosch side channel blower would be a suitable unit.

6.3.5 Vacuum Level Control

The flow rate for a given vacuum level is dependant on the number of preform laminates that have been laid onto the lay-up surfaces. As the number of layers is multiplied, the air flow is progressively restricted. As the flow resistance increases, the gauge vacuum level will increase.

As the vacuum level increases at the expense of air flow two problems can occur. Firstly, it was feared that at higher

levels of gauge, vacuum nozzle witness or "pock" marks would appear in the preform. Since the witness marks would effectively act as wrinkles in the preform surface, they were considered unacceptable from a stress perspective (section 2.5). Secondly, the decreasing flow and increasing gauge vacuum would tend to stall the pump, causing overheating. If the pump were to shut down unexpectedly in this manner, the hold down force would be lost, the preform would slip and lay-up would have to be abandoned.

Two methods have been considered to avoid potential problems. Both approaches involve continuous monitoring of the system vacuum level:

i) Atmospheric Venting

The first technique considered was to vent the system to atmosphere in order to maintain constant vacuum level. It was believed that this could be achieved by exploiting an electrically actuated control valve wired to a vacuum monitoring system. It is also possible that a self monitoring mechanical unit could be successfully used.

ii) Variable Pump Speed

The second method was to equip the pump with a variable speed controller so that the pumping rate could be decreased to maintain a constant vacuum as the flow resistance increased. Speed control of AC motors is most effectively achieved by manipulating the supply frequency which requires the use of an AC inverter drive. Such drives are relatively expensive in terms of initial capital cost, but may be justified in the long term through power savings and reduced contamination of the air filtration unit used to protect the pump.

Controlled venting to atmosphere was initially selected for use in the Demonstrator Cell to avoid the comparatively high cost of an AC inverter drive. When the system is finally developed for a production cell, it will be appropriate to fully investigate the cost effectiveness of controlling the running speed of the vacuum pump by means of a suitable inverter.

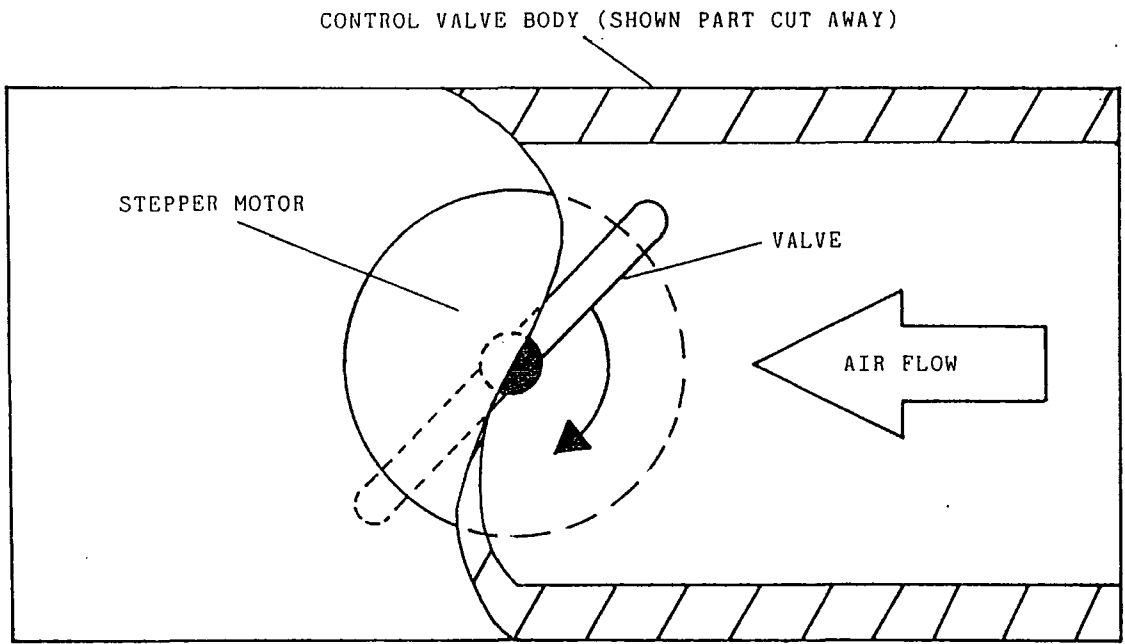

Figure 6-16. Vacuum Level Control Valve

The design of the vacuum level control valve developed (figure 6-16) is based on the principles of a butterfly valve. The advantage of the butterfly configuration is that since the forces on a valve plate are more or less balanced during operation, the torque needed for actuation is low (there is a very small resistive torque due to fluid dynamic / frictional forces) and so a low power motor can be employed. For compatibility with the Lay-up Station PC based control package, a small stepper motor was selected for the task.

6.4 System Operation

The overall sequence of lay-up station operations is that proposed in section 4.2.2. The sequence begins with the root gap being automatically set to the required reference starting gap and mechanically locked in position. The handling device (Chapter VII) deposits the first layer set of plies which are held in place by lay-up surface vacuum. The gap is reduced ready for the next layer which is heat tacked onto the first. The cycle repeats until all layers have been deposited and tacked into place to complete the flat preform. The ply is then removed from the table for folding.

consolidation, pre moulding assembly and impregnation.

6.5 Industrial Performance Trials

In order to prove the capability of the Lay-up station, the fully automated system underwent practical industrial trials in the Dowty Composite Blade Shop. The trials covered the complete manufacture of three identical propfan blades from pre-cut plies to moulded blade.

The specific objectives of the trials were to prove the flat lay-up concept, assess the operational accuracy of the system under operational conditions, and to establish how the Station performance might be improved.

6.5.1 Nature of the Trials

The manual method used to manufacture the trial propfan blades was the same as that normally used by Dowty, except that the automated Lay-up Station replaced the existing lay-up jig. The final production Lay-up Station is intended to be used in conjunction with a suitable robotic handling device which will ensure that accurate lay-up is consistently

achieved. Robotic assistance was not, however, practical at the time of the trials since the gripper technology research (Chapter VII) was at a very early stage. It was, therefore, necessary to manually manipulate and then tack (by means of a hot iron) each ply into place to simulate the robotic operation; it was clear that if the system produced acceptable results via manual lay-up, it would certainly perform within an automated environment.

For the duration of the trials the vacuum level of the hold down system was maintained within the range of 100 and 120 mbar by continuous adjustment of the vacuum level control valve.

6.5.2 Trial Observations

During each of the three trials the operational performance characteristics of the Station were monitored. This was carried out with a view to improving the system, where practical, as the trials progressed by relating the observations made to the quality of the resultant resin impregnated blade. To this end it, was important to record the accuracy of the lay-up gap at each step. It was also essential to closely observe the general performance of the

system and the behaviour of the preform throughout.

{All dimensions were recorded in inches in line with the then current Dowty convention}

6.5.2 (a) General Observations

A number of general observations were made relating to all three trials. These were:

a) Premature Root Sag

Because each root tab was unsupported when laid across the gap between the lay-up surfaces, they tended to sag slightly before adequate inter ply tacking could be carried out. Clearly, this affects the accuracy of the root tab length making it slightly longer than the measured root gap. The problem could be avoided in a production cell by heat tacking each ply (with a root tab) as it is robotically placed. This implies that the handling device would need to have an on-board heat tacking capability. To simplify the task, the simultaneous tacking could be limited to the ply areas directly adjacent to the lay-up gap (figure 6-17).

b) Ensuring Downward Buckling of Each Root Tab

At each gap decrement, the uppermost root tab held across the lay-up gap was intended to buckle downwards (the buckling instability induced by gravity). In practice, it was found that the tab could either buckle upwards or downwards. The required downward bow could, however, be ensured by applying a small, timely downward force across the centre of the tab (figure 6-18). Once the downward buckle has been initiated, it invariably continued downwards without further encouragement. This force had to be applied manually during the industrial trials, but a device incorporated into the gripper unit would be appropriate for applying the force in the fully automated cell.

c) Table Position Lock

A single, screw down, manual clamp was used to lock the lay-up surfaces after the required gap had been achieved, at each step. This was found to be inadequate because the manual tightening of the screw tended to disturb the gap dimension. Although careful tightening diminished the problem, pairs of automatic electromagnetic brakes fitted to the base of each lay-up surface would be far more effective.

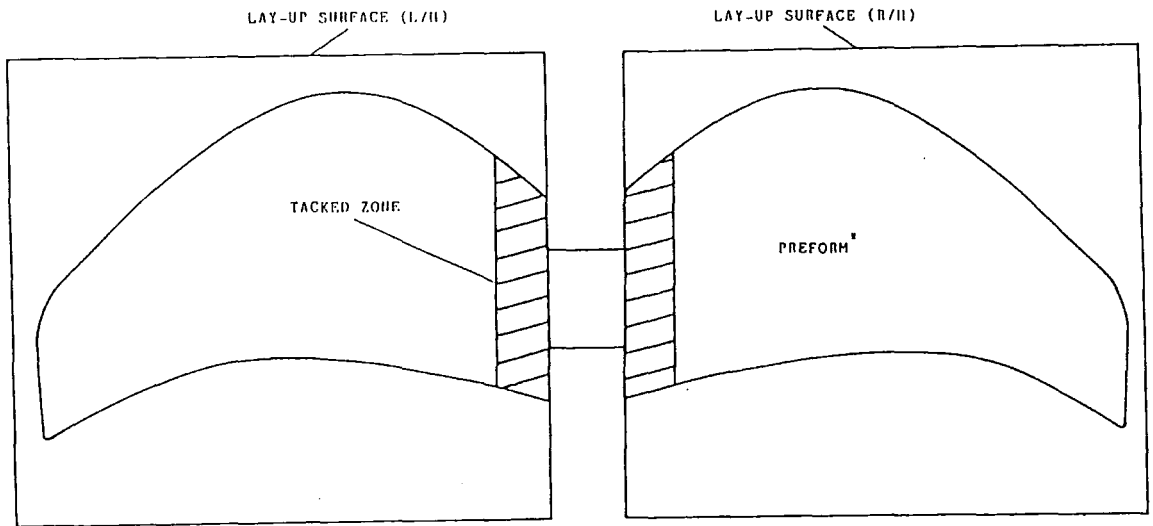

* FOR CLARITY, ONLY OUTER SHAPE OF PREFORM IS DEPICTED

Figure 6-17. Simultaneous Lay-up and Tacking (Tacked Zones)

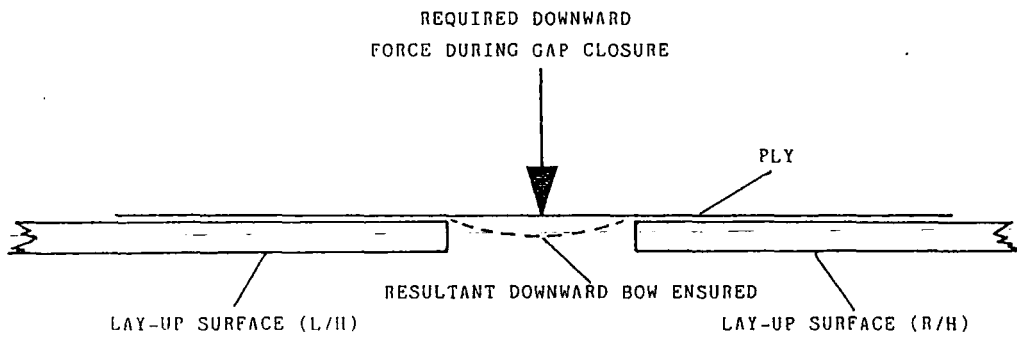

Figure 6-18. Force Application to Induce Downward Buckling of Each Root Tab

6.5.2 (b) Specific Observations by Trial

a) Trial I

The first trial was based on Dowty calculations for the required length of each root tab. The root gap at each layer was set such that the entire length of each root tab was suspended across the lay-up gap (as per figure 6-17).

i) Lay-up Station Gap Error

The performance of the Station in terms of gap accuracy during all of the three trials was recorded (Appendix III). The allowable root gap error range was set (section 6.1.3) at 0.1 mm (0.004") based on the severity of wrinkling that could theoretically be generated. The lower limit of the allowable tolerance range was defined as the greatest negative gap error observed; this will induce the tightest layer within the root when then the preform is folded (-0.001" in Trial I). The principle is that the tightest layers cannot stretch and, therefore, all looser layers must wrinkle if they are to be accommodated (section 6.1.3). For Trial I, the upper limit was then 0.003" (lower limit (-0.001") plus tolerance band (0.004")).

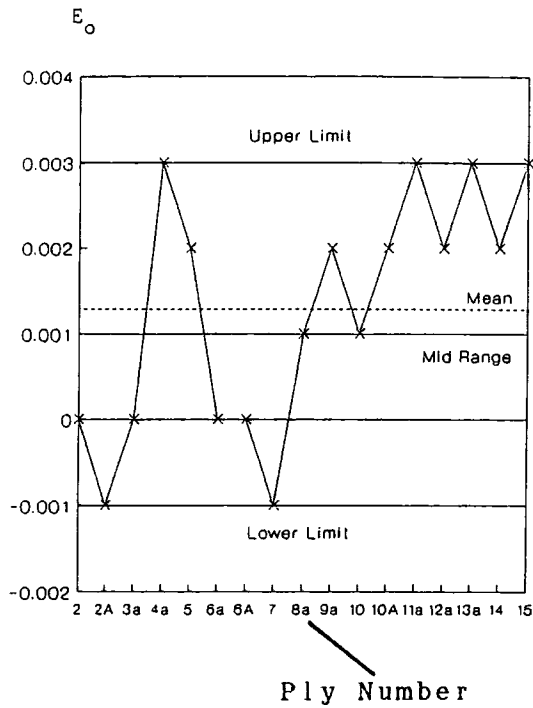

Figure 6-19(a). Root Gap Error (E_o) - [Inches]

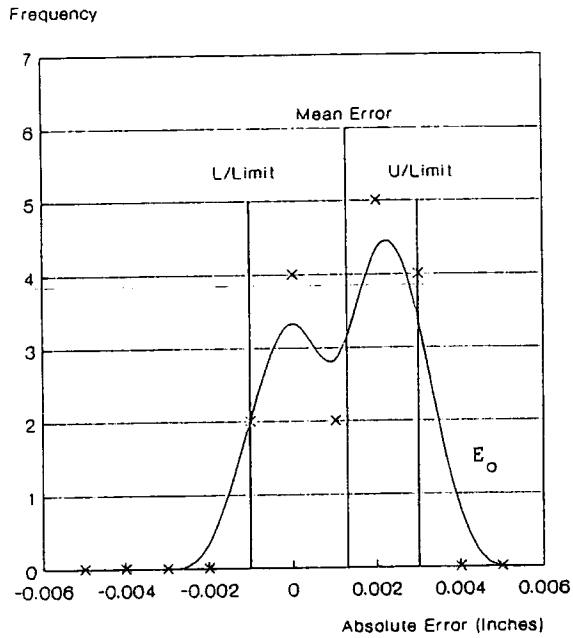

Figure 6-19(b). Statistical Distribution of Error (E_o)

All the root gap errors recorded were within the required 0.004" tolerance band. The system, then, operated within specification based on readings taken at the opposite side of the table to the encoder. Analysis (Appendix III) of the data (figure 6-19 (b)) indicates, however, that E_0 will statistically be outside the tolerance band for 15% of layers. For a seventeen root tabbed layer preform, this equates to an acceptable preform rate of only 6.3% (if E_0 is taken to represent root tab length error).

ii) Quality of the Consolidated Preform

The three dimensional heat-vacuum consolidated preform (plate 6-2) was found to have a large multi-layer wrinkle at the base of the pitch side of the root lug. This wrinkle, which most noticeably affected the innermost root tabs, measured 10 mm in length and 3 mm in amplitude, far in excess of the acceptance limits set (section 6.1.3.). The preform was, therefore, rejected before resin impregnation was attempted.

iii) Discussion

The amplitude of the wrinkle was too great to be explained by the gap errors alone which would have theoretically produced



Plate 6-2. Consolidated Preform (Showing Root when Folded)

a worst case wrinkle of between 0.6 and 0.7 mm amplitude over the 10 mm wrinkle length. Several possible causes were proposed:

- * The method of vacuum consolidation was set up to evacuate the preform, sealed in a vacuum bag, from tip to root. It was, therefore, possible that aerofoil pitch face may have been squeezed towards the root during consolidation. The fabric on the pitch side of the root base would have consequently been compressed, generating the observed wrinkle.

- * The original Dowty calculated data, used to program the lay-up gap at each step was inaccurate.

- * Accommodating the entire root tab of each layer across the lay-up gap meant that a comparatively large amount of fabric had to be suspended between the two lay-up surfaces. This both encouraged premature root sag and made the preform difficult to fold evenly onto the consolidation jig.

To eliminate these factors, several remedial steps were taken simultaneously (eliminating each potential cause sequentially

was not appropriate given the limited number of trials that were to be carried out). Firstly, the original Dowty input data was revised to accurately reflect theoretical values calculated from the derived formula (section 6.1.1) (angle α was neglected, however, such that θ was assumed to be 180°). Also, the lay-up gap dimension was reduced by a constant value for each layer, setting it equal to only the arc, not the entire tab length (figure 6-20 and plate 6-3). Finally, the method of vacuum bagging was changed so that evacuation would occur from root to tip; this was to be achieved by attaching the vacuum connectors as close to the root as possible (figure 6-21).

The poor results of the capability analysis were disappointing, but not cause for major concern in terms of proof of concept. The "worse case" single wrinkle scenario proposed (section 6.1.3) was also thought unrealistic, since excess fabric was seen to form into several distributed wrinkles. Moreover, it will quite practical to optimize aspects of the Lay-up Station for greater accuracy before it is employed in a production cell.

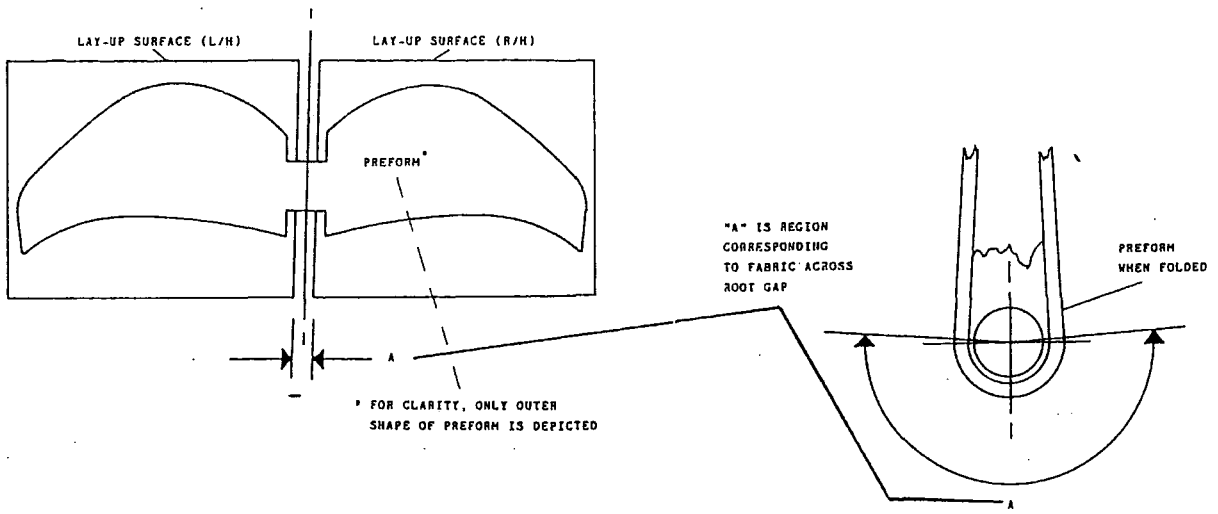

Figure 6-20. Region Corresponding to Fabric Across Root Gap

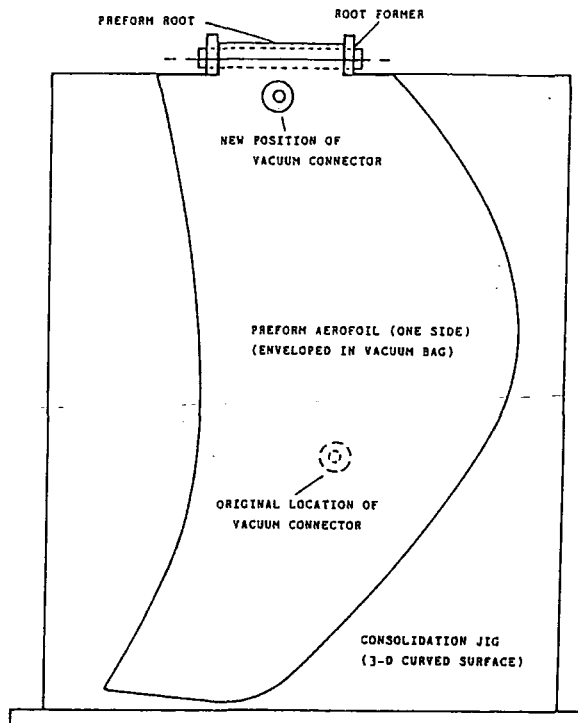

Figure 6-21. New Position for Vacuum Bag Connectors Heat-Vacuum Consolidation Jig

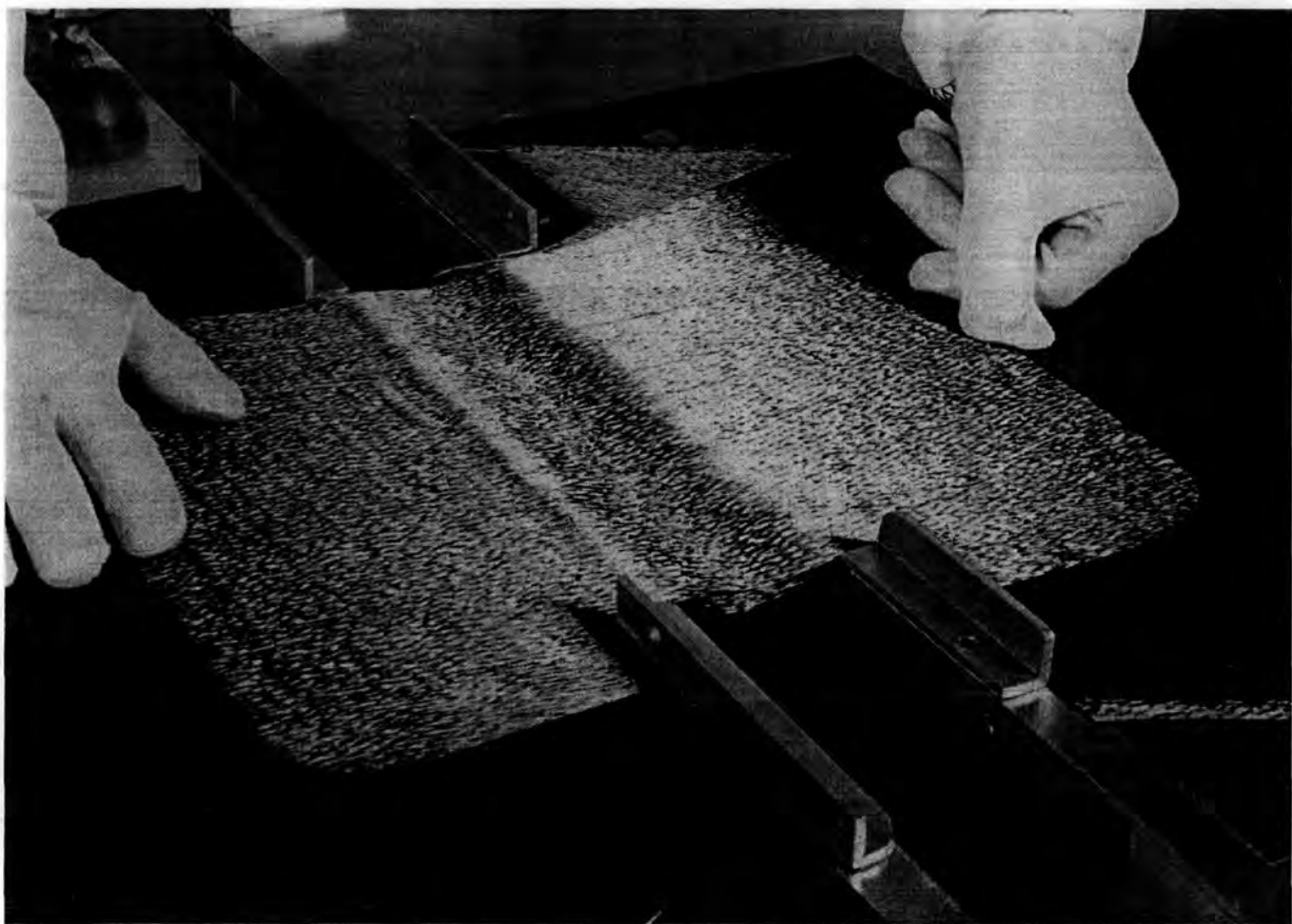

Plate 6-3. Preform Root During Lay-Up (Trails II & III)

b) Trail II

The method and equipment used in the second trial were identical to those in the first, except where remedial improvements had been implemented. The validity of the results was also enhanced by taking gap readings at opposite sides of the lay-up table by means of two permanently attached dial indicators (figure 6-22) one of which was placed over the encoder.

i) Lay-up Station Gap Error

Examination of the lay-up gap errors showed that:

At the encoder all but three root gap readings were within the assigned tolerance band (figures 6-23(a)). The error range was 0.005 ". The capability analysis (figure 6-23(b) and Appendix III) suggested that around 27% of gaps (if measured at the encoder) would have excessive error. The extrapolated capability at the encoder is a 0.5% preform acceptability rate.

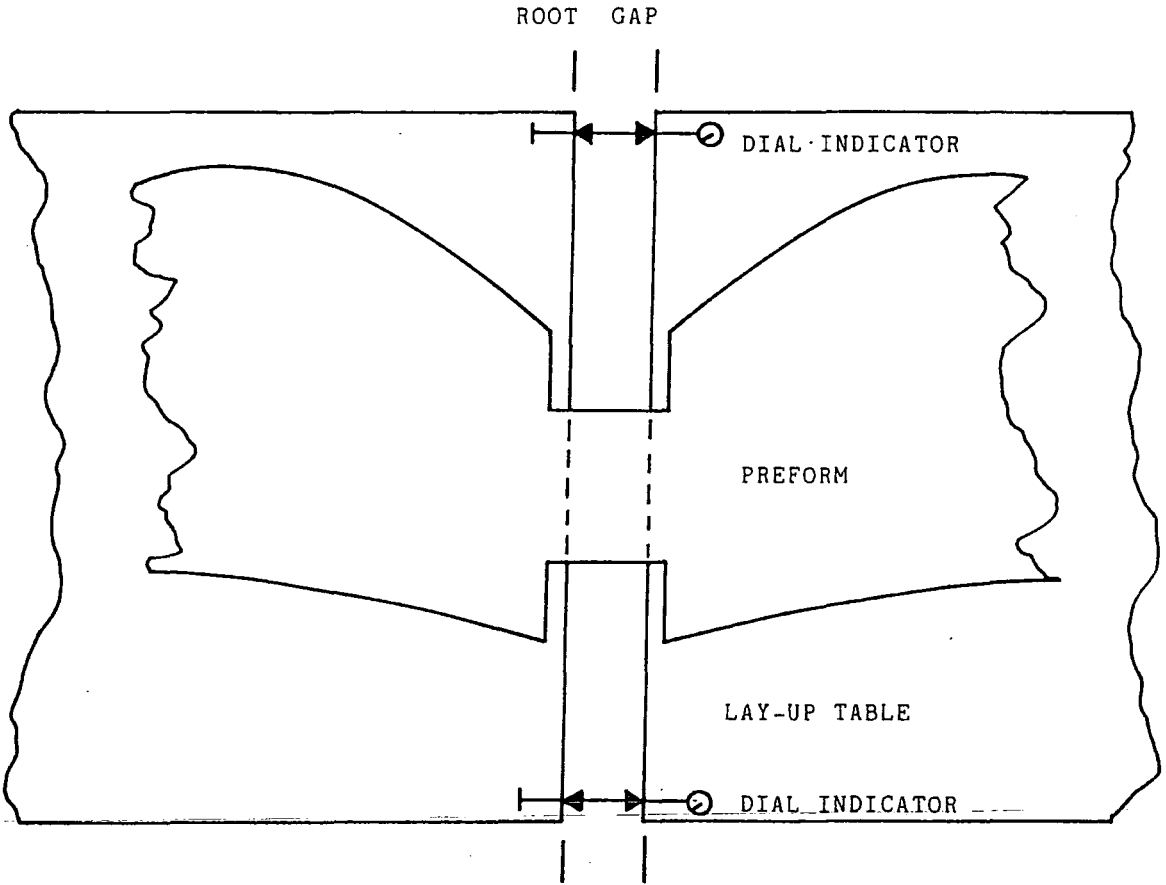

Figure 6-23 Position of Dial Indicators

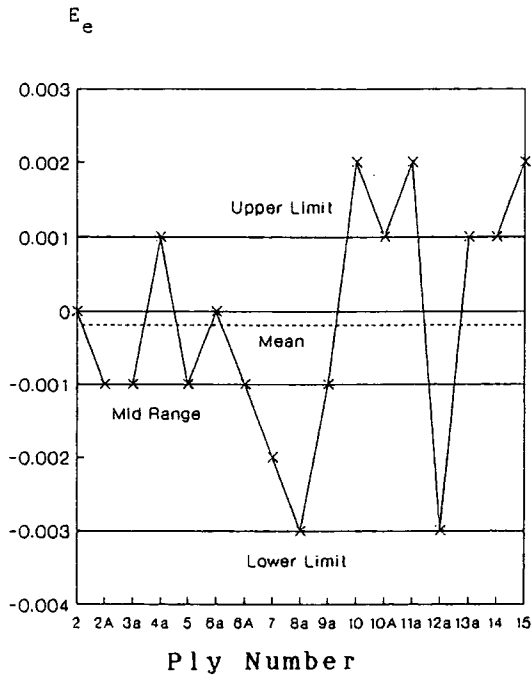

Figure 6-23(a). Root Gap Errors (E_e) - [Inches]

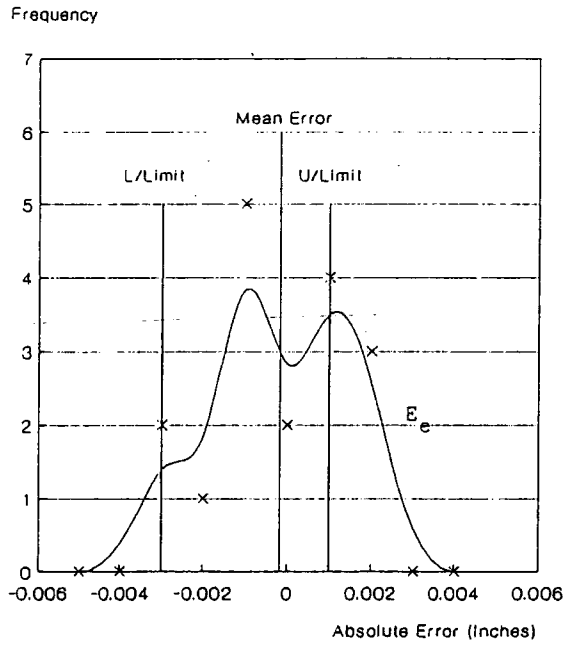

Figure 6-23(b). Statistical Distribution of Errors (E_e)

At the root leading edge (Appendix III) five calculated root gap values were outside tolerance; two of these were 0.001" and three 0.002" outside, giving a range of 0.006". The capability analysis indicated that 36% of gaps would be out of tolerance, an acceptable preform capability of only 0.1%.

At the root trailing edge (Appendix III) the calculated root gap values were worse than those tabled for the leading edge. Six values were out of tolerance, with a range of 0.007": one at 0.005", two at 0.006" and the remaining three at 0.007". The capability analysis predicted a particularly high out of tolerance probability of 49% for each root layer; this gives a preform acceptance rate of just 0.001%.

ii) Quality of the Consolidated Preform

Consolidation of the second preform produced a far better result than observed in Trial I. No wrinkles were evident, although the poorly blended joins between the aerofoil and root sections of the original Dowty consolidation jig had left slight indentations inside of the preform at both sides of the base of the root.

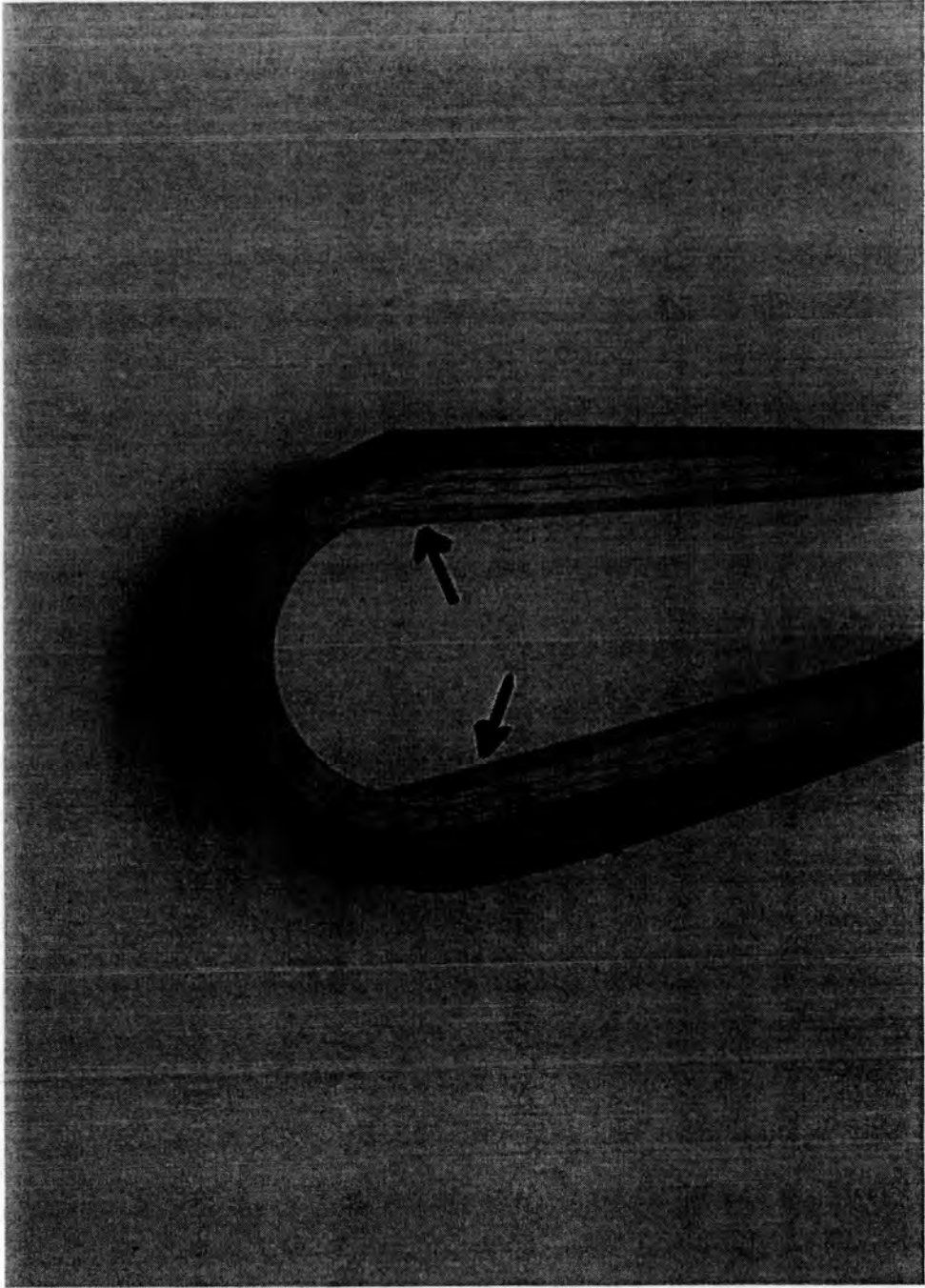

Plate 6-4. Cross Section of Root Manufactured via Lay-Up Station (Trial II)

The blade was subsequently assembled with a foam core and metal root insert; it was then resin impregnated in the usual manner. The root of the cured blade produced was cut into cross sections at 25mm intervals to allow inspection of the fibre path around the root's geometry. Each cross section (e.g. plate 6-4) revealed that all the root tabs had followed their required paths around the arc of the root, with only minor wrinkles evident.

The minor wrinkles were noted to be of two kinds:

- * Short length wrinkles affecting individual layers, measuring typically 2mm in length and less than 0.2 mm in amplitude - these were distributed fairly evenly around the root arc.

- * Longer more pronounced wrinkles of typically 5mm length and 0.5mm amplitude affecting the regions where the root arc blended into the aerofoil. These were virtually uniform through the root cross sections.

The shorter distributed wrinkles are thought to have been due to root gap error or sag during lay-up. These were of an acceptable magnitude, although slightly greater than the best

root section manufactured through existing techniques at Dowty.

It was believed that the longer wrinkles affecting the entire cross section may have been due to:

- * A kink in the consolidated preform caused by an observed step in the consolidation jig between the aerofoil and root areas;
- * Pinching of the root section in the affected areas during heat-vacuum consolidation; this may in turn be occurring because the folded root was not pulled taught around the top of the consolidation jig.

In order to avoid these problems the consolidation jig presently used by Dowty would have to be modified. Firstly, the step between the root and aerofoil sections of the jig would have to be smoothed out so as not to cause indentations in the preform. Secondly, the root section of the jig would require independent vertical actuation, so that it could be used to tension the preform root before vacuum bag evacuation (figure 6-24). Unfortunately, appropriate changes were not practical to implement during the timescale of the trials.

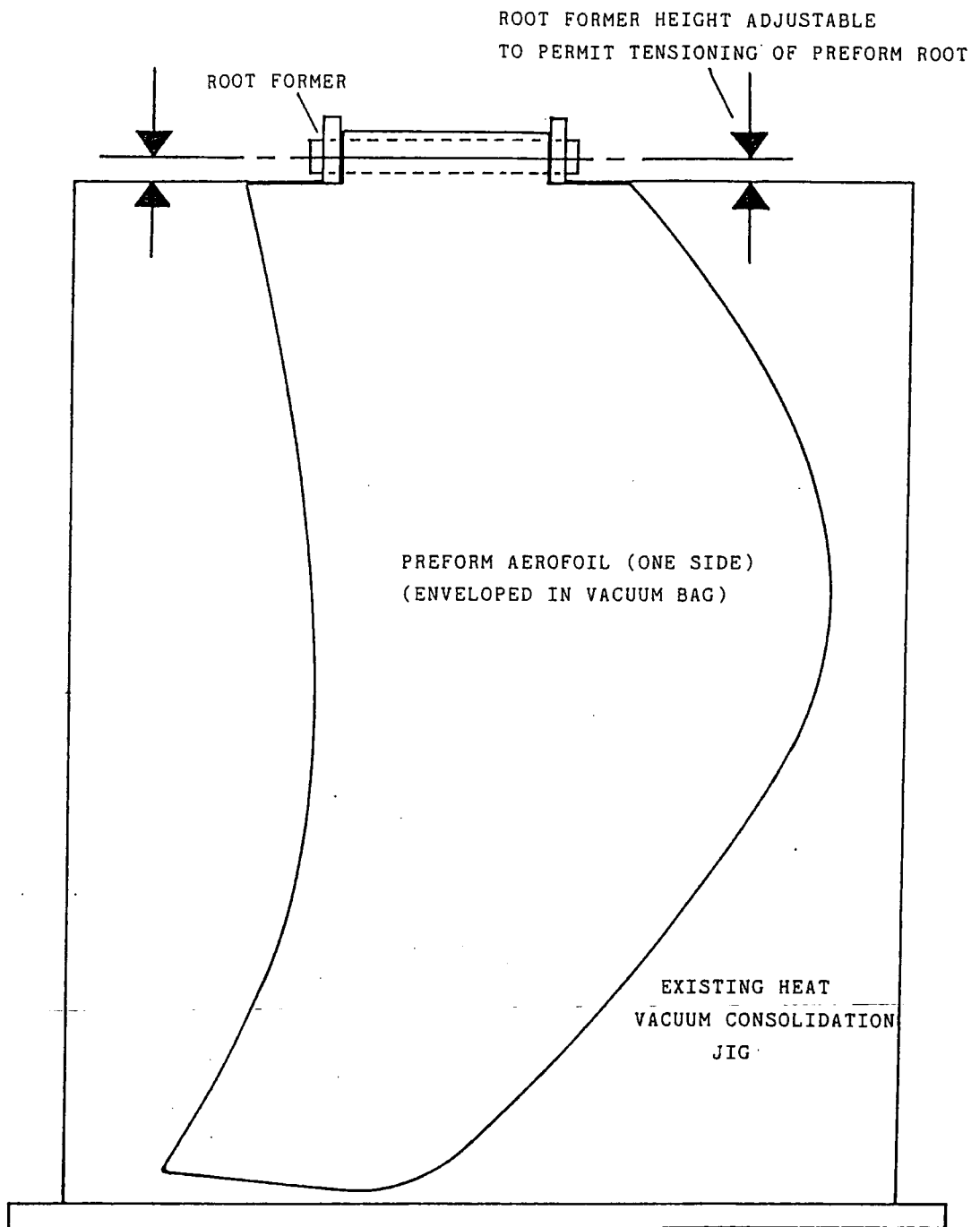

Figure 6-24. New Consolidation Jig

The blade aerofoil was cut into sections at 50mm longitudinal intervals to allow internal inspection to check that post forming the aerofoil region to a three dimensional form, after lay-up, had not caused wrinkling in the fibre laminates. No significant wrinkles were observed and it was concluded that post forming had been successful.

iii) Discussion

Despite the apparent physical success of the new lay-up technique indicated by the quality of the resin impregnated preform, the analysed capability was again very low. The implication is that the theoretical performance criteria could most likely be relaxed in line with empirical findings.

c) Trial III

The method and equipment in Trial III were identical to those in Trial II, except that the programmed lay-up gap values were refined such that the small angle α (section 6.1.1) was taken into account (figure 6-1).

i) Lay-up Station Gap Error

Examination of the gap error values for the third trial showed that:

At the encoder, all readings were within the tolerance band (figure 6-26(a)). Analysis of the statistical spread (figure 6-26(b) and Appendix III) suggested that the long term performance would be an 11% out of tolerance tab rate or an acceptable preform rate of 13%.

At the root leading edge, no calculated gap dimension values were out of tolerance (Appendix III). The statistical analysis suggested, however, that over time 9% of gaps could be expected to be out of tolerance, equating to a 22% acceptable preform rate.

At the Root Trailing Edge (Appendix III), all but one of the calculated error readings were within the nominated tolerance band (with a range of 0.005") but statistically, 14% of gaps would be expected to be outside the required tolerance. The consequent preform acceptance rate would be 8%.

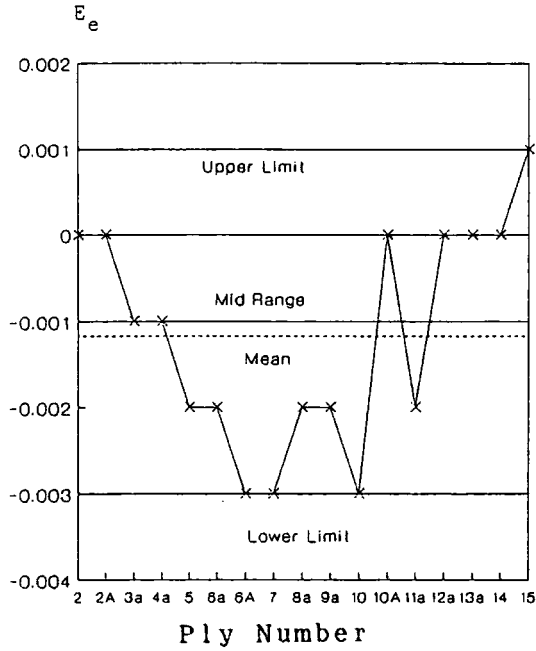

Figure 6-25(a). Root Gap Errors (E_e) - [Inches]

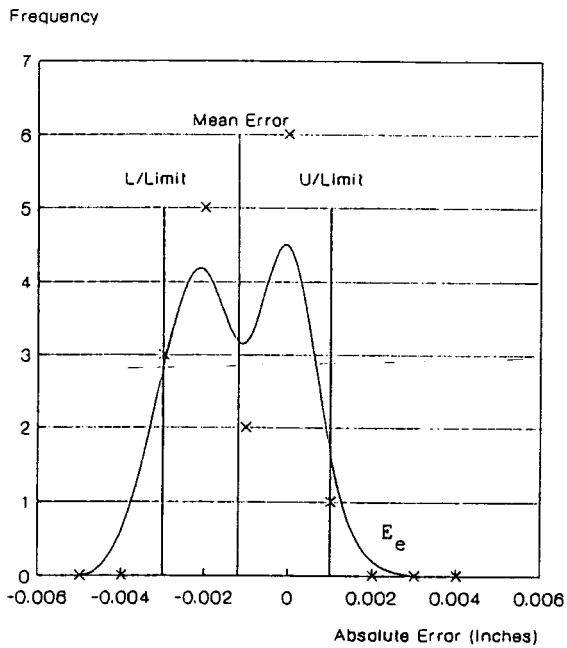

Figure 6-25(b). Statistical Distribution of Errors (E_e)

The improved statistical performance of the system was considered to be the result of the great care taken when tightening the table positional lock at each lay-up step.

ii) Quality of the Consolidated Preform

The third preform appeared to be an improvement on the second. No wrinkles were detectable in the consolidated preform, but again there were slight witness lines left by the step in the heat-vacuum consolidation jig.

After assembly and resin impregnation, cross sections (e.g. plate 6-5) of the component were examined. Only a few very minor wrinkles were evident in the root zone and these were less than 0.2mm in amplitude and 2mm in length; the product was approaching a highly acceptable standard. Lateral cross sections of the aerofoil similarly showed no significant wrinkling, indicating that post forming the aerofoil curvature during the consolidation stage had been completely successful.

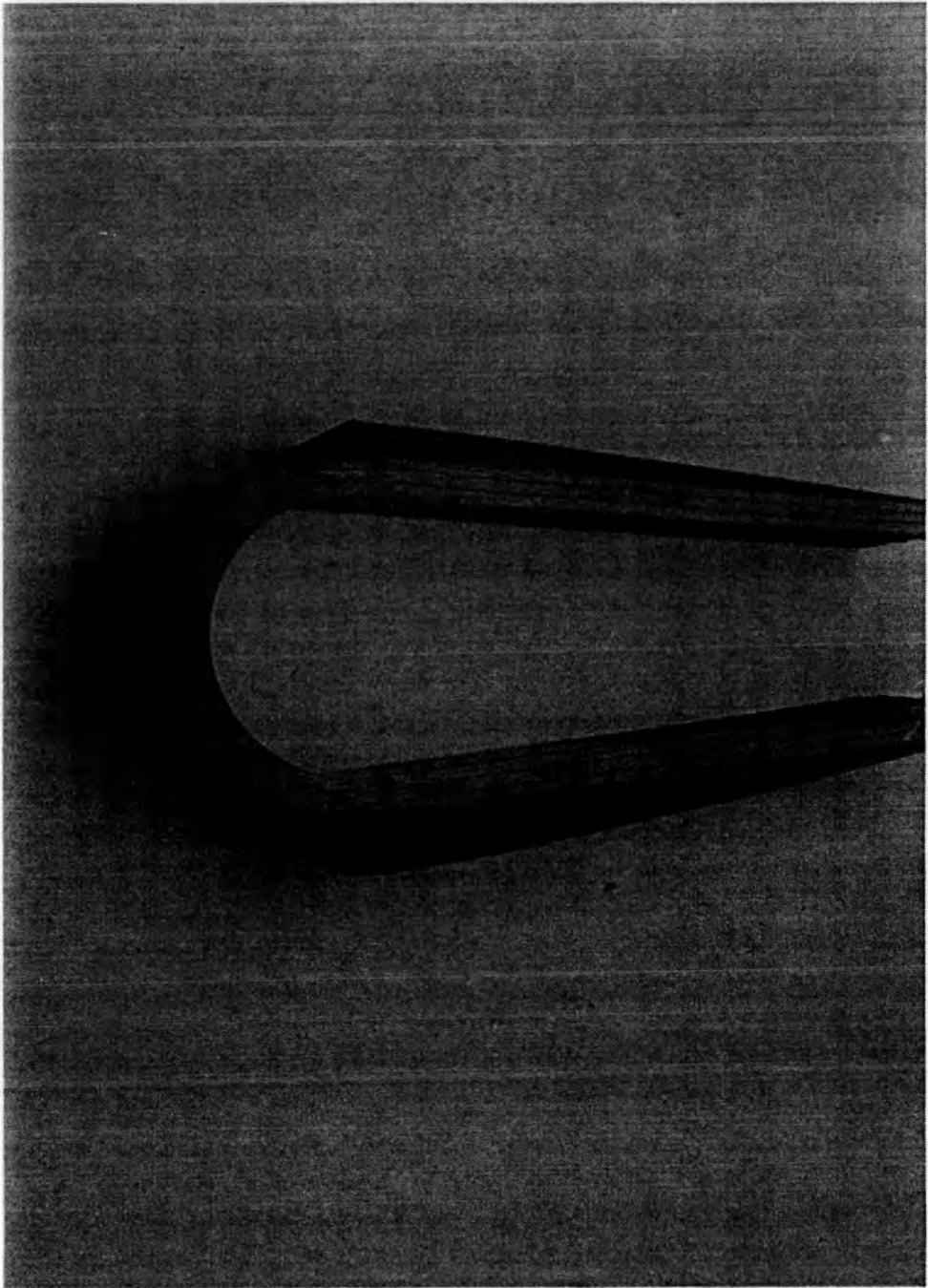

Plate 6-5. Cross Section of Root Manufactured via Lay-Up Station (Trial III)

6.6 Conclusions

The development of a successful flat lay-up technology was considered to be the foundation for the successful application of a practical gripper technology for propfan preform manufacture. This Chapter has discussed how the concept of a flat lay-up station has been implemented and tested.

Industrial trials have shown that propfan blades can be produced with a root very near to the required quality, even by prototype equipment. The flat lay-up and subsequent three dimensional consolidation of the preform aerofoil appeared also to be successful. The capability of the prototype system in terms of root formation was, however, significantly outside the standard theoretically needed to ensure consistent high quality root formation; evidence does suggests, though, that the theoretical worse case, upon which tolerance bands were set, may be too harsh. Better results would, of course, be expected with automated lay-up since the manual lay-up used in the trials imposed significant additional process variables.

Further work will be required, either at the research stage

or as part of a later production hardware development programme to improve the system so that a consistently high quality standard can be assured. Several modifications could be made immediately to greatly improve the Station's performance. These are:

a) Encoder Position

The encoder should be repositioned to a central location. Alternatively, a pair of encoders could be employed, at opposite sides of the lay-up gap and a mean of their readings used for control purposes.

b) Locking Mechanism

The manual, screw down locking mechanism should be replaced by an automatic brake system which will not disturb the correct lay-up gap established by the encoder.

c) Table Actuation

One of the pair of moving tables should be fixed so that the gap dimension is controlled by the movement of one lay-up surface only. This will improve the resolution of the

actuation system and minimize any dimensional discrepancy between one side of the gap and the other.

d) Wrinkle Severity

In order to establish more practical design parameters for lay-up gap accuracy, research work would be useful to fully evaluate the quantitative relationship between wrinkle severity and impact strength.

REFERENCES

- [1] Lubin, G., (Editor), *Handbook of Fibreglass and Advanced Plastics Composites*, Robert E. Krieger Publishing Company, New York, 1975.
- [2] Groover, M.P., *Automation, Production Systems, and Computer Integrated Manufacturing*, Prentice-Hall Inc., 1987.
- [3] Klafter, D., Chmeilewski, T.A., and Negin, M., *Robotic Engineering - An Integrated Approach*, Prentice Hall Inc., 1989.

C H A P T E R V I I

H A N D L I N G D E V I C E S

CHAPTER VII

HANDLING DEVICES

The formulation of a new conceptual lay-up process was based on the development of a new technology lay-up station which would simplify the handling requirements for automated propfan preform lay-up. Having successfully developed confidence in the lay-up station concept, the research turned to developing handling technologies.

Chapter VII discusses this handling technology research, starting with an review of the functional handling requirements and how these generate design criteria. Gripper types considered and investigated at a pre-prototype level are then outlined. The chapter goes on to cover design, operation and laboratory trials of a half size gripper unit, finally proposing the design of a full size prototype model to be used in the integrated Research Demonstrator Cell.

7.1 Functional Requirements

Four significant functional requirements of the handling device were recognised as dictating the primary design criteria. These are to:

- i) pick-up each of the series of dry fibre carbon plies from a nest of cut plies resting on a cutting table surface, without disturbing surrounding fabric which may be either waste material or adjacent plies.
- ii) reliably transfer such plies from the cutter table to the Lay-up Station.
- iii) accurately place each ply within $\pm 0.5\text{mm}$ of a predetermined position at the Lay-up Station without disturbing previously laid plies.

In order to achieve these criteria the handling device must be capable of:

- a) reliably applying sufficient force(s) to each ply to pick it clear of a cutting table surface and hold it firmly during transfer (the method of applying these

forces must not damage the fabric weave or the individual tow filaments, thus avoiding impairment of reinforcement performance in the finished blade);

- b) effectively and reliably releasing each ply during the placement operation;
- c) adequately supporting each ply during the transfer operation to avoid profile distortion, since any significant distortion of a given profile will render the ply virtually impossible to lay robotically in an accurate position;
- d) highly reliable long term repetitive operation;
- e) accommodating the largest ply envelope (2.1m X Ø.75m);
- f) providing sufficient resolution to apply adequately distributed pick up forces only where required and not to surrounding material;
- g) offering sufficient rigidity and strength to tolerate both static and dynamic loadings during operational cycles.

7.2 Gripper Types

To effectively meet the design criteria, a wide range of gripper types were considered. The more promising of these were developed to pre-prototype model stage to gauge their potential.

A major difficulty envisaged at the start of the programme was the requirement to selectively handle large flexible plies. This was initially envisaged to necessitate the use of a large, probably high mass gripper head. It was, consequently, believed that it would be useful to investigate the feasibility of designing an a small gripper head that would effectively handle large plies. The consequent avenues of research are discussed in the remainder of this section.

7.2.1 Gripper Head to Handle Plies Cut into Narrow Strips

In order to reduce the required size of the gripper, the option of cutting plies into strips (and then butting them side by side during lay-up) was considered (figure 7-1(a)). There are, however, a number of reasons why the approach is impractical.

First, carbon tows within each ply must be continuous to impart maximum structural benefit to the impregnated blade. Strips could only, therefore, be cut parallel to the fabric fibre axis (appended samples) if preform properties are to be maintained.

In the case of unidirectional fabric plies:

- the strip would have to run parallel to the ply warp axis and, therefore, the maximum strip length would be approximately equal to the length of the longest ply with a 0° lay-up orientation (2.1m) (figure 7-1(a));

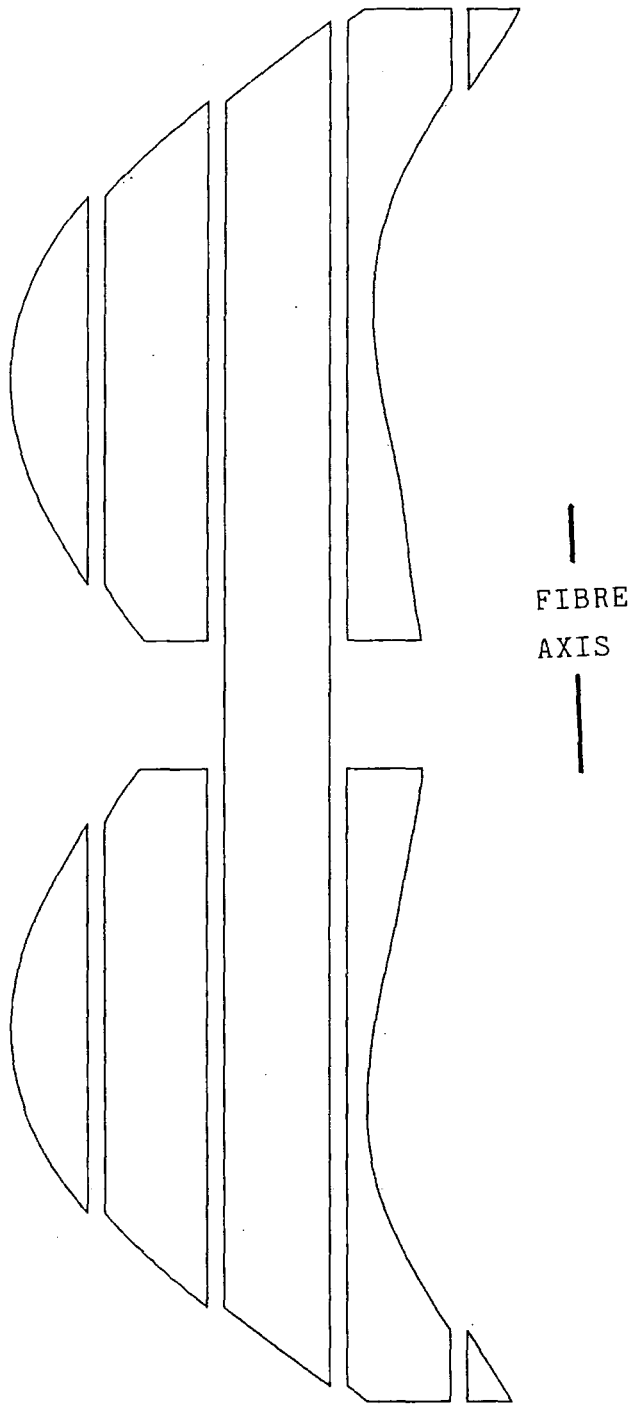

Figure 7-1(a). 0° Fibre Oriented Unidirectional Ply Cut into Strips for Handling

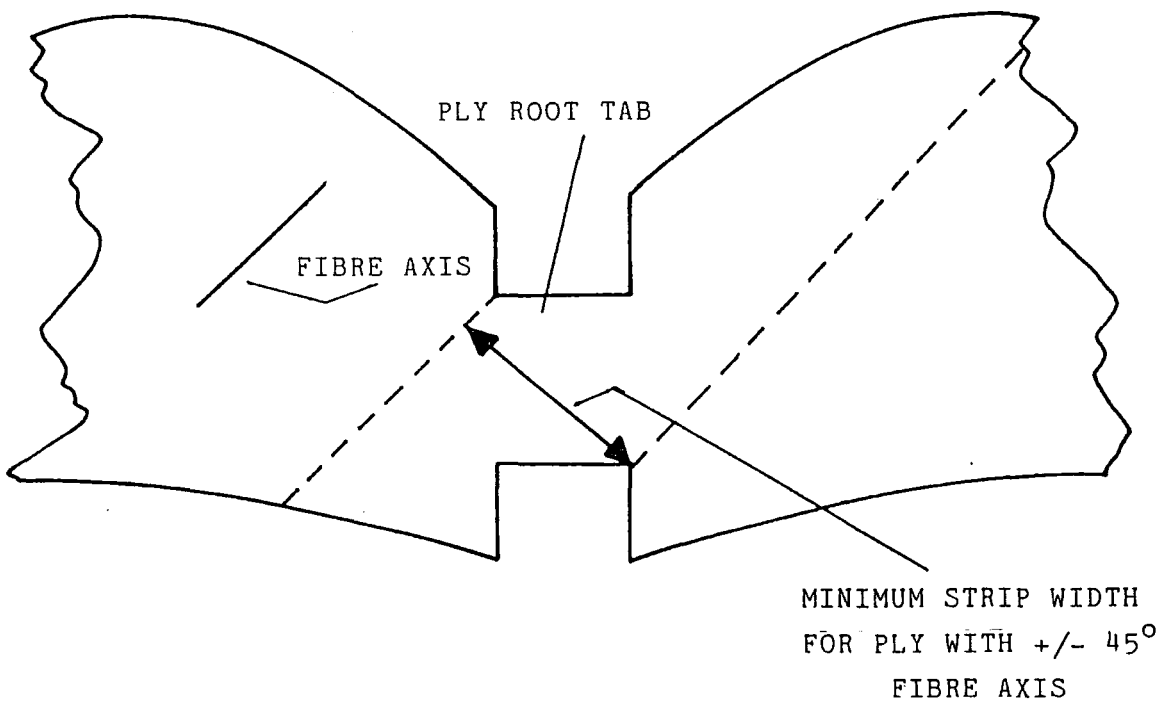

Figure 7-1(b). +/- 45° Fibre Oriented Unidirectional Ply Cut into Strips for Handling (Strip across Root Tab Shown Only)

- the root tab section should be contained within a single strip to ensure fault free folding after preform lay-up. The greatest strip width will, therefore, be required when the fibre axis runs at 45° to the lay-up axis; for the longest root tab, the calculated value for a suitable strip width would be 0.26m (figure 7-1(b)).

The gripping area of a strip handling flat gripper for unidirectional plies only, would thus still have to be large (2.1 m X 0.26 m). Moreover, woven fabric plies could not be cut into strips and handled in this way, since they have two perpendicular fibre axes each requiring tow continuity.

7.2.2 Cylindrical Gripper Heads

Another approach considered to minimize handling device size, whilst retaining full ply handling capacity was to pick (and place) plies by rolling (and unrolling) them onto (and from) from a cylindrical gripper drum (figure 7-2). Given the comparatively high length to width ratio of typical plies, the cylinder axis would be most usefully aligned across the width of the working envelope such that the width of the gripper would remain at 0.75m, but the entire ply length would be wrapped around the cylinder diameter.

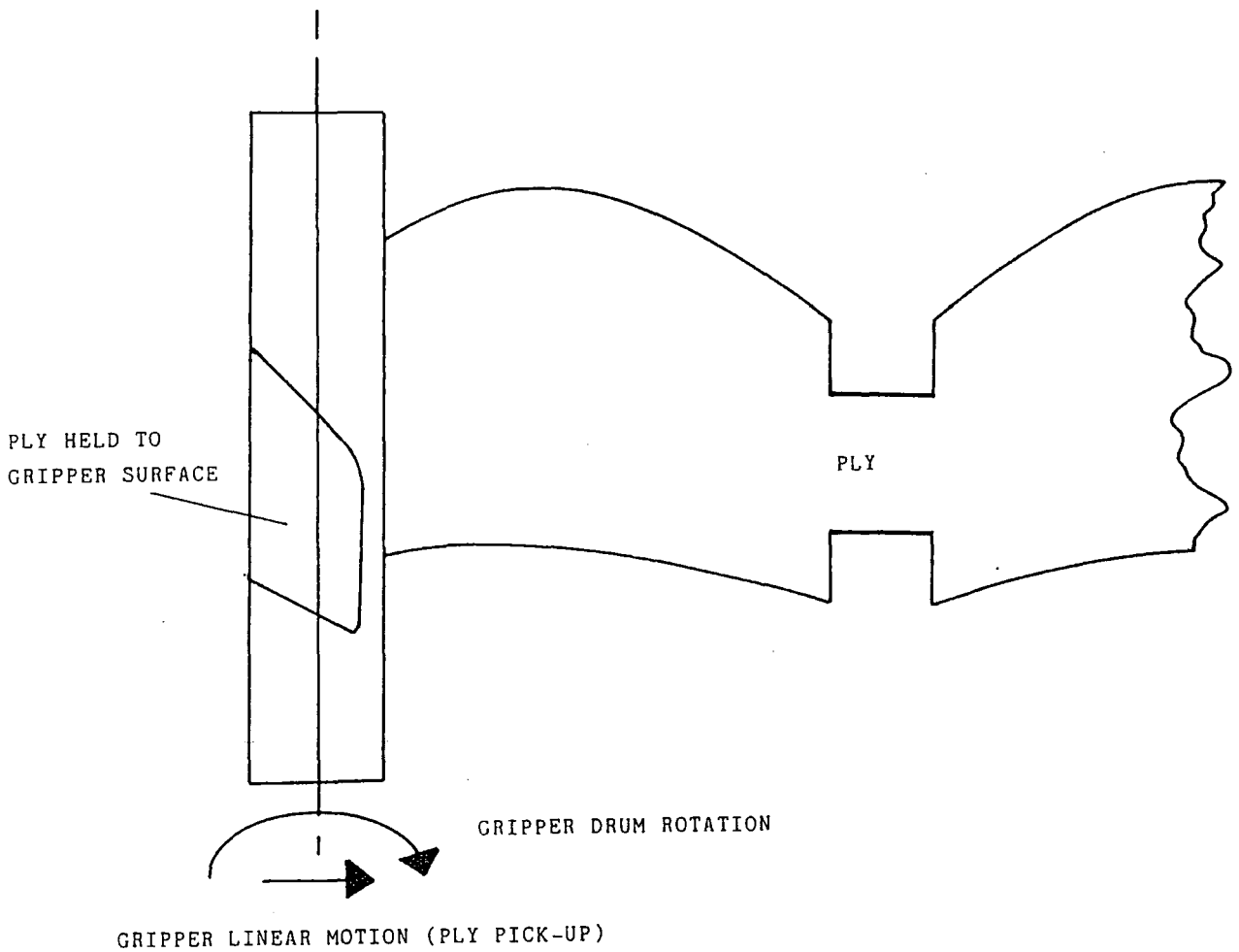

Figure 7-2. Basic Principle of a Cylindrical Gripper Head

To roll any of the range of plies around a cylindrical gripper in a single rotation only, the cylinder diameter would have to be large (around \emptyset .7m for a 2.1m long ply). Such a cylinder diameter would be too large for effective robotic handling. If, however, the ply length could be successfully coiled around the gripper head in several rotations, the cylinder diameter could be reduced to more practical proportions. The viability of the latter approach was fully investigated through the development of pre-prototype gripper models.

Three types of mechanism were considered as a means attaching plies to the pre-prototype gripper drum: a matrix of fabric penetrating needles; an electrostatic surface; and rows of vacuum nozzles.

The action of the needle matrix depends on rows of needles locking against weft or weft fibres. In the case of apparel cloths, the principle had already been found to work well by Durham University^[1] with the needles locking positively into the closely woven relatively stable and secure weave of the garment fabric. Initial tests with propfan type dry composite fabrics, however, showed that the needles tended to slip through the weave until they snagged on a row of weft fibres.

Moreover, were the weft fibres were either fine or poorly adhered to the fabric, they could be teased out in the warp direction on snagging, allowing further slippage, accompanied by weave damage, to occur.

During the early stages, electrostatic and vacuum options were considered more viable gripping means based on the work already carried out by a number of organisations such as Hull University[2] and Queen's University (Belfast)[3]. It was these two concepts which were consequently carried through into the next stage of investigations.

To test the basic application effectiveness of cylindrical gripping, several vacuum gripper drums were made and tested. The vacuum option was adopted for the pre-prototypes simply because the basic principles of coiling a ply around a cylindrical gripper in several rotations (whether by vacuum or electrostatic means) could be efficiently tested by exploiting the most simple, easily set up mechanism. Although the principles of vacuum and electrostatic gripping are very different, both mediums are similar, for the purposes of preliminary trials, in that each will exert a surface force (governed by the equation given below (figure 7-3)) which holds the fabric against the gripper circumference.

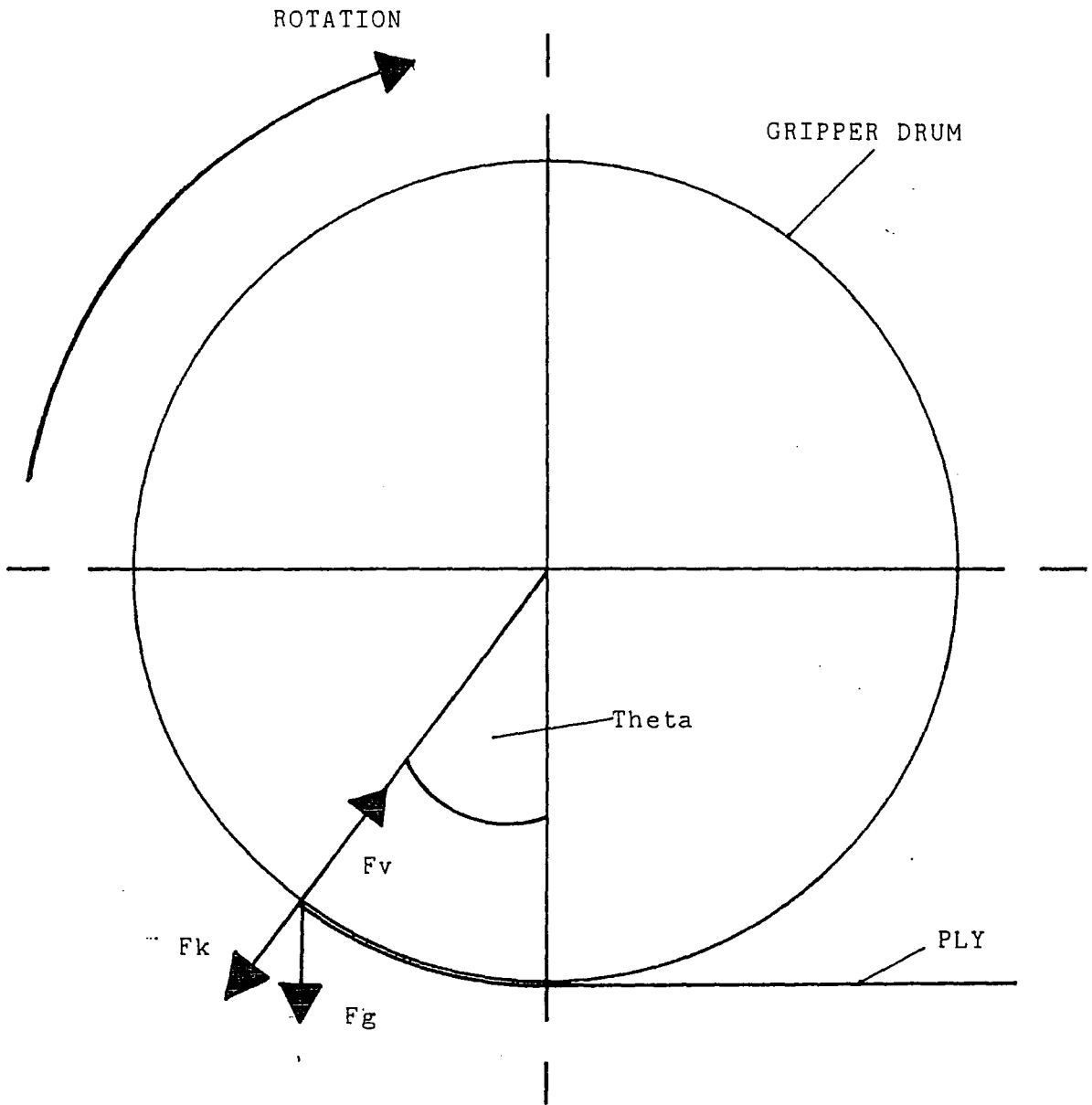

Figure 7-3. Governing Equation for Vacuum or Electrostatic Attachment

For an element of small fabric:

$$F_v = F_k + F_g \cos \theta$$

Also: $F_k = C/r$

Where C is a constant related to the fabric stiffness.

Therefore: $F = F_g \cos \theta + C/r$

In order to evaluate the application viability of cylindrical gripping, a series of experiments were carried out using three pre-prototype units. Unit I was intended to test the basic feasibility of roller gripping rectangular pieces of both the unidirectional and woven fabrics. Unit II was configured to extend the testing to real ply profiles, while Unit III was aimed at observing the effect of increased cylinder diameter on gripper performance. Each sequence of experiments was carried out with the test ply initially laid out on a flat non-porous baseplate.

a) Pre-prototype Unit I

i) Description:

Unit I, designed to pick-up / place small, simple, 200mm X 200mm rectangular test plies, tested the basic rolling gripper action and measured 280mm in length and 165mm in diameter. A single row of twenty 5mm diameter holes was drilled into the drum surface at 10mm centres across the cylinder width; these acted as vacuum nozzles.

ii) Operation:

The principal of operation was to roll the cylinder towards a selected edge of the test ply, so that the nozzle row rolled over an imaginary line on the fabric 10mm (+/- 1mm) behind that edge. The same action was repeated for a range of vacuum levels until the edge of the ply was successfully lifted and the whole test ply could be taken up onto the cylinder by continuing the rolling action. The series of tests plies included both unidirectional and woven carbon fibre fabrics with each possible fibre orientation (0°, 90°, and +/- 45°).

iii) Observations:

Repeated operation showed that small rectangular dry composite fabric test plies could be successfully rolled up without noticeable profile distortion, fabric rucking or weave damage. This applied to either fabric at any fibre orientation.

The required gauge vacuum within the cylinder to pick each sample is charted below.

FABRIC TYPE	ROLL AXIS	GAUGE VACUUM REQ'D	
	ANGLE° W.R.T	TO PICK	
	WARP AXIS	MEAN(mbar)*	MAXIMUM(mbar)*
Unidirectional	0	18	20
	45	9	14
	90	5	6
Woven	0	6.75	8
	45	5.5	7
	90	4.25	5

(* = of ten samples)

b) Pre-prototype Unit II

i) Description:

The second pre-prototype cylinder was identical to the first, except it had an increased width of $\varnothing.75\text{m}$ allowing true to life test plies to be handled. For each test, nozzles within the single nozzle row were selectively taped over or left open to provide a vacuum pattern matching the ply edge to be initially picked up by the gripper (figure 7-4). The cylinder was mounted into a wheeled framework and track arrangement which ensured that the unit could travel smoothly in a straight line while the cylinder rolled freely along on the baseplate or over a test ply. This technique was employed to avoid any ply distortion which might have been caused through non-linear gripper travel. The frame also afforded the drum some vertical (z-axis) freedom to allow for the increased effective rolling diameter of the cylinder as it collected fabric.

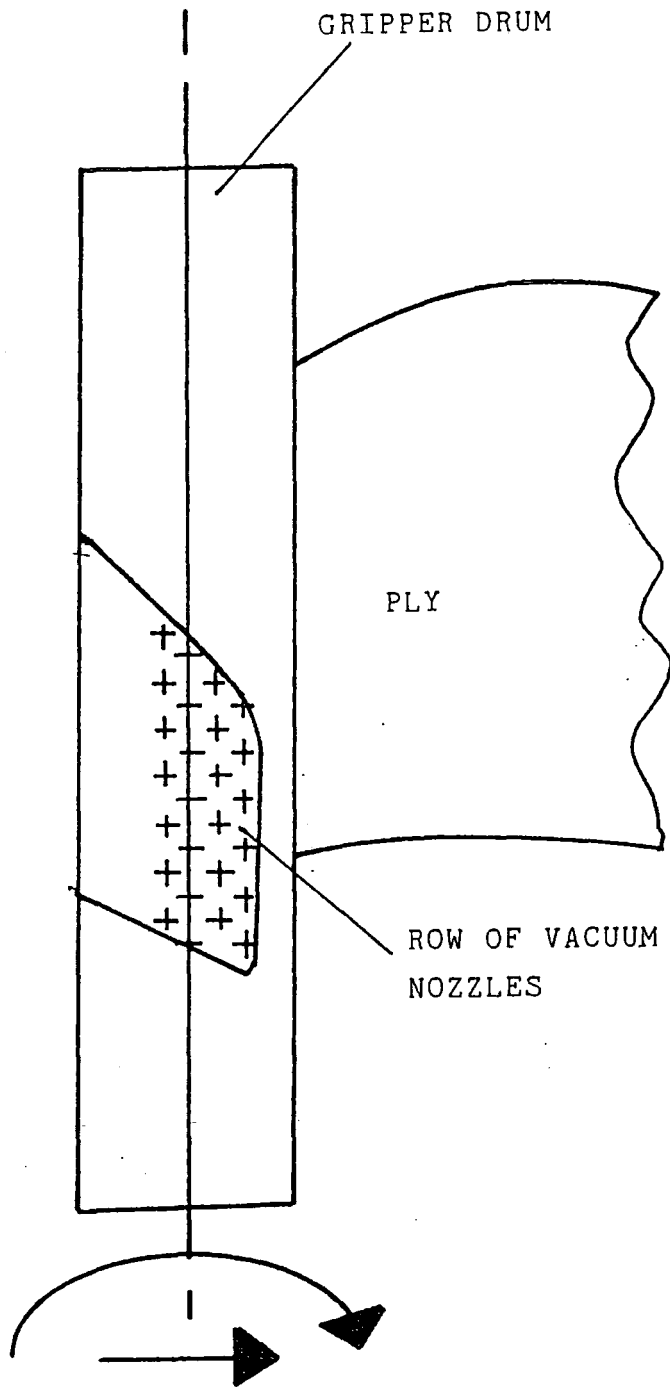

Figure 7-4. Example of a Single Row Nozzle Configuration for Picking a Typical Test Ply

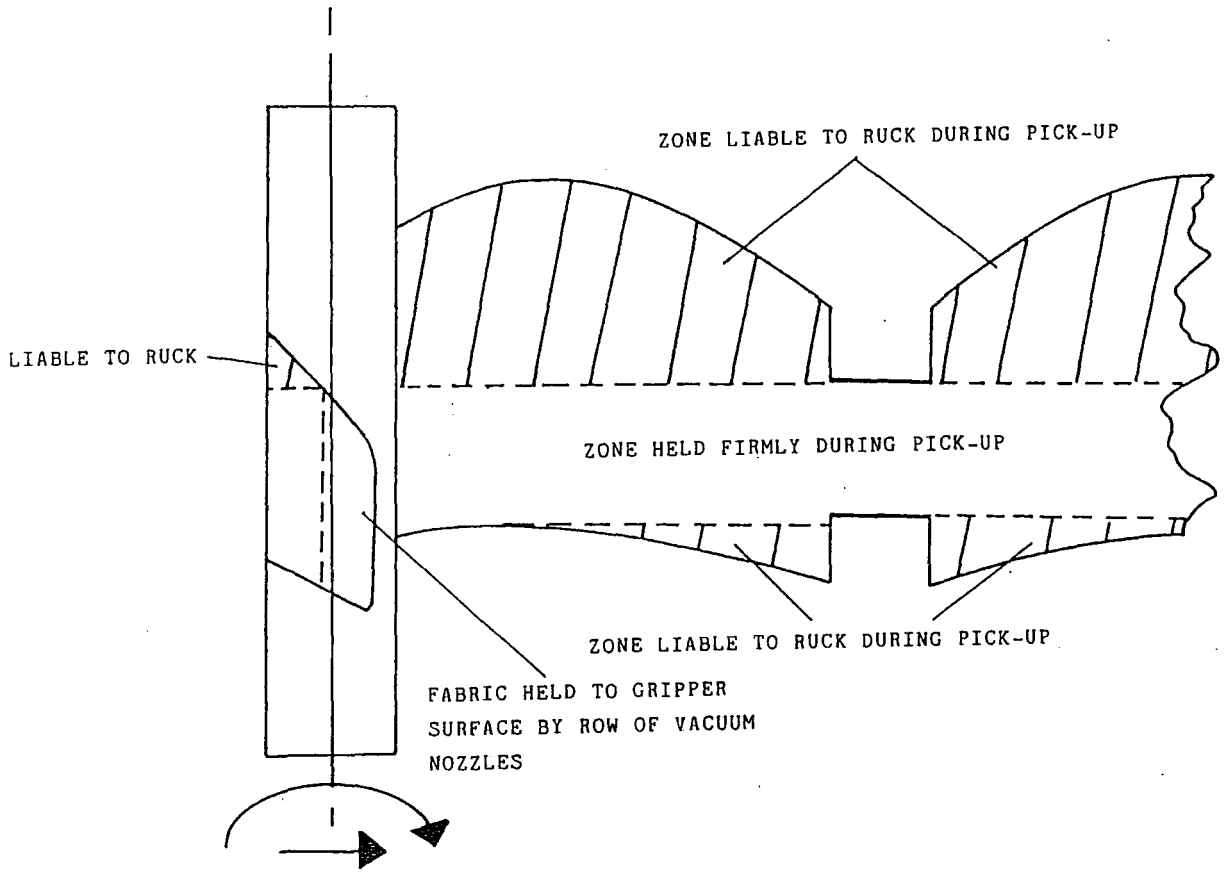

Figure 7-5. Zone Liable to Ruck during Rolling

ii) Operation:

For each initial experiment, the gripper was rolled over the ply such the row of active nozzles passed directly over an imaginary line 10mm (+/- 1mm) from the selected pick-up edge of the test ply. Once the nozzles had "gripped" the pick-up edge, the rolling action was continued slowly (approximately 20 mm/s) until the ply was fully wound around the gripper unit. To deposit the ply back onto the baseplate, the operation was reversed, with vacuum being cut off to the drum just before the initial pick-up edge of the ply reached its original position. Care was taken to match the forward velocity of the frame with angular velocity of the cylinder circumference so that the cylinder did not skid as it rolled.

The trials were carried out with a representative series of ply profiles in both woven and unidirectional fabric and at each possible fibre orientation (0°, 90° and +/- 45°).

iii) Observations

It was found that although approximately rectangular profiles could be wound onto and off of the gripper successfully, plies with a swept geometry (more typical of those used in a

propfan preform) tended to ruck up during rolling. The ruck amplitude was found to grow to 50mm in the worst cases. The rucks were observed to be initiated where the fabric was not circumferentially in line (figure 7-5) with the with the "gripped" fabric edge (held firmly to the cylinder by the row of vacuum nozzles).

The phenomena can be explained. Where ply fabric is in line with the gripped edge, it is tightly wound around the drum. The fabric out of line is not directly held to the drum and is, therefore, comparatively loosely wound and so tries to run at a greater radius, thus forming the observed rucks. After one complete revolution of the drum, wound fabric must pass between the cylinder and the surface on which the cylinder is running. The tight wound fabric is able to do this smoothly since it remains at its natural running radius. The ruck in the looser wound fabric, however, builds up at this location until it is finally dragged under and crushed beneath the gripper drum.

In an attempt to prevent the formation of these rucks, a larger number of vacuum nozzles were opened up around the entire gripper circumference. In this way, one revolution of the ply could be held firmly in place during pick-up. During

operation, no rucking occurred during the first full revolution of the cylinder. On further rolling, however, the fabric being wound was no longer directly held by the vacuum nozzles (which were covered by fabric) and rucking once again commenced. It was concluded that unless the cylinder diameter is large enough to allow the entire ply length to be wound in a single revolution, the use of vacuum nozzles around the complete circumference merely postpones the onset of rucking.

c) Pre-prototype Unit III

A third cylindrical gripper unit was prepared, similar to Unit II but with an increased diameter (220mm), to observe the benefit of a greater drum radius. The reduction in the severity of rucking was, however, found to be negligible.

d) Conceptual Pre-prototype Unit IV

The trails on pre-prototype units II and III indicated that in order to prevent rucking it would be necessary to ensure that the entire propfan blade ply area was held tightly and uniformly to the gripper cylinder during the complete rolling and unrolling cycles. A conceptual mechanism was devised to attempt to achieve this (figure 7-6).

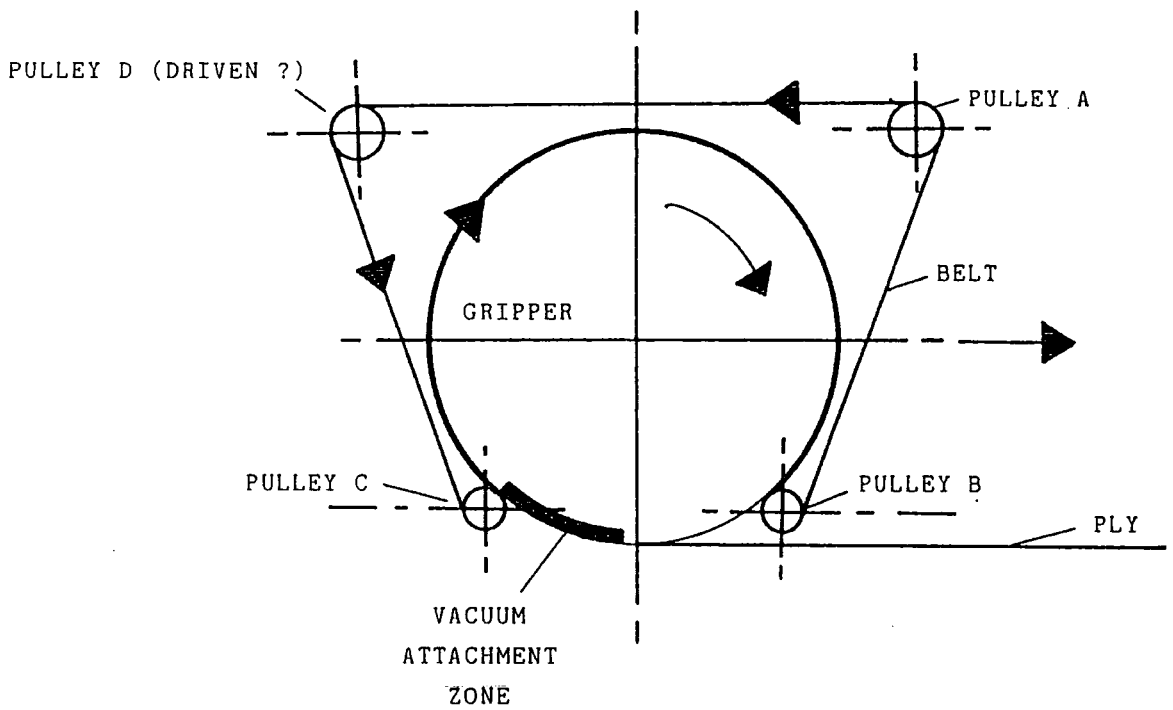

Figure 7-6. Conceptual Roller Gripper For Handling Propfan Plies

The technique was intended to exploit a wide timing belt to achieve constant pressure on the ply around the majority of the cylinder circumference. Vacuum (or electrostatic) gripping would be provided in a fixed (non rotating) "vacuum attachment zone" to provide initial pick up. The timing belt pulleys (A, B and C) would have self adjusting centres to account for the increasing effective diameter of the cylinder as fabric is wound on. The belt itself could be driven either directly, via contact with the drum, or by motor (through pulley D). If a motor were to be adopted, it would have to run at a precisely synchronized rate to match the effective surface speed of the outer fabric layer on the gripper cylinder.

The concept was, however, rejected on the grounds that it would be difficult to control effectively and that its construction would inevitably be complex and of high mass. It was also thought that there would be a high probability that rucking would still occur in the fabric as it passed, unsupported, between pulleys B and C.

7.2.3 Cylindrical Grippers - The Verdict

The investigatory trials described in section 7.2.2

indicated that cylindrical grippers could be suitable for handling: i) small plies which could be completely accommodated on a practical drum diameter in a single revolution; and ii) larger plies with an approximately rectangular profile, where the whole ply area could be tightly wound several times around the gripper cylinder. Typical propfan plies are unfortunately neither small nor rectangular. Their size precludes wrapping the entire ply length around a practically sized gripper cylinder in a single rotation; their particularly swept shape tends to induce severe rucking.

The use of roller grippers as a effective means of handling dry composite fabric plies, typical to propfan blade preforms, was consequently rejected.

7.3 Flat Grippers

With the rejection of cylindrical grippers, attention had to be focused on the development of a practical flat gripper. This would have to be capable of picking plies up from a flat surface, transferring them flat, and finally placing them flat at the Lay-Up Station. The premise was that provided the

ply was well supported by the gripping mechanism during this sequence of operations, there could be no possibility of ply rucking nor distortion.

7.3.1 Gripping Means

Since composite fabric is highly flexible, it must be supported at regular intervals, especially where the weave is unstable. Moreover, in order to pick up plies from a cutting table nest without disturbing surrounding fabric, any flat gripper must be able to apply forces to the fabric in a highly selective manner. Combining these two factors, the gripper would appear to need a high density of individually controlled force applying cells.

Several potential methods of applying a suitable lifting force were considered. These were needle gripper units, electrostatics plates, and vacuum nozzles.

The use of needle grippers on a simple flat gripper had already been investigated, in brief, on Dowty's behalf by the National Engineering Laboratories at East Kilbride^[4]. Their findings concluded that cork screw like helical needle grippers (which rotate in one direction to grip fabric and

the opposite direction to release it) could be effectively used to handle dry composite fabrics such as those used in propfan blade manufacture. Their tests were, however, restricted to the handling of rectangular (200mm X 300mm and 450mm X 700mm) test panels and did not address the implications of a complex range of ply profiles.

To adapt the NEL approach for use with complex profiles, a large number of small needle grippers, packed in close formation within a gripper frame, would be necessary to provide a high resolution matrix over the required area. Alternatively, a smaller number of units, able to automatically moved be a range of positions within the gripper frame, could be exploited. Both of these solutions would be complex, expensive, of high mass and difficult to control effectively.

Electrostatic gripping was initially considered unattractive because it was envisaged that it would be industrially unacceptable to use very high electrical potential equipment in an environment rich with conducting carbon fibre filaments and dust; Dowty's past experience had shown that dry carbon fibre strands and dust regularly found their way into electrical equipment causing short circuits. There were also

concerns about the field effects of using large highly charged gripper surfaces near a robotic controller, sensors and other sensitive microelectronic equipment.

Vacuum gripping, on the other hand, was known to be intrinsically safe. Its successful use had already been documented [2,5,6,7,8,9,10] on other composites handling research programmes concerned with manipulating prepreg panels. The problem still remained, however, to achieve a method of providing a highly selective gripper mechanism which could adequately support complex shaped, dry fabric plies during handling but with the minimum of mass, complexity of control and capital cost.

The investigations leading to the development of a suitable vacuum gripper are documented in the remaining sections of this chapter.

7.4 Flat Vacuum Grippers

The first stage in the development of the gripper technology was to consider and investigate methods of achieving high pick selectivity over a large gripper area with: minimum

control valving, vacuum nozzles, and unit mass / angular inertia. A number of approaches were pursued before a practical technology was established:

a) High Density Vacuum Nozzle Matrix

In order to provide a high degree of ply support with high gripper resolution, a matrix of vacuum nozzles covering the entire gripper surface could be employed. These nozzles could be individually controlled to produce vacuum patterns closely matching the profile of the ply being handled. The concept was be similar to that adopted by Queen's University[3].

The required resolution needed to handle propfan plies is, however, necessarily high such that the highly flexible plies are adequately supported right up (and only up to) to their edges; this is especially important with unidirectional fabric plies in regions where the warp axis runs parallel to the ply profile and the weave is floppy perpendicular the fabric edge. In order to achieve sufficient resolution, individual nozzles would have to be spaced at approximately 10mm X 20mm area intervals. Over a large gripper area of 0.75m X 2.1m the number of individual cells required would be 7,875. Each cell would in turn need its own air flow control

valve positioned either at the gripper surface or at a remote, off robot location. The Queen's type solution was, therefore, considered inappropriate for the application.

b) Variable Position Nozzles

In order reduce the number of nozzles required, the possibility of mounting a limited number of vacuum nozzle cells on miniature slideways within the gripper framework, allowing each to move in the x-axis and y-axes, was considered.

Analysis indicated, however, that over forty cells would still typically be required to adequately support the range of plies. The mechanical complexity and mass of such a system would be unacceptable.

c) Progressive Two Stage Pick-up

A more radical approach was examined which aimed to reduce the number of controlled nozzles to a minimum without losing effective resolution. The method, tested on a pre-prototype basis, relied on a two stage pick up sequence using a gripper unit divided into two nominal control zones. Zones "A",

comprised of a small area matrix of individually controlled vacuum nozzles. Zone "B", had a large area matrix of nozzles controlled en masse.

i) Description:

The pre-prototype unit (figure 7-7) was made up of two separate vacuum pockets ("A" and "B"), corresponding to zones A and B. Each was covered by a vacuum nozzle perforated surface. Pocket A was connected directly to a vacuum pump, while pocket B was connected to A by means of a single "interpocket" valve; this could be actuated during trials.

ii) Operation:

The operational sequence was:

- Lower unit onto a sample ply with gripper axis parallel to fibre axis (or either fibre axis in the case of woven fabric) and zone A nozzles located over a selected ply edge;

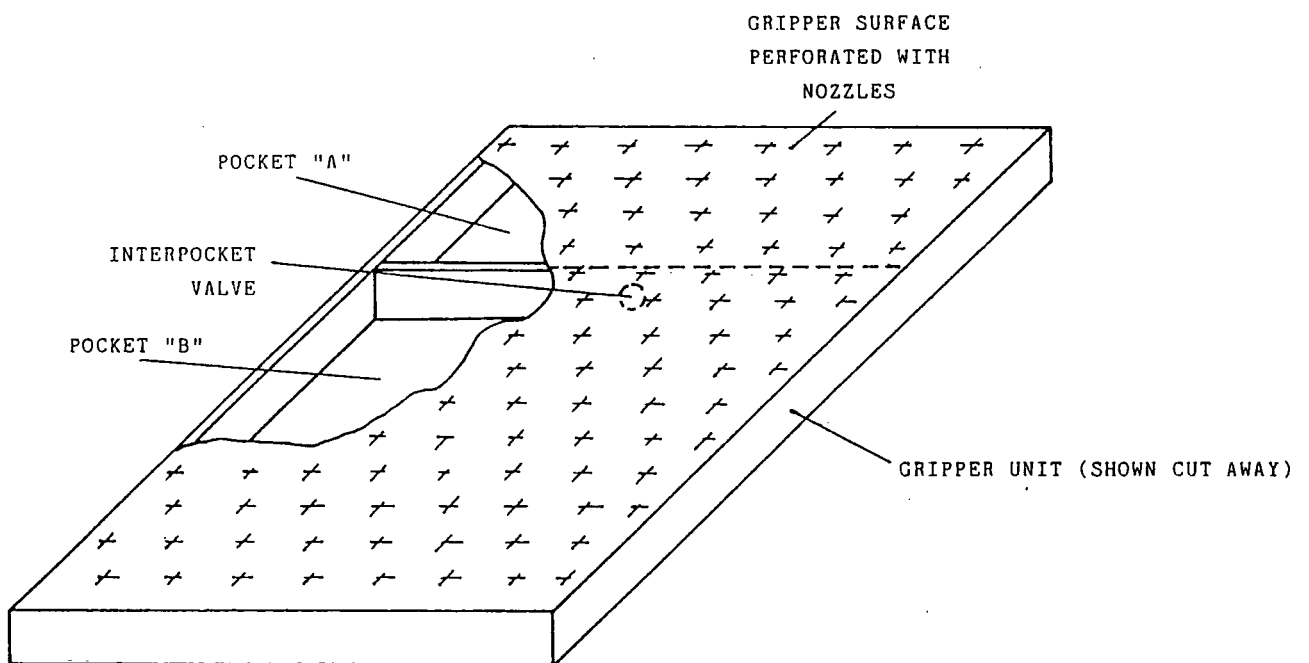

Figure 7-7. Progressive Two Stage Gripper Pre-Prototype

- Apply vacuum to pocket A with the interpocket valve closed to isolate zone B;

- Raise unit by a small preset distance (10mm) and hold horizontally at that height. Only the area of the ply initially covered by the vacuum nozzles of zone A was intended to be lifted at this stage (figure 7-8).

- Open interpocket valve to induce a "vacuum" in pocket B. At this point the rest of the ply was intended to be lifted in a progressive reverse peeling action until the whole ply attaches itself to the gripper surface.

- Release is affected by lowering the gripper onto the baseplate and cutting off the vacuum supply to both zones simultaneously.

The progressive pick up approach was considered to be potentially useful because a small area of the gripper (corresponding to zone A) can be assigned the task of providing high resolution selective pick up, with the remaining far larger area controlled by a single air flow valve (no resolution). In practice, however, the latter area would have to be divided into a number of individually

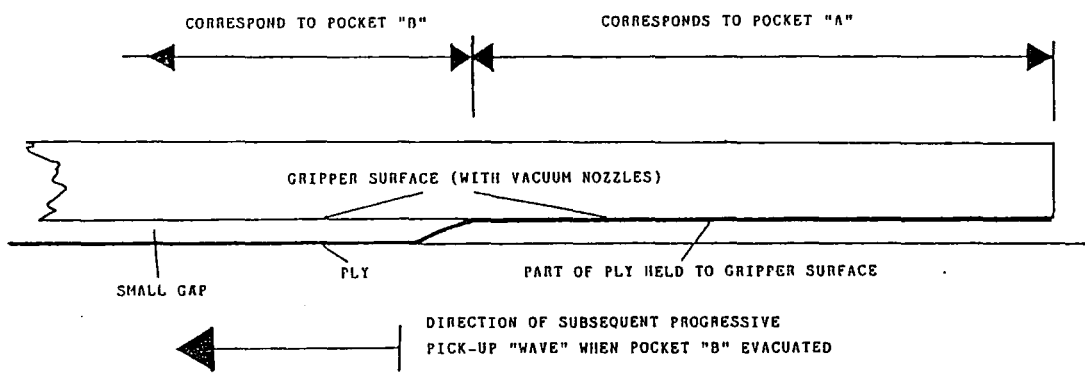

Figure 7-8. Progressive Two Stage Pick-Up

controlled zones, which could be shut off to minimize vacuum loss through nozzles not covered by a ply.

iii) Observations

It was found that the trial gripper could progressively pick up woven fabric and small rectangular unidirectional samples effectively. It was, however, necessary to ensure that the progressive pick-up acted along the relatively stiff warp axis in the case of the unidirectional type fabric. Otherwise, the peeling action tended to take on a wave like motion along the flexible weft, where the wave was unstable and tended to trip itself to form short sharp rucks in the fabric as it attached to the gripper (figure 7-9). Moreover, long thin ply areas were found to wander significantly, distorting the ply profile. There was also a tendency for surrounding waste fabric to be lifted unintentionally with the selected ply.

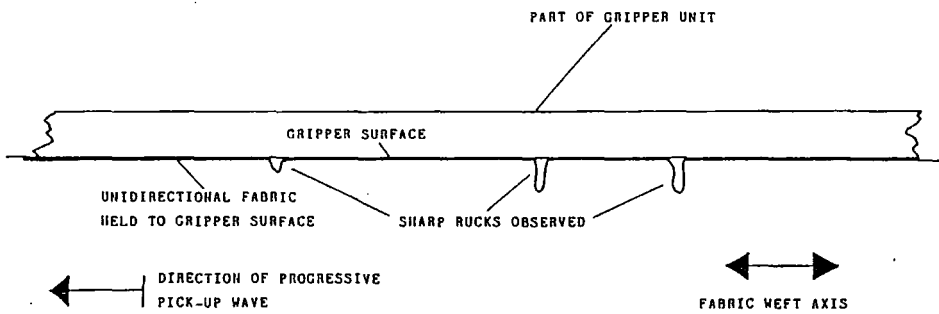

Figure 7-9. Rucking on Progressive Pick Up along Weft Axis

d) Strategic Vacuum Nozzle Configuration

The final method considered was to specially configure a relatively low number of vacuum nozzles on the gripper surface to provide adequate support and high resolution in strategic areas of each ply only. The principle was seen to have the additional advantage that a dramatic reduction in the number of valves required could be realized if the configuration could be designed such that each valve controlled a pattern of nozzles.

The concept can be explained by way of a simplified example (figure 7-10). In the example for instance, valve a6, when activated, allows vacuum flow to be induced at all the nozzles required to adequately support ply 6A, while Valve a5 (actuated simultaneously) with Valve a6 activates all vacuum nozzles necessary to support ply 5A. Similarly, ply 3B could be suitably supported when valves b3, a1, a5 and b6 are all actuated. In this way, a range of separate nozzle patterns can be made to interact to efficiently handle an extensive range of plies.

To test the viability of the configured vacuum nozzle approach, and develop a suitable nozzle pattern, a test board

(figure 7-11) was constructed. The board comprised of a flat PVC plate perforated over its entire area with a matrix of vacuum nozzles. The nozzle were spaced at 30mm between centres along the length axis by 20mm across the width. Each nozzles inlet could be taped over to provide a simple means of creating any conceived nozzle pattern.

For ease of experimentation, the surface of the test board was manufactured to only half of the required length of the final gripper envisaged. For this reason, the unit could accommodate the camber side only of root tabbed plies but full camber face plies. The results, however, were also valid, if reflected, for the pitch face plies (and the pitch halves of root tabbed plies), since the preform pitch face is approximately a mirror image of the camber face.

The nozzle plate itself was fastened onto a 50mm deep vacuum box which was intended to provide an even vacuum to all nozzles. The box and plate assembly were mounted on a frame which allowed the test board to be pivoted about a horizontal axis. The pivot facility was adopted to allow easy manual placement of test plies onto the upward facing "gripper" surface; to test the effectiveness of the vacuum pattern, the board was rotated by 180°, so the plate faced downwards.

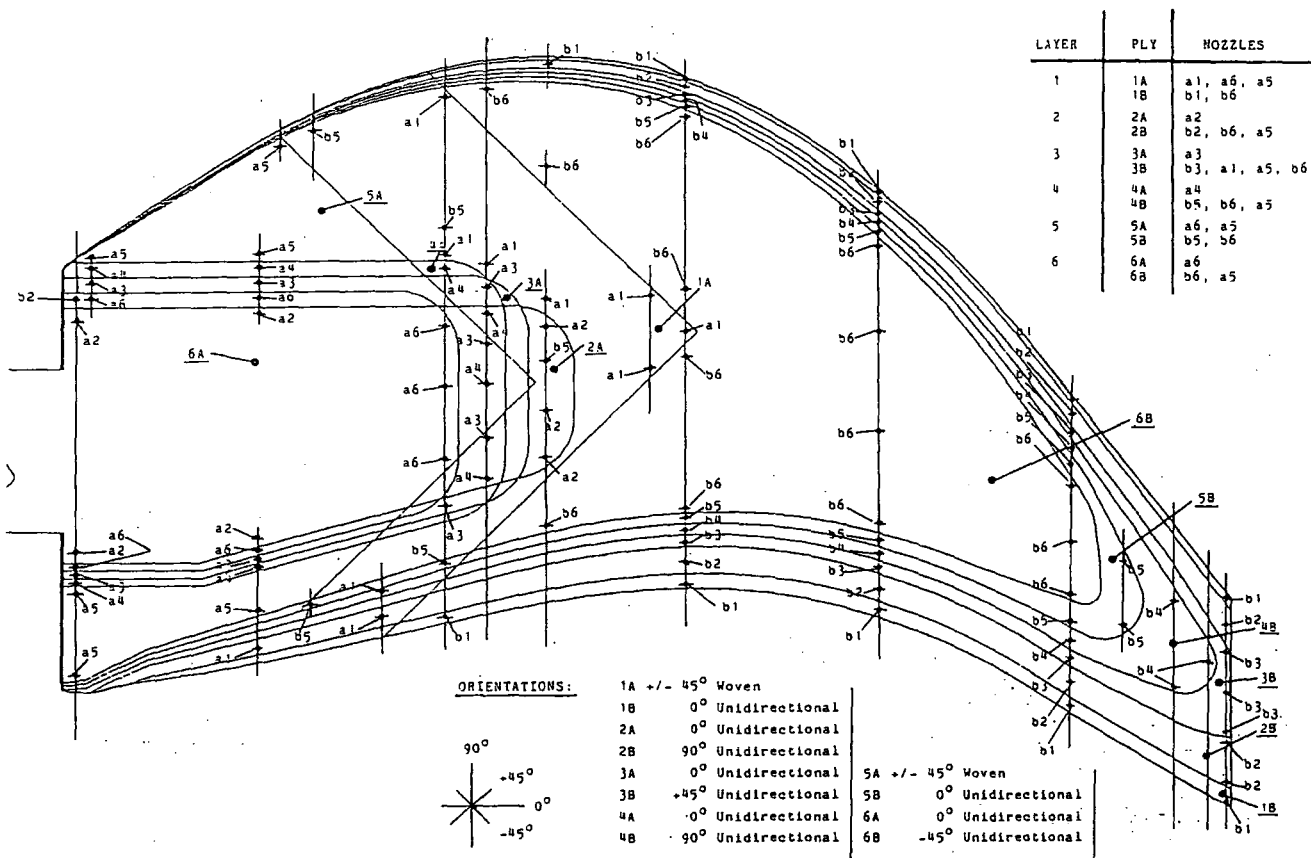

Figure 7-10. Simplified Example of Interacting Nozzle Pattern Principle

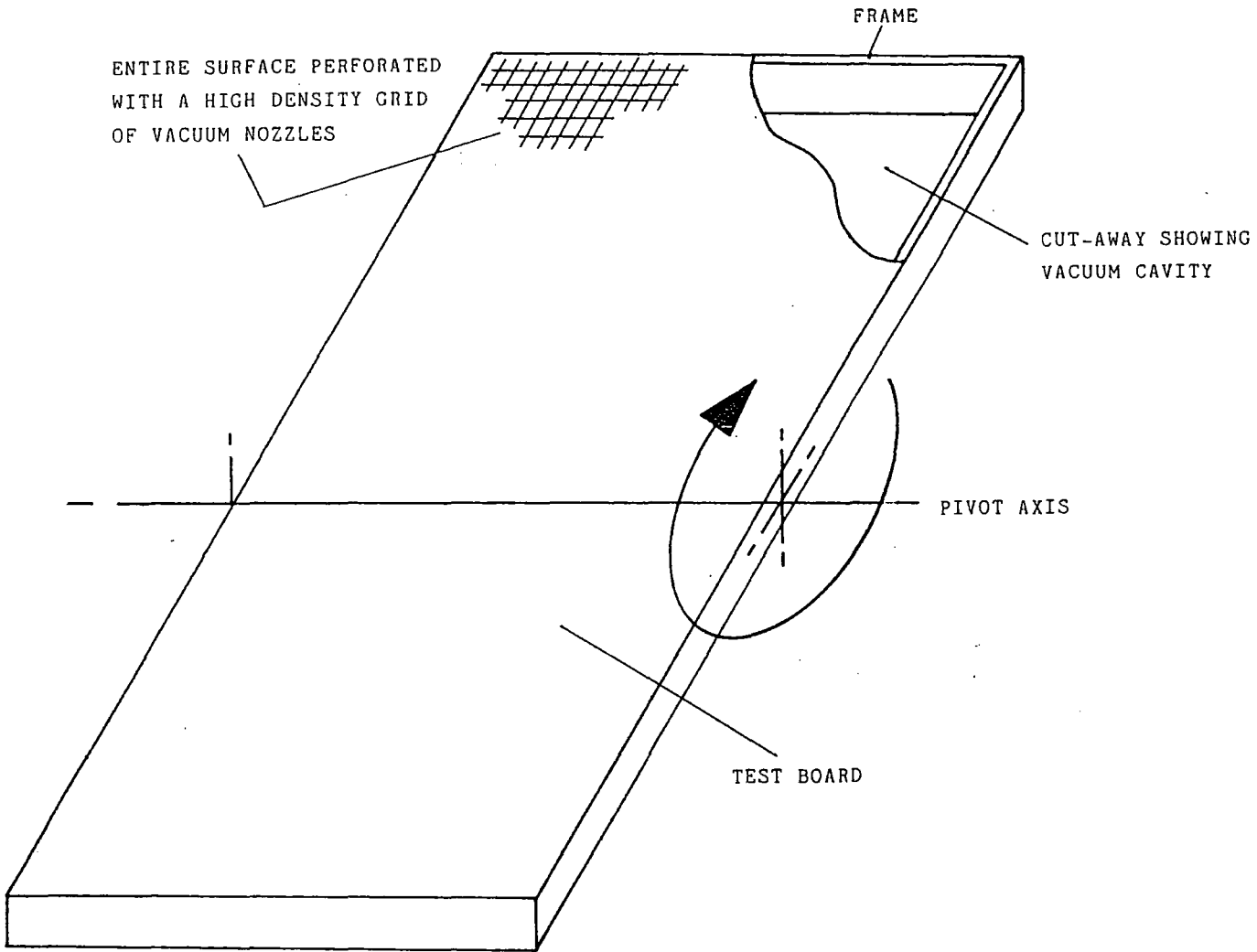

Figure 7-11. Test Board and Frame

As testing progressed on the thirty representative plies, it was possible to systematically reduce the number of nozzles needed to support each ply. The final configuration required only 200 nozzles (controlled by 30 valves) to satisfactorily and selectively hold the range of ply profiles. The nozzle requirements for a full blade would, then, be 400 (given the mirror image argument). The number of control valves would, however, be only 40 (one per ply) since twenty of the full plies wrap over the preform root and occupy both the pitch and camber aerofoil faces.

The developed configuration, appeared to successfully combine high resolution (over a large area) with a minimum of vacuum nozzles and valves necessary to provide adequate support to selectively pick and place a full range of plies.

7.5 Prototype (Half Size) Flat Vacuum Gripper

In order to develop the configured vacuum nozzle concept into a practical technology, a half length (1.1m X 0.75m) prototype gripper was designed and constructed for operation as a robotic end effector (plate 7-1 and figure 7-12). The gripper was built half size because of the limited payload

capacity of the initially robot initially available. To simplify construction of the prototype and further limit its mass for initial robot mounting, the unit was valved to be able to handle only ten representative ply profiles. It was considered that the concept could be fairly comprehensively proven in this way before committing to a full length gripper and purchasing a more suitable robot.

7.5.1 The Design

The functional surface of the half size prototype was a 3mm thick transparent perspex sheet, suitably drilled to offer a matrix of vacuum nozzles. The plate was screwed to a rigid but low mass welded aluminium framework (figure 7-12).

a) Selection of Tubing

The flexible tubing running between selected nozzles and the manifold was selected to have a combination of minimum mass per unit length and maximum flexibility. At the same time it was required to withstand internal vacuum (up to 100 mbar gauge) and be resistant to kinking. In order to minimize the amount of tubing required, each was branched near to the gripper surface to service a pair of nozzles; this virtually

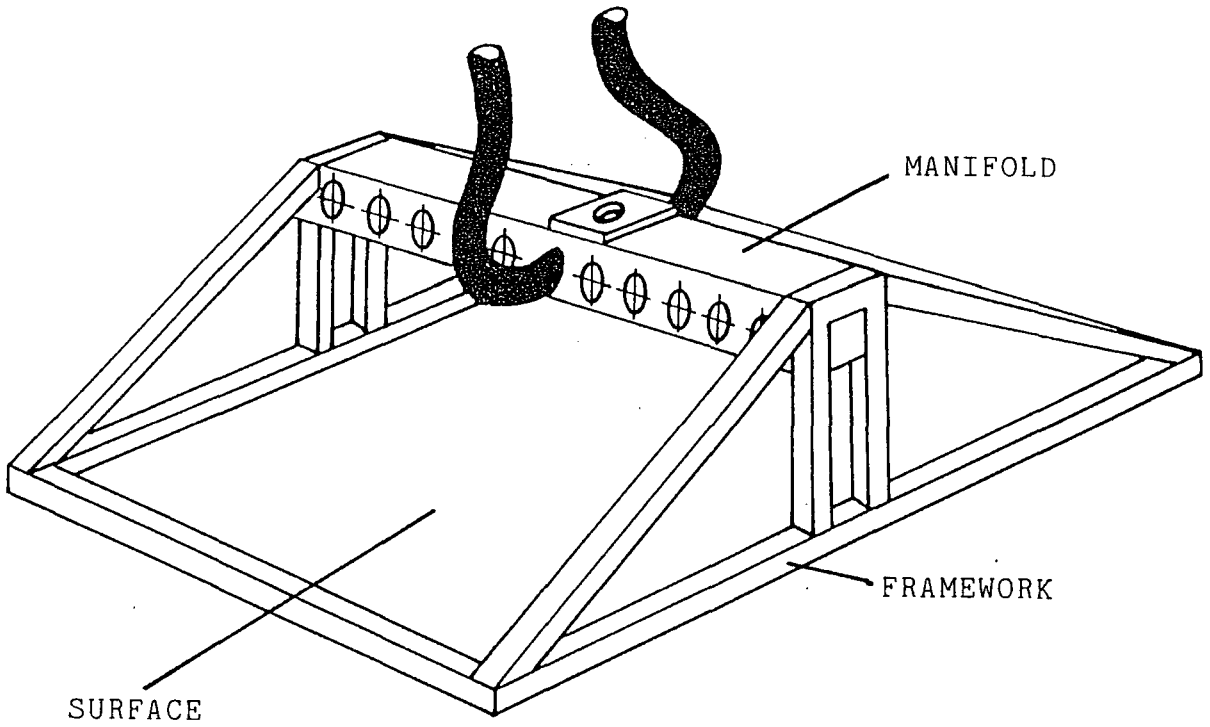

Figure 7-12. Half Size Flat Gripper: Surface, Framework and Manifold

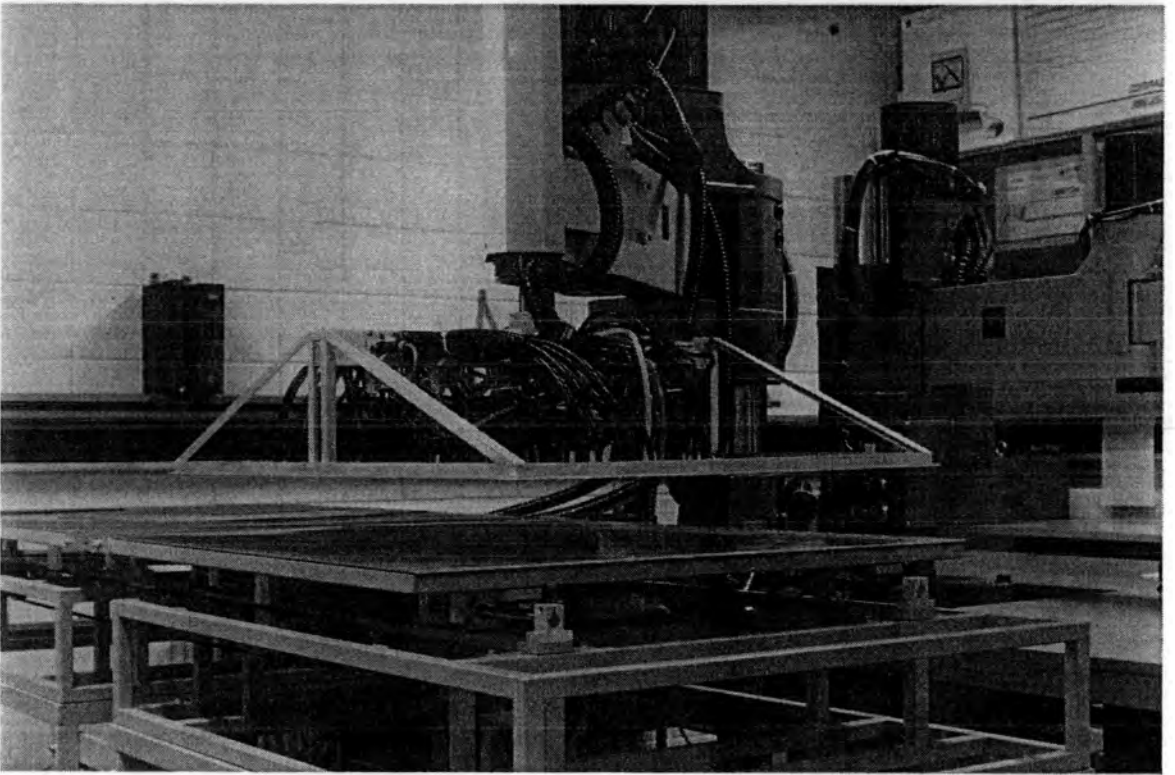
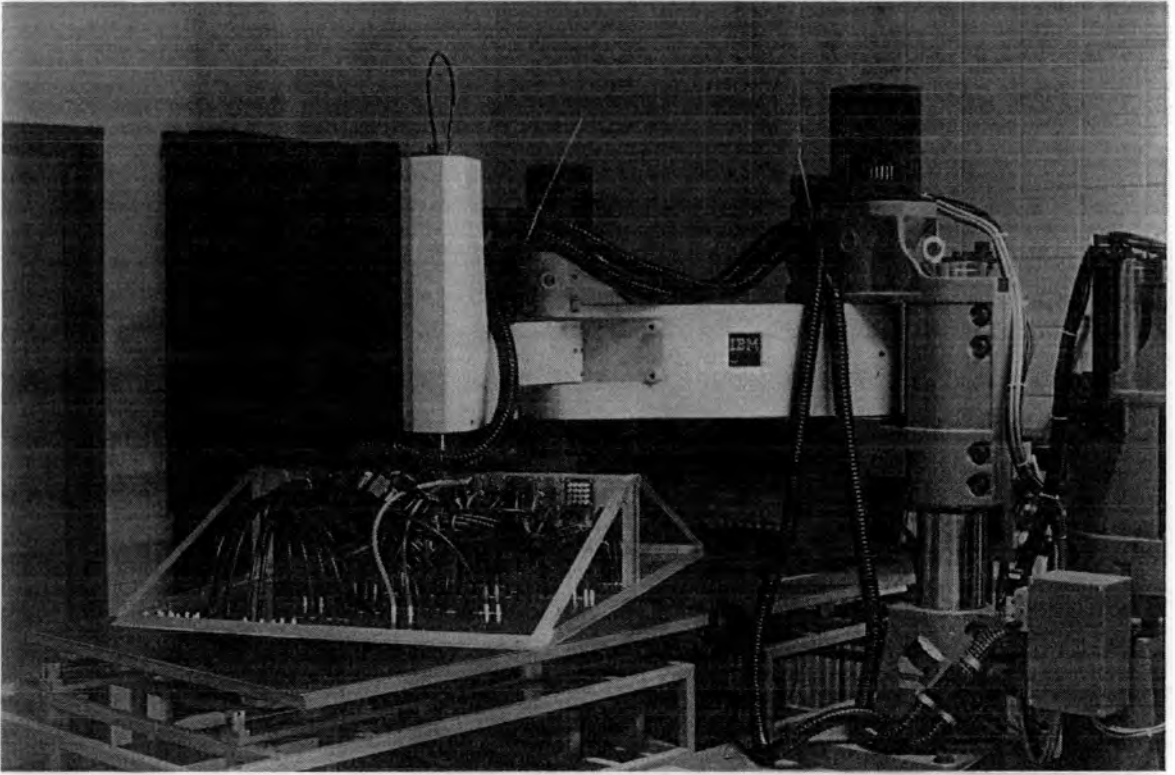

Plate 7-1. Half Size Prototype Flat Gripper: Two Views

halved the amount of tubing required. The physical connection between each tube and nozzle was a miniature plastic fitting bonded to the back of the gripper plate (plate 7-2).

b) Positioning of Air Flow Valves

Two options for the positioning of the air flow control valves were originally considered. The first was to mount them on board the gripper and the second to position them remotely "off robot".

Remote positioning was superficially attractive since the valves do not have to be transported by the gripper. If the valves had been remote, however, a bundle of (approximately 20mm diameter) vacuum flow hoses (one for each vacuum pattern) would have had to have run up the robot arm from the gripper to the remote control point. In the case of the half size prototype gripper, ten of these hoses would have been required and these would have tended to impede manipulator motion. The corresponding restriction on movement for the full scale gripper, requiring forty such hoses (section 7-4 (d)) would have been severe. On board valves were, therefore, selected (plate 7-3).

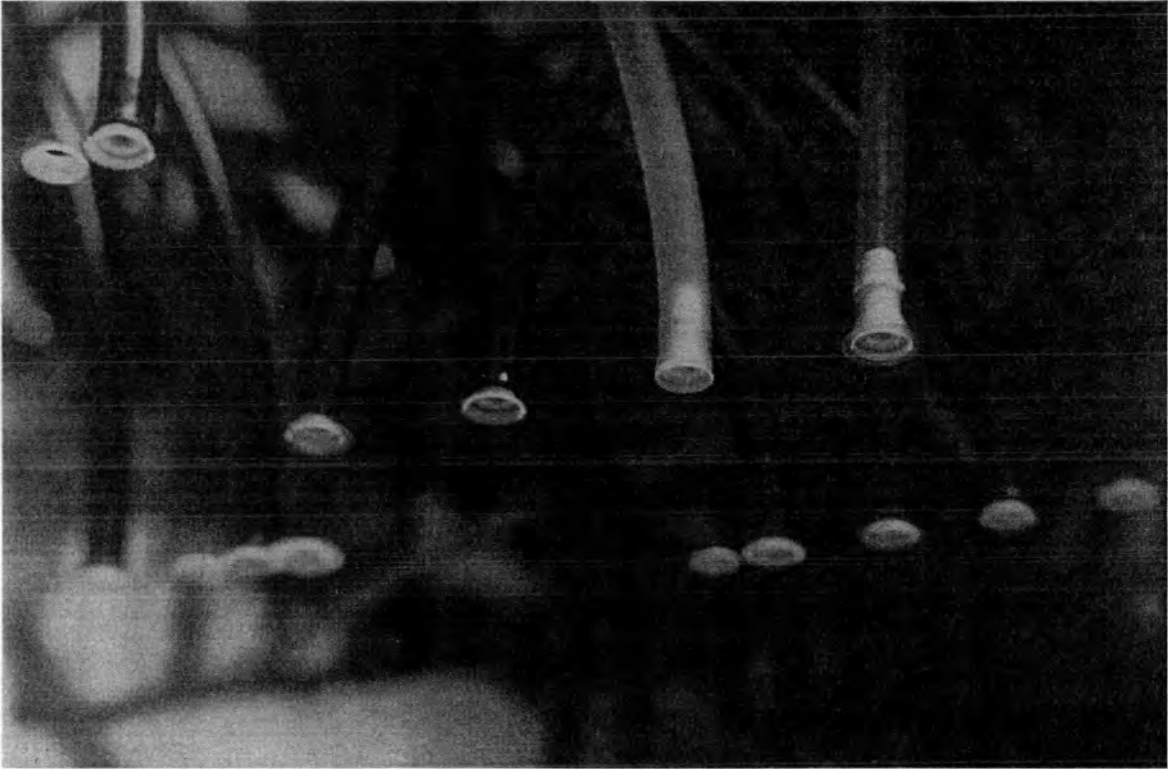
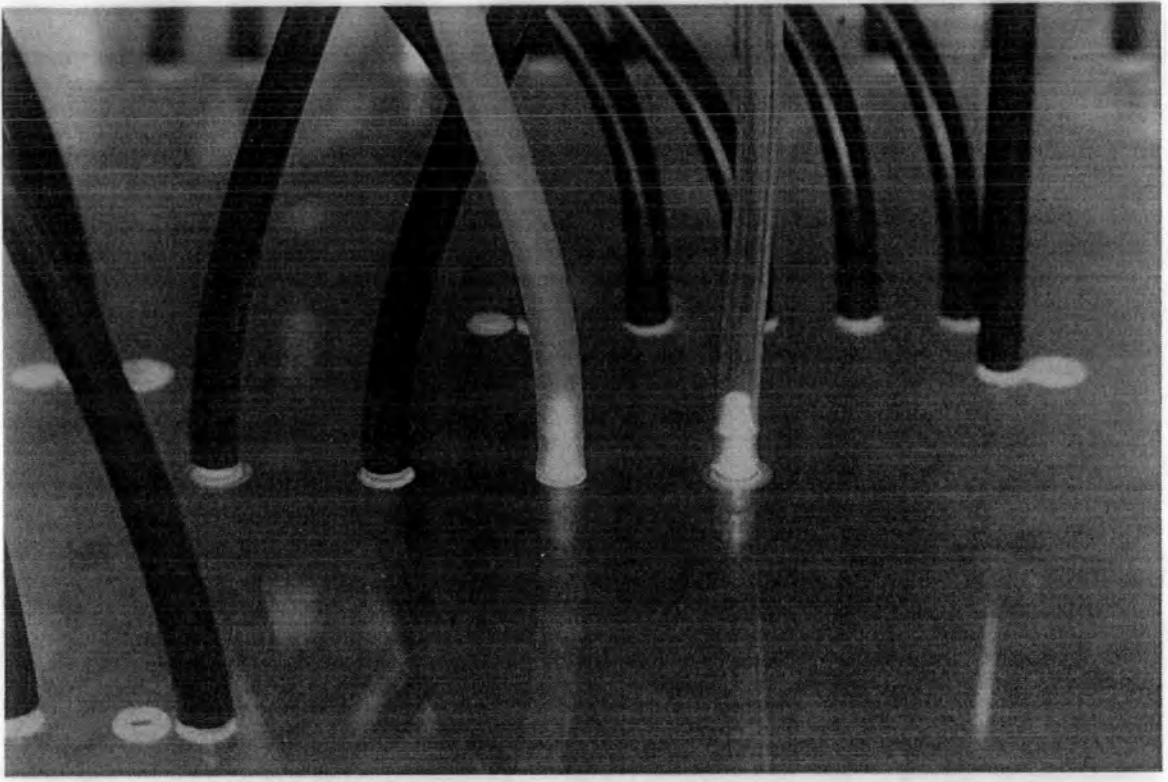

Plate 7-2. Vacuum Tubes Connected to Nozzles on Gripper Plate

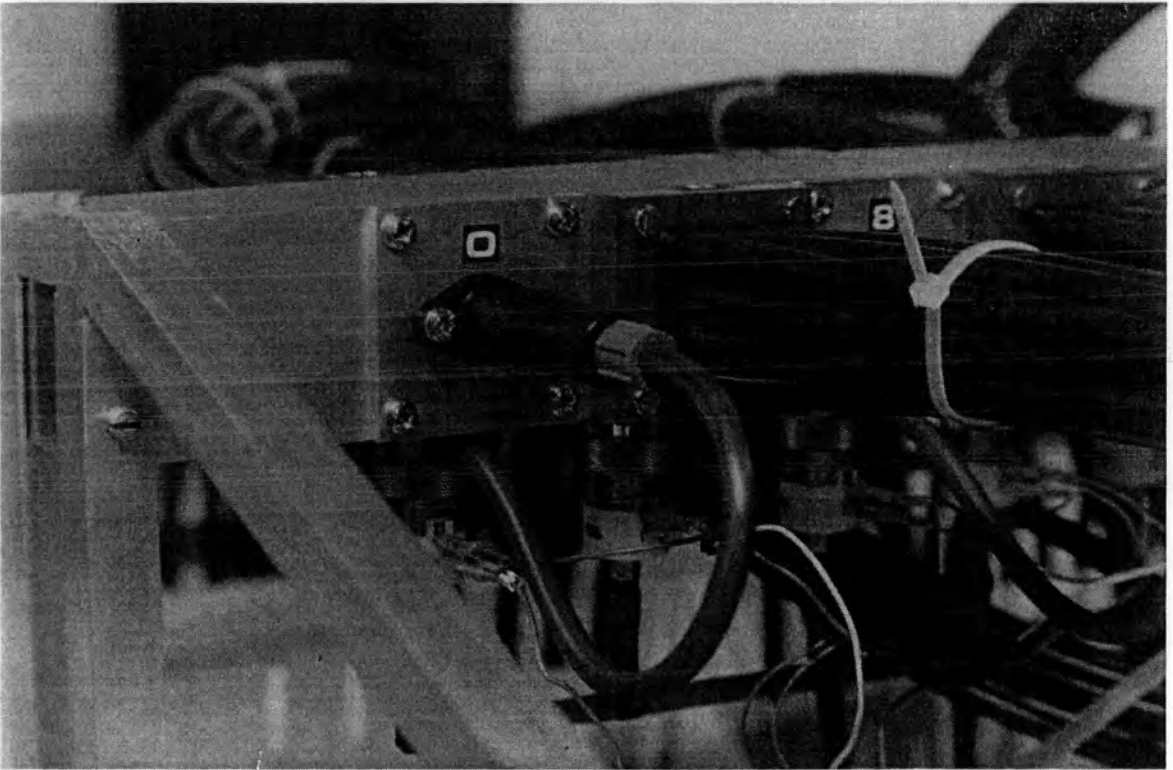
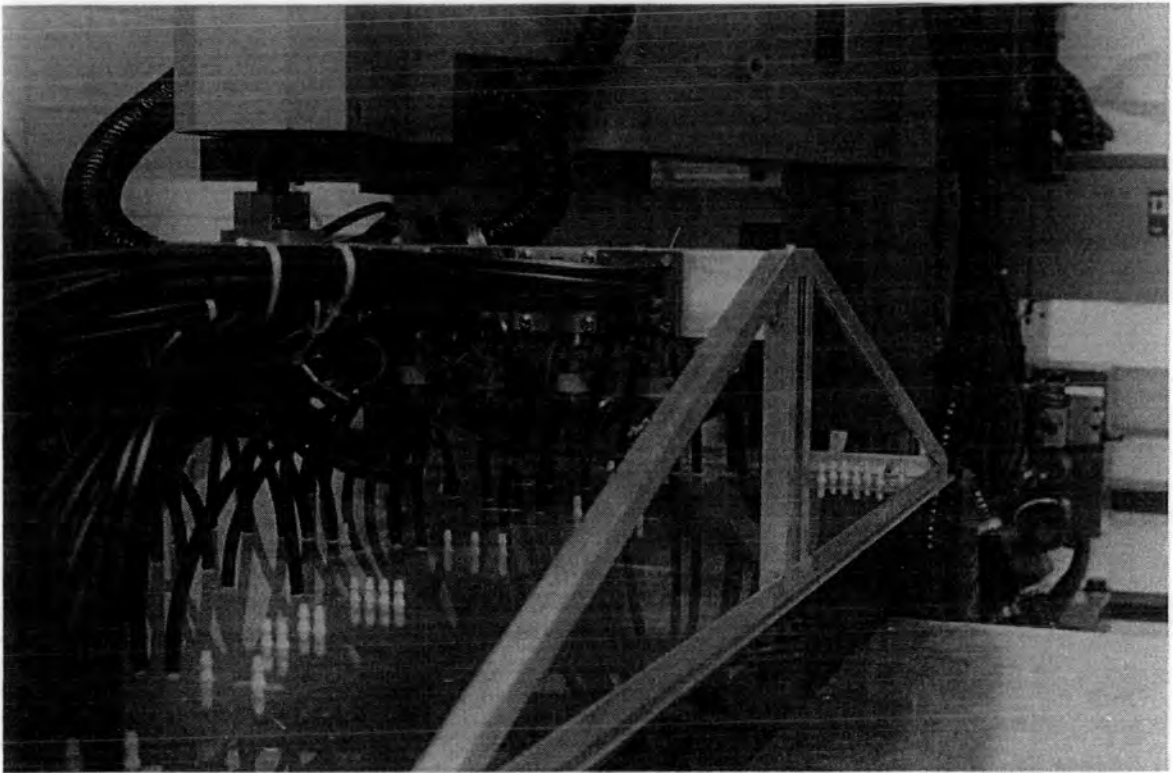

Plate 7-3. On Board Flow Control Valve in Situ

Mounting the valves onto the gripper unit itself was a more appropriate solution since only a single vacuum "supply" hose is necessary to connect the gripper manifold to an off robot vacuum source. The corresponding necessity to run a small diameter (3mm) pneumatic line and a light weight, low power electrical ribbon along the robot arm to service the air flow valves is acceptable.

The half length prototype was, in fact, fitted with two 1.25" diameter flexible manifold exhaust hoses fitted on opposite sides of the gripper manifold. This acted to balance hose contraction forces during vacuum actuation. The pneumatic supply line and all the electrical wiring were ducted, for protection, through the exhaust hoses.

c) Air Flow Valve Design

The design (figure 7-13), minimized gripper mass by incorporating each valve into the gripper manifold bar, also acting as a gripper frame structural member. Valves were pneumatically actuated by low mass plastic single acting spring return cylinders (57N rated). The shut off force was well in excess of that required to counter the pressure across the valve ($0.05N$ at $100mbar$) and thus ensured a seal.

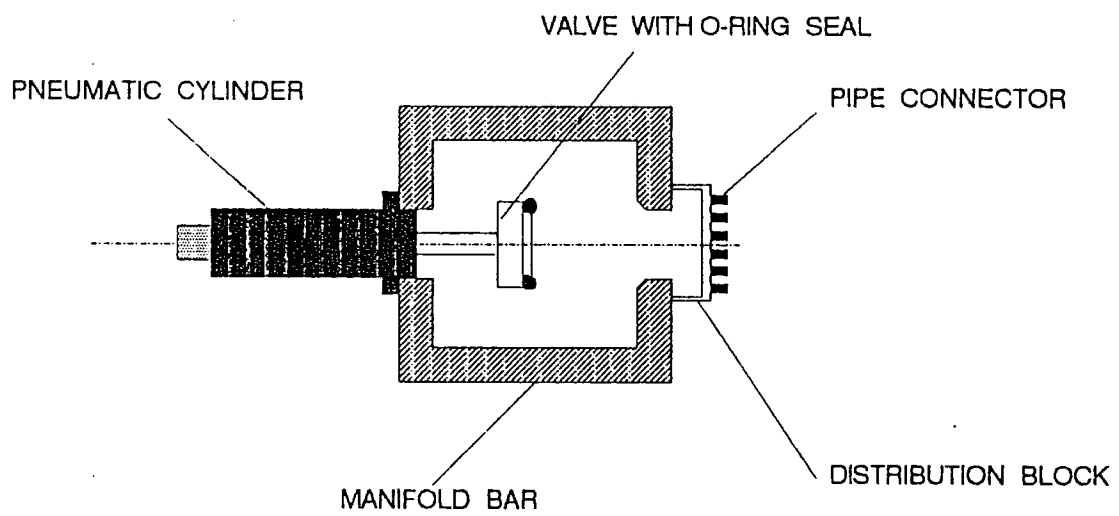

Figure 7-13. Air Flow Control Valve

The cylinders were actuated by means of a bank of miniature low mass electro-pneumatic three way solenoid valves (of the normally open type). In the event of an electrical supply failure at the solenoid or a loss of pneumatic pressure, these valves will default to the open position inducing air flow at all the nozzles; in this fail-safe condition, a ply cannot be dropped mid-cycle due to a pneumatic or electrical failure at the gripper. The rugged construction and powerful action of the valves was necessary to enable them to operate reliably, over extremely long maintenance free periods, in a carbon fibre contaminated environment.

d) Gripper Mass

The mass of the complete operational half size prototype unit was 9 Kg.

7.5.2 Operation

For the duration of the operational trials involving half size prototype, the gripper was attached to an available *IBM 7547* SCARA type robot with a 20Kg maximum payload capacity. Although the SCARA robot was not ideal for the application, it served as an adequate proof-of-principle test bed.

Electronic control of air flow valve actuation was carried out from the robot's control hardware. Cycle programming was performed on a personal computer using the *IBM AML/Entry* language; this was subsequently compiled and down loaded to the robot controller.

To achieve pick-up, the gripper unit was rapid traversed in the x- and y-axes to a point directly above a designated ply. During rapid traverse, the robot's z-axis (up/down) was kept fully retracted for maximum dynamic rigidity. The gripper was then lowered rapidly to a stand off height 10mm above the ply surface. Since the rotary axis at the end of the SCARA arm is not designed to revolve an end effector with a high angular inertia, its torsional stability is poor. Consequently, all but the slowest movements of the gripper, particularly those involving a gripper rotation, tended to induce significant angular oscillation at the end effector. To allow this oscillation to damp out, it was essential to dwell at a stand off position directly above the lay-up location for at least two seconds. The final downward motion was performed at a slow speed (5 mm/s) to avoid further oscillation. Once the gripper had been lowered to touch the ply surface, the appropriate valves were opened to create the required vacuum pattern.

On ply attachment, the gripper could be elevated. The motion was kept slow for the first 10 mm to prevent sudden induced air flows beneath the gripper plate which might disturb the gripped ply or surrounding plies and waste fabric. Subsequent elevation to full z-axis retraction was rapid.

The gripper was finally fast traversed and, if appropriate, rotated to the specified lay-up position; during traverse, the z-axis was again kept fully retracted. The z-axis motions adopted for ply pick-up were then repeated until the gripper had reached the placement height. Vacuum air flow was then simultaneously shut off to immediately release the ply.

7.5.3 Trials

A series of performance trials were carried out. These were to test the gripper's: general ability to pick and place a representative range of propfan plies; ability to selectively pick a nested ply from surrounding waste fabric; ability to place plies onto a simulated preform stack; reliability; and ability to de-stack.

a) General Ability to Pick and Place

Ten representative profile test plies were handled representing each of the two relevant fabrics (unidirectional and satin weave IM7) and possible fibre orientations (0° , 90° , $\pm 45^\circ$). For each of the ten plies, the handling cycle was repeated twenty times to confirm the result.

It was found that:

- All ten test plies could be both picked and placed without any weave damage or profile distortion.
- The required gauge vacuum level at the manifold to achieve effective pick-up was between 10 and 20 mbar.
- Since the vacuum manifold at the gripper acts as a vacuum "reservoir", the volume of the tubing between the manifold and each nozzle is small and the pumping flow rate high, the time delay between valve actuation and fully developed vacuum flow at the nozzle / fabric interface was negligible. It was not surprising, therefore, that pick up and release of the (porous) plies was instantaneous within measurable limits.

- Unidirectional fabric suspended across its thermoplastic weft filaments between adjacent sets of vacuum nozzles tended to sag by up to 5 mm, as expected from the initial material testing carried out (section 3.1.2). No significant sagging was observed when unidirectional fabric was suspended along warp tows. Sagging was negligible for woven fabric plies, regardless of the way in which it was suspended between adjacent nozzles.

- If the gripper unit was pressed down too hard onto the ply during pick-up and placement, the gripper buckled and twisted slightly out of position. This was due to a slight gripper to pick up surface misalignment and the imperfect flatness of the gripper surface. It was discovered, however, that plies could be picked up and released with the gripper plate standing off from the ply surface by up to five millimetres without causing either ply distortion or weave damage. It was, therefore, concluded that it was not necessary for the gripper to actually touch the pick-up surface during handling; problems associated with misalignment and gripper plate flatness were thereby avoided.

Formal measurement of placement accuracy / repeatability was inappropriate since the SCARA robot's end effector rotational axis was too unstable to give useful data. It was quite clear, however, that plies did not move on the gripper surface once gripped and that placement repeatability would be wholly dependant on robot performance.

b) Selective Pick-up from Waste

Trial (a) was concerned with proving the gripper capability in picking and placing discrete plies. It was also essential to establish how effective the unit would be in selective pick-up from surrounding waste fabric (figure 7-14). Waste in these tests was butted up closely around the mating test ply to simulate, as nearly as possible, a profile freshly cut with a fine cutting tool (such as a laser or ultrasonic knife) and resting on a cutting table surface. The robotic cycle was identical to that used in Trial (a).

The "just cut" simulation assumed that ply profiles would be cut cleanly by the cutting system adopted. If fibres were to be left uncut between the ply and surrounding waste fabric, or if there were to be inter-edge fusion (as could occur with a laser cutter) it would be impossible to lift plies clear of

the cutting table surface without dragging up unwanted fabric and disturbing the remaining nest.

Trial (b) involved handling two different nested profiles, with one hundred cycles being carried out on each. During the trial no disturbance of the surrounding fabric was observed. It was consequently concluded that pick-up from waste is effective and repeatable as long as each ply can be cleanly cut.

c) Ability to Place in Preform Stack

In order test the prototype's ability to stack plies into a preform during lay-up, the unit was used to automatically build up a series of seven representative plies onto a six layer preform (figure 3-6). Several plies were to be butted together during lay-up to form single layers. The robotic cycle used in Trial (a) was again adopted but, at each new layer, the placement height was elevated by one fabric thickness ($0.010''$), to take account of the increasing height of the preform stack. Since the amount of fabric available was limited, plies were not tacked together during the trial so that the preform could be dismantled and reused for repeat tests.

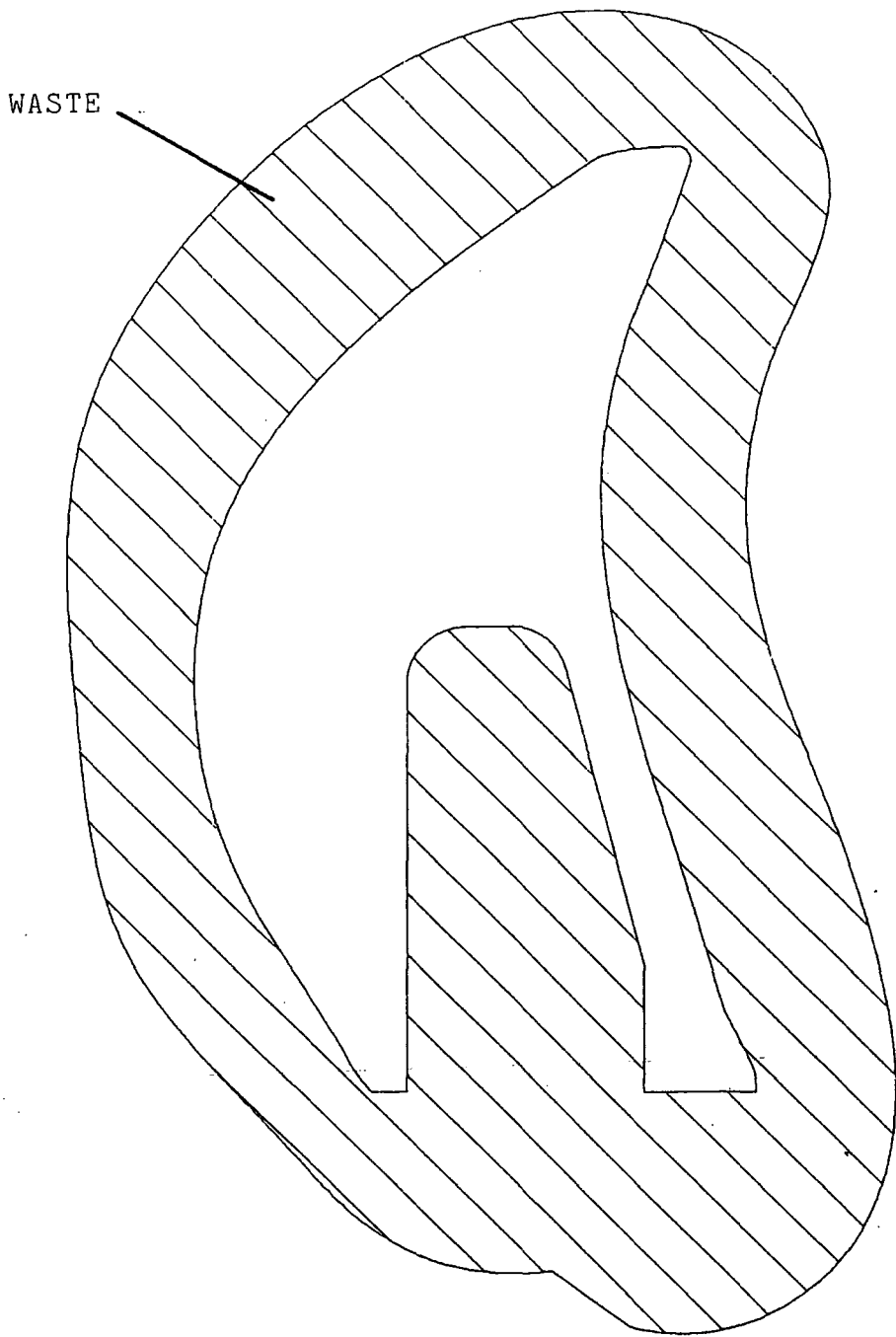

Figure 7-14. Typical "Just Cut" Ply Nested in Waste Fabric

Ten preforms were laid up successfully with no rucks or ply distortion and it was concluded that the presence of a stack did not diminish gripper performance.

d) Grip-Release Reliability

High reliability of the grip-release mechanism is essential for the successful operation of a handling device in a production environment. In order to test this reliability, a series of tests were performed based on the repetitive pick up and placement of six representative plies. Two hundred consecutive cycles were carried out with each ply. Each cycle was carried out by moving the gripper in the z-axis steps of the robotic cycle adopted in Trial (a) only; in cycle x- or y-axis movements were not attempted since this would have led to a build up of x,y positional errors such that test sequence would have had to have been stopped and reset continuously.

During the total of 1,200 cycles monitored, no grip or release malfunctions were observed. The trial concluded, therefore, that the grip-release mechanism was reliable.

e) Ability to De-stack

Removing plies from a stack was not a part of the new lay-up process developed in Chapter IV. It was, however, considered useful from a research point of view to test the gripper's de-stacking capability. For the trial, two sets of ten rectangular (255 X 150 mm) plies were cut. The first set was cut from the woven fabric and the second from the unidirectional thermoplastic wefted fabric.

The procedure was to manually stack each set of plies and then attempt to robotically de-stack them ply by ply (the plies were not tacked together).

Although de-stacking was possible, it was found that the effectiveness of the action was extremely variable. With the unidirectional fabric, a single ply could be successfully picked up with the manifold at a gauge vacuum of between 4 and 40 mbar. If a higher vacuum level was applied two plies could be picked at once. Disturbance of the lower ply in the stack during pick up was, however, noted at manifold gauge vacuum levels as low as 10 mbar. It was observed that the disturbance occurred as a result of the lower (second) ply being lifted for several millimetres before peeling away and

dropping to a new position out of line with the rest of the stack.

The plies cut from woven fabric behaved in a similar way, except that the second ply tended to be picked up at around 20 mbar. Given that woven fabric has a higher porosity than unidirectional fabric (section 3.1.4), this difference would be expected.

It was concluded that although de-stacking was possible with the developed gripper, the reliability was very poor indeed and the gripper unit would, therefore, be unsuitable for this type of operation.

f) Trial Conclusions

The trials showed that the concept of configured nozzles performed well in practice, at least with the range of representative profiles tested. The gripper's only fault was its poor reliability in de-stacking but this cannot be considered significant to this application because de-stacking is not a part of the new lay-up process strategy (Chapter IV).

Minor amendments to the position of individual nozzles and the addition of a few extra nozzles would have been useful to improve the support of some of the profiles handled; this was not practical with the fixed design of gripper plate adopted for the half size prototype.

7.6 A Full Size Gripper for the Integrated Research Cell

Given the experimental success of the half size prototype, it was decided that a full length (2.2m X Ø.8m) gripper should be constructed along similar lines. Such a unit would be suitable for handling a complete blade set of propfan preform plies in an integrated research cell.

7.6.1 Construction

The design of the full sized gripper (framework in figure 7-15) is based upon the same structural concepts and operating principles as its predecessor, the half size prototype unit.

GRIPPER MANIFOLD AND FRAME

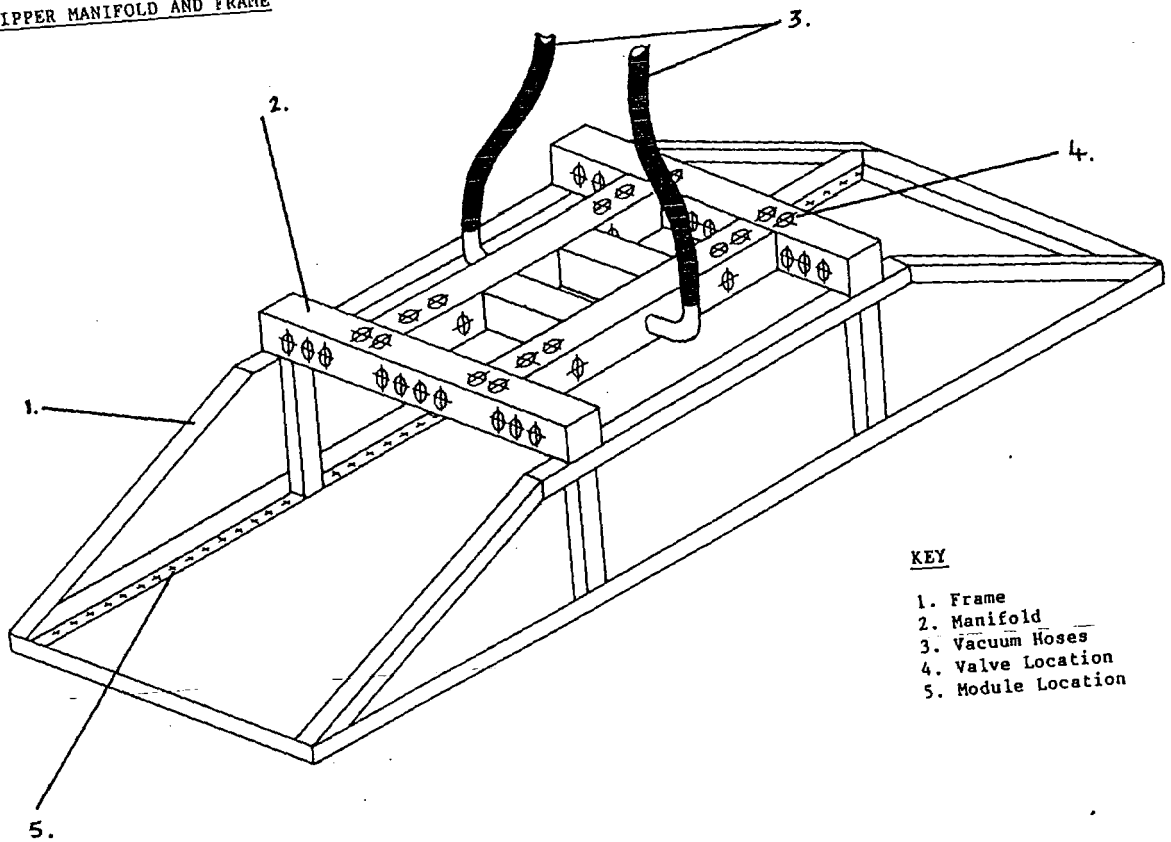

KEY

- 1. Frame
- 2. Manifold
- 3. Vacuum Hoses
- 4. Valve Location
- 5. Module Location

Figure 7-15. Framework of Full Size Prototype Gripper

The new gripper's design did, however, differ in three significant respects:

a) Ply Envelope Capacity

The ply envelope carrying capacity of the gripper was increased to 2.2 X 0.8 m and the frame was, therefore, twice as long (necessitating the use of heavier gauge members to retain comparable rigidity).

b) Increased Number of Valves

The number of vacuum control valves was increased to forty, permitting the handling of the full range of plies used in a single preform. The manifold, retaining its original structural role, was designed in an "H" configuration (figure 7-15).

c) Reconfiguration Flexibility

In order to allow the nozzle configuration to be easily modified during research trials, the gripper plate was superseded by a number of modular vacuum nozzle carrier bars; each spanned the width of the gripper (figure 7-16). These

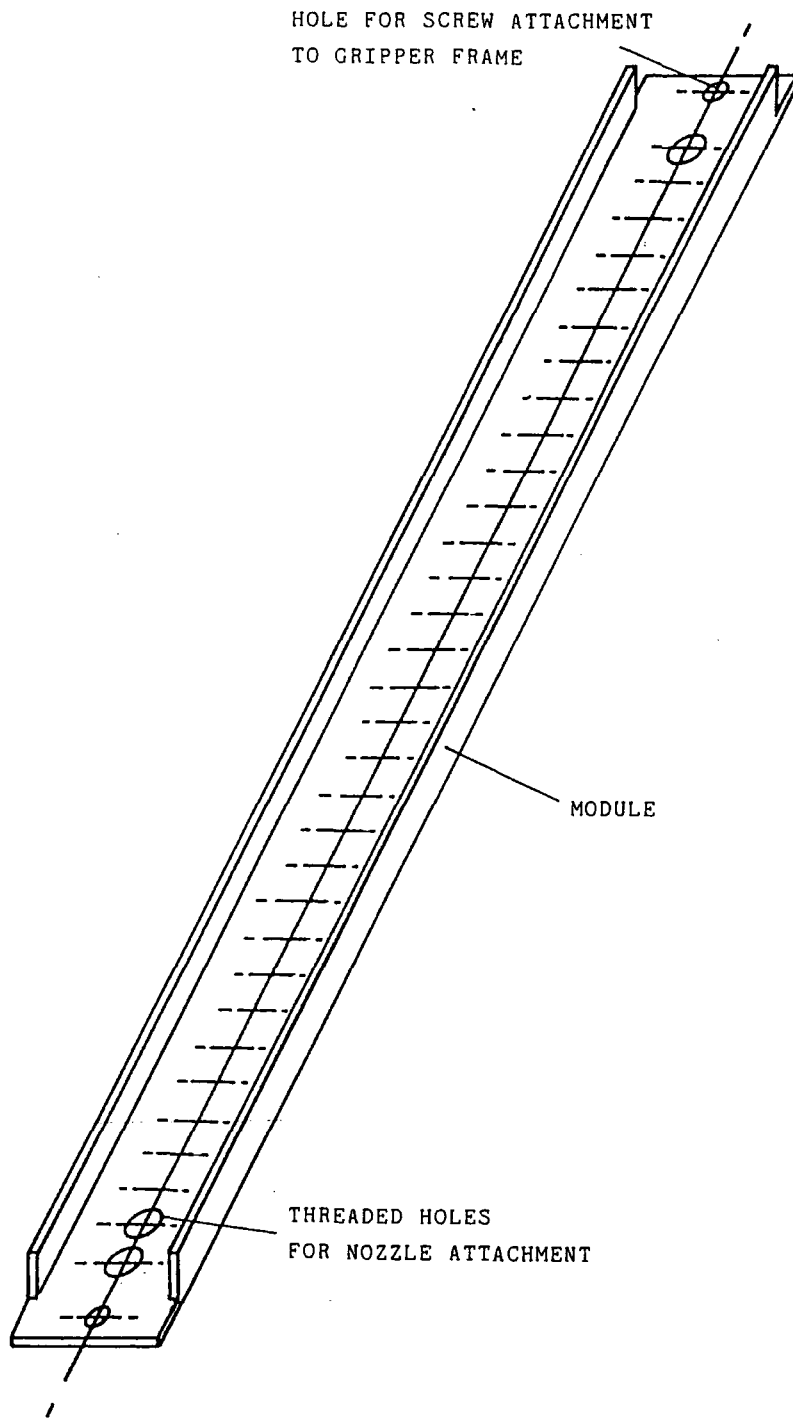

Figure 7-16. Modular Vacuum Nozzle Carrier Bar

modules were designed to be positioned at any required position along the base of the framework by means of a series of taped holes located at 10mm intervals. Each carrier bar was intended to accommodate a row of up to sixty 13 mm centred threaded vacuum nozzle location holes (figure 7-16). Each nozzle location could be connected to any vacuum manifold valve via miniature threaded plastic fittings pushed into the end of the vacuum tubes. The modules were considered to have the additional advantage that they could be used, if necessary, in conjunction with other modular elements such as heating or sensor units.

At the end of the Authors' secondment to the Project, the construction of the full size gripper unit was nearing completion, pending fitment of vacuum tubing between nozzles and the manifold (plate 7-4).

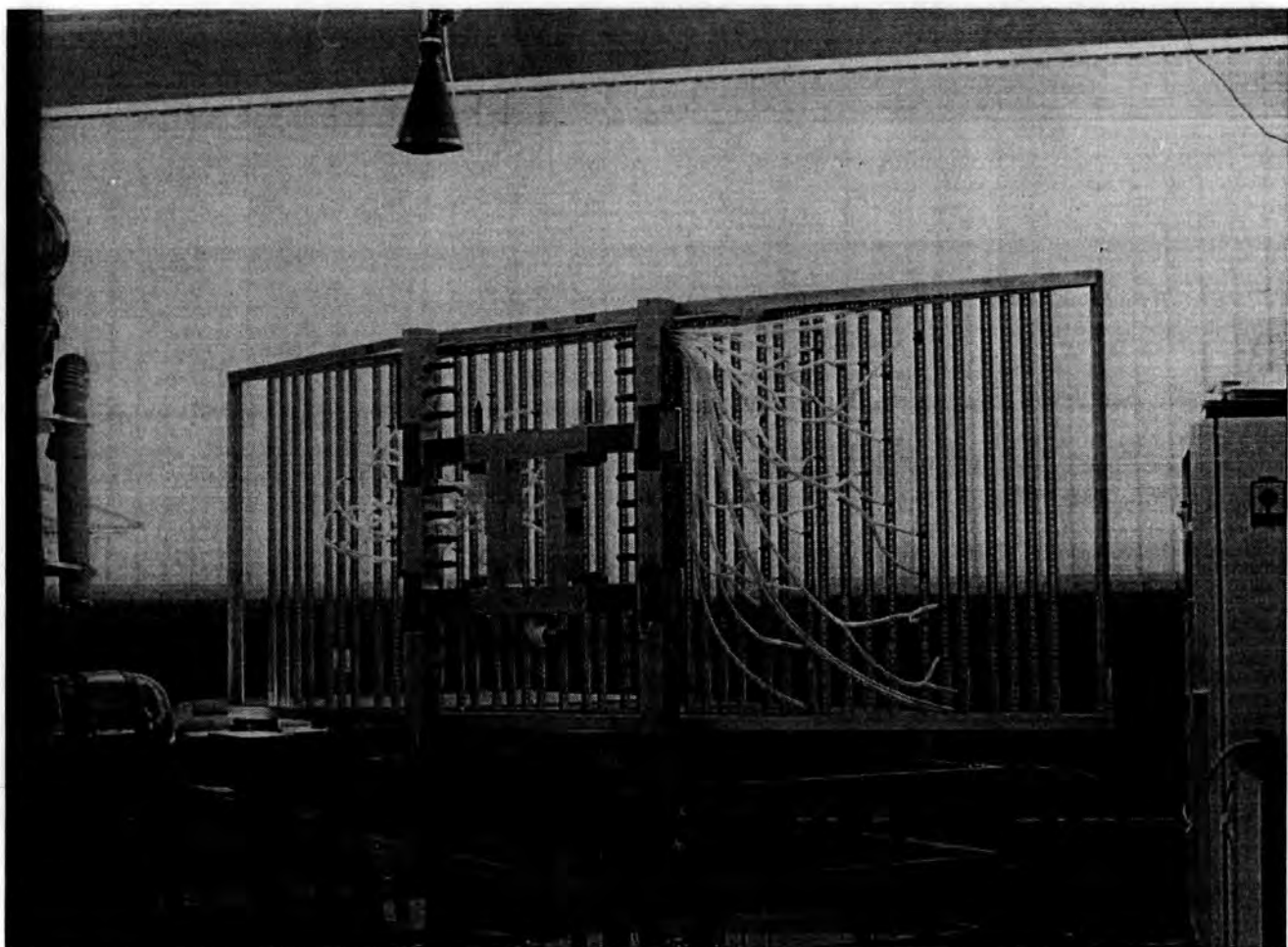

Plate 7-4. Full Scale Gripper Awaiting Fitment of Vacuum
Tubing

REFERENCES

- [1] Nicholson, P.R., Marshall, S.J.L., and Sarhadi, M., "Strategies for Automated Garment Manufacture", Xth International Conference on Production Research, Nottingham, 1989.

- [2] Johnson, D.G., and Hill, J.J., "A Sensory Gripper for Composite Handling.", Proceeding of the 4th. International Conference on Robot Vision and Sensory Controls, 1984.

- [3] Wright, E.J., Curran, J.P.J., Armstrong, P.J., "Robotics: Handling of Composite Materials in a Lay-Up Cell", IMechE Proceedings, 1986.

- [4] National Engineering Laboratory, "Automation of a Dry Reinforcement Charge Assembly for an Aerospace Composite Component.", report on an investigation for Dowty Aerospace Gloucester, June 1987.

- [5] Sarh, B., "Principle Tests for the Automated Production of the Airbus Fin Assembly with Fiber Composite Materials," 29th. National SAMPE Symposium, April 3-5, 1984.
- [6] Stone, K.L., "Automation in Composites Processing", 29th. National SAMPE Symposium, April 3-5, 1984.
- [7] Coad, C.L, Werner, S.M., and Dharan, C.K.H., "Design of a Composite Four-Axis Robot for Prepreg Layup.", SAMPE Journal, Jan/Feb 1985.
- [8] Anon, "Composites and Robotics: Pushing Technology Forward.", Robotics Today, Fall 1980.
- [9] Bubeck, K.B., "Advanced Composites Handling Application.", Proceedings of the 13th. International Symposium on Industrial Robots, Chicago, April 18-21, 1983.
- [10] Goldsworthy, W.B., "Tow, Tape and Broadgoods in Automated Layup.", Proceedings of Automated Composites 88 (The Plastics and Rubber Institute), Noordwijkerhout, Netherlands, September 26-28, 1988.

C H A P T E R V I I I

C O N C L U S I O N S
A N D R E C O M M E N D A T I O N S
F O R F U R T H E R W O R K

CHAPTER VIII

CONCLUSIONS AND RECOMMENDATIONS FOR FURTHER WORK

Chapter VIII brings together the elements of the Thesis to summarize the conclusions which have been drawn and discussed in previous chapters. It aims to assess the degree of success achieved in the approach taken and the validity of the new techniques and technologies developed through the Author's research. Recommended proposals for continued research and development are also presented.

8.1 Conclusions

The conclusions set out below focus on the redesign of the existing lay-up technique employed by Dowty, the specialized Lay-up Station on which it depends, handling technologies and the implications for the viability of automated propfan preform lay-up.

Chapter I set out the case for automation of propfan type propeller blade preform manufacture. The main arguments related to: the comparatively large scale of production that could be required to match the potential market for propfan blades which could far exceed that expected with traditional propeller types; the high cost per blade which would be incurred in the event of scrap through incorrect lay-up; and the high proportion of labour cost attached to the current manual lay-up process.

Despite the potential benefits to be gained from lay-up automation, it was realized that the development of a cost effective automated production cell would require considerable simplification of the existing high manual dexterity lay-up technique through process redesign. Without process simplification, the initial capital cost of automation equipment could not be justified.

The new flat lay-up concept proposed (Chapter IV), after a close "hands-on" study of the manual lay-up technique, offered process simplifications converting the three dimensional lay-up task into a 2-D operation; this would significantly reduce the handling dexterity required. It did,

however, depend on the successful development of a specialized lay-up station. Such technology would permit plies to be laid-up flat to generate a planar preform which could be subsequently folded and post formed to the required three dimension geometry (prior to loading to mould for resin impregnation). The viability of post forming aerofoil contours into the flat preform would depend upon the ability of a preform stack of plies to take up a gentle curvature during heat-vacuum consolidation, without inducing laminate wrinkles. Root post forming would be based on generating, during flat lay-up, controlled slack fabric at the root section of each layer across a variable gap between the two lay-up surfaces supporting the pitch and camber face aerofoil portions of the preform. Each slack layer of root fabric would be generated to be the correct length to take up its required arc within the "U"-shaped root geometry when the preform was-subsequently folded onto a consolidation jig.

Industrial "real blade" trials of the developed Lay-up Station technology showed that it was possible to post form flat propfan preforms without causing fibre reinforcement wrinkles. The results also showed that wrinkle free "U"-shaped root post forming was practical if the amount of slack material in the root area at each layer was controlled

accurately. It was, however, evident from capability analyses (section 6.5) that some modifications to the lay-Up gap control mechanism would be necessary to ensure consistent wrinkle free results in a production cell (section 8.2).

The successful development of a simplified lay-up technique and corresponding enabling technology thereby set clear parameters for ply handling technology research.

8.1.2 Handling Technologies

The potential for over complicating the handling technology elements of the Lay-Up Cell was appreciated early in the Project. In addition to the high dexterity handling problems removed by exploiting a flat lay-up / post forming technique, there was the challenge of accurately handling highly flexible, easily distorted fabrics which were cut into a range of forty large, complex profiled plies of varying size and profile. These plies also had to be collected from an automated cutting station without disturbing surrounding fabric on the cutting table surface.

Initial work was targeted at finding a suitable means of attaching plies to and releasing plies from a gripper

surface. Several options were investigated including needle action, vacuum and electrostatics. Each of the needle gripping means considered were rejected for use with Dowty's fabrics on at least one of the following counts: failure to provide positive location (fabric often slipped after engagement); the high complexity and mass of suitable arrangements for effectively handling the given range of plies; and risk of fibre or weave damage. Vacuum gripping through a matrix of nozzles was, however, found to perform extremely well with the semi-porous carbon fibre (and glass fibre) fabrics being positively attached to the gripper surface, with no damage to the fabric structure. Consideration of electrostatic means was initially put aside due to the perceived dangers of employing high electrical potentials in an environment contaminated with electrically conductive particles of carbon.

Vacuum gripping was consequently selected as the preferred gripping means (although subsequent work by the research team has shown that electrostatic gripping can also be effective in the application).

The initial approach to achieving effective ply handling was through cylindrical grippers which exploited a rolling action

to pick and place plies. These were considered to have a size advantage over flat grippers since large plies could, in principle, be coiled around the surface of a relatively small gripper drum. Unfortunately, research showed that the typical plies could not be rolled onto a practical roller diameter without severe fabric rucking and ply profile distortion. The phenomenon was concluded to be due to a combination of ply shape (thin profiles and sweeping curves), which made it difficult to apply winding forces evenly and the instability of the fabrics in shear. Several remedies were attempted, but rucking could not be avoided without recourse to a large drum diameter inappropriate for use as a robot end effector. It was, then, concluded that cylindrical grippers were impractical for the application.

The negative results of the roller gripping research directed effort towards the development of an acceptable flat gripper technology. The challenge was to develop a reliable, large area, high effective resolution gripper (with minimum mass, complexity and cost) which was capable of selective pick up of a full range of plies from waste material on a cutting table.

The simplest conceptual solution would have been to apply

vacuum nozzles at the required resolution spacing (estimated at 20mm X 10mm) and control each of these nozzles with a separate solenoid valve. This was considered impractical since about 7,500 separately controlled nozzles would have been required over the 1.5m² gripper surface. By adopting a gripper concept exploiting a logically configured vacuum nozzle pattern, however, it was possible to achieve the functional requirements with a comparatively small number of vacuum nozzles and minimized control complexity. The approach was adopted, after initial investigations, for use in a half length prototype capable of selectively handling a range of ten different plies. By utilizing low mass components, it was also possible, with the configured nozzle pattern concept, to carry all control valve gear on board the gripper, thus removing any need to run a bulky bundle of vacuum tubes between the gripper surface and the robot control system; this set up maximized robot arm manoeuvrability.

Tested at half size prototype stage on a series of representatively shaped carbon fibre fabric plies, the concept proved well suited to the application. Trials covering repeated rapid pick and release, pick from waste without disturbing surrounding fabric, and lay-up of a stack of plies showed that the embodied concept was both functional

and reliable. The trials did, however, show that the gripper was not capable of reliable de-stacking plies; this was not significant since the new lay-up strategy did not call for ply de-stacking.

It was possible to transfer the principles of the successful half size prototype directly to the design of a full length gripper capable of handling forty "real" plies. Several modifications were, however, introduced at this point to improve the gripper's adaptability so that the vacuum pattern could be optimized and so that new ply profiles could be relatively easily accommodated. The full size unit, the manufacture of which was nearing completion at the end of the Author's secondment, was intended to be finally integrated into the Research Demonstrator Cell.

The configured vacuum pattern approach is not ideal in that any one gripper is tied to a specified range of plies, at least in the short term; it must be manually reconfigured to carry any new ply profiles. If the automated production cell was to be required to switch rapidly between the manufacture of two (or more) types of preform, it was suggested, however, that a "tool change" approach could be successfully adopted. Tool change would involve exchanging gripper heads on robot, each time automatically recoupling all electrical, pneumatic

and vacuum connectors; the developed design particularly lends itself to such strategy because of the low number of gripper connections needed.

8.1.3 **The Practicality of Automated Propfan Lay-Up**

The aim of the Author's work was to develop a practical means of automatically collecting cut plies from a cutting table and laying them up to build a propfan preform. The successful research into a new lay-up method greatly simplified the task, which would have otherwise been impracticable within the constraints of capital cost and complexity. Further development of a configured vacuum pattern type flat gripper made it practical to effectively handle the range of highly flexible, easily distorted plies with minimized gripper complexity and cost. The full size gripper mass (expected to be around 30Kg), although higher than originally desired, is unlikely to be a major problem if an industrial gantry type robot is exploited.

The essential core handling technologies for propfan preform lay-up have, then, been successfully established, making automated lay-up physically practical. It should, of course, be noted that a number of complimentary technologies will

also need to be developed to realize full automation. The major areas are interlaminar heat bonding, computer vision for guidance / inspection, and cell control; all of these are being investigated and developed as part of the continuing research programme.

8.2 Recommendations for Further Work

Some further development work will be required to fully prepare the Lay-Up Station and gripper technology for use in the research Demonstrator Cell.

8.2.1 Further Development: The Lay-Up Station

Industrial trials of the Lay-Up Station's operational performance showed that although the root forming concept was practical, the capability of the prototype stage unit was too low for statistically reliability. Relatively minor modifications to the system would, it is believed, improve accuracy and repeatability to a level where wrinkle free preforms can be assured.

The most significant improvement would be gained by driving just one of lay-up surfaces (the other being permanently

fixed) rather than simultaneously actuating both. This is quite acceptable, since the robot programme can account for translation of the lay-up gap transverse centreline during automated operation. The benefit would be to potentially halve any yaw discrepancy in lay-up gap (due to linear bearing play) at the leading and trailing edges of the preform. It would also allow the linear drive belt length to be reduced, thus reducing transmission backlash.

Significant benefit could also be gained from repositioning the gap monitoring encoder, originally located at an extreme edge of the root gap. The preferred option would be to place the encoder below the single moving lay-up surface, directly in line with the longitudinal centreline of the preform.

Another enhancement would be to improve the method of locking table position after the correct gap has been achieved at each lay-up step; effective locking is essential to ensure that the precise gap dimension cannot be disturbed during the lay-up sequence. The manual screw clamping mechanism used during the trials was inadequate because the very act of tightening the screw tended to disturb table position. An automated locking mechanism would be preferable and this would best be served by an electromagnetic brake acting on the moveable lay-up surface. Suitable hardware needs to be

sought and fitted to the Lay-Up Station before it is incorporated into the Demonstrator Cell.

To ensure successful initialization of downward buckling of root tab fabric during each lay-up gap closure, it is proposed that a knife edge mechanism is incorporated into the Lay-Up Station design (section 6.5.2). The knife edge, which would have to exert minimal force on each root tab, would have to operate approximately above the transverse centreline of the gap (figure 6-18). The mechanism would have to be able to move clear of the gripper path during lay-up to prevent collision.

The indicated measures should greatly improve the capability of the Lay-Up Station. It may be found through extended trials, however, that it is not possible to ensure consistent wrinkle free roots by means of the basic Lay-up Station equipment alone. If this proves to be the case, it will be necessary to research the practicality of a subsequent operation capable of removing minor wrinkles. The proposed method is to incorporate a root tensioning mechanism into the post lay-up consolidation jig (section 6.5.2(b)). This would permit the application of controlled root tension during the heat-vacuum consolidation operation (figure 6-24).

Having successfully completed trials on the half length prototype, vacuum gripper research will focus on the full size (demonstrator cell) unit. A small amount of development is required, followed by extensive trials within the Demonstrator Cell.

The next element of continued work will be the preparation of a detailed nozzle configuration on the full size gripper; this will need to be devised on the basis of the proven principles of the half size prototype. To assist in the task and to make reconfiguration highly efficient for new / modified blade designs, it has been proposed that a computer aided vacuum pattern configuration package could be developed.

The final configuration will need to be fully tested at operational speeds with special attention being paid to the aerodynamic implications of replacing the original perspex gripper plate (as used in the half size prototype) with discrete nozzle carrying cross members.

In order to ensure that ply root tabs suspended across the

Lay-Up Station root gap are not disturbed immediately after being deposited, it is recommended that two small areas immediately adjacent to the gap are heat bonded onto the preform stack by the gripper before it withdraws from the lay-up surface. To achieve this, a pair of suitable small onboard heating units should be developed and fitted to the gripper. The design concept for these units should be considered as an integral part of research into ply heat bonding enabling technologies.

The existing full scale gripper is almost exclusively of aluminium alloy construction and has a mass of around 30Kg. If Project time resources allow, it would be useful to consider the potential for gripper mass-inertia reduction through the exploitation of alternative materials such as glass or carbon fibre - epoxy composites. Although these materials would increase gripper cost, it might be possible to utilize a smaller robot and thus save on the capital cost of the final industry based production cell.

With the adoption of the above recommendations, the full size gripper should offer effective and fully reliable operation complementing the Lay-up Station within the Demonstrator Cell.

A P P E N D I C E S

APPENDIX I

THE PROPFAN

A basic form of the jet engine is the turbojet. Turbojets operate on the principle that air drawn in at the front of the engine is compressed into a combustor where it is mixed with fuel and ignited. The hot combustion gases expand at high velocity through the rear of the engine, producing thrust. Ejecting small quantities of air at high velocities to produce thrust in this way is, however, a relatively inefficient means of propulsion, and far less energy is consumed for a given thrust output if larger quantities of gas can be ejected at lower speed. A more sophisticated form of the jet engine is, then, the turbofan, which achieves greater fuel efficiency by harnessing the high velocity exhaust gases to drive a turbine which in turn drives a large fan at the front of the engine. The air ejected by the fan, which bypasses the main core of the engine, typically develops just under three quarters of the total thrust output. The remaining thrust is generated by exhaust gases emerging from the engine core. Fan units have become progressively larger so that greater quantities of slow moving air can bypass the main core, thereby increasing

propulsive efficiency.

A yet more efficient means of generating thrust from a jet engine is to replace the fan unit with propellers; these are far more suited to moving large volumes of air. This has been the principle behind turboprops which use exhaust rotated turbines to drive propellers via a transmission system. The application of turboprops is, however, been limited to relatively slow flying aircraft because of the traditional propeller's thrust limitations.

It is now possible to build a form of jet engine, the "propfan"[1,2] (plate 1-1), which combines the thrust and speed performance of a turbofan with the fuel efficiency of a turboprop. The propfan is essentially a turbofan engine where the forward fan unit has been replaced by a radical unducted, high speed, swept blade propeller system. When compared to turbofans, propfans offer substantial fuel savings of up to 15% for long haul and 30% for medium haul aircraft, along with reduced fuel payload but with no compromise in terms of flying speeds or altitude[1,2].

REFERENCES

- [1] Anon, "Technology Brief - Jet Engines Sprout Propellers", The Economist, March 12, 1988.

- [2] Chase, V.D., "Propfans - A New Twist for the Propeller", Mechanical Engineering, November 1986.

APPENDIX II
DRIVE CHAIN CALCULATIONS

Appendix II deals with the required theoretical considerations for the Lay-Up Station drive chain and assesses the selected components of the drive chain.

The drive chain components were required to meet a set down specification which was necessary to obtain satisfactory performance from the Lay-Up Station. The performance criteria were: i) sufficient closure force to compress the root plies in the preform pack at each lay-up step; ii) a mechanical resolution at the lay-up gap of 0.1 mm or less; iii) a nominal steady state gap closure rate of 0.01 m/s.

Three factors are analysed relating to the performance specification: a) the maximum linear force exertable by drive chain on the root of a preform held on the lay-up surfaces; b) the required output speed of the stepper motor; and c) the achievable linear mechanical resolution of the lay-up gap.

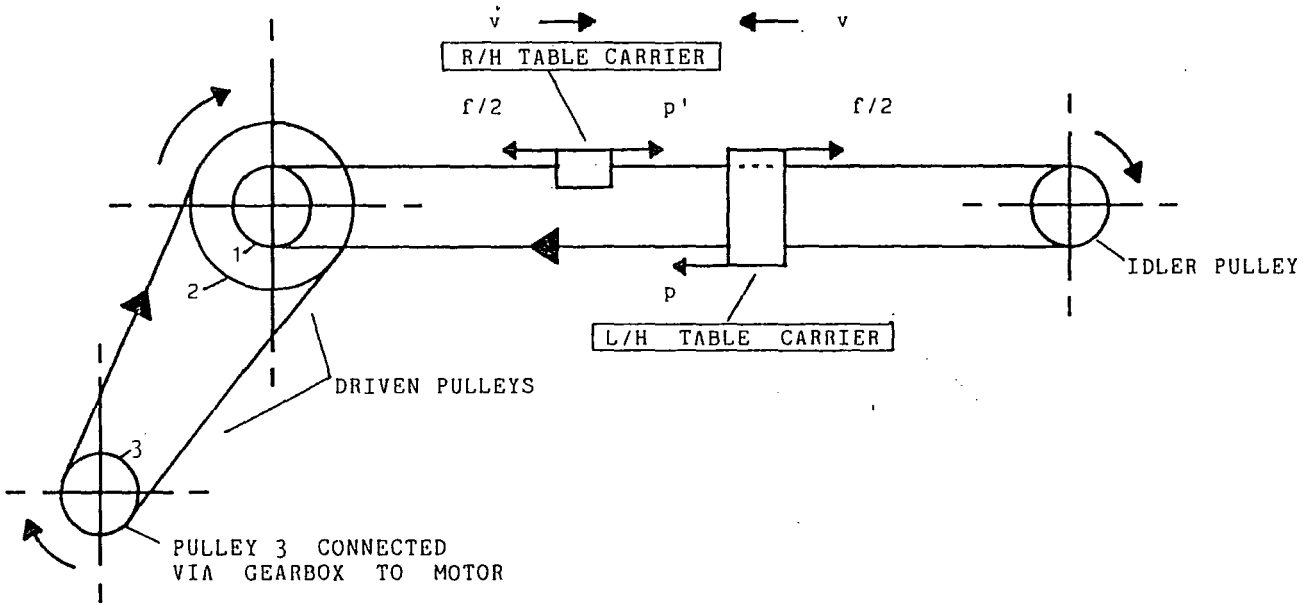

Pulley Attributes:

- 1) At Pulley 1: r_1, N_1, ω_1, T_1
- 2) At Pulley 2: $r_2, N_2, \omega_2, T_2,$
- 3) At Pulley 3: r_3, N_3, ω_3, T_3

Where: r is effective radius of pulley, N is number of sprockets, ω is angular velocity (in direction of arrow) and T is torque at the pulley indicated.

Figure A2-1. Drive Chain

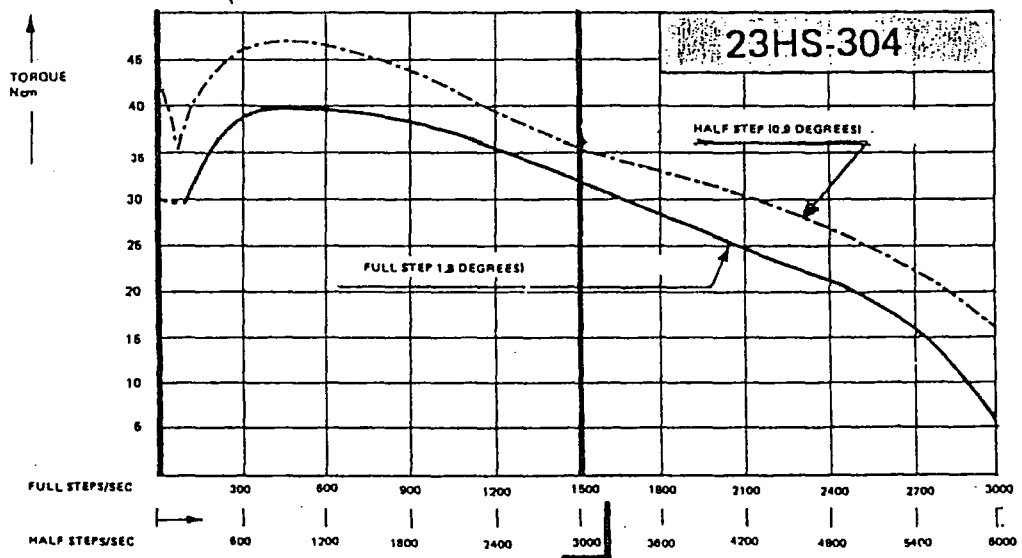

Fig A2-2. Stepper Motor Characteristics

A2.1 Force and Torque Relationships

To calculate the relationship between output force at the lay-up gap and input torque at the stepper motor:

From diagram (figure A2-1):

$$p = f/2 - p'$$

$$p' = f/2$$

where p and p' are belt tensions (figure A2-1).

Therefore:

$$p = f, \quad (1)$$

Also:

$$p = T_1/r_1$$

Pulley 1 and pulley 2 are directly coupled so:

$$T_1 = T_2$$

From (1):

$$f = T_1/r_1 = T_2/r_1$$

Therefore:

$$T_2 = fr_1, \quad (1)$$

Now:

$$p_{2,3} = T_3/r_3 = T_2/r_2$$

So:

$$T_3 = T_2 r_3 / r_2,$$

But:

$$r_2 / r_3 = N_2 / N_3$$

So

$$T_3 = T_2 N_3 / N_2, \quad (\text{III})$$

From (II) and (III),

$$T_3 = f r_1 (N_3 / N_2), \quad (\text{IV})$$

If the motor reduction gearbox ratio is n :

$$n = \omega_m / \omega_3 = \omega_m / \omega_3 = T_3 / T_m$$

Where T_m is motor torque.

Then from (IV):

$$T_m = f r_1 (N_3 / N_2) / n, \quad (\text{Va})$$

OR

$$f = T_m n (N_2 / N_3) / r_1, \quad (\text{Vb})$$

A2.2 Velocity and Angular Velocity Relationships

To calculate the relationship between lay-Up gap closure rate and the angular velocity of the stepper motor:

The closure rate of the table gap (ψ) is twice the closure

velocity (v) of each lay-up surface (figure A2-1):

$$v = \psi/2$$

But:

$$v = r_1 \omega_1$$

Since Pulley 1 and Pulley 2 are directly coupled:

$$\omega_1 = \omega_2$$

Therefore:

$$\omega_2 = (\psi/2)/r_1, \quad (\text{VI})$$

Now

$$\omega_2/\omega_3 = r_3/r_2 = N_3/N_2$$

So

$$\omega_3 = \omega_2(N_2/N_3), \quad (\text{VII})$$

From (VI) and (VII):

$$\omega_3 = (\psi/2r_1)(N_2/N_3), \quad (\text{VIII})$$

For a gearbox ratio n :

$$n = \omega_m/\omega_3 = \omega_m/\omega_3$$

Therefore from (VIII):

$$\omega_m = \psi(n/2r_1)(N_2/N_3), \quad (\text{IXa})$$

Or:

$$\psi = \omega_m(2r_1/n)(N_3/N_2), \quad (\text{IXb})$$

A2.3 Resolution and Angular Resolution Relationships

To calculate the relationship between output resolution at the lay-Up gap and angular resolution at the stepper motor:

The required resolution at the table gap is e and the required resolution at the motor is e_m .

Since distance is given by velocity multiplied by time, the result can be directly obtained by simple adaption of equation (IXa) and (IXb) above:

$$e_m = e(n/2r_1)(N_2/N_3), \quad (Xa)$$

$$e = e_m(2r_1/n)(N_3/N_2), \quad (Xb)$$

A2.4 Calculations

For research economy an existing Project Group stepper motor and two drive belt pulleys were selected for use as drive chain components. Their specifications were analysed against the equations derived to ensure that drive chain mechanical performance would be satisfactory.

A2.4.1 Values Attributed to Selected Items

i) Pulleys: $N_1 = 24$

$N_2 = 60$

$N_3 = 10$

$r_1 = 36.378 \text{ mm}$

ii) Motor: McLennan 23HS-304

Available resolution (1/2 step): $e_m = 5 \times 10^{-3} \pi$
radians

$T_m(\text{Holding}) = 0.8 \text{ Nm}$ (manufacturer's data)

$T_m(\text{Dynamic}) = (\text{c.f. figure A2-2})$

iii) Gearbox: McLennan Precision Gearhead S60

$T_3(\text{Peak Rating}) = 8 \text{ Nm}$ (manufacturer's data)

$n = 20$ (reduction gear ratio)

A2.4.2 Force and Torque Calculations

From equation (Vb) the maximum (linear) compressive holding force at the root gap can be calculated as limited by the stepper motor and the gearbox specifications. The maximum dynamic compression force, as limited by the stepper motor output, can also be evaluated.

a) Maximum Root Gap Holding Force

i) Motor Limited:

$$\begin{aligned} f(\text{Max. Static}) &= T_m(\text{Holding}) n(N_2/N_3)/r_1 \\ &= (0.8 \times 20 (60/10)/0.0364) \text{ N} \\ &= 2637 \text{ N} \end{aligned}$$

ii) Gearbox Limited:

$$\begin{aligned} f(\text{Max. Static}) &= T_3(\text{Peak rating})(N_2/N_3)/r_1 \\ &= (8 \times (60/10)/0.0364) \text{ N} \\ &= 1319 \text{ N} \end{aligned}$$

The maximum available holding compressive force which the system will be able to apply to the preform root is, therefore, 1319 N (i.e. gearbox limited in the static mode).

b) Maximum Dynamic Root Compression Force

If it is assumed that the stepping rate will not exceed 3000 half steps per second (this assumption is validated in section A2.4.3), the available dynamic torque output is at least 35 Nm according to manufacturer's data (figure A2-2).

i) Motor limited:

$$\begin{aligned} f(\text{Max. Dynamic}) &= T_m(\text{Max. Dynamic}) n(N_2/N_3)/r_1 \\ &= (0.35 \times 20(60/10)/0.0364) \text{ N} \\ &= 1154 \text{ N} \end{aligned}$$

The maximum load that can be applied to the root of a preform during lay-up is then 1154 N, limited by the dynamic torque of the stepper motor.

c) Comparison with required compression loading to buckle down the root tab pack

The results (figure 6-8) of the compression test carried out on a simulated root pack of 17 layers (section 6.1.4) show that the required compressive forces are below 30 N, making the valid assumption that the required gap step never exceeds 10 mm (actual step used was in the region of 1 mm (Appendix III)). The compression forces available will, therefore, be in excess of the those required, as long as the forces exerted for system acceleration and to overcome friction do not exceed $1154 \text{ N} - 30 \text{ N} = 1124 \text{ N}$.

A2.4.3 Velocity and Angular Velocity Calculations

The required closure rate (ψ , (figure A2-1)) of the lay-up gap was nominally set at 0.01 m/s.

Therefore from equation (IXa):

$$\begin{aligned}w_m &= \psi(n/2r_1)(N_2/N_3) \\ &= 0.01(20/(2 \times 0.0364))(60/10) \text{ rad/s} \\ &= 16.48 \text{ rad/s} \\ &= 944^\circ/\text{s} \\ &= 1049 \text{ half steps/s}\end{aligned}$$

Comparing this with manufacturer's data (figure A2-2), the value complies with the maximum condition of not greater than 3000 half steps/s or 47 rad/s (section A2.4.2(b)).

From equation (IXb), the maximum available closure rate of the gap is (with no less than 1154 N closure force):

$$\begin{aligned}\psi &= \omega_m(2r_1/n)(N_3/N_2) \\ &= (47(2 \times 0.0364/20))(10/60) \text{ m/s} \\ &= 0.029 \text{ m/s}\end{aligned}$$

A2.4.4 Resolution and Angular Resolution Calculations

The resolution of the gap is related to the motor angular resolution by equation (Xb):

$$e = e_m(2r_1/n)(N_3/N_2)$$

And:

$$e_m = 0.9^\circ = 5 \times 10^{-3} \pi \text{ rad/s}$$

Therefore:

$$\begin{aligned} e &= (5 \times 10^{-3} \pi (2 \times 0.0364 / 20) (10 / 60)) \text{ m} \\ &= 9.53 \times 10^{-6} \text{ m} \\ &= 9.53 \times 10^{-3} \text{ mm} \end{aligned}$$

The drive chain resolution, therefore, substantially exceeds specification.

APPENDIX III

LAY-UP STATION CAPABILITY ANALYSIS

Appendix III presents and analyses the actual versus specified gap readings recorded during the industrial trial of the Lay-Up Station in order to evaluate the its statistical capability.

A3.1 Theoretical Background

The aim of the capability analysis is to establish statistically the extent to which the Lay-Up Station is able to produce consistantly wrinkle free preform roots. The analysis involves comparing the actual root errors recorded during trials with the accuracy required to avoid unacceptably severe wrinkles (section 6.1.3). Specifically, the principle has been to establish the probability, $P(\text{Accept Preform})$, that a Lay-Up Station produced preform will not have a wrinkle related defective root caused by excessive gap error during lay-up.

The recorded values of root gap error must lie within a

0.004" range to satisfy the specification (section 6.1.3). The lowest negative recorded value ("too short") of error (E_{min}) is, by definition, the lower tolerance limit since wrinkles will form in any root tab which is looser than the tightest tab. The highest positive value allowable (E_{max}) is then given by:

$$E_{max} = E_{min} + 0.004" \text{ (i.e. tolerance band)}$$

To simplify calculation, a standardized form of each error is used such that E_{min} is converted to a reference value ϵ_{min} of 0.000" and E_{max} is converted to ϵ_{max} having a value of 0.004". Hence any value of E is converted to a corresponding value ϵ by the equation:

$$\epsilon = E - E_{min}$$

Values of ϵ are assumed to have a normal (Gaussian) distribution (figure A3-1) defined in terms of standard deviation (σ) and mean value (μ).

Where:

$$\sigma = ((\sum \epsilon^2) / n - (\mu)^2)^{1/2}$$

And:

$$\mu = \Sigma \epsilon / n$$

The analysis exploits the standardized form of the normal distribution^[1] curve (figure A3-2) given by the formula:

$$y = (1/\sigma(2\pi)^{1/2})e^{-z^2/2}$$

Where:

$$z = (\epsilon - \mu)/\sigma$$

The probability of a root gap dimension being within tolerance found by evaluating the area under the standard normal curve between the limits of z corresponding to the lower error limit (ϵ_{\min}) and the upper error limit (ϵ_{\max}), i.e. between i) z_1 and $z = 0$ and ii) $z = 0$ and z_2 . The area is found by reference to tabulated values of the standard normal probability integral^[1].

$$z_1 = (\epsilon_{\min} - \mu)/\sigma$$

$$z_2 = (\epsilon_{\max} - \mu)/\sigma$$

$P(\text{Accept Preform})$ is equivalent to the probability of all root gaps being within tolerance during the preform lay-up cycle. This is given by the equation (where $P(\text{Accept Tab})$ is the probability of any single root tab standardized length error (ϵ) will be between zero and ϵ_{\max}).

$$P(\text{Accept Prefrom}) = P(\text{Accept Tab})^n$$

Where n is the number of root tabbed layers per preform ($n = 17$ for the typical preform being considered).

A3.2 Gap Dimension Results and Capability Calculations

A3.2.1 Key to Variables

Key to mathematical variable symbols (figure A3-1):

- D - specified gap dimension.
- D_e - actual gap dimension measured at encoder.
- D_o - actual gap dimension measured opposite to the encoder.
- D_l - calculated actual gap dimension at the leading edge of the root tab.
- D_m - calculated actual gap dimension midway between the leading and trailing edges of the root tab
- D_t - calculated actual gap dimension at the trailing edge.
- E_e - gap error at the encoder.
- E_l - calculated gap error at the root tab leading edge.

- E_t - calculated gap error at the root tab trailing edge.
- ϵ - standardized gap error (with suffix)
- σ - standard deviation of ϵ (with suffix)

NOTE:

The results for Trial I were limited in their usefulness in that they were based on absolute gap measurement at the opposite side of the gap to the encoder. In subsequent trials the convention was changed with the gap dimension and absolute error measured at the encoder side and at the side opposite to the encoder. The change in convention improved the usefulness of the results because the effects of lay-up surface yaw (permitted through bearing ply) could also be monitored. A significant point is that the encoder should ideally be placed in the centre of the table to avoid yaw error at the encoder centreline.

3.2.1 Trial I

LAY-UP STATION CAPABILITY ANALYSIS: TRIAL I

LAYER	D	D _a	D _o
2	3.950	N/A	3.960
2A	3.929	N/A	3.928
3a	3.898	N/A	3.898
4a	3.855	N/A	3.869
5	3.835	N/A	3.837
6a	3.803	N/A	3.803
6A	3.772	N/A	3.772
7	3.740	N/A	3.739
8a	3.709	N/A	3.710
9a	3.678	N/A	3.680
10	3.646	N/A	3.647
10A	3.615	N/A	3.617
11a	3.583	N/A	3.586
12a	3.552	N/A	3.554
13a	3.521	N/A	3.524
14	3.489	N/A	3.491
15	3.458	N/A	3.461

LAYER	S _a	S _o
2	.000	.001
2A	-.001	.000
3a	.000	.001
4a	.003	.004
5	.002	.003
6a	.000	.001
6A	.000	.001
7	-.001	.000
8a	.001	.002
9a	.002	.003
10	.001	.002
10A	.002	.003
11a	.003	.004
12a	.002	.003
13a	.003	.004
14	.002	.003
15	.003	.004
Lower Limit	-.001	.000
Upper Limit	.003	.004
Mean Value (μ)		.002

Table A3-1. Trial I Results

	51661'
	.990121
Standard Dev:	σ
	.001761863
	(min. σ-uo)/σ
	-1.698
	(max. σ-uo)/σ
	1.253
P(Accept Tab)	84.98%
P(Accept Preform)	5.29%

Table A3-1. (Cont) Trial I Results

3.2.2

Trail II

LAY-UP STATION CAPACITY ANALYSIS: TRIAL II

LAYER	D	D _e	D _o	D _l	D _m	D _t
2	2.560	2.560	2.560	2.560	2.560	2.560
2A	2.529	2.529	2.527	2.528	2.529	2.527
3a	2.497	2.496	2.491	2.494	2.494	2.493
4a	2.466	2.467	2.462	2.455	2.465	2.464
5	2.434	2.433	2.429	2.431	2.431	2.430
6a	2.403	2.403	2.396	2.400	2.400	2.399
6A	2.372	2.371	2.364	2.369	2.368	2.367
7	2.340	2.339	2.331	2.335	2.335	2.334
8a	2.309	2.306	2.301	2.304	2.304	2.303
9a	2.278	2.277	2.272	2.275	2.275	2.274
10	2.246	2.249	2.245	2.247	2.247	2.246
10A	2.215	2.216	2.214	2.215	2.215	2.215
11a	2.183	2.185	2.183	2.184	2.184	2.184
12a	2.152	2.149	2.149	2.149	2.149	2.149
13a	2.121	2.122	2.122	2.122	2.122	2.122
14	2.089	2.090	2.079	2.086	2.095	2.093
15	2.058	2.060	2.049	2.056	2.055	2.053

LAYER	ε _e	ε _o	ε _l	ε _i	ε _t	ε _t
2	.000	.003	.000	.005	.000	.005
2A	-.001	.002	-.001	.004	-.002	.005
3a	-.001	.002	-.003	.002	-.004	.002
4a	.001	.004	-.001	.004	-.002	.004
5	-.001	.002	-.003	.002	-.004	.002
6a	.000	.003	-.003	.002	-.004	.002
6A	-.001	.002	-.004	.001	-.005	.001
7	-.002	.001	-.005	.000	-.006	.000
8a	-.003	.000	-.005	.000	-.006	.000
9a	-.001	.002	-.003	.002	-.004	.002
10	.002	.005	.001	.005	.000	.007
10A	.001	.004	.000	.005	.000	.006
11a	.002	.005	.001	.006	.001	.007
12a	-.003	.000	-.003	.002	-.003	.003
13a	.001	.004	.001	.005	.001	.007
14	.001	.004	-.003	.002	-.006	.001
15	.002	.005	-.002	.003	-.005	.002
Lower Limit (ε _{min})	-.003	.000	-.005	.000	-.006	.000
Upper Limit (ε _{max})	.001	.004	-.001	.004	-.002	.004
Mean Value (μ)		.003		.003		.003

Table A3-2. Trail II Results

	$\Sigma(\epsilon_1)^2$	$\Sigma(\epsilon_1)^2$	$\Sigma(\epsilon_1)^2$
	.000178	.000218203	.000300328
Standard Dev:	se	sl	st
	.001589692	.001493407	.002465023
	$(\epsilon_{min, e-pl})/se$	$(\epsilon_{min, l-pl})/sl$	$(\epsilon_{min, t-pt})/st$
	-1.795	-1.595	-1.381
	$(\epsilon_{max, e-pl})/se$	$(\epsilon_{max, l-pl})/sl$	$(\epsilon_{max, t-pt})/st$
	.744	.515	.242
P(Accept Tab)	73.49%	64.40%	51.10%
P(Accept Prefrom)	.52%	.06%	.00%

Table A3-2. (Cont) Trail II Results

3.2.3

Trial III

LAY-UP STATION CAPABILITY ANALYSIS: TRIAL III

LAYER	D	De	Do	DI	Dm	Dt
2	2.684	2.684	2.684	2.684	2.684	2.684
2A	2.651	2.651	2.653	2.652	2.652	2.652
3a	2.618	2.617	2.619	2.618	2.618	2.618
4a	2.585	2.584	2.584	2.584	2.584	2.584
5	2.552	2.550	2.551	2.550	2.551	2.551
6a	2.519	2.517	2.517	2.517	2.517	2.517
6A	2.486	2.483	2.483	2.483	2.483	2.483
7	2.453	2.450	2.450	2.450	2.450	2.450
8a	2.420	2.418	2.417	2.418	2.418	2.417
9a	2.388	2.386	2.385	2.386	2.386	2.385
10	2.355	2.352	2.351	2.352	2.352	2.351
10A	2.322	2.322	2.318	2.321	2.320	2.320
11a	2.289	2.287	2.284	2.286	2.286	2.285
12a	2.255	2.256	2.253	2.255	2.255	2.254
13a	2.223	2.223	2.220	2.222	2.222	2.221
14	2.190	2.190	2.186	2.189	2.188	2.188
15	2.157	2.158	2.153	2.156	2.156	2.155

LAYER	Se	Es	SI	EI	St	Et
2	.000	.003	.000	.003	.000	.004
2A	.000	.003	.001	.004	.001	.005
3a	-.001	.002	.000	.003	.000	.004
4a	-.001	.002	-.001	.002	-.001	.003
5	-.002	.001	-.002	.002	-.001	.003
6a	-.002	.001	-.002	.001	-.002	.002
6A	-.003	.000	-.003	.000	-.003	.001
7	-.003	.000	-.003	.000	-.003	.001
8a	-.002	.001	-.002	.001	-.003	.001
9a	-.002	.001	-.002	.001	-.003	.001
10	-.003	.000	-.003	.000	-.004	.000
10A	.000	.003	-.002	.002	-.003	.001
11a	-.002	.001	-.003	.000	-.004	.000
12a	.000	.003	-.001	.002	-.002	.002
13a	.000	.003	-.001	.002	-.002	.002
14	.000	.003	-.002	.002	-.003	.001
15	.001	.004	-.001	.003	-.002	.002
Lower Limit (Emin)	-.003	.000	-.003	.000	-.004	.000
Upper Limit (Emax)	.001	.004	.001	.004	.000	.004
Mean Value (μ)		.002		.002		.002

Table A3-3. Trial III Results

	$\Sigma(\epsilon_e)^2$	$\Sigma(\epsilon_l)^2$	$\Sigma(\epsilon_t)^2$
	.090083	.000074516	.000025891
Standard Dev:	σ_e	σ_l	σ_t
	.001247835	.001137973	.00136537
	$(\epsilon_{min,e}-u_e)/\sigma_e$	$(\epsilon_{min,l}-u_l)/\sigma_l$	$(\epsilon_{min,t}-u_t)/\sigma_t$
	-1.451	-1.544	-1.459
	$(\epsilon_{max,e}-u_e)/\sigma_e$	$(\epsilon_{max,l}-u_l)/\sigma_l$	$(\epsilon_{max,t}-u_t)/\sigma_t$
	1.744	1.971	1.524
P(Accept Tabl)	88.70%	91.40%	86.50%
P(Accept Freeform)	13.02%	21.68%	8.50%

Table A3-3. (Cont) Trial III Results

REFERENCES

- [1] Stroud, K.A., Engineering Mathematics, Macmillan Education, 1987.

APPENDIX IV
VACUUM PUMP SPECIFICATION

In order to establish a specification for the vacuum pump to service the Lay-Up Station and also the vacuum gripper selected (Chapter VII), empirical testing was carried out to determine air flow rate through each device under expected worse case operating conditions. 100mb was set as the nominal system gauge vacuum and, therefore, air flow rates were measured at this level; 100mb was selected because it had provided a reliable gripping vacuum, both with the lay-up and gripper surface nozzles and was the maximum vacuum that could be applied without inducing witness pock marks in fabric being held. Two specific tests were carried out to simulate the worse case air flow condition of one layer of fabric being held on the Lay-Up Station while the largest ply was being held by the gripper; woven fabric was used as the test medium since it had been shown to have the greatest porosity of the carbon fabrics to be handled. Test (i) measured air flow through one of the lay-up surfaces (equating to ninety 5mm diameter nozzles) covered by one layer of woven fabric; and test (ii) measured air flow through the half size flat gripper (Chapter VII) (equating to 160 8mm diameter nozzles)

covered by a single layer of woven fabric. Air flow in each case was measured using an orifice plate apparatus (section 3.1.4).

Since the Research Demonstrator Cell Lay-Up Station was expected to operate with approximately two hundred nozzles and the full size gripper to have around five hundred nozzles, it was necessary to extrapolate the test results to provide a pump specification. The assumption was made that it was reasonable, given the approximate accuracy necessary, to take flow rate as being directly proportional to the number of nozzles.

i) Test I: Lay-up surfaces at 1000mb (gauge vacuum)

Flow Rate (90 nozzles of 5mm dia.): 8.8m³/h

Therefore, by extrapolation:

Flow Rate (200 nozzles of 5mm dia.): 20m³/h.

ii) Test II: Gripper at 1000mb (gauge vacuum)

Flow Rate (160 nozzles of 8mm dia.): 29.4m³/h

Therefore, by extrapolation:

Flow Rate (500 nozzles of 8mm dia.): $92\text{m}^3/\text{h}$

For the gripper and lay-up surfaces combined, therefore, the worse case flow rate at the nominal level of 100mb (gauge vacuum) is:

$$(20 + 92)\text{m}^3/\text{h} = 112\text{m}^3/\text{h}$$

XXX



CARBON FIBRE
FABRIC SAMPLES



UNIDIRECTIONAL FABRIC

FIBRE AXIS:

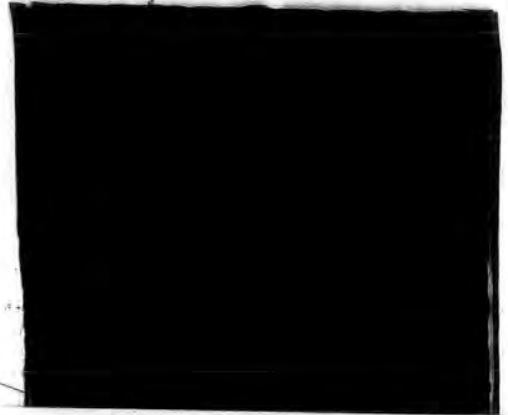

WOVEN FABRIC

FIBRE AXIS:

