

## Durham E-Theses

---

*The effect of moisture conditioning on the mechanical and physical properties of long glass fibre reinforced nylon 66 materials*

Jethwa, Jagdish Keshav

### How to cite:

---

Jethwa, Jagdish Keshav (1991) *The effect of moisture conditioning on the mechanical and physical properties of long glass fibre reinforced nylon 66 materials*, Durham theses, Durham University. Available at Durham E-Theses Online: <http://etheses.dur.ac.uk/6099/>

### Use policy

---

The full-text may be used and/or reproduced, and given to third parties in any format or medium, without prior permission or charge, for personal research or study, educational, or not-for-profit purposes provided that:

- a full bibliographic reference is made to the original source
- a [link](#) is made to the metadata record in Durham E-Theses
- the full-text is not changed in any way

The full-text must not be sold in any format or medium without the formal permission of the copyright holders.

Please consult the [full Durham E-Theses policy](#) for further details.

THE EFFECT OF MOISTURE CONDITIONING ON THE MECHANICAL  
AND PHYSICAL PROPERTIES OF LONG GLASS FIBRE REINFORCED  
NYLON 66 MATERIALS.

This Thesis is submitted for the degree of Master of  
Science  
of the  
UNIVERSITY OF DURHAM  
School of Engineering and Applied Science

by

Jagdish Keshav Jethwa

MAY 1991

The copyright of this thesis rests with the author.  
No quotation from it should be published without  
his prior written consent and information derived  
from it should be acknowledged.



21 JUL 1992

I certify, that neither my thesis nor the original work contained herein has been submitted to this or any other institution for a degree.

The copyright of this thesis rests with the author. No quotation from it should be published without his prior written consent and information derived from it should be acknowledged.

## ACKNOWLEDGEMENTS

I would like to thank Dr T.V. Parry for his invaluable advice and guidance throughout the entire program of research.

Also Dr C.R. Gore of ICI for his time and helpful suggestions, particularly during the demanding times of writing up. I appreciate the extensive support provided by ICI Wilton, necessary to undertake this research.

Thanks are also due to Dr's P.A.T. Gill and N.I. Bagdatlioglu for their help and advice, especially in the initial stages.

I would also like to thank J.H. Fenner & Co. Ltd., for their generous financial contribution to this project, from the DTI Materials Research Grant. In particular Mr P.J. Thompson for his support and advice.

Finally, for making it all possible I wish to say thank you to Miss D. Kaur for her tolerance and patience.

## ABSTRACT

The effect of moisture conditioning on the mechanical and physical properties of ICI's 'Verton' range of long glass fibre reinforced Nylon 66 materials have been investigated using injection moulded test specimens. Natural and black grades, at glass loadings of 35%, 50% and 60% by weight have been examined together with a natural un-reinforced Nylon 66 grade.

The tensile strength of the matrix polymer reduced from 80 MPa at dry - "as moulded" to 30 MPa when fully moisture saturated.

Dry - "as moulded" tensile strength values for the glass reinforced grades ranged between 198 MPa and 255 MPa for the natural grades and between 183 MPa and 251 MPa for the black. With moisture conditioning for 1000 hours (42 days) at 60°C these values were reduced from 92 MPa to 119 MPa for the natural grades and 87 MPa to 120 MPa for the black.

The dry - "as moulded" flexural strength values ranged between 280 MPa to 365 MPa and 249 MPa to 369 MPa for the natural and black materials, respectively. As with tensile strength these values were also reduced with moisture uptake. For the same moisture conditions the values of strength measured in flexure were reduced more than in tension. For natural materials the values ranged between 80 MPa to 102 MPa and from 70 MPa to 92 MPa for the black.

The dry impact strength of notched samples ranging from 22 kJ/m<sup>2</sup> to 42 kJ/m<sup>2</sup> was found to increase to approximately 63 kJ/m<sup>2</sup> for the natural glass/Nylon 66 materials when fully moisture conditioned. The impact strength of black materials ranged from 15 kJ/m<sup>2</sup> to 37 kJ/m<sup>2</sup> dry and increased to approximately 61 kJ/m<sup>2</sup> with moisture conditioning for 1000 hours at 60°C.

All changes in mechanical and physical properties were interpreted in terms of the effects of Fickian moisture uptake on the likely properties of the 'skin' and 'core' regions of injection moulded samples.

## CONTENTS

	Page	
<b>CHAPTER 1.0</b>	<b>INTRODUCTION</b>	1
<b>CHAPTER 2.0</b>	<b>FIBRE REINFORCEMENT OF THERMOPLASTICS</b>	9
2.1	Continuous Fibre Reinforced Thermoplastics (CFRTPs)	9
2.2	Discontinuous Fibre Reinforced Thermoplastics (SFRTPs and LFRTPs)	25
2.2.1	SFRTPs	25
2.2.2	LFRTPs	26
2.3	Analysis of Discontinuous Fibre Composites	29
2.4	Fibre Orientations During Processing	41
<b>CHAPTER 3.0</b>	<b>ENVIRONMENTAL EFFECTS</b>	46
3.1	Mechanisms of Moisture Absorption in Nylon 66	49
3.2	Fick's Theory of Diffusion	52
<b>CHAPTER 4.0</b>	<b>EXPERIMENTAL PROCEDURE</b>	55
4.1	Materials Investigated	55
4.2	Injection Moulding	56
4.3	Mechanical Testing	61
4.3.1	Determination of Tensile Strength	62
4.3.2	Determination of Flexural Strength and Flexural Modulus	64
4.3.3	Charpy Impact Test	67

<b>CHAPTER 5.0</b>	<b>RESULTS</b>	<b>70</b>
5.1	Moisture Absorption with Soak-Time	70
5.2	Mechanical Properties	76
5.2.1	Tensile Strength	76
5.2.2	Flexural Strength	84
5.2.3	Flexural Modulus	91
5.2.4	Charpy Impact Strength	97
5.3	Physical Properties	104
5.3.1	Changes in Sample Length, Width and Thickness	104
<b>CHAPTER 6.0</b>	<b>DISCUSSION OF RESULTS</b>	<b>114</b>
6.1	Moisture Absorption	115
6.2	Mechanical Properties	122
6.3	Changes in Sample Dimensions	140
<b>CHAPTER 7.0</b>	<b>CONCLUSIONS</b>	<b>143</b>
<b>CHAPTER 8.0</b>	<b>RECOMMENDATIONS FOR FURTHER WORK</b>	<b>148</b>
<b>REFERENCES</b>		
<b>APPENDICES</b>		

## CHAPTER 1.0

### INTRODUCTION

From prehistoric days right up to modern times there has always been a great demand for strong materials and therefore human society has always been in search of stronger and stronger materials.

For the design engineer the ideal material should be strong, stiff, tough and light. Metals and their alloys come close to satisfying most of these requirements. They are strong and tough but not very light. Plastics are light, but are often considered as cheap and mechanically weak for they lack stiffness, strength and often toughness. Therefore, an obvious approach to attaining an ideal material would be to combine two materials with complementary properties. Such composite materials should have the combined advantage of their constituents without their disadvantages.

The concept of composite materials itself is not new. During the days of Pharaohs in Egypt it was a common practice to use chopped straws in bricks, which prevented them from cracking [1]. For the same purpose, plant fibre was used in ancient



Inca and Maya potteries [1]. The Egyptian mummy cases were made of papier-mâché, a composite material containing sheets of papyrus that was used as writing material in Egypt [1].

The use of moss to strengthen ice by the Eskimos is another example of the fabrication of composite material. Ice is quite hard but very brittle, the freezing of moss incorporates the fragments of cellulose into ice, which prevents the propagation of cracks [2].

Fibre reinforced thermoplastic moulding compounds have been produced now for about 30 years. They have been manufactured using extrusion compounding processes and have achieved a good range of reinforcement properties. However, performance is limited by the fact that the fibres are broken down to sub millimetre lengths in the extruder.

More recently, this fibre length deficiency has been tackled by developments in pultrusion technology, whereby continuous fibres are wetted by molten polymer in impregnation equipment. The continuous laces are chopped into practical lengths, typically 10mm, for feeding into injection moulding machines. The ICI 'Verton' [3] range of long fibre reinforced thermoplastic moulding compounds is an example of this type. The reinforcing fibres are the same length as the granules, and

even after moulding into the final component, 'Verton' achieves an approximate 10 fold increase in length compared to short fibre products.

It is this increase in fibre length that gives 'Verton' its enhanced mechanical properties and allows it to compete successfully in the replacement of metals and other thermoplastics.

It is well established [4,5] that environmental effects such as moisture and temperature can change the performance of the composite, often with a loss of mechanical properties.

The aim of this thesis is to quantify the degree of change, in the mechanical and physical properties with moisture uptake. This knowledge is essential for efficient plastics design. The mechanical properties investigated are :

- (i) Tensile Strength
- (ii) Flexural Strength
- (iii) Flexural Modulus and
- (iv) Impact Strength (Notched and Un-notched)

The physical properties measured are the change in sample length, width and thickness as a function of moisture content.

The materials studied are 'Verton' :

- (i) RF 700-07 (Natural) - 35% Glass/Nylon 66
- (ii) RF 700-07 (Black) - 35% Glass/Nylon 66
- (iii) RF 700-10 (Natural) - 50% Glass/Nylon 66
- (iv) RF 700-10 (Black) - 50% Glass/Nylon 66
- (v) RF 700-12 (Natural) - 60% Glass/Nylon 66
- (vi) RF 700-12 (Black) - 60% Glass/Nylon 66

As a comparison, 'Maranyl' A100 (Natural) - un-reinforced Nylon 66 is also investigated, ('Maranyl' is an ICI trade mark for it's range of un-reinforced and short fibre reinforced Nylon compounds).

As shown in Table 1.1 all un-reinforced thermoplastics can be classified in engineering terms, as low strength materials [6]. However, their strength to weight ratio or specific strength, is more impressive because of the low density exhibited by plastics. For example un-reinforced Nylon 66 with a yield strength of 80 MPa and a density of 1.14 tonnes/m<sup>3</sup> has a strength to weight ratio equal to that of a medium carbon alloy steel.

The addition of certain "fillers" to thermoplastics can improve many properties of the base polymer [7], whilst retaining the ability to be shaped by processes such as injection moulding. Hence, with careful choice of filler type and quantity, the material can be tailored to give an optimum balance between cost and performance.

	MPa		MPa
PPO	66-85	PVC	50-60
Polyethersulphone	85	GP polystyrene	40-50
Acrylic	60-80	ABS	25-50
SAN	75	Polypropylene	25-35
Polyacetal	60-70	HD polyethylene	25-30
Polysulphone	70	Toughened Polystyrene	30
Nylon 66 (dry)	70	PTFE	20
Nylon 6 (dry)	60	LD polyethylene	8-10
Polycarbonate	60	PMMA	40-60

Table 1.1 SHORT-TERM TENSILE STRENGTHS OF UNFILLED THERMOPLASTICS

Table 1.2 shows the strength and stiffness of some commercially available fibres and composites [8].

FIBRE	TENSILE STRENGTH (MPa)	TENSILE MODULUS (GPa)	DENSITY TONNES/m <sup>3</sup>
E-Glass (specially prepared)	3000	70	2.54
E-Glass (ordinary)	1500-2000	70	2.50
S-Glass (specially prepared)	4300	80	2.49
S-Glass (ordinary)	2600	86	2.52
Carbon-fibre I (high modulus)	2000-2500	400	2.00
Carbon-fibre II (high modulus)	3000-3500	200	1.70
Carbon-fibre Type A	2400	220	1.90
Carbon (Mesophase pitch)	2000-2400	380	2.02
Boron	3500	420	2.65
Kevlar 49	2700	130	1.45
Kevlar 29	2700	60	1.44
Polyester matrix	20-40	1-3	1.4-2.2
Epoxy matrix	40-90	1-4	1.6-1.9
High Carbon Steel	2800	210	7.8
GFRP chopped mat 30% glass	110	10	1.5
GFRP woven cloth 50% glass	240	14	1.7
GFRP Unidirectional 60% glass	550	30	1.6
GFRP Unidirectional 80% glass	1200	50	2.0
CFRP Unidirectional HT fibre	1600	129	1.5
CFRP Unidirectional HM fibre	1280	192	1.6

Table 1.2 MECHANICAL PROPERTIES OF VARIOUS FIBRES AND COMPOSITES

While composite materials owe their unique balance of properties to the combination of matrix and reinforcement, it is the reinforcement system that is primarily responsible for structural properties such as strength and stiffness. Whether particulate filler, microsphere or fibre, the reinforcement is the key to optimising cost and performance for a given application.

Minerals, conductive flakes, whiskers and microspheres all play an important role as constituents in many composite systems. However, fibre reinforcement dominates this field in terms of volume, properties and design versatility.

Glass, carbon/graphite, ceramic, aramid and a wide range of other organic fibres are now established for use in high performance applications. The most widely used reinforcement is glass fibre which accounts for some 90% of the reinforced plastics market. First commercialised in 1939 by Owen - Corning, glass fibre for composite use gained acceptance during World War II because of its light weight, high strength and non-metallic characteristics.

The two most common reinforcement grades of glass fibre are "E" (for electrical) and "S" (for high strength) grades. E-glass provides a high strength to weight ratio (roughly twice that of steel), good fatigue resistance, outstanding

dielectric properties, retention of 50% of its tensile strength up to 350°C and excellent resistance to chemical/environmental corrosion.

E-glass is available in the form of continuous filament, chopped staple and as random fibre mats. All suitable for a variety of methods of polymer impregnation and composite fabrication. These fibres are further tailored for use in composites by surface treatment with specific coupling agents such as Silane, that make them especially compatible with particular polymer systems without changing the basic character of the glass fibre.

Use of coupling agents (or sizings) improves the overall mechanical properties of the composite, especially in areas of moisture/chemical resistance and interlaminar shear strength.

## CHAPTER 2.0

### FIBRE REINFORCEMENT OF THERMOPLASTICS.

The two most common types of fibre reinforced thermoplastics are :

- (i) Continuous Fibre Reinforced Thermoplastics (CFRTPs),  
and
- (ii) Discontinuous Fibre Reinforced Thermoplastics  
(These include Short and Long Fibre products -  
SFRTTPs and LFRTTPs).

#### 2.1 Continuous Fibre Reinforced Thermoplastics (CFRTPs).

The simplest form of continuous fibre reinforcement is filament winding (Figure 2.1). The process simply consists of winding continuous filament over a suitably shaped mandrel. The filament are in bundles called rovings that usually consist of thousands of individual fibres. The fibres are impregnated with resin just before they go onto a mandrel. This technique enables very high strengths to be achieved and is particularly suited to pressure vessels, where reinforcement in the highly



stressed hoop direction is important. The main limitation of the process is that it can only be used for products that have some degree of symmetry about a central axis.

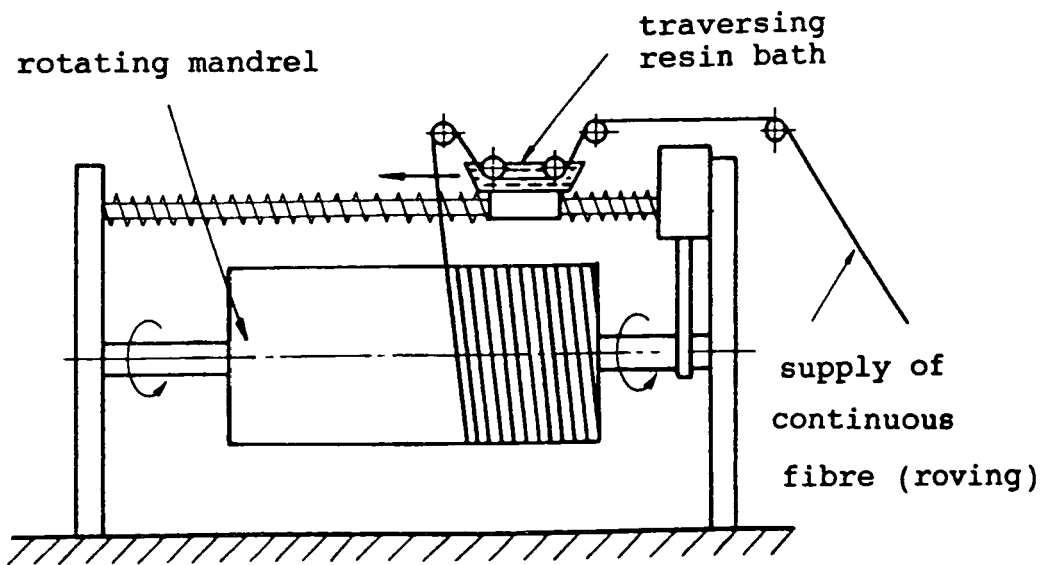

Figure 2.1 FILAMENT WINDING

Another form of continuous fibre reinforcement is the manufacture of prepegs which can be in the form of tapes or sheets with woven or straight fibres. This kind of fibre reinforcement allows total control of fibre alignment and orientation to maximize its contribution to strength and stiffness. They are commonly used in the aerospace industry because of their very high strength and stiffness to weight ratios.

Since the fibres run continuously throughout the length of the component, load is applied directly to them so that the stress is constant over the whole length of the fibre. Little or no load is transferred by the matrix, so the principle purpose of the matrix is to bind the fibres together into a composite.

### 2.1.1 Analysis of CFRTPs.

The most effective method for improving the strength and stiffness of thermoplastics is to reinforce them with unidirectional continuous fibres [9].

#### Properties In The Longitudinal Direction.

Consider a composite with continuously aligned fibres (Figure 2.2).

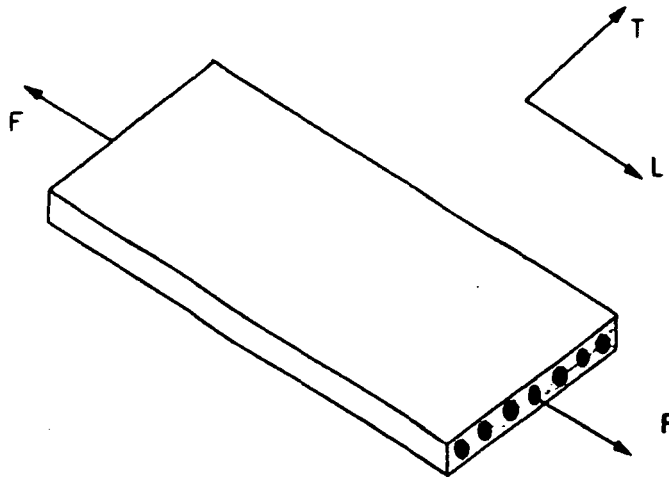

Figure 2.2 UNI-DIRECTIONAL FIBRE COMPOSITE  
SUBJECTED TO AXIAL FORCE

If the moduli of the matrix and fibres are  $E_m$  and  $E_f$ , respectively, then the modulus of the composite may be determined as follows.

#### Equilibrium Equation

The applied force on the composite,  $F_{cl}$ , is shared by the fibres and the matrix. Hence

$$F_{cl} = F_f + F_m \quad (2.1)$$

where L refers to longitudinal (fibre) direction.

#### Geometry of Deformation Equation

The strain,  $\epsilon$ , is the same in the fibres and matrix and is equal to the strain in the composite.

$$\epsilon_{cl} = \epsilon_f = \epsilon_m \quad (2.2)$$

#### Stress - Strain Relationships

$$\begin{aligned} \sigma_{cl} &= E_{cl} \epsilon_{cl} \\ \sigma_f &= E_f \epsilon_f \\ \sigma_m &= E_m \epsilon_m \end{aligned} \quad (2.3)$$

Combining equations (2.2) and (2.3)

$$E_{cl}\epsilon_{cl}A_c = E_f\epsilon_f A_f + E_m\epsilon_m A_m$$

and using equation (2.1)

$$E_{cl} = E_f \left( \frac{A_f}{A_c} \right) + E_m \left( \frac{A_m}{A_c} \right)$$

If the fibres have a uniform cross-section, then the area fraction will equal the volume fraction, so

$$E_{cl} = E_f V_f + E_m V_m$$

assuming the composite is void free and  $V_f + V_m = 1$   
then

$$E_{cl} = E_f V_f + E_m (1 - V_f) \quad (2.4)$$

This relationship states that the modulus of a unidirectional fibre composite is proportional to the volume fractions of the materials in the composite, it is known as the rule of mixtures.

It may also be used to determine the density of a composite as well as other properties such as the strength, thermal conductivity and electrical conductivity in the fibre direction.

The stress in the composite may also be predicted by the rule of mixtures as,

$$\sigma_{cl} = \sigma_f V_f + \sigma_m (1 - V_f) \quad (2.5)$$

and

$$\frac{\sigma_{cl}}{\sigma_f} = V_f + \frac{\sigma_m}{\sigma_f} (1 - V_f)$$

Assuming the strains are the same in the matrix and fibres

$$\frac{\sigma_m}{\sigma_f} = \frac{E_m}{E_f}$$

then

$$\frac{\sigma_{cl}}{\sigma_f} = V_f + \frac{E_m}{E_f} (1 - V_f)$$

Under stress - strain tests, uniaxially aligned fibre composites show their behaviour to lie intermediately between that of the fibres and that of the matrix. For the strength of the composite,  $\sigma_{cu}$ , the rule of mixtures has to be modified to relate to the matrix stress,  $\sigma'_m$ , at the fracture strain of the fibres rather than the ultimate tensile strength,  $\sigma_{mu}$ , for the matrix. This is because with brittle fibres, failure of the composite will occur when the fibres reach their fracture strain. At this point, the matrix is subjected to the full applied load, which it is unable to sustain.

The ultimate strength of the composite may be predicted by the rule of mixtures as,

$$\sigma_{cu} = \sigma_{fu} V_f + \sigma'_m (1 - V_f) \quad (2.6)$$

This equation only applies when the volume fraction is greater than the critical value,  $V_{crit}$ . From Figure 2.3 this is defined as

$$\sigma_{m_u} (1 - V_{crit}) = \sigma_{fu} V_{crit} + \sigma'_m (1 - V_{crit})$$

$$V_{crit} = \frac{\sigma_{m_u} - \sigma'_m}{\sigma_{fu} + (\sigma_{m_u} - \sigma'_m)} \quad (2.7)$$

It can also be seen that the strengthening effect of the fibres is only observed when the volume fraction is greater than a certain value  $V_1$  (i.e.  $\sigma_{cu} > \sigma_{m_u}$ ). From Figure 2.3 the value of  $V_1$  is obtained from

$$\sigma_{m_u} = \sigma_{fu} V_1 + \sigma'_m (1 - V_1)$$

$$V_1 = \frac{\sigma_{m_u} - \sigma'_m}{\sigma_{fu} - \sigma'_m} \quad (2.8)$$

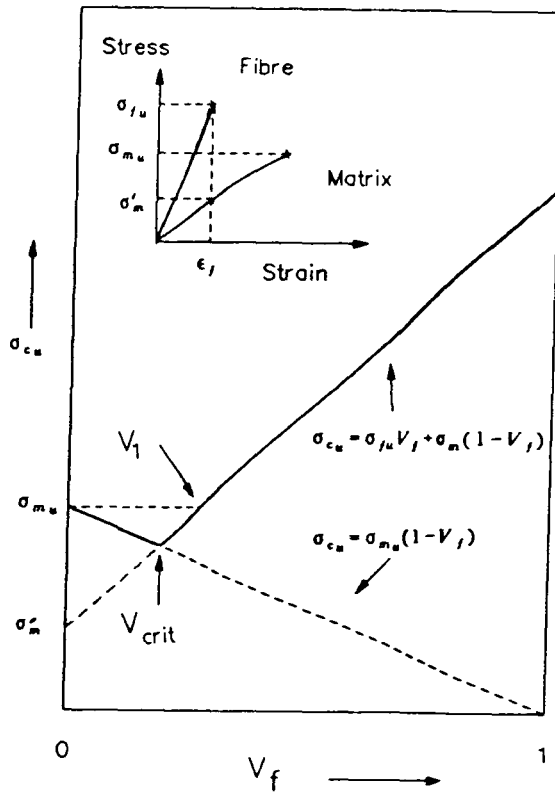

Figure 2.3 EFFECT OF VOLUME FRACTION - ON STRENGTH

In this case the fibres fail first and at low fibre volume fractions,  $V_f$ , the load is transferred to the matrix which can withstand it, but the cross-section is reduced by  $V_f$ , and therefore the composite is weaker than if the fibres were absent. Although initially, the strengthening is negative the stiffening will be positive:

$$\sigma_{cu} = \sigma_{m_u}(1 - V_f) \quad (2.9)$$



In the case where  $\epsilon_f > \epsilon_m$ , at low  $V_f$ , the matrix fails first and the load thrown onto the fibres cannot be sustained and the whole composite fails. The strength of the composite is,

$$\sigma_{cu} = \sigma'_f V_f + \sigma_{m_u} (1 - V_f) \quad (2.10)$$

At High  $V_f$ , the fibres can carry the load following failure of the matrix and the composite can continue to be loaded, (Figure 2.4) it's strength being determined by the fibres,

$$\sigma_{cu} = \sigma_{f_u} V_f \quad (2.11)$$

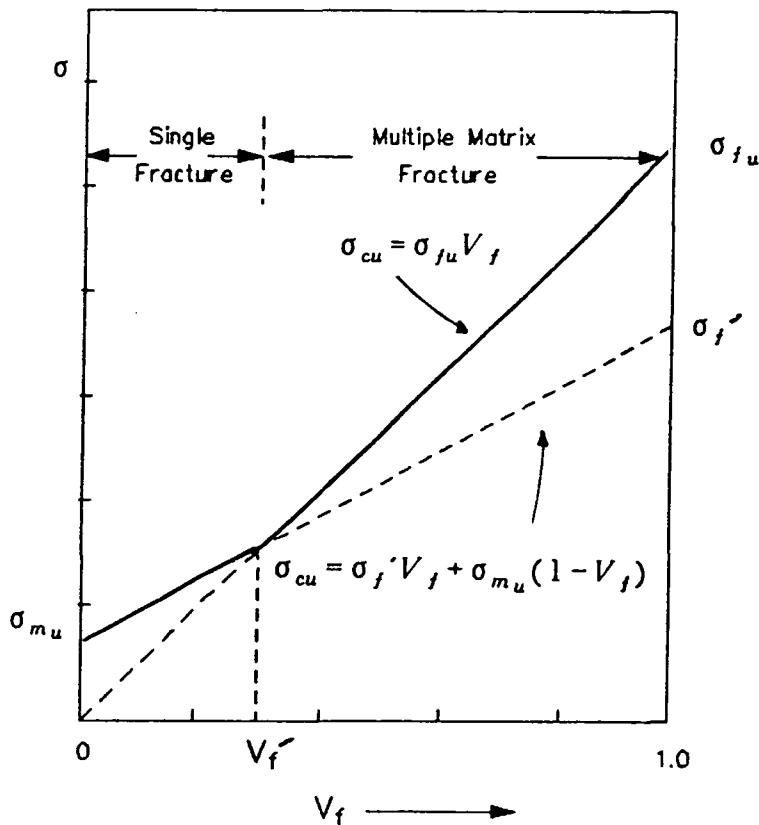

Figure 2.4 EFFECT OF VOLUME FRACTION ON STRENGTH

### Properties In The Transverse Direction

The properties of unidirectional fibre composites are not as good in the transverse direction as in the longitudinal direction. However, as a material in service it is likely to be subjected to stresses and strains in all directions, so it is important that properties in both directions are carefully considered.

The transverse modulus,  $E_{CT}$ , may be determined in a manner similar to that described for the longitudinal modulus.

Consider a unidirectional fibre composite subjected to a transverse force,  $F_{CT}$ , in the direction perpendicular to the fibre axis.

### Equilibrium Condition

Assume that the stress in the fibre is equal to the stress in the matrix, so

$$\sigma_{CT} = \sigma_f = \sigma_m \quad (2.12)$$

### Geometry of deformation equation

The total transverse deformation will be the sum of the deformations in the matrix,  $\delta_m$ , and fibres,  $\delta_f$  :

$$\begin{aligned}\delta_{cT} &= \delta_f + \delta_m \\ \epsilon_{cT} h_c &= \epsilon_f h_f + \epsilon_m h_m\end{aligned}\quad (2.13)$$

### Stress - Strain Relations

$$\begin{aligned}\sigma_{cT} &= E_{cT} \epsilon_{cT} \\ \sigma_f &= E_f \epsilon_f \\ \sigma_m &= E_m \epsilon_m\end{aligned}\quad (2.14)$$

Then from (2.13) and (2.14) it can be written

$$\frac{\sigma_{cT}}{E_{cT}} = \frac{\sigma_f h_f}{E_f h_c} + \frac{\sigma_m h_m}{E_m h_c}$$

Using equation (2.12) and because the thickness ratios will be equal to the corresponding volume fractions :

$$\frac{1}{E_{cT}} = \frac{V_f}{E_f} + \frac{V_m}{E_m}\quad (2.15)$$

$$E_{cT} = \frac{E_f E_m}{V_f E_m + V_m E_f}\quad (2.16)$$

Figure 2.5 shows how the longitudinal and transverse moduli vary with volume fraction for a unidirectional fibre composite.

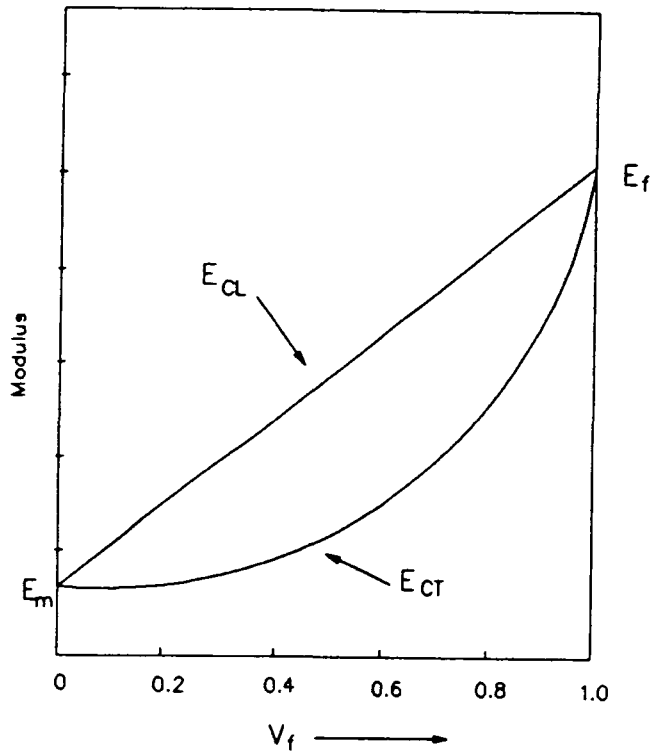

Figure 2.5 COMPOSITE MODULI AS A FUNCTION OF VOLUME FRACTION

Figure 2.6 illustrates the more general situation regarding strength and stiffness at any angle in composites of this type.

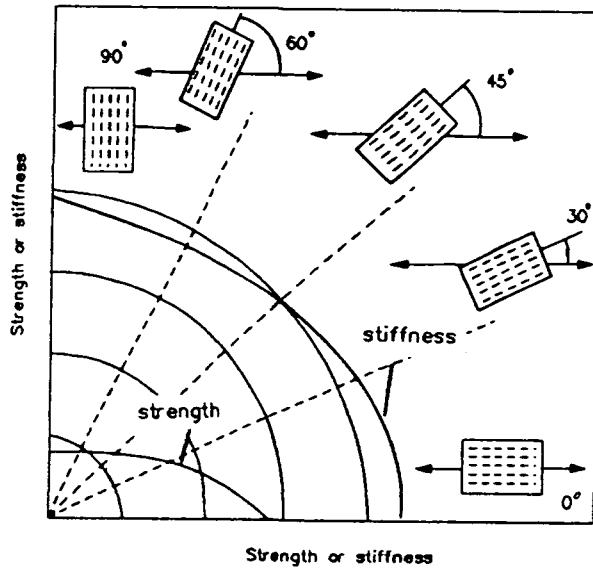

Figure 2.6 DIRECTIONAL VARIATION OF STRENGTH AND STIFFNESS IN CONTINUOUS FIBRE COMPOSITES

In practical terms this analysis contains inaccuracies, particularly regarding the assumption that the stresses in the fibre and matrix are equal. Generally the fibres are dispersed randomly at any cross section of the composite and so the applied force will be shared by the fibres and matrix, but not necessarily equally. Other inaccuracies also arise

due to the mismatch of the Poisson's ratios for the fibres and matrix. Equations to take these factors into account have been established.

One of these is the Halpin-Tsai equation [10] :

$$E_{cT} = E_m \left( \frac{1 + 2\beta V_f}{1 - \beta V_f} \right) \quad (2.17)$$

where

$$\beta = \frac{(E_f/E_m) - 1}{(E_f/E_m) + 2}$$

Another alternative is the Brintrup equation [10], which, gives  $E_{cT}$  as

$$E_{cT} = \frac{E'_m E_f}{E_f(1 - V_f) + V_f E'_m} \quad (2.18)$$

where

$$E'_m = E_m / (1 - \nu_m^2)$$

The transverse strength of unidirectional fibre composites is generally less than that of the matrix,  $\sigma_{m_u}$ . The reason is that the fibres, rather than reinforcing the matrix, tend to act as stress concentrators and so the matrix strength is reduced. The properties of uni-directional fibre composites are highly anisotropic and therefore, it is better to build

up laminates consisting of a number of continuously aligned fibres - plys, in the desired direction. This would provide a better material to resist multi-axial stresses. This process is very labour intensive and can therefore be expensive. Materials such as long fibre reinforced thermoplastics are said to "bridge the gap" between the versatility of short fibre products and the mechanical performance of uni - directional fibre composites.

## 2.2 Discontinuous Fibre Reinforced Thermoplastics - (SFRTPs and LFRTPs).

### 2.2.1 SFRTPs

The easiest form of short fibre reinforcement is achieved by simply mixing randomly chopped strands of fibre (3 - 4mm in length) such as glass or carbon with molten polymer. The mixture is then extruded to form granules, which can be subsequently injection moulded into components.

The properties of SFRTPs are not as good as those of laid up continuous fibres, but they can be orientated to a certain extent, to maximize their contribution to strength and stiffness.

The flow of fibre filled melt into the mould causes complex fibre orientation distributions, [11,12,13] in the injection moulded component.

Generally, the fibre orientation pattern changes through the thickness of the moulding at any chosen place, and this pattern itself varies with position in the moulding. This results in non-homogeneity and anisotropy of mechanical properties making design for stiffness and strength with SFTRPs uncertain [14].



### 2.2.2 LFRTPs

It has been well established [15,16] that increasing the fibre length in SFRTPs, would improve mechanical properties, including strength, stiffness and impact resistance.

Until the production of 'Verton' LFRTPs, there had been little success in commercially producing thermoplastic materials reinforced with long fibres (10-12mm). The main problems encountered were that of poor impregnation of the polymer melt and fibre breakage during impregnation and injection moulding.

The 'Verton' range of materials are successfully manufactured employing a patented pultrusion technique [17], that achieves maximum wetting of individual fibres with polymer, with reduced fibre damage (Figure 2.7). Fibres are aligned in a parallel array and extend unbroken through the entire length of the chopped LFRTP pellets.

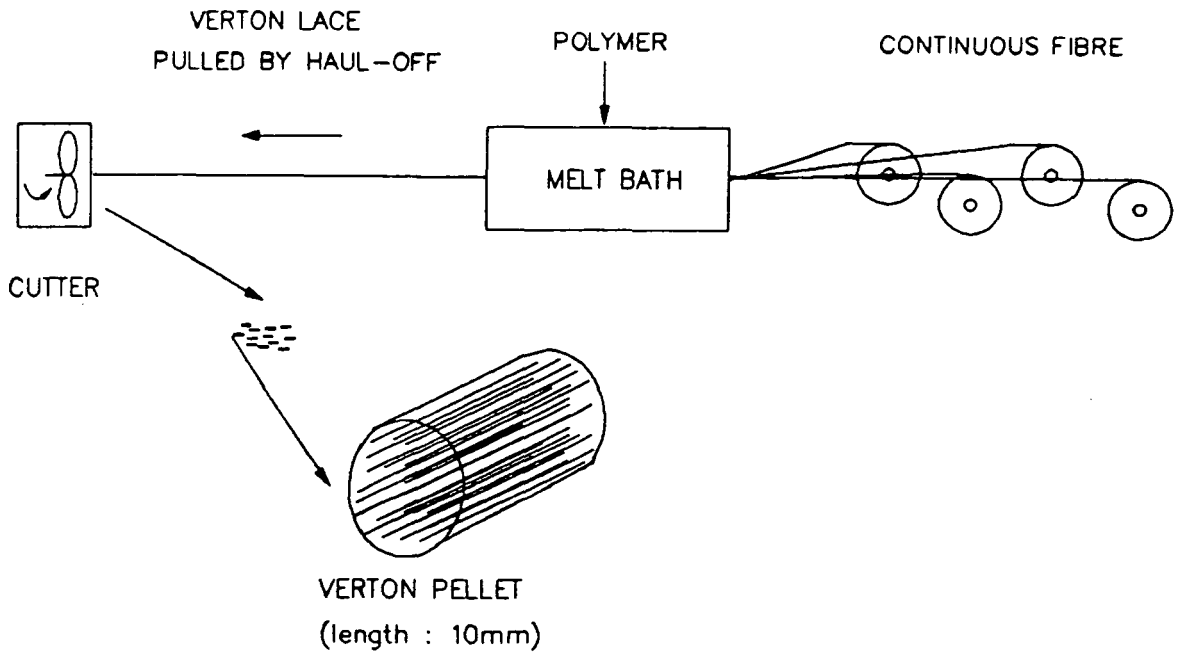

Figure 2.7 MANUFACTURE OF VERTON - A PULTRUSION PROCESS

When moulded some fibre breakage occurs, but the wetted fibres are somewhat protected, so the fibre lengths in the moulded article are some ten times greater than in short fibre composites. It is this substantial increase in fibre length that improves the mechanical properties such as strength, stiffness and impact resistance (Table 2.1).

	A100 U/F	A190 33% SF	RF 700-06 30% LF	A690 50% SF	RF 700-10 50% LF	RF 700-12 60% LF
TENSILE STRENGTH (MPa)	85	180	195	200	230	250
FLEXURAL STRENGTH (MPa)	105	250	320	320	400	400
FLEXURAL MODULUS (GPa)	2.8	8.7	10.0	12.0	15.8	19.0
CHARPY IMPACT STRENGTH (Ntchd.) (kJ/m <sup>2</sup> )	6	9	18	11	27	32

Table 2.1 MECHANICAL PROPERTIES OF SHORT AND LONG  
GLASS FIBRE REINFORCED NYLON 66 MATERIALS

'Maranyl' A100 - Unfilled Nylon 66

'Maranyl' A190 - 33% Short Glass Fibre Reinforced Nylon 66

'Maranyl' A690 - 50% Short Glass Fibre Reinforced Nylon 66

'Verton' RF 700-06 - 30% Long Glass Fibre Reinforced Nylon 66

'Verton' RF 700-10 - 50% Long Glass Fibre Reinforced Nylon 66

'Verton' RF 700-12 - 60% Long Glass Fibre Reinforced Nylon 66

Note: For 'Verton' grades, multiplying the last two digits  
by 5 indicates the percentage weight fraction of glass  
fibre in the compound.

### 2.3 Analysis Of Discontinuous Fibre Composites

#### Elastic fibre - matrix stress transfer

The presence of fibres restrain the deformation of the matrix as shown in Figure 2.8. The external loading applied through the matrix is transferred to the fibres by shear at the fibre/matrix interface.

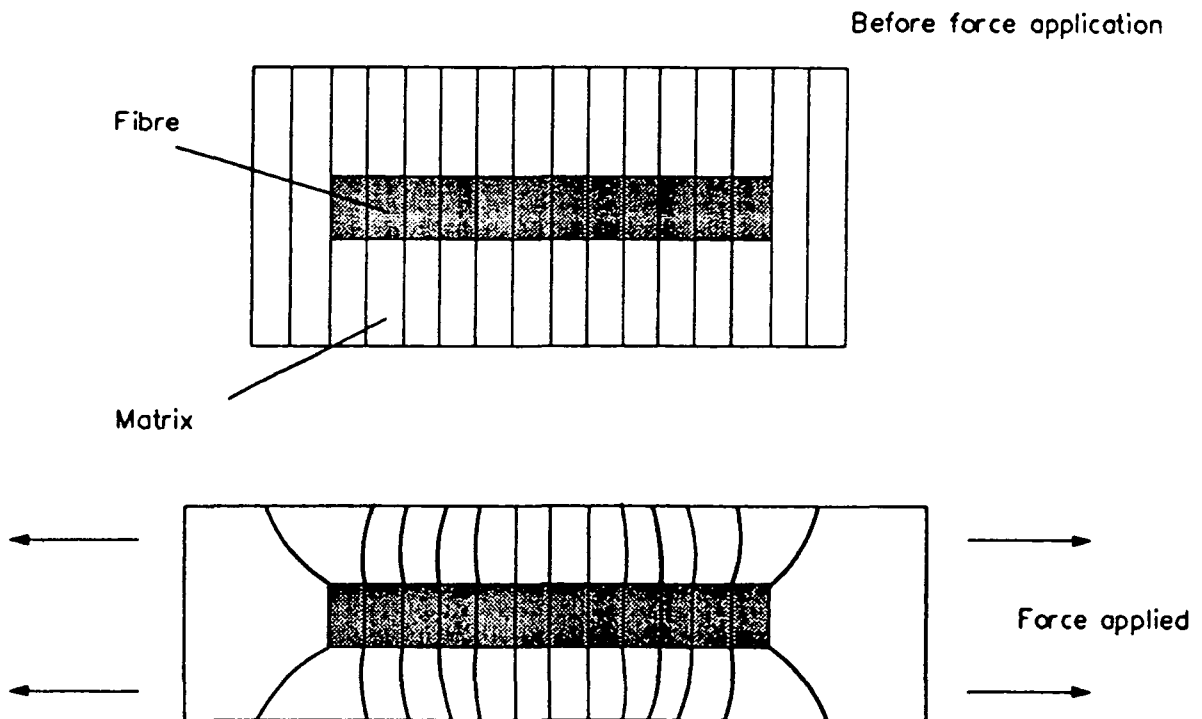

Figure 2.8 EFFECT OF FIBRE ON MATRIX DEFORMATION

Elastic fibre - matrix stress transfer was first considered by Cox in 1952 [18].

Two assumptions were made in this theory :

- (i) a perfect bond exists between the fibre and the matrix,
- (ii) the lateral contraction of the fibre and matrix are equal.

This effectively means that there is no load transfer through the ends of the fibre.

The resultant stress distributions in the fibre and matrix are complex. In short fibres the tensile stress increases from zero at the ends to a value  $(\sigma_f)_{\max}$  which it would have if the fibre was continuous. This is shown in Figure 2.9. As shown previously  $(\sigma_f)_{\max}$  may be determined from

$$\frac{(\sigma_f)_{\max}}{E_f} = \frac{\sigma_c}{E_{cl}} \quad (2.19)$$

where  $\sigma_c$  is the stress applied to the composite and  $E_{cl}$  may be determined from the rule of mixtures.

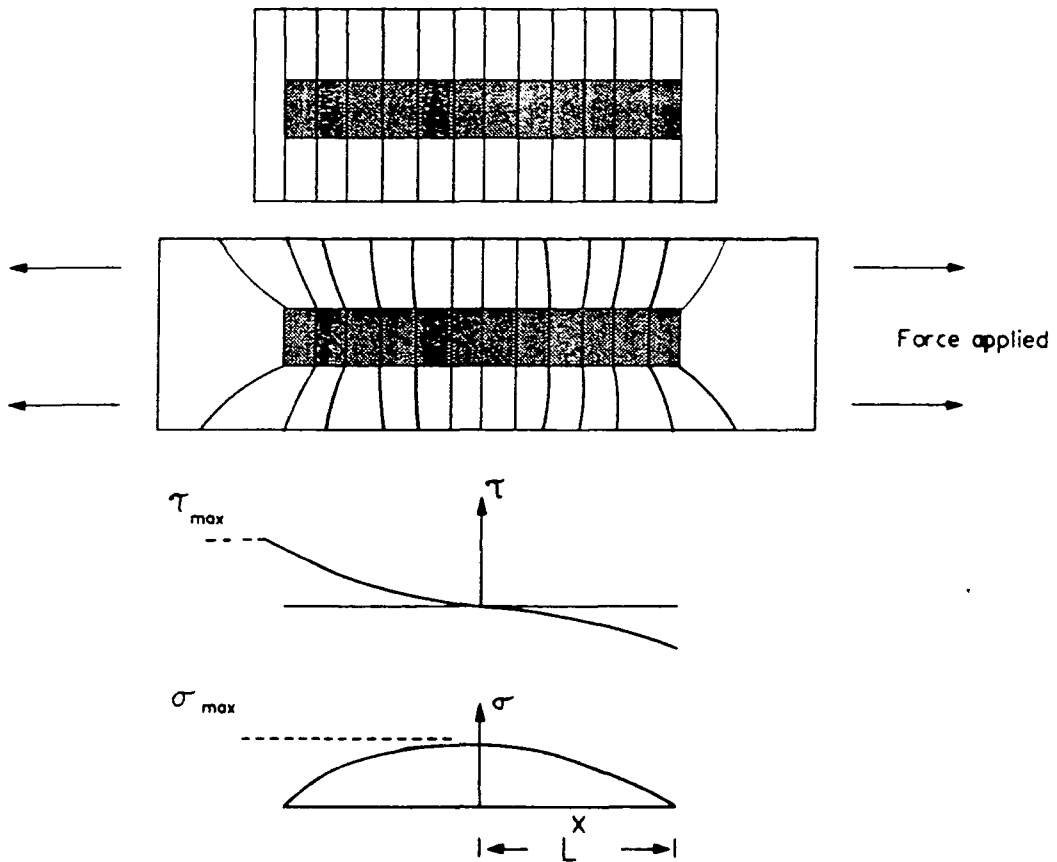

Figure 2.9 ELASTIC FIBRE - MATRIX STRESS TRANSFER

### Stress transfer by slip

The stress distribution in short fibres is often simplified to the form shown in Figure 2.10. The response of a straight fibre which is perfectly elastic up to fracture, embedded in a perfectly elastic matrix (Figure 2.10 (a)) subjected to a stress, shown in Figure 2.10 (b) for the case where the fibre is stiffer than the matrix. The resulting normal stress ( $\sigma$ ) and shear stress ( $\tau$ ) distribution is illustrated in Figure 2.10 (c) assuming that stress is transferred from the matrix to the fibre by slip.

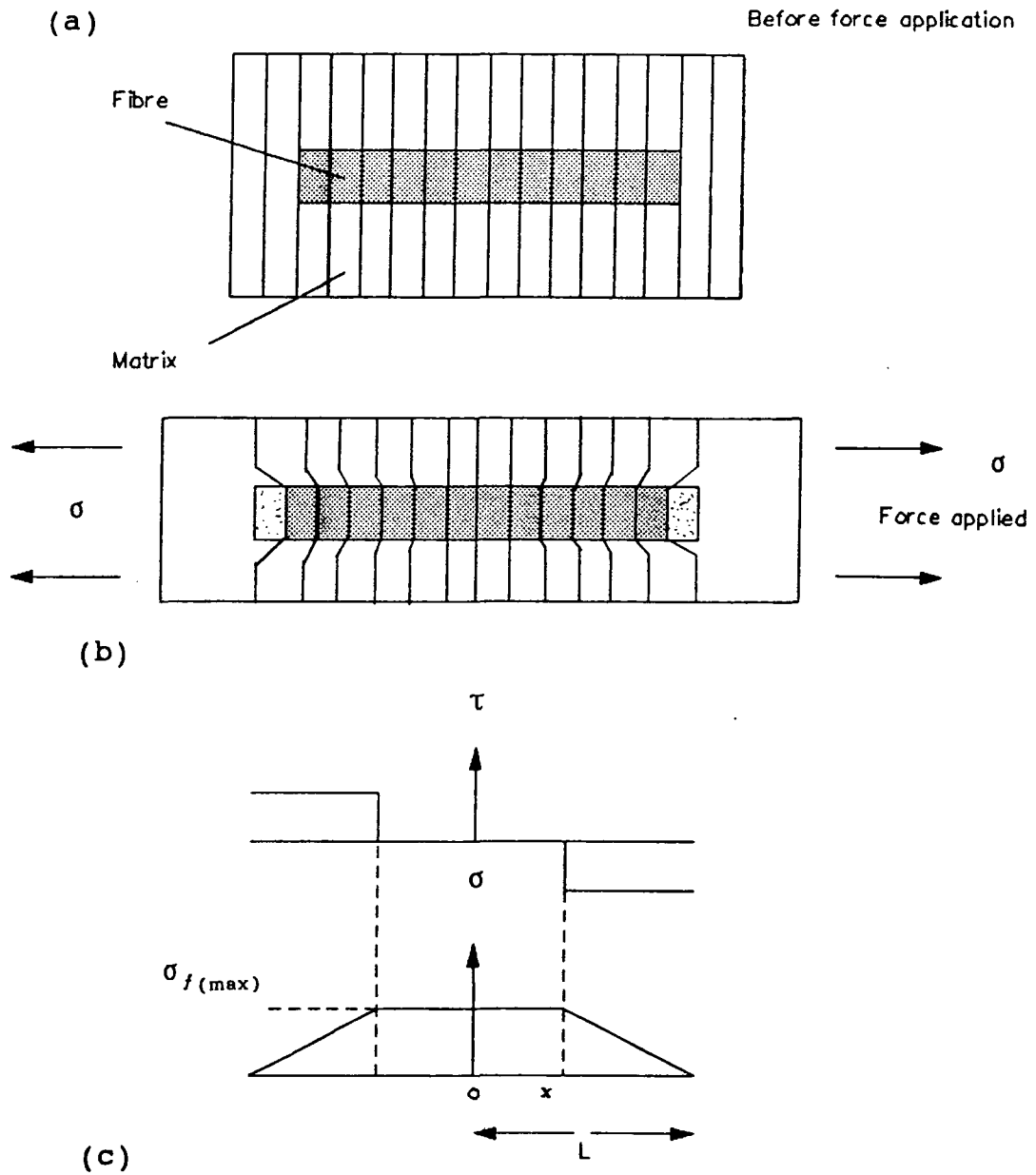

Figure 2.10 STRESS TRANSFER BY SLIP IN SHORT FIBRE COMPOSITES

Within the end region of the fibre the normal stress in the fibre will change from  $\sigma_f$  to  $\sigma_f + d\sigma_f$ , along an element of length  $dx$  as shown in Figure 2.11. For longitudinal equilibrium the surface shear forces must balance the tensile forces in the fibre. For a fibre of radius  $r$  :

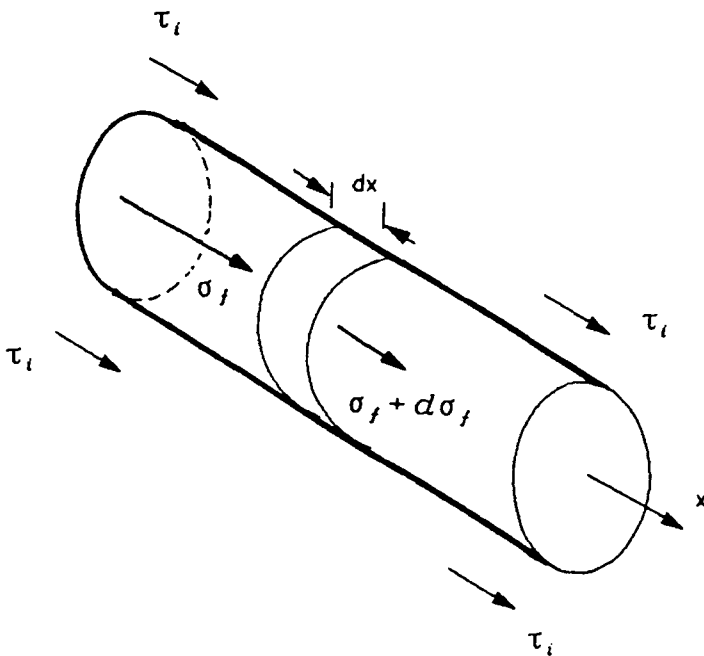

Figure 2.11 SHORT LENGTH OF FIBRE NEAR END

$$\pi r^2 d\sigma_f = -2\pi r dx \tau_i \quad (2.20)$$

$$\frac{d\sigma_f}{dx} = \frac{-2\tau_i}{r} \quad (2.21)$$



If  $\sigma_f = 0$  at  $x = L$  this integrates to :

$$\sigma_f = \frac{2\tau_i}{r}(L-x) \quad (2.22)$$

where  $\tau_i$  is the shear strength of the fibre - matrix interface.

The average fibre stress  $\bar{\sigma}_f$ , is obtained by dividing the area under the stress-fibre length graph by the fibre length, and the longer the fibre length, the less significant are the end effects. In the central region :

$$\sigma_{f(\max)} = \frac{2\tau_i}{r}L \quad (2.23)$$

where  $L/r$  is the fibre aspect ratio.

It can be seen from Figure 2.9 that there is a minimum fibre length which will permit the fibre to achieve its full load bearing potential. The minimum fibre length in which the maximum fibre stress,  $(\sigma_f)_{\max}$ , can be achieved is called the load transfer length,  $l_t$ . The value of  $l_t$  may be determined from the following force balance,

force transmitted by shear at interface :

$$\tau_y \left( \frac{l}{2} \right) \pi d$$

force exerted by fibre :

$$\sigma_f \left( \pi \frac{d^2}{4} \right)$$

hence,

$$l_t = \frac{(\sigma_f)_{\max} d}{2\tau_y} \quad (2.24)$$

where,  $\tau_y$  is the shear strength of the fibre - matrix interface.

The maximum value of the  $l_t$  will occur when  $(\sigma_f)_{\max}$  reaches the tensile strength of the fibre,  $\sigma_{fu}$ , and this is defined as the critical fibre length,  $l_c$ .

$$l_c = \frac{\sigma_{fu} d}{2\tau_y} \quad (2.25)$$

It may be seen from Figure 2.9 that due to the ineffective end portions of short fibres, the average stress in the fibre will be less than in a continuous fibre. The exact value of

the average stress will depend on the length of the fibres. Using the stress distributions shown in Figure 2.9 the fibre stresses may be analysed as follows :

$$F_1 = \sigma_f \left( \frac{\pi d^2}{4} \right)$$

$$F_2 = \left[ \sigma_f + \left( \frac{d\sigma_f}{dx} \right) dx \right] \frac{\pi d^2}{4}$$

$$F_3 = (\tau_y \pi d) dx$$

Now, for equilibrium of forces  $F_1 = F_2 + F_3$

$$\sigma_f \left( \frac{\pi d^2}{4} \right) = \left( \sigma_f + \frac{d\sigma_f}{dx} dx \right) \left( \frac{\pi d^2}{4} \right) + (\tau_y \pi d) dx$$

$$\left( \frac{d}{4} \right) d\sigma_f = -\tau_y dx$$

Integrating this equation gives

$$\left( \frac{d}{4} \right) \int_0^{\sigma_f} d\sigma_f = - \int_{\frac{1}{2}l}^x \tau_y dx$$

$$\sigma_f = 4\tau_y \frac{\left( \frac{1}{2}l - x \right)}{d} \quad (2.26)$$

This is the general equation for the stress in the fibres but

there are three cases to consider, as shown in Figure 2.11.

(i) Fibre length less than  $l_t$

In this case the peak value of stress occurs at  $x = 0$ , so from equation 2.26

$$\sigma_f = \frac{2\tau_y l}{d}$$

The average fibre stress,  $\bar{\sigma}_f$ , is obtained by dividing the area under the stress-fibre length graph by the fibre length.

$$\bar{\sigma}_f = \frac{1}{2} l \frac{\left(\frac{2\tau_y l}{d}\right)}{l} = \frac{\tau_y l}{d}$$

Now from (2.5)

$$\sigma_c = \left(\frac{\tau_y l}{d}\right) V_f + \sigma'_m (1 - V_f) \quad (2.27)$$

(ii) Fibre length equal to  $l_t$

In this case the peak stress is equal to the maximum fibre stress.

So at  $x = 0$

$$\sigma_f = (\sigma_f)_{\max} = \frac{2\tau_y l_t}{d} \quad (2.28)$$

Average fibre stress,

$$\bar{\sigma}_f = \frac{\frac{1}{2} \left( \frac{2\tau_y l_t}{d} \right) l_t}{l_t}$$

$$\bar{\sigma}_f = \frac{\tau_y l_t}{d}$$

So from 2.5

$$\sigma_c = \left( \frac{\tau_y l_t}{d} \right) V_f + \sigma'_m (1 - V_f) \quad (2.29)$$

(iii) Fibre length greater than  $l_t$

(a) For  $\frac{1}{2}l > x > \frac{1}{2}(l - l_t)$

$$\sigma_f = \frac{4\tau_y}{d} \left( \frac{1}{2}l - x \right)$$

(b) For  $\frac{1}{2}(l - l_t) > x > 0$

$\sigma_f = \text{constant} = (\sigma_f)_{\max}$

$$\sigma_f = \frac{2\tau_y l_t}{d}$$

Also, as before, the average fibre stress may be obtained from

$$\bar{\sigma}_f = \frac{[(\sigma_{f \max})](l - l_t) + [(\sigma_{f \max})] \frac{1}{2} l_t}{l} = [(\sigma_{f \max})] \left( 1 - \frac{l_t}{2l} \right)$$

So from 2.5

$$\sigma_c = V_f(\sigma_{f, \max}) \left(1 - \frac{l_t}{2l}\right) + \sigma' m(1 - V_f) \quad (2.30)$$

In order to get the average fibre stress as close as possible to the maximum fibre stress, the fibres need to be considerably longer than the critical length. At the critical length the average fibre stress is only half of the value achieved in continuous fibres.

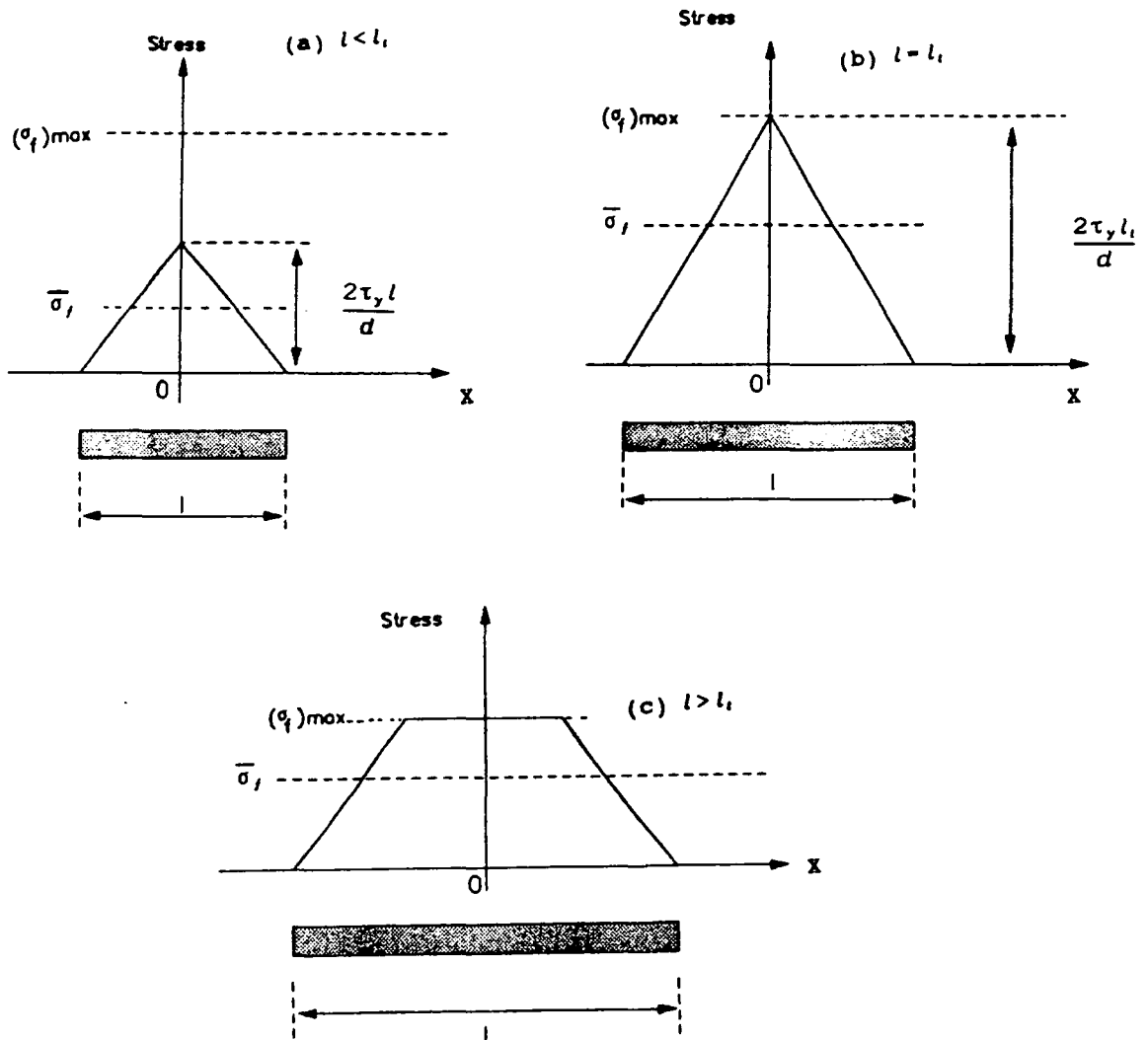

Figure 2.11 STRESS VARIATIONS IN SHORT FIBRES

The load transfer length,  $l_t$ , and the critical fibre length,  $l_c$ , in 'Verdon' mouldings can be approximated as follows,

assume for 'Verdon' RF 700-10 (50% glass/Nylon 66) :

Volume fraction of fibres,  $V_f = 0.4$

Tensile strength of fibres,  $\sigma_{fu} = 2 \text{ GPa}$

Tensile modulus of fibres,  $E_f = 75 \text{ GPa}$

Diameter of fibres,  $d = 17 \mu\text{m}$

Design stress,  $\sigma_c = 100 \text{ MPa}$

Interfacial shear strength for glass/Nylon,  $\tau_y = 0.1 \times (\sigma_f)_{\max}$ , [19].

Then

$$E_{cl} = E_f V_f + E_m V_m$$

$$E_{cl} = 75(0.4) + 2(0.6) = 31.2 \text{ GPa}$$

$$\text{(using 2.19)} \quad (\sigma_f)_{\max} = E_f \left( \frac{\sigma_c}{E_{cl}} \right) = 75 \left( \frac{100}{31.2} \right) = 240 \text{ MPa}$$

$$\text{(using 2.24)} \quad l_t = \frac{(\sigma_f)_{\max} \cdot d}{2\tau_y} = \frac{240(17 \times 10^{-6})}{2 \times 24} = 0.09 \text{ mm}$$

$$\text{(using 2.25)} \quad l_c = \frac{\sigma_{fu} \cdot d}{2\tau_y} = \frac{2000(17 \times 10^{-6})}{2 \times 24} = 0.71 \text{ mm}$$

The average fibre length in moulded components is far greater than  $l_c$ , at 1-2 mm.

In practice, discontinuous fibre mouldings result a complex microstructure of skin-core layers. This often makes the task

of analysing and predicting their performance very difficult. However, the stiffness of such systems may be predicted using the formula,

$$E_{random} = \frac{3}{8}E_L + \frac{5}{8}E_T \quad (2.31)$$

$E_L$  and  $E_T$  refer to the longitudinal and transverse moduli for aligned fibre composites, equations (2.4) and (2.16), respectively.

#### 2.4 Fibre Orientations During Processing

Fibre length, distribution and orientation all have a significant effect on the mechanical and physical properties of discontinuous fibre reinforced thermoplastics [15]. Changes in the fibre orientation occur during the processing of these materials. The changes are related in a complex way to the geometrical properties of the fibres, the viscoelastic properties of the matrix and the shape of the component being moulded.

During processing the polymer melt undergoes both extensional and shear flow. The effect of these flow processes on the fibre orientation is illustrated in Figure 2.12 for simple two dimensional deformation [19].



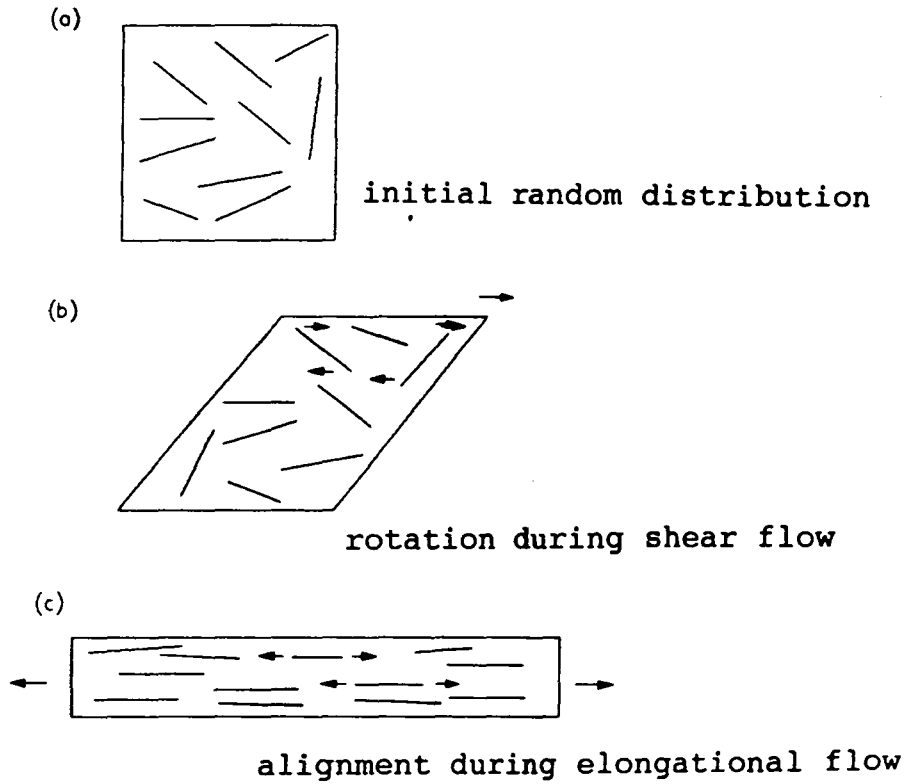

Figure 2.12 CHANGES IN FIBRE ORIENTATION OCCURING DURING FLOW

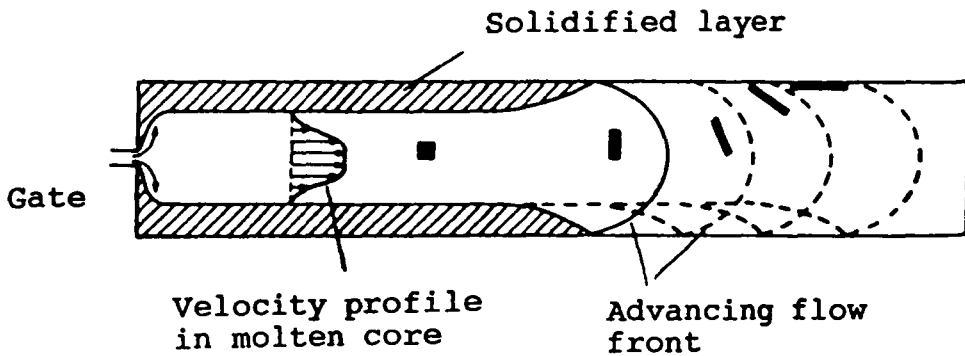

Figure 2.13 MOULD FILLING PROCESS TYPICAL FOR S-LFRTP

The viscosity of the matrix affects the final orientation distribution, mainly through its effect on the way in which the mould fills. This, in turn, determines the distribution of elongational and shear fields.

The mould filling process typical for an injection moulded glass fibre reinforced thermoplastic is shown in figure 2.13 [20]. When the material is injected or extruded through the gate from the barrel of the machine into the mould cavity, it experiences large elongational and compressional fields. The material solidifies at the surface of the mould forming a skin, the mould is then filled by material which flows through the core region to the advancing front, a velocity profile is established within the core. The deformation field in the region of the solidifying skin, involves a large amount of elongational flow as indicated by the change in shape of the initially square fluid element. Solidification of the core occurs after complete mould filling, under completely different flow fields than the skin.

As with short fibre materials, 'Vertron' also exhibits pronounced skin - core microstructure when injection moulded [16] (Figure 2.14). As explained earlier, this arises because the fibres are forced into different alignments at the centre than at the surface of the mould by shear forces, exerted during mould filling. The fibres in the skin layer are oriented in

the direction of the flow as the material fills the cavity, while those in the core are oriented, although to a lesser extent, transverse to the direction of flow. With 'Verton' materials, the long fibres are less mobile in the melt causing a thicker core than in short fibre mouldings.

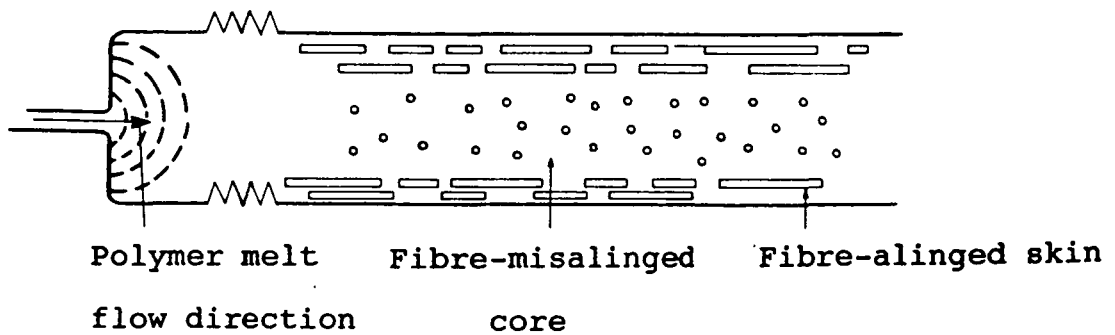

Figure 2.14 ILLUSTRATION TO SHOW SKIN CORE STRUCTURE IN A MOULDING

In a study of 50% short and long glass fibre reinforced Nylon 66 compounds [21], a core thickness of 17% of the total part thickness was measured in the SF RTP where as the core thickness in the LF RTP was significantly higher, measuring 29%. The skin and core layers of 'Verton' materials also differ in fibre length distribution and fibre concentration. In a study of the microstructure of 'Verton' 50% glass/Nylon 66, [16], the core fibres were found to be two and a half times greater in number average length than skin layer fibres. The presence of very long, highly oriented fibres near the part surface contributes to the flexural property and fracture toughness improvements in 'Verton' materials. The concentration of fibres is also higher in the core section of 'Verton' mouldings [21]. A recent study on fibre orientation mechanisms for injection moulding of long fibre composites [22] concluded that, the injection moulding process has a profound effect upon the fibre orientation structure in composites containing finite length fibres. Of the conditions investigated the most pronounced effect upon the skin - core structures was obtained from :

- (i) injection speed,
- (ii) mould and barrel temperatures,
- (iii) back pressure and the
- (iv) holding pressure cycle.

If the fibres are to be used efficiently in moulded components, the injection speed and holding pressure cycle are the two most practical contributors to increasing fibre alignment in the flow direction [23]:

(i) Injection Speed

It is the presence of a velocity gradient (Figure 2.15) which causes fibre alignment. At slow injection speeds, the melt velocity profile is roughly as depicted in figure 2.15 (a). There is a relatively large region (A) in which a velocity gradient exists, with a region of uniform velocity in the core. At high injection speeds (2.15 (b)) however, the region (A') in which the velocity gradient exists is much narrower and at the same time much steeper. The result is that at high injection speeds, mouldings with thin, but highly aligned skins are produced, whilst slow injection speeds give rise to mouldings having thicker, but less well aligned skins. The situation for medium injection speeds falls between these two extremes. There is also evidence that high injection speeds lead to some fibre damage, owing to the greater shear involved.

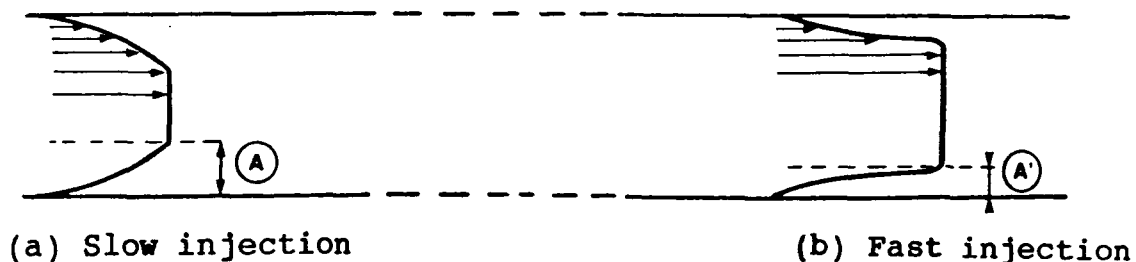

Figure 2.15 EFFECT OF INJECTION SPEED ON THE MICROSTRUCTURE OF MOULDINGS

## (ii) Holding Pressure and Time

Increasing holding pressure results in greater packing of material into the core. This ensures that the problems of shrinkage (voids and sink marks) caused by the polymer solidifying in the mould are accommodated, without affecting the moulding dimensions, however, this can give rise to parts having high moulded in stress. The most significant effect on the microstructure is to enhance fibre alignment in the core itself (Figure 2.16). Material near the cool mould wall freezes sooner and so has a higher viscosity and lower speed under a given pressure, than that near the more fluid core. As holding pressure continues to be applied, it is that material nearer the centre which is most mobile, allowing fibres to rotate and align more before freezing.

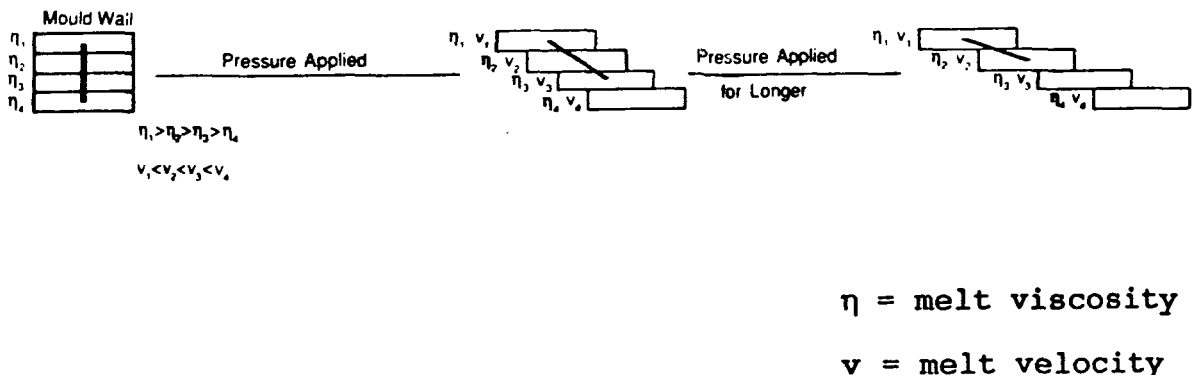

Figure 2.16 FIBRE ALIGNMENT IN THE CORE RESULTING FROM APPLICATION OF HOLDING PRESSURE

## CHAPTER 3.0

### ENVIRONMENTAL EFFECTS

Unlike metallic materials, some polymer composites are highly susceptible to moisture, for example, Polyamides. Temperature resistance is also usually lower. These environmental effects are known to cause significant changes in the mechanical and physical properties of composites. Often the mechanical properties are reduced, although impact strength is an exception. The absorption of moisture causes these materials to swell, the amount of swelling is dependent on the uptake of moisture which it self is governed by many factors, including polymer and fibre type, fibre volume fraction, sample dimensions, soak time and temperature.

### 3.1 Mechanisms of Moisture Absorption in Nylon 66

The molecular structure of Nylon 66 consists of two functional groups (an amino group and an acid group), belonging to different molecules, a diamine and a dicarboxylic acid :

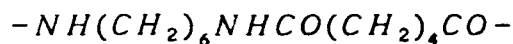

The uptake of water is caused by the amide group  $-NH-CO-$ , which has an affinity for water because of its high polarity. Figure 3.1 illustrates the formation of hydrogen bonding and self association in Nylons after moisture uptake [24].

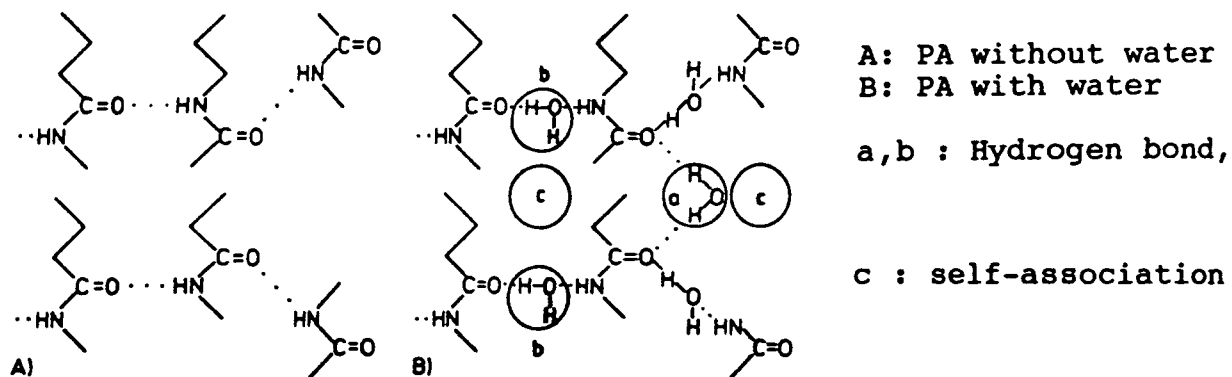

Figure 3.1 POSSIBLE FORMS OF WATER OCCLUSION IN POLYAMIDES

In the case of occlusion by hydrogen bonding, water molecules penetrate into the Nylon and loosen the existing hydrogen



bonds in the polymer, forming their own hydrogen bonds to the amide groups. The intermolecular forces in the Polyamides become weaker, and as a result those molecular segments that are not fixed in crystallites become more flexible. The increase in the flexibility of the molecular segments causes a reduction in the glass transition temperature ( $T_g$ ) for the amorphous regions. Not only does the increase in moisture content lower  $T_g$ , it also decreases the heat deflection temperature.

Glass transition temperatures are normally evaluated under a stress free condition and absorption of water is limited to the amorphous regions. In heat distortion tests, samples are subjected to a combined thermal and mechanical stress and it is possible for water to penetrate crystalline domains, which by then would be distorted. Heat distortion temperatures are a more appropriate design parameter than glass transition temperatures because they are related to moulding conditions, moulded in stresses, thickness and water content.

The diffusion of water is a slow process. Sample thickness influences the process but not the equilibrium value. Absorption of water in Nylons is a physiochemical process. First water is absorbed on the surface, and when the surface layer is saturated, absorbed water starts diffusing inside the body. From infra red, X-ray and density studies [25] it

has been shown that moisture diffuses mostly in the amorphous regions rather than in the crystalline region. Once the diffused water reaches to an accessible  $-CONH-$  group, it is chemically absorbed.

Excess water, which is free and not chemically bound, will increase the samples volume and hence cause swelling. During the absorption process, compressive stresses are developed in the surface layer and tensile stresses are developed within the body. During desorption, this is reversed [26]. These stresses initiate bending of the sample and alters its creep behaviour.

Impact strength of plastics increase with the addition of plasticizers. Since water acts as a plasticizer, impact strength can be expected to rise with moisture uptake.

Many researchers have studied the effects of moisture and temperature, and have managed to develop analytical models for the diffusion process in various composites. For example Shen and Springer [27], have presented extensive work on the moisture absorption behaviour of neat epoxy resin, glass and graphite fibre composites, based on the Fickian diffusion model. Similar work for these composites has also been reported by many authors [28,29,30].

### 3.2 Fick's Theory of Moisture Diffusion

The one-dimensional moisture diffusion process taking place through two large opposite faces of an infinite plate is shown in Figure 3.2 and can be described by Fick's second law of diffusion [30].

$$\frac{\partial c}{\partial t} = D_x \frac{\partial^2 c}{\partial x^2} \quad (3.1)$$

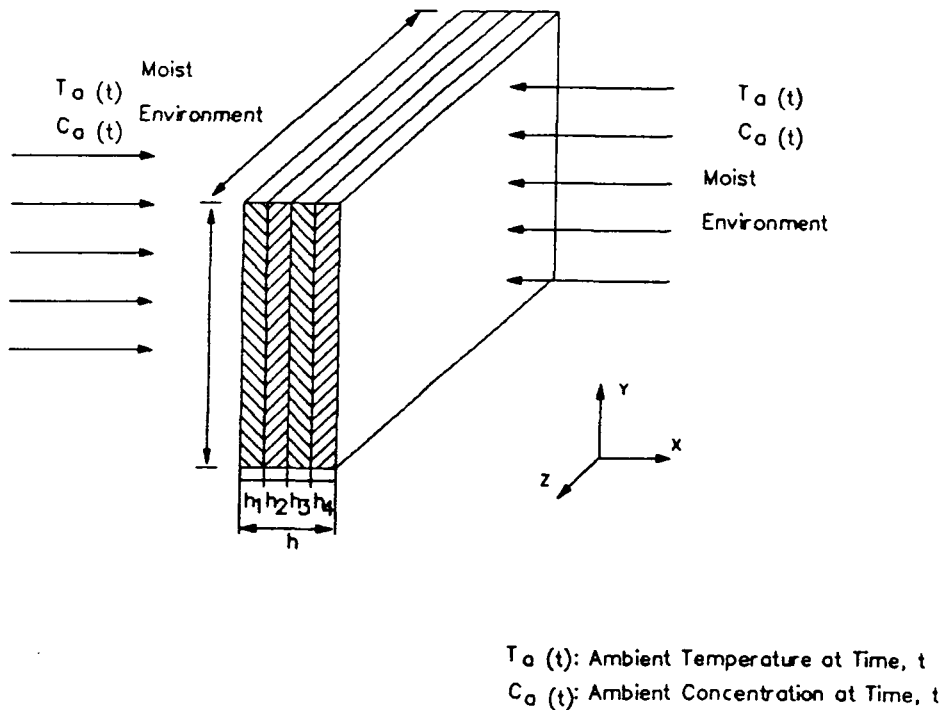

Figure 3.2 GEOMETRY OF TEST SPECIMEN - TO SHOW FICK'S THEORY OF DIFFUSION

where :

$t$  = time

$x$  = space co-ordinate in the direction of sheet thickness

$C$  = concentration of diffusion

$D_x$  = diffusion coefficient for the material

$M_i$  = the initial weight of the moisture in the material

$M_m$  = the weight of the material when fully saturated

The boundary conditions are

$$C = C_i \quad 0 < x < h \quad t < 0$$

$$C = C_a \quad x = 0; x = h \quad t > 0$$

The solution for Equation 3.1 with the above boundary conditions is :

$$\frac{C_a - C_i}{C_m - C_i} = 1 - \frac{4}{\pi} \sum_{j=0}^{\infty} \frac{1}{(2j+1)} \frac{(2j+1)\pi X}{h} \exp\left[-(2j+1)^2 \pi^2 \frac{D_x t}{h^2}\right] \quad (3.2)$$

$j$  is a summation counter, an arbitrary number chosen depending upon the required accuracy, to represent the number of slices of thickness,  $h$ .

The total weight of moisture is obtained by integrating Equation (3.2) over the plate thickness  $h$ .

$$M = A \int_0^h c dx \quad (3.3)$$

Where  $A$  is the exposed surface area.

The result of the integration provides the fractional moisture absorbed in the composite ( $G$ ).

$$G = \frac{M_t - M_i}{M_m - M_i} = 1 - \frac{8}{\pi^2} \sum_{j=0}^{\infty} \frac{[-(2j+1)^2 \left(\frac{D_x t}{h^2}\right)^2]}{(2j+1)^2} \quad (3.4)$$

The diffusion coefficient,  $D_x$ , can be deduced from the initial slope of the  $M_m$  versus  $\sqrt{t}$  curve, since

$$D_x = \pi \left( \frac{h}{4M_m} \right)^2 \left( \frac{M_2 - M_1}{\sqrt{t_2} - \sqrt{t_1}} \right)^2 \quad (3.5)$$

A plot of the dimensionless absorption parameter  $\left(\frac{M_t}{M_m}\right)$  against the dimensionless diffusion parameter  $\left(\frac{D_x t}{h^2}\right)$  represents the Fickian diffusion curve for the composite, (Figure 3.3). A good fit of the experimental data with this curve, would therefore confirm the applicability of a Fickian diffusion model for the material considered.

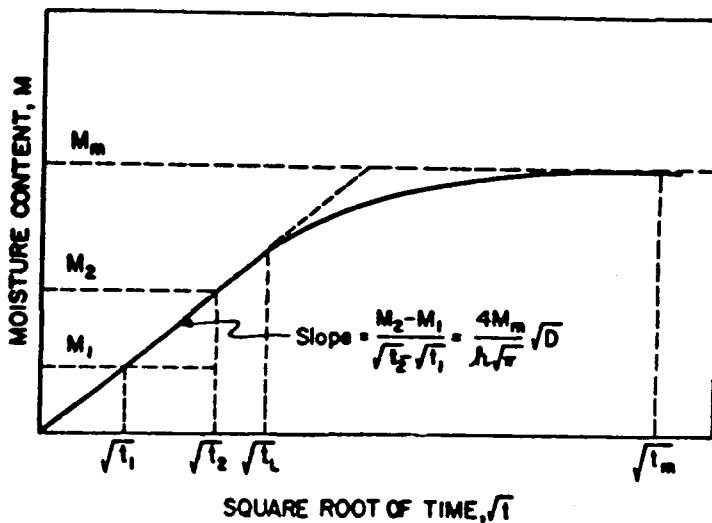

Figure 3.3 CHANGE IN MOISTURE CONTENT WITH  $\sqrt{t}$ , FOR FICKIAN DIFFUSION

**CHAPTER 4.0****EXPERIMENTAL PROCEDURE****4.1 Materials Investigated**

Seven materials in total were investigated, six LFRTPs (natural and black) and one un-reinforced Nylon 66 (natural) :

- (i) 'Verton' RF 700-07 (Natural) - 35% LGFR Nylon 66
- (ii) 'Verton' RF 700-07 (Black) - 35% LGFR Nylon 66
- (iii) 'Verton' RF 700-10 (Natural) - 50% LGFR Nylon 66
- (iv) 'Verton' RF 700-10 (Black) - 50% LGFR Nylon 66
- (v) 'Verton' RF 700-12 (Natural) - 60% LGFR Nylon 66
- (vi) 'Verton' RF 700-12 (Black) - 60% LGFR Nylon 66
- (vii) 'Maranyl' A100 (Natural) - U/F Nylon 66

All test specimens were immersed in water at three temperatures 23°C, 40°C and 60°C.

At the following soak intervals they were removed from the water bath for mechanical testing :

Soak-Time (hours)

-----

2	
4	
24	(1 day)
168	(7 days)
288	(12 days)
432	(18 days)
672	(28 days)
1000	(42 days)

Prior to moisture conditioning, the materials were all tested in the dry - "as-moulded" state.

#### 4.2 Injection Moulding

These materials were all injection moulded in accordance with BS 2782 [31] into test specimen employing a Demag D80 moulding machine (Figure 4.1).



Figure 4.1 DEMAG D80 MOULDING MACHINE



Moulded samples were all stored in an air tight container, in the presence of Silica gel immediately after moulding. The moulding conditions (Appendix 1) were generally set to ensure maximum fibre length was preserved.

A family mould tool was used for the injection moulding of test specimens in one shot (Figure 4.2), :

- (i) Tensile bar (200 x 9.96 x 3.31mm)
- (ii) Charpy bar - moulded in notch (50.28 x 5.94 x 4.10mm)
- (iii) Charpy bar - moulded without notch (as above).

Dimensions quoted are for 'Verton' 50% glass/Nylon 66 (natural), measured dry - "as moulded". Sample dimensions for all materials are given in the appendices.

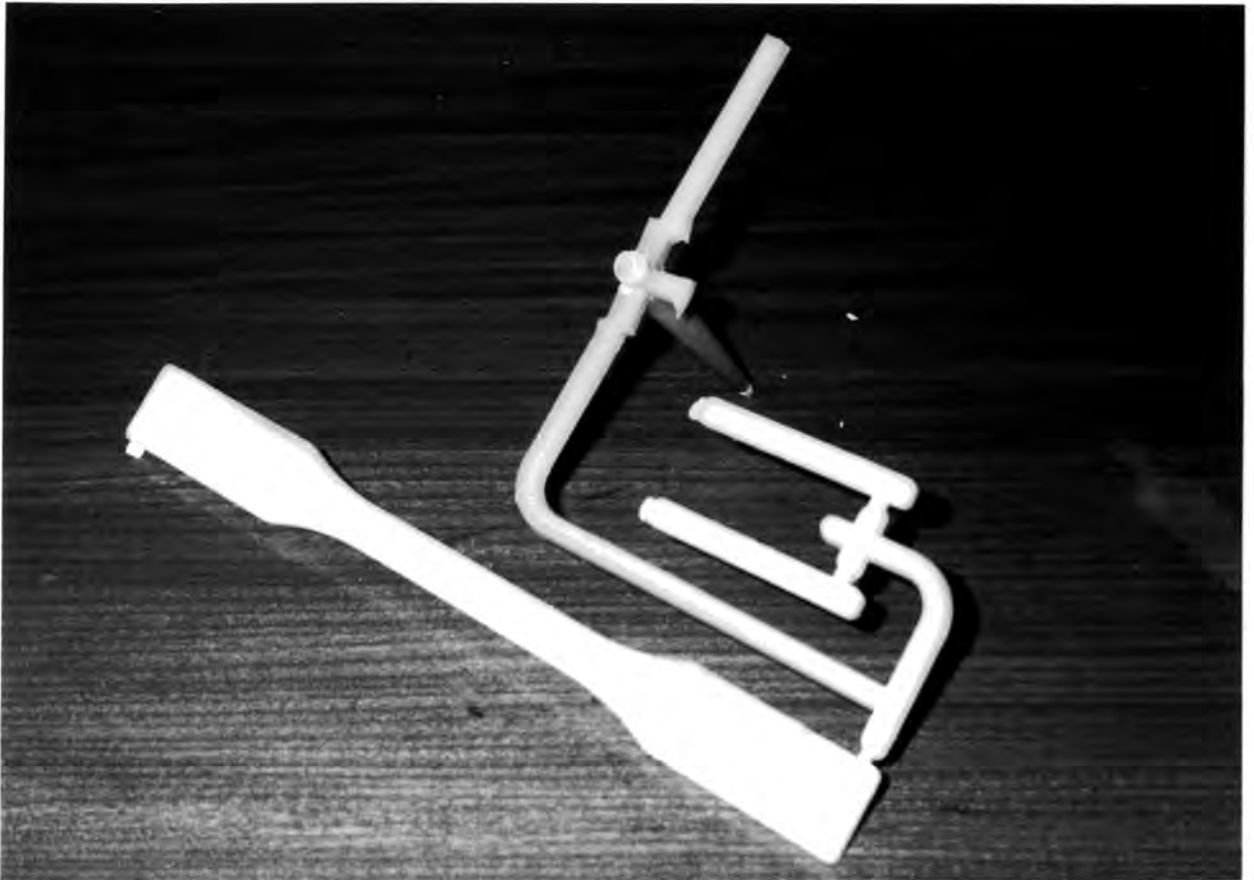

Figure 4.2 ONE SHOT MOULDING OF TEST SAMPLES

The moulded test samples were conditioned in accordance with ISO 175 and ISO R 462 [32,33] as follows :

(i) Samples weighed in the dry "as moulded" condition (to 3 decimal places).

(ii) Dimensions measured to an accuracy of  $\pm 0.01$  mm

(iii) Samples immersed in an agitated constant temperature water bath (Figure 4.3). The surface of the water was covered with polystyrene spheres to minimize heat loss. The tensile specimens were vertically suspended, whilst the Charpy impact bars were placed in a plastic (weighted) beaker. The beaker was perforated to allow adequate water circulation.

(iv) At specified intervals, the test samples were taken out of the bath, excessive surface moisture removed by wiping with "kimwipes", and tested.

(v) The amount of water absorbed by the test samples was calculated by re-weighing as stated in ISO 175 [34]. The changes in physical dimensions were also noted.

In total five samples were taken per test.

$M_1$  : Mass of test specimen before immersion (g)

$M_2$  : Mass of test specimen after immersion (g)

Water absorption as a percentage increase in mass was calculated as :

$$\frac{(M_2 - M_1)}{M_1} \times 100$$



Figure 4.3 CONSTANT TEMPERATURE WATER BATH

### 4.3 Mechanical Testing

The testing machine used for determining both tensile and flexural properties was a Lloyd Instruments, model L 6000R, 30 kN bench machine (Figure 4.4)



Figure 4.4 LLOYD INSTRUMENTS 30 kN BENCH MACHINE  
(set up for Tensile Tests)

#### 4.3.1 Determination Of Tensile Strength

The tensile strength of the materials, was evaluated in accordance with BS 2782 [35] before and after conditioning.

The gauge length was set at 115 mm with a grip separation rate of 10 mm/min. The results obtained were graphs of Load (N) against Extension (mm) (Figure 4.5)

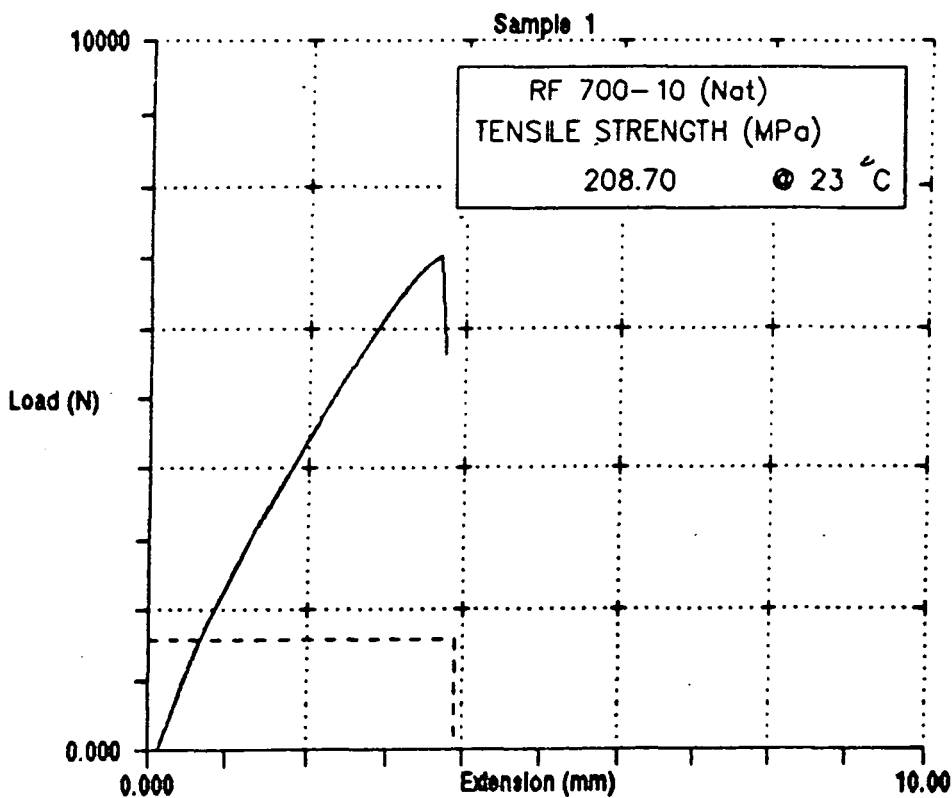

Figure 4.5 LOAD-EXTENSION CURVE FOR TENSILE TESTS

### Calculation Of Tensile Strength

$$\sigma_{t(\max)} = \frac{F}{A}$$

where

$\sigma_{t(\max)}$  = maximum Tensile Strength (Pa)

F = maximum force (N)

A = cross-sectional area

#### 4.3.2 Determination of Flexural Strength and Flexural Modulus

The flexural strength and flexural modulus of the materials were determined in accordance with BS 2782 [36], using the Lloyd testing machine, mounted with a three point bending apparatus, (Figure 4.6). Flexural tests were conducted using tensile specimens with the span fixed at 80 mm and the rate of the loading roller set at 2mm/min. The results obtained were in the form of Load - Deflection curves (Figure 4.7).



Figure 4.6 LLOYD TESTING MACHINE SET UP  
FOR 3-POINT BENDING TESTS

Calculation of Flexural Strength.

$$\sigma_{fmax} = \frac{3FL}{2bh^2}$$

$\sigma_{fmax}$  = Maximum Flexural Strength (Pa)

F = Maximum Load at Break (N)

L = Specimen Length

b = Specimen Width

h = Specimen Thickness

Calculation of Flexural Modulus (modulus of elasticity).

Flexural modulus was determined from the initial linear part of the Load - Deflection curve.

$$E_b = \frac{L^3 F}{4bh^3y}$$

$E_b$  = Flexural Modulus (Pa)



$L$  = Span Length

$b$  = Specimen Width

$F$  = Load at a chosen point on the initial linear portion of the load deflection curve (N)

$y$  = Deflection corresponding to load  $F$

$h$  = Specimen Thickness

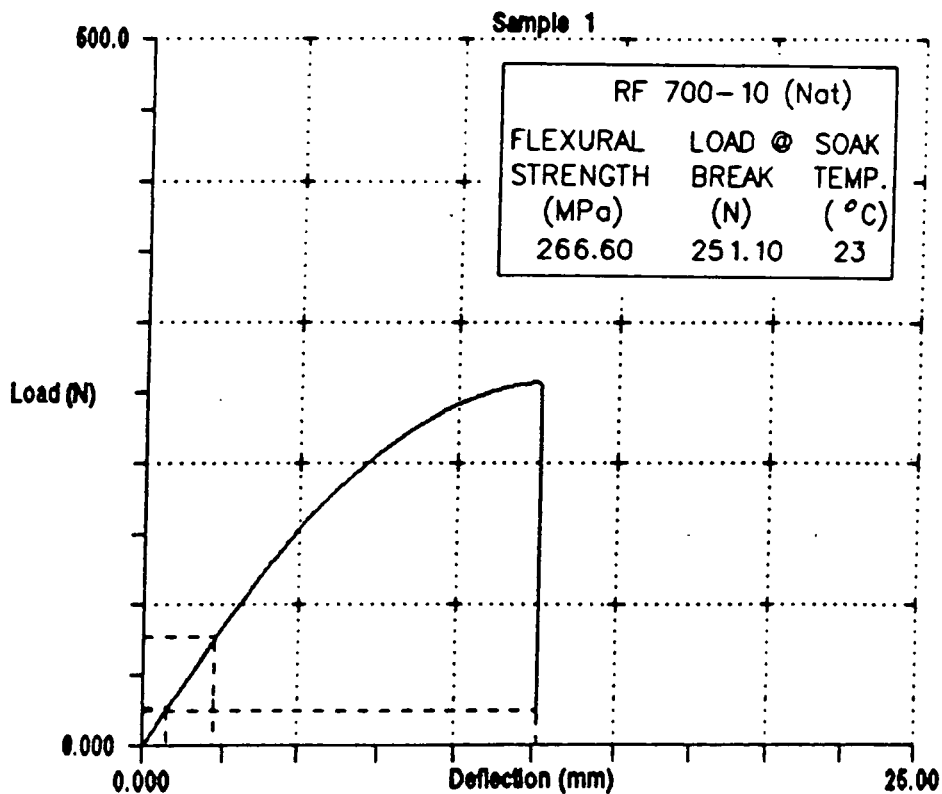

Figure 4.7 LOAD DEFLECTION CURVE FOR 3 POINT BENDING TESTS

#### 4.3.3 Charpy Impact Test

The Charpy impact test was performed in accordance with ISO 179 [37], using a Hounsfield Plastic Testing Machine (Figure 4.8). This simple apparatus consisted of a pendulum of known weight and height, which struck the test sample (either notched or un-notched) resulting in a reading on a scale of 0 - 1.0. This represented the amount of energy (potential) absorbed by the specimen on impact.

0 - No absorption of energy.

1.0 - Total absorption of energy (kinetic/potential).



Figure 4.8 HOUNSFIELD IMPACT TESTING MACHINE

### Calculation of Impact Strength

Figure 4.9 illustrates the Charpy impact test. The pendulum with a hammer-like weight, strikes the sample and the energy required to break it is determined from the loss in kinetic energy of the weight.

The sample could either be :

- (i) un-notched - determining the energy needed to initialize a crack or
- (ii) notched - determining the energy required to propagate a crack.

The impact strength of notched samples is expected to be much smaller than un-notched ones, because notches are stress concentrators.

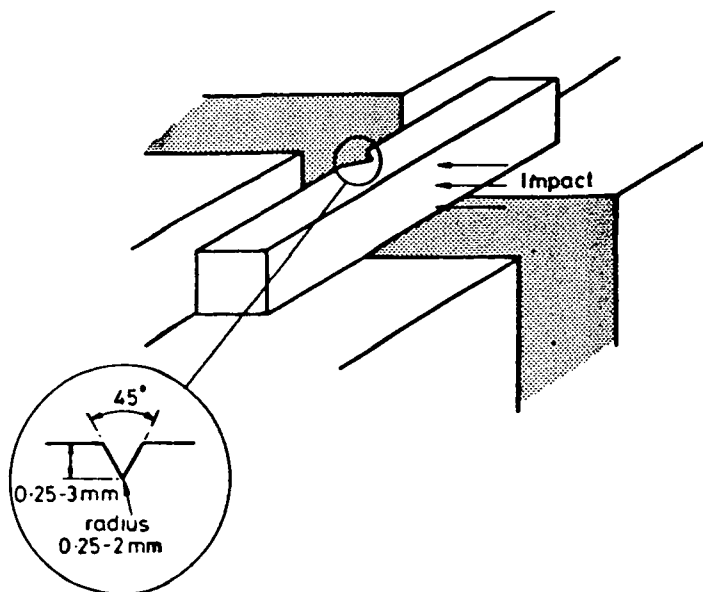

Figure 4.9 ILLUSTRATION TO SHOW CHARPY IMPACT TEST

Potential Energy (PE) of pendulum (J) =  $Mgh$

where :

M = Mass of pendulum (kg)

g = Gravitational acceleration ( $m/s^2$ )

h = Height of pendulum (m)

Energy to break = Fraction of PE absorbed after impact,  
(scale reading 0 - 1.0)

Impact strength ( $J/m^2$ ) = 
$$\frac{\text{Energy to Break}}{\text{cross-sectional area}}$$

## CHAPTER 5.0

### RESULTS

#### 5.1 Moisture Absorption with Soak-Time

The uptake of moisture by thermoplastic composite materials is dependent upon many factors, some of these include :

- (i) polymer - fibre type
- (ii) fibre volume fraction
- (iii) presence of other "fillers and modifiers"
- (iv) sample dimensions
- (v) humidity
- (vi) soak-time and temperature.

Table 5.1 shows the uptake of moisture with time, for all materials immersed in water at 23°C, 40°C and 60°C.

The values quoted are averages taken by measuring five tensile bars, of thickness 3.3 mm.

## Moisture Uptake With Soak-Time(%)

Soak-Temperature : 23°C

SOAK TIME (Hrs)	A100	RF 700-07		RF 700-10		RF 700-12	
	(Nat)	(Nat)	(Blk)	(Nat)	(Blk)	(Nat)	(Blk)
2	3.184	0.098	0.196	0.171	0.057	0.075	0.064
4	3.214	1.978	1.561	1.050	0.593	0.985	0.597
24	4.141	2.420	1.652	1.529	1.307	1.325	0.742
168	4.821	2.568	1.811	1.555	1.473	1.425	1.038
288	5.536	2.645	2.035	1.727	1.562	1.542	1.177
432	6.250	2.722	2.608	1.993	1.657	1.630	1.252
672	6.857	2.989	3.078	2.214	2.308	1.830	1.438
1000	7.054	3.136	3.305	2.443	2.684	1.953	1.919

Soak-Temperature : 40°C

SOAK TIME (Hrs)	A100	RF 700-07		RF 700-10		RF 700-12	
	(Nat)	(Nat)	(Blk)	(Nat)	(Blk)	(Nat)	(Blk)
2	3.512	0.954	0.525	0.305	0.166	0.339	0.326
4	4.210	2.273	1.608	1.615	2.174	1.513	0.887
24	5.510	3.178	3.356	2.080	2.563	1.630	1.467
168	6.782	3.304	3.760	2.171	2.920	1.847	1.757
288	7.140	3.360	4.075	2.660	3.111	2.024	1.979
432	7.200	3.522	4.375	2.838	3.270	2.358	2.414
672	7.420	3.550	4.484	3.325	3.347	2.647	2.772
1000	7.750	3.718	4.565	3.454	3.404	2.736	2.865

Soak-Temperature : 60°C

SOAK TIME (Hrs)	A100	RF 700-07		RF 700-10		RF 700-12	
	(Nat)	(Nat)	(Blk)	(Nat)	(Blk)	(Nat)	(Blk)
2	3.864	2.217	1.337	0.584	0.108	0.498	0.464
4	4.464	2.743	1.780	1.458	2.703	1.948	2.425
24	6.271	3.580	4.236	2.515	3.404	2.393	2.679
168	8.036	4.172	4.327	3.250	3.595	2.804	2.858
288	8.080	4.322	4.378	3.307	3.825	2.818	2.887
432	8.116	4.532	4.607	3.345	3.876	2.863	2.917
672	8.125	5.029	5.090	3.556	3.984	3.169	3.063
1000	8.134	5.037	5.160	3.606	4.195	3.273	3.143

Table 5.1 MOISTURE UPTAKE WITH SOAK-TIME, AT 23°C, 40°C AND 60°C

The increase in moisture content with square root of soak-time for A100 (Nat), RF 700-07 (Nat and Blk), RF 700-10 (Nat and Blk) and RF 700-12 (Nat and Blk) immersed in water at 23°C, 40°C and 60°C is given in figures 5.1 (a), (b), (c) and (d) to 5.3 (a), (b), (c) and (d) respectively on pages 73 - 75.

Moisture Content against Square Root of Time  
Soak Temperature 23° C

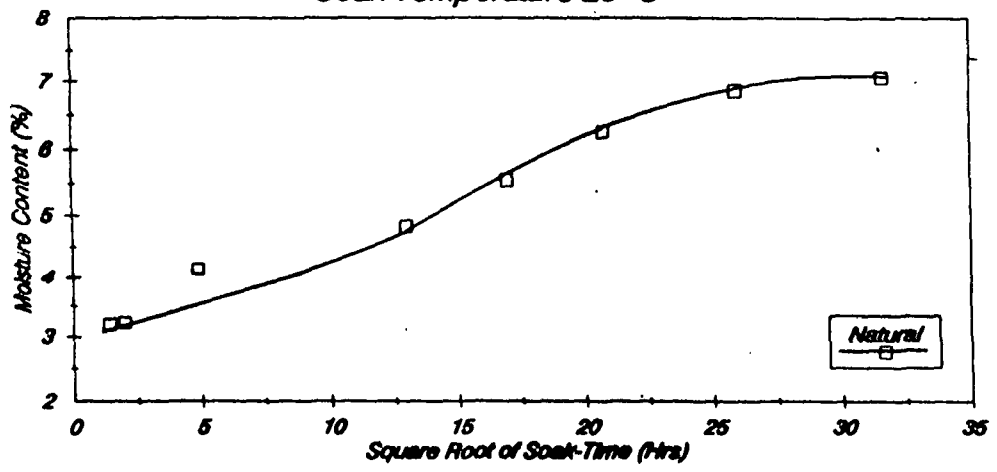

(a) 'Maranyl' A100 (Nat)

Moisture Content against Square Root of Time  
Soak Temperature 23° C

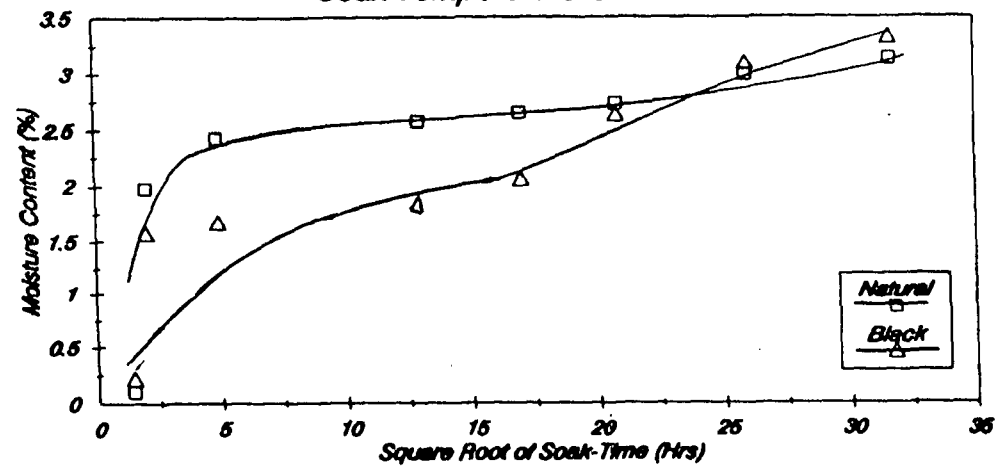

(b) 'Verton' RF 700-07 (Nat & Blk)

Moisture Content against Square Root of Time  
Soak Temperature 23° C

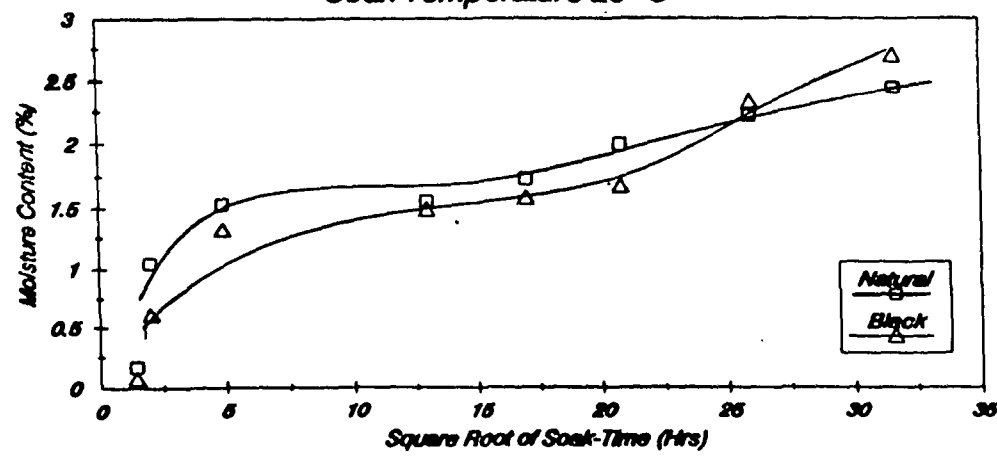

(c) 'Verton' RF 700-10 (Nat & Blk)

Moisture Content against Square Root of Time  
Soak Temperature 23° C

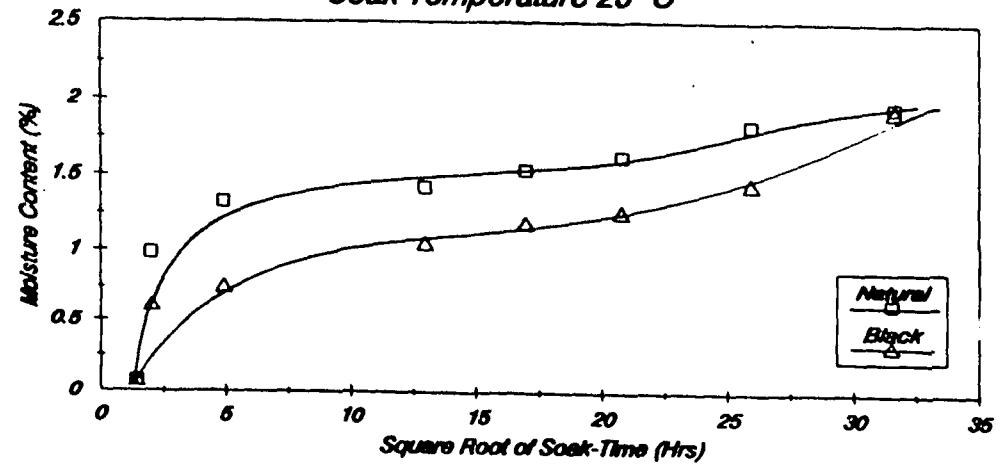

(d) 'Verton' RF 700-12 (Nat & Blk)

Figure 5.1 MOISTURE CONTENT AGAINST SQ. ROOT OF SOAK-TIME AT 23°C



**Moisture Content against Square Root of Time  
Soak Temperature 40° C**

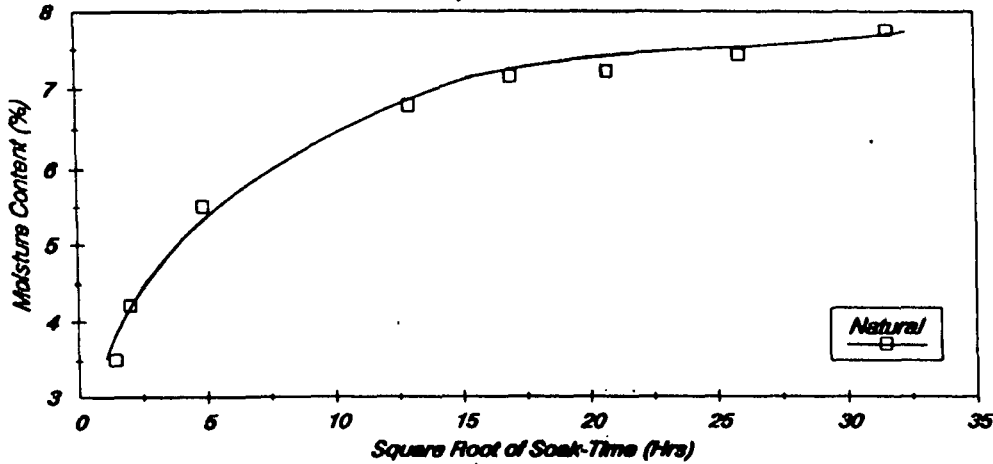

(a) 'Maranyl' A100 (Nat)

**Moisture Content against Square Root of Time  
Soak Temperature 40° C**

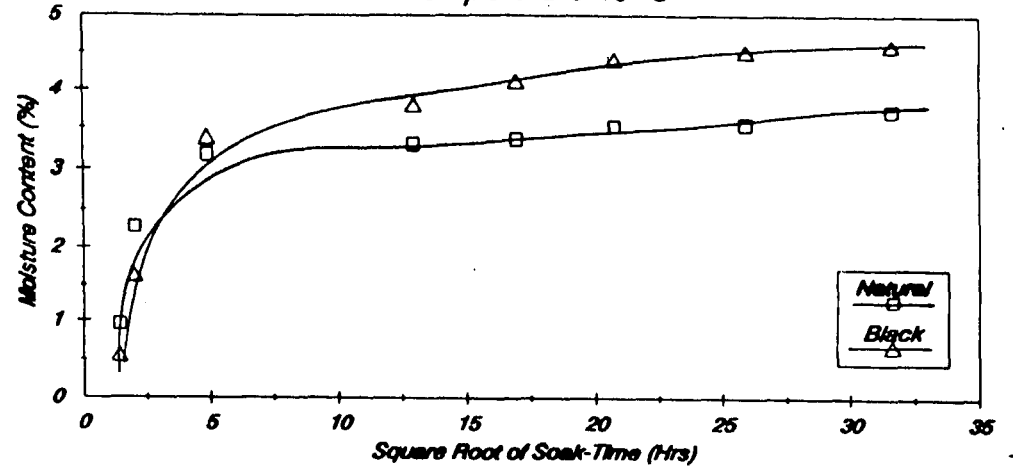

(b) 'Verton' RF 700-07 (Nat & Blk)

**Moisture Content against Square Root of Time  
Soak Temperature 40° C**

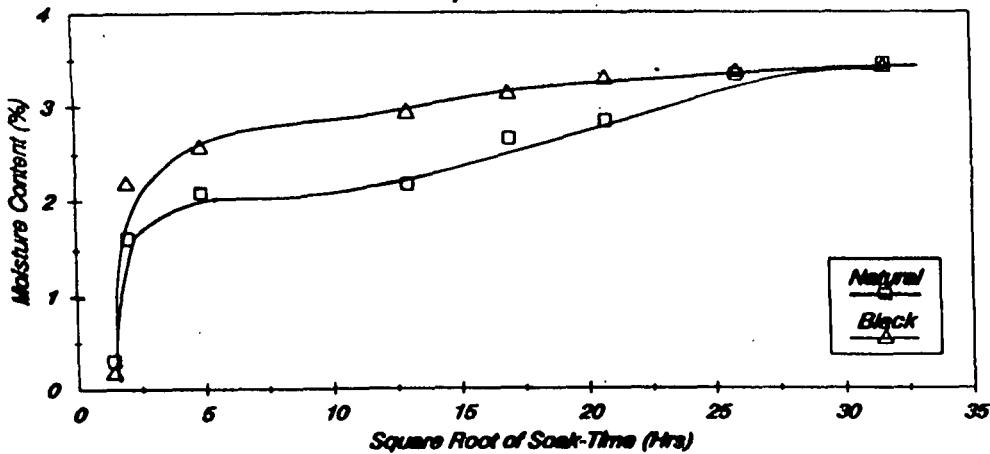

(c) 'Verton' RF 700-10 (Nat & Blk)

**Moisture Content against Square Root of Time  
Soak Temperature 40° C**

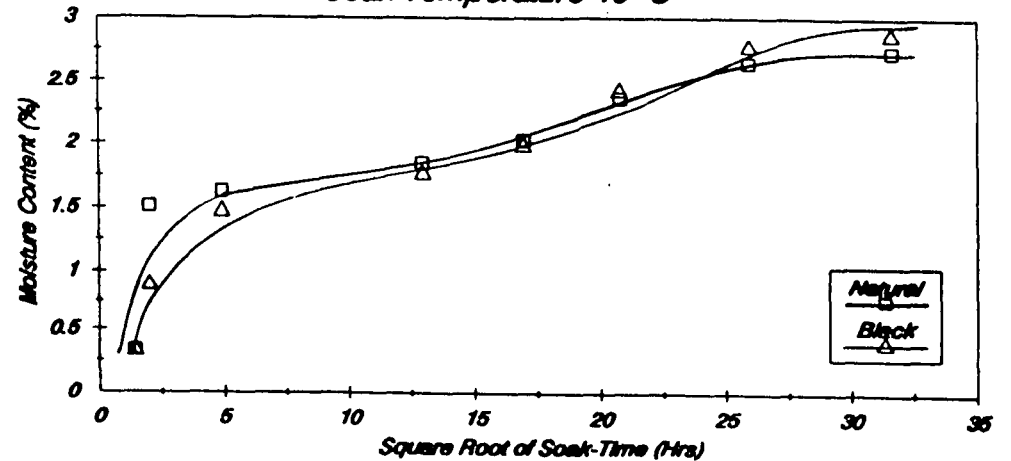

(d) 'Verton' RF 700-12 (Nat & Blk)

Figure 5.2 MOISTURE CONTENT AGAINST SQ. ROOT OF SOAK-TIME AT 40°C

**Moisture Content against Square Root of Time  
Soak Temperature 60° C**

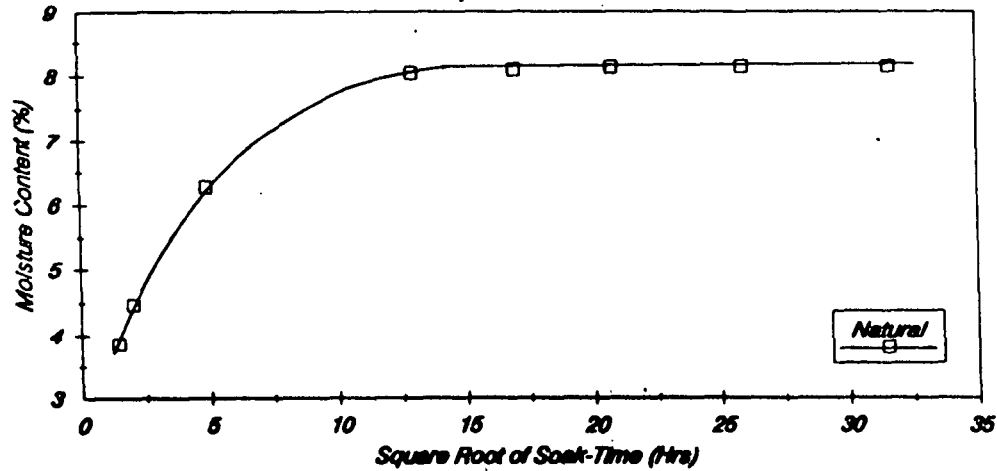

(a) 'Maranyl' A100 (Nat)

**Moisture Content against Square Root of Time  
Soak Temperature 60° C**

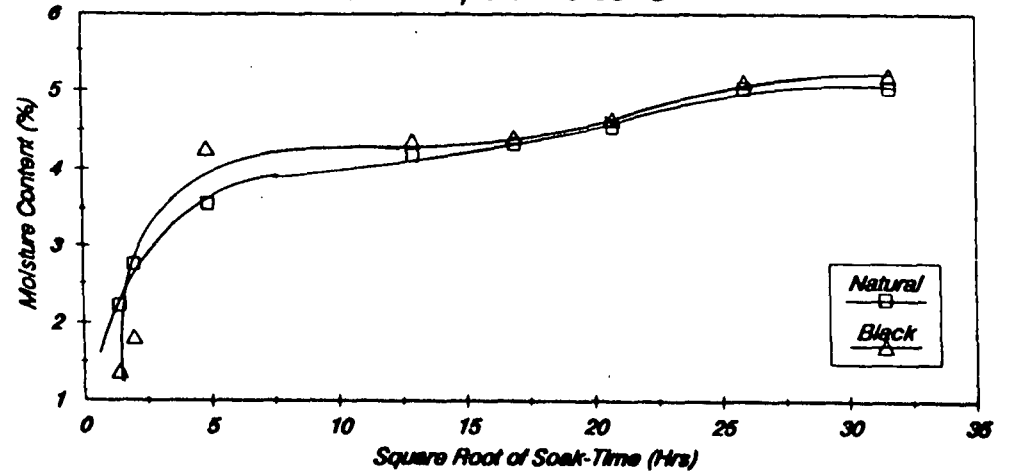

(b) 'Verton' RF 700-07 (Nat & Blk)

**Moisture Content against Square Root of Time  
Soak Temperature 60° C**

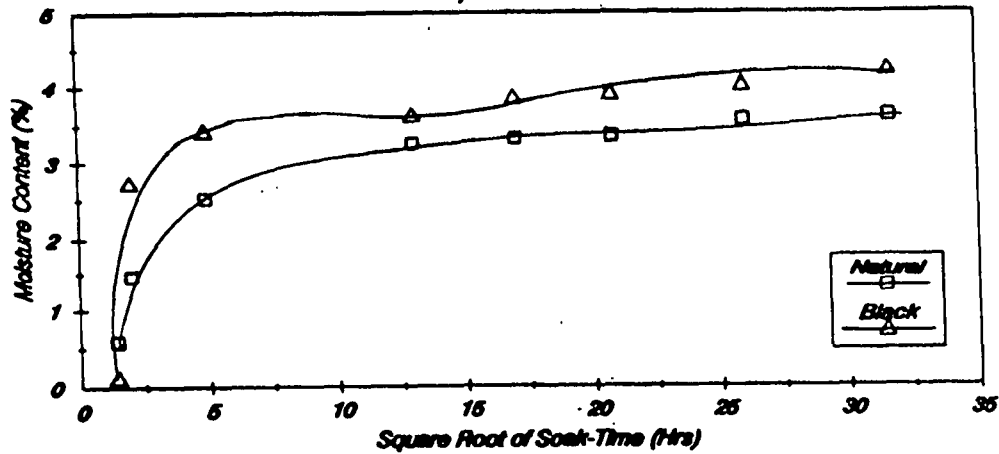

(c) 'Verton' RF 700-10 (Nat & Blk)

**Moisture Content against Square Root of Time  
Soak Temperature 60° C**

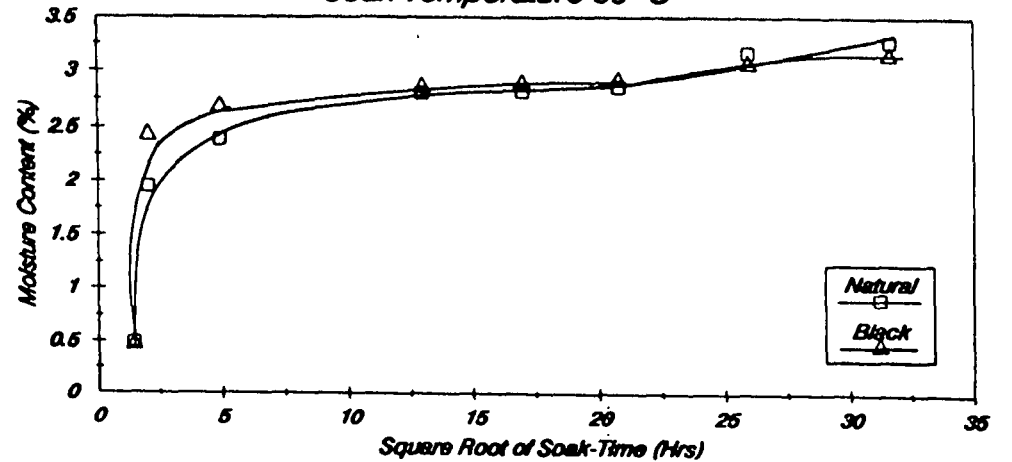

(d) 'Verton' RF 700-12 (Nat & Blk)

**Figure 5.3 MOISTURE CONTENT AGAINST SQ. ROOT OF SOAK-TIME AT 60° C**

## 5.2 Mechanical Properties

### 5.2.1 Tensile Strength

Tensile strength of samples tested in the dry - "as moulded" condition is shown in Table 5.2. The same data are presented graphically in Figure 5.4.

Table 5.2

TENSILE STRENGTH (MPa)	A100	RF 700-07	RF 700-10	RF 700-12
Natural	80	198	228	255
Black	-	183	219	251

TENSILE STRENGTH FOR SAMPLES TESTED DRY - "AS MOULDED"

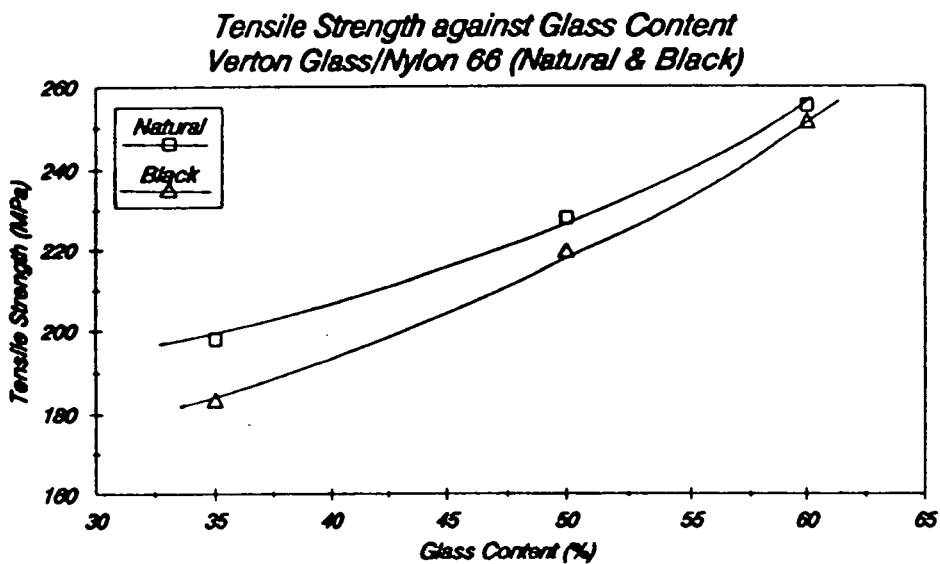

Figure 5.4 TENSILE STRENGTH AGAINST GLASS CONTENT - 'VERTON' GLASS/NYLON 66

After accelerated moisture conditioning for up to 1000 hours at soak temperatures of 23°C, 40°C and 60°C, the tensile strength was found to reduce drastically.

To show the general reduction in tensile strength with moisture uptake, results after 24 hours, 432 hours (18 days) and 1000 hours (42 days) are shown in Table 5.3.

The results of the complete conditioning program, including Load - Extension curves, can be seen in the appendices (A2-A3).

The reduction in tensile strength with increase in (a) moisture content and (b) square root of soak-time for A100 (Nat) is given in figures 5.5 (a) and (b) respectively on page 79.

Soak-Time : 24 hours

TENSILE STRENGTH (MPa)	A100 (Nat)	RF 700-07 (Nat) (Blk)		RF 700-10 (Nat) (Blk)		RF 700-12 (Nat) (Blk)	
Soak temp 23°C	65	170	150	205	192	225	220
Moisture Content(%)	4.14	2.42	1.65	1.53	1.31	1.33	0.74
Soak temp 40°C	58	154	145	192	180	210	212
Moisture Content(%)	5.51	3.18	3.36	2.08	2.56	1.63	1.47
Soak temp 60°C	41	130	123	173	162	196	193
Moisture Content(%)	6.27	3.58	4.24	2.52	3.40	2.40	2.09

Soak-Time : 432 hours

TENSILE STRENGTH (MPa)	A100 (Nat)	RF 700-07 (Nat) (Blk)		RF 700-10 (Nat) (Blk)		RF 700-12 (Nat) (Blk)	
Soak temp 23°C	48	110	109	144	131	181	171
Moisture Content(%)	6.25	2.72	2.61	1.99	1.66	1.63	1.25
Soak temp 40°C	37	97	96	116	108	137	129
Moisture Content(%)	7.20	3.52	4.38	2.84	3.27	2.36	2.41
Soak temp 60°C	31	93	88	109	105	122	122
Moisture Content(%)	8.12	4.53	4.61	3.35	3.88	2.86	2.92

Soak-Time : 1000 hours

TENSILE STRENGTH (MPa)	A100 (Nat)	RF 700-07 (Nat) (Blk)		RF 700-10 (Nat) (Blk)		RF 700-12 (Nat) (Blk)	
Soak temp 23°C	41	100	94	123	114	151	141
Moisture Content(%)	7.05	3.14	3.31	2.44	2.68	1.95	1.92
Soak temp 40°C	33	96	90	104	101	128	121
Moisture Content(%)	7.75	3.72	4.57	3.45	3.40	2.74	2.87
Soak temp 60°C	30	92	87	101	99	119	120
Moisture Content(%)	8.13	5.04	5.16	3.61	4.20	3.27	3.14

Table 5.3 TENSILE STRENGTH WITH MOISTURE UPTAKE, AFTER 24, 432 AND 1000 HOURS AT 23°C, 40°C AND 60°C

5.5 (a) *Tensile Strength against Moisture Content*  
Soak - Temperatures : 23, 40 and 60° C

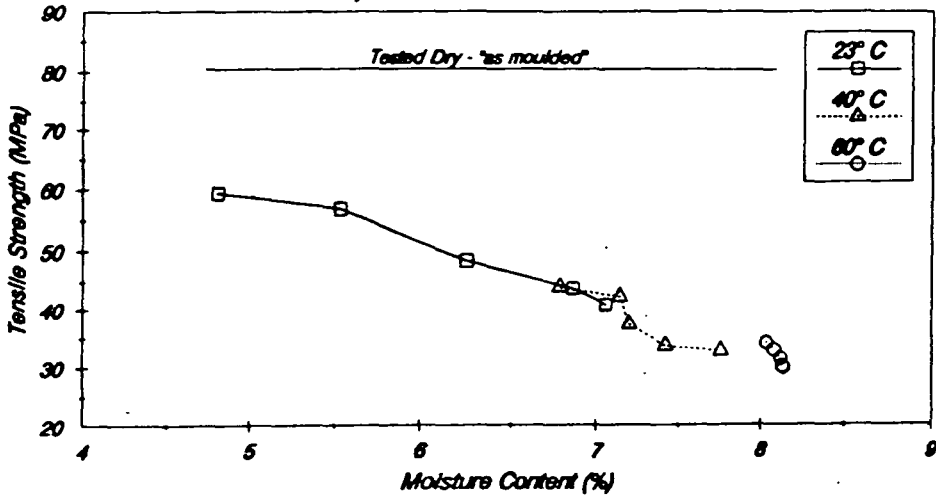

5.5 (b) *Tensile Strength against  $\sqrt{\text{Soak - Time}}$*   
Soak - Temperatures : 23, 40 & 60° C

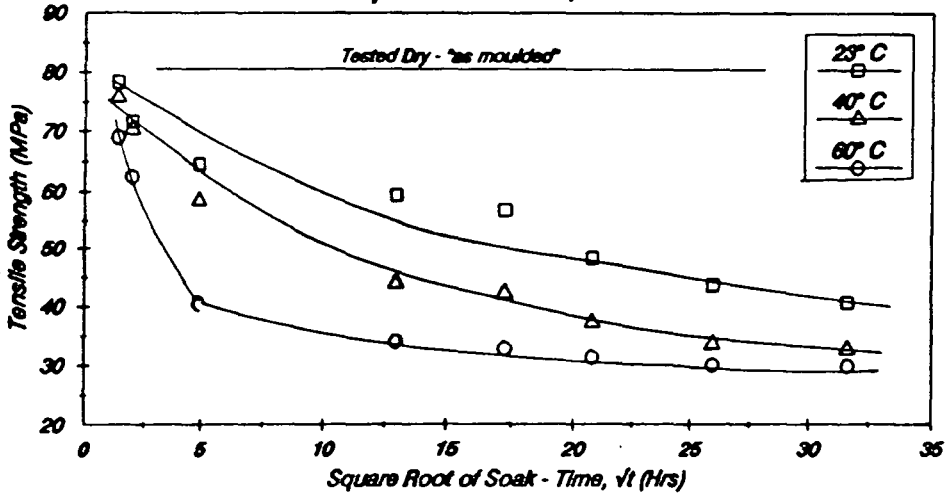
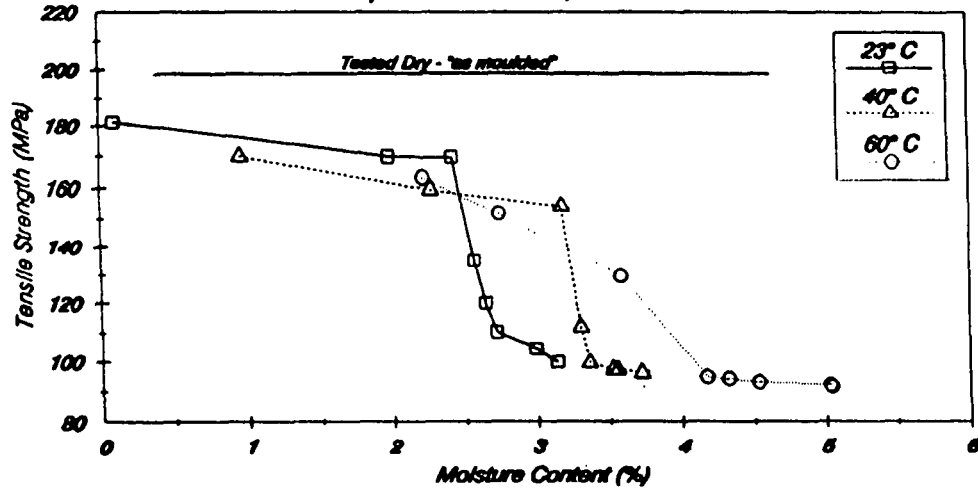

Figure 5.5 'MARANYL' A100 (Natural)

The reduction in tensile strength with increase in (a) moisture content and (b) square root of soak-time for RF 700-07 (Nat), RF 700-07 (Blk), RF 700-10 (Nat), RF 700-10 (Blk), RF 700-12 (Nat) and RF 700-12 (Blk) is given in figures 5.6 (a) and (b) to 5.11 (a) and (b) respectively on pages 81 - 83.

5.6 (a) Tensile Strength against Moisture Content  
Soak - Temperatures : 23, 40 and 60° C



5.7 (a) Tensile Strength against Moisture Content  
Soak - Temperatures : 23, 40 and 60° C

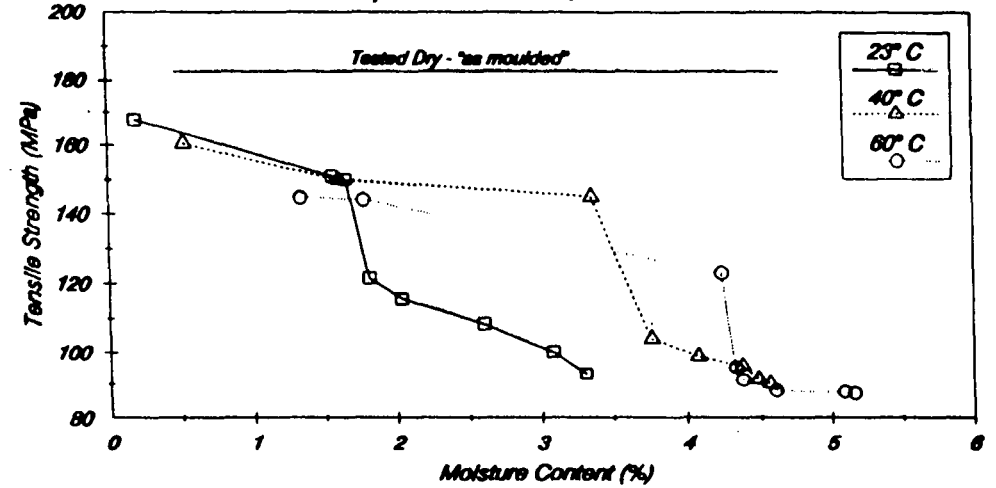

5.6 (b) Tensile Strength against  $\sqrt{t}$  Soak - Time  
Soak - Temperatures : 23, 40 & 60° C

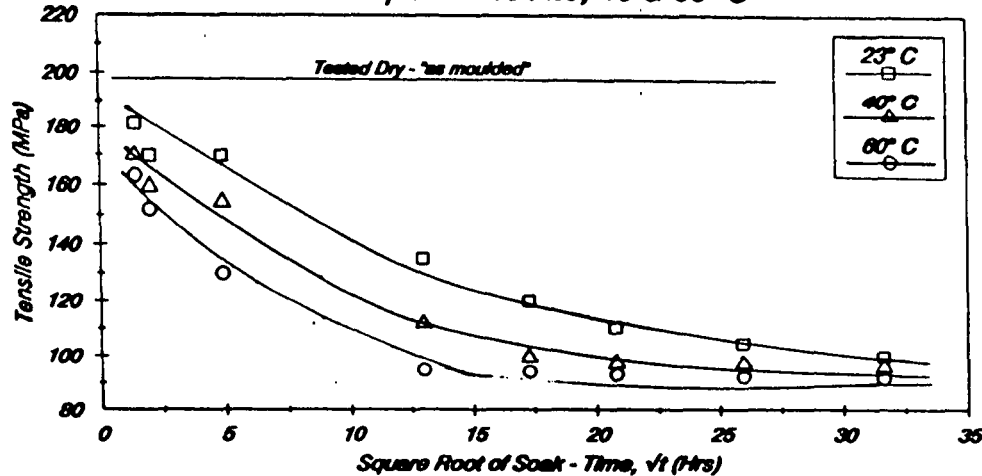

5.7 (b) Tensile Strength against  $\sqrt{t}$  Soak - Time  
Soak - Temperatures : 23, 40 & 60° C

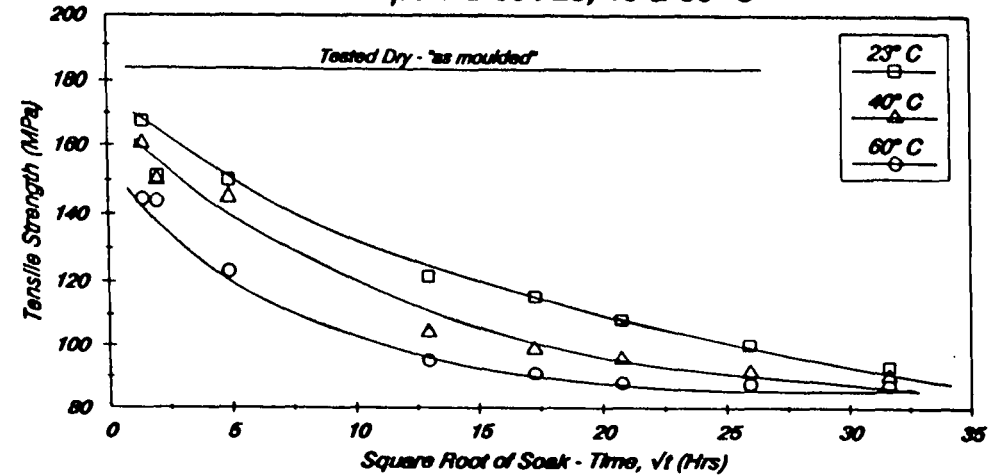
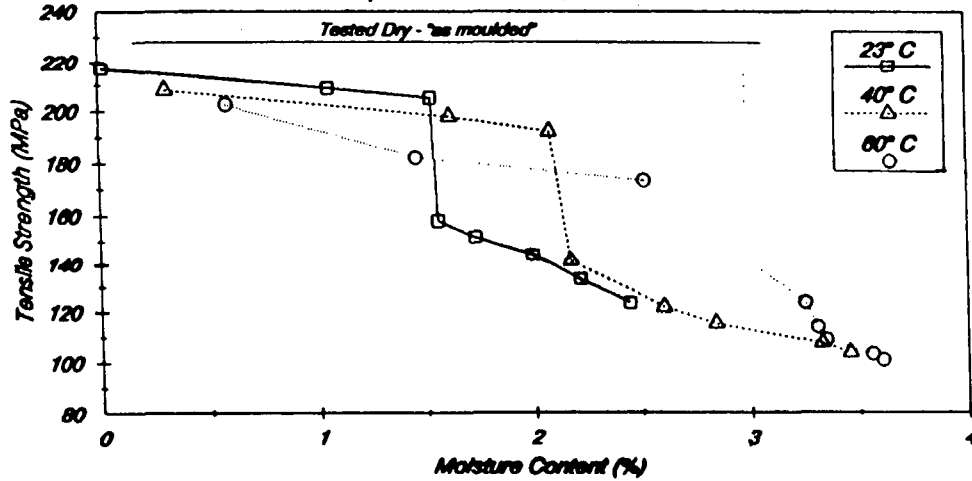

Figure 5.6 'VERTON' RF 700-07 (Nat)

Figure 5.7 'VERTON' RF 700-07 (Blk)



5.8 (a) Tensile Strength against Moisture Content  
Soak - Temperatures : 23, 40 and 60° C



5.9 (a) Tensile Strength against Moisture Content  
Soak - Temperatures : 23, 40 and 60° C

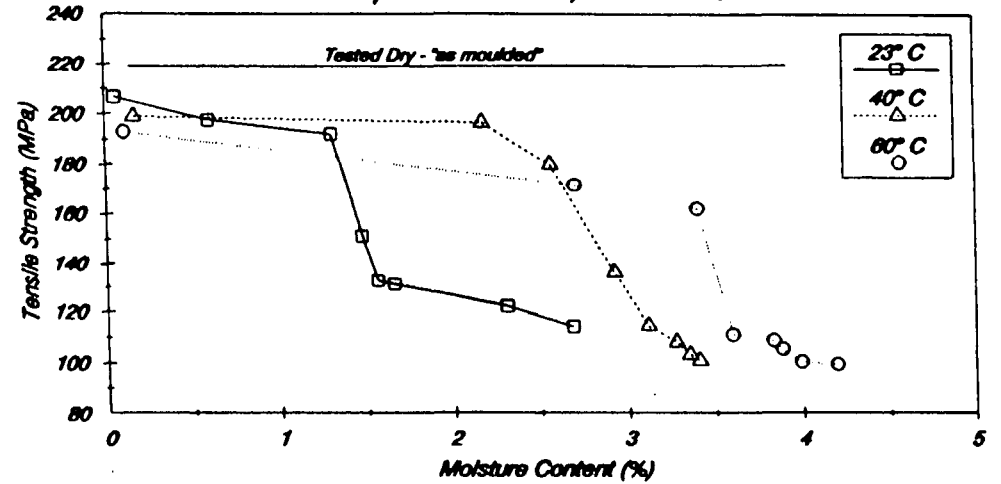

5.8 (b) Tensile Strength against  $\sqrt{\text{Soak - Time}}$   
Soak - Temperatures : 23, 40 & 60° C

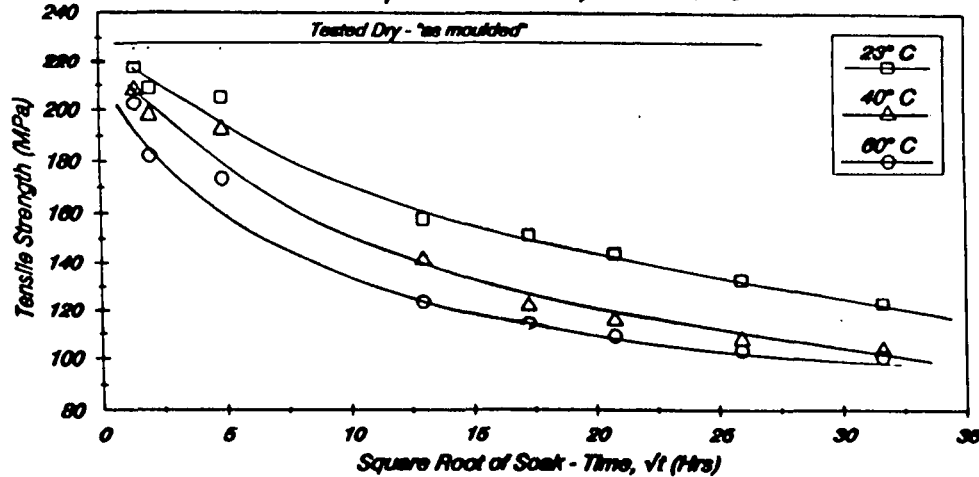

5.9 (b) Tensile Strength against  $\sqrt{\text{Soak - Time}}$   
Soak - Temperatures : 23, 40 & 60° C

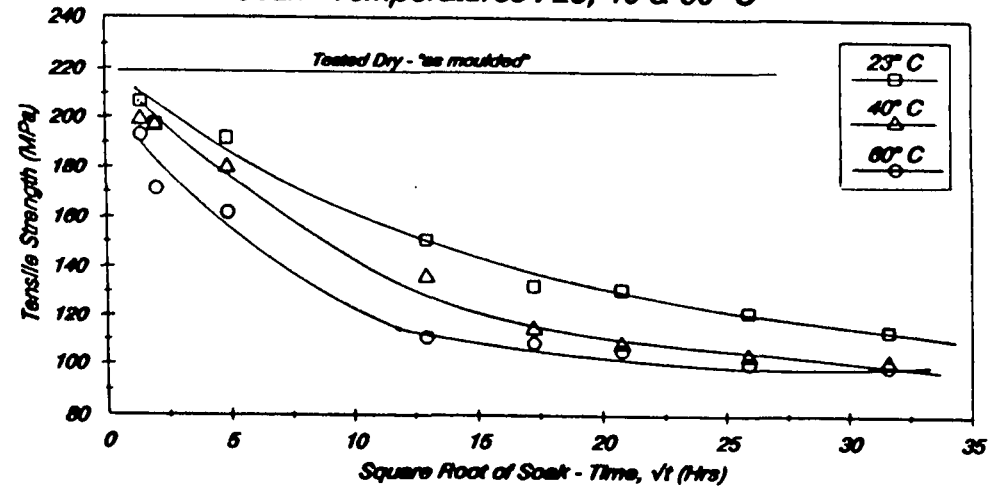
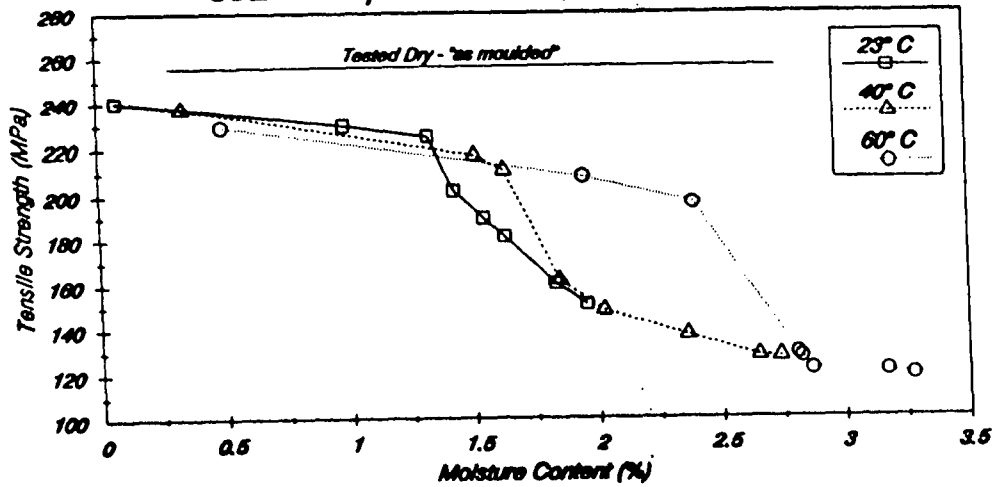

Figure 5.8 'VERTON' RF 700-10 (Nat)

Figure 5.9 'VERTON' RF 700-10 (Blk)

5.10(a) Tensile Strength against Moisture Content Soak - Temperatures : 23, 40 and 60° C



5.11(a) Tensile Strength against Moisture Content Soak - Temperatures : 23, 40 and 60° C

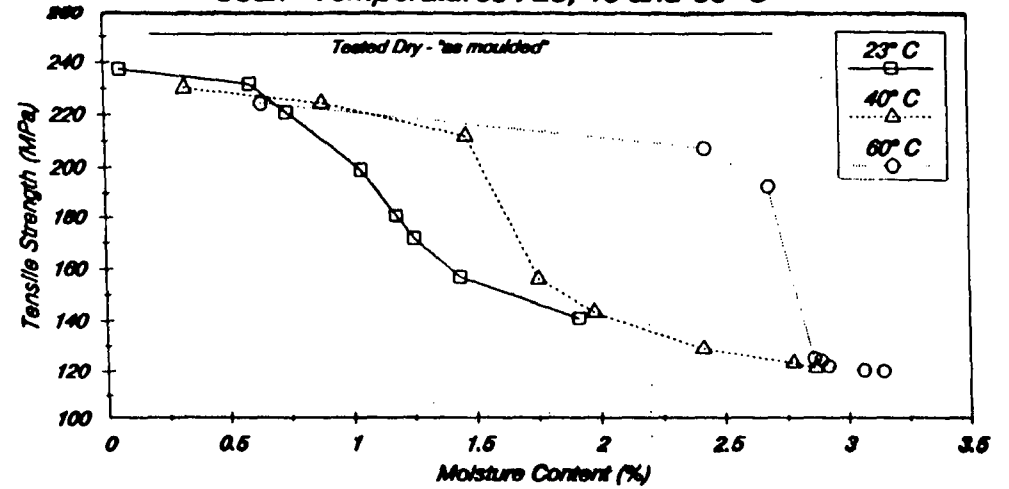

5.10(b) Tensile Strength against  $\sqrt{\text{Soak - Time}}$  Soak - Temperatures : 23, 40 & 60° C

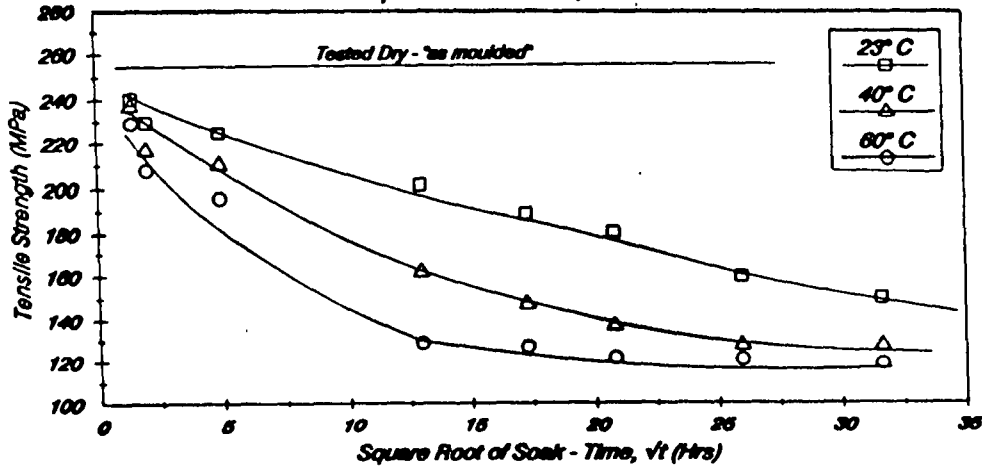

5.11(b) Tensile Strength against  $\sqrt{\text{Soak - Time}}$  Soak - Temperatures : 23, 40 & 60° C

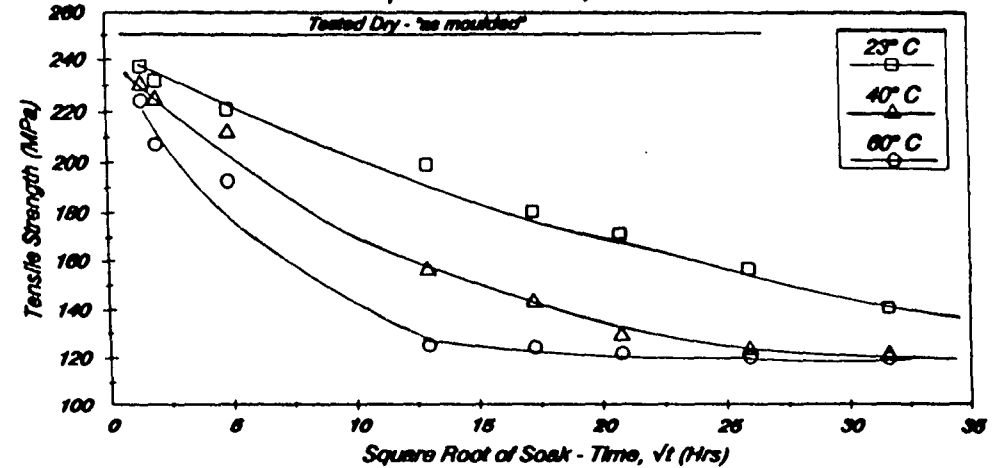

Figure 5.10 'VERTON' RF 700-12 (Nat)

Figure 5.11 'VERTON' RF 700-12 (Blk)

### 5.2.2 Flexural Strength

Flexural strength of 'Verton' samples tested in the dry - "as moulded" condition are shown in Table 5.4.

Figure 5.12 shows the increase in flexural strength with increase in glass content for all 'Verton' materials.

Table 5.4

FLEXURAL STRENGTH (MPa)	A100	RF 700-07	RF 700-10	RF 700-12
Natural	-	280	321	365
Black	-	249	310	369

FLEXURAL STRENGTH FOR SAMPLES TESTED DRY - "AS MOULDED"

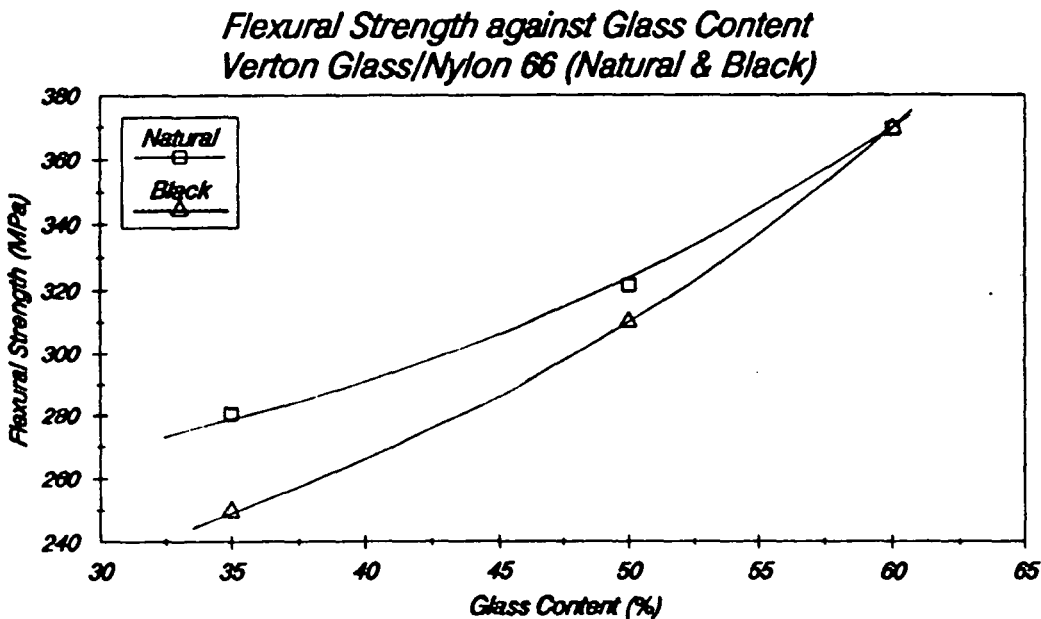

Figure 5.12 FLEXURAL STRENGTH AGAINST GLASS CONTENT -  
'VERTON' GLASS/NYLON 66

The flexural strength and flexural modulus of 'Maranyl' A100 were not determined, the reason being, the 3 - point bending apparatus fixed with a span length of 80mm did not allow the test sample to break. Figure 5.13 shows the Load - Deflection curve obtained for the test.

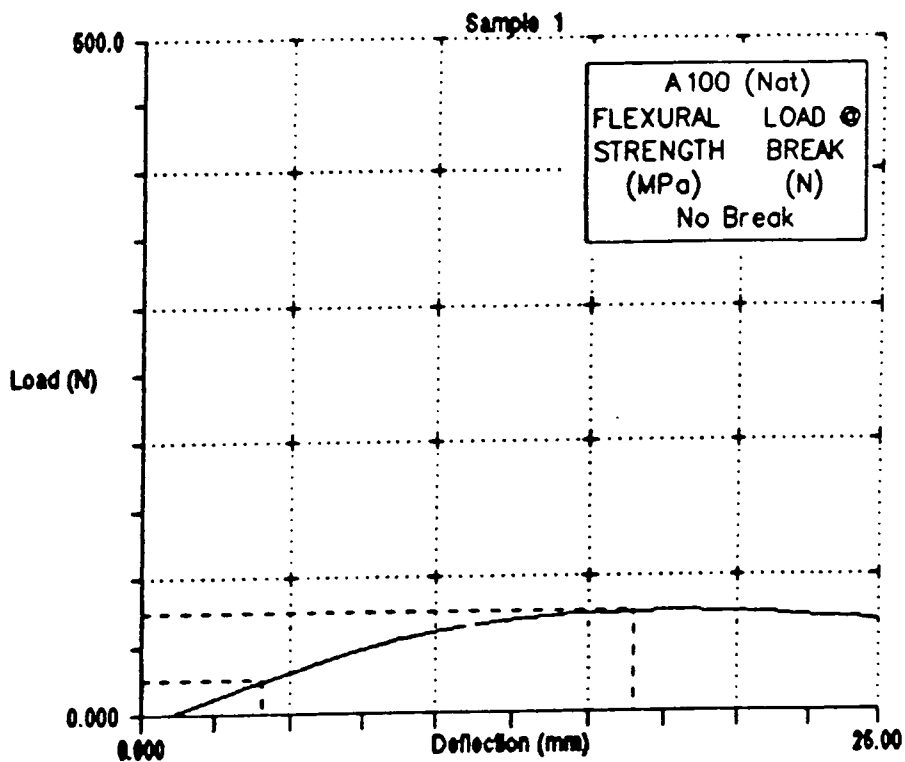

Figure 5.13 LOAD-DEFLECTION CURVE FOR 'MARANYL' A100 (Nat)

The changes in flexural strength of 'Verton' materials with moisture uptake, at soak-temperatures of 23°C, 40°C and 60°C is shown in Table 5.5.

Soak-Time : 24 hours

FLEXURAL STRENGTH (MPa)	RF 700-07		RF 700-10		RF 700-12	
	(Nat)	(Blk)	(Nat)	(Blk)	(Nat)	(Blk)
② Soak temp 23°C	221	205	264	262	324	295
Moisture Content(%)	2.42	1.65	1.53	1.30	1.33	0.74
② Soak temp 40°C	193	162	240	221	295	286
Moisture Content(%)	3.18	3.56	2.08	2.56	1.63	1.47
② Soak temp 60°C	128	134	186	187	226	227
Moisture Content(%)	3.58	4.24	2.52	3.40	2.40	2.68
Soak-Time : 432 hours						
FLEXURAL STRENGTH (MPa)	RF 700-07		RF 700-10		RF 700-12	
	(Nat)	(Blk)	(Nat)	(Blk)	(Nat)	(Blk)
② Soak temp 23°C	120	107	158	138	179	199
Moisture Content(%)	2.72	2.61	1.99	1.66	1.63	1.26
② Soak temp 40°C	87	74	109	108	148	124
Moisture Content(%)	3.52	4.38	2.84	3.27	2.36	2.41
② Soak temp 60°C	76	71	103	87	127	113
Moisture Content(%)	4.53	4.61	3.35	3.88	2.86	2.92
Soak-Time : 1000 hours						
FLEXURAL STRENGTH (MPa)	RF 700-07		RF 700-10		RF 700-12	
	(Nat)	(Blk)	(Nat)	(Blk)	(Nat)	(Blk)
② Soak temp 23°C	91	84	114	111	119	104
Moisture Content(%)	3.14	3.31	2.44	2.68	1.95	1.92
② Soak temp 40°C	92	68	109	91	104	95
Moisture Content(%)	3.72	4.57	2.45	3.40	2.74	2.87
② Soak temp 60°C	80	70	101	87	102	92
Moisture Content(%)	5.04	5.16	3.61	4.20	3.27	3.14

Table 5.5 FLEXURAL STRENGTH WITH MOISTURE UPTAKE, AFTER 24, 432 AND 1000 HOURS AT 23°C, 40°C AND 60°C

The reduction in flexural strength with increase in (a) moisture content and (b) square root of soak-time for RF 700-07 (Nat), RF 700-07 (Blk), RF 700-10 (Nat), RF 700-10 (Blk), RF 700-12 (Nat) and RF 700-12 (Blk) is given in figures 5.14 (a) and (b) to 5.19 (a) and (b) respectively on pages 88 - 90.

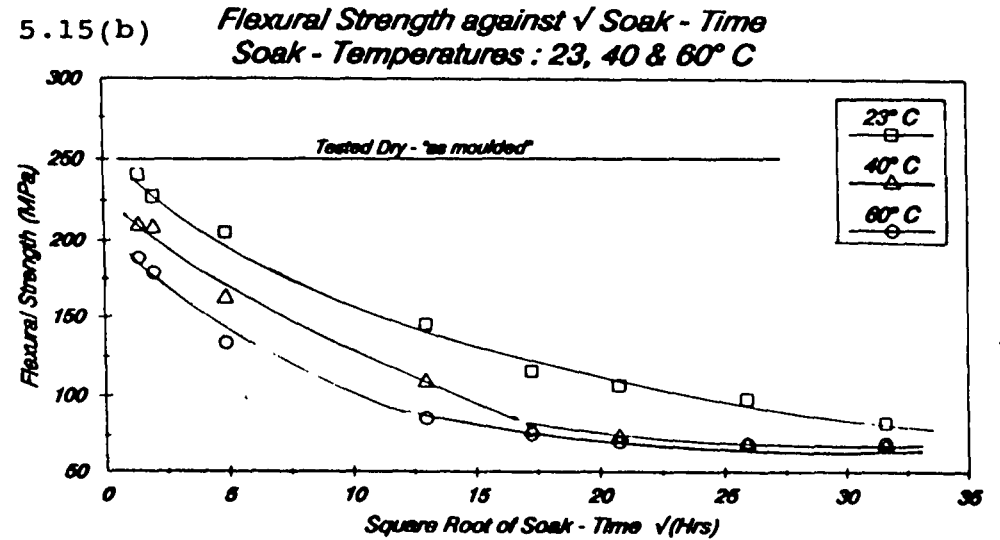
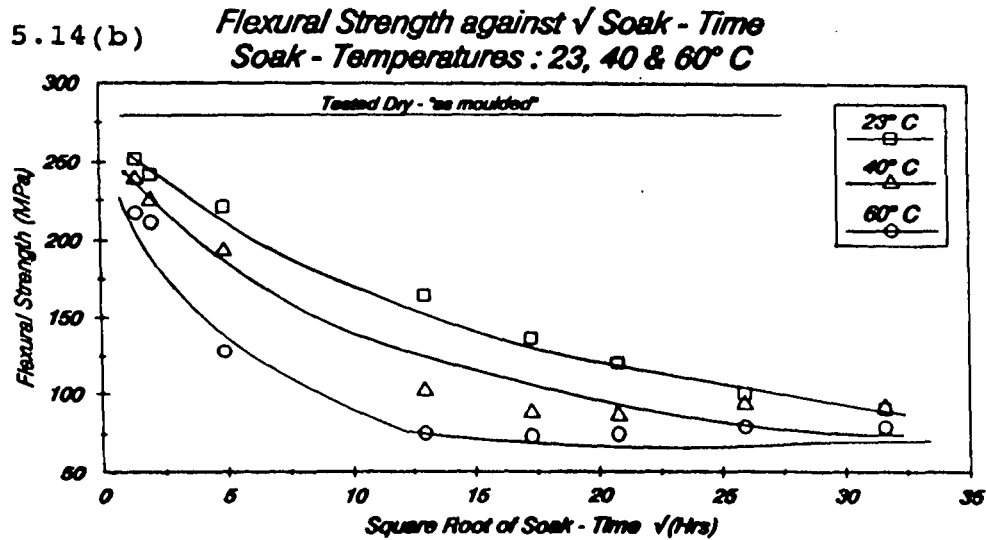
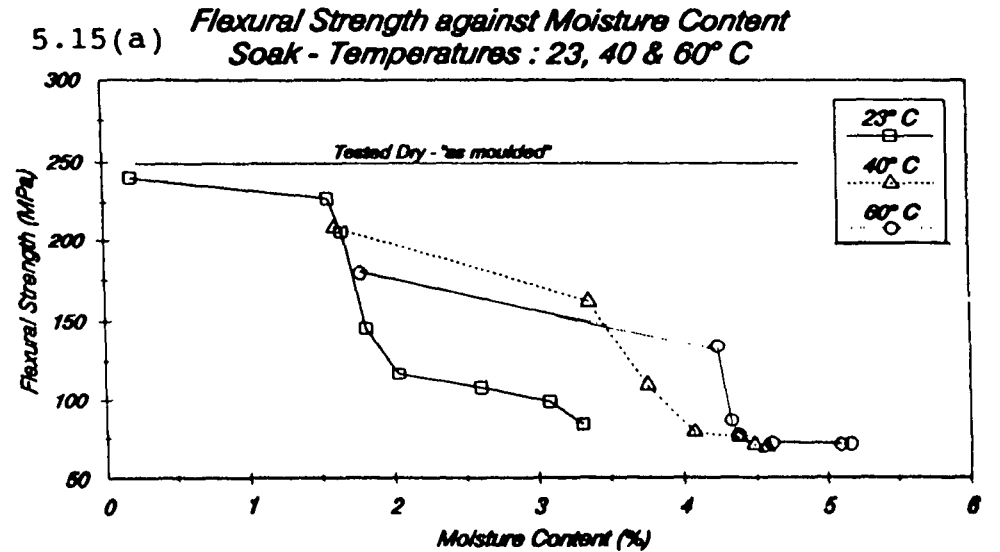
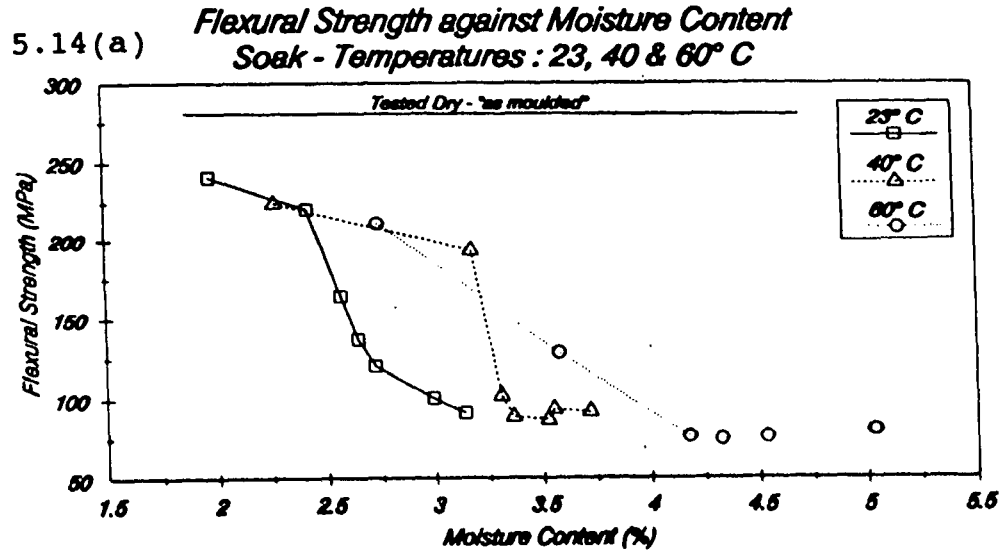
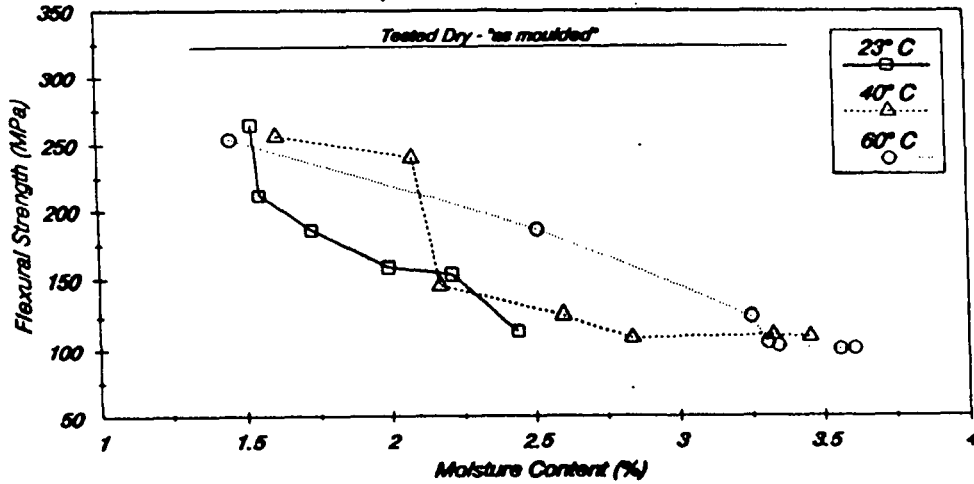

Figure 5.14 'VERTON' RF 700-07 (Nat)

Figure 5.15 'VERTON' RF 700-07 (Blk)

5.16(a) Flexural Strength against Moisture Content  
Soak - Temperatures : 23, 40 & 60° C



5.17(a) Flexural Strength against Moisture Content  
Soak - Temperatures : 23, 40 & 60° C

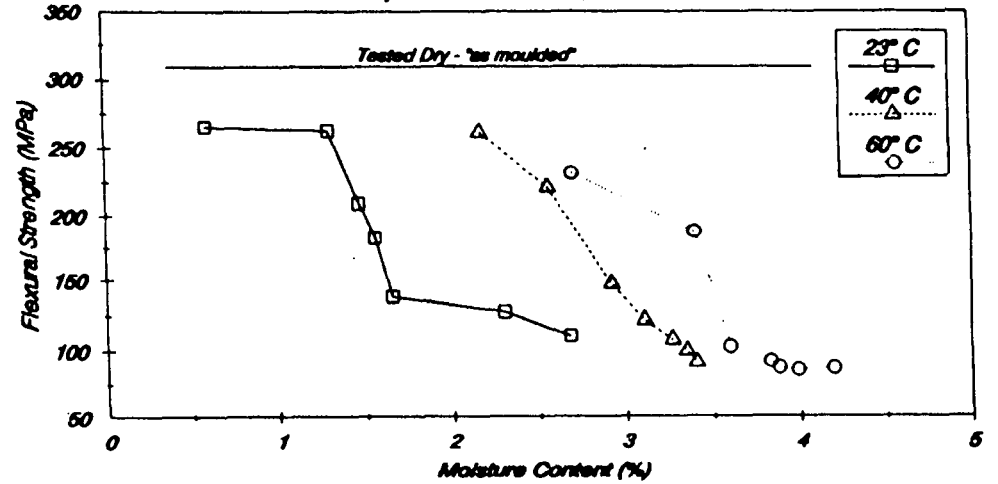

5.16(b) Flexural Strength against  $\sqrt{\text{Soak - Time}}$   
Soak - Temperatures : 23, 40 & 60° C

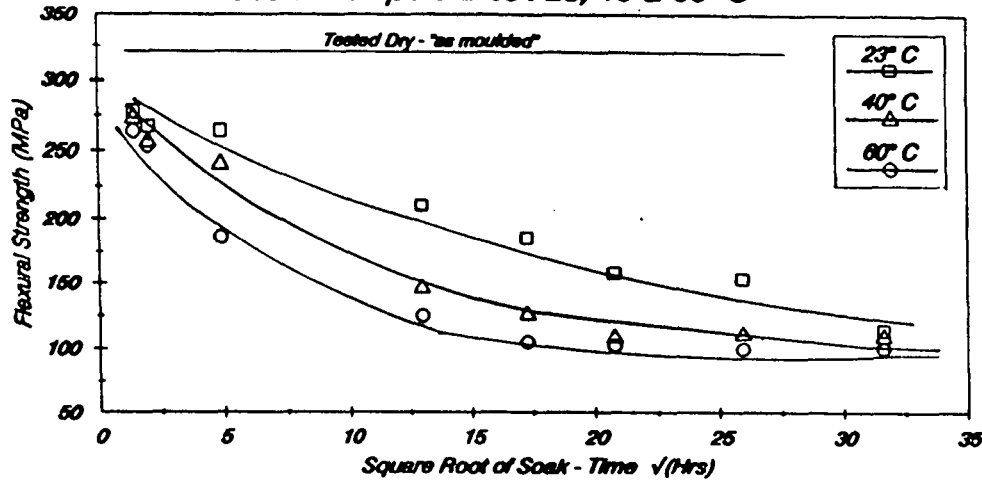

5.17(b) Flexural Strength against  $\sqrt{\text{Soak - Time}}$   
Soak - Temperatures : 23, 40 & 60° C

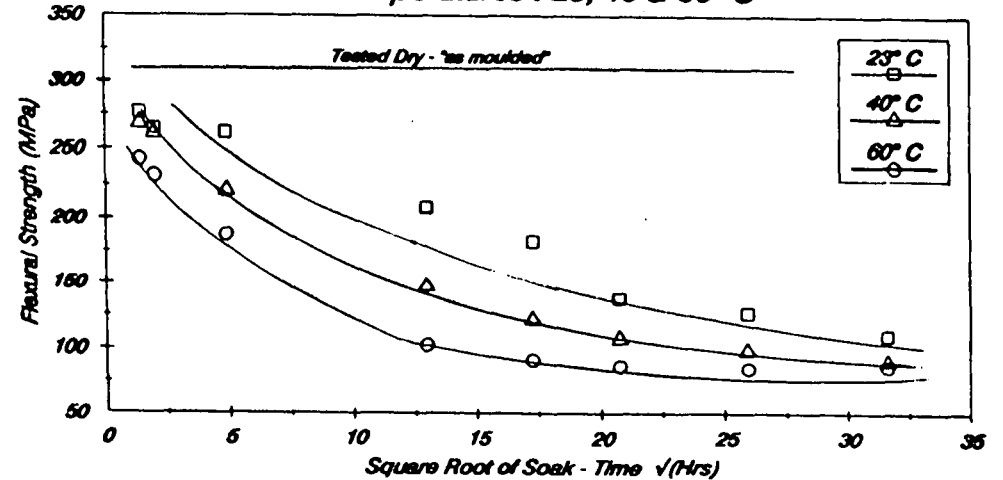
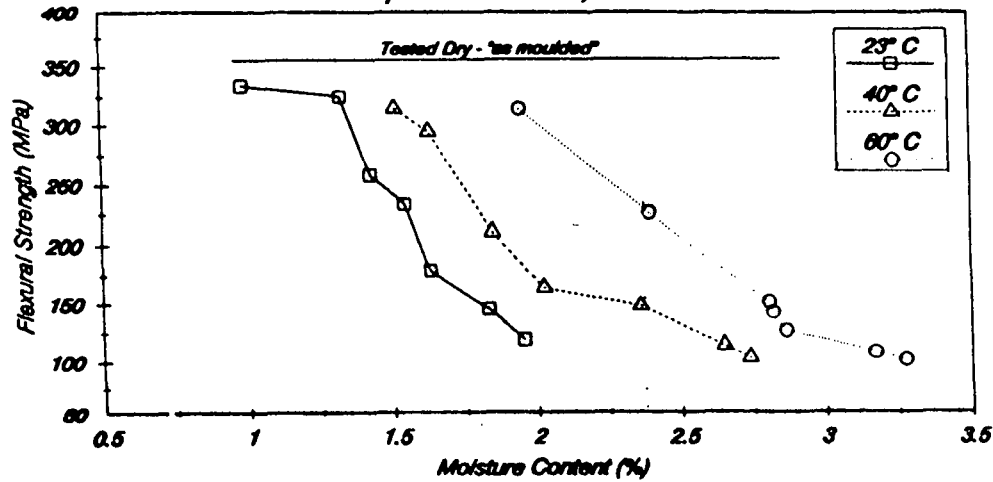

Figure 5.16 'VERTON' RP 700-10 (Nat)

Figure 5.17 'VERTON' RP 700-10 (Blk)



5.18(a) Flexural Strength against Moisture Content  
Soak - Temperatures : 23, 40 & 60° C



5.19(a) Flexural Strength against Moisture Content  
Soak - Temperatures : 23, 40 & 60° C

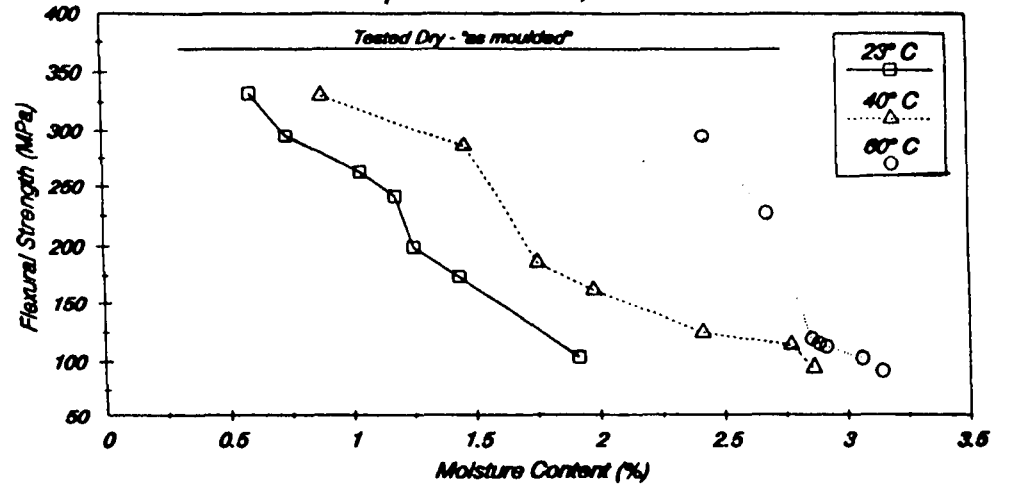

5.18(b) Flexural Strength against  $\sqrt{\text{Soak - Time}}$   
Soak - Temperatures : 23, 40 & 60° C

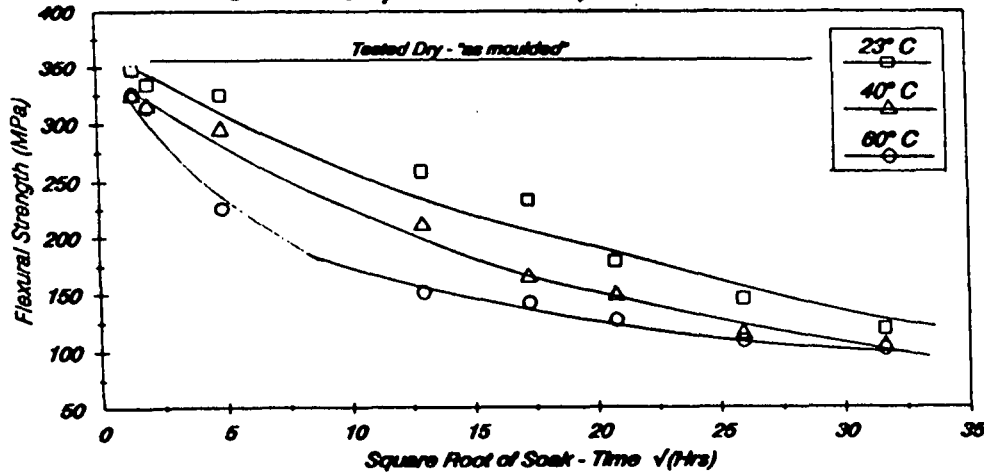

5.19(b) Flexural Strength against  $\sqrt{\text{Soak - Time}}$   
Soak - Temperatures : 23, 40 & 60° C

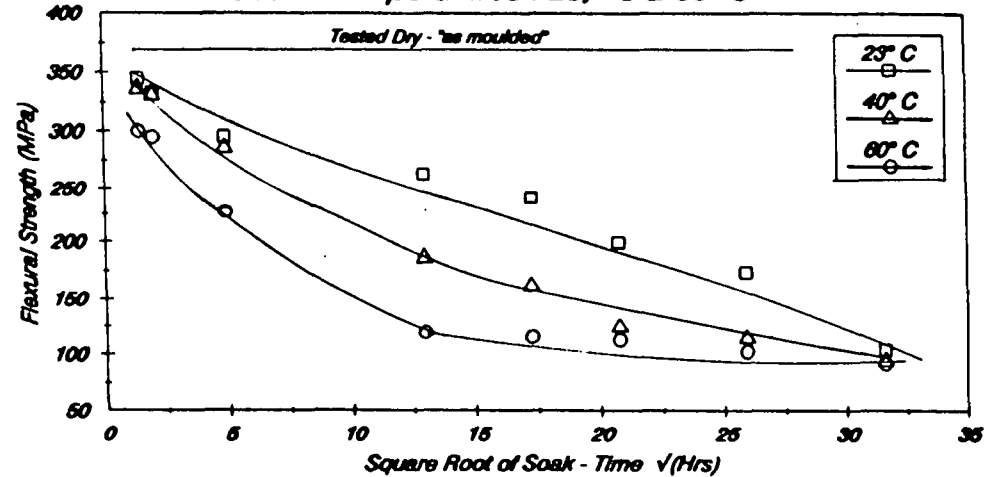

Figure 5.18 'VERTON' RF 700-12 (Nat)

Figure 5.19 'VERTON' RF 700-12 (Blk)

### 5.2.3 Flexural Modulus

Table 5.6 shows the flexural modulus of 'Verton' materials, tested, dry - "as moulded"

Figure 5.20 shows the increase in flexural modulus with increase in glass content.

Table 5.6

FLEXURAL MODULUS (GPa)	A100	RF 700-07	RF 700-10	RF 700-12
Natural	-	10.6	14.5	18.9
Black	-	10.1	14.6	19.3

FLEXURAL MODULUS FOR SAMPLES TESTED DRY - "AS MOULDED"

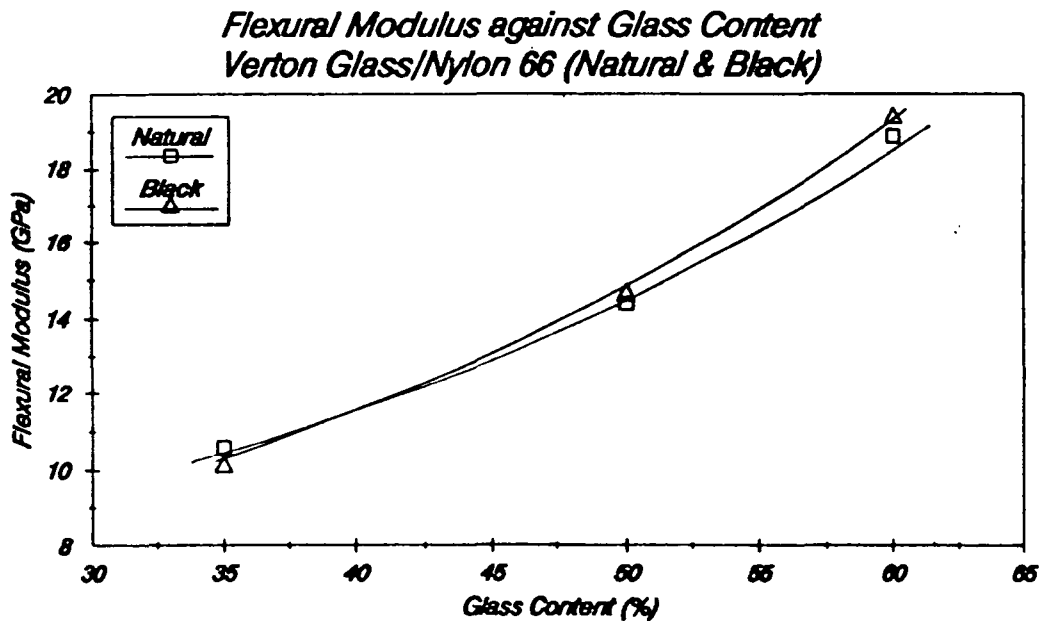

Figure 5.20 FLEXURAL MODULUS AGAINST GLASS CONTENT - 'VERTON' GLASS/NYLON 66

Table 5.7 shows the general reduction in flexural modulus with moisture uptake, at soak temperatures of 23°C, 40°C and 60°C. Again, the results of the entire conditioning program can be seen in the appendices (A2 and A4).

Table 5.7

Soak-Time : 24 hours

FLEXURAL MODULUS (GPa)	RF 700-07		RF 700-10		RF 700-12	
	(Nat)	(Blk)	(Nat)	(Blk)	(Nat)	(Blk)
Soak temp 23°C	8.1	7.7	11.3	11.8	16.1	15.8
Moisture Content(%)	2.42	1.65	1.53	1.30	1.33	0.74
Soak temp 40°C	7.0	6.5	10.0	9.6	14.3	13.9
Moisture Content(%)	3.18	3.56	2.08	2.56	1.63	1.47
Soak temp 60°C	5.5	5.2	8.2	8.2	11.9	11.5
Moisture Content(%)	3.58	4.24	2.52	3.40	2.40	2.68

Soak-Time : 432 hours

FLEXURAL MODULUS (GPa)	RF 700-07		RF 700-10		RF 700-12	
	(Nat)	(Blk)	(Nat)	(Blk)	(Nat)	(Blk)
Soak temp 23°C	5.1	4.5	7.7	6.9	10.1	11.0
Moisture Content(%)	2.72	2.61	1.99	1.66	1.63	1.26
Soak temp 40°C	4.6	4.4	6.5	6.3	9.6	9.1
Moisture Content(%)	3.52	4.38	2.84	3.27	2.36	2.41
Soak temp 60°C	4.4	4.2	6.6	6.1	9.4	9.4
Moisture Content(%)	4.53	4.61	3.35	3.88	2.86	2.92

Soak-Time : 1000 hours

FLEXURAL MODULUS (GPa)	RF 700-07		RF 700-10		RF 700-12	
	(Nat)	(Blk)	(Nat)	(Blk)	(Nat)	(Blk)
Soak temp 23°C	4.2	4.7	6.5	5.0	9.8	9.1
Moisture Content(%)	3.14	3.31	2.44	2.68	1.95	1.92
Soak temp 40°C	4.7	4.0	6.8	6.2	9.5	8.5
Moisture Content(%)	3.72	4.57	2.45	3.40	2.74	2.87
Soak temp 60°C	4.2	3.9	6.3	6.1	8.8	8.2
Moisture Content(%)	5.04	5.16	3.61	4.20	3.27	3.14

FLEXURAL MODULUS WITH MOISTURE UPTAKE, AFTER 24,  
432 AND 1000 HOURS AT 23°C, 40°C AND 60°C

The reduction in flexural modulus with increase in (a) moisture content and (b) square root of soak-time for RF 700-07 (Nat), RF 700-07 (Blk), RF 700-10 (Nat), RF 700-10 (Blk), RF 700-12 (Nat) and RF 700-12 (Blk) is given in figures 5.21 (a) and (b) to 5.26 (a) and (b) respectively on pages 94 - 96.

5.21 (a) *Flexural Modulus against Moisture Content*  
Soak - Temperatures : 23, 40 & 60° C

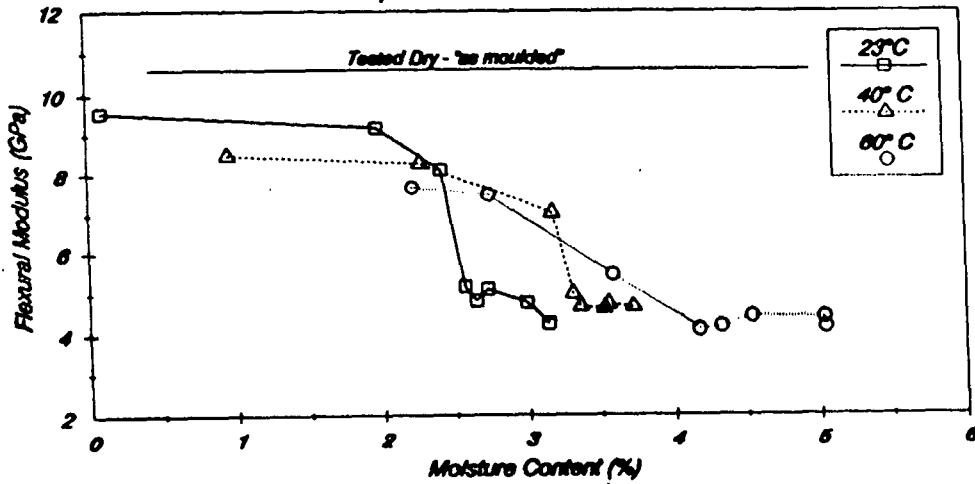

5.22 (a) *Flexural Modulus against Moisture Content*  
Soak - Temperatures : 23, 40 & 60° C

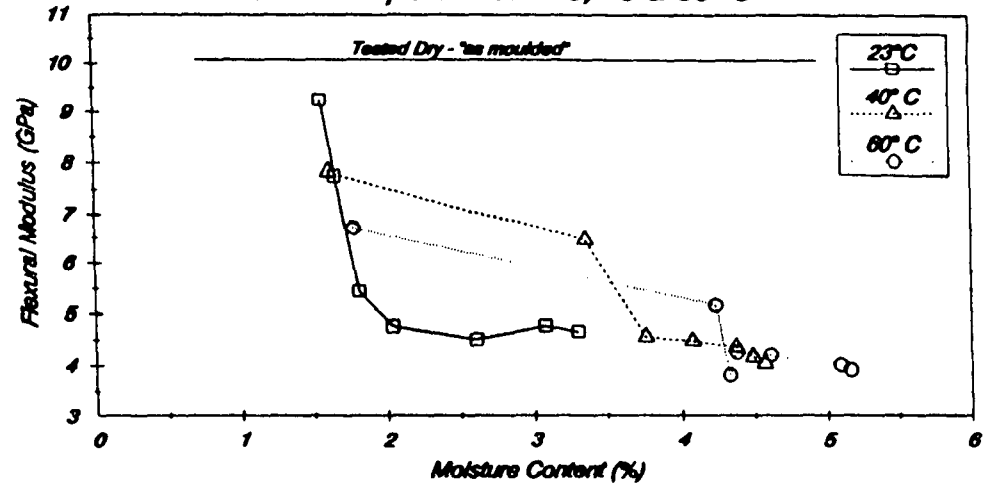

5.21 (b) *Flexural Modulus against  $\sqrt{\text{Soak - Time}}$*   
Soak - Temperatures : 23, 40 & 60° C

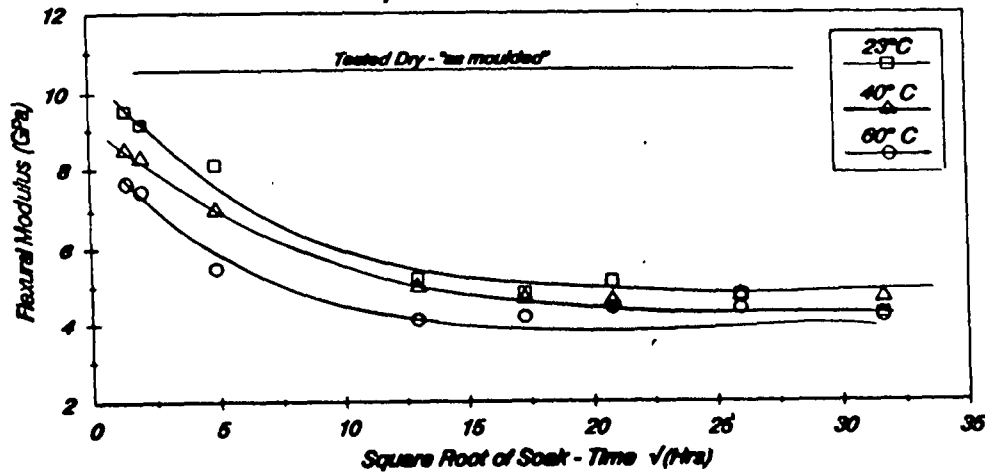

Figure 5.21 'VERTON' RF 700-07 (Nat)

5.22 (b) *Flexural Modulus against  $\sqrt{\text{Soak - Time}}$*   
Soak - Temperatures : 23, 40 & 60° C

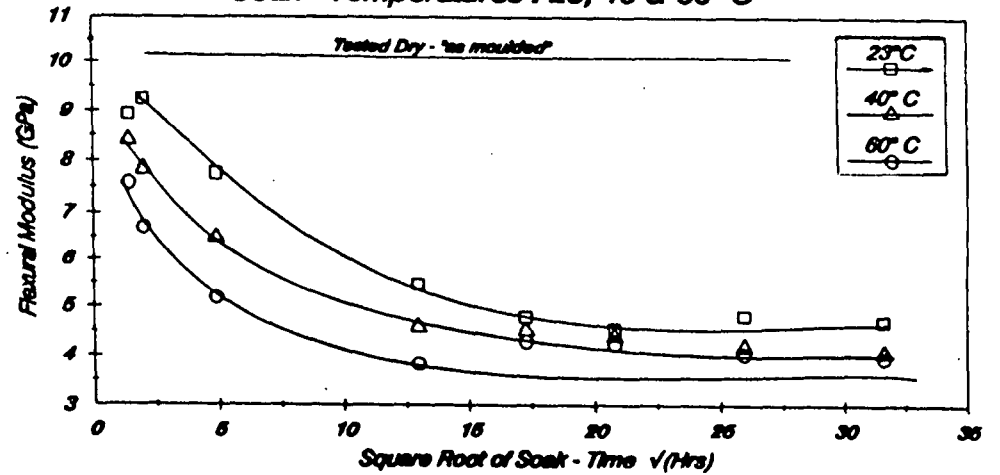
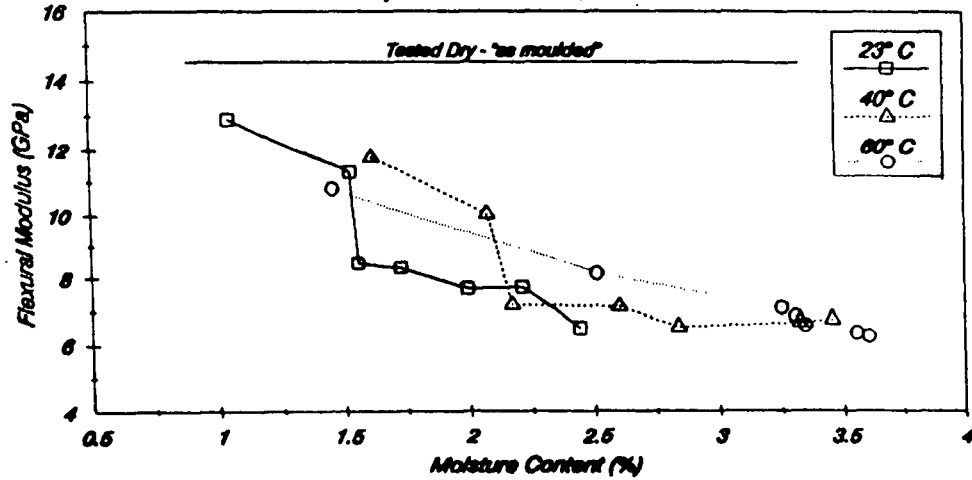
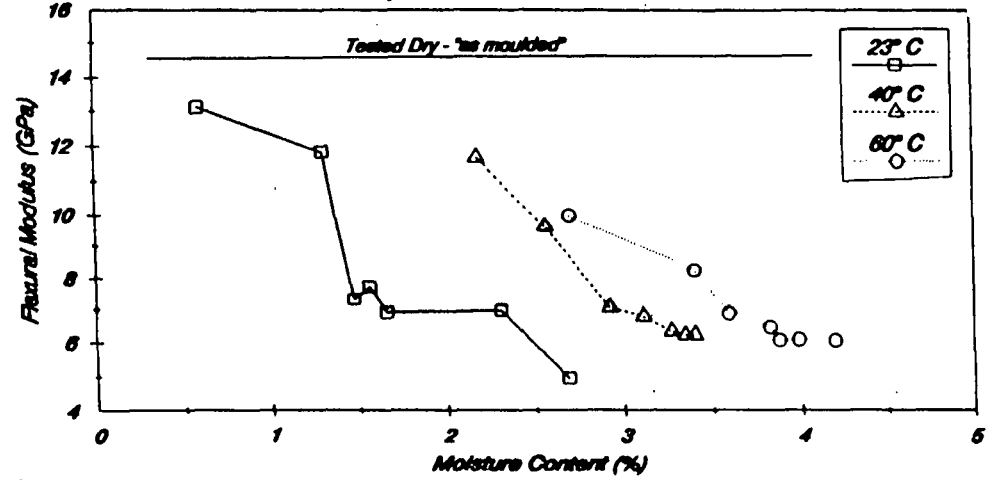

Figure 5.22 'VERTON' RF 700-07 (Blk)

5.23(a) Flexural Modulus against Moisture Content  
Soak - Temperatures : 23, 40 & 60° C



5.24(a) Flexural Modulus against Moisture Content  
Soak - Temperatures : 23, 40 & 60° C



5.23(b) Flexural Modulus against  $\sqrt{\text{Soak - Time}}$   
Soak - Temperatures : 23, 40 & 60° C

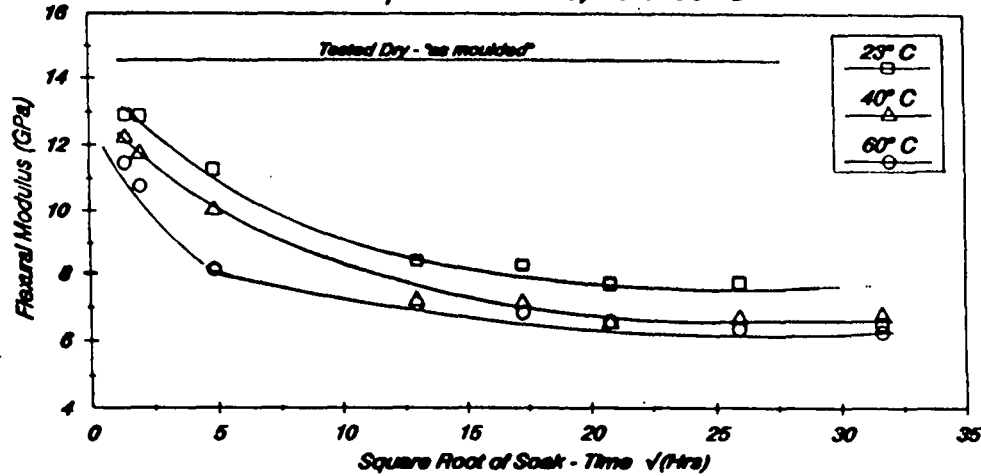

5.24(b) Flexural Modulus against  $\sqrt{\text{Soak - Time}}$   
Soak - Temperatures : 23, 40 & 60° C

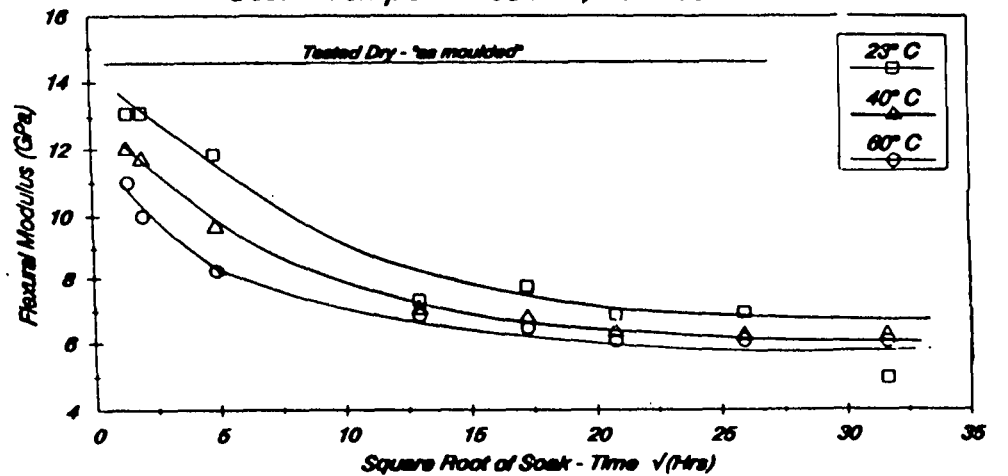
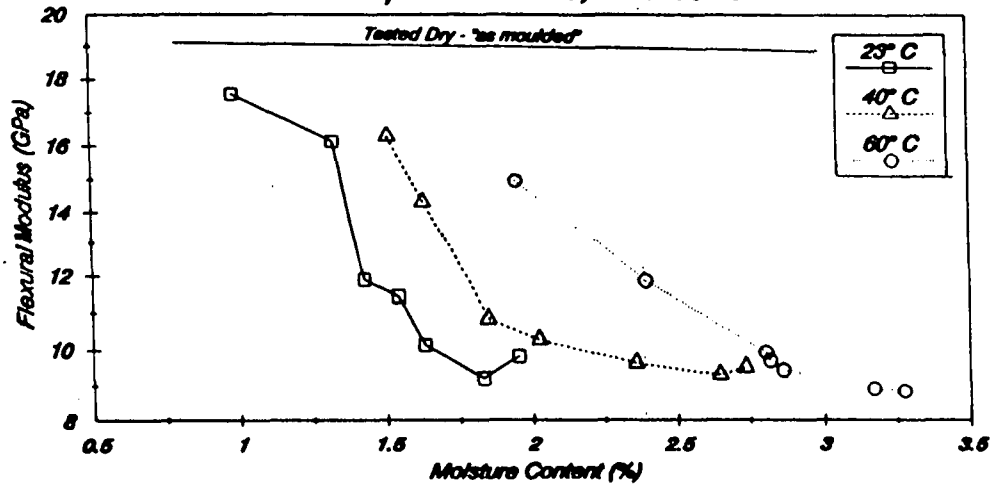

Figure 5.23 'VERTON' RF 700-10 (Nat)

Figure 5.24 'VERTON' RF 700-10 (Blk)

5.25 (a) Flexural Modulus against Moisture Content  
Soak - Temperatures : 23, 40 & 60° C



5.26 (a) Flexural Modulus against Moisture Content  
Soak - Temperatures : 23, 40 & 60° C

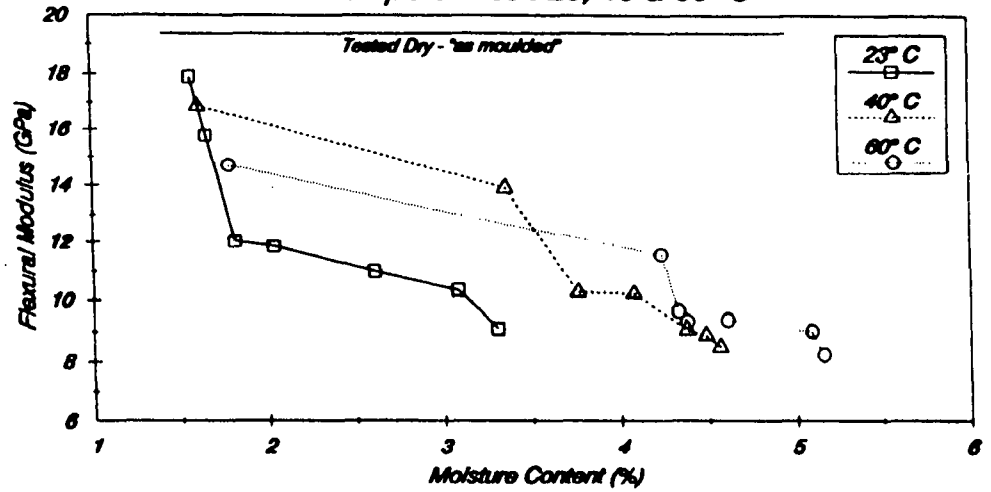

5.25 (b) Flexural Modulus against  $\sqrt{\text{Soak - Time}}$   
Soak - Temperatures : 23, 40 & 60° C

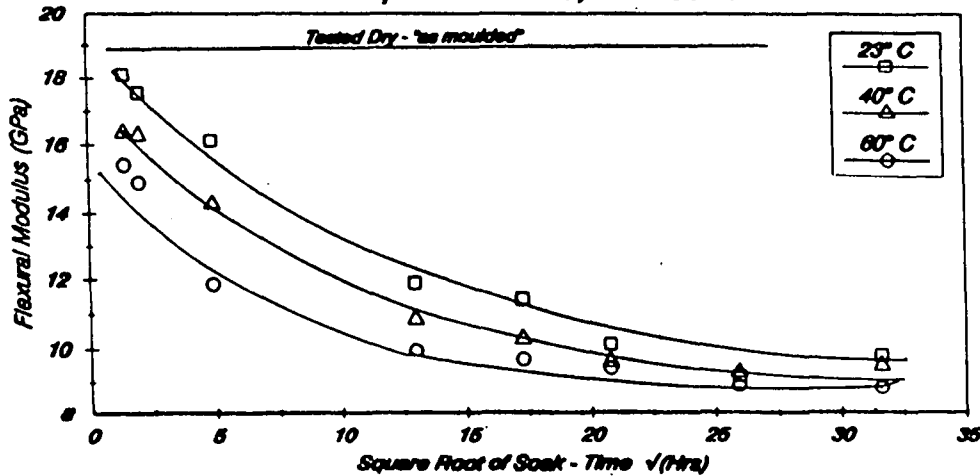

5.26 (b) Flexural Modulus against  $\sqrt{\text{Soak - Time}}$   
Soak - Temperatures : 23, 40 & 60° C

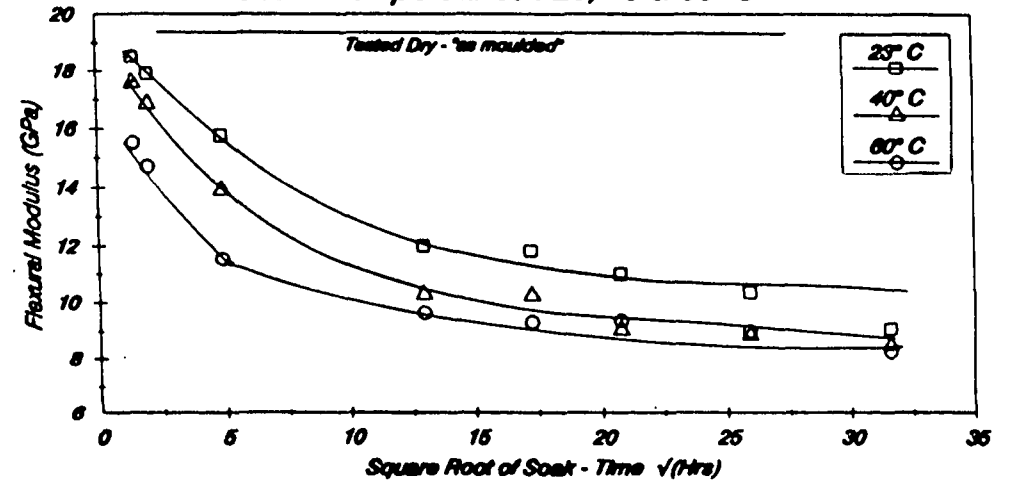

Figure 5.25 'VERTON' RF 700-12 (Nat)

Figure 5.26 'VERTON' RF 700-12 (Blk)

### 5.2.4 Charpy Impact Strength

The Charpy impact strength was initially determined using both type of samples:

- (i) notched and
- (ii) un-notched

with uptake of moisture, however, the mass of the largest pendulum available was insufficient to completely break all the un-notched samples. Therefore, the impact testing of un-notched samples was aborted. Even when tested dry "as moulded", the un-notched samples of 'Maranyl' A100 did not break.

Tables 5.8 and 5.9 show the impact strength of notched and un-notched samples respectively, tested dry - "as moulded".

IMPACT STRENGTH (kJ/m <sup>2</sup> )	A100	RF 700-07	RF 700-10	RF 700-12
Natural	6	22	39	42
Black	-	15	21	37

Table 5.8 IMPACT STRENGTH FOR NOTCHED SAMPLES  
TESTED DRY - "AS MOULDED"

IMPACT STRENGTH (kJ/m <sup>2</sup> )	A100	RF 700-07	RF 700-10	RF 700-12
Natural	-	54	86	91
Black	-	49	62	81

Table 5.9 IMPACT STRENGTH FOR UN-NOTCHED SAMPLES  
TESTED DRY - "AS MOULDED"



Figures 5.27 and 5.28 show the change in impact strength with increase in glass content for notched and un-notched samples, respectively. The values quoted are an average taken from five test samples.

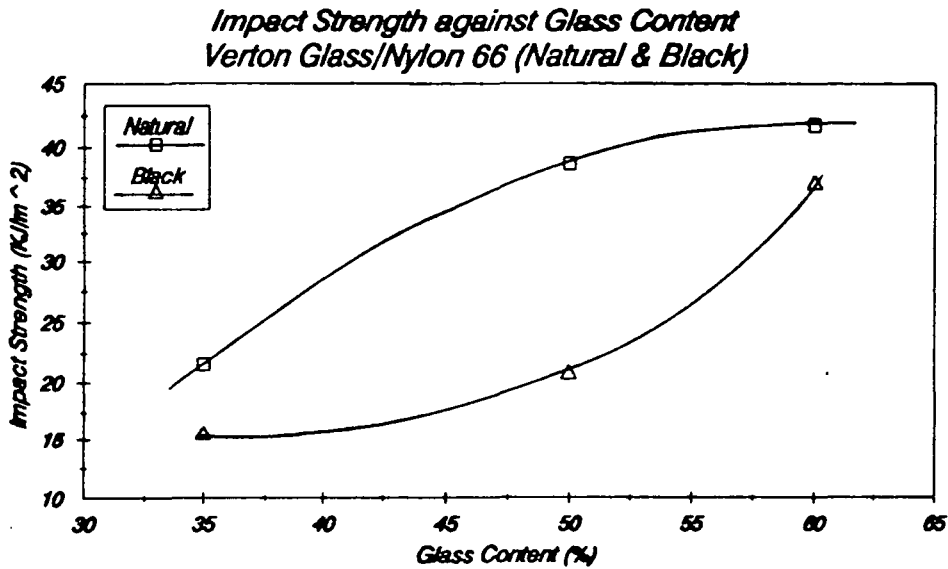

Figure 5.27 IMPACT STRENGTH AGAINST GLASS CONTENT - 'VERTON' GLASS/NYLON 66 (NOTCHED SAMPLES)

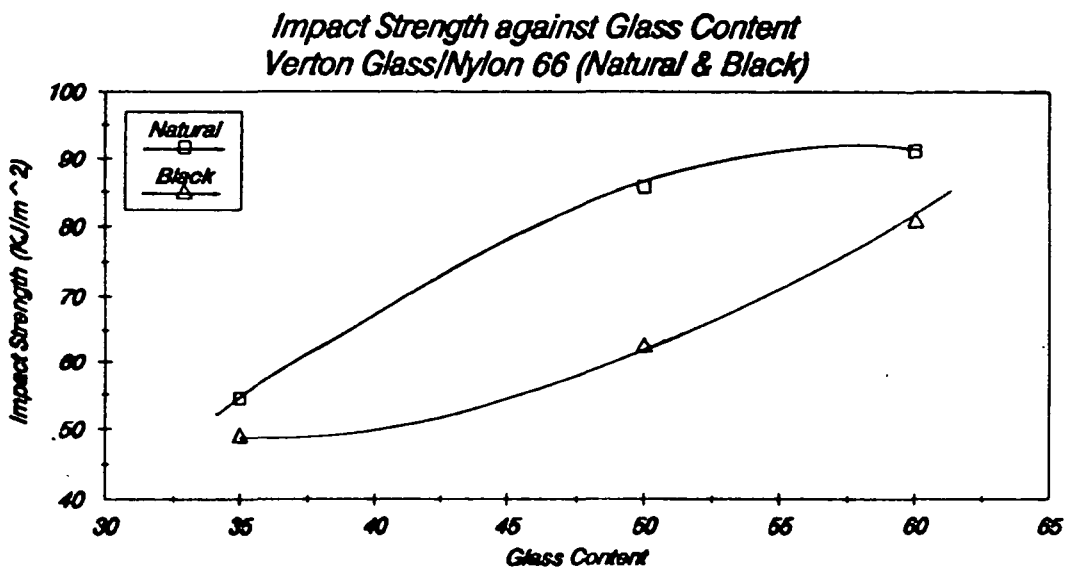

Figure 5.28 IMPACT STRENGTH AGAINST GLASS CONTENT - 'VERTON' GLASS/NYLON 66 (UN-NOTCHED SAMPLES)

Table 5.10 shows the change in impact strength with moisture uptake, at soak temperatures of 23°C, 40°C and 60°C.

Soak-Time : 24 hours

IMPACT STRENGTH (kJ/m <sup>2</sup> )	A100 (Nat)	RF 700-07 (Nat) (Blk)		RF 700-10 (Nat) (Blk)		RF 700-12 (Nat) (Blk)	
Soak temp 23°C	-	23	20	49	41	48	44
Moisture Content(%)	4.14	1.94	1.33	1.33	1.42	1.05	1.06
Soak temp 40°C	-	24	21	52	44	49	45
Moisture Content(%)	5.51	2.53	1.63	1.87	1.69	1.32	1.39
Soak temp 60°C	-	30	26	60	48	55	54
Moisture Content(%)	6.27	2.86	1.81	2.50	2.30	1.93	2.08
Soak-Time : 432 hours							
IMPACT STRENGTH (kJ/m <sup>2</sup> )	A100 (Nat)	RF 700-07 (Nat) (Blk)		RF 700-10 (Nat) (Blk)		RF 700-12 (Nat) (Blk)	
Soak temp 23°C	-	41	34	66	52	54	51
Moisture Content(%)	6.25	2.18	2.09	1.63	1.80	1.31	1.35
Soak temp 40°C	-	45	48	74	67	59	55
Moisture Content(%)	7.20	2.85	2.95	2.66	2.71	1.89	1.90
Soak temp 60°C	-	53	57	83	72	60	59
Moisture Content(%)	8.12	3.63	3.56	2.94	3.09	2.54	2.60
Soak-Time : 1000 hours							
IMPACT STRENGTH (kJ/m <sup>2</sup> )	A100 (Nat)	RF 700-07 (Nat) (Blk)		RF 700-10 (Nat) (Blk)		RF 700-12 (Nat) (Blk)	
Soak temp 23°C	41	54	50	75	67	60	55
Moisture Content(%)	7.05	2.51	2.67	2.31	2.41	1.73	1.80
Soak temp 40°C	33	59	58	84	74	61	58
Moisture Content(%)	7.80	3.10	3.26	2.89	2.91	2.18	2.21
Soak temp 60°C	30	62	61	86	77	63	61
Moisture Content(%)	8.13	3.90	3.96	3.12	3.32	2.70	2.71

Table 5.10 IMPACT STRENGTH WITH MOISTURE UPTAKE, AFTER 24, 432 AND 1000 HOURS AT 23°C, 40°C AND 60°C (NOTCHED SAMPLES)

The change in impact strength (notched samples) with increase in (a) moisture content and (b) square root of soak-time for RF 700-07 (Nat), RF 700-07 (Blk), RF 700-10 (Nat), RF 700-10 (Blk), RF 700-12 (Nat) and RF 700-12 (Blk) is given in figures 5.29 (a) and (b) to 5.34 (a) and (b) respectively on pages 101 - 103.

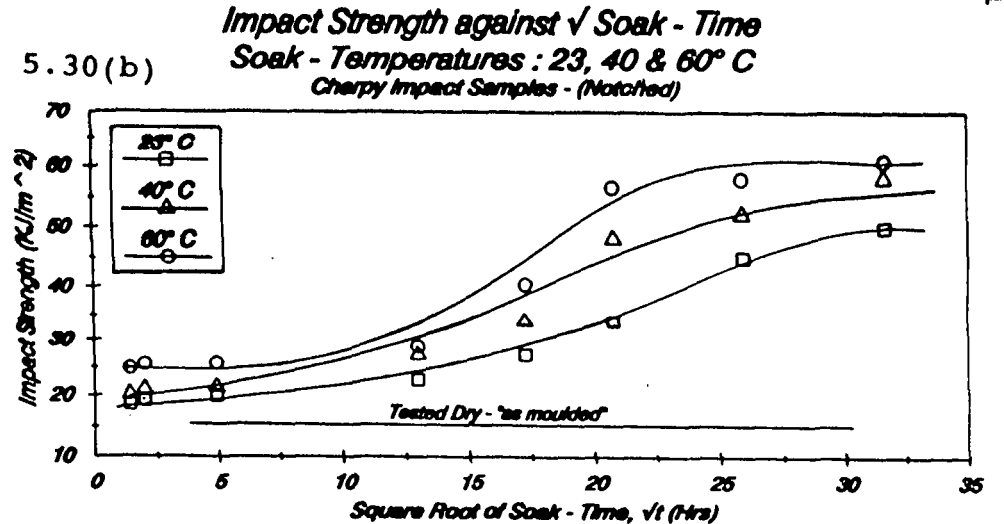
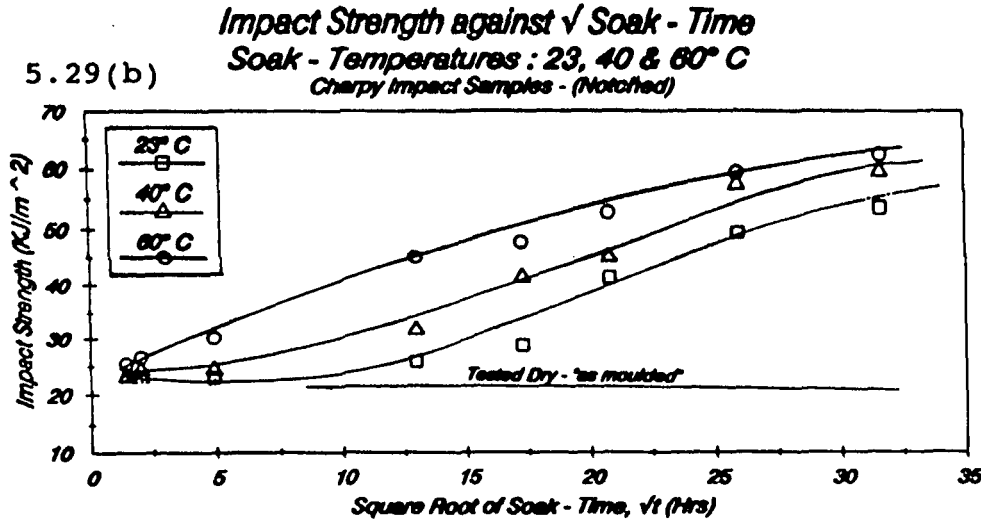
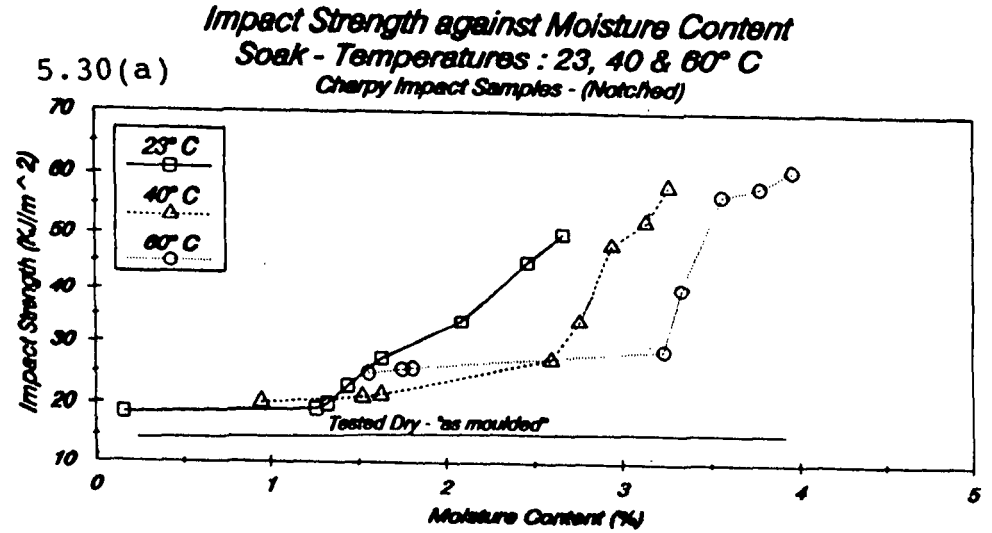
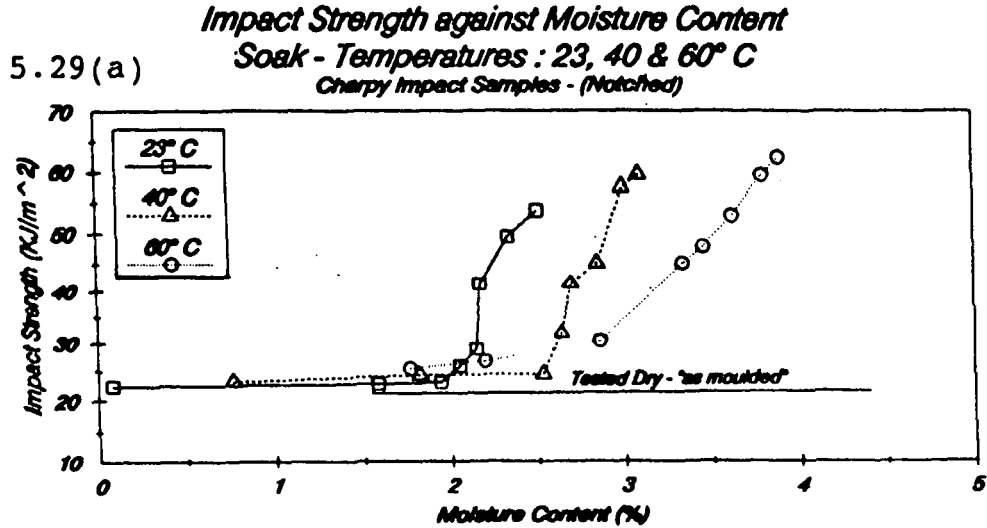

Figure 5.29 'VERTON' RF 700-07 (Nat)

Figure 5.30 'VERTON' RF 700-07 (Blk)

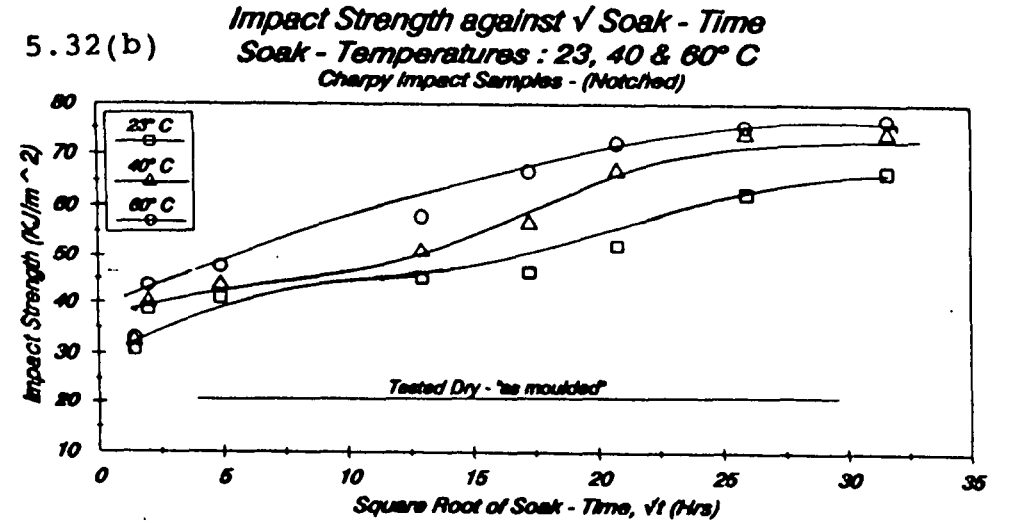
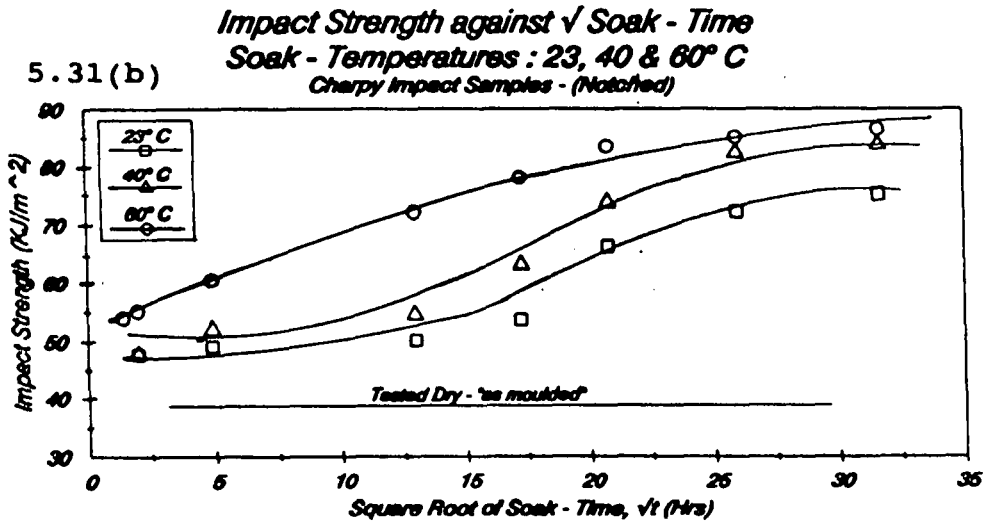
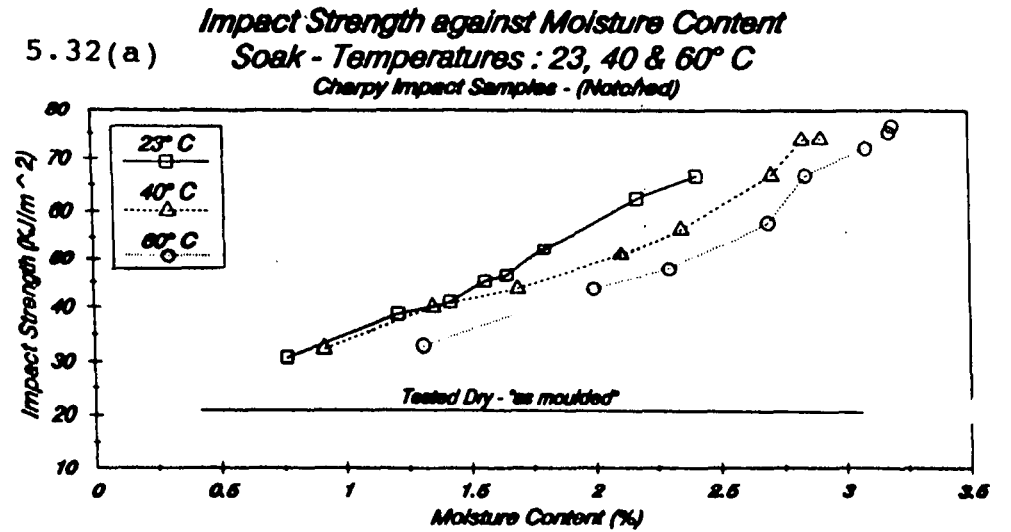
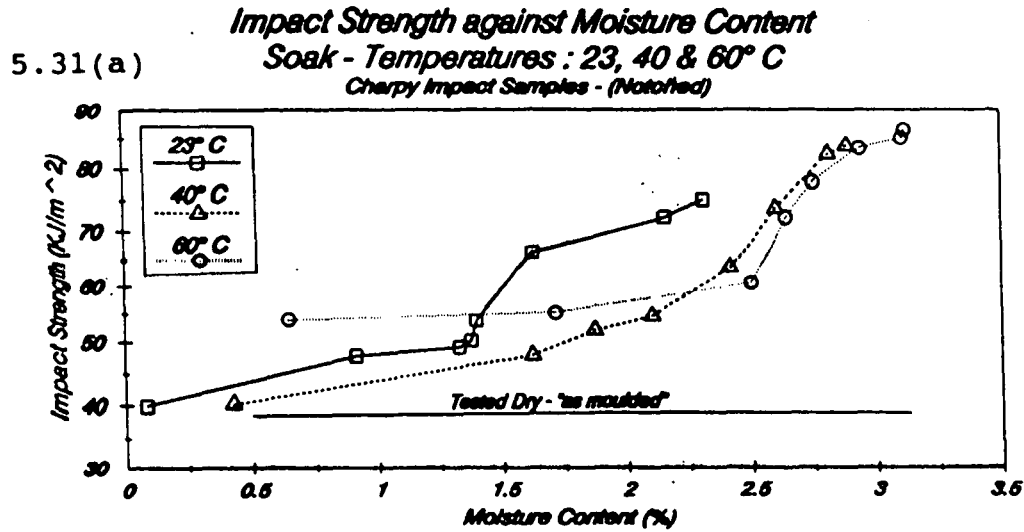
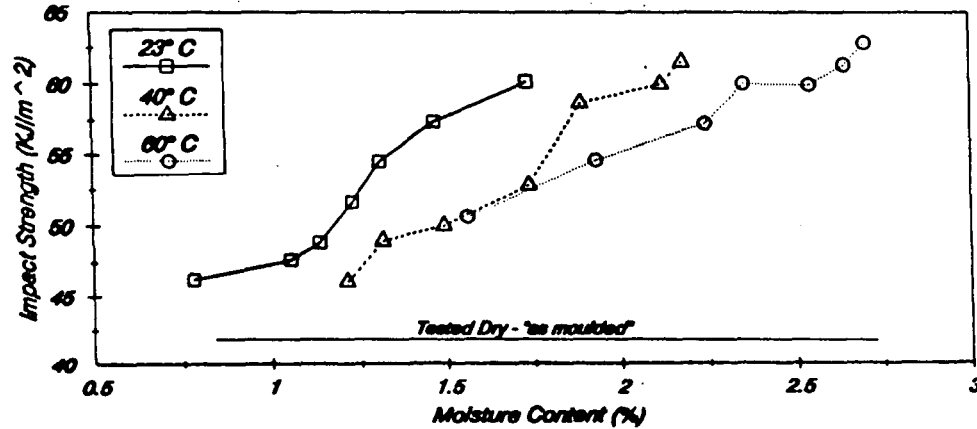

Figure 5.31 'VERTON' RF 700-10 (Nat)

Figure 5.32 'VERTON' RF 700-10 (Blk)

5.33(a) **Impact Strength against Moisture Content**  
 Soak - Temperatures : 23, 40 & 60° C  
 Charpy Impact Samples - (Notched)



5.34(a) **Impact Strength against Moisture Content**  
 Soak - Temperatures : 23, 40 & 60° C  
 Charpy Impact Samples - (Notched)

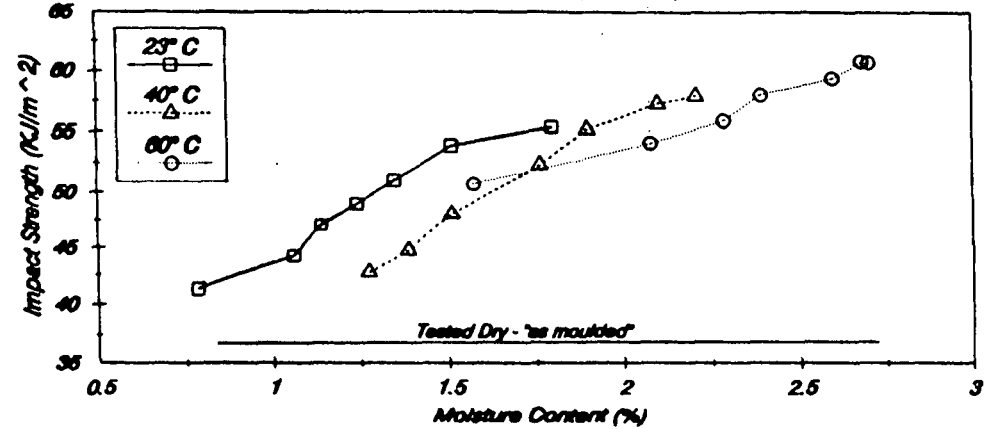

5.33(b) **Impact Strength against √ Soak - Time**  
 Soak - Temperatures : 23, 40 & 60° C  
 Charpy Impact Samples - (Notched)

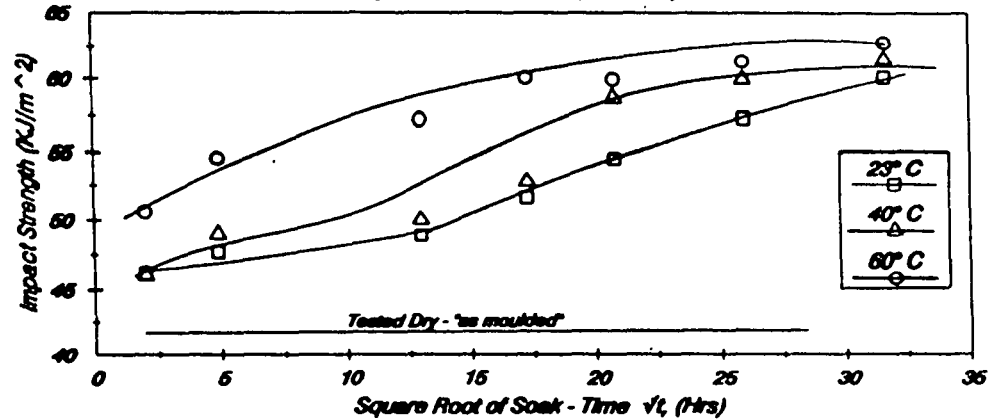

5.34(b) **Impact Strength against √ Soak - Time**  
 Soak - Temperatures : 23, 40 & 60° C  
 Charpy Impact Samples - (Notched)

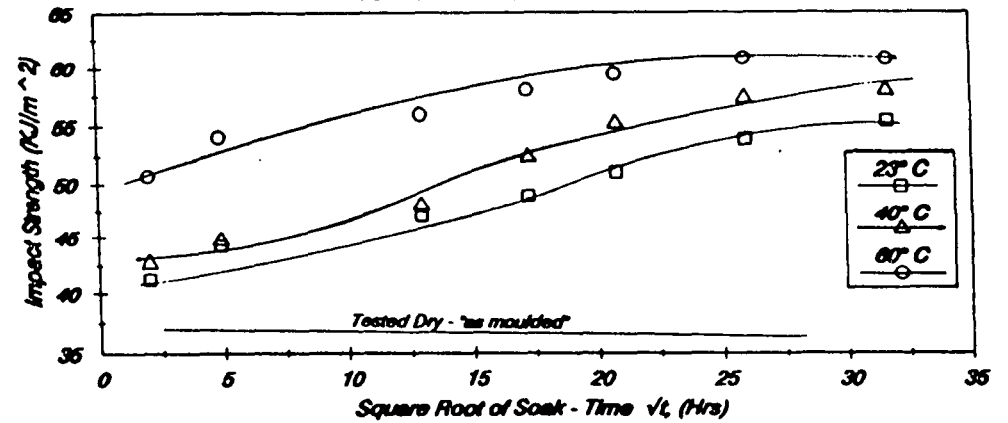

Figure 5.33 'VERTON' RF 700-12 (Nat)

Figure 5.34 'VERTON' RF 700-12 (Blk)

### 5.3 PHYSICAL PROPERTIES

#### 5.3.1 Changes in Sample Length, Width and Thickness

Table 5.11 shows the general change in sample dimensions with moisture uptake after 24 hours, 432 hours (18 days) and 1000 hours (42 days), at 23°C, 40°C and 60°C. As with all data in this chapter, the individual results at each stage of the conditioning program can be seen in the appendices (A 2.1 - A 2.19).

The values quoted are averages, measured using five Charpy impact samples (notched). The main reason for using Charpy impact samples as opposed to tensile bars, was that the micrometer available for this study was only capable of measuring lengths of up to 150 mm (average length of tensile bars :~ 200 mm).

Soak-Time : 24 hours

DIMENSIONAL CHANGE (Z)	A100 (Nat)	RF 700-07 (Nat) (Blk)		RF 700-10 (Nat) (Blk)		RF 700-12 (Nat) (Blk)	
@ 23°C :							
Length	-	0.01	0.03	0.01	0.02	0.01	0.01
Width	1.23	0.51	0.29	0.40	0.46	0.30	0.31
Thickness	1.49	0.24	0.37	0.20	0.54	0.18	0.20
@ 40°C :							
Length	-	0.03	0.04	0.03	0.05	0.03	0.03
Width	1.75	0.84	0.67	0.63	0.80	0.62	0.63
Thickness	2.20	0.49	0.62	0.41	0.78	0.40	0.42
@ 60°C :							
Length	-	0.06	0.07	0.07	0.08	0.06	0.07
Width	2.84	1.01	1.09	1.00	1.20	0.87	0.90
Thickness	3.28	0.98	1.23	1.11	1.35	1.10	1.12

Soak-Time : 432 hours

DIMENSIONAL CHANGE (Z)	A100 (Nat)	RF 700-07 (Nat) (Blk)		RF 700-10 (Nat) (Blk)		RF 700-12 (Nat) (Blk)	
@ 23°C :							
Length	-	0.08	0.09	0.07	0.08	0.06	0.07
Width	1.54	1.26	1.04	1.00	1.10	0.80	0.81
Thickness	2.09	1.59	1.55	1.40	1.52	1.32	1.35
@ 40°C :							
Length	-	0.16	0.16	0.14	0.16	0.12	0.14
Width	2.70	1.52	1.40	1.15	1.25	1.15	1.17
Thickness	3.38	1.91	1.72	1.68	1.79	1.60	1.60
@ 60°C :							
Length	-	0.21	0.22	0.18	0.21	0.16	0.16
Width	3.39	1.58	1.68	1.39	1.49	1.32	1.40
Thickness	3.58	2.02	1.92	1.84	2.14	1.77	1.80

Soak-Time : 1000 hours

DIMENSIONAL CHANGE (Z)	A100 (Nat)	RF 700-07 (Nat) (Blk)		RF 700-10 (Nat) (Blk)		RF 700-12 (Nat) (Blk)	
@ 23°C :							
Length	-	0.16	0.18	0.14	0.15	0.11	0.11
Width	1.93	1.52	1.58	1.21	1.32	1.10	1.20
Thickness	2.69	1.95	1.99	1.75	1.86	1.64	1.67
@ 40°C :							
Length	-	0.22	0.22	0.19	0.20	0.15	0.16
Width	3.00	1.60	1.77	1.31	1.40	1.28	1.40
Thickness	3.50	2.07	2.07	1.88	2.01	1.79	1.80
@ 60°C :							
Length	-	0.24	0.36	0.20	0.24	0.17	0.18
Width	3.41	1.67	1.84	1.54	1.64	1.41	1.15
Thickness	3.58	2.20	2.14	2.00	2.24	1.90	1.91

Table 5.11 SAMPLE DIMENSIONS WITH MOISTURE UPTAKE, AFTER 24, 432 AND 1000 HOURS AT 23°C, 40°C AND 60°C (NOTCHED SAMPLES)



The change in sample dimensions with increase in moisture content at (a) 23°C, (b) 40°C and (c) 60°C for A100 (Nat), RF 700-07 (Nat), RF 700-07 (Blk), RF 700-10 (Nat), RF 700-10 (Blk), RF 700-12 (Nat) and RF 700-12 (Blk) is given in figures 5.35 (a), (b) and (c) to 5.41 (a), (b) and (c) respectively on pages 107 - 113.

For 'Maranyl' A100 (Natural), unfortunately due to the unavailability of moulded Charpy samples, dimensional changes were measured using tensile specimens and therefore changes only in width and thickness are quoted.

Figure 5.35 (a) *The change in dimensions of A100 (Nat) mouldings on immersion in water at 23°C*

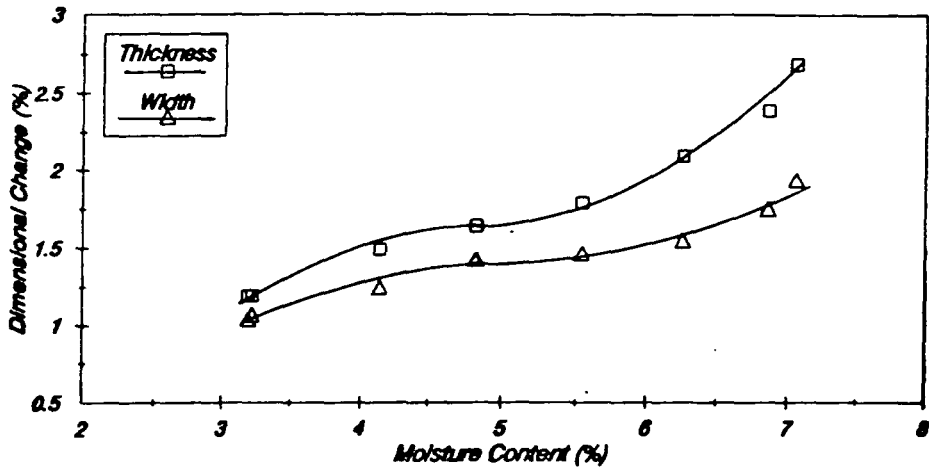

Figure 5.35 (b) *The change in dimensions of A100 (Nat) mouldings on immersion in water at 40°C*

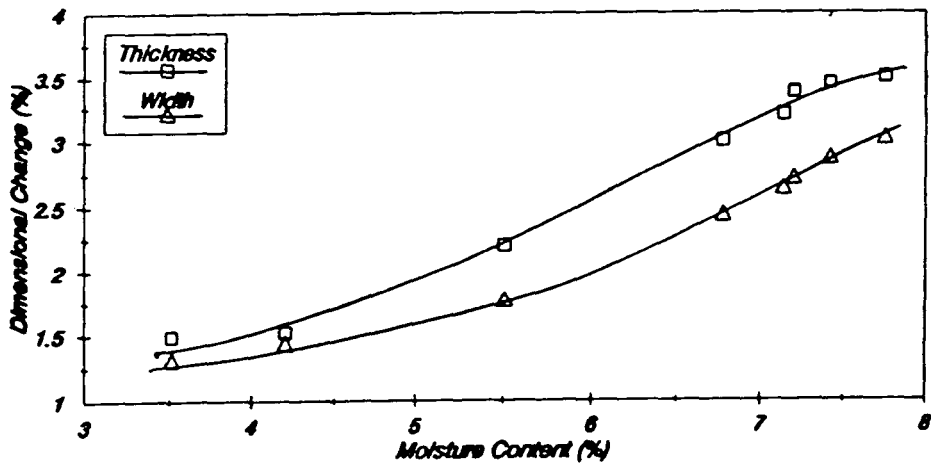
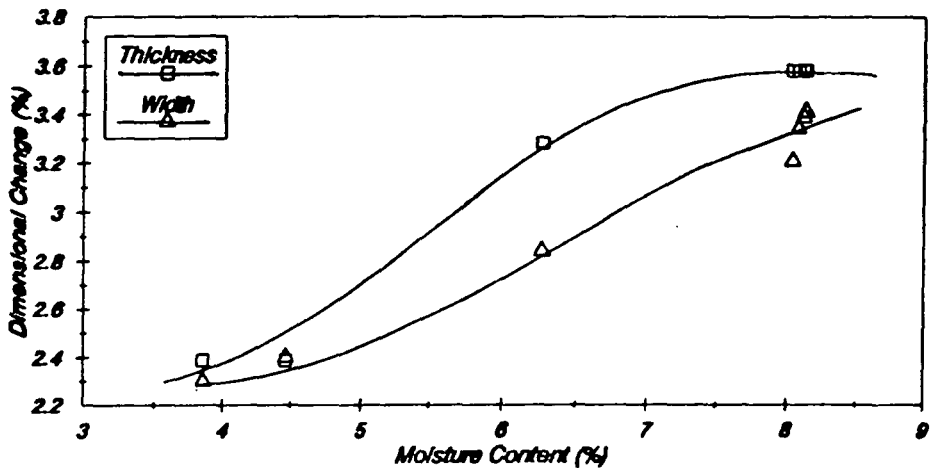

Figure 5.35 (c) *The change in dimensions of A100 (Nat) mouldings on immersion in water at 60°C*



Tensile samples, dimensions : 9.90 x 3.3mm

Figure 5.36 (a) *The change in dimensions of RF 700-07 (Nat) mouldings on immersion in water at 23°C*

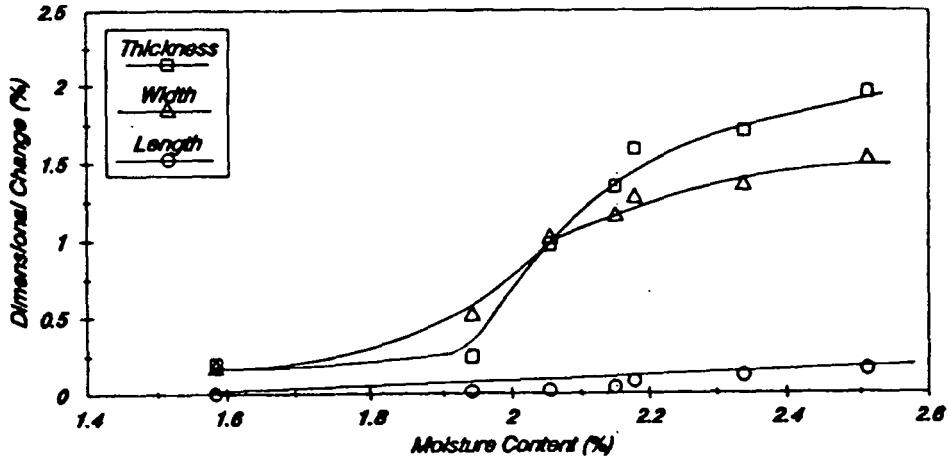

Figure 5.36 (b) *The change in dimensions of RF 700-07 (Nat) mouldings on immersion in water at 40°C*

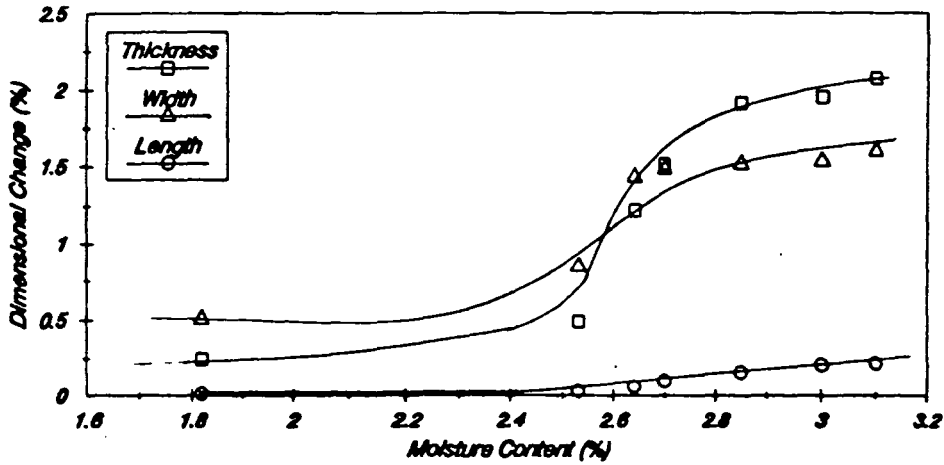
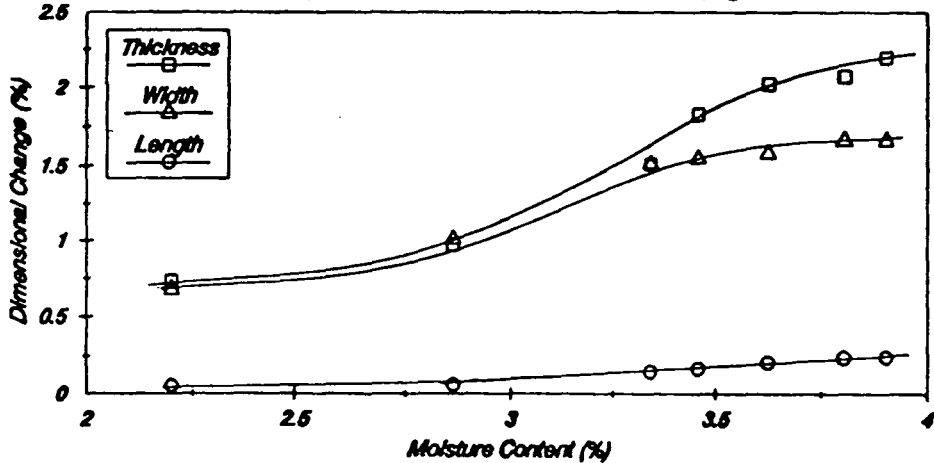

Figure 5.36 (c) *The change in dimensions of RF 700-07 (Nat) mouldings on immersion in water at 60°C*



Charpy impact samples, dimensions : 50.28 x 5.94 x 4.10mm

Figure 5.37 (a) *The change in dimensions of RF 700-07 (Blk) mouldings on immersion in water at 23°C*

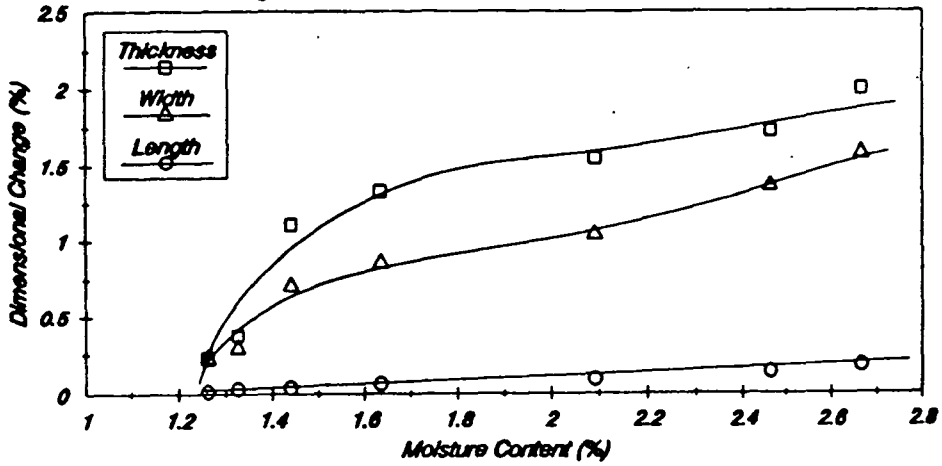

Figure 5.37 (b) *The change in dimensions of RF 700-07 (Blk) mouldings on immersion in water at 40°C*

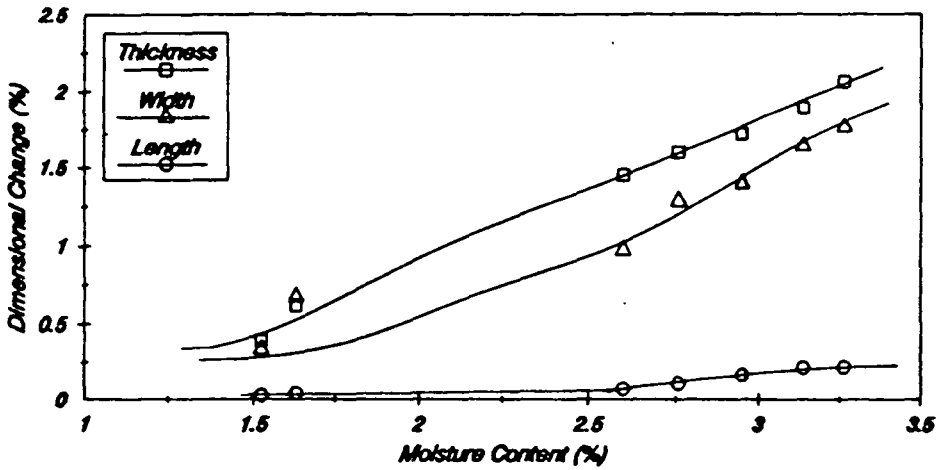
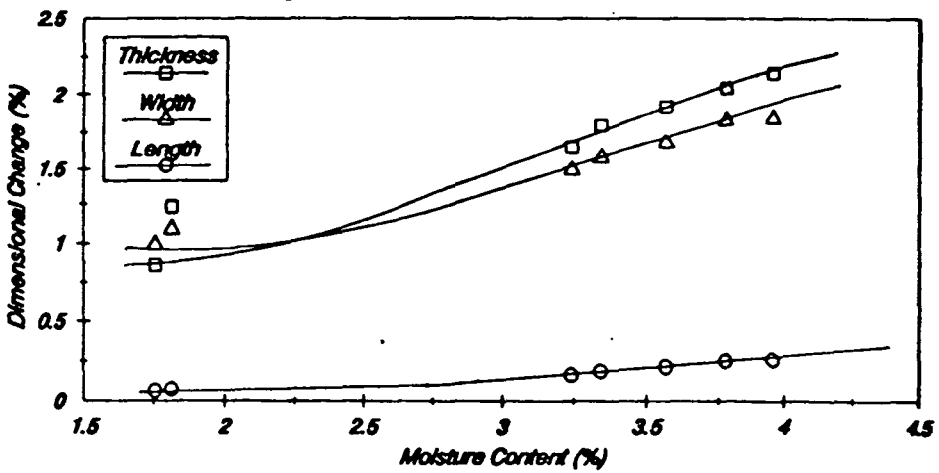

Figure 5.37 (c) *The change in dimensions of RF 700-07 (Blk) mouldings on immersion in water at 60°C*



Charpy impact samples, dimensions : 50.28 x 5.97 x 4.07mm

Figure 5.38 (a) *The change in dimensions of RF 700-10 (Nat) mouldings on immersion in water at 23°C*

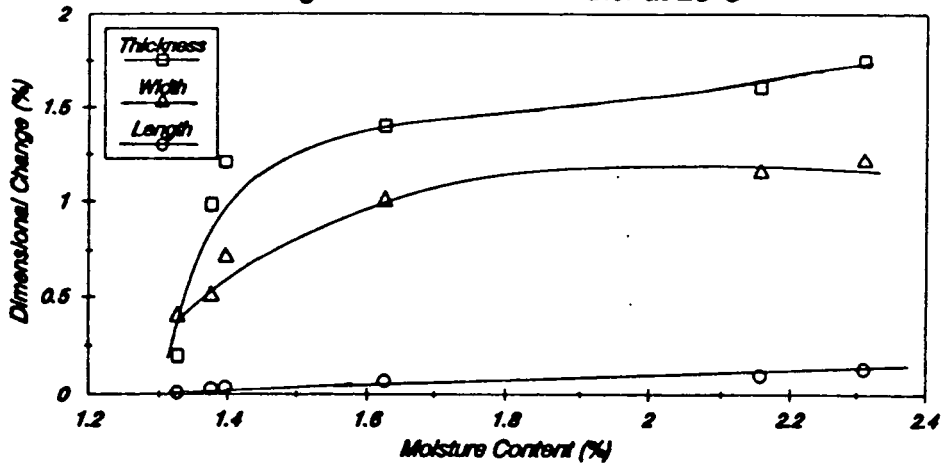

Figure 5.38 (b) *The change in dimensions of RF 700-10 (Nat) mouldings on immersion in water at 40°C*

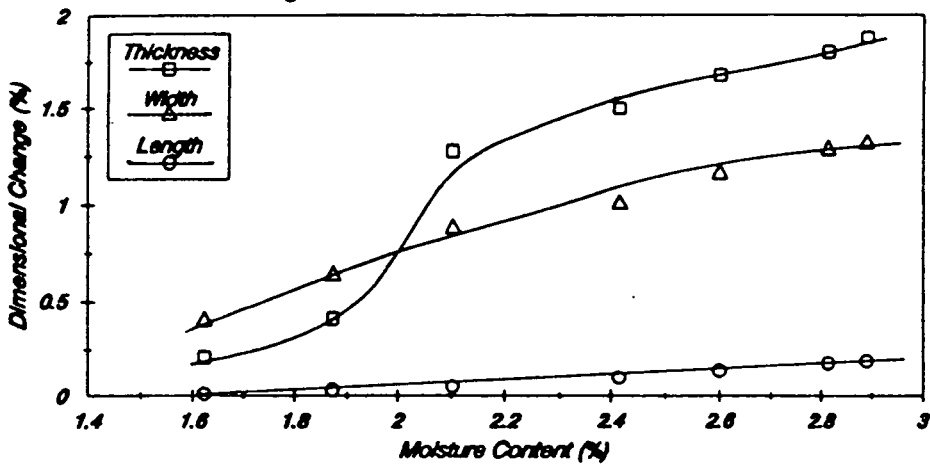
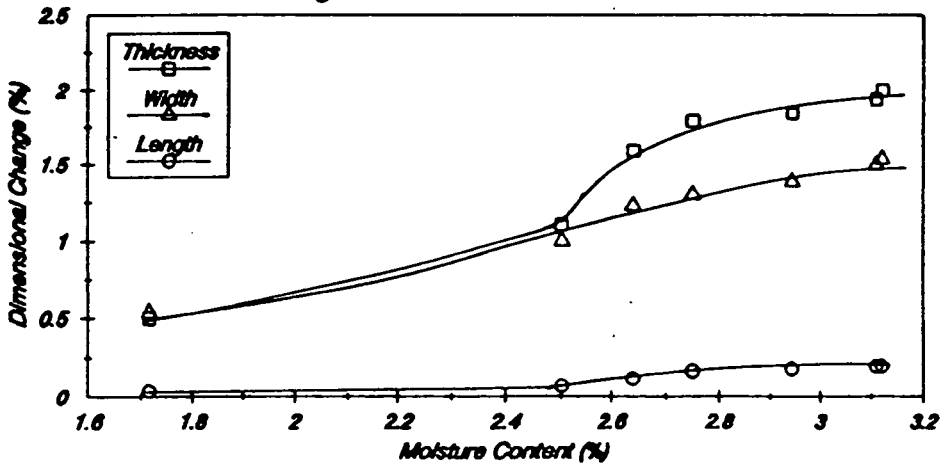

Figure 5.38 (c) *The change in dimensions of RF 700-10 (Nat) mouldings on immersion in water at 60°C*



Charpy impact samples, dimensions : 50.30 x 5.97 x 4.07mm

Figure 5.39 (a) *The change in dimensions of RF 700-10 (Blk) mouldings on immersion in water at 23°C*

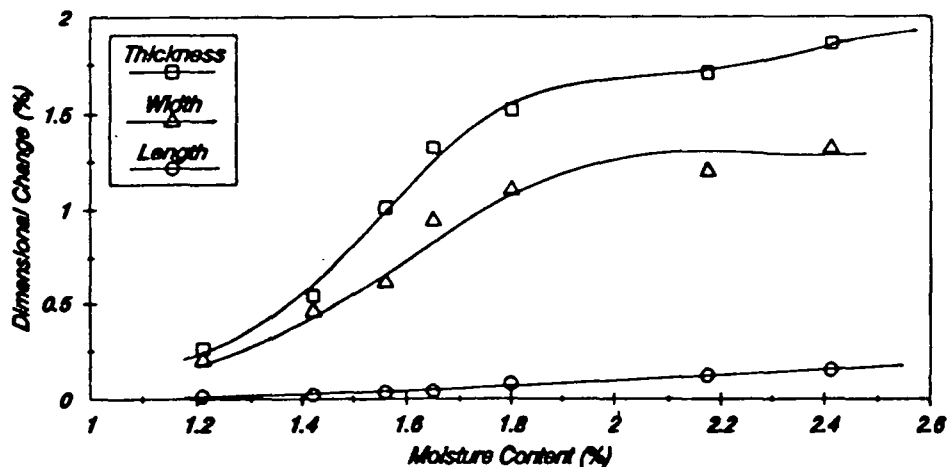

Figure 5.39 (b) *The change in dimensions of RF 700-10 (Blk) mouldings on immersion in water at 40°C*

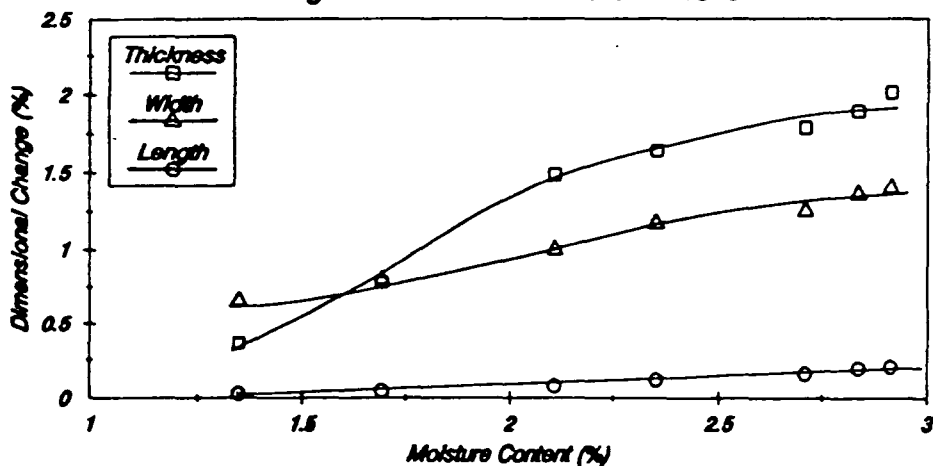
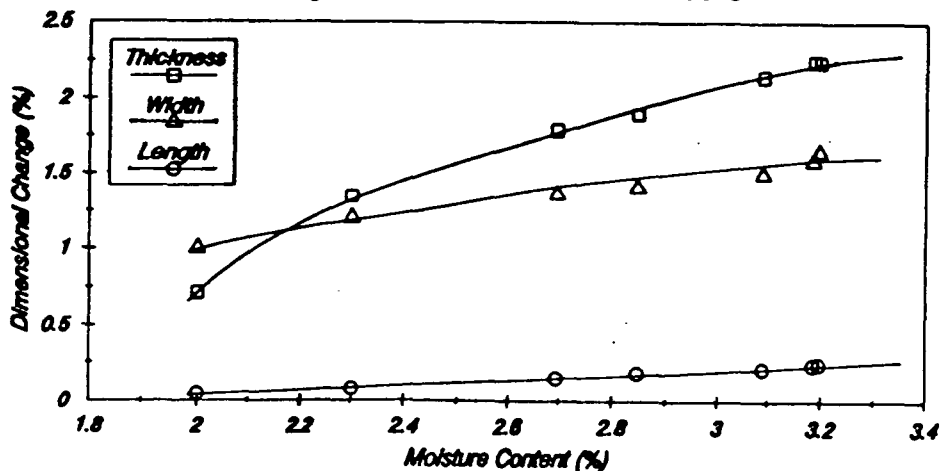

Figure 5.39 (c) *The change in dimensions of RF 700-10 (Blk) mouldings on immersion in water at 60°C*



Charpy impact samples, dimensions : 50.30 x 5.99 x 4.09mm

Figure 5.40 (a) *The change in dimensions of RF 700-12 (Nat) mouldings on immersion in water at 23°C*

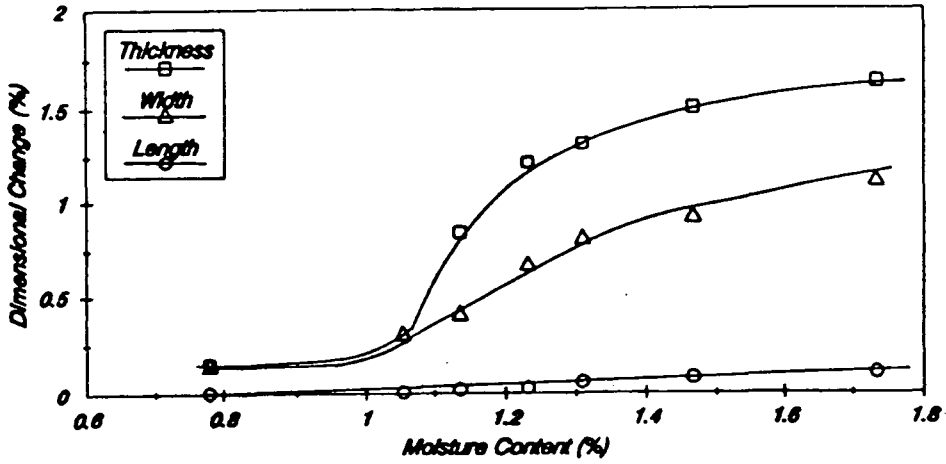

Figure 5.40 (b) *The change in dimensions of RF 700-12 (Nat) mouldings on immersion in water at 40°C*

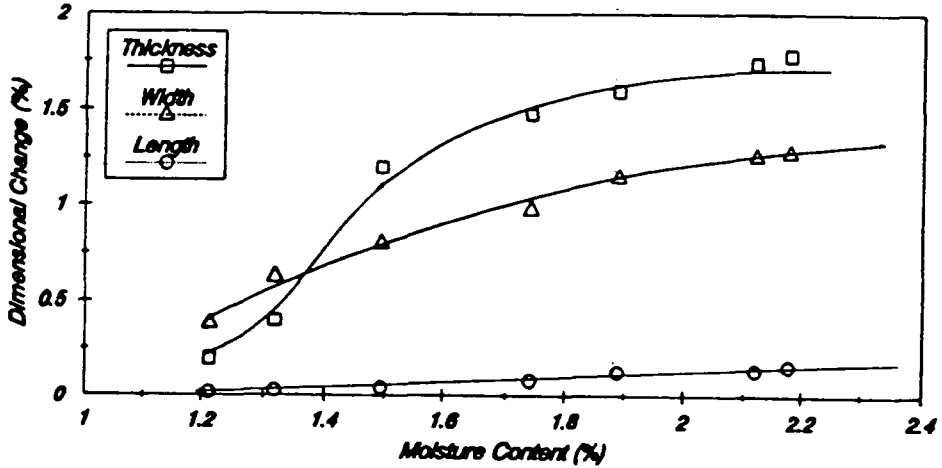
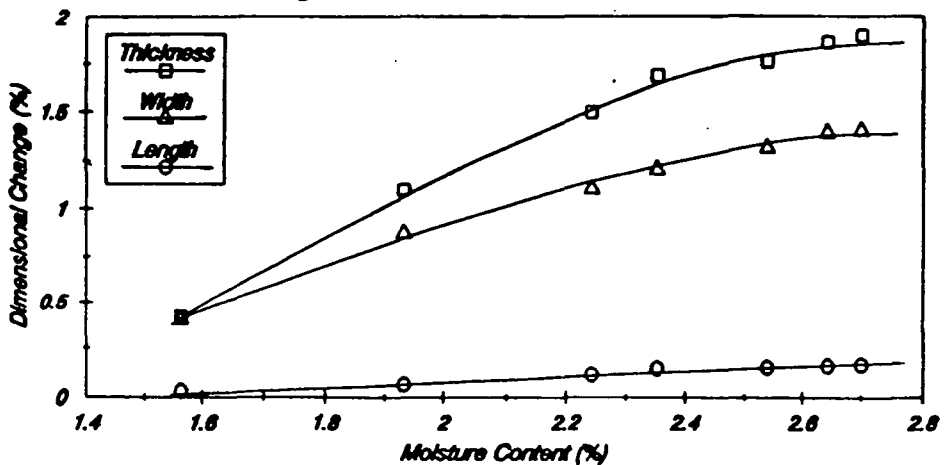

Figure 5.40 (c) *The change in dimensions of RF 700-12 (Nat) mouldings on immersion in water at 60°C*



Charpy impact samples, dimensions : 50.32 x 5.98 x 4.07mm

Figure 5.41 (a) *The change in dimensions of RF 700-12 (Blk) mouldings on immersion in water at 23°C*

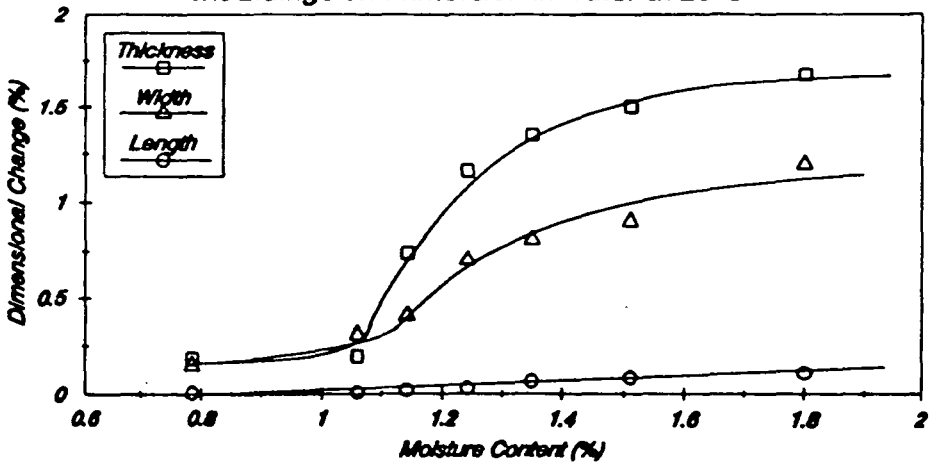

Figure 5.41 (b) *The change in dimensions of RF 700-12 (Blk) mouldings on immersion in water at 40°C*

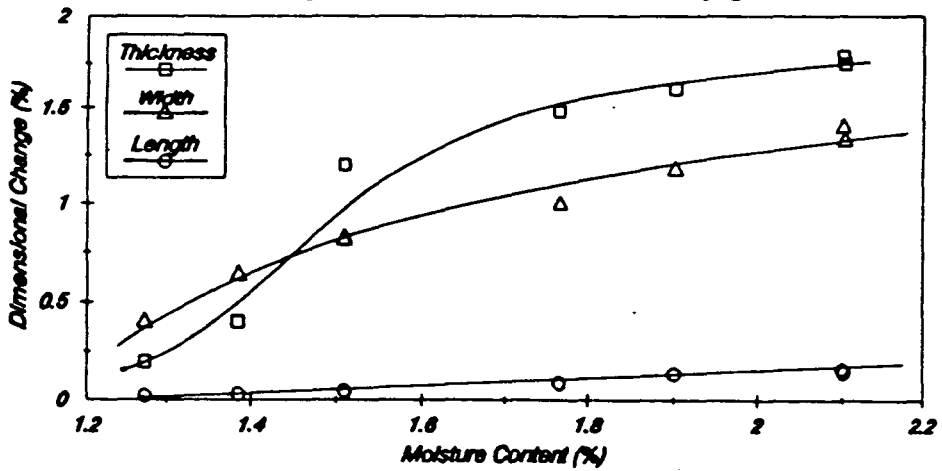
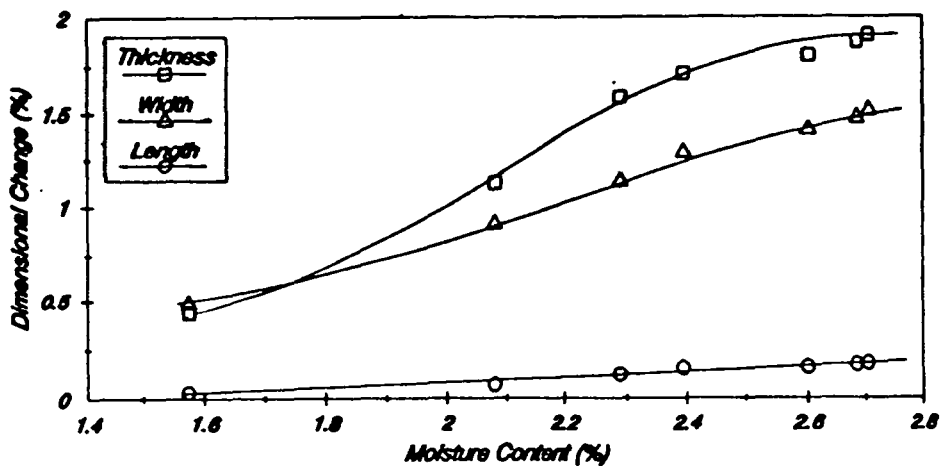

Figure 5.41 (c) *The change in dimensions of RF 700-12 (Blk) mouldings on immersion in water at 60°C*



Charpy impact samples, dimensions : 50.32 x 6.01 x 4.08mm



## CHAPTER 6.0

## DISCUSSION OF RESULTS

The objective of this study was to investigate the influence of moisture conditioning on the mechanical performance and dimensional changes of long glass fibre reinforced Nylon 66 materials. The materials studied were ICI's range of 'Verton' long glass fibre reinforced Nylon 66 compounds, in natural and black grades. To comment on their behaviour in terms of moisture uptake and consequent changes in mechanical and physical properties, it is necessary to look at their formulations. Table 6.1 shows the formulations of the 'Verton' grades studied [38].

CONTENT (% wt/wt)	RF 700-07	RF 700-10	RF 700-12
<u>Natural</u> :			
Nylon 66	65	50	40
Glass-Fibre	35	50	60
<u>Black</u> :			
Nylon 66	62.9	48.4	38.4
Glass-Fibre	35	50	60
Colloids - Masterbatch (54-12)	2.1	1.6	1.6

Table 6.1 FORMULATIONS OF 'VERTON' GRADES STUDIED.

Colloids Masterbatch grade 54-12 is made up of the following compounds in a Nylon 6 carrier :

0.6%	Copper Acetate
2.5%	Potassium Iodide
8.96%	Nigrosine (black dye)
11.94%	Carbon black (monarch 880)

Addition levels equating to 66 ppm Cu and 600 ppm I, constitute a heat aging stabilizer which slows down the oxidation of Nylon 66 in air. Carbon black and Nigrosine are both well dispersed during compounding to give the homogeneous black colour in moulded articles.

#### 6.1 Moisture Absorption.

Moisture uptake rates for all materials were found to increase with rise in soak-temperature. This is expected, since water at elevated temperatures penetrates into the skin of the sample more rapidly by diffusion.

Figures 5.1 - 5.3 show the increase in moisture content of natural and black compounds with soak-time, at soak-temperatures of 23°C, 40°C and 60°C, respectively. From these graphs it is apparent that the rate of moisture uptake, measured as a percentage increase in weight, is highest during the

first 24 hours of conditioning. This is because the driving force resulting from the difference in moisture content on each side of the sample surface is greatest. As the sample absorbs moisture, this concentration gradient is reduced and the rate of moisture absorption falls until an equilibrium state is achieved.

Unfilled Nylon 66 absorbed 4.1% moisture at a soak-temperature of 23°C in the first 24 hours of conditioning, and continued to increase reaching about 7% after 40 days.

Another sample, after 24 hours at a much higher soak-temperature of 60°C (Figure 5.3(a)) showed only a further small rise in moisture uptake, plateauing out at 8.1%. Therefore it can be considered to have reached its saturation point. It can be concluded that the equilibrium moisture content for Nylon 66 (natural) is 8.1%. Although the lower temperature experiments did not reach complete equilibrium, it may be concluded that the equilibrium moisture content is independent of temperature.

Like unfilled materials, long glass fibre reinforced Nylon 66 compounds also increased their rate of moisture uptake with soak-temperature. However, their rate of moisture uptake was considerably lower than unfilled Nylon 66. The rate and final

equilibrium level fell with increase in glass content. Glass fibres themselves are impermeable to moisture and do not take up any significant quantities.

At a soak-temperature of 23°C, after 24 hours, 35% glass/Nylon 66 (natural) absorbed nearly 42% less moisture than unfilled Nylon 66 (natural). At the same conditions 50% and 60% glass/Nylon 66 materials absorbed even less, at 63% and 68% respectively. Figure 6.1 shows the fall in moisture uptake with increase in glass content after 24 hours of conditioning at 23°C, 40°C and 60°C. From this it can be concluded that moisture uptake is proportional to the Nylon content.

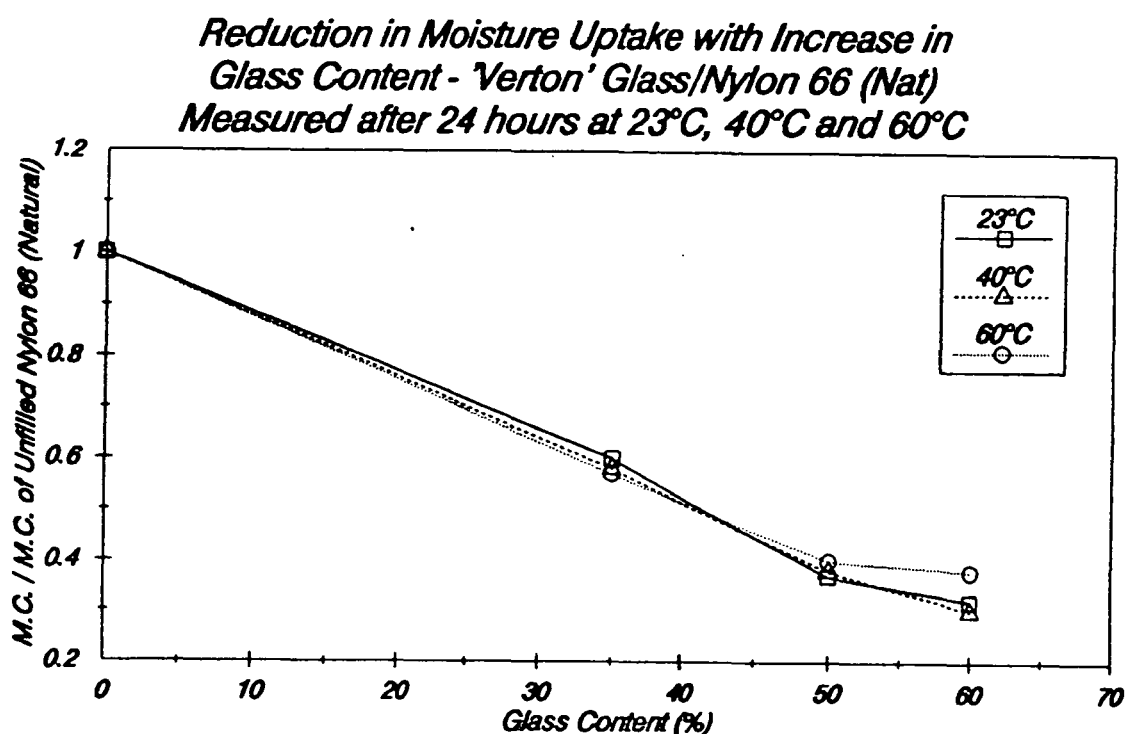

**Figure 6.1 REDUCTION IN MOISTURE UPTAKE  
WITH INCREASE IN GLASS CONTENT**

At 23°C, all the black range of glass/Nylon 66 materials showed lower levels of moisture absorption (figures 5.1(b), (c) and (d)). This was often seen at other soak-temperatures, but only during the initial stages of conditioning. After a soak time of 20 days at 23°C, the black glass reinforced materials absorbed slightly higher amounts than the natural. This cross-over point is shown in figures 5.1(b) and (c) for 35% and 50% glass/Nylon 66 grades respectively.

At higher soak-temperatures, this initial suppression by the black mouldings, lasted only for the first 2-4 hours and the black mouldings showed a greater increase in the moisture content than the natural. However, with increase in glass content this difference was reduced.

These distinct differences in the moisture uptake between the natural and black long glass fibre reinforced materials, indicate that the addition of the black Masterbatch suppresses moisture conditioning, especially at temperatures below 40°C.

Without a thorough study of the effects of each constituent in the Masterbatch on the moisture uptake rates of black mouldings, it is difficult to say which of the constituents is directly responsible for the suppression of moisture absorption.

Although Carbon black itself is impermeable to moisture, it replaces only a very small fraction of the hygroscopic Nylon and therefore there must be other reasons for the materials reduced moisture uptake. The presence of Carbon black during processing encourages nucleation and can therefore increase the level of crystallinity within black mouldings. Since molecules in crystalline regions are more tightly packed compared to the amorphous ones, they have a greater resistance to moisture uptake. Moisture diffusion through the amorphous regions is relatively easy. This crystallinity difference between the natural and the black samples could be checked in any future work by measuring their densities. This may be possible using a density gradient column of Carbon tetrachloride and toluene at 23°C or alternatively the levels of crystallinity could be measured by Differential Scanning Calorimetry (DSC).

Although Carbon black increases crystallization by encouraging nucleation, Nigrosine is recognized as a very effective nucleation suppressent. Therefore, further studies would be required to determine which of the two effects dominate.

The moisture uptake behaviour of the materials during the early stages of conditioning will consequently affect their mechanical and physical properties. The moisture uptake of natural, unreinforced and long glass fibre reinforced Nylon

66 materials was compared to the predictions of Fick's Law of diffusion by plotting moisture content against the square root of soak-time, as shown in figures 5.1 - 5.3.

From these curves the diffusion coefficient, a measure of the material's ability to transmit moisture was calculated. When plotted against glass content for 'Verton' glass/Nylon 66 (Natural), at 60°C (Figure 6.2), it suggests that the resistance to moisture uptake increases with increasing glass content. However, at 23°C, increases in glass content did not have any significant effect on the values of the diffusion coefficient.

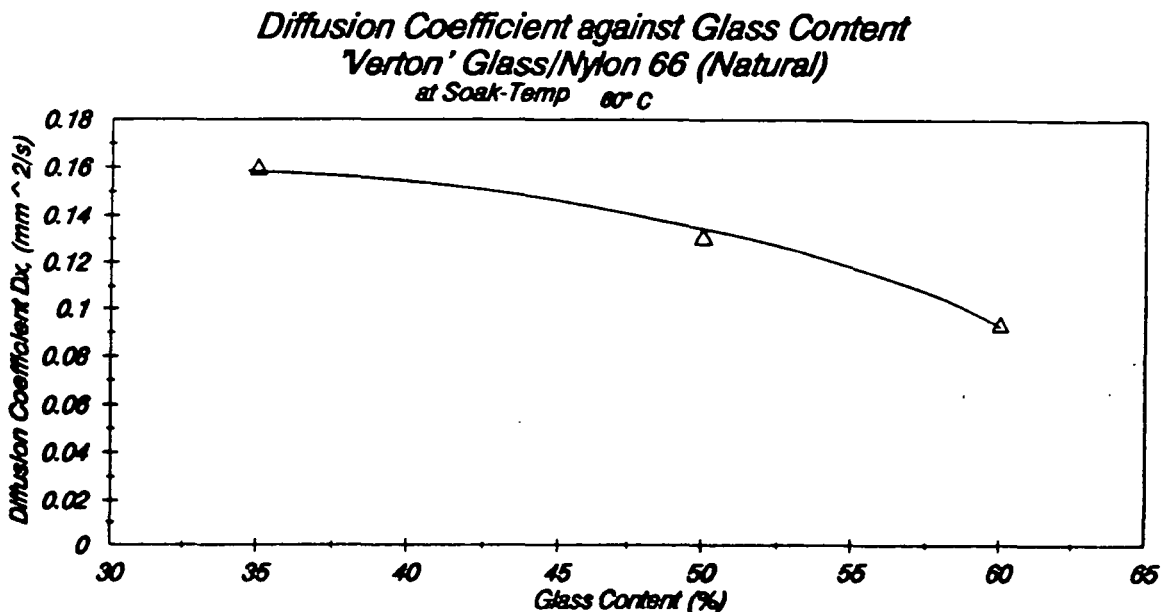

Figure 6.2 CHANGE IN DIFFUSION COEFFICIENT,  $D_x$  WITH INCREASE IN GLASS CONTENT

A plot of the absorption parameter against the diffusion parameter (Figure 6.3) for all the natural materials at 60°C, show that they broadly obey Fick's Law.

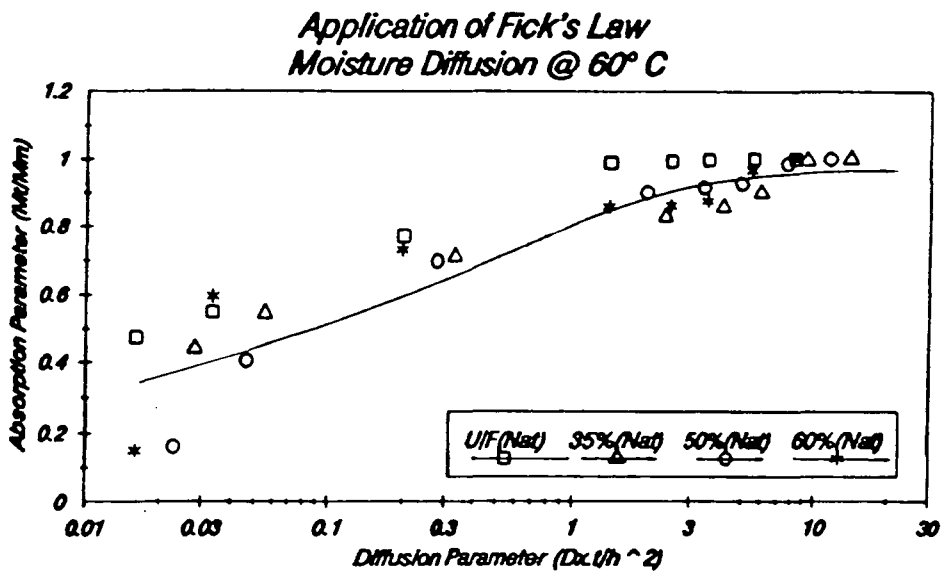

Figure 6.3 ABSORPTION PARAMETER AGAINST DIFFUSION PARAMETER AT A SOAK-TEMPERATURE OF 60°C



## 6.2 Mechanical Properties.

The addition of long glass fibres enhances the mechanical properties of Nylon 66. By progressively increasing the weight fraction of these stronger and stiffer fibres, the mechanical properties improve up to a maximum. Above a weight fraction of 60% or so, there may be insufficient polymer to bind the discontinuous fibres into a strong composite and hence instead of reinforcing the matrix, un-wetted fibre clumps may act as points of weakness. Additionally moulded in stresses and other imperfections lower the mechanical performance of the composite.

Figures 6.4 and 6.5 show the benefit of increasing the fibre fraction from 35% up to 60% on the values of:

- (i) tensile strength
- (ii) flexural strength and
- (iii) impact strength (notched and un-notched)

for natural and black glass/Nylon 66 materials, tested dry - "as moulded", respectively.

The values of strength quoted are normalized to show the improvement in strength from the addition of glass fibre beyond 35%, i.e. the values quoted are calculated as absolute strength

divided by strength at 35% glass content.

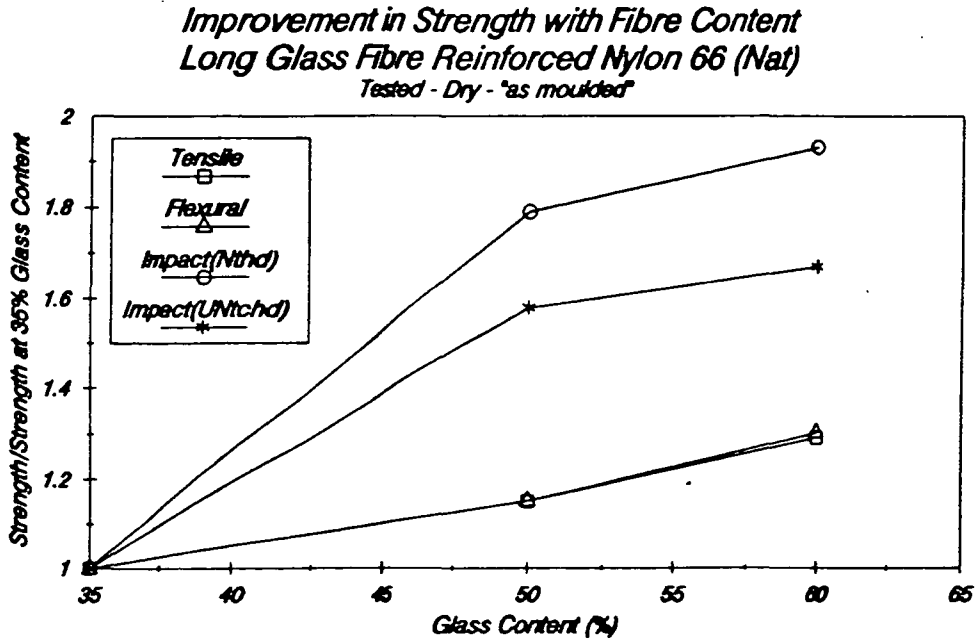

Figure 6.4 NORMALIZED STRENGTH AGAINST GLASS CONTENT FOR NATURAL 'VERTON' MATERIALS

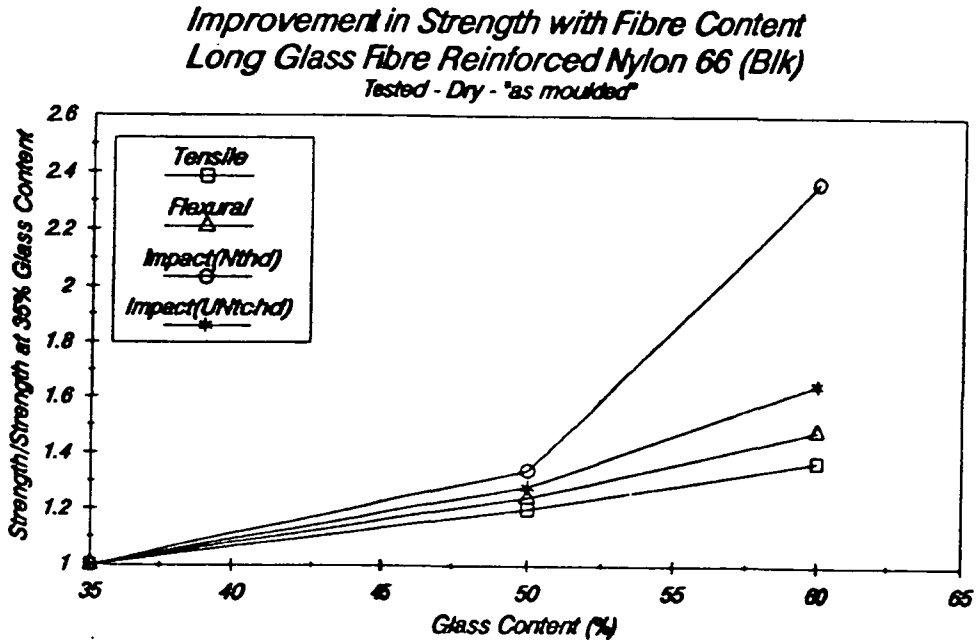

Figure 6.5 NORMALIZED STRENGTH AGAINST GLASS CONTENT FOR BLACK 'VERTON' MATERIALS

For natural glass/Nylon 66 materials the dry - "as moulded" values of tensile strength and flexural strength were different. The flexural strength was approximately 40% higher than the tensile strength. One explanation for this observation could be that in a 3 - point bending test, the samples experience the greatest tensile stress at the surface opposite to the loading roller. This surface consists of a skin of highly aligned fibres (Figure 2.14). At the outer surface, a crack is initiated which results in the failure of the samples. In a tensile test, the sample experiences its maximum stress through the entire cross-section. This need not always be at the centre of the gauge length. As with the glass/Nylon 66 materials tested, the break often occurred at a point, 1/4 of the sample length nearest to the gate. This suggests that fibres within the skin up to that point were not fully aligned.

The cross-section of the test specimen consists of a sandwich of highly aligned fibres in a strong skin and randomly oriented fibres in the weaker core. This explains the lower strength values measured in tension compared to those determined in flexure. However, from Figure 6.4 it can be seen that for natural glass reinforced materials, the improvement in both tensile and flexural strength (normalized) is almost directly

proportional to the increase in glass content. This is because an increase in glass content increases the fraction of fibres in the core as well as the skin.

The impact strength of all un-notched samples was much higher than that of the notched. This was not surprising since notches are stress concentrators and less energy is required to break the sample. Both notched and un-notched samples showed improvements in the impact strength with increasing fibre content. However, for the same increase in glass content, all notched samples showed a greater improvement than the un-notched. One reason for this observation is that a notched sample measures the energy required to propagate a crack and therefore increasing the glass content increases the energy required to cause debonding and fibre pullout from within the matrix. For the un-notched samples, although the impact strength increased with increase in glass content, the improvement was not as large. This is because the un-notched samples measure the energy required to initiate a crack and once a crack has been initiated, the increase in fibre fraction allows the crack to propagate easily across the matrix and fibres. The absorption of energy is lower since fewer, if any fibres are pulled out of the matrix. There is also less plasticized matrix with increase in glass content.

From Figure 6.5 it can be seen that the improvement in the impact strength of black glass/Nylon 66 grades, of both notched and un-notched samples is severely retarded particularly up to a glass content of 50%. This may be attributed to the presence of Carbon black particles producing defects in the mouldings or possibly some hindrance in the formation of a good fibre - matrix bond. This may also partly explain why lower improvements were seen in the tensile strength compared to the flexural strength.

Figure 6.6 shows the improvement in the flexural modulus (normalized) of glass/Nylon 66 materials (natural and black) with increase in glass content. It is the only mechanical property which appears to be improved by the presence of Carbon black. The flexural modulus increases as expected with glass content. However, the black materials show almost a 10% improvement over the natural. Flexural modulus is a measure of the material's stiffness, and the presence of Carbon black during processing can give rise to regions of higher crystallinity and hence an increase in the material's density. This could explain why the black materials show an improvement in the normalized values of flexural modulus.

It is more likely, however, that since Carbon itself has a very high modulus, the addition of Carbon black alone would also produce an improvement in the stiffness of the polymer.

It is a normal practice in the manufacture of tyres to add Carbon to natural rubber, not only for colouring purposes but also to increase its stiffness.

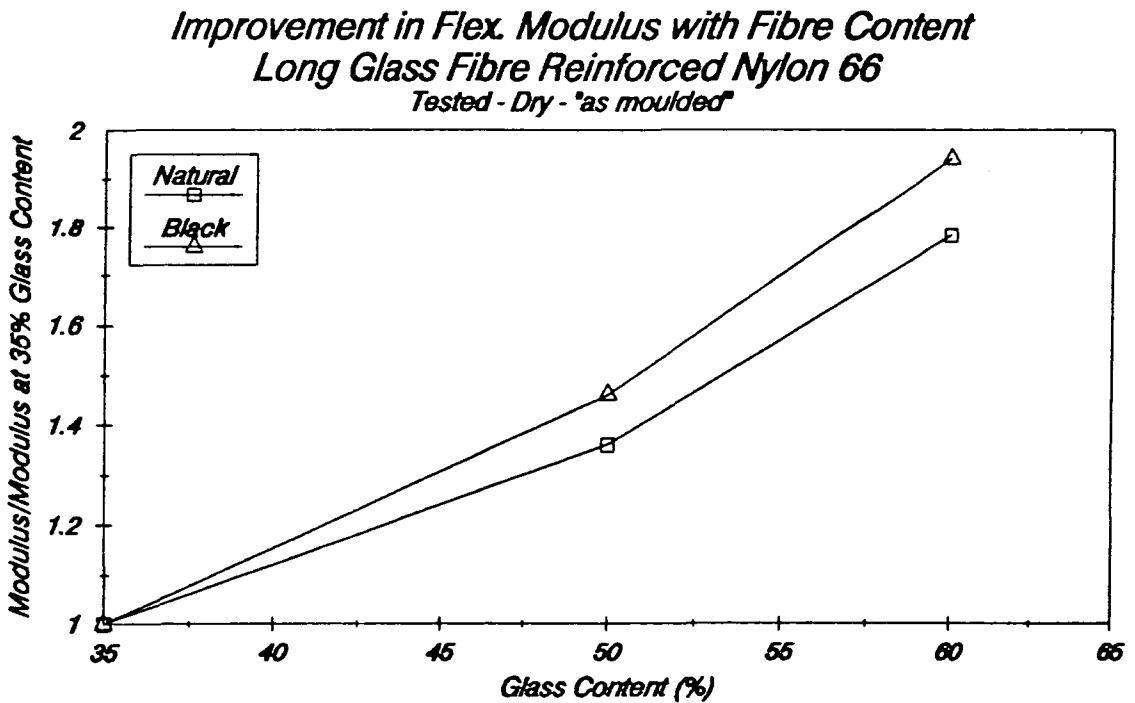

Figure 6.6 NORMALIZED FLEXURAL MODULUS AGAINST GLASS CONTENT FOR NATURAL 'VERTON' MATERIALS

Except for impact strength, all other mechanical properties were reduced with increasing moisture content. Figures 6.7(a) - (c) show the reduction in the tensile strength and flexural strength of 35% glass/Nylon 66 (natural) with increase in square root of soak-time, at a soak-temperature of 23°C, 40°C and 60°C respectively.

It is interesting to note that increasing glass content showed almost identical improvements in tensile and flexural strength, whereas an increase in soak-time showed reductions in tensile and flexural strength to differ. The higher values of strength measured in flexure have been attributed to the maximum stress being experienced by the highly aligned fibres at the skin. In tensile tests the stress is carried by the full cross-sectional area of the specimen, which includes both the skin and a much weaker core of randomly oriented fibres. The initial rapid loss of strength, measured in flexure, can therefore be explained due to the immediate effects of moisture on the skin. Values measured in tension are an average of skin and core properties and will therefore take longer to be fully affected by the moisture.

With moisture uptake the flexural modulus, a measure of the materials stiffness, was considerably reduced. For 35% glass/Nylon 66 (natural), after soaking for 42 days at 60°C, the reduction in the flexural modulus was more than 60%.

**Immersion in Water at 23°C**  
**35% Glass/Nylon 66 (Natural)**

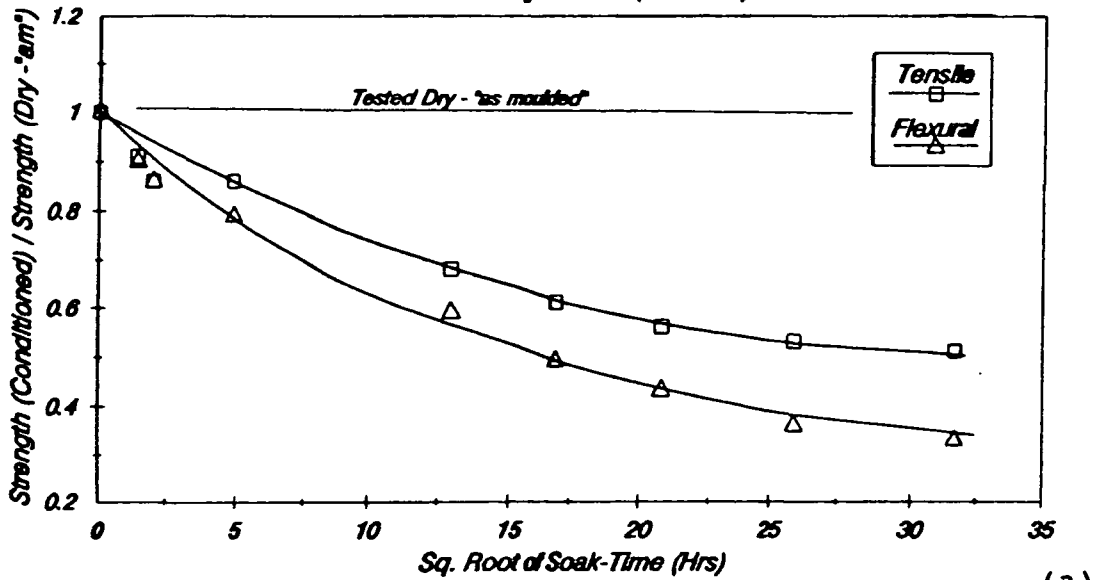

(a)

**Immersion in Water at 40°C**  
**35% Glass/Nylon 66 (Natural)**

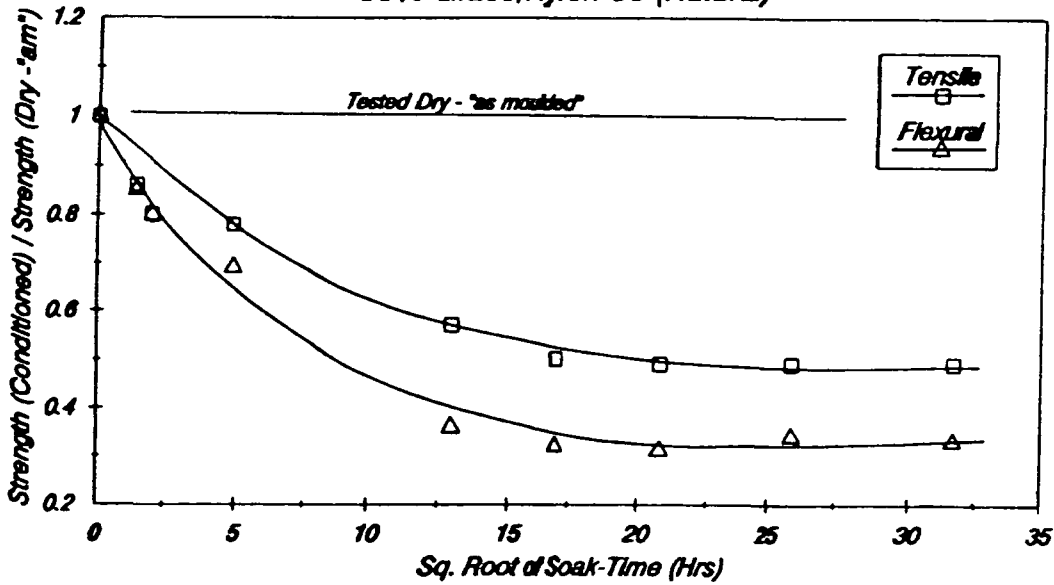

(b)

**Immersion in Water at 60°C**  
**35% Glass/Nylon 66 (Natural)**

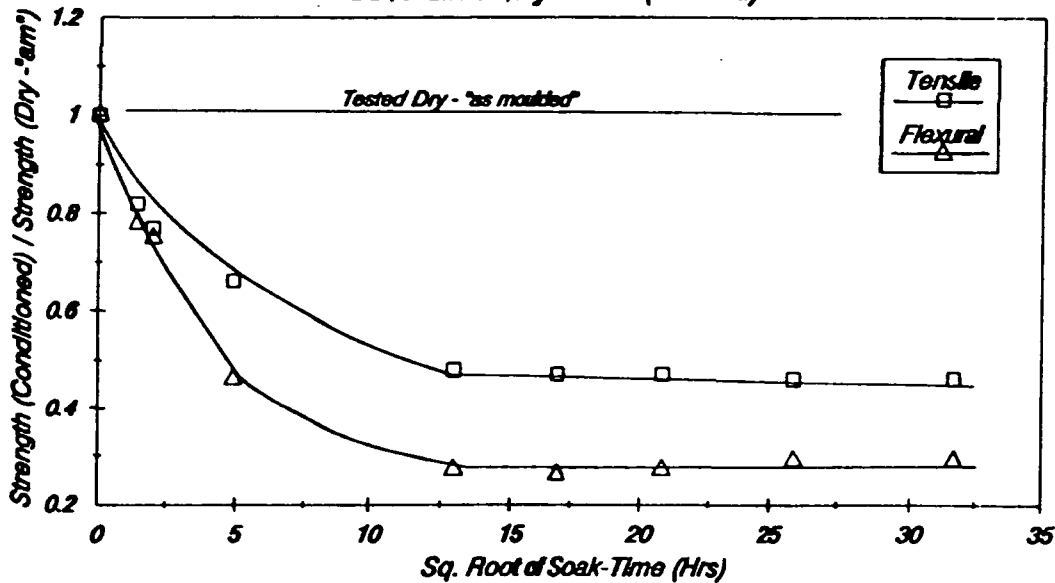

(c)

**Figure 6.7 REDUCTION IN STRENGTH WITH  
 INCREASE IN SOAK-TIME**



Figures 6.8(a) - (c) show the reduction in the flexural modulus (normalized) with increase in square root of soak-time, for 35% glass/Nylon 66 (natural and black), at soak-temperatures of 23°C, 40°C and 60°C respectively.

At all soak-temperatures the greatest loss in flexural modulus was experienced during the first 7 days of conditioning. Immediately, on immersion in water the skin of the sample is penetrated by the moisture, resulting in this loss of stiffness. Plasticization of Nylon changes the failure type of the materials from brittle to ductile.

Figures 6.9(a) - (c) show the reduction in the tensile modulus and flexural modulus (normalized) of 35% glass/Nylon 66 (natural), with increase in square root of soak-time, at 23°C, 40°C and 60°C respectively. As shown earlier in the case of tensile and flexural strength, figures 6.8(a) - (c), the stiffness measured in flexure is also reduced more than for that measured in tension.

**Immersion in Water at 23°C**  
**35% Glass/Nylon 66 (Nat & Blk)**

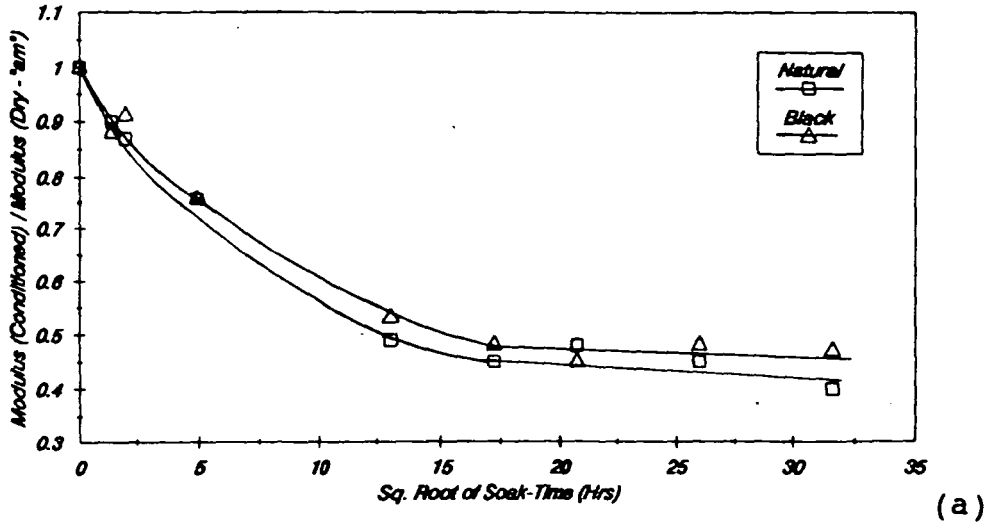

**Immersion in Water at 40°C**  
**35% Glass/Nylon 66 (Nat & Blk)**

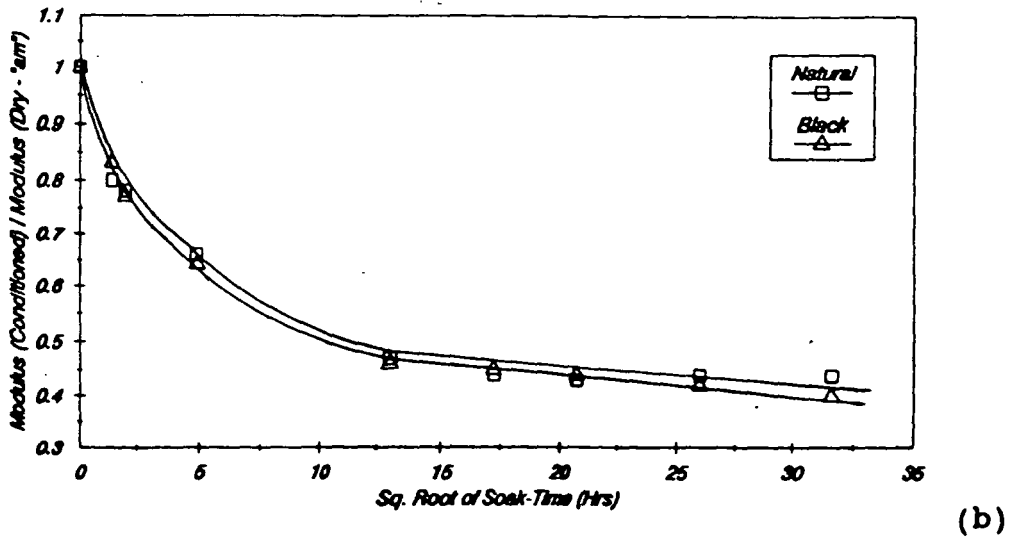

**Immersion in Water at 60°C**  
**35% Glass/Nylon 66 (Nat & Blk)**

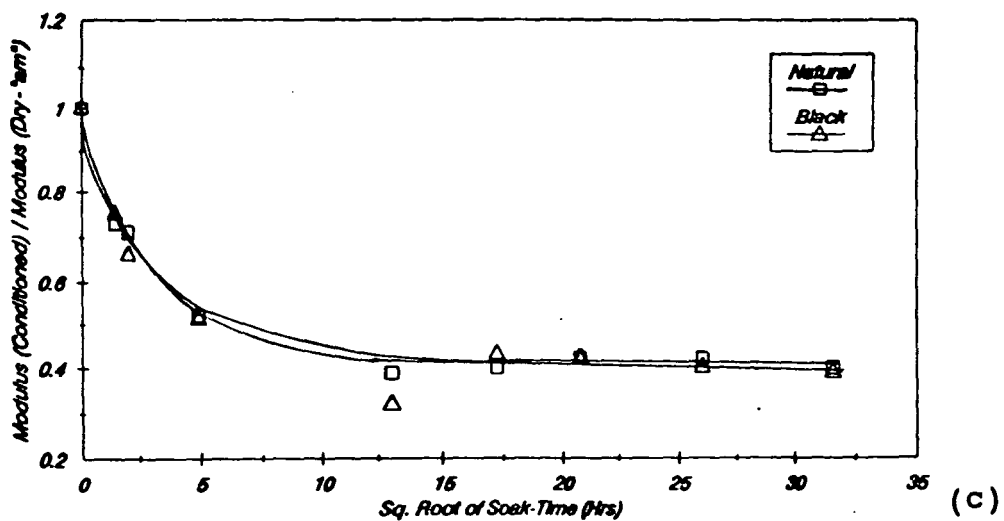

**Figure 6.8 REDUCTION IN FLEXURAL MODULUS WITH SQ.ROOT OF SOAK-TIME (NORMALIZED)**

*Immersion in Water at 23°C  
35% Glass/Nylon 66 (Natural)*

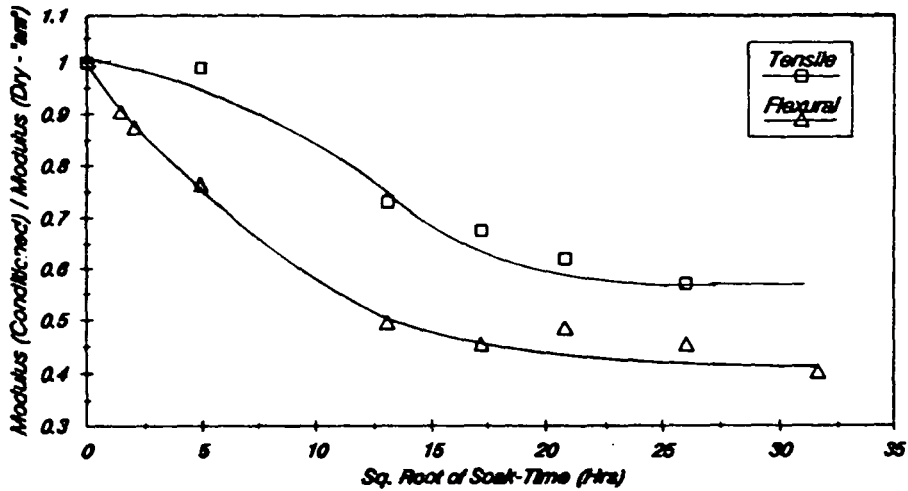

(a)

*Immersion in Water at 40°C  
35% Glass/Nylon 66 (Natural)*

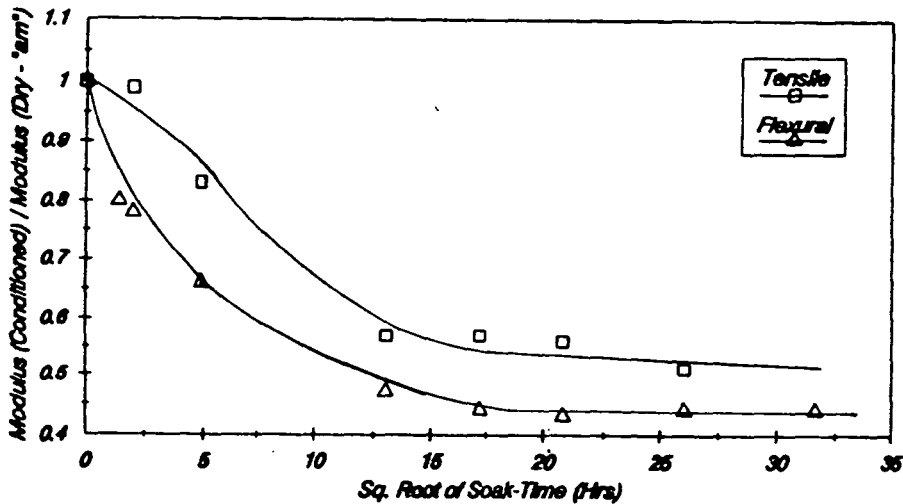

(b)

*Immersion in Water at 60°C  
35% Glass/Nylon 66 (Natural)*

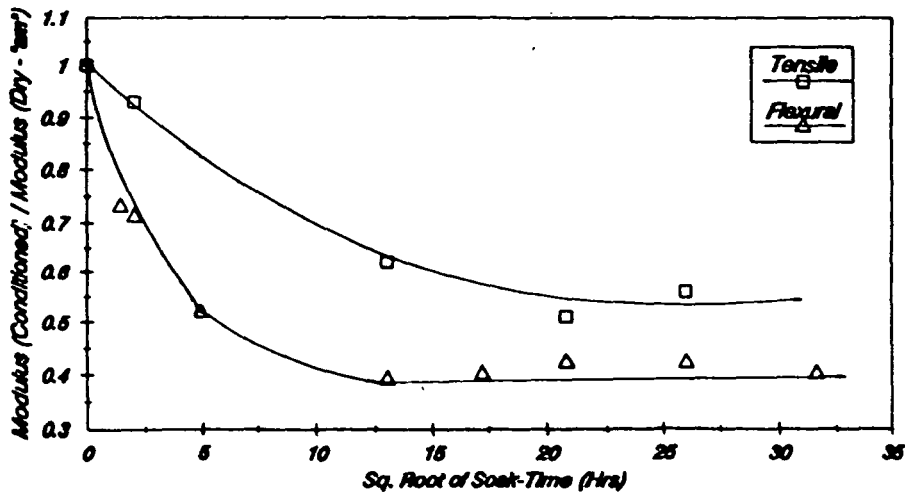

(c)

Figure 6.9 REDUCTION IN MODULUS WITH  
SQ.ROOT OF SOAK-TIME (NORMALIZED)

Observations have shown that the strength and stiffness are considerably reduced with moisture uptake. The main cause of this reduction has so far been attributed to the plastification of the Nylon. It is well known that this causes a reduction in the materials  $T_g$  and consequent weakening of intermolecular forces between the polymer chains.

From figures 5.5(a) and (b) the loss in tensile strength of the matrix polymer, Nylon 66 (natural) with increase in (a) moisture content and (b) square root of soak-time respectively can be seen. After 1000 hours at 60°C, the tensile strength of the Nylon was reduced from 80 MPa to 30 MPa, a loss of over 60%. This loss in the matrix strength will consequently reduce the strength and stiffness of the composite.

For a given loss in matrix strength or stiffness, the resulting loss in the composite can be calculated as follows [39] :

Consider a discontinuous fibre composite comprising of equal layers of skin and core :

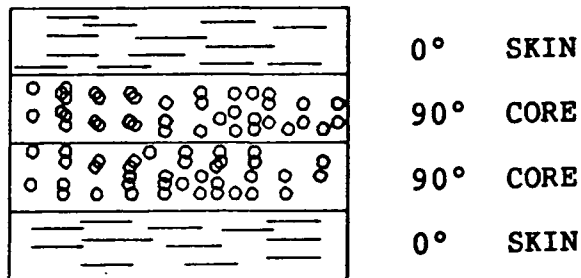

In tension, the stiffness of the composite,  $E_c$ , is equal to the sum of the stiffness of the skin,  $E_{skin}$ , and the core  $E_{core}$

$$E_c = \sum E_{skin} + \sum E_{core}$$

From the rule of mixtures, the modulus of a unidirectional composite can be applied to discontinuous fibre analysis provided it is multiplied by a suitable reduction factor,  $n_l$ , for the purpose of this argument 0.9 will suffice.

Stiffness of the composite,  $E_c$  is calculated as :

$$E_c = \frac{2 \times E_{skin} + 2 \times E_{core}}{N}$$

where N = No. of layers in the composite, in this case N = 4

$$N \cdot E_c = 2 \times [E_f V_f n_l + E_m (1 - V_f)] + 2 \times \left[ \frac{V_f}{E_f} + \frac{(1 - V_f)}{E_m} \right]^{-1}$$

$$E_{skin} \quad + \quad E_{core}$$

For 'Verton' 50% glass/Nylon 66 assume

$$V_f = 0.4$$

$$E_f = 75 \text{ GPa}$$

$$E_m = 2 \text{ GPa}$$

Then  $E_c$  = calculated as 15.7 GPa

Experimentally the modulus has been measured to be 15 GPa, therefore the model can be assumed to be reasonable.

Assume after moisture uptake the modulus of the matrix is reduced by 75% from 2 GPa to 0.5 GPa as a result of plasticization.

This only reduces the stiffness of the composite,  $E_c$  to 14.0 GPa. So a 75% loss in the stiffness of the matrix accounts for only a loss of about 10% in the composite stiffness.

Plasticization, therefore, accounts for only a small contribution to the loss in stiffness. If this is the case then there must be another reason for the loss in the strength and stiffness of glass reinforced/Nylon 66 materials.

The most likely cause would therefore be a breakdown in the interfacial bond between the fibre and the matrix. With further research into the effects of moisture conditioning on the interfacial strength of glass/Nylon 66 materials, it may be possible to say precisely what contributes to the loss in mechanical properties.

Figures 6.10(a) - (c) show the increase in impact strength (normalized) with square root of soak-time, for 35% glass/Nylon 66 (natural and black) at 23°C, 40°C and 60°C respectively. As expected, the impact strength increased with rise in moisture content. For 35% glass/Nylon 66 (natural) the impact strength increased by almost a factor of 3, from 22 kJ/m<sup>2</sup> to 62 kJ/m<sup>2</sup> after immersion in water for 42 days at 60°C.

In addition to the plasticization of Nylon 66, causing a change in the mode of failure from brittle to ductile, a loss in the fibre-matrix bond would also increase the impact strength. The reason being, if there is a strong fibre-matrix bond then cracks would propagate across the matrix and the fibres with very little absorption of energy, as opposed to running along the fibre-matrix interface, where absorption of energy would be higher.

These observations also support the earlier recommendation regarding further research into the effects of moisture on interfacial strength.

From graphs of impact strength against moisture content (figures 5.29(a) - 5.34(a)) for 35%, 50% and 60% glass/Nylon 66 natural and black respectively, there exists a clear phase transition between 24 hours and 7 days of conditioning. For higher glass content materials, this transition occurs much

**Immersion in Water at 23°C**  
 35% Glass/Nylon 66 (Natural & Black)

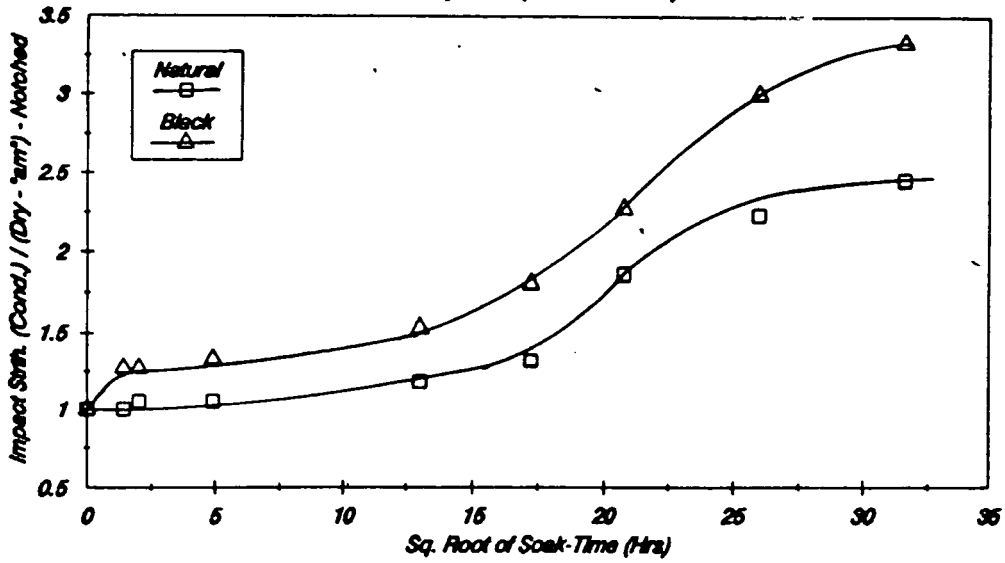

**Immersion in Water at 40°C**  
 35% Glass/Nylon 66 (Natural & Black)

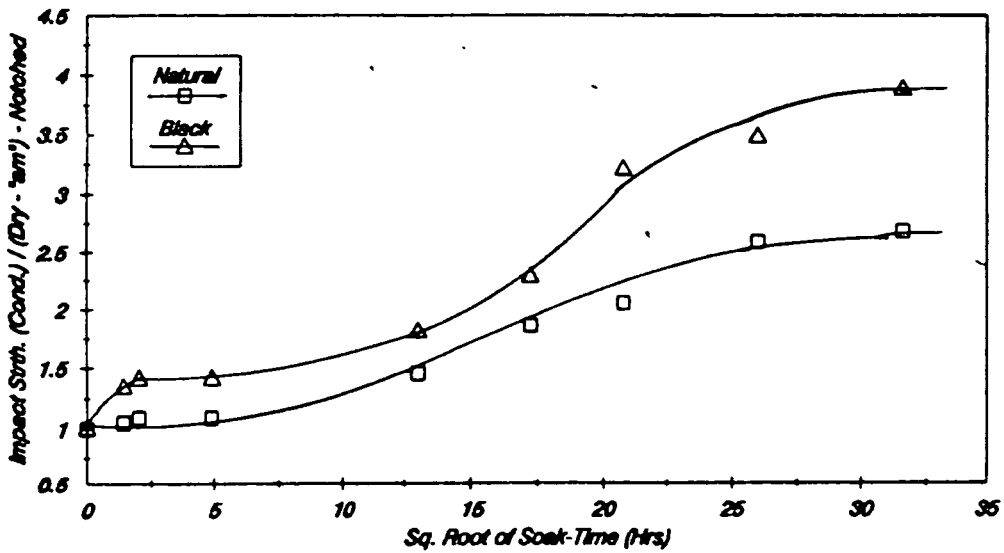

**Immersion in Water at 60°C**  
 35% Glass/Nylon 66 (Natural & Black)

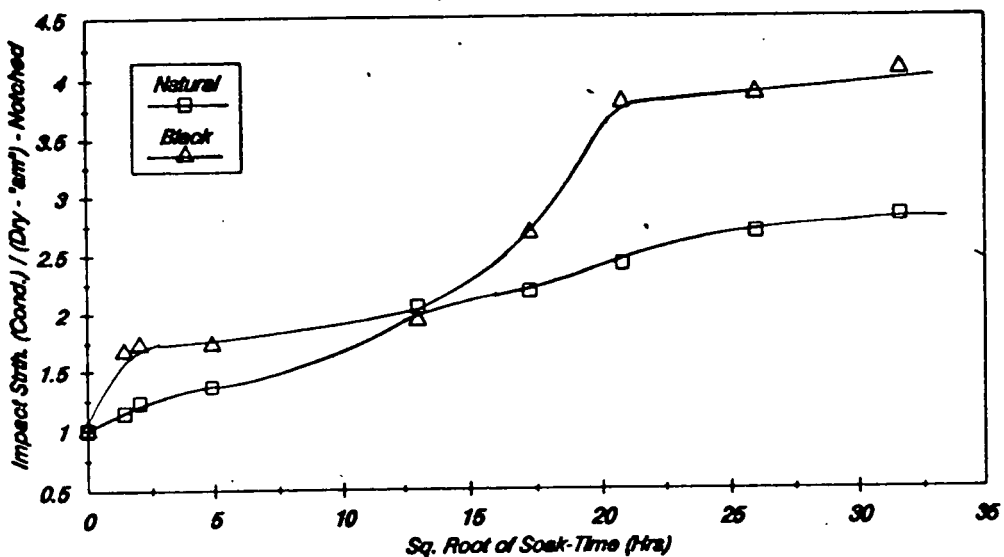

Figure 6.10 INCREASE IN IMPACT STRENGTH WITH SQ.ROOT OF SOAK-TIME



sooner, after only 4 hours of conditioning. Hence any further research should be concentrated between these soak-intervals to reveal any possible changes in interfacial properties.

It was also observed, that in the short term before equilibrium was attained, the tensile strength was affected by not only the moisture content, but by also the mode in which the material was conditioned i.e. soak-time and temperature.

Figures 5.6(a) - 5.11(a) show the reduction in tensile strength with increase in moisture content for 35%, 50% and 60% glass/Nylon 66 (natural and black) respectively. From these curves it can be seen that materials conditioned rapidly by immersion in hot water, show up to 50% higher tensile strength than for those conditioned at a lower temperature (to an equivalent moisture content) by soaking for a longer time. This is seen for all materials including natural and black grades.

This difference in strength is observed only during the early stages of conditioning, i.e. before total saturation occurs. After saturation all values, regardless of soak-temperature plateau to a minimum.

A possible reason for this difference in tensile strength, could be attributed to the manner in which the moisture

permeates through the thickness of the sample. At a soak-temperature of 23°C, the ingress of moisture is slow and maybe it therefore penetrates through the entire thickness of the sample, from the skin through to the centre core. At a soak-temperature of 40°C moisture uptake is much faster but penetration to the inner layers has not been achieved, i.e. the moisture reaches only the skin and not the core. This would explain why the tensile strength of the rapidly conditioned sample is higher.

At 60°C (figures 5.6(a) and 5.7(a)) however, the tensile strength is lower than by conditioning at 40°C. This suggests that moisture is held in the skin layer for only a short period of time, before travelling into the core. This difference in the strength is observed also for flexural properties, however, the difference in the strength of samples conditioned in this manner is only approximately 30%. This difference is expected to be lower since the skin contributes more than the core in bending. Therefore any moisture held in the skin will reduce the strength.

### 6.3 Changes in Sample Dimensions

The change in sample dimensions of moulded articles with moisture uptake can sometimes be a problem, particularly when designing to fairly high tolerances. The expansion of the component resulting from a rise in moisture content must therefore be taken into account when calculating the design of the injection mould tool.

Figures 5.35(a), (b) and (c) - 5.41(a), (b) and (c) show the change in sample dimensions on immersion in water at (a) 23°C (b) 40°C and (c) 60°C, respectively for :

Unfilled Nylon 66 (Natural)  
35% glass/Nylon 66 (Natural)  
35% glass/Nylon 66 (Black)  
50% glass/Nylon 66 (Natural)  
50% glass/Nylon 66 (Black)  
60% glass/Nylon 66 (Natural)  
60% glass/Nylon 66 (Black)

Sample dimensions were found to increase with moisture uptake. However, initially at low soak-temperatures expansion in all directions was extremely small. The increase in the width and thickness of unfilled Nylon 66 was measured to be less than 1.5%. The glass reinforced materials showed increases

of less than 0.6% in the width and thickness. The length showed no significant increase even up to a moisture content of 2%.

Initially, at low soak-temperatures expansion in all directions is expected to be very small, since immersion in water causes the samples to contract due to stress relaxation (annealing). Depending upon the processing history of the moulded article, it can sometimes result a net contraction.

It is common for injection moulders to anneal mouldings to reduce internal stresses and improve the component's toughness, by submerging in cold water for up to 24 hours or so.

With prolonged conditioning at high temperatures, the dimensions increased rapidly with moisture uptake. For unfilled Nylon 66, at saturation the overall increase in width and thickness was measured to be 3.4% and 3.6% respectively. With glass reinforced materials the overall increase in dimensions was considerably smaller. The reason being, in addition to the reduction in the polymer fraction and hence a reduction in moisture uptake, the highly aligned fibres in the skin restrict the amount of extension in the length. Even after more than 40 days at a soak-temperature of 60°C, 35% glass/Nylon 66 natural and black showed an increase in length of only 0.24% and 0.36%, respectively. Expansion in the width

and thickness were almost 10 times higher. This as mentioned earlier, is attributed to fibre orientations. Moisture absorbed by the sample is transmitted through the skin into the core. Initially, the process is slow since the highly aligned fibres in the skin offer the greatest resistance to moisture uptake. Once the moisture finds a suitable path, possibly by interfacial damage, moisture is absorbed quickly into the core of the sample. From figures 5.36(a) - 5.36(c) the time taken by the moisture to find this path is indicated to be approximately 4 hours, by which time about 2 - 3% moisture is already taken up into the skin, it is at this point the greatest percentage increase (up to 6 fold) in the sample width and thickness was observed. The rapid change in dimensions may be attributed to the randomly oriented fibres in the core, where reduced resistance is offered.

## CHAPTER 7.0

## CONCLUSIONS

- (1) The rate of moisture uptake is significantly effected by soak-temperature especially during the first 24 hours of conditioning. Increasing the temperature from 23°C to 40°C, increases the rate of moisture uptake in the natural materials by approximately 35%. For 35% glass/Nylon 66 (natural) this rise in temperature increased the moisture content from 2.42% to 3.18%, after 24 hours of conditioning.
  
- (2) At low soak-temperatures, for up-to 48 hours of conditioning, all black glass/Nylon 66 materials have 30-40% lower moisture absorption levels than the equivalent natural grades. For example, 35% glass/Nylon 66 (natural) attained a moisture content of 2.42% after 24 hours at 23°C, whereas its black equivalent absorbed only 1.65%. Therefore, the addition of Colloids black Masterbatch (54-12) appears to suppress moisture absorption at temperatures below 40°C. Above 40°C, absorption of moisture by the black grades is approximately 20% higher than natural equivalents, but it falls to less than 12% with increasing glass content.

- (3) All materials studied absorbed moisture in a Fickian manner during prolonged conditioning only. Values of the diffusion coefficient fell, for example, from  $0.16 \text{ mm}^2/\text{hr}$  to  $0.09 \text{ mm}^2/\text{hr}$  with increase in glass content from 35% to 60%, measured at a soak-temperature of  $60^\circ\text{C}$ .
- (4) Natural long glass fibre reinforced Nylon 66 materials increased their tensile strength by almost 30% from 198 MPa to 255 MPa (tested dry - "as moulded") with increasing glass content from 35% to 60%, respectively. The same increase in glass content increased the tensile strength of the black materials by almost 40%, from 183 MPa to 251 MPa.
- (5) The impact strength of notched and un-notched glass/Nylon 66 (natural) samples tested dry - "as moulded", increased from  $22 \text{ kJ/mm}^2$  to  $42 \text{ kJ/mm}^2$  and from  $54 \text{ kJ/mm}^2$  to  $91 \text{ kJ/mm}^2$  with increase in glass content from, 35% to 50% respectively. A further 10% increase in glass content from 50% to 60% showed only small improvements, of less than 10% in the impact strengths.
- (6) Improvements in the impact strength of black glass/Nylon 66 materials notched and un-notched, were less pronounced. An increase in glass content from 35% to 50% improved the notched impact strength from  $15 \text{ kJ/m}^2$  to  $21 \text{ kJ/m}^2$  and

the un-notched strength from 49 kJ/m<sup>2</sup> to 62 kJ/m<sup>2</sup>. This was seen only up to a glass content of 50%. Above this the impact strength improved dramatically by 80% for notched samples and 30% for the un-notched.

- (7) Increasing the glass content from 35% to 50%, improved the flexural modulus of black glass/Nylon 66 materials (tested dry - "as moulded") from 10.1 GPa to 14.6 GPa. An improvement of more than 10% for the same increase in glass compared to the natural materials.
- (8) With moisture uptake the flexural strength was observed to reduce more than the tensile strength. After 24 hours at 23°C, 35% glass/Nylon 66 (natural) reduced its tensile strength from 198 MPa to 170 MPa (a reduction of 14%), flexural strength was reduced from 280 MPa to 221 MPa (a reduction of 21%). This was attributed to skin - core effects.
- (9) Flexural modulus for 35% glass/Nylon 66 (natural) was reduced by more than 60%, from 10.6 GPa to 4.2 GPa for samples conditioned to 3% moisture content by immersion in water at 60°C for 1000 hours. As with tensile strength, the values of modulus in flexure reduced more than those measured in tension.



- (10) The matrix strength of the glass/Nylon 66 materials reduced by over 60% from 80 MPa to 30 MPa when moisture conditioned to 8%. This could be achieved by immersion in water at 60°C for 1000 hours.
- (11) It was shown that a 75% reduction in matrix stiffness accounted for only about a 10% reduction in the composite stiffness. Therefore, the loss in strength and stiffness of the composite was not due to plasticization of Nylon 66 alone, but also changes in interfacial properties between the fibre and matrix.
- (12) For all the mechanical and physical properties measured, there exists pronounced phase transitions between two close intervals of conditioning time. It is between these intervals that the maximum loss in strength and stiffness and the gain in impact strength is experienced. These phase transitions often occur between 24 hours and 1 week of conditioning. The tensile strength of 35% glass/Nylon 66 (natural) was reduced from 170 MPa to 135 MPa with increase in soak-time from 24 hours to 168 hours (1 week).
- (13) In the short term before equilibrium is attained, the values of the mechanical properties of samples are affected not only by the moisture content but by also the mode of conditioning i.e. the soak-time and temperature. Values

measured on samples conditioned rapidly in hot water were found to be higher than those of samples conditioned (to an equivalent moisture content) for much longer, at low soak temperatures. For example, 35% glass/Nylon 66 (natural) conditioned for 24 hours at 40°C, attained a moisture content of 3.2% which resulted in a tensile strength value of 154 MPa. Another sample conditioned for 40 days at 23°C attained a slightly lower moisture content of 3.1%, yet measured a tensile strength value of only 100 MPa.

- (14) Sample dimensions increased with moisture uptake. At low soak-temperatures, expansion in all directions was very small. It was less than 1.5% for the width and thickness of the un-filled Nylon 66 and less than 0.6% for the glass reinforced materials. No significant increase in length was measured at 23°C for up-to 2% moisture content.
- (15) Initially, only small increases in sample dimensions were observed. However, between 4-24 hours of conditioning the increase in dimensions was dramatic, up-to 6 fold.

## CHAPTER 8.0

## RECOMMENDATIONS FOR FUTURE WORK

- (1) As has already been mentioned, in any future work it would be interesting to know the effects of different skin-core structures on the moisture absorption rates and hence their mechanical and physical properties. The different skin-core structures can be obtained by varying injection moulding parameters, such as injection speeds and pressures, back pressure and cycle times. Different melt and mould temperatures may effect the crystallinity of the polymer and hence its moisture absorption behaviour and properties.
  
- (2) As observed in this study, the mechanical properties were effected by not only the moisture content, but also the mode of conditioning, i.e. the soak-time and temperature. These observations should be further studied by measuring the ingress of a moisture gradient within the sample. One possible way of doing this would be to moisture condition samples for short periods of time at high soak-temperatures. Then, just before mechanical testing, the skin should be removed by machining (to various depths) and the sample tested. If as predicted, the moisture is held in the skin, then the removal of the skin should not alter the

properties very much. This would be difficult experimentally, however, diffusion of a dye might reveal the moisture gradient.

- (3) In addition to evaluating the individual effects of Carbon black and Nigrosine, it would be useful to study the influence of other additives and colouring agents, for example Titanium Dioxide, the pigment used for giving a white colour in mouldings. Other additives could include rubber modifiers, or lubricants used for aiding surface finish and mould release.
- (4) Pre-treatment of mouldings with various coatings would be a useful study to establish their effectiveness to resist moisture absorption, especially at high soak temperatures.
- (5) The samples in this study were moisture conditioned in a stress free state. Hence, it is important to know the effect of stressed samples, since in service the moulded component would be subjected to loads, possibly in more than one direction. The samples during moisture conditioning should be loaded at various levels up to the materials ultimate tensile strength, in more than one direction if possible. This would possibly increase the initial moisture absorption rates, due to early

formation of micro-cracks within the sample and may result to some loss in the materials interfacial strength.

- (6) Interfacial strength measurements would be useful for samples moisture conditioned up-to 7 days to determine the cause of the phase transitions observed.
  
- (7) The effects of other solvents on the mechanical and physical properties of long fibre reinforced thermoplastics would be beneficial. For example, in the design of automotive applications the effects of antifreeze, petrol, oil and grease would need to be considered.

## REFERENCES

- (1) Gordon, G.E., "The New Science of Strong Materials or Why You Don't Fall Through the Floor", Penguin Books, (1974), pp 173-176.
- (2) Tewary, V.K., "Mechanics of Fibre Composites", Wiley Eastern Ltd., (1978), pp 2-3.
- (3) 'Verton' is an ICI trade mark for its range of Long Fibre Reinforced Thermoplastics.
- (4) Rao, R.M.V.G.K., "Diffusion Phenomenon in Polymer Composites : Permeable and Impermeable Fibre Composites", Ph.D. Thesis Dept. of Chemical Engineering, Indian Inst. Sc., Bangalore (1982).
- (5) Deiasi, R., and Whiteside, J.B., "Effect of moisture on Epoxy Resins and Composites", Advanced Composites Materials - Environmental Effects (1978), ASTM pp 2-20.
- (6) Powell, P.C., "Selection and Use of Thermoplastics", Engineering Design Guide No. 19. Design Council (1977).
- (7) English, L.K., "Fabricating the Future with Composite Materials", Materials Engineering (Sept 1987), pp 25-32.
- (8) Clegg, P.L., and Turner, S., "Metallurgical Materials Technology", (1975).
- (9) Piggott, M.R., "Load Bearing Fibre Composites", Pergamon Press (1980), pp 94-99.
- (10) Crawford, R.J., "Plastics Engineering", Pergamon Press (1987), pp 91-100.
- (11) Bailey, R.S., and Hutchinson, A., "Fibre Lengths in 'Verton'- An Overview", ICI Internal Report IC 05436, (1988).
- (12) Gibson, A.G., and McClelland, A.N.R., "Behaviour of Long Fibre Reinforced Polypropylene and Nylon 66 in injection mouldings", Proc. Inst. Mech. Eng. April (1986).
- (13) Folkes, M.J., "Short Fibre Reinforced Thermoplastics", Research Studies Press, (1982).

- (14) Bright, P.F., and Darlington, M.W., "Factors influencing Fibre Orientation and Mechanical Properties in Fibre Reinforced Thermoplastics Injection Mouldings", *Plastics and Rubber Processing and Applications*, (1981), pp139-147.
- (15) Darlington, M.W., and Upperton, P.H., "Designing with Short Fibre Reinforced Thermoplastics", *Institute of Mechanical Engineers*, (1986).
- (16) Gore, C.R., and Cuff, G., "Long-Short Fibre Reinforced Thermoplastics", *SPI RF/CI 41st Annual Conference*, Atlanta (1986).
- (17) ICI, European Patent No. 31662
- (18) Holister, G.S., and Thomas, C., "Fibre Reinforced Materials", *Elsevier Publishing Co. Ltd.*, pp 14-65.
- (19) Hull, D., "An Introduction to Composite Materials", *Cambridge University Press* (1981), pp 47-50.
- (20) Folkes, M.J., and Russell D.A.M., "Orientation Effects during the flow of Short Fibre Reinforced Thermoplastics", *Polymers* 21 (1980), pp 1252-8.
- (21) Rzepka, B., and Bailey, R.S., "Determination of the Glass Fibre Orientations in LF and SF Thermoplastics and their Dependence on the Injection moulding Process", *PPS Conferance, Orlando* (1988).
- (22) Bailey, R.S., and Rzepka, B., "Fibre Orientation Mechanisms for injection moulding of Long Fibre Composites", *Int. Polymer Processing* (1991).
- (23) ICI Advanced Materials - Technical Service note, "The significance of Fibre Length and Orientation", (1989).
- (24) Song, J., and Ehrenstein, Kessel, G.W., "Effect of Water Uptake on the Properties of Polyamides", *Kunststoffe* 80 (1990), pp 722-726.
- (25) Pai, C.C., Jeng, R.J., Grossman S.J., and Huang, J.C., "Effects of Moisture on Thermal and Mechanical Properties of Nylon 66", *Advances in Polymer Tech.*, Vol. 9 No. 2 pp 157-163.
- (26) Gitschner, H.W., Menger, G., and Putz, D., *SPE ANTEC Tech paper*. (1979), p 837.
- (27) Shen, C.H., and Springer, G.S., "Moisture Absorption of Composite Materials", *J. Composite Materials*. Vol 10 (1979).

- (28) Loos, A.C., and Springer, G.S., "Moisture Absorption of Graphite-Epoxy Composites Immersed in Liquids and Humid Air", J. Composite Materials. Vol 13 (1979).
- (29) Loos, A.C., and Springer, G.S., "Moisture Absorption of Polyester-E-Glass Composites", J. Composite Materials. Vol 14 (1979).
- (30) Gopalan, R., Rao, R.M.V.G.K., Murthy, M.V.V, and Dattaguru, B., "Diffusion Studies on Advanced Fibre Hybrid Composites", J. Reinforced Plastics and Composites. Vol 5 (1986).
- (31) British Standard Methods of Testing - BS 2782 : Part9 : Method 910A : 1977 / ISO 294 - 1975 "Injection moulding test specimens of thermoplastic materials".
- (32) International Organisation For Standardisation ISO 175 "Plastics - Determination of the effects of liquid chemicals, including water", First Edition - 1981.
- (33) International Organisation For Standardisation ISO R 462 "Plastics - Recommended practice for the determination of change of mechanical properties after contact with chemical substances", First Edition - 1965.
- (34) International Organisation For Standardisation ISO 175 "Plastics - Determination of water absorption", First Edition - (1980).
- (35) British Standard Methods of Testing - BS 2782 : Part10 : Method 1003 : 1977 EN 61 "Determination of tensile properties".
- (36) British Standard Methods of Testing - BS 2782 : Part3 : Method 335A : 1978 / ISO 178 - 1975 "Determination of flexural properties of rigid plastics".
- (37) International Organisation For Standardisation ISO 179 "Plastics - Determination of Charpy impact strength of rigid materials", First Edition - (1982).
- (38) Formulations of 'Verton' grades obtained from Rogers, M.D., 'Verton' research and product development group, ICI Wilton, U.K., (May 1991).
- (39) Discussions with Robinson, I.M., Mechanical Properties Group, ICI Wilton, U.K., (May 1991).



APPENDICES

## APPENDICES

- APPENDIX 1.0 : Table of injection moulding parameters.
- APPENDIX 2.0 : Table of test results showing the change in mechanical and physical properties with moisture uptake.
- APPENDIX 3.0 : Results of Tensile Tests - Load - Extension curves.
- APPENDIX 4.0 : Results of 3 - Point Bending Tests - Load - Deflection curves.
- APPENDIX 5.0 : Parameters calculated from the application of Fick's theory of moisture diffusion.

**APPENDIX 1.0 : Injection Moulding Parameters**

**A 1.1**                    **Run sheet for recording injection  
moulding parameters.**

**A 1.2**                    **Injection moulding parameters used for  
moulding test pieces.**

**NOZZLE & BARREL TEMPERATURES**

**MOULD TEMPERATURE**

**SELECTOR BUTTONS FOR :**

- 1b31 PUMP DRIVE MOTOR
- 1b43 HYDRAULIC OIL PRE-HEATING
- 6b31 SCREW CYLINDER HEATING
- 1b33 CONTROLS OFF
- 1b34 MANUAL OPERATION
- 1b33 SEMI-AUTOMATIC OPERATION
- 1b36 AUTOMATIC OPERATION

- 2d1 PAUSE TIME
- 4d1 INJECTION TIME
- 4d31 FOLLOW UP PRESSURE TIME I
- 4d32 FOLLOW UP PRESSURE TIME II
- 4d33 FOLLOW UP PRESSURE TIME III
- 2d1 COOLING TIME

- 4d5 METERING DELAY TIME
- 3d2 DELAY TIME NOZZLE RETURN
- 3d4 NOZZLE RETURN TIME
- 1d1 CYCLE CONTROL TIME
- 2d9 MOULD COOLING
- 2b72 MOULD CLOSING SPEED
- 2B75 MOULD SPEED - LOW DELIVERY
- 2b73 MOULD OPENING SPEED
- 2b47 HYDRAULIC MOTOR SCREW SPEED

- 4b46 INJECTION SPEED I
- 4b53 INJECTION SPEED II
- 4b54 INJECTION SPEED III
- 4b55 INJECTION SPEED IV

- 4b52 SCREW BACK PRESSURE
- 4b48 INJECTION PRESSURE
- 4b49 FOLLOW UP PRESSURE I
- 4b50 FOLLOW UP PRESSURE II
- 4b51 FOLLOW UP PRESSURE III
- 3b36 NOZZLE SEALING FORCE

A 1.1

Run sheet for recording injection  
moulding parameters.

OPERATOR _____ DEMAG D80		DATE _____		PAGE NO. _____																																																																																																																																																							
MOULD _____		MATERIAL _____		BATCH NO. _____																																																																																																																																																							
SPRUE BUSH _____ NOZZLE TYPE _____		GRADE _____		SHOT WEIGHT _____																																																																																																																																																							
CYLINDER TYPE _____ OIL TEMP. _____		COLOUR _____		No OFF REQD. _____																																																																																																																																																							
ORIGINATOR _____		MOULD TEMP. SET _____		FIXED _____ MOVING _____																																																																																																																																																							
OBJECTIVE _____		402u3 PHILLIPS CONTROL																																																																																																																																																									
<table border="1" style="width: 100%; text-align: center;"> <tr> <td><input type="checkbox"/></td> <td><input checked="" type="checkbox"/></td> <td><input type="checkbox"/></td> <td><input type="checkbox"/></td> <td><input type="checkbox"/></td> </tr> <tr> <td>Nozzle</td> <td>N.F.</td> <td>Front</td> <td>Centre</td> <td>Rear</td> </tr> <tr> <td><input type="checkbox"/></td> <td><input type="checkbox"/></td> <td><input type="checkbox"/></td> <td><input type="checkbox"/></td> <td><input type="checkbox"/></td> </tr> <tr> <td>6u8</td> <td>4u3.1</td> <td>403ul</td> <td>4u3</td> <td>4u2 4878</td> </tr> </table>		<input type="checkbox"/>	<input checked="" type="checkbox"/>	<input type="checkbox"/>	<input type="checkbox"/>	<input type="checkbox"/>	Nozzle	N.F.	Front	Centre	Rear	<input type="checkbox"/>	<input type="checkbox"/>	<input type="checkbox"/>	<input type="checkbox"/>	<input type="checkbox"/>	6u8	4u3.1	403ul	4u3	4u2 4878	<table border="1" style="width: 100%; text-align: center;"> <tr> <td>1 Cavity Pressure</td> <td>On or Off</td> </tr> <tr> <td>2 Injection Pressure</td> <td>On Off</td> </tr> <tr> <td>3 Position</td> <td>On Off</td> </tr> <tr> <td>4 External Set Value</td> <td>On Off</td> </tr> </table>				1 Cavity Pressure	On or Off	2 Injection Pressure	On Off	3 Position	On Off	4 External Set Value	On Off																																																																																																																										
		<input type="checkbox"/>	<input checked="" type="checkbox"/>	<input type="checkbox"/>	<input type="checkbox"/>	<input type="checkbox"/>																																																																																																																																																					
Nozzle	N.F.	Front	Centre	Rear																																																																																																																																																							
<input type="checkbox"/>	<input type="checkbox"/>	<input type="checkbox"/>	<input type="checkbox"/>	<input type="checkbox"/>																																																																																																																																																							
6u8	4u3.1	403ul	4u3	4u2 4878																																																																																																																																																							
1 Cavity Pressure	On or Off																																																																																																																																																										
2 Injection Pressure	On Off																																																																																																																																																										
3 Position	On Off																																																																																																																																																										
4 External Set Value	On Off																																																																																																																																																										
<table border="1" style="width: 100%; text-align: center;"> <tr> <td colspan="6">N.F.</td> </tr> <tr> <td colspan="6">IN OR OUT</td> </tr> <tr> <td>2b41</td> <td>1b101</td> <td>6b52</td> <td>3b33</td> <td>4b35</td> <td>4b37</td> <td>4b39</td> </tr> <tr> <td colspan="6">IN OR OUT</td> </tr> <tr> <td>4b34</td> <td>4b36</td> <td>2b49</td> <td>2b52</td> <td>2b21</td> <td>2b28</td> <td>2b42</td> </tr> <tr> <td colspan="6">IN OR OUT</td> </tr> <tr> <td>1b33</td> <td>1b34</td> <td>1b35</td> <td>1b36</td> <td>402u3</td> <td>4u3.1</td> <td>403u1</td> <td>4u3</td> </tr> <tr> <td colspan="6">IN OR OUT</td> </tr> <tr> <td>1b31</td> <td>4b41</td> <td>6b31</td> <td>1b43</td> <td colspan="3"></td> </tr> </table>		N.F.						IN OR OUT						2b41	1b101	6b52	3b33	4b35	4b37	4b39	IN OR OUT						4b34	4b36	2b49	2b52	2b21	2b28	2b42	IN OR OUT						1b33	1b34	1b35	1b36	402u3	4u3.1	403u1	4u3	IN OR OUT						1b31	4b41	6b31	1b43				<table border="1" style="width: 100%;"> <tr> <td>CM/S</td> <td>BAR</td> <td>BAR</td> </tr> <tr> <td>Injection Speed</td> <td>Injection Pressure</td> <td>Cavity Pressure</td> </tr> <tr> <td colspan="3" style="text-align: center;"> </td> </tr> <tr> <td>BAR</td> <td>BAR</td> <td>MM</td> </tr> <tr> <td>Holding Pressure</td> <td>Back Pressure</td> <td>Dosing Stroke</td> </tr> </table>				CM/S	BAR	BAR	Injection Speed	Injection Pressure	Cavity Pressure				BAR	BAR	MM	Holding Pressure	Back Pressure	Dosing Stroke																																																																												
		N.F.																																																																																																																																																									
IN OR OUT																																																																																																																																																											
2b41	1b101	6b52	3b33	4b35	4b37	4b39																																																																																																																																																					
IN OR OUT																																																																																																																																																											
4b34	4b36	2b49	2b52	2b21	2b28	2b42																																																																																																																																																					
IN OR OUT																																																																																																																																																											
1b33	1b34	1b35	1b36	402u3	4u3.1	403u1	4u3																																																																																																																																																				
IN OR OUT																																																																																																																																																											
1b31	4b41	6b31	1b43																																																																																																																																																								
CM/S	BAR	BAR																																																																																																																																																									
Injection Speed	Injection Pressure	Cavity Pressure																																																																																																																																																									
BAR	BAR	MM																																																																																																																																																									
Holding Pressure	Back Pressure	Dosing Stroke																																																																																																																																																									
<table border="1" style="width: 100%; text-align: center;"> <tr> <td colspan="3">TIME SET</td> </tr> <tr> <td>No</td> <td>Function</td> <td>Sec</td> <td>No</td> <td>Function</td> <td>Sec</td> <td>No</td> <td>Function</td> <td>Sec</td> </tr> <tr> <td>00</td> <td>2d2</td> <td></td> <td>06</td> <td>4d8</td> <td></td> <td>12</td> <td>1d1</td> <td></td> </tr> <tr> <td>01</td> <td>4d1</td> <td></td> <td>07</td> <td>2d2</td> <td></td> <td>13</td> <td></td> <td></td> </tr> <tr> <td>02</td> <td>4d31</td> <td></td> <td>08</td> <td>3d4</td> <td></td> <td>14</td> <td></td> <td></td> </tr> <tr> <td>03</td> <td>4d32</td> <td></td> <td>09</td> <td>2d8</td> <td></td> <td>15</td> <td></td> <td></td> </tr> <tr> <td>04</td> <td>4d33</td> <td></td> <td>10</td> <td>2d8</td> <td></td> <td>16</td> <td>2d9</td> <td></td> </tr> <tr> <td>05</td> <td>2d1</td> <td></td> <td>11</td> <td>2d4</td> <td></td> <td>17</td> <td>2d8</td> <td></td> </tr> </table>		TIME SET			No	Function	Sec	No	Function	Sec	No	Function	Sec	00	2d2		06	4d8		12	1d1		01	4d1		07	2d2		13			02	4d31		08	3d4		14			03	4d32		09	2d8		15			04	4d33		10	2d8		16	2d9		05	2d1		11	2d4		17	2d8		<table border="1" style="width: 100%;"> <tr> <td>Up</td> <td>S.C.</td> <td>Back Pressure</td> </tr> <tr> <td>(O)</td> <td>Ruckholung</td> <td>Dial Set.</td> </tr> <tr> <td>Down</td> <td></td> <td></td> </tr> </table>				Up	S.C.	Back Pressure	(O)	Ruckholung	Dial Set.	Down																																																																													
		TIME SET																																																																																																																																																									
No	Function	Sec	No	Function	Sec	No	Function	Sec																																																																																																																																																			
00	2d2		06	4d8		12	1d1																																																																																																																																																				
01	4d1		07	2d2		13																																																																																																																																																					
02	4d31		08	3d4		14																																																																																																																																																					
03	4d32		09	2d8		15																																																																																																																																																					
04	4d33		10	2d8		16	2d9																																																																																																																																																				
05	2d1		11	2d4		17	2d8																																																																																																																																																				
Up	S.C.	Back Pressure																																																																																																																																																									
(O)	Ruckholung	Dial Set.																																																																																																																																																									
Down																																																																																																																																																											
<table border="1" style="width: 100%; text-align: center;"> <tr> <td>2b72</td> <td>2b75</td> <td>2b73</td> <td>4b47</td> <td>4b59</td> <td>4b58</td> <td>4b56</td> <td>4b54</td> <td>4b53</td> <td>4b46</td> </tr> <tr> <td colspan="10"> <table border="1" style="width: 100%; text-align: center;"> <tr> <td colspan="10">IN OR OUT</td> </tr> <tr> <td>2b71.1</td> <td>2b71.2</td> <td>3b38</td> <td colspan="3"><input checked="" type="checkbox"/></td> <td>4b41</td> <td>4b50</td> <td>4b49</td> <td>4b48</td> <td>4b52</td> </tr> <tr> <td colspan="10"> <table border="1" style="width: 100%; text-align: center;"> <tr> <td>4b8</td> <td>4b21</td> <td>4b22</td> <td>4b23</td> <td>4b24</td> <td>4b25</td> </tr> <tr> <td>mm</td> <td>mm</td> <td>mm</td> <td>mm</td> <td>mm</td> <td>mm</td> </tr> </table> </td> </tr> </table> </td> <td colspan="4"> <table border="1" style="width: 100%;"> <tr> <td colspan="3">% SPEED</td> </tr> <tr> <td>100</td> <td>90</td> <td>80</td> <td>70</td> <td>60</td> <td>50</td> <td>40</td> <td>30</td> <td>20</td> <td>10</td> </tr> <tr> <td colspan="10" style="text-align: center;"> </td> </tr> <tr> <td colspan="10" style="text-align: center;">Injection →</td> </tr> </table> </td> </tr> <tr> <td colspan="2" rowspan="2"> <table border="1" style="width: 100%;"> <tr> <td colspan="10">% HOLDING PRESSURE</td> </tr> <tr> <td>100</td> <td>90</td> <td>80</td> <td>70</td> <td>60</td> <td>50</td> <td>40</td> <td>30</td> <td>20</td> <td>10</td> </tr> <tr> <td colspan="10" style="text-align: center;"> </td> </tr> <tr> <td colspan="10" style="text-align: center;">Holding Pressure Time</td> </tr> </table> </td> <td colspan="4"> <table border="1" style="width: 100%;"> <tr> <td colspan="4">REMARKS GENERAL</td> </tr> <tr> <td colspan="4">REMARKS SPECIAL TO MATERIAL</td> </tr> </table> </td> </tr> </table>		2b72	2b75	2b73	4b47	4b59	4b58	4b56	4b54	4b53	4b46	<table border="1" style="width: 100%; text-align: center;"> <tr> <td colspan="10">IN OR OUT</td> </tr> <tr> <td>2b71.1</td> <td>2b71.2</td> <td>3b38</td> <td colspan="3"><input checked="" type="checkbox"/></td> <td>4b41</td> <td>4b50</td> <td>4b49</td> <td>4b48</td> <td>4b52</td> </tr> <tr> <td colspan="10"> <table border="1" style="width: 100%; text-align: center;"> <tr> <td>4b8</td> <td>4b21</td> <td>4b22</td> <td>4b23</td> <td>4b24</td> <td>4b25</td> </tr> <tr> <td>mm</td> <td>mm</td> <td>mm</td> <td>mm</td> <td>mm</td> <td>mm</td> </tr> </table> </td> </tr> </table>										IN OR OUT										2b71.1	2b71.2	3b38	<input checked="" type="checkbox"/>			4b41	4b50	4b49	4b48	4b52	<table border="1" style="width: 100%; text-align: center;"> <tr> <td>4b8</td> <td>4b21</td> <td>4b22</td> <td>4b23</td> <td>4b24</td> <td>4b25</td> </tr> <tr> <td>mm</td> <td>mm</td> <td>mm</td> <td>mm</td> <td>mm</td> <td>mm</td> </tr> </table>										4b8	4b21	4b22	4b23	4b24	4b25	mm	mm	mm	mm	mm	mm	<table border="1" style="width: 100%;"> <tr> <td colspan="3">% SPEED</td> </tr> <tr> <td>100</td> <td>90</td> <td>80</td> <td>70</td> <td>60</td> <td>50</td> <td>40</td> <td>30</td> <td>20</td> <td>10</td> </tr> <tr> <td colspan="10" style="text-align: center;"> </td> </tr> <tr> <td colspan="10" style="text-align: center;">Injection →</td> </tr> </table>				% SPEED			100	90	80	70	60	50	40	30	20	10											Injection →										<table border="1" style="width: 100%;"> <tr> <td colspan="10">% HOLDING PRESSURE</td> </tr> <tr> <td>100</td> <td>90</td> <td>80</td> <td>70</td> <td>60</td> <td>50</td> <td>40</td> <td>30</td> <td>20</td> <td>10</td> </tr> <tr> <td colspan="10" style="text-align: center;"> </td> </tr> <tr> <td colspan="10" style="text-align: center;">Holding Pressure Time</td> </tr> </table>		% HOLDING PRESSURE										100	90	80	70	60	50	40	30	20	10											Holding Pressure Time										<table border="1" style="width: 100%;"> <tr> <td colspan="4">REMARKS GENERAL</td> </tr> <tr> <td colspan="4">REMARKS SPECIAL TO MATERIAL</td> </tr> </table>				REMARKS GENERAL				REMARKS SPECIAL TO MATERIAL			
		2b72	2b75	2b73	4b47	4b59	4b58	4b56	4b54	4b53	4b46																																																																																																																																																
<table border="1" style="width: 100%; text-align: center;"> <tr> <td colspan="10">IN OR OUT</td> </tr> <tr> <td>2b71.1</td> <td>2b71.2</td> <td>3b38</td> <td colspan="3"><input checked="" type="checkbox"/></td> <td>4b41</td> <td>4b50</td> <td>4b49</td> <td>4b48</td> <td>4b52</td> </tr> <tr> <td colspan="10"> <table border="1" style="width: 100%; text-align: center;"> <tr> <td>4b8</td> <td>4b21</td> <td>4b22</td> <td>4b23</td> <td>4b24</td> <td>4b25</td> </tr> <tr> <td>mm</td> <td>mm</td> <td>mm</td> <td>mm</td> <td>mm</td> <td>mm</td> </tr> </table> </td> </tr> </table>										IN OR OUT										2b71.1	2b71.2	3b38	<input checked="" type="checkbox"/>			4b41	4b50	4b49	4b48	4b52	<table border="1" style="width: 100%; text-align: center;"> <tr> <td>4b8</td> <td>4b21</td> <td>4b22</td> <td>4b23</td> <td>4b24</td> <td>4b25</td> </tr> <tr> <td>mm</td> <td>mm</td> <td>mm</td> <td>mm</td> <td>mm</td> <td>mm</td> </tr> </table>										4b8	4b21	4b22	4b23	4b24	4b25	mm	mm	mm	mm	mm	mm	<table border="1" style="width: 100%;"> <tr> <td colspan="3">% SPEED</td> </tr> <tr> <td>100</td> <td>90</td> <td>80</td> <td>70</td> <td>60</td> <td>50</td> <td>40</td> <td>30</td> <td>20</td> <td>10</td> </tr> <tr> <td colspan="10" style="text-align: center;"> </td> </tr> <tr> <td colspan="10" style="text-align: center;">Injection →</td> </tr> </table>				% SPEED			100	90	80	70	60	50	40	30	20	10											Injection →																																																																											
IN OR OUT																																																																																																																																																											
2b71.1	2b71.2	3b38	<input checked="" type="checkbox"/>			4b41	4b50	4b49	4b48	4b52																																																																																																																																																	
<table border="1" style="width: 100%; text-align: center;"> <tr> <td>4b8</td> <td>4b21</td> <td>4b22</td> <td>4b23</td> <td>4b24</td> <td>4b25</td> </tr> <tr> <td>mm</td> <td>mm</td> <td>mm</td> <td>mm</td> <td>mm</td> <td>mm</td> </tr> </table>										4b8	4b21	4b22	4b23	4b24	4b25	mm	mm	mm	mm	mm	mm																																																																																																																																						
4b8	4b21	4b22	4b23	4b24	4b25																																																																																																																																																						
mm	mm	mm	mm	mm	mm																																																																																																																																																						
% SPEED																																																																																																																																																											
100	90	80	70	60	50	40	30	20	10																																																																																																																																																		
Injection →																																																																																																																																																											
<table border="1" style="width: 100%;"> <tr> <td colspan="10">% HOLDING PRESSURE</td> </tr> <tr> <td>100</td> <td>90</td> <td>80</td> <td>70</td> <td>60</td> <td>50</td> <td>40</td> <td>30</td> <td>20</td> <td>10</td> </tr> <tr> <td colspan="10" style="text-align: center;"> </td> </tr> <tr> <td colspan="10" style="text-align: center;">Holding Pressure Time</td> </tr> </table>		% HOLDING PRESSURE										100	90	80	70	60	50	40	30	20	10											Holding Pressure Time										<table border="1" style="width: 100%;"> <tr> <td colspan="4">REMARKS GENERAL</td> </tr> <tr> <td colspan="4">REMARKS SPECIAL TO MATERIAL</td> </tr> </table>				REMARKS GENERAL				REMARKS SPECIAL TO MATERIAL																																																																																																									
		% HOLDING PRESSURE																																																																																																																																																									
100	90	80	70	60	50	40	30	20	10																																																																																																																																																		
Holding Pressure Time																																																																																																																																																											
REMARKS GENERAL																																																																																																																																																											
REMARKS SPECIAL TO MATERIAL																																																																																																																																																											

OPERATOR J. JETHWA DEMAG D80

DATE 10 JAN 790 PAGE NO.

MOULD TENSILE/CHARPY

SPRUE BUSH THROUGH NOZZLE TYPE STD

CYLINDER TYPE STD OIL TEMP.

ORIGINATOR

OBJECTIVE MOULD TEST SAMPLES

MATERIAL VECTON  
 GRADE RF700-07  
 COLOUR NATURAL

BATCH NO.  
 SHOT WEIGHT 29.68g  
 No OFF REQD.

315 Nozzle	<input checked="" type="checkbox"/> N.F.	300 Front	295 Centre	295 Rear
80 808	4u3.1	403af	4u3	4g2   4879   108

MOULD TEMP. SET      FIXED      MOVING

402u3 PHILLIPS CONTROL

1 Cavity Pressure	On or Off
2 Injection Pressure	On Off
3 Position	On Off
4 External Set Value	On Off

IN OR OUT

2b41	1b101	6b62	3b33	4b35	4b37	4b39	
4b34	4b38	2b59	2b92	2b121	2b38	2b42	
1b33	1b34	1b35	1b36	402u3	4u3.1	403u1	4u3
1b31	4b41	6b31	1b42	IN OR OUT			

15.0	124.0	455
CM/S Injection Speed	BAR Injection Pressure	BAR Cavity Pressure
110.0	0.9	092.0
BAR Holding Pressure	BAR Back Pressure	MM Dosing Stroke
Up Down	S.C. Ruckholung	Back Pressure Dial Set

TIME SET

No	Function	Sec	No	Function	Sec	No	Function	Sec
00	282	1.0	06	465	1.0	12	1d1	999
01	481	3.0	07	3a2	1.0	13		/
02	481	10.0	08	3a4	4.0	14		/
03	482	/	09	2a8	2.0	15		/
04	483	/	10	2a6	/	16	2a9	600
05	281	32.0	11	2a4	/	17	2a8	/

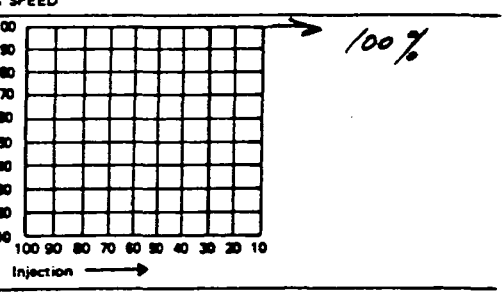

3	3	3	4	/	0	0	0	12	
2b72	2b75	2b73	4b47	4b59	4b58	4b55	4b54	4b53	4b48

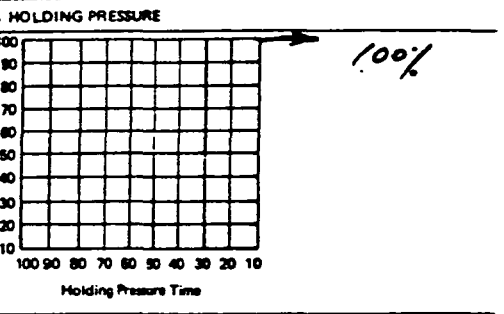

15	15	<input checked="" type="checkbox"/>	<input checked="" type="checkbox"/>	0	0	2	3	0	3
2b76	2b77	3b38	<input checked="" type="checkbox"/>	4b51	4b50	4b49	4b48	4b52	4b56
4b6	4b3	4b2	4b5	4b21	4b22	4b23	4b24	4b25	4b26

REMARKS GENERAL

*Initial problems with feeding resulted in short shots, this was overcome by trickle feeding.*

REMARKS SPECIAL TO MATERIAL

*For 50% & 60% grades higher melt temperatures (10-15C), use typical & slower screw back speeds (~20%).*

A 1.2 Injection moulding parameters used for moulding test pieces.

APPENDIX 2.0 : Table of test results showing the change in mechanical and physical properties with moisture uptake.

#### TENSILE TESTS

A 2.1	'Maranyl' A100 (Natural)
A 2.2	'Verton' RF 700-07 (Natural)
A 2.3	'Verton' RF 700-07 (Black)
A 2.4	'Verton' RF 700-10 (Natural)
A 2.5	'Verton' RF 700-10 (Black)
A 2.6	'Verton' RF 700-12 (Natural)
A 2.7	'Verton' RF 700-12 (Black)

#### 3 - POINT BENDING TESTS

A 2.8	'Verton' RF 700-07 (Natural)
A 2.9	'Verton' RF 700-07 (Black)
A 2.10	'Verton' RF 700-10 (Natural)
A 2.11	'Verton' RF 700-10 (Black)
A 2.12	'Verton' RF 700-12 (Natural)
A 2.13	'Verton' RF 700-12 (Black)

CHARPY IMPACT TESTS (Notched)

A 2.14	'Verton' RF 700-07 (Natural)
A 2.15	'Verton' RF 700-07 (Black)
A 2.16	'Verton' RF 700-10 (Natural)
A 2.17	'Verton' RF 700-10 (Black)
A 2.18	'Verton' RF 700-12 (Natural)
A 2.19	'Verton' RF 700-12 (Black)

## TENSILE TESTS

'Maranyl' Un-Reinforced Nylon 66 (Natural)

Soak Time (Hrs)	Moisture Content (%)	Increase in Width (%)	Increase in Thkns (%)	X.S. Area (mm <sup>2</sup> )	X.S. Swell (%)	Load @ Break (N)	Tensile Strength (MPa)	Redn. in Strength (%)
Dry	-----	-----	-----	32.769	-----	2637	80	-----

Soak - Temperature 23°C :

Soak Time (Hrs)	Moisture Content (%)	Increase in Width (%)	Increase in Thkns (%)	X.S. Area (mm <sup>2</sup> )	X.S. Swell (%)	Load @ Break (N)	Tensile Strength (MPa)	Redn. in Strength (%)
2	3.184	1.023	1.194	33.508	2.255	2622	78	3
4	3.214	1.056	1.194	33.519	2.289	2402	72	11
24	4.141	1.230	1.493	33.678	2.775	2174	65	20
168	4.821	1.412	1.642	33.791	3.118	2005	59	26
288	5.536	1.450	1.791	33.854	3.311	1921	57	29
432	6.250	1.536	2.090	33.984	3.708	1640	48	40
672	6.857	1.742	2.388	34.156	4.233	1491	44	46
1000	7.054	1.925	2.687	34.321	4.735	1398	41	49

Soak - Temperature 40°C :

Soak Time (Hrs)	Moisture Content (%)	Increase in Width (%)	Increase in Thkns (%)	X.S. Area (mm <sup>2</sup> )	X.S. Swell (%)	Load @ Break (N)	Tensile Strength (MPa)	Redn. in Strength (%)
2	3.512	1.300	1.490	33.703	2.850	2549	76	6
4	4.210	1.420	1.520	33.754	3.006	2372	70	13
24	5.510	1.750	2.200	34.103	4.071	1993	58	27
168	6.782	2.420	3.000	34.620	5.650	1518	44	46
288	7.140	2.623	3.200	34.764	6.088	1465	42	48
432	7.200	2.700	3.375	34.855	6.365	1301	37	54
672	7.420	2.850	3.450	34.936	6.612	1172	34	58
1000	7.750	3.000	3.500	35.008	6.832	1146	33	59

Soak - Temperature 60°C :

Soak Time (Hrs)	Moisture Content (%)	Increase in Width (%)	Increase in Thkns (%)	X.S. Area (mm <sup>2</sup> )	X.S. Swell (%)	Load @ Break (N)	Tensile Strength (MPa)	Redn. in Strength (%)
2	3.864	2.300	2.388	34.351	4.828	2370	69	14
4	4.464	2.400	2.388	34.386	4.935	2149	62	22
24	6.271	2.840	3.284	34.848	6.343	1413	41	50
168	8.036	3.210	3.582	35.083	7.062	1193	34	58
288	8.080	3.345	3.582	35.132	7.212	1152	33	59
432	8.116	3.390	3.582	35.149	7.262	1104	31	61
672	8.125	3.412	3.582	35.157	7.286	1058	30	63
1000	8.134	3.412	3.582	35.157	7.286	1050	30	63

A 2.1 'Maranyl' A100 (Natural)

Dimensions dry - "as moulded"

Width: 9.90mm

Thickness: 3.30mm



'Verton' 35% Glass/Nylon 66 (Natural)

Soak Time (Hrs)	Moisture Content (%)	Increase in Width (%)	Increase in Thkns (%)	X.S. Area (mm <sup>2</sup> )	X.S. Swell (%)	Load @ Break (N)	Tensile Strength (MPa)	Redn. in Strength (%)
Dry	-----	-----	-----	32.968	-----	6528	198	-----

Soak - Temperature 23°C :

Soak Time (Hrs)	Moisture Content (%)	Increase in Width (%)	Increase in Thkns (%)	X.S. Area (mm <sup>2</sup> )	X.S. Swell (%)	Load @ Break (N)	Tensile Strength (MPa)	Redn. in Strength (%)
2	0.098	0.402	0.302	33.200	0.705	6019	181	8
4	1.978	0.803	1.208	33.634	2.021	5708	170	14
24	2.420	1.004	1.511	33.802	2.530	5733	170	14
168	2.568	1.054	1.813	33.919	2.886	4576	135	32
288	2.645	1.104	2.115	34.037	3.243	4091	120	39
432	2.722	1.305	2.115	34.104	3.448	3762	110	44
672	2.989	1.506	2.115	34.172	3.653	3571	105	47
1000	3.136	2.008	2.719	34.544	4.782	3447	100	50

Soak - Temperature 40°C :

Soak Time (Hrs)	Moisture Content (%)	Increase in Width (%)	Increase in Thkns (%)	X.S. Area (mm <sup>2</sup> )	X.S. Swell (%)	Load @ Break (N)	Tensile Strength (MPa)	Redn. in Strength (%)
2	0.954	0.502	0.604	33.333	1.109	5660	170	14
4	2.273	0.803	1.511	33.734	2.326	5374	159	20
24	3.178	1.155	1.813	33.953	2.988	5232	154	22
168	3.304	1.406	1.813	34.037	3.244	3805	112	44
288	3.360	1.606	2.115	34.206	3.755	3400	99	50
432	3.522	1.908	2.417	34.409	4.371	3348	97	51
672	3.550	2.008	2.417	34.442	4.473	3344	97	51
1000	3.718	2.309	3.323	34.850	5.709	3346	96	52

Soak - Temperature 60°C :

Soak Time (Hrs)	Moisture Content (%)	Increase in Width (%)	Increase in Thkns (%)	X.S. Area (mm <sup>2</sup> )	X.S. Swell (%)	Load @ Break (N)	Tensile Strength (MPa)	Redn. in Strength (%)
2	2.217	0.803	1.813	33.835	2.630	5518	163	18
4	2.743	1.004	2.115	34.003	3.140	5162	152	23
24	3.580	1.406	2.417	34.239	3.857	4441	130	34
168	4.172	1.807	2.417	34.375	4.268	3259	95	52
288	4.322	1.908	2.719	34.510	4.679	3247	94	52
432	4.532	2.309	3.021	34.748	5.400	3232	93	53
672	5.029	2.309	3.323	34.850	5.709	3213	92	53
1000	5.037	2.410	3.323	34.884	5.813	3195	92	54

A 2.2

'Verton' RF 700-07 (Natural)

Dimensions dry - "as moulded"

Width: 9.96mm

Thickness: 3.31mm

'Verton' 35% Glass/Nylon 66 (Black)

Soak Time (Hrs)	Moisture Content (%)	Increase in Width (%)	Increase in Thkns (%)	X.S. Area (mm <sup>2</sup> )	X.S. Swell (%)	Load @ Break (N)	Tensile Strength (MPa)	Redn. in Strength (%)
	-----	-----	-----	33.067	-----	6048	183	-----

Soak - Temperature 23°C :

Soak Time (Hrs)	Moisture Content (%)	Increase in Width (%)	Increase in Thkns (%)	X.S. Area (mm <sup>2</sup> )	X.S. Swell (%)	Load @ Break (N)	Tensile Strength (MPa)	Redn. in Strength (%)
2	0.196	0.602	0.602	33.467	1.208	5606	168	8
4	1.561	0.803	1.205	33.734	2.018	5094	151	17
24	1.652	1.104	1.506	33.936	2.627	5090	150	18
168	1.811	1.205	1.807	34.070	3.034	4146	122	33
288	2.035	1.305	2.108	34.205	3.441	3961	116	37
432	2.608	1.406	2.410	34.340	3.849	3726	109	41
672	3.078	1.707	2.711	34.543	4.464	3465	100	45
1000	3.305	1.908	2.711	34.612	4.670	3236	94	49

Soak - Temperature 40°C :

Soak Time (Hrs)	Moisture Content (%)	Increase in Width (%)	Increase in Thkns (%)	X.S. Area (mm <sup>2</sup> )	X.S. Swell (%)	Load @ Break (N)	Tensile Strength (MPa)	Redn. in Strength (%)
2	0.525	0.803	0.602	33.534	1.410	5379	160	12
4	1.608	1.004	1.506	33.902	2.525	5079	150	18
24	3.356	1.104	1.807	34.037	2.932	4928	145	21
168	3.760	1.305	2.108	34.205	3.441	3564	104	43
288	4.075	1.707	2.108	34.341	3.851	3393	99	46
432	4.375	1.958	2.108	34.425	4.108	3298	96	48
672	4.484	2.008	2.711	34.646	4.773	3174	92	50
1000	4.565	2.209	3.012	34.816	5.287	3144	90	51

Soak - Temperature 60°C :

Soak Time (Hrs)	Moisture Content (%)	Increase in Width (%)	Increase in Thkns (%)	X.S. Area (mm <sup>2</sup> )	X.S. Swell (%)	Load @ Break (N)	Tensile Strength (MPa)	Redn. in Strength (%)
2	1.337	1.004	0.904	33.701	1.917	4870	145	21
4	1.780	1.104	2.410	34.238	3.541	4927	144	21
24	4.236	1.506	2.711	34.475	4.258	4247	123	33
168	4.327	1.807	2.952	34.659	4.812	3306	95	48
288	4.378	2.008	2.861	34.696	4.927	3168	91	50
432	4.607	2.058	2.922	34.734	5.040	3060	88	52
672	5.090	2.159	2.982	34.788	5.205	3051	88	52
1000	5.160	2.410	3.042	34.894	5.525	3046	87	52

A 2.3

'Verton' RF 700-07 (Black)

Dimensions dry - "as moulded"

Width: 9.96mm

Thickness: 3.32mm

'Verton' 50% Glass/Nylon 66 (Natural)

Soak Time (Hrs)	Moisture Content (%)	Increase in Width (%)	Increase in Thkns (%)	X.S. Area (mm <sup>2</sup> )	X.S. Swell (%)	Load @ Break (N)	Tensile Strength (MPa)	Redn. in Strength (%)
Dry	-----	-----	-----	32.968	-----	7517	228	-----

Soak - Temperature 23°C :

Soak Time (Hrs)	Moisture Content (%)	Increase in Width (%)	Increase in Thkns (%)	X.S. Area (mm <sup>2</sup> )	X.S. Swell (%)	Load @ Break (N)	Tensile Strength (MPa)	Redn. in Strength (%)
2	0.171	0.301	0.302	33.167	0.604	7204	217	5
4	1.050	0.402	1.208	33.500	1.615	6995	209	8
24	1.529	0.703	1.511	33.701	2.224	6905	205	10
168	1.555	0.803	1.662	33.785	2.478	5331	158	31
288	1.727	0.904	1.813	33.869	2.733	5131	152	34
432	1.993	1.004	1.873	33.922	2.896	4881	144	37
672	2.214	1.406	1.934	34.077	3.366	4536	133	42
1000	2.443	1.516	2.115	34.175	3.663	4214	123	46

Soak - Temperature 40°C :

Soak Time (Hrs)	Moisture Content (%)	Increase in Width (%)	Increase in Thkns (%)	X.S. Area (mm <sup>2</sup> )	X.S. Swell (%)	Load @ Break (N)	Tensile Strength (MPa)	Redn. in Strength (%)
2	0.305	0.602	0.906	33.467	1.514	6961	208	9
4	1.615	0.803	1.511	33.734	2.326	6669	198	13
24	2.080	1.004	1.813	33.900	2.827	6519	192	16
168	2.171	1.104	1.813	33.936	2.937	4785	141	38
288	2.660	1.205	1.813	33.970	3.039	4131	122	47
432	2.838	1.406	1.813	34.037	3.244	3931	116	49
672	3.325	1.807	2.115	34.273	3.960	3684	108	53
1000	3.454	1.908	2.417	34.409	4.371	3565	104	55

Soak - Temperature 60°C :

Soak Time (Hrs)	Moisture Content (%)	Increase in Width (%)	Increase in Thkns (%)	X.S. Area (mm <sup>2</sup> )	X.S. Swell (%)	Load @ Break (N)	Tensile Strength (MPa)	Redn. in Strength (%)
2	0.584	0.502	1.511	33.634	2.020	6807	202	11
4	1.458	1.004	1.813	33.902	2.835	6177	182	20
24	2.515	1.205	2.115	34.070	3.345	5901	173	24
168	3.250	1.406	2.115	34.138	3.550	4219	124	46
288	3.307	1.606	2.417	34.307	4.062	3918	114	50
432	3.345	1.857	2.417	34.392	4.319	3749	109	52
672	3.556	1.908	2.417	34.409	4.371	3551	103	55
1000	3.606	2.008	2.447	34.453	4.504	3476	101	56

A 2.4

'Verton' RF 700-10 (Natural)

Dimensions dry - "as moulded"  
 Width: 9.96mm  
 Thickness: 3.31mm

'Verton' 50% Glass/Nylon 66 (Black)

Soak Time (Hrs)	Moisture Content (%)	Increase in Width (%)	Increase in Thkns (%)	X.S. Area (mm <sup>2</sup> )	X.S. Swell (%)	Load @ Break (N)	Tensile Strength (MPa)	Redn. in Strength (%)
Dry	-----	-----	-----	33.100	-----	7249	219	-----

Soak - Temperature 23°C :

Soak Time (Hrs)	Moisture Content (%)	Increase in Width (%)	Increase in Thkns (%)	X.S. Area (mm <sup>2</sup> )	X.S. Swell (%)	Load @ Break (N)	Tensile Strength (MPa)	Redn. in Strength (%)
2	0.057	0.000	0.604	33.300	0.604	6876	207	6
4	0.593	0.400	1.208	33.634	1.613	6643	198	10
24	1.307	0.500	1.511	33.768	2.018	6483	192	12
168	1.473	0.550	1.813	33.885	2.373	5117	151	31
288	1.562	0.700	1.813	33.936	2.525	4500	133	39
432	1.657	0.750	1.813	33.953	2.576	4451	131	40
672	2.308	0.850	2.417	34.188	3.287	4171	122	44
1000	2.684	1.300	2.417	34.341	3.748	3915	114	48

Soak - Temperature 40°C :

Soak Time (Hrs)	Moisture Content (%)	Increase in Width (%)	Increase in Thkns (%)	X.S. Area (mm <sup>2</sup> )	X.S. Swell (%)	Load @ Break (N)	Tensile Strength (MPa)	Redn. in Strength (%)
2	0.166	0.200	0.906	33.467	1.108	6650	199	9
4	2.174	0.500	1.813	33.869	2.322	6648	196	10
24	2.563	0.600	2.417	34.103	3.031	6132	180	18
168	2.920	0.800	2.477	34.191	3.297	4657	136	38
288	3.111	0.850	2.598	34.249	3.470	3911	114	48
432	3.270	1.110	2.719	34.377	3.859	3713	108	51
672	3.347	1.600	2.719	34.544	4.363	3565	103	53
1000	3.404	1.800	3.021	34.714	4.876	3499	101	54

Soak - Temperature 60°C :

Soak Time (Hrs)	Moisture Content (%)	Increase in Width (%)	Increase in Thkns (%)	X.S. Area (mm <sup>2</sup> )	X.S. Swell (%)	Load @ Break (N)	Tensile Strength (MPa)	Redn. in Strength (%)
2	0.108	0.200	1.208	33.567	1.411	6475	193	12
4	2.703	0.900	2.115	34.104	3.034	5839	171	22
24	3.404	0.900	2.115	34.104	3.034	5521	162	26
168	3.595	1.200	2.719	34.408	3.952	3816	111	49
288	3.825	1.300	2.719	34.442	4.054	3744	109	50
432	3.876	1.300	2.719	34.442	4.054	3627	105	52
672	3.984	1.700	2.870	34.629	4.619	3473	100	54
1000	4.195	1.800	3.021	34.714	4.876	3451	99	55

A 2.5

'Verton' RF 700-10 (Black)

Dimensions dry - "as moulded"

Width: 10.00mm

Thickness: 3.31mm

'Verton' 60% Glass/Nylon 66 (Natural)

Soak Time (Hrs)	Moisture Content (%)	Increase in Width (%)	Increase in Thkns (%)	X.S. Area (mm <sup>2</sup> )	X.S. Swell (%)	Load @ Break (N)	Tensile Strength (MPa)	Redn. in Strength (%)
Dry	-----	-----	-----	33.067	-----	8445	255	-----

Soak - Temperature 23°C :

Soak Time (Hrs)	Wt Gain (%)	Increase in Width (%)	Increase in Thkns (%)	X.S. Area (mm <sup>2</sup> )	X.S. Swell (%)	Load @ Break (N)	Tensile Strength (MPa)	Redn. in Strength (%)
2	0.075	0.201	0.301	33.233	0.503	7986	240	6
4	0.985	0.402	0.602	33.400	1.006	7672	230	10
24	1.325	0.502	0.753	33.483	1.259	7527	225	12
168	1.425	0.713	0.904	33.604	1.623	6785	202	21
288	1.542	0.803	1.205	33.734	2.018	6383	189	26
432	1.630	0.853	1.355	33.801	2.220	6121	181	29
672	1.830	0.884	1.506	33.862	2.403	5438	161	37
1000	1.953	1.004	1.566	33.922	2.586	5115	151	41

Soak - Temperature 40°C :

Soak Time (Hrs)	Wt Gain (%)	Increase in Width (%)	Increase in Thkns (%)	X.S. Area (mm <sup>2</sup> )	X.S. Swell (%)	Load @ Break (N)	Tensile Strength (MPa)	Redn. in Strength (%)
2	0.339	0.502	0.602	33.433	1.107	7924	237	7
4	1.513	0.803	0.904	33.634	1.714	7288	217	15
24	1.630	0.904	1.205	33.768	2.119	7101	210	18
168	1.847	0.954	1.506	33.885	2.474	5489	162	37
288	2.024	1.104	1.506	33.936	2.627	5012	148	42
432	2.358	1.205	1.657	34.020	2.881	4661	137	46
672	2.647	1.707	1.687	34.199	3.422	4367	128	50
1000	2.736	1.807	1.807	34.273	3.647	4370	128	50

Soak - Temperature 60°C :

Soak Time (Hrs)	Wt Gain (%)	Increase in Width (%)	Increase in Thkns (%)	X.S. Area (mm <sup>2</sup> )	X.S. Swell (%)	Load @ Break (N)	Tensile Strength (MPa)	Redn. in Strength (%)
2	0.498	0.803	0.904	33.634	1.714	7709	229	10
4	1.948	1.004	1.205	33.802	2.221	7027	208	19
24	2.393	1.104	1.506	33.936	2.627	6645	196	23
168	2.804	1.255	1.657	34.037	2.932	4387	129	50
288	2.818	1.305	1.747	34.084	3.075	4335	127	50
432	2.863	1.506	1.747	34.152	3.279	4163	122	52
672	3.169	1.807	1.807	34.273	3.647	4150	121	53
1000	3.273	1.938	1.867	34.337	3.841	4096	119	53

A 2.6

'Verton' RF 700-12 (Natural)

Dimensions dry - "as moulded"

Width: 9.96mm

Thickness: 3.32mm

'Verton' 60% Glass/Mylon 66 (Black)

Soak Time (Hrs)	Moisture Content (%)	Increase in Width (%)	Increase in Thkns (%)	X.S. Area (mm <sup>2</sup> )	X.S. Swell (%)	Load @ Break (N)	Tensile Strength (MPa)	Redn. in Strength (%)
Dry	-----	-----	-----	33.100	-----	8308	251	-----

Soak - Temperature 23°C :

Soak Time (Hrs)	Moisture Content (%)	Increase in Width (%)	Increase in Thkns (%)	X.S. Area (mm <sup>2</sup> )	Swell (%)	Load @ Break (N)	Tensile Strength (MPa)	Redn. in Strength (%)
2	0.064	0.201	0.602	33.367	0.804	7918	237	5
4	0.597	0.602	0.904	33.601	1.511	7785	232	8
24	0.742	0.692	1.114	33.701	1.814	7445	221	12
168	1.038	0.792	1.205	33.765	2.007	6719	199	21
288	1.177	0.802	1.325	33.808	2.138	6109	181	28
432	1.252	0.853	1.476	33.875	2.341	5813	172	32
672	1.438	1.003	1.777	34.027	2.798	5342	157	37
1000	1.919	1.204	2.108	34.205	3.337	4819	141	44

Soak - Temperature 40°C :

Soak Time (Hrs)	Moisture Content (%)	Increase in Width (%)	Increase in Thkns (%)	X.S. Area (mm <sup>2</sup> )	Swell (%)	Load @ Break (N)	Tensile Strength (MPa)	Redn. in Strength (%)
2	0.326	0.602	0.904	33.601	1.511	7731	230	8
4	0.887	0.903	1.145	33.781	2.058	7581	224	11
24	1.467	1.003	1.506	33.936	2.524	7184	212	16
168	1.757	1.103	1.657	34.020	2.778	5311	156	38
288	1.979	1.204	1.657	34.054	2.880	4873	143	43
432	2.414	1.555	1.807	34.223	3.390	4401	129	49
672	2.772	1.705	1.928	34.314	3.666	4224	123	51
1000	2.865	1.825	2.319	34.486	4.187	4180	121	52

Soak - Temperature 60°C :

Soak Time (Hrs)	Moisture Content (%)	Increase in Width (%)	Increase in Thkns (%)	X.S. Area (mm <sup>2</sup> )	Swell (%)	Load @ Break (N)	Tensile Strength (MPa)	Redn. in Strength (%)
2	0.464	0.802	1.205	33.768	2.017	7574	224	11
4	2.425	0.903	1.506	33.902	2.422	7025	207	17
24	2.679	1.103	1.807	34.070	2.930	6562	193	23
168	2.858	1.204	1.958	34.155	3.185	4273	125	50
288	2.887	1.605	2.108	34.341	3.747	4265	124	51
432	2.917	1.705	2.410	34.476	4.156	4199	122	51
672	3.063	1.846	2.771	34.645	4.668	4164	120	52
1000	3.143	1.926	2.952	34.734	4.934	4161	120	52

A 2.7

'Verton' RF 700-12 (Black)

Dimensions dry - "as moulded"  
 Width: 9.97mm  
 Thickness: 3.32mm

### 3 - POINT BENDING TESTS

'Verton' 35% Glass/Nylon 66 (Natural)

soak Time (Hrs)	Moisture Content (%)	Sample Width (mm)	Sample Thickns. (mm)	Gradient of Curve (N/mm)	Load @ Break (N)	Flexural Strength (MPa)	Flexural Modulus (GPa)	Redn. in Strength (%)	Redn. in Modulus (%)
Dry	-----	9.960	3.310	29.82	255	280	10.6	-----	-----

Soak - Temperature 23°C :

soak Time (Hrs)	Moisture Content (%)	Sample Width (mm)	Sample Thickns. (mm)	Gradient of Curve (N/mm)	Load @ Break (N)	Flexural Strength (MPa)	Flexural Modulus (GPa)	Redn. in Strength (%)	Redn. in Modulus (%)
2	0.098	10.000	3.320	27.27	231	252	9.5	10	10
4	1.978	10.040	3.350	27.01	226	241	9.2	14	13
24	2.420	10.060	3.360	24.17	209	221	8.1	21	23
168	2.568	10.065	3.370	15.56	156	164	5.2	41	51
288	2.645	10.070	3.380	14.60	131	137	4.8	51	55
432	2.722	10.090	3.380	15.54	115	120	5.1	57	52
672	2.989	10.110	3.380	14.53	97	101	4.8	64	55
1000	3.136	10.160	3.400	13.26	89	91	4.2	68	60

Soak - Temperature 40°C :

soak Time (Hrs)	Moisture Content (%)	Sample Width (mm)	Sample Thickns. (mm)	Gradient of Curve (N/mm)	Load @ Break (N)	Flexural Strength (MPa)	Flexural Modulus (GPa)	Redn. in Strength (%)	Redn. in Modulus (%)
2	0.954	10.010	3.330	24.45	220	238	8.5	15	20
4	2.273	10.040	3.360	24.58	212	224	8.3	20	22
24	3.178	10.075	3.370	21.11	184	193	7.0	31	34
168	3.304	10.100	3.370	15.00	97	102	5.0	64	53
288	3.360	10.120	3.380	14.24	85	89	4.7	68	56
432	3.522	10.150	3.390	14.24	84	87	4.6	69	56
672	3.550	10.160	3.390	14.61	91	94	4.7	67	55
1000	3.718	10.190	3.420	14.84	91	92	4.7	67	56

Soak - Temperature 60°C :

soak Time (Hrs)	Moisture Content (%)	Sample Width (mm)	Sample Thickns. (mm)	Gradient of Curve (N/mm)	Load @ Break (N)	Flexural Strength (MPa)	Flexural Modulus (GPa)	Redn. in Strength (%)	Redn. in Modulus (%)
2	2.217	10.040	3.370	22.99	206	217	7.7	23	28
4	2.743	10.060	3.380	22.67	203	211	7.5	25	29
24	3.580	10.100	3.390	16.78	124	128	5.5	54	48
168	4.172	10.140	3.390	12.66	74	76	4.1	73	61
288	4.322	10.150	3.400	13.00	73	74	4.2	74	61
432	4.532	10.190	3.410	13.95	75	76	4.4	73	58
672	5.029	10.190	3.420	13.98	79	80	4.4	71	58
1000	5.037	10.200	3.420	13.25	79	80	4.2	72	61

A 2.8

'Verton' RF 700-07 (Natural)

Dimensions dry - "as moulded"  
 Width: 9.96mm  
 Thickness: 3.31mm

'Verton' 35% Glass/Nylon 66 (Black)

soak Time (Hrs)	Moisture Content (%)	Sample Width (mm)	Sample Thickns. (mm)	Gradient of Curve (N/mm)	Load @ Break (N)	Flexural Strength (MPa)	Flexural Modulus (GPa)	Redn. in Strength (%)	Redn. in Modulus (%)
Dry	-----	9.960	3.320	28.715	228	250	10.1	-----	-----

Soak - Temperature 23°C :

soak Time (Hrs)	Moisture Content (%)	Sample Width (mm)	Sample Thickns. (mm)	Gradient of Curve (N/mm)	Load @ Break (N)	Flexural Strength (MPa)	Flexural Modulus (GPa)	Redn. in Strength (%)	Redn. in Modulus (%)
2	0.196	10.020	3.340	26.040	224	240	8.9	4	11
4	1.561	10.040	3.360	27.490	215	227	9.2	9	8
24	1.652	10.070	3.370	23.320	196	205	7.7	18	23
168	1.811	10.080	3.380	16.548	140	146	5.4	42	46
288	2.035	10.090	3.390	14.613	112	116	4.8	53	53
432	2.608	10.100	3.400	13.995	104	107	4.5	57	55
672	3.078	10.130	3.410	15.000	97	98	4.8	61	53
1000	3.305	10.150	3.410	14.654	82	84	4.7	66	54

Soak - Temperature 40°C :

soak Time (Hrs)	Moisture Content (%)	Sample Width (mm)	Sample Thickns. (mm)	Gradient of Curve (N/mm)	Load @ Break (N)	Flexural Strength (MPa)	Flexural Modulus (GPa)	Redn. in Strength (%)	Redn. in Modulus (%)
2	0.525	10.040	3.340	24.530	195	209	8.4	16	17
4	1.608	10.060	3.370	23.545	198	208	7.8	17	22
24	3.356	10.070	3.380	19.650	155	162	6.5	35	36
168	3.760	10.090	3.390	14.000	105	109	4.6	56	55
288	4.075	10.130	3.390	13.797	76	78	4.5	69	56
432	4.375	10.155	3.390	13.495	72	74	4.4	70	57
672	4.484	10.160	3.410	13.100	68	69	4.2	72	59
1000	4.565	10.180	3.420	12.850	68	68	4.0	73	60

Soak - Temperature 60°C :

soak Time (Hrs)	Moisture Content (%)	Sample Width (mm)	Sample Thickns. (mm)	Gradient of Curve (N/mm)	Load @ Break (N)	Flexural Strength (MPa)	Flexural Modulus (GPa)	Redn. in Strength (%)	Redn. in Modulus (%)
2	1.337	10.060	3.350	22.365	177	189	7.6	24	25
4	1.780	10.070	3.400	20.680	174	179	6.7	28	34
24	4.236	10.110	3.410	16.195	131	134	5.2	46	49
168	4.327	10.140	3.418	12.100	85	86	3.8	65	62
288	4.378	10.160	3.415	13.460	76	76	4.3	69	58
432	4.607	10.165	3.417	13.320	70	71	4.2	72	58
672	5.090	10.175	3.419	12.754	69	70	4.0	72	60
1000	5.160	10.200	3.421	12.540	70	70	3.9	72	61

A 2.9 'Verton' RF 700-07 (Black)

Dimensions dry - "as moulded"  
 Width: 9.96mm  
 Thickness: 3.32mm



'Verton' 50% Glass/Mylon 66 (Natural)

soak Time (Hrs)	Moisture Content (%)	Sample Width (mm)	Sample Thickns. (mm)	Gradient of Curve (N/mm)	Load @ Break (N)	Flexural Strength (MPa)	Flexural Modulus (GPa)	Redn. in Strength (%)	Redn. in Modulus (%)
Dry	-----	9.960	3.310	40.97	292	321	14.5	-----	-----

Soak - Temperature 23°C

soak Time (Hrs)	Moisture Content (%)	Sample Width (mm)	Sample Thickns. (mm)	Gradient of Curve (N/mm)	Load @ Break (N)	Flexural Strength (MPa)	Flexural Modulus (GPa)	Redn. in Strength (%)	Redn. in Modulus (%)
2	0.017	9.990	3.320	36.91	255	278	12.9	14	11
4	1.050	10.000	3.350	37.86	250	267	12.9	17	11
24	1.529	10.030	3.360	33.50	250	264	11.3	18	22
168	1.555	10.040	3.365	25.21	200	211	8.4	34	42
288	1.727	10.050	3.370	24.95	177	186	8.3	42	43
432	1.993	10.060	3.372	23.18	151	158	7.7	51	47
672	2.214	10.100	3.374	23.48	147	154	7.7	52	47
1000	2.443	10.111	3.380	19.85	110	114	6.5	64	55

Soak - Temperature 40°C

soak Time (Hrs)	Moisture Content (%)	Sample Width (mm)	Sample Thickns. (mm)	Gradient of Curve (N/mm)	Load @ Break (N)	Flexural Strength (MPa)	Flexural Modulus (GPa)	Redn. in Strength (%)	Redn. in Modulus (%)
2	0.305	10.020	3.340	35.66	254	273	12.2	15	16
4	1.615	10.040	3.360	34.90	242	256	11.7	20	19
24	2.080	10.060	3.370	30.15	229	240	10.0	25	31
168	2.171	10.070	3.370	21.65	139	146	7.2	55	50
288	2.600	10.080	3.370	21.46	120	126	7.1	61	51
432	2.838	10.100	3.370	19.74	104	109	6.5	66	55
672	3.325	10.140	3.380	20.42	107	111	6.7	65	54
1000	3.454	10.150	3.390	20.89	106	109	6.8	66	53

Soak - Temperature 60°C

soak Time (Hrs)	Moisture Content (%)	Sample Width (mm)	Sample Thickns. (mm)	Gradient of Curve (N/mm)	Load @ Break (N)	Flexural Strength (MPa)	Flexural Modulus (GPa)	Redn. in Strength (%)	Redn. in Modulus (%)
2	0.584	10.010	3.360	33.97	249	264	11.5	18	21
4	1.458	10.060	3.370	32.39	242	254	10.8	21	26
24	2.515	10.080	3.380	24.82	179	186	8.2	42	44
168	3.250	10.100	3.380	21.64	120	125	7.1	61	51
288	3.307	10.120	3.390	21.07	102	105	6.8	67	53
432	3.345	10.145	3.390	20.33	100	103	6.6	68	55
672	3.556	10.150	3.390	19.65	97	100	6.4	69	56
1000	3.606	10.160	3.391	19.43	98	101	6.3	69	57

A 2.10

'Verton' RF 700-10 (Natural)

Dimensions dry - "as moulded"

Width: 9.96mm

Thickness: 3.31mm

'Verton' 50% Glass/Nylon 66 (Black)

soak Time (Hrs)	Moisture Content (%)	Sample Width (mm)	Sample Thickns. (mm)	Gradient of Curve (N/mm)	Load @ Break (N)	Flexural Strength (MPa)	Flexural Modulus (GPa)	Redn. in Strength (%)	Redn. in Modulus (%)
Dry	-----	10.000	3.310	41.37	282.65	310	14.6	-----	-----

Soak - Temperature 23°C

soak Time (Hrs)	Moisture Content (%)	Sample Width (mm)	Sample Thickns. (mm)	Gradient of Curve (N/mm)	Load @ Break (N)	Flexural Strength (MPa)	Flexural Modulus (GPa)	Redn. in Strength (%)	Redn. in Modulus (%)
2	0.057	10.000	3.330	37.77	255.55	277	13.1	11	10
4	0.593	10.040	3.350	38.66	249.00	265	13.1	14	10
24	1.304	10.050	3.360	35.26	248.00	262	11.8	15	19
168	1.473	10.055	3.370	22.04	198.75	209	7.3	33	50
288	1.562	10.070	3.370	23.32	174.07	183	7.7	41	47
432	1.657	10.075	3.370	20.77	131.90	138	6.9	55	53
672	2.306	10.080	3.390	21.35	123.25	128	7.0	59	52
1000	2.683	10.130	3.390	15.33	107.45	111	5.0	64	66

Soak - Temperature 40°C

soak Time (Hrs)	Moisture Content (%)	Sample Width (mm)	Sample Thickns. (mm)	Gradient of Curve (N/mm)	Load @ Break (N)	Flexural Strength (MPa)	Flexural Modulus (GPa)	Redn. in Strength (%)	Redn. in Modulus (%)
2	0.166	10.020	3.340	34.97	250.10	268	12.0	13	18
4	2.177	10.050	3.370	35.07	248.23	261	11.7	16	20
24	2.563	10.060	3.390	29.51	212.80	221	9.6	29	34
168	2.920	10.080	3.392	21.65	142.52	147	7.0	52	52
288	3.111	10.085	3.396	20.88	117.95	122	6.8	61	54
432	3.270	10.111	3.400	19.63	105.10	108	6.3	65	57
672	3.347	10.160	3.400	19.38	97.27	99	6.2	68	57
1000	3.402	10.180	3.410	19.64	89.97	91	6.2	71	57

Soak - Temperature 60°C

soak Time (Hrs)	Moisture Content (%)	Sample Width (mm)	Sample Thickns. (mm)	Gradient of Curve (N/mm)	Load @ Break (N)	Flexural Strength (MPa)	Flexural Modulus (GPa)	Redn. in Strength (%)	Redn. in Modulus (%)
2	0.108	10.020	3.350	32.37	227.55	243	11.0	22	25
4	2.702	10.090	3.380	30.37	222.50	232	10.0	25	32
24	3.401	10.090	3.380	25.09	180.00	187	8.2	39	44
168	3.595	10.120	3.400	21.32	100.24	103	6.9	67	53
288	3.825	10.130	3.400	20.08	89.67	92	6.5	70	56
432	3.876	10.130	3.400	18.92	85.25	87	6.1	72	58
672	3.986	10.170	3.405	19.10	84.28	86	6.1	72	58
1000	4.195	10.180	3.410	19.10	85.85	87	6.1	72	59

A 2.11

'Verton' RF 700-10 (Black)

Dimensions dry - "as moulded"  
 Width: 10.00mm  
 Thickness: 3.31mm

'Verton' 60% Glass/Nylon 66 (Natural)

soak Time (Hrs)	Moisture Content (%)	Sample Width (mm)	Sample Thickns. (mm)	Gradient of Curve (N/mm)	Load @ Break (N)	Flexural Strength (MPa)	Flexural Modulus (GPa)	Redn. in Strength (%)	Redn. in Modulus (%)
Dry	-----	9.960	3.320	53.75	334	365	18.9	-----	-----

Soak - Temperature 23°C :

soak Time (Hrs)	Moisture Content (%)	Sample Width (mm)	Sample Thickns. (mm)	Gradient of Curve (N/mm)	Load @ Break (N)	Flexural Strength (MPa)	Flexural Modulus (GPa)	Redn. in Strength (%)	Redn. in Modulus (%)
2	0.075	9.980	3.330	52.10	320	347	18.1	5	4
4	0.985	10.000	3.340	51.06	310	333	17.5	9	7
24	1.325	10.010	3.345	47.21	303	324	16.1	11	15
168	1.425	10.031	3.350	35.07	242	258	11.9	29	37
288	1.542	10.040	3.360	34.01	220	233	11.4	36	39
432	1.630	10.045	3.365	30.34	169	179	10.1	51	46
672	1.830	10.048	3.370	27.66	138	146	9.2	60	51
1000	1.953	10.060	3.372	29.58	114	119	9.8	67	48

Soak - Temperature 40°C :

soak Time (Hrs)	Moisture Content (%)	Sample Width (mm)	Sample Thickns. (mm)	Gradient of Curve (N/mm)	Load @ Break (N)	Flexural Strength (MPa)	Flexural Modulus (GPa)	Redn. in Strength (%)	Redn. in Modulus (%)
2	0.339	10.010	3.340	47.65	301	324	16.4	11	13
4	1.513	10.040	3.350	48.00	295	314	16.3	14	14
24	1.630	10.050	3.360	42.52	279	295	14.3	19	24
168	1.847	10.055	3.370	32.57	200	210	10.8	42	43
288	2.024	10.070	3.370	30.99	157	164	10.3	55	45
432	2.358	10.080	3.375	29.16	142	148	9.6	59	49
672	2.647	10.130	3.376	28.35	110	114	9.3	69	51
1000	2.736	10.140	3.380	29.14	100	104	9.5	72	50

Soak - Temperature 60°C :

soak Time (Hrs)	Moisture Content (%)	Sample Width (mm)	Sample Thickns. (mm)	Gradient of Curve (N/mm)	Load @ Break (N)	Flexural Strength (MPa)	Flexural Modulus (GPa)	Redn. in Strength (%)	Redn. in Modulus (%)
2	0.496	10.040	3.350	45.48	306	325	15.4	11	18
4	1.948	10.060	3.360	44.47	297	314	14.9	14	21
24	2.393	10.070	3.370	35.73	215	226	11.9	38	37
168	2.804	10.085	3.375	30.12	145	151	9.9	59	47
288	2.818	10.090	3.378	29.48	136	142	9.7	61	49
432	2.863	10.110	3.378	28.75	122	127	9.4	65	50
672	3.169	10.140	3.380	27.25	105	109	8.9	70	53
1000	3.273	10.153	3.382	27.10	99	102	8.8	72	53

A 2.12

'Verton' RF 700-12 (Natural)

Dimensions dry - "as moulded"  
 Width: 9.96mm  
 Thickness: 3.32mm

'Verton' 60% Glass/Nylon 66 (Black)

soak Time (Hrs)	Moisture Content (%)	Sample Width (mm)	Sample Thickns. (mm)	Gradient of Curve (N/mm)	Load @ Break (N)	Flexural Strength (MPa)	Flexural Modulus (GPa)	Redn. in Strength (%)	Redn. in Modulus (%)
Dry	-----	9.970	3.320	55.15	338	369	19.3	-----	-----

Soak - Temperature 23°C :

soak Time (Hrs)	Moisture Content (%)	Sample Width (mm)	Sample Thickns. (mm)	Gradient of Curve (N/mm)	Load @ Break (N)	Flexural Strength (MPa)	Flexural Modulus (GPa)	Redn. in Strength (%)	Redn. in Modulus (%)
2	0.064	9.990	3.340	53.76	320	345	18.5	7	4
4	0.597	10.030	3.350	52.67	312	332	17.9	10	8
24	0.742	10.039	3.357	46.81	279	296	15.8	20	18
168	1.040	10.049	3.360	35.75	248	263	12.0	29	38
288	1.180	10.050	3.364	35.34	228	241	11.8	35	39
432	1.255	10.055	3.369	33.00	189	199	11.0	46	43
672	1.438	10.070	3.379	31.45	166	174	10.4	53	46
1000	1.917	10.090	3.390	27.93	100	104	9.1	72	53

Soak - Temperature 40°C :

soak Time (Hrs)	Moisture Content (%)	Sample Width (mm)	Sample Thickns. (mm)	Gradient of Curve (N/mm)	Load @ Break (N)	Flexural Strength (MPa)	Flexural Modulus (GPa)	Redn. in Strength (%)	Redn. in Modulus (%)
2	0.326	10.030	3.350	51.75	315	336	17.6	9	9
4	0.887	10.060	3.358	50.13	312	330	16.8	11	13
24	1.467	10.070	3.370	41.85	273	286	13.9	23	28
168	1.757	10.080	3.375	31.18	177	185	10.3	50	47
288	1.979	10.090	3.375	31.03	155	162	10.2	56	47
432	2.414	10.125	3.380	27.67	120	124	9.1	66	53
672	2.772	10.140	3.384	27.22	110	114	8.9	69	54
1000	2.865	10.152	3.397	26.38	92	95	8.5	74	56

Soak - Temperature 60°C :

soak Time (Hrs)	Moisture Content (%)	Sample Width (mm)	Sample Thickns. (mm)	Gradient of Curve (N/mm)	Load @ Break (N)	Flexural Strength (MPa)	Flexural Modulus (GPa)	Redn. in Strength (%)	Redn. in Modulus (%)
2	0.462	10.050	3.360	46.24	284	300	15.5	19	20
4	2.425	10.060	3.370	44.23	281	295	14.7	20	24
24	2.679	10.080	3.380	35.07	218	227	11.5	39	40
168	2.858	10.090	3.385	29.54	115	119	9.7	68	50
288	2.887	10.130	3.390	28.73	112	115	9.3	69	52
432	2.917	10.140	3.400	29.19	110	113	9.4	69	52
672	3.063	10.154	3.412	28.40	101	103	9.0	72	53
1000	3.143	10.162	3.418	26.10	91	92	8.2	75	57

A 2.13

'Verton' RF 700-12 (Black)

Dimensions dry - "as moulded"

Width: 9.97mm

Thickness: 3.32mm

## CHARPY IMPACT TESTS (Notched)

'Verton' 35% Glass/Nylon 66 (Natural)

Soak Time (Hrs)	Moisture Content (%)	Increase in Width (%)	Increase in Thkns (%)	Increase in Length (%)	X.S. Area (mm <sup>2</sup> )	X.S. Swell (%)	Impact Reading	Impact Strength (KJ/m <sup>2</sup> )	Inc. in Strength (%)
Dry	----	----	----	----	24.354	----	0.140	22	----

Soak - Temperature 23°C :

Soak Time (Hrs)	Moisture Content (%)	Increase in Width (%)	Increase in Thkns (%)	Increase in Length (%)	X.S. Area (mm <sup>2</sup> )	X.S. Swell (%)	Impact Reading	Impact Strength (KJ/m <sup>2</sup> )	Inc. in Strength (%)
2	0.079	0.017	0.049	0.000	24.370	0.066	0.145	22	4
4	1.583	0.168	0.195	0.002	24.443	0.364	0.148	23	5
24	1.940	0.505	0.244	0.010	24.537	0.750	0.150	23	6
168	2.054	1.010	0.976	0.020	24.840	1.996	0.170	26	19
288	2.150	1.145	1.341	0.040	24.963	2.502	0.191	29	33
432	2.178	1.263	1.585	0.080	25.052	2.868	0.275	41	91
672	2.340	1.347	1.707	0.119	25.103	3.077	0.330	49	129
1000	2.510	1.515	1.951	0.159	25.205	3.496	0.360	54	148

Soak - Temperature 40°C :

Soak Time (Hrs)	Moisture Content (%)	Increase in Width (%)	Increase in Thkns (%)	Increase in Length (%)	X.S. Area (mm <sup>2</sup> )	X.S. Swell (%)	Impact Reading	Impact Strength (KJ/m <sup>2</sup> )	Inc. in Strength (%)
2	0.760	0.084	0.171	0.004	24.416	0.255	0.150	23	7
4	1.820	0.505	0.244	0.014	24.537	0.750	0.158	24	12
24	2.530	0.842	0.488	0.030	24.679	1.334	0.160	24	13
168	2.640	1.431	1.220	0.060	25.004	2.668	0.210	32	46
288	2.700	1.481	1.512	0.099	25.089	3.016	0.275	41	91
432	2.850	1.515	1.910	0.159	25.115	3.125	0.300	45	108
672	3.000	1.532	1.951	0.209	25.210	3.513	0.385	57	166
1000	3.100	1.599	2.073	0.217	25.256	3.706	0.400	59	176

Soak - Temperature 60°C :

Soak Time (Hrs)	Moisture Content (%)	Increase in Width (%)	Increase in Thkns (%)	Increase in Length (%)	X.S. Area (mm <sup>2</sup> )	X.S. Swell (%)	Impact Reading	Impact Strength (KJ/m <sup>2</sup> )	Inc. in Strength (%)
2	1.770	0.168	0.244	0.006	24.455	0.413	0.165	25	17
4	2.200	0.673	0.732	0.054	24.697	1.410	0.175	27	23
24	2.860	1.010	0.976	0.060	24.840	1.996	0.200	30	40
168	3.340	1.515	1.512	0.149	25.097	3.050	0.300	45	108
288	3.457	1.549	1.829	0.169	25.184	3.406	0.320	48	121
432	3.626	1.582	2.024	0.209	25.240	3.639	0.355	53	145
672	3.800	1.667	2.073	0.239	25.273	3.774	0.400	59	175
1000	3.900	1.667	2.195	0.241	25.303	3.898	0.420	62	189

A 2.14

'Verton' RF 700-07 (Natural)

Dimensions dry - "as moulded"

Length: 50.28mm

Width: 5.94mm

Thickness: 4.10mm

'Verton' 35% Glass/Nylon 66 (Black)

Soak Time (Hrs)	Moisture Content (%)	Increase in Width (%)	Increase in Thkns (%)	Increase in Length (%)	X.S. Area (mm <sup>2</sup> )	X.S. Swell (%)	Impact Reading	Impact Strength (KJ/m <sup>2</sup> )	Inc. in Strength (%)
Dry	-----	-----	-----	-----	24.268	-----	0.100	15	-----

Soak - Temperature 23°C :

Soak Time (Hrs)	Moisture Content (%)	Increase in Width (%)	Increase in Thkns (%)	Increase in Length (%)	X.S. Area (mm <sup>2</sup> )	X.S. Swell (%)	Impact Reading	Impact Strength (KJ/m <sup>2</sup> )	Inc. in Strength (%)
2	0.159	0.067	0.098	0.010	24.308	0.165	0.120	19	20
4	1.262	0.218	0.221	0.014	24.375	0.440	0.125	19	24
24	1.326	0.285	0.369	0.032	24.427	0.655	0.130	20	29
168	1.440	0.704	1.107	0.038	24.709	1.818	0.150	23	47
288	1.635	0.854	1.328	0.060	24.800	2.194	0.180	27	76
432	2.090	1.039	1.550	0.089	24.900	2.604	0.224	34	118
672	2.465	1.357	1.722	0.133	25.021	3.102	0.300	45	191
1000	2.665	1.575	1.993	0.175	25.141	3.599	0.335	50	223

Soak - Temperature 40°C

Soak Time (Hrs)	Moisture Content (%)	Increase in Width (%)	Increase in Thkns (%)	Increase in Length (%)	X.S. Area (mm <sup>2</sup> )	X.S. Swell (%)	Impact Reading	Impact Strength (KJ/m <sup>2</sup> )	Inc. in Strength (%)
2	0.950	0.251	0.221	0.018	24.383	0.473	0.130	20	29
4	1.523	0.335	0.394	0.024	24.445	0.730	0.137	21	36
24	1.630	0.670	0.615	0.040	24.581	1.289	0.140	21	38
168	2.600	0.972	1.451	0.072	24.859	2.437	0.180	27	76
288	2.757	1.281	1.599	0.107	24.972	2.901	0.225	34	119
432	2.946	1.390	1.722	0.163	25.029	3.136	0.321	48	211
672	3.140	1.642	1.894	0.213	25.134	3.567	0.350	52	238
1000	3.264	1.769	2.066	0.219	25.208	3.872	0.391	58	276

Soak - Temperature 60°C

Soak Time (Hrs)	Moisture Content (%)	Increase in Width (%)	Increase in Thkns (%)	Increase in Length (%)	X.S. Area (mm <sup>2</sup> )	X.S. Swell (%)	Impact Reading	Impact Strength (KJ/m <sup>2</sup> )	Inc. in Strength (%)
2	1.560	0.402	0.615	0.018	24.515	1.019	0.162	25	60
4	1.754	0.988	0.861	0.064	24.719	1.858	0.168	26	65
24	1.812	1.089	1.230	0.074	24.834	2.332	0.170	26	66
168	3.240	1.491	1.648	0.163	25.036	3.164	0.192	29	86
288	3.342	1.575	1.796	0.189	25.093	3.399	0.270	40	161
432	3.564	1.675	1.919	0.215	25.148	3.626	0.380	57	267
672	3.776	1.826	2.042	0.251	25.216	3.905	0.390	58	275
1000	3.958	1.843	2.140	0.263	25.244	4.022	0.410	61	294

A 2.15

'Verton' RF 700-07 (Black)

Dimensions dry - "as moulded"

Length: 50.28mm

Width: 5.97mm

Thickness: 4.07mm

'Verton' 50% Glass/Nylon 66 (Natural)

Soak Time (Hrs)	Moisture Content (%)	Increase in Width (%)	Increase in Thkns (%)	Increase in Length (%)	X.S. Area (mm <sup>2</sup> )	X.S. Swell (%)	Impact Reading	Impact Strength (KJ/m <sup>2</sup> )	Inc. in Strength (%)
Dry	-----	-----	-----	-----	24.298	-----	0.250	39	-----

Soak - Temperature 23°C

Soak Time (Hrs)	Moisture Content (%)	Increase in Width (%)	Increase in Thkns (%)	Increase in Length (%)	X.S. Area (mm <sup>2</sup> )	X.S. Swell (%)	Impact Reading	Impact Strength (KJ/m <sup>2</sup> )	Inc. in Strength (%)
2	0.082	0.080	0.023	0.005	24.323	0.103	0.258	40	3
4	0.912	0.156	0.178	0.002	24.379	0.335	0.310	48	24
24	1.327	0.395	0.200	0.008	24.443	0.598	0.320	49	27
168	1.375	0.503	0.983	0.030	24.663	1.503	0.330	50	30
288	1.396	0.712	1.210	0.036	24.772	1.951	0.354	54	39
432	1.625	1.001	1.400	0.071	24.892	2.445	0.440	66	72
672	2.156	1.149	1.612	0.100	24.983	2.820	0.480	72	87
1000	2.310	1.210	1.750	0.137	25.034	3.028	0.500	75	94

Soak - Temperature 40°C :

Soak Time (Hrs)	Moisture Content (%)	Increase in Width (%)	Increase in Thkns (%)	Increase in Length (%)	X.S. Area (mm <sup>2</sup> )	X.S. Swell (%)	Impact Reading	Impact Strength (KJ/m <sup>2</sup> )	Inc. in Strength (%)
2	0.423	0.123	0.151	0.002	24.365	0.275	0.261	40	4
4	1.623	0.400	0.210	0.008	24.447	0.613	0.312	48	24
24	1.871	0.632	0.410	0.031	24.553	1.050	0.340	52	35
168	2.102	0.875	1.275	0.050	24.829	2.186	0.360	54	41
288	2.415	1.000	1.500	0.100	24.917	2.548	0.420	63	64
432	2.600	1.154	1.678	0.140	25.001	2.894	0.490	74	90
672	2.814	1.280	1.800	0.179	25.064	3.153	0.550	82	113
1000	2.889	1.312	1.880	0.189	25.093	3.271	0.560	84	117

Soak - Temperature 60°C :

Soak Time (Hrs)	Moisture Content (%)	Increase in Width (%)	Increase in Thkns (%)	Increase in Length (%)	X.S. Area (mm <sup>2</sup> )	X.S. Swell (%)	Impact Reading	Impact Strength (KJ/m <sup>2</sup> )	Inc. in Strength (%)
2	0.645	0.152	0.241	0.005	24.394	0.394	0.350	54	39
4	1.715	0.532	0.500	0.036	24.551	1.040	0.360	55	43
24	2.500	1.000	1.105	0.071	24.818	2.139	0.400	60	57
168	2.640	1.225	1.590	0.120	24.997	2.876	0.480	72	87
288	2.750	1.297	1.790	0.167	25.066	3.161	0.520	78	102
432	2.941	1.385	1.840	0.182	25.101	3.305	0.558	83	116
672	3.108	1.500	1.940	0.199	25.156	3.531	0.570	85	120
1000	3.120	1.540	2.000	0.200	25.182	3.637	0.580	86	124

A 2.16

'Verton' RF 700-10 (Natural)

Dimensions dry - "as moulded"

Length: 50.30mm

Width: 5.97mm

Thickness: 4.07mm

'Verton' 50% Glass/Nylon 66 (Black)

Soak Time (Hrs)	Moisture Content (%)	Increase in Width (%)	Increase in Thkns (%)	Increase in Length (%)	X.S. Area (mm <sup>2</sup> )	X.S. Swell (%)	Impact Reading	Impact Strength (KJ/m <sup>2</sup> )	Inc. in Strength (%)
Dry	-----	-----	-----	-----	24.499	-----	0.135	21	-----

Soak - Temperature 23°C :

Soak Time (Hrs)	Moisture Content (%)	Increase in Width (%)	Increase in Thkns (%)	Increase in Length (%)	X.S. Area (mm <sup>2</sup> )	X.S. Swell (%)	Impact Reading	Impact Strength (KJ/m <sup>2</sup> )	Inc. in Strength (%)
2	0.765	0.103	0.089	0.006	24.546	0.192	0.201	31	49
4	1.210	0.200	0.265	0.015	24.613	0.467	0.254	39	87
24	1.420	0.456	0.540	0.020	24.745	1.004	0.270	41	98
168	1.560	0.610	1.012	0.038	24.901	1.642	0.300	45	119
288	1.650	0.940	1.327	0.040	25.064	2.306	0.310	46	124
432	1.800	1.102	1.523	0.081	25.155	2.678	0.350	52	152
672	2.174	1.200	1.705	0.124	25.227	2.970	0.420	62	202
1000	2.412	1.320	1.856	0.152	25.296	3.254	0.450	67	223

Soak - Temperature 40°C :

Soak Time (Hrs)	Moisture Content (%)	Increase in Width (%)	Increase in Thkns (%)	Increase in Length (%)	X.S. Area (mm <sup>2</sup> )	X.S. Swell (%)	Impact Reading	Impact Strength (KJ/m <sup>2</sup> )	Inc. in Strength (%)
2	0.912	0.265	0.186	0.008	24.610	0.453	0.212	32	56
4	1.350	0.650	0.364	0.025	24.749	1.022	0.264	40	94
24	1.693	0.800	0.780	0.047	24.891	1.599	0.289	44	111
168	2.109	1.000	1.485	0.075	25.120	2.533	0.340	51	146
288	2.350	1.168	1.640	0.115	25.202	2.869	0.380	57	174
432	2.710	1.250	1.789	0.156	25.261	3.110	0.450	67	223
672	2.834	1.360	1.894	0.187	25.316	3.336	0.498	74	257
1000	2.910	1.400	2.014	0.200	25.358	3.504	0.500	74	258

Soak - Temperature 60°C :

Soak Time (Hrs)	Moisture Content (%)	Increase in Width (%)	Increase in Thkns (%)	Increase in Length (%)	X.S. Area (mm <sup>2</sup> )	X.S. Swell (%)	Impact Reading	Impact Strength (KJ/m <sup>2</sup> )	Inc. in Strength (%)
2	1.310	0.423	0.349	0.012	24.689	0.777	0.217	33	60
4	2.000	1.000	0.710	0.047	24.924	1.732	0.290	44	111
24	2.300	1.200	1.345	0.080	25.135	2.594	0.320	48	131
168	2.694	1.356	1.784	0.150	25.287	3.216	0.390	58	180
288	2.845	1.400	1.890	0.182	25.326	3.374	0.451	67	223
432	3.089	1.489	2.140	0.212	25.413	3.731	0.489	72	249
672	3.185	1.580	2.240	0.236	25.463	3.933	0.512	75	265
1000	3.196	1.640	2.241	0.241	25.479	3.998	0.521	77	271

A 2.17

'Verton' RF 700-10 (Black)

Dimensions dry - "as moulded"

Length: 50.30mm

Width: 5.99mm

Thickness: 4.09mm



'Verton' 60% Glass/Nylon 66 (Natural)

Soak Time (Hrs)	Moisture Content (%)	Increase in Width (%)	Increase in Thkns (%)	Increase in Length (%)	X.S. Area (mm <sup>2</sup> )	X.S. Swell (%)	Impact Reading	Impact Strength (KJ/m <sup>2</sup> )	Inc. in Strength (%)
Dry	-----	-----	-----	-----	24.288	-----	0.270	42	-----

Soak - Temperature 23°C

Soak Time (Hrs)	Moisture Content (%)	Increase in Width (%)	Increase in Thkns (%)	Increase in Length (%)	X.S. Area (mm <sup>2</sup> )	X.S. Swell (%)	Impact Reading	Impact Strength (KJ/m <sup>2</sup> )	Inc. in Strength (%)
2	0.064	0.071	0.019	0.003	24.310	0.090	0.275	42	2
4	0.780	0.142	0.150	0.004	24.359	0.293	0.300	46	11
24	1.054	0.301	0.181	0.008	24.406	0.484	0.310	48	14
75	1.137	0.401	0.840	0.021	24.593	1.253	0.320	49	17
288	1.230	0.659	1.121	0.030	24.727	1.804	0.340	52	24
432	1.309	0.801	1.320	0.060	24.812	2.156	0.360	54	31
624	1.468	0.914	1.504	0.084	24.887	2.463	0.380	57	37
1000	1.734	1.101	1.640	0.109	24.968	2.799	0.400	60	44

Soak - Temperature 40°C :

Soak Time (Hrs)	Moisture Content (%)	Increase in Width (%)	Increase in Thkns (%)	Increase in Length (%)	X.S. Area (mm <sup>2</sup> )	X.S. Swell (%)	Impact Reading	Impact Strength (KJ/m <sup>2</sup> )	Inc. in Strength (%)
2	0.281	0.111	0.134	0.010	24.348	0.245	0.285	44	5
4	1.213	0.384	0.196	0.018	24.430	0.583	0.300	46	10
24	1.317	0.621	0.401	0.026	24.539	1.030	0.320	49	17
75	1.494	0.800	1.201	0.041	24.782	2.032	0.330	50	20
288	1.740	0.978	1.480	0.078	24.897	2.505	0.350	53	26
432	1.889	1.145	1.600	0.124	24.969	2.803	0.390	59	41
624	2.119	1.258	1.741	0.132	25.034	3.068	0.400	60	44
1000	2.179	1.277	1.785	0.154	25.050	3.134	0.410	61	47

Soak - Temperature 60°C

Soak Time (Hrs)	Moisture Content (%)	Increase in Width (%)	Increase in Thkns (%)	Increase in Length (%)	X.S. Area (mm <sup>2</sup> )	X.S. Swell (%)	Impact Reading	Impact Strength (KJ/m <sup>2</sup> )	Inc. in Strength (%)
2	0.370	0.142	0.196	0.015	24.371	0.339	0.320	49	18
4	1.562	0.400	0.420	0.031	24.489	0.825	0.330	51	21
24	1.932	0.869	1.100	0.064	24.774	1.999	0.360	55	31
75	2.243	1.100	1.500	0.116	24.933	2.652	0.380	57	37
288	2.354	1.209	1.690	0.148	25.008	2.964	0.400	60	44
432	2.540	1.321	1.765	0.155	25.056	3.159	0.400	60	44
624	2.642	1.400	1.864	0.164	25.101	3.346	0.410	61	47
1000	2.700	1.410	1.900	0.170	25.113	3.395	0.420	63	50

A 2.18

'Verton' RF 700-12 (Natural)

Dimensions dry - "as moulded"

Length: 50.32mm

Width: 5.98mm

Thickness: 4.07mm

'Verton' 60% Glass/Nylon 66 (Black)

Soak Time (Hrs)	Moisture Content (%)	Increase in Width (%)	Increase in Thkns (%)	Increase in Length (%)	X.S. Area (mm <sup>2</sup> )	X.S. Swell (%)	Impact Reading	Impact Strength (KJ/m <sup>2</sup> )	Inc. in Strength (%)
Dry	-----	-----	-----	-----	24.470	-----	0.240	37	-----

Soak - Temperature 23°C :

Soak Time (Hrs)	Moisture Content (%)	Increase in Width (%)	Increase in Thkns (%)	Increase in Length (%)	X.S. Area (mm <sup>2</sup> )	X.S. Swell (%)	Impact Reading	Impact Strength (KJ/m <sup>2</sup> )	Inc. in Strength (%)
2	0.070	0.079	0.022	0.003	24.495	0.101	0.255	39	6
4	0.785	0.147	0.184	0.004	24.552	0.332	0.270	41	12
24	1.061	0.311	0.200	0.009	24.596	0.513	0.290	44	20
75	1.140	0.412	0.740	0.022	24.755	1.162	0.310	47	28
288	1.241	0.701	1.164	0.031	24.933	1.892	0.325	49	33
432	1.349	0.810	1.350	0.070	25.008	2.196	0.340	51	39
624	1.510	0.907	1.502	0.089	25.071	2.454	0.360	54	46
1000	1.800	1.200	1.673	0.112	25.189	2.937	0.372	55	51

Soak - Temperature 40°C :

Soak Time (Hrs)	Moisture Content (%)	Increase in Width (%)	Increase in Thkns (%)	Increase in Length (%)	X.S. Area (mm <sup>2</sup> )	X.S. Swell (%)	Impact Reading	Impact Strength (KJ/m <sup>2</sup> )	Inc. in Strength (%)
2	0.295	0.184	0.174	0.015	24.558	0.359	0.260	40	8
4	1.274	0.396	0.204	0.021	24.618	0.603	0.280	43	16
24	1.385	0.634	0.419	0.031	24.730	1.061	0.295	45	22
75	1.510	0.813	1.265	0.045	24.987	2.111	0.320	48	31
288	1.765	0.991	1.500	0.086	25.092	2.539	0.350	52	42
432	1.901	1.174	1.602	0.135	25.164	2.835	0.370	55	50
624	2.102	1.328	1.700	0.145	25.229	3.099	0.385	57	56
1000	2.210	1.400	1.803	0.159	25.274	3.282	0.390	58	57

Soak - Temperature 60°C :

Soak Time (Hrs)	Moisture Content (%)	Increase in Width (%)	Increase in Thkns (%)	Increase in Length (%)	X.S. Area (mm <sup>2</sup> )	X.S. Swell (%)	Impact Reading	Impact Strength (KJ/m <sup>2</sup> )	Inc. in Strength (%)
2	0.402	0.165	0.204	0.017	24.561	0.370	0.310	47	29
4	1.574	0.481	0.435	0.033	24.696	0.922	0.334	51	38
24	2.080	0.904	1.117	0.070	24.973	2.052	0.360	54	47
75	2.289	1.124	1.583	0.124	25.147	2.764	0.375	56	52
288	2.394	1.280	1.706	0.156	25.218	3.055	0.390	58	58
432	2.601	1.402	1.800	0.160	25.273	3.281	0.400	59	61
624	2.684	1.468	1.869	0.172	25.308	3.423	0.410	61	65
1000	2.705	1.510	1.905	0.180	25.328	3.505	0.410	61	65

A 2.19

'Verton' RF 700-12 (Black)

Dimensions dry - "as moulded"

Length: 50.32mm

Width: 6.01mm

Thickness: 4.08mm

APPENDIX 3 : Tensile Tests.

Load - Extension curves.

Maranyl A100 (Natural)

A 3.1 Dry - "as moulded"

A 3.2 Soaked for 24 hours at 23, 40 and 60°C

Verton RF 700-07 /-10 /-12

(Natural and Black)

A 3.3 Dry - "as moulded"

Soak - Time : 4 hours (at 23, 40 and 60°C)

A 3.4 Verton RF 700-07 (Natural and Black)

A 3.5 Verton RF 700-10 (Natural and Black)

A 3.6 Verton RF 700-12 (Natural and Black)

Soak - Time : 24 hours (at 23, 40 and 60°C)

A 3.7 Verton RF 700-07 (Natural and Black)

A 3.8 Verton RF 700-10 (Natural and Black)

A 3.9 Verton RF 700-12 (Natural and Black)

Soak - Time : 432 hours (18 Days)

(at 23, 40 and 60°C)

- A 3.10 Verton RF 700-07 (Natural and Black)
- A 3.11 Verton RF 700-10 (Natural and Black)
- A 3.12 Verton RF 700-12 (Natural and Black)

Soak - Time : 672 hours (28 Days)

(at 23, 40 and 60°C)

- A 3.13 Verton RF 700-07 (Natural and Black)
- A 3.14 Verton RF 700-10 (Natural and Black)
- A 3.15 Verton RF 700-12 (Natural and Black)

TENSILE TESTS

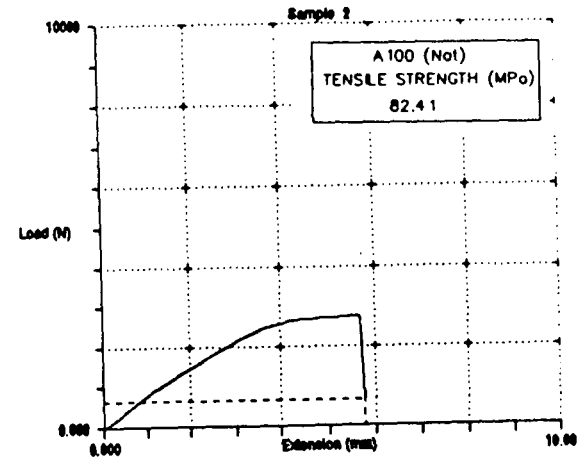
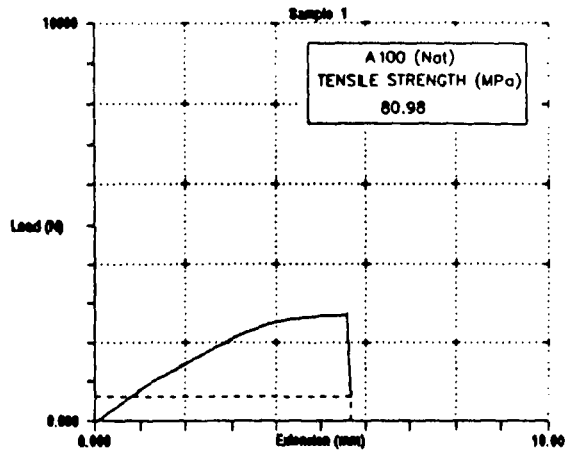

CONDITION : DRY - "AS MOULDED"

TENSILE TESTS

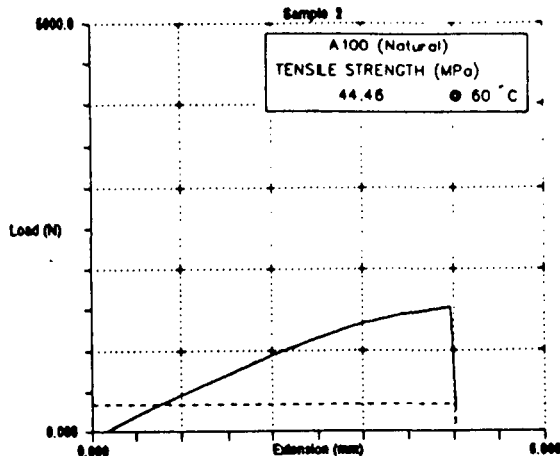
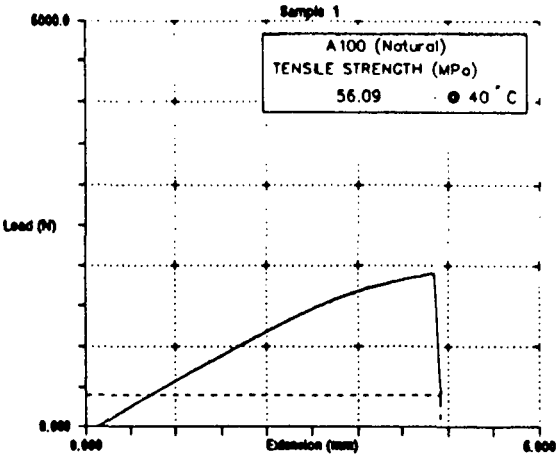
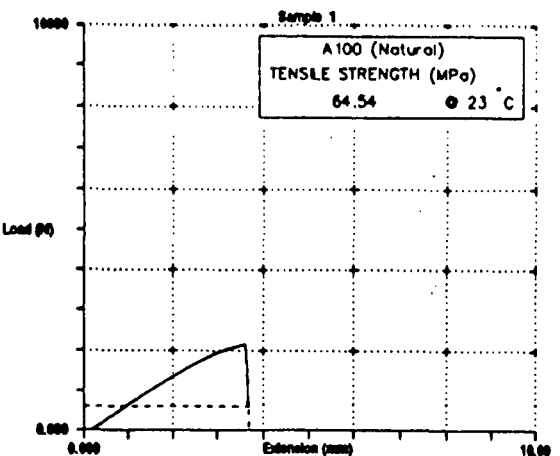

SOAK-TIME : 24 HOURS

# TENSILE TESTS

A 3.3

Verton RF 700-07 /-10 /-12  
(Natural and Black)

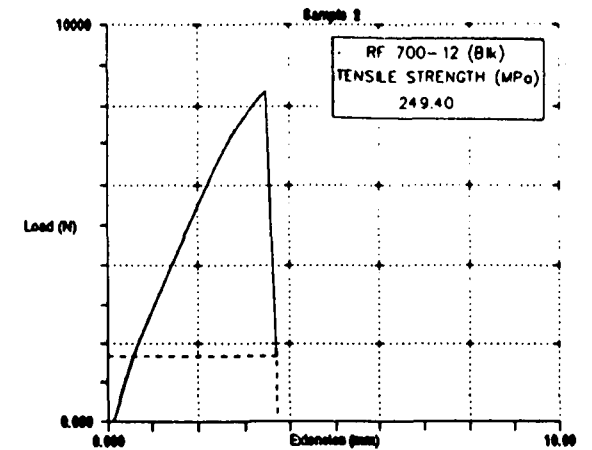
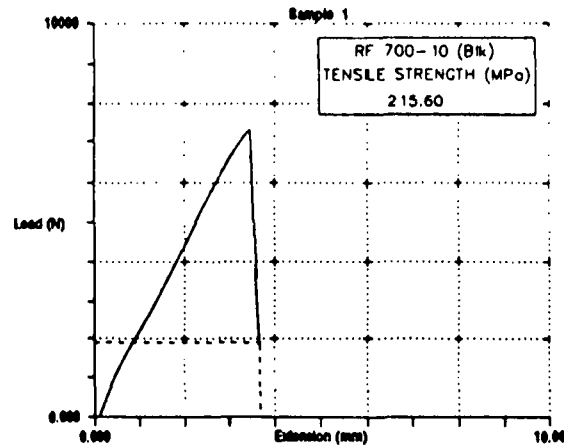
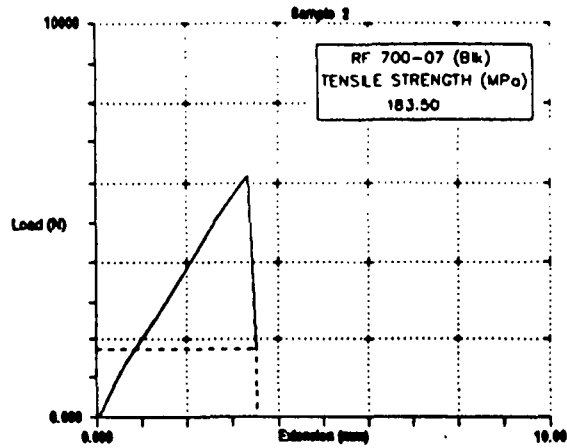
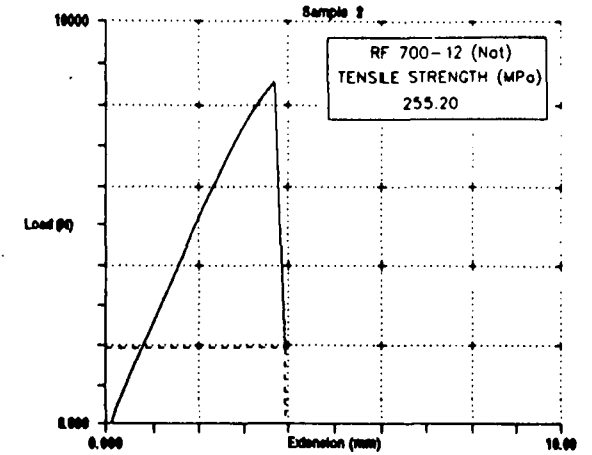
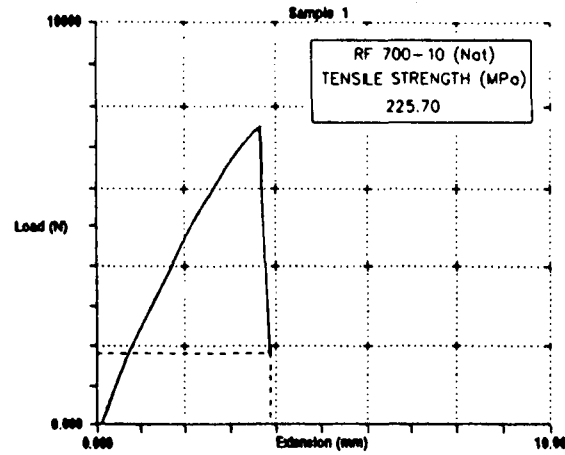
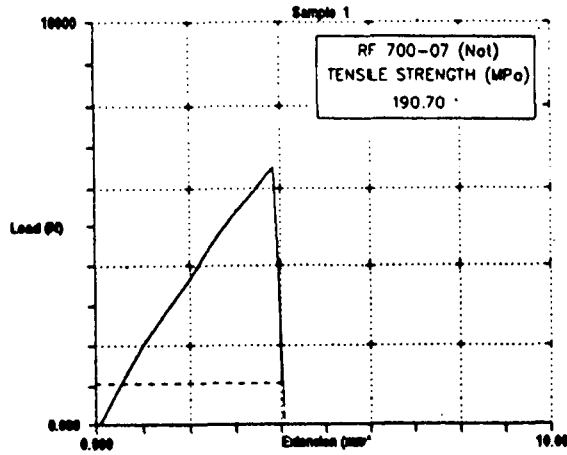

CONDITION : DRY - "AS MOULDED"

TENSILE TESTS

(Natural and Black)

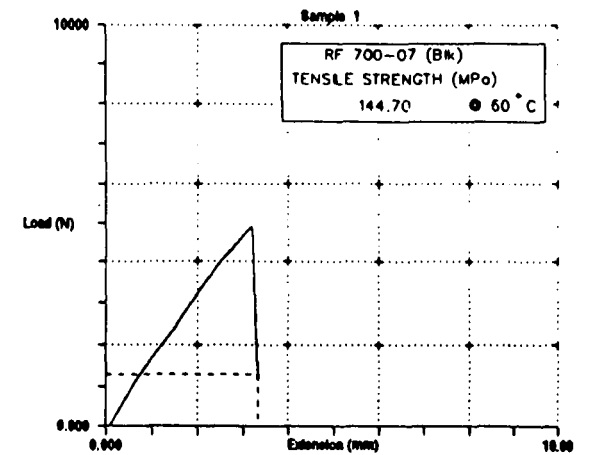
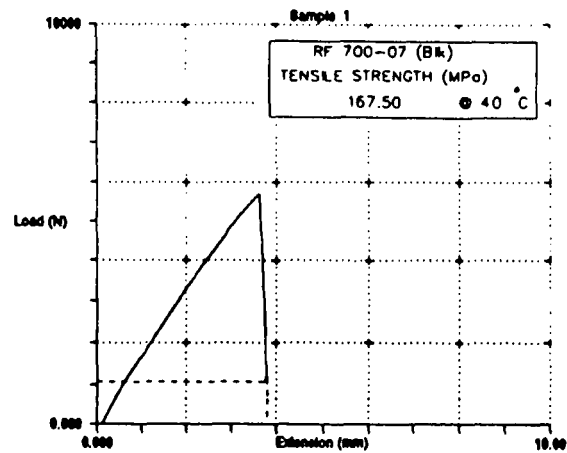
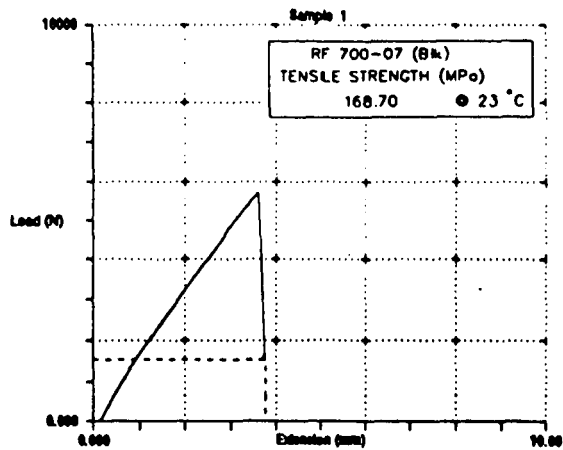
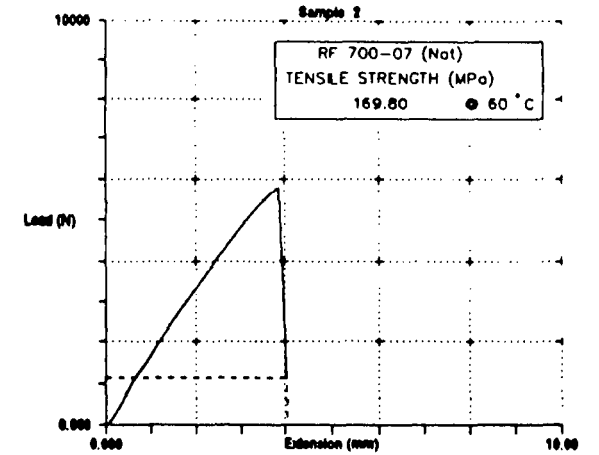
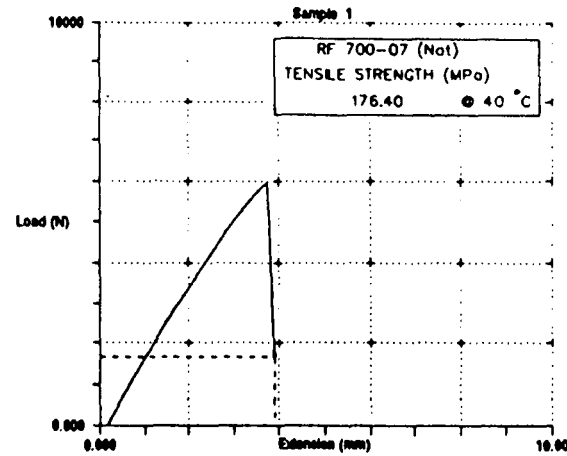
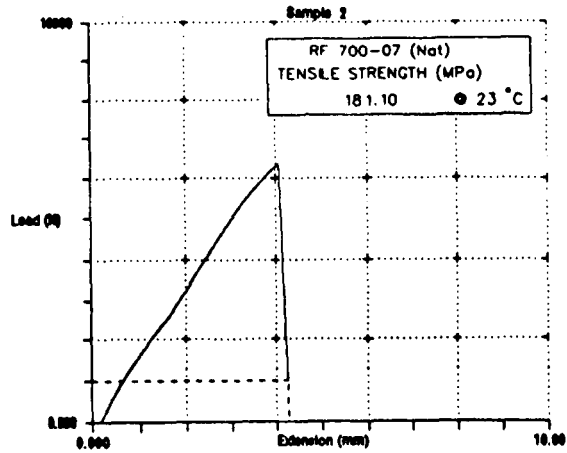

SOAK-TIME : 4 HOURS



TENSILE TESTS

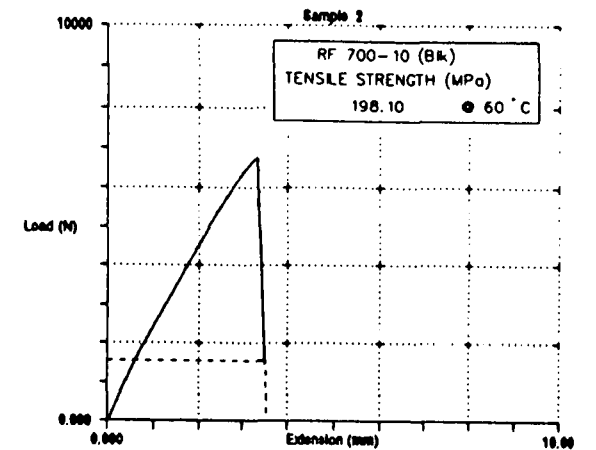
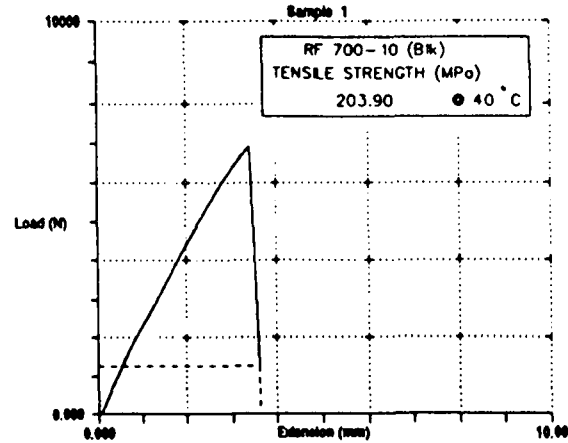
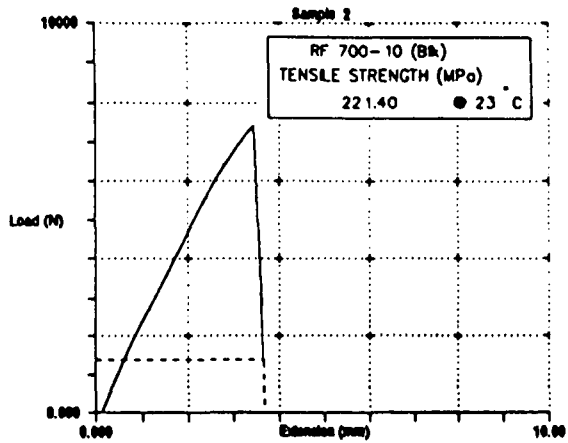
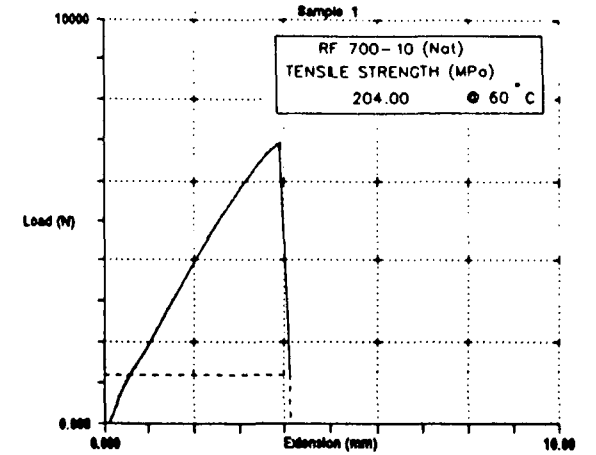
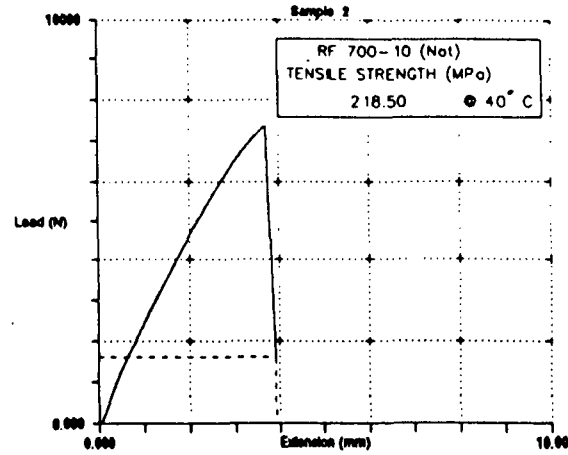
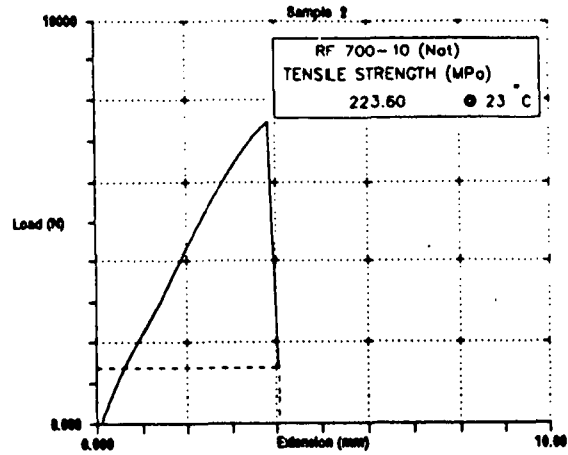

SOAK-TIME : 4 HOURS

TENSILE TESTS

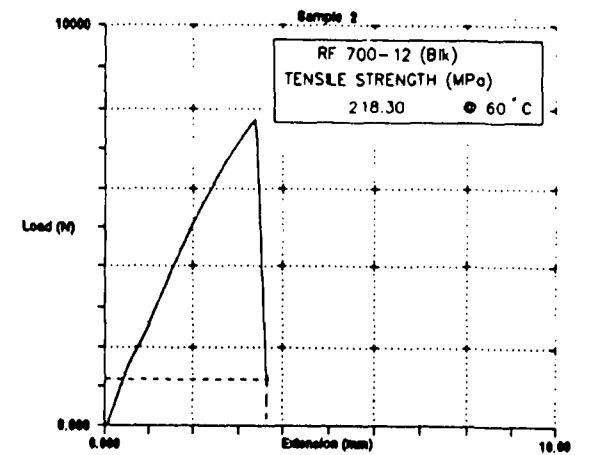
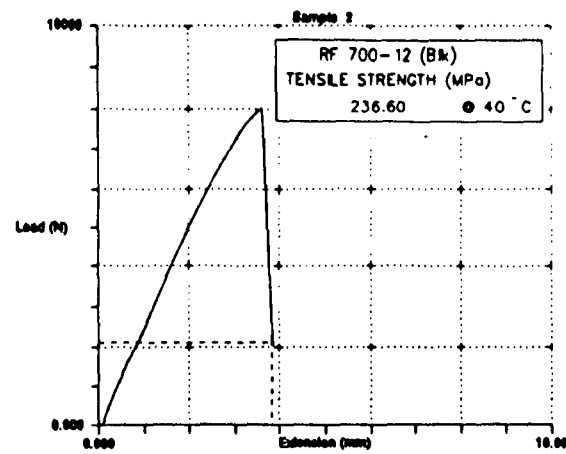
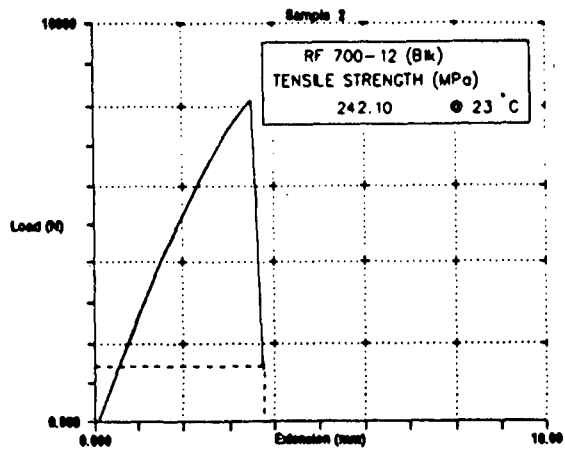
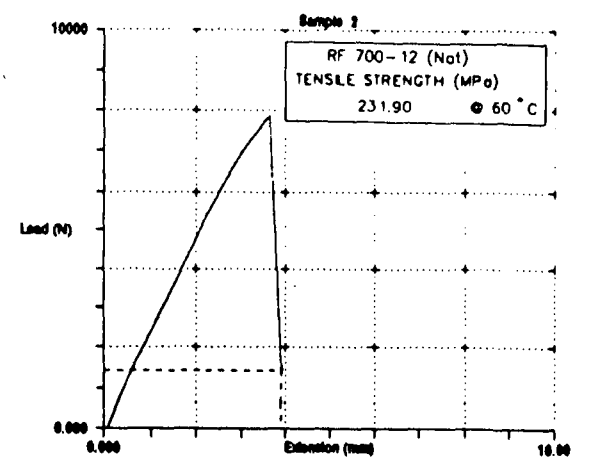
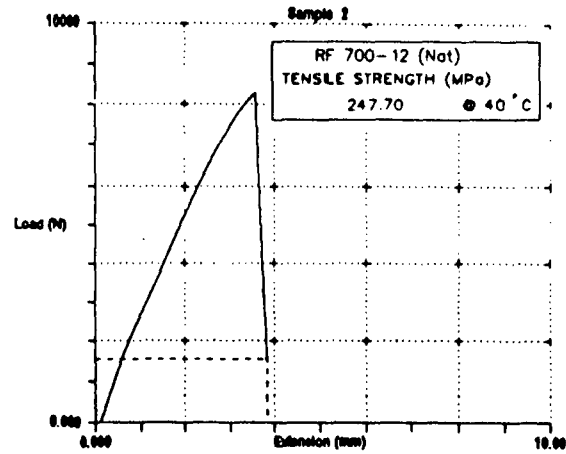
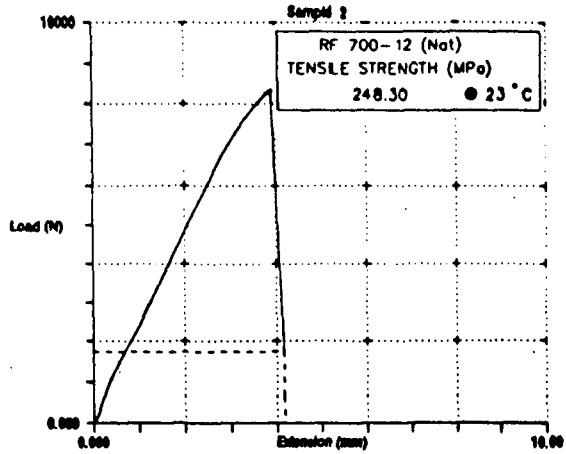

SOAK-TIME : 4 HOURS

TENSILE TESTS

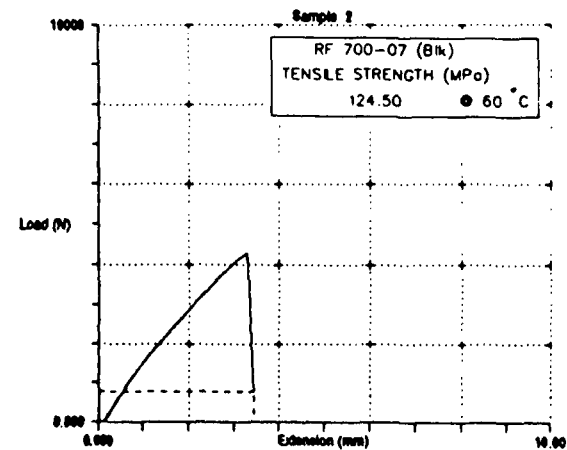
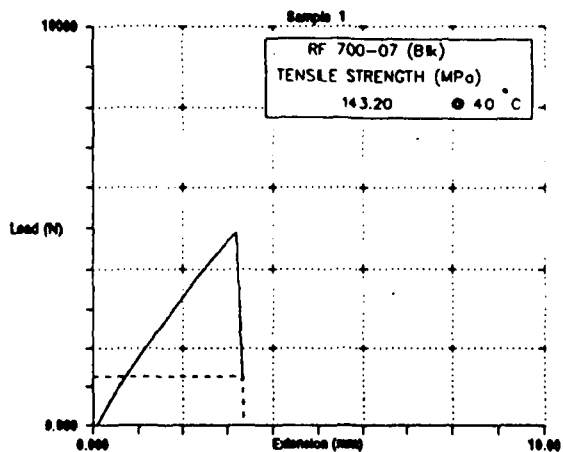
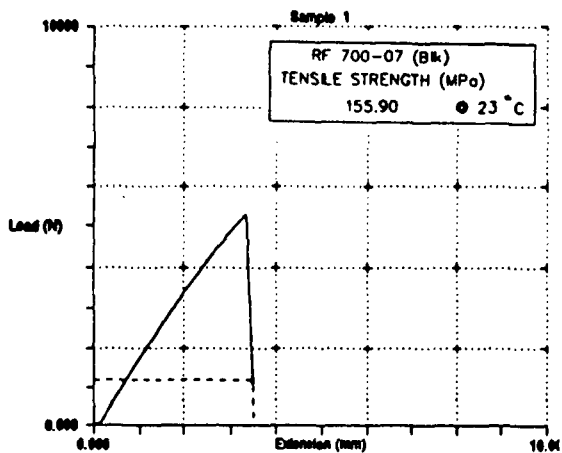
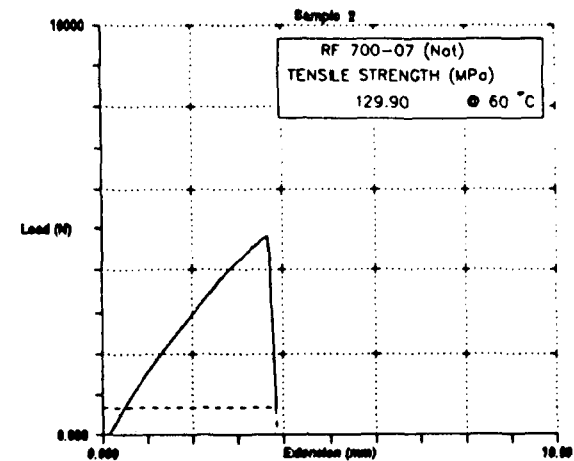
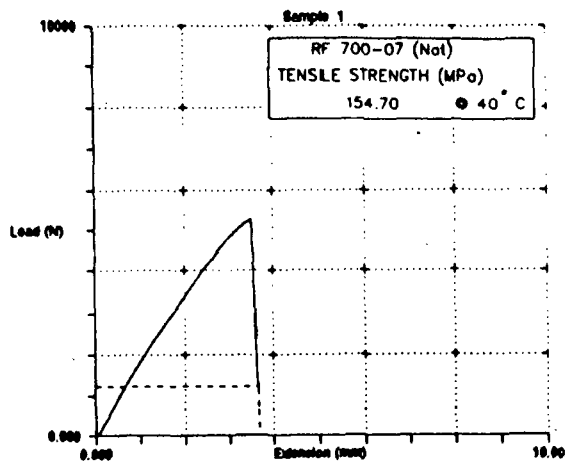
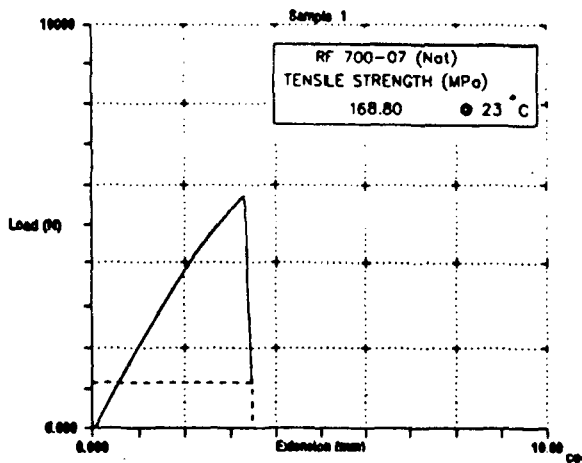

SOAK-TIME : 24 HOURS

TENSILE TESTS

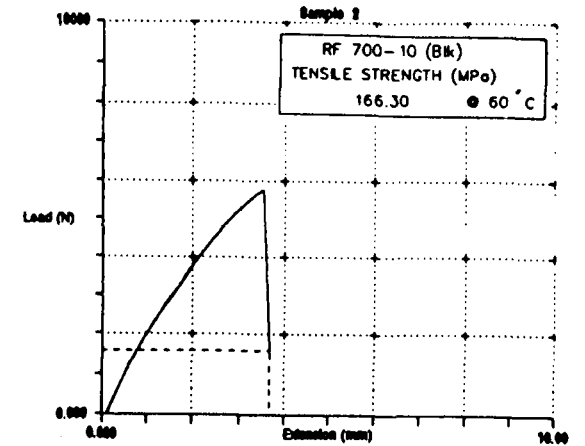
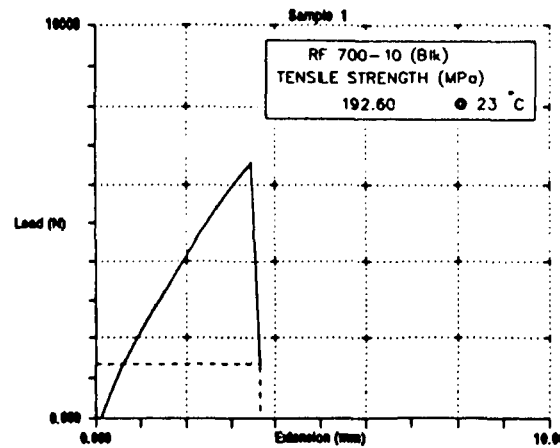
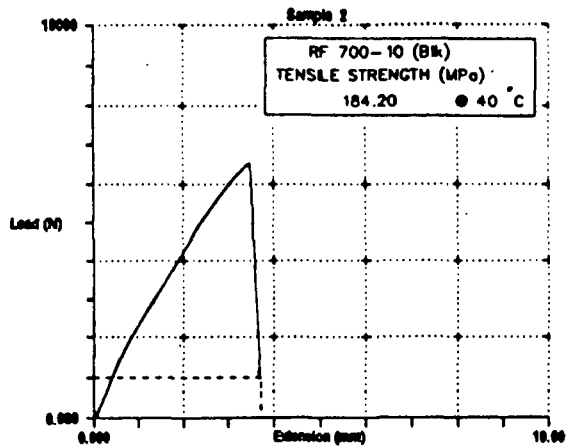
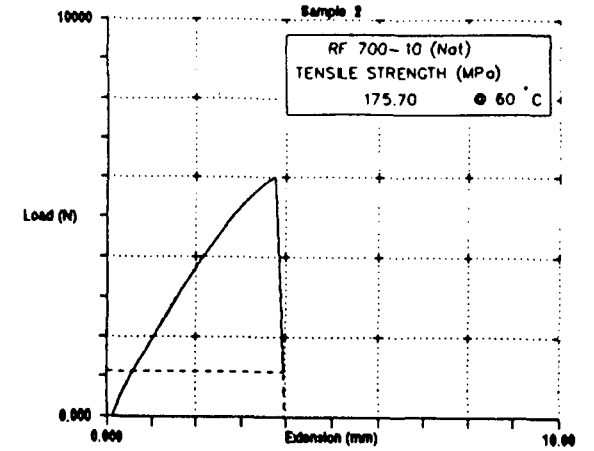
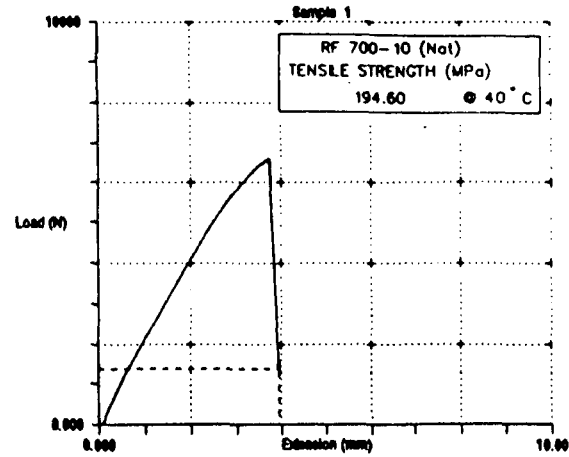
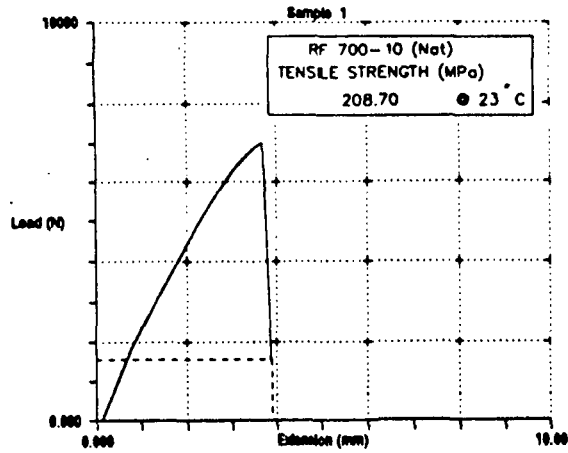

SOAK-TIME : 24 HOURS

TENSILE TESTS

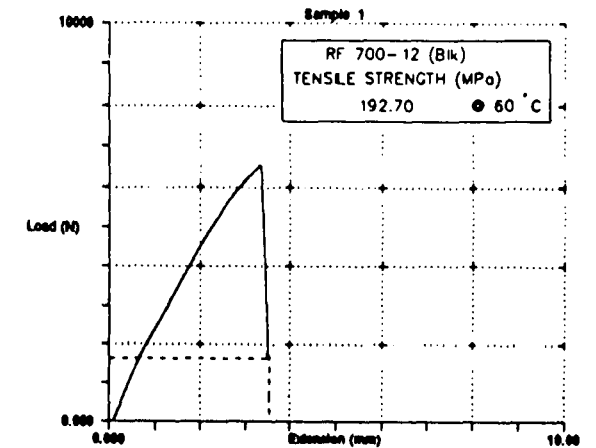
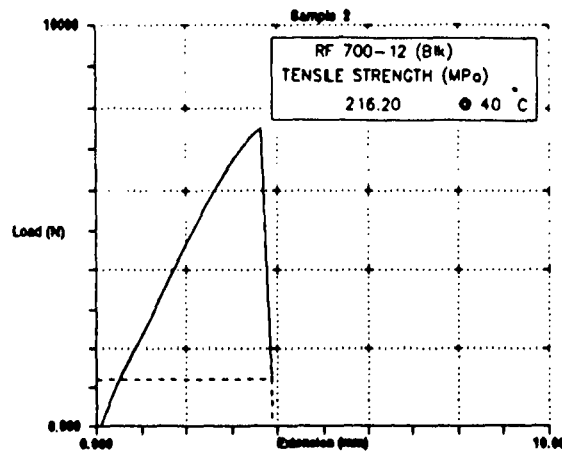
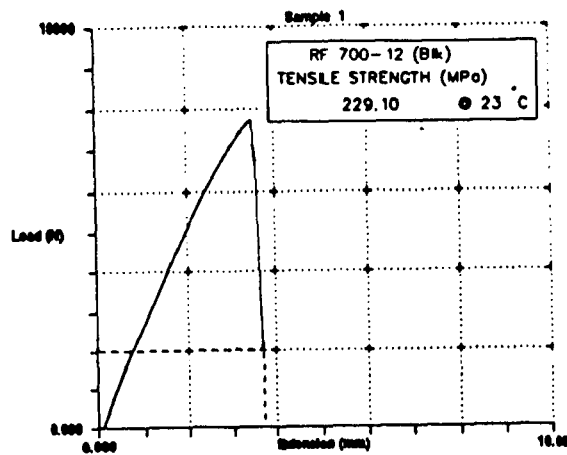
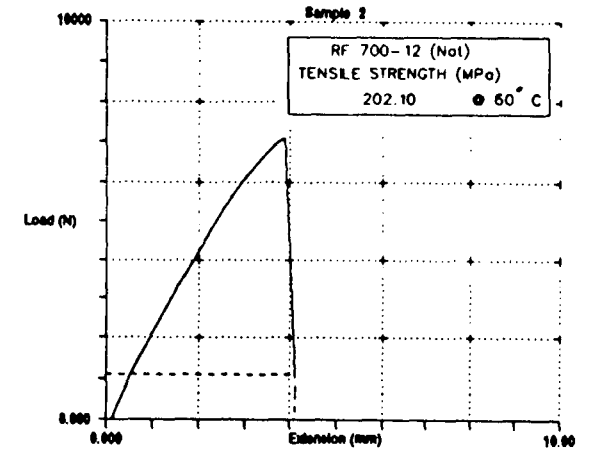
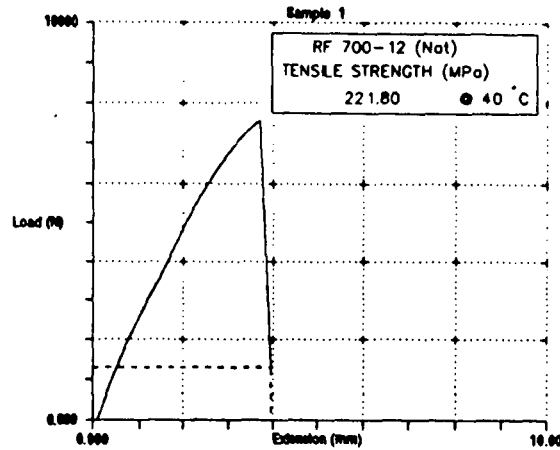
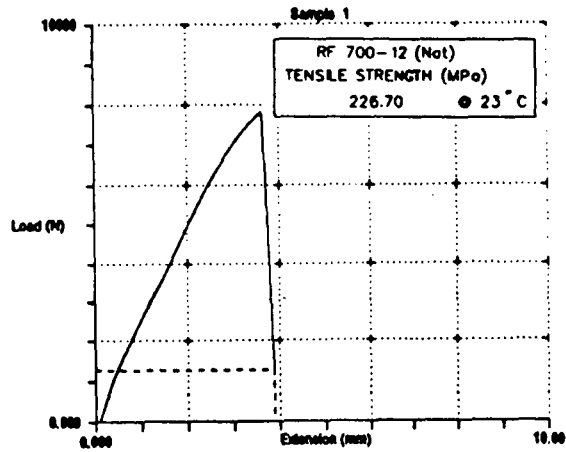

SOAK-TIME : 24 HOURS

# TENSILE TESTS

A 3.10

Verton RF 700-07  
(Natural and Black)

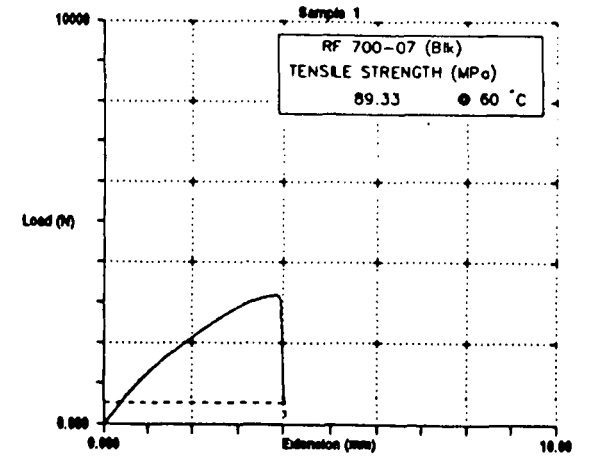
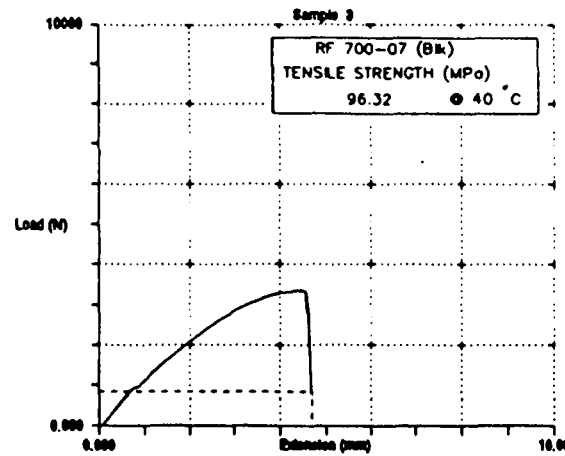
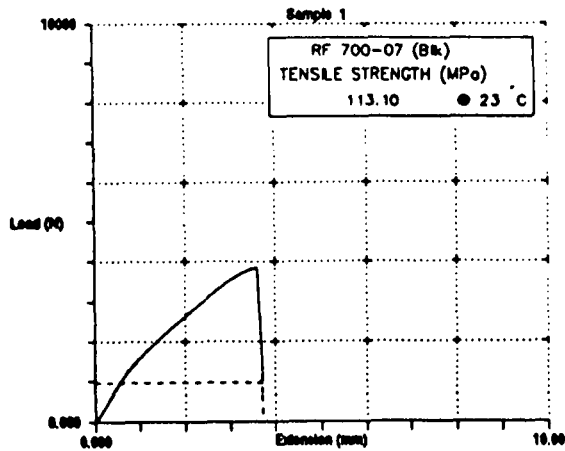
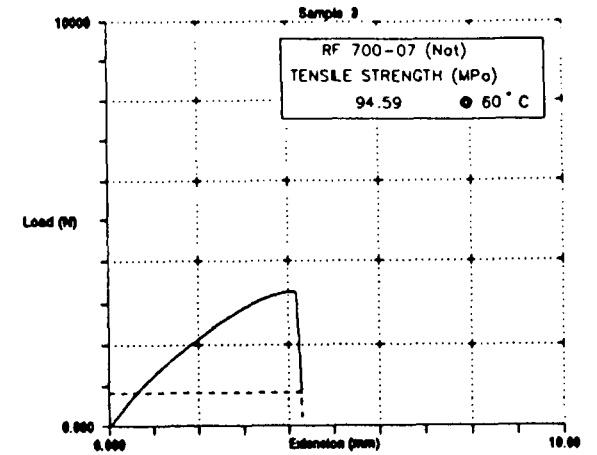
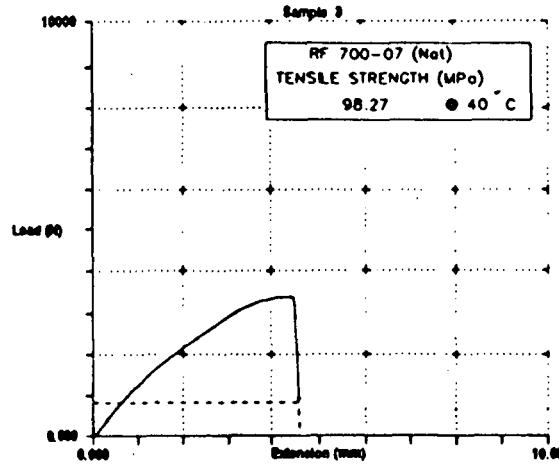
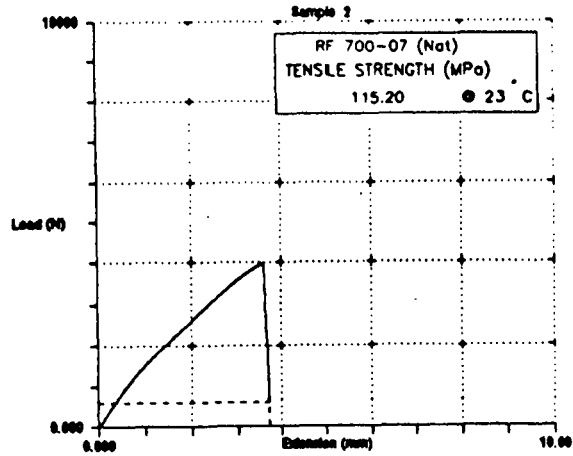

SOAK-TIME : 432 HOURS (18 Days)

TENSILE TESTS

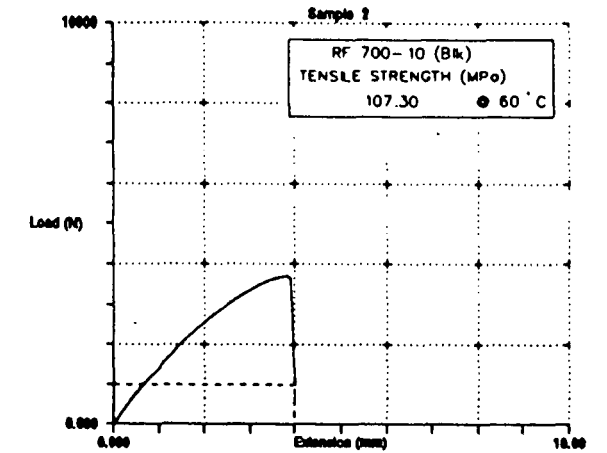
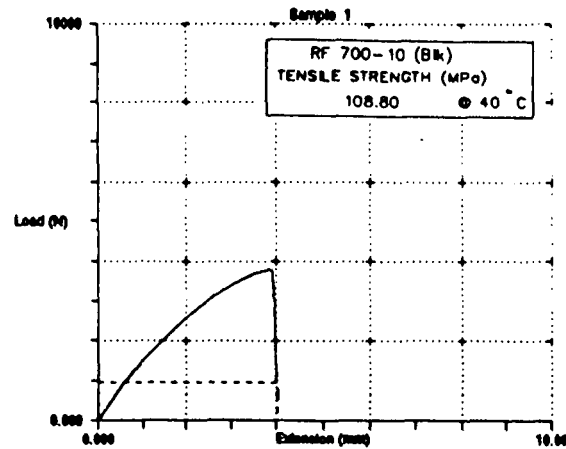
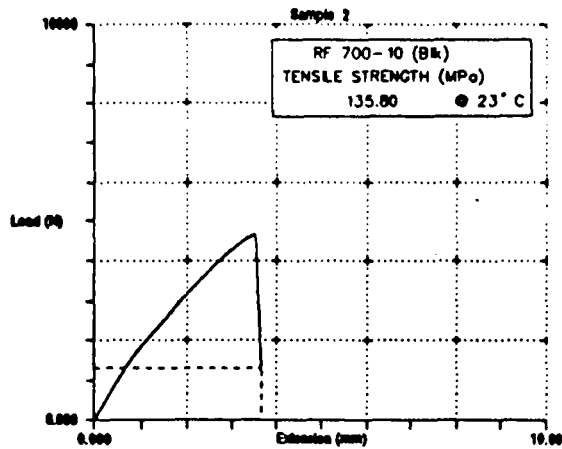
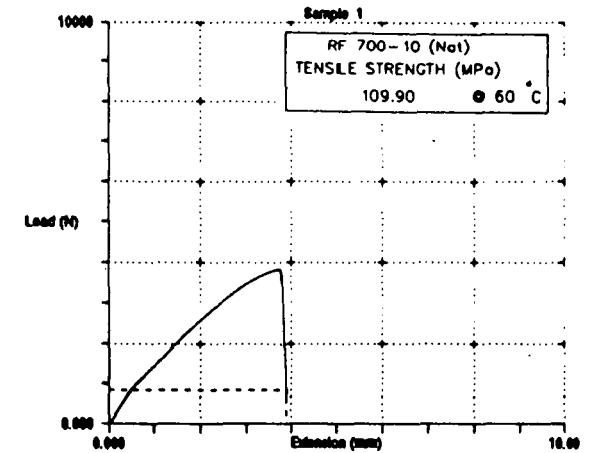
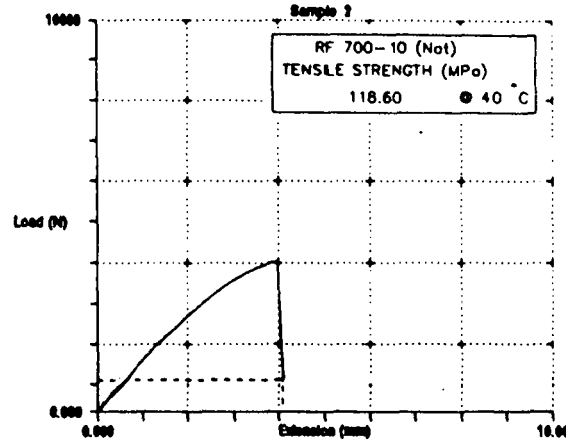
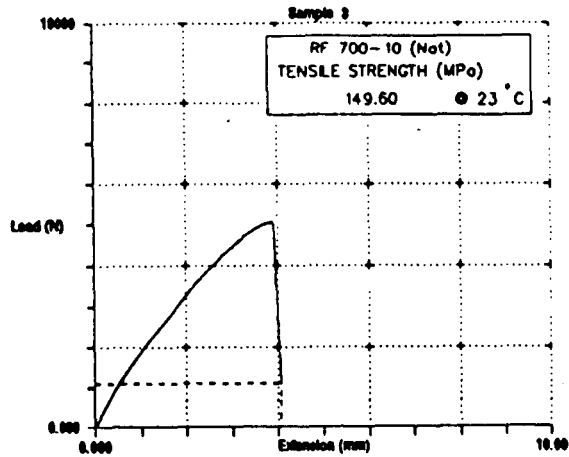

SOAK-TIME : 432 HOURS (18 Days)

TENSILE TESTS

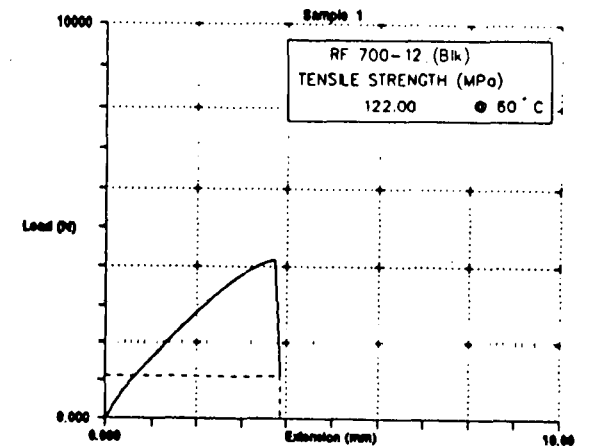
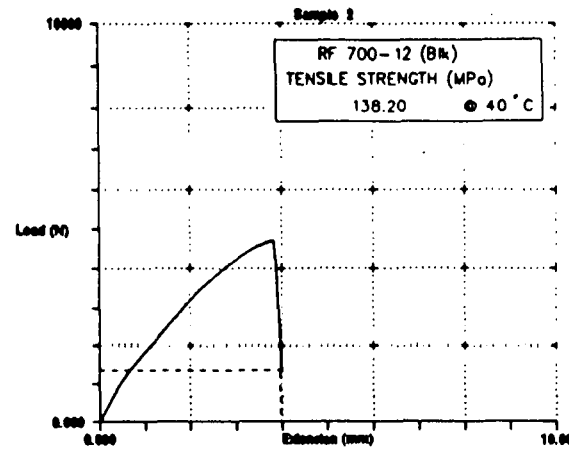
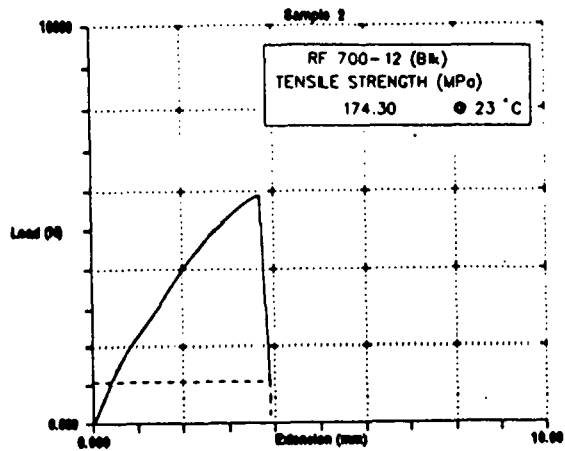
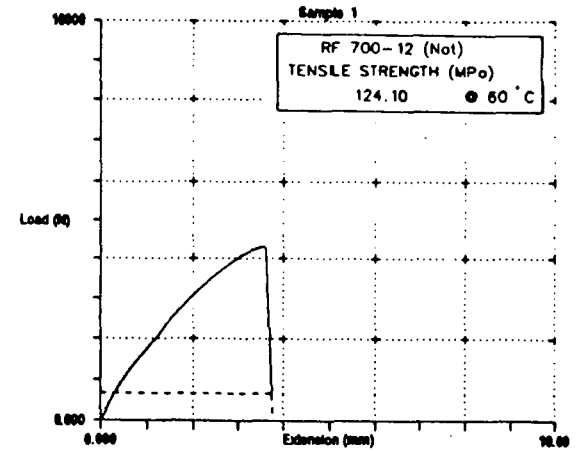
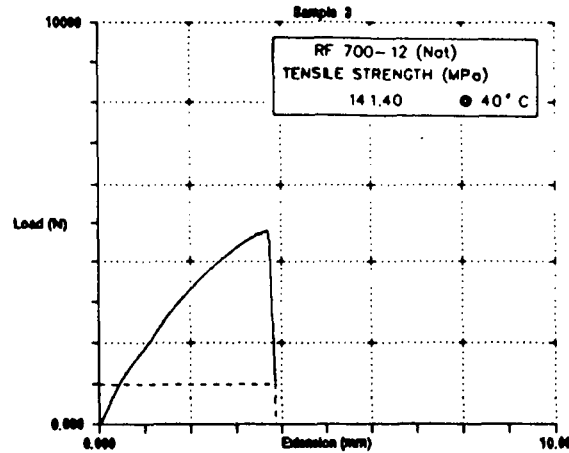
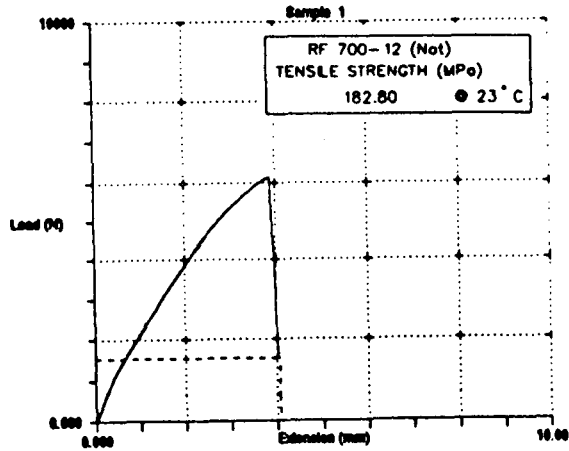

SOAK-TIME : 432 HOURS (18 Days)



TENSILE TESTS

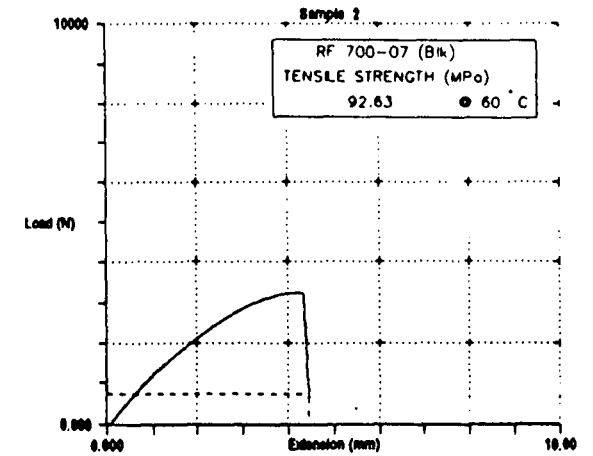
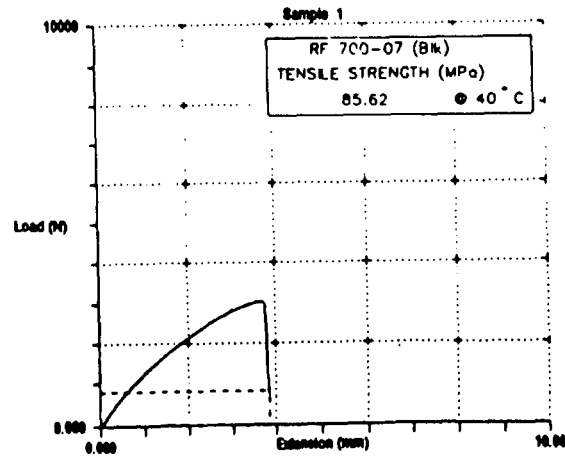
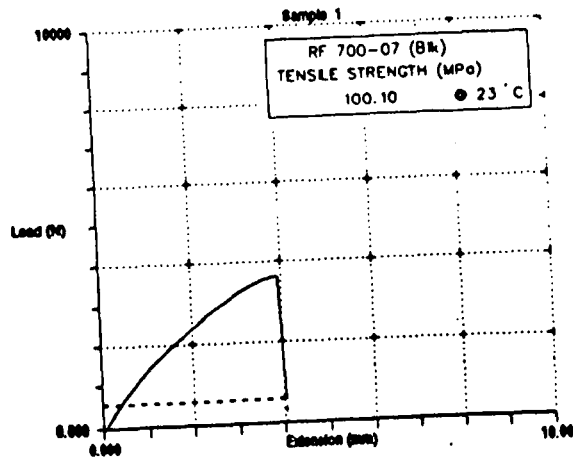
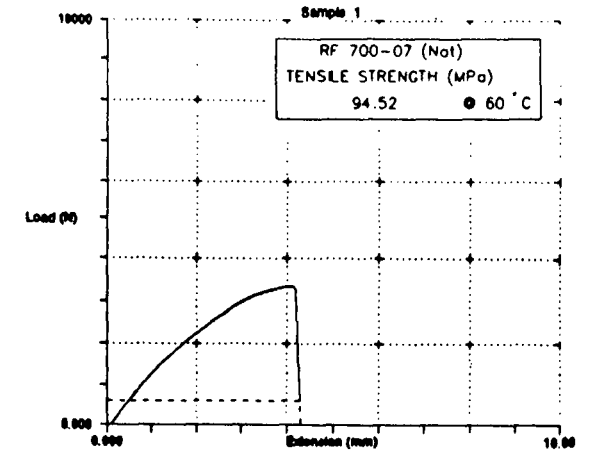
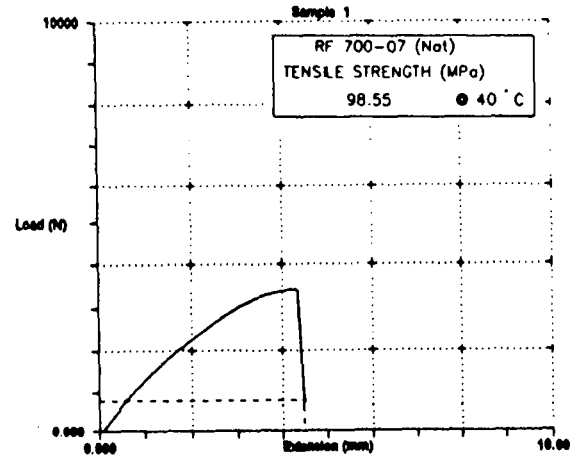
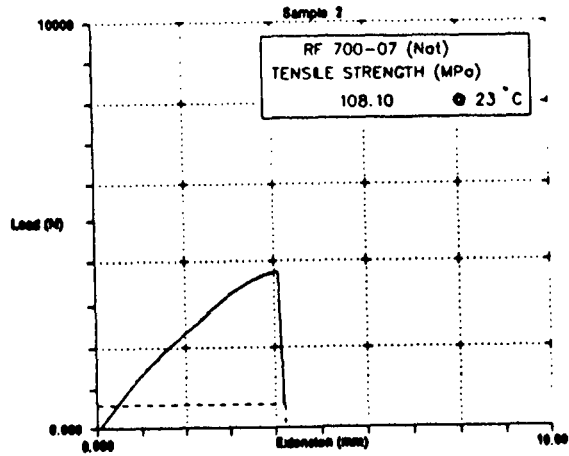

SOAK-TIME : 672 HOURS (28 Days)

TENSILE TESTS

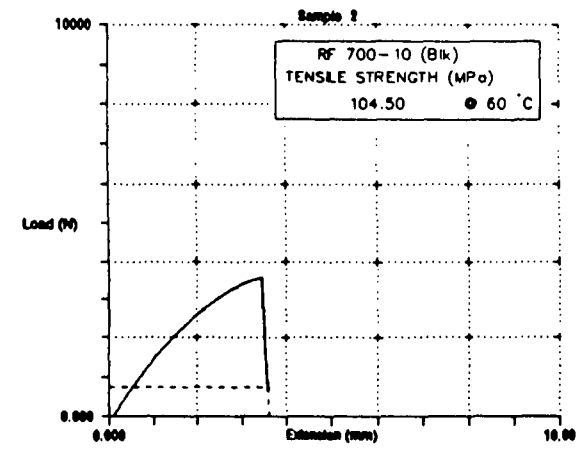
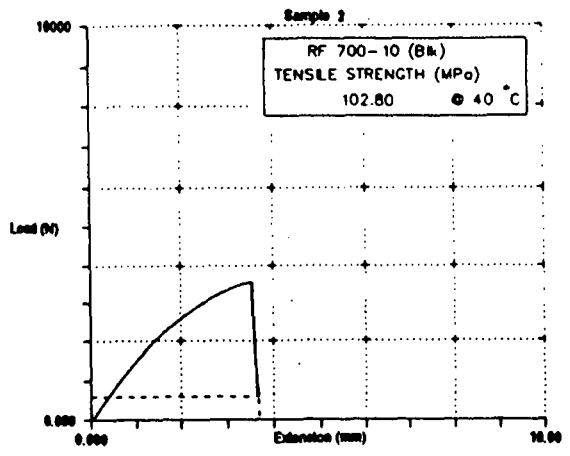
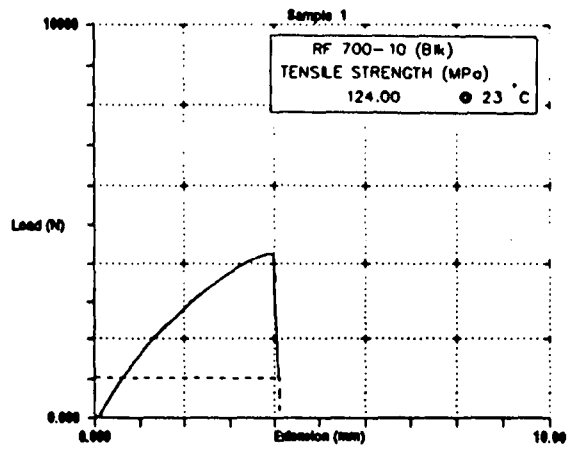
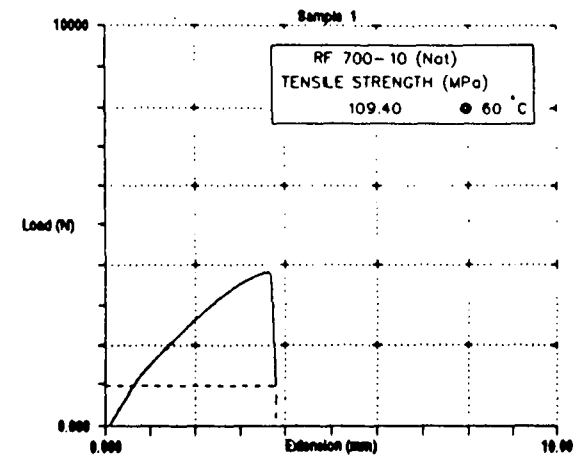
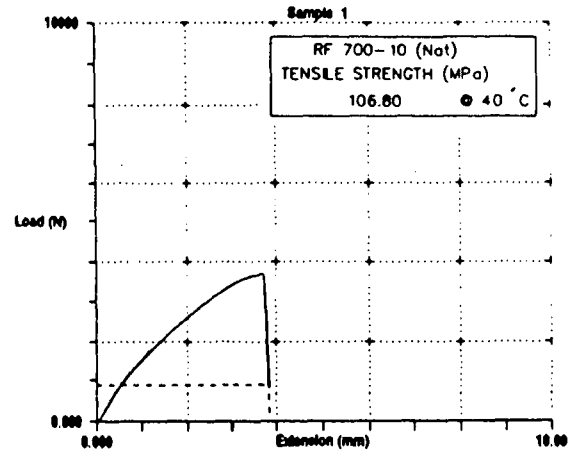
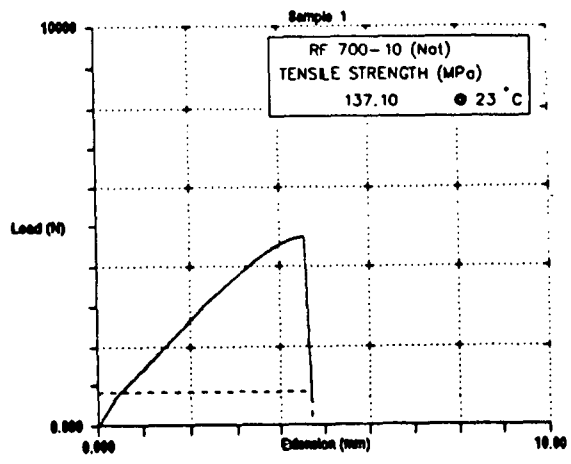

SOAK-TIME : 672 HOURS (28 Days)

(Natural and Black)

TENSILE TESTS

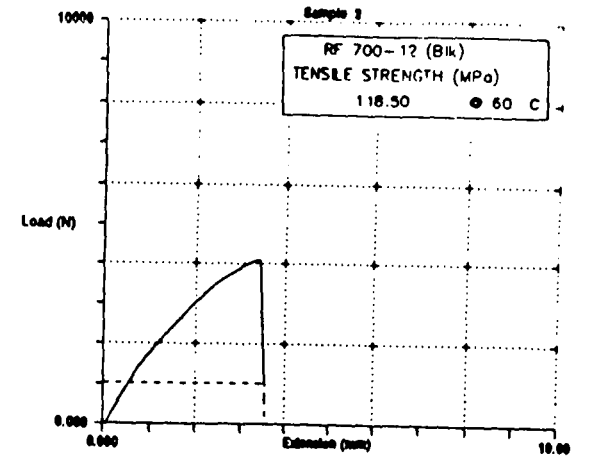
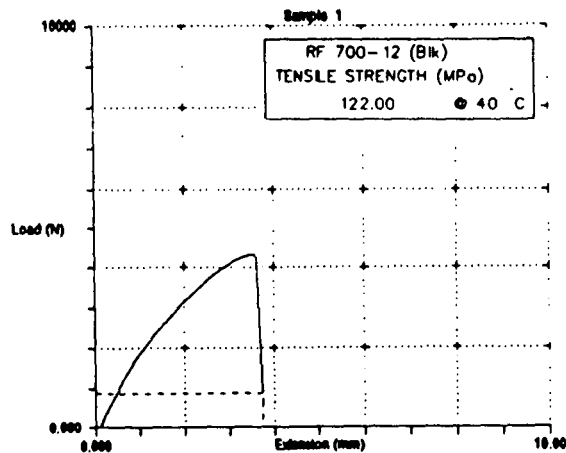
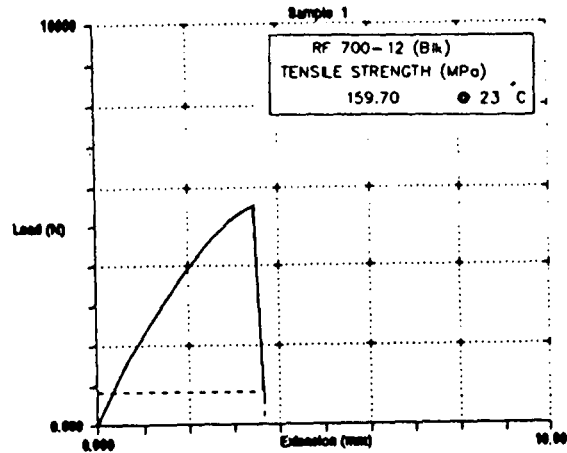
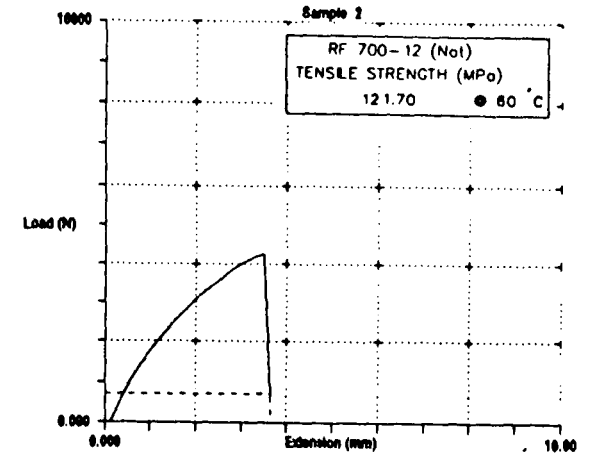
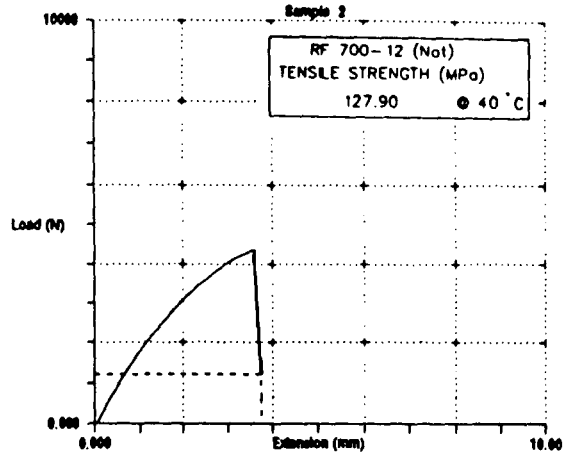
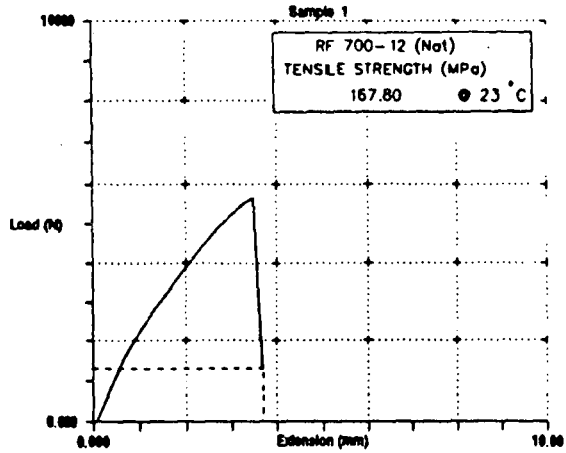

SOAK-TIME : 672 HOURS (28 Days)

APPENDIX 4 : 3 - Point Bending Tests.

Load - Deflection curves.

Verton RF 700-07 /-10 /-12

(Natural and Black)

A 4.1 Dry - "as moulded"

Soak - Time : 4 hours (at 23, 40 and 60°)

A 4.2 Verton RF 700-07 (Natural and Black)

A 4.3 Verton RF 700-10 (Natural and Black)

A 4.4 Verton RF 700-12 (Natural and Black)

Soak - Time : 24 hours (at 23, 40 and 60°C)

A 4.5 Verton RF 700-07 (Natural and Black)

A 4.6 Verton RF 700-10 (Natural and Black)

A 4.7 Verton RF 700-12 (Natural and Black)

Soak - Time : 168 hours (7 Days)

(at 23, 40 and 60°C)

- A 4.8           Verton RF 700-07 (Natural and Black)
- A 4.9           Verton RF 700-10 (Natural and Black)
- A 4.10          Verton RF 700-12 (Natural and Black)

Soak - Time : 672 hours (28 Days)

(at 23, 40 and 60°C)

- A 4.11          Verton RF 700-07 (Natural and Black)
- A 4.12          Verton RF 700-10 (Natural and Black)
- A 4.13          Verton RF 700-12 (Natural and Black)

(Natural and Black)

3 - POINT BENDING TESTS

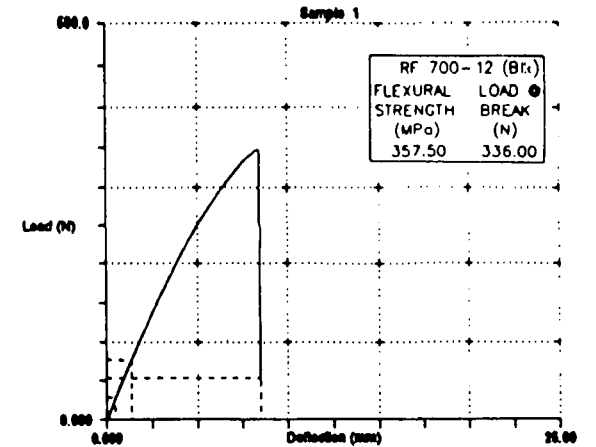
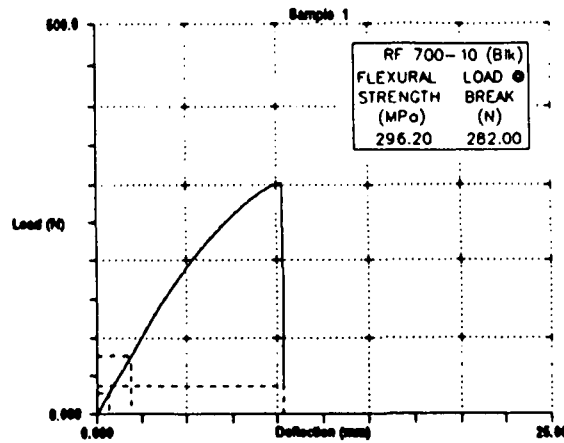
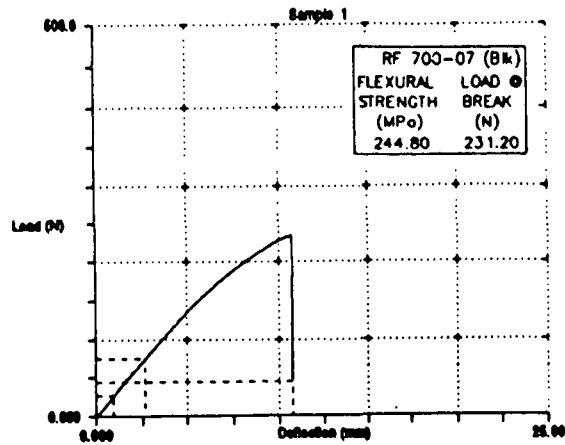
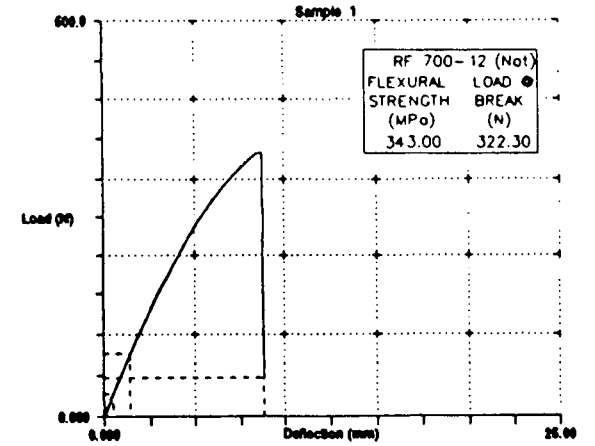
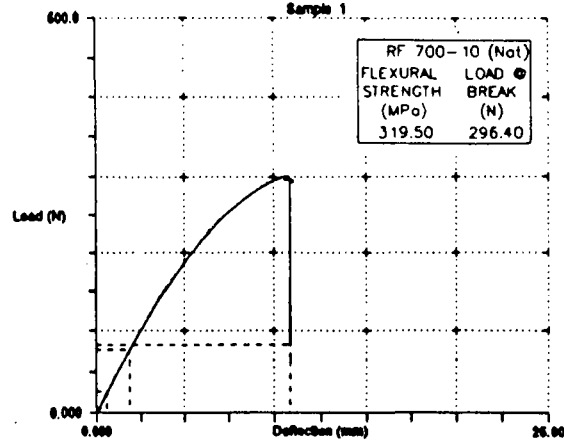
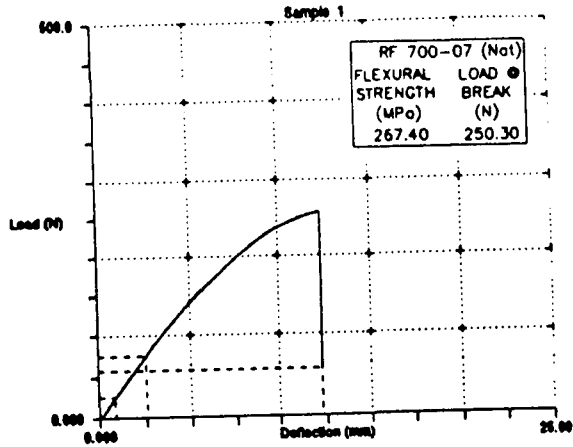

CONDITION : DRY - "AS MOULDED"

3 - POINT BENDING TESTS

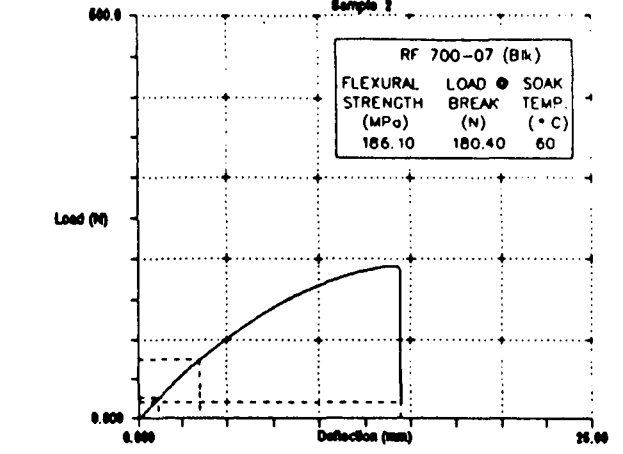
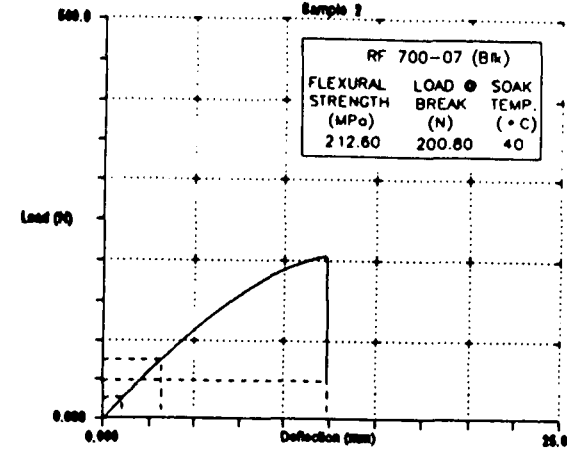
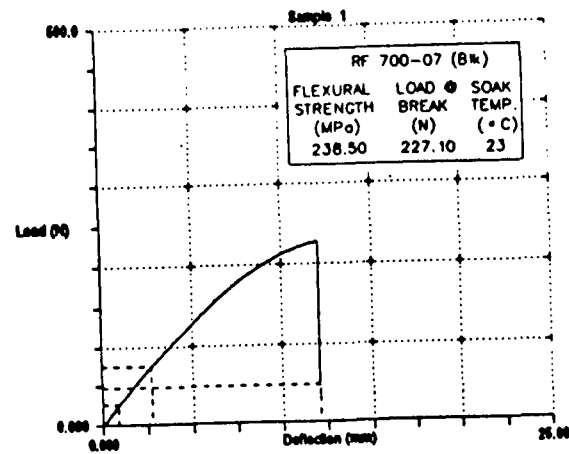
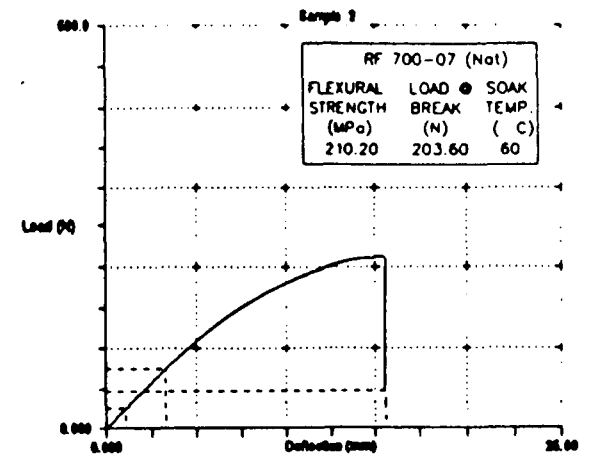
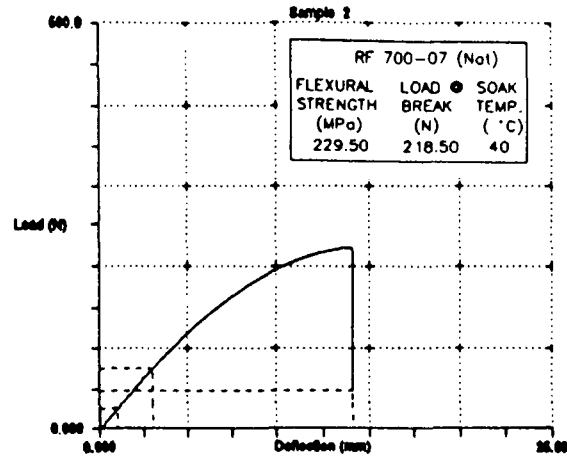
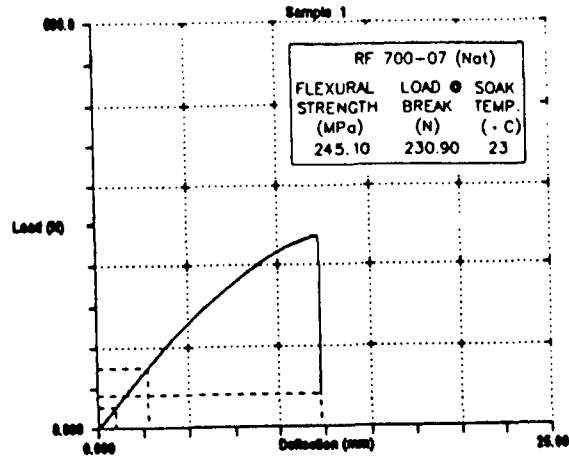

SOAK-TIME : 4 HOURS

3 - POINT BENDING TESTS

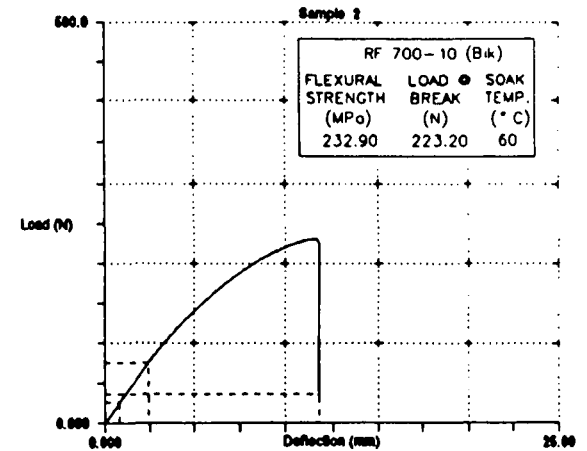
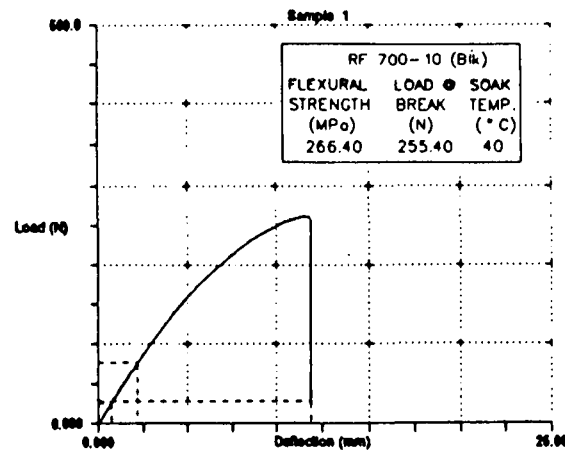
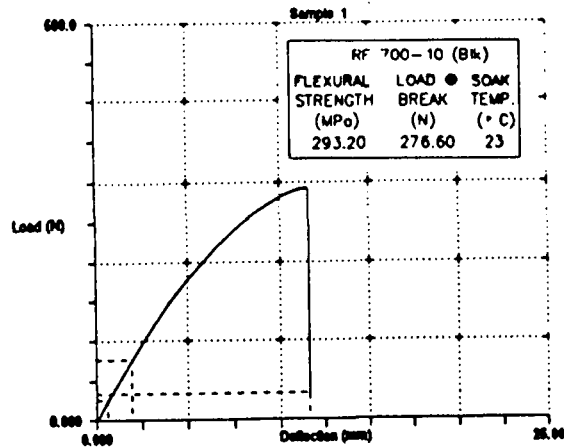
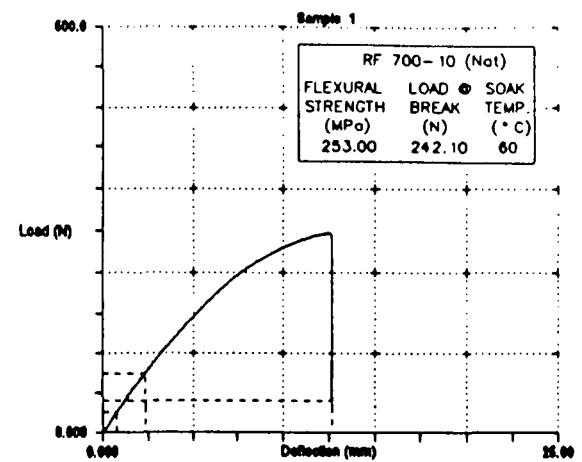
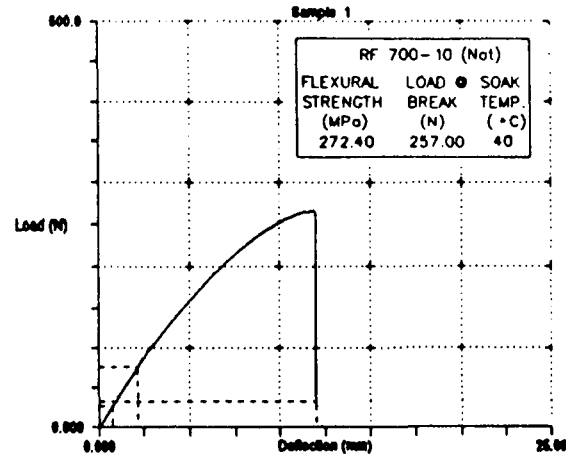
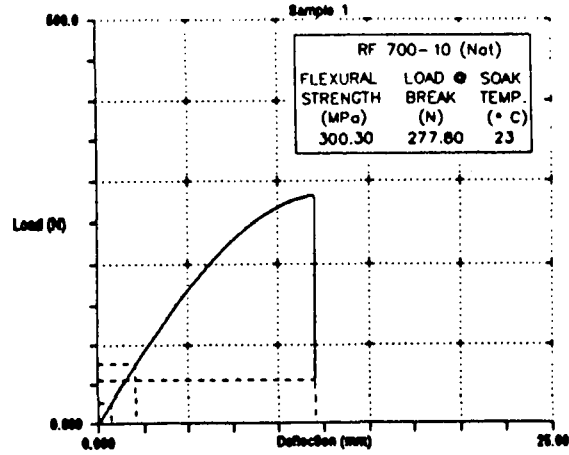

SOAK-TIME : 4 HOURS



3 - POINT BENDING TESTS

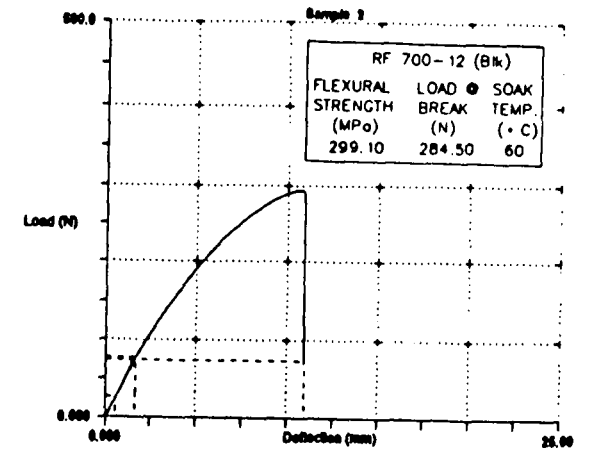
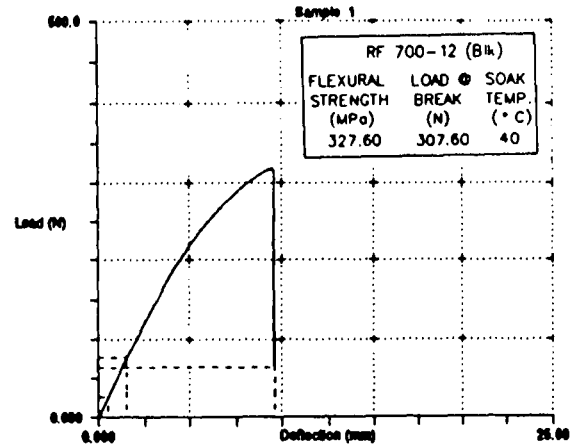
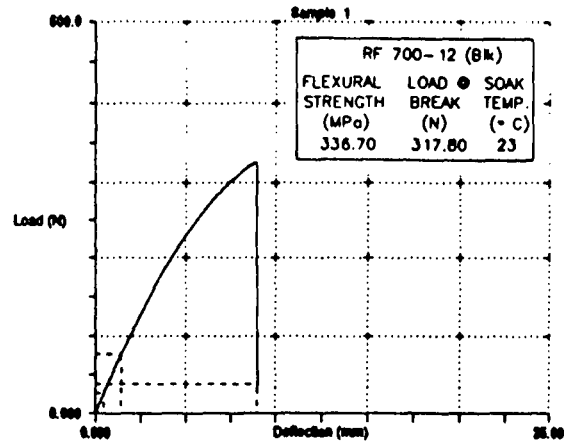
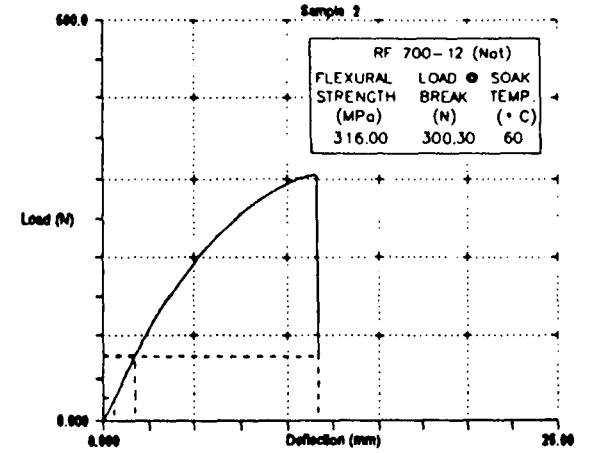
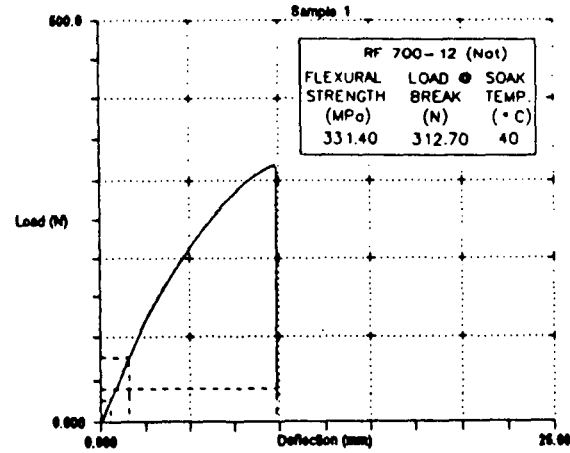
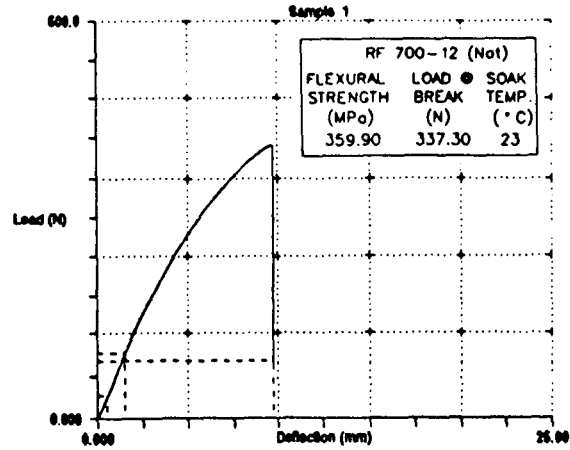

SOAK-TIME : 4 HOURS

3 - POINT BENDING TESTS

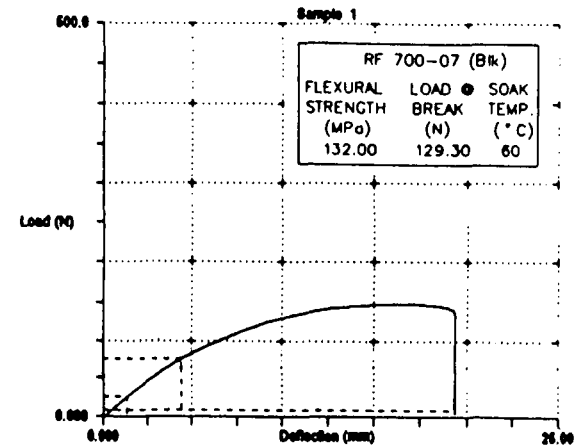
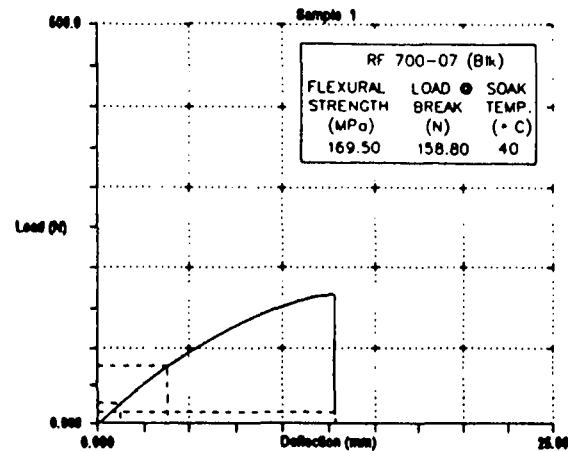
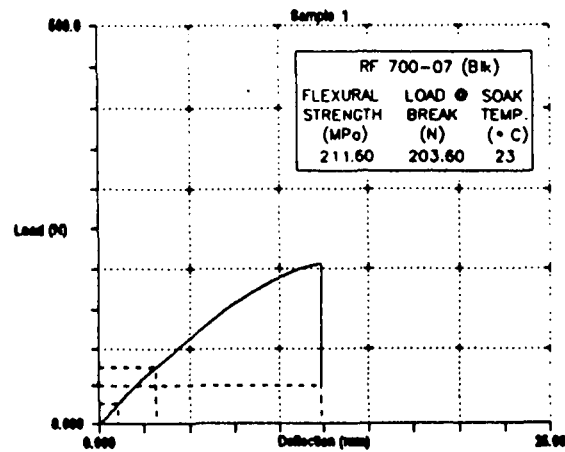
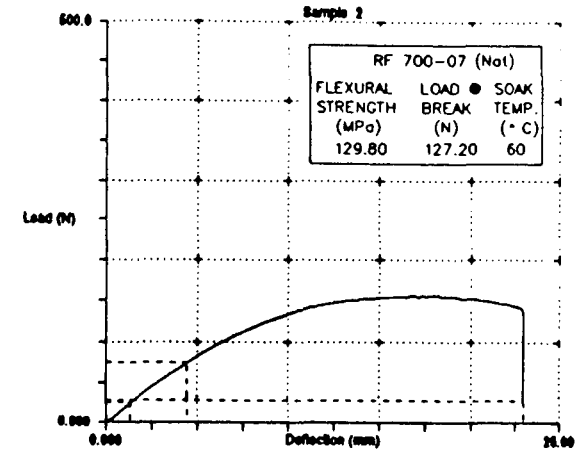
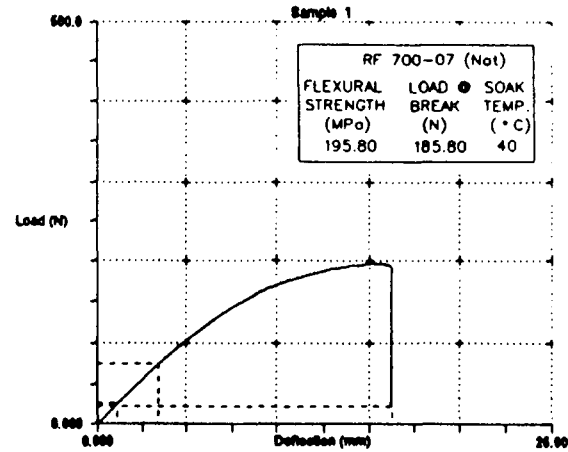
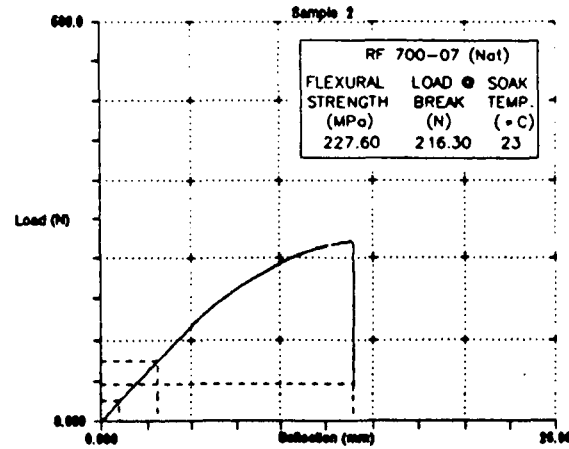

SOAK-TIME : 24 HOURS

3 - POINT BENDING TESTS

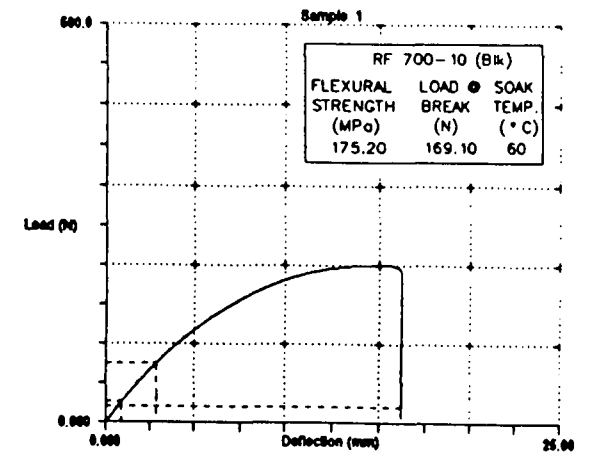
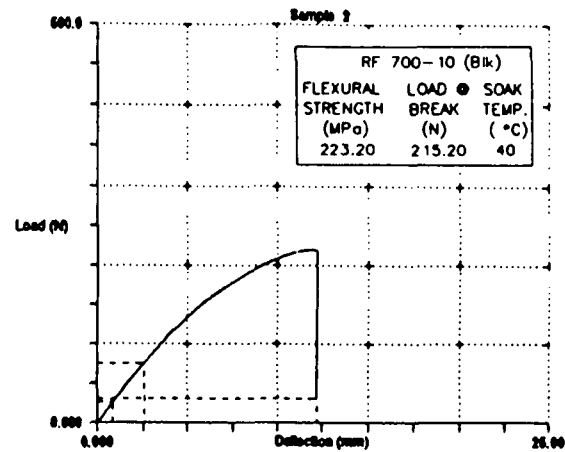
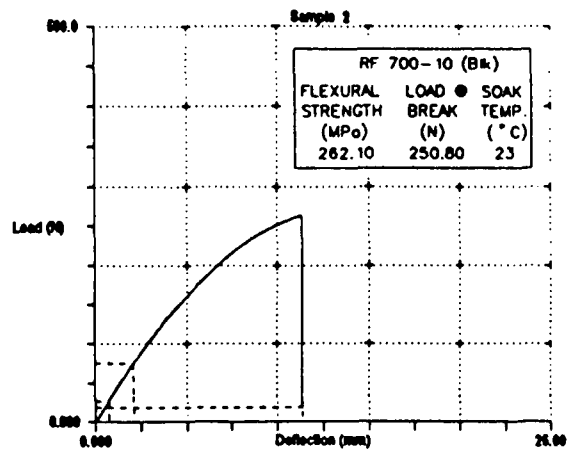
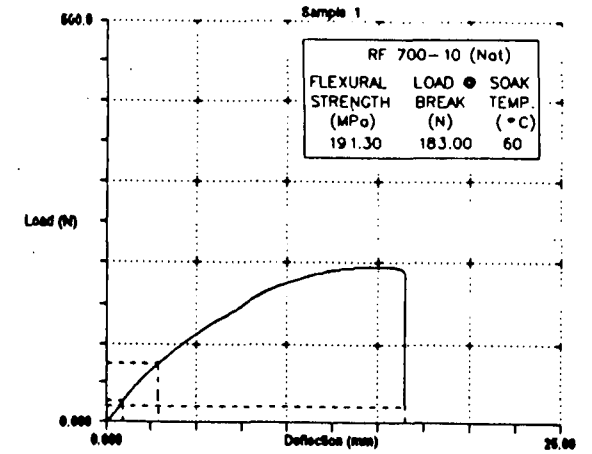
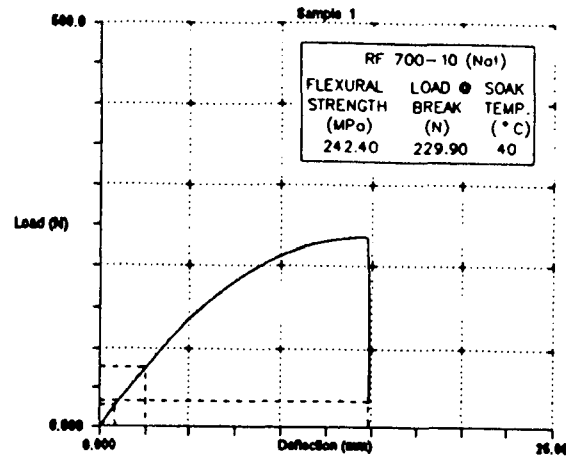
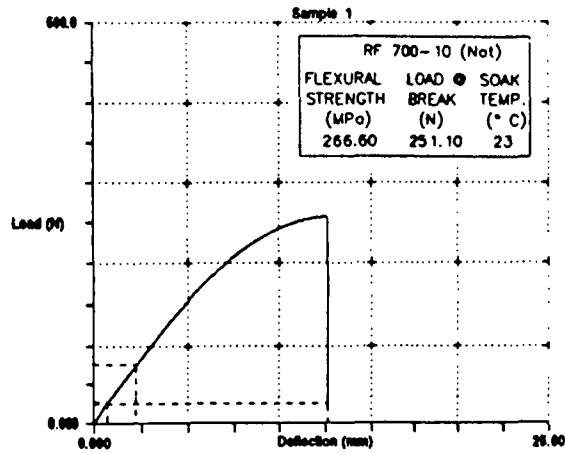

SOAK-TIME : 24 HOURS

(Natural and Black)

3 - POINT BENDING TESTS

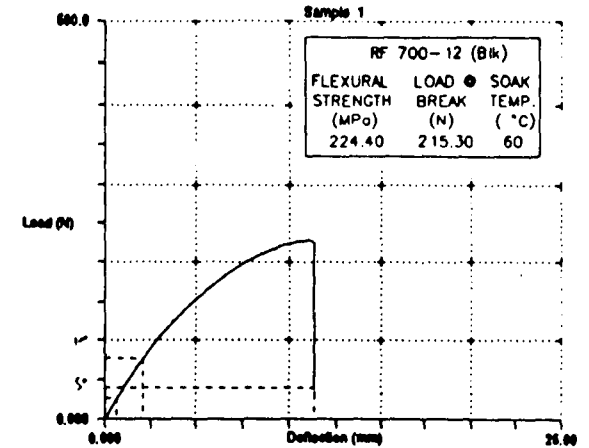
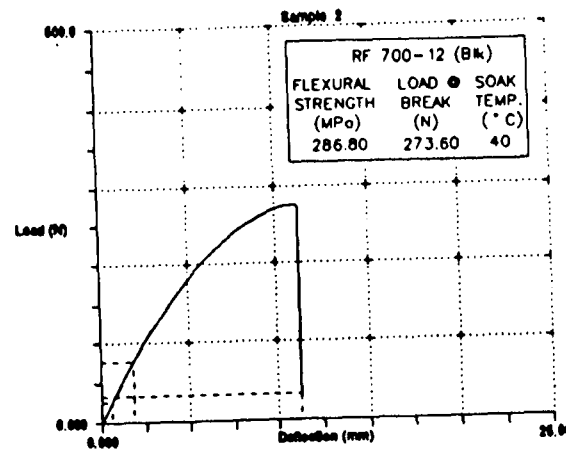
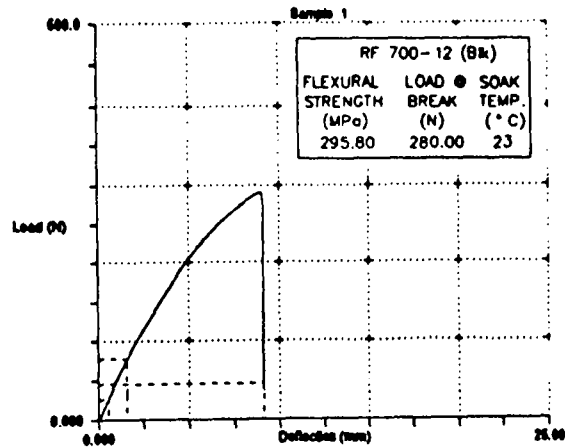
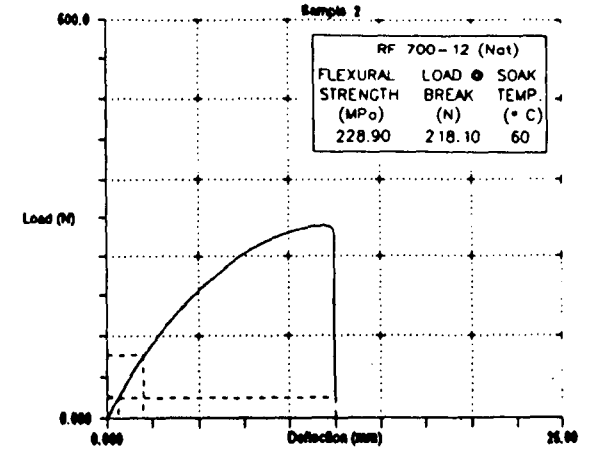
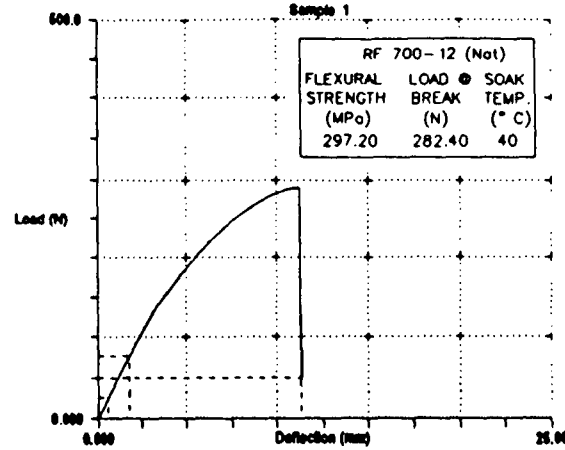
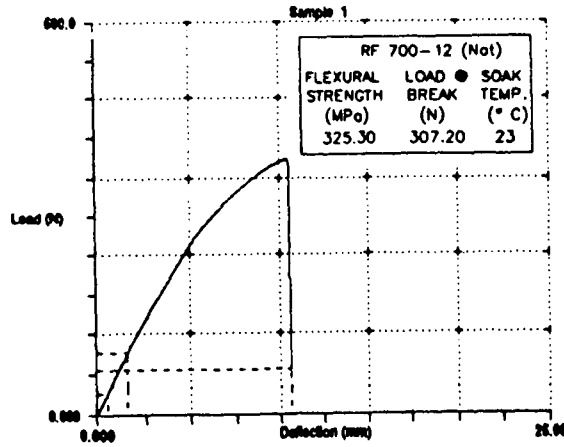

SOAK-TIME : 24 HOURS

3 - POINT BENDING TESTS

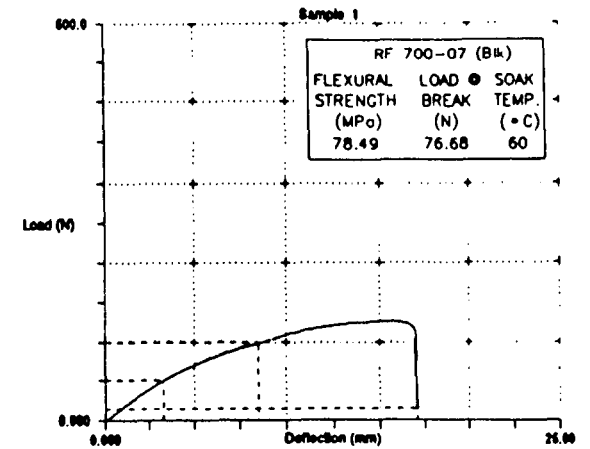
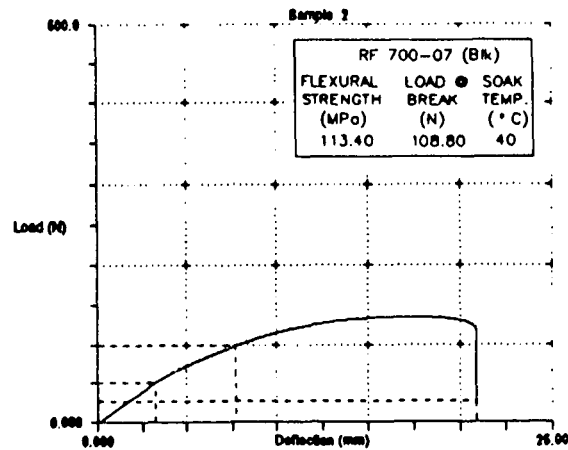
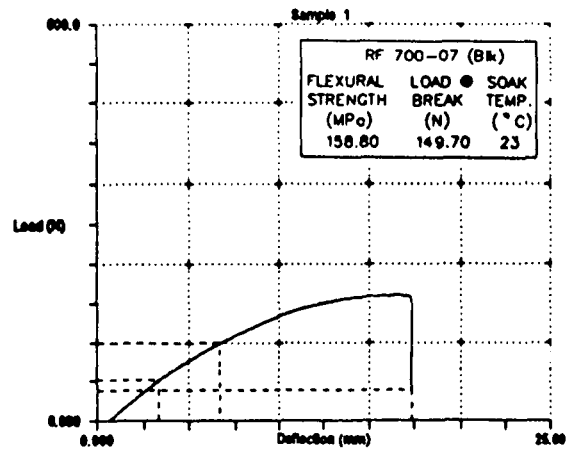
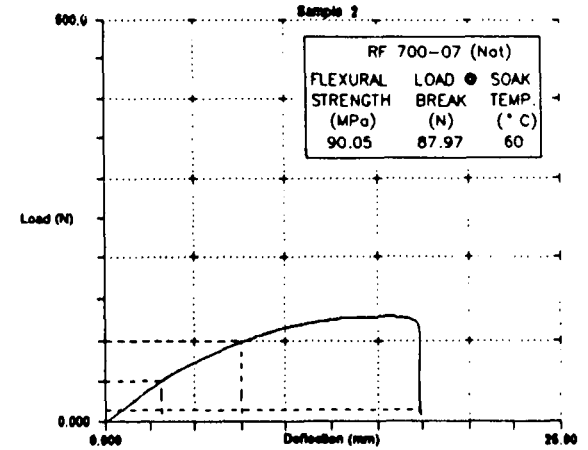
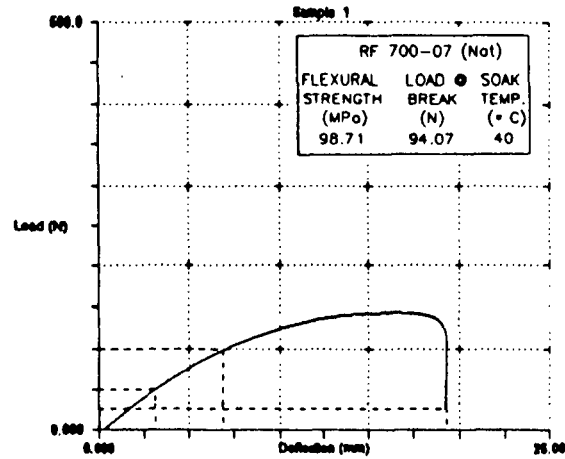
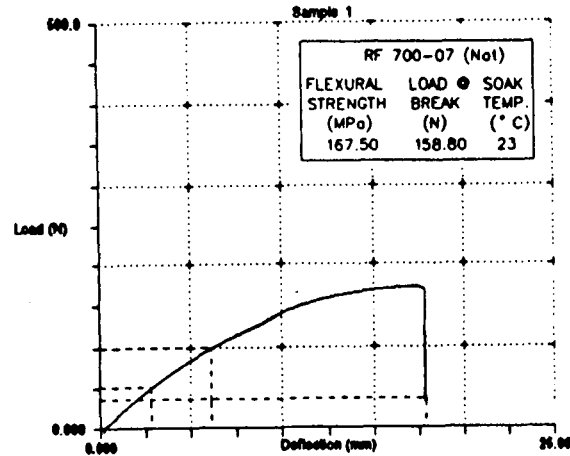

SOAK-TIME : 168 HOURS (7 Days)

3 - POINT BENDING TESTS

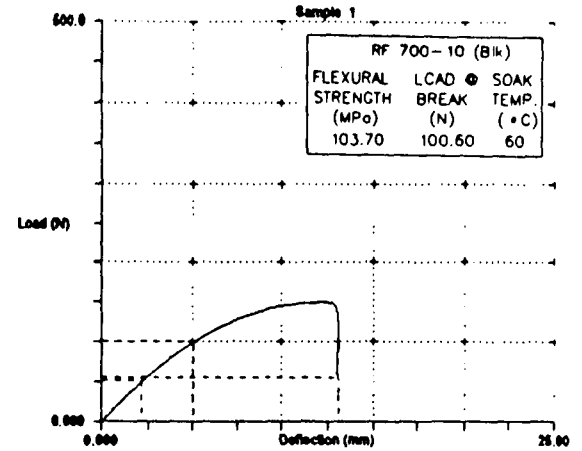
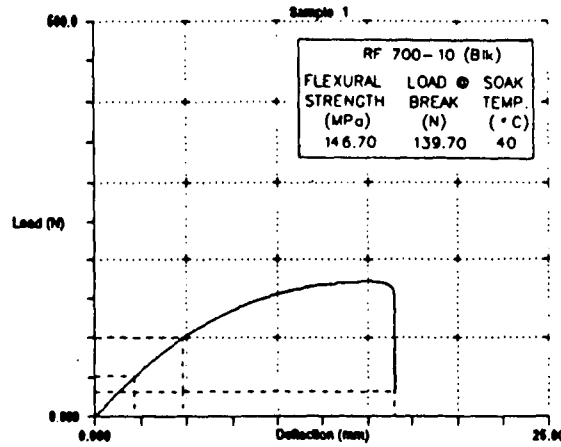
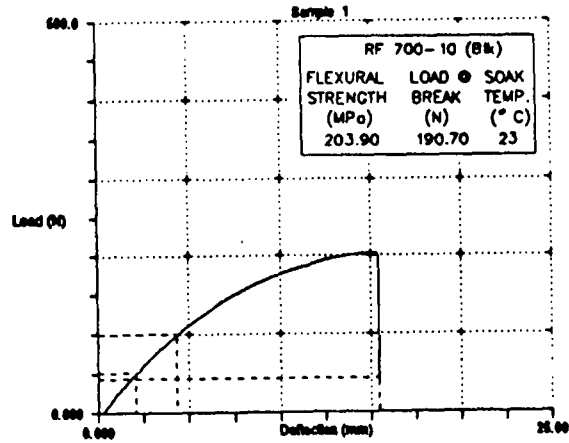
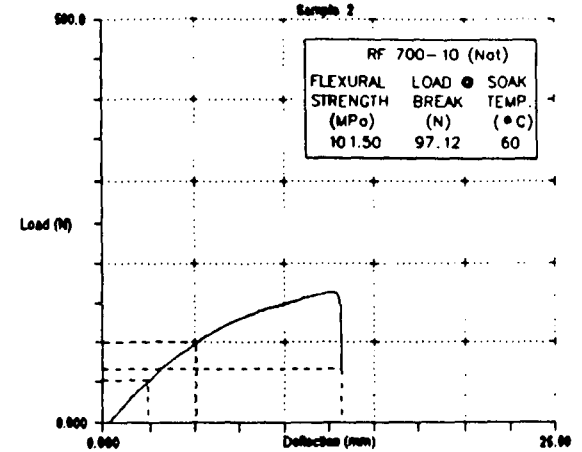
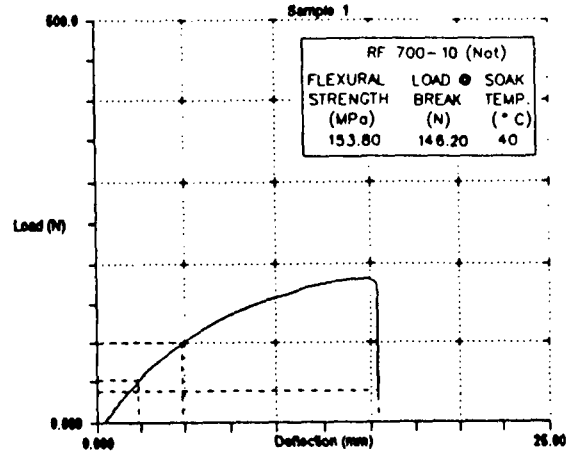
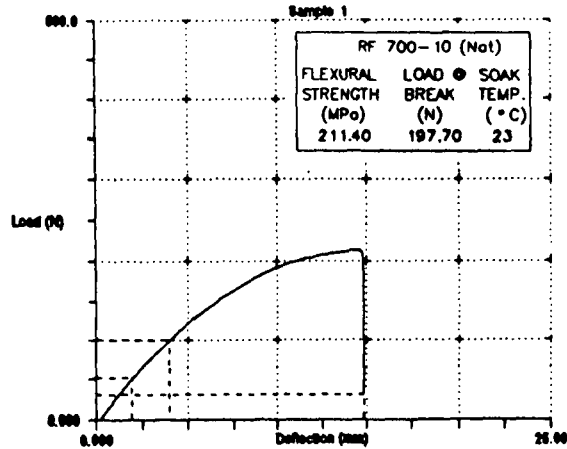

SOAK-TIME : 168 HOURS (7 Days)

3 - POINT BENDING TESTS

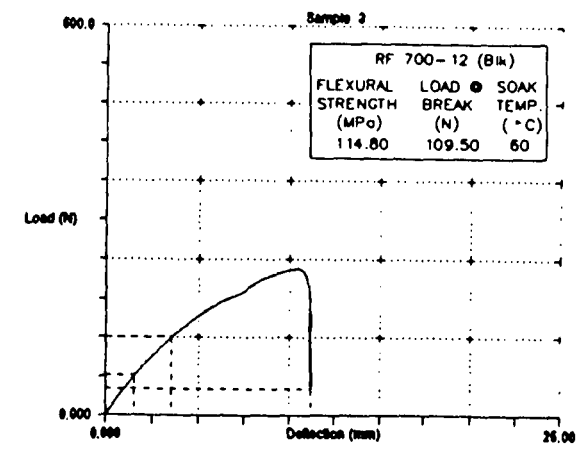
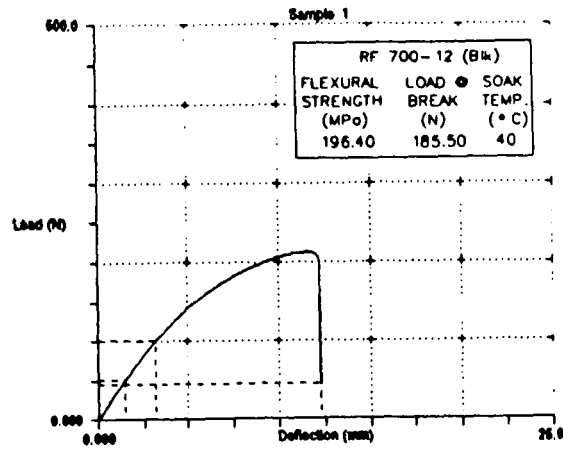
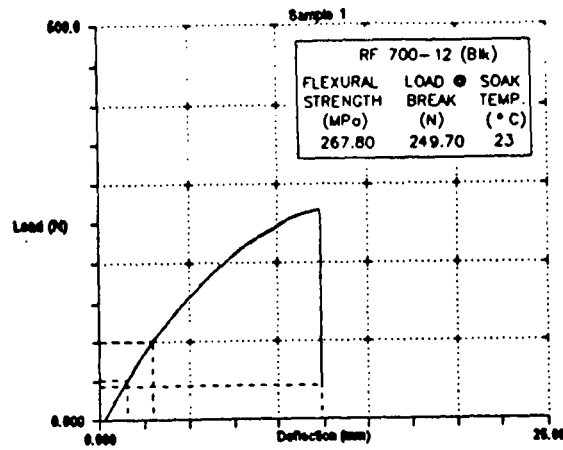
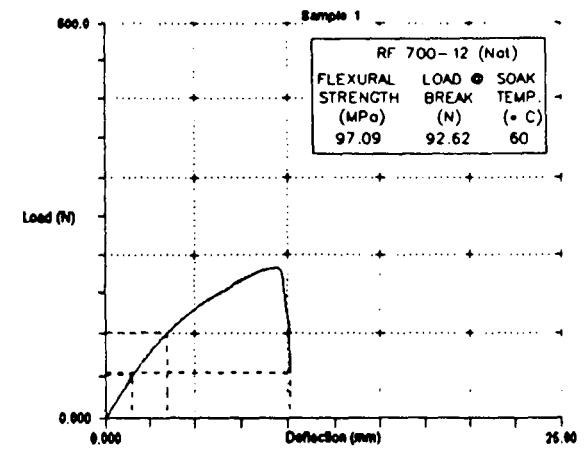
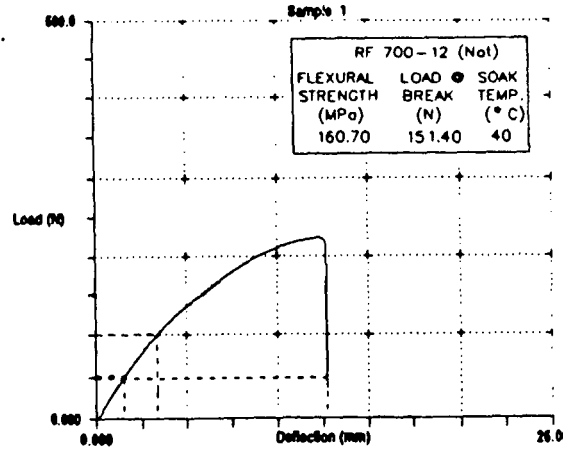
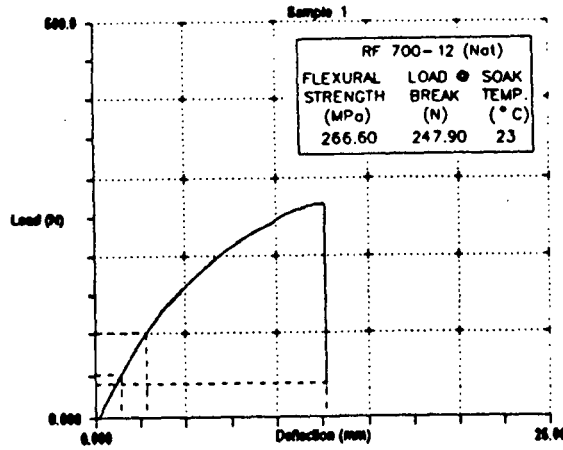

SOAK-TIME : 168 HOURS (7 Days)

3 - POINT BENDING TESTS

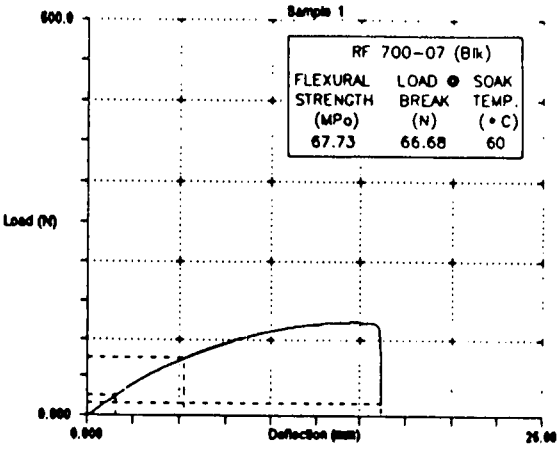
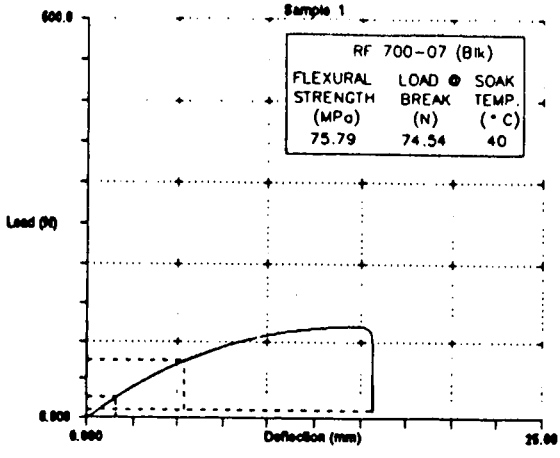
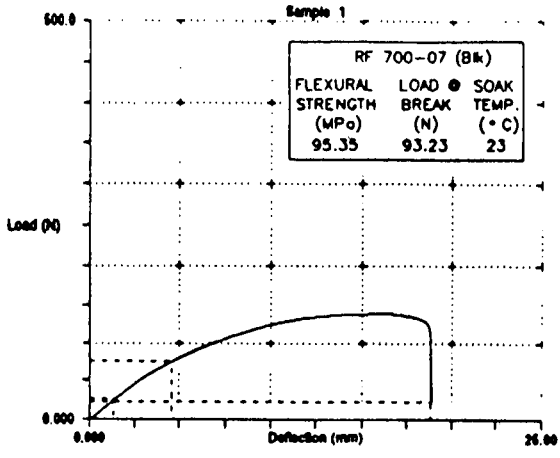
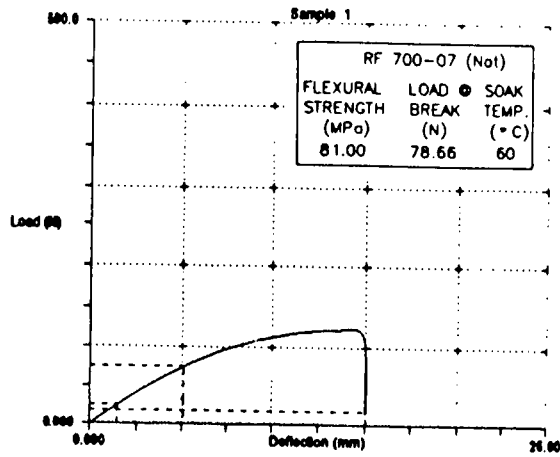
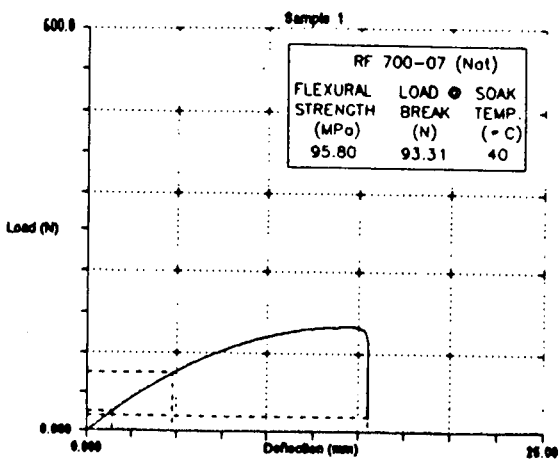
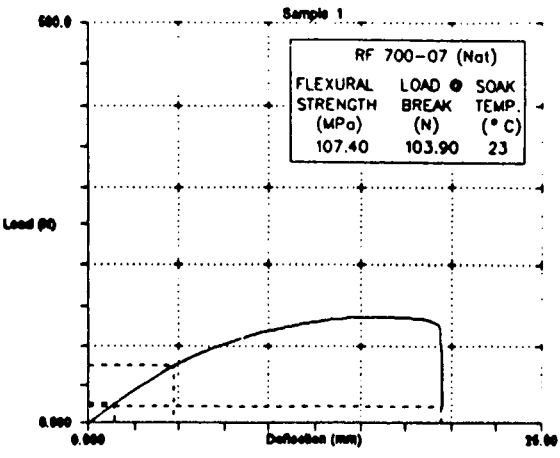

SOAK-TIME : 672 HOURS (28 Days)



3 - POINT BENDING TESTS

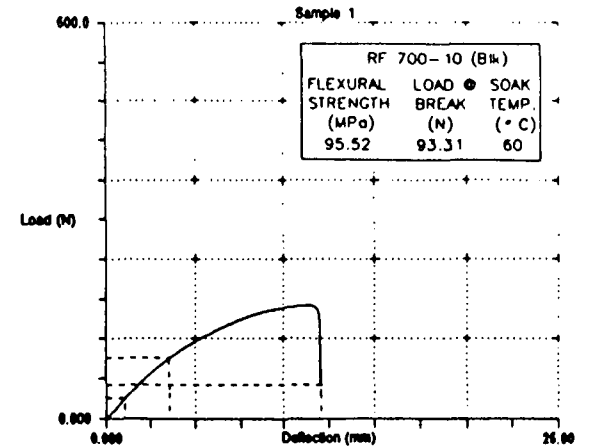
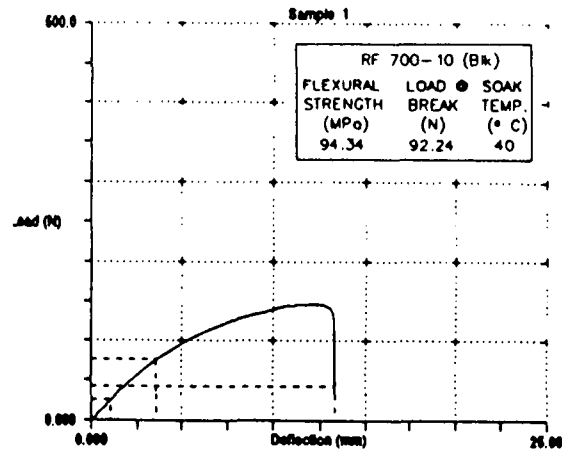
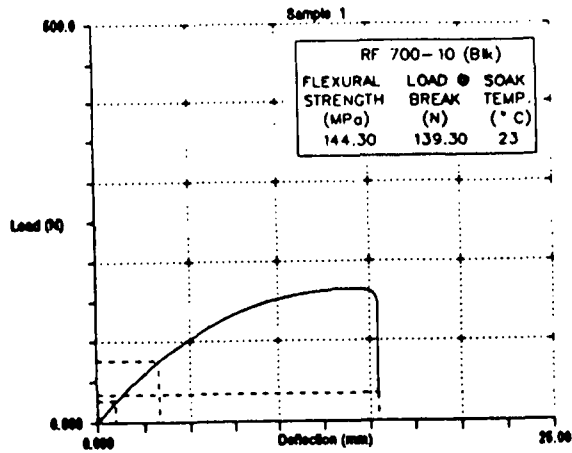
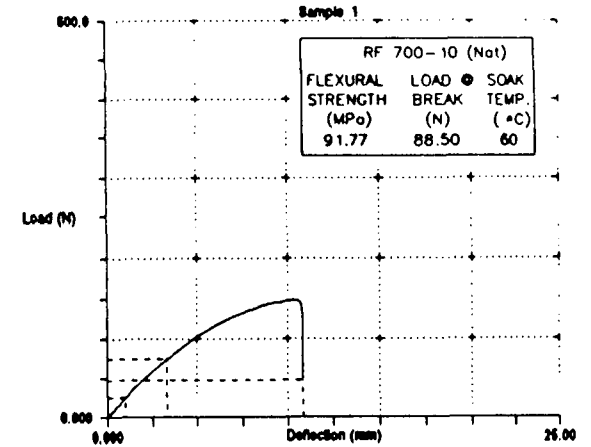
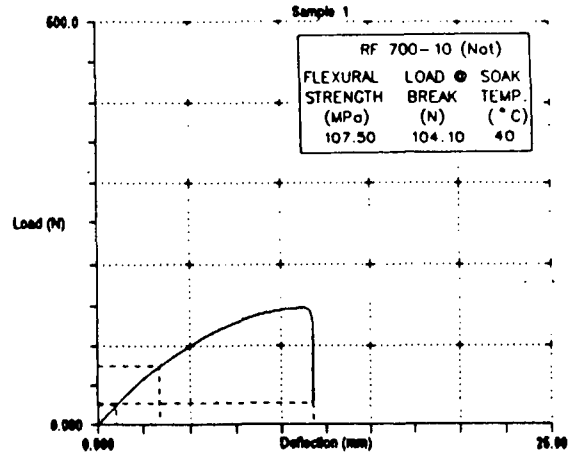
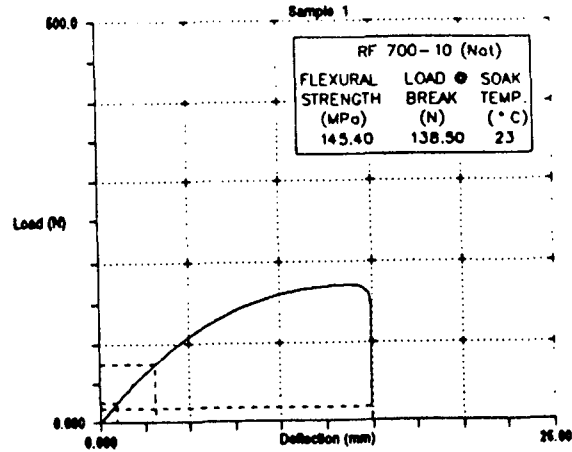

SOAK-TIME : 672 HOURS (28 Days)

3 - POINT BENDING TESTS

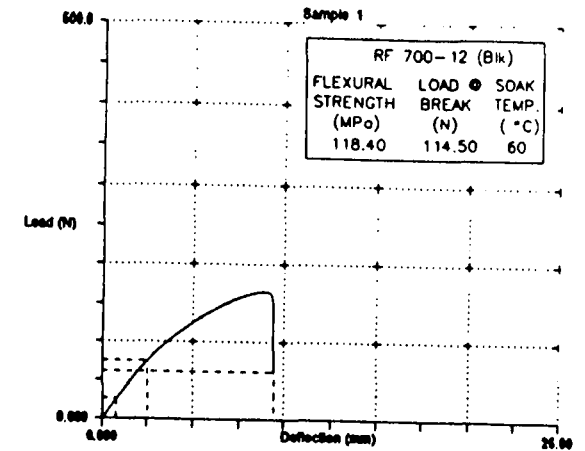
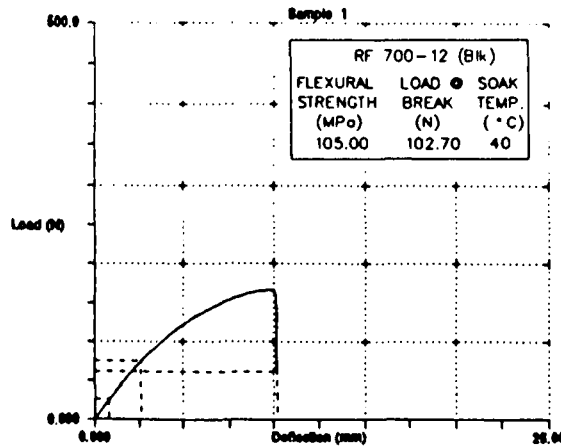
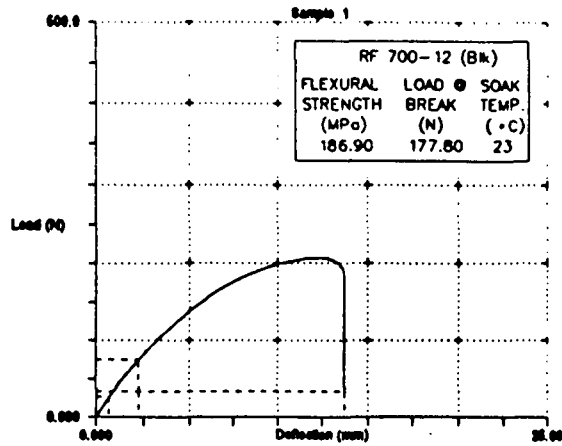
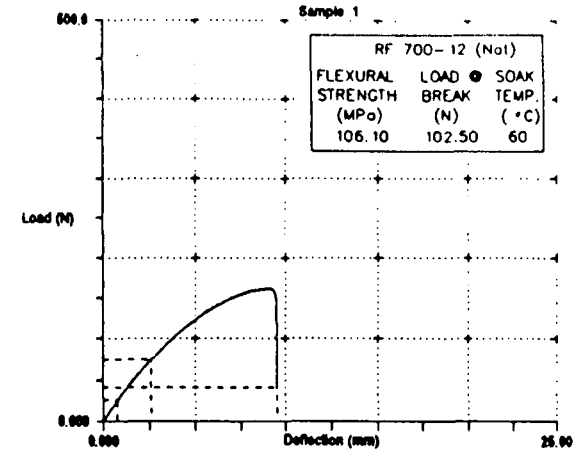
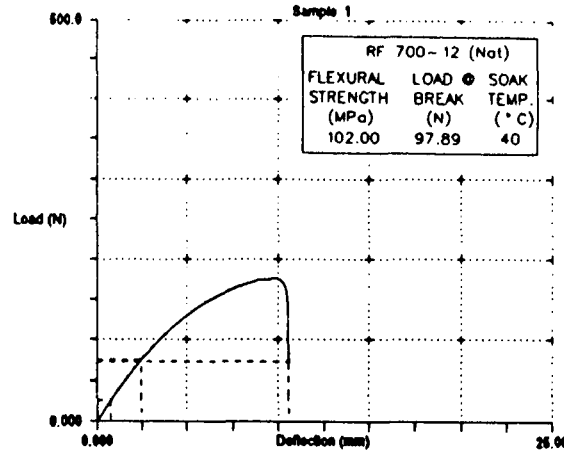
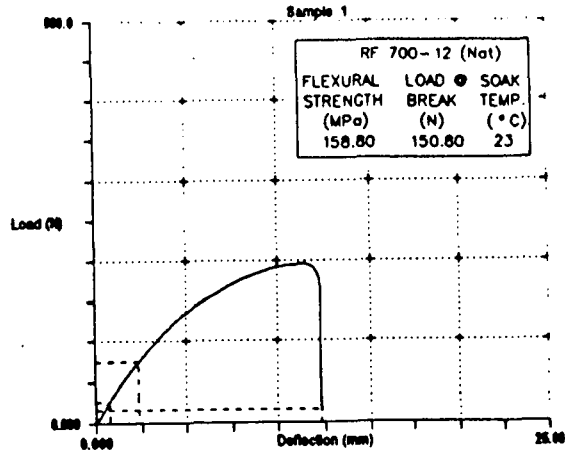

SOAK-TIME : 672 HOURS (28 Days)

APPENDIX 5.0 : Parameters calculated from the application of Fick's theory of moisture diffusion.

A 5.1                   Moisture Diffusion at 23°C

A 5.2                   Moisture Diffusion at 60°C

A 5.1

Moisture Diffusion at 23°C

Material : 'Maranyl' Un-Filled Nylon 66 (Natural)

Gradient for initial part of Mt Vs  $\sqrt{t}$  curve : 0.867

Maximum moisture content (Mm, %) : 7.054

Soak Time, t (Hrs)	Sq Root Time ( $\sqrt{t}$ )	Moisture Content, Mt (%)	Mt/Mm (Y-Axis)	Sample Thkns, h (mm)	Diffusion Coefnt, Dx ( $\text{mm}^2/\text{Hr}$ )	Dx.t/h <sup>2</sup> (X-Axis)
2	1.414	3.184	0.451	3.350	0.033	0.006
4	2.000	3.214	0.456	3.350	0.033	0.012
24	4.899	4.141	0.587	3.360	0.033	0.071
168	12.961	4.821	0.683	3.365	0.034	0.498
298	17.263	5.536	0.785	3.370	0.034	0.884
432	20.785	6.250	0.886	3.380	0.034	1.281
672	25.923	6.857	0.972	3.390	0.034	1.993
1000	31.623	7.054	1.000	3.400	0.034	2.966

Material : 'Verton' 50% Long Glass Fibre Reinforced Nylon 66 (Natural)

Gradient for initial part of Mt Vs  $\sqrt{t}$  curve : 0.240

Maximum moisture content (Mm, %) : 2.443

Soak Time, t (Hrs)	Sq Root Time ( $\sqrt{t}$ )	Moisture Content, Mt (%)	Mt/Mm (Y-Axis)	Sample Thkns, h (mm)	Diffusion Coefnt, Dx ( $\text{mm}^2/\text{Hr}$ )	Dx.t/h <sup>2</sup> (X-Axis)
2	1.414	0.171	0.070	3.320	0.021	0.004
4	2.000	1.050	0.430	3.350	0.021	0.008
24	4.899	1.529	0.626	3.360	0.021	0.045
168	12.961	1.555	0.637	3.365	0.021	0.318
298	17.263	1.727	0.707	3.370	0.022	0.585
432	20.785	1.993	0.816	3.372	0.022	0.819
672	25.923	2.214	0.906	3.374	0.022	1.273
1000	31.623	2.443	1.000	3.380	0.022	1.895

Material : 'Verton' 35% Long Glass Fibre Reinforced Nylon 66 (Natural)

Gradient for initial part of M Vs  $\sqrt{t}$  curve : 0.333

Maximum moisture content (Mm, %) : 3.136

Soak Time, t (Hrs)	Sq Root Time ( $\sqrt{t}$ )	Moisture Content, Mt (%)	Mt/Mm (Y-Axis)	Sample Thkns, h (mm)	Diffusion Coefnt, Dx ( $\text{mm}^2/\text{Hr}$ )	Dx.t/h <sup>2</sup> (X-Axis)
2	1.414	0.098	0.031	3.320	0.024	0.004
4	2.000	1.978	0.631	3.350	0.025	0.009
24	4.899	2.420	0.772	3.360	0.025	0.053
168	12.961	2.568	0.819	3.370	0.025	0.372
298	17.263	2.645	0.843	3.380	0.025	0.660
432	20.785	2.722	0.868	3.380	0.025	0.956
672	25.923	2.989	0.953	3.380	0.025	1.488
1000	31.623	3.136	1.000	3.400	0.026	2.214

Material : 'Verton' 60% Long Glass Fibre Reinforced Nylon 66 (Natural)

Gradient for initial part of Mt Vs  $\sqrt{t}$  curve : 0.166

Maximum moisture content (Mm, %) : 1.953

Soak Time, t (Hrs)	Sq Root Time ( $\sqrt{t}$ )	Moisture Content, Mt (%)	Mt/Mm (Y-Axis)	Sample Thkns, h (mm)	Diffusion Coefnt, Dx ( $\text{mm}^2/\text{Hr}$ )	Dx.t/h <sup>2</sup> (X-Axis)
2	1.414	0.075	0.038	3.330	0.016	0.003
4	2.000	0.985	0.504	3.340	0.016	0.006
24	4.899	1.325	0.678	3.345	0.016	0.034
168	12.961	1.425	0.730	3.350	0.016	0.238
298	17.263	1.542	0.790	3.360	0.016	0.423
432	20.785	1.630	0.835	3.365	0.016	0.613
672	25.923	1.830	0.937	3.370	0.016	0.953
1000	31.623	1.953	1.000	3.372	0.016	1.419

A 5.2

Moisture Diffusion at 60°C

Material : 'Maranyl' Un-Filled Nylon 66 (Natural)

Gradient for initial part of Mt Vs  $\sqrt{t}$  curve : 1.667

Maximum moisture content (Mm, %) : 8.134

Soak Time, t (Hrs)	Sq Root Time ( $\sqrt{t}$ )	Moisture Content, Mt (%)	Mt/Mm (Y-Axis)	Sample Thkns, h (mm)	Diffusion Coefnt, Dx ( $\text{mm}^2/\text{Hr}$ )	Dx.t/h <sup>2</sup> (X-Axis)
2	1.414	3.864	0.475	3.390	0.095	0.016
4	2.000	4.464	0.549	3.390	0.095	0.033
24	4.899	6.271	0.771	3.420	0.096	0.198
168	12.961	8.036	0.988	3.430	0.097	1.385
298	17.263	8.080	0.993	3.430	0.097	2.458
432	20.785	8.116	0.998	3.430	0.097	3.563
672	25.923	8.125	0.999	3.430	0.097	5.542
1000	31.623	8.134	1.000	3.430	0.097	8.247

Material : 'Verton' 50% Long Glass Fibre Reinforced Nylon 66 (Natural)

Gradient for initial part of Mt Vs  $\sqrt{t}$  curve : 0.869

Maximum moisture content (Mm, %) : 3.606

Soak Time, t (Hrs)	Sq Root Time ( $\sqrt{t}$ )	Moisture Content, Mt (%)	Mt/Mm (Y-Axis)	Sample Thkns, h (mm)	Diffusion Coefnt, Dx ( $\text{mm}^2/\text{Hr}$ )	Dx.t/h <sup>2</sup> (X-Axis)
2	1.414	0.584	0.162	3.360	0.129	0.023
4	2.000	1.458	0.404	3.370	0.130	0.046
24	4.899	2.515	0.697	3.380	0.130	0.274
168	12.961	3.250	0.901	3.380	0.130	1.916
298	17.263	3.307	0.917	3.390	0.131	3.398
432	20.785	3.345	0.928	3.390	0.131	4.926
672	25.923	3.556	0.986	3.390	0.131	7.663
1000	31.623	3.606	1.000	3.391	0.131	11.403



Material : 'Verton' 35% Long Glass Fibre Reinforced Nylon 66 (Natural)

Gradient for initial part of Mt Vs  $\sqrt{t}$  curve : 1.333

Maximum moisture content (Mm, %) : 5.037

Soak Time, t (Hrs)	Sq Root Time ( $\sqrt{t}$ )	Moisture Content, Mt (%)	Mt/Mm (Y-Axis)	Sample Thkns, h (mm)	Diffusion Coefnt, Dx ( $\text{mm}^2/\text{Hr}$ )	Dx.t/h <sup>2</sup> (X-Axis)
2	1.414	2.217	0.440	3.370	0.156	0.028
4	2.000	2.743	0.545	3.380	0.157	0.055
24	4.899	3.580	0.711	3.390	0.158	0.330
168	12.961	4.172	0.828	3.390	0.158	2.310
298	17.263	4.322	0.858	3.400	0.159	4.098
432	20.785	4.532	0.900	3.410	0.160	5.941
672	25.923	5.029	0.998	3.420	0.161	9.241
1000	31.623	5.037	1.000	3.420	0.161	13.751

Material : 'Verton' 60% Long Glass Fibre Reinforced Nylon 66 (Natural)

Gradient for initial part of Mt Vs  $\sqrt{t}$  curve : 0.667

Maximum moisture content (Mm, %) : 3.273

Soak Time, t (Hrs)	Sq Root Time ( $\sqrt{t}$ )	Moisture Content, Mt (%)	Mt/Mm (Y-Axis)	Sample Thkns, h (mm)	Diffusion Coefnt, Dx ( $\text{mm}^2/\text{Hr}$ )	Dx.t/h <sup>2</sup> (X-Axis)
2	1.414	0.496	0.152	3.350	0.092	0.016
4	2.000	1.948	0.595	3.360	0.092	0.033
24	4.899	2.393	0.731	3.370	0.093	0.196
168	12.961	2.804	0.857	3.375	0.093	1.370
298	17.263	2.818	0.861	3.378	0.093	2.430
432	20.785	2.863	0.875	3.378	0.093	3.523
672	25.923	3.169	0.968	3.380	0.093	5.480
1000	31.623	3.273	1.000	3.382	0.093	8.154