

## Durham E-Theses

---

### *Some potential precursor routes to aromatic polyesters via quinone methides*

Cadd, Duncan Howard

#### How to cite:

---

Cadd, Duncan Howard (1992) *Some potential precursor routes to aromatic polyesters via quinone methides*, Durham theses, Durham University. Available at Durham E-Theses Online:  
<http://etheses.dur.ac.uk/6032/>

#### Use policy

---

The full-text may be used and/or reproduced, and given to third parties in any format or medium, without prior permission or charge, for personal research or study, educational, or not-for-profit purposes provided that:

- a full bibliographic reference is made to the original source
- a [link](#) is made to the metadata record in Durham E-Theses
- the full-text is not changed in any way

The full-text must not be sold in any format or medium without the formal permission of the copyright holders.

Please consult the [full Durham E-Theses policy](#) for further details.

**Some Potential Precursor Routes to  
Aromatic Polyesters via  
Quinone Methides**

by

**Duncan Howard Cadd**

**BSc (Hons.) Chemistry, University of Southampton 1980**

**MSc New Polymer Synthesis, University of Lancaster 1985**

**Submitted for the degree of PhD**

**University of Durham, Department of Chemistry, 1992**

The copyright of this thesis rests with the author.  
No quotation from it should be published without  
his prior written consent and information derived  
from it should be acknowledged.



16 OCT 1992

## Some Potential Precursor Routes to Aromatic Polyesters via Quinone Methides

by

Duncan Howard Cadd

### Abstract

Poly(*para*-hydroxybenzoic acid) [pHBA] was discovered in the late 1950s and found to have chemical and mechanical properties which make it attractive for use as a high-performance polymer, potentially in engineering applications. However, the same properties make it difficult to fabricate into films or fibres. This thesis examines the philosophy of the precursor approach to intractable polymers as applied to the synthesis of aromatic polyesters generally and to pHBA specifically, by means of a review on the production of benzene derivatives by ring synthesis, and the polymerisation of 1,4-benzoquinone methides. Work undertaken includes the synthesis and characterisation of a precursor to 7,7-dichloro-1,4-benzoquinone methide, *endo-cis*-6-dichloromethylenetricyclo[6.2.1.0<sup>2,7</sup>]undeca-4,9-dien-3-one, and the assignments of the <sup>1</sup>H and <sup>13</sup>C NMR spectra of *endo-cis*-6,6-dimethoxytricyclo[6.2.1.0<sup>2,7</sup>]undeca-4,9-dien-3-one (a correction to the published assignment) and its intramolecular 2+2 photocycloaddition product, 8,8-dimethoxypentacyclo[8.1.0<sup>1,5</sup>.0<sup>2,9</sup>.0<sup>4,7</sup>.0<sup>6,10</sup>]undecan-3-one.

### **Declaration**

The work herein is that of the Author, except where specifically acknowledged otherwise in respect of analytical services, and has not previously been submitted for any qualification.

### **Copyright**

The copyright of this thesis rests with the Author. No quotation from it should be published without his prior written consent and information derived from it should be acknowledged.

© Duncan Cadd, 1992



**Dedication**

*To *Hordeum vulgare*, *Saccharomyces cerevisiæ* and *Humulus lupulus*.*

The Noble Tapster by his worthy art  
Doth cheer our weary lives and make us merry!

*Wm. Waldon, 1787-1853*

## Acknowledgements

The author is indebted to many people, for analytical services, scientific debate and critique, support both financial and moral, and companionship. The roll call of honour contains the following names.

Courtaulds Research, Coventry, for the financial support which made this project possible.

Dr. Jerry Winter, Courtaulds Research, Coventry, for helpful discussions during the course of this research.

The SERC Solid State CPMAS  $^{13}\text{C}$  NMR Service at the Industrial Research Laboratories, University of Durham.

The Academic and Technical Staff of the Chemistry Department, and of the Interdisciplinary Research Centre in Polymer Science and Technology, University of Durham amongst whom the following deserve mention in despatches for service beyond the call of duty:

Mr. Ray Hart and Mr. Gordon Haswell for glassblowing skills. (Recommendations for Gallantry Awards pending.)

Mr. Dave Hunter for advice on high pressure vessels, techniques and safety matters relating thereto.

Dr. Mike Jones and Mr. Vince McNeilly for mass spectroscopic services and discussions relating thereto.

Dr. Alan Kenwright and Mrs. Julia Say for solution state nmr spectroscopic services and discussions relating both thereto and otherwise. (Field Marshall's Batons apiece.)

Dr. Mel Kilner for advice on and the loan of equipment for high pressure hydrogenation reactions.

Mr. Lenny Lauchlan for advice on GC and for running HPLC.

Dr. Dave Parker and Mr. Bill Harris for advice on and apparatus for electrolytic syntheses.

Dr. Dave Parker (again) for the use of his HPLC column and constructive criticism in the first year viva.

I should also like to thank my fellow members of the Polymer Group, past and present, for their companionship, and in particular Dr. Cameron Alexander, Dr. Pete Clemenson, Dr. Dave Harrison, Mr. Dave Parker and Dr. Keith Yeats, for Conspicuous Humour in the Face of Adversity (and Dr. Clemenson.)

Finally, I must thank my Supervisor, Prof. Jim Feast, for preparing my way and making my path straight. Yea, verily, he hath made my day.

## Contents

### Page

#### **Chapter 1. Poly(*para*-hydroxybenzoic acid). Problems and Potential Solutions.**

A discussion of the philosophy of the precursor approach and a literature review on benzene ring synthesis.

1

#### **Chapter 2. Some Initial Investigations into Possible Precursor Routes.**

Synthetic approaches taken to carbonyl synthons and benzene ring synthesis.

34

#### **Chapter 3. Potential Routes to Poly(*para*-hydroxybenzoic acid) via Quinone Methides.**

A literature review of selected quinone methide chemistry and synthetic work undertaken to make 7,7-dichloro-1,4-benzoquinone methide. Synthesis of its precursor, *endo-cis*-6-dichloromethylene[6.2.1.0<sup>2,7</sup>]undeca-4,9-dien-3-one.

45

#### **Chapter 4. Miscellaneous Methods.**

The possible route via anionic ring-opening polymerisation of substituted 2-oxabicyclo[2.2.2]octan-3-ones. An attempted route via tricyclo[6.2.1.0<sup>2,7</sup>]undeca-4,9-dien-3-one.

96

**Chapter 5. The structures of some Diels-Alder adducts and products of their intramolecular 2+2 photocycloaddition as revealed by detailed analysis of their <sup>1</sup>H and <sup>13</sup>C n.m.r. spectra.**

Corrections to the published assignments for *endo-cis*-6,6-dimethoxytricyclo[6.2.1.0<sup>2,7</sup>]undeca-4,9-dien-3-one. The first known structural determination of a pentacyclo[8.1.0<sup>1,5</sup>.0<sup>2,9</sup>.0<sup>4,7</sup>.0<sup>6,10</sup>]undecan-3-one derivative by n.m.r. alone: 8,8,-dimethoxypentacyclo[8.1.0<sup>1,5</sup>.0<sup>2,9</sup>.0<sup>4,7</sup>.0<sup>6,10</sup>]undecan-3-one. Prediction of the relative sizes of bond angles via molecular orbital calculations.

106

**Chapter 6. Experimental.**

Synthetic work undertaken.

173

**Appendix 1. Spectra referred to in Chapter 5.**

215

**Appendix 2. Spectra referred to in Chapter 6.**

234

**Chapter 7. Suggestions for further work.**

A brief review of other recent work in this area and suggestions derived from it.

283

**Conclusions.**

290

**Page**

**Research Colloquia and Conferences.**

A declaration required by the Board of Studies in Chemistry.

293

**Apparatus and Reagents.**

A list of suppliers and services.

301

**References.**

304

## Chapter 1. Poly(*para*-hydroxybenzoic acid). Problems and Potential Solutions

### 1.1) Poly(*para*-hydroxybenzoic acid). Manufacture, properties and problems.

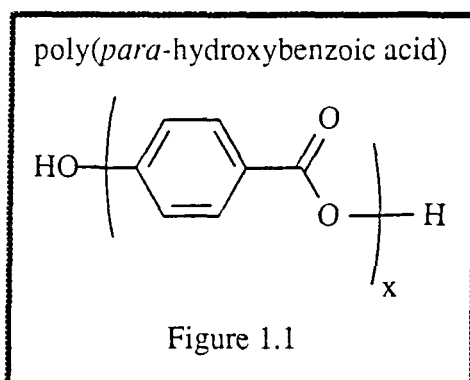

The title polymer, shown in figure 1.1, is one of a number of potentially interesting materials made in the late fifties and sixties which did not find immediate application because, as in "The Man in the White Suit,"<sup>[1]</sup> the mechanical and chemical properties of the new material were so outstanding that conventional melt or solution processing found it difficult to handle. The synthesis is not difficult and the polymer can be made by a variety of methods. Thermal processing is expensive in energy because of the high melting point and decomposition problems (*vide infra*.) Except in some unusual solvent systems such as polychlorinated polyphenyl<sup>[2]</sup>, the polymer is totally insoluble.

In 1959 Gilkey and Caldwell<sup>[3]</sup> reported the synthesis of poly(*para*-hydroxybenzoic acid), p(HBA), and its copolymers with the *meta*-isomer by removing acetic acid from the acetoxybenzoic acids at 300°C under a reduced pressure nitrogen blanket and using a magnesium transesterification catalyst. The polymer crystallinity was found to be proportional to the *para*- content and crystalline blocks of p(HBA) were formed in the copolymers. If the *meta*- content was greater than 55mol% the copolymers were soluble

in several solvents. The *meta*-homopolymer melted at 176°C whilst the p(HBA) began to decompose at 350°C but did not melt even at 450°C. They found the polymers to be oxidatively stable but susceptible to hydrolysis. The tensile strengths were ca. 10,000psi at elongations of 6-40%. Hanna and Windle<sup>[4]</sup> have reported that the polymer undergoes a phase transition around 350°C and that it becomes a condis crystal. According to Grebowicz and Wunderlich<sup>[5]</sup> a condis crystal is a material, not necessarily a polymer, which possesses a mesophase in which there is **conformational disorder**, i.e. the polymer chains are parallel as per a conventional crystal, but conformational isomers are available on the monomer scale which partially disorder the crystal and by means of coöperative motion, a liquid-like state is achieved. This is equivalent to hindered internal rotation and may be viewed as a kind of localised and highly restricted reptation. The crystallinity is greater than 75%. Gleim patented<sup>[6]</sup> a method for p(HBA) production by distilling methyl acetate from methyl *para*-acetoxybenzoate in tributylamine at 208°C. Including work subsequently done on copolymers with a view to producing a processable material, there are dozens of variations on the above themes, concerning choice of catalyst, reaction temperature and time, substrate esters and solvent systems.

The decomposition of p(HBA) has been studied by, *inter alia*, Ivanov and Slavcheva<sup>[7]</sup>, Jellinek and Fujiwara<sup>[8]</sup> and Economy *et al*<sup>[9,10]</sup>. Thus, the polymer exhibits high oxidative stability, losing weight at a rate of 0.06%/hour at 325°C and 3%/hour at 450°C in air. The decomposition products include phenol, carbon monoxide and dioxide, water, *para*-hydroxybenzoin and phenyl-*para*-hydroxybenzoate, of which the first three predominate, but the proportions do vary according to the temperature of degradation. The kinetics of decomposition are zero or first order, but the precise mechanism has not been elucidated. The thermal stability of p(HBA) lies between that of polythene and PTFE.



Both solution and melt processing appear to be ruled out because of the low solubility in convenient solvents and the very high melting point, but Economy *et al*<sup>[11]</sup> have proposed compression moulding at 438°C and 6000-12000psi. The polymer is commercially available under the tradename Ekonol.

It is evident that p(HBA) has attractive properties and would make an excellent high-performance engineering polymer if it could be readily fabricated into finished products.

## **1.2) Possible solutions. The precursor approach.**

The concept of fabricating a product out of a material which is tractable and subsequently converting it to one which is intractable is not new. The manufacture of pottery and bricks from clay is an ancient example. A modern equivalent is the Bakelite process, another would be the conversion of poly(amic acids) to poly(imides). However, in the case of the firing of clay or the curing of a Bakelite, the conversion is composed of many reactions which are non-specific and the microstructure of the end product is random and poorly-defined. In order to make a regular structure, the nature of the conversion process must be understood in detail and it must be capable of being controlled. This is the case in the production of poly(imide) coatings by the dehydration of poly(amic acids).

In an Utopian laboratory, it would be possible to take some simple starting materials and, in one pot in one reaction make e.g. vitamin B<sub>12</sub> in excellent yield, without having to deal with intermediates or remove by-products and various isomers. If chemistry worked in such a way, all syntheses would be done in a single step and life would be wonderful, but it is common experience that chemistry does not work that way, and



multi-step syntheses are *de rigueur*. However, there are three reasons why one might *want* to make a product by a two-or-more stage synthesis via a stable intermediate which can be handled at leisure with convenience.

The first of these reasons is that we may wish to make a derivative of a compound which is itself unstable. It may be feasible to approach the synthesis via another, similar compound which can be derivatised and the derivative then chemically modified to be identical to the molecule we should have made by the direct route were it possible to do so. In terms of polymer chemistry, the classical example is the synthesis of poly(vinyl alcohol) by the polymerisation of vinyl acetate followed by hydrolysis of the poly(vinyl acetate). Vinyl alcohol only exists as a tautomer of acetaldehyde, and although it is perfectly stable, it is only ever possible to obtain tiny amounts at any moment and then as an equilibrium mixture with acetaldehyde in which the latter predominates.

The second reason for selecting a precursor synthesis is that we may wish to impart a particular microstructural physical characteristic to a product which is itself difficult to manipulate. This physical characteristic may however be imposed on a material whose microstructure is readily controlled and the modified material subsequently converted to the desired product with retention of the microstructure. It is not hard to make carbon by the pyrolysis of wood, but the tough, fibrous structure which nature constructs is destroyed during baking and airframes cannot be made from charcoal. The controlled pyrolysis of poly(acrylonitrile) fibres does, however, result in the production of carbon with retention of the original fibrous microstructure.

The third reason for using a precursor strategy is temporarily to impart some chemical or physical property to a material. The usual reason for wishing to do this is that the temporary property is processability in a material which is usually intractable. This is

the case in p(HBA) but the strategy of precursor synthesis has already been applied with success to other polymers.

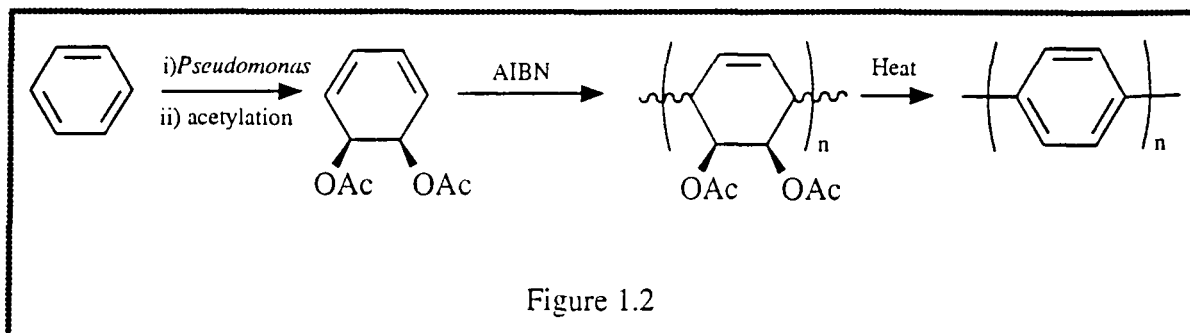

Workers at ICI have produced poly(*para*-phenylene) by pyrolysis of a precursor made by the free radical polymerisation of cyclohexa-1,3-dien-5,6-*cis*-diyl diacetate<sup>[12]</sup>, see figure 1.2. The *cis*-diol is prepared by the bacterial oxidation of benzene using a genetically modified strain of *Pseudomonas putida*.

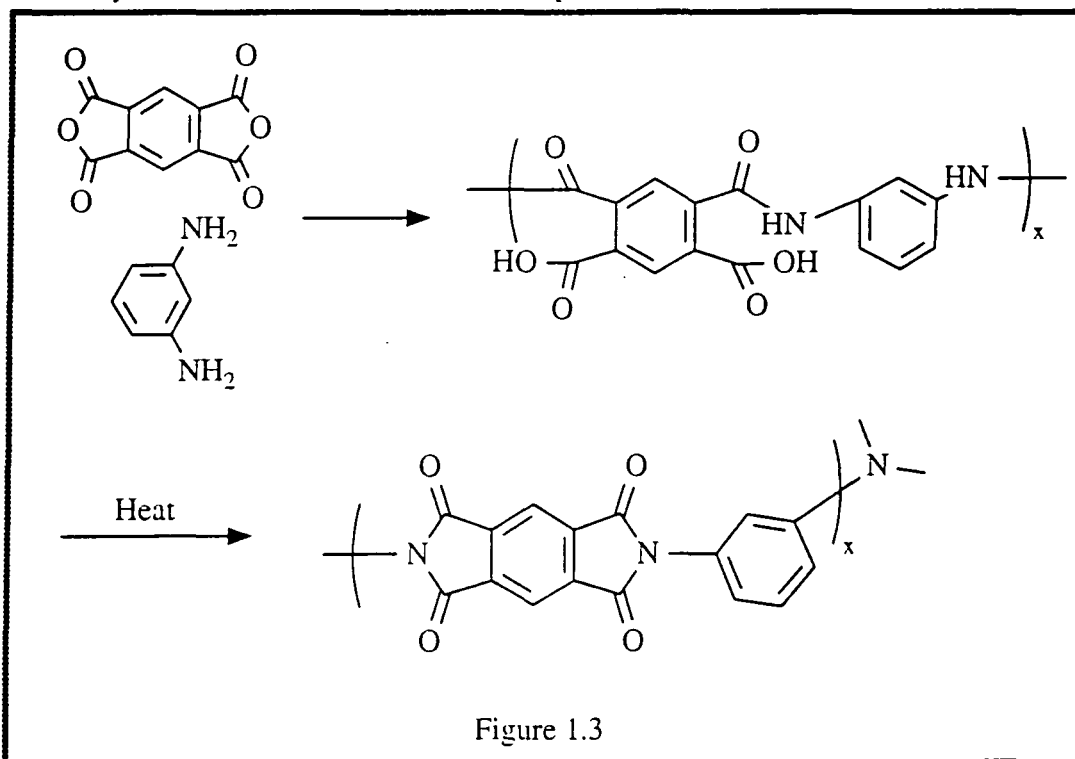

Poly(imides) such as poly(1,3-benzenepyromellitimide) are made in two steps<sup>[13]</sup>, see figure 1.3. In the first, 1,3-diaminobenzene is condensed with pyromellitic dianhydride to form poly(amic acid) oligomers. These are processable, and when in the form of the final product, the poly(amic acid) oligomers may be cyclised by the application of heat or use of dehydrating agents to give the final product.

It may be mentioned briefly that precursors are of great commercial importance in the field of inorganic ceramics<sup>[14]</sup>.

### 1.3) A general precursor approach to aromatic polymers.

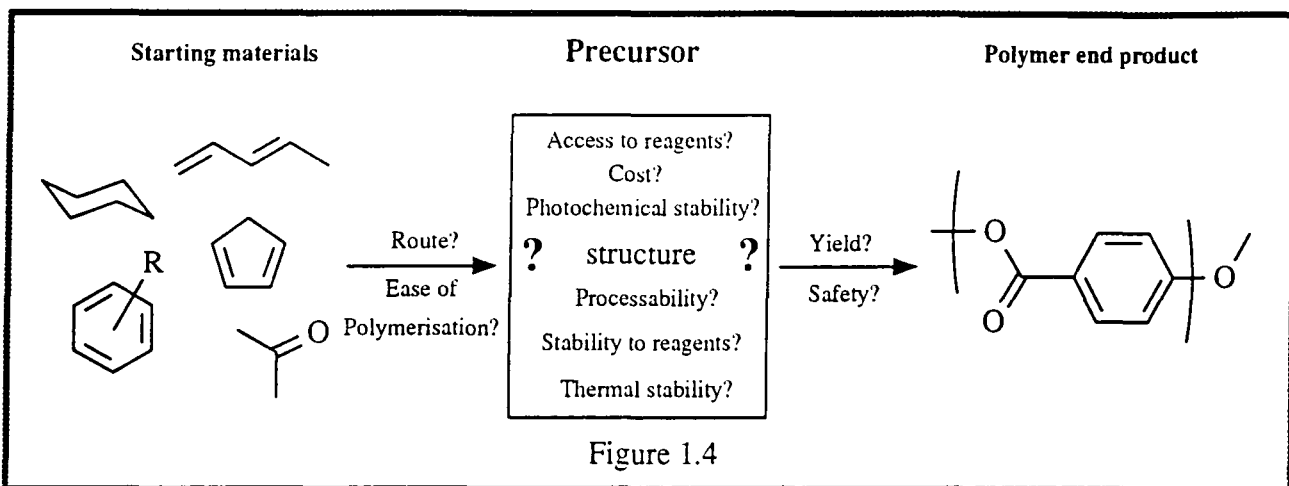

To design a successful precursor route to a polymer is hard. The major difficulty is that the target molecule is an unknown quantity in the synthetic equations. In the synthesis of poly(HBA) by a precursor route, the target molecule is *NOT* poly(HBA). It is something which can be *converted into* poly(HBA), subject to certain other important constraints, see figure 1.4. The synthetic problem is twofold; firstly to guess the structure of a likely precursor and secondly to attempt to make it. To some extent this is the same problem found in all organic syntheses, particularly the second part, and is usually approached via the disconnection concept. However, in conventional organic chemistry the ultimate structure is the goal of the synthesis and the *penultimate* structure, its properties, in particular its stability and the efficiency with which it is converted to the final product, are of secondary importance. In contrast, the properties of the penultimate structure in a precursor synthesis, i.e. the precursor itself, are of major significance because even if the synthesis problem is solved, it may be that the precursor will not "precure" satisfactorily for a variety of reasons. These include the ease of polymerisation, stability, processability and conversion yield, and ease of

access of reagent to the precursor. Conventional organic synthesis has had occasion to tackle this problem under less drastic restrictions, but only in circumstances e.g. the synthesis of a cyclobutadiene<sup>[15]</sup> precursor, where a storable compound is required for the convenient production of unstable, theoretically-interesting materials. Even then, the yield of the desired material is often of little consequence provided enough is made for the desired study, whereas in a polymer synthesis the conversion yield determines the polymer microstructure and performance.

There are two fundamental types of potential precursor. The first is a structural isomer of the desired product which can be persuaded to rearrange under suitable conditions without the elimination of any fragments. The possibility of making such a precursor depends critically on the structure of the product and the likelihood of success is low. The synthesis and isomerisation of Dewar benzenes is an example, *vide infra*. The second type of precursor, the more usual approach, relies upon the elimination or substitution of some fragment of the precursor molecule, with or without rearrangement. The most important decision to be taken is the nature of the fragment to be removed, whether it is a fragment of the monomer molecule, or whether it is a segment of the polymer backbone i.e. an oligomer. This decision will affect the conditions required for the conversion, the safety, the stability of the precursor, the feasibility of the synthesis, the conversion yield and hence the microstructure of the product, and will ultimately decide whether the approach is successful.

#### **1.4) Removal of Substituents.**

The replacement of substituents on aromatic molecules, figure 1.5, is possibly adaptable to precursor synthesis, but its chance of success is limited by the chemistry available. Some replacement reactions are easy, e.g. the wide range of aromatic

substitution reactions which involve the replacement of a proton by an electrophile, or the replacement of chloride by hydroxide in the hydrolysis of picryl chloride, but most

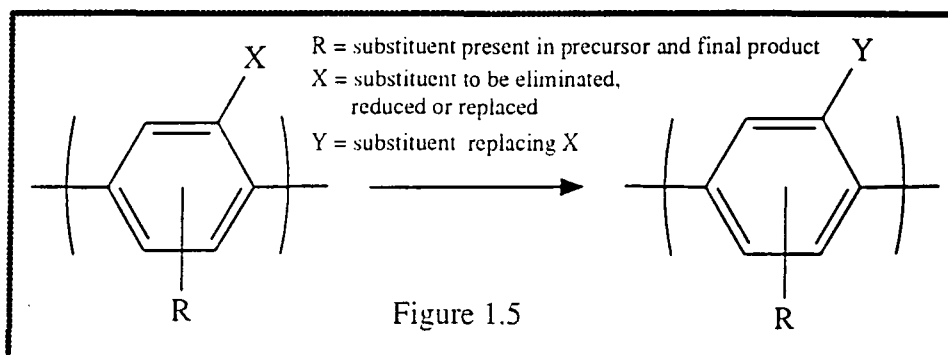

others are difficult, for example when the replacement required is a reduction of a poor leaving group, e.g. Ar-R to Ar-H. The approach has been explored on a limited scale e.g. by Li<sup>[16]</sup> and Mullen<sup>[17]</sup> who have succeeded in removing *tert*butyl groups by warming the substituted aromatic with a Lewis acid catalyst, sometimes in the presence of anisole, which is a reactive trap for the intermediate carbenium ion. Olah<sup>[18]</sup> has stated that the Friedel-Crafts reaction should not be considered reversible in the usual sense, since although alkyl groups migrate, no free alkene is liberated. A variety of general synthetic methods covering a truly comprehensive range has been tabulated in Larock's excellent *Comprehensive Organic Transformations*<sup>[19]</sup>. The classic technique of replacement of an amino-group by hydrogen<sup>[20]</sup> via diazotisation has functional group tolerance to commend it, but the yield of the replacement reaction is low. There are other methods which improve the yield by the use of more exotic and expensive reagents<sup>[21]</sup>. Aryl ethers can be converted to the arene by alkali metals<sup>[22]</sup> or by treatment with ethanethiol and aluminium chloride<sup>[23]</sup> which also reduces phenols to arenes. Aryl aldehydes can be decarbonylated by palladium on charcoal<sup>[24]</sup> or using homogeneous catalysis by rhodium complexes<sup>[25]</sup>. Aryl carboxylic acids can be decarboxylated by the classic technique of heating with soda-lime<sup>[26]</sup> or by hydrogenolysis over nickel or palladium catalysts at elevated temperature<sup>[27]</sup>. Halogen substituents can be removed by hydrogenation<sup>[28]</sup> over Raney nickel catalysts.

But the heterogeneity of these reactions on the *microscopic* scale is a major stumbling block to many potential precursor routes. It applies to all potential precursor syntheses of high-performance engineering polymers with equal force, since one of the reasons for adopting the precursor philosophy in these cases is that the desired polymer is insoluble, infusible or both. It is thus essential that the conversion can be performed on the precursor polymer in the state of the finished product, which for the reasons of access of reagents, egress of fragments and safety (*vide infra*) means that the product will be made in the form of a fibre or a film. The production of bulky components via precursor synthesis is restricted to special cases, for example, the compression moulding of a novolak resin which acts as the precursor to an insoluble, infusible, cross-linked product, and there are many other examples of such technology. However, these are not precursors in the current context, which requires that the precursor should have the same degree of polymerisation as the end product. The conversion by chemical treatment of a precursor polymer film or fibre is thus bound to be heterogeneous on the *macroscopic* scale and relies on the diffusion of reagent into the fibre or film and the diffusion of fragments and spent reagent out. It follows that reactions which are heterogeneous *for small molecules* are only suited to the conversion step of a precursor polymer if it is feasible to conduct the reaction in the solid precursor or the highly viscous phase from which the precursor is spun and it is acceptable to leave e.g. catalyst residue in the solid product. This is unlikely to be the case, particularly for high-performance polymers where the final engineering application will usually demand that the finished product be free of all sources of mechanical defects and chemical impurities, which might otherwise lead to stress concentration or localised sites of chemical attack, both of which promote mechanical failure.

In summary, the replacement of substituents on an aromatic ring is usually a difficult process and frequently needs heterogeneous reaction conditions, or the use of expensive reagents which are incompatible with the needs of a precursor polymer. In

spite of the utility of the technique in small molecule chemistry, it appears from the above considerations to be generally inapplicable to aromatic precursor polymer synthesis and conversion.

### **1.5) The Use of Molecular Adducts.**

A minor candidate for precursor syntheses is the use of molecular adducts. It has long been known that many aromatic compounds form complexes with picric acid, styphnic acid, 1,3,5-trinitrobenzene or 2,4,7-trinitro-9-fluorenone and that these compounds are in many instances capable of being dissociated by the action of hydroxylic solvents<sup>[29a-m]</sup>. The fact that the complexing agent can be recovered and recycled is an attractive feature in precursor synthesis. However, the explosive nature of most of these agents strongly dissuades large scale experimentation or commercial use. It is possible that other compounds will be discovered which will be more satisfactory in this respect and the idea is therefore worth bearing in mind. Further factors in its favour are that cheap homopolymer can in principle be doped with the complexing agent and that it should not be necessary to aim for 1:1 complex formation, as a small quantity of the complex should disorder the polymer sufficiently to depress the melting point or enhance the solubility enough for processing. If a suitable compound could be found, this would be a simple and economic technique with wide applicability.

### **1.6) The Ring Synthesis Approach.**

A particularly attractive precursor approach to poly(HBA), which would have general applicability to other high-performance aromatic polymers, requires the synthesis of the benzene ring via isolable "metastable" intermediates which could be thermally, chemically or photochemically converted to the aromatic compound. Such a method would open the way for commercially-attractive processing of poly(aramids), ladder

polymers, rigid rod polymers and the like. There is, however, a major problem in that the ring synthesis of benzenoids has not been comprehensively studied and discussed in the literature. This merits some evangelical comment.

Routes for the synthesis of heterocyclic aromatics such as thiazole,<sup>[30]</sup> quinoline,<sup>[31]</sup> phenanthroline<sup>[32]</sup> and indole<sup>[33]</sup> via ring closure and (often simultaneous) aromatisation reactions were created early in the development of synthetic organic chemistry. Necessity was the driving force, since while benzene itself has a superabundance of substitution chemistry, the heterocyclic aromatics are characterised by substitution reactions which are seldom "clean" and which require considerable experimental skill to obtain what in terms of benzene chemistry would be moderate to fair yields. Ring synthesis was and still is a vital general method for making derivatives of the parent compounds. Consequently, the ring syntheses of heterocyclic aromatics have been systematically explored and welded into a coherent literature, readily accessible and well-defined. Today, this is a recognised area of research in which many groups are active.

In contrast, the ease of obtaining most benzene derivatives by substitution reactions has meant that their ring synthesis occupies something of a synthetic backwater. It is neither a subject of concerted research nor undergraduate teaching. Since chemists generally have not *needed* benzene ring syntheses, no systematic effort has been applied to their invention. This has resulted in the production of specific examples of the approach, as and when needs arose which could not be readily satisfied by the abundant substitution chemistry, rather than by the deliberate discovery and exploitation of general methods. The fact that these examples occur in diverse areas of chemistry makes searching for such methods a slow and unproductive task. It is complicated by the fact that many examples are not indexed under obvious headings like "benzene derivatives, ring synthesis of" precisely because the ring synthesis of



benzene derivatives enjoys no recognition as a separate and important branch of general synthetic chemistry. It is, in a sense, in a similar situation as was polymer chemistry before Staudinger and others gave it the publicity it deserved, at which stage the term "polymer" might have appeared in a paper, but was unlikely to be referenced by Chemical Abstracts. Few review articles<sup>[34,35]</sup> have been written on the subject; in complete contradistinction to the heterocyclic aromatics there appear to be no standard texts dealing with the ring closure and aromatisation approach to benzene derivative synthesis.

This lack of methodical investigation is simultaneously frustrating and exciting. It is frustrating because of the difficulty of locating the few extant examples, and exciting since nobody appears to have given this curious omission serious consideration. The synthetic challenge is thought-provoking, and if capable of economic solution it holds great promise of useful precursor routes to many classes of otherwise intractable - and thus commercially unattractive - high performance aromatic polymers.

The need for the invention of ring synthesis chemistry is not the sole requirement for the general aromatic precursor approach to succeed. The synthesis must proceed via an isolable intermediate which is readily converted with simple treatment into the desired aromatic in 100% yield, and which can be polymerised in high yield and without decomposition to give the soluble or melt-processable precursor. It will be noticed that many examples in this chapter (*vide infra*) fail to satisfy some or all of these requirements. In the specific instance of poly(HBA), the precursor also requires a carboxyl function *para* to an hydroxyl group. Perusal of these examples indicates that whilst there are a few routes which might be modified to provide monomeric HBA, none will do so via an isolable intermediate which can be polymerised and subsequently converted to the aromatic at one's convenience. Attempts to alter the molecules in those examples which do proceed via an isolable intermediate so that the

end product is the desired precursor result in the generation of some highly improbable starting materials.

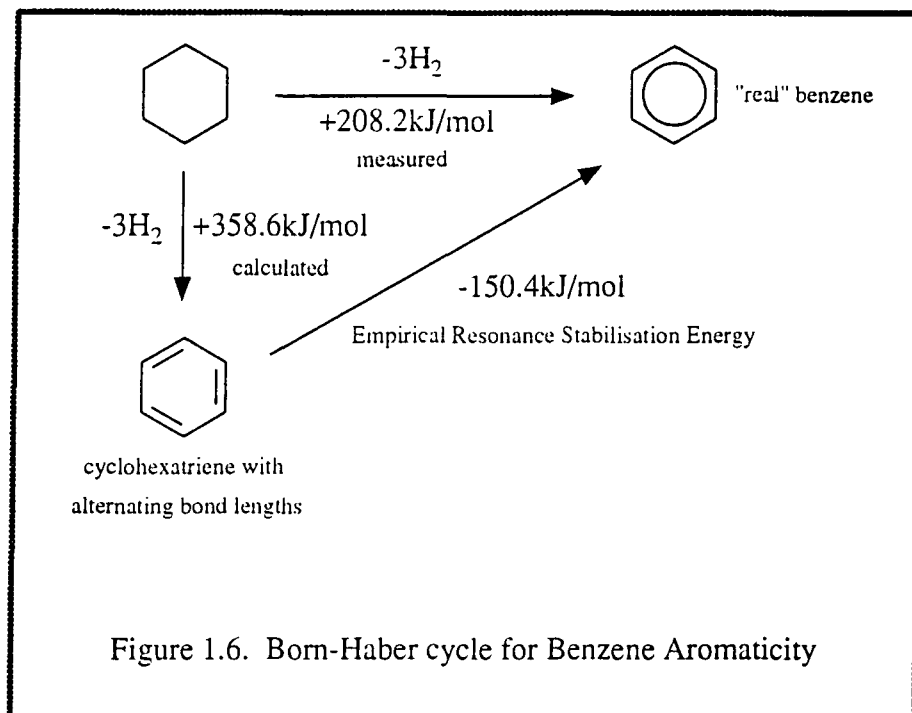

But there are other problems in the use of benzenoid precursors in a precursor polymer. The empirical resonance stabilisation energy for benzene, determined by comparison of the experimentally determined heat of hydrogenation of benzene (see figure 1.6) with values calculated from non-conjugated model compounds, is  $150\text{kJ/mol}$ <sup>[36]</sup> and the evolution of so much energy upon conversion of a precursor to finished product poses a significant hazard. If one assumes that the precursor loses a quarter to a third of its mass on conversion, then a precursor homopolymer is likely to release around  $1000\text{MJ}$  per tonne. The handling and particularly the storage of such a material poses non-trivial problems.

In a variant on the Durham route to poly(acetylene) it was observed<sup>[37]</sup> that the precursor, which decomposes to yield 1,2-di(trifluoromethyl)benzene as by-product, is capable of explosive decomposition which can be initiated by friction, see figure 1.7. From the viewpoint of safety it is thus desirable to "dilute" an aromatic precursor with oligomers of the final product, obviously at a concentration where the disordering

effects of the precursor are still sufficient to render the copolymer processable. This conclusion may also be reached from alternative considerations. Thus, one of the goals

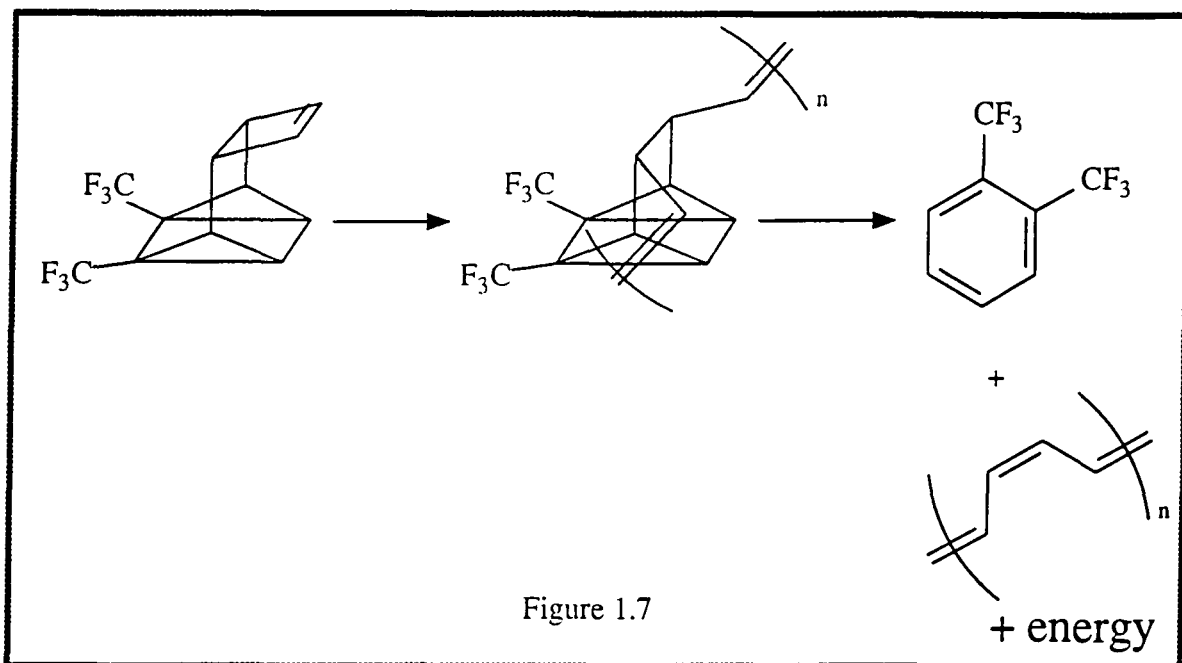

Figure 1.7

of using polymers to replace metals is the energy saving which is made in processing and fabrication, and one of the goals of using a precursor approach to a high-performance polymer is to reduce the energy expenditure in processing that polymer. If the precursor is an intrinsically high-energy material, part of the philosophy behind using polymers in general and the use of a precursor approach in particular will be negated; at 1GJ per tonne, such a solution is self-defeating. Another alternative consideration is cost. The synthesis of a polymer via a precursor is likely to be expensive, partly because the chemistry itself is expensive but also because perhaps a third of the mass of the precursor will be thrown away upon conversion. The dilution of the monomer with cheap oligomers of the finished product is therefore economically attractive, as well as being philosophically sound, environmentally sensitive and safety-conscious. However, the production of such copolymers is more of a developmental problem; the synthesis of a suitable precursor homopolymer on the gram scale is a necessary prelude to that development, and bearing the above in mind it clearly helps if the synthesis is so designed that the eliminated fragment of the

precursor can be recovered and recycled. Unless this fragment is particularly cheap and the end product commands a very high premium, e.g. the production of carbon fibre from poly(acrylonitrile) in which water and nitrogen are lost and the potential use of the end product is in aerospace applications, fulfilment of this last requirement is likely to be crucial for commercial exploitation.

The following is a review of the known techniques of the ring synthesis of benzenoid aromatics. These techniques can be arbitrarily subdivided into four classes, although the distinctions e.g. between rearrangement and elimination reactions are sometimes blurred.

The trimerisation of alkenes or alkynes forms the first class and is of limited application. The procedure normally gives 1,3,5-trisubstituted benzenes from monosubstituted substrates and hexasubstituted benzenes from disubstituted substrates, although the use of catalysts can promote the formation of 1,2,4-trisubstituted benzenes from the former. The use of asymmetrically-disubstituted alkenes or alkynes has attracted little attention and the use of mixtures does not appear to have been much studied, possibly because control of regioselectivity is a problem. Under this heading has been included the trimerisation of ketones and enamines, since there is a close structural similarity between the products of their condensation and the trimerisation products of monosubstituted alkenes or alkynes.

There are a few examples of ring synthesis of benzenoid aromatics via rearrangement reactions, but these are limited in their potential by the specificity of the synthesis, the inaccessibility of the starting material or the frequently poor yields which rearrangements provide. These form the second class.

The third class of benzene ring syntheses proceeds via addition-elimination reactions.

Those which involve polycarbonyl compounds are broadly analogous to the classical techniques of heterocyclic aromatic chemistry.

The fourth class of methods is the production of benzenoid aromatics via Diels-Alder and related electrocyclic reactions.

### 1.6.1) The Trimerisation of Alkenes or Alkynes

When used with single reactants this method is limited in application to hexa-substituted benzenes and 1,3,5- or 1,2,4- trisubstituted benzenes in which the substituents are the same. All other head-tail isomers are redundant in cyclic trimer formation. The products are

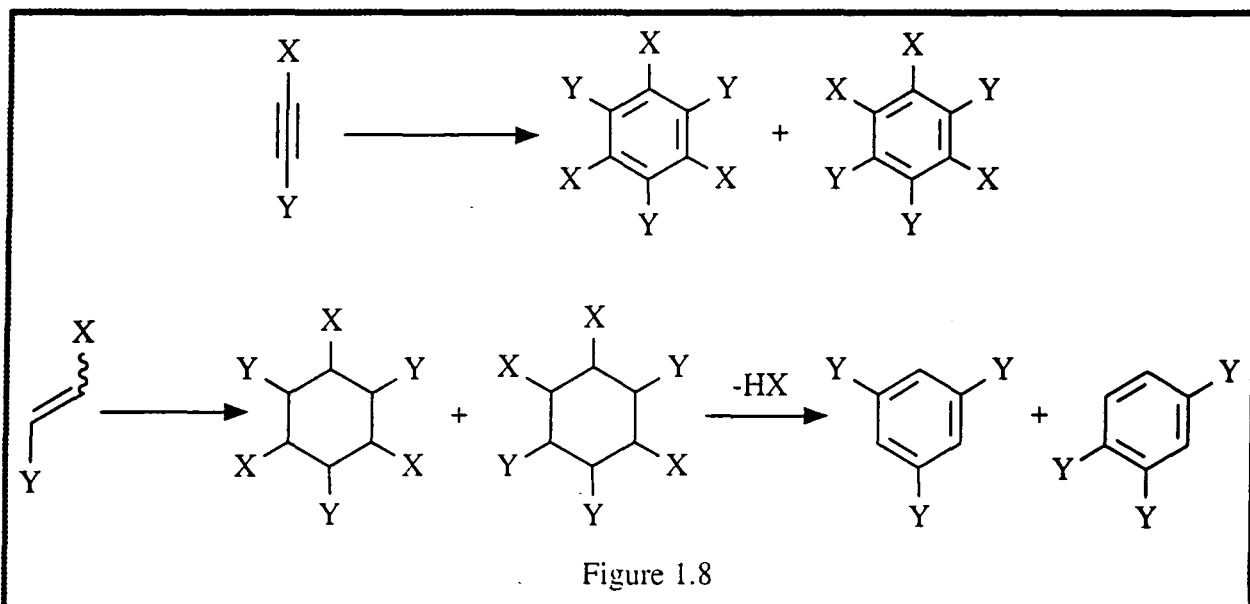

Figure 1.8

shown in figure 1.8. It appears that no work has yet been done on the trimerisation of 1,2-disubstituted alkenes or alkynes bearing different (non-hydrogen) substituents, and it may be the case that the trimerisation of these substrates will only proceed if they are also capable of being polymerised under e.g. free radical conditions. It is common experience that 1,2-disubstituted alkenes do not readily polymerise and it may be that those factors which operate to inhibit polymerisation also prevent trimerisation in

benzene ring syntheses. Thus with the exception of ketone and enamine condensations, all examples are consistent with  $X=Y$ ,  $X, Y \neq H$  or  $X \neq Y$ ,  $X=H$  in figure 1.8.

The use of mixtures is illustrated by one example due to Boekelheide and Nottke<sup>[47]</sup> which uses an alkyne together with a ketone, which reacts as the enolate, to give dimethyl 4,5-diphenylisophthalate. This synthesis might usefully be adapted to yield other 1,2,3,5-tetrasubstituted benzene derivatives, which are hard to make by other means. Kröhnke and Vogt<sup>[45]</sup> hydrolysed an enamine to yield 1,3,5-tri-(4-nitrophenyl)benzene. This may provide a general method for making 1,3,5-trisubstituted benzenes, since enamines are readily accessible.

In the trimerisation of *tert*-butylacetylene<sup>[42]</sup> the steric hindrance of the *tert*-butyl groups is overcome in an intermediate cobalt complex and this compound is efficiently converted to 1,2,4-tri-*tert*-butylbenzene. Unfortunately, the preparation of this complex in the first step of the synthesis proceeds in only 30% yield and the method does not appear to be general. The synthesis due to Schäfer<sup>[46]</sup> is particularly interesting, as it proceeds via a Dewar benzene, which itself is formed via a cyclobutadiene-aluminium chloride coordination complex. Other benzene ring syntheses have been achieved via Dewar benzene isomerisation reactions and these are included in the next subdivision, 1.6.2.





Reactant(s)	Conditions	Benzene Substitution Product, Yield %	Ref
	N,N-diethylacetamide 10mins, reflux	1,3,5-  34%	38
$F_3C-C\equiv C-CF_3$	$N_2$ , 15hrs, 1000atm	hexa- $CF_3$ , 70%	39
$Et-C\equiv C-Et$	$Et_3Al$ , $TiCl_4$ , $43^\circ C$ , 12hrs	hexa-Et, 76%	40
	$CrCl_3(THF)_3$ , $N_2$ , THF $EtMgBr$ , $-20^\circ C$ , & 3days RT	hexa-Me, 60%	41
 Bu(t)	i) $Co_2(CO)_8$ , petrol, 5hrs RT 3hrs $90-100^\circ C$ ii) $Br_2$ , $CCl_4$ , $0^\circ C$ , 1hr	1,2,4-tritertbutyl 20%	42
$MeO_2C-C\equiv C-CO_2Me$	10% Pd/C, benzene, reflux 72hrs	hexa- $CO_2Me$ 93%	43
	HCl/EtOH 30 days	1,3,5-  74%	44
	c.HBr, AcOH, 5mins	1,3,5-  70%	45
	Either: 1) $AlCl_3$ , benzene, $20-35^\circ C$ Or 2) $AlCl_3$ , benzene, reflux	1  70% 2  80-90%	46
 +2x $\equiv C-CO_2Me$	i) NaH/diglyme, 5mins $0^\circ C$ ii) 4hrs RT	 58%	47
	Pyridine, 40hrs RT, $N_2$	tri-  81%	48

Figure 1.9

### 1.6.2) Benzenoid Aromatics via Rearrangement Reactions.

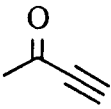
The syntheses under this heading can be split into the separate topics of ring expansions and contractions, isomerisation reactions of Dewar benzenes and group migration reactions.

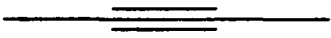
Reactant	Conditions	Product, Yield%	Ref
	KOH, EtOH, 10mins	 77%	49
	30% H <sub>2</sub> O <sub>2</sub> , 2N HCl AcOH, benzene	 84%	50
	Cyclohexane, reflux 15mins	 >90%	51
	HBF <sub>4</sub> (50%), Et <sub>2</sub> O 2 mins.	 88%	52
	Na <sub>2</sub> CO <sub>3</sub> , MeOH	 90%	53
	Bromoform, hexane KOBu <sup>t</sup> , 3hrs, -20°C N <sub>2</sub>	 32%	54
	Benzene, 16hrs, reflux dicyano- dichloroquinone	 82%	55

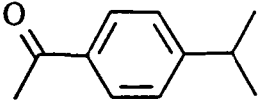
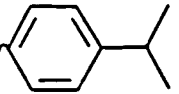
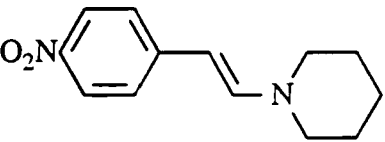
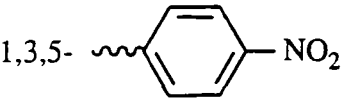
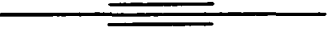
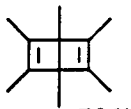
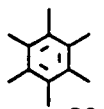
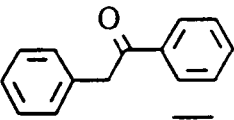
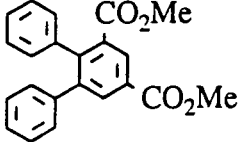
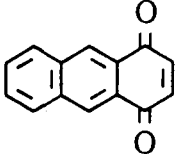
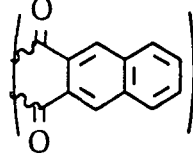
Figure 1.10

Ring expansions and contractions usually give excellent yields of substituted benzenes, but are often specific and the starting materials rather inaccessible. Thus, Doering and Knox<sup>[49]</sup> obtained *para*-phenylbenzoic acid in 77% yield from the ring contraction of 2-chloro-5-phenyltropo-2,4,6-trien-1-one. Jutz and Voithenleitner<sup>[50]</sup> oxidised *para*-tolyltropylium perchlorate with hydrogen peroxide to obtain 1-methylbiphenyl in



84% yield. The ring expansion and contraction syntheses are summarised in figure 1.10.

The isomerisation of Dewar benzenes ([2.2.0]bicyclohexa-2,5-dienes) to benzenes is readily accomplished in excellent yield. However, the yield and facility of Dewar benzene synthesis is variable, as is their thermal stability. The first synthesis was reported by van Tamelen and Pappas<sup>[56]</sup> who subsequently<sup>[57]</sup> made the parent compound. Photochemistry was used in both cases to effect symmetry-allowed disrotatory conversion of a substituted benzene or *cis*-dihydrobenzene to the Dewar benzene. The photochemical conversion of a substituted benzene to the corresponding Dewar isomer is a potentially useful method of making a monomer for precursor polymer synthesis since the starting material is likely to be cheap and the conversion of the precursor efficient, as there is no problem over access of reagents or diffusion of eliminated fragments. However, van Tamelen and Pappas pointed out<sup>[56]</sup> that the success of the photochemical reaction critically depends on the substituents. As a method of making benzene derivatives from non-benzenoid starting materials, it is clearly of limited use, but Criegee and Zanker<sup>[58]</sup> have prepared a Dewar benzene via a cyclobutadiene intermediate, see figure 1.11.

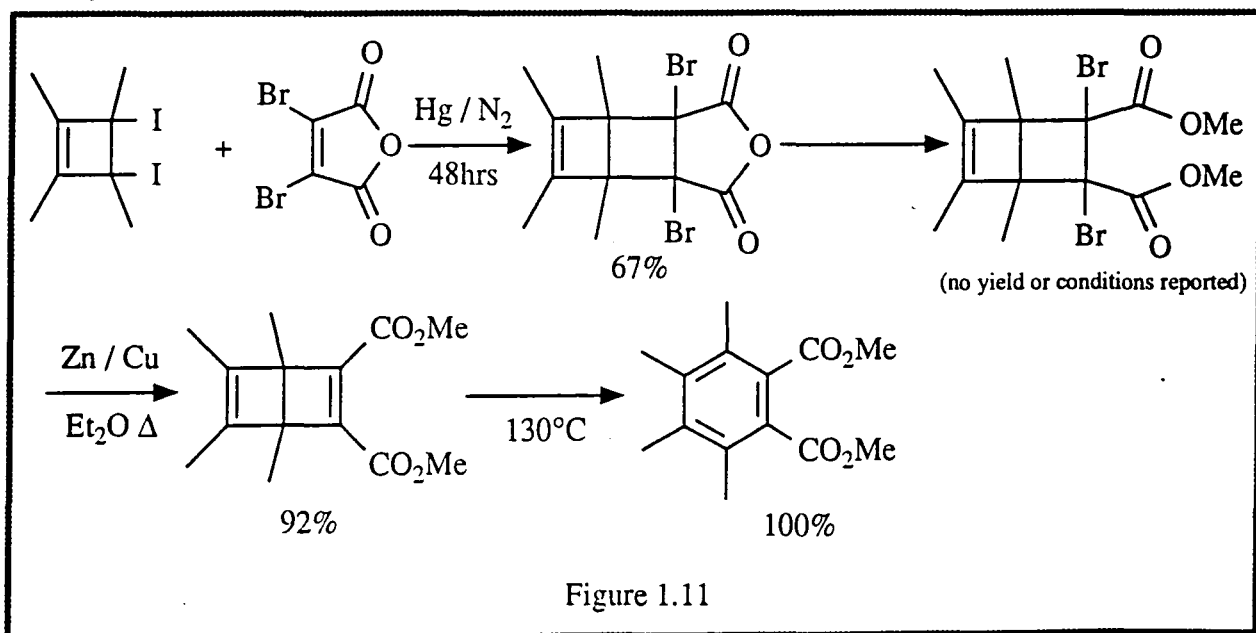

Figure 1.11

Group migration reactions are highly specific and proceed from starting materials which have little applicability to general methods of benzene ring synthesis. The yields can be good. It is of interest to note that two examples, those of Dieckmann<sup>[59]</sup> and Allen and van Allen<sup>[60]</sup> are closely related to cyclone chemistry, section 1.6.4, the former involves the dimethyl ketal of tetrachlorocyclone and the latter the Diels-Alder dimer of 2-methyl-3,4-diphenylcyclohexadiene. They are tabulated in figure 1.12.

Reactant	Conditions	Product, Yield%	Ref
	Xylene or toluene, Reflux	 75%	59
	240°C, 3hrs	 66%	60
	48% HBr/AcOH 20mins, Δ	 70%	61
	25% H <sub>2</sub> SO <sub>4</sub> 3hrs, 100°C	 72%	62
	NaOH aq., Δ	 88%	63

Figure 1.12

### 1.6.3) Ring Synthesis via Addition-Elimination

The synthesis of the benzene ring by means of the condensation reactions of polycarbonyl compounds, or by the co-condensation of reagents such as nitriles with aldehydes, are closely analogous to the classical techniques of heterocyclic synthesis. Some ring syntheses occur by the substitution of carbon for a heteroatom in heterocyclic aromatics, whilst there are a few examples which are so obscure as to defy being placed in a niche and these must be considered separately.

**1.6.3a** Condensation reactions of carbonyl compounds can provide a variety of substituted benzenes, but the syntheses often have only moderate overall yield. These reactions are tabulated in figures 1.13a and 1.13b. There is considerable variation in the number and type of substituents and their placement on the ring.

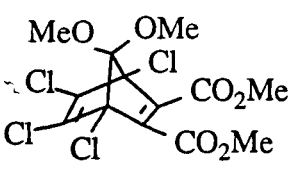
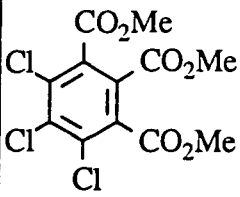
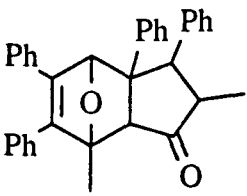
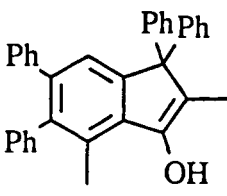
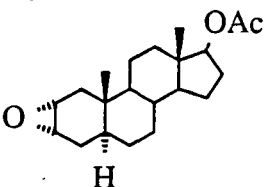
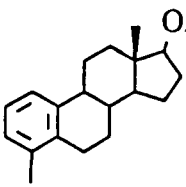
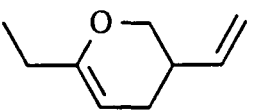
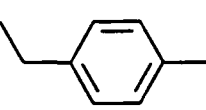
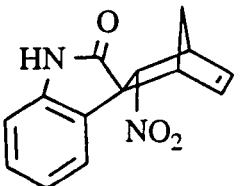
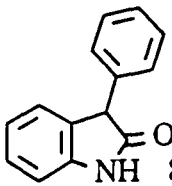
Reactant(s)	Conditions	Product, Yield%	Ref
	i) NaOEt, EtOH ii) c. HCl iii) Br <sub>2</sub> , AcOH iv) H <sub>2</sub> /Pd v) NaOH/Δ vi) HCl/Δ	 29%	64
	i) 2 weeks 75°C ii) c. H <sub>2</sub> SO <sub>4</sub> , 40°C 30 mins	 60-70%	65
	Dry piperidine, 3.5hrs, Δ	 65%	66
	i) 48 hrs ii) KOH aq.	 76%	67
	96-100% HF Δ 100°C, 3hrs	 42%	68
	K <sub>2</sub> CO <sub>3</sub> , benzene, 4hrs. Δ	 85%	69

Figure 1.13a

Reactant(s)	Conditions	Product, Yield%	Ref
	i) 5hrs 0.1N HCl ii) 2 weeks	 56%	70
	2M KOH, 5hrs RT	 56%	71
1  OR 2 	$(\text{MeO})_2\text{CHNMe}_2$ 150-200°C, $\text{N}_2$	1  90% $\text{CONMe}_2$ 2  57% $\text{OMe}$ $\text{CONMe}_2$	72
	$\text{SnCl}_4$ , 0°C, 10-20mins	 51%	73
	i) tr. Morpholine, MeOH, 24hrs, RT ii) Subl. 190°C, @ 1mm Hg	 63%	74
	EtOH, 0.18M NaOEt Ar, RT 1hr	 80%	75

Figure 1.13b

**1.6.3b** The replacement of heteroatoms in ring systems has limited application, the starting materials can be hard to make in quantity, but the yields are generally good. Examples of this methodology are presented in figure 1.14.

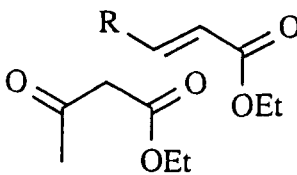
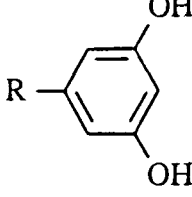
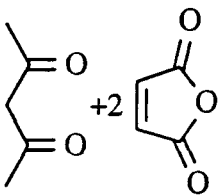
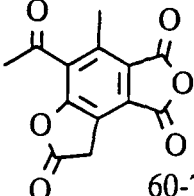
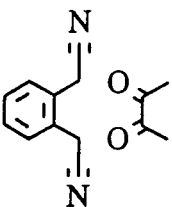
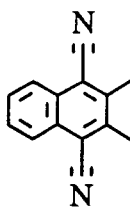
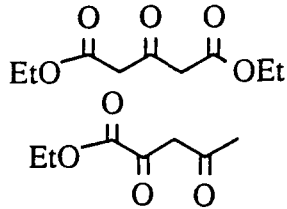
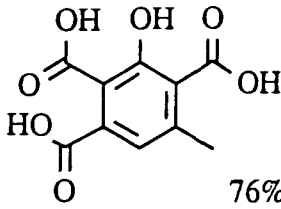
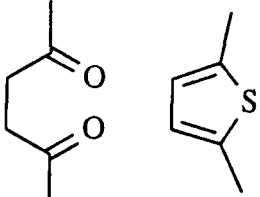
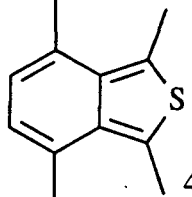
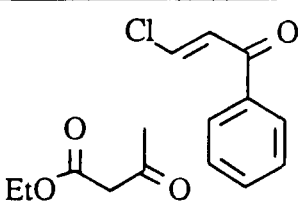
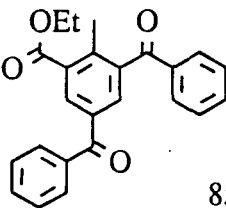
Reactant(s)	Conditions	Product, Yield%	Ref
	KOBu <sup>t</sup> , Δ, 45mins	 85%	76
	2 BrMg- <i>p</i> -PhOMe	 63%	77
	Ph <sub>3</sub> P <sup>+</sup> -CH <sub>2</sub> <sup>-</sup> , 30mins, Δ	 59%	78
	CH <sub>2</sub> (CN) <sub>2</sub> , EtOH, 1hr, ( <sup>i</sup> Pr) <sub>2</sub> EtN, Δ	 72%	79
	DMSO, N <sub>2</sub> , NaH, 4hrs 70°C	 86%	80

Figure 1.14

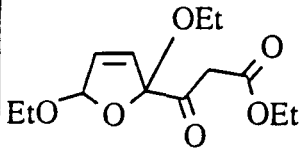
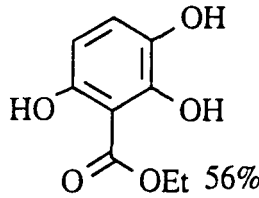
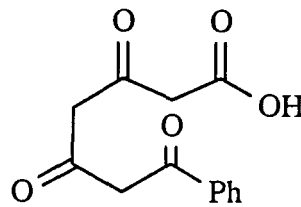
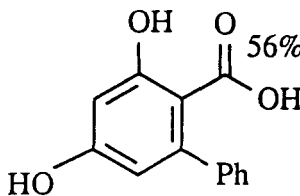
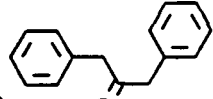
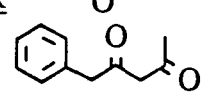
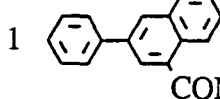
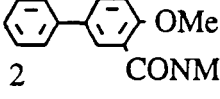
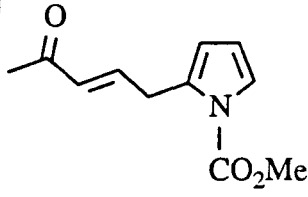
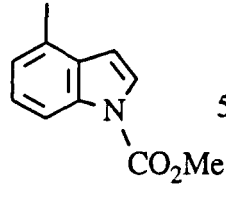
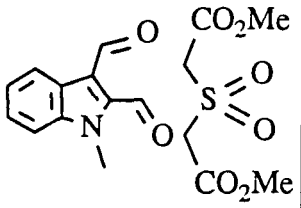
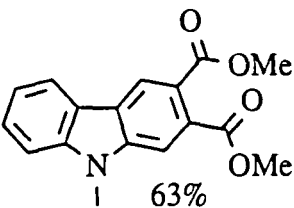
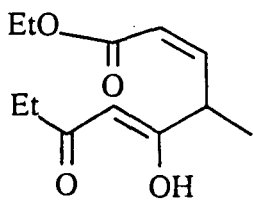
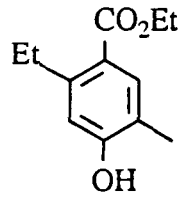
1.6.3c There remain a few examples of benzene ring synthesis which defy ready categorisation. The synthesis due to Eberbach and Carré<sup>[81]</sup> proceeds via the ring-opening of an epoxide and subsequent elimination of water, to give dimethyl terephthalate in 80% yield:



Hashem<sup>[82]</sup> produced a benzofuran via intramolecular Friedel-Crafts reaction in 73% yield:

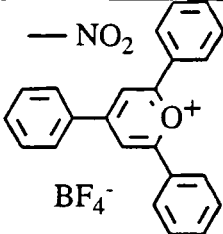
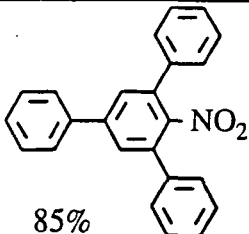
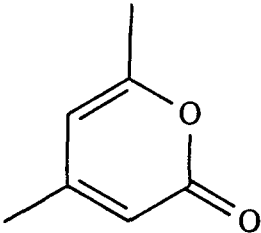
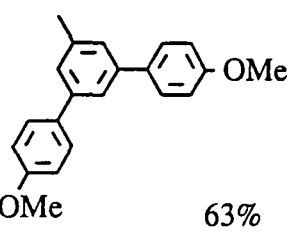
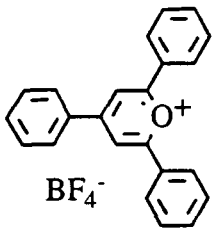
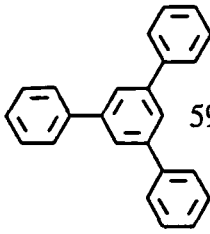
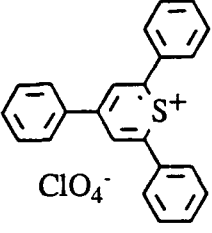
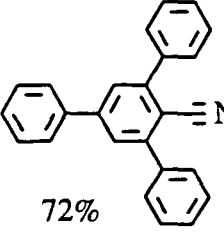
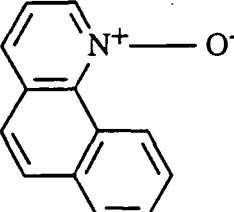
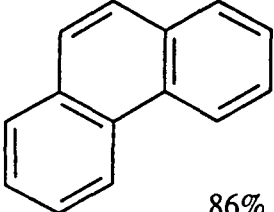
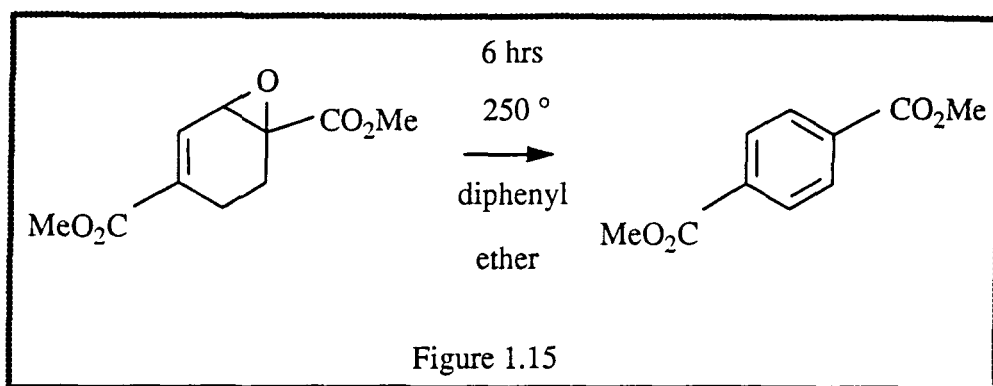
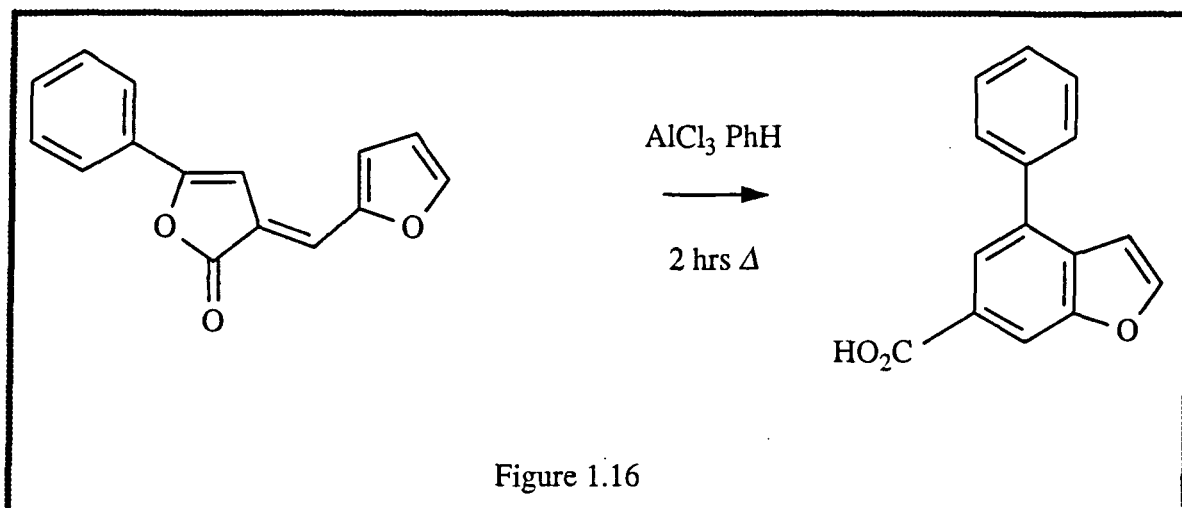

whilst Blechert *et al*<sup>[83]</sup> performed the following aromatic annulation in 37% overall yield:

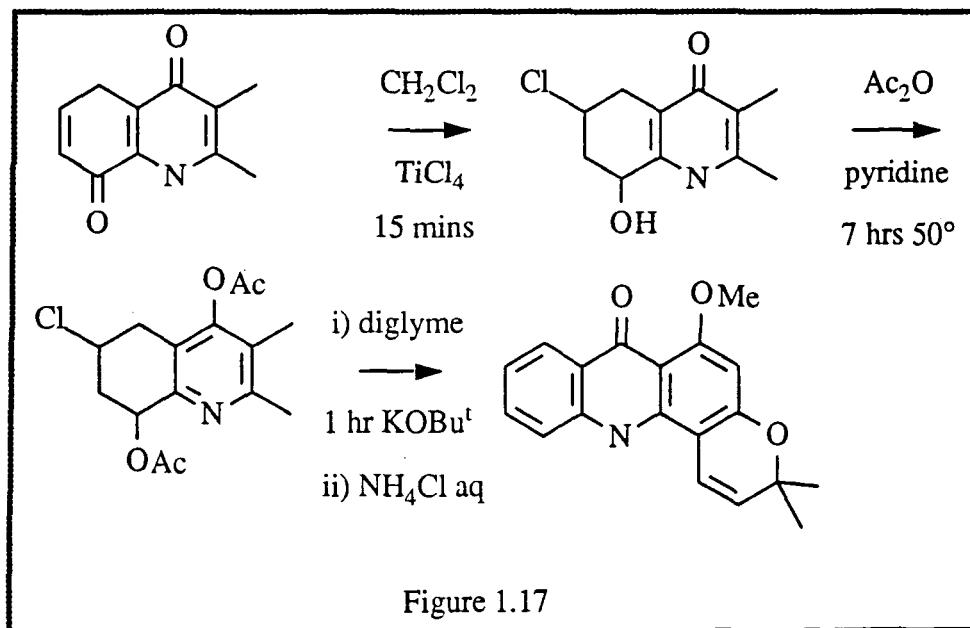

**1.6.4** Diels-Alder and ene-type electrocyclic reactions are quite productive sources of benzenoid rings. Frequently, an oxidant or dehydrogenation catalyst must be used to effect aromatisation of the initially-formed adduct. An alternative approach is to provide substituents on the reactants which are reasonable leaving groups and which can be eliminated to give the aromatic product. If their Diels-Alder adducts are moderately stable, i.e. if the leaving groups are particularly poor, then these are likely candidates for aromatic precursor molecules. The examples include the Diels-Alder reactions of cyclopentadienones ("cyclones") the adducts of which lose carbon monoxide, often spontaneously, to yield benzene derivatives, figure 1.18. Cyclones are highly reactive molecules which readily undergo Diels-Alder dimerisation. Only the sterically-stabilised analogues can be obtained as monomers and this limits their potential usefulness. All the examples found use tetraphenyl-substituted cyclone and thus produce derivatives of 1,2,3,4-tetraphenylbenzene.

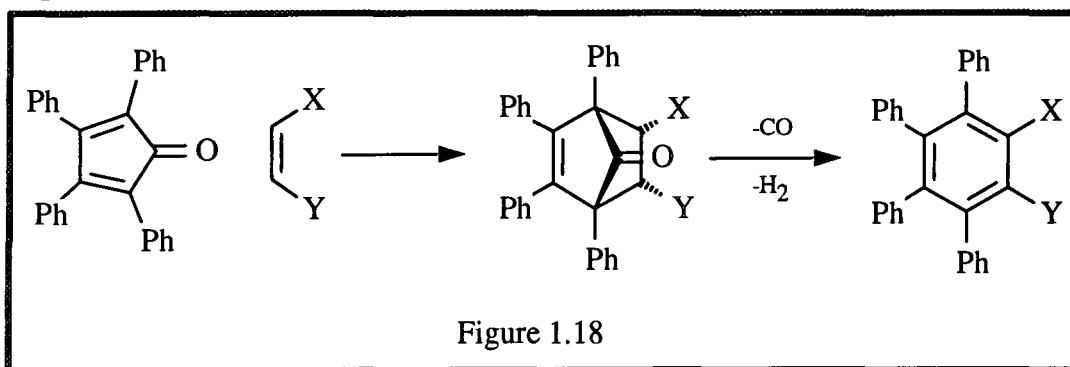

Figure 1.18

The reactions illustrated in figure 1.19 are in accordance with the reaction scheme shown in figure 1.18. The utility of this method of ring synthesis is clearly limited, but the reaction yields are generally good. Methods which use the Diels-Alder reaction, the ene reaction or the corresponding *retro*- reactions appear in figures 1.20a-1.20d.



Reactant	Conditions	Product, Yield %	Ref
	8hrs, 170-80°C	 73%	84
	PhBr, 3.5hrs, reflux Reflux intermediate 3hrs	 87%	85
	Pd/C 5% <i>p</i> -cymol 8.5hrs, reflux	 80%	86
	PhBr, 6-10hrs, reflux	 76%	87
	PhBr, 8hrs, 156°C	 62%	88
	Xylene, 15hrs, reflux	 87%	89
	PhNO <sub>2</sub> , 12hrs, reflux	 90-95%	90
	Xylene, 10-12hrs, reflux	 50-60%	91

Figure 1.19

Reactant(s)	Conditions	Product, Yield%	Ref
	Chloranil	 100%	92
	N <sub>2</sub> , 480°C	 83%	93
	i) EtO <sub>2</sub> C≡CO <sub>2</sub> Et O-dichlorobenzene, 3hrs, Δ ii) EtOH/KOH, 2hrs, Δ iii) Na <sub>2</sub> CO <sub>3</sub> , K <sub>3</sub> Fe(CN) <sub>6</sub>	 52%	94
	16-18hrs, 300°C, picric acid, hydroquinone	 55%	95
	i) 1,3-Diene ii) P <sub>2</sub> O <sub>5</sub> , 200-300°C	 72%	96
	i)  ii) c. HCl, Ac <sub>2</sub> O	 75%	97
	Reflux, benzene	 75%	98

Figure 1.20a

Reactant(s)	Conditions	Product, Yield%	Ref
	10% Pd/C, 15mins, 180°C	 96%	99
	i) Diglyme, N <sub>2</sub> , 200°C 20 hrs. ii) EtOH/KOH/N <sub>2</sub> 12hrs, Δ	 49%	100
	Reflux, di- <sup>n</sup> butylether hydroquinone, 12hrs.	 55%	101
	Pd(OAc) <sub>2</sub> , NaOAc, AcOH, 85°C	 75%	102
	4hrs, 70-75°C, NaH, DMSO	 87%	103
	<i>p</i> -TsOH, Δ 54hrs	 80%	104
	Cyclohexane, I <sub>2</sub> , N <sub>2</sub> 4hrs., 16x 75W, 253nm X=I,H	 80-90%	105

Figure 1.20b

Reactant(s)	Conditions	Product, Yield%	Ref
	60hrs, N <sub>2</sub> , Δ	 70%	106
	Dimethylfumarate, 6hrs, 170°C	 70%	107
	POCl <sub>3</sub> , Δ, pyridine, 10 mins	 74%	108
	1) 375°C, 6secs OR 2) 280°C, @20mmHg	 100%	109
	Benzene, <i>p</i> -TsOH, reflux, 20mins.	 84%	110
	6hrs, reflux, xylene	 50%	111
	16hrs, CHCl <sub>3</sub> , RT	 94%	112

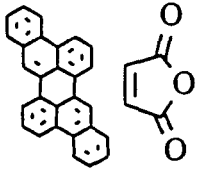
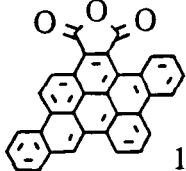
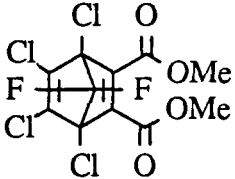
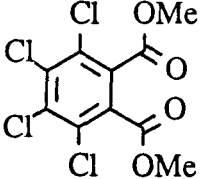
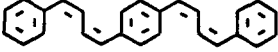
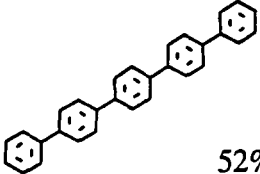
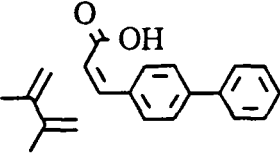
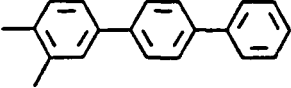
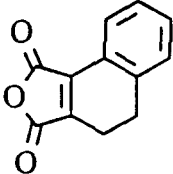
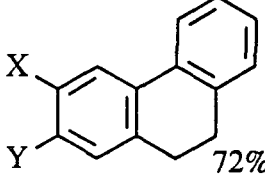
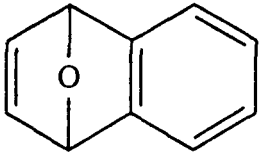
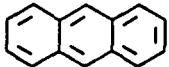
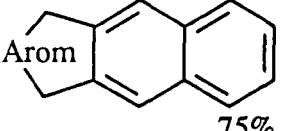
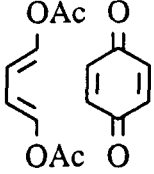
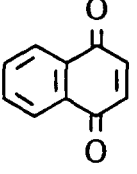
Figure 1.20c

Reactant(s)	Conditions	Product, Yield%	Ref
	i) Toluene, 25°C, 5hrs ii) Silica gel, 2hrs, 60°	 89%	113
	i) Not recorded ii) BF <sub>3</sub> .Et <sub>2</sub> O	 not quoted	114
	100°C, 1-2hrs, CDCl <sub>3</sub> CF <sub>3</sub> CO <sub>2</sub> H	 95%	115
	PhBr, 3hrs, reflux	 79%	116
	Benzene, 160°C	 84%	117

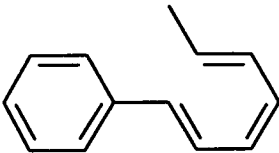
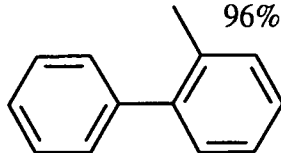
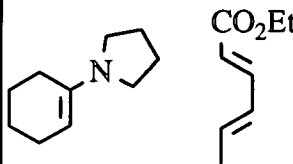
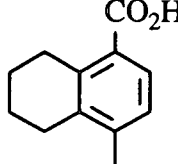
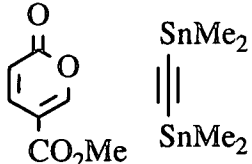
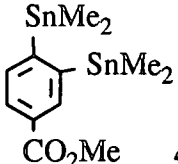
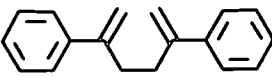
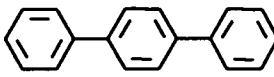
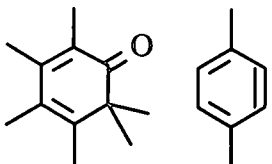
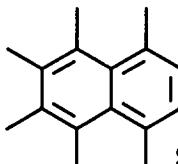
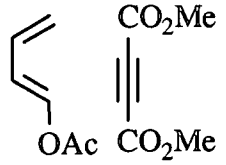
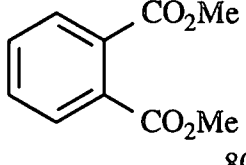
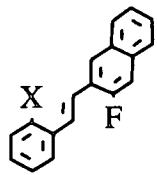
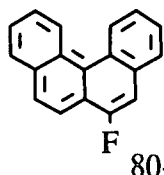
Figure 1.20d

### Summary of Ring Synthesis Methods

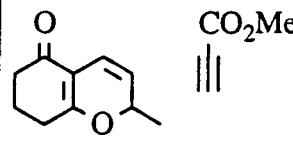
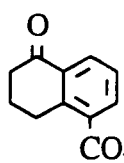
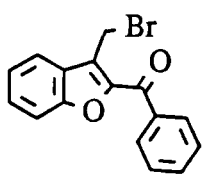
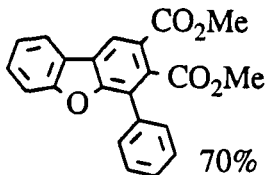
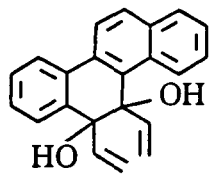
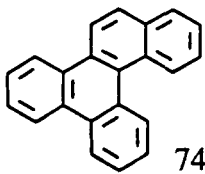
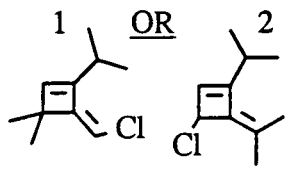
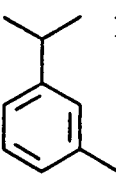
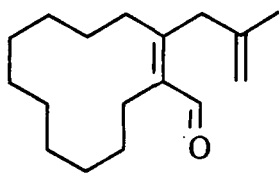
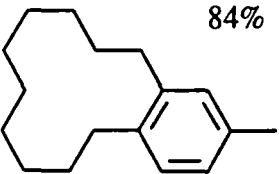
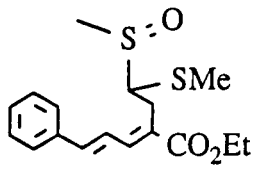
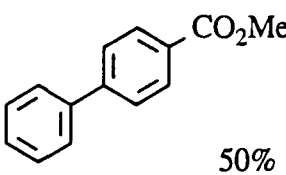
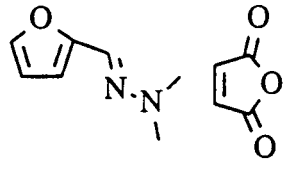
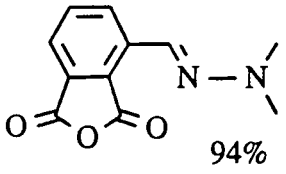
This survey of the methods of benzene ring synthesis makes no claim of completeness. The indexing of this area of work makes it virtually certain that other examples, which should have appeared, have been missed. More would have been omitted without *Theilheimer's Synthetic Methods*<sup>[118]</sup> which proved to be a facile point of entry to the literature on benzenoid ring syntheses. It is clear, however, that although many methods have been discovered, nobody has yet directed their research towards producing a general synthetic route which would readily lend itself to the production of aromatic polymers via precursor molecules, and that the existing techniques fail to satisfy the

necessary criteria for success. The nearest approaches come, perhaps not surprisingly, from polymer chemists. The ICI route to poly(*para*-phenylene), which was discussed in section 1.2, evidently fulfils the necessary requirements for commercial applicability, but lacks the versatility to be adapted to other aromatic systems. The Durham route to poly(acetylene), mentioned in section 1.6, allows convenient manipulation of this intractable material, but the chemistry is expensive and not adaptable to the general precursor synthesis of aromatic polymers. So far, the needs of precursor routes to various polymers have been met by specific solutions, and it remains to be seen whether a general route is practicable.

#### 1.7) Protecting Group Precursors.

The final possibility for a precursor route is to make use of the widely-available literature on protecting group synthesis and removal. This is obviously only possible if the polymer bears functional groups which can be easily reacted with suitable reagents. For most high-performance polymers this is unfortunately not the case, as functional groups are capable, by definition, of undergoing chemical reactions and it is the absence of these which is responsible for the solvent, acid and base tolerance and high thermal and oxidative stability of the desired polymer. The replacement of substituents on the aromatic ring, section 1.4, is really a special case of protecting group removal in which the protected group is hydrogen. This must be one of the most difficult "functional groups" to devise "protection" for. If there was a general route for solving this problem, compatible with the heterogeneous conditions of precursor conversion, it would provide another possibility for an all-embracing precursor synthesis.

## Chapter 2

### Some Initial Investigations into Possible Precursor Routes

#### Synthetic Approaches

The target polymer, poly(*para*-hydroxybenzoic acid), poly(HBA), figure 2.1, can be disassembled in a number of ways. These ways derive from two fundamental considerations, as discussed in chapter 1, namely:

- synthesis of the carbonyl group e.g. via a masking functionality, and
- synthesis of the benzene ring itself.

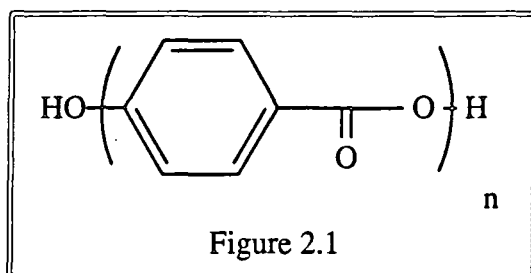

#### a) Carbonyl Synthons

Under (a) above might be grouped such approaches typified by the structure shown in figure 2.2.

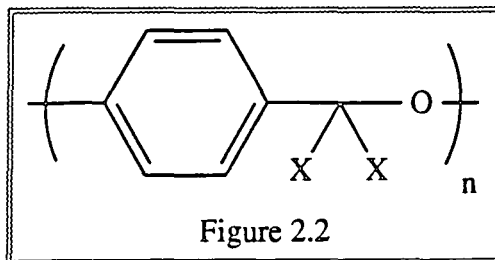

Structure 2.2 contains the masked carbonyl function CX<sub>2</sub> where X could be OMe, i.e. a

ketal, or halogen e.g. Cl, either of which would readily hydrolyse to give a carbonyl. There are some potential problems. If X is methoxy, then the structure as shown is a poly(orthoester) and the backbone link could hydrolyse at a rate comparable with that for the pendant methoxy groups, i.e. degradation of the polymer chain resulting in oligomer formation. If X is chlorine then the structure of 2.2 is that of an  $\alpha,\alpha$ -dichloroether. Assuming that the synthesis of 2.2 with X=Cl could be achieved, the precursor polymer so formed might be processable. The reason for the high melting point of poly(HBA) is the dipolar interaction of the carbonyl groups with one another and the poor flexibility of the polymer chain. If the carbonyl groups were replaced by dichloromethyl ethers, one would expect that the melting point would be reduced and it is also probable that the solubility would be increased.  $\alpha,\alpha$ -Dihaloethers are known compounds, e.g.  $\alpha,\alpha$ -dichloromethyl methyl ether, which is a potent carcinogen. An  $\alpha,\alpha$ -dichloroether must occur as an intermediate in the first step of the synthesis of orthoesters<sup>[119]</sup> from chloroform, figure 2.3.

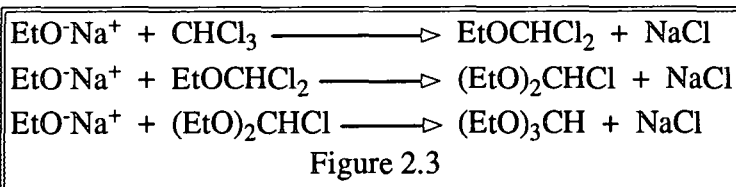

$\alpha,\alpha$ -Dichloro ethers are thus likely to be susceptible to attack by hydroxide ion, which is the desired reaction for the precursor polymer to undergo in order for conversion to poly(HBA) to occur. They might also be acid-labile.

## b) Ring Syntheses

The problems surrounding the concept of a precursor approach via benzene ring synthesis have been discussed in depth in chapter 1. Two potential routes were investigated in this work; both necessitated changing the target molecule in order to use the available chemistry.



## Initial Synthetic Efforts

### a) Via a Carbonyl Precursor.

The initial route investigated was based on a carbonyl synthon and the starting material chosen was *p*-hydroxybenzaldehyde. It was acetylated under standard Schotten-Baumann conditions<sup>[120]</sup> and the ester-aldehyde was subsequently converted into the acetal by the method of Claisen, using triethyl orthoformate in anhydrous ethanol under mild acid catalysis<sup>[121]</sup> in the cold, figure 2.4.

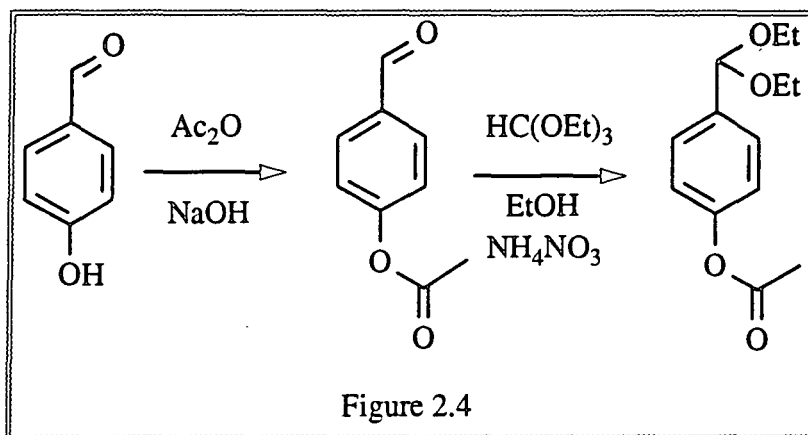

Initial attempts to prepare the acetal without first masking the hydroxy-group produced tar, possibly low molecular weight poly(acetals). As a matter of record, the standard Dean and Stark procedure for preparing a glycol acetal also failed, even with the ester-aldehyde, and this is attributed to transesterification to give back the phenolic hydroxy-group with subsequent tar formation as before.

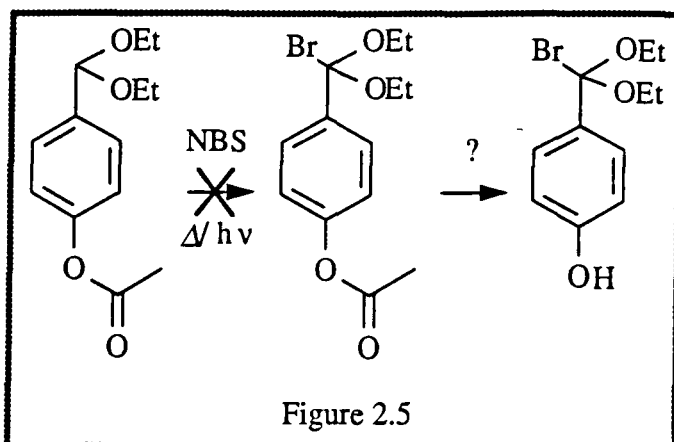
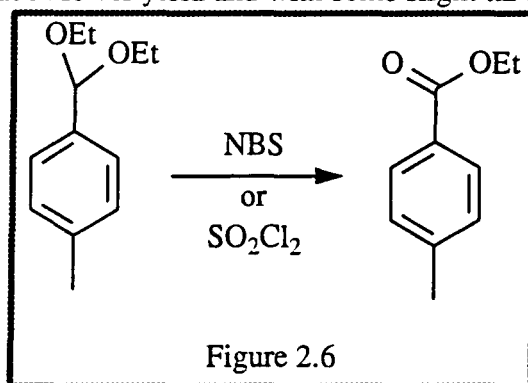
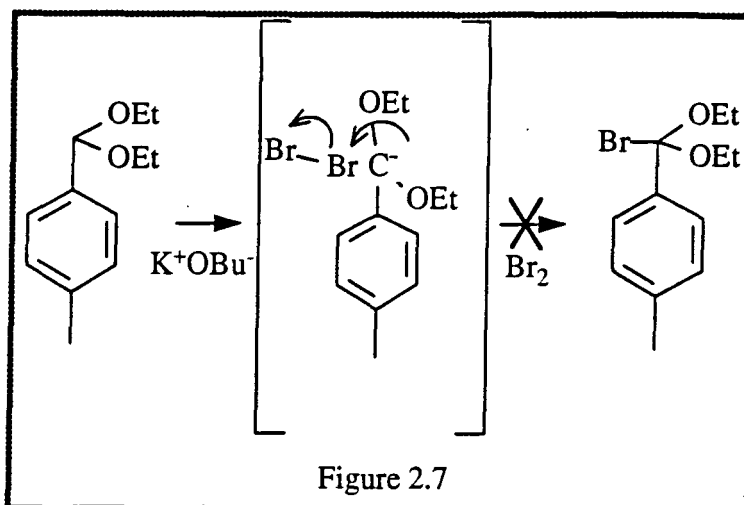

Figure 2.5 depicts the intended synthetic sequence. However, in a model study using tolualdehyde acetal, treatment with NBS in dry carbon tetrachloride, with heating or illumination, did not give the bromoacetal. The reaction gave instead the ester, as shown in scheme 2.6, and this was subsequently found to be a known reaction<sup>[122]</sup>. Treatment of the acetal with sulphuryl chloride and a trace of benzoyl peroxide gave the ester once again, but in lower yield and with some slight tar formation.



One further attempt was made to prepare a haloacetal. It was felt that the oxidation of acetal to ester was in part due to the fact that both reactions tried involve radical intermediates. Thus, in figure 2.7, the model compound tolualdehyde diethyl acetal was treated first with potassium *sec*-butoxide in *sec*-butanol to hopefully generate the benzylic anion, and then neat bromine was added by syringe. It is unclear what the reaction products were, but the bromoacetal was certainly not obtained. The alkoxide in the presence of bromine probably gave a hypobromite and subsequent complex chemistry.



b) Via Benzene Ring Synthesis.

As there were no directly-suitable ring synthesis routes, the target molecule was changed to suit the available chemistry.

The initial model compound investigated was the adduct between furan and maleic anhydride which was converted to the half ester. It was hoped that this could be decarboxylated to the benzoate ester, as such derivatives have been aromatised (see chapter 1) but treatment with acids<sup>[123]</sup> caused tar formation, whilst heating above 60°C produced only the retro Diels-Alder reaction (figure 2.8.) From this latter observation it seemed unlikely to be stable enough for precursor polymer synthesis, even if the decarboxylation could be made to go, since the transesterification of a suitably-substituted derivative of 1, figure 2.8, required to form polymer, would occur at around 200°C. Had this route looked promising, a precursor might have been devised either via a "bis"furan such as furoin, or via the Alder-Rickert<sup>[124]</sup> sequence shown in figure 2.9.

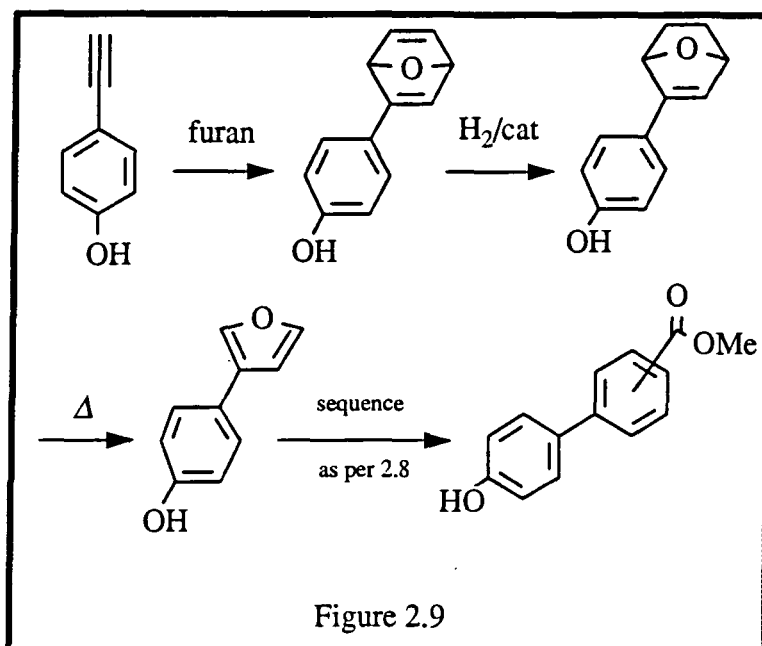
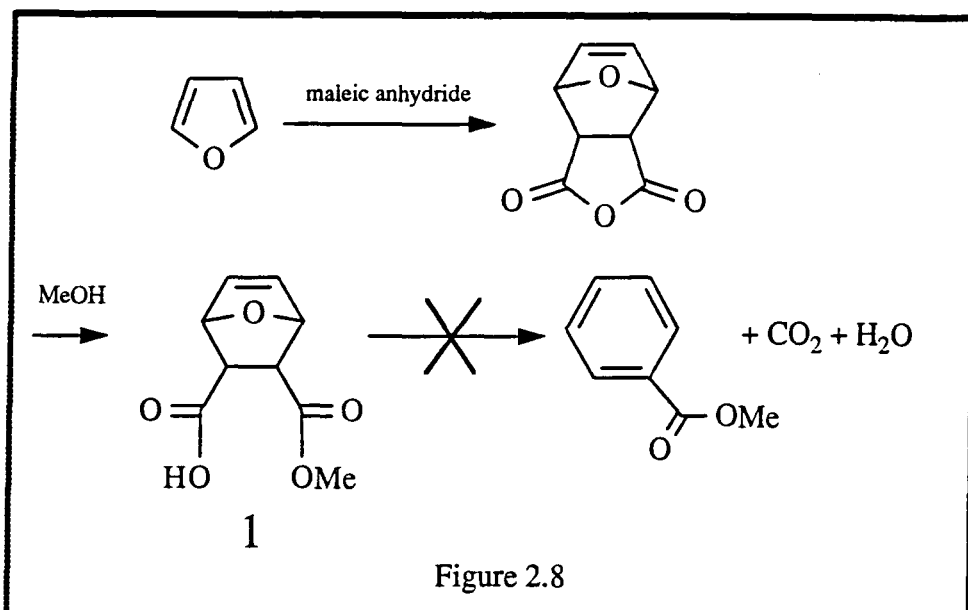

Another method of making the benzene ring was developed by Paquette *et al*<sup>[125]</sup> and uses the Diels-Alder reaction of phenyl vinyl sulphoxide with a diene, e.g. diphenylbutadiene (figure 2.10) under forcing conditions in which the postulated intermediate is not seen. It was thought that by conducting the reaction under less drastic conditions, the intermediate might be intercepted and serve as the precursor. However, attempts to conduct the reaction in refluxing carbon tetrachloride (48hrs), toluene (48hrs) or chlorobenzene (4 days) all resulted in recovery of starting material. It

thus seems likely that for this reaction sequence, the activation energy of the elimination step is lower than that of the cycloaddition, and the required intermediate cannot be isolated.

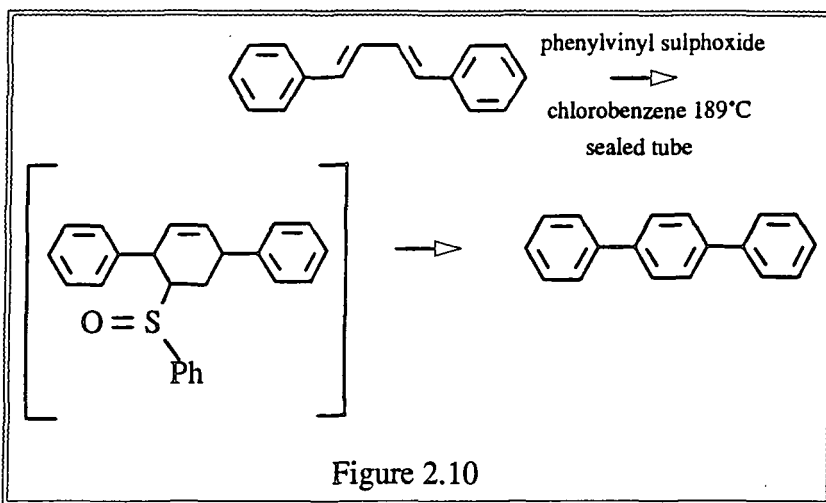

The use of cyclopentadienones ("cyclones") as Diels-Alder dienes to give benzene derivatives is also well known in the literature, see chapter 1 section 1.6.4.

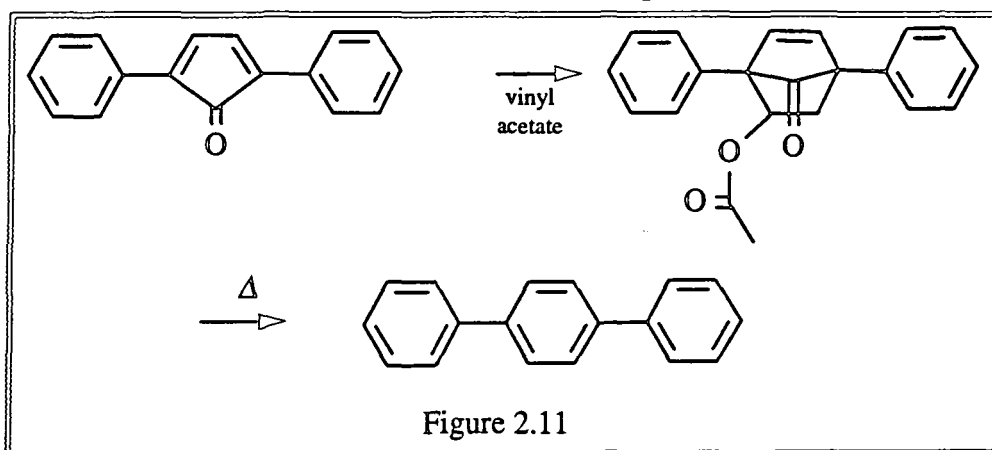

Reaction with e.g. vinyl acetate might give a useful precursor, and this route was explored (figure 2.11) up to the point of attempting to synthesize dibenzyl ketone via Grignard reaction (figure 2.12) when difficulties became apparent.

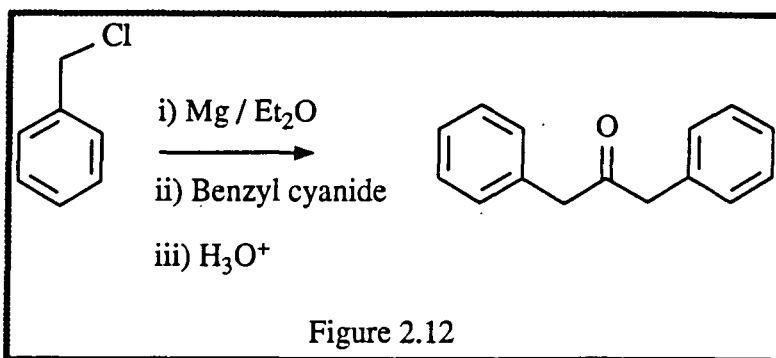

If the benzylic cyanide and the benzylic halide contained protected hydroxyl- and protected carboxyl- groups in the *para*- positions, the resulting asymmetric dibenzyl ketone could be incorporated into a polyester, perhaps as a copolymer with *para*-hydroxybenzoic acid, which would be more economical with the precursor fragment. It was envisaged that the dibenzyl ketone could then be reacted with glyoxal or a masked form of glyoxal in a simple condensation synthesis of the cyclone (figure 2.13.)

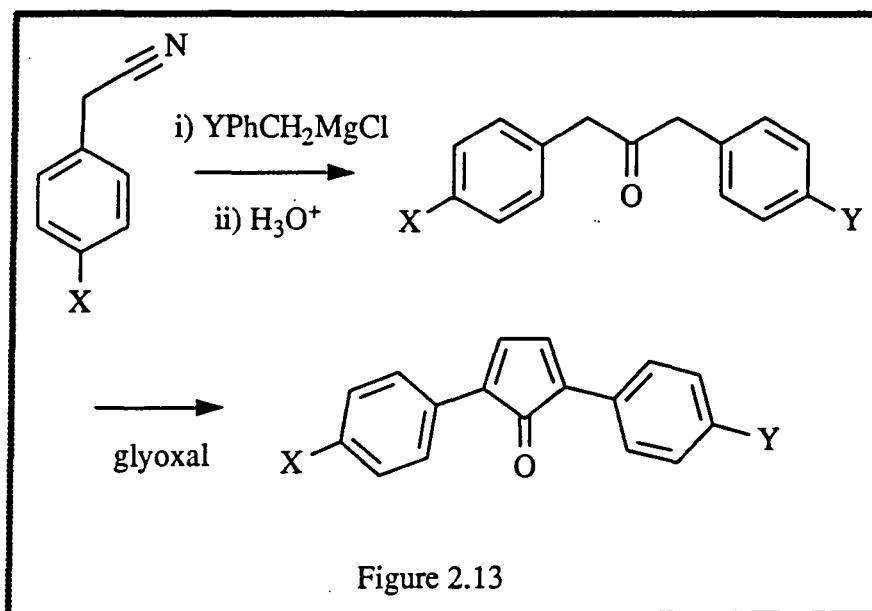

Two problems surfaced with this approach. The first came with the synthesis of the dibenzyl ketone (dibenzyl ketone itself was synthesized as a model study.) Whilst the author is well aware of the problems which frequently manifest themselves with the use of benzylic Grignard reagents the degree of Wurtz-type self-coupling between Grignard and unreacted benzyl chloride was surprisingly large and typically the bis(benzyl) coupling product constituted fifty percent of the isolated material. Additionally, other

unidentified by-products were significant components of the reaction, including, it is thought, an isonitrile, 'identified' by its nauseating stench. The yield of ketone was never above 40%. Thus it became clear that provision of suitable 4,4'-disubstituted dibenzyl ketones might be a problem.

At this juncture, it was decided to investigate the synthesis of the cyclone from commercial dibenzyl ketone in order to save a little time. Here the other problem first appeared. Glyoxal is cheap and readily available as aqueous solution, but rapidly polymerizes in the presence of bases, e.g. catalysts for the aldol condensation. It had been noticed in a literature survey through Chem. Abs. that the desired cyclone has not been studied to the same extent as other, more substituted cyclones. According to that search, the only Chem. Abs. reference to this compound was in regard to its *postulated* production in the pyrolysis of an iron organometallic complex<sup>[126]</sup>. Whilst there are a number of good synthetic papers on 2,3,4,5-tetrasubstituted-2,4-cyclo-pentadien-1-ones in the literature<sup>[127]</sup> there is an absence of synthetic information regarding the production of 2,5-disubstituted cyclones. It was decided to press ahead with a speculative synthesis, as indicated in scheme 2.14.

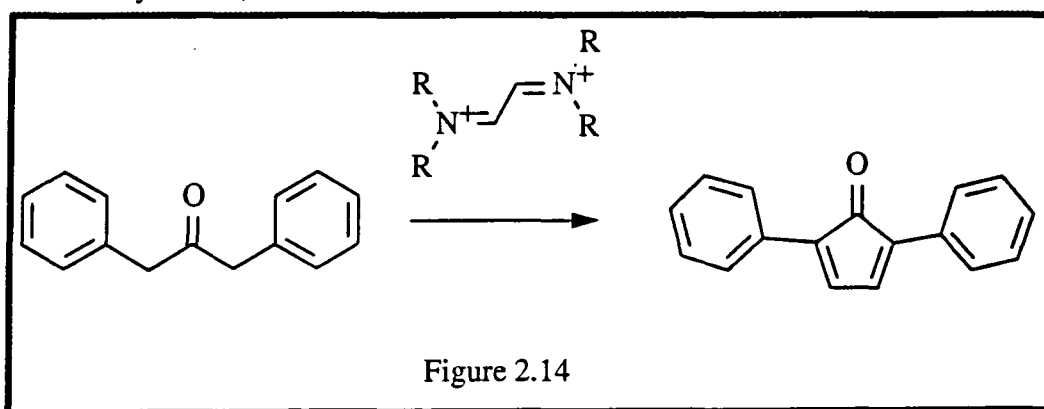

The interesting part of this speculative synthesis is the provision of the masked form of glyoxal, i.e. the iminium salt. Iminium salts are known intermediates in the Mannich reaction (another possibility for synthesis of the cyclone) and the simplest compound of this type, Eschenmoser's salt  $\text{H}_2\text{C}=\text{N}^+\text{Me}_2 \text{I}^-$  has been used in a number of syntheses. The author was given a very simple and attractive method<sup>[128]</sup> for the preparation of the

cognate chloride (the synthesis of Eschenmoser's salt itself is tedious and difficult in the author's experience) which suggested a method for preparing the *bisiminium* salt as in 2.14. The method of synthesizing the Eschenmoser chloride salt is shown in scheme 2.15.

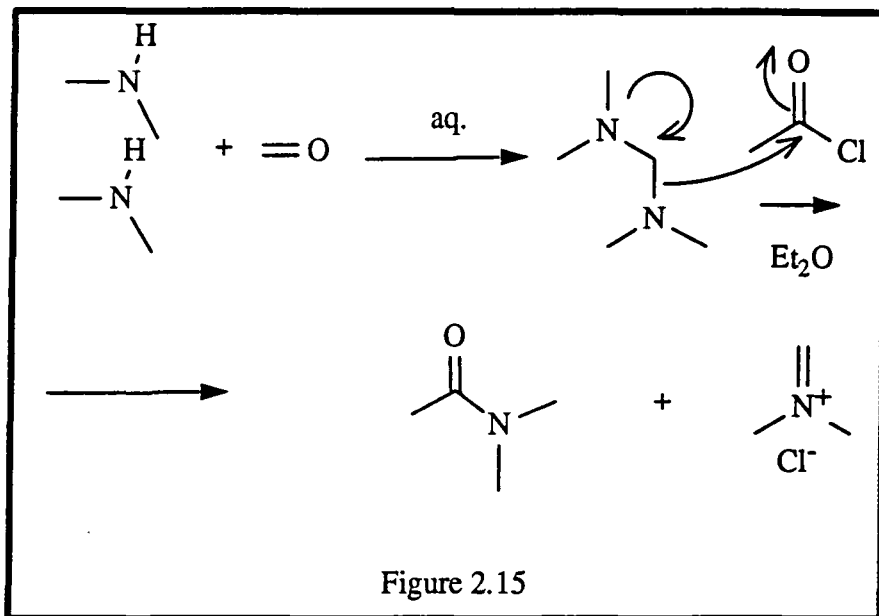

It was felt that this approach might usefully be extended by replacing formaldehyde with glyoxal. However, simply repeating the reaction using dimethylamine would not be satisfactory. The literature suggested that stable *tetrakis* amine adducts of glyoxal could only be formed with a few hindered amines, such as morpholine. Whilst other amines react with glyoxal, the tetrasubstituted ethane formed immediately eliminates amine to give trisubstituted ethylene derivatives. Accordingly, a preparation of 1,1,2,2-tetramorpholinoethane<sup>[129]</sup> was pursued with success, the desired compound being isolated in excellent yield. However, upon treatment with acetyl chloride in tetrahydrofuran (the tetramorpholinoethane is only sparingly soluble in ether) a deep purple precipitate appeared which proved difficult to characterize. It was shown by elemental analysis that it was not the desired salt.

The conclusions drawn from this initial work are as follows.

- 1) Acetals cannot be halogenated using reagents which generate radicals or



which are likely to produce acids.

- 2) The limited benzene ring synthesis chemistry explored is not satisfactory for a precursor route.

These preliminary investigations had occupied six months and appeared to be leading nowhere. However, the first attempts to hydrolyse the acetoxy- group of *para*-acetoxybenzaldehyde diethyl acetal had produced an unusual result which was followed up as indicated in chapter 3.

### Chapter 3. Potential Routes to Poly(*para*-hydroxybenzoic acid) via Quinone Methides

The initial investigations which occupied the first six months of this project had shown that a benzene ring synthesis was poorly supported by the literature (see chapter 1) and that those syntheses which were known, were limited in their scope by the necessity to have various substituents on the benzene ring and in specific positions. Having examined these methods, it was becoming clear that this approach was unlikely to be of service, given the facts that oxygen has to be attached *para* to the carboxylic acid function *and* without other substituents on the ring. For other systems, more encouraging results might have been produced, but after much pushing of curly arrows and combing of the literature, it was reluctantly conceded that the very specific requirements of the precursor made the approach via generation of a benzene ring unlikely to succeed. Attempts to change the target molecule (see chapter 2) so as to make the synthetic problems easier were unsuccessful. It also seemed probable that, simultaneously with offering potential solutions to some aspects of the synthetic problem, new problems had been created which were not necessarily going to be any easier to solve. The rather naïve approaches to halogenating ketals had simply substantiated existing synthetic work in the literature and had made no progress towards the goal, except in one surprising and irreproducible reaction.

A small quantity of *para*-acetoxybenzaldehyde diethyl acetal (1, figure 3.1) had been made, and efforts were under way to try to find synthetic conditions which would permit the hydrolysis of the ester to liberate *para*-hydroxybenzaldehyde diethyl acetal

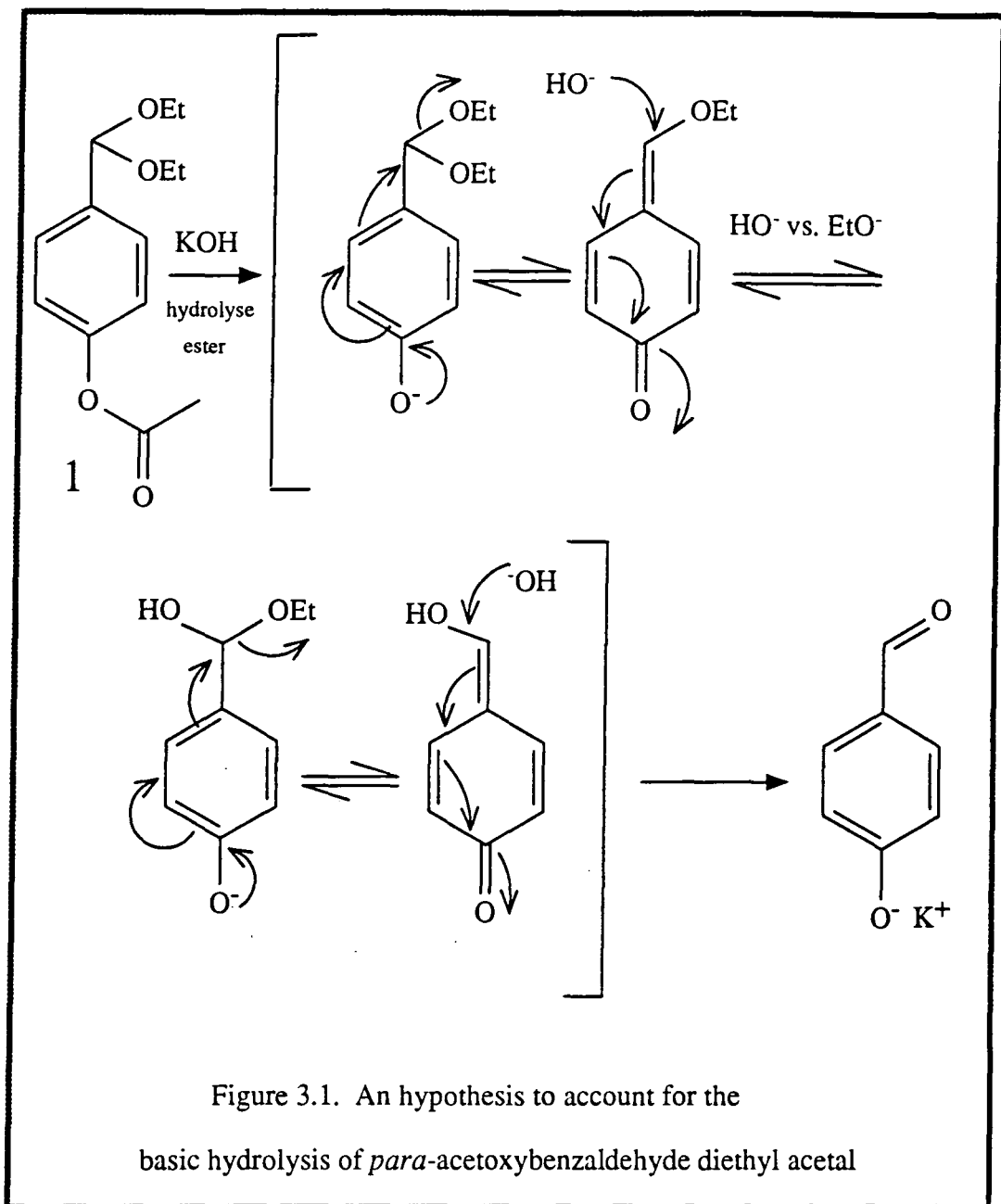

such that the acetal function was left intact (which precluded anything acidic) and which would also ensure that the corresponding  $\alpha$ -haloacetal (if it could be made) would not be harmed. As a first step, it was decided to boil the ester-acetal with ethanolic potassium hydroxide; hardly the conditions which would be expected to leave a reactive benzylic halide intact, but chosen to demonstrate that the ester could at least be cleaved. It was intended to then modify the reaction conditions to the point that survival of a benzylic halide was more likely, perhaps by modifying the approach to ester exchange using a neutral catalyst e.g. titanium tetrabutoxide in an anhydrous

alcohol. In the event this was unnecessary, since no  $\alpha$ -haloacetal was made, but the hydrolysis with ethanolic potassium hydroxide produced not the hydroxy-acetal, but most unexpectedly *para*-hydroxybenzaldehyde. This reaction was subsequently repeated but the result could not be reproduced. Perhaps the flask used for the first reaction had contained a strong acid catalyst which had adsorbed on the glass. Whatever the reason, whether the result was genuine but irreproducible, or the product of unknown impurities, this result is recorded because it started a chain of thought.

It was evident that direct displacement of an ethoxide ion from the acetal by hydroxide ion was impossible. It was equally clear that at some point in the reaction, *para*-hydroxybenzaldehyde diethyl acetal had probably been produced. Working under the (probably incorrect) assumption that the observed formation of *para*-hydroxybenzaldehyde really was brought about purely by these reaction conditions, the mechanism shown in figure 3.1 was conceived. There are several aspects of this mechanism which though contrary to common experience are not unique. Expulsion of an ethoxide ion by a phenoxide seems most unusual. Maybe the fact that it occurs by "long range" neighbouring group participation mitigates it, but the author is unaware of any examples where such a displacement occurs *intermolecularly*, e.g. by  $S_N2$ . On the other hand, there are indeed *intramolecular* examples. The most appropriate of these is that furnished by Orlando<sup>[130]</sup> who discovered that

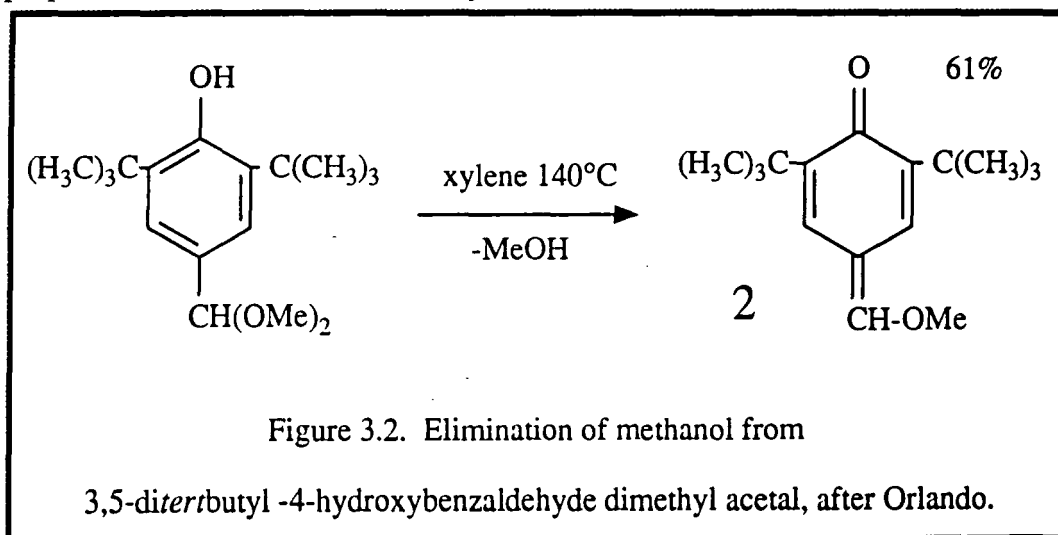
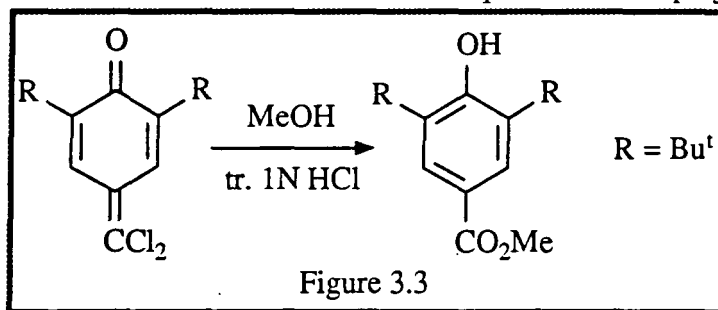

Figure 3.2. Elimination of methanol from

3,5-ditertbutyl -4-hydroxybenzaldehyde dimethyl acetal, after Orlando.

3,5-ditertbutyl-4-hydroxybenzaldehyde dimethyl acetal loses methanol at 140°C in refluxing xylene to give 7-methoxy-2,6-ditertbutyl-1,4-benzoquinonemethide, 2 in Figure 3.2. In this case the product is stable and is isolated by recrystallisation from hexane. The next stage in the proposed mechanism also gives rise to concern, in that hydroxide is depicted as the successful attacking nucleophile when the reaction is actually performed in an equilibrium hydroxide-ethoxide mixture. Ethoxide ion is the better nucleophile of the two. The attack of nucleophiles upon quinone methides is well-documented, e.g. the work of Volod'kin *et al*<sup>[131]</sup> who showed that halogen acids react with quinone methides. Wang<sup>[132]</sup> showed that methanol adds to a dichloroquinonemethide under acid catalysis, to yield an ester, figure 3.3. This observation was deemed to be of considerable consequence for this project.



In the proposed scheme for the basic hydrolysis of *para*-acetoxybenzaldehyde diethyl acetal, it may be that since the equilibrium between hydroxide and ethoxide in ca. 97% ethanol(aq.) favours hydroxide, a statistical factor determines that hydroxide may compete effectively with ethoxide for the quinone methide intermediate. In any event, if ethoxide does react, the phenoxide ion of *para*-hydroxybenzaldehyde diethyl acetal would be regenerated. Only a small success of attack by hydroxide would thus be needed to tip the balance to the hemiacetal product side. Similar comments can be made about the next stage, the *intramolecular* expulsion of ethoxide rather than hydroxide. If it succeeds, product is formed and if not, the quinone methide is regenerated. It is possible that ethoxide is effectively removed from these reactions by the hydroxide-ethoxide equilibrium and that this provides a driving force.

The entire mechanism depicted is in all likelihood wrong; the supposedly basic hydrolysis reaction of an acetal which requires a mechanistic explanation probably happened as a consequence of some acidic impurity or during work-up, **BUT** the notion it gave rise to, *that a quinone methide might be put to use in the synthesis which was the objective of this study*, was deemed important and potentially useful.

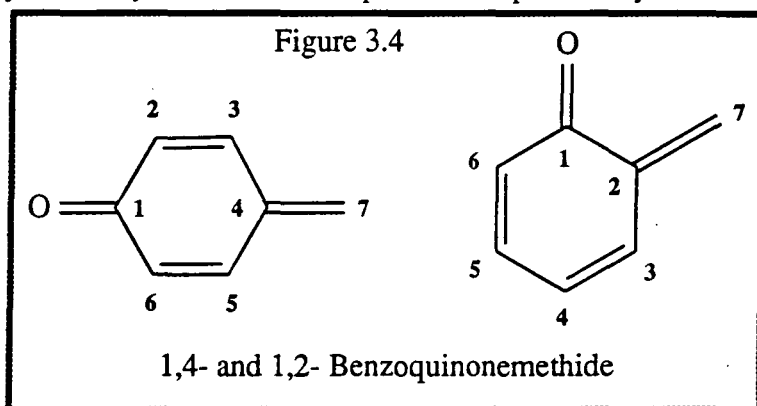

1,4-Quinone methides are, generally speaking, reactive molecules. Only in cases where attack at the exocyclic alkylidene (the 7-position) and the positions *ortho*- to the carbonyl has been blocked by suitable substituents, can they be isolated. Similar restrictions apply to 1,2-quinonemethides. The simpler, less-substituted, members of the group are highly reactive and unstable intermediates whose existence frequently can only be inferred by, for example, their addition products with nucleophiles, or proved only via spectroscopy on matrix-isolated samples at low temperature. Quinone methides are known to be intermediates in the formation of phenol-formaldehyde resins<sup>[133,134]</sup> in which process mixtures of 1,2- and 1,4- quinone methides undergo uncontrolled cross-linking as part of the mechanism of formation.

They are related to the equally unstable and reactive quinodimethanes, the parent compound of which, *para*-benzoquinodimethane, occupies an important niche in polymer chemistry as the progenitor of poly(*para*-xylylene) in several syntheses. Errede and Szwarc<sup>[135]</sup> have undertaken intensive studies on this latter system. The intermediate *para*-benzoquinodimethane is made via vacuum pyrolysis of *para*-cyclophane and is used to produce surface coatings. These coatings are known to

be highly cross-linked and, as made, to contain a high spin density.

One of the first syntheses of *para*-benzoquinodimethane was reported in 1954 by Mann and Stewart<sup>[136]</sup> who observed the formation of low molecular weight<sup>[135]</sup> polymer from the decomposition of Grignard reagents of the kind shown below in figure 3.5. In the absence of any compelling evidence they postulated the intermediacy of 1,4- and 1,2- benzoquinonemethide and their subsequent polymerisation.

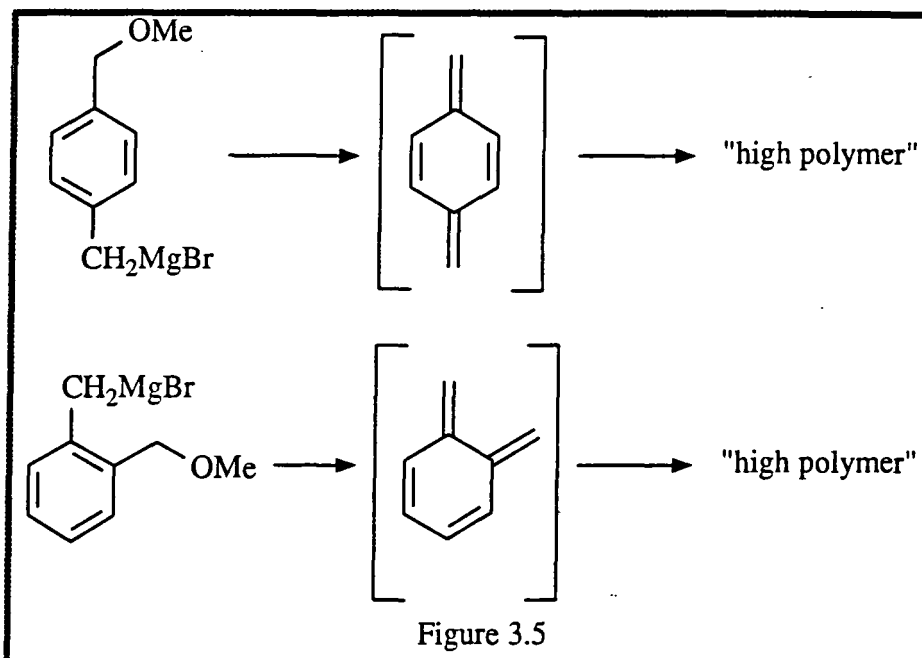

Interestingly, the *meta*- Grignard was obtained in good yield. There is no conjugation between the Grignard and the *meta*-benzylic ether, which accounts for the suppression of elimination. *Meta*-quinone methides and *meta*-quinodimethanes are, like *meta*-quinones, unknown. It is also of interest that Mann and Stewart found the polymer from the *ortho*- Grignard softened at 60°C and could be drawn into fibres, whereas the *para*- Grignard product did not soften even at 200°C. Mann and Stewart's solution phase synthesis may well have given a linear, structurally homogenous material.

Thiele and Dimroth<sup>[137]</sup> had observed an analogous phenomenon in 1899, but were unable to explain it since the concept of the macromolecule was then unaccepted. They

had synthesised *ortho*-hydroxybenzylmethyl ether, but found that whenever they attempted to distil it or to dry it with calcium chloride, it decomposed and gave a "resin", figure 3.6.

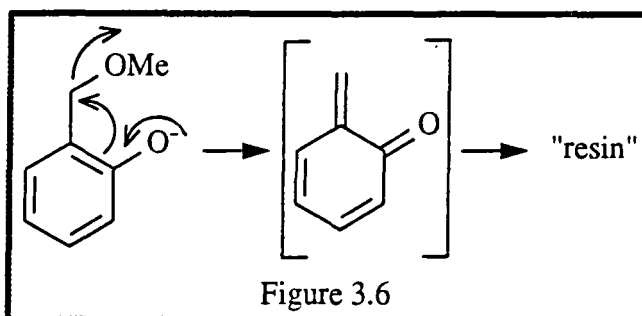

Figure 3.6

They discovered that their calcium chloride contained traces of base and that when they used a non-basic drying agent the compound did not undergo decomposition on drying. It seems likely that the initial decomposition product was 1,2-benzoquinonemethide, which being unsubstituted, rapidly polymerised.

The initial elimination reaction is akin to the elimination of ethoxide from *para*-hydroxybenzaldehyde diethyl acetal in the proposed basic hydrolysis of *para*-acetoxybenzaldehyde diethyl acetal. It has subsequently been reported<sup>[138]</sup> that under controlled conditions at -20°C, 1,2-benzoquinonemethide trimerises as shown below, figure 3.7.

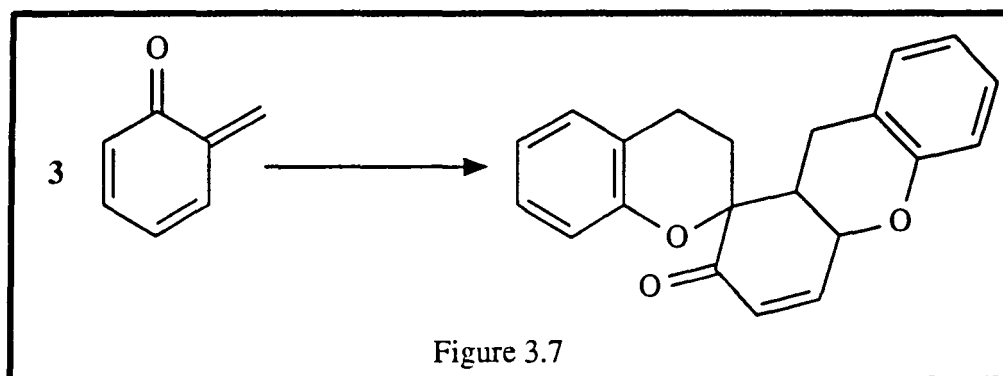
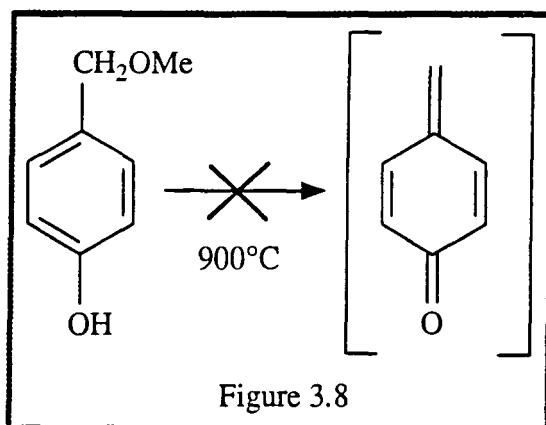

Figure 3.7

However, Cavitt *et al*<sup>[139]</sup> found that *para*-hydroxybenzylmethyl ether did not lose methanol by pyrolysis, even at 900°C, figure 3.8. This is in surprising contrast to the observations made by Orlando (*vide supra*) and by Thiele and Dimroth.





A related observation was made by Auwers in 1903<sup>[140]</sup> who undertook a considerable range of investigations on simple quinone methides, although it is debatable whether he really isolated some of the molecules claimed. He did, however, recognise that he had obtained polymerisation products in place of monomeric 1,4-benzoquinonemethide, although the macromolecular nature of polymers was still not accepted; they were then thought to be colloids of some kind.

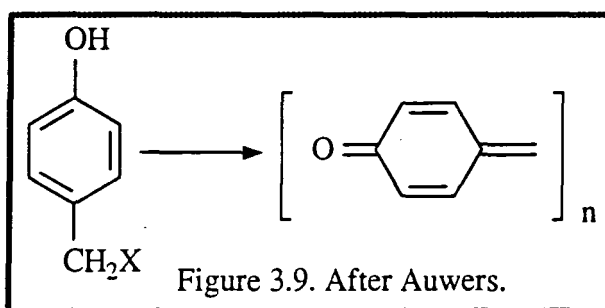
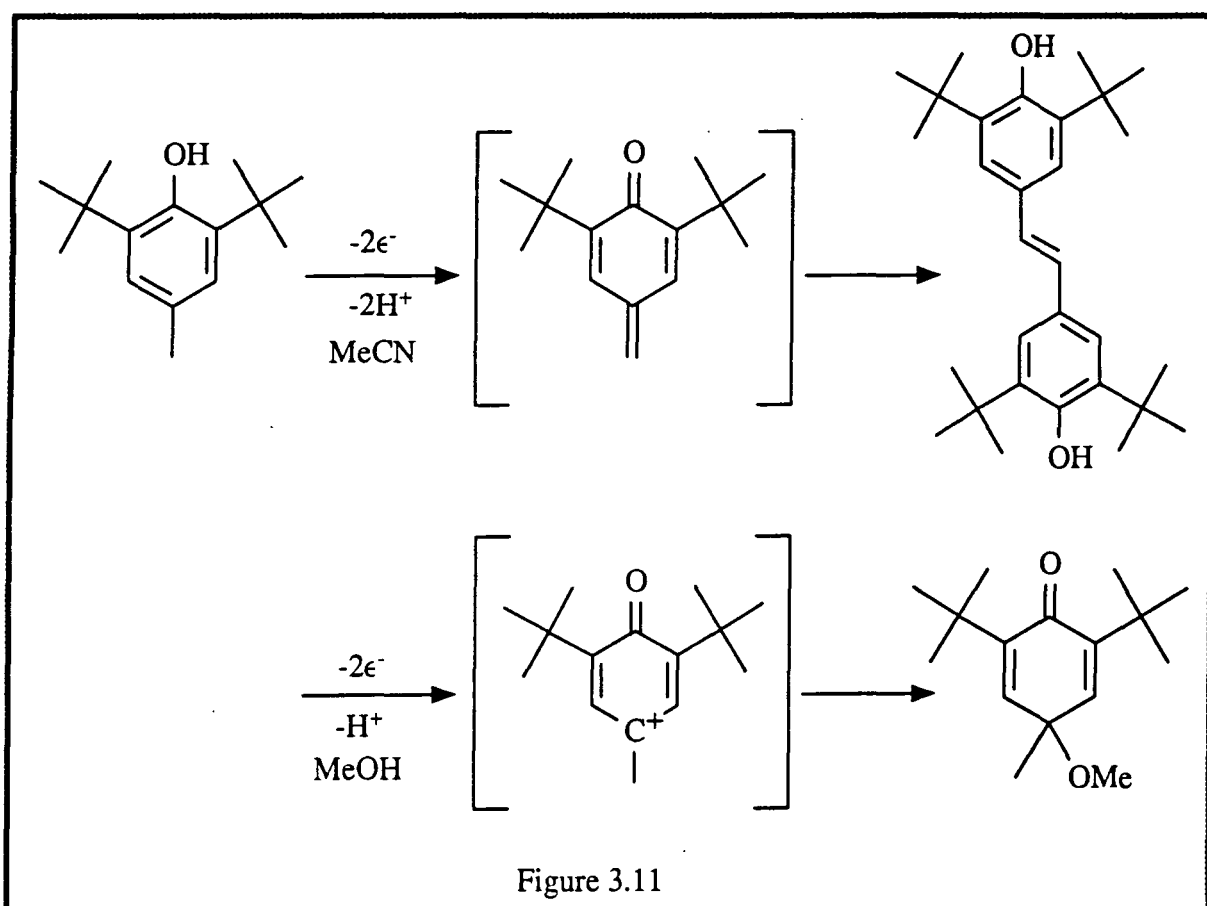
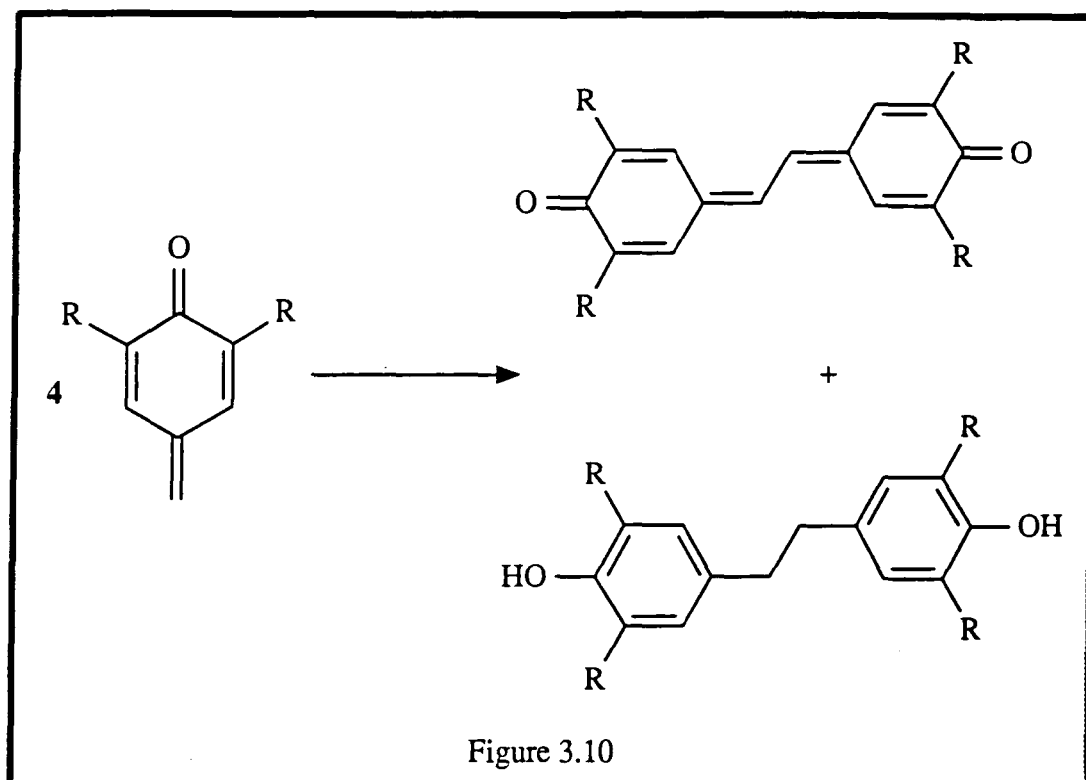

Figure 3.9 is taken from Auwers' paper and clearly indicates his understanding that he had not obtained a monomeric product. The X atom was understood to be halogen or a secondary amino moiety. The reaction conditions were treatment with aqueous base. He also noted that an isomeric material was produced in the reaction and he believed this to be a stilbene derivative. Compounds similar to stilbene are now known to be formed<sup>[141]</sup> in certain preparations of quinone methides by disproportionation reactions, figure 3.10, particularly when the *ortho*- positions are blocked.



Parker<sup>[142]</sup> reported that stilbenes are formed from the electrolytic oxidation of phenols

in non-nucleophilic solvents, and points out that the reaction proceeds via quinone methide intermediates, figure 3.11.

A particularly interesting observation was reported by Jones<sup>[143]</sup> in 1947. When *para*-trifluoromethylphenol was treated with dilute (1N sodium hydroxide) aqueous base, a water-insoluble material was precipitated which could be dissolved in ether. This too was regarded as "high polymer" and it was suggested that it was a linear material. Since it was soluble, it was not cross-linked.

However, Jones observed that the fluorine remaining in the polymer could not be readily removed by hydrolysis. This was in marked contrast to the result observed when decomposition of *para*-trifluoromethylphenol was brought about by a trace of hydrofluoric acid in place of base. In this instance, the residue obtained was insoluble in petroleum ether and after boiling with 12N sodium hydroxide, *para*-hydroxybenzoic acid was isolated. A possible rationalisation of Jones' observations is outlined below. The intermediate ether, 3, figure 3.12, was not suggested by Jones, but the elemental analysis reported fits this structure. The polyether 4, figure 3.13, was suggested as the product of dilute base treatment.

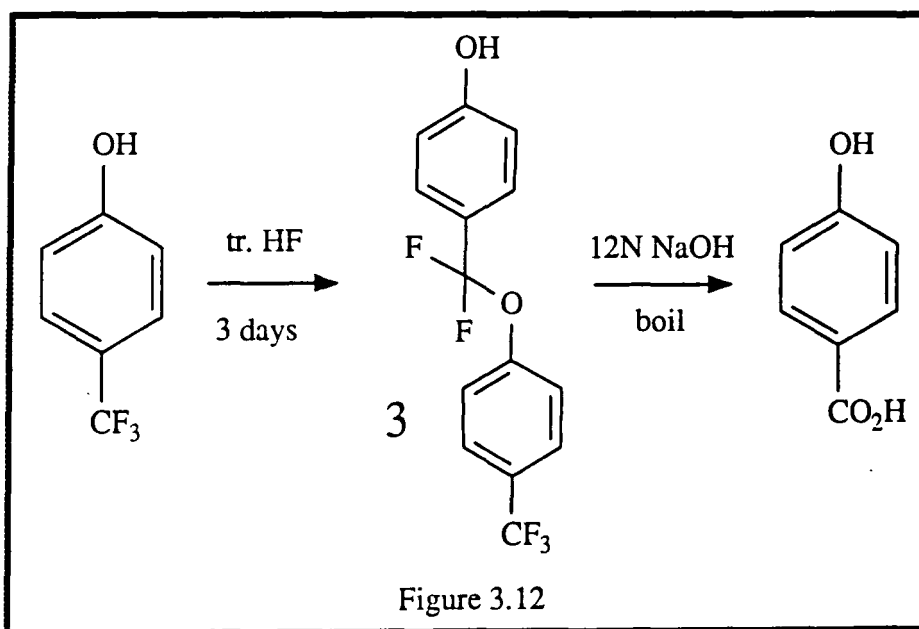
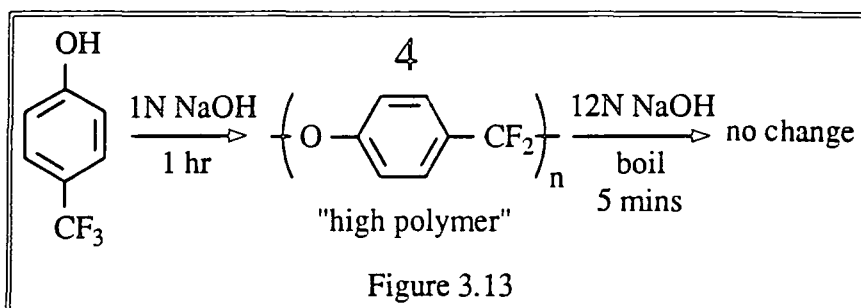
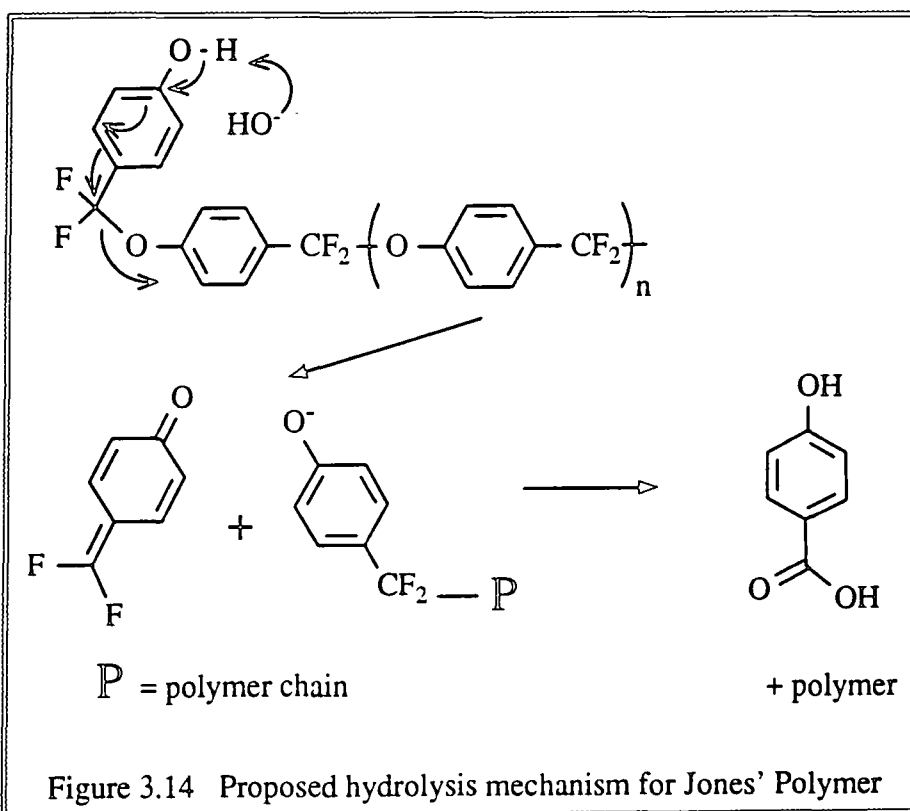

Figure 3.12



It is possible that the reason why the "high polymer" did not hydrolyse when boiled with aqueous sodium hydroxide is that access by hydroxide ion to the difluoromethylene groups is prevented in this heterogeneous reaction between an aqueous reagent and a water-insoluble polymer, even though x-ray scattering measurements undertaken by the author showed that it is of low crystallinity. Alternatively, if hydrolysis itself proceeds by intermediacy of a quinone methide, the chain can only degrade from the hydroxyl-terminated chain end. In either case, access is highly restricted at the surface and chain ends and the reaction would be expected to be slow.



Jones had observed that when *para*-trifluoromethylphenol was treated with 12N sodium

hydroxide, only *para*-hydroxybenzoic acid was produced. Thus the lifetime of 7,7-difluoro-1,4-benzoquinone methide is apparently strongly dependent on the base concentration. In relatively dilute base (1N sodium hydroxide) the quinone methide can polymerise faster than the difluoromethylene group is hydrolysed, i.e. it adds to itself faster than it is attacked by the hydroxide ion. Attainment of high molecular weight is limited by the precipitation of the polymer from the reaction medium.

The preparation of Jones' polymer was repeated and analysis by gel permeation chromatography (GPC) in tetrahydrofuran (THF) indicated a peak molecular weight (polystyrene equivalent) of ca. 9000, see Appendix 2. By 1947 standards this is indeed "high polymer" and corresponds to a degree of polymerisation of ca. 63 monomer units. HPLC in 40% acetonitrile (balance water) on a Hypersil 5 ODS reverse phase column (flow 1.5ml/min) showed the presence of three major, low-molecular weight impurities constituting 5%, 6.2% and 5.5% of the total respectively.

It seemed possible that a much higher molecular weight material than that synthesised by Jones might be obtained by manipulation of the synthetic conditions. Firstly, nucleophilic attack on and hydrolysis of the quinone methide intermediate by the base would have to be prevented. The polymerisation "initiator" would thus need to be a sterically-hindered, non-nucleophilic base. Secondly, the growing polymer chain would have to be kept in solution and access to the chain ends kept open by choice of a suitable solvent. It appeared that *tert*-butyllithium might be a suitable base. Acidic proton abstraction being much faster than halogen exchange at ambient temperature, it was decided to perform the reaction with only moderate cooling (ice bath) on a small scale. The solvent chosen was THF, which was already known to dissolve the polymer and which is capable of solvating partial charges.

However, on work-up, no polymer was obtained from the solution. Instead, nearly all

of the material was water-soluble, and after standing for some time, a precipitate was deposited from the aqueous washings. The conclusion was reached that the intermediate quinone methide did not polymerise in the absence of a nucleophilic "initiator". The organic-soluble material was shown to be starting material by nmr, whilst the precipitate which was deposited from the aqueous washings was identical with Jones' polymer.

A similar polymerisation was observed by Murray<sup>[144]</sup>, who treated *para*-(2-chloro-perfluoro-2-propyl)phenol with base and obtained a polymer which yielded 7,7-di(trifluoromethyl)-1,4-benzoquinonemethide upon vacuum pyrolysis, and which was isolated in an argon matrix, figure 3.15.

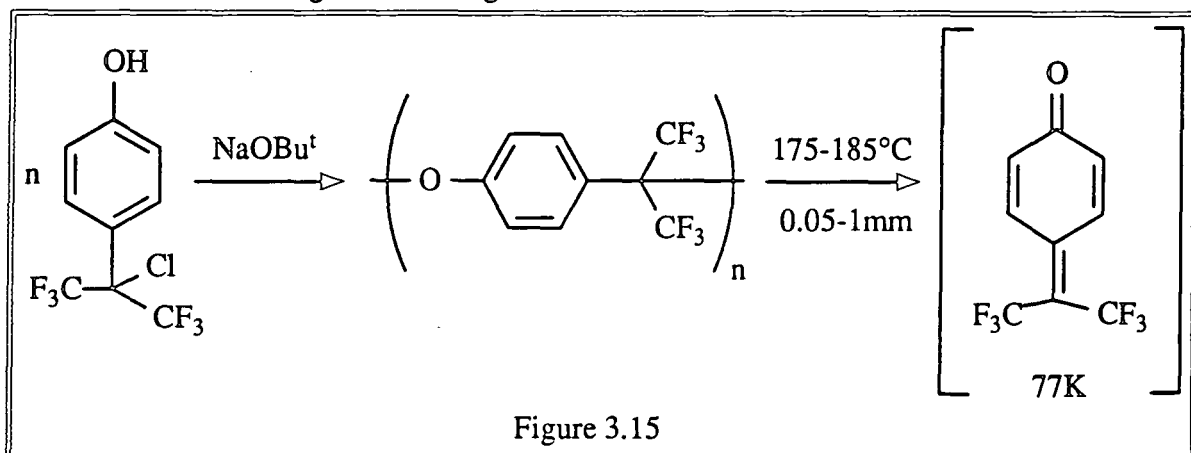

On the basis that 7,7-difluoro- and 7,7-di(trifluoromethyl)-1,4-benzoquinonemethide undergo polymerisation to give a linear polymer, it was felt that 7,7-dichloro-1,4-quinonemethide might also do so. It was expected that the benzylic chlorines in the product would hydrolyse much more easily than the benzylic fluorines in Jones' polymer, by  $S_N1$  displacement rather than via the quinone methide, as chloride is a far superior leaving group. It was additionally intended to block any possibility of chain scission via quinone methide intermediates by end-capping the polymer with e.g. iodomethane.

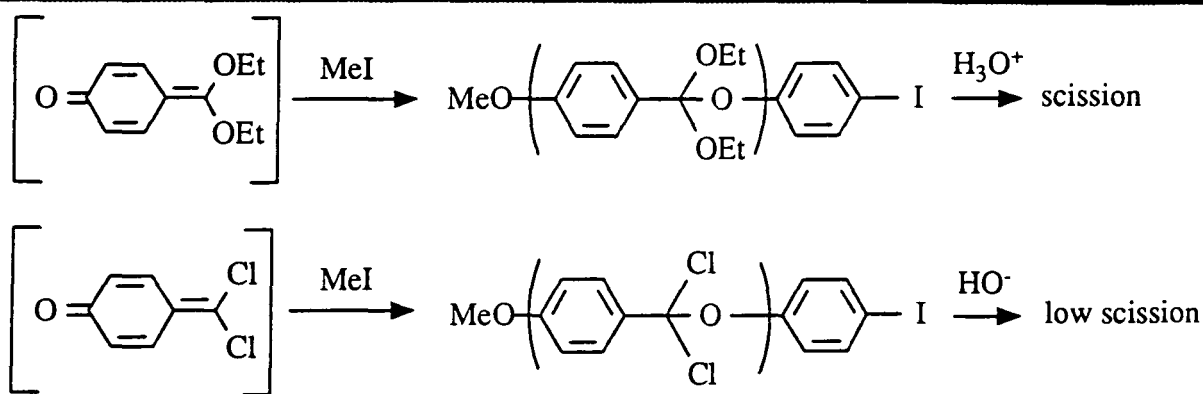

Figure 3.16. Hydrolysis of precursor polymers

Upon conversion of the precursor polymers shown above by hydrolysis, the polymer of 7,7-diethoxy-1,4-benzoquinonemethide will undergo chain scission, since phenoxide is a better leaving group than ethoxide. With the alternative precursor shown, the linear polymer of 7,7-dichloro-1,4-benzoquinonemethide, the reverse is true. Little chain scission would be expected, as chloride is a much better leaving group than phenoxide.

One possible problem which would have to be faced, would be the gradual reduction of access to hydroxide ion as the precursor polymer, poly(7,7-dichloro-1,4-benzoquinonemethide), began to convert to poly(*para*-hydroxybenzoic acid). The problem would be expected as the product is known to be highly crystalline and insoluble in almost every solvent. Certainly it is insoluble in anything compatible with basic hydrolysis of the precursor. Regardless of the precursor polymer chosen, if the conversion step involved treatment with a reagent, this problem would very probably remain the same. It would be desirable to maximise the surface area to volume ratio of the precursor molecules to increase accessibility to reagent, and this suggests a fine fibre. However, it would also be essential to minimise crystallinity in the fibre, as diffusion of reagent can only occur through amorphous regions. An undrawn fibre would thus be preferable.

However, in the synthesis of poly(*para*-hydroxybenzoic acid) from the carbonyl precursors considered, drawing of the precursor fibre prior to conversion could be advantageous. Conformational changes from random coil with short persistence length to a more rod-like material would be expected to occur during hydrolysis of the precursor. Drawing prior to conversion would effectively lower the activation energy barrier for the conversion process, since the starting material, the precursor polymer, would already be in a conformation similar to a product-like i.e. poly(*para*-hydroxybenzoic acid)-like transition state. The trade-off would be that a lowered activation energy for conversion would be useless if the reactants and by-products could not diffuse in and out of the fibre. Clearly, these conflicting requirements would need detailed examination if a suitable precursor route could be established.

It was thus decided to attempt the synthesis of 7,7-dichloro-1,4-benzoquinonemethide, since there was a reasonable chance that it would spontaneously polymerise to give a suitable precursor polymer. A suitable synthetic route was needed to prepare it.

### 1) Staudinger's Ketene Route

One of the first preparations of isolable quinone methides was achieved by Staudinger<sup>[145]</sup> who reacted *p*-benzoquinone with diphenylketene. The intermediate *spirolactone* was isolated and could be pyrolysed *in vacuo* to yield the desired quinone methide plus carbon dioxide.



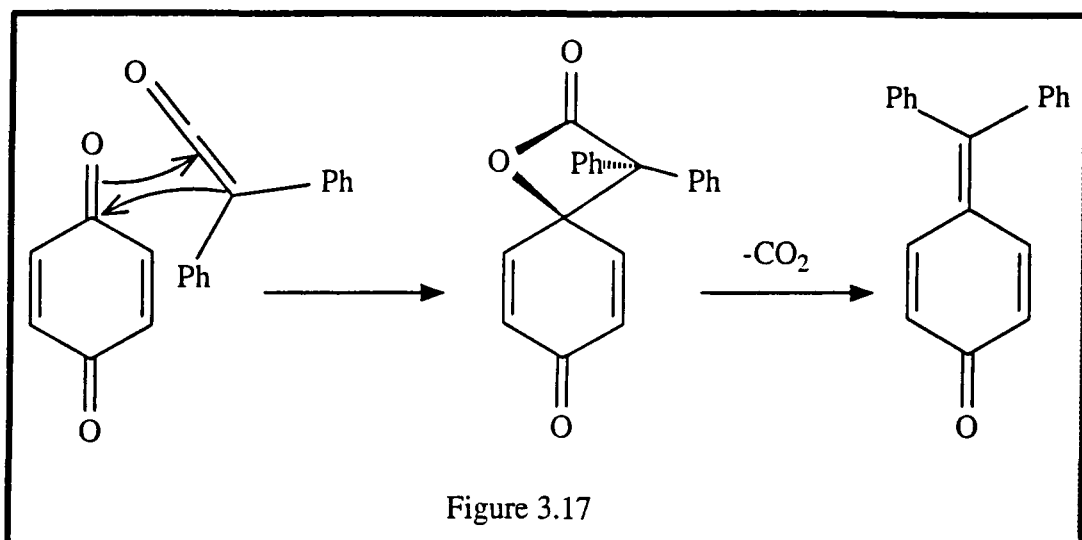

The initial step of this synthesis is a symmetry-allowed  $[\pi 2_s + \pi 2_a]$  cycloaddition. The reaction is more commonly encountered in the formation of cyclobutanes<sup>[146]</sup> from ketenes plus olefins, a reaction which is known to be concerted<sup>[147]</sup>.

The foregoing implies that 7,7-dichloro-1,4-benzoquinonemethide might be produced via the 2+2 cycloaddition of dichloroketene with *p*-benzoquinone. Dichloroketene has been much-used in 2+2 cycloaddition reactions. Many examples exist of its addition to carbon-carbon double bonds<sup>[148]</sup> and there are a few examples of addition to carbonyls<sup>[149]</sup>. Ketene itself is known to participate in this reaction although only the 1:2 *p*-benzoquinone:ketene adduct has been studied, which pyrolyses to 1,4-quinodimethane. Hagemeyer<sup>[150]</sup> has studied this reaction and claimed it as a route to poly(*para*-xylylene).

The author made a number of attempts to produce the required adduct for the synthesis of 7,7-dichloro-1,4-benzoquinonemethide. Following the literature, two main methods were used to produce the dichloroketene.

One method uses elimination of hydrogen chloride from dichloroacetyl chloride by

triethylamine<sup>[151]</sup> at reduced temperature, usually  $-20^{\circ}\text{C}$ . The reaction is exothermic and needs to be controlled, not only from the point of view of safety, but also from the viewpoint of increased practical success, since dichloroketene polymerises to a black tar very readily at ambient temperatures and above. The appearance of precipitated amine hydrochloride in the reaction vessel gives a measure of the reaction rate, allows the efficient regulation of the rate of addition of acid chloride to base and thence good temperature control. The addition to the quinone is performed *in situ*, or alternatively, the solution can be filtered through a sinter under a dry gas blanket and the substrate for the addition then added, together with any catalysts required. Experimentally, the *in situ* method is preferred, as both dichloroacetyl chloride and dichloroketene solutions are noxious and the latter is very reactive. Generating the ketene in the presence of the substrate minimises material losses and practical difficulties. It also avoids the problem of the dichloroketene solution warming considerably during filtration, a problem which often arose when this technique was used owing to partial blockage of the sinter by finely-divided amine hydrochloride. Unfortunately, it is sometimes essential to remove the precipitated amine hydrochloride. Some literature sources suggest that amine hydrochlorides may be detrimental to 2+2 cycloaddition reactions of ketenes<sup>[152]</sup> and prefer to remove the precipitate. Others<sup>[153]</sup> find that addition reactions of dichloroketene are sluggish unless catalysed and remove amine hydrochloride so that incompatibility with Lewis acid catalysts, such as zinc chloride<sup>[154]</sup> which is widely used in these procedures, may be avoided. Unless it is essential to filter the dichloroketene solution, hydrolysis may be satisfactorily prevented by means of a drying tube on the vessel and the use of dry nitrogen is unnecessary. When filtration is essential, losses of dichloroketene to tar formation can be minimised by cooling the reaction product mixture to a much lower temperature than that used for the reaction, e.g.  $-78^{\circ}\text{C}$ , prior to filtration. Pre-cooling the filtration apparatus proved inconvenient and increased the chances of losses due to hydrolysis, by encouraging condensation of moisture before the reaction mixture could be introduced.

The major alternative to this method of dichloroketene production is the reaction of trichloroacetyl chloride with activated zinc<sup>[155]</sup>. Again there is a problem of containment and handling regarding the acid chloride and dichloroketene, because of toxicity. The other problems with this method arise from the fact that the reaction between the acid chloride and zinc is critically dependent upon the surface of the zinc. It is also essential to employ zinc powder or dust in order to achieve a satisfactory rate of reaction. Initially the zinc was passed through a fine (90 $\mu$ m) sieve. It came as something of a surprise to find that residue from the first preparations of dichloroketene by this method, in which the zinc had not been sieved, contained foreign matter such as broken glass and unidentified metal particles (which were probably steel.) These contaminants must have been present in the BDH product.

Two main methods exist for the activation of zinc powder. One uses acid etching of the surface, followed by washing to neutrality with water, removal of water by washing with alcohol and final drying *in vacuo*<sup>[156]</sup>. The other<sup>[157]</sup> etches the surface by electrolytic metal exchange, using an aqueous solution of copper (II) sulphate to wash the zinc and prepare a zinc-copper couple, which is then washed and dried as for the previous method. It is essential to store the prepared zinc under a dry, inert atmosphere and to use it as soon as possible, since the surface is easily contaminated. In terms of practical convenience, there is nothing to choose between these methods and they appear to have been used equally, as judged by literature reports. The practical success rate is purportedly good, but some authors<sup>[158]</sup> comment on the induction period which was often observed during the course of this research in the reaction with trichloroacetyl chloride. The experience obtained in the course of this project was that both methods of activation are equally unreliable. Irrespective of the method of activation chosen and the source of the zinc, some reactions failed to proceed at all whilst others "took off" with considerable vigour. This was even true when the zinc and

acid chloride were from the same batches and used on the same day. The lack of reproducibility was minimised by ensuring that the acid chloride was vacuum transferred prior to use, but even so, the reactions were disagreeable to conduct. It was noticeable that more problems with lengthy induction periods were encountered when vacuum transferred samples had been allowed to stand overnight.

Control of the zinc-acid chloride reaction was, as stated above, difficult and the experiments could be unpleasant. The dehalogenation is exothermic; the heat of formation of zinc chloride is about 420kJ/mol and the exotherm is increased by the heat of solution. This provides its own problems, for a lack of good control promotes the production of large amounts of tarry, polymeric by-products from the dichloroketene. Aside from the waste this represents, and the concomitant low yield of products, it also makes work-up an unpleasant operation, since the tar is corrosive, toxic and foul-smelling, attacks rubber gloves, shares solubility properties with both substrate and products and "streaks" on chromatographic supports. Isolating pure materials from such a mess proved to be impossible and it was rapidly recognised that the only sensible approach to the products arising from thermal runaway was to discard them and do the reaction again. On the positive side, the zinc chloride produced from the dehalogenation is an effective catalyst for the 2+2 cycloaddition, which results in less wastage of dichloroketene due to poor temperature control than would be the case for the amine-dichloroacetyl chloride reaction, since the ketene is more effectively scavenged by the substrate. If there was no catalyst present in the reaction, it seems probable that this method of preparation would not yield acceptable results at all, as is the case for the dehydrohalogenation reaction when conducted at ambient temperature, under which conditions only tarry dichloroketene polymers are produced. Using ether as the reaction solvent helps the thermal control problem, since the maximum temperature is limited to 35°C. However, it has disadvantages since serious thermal runaways also have more serious potential consequences. It is essential for this reason,

in addition to preventing hydrolysis, that the reactions be conducted under a blanket of dry, inert gas. It is possible to use other solvents for this reaction, but they must be compatible with acid chlorides and capable of dissolving zinc chloride. In practice this means ethers, except for cyclic ethers such as tetrahydrofuran which may polymerise under these conditions<sup>[159]</sup>. Unfortunately, higher-boiling solvents aggravate the problem of tar production.

Two variants on the above preparations of dichloroketene were tried. Both used flow systems. The object of this was to make the dichloroketene and then quickly condense it at low temperature in a liquid air trap containing the substrate, where it would remain monomeric until needed. Its addition could then be controlled by careful warming. The flow system ensured low residence time at the temperature of ketene synthesis and reduced opportunity for polymer formation. Any polymer which did form, coated the reactor and was thus excluded from the trap and subsequent reactions. This, at least in theory, would make work-up easier.

In the first method, triethylamine and dichloroacetyl chloride were mixed in the vapour phase at reduced pressure in a cooled tubular reactor. The resulting dichloroketene was filtered through an in-line glass wool plug to separate the product from amine hydrochloride "smoke" and was then condensed in a cold trap. Unfortunately, whilst this method was very good at producing dichloroketene free from amine hydrochloride, without the unpleasant manipulation problems associated with filtration of a dichloroketene solution under a nitrogen blanket through a sinter, it was very difficult to regulate the flow of reagents. If the flow was not precisely controlled to give an equimolar mixture in the gas phase, excess reagents passed into the trap. This proved hazardous, since dehydrohalogenation could then occur uncontrolled when solvent was added and the mixture warmed up. With practice, the transfer rate could be judged nicely and some success was obtained in producing uncontaminated dichloroketene this

way, although for safety this method could only be used on a small scale. Absence of ether-insoluble amine hydrochloride in the trap was taken as evidence of a good run. However, considering the potential hazard and the difficulty of regulating the flow of the reactants, it cannot be said that the method was much superior to the more conventional liquid phase technique. It did avoid the leakage and blockage problems associated with filtration of solutions of the ketene at low temperature, and was used primarily as an alternative to it when clean dichloro $\alpha$ -ketene solutions were needed for use with zinc chloride-catalysed additions, for which *in situ* preparations were inappropriate.

The flow system devised for the zinc-trichloroacetyl chloride reaction was less successful. A tubular reactor was packed with activated zinc powder (prepared by either of the two methods) and enclosed in a furnace which had been calibrated with the empty tube in place. Trichloroacetyl chloride vapour was drawn through the bed of zinc under reduced pressure, either with or without assistance of a nitrogen purge. The emerging gases were passed through a cold trap. Below 200°C, reaction was insignificant and unchanged trichloroacetyl chloride was recovered from the trap and could be recycled. Above 350°C, no material reached the trap. A continuous gradation of reactivity was observed between these limits. Either the acid chloride was condensed unchanged, or it reacted and the resulting dichloro $\alpha$ -ketene decomposed on the column of zinc before it could be trapped. Even when nitrogen flow was removed and the system run at  $10^{-2}$  mbar and below, the residence time was too long for the survival of the ketene. The only material which ever collected in the trap was unreacted acid chloride and only the mass balance of the reaction varied with temperature and flow rate. This suggests that there is no selectivity between the removal of the first mole of chlorine from the acid chloride and the removal of the second mole from the *gem*-dichloro-group of the dichloro $\alpha$ -ketene, which is surprising. It may be that the removal of the second mole is actually easier, but this runs contrary to common experience of the

reactivity of organic chlorine compounds, in which the chlorine in acid chlorides and in trichloromethyl groups is always regarded as more reactive to abstraction and displacement than chlorine in  $\alpha,\alpha$ -dichloro-olefins. Perhaps the dichloroketene produced in the flow system coordinates efficiently with the zinc chloride which is simultaneously produced, and the increased residence time brought about by that coordination gives chance for further decomposition. Lewis acids do form coordination complexes with carbonyl compounds; much use is made of this in the Friedel-Crafts acylation.

Benzoquinone and cyclohexanone were reacted with dichloroketene made by both dehydrohalogenation and dehalogenation. It has been reported<sup>[160]</sup> that the yield from dichloroketene additions is dependent on the method of synthesis. Whether this is brought about as a consequence of impurities in the starting materials or the by-products of the reaction is unknown. The latter is more likely, as triethylamine hydrochloride is reported to inhibit 2+2 cycloadditions<sup>[161]</sup> whilst the zinc chloride produced in the dehalogenation scheme is a Lewis acid catalyst and is known to promote some 2+2 cycloadditions<sup>[162]</sup>. Both methods were tried. In the case of dehydrohalogenation, this was tried both *in situ* and via preparation of dichloroketene solutions free of amine hydrochloride, which were then used both with and without added ethereal zinc chloride catalyst. Some support for the Lewis acid hypothesis of differing dichloroketene reactivity was obtained, in that some of those reactions which worked with dichloroketene made by dehalogenation also worked with dichloroketene made by dehydrohalogenation when zinc chloride solution in ether was added, but not without it. However, catalysis was not observed when trace amounts were used. Reasonable yields (conversions in the case of benzoquinone) were only observed with large (molar equivalent) proportions of added catalyst, but reproducibility of these results was poor. This was in part owing to the thermal runaway and zinc

activation/reactivity problems associated with the dehalogenation route to dichloroketene, which made it difficult to assess whether a reaction had really succeeded or failed. One attempt was made to catalyse addition of dichloroketene to cyclohexanone with ultraviolet light. The reaction produced a large amount of polymeric tar; evidently the addition of dichloroketene to itself is also well-catalysed under these conditions, although there are other possible products from such a reaction. Staudinger reported<sup>[163]</sup> that the initially-formed  $\beta$ -lactone is itself sensitive to ultra-violet light and undergoes a rearrangement reaction.

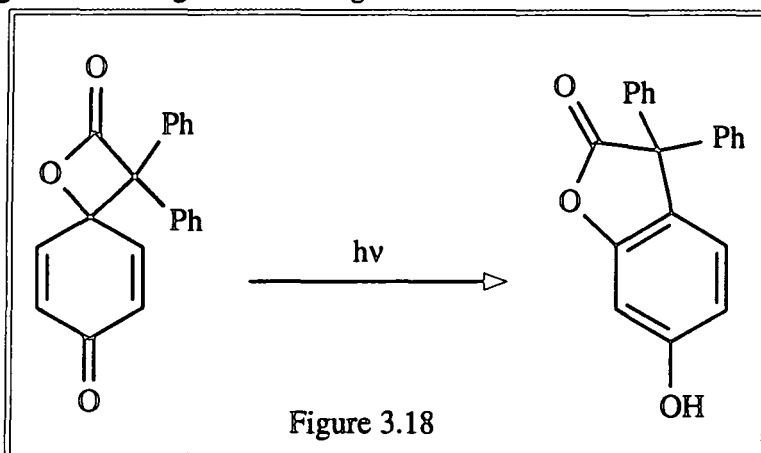

The outcome of these attempts was that no pure *spiro*lactone was isolated from reactions on benzoquinone. However, that is not to say that dichloroketene did not react with benzoquinone. With "successful" dehalogenation syntheses, benzoquinone reacted to give complex mixtures of tarry products in excellent yield. Unfortunately, nothing identifiable could be isolated from them. With zinc chloride-catalysed dehydrohalogenation reactions, the results were conflicting. Sometimes the reactions followed a similar course to the above to give tarry products, sometimes benzoquinone could be recovered unchanged.

With uncatalysed *in situ* dehydrohalogenation reactions, it appeared by mass balance that an adduct was formed in 80-97% yield based on the expected *spiro*lactone, although any attempt to purify it by recrystallisation resulted in the production of some tar and the recovery of some benzoquinone. This yellow material was hard to handle, as



it readily decomposed, and was difficult to characterise, the data collected suggesting conflicting conclusions. The solid melted at ca. 70°C with decomposition, resolidified and remained solid to 400°C, the limit of the melting point apparatus. Infra-red (KBr disk) indicated that the product contained C-O single bonds (strong absorption at ca. 1200cm<sup>-1</sup>.) The carbonyl frequency of the expected β-lactone ring should be increased over that of an aliphatic ester carbonyl, both by the small ring size and the α-chlorine substituents. In the yellow product, there is an absorption at 1850cm<sup>-1</sup> which probably corresponds to the lactone carbonyl stretch. Generally, β-lactones have carbonyl absorptions of ca. 1840cm<sup>-1</sup> [164] whilst α-substitution of chlorine can add 10-20 wavenumbers to this figure.

On a TLC plate (silica, ethyl acetate eluent) the material "streaked" but at least four "components" were visible, although it is possible that these were simply decomposition products. The solid also underwent spontaneous decomposition at ambient temperature, converting to a brown tar overnight. Brady *et al* [165] noted that the lactones formed by dichloroketene addition to carbonyl compounds were particularly susceptible to thermal decomposition. Carbon-13 nmr suggested that the material was a mixture, containing benzoquinone, yet when it was heated under vacuum, no benzoquinone sublimed out of it. The remaining peaks in the spectrum are possibly consistent with the expected lactone, plus other contaminants.

Despite the inconsistencies, these latter *in situ* dehydrohalogenation reactions were nevertheless of some interest. If the solid yellow adduct resulting from these reactions was heated *in vacuo* (aspirator pump) it became a tar at 60-70°C, copious quantities of gas were evolved and a red solid was left in the flask. The weight loss in these reactions closely matched the expected loss for the evolution of carbon dioxide from the expected lactone. This evidence suggested that reaction of dichloroketene with benzoquinone had occurred and that the initial product of this reaction, the yellow

solid, was not simply a mixture of benzoquinone plus other materials.

The fact that no pure intermediate could be isolated, taken in conjunction with the spectroscopic evidence, suggested that perhaps a reversible complex formation was taking place. If the material dissociated in solvents, it would explain the ability to recover benzoquinone and produce tarry polymers when attempts were made to recrystallise it, would explain the appearance of the  $^{13}\text{C}$  spectrum in solution, yet simultaneously explain why heating the product dry caused irreversible decomposition. It would also explain why catalytic addition of dichloroketene to benzoquinone using zinc chloride could bring about decomposition to complex products, without being able to isolate even the labile intermediate. It is possible that, unlike ketene-olefin addition, ketene addition to a carbonyl is not a concerted, one-step reaction, but there is no evidence to support this. If this is a two-stage addition, like the Wittig reaction where betaine formation<sup>[166]</sup> takes place in two stages, it could be that the zwitterionic intermediate shown below in figure 3.19 is unusually stable when dichloroketene is used, owing to the ability of the two chlorines to stabilise a negative charge, whilst the quinone ring can stabilise a charge by delocalising it.

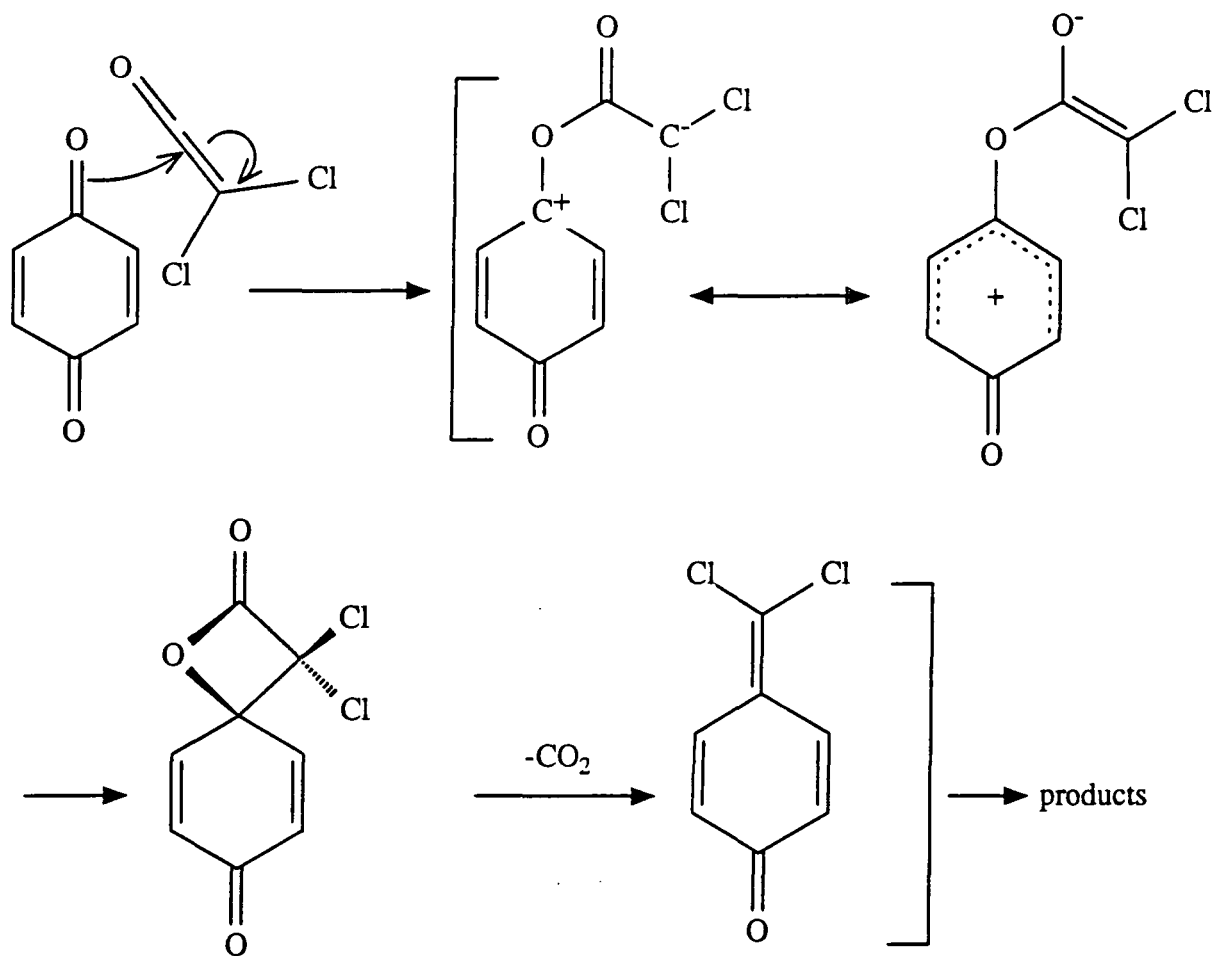

Figure 3.19

Perhaps it is this intermediate which is present in the solutions from uncatalysed reactions of benzoquinone with dichloroacetylene, produced by the dehydrohalogenation route. Evidently, in the case of cyclohexanone model studies, there is no chance for the corresponding positive charge to be delocalised on the cyclohexane ring, as it can be over the quinonoid ring, which probably accounts for the lack of an equivalent observation in the reactions with cyclohexanone.

The carbon-13 spectrum of the yellow product, recorded at 250MHz (Bruker AC250) in deuteriochloroform, contains the following lines: 9.1, 46.7, 125.1, 130.7, 133.2, 137.0, 139.8, 161.0, 183.5 and 187.8ppm. There are also clusters of weak lines around 65ppm and 81ppm, plus one weak aromatic/vinylic signal at 132ppm. Of these, the

peaks at 187.8 and 137.0ppm correspond to benzoquinone. The peaks at 183.5 and 161.0ppm are consistent with the cyclohexadienone ring carbonyl and lactone carbonyl in the intermediate; both signals are weak. It is tempting to assign the 9.1ppm resonance to the proposed zwitterionic intermediate, the dichloromethyl carbon which carries a negative charge, but there is no conclusive proof that this exists.

Model studies on cyclohexanone showed that not only was the expected *spiro*lactone produced from the addition reaction when the dehalogenation route was used, but that it spontaneously decomposed to give the dichloro-olefin *and* underwent ring-opening polymerisation to yield an insoluble polyester, which was characterised by infra-red spectroscopy. Zaugg<sup>[167]</sup> reports that  $\beta$ -lactones readily undergo ring-opening polymerisation, especially if substituted at the  $\alpha$ -carbon atom.

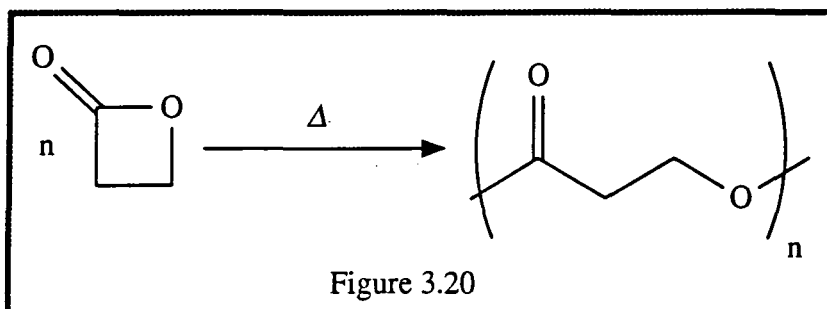

This latter reaction only occurred with *in situ* dehalogenation zinc chloride catalysis, which would go some way to explaining the complex tarry products obtained when benzoquinone was the subject of similar experiments. The polyester was swellable in dimethylsulphoxide at 150°C but gave poor (broad line) nmr spectra, suggesting either an irregular structure, or a reasonable molecular weight, or possibly both. The lactone, contaminated with some dichloromethylenecyclohexane arising through spontaneous thermal decomposition, was characterised by infra-red and nmr spectroscopy (see experimental section.)

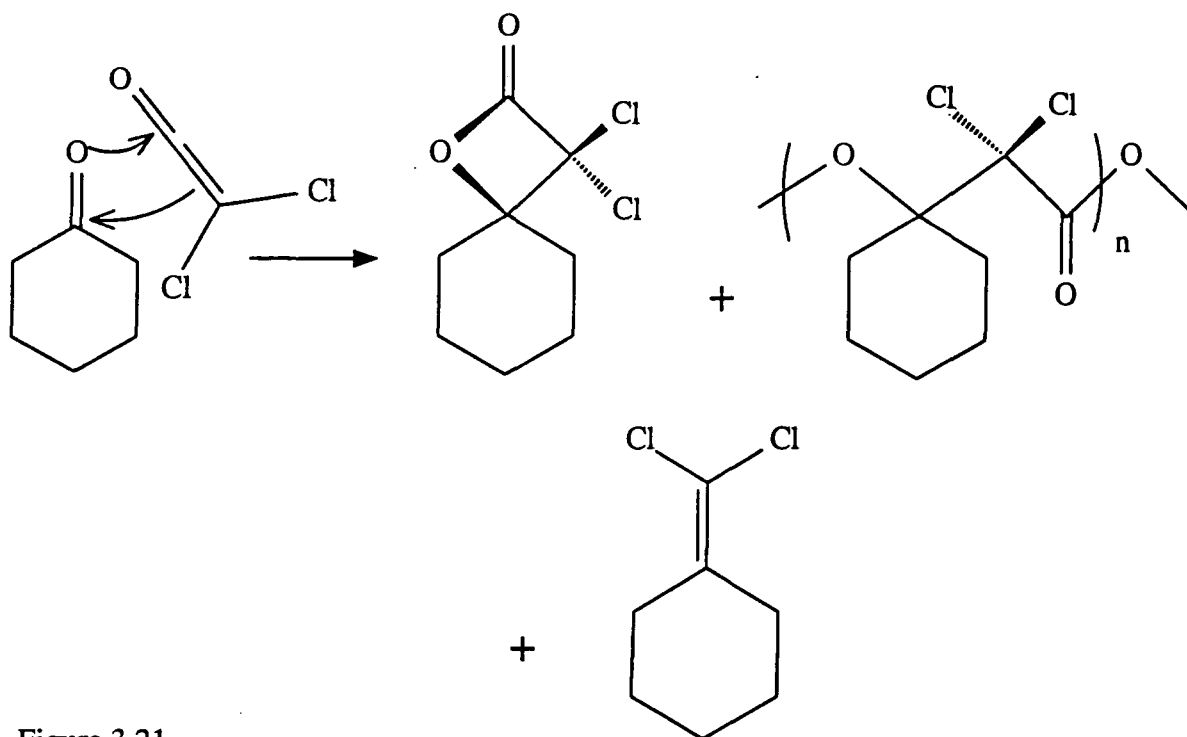

Figure 3.21

Formation of *spiro*lactone and polyester from addition of dichloroketene to cyclohexanone

In the case of catalysed additions of dichloroketene to benzoquinone, one would expect the polyesters produced to be partially cross-linked via production of the *bis*adduct. It may also be that some 2+2 cycloaddition was occurring between the ketene and the quinone ring carbon-carbon double bonds. Such additions are known for isolated olefins, but not for  $\alpha,\beta$ -unsaturated carbonyl compounds. In these latter cases, addition of dichloroketene takes place at the carbonyl double bond, but gives only low yields (ca. 35%) of identified products<sup>[168]</sup>. There are no examples of dichloroketene addition to quinones.

The red material, which was made by the heating under vacuum of the yellow benzoquinone-dichloroketene adduct, was further investigated, as was the insoluble orange precipitate recovered from the brown tar which resulted from its gradual decomposition at ambient temperature, although it was evident from the difficulties experienced with the yellow product that pure compounds were unlikely to be

characterised.

Unlike the original yellow product, the pale orange material was insoluble in all common solvents and did not undergo further decomposition on heating. The melting point could not be ascertained, as it was above 400°C. Mass spectral characterisation was unsuccessful, owing to the involatility and insolubility of the product. A white precipitate having similar properties was deposited from a deuteriochloroform solution of the yellow initial product, which had been submitted for nmr and left to stand. The insoluble orange material was submitted for solid state CPMAS  $^{13}\text{C}$  nmr, recorded at 75.431MHz. The spectral lines are broad; the FWHM is ca. 400-450Hz, probably indicating a structurally and spatially inhomogeneous material. The spectrum shows aromatic protonated carbons at 115(w=weak), 126 and 131ppm, plus a protonated alkyl carbon at 46(w). Non-protonated carbon signals appear at 46(w, perhaps spurious), 97, 118(w), 122-131(w, a cluster of probably spurious peaks arising through incomplete suppression) 139, 150(w), 155(w), 163(w) and 167ppm(w). Consulting one reference<sup>[169]</sup> suggested that a dichloromethyl ether carbon,  $\text{Ar}\underline{\text{C}}\text{Cl}_2\text{OAr}$ , would appear around 98-102ppm, which is in good agreement with the observed 97ppm signal. The 46ppm signal, which appears in both protonated and non-protonated carbon spectra, is consistent with  $\text{R}\underline{\text{C}}\text{HCl}_2$ . It is possible that rapid rotation would cause it to appear in the non-protonated carbon spectrum via partial loss of coupling. The remaining signals are consistent with a mixture of structures, possibly containing ester carbonyl carbons (163, 167ppm) but clearly the sample is not a pure compound or regular polymer.

The red material was not significantly soluble in any common solvent, although it could be soxhlet extracted with carbon tetrachloride. This product also had a melting point of over 400°C and mass spectral characterisation was again unhelpful. Solid state CPMAS  $^{13}\text{C}$  indicates an apparent unexpected "quaternary" signal at 31ppm. This could be a methyl group in which coupling to the protons was lost by rapid rotation,

although a methyl group is equally unexpected. Three different non-quaternary aromatic signals are present, 117, 123 and 132ppm, plus three quaternary signals, 149, 155 and 163ppm, one of which could be an aromatic ester carbonyl (163ppm.) No evidence was seen for a dichloromethylene carbon, neither for a dichloromethyl ether carbon. The lineshapes were broad, FWHM ca. 400-450Hz, suggesting similar conclusions as before. The material is clearly not a pure compound nor is it a regular polymer.

In summary, the conclusions reached from this work are:

- 1) Benzoquinone reacts with dichloroketene.
- 2) The reaction is not readily controlled.
- 3) Production of the desired 7,7-dichloro-1,4-benzoquinonemethide is hampered by side reactions which include ring-opening polymerisation of the intermediate  $\beta$ -lactone to give a polyester.
- 4) It is likely that the desired 7,7-dichloro-1,4-benzoquinonemethide was made in the attempted syntheses, but the reaction conditions were insufficiently controlled to yield the desired linear polymer.

## 2) Routes via Wittig Reaction

### i) On Benzoquinone-Cyclopentadiene Diels-Alder Adducts.

It is reported<sup>[170]</sup> that *endo-cis-anti-endo-cis*-pentacyclo[10.2.1.1<sup>5,8</sup>.0<sup>2,11</sup>.0<sup>4,9</sup>]-hexadeca-6,13-dien-3,10-dione, 5 in figure 3.22, undergoes reaction with methylenetriphenylphosphorane to give the Wittig adduct, 10-methylene-pentacyclo[10.2.1.1<sup>5,8</sup>.0<sup>2,11</sup>.0<sup>4,9</sup>]hexadeca-6,13-dien-3-one, 6, in 45% yield. This can be

pyrolysed to give 1,4-benzoquinonemethide.

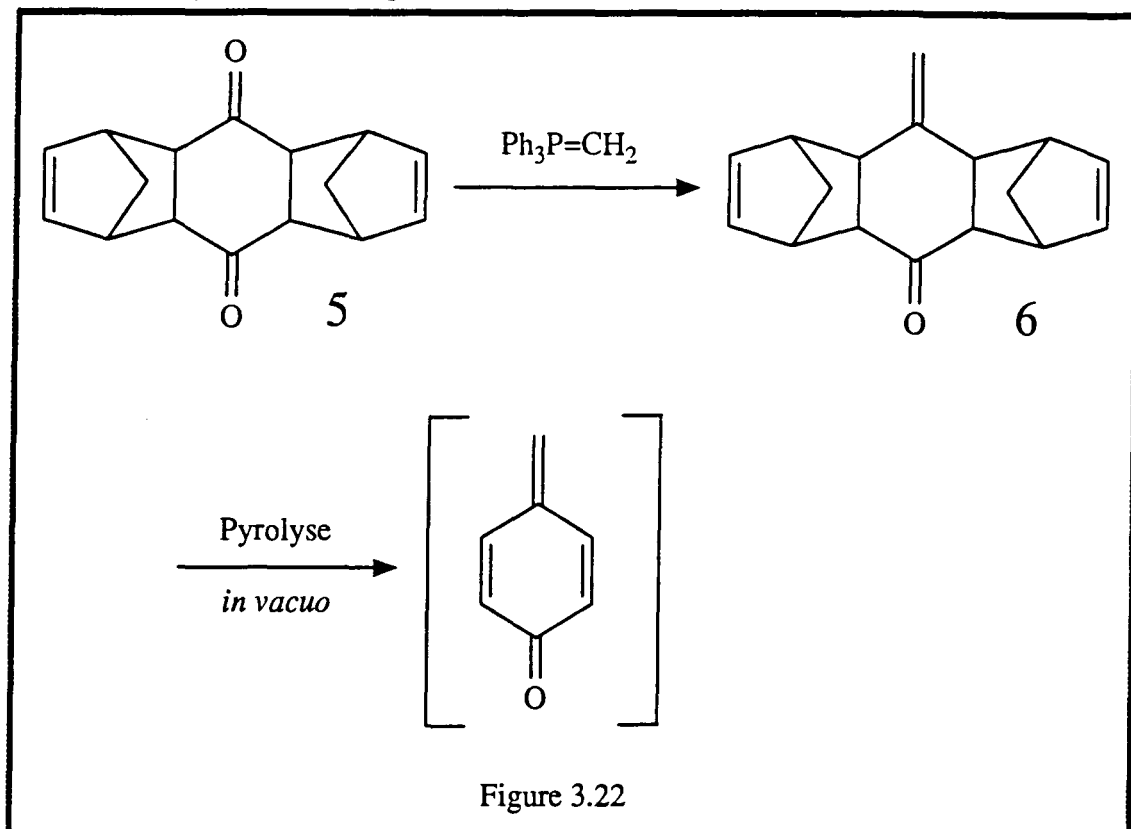

This synthesis gave rise to some scepticism, on the grounds that Cookson, Hill and Hudec<sup>[171]</sup> found that similar but saturated compounds are inert to nucleophilic attack on the carbonyl by isopropyl- and methyl-lithium. Only when the adduct was *exo*-,*exo*- was reaction at the carbonyl observed in the hydrogenated analogues<sup>[171]</sup>. Unfortunately, the *exo*-,*exo*- isomers of the unsaturated compound desired were unknown until very recently. Yates and Switlak<sup>[172]</sup> have succeeded in preparing the *exo*-*cis*-*anti*-*exo*-*cis*- isomer in unspecified yield in admixture with other isomers.

Assuming the reaction would proceed with *endo*-*cis*-*anti*-*endo*-*cis*-pentacyclo-[10.2.1.1<sup>5,8</sup>.0<sup>2,11</sup>.0<sup>4,9</sup>]hexadeca-6,13-dien-3,10-dione, 5, methods were sought to prepare dichloromethylenetriphenylphosphorane. The earliest syntheses<sup>[173]</sup> generated the ylid by reaction of triphenylphosphine with carbon tetrachloride. The work of Clement and Soulen showed that it could be produced efficiently if one of the chlorine atoms of carbon tetrachloride was replaced by bromine<sup>[174]</sup>. The ylid may also be made



by reaction of dichlorocarbene (from chloroform and base, typically potassium *tert*-butoxide) with triphenylphosphine<sup>[175]</sup>. It has subsequently been synthesized in pure form and isolated as a thermally stable yellow solid by Appel *et al*<sup>[176]</sup>. As an alternative to triphenylphosphine in these reactions, use has been made of tris(dimethylamino)phosphine<sup>[177]</sup>, which produces water-soluble hexamethylphosphorictriamide as reaction by-product instead of triphenylphosphine oxide. Whilst easier to work-up, the former reagent is toxic and the hexamethylphosphorictriamide produced in the reaction is carcinogenic. Nevertheless it was decided to use it.

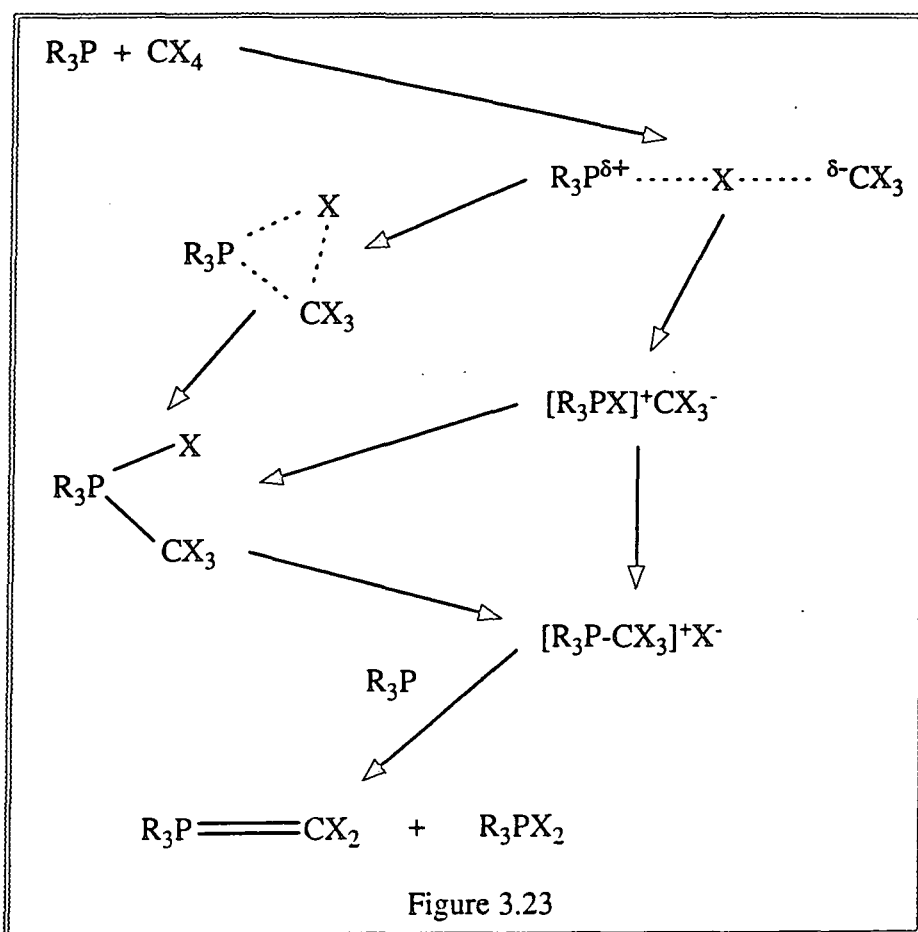

An ionic mechanism has been proposed by Appel *et al*<sup>[178]</sup> to explain the reaction of phosphines with carbon tetrahalides, figure 3.23. Cryoscopic depression experiments<sup>[179]</sup> show that the ylid, dichloromethylenetriphenylphosphorane, is monomeric in solution.

Both ylids, dichloromethylenetriphenylphosphorane and dichloromethylenetris-(dimethylamino)phosphorane, were reacted with *endo-cis-anti-endo-cis*-pentacyclo-[10.2.1.1<sup>5,8</sup>.0<sup>2,11</sup>.0<sup>4,9</sup>]hexadeca-6,13-dien-3,10-dione, 5, and with *endo-cis-anti-endo-cis*-tricyclo[8.4.0.0<sup>3,8</sup>]tetradeca-5,12-dien-2,9-dione, 7 in figure 3.24 below.

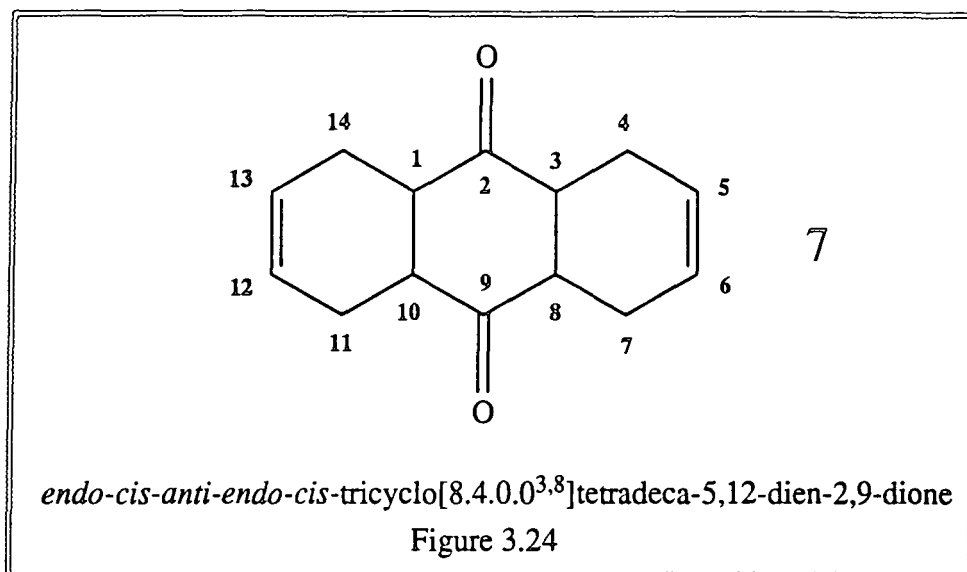

In neither case was product formation detected. Following aqueous work-up and chromatography on silica, eluting with ethyl acetate/hexanes, only starting material, phosphine oxide and highly coloured matter (most likely comprising quinones and enediones, which can be produced via autoxidation of the deprotonated Diels-Alder adducts<sup>[180]</sup>) could be isolated. The use of added lithium chloride, in attempts to catalyse the addition, was unsuccessful. Since one function of this catalyst<sup>[181]</sup> is to break up ylid aggregates, this result is not surprising (*vide supra* comments on the monomeric nature of the ylid.) As a check on experimental procedure, the same reactions conducted on cyclohexanone permitted the isolation of dichloromethylenecyclohexane in good yield.

Although disappointing, these failures were of some slight interest. It was proposed<sup>[171]</sup> that the reason for the failure of alkyl-lithium addition to the carbonyl was the steric hindrance of the ethylene bridges in the *endo-endo*- or *endo-exo*- isomers, both of

which were unreactive to nucleophiles, which presumably would not be the case in the *exo-exo*- isomers. It had been observed that the *exo-cis-anti-exo-cis*- isomer of pentacyclo[10.2.1.1<sup>5,8</sup>.0<sup>2,11</sup>.0<sup>4,9</sup>]hexadeca-3,10-dione, produced by hydrogenation of the all-*endo*- dienone, 5 in figure 3.22, and isomerisation by aqueous alkali, underwent nucleophilic attack by alkyl-lithium reagents. This seemed to confirm the above hypothesis. However, the tetradecadiendione, 7 in figure 3.24, is devoid of the methylene bridges which make the hexadecadiendione fluxionally immobile in the outer rings, lending the belief that conformational changes in the outer rings of the tetradecadiendione might allow access to the carbonyl groups irrespective of the stereochemistry of the Diels-Alder addition. These fluxional changes are quite slow, being readily observable on the timescale of the nmr experiment (*vide infra*, chapter 5) and one might expect that the attack of a nucleophile might occur faster than this. That this is not the case for the ylids demonstrates the influence which an *endo*- substituent must have on this reaction; the observation of Lasne, Ripoll and Denis<sup>[170]</sup> must be seen as an exception. However, Tavernier, Hosten and Anteunis demonstrated that the tetradecadiendione, 7, does react with tosylhydrazine<sup>[182]</sup> to give the expected tosylhydrazone. The steric hindrance which prevents the Wittig reaction must arise in part from the phosphine ligands (see below.)

The author has studied the reaction of these two ylids with the corresponding 1:1 benzoquinone - buta-1,3-diene and benzoquinone - cyclopentadiene Diels-Alder adducts, 8 and 9 in figure 3.25, below.

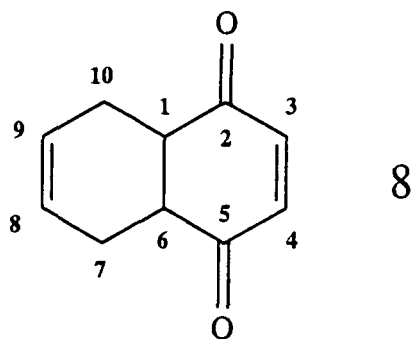

*endo-cis*-bicyclo[4.4.0]deca-3,8-dien-2,5-dione

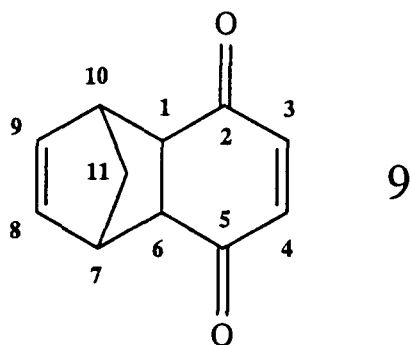

*endo-cis*-tricyclo[6.2.1.0<sup>1,6</sup>]undeca-3,8-dien-2,5-dione

Figure 3.25

In neither case was the desired product isolated, but in contrast to the 2:1 adducts above, these compounds underwent complex reactions. The mixtures recovered contained too many components by TLC for a chromatographic separation to be successful. It is likely that several competing processes occurred. These compounds will readily deprotonate. It is reported in the patent literature<sup>[183]</sup> that boiling these adducts in as mild a base as aqueous alcohol effects their conversion to the corresponding hydroquinones in excellent yield, so it is likely that deprotonation is aromaticity-driven for the 1:1 adducts 8 and 9. Ylids are, like other nucleophiles, partly basic in character and it seems possible that deprotonation by the ylid occurs, in these cases to give the hydroquinone. The 2:1 adducts 5 and 7 also deprotonate readily, giving rise to autoxidation products when the solution is exposed to air during work-up or recrystallisation. If hydroquinones are produced in the reactions on the 1:1 adducts,

it is likely that aryl halides are also produced. The ylid-forming reaction consumes two moles of phosphine per mole of bromotrichloromethane. One phosphine ends up as ylid, whilst the other reacts with the initial phosphine-alkyl halide adduct to give a bromochlorophosphine, as shown in figure 3.23. This dihalophosphine is known to be capable of converting phenols to aryl halides in good yield<sup>[184]</sup>.

There is also the possibility of Michael addition to the unsaturated system to give a phosphonium salt. The enol-keto tautomer produced from this reaction might then deprotonate to a hydroquinone, or autoxidise when exposed to air as for the 2:1 adducts, giving rise to further complex products.

For both the 2:1 and 1:1 adducts, addition of lithium chloride to the ylid prior to addition to dione, or to the dione prior to addition of ylid, made no difference to the result of the reaction and it has been previously noted that dichloromethylenetriphenylphosphorane is monomeric in solution. It is reported that benzoic acid can catalyse the Wittig reaction<sup>[185]</sup>. This is surprising because the usual requirement for success in the Wittig reaction (and its derivatives) is rigorous exclusion of acidic protons. Nevertheless a reaction was tried in the presence of a catalytic amount of benzoic acid; not surprisingly, it failed.

To investigate these failures a little further, another model study was performed on 2,6-dimethylcyclohexan-1-one, obtained commercially as a mixture of the equatorial, equatorial *cis*- and the axial, equatorial *trans*- isomers. Attempts to react the two ylids with this ketone failed to produce evidence of any dichloromethylene-substitution. It seems likely that the reason that the 2:1 Diels-Alder adducts of cyclopentadiene or butadiene with benzoquinone fail to react, is not necessarily due to the steric hindrance of the methylene or ethylene bridges, although it is conceded that this might be a contributory factor.

Since this mixture of isomers of 2,6-dimethylcyclohexan-1-one simulates the conformational environments found in *anti*- and *syn*- 2:1 adducts of dienes plus benzoquinone, whether *exo-cis*- or *endo-cis*-, the failure of this model to react with either ylid strongly suggests that it is the steric hindrance of the phosphine ligands which prevents the reaction, rather than the methylene or ethylene bridges, although clearly their presence will further inhibit the reaction. The observation of Lasne *et al*.<sup>[170]</sup> suggests that there is also an electronic effect; the stabilising -I property of the dichloro-substituents makes the ylids used "softer" in comparison to methylenetriphenylphosphorane.

ii) On 1,4-benzoquinone.

Reaction of either of the two ylids on 1,4-benzoquinone gave complex mixtures from which no pure compounds could be isolated. This was not a great surprise, as Michael addition can compete in this case also, whilst the quinone methide is probably attacked at the 7 position by the ylid faster than attack occurs at the quinone carbonyl. Molecular orbital calculations<sup>[186]</sup> show that benzoquinone carbonyls have a low susceptibility to nucleophilic attack, whilst the 7 position in 1,4-quinone methides is highly susceptible to it.

iii) On 4,4-dimethoxycyclohexa-2,5-dien-1-one.

Whilst infra-red and 60MHz proton nmr analysis of the crude product indicated that the above compound had reacted with dichloromethylenetriphenylphosphorane, it was also clear that the product, 1,1-dimethoxy-4-dichloromethylenecyclohexa-2,5-diene, spontaneously underwent decomposition. It is likely that this was partly due to hydrolysis on aqueous work-up, as the ketal would be expected to be very sensitive to hydrolysis and halogen acid is produced when the dihalophosphine by-product (*vide*

*supra*) hydrolyses.

### 3) Routes via Wittig-Horner Reaction

It was decided to try a Wittig-Horner equivalent of the above ylids, on the basis that these are much more reactive towards ketones. It was reported by Kosolapoff<sup>[187]</sup> that carbon tetrachloride reacts with triethylphosphite in a Michaelis-Arbuzov reaction to give diethyl trichloromethylphosphonate. This synthesis was repeated and gave the desired product in excellent yield. Savignac *et al*<sup>[188]</sup> and Seyferth and Marmor<sup>[189]</sup> used this and similar phosphonate esters in Wittig-Horner reactions with ketones. Kukhar and Sagina<sup>[190]</sup> found that the tribromo-analogue is difficult to isolate, as the initially-formed diethyl tribromomethylphosphonate reacts further with phosphite, even at low temperature, and the yields of the desired product are always poor. Kamai and Kharrasova<sup>[191]</sup> postulated a radical mechanism for the carbon tetrachloride-triethyl phosphite reaction, figure 3.26.

The phosphonate ester, prepared as above, was used in reactions on the following compounds.

i) On *Endo-cis*-Tricyclo[6.2.1.0<sup>2,7</sup>]undeca-4,9-dien-3,6-dione, 9.

The lithiated phosphonate was yellow as made and upon addition of the ketone below -80°C, the colour intensified instantly. The molar absorption was so high that the colour could not be determined, suggesting either extended conjugation or formation of a charge transfer complex. TLC indicated a large number of products from this reaction.

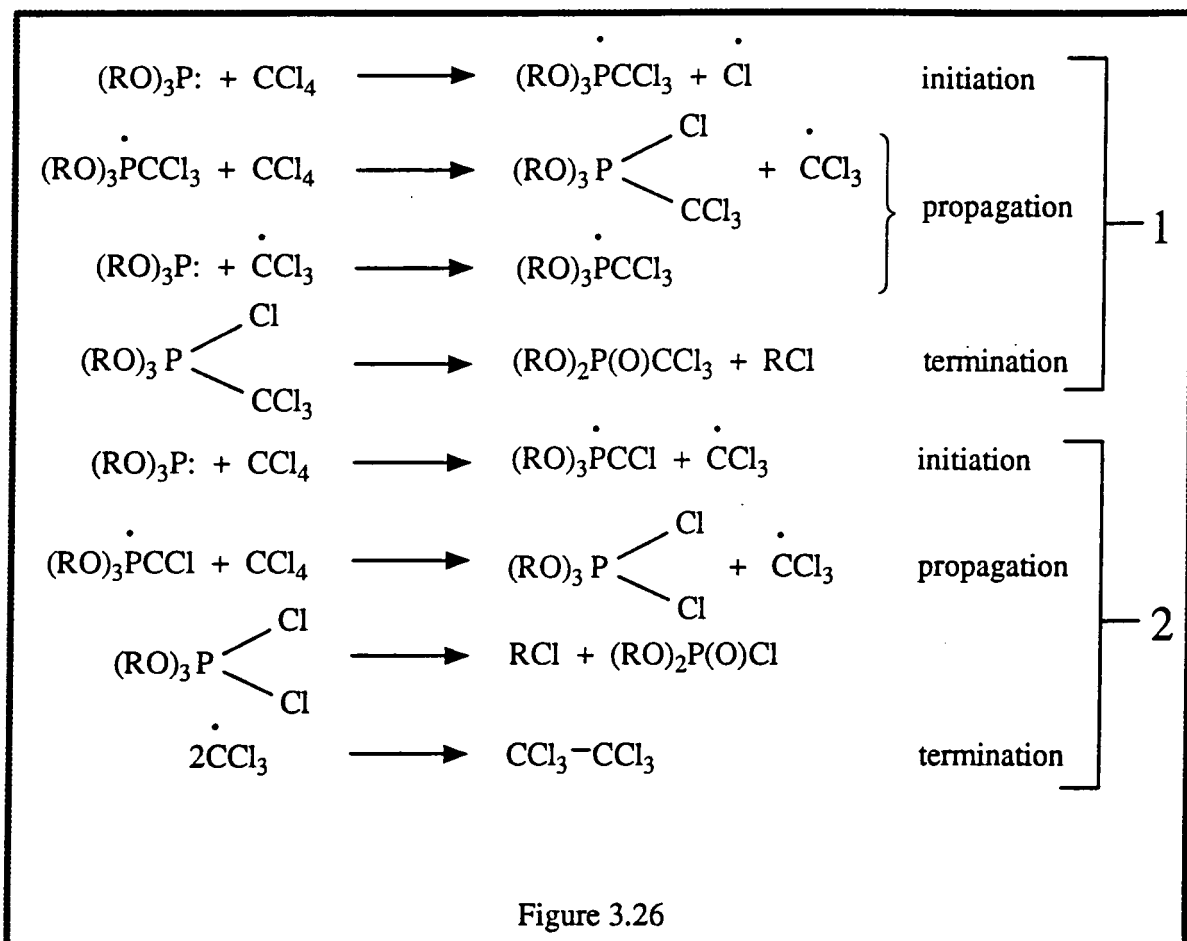

ii) On 4,4-dimethoxycyclohexa-2,5-dien-1-one.

The reaction mixture rapidly darkened when the ketone was added to the lithiated phosphonate, but not to such an extent as in the previous case and the solution was red. Work-up yielded an orange oil which was shown by proton nmr to contain mainly unreacted starting material.

iii) On *Endo-cis*-Bicyclo[4.4.0]deca-3,8-dien-2,5-dione, 8.

The reaction produced an intensely-coloured solution which yielded a complex mixture of products. Addition of lithium chloride made no difference to the outcome of the reaction.

iv) On *Endo-cis*-6,6-Dimethoxytricyclo[6.2.1.0<sup>2,7</sup>]undeca-4,9-dien-3-one, 10 in figure 3.27



The reaction yielded a red solution which, after work-up, gave a yellow oil which was recrystallised from cold hexane. Proton nmr indicated that reaction had occurred accompanied by hydrolysis of the ketal, probably during work-up, and the product, *endo-cis*-6-dichloromethylenetricyclo[6.2.1.0<sup>2,7</sup>]undeca-4,9-dien-3-one, 11, was obtained as pale yellow crystals in moderate yield. It should be noted that this compound is a potent irritant and is vinylogous to phosgene.

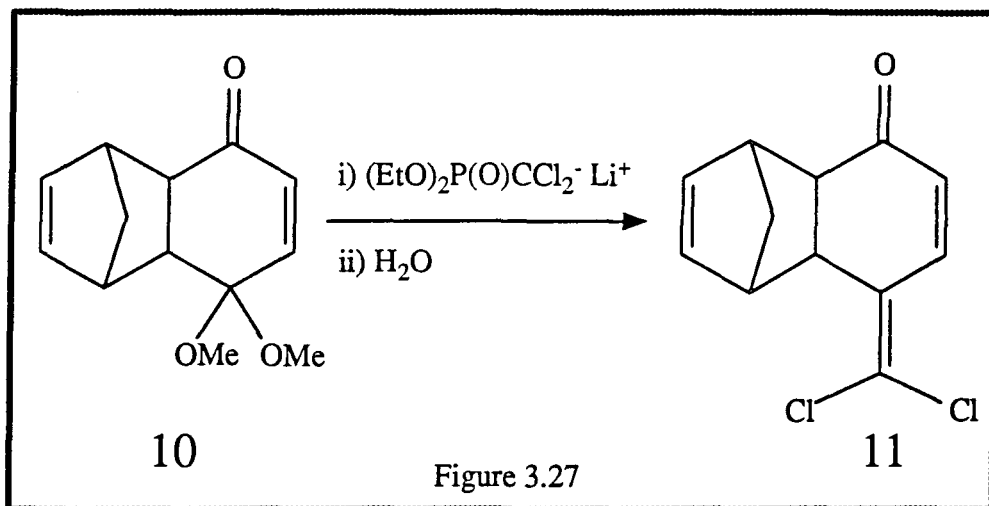

The successes and failures of the above reactions bear further inspection in the light of the observations made by Castells *et al*<sup>[192]</sup> a summary of which is shown in Figure 3.28. Castells suggested that deconjugation of the enone system takes place prior to addition of the phosphonate, and that in systems where deconjugation is impossible, reaction is prevented. Interestingly, whilst this might explain the reluctance of the Wittig-Horner reaction to proceed with the benzoquinone-diene Diels-Alder adducts, or with 4,4-dimethoxycyclohexa-2,5-dien-1-one, the one case in this author's research where the Horner reagent succeeded in reacting (iv above) is a case in which it is impossible for deconjugation to occur. It has also been reported by Yamashita *et al*<sup>[193]</sup> that phosphonate esters can be used to prepare tetrathiofulvalene derivatives by reaction with benzoquinone-diene Diels-Alder adducts, see figure 3.29 overleaf.

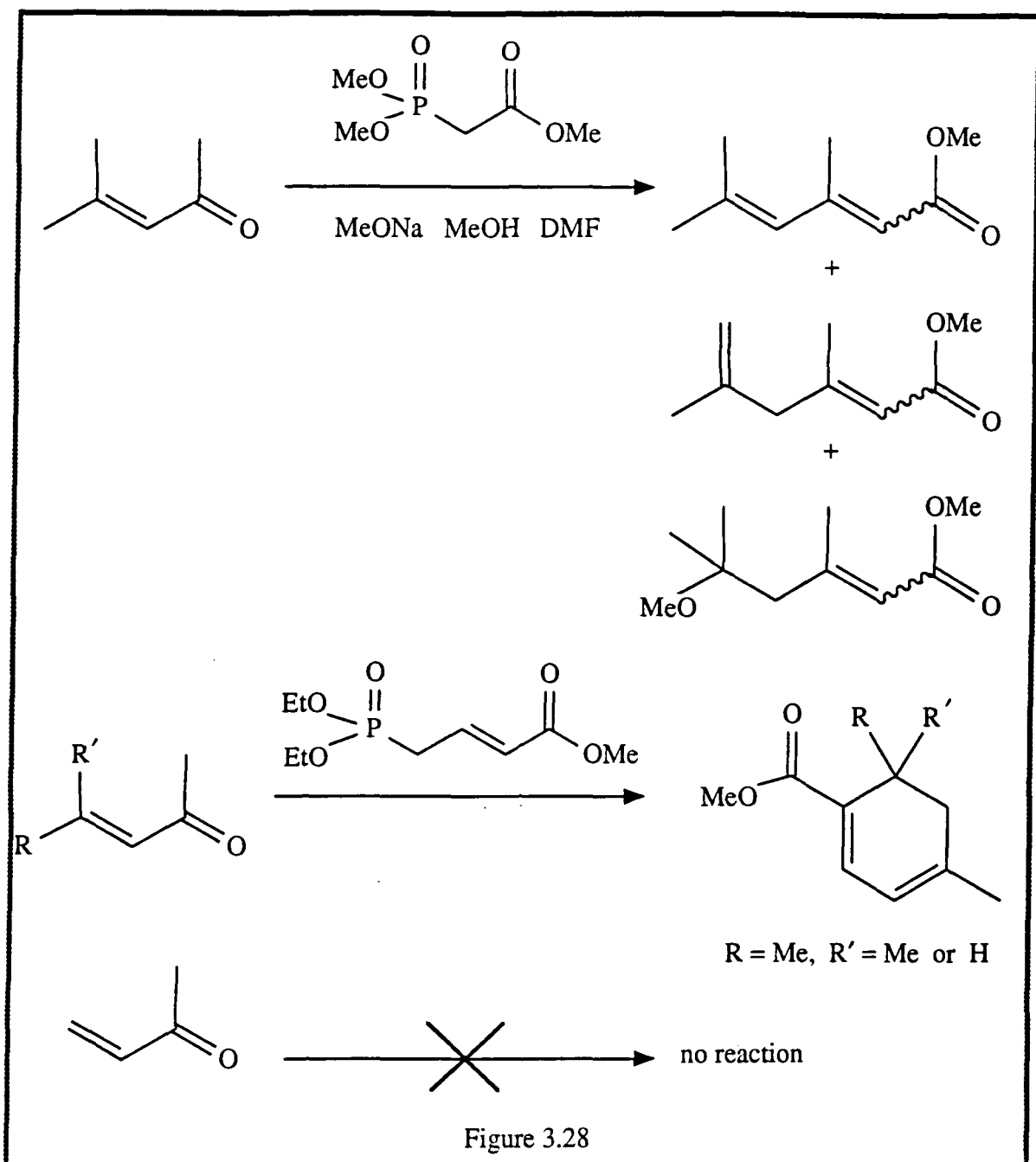

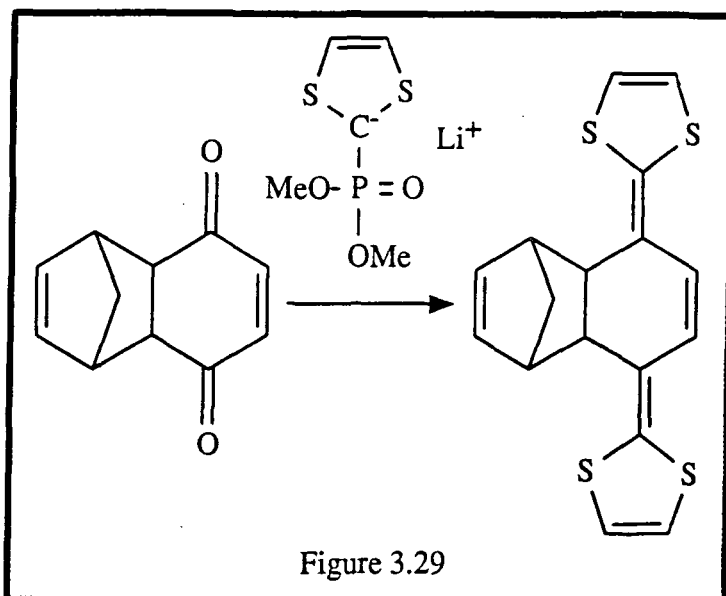

It is worth commenting on the synthesis of *endo-cis*-6,6-dimethoxytricyclo[6.2.1.0<sup>2,7</sup>]-undeca-4,9-dien-3-one, 10. The material was made according to the method of Fariña *et al*<sup>[194]</sup> by the Diels-Alder reaction of cyclopentadiene with 4,4-dimethoxycyclohexa-2,5dien-1-one, figure 3.30.

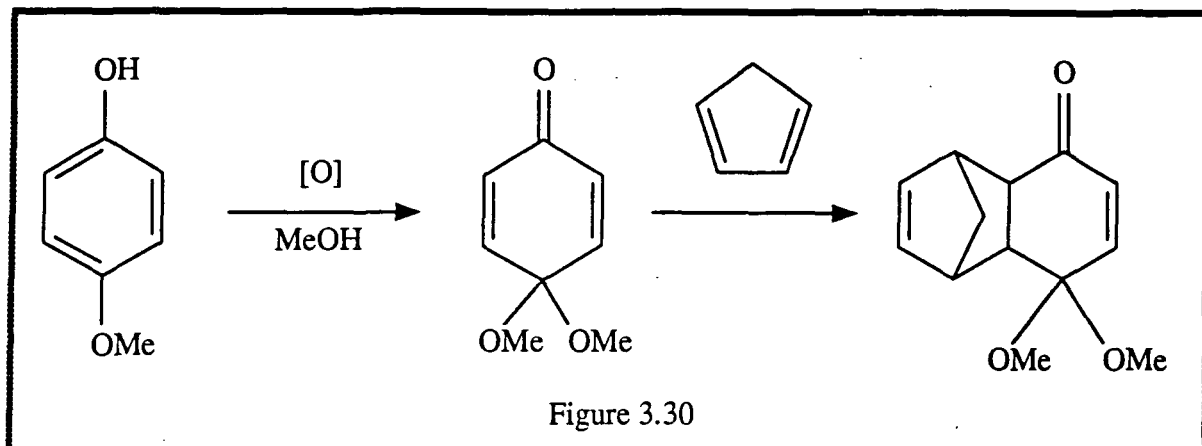

This reaction was found to be rather fey, and much ketal was lost in repeated attempts to make the adduct. No satisfactory explanation was found for this observation. The loss of ketal was particularly frustrating as it is not a simple compound to make in quantity. McKillop *et al*<sup>[195]</sup> produced it by thallium (III) nitrate oxidation of *para*-methoxyphenol, see figure 3.31. This reaction was repeated many times, usually with success, but aside from the toxicity and expense of thallium, there is another important reason which restricts its application to the gram scale. The additional hazard of this synthesis does not appear to have attracted comment in the literature, and it is

felt worthwhile to make the point here.

The by-product of the synthesis, which is conducted in anhydrous methanol plus trimethyl orthoformate, is two molar equivalents of nitric acid. The orthoformate ester is present to ensure that the solvent remains anhydrous, to prevent hydrolysis of the thallium salts. However, it also provides near-perfect conditions for the esterification of methanol by nitric acid.

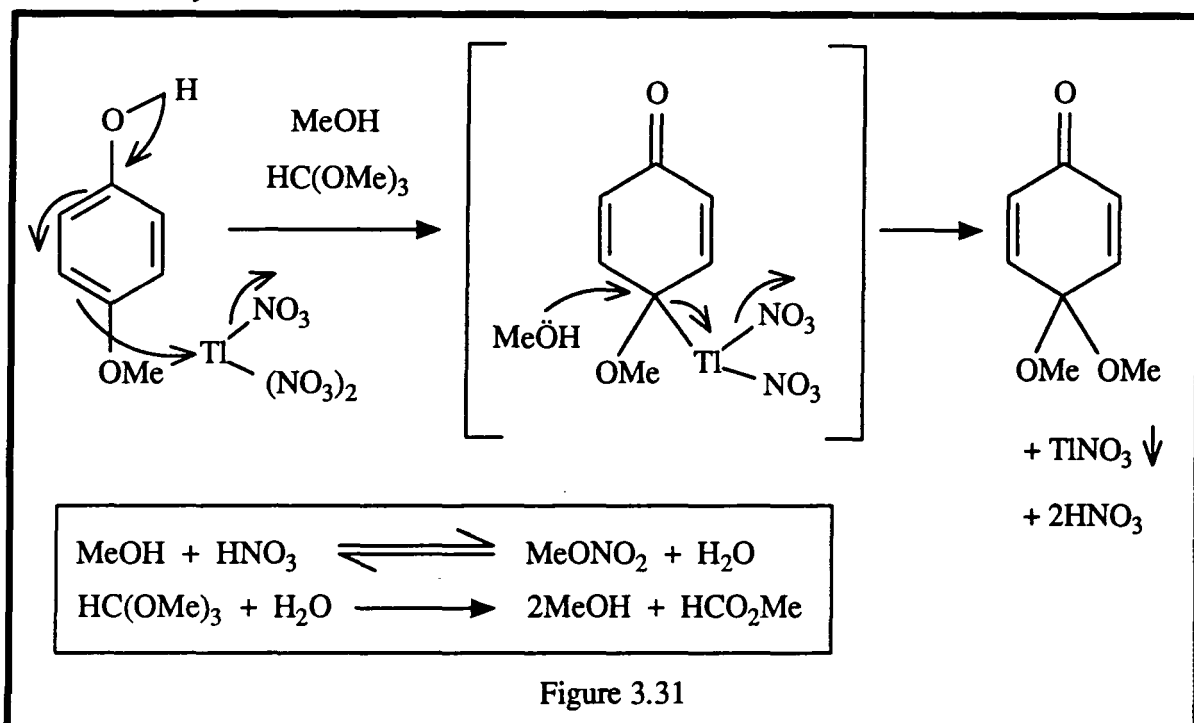
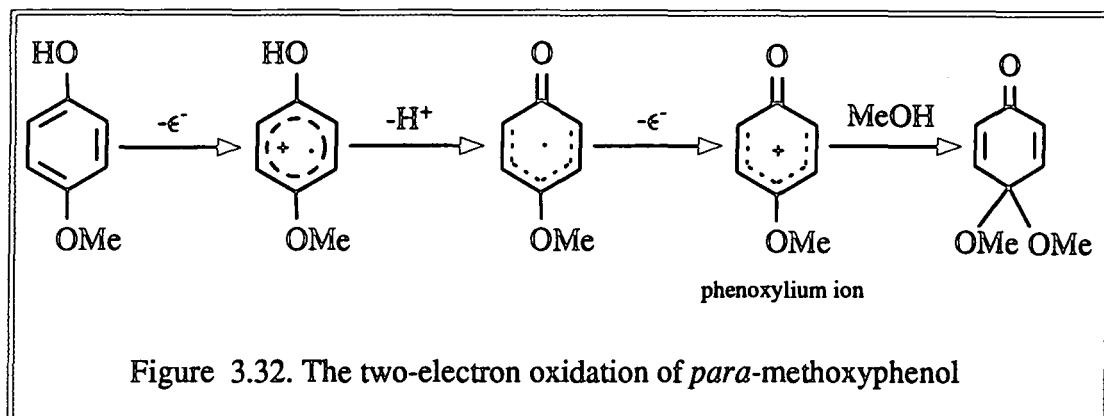

Figure 3.31

Methyl nitrate was recognised as a potentially useful explosive by Nobel in a patent<sup>[196a]</sup> which predates his famous Dynamite work by four years. According to Davis<sup>[196b]</sup> it is more destructive than glyceryl trinitrate ("nitroglycerin") but less sensitive to mechanical shock. Whilst it is obvious in the original paper that the nitric acid is produced, and that the basic alumina is employed to remove it and prevent violent oxidation of the solvent<sup>[197]</sup> when the latter is concentrated, the possibility of synthesising a detonable by-product has never been remarked upon. It is probable that the basic alumina used to neutralise the nitric acid simultaneously hydrolyses any methyl nitrate produced, and the low boiling point of the ester (65-6°C<sup>[196b]</sup>) reduces the likelihood of concentrating the solution by rotary evaporation, but one should be

aware of the potential hazard.



An alternative method to thallium (III) nitrate oxidation of *para*-methoxyphenol, is to use electrolytic oxidation<sup>[198]</sup> of the same compound. The oxidation, which is conducted in methanol solution at a platinum anode, does not proceed via the generation of methoxy radicals, in spite of the fact that methanol should be oxidised more readily than methoxyphenol. Phenols adsorb more readily at the electrode surface<sup>[199]</sup> and are thus preferentially oxidised. It is a two-electron oxidation which proceeds via a phenoxylum ion, figure 3.32. Unfortunately, such electrolytic oxidations are critically dependent upon the characteristics of the electrode surface, which plays such an important role in selectively adsorbing the substrate. It was found that, whilst the claimed yield for this process was 93%, the best result achieved was only 30%. The greatest synthetic problem encountered was not the poor yield *per se*, but the separation of the desired product from the other 70%, which was a black tar. Sometimes, no product could be recovered from the tar. The separation, which required large amounts of chromatographic adsorbent, was very slow, because of the tendency of the tar to plug the column. The recovered product was contaminated and required further purification, which was achieved with difficulty by vacuum transfer at  $\leq 10^{-5}$  mbar (the material thermally decomposes if heated above ca. 50°C and vacuum distillation at poorer vacuum was found to be ineffective.)

The success of the synthesis of *endo-cis*-6-dichloromethylenetricyclo[6.2.1.0<sup>2,7</sup>]-

undeca-4,9-dien-3-one made it possible in theory to produce the desired 7,7-dichloro-1,4-benzoquinonemethide by retro-Diels-Alder reaction, but synthesis of the starting material, *endo-cis*-6,6-dimethoxytricyclo[6.2.1.0<sup>2,7</sup>]undeca-4,9-dien-3-one, proved irreproducible, *vide supra*, as did the Wittig-Horner reaction. However, sufficient material was made to try some reactions on the 10mg scale.

One synthetic possibility, other than pyrolysis of the compound to yield the quinone methide, was to attempt hydrolysis of the conjugated dichloromethylene group which was expected to yield an hydroxy-acid which might then have been polymerised to give a precursor polymer.

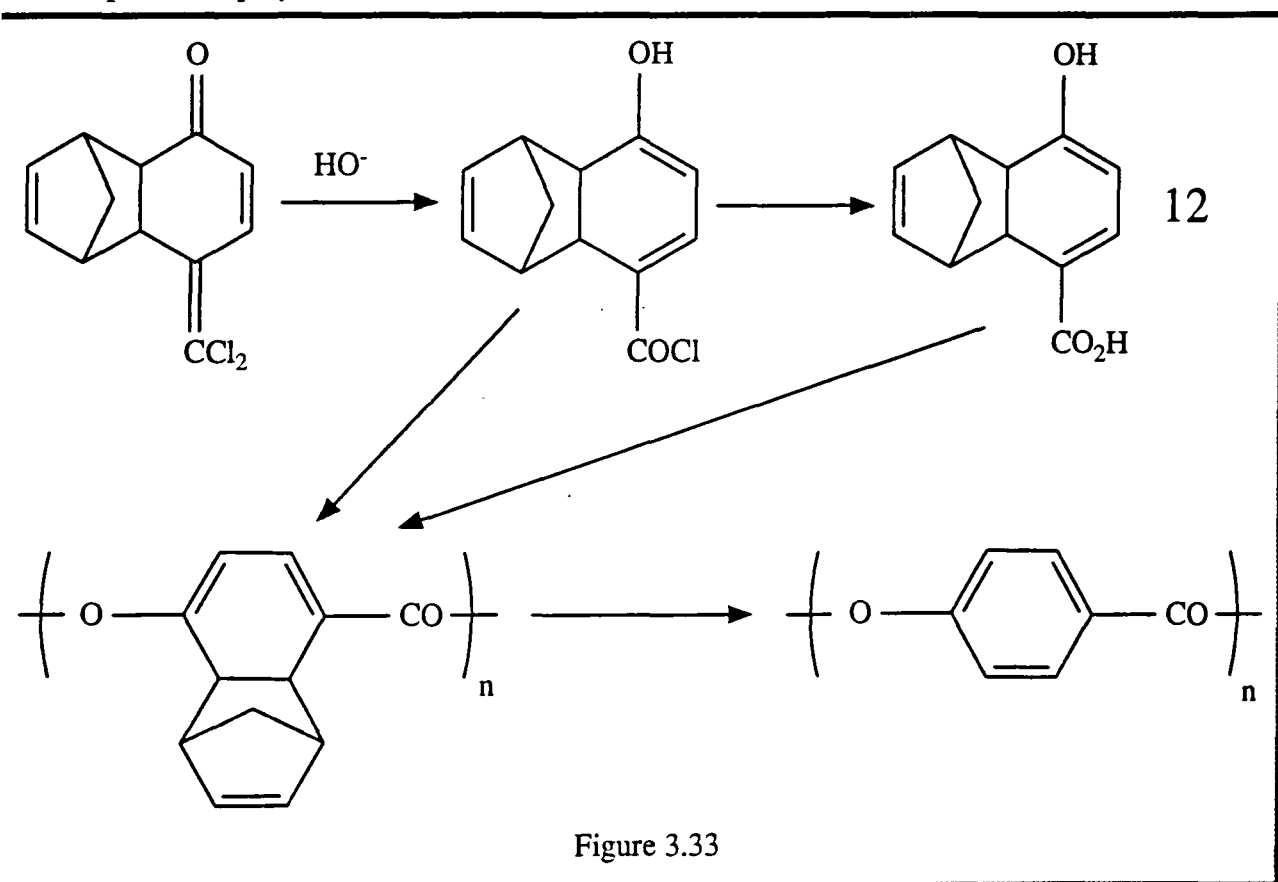
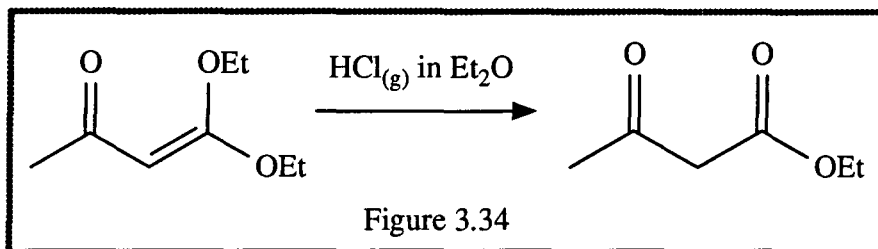

Figure 3.33

It has been reported by Mirskova *et al*<sup>[200]</sup> that 4,4-dichloro-3-buten-2-one undergoes attack by sulphur-containing nucleophiles to give the expected products of Michael addition-elimination, and by Nesmeyanov *et al*<sup>[201]</sup> that oxygen nucleophiles react similarly. In the latter case, the relative rate of reaction is EtO<sup>-</sup> < <sup>i</sup>PrO<sup>-</sup> < <sup>t</sup>BuO<sup>-</sup>; with

tertiary butoxide the reaction is violent, possibly because the initial step is not Michael addition, but elimination of hydrogen chloride to give an acetylenic ketone which then polymerises rapidly. The product of attack by ethoxide is isolable, and gives ethyl acetoacetate on treatment with dry HCl in ether, figure 3.34.



In the case of the desired hydrolysis, the hydroxy-acid obtained (12 in figure 3.33 above) would be expected to be thermally unstable and room-temperature polyesterification would be essential. Fortunately, there is a technique developed by Hassner and Alexanian<sup>[202]</sup> which provides esters at low temperature in good yield.

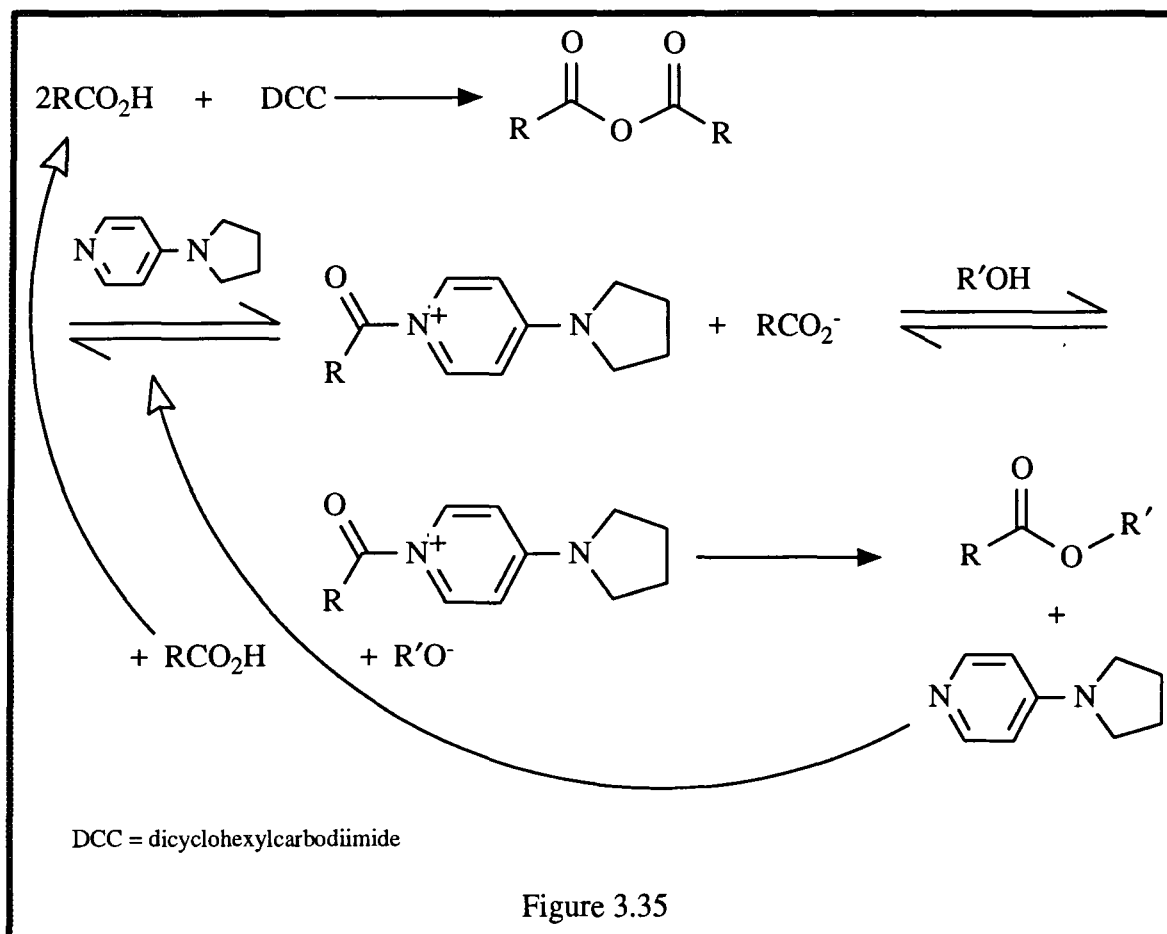

However, when *endo-cis*-6-dichloromethylenetricyclo[6.2.1.0<sup>2,7</sup>]undeca-4,9-dien-3-one was reacted with base, a yellow solution was formed, which was thermally stable and

which when neutralised yielded a colourless solution from which the starting material could be recovered unchanged. Likewise, treatment with dilute acid gave a yellow solution which could be rendered colourless by base and from which the starting material could be recovered. These changes suggested that reversible protonation-deprotonation of the starting material was taking place. To confirm this, a basic yellow solution of the compound was boiled for ten minutes under nitrogen and allowed to cool. Neutralising it allowed recovery of starting material. The starting material is so thermally unstable with respect to the retro-Diels-Alder reaction that allowing it to stand overnight at room temperature is enough to bring about significant decomposition (it may be noted that half of the original material was inadvertently lost in this way before the instability of the compound was realised.) The thermal stability of the basic solution must be due to the enolate, which cannot undergo the retro-reaction to the quinone methide and cyclopentadiene.

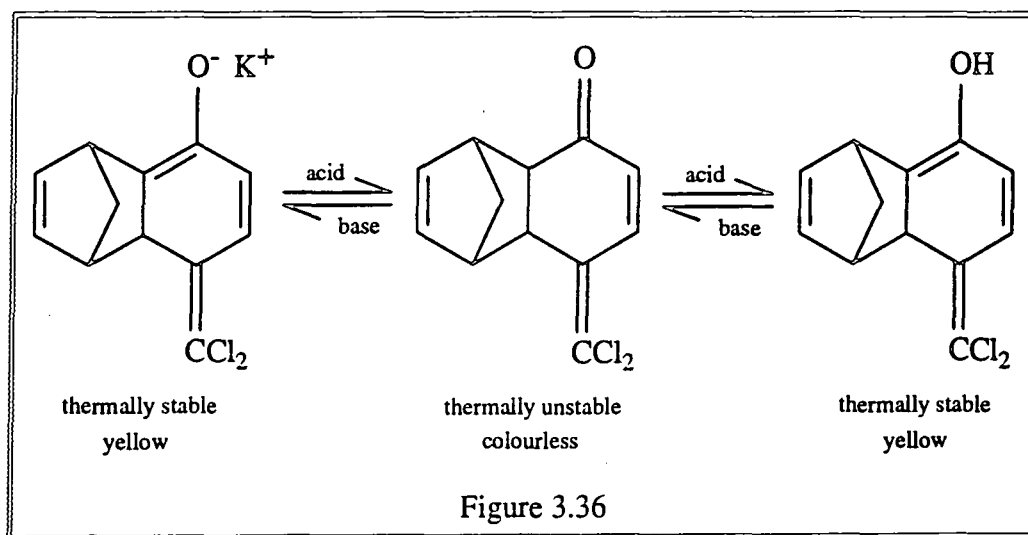

It is surprising, given the thermodynamic driving force of aromaticity, that 1,3-prototropic shift does not occur in hydrolysis. However, when the compound was treated with boron trifluoride etherate, a vigorous reaction occurred and an insoluble black material precipitated from the solution. The soluble material, recovered from the product in poor yield, was shown to be unreacted starting material. The insoluble black material could not be identified.



The work of Yamashita *et al*<sup>[193]</sup> suggested that reaction of a phosphonate derived from 1,3-dithiane with *endo-cis*-bicyclo[4.4.0]deca-3,8-dien-2,5-dione might be successful, and if it was, hydrolysis of the resulting ketene thioacetal would give an hydroxy-acid, similar to that expected from the attempted hydrolyses above and which might likewise be used in the synthesis of a precursor polymer. A number of methods exist for hydrolysing ketene thioacetals but most of these require extended heating. However, there are a few room temperature methods<sup>[203]</sup> which suggested that this route was worth trying. Unfortunately, TLC indicated that only complex products were formed. It may be that the reaction proceeded and the initially-formed adduct underwent thermal decomposition more readily than *endo-cis*-6-dichloromethylenetricyclo[6.2.1.0<sup>2,7</sup>]-undeca-4,9-dien-3-one. If so, the dithio-substituted quinone methide produced would be expected to be much less stable than the tetrathiofulvalene analogues prepared by Yamashita.

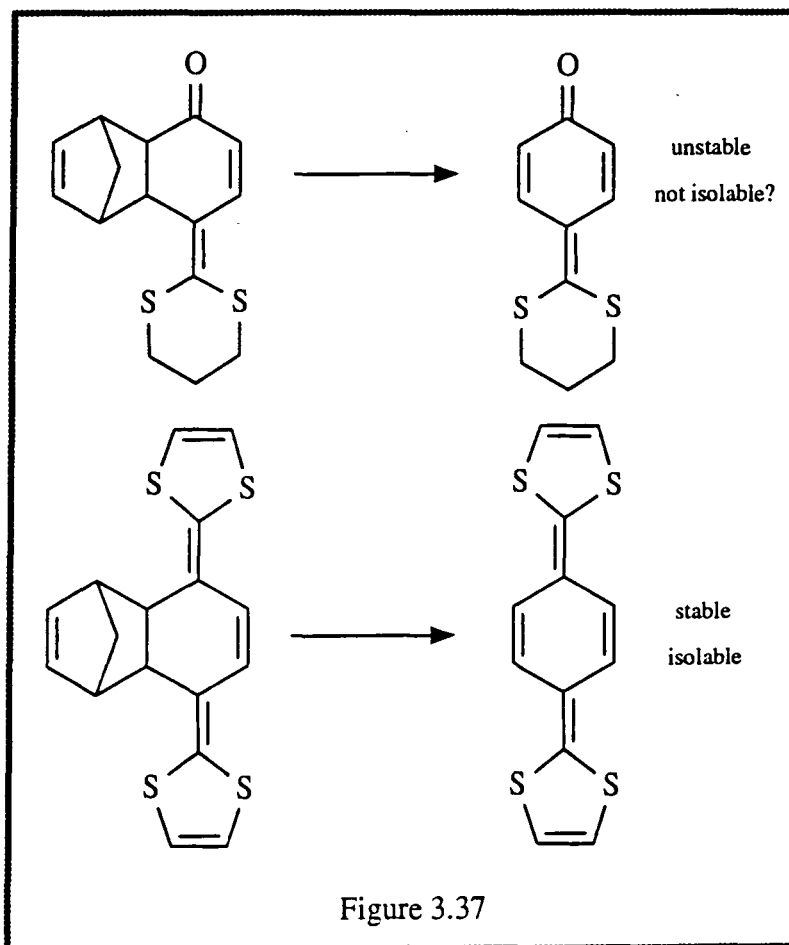
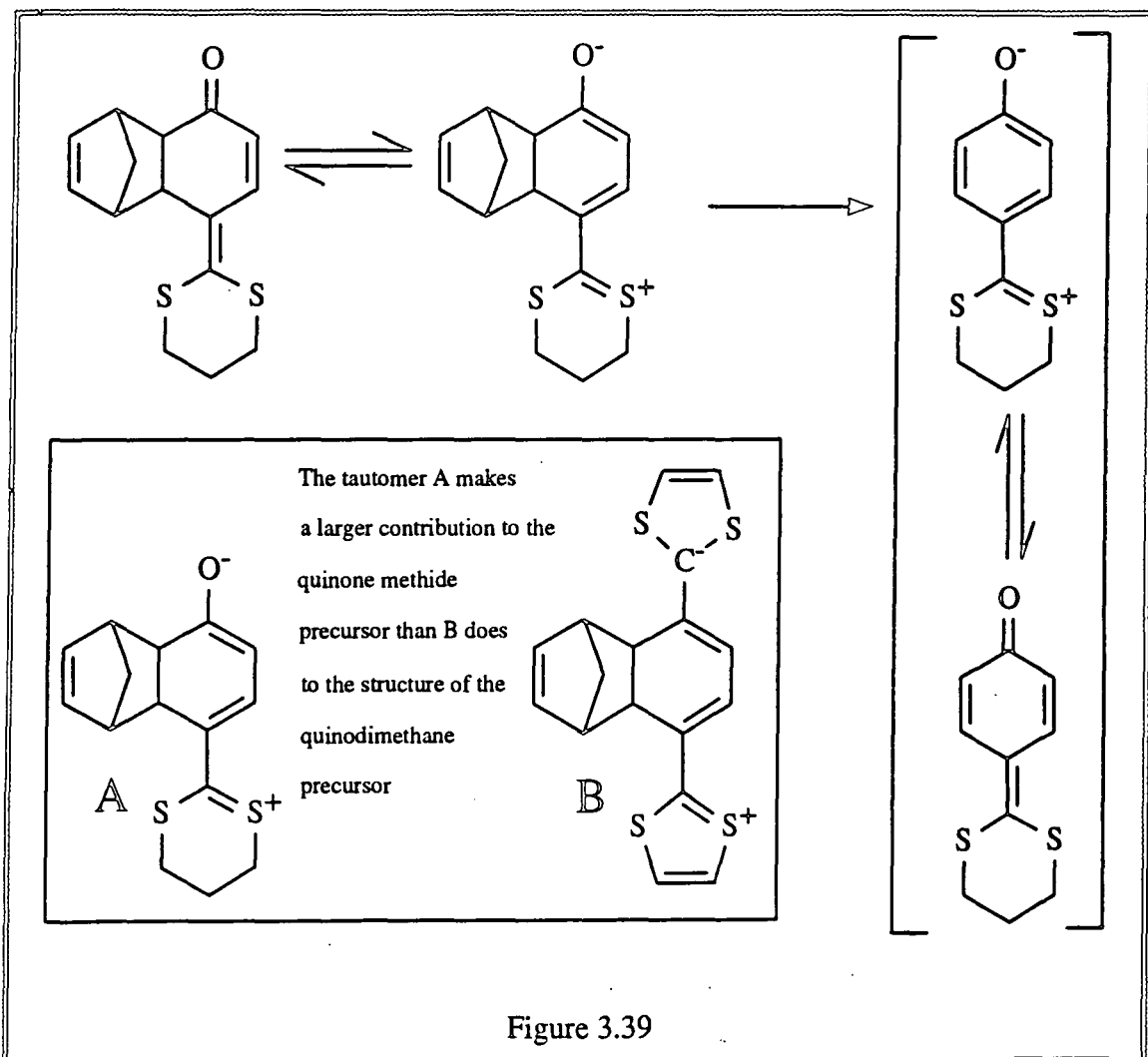
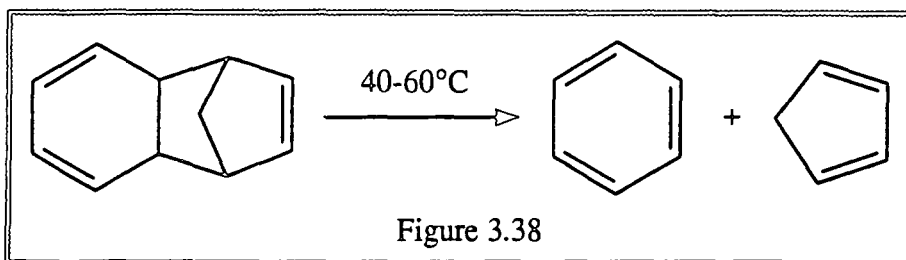

Figure 3.37

Rye and Wege<sup>[204]</sup> prepared and studied the cycloreversion of exo- and endo-tricyclo[6.2.1.0<sup>2,7</sup>]undeca-3,5,9-triene. They found it underwent the retro-reaction at only moderately elevated temperature.



It might be expected that the precursor to the 7,7-dithio-substituted quinone methide (A in figure 3.39 below) would be more unstable with respect to the retro-Diels-Alder reaction than the precursor (B in figure 3.39 below) to the tetrathiofulvalene analogue, the quinodimethane. The zwitterionic tautomer would contribute more to the electronic

structure of the former molecule, and with aromaticity as the driving force for the retro-reaction, might be expected to undergo this reaction at room temperature.

#### 4) Routes via Silicon Chemistry

As there were practical difficulties in obtaining more *endo-cis*-6-dichloromethylene-tricyclo[6.2.1.0<sup>2,7</sup>]undeca-4,9-dien-3-one for further studies, an attempt was made to react *endo-cis*-bicyclo[4.4.0]deca-3,8-dien-2,5-dione under Petersen olefination<sup>[205]</sup> conditions. 1,3-Dithiane was reacted with butyl-lithium, the anion quenched with trimethylsilylchloride and the silylated dithiane reacted *in situ*<sup>[206]</sup> with a further equivalent of base, followed by the dione. Proton nmr showed that the product was a complex mixture. Similar comments apply as for the above attempted synthesis using the dithiane phosphonate ester.

As a final attempt to get an alternative route to a 7,7-dichloro-1,4-benzoquinonemethide precursor, several reactions were tried using the chemistry developed by Entmayer and Köbrich<sup>[207]</sup> which is a two-stage process, illustrated in figure 3.40.

The trimethylsilyl ether can be isolated, or the two stages can be conducted *in situ*. A model study, conducted as in the above scheme, allowed the isolation of the trimethylsilyl ether derived from cyclohexanone in good yield. However, it was obvious that the method was inapplicable to the 1:1 Diels-Alder adducts of benzoquinone or its monoketal, since treatment of the ether with base would not result in the desired elimination. With the 2:1 adducts, it had already been shown that nucleophilic attack at the carbonyl was difficult, and indeed no such attack was observed when the reactions were tried. When benzoquinone was the subject of a similar experiment, complex products resulted from which nothing was isolated. Gas chromatography/mass spectroscopy on the mixture indicated the presence of some hydroquinone.

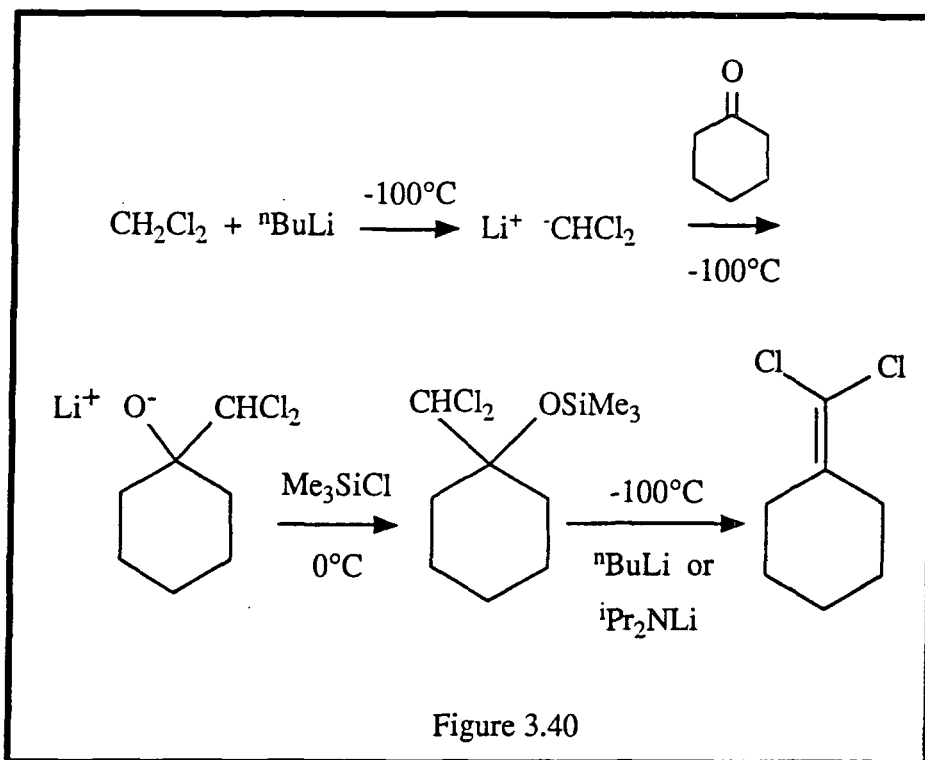

The conclusions reached from this work are:

- 1) Diels-Alder adducts of benzoquinone are generally unsuitable for preparations which depend on nucleophilic attack at the carbonyl groups. Only in very specific instances can any pure compounds be isolated.
- 2) The Diels-Alder adducts of *protected* benzoquinone, such as *endo-cis*-6,6-dimethoxytricyclo[6.2.1.0<sup>2,7</sup>]undeca-4,9-dien-3-one, are suitable candidates for use with nucleophiles in synthesis. There are, however, problems with the synthesis of these compounds and problems with the thermal stability of the products, which may render further reactions upon them difficult.
- 3) Synthesis of a suitable precursor to 7,7-dichloro-1,4-benzoquinone-methide has been achieved. The precursor is *endo-cis*-6-dichloromethylenetricyclo[6.2.1.0<sup>2,7</sup>]undeca-4,9-dien-3-one.

## Chapter 4. Miscellaneous Methods

Three additional methods were explored as potential routes to the desired precursor polymer. One of these derives from work by Sokolova *et al*<sup>[208]</sup> in which the ring-opening copolymerisation of a lactam with a lactone gave a high melting copolyester-amide which could be drawn into fibres, figure 4.1, and the work of Ceccarelli *et al*<sup>[209]</sup> in which the ring-opening polymerisation of the same lactone gave a polyester, which was tough and film-forming, figure 4.2.

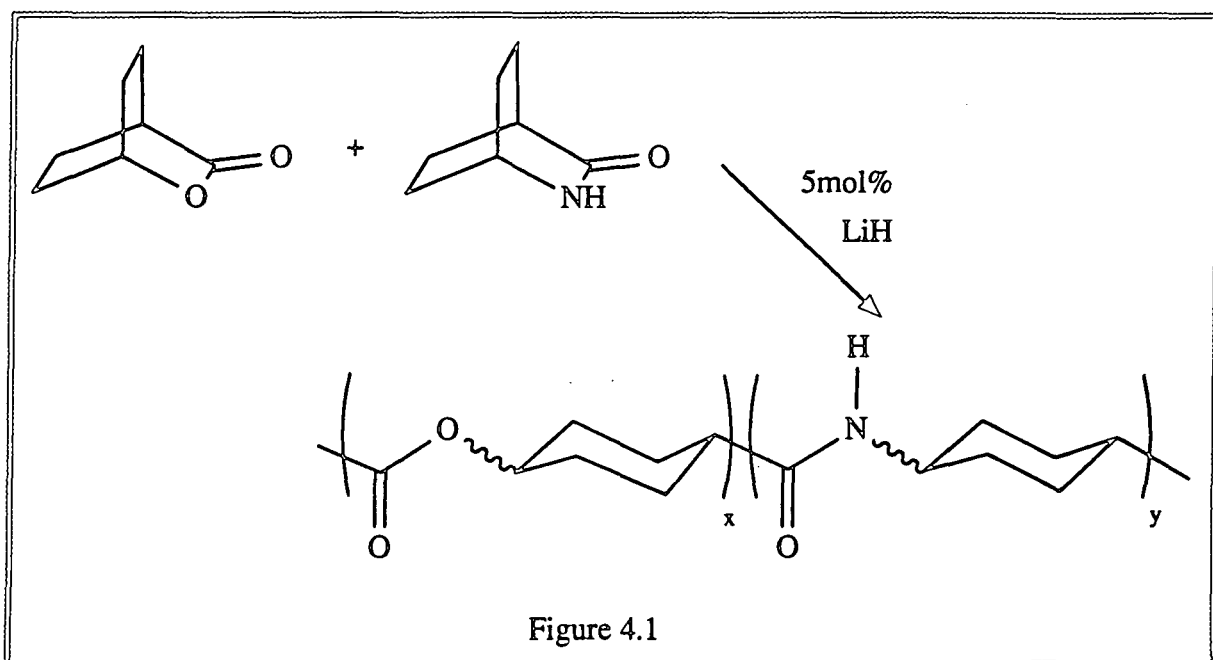

Two different bond cleavage mechanisms operate in these polymerisations. Nucleophilic attack at the carbonyl group leads to acyl-oxygen or acyl-nitrogen cleavage, and the active propagating species are alkoxides or lithium salts of amines, although the latter are unlikely intermediates. This mode of propagation leads to polymers containing *cis*- structural units. The alternative is  $S_N2$  displacement, i.e. alkyl-oxygen or alkyl-nitrogen cleavage, leading to the propagating species being carboxylates or amides, which produces *trans*- structural units. For the lactam, it is also possible (and likely) that deprotonation of the nitrogen occurs as the initial step and that

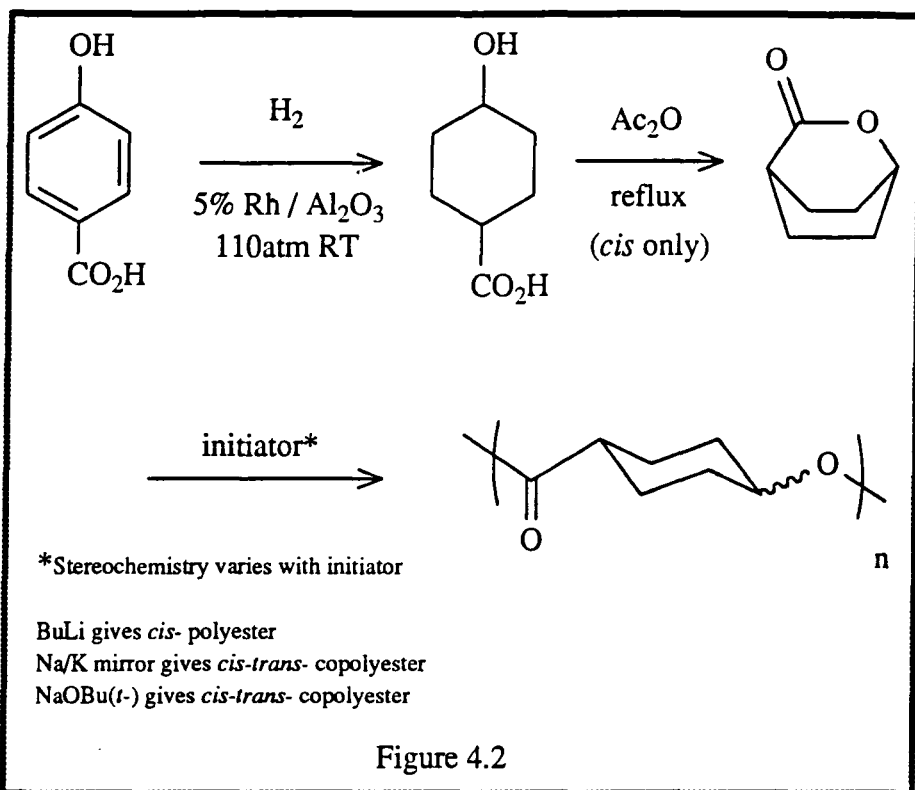

this lithiated lactam then serves as the nucleophile. Ceccarelli<sup>[209]</sup> made a thorough study by <sup>13</sup>C nmr of the polymer microstructure produced when 2-oxabicyclo[2.2.2]octan-3-one was polymerised with a variety of initiators. It was thought possible that, with modification, this could serve as a precursor route to an

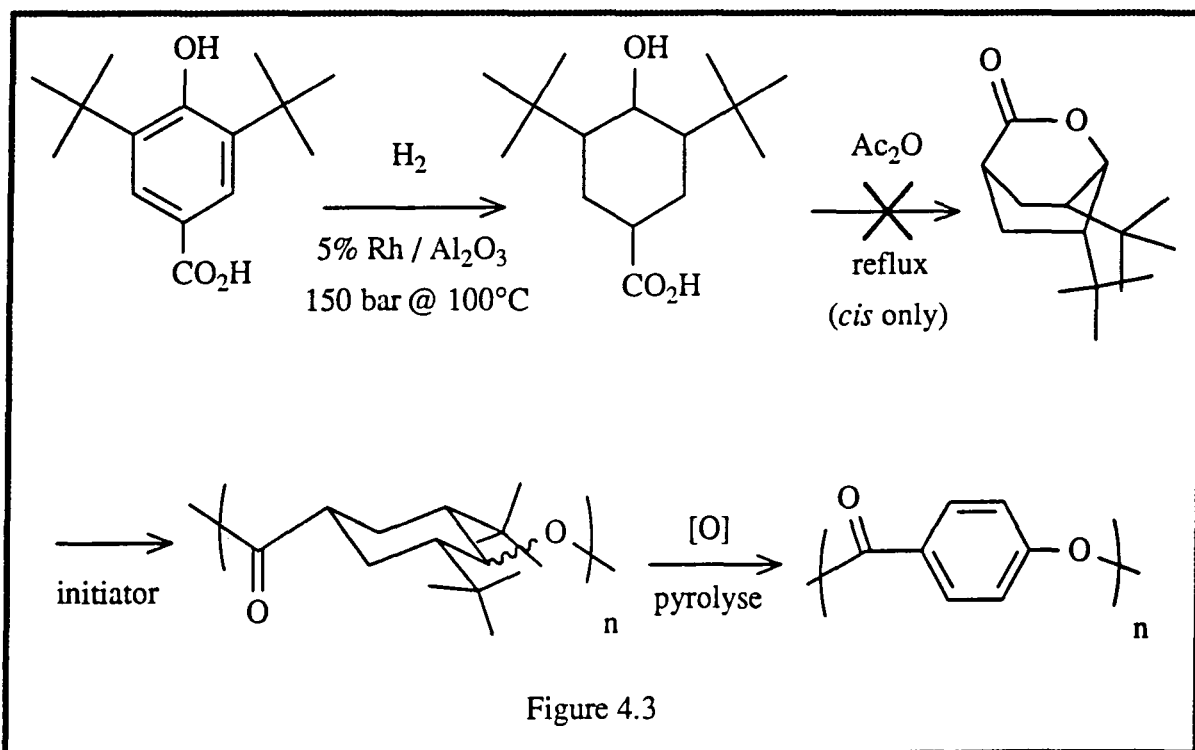

aromatic polyester, a possible scheme is outlined in figure 4.3. The reduction step proved difficult to achieve. Repeated attempts with various combinations of temperature and pressure conditions failed to hydrogenate the starting material. Model studies with phenol demonstrated that something was amiss and initially the catalyst was suspected. Simple phenols are easily reduced by rhodium catalysts. For example, Chebaane *et al*<sup>[210]</sup> report the ready reduction of 7-methoxy-2-naphthol by a rhodium-on-carbon catalyst, figure 4.4

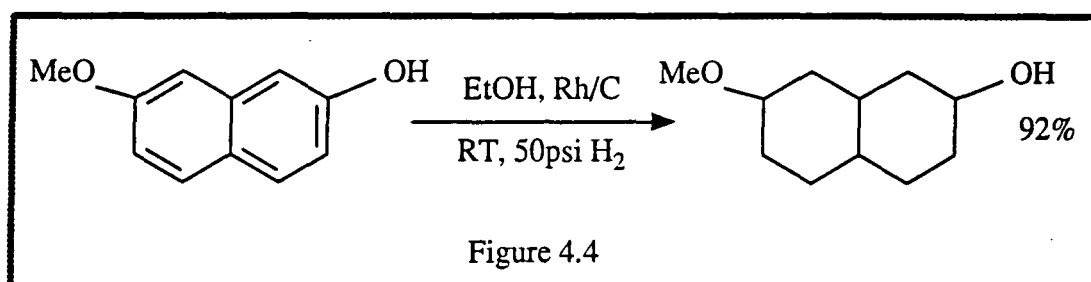

and Meyers *et al*<sup>[211]</sup> report a similar reduction for 1-naphthol using rhodium on alumina, figure 4.5.

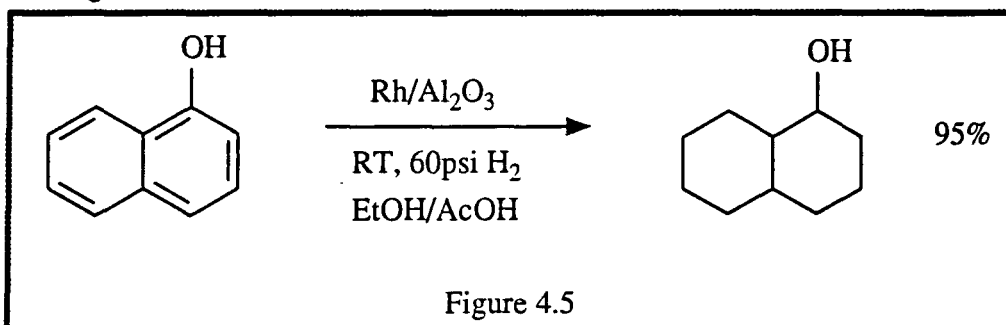

Further investigation traced the problem to laboratory plumbing of dubious quality, which had allowed the hydrogen cylinder to become contaminated with synthesis gas. One obvious requirement for successful hydrogenations is that one uses hydrogen. Carbon monoxide is clearly a potent catalyst poison for rhodium, and under these conditions probably forms stable carbonyl complexes with it which have no catalytic activity. With new plumbing and a fresh hydrogen cylinder, the attempts at reducing 3,5-*di-tert*butyl-4-hydroxybenzoic acid still failed to proceed, even under the conditions used by Ceccarelli. Only when the starting material had been twice recrystallised and the conditions made more vigorous (150atm H<sub>2</sub> at 100°C) did reduction proceed, slowly but very efficiently, to yield 3,5-*di-tert*butyl-4-hydroxycyclohexanecarboxylic

acid as a mixture of two isomers. The difference between these isomers obviously does not involve the *tert*butyl groups and concerns only the stereochemical relationship between the hydroxyl and carbonyl functions.

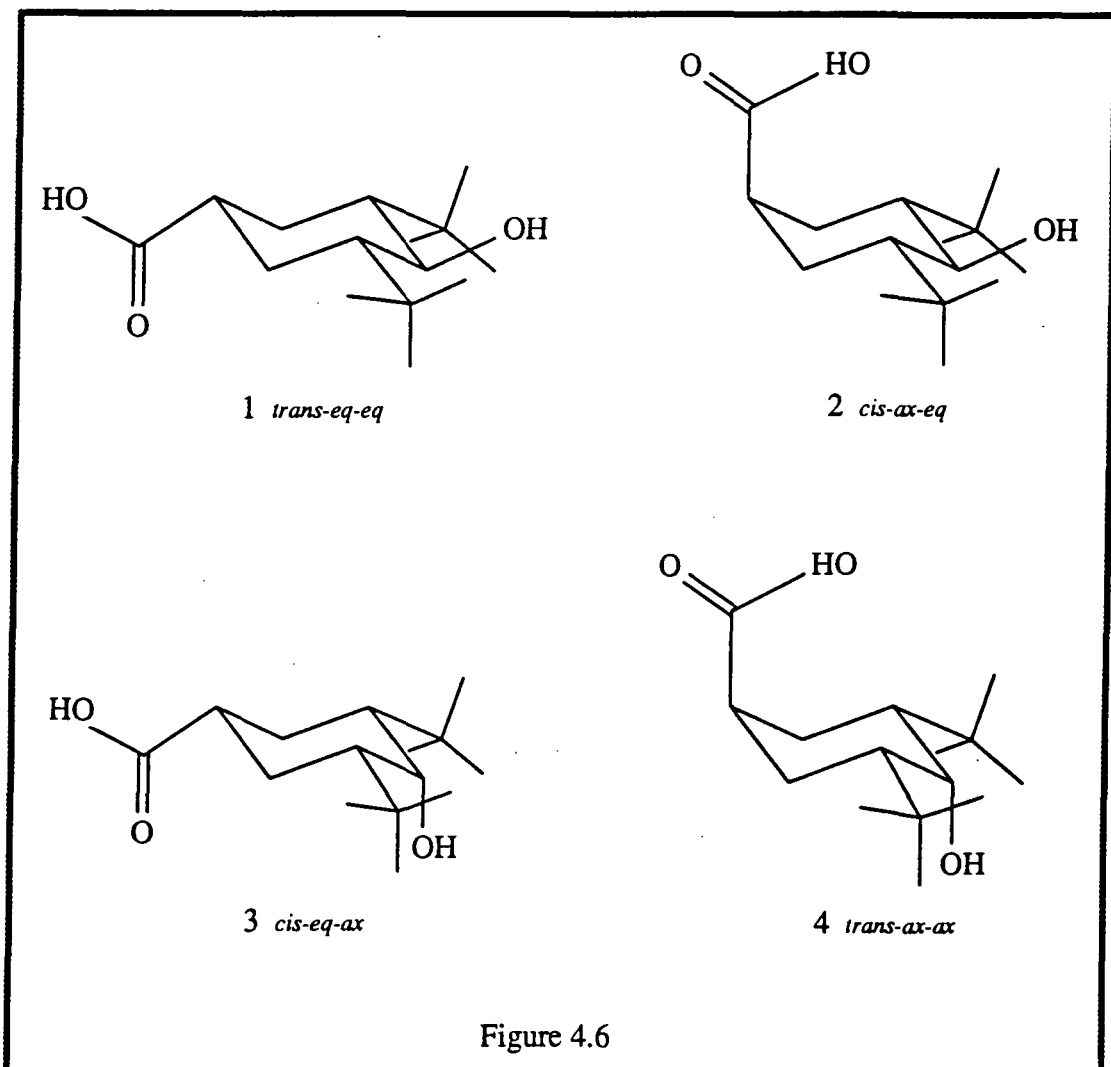

Of the various isomers possible, only isomer 3 is capable of undergoing cyclisation via the boat conformer. Identification of the isomers produced by the reduction is therefore important. Since heterogeneous hydrogenation proceeds at the catalyst surface via *syn*-addition of hydrogen, isomers 1 and 2 are ruled out, since these require that hydrogen adds at the hydroxyl group from the opposite face of the molecule than for reduction at the *tert*butyl groups. This is extremely unlikely because of the steric hindrance of these groups. Similar considerations suggest that isomer 3 should be dominant in the mixture, with isomer 4 being the minor component. Thus it appears from steric constraints that substitution by bulky groups on the benzene ring in the



3,5-positions greatly favours the production of the necessary isomer, reducing the losses in the cyclisation step.

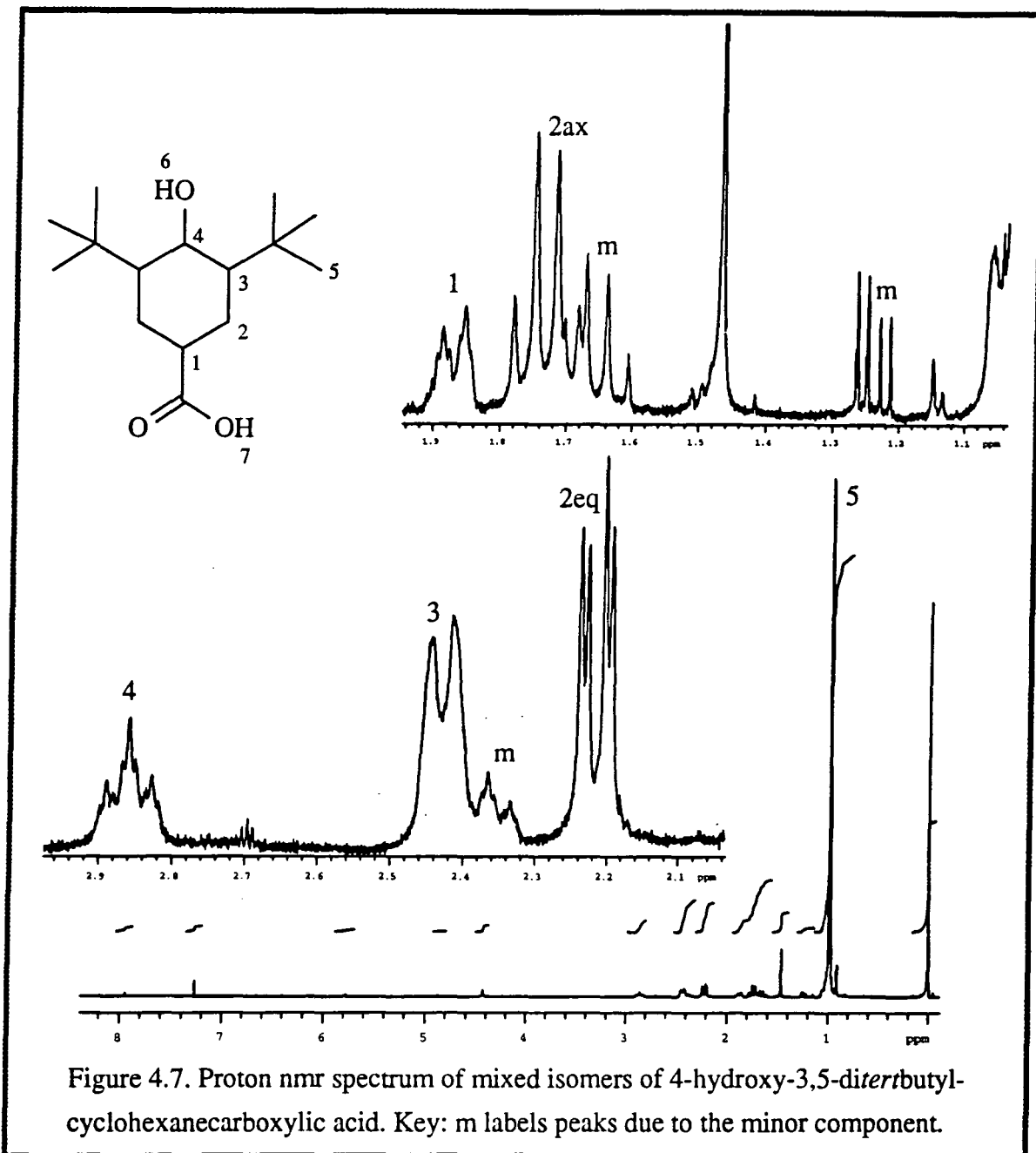

Figure 4.7 shows the proton spectrum of the mixture. The components were not separable by chromatography or recrystallisation, but the splitting observed for the *tert*butyl resonance makes it clear that two compounds are present, and this is confirmed by the  $^{13}\text{C}$  spectrum, *vide infra*. The splitting patterns obtained for the ring protons 2 (axial) and 1 are unusual. In the case of the axial protons 2, the quartet arises because, coincidentally, the coupling constants to 2 (equatorial), 1 and 3 are the same.

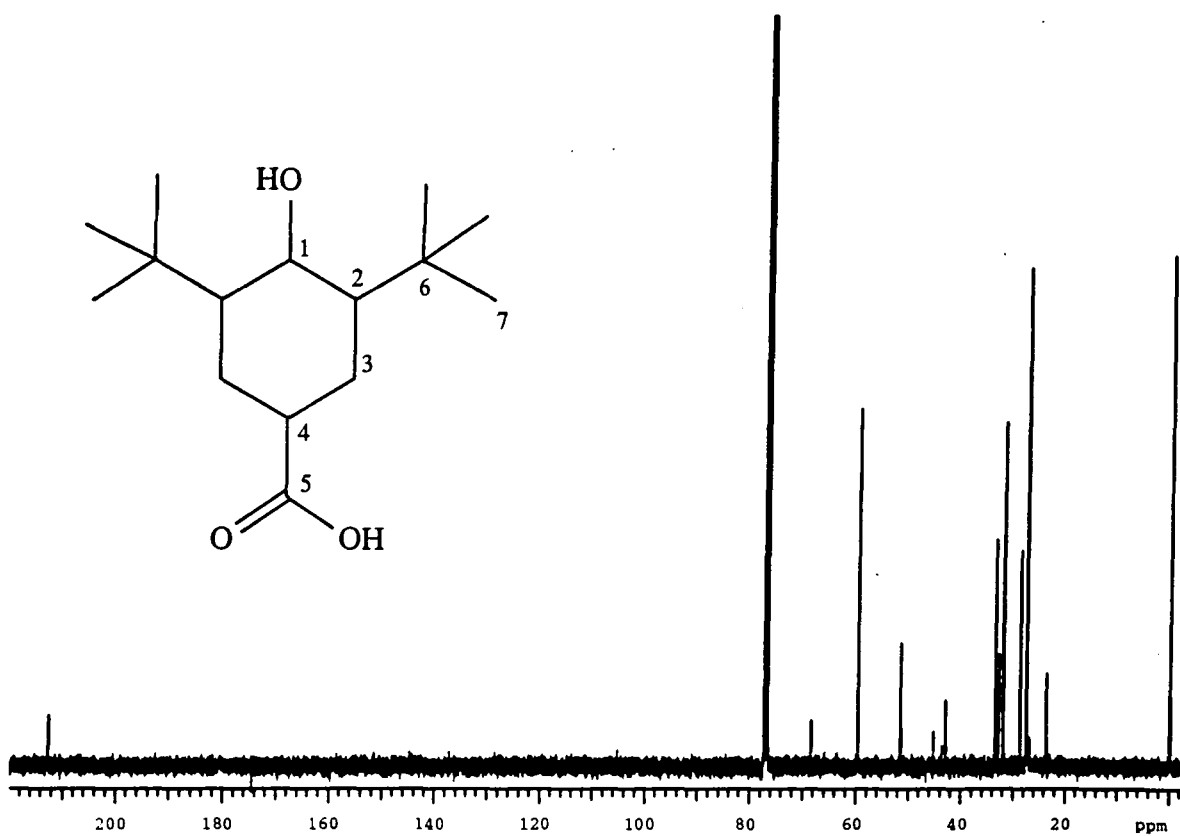
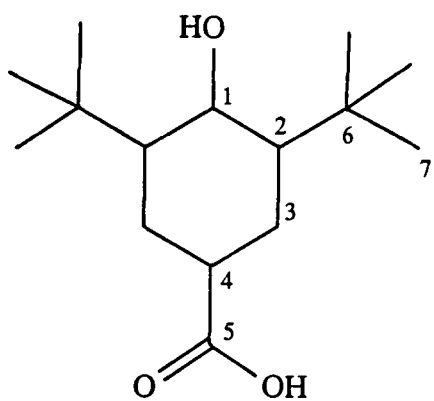
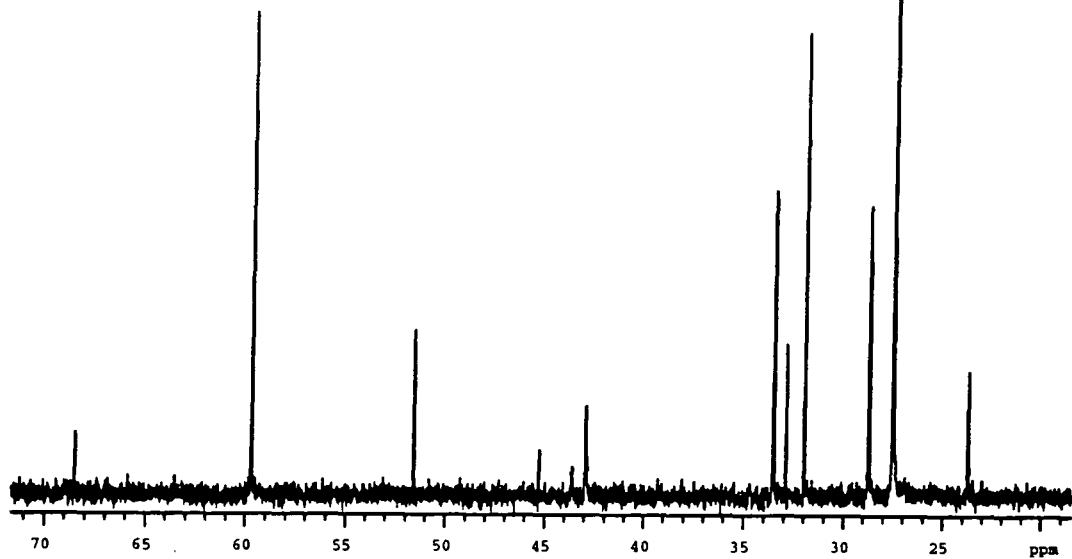

Figure 4.8. Carbon-13 nmr spectrum of mixed isomers of 4-hydroxy-3,5-ditertbutylcyclohexane-carboxylic acid. Obtained in  $\text{CDCl}_3$ .

This strongly suggests that proton 1 is axial, which is consistent with the prediction



made above regarding the likely stereochemistry of the major isomer in the mixture. The appearance of the resonance for proton 1, a broad, distorted doublet, is unexpected and must be due to the triplet caused by coupling to the H2 axial protons being further complicated by the H2 equatorial protons.

The carbon spectrum, figure 4.8, shows only one carbonyl absorption, but it is probable that the absorption for the minor isomer is too weak to be observed. The expansion shows twelve distinct peaks in the aliphatic region, consistent with there being two isomers present.

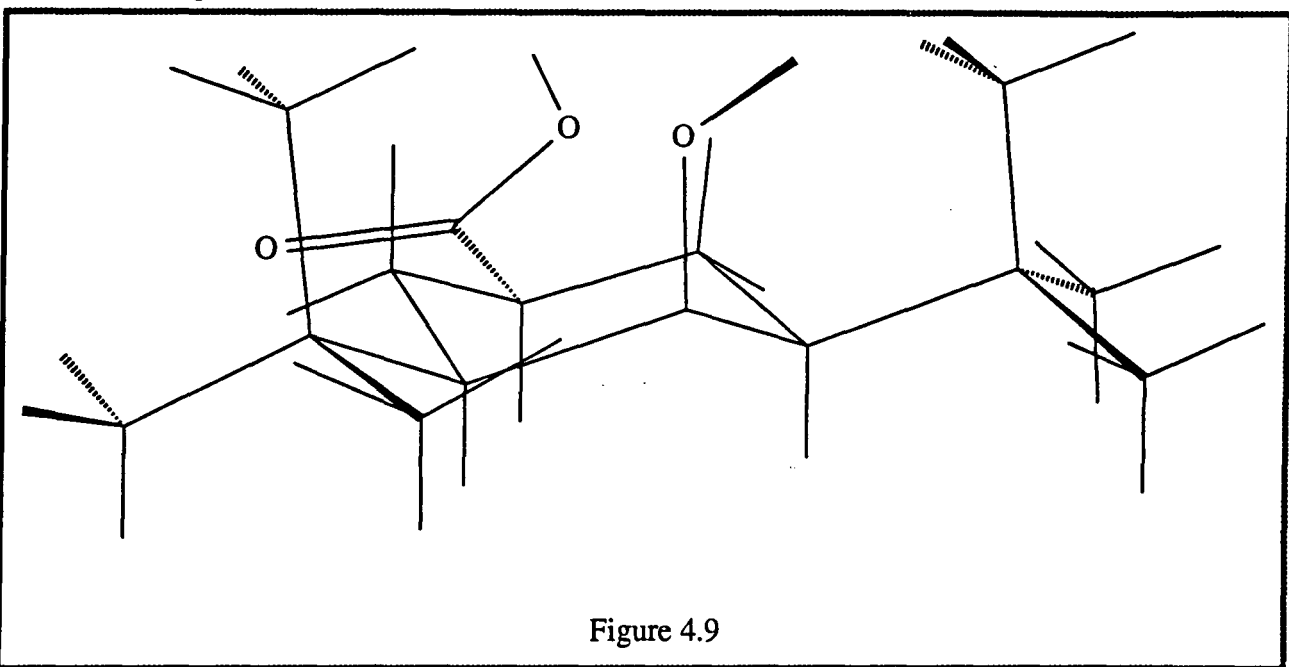

The problem of cyclisation of the hydroxyacid was not solved, either by Giudici and Bruce's original procedure<sup>[212]</sup> of refluxing the compound in acetic anhydride, or by treatment with thionyl chloride. Benzoyl chloride also failed to esterify the hydroxyl group. It is hard to believe that the non-bonded interactions from the axial ring protons and the *tert*butyl groups are sufficient to prevent this reaction, but a perspective view of the molecule aids visualisation. The axial hydroxyl is indeed highly hindered, more so than in the starting material where the *tert*butyl groups are coplanar with the hydroxyl and further from it. The modelling package COSMIC suggests that the closest approach of a proton in the *tert*butyl groups to the hydroxyl oxygen is ca. 2Å in the saturated

hydroxyacid and 2.2Å in the aromatic compound. From none of these reactions was ester or lactone obtained. No homopolyester formation was observed with thionyl chloride.

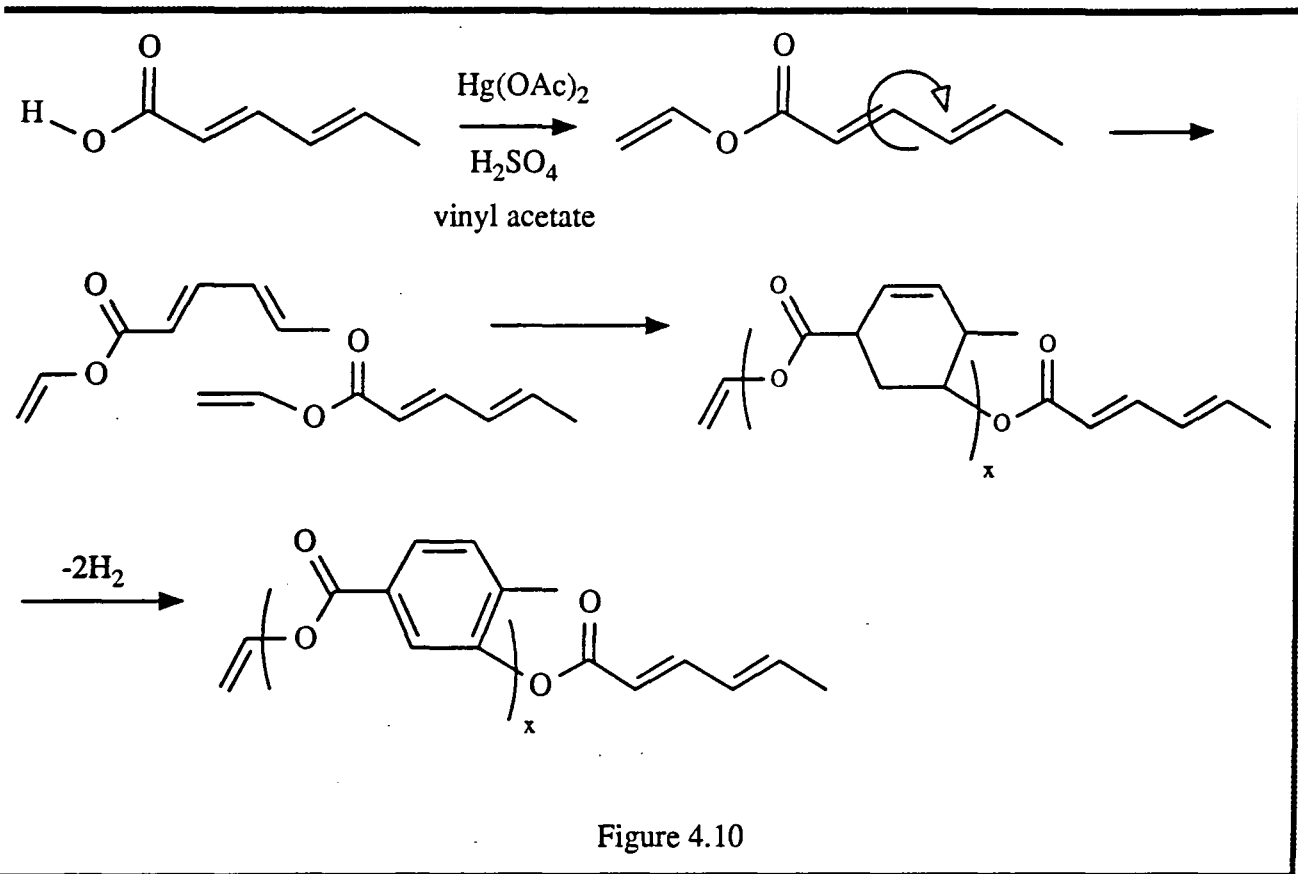

Figure 4.10

No further progress could be achieved with this route, but it is interesting to note the work of Li<sup>[16]</sup> who has polymerised 3-*tert*butyl-4-hydroxybenzoic acid and succeeded in obtaining 95% conversion to poly(*parahydroxybenzoic acid*) upon warming the precursor polymer to 40°C with trifluoromethanesulphonic acid. Other Lewis acid catalysts caused the Fries rearrangement as a side reaction. The conversion process is reported to have taken two hours, but the problem of access manifests itself as the reaction approaches high conversion and the product becomes increasingly crystalline; the last 5% of the *tert*butyl groups are resistant to removal.

The second of these miscellaneous approaches was an attempt to make an irregular aromatic polyester via the Diels-Alder reaction, figure 4.10.

Vinyl acetate was reacted with hexane-2,4-dienoic acid using acid and mercuric acetate catalysis to give vinyl hexa-2,4-dienoate. This compound has been reported previously<sup>[213]</sup>. The ester was heated in toluene solution in a Carius tube at various temperatures and for various durations, in the presence of some 2,6-di-*tert*butyl-*para*-cresol as radical polymerisation inhibitor. Only when left for three days at 220°C was there appreciable polymer formation. However, nmr indicated that the product from this reaction was highly irregular and no evidence for the Diels-Alder polymer was seen.

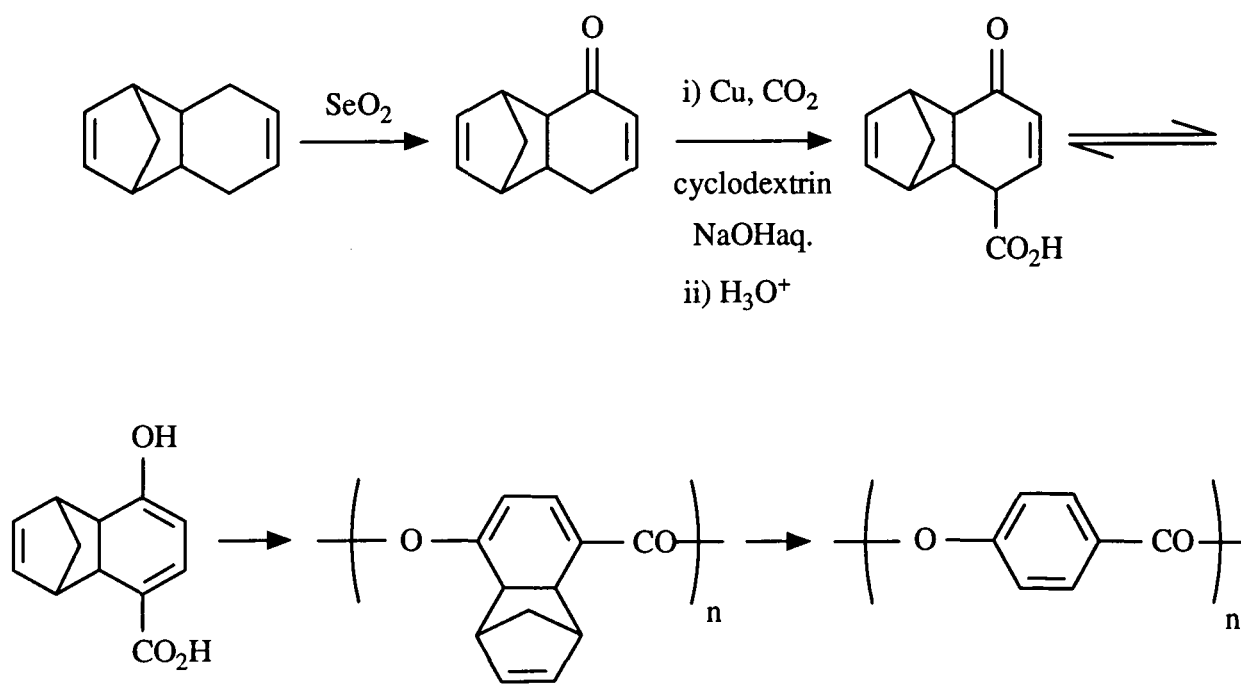

Figure 4.11

A third attempt at a precursor polymer was made via the attempted allylic oxidation of tricyclo[6.2.1.0<sup>2,7</sup>]undeca-4,9-diene to tricyclo[6.2.1.0<sup>2,7</sup>]undeca-4,9-dien-3-one, a reaction which has been reported by Lasne, Ripoll and Denis<sup>[214]</sup>. Selenium dioxide was used by these workers to perform this oxidation, but their paper gives no experimental detail and there are no other references to this compound. Despite

repeated attempts, and the use of sodium dichromate<sup>[215]</sup> instead of selenium dioxide, none of the desired material could be isolated. It was hoped to carboxylate the ketone under the conditions developed for the carboxylation of phenol by Komiyama and Hirai<sup>[216]</sup> which would yield the same hydroxy-acid as should have been produced by the hydrolysis of *endo-cis*-6-dichloromethylenetricyclo[6.2.1.0<sup>2,7</sup>]undeca-4,9-dien-3-one (see chapter 3, figure 3.33.)

The intended reaction sequence is shown in figure 4.11. The carboxylation reaction, which is copper-catalysed, is unusual in that the substrate (phenol in the original paper) is temporarily bound within the cyclodextrin molecule and the phenolate anion, generated by the base present, is accessible to carbon dioxide only at the *para*- position. In the case of the intended synthesis shown above, the enone substrate might not fit so well into the cyclodextrin cavity and a larger cyclic polysaccharide might be necessary. In the event, these considerations could not be explored.

The conclusions from this work are as shown below.

- 1) 2,6-Ditertbutyl-4-hydroxycyclohexanecarboxylic acid is too hindered to form polymers. In addition, work conducted at the University of Leeds<sup>[16]</sup> suggests that the acid-catalysed removal of *tert*butyl groups from substituted benzoic acid polymers does not proceed to completion and that similar methods are unlikely to yield a suitable precursor route for that reason. Our intended route involved a simple thermal elimination and may have been more effective, although this idea could not be tested
- 2) There is a possibility of making a suitable precursor if the work of Lasne *et al*<sup>[214]</sup> could be reproduced (see figure 4.11.)

## Chapter 5

### The structures of some Diels-Alder adducts and products of their intramolecular 2+2 photocycloaddition as revealed by detailed analysis of their $^1\text{H}$ and $^{13}\text{C}$ n.m.r. spectra

In the course of this project, a number of Diels-Alder adducts and some of their photocycloaddition products have been prepared and characterised. The purpose of this chapter is to show that a complete assignment of their nmr spectra unambiguously proves their structures. All chemical shifts are expressed with positive values to high frequency of TMS. The signs of coupling constants ( $J$ ) are unknown, but have been quoted as positive numbers, thus  $J = X$  Hz, should be read as  $J = \pm X$  Hz. Most of the relevant spectra are presented in this chapter in close juxtaposition to the text which discusses them. However, the ability to import digitised n.m.r. spectra from the Varian VXR400S into the word processing program only became possible in late October 1991, and some of the data are of necessity presented as photocopied spectra in appendix 1.

#### 1. *Endo*- and *exo-cis*-Tricyclo[6.2.1.0<sup>2,7</sup>]undeca-4,9-diene

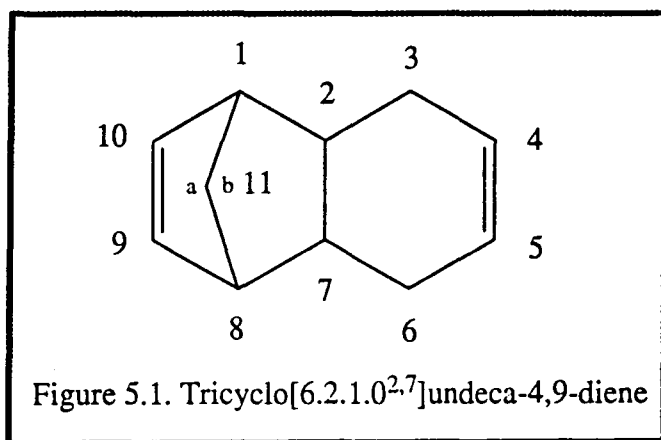

This compound was prepared by the method of Alder *et al*.<sup>[217]</sup> and is the least functionalised adduct of the series studied. Alder assigned this as the *exo*- isomer since

the infra-red spectrum of its hydrogenation product was identical to the infra-red spectrum of the hydrogenation product of the adduct of buta-1,3-diene with bicyclo[2.2.1]heptene, which was known to be the *exo*- isomer.

### The $^1\text{H}$ Spectral Evidence

The  $^1\text{H}$  nmr spectrum at 399.952 MHz in deuteriochloroform, figure 5.2, shows that there is clearly a mixture of compounds in the sample. The original paper claims that the product is *exo-cis* but glc evidence confirms the presence of a second component.

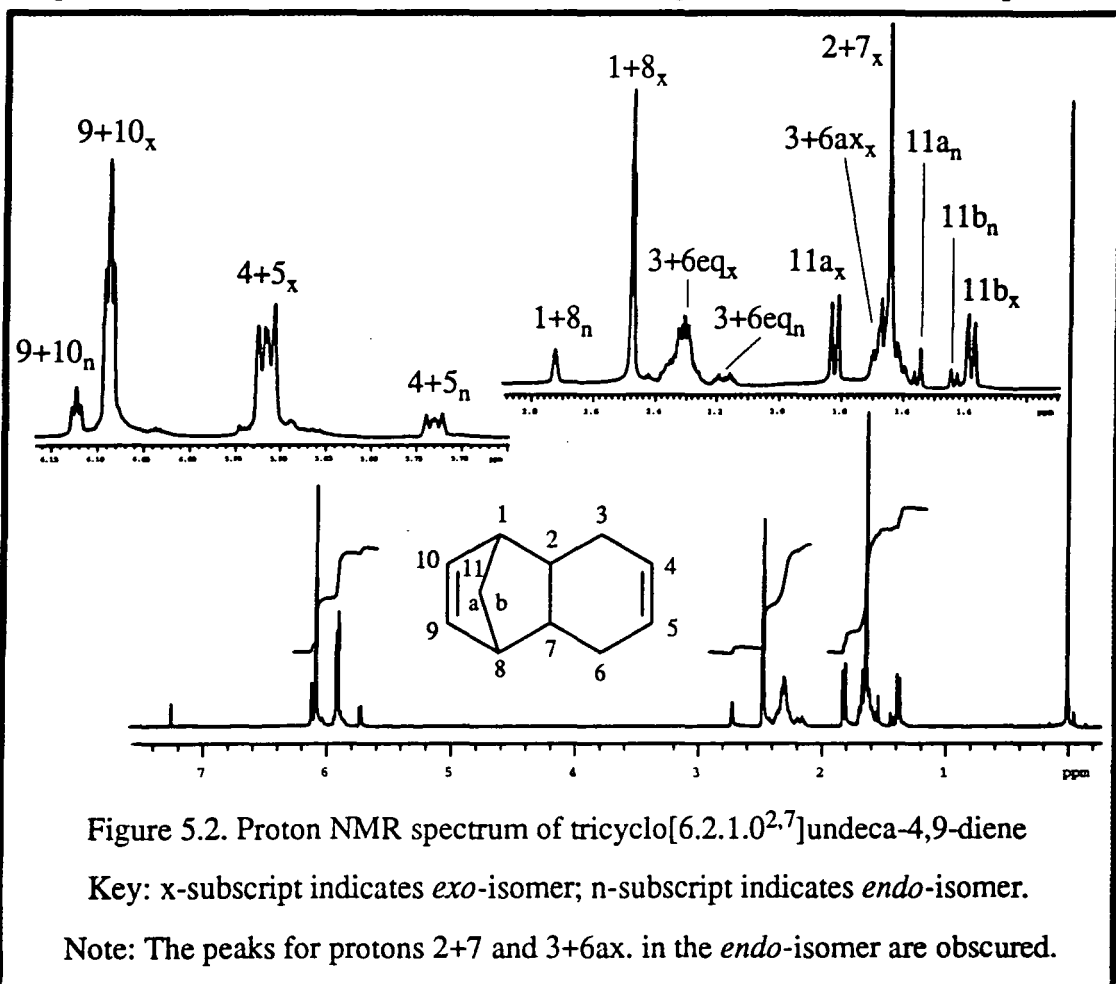

Their poor separation, even on a capillary glc column, does not bode well for a preparative separation whether by glc or distillation. No separation was achieved in practice with a Fischer-Spaltrohr apparatus.

Consideration of the readily-identifiable major peaks in the spectrum shows



immediately the presence of the olefinic protons 4+5 or 9+10 at either 6.1ppm or 5.9ppm, both of which peaks integrate to two protons. The 6.1ppm peak is apparently a triplet with an ideal 1:2:1 intensity ratio; the 5.9ppm peak is an apparent doublet of doublets with approximately equal intensity. The qualifying term "apparent" must be used as, although superficial inspection suggests a triplet might be expected for protons 4+5, the same naïve approach predicts a simple doublet for protons 9+10. As will be made clear later, both of these expectations are wrong; the coupling patterns are complex. The values of the apparent coupling constants are:

For the 6.1ppm "triplet",  $J=1.75\text{Hz}$

For the 5.9ppm "doublet of doublets",  $J=4\text{Hz}$ ,  $J=2.75\text{Hz}$ .

The peak at 2.5ppm integrates to two protons and is apparently a quintet, but the intensity ratio of 1:3:4:3:1 makes it clear that it is not a first order quintet and a triplet of triplets is a better candidate. The coupling constants for the two sets of triplets are nearly equal. Examination of the outer pairs of lines having 1:3 intensity ratio indicates a  $J$  value of ca. 1.67Hz, whilst examination of the centre three lines of 3:4:3 ratio suggests a  $J$  value of ca. 1.79Hz. At the instrument resolution achievable, the  $\approx 0.1\text{Hz}$  difference is perhaps significant, although quoting the  $J$  values to two decimal places is probably not justified on account of the overlap of the lines, consequent broadening of the peaks and ambiguity over the precise peak position. As will be seen later, the protons in one of the pairs, which give rise to one of the "triplet" splittings, are non-equivalent. This complicates matters further, since this "triplet" splitting is therefore a superimposed doublet of doublets.

For the 2.5ppm triplet of "triplets",  $J=1.7\text{Hz}$ ,  $J=1.8\text{Hz}$ .

There appears at ca. 2.3ppm a broad hump which integrates to two protons. No detailed

splittings are recognisable and no J values can be estimated, even when the spectrum is obtained at 399.952MHz. These protons are evidently subject to some complex interactions.

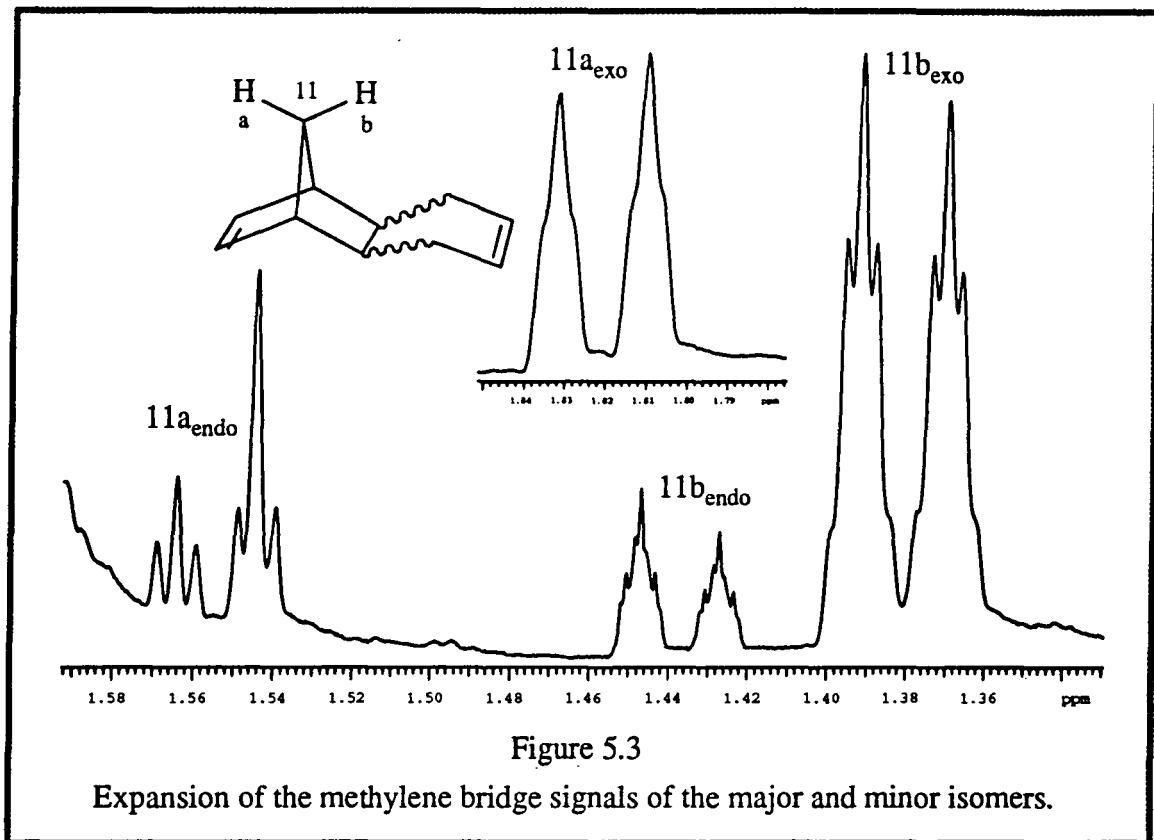

At 1.8ppm there appears a distorted doublet which is evidently one arm of an AB system and which integrates to one proton, see figure 5.3. (Strictly, the system is not an AB unless the chemical shift difference is similar to the coupling constant. However, the practice of referring to such AM systems as above by the AB nomenclature is commonplace amongst organic chemists and the error will be repeated here.) The other arm of this AB system appears at 1.4ppm and is clearly due to the methylene bridge protons, 11. Closer inspection of each of the four peaks, using resolution enhancement data processing, indicates that they are further split, the pair at ca. 1.8ppm being distorted triplets of 1:2:1 ratio (triplets of triplets?) and the pair at ca. 1.4ppm being distinct triplets of triplets, appearing as quintets of intensity ratio ca. 1:3:4:3:1. Measurement of J values under resolution enhancement conditions suggests that the coupling constants within all these triplets may be of the order of  $\approx 1.5\text{Hz}$ . In the

spectrum recorded at 399.952MHz it can be clearly seen that there is a second AB system which evidently belongs to the minor component in the mixture. The peaks associated with this minor component appear at ca. 1.43, 1.45, 1.54 and 1.57ppm.

For the AB methylene bridge system, at C-11,  $J_{AB}=8.7\text{Hz}$ .

For the resolution-enhanced data on the further splittings of each AB peak into triplets of triplets,  $J\approx 1.5\text{Hz}$  for all splittings.

For the AB methylene bridge in the minor component,  $J_{AB}=7.7\text{Hz}$ .

A group of peaks appears at ca. 1.6-1.8ppm which integrates to four protons. On closer inspection, it is comprised of an apparent singlet superimposed upon a broad hump, very like that at 2.3ppm.

Given that two similar broad humps are seen, each of which corresponds to two protons, it is tempting to assign them to the  $\text{CH}_2$  groups at positions 3 and 6. Evidently these methylenes are non-equivalent protons and part of the complexity of these humps is because they are in the first instance arms of two equivalent AB systems, one hump corresponding to the equatorial protons and the other to the axial protons in the fused cyclohexene ring. Even assuming that the cyclohexene ring has some degree of fluxional freedom, the methylene protons would not be equivalent. In addition, these methylene protons are also coupled to those at positions 4+5 and 2+7. The coupling constants between these protons and the methylenes would also be subject to some variation with motion. There is at least adequate reason for anticipating a complex splitting pattern for these  $\text{CH}_2$  groups. If this assignment is correct, then the axial protons should be at lower frequency since the equatorial protons are closer to the plane of the carbon-carbon single bonds.

The "singlet" at ca. 1.65ppm turns out to be a rather distorted "quintet" ("septet"?) on

resolution enhancement. However, if it is a second order quintet it is not as simple a quintet as those previously encountered, the intensity ratios being 2:8:14:7:3. Allowing for distortion, perhaps 1:3:7:3:1. This is clearly not a triplet of triplets and neither is it a slightly distorted first order quintet. It does, however, correspond to two protons and this together with the peaks at 2.5ppm are probably protons 2+7 and 1+8. In this instance, the only clearly defined peaks from which measurements can be taken suggest that  $J=1-1.3\text{Hz}$ . Other unquantifiable couplings are certainly present.

The proton evidence allows only the unambiguous assignment of the methylene bridge protons 11, although it cannot be stated which proton, 11a or 11b, gives rise to which of the 1.8 and 1.4ppm peaks. It is clear where the olefinic protons appear (5.9 and 6.1ppm, with the minor component of the sample mixture at 5.7 and 6.12ppm) but again it is not possible to state which peak is due to the protons at positions 4+5 and which to those at 9+10. The  $J$  values do suggest that the 6.1ppm peak is coupled to the 2.5ppm peak, and this was confirmed by proton decoupling. Tentative assignments place the equatorial methylene protons  $3+6_{\text{eq}}$  at 2.3 and the axial protons  $3+6_{\text{ax}}$  at 1.65ppm (broad humps), whilst protons 2+7 and 1+8 probably correspond to 2.5 and 1.65ppm (non-first order "quintets") although which of these two peaks is due to which pair of protons cannot be said on the basis of this evidence.

### The $^{13}\text{C}$ Spectral Evidence

The decoupled  $^{13}\text{C}$  spectrum obtained at 100.577MHz, figure 5.4, shows not only the expected six peaks for the carbon signals in the main component of the mixture, but each major signal also has an accompanying minor peak. It is a fair assumption that the product obtained from the Diels-Alder reaction was in fact a mixture of *endo-cis*- and *exo-cis*- isomers, and the proton spectra lend some support to this. Assuming that the relaxation times of carbon atoms occupying the same ring position in the two isomers

will be similar, measurement of the peak heights suggests a ratio of between 6:1 and 8:1 for major to minor isomers. Part of the reason for the spread of values is that some adjacent peaks in the spectrum turn out on further investigation to correspond to different ring positions in the two isomers (and thus the relaxation times are not comparable.) Another reason for the spread is that there will in fact be a difference in relaxation times between corresponding carbon atoms in the two isomers, i.e. the above

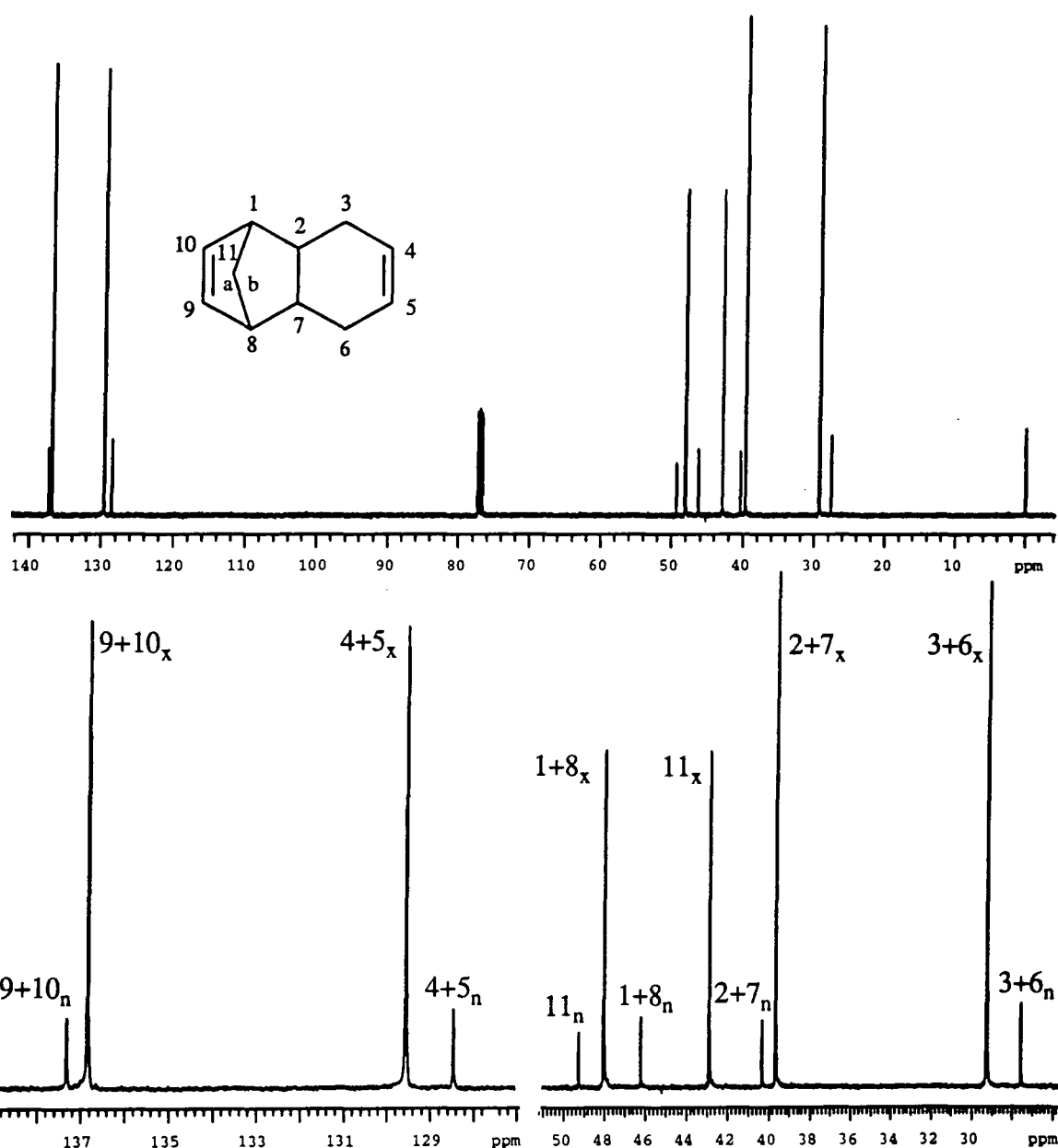

Figure 5.4.  $^{13}\text{C}$  Spectrum of tricyclo[6.2.1.0<sup>2,7</sup>]undeca-4,9-diene (above) and expansion (below)

Key: x-subscript indicates *exo*-isomer, n-subscript indicates *endo*-isomer.

assumption is a poor one. Finally, the nmr experiment performed was not a quantitative one. GLC suggested a ratio of ca. 9:1 to 4:1, and this result varied considerably due to the poor separation achieved. Integration of the proton spectra suggests a ratio of 6:1.

The vinylic carbons in the major isomer can be seen clearly at 129.58 and 136.86ppm, but an assignment cannot be made straight away. Similarly, the other carbons appear between 27 and 50ppm. Peak intensity tempts the assignment of peaks at 29.31 and 39.72ppm to methylene carbons 3+6 and 11 whilst those at 42.94 and 48.10ppm tempt the assignments 2+7 and 1+8, but application of either APT or DEPT proves that the peaks at 29.31 and 42.94ppm are the CH<sub>2</sub> carbons, see figure 1 in Appendix 1. Although the nuclear Overhauser effect enhances carbon signal strength, assigning peaks on the basis of the signal enhancement so-produced is risky. The corresponding CH<sub>2</sub> peaks for the minor isomer are at 27.62 and 49.33ppm, with CH carbons at 40.38 and 46.28ppm. The olefinics appear at 128.48 and 137.34ppm.

### The 2D Spectral Evidence

Both homonuclear correlation (<sup>1</sup>H COSY 45° on the Varian Gemini 200) and heteronuclear correlation (HETCOR on the Varian VXR400) were used to complete assignment of most peaks for the major isomer. These spectra appear in Appendix 1, figures 2 and 3. The single most important piece of evidence came from HETCOR and demonstrates that the carbon at 29.31 (a CH<sub>2</sub> carbon) sees the broad humps at 1.65 and 2.3ppm in the proton spectrum, **and not the methylene bridge AB signals.** (For some reason, the other CH<sub>2</sub> carbon did not correlate with any of the proton signals.) Thus at a stroke may be assigned the following:

Carbon at 29.31ppm corresponds to positions 3+6 and protons at 1.65 and 2.3ppm

(broad humps) are indeed the methylene groups in the cyclohexene ring, 3+6.

Vinylic protons at 5.9ppm must be those connected to the methylenes at 3+6, i.e. 5.9ppm protons are positions 4+5, since homonuclear decoupling showed that vinylic protons at 6.1ppm were seeing those at 2.5ppm, the 6.1ppm signal must correspond to positions 9+10.

Likewise, protons at 2.5ppm must be the bridgehead positions 1+8 (the "quintet" which is a triplet of doublets of doublets, appearing as a triplet of "triplets" because the coupling constant between positions 1+8 and 2+7 is nearly the same as between 1+8 and 9+10), and thus protons at 1.65ppm (the "singlet" which turned out to be a very unusual distorted second order "quintet" or "septet") are those at positions 2+7. It seems possible that this peak is a doublet of doublets of doublets, with complications perhaps due to fluxional variation of coupling constants to the two non-equivalent protons of the cyclohexene methylene.

$^1\text{H}$  COSY 45° confirms these assignments, and everything which should be coupled, is. HETCOR permits the assignment of the remaining carbons for the major isomer.

The minor isomer peaks can also be identified and assigned, except for two proton peaks which are obscured by the major isomer. Nevertheless, HETCOR allows their chemical shifts to be estimated. Curiously, the methylene bridge protons 11 again exhibit no apparent proton-carbon coupling in HETCOR. Assignment of the peaks is, however, possible as follows.

The vinylic protons 4+5 and 9+10 can be identified in the proton spectrum by the chemical shift and splitting similarity to the peaks for the major isomer. On going from the *exo*- to the *endo*- isomer, little change in splitting pattern would be anticipated, but

in fact the pattern for protons 4+5 (at 5.73ppm) has become slightly more complex, the central two peaks of the apparent doublet of doublets in the major isomer having become an apparent triplet, although the asymmetrical coupling and non-first order peak intensity demonstrates that it is something more complex (and thus this is also likely to be the case for the major isomer.) The splitting pattern for 9+10 (at 6.12ppm) is the same as for the major isomer, an apparent first-order triplet (although again it obviously can't be) with  $J=1.9\text{Hz}$ . Carbon assignment follows via HETCOR, 4+5 are at 128.48ppm and 9+10 are at 137.34ppm. The methylene carbons 3+6 and 11 can be seen from the APT spectrum, Appendix 1 figure 1, and the protons 3+6 are thus, from HETCOR, at ca. 1.65ppm (obscured by the major isomer) and 2.18ppm, the latter consisting of a broad hump, which when examined more closely, consists of two similar overlapping humps of seven (or possibly nine) peaks each. The two humps have between them a geminal coupling constant  $J_{AB}=14.2\text{Hz}$ . Within these two non-first order septets, the coupling constant has a range  $J=2.2\text{-}2.8\text{Hz}$  between adjacent peaks. Without knowing the origins of this unusual splitting pattern, (intensity ratios are unhelpful) further  $J$  values cannot be estimated. Carbons 3+6 appear at 27.62ppm and carbon 11 is at 49.38ppm.

Protons 11 are at ca. 1.43 and 1.55ppm, with  $J_{AB}=8\text{Hz}$ , although which is 11a and which 11b cannot be said from this evidence alone. Further coupling can be seen within the peaks, which are clearly triplets of triplets. For the AB arm at ca. 1.43ppm, there is a major splitting into triplets with  $J=1.5\text{Hz}$ . The sub-splitting into triplets of triplets has  $J=0.5\text{Hz}$ . The larger splitting of 1.5Hz is probably  $J_{11a \text{ or } b, 1+8}$  i.e. the bridgeheads, whilst the smaller splitting is possibly  $J_{11a \text{ or } b, 9+10}$  i.e. to the vinylic protons in the norbornene ring. The other arm of the AB, at ca. 1.55ppm, has peaks which are split into triplets with  $J=1.9\text{Hz}$ . However, further splitting cannot be seen clearly enough to work out coupling constants, but it is obviously present from the lineshapes. Evidently it is rather smaller than the 0.5Hz coupling present in the other arm of the AB.



Calculations were performed using the COSMIC and AMPAC molecular modelling packages which were run on a DEC Microvax 2 computer. COSMIC allows molecules to be drawn and also permits, amongst other things, rough minimisation of strain within the model by optimising bond lengths and angles by a variety of algorithms. AMPAC is a molecular orbital modelling program which includes a variety of Hamiltonians and which offers a wide range of M.O. calculations. One option is to provide better optimisation of bond angles and lengths in a molecular model drawn in COSMIC than can be achieved by COSMIC's empirical approach. For these Diels-Alder adducts, the AM1 Hamiltonian was used which gives reliable results for elements up to oxygen in the periodic table. When applied to both *endo*- and *exo*- isomers of *cis*-tricyclo[6.2.1.0<sup>2,7</sup>]undeca-4,9-diene, this predicted that the dihedral angle between the bridgeheads 1+8 and 11a is slightly smaller (60.6°) than between 1+8 and 11b (65.3°) and thus it would be expected from the Karplus

$$\text{equation}^{[218]} \quad J = \begin{cases} 8.5\cos^2\Phi - 0.28 & 0^\circ \leq \Phi \leq 90^\circ \\ 9.5\cos^2\Phi - 0.28 & 90^\circ \leq \Phi \leq 180^\circ \end{cases} \quad \text{that } J \text{ should be slightly larger}$$

for 11a than 11b for methylene bridge-bridgehead coupling. Since these J values are 1.5Hz and 1.9Hz for the peaks around 1.43ppm and 1.55ppm respectively, it is tempting to assign these to 11b and 11a respectively. As the prediction was the same for both isomers, this information could not be used to assign the major and minor components in the spectrum, but it was assumed that the same relative order of the chemical shifts for the methylene bridge protons, i.e. 11b is downfrequency from 11a, holds true for the major isomer, since the dihedral angles predicted by COSMIC/AMPAC were as follows. The angle between the bridgehead protons 1 or 8 and 11a was 60.5° for the *exo*- isomer and 60.3° for the *endo*- isomer. The angle between protons 1 or 8 and 11b was 65.2° for the *exo*- isomer and 65.8° for the *endo*- isomer. Given the similarity of these angles as predicted by COSMIC/AMPAC, the

above assumption is probably good.

It is known<sup>[219]</sup> that geminal coupling constants are usually negative and become larger (in an arithmetic sense) as the angle between the protons increases. Thus in suitably substituted cyclohexanes, where the angle approaches the ideal tetrahedral angle of  $109^{\circ}28'$ ,  $J = -(12-14\text{Hz})$  whilst in a terminal vinylic methylene, the angle is ca.  $120^{\circ}$ ,  $J = -(0-3\text{Hz})$  and may even be positive. The 11A-11-11B angle for the two isomers were predicted to be the same by COSMIC and AM1 calculations (for the *exo*- isomer  $109.9^{\circ}$ , for the *endo*- isomer,  $110.0^{\circ}$ ) thus preventing any sensible assignment on the basis of the coupling constants. The measured values of the coupling constants,  $J_{AB}$  for the 11A-11B coupling are 8.7Hz and 7.7Hz, about 60% of the value anticipated for the size of the angles predicted. It is known that substituent effects can easily mask angle effects on geminal J values; bond strain is a likely contributor to the size of the geminal coupling constant in norbornene systems such as this.

It is possible to assign the isomers by the chemical shift difference,  $\Delta\delta$ , between the peaks for 11A and 11B. In the *exo*- isomer these protons experience a greater asymmetry of shielding than in the *endo*- isomer, the difference is  $\Delta\delta_{exo} = 0.44\text{ppm}$  and  $\Delta\delta_{endo} = 0.12\text{ppm}$ . The *cis*- stereochemistry is determined by the single resonance for protons 2 and 7. The chemical shifts of both isomers appear in figure 5.5.

The coupling constants for both *exo*- and *endo*- isomers are shown in figures 5.6 and 5.7. The tables are incomplete due to problems with the extraction of coupling constants from some of the complex splitting patterns observed.

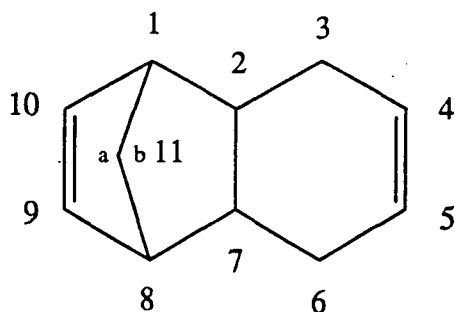

(*exo*- or *endo*-) *cis*- tricyclo[6.2.1.0<sup>2,7</sup>]undeca-4,9-diene

Position	Proton	Exo- Isomer	Carbon	Proton	Endo- Isomer	Carbon
1+8	2.48		48.10	2.72		46.28
2+7	1.65		39.72	2.36*		40.38
3+6 ax.	1.65 (b)		29.31	1.65 (b)*		27.62
3+6 eq.	2.3 (b)			2.18 (b)		
4+5	5.9		129.58	5.73		128.48
9+10	6.09		136.86	6.12		137.34
11a	1.82		42.94	1.555		49.33
11b	1.38			1.435		

Figure 5.5

Proton and Carbon Chemical Shift Data for *exo*- and *endo*-*cis*-tricyclo[6.2.1.0<sup>2,7</sup>]undeca-4,9-diene. Obtained on a Varian VXR400. Proton frequency 399.952MHz, carbon frequency 100.577MHz. Shifts are expressed in ppm relative to TMS. Spectra obtained in CDCl<sub>3</sub> solution. Key: \*=obscured by *exo*- isomer peak, (b)=broad.

H Atom	1/8	2/7	3/6ax.	3/6eq.	4/5	10/9	11a	11b
1/8		?				1.75	1.5	1.5
2/7	?		?	?				
3/6ax.		?		?	2.75			
3/6eq.		?	?		4			
4/5			2.75	4				
10/9	1.75							
11a	1.5							8.7
11b	1.5						8.7	

Figure 5.6

Some coupling constants for the *exo*- isomer in the mixture *endo*- and *exo*-*cis*-tricyclo-[6.2.1.0<sup>2,7</sup>]-undeca-4,9-diene.

H Atom	1/8	2/7	3/6ax.	3/6eq.	4/5	10/9	11a	11b
1/8		?				1.9	1.9	1.5
2/7	?		?	?				
3/6ax.		?		?	2.75			
3/6eq.		?	?		4			
4/5			2.75	4				
10/9	1.9						<0.5	0.5
11a	1.9					<0.5		7.7
11b	1.5					0.5	7.7	

Figure 5.7

Some coupling constants for the *endo*- isomer in the mixture *endo*- and *exo-cis*-tricyclo-[6.2.1.0<sup>2,7</sup>]-undeca-4,9-diene.

## 2. *Endo-cis*-6,6-Dimethoxytricyclo[6.2.1.0<sup>2,7</sup>]undeca-4,9-dien-3-one

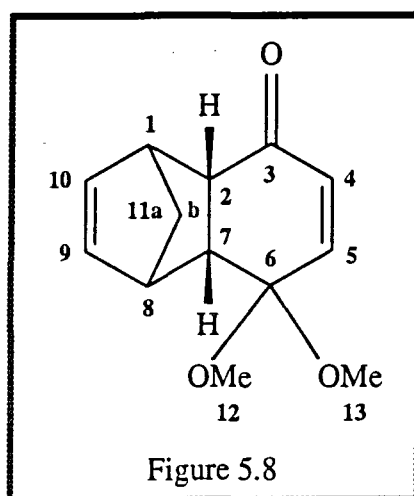

Figure 5.8

This compound was prepared by the method of Fariña et al. Their paper<sup>[194]</sup> published incomplete proton nmr data recorded at 60MHz, enhanced by the use of a chemical shift reagent. No further details have been published on it. Some of the assignments in the original paper have been shown to be incorrect by the present work.

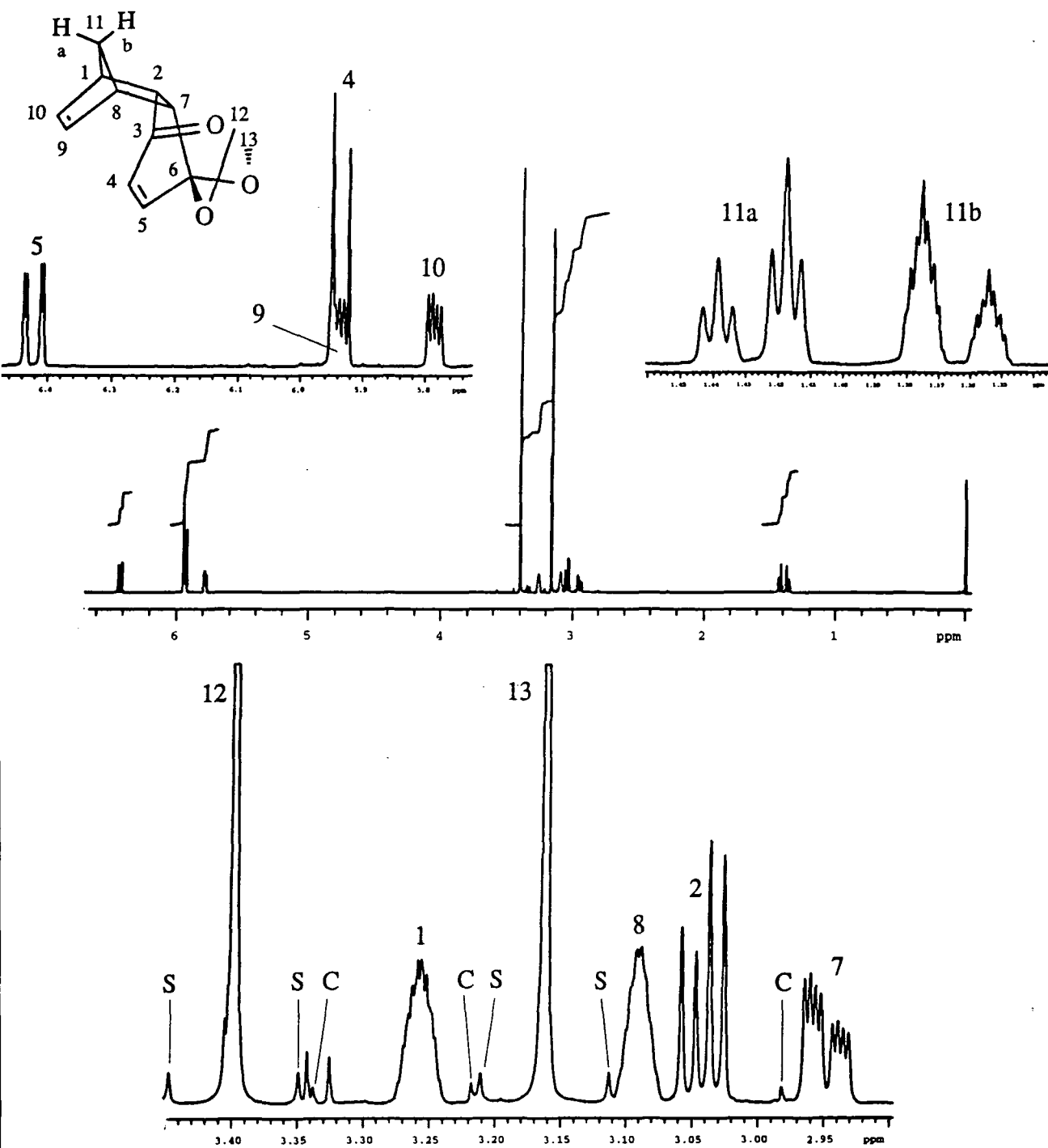

Figure 5.9. Proton NMR Spectrum of *Endo-cis*-6,6-dimethoxytricyclo[6.2.1.0<sup>2,7</sup>]undeca-4,9-dien-3-one  
Centre: Full spectrum. Above and below: Expansions.

Key: S=spin sidebands C=<sup>13</sup>C satellites

### The $^1\text{H}$ Spectral Evidence

The proton spectrum, recorded at 399.952MHz in deuteriochloroform, figure 5.9, shows two singlets, attributable to the methoxy groups 12 and 13, at 3.16 and 3.4ppm, although it is not immediately possible to say which is which. All other protons appear as multiplets.

The vinylic protons are clearly seen as three multiplets in the ratio 1:2:1 at 6.42, 5.94 and 5.78ppm. Closer inspection reveals that the 5.94ppm multiplet is due to the superposition of two separate groups of peaks, and analysis of the coupling constants shows that one group is coupled to those peaks at 5.78ppm, and the other group to those at 6.42ppm. The vinylic signals arise from two AB systems with the B signal of the higher frequency pair coincident with the A signal of the lower frequency pair.

The assignment may be made as follows. The enone system 4+5 would give rise to the AB with  $\delta_A=6.42\text{ppm}$  (5, four lines of nearly equal intensity, "leaning" towards the 5.94ppm signal) and  $\delta_B=5.94\text{ppm}$  (a sharp 1:1 doublet, 4) because the  $\beta$ -proton in an  $\alpha,\beta$ -unsaturated system is always less shielded than the  $\alpha$ -proton, as conjugation to the carbonyl reduces the electron density on the  $\beta$ -carbon more effectively than is the case for the  $\alpha$ -carbon, and thus the  $\beta$ -proton signal appears at a larger shift than the  $\alpha$ -proton. Proton 5 would be expected to be more deshielded than any of the other protons in this compound, both for the above reason and because the neighbouring carbon 6 is attached to two methoxy groups. The 6.42ppm resonance can thus be unambiguously assigned to proton 5. Protons 4+5 are coupled to each other with a vicinal coupling constant  $J_{AB}=10.5\text{Hz}$ . Proton 4 is not coupled further to proton 2, presumably because of the carbonyl at position 3. Proton 5 is coupled to the proton at position 7 via the quaternary carbon at 6. The AB system corresponding to protons 9+10 exhibits eight lines of nearly equal intensity (the A and B arms "lean" towards one another) indicating that not only do 9+10 see each other, but that they also see the

bridgeheads 1+8. Whilst it is possible to identify the resonances for protons 4+5, the assignments for protons 9+10 are ambiguous, with consequential problems for the corresponding carbon assignments. Fariña<sup>[194]</sup> assigned the vinylic signals incorrectly; in the original paper the signals at 6.42 and 5.94ppm (384Hz and 352Hz in the original) were correctly assigned to 5+6, but the two AB systems would probably be unresolved at 60MHz and the 5.94ppm signal was assumed to integrate to one proton. The signal at 5.78ppm (348Hz in the original) was erroneously assumed to integrate to two protons and was assigned to both 9+10.

For the vinylic signals:

ABq ( $\delta_A=6.42\text{ppm}$ , proton 5;  $\delta_B=5.94\text{ppm}$ , proton 4;  $J_{AB}=10.5\text{Hz}$ ,  $J_{5,7}=1.6\text{Hz}$ )

ABq ( $\delta_A=5.94\text{ppm}$ ;  $\delta_B=5.78\text{ppm}$ ;  $J_{AB}=5.55\text{Hz}$ ,  $J_{9 \text{ or } 10,8 \text{ or } 1}=2.75\text{Hz}, 2.9\text{Hz}$ ) An immediate assignment cannot be made, *vide infra*.

The margin of error in the coupling constants, determined by measuring  $J_{AB}$  for protons 4+5 in both the 6.42 and 5.94ppm signals, is  $\pm 0.05\text{Hz}$ .

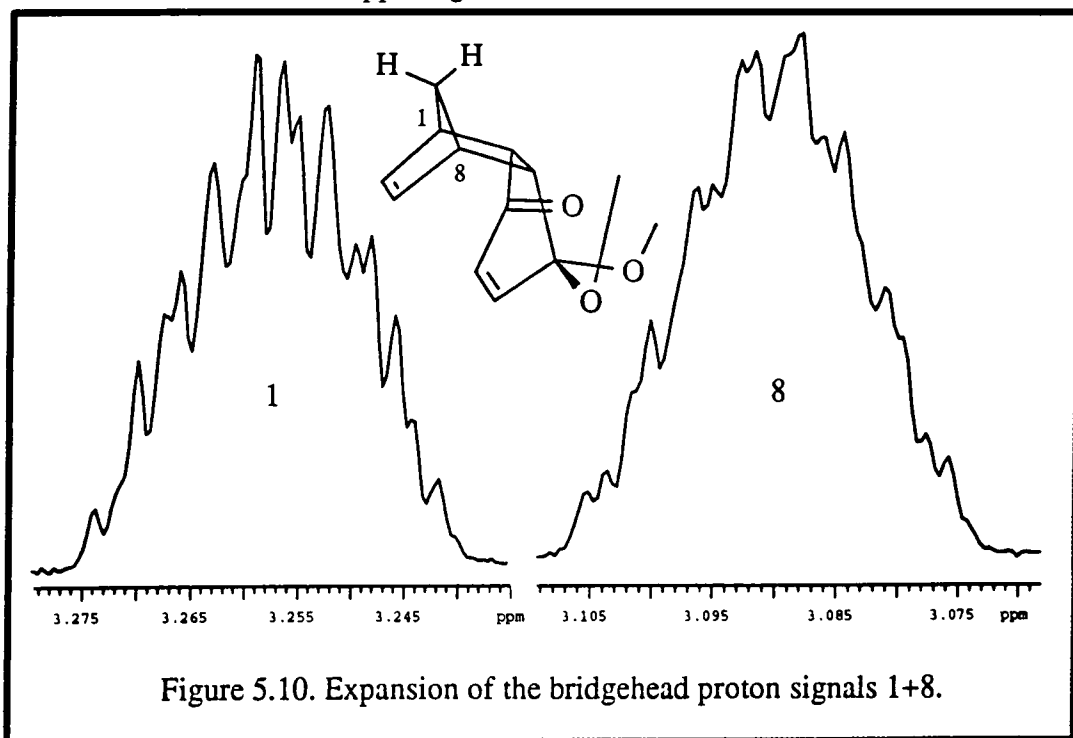

Figure 5.10. Expansion of the bridgehead proton signals 1+8.

Adjacent to the methoxy singlets appear two broad humps at 3.26 and 3.09ppm which

under high resolution appear as symmetrical, complex multiplets containing at least sixteen lines, figure 5.10. In contrast to the spectra of tricyclo[6.2.1.0<sup>2,7</sup>]undeca-4,9-diene (Section 1) where the protons at the ring fusion gave similar complex signals, it is likely that these humps correspond to the bridgehead protons 1+8. The coupling constants to 1+8 were obtained from analysis of the peaks due to the adjacent protons 2, 7, 9, 10, 11A and 11B (*vide supra et infra*) and allow the splittings to be estimated graphically. The patterns observed and constructed are consistent suggesting that the assignment is correct. It would only be possible to produce an accurate simulation by computer if the signs of all the coupling constants were known; additionally, the problem becomes unmanageably complex for the eight interacting, non-equivalent spins required. The protons at 2+7 give rise to relatively simple, unambiguously identified signals, see below.

Another AB appears at A=3.04ppm (four lines, ca. 1:1:2:2) with  $J_{AB}=8.47\text{Hz}$  and  $J=4.35\text{Hz}$ , and B=2.95ppm (eight lines, ca. 3:3:3:3:2:2:2:2) with  $J_{AB}=8.43\text{Hz}$ ,  $J=3.24\text{Hz}$ ,  $J=1.64\text{Hz}$ . These peaks correspond to protons 2+7 which have a vicinal coupling constant of 8.45Hz. The  $J=1.64\text{Hz}$  splitting corresponds to the  $J=1.6\text{Hz}$  splitting for the 6.42ppm proton 5 peaks, thus the group at B=2.95ppm is due to proton 7, which sees proton 8 ( $J=3.24\text{Hz}$ .) Proton 2 (3.04ppm) sees proton 1 with a significantly different coupling constant ( $J=4.35\text{Hz}$ ) suggesting some skewing of the norbornene ring. It follows from the Karplus equation that the dihedral angle 1-2 must be smaller than the corresponding angle 7-8. Modelling the molecule by COSMIC/AMPAC using the AM1 Hamiltonian as before predicts that these angles are 1-2=44.3° and 7-8=52.5° for the closed *endo*- conformation as drawn at the head of this section. (For the open *endo*- conformation, see Figure 5.18.)

ABq ( $\delta_A=3.04\text{ppm}$ , proton 7;  $\delta_B=2.95\text{ppm}$ , proton 2;  $J_{AB}=8.45\text{Hz}$ ; the resonances are further split:  $J_{2,1}=4.35\text{Hz}$ ,  $J_{7,8}=3.24\text{Hz}$ ,  $J_{7,5}=1.65\text{Hz}$ )



All of the signals for protons 1, 2, 7 and 8 were unresolved at 60MHz and Fariña observed these as a single complex resonance.

The methylene bridge AB occurs at ca. 1.36 and 1.43ppm and is similar to the AB patterns seen for the *endo-exo*-mixture of tricyclo[6.2.1.0<sup>2,7</sup>]undeca-4,9-diene isomers. The small  $\Delta\delta$  for the minor isomer in that hydrocarbon mixture, 0.12ppm, is comparable to the small  $\Delta\delta$  observed here, 0.07ppm, suggesting that this is the *endo*-isomer (and this was proved to be so by intramolecular photocycloaddition, which also proves the *cis*-stereochemistry at the ring fusion.) It is not possible from the <sup>1</sup>H spectrum to assign the A and B arms to protons 11a or b, although examination with other techniques (decoupling, NOE1D) does resolve the ambiguity, see figure 5.11. When the peak at 5.78ppm was irradiated in a homonuclear decoupling experiment, the methylene bridge AB showed simplification of the B arm only, at 1.36ppm. This indicates that one proton of the pair 11a and 11b is coupled more closely to 9+10, and it would be expected from the Karplus equation that this is proton 11b which is at an angle of ca. 180° to 9+10. For the methylene bridge protons 11a and 11b,  $J_{AB}=8.44\text{Hz}$ ; again the value of the geminal coupling constant is about 60% of the usual value observed in cases where the geminal angle is 110° and bond strain is the likely cause. The peaks around 1.43ppm appear as triplets of intensity 1:2:1, 2:4:2, although the lineshape suggests that they are in fact further coupled and as was the case with tricyclo[6.2.1.0<sup>2,7</sup>]undeca-4,9-diene, these peaks are probably triplets of triplets,  $J=1.8\text{Hz}$ . The peaks centred on 1.365ppm are certainly triplets of triplets, intensity ca. 2:4:5:8:5:4:2, 1:2:3:4:3:2:1. The larger coupling  $J=1.5\text{Hz}$  and the smaller coupling  $J=0.7\text{Hz}$ . The  $J=1.8\text{Hz}$  and  $J=1.5\text{Hz}$  couplings are from 11a or b to the bridgehead protons 1 and 8. Evidently the bridgeheads do not see each of the methylene bridge protons with the same coupling constant, which is probably a factor in the complexity of the splitting patterns observed for protons 1+8. This is supported by COSMIC/AMPAC predictions concerning the dihedral angles between the bridgehead

protons 1 or 8 and the methylene bridge protons 11a or 11b. The predicted angles are:

Angle H1-C1-C11-H11a 61.9°

H1-C1-C11-H11b 63.3°

H8-C8-C11-H11a 59.7°

H8-C8-C11-H11b 66.2°

One of the pair 11a and b is coupled to the vinylic protons 9+10 (confirmed by decoupling experiments, though these alone do not say which of pair 11a+b is coupled to 9+10) but the 0.7Hz coupling constant is not resolved in the vinylic peaks at 5.78 and 5.94ppm.

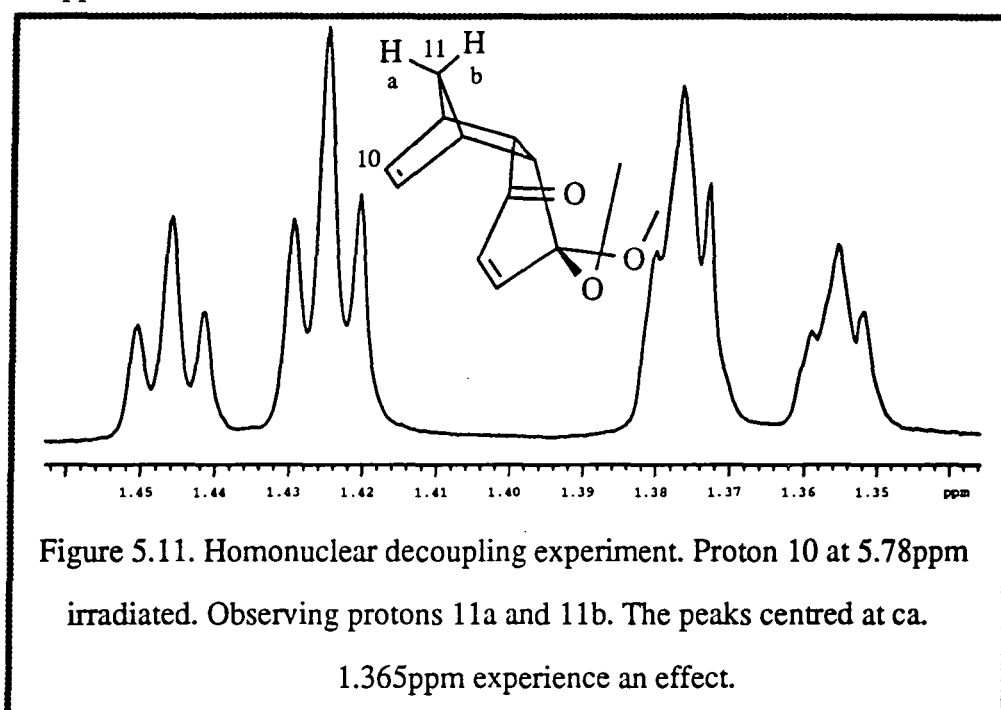

ABq ( $\delta_A=1.43\text{ppm}$ ;  $\delta_B=1.36\text{ppm}$ , these cannot be immediately assigned to protons 11a or b;  $J_{AB}=8.44\text{Hz}$ ; the resonances are further split:  $J_{11a \text{ or } b, 1+8}=1.8, 1.5\text{Hz}$ ,  $J_{11a \text{ or } b, 9+10}=0.7\text{Hz}$ )

### The $^{13}\text{C}$ Spectral Evidence

The decoupled carbon spectrum obtained at 100.577MHz in deuteriochloroform exhibits thirteen lines, see figure 5.12. Three of these are capable of instant assignment. The carbonyl 3 appears at 201.02ppm, the vinylic carbon 5 at 146.98ppm and the quaternary

carbon 6 at 97.63ppm. The other signals are so closely crowded together that it is only possible to say that the three signals at 133.36, 134.24 and 134.86ppm correspond to vinylic carbons 4,9 and 10, in no particular order, and that the clump of lines at 44.58, 45.64, 48.31, 48.54, 49.15, 49.19 and 50.11ppm are carbons 1,2,7,8,11,12 and 13, again

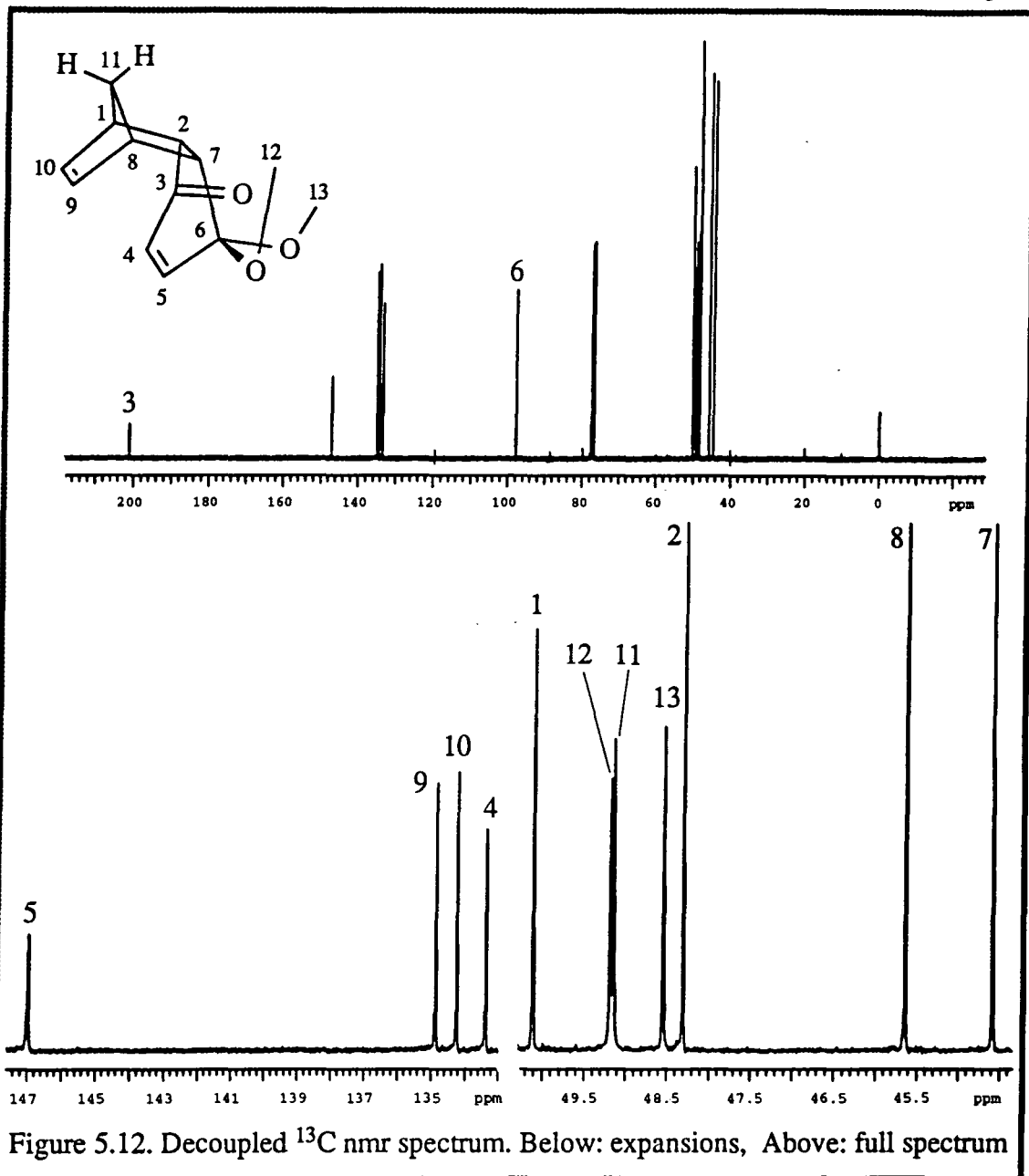

in no particular order. One might expect the peak intensities to give away the identity of the methoxy carbons 12 and 13, but this is not the case. Application of APT allows assignment of the methylene bridge carbon at 49.15ppm, whilst DEPT indicates that the methoxy carbons 12 and 13 are at 48.54 and 49.19ppm, although it cannot be said

which is which. These spectra appear in Appendix 1 as figures 4 and 5.

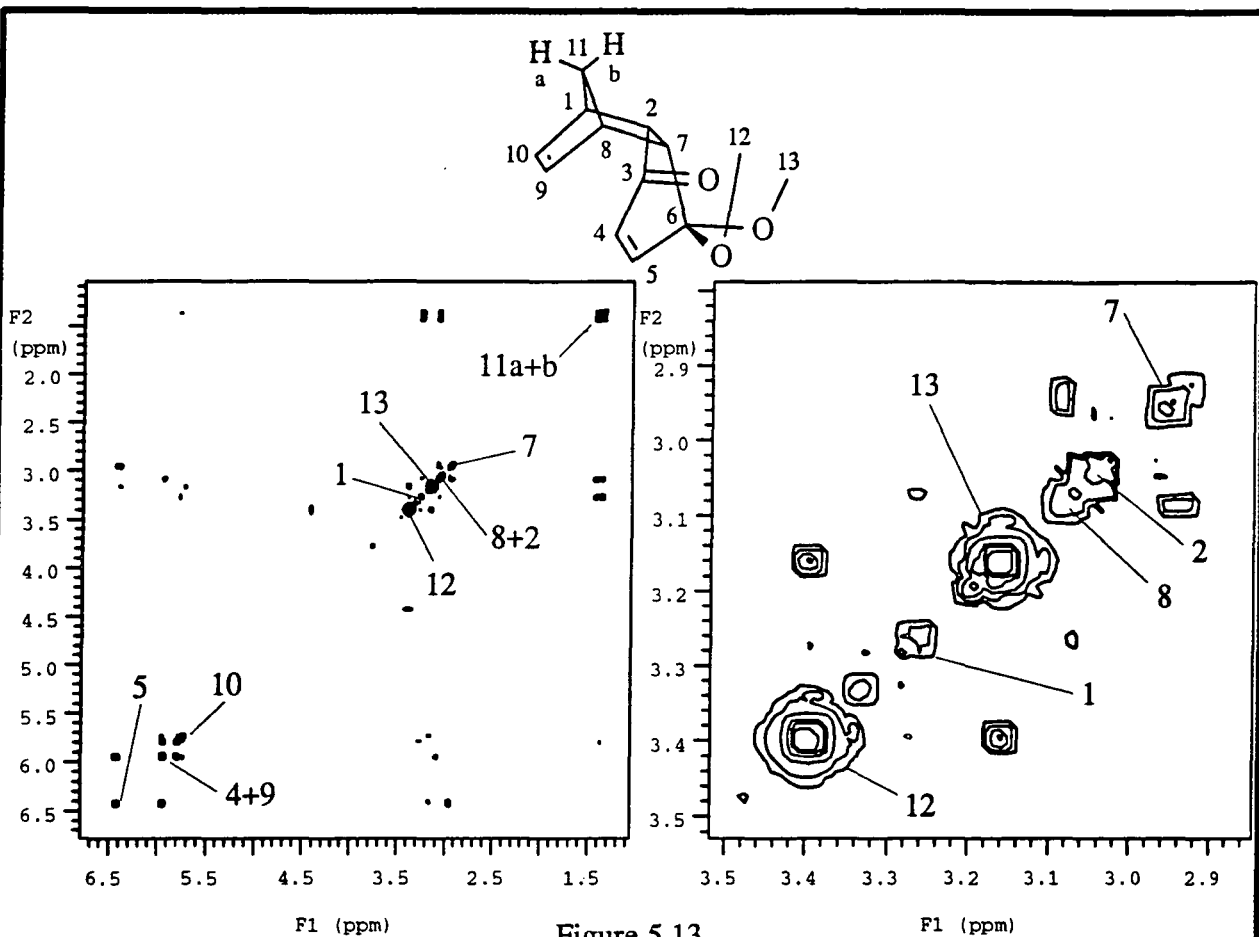

Figure 5.13

COSY 45° Spectrum of *Endo-cis-6,6-dimethoxytricyclo[6.2.1.0<sup>2,7</sup>]undecan-4,9-dien-3-one*.

Left: full spectrum Right: expansion

### The 2D Spectral Evidence

Proton COSY, figure 5.13, helped to confirm that the broad humps at 3.26 and 3.09ppm are indeed the bridgehead protons 1+8 as coupling to methylene bridge protons 11a and b is clearly seen. Coupling between proton 7 at 2.95ppm with the hump at 3.09ppm assigns the latter resonance to proton 8. Proton 1 is thus at 3.26ppm. COSY also permits the assignment of the protons on the non-conjugated double bond. Proton 9 is at 5.94ppm and proton 10 is at 5.78ppm because 10 couples with 1 and 9 with 8.

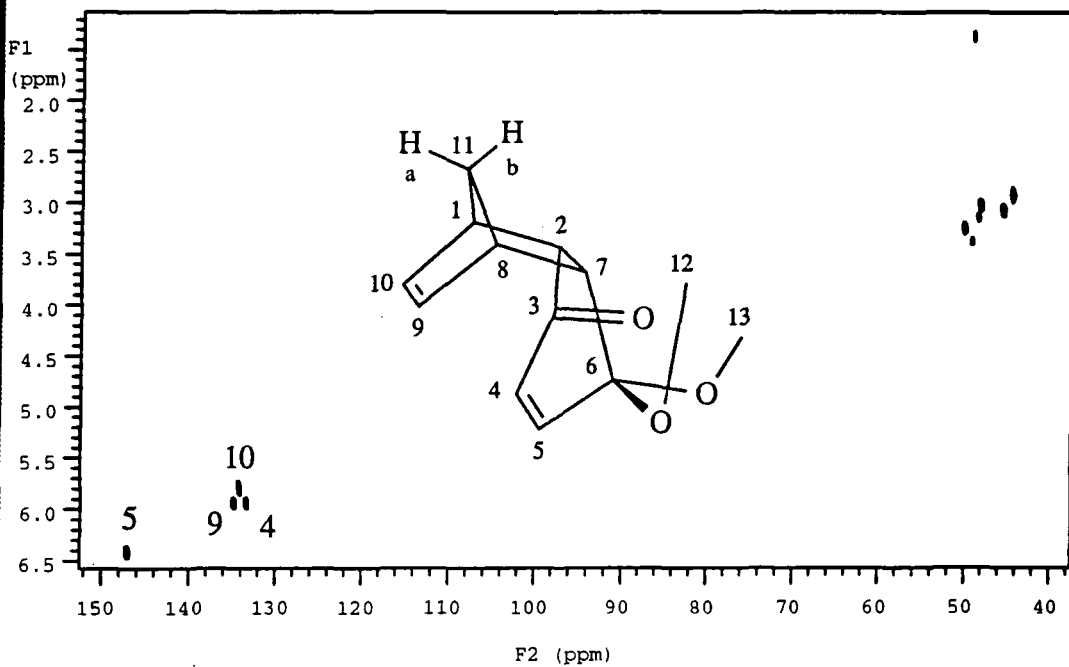
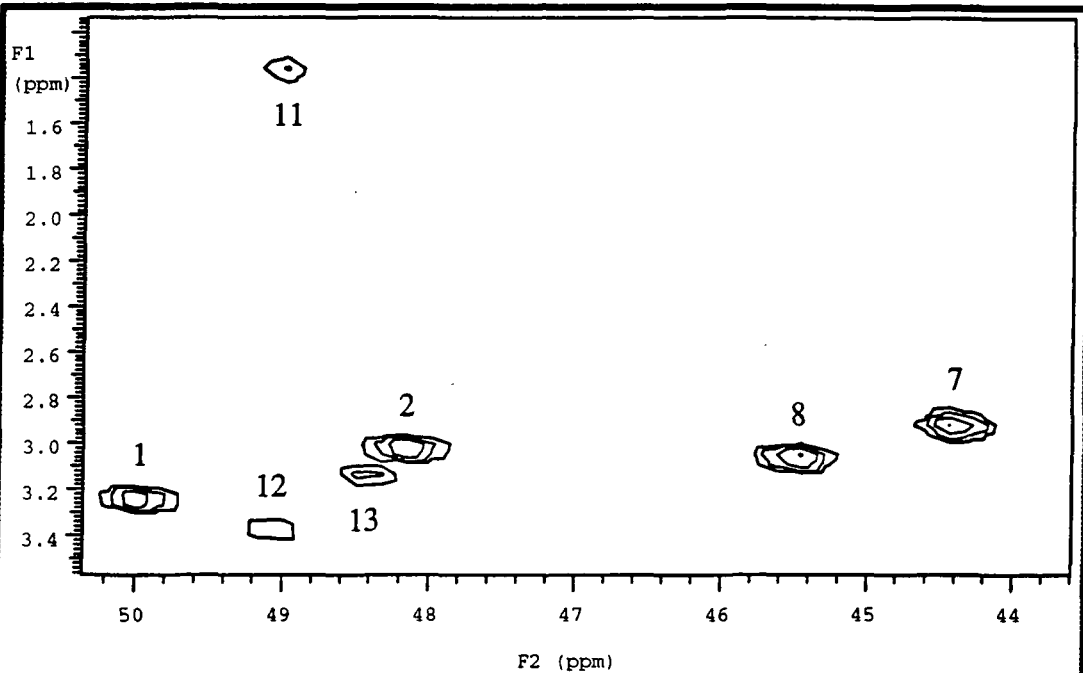

Figure 5.14. HETCOR Spectrum of *Endo-cis*-6,6-dimethoxytricyclo[6.2.1.0<sup>2,7</sup>]-undeca-4,9-dien-3-one. F1 corresponds to the  $^1\text{H}$  spectrum, F2 to the  $^{13}\text{C}$  spectrum.

Below: full spectrum    Top: expansion

HETCOR was used to assign most of the carbon resonances via the proton spectrum, see figure 5.14. Those assignable are:

Carbons 1+8 at 50.11 and 45.64ppm, carbons 2+7 at 48.31 and 44.58ppm, carbons 3

and 6 were assigned immediately by inspection at 201.02 and 97.63ppm, carbons 4+5 at 133.36 or 134.86 for 4 and 146.98ppm for 5 (the latter assigned by inspection), carbons 10+9 at 134.24 for 10 and 133.36 or 134.86ppm for 9, carbon 11 at 49.15ppm (already assigned via APT) and carbons 12+13 at 48.54 or 49.19ppm (assigned via DEPT; ambiguous because no assignment is possible for the two methoxy singlets in the proton spectrum.)

Ambiguities remain, however. As mentioned above, the two methoxy groups which were identified from APT/DEPT, could still not be assigned specifically to 12 or 13. Likewise there is a problem assigning carbons 9 and 4, since their proton signals coincide. The methylene bridge protons 11a and b could not be specifically assigned either. However, one-dimensional nuclear Overhauser spectroscopy (NOE1D) allows some of this ambiguity to be removed. The one thing it cannot do is remove the uncertainty over the carbon assignments for 9 and 4. This requires the elegant long-range 2D heteronuclear coupling experiment, FLOCK.

### The Nuclear Overhauser Evidence

Nuclear Overhauser spectra (NOE1D) demonstrated the following.

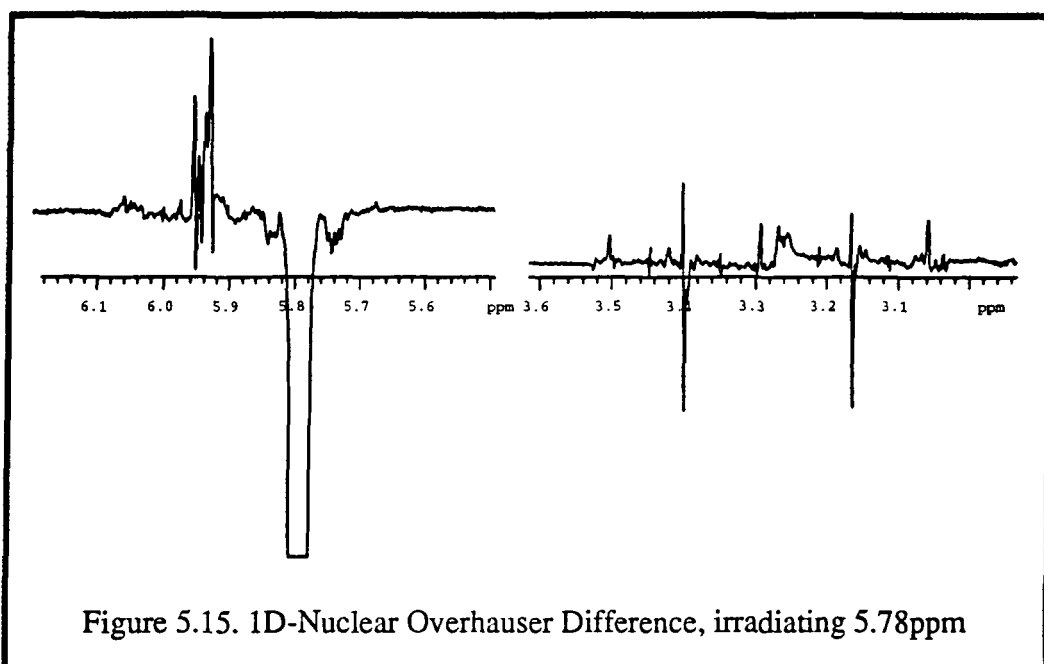

A) When the peak at 5.78ppm (proton 10) was irradiated, the clearest NOE differences were for the two methoxy groups, that at 3.4ppm having a larger NOE difference than that at 3.16ppm. The signal at 5.94ppm was also enhanced, but as this could be either proton 4 or 9, this result is unhelpful. See figure 5.15.

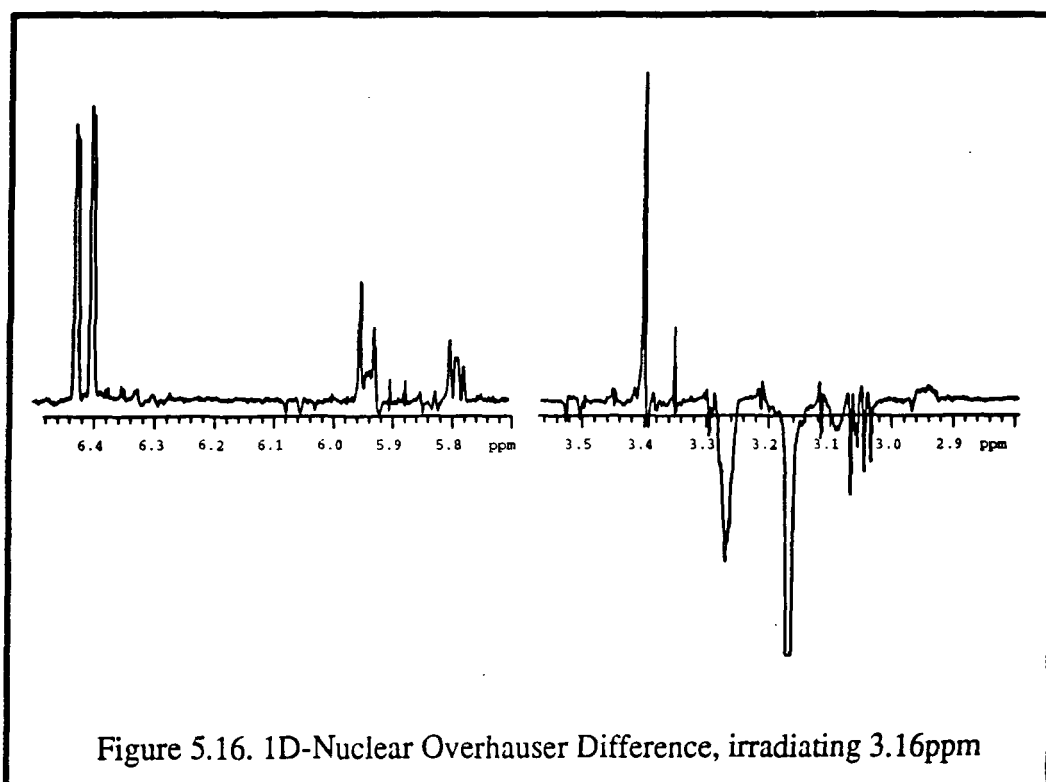

B) When the 3.16ppm methoxy was irradiated, the 6.42ppm proton (H5)

exhibited a greater NOE difference than the other vinylic protons. Proton 1 (3.26ppm) had a greater NOE difference than proton 8 (3.09ppm) and proton 2 (3.04ppm) had a greater NOE difference than proton 7 (2.95ppm.) See figure 5.16.

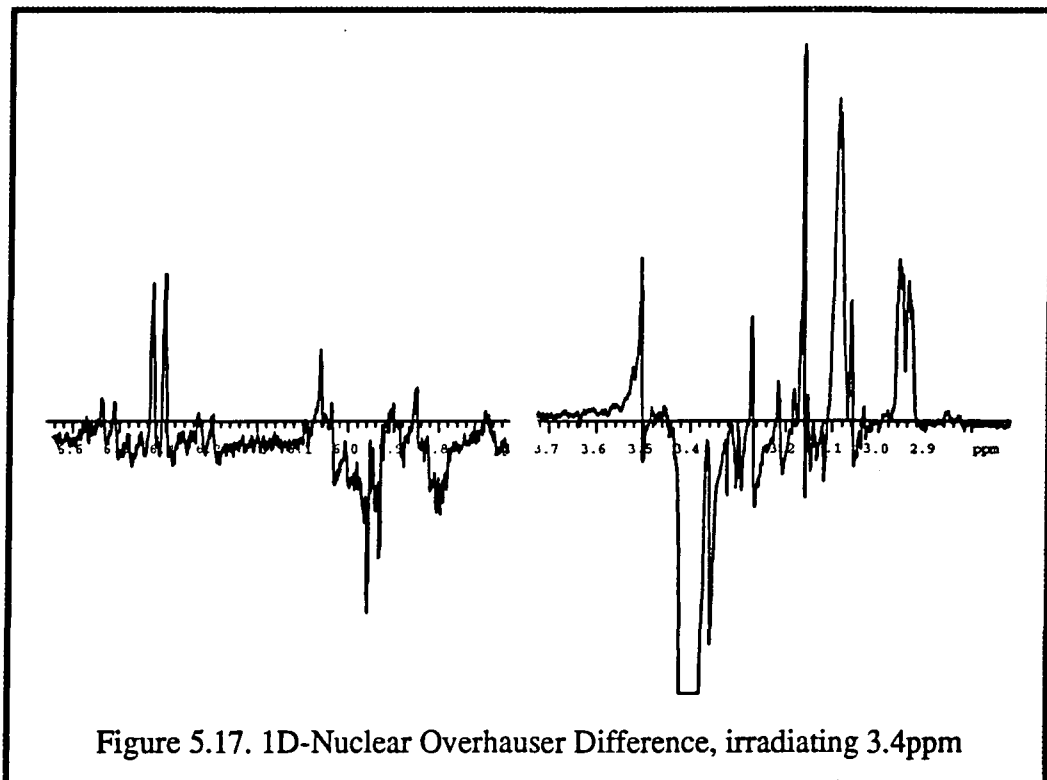

C) When the 3.40ppm methoxy was irradiated, proton 5 (6.42ppm) still had a greater NOE difference than the other vinylic protons. Proton 8 (3.09ppm) now had a larger NOE difference than proton 1 (3.26ppm) and proton 7 (2.95ppm) a greater NOE difference than proton 2 (3.04ppm.) See figure 5.17.

Assignment of the two methoxy groups is complicated by the fact that the molecule can exist in both an open and closed *endo*-conformation, figure 5.18.



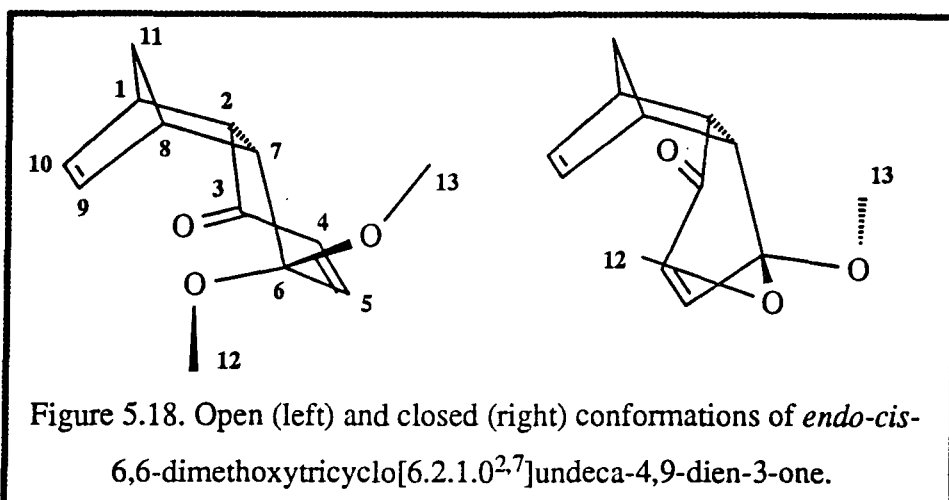

Heatley *et al*<sup>[220]</sup> prepared a series of Diels-Alder adducts of cyclopentadiene and substituted benzoquinones and found by relaxation time and NOE measurements that the preferred conformation is the open one. However, these compounds lack the non-bonded interaction of the two methoxy groups with the norbornene residue.

Experiment (A) demonstrates that the 3.4ppm methoxy is closer to proton 10 than is the 3.16ppm methoxy, whilst experiments (B) and (C) suggest that the 3.16ppm methoxy is closer to protons 1+2 than to 7+8, and that the 3.4ppm methoxy is closer to 7+8 than to 1+2. Consideration of the open and closed conformations demonstrates unambiguously that if the conformation is open, the methoxy which is closer to proton 10 is also the methoxy which is closer to protons 1+2 - the exact opposite of the observation. Only in the closed conformation is it possible for the methoxy closer to proton 10 to be closer to protons 7+8. The conformation which permits this most easily is one halfway between the two extremes, in which coplanarity of the enone  $\pi$ -system is preserved, although a Dreiding model suggests this is highly strained. The conformation is drawn at the top of figure 5.20. It seems unlikely that the two conformational extremes are freely interconverting, as chemical shift differences for the vinylic protons would be expected from non-bonded interactions on going from one conformer to the other and considerable differences in chemical shift would be expected for the methoxy groups; the proton spectrum is well-resolved with no sign of line broadening in the methoxy

signals. The methoxy group 12 may be assigned to the resonance at 3.4ppm and 13 appears at 3.16ppm. Further assistance with this analysis is available from the infra-red and ultra-violet data, see Appendix 1 figures 6 and 7, and also from analysis of the nmr of the photocyclisation product, *vide infra*.

The infra-red carbonyl absorption of unstrained, aliphatic, saturated ketones occurs at ca.  $1715\text{cm}^{-1}$ , whereas the carbonyl absorption for this compound occurs at  $1660\text{cm}^{-1}$ . This is evidence that the carbonyl is conjugated to the C=C double bond (delocalisation=lower force constant) but the absorption is still a little lower than might be expected. It may also be the case that the strain commented upon above, which tends to *increase* the C-(CO)-C bond angle above  $120^\circ$ , contributes to the reduction in carbonyl frequency. It is known that as this angle is decreased<sup>[221]</sup> in the series cyclohexanone, cyclopentanone, cyclobutanone the carbonyl frequency increases.

### FLOCK Spectrum

There remains the ambiguity of the assignments for carbons 4 and 9 caused by the overlap of the signals of the protons they bear. FLOCK permits the examination of long-range heteronuclear coupling. In this instance, 3-bond C-H coupling was examined, where the coupling constant is about 8Hz for a  $180^\circ$  C-C-C-H angle, see Appendix 1 figure 8. Strong coupling is observed between the methoxy group protons 12 and 13 and carbon 6, also between carbonyl carbon 3 and proton 5, between carbon 6 and the ambiguous proton peaks at 5.94ppm (although evidently it is proton 4 which responds), between proton 11a and carbons 2+7 and most importantly, between proton 11b and carbons 9+10. Unambiguous assignment of carbon 4 at 133.36ppm and carbon 9 at 134.86 then follows. Weaker coupling is also visible between carbon 5 and proton 7, between carbon 9 and proton 7 and between carbon 10 and proton 2.

A complete and unambiguous assignment of all proton and carbon resonances together

with the elucidation of most proton-proton coupling constants has thus been achieved for  $\text{CDCl}_3$  solution nmr spectra of *endo-cis*-6,6-dimethoxytricyclo[6.2.1.0<sup>2,7</sup>]-undeca-4,9-dien-3-one and these are summarised in figures 5.19 and 5.20.

Position	Proton Shift	Carbon Shift
1	3.26	50.11
2	3.04	48.31
3		201.02
4	5.94	133.36
5	6.42	146.98
6		97.63
7	2.95	44.58
8	3.09	45.64
9	5.94	134.86
10	5.78	134.24
11		49.15
11a	1.43	
11b	1.36	
12	3.4	49.19
13	3.16	48.54

Figure 5.19

NMR Spectral assignments for *endo-cis*-6,6-dimethoxytricyclo[6.2.1.0<sup>2,7</sup>]-undeca-4,9-dien-3-one. Chemical shifts are ppm relative to TMS. Spectra obtained on a Varian VXR400. Proton frequency 399.952 MHz, carbon frequency 100.577 MHz. Spectra were obtained in  $\text{CDCl}_3$  solution.

*endo-cis*-6,6-dimethoxytricyclo[6.2.1.0<sup>2,7</sup>]-undeca-4,9-dien-3-one

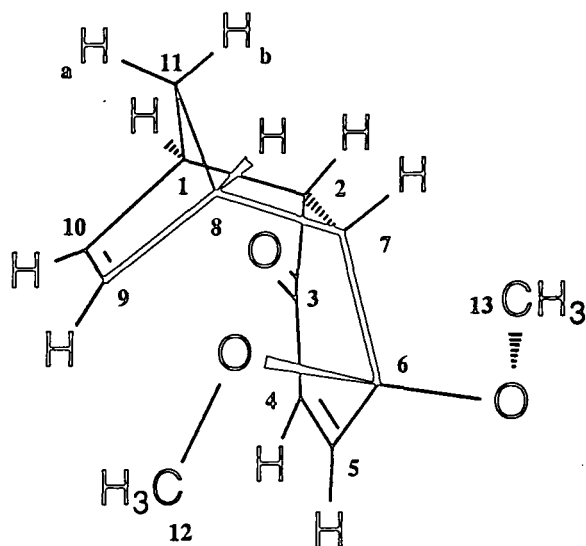

H Atom	1	2	4	5	7	8	9	10	11a	11b
1		4.35						2.75	1.8	1.5
2	4.35				8.45					
4				10.5						
5			10.5		1.65					
7		8.45		1.65		3.25				
8					3.25		2.9		1.85	1.35
9						2.9		5.55		0.7*
10	2.75						5.55			0.7*
11a	1.8					1.85				8.55
11b	1.5					1.35	0.7*	0.7*	8.55	

Figure 5.20

Proton-proton coupling constants,  $J$ , for *endo-cis*-6,6-dimethoxytricyclo[6.2.1.0<sup>2,7</sup>]-undeca-4,9-dien-3-one in Hz, recorded in CDCl<sub>3</sub> solution. Values are accurate to  $\pm 0.05$  Hz except for \*  $J_{11b-9}$  and  $J_{11b-10}$  which are accurate to  $\pm 0.1$  Hz.

### 3. 8,8-Dimethoxypentacyclo[8.1.0<sup>1,5</sup>.0<sup>2,9</sup>.0<sup>4,7</sup>.0<sup>6,10</sup>]undecan-3-one.

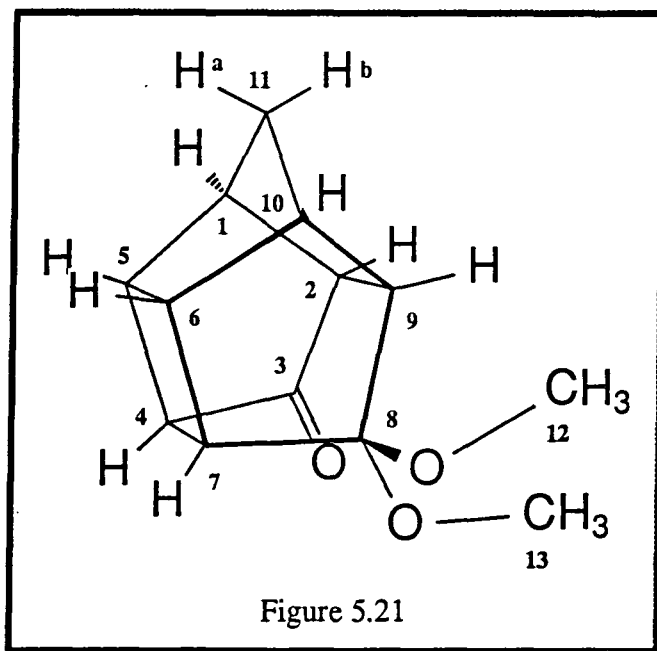

This compound, figure 5.21, was prepared by intramolecular 2+2 photocycloaddition of *endo-cis*-6,6-dimethoxytricyclo[6.2.1.0<sup>2,7</sup>]-undeca-4,9-dien-3-one. The fact that this reaction proceeds is itself proof that the starting material is the *endo-cis*- isomer<sup>[222]</sup>. This is the first example of a derivative of this ring system for which the structure has been proved exclusively by nmr. Marchand *et al*<sup>[223]</sup> have studied similar compounds by X-ray crystallography.

#### The <sup>1</sup>H Spectral Evidence

The proton spectrum recorded at 399.952MHz in CDCl<sub>3</sub> was highly complex, figure 5.22. The methoxy singlets are clearly visible at 3.19 and 3.22ppm, an interesting observation which bears comparison with the shifts observed in the starting material (see previous section.) Whilst one methoxy group (13) appears to have experienced small change in its chemical environment, the other (12) has moved ca. 0.2ppm. This is consistent with methoxy 12 experiencing deshielding from one of the C=C double

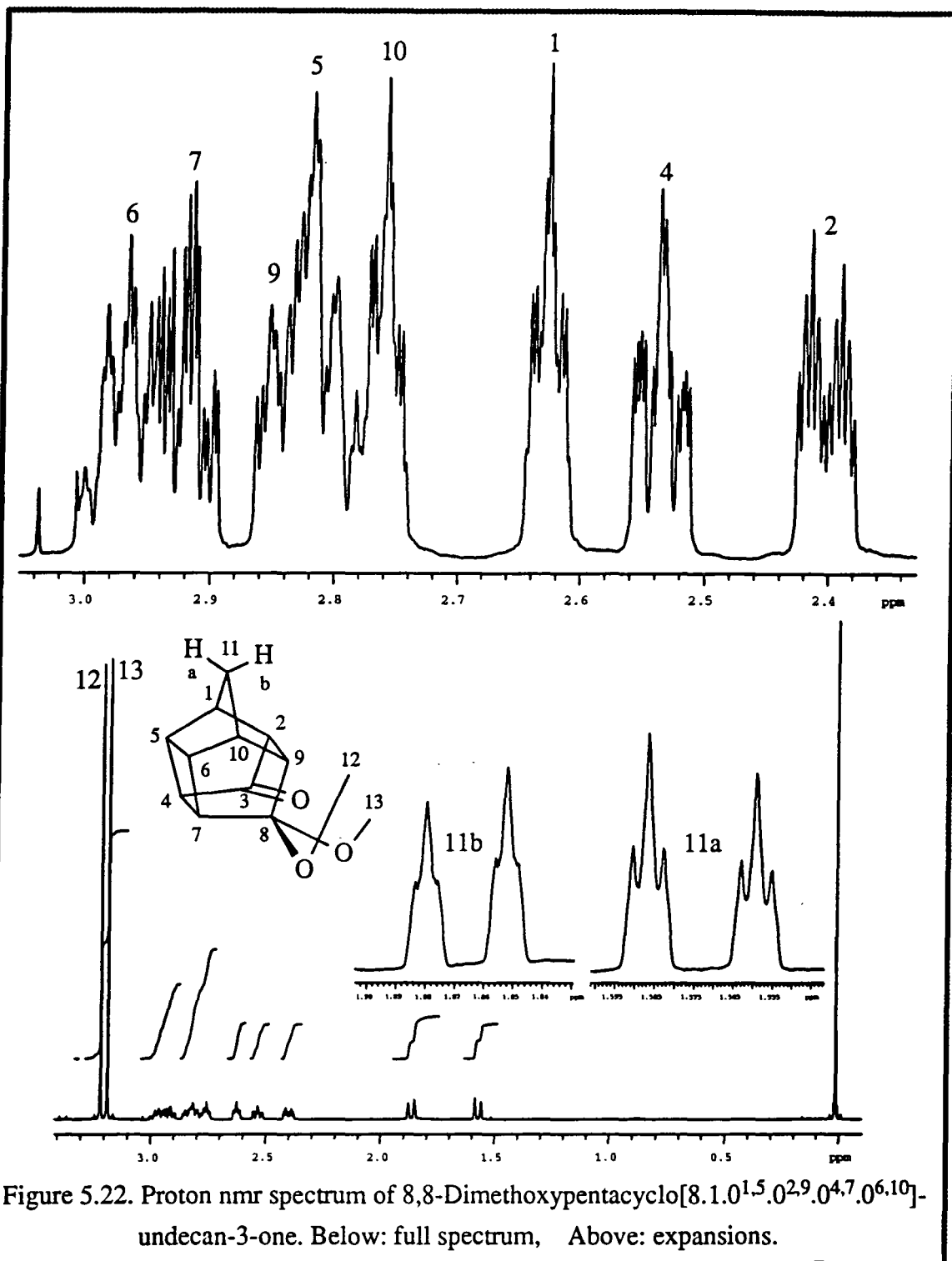

Figure 5.22. Proton nmr spectrum of 8,8-Dimethoxypentacyclo[8.1.0<sup>1.5</sup>.0<sup>2.9</sup>.0<sup>4.7</sup>.0<sup>6.10</sup>]-undecan-3-one. Below: full spectrum, Above: expansions.

bonds in the starting material, suggesting that it lies in the plane of one them<sup>[224]</sup>. The methylene bridge protons 11a and b are present at either 1.57 or 1.87ppm, with  $J_{AB}=11.0\text{Hz}$ . The signals at 1.57ppm are further split into triplets with  $J=1.5\text{Hz}$ . None of these resonances can be assigned to a specific proton or methyl group. All CH

protons are observed in a 0.7ppm range and all appear as highly complex multiplets. The remaining signals can all be assigned as sidebands and  $^{13}\text{C}$  satellites. In complete contradistinction to the proton spectrum of *endo-cis*-6,6-dimethoxytricyclo[6.2.1.0<sup>2,7</sup>]-undeca-4,9-dien-3-one, the range of CH resonances is too small to assign protons next to a carbonyl, or protons in a strained four-membered ring simply by inspection. The multiplets corresponding to the eight methine protons are as follows:

3.0-2.89ppm. This multiplet integrates to two protons and can be divided at ca. 2.94ppm into two distinctly different signals, each corresponding to one proton and centred on 2.92 and 2.97ppm respectively. No coupling constants are readily estimable due to the complexity of the splitting, which is an apparent quintuplet of quintuplets for the 2.97ppm proton and an apparent quadruplet of doublets of doublets for the 2.92ppm proton.

2.87ppm-2.74ppm. This multiplet integrates to three protons and can be divided at ca. 2.78ppm to yield an apparent triplet of multiplets corresponding to one proton and centred on ca. 2.76ppm. The remaining cluster of peaks between 2.89 and 2.78ppm is not readily divisible into the two proton resonances of which it is composed, although the resonances are probably centred around ca. 2.81 and 2.84ppm.

2.64-2.59ppm. This multiplet integrates to one proton, centred on ca. 2.63ppm and is an apparent triplet of multiplets very similar in appearance to that at 2.76ppm.

2.55-2.49ppm. This multiplet integrates to one proton, centred on ca. 2.52ppm and is an apparent triplet of distorted apparent doublets of doublets.

2.42-2.36ppm. This multiplet integrates to one proton, centred on ca. 2.39ppm and is a doublet of apparent quintuplets, which may be triplets of triplets.  $J=10.1\text{Hz}$  for the

doublet splitting. The relative simplicity of this splitting pattern suggests that it may be proton 2, which by analogy with *endo-cis*-6,6-dimethoxytricyclo[6.2.1.0<sup>2,7</sup>]-undeca-4,9-dien-3-one, would be expected to couple strongly with proton 9 (the analogous coupling constant is 8.45Hz) and to some extent with proton 1 (analogous coupling constant 4.35Hz) but not with proton 4 across the carbonyl. It is the only proton which would be expected to couple with only two others, but the complexity of the secondary splitting into postulated triplets of triplets indicates that matters are more complex than this and it is unsafe to make this assignment from the proton spectrum alone.

Upon photocyclisation of the starting material, *endo-cis*-6,6-dimethoxytricyclo[6.2.1.0<sup>2,7</sup>]-undeca-4,9-dien-3-one, it is clear that many new couplings have been produced. Their complexity is such that it effectively prevents the extraction of coupling constants for most of the molecule, which is unfortunate as it renders assigning the resonances and explaining their appearance very much more difficult.

### The <sup>13</sup>C Spectral Evidence

The carbon spectrum, figure 5.23, contains the expected thirteen lines, only two of which are immediately capable of assignment by inspection. The carbonyl resonance 3 is at 214.56ppm and the quaternary carbon to which the two methoxy groups are attached, carbon 8, is at 107.56ppm. A curious observation is that the carbonyl resonance is clearly not a single line, but is quite plainly composed of *three* lines, see Appendix 1 figure 9. This is not a shimming or tube fault, as upon this discovery all other lines in the spectrum were closely inspected and found to be quite unexceptional. The separation is very small, being 0.06ppm between the main two lines, with a shoulder on the highest frequency (and most intense) resonance which is no more than 0.02ppm downfrequency from it. This odd resonance may be caused by different combinations of conformations of the methoxy groups, which are the only mobile



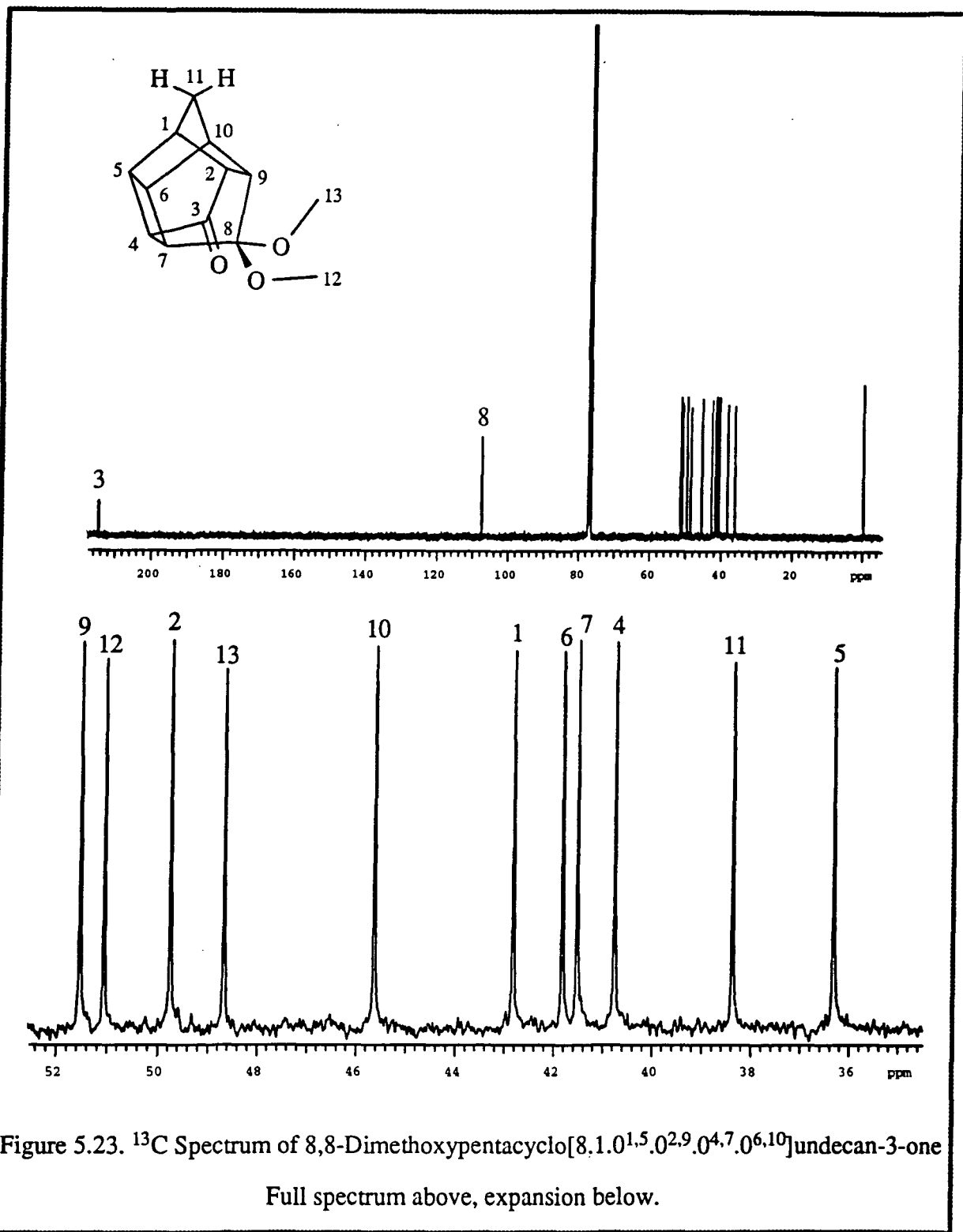

structural subunits of the molecule and which by inspection of molecular models evidently enjoy only limited rotational motion. Interaction between the oxygen  $sp^3$  lone pairs on methoxy 13 and the carbonyl  $2p_z$  orbital might provide a mechanism, or it

could be due to different amounts of strain induced by steric effects as the methoxy groups adopt different conformations, see figure 5.24 below.

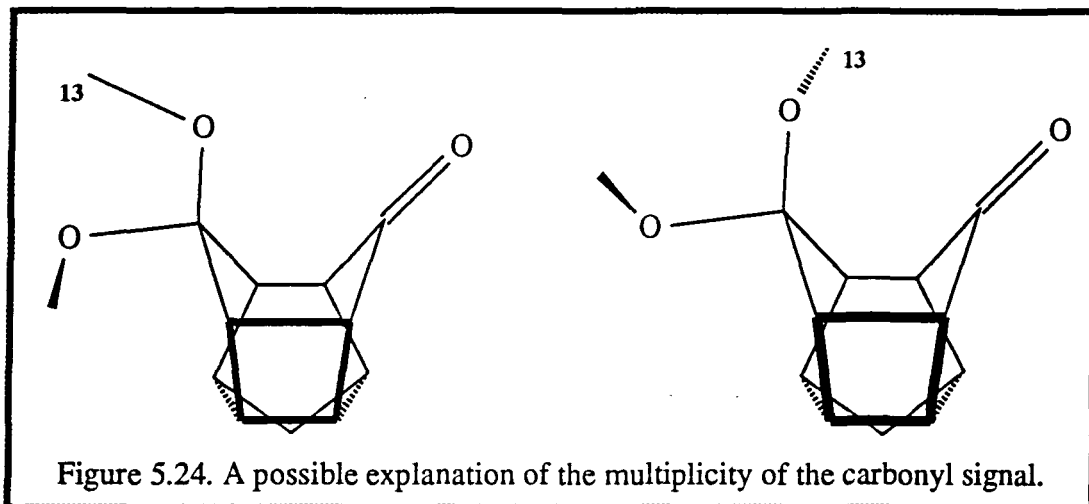

The remaining eleven carbon signals occur over a narrow range, 52-36ppm. Assignment by inspection is impossible, but DEPT allows the methoxy carbons 12 and 13 to be picked out, see Appendix 1 figure 10. These are at 51.05 and 48.67ppm, but clearly one cannot say which is which. The methylene bridge 11 appears at 38.37ppm.

The methine carbons are:

51.53, 49.75, 45.64, 42.82, 41.83, 41.52, 40.76 and 36.32ppm.

### The 2D Spectral Evidence

A comprehensive battery of spectroscopic techniques was brought to bear upon this molecule. The similarity of all the proton resonances, i.e. their complexity, made obtaining a "handle" on the molecule possible only with the aid of FLOCK. The methylene bridge signals could thus be correlated with the bridgeheads 1 and 10 via 3Hz couplings (2 bond FLOCK) and to carbons 5+6 and 2+9, via 8Hz strong couplings (3 bond FLOCK.)

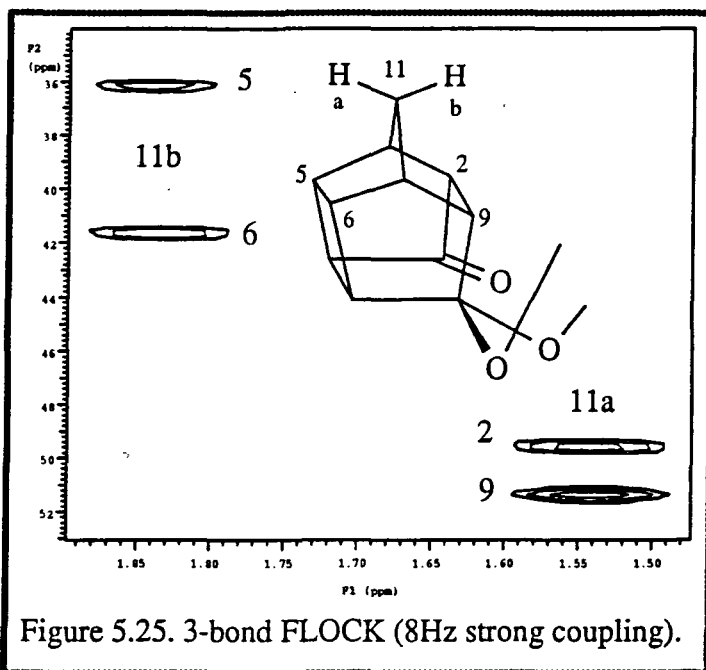

The 2 bond FLOCK was extensively corrupted with spurious signals, but very clearly showed that carbons 1+10 are at 45.64 and 42.82ppm, without saying which is which, see Appendix 1 figure 11. Three bond FLOCK, figure 5.25, showed that one of protons 11a or 11b at 1.87ppm is strongly coupled to carbons at 36.32 and 41.83ppm, whilst the other proton at 1.57ppm is coupled to carbons 49.75 and 51.53ppm. It is virtually certain as a consequence of the Karplus equation that the proton which couples is that which lies on the opposite side of the methylene bridge to the carbons concerned, as was the case with the starting material, *endo-cis*-6,6-dimethoxytricyclo[6.2.1.0<sup>2,7</sup>]-undeca-4,9-dien-3-one. Thus 11a will be coupled to 2+9 and 11b to 5+6.

It is evident that these four carbon resonances correspond to carbon pairs 5+6 and 2+9 respectively, the difference in shift being sufficient to assign one pair unambiguously to the positions nearest the carbonyl 3 and methoxy-bearing carbon 8. However, it is not clear from this evidence which of the resonances 36.32 and 41.83ppm corresponds to which of carbons 5+6. Neither is it safe to assign 2+9 specifically to either of the resonances 49.75 and 51.53ppm.

By default, carbons 4+7 must therefore be at 41.52 and 40.76ppm, although again an absolute assignment cannot be made.

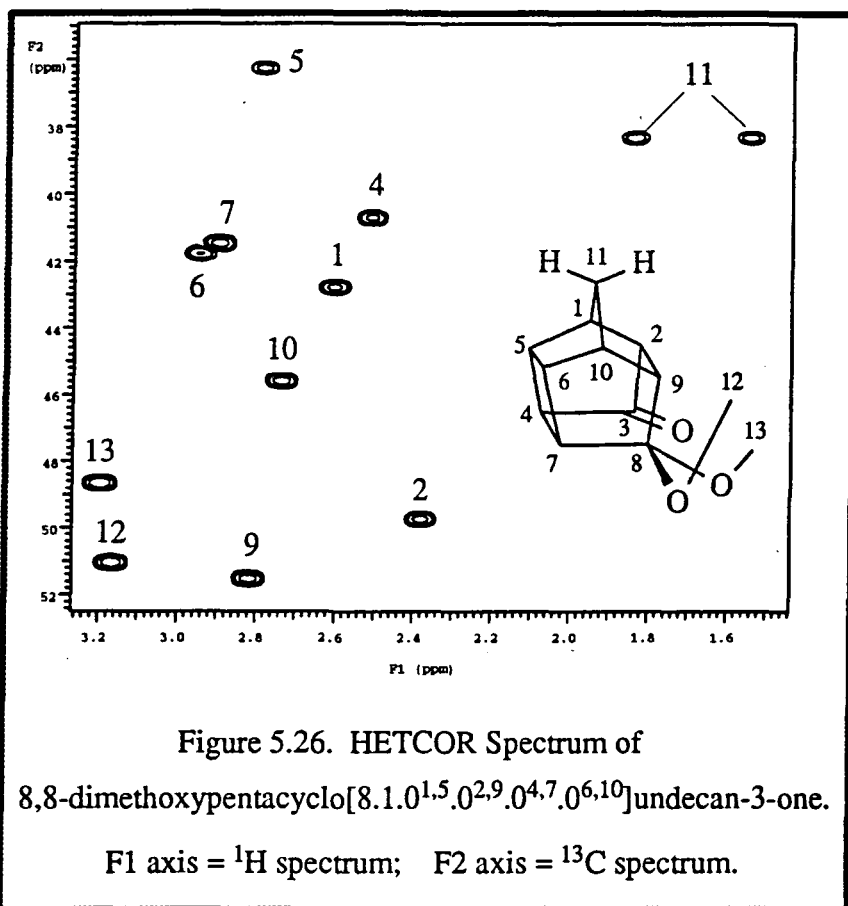

HETCOR enabled these carbons to be correlated very easily with the respective protons, figure 5.26. The bridgehead carbons 1+10, at 42.82 or 45.64ppm, correspond to the proton signals at 2.63 and 2.76ppm respectively. Carbons 2+9, at 49.75 or 51.53ppm, are coupled to protons at 2.39 and 2.84ppm. Carbons 4+7 at 40.76 or 41.52ppm are coupled to protons at 2.39 and 2.84ppm. Carbons 5+6 at 36.32 or 41.83ppm are coupled to protons at 2.52 and 2.92ppm. Carbons 8+11 at 38.32 or 38.32ppm see protons at 1.81 and 1.97ppm. However, no unambiguous assignment for these pairs was yet possible.

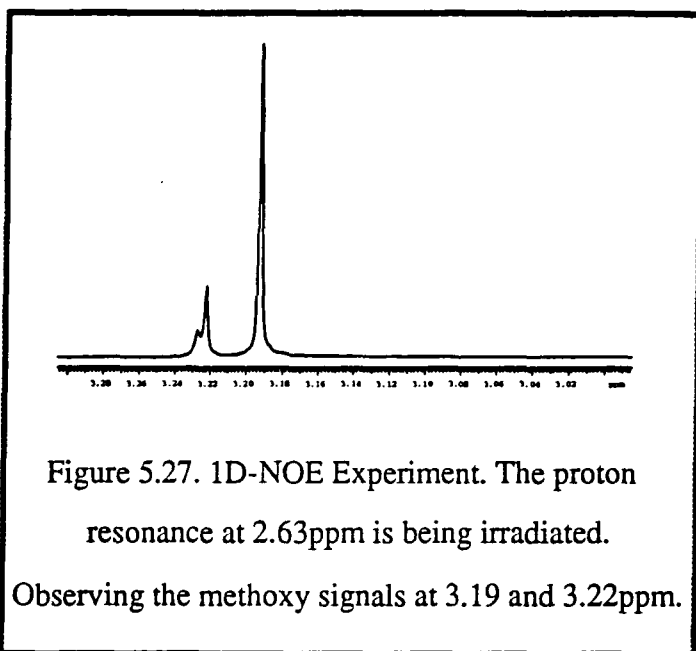

However, since the bridgehead protons 1+10 could be identified as either 2.63 or 2.76ppm, use could be made of nuclear Overhauser spectroscopy (NOE1D) to assign the methoxy signals. It will be discussed under the 2D heading since it follows logically on from the FLOCK and HETCOR evidence. NOE is sometimes accused of giving results which are ambiguous, but in this case a very decisive experiment was performed. It was not possible to irradiate the methoxy groups selectively and observe enhancement of the methine signals to good effect, since the proximity of the methoxy signals to one another and to the methine region caused some spillover and the experiment was inconclusive. In addition, this is not the best way to get good sensitivity. It was, however, possible to selectively irradiate the proton resonance at ca. 2.63ppm and observe the difference in the methoxy signals, figure 5.27. This is a particularly good experiment because the nuclear Overhauser enhancement is brought about in this instance via interaction of three methoxy protons with the proton being irradiated. It may be noted that the difference spectrum so obtained is particularly free of noise, glitches and confusing responses from methine protons, only the two methoxy groups being significantly stimulated by the experiment. The signal at 3.19ppm received greater enhancement than that at 3.22ppm. Whilst this result is very clear, the

consequent assignment is unfortunately not! If the proton at 2.63ppm is proton 1, then methoxy signal at 3.19ppm is probably 13. If on the other hand it is proton 10, then the methoxy at 3.19ppm must be 12. However, consideration of the various conformations possible using a Dreiding model, suggested that the latter assignment was preferable. The nuclear Overhauser effect is a short-range phenomenon which falls off rapidly with distance. Under ideal conditions, this diminution follows an inverse sixth power law. The distances between proton 1 and the two methoxy groups suggested that nuclear Overhauser enhancement of the methoxy signal(s) from exciting the resonance of this proton was unlikely. However, the possibility that the 2.63ppm resonance was proton 1 could not be positively eliminated. Until the proton resonance at 2.63ppm could be rigorously assigned, ambiguity still remained.

Homonuclear proton COSY was applied in an attempt to decide which proton in any pair could be assigned unambiguously, but it quickly became obvious that, although the proton resonances as assigned via HETCOR were completely consistent with those obtainable from COSY it was possible to "walk around" the molecule irrespective of whether e.g. proton 2 was assigned to the peak at 2.39ppm or at 2.84ppm or whether proton 1 or 10 was assigned to 2.63ppm, see figure 5.28. The ambiguity was not resolved by this technique. However, if proton 10 really was at 2.63ppm, as suggested by the NOE1D experiment detailed above, assignment of the remaining proton resonances follows easily.

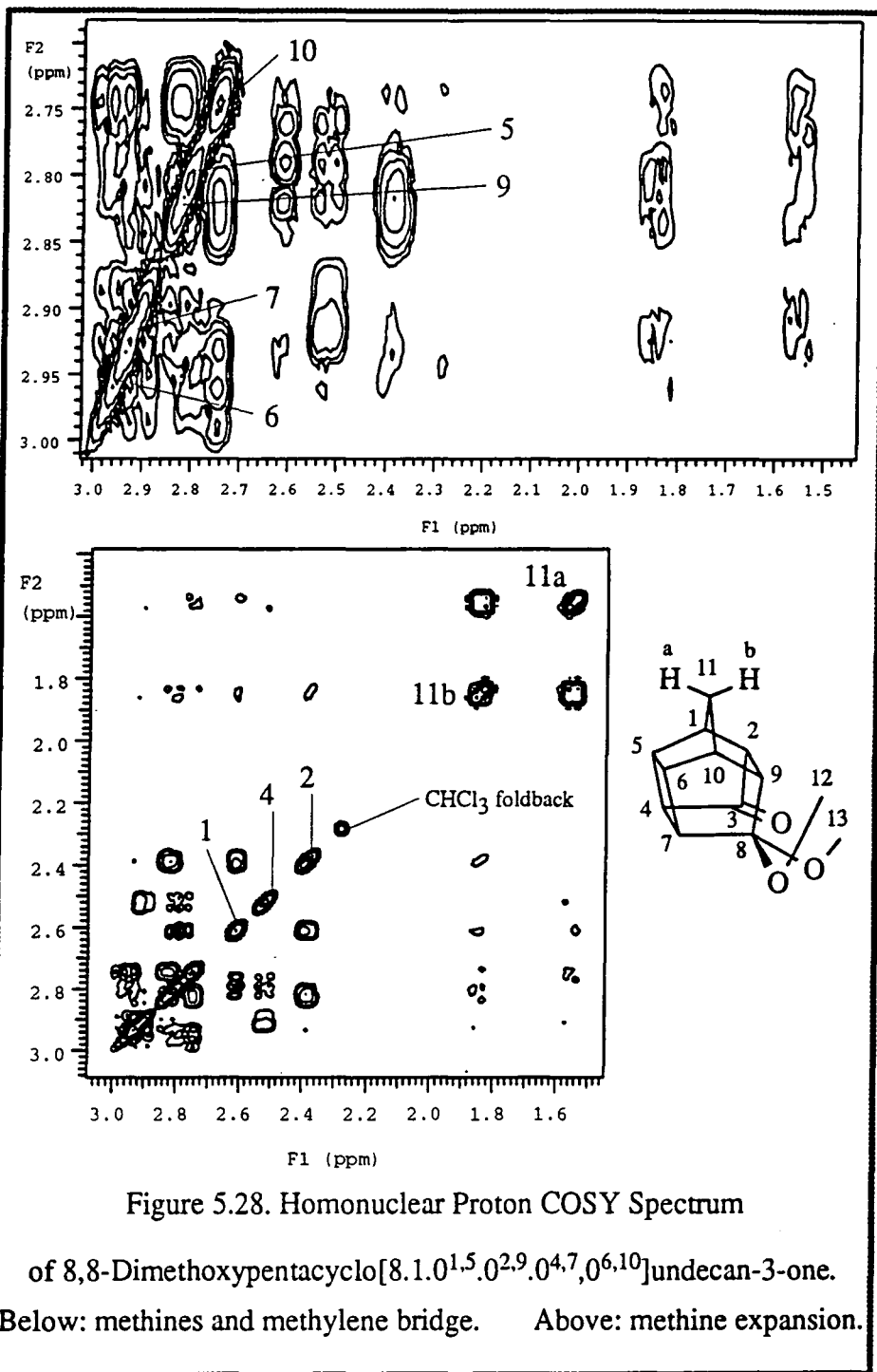

Unfortunately, FLOCK did not show any coupling between either the carbonyl 3 or the quaternary carbon 8 and any of the protons in the fused ring system. No "handle" could be obtained on the molecule.

It was decided that the only certain way of removing the ambiguity of the proton spectrum and thence deciding on the correct assignments of the pairs of carbon resonances deduced from FLOCK and HETCOR was to obtain an INADEQUATE spectrum of the compound, see Appendix 1 figure 12. Fortunately, it was very soluble in deuteriochloroform and plenty of material was to hand. Unfortunately, the quaternary carbon bearing the two methoxy groups, 8, had a lengthy  $T_1$  of about 15 seconds. Thus it proved difficult to obtain an INADEQUATE spectrum in reasonable time in which  $^{13}\text{C}$ - $^{13}\text{C}$  coupling for this carbon was easily visible.

The following carbon assignments were already known:

Carbon 3=214.56ppm.

Carbon 8=107.56ppm.

Carbon 11=38.37ppm.

The starting point for the assignment was the information given by FLOCK 2-bond, that the bridgeheads 1+10 were either of 45.64 or 42.82ppm. Both have a connectivity of three in the INADEQUATE experiment, and one connection, to 11 at 38.37ppm, is the same for both. On one side they are coupled to 2+9 and on the other to 5+6.

The carbonyl, 3, at 214.56ppm is clearly coupled to the carbons at 49.75 and 40.76ppm, and this must be the pair 2+4.

From the information given by FLOCK 3-bond, that 5+6, 2+9 are 36.32, 41.83, 49.75 and 51.53ppm, it is obvious that 2 must be 49.75ppm since it is the only signal in that group of four carbons seen by the carbonyl, 3.

Carbon 2=49.75ppm.



Carbon 9 is thus 51.53ppm since FLOCK 3-bond pairs it with 2. This is confirmed by the connectivity seen in INADEQUATE between 9 and the quaternary carbon, 8, at 107.56ppm.

Carbon 9=51.53ppm.

Carbon 4 is the other one of the pair 2+4 connected to the carbonyl, 3, i.e. the peak at 40.76ppm. Since 2 at 49.75ppm is able to see the 42.82ppm signal, the latter is evidently carbon 1, and the other one of the pair, at 45.64ppm, must be carbon 10, confirmed by connectivity to carbon 9.

Carbon 4=40.76ppm.

Carbon 1=42.82ppm.

Carbon 10=45.64ppm.

It is evident that as 4+7 are the pair 40.76 and 41.52, given by elimination from the FLOCK assignments for the norbornane residue carbons, that with 4 already assigned by connectivity to the carbonyl, 7 must be 41.52ppm, which is confirmed by connectivity to quaternary carbon 8.

Carbon 7=41.52ppm.

This leaves assignments for 5+6, which are known by the above elimination of 2+9 from the FLOCK 3-bond data to be 36.32 and 41.83ppm, and also by their chemical shift relative to the pair 2+9 (the latter being closer to 3+8 at 214.56 and 107.56ppm.)

Connectivity between 10 at 45.64ppm and the signal at 41.83ppm demonstrates that the

latter is carbon 6. Carbon 5 is thus at 36.32ppm.

Carbon 5=36.32ppm.

Carbon 6=41.83ppm.

It is now possible to use the HETCOR data to assign the proton resonances. Proton 10, important for understanding the NOE1D assignments for the methoxy groups 12 and 13 (and thence carbons via HETCOR) is evidently that signal corresponding to the carbon at 45.64ppm, i.e. 2.76ppm. Thus it was proton 1 which was irradiated during this experiment, at 2.63ppm. Therefore, the methoxy group which received the greater signal enhancement by NOE was in fact methoxy 13 which thus resonates at 3.19ppm, whilst 12 resonates at 3.22ppm, the opposite of what had been expected by inspection (which shows how risky assigning by inspection can be.) Carbons 13 and 12 are, via HETCOR, at 48.67 and 51.05ppm respectively.

A complete and unambiguous assignment of all proton and carbon resonances has been made for 8,8-dimethoxypentacyclo[8,1,0<sup>1,5</sup>,0<sup>2,9</sup>,0<sup>4,7</sup>,0<sup>6,10</sup>]undecan-3-one, figure 5.29. Coupling constant data is only possible to obtain in a few instances.

This investigation has been, to some extent, "art for art's sake" although it not only demonstrates the capabilities of state-of-the-art nmr technology, but also provides a precedent to enable the structural determination of other similar compounds by nmr, which previously have had their structures elucidated by x-ray crystallography, presumably because interpretation of their nmr spectra was believed to be too difficult in comparison with x-ray data.

Position	Proton Shift	Carbon Shift
1	2.63	42.82
2	2.39	49.75
3		214.56*
4	2.52	40.76
5	2.81	36.32
6	2.97	41.83
7	2.92	41.52
8		107.56
9	2.84	51.53
10	2.76	45.64
11		38.37
11a	1.57	
11b	1.87	
12	3.22	51.05
13	3.19	48.67

Figure 5.29

NMR Spectral assignments for 8,8-dimethoxypentacyclo[8.1.0<sup>1,5</sup>.0<sup>2,9</sup>.0<sup>4,7</sup>.0<sup>6,10</sup>]-undecan-3-one. Chemical shifts are ppm relative to TMS. Spectra obtained on a Varian VXR400. Proton frequency 399.952 MHz, carbon frequency 100.577 MHz. Spectra were obtained in CDCl<sub>3</sub> solution. Key: \*-The carbonyl peak was composed of three lines. The shift given is for the major line. Two others appeared at 0.02 and 0.06 ppm downfrequency from it.

The coupling constants obtained are:

ABq ( $\delta_A=1.87$ ppm;  $\delta_B=1.57$ ppm, A=11b, B=11a;  $J_{AB}=11.0$ Hz; the resonances are further split:  $J_{11a,2+9}=1.5$ Hz)

ABq ( $\delta_A=2.84$ ppm;  $\delta_B=2.39$ ppm, A=9, B=2;  $J_{AB}=10.1$ Hz)

4. *Endo-cis*-6-Dichloromethylenetricyclo[6.2.1.0<sup>2,7</sup>]undeca-4,9-dien-3-one.

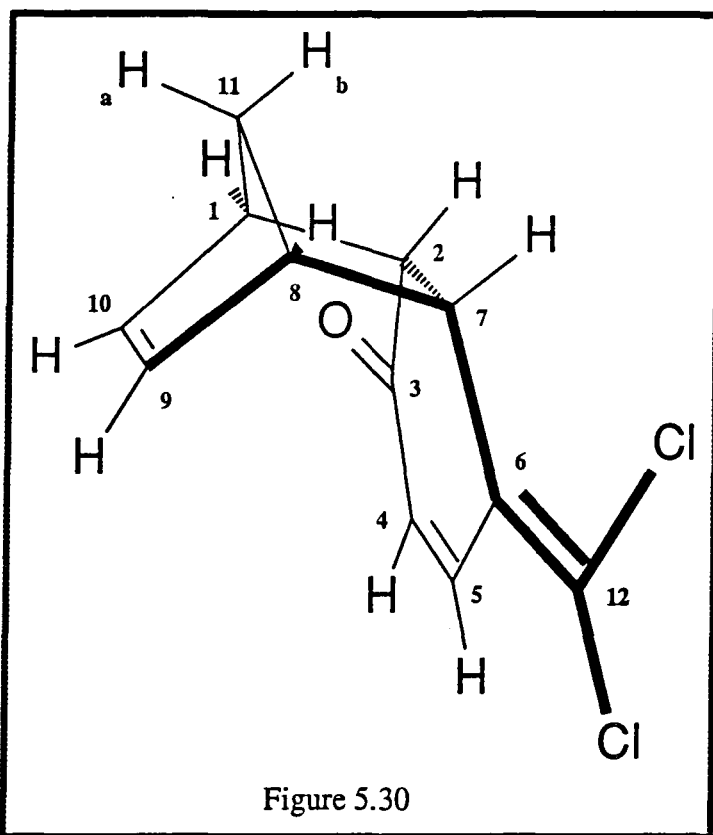

This important precursor to 7,7-dichloro-1,4-quinonemethide was made by a Wittig-Horner reaction on *endo-cis*-6,6-dimethoxytricyclo[6.2.1.0<sup>2,7</sup>]-undeca-4,9-dien-3-one, see chapter 3 section 3(iv).

### The <sup>1</sup>H Spectral Evidence

The proton spectrum obtained at 399.952MHz, figure 5.31, can be assigned by analogy with the spectrum obtained for the starting material.

The AB observed for the protons 11a and 11b is at 1.42 and 1.455ppm.  $J_{AB}$  = 8.8Hz and  $J_{AX}$  = 1.7Hz. The latter coupling is to the bridgeheads 1+8.

At 3.04ppm is a 1:1:1:1 doublet of doublets integrating to one proton. This is proton 7.  $J_{AB}$  = 9.1Hz and  $J_{AX}$  = 3.9Hz. The latter coupling is to the bridgehead 8. No coupling to 5 is visible across the sp<sup>2</sup> carbon 6.

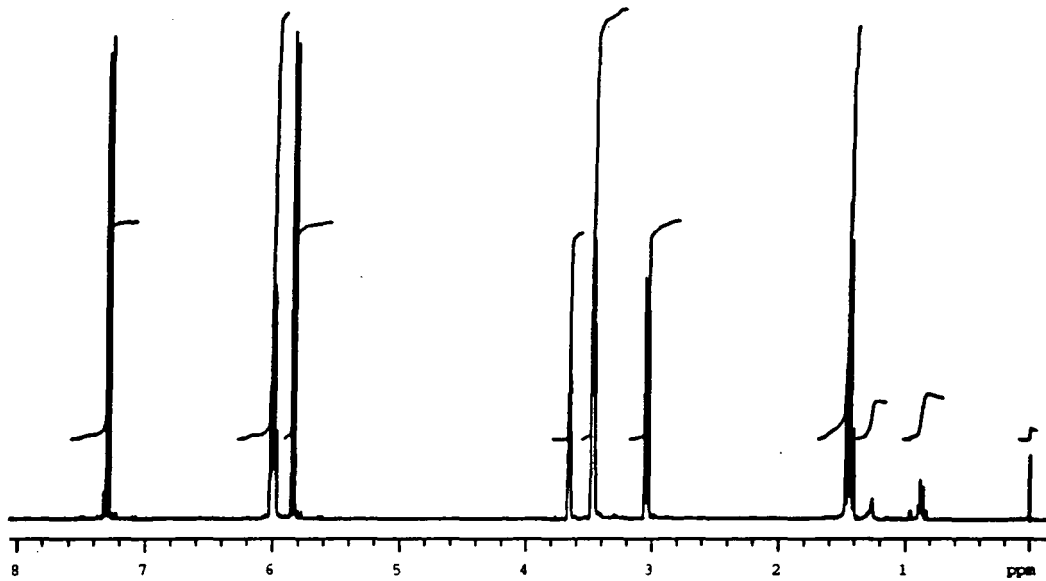
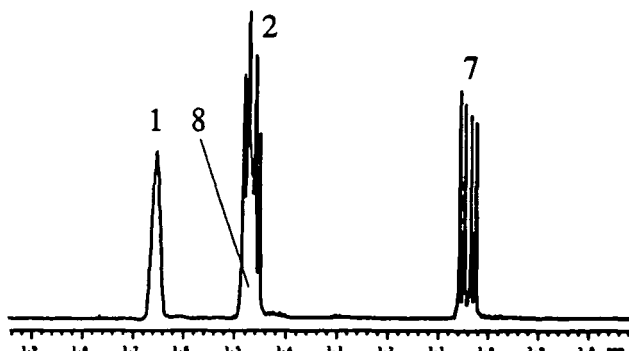
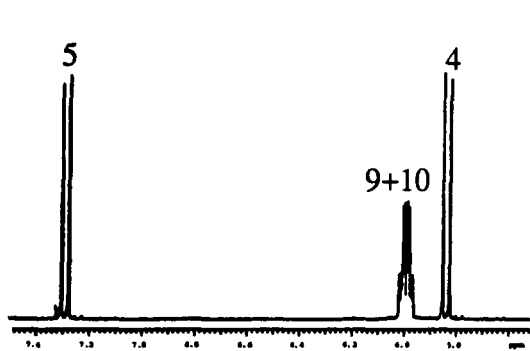
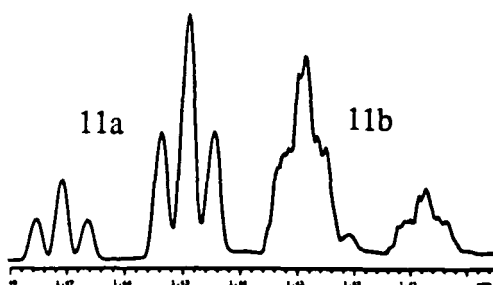
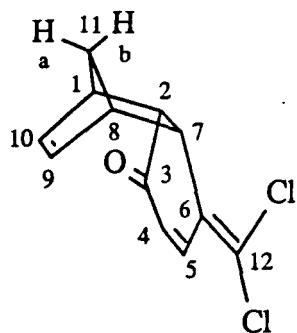

Figure 5.31. Proton NMR Spectrum of *Endo-cis*-6-dichloromethylenetricyclo[6.2.1.0<sup>2,7</sup>]-undeca-4,9-dien-3-one. Full spectrum at bottom. Centre: expansions of vinylics and methines. Top: expansion of methylene bridge.

At 3.47ppm is a multiplet integrating to two protons. Part of this multiplet is clearly the companion to the 3.04ppm peaks, with  $J_{AB}$  and  $J_{AX}$  identical to the values for proton 7. This is proton 2. The buried signal is the bridgehead 8.

The companion to the obscured resonance for 8 appears at 3.65ppm and is a broad hump integrating to one proton and appearing similar to those observed in the starting material for the same protons. No coupling constants can be extracted. This is proton 1.

At 5.84ppm a sharp doublet 1:1 appears, leaning slightly upfrequency. It integrates to one proton and corresponds to proton 4.  $J_{AB} = 10.2\text{Hz}$ . As was the case for the starting material, no coupling is seen across the carbonyl to 2. The A arm of this AB appears at 7.29ppm and is identical except for leaning downfrequency. No coupling is seen across the  $\text{sp}^2$  carbon, 6, to proton 7.

At ca. 6ppm is a multiplet 2:2:5:5:5:5:2:2 which integrates to two protons and which is evidently an  $\text{ABX}_2$  system where A and B are protons 9 and 10. The X protons are the bridgeheads 1+8. The coupling constants are  $J_{AB} = 5.8\text{Hz}$  and  $J_{AX} \approx J_{BX} = 2.8\text{Hz}$ . The chemical shifts for these two protons, calculated according to the usual method (see below, figure 5.32) are 5.98ppm and 6.005ppm.

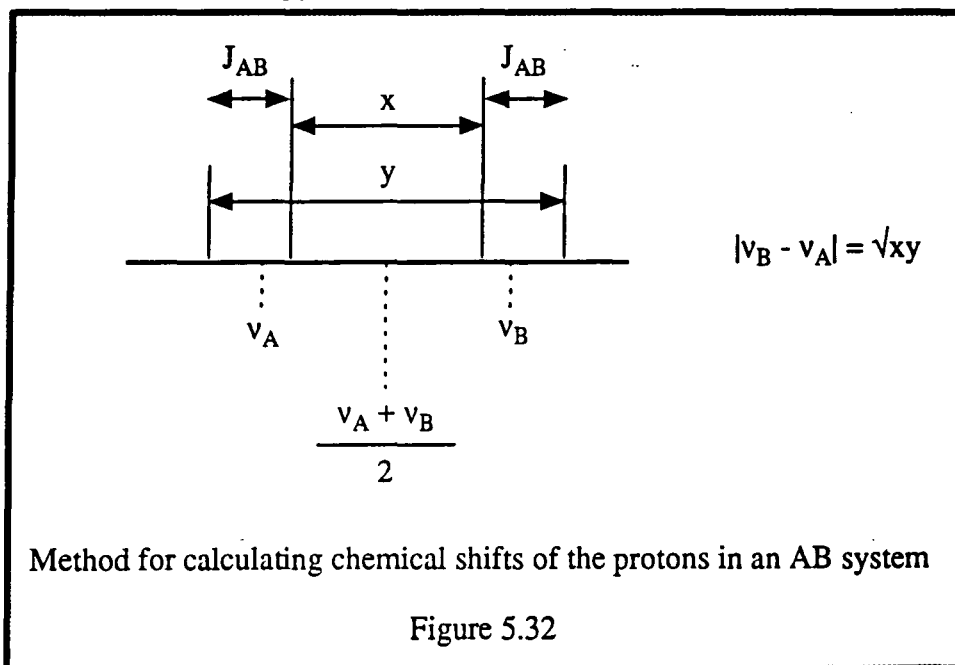

When the arms of an AB system are separated by a shift which is large in comparison to the coupling constant e.g. an order of magnitude greater or more, this method makes little difference to the shifts produced by estimation by eye of the midpoint of  $J_{AB}$ . In

this case, however, the separation is not so great and the scheme above must be used.

The only ambiguities arising from the proton data are the identity of protons 11a and 11b, and because of the small chemical shift difference, the identity of protons 9 and 10.

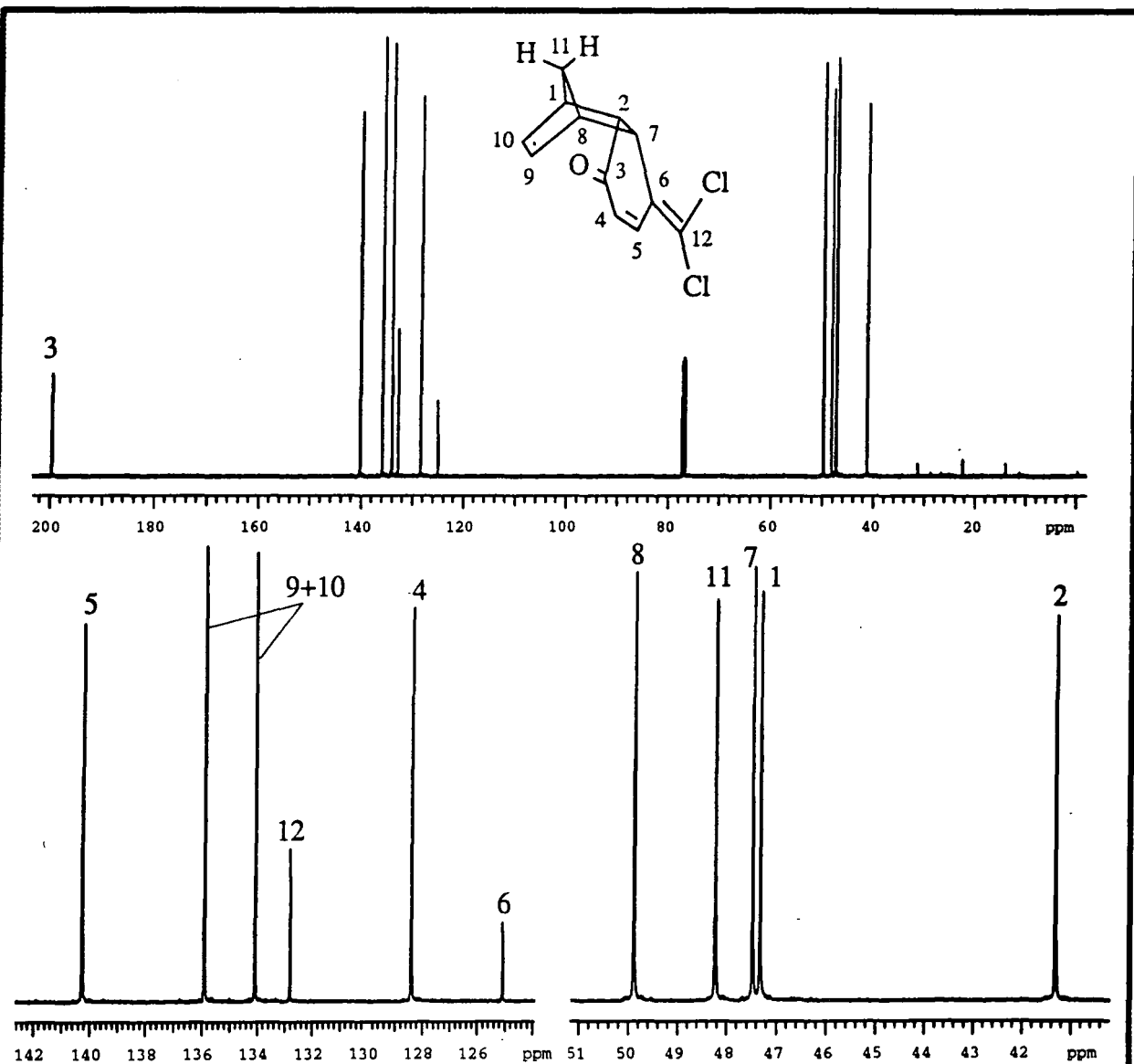

Figure 5.33

$^{13}\text{C}$  Spectrum of *Endo-cis*-6-dichloromethylenetricyclo[6.2.1.0<sup>2,7</sup>]undeca-4,9-dien-3-one.

Top: full spectrum; Below: expansion.

### The $^{13}\text{C}$ Spectral Evidence

The carbon spectrum recorded in deuteriochloroform at 100.577MHz shows the

expected twelve lines, figure 5.33. It is possible to assign the carbonyl, 3, at 199.68ppm by inspection. It is clear from their low peak intensity that the quaternary carbons 6 and 12 occur at 125.10 and 132.83ppm, but it is not possible to say which is which for certain, although it is likely that 12, attached to two chlorine atoms, is the carbon at 132.83ppm. The vinylic carbons 4+5, 9+10 are at 128.42, 134.11, 135.93 and 140.28ppm. Since 9+10 *protons* have very close proton chemical shifts it is tempting to assign the corresponding carbons to the peaks at 134.11 and 135.93ppm, whilst carbon 5 is likely to have the most upfrequency shift, at 140.28ppm and 4 at 128.42ppm. All these assignments are tentative, however. The problem is more difficult for the methine/methylene region where four carbons appear within a ca. 2.5ppm range. The five signals for 1+8, 2+7 and 11 occur at 41.32, 47.34, 47.49, 48.24 and 49.90ppm. Safe assignments for all but the carbonyl carbon must be made with the aid of HETCOR. It was decided not to submit the sample for APT/DEPT first, since the compound is thermally unstable and readily undergoes the *retro*-Diels-Alder reaction at ambient temperature. Only the methylene bridge could be assigned by these experiments and it was not felt to be worthwhile, when the risk of losing the sample was taken into account.

### The 2D Spectral Evidence

HETCOR gives the connectivity between the proton spectrum, already mostly assigned, and the carbon spectrum, see Appendix 1 figure 13. As predicted, carbon 5 is the most upfrequency of the vinylics, at 140.28ppm and 4 appears at 128.42ppm. Carbons 9+10 are at 134.11 and 135.93ppm, although an absolute assignment cannot be made without knowing which of the corresponding protons is at 5.98 and which at 6.005ppm. Interestingly enough, it is possible to see from HETCOR that the more upfrequency carbon is attached to the more downfrequency proton, 134.11ppm carbon corresponding to the 6.005ppm proton.



For the methines and methylene bridge, HETCOR provides an unambiguous connectivity, despite the close proximity of some of the carbon and proton peaks. Carbon 1 is at 47.34ppm and carbon 8 appears at 49.90ppm. Again, the carbon shifts are in the opposite shift order to the corresponding proton shifts. Carbons 2 and 7 are at 41.32 and 47.49ppm - another reversal of the shift order. The methylene bridge 11 is at 48.24ppm.

Atom no.	Proton shift	Carbon shift
1	3.65	47.34
2	3.47	41.32
3		199.68
4	5.84	128.42
5	7.29	140.28
6		125.10
7	3.04	47.49
8	3.47	49.90
9	5.98*	135.93*
10	6.005*	134.11*
11		48.24
11a	1.455	
11b	1.42	
12		132.83

Figure 5.34. Chemical shift data for *endo-cis*-6-Dichloromethylenetricyclo[6.2.1.0<sup>2,7</sup>]undecan-4,9-dien-3-one. All shifts relative to TMS. Spectra recorded in CDCl<sub>3</sub>. Proton frequency 399.952MHz, carbon frequency 100.577MHz.

Key: \* proton and carbon signals for 9+10 are exchangeable, but the proton and carbon signals are paired as indicated.

Since carbons 6 and 12 are quaternary, it is not possible to distinguish between them with HETCOR, but the initial assignment of the more upfrequency carbon to 12 at 132.83ppm is probably correct. FLOCK would no doubt prove it, but it is not possible to run long experiments (>2hrs) at low temperature due to problems with dry nitrogen supply to the probe.

Atom no.	1	2	4	5	7	8	9	10	11a	11b
1								2.8	1.7	1.7
2					9.1					
4				10.2						
5			10.2							
7		9.1				3.9				
8					3.9		2.8		1.7	1.7
9						2.8		5.8		
10	2.8						5.8			
11a	1.7					1.7				8.8
11b	1.7					1.7			8.8	

Figure 5.35. Proton-proton coupling constants (J) for *endo-cis*-6-Dichloromethylenetricyclo[6.2.1.0<sup>2,7</sup>]undeca-4,9-dien-3-one, from spectrum recorded in CDCl<sub>3</sub> at 399.952MHz.

### 5. Pentacyclo[8.1.0<sup>1,5</sup>.0<sup>2,9</sup>.0<sup>4,7</sup>.0<sup>6,10</sup>]undecan-3,10-dione.

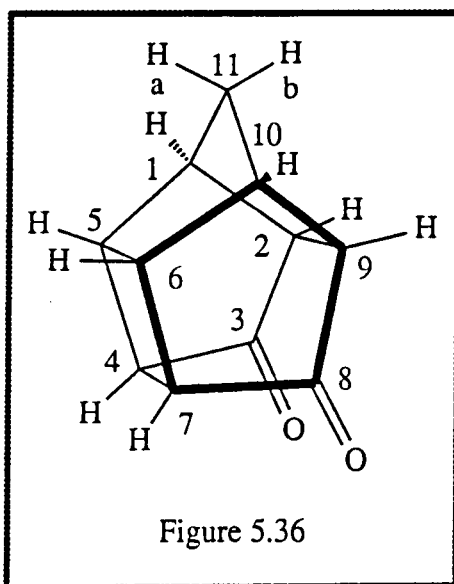

This compound was prepared by the 2+2 intramolecular photocycloaddition of *endo-cis*-tricyclo[6.2.1.0<sup>2,7</sup>]undeca-4,9-dien-3,6-dione. The synthesis has been reported

previously<sup>[222]</sup>, but no detailed nmr study has been undertaken.

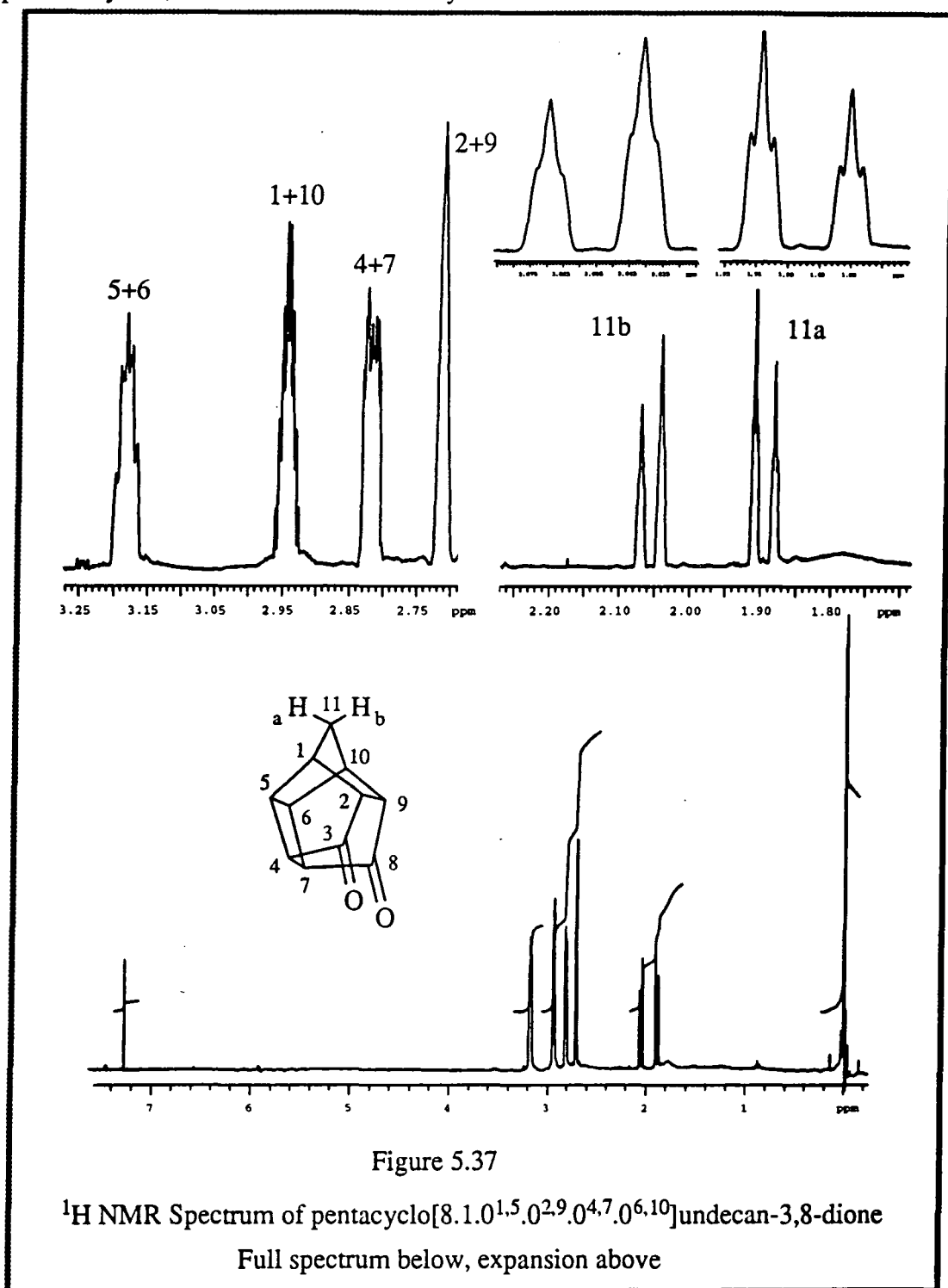

### The <sup>1</sup>H Spectral Evidence

The proton spectrum, acquired in deuteriochloroform at 399.952MHz contains the expected five regions, each of which integrates to two protons, see figure 5.37. The methylene bridge protons 11a and b occur at 1.9 and 2.05ppm,  $J_{AB} = 11.4\text{Hz}$ . The

lineshape shows that there is further coupling, but the coupling constant cannot be measured. Accordingly, it is not possible to say from this evidence whether 11a is the more upfrequency proton or the more downfrequency proton.

The singlet at 2.71ppm also has a lineshape which suggests that coupling is present. This, by analogy with 8,8-dimethoxypentacyclo[8.1.0<sup>1,5</sup>.0<sup>2,9</sup>.0<sup>4,7</sup>.0<sup>6,10</sup>]undecan-3-one, is protons 2+9 which experience only weak coupling to the bridgeheads 1+10.

The complex multiplet at 2.81ppm is likely to be either 4+7 or 5+6 and by analogy it is more likely to be 4+7. The coupling is complex because not only does proton 4 couple with proton 5, but also with proton 6, diagonally across the 4-membered ring. It is probable that there is further long range coupling.

Protons 1+10 appear as a nicely symmetrical "octet" at 2.95ppm. The splitting is probably a doublet of doublets of doublets of doublets. The individual coupling constants are hard to pick out because of uncertainty over the origin of the splitting pattern, but can be roughly estimated as  $J=8\text{Hz}$ ,  $J=4\text{Hz}$ ,  $J=2\text{Hz}$ ,  $J=2\text{Hz}$ . The margin of error is likely to be  $\pm 1\text{Hz}$ . The assignment is felt to be safe on the grounds that the bridgehead protons in this series of adducts generally possess a symmetrical splitting pattern, even when subject to the most complex coupling.

The complex multiplet at 3.18ppm corresponds to protons 5+6 by analogy. No coupling constants can be extracted. As is the case for protons 4+7, coupling across the four-membered ring is likely and longer range effects are possible.

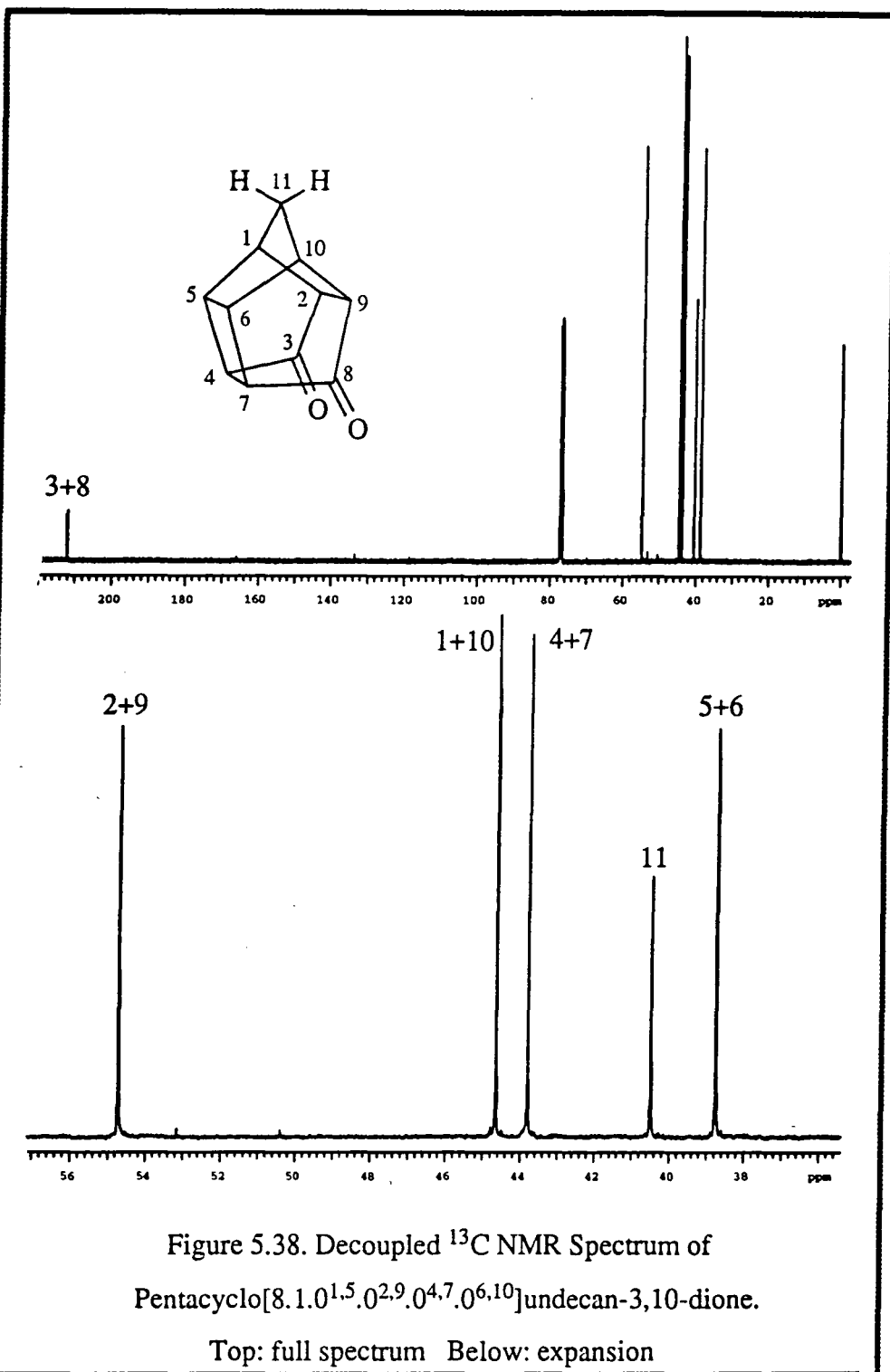

### The $^{13}\text{C}$ Spectral Evidence

The carbon spectrum, recorded at 100.577MHz in deuteriochloroform contains the expected six lines, see figure 5.38. The carbonyls, 3+8, can be assigned by inspection at 212.12ppm.

The remaining peaks are a little too close to one another for a confident assignment by analogy, and occur at 38.76, 40.49, 43.81, 44.66 and 54.74ppm.

### The 2D Spectral Evidence

HETCOR allows straightforward assignment of the carbon spectrum. Carbons 2+9 are the furthest upfrequency methines at 54.74ppm. The methylene bridge, 11, appears at 40.49ppm, and the remaining methines 1+10, 4+7 and 5+6 at 44.66, 43.81 and 38.76ppm respectively. See Appendix 1 figure 14.

All of the proton and carbon signals for this compound can be assigned, see figure 5.39, but extraction of coupling constants is not possible, with the sole exception of the methylene bridge AB, for which  $J_{AB}=11.4\text{Hz}$ . Estimates can be made of the coupling constants for the bridgehead protons 1+10, but these cannot be specifically assigned to particular interactions.

Atom no.	Proton shift	Carbon shift
1+10	2.95	44.66
2+9	2.71	54.74
3+8		212.12
4+7	2.81	43.81
5+6	3.18	38.76
11		40.49
11a	1.90	
11b	2.05	

Figure 5.39

Chemical shift assignments for pentacyclo[8.1.0<sup>1,5</sup>.0<sup>2,9</sup>.0<sup>4,7</sup>.0<sup>6,10</sup>]-undecan-3,8-dione, in ppm referenced to internal TMS. Spectra were obtained in deuteriochloroform. Proton frequency 399.952MHz, carbon frequency 100.577MHz.

**6. *Endo-cis*-Tricyclo[6.2.1.0<sup>2,7</sup>]undeca-4,9-dien-3,6-dione.**

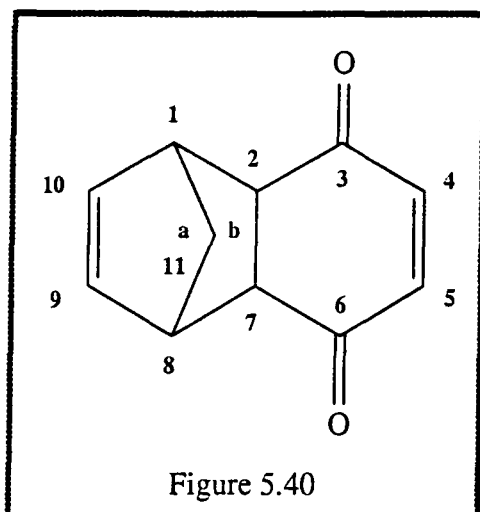

This compound was prepared by the method of Albrecht<sup>[225]</sup>. Yates and Switlak have recently published a paper<sup>[226]</sup> dealing with the preparation of new benzoquinone-cyclopentadiene Diels-Alder adducts and their characterisation by nmr.

### The <sup>1</sup>H Spectral Evidence

The proton spectrum, recorded in deuteriochloroform at 399.952MHz appears as expected.

Protons 4+5 appear as a singlet at 6.58ppm. Protons 9+10 give an apparent triplet at 6.07ppm, which is evidently a doublet of doublets with both coupling constants the same at  $J \approx 2\text{Hz}$ . The coupled protons are 1 or 8 and 11b.

The bridgeheads 1+8 give a symmetrical multiplet at 3.55ppm but extraction of coupling constants is difficult without knowing the origins of the observed splitting.

Protons 2+7 appear at 3.23ppm, an overlapping doublet of doublets which is nearly a triplet because evidently the two coupling constants are very similar. The coupled protons are 1 or 8 and 11a. One coupling constant is ca.  $J = 2\text{Hz}$  with the other being slightly less to account for the broad appearance of the central peak.

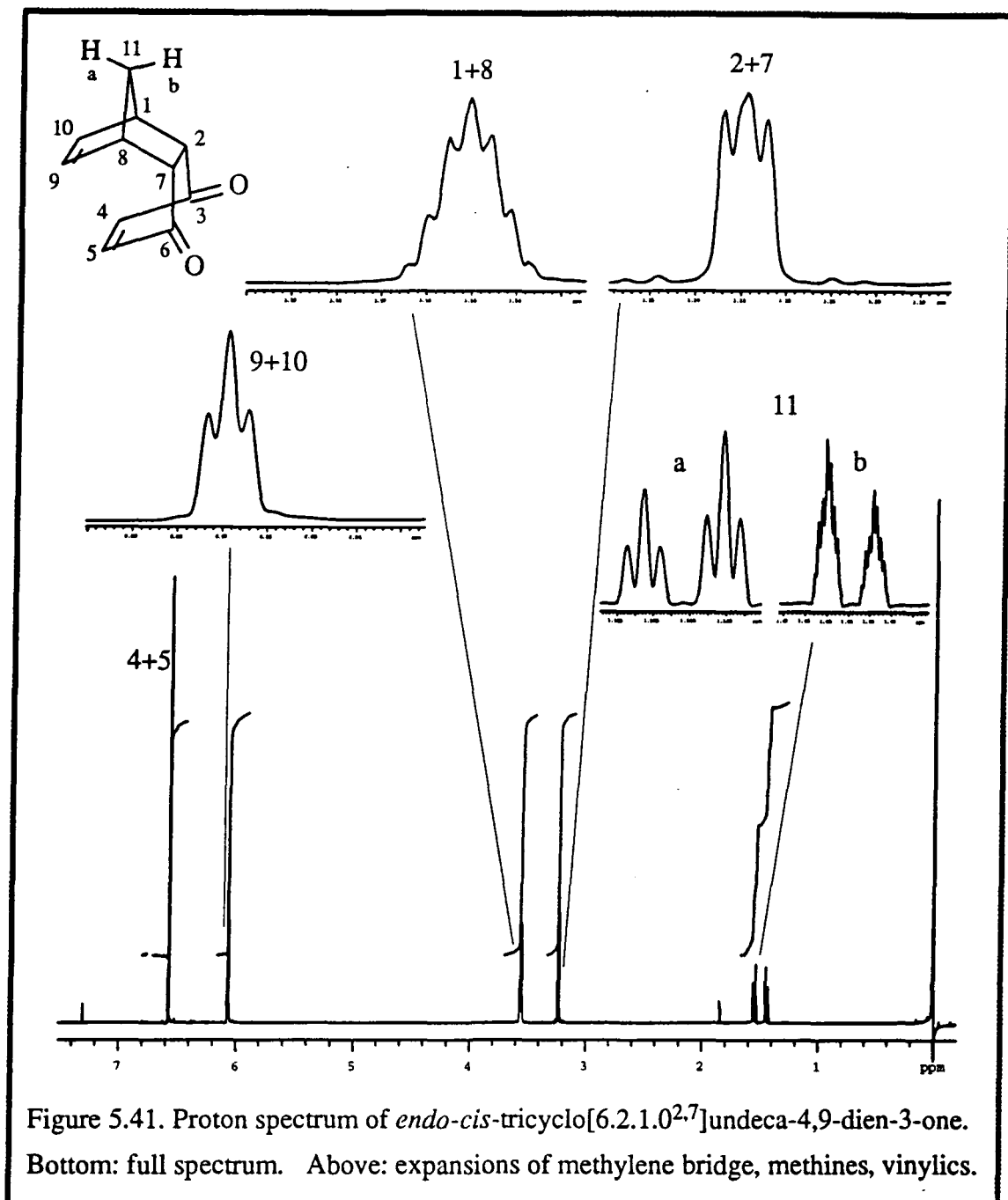

Figure 5.41. Proton spectrum of *endo-cis*-tricyclo[6.2.1.0<sup>2,7</sup>]undeca-4,9-dien-3-one. Bottom: full spectrum. Above: expansions of methylene bridge, methines, vinylics.

The methylene bridge resonates at 1.55 and 1.44ppm, the former being 11a because the splitting of the A arm of the signal into triplets is clearly resolved with  $J=1.8\text{Hz}$ , whilst the B arm has unresolved splitting, i.e. the coupling constant is smaller. This is consistent with the COSMIC/AMPAC prediction for this molecule that the dihedral angle  $\text{H1-C1-C11-H11a}$  is  $61.4^\circ$  whilst the angle  $\text{H1-C1-C11-H11b}$  is  $64.2^\circ$ . The geminal coupling constant,  $J_{\text{AB}}=8.4\text{Hz}$ , is smaller than expected given the H-C-H



angle predicted by COSMIC/AMPAC calculations of  $109.9^\circ$  but is consistent with similar coupling constants in other molecules in this series.

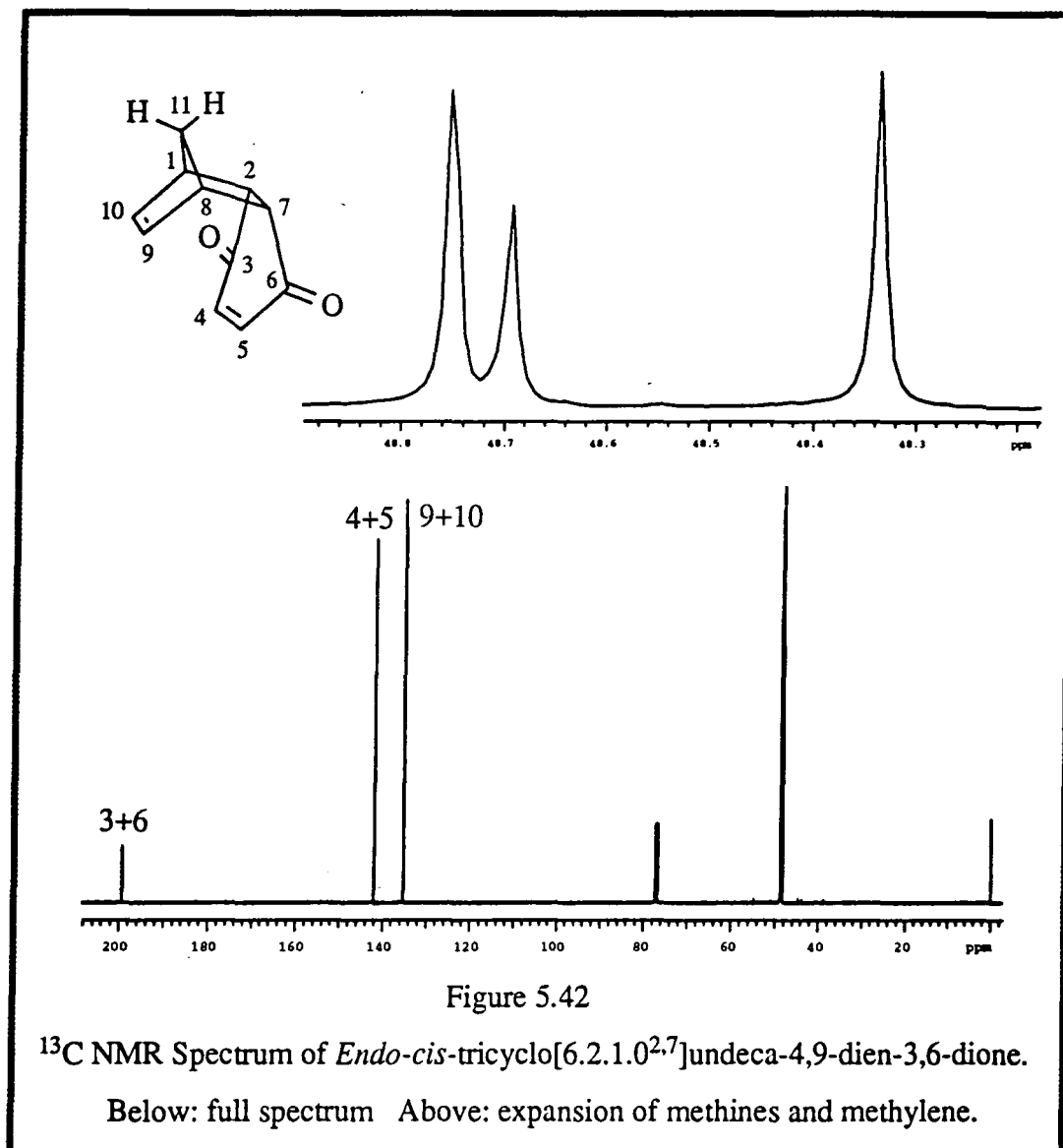

Figure 5.42

$^{13}\text{C}$  NMR Spectrum of *Endo-cis*-tricyclo[6.2.1.0<sup>2,7</sup>]undeca-4,9-dien-3,6-dione.

Below: full spectrum Above: expansion of methines and methylene.

### The $^{13}\text{C}$ Spectral Evidence

The carbon spectrum, recorded at 100.577MHz in deuteriochloroform, contains the expected six lines. Three can be assigned by inspection.

The carbonyls 3+6 are at 199.39ppm, the vinylics 4+5 at 142.04ppm and 9+10 at 135.29ppm.

Unfortunately, the methine and methylene carbons occur within a very narrow range of

0.4ppm, at 48.34, 48.69 and 48.75ppm. The HETCOR spectrum allows the unambiguous assignment of carbons 2+7 and appears in Appendix 1 as figure 15. C2+C7 are at 48.34ppm. Unfortunately, HETCOR does not show sufficient resolution in this case to distinguish C1+C8 from C11 and this assignment was made with the aid of DEPT, see Appendix 1 figure 16. C1+C8 appear at 48.75ppm and C11 resonates at 48.69ppm. The chemical shift data are summarised in figure 5.43.

Atom no.	Proton shift	Carbon shift
1+8	3.55	48.75
2+7	3.23	48.34
3+6		199.39
4+5	6.58	142.04
9+10	6.07	135.29
11		48.69
11a	1.55	
11b	1.44	

Figure 5.43

Chemical shift assignments for *endo-cis*-tricyclo[6.2.1.0<sup>2,7</sup>]undecan-3,6-dione, in ppm referenced to internal TMS. Spectra were obtained in deuteriochloroform. Proton frequency 399.952MHz, carbon frequency 100.577MHz.

Few coupling constants were obtained. Of those which were measured, all bar the methylene bridge geminal coupling constant were approximately 2Hz.  $J_{11a,11b}=8.4\text{Hz}$ ;  $J_{9+10,1+8} \approx J_{9+10,11b} \approx J_{2+7,1+8} \approx J_{2+7,11a} \approx J_{11a,1+8} \approx 2\text{Hz}$ .

### 7.*Endo-cis*-Bicyclo[4.4.0]deca-3,8-dien-2,5-dione.

This compound was prepared according to the method of van Tamelen *et al*<sup>[227]</sup>.

#### The <sup>1</sup>H Spectral Evidence

The proton spectrum, recorded in deuteriochloroform at 199.975MHz could be assigned by inspection, but showed details of unexpected complexity. See Appendix 1 figure 17.

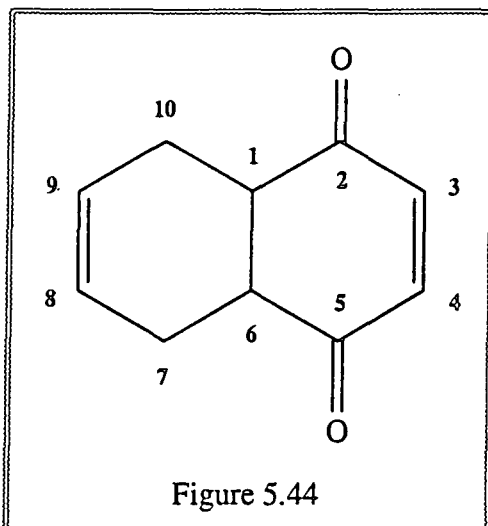

Protons 3+4 are a singlet at 6.68ppm, but protons 8+9 are a most unusual "quintet" of intensity ca. 1:4:9:4:1 at 5.7ppm. The former is to be expected, but the latter was surprising. It was anticipated that either of the protons 8+9 would see the methylene protons 7 or 10 as non-equivalent axial and equatorial protons, with a doublet splitting from each coupling. The angle between e.g. 7<sub>eq.</sub> and 8 is small, hence a large coupling would be expected from the Karplus equation, whilst between 7<sub>ax.</sub> and 8 is close to 90° and thus a small coupling would be expected, and thence a doublet of doublets. There may be allylic coupling so that each proton 8 and 9 sees four magnetically non-equivalent protons, i.e. an AMM'XX' system, but there is evidence elsewhere in the spectrum that the reason for the splitting observed may be more involved.

Protons 1+6 appear as a complex multiplet at 3.25ppm. In this case there is no question of allylic coupling, and the magnitude of four bond H-C-C-C-H coupling to 8+9 (likely to be 1Hz or less) is not sufficient to explain the observed splitting pattern.

The AB for the axial and equatorial protons 7+10 is extremely complex and its complexity gives a hint to the origins of the other complex splitting patterns observed in the spectrum. One arm, the A at ca. 2.5ppm must evidently correspond to the equatorial protons and the other, the B at ca. 2.2ppm, to the axial protons, on the basis

that the higher frequency protons are in the plane of the neighbouring C-C bonds<sup>[224]</sup>.

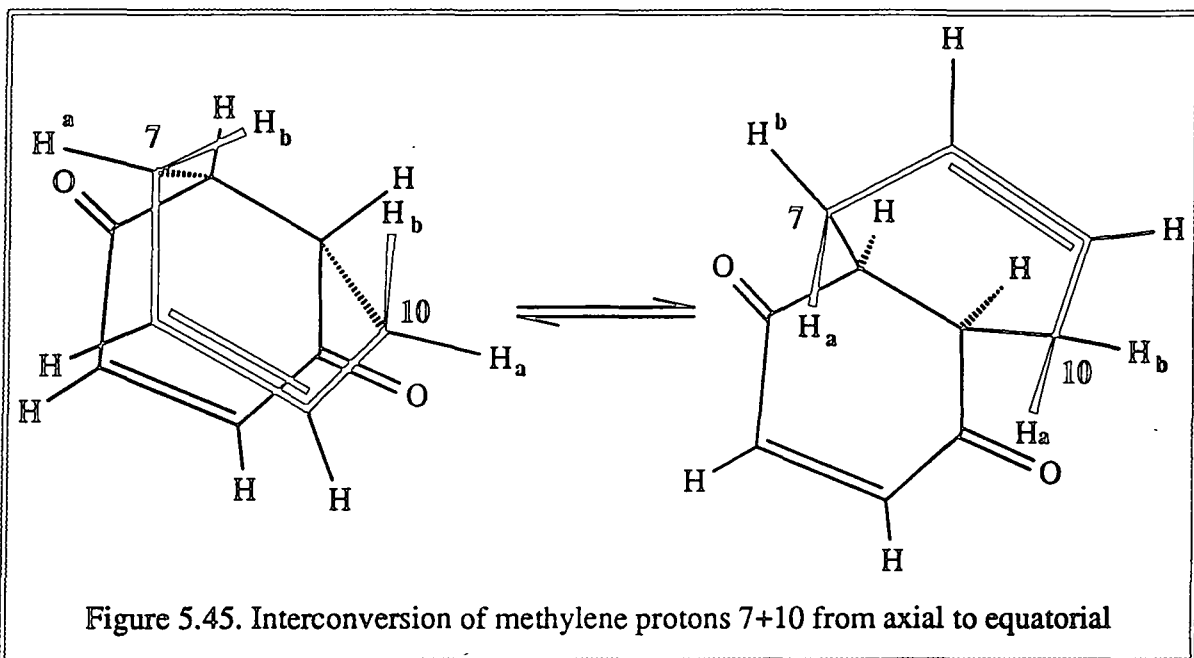

However, if the ring containing the methylenes is fluxional on a timescale roughly equal to that of the nmr experiment, then during the acquisition the axial and equatorial protons a and b will interchange, and swap chemical shifts; axial b becomes equatorial b, whilst equatorial a becomes axial a. The chemical shifts for the axial protons (and the equatorial protons) are changed by a small amount in the process. The coupling constants will also change. Neither the chemical shifts nor the coupling constants will be identical from one conformer to the other, as the stereochemistry of the molecule will impose different chemical environments. One way to test this is obviously to run a variable temperature (VT) experiment, in order to see if the splitting pattern simplifies as the flipping of the ring speeds up with increasing T. Cooling the sample would result in the molecule freezing (on the nmr timescale; it is not implied that molecular motion is necessarily stopped) into both conformers, thus without much simplification. It should also be mentioned that the other ring, containing the two carbonyls, is also capable of flipping (assuming that the electronic advantages of coplanarity of the ene-dione system are not too great and thus that it can exist as a boat conformation in the first place) but if it does then it must be at a faster interconversion and thus the effects are not seen on the timescale of the experiment.

There is a second way of investigating whether ring flipping is responsible for the complexity of splitting seen for the methylene AB, namely to subject the molecule to 2+2 intramolecular photocycloaddition and then investigate the spectrum of the fused ring system in which the methylenes are rigidly locked. However, it may be anticipated from the other analogous compounds that some complications might arise through long-range coupling effects and care may be needed in making comparisons.

There is, at least hypothetically, a third way of investigating thermal interconversion of conformers, but it is barely practical. It depends on recording the spectrum at two very different proton frequencies. Rarely are the spectroscopic facilities available and it is usually simpler to conduct the variable temperature experiment. If the limits of high resolution nmr are taken as 60MHz and 600MHz, then changing the proton frequency gives one order of magnitude difference in timescale at most, and at a price. On the other hand, changing the sample temperature by 30-40° will often produce an equivalent change in the interconversion frequency. In practical terms this is much easier and cheaper to do.

When the difference in chemical shift of the axial and equatorial protons in Hertz is large in comparison to the interconversion frequency in Hertz, then couplings to those different protons can be seen (instrument resolution permitting.) A gradual change occurs as the flipping frequency approaches the same value as  $\Delta\delta$ , with steady loss of resolution and the coalescence of the splitting patterns. The loss of resolution is not a sudden phenomenon.

There is thus a temperature-frequency equivalence, both in terms of the flipping frequency being temperature-related and in terms of the dispersion of the instrument (and hence  $\Delta\delta$  in Hz) improving with magnetic field strength and allowing more rapid

interconversions to be "frozen" at e.g. ambient temperature. Simultaneously with the instrument resolution improving with higher field magnets, the reduction in nmr timescale at the higher frequencies employed with those magnets permits the observation of faster-exchanging nuclei as separate resonances.

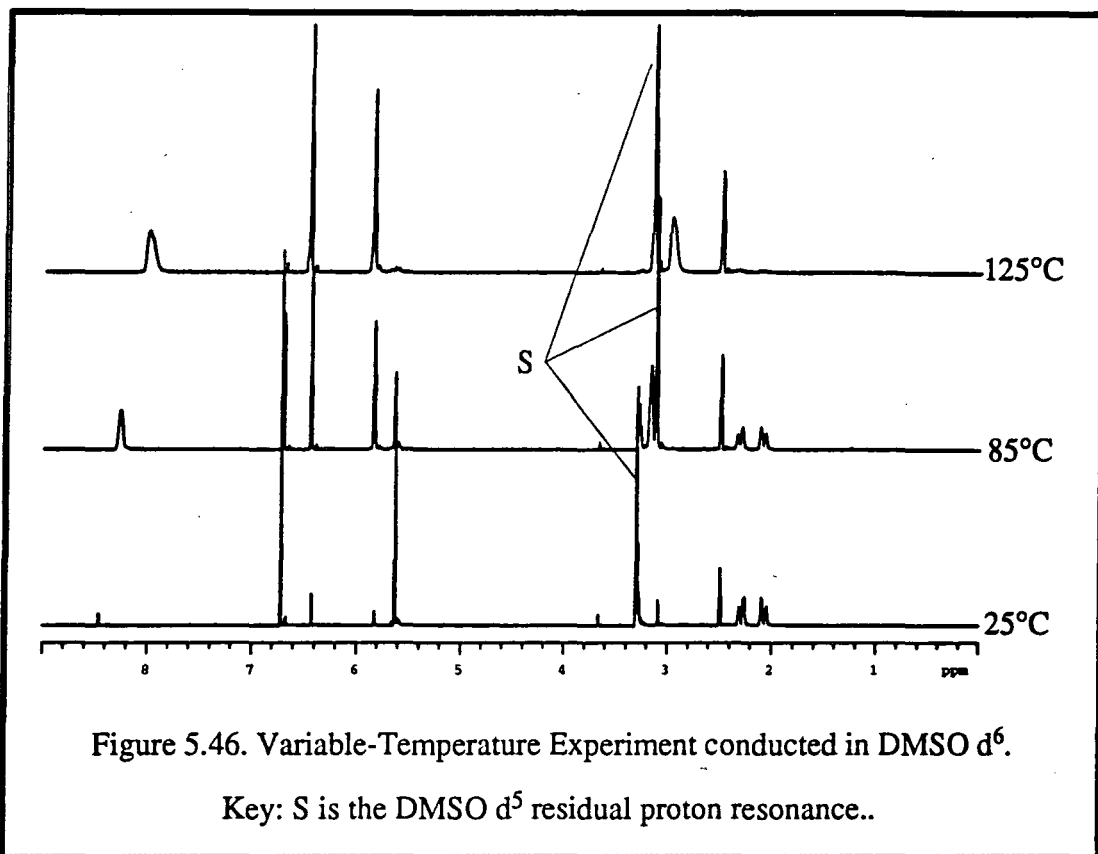
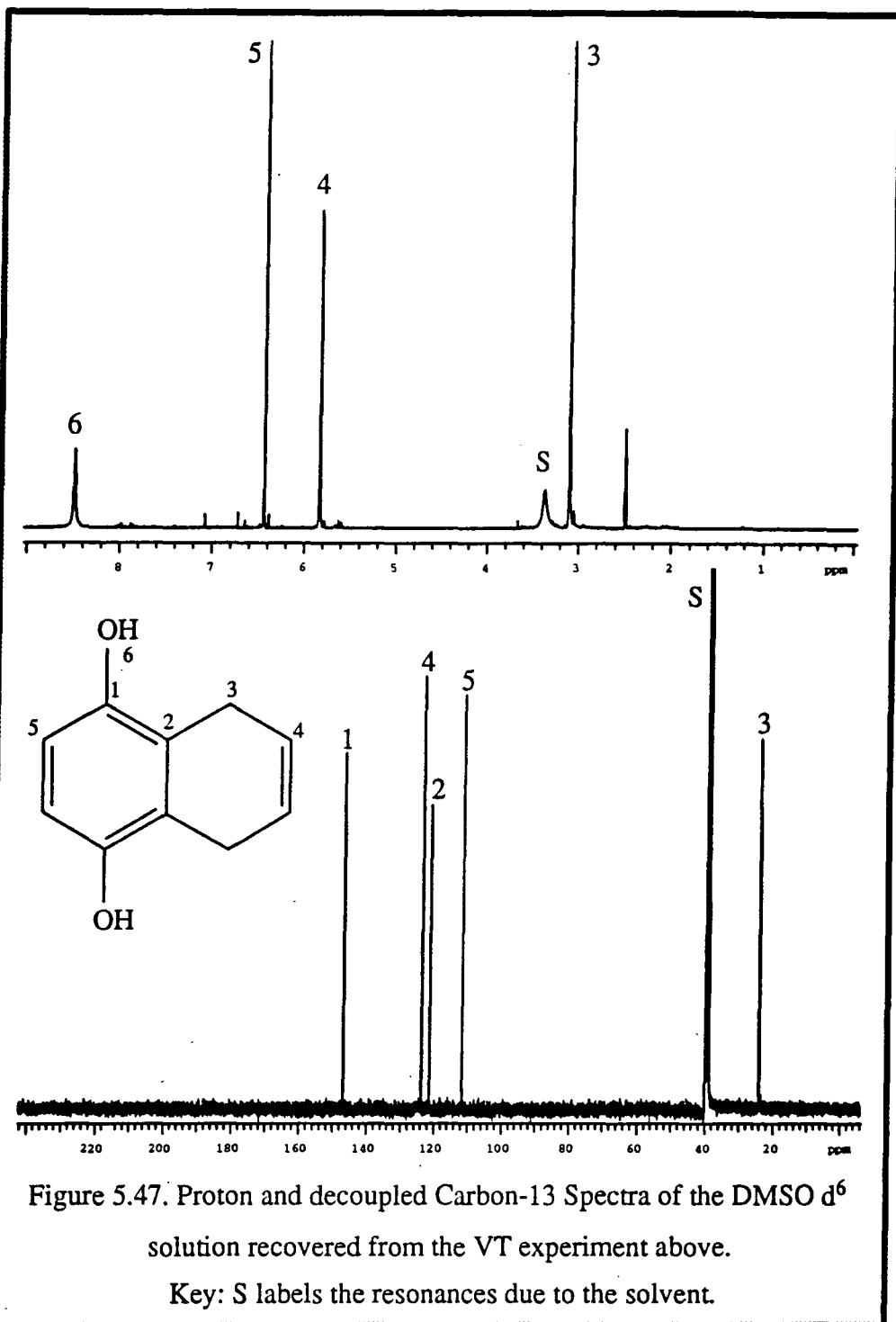

Figure 5.46. Variable-Temperature Experiment conducted in DMSO d<sup>6</sup>.

Key: S is the DMSO d<sup>5</sup> residual proton resonance..

In anticipation of observing the simplification in the methylene signals predicted above, a variable temperature experiment was performed with the sample dissolved in DMSO d<sup>6</sup>. Unfortunately, the residual proton signal from DMSO d<sup>5</sup> coincides with the methine peak in the starting material, but no alternative deuterated solvents were available for the required temperature range. However, it was evident that the prediction referred to was not borne out by the experiment and the spectra (see figure 5.46) demonstrated that a chemical reaction was taking place in the nmr tube. When cold, the same sample produced the proton and carbon spectra which are shown in figure 5.47.



Carlson<sup>[183]</sup> reported that refluxing the Diels-Alder adducts of benzoquinone plus various 1,3-dienes in aqueous methanol for three hours produces the corresponding hydroquinone in excellent yield via tautomerism. The above reaction is thus known, but it was not anticipated that it would occur in about half an hour during the VT experiment.

### The $^{13}\text{C}$ Spectral Evidence

In contrast to the proton spectrum, the decoupled carbon spectrum of *endo-cis*-bicyclo[4.4.0]deca-3,8-dien-2,5-dione recorded in deuteriochloroform at 50.289MHz is uncomplicated and contains the expected five lines, see Appendix 1 figure 18. All resonances can be assigned by inspection.

Carbons 7+10 are at 24.15ppm, 1+6 at 46.29ppm, 8+9 at 124.39ppm, 3+4 at 139.29ppm and the carbonyls 2+5 at 199.97ppm.

The chemical shift data are presented in figure 5.48. No coupling constants were extracted.

Atom no.	Proton shift	Carbon shift
1+6	3.25	46.29
2+5		199.97
3+4	6.68	139.29
7+10		24.15
7+10ax.	2.2	
7+10eq.	2.5	
8+9	5.70	124.39

Figure 5.48

Chemical shift assignments for *endo-cis*-bicyclo[4.4.0]deca-3,8-dien-2,5-dione, in ppm referenced to internal TMS. Spectra were obtained in deuteriochloroform. Proton frequency 199.975MHz, carbon frequency 50.289MHz.

### Conclusions

- 1) The spectra which were obtained in the course of this work constitute a good example of the capabilities of current state-of-the-art nmr technology.



- 2) It has proved possible for the first time to assign the structures of two pentacyclo[8.1.0<sup>1,5</sup>.0<sup>2,9</sup>.0<sup>4,7</sup>.0<sup>6,10</sup>]undecane derivatives purely on the basis of nmr experiments.
- 3) The work has found that corrections to the literature are required in respect of some of the assignments of the proton spectrum of *endo-cis*-6,6-dimethoxytricyclo[6.2.1.0<sup>2,7</sup>]undeca-4,9-dien-3-one.
- 4) Molecular orbital calculations have been shown to provide a useful adjunct to the nmr data. Predictions made by such calculations regarding the relative sizes of vicinal coupling constants have been borne out in the values measured.

## Chapter 6. Experimental.

### 1) Preparation of *p*-acetoxybenzaldehyde diethyl acetal.

Ammonium nitrate (300mg) was dissolved with warming in anhydrous ethanol (10ml) in a 100ml round-bottomed flask, under nitrogen. To this solution, *p*-acetoxybenzaldehyde (13.6g, 11.6ml, 83mmol), prepared from *p*-hydroxybenzaldehyde by the method of Richter<sup>[228]</sup>, was added. The solution was warmed to keep the ammonium nitrate in solution, and triethyl orthoformate (20ml) was added. The mixture became turbid, and after leaving overnight, a mass of crystals had deposited. The supernatant liquid was decanted and distilled from anhydrous potassium carbonate under nitrogen at reduced pressure to give *p*-acetoxybenzaldehyde diethyl acetal (16g, 88%); a colourless liquid, b.p. 98-104°C @ 0.25mmHg; calculated for C<sub>13</sub>H<sub>18</sub>O<sub>4</sub>: C 65.53%, H 7.61%; accurate mass (m/e) 238.120509226; found C 65.45% H 7.80%; (m/e) 238.11337. Spectra are presented in Appendix 2. Figure A2.1 shows the proton and decoupled proton spectra in deuteriochloroform at 250.133MHz, figure A2.2 shows the carbon spectrum and DEPT at 62.896MHz plus the infra-red spectrum, whilst the mass spectrum appears in figure A2.3. The compound does not appear to have been prepared previously.

### 2) Attempted brominations of *p*-tolualdehyde diethyl acetal.

#### a) With NBS.

N-Bromosuccinimide (4.45g, 25mmol) and *p*-tolualdehyde diethyl acetal (4.85g, 25mmol) prepared as for acetoxybenzaldehyde diethyl acetal, were illuminated under nitrogen in refluxing carbon tetrachloride (20ml) in the presence of benzoyl peroxide (40mg) using a 60W frosted lamp, which supplied both heat and light. Heating was continued for two hours, and the mixture was then distilled under nitrogen at reduced

pressure, to give ethyl *p*-methylbenzoate, (2.5g, 61%); b.p. 65°C, 0.1mmHg; required for C<sub>10</sub>H<sub>12</sub>O<sub>2</sub>: C 73.15, H 7.37; found C 73.20%, H 7.32%. The product was identified by infra-red and mass spectroscopy and by proton nmr at 60MHz;  $\delta$ (ppm vs. internal TMS in CDCl<sub>3</sub>) 1.3(t, 3H, J=7Hz), 2.25(s, 3H), 4.2(q, 2H, J=7Hz), 7.0(d, 2H, J=8Hz), 7.7(d, 2H, J=8Hz). The infra-red and mass spectra appear in figure A2.4.

b) With bromine.

Potassium metal (0.2g, 5mmol) was reacted with *sec*-butanol (25ml, 20.2g, 0.27mol), the solution was degassed *in vacuo* and dry nitrogen admitted. The acetal (1g, 1ml, 5.2mmol) was added by syringe and the mixture stirred magnetically. A yellow colour developed. Neat bromine (0.8g, 0.25ml, 10mmol) was added by syringe and a white precipitate appeared (0.6g) which was filtered off and washed with ether. It was identified as potassium bromide by elemental analysis. The organic layer was evaporated to yield a lachrymatory brown oil, 1.4g, which TLC (silica, ethyl acetate) showed to contain a large number of products which were not further purified.

3) Preparation of the *exo-cis*-adduct of furan with maleic anhydride.

Maleic anhydride (9.8g, 0.1mol) was dissolved in diethyl ether (50ml) and furan (6.8g, 7.3ml, 0.1mol) was added. The mixture was left to stand overnight and the resulting crystals recovered by filtration to give *exo-cis*-4,10-*oxa*-tricyclo[5.2.1.0<sup>1,7</sup>]decan-8-ene-3,5-dione, (11.7g, 70%) m.p. dec. ca. 120°C, lit.<sup>[229]</sup> 125°C. Required for C<sub>8</sub>H<sub>6</sub>O<sub>4</sub>: C 57.84%, H 3.64%; found C 57.71%, H 3.61%. The compound cannot be recrystallised as it undergoes the *retro* reaction in warm solvents. The proton nmr spectrum (250.133MHz in CDCl<sub>3</sub>) appears in figure A2.5.

4) Methanolysis of the *exo-cis*-adduct of furan with maleic anhydride.

The above adduct (10g, 60mmol) was dissolved in methanol (200ml) and left to stand for 72 hours. The solvent was removed on a rotavap below 35°C and the crude product

was dried in vacuo. The crude material contained about 25% of starting material, as indicated by 60Mhz proton nmr analysis, and was recrystallised from warm methanol (below 35°C) using cardice cooling to force crystallisation. Some loss of material was observed, as anticipated. The purified product, monomethyl *exo-cis-7-oxa-bicyclo-[2.2.1]hept-5-ene-2-carboxylate-3-carboxylic acid*, was obtained as colourless crystals (6g, 50%). Required for C<sub>9</sub>H<sub>10</sub>O<sub>5</sub>: C 54.55%, H 5.09%; found C 54.43%, H 5.12%. When an attempt was made to distil a portion under high vacuum, the compound underwent the *retro*-Diels-Alder reaction.

##### 5) Preparation of benzyl methyl ketone via Grignard synthesis.

Benzyl chloride (12.6g, 11.5ml, 0.1 mol) in ether (15ml) was added to magnesium turnings (2.43g, 0.1mol) in ether (10ml) and after addition was complete, the mixture was refluxed for 15 minutes. Acetonitrile (4.1g, 5.2ml, 0.1mol) in 10ml ether was added, and the resulting iminium salt was hydrolysed by addition of 10% hydrochloric acid. The mixture separated into two layers. The aqueous layer was washed with two 20ml portions of ether, the ether washings combined with the ethereal layer from the reaction flask and dried with magnesium sulphate, and the solvent removed by rotavap. The residue was fractionated and found to contain bibenzyl, identified by its melting point of 49-52°C. Also present was a particularly vile-smelling oil which was not further characterised. Benzyl methyl ketone was obtained (2g, 15%), as a yellow oil which gradually solidified. B.p. 212-214°C, required for C<sub>9</sub>H<sub>10</sub>O: C 80.56%, H 7.51%; found C 80.70%, H 7.45%.

##### 6) Preparation of Dibenzyl Ketone via Grignard Synthesis.

The preparation followed the scheme outlined above for the synthesis of benzyl methyl ketone, but the reagents used were, benzyl chloride (38.4ml, 42.2g, 0.33mol) in ether (150ml), magnesium turnings (8.1g, 0.33mol) in ether (30ml) and benzyl cyanide (40.1ml, 39g, 0.33mol) in ether (40ml). A one litre flask was used for this preparation

because hydrolysis of the iminium salt formed by the reaction was exothermic and produced considerable frothing during work-up. A double-surface condenser was necessary to aid control of the vigorous refluxing which this caused. Fractionation of the crude material gave dibenzyl ketone as a pale yellow oil which gradually solidified, (18.8g, 27%) b.p. 148-151°C @ 0.2mmHg. Required for C<sub>15</sub>H<sub>14</sub>O: C 85.68%, H 6.71%; found C 85.55%, H 6.80%. The mass spectra of the recovered bibenzyl and dibenzyl ketone appear in figure A2.6.

7) Attempted chlorination of *p*-tolualdehyde diethyl acetal.

*p*-Tolualdehyde diethyl acetal (5g, 25.7mmol) prepared as for acetoxybenzaldehyde diethyl acetal was refluxed with sulphuryl chloride (3.5g, 2ml, 25.7mmol) in carbon tetrachloride (25ml) with benzoyl peroxide (25mg) for half an hour. Proton nmr (60MHz) indicated that the acetal had been hydrolysed and there was no evidence of any chlorinated product.

8) Diels-Alder reaction of 1,4-diphenylbutadiene with phenyl vinyl sulphoxide.

Phenyl vinyl sulphoxide (1g, 6.6mmol) was refluxed in carbon tetrachloride (25ml) with 1,4-diphenylbutadiene (1.36g, 6.6mmol) under nitrogen. The mixture was periodically inspected by tlc (silica, ether:petrol 1:1) but after 48 hours, no reaction had occurred and the experiment was discontinued. The same observation was made after a similar experiment was conducted in boiling toluene for 72 hours and when it was repeated in refluxing chlorobenzene for four days. However, repetition of the reaction under the conditions used by Paquette<sup>[230]</sup> (sealed tube, chlorobenzene, 190°C) allowed the isolation of *p*-terphenyl, identified by its melting point of 206-7°C and its analysis. Required for C<sub>18</sub>H<sub>14</sub>: C 93.87% H 6.13%; found C 93.97%, H 6.04%.

9) Synthesis of 1,1,2,2-tetrakis(morpholino)ethane.

The preparation was performed according to the method used by Kliegman and

Barnes<sup>[231]</sup>. Glyoxal 40wt% (aq) (70g, 0.482mol) was added to excess cooled morpholine (195ml, 195g, 2.24mol) with stirring. The temperature was regulated between 5-10°C. After ca. two thirds of the glyoxal had been added the suspension of product was so thick that a further 100ml of morpholine was added to facilitate stirring. Upon completion of addition, the mixture was left to stand at 0-5°C for 1 hour. The suspension was agitated with hexane (2x 100ml) the supernatant liquid discarded and the resulting sludge filtered with considerable difficulty. The solid, still heavily contaminated with morpholine, was transferred to a vacuum dessicator and the residual morpholine removed by pumping via a large capacity cold trap. 1,1,2,2-*Tetrakis*(morpholino)ethane was obtained as a white powder (129g, 81%). Required for C<sub>18</sub>H<sub>34</sub>N<sub>4</sub>O<sub>4</sub>: C 58.35%, H 9.25%, N 15.12%; found C 58.61%, H 9.33%, N 15.27%. The proton nmr spectrum recorded at 60MHz in deuteriochloroform showed the following peaks ( $\delta$ , ppm vs. internal TMS) 2.8(m, 16H) 3.8(m, 16H) 4.1(s, 2H.)

10) Reaction of 1,1,2,2-tetrakis(morpholino)ethane with acetyl chloride. Attempted preparation of 1,2-bis(morpholinium)ethane dichloride.

A suspension of 1,1,2,2-*tetrakis*(morpholino)ethane (10g, 27mmol) in THF (100ml) was added to an ice cooled solution of acetyl chloride (3.8ml, 4.24g, 54mmol) in THF (20ml.) A deep purple precipitate formed and the reaction was allowed to stand for an hour. The solid was filtered off, washed with dry ether and the solvent removed in vacuo. Yield 8.5g, more than 100% based on 7.3g expected 1,2-*bis*(morpholinium)ethane dichloride. Calculated for C<sub>10</sub>H<sub>18</sub>N<sub>2</sub>O<sub>2</sub>Cl<sub>2</sub>: C 44.62%, H 6.74%, N 10.41%, Cl 26.34%; found C 50.11%, H 7.65%, N 10.61% Cl 13.53%. The solid became pale brown when completely dry and was exceptionally hygroscopic, small samples liquifying in seconds when exposed to moist air.

11) Treatment of *p*-trifluoromethylphenol with base.

a) *p*-Trifluoromethylphenol (2g, 12.3mmol) was shaken with 15ml of 1M sodium

hydroxide solution. A thick white precipitate formed which was allowed to stand overnight. The product was filtered off and washed with water, dissolved in ether, dried with magnesium sulphate and evaporated by rotavap. Yield 1.6g, 91% on the expected linear polymer described by Jones<sup>[232]</sup>. The GPC trace appears in Appendix 2. The polydispersity was 1.5, with peak molecular weight ca. 9,000 (polystyrene equivalent, obtained in THF.) Required for  $(C_7H_4OF_2)_n$ : C 59.17%, H 2.84%, F 26.74%; found C 59.03%, H 2.91%, F 26.8%. The proton (250.133MHz) and carbon (62.896MHz) spectra, recorded from  $CDCl_3$  solution, appear in figure A2.7. The fluorine nmr spectrum (376.289MHz) and infra-red spectrum appear in figure A2.8 and the FAB mass spectrum plus GPC are shown in figure A2.9.

b) *p*-Trifluoromethylphenol (1.4g, 8.6mmol) was dissolved in dry THF (2ml) and added by syringe to butyl-lithium (5ml of 1.7M) in THF (25ml) under dry nitrogen at 0°C. There was an instant loss of the colour of the butyl-lithium solution. The mixture was left to stir overnight. The volatiles were removed by rotavap, ether (100ml) and water (100ml) were used to wash out the flask and the ethereal extract washed with water, dried over magnesium sulphate and evaporated. The ether layer contained 0.1g of a yellow oil which was shown by nmr to be mainly unreacted starting material. The aqueous layer, which was turbid, was combined with the washings and a precipitate gradually began to form. The washings were left overnight, and the precipitate filtered off and treated as for the product of 11(a). GPC in THF (Appendix 2) showed that the material was not substantially different from the material prepared in (1) above. HPLC (reverse phase) on a Hypersil 5 ODS column at 1.5ml/minute eluting with 40% acetonitrile (aq) indicated the presence of three low molecular weight impurities, but these were not further characterised. The HPLC and GPC traces are shown in figure A2.10.

## 12) Preparation of activated zinc for the generation of dichloroketene.

Zinc powder (May and Baker, 1Kg) was sieved through a fine mesh to remove foreign matter (the sample treated was found to contain large amounts of broken glass) and large particles. The sieve used had a mesh size of 90 $\mu$ m. The zinc was then thoroughly degreased by washing with petrol (40-60°) using a volume sufficient to cover the zinc by about twice the depth of the layer of powder. Having rendered the zinc mechanically clean from extraneous matter and organic surface contamination, the oxide film was removed by one of two methods.

a) The acid-wash method. The sieved and degreased zinc was washed with a large volume of dilute hydrochloric acid (1l of 10% v/v.) The zinc was left to pickle for several minutes, until the evolution of hydrogen became rapid and the mass of powder swelled up like a sponge and began to float in the acid. It was then washed free of acid with many repeated washings of distilled water. The clean zinc was dried by washing four times with acetone and twice with ether and whilst still moist with ether, was transferred through a powder funnel assisted by a spatula into a 1000ml round bottomed flask. The washings with water and organic solvents had to be conducted in such a way that the zinc was not allowed to dry out in the air and when filtered, had no air sucked through it whilst on the filter. The moist zinc was pumped down at room temperature via a large capacity cold trap. The trap needed attention periodically until the vacuum gauge indicated a pressure of about 10<sup>-1</sup>mbar (ca. 1 hour.) Once the pressure had fallen to 10<sup>-2</sup>mbar (about four or five hours at room temperature) the flask was immersed in a water bath and heated at 95-100°C until the pressure dropped again to 10<sup>-2</sup>mbar, when the water bath was changed for an oil bath and heating continued to 170°C and maintained at that temperature until the pressure fell once more to 10<sup>-2</sup>mbar, all of which took a further day. The activated zinc was stored under nitrogen until it was needed.

b) The copper sulphate method. The degreased zinc was agitated in a solution of copper (II) sulphate (10g of the pentahydrate in 1l water) until the colour of the solution



was discharged. It was then filtered off and washed as in 12(a) and dried *in vacuo* as before, and stored under nitrogen until needed.

13) A flow system for the generation of dichloroacetene.

A pyrolysis tube was prepared from borosilicate glass tubing 46mm diameter and 50cm long. To one end was affixed a B34 socket and to the other an 8mm bore vacuum stopcock, the open end of which terminated in a B34 cone. Indentations were made 10cm from the stopcock end of the tube, and glass wool inserted from the socket end to form a support over the indentations for activated zinc powder. The tube was filled with activated zinc powder (acid method) to within 10cm of the socket end, and a plug of glass wool inserted to retain the zinc. The charged pyrolysis tube was inserted into a horizontal tube furnace which was powered by a Variac and which had previously been calibrated with the empty tube in place by use of a thermocouple probe. The B34 cone at the stopcock end was mated with a liquid air-cooled glass trap and the exit side of the trap connected to a vacuum line. The socket end of the tube was equipped with a flask adaptor, which permitted a B24 round bottomed flask to be connected vertically to the horizontal pyrolysis assembly via an oblique-type two way tap. The outlet of this tap was connected to a B34 cone which provided the connection to the socket of the pyrolysis tube. One of the entry lines to this tap came from a nitrogen line (to allow the system to be purged with nitrogen before and after use) whilst the other was joined to a B24 cone to allow connection with the round bottomed flask. The flask possessed two necks, the spare one of which was equipped with a very fine capillary nitrogen inlet. See figure 6.1.

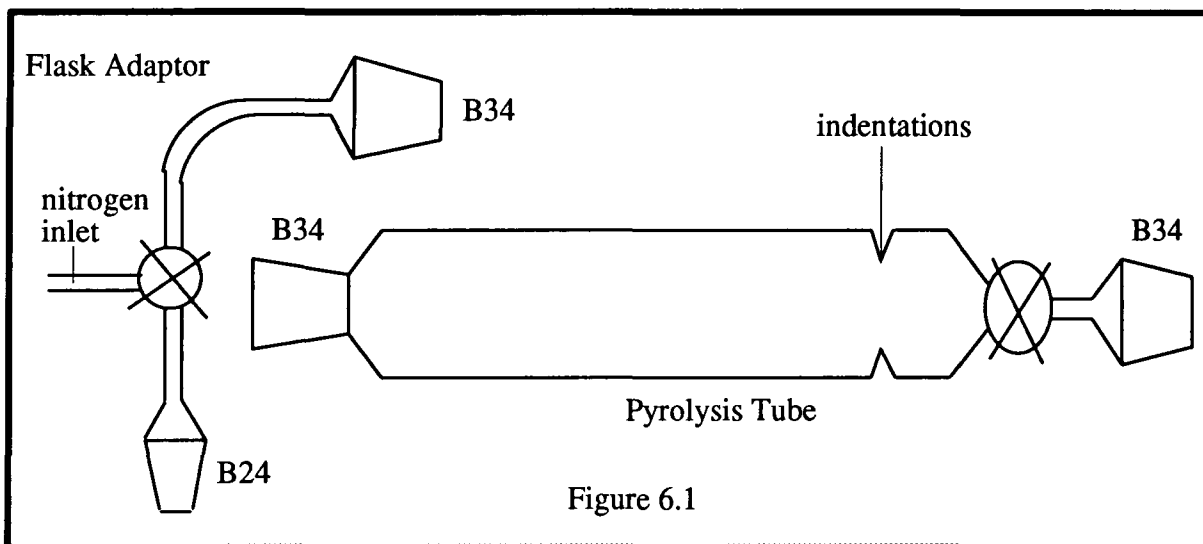

Figure 6.1

14) Flow synthesis of dichloroketene using trichloroacetyl chloride and activated zinc powder.

The apparatus, set up as described in 13, was cautiously pumped down (to avoid zinc dust being drawn into the cold trap by vigorous gas flow) and nitrogen was cautiously admitted, the process being repeated three times to ensure that no air was left in the pyrolysis tube. The furnace was then heated to 350°C (monitored by thermocouple probe) whilst under continuous evacuation, and left until the vacuum had improved to 10<sup>-2</sup>mbar (about two hours.) The two way tap was opened with care so that trichloroacetyl chloride vapours from the round bottomed flask (which contained 10g of the acid chloride) were drawn through the zinc. The vacuum fell abruptly to 1mbar, mostly due to the capillary nitrogen bleed. Once all the liquid had been used up, the furnace was switched off and the pyrolysis tube allowed to cool under vacuum. Nitrogen was cautiously admitted to the tube. Whilst the assembly was cooling, the 8mm vacuum stopcock between the tube and cold trap was closed, the trap let down to nitrogen and removed for examination, to see how much dichloroketene had collected. The trap was empty, and upon inspection of the pyrolysis tube assembly once cold, it was evident that a combination of the heat of the furnace and the exothermicity of the reaction had melted a portion of the zinc (mp 419°C) and completely destroyed the acid

chloride. It was, however, ascertained that the melting had been confined to one small zone near the inlet end of the tube, and the apparatus was therefore reassembled and further experiments conducted. In these, however, it was decided to improve the vacuum to the highest attainable and the nitrogen bleed in the reactant flask was removed, bumping now being prevented by means of vigorous magnetic stirring. Initially, the furnace was heated to 140-50°C, and a vacuum of  $10^{-2}$  mbar was used to draw the acid chloride vapours through the tube. The cold trap now collected material, but on cessation of the experiment and examination of the trap contents (the zinc was kept hot and the trap removed by means of isolating the pyrolysis tube with the 8mm stopcock) no reaction had occurred and the acid chloride had simply been vac transferred through a bed of hot zinc. The reagent was recycled at a temperature of 240-50°C, but there was still no signs of reaction occurring. It was decided to repeat this last attempt with the addition of a large crystal of iodine to the acid chloride; the iodine vapour was drawn into the pyrolysis tube and evidently consumed as no purple solid collected in the cold trap, but the acid chloride still managed to distil through the hot zinc, although the recovery was now much less than 100%. A repeat of this attempt, again using iodine but at 300-10°C, produced another disappointing lack of dichloroketene in the cold trap. Upon cooling and disassembly of the apparatus, it was evident that a quantity of carbonaceous material had collected in the pyrolysis tube, and it is likely (particularly in view of other experiments) that dichloroketene had indeed been produced, but had instantly polymerised in the heat of the furnace, in spite of the vacuum being high enough to ensure a relatively brief residence time. The zinc was now melted over a much wider zone and outside of this area (indicated by a dull metallic mirror on the inside of the pyrolysis tube) it had extensively sintered and made cleaning by means of acid the only way of emptying the tube contents.

15) Flow synthesis of dichloroketene using dichloroacetyl chloride and triethylamine.

The apparatus used in the pyrolysis experiments was modified so that it could be used for an alternative method of producing the dichloroketene under conditions where it was less likely to undergo thermally-induced polymerisation. The furnace was dispensed with and the tube was packed with glass wool to act as a filter to remove triethylamine hydrochloride particles from the expected vapour stream. A space was left, 10cm long, at the socket end of the tube, to allow room for a new flask adaptor to be connected. The new adaptor allowed the connection of two round bottomed flasks, without the interposition of a two-way tap, and was so constructed that the vapours from the flasks entered the reaction tube (ex-pyrolysis tube) by means of two apertures, one circular from one flask, and the other concentric with the circle in cross section and forming an annulus around it. The central tube, the circular aperture, extended for eight centimetres inside the reaction tube, so that mixing of the vapour streams would not occur until well inside the intended reaction zone and thus deposition of amine hydrochloride in the reactant flasks by backstreaming of vapours should be avoided. The adaptor was so constructed that the cross-sectional areas of circular and annular apertures were approximately the same. See figure 6.2.

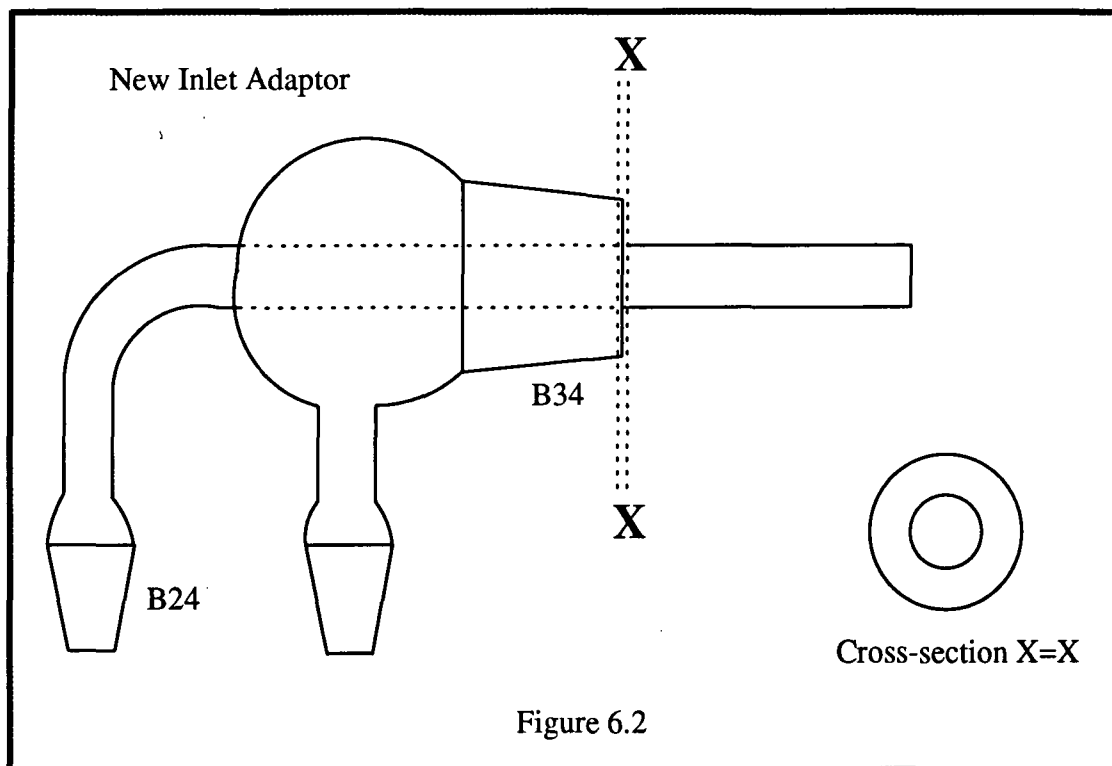

Figure 6.2

The apparatus was assembled as for pyrolysis, but without the tube furnace and with the new flask adaptor in place. Into one flask dichloroacetyl chloride (5ml, 7.7g, 52mmol) was placed and into the other triethylamine (7.25ml, 52mmol.) The apparatus was then evacuated via the cold trap, and instantly a mist of triethylamine hydrochloride began to appear inside the tube. Also, a thick brown deposit began to appear around the mouth of the central tube which admitted the trichloroacetyl chloride and upon the upper wall of the reaction tube slightly downstream of the mixing zone. The temperature of this area was casually checked by hand, and was found to be extremely hot. No dichloroketene was trapped, and evidently the brown mass was unwanted polyketene. The experiment was repeated, but this time the exit tubes from the flask adaptor fed into a highly efficient three coil condenser which was inserted into the socket of the reaction tube. The initial mixing then took place in a cooled vessel, but the cooling was still insufficient to suppress ketene polymerisation. It was decided to further modify the reaction tube and provide it with a cooling jacket in which acetone-cardice could be used to maintain the entire tube and glass wool filter at low temperature. This was successful provided the temperature of the cold bath surrounding the tube was well-regulated, and dichloroketene could be prepared and isolated in solution from the cold trap in small quantities by this technique.

16) Solution phase synthesis of dichloroketene from dichloroacetyl chloride and triethylamine and its reaction with cyclohexanone without catalysis.

Dichloroacetyl chloride (9.6ml, 14.7g, 0.1mol) in dry 40-60° petrol (50ml) was added dropwise with acetone-cardice cooling to a magnetically stirred solution of triethylamine (10.1g, 14ml, 0.1mol) in 200ml petrol under nitrogen at -20°C. The mixture was then cooled to -70°C and filtered under nitrogen through a sinter to remove triethylamine hydrochloride. Cyclohexanone (9.8g, 10.4ml, 0.1mol) was then added, and the mixture left at -10°C in the freezer overnight. The mixture was then evaporated, vac transferred and submitted for GC/MS, but no *spiropropiolactone* or

dichloro-olefin was observed.

17) Reaction of dichloroketene with benzoquinone catalysed by zinc chloride.

A suspension of activated zinc (copper sulphate method, 13g, 0.2mol) in ether (150ml) was cooled to 0° to -10°C by acetone-cardice and stirred magnetically under dry nitrogen in the presence of benzoquinone (7g, 65mmol), to which trichloroacetyl chloride (7.4ml, 12g, 66mmol) in ether (15ml) was added dropwise over three hours. The solution was allowed to warm to room temperature and filtered to remove unreacted zinc. On cooling in an acetone-cardice bath, yellow crystals separated (4g) which were shown to be unreacted benzoquinone. The supernatant liquid was washed with saturated sodium bicarbonate solution (1x 100ml) and water (1x 100ml) dried over magnesium sulphate and evaporated to yield a red solid (3g) which rapidly turned green and then black. TLC (silica, ether:petrol 1:4) showed that this product was a highly complex mixture.

18) Reaction of dichloroketene with cyclohexanone catalysed by zinc chloride.

A suspension of activated zinc (copper sulphate method, 6.5g 0.1mol) was stirred in ether (75ml) at 0-5°C under dry nitrogen and cyclohexanone (6.7ml, 6.3g, 65mmol) was added. Trichloroacetyl chloride (7.25ml, 11.8g, 65mmol) in ether (7.5ml) was added cautiously over 2.5 hours. Two spontaneous exotherms were observed which rose to 20°C before control could be regained. The reaction was allowed to stir at room temperature overnight. By morning, a voluminous white precipitate had formed which was separated from unreacted zinc by decantation and washing with ether. The ethereal solution was washed with water (3x 100ml) dried with magnesium sulphate and evaporated to yield 5.6g of a yellow liquid which was vacuum transferred and examined by GC/MS, which showed the presence of dichloromethylenecyclohexane and the expected *spiropropiolactone*, 1,1-dichloro-3-oxa-spiro[3.5]nonan-2-one The white solid, 5g, was insoluble in all common solvents, but swelled a little in dimethyl

sulphoxide. It was hydrolysed by refluxing in aqueous ethanolic potassium hydroxide. The infra-red spectrum of this compound suggested that it was an ester (see Appendix 2) and it is probable that it was a polyester formed by ring-opening polymerisation of the *spiropropiolactone*. The infra-red spectra of the white precipitate and the *spirolactone* appear in figure A2.11. The infra-red and mass spectra of dichloromethylenecyclohexane appear in figure A2.12, whilst the proton and carbon nmr spectra are shown in figure A2.13. The proton and carbon nmr spectra of the lactone are shown in figure A2.14, the proton and carbon nmr spectra of the precipitated polyester in DMSO  $d_6$  appear in figure A2.15. The proton and carbon nmr spectra of the hydrolysed polymer appear in figure A2.16.

19) Reaction of dichloroketene with cyclohexanone catalysed by added zinc chloride, aluminium tribromide or boron trifluoride diethyl etherate.

Dichloroacetyl chloride (14.7g, 9.6ml, 0.1mol) in ether (50ml) was added to triethylamine (10.1g, 13.9ml, 0.1mol) in ether (200ml) at  $-20^{\circ}\text{C}$  with magnetic stirring. The reaction was protected by a calcium chloride drying tube. The solution was filtered under dry nitrogen at  $-78^{\circ}\text{C}$  through a sinter and cyclohexanone (9.8g, 10.3ml, 0.1mol) and zinc chloride (100ml of 1M in ether) were added. The solution was allowed to warm to room temperature overnight. The solution was transferred to a separating funnel and washed with water (3x 100ml) dried over magnesium sulphate and evaporated to yield a brown oil, 10g, having a strong smell of cyclohexanone. TLC (silica, ether:petrol 1:4) showed that the cyclohexanone remained largely unchanged.

The experiment was repeated and aluminium bromide was added to the mixture containing cyclohexanone, but there was still no sign of adduct formation. When a similar reaction was performed using boron trifluoride etherate catalyst, there was no observed product formation.

20) Reaction of benzoquinone with dichloroketene.

Benzoquinone (10.8g, 0.1mol) was suspended in 200ml anhydrous ether containing triethylamine (9.4g, 12.9ml, 0.1mol.) Dichloroacetyl chloride (13.6g, 8.9ml, 0.1mol) was added dropwise with cooling by cardice/acetone to keep the temperature at -10 to -15°C. The solution was allowed to warm to room temperature and filtered; the precipitate was identified as triethylamine hydrochloride. The solution was concentrated to yield yellow crystals, which were thermally unstable and poorly-characterised, possibly 1,1-dichloro-3-oxa-spiro[3.5]nona-5,8-dien-2,7-dione (16g, 79%.) Examination by tlc on silica (ether:petrol 1:1) showed only a trace of residual benzoquinone to be present. The yellow crystals decomposed at 70°C, resolidified and remained solid to over 250°C. The yellow solid decomposed if left overnight at room temperature to yield a viscous brown oil. The carbon nmr spectrum appears in figure A2.17, the infra-red spectra of the adduct and benzoquinone appear in figure A2.18.

21) Thermal decarboxylation of benzoquinone-dichloroketene adduct.

The yellow product from the above reaction (12.8g) was pyrolysed with a hot air gun at 20mmHg in a flask equipped with reflux condenser. A large volume of gas was evolved, and some material was lost by violent expulsion via the condenser and vacuum connection. A hard red solid remained in the flask and was scraped out with a steel spatula. Allowing for the material lost up the condenser, the weight loss was 2.2g. The expected weight loss for the decarboxylation is 2.6g. The red solid remaining did not melt below 400°C, the limit of the apparatus. A portion was extracted in a Soxhlet with carbon tetrachloride which removed only a very little material. The residue was then extracted with acetone overnight, and in contrast all of the red solid was extracted, although the solubility was very low and most appeared in the extraction flask as a precipitate. The solid state <sup>13</sup>C CPMAS spectrum appears in figure A2.19a. Required for (C<sub>7</sub>H<sub>4</sub>Cl<sub>2</sub>O)<sub>n</sub>: C 48.04%, H 2.30%, Cl 40.51%; found C 54.59%, H 2.35%, Cl



21.55%.

A repetition of the above experiment, but in the solution state (1g yellow adduct in 50ml chloroform, refluxed overnight) gave 0.8g of a white solid, which was also highly insoluble and gave the analysis C 40.38%, H 1.39%, Cl 51.42%. The solid state  $^{13}\text{C}$  CPMAS spectrum appears in figure A2.19b. The infra-red spectra of the red and white solids appear in figure A2.20. The proton and carbon nmr spectra of the acetone extract of the red solid are shown in figure A2.21.

The mass spectra (EI, CI) of the red material appear in figure 2.22. However, FAB showed nothing, possibly because the material is highly involatile and poorly soluble. The EI/CI spectra showed no molecular ion, but there were peaks at *inter alia* m/e 121 and 155 in both, indicating that these were fragments. The latter peak had a companion at m/e 157 and the relative intensity of the two was in the ratio 3.2:1, whilst the ratio expected for the presence of one chlorine in the fragment is 3.1:1. The spectra demonstrate that there is no benzoquinone in the product, but the identity of the red material could not be elucidated.

## 22) Thallium (III) nitrate oxidation of 4-methoxyphenol.

Thallium trinitrate trihydrate (11.1g, 25mmol) dissolved in methanol (40ml) and trimethyl orthoformate (40ml, 38.7g, 0.36mol) was added at  $-70^{\circ}\text{C}$  to a stirred solution of 4-methoxyphenol (3.1g, 25mmol) in methanol (35ml) and trimethyl orthoformate (35ml, 33.8g, 0.32mol.) The reaction mixture was protected by a dry nitrogen blanket. The solution was allowed to warm to room temperature and the oxidation proceeded smoothly, without vigorous exotherm, depositing a heavy white precipitate of thallium (I) nitrate. The solution, now containing two equivalents of nitric acid, was quickly neutralised with excess methanolic potassium hydroxide (3.3g, 59mmol, in 50ml methanol) and 60-80° petrol (100ml) was added to reduce the solubility of remaining

thallium (I) nitrate, and also to form a floating liquid seal to reduce hydrolysis by ingress of moisture. The precipitated thallium and potassium nitrates were filtered off, and the liquid concentrated to ca. 10-20ml by rotavap *below 35°C*. **[HAZARD! Residual nitric acid, if present, may cause violent oxidation of the concentrated organic solution. The ester methyl nitrate may also be present. *It is a brisant high explosive with an energy content and sensitivity to detonation similar to "nitroglycerin."*]** The concentrated solution was put onto an 8 x 1.25 inch column of basic activated alumina, and eluted with 60-80° petrol to remove residual acid, thallium salts and unreacted phenol. The process of eluting the methanolic solution was highly exothermic and lower-boiling petrol fractions could not be used; considerable quantities of vapour bubbles were formed in the column, but efficiency of separation was not impaired. The eluate was concentrated by rotavap below 50°C (water bath temperature) to prevent decomposition of the product and when as much methanol, trimethyl orthoformate and high-boiling petrol residues had been removed as possible at this temperature, the pale yellow liquid (4,4-dimethoxycyclohexa-2,5-dienone) was vac transferred at the highest attainable vacuum ( $10^{-5}$ mbar) and the lowest necessary water bath temperature (ca. 50°C.) When pure it is colourless, but is inevitably contaminated with a minute amount of benzoquinone resulting from hydrolysis and which, because of its tendency to sublime in the vapour stream, is not possible to remove. Yield 3.6g, 92%. Modifying this procedure by using a basic ion exchange resin (Amberlite IRA400[OH]) to remove the acid instead of basic alumina was successful in doing this, but the product ketal also stuck to the column and could not be eluted. An attempt to neutralise the nitric acid byproduct with solid anhydrous potassium carbonate failed, possibly because this base is insoluble in the reaction mixture. The proton and carbon nmr spectra are shown in figure A2.23, whilst the infra-red spectrum appears in figure A2.24.

### 23) Iron (III) chloride oxidation of 4-methoxyphenol<sup>[233]</sup>.

4-Methoxyphenol (1.4g, 11.3mmol) was stirred vigorously in 70ml methanol and with

anhydrous potassium carbonate (8g, 58mmol) suspended in the mixture, contained in a one litre tall form beaker. Anhydrous iron (III) chloride (9.4g, 58mmol) was added all in one portion. There was vigorous effervescence. The mixture was left to stir for half an hour, and poured into saturated sodium bicarbonate solution (100ml.) The suspension was extracted with ether (3x 100ml) the extracts combined, washed with brine, dried with magnesium sulphate, evaporated and vac transferred. A trace of yellow benzoquinone was found in the product, but the remainder was unreacted starting material.

#### 24) Electrolytic oxidation of *p*-Methoxyphenol.

Many electrolysis experiments were conducted in order to improve on the quantities of 4,4-dimethoxycyclohexa-2,5-dienone obtainable by thallium (III) nitrate oxidation. Whilst thallium chemistry works in excellent yield, the scale on which it can be employed is limited by safety and cost considerations. The method developed by Nilsson, Ronlán and Parker<sup>[198]</sup> which proceeds via the electrolytic oxidation of *para*-methoxyphenol in methanol was thus attractive, as the claimed yield is 97% and the electrolysis may be scaled up safely. However, the claimed yield was not borne out in practise and the best which could be obtained was 32%. A letter to the authors asking for suggestions to improve the yield met with no response.

The cell used for these experiments is shown overleaf with the electrode assembly, figures 6.3 and 6.4. The cathode was a piece of tungsten wire, 0.5mm diameter and 5cm long. The anode was a piece of 0.025mm platinum foil 5cmx5cm, rolled into a half-cylindrical shape to fit inside the cooling coil. The anode supports were two 2.5cm lengths of 1mm diameter platinum wire.

The platinum components were joined by hammer welding at red heat. The soldered junctions with the lead-in wires (copper) were covered with a proprietary sealant to prevent participation of the solder in the electrochemical reactions.

The first six attempts used the platinum foil in its original 'as received' condition, i.e.

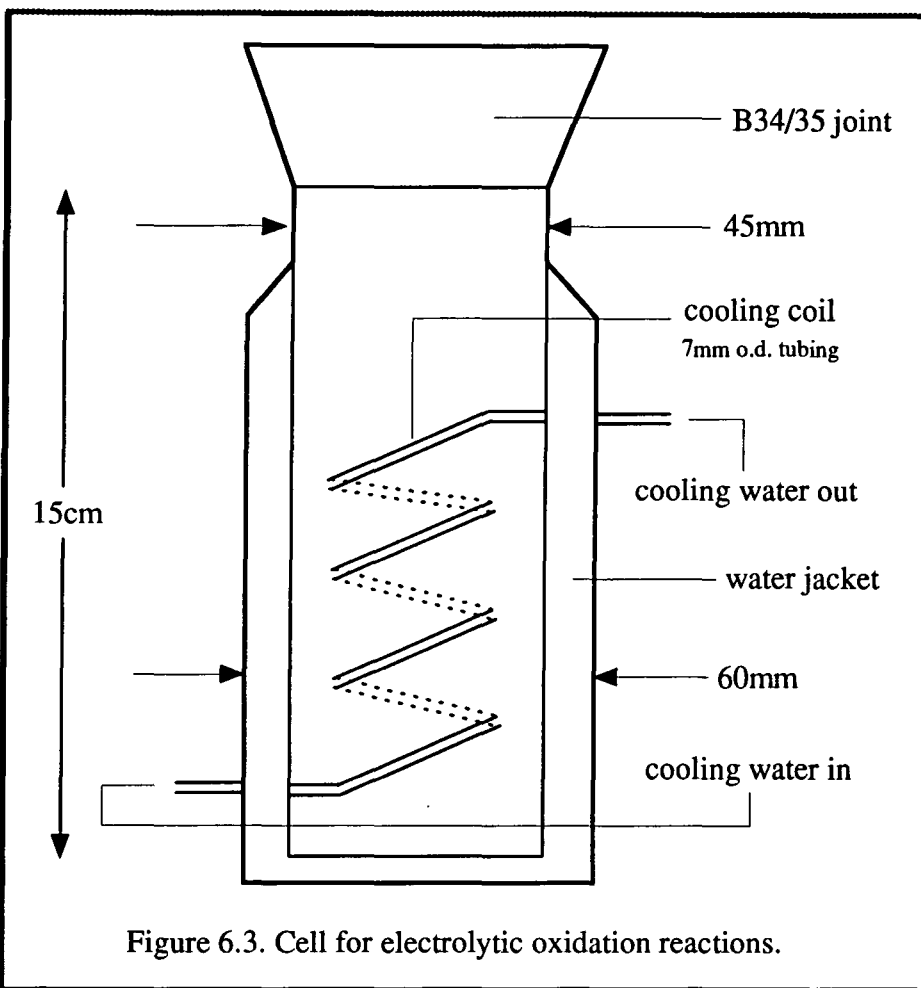
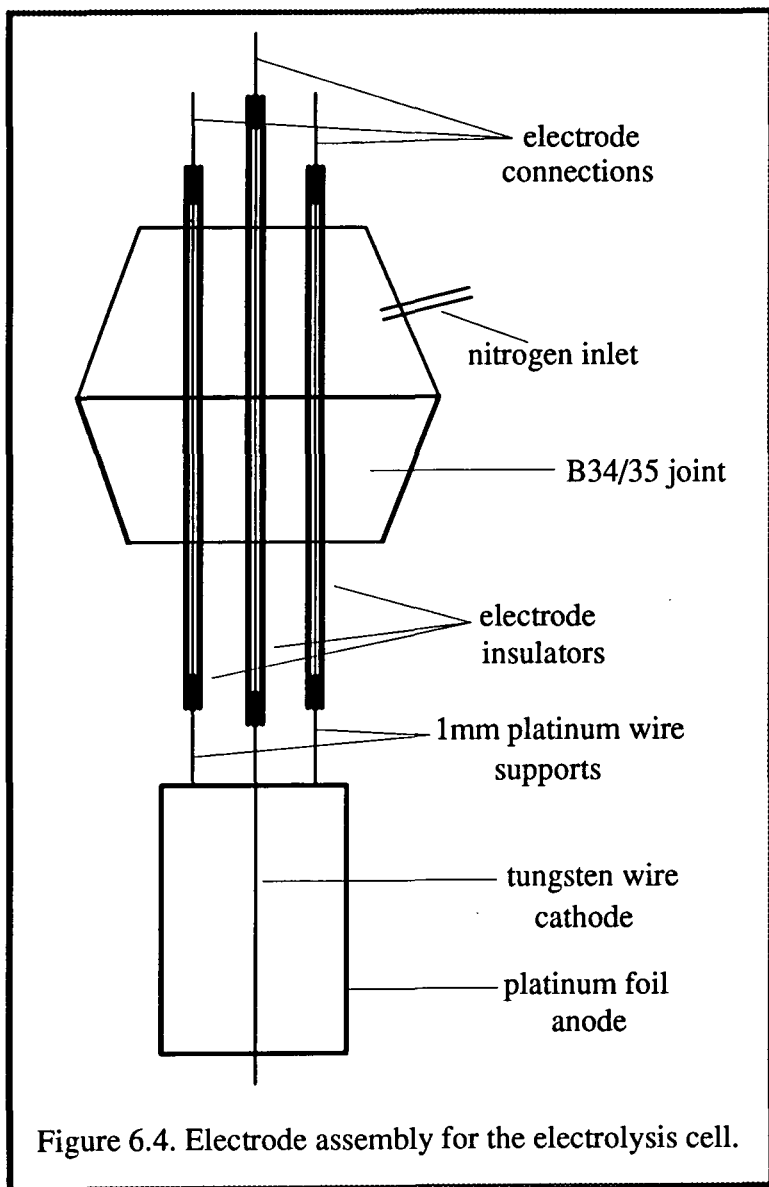

Figure 6.3. Cell for electrolytic oxidation reactions.

springy, shiny and not annealed except in the area of the welds with the support wires. The next two attempts used the electrode after it had been made the cathode in another cell, filled with a 3wt% solution of chloroplatinic acid containing 0.02wt% lead acetate, and electrolysed against a platinum rod anode at 500mA for five minutes. This deposited a thick layer of 'platinum black' on the anode. The remaining attempts were made with the anode after it had been pickled in concentrated nitric acid, 10wt% aqueous potassium hydroxide, washed with distilled water and heated to red heat in a Bunsen flame. In this condition, the surface was dull and the metal soft and easily deformed.

All experiments used a solution of *p*-methoxyphenol (10g, 80mmol) in methanol (AR grade, 60ml) with various other additives. This will be referred to as the standard solution. Work-up was identical in each case. The solution was poured into 300ml of



pH6 phosphate buffer (made by adding 112ml of 0.1M sodium hydroxide to a solution of 13.6g of potassium dihydrogen phosphate in one litre of water) and extracted with dichloromethane (3x 150ml.) The extracts were dried over magnesium sulphate and evaporated to yield the crude product.

#### 24.1. Experiments with the 'as supplied' anode.

a) Anhydrous lithium perchlorate (4g) was added to the standard solution as support electrolyte and a constant current source was used to provide 500mA for the duration of the electrolysis, which was conducted under nitrogen with magnetic stirring. According

to Nilsson *et al*<sup>[198]</sup> the reaction requires 3.5F/mol, thus for this experiment 15 hours (overnight) were allowed. The voltage drop across the cell at the start was 7v, at the end it was 9v, lit. 21v. The reaction yielded 14g of a brown tar containing none of the desired product (nmr analysis.) The anode was heavily coated with black sludge.

b) This experiment was conducted as for 24.1(a) but using a lower current density. The constant current supply was set to deliver 250mA and the reaction carried out for 24 hours. Work-up gave a brown tar, ca. 14g, containing none of the desired product (nmr analysis.) The anode was again heavily coated by oxidation products.

c) This experiment was conducted as for 24.1(b) but with the addition of sodium bicarbonate (6.88g, 82mmol) as an additional safeguard against acidity for any of the desired ketal which might have been formed. The back emf across the cell was 5v at 250mA. The product was again a tar, ca. 14g, but in contrast to 24.1(a) and (b) there was no adhering slime on the anode. NMR of the crude product indicated none of desired product was present.

d) This experiment was conducted as for 24.1(a) with the addition of potassium hydroxide (0.55g, 9.8mmol) to the standard solution. Again, the product was a brown tar, yield 14g, but nmr indicated a trace of the desired material.

e) This experiment was performed as per experiment 24.1(a), but using anhydrous methanol and a current of 3A which gave a back emf of 21v across the cell. The reaction was stopped after 1.5 hours (theoretically, the time required was 2.5 hours.) The product, 14g, was a black tar containing no product by nmr.

f) The back emf in the absence of *p*-methoxyphenol was measured by filling the cell with a solution of lithium perchlorate (4g) in anhydrous methanol (60ml) and passing

500mA from the constant current supply. It was found to be 7.5v. Bearing this in mind, an experiment was conducted using the standard solution to which lithium perchlorate (0.8g) was added, with sodium bicarbonate (0.7g, 8mmol) added as buffer. The electrolysis was performed under a nitrogen blanket with magnetic stirring. A current of 500mA was used for 15 hours and this gave a back emf of 22-23v across the cell. Following the standard work-up, a brown tar, 14g, was recovered which by nmr contained none of the desired product.

#### 24.2. Experiments with the modified anode, coated with 'platinum black.'

a) The standard solution was used with lithium perchlorate (4g) as the support electrolyte and a current of 500mA. The back emf varied between 7-9v. The reaction was performed under nitrogen with magnetic stirring. Work-up gave a brown solid, 10g, which by nmr was unreacted starting material.

b) The standard solution was used with lithium perchlorate (0.8g) giving a back emf of 20v across the cell at a current of 500mA. The reaction was performed under nitrogen with magnetic stirring. Work-up gave a brown solid, 10g, which nmr showed to be unreacted starting material.

#### 24.3. Experiments with the modified anode, after acid and base treatment and annealing.

a) The standard solution, containing lithium perchlorate (0.8g) and a suspension of sodium carbonate (6g, 57mmol) was electrolysed under nitrogen with magnetic stirring at a constant current of 500mA, which fell at the end of the electrolysis to 60mA. The back emf rose from 23v to 25v. The product, after standard work-up, was a black tar, 12g, containing some of the desired product by nmr.

b) The experiment was scaled up, using 1.5 times the quantities of reagents used in

24.3(a) except for sodium carbonate (6g, 57mmol.) The electrolysis was performed for 22 hours. Yield of black tar, containing some of the desired product, 16g.

Repetition of 24.3(b) six times gave a total yield of tar of 140g. This was subjected to column chromatography on basic alumina (900g) in a 50mm o.d. column, eluting with 40-60° petrol containing between 0 and 8% methanol (gradient elution.) The tar blocked the column and elution was very slow. The tar separated into two bands, the higher R<sub>f</sub> material was collected as a yellow solution, which on evaporation gave a yellow oil, 50g. This was shown by nmr to be predominantly the desired product. The material was vacuum transferred at the highest vacuum attainable on the line with a diffusion pump, 10<sup>-5</sup>mbar, with a water bath temperature not exceeding 50°C. 4,4-Dimethoxycyclohexa-2,5-dienone was obtained as a yellow liquid with a pleasant fruity smell (40g, 26%.) The nmr spectra appear in Appendix 2.

Subsequently it was necessary to prepare more ketal, but repetition of 24.3(b) failed to yield any of the desired product. This was ascribed to the anode surface having changed in the intervening months. In spite of treating the anode with nitric acid and potassium hydroxide, and annealing it as before, no ketal could be obtained. The constant current supply was replaced by a potentiostat and the oxidation conducted as for 24.3(b) at a controlled potential of 2v (anode potential vs. a silver reference electrode placed close to it) but no product was detected in the black tar recovered. The reaction is evidently highly sensitive to the condition of the anode and it is clearly advisable, once a working system has been achieved, to obtain as large a quantity of 4,4-dimethoxycyclohexa-2,5-dienone as possible since the conditions are not reproducible and the nature of the anode surface is unstable with respect to time.

## 25) Wittig and Wittig-Horner Reactions.

All needles and cannulas used for these reactions were brought to red heat in a Bunsen



flame before use (including Luer fittings.) Syringes were dried in an oven and flasks were dried under dynamic vacuum according to the following procedure. A spirit-based marker pen was used to draw a cross on the base of the flask, the arms of which extended to half way up the sides. Vacuum was applied and a Bunsen used to heat the flask evenly with a blue flame (no inner cone visible) until all the ink was burned off. The temperature attained is unknown, but it was insufficient to soften the glass and the ink markings ensured that heat was evenly distributed. A large number of Wittig and Wittig-Horner reactions were performed. The following examples are representative.

25.1) Dichloromethylenetriphenylphosphorane and dichloromethylenetris-(dimethylamino)phosphorane reactions.

a) On *endo-cis-anti-endo-cis*-pentacyclo[10.2.1.1<sup>5,8</sup>.0<sup>2,11</sup>.0<sup>4,9</sup>]hexadeca-6,13-dien-3,10-dione.

Triphenylphosphine (5.458g, 21mmol) was rapidly transferred into a 2-necked round bottomed flask. THF dried over potassium wire (50ml) was added under nitrogen, followed by bromotrichloromethane (8.2g, 4.1ml, 41mmol) with magnetic stirring. The solution was cooled by ice whilst stirring was continued for 1.5 hours. The initially colourless mixture became orange and was transferred by cannula onto *endo-cis-anti-endo-cis*-pentacyclo[10.2.1.1<sup>5,8</sup>.0<sup>2,11</sup>.0<sup>4,9</sup>]hexadeca-6,13-dien-3,10-dione (2.5g, 10mmol) and stirring continued under nitrogen. The solid dissolved and the solution became dark brown. After four days, a precipitate had formed and hexane (25ml) was added and the precipitate filtered off. The filtrate was concentrated and deposited crystals amounting to 1.2g, which were shown to be starting material by infra-red spectroscopy. The precipitate was extracted by washing with ethyl acetate (100ml) and the solution concentrated and subjected to column chromatography on silica, eluting with ethyl acetate. A further quantity of starting material was obtained and also some triphenylphosphine oxide. The residual solid which did not dissolve in ethyl acetate was shown to contain triphenylphosphine oxide and bromochlorotriphenylphosphorane. No dichloro-olefin was recovered. Final recovery

of starting material ca. 80%.

The reaction was repeated with a two molar excess of lithium chloride over the amount of ylid used, but the reaction again yielded mostly unreacted starting material. Proton and carbon nmr spectra (figure A2.25) suggested that the ylid was deprotonating the starting material.

Another preparation was attempted using *tris*(dimethylamino)phosphine (3.25g, 3.5ml, 20mmol) in place of triphenylphosphine. The *tris*(dimethylamino)phosphine was added in THF (10ml) solution by syringe to a mixture of bromotrichloromethane (8g, 4ml, 40mmol) and *endo-cis-anti-endo-cis*-pentacyclo[10.2.1.1<sup>5,8</sup>.0<sup>2,11</sup>.0<sup>4,9</sup>]hexadeca-6,13-dien-3,10-dione (2.5g, 10mmol) in THF (50ml) with stirring. This reaction required more efficient cooling (acetone-cardice, -20°C) as the ylid-forming reaction is more vigorous with this phosphine. The reaction mixture was allowed to warm to room temperature overnight and the volatiles then removed by rotavap. The resulting mixture was partitioned between ether (200ml) and saturated sodium bicarbonate solution (2x100ml) and the ether layer washed with water (3x100ml) dried over magnesium sulphate and evaporated. TLC (silica, ether-petrol 1:4) indicated no product formation.

b) On *endo-cis-anti-exo-cis*-pentacyclo[10.2.1.1<sup>5,8</sup>.0<sup>2,11</sup>.0<sup>4,9</sup>]hexadeca-6,13-dien-3,10-dione.

The starting material was prepared by refluxing the *endo-cis-anti-endo-cis*- isomer in ethanolic potassium hydroxide under nitrogen<sup>[234]</sup>. Triphenylphosphine (5.245g, 20mmol) was dissolved in THF (50ml) under nitrogen and bromotrichloromethane (8g, 4ml, 40mmol) was added with ice cooling. The ylid solution was added to the *endo-exo*- adduct (2.5g, 10mmol) by cannula and worked up as for the previous reaction. TLC (silica, ether-petrol 1:4) showed no product formation after 2 days.

c) On *p*-benzoquinone.

Benzoquinone (1.08g, 10mmol) and triphenylphosphine (5.25g, 20mmol) were dissolved in THF (50ml) under nitrogen with stirring and bromotrichloromethane (2.7ml, 5.35g, 27mmol) was added at 0°C. The mixture was left overnight, treated with hexane and filtered to give a brown solution which gave a thick tar on evaporation, which slowly crystallised. Yield 1.1g, 58%. TLC (silica, ether:petrol 1:4) indicated a complex mixture of products.

d) On cyclohexanone.

The above synthesis was repeated using cyclohexanone (2ml, 1.9g, 19mmol) triphenylphosphine (10g, 38mmol) bromotrichloromethane (5ml, 10g, 51mmol) in 50ml dry THF under nitrogen. Work-up was by adding 40-60° petrol (50ml) and filtering, removing solvent by rotavap and vac transferring the product. The distillate, ca. 2ml, was submitted for GC/MS which indicated that the dichloro-olefin had been formed, albeit in around 10% yield (by GC integration.) This was subsequently increased to ca. 60% by repeated attempts. Required for C<sub>7</sub>H<sub>10</sub>Cl<sub>2</sub>: C 51.21% H 6.14%, Cl 42.64%; found C 50.94%, H 6.11%, Cl 42.96%.

e) On *endo-cis-anti-endo-cis*-tricyclo[8.4.0.0<sup>3,8</sup>]tetradeca-5,12-dien-2,9-dione.

This compound (1.15g, 5.3mmol) plus triphenylphosphine (2.79g, 10.6mmol) were dissolved in THF (100ml) under nitrogen with stirring and bromotrichloromethane (4g, 2ml, 20mmol) was added by syringe with ice cooling. The reaction was left overnight and hexane (40ml) was added. Bromochlorotriphenylphosphorane was hydrolysed by shaking with water (5ml) and the mixture was filtered to remove triphenylphosphine oxide. The volatiles were removed by rotavap, the residue taken up in ether and washed with water (100ml) dried over magnesium sulphate and evaporated. TLC (silica, ether-petrol 1:4) indicated no product formation.

Another preparation was attempted using a mixture of the title compound (1g, 3.8mmol) and bromotrichloromethane (3g, 1.5ml, 30mmol) in THF (50ml) under nitrogen to which *tris*(dimethylaminophosphine) (1.24g, 1.4ml, 7.6mmol) in THF (10ml) was added by syringe with stirring, and cooling by acetone-cardice (-20°C.) The mixture was left to warm to room temperature overnight. The volatiles were removed by rotavap and the residue partitioned between ether (100ml) and saturated sodium bicarbonate (2x100ml) and washed with water (3x100ml), dried over magnesium sulphate and evaporated. TLC (silica, ether-petrol 1:4) indicated no product formation.

f) On *endo-cis*-tricyclo[6.2.1.0<sup>2,7</sup>]undeca-4,9-dien-3,6-dione.

The title compound (8.7g, 0.05mol) was dissolved in THF (150ml) with bromotrichloromethane (7.5ml, 15g, 0.075mol) and the mixture stirred under nitrogen. *Tris*(dimethylamino)phosphine (16.3g, 18ml, 0.1mol) in THF (50ml) was added by cannula with cooling by cardice-acetone (-20°C) and magnetic stirring. The reaction was left to stir and warm to room temperature overnight. A thick suspension formed which stirred with difficulty. Water (15ml) was added and the suspension dissolved. Two layers formed. The upper layer was separated, evaporated, taken up in ether (100ml), washed with water (2x50ml) dried and evaporated. Nothing was present in this extract. The aqueous washings were combined with the aqueous layer from the reaction and evaporated at or below 50°C by rotavap. The residue was pumped to dryness on the vacuum line via a cold trap in which hexamethylphosphorictriamide condensed. The dry material, a yellow solid, 6.7g, was examined by TLC (silica, chloroform) and found to be different from the starting material. It was insoluble in ether, pentane and ethyl acetate. The solid was purified by column chromatography on silica, eluting with chloroform. NMR indicated that the product was not starting material, but neither was it the anticipated product of the Wittig reaction. The proton and carbon nmr spectra appear in figure A2.26. It was evident that the recovered solid contained hexamethylphosphorictriamide, and it seems likely that it was either a

tightly-bound complex or a Michael-addition product.

g) On 2,6-dimethylcyclohexanone.

Synthesis (25.1.d) was repeated with triphenylphosphine (5.245g, 20mmol) bromotrichloromethane (5.4g, 2.7ml, 28mmol) and 2,6-dimethylcyclohexanone (1.26g, 1.3ml, 10mmol) in 50ml dry THF. Work-up was as before but GC/MS indicated no product formation.

h) On 4,4-dimethoxycyclohexa-2,5-dienone.

The above compound (1.5g, 1.35ml, 9.7mmol) was added by syringe to a solution of dichloromethylenetriphenylphosphorane, prepared as above from triphenylphosphine (5.1g, 19.4mmol) and bromotrichloromethane (5.2g, 2.6ml, 26mmol) in THF (50ml) under nitrogen with ice cooling. The solution was allowed to warm to room temperature over two hours and stirred overnight. Dry 40-60° petrol (20ml) was added, the solution filtered and evaporated. The resulting deep purple oil was vacuum transferred and the colourless liquid, yield 1.5g, 70% on the expected product, examined by proton nmr (250MHz) and GC/MS. The material rapidly darkened, even under nitrogen in the freezer. GC/MS indicated that the product was a mixture, but contained ca. 40% of a material which gave *inter alia* m/e=189, 191, 193 with intensity ratios consistent with two chlorines. It seems probable that the 4-dichloromethylenedimethoxycyclohexa-2,5-diene decomposed through loss of CH<sub>3</sub>O to yield a tropylium ion with this mass. The proton and carbon spectra are shown in figure A2.27 whilst the infra-red and mass spectra appear in figure A2.28.

## 25.2) Diethyl trichloromethylphosphonate reactions.

a) The above compound was prepared by the method of Kosolapoff<sup>[235]</sup>. Triethyl phosphite (50ml, 47.75g, 287mmol) was refluxed overnight with carbon tetrachloride

(250ml, 398g, 2.58mol) and the excess carbon tetrachloride removed by rotary evaporation. The residue was distilled through a short Vigreux column and the desired fraction redistilled at higher vacuum. Diethyl trichloromethylphosphonate was obtained as a mobile, colourless liquid, (64g, 83%); b.p. 139-142°C @ 18mmHg, 65-8°C @ 0.1mmHg, lit<sup>[234]</sup> 127-8°C @ 13mmHg. The proton and carbon nmr spectra are shown in figure A2.29 and the infra-red spectrum appears in figure A2.30.

b) On *endo-cis*-tricyclo[6.2.1.0<sup>2,7</sup>]undeca-4,9-dien-3,6-dione.

The title compound (4.25g, 24mmol) was dissolved in THF (50ml) under dry nitrogen. In a separate flask, diethyl trichloromethylphosphonate (6.9g, 4.9ml, 27mmol) was added to THF (50ml) under dry nitrogen and the mixture was magnetically stirred and cooled to -90°C with a liquid air-acetone slush bath. Butyl-lithium (18ml of 1.64M in pentanes) was added slowly, the temperature at all times was less than -80°C, and the mixture stirred for half an hour. The solution of the diketone was added by cannula at or below the same temperature and the solution left to warm to room temperature overnight. The colour became intense on addition of the diketone and by morning was deep red. The mixture was evaporated to dryness by rotavap, and the residue taken up in ethyl acetate (150ml) and washed with saturated brine (2x100ml), dried over magnesium sulphate and evaporated. The crude product, 4.5g, was dark red and TLC (silica, ether-petrol 1:4) showed streaking and many spots. No attempt was made to effect further purification or to identify the components of the mixture.

c) On 4,4-dimethoxycyclohexa-2,5-dienone.

The title compound (5.5g, 5ml, 36mmol) in THF (50ml) was added with magnetic stirring, at or below -80°C, by cannula to a solution prepared by the addition of butyl lithium (24ml of 1.64M in pentanes) to diethyl trichloromethylphosphonate (10g, 7.25ml, 39mmol) in THF (100ml) under nitrogen at or below -80°C. The colour darkened instantly. The mixture was left to warm to room temperature overnight. The

deep red solution was evaporated, the residue taken up in dichloromethane (200ml), washed with pH7.5 phosphate buffer (3x 330ml) dried over magnesium sulphate and evaporated to yield an orange oil, 4.75g. Proton nmr indicated that the product was mainly unreacted starting material, see figure A2.31.

d) On *endo-cis*-bicyclo[4.4.0]deca-3,8-dien-2,5-dione.

The title compound (5g, 31mmol) was dissolved in dry THF (150ml) with magnetic stirring under nitrogen. The solution was cooled to -90°C by acetone-liquid air slush. Diethyl trichloromethylphosphonate (7.9g, 5.6ml, 31mmol) and anhydrous lithium chloride (5g, 118mmol) were dissolved in a separate flask in THF (100ml) under dry nitrogen. The solution was cooled to -90°C by liquid air-acetone slush. Butyl-lithium (19ml of 1.64M in pentanes) was added at or below -80°C and the mixture stirred for half an hour. This solution was transferred by cooled cannula (see figure 6.5) to the diketone solution and the mixture allowed to warm to room temperature overnight. The solution yielded a red solid on evaporation which was taken up in dichloromethane (200ml) washed with water (3x 100ml) dried over magnesium sulphate and evaporated to yield a viscous red oil, 7.5g, which was shown by proton nmr (figure A2.32) to be a complex mixture of compounds, see Appendix 2.

e) On *endo-cis*-6,6-dimethoxytricyclo[6.2.1.0<sup>2,7</sup>]undeca-4,9-dien-3-one.

The title compound (1g, 4.5mmol) was dissolved in THF (50ml) under nitrogen with magnetic stirring and was cooled to -100°C by acetone-liquid air slush. Diethyl trichloromethylphosphonate (1.2g, 0.85ml, 4.7mmol) was treated in THF (100ml) solution at -100°C with butyl-lithium (2.9ml of 1.64M) and the mixture stirred for half an hour. The ketone solution was added by cooled cannula at or below -90°C and the mixture allowed to warm to room temperature overnight. The solvent was removed by rotavap and the residue partitioned between water and hexane (100ml:100ml.) The hexane layer was dried with magnesium sulphate and evaporated to give a yellow oil

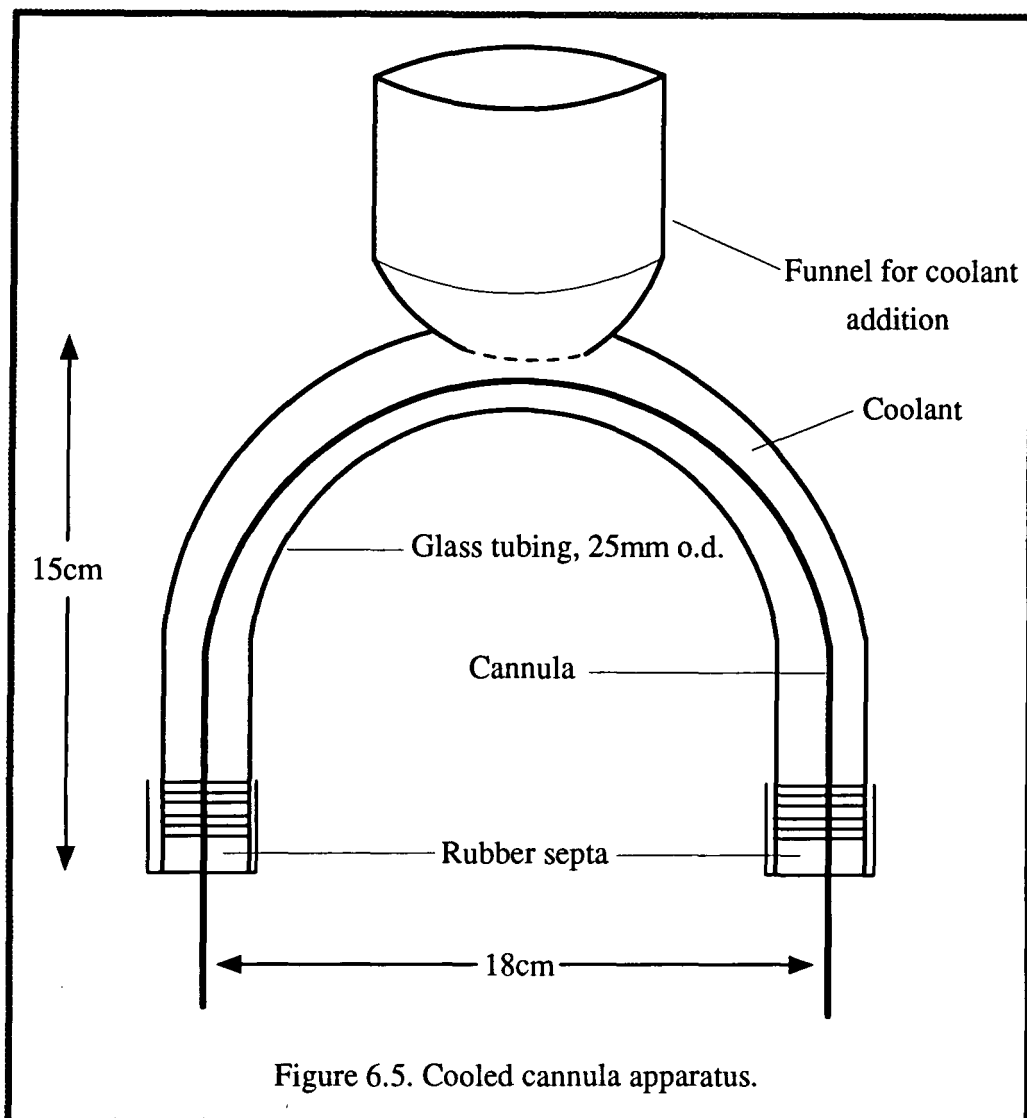

Figure 6.5. Cooled cannula apparatus.

which was recrystallised from cold pentane to give endo-cis-6-dichloromethylene-tricyclo[6.2.1.0<sup>2,7</sup>]undeca-4,9-dien-3-one (500mg, 46%) as pale yellow crystals. Calculated for  $C_{12}H_{10}OCl_2$ : C 60.00%, H 4.20%, Cl 29.14%; found C 60.21%, H 4.33%, Cl 28.90%. Accurate mass, calculated (m/e) 240.010870468; found (m/e) 240.01081. The nmr spectra appear in chapter 5 section 4. The infra-red and mass spectra appear in figure A2.33. This reaction was subsequently repeated but the result could not be reproduced. The compound readily undergoes the retro-Diels-Alder reaction and must be kept in the freezer; half of the initially-prepared material was lost overnight as a consequence of it being stored at room temperature *in vacuo* in an attempt to remove residual solvent.



26) Attempted hydrolyses of *endo-cis*-6-dichloromethylenetricyclo[6.2.1.0<sup>2,7</sup>]-undeca-4,9-dien-3-one.

a) The title compound (100mg, 0.4mmol) was dissolved in ethanol (1ml) and ethanolic potassium hydroxide (70mg, 1.2mmol in 1ml ethanol) was added. The solution became yellow. The mixture was stirred for 1.5 hours at room temperature, evaporated to dryness by rotavap (vacuum line through cold trap at room temperature) and the residue partitioned between hexane (5ml) and a solution of ammonium nitrate (100mg, 1.2mmol) in water (5ml.) The hexane layer was separated, taken to dryness as above and the residue recrystallised from pentane to yield off-white crystals, 85mg, which were shown by nmr to be unreacted starting material.

b) The above reaction was repeated, but the basic solution was heated to boiling under nitrogen for ten minutes, allowed to cool and then worked up as before. Off-white crystals, 76mg, were recovered and shown to be unreacted starting material by nmr.

c) The title compound (100mg, 0.4mmol) was dissolved in ethanol (1ml) and concentrated hydrochloric acid (1 drop) added by pasteur pipette. A yellow colour was instantly produced. The mixture was stirred at room temperature for one hour and saturated aqueous sodium bicarbonate solution (5 drops) was added by pasteur pipette. The solution became colourless. It was diluted to 20ml with water and extracted with pentane, dried over magnesium sulphate and evaporated to yield pale yellow crystals, 65mg, which were shown by nmr to be unreacted starting material.

d) The title compound (10mg, 0.04mmol) was dissolved in ether (1ml) and freshly distilled boron trifluoride diethyl etherate added (5ml.) The solution became yellow and darkened rapidly. Water was added (5ml) and a black precipitate appeared which was

filtered off. The filtrate was separated, the ether layer dried with magnesium sulphate and evaporated to yield perhaps 1mg of an oil which was shown by nmr to be unreacted starting material. The black matter, perhaps 4mg, was insoluble in chloroform and acetone and further characterisation was not attempted.

## 27) 1,3-Dithiane Reactions.

27.1 The anion of 1,3-dithiane was reacted with *endo-cis*-bicyclo[4.4.0]deca-3,8-dien-2,5-dione. 1,3-Dithiane (1.2g, 10mmol) was dissolved in dry THF (50ml) under dry nitrogen with magnetic stirring and cooled to -25°C by acetone-cardice. Butyl-lithium (6ml of 1.64M in pentanes) was added and the mixture stirred for one hour. Trimethylsilyl chloride (1.4ml, 1.2g, 11mmol) was added and the mixture stirred for half an hour at -25°C and half an hour at room temperature. Butyl lithium (6ml of 1.64M in pentanes) was added at -25°C and the mixture stirred for one hour. The diketone (1.54g, 9.5mmol) in dry THF (50ml) was added by syringe at -25°C and the mixture became deep yellow. The reaction was allowed to warm to room temperature overnight to give a deep orange solution. The nitrogen line was disconnected and a particularly beautiful dark turquoise colour was instantly produced. The volatiles were removed by rotavap to give an orange oil, which on exposure to air instantly became turquoise again. The oil was taken up in ether (150ml) and washed with water (3x 100ml) dried over magnesium sulphate and evaporated to give a brown tar. The tar was washed with pentane yielding a yellow solution which deposited black "crystals" on crash cooling with acetone-cardice. On warming to room temperature, these "crystals" became a black tar which was insoluble in pentane(!) and which nmr showed was a highly complex mixture of products, see figure A2.34.

27.2 Wittig-Horner reaction on *endo-cis*-bicyclo[4.4.0]deca-3,8-dien-2,5-dione.

1,3-Dithiane (1.2g, 10mmol) was dissolved in chloroform (25ml) and cooled to -40°C under nitrogen with magnetic stirring. Sulphuryl chloride (1.5g, 0.9ml, 11mmol) in

chloroform (5ml) was added by syringe. A white precipitate of the chlorosulphonium chloride formed instantly. The suspension was warmed to room temperature over 30 minutes and stirred for a further half hour. It was cooled to 0°C by ice/water and evaporated at that temperature on the vacuum line via a cold trap to give an off white solid, 2-chloro-1,3-dithiane. Dry THF (25ml) was added, followed by triethyl phosphite (1.7g, 1.75ml, 10mmol) and the mixture stirred at room temperature for three hours. All volatiles were removed on the vacuum line via a cold trap. Dry THF (25ml) was added and the solution cooled to -20°C by acetone-cardice. Butyl-lithium (6ml of 1.64M in pentanes) was added and the solution developed a deep red colour. The solution was warmed to room temperature and stirred for thirty minutes. It was transferred by cannula to a solution of the title diketone (1.6g, 9.9mmol) in THF (25ml) and the mixture stirred overnight. All volatiles were removed by rotavap to yield the crude product, a black tar. It was washed with hexane, in which some material dissolved to give a pale yellow solution which on cooling with acetone-cardice gave dark "crystals" as before, which on reaching room temperature became a gum, insoluble in hexane and which was not further characterised.

#### 28) Reaction of lithium dichloromethide with cyclohexanone.

A mixture of anhydrous THF, ether and 40-60° petrol, 4:1:1 v/v (100ml, Trapp solvent mix) was cooled to -100°C. Dichloromethane (3.8ml, 5g, 60mmol) was added, followed by a pre-cooled (-100°C) solution of butyl-lithium (25.5ml of 2M, in pentanes) in petrol (25ml), added by cannula. The exotherm was comparatively mild, because of the pre-cooling of the base. The solution was stirred for 45 minutes at -105° to -95°C. Cyclohexanone (5g, 5.3ml, 51mmol) in ether (30ml) was pre-cooled and added by cannula and the mixture stirred for a further 2 hours at the same temperature. Chlorotrimethylsilane (6.5ml, 5.8g, 54mmol) was added and the mixture left to warm overnight. The solvent was removed by rotavap and the residue vac transferred and submitted for GC/MS. Two vac transfer fractions were collected; one coming over at or

below room temperature and the other requiring some heat to drive it across (vacuum 0.01mbar.) GC/MS indicated that the higher boiling fraction was almost pure 1-dichloromethylcyclohexan-1-ol trimethylsilyl ether, (8.5g, 70%) a colourless liquid. Required for  $C_{10}H_{20}SiCl_2$ : C 50.20%, H 8.43%, Cl 29.64%; found C 49.93%, H 8.32%, Cl 29.25%. A white precipitate recovered from the flask was shown to be lithium chloride by flame test and analysis for chlorine, produced in theoretical yield. The mass spectrum is shown in figure A2.35a.

29) Reaction of lithium dichloromethide with 2,6-dimethylcyclohexanone.

The reaction was conducted as for the above preparation with cyclohexanone, but using 7ml, 6.4g, 51mmol of freshly dried and vac transferred 2,6-dimethylcyclohexanone. GC/MS on the product distillate showed a very complex mixture having over forty components. No 1,2-addition to the carbonyl had taken place, but there was evidence from the mass spectrum of one of the GC fractions that deprotonation at the  $\alpha$ -carbon had occurred, with the subsequent formation of the trimethylsilyl enol ether of 2,6-dimethylcyclohexanone. The mass spectrum appears in figure A2.35b.

30) Reaction of lithium dichloromethide with benzoquinone.

The quantities of reagents used to generate the nucleophile were as before in the previous syntheses, but the lithium dichloromethide was transferred by cannula to benzoquinone (5.5g) in Trapp solvent mix (120ml) at  $-100^\circ\text{C}$ . Instantaneously, a deep blue colour appeared. After stirring for two hours at  $-100^\circ\text{C}$ , the solution was allowed to warm to  $-70^\circ\text{C}$  and chlorotrimethylsilane (6.5ml) was added. The blue colour was discharged as the solution warmed above  $-30^\circ\text{C}$ . The precipitate of lithium chloride was filtered off, the solvent removed by rotavap and the residue vac transferred and submitted for GC/MS. A complex mixture was seen, in which there was evidence for the formation of an addition product, but it was clear from the GC trace that isolating it was going to be impossible. The loss of a mass fragment of 83 ( $\text{CHCl}_2$ ) suggests by

analogy with section 28 that the 1,2-addition product was formed rather than the 1,4-, and this would be consistent with the low temperature of the addition favouring the kinetic rather than thermodynamic product. The mass spectrum and GC trace are shown in figure A2.36.

### 31) Hydrogenation of 3,5-ditertbutyl-4-hydroxybenzoic acid.

Ten attempts were made at reducing this compound. It was discovered that the reason for the failure of most of the reactions was contamination of the hydrogen cylinder with synthesis gas, which made it impossible to reduce phenol even under forcing conditions. When the high pressure plumbing had been thoroughly purged and parts of it replaced, a new hydrogen cylinder permitted the ready reduction of phenol. The successful experiment described below was made following these changes and the conditions reported assume a satisfactory source of hydrogen and high pressure plumbing of good quality.

The title compound was twice recrystallised from ethanol to remove trace impurities which had been shown by previous experiments to inhibit the catalyst, material used "as received" or after only one recrystallisation having failed to undergo reduction. The twice recrystallised material (7.5g, 30mmol) was dissolved in isopropanol (100ml) and 5% rhodium on alumina (1g) was added. The mixture was introduced into a 150ml autoclave and hydrogenated with vigorous stirring by a Magnadrive sealed stirrer unit at 143bar and 100°C for 48 hours. It should be noted that no uptake of hydrogen occurred at 125bar at this temperature. The solution was filtered and the catalyst disposed of whilst wetted with water. The filtrate was evaporated and the product recrystallised from hexane-ether to give 3,5-ditertbutyl-4-hydroxycyclohexane-carboxylic acid as a mixture of isomers in which the *cis*- predominated (7.5g, 98%) m.p. 192.8-193.2°C. Calculated for C<sub>15</sub>H<sub>28</sub>O<sub>3</sub>: C 70.27%, H 11.01%; Accurate mass calculated (m/e) 256.203844956; found C 70.45%, H 11.11%, found (m/e) 257.20662, calculated for self-protonated ion C<sub>15</sub>H<sub>29</sub>O<sub>3</sub><sup>+</sup> 257.21167008. The nmr spectra appear in

chapter 4. The infra-red and mass spectra are shown in figure A2.37.

## 32) Preparation of Diels-Alder adducts.

### 32.1) Adducts of benzoquinone.

#### a) With cyclopentadiene.

The 1:1 and 1:2 adducts of benzoquinone with cyclopentadiene were prepared by the method of Albrecht<sup>[225]</sup>.

Thus for the 1:1 adduct, benzoquinone (10.8g, 0.1mol) was dissolved in methanol (150ml) and freshly distilled cyclopentadiene (8.25ml, 6.6g, 0.1mol) was added. The mixture was left under magnetic stirring for two days. The solvent was evaporated and the crystalline mass recrystallised from 40-60° petrol to yield the desired product, *endo-cis*-tricyclo[6.2.1.0<sup>2,7</sup>]undeca-4,9-dien-3,6-dione, (12.5g, 72%.) The nmr spectra of this compound appear in chapter 5 section 6.

The 1:2 adduct was prepared by adding benzoquinone (54g, 0.5mol) to ethanol (1.5l) cooled by ice/water, and adding freshly distilled cyclopentadiene (66g, 82ml, 1mol.) The solution was stirred mechanically under nitrogen for two days. The quinone rapidly dissolved and the solution became brown. The crystals formed were filtered off, the filtrate reduced to one quarter of its original volume, and a further quantity of crystals filtered off. Water (100ml) was added to the filtrate and the mixture left overnight for another crop of crystals to form. The crude material (105g, 87%) was recrystallised from ethanol under nitrogen. M.p. 153-4°C, lit<sup>[236]</sup> 155°C. The proton and carbon nmr spectra appear in figure A2.38.

#### b) With 1,3-butadiene.

The 1:1 adduct of benzoquinone with 1,3-butadiene was prepared by the method of van Tamelen *et al*<sup>[237]</sup>. Thus, benzoquinone (25g, 0.23mol) was added to toluene (175ml) in a glass pressure vessel and 1,3-butadiene (15.5g, 25ml, 0.29mmol) was added by vacuum transfer at liquid air temperature. The vessel was sealed under vacuum whilst

the contents were solid and allowed to warm to room temperature behind a safety screen. Thereafter it was shaken once a day for three weeks. The benzoquinone gradually dissolved. The solution was filtered, the solvent removed by rotary evaporation below 40°C and the solid recrystallised three times from 40-60°C petrol to yield pale yellow crystals of *endo-cis*-bicyclo[4.4.0]deca-3,8-dien-2,5-dione, (21g, 56%.) The nmr spectra appear in chapter 5 section 7.

The 1:2 adduct was prepared by the method of Alder and Stein<sup>[238]</sup>, by heating for 24 hours at 100°C a mixture of benzoquinone (21.6g, 0.2mol) with 1,3-butadiene (29g, 47ml, 0.54mol) in toluene (20ml) in an autoclave which was sealed under vacuum whilst the contents were frozen in liquid air. The reaction produced directly a mass of creamy crystals which were washed from the bomb with the aid of methanol (200ml) and all volatiles removed by rotavap below 40°C. The crude material was soxhlet extracted with ethyl acetate and the solvent removed to give the desired product (30g, 69%), m.p. 153-4°C, lit<sup>[237]</sup> 154-5°C. The nmr spectra appear in figure A2.39.

c) Isomerisation of *endo-cis-anti-endo-cis*-pentacyclo[10.2.1.1<sup>5,8</sup>.0<sup>2,11</sup>.0<sup>4,9</sup>]-hexadeca-6,13-dien-3,10-dione. The isomerisation was performed according to Alder and Stein's method<sup>[239]</sup>. The title compound (10g, 40mmol) was refluxed in ethanol (100ml) containing 50ml of 15wt% aqueous potassium hydroxide under nitrogen for 30 minutes. The solution was filtered when cold, the crystals washed with water and decolourised with charcoal/ethanol. The *endo-cis-anti-exo-cis*- isomer (6g, 60%) was obtained as colourless crystals, m.p. 185-186°C, lit<sup>[239]</sup> 186°C.

32.2) Preparation of mixed *endo-cis*- and *exo-cis*- isomers of tricyclo[6.2.1.0<sup>2,7</sup>]undeca-4,9-diene.

This mixture of isomers was prepared by the method of Alder *et al*<sup>[240]</sup>. Thus, bicyclo[2.2.1]hepta-2,5-diene (68g, 75ml, 0.74mol) was heated in a 150ml bomb with 1,3-butadiene (20g, 32ml, 0.37mol) at 140°C for 24 hours. The product mixture was

filtered and excess bicyclo[2.2.1]hepta-2,5-diene was removed by rotavap. The residue was flash distilled and fractionated on a Fischer Spaltrohr column, to give the title compound, (17.6g, 35% on the 1,3-butadiene) b.p. 70.4-70.8°C @ 11mmHg. The nmr spectra of this mixture of isomers appear in chapter 5 section 1. The relative proportions of the isomers were best estimated by integration of the nmr spectral data and suggest a 6:1 ratio of *exo-cis*- to *endo-cis*-. The infra-red spectrum is shown in figure A2.40.

### 32.3) Preparation of *endo-cis*-6,6-dimethoxytricyclo[6.2.1.0<sup>2,7</sup>]undeca-4,9-dien-3-one.

This compound was prepared by the method of Fariña *et al*<sup>[194]</sup>. Thus, 4,4-dimethoxycyclohexa-2,5-dienone (1g, 6.5mmol) was added to ethanol (10ml) and freshly distilled cyclopentadiene (1.1ml, 0.9g, 13.6mmol) was added. The mixture was stirred overnight, the volatiles removed by rotavap at ambient temperature and the residue pumped on the vacuum line for two hours. The residual oil was taken up in ether (3ml) and kept in the freezer overnight, yielding yellowish crystals which were recrystallised from cold pentane to give white crystals of the title compound, (1.1g, 76%.) The nmr spectra of this compound appear in chapter 5, section 2. This reaction was found to be unpredictable for reasons which were never elucidated and it is unwise to attempt scaling it up beyond the 5g scale.

### 33) Photocyclisation reactions of some Diels-Alder adducts.

a) Photocyclisation of *endo-cis*-6,6-dimethoxytricyclo[6.2.1.0<sup>2,7</sup>]undeca-4,9-dien-3-one. The title compound (600mg, 2.7mmol) was dissolved in pentane (100ml) and irradiated in a water-cooled quartz tube under nitrogen overnight with a 60W medium pressure mercury vapour lamp with most of its output at 254nm. The pale precipitate formed was filtered off and discarded and the filtrate evaporated to yield an oil which was pumped on the vacuum line and twice recrystallised from cold 40-60° petrol (AR grade) to yield the desired product, 8,8-dimethoxypentacyclo[8.1.0<sup>1,5</sup>.0<sup>2,9</sup>.0<sup>4,7</sup>.0<sup>6,10</sup>]-



undecan-3-one, (500mg, 83%), as white crystals. Calculated for  $C_{13}H_{16}O_3$ : C 70.89%, H 7.32%; accurate mass calculated (m/e) 220.109944512; found C 70.67%, H 7.22%, accurate mass (m/e) 220.10776. The nmr spectra appear in chapter 5 section 3. The infra-red and mass spectra are shown in figure A2.41.

b) Photocyclisation of *endo-cis*-tricyclo[6.2.1.0<sup>2,7</sup>]undeca-4,9-dien-3,6-dione.

The title compound (750mg, 4.3mmol) was dissolved in pentane (120ml) and irradiated in a water-cooled quartz tube under nitrogen overnight with a 60W medium pressure mercury vapour lamp with most of its output at 254nm. The pale precipitate formed was filtered off and discarded and the filtrate evaporated to yield yellowish crystals which were twice recrystallised from cold 40-60° petrol (AR grade) to yield the title compound (220mg, 29%). Required for  $C_{11}H_{10}O_2$ : C 75.84%, H 5.79%; found C 75.74%, H 5.64%. The nmr spectra appear in chapter 5 section 5. The compound has been previously prepared<sup>[241]</sup>.

34) Attempted esterification of 3,5-ditertbutyl-4-hydroxycyclohexanecarboxylic acid

The title compound (1g, 3.9mmol) was refluxed under nitrogen in pyridine (25ml, dried over potassium hydroxide and freshly distilled) with benzoyl chloride (freshly vacuum transferred, 0.55g, 0.45ml, 3.9mmol) for 24 hours. The volatiles were removed by rotavap (vacuum line pressure via a large cold trap) and the crude material examined by TLC (silica, ether:petrol 1:4) which showed no signs of product formation.

35) Preparation of vinyl *E,E*-hexa-2,4-dienoate.

The title compound is known<sup>[242]</sup> but the following is felt to be a more convenient preparation. *E,E*-Hexa-2,4-dienoic acid (27g, 0.24mol) was dissolved in vinyl acetate (130ml, 121g, 1.4mol) containing mercury (II) acetate (1g, 3mmol) and 100% sulphuric acid (0.1ml, 0.18g, 1.8mmol, prepared from oleum and concentrated sulphuric acid) was cautiously added. A brown colour was produced. The solution was vigorously

stirred and refluxed for five hours. The mixture was filtered, and powdered sodium acetate trihydrate (0.51g, 3.7mmol) was added with stirring. The excess vinyl acetate was removed by rotavap and the residue given a flash distillation prior to being fractionated on a Fischer Spaltrohr column; the distillation flask contained 2,6-ditertbutylparacresol as a radical polymerisation inhibitor. Vinyl *E,E*-hexa-2,4-dienoate (25g, 75%) was obtained as a colourless liquid with a pungent aniseed-like smell, b.p. 73-5°C @ 20mmHg. The proton and carbon nmr spectra appear in figure A2.42, the COSY and HETCOR spectra are shown in figure A2.43 and the infra-red and mass spectra appear in figure A2.44.

36) Attempted Diels-Alder polymerisation of vinyl *E,E*-hexa-2,4-dienoate.

The title compound (1g, 7.2mmol) was placed in a Carius tube (15cm x 15mm) with toluene (2.5ml) and 2,6-ditertbutylparacresol (50mg) as a radical polymerisation inhibitor. The tube was heated in a furnace at 200°C for four days. The contents were poured into methanol (100ml) and the product filtered off and dried *in vacuo*. Yield 0.2g, 20% on the expected Diels-Alder polymer. NMR indicated that the product did not have the anticipated structure, see figure A2.45. Other reactions were tried at lower temperatures and for shorter times without improving on this result. At 225°C, the tubes exploded, other conditions remaining the same.

37) Attempted allylic oxidations of tricyclo[6.2.1.0<sup>2,7</sup>]undeca-4,9-diene (mixture of isomers.)

a) Sodium chromate tetrahydrate (9.36g, 40mmol) was dissolved in glacial acetic acid (120ml) containing acetic anhydride (15ml) and the mixture was cooled in ice-water. The title compound (2.92g, 20mmol) was added and the mixture stirred overnight. The solution was diluted with water (500ml), neutralised by the addition of solid sodium bicarbonate, extracted with ether (200ml), the ether extract washed with water (2x 50ml) dried over magnesium sulphate and evaporated to yield an orange

gum, 1.5g. The proton and carbon nmr spectra are shown in figure A2.46. The infra-red spectrum (figure A2.47) showed a carbonyl absorption at  $1735\text{cm}^{-1}$  which is inconsistent with the expected enone.

b) The title compound (5g, 34mmol) was added to ethanol (160ml) and selenium dioxide (7.6g, 68mmol) in water (10ml) was added. The mixture was refluxed overnight, the solution filtered and evaporated. The residue was agitated in ether which dissolved only a portion, leaving lumps of insoluble gum. The ether solution was washed with saturated sodium bicarbonate solution (3x 150ml) dried over magnesium sulphate and evaporated to give a yield of crude material of 5.4g. The proton and carbon nmr spectra (figure A2.48) demonstrated that it was not the desired enone.

## Appendix 1.

Spectra referred to in Chapter 5.

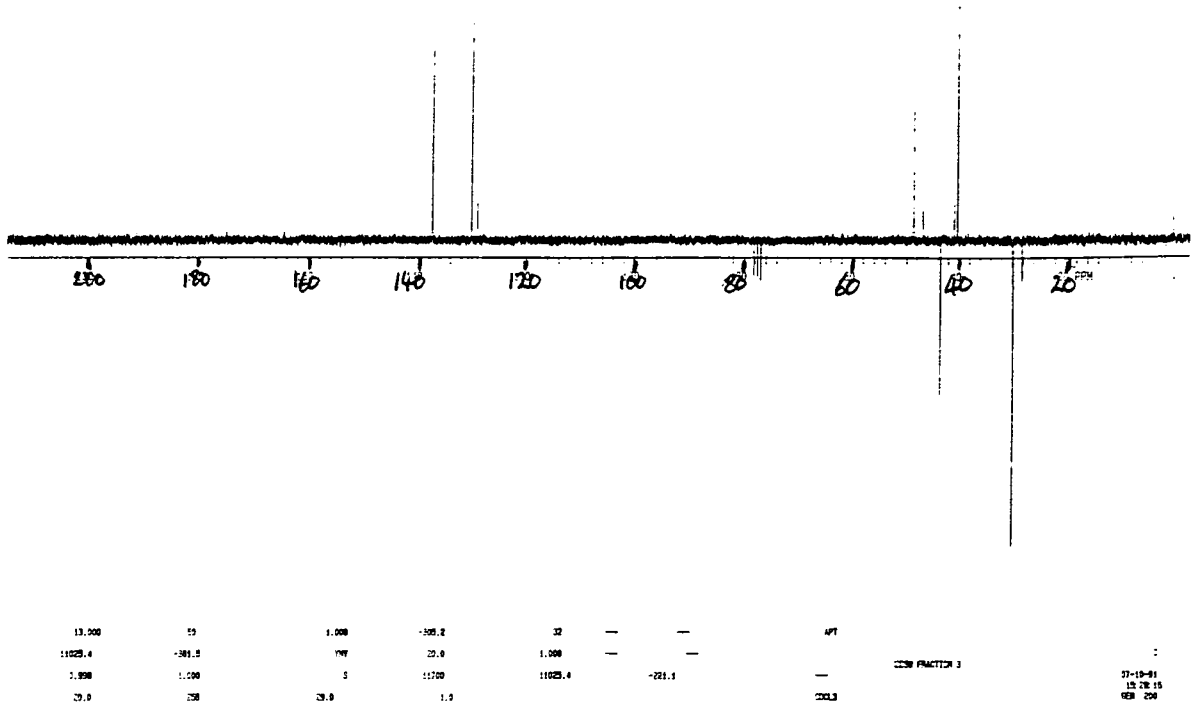

CH CARBONS ONLY

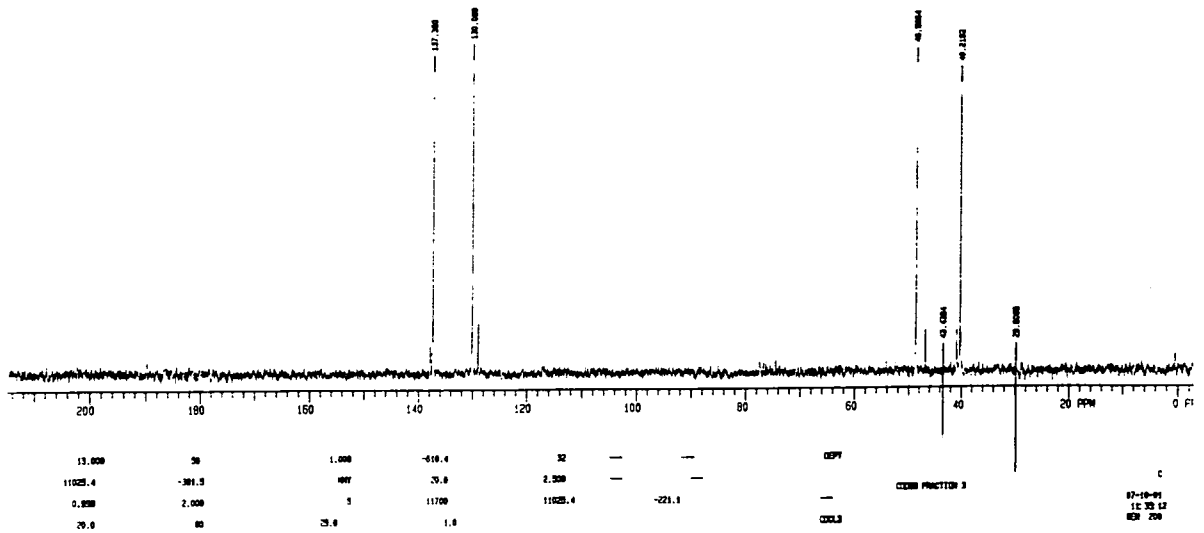

Figure A1.1

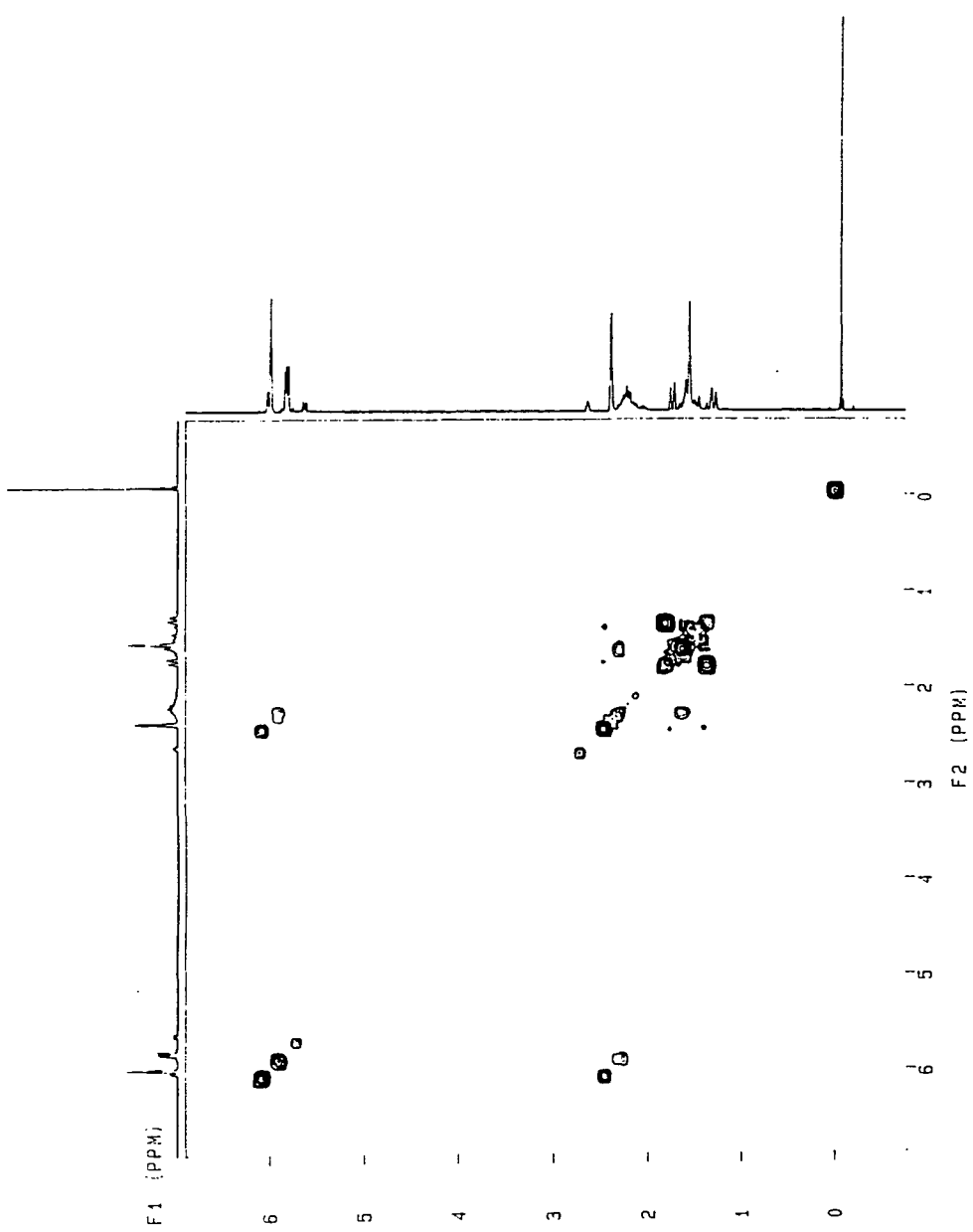

Figure A1.2

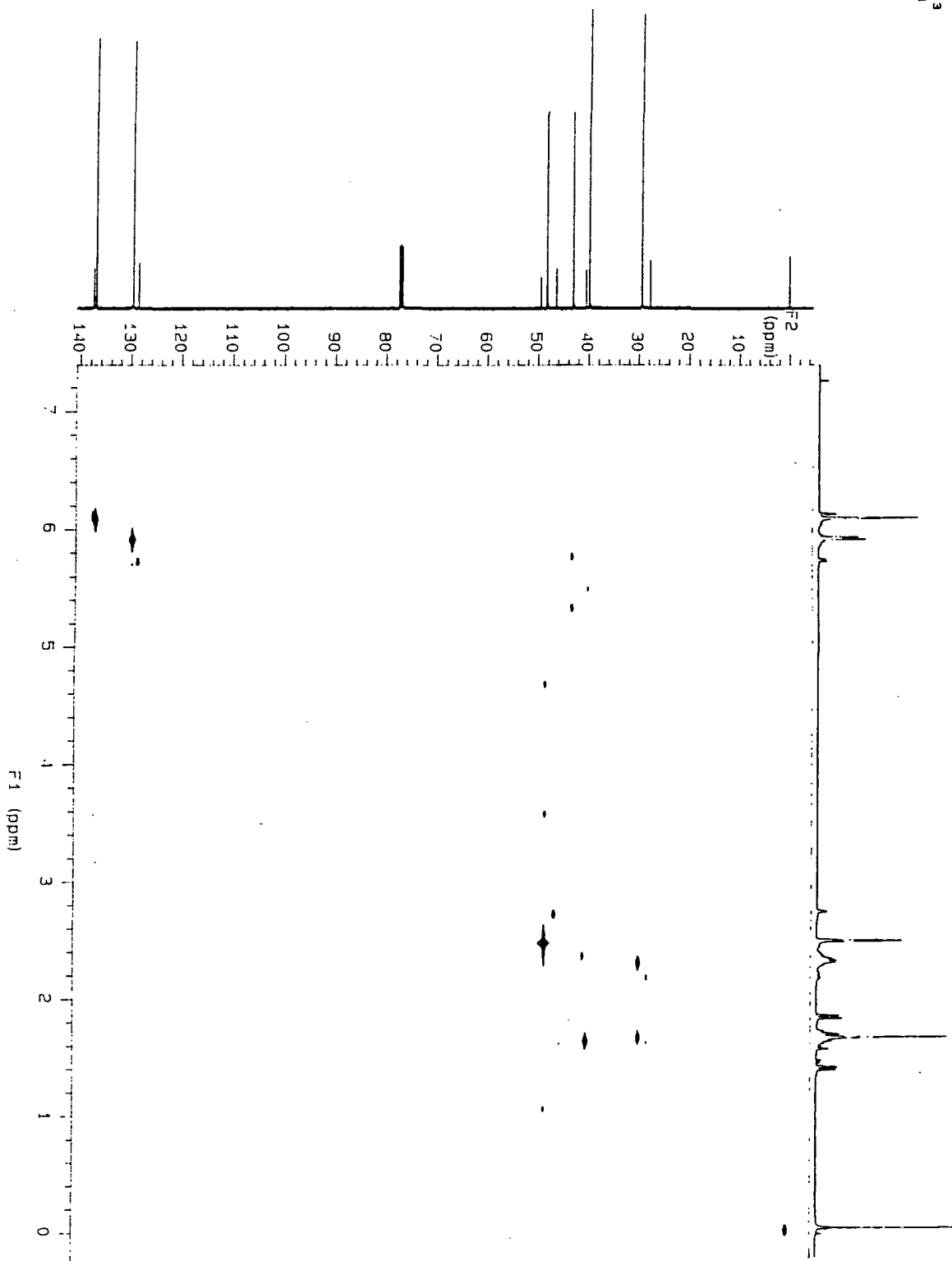

Figure A1.3

CD048  
EXP2 PULSE SEQUENCE: APT  
DATE 07-24-91  
SOLVENT CCL3  
FILE C

APT PULSE SEQUENCE  
OBSERVE CARBON  
FREQUENCY 50.289 MHZ  
SPECTRAL WIDTH 11025.4 HZ  
ACQ. TIME 0.998 SEC  
RELAXATION DELAY 1.0 SEC  
EVOLUTION DELAY 7.0 MSEC  
PULSE WIDTH 90 DEGREES  
FIRST PULSE 180 DEGREES  
AMBIENT TEMPERATURE

NO. REPETITIONS 128

NO. OF CHANNELS 8  
LIM POWER 23.00  
WALTZ-16 MODULATED  
DOUBLE PRECISION ACQUISITION  
DATA PROCESSING  
LINE BROADENING 1.0 HZ  
FT SIZE 32K

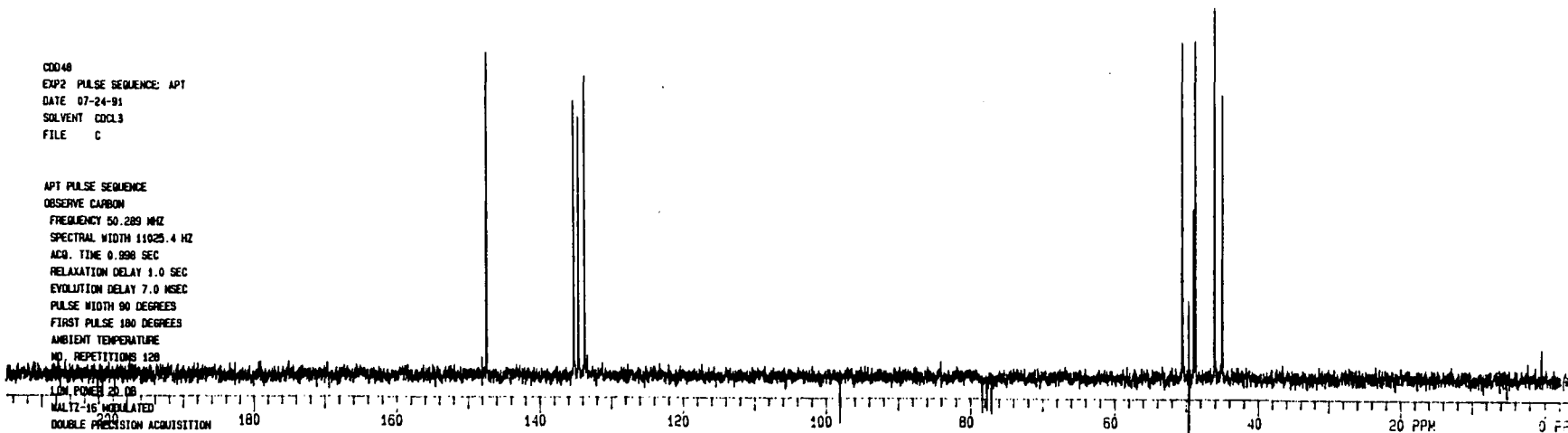

Figure A1.4



00049  
EXP3 PULSE SEQUENCE: DEPT  
DATE 07-24-91  
SOLVENT CDCL3  
FILE C

CH CARBONS ONLY

DEPT PULSE SEQUENCE  
OBSERVE CARBON  
FREQUENCY 50.269 MHz  
SPECTRAL WIDTH 11025.4 HZ  
ACQ. TIME 0.998 SEC  
RELAXATION DELAY 2.0 SEC  
PULSE WIDTH 90 DEGREES  
J 140 HZ  
AMBIENT TEMPERATURE  
NO. REPETITIONS 64  
DECOUPLE PROTON  
LOW POWER 20 DB  
MALTZ-16 MODULATED  
DOUBLE PRECISION ACQUISITION  
DATA PROCESSING  
LINE BROADENING 2.5 HZ  
FT SIZE 32K

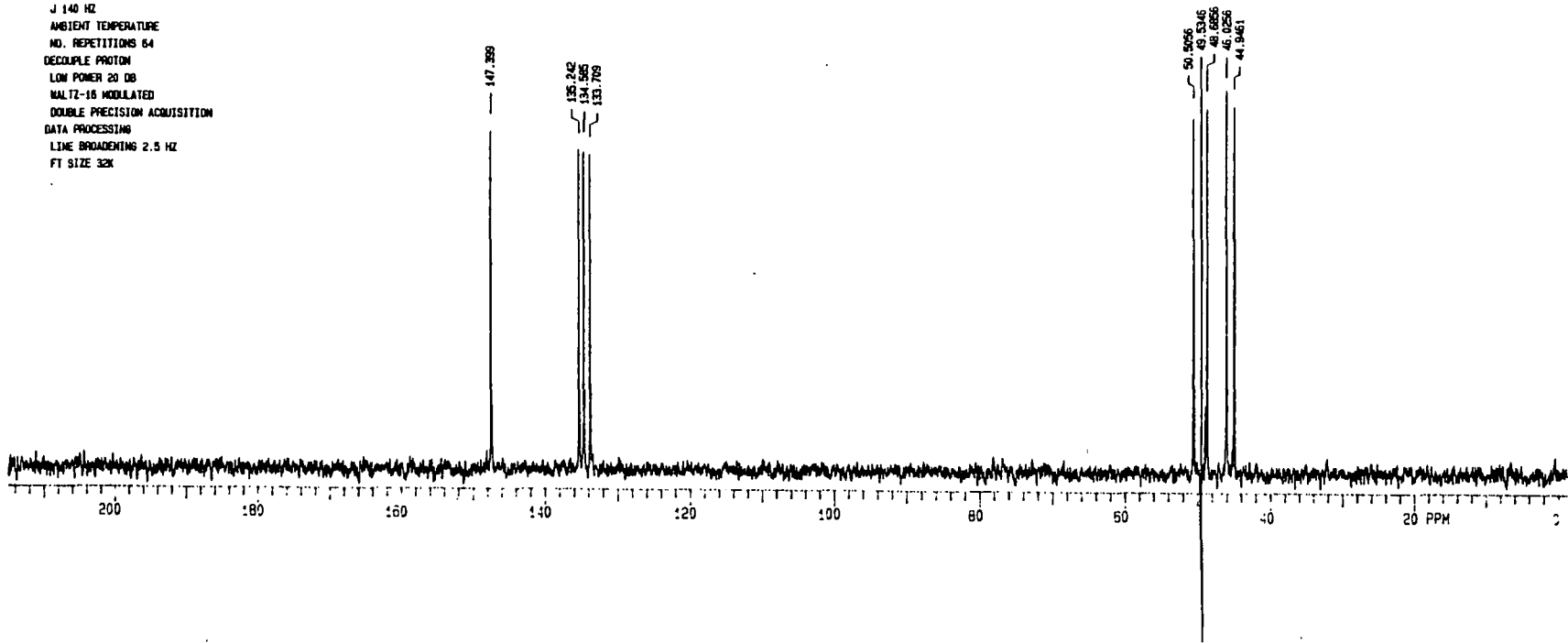
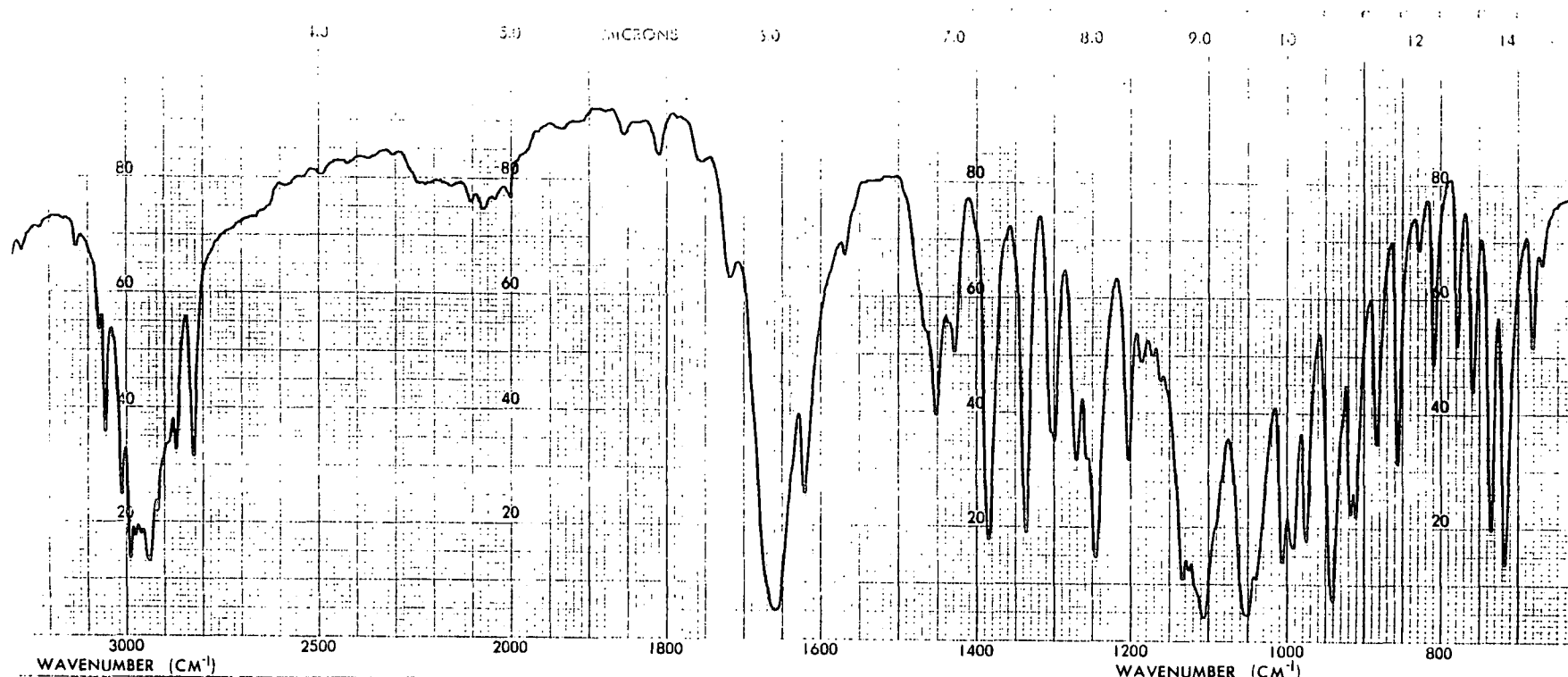
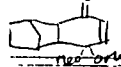

Figure A1.5

Figure A1.6



From Diels-Alder reaction  

SOLVENT \_\_\_\_\_  
 CONCENTRATION KBr DISK  
 CELL PATH \_\_\_\_\_  
 REFERENCE \_\_\_\_\_

REMARKS \_\_\_\_\_

SCAN SPEED 12 cm/s  
 SLIT N  
 No 457-5001

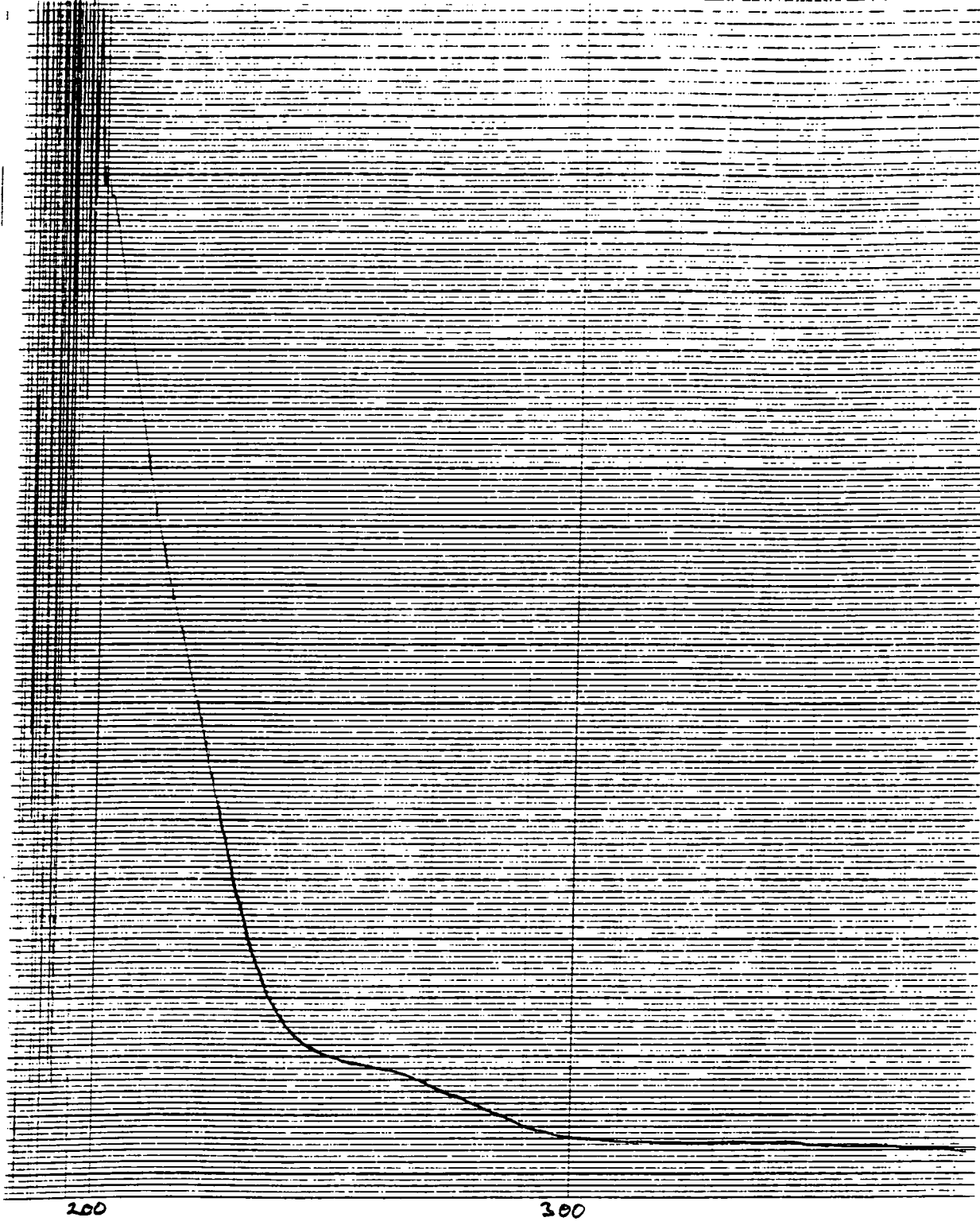

Figure A1.7

C0048  
RUN ON Jul 26 91  
SOLVENT C0C13  
OBSERVE C13

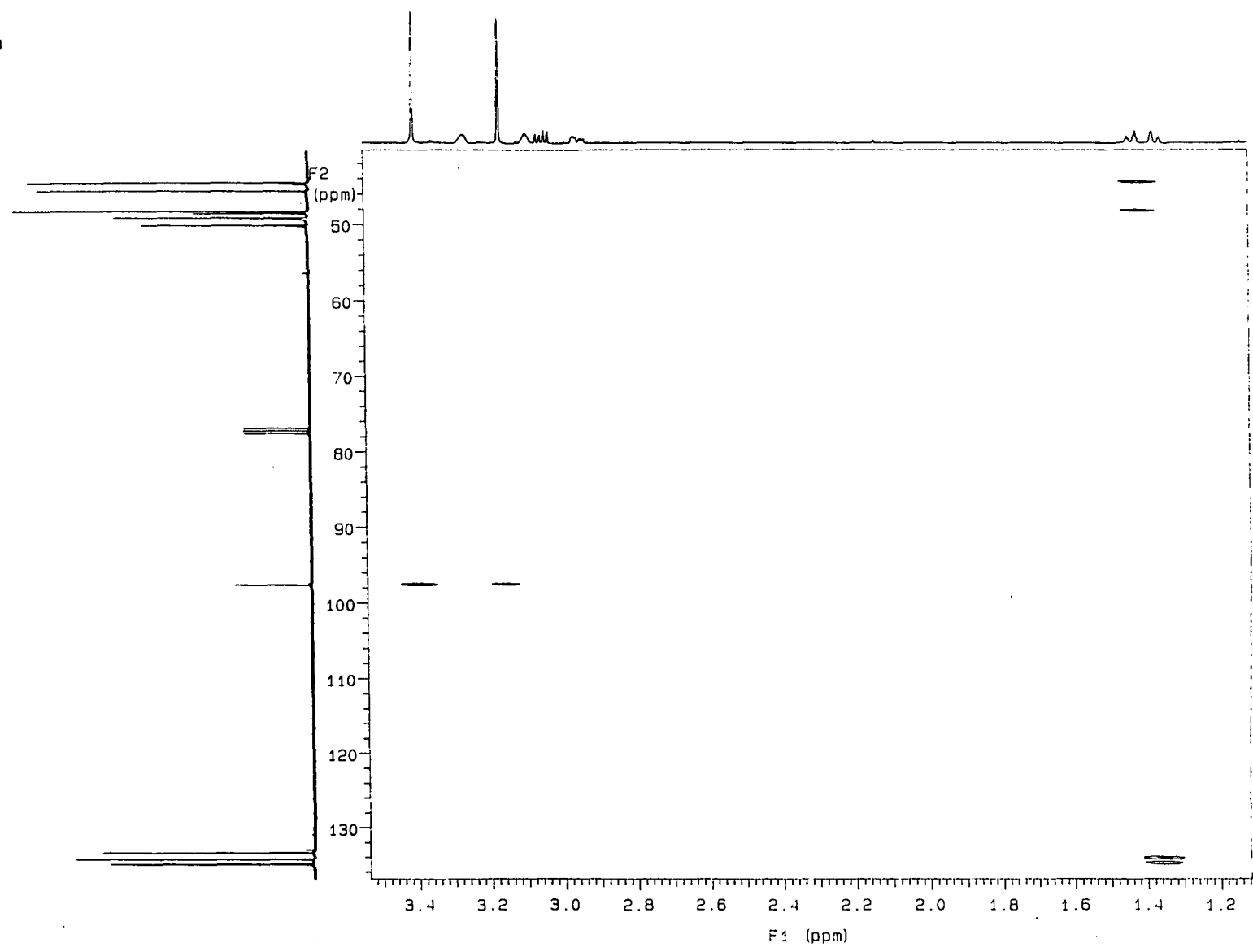

Figure A1.8

CDD 53  
RUN ON 30 SEP 1982  
SOLVENT CDCl3  
OBSERVE C13

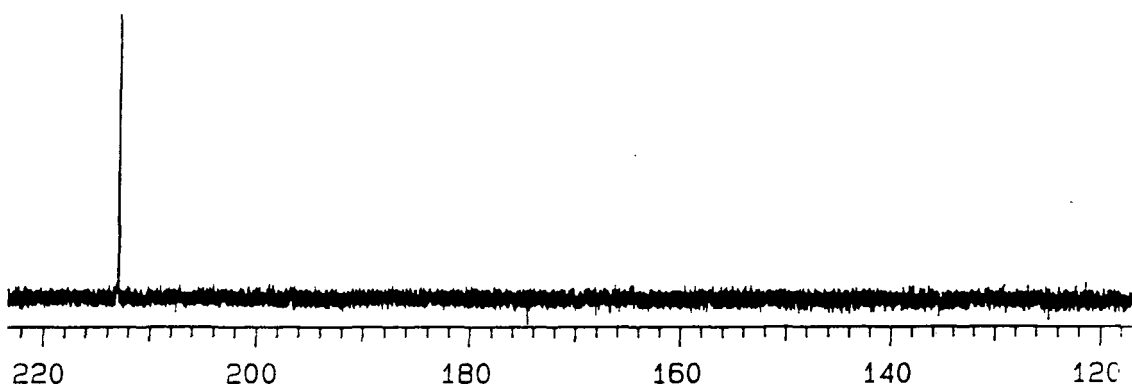
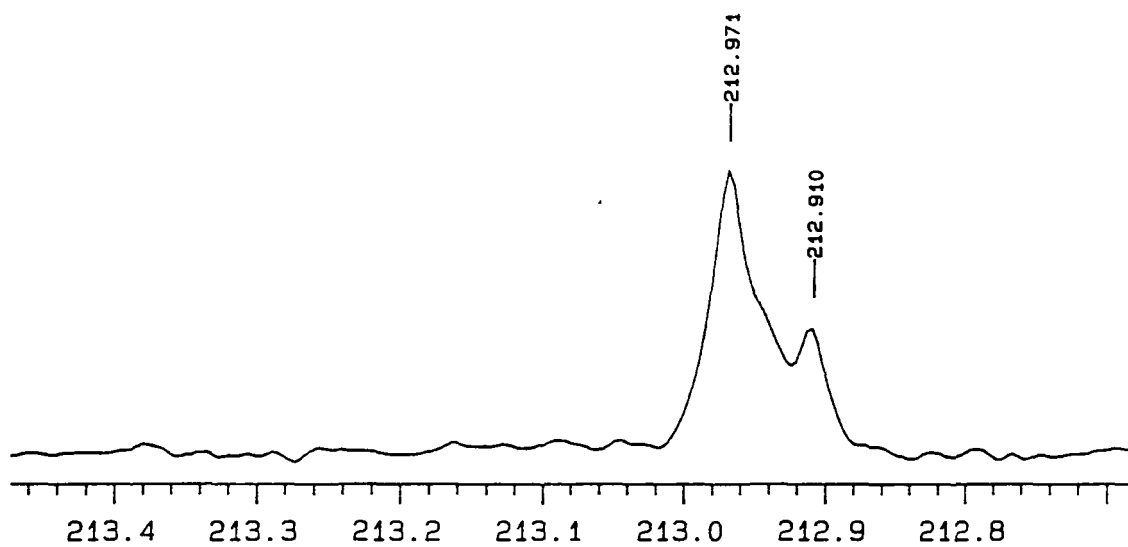

Figure A1.9

COJ-53  
RUN ON JUL 10 90  
SOLVENT CCl3  
OBSERVE C13

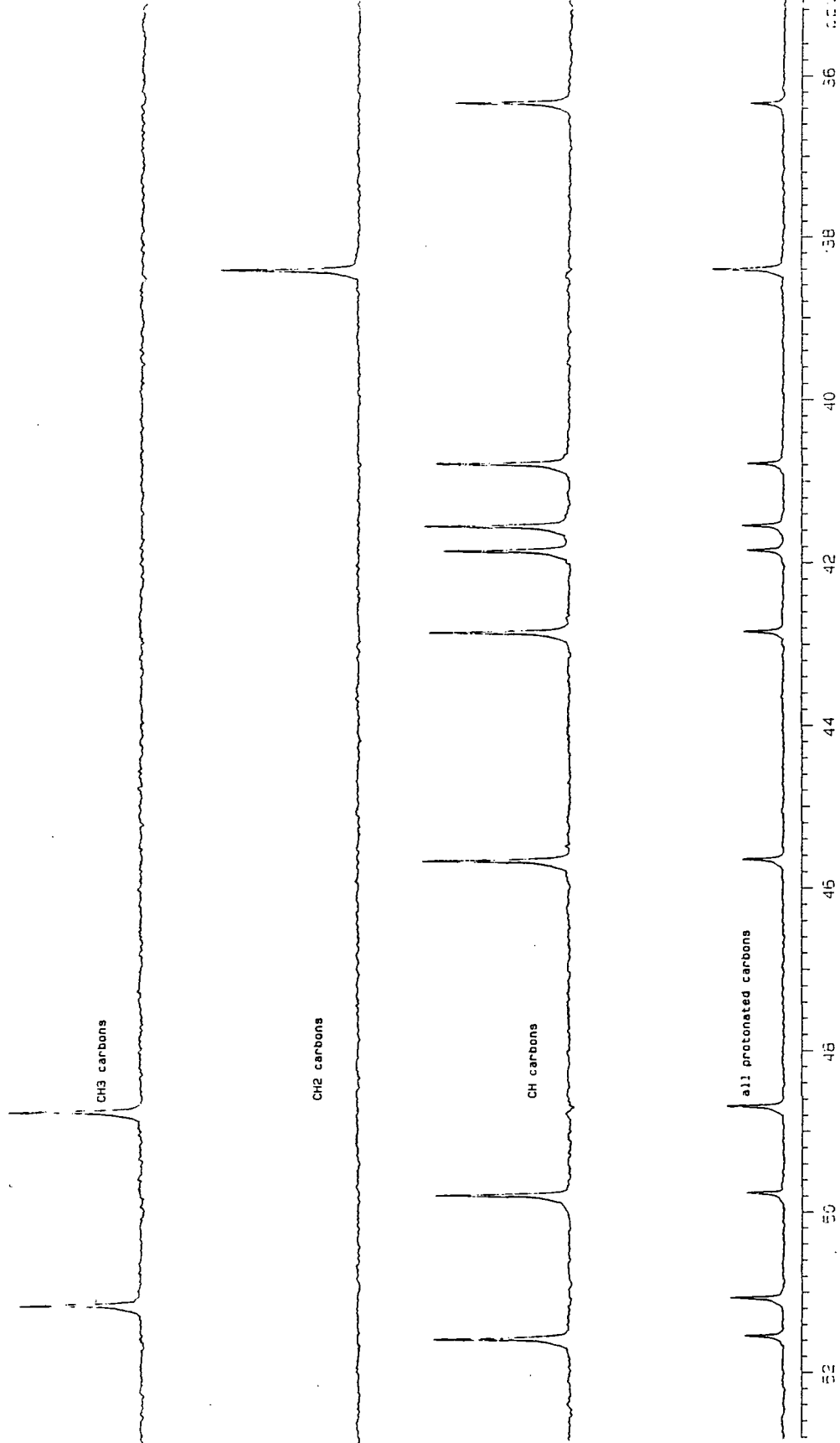

Figure A1.10

CDD-53  
RUN ON Jul 11 90  
SOLVENT CDCl3

Pulse sequence flock J=3Hz - 2 band(?)  
OBSERVE C13

Frequency 100.577 MHz  
Spectral width 19417.5 Hz  
2D Spectral width 896.6 Hz  
Acquisition time 0.053 sec  
Relaxation delay 1.000 sec  
Pulse width 13.5 usec  
Ambient temperature

No. repetitions 256  
No. increments 64  
DECOUPLE H1  
High power 40  
Decoupler gated on during acquisition  
Decoupler gated off during delay  
WALTZ-16 modulated  
Double precision acquisition

DATA PROCESSING  
Sine bell 0.026 sec  
FT size 2048  
F1 DATA PROCESSING  
Sine bell 0.036 sec  
FT size 256  
Total acquisition time 5.0 hours

F1

(ppm)

1.6  
1.8  
2.0  
2.2  
2.4  
2.6  
2.8  
3.0  
3.2  
3.4

56 54 52 50 48 46 44 42 40 38 36

F2 (ppm)

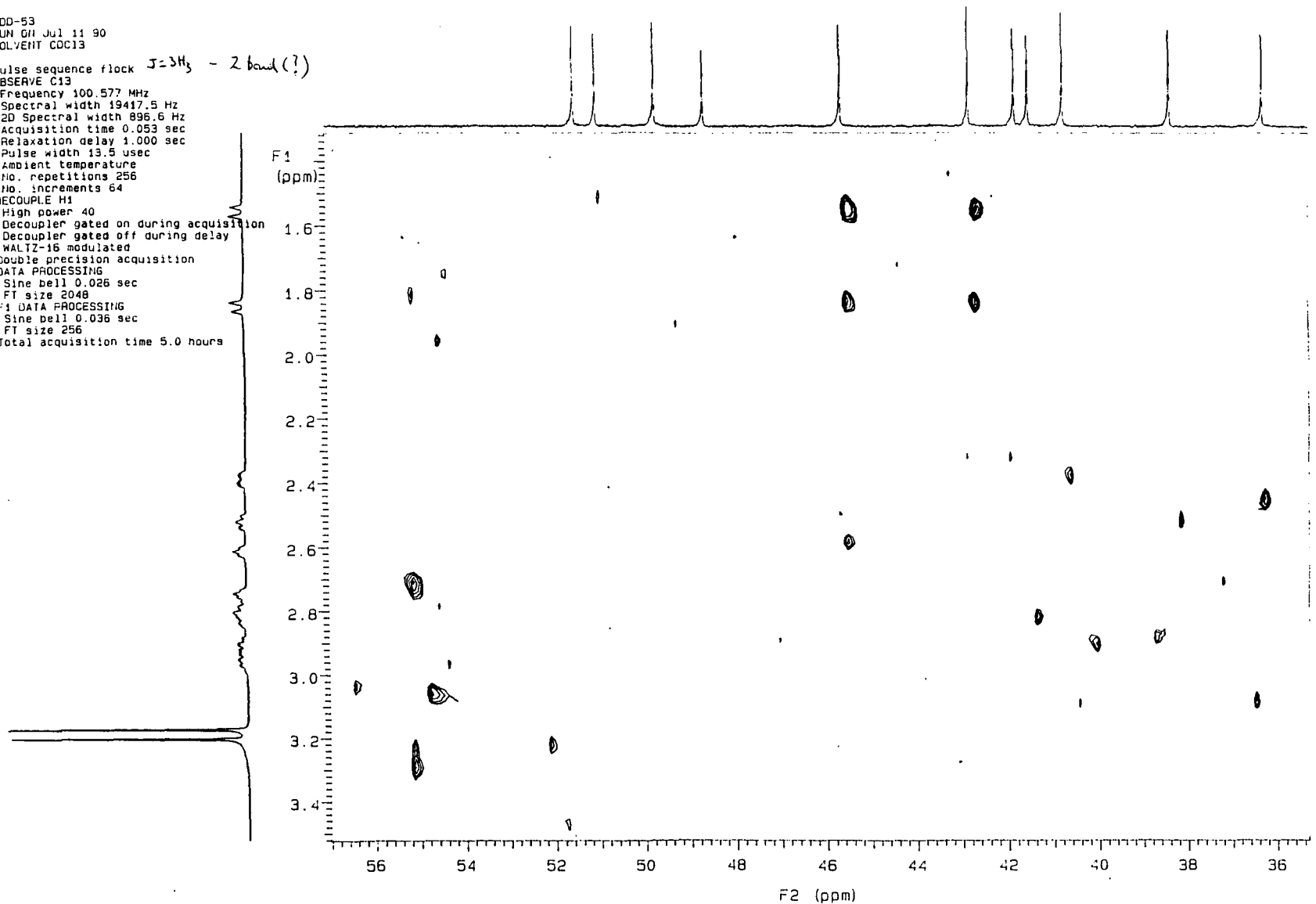
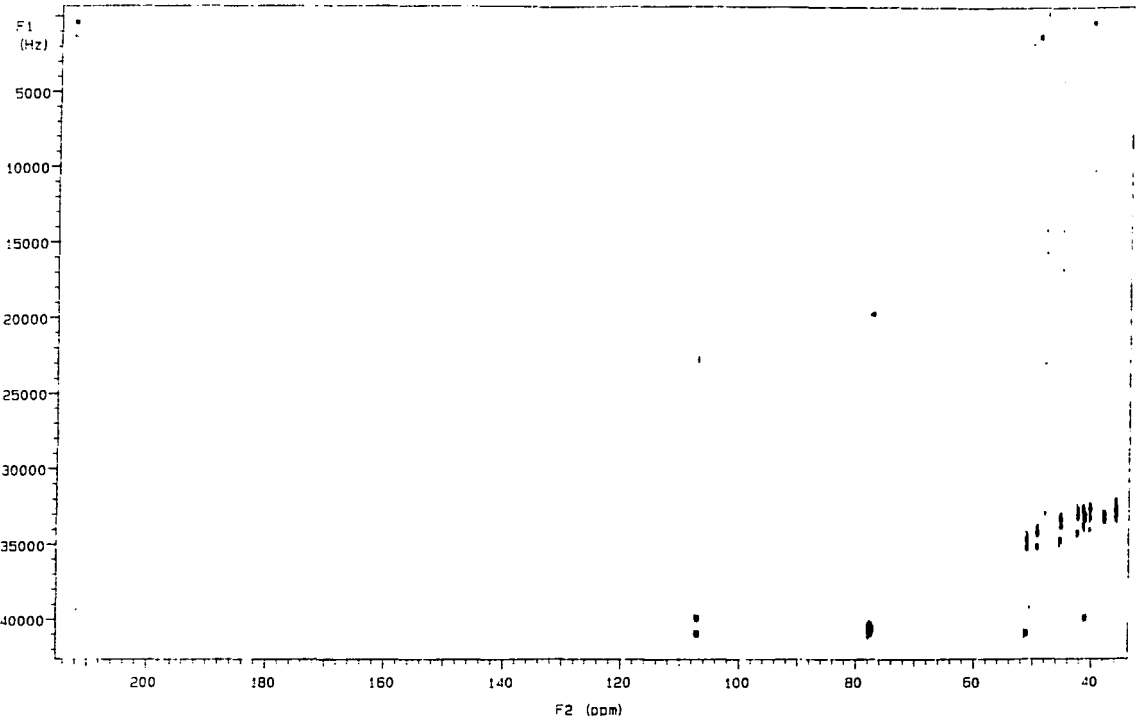

Figure A1.11

CD0 53  
RUN ON Sep 28 90  
SOLVENT CDCl3  
OBSERVE C13



CD0 53  
RUN ON Sep 28 90  
SOLVENT CDCl3  
OBSERVE C13

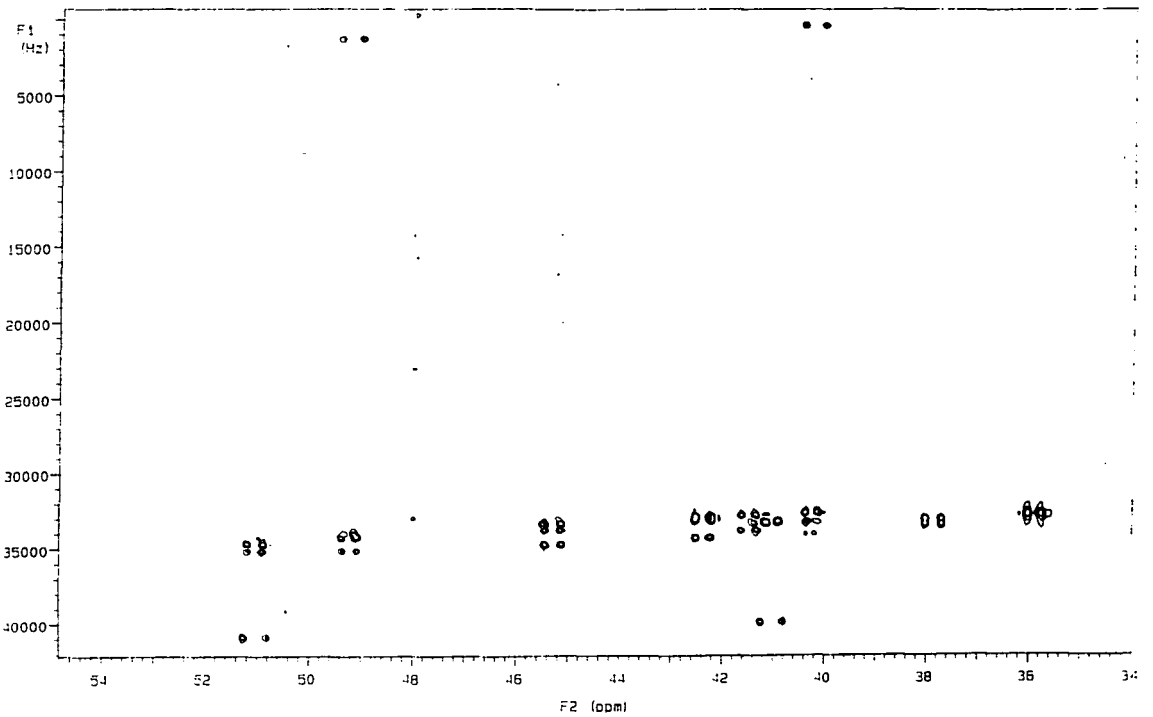

Figure A1.12



CDD 64  
RUN ON AUG 14 91  
SOLVENT CCl<sub>4</sub>  
OBSERVE C13

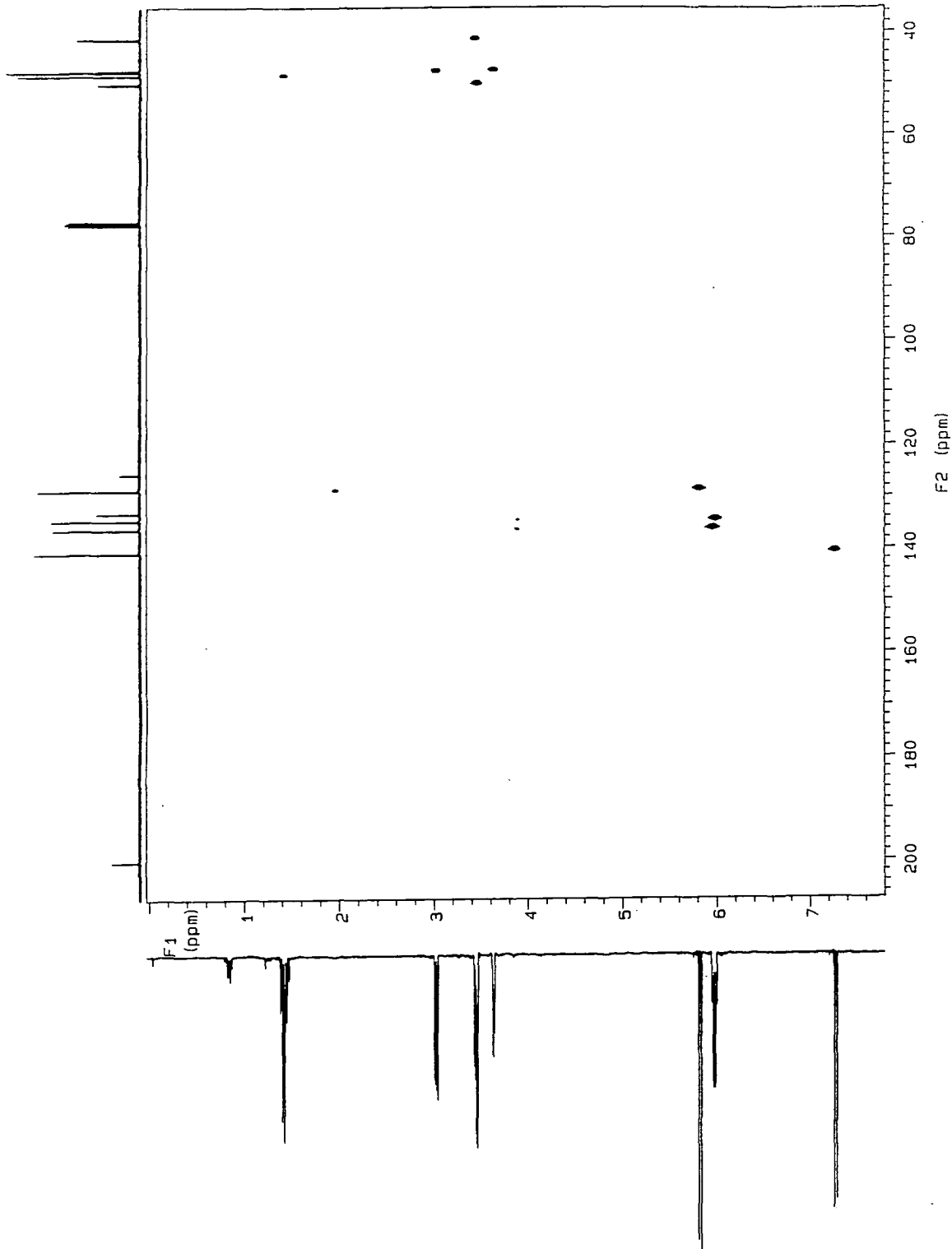

Figure A1.13

COO 59  
RUN ON NOV 11 91  
SOLVENT CDCl3  
OBSERVE C13

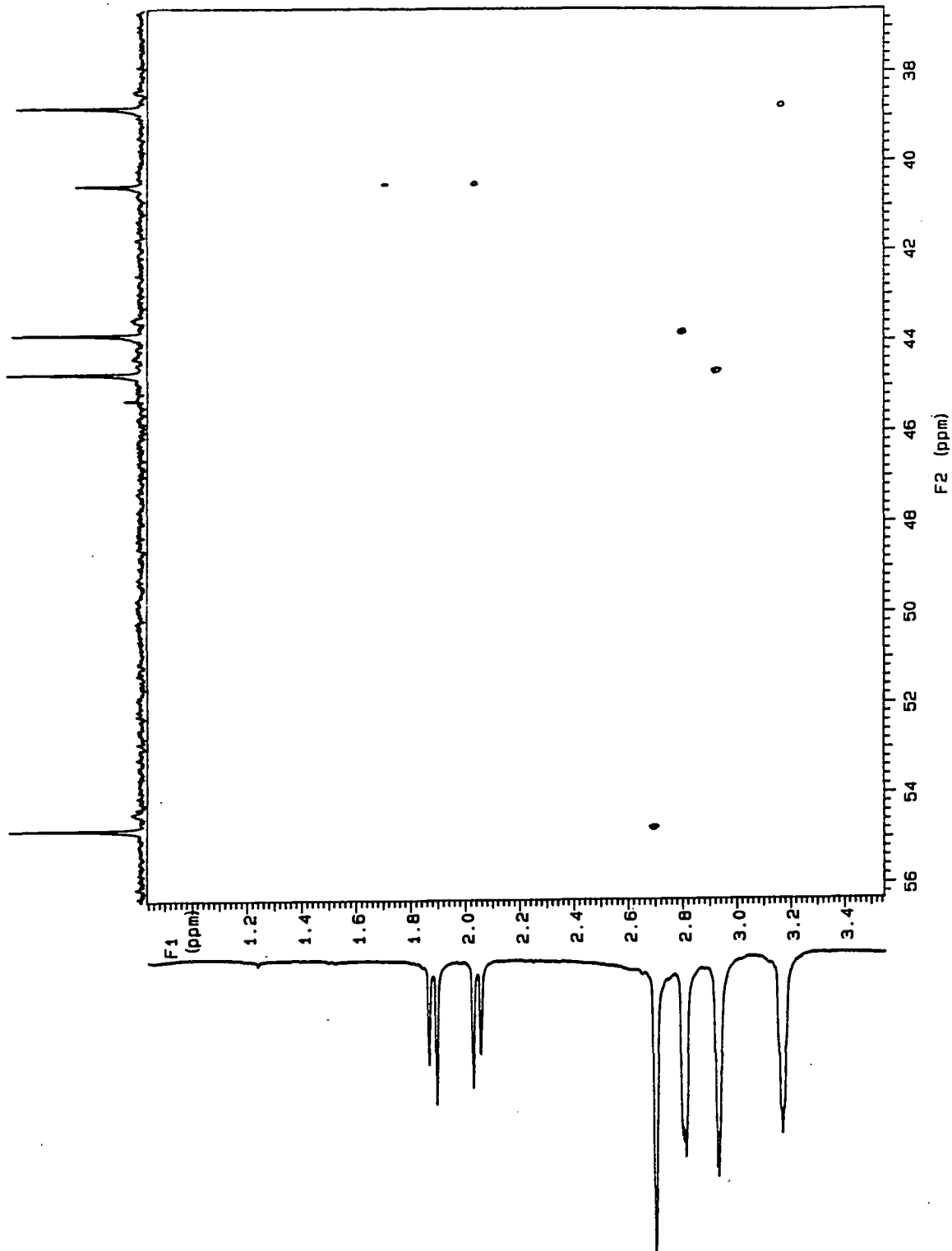

Figure A1.14

COO 58  
RUN ON Nov 18 91  
SOLVENT CDCl3  
OBSERVE C13

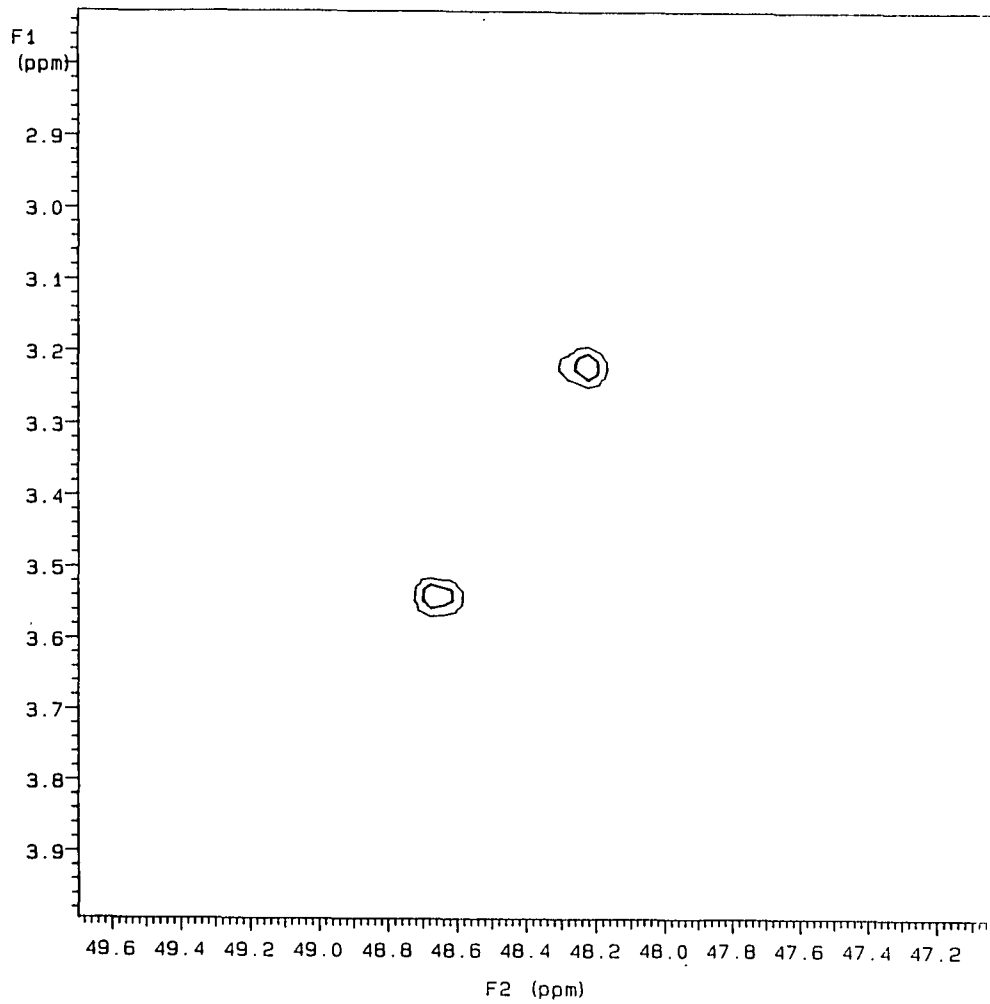

Figure A1.15

CD0 56  
FILM ON Nov 18 91  
SOLVENT CCl3  
OBSERVE C13

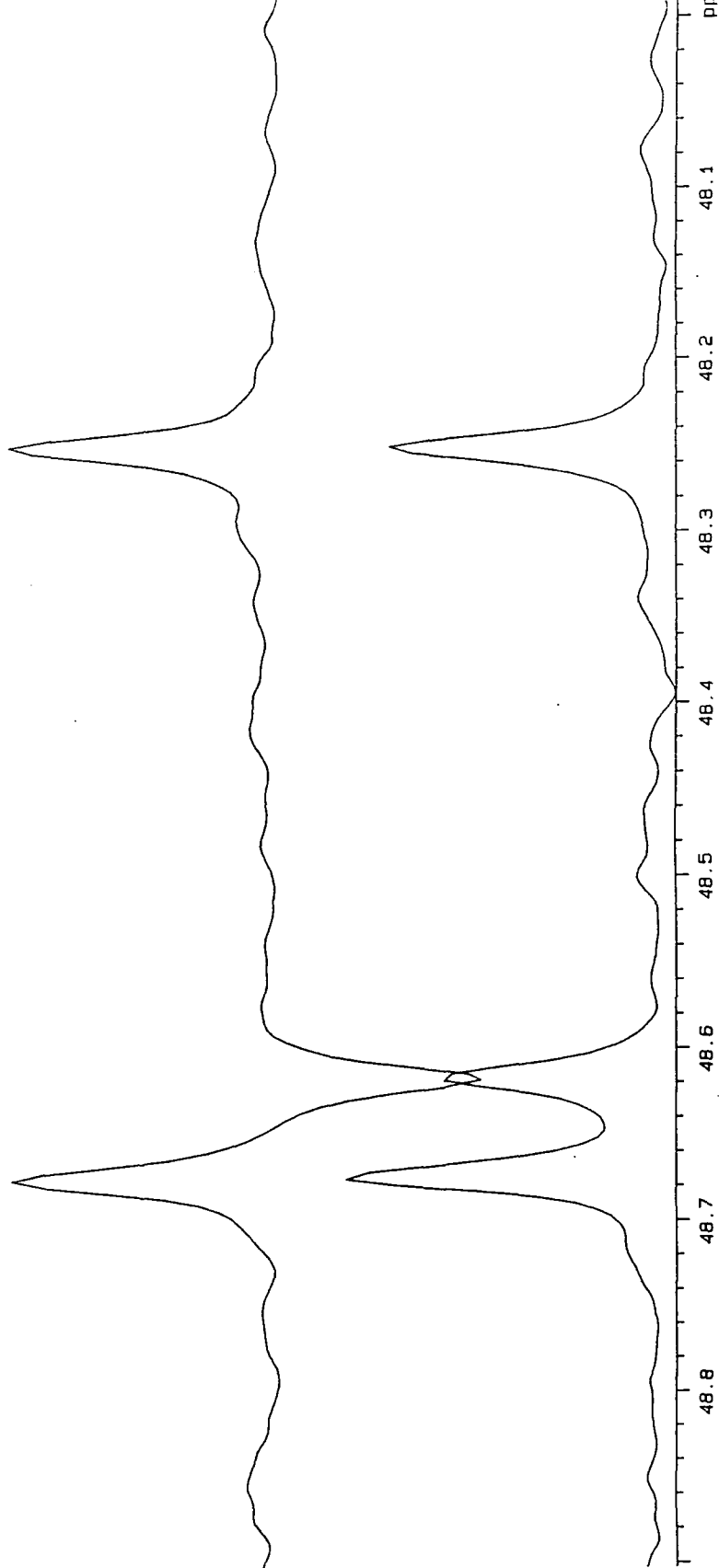

Figure A1.16

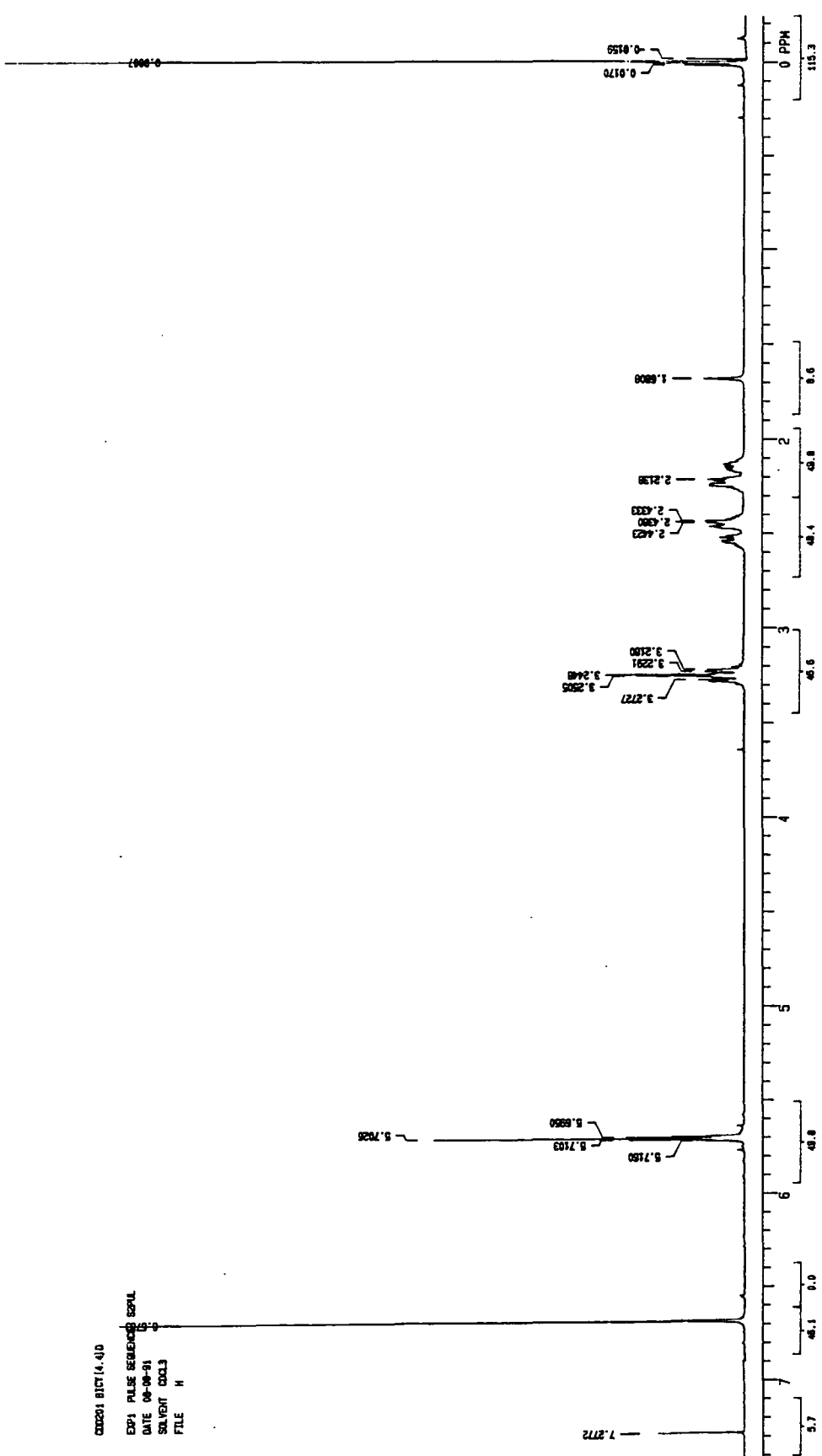

Figure A1.17

000201 81C7(4.410)

EXP2 PULSE SEQUENCE: SEPAL

DATE 06-08-91

SOLVENT CDCL3

FILE C

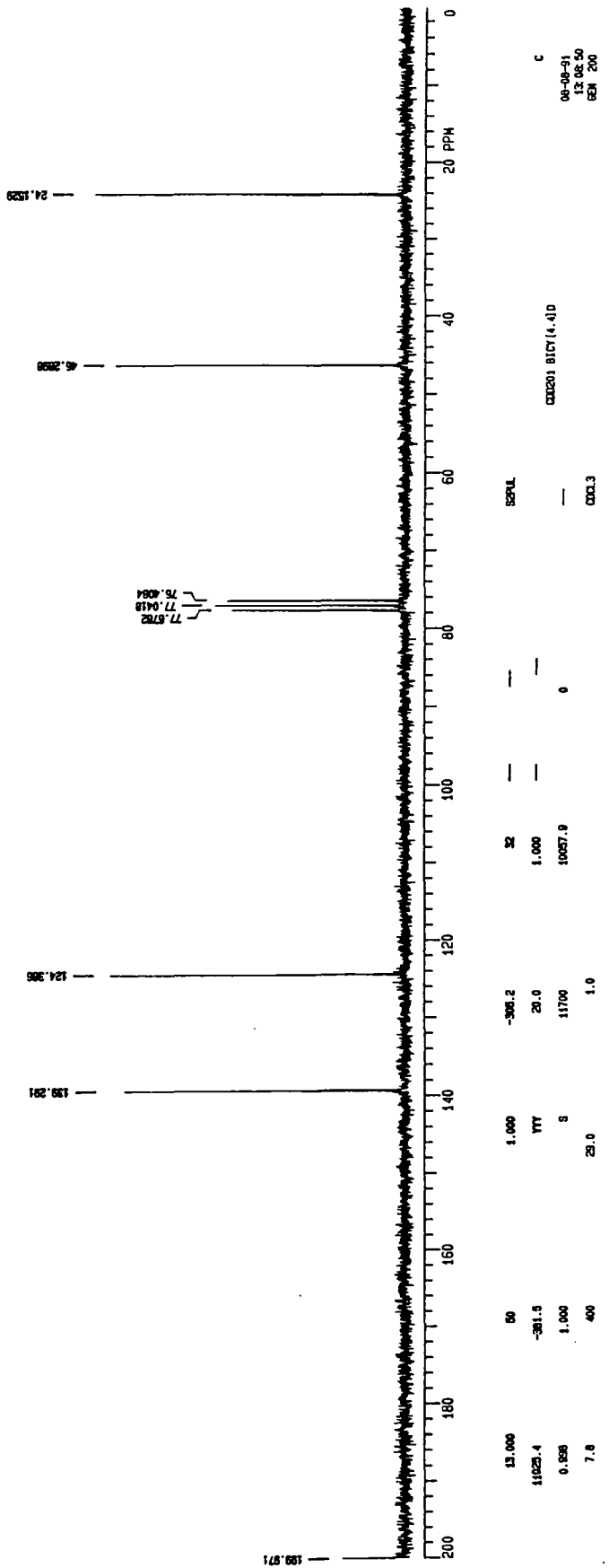

C  
06-08-91  
13.06.50  
621 200

Figure A1.18

## Appendix 2.

Spectra referred to in Chapter 6.

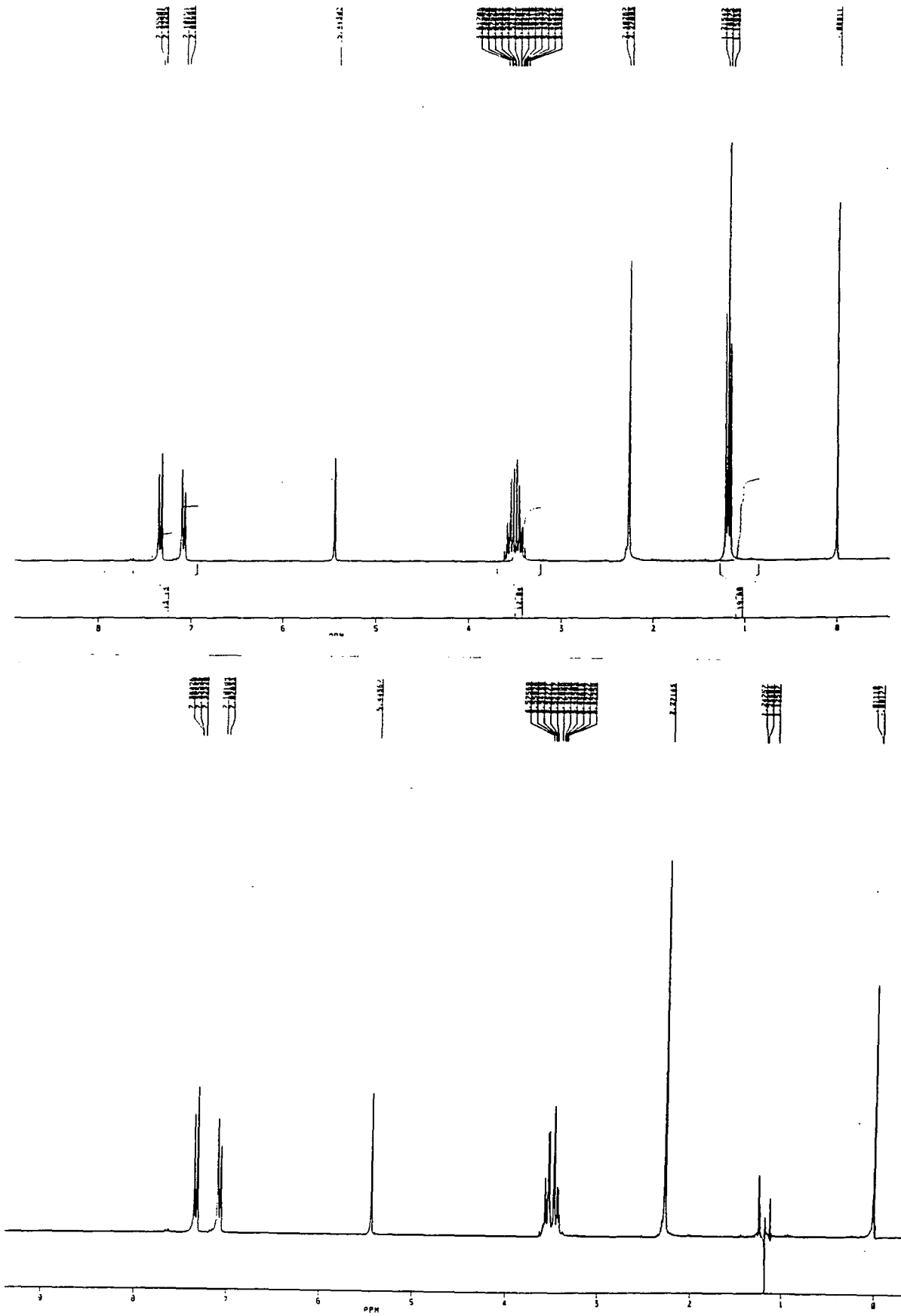
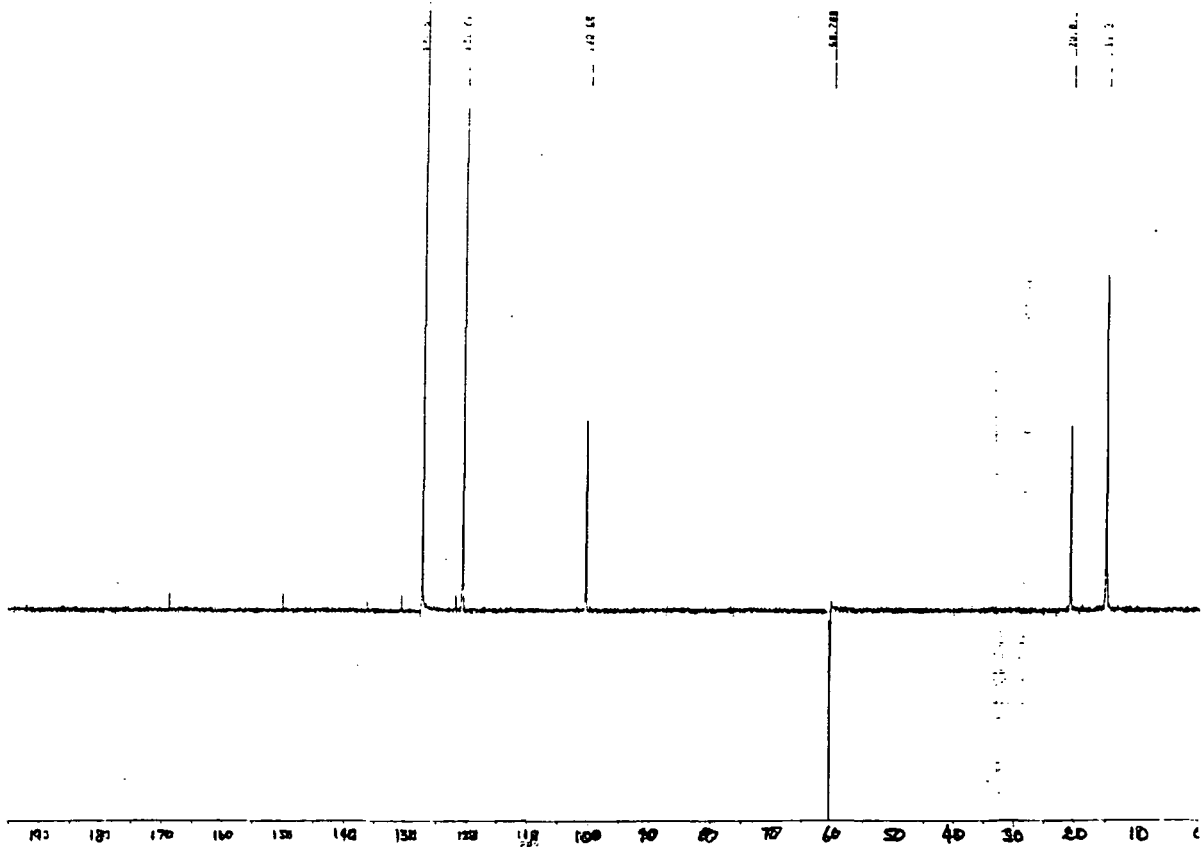
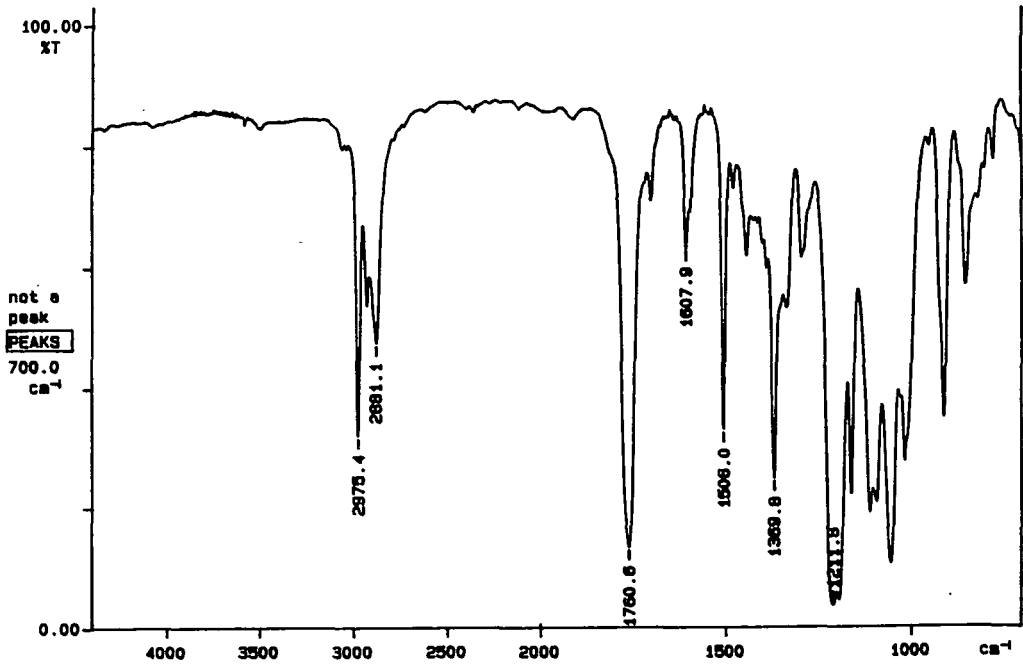

Figure A2.1





PERKIN ELMER



91/12/13 20: 41  
X: 16 scans, 4.0cm<sup>-1</sup>

Figure A2.2

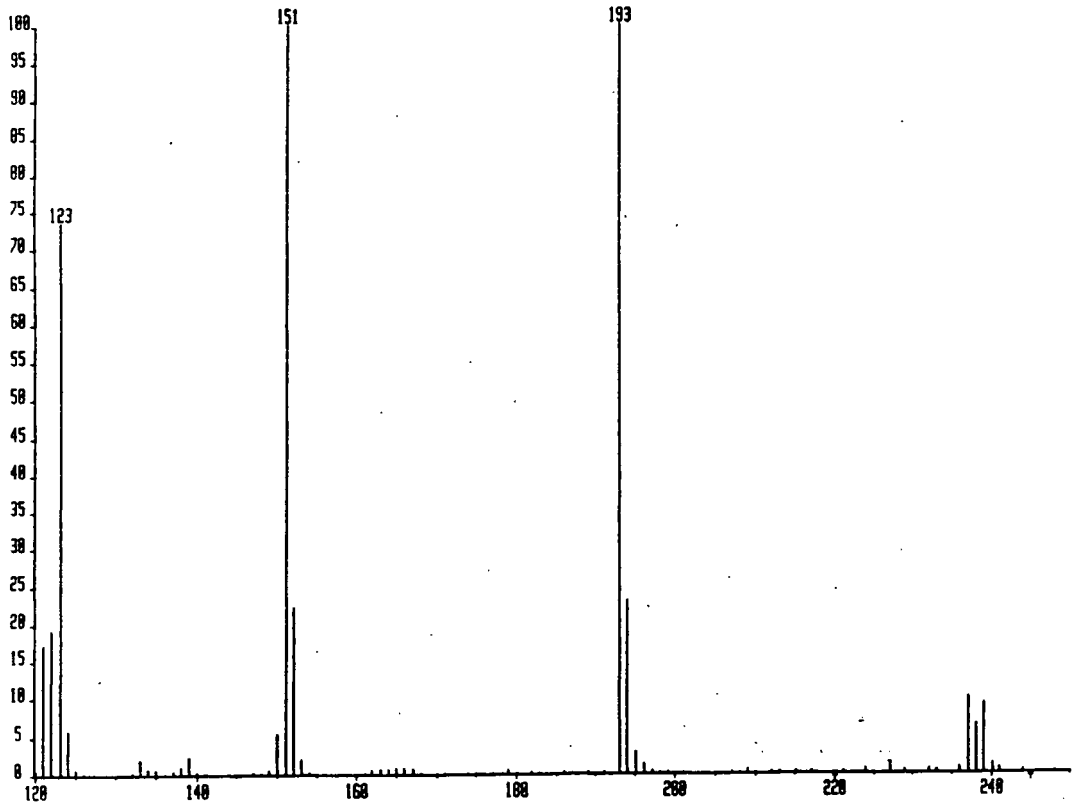

Page 1 of 1

12-NOV-91 12:39 AVE report on C:DCS2

AVE C:DCS2160-95,DCS2A,DCS2R/U

W DB WIN FW LM HM INT PMI Scans

NO SCAN FIX 100 233 243 0% 1 36

Window	Int (%)	Mass (amu)	SD(amu)	SD(ppm)	Time	Contributions
1	65.89	242.98956	0.02	0.07	8703.12	36
2	5.77	241.02756	10.62	44.05	8983.60	36
3	11.01	240.12578	4.91	20.45	9113.46	34
4	84.31	239.11999	4.03	16.86	9259.03	36
5	66.38	238.11337	3.81	16.01	9405.24	36
6	100.00	237.10461	2.79	11.76	9552.37	36
7	10.37	235.98991	4.64	19.68	9715.67	36
8	2.93	233.02646	8.78	37.67	10153.53	36

Average Standard Deviation: 4.95 20.82

Figure A2.3

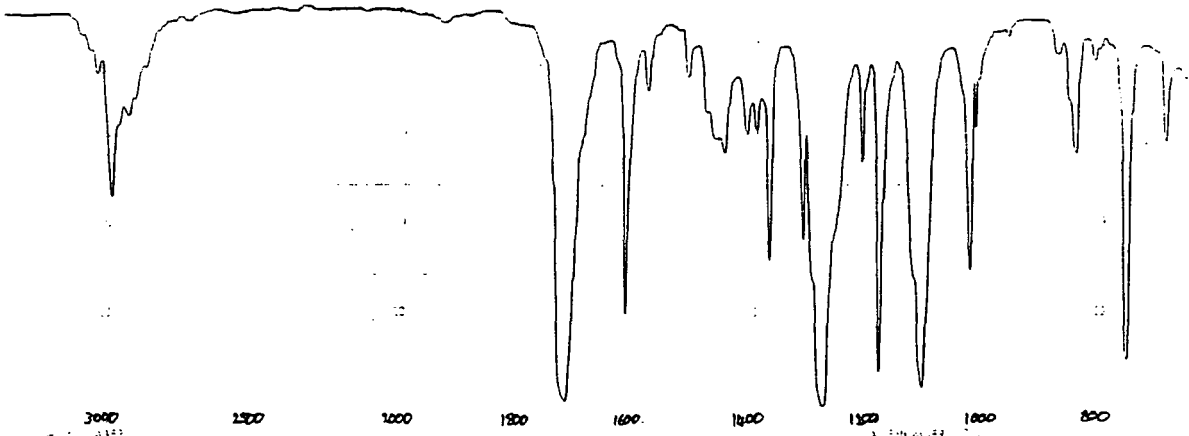

3000 2500 2000 1800 1600 1400 1200 1000 800  
 Wavenumber (cm⁻¹)

DCMS1050 x1 Bgd=1 12-JUL-88 16:40:00:39 78E EI+  
 SpM=0 I=6.9v Hw=449 TIC=135958888 Acnt: Sys:ACE  
 D.CROD PT= 0° Cal:PFK HMR: 45194888  
 MASS: 119

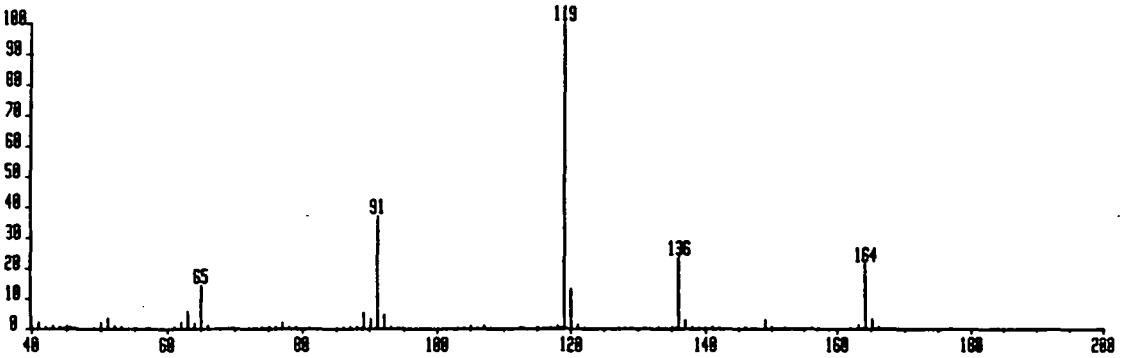

DCMS10150 x1 Bgd=11 12-JUL-88 16:40:01:21 78E CI+  
 SpM=0 I=10v Hw=440 TIC=128645888 Acnt: Sys:ACE  
 D.CROD PT= 0° Cal:PFK HMR: 27334888  
 MASS: 165

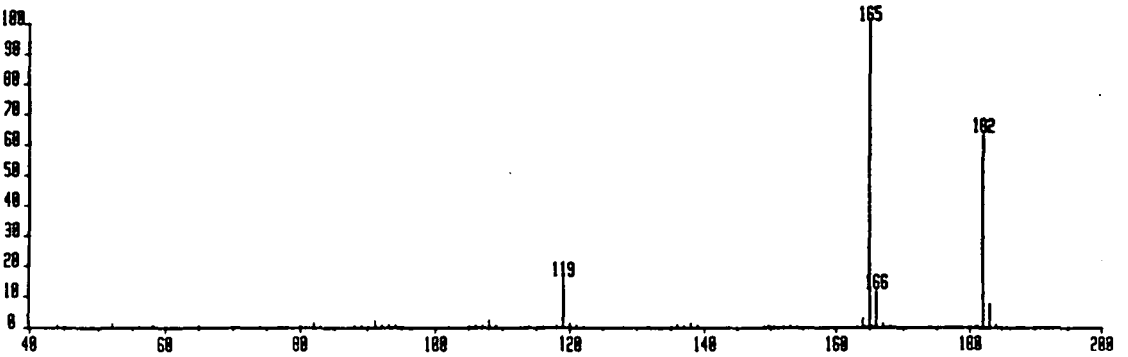

Figure A2.4

1.000  
0.000  
239  
92

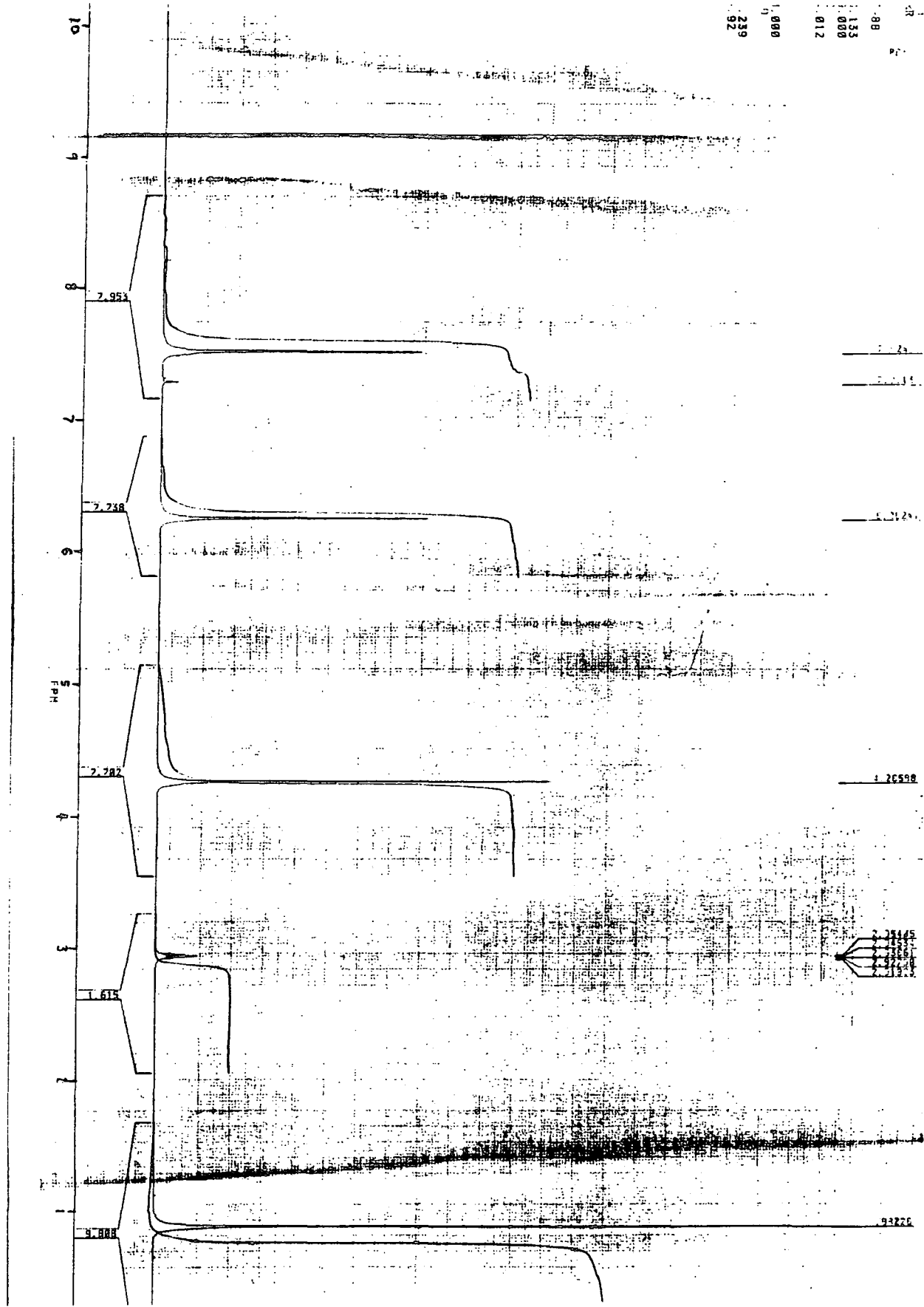
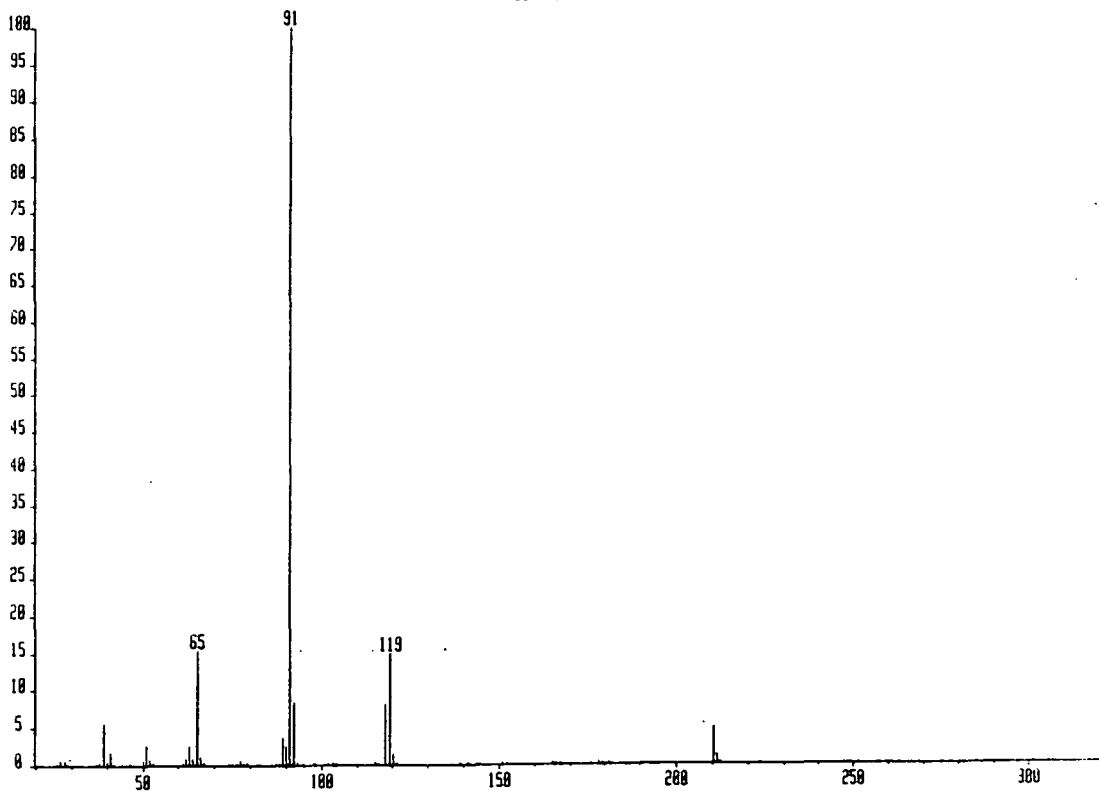

Figure A2.5



OCM521946 x1 Bgd=936 27-OCT-88 09:40:16:49 7BE C1\*  
 BpM=8 I=886uv Ha=184 TIC=12487808 Acnt: Sys: CROD HNR: 5889808  
 GC= 197<sup>o</sup> Cal: PFK MASS: 91

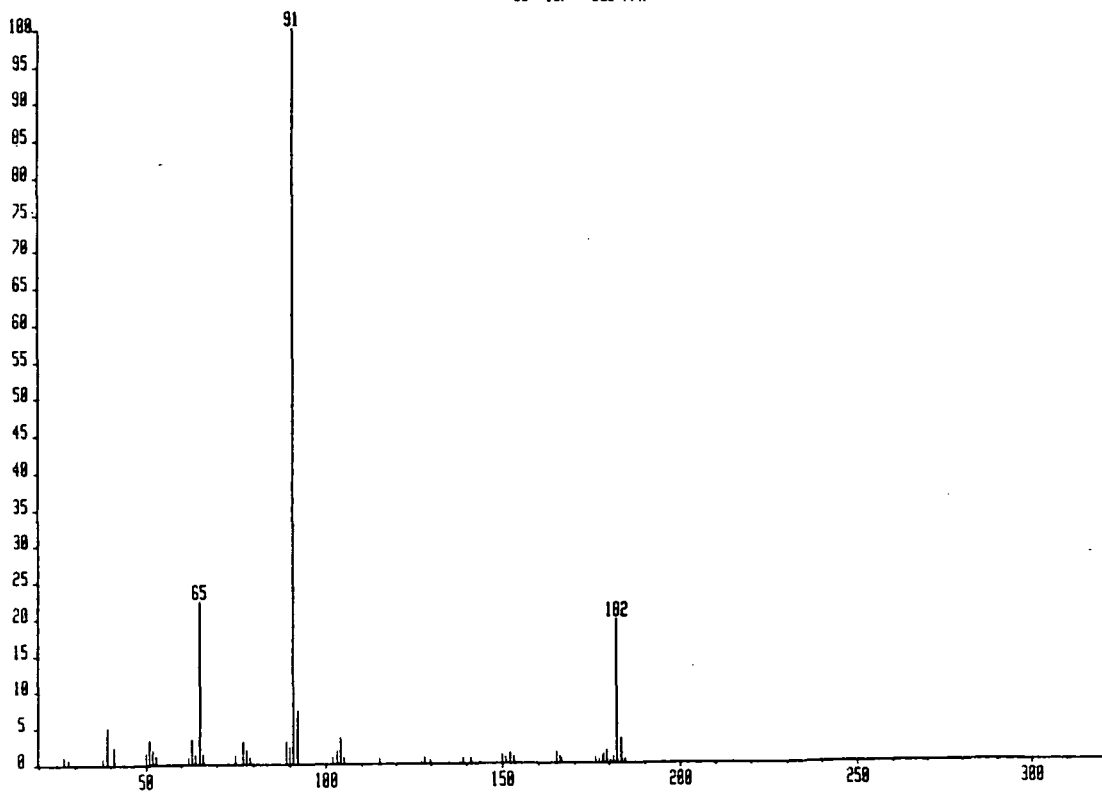
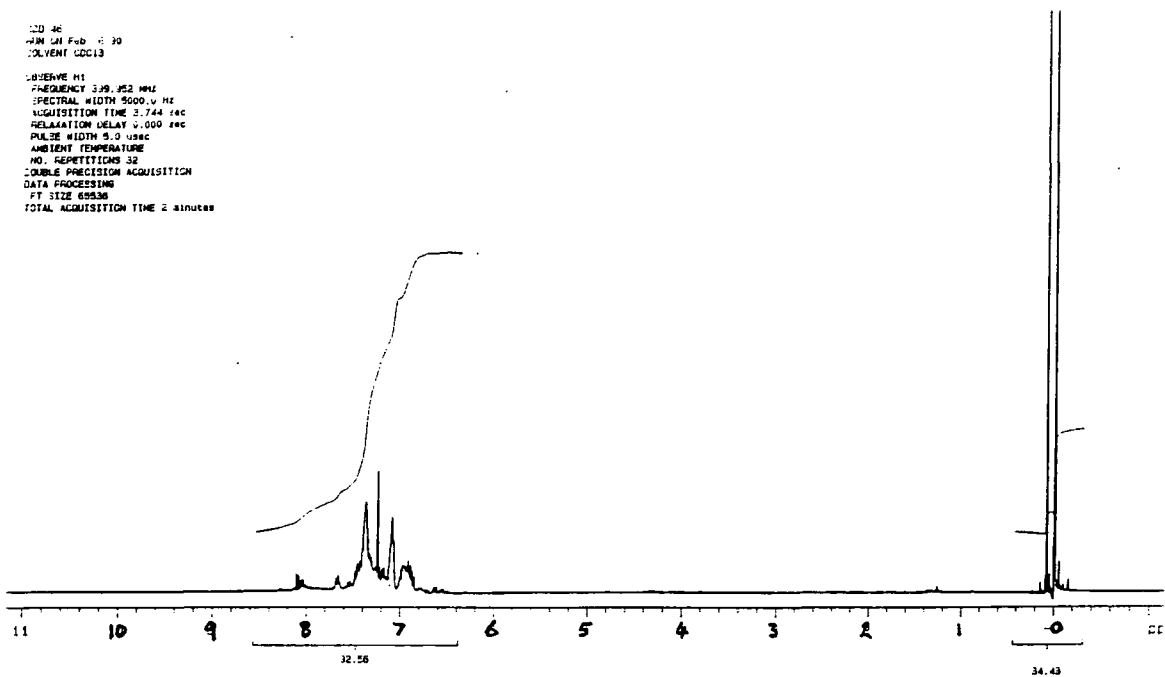

Figure A2.6

CDD46  
 RUN ON Feb 6 90  
 SOLVENT CDD13  
 OBSERVE H1  
 FREQUENCY 339.052 MHz  
 SPECTRAL WIDTH 5000.0 Hz  
 ACQUISITION TIME 3.744 sec  
 RELAXATION DELAY 0.000 sec  
 PULSE WIDTH 5.0 usec  
 AMBIENT TEMPERATURE  
 NO. REPETITIONS 32  
 DOUBLE PRECISION ACQUISITION  
 DATA PROCESSING  
 FT SIZE 65936  
 TOTAL ACQUISITION TIME 2 minutes



CDD46  
 RUN ON Feb 7 90  
 SOLVENT CDD13  
 OBSERVE C13  
 FREQUENCY 100.577 MHz  
 SPECTRAL WIDTH 28000.0 Hz  
 ACQUISITION TIME 1.199 sec  
 RELAXATION DELAY 3.000 sec  
 PULSE WIDTH 6.0 usec  
 AMBIENT TEMPERATURE  
 NO. REPETITIONS 1024  
 DECOUPLE H1  
 HIGH POWER 42  
 DECOUPLER CONTINUOUSLY ON  
 MALTZ-16 MODULATED  
 DATA PROCESSING  
 GAUSSIAN APODIZATION 0.100 sec  
 FT SIZE 65936  
 TOTAL ACQUISITION TIME 71 minutes

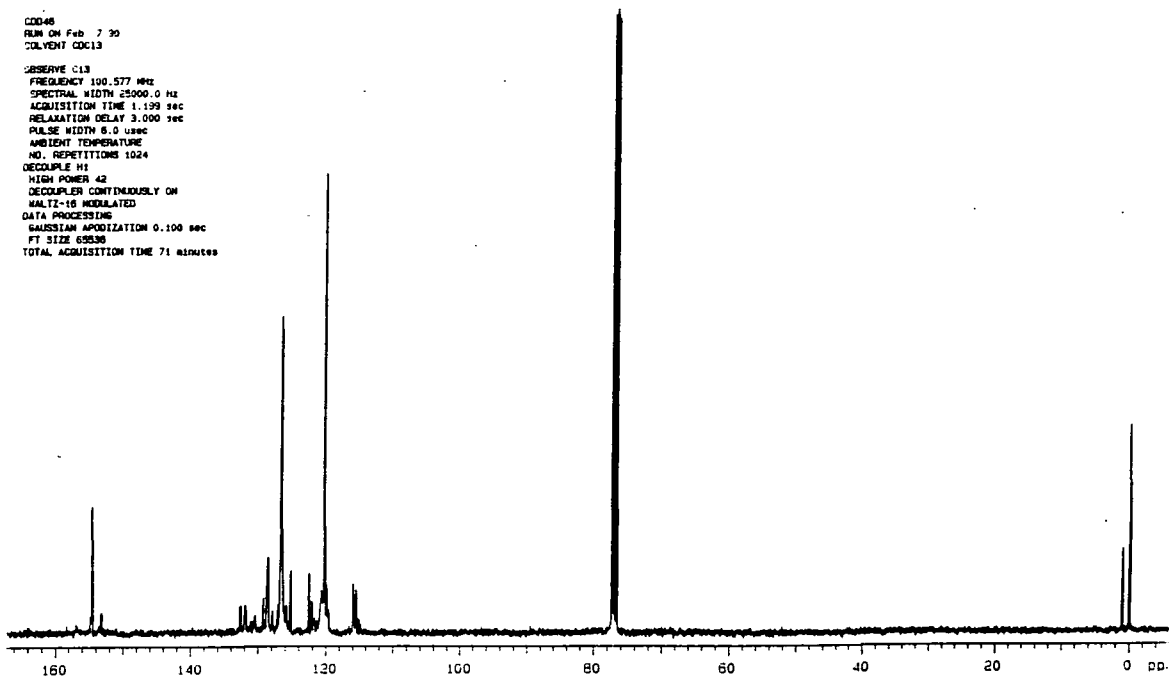
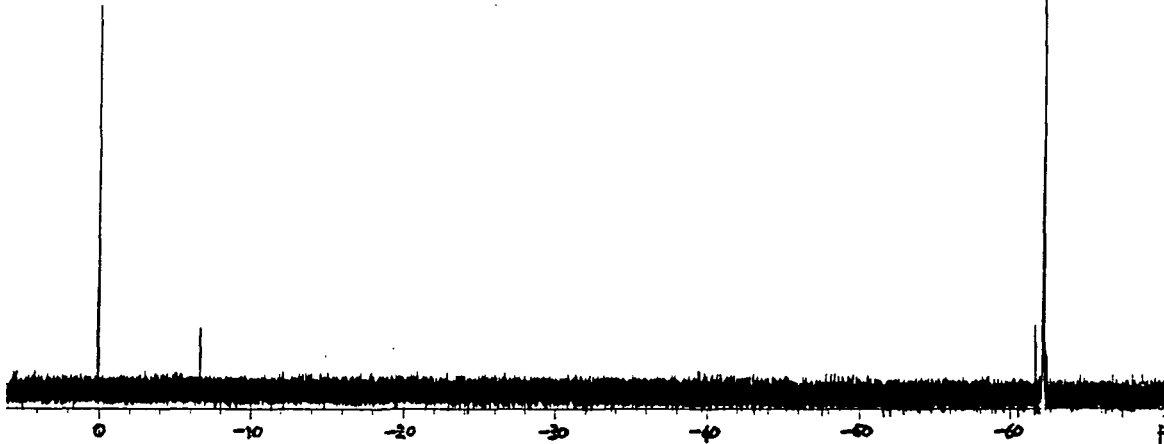
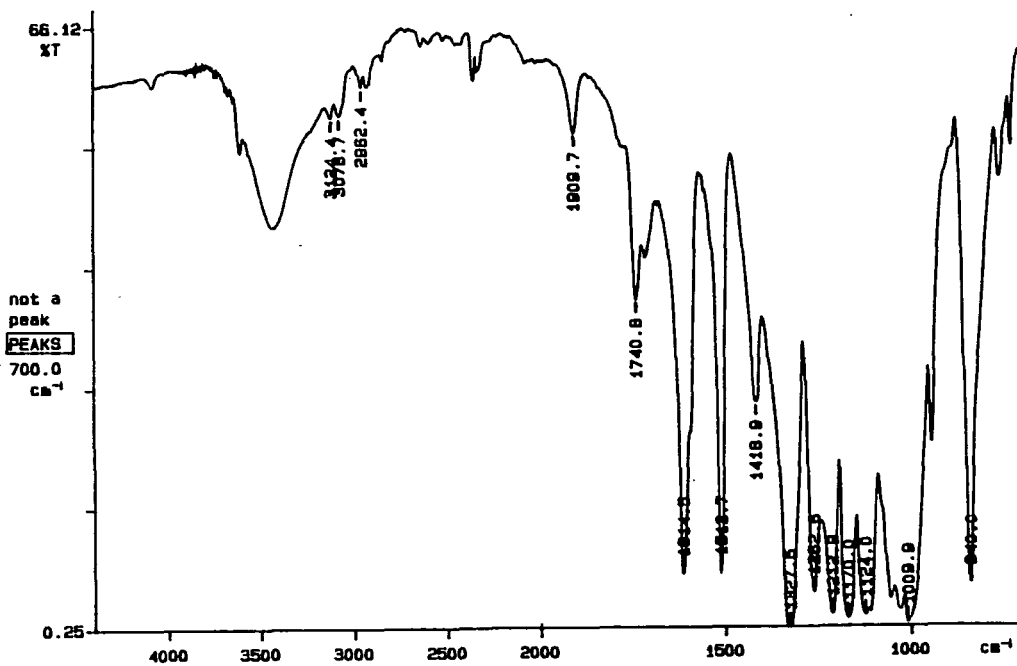

Figure A2.7

CG 40  
 RUN ON F-0 1 90  
 SOLVENT 2013  
 OBSERVE F13  
 FREQUENCY 376.109 MHz  
 SPECTRAL WIDTH 31481.0 Hz  
 ACQUISITION TIME 0.200 sec  
 RELAXATION DELAY 4.000 sec  
 PULSE WIDTH 9.0 usec  
 AMBIENT TEMPERATURE  
 NO. REPETITIONS 64  
 DATA PROCESSING  
 GAUSSIAN APPROXIMATION 0.050 sec  
 FT SIZE 132144  
 TOTAL ACQUISITION TIME 5.45 minutes



PERKIN ELMER



91/12/13 21:06  
 X: 16 scans, 4.0cm<sup>-1</sup>

Figure A2.8

DCMS20F14 x1 Bgd=1 1-MAY-90 15:26:01:02 78E FB+  
 BpM=0 l=10v Hm=674 TIC=1076657024 Acnt: Sys:FB  
 DUNCAN PT= 0° Cal:GLYIMAY

HMR: 65534000  
 XASS: 167

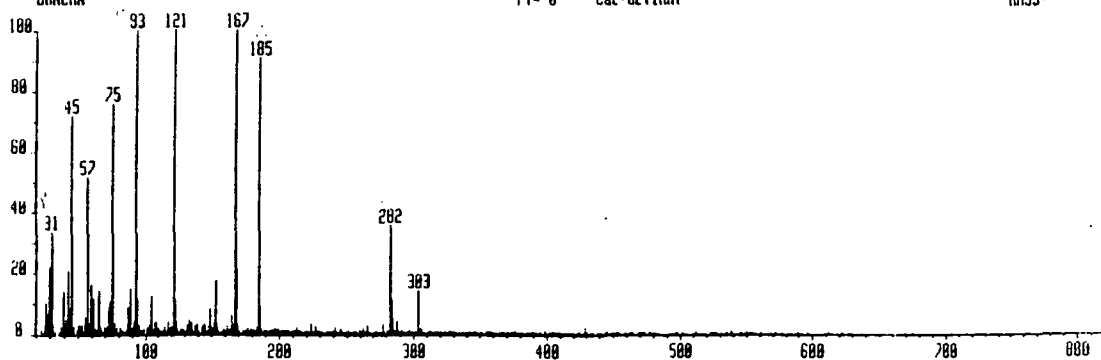

DCMS20F10 x1 Bgd=6 1-MAY-90 15:26:01:38 78E FB-  
 BpM=0 l=3.6v Hm=688 TIC=120205000 Acnt: Sys:FB  
 DUNCAN PT= 0° Cal:GLYIMAY

HMR: 23520000  
 XASS: 161

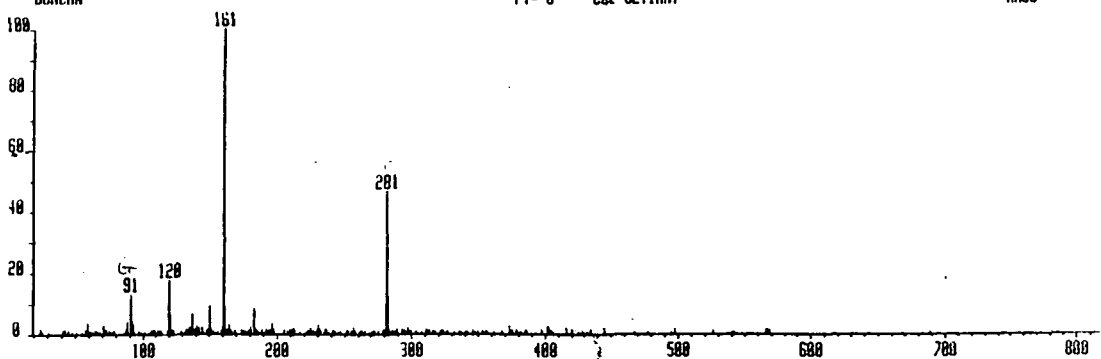

For No. 62507

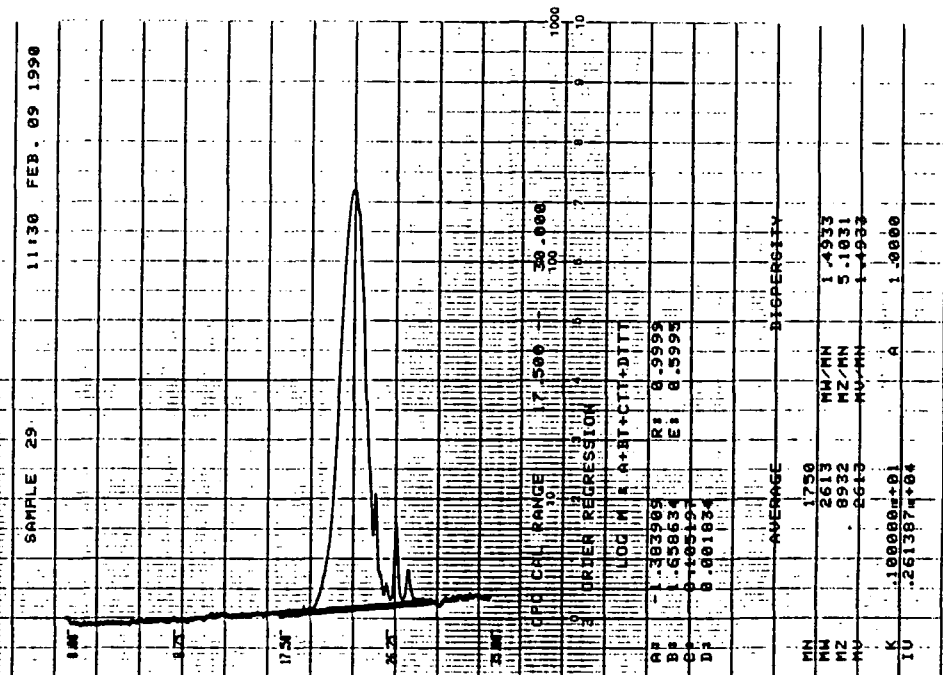

Figure A2.9



Figure A2.10

Title : DCANAL  
 Run File : C:\STAR\MODULE04\DC003.RUN  
 Method File : c:\star\durl.mth  
 Sample ID : Manual Sample

Injection Date: 19-AUG-91 3:02 PM

Operator : Number 1                    Detector Type: 8065  
 Workstation:                            Bus Address : 4  
 Instrument : Varian Star                Sample Rate : 2.71 Hz  
 Channel : 14 = 254 nn                 Run Time : 34.971 min

\*\*\*\*\* Varian Star Workstation \*\*\*\*\* Rev. C 08/20/90 \*\*\*\*\*

Chart Speed = 0.46 cm/min    Attenuation = 251    Zero Offset = 1%  
 Start Time = 0.000 min    End Time = 34.971 min    Min / Tick = 1.0

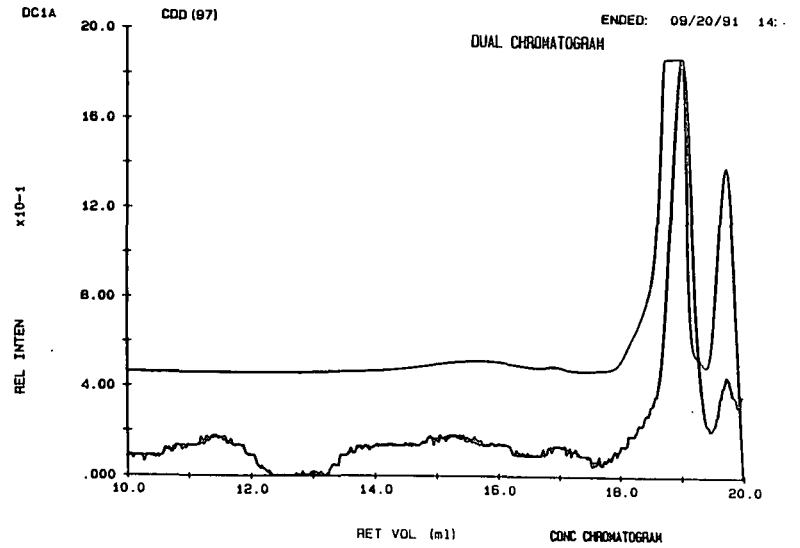
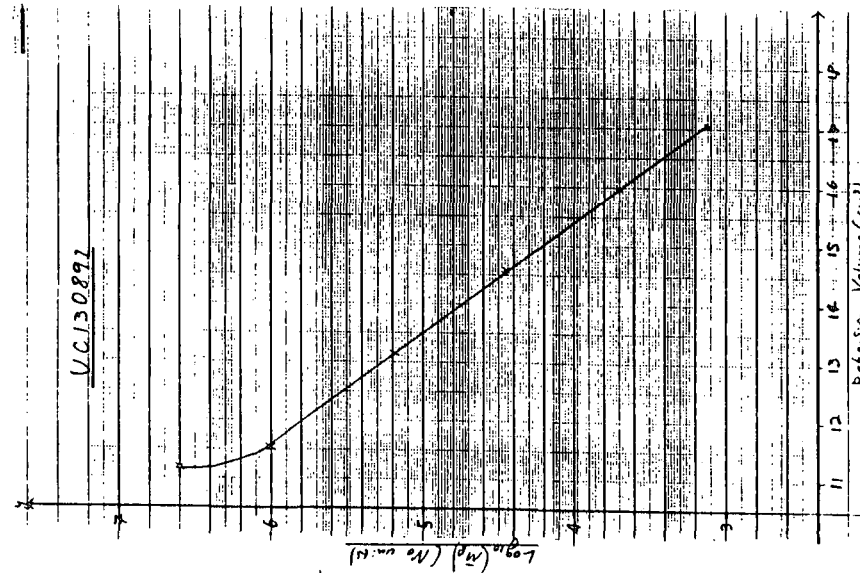
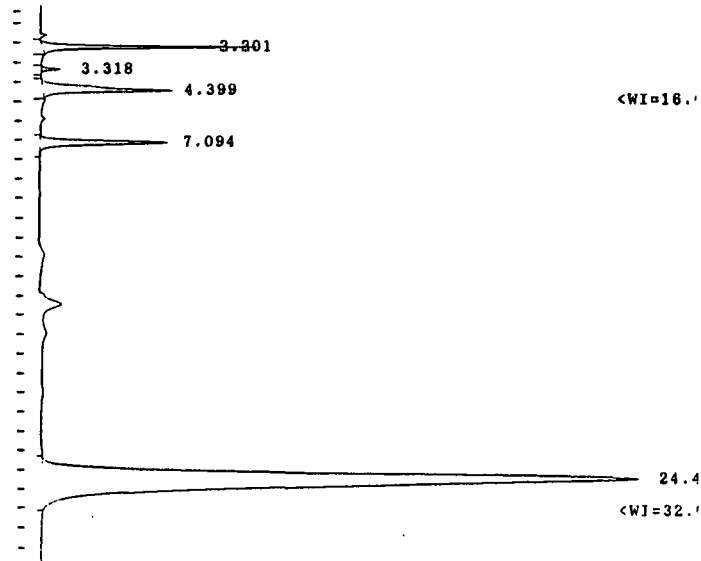

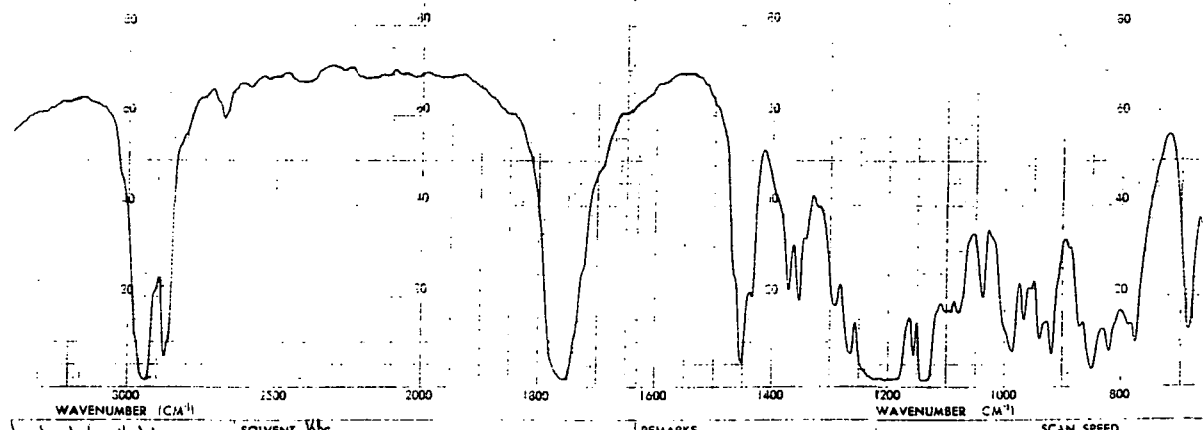

it extracted with benzene, and the liquid

SOLVENT <i>benzene</i>	REMARKS	SCAN SPEED
CONCENTRATION		SLIT
CELL PATH		No 457-5001
REFERENCE		

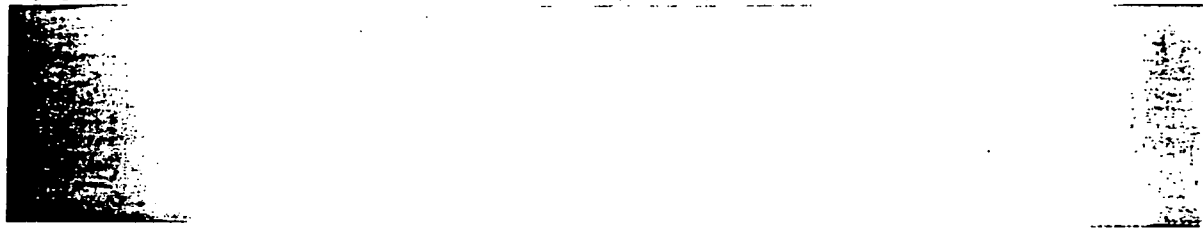

1.0 2.0 3.0 4.0 5.0 6.0 7.0 8.0 9.0 10.0 11.0 12.0 13.0 14.0

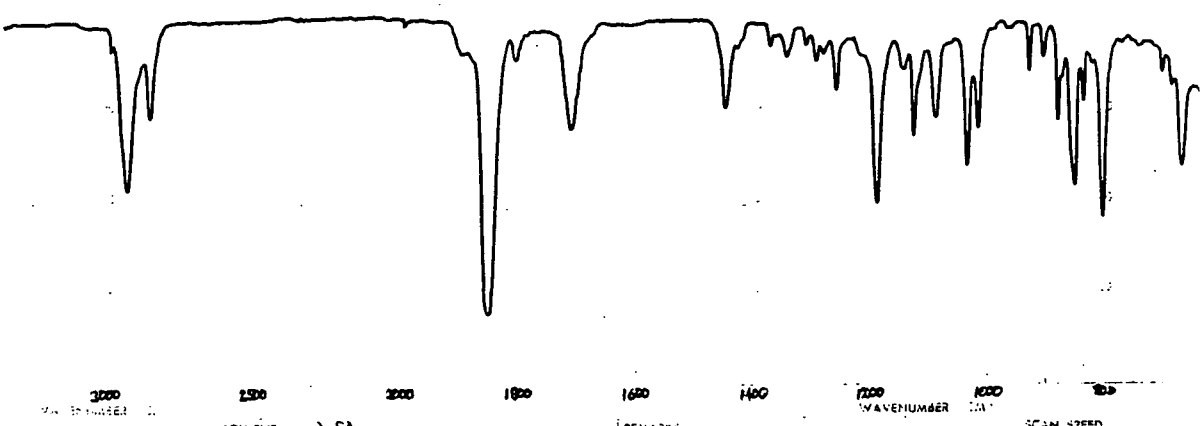

SOLVENT <i>benzene</i>	REMARKS	SCAN SPEED
CONCENTRATION		SLIT
CELL PATH		No 457-5001
REFERENCE		

Figure A2.11

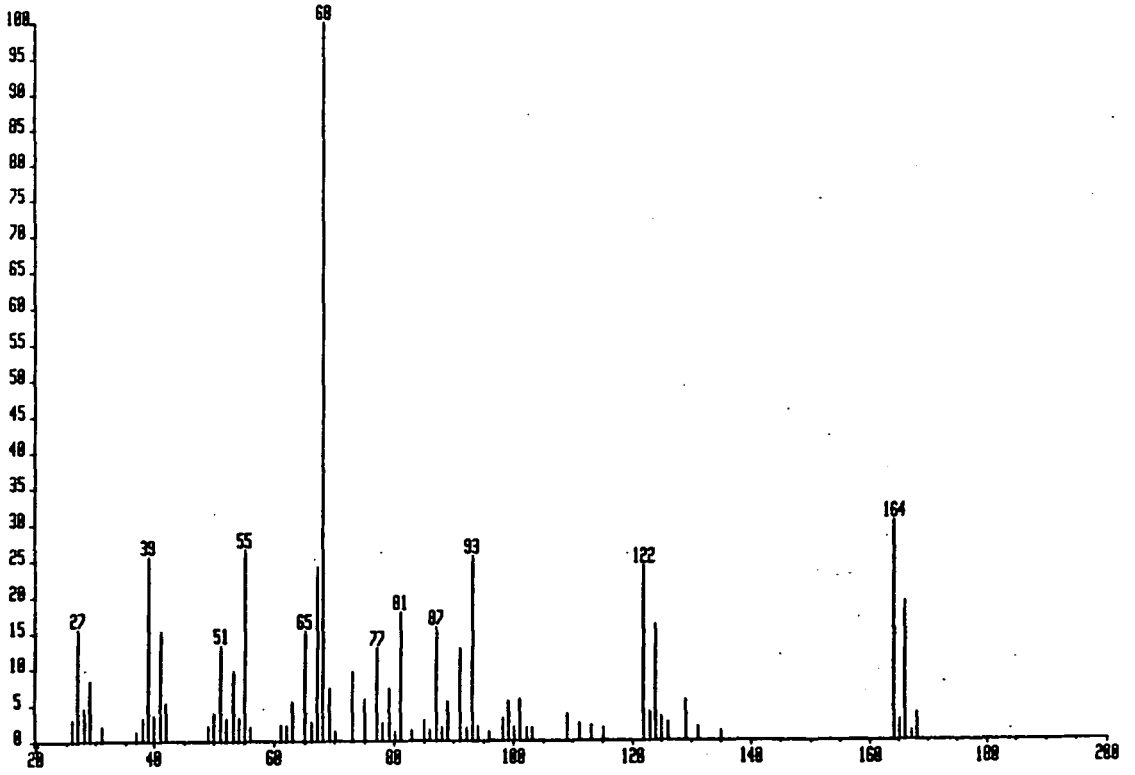

PERKIN ELMER

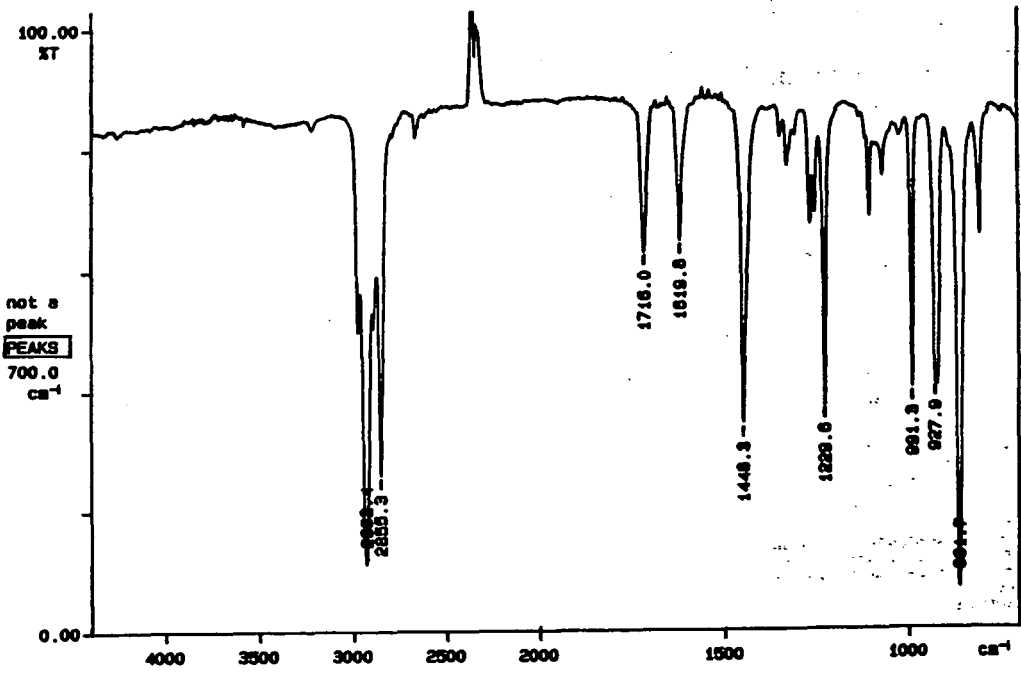

91/12/13 20: 22  
 X: 16 scans, 4.0cm<sup>-1</sup>

Figure A2.12

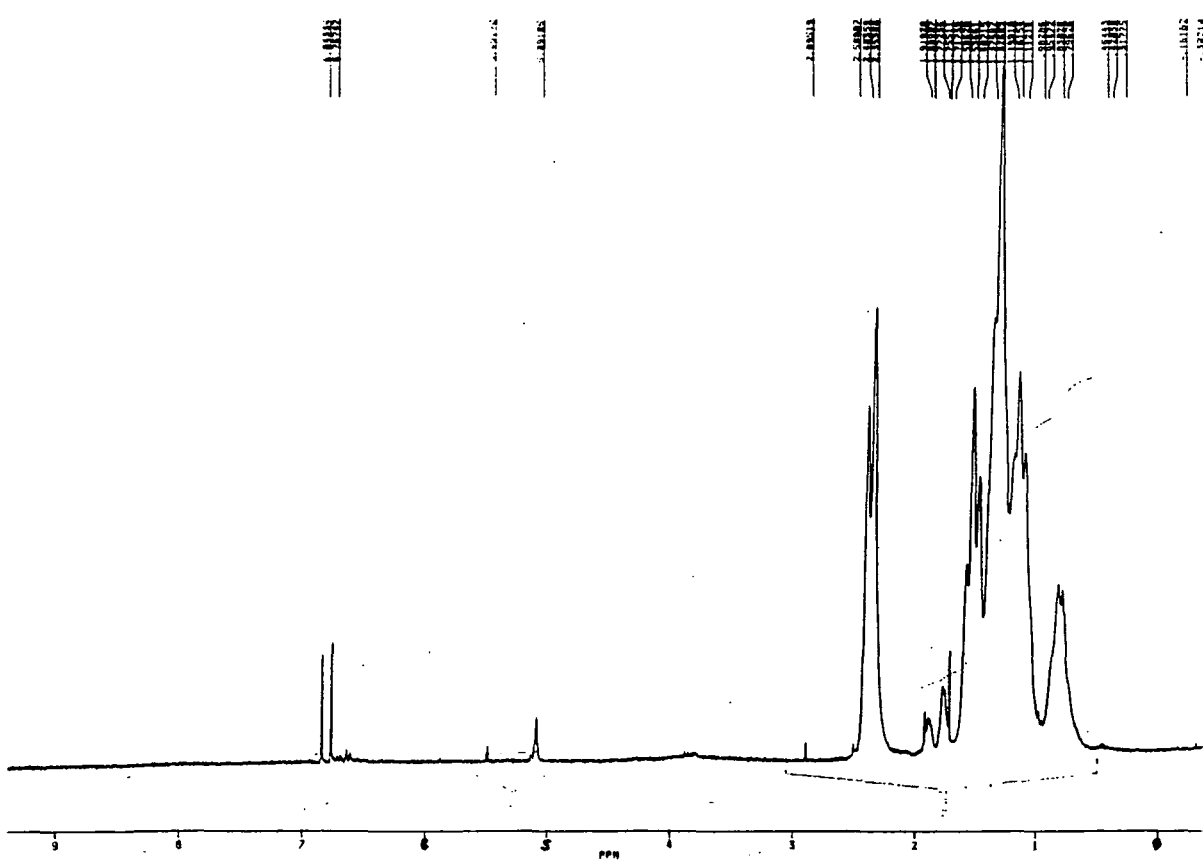

000 00  
 FILE /usr/ufp2/vmr1/vmrays/data/cdd10dec.f10  
 RUN ON Dec 10 90  
 SOLVENT CCl3

OBSERVE C13  
 Frequency 100.627 MHz  
 Spectral width 25000.0 Hz  
 Acquisition time 1.139 sec  
 Relaxation delay 3.000 sec  
 Pulse width 6.0 usec  
 Ambient temperature  
 No. repetitions 1024  
 DECOUPLE H1  
 High power 40  
 Decoupler continuously on  
 MALTZ-16 associates  
 Double precision acquisition  
 DATA PROCESSING  
 Line broadening 0.8 Hz  
 FT size 131072  
 Total acquisition time 71 minutes

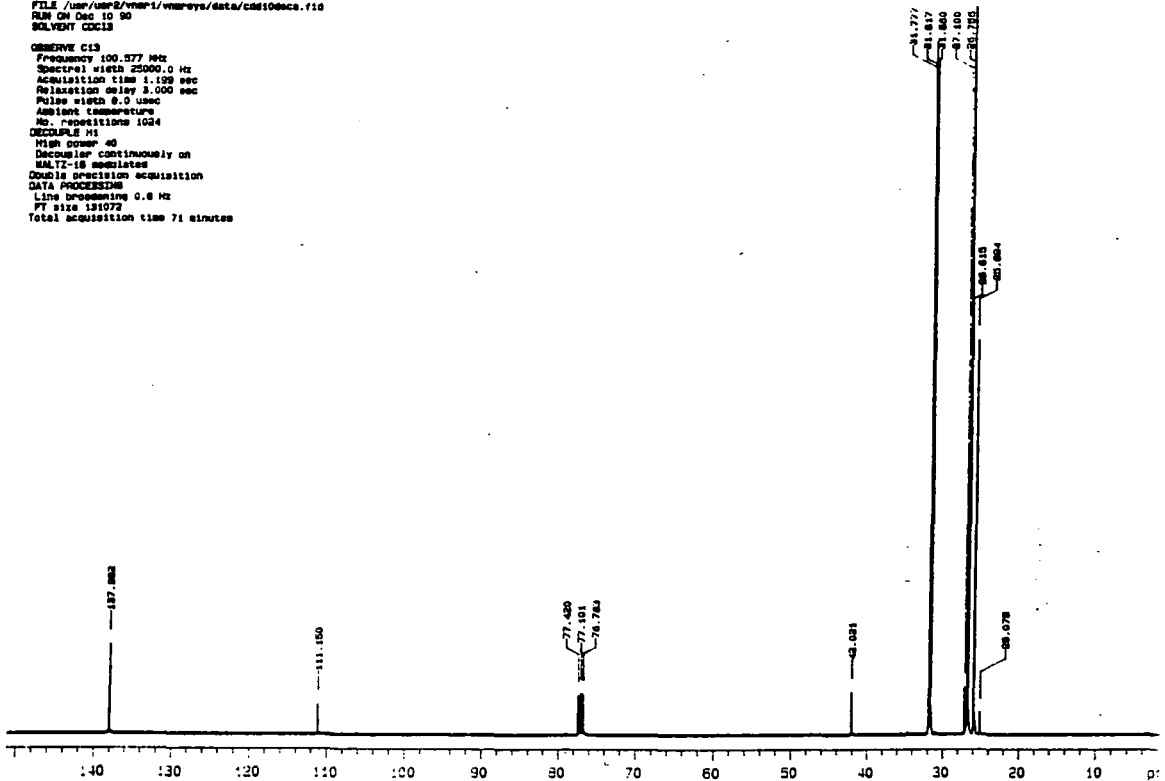
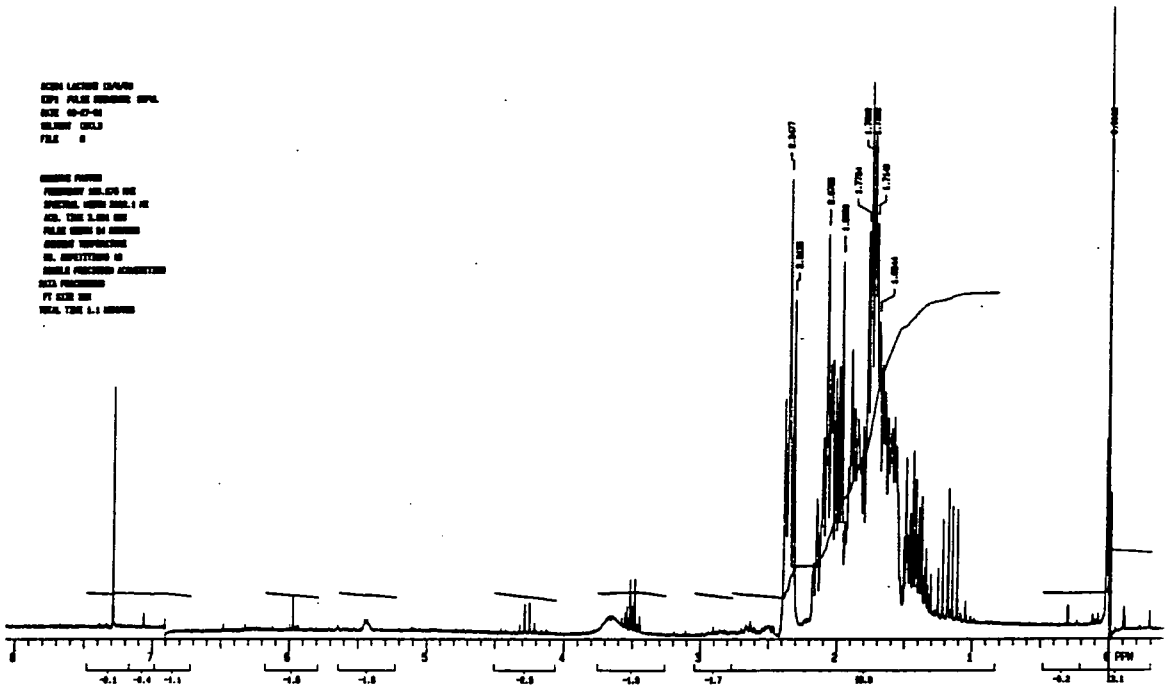

Figure A2.13

SCM LACTIC ACID  
CPM FILE NUMBER 0901  
DATE 09-27-81  
SOLVENT CDCL3  
FILE B

SCM PPM  
PULSED NMR 90  
SPECTRA VIEW 000.1 02  
AQ. 120 3.00 000  
PULSE WIDTH 0.0000  
GAIN 1000000  
OL. 00000000 00  
DATA PROCESSING 00000000  
SOL. PROCESSED  
PT 000 000  
NMR. TIME 1.1 00000



SCM LACTIC ACID

CPM FILE NUMBER 0901  
DATE 09-27-81  
SOLVENT CDCL3  
FILE C

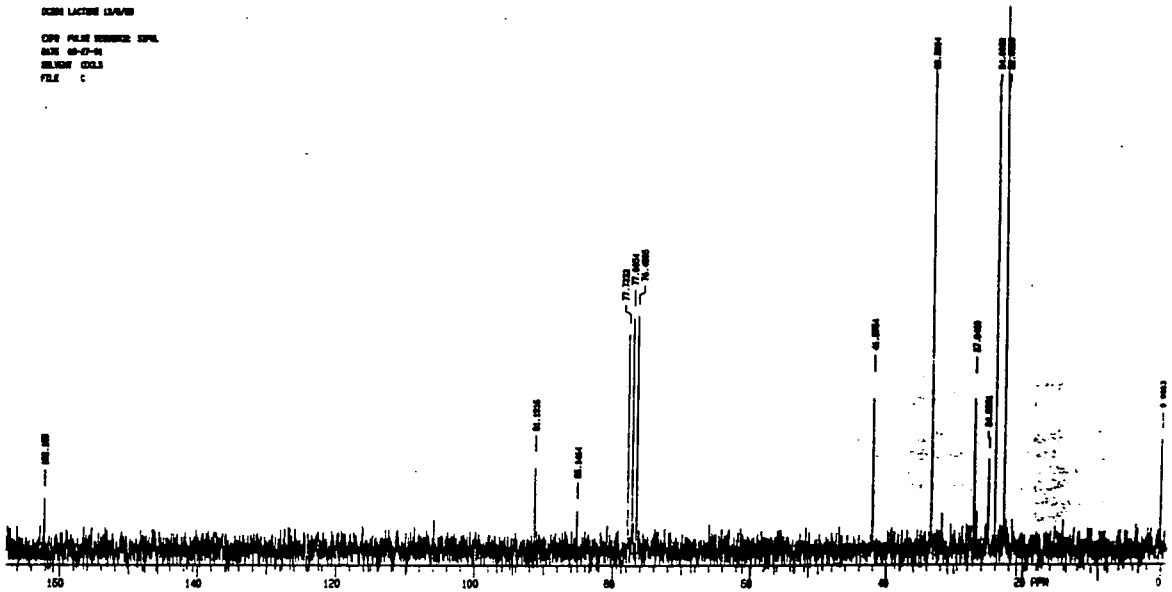
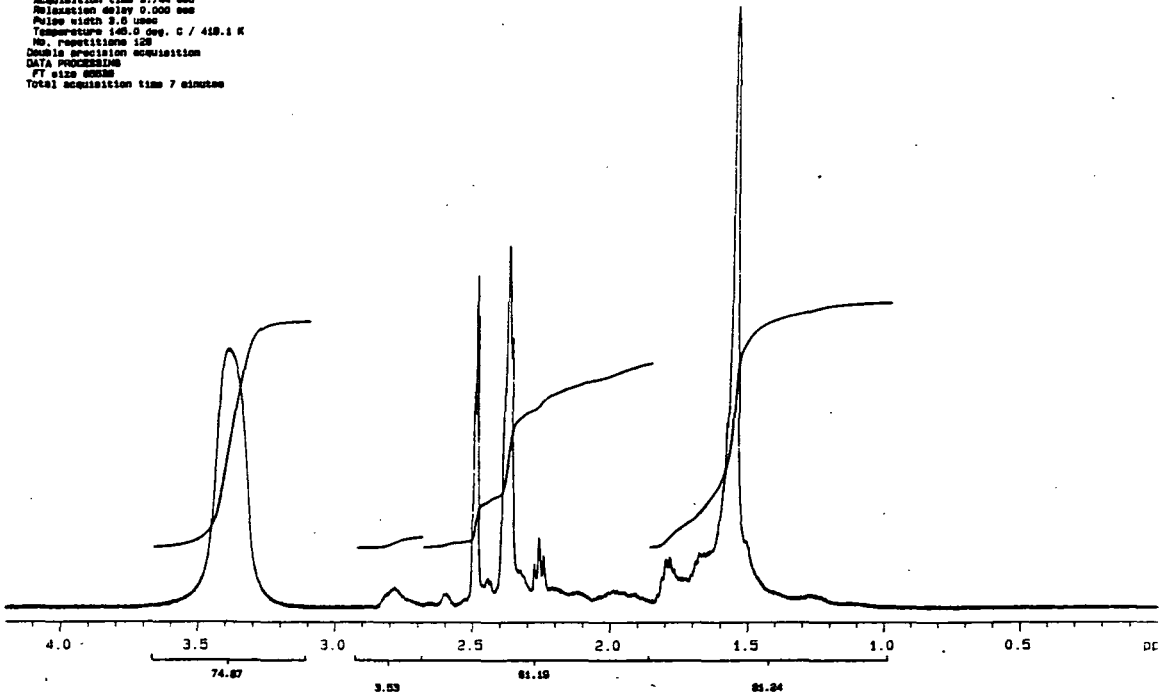

Figure A2.14

000 32  
FILE /usr2/vmr1/vmrays/data/csd20met1.fid  
RUN ON Sep 25 91  
SOLVENT CH2O

OBSERVE H1  
Frequency 300.000 MHz  
Spectral width 6000.0 Hz  
Acquisition time 3.744 sec  
Relaxation delay 0.000 sec  
Pulse width 3.0 usec  
Temperature 140.0 deg. C / 410.1 K  
No. F2 partitions 128  
Double precision acquisition  
DATA PROCESSING  
FT size 65536  
Total acquisition time 7 minutes



000 32  
FILE /usr2/vmr1/vmrays/data/csd20met1.fid  
RUN ON Sep 25 91  
SOLVENT CH2O  
OBSERVE C13

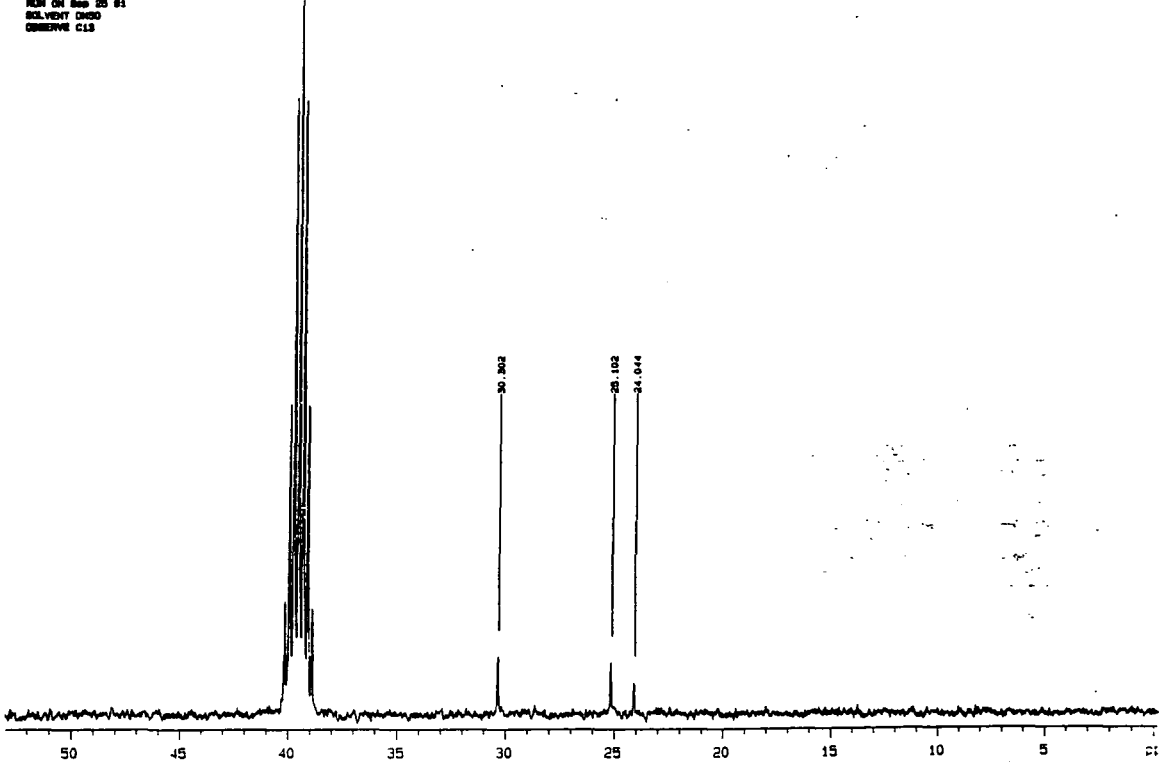
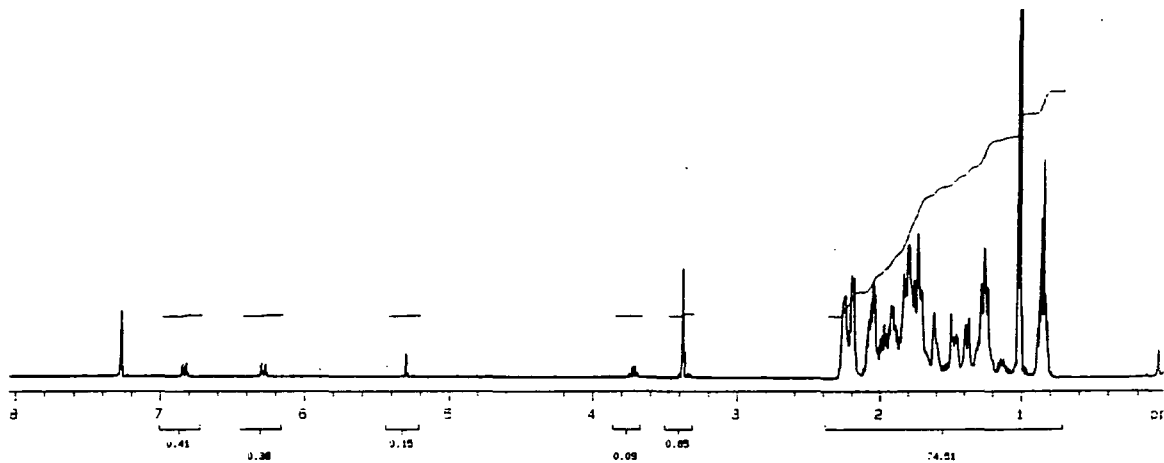

Figure A2.15

0047  
 RUN ON Feb 14 90  
 SOLVENT CDCl3  
 OBSERVE H1  
 FREQUENCY 500.132 MHz  
 SPECTRAL WIDTH 5000.0 MHz  
 ACQUISITION TIME 3.744 sec  
 RELAXATION DELAY 0.500 sec  
 PULSE WIDTH 8.0 usec  
 AMBIENT TEMPERATURE  
 NO. REPETITIONS 128  
 LOCAL PRECISION ACQUISITION  
 DATA PROCESSING  
 FT SIZE 65536  
 TOTAL ACQUISITION TIME 7 minutes



0047  
 FILE /usr/local/nmr1/rnmryst/data/0047c113.r10  
 RUN ON Feb 14 90  
 SOLVENT CDCl3  
 OBSERVE C13  
 FREQUENCY 100.627 MHz  
 SPECTRAL WIDTH 15000.0 MHz  
 ACQUISITION TIME 1.129 sec  
 RELAXATION DELAY 0.500 sec  
 PULSE WIDTH 8.0 usec  
 AMBIENT TEMPERATURE  
 NO. REPETITIONS 1024  
 DECOUPLE H1  
 HIGH POWER 42  
 DECOUPLER CONTINUOUSLY ON  
 MALTZ-16 MODULATED  
 DATA PROCESSING  
 GAUSSIAN APERTIZATION 0.300 sec  
 FT SIZE 65536  
 TOTAL ACQUISITION TIME 71 minutes

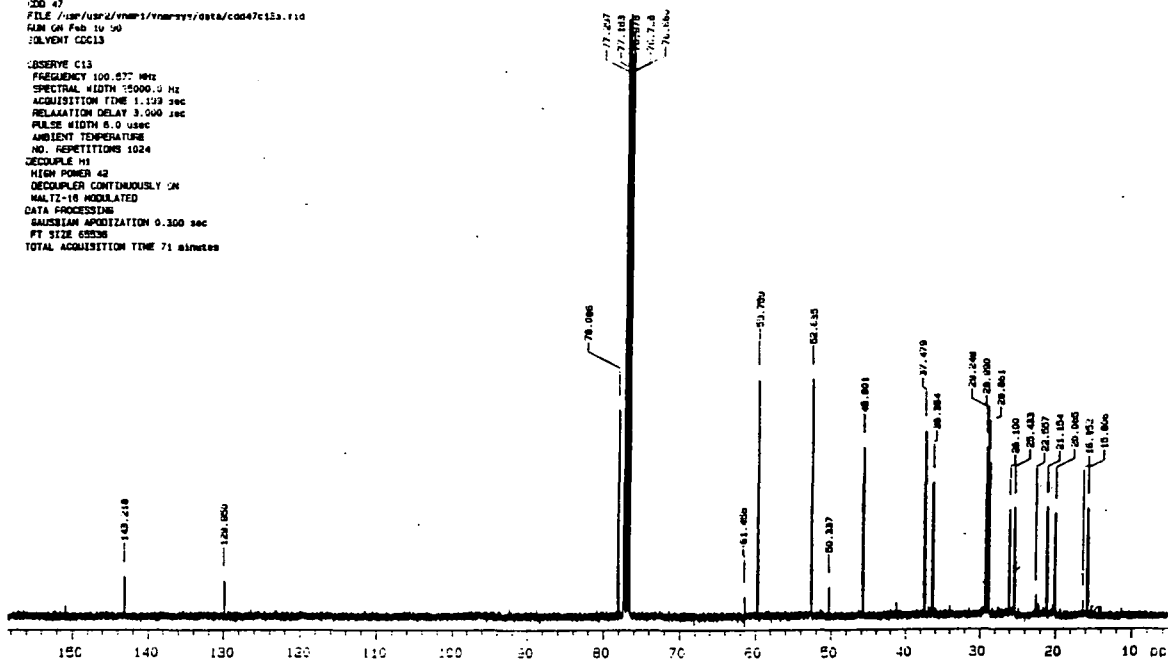

Figure A2.16

Request  
7-12-93  
52.936  
1480.800  
3192  
15131.515  
270  
J200.030  
12.88  
CR 3.4  
0321.39

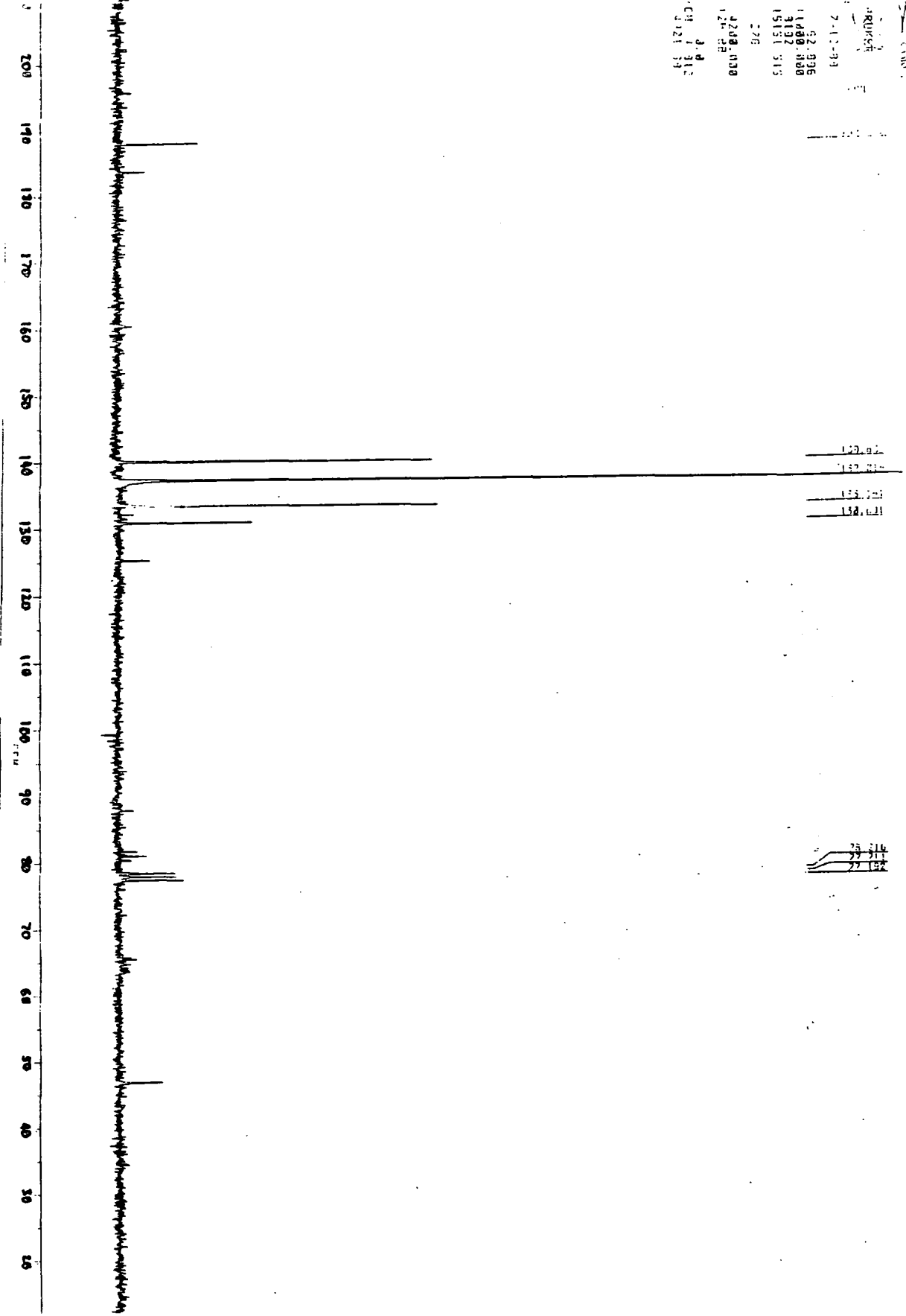
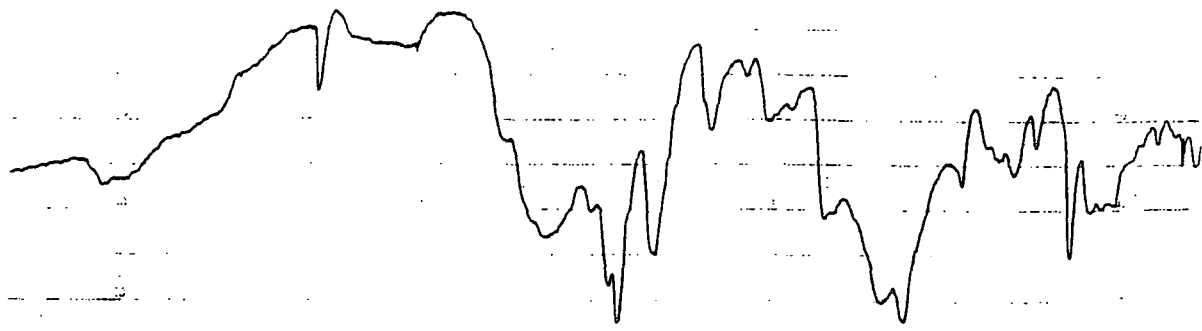
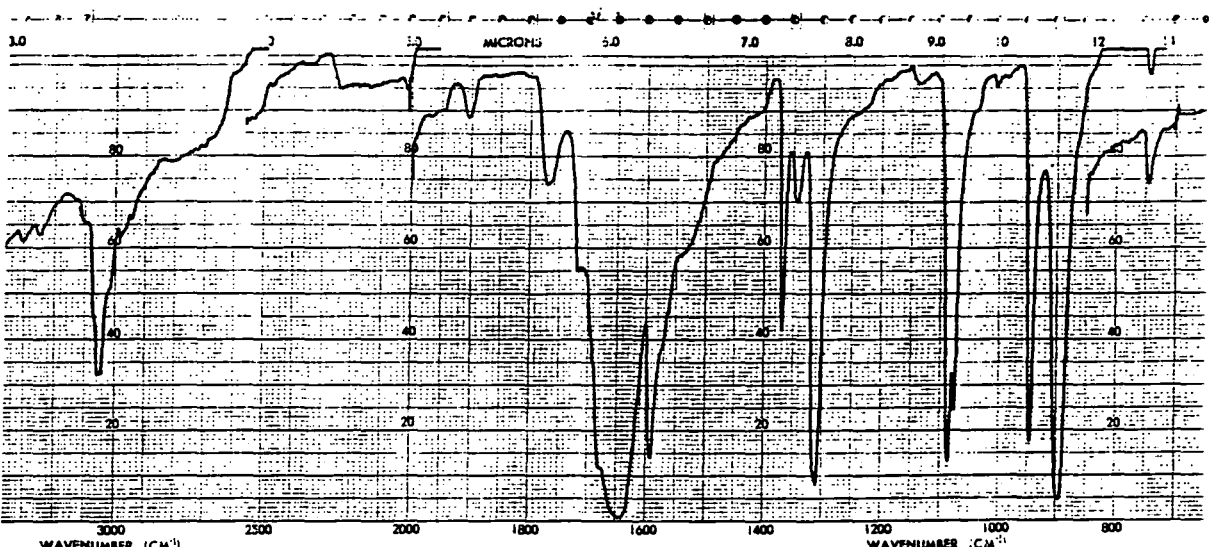

Figure A2.17





3000 WAVENUMBER (CM <sup>-1</sup> )	2500	2000	1800	1600	1400	1200	1000	800 WAVENUMBER (CM <sup>-1</sup> )
SOLVENT <u>KSCl<sub>2</sub></u> CONCENTRATION _____ CELL PATH _____ REFERENCE _____						REMARKS _____		SCAN SPEED _____ SLIT _____ No 457-5001



3000 WAVENUMBER (CM <sup>-1</sup> )	2500	2000	1800	1600	1400	1200	1000	800 WAVENUMBER (CM <sup>-1</sup> )
SOLVENT <u>KSCl<sub>2</sub></u> CONCENTRATION _____ CELL PATH _____ REFERENCE _____						REMARKS _____		SCAN SPEED _____ SLIT _____ No 457-5001

Figure A2.18

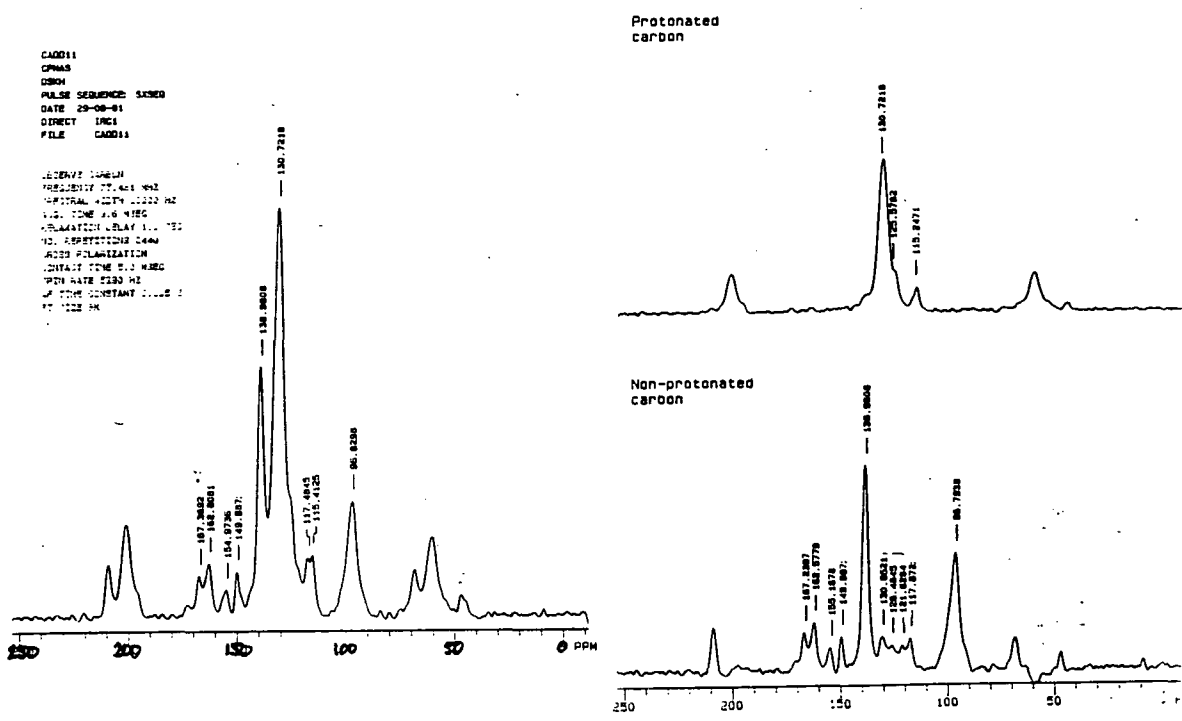
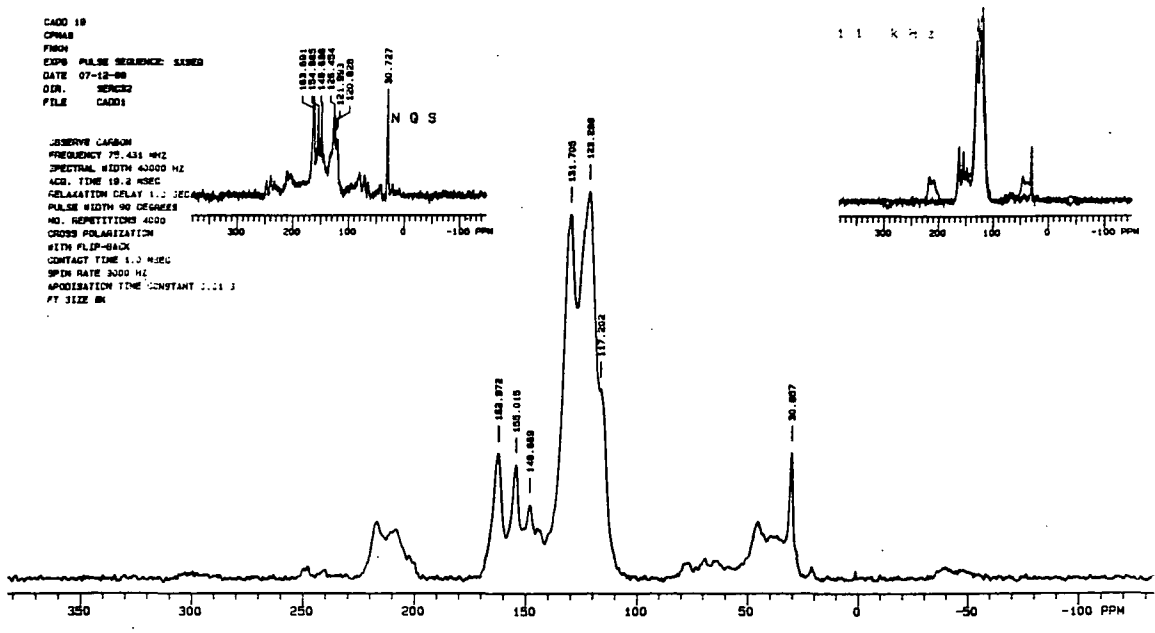
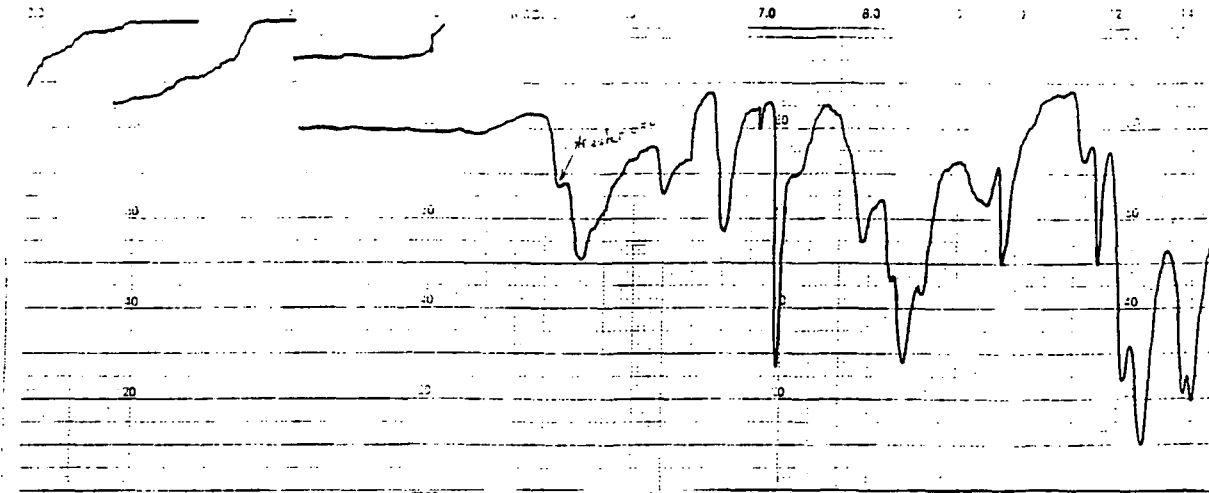
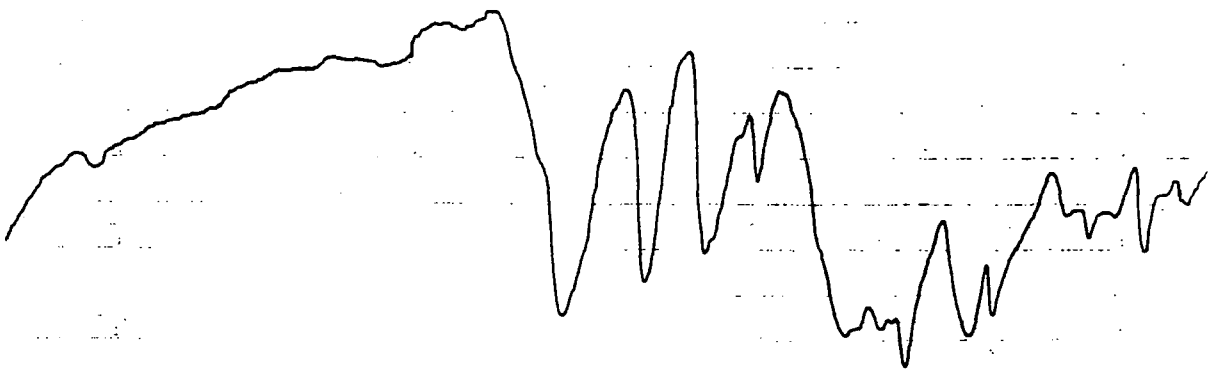

Figure A2.19



3000 WAVENUMBER (CM <sup>-1</sup> )	2500	2000	1800	1600	1400	1200	1000	800 WAVENUMBER (CM <sup>-1</sup> )
SOLVENT <u>KBr disc</u> CONCENTRATION _____ CELL PATH _____ REFERENCE _____						REMARKS		SCAN SPEED _____ SLIT _____ No 457-5001



3000 WAVENUMBER (CM <sup>-1</sup> )	2500	2000	1800	1600	1400	1200	1000	800 WAVENUMBER (CM <sup>-1</sup> )
SOLVENT <u>KBr disc</u> CONCENTRATION _____ CELL PATH _____ REFERENCE _____						REMARKS		SCAN SPEED _____ SLIT _____ No 457-5001

Figure A2.20

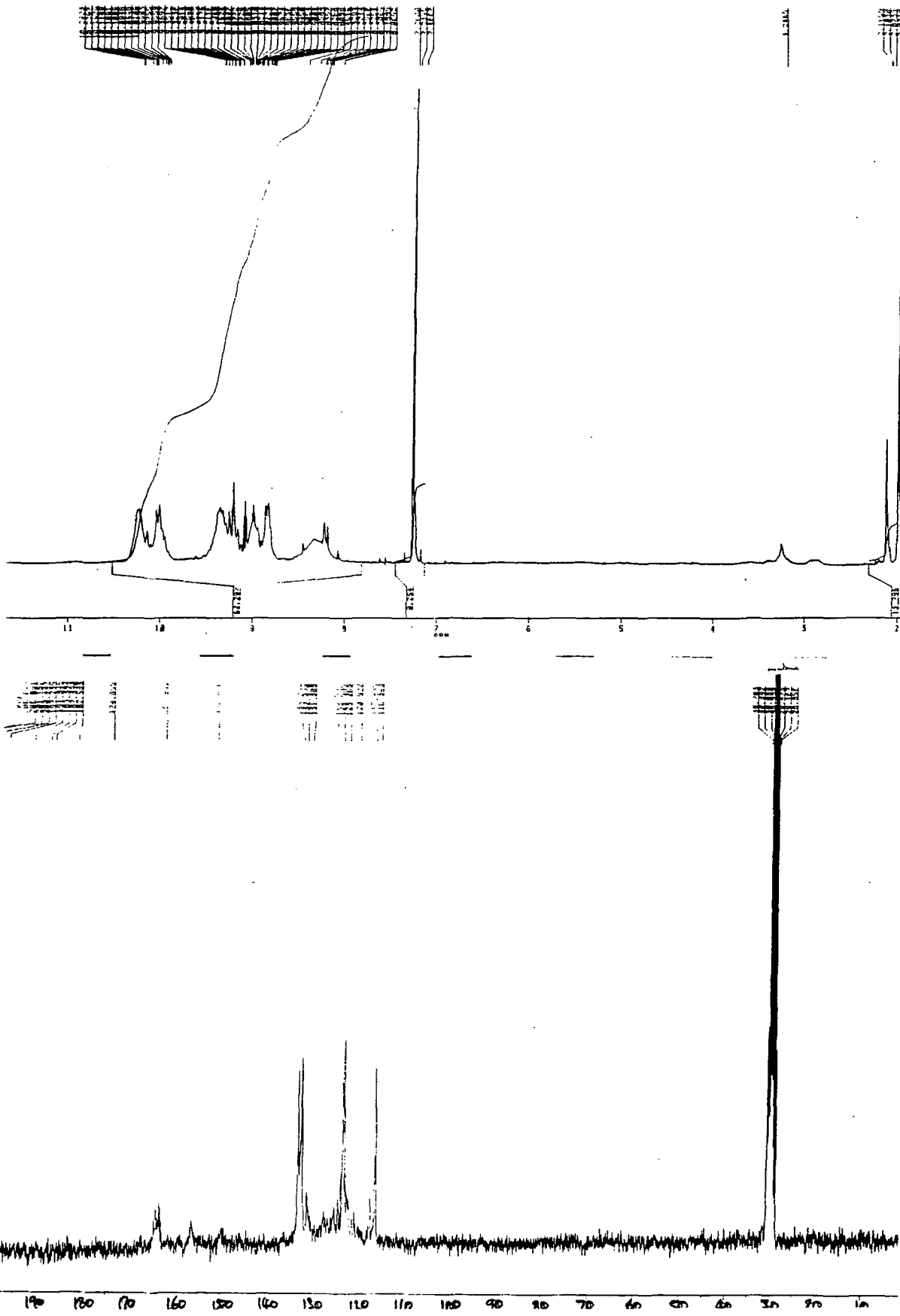
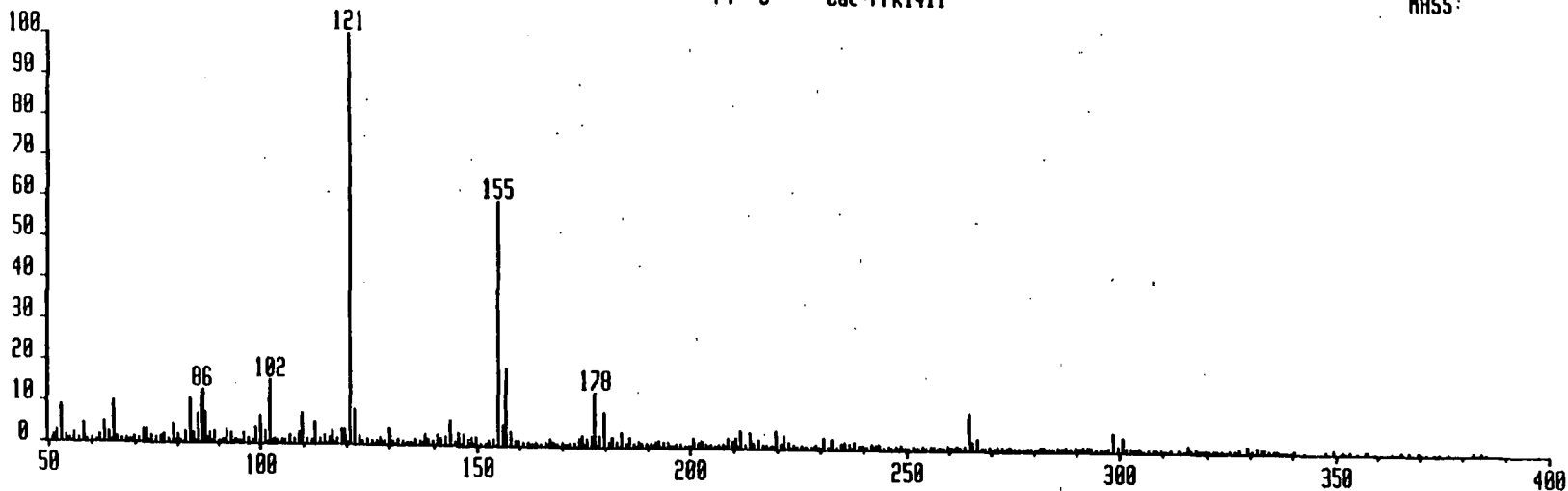

Figure A2.21

bpm=0 I=2.5v Hn=446 TIC=124740000

Acnt: Sys:ACE  
PT= 0° Cal:PFK1411

HMR: 16592000  
MASS: 121



DCMS3W43\* x1 8gd=25 21-NOV-08 10:50:03:12 70E E1+  
Bpm=0 I=2.0v Hn=446 TIC=59325000

Acnt: Sys:ACE  
PT= 0° Cal:PFK1411

HMR: 12041000  
MASS: 121

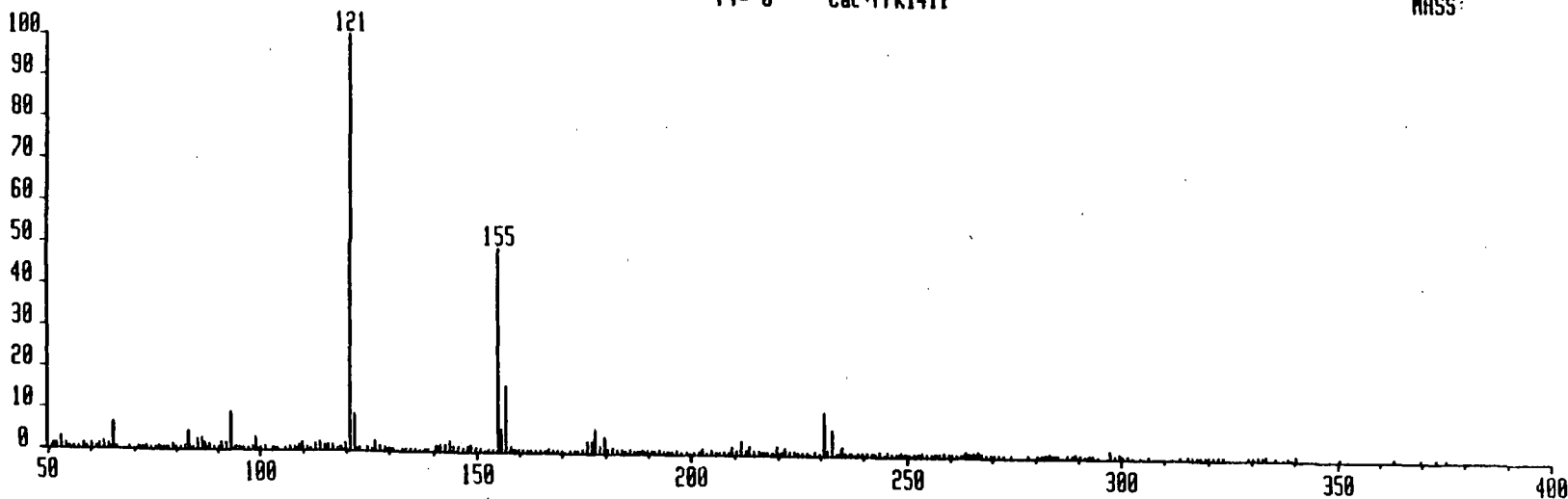

Figure A2.22

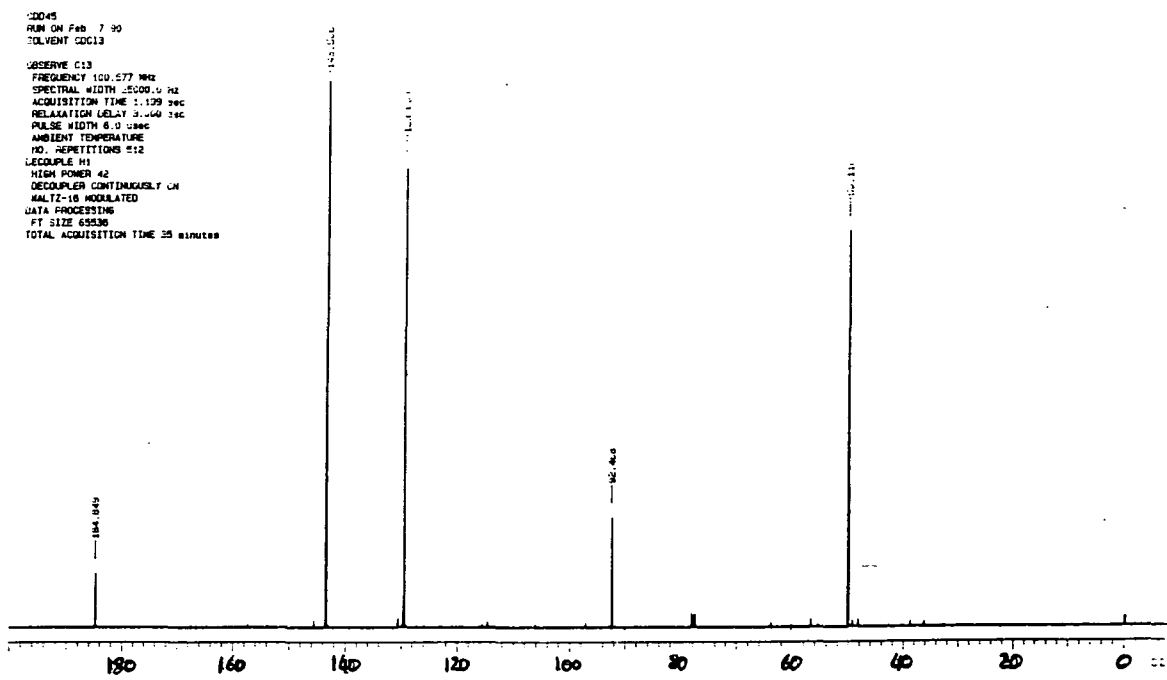
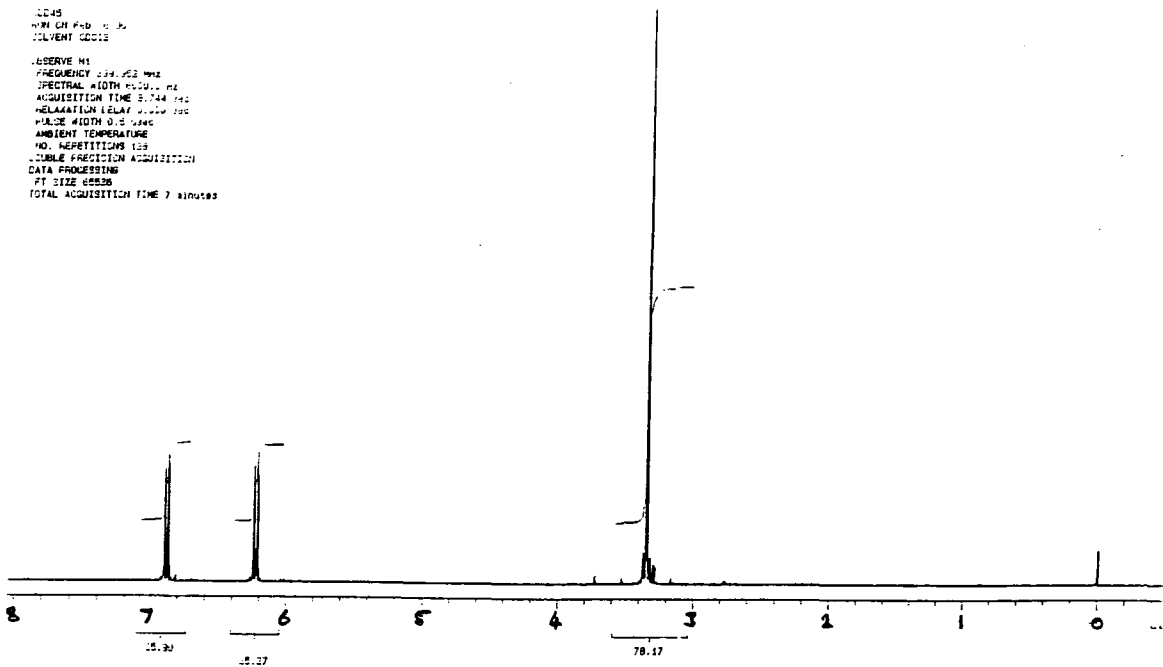

Figure A2.23

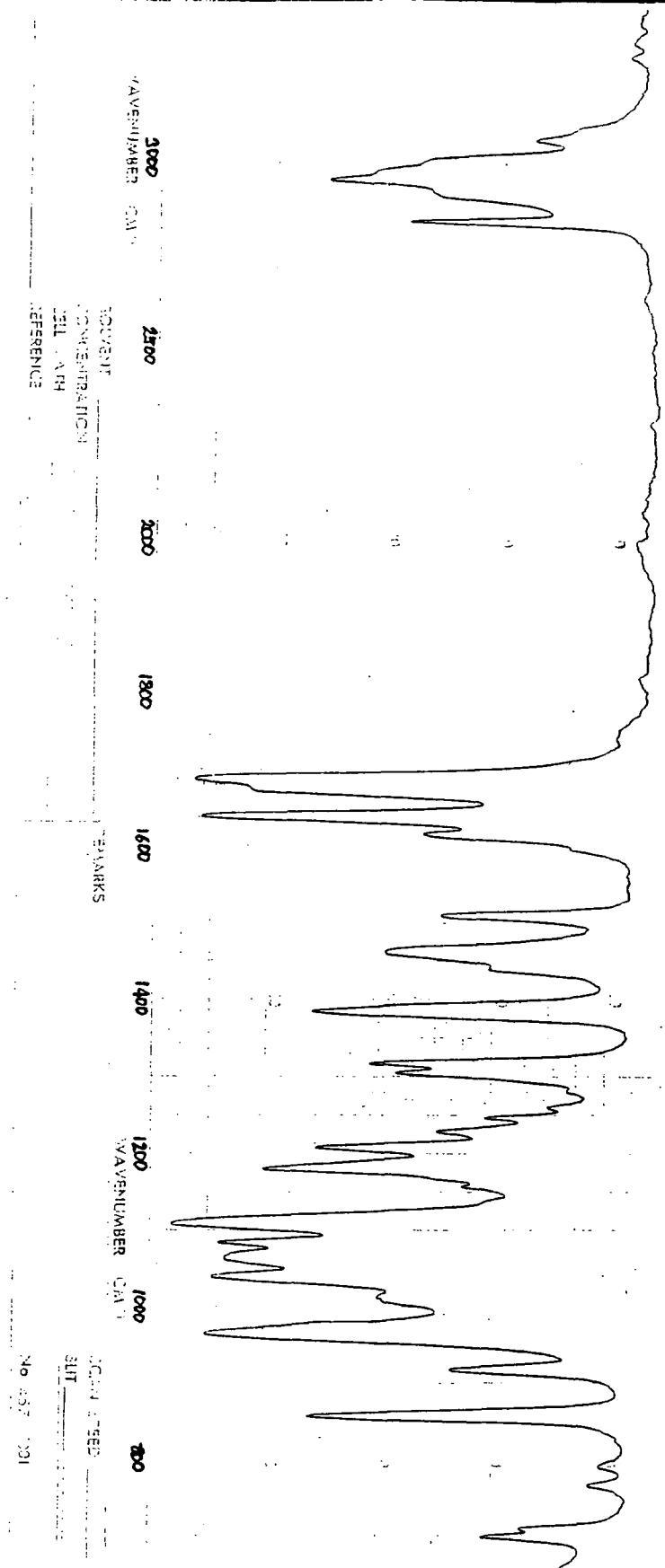

Figure A2.24

FID1  
 DATE 23-2-89  
 SF 400.133  
 OI 4880.000  
 SI 8192  
 SW 2994.812  
 NS 16  
 O2 3200.000  
 OP 63L PD  
 LB 0.0  
 PPM/CM 239  
 SR 2854.88

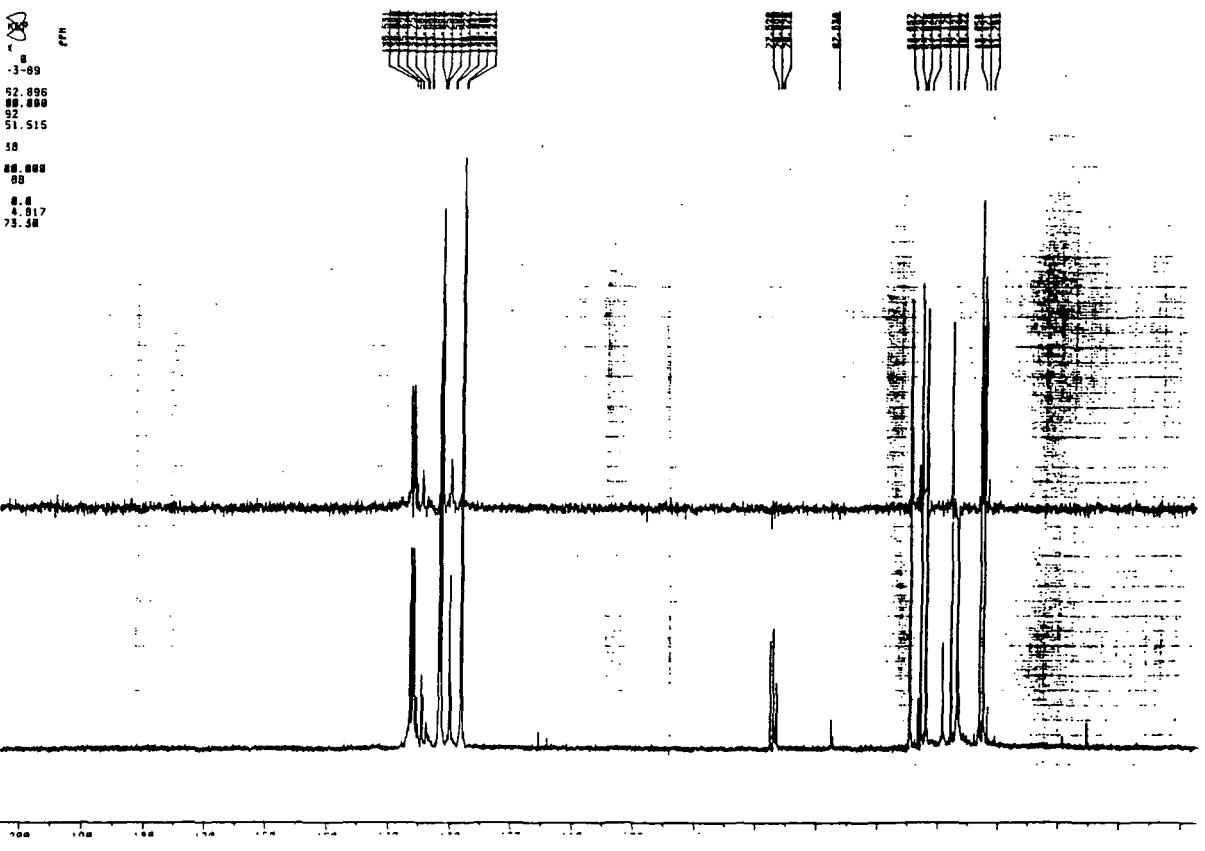
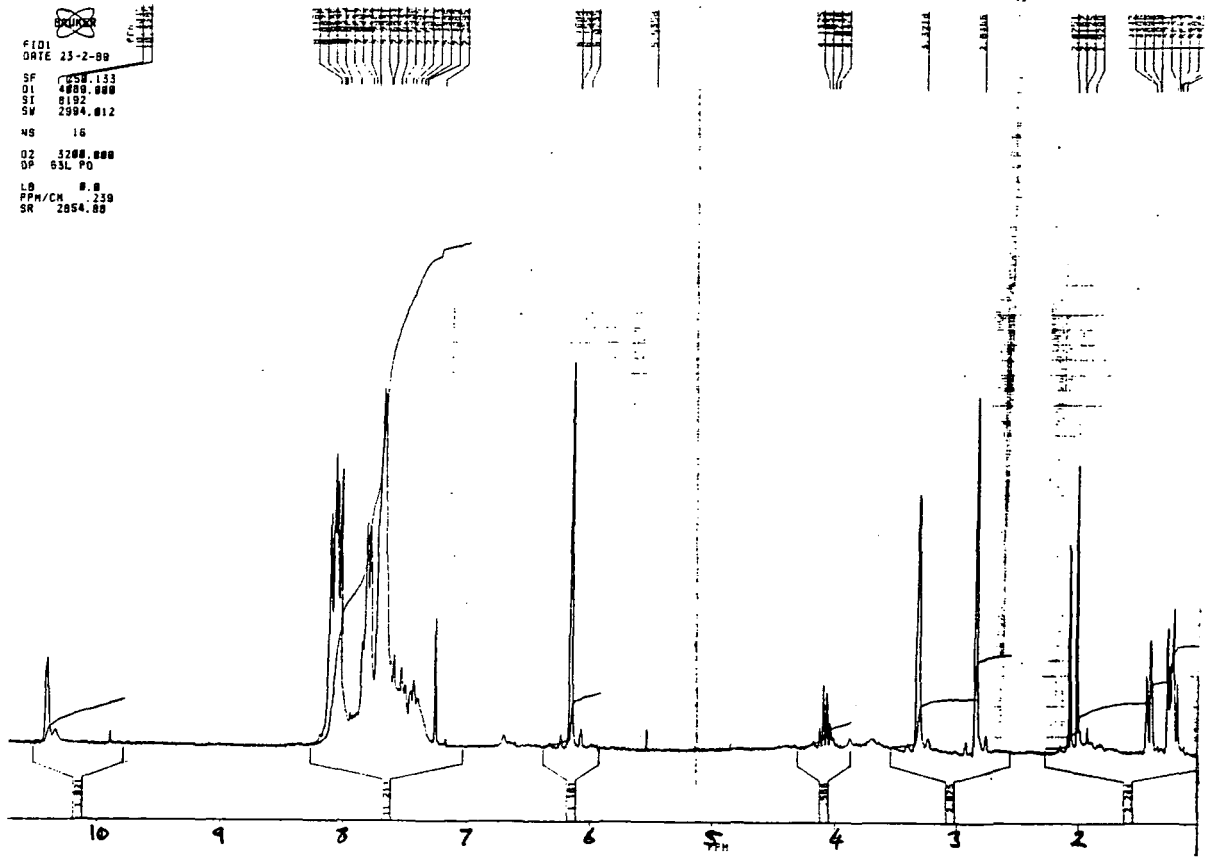
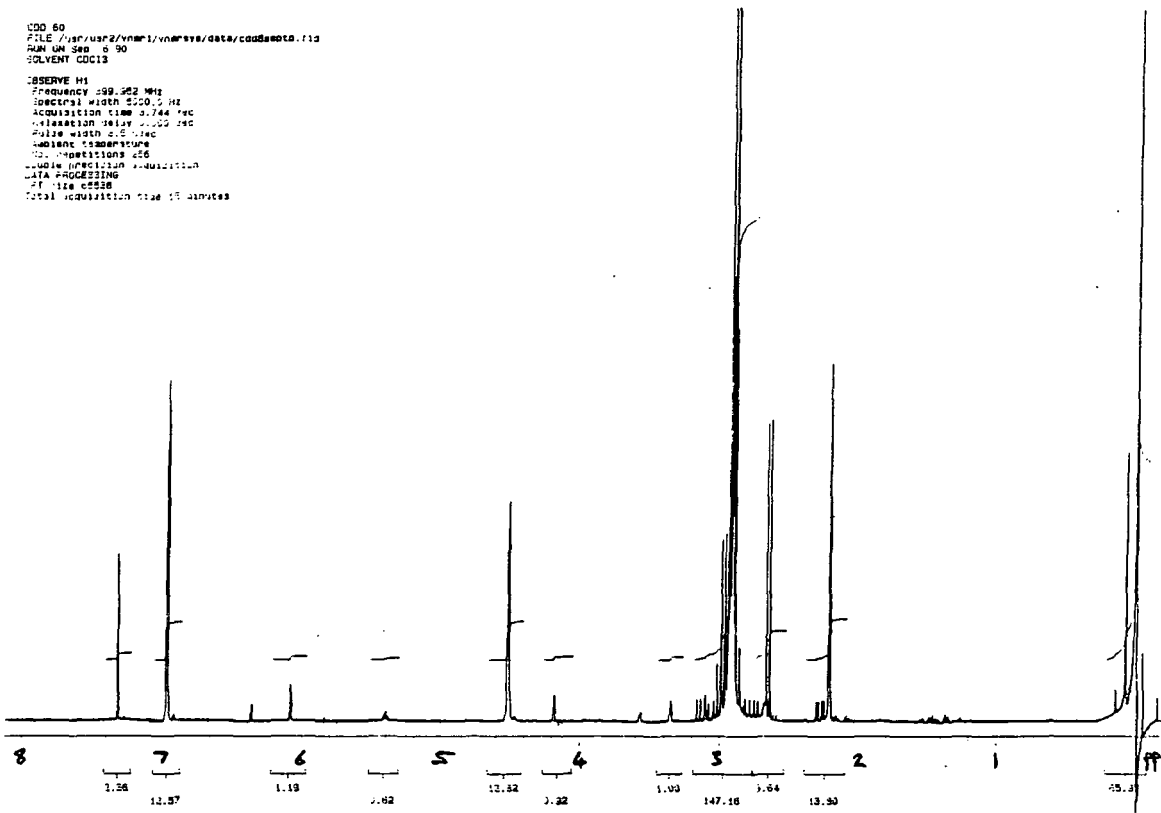

Figure A2.25



CD0 80  
FILE /usr/local/nmr/vnmr1/vnmrsta/data/cdd80a01.fid  
RUN ON SEP 8 90  
SOLVENT CDCl3

OBSERVE H1  
Frequency 299.922 MHz  
Spectral width 2200.0 Hz  
Acquisition time 3.744 sec  
Relaxation delay 2.000 sec  
Pulse width 2.500 sec  
Solvent temperature  
10.000000000000000  
Solve precision acquisition  
DATA PROCESSING  
FT file cdd80  
Total acquisition time 15 minutes



CD0 80  
FILE /usr/local/nmr/vnmr1/vnmrsta/data/cdd80a01.fid  
RUN ON SEP 8 90  
SOLVENT CDCl3

OBSERVE F2  
Frequency 125.767 MHz  
Spectral width 2100.0 Hz  
Acquisition time 1.000 sec  
Relaxation delay 2.000 sec  
Pulse width 4.000 sec  
Solvent temperature  
10.000000000000000  
Solve precision acquisition  
DATA PROCESSING  
Line broadening 0.2 Hz  
Russian acquisition 1.000 sec  
FT file cdd80  
Total acquisition time 2.4 hours

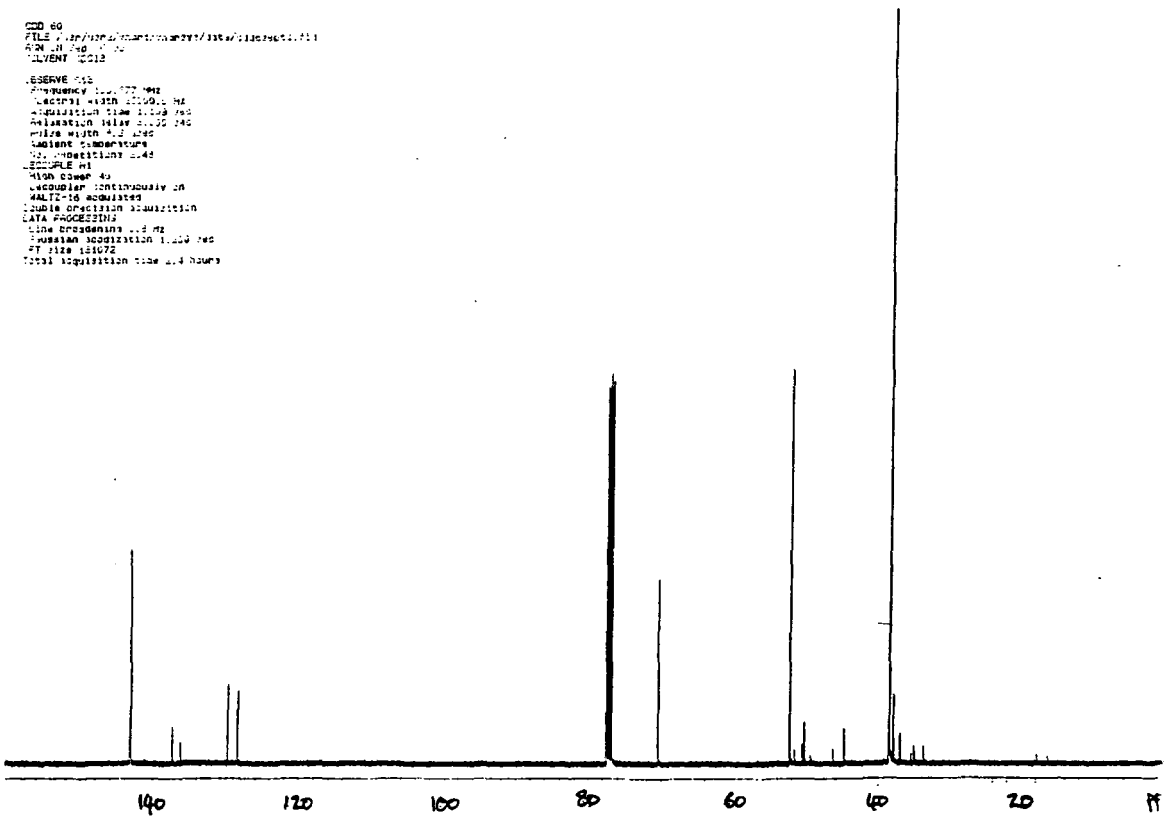

Figure A2.26

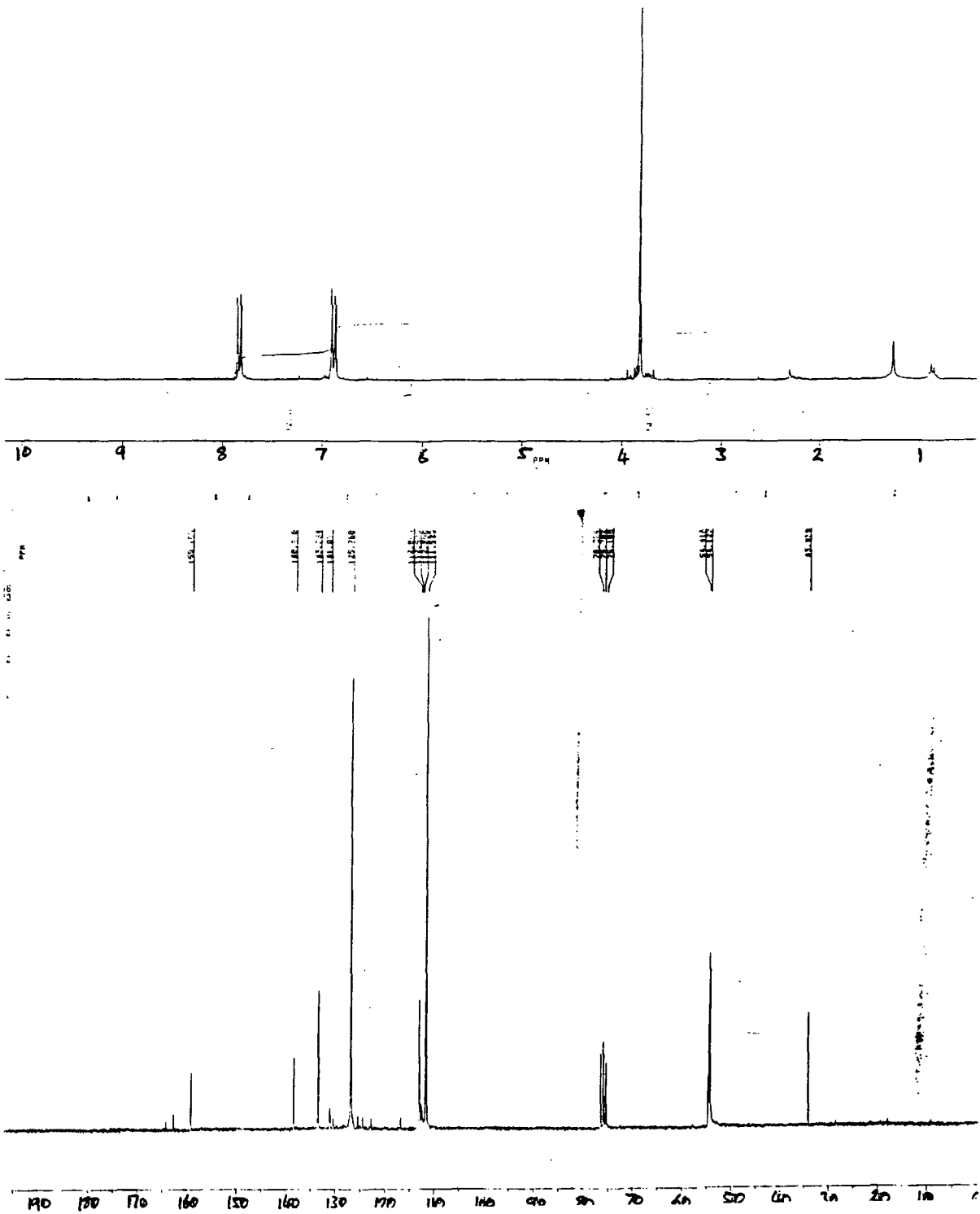
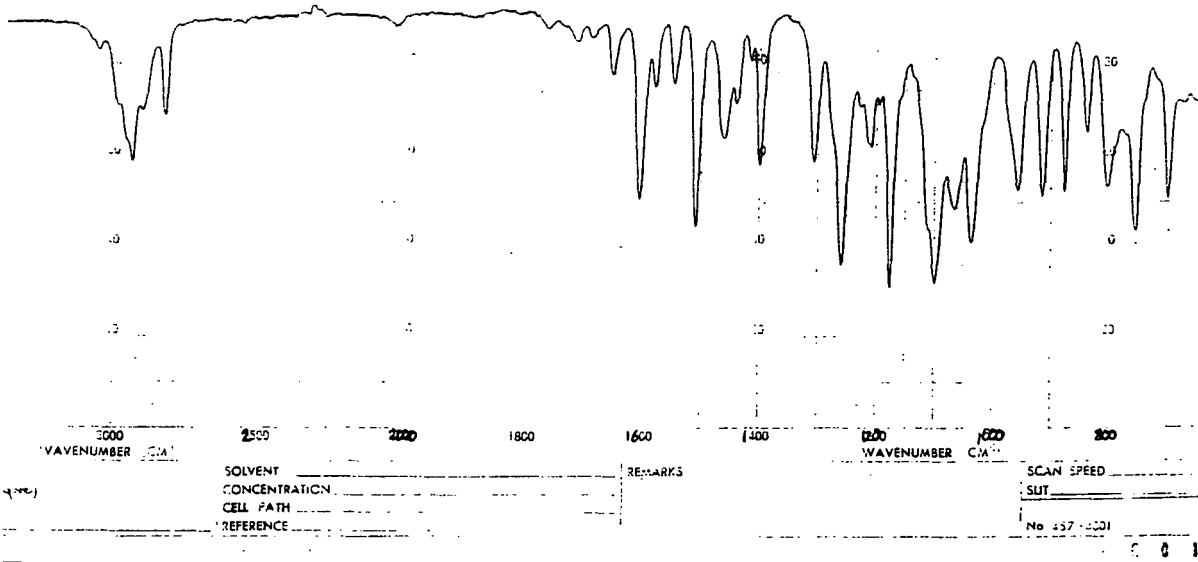

Figure A2.27



DCMS24011326 x1 Bgd=1124 8-MAR-98 16:38:01:54 78C EI-  
 BpM=0 I=9.2v Hw=229 TIC=217583888 Acnt: Sys: CROO HNR: 68357888  
 FR3 8.1 NSEC GC= 189 Cal: PFK16JRM NRSS: 189

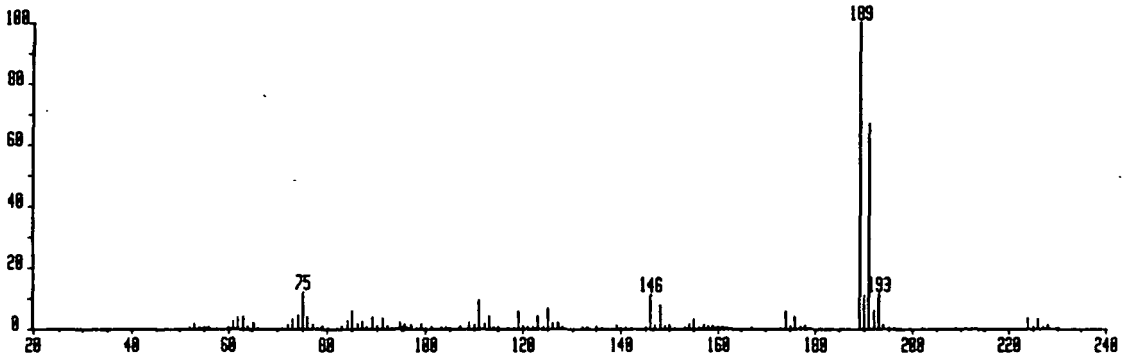
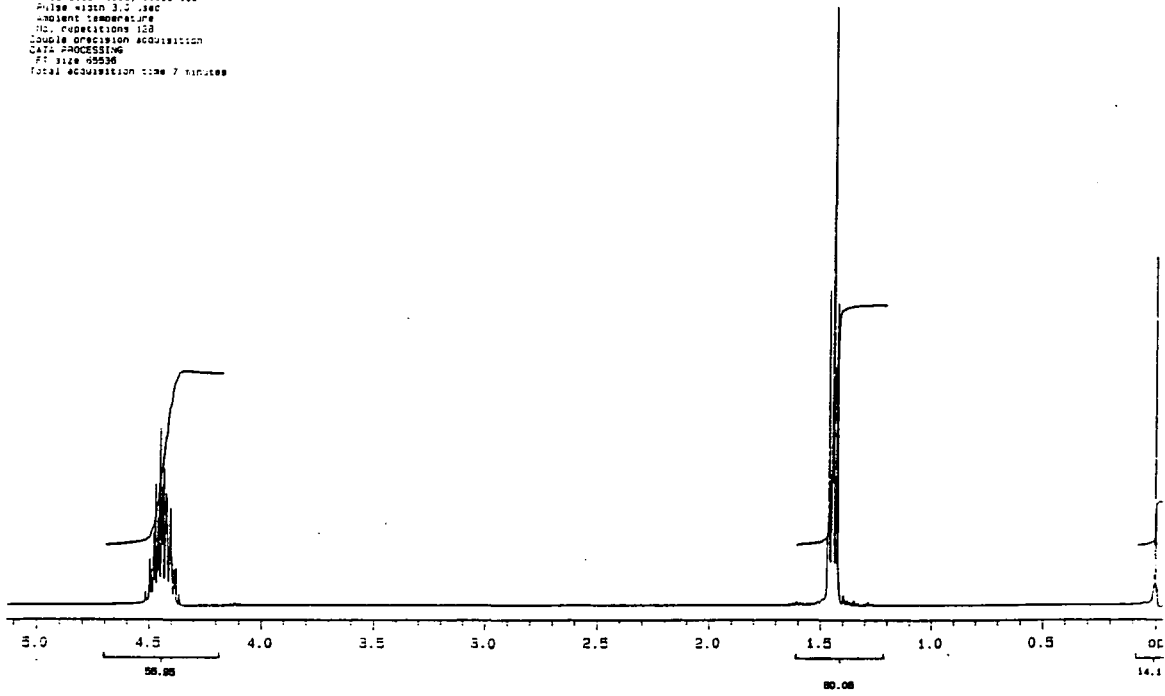

Figure A2.28

C00 62  
 RUN ON Oct 12 90  
 SOLVENT CDCl3  
 OBSERVE H1  
 Frequency 399.952 MHz  
 Spectral width 5000.0 Hz  
 Acquisition time 3.742 sec  
 Relaxation delay 0.000 sec  
 Pulse width 3.000 sec  
 Ambient temperature  
 No. repetitions 128  
 Double precision acquisition  
 DATA PROCESSING  
 FT size 65536  
 Total acquisition time 7 minutes



C00 63  
 RUN ON Oct 12 90  
 SOLVENT CDCl3  
 OBSERVE C13  
 Frequency 100.577 MHz  
 Spectral width 22000.0 Hz  
 Acquisition time 1.198 sec  
 Relaxation delay 3.000 sec  
 Pulse width 8.300 usec  
 Ambient temperature  
 No. repetitions 512  
 DECOUPLE H1  
 High power 45  
 Decoupler continuously on  
 HALTZ-16 modulated  
 Double precision acquisition  
 DATA PROCESSING  
 Line broadening 0.8 Hz  
 Gaussian apodization 0.600 sec  
 FT size 131072  
 Total acquisition time 35 minutes

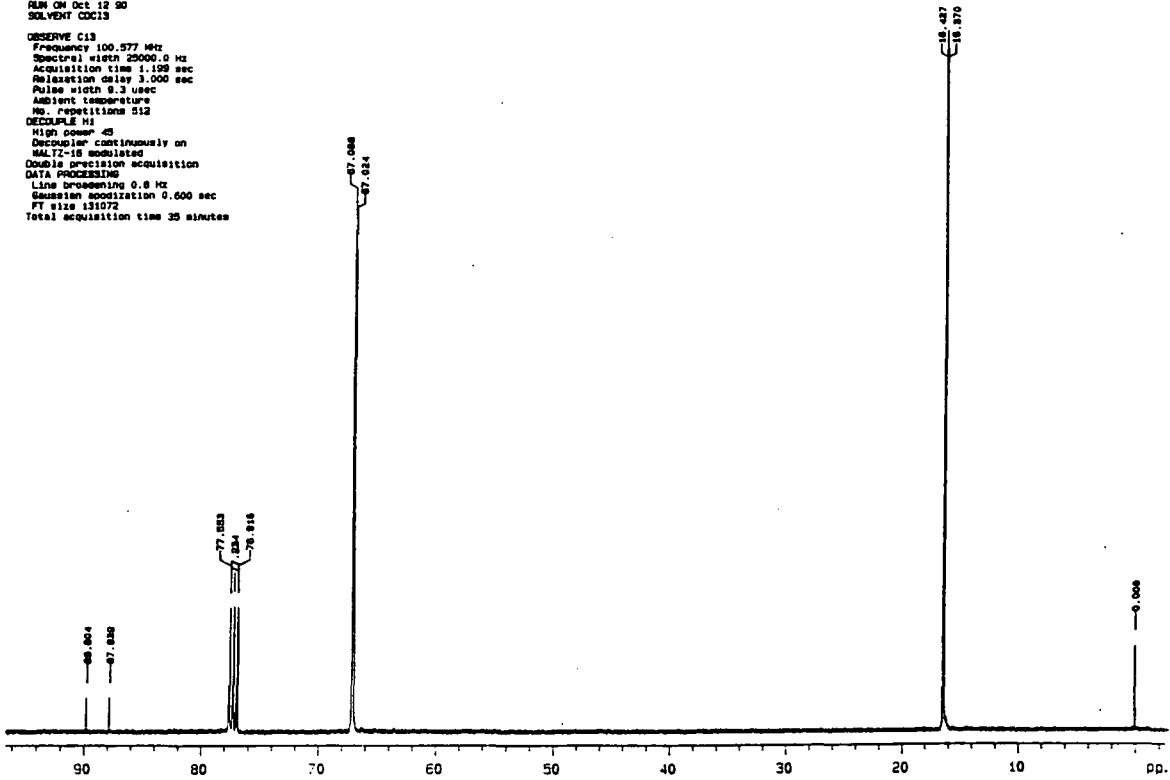
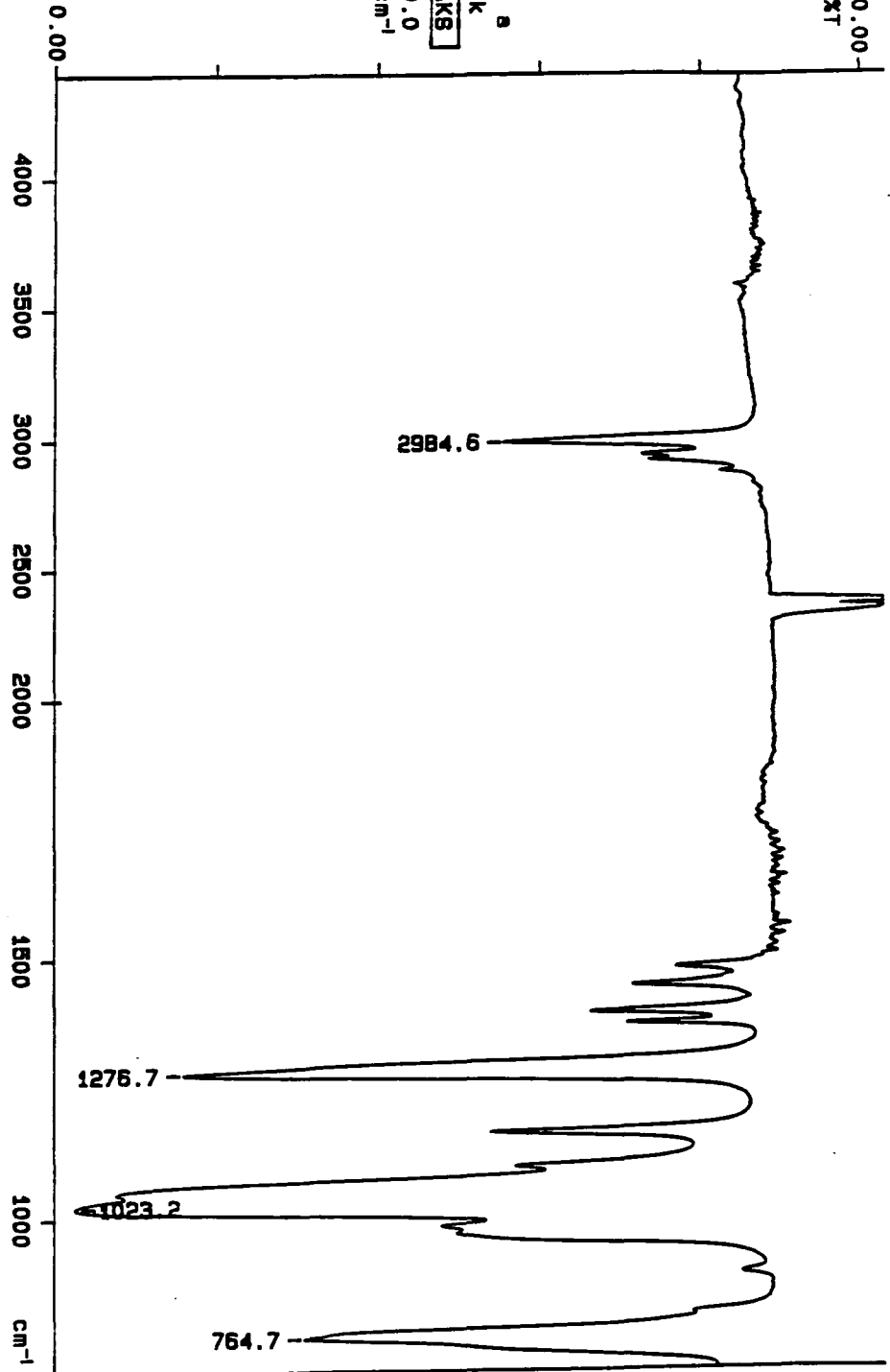

Figure A2.29

100.00  
XT

not a  
peak  
PEAKS  
700.0  
cm<sup>-1</sup>



94/12/13 20:33  
X: 16 scans, 4.0cm<sup>-1</sup>

Figure A2.30

CDD 61  
RUN ON Sep 19 90  
SOLVENT CDC13

OBSERVE H1  
Frequency 399.952 MHz  
Spectral width 5000.0 Hz  
Acquisition time 3.744 sec  
Relaxation delay 0.000 sec  
Pulse width 3.5 usec  
Ambient temperature  
No. repetitions 128  
Double precision acquisition  
DATA PROCESSING  
FT size 65936  
Total acquisition time 7 minutes

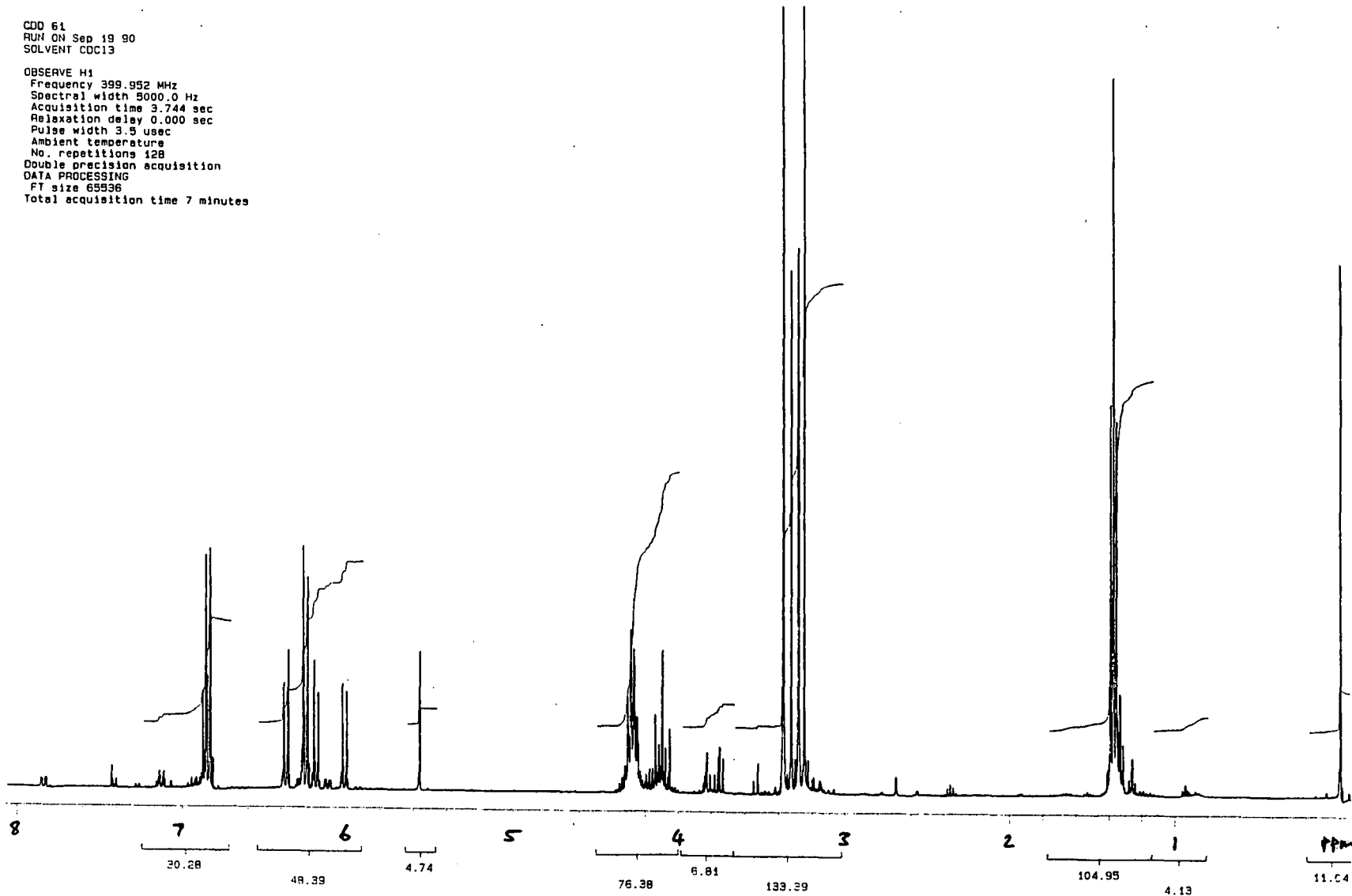

Figure A2.31

CDD 63  
FILE /usr/usr2/vmr1/vmrays/data/cdd9octa.fid  
RUN ON Oct 9 90  
SOLVENT CDC13

OBSERVE H1  
Frequency 309.852 MHz  
Spectral width 5000.0 Hz  
Acquisition time 3.744 sec  
Relaxation delay 0.000 sec  
Pulse width 3.0 usec  
Ambient temperature  
No. repetitions 128  
Double precision acquisition  
DATA PROCESSING  
FT size 65536  
Total acquisition time 7 minutes

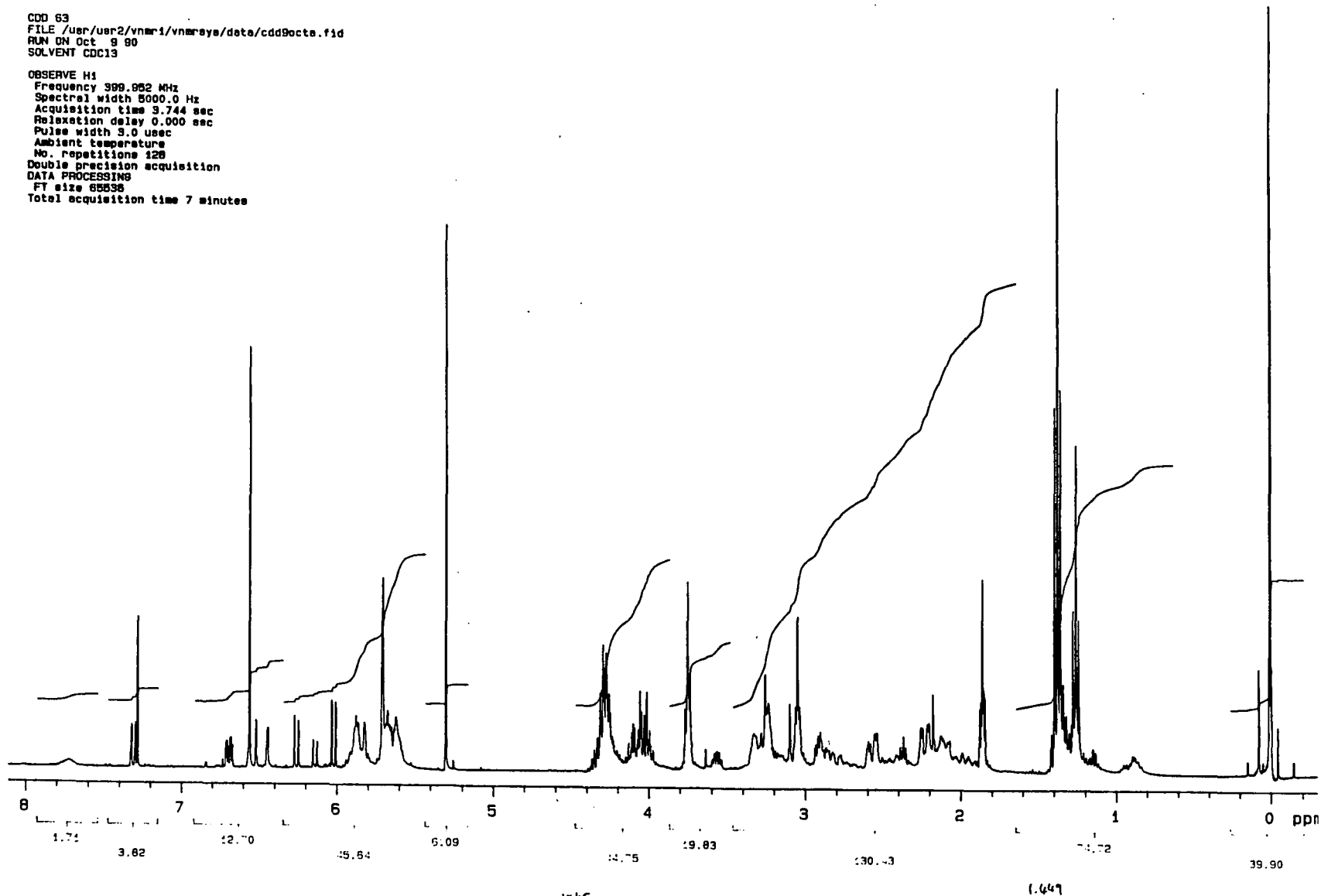
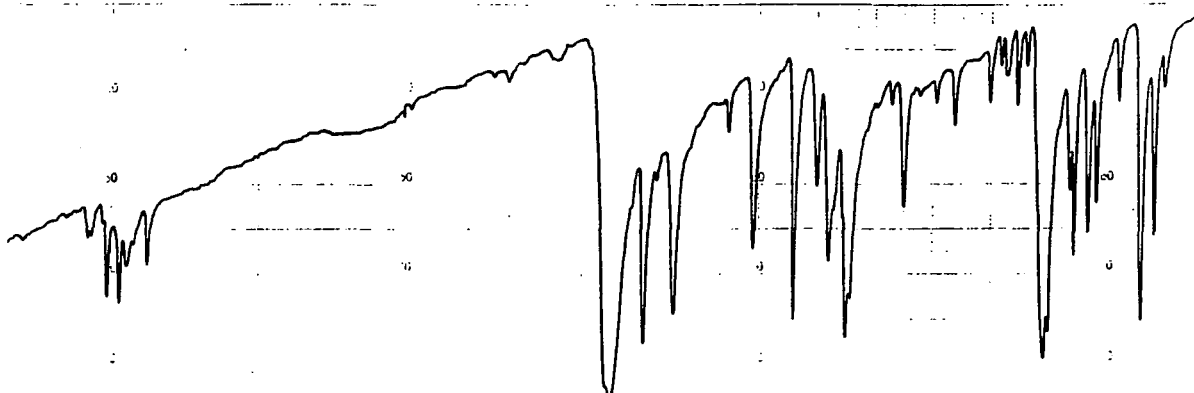

Figure A2.32



3000 2500 2000 1800 1600 1400 1200 1000 800  
 WAVELENGTH (MICRONS) WAVELENGTH (MICRONS)  
 SOLVENT \_\_\_\_\_ REMARKS \_\_\_\_\_  
 CONCENTRATION \_\_\_\_\_  
 CELL PATH \_\_\_\_\_  
 REFERENCE \_\_\_\_\_  
 SCAN SPEED \_\_\_\_\_  
 SUT \_\_\_\_\_  
 No 337 13

NGV-90 12 37 AVE report on C CADDACC Page 1 of 1  
 C CADDACC40-100.CADDACC.DDR/U

DB MIN	Fw	LM	HM	INT	PMI	Scans
CONT FIX	50	170	250	1%	1	61
1	1.59	242.00956	1.09	4.52	25669.27	31
2	2.27	240.01081	2.59	10.74	26240.77	39
3	0.62	235.99081	2.81	11.89	27393.97	8
4	0.31	231.99302	0.35	1.51	28574.75	2
5	0.44	223.99236	0.61	2.74	30999.52	5
6	0.95	218.98851	0.75	3.46	33192.64	11
7	0.55	212.98053	2.01	9.43	34475.61	7
8	0.96	211.98026	3.18	14.87	34903.15	12
9	2.11	206.99924	2.04	9.97	36448.73	39
10	1.16	205.99828	1.06	5.17	37786.97	13
11	0.70	200.99667	3.02	15.03	38480.24	9
12	0.90	185.99313	0.78	4.22	43836.01	11
13	0.59	181.99528	1.84	10.14	45336.41	7
14	2.31	179.97205	1.79	9.93	46121.69	41
15	23.81	178.96594	2.77	15.45	48507.31	61
16	12.70	177.97151	2.31	12.98	46892.16	61
17	31.55	176.96784	0.95	5.36	47281.04	61
18	28.27	175.96985	1.28	7.29	47673.40	61
19	100.00	174.96928	2.52	14.43	48664.40	61
20	19.90	173.96437	2.74	15.77	49465.01	61
21	2.83	170.06679	2.84	18.69	50031.73	39
22	0.45	170.01024	0.56	3.28	50039.41	2

page Standard Deviation. 1.81 9.31

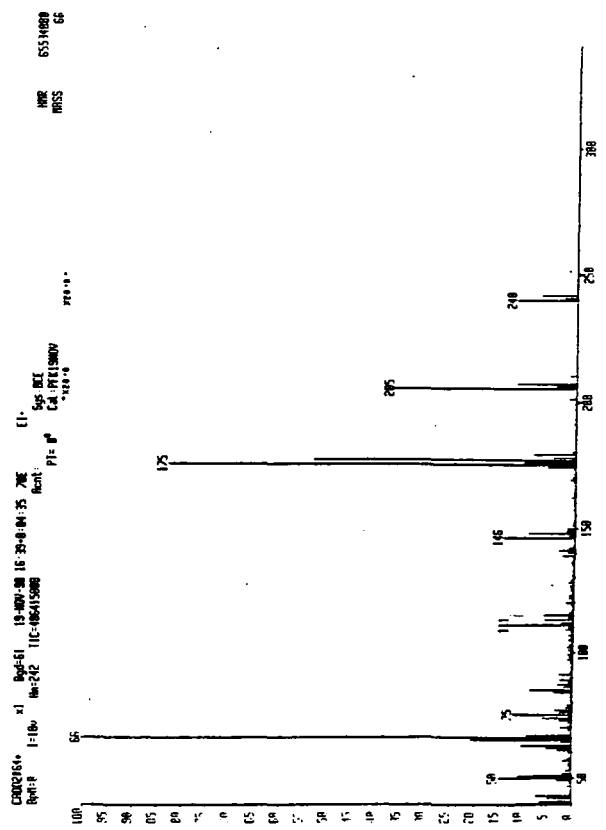

Figure A2.33



CDD 67  
FILE /usr/usr2/vnmr1/vnmr1s/data/cdd5deca.fid  
RUN ON Dec 5 90  
SOLVENT CDCl3

OBSERVE H1  
Frequency 399.952 MHz  
Spectral width 5000.0 Hz  
Acquisition time 3.744 sec  
Relaxation delay 0.000 sec  
Pulse width 3.6 usec  
Ambient temperature  
No. repetitions 128  
Double precision acquisition  
DATA PROCESSING  
FT size 65536  
Total acquisition time 7 minutes

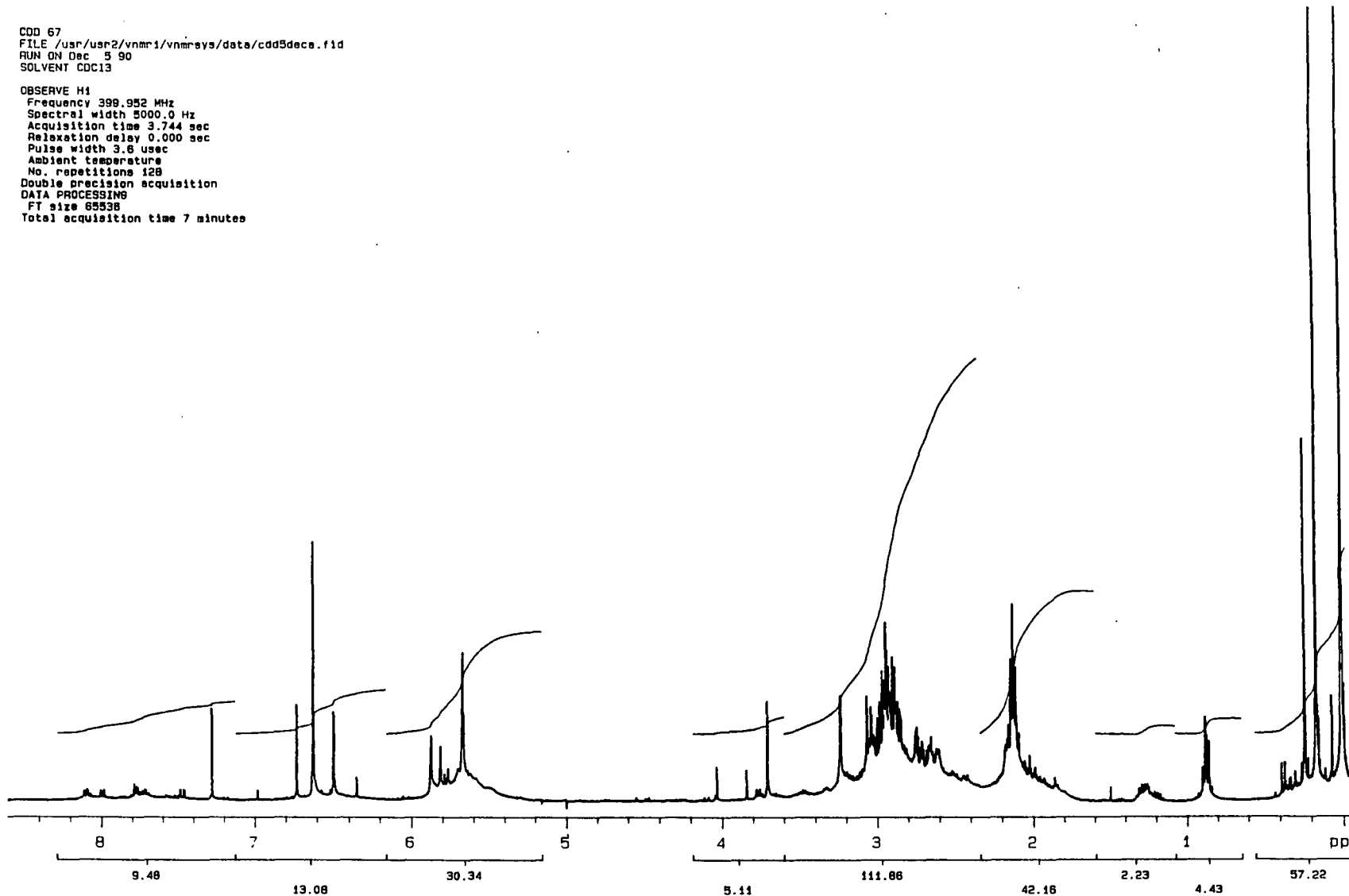

Figure A2.34

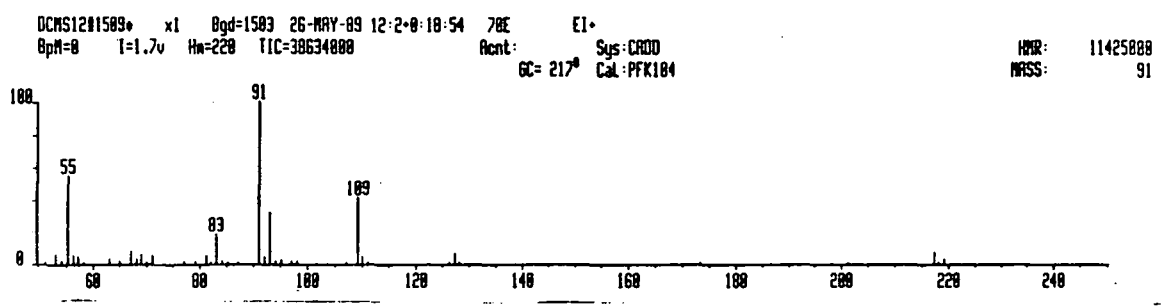
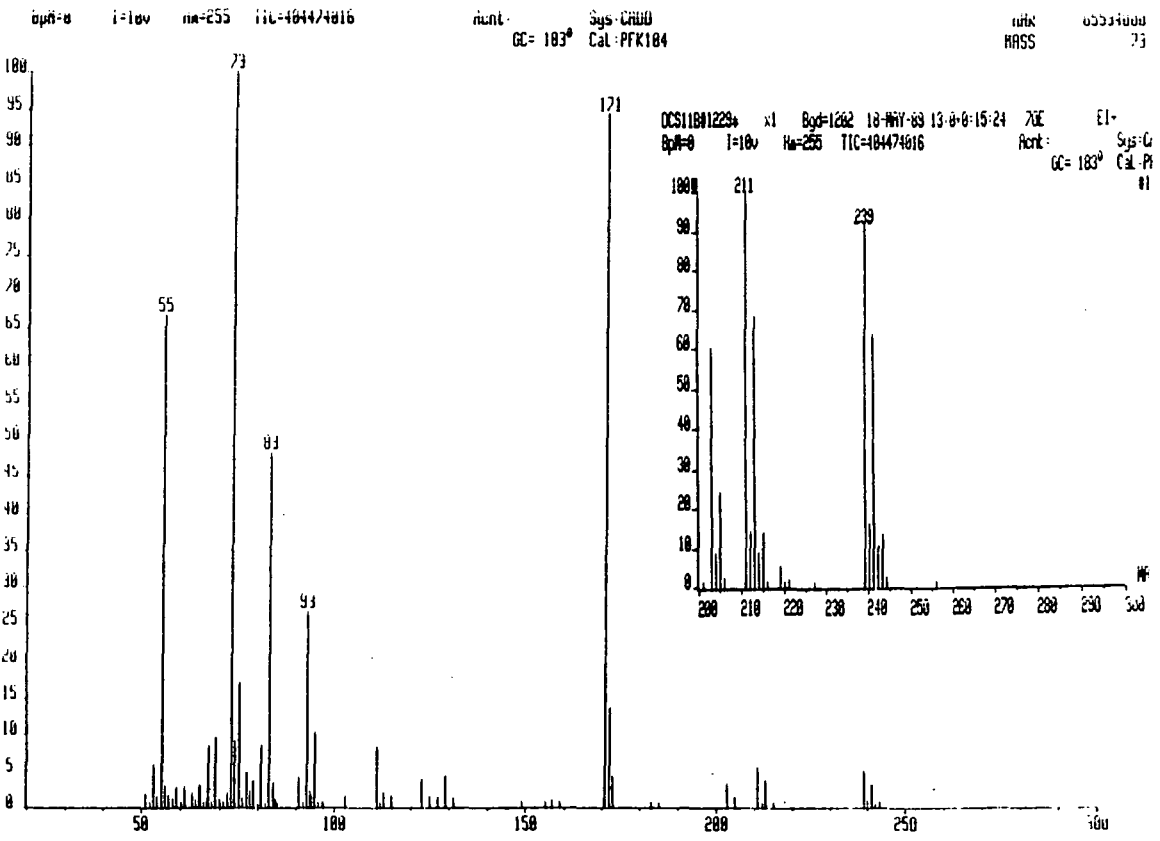

Figure A2.35

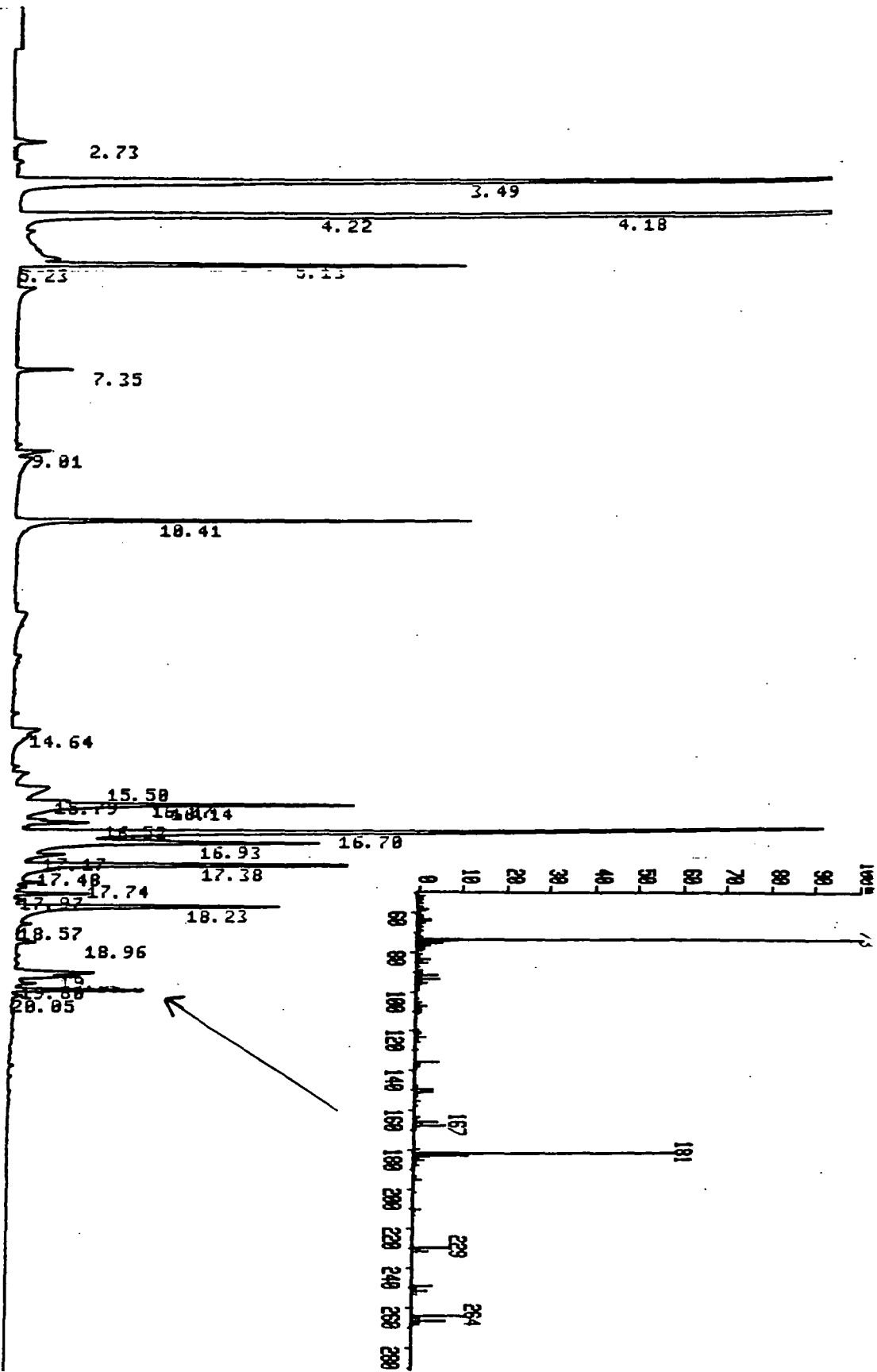
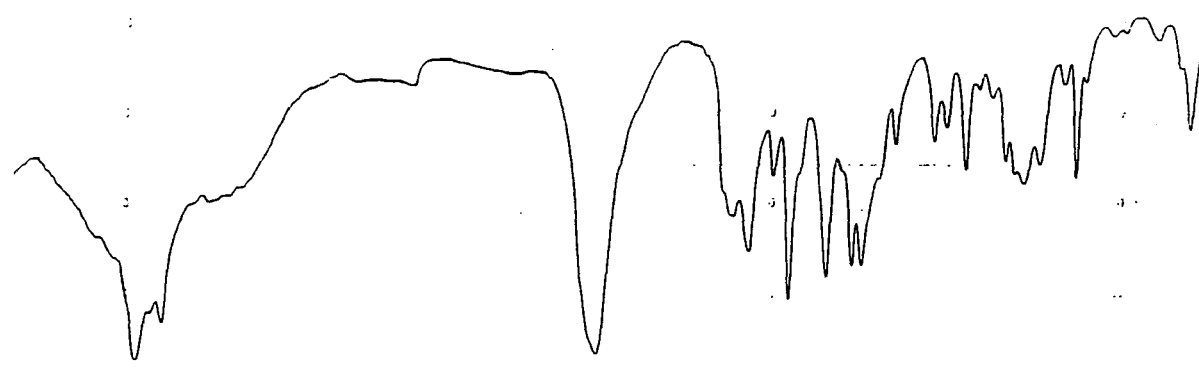

Figure A2.36



3000	2500	2000	1800	1600	1400	1200	1000	800
WAVENUMBER (CM <sup>-1</sup> )				WAVENUMBER (CM <sup>-1</sup> )				
SOLVENT <u>KBr disc</u>				REMARKS				SCAN SPEED
CONCENTRATION								SMT
CELL PATH								No 457-5001
REFERENCE								

Wavenumber (cm <sup>-1</sup> )	Transmittance (%)	Mass (amu)	SD (amu)
3000	95.00	259	95.02
2950	95.00	257	95.02
2900	95.00	255	95.02
2850	95.00	253	95.02
2800	95.00	251	95.02
2750	95.00	249	95.02
2700	95.00	247	95.02
2650	95.00	245	95.02
2600	95.00	243	95.02
2550	95.00	241	95.02
2500	95.00	239	95.02
2450	95.00	237	95.02
2400	95.00	235	95.02
2350	95.00	233	95.02
2300	95.00	231	95.02
2250	95.00	229	95.02
2200	95.00	227	95.02
2150	95.00	225	95.02
2100	95.00	223	95.02
2050	95.00	221	95.02
2000	95.00	219	95.02
2000	95.00	217	95.02
2000	95.00	215	95.02
2000	95.00	213	95.02
2000	95.00	211	95.02
2000	95.00	209	95.02
2000	95.00	207	95.02
2000	95.00	205	95.02
2000	95.00	203	95.02
2000	95.00	201	95.02
2000	95.00	199	95.02
2000	95.00	197	95.02
2000	95.00	195	95.02
2000	95.00	193	95.02
2000	95.00	191	95.02
2000	95.00	189	95.02
2000	95.00	187	95.02
2000	95.00	185	95.02
2000	95.00	183	95.02
2000	95.00	181	95.02
2000	95.00	179	95.02
2000	95.00	177	95.02
2000	95.00	175	95.02
2000	95.00	173	95.02
2000	95.00	171	95.02
2000	95.00	169	95.02
2000	95.00	167	95.02
2000	95.00	165	95.02
2000	95.00	163	95.02
2000	95.00	161	95.02
2000	95.00	159	95.02
2000	95.00	157	95.02
2000	95.00	155	95.02
2000	95.00	153	95.02
2000	95.00	151	95.02
2000	95.00	149	95.02
2000	95.00	147	95.02
2000	95.00	145	95.02
2000	95.00	143	95.02
2000	95.00	141	95.02
2000	95.00	139	95.02
2000	95.00	137	95.02
2000	95.00	135	95.02
2000	95.00	133	95.02
2000	95.00	131	95.02
2000	95.00	129	95.02
2000	95.00	127	95.02
2000	95.00	125	95.02
2000	95.00	123	95.02
2000	95.00	121	95.02
2000	95.00	119	95.02
2000	95.00	117	95.02
2000	95.00	115	95.02
2000	95.00	113	95.02
2000	95.00	111	95.02
2000	95.00	109	95.02
2000	95.00	107	95.02
2000	95.00	105	95.02
2000	95.00	103	95.02
2000	95.00	101	95.02
2000	95.00	99	95.02
2000	95.00	97	95.02
2000	95.00	95	95.02
2000	95.00	93	95.02
2000	95.00	91	95.02
2000	95.00	89	95.02
2000	95.00	87	95.02
2000	95.00	85	95.02
2000	95.00	83	95.02
2000	95.00	81	95.02
2000	95.00	79	95.02
2000	95.00	77	95.02
2000	95.00	75	95.02
2000	95.00	73	95.02
2000	95.00	71	95.02
2000	95.00	69	95.02
2000	95.00	67	95.02
2000	95.00	65	95.02
2000	95.00	63	95.02
2000	95.00	61	95.02
2000	95.00	59	95.02
2000	95.00	57	95.02
2000	95.00	55	95.02
2000	95.00	53	95.02
2000	95.00	51	95.02
2000	95.00	49	95.02
2000	95.00	47	95.02
2000	95.00	45	95.02
2000	95.00	43	95.02
2000	95.00	41	95.02
2000	95.00	39	95.02
2000	95.00	37	95.02
2000	95.00	35	95.02
2000	95.00	33	95.02
2000	95.00	31	95.02
2000	95.00	29	95.02
2000	95.00	27	95.02
2000	95.00	25	95.02
2000	95.00	23	95.02
2000	95.00	21	95.02
2000	95.00	19	95.02
2000	95.00	17	95.02
2000	95.00	15	95.02
2000	95.00	13	95.02
2000	95.00	11	95.02
2000	95.00	9	95.02
2000	95.00	7	95.02
2000	95.00	5	95.02
2000	95.00	3	95.02
2000	95.00	1	95.02

Figure A2.37

CD0 DC F40 2  
FILE /usr/ufp-2/vmr1/vmrays/data/cd02hovo.113  
RUN ON Nov 28 90  
SOLVENT CDCl3  
OBSERVE H1

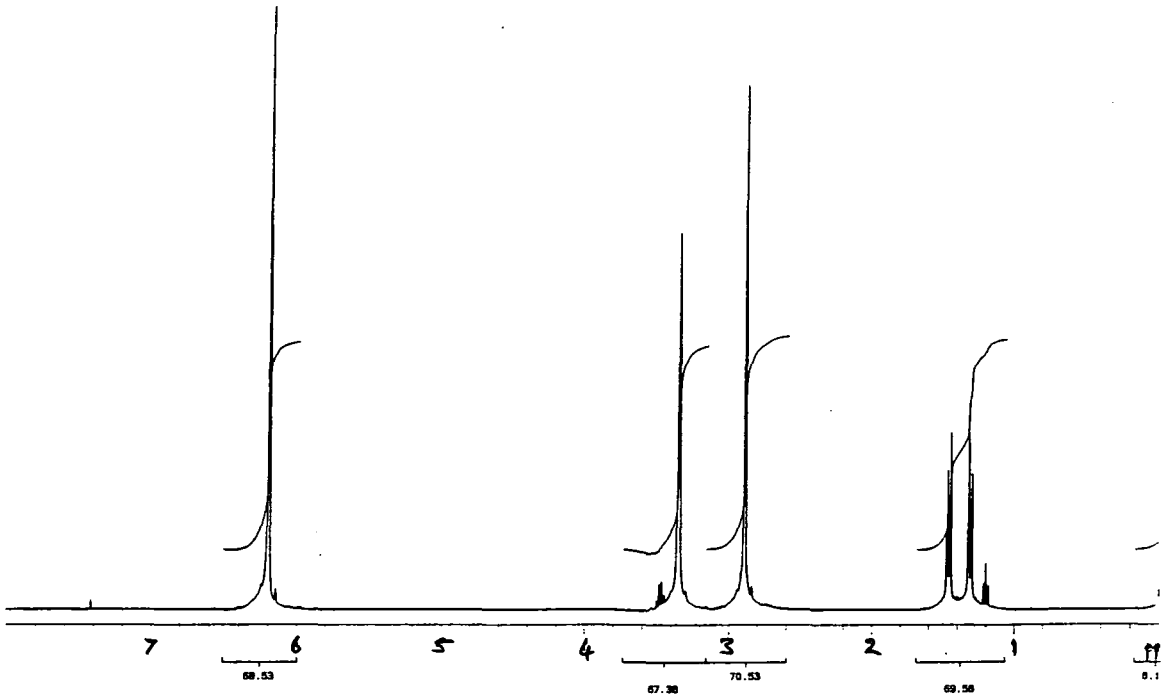

CD0 DC F40 2  
RUN ON Nov 28 90  
SOLVENT CDCl3  
OBSERVE C13

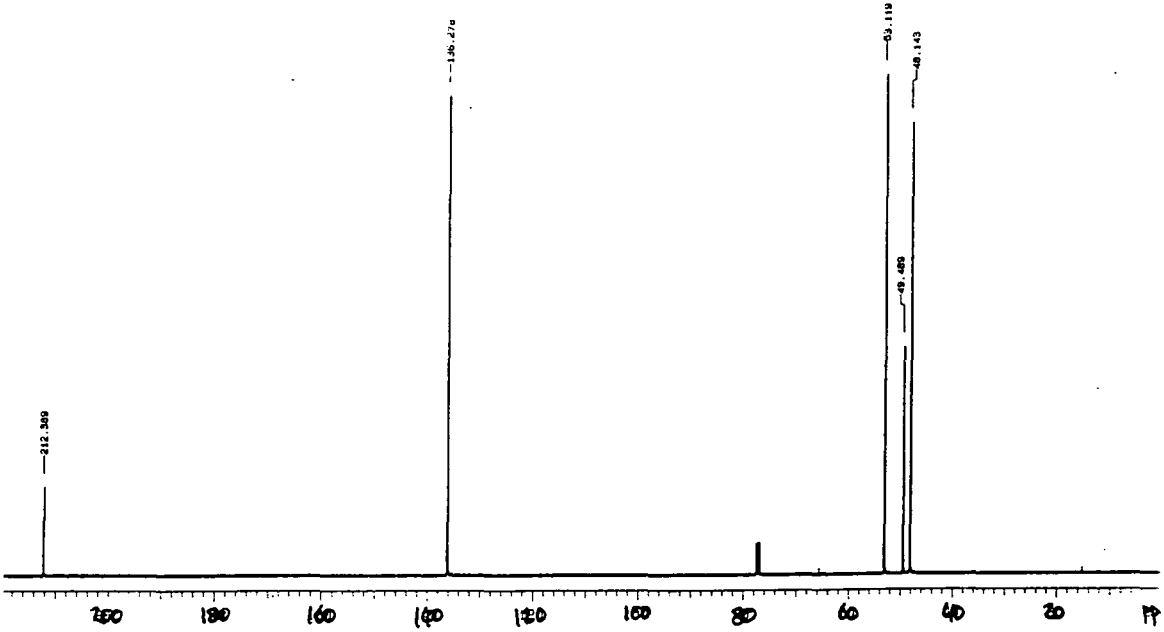
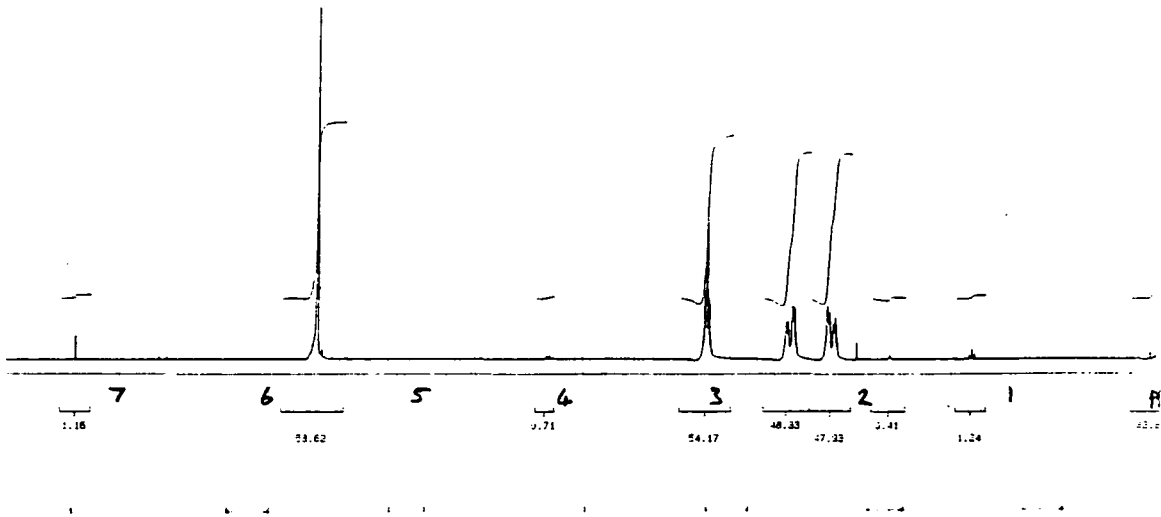

Figure A2.38

CDD 57  
 RUN ON JUN 21 90  
 SOLVENT CCl3  
 OBSERVE M1  
 Frequency 300.032 MHz  
 Spectral width 20000.0 Hz  
 Acquisition time 3.744 sec  
 Relaxation delay 0.000 sec  
 Pulse width 5.0 usec  
 Ambient temperature  
 No. repetitions 128  
 Double precision acquisition  
 DATA PROCESSING  
 FT size 65536  
 Total acquisition time / minutes



CDD 57  
 RUN ON JUN 21 90  
 SOLVENT CCl3  
 OBSERVE C13  
 Frequency 100.577 MHz  
 Spectral width 25000.0 Hz  
 Acquisition time 1.199 sec  
 Relaxation delay 3.000 sec  
 Pulse width 5.0 usec  
 Ambient temperature  
 No. repetitions 4096  
 DECOUPLE M1  
 High power 38  
 Decoupler continuously on  
 HALT-18 modulated  
 Double precision acquisition  
 DATA PROCESSING  
 Gaussian optimization 1.100 sec  
 FT size 65536  
 Total acquisition time 4.9 hours

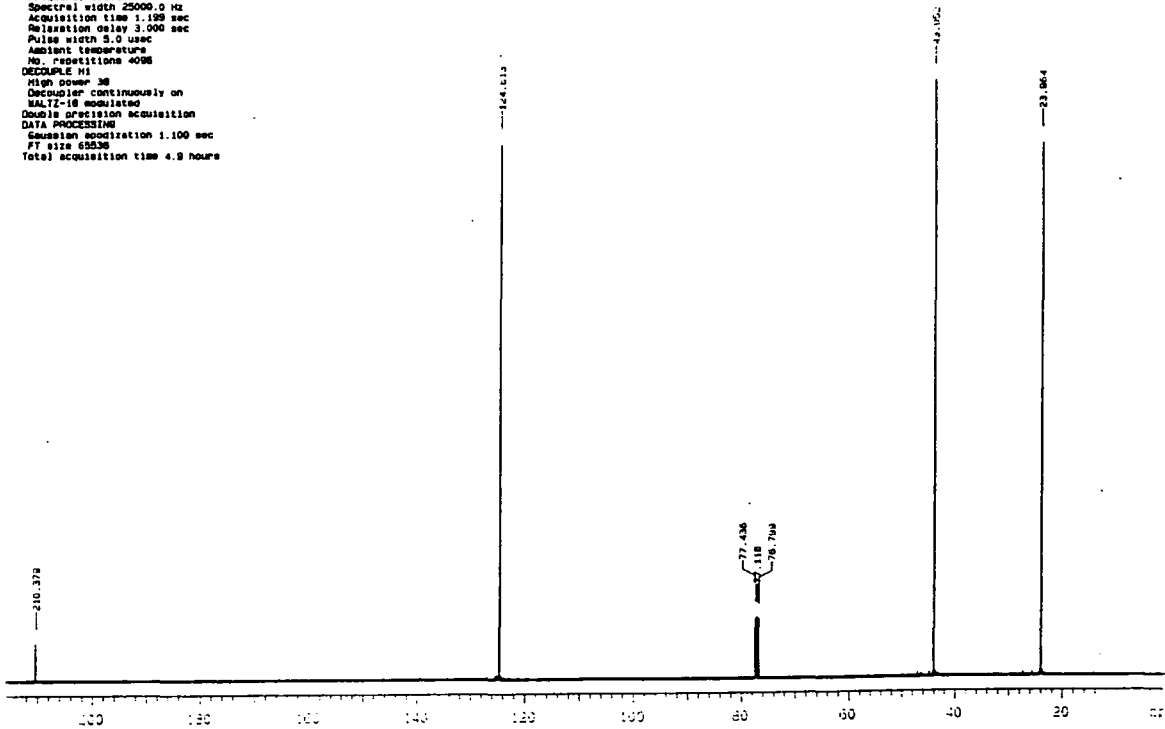
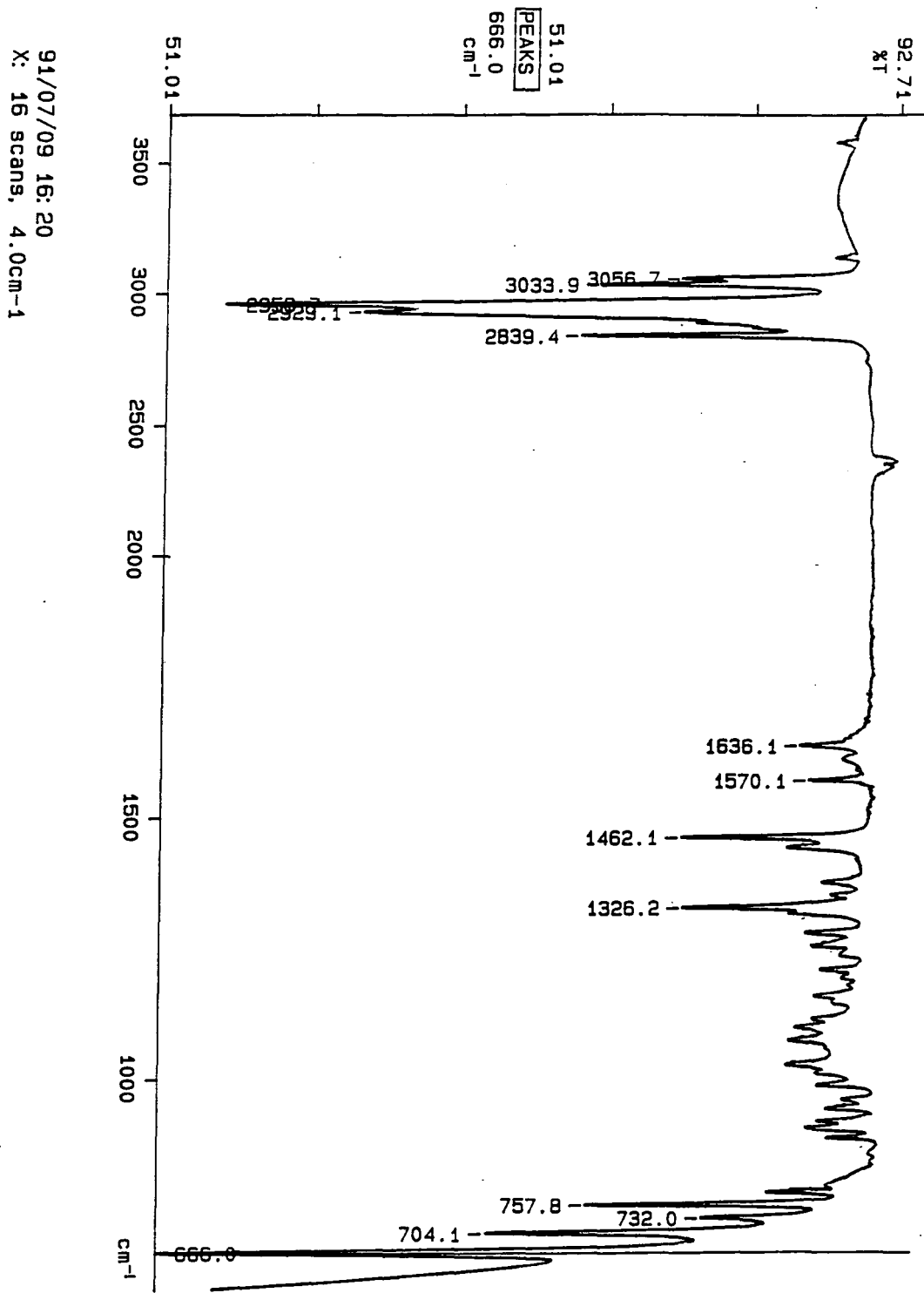
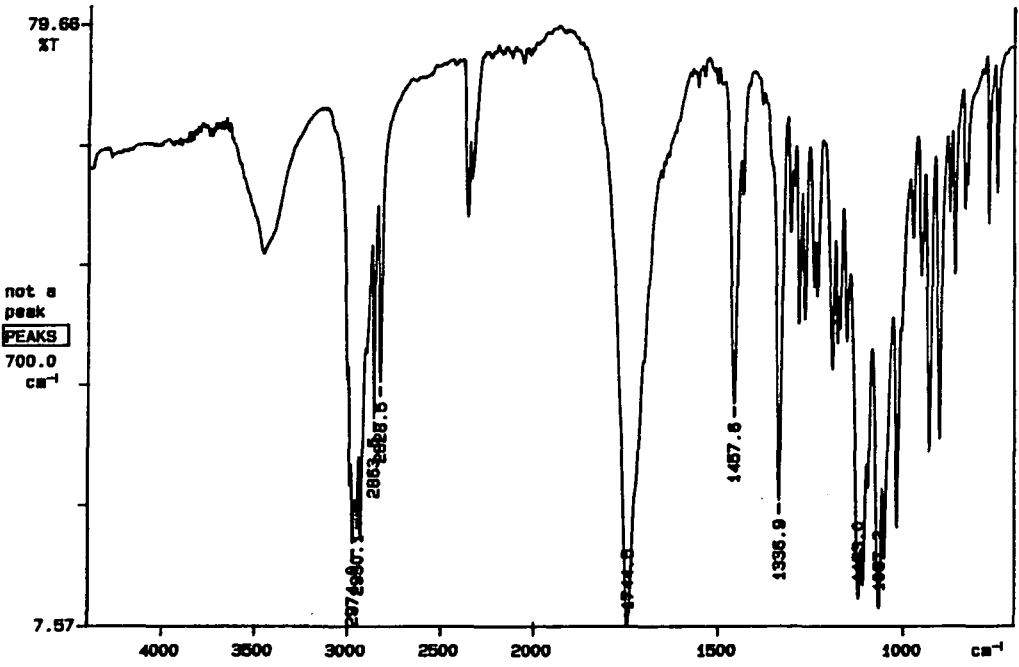

Figure A2.39



91/07/09 16:20  
X: 16 scans, 4.0cm<sup>-1</sup>

Figure A2.40



91/12/13 21: 25  
 X: 16 scans, 4.0cm-1

Window Int (12)      Mass (amu)      SOI (amu)      SOI (ppm)      Time      CONTRIBUTIONS

1	0.41	224	99882	3.88	1979.92	21
2	0.31	223	99187	5.01	18134.62	21
3	0.13	222	11820	4.74	16289.83	5
4	1.54	222	11814	4.45	16424.95	21
5	14.54	221	11308	5.16	16581.06	21
6	0.08	220	10742	88.19	16581.18	5
7	100.00	220	10776	5.46	16738.27	21
8	0.10	218	98503	140.46	16820.77	5
9	2.27	218	11507	1.52	16884.89	12
10	0.08	218	95074	74.21	17062.10	5
11	0.12	216	98802	10.03	17229.75	14
12	0.09	214	94471	7.10	17706.42	2
13	2.15	212	98076	4.21	18770.94	21
14	1.46	211	97058	3.45	18044.28	21
15	0.48	208	98210	3.53	18520.76	21
16	0.79	208	9816	3.13	18581.28	21
17	4.40	207	90276	1.88	18648.18	21
18	4.00	205	90425	1.88	19007.74	21
19	30.67	205	9025	1.63	19176.51	21
20	0.14	201	95753	7.19	19698.47	13
21	3.68	200	95109	1.91	19970.70	21

Average Standards Deviation      18.08      92.75

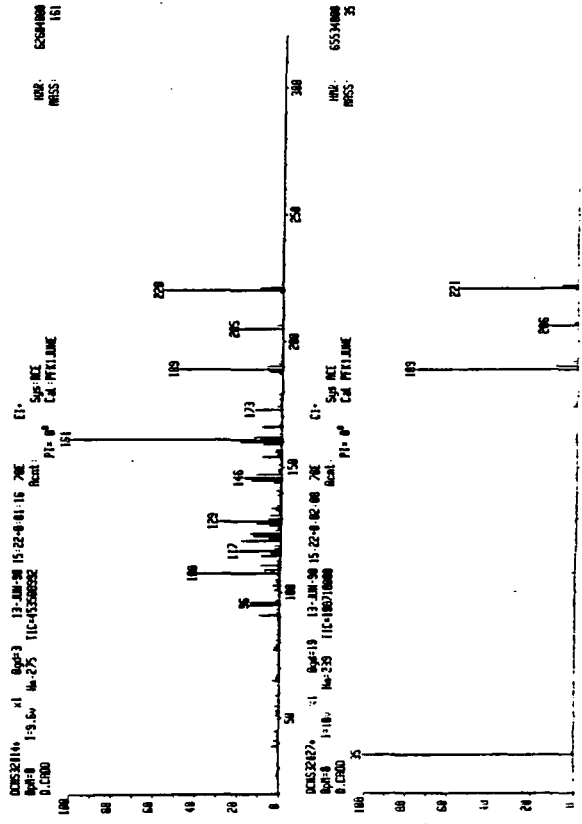
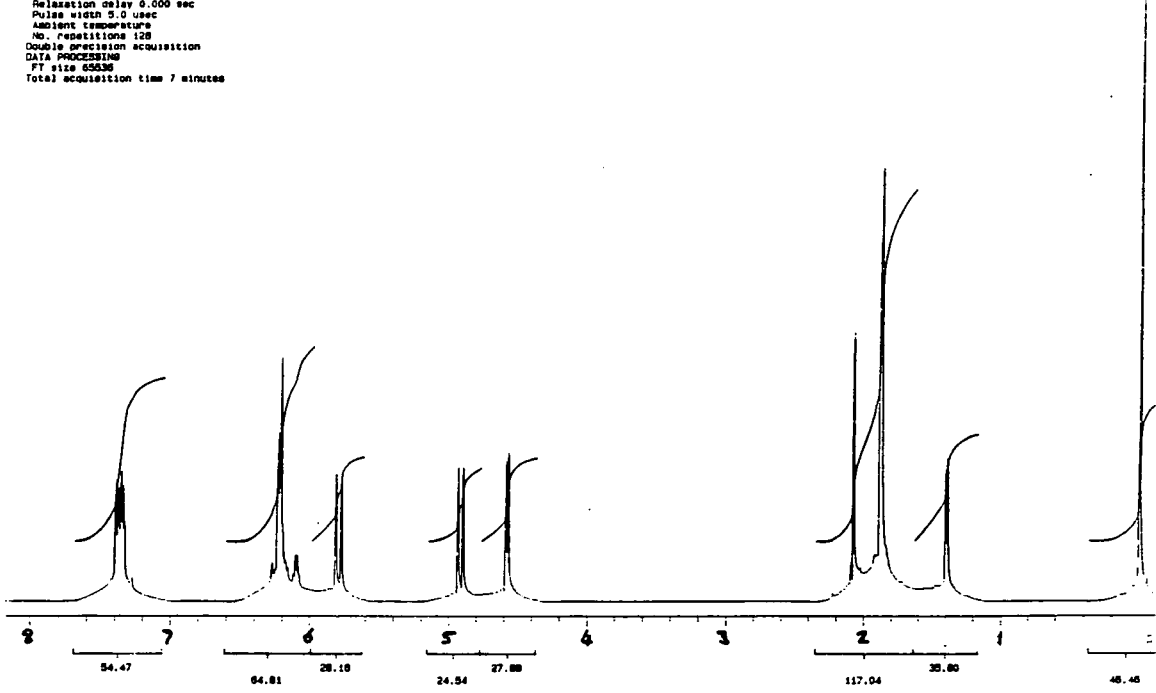

Figure A2.41



CDD 02  
 FILE /usr/usb2/vnmr1/vnmrsvs/data/cdd00mava.f10  
 RUN ON May 8 91  
 SOLVENT CDC13  
 OBSERVE H1  
 Frequency 399.852 MHz  
 Spectral width 5000.0 Hz  
 Acquisition time 3.744 sec  
 Relaxation delay 0.000 sec  
 Pulse width 5.0 usec  
 Ambient temperature  
 No. repetitions 128  
 Double precision acquisition  
 DATA PROCESSING  
 FT size 65536  
 Total acquisition time 7 minutes



CDD 02  
 FILE /usr/usb2/vnmr1/vnmrsvs/data/cdd00mava.f10  
 RUN ON May 8 91  
 SOLVENT CDC13  
 OBSERVE C13

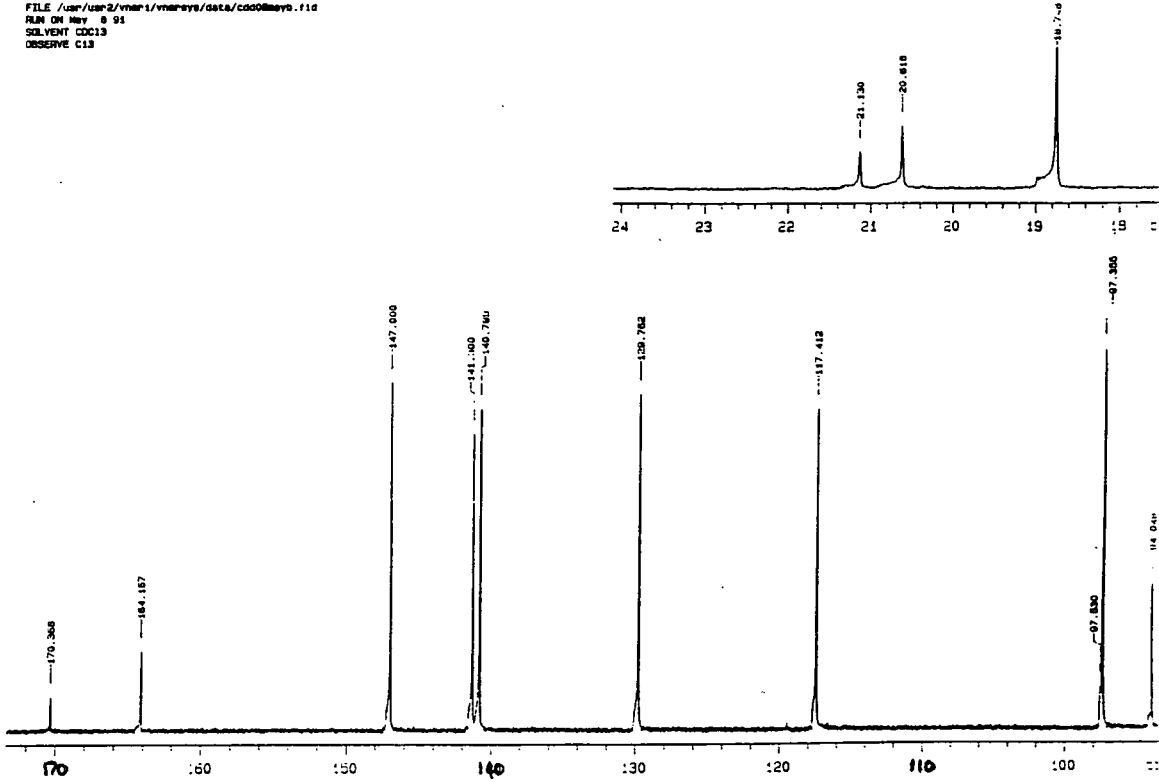
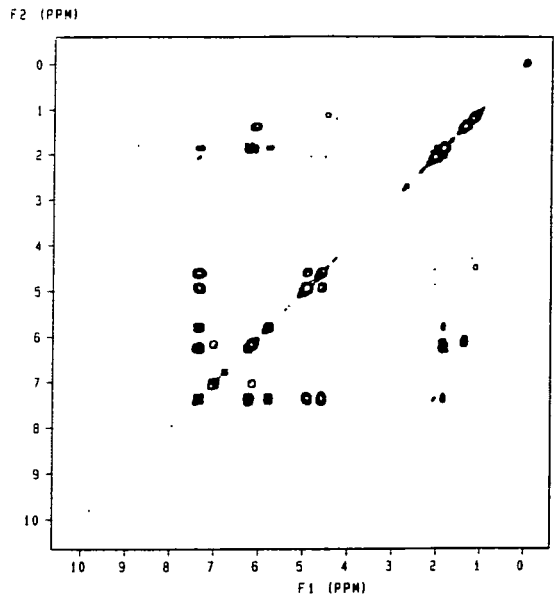

Figure A2.42

CDX  
CPM FILE SERVICE CBT  
DATE 00-04-91  
SOLVENT CDCL3  
FILE CBT



CDX 82  
RUN ON MAY 20 91  
SOLVENT CDCL3  
OBSERVE C13

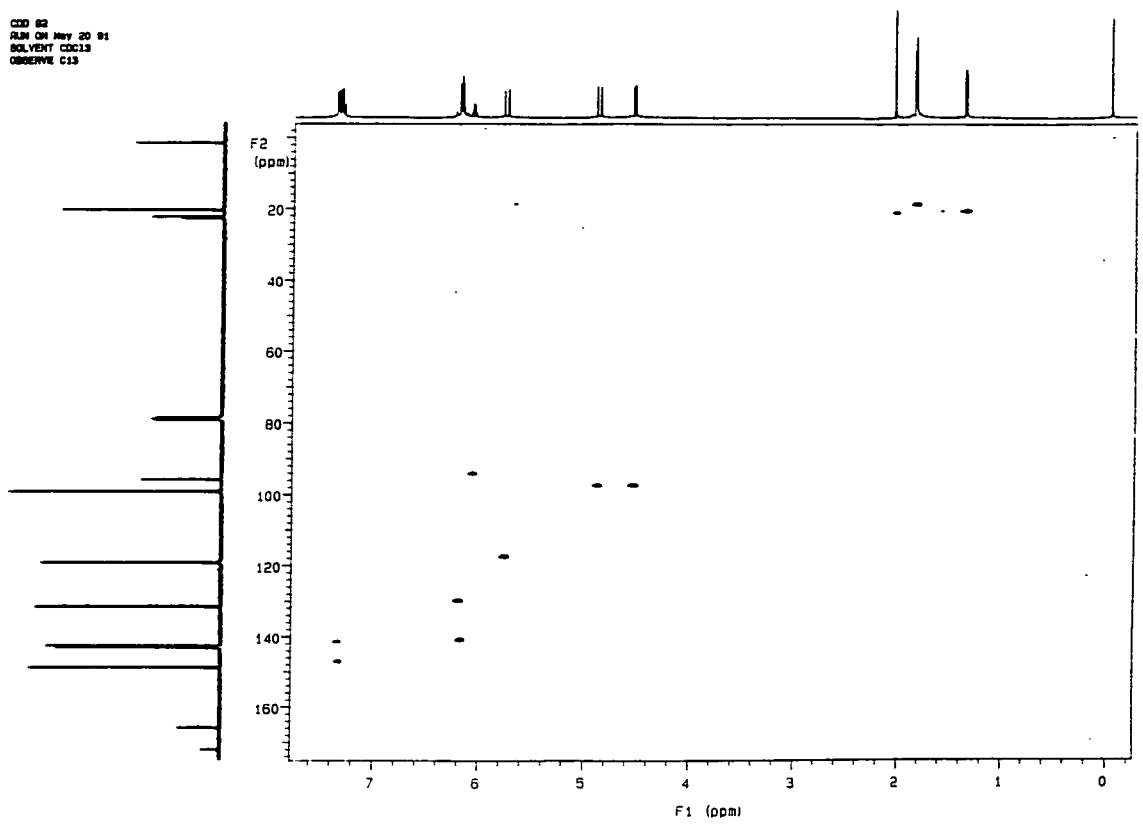
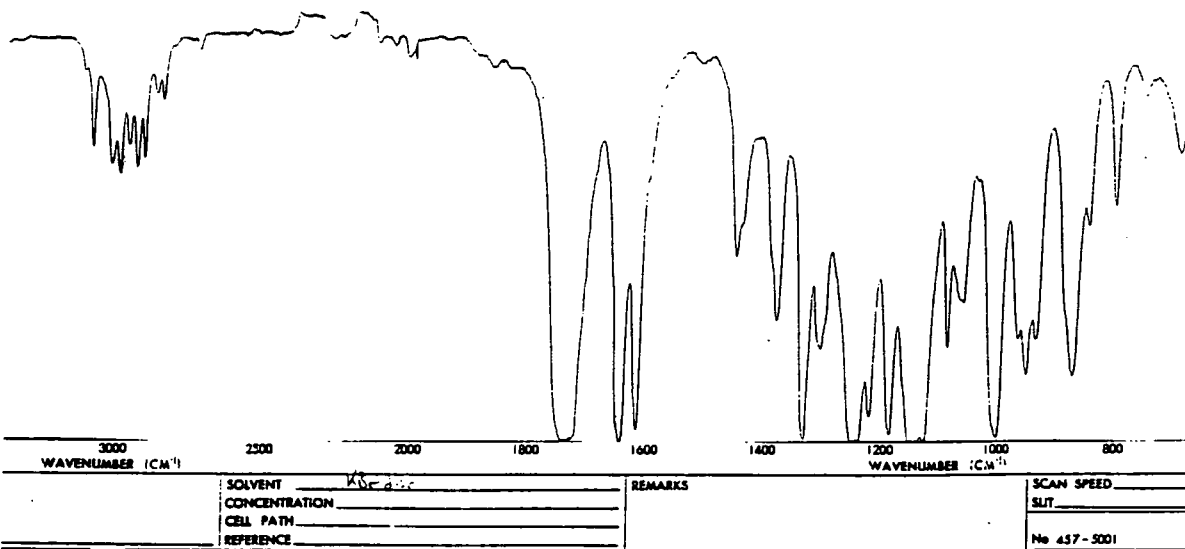
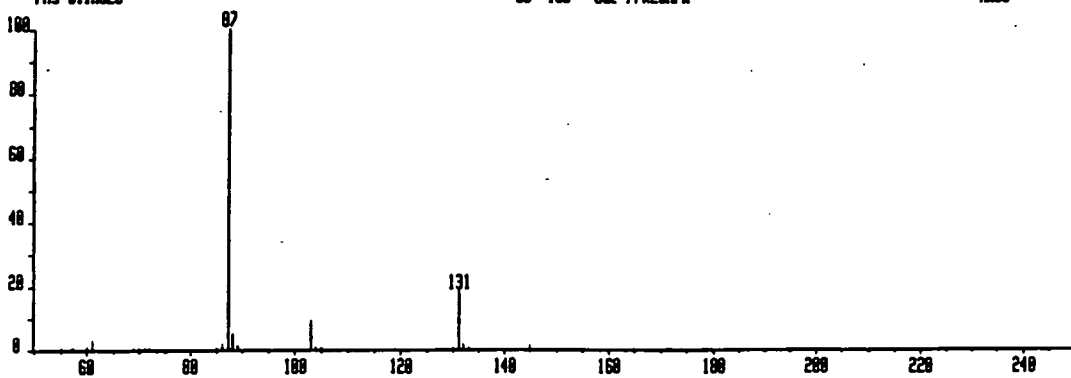

Figure A2.43



BpH=0 1-948w No=145 TIC=8896888 Rcnt: GC=135° Sys: CROD Cal: PFK298PR  
 FR3 0.1INSEC HNR: 616388  
 HESS: 87



C00981900 x1 Bpd=800 29-APR-91 10:46:01:09 78C EI-  
 BpH=0 1-6.0w No=147 TIC=82464888 Rcnt: GC=140° Sys: CROD Cal: PFK298PR  
 FR3 0.1INSEC HNR: 33284888  
 HESS: 95

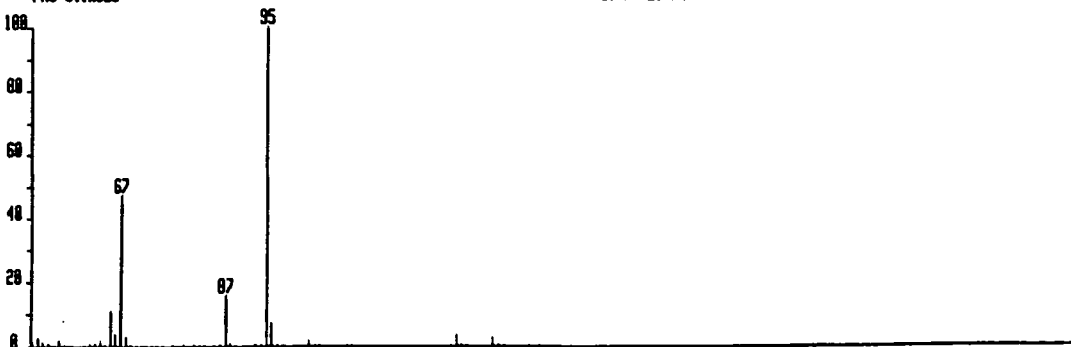
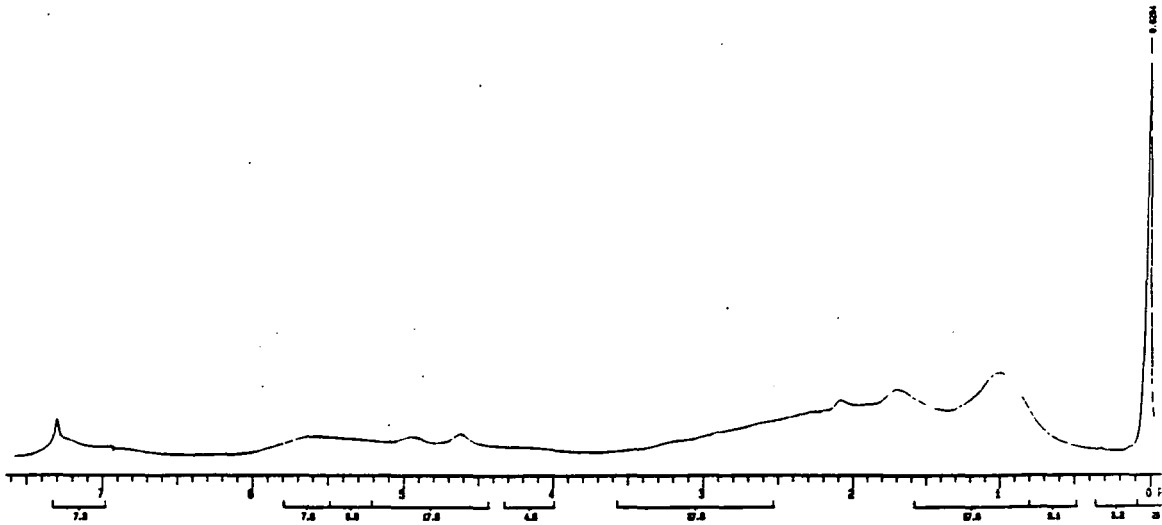

Figure A2.44

CHEM 01/28/80 00 00 00  
 DPA 01/28/80 00 00 00  
 002 00-00-00  
 01/28/80 00  
 FILE 0



002 07  
 FILE /usr/comp1/wwr/wwr/data/002/002070.f10  
 01/28/80 00 00 00  
 SOLVENT CDCl3  
  
 CONSOLE C10  
 Frequency 100.6277 MHz  
 Spectral width 8000.0 Hz  
 Acquisition time 1.100 sec  
 Relaxation delay 3.000 sec  
 Pulse width 4.3 usec  
 Ambient temperature  
 No. repetitions 32000  
  
 DECP0101 H1  
 N120 0000 00  
 Decoupler continuously on  
 HALT-10 resolution  
 Turbo resolution acquisition  
 DATA PROCESSING  
 Line broadening 3.0 Hz  
 Gamma deconvolution 0.700 usec  
 FT size 121672  
 Total acquisition time 00.3 hours

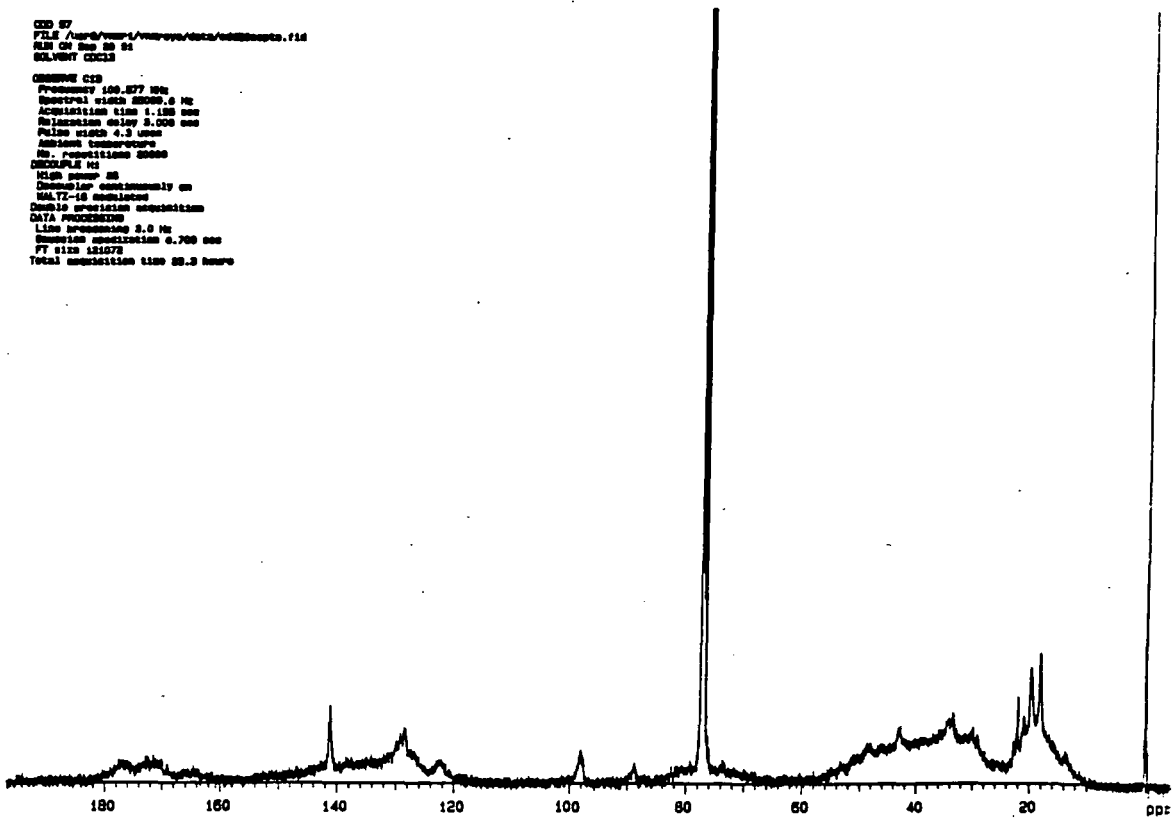
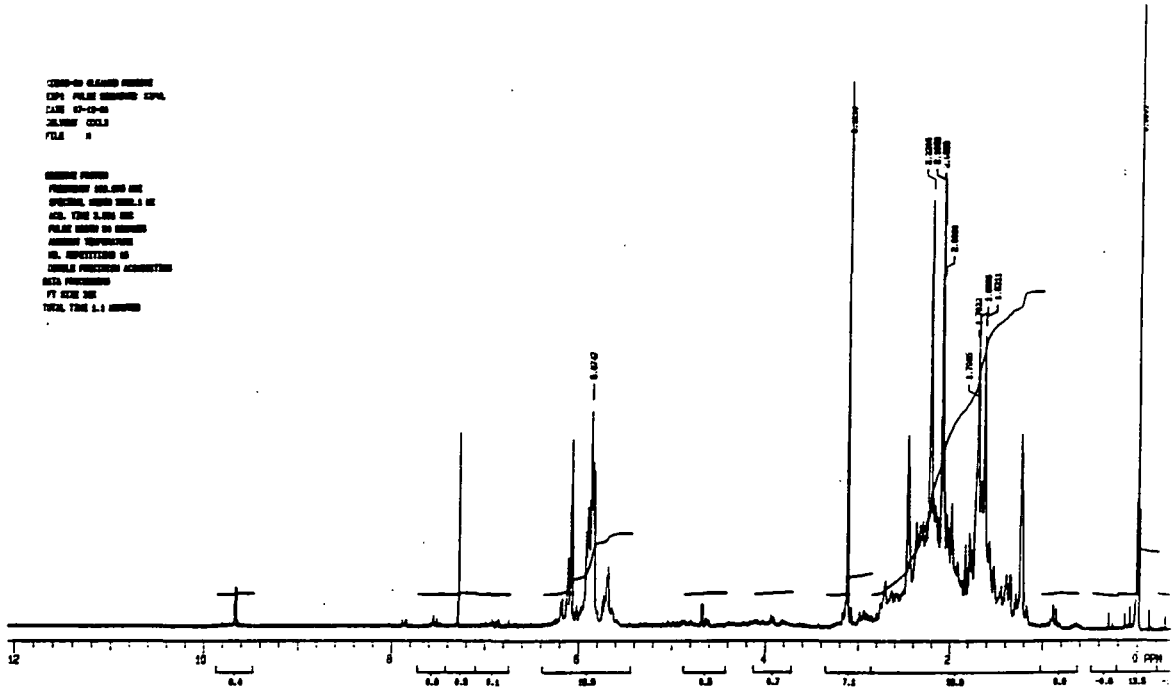

Figure A2.45

CPM-46 GLASS BEWARE  
CPM FILM BEWARE CPM  
DATE 12-15-66  
SOLVENT CDCl<sub>3</sub>  
FILE A

INTEGRATION  
PROMPT 100.000 Hz  
SPINNING 3000 Hz  
ACQ. TIME 3.000 Hz  
FILM NAME IN BEWARE  
ANALYST T. J. BROWN  
NO. REPEATS 10  
ORIGIN PROCESSOR ADMINSTR  
SOLV PROGRAM  
PT 000000  
TOTAL TIME 3.10000



CPM-46 GLASS BEWARE  
CPM FILM BEWARE CPM  
DATE 12-15-66  
SOLVENT CDCl<sub>3</sub>  
FILE C

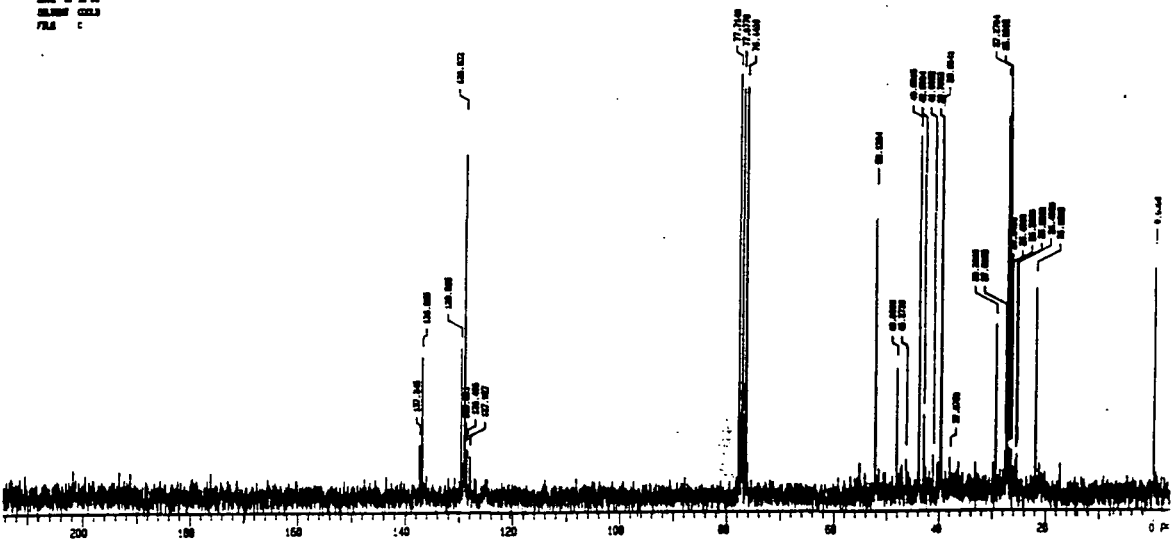

Figure A2.46

91/07/16 11:26  
X: 16 scans, 4.0cm<sup>-1</sup>

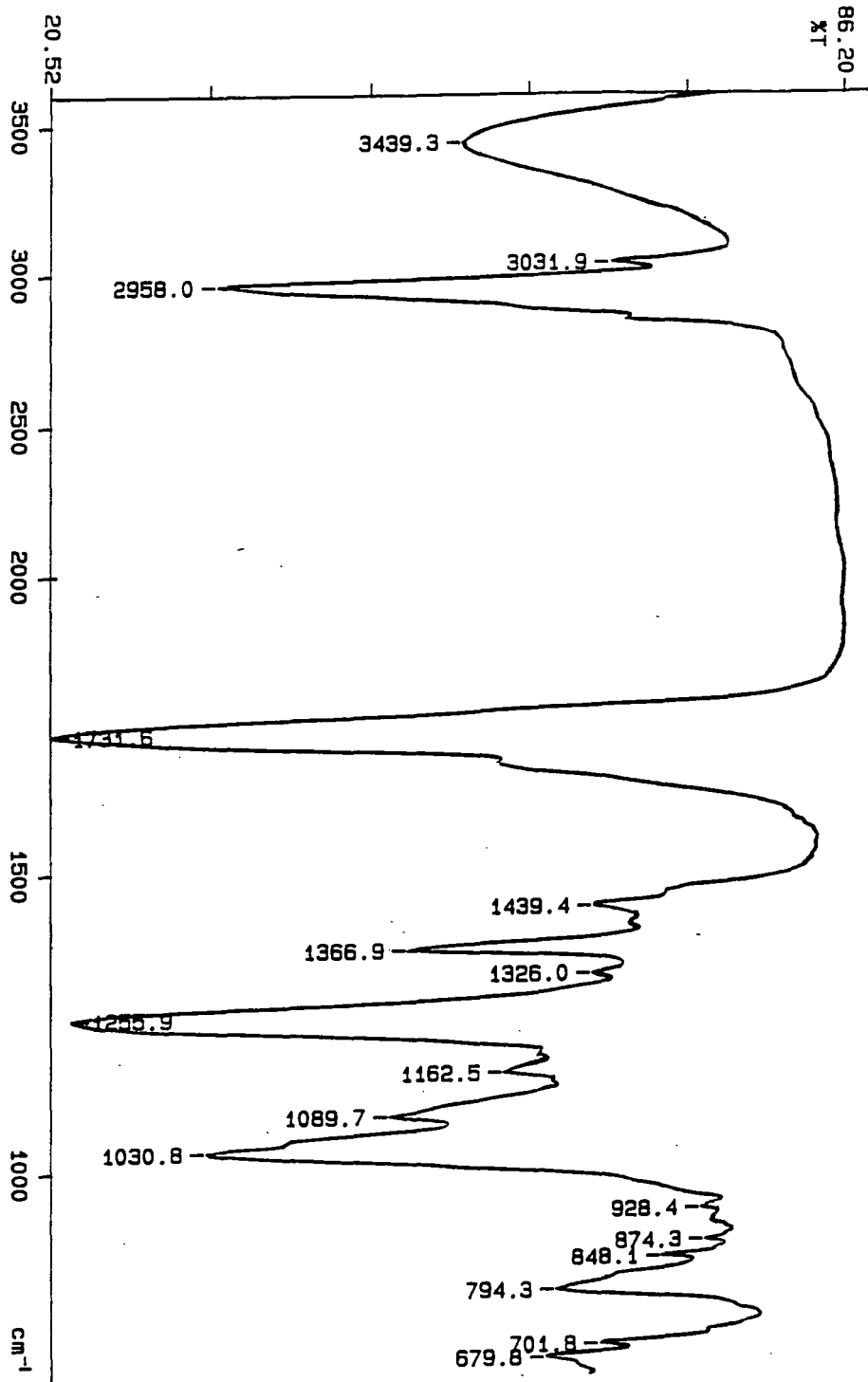
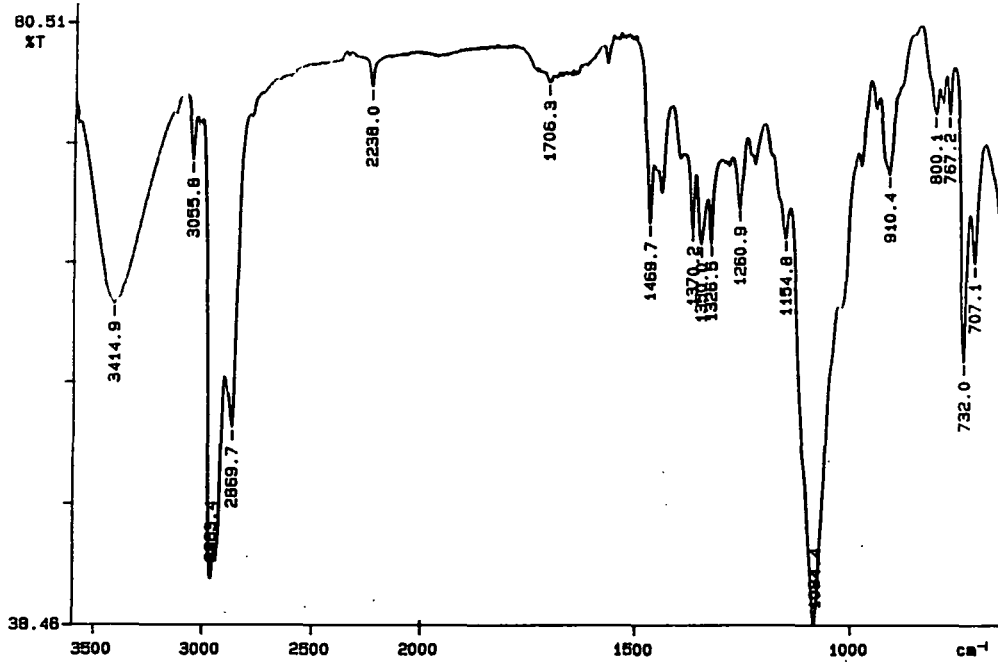

Figure A2.47



91/07/17 11:49  
X: 16 scans, 4.0cm<sup>-1</sup>

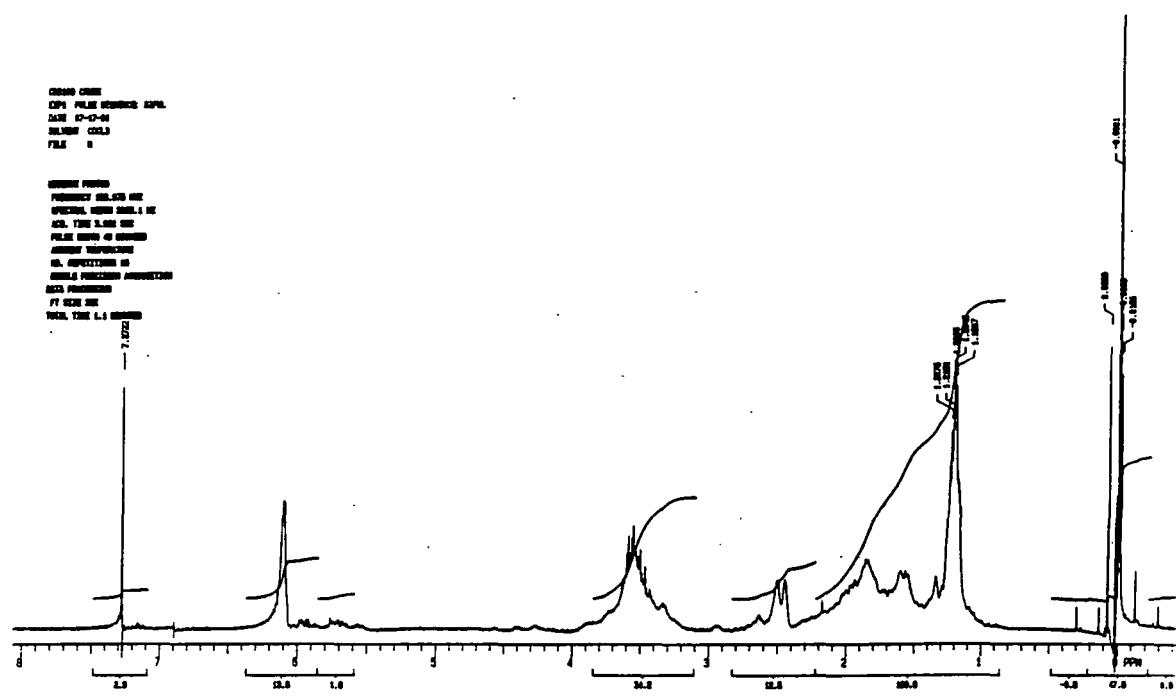
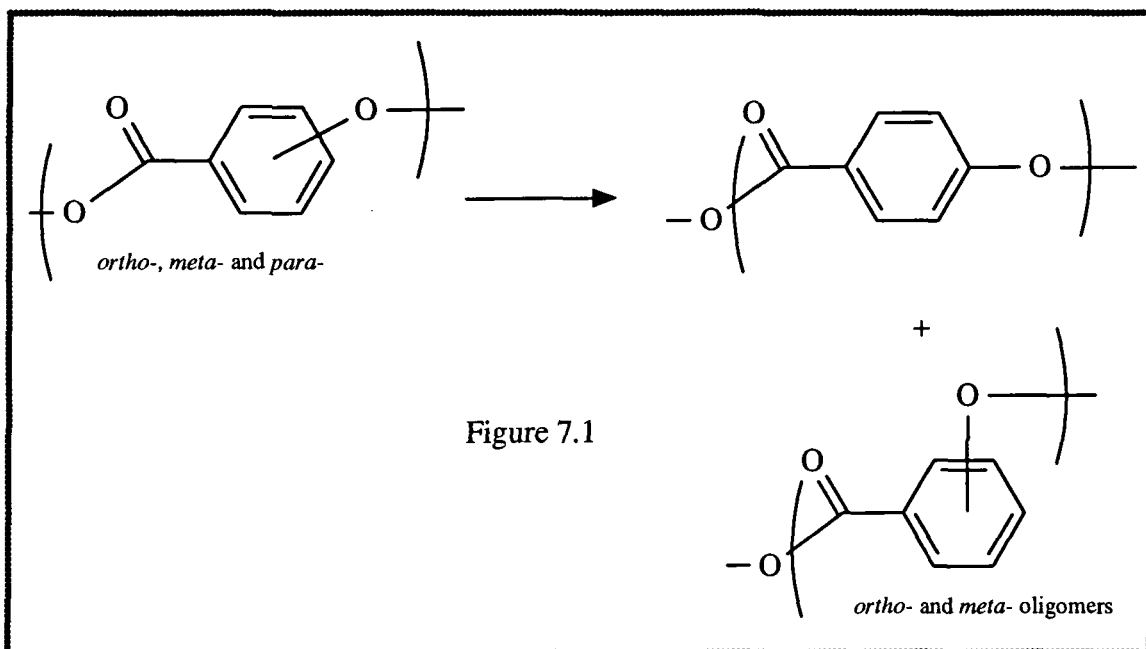

Figure A2.48

## Chapter 7. Suggestions for Further Work.

Recently there have been a few encouraging results from other research groups who are also working on precursor routes to poly(*parahydroxybenzoic acid*). The efforts made by other workers to produce poly(*parahydroxybenzoic acid*) by catalytic elimination of substituents on the benzene ring<sup>[16,17]</sup> (see chapter 1) from substituted hydroxybenzoic acid (HBA) polymers suggest that whilst this is feasible, it never leads to pure homopolymer, because of access problems brought about by insolubility and crystallisation, or side reactions.



The approach via elimination of cyclic HBA oligomers<sup>[243]</sup> from copolymers of *ortho*-, *meta*- and *para*- HBA (figure 7.1) does give some homopolymer, but the involatility of the oligomers and the insolubility and crystallinity of the product must create difficult problems in its practical application. The attempt to partially circumvent this difficulty by elimination of oligomers of ethylene isophthalate from HBA-isophthalic acid-ethylene glycol copolymers<sup>[244]</sup> (figure 7.2) evidently enjoys some success, but again involatility of the eliminated material and the insolubility and crystallinity of the



product is still a problem.

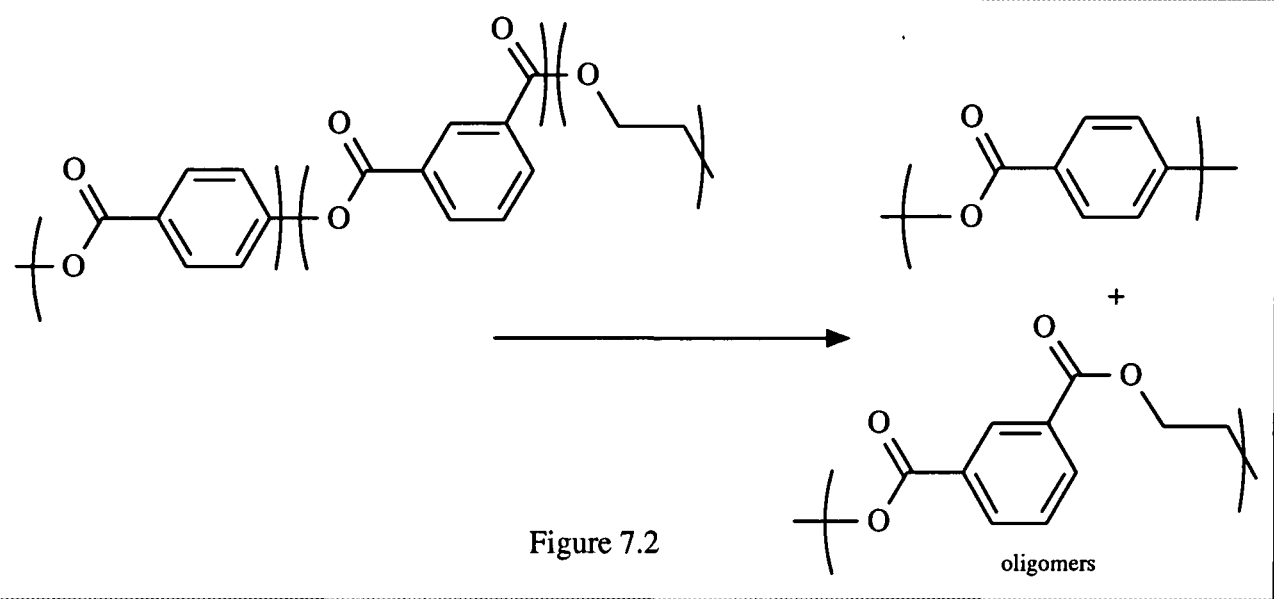

If the elimination of some component of the polyester chain is to be successful in the commercial sense, then it must be capable of taking place in the fibre and the byproducts must be readily removed. Whilst the above attempts have yet to appear in the literature, it seems from limited advance information that they are restricted to bulk eliminations. But making poly(*para*-HBA) is not a problem. As was stated in Chapter 1, the problem revolves around the nature of the precursor and has two parts:

- a) The provision of a suitable precursor polymer and
- b) Persuading it to convert whilst in the form of the finished product.

Consideration of the likely uses of poly(*para*-HBA) makes it apparent that only fibres or films are likely contenders for the finished product in (b) and any precursor which requires a conversion process which will only occur in the melt or in solution makes it unlikely to conform to the definition of "suitable" in (a). Further consideration of the insolubility and crystallinity of poly(*para*-HBA) and analysis of the few attempts to solve the precursor problem leads one to conclude that conversion processes which depend on treatment with a reagent are also doomed to only partial, perhaps 95%, success. Bearing the above in mind, the following possibilities are suggested.

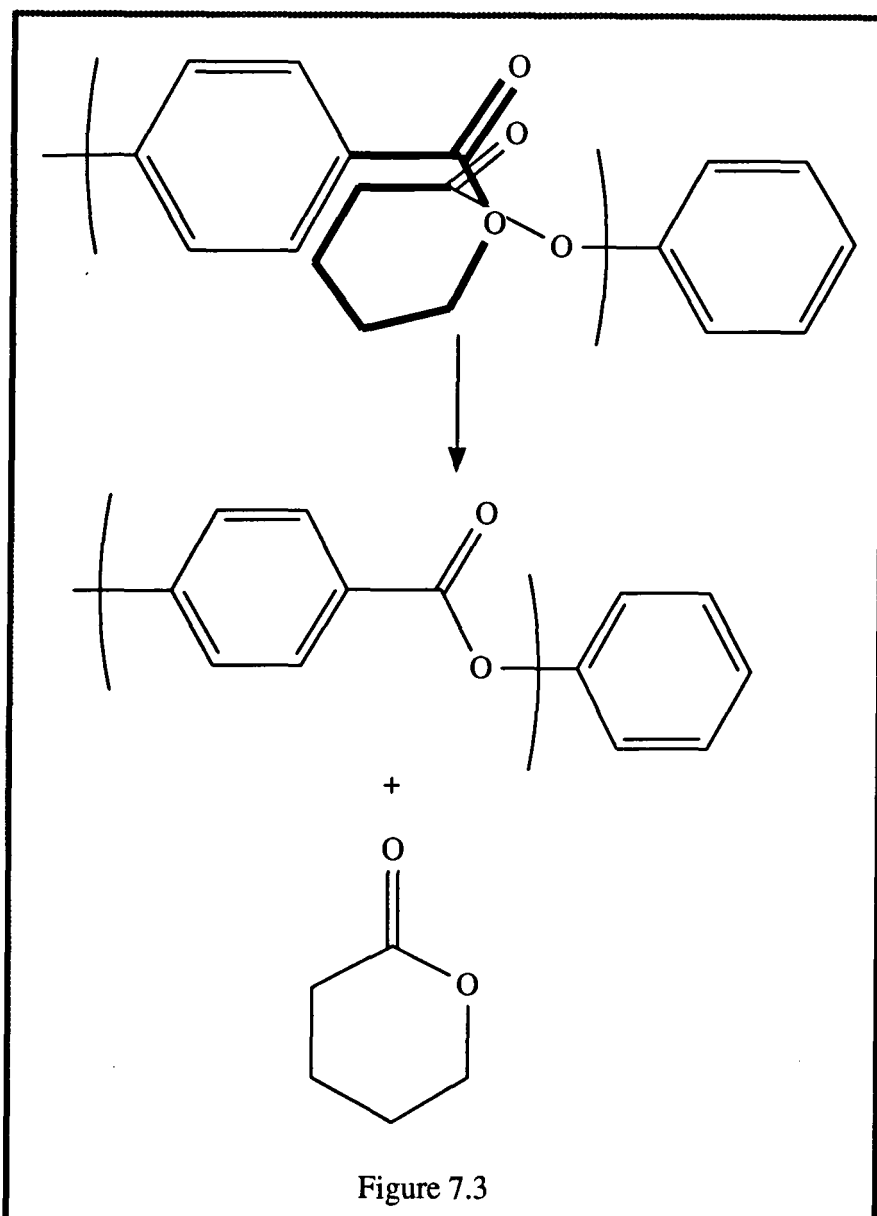

Copolymers of poly(*para*-HBA) with aliphatic  $\omega$ -hydroxyacids such as 5-hydroxy-1-pentanoic acid would give copolyesters from which the lactone of the hydroxy-acid might be eliminated via the ready ring-closure of the intermediate 6-membered ring conformation, figure 7.3. The plus points are that the polymer synthesis should be facile, the polymer soluble and spinnable from solution or melt, the lactone should be volatile enough to be distilled out *in vacuo* thus averting problems of access to reagents and the lactone could be recovered and recycled directly in the polymerisation. The minus points are that the elimination might be slow without a transesterification catalyst, that the elimination might not proceed in the solid fibre and

that the chain mobility needed to adopt the required conformation might be too entropically unfavourable and impossible in the solid phase.

Another possibility, although not suited to commercial production, makes use of the Diels-Alder reaction of norbornadiene with  $\alpha$ -pyrone, figure 7.4. The pyrone itself is easily prepared<sup>[245]</sup> from coumalic acid, which is available commercially (price in 1991 ca. £20 for 25g, Janssen Chimica.) The pyrone has been used in a number of studies on transient species<sup>[246]</sup> because it is locked in a favourable conformation and is thus very reactive towards olefins and dienes in the Diels-Alder reaction. Most of these adducts are thermally unstable, being derived from furans or isofurans, or their nitrogen analogues. They readily lose carbon dioxide to yield aromatic systems.

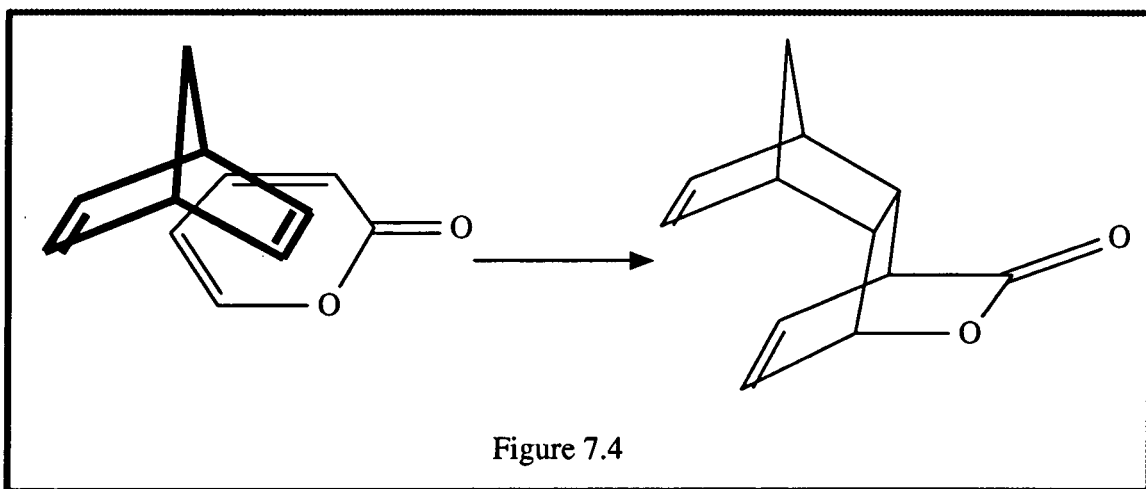

The norbornadiene adduct, if sufficiently thermally stable, is capable of being used in two ways. Firstly, it might prove possible to subject it to anionic ring-opening polymerisation along the lines of the work done by Sokolova *et al*<sup>[208]</sup> and Ceccarelli *et al*<sup>[209]</sup> which would allow good control of molecular weight. Secondly, it could be hydrolysed to an hydroxy-acid which might then be polymerised, figure 7.5. The resulting polyester could then be oxidised, perhaps by atmospheric oxygen and cyclopentadiene eliminated to yield poly(*para*-HBA). Alternatively, the intermediate hydroxy-acid, 1 in figure 7.6 could be oxidised to the ketone, 2, and tautomerisation would then yield an hydroxy-acid, 4, in the correct oxidation state for elimination to

occur directly. This intermediate is the same as that proposed during the attempts to hydrolyse the 7,7-dichloro-1,4-benzoquinonemethide precursor, *endo-cis*-6-dichloro

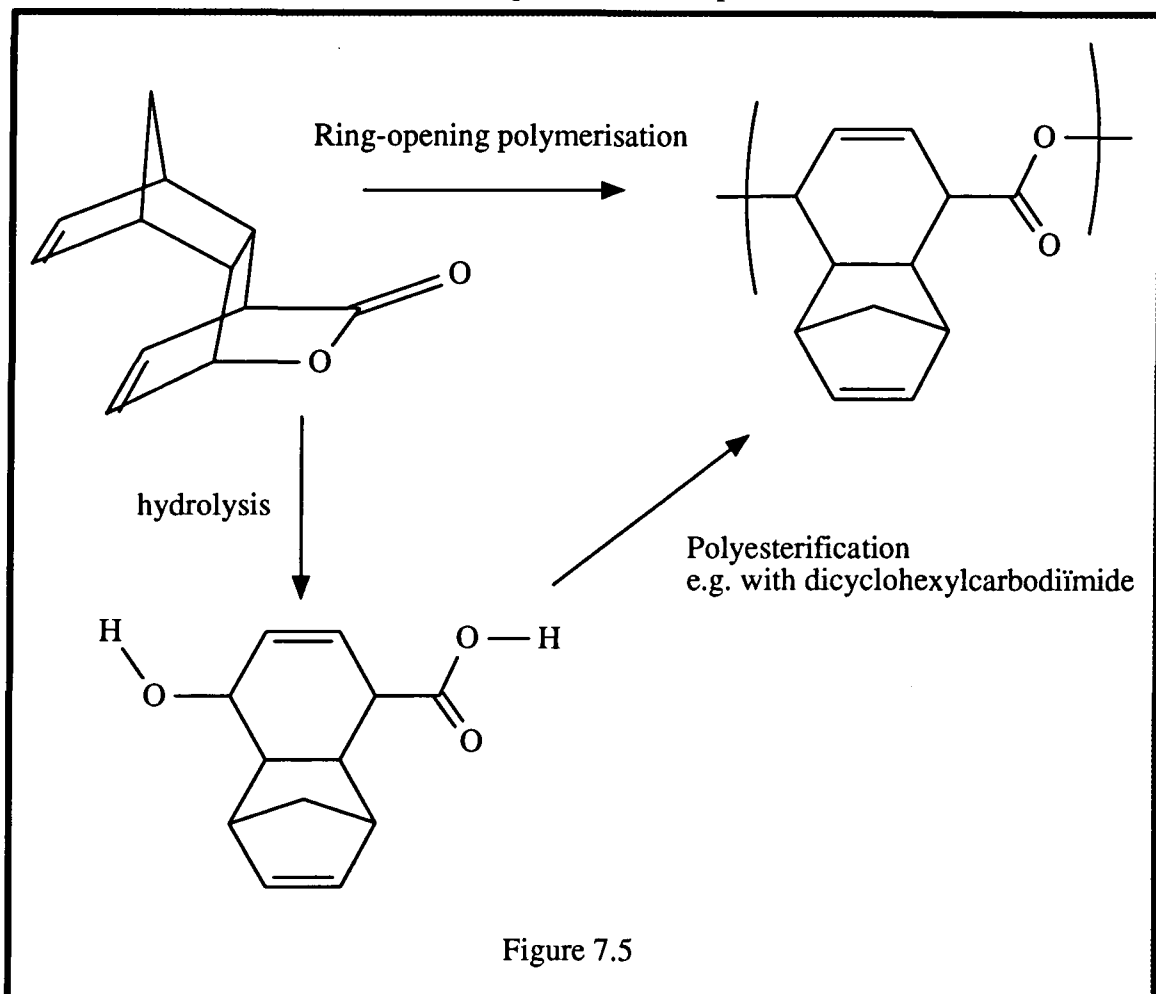

methylenetricyclo[6.2.1.0<sup>2,7</sup>]undeca-4,9-dien-3-one. It is possible that tautomerisation of the ketone would give a more attractive precursor monomer, *endo-cis*-6-hydroxy-tricyclo[6.2.1.0<sup>2,7</sup>]undeca-4,6,9-trien-3-carboxylic acid, 3. This monomer would be resistant to the retro-Diels-Alder reaction until a sufficiently high temperature was reached for 1,3-proton migration to occur. It might prove advantageous to deliberately attempt to achieve reaction conditions which maximised the proportion of this tautomer in the mixture. The added thermal stability provided in 3 would make for far easier handling of the monomer and precursor polymer. The copolymer composition and its microstructure would also prove interesting studies, as would kinetic studies on the conversion e.g. by differential scanning calorimetry. However, the other isomer, 4, in

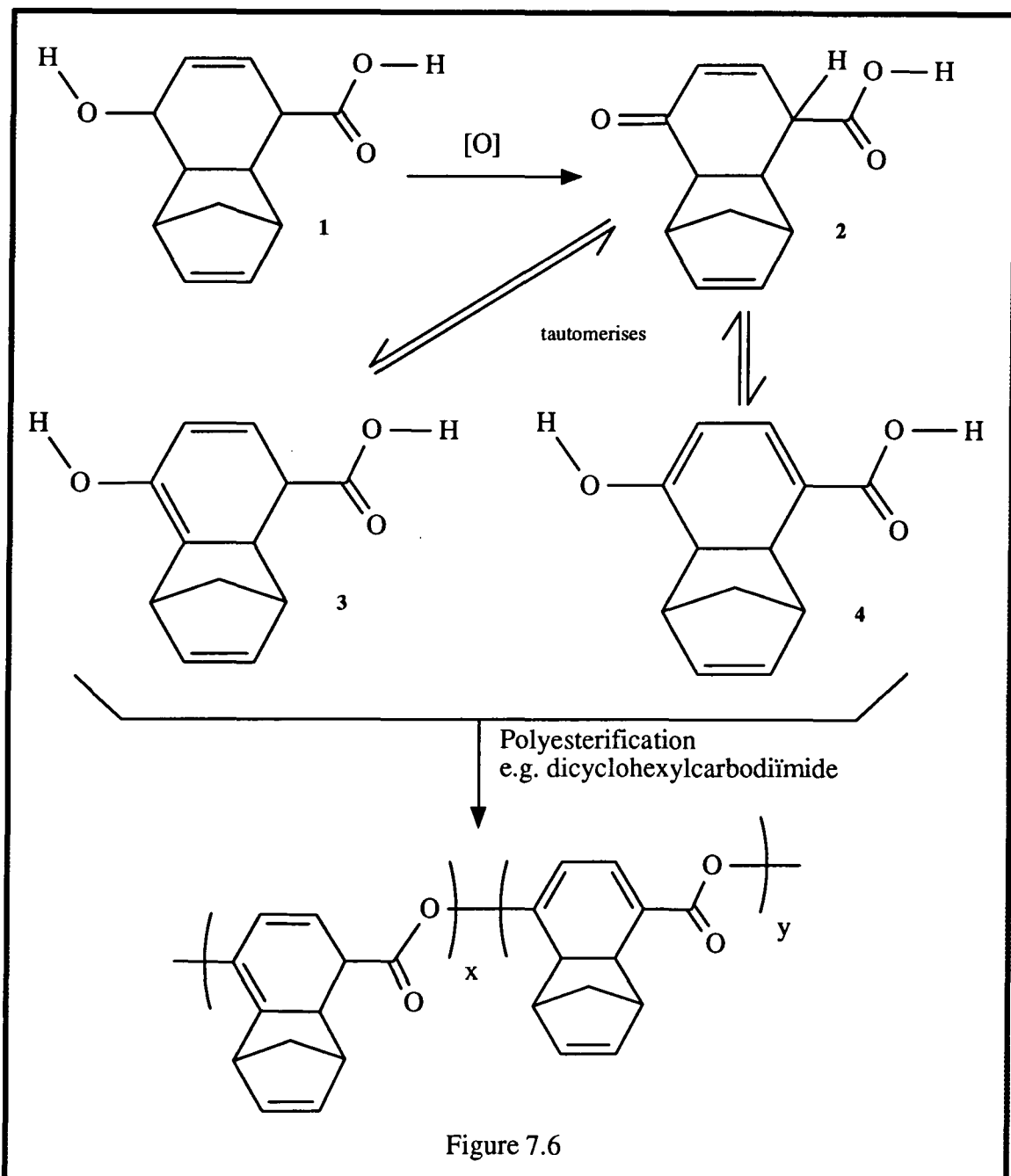

the mixture might prove useful if it was sufficiently stable. It is known from work done by Cookson *et al*<sup>[241]</sup> that such *endo-cis*-Diels-Alder adducts readily undergo intramolecular 2+2 photocycloaddition, even in the solid phase. These compounds do not undergo the retro-Diels-Alder reaction. A mechanism is thus available for using such a precursor polymer as a lithographic photo-resist, which has been done previously using the Durham precursor to poly(acetylene)<sup>[247]</sup>. The monomers which converted to poly(*para*-HBA) would be insoluble, whilst those which photocyclised

and did not eliminate cyclopentadiene would retain their solubility. A possible adaption of this chemistry would depend upon the ease with which the retro-reaction occurs. If instead of photocyclising the monomer units with ultra-violet light to keep them soluble, an infra-red laser (such as is now commonly used in laser printers and compact disc players) was used to write upon the polymer, the heating achieved by the beam might directly cause the elimination reaction and make the irradiated areas insoluble, thereby giving the option of either a positive or a negative photoresist from the same material.

## Conclusions

The philosophy of the precursor approach to intractable polymers was critically examined, some obstacles to a successful precursor synthesis of poly(*para*-hydroxybenzoic acid) were identified, and several speculative routes to precursor polymers were devised and experimentally investigated.

Examination of the literature showed that whilst a number of specific routes to the synthesis of benzene derivatives exist, via ring closure and aromatisation, none of these appear suitable for a general precursor route to aromatic polyesters. However, the ring synthesis of benzene derivatives has not been investigated to the same extent as the ring synthesis of heterocyclic aromatics, and it is possible that future discoveries may render this approach to aromatic precursor polymers more attractive. The limited experiments made in the course of this project were not encouraging.

A number of approaches were explored in attempts to produce a precursor polymer containing the carbonyl group of poly(*para*-hydroxybenzoic acid) in a masked form. These efforts were directed towards the synthesis of 7,7-dichloro-1,4-benzoquinone methide which was anticipated to polymerise spontaneously to give the precursor polymer directly. However, the addition of dichloroketene to carbonyl compounds proved difficult to control because of the high reactivity of dichloroketene, whilst Wittig and Wittig-Horner syntheses intended to make dichloromethylene compounds were *generally* unsuccessful, either because the ketone starting materials were insufficiently reactive towards the ylids or because there were competitive reactions occurring which minimised the yield of the desired products.

However, it was possible to make a precursor to 7,7-dichloro-1,4-benzoquinone methide by Wittig-Horner chemistry, although this compound, *endo-cis*-6-dichloromethylenetricyclo[6.2.1.0<sup>2,7</sup>]undeca-4,9-dien-3-one, could not be synthesised repeatably and had poor thermal stability. It was not possible to make

sufficient of this compound to see if the desired quinone methide would indeed polymerise to give the postulated polymer. The successful Wittig-Horner synthesis casts some doubt on the hypothesis of Castells *et al*<sup>[192]</sup> which states that deconjugation of an  $\alpha,\beta$ -unsaturated ketone occurs prior to attack at the carbonyl group. Attempts to use organosilicon reagents (Petersen or Köbrich olefination) or dithiane chemistry to circumvent the synthetic problems were unsuccessful.

It was noted that hydrolysis of this same quinone methide precursor should give an hydroxy-acid, *endo-cis*-6-hydroxytricyclo[6.2.1.0<sup>2,7</sup>]undeca-3,5,9-trien-3-carboxylic acid, which it should be possible to polymerise to give a precursor polymer which would yield the desired poly(*para*-hydroxybenzoic acid) by *retro*-Diels-Alder reaction. When attempts to hydrolyse *endo-cis*-6-dichloromethylenetricyclo[6.2.1.0<sup>2,7</sup>]-undeca-4,9-dien-3-one failed, alternative methods of making the hydroxy-acid were tried, but without success.

A number of Diels-Alder adducts and their intramolecular photocycloaddition products were made during the course of this study and examined by nmr spectroscopy. Detailed analysis of the spectra obtained has resulted in the first known structural assignment of a pentacyclo[8.1.0<sup>1,5</sup>.0<sup>2,9</sup>.0<sup>4,7</sup>.0<sup>6,10</sup>]undecane derivative purely by nmr and a correction to the published assignment of the proton spectrum of *endo-cis*-6,6-dimethoxytricyclo[6.2.1.0<sup>2,7</sup>]undeca-4,9-dien-3-one. Molecular orbital calculations on some of these compounds predicted bond angles which were consistent with the coupling constants observed. It is intended that these results will be submitted for publication.

This study has not yielded a viable precursor route to poly(*para*-hydroxybenzoic acid) but it has permitted the identification of some of the difficulties which must be tackled and has suggested a number of speculative routes which might prove successful given further work. These are:

- 1) General precursor routes via benzene ring synthesis given that this chemistry is explored in greater depth (see Chapters 1 and 2.)



- 2) A possible specific route via the *retro*-Diels-Alder reaction of poly(*endo-cis*-6-hydroxytricyclo[6.2.1.0<sup>2,7</sup>]undeca-3,5,9-trien-3-carboxylic acid), (see Chapter 3.)
- 3) A potential route via the elimination of  $\omega$ -hydroxy-acids from their copolymers with *para*-hydroxybenzoic acid (see Chapter 7.)
- 4) A potential route via the Diels-Alder reaction of  $\alpha$ -pyrone with [2.2.1]bicycloheptadiene, followed by anionic ring-opening polymerisation and oxidation, or hydrolysis, polycondensation and oxidation (see Chapters 4 and 7.)

**RESEARCH COLLOQUIA, SEMINARS, LECTURES AND**  
**CONFERENCES**

The Board of Studies in Chemistry requires that each postgraduate research thesis contains an appendix listing:

(a) all research colloquia, seminars and lectures arranged by the Department of Chemistry during the period of the author's residence as a postgraduate student

(b) all research conferences attended by the author during the period of study.

COLLOQUIA, LECTURES AND SEMINARS GIVEN BY INVITED SPEAKERS  
1ST AUGUST 1988 to 31st JULY 1989

<u>AVEYARD</u> , Dr. R. (University of Hull) Surfactants at your Surface	15th March, 1989
<u>AYLETT</u> , Prof. B.J. (Queen Mary College, London) Silicon-Based Chips:- The Chemist's Contribution	16th February, 1989
<u>BALDWIN</u> , Prof. J.E. (Oxford University) Recent Advances in the Bioorganic Chemistry of Penicillin Biosynthesis	9th February, 1989
<u>BALDWIN &amp; WALKER</u> , Drs. R.R. & R.W. (Hull University) Combustion: Some Burning Problems	24th November, 1988
<u>BUTLER</u> , Dr. A.R. (St. Andrews University) Cancer in Linxiam: The Chemical Dimension	15th February, 1989
<u>CADOGAN</u> , Prof. J.I.G. (British Petroleum) From Pure Science to Profit	10th November, 1988
<u>CASEY</u> , Dr. M. (University of Salford) Sulphoxides in Stereoselective Synthesis	20th April, 1989
<u>CRICH</u> , Dr. D. (University College London) Some Novel Uses of Free Radicals in Organic Synthesis	27th April, 1989
<u>DINGWALL</u> , Dr. J. (Ciba Geigy) Phosphorus-containing Amino Acids: Biologically Active Natural and Unnatural Products	18th October, 1988
<u>ERRINGTON</u> , Dr. R.J. (University of Newcastle-upon-Tyne) Polymetalate Assembly in Organic Solvents	1st March, 1989
<u>FREY</u> , Dr. J. (Southampton University) Spectroscopy of the Reaction Path: Photodissociation Raman Spectra of NOCl	11th May, 1989
* <u>GRADUATE CHEMISTS</u> , (Polytechs and Universities in North East England) R.S.C. Symposium for presentation of papers by postgraduate students	12th April, 1989
* <u>HALL</u> , Prof. L.D. (Addenbrooke's Hospital, Cambridge) NMR - A Window to the Human Body	2nd February, 1989
* <u>HARDGROVE</u> , Dr. G. (St. Olaf College, U.S.A.) Polymers in the Physical Chemistry Laboratory	December, 1988
<u>HARWOOD</u> , Dr. L. (Oxford University) Synthetic Approaches to Phorbols Via Intramolecular Furan Diels-Alder Reactions: Chemistry under Pressure	25th January, 1988

- JÄGER, Dr. C. (Friedrich-Schiller University GDR) 9th Decemboer, 1988  
NMR Investigations of Fast Ion Conductors of the NASICON Type
- JENNINGS, Prof. R.R. (Warwick University) 26th January, 1989  
Chemistry of the Masses
- JOHNSON, Dr. B.F.G. (Cambridge University) 23rd February, 1989  
The Binary Carbonyls
- LUDMAN, Dr. C.J. (Durham University) 18th October, 1988  
The Energetics of Explosives
- MACDOUGALL, Dr. G. (Edinburgh University) 22nd February, 1989  
Vibrational Spectroscopy of Model Catalytic Systems
- MARKO, Dr. I. (Sheffield University) 9th March, 1989  
Catalytic Asymmetric Osmylation of Olefins
- McLAUCHLAN, Dr. K.A. (University of Oxford) 16th November, 1988  
The Effect of Magnetic Fields on Chemical Reactions
- MOODY, Dr. C.J. (Imperial College) 17th May, 1989  
Reactive Intermediates in Heterocyclic Synthesis
- PAETZOLD, Prof. P. (Aachen) 23rd May, 1989  
Iminoboranes  $\text{XB}\equiv\text{NR}$ : Inorganic Acetylenes?
- PAGE, Dr. P.C.B. (University of Liverpool) 3rd May, 1989  
Stereocontrol of Organic Reactions Using 1,3-dithiane-1-oxides
- POLA, Prof. J. (Czechoslovak Academy of Sciences) 15th June, 1989  
Carbon Dioxide Laser Induced Chemical Reactions - New Pathways in Gas-Phase Chemistry
- REES, Prof. C.W. (Imperial College London) 27th October, 1988  
Some Very Heterocyclic Compounds
- SCHMUTZLER, Prof. R. (Technische Universität Braunschweig) 6th October, 1988  
Fluorophosphines Revisited - New Contributions to an Old Theme
- \* SCHROCK, Prof. R.R. (M.I.T.) 13th February, 1989  
Recent Advances in Living Metathesis
- SINGH, Dr. G. (Teesside Polytechnic) 9th November, 1988  
Towards Third Generation Anti-Leukaemics
- SNAITH, Dr. R. (Cambridge University) 1st December, 1988  
Egyptian Mummies: What, Where, Why and How?
- STIBR, Dr. R. (Czechoslovak Academy of Sciences) 16th May, 1989  
Recent Developments in the Chemistry of Intermediate-Sited Carboranes
- VON RAGUE SCHLEYER, Prof. P. (Universität Erlangen Nürnberg) 21st October, 1988  
The Fruitful Interplay Between Computational and Experimental Chemistry
- WELLS, Prof. P.B. (Hull University) 10th May, 1989  
Catalyst Characterisation and Activity

COLLOQUIA, LECTURES AND SEMINARS GIVEN BY INVITED SPEAKERS  
1ST AUGUST 1989 TO 31ST JULY 1990

<u>BADYAL</u> , Dr. J.P.S. (Durham University) Breakthroughs in Heterogeneous Catalysis	1st November, 1989
<u>BECHER</u> , Dr. J. (Odense University) Synthesis of New Macrocylic Systems using Heterocyclic Building Blocks	13th November, 1989
* <u>BERCAW</u> , Prof. J.E. (California Institute of Technology) Synthetic and Mechanistic Approaches to Ziegler-natta Polymerization of Olefins	10th November, 1989
<u>BLEASDALE</u> , Dr. C. (Newcastle University) The Mode of Action of some Anti-tumour Agents	21st February, 1990
<u>BOWMAN</u> , Prof. J.M. (Emory University) Fitting Experiment with Theory in Ar-OH	23rd March, 1990
<u>BUTLER</u> , Dr. A. (St. Andrews University) The Discovery of Penicillin: Facts and Fancies	7th December, 1989
* <u>CHEETHAM</u> , Dr. A.K. (Oxford University) Chemistry of Zeolite Cages	8th March, 1990
<u>CLARK</u> , Prof. D.T. (ICI Wilton) Spatially Resolved Chemistry (using Nature's Paradigm in the Advanced Materials Arena)	22nd February, 1990
* <u>COLE-HAMILTON</u> , Prof. D.J. (St. Andrews University) New Polymers from Homogeneous Catalysis	29th November, 1989
<u>CROMBIE</u> , Prof. L. (Nottingham University) The Chemistry of Cannabis and Khat	15th February, 1990
<u>DYER</u> , Dr. U. (Glaxo) Synthesis and Conformation of C-Glycosides	31st January, 1990
<u>FLORIANI</u> , Prof. C. (University of Lausanne, Switzerland) Molecular Aggregates - A Bridge between homogeneous and Heterogeneous Systems	25th October, 1989
<u>GERMAN</u> , Prof. L.S. (USSR Academy of Sciences - Moscow) New Syntheses in Fluoroaliphatic Chemistry: Recent Advances in the Chemistry of Fluorinated Oxiranes	9th July, 1990
<u>GRAHAM</u> , Dr. D. (B.P. Reserch Centre) How Proteins Absorb to Interfaces	4th December, 1989
<u>GREENWOOD</u> , Prof. N.N. (University of Leeds) Novel Cluster Geometries in Metalloborane Chemistry	9th November, 1989

<u>HOLLOWAY</u> , Prof. J.H. (University of Leicester) Noble Gas Chemistry	1st February, 1990
<u>HUGHES</u> , Dr. M.N. (King's College, London) A Bug's Eye View of the Periodic Table	30th November, 1989
* <u>HUISGEN</u> , Prof. R. (Universität München) Recent Mechanistic Studies of [2+2] Additions	15th December, 1989
* <u>KLINOWSKI</u> , Dr. J. (Cambridge University) Solid State NMR Studies of Zeolite Catalysts	13th December 1989
<u>LANCASTER</u> , Rev. R. (Kimbolton Fireworks) Fireworks - Principles and Practice	8th February, 1990
<u>LUNAZZI</u> , Prof. L. (University of Bologna) Application of Dynamic NMR to the Study of Conformational Enantiomerism	12th February, 1990
<u>PALMER</u> , Dr. F. (Nottingham University) Thunder and Lightning	17th October, 1989
* <u>PARKER</u> , Dr. D. (Durham University) Macrocycles, Drugs and Rock 'n' roll	16th November, 1989
<u>PERUTZ</u> , Dr. R.N. (York University) Plotting the Course of C-H Activations with Organometallics	24th January, 1990
<u>PLATONOV</u> , Prof. V.E. (USSR Academy of Sciences - Novosibirsk) Polyfluoroindanes: Synthesis and Transformation	9th July, 1990
<u>POWELL</u> , Dr. R.L. (ICI) The Development of CFC Replacements	6th December, 1989
* <u>POWIS</u> , Dr. I. (Nottingham University) Spinning off in a huff: Photodissociation of Methyl Iodide	21st March, 1990
<u>ROZHKOVA</u> , Prof. I.N. (USSR Academy of Sciences - Moscow) Reactivity of Perfluoroalkyl Bromides	9th July, 1990
* <u>STODDART</u> , Dr. J.F. (Sheffield University) Molecular Lego	1st March, 1990
<u>SUTTON</u> , Prof. D. (Simon Fraser University, Vancouver B.C.) Synthesis and Applications of Dinitrogen and Diazo Compounds of Rhenium and Iridium	14th February, 1990
* <u>THOMAS</u> , Dr. R.K. (Oxford University) Neutron Reflectometry from Surfaces	28th February, 1990
<u>THOMPSON</u> , Dr. D.P. (Newcastle University) The role of Nitrogen in Extending Silicate Crystal Chemistry	7th February, 1990

COLLOQUIA, LECTURES AND SEMINARS GIVEN BY INVITED SPEAKERS  
1ST AUGUST 1990 TO 31ST JULY 1991

- ALDER, Dr. B.J. (Lawrence Livermore Labs., California) 15th January, 1991  
Hydrogen in all its Glory
- \* BELL<sup>†</sup>, Prof. T. (SUNY, Stony Brook, U.S.A.) 14th November, 1990  
Functional Molecular Architecture and Molecular Recognition
- \* BOCHMANN<sup>†</sup>, Dr. M. (University of East Anglia) 24th October, 1990  
Synthesis, Reactions and Catalytic Activity of Cationic Titanium Alkyls
- BRIMBLE, Dr. M.A. (Massey University, New Zealand) 29th July, 1991  
Synthetic Studies Towards the Antibiotic Griseusin-A
- BROOKHART, Prof. M.S. (University of N. Carolina) 20th June, 1991  
Olefin Polymerizations, Oligomerizations and Dimerizations Using Electrophilic Late Transition Metal Catalysts
- BROWN, Dr. J. (Oxford University) 28th February, 1991  
Can Chemistry Provide Catalysts Superior to Enzymes?
- \* BUSHBY<sup>†</sup>, Dr. R. (Leeds University) 6th February, 1991  
Biradicals and Organic Magnets
- \* COWLEY, Prof. A.H. (University of Texas) 13th December, 1990  
New Organometallic Routes to Electronic Materials
- CROUT, Prof. D. (Warwick University) 29th November, 1990  
Enzymes in Organic Synthesis
- DOBSON<sup>†</sup>, Dr. C.M. (Oxford University) 6th March, 1991  
NMR Studies of Dynamics in Molecular Crystals
- GERRARD<sup>†</sup>, Dr. D. (British Petroleum) 7th November, 1990  
Raman Spectroscopy for Industrial Analysis
- HUDLICKY, Prof. T. (Virginia Polytechnic Institute) 25th April, 1991  
Biocatalysis and Symmetry Based Approaches to the Efficient Synthesis of Complex Natural Products
- JACKSON<sup>†</sup>, Dr. R. (Newcastle University) 31st October, 1990  
New Synthetic Methods:  $\alpha$ -Amino Acids and Small Rings
- KOCOVSKY<sup>†</sup>, Dr. P. (Uppsala University) 6th November, 1990  
Stereo-Controlled Reactions Mediated by Transition and Non-Transition Metals

- \* LACEY, Dr. D. (Hull University)  
Liquid Crystals 11st January, 1991
- LOGAN, Dr. N. (Nottingham University)  
Rocket Propellants 1st November, 1990
- MACDONALD, Dr. W.A. (ICI Wilton)  
Materials for the Space Age 11th October, 1990
- MARKAM, Dr. J. (ICI Pharmaceuticals)  
DNA Fingerprinting 7th March, 1991
- \* PETTY, Dr. M.C. (Durham University)  
Molecular Electronics 14th February, 1991
- PRINGLE<sup>+</sup>, Dr. P.G. (Bristol University)  
Metal Complexes with Functionalised Phosphines 5th December, 1990
- PRITCHARD, Prof. J. (Queen Mary & Westfield College,  
London University) 21st November, 1990  
Copper Surfaces and Catalysts
- SADLER, Dr. P.J. (Birkbeck College London) 24th January, 1991  
Design of Inorganic Drugs: Precious Metals,  
Hypertension + HIV
- SARRE, Dr. P. (Nottingham University) 17th January, 1991  
Comet Chemistry
- \* SCHROCK, Prof. R.R. (Massachusetts Institute of Technology) 24th April, 1991  
Metal-ligand Multiple Bonds and Metathesis Initiators
- SCOTT, Dr. S.K. (Leeds University) 8th November, 1990  
Clocks, Oscillations and Chaos
- SHAW<sup>+</sup>, Prof. B.L. (Leeds University) 20th February, 1991  
Syntheses with Coordinated, Unsaturated Phosphine  
Ligands
- SINN<sup>+</sup>, Prof. E. (Hull University) 30th January, 1991  
Coupling of Little Electrons in Big Molecules.  
Implications for the Active Sites of (Metalloproteins  
and other) Macromolecules
- \* SOULEN<sup>+</sup>, Prof. R. (South Western University, Texas) 26th October, 1990  
Preparation and Reactions of Bicycloalkenes
- \* WHITTAKER<sup>+</sup>, Dr. B.J. (Leeds University) 28th November, 1990  
Two-Dimensional Velocity Imaging of State-Selected  
Reaction Products

<sup>+</sup> Invited specifically for the postgraduate training programme.



## Conferences

The following conferences were attended by the Author.

- |                          |   |
|--------------------------|---|
| 15th March 1989          | University of Lancaster Macro Group UK<br>Polymer Conference                            |
| 5th-7th April 1989       | University of Hull RSC Liquid Crystal Polymer<br>Conference                             |
| 5th January 1990         | Imperial College, London, IBM Postgraduate<br>Seminar in Polymer Science and Technology |
| 21st March 1990          | University of Lancaster Macro Group UK<br>Polymer Conference                            |
| 10th-12th September 1990 | University of Durham, RSC Macro Group<br>International Symposium, New Organic Materials |
| 26th-28th March 1991     | University of Lancaster Macro Group UK<br>Polymer Conference                            |

## Apparatus and Reagents

Fractional distillation was performed, when specified, with a Fischer-Spaltrohr apparatus. This comprised an HMS-500 column with heated jacket, a system 0200/01 oil bath controller, a VKH200 constant vacuum controller, a DT4 digital thermometer and a Fischer variable reflux ratio and column jacket temperature controller.

The following Analytical Services were used.

Infra-red spectra were obtained by the author on either a Perkin-Elmer PE1600 FT instrument or a Perkin-Elmer PE577 Grating Dispersion instrument.

Ultra-violet/visible spectra were obtained by the author on a Perkin-Elmer PE330 Spectrophotometer.

Mass spectra were provided by the Departmental service. The instrument was a VG Analytical 7070E spectrometer with a Hewlett-Packard HP5790A gas chromatograph and 25m SE30 capillary column.

NMR spectra were obtained from several instruments.

60MHz proton spectra were run by the author on an Hitachi/Perkin-Elmer R24B continuous wave instrument.

250.133MHz proton and 62.869MHz carbon spectra were run on a Bruker AC250 FT spectrometer by the Departmental service.

199.975Mhz proton and 50.289MHz spectra, plus several proton COSY spectra, were run by the author on a Varian Gemini 200 FT spectrometer.

399.952MHz proton spectra, 276.289MHz fluorine spectra and 100.577MHz carbon spectra, plus all other 2D spectra, were run on a Varian VXR400S FT spectrometer by the Interdisciplinary Research Centre in Polymer Science and Technology NMR service.

Elemental analyses for carbon, hydrogen and nitrogen were obtained by combustion

analysis by the Departmental service, using a Carlo Erba 1106 analyser. Other elemental analyses were performed by oxygen flask combustion and titration by the Departmental service.

Gel Permeation Chromatography was performed by the author using a Waters 590 pump and a Waters R401 differential refractometer or by the Interdisciplinary Research Centre service using a Viscotek differential refractometer and viscometer and Knauer HPLC pump, in both cases using two 30cm Polymer Laboratories 10 $\mu$  mixed gel columns in series.

HPLC was obtained via the Departmental service using a Varian 9010 pump, 9065 polychrom UV/visible detector and Varian Star workstation, with a 30cm x 5mm Hypersil 5 ODS column.

Gas chromatography was performed by the author using a Hewlett-Packard HP5890 series II chromatograph, a SE30 25m capillary column and a Hewlett-Packard HP3396A integrator.

Reagents and chromatographic materials for TLC and column chromatography were obtained from Aldrich, with the exception of solvents and inorganic acids which were Rhône-Poulenc, and the additional specific exceptions listed below. All were used as received unless otherwise stated.

Tris(dimethylamino)phosphine from Fluka. This was vacuum transferred prior to use.

Platinum and tungsten electrodes from Goodfellow Metals, Cambridge. These were used as described in Chapter 6.

Butyl-lithium was obtained from Janssen, in addition to some material from Aldrich.

Zinc dust and ammonium nitrate were obtained from BDH.

## Glossary of Journal Abbreviations

The following non-standard journal abbreviations have been used:

Adv.Mater.	Advanced Materials
Ang.Chem.	Angewandte Chemie
Ang.Chem.Int.Ed.Engl.	Angewandte Chemie, International Edition in English
Ann.	Justus Liebigs Annalen der Chemie
Ber.	Chemische Berichte
CA	Chemical Abstracts
C.R.Acad.Sci.	Comptes Rendus Hebdomadaires des Seances d'Academie des Sciences
Chem.Com.	Chemical Communications
Chem.Ind.	Chemistry and Industry (London)
Ind.J.Chem.	Indian Journal of Chemistry
JACS	Journal of the American Chemical Society
JCS	Journal of the Chemical Society
JCS Perkin 1	Journal of the Chemical Society, Perkin Transactions 1
J.Het.Chem.	Journal of Heterocyclic Chemistry
JOC	Journal of Organic Chemistry
J.Polym.Sci. Part A-1	Journal of Polymer Science, Part A-1
J.Polym.Sci.,Polym.Phys.	Journal of Polymer Science, Polymer Physics Edition
Polym.Comms.	Polymer Communications
Quart.Rev.	Quarterly Reviews
Tet.	Tetrahedron
Tet. Letts.	Tetrahedron Letters

## References

1. Alec Guinness in "The Man in the White Suit", Sydney Cole (Director), Ealing Studios, (1951). See also L. Halliwell, p.645 in Halliwell's Film Guide, 7th edition, Paladin (Collins) London (1989).
2. See, for example:  
J. Economy and B.E. Nowak, Fr. 1,568,152 (1969); CA 72 13412x  
B.E. Nowak, J. Economy and S.G. Cottis, Ger. Offen. 2,025,949 (1970); CA 74 43194m  
*idem*, Ger. Offen. 2,025,516 (1970); CA 74 54785f
3. R. Gilkey and J.R. Caldwell, J.Appl.Polym.Sci., 2 198 (1959)
4. S. Hanna and A.H. Windle, Polym.Comms., 29 236 (1988)
5. J. Grebowicz, S.Z. Cheng and B. Wunderlich, J.Polym.Sci., Polym.Phys., 24 675 (1986)
6. W.K.T. Gleim, US 3,039,994 (1962); CA 57 8738g
7. G.Ivanov and L. Slavcheva, Khim.Ind. (Sofia), 38(10) 458 (1966); CA 67 32424r
8. H.H.G. Jellinek and H. Fujiwara, J.Polym.Sci.Part A-1, 10 1719 (1972)
9. J.Economy, B.E. Nowak and S.G. Cottis, Polym.Prepr.,Amer.Chem.Soc., Div.Polym.Chem., 11 332 (1970); CA 76 4578m
10. S.G. Cottis, R.S. Storm, B.E. Nowak and J. Economy, Amer.Chem.Soc., Div.Org.Coatings Plast.Chem.,Pap., 30 197 (1970); CA 77 5990x (1972).
11. see ref. 9.
12. D.G.H. Ballard, A. Courtis, I.M. Shirley and S.C. Taylor, Chem.Com., 954 (1983)
13. B. Sillion, Chapter 30 in "Comprehensive Polymer Science" 5 499 (1989),

Eds. Sir Geoffrey Allen, J.C. Bevington, G.C. Eastmond, A. Ledwith, S. Russo and P. Sigwalt; Pergamon, Oxford.

14. See, for example, J.C.W. Chien, B.M. Gong, Y. Yang, I. Cabrera, J. Effing and H. Ringsdorf, *Adv.Mater.*, 2 305, 308-9 (1990); CA 113 222012w
15. E.K.G. Schmidt, L. Brener and R. Pettit, *JACS*, 92 3240 (1970)
16. Z.G. Li, University of Leeds. Poster exhibited at the annual Polymer Conference, University of Lancaster, 1991.
17. U. Fahrenstich, K.H. Koch and K. Müllen, *Makromol.Chem. Rapid Comm.*, 10 563 (1989)
18. G.A. Olah, Chapter 2 in "Friedel-Crafts and Related Reactions" 1 pp36-38 (1963); Ed. by G.A Olah, John Wiley Interscience, London.
19. R.C. Larock, "Comprehensive Organic Transformations", VCH Publishers, New York, (1989).
20. A.I. Vogel, "Vogel's Textbook of Practical Organic Chemistry", 4th edition, 709 (1978); Revised by B.S. Furniss, A.J. Hannaford, V. Rogers, P.W.G. Smith and A.R. Tatchell, Longman Group, London.
21. See ref. 19, pp 24-25.
22. U. Azzena, T. Denurra, G. Melloni and G. Rassa, *Chem.Com.*, 1549 (1987)
23. M. Node, K. Nishide, K. Ohta and E. Fujita, *Tet.Letts.*, 689 (1982)
24. K. Tadano, Y. Idogaki, H. Yamada and T. Suami, *JOC*, 52 1201 (1987)
25. D.H. Doughty and L.H. Pignolet, *JACS*, 100 7083 (1978)
26. See ref. 20, p. 933.
27. W.F. Maier, W. Roth, I. Thies and P.v. Ragué Schleyer, *Ber.*, 115 808 (1982)
28. V. Böhmer, F. Marschollek and L. Zetta, *JOC*, 52 3200 (1987)
29. a See ref. 20, pp.1093-4.

See also:

- b P. Hepp, *Ann*, 215 356 (1882); Trinitrobenzene, trinitrotoluene and picramide addition complexes with aromatic amines. Trinitrobenzene complex with benzene. Naphthalene complexes with trinitrobenzene, trinitrotoluene and *m*- and *p*- dinitrobenzene.
- c J.J. Sudborough, *JCS*, 79 522 (1901); Trinitrobenzene plus  $\alpha$ - and  $\beta$ -naphthylamines. Also complexes formed with ethyl trinitrobenzoate, methyl and ethyl picrate, picramide and TNT.
- d *idem, ibid*, 83 1334 (1903)
- e *idem, ibid*, 89 583 (1906)
- f J.J. Sudborough and S.H. Beard, *ibid*, 97 773 (1910); A large number of trinitrobenzene derivatives of amines, phenylhydrazines, Schiff bases and other nitrogen-containing compounds.
- g *idem, ibid*, 99 209 (1911); Trinitrobenzene derivatives of phenolic ethers and aryl esters.
- h J.J. Sudborough, *ibid*, 109 1339 (1916); Benzyl salicylate forms a 1:2 complex with trinitrobenzene.
- i F. Sachs and P. Steinert, *Ber.*, 37 1733 (1904); See page 1745 for a description of the synthesis of adducts of TNT plus aminobenzaldehydes.
- j E. Nölting and E.O. Sommerhoff, *ibid*, 39 76 (1906); Trinitrobenzene derivatives of amines.
- k R. Kreman, *ibid*, 39 1022 (1906); Dinitrobenzene forms labile adducts with aromatic amines. Their existence can be demonstrated by taking the melting point of mixtures of amine plus DNB in various proportions and inspecting the melting point/composition graph so produced.
- l S.G. Sastry, *JCS*, 109 270 (1916); TNB complexes with quinolines and acridines.
- m D.Ll. Hammick and G. Sixsmith, *JCS*, 972 (1939); Aromatic hydrocarbon

complexes of methyl 4,6,4',6'-tetranitrodiphenate.

30. A. Hantzsch, Ber., 21 942 (1888)
31. Z.H. Skraup, Monatsh.Chem., 3 531
32. Z.H. Skraup and O.W. Fischer, Monatsh.Chem., 5 523
33. E. Fischer and O. Hess, Ber., 17 559 (1884)
34. P. Bamfield and P.E. Gordon, Chem.Soc.Revs., 13(4) 441 (1984)
35. See ref. 19, pp 93-103.
36. A.J. Gordon and R.A. Ford, "The Chemist's Companion" pp 130-1. John Wiley and Sons, New York (1972).
37. W.J. Feast, D. Parker, J.N. Winter, D.C. Bott and N.S. Walker, Springer Series in Solid State Sciences, 63 45 (1985)
38. F. Wille and F. Knörr, Ber., 85 841 (1952)
39. J.F. Harris Jr., R.J. Harder and G.N. Sausen, JOC, 25 633 (1960)
40. E.F. Lutz, JACS, 83 2551 (1961)  
F.W. Hoover, O.W. Webster and C.T. Handy, JOC, 26 2234 (1961)
41. W. Herwig, W. Metlesics and H. Zeiss, JACS, 81 6203 (1959)  
W. Hübel and C. Hoogzand, Ber., 93 103 (1960)
42. U. Krüerke, C. Hoogzand and W. Hübel, Ber., 94 2817 (1961)
43. D. Bryce-Smith, Chem.Ind., 239 (1964)
44. R.E. Lyle, E.J. DeWitt, N.M. Nicholls and W. Cleland, JACS, 75 5959 (1953)
45. F. Kröhnke and I. Vogt, Ann., 589 52 (1954)
46. W. Schäfer, Ang.Chem., 78 716 (1966)
47. V. Boekelheide and J.E. Nottke, JOC, 34 4134 (1969)
48. H. Brockman and H. Laatsch, Ber., 106 2058 (1973)
49. W. von E. Doering and L.H. Knox, JACS, 75 297 (1953)
50. C. Jutz and F. Voithenleitner, Ber., 97 29 (1964)
51. J.D. Hobson and J.R. Malpass, Chem.Com., 141 (1966)



52. K. Bangert and V. Boekelherde, JACS, 86 1159 (1964)
53. W. Kirmse and F. Scheidt, Ang.Chem., 83 251 (1971)
54. S. Hirano, H. Hara, T. Hiyama, S. Fujita and H. Nozaki, Tet., 31 2219 (1975)
55. M.S. Newman, V.K. Khanna and K. Kanakarajan, JACS, 101 6788 (1979)
56. E.E. van Tamelen and S.P. Pappas, JACS, 84 3789 (1962)
57. E.E. van Tamelen and S.P. Pappas, JACS, 85 3297 (1963)
58. R. Criegee and F. Zanker, Ang.Chem., 76 716 (1964)
59. J. Dieckmann, JOC, 28 2880 (1963)
60. C.F.H. Allen and J.A. van Allan, JOC, 14 1051 (1949)
61. J.R. Hanson and H.J. Shapter, JCS Perkin 1, 1445 (1972)
62. T.D.J. D'Silva, W.E. Walker and R.W. Manyik, Tet., 30 1015 (1974)
63. D.R. Long and C.G. Richards, Tet.Letts., 1603 (1975)
64. R.M. Anker and A.H. Cook, JCS, 311 (1945)
65. E. Berner, JCS, 1052 (1946)
66. W.B.sH. Moureu, P. Chovin and G. Rivoal, Bull.Soc.Chim.France, 106 (1946)
67. H. Mühlemann, Pharma.Acta Helv., 24 351, 356 (1949)
68. O. Dann, M. Kokorudz and R. Gropper, Ber., 87 140 (1954)
69. N.K. Kochetkov, L.I. Kudryashov and T.M. Senchenkova, J.Gen.Chem.USSR, 19 643 (1959) in English, trans. from Zh.Obshch.Khim., 19 650 (1959)  
*idem*, Tet., 12 63 (1961)
70. M. Murakami and J.-C. Chen, Bull.Chem.Soc.Japan, 36 263 (1963)
71. T.T. Howarth and T.M. Harris, JACS, 93 2506 (1971)
72. R.F. Abdulla, K.H. Fuhr, R.P. Gajewski, R.G. Suhr, H.M. Taylor and P.L. Unger, JOC, 45 1724 (1980)
73. M. Natsume and H. Muratake, Tet.Letts., 3477 (1979)

74. G. Dupas, J. Duflos and G. Quéguiner, *J.Het.Chem.*, 20 967 (1983)
75. A.B. Smith 3rd and S.N. Kilényi, *Tet.Letts.*, 26 4419 (1985)
76. K. Dimroth, G. Neubauer and G. Bräuninger, *Ber.*, 90 1634 (1957)  
K. Dimroth, G. Neubauer, H. Müllenkamp and G. Oosterloo, *Ber.*, 90  
1668 (1957)
77. S.R. Gompper and O. Christmann, *Ber.*, 94 1784, 1795 (1961)
78. G. Märkl, *Ang.Chem.*, 74 696 (1962)
79. G.A. Reynolds and J.A. van Allan, *J.Het.Chem.*, 8 301 (1971)
- See also
- Z. Yoshida, S. Yoneda, H. Sugimoto and T. Sugimoto, *Tet.*, 27 6083  
(1971)
80. Y. Hamada, I. Takeuchi and M. Hirota, *Tet. Letts.*, 495 (1974)
81. W. Eberbach and J.C. Carré, *Tet.Letts.*, 3299 (1976)
82. A.I. Hashem, *J.Prakt.Chem.*, 319 689 (1977)
83. S. Blechert, K.E. Fichter and E. Winterfeldt, *Ber.*, 111 439 (1978)
84. V.S. Abramov, *Bull.Acad.Sci.URSS Classe Sci.Chem.*, 330 (1945); *CA*  
40 5024, 5025
85. O. Grummitt, *Org.Synth.*, 23 93 (1943)
86. O. Grummitt and E.I. Becker, *JACS*, 70 149 (1948)
87. E.C. Schreiber and E.I. Becker, *JACS*, 72 4829 (1950)  
F.J. Thaller, D.E. Trucher and E.J. Becker, *JACS*, 73 228 (1951)  
M.E. Synerholm, *JACS*, 67 1229 (1945)
88. R.F. Doering, R.S. Miner Jr., L. Rothman and E.I. Becker, *JOC*, 23 520  
(1958)
89. W. Tochtermann, C. Franke and D. Schäfer, *Ber.*, 101 3122 (1968)
90. F.W. Harris and S.O. Norris, *J.Het.Chem.*, 9 1251 (1972)
91. K. Ghosh and A.J. Bhattacharya, *Ind.J.Chem.*, 15B 32 (1977)
92. E. Clar and H. Frömmel, *Ber.*, 82 46 (1949)

93. E.T. McBee, D.K. Smith and H.E. Ungnade, *JACS*, 77 387 (1955)
94. T.W. Campbell and R.N. McDonald, *Org.Synth.*, 40 85 (1960)  
*idem*, *JOC*, 24 1969 (1959)  
*idem*, *Org.Syn.*, 40 36 (1960)  
H. Lohaus, *Ann.*, 516 295 (1935)  
L.F. Fieser and M.J. Haddadin, *JACS* 86 2392 (1964)
95. V.R. Skvarchenko, D.Ts. Tsybikova and R.Ya. Levina,  
*J.Gen.Chem.USSR*, 30 3477 (1960) in English, trans. from  
*Zh.Obshch.Khim.*, 30 3504 (1960)
96. V.R. Skvarchenko, L.A. Chervoneva, V.A. Puchnova and R. Ya. Levina,  
*J.Gen.Chem.USSR*, 30 56 (1960) in English, trans. from  
*Zh.Obshch.Khim.*, 30 54 (1960)
97. G. Wittig, H. Härle, E. Knauss and K. Niethammer, *Ber.*, 93 951 (1960)
98. R.K. Hill and R.M. Carlson, *Tet.Letts.*, 1157 (1964)  
*idem*, *JOC*, 30 1571, 2414 (1965)
99. F.S. Edmunds and R.A.W. Johnstone, *JCS*, 2898 (1965)  
C.W. Spangler, *JOC*, 31 346 (1966)
100. S. Danishefsky and R. Cunningham, *JOC*, 30 3676 (1965)
101. A.B. Evinin and D. Seyferth, *JACS*, 89 952, 4793 (1967)
102. H.C. Volger, M.M.P. Boot and J.W.F.M. Lemmers,  
*Rec.Trav.Chim.Pays-Bas*, 86 677 (1967)
103. A. Oku, T. Kakihana and H. Hart, *JACS*, 89 4554 (1967)
104. J. Wolinsky and R.B. Login, *JOC*, 35 3205 (1970)
105. G.S. Marx and E.D. Bergmann, *JOC*, 37 1807 (1972)  
J.H. Dopfer, D. Oudman and H. Wynberg, *JACS*, 95 3692 (1973)
106. R.G. Salomon, J.R. Burns and W.J. Dominic, *JOC*, 41 2918 (1976)
107. A. Shafiee and E. Behnam, *J.Het.Chem.*, 15 1459 (1978)
108. K.B. Sukumaran and R.G. Harvey, *JOC*, 46 2740 (1981)

109. R. Maurin, C. Piscot and Z. Charrouf-Chafchaoumi, *Tet.Letts.*, 2425 (1980)
110. M.A. Tius and S. Ali, *JOC*, 47 3163 (1982)
111. T. Minami, K. Nishimura and I. Hirao, *JOC*, 47 2360 (1982)
112. K.T. Potts and E.B. Walsh, *JOC*, 49 4099 (1984)
113. R.L. Snowden and M. Wüst, *Tet.Letts.*, 27 703 (1986)
114. L.M. Gomes, *C.R.Acad.Sci.*, 270C 347 (1970)
115. J.A. Cella, *JOC*, 53 2099 (1988)
116. C.J. Moody, P. Shah and P. Knowles, *Tet.Letts.*, 2693 (1988)
117. U. Gruseck and M. Heuschmann, *Tet.Letts.*, 6027 (1987)
118. "Theilheimer's Synthetic Methods of Organic Chemistry", vols. 1-44, 1948-1990; Karger, Basel.
119. See ref. 20, p.515.
120. See ref. 20, p.682.
121. L. Claisen, *Ber.*, 26 2729 (1893), *Ann.*, 297 76 (1897)
122. E.N. Marwell and M.J. Joncich, *JACS*, 73 973 (1951)
123. A.A. Berlin, B.I. Liogon'kii, B.I. Zapadinskii, E.A. Kazantseva and A.O. Stankevich, *Bull.Acad.Sci.USSR Div.Sci.Chem.*, 26 790 (1977) in English, trans. from *Izv.Akad.Nauk.SSSR Ser.Khim.*, 4 867 (1977)  
A.P. Dunlop and F.N. Peters, "The Furans", Reinhold, NY (1953) p59
124. K. Alder and H.F. Rickert, *Ber.*, 70 1354 (1937)
125. L.A. Paquette, R.E. Moerck, B. Harirchian and P.D. Magnus, *JACS*, 100 1597 (1978)
126. W. Hübel and E.H. Braye, *J.Inorg.Nucl.Chem.*, 10 250 (1959)
127. C.F.H. Allen and J.A. van Allan, *JOC*, 17 845 (1952)
128. P.J. Parsons, University of Southampton, personal communication.
129. P. Ferruti, A. Segre and A. Fere, *JCS(C)*, 2721 (1968)

See also:

- J.M. Kliegman and R.K. Barnes, *J.Het.Chem.*, 7 1153 (1970)
130. C.M. Orlando Jr., *JOC*, 35 3714 (1970)
131. B.A.A. Volod'kin, V.V. Ershov, G.D. Ostapets-Sveshnikova and I.S. Belostotskaya, *Bull.Acad.Sci.USSR, Chem.*, 1030 (1966) in English, trans. from *Izv.Nauk.Akad.Sci., Chem.*, 1081 (1966)
132. R.H.S. Wang, *JOC*, 37 2771 (1972)
133. K. Hultzsch, *Ber.*, 74 898, 1533, 1539 (1941); 75 106 (1942)
134. A. Zincke and E. Ziegler, *Ber.*, 74 1729 (1941)
135. L.A. Errede and M. Szwarc, *Quart.Rev.*, 12 301 (1958)
136. F.G. Mann and F.H.C. Stewart, *JCS*, 2826 (1954)
137. J. Thiele and O. Dimroth, *Ann.*, 305 110 (1899)
138. A.B. Turner, *Quart.Rev.*, 18 347 (1964)
139. S.B. Cavitt, H. Sarrafzadeh and P.D. Gardner, *JOC*, 27 1211 (1962)
140. K. Auwers, *Ber.*, 36 1878 (1903)
141. P. Gruenanger, p401 in "Chinonmethide", *Houben-Weyl Methoden der Organischen Chemie*, VII(3b) Chapter 18, 395 (1979); Ed. by E. Mueller and O. Bayer, publ. G. Thieme Verlag, Stuttgart.
142. V.D. Parker p531 in *Organic Electrochemistry*; Ed. by Manuel M. Baizer, publ. Marcel Dekker Inc., New York, (1973)
143. R.G. Jones, *JACS*, 69 2346 (1947)
144. J.J. Murray, *JOC*, 33 3306 (1968)
145. H. Staudinger, *Ber.*, 41 1355 (1908) and with S. Bereza, *Ann.*, 380 243 (1911)
146. H. Staudinger, "Die Ketene" Enke, Stuttgart, 1912
147. R.B. Woodward and R. Hoffmann, pp163-168 in *The Conservation of Orbital Symmetry*, Verlag Chemie GmbH, Academic Press Inc., Weinheim, (1970)
148. H.C. Stevens, D.A. Reich, D.R. Brandt, K.R. Fountain and E.J. Gaughan,

- JACS, 87 5257 (1965)
- R.W. Turner and T. Seden, JCS Chem.Com., 399 (1966)
- W.T. Brady and O.H. Waters, JOC, 32 3703 (1967)
- R. Montaigne and L. Ghosez, Ang.Chem.Int.Ed.Engl., 7 221 (1968)
- L. Ghosez, R. Montaigne, A. Roussel, H. Vanlierde and P. Mollet, Tet., 27 615 (1971)
149. H. Staudinger, Ber., 41 1493 (1908)
- H.J. Hagemeyer, Ind.Eng.Chem., 41 765 (1949)
150. H.J. Hagemeyer, USP 2,481,742 (1949); see CA 44 4504a
151. D. Borrmann and R. Wegler, Ber., 102 64 (1969)
152. H. Staudinger and H.W. Klever, Ber., 41 594 (1908)
153. W.T. Brady and A.D. Patel, J.Het.Chem., 8 739 (1971)
154. W.T. Brady and L. Smith, JOC, 36 1637 (1971)
155. See ref. 148.
156. C.-Y. Liu, Yu Chi Hua Hsueh, 1 75 (1981); see CA 95 96893d.
157. W.T. Brady, H.G. Lidell and W.L. Vaughn, JOC 31 626 (1966)
158. They do, but the reference has gone AWOL.
159. S. Penczek and P.Kubisa, Chapter 48 in "Comprehensive Polymer Science" 3 751 (1989), Eds. Sir Geoffrey Allen, J.C. Bevington, G.C. Eastmond, A. Ledwith, S. Russo and P. Sigwalt; Pergamon, Oxford.
160. A. Hassner, V.R. Fletcher and D.P.G. Hamon, JACS, 93 264 (1971)
161. See refs. 152 and 157.
- J.C. Sauer, JACS, 69 2444 (1947)
162. H.O. Krabbenhoft, JOC, 43 1305 (1978)
163. H. Staudinger and S. Bereza, Ann., 380 243 (1911)
164. A.J. Gordon and R.A. Ford, p.196 in "The Chemist's Companion", John Wiley & Sons, New York (1972)
165. see ref. 162.

- W.T. Brady and K. Saidi, JOC, 44 733 (1979)
166. G. Wittig and U. Schöllkopf, Ber., 87 1318 (1954)  
There is some suggestion that dichloroketene addition *can* go via an ionic intermediate; see H.-U. Wagner and R. Gompper, Tet.Letts., 2819 (1970)
167. H.E. Zaugg, Org.React., 8 305 (1954)
168. W.T. Brady and K. Saidi, JOC, 44 733 (1979)
169. W. Bremser, B. Frank and H. Wagner, Chemical Shift Ranges in Carbon-13 NMR Spectroscopy, Verlag Chemie, Weinheim (1982)
170. M.C. Lasne, J.L. Ripoll and J.M. Denis, Tet. 37 503 (1981)
171. R.C. Cookson, R.R. Hill and J. Hudec, JCS, 3043 (1964)
172. P. Yates and K. Switlak, Can.J.Chem., 68 1894 (1990)
173. R. Rabinowitz and R. Marcus, JACS, 84 1312 (1962)
174. B.A. Clement and R.L. Soulen, JOC, 41 556 (1976)
175. A.J. Speziale and K.W. Ratts, JACS, 84 854 (1962)
176. R. Appel, F. Knoll and H. Veltmann, Ang.Chem.Int.Ed.Engl., 15 315 (1976)
177. W.G. Salmond, M.C. Sobala and K.D. Maisto, Tet.Letts., 1237 (1977)  
W.G. Salmond, Tet.Letts., 1239 (1977)
178. See ref. 176.
179. R. Appel, Ang.Chem.Int.Ed.Engl., 14 801 (1975)
180. R.C. Cookson, R.R. Hill and J. Hudec, JCS, 3043 (1964)
181. D. Parker, University of Durham, personal communication.
182. D. Tavernier, N. Hosten and M. Anteunis, Synthesis, 613 (1979)
183. A.W. Carlson, U.S. 3,810,945; See CA 81 63391w
184. G.A. Wiley, R.L. Hershkowitz, B.M. Rein and B.C. Chung, JACS, 86 964 (1964)
185. C. Rüchardt, S. Eichler and P. Panse, Ang.Chem.Int.Ed.Engl., 2 619 (1963)

186. H.-U. Wagner and R. Gompper, Chapter 18 in: The Chemistry of the Quinonoid Compounds (part 2), edited by S. Patai, J. Wiley & Sons, London (1974)
187. G.M. Kosolapoff, JACS, 69 1002 (1947)
188. P. Savignac, J. Petrova, M. Dreux and P. Coutrot, Synthesis, 535 (1975)
189. D. Seyferth and R.S. Marmor, J.Organomet.Chem., 59 237 (1973) see also p.250.
190. V.P. Kukhar and E.I. Sagina, Zh.Obshch.Khim., 49 1470 (1979) reprinted in English as J.Gen.Chem.USSR, 49 1284 (1979)
191. G. Kamai and F.M. Kharrasova, Zh.Obshch.Khim., 27 953 (1957) reprinted in English as J.Gen.Chem.USSR, 27 1034 (1957)
192. J. Castells, J. Font, T. Ibarra, A. Llitjos and M. Moreno-Manas, An.Quim., 74 773 (1978)
193. Y. Yamashita, Y. Kobayashi and T. Miyashi, Ang. Chem., 101 1090 (1989)
194. F. Fariña, A. Galan and J.L. Garcia Ruano, An. Quim., 74 954 (1978)
195. A.M. McKillop, D.H. Perry, M. Edwards, S. Antus, L. Farkas, M. Nógrádi and E.C. Taylor, JOC, 41 282 (1976)
- 196a. A. Nobel, Brit.Pat. 2359 (1863)
- 196b. T.L. Davis, p192 in "The Chemistry of Powders and Explosives." Originally published in two parts in 1943, reprinted in one volume by Angrif Press, Hollywood Calif. (no date) reprint ISBN 0913022-00-4.
197. "As he that taketh away a garment in cold weather, *and as* vinegar upon nitre, *so is* he that singeth songs to an heavy heart." Proverbs 25, vs20. The unpleasant reaction of nitric acid with organic matter seems to have been known from ancient times.
198. A. Nilsson, A. Ronlán and V.D. Parker, Tet.Letts., 1107 (1975)
199. A. Nilsson, U. Palmquist, T. Petterson and A. Ronlán, JCS Perkin 1, 696



- (1978)
200. A.N. Mirskova, G.G. Levkovskaya, I.D. Kalikhman, T.I. Vakul'skaya, V.A. Pestnovich and M.G. Voronkov, *Izv.Akad.Nauk SSSR, Ser.Khim.*, 2040 (1976), reprinted in English as *Bull.Acad.Sci.USSR, Div.Chem.*, 25 1913 (1976)
201. A.N. Nesmeyanov, O.A. Reutov and A.S. Gudkova, *Izv.Akad.Nauk SSSR, Ser.Khim.*, 260 (1961), reprinted in English as *Bull.Acad.Sci.USSR, Div.Chem.*, 237, (1961).
202. A. Hassner and V. Alexanian, *Tet.Letts.*, 4475 (1978)
203. E. Vedejs and P.L. Fuchs, *JOC*, 36 366 (1971)  
H.-L. Chang, *Tet.Letts.*, 1989 (1972)
204. A.R. Rye and D. Wege, *Aust.J.Chem.*, 27 1943 (1974)
205. D.J. Petersen, *JOC*, 33 780, (1968)
206. E.J. Corey, D. Seebach and R. Freedman, *JACS*, 89 434 (1967)  
D. Seebach, M. Kolb and B.T. Gröbel, *Ber.*, 106 2277 (1973)  
D. Seebach, B.T. Gröbel, A.K. Beck, M. Braun and K.H. Geiss, *Ang.Chem.Int.Ed.Engl.*, 11 443 (1972)
207. P. Entmayr and G. Köbrich, *Ber.*, 109 2175 (1976)
208. T.S. Sokolova, A.V. Volokhina and G.I. Kudryavtsev, *Vysokomol.Soedin., Ser.B.*, 9 395 (1967): see CA 68 3209q
209. G. Ceccarelli, F. Andruzzi and M. Paci, *Polymer*, 20 605 (1979)
210. K. Chebaane, M. Guyot and D. Molko, *Bull.Soc.Chim.Fr.*, 244 (1975)
211. A.I. Meyers, W.M. Beverung and R. Gault, *Org.Syn.*, 51 103 (1971)
212. T.A. Giudici and T.C. Bruice, *JOC*, 35 2386 (1970)
213. N.M. Morlyan, A.G. Muradyan and D.E. Kirakosyan, *Metody Poluch. Khim. Reaktivov Prep.*, 23 40 (1971) see CA79 65749b  
T. Mitsudo, Y. Hori, Y. Yamakawa and Y. Watanabe, *JOC*, 52 2230 (1987)

214. M.C. Lasne, J.L. Ripoll and J.M. Denis, *Tet.Letts.*, 463 (1980)
215. A.G. Schultz, F.P. Lavieri, M. Macielag and M. Plummer, *JACS*, 109 3991 (1987)
216. M. Komiyama and H. Hirai, *JACS*, 106 174 (1984)
217. K. Alder, J. Mönch and H. Wirtz, *Ann.*, 627 47 (1959)
218. M. Karplus, *J.Chem.Phys.*, 30 11 (1959)
219. F.A. Bovey, *NMR Spectroscopy*, Academic Press, New York (1969)
- A.A. Bothner-By, *Adv.Magn.Res.*, 1 195 (1965)
220. R.A. Hamdany, J.M. Bruce, F. Heatley and J. Khalafy, *JCS Perkin II*, 1395 (1985)
221. A.J. Gordon and R.A. Ford, p.196 in "The Chemist's Companion", John Wiley & Sons, New York (1972)
222. R.C. Cookson, E. Crundwell, R.R. Hill and J. Hudec, *JCS*, 3062 (1964)
223. See, for example:
- A.P. Marchand and G.M. Reddy, *Tet.Letts.*, 1811 (1990)
- A.P. Marchand and P. Annapurna, *Synth.Comms.*, 19 3477 (1989)
- A.P. Marchand, S.P. Reddy, D. Rajapaksa and C.T. Ren, *JOC*, 55 3493 (1990)
- See also G. Mehta and K.R. Reddy, *JOC*, 52 460 (1987)
224. A.A. Bothner-By and J.J. Pople, *Ann.Rev.Phys.Chem.*, 16 43 (1965)
225. W. Albrecht, *Ann.*, 348, 31 (1906)
226. P. Yates and K. Switlak, *Can.J.Chem.*, 68 1894 (1990)
227. E.E. van Tamelen, M. Shamma, A.W. Burgstahler, J. Wolinsky, R. Tamm and P.E. Aldrich, *JACS*, 91 7324 (1969)
228. W. Richter, *Ber.*, 34 4292 (1901)
229. K. Alder and K.H. Backendorf, *Ann.*, 535 113, (1938)
- O. Diels and K. Alder, *Ber.*, 62 557 (1929)
- O. Diels and K. Alder, *Ann.*, 490 243 (1931)

- R.B. Woodward and H. Baer, JACS, 70 1161 (1948)
230. L.A. Paquette, R.V. Williams, R.V.C. Carr, P. Charumilind and J.F. Blount, JOC, 47 566 (1982)
231. J.M. Kliegman and R.K. Barnes, J.Het.Chem., 7 1153 (1970)
232. R.G. Jones, JACS 69 2346 (1947)
233. G. Büchi, P.-S. Chu, A. Hoppmann, C.-P. Mak and A. Pearce, JOC, 43 3983 (1978)
234. K. Alder and G. Stein, Ann., 501 247 (1933)
235. G.M. Kosolapoff, JACS, 69 1002 (1947)
236. See ref. 225.
237. E.E. van Tamelen, M. Shamma, A.W. Burgstahler, J. Wolinsky, R. Tamm and P.E. Aldrich, JACS, 91 7324 (1969)
238. See ref. 234.
239. See ref. 234.
240. K. Alder, J. Mönch and H. Wirtz, Ann., 627, 47 (1959)
241. R.C. Cookson, E. Crundwell, R.R. Hill and J. Hudec, JCS, 3062 (1964)
242. N.M. Morlyan, A.G. Muradyan and D.E. Kirakosyan, Metody Poluch. Khim. Reaktivov Prep., 23 40 (1971) see CA79 65749b
- T. Mitsudo, Y. Hori, Y. Yamakawa and Y. Watanabe, JOC, 52 2230 (1987)
243. A. Rankin and J.G. Tomka, Department of Textile Industries, University of Leeds. Poster presented at the Annual Polymer Conference, University of Lancaster (1991)
244. K.H. Matthews, Department of Textile Industries, University of Leeds. Poster presented at the Annual Polymer Conference, University of Lancaster (1991)
245. H.E. Zimmerman, G.L. Grunewald and R.M. Paufler, p982 in Organic Syntheses Collective Volume 5, edited by H.E. Baumgarten, Wiley, New

York (1973)

246. L.F. Fieser and M.J. Haddadin, JACS, 86 2081 (1964)  
*idem*, Can.J.Chem., 43 1599 (1965)  
T. Sasaki, T. Manabe and S. Nishida, JOC, 45 476 (1980)
247. P.I. Clemenson, W.J. Feast, M.A. Ahmad, P.C. Allen, D.C. Bott, C.S. Brown, L.M. Connors, N.S. Walker and J.N. Winter, Polymer, (1992), submitted.

