

Durham E-Theses

Use of Topical (Intra-articular) Tranexamic Acid to Minimise Blood Loss and Transfusion in Total Knee Replacement Surgery

ALSHRYDA, SATTAR,JABER,MOHR

How to cite:

ALSHRYDA, SATTAR,JABER,MOHR (2010) *Use of Topical (Intra-articular) Tranexamic Acid to Minimise Blood Loss and Transfusion in Total Knee Replacement Surgery* , Durham theses, Durham University. Available at Durham E-Theses Online: <http://etheses.dur.ac.uk/597/>

Use policy

The full-text may be used and/or reproduced, and given to third parties in any format or medium, without prior permission or charge, for personal research or study, educational, or not-for-profit purposes provided that:

- a full bibliographic reference is made to the original source
- a [link](#) is made to the metadata record in Durham E-Theses
- the full-text is not changed in any way

The full-text must not be sold in any format or medium without the formal permission of the copyright holders.

Please consult the [full Durham E-Theses policy](#) for further details.

**Use of Topical (Intra-articular) Tranexamic
Acid to Minimise Blood Loss and Transfusion
in Total Knee Replacement Surgery**

Mr Sattar Alshryda

PhD Thesis

The School of Medicine and Health

Durham University

2010

Supervised by:

Professor James Mason

Professor Pali Hungin

Personal tribute

I dedicate this work to those patients who took part in my research in order to advance patient care.

Acknowledgments

I would like to thank the following for their contribution, support and help in my research and in the writing of my thesis:

1. My wife (Ania Milkowski) for her immense help and support.
2. Professor James Mason and Professor Pali Hungin, the School of Medicine and Health, Durham University, UK.
3. Dr Eileen Scott, post-doctoral research fellow, the School of Medicine and Health, Durham University, UK.
4. Professor Tony Unsworth, Department of Biomechanical Engineering, Durham University, UK.
5. Dr June Jie Wu, assistant professor, Department of Biomechanical Engineering, Durham University, UK.
6. Mr Praveen Sharda, associate specialist in trauma and orthopaedic in the University Hospital of North Tees and Hartlepool, UK.
7. Mr. Mohamed Sukeik, clinical Research Fellow in Trauma & Orthopaedics, University College London Hospital, London, UK.
8. Homeward teams and Joints Replacement Unit in the University Hospital of North Tees and Hartlepool, Stockton-on-Tees, UK.
9. Trauma and orthopaedic consultants' surgeons in the University Hospital of North Tees and Hartlepool, Stockton-on-Tees, UK.
10. Theatre staff in the University Hospital of North Tees and Hartlepool, Stockton-on-Tees, UK.
11. The research and development staff in the University Hospital of North Tees and Hartlepool, Stockton-on-Tees, UK.
12. Mr John Blenkinsopp, clinical effectiveness adviser, Clinical Effectiveness Unit, University Hospital of North Tees and Hartlepool, Stockton-on-Tees, UK.
13. Mr Raymond Pollock, research advisor, the University Hospital of North Tees and Hartlepool, Stockton-on-Tees, UK.

14. Mr Tony Brady, independent statistician, Sealed Envelope Ltd, London, UK.
15. Dr T Lou, orthopaedic senior house officer, the James Cook University Hospital, Middlesbrough, UK.
16. Dr Roy Harvey, clinical research manager, Knees & Orthobiologics, DePuy International Limited, Leeds, UK.
17. Mr Martin Stanley, PhD student in the Department of Biomechanical Engineering, Durham University, UK.

Abbreviations

Order	Abbreviations	Meaning
A	AE	Adverse Event
	ANOVA	Analysis of variance
	AR	Adverse Reaction
	AHH	Acute hypervolumic haemodilution
	ANH	Acute normovolumic haemodilution
C	C	Centigrade
	CI	Confidence interval
	Co-Cr	Cobalt-Chromium
	CVA	Cerebrovascular accident (Stroke)
D	df	Degree of freedom
	DVT	Deep venous thrombosis
E	EACA	Epislon Amino Caproic acid
	EDTA	Ethylene Diamine Tetraacetic Acid
	EQ-5D	EuroQol five dimension score
	EQ-VAS	EuroQol visual analogue scale
	EPO	Erythropoietin
	EU	European Community
F	FDP	Fibrinogen (Fibrin) degradation products
G	g	Gram
	GA	General anaesthetic
I	Intraop	Intra-operative
K	Kg	Kilogram
	KST	Kolmogorov-Smirnov test
L	LOS	Length of stay
M	M	Meter(s)
	M-H	Mantel-Haenszel method
	MD	Mean difference
	MHRA	Medicine and Health products Regulatory Authority
	min	Minute(s).
	MWT	Mann-Whitney U test (a non parametric test)
N	NB	Nerve Block
	NHP	Nottingham Health Profile
	NSAID	Non steroidal anti-inflammatory drugs
O	OR	Odds ratio

	OKS	Oxford knee score	
P	P	P-value	
	PAD	Preoperative autologous blood donation	
	PE	Pulmonary embolism	
	Postop	Postoperative	
	Preop	Preoperative	
	PV	Peak-valley ratio	
Q	QAS	Quality assessment score	
R	Ra	Roughness average	
	R&D	Research and development	
	REC	Research and Ethical Committee	
	RCT(s)	Randomised controlled trial(s)	
	RD	Risk difference	
	ROM	Range of motiom	
	RR	Risk ratio	
	rms	Root mean square	
	S	SA	Spinal anaesthetic
		SAE	Serious adverse Event
SAR		Serious adverse Reaction	
SD		Standard deviation	
Sig		Significance	
SmPC		Summary of Product Characteristics	
SSAR		Suspected serious adverse reaction	
SUSAR		Suspected unexpected serious adverse reaction	
SWT		Shapiro-Wilk's test	
T		TIA	Transient ischaemic attack (minor stroke)
	TKR	Total knee replacement	
	THR	Total hip replacement	
	TRALI	Transfusion-related acute lung injury	
	TT	Tourniquet time	
	TXA	Tranexamic acid	
V	VAS	Visual analogue scale	
	vs.	Versus	
U	UKR	Unicompartmental knee replacement	
	UHMWPE	Ultra high molecular weight polyethylene	
W	WOMAC	The Western Ontario and McMaster Universities Index of Osteoarthritis	
X	χ^2	Chi square	

Abstract

Use of Topical (Intra-articular) Tranexamic Acid to Minimise Blood Loss and Transfusion in Total Knee Replacement Surgery

Introduction

Total knee replacement (TKR) is a common orthopaedic procedure, with 20-70% of patients needing 1-3 units of blood, although allogeneic transfusion is not risk free. Tranexamic acid (TXA) is a synthetic antifibrinolytic agent used intravenously to stop bleeding in TKR and other surgical procedures.

Objectives

To determine whether intra-articular TXA is effective, safe and cost-effective in reducing blood loss and subsequent blood transfusion after TKR.

Design

This thesis describes three research projects to address the objectives:

1. A systematic review and meta-analysis of the use of intravenous (IV) TXA in TKR.
2. A randomised controlled trial of the topical (intra-articular) use TXA in TKR.
3. A biomechanical study of the effect of local TXA on TKR materials.

Outcome measures

The primary aim of intra-articular TXA was to reduce the blood transfusion rate. Secondary outcomes included reduced blood loss, length of stay, complications and cost and improved functional outcome measures. To explore whether TXA degrades TKR materials, tensile properties, wear rate and surface topographic profile were biomechanically tested.

Results

The systematic review found that IV TXA reduced blood loss and transfusion significantly but there was significant heterogeneity between trials. A first trial of topical (intra-articular) TXA in TKR found TXA to be effective and safe in reducing blood loss and transfusion. Thirteen patients (16.7%) were transfused in the placebo group versus 1 (1.3%) patient in the TXA group (χ^2 ; P=0.001). Blood loss was reduced from 465 ml in the placebo group to 297 ml in the TXA group (t-test; P=0.00025). TXA use resulted in a net cost saving of £333 per patient (P=0.044). There was no adverse effect of TXA on the biomechanical properties of the joint materials.

Conclusion

Topically Applied TXA in TKR is effective, safe and cost-effective in reducing blood loss and transfusion in TKR, and avoiding the potential complications of intravenous administration.

Contents

Headings	Page
Tables	13
Figures	14
1. Background to the thesis	16
1.1 Introduction	17
1.2 A brief history of total joint replacement	17
1.3 Surgical technique of total knee replacement	21
1.4 Blood Loss in Joint Replacement	25
1.5 Haemostasis, Coagulation and Fibrinolysis System	26
1.5.1 Vasospasm	26
1.5.2 Platelet plugs formation	27
1.5.3 Coagulation and fibrinolysis	27
1.6 Antifibrinolytics and Tranexamic Acid	30
1.6.1 Aprotinin	31
1.6.2 Tranexamic Acid	31
1.6.3 Epsilon Aminocaproic Acid (EACA)	32
1.7 Blood Conservation in Elective Orthopaedic Surgery	32
1.7.1 Pre-Operative Assessment and Optimisation	33
1.7.2 Intra-Operative Blood Conservation and Cell Salvage	35
1.7.3 Post-Operative Conservation Techniques	38
1.8 Summary of Background to the Study	39
2. The literature review, systematic review and meta-analysis	40
2.1 Overview	41
2.2 Objectives	43
2.3 Methods	44
2.3.1 Criteria for considering studies for this review	44
2.3.1.1 Types of studies	44
2.3.1.2 Types of participants	44
2.3.1.3 Types of interventions	44
2.3.1.4 Types of outcome measures	44
2.3.2 Search methods for identification of studies	45
2.3.3 Data collection and analysis	45
2.3.3.1 Selection of the studies	45
2.3.3.2 Assessment of methodological quality of included studies	46
2.3.3.3 Data extraction and management	46

2.3.3.4 Measures of treatment effect	48
2.3.3.5 Subgroup analysis	49
2.4 Results	49
2.4.1 Description of studies	49
2.4.2 Effects of interventions	53
2.4.2.1 Blood transfusion	53
2.4.2.2 Amount of blood transfusion	54
2.4.2.3 Blood loss	55
2.4.2.3 Length of Stay	58
2.4.2.4 Complications	58
2.4.2.4.1 Deep Venous Thrombosis (DVT)	58
2.4.2.4.2 Pulmonary embolism (PE)	60
2.4.2.4.3 Mortality	60
2.4.2.4.4 Other outcomes	61
2.5 Discussion	61
2.5.1 Limited evidence for the use of topical TXA	67
3. Research methodology	70
3.1 Introduction	71
3.2 Trial Design	72
3.3 Recruitment	72
3.4 Inclusion and exclusion criteria	72
3.5 Allocation and blinding	73
3.6 Intervention	74
3.7 Outcome measures	75
3.7.1 Primary outcome : blood loss	75
3.7.2 Secondary outcomes	76
3.7.2.1 The drain blood loss (first 48 hours)	76
3.7.2.2 Haemoglobin and Haematocrit drops	76
3.7.2.3 Generic quality of life measure: The EuroQol Questionnaire	77
3.7.2.4 Disease specific scale: The Oxford knee score	78
3.7.2.5 Length of stay (LOS)	78
3.7.2.6 Economic analysis	78
3.7.2.7 Complications	78
3.7.2.7.1 Wound infection	78
3.7.2.7.2 Deep venous thrombosis (DVT)	79
3.7.2.7.3 Pulmonary embolism (PE)	79
3.7.2.7.4 Myocardial infarction (MI)	80
3.7.2.7.5 Cerebrovascular accident (CVA)	80
3.7.2.7.6 Death before discharge	80

3.8 Number of Subjects and Duration	81
3.8.1 Number of Subjects (sample size)	81
3.8.2 Time frame	81
3.9 Deep venous thrombosis prophylaxis protocol	81
3.10 Withdrawal from the trial	82
3.11 Data management and analysis	82
3.12 Safety Profile	83
3.12.1 Definitions	83
3.12.2 Adverse Events / Reactions Monitoring	85
3.12.3 Adverse Event / Reaction Reporting	85
3.12.4 Data monitoring committee and interim analysis	86
4. Results	88
4.1 Introduction	89
4.2 Ethical approvals	89
4.3 Recruitment and participants' flow chart	89
4.4 Characteristics of the study population	90
4.5 Operative data	91
4.5.1 Surgeons	91
4.5.2 Type of anaesthesia	92
4.5.3 Tourniquet times (TT)	93
4.5.4 Operative blood loss	93
4.6 Outcomes (postoperative) data	93
4.6.1 Blood transfusion	93
4.6.2 Drain blood loss	94
4.6.3 Postoperative Hb and Hct	95
4.6.4 Length of stay (LOS)	96
4.6.5 Sensitivity analyses of gender imbalance	97
4.6.6 Postoperative outcome scores	98
4.6.7 Range of motion (ROM)	99
4.6.8 Complications	99
4.6.9 Cost analysis	100
4.7 Interpretation of trial findings	103
4.7.1 Blood transfusion	103
4.7.2 Drain blood loss	105
4.7.3 Length of stay	110
4.8 Summary of findings	110
5. The effect of Tranexamic acid on artificial joint materials	112
5.1 Introduction	113
5.2 Declaration	114

5.3 Methodology	114
5.3.1 Tensile testing	116
5.3.2 Wear rate	118
5.3.2.1 Plates wear rate testing	120
5.3.2.2 The lubricant	120
5.3.2.3 Pins wear rate testing	121
5.3.2.4 Wear rate assessment	122
5.3.3 Surface topography	123
5.4 Results	124
5.4.1 Tensile testing	124
5.4.2 Wear test	125
5.4.3 Surface topography	129
5.4 Discussion	130
6.Discussion	132
6.1 Overview	133
6.2 The results of TRANX-K trial	133
6.2.1 Can topically applied TXA reduce blood transfusion?	133
6.2.2 Can topically applied TXA reduce blood loss?	134
6.2.3 Can topically applied TXA reduce Length of stay?	135
6.2.4 Economic analysis	136
6.2.5 The affect of TXA on the Oxford Knee Score and EuroQol	138
6.2.6 Complications following TKR	139
6.3 The effect of TXA on artificial implants (BioTRANX study)	139
6.4 Trial quality measures	140
6.4.1 Strength of the study	140
6.4.1.1 Overview	140
6.4.1.2 Study bias and group comparability	141
6.3.1.3 Protocol adherence	142
6.3.2 Weaknesses of the study	143
6.3.3 Long term safety	143
6.4 Future study	143
6.5 Barriers to adoption	144
6.6 Conclusions	145
7.Bibliography	146
8.Appendices	154
2.1 Metanalysis data extraction sheet	155
2.2 Detailed summary of the included trials	156
3.1 Research protocol	165
3.2 Patient's information sheet	179

3.3 Consent form	183
3.4 General practitioner notification letter	184
3.5 Data collection sheets	185
3.6 Trial checklist	186
3.7 Pharmacy and theatre protocol	187
3.8 Blood transfusion policy	188
3.9 EuroQol Questionnaire	189
3.10 Oxford knee score	191
3.11 Power calculation	193
3.12 Interim analysis	194
4.1 Research and development approval	198
4.2 National Research Ethic Committee approval	199
4.3 Local Research Ethic Committee approval	200
4.4 Medicine and health products regulatory authority (MHRA) approval letter	201
4.5 Characteristics of the study population	202
4.5 Analysis of patients who did not receive blood transfusion	217

Tables

Tables	Title	Page
Table 1.1	Incidence of adverse events associated with allogeneic blood transfusions	24
Table 1.2	Common faults of haemostasis that lead to bleeding tendency	30
Table 1.3	Preoperative, intra operative and postoperative blood conservation techniques.	33
Table 2.1	Quality assessment items and possible scores	47
Table 2.2	Characteristics of excluded studies	50
Table 2.3	Characteristics of the included studies	52
Table 2.4	Studies reported the amount of blood transfusion	55
Table 2.5	Subgroup analysis of transfusion rate by dose of TXA	62
Table 4.1	Baseline characteristics of the study population	91
Table 4.2	Number of procedures performed by surgeons	92
Table 4.3	Type of anaesthesia used during surgery	92
Table 4.4	Tourniquet times between the two arms of the study	93
Table 4.5	Drain blood loss between the two arms of the trial (t-tests)	95
Table 4.6	Bootstrap for t-test of drain blood loss between the two arms of the trial	95
Table 4.7	Postoperative Hb and Hct between the two groups	96
Table 4.8	Bootstrap for the length of stay in the two groups	97
Table 4.9	The effect of gender on trial findings in the placebo group	97
Table 4.10	The effect of gender on trial findings in the TXA group	98
Table 4.11	Preoperative and postoperative outcomes scores; parametric: t-test	99
Table 4.12	Complications in both arms of the trial	100
Table 4.13	Distribution of Tariff codes between the two groups of the study	101
Table 4.14	Net cost saving; parametric t-test	102
Table 4.15	Net cost saving; non parametric test: Bootstrap	102
Table 4.16	Trials providing data on drain blood loss and blood transfusion rate	107
Table 5.1	Tensile test results of the UHMWPE specimens	124
Table 5.2	cumulative volume loss in mm ³ in plates and pins	127
Table 5.3	Wear factors of plates and pins	128
Table 5.4	Wear factors of plates and pins; Parametric t-test	129
Table 5.5	Surface topography	129
Table 5.6	Post wears surface topography findings	130
Table 6.1	Trials providing data on drain blood loss and blood transfusion rates	130

Figures

Figures	Titles	Page
Figure 1.1	The trend in joints arthroplasty in England and Wales	21
Figure 1.2	The surgical incision and approach of TKR	22
Figure 1.3	The femur articular surfaces cuts	22
Figure 1.4	The tibial articular surface cut and preparation	23
Figure 1.5	The patellar articular surface cut using a patellar jig	23
Figure 1.6	The Cementing of the three components of TKR	24
Figure 1.7	The Coagulation pathways	28
Figure 1.8	The Fibrinolysis system	29
Figure 1.9	The structural formula of Tranexamic acid	31
Figure 2.1	Flow chart of studies selection	50
Figure 2.2	Trials of TXA vs. Placebo; Forest plot of blood transfusion rate	53
Figure 2.3	Trials of TXA vs. Placebo; Funnel plot of TXA effect on blood transfusion	54
Figure 2.4	Trials of TXA vs. Placebo; Forest plot of drain blood loss	56
Figure 2.5	Trials of TXA vs. Placebo; Forest plot of total blood loss	57
Figure 2.6	Trials of TXA vs. Placebo; Funnel plot blood loss	57
Figure 2.7	Trials of TXA vs. Placebo; Forest plot of length of stay	58
Figure 2.8	Trials of TXA vs. Placebo; Forest plot of DVT rate	59
Figure 2.9	Trials of TXA vs. Placebo; Funnel plot of DVT rate	59
Figure 2.10	Trials of TXA vs. Placebo; Forest plot of PE rate	60
Figure 2.11	Trials of TXA vs. Placebo; Forest plot of mortality rate	61
Figure 2.12	Trials of TXA vs. Placebo; Forest plot of other complications	61
Figure 2.13	Subgroup analysis of transfusion rate by dose of TXA; Forest plot	63
Figure 2.14	Scatter plot of TXA doses vs. risk ratio of blood transfusion reduction	64
Figure 2.15	Scatter plot of TXA doses vs. reduction in mean drain blood loss	65
Figure 2.16	Scatter plot of TXA doses vs. percentage reduction in mean drain blood loss	66
Figure 4.1	Flow chart of patients recruitment and allocation	90
Figure 4.2	Trials of TXA vs. Placebo; forest plot of transfusion rate; including Tranx-K trial	104
Figure 4.3	Scatter plot of TXA Dose versus the reduction in blood transfusion rates	104
Figure 4.4	Graph of TXA Dose versus percentage reduction in drain blood loss	106
Figure 4.5	Graph of the differences in mean drain blood loss and risk ratio of transfusion	107
Figure 4.6	Mean drain blood loss among published trials including Tranx-K study	108
Figure 4.7	Trials of TXA vs. Placebo; forest plot of LOS after TKR including Tranx-k study	110
Figure 5.1	Peak-Valley ratio (PV)	115
Figure 5.2	Surface roughness average (Ra)	115

Figure 5.3	Tensile specimens made of UHMWPE	116
Figure 5.4	Tensile testing machine with a specimen made of UHMWPE mounted	117
Figure 5.5	A typical stress-strain curve	118
Figure 5.6	Schematic diagram of the pin-on-plate machine	119
Figure 5.7	The pin-on-plate machine sledge with four Co-Cr plates mounted	120
Figure 5.8	An UHMWPE pin mounted on a motor	121
Figure 5.9	Profilemeter view of surface topography of a Co-Cr plate	123
Figure 5.10	Stress strain curves of tensile specimens	125
Figure 5.11	Volume loss of the pins and plates plotted against sliding distance	128

Chapter 1

Background to the thesis

1.1 Introduction

Work reported in this thesis addresses the topical (intra-articular) use of Tranexamic acid (an antifibrinolytic agent) as means to reduce blood loss and subsequent blood transfusion associated with artificial total knee joint replacement (TKR). To set the context for the research, it is useful to summarise current techniques in TKR. This introduction is structured to cover the following topics:

- A brief history of total joint replacement.
- The surgical technique of total knee replacement.
- Blood loss in joint replacement and its consequences.
- Haemostasis (The natural process of our body to stop bleeding):
 - Vasospasm
 - Platelet plug formation
 - Coagulation and the fibrinolysis system
 - Antifibrinolytics
- Overview of current techniques of blood conservation in elective orthopaedic surgery:
 - Pre-operative assessment and optimisation.
 - Intra-operative blood conservation and cell salvage.
 - Post-operative conservation techniques, including indications for transfusion, and postoperative cell salvage.

1.2 A Brief History of Total Joint Replacement

Arthritic joint failure is a common and crippling disease causing severe pain and significant disability. Although medical treatment such as pain killers and local injections can be successful in the early stages, they are less effective in the advanced stages of the disease. Worldwide, scientists and surgeons have worked together to find a lasting, safe and effective way to treat this condition. Artificial joints have been introduced and become one of the most effective ways to treat advanced arthritis.

Historically, because of its greater disability, arthritis of the hip has been of more interest to orthopaedic surgeons than arthritis of the knee. The hip has a more

complex range of movement and function than the knee joint. Sufferers usually have difficulty in walking, sitting, bending and even turning in bed. Hence, new surgical treatments and techniques to treat hip joint arthritis have preceded those for knee arthritis. Treatment and techniques for hip arthritis have been subsequently adapted to treat knee arthritis. Therefore we need to understand how hip replacement developed to properly summarise modern knee replacement.

Initial attempts to treat arthritic hips and knees surgically were varied and ranged from arthrodesis (fusion of the joint) to excision of the joint. Fusion of the joint can be a very successful operation to alleviate pain but it sacrifices movement. Alternatively, excision of the joint (excisional arthroplasty), although retaining some movement, can be a very disabling operation, particularly in a big, weight bearing joint such as the hip or the knee. Other surgical modalities such as osteotomy, joint debridement and nerve division have been practised with variable success. The goal of bony osteotomy is to realign the joint so that the weight load is distributed evenly across the joint surface. Joint debridement involves removing arthritic spurs, calcium deposits, and irregular cartilage in an attempt to smooth the surfaces of the joint. Although, nerve division can be helpful in improving symptoms, it accelerates the rate of joint wear and destruction. Furthermore, it is also not always possible, being dependent on the anatomy of that particular nerve and other structures it supplies.

There has been a long history of research for a material which could be utilized to resurface or even replace the hip and the knee joints. Materials considered included muscle, fat, chromatised pig bladder, gold, magnesium and zinc, all without success. The problem was to find a material which was biocompatible with the body, and yet strong enough to withstand the tremendous forces placed on the hip joint.

In 1925, an American surgeon, Dr Smith-Petersen, moulded a piece of glass into the shape of a hollow hemisphere. This fitted over the ball of the hip joint and provided a new smooth surface for movement. While proving biocompatible, the glass could not withstand the stress of walking and quickly failed [1].

A dramatic advance came in 1936 when scientists developed a cobalt-chromium alloy which was almost immediately applied to orthopaedics. This new alloy was both very strong and resistant to corrosion, and has continued to be employed in various prostheses since that time. During the 1940s, mould arthroplasty was the gold standard for severe joint arthritis.

In 1938, Dr. Jean Judet and his brother, Dr. Robert Judet, of Paris, attempted to use an acrylic material to replace arthritic hip surfaces. This acrylic provided a smooth surface, but unfortunately tended to come loose.

In England, Sir John Charnley worked on the ongoing problem of hip repair, looking for a way to replace both the femoral head and acetabulum of the hip with different materials [1]. He tried using stainless steel to replace the femoral head and he replaced the eroded arthritic socket with a Teflon implant. He hoped this would allow for a smooth joint surface to articulate with the metal ball component. This approach failed as the Teflon debris created a harmful body reaction. Undaunted, he went on to try polyethylene which worked well because it has a better biomechanical and wear properties than Teflon and wear debris caused much less harmful reactions. In order to fix the polyethylene socket as well as the femoral implant to the bone, Charnley used polymethylmethacrylate as used by dentists. This substance, known as bone cement, was mixed during the operation then used as a strong grouting agent to firmly secure the artificial joint to the bone. Charnley closely followed-up each patient and after their death, he retrieved the hip to see how it had performed. He questioned his ideas and designs and continually worked on improving them. He was knighted in 1977.

With regard to knee replacement, Themistocles Gluck became the first surgeon to implant an artificial knee in 1890. He devised a hinge linked to ivory stems that could be attached to bone. All Gluck's joint replacements became infected due to the lack of antisepsis and antibiotics. This was a major factor in slowing down the development of modern artificial total knee replacement [1]. In the modern era, another attempt came at the end of 1950 when Guepar used a

prosthesis which was really a hinge fixed to the bones with stems into the medullary canals of the adjacent bones. These hinges provided good short term pain relief but function was not always great due to the limitations of motion. After a few short years, this prosthesis showed severe problems with loosening and infection and was abandoned.

Some surgeons tried to treat arthritis of the knee with a metal spacer which was placed between the bones of the knee to eliminate the rubbing of irregular surfaces against each other. These implants, the McKeever (1957) and MacIntosh (1958), achieved some success but were not predictable, and many patients continued to experience significant symptoms.

The introduction of polyethylene as an artificial bearing surface in 1963 and the approval of methylmethacrylate for general use in the United States in 1971 set the stage for the development of alternatives to hinged knee replacement for the treatment of severe knee arthritis. During the late 1960s, a Canadian orthopaedic surgeon, Frank Gunston, from Sir John Charnley's Hip Centre, developed a metal on plastic knee replacement secured to the bone with cement marking the beginning of era of total knee arthroplasty. In 1972, Dr John Insall, designed what has become the prototype for current total knee replacements. It was called the TC knee (Total Condylar knee). This was a prosthesis made of three components which would resurface all three surfaces of the knee - the femur, tibia and patella (kneecap). They were each fixed with bone cement and the results were a significant advance [2].

Current research in TKR is aimed at refining the design to improve patient function. The aim is to achieve greater knee range of motion and permanence.

Today, TKR has become one of the commonest operations in orthopaedic practice. The sixth annual report of the National Joint Registry [3] showed that there were around 65 979 primary TKRs performed in England and Wales during 2008. Fifty seven percent were in female and 43% were in male patients. In 97% of patients, advanced osteoarthritis was the condition underlying the indication for surgery. Interestingly, there has been steady increase of the number

of TKRs performed in England and Wales surpassing total hip replacement (THR) as shown in figure 1.1.

Figure 1.1 The trend in joint arthroplasty in England and Wales

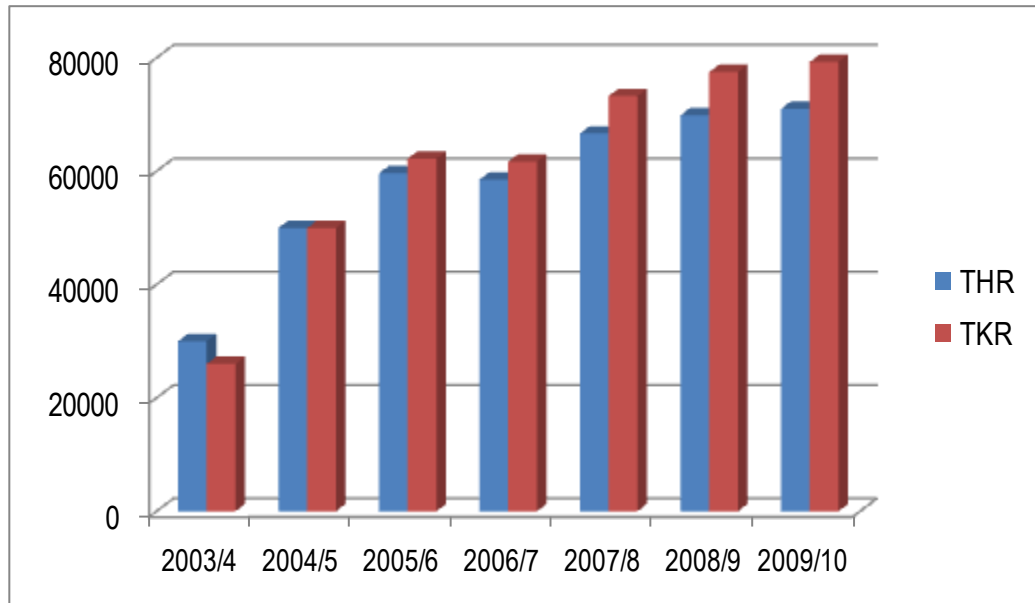

Source: the 6th and 7th annual reports of the national joint registry [3, 4].

1.3 Surgical Technique of Total Knee Replacement

There follows a brief description of the surgical technique of modern TKR, specifically, the P.F.C Sigma total knee replacement as recommended by the manufacturer DePuy International Ltd [5]. This is by far the commonest type used in our centre and in the UK [3].

The operation is performed under spinal (SA) or general anaesthetic (GA). The patient is positioned supine on the operating table. A tourniquet is applied around the thigh and after preparation and draping it is inflated to 350 mm Hg to ensure a bloodless surgical field.

The standard approach is used by making a longitudinal midline incision centred over the patella and extending from the middle of the thigh to the tibial tubercle. The joint is entered through a medial parapatellar capsular approach as in figure 1.2.

Figure 1.2 The surgical incision and approach of TKR

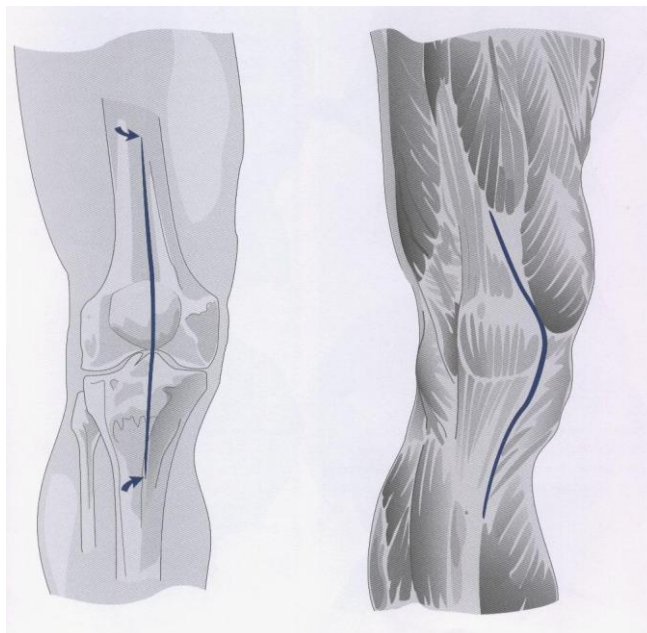

Reproduced by permission of DePuy International Ltd.

Menisci, anterior cruciate ligament and fat are excised to expose the end of bones. Femoral, tibial and patellar articular surfaces are then excised using specifically designed jigs to accommodate the artificial prosthetic components. The femoral end is shaped with three different cuts as shown by figure 1.3.

Figure 1.3 The femoral articular surface cuts

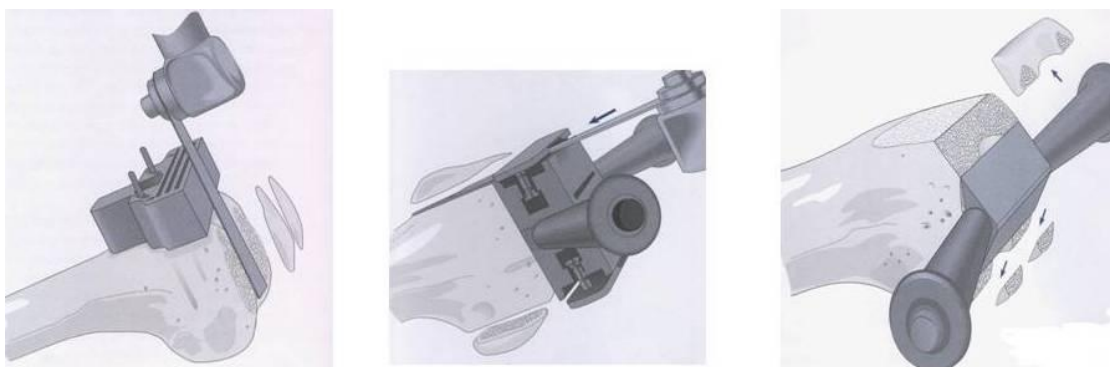

Reproduced by permission of DePuy International Ltd.

The tibial articular surface is cut almost perpendicular to the main axis of the tibia (figure 1.4). The patellar articular surface is excised using a special jig (figure 1.5). Some surgeons do not replace the patella.

Figure 1.4 the tibial articular surface cut and preparation

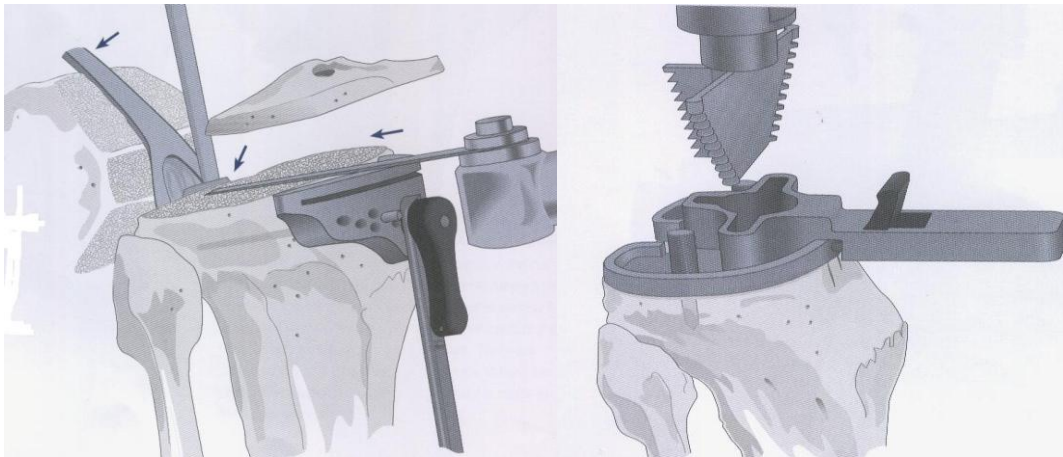

Reproduced by kind permission of DePuy International Ltd.

Figure 1.5 the patellar articular surface cut using a patellar jig

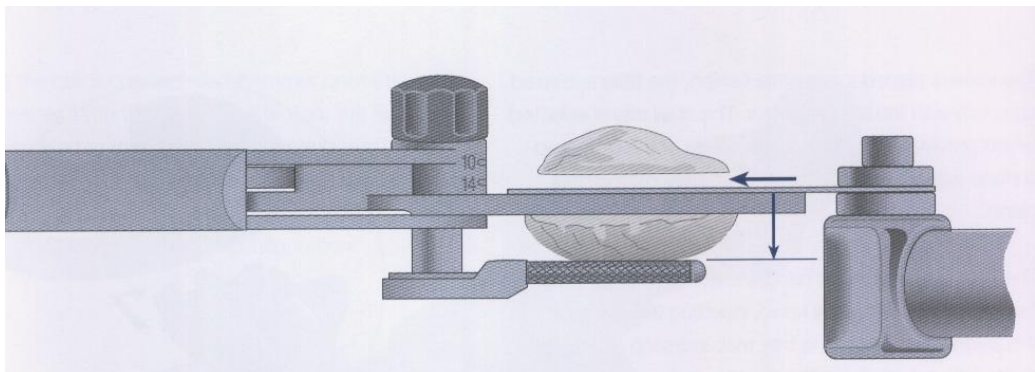

Reproduced by permission of DePuy International Ltd.

Trial implants are used to confirm sizes and check stability and range of movement. Then the permanent components are fixed to the bone using bone cement (Methylmethacrylate). The joint is then washed out thoroughly. Two drains are inserted on each side of the new joint. The wound is closed in layers using absorbable sutures. The skin is usually closed using skin clips. The wound is dressed with a dry dressing and a doubled layer of soft band and crepe band-

dage, commonly known as a pressure bandage. Then the tourniquet is deflated. Typically, the operation lasts about 60 minutes.

**Figure 1.6 Cementing the three components of TKR
(tibial, femoral and patellar components)**

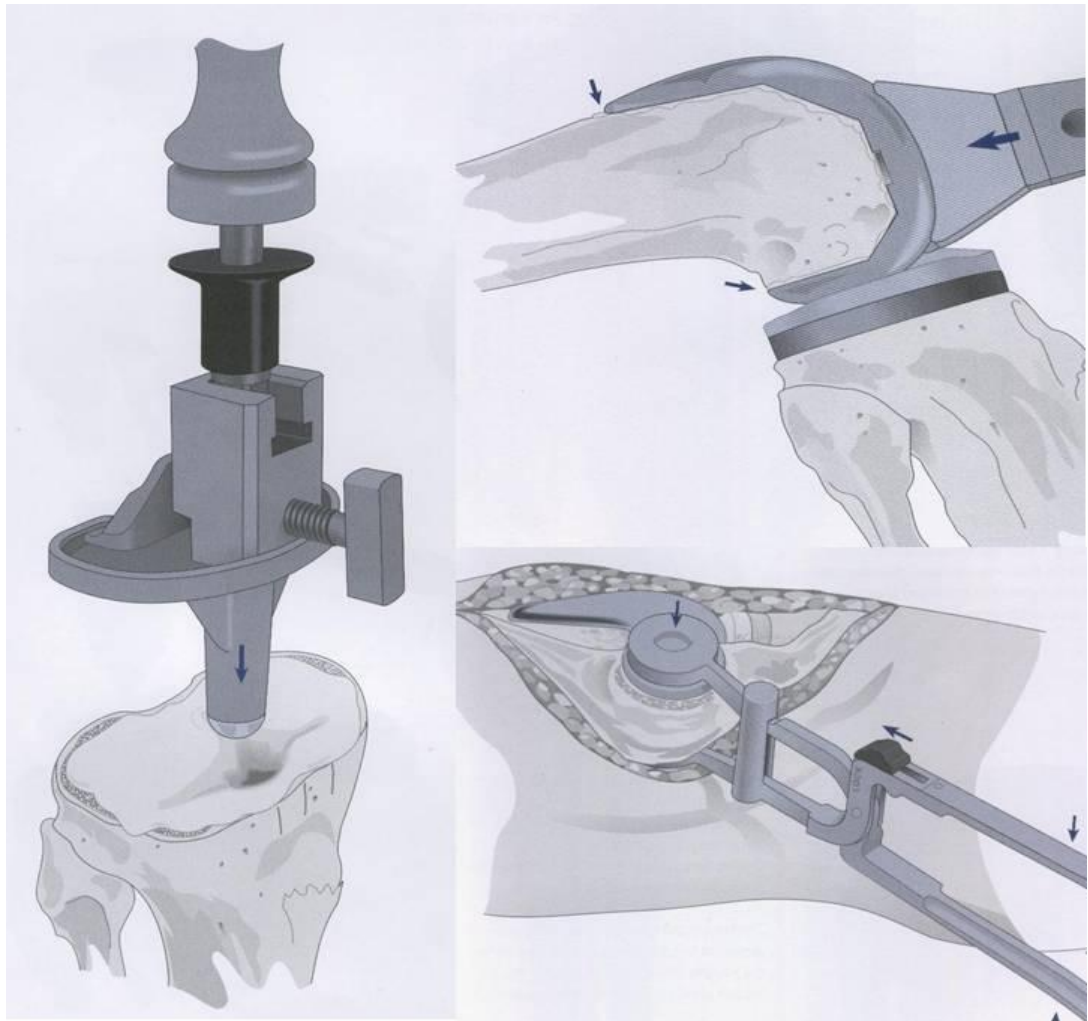

Reproduced by kind permission of DePuy International Ltd.

Vacuum type drains are used. In our centre, they are released after applying a doubled layer pressure bandage. They are usually removed after 48 hours unless there is excessive bleeding in which case they are left longer. In other centres, the practice may vary. Some do not use drains at all; others leave the drains clamped for a variable length of time from 15 to 60 minutes.

1.4 Blood Loss in Joint Replacement

Blood loss is common after joint replacement. A patient who is undergoing TKR can lose up to 2300 ml of blood, which is almost one third of the total circulating blood volume [6]. This carries significant general and local risk. An aging population has meant an increase in the number of major orthopaedic surgical interventions in the elderly. Older patients have a low tolerance to blood loss and its consequences because of their low physiological reserve and associated comorbidities such as ischaemic heart disease and lung disease. Blood transfusion is routine for significant blood loss and it is estimated that 20-70% of patients undergoing TKR need 1-3 units (around 300 to 1000 ml) of blood [7-9].

Although safer than ever, allogeneic blood transfusion is still associated with risks for the recipient: fluid overload, autoimmune haemolysis, infection, immunosuppression and transfusion-related acute lung injury (TRALI, see Table 1.1) [10]. Moreover, the cost of allogeneic blood products is expected to rise because of the high cost of screening; safety management and the increasing imbalance between blood donation and use [11]. To control both inherent risks and increasing costs, allogeneic transfusion should be minimized during surgical procedures.

Total knee replacement is performed with an occlusive tourniquet. As a result, TKR is associated with minimal intra-operative blood loss; however, patients lose a lot of blood in the postoperative period. Consequently, TKR is ideally suited to pharmacological manipulation of the coagulation and fibrinolysis systems.

**Table 1.1 Incidence of adverse events associated
with allogeneic blood transfusions**

Adverse event	Incidence per transfused units
Infectious	
Viral infection	
Hepatitis A	1:2 000 000
Hepatitis B	1:31 000 to 1:81 000
Hepatitis C	1:1 935 000 to 1:3 100 000
HIV	1:2 135 000 to 1:4 700 000
HTLV I/II	1:1 900 000
Bacterial contamination	1:14 000 to 1:28 000
Parasitic infection	1:4 000 000
Prion disease	Rare
Non infectious	
Febrile non haemolytic reaction	1:500
Urticarial reaction	1:50 to 1:100
Anaphylactic reaction	1:23 000
Haemolytic transfusion reaction	1:9 000
Transfusion-related acute lung injury (TRALI)	1:1 300 to 1:5 000
Transfusion-associated circulatory overload	1:17 000
Post-transfusion purpura	1:143 000

1.5 Haemostasis, Coagulation and Fibrinolysis System

The prevention of bleeding depends upon maintaining the integrity of the blood vessel walls; ensuring that any breaches are rapidly sealed by deposition of platelets and fibrin. This process is divided into 3 stages[12]:

1.5.1 Vasospasm

Damage to the blood vessel wall results in immediate vasoconstriction of the injured and adjacent vessels resulting in a transient reduction of the blood flow to the affected area. This has a dual effect. It reduces blood loss and allows more time for blood components to seal the breach.

Diseases may weaken the blood vessel wall and may cause rash, skin bruises or frank bleeding. Hereditary haemorrhagic telangiectasia, Ehler Danlos syndrome and Marfan syndrome are known to cause bleeding by weakening of the blood vessel wall.

1.5.2 Platelet plugs formation

The body contains about 300,000 platelets/dl of the circulating blood. Platelets are complex highly specialised cells within the blood with a lifespan of about 10 days. They are capable of responding quickly to a variety of stimuli. Damage to the blood vessels can activate platelets inducing morphological (change from discoid into spherical) and physiological changes. They become adherent to the vessel wall and to each other forming a plug to seal the breach. These platelets also release chemical factors which cause further vasospasm (namely serotonin and Thromboxane A_2) and activate the coagulation system.

However, the optimum number of the platelets is vital to their function. Increase or decrease of the platelets in the blood can cause bleeding. There are several pathological conditions that can affect the number or functions of the platelets. Idiopathic Thrombocytopenic Purpura (ITP) and thrombocytosis are two medical conditions in which platelets numbers are low or high respectively. Both conditions are associated with bleeding tendency. Von Willebrand Disease is another medical condition in which the count of platelets is normal but the function is abnormal making the sufferers prone to bleeding.

The plug-forming stage can be modified pharmacologically to achieve desired effects. For example, aspirin is widely used to reduce the incidence of heart attack and stroke by impairing platelet function and reducing thrombosis. Clopidogrel and dipyridamole are another two drugs that affect platelet function through different mechanisms and can cause bleeding.

1.5.3 Coagulation and fibrinolysis

Coagulation involves a series of complex enzymatic reactions among different coagulation factors leading to the conversion of soluble plasma fibrinogen to an insoluble fibrin clot which further stabilises the platelet plug.

The conversion of fibrinogen to fibrin is catalysed by thrombin. This is a serine protease formed from its circulating precursor, pro-thrombin by action of the activated factor X. Factor X activation occurs through either the intrinsic or extrinsic system. Factor X activation through the intrinsic system occurs when the

blood is exposed to the collagen fibres underlying the endothelium in the blood vessels. Factor X is activated through the extrinsic system by the release of thromboplastin (a protein-phospholipids mixture) from damaged tissues[13]. The following diagram summarises these two coagulation systems [14, 15].

Figure 1.7 Coagulation pathways

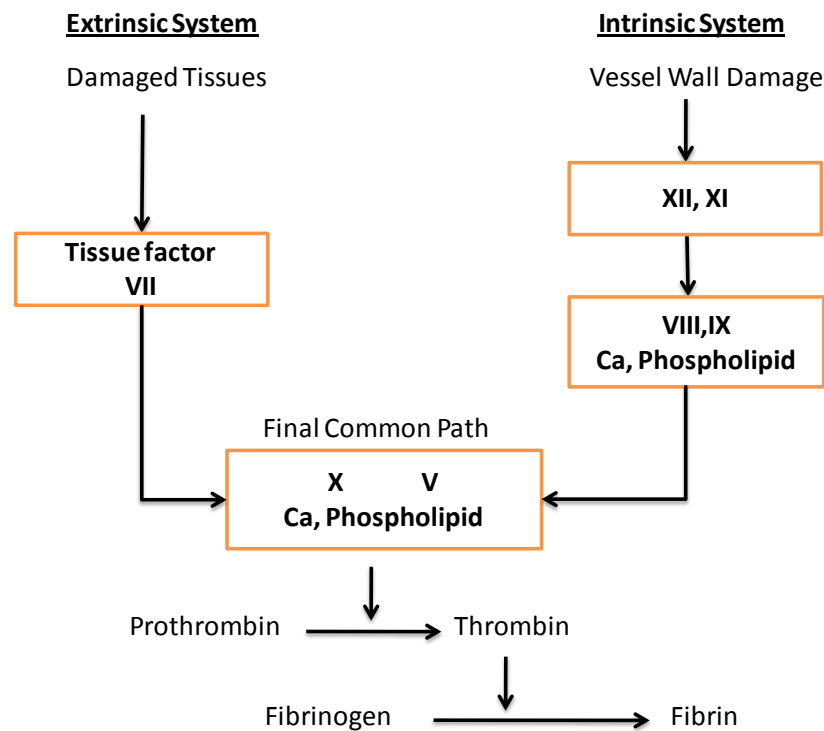

The preservation of an intact vascular system requires not only that blood be capable of coagulating but also that the products of coagulation can be processed when they have served their purpose of stopping a vascular leak. This is the function of the fibrinolysis system. In this system, a plasma protein called Plasminogen is activated and converted to Plasmin. The latter is a serine protease which breaks down the fibrinogen and fibrin into several fragments known as fibrinogen (fibrin) degradation products (FDP). Plasmin is also capable of breaking down other coagulation factors such as factor V and VIII [15]

The fibrinolysis system is activated by the presence of fibrin in the blood. Like the coagulation system this can occur through either an extrinsic or intrinsic system. There are several Plasminogen activators. The most potent one is tissue Plasminogen activator (t-PA) which is derived from the vascular endothelium

(extrinsic activation). Intrinsic Plasminogen activators such as factor XII and Kallikrein are of minor physiological importance.

Inactivators of Plasmin (such as $\alpha 2$ antiplasmin) are also present in the plasma and contribute to the regulation of the fibrinolysis figure 1.8.

Figure 1.8 Fibrinolysis system

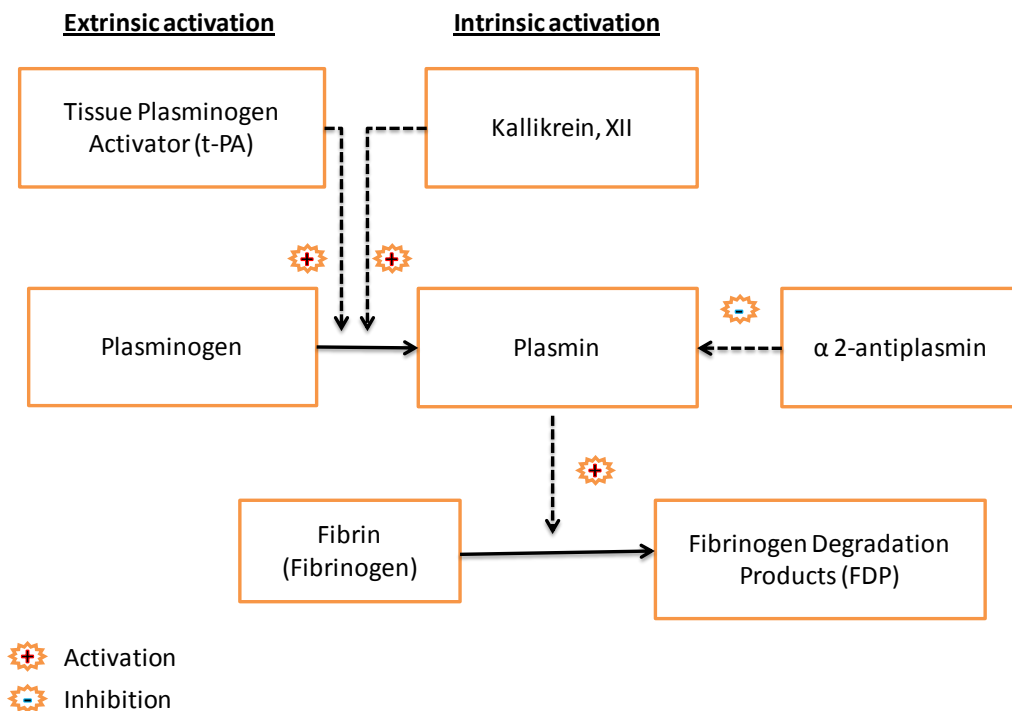

Coagulation and fibrinolysis systems can also malfunction. Congenital deficiencies of different factors are well known and some of them are common. Haemophilia is a disorder caused by deficiency of factor VIII while Christmas disease is caused by deficiency of factor IX. Nutritional deficiency of Vitamin K can lead to serious bleeding because it is important for the synthesis of factors (X, IX, VII and II). Table 1.2 summarises the common diseases that affect the blood haemostasis.

With advancing medicine, these interacting coagulation and fibrinolysis systems can be manipulated to produce a favourable state of bleeding depending on the clinical need. For example, patients with deep venous thrombosis or pulmonary embolism can be treated with Warfarin. This interferes with the metabolism of

vitamin K in the liver, inhibiting the synthesis of the factor (X, IX, VII and II), hence there is less clotting. Patients with heart attack, if they present early, can be treated with Alteplase. Alteplase is a potent tissue Plasminogen activator produced by recombinant technology. It binds strongly to Fibrin and is capable of dissolving the clots that caused the attack.

Conversely, antifibrinolytic agents such as Tranexamic acid (TXA), Aprotinin and Epsilon Aminocaproic acid (EACA) inhibit the fibrinolysis system, preventing premature clot dissolution and excessive bleeding.

Table 1.2 Common faults of haemostasis that lead to bleeding tendency

Blood vessels (Vasospasm)	Platelets	Coagulation factors
1. Vasculitis	1. Thrombocytopenia (Reduced in number).	1. Factor I deficiency (Afibrinogenemia)
2. Senile purpura	i. Idiopathic	2. Factor II deficiency (Hypoprothrombinaemia)
3. Henocho Schonlin Purpura	ii. Drug induced	3. Factor V deficiency (Parahaemophilia)
4. Hereditary Haemorrhagic Telangiectasia	iii. Bone marrow failure	4. Factor VII (Hypoconvertinemia)
5. Ehler Danlos Syndrome	2. Thrombocytosis (Increased in number)	5. Factor VIII deficiency (Haemophilia)
6. Aneurysms	i. Reactive	6. Factor IX deficiency (Christmas Disease)
	ii. Essential thrombocytosis	7. Factor X deficiency (Stuart-Prower Disease)
	iii. Myelofibrosis	8. Factor XII deficiency (Hageman trait)
	iv. Leukaemia	
	3. Thrombosthenia (Abnormal function).	
	i. Bernard-Soulier Syndrome	
	ii. Dense granule deficiency	
	iii. Drug induced.	

1.6 Antifibrinolytics and Tranexamic Acid

Antifibrinolytic agents interfere and inhibit the fibrinolysis system preventing premature clot lyses and preventing excessive bleeding. They have been ex-

tensively used in clinical practice. They have been successfully used to stop bleeding after dental treatment, removal of tonsils, prostate surgery, heavy menstrual bleeding, eye injuries and in patients with Haemophilia [16-21]. There are three commonly used agents; these are Aprotinin, Tranexamic acid (TXA) and Epsilon Amino Caproic Acid (EACA).

1.6.1 Aprotinin

Aprotinin is a naturally occurring inhibitor of Plasmin (obtained from bovine lung) which has been used for the treatment of life threatening haemorrhage.

Aprotinin is a non-specific, serine protease inhibitor, with antifibrinolytic properties. It inhibits several serine proteases, including trypsin, Plasmin, plasma Kallikrein and tissue Kallikrein. During open heart surgery the negatively charged surface of the cardiopulmonary bypass circuit activates factor XII, converting prekallikrein to Kallikrein which further activates factor XII. This positive feedback loop acts to intensify the intrinsic coagulation cascade. By inhibiting plasma Kallikrein, Aprotinin minimises derangements in coagulation and fibrinolysis [22]. There is also evidence that Aprotinin exerts an indirect preservative effect on platelet function during extracorporeal circulation [23]. In many countries Aprotinin is specifically indicated for the reduction of blood loss during cardiopulmonary bypass.

1.6.2 Tranexamic acid

Tranexamic acid was first used in Sweden in 1969. Its chemical name is trans-4- (aminomethyl) cyclohexanecarboxylic acid. The empirical formula is $C_8H_{15}NO_2$. The structural formula is shown in figure 1.9. Molecular weight is 157.2.

Figure 1.9 The structural formula of Tranexamic acid

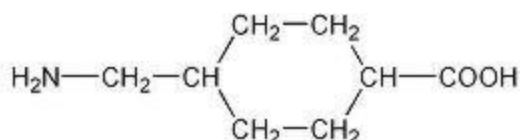

It is a synthetic lysine analogue that acts as an effective inhibitor of fibrinolysis. TXA acts principally by blocking the lysine binding sites on Plasminogen molecules, inhibiting the formation of Plasmin and therefore inhibiting fibrinolysis. Tranexamic acid is about ten times more potent than EACA and binds much more strongly to both the strong and weak sites of the Plasminogen molecule than EACA [24]. Tranexamic acid undergoes negligible metabolism in the body and is eliminated unchanged in the urine.

1.6.3 Epsilon Aminocaproic Acid (EACA)

It is chemically related to TXA. EACA is a derivative and analogue of the amino acid lysine. It has the same mechanism of action of TXA by blocking the lysine binding sites on Plasminogen molecules inhibiting the formation of Plasmin and therefore inhibiting fibrinolysis. In TXA, the 4-carbon chain of EACA is substituted by a cyclohexane molecule enhancing potency by 7-10 times. It has a similar safety profile to the TXA. For these reasons, EACA is now seldom used and is no longer registered for clinical use in many countries [25].

1.7 Blood Conservation in Elective Orthopaedic Surgery

Responding to the issue of blood loss and its consequences for patients, the British Orthopaedic Association (BOA) introduced the concept of blood conservation surgery and produced guidelines in elective orthopaedic surgery [26]. It is accepted that blood conservation in orthopaedic surgery goes hand-in-hand with good orthopaedic surgical practice. Surgical procedures should be done with the minimum of blood loss and, if possible, lost blood should be returned to the patient.

The guidance covers three stages in the patient journey where a variety of techniques can be utilised to reduce blood loss and / or the need for allogeneic blood transfusion:

- Pre-operative assessment and optimisation.
- Intra-operative blood conservation and cell salvage.
- Post-operative conservation techniques, including indications for transfusion, and postoperative cell salvage.

A successful blood conservation programme addresses all three areas. Table 1.3 summarises these techniques and the following sections review the rationale and the evidence for each technique.

Table 1.3 Preoperative, intra operative and postoperative blood conservation techniques

Preoperative

Iron therapy
 Erythropoietin (EPO)
 Preoperative autologous blood donation (PAD)
 Acute normovolemic haemodilution (ANH)
 Acute hypervolemic haemodilution (AHH)

Intra-operative

Surgical technique
 Anaesthetic technique
 Intra-operative cell salvage
 Pharmacological agents
 Artificial blood substitute

Postoperative

Iron therapy
 Transfusion trigger
 Postoperative cell salvage

1.7.1 Pre-Operative Assessment and Optimisation

Artificial joint replacement is regarded as a grade 4 (major +) surgery by the National Institute of Clinical Excellence (NICE) [27] reflecting the potential risk this surgery poses to patients. Patients undergoing this type of surgery require thorough assessment and investigation to establish their fitness for surgery and optimise their physiological reserve to withstand its effects.

One important aspect of preoperative assessment is to identify patients who are likely to bleed excessively, such as patients with bleeding disorders (see table 1.2) and those who take warfarin, Clopidogrel and Aspirin. Anticoagulants medications intended to prevent blood clotting and may cause serious bleeding;

ideally they should be stopped for few days before surgery. Alternatives with a lower tendency to cause bleeding are available and can be used [28].

Patients with a low pre-operative haemoglobin level (less than 12 g/dl) have an increased risk of needing a blood transfusion [29]. Iron deficiency anaemia is probably the commonest cause of preoperative low haemoglobin in patients undergoing artificial joint replacement. Iron therapy is indicated to increase red blood cell and haemoglobin production. Some evidence suggests that ferrous sulphate, given for four weeks preoperatively to all patients undergoing elective orthopaedic surgery, leads to improved post-operative haemoglobin [30, 31].

An alternative and increasingly popular treatment for low preoperative haemoglobin is the use of Erythropoietin (EPO): a natural hormone produced by the kidney that promotes the formation of red blood cells in the bone marrow. Using recombinant DNA technology, EPO has been synthetically produced for use by patients with certain types of anaemia. It is particularly effective in the management of mild to moderate anaemia prior to surgery (Hb 10-13g/dl). EPO is safe, with relatively few side effects. However, it works only when iron stores are adequate [32].

Another technique is preoperative autologous blood donation (PAD). Using autologous (self donated) rather than allogeneic blood reduces the risk of transmitting infection and immunological reactions, but it introduces other risks such as mismatched transfusion (giving the patient the wrong blood) and bacterial contamination. During PAD, autologous blood is collected weekly in the 4-6 weeks preceding surgery. The number of PAD units needed is calculated depending on the type of surgery, the likelihood of requiring a transfusion, and the interval between the collection time and the date of surgical procedure. It is used for those procedures likely to have large blood loss. PAD is contraindicated in patients with ischaemic heart disease, heart failure and it is not accepted by Jehovah Witnesses.

Two other preoperative techniques are called acute normovolemic haemodilution (ANH) and acute hypervolemic haemodilution (AHH). During haemorrhage,

haemodiluted patients lose fewer red blood cells than normal. In ANH, blood is exchanged with a similar volume of a cell-free crystalloid (3: 1 exchange) or colloid solution (1: 1 exchange) directly prior to surgery. Depending on the target haematocrit (Hct), a variable amount of fresh autologous whole blood, including platelets and coagulation factors, is withdrawn from the patient. In clinical practice, ANH is targeted to an Hct of 20% in healthy patients and an Hct of 30% in patients suffering from mild cardiac co morbidity. ANH blood has to be stored in theatre and is therefore immediately available in case of intra-operative bleeding.

Similarly, AHH dilutes the circulating blood reducing the number of lost red cells of intra-operative blood loss. However, in contrast to ANH, this objective is achieved by the additional infusion of crystalloid and colloidal solutions, i.e. without the simultaneous withdrawal of whole blood. During AHH, the patient's intravascular volume is significantly increased. Hence the technique is recommended only for patients without cardiac co-morbidity.

PAD, AHH and ANH are equipotent in terms of their allogeneic blood-sparing effect when blood loss is around 1000 ml [33-35]. However, ANH and AHH are less expensive and allow for flexible surgery schedules.

1.7.2 Intra-Operative Blood Conservation and Cell Salvage

Bleeding is an inevitable part of surgery; however, the amount of blood loss is partially controllable. It is well known that the surgeon plays a major role in controlling surgical haemorrhage. Good surgical technique is important in keeping haemorrhage to the minimum during surgery.

In practice, the surgical site is positioned at or even above heart level (e.g. 20° Trendelenburg or bending the knee) to reduce hydrostatic blood vessel engorgement. The use of an appropriately sized and fitted tourniquet is a very effective way in achieving a bloodless surgical field. The tourniquet should be inflated to the appropriate pressure necessary to occlude the arterial blood flow to the limb. Good surgical technique also includes rapid and careful soft tissue

handling using the right tools as well as rigorous haemostasis at the time of exposure using electric diathermy to lower blood loss.

Tissue adhesives derived from human proteins (sealants) or animal proteins (glues) may have a useful place in blood management during spinal surgery, revision arthroplasty or bilateral knee replacement. They have also been shown to reduce blood loss in primary hip and knee arthroplasty, but further work is needed to establish their cost-effectiveness [36].

Minimally invasive surgical techniques have been promoted as another way to reduce overall blood loss, however, these remain controversial and may not be appropriate for all patients.

With advancing techniques, the anaesthetist's role has become increasingly important in reducing blood loss and transfusion. Blood loss varies with the type of anaesthesia. Blood loss may be less in patients having regional anaesthesia than general anaesthesia. Similarly patients with general anaesthesia with spontaneous ventilation may experience less blood loss than with general anaesthesia combined with positive pressure ventilation. If general anaesthesia is indispensable, total intravenous anaesthesia is preferable to balanced anaesthesia with inhalation anaesthetics to better control vasodilatation [37].

The use of hypotensive anaesthesia significantly and safely reduces blood loss safely, provided patients are selected and monitored appropriately [38, 39]. Deliberate hypotension is induced pharmacologically with the use of inhaled anaesthetics, nitro-glycerine, urapidil or epidural anaesthesia to decrease the systolic arterial pressure to 80 mmHg or the mean arterial pressure to 50 mmHg. Patients with restricted auto-regulation of organ perfusion (peripheral and coronary artery disease, hypertension, cerebrovascular insufficiency, hypovolemia, anaemia) are excluded from deliberate hypotension, as are patients suffering from renal and/or hepatic insufficiency.

Maintenance of normal temperature reduces blood loss. Some steps in the coagulation cascade as well as platelet function are temperature-dependent. Mild

hypothermia ($35.0 \pm 0.5^{\circ}\text{C}$) increases intra-operative blood loss and transfusion need. Suitable fluid warming and forced air warming devices are essential for major surgical cases. [40-42].

The type of intravenous fluid administered may influence coagulation. Balanced salt solutions (e.g. Hartmann's), gelatine based colloids and medium molecular weight starches (e.g. Voluven) cause fewer coagulation problems than Dextrans and other Starches.

Intra-operative red cell salvage is one of major advances in blood conservation surgery which greatly reduces the need for allogeneic blood transfusion and can be life-saving [43]. Intra-operative blood salvage involves aspirating the blood directly from surgical wound then removing any clots or debris. Subsequently the collected blood is washed re-transfused back to the patient. The technique produces autologous red blood cell units with Hct values ranging from 60% to 70% and is suitable for surgical interventions with an estimated blood loss of 800 to 1000 ml.

Potential bacterial contamination of the collected wound blood represents an absolute contraindication to auto-transfusion in patients undergoing joint replacement surgery. In tumour surgery, auto-transfusion is possible if the processed red blood cell concentrate is gamma-irradiated (50 Gray) [44]. Jehovah's Witnesses accept auto-transfusion as long as the patient, collection system, processing unit and final blood bag form a closed system.

Newly introduced cell salvage devices (e.g. 'Orthopat'), which allow both intra-operative and post-operative collection, may become cost effective in primary total hip and total knee arthroplasty.

Pharmacological agents have gained more popularity as a means of reducing blood transfusion and its inherent risks. There are three main groups of such pharmacological agents: antifibrinolytics (see 1.6), Desmopressin and Recombinant activated factor VII. Desmopressin is a synthetic vasopressin (a naturally present hormonal polypeptide) analogue. It is more active than the vasopressin

and has a wide range of activities. Desmopressin is known to release platelets from the bone marrow and increase plasma concentrations of factor VIII and von Willebrand cofactor (after 4–12 hours). Hence, it is used to treat mild haemophilia. There is evidence to support the use of Desmopressin in patients with pre-existing coagulation disorders. Potential indications for Desmopressin to reduce perioperative blood losses are urgent surgery in patients under pharmacologic platelet inhibition; urgent surgery in patients dependent on haemodialysis; and on-pump cardiac surgery [45]. It is not recommended for routine use to reduce blood loss in elective surgery.

Recombinant activated factor VII is a coagulation factor concentrate that is newly licensed to use in patients with haemophilia and other bleeding disorders. Factor VII forms complexes with tissue factors and activates factor X, particularly at the site of injured vessels and damaged tissue. A recent Cochrane review [46] assessed the effectiveness of recombinant activated factor VII in stopping bleeding in patients without haemophilia and concluded that its value was uncertain. In some cases of extreme blood loss after trauma or during surgery, recombinant activated factor VII has been successfully administered as the final therapeutic option and saved lives. High cost and the lack of evidence prohibit its routine use in high blood loss surgery [47, 48].

Artificial blood substitutes such as Perfluorocarbons and haemoglobin solutions are being assessed and may have a role to play in reducing the need for allogeneic blood transfusion but minimal data is available in the field of orthopaedic surgery and they are not yet licensed for general use.

1.7.3 Post-Operative Conservation Techniques

Post-operative techniques are not unique but rather draw on techniques from the earlier stages of surgery. Postoperative red cell salvage involves the continued collection of drain blood loss, washing and re-transfusion of autologous blood. The method has been shown to be safe and has been used repeatedly over the last 10 years with few reported problems [49].

Restrictive transfusion triggers have been proven to be of great value in standardising blood transfusion practice in the field of orthopaedics and have reduced unnecessary blood transfusion. The following restrictive transfusion triggers are recommended by the BOA, Blood Transfusion Task Force and British Committee on Haematology Standard [50-52]:

- Patients should not normally be transfused if the haemoglobin concentration is above 10g/dl.
- A strong indication for transfusion is a haemoglobin concentration below 7 g/dl.
- A haemoglobin concentration between 8 and 10 g/dl is a safe level, even for those patients with significant cardio-respiratory disease.
- Symptomatic patients should be transfused.

Intra-operative transfusion triggers should be decided on an individual patient basis; near patient testing (e.g. using the 'Haemocue' device) can be used to closely monitor haemoglobin level.

Post-operative iron therapy is widely used in orthopaedic practice; however, there is little evidence that the use of oral iron therapy in the immediate post-operative phase hastens the recovery of the patient's haemoglobin.

1.8 Summary of the background to the thesis

Artificial joint replacement surgery has evolved into a very successful intervention. This has been achieved by the global contribution of scientists and surgeons. Research is still continuing to improve the outcome and safety of this type of surgery.

Blood loss and subsequent transfusion are the important and modifiable safety aspects of knee surgery. This chapter has summarised the current variety of techniques and strategies available. In chapter 2, I examine the current application of TXA in orthopaedic practice.

Chapter 2

Literature review, systematic review and meta-analysis

2.1 Overview

Since the era of total knee replacement (TKR) began in the late 1960s, it has become one of the commonest operations in orthopaedic practice. In England and Wales, there were 65 979 TKRs performed in 2008 [3]. The number is probably higher as the national joint registry is not mandatory.

TKR is frequently associated with transfusion of allogenic blood [8, 53]. In my centre (The University Hospital of North Tees and Hartlepool), around 30% of patients who underwent TKR received allogenic blood transfusion perioperatively in 2006. Although, serological screening has reduced the risk for viral infection to a very low level [54, 55], patients are still concerned about this potentially serious complication. Allogenic blood transfusion can also be associated with other non-infectious complications such as haemolysis, immunosuppression, transfusion-related acute lung injury and even death [56]. Therefore, strategies to avoid exposure to allogeneic blood need further development. Amongst the technologies to minimise the need for blood transfusion is the use of the antifibrinolytic drugs such as Aprotinin, Tranexamic acid (TXA), and epsilon aminocaproic acid (EACA) [57, 58].

Antifibrinolytics stop bleeding by inhibiting the dissolution of blood clots through different mechanisms (see chapter 1). They have been successfully used to stop bleeding after dental extractions, removal of tonsils, prostate surgery, heavy menstrual bleeding, eyes injuries and in patients with haemophilia. Numerous studies, including RCTs have investigated the efficacy of intravenous use of antifibrinolytic agents in reducing blood losses and transfusion requirements in TKR. These studies have been variously criticised for poor design, low power, inconclusive results and inadequate follow up.

There are a few systematic reviews and meta-analysis on the antifibrinolytics effects on blood loss and blood transfusion. The reviews vary in quality and their inclusion and exclusion criteria. Although, they are useful in showing a positive effect of antifibrinolytic agents in reducing blood loss and blood transfusion in elective surgery in general; none are specific for TXA in TKR. This creates a confusing message about the value of TXA in TKR, particularly when

considering some complications which are more relevant for other surgeries such as cardiac surgery than TKR.

A Cochrane review led by Professor Henry from Australia [59] studied 211 trials that used one or more of the three antifibrinolytic drugs (Aprotinin, TXA and EACA). One hundred and forty seven trials were conducted in cardiac surgery, 42 trials were in orthopaedic surgery, 14 in liver surgeries, 4 in vascular surgery, 2 in thoracic surgery, 1 in neurosurgery and 1 in orthognathic surgery. One hundred and sixteen trials evaluated Aprotinin, 45 evaluated TXA and 11 evaluated EACA versus control. Thirty nine trials compared Aprotinin, TXA, and EACA.

The Cochrane review concluded that antifibrinolytic drugs are effective in reducing blood loss, the need for allogeneic red cell transfusion, and the need for re-operation due to continued post-operative bleeding in cardiac surgery (where most trials were performed) and stated that lysine analogues (TXA and EACA) are probably as effective as Aprotinin and are cheaper. The evidence was stronger for TXA than for EACA.

Paul Zufferey [58] reviewed 43 trials of antifibrinolytic in orthopaedic practice. Twenty five were in THR, 12 in TKR, 4 in spine surgery and 2 in cancer surgery. He included the studies that used intravenous preparations only. Twenty trials used TXA with a total of 1084 patients. Only studies with a transfusion protocol were included in the analysis which resulted in 4 studies of TXA being excluded. In agreement with Professor Henry, he found Aprotinin and TXA reduced the blood loss and blood transfusion rate but in contradiction to Professor Henry, he found that EACA did not lead to a significant reduction in blood transfusion or blood loss.

Ho and Ismail [60] studied the effect of TXA on reducing blood transfusion after total hip and knee joint replacements. Blood loss was collectively defined as 'perioperative blood losses despite including results of total blood loss as well as postoperative blood loss under this definition when studies were analysed.

Of special mention, the Bart study [61] findings cast a shadow on the safety profile of Aprotinin which was terminated prematurely due to high mortality in the Aprotinin group. This was a multicentre, blinded study to determine whether Aprotinin was superior to either TXA or EACA in decreasing postoperative bleeding and other clinically important outcomes such as death. It recruited 2331 participants undergoing cardiac surgery. They were randomly assigned to one of three groups: 781 received Aprotinin, 770 received TXA, and 780 received EACA.

The primary outcome was massive postoperative bleeding, which was defined as bleeding from chest tubes that exceeded 1.5 litres during any 8-hour period or massive transfusion, which was defined as the administration of more than 10 units of blood within 24 hours after surgery. Secondary outcomes included death from any cause at 30 days. The trial was terminated early because of a higher rate of death in patients receiving Aprotinin. At 30 days, the rate of death from any cause was 6.0% in the Aprotinin group, as compared with 3.9% in the TXA group (relative risk, 1.55; 95% CI, 0.99 to 2.42) and 4.0% in the EACA group (relative risk, 1.52; 95% CI, 0.98 to 2.36). The relative risk of death in the Aprotinin group, as compared with that in both groups receiving lysine analogues, was 1.53 (95% CI, 1.06 to 2.22).

These results have led to the underutilisation of these potentially valuable agents in orthopaedic practice. Hence the study described in this thesis aims to evaluate TXA further. It is cheaper and potentially as effective as Aprotinin as shown by the Cochrane review [62]. It is safer than Aprotinin as suggested by the Bart study [61]. In contrast to EACA, it is 10 times more potent [62] and its reputation for minimising blood loss has not been questioned in the literature [58].

2.2 Objectives

This review investigates the evidence for the efficacy of TXA in reducing perioperative blood loss and blood transfusion after TKR. Additional objectives include changes in clinical outcomes such as reduction in re-operation rates or increase in complication rates and patients outcome measures.

2.3 Methods

The review was conducted in accordance with guidelines described in the Cochrane handbook for systematic review and meta-analysis of interventions [63]. In order to meet the methodological requirements of a Cochrane review, the review team included a second reviewer (MS) who assisted with the review process. Two senior reviewers (AN & JM) provided methodological advice and resolved disagreement about study selection and abstraction (see acknowledgement).

2.3.1 Criteria for considering studies for this review

2.3.1.1 Types of studies

Randomised controlled trials (RCTs) and quasi-randomised (for example, allocation by hospital number or date of birth) trials have been considered within this review.

2.3.1.2 Types of participants

The participants were adults who underwent a primary TKR regardless of the type or the size of prosthesis used. Synchronous or sequential bilateral primary TKR and revision surgery for TKR were excluded.

2.3.1.3 Types of interventions

The intervention considered was the use of TXA. Control groups could be a placebo or another antifibrinolytic.

2.3.1.4 Types of outcome measures

The primary outcome measure was:

1. The proportion of patients who were transfused with allogeneic blood, with autologous blood, or with both.

The secondary outcome measures were:

1. The amount of blood lost perioperatively (ml). This includes operative blood loss, drain blood loss and total blood loss.
2. The amounts of allogeneic and autologous blood transfused (ml).
3. Length of stay (LOS) (days).

4. Functional knee outcome measures (e.g Oxford knee score).
5. General quality of life outcome measure (e.g. SF-12, SF-36 or EuroQol).
6. Complications: death, non-fatal myocardial infarction, stroke, deep vein thrombosis, pulmonary embolism, any thrombosis, renal failure and re-operation due to bleeding).

2.3.2 Search methods for identification of studies

The following exploded MeSH terms were used for the initial literature search: “Antifibrinolytics”, “Tranexamic acid”, “Cyklokapron”, “Aprotinin”, “Trasylol”, “epsilon aminocaproic acid” and “Amicar”. Text searches of key fields were included. A MEDLINE search was then refined to clinical trials and randomised controlled trials in human adults. The search was extended to other data bases, namely EMBASE, the Cochrane Controlled Trials Register, HealthSTAR and CINAHL, Google and Google scholar for trials of antifibrinolytics and total knee replacement published in any language from 1966 to December 2007. The bibliographies of retrieved trials and other relevant publications, including reviews and meta-analyses, were examined for additional articles.

Additionally, we searched the following websites to identify unpublished and ongoing studies:

1. Current Controlled Trials (www.controlled-trials.com)
2. Centre Watch (www.centerwatch.com)
3. Trials Central (www.trialscentral.org/ClinicalTrials.aspx)
4. The UK National Research Register (www.nrr.nhs.uk)

We also searched the Journal of Bone and Joint Surgery - British Volume and American Volume (www.ejbs.org), and the American Academy of Orthopaedic Surgeons (www.aaos.org).

2.3.3 Data collection and analysis

2.3.3.1 Selection of the studies

Two authors (SA & MS) independently applied the search strategy, selecting references from the database searches. Article titles and abstracts were reviewed independently and articles were retrieved. When appropriate, references

of retrieved articles were reviewed for further studies. The two authors independently assessed each full study report to see if it met the review inclusion criteria. Disagreements were discussed with the senior reviewers (AN & JM) and if no consensus could be reached, the study was excluded.

2.3.3.2 Assessment of methodological quality of included studies

The review authors used a modification of the generic evaluation tool used by the Cochrane Bone, Joint and Muscle Trauma Group [64] (Table 2.1). Two authors (SA & MS) assessed the methodological quality of each study. Disagreement was resolved by the senior reviewers (AN & JM). The total quality assessment score (QAS) was reported with each study.

2.3.3.3 Data extraction and management

A data extraction form was designed and agreed by the review team. A pilot test using five articles was performed to ensure the form's consistency. The form was then refined accordingly (Appendix 2.1). Initially, two authors (SA&MS) extracted data independently and reviewed extracted data jointly. Disagreements were resolved by consensus or consultation with the senior reviewers (AN & JM). If necessary, authors of individual trials were contacted directly to provide clarification.

Table 2.1 Quality assessment items and possible scores

A. Was the assigned treatment adequately concealed prior to allocation?

2 = method did not allow disclosure of assignment.

1 = small but possible chance of disclosure of assignment or unclear.

0 = quasi-randomized or open list/tables.

B. Were the outcomes of participants who withdrew described and included in the analysis (intention to treat)?

2 = withdrawals well described and accounted for in analysis.

1 = withdrawals described and analysis not possible.

0 = no mention, inadequate mention, or obvious differences and no adjustment.

C. Were the outcome assessors blinded to treatment status?

2 = effective action taken to blind assessors.

1 = small or moderate chance of unblinding of assessors.

0 = not mentioned or not possible.

D. Were the treatment and control group comparable at entry? (Likely confounders may be age, weight or co morbidity).

2 = good comparability of groups, or confounding adjusted for in analysis.

1 = confounding small; mentioned but not adjusted for.

0 = large potential for confounding, or not discussed.

E. Were the participants blind to assignment status after allocation?

2 = effective action taken to blind participants.

1 = small or moderate chance of unblinding of participants.

0 = not possible, or not mentioned (unless double-blind), or possible but not done.

F. Were the treatment providers blind to assignment status?

2 = effective action taken to blind treatment providers.

1 = small or moderate chance of unblinding of treatment providers.

0 = not possible, or not mentioned (unless double-blind), or possible but not done.

G. Were care programmes, other than the trial options, identical?

2 = care programmes clearly identical.

1 = clear but trivial differences.

0 = not mentioned or clear and important differences in care programmes.

H. Were the inclusion and exclusion criteria clearly defined?

2 = clearly defined.

1 = inadequately defined.

0 = not defined.

I. Were the interventions clearly defined?

2 = clearly defined interventions are applied with a standardised protocol.

1 = clearly defined interventions are applied but the application protocol is not standardised.

0 = intervention and/or application protocol are poorly or not defined.

J. Were the outcome measures used clearly defined?

2 = clearly defined.

1 = inadequately defined.

0 = not defined.

K. Were diagnostic tests used in outcome assessment clinically useful?

2 = optimal.

1 = adequate.

0 = not defined, not adequate.

L. Was the surveillance active, and of clinically appropriate duration?

2 = active surveillance and appropriate duration.

1 = active surveillance, but inadequate duration.

0 = surveillance not active or not defined.

2.3.3.4 Measures of treatment effect

Continuous data was recorded as mean, standard deviation and group size.

The treatment effect was the mean difference. We used the weighted mean difference to summarise trial findings if outcomes were measured in the same way between trials. However, we used the standardised mean difference to compare trials findings that measured the same outcome, but used different methods. It was expected that most trials would measure outcomes in the same way.

Dichotomous data were expressed as proportions or risks, and the treatment effect as a relative risk or risk ratio. Missing data was sought from the authors. Where this was not possible or data was missing through loss to follow-up, intention-to-treat principles were used. Trials with multiple arms were conflated to a single comparator of TXA or placebo.

Review Manager (RevMan 5, The Nordic Cochrane Centre, Copenhagen), was used to present study findings and combine the estimates of the effect of treatments. Summary estimates of the overall effect of treatment are provided in the form of a forest plot. The Mantel-Haenszel (H-M) method was used to combine studies using a fixed effects model. The presence of statistical heterogeneity was assessed through Q and I^2 statistics, a value of >50% being considered substantial heterogeneity.

2.3.3.5 Subgroup analysis

The following sub-group analyses were prospectively planned:

1. Diagnosis (rheumatoid vs. osteoarthritis).
2. Gender (male vs. female)
3. Cementation technique (cemented vs. uncemented).
4. Use of transfusion protocols.
5. Dose and mode of administration.

The data on the first three subgroups were lacking and it was not possible to conduct meaningful analyses.

2.4 Results

2.4.1 Description of studies

Three hundred and twenty three citations were identified as potentially relevant studies. Subsequent scrutiny led to the exclusion of 290 of these citations. Full publications were obtained for 33 citations. These were assessed and seven further citations were excluded, see table 2.2 [16, 60, 65-68].

Figure 2.1 Flow chart of study selection

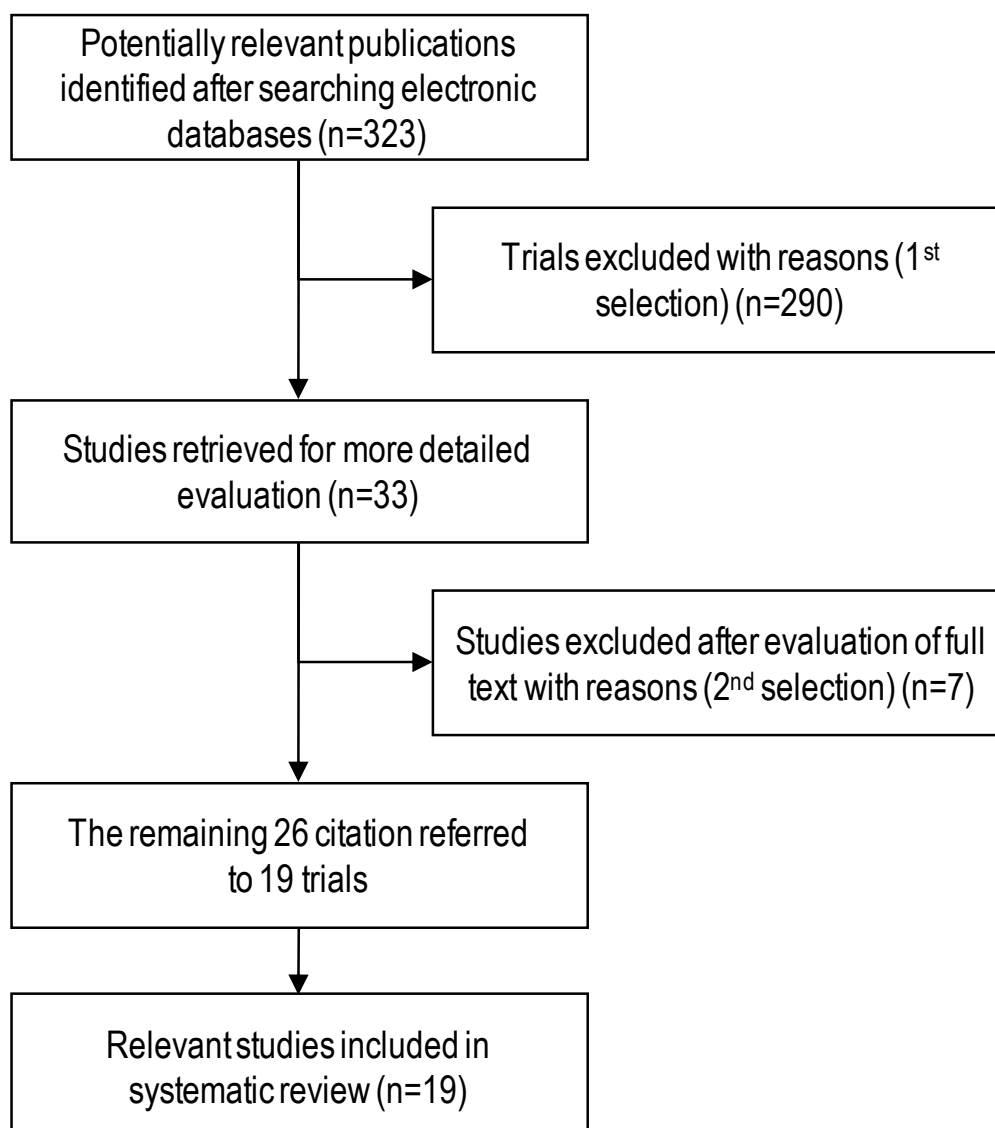

Table 2.2 Characteristics of excluded studies (2nd selection)

Excluded studies	Reasons for exclusions
Akizuki 1997a	It is not a randomised controlled trial.
Benoni 1997	It is the same trial that was published in 1996 (Benoni 1996)
Benoni 2000	It deals with hip arthroplasty.
Ho 2003	It is a not randomised trial.
MacGillivray 2010	It recruited concurrent bilateral TKR.
Neilipovitz 2001	It deals with patients with scoliosis.
Niskanen 2005	It deals with hip arthroplasty.

The remaining 26 citations referred to 19 RCTs. All involved IV administration of TXA. One study additionally examined oral administration. Nineteen RCTs were included in the review (table 2.3) (see Appendix 2.2 for a detailed summary of the included trials).

Most were small trials with participant number ranging from 24 to 136. However, they were relatively well designed and the quality assessment scores were high in most of the trials. The mode was 24 (the highest possible score) and the range was 14-24. Five studies scored less than 20.

Different doses and modes of delivery were used. The dose ranged from approximately 700mg to 10500 mg [7, 69]. All studies used LMWH as a DVT prophylaxis apart from Ido and Molloy's studies [6, 70]. The former did not use any chemical prophylaxis and the latter used aspirin. The transfusion trigger was an important consideration in the trials designs and apart from Ido's study, all studies specified clearly their transfusion triggers as shown in Table 2.3.

Table 2.3: Characteristics of the included studies

Study	N	Intervention	BT trigger	DVT Rx	QAS
Alvarez 2008	95	(1) TXA 10mg/kg IV then 1mg/kg/h infusion for 6h. (2) Control: normal saline.	Hb < 80 g/l	LMWH	22
Benoni1996	86	(1) TXA 10mg/kg IV before tourniquet deflation then 10mg/kg after 3h (an extra dose of 10mg/kg given if blood loss >500ml within 1h or 1000ml within 4h). (2) Control: normal saline.	Hb < 85-100 g/l	LMWH	22
Camarasa 2006	136	(1) TXA 10mg/kg IV before tourniquet deflation then 10mg/kg after 3h. (2) EACA 100mg/kg then 3 g/h for 3h.(3) Control: normal saline.	Hb < 80 g/l	LMWH	24
Ellis 2001	30	(1) TXA 15mg/kg IV before tourniquet deflation then 10mg/kg/h infusion for 12h. (2) Desmopressin 0.3 mcg/kg IV before tourniquet deflation then IV saline over 12h. (3) Control: normal saline.	Hct < 27%	LMWH	22
Engel 2001	36	(1) TXA 15mg/kg IV before tourniquet deflation then 10mg/kg after 3h. (2) Aprotinin 1 million units before tourniquet deflation then 0.5 million units/h for 4h. (3) Control: None	Hb < 100 g/l	LMWH	18
Good 2003	51	(1) TXA 10mg/kg IV before tourniquet deflation then 10mg/kg after 3 h. (2) Control: normal saline.	Hb < 90 g/l	LMWH	24
Hiippala 1995	28	(1) TXA 15 mg/kg IV before tourniquet deflation. (2) Control: normal saline.	Hb < 100 g/l	LMWH	19
Hiippala 1997	77	(1) TXA 15mg/kg IV before tourniquet deflation then two additional doses of 10mg/kg after 3-4h and 6-7h. (2) Control: normal saline.	Hb< 100 g/l	LMWH	22
Ido 2000	43	(1) TXA 1g IV before tourniquet deflation then 1g after 3h. (2) Control: None.	None	None	14
Kakar 2009	24	(1) TXA 10mg/kg IV before tourniquet inflation and 1mg/kg/h until wound closure. (2) Control: normal saline.	Hb < 80 g/l	LMWH	22
Jansen 1999	42	(1) TXA 15mg/kg IV before surgery then 15 mg/kg 8 hourly for 3 days. (2) Control: normal saline.	PCV < 26%	LMWH	24
Molloy 2007	150	(1) TXA 500mg IV before tourniquet deflation and 500mg after 3h. (2) Fibrin 10 ml spray. (3) Control: None.	Hct < 26%	Aspirin	22
Orpen 2006	29	(1) TXA 15mg/kg at cementation. (2) Control: normal saline.	Hb < 100 g/l	LMWH	24
Tanaka 2001	99	(1) Preoperative: TXA 20mg/kg 10 min before surgery and saline 10 min before tourniquet deflation. (2) Intraoperative: Saline 10 min. before surgery and TXA 20mg/kg 10 min before tourniquet deflation. (3) Perioperative: TXA 10mg/kg 10 min before surgery and 10mg/kg 10 min before tourniquet deflation. (4) Control: normal saline.	Hb < 70-100 g/l	None	24
Veien 2002	30	(1) TXA 10 mg/kg IV before tourniquet deflation then 10mg/kg after 3h. (2) Control: None	Hct < 28%	LMWH	22
Zhang 2007	102	(1) TXA 1 g IV before tourniquet deflation then 1 g after 3h. (2) Control; normal saline.	NA	NA	NA
Zohar 1999	40	(1) TXA 15 mg/kg IV before tourniquet deflation then 10mg/kg/h infusion for 12h. (2) Normovolemic haemodilution (NVHD) group bled to target 28%, IV volume maintained with ringer lactate and all the autologous blood was transfused.	Hct < 27%	LMWH	18
Zohar 2001	40	(1) TXA 15mg/kg IV before tourniquet deflation then 10mg/kg/hr infusion for 12h. (2) Desmopressin 0.3 mg/kg IV then IV saline over 12h	Hct < 27%	LMWH	22
Zohar 2004	80	(1) TXA long 15mg/kg IV before tourniquet deflation then 10mg/kg/h infusion for 12h. (2) TXA short as above but infusion for 2h then oral 1g at 6 and 12h. (3) TXA oral, 1g 6h preoperative then 6 hourly for 18 h. (4) Control: None	Hct < 28%	LMWH	16

2.4.2 Effects of interventions

2.4.2.1 Blood transfusion

Sixteen studies (944 participants) provided usable data on the effect of TXA on blood transfusion after TKR [6-8, 17-21, 69, 71-77]. TXA led to a reduction in the proportion of patients who required blood transfusion (RR 2.72; 95% CI: 2.25 to 3.27; $P=0.00001$). In this presentation the RR describes relatively by how many times the risk of blood transfusion was reduced. There was significant heterogeneity among the studies ($Q, P=0.00001$; $I^2 = 77%$) as in figure 2.2.

Figure 2.2 Trials of TXA vs. Placebo; Forest plot of blood transfusion rate

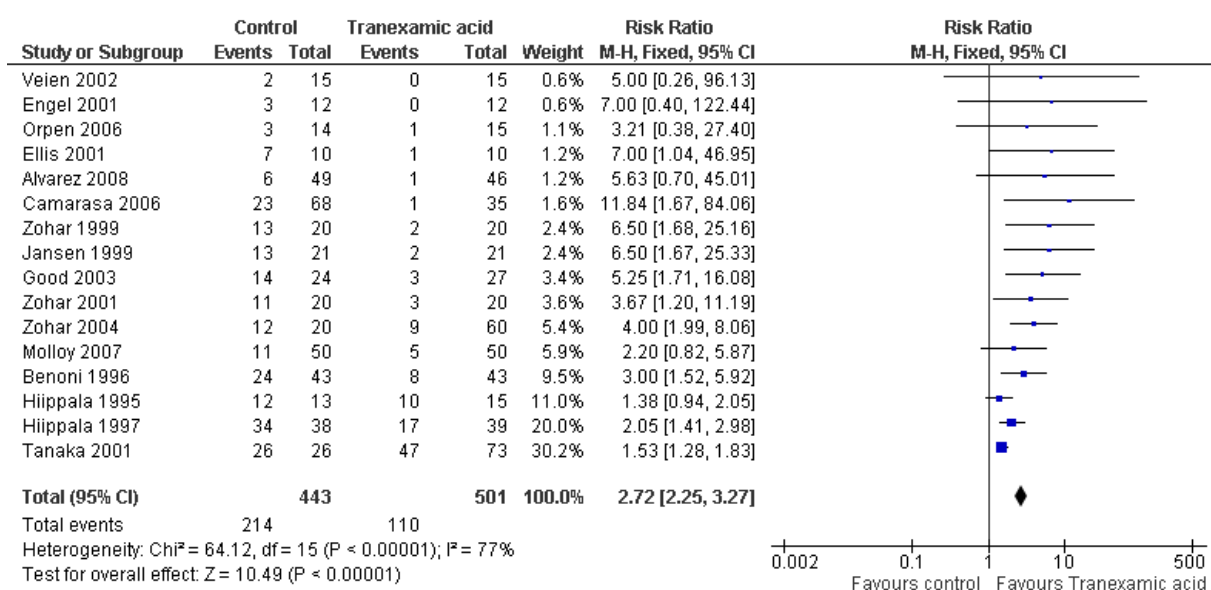

There are various ways to measure of the influence of each study upon the meta-analytic finding. In our review, we used the standard error as a measure for the study size as recommended by Sterne and Egger [78]. The Funnel plot (figure 2.3) shows trials scattered asymmetrically around the pooled RR with small trials having greater effect. This may be due to smaller trials of lower quality tending to overestimate true effect. It might also reflect publication bias where small negative trials are less likely to be published than small positive ones.

Figure 2.3 Trials of TXA vs. Placebo; Funnel plot of blood transfusion

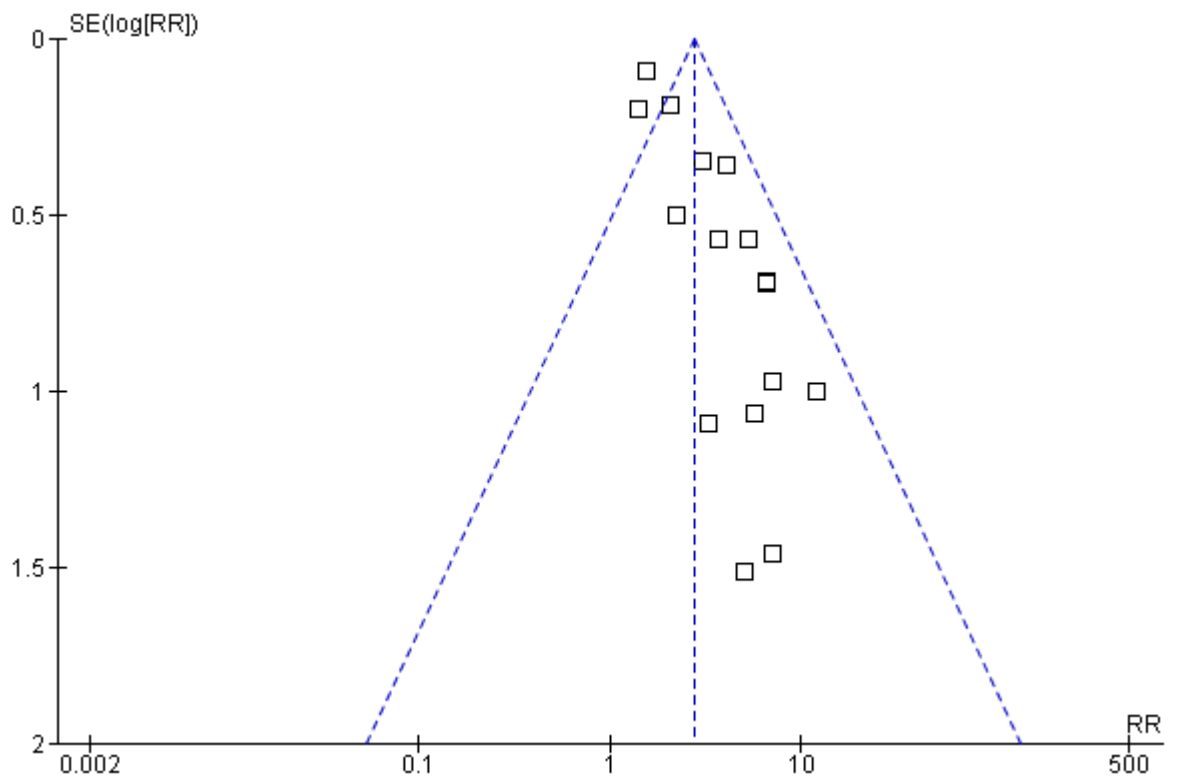

2.4.2.2 Amount of blood transfusion

Fourteen trials including 976 participants (463 in TXA arm and 408 in placebo arm) provided usable data on the amount of blood transfused in units. Crude pooled data showed that there is a fourfold rise in the number of units transfused when TXA was not used (table 2.4).

Table 2.4 Studies reported the amount of blood transfusion

Study	TXA		control		
	N	Units	Participants	Units	Participants
Alvarez 2008	95	1	46	11	49
Benoni1996	86	12	43	40	43
Camarasa 2006	136*	1	35	35	68
Ellis 2001	30*	1	10	11	10
Engel 2001	36*	0	12	6	12
Good 2003	51	7	27	35	24
Hiippala 1997	77	38	39	117	38
Kakar 2009	24	1	12	5	12
Jansen 1999	42	3	21	20	21
Molloy 2007	150*	8	50	17	50
Tanaka 2001	99	32	73	52	26
Veien 2002	30	0	15	2	15
Zohar 1999	40	2	20	19	20
Zohar 2004	80	12	60	18	20
Total	976	118	463	388	408
Rate of BT		0.25		0.95	
Units/participant					

* Trial has more than one arm. TXA and Placebo only are considered.

2.4.2.3 Blood loss

Fifteen trials (869 participants) provided usable data on blood loss. Studies measured external blood loss as drain volume, total blood loss or a combination of both. Ten trials provided data on external (drain) blood loss [17, 19-21, 70-72, 77, 79, 80]. Using TXA significantly reduced external blood loss by an average of 192 ml (95% CI: 168 to 217 m; $P = 0.00001$). However, there was significant heterogeneity in the finding ($P=0.00001$; $I^2 =89\%$.) (See figure 2.4.)

This finding indicates that there is a robust statistically significant reduction in drain blood loss but the magnitude is poorly described by the fixed effect model due to heterogeneity among the trial findings. Some systematic variations are to be determined.

Figure 2.4 Trials of TXA vs. Placebo; Forest plot of drain blood loss*

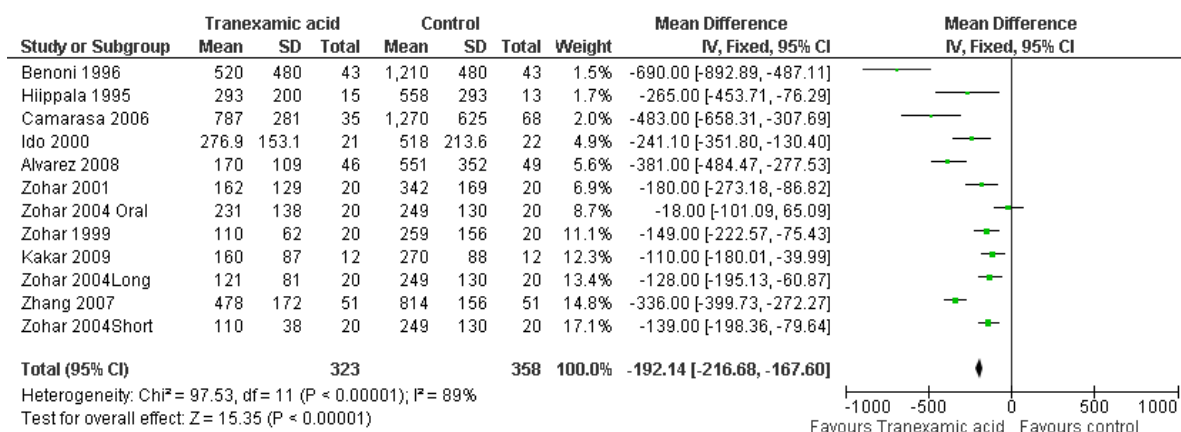

* Note: the RevMan software produces spuriously precise estimates of the mean difference. Although these have not been edited, only the first 3 or 4 significant figures are meaningful.

Zohar 2004 [21] compared three different modes of TXA administration to placebo (see table 2.3). These are labelled Zohar 2004 long, Zohar 2004 short, Zohar 2004 oral and placebo. They were analysed separately. This may be criticised for repeated usage or overinflating the placebo group, however, sensitivity analysis by sequential removal of each arm did not show significant overinflation.

Nine trials provided data on the effect of TXA on total blood loss. TXA had a more profound effect on total blood loss than drain blood loss. It significantly reduced total blood loss by an average of 591ml (95% CI: 536 to 646 ml; P=0.00001). Again, there was significant heterogeneity in the finding (P=0.0001; I² =78 %) as in figure 2.6.

Figure 2.5 Trials of TXA vs. Placebo; Forest plot of total blood loss

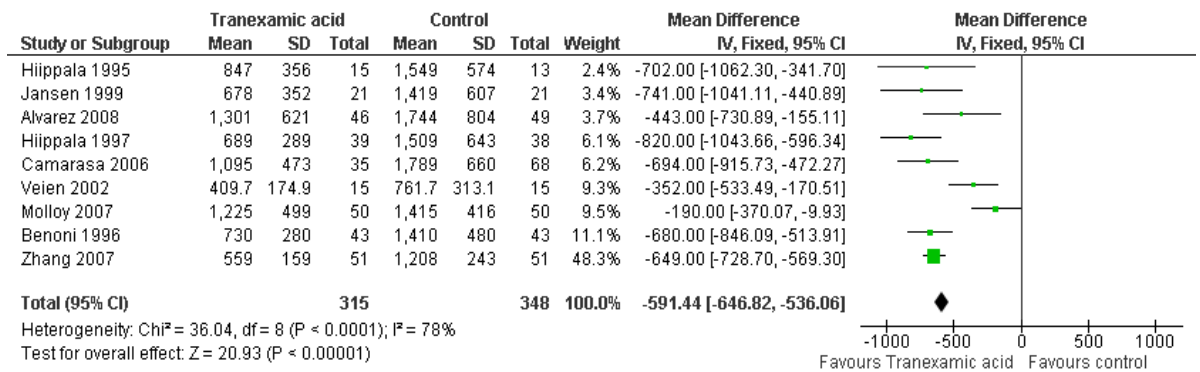

The funnel plot (figure 2.6) showing the effect size against precision is clearly not symmetrical. As before, this may be evidence of publication bias where some smaller trials with null findings may be missing or may be due to methodological heterogeneity related to study size.

Figure 2.6 Trials of TXA vs. Placebo; Funnel plot of drain blood loss*

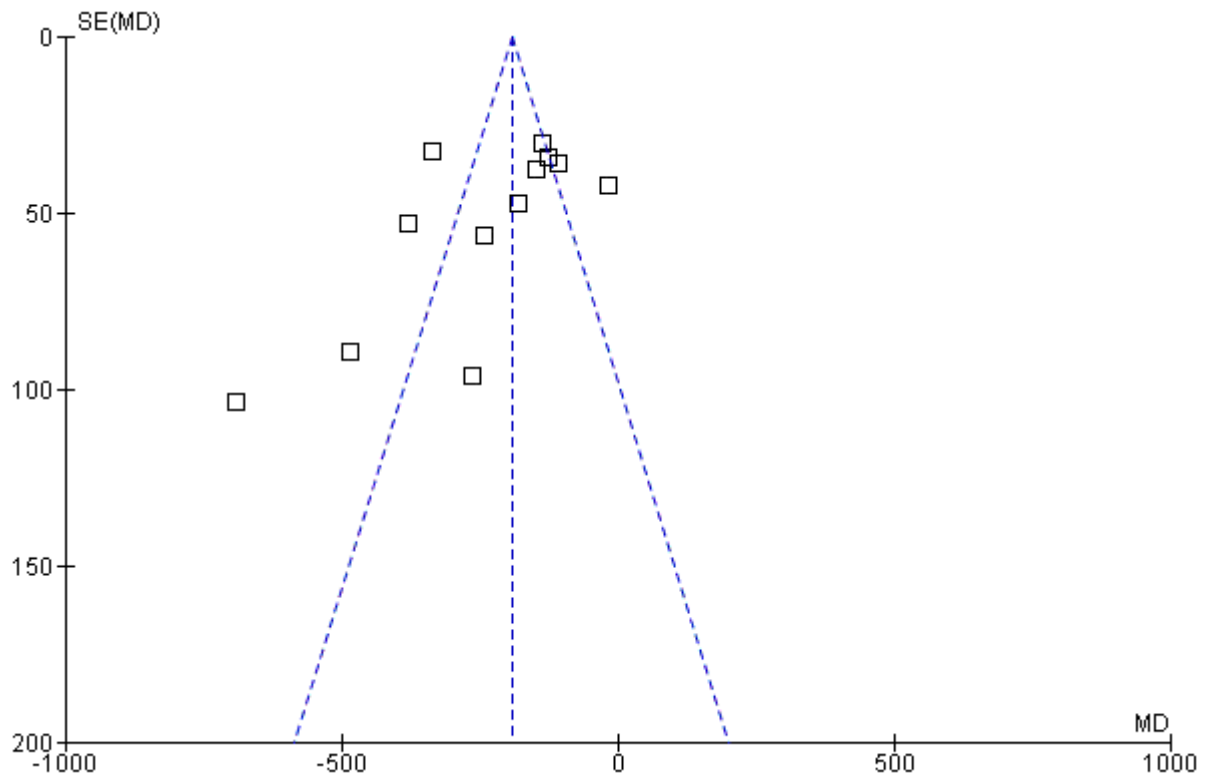

* Note: This funnel plot is related to figure 2.4.

2.4.2.3 Length of Stay

Three studies presented data on length of stay (LOS) including 140 participants (90 participants received Tranexamic acid and 50 received a placebo). Patients receiving TXA spent an average of 0.70 days less in hospital than the control group but this was not statistically significant (95% CI: -1.55 to 0.14 days; P= 0.10). There was no significant heterogeneity in the finding (Q, P=0.58; I²=0%.)

Figure 2.7 Trials of TXA vs. Placebo; Forest plot of length of stay

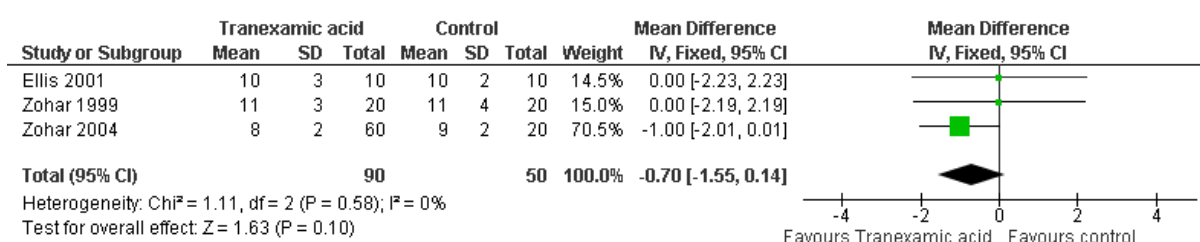

2.4.2.4 Complications

2.4.2.4.1 Deep Venous Thrombosis (DVT)

Thirteen trials provided useful data on DVT including 801 patients of whom 409 patients received TXA. The use of TXA was not associated with increased risk of DVT, RD 0% (95% CI: -0.04 to 0.03; P=0.98). There was no evidence of heterogeneity (Q; P=0.98; I²=0%). A similar finding was shown by Henry et al [62] and Zufferey et al [58].

Figure 2.8 Trials of TXA vs. Placebo; Forest plot of DVT rate

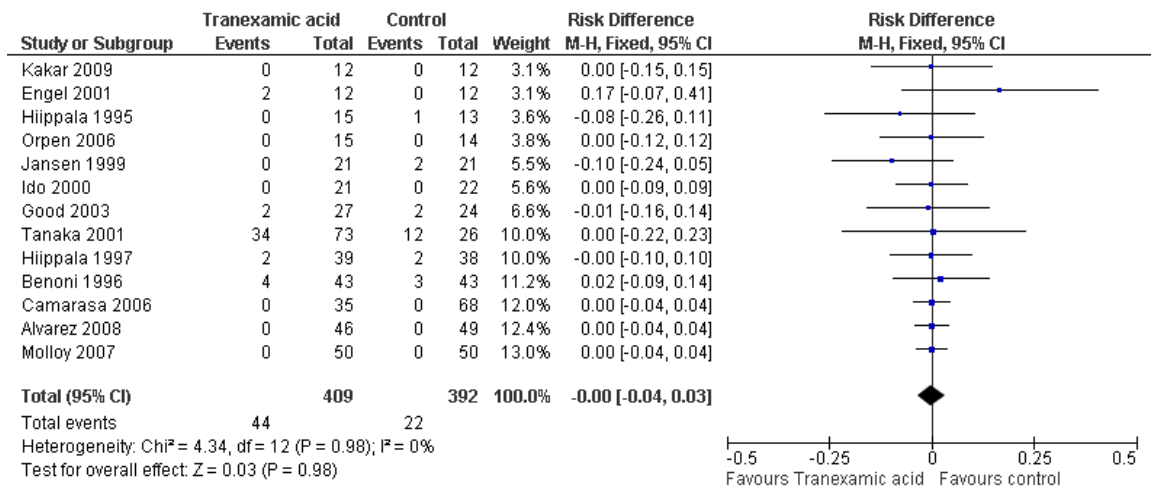

The funnel plot shows trials scattered symmetrically around the pooled RD.

Figure 2.9 Trials of TXA vs. Placebo; Funnel plot of DVT rate

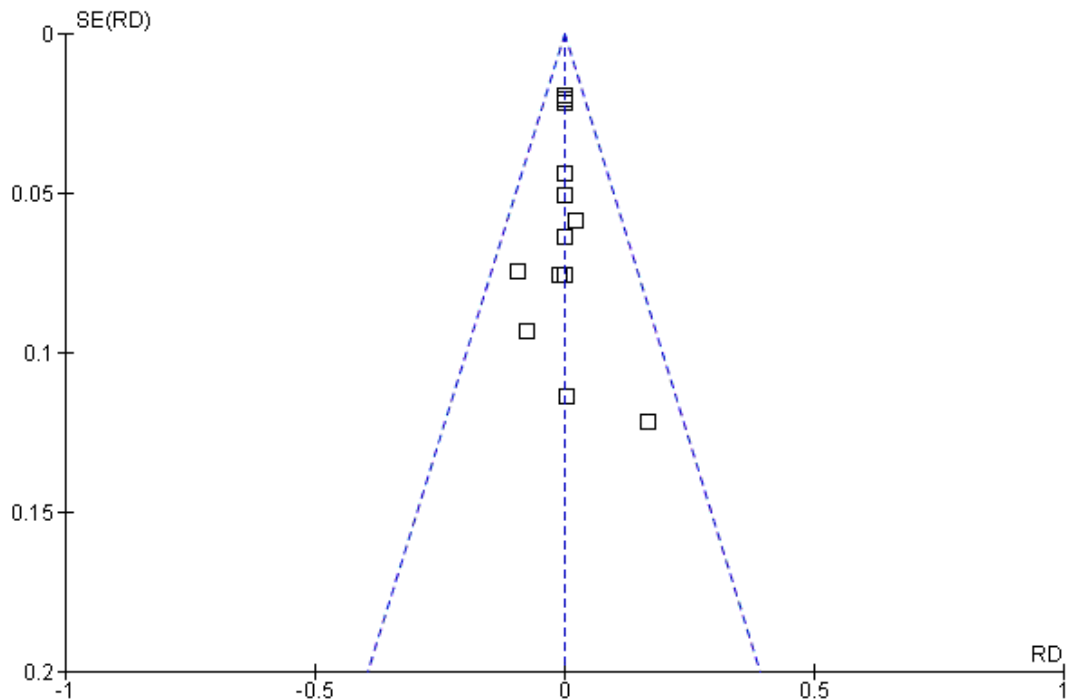

2.4.2.4.2 Pulmonary embolism (PE)

There were five cases of pulmonary embolism within 18 trial reports. One occurred in a patient who received TXA and the rest in the control group. This was not statistically significant and there was no significant heterogeneity (Q, P= 0.27 and I²= 0%).

Figure 2.10 Trials of TXA vs. Placebo; Forest plot of PE rate

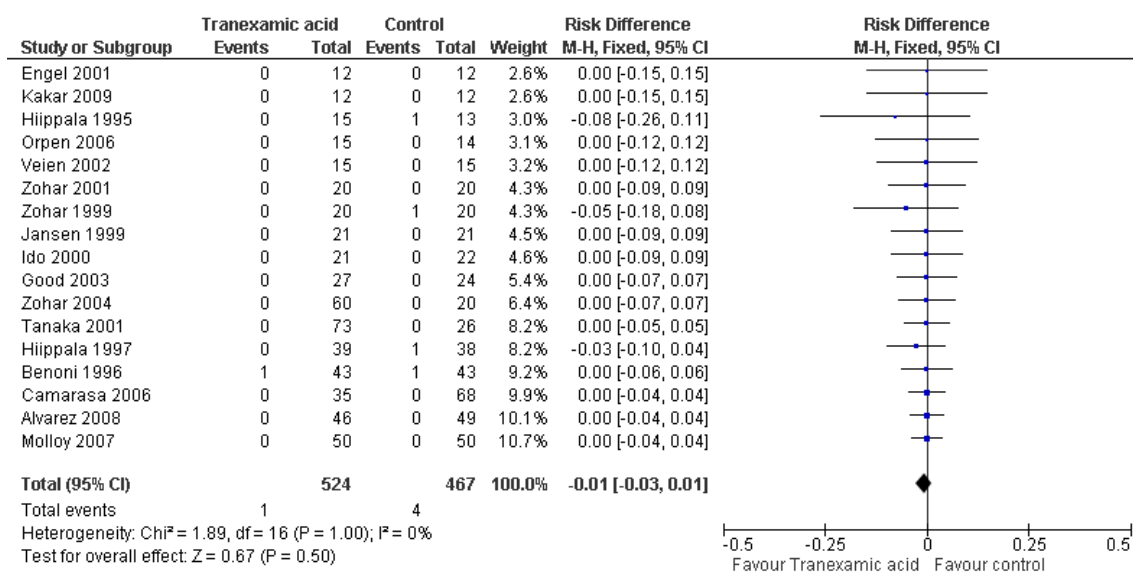

2.4.2.4.3 Mortality

Although seldom reported by trials, there were two reported deaths. Hiippala 1997 reported one death in the control group. Camarasa 2006 reported one death in a patient who had received TXA and died six months later from unrelated condition (author communication). Statistically there was no increased risk associated with the use of TXA RD 0% (95% CI:-0.05 to 0.05; Q, P=0.89) and there was no evidence of significant heterogeneity (I²=18%).

Figure 2.11 Trials of TXA vs. Placebo; Forest plot of mortality rate

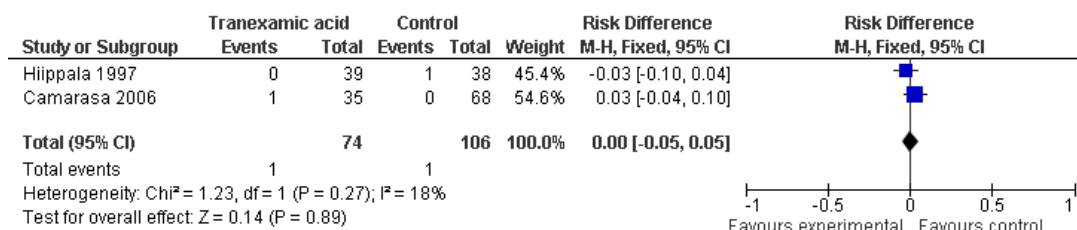

2.4.2.4.4 Other outcomes

We compared any other reported adverse events among the groups such haematoma formation, aggregated infections, etc. There was no significant difference between the groups. This should be interpreted with caution as this is aggregate of other events which might not be consistently reported across studies.

Figure 2.12 Trials of TXA vs. Placebo; Forest plot of other complications

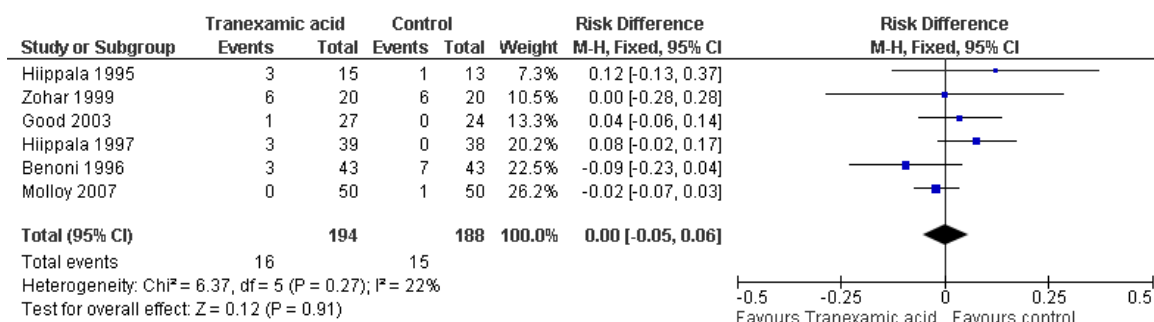

2.5 Discussion

A systematic review and meta-analysis with homogeneity of findings with multiple trials is regarded as level Ia evidence. This review focused on the use of TXA in total knee replacement as a single treatment modality. This was to reduce variability found in other reviews relating to other antifibrinolytic agents or other types of surgery.

The most convincing finding for TXA is its effect on blood transfusion rate. The review findings confirm a positive effect of the use of TXA in reducing the proportion of patients who received blood transfusion.

There was significant heterogeneity in the study findings; subgroup analysis among the studies showed a consistent but heterogeneous effect when analysed according to transfusion protocol (Hb, Hct or PCV triggers), low or high dose, single or multiple doses, or the timing of administration (see table 2.5 and figure 2.13). Interestingly, there is a direct relationship between the dose of TXA and the reduction in blood transfusion rate.

Table 2.5 Subgroup analysis of transfusion rate by dose of TXA

Trial ID	TXA		Control		Mean dose (mg)	Risk ratio (RR) [95 % CI]
	Trans-fused	Total	Trans-fused	Total		
High dose						
Ellis 2001	1	10	7	10	9450	7.00 [1.04, 46.95]
Jansen 1999	2	21	13	21	10500	6.50 [1.67, 25.16]
Zohar 1999	2	20	13	20	9450	6.50 [1.68, 25.33]
Zohar 2001	3	20	11	20	9450	3.67 [1.2, 11.19]
Zohar 2004Long	3	20	12	20	9450	4.00 [1.3,12.5]
Total	11	91	56	91		5.09 [2.86, 9.08]
Low dose						
Alvarez 2008	1	46	6	49	1120	5.63 [0.70, 45]
Benoni 1996	8	43	24	43	1400	3.00 [1.52, 5.92]
Camarasa 2006	1	35	23	68	1400	11.64 [1.67, 84]
Engel 2001	0	12	3	12	1750	7.00 [0.40, 122.44]
Good 2003	3	27	14	24	1400	5.25 [1.71, 16.08]
Hiippala 1995	10	15	12	13	1050	1.38 [0.94, 2.05]
Hiippala 1997	17	39	34	38	2450	2.05 [1.41, 2.98]
Molloy 2007	5	50	11	50	1000	2.20 [0.82, 5.87]
Orpen 2006	1	15	3	14	1050	3.21 [0.38, 27.4]
Tanaka 2001	47	73	26	26	1400	1.53 [1.28, 1.83]
Veien 2002	0	15	2	15	1400	5.00 [0.26, 96.13]
Zohar 2004Short	6	40	12	20	4450	4.00 [1.75, 9.09]
Total	99	410	170	372		2.41 [1.99, 2.93]

Figure 2.13 Subgroup analysis of transfusion rate by dose of TXA; Forest plot

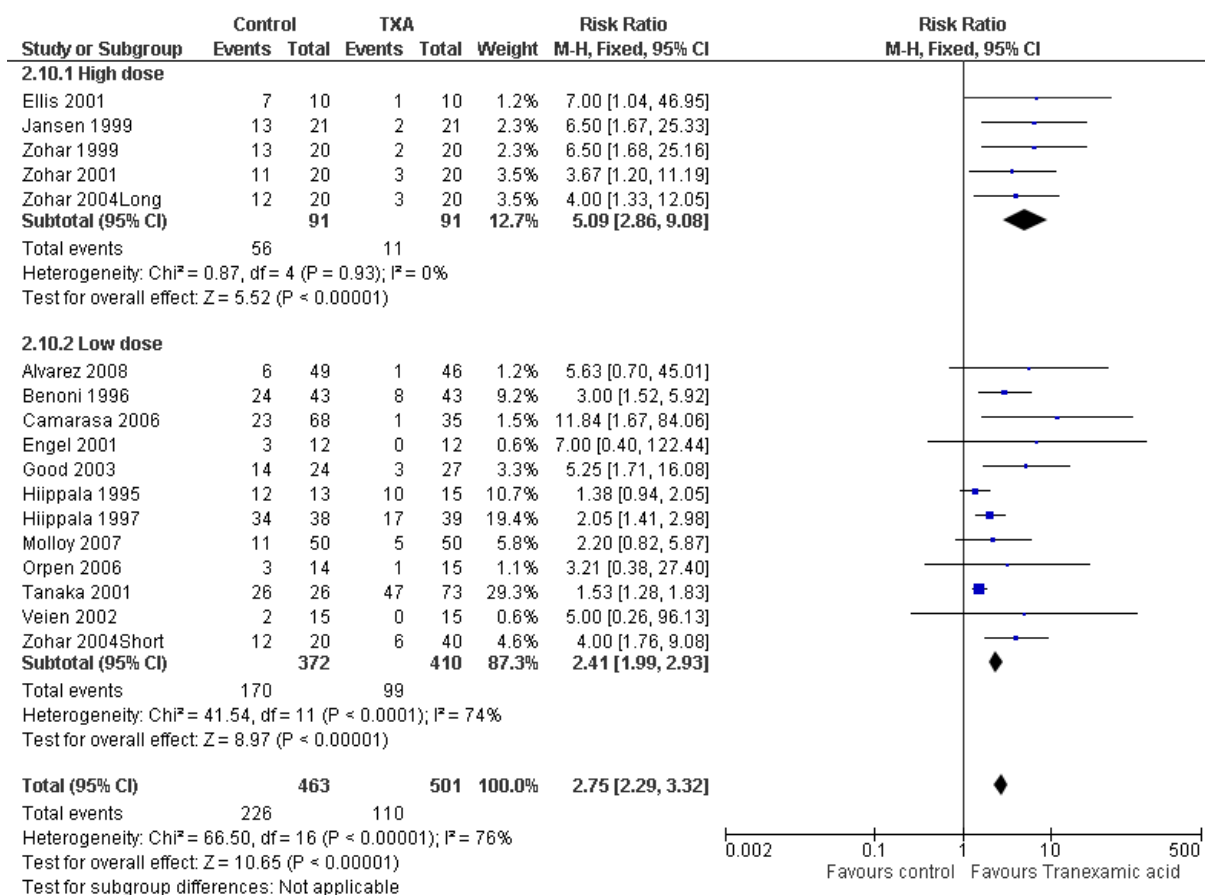

When the weighted effect estimates (RR) are plotted against the estimated mean dose used in the trials, there seems to be a trend in the relationship. The effect was larger and homogenous in trials that used higher doses of TXA (RR 5.09; Q; P < 0.00001; I² = 0%) but this was not true for the trials that used low doses. Further scrutiny of figure 2.14 showed that most trials used a dose of less than 5000 mg of Tranexamic acid while a few used almost double dose (about 10 000 mg).

Figure 2.14 Scatter plot of TXA doses vs. risk ratio for blood transfusion reduction

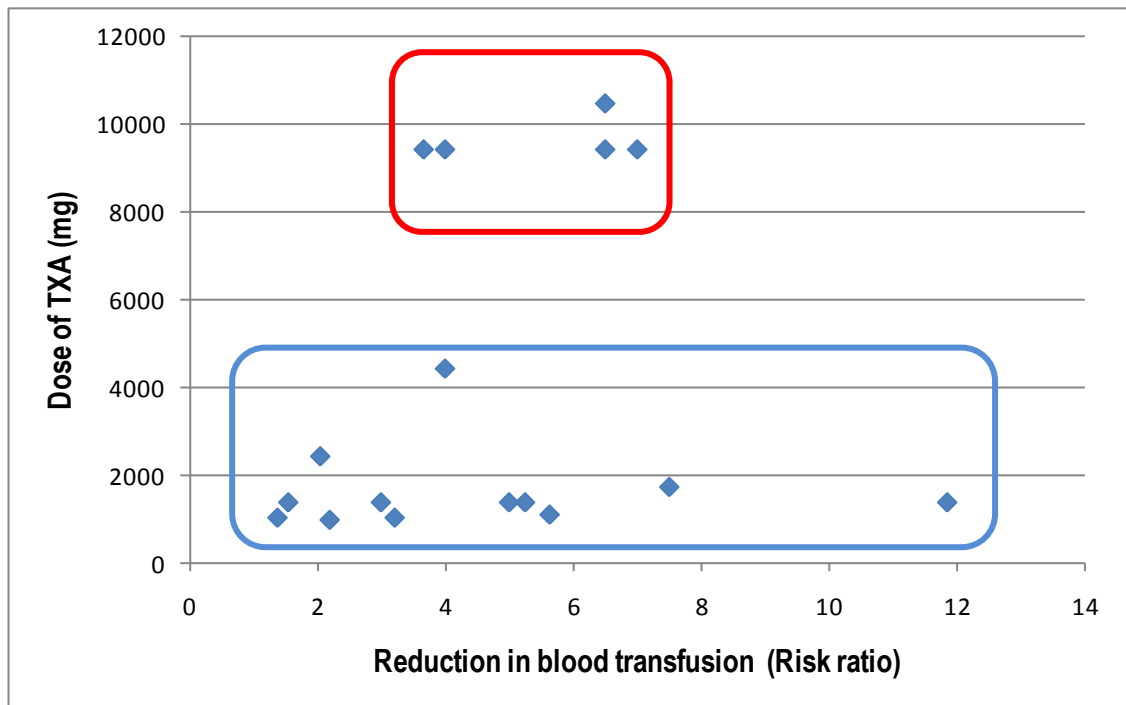

The review has also shown that TXA significantly reduces external and total blood loss. However; there is significant heterogeneity among the included studies as shown by the high value of I^2 and therefore the results should be interpreted with caution.

There are several sources of the heterogeneity that can be summarised as follows:

1. Drain blood loss was measured at various times after the operation limiting comparability. Clearly measuring the drain blood loss after 24 hours would show less blood loss than measuring it after 48 hours.
2. Authors of the included trials have used different terms interchangeably. For example, some authors used “total blood loss” to refer to the “total drain loss”, others used the same term to refer to the combined operative and postoperative blood loss. Some authors used the term ‘recovery drain loss’ or ‘ward blood loss’ without specifying the timing of measurement.

3. Different measures are used to describe the blood loss including mean, median, SD and range.
4. Operative techniques varied among the trials. Some authors released the tourniquet before closing the skin to stop any bleeding vessels and then inserted the drain catheter and closed the wound. Others did not do this relying on the pressure dressing to stop such bleedings vessels. The first method would be expected to have more operative bleeding but less postoperative (drain) blood loss.
5. The dose, timing and the mode of administration of the TXA were different among different studies as shown in tables 2.3 and 2.5.
6. Figure 2.6 showed some evidence for possible publication bias where some smaller trials with null findings may be missing.

In comparison with subgroup analysis of blood transfusion rate, the dose-effect relationship is more complicated and difficult to predict. When the mean difference of drain blood loss in the TXA group is plotted against the estimated mean dose used in the trials, there is a smaller difference in the trials that used higher doses (figure 2.15).

Figure 2.15 Scatter plot of TXA doses vs. reduction in mean drain blood loss

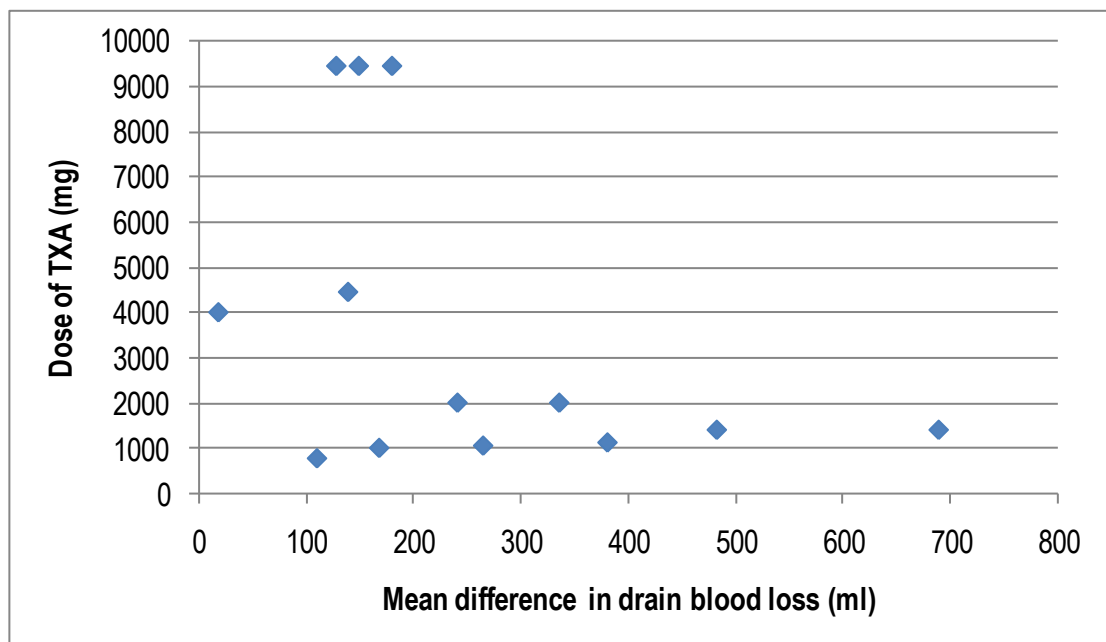

When the percentage reduction in the mean drain blood loss is plotted against the estimated mean dose used in the trials, the magnitude of reduction in drain blood loss was similar. Drain blood loss reduced by 40-60%. Interestingly, the one study of oral TXA showed the least percentage reduction (7.2%) in the mean blood loss as shown in (figure 2.16).

Figure 2.16 Scatter plot of TXA doses vs. percentage reduction in mean drain blood loss *

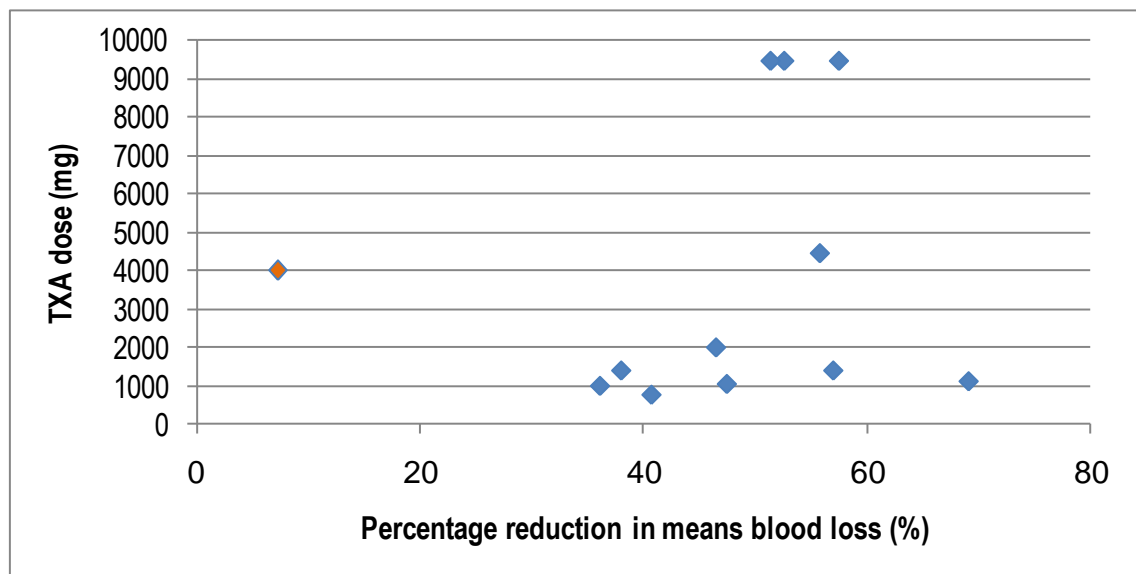

* The study that used oral TXA is represented by an orange diamond.

Theoretically, TXA carries a risk of thrombosis. However the review did not show an association between the use of TXA and the increased risk of DVT, PE or mortality.

Interestingly, figure 2.10 showed there were less PE events in the TXA group in comparison with control. Although this did not reach statistical significance, it is possible that TXA may reduce thrombosis by reducing blood transfusion which is a thrombogenic intervention.

The review identified a number of non randomised studies that nonetheless provide interesting correlation of findings. A recent study from Spain [81] evaluated the effect of TXA on blood transfusion and thromboembolic complications

in TKR. They retrospectively studied 414 patients, 215 immediately before introducing TXA treatment (control group) and in 199 patients after its introduction. Patients undergoing TXA treatment were without a history of thromboembolic disease. Fifty-four per cent of the control group patients (before introducing TXA) received blood transfusion while only 17.6% of TXA group patients received blood transfusion. Thromboembolic complications were diagnosed in 2.8% of the patients in the control group (before introducing TXA) and in 1.5% in the TXA group. Asymptomatic distal deep venous thrombosis was found in 54 (14.8%) of TXA group patients and 54 (30.1%) of control patients (before introducing TXA). These latter findings were not statistically significant. However they support our impression that TXA may reduce risk of thromboembolic complications.

In conclusion, this review and meta-analyses have shown that TXA delivered systemically (intravenously or orally) has a marked beneficial effect in reducing blood loss and blood transfusion.

Although, no increase in adverse effects of TXA is evident with such a mode of delivery, the orthopaedic community is still sceptical about its potential systemic side effects. None of the trials were powered to detect an increase in such rare side effects. Topical (intra-articular) use of TXA may overcome this problem.

2.5.1 Limited evidence for the use of topical TXA

The effect of topically applied TXA on blood loss has been reported in two studies in oral surgery [82, 83], three studies in cardiac surgery [84-86], one in bladder surgery [87], one in gynaecology [88] and one study in spinal surgery [89] .

Sindet-Pedersen performed two studies using topical TXA in oral surgery in patients with bleeding disorders. The first study [83] investigated the effect of adding systemically and locally delivered TXA on factor VIII concentrate in haemophilic patients. The study showed that topically applied TXA as a supplement to systemically delivered TXA significantly reduced the amount of replacement therapy with factor VIII. The second study [82] was a randomised controlled, double-blind trial of 39 patients undergoing oral surgery. Patients were receiving anticoagulant agents because of the presence of a prosthetic cardiac valve. The

patients did not stop anticoagulant therapy. Before wound closure, the wound was irrigated with 10 ml of a 4.8 percent aqueous solution of TXA in 19 patients and with a placebo solution in 20 patients. For seven days thereafter, patients were instructed to rinse their mouths with 10 ml of the assigned solution for two minutes four times a day. Eight patients in the placebo group had a total of 10 postoperative bleeding episodes, whereas only 1 patient in the TXA group had a bleeding episode ($P = 0.01$). There were no systemic side effects. Another study showed that mouth washing with TXA does not lead to increase in serum levels [90] .

De Bonis [84] conducted a small prospective, randomised, double-blind trial of patients undergoing coronary artery bypass operations: twenty patients received topical TXA and 20 received placebo.

Chest tube drainage in the first 24 hours was 485 ± 166 ml in the TXA group and 641 ± 184 ml in the placebo group ($P = 0.01$). Total postoperative blood loss was 573 ± 164 ml and 739 ± 228 ml, respectively ($P = 0.01$). There was no significant difference in blood transfusion between the two groups. TXA could not be detected in any of the blood samples collected blinded from 24 patients to verify whether any systemic absorption of the drug occurred.

A randomised controlled trial from Egypt recruited 100 patients scheduled for elective open heart surgery. In one group, TXA (2g in 100 ml of saline solution) was poured into the pericardial cavity before sternal closure. The placebo group received 100 ml of saline. Blood loss was significantly higher in the placebo group compared to topically applied TXA (1208 ± 121 ml vs. 733 ± 93 ml; $P < 0.001$). The placebo group received (4.54 ± 1.4 units) as compared to TXA (2.64 ± 1.5 units) ($P < 0.01$).

In a recent publication, Baric-Daver [86] and colleagues compared the efficacy of topical application of 1 million IU of Aprotinin, 2.5 gram of TXA and a placebo in 300 adult undergoing cardiac surgery. They concluded that topical use of either TA or Aprotinin efficiently reduces postoperative bleeding. The authors noted that TXA seemed to be at least as potent as Aprotinin, but potentially safer and with better a cost-effectiveness ratio.

Krohn investigated the effect of TXA given locally in the wound after spinal surgery in 30 patients [89]. Sixteen participants received topical TXA and 14 received a placebo. Blood loss was reduced by half from 525 (325-750) ml to 252 (127-465) ml, ($P = 0.02$). None received allogeneic blood transfusion; however, two patients received autologous blood in the TXA versus 9 in the placebo group.

Compared with IV administration there are obvious potential advantages to the topical use of TXA. It is easier to prepare, quicker to administer and provides a higher concentration at the bleeding site without systemic involvement. Hence, this mode of administration was chosen to be investigated in a placebo-controlled trial of topical (intra-articular) TXA in total knee replacement.

Chapter 3

Research Methodology

3.1 Introduction

It is apparent from the systematic review of published studies (chapter 2) that no trial has been attempted of topical Tranexamic acid (TXA) to reduce bleeding in total knee replacement (TKR). Thus, the research hypothesis is that topically applied TXA can reduce blood loss and blood transfusion significantly in TKR.

The rationale for topical (intra-articular) application includes:

1. Delivering a maximum concentration at the bleeding site, potentially enhancing the treatment effect.
2. Reducing systemic TXA concentration, which may reduce systemic side effects.
3. Quicker preparation and easier application.

Randomised controlled trials (RCT), when appropriately designed, conducted, and reported, represent the gold standard in evaluating healthcare interventions [91]. They are prospective in design with random allocation of participants to control and intervention groups. When adequately powered and designed an RCT can detect differences between a new treatment (such as our intervention) and routine practice with the difference confidently attributed to the intervention. Hence, this design was chosen to investigate topical (intra-articular) TXA in TKR surgery.

The trial research protocol (Appendix 3.1 Research protocol) and methodology were developed and reviewed by official research bodies, internal and external reviewers who are experts in their fields. Comments received strengthened different aspects of the trial methodology and refined the protocol to adequately address the research question.

Consensus amongst clinical colleagues was that a reduction in the blood transfusion rate from 30% to 10% and a 50% reduction in blood loss would be clinically important. This view was supported by the literature and several studies which showed this amount of reduction is achievable using antifibrinolytics. As seen in chapter 2, TXA and other antifibrinolytics agents when used intravenously reduced blood loss and blood transfusion by about 50%.

3.2 Trial design

This was a parallel arm, double blind randomised controlled trial. Participants, surgeons and assessors were blinded to the assigned intervention. Allocation to treatment and placebo groups was in the ratio 1:1.

3.3 Recruitment

Patients were introduced to the trial in the pre-assessment clinic at approximately 3 weeks before their operation. The trial was discussed with them and a written information sheet was supplied (Appendix 3.2 Patient information sheet). Contact details were provided so that potential participants could discuss any issues before admission.

On admission, medical records of potential participants were checked to confirm that they met the inclusion criteria and they had not already refused to take part in the trial. Then they were approached by a designated, trained research staff. The trial was explained again, participants were given the opportunity to ask any further questions. If they agreed to take part in the study, they were asked to complete and sign the consent form (Appendix 3.3 Consent form). It was repeatedly made clear that there was no requirement to participate and that refusal would not prejudice continued care in any way. The general practitioners (GP) of the recruited patients were informed by a postal letter (Appendix 3.4 General practitioner notification letter).

Outcome measures (Oxford knee score and EuroQol) were completed in the pre-assessment clinic; however, if this was not the case, they were completed at this stage. Baseline demographics were recorded in data collection sheet (Appendix 3.5 Data collection sheet).

3.4 Inclusion and exclusion criteria

Inclusion criteria:

1. Patients undergoing a unilateral primary cemented total knee replacement.

Exclusion criteria:

1. Patients undergoing primary total knee replacement for trauma or tumour, bilateral TKR or revision TKR.
2. Allergic to TXA.
3. Bleeding tendency (e.g. haemophilic and platelets disorders).
4. Warfarin, treatment dose of LMWH or conventional heparin.
5. Paget's disease.
6. History of DVT or pulmonary embolism.
7. Renal failure with creatinine > 250 micromole/l.
8. Pregnant (all female subjects of child bearing potential must have a negative pregnancy test).

Permitted therapies included:

1. Aspirin.
2. Subcutaneous prophylactic conventional or LMW heparin.

Some exclusion criteria were included to minimise the variation in blood loss. Small numbers of patients with haemophilia, platelets disorders and Paget's disease could bleed excessively and adversely affect the results. However, participants with such exclusion criteria may be ideal candidates for TXA treatment. Exclusion criteria were printed as a checklist on the back of the consent form. All items in the list had to be checked when patients were randomised (Appendix 3.6 Trial checklist).

3.5 Allocation and blinding

On arrival to theatre, a designated research nurse verified the relevant documents and ensured eligibility for inclusion in the study. The participant was then randomised through the sealed envelope web site:

<http://www.sealedenvelope.com/tranxk/>

“Sealed Envelope” is an independent company that provides online / phone randomisation. Designated theatre staff were issued with passwords and trained to randomise participants, prepare the study medicine and complete the trial registry which was kept in theatre as described in the theatre protocol (Appendix 3.7 Pharmacy and theatre protocol).

This method of randomisation protects the concealment of allocation, removing potential biases and inefficiencies that can occur with traditional sealed envelope or coin tossing methods. The allocation of treatment was kept concealed from all professionals delivering patient care. Both treatment and placebo have the same colour, smell and feel ensuring blinding is maintained throughout the trial.

Blocked randomisation was used in blocks of six in order to keep the sizes of treatment groups similar. Randomisation was stratified at the level of the surgeon to achieve balance within the two groups since differences among surgeons were seen as an important potential source of variation.

The trial registry was kept in theatre and could be accessed in emergency situations. A trial label was stuck on the front of each participant medical record showing the name of the trial, the identifier number, date and contact details.

3.6 Intervention

The operation was performed in the standard manner as described in chapter 1. Normally, no chemical intervention is used to reduce blood loss. In this study, at the end of the operation and before closing the wound, the study drug (either TXA or a placebo) was applied by spray into the wound. The wound was then closed and dressed in the normal way followed by the release of the tourniquet. Drains were released after one hour in recovery as is routine.

The designated theatre staff prepared the study drug under completely aseptic conditions. Tranexamic acid (1 g) was made up to 50 ml with normal saline. Placebo was 50 ml of saline.

Type of anaesthesia, type of warming, tourniquet time, operative blood loss and any unexpected events were all recorded on the trial data collection sheet (Appendix 3.5 Data collection sheet).

Operative blood loss (ml) was calculated by subtracting the washout fluid from suction drain volume. This was added to the amount soaked up by the swabs.

Swabs were weighed before (dry weight) and after the operation. The difference between the two equals the amount of blood soaked up by the swabs.

Because TKR is usually performed in a bloodless field using a tourniquet, operative blood loss was negligible unless the tourniquet was faulty or inappropriately applied.

3.7 Outcome measures

3.7.1 Primary outcome: blood transfusion

The need for blood transfusion was the primary outcome measure given its important for patients, doctors and managers. The proportion of participants who received blood transfusions and the amount of blood transfusions in units were recorded for both arms of the trial until patients were discharged.

Although guidelines are available for blood transfusion, there is a wide variation in the blood products prescribed in different regions and hospitals in the UK [92, 93]. To standardise blood transfusion practice and prevent unnecessary blood transfusion (chapter 2), a blood transfusion policy was introduced (Appendix 3.8 Blood transfusion policy). This policy was based on the recommendation of the British Orthopaedic Association (BOA) [28], Blood Transfusion Task Force, The British Committee for Standards in Haematology [52] and the UK blood transfusion and tissue transplantation services [94].

The policy regulated the blood transfusion indications as follows:

- Blood transfusion is not indicated when Haemoglobin concentration is more than 10 g/dl.
- Blood transfusion is indicated when Haemoglobin concentration is < 7 g/dl. Blood transfusion should be given in relation to the rate of red cell loss. In otherwise stable patient, 2 units of red cell should be transfused and then the clinical situation and Haemoglobin concentration should be reassessed.
- In patients who tolerate anaemia poorly, for example, patients over 65 years or those with cardiovascular diseases or respiratory diseases, con-

sider adopting a higher threshold level for blood transfusion (when Haemoglobin concentration is < 8 g/dl).

- Blood transfusion is indicated in patients with haemoglobin between 7 and 10 g/dl if they are symptomatic.
- The Haemoglobin level should be checked the next day after the transfusion and the same protocol is applied if the Haemoglobin level is low.

3.7.2 Secondary outcomes

3.7.2.1 Drain blood loss (first 48 hours)

Total knee replacement is performed in a bloodless field. The blood is exsanguinated from the limb and a tourniquet applied around the thigh. At the end of the operation, a vacuum drain is placed in the joint cavity. The wound is closed and a pressure dressing is applied. Then the tourniquet is released allowing the blood to flow into the limb. Any bleeding is removed by the vacuum drain. Hence drain blood loss is a good reflection of total blood loss after total knee replacement.

Measuring the drain blood loss was standardised as follows:

1. Drains should remain clamped after the operation for 30 minutes.
2. The reading should be performed by placing the drain bottle on a flat table with the eyes level with the blood level.
3. The amount of blood is recorded at least twice a day.
4. When the drain becomes full, it is clamped, recorded and replaced. The time of replacement is noted.
5. The drains are removed after 48 hours.

The outcome was the total amount of drainage over 48 hours measured in ml.

3.7.2.2 Haemoglobin and Haematocrit drops

Blood tests were performed in the pre-assessment clinic and on the second postoperative day unless there was a specific reason to do it earlier or more frequently. Fall in the Hb and Hct levels are good indicators of blood loss during surgery. However, these levels may be normal during the immediate postoperative period and not reflect the true amount of blood loss. This is because during acute blood loss, there is a loss of both red blood cells and plasma (solutes and solvent) so the concentration remains normal or minimally changed. The body

starts compensating over the first 48 hours by conserving water thus diluting the blood. Therefore Hb and Hct levels will fall subsequently.

3.7.2.3 Generic quality of life measure (the EuroQol Questionnaire)

The EuroQol Questionnaire is designed for self-completion by participants in two parts: EQ-5D and EQ-VAS. It is cognitively simple and takes only a few minutes to complete (Appendix 3.9 the EuroQol Questionnaire). The EQ-5D descriptive system is comprised of five questions in the dimensions of: mobility, self care, usual activities, pain/discomfort and anxiety and depression. Each dimension has three levels scored from 1 to 3: no problems (1), some problems (2) and severe problem (3). For example, state 11111 indicates no problems on any of the 5 dimensions while state 11223 indicates no problems with mobility (1) and self care (1), some problems with performing usual activities (2), moderate pain and discomfort (2) and extreme anxiety or depression (3). This descriptive system can be converted to a weighted index to aid statistical comparison. Additionally, the EQ-VAS records the participant's self rated health on a vertical visual analogue scale (VAS) where the top of the scale represents the best imaginable health state and the bottom of the scale represents the worst imaginable health state.

EuroQol instrument was developed by the EuroQol group between 1987 and 1990 [95] and underwent subsequent validation and reliability testing. The EuroQol questionnaire has been assessed for construct and convergent validation as well as test-retest reliability [96, 97]

There are studies which looked at other aspects of the valuation of the EuroQol such as response-bias, feasibility, interclass reliability and effect of duration. These provide evidence that the EuroQol is a valid, reliable, patient and clinician friendly instrument.

The questionnaire is completed in the pre-assessment clinic or on admission for preoperative health state and at about 3 months after the operation in the follow up clinic for postoperative health state. This was completed as recommended by the EuroQol group in their user guide version 1.0 November 2007 [98].

3.7.2.4 Disease specific scale: Oxford knee score

The Oxford knee score was developed by the Oxford Group in 1998. It has been validated against the Health Assessment Questionnaire, SF-36, The American Knee Society Scoring System, The WOMAC (Western Ontario and McMaster Universities) Index of Osteoarthritis, the Nottingham Health Profile (NHP), and sickness impact profile [99-101]. It is comprised of 12 questions each scored from 4 to 0, with 4 representing the best outcome/least symptoms (Appendix 3.10 The Oxford knee score). The scores of each question are added so that the overall figure lies between 0 to 48 as recommended [102]. The OKS is completed in the pre-assessment clinic or on admission and at about 3 months after the operation.

3.7.2.5 Length of stay (LOS)

All participants were admitted on the day of surgery as per routine practice. The discharge day was not counted as part of length of stay. For example, a patient who was admitted on the first day of May and discharged on the fifth of May would have stayed 4 days only. Patients who were transferred to other specialties due to complications were not considered discharged and the period was counted as part of the LOS.

3.7.2.6 Economic analysis

Inpatient resources that might vary between the TXA and placebo groups were identified and recorded for each participating patient. These included length of stay, blood transfusion, TXA and complications. Resources were costed using hospital unit costs. The economic analysis took the form of a cost and consequences analysis where the net cost of care is set against the profile of treatment effects rather than having one unambiguous treatment effect (cost-effectiveness analysis)

3.7.2.7 Complications

3.7.2.7.1 Wound infection

Wound infection occurs in 0.2-1.7% of patients and determined by a clinical diagnosis. Swelling, redness, hotness, tenderness and high temperature are cardinal signs of infection, which is usually associated with rising white blood cell and inflammatory markers and confirmed by microbiological test. For the pur-

pose of the study, clinical findings are essential to the diagnosis of infection, with or without investigative confirmation. Raised WBC and inflammatory markers are common after TKR. Microbiology swabs can be contaminated and can be inconclusive. Infection is considered superficial if resolved with oral antibiotics only and it is considered deep if not controlled with oral antibiotic or required a washout/ debridement or revision surgery [103, 104].

3.7.2.7.2 Deep venous thrombosis (DVT)

The occurrence of DVT after TKR is controversial and its frequency has changed with the changing practice of joint arthroplasty over the decades. Early studies when patients were kept immobilised in bed for long period of time showed a very high incidence of 41%-85% for distal DVT and 5-22% for proximal DVT [105]. More recent studies report much lower rates. DVT is taken seriously by the orthopaedic team because its treatment by anticoagulation carries a significant risk to joint replacements by haematoma or infection. Two thirds of DVTs are silent and do not cause symptoms, others can present with classical features of swelling of the leg, hotness and pain in the calf. Unfortunately, these symptoms and signs are very common after TKR making clinical diagnosis unreliable. The current practice is to start patients with suspected DVT on a treatment dose of LMWH and perform a confirmatory test such as a Doppler ultrasound or venogram as soon as possible. Ultrasound has an average sensitivity and specificity of 97% for proximal deep vein thrombosis [106]. Contrary to diagnosing infection, the diagnosis of DVT in our study is based on confirmatory ultrasound rather than the clinical finding. If the scan is negative, the diagnosis of DVT is excluded. Occasionally, when the clinical picture of DVT is convincing, the ultrasound scan is repeated.

3.7.2.7.3 Pulmonary embolism (PE)

Pulmonary embolism occurs when a thrombus or clot migrates to the lung. It can be asymptomatic, symptomatic or fatal. As with DVT, the incidence is controversial and the reported figures of symptomatic PE vary from 1.5 to 10% and fatal PE from 0.1 to 1.7%. Unfortunately, all available objective tests have clinical or practical limitations. The ventilation-perfusion lung scan has been the first-line test for more than 20 years. However, 60% to 70% of lung scans are non-diagnostic. Use of helical CT in the diagnosis of PE has not been ade-

quately evaluated, particularly in peripheral PE. The safety of withholding anticoagulant treatment in patients with negative results using helical CT is uncertain. Pulmonary angiography is the gold standard, but it is invasive and expensive, may be impractical or unavailable in some clinical settings and carries cardiac or pulmonary complications in 3% to 4% of patients. In our current practice, a physician is consulted to make a definite diagnosis. Pragmatically, if a patient were treated for PE by a physician, they were regarded as having a PE. The use of a confirmatory test was noted [105, 107, 108] .

3.7.2.7.4 Myocardial infarction (MI)

The reported incidence of MI is 0.4% usually presenting as chest pain which must be differentiated from other causes of chest pain common in patients on orthopaedic wards. An MI can be silent without any pain, particularly in postoperative patients with diabetes mellitus. Within the trial, the diagnosis of MI needed to be confirmed by rising cardiac enzyme (Troponin T) and / or ECG changes in the form of ST elevation, Q-wave and T wave changes [109].

3.7.2.7.5 Cerebrovascular accident (CVA)

CVA is not common after joint replacement and diagnosis can be difficult because similar clinical events can be caused by different pathological processes. A CT scan is the gold standard test, readily available in our centre as indicated for patients with a suspected stroke. A CT scan will usually demonstrate the site of a lesion and distinguish between a haemorrhage and infarction. It also rules out or shows unexpected causes. A limitation of CT scan comes in diagnosing a CVA caused by infarction as it may take several days before an infarction is detectable by a CT scan [15].

3.7.2.7.6 Death before discharge

Seah et al [108] reviewed 2219 TKRs performed in their centre from 1998 to 2001. They found the mortality rate within 30 days of TKR was 0.27% (6 of 2219 patients). Gill [110] investigated 90 day mortality in 3048 consecutive primary TKRs, the mortality rate was 0.46%. Death before discharge was recorded although the study was not powered to show changes in this outcome.

3.8 Number of subjects and duration

3.8.1 Number of subjects (sample size)

To detect a reduction in the transfusion rate from 30% to 10% with 80% power and alpha of 5% required a sample size of 144 patients (72 in each group) (corrected Fisher exact test).

A previous study [111] reported mean blood loss of 1191 ml (SD 669) following TKR. By design, 90% power to detect a 50% reduction in mean blood loss (from 1191ml to 595ml) at the 5% significance level requires 54 patients (27 in each group). Thus the study was overpowered to detect reduction in blood loss (Appendix 3.11 Power calculation).

The aim was to recruit 150 patients allowing for dropout rate of 10% and providing adequate power for both primary and secondary endpoints.

3.8.2 Time frame

Our centre performs around 400 total knee replacements a year. From past experience, it was estimated that 50% would be willing to participate and that it would take about one year to complete recruitment.

3.9 Deep venous thrombosis prophylaxis protocol

Deep venous thrombosis and pulmonary embolism are not uncommon after knee replacement. There has been a wide range of prophylaxis protocols for DVT and PE. These have ranged from Physical methods (such as graduated compression/anti-embolism stockings, foot impulse and intermittent pneumatic compression devices) to pharmacological treatments (such as heparin and warfarin). Both physical and pharmacological treatments have been shown to reduce the incidence of DVT under study conditions.

The pharmacological methods carry a low but significant risk of bleeding. Under some circumstances, a low volume bleeding can be a very major complication. A few millilitres of bleeding into the brain or compressing the spinal cord within the vertebral canal can cause death or permanent disability. Small haemato-

mata entering an artificial joint can lead a serious infection causing the operation to fail, leaving the patient worse off than before surgery.

Our centre has a clear protocol for deep venous thrombosis prophylaxis which includes the followings:

- High risk patients (such as patients with a previous history of DVT or PE or overweight with a BMI of more than 30 g/m²) should receive a low molecular weight heparin and calf pump.
- Low risk patients should receive a calf pump only.

Patients with previous history of DVT and PE were excluded from our study.

3.10 Withdrawal from the trial

All patients were permitted to withdraw from the study at any point without prejudice to the routine care available.

3.11 Data management and analysis

All data was stored on a hospital computer in accordance with the Data Protection Act and accessible only to researchers and the Research Governance Committee. The master excel sheet contained no identifiable records. Each patient had a unique identifiable number which could be traced (if needed) to a particular patient. The spreadsheet was encrypted and password protected to prevent access in case of accidental loss.

Data analysis was conducted on an intention to treat basis and checked for normality using the Kolmogorov-Smirnov test (KST) and the Shapiro-Wilk's test (SWT). The former was utilised when the sample size more than 50 which was the case for most of analyses. The latter test was used when sample sizes are small ($n < 50$). If substantial non-normality was indicated ($p < 0.05$) then non parametric estimate was provided alongside the parametric findings.

Consistent with large sample assumption, parametric tests were used throughout. The premise of central limit theorem and large samples is that the theoretical distribution of sampled means will be normal even if the sampled data are not. Where KST or SWT indicated substantial non normality in the sampled

data, a bootstrap estimate was provided to explore robustness of estimates [112]. Continuous outcomes were analysed by independent (unpaired) t-tests. Blood loss, volume transfused, Hb and Hct drop, EuroQol index, Oxford knee score, length of stay and overall cost are continuous data. Categorical outcomes were analysed using Chi Square test or Fisher exact test depending on the sample size. The proportion of patients requiring blood transfusion, the proportion of patients taking antiplatelets or anticoagulants and the proportion of patients whose operation was done by a particular surgeon are categorical data.

The primary endpoint was the proportion of patients undergoing transfusion. Secondary endpoints were seen as supportive to the primary endpoint only. Thus there is no adjustment of statistical significance for multiple inferences. All tests were two-tailed and considered statistically significant at the 5% level. Statistics were obtained using SPSS for Windows statistical programme version 19 (SPSS Inc., Chicago, USA).

3.12 Safety Profile

3.12.1 Definitions

Adverse Reaction (AR): A treatment related untoward and unintended response in a participant to the study treatment as stated in the Summary of Product Characteristics (SmPC) for TXA. The followings are recognised reactions to TXA [113]:

1. Nausea
2. Dizziness
3. Vomiting
4. Diarrhoea
5. Allergic skin reaction (uncommon)
6. Rare cases of thromboembolic events and impaired colour vision have been reported with use of TXA.

Adverse Event (AE): Any untoward medical occurrence in a participant to whom the study drug has been administered. These include the complications of TKR

as well as ARs mentioned above. The followings have been reported as potential complications [50, 103-105, 108, 109]

1. Nausea and Vomiting.
2. Dizziness.
3. Pain (acute and chronic).
4. Bleeding.
5. Stiffness.
6. Neurovascular injuries.
7. Deep venous thrombosis.
8. Chest infection.
9. Pulmonary embolism.
10. Myocardial infarction.
11. Cerebrovascular accidents.
12. Infection.
13. Loosening of the prosthesis.
14. Death.

Serious Adverse Event (SAE) or Serious Adverse Reaction (SAR): Means any of the above AEs or ARs respectively if:

1. They results in death.
2. They are life threatening.
3. They results in inpatient hospitalisation.
4. They results in a persistent or significant disability / incapacity.
5. Important medical events that may not result in death, be life threatening, or require hospitalisation may be considered serious adverse drug events when, based on appropriate medical judgement, they may jeopardise the patient and may require medical or surgical intervention to prevent one of the outcomes listed in this definition. Examples of such medical events include acute renal failure, allergic bronchospasm requiring intensive treatment or blood dyscrasias.

Suspected Serious Adverse Reaction (SSAR): means one of the above mentioned adverse reactions of the Tranexamic acid that is classed in nature as serious.

Suspected Unexpected Serious Adverse Reaction (SUSAR): means an adverse reaction that is classed in nature as serious and which is not consistent with prior information about Tranexamic acid.

3.12.2 Adverse Events / Reactions Monitoring

The occurrence of serious and non serious AEs and ARs in patients on both trial arms were recorded while they were in hospital or at each subsequent hospital visit. Patients were asked about hospitalisations, consultations with other medical practitioners, disabilities or incapacity or whether any other adverse events had occurred.

SAEs were assessed and recorded in the patient's medical notes including the start dates (if known) of the onset of the event as well as the date the event stopped or changed, treatment and outcome; if applicable.

3.12.3 Adverse Event / Reaction Reporting

A standard operating procedure was developed to regulate AE and AR reporting. This includes the following:

- Non serious adverse events were recorded but not reported to the regulatory authorities. These are quite common and mostly self limiting in the first few days after surgery.
- Serious adverse events were reported to the Principal and Chief Investigators within 24 hours and evaluated for seriousness, expectedness and severity by them.

If there was a significant increase in the incidence of SAEs above the reported incidence, the local trust R&D department (the sponsor) was informed and consulted. The causality of each SAE was evaluated by the data monitoring committee (see below) and if the causality of these SAEs was linked to the Tranexamic acid, it was reported to the Medicine and Health Products Regulatory Authority (MHRA) and Research and Ethics

NHS Committee (REC) within 7 days if the event was fatal or life threatening or 15 days if the event was not fatal or life threatening.

- In accordance with the EU directive (article 16 & 17) the principal investigator reported SUSARs to the chief investigator and the local trust R&D department (the sponsor) within 24 hours of becoming aware of the event. The chief investigator and the sponsor reported SUSARs to the MHRA and REC within the required reporting timelines.

We provided the following information when reporting an SAE:

1. Protocol identification (Centre number and patient unique identification number).
2. Subject identification (Patient initials, date of birth, sex).
3. The description of the SAE, intervention and the outcome.
4. Relevant medical background.
5. Any other available information requested by the MHRA and REC or the local R&D department.

3.12.4 Data monitoring committee and interim analysis

A data monitoring committee was convened and included Professor James Mason and Professor Hungin from the School of Health and Medicine, University of Durham. They were not actively involved in the delivery of research project. Data were reviewed by them when 75 patients had been recruited to assess the safety profile or earlier if safety concerns arose. The O'Brien-Fleming approach [114] was used to conduct one interim analyses for the first 75 participants. Example calculations for prematurely stopping the trial were conducted (see Appendix 3.12 for detailed interim analysis calculations).

The primary outcome was blood transfusion rate. A reduction in the rate from 30% to 10% was considered significant. The study was aimed to recruit 150 to achieve 80% power at alpha of 0.05. The equivalent nominal P-value to stop the trial prematurely is 0.003 for the first 75 patients.

Simulating this calculation means the trial would be stopped if 19 out of 37 patients received a blood transfusion in the placebo group versus 5 out of 38 in the TXA group. This would be statistically significant with a P-value of 0.000393.

Another scenario to stop the trial prematurely would be if there was an increase of the proximal DVT incidence from 15% to 25%. The nominal P-value to stop the trial would be 0.0002. For example, this would happen if 21 patients out of 38 who received TXA developed DVT versus 5 patients out of 37 who received placebo developed DVT. This would give a P-value of 0.00021.

Theoretically, these interim analyses involve alpha spending and the value of statistical significance for the study endpoint should be adjusted. Given the small alpha spend; statistical significance remained at 5% for the primary endpoint.

Chapter 4

Results

4.1 Introduction

The evidence for the value of Tranexamic acid (TXA) by IV administration in total knee replacement (TKR) surgery has been established (chapter 2). The use of TXA topically applied to the joint is novel and thus is the subject of a trial. The methods of the trial are reported in chapter 3 and the findings are summarised in this chapter.

4.2 Ethical approvals

The trial was started on the 1st August 2008 after obtaining the mandatory approvals from:

1. University Hospital of North Tees and Hartlepool Research and Development Department: 7 April 2008 (Reference ORTHO-13) (Appendix 4.1).
2. National Research Ethic Service/ Newcastle and North Tyneside 2 Research Ethics Committee: 6 June 2008 (Reference 08/H0906/57) (Appendix 4.2).
3. Local Research Ethics Committee /County Durham & Tees Valley 2: 23 June 2008 (Appendix 4.3).
4. Medicine and Health Products Regulatory Authority (MHRA): 17 July 2008 (Reference 21166/0001/001-0002) (Appendix 4.4).

4.3 Recruitment and participants' flow chart

Recruitment occurred in the period from 14 August 2008 to 17 June 2009.

Three hundred and eighty patients were scheduled for TKR during this period. One hundred and sixty were not approached at admission due to the non availability of the designated research staff. Thirty five refused to take part in the study; twenty seven patients were excluded for various reasons such as a history of previous DVT, PE or were on Warfarin. One hundred and fifty eight patients were consented and randomised into the study. One patient allocated to TXA was excluded as he underwent a unicompartmental knee replacement (UKR) instead of TKR. He did not receive TXA and no postoperative data was collected. Therefore the study consisted of 157 participants, 78 were randomised to a placebo and 79 were randomised to TXA (Figure 4.1). Of all patients

scheduled for TKR during the study period 42% participated. Of all patients eligible and invited, 82% participated.

Figure 4.1 Flow chart of patients' recruitment and allocation

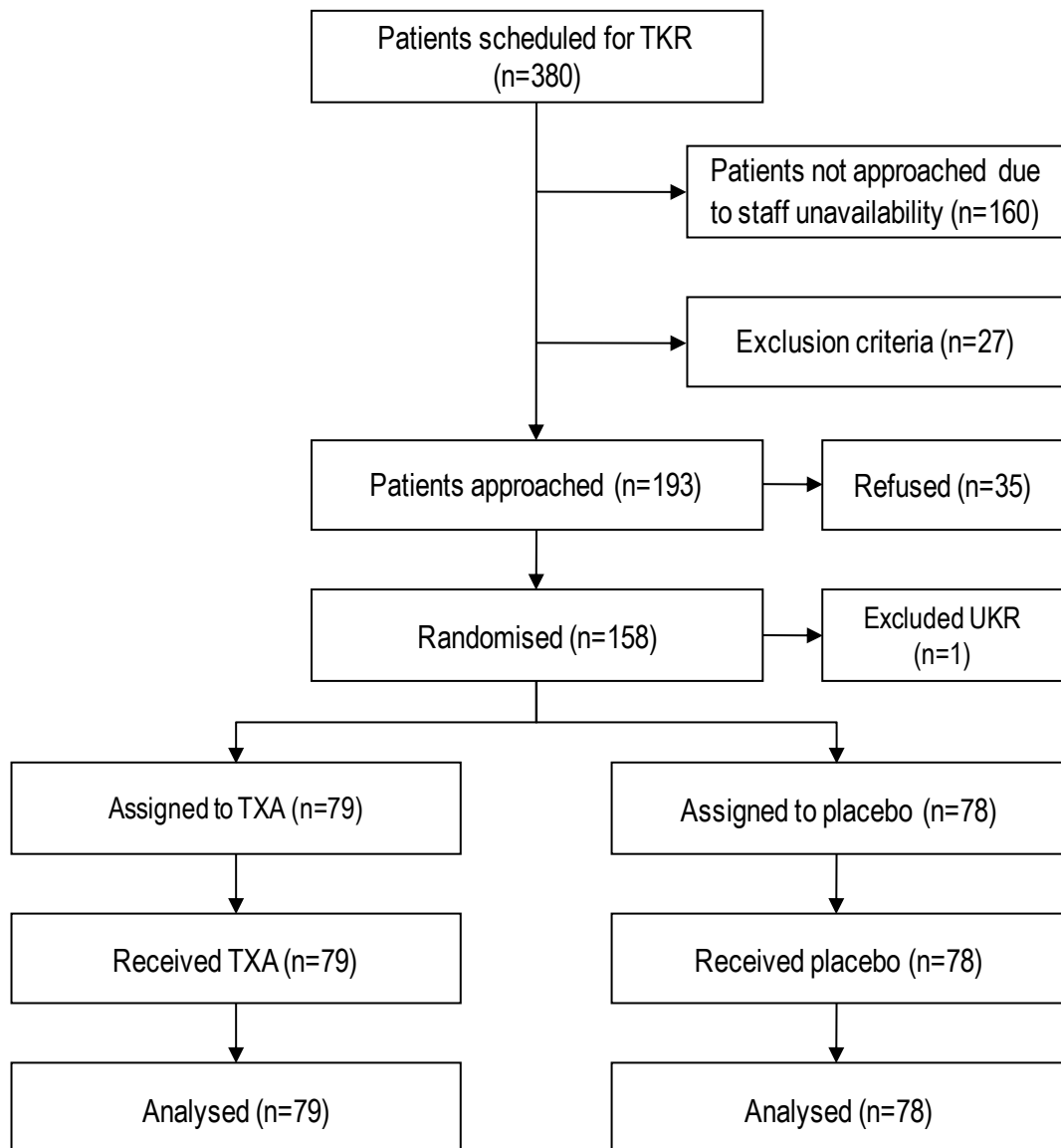

4.4 Characteristics of the study population

The two groups were compared in terms of baseline demographic characteristics, preoperative and operative variables to assess comparability as shown in table 4.1 (see Appendix 4.5 for detailed statistical analyses). There was a chance imbalance in gender with a greater proportion of male patient in the placebo group (56% versus 39%) in the TXA group (χ^2 ; $P=0.025$). The effect of this imbalance upon the findings was explored in a sensitivity analyses (see 4.6.5),

although there is no prior rationale to believe gender will interact with treatment study.

Table 4.1 Baseline characteristics of the study population*

Variables	Placebo	TXA	P-value
Number	78	79	
Age (y)	67.1 (SD 10.2)	65.5 (SD 9.6)	0.316
Male (%)	44 (56%)	30 (38%)	0.025†
BMI (kg/M ²)	31.05 (SD 5.03)	32.24 (SD 5.93)	0.209
OA / RA	65/3	72/4	0.448
IHD (%)	14 (18%)	12 (15%)	0.327
HT (%)	43 (55%)	39 (49%)	0.144
CVA / TIA (%)	4 (5%)	1 (1%)	0.159
DM (%)	5 (6%)	6 (8%)	0.557
Antiplatelets (%)	27 (35%)	25 (32%)	0.306
NSAID (%)	21 (27%)	25 (32%)	0.422
Preoperative HB (g/dl)	13.6 (SD 1.3)	13.2 (SD 1.3)	0.134
Preoperative Hct	0.397 (SD 0.036)	0.39 (SD 0.038)	0.228
Preoperative ROM (°)	93.55 (SD 28.14)	96.38 (SD 18.38)	0.609
Preoperative OKS	19.4 (SD 7.7)	19.34 (SD 7.7)	0.968
Preoperative EQ index	0.431 (SD 0.33)	0.377 (SD 0.31)	0.351
Preoperative EQ VAS (100)	59.35 (SD 18.3)	61.48 (SD 21.8)	0.579
DVT prophylaxis (LMWH) (%)	32 (41%)	38 (48%)	0.580
Tourniquet time (min).	72 (SD 10.2)	74 (SD 10.2)	0.739
Anaesthesia (GA/SA)	7/65	3/66	0.272

* See Appendix 4.5 for detailed statistics.

† Significantly greater proportion of male patients in the placebo group.

4.5 Operative data

4.5.1 Surgeons

It is understood that surgeons may vary in their surgical clinical outcomes including the level of bleeding and the need for transfusion [115, 116]. Randomisation was stratified by surgeon with a block size of 6 so that each surgeon provided a comparable number of participants in each arm of the trial.

Eight surgeons took part in the trial (Table 4.2). Their contributions varied from as low as 2 patients to 37 patients however, this was balanced between the two arms of the trial (χ^2 ; P=0.999).

Table 4.2 Number of procedures performed by surgeons

		Group		Total
		Placebo	TXA	
Surgeon	1	4	4	8
	2	7	8	15
	3	7	8	15
	4	20	17	37
	5	27	29	56
	6	1	1	2
	7	5	6	11
	8	7	6	13
Total		78	79	157

4.5.2 Type of anaesthesia

The majority of the participants (125) underwent TKR under spinal anaesthesia (SA), ten had general anaesthetics (GA), one had GA supplemented with nerve block (NB) and one had SA which did not work well and subsequently changed to GA (table 4.3).

Table 4.3 Type of anaesthesia used during surgery

		Group		Total
		Placebo	TXA	
Type anaesthesia	GA	7	3	10
	SA	61	64	125
	GA&SA	0	1	1
	GA&NB	0	1	1
Total		68	69	137

There was no difference in the proportion of participants who underwent GA or SA in the two arms of the trial (χ^2 ; P=0.272)

4.5.3 Tourniquet times (TT)

Tourniquet time in our surgical practice is almost equivalent to the operative time. All surgeons who took part in the trial followed the theatre protocol which stated that the tourniquet should be inflated after draping and before the surgery was started. There is a controversy whether tourniquet time affects blood loss and subsequent need for transfusion [117-120]. Data on tourniquet times were available for more than 85% of the participants. There was no significant difference between groups (t-test; $P=0.788$) (table 4.4).

Table 4.4 Tourniquet times between the two arms of the study

	Group	N	Mean	SD	Mean Difference	95% CI P-Value
TT (min)	Placebo	66	73.08	17.284	-0.767	-6.42 to 4.88 0.788
	TXA	70	73.84	16.036		

4.5.4 Operative blood loss

All TKRs were performed in a bloodless field using a tourniquet so that intra-operative blood loss should be minimal [9]. To achieve a true bloodless field depends on number factors including the pressure of the tourniquet, the size and shape of the leg and the pneumatic cuff, the blood pressure of the patients and type of anaesthesia. This range of factors explains the wide range of intra-operative blood loss in our series (30 ml to 600 ml, median 50 ml). As expected intra-operative blood loss was not normally distributed (Kolmogorov-Smirnov test; $P<0.0001$).

The median operative blood loss was 50 ml (range 30-600 ml) in the placebo group and 68 ml (range 35-500 ml) in the TXA group. The difference in medians was 18 ml and this was not statistically significant (Mann Whitney U test; $P=0.577$) (see Appendix 4.6 for detailed statistical analyses).

4.6 Outcomes (postoperative) data

4.6.1 Blood transfusion

Fourteen participants received a blood transfusion ranging from 2 to 6 units. Thirteen participants (16.7%) were in the placebo group and one patient (1.3%)

in the TXA group. There was a statistically significant reduction in the use of transfusion (Fisher exact test; $P=0.001$).

A total of 34 units of blood were used. Thirty two units were transfused to participants in the placebo group versus two units only to a participant in the TXA group. This was a statistically significant finding (Mann Whitney U, $Z=-3.38$; $P=0.001$).

Within the Tranx-K trial, a single participant received a blood transfusion in the TXA group. She was 76 years old lady, overweight (BMI=48.5) with significant co-morbidities including ischaemic heart disease, hypertension and hypercholesterolemia, and on aspirin. Her drain blood loss was 450 ml and her postoperative Hb level was 8.6 g/l. She developed chest pain and tachycardia which was relieved by her anti-angina treatment. She was given two units of blood as per trial protocol. The same patient developed a DVT later which was subsequently treated with Warfarin.

4.6.2 Drain blood loss

Drain blood loss was measured in ml. Data from 83% of participants were eligible for inclusion and analysis. Some drains were removed without recording the amount of blood loss and several drains fell out during recovery. Data on drain blood loss was non-normally distributed ($KST < 0.001$). Although the large sample assumption validates a parametric testing approach, non parametric findings are also provided.

The mean drain blood was 465 ml (SD 298, $N=65$) in the placebo group and 296.7 ml (SD 195.6, $N=64$) in the TXA group. The mean difference was 168 ml (95% CI: 80 to 256 ml, $p=0.00025$). The Bootstrapped estimate of the mean difference was 168 ml (95% CI: 85 to 256 ml, $P=0.001$) (tables 4.5 and 4.6).

Table 4.5 Drain blood loss; parametric t-test

	Group	N	Mean	SD	Mean difference	95% CI P-value
Drain	Placebo	65	465	298	168	80 to 256
	TXA	64	297	196		0.00025

Table 4.6 Drain blood loss; non parametric bootstrap

		Mean Difference	Bootstrap ^a			
			Bias	Std. Error	Sig. (2-tailed)	95% Confidence Interval Lower Upper
Drain	Equal variances assumed	168	0.347	44	0.001	84 256
	Equal variances not assumed	168	0.347	44	0.001	84 256

a. Unless otherwise noted, bootstrap results are based on 10000 bootstrap samples

For completeness, a further non parametric test (the Mann Whitney U) was also estimated the finding remained significant (Mann Whitney U, Z= -4.015; P<0.001).

4.6.3 Postoperative Hb and Hct

Blood tests for Hb and Hct were performed on postoperative day 2 unless there was a clinical need to do it earlier. There was a full set of data for these variables. Data were normally distributed. There were statistically significant difference in the reduction of postoperative Hb (-0.83 g/dl; P<0.0001) and Hct (-0.027; P<0.0001) in the TXA group when compared to placebo (Table 4.7).

Table 4.7 postoperative Hb and Hct between the two groups

	Group	N	Mean	SD	Mean difference	95% CI P-value
Postop Hb	Placebo	78	10.69	1.35	-0.83	-0.84 to -1.43
	TXA	79	11.52	1.33		<0.0001
Postop Hct	Placebo	78	0.31	0.04	-0.027	-1.26 to -0.41
	TXA	79	0.34	0.04		<0.0001

For completeness these findings were also analysed as change in scores. The drop in Hb level after the operation was calculated by subtracting the postoperative Hb level from the preoperative Hb level for the two arms of the trial. The mean drop in Hb level was significantly higher in the placebo group. It was 2.89 g/l in the placebo group vs. 1.75 g/l in the TXA group. Mean difference between the two arms was 1.138 g/l (95% CI: 0.84 to 1.43; P<0.00001).

4.6.4 Length of stay (LOS)

Length of stay data was available for more than 95% of the participants. As data were non-normal (Kolmogorov-Smirnov test, P<0.0001), parametric and non parametric tests were used to assess the significance of this important outcome. Patients who received placebo had a mean of stay of 6.1 days in hospital while patients received TXA spent 4.8 days with a mean difference of 1.2 days (95% CI: 0.053 to 2.425, p-value 0.041), using a parametric approach. Additionally, the mean and confidence interval were estimated using a bootstrapping approach. This found a mean difference of 1.24 days (95% CI: 0.19 to 2.43; P=0.052) (Table 4.9). This finding was very similar to the parametric mean and confidence interval.

Table 4.8 Bootstrap for the length of stay in the two arms of the trial

		Mean Difference	Bootstrap ^a				
			Bias	Std. Error	Sig. (2- tailed)	95% Confidence Interval	
						Lower	Upper
LOS	Equal variances assumed	1.239	0.0001	0.590	0.052	0.137	2.462
	Equal variances not assumed	1.239	0.0001	0.590	0.053	0.137	2.462

a. Unless otherwise noted, bootstrap results are based on 10000 bootstrap samples

4.6.5 Sensitivity analyses of gender imbalance

The finding that Table 4.1 reveals that only gender was unusually different between the two groups. This was explored further by investigating the effect of gender (being a male or female) on blood transfusion rate, drain blood loss, Hb drop and LOS in the placebo and TXA groups. There were no significant differences among these outcomes (Table 4.9 and 4.10). Hence, this imbalance between the two arms of the study regarding the gender had no influence on the final conclusion; consistent with prior clinical expectation.

Table 4.9 the effect of gender on the trial findings in the placebo group

Variable	sex	N	Mean	P-Value
BT	Male	44	5	0.542
	Female	34	8	
Drain (ml)	Male	38	475	0.723
	Female	29	448	
LOS (days)	Male	42	6.33	0.565
	Female	31	5.71	
HB-drop	Male	44	2.95	0.578
	Female	34	2.82	

Table 4.10 the effect of gender on trial findings in the TXA group

Variable	sex	N	Mean	P-Value
BT	Male	30	0	1.000
	Female	49	1	
Drain (ml)	Male	24	357	0.094
	Female	40	261	
LOS (days)	Male	30	4.80	0.894
	Female	47	4.87	
HB-drop	Male	30	1.87	0.337
	Female	49	1.68	

Of interest, both tables revealed that males bled slightly more than females as shown by higher drain blood losses and Hb drops. Although, this did not reach clinical or statistical significance to influence our conclusions, but the study was not powered to detect such a difference (Type II error).

4.6.6 Postoperative outcomes scores

Postoperative outcome measures (OKS, EQ-5D and EQ-VAS) were completed about three months after the operation. Data showed a non normal distribution. The differences were estimated parametrically and non-parametrically. There were no significant differences between the two arms of the study with regards to these three outcomes (table 4.11).

**Table 4.11 Preoperative and postoperative outcomes scores;
parametric: t-test**

	Mean Placebo	Mean TXA	Mean Difference	Sig. (2-tailed)	Std. Error Difference	95% Confidence Interval	
						Lower	Upper
Preoperative OKS	19.4	19.34	0.056	0.968	1.394	-2.704	2.816
Postoperative OKS	35.91	34.83	1.081	0.557	1.832	-2.555	4.717
Preoperative EQ-5D Index	0.431	0.377	0.054	0.351	0.058	-0.060	0.168
Postoperative EQ-5D Index	0.780	0.705	0.075	0.187	0.057	-0.037	0.188
Preoperative EQ-VAS	59.35	61.48	2.131	0.579	3.827	-9.714	5.453
Postoperative EQ-VAS	75.57	75.19	0.382	0.917	3.649	-6.861	7.625

4.6.7 Range of motion (ROM)

Postoperative ROM was measured before the operation and about three months after the operation. Data were normal for TXA group but non-normal for the placebo group. The differences were estimated parametrically and non-parametrically and there were no significant differences between the two groups of the study (MD=2.8°; 95% CI: -5 to 11, t-test; P=0.45).

4.6.8 Complications

There were few complications in both arms of the study. These are summarised in table 4.12. There were no statistically significant differences between the two arms of the study with regards to any of these complications.

Table 4.12 Complications in both arms of the trial

Complications	Placebo	TXA	Fisher exact test
Deep Venous Thrombosis	0	2	0.497
Pulmonary Embolism	0	0	
CVA / TIA	1	0	0.241
Chest infection	1	0	0.427
Periprosthetic fracture	1	0	0.427
Superficial infection	1	1	0.736
Deep infection	1	0	0.427

4.6.9 Cost analysis

The main cost was that of the index operation which was similar in both arms of the trial. However, extra costs were incurred by the cost of blood transfusion, LOS and the complications.

Costs were obtained from the Trust's Finance department. Hospital procedures are charged according to nationally determined tariffs. These are coarsely costed by procedures type with some adjustment for complexity. Five tariff codes had been used to price the primary TKR in the study (table 4.13). The code HO4 was used in the year 2008/9 while others were used in the year 2009/10. The majority of the operations (n = 104) were priced according to the code HO4 which is equivalent to £5663. There was no significant difference between the two group regarding the tariff codes distribution (χ^2 ; P=0.29).

**Table 4.13 Distribution of Tariff codes
between the two groups of the study**

Tariff Code	Value (£)	Group		Total
		Placebo	TXA	
HB21C	4102	6	1	7
HB21B	4922	18	22	40
HO4	5663	52	52	104
HA06Z	7248	1	1	2
HB21A	7747	1	3	4
Total		78	79	157

Based on tariff charges, the mean cost per patient in the TXA group was £5536 (SD £607.5) and £5419 (SD £689) in the placebo group. As expected, the data was non-normally distributed (KST, $P < 0.0001$). Neither parametric nor non-parametric tests showed a significant difference in the two groups. The limitation of the use of tariffs is that they are too crude to capture actual variation in the use of resources between patients.

Trial findings showed that patients in the TXA arm had fewer transfusions 2 units versus 34 units and reduced LOS (4.8 vs. 6.1 days) compared to the control group. The current cost of one unit of blood is £133 and the cost of one day stay in hospital is £230. The cost of two TXA ampoules (1g) is £2.20. The net cost of TXA, transfused blood and hospital stay was calculated. The data was non-normal (KST $P < 0.0001$). Parametric and non-parametric tests were used to assess the significance of differences in these patient level costs.

The net cost saving was £333 per patient. The mean net cost was £1117.6 (SD 537.7) in the TXA group and £1450.8 (SD 1157) in the placebo group. This was statistically significant using parametric test (95% CI: 37 to 630; $P = 0.028$) (table 4.15). A bootstrapping approach based on 10 000 bootstrap samples found a similar result to that of the parametric test; mean difference of £333 (95% CI: 62.35 to 641.21; $P = 0.044$) (table 4.16).

Table 4.14 Net cost saving; parametric t-test

	Group	N	Mean	SD	Mean difference	95% CI P-value
Net Cost Saving	Placebo	72	1450.88	1156.99	333.27	36.65 to 629.9 0.028
	TXA	77	1117.61	537.7		

Table 4.15 Net cost saving; non parametric test: Bootstrap

		Mean Difference	Bootstrap ^a		Sig. (2-tailed)	95% Confidence Interval	
			Bias	Std. Error		Lower	Upper
Net Cost	Equal variances assumed	333.28	0.055	147.23	0.042	62.35	641.21
	Equal variances not assumed	333.28	0.055	147.23	0.044	62.35	641.21

a. Unless otherwise noted, bootstrap results are based on 10000 bootstrap samples

This was not statistically significant using non-parametric test (Mann Whitney U test P=0.057).

It was not possible to include the cost of rare complications within studies (see 4.6.7) because of their chance nature and difficulty identifying total cost of care. However, complications identified would be likely to increase the net saving due to TXA.

In overview there were borderline statistically significant cost savings which should be set alongside the significant reduction in length of stay and transfusion which are important clinical and patient outcomes.

4.7 Interpretation of trial findings

4.7.1 Blood transfusion

In the systematic review and meta-analysis described in this thesis (chapter 2), 19 trials were reviewed that used IV TXA in TKR including 1218 participants. Thirteen trials compared TXA to a placebo, 2 trials compared TXA to Desmopressin, 1 trial compared TXA to Aprotinin, 1 trial compared TXA to EACA and 1 trial compared TXA to fibrin spray. All trials but one used IV preparations. The mean dose of TXA used ranged from 700 to 10500 mg.

TXA led to a significant reduction in the blood transfusion rate in the 16 trials that reported on blood transfusion as an outcome. Of 944 participants, 501 received TXA and 443 received a placebo. One hundred and ten (21.9%) participants received blood transfusion in the TXA group while 214 (48.3%) received blood transfusions in the placebo group. Systematically delivered TXA reduced the risk of transfusion to about 45% of placebo level (from 48.3% to 21.9%). This was statistically significant (RR 2.72; 95% CI: 2.25 to 3.27; $P < 0.00001$). However, there was evidence of significant heterogeneity among the studies ($Q, P = 0.00001$; $I^2 = 77\%$).

The Tranx-K trial recruited 177 participants with 79 receiving TXA and 78 received a placebo. One participant (1.2%) only received blood transfusion in the TXA group while 13 participants (16.6%) received blood transfusion in the placebo group. Thus topically applied TXA reduced the risk of transfusion 13 folds, a statistically significant finding (Fisher exact test; $P = 0.001$). When compared to previous IV administered trials (Figure 4.2 and 4.3), the efficacy of topical TXA in reducing blood transfusion was greater. This result was almost matched by one trial only (Camarasa 2006) [72] of 127 participants comparing TXA, EACA and placebo. One participant (2.8%) received blood transfusion in TXA group, 4 (12.8%) received blood in the EACA group and 23 (33.8%) received blood transfusion in the placebo group. In spite of the comparable transfusion trigger, there was a higher transfusion rate in their placebo group (33.8%) than our study placebo group (16.6%). A potential confounding factor was the use of perioperative Cell Saver in 23.3% of placebo group and 28.6% of the TXA group which might have affected the transfusion rate.

Figure 4.2 Trials of TXA vs. Placebo; forest plot of blood transfusion rate including Tranx-K trial

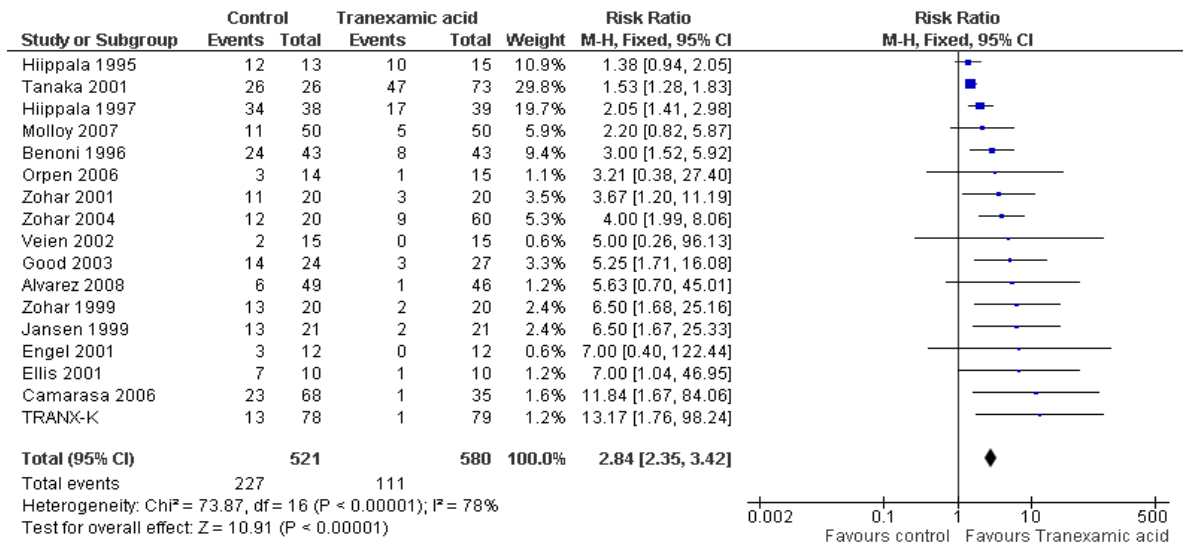
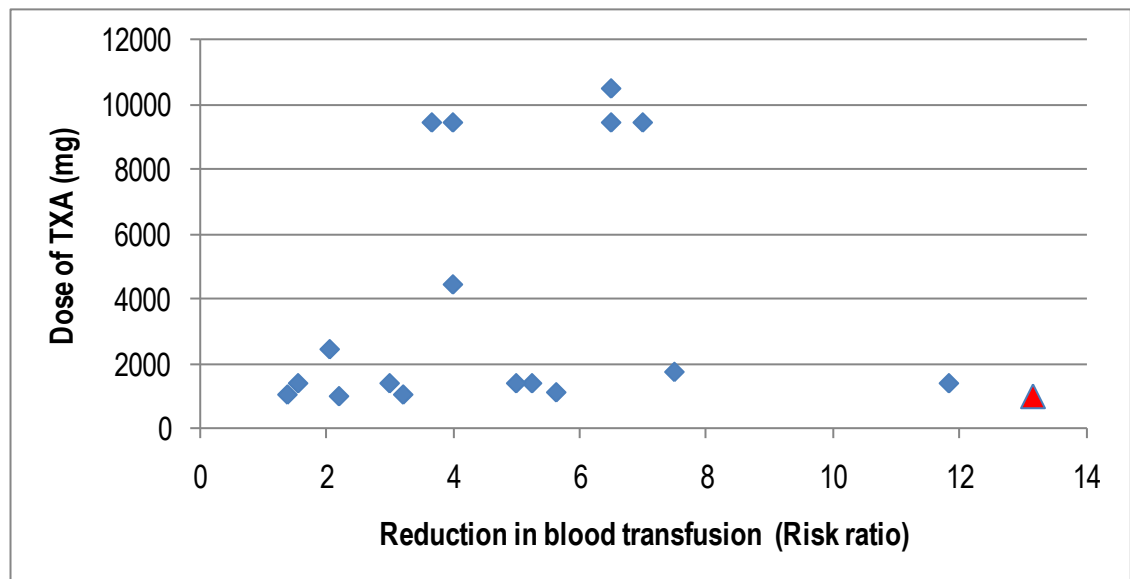

Figure 4.3 Scatter plot of TXA Dose versus the reduction in blood transfusion rates*



* *Tranx-K trial is represented by the red triangle*

The implication of the Tranx-K trial finding is that a low dose topically applied TXA is more effective than intravenously delivered TXA. This could be explained by the difference in the volume of distribution of the two mode of delivery. Intravenous TXA is distributed in the whole body fluid reducing its therapeutic

tic concentration in the knee while topically applied TXA is distributed in the knee joint cavity predominantly, thus achieving a higher therapeutic concentration.

4.7.2 Drain blood loss

The meta-analysis (chapter 2) showed that systemically delivered TXA significantly reduced external blood loss by 192 ml (95% CI: 168 to 217 ml; $P = 0.00001$) and total blood loss by 591 ml (95% CI: 536 to 646 ml; $P = 0.00001$) respectively. There was significant heterogeneity in the finding ($Q, P = 0.00001; I^2 = 89\%$) and ($Q, P = 0.0001; I^2 = 78\%$) respectively.

In the Tranx-k trial, this study, the drain blood loss was significantly lower in the TXA group. The mean drain blood was 465 ml in the placebo group and 296.7 ml in the TXA group. The mean difference was 168 ml (95% CI: 80 to 256 ml, $p = 0.00025$). When this is plotted against other trials results, the study has a similar efficacy in reducing drain blood loss to IV TXA, but excluding oral TXA (Figure 4.4).

Figure 4.4 Graph of TXA dose versus percentage reduction in drain blood loss*

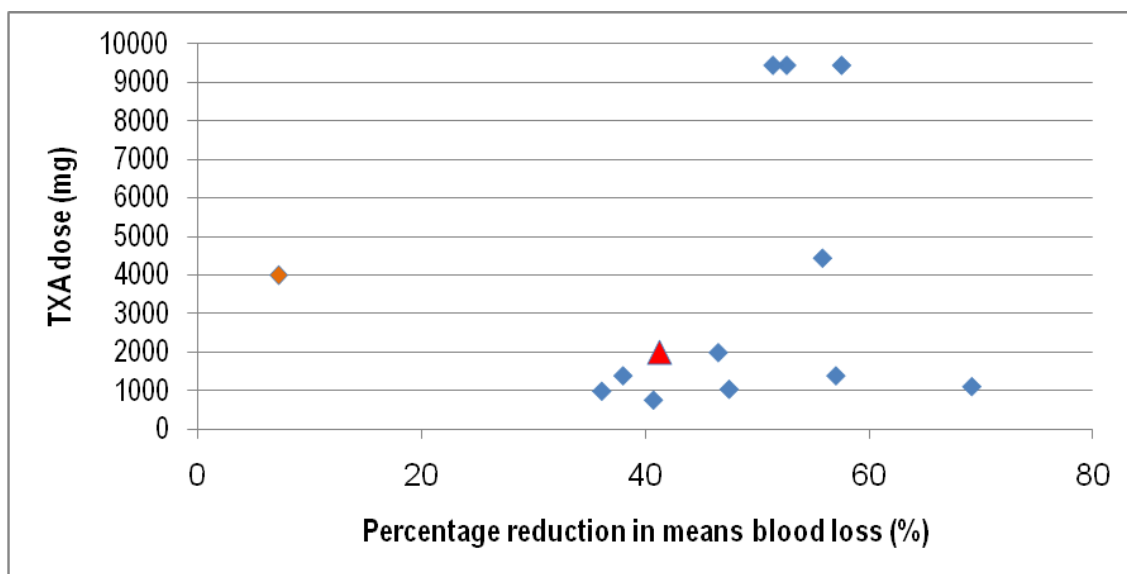

* *Tranx-K trial is represented by the red triangle. Trial used oral TXA represented by an orange diamond.*

This prompts the question of how topical TXA can be superior in reducing blood transfusion in TKR, but no better at reducing drain blood loss. Operative blood loss was negligible in our trial and in published trials and therefore cannot explain this paradox.

Careful scrutiny of the drain blood loss and transfusion rate among the published trials showed no relationship (Table 4.17 and Figure 4.5). For example, Zohar [20] showed TXA reduced mean drain blood loss from 259 ml to 110 ml and transfusion rate from 65% to 10%. This is a small amount of drain blood loss but a big drop in transfusion rate. Benoni [17] reduced the mean drain blood loss from 1210 ml to 520 ml and transfusion rate from 56% to 19%. This is a bigger reduction in mean drain blood loss than Zohar, but a smaller drop in transfusion rate.

Table 4.16 Trials providing data on drain blood loss and blood transfusion rate

Study	Drain Blood loss in placebo	Transfusion rate in placebo	Drain Blood loss in TXA	Transfusion rate in TXA
Zohar 1999	259	0.65	110	0.10
Alvarez 2008	551	0.12	170	0.02
Camarasa 2006	1270	0.34	787	0.03
Zohar 2001	342	0.55	162	0.15
Benoni 1996	1210	0.56	520	0.19
Zohar 2004 short	249	0.60	110	0.10
Zohar 2004 Long	249	0.60	121	0.15
Zohar 2004 Oral	249	0.60	231	0.20
Hiippala 1995	558	0.92	293	0.67

Figure 4.5 Graph of the mean differences in drain blood loss and risk ratio of blood transfusion rates

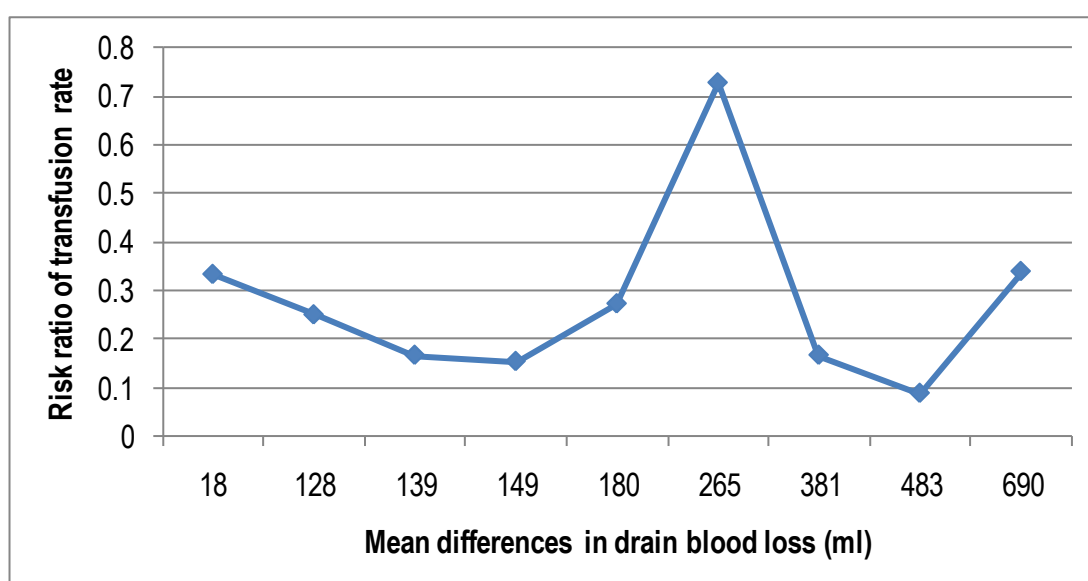

The review (chapter 2) showed significant heterogeneity in the data of drain blood loss in the included trials ($Q, P=0.00001$; $I^2 = 89\%$) (Figure 2.4) and the source of heterogeneity was explored. Tranx-K mean drain blood loss in the placebo group data was low when compared to other trials (Figure 4.6). This may partly explain the low reduction in mean drain blood loss.

Figure 4.6 Mean drain blood loss in the placebo groups in the published trials including Tranx-K trial*

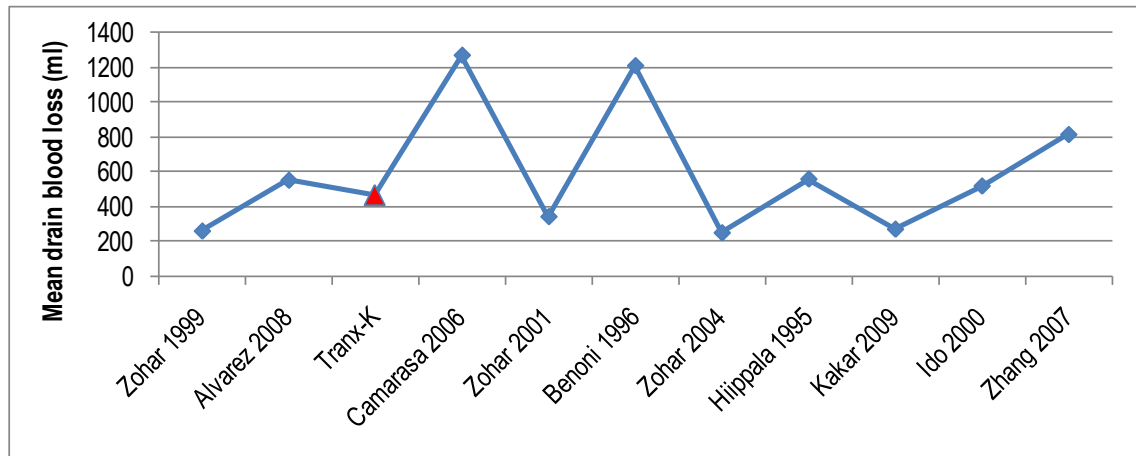

* *Tranx-K trial is represented by the red triangle.*

It is clear that there was a significant amount of blood loss not accounted for. The reduction in the amount of drain blood loss and the recorded total blood loss were too low to explain the magnitude of reduction in the blood transfusion rate. This is true for other published trials.

It is well known that some blood loss is not clinically visible. Eipe [121] showed that 64% of surgical blood loss was underestimated using clinical methods assessing blood soaked mops and gauze pieces, measuring blood lost to suction bottles and the vacuum drain. He recommended using a biochemical method based on Hct. Several formulas can measure the total blood loss using Hct changes, such Gross's formula [121, 122]. According to this formula, the total blood loss can be estimated by the following steps:

1. The estimated total blood volume (EBV) of an average adult male is about 75 ml/kg and that of an average female is about 65ml/kg.
2. The estimation of red blood cell volume (RBCV) at preoperative Hct.

$$RBCV_{preop} = TBV \times Hct_{preop}.$$
3. The estimation of red blood cell volume (RBCV) at postoperative Hct.

$$RBCV_{postop} = TBV \times Hct_{Postop}.$$
4. The difference in RBCV represents the amount blood loss.

$$RBCV_{dif} = RBCV_{preop} - RBCV_{Postop}.$$

5. The blood loss is calculated from the fall in red blood cell volume.

$$\text{Blood loss} = \text{RBCV}_{\text{dif}} / \text{Hct}_{\text{Postop}}$$

The total blood volume of patients at baseline was comparable in the two arms of the study. The mean blood volume in the placebo group was 6148 ml (SD 1595 ml) and 6050 ml (SD 1469 ml) in the TXA group and these variables were normally distributed (KST 0.2). The mean difference was 98.6 ml (95% CI: -443.8 to 641.1 ml; P=0.72). The mean estimated total blood loss was 1725 ml (SD 823 ml) in the placebo group and 918.6 ml (SD 487.3ml) in the TXA with a mean difference of 806.3 ml a statistically significant difference (95% CI: 564.7 to 1048 ml; P<0.0001). This finding was anticipated from fall in Hct and Hb after the operation.

The difference between the visible and estimated blood loss, which may also be referred to as hidden blood loss, is caused by haemodilution, haemolysis and the blood dissipated in the tissue planes, cavities or drapes. The amount of bleeding in the tissues around the wound is difficult to estimate and may be of clinical importance. Researchers have tried several techniques to estimate such blood loss, all have some limitations.

Benoni et al [17] measured the knee circumference just above the patella on the day before surgery and three days after operation. It was found that there was no statistical difference between the placebo group and the TXA group in their study (2.7 ± 2.9 cm vs. 21.1 ± 4 cm). It is well known that postoperative swelling is not always caused by bleeding or haematoma rendering this approach of limited value in estimating hidden blood loss. Postoperative swelling can be caused by inflammation, tissue swelling, uneven layers closure, anatomical changes caused by implant size and position. Furthermore, postoperative swelling reduced at various rates among patients.

Ultrasound assessment has been shown as an accurate method to assess the number and size of haematomas [123]. Benoni et al [124] investigated the effect of TXA on blood loss in total hip replacement (THR) in a placebo controlled trial. They used ultrasound to assess the number and size of haematomas in the operated thigh by the same radiologist and found that there was no difference in the number and size of haematomas between the two groups (TXA group: 270

ml vs. placebo: 319 ml; P=0.20). Calculating the true volume of effusion and haematoma using ultrasound is very difficult because of the numerous synovial recesses and complex anatomy of the knee joint and it is operator dependent [125]. Furthermore, it is not always readily available and incurs some cost.

In our study, hidden blood loss was estimated using Gross's formula. There was a statistically significant difference between the two groups with regard to the hidden blood loss in favour of TXA use. The mean difference was 538 ml (95% CI: 312 to 763 ml, t-test; P<0.001). The effect of this hidden blood loss on knee function was assessed using the Oxford knee score, EuroQol questionnaire, range of motion and wound complications. There were no significant differences between the above variables in the two groups.

4.7.3 Length of stay

Tranx-K trial found that patients receiving TXA stayed on average 1.24 days less than patients receiving placebo (95% CI: 0.19 to 2.43; P=0.052). The pooled data from 3 published trials which provided data on LOS (Figure 2.7) showed that patients receiving TXA spent an average of 0.77 day less in hospital than the control group but this was not statistically significant (95% CI: -1.55 to 0.14 days; P= 0.10). However, including the result of our trial in the analysis shifted this to a statistically significant difference of 0.9 day (95% CI: -1.58 to -0.22; P=0.01) (figure 4.7).

Figure 4.7 Trials of TXA vs. Placebo; forest plot of LOS after TKR including Tranx-k study

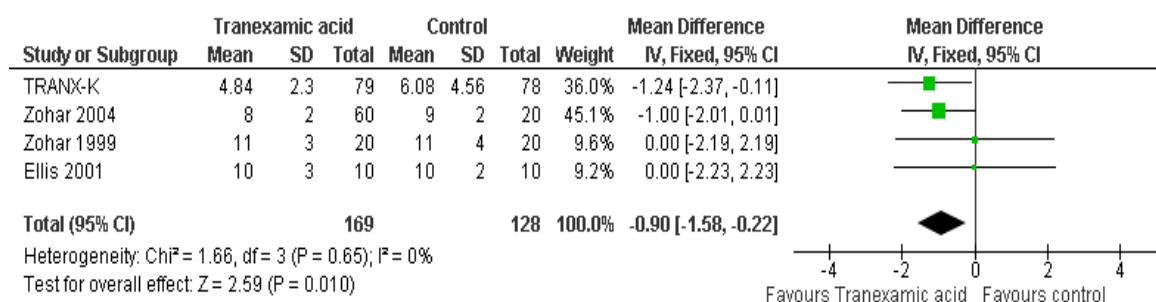

4.8 Summary of findings

The first trial of topically applied TXA in TKR produced clinically important findings. There was a significant and important reduction in primary end point of blood transfusion by 13 folds (16% vs. 1.3%; FET; P=0.01). This effect was greater than that achieved by oral or intravenous modalities published in other trials.

Secondary endpoints provided supportive findings consistent with the primary endpoint. There were significant reduction in total and drain blood loss, Hb and Hct drops and length of stay. There were borderline cost savings from reduced transfusion rate and length of stay.

There was no evidence of short term influence on the patient outcome measures OKS, EQ-5D and EQ-VAS although these measures are not sometimes sensitive enough to find small changes in a trial of this size.

Chapter 5

The Effect of Tranexamic Acid on Artificial Joint Materials

5.1 Introduction

A major cause of artificial joint failure is the loosening that occurs as a consequence of wear and tear of the bearing surfaces. Even a well performing prosthetic joint releases billions of microscopic wear particles (debris) into the joint space. When an excessive amount of debris is generated it may stimulate a severe body reaction in the capsular tissues and bone leading to inflammation and osteolysis. The resulting loss of supporting bone may lead to loosening of the implants requiring difficult revision surgery.

The artificial knee joint consists of two metal surfaces which are made of cobalt chromium (Co-Cr) alloy and an insert made of ultra high molecular weight polyethylene (UHMWPE) (chapter 1). The mechanical properties of these two materials are influenced by several chemical and physical factors. Oxidation breaks down the molecular chains in UHMWPE resulting in increased brittleness and reduced resistance to crack propagation. Historically, there have been unfortunate consequences within artificial joints when unexpected and unwanted chemical or physical reactions led to severe wear and joint failure. One example arose from the storage of artificial implants in air filled packets after sterilization using gamma radiation. This mode of storage led to gradual oxidation of the UHMWPE and deterioration of its mechanical properties. This was partly overcome by storage within a vacuum-sealed packet. Another example was post irradiation thermal treatment to reduce free radicals in the polyethylene. This could cause a partial reduction in crystallinity of the material that, in turn reduced the resistance to crack propagation [126].

The use of local TXA to reduce blood loss in artificial joint replacement might affect the biomechanical properties of artificial implants, wear rate and subsequent loosening and failure. A rigorous search of the published literature, contact with manufacturers and contact with the community publishing on the use of TXA uncovered no research to address this issue. Consequently, reported here, is the first study to investigate the effect of local TXA upon artificial joint biomechanical properties and performance. The research is named the Bio-TRANX study.

Tranexamic acid is a white crystalline powder. The aqueous solution for injection has a pH of 6.5 to 8.0 ranging from mild acid to mild alkaline.

5.2 Declaration

The BioTRANX study was conducted in the Bioengineering laboratory of School of Engineering and Computing Sciences, Durham University, South Road, Durham DH1 3LE between October 2009 and April 2010. All testing materials were provided free of charge by DePuy International Ltd.

5.3 Methodology

In this biomechanical study we investigated the effects of TXA on the following biomechanical properties of artificial knee materials:

1. Tensile properties of the UHMWPE:
 - a. Ultimate strength.
 - b. Stiffness.
 - c. Young Modulus.

2. The wear rate using a multi-directional pin-on-plate machine. Pins were made of UHMWPE and plates were made of Co-Cr.

3. The surface topography of pins and plates before and after wear rate testing:
 - a. Peak-Valley ratio (PV). The distance between the highest peak and the deepest valley over the entire evaluation length (Figure 5.1).

Figure 5.1 Peak-Valley ratio (PV)

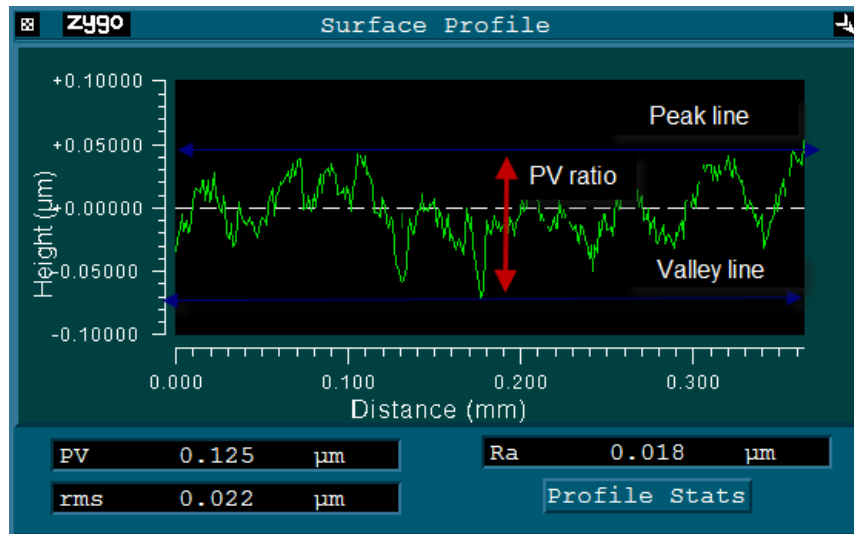

- b. Root mean square roughness (rms). An average of the measured height deviations taken within the evaluation length or area and measured from the mean linear surface.
- c. Surface roughness average (Ra). The average roughness or deviation of all points from a plane (centre line) fitted to the test surface (Figure 5.2).

Figure 5.2 Surface roughness average (Ra)

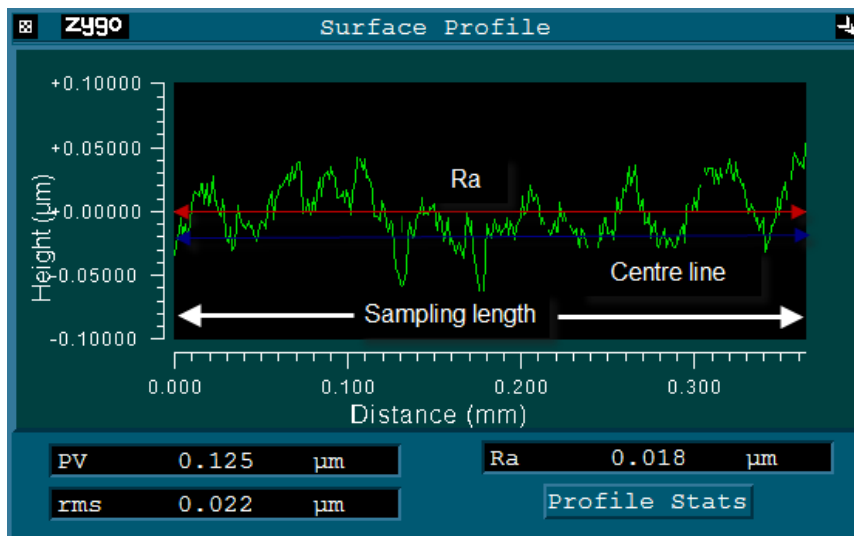

5.3.1 Tensile testing

The test was conducted by gripping the ends of a standardised test specimen made of UHMWPE (Figure 5.3), in a tensile test machine (Figure 5.4) and then applying a gradually increasing axial load until failure occurs. This produces a typical stress-strain curve (Figure 5.5).

Figure 5.3 Tensile specimens made of UHMWPE

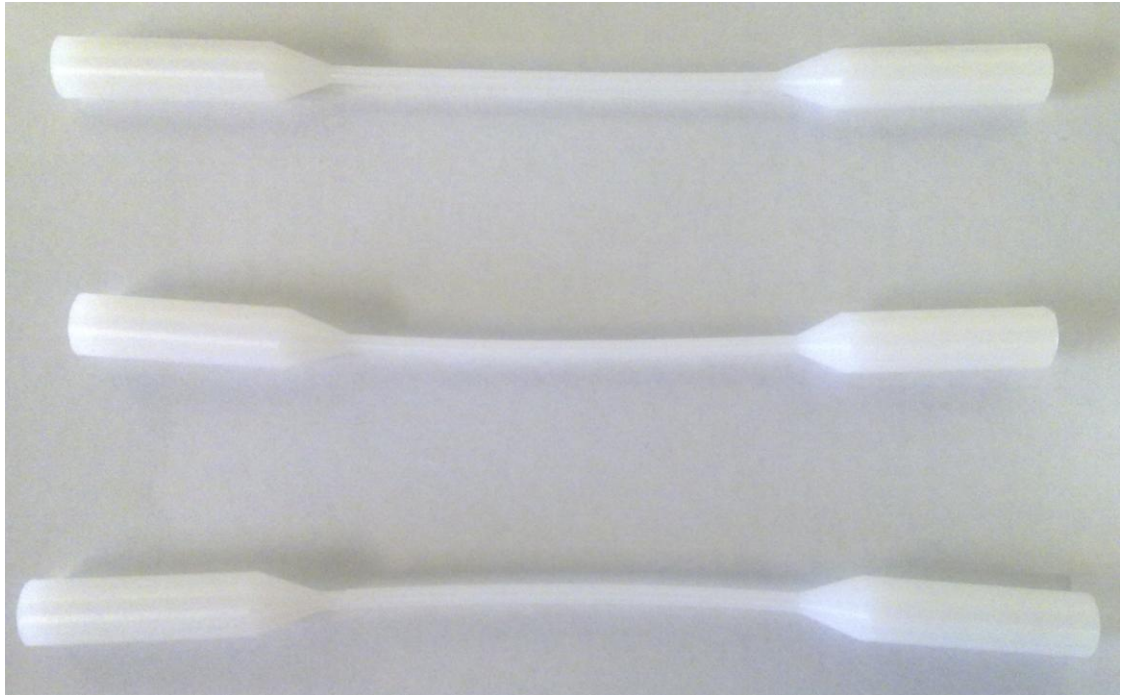
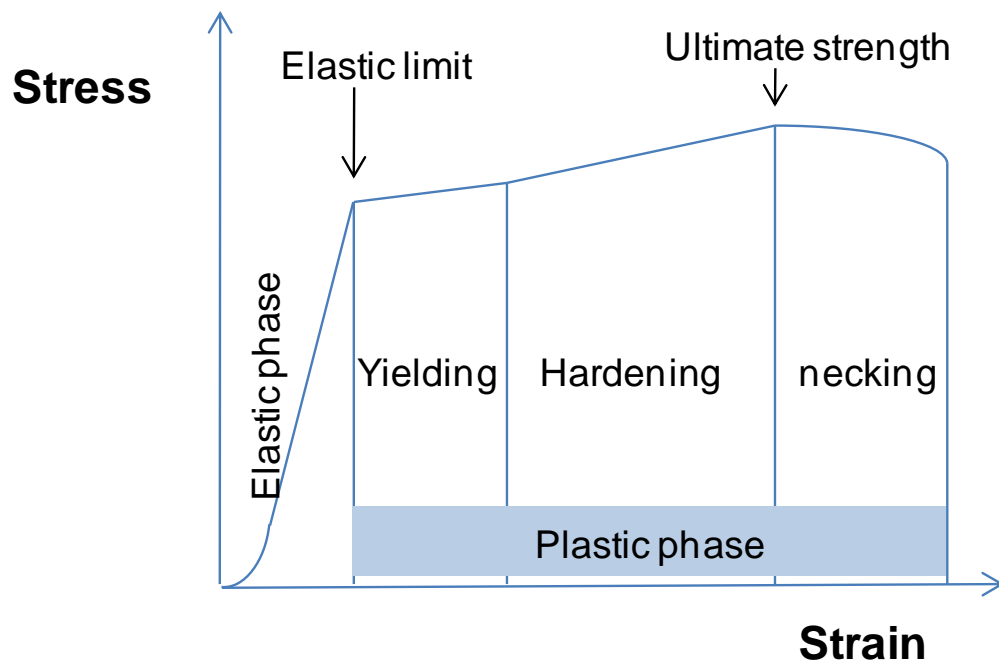

Figure 5.4 Tensile testing machine with a specimen made of UHMWPE mounted



Several calculations can be made to describe the biomechanical properties of a material from its stress-strain curve. Stress is the force applied per unit area (N/m^2). Strain is the change in length divided by the original length. The stress obtained at the highest applied force is the Ultimate Tensile Strength. The stiffness is the resistance of material to deformation while Young's modulus is found by dividing the stress by strain over the linear portion of stress strain curve [127].

Figure 5.5 A typical stress-strain curve



Fifteen tensile specimens were made of UHMWPE (Figure 5.3), five were soaked in TXA solution (1 g / 50 ml saline) for 48 hours, five were soaked in 50 ml of saline and the other five were used to standardise the tensile testing machine. Specimens were placed in the testing machine and a gradually increasing load was applied until failure of the specimen. Ultimate tensile strength, stiffness and Young's modulus were calculated for each specimen.

5.3.2 Wear rate

In addition to simple load testing, continuous motion wear testing was performed to assess the influence of TXA under accelerated body wear conditions. This test was performed using a multidirectional pin-on-plate machine (Figure 5.6). It is a four station machine applying both reciprocational and rotational motion. The reciprocation was applied by a sledge moving forward and backward over a 4 cm range (± 2 cm) at 60 cycles per minutes. The heated bed, lubricant tray, level sensor and plate holders are positioned on this sledge.

Figure 5.6 Schematic diagram of the pin-on-plate machine

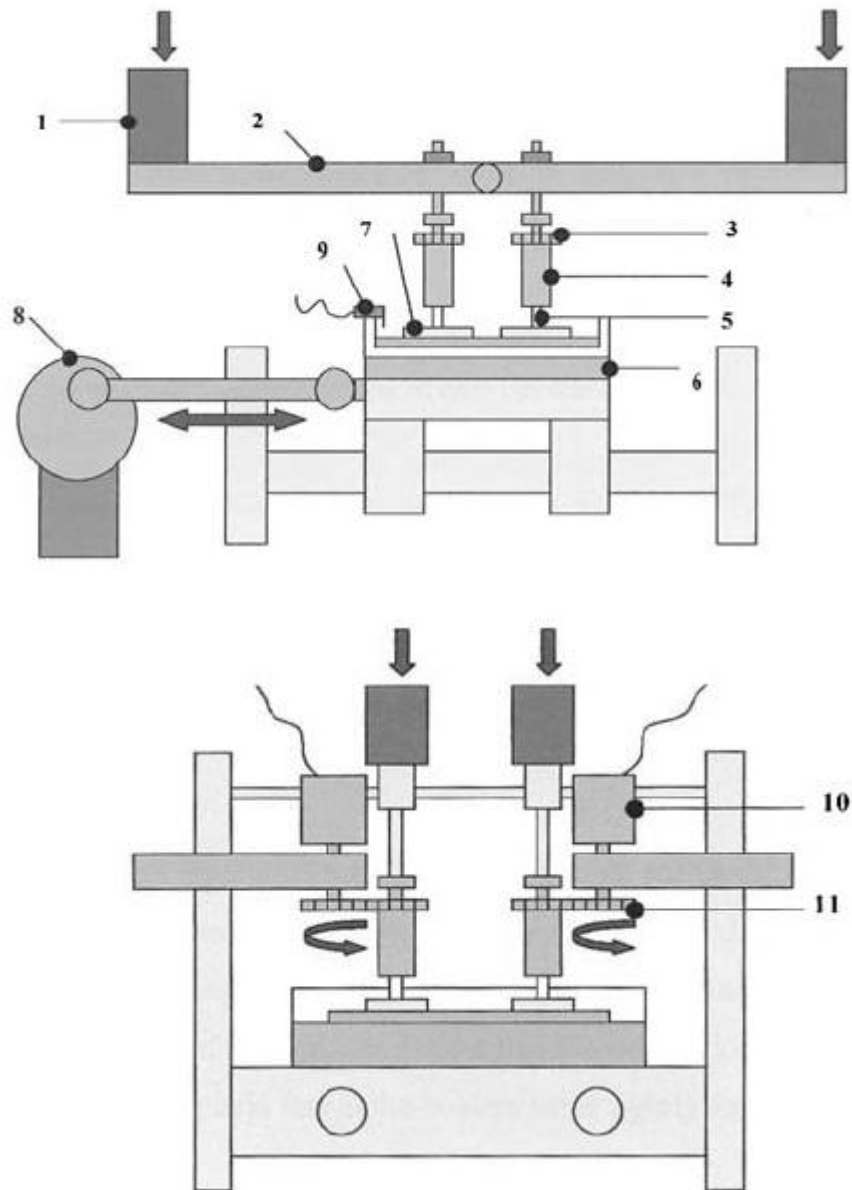

1= weight to provide load; 2= lever arm; 3= gear; 4= pin holder; 5=UHMWPE pin; 6=heater bed; 7=Co-Cr plate; 8=motor to provide reciprocation; 9=level sensor; 10=motor; 11=gear).

Reproduced with permission of SAGE Publications Ltd, London, UK

5.3.2.1 Plates wear rate testing

The plates were made of Co-Cr. Four plates were fitted to the tray and secured with three metal plates and screws. They were covered with lubricant and heated to 37° C (body temperature) (Figure 5.7).

Figure 5.7 The pin-on-plate machine sledge with four Co-Cr plates mounted

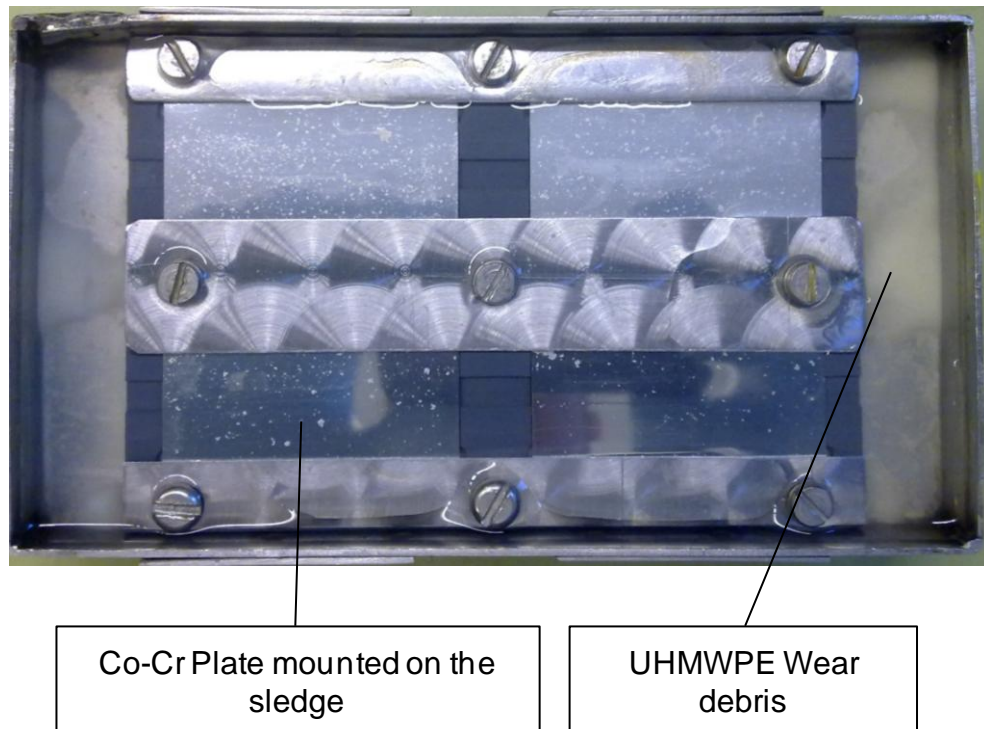

5.3.2.2 The lubricant

The lubricant used in all tests was a 24.5% concentration of bovine serum (protein content: 15 g/l) and was prepared in the following protocol:

1. Defrost concentrated serum in a heated water bath at a temperature of 37°C.
2. Fill a large beaker with 3L of deionised water and place on a stirring stage.
3. Add 6 pellets of Sodium Hydroxide and stir for 5 minutes until the pellets have fully dissolved.
4. Add 29.78 g of EDTA and stir for 5 minutes until the EDTA fully dissolves. This was used to prevent calcium deposition.

5. Add 8.0 g of Sodium Azide and stir for 5 minutes until solution is clear.
Sodium Azide was used to slow the growth of bacteria.
6. Add 1L of concentrated Serum and stir until dispersed equally in solution.
7. Transfer to 8 x 500ml bottles, label, and store in freezer.

Each test episode consumed a single bottle of lubricant. A lubricant level sensor was attached to the lubricant tray to allow the lubricant to be maintained at an almost constant level. This was topped up from a reservoir of distilled water. The rotational motion was provided by 4 small motors.

5.3.2.3 Pins wear rate testing

Pins were made of UHMWPE. Each pin was numbered, notched and tightly fitted to the pin holders at the end of each motor (Figure 5.8). The cycle frequency was set at 60 per minutes (1Hz).

Figure 5.8 An UHMWPE pin mounted on a motor

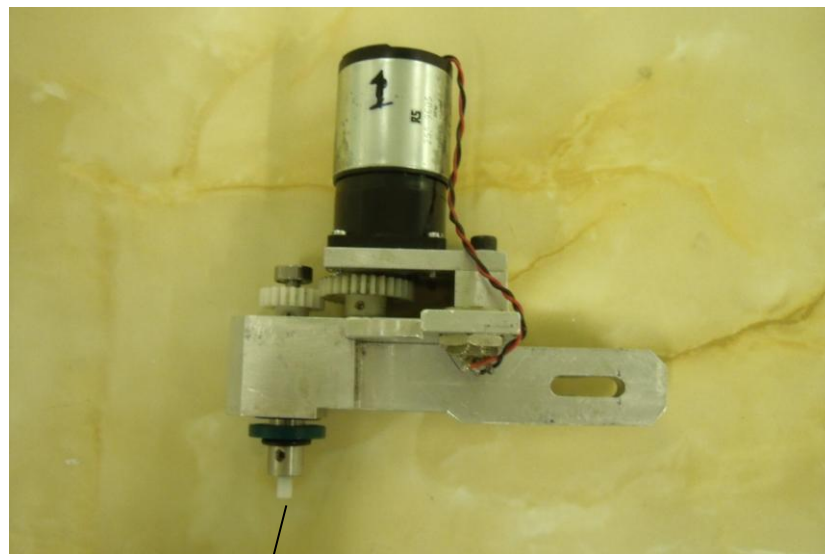

UHMWPE pin mounted on a motor

The four loaded pins were held in stainless steel holders and mounted so that each pin rested on the corresponding plate. A load of 40N was applied to each station via a lever arm mechanism.

5.3.2.4 Wear rate assessment

The wear was assessed gravimetrically (loss of mass) and volumetric loss was calculated by dividing the mass by the density. Twice a week (approximately every 0.25 million cycles), the machine was stopped to allow for the measurement and to clean the machine. The pins and plates were cleaned, dried and weighed using the following protocol:

Pins and plates cleaning

1. Rinse with distilled water to remove bulk contaminants.
2. Immerse in a 1% solution of Neutracon and place in an ultrasonic bath for 15 minutes at room temperature.
3. Rinse in a stream of distilled water.
4. Immerse in distilled water and place in an ultrasonic bath for 5 minutes at room temperature.
5. Dry with a lint free tissue.
6. Immerse in Isopropanol for 3 minutes.
7. Dry with a lint free tissue.
8. Allow to dry in a biological flow cabinet at room temperature for 30 minutes before weighing.

Pins and plates weighing

1. For this test the Mettler Toledo AX205 Balance was used (accuracy of 0.01mg).
2. Place Pin (or plate) 1 on balance and wait for a stable reading and record.
3. Repeat for all pins (or plates) in sequence.
4. Repeat cycle until three readings of each pin (or plate) are within 0.1mg of each other.
5. Use the average of these three values.

Control specimens were used to take account of the lubricants absorption of both the pins and plates during the test. The wear volumes were plotted against the sliding distance and the gradient of the line provided the wear rate. The wear rate was then divided by the load to determine the wear factor, K (mm^3/Nm).

5.3.3 Surface topography

Surface topography measurements were performed using a Zygo NewView 100 non-contacting three-dimensional profilometer. Ten measurements were taken of the pins and plates before and after pin-on-plates wear testing. Each measurement provided visual and numerical data of the surface profile of the specimens (figure 5.9). Visual data includes intensity map, two and three dimensional profiles of surface roughness. This provides a quick scan of a wider area of the specimens to get an overall impression on how rough the surface is. Numerical data included peak to valley ratio (PV), root mean square (rms) and surface roughness average (Ra).

Figure 5.9 Profilometer view of surface topography of a Co-Cr plate

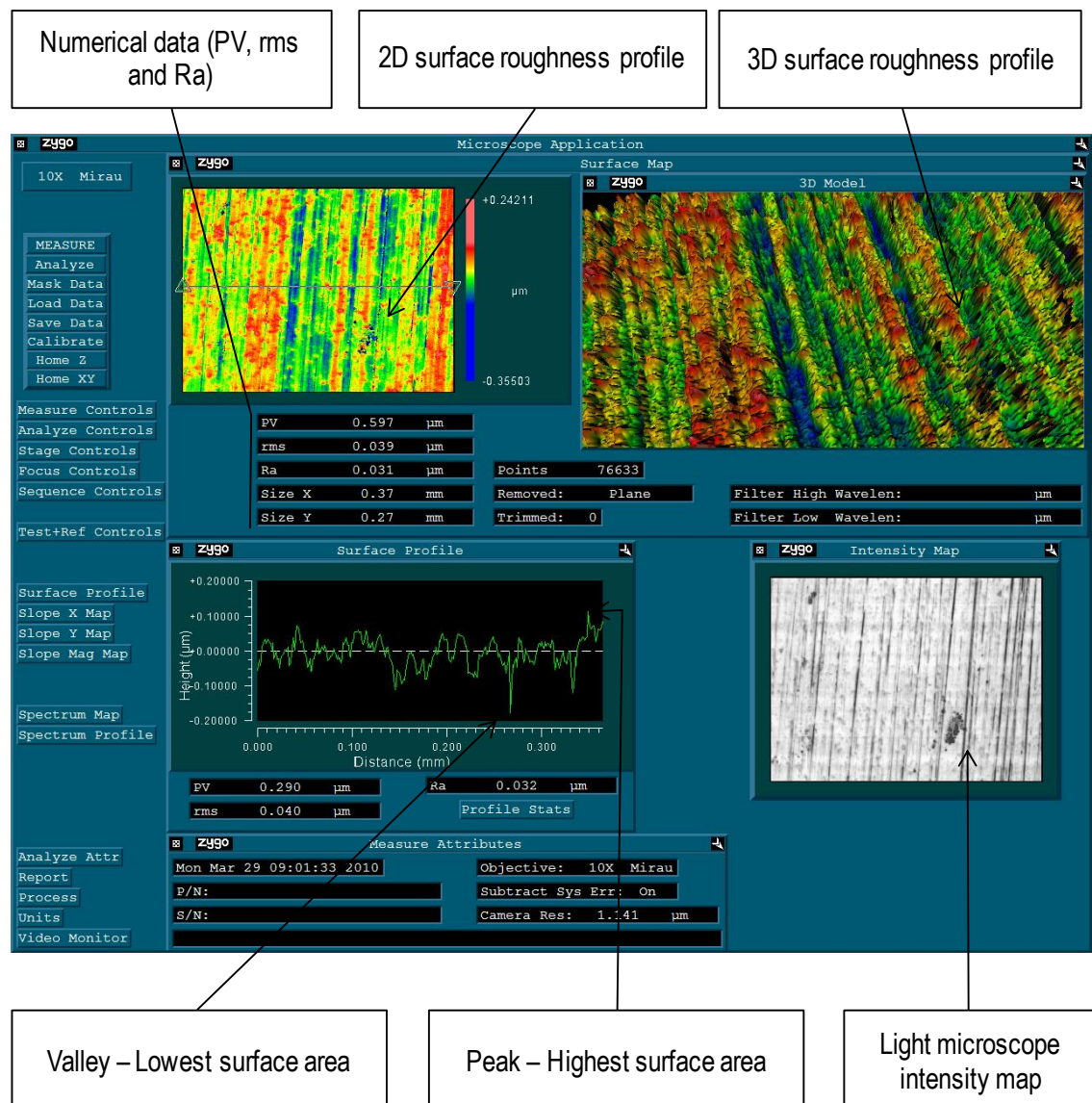

5.4 Results

5.4.1 Tensile testing

The test showed that the stiffness, Young's modulus, load to break and stress at break values were not affected by immersion in TXA or saline for 48 hours.

The two groups were comparable in term of stiffness, Young's modulus of elasticity, load at break and stress at break (Table 5.1). There were no statistically significant differences comparing saline and TXA immersed UHMWPE.

Table 5.1 Tensile test results of the UHMWPE specimens

Variable	Specimens	N	Mean (SD)	Mean Difference	P-Value (95% CI)
Stiffness (N/m)	Saline	5	81588 (10518)	1964	0.740 (-15146 to 11218)
	TXA	5	83552 (7262)		
Young's Modulus (MPa)	Saline	5	923 (119)	23	0.740 (-171 to 127)
	TXA	5	946 (82)		
Load at Break (N)	Saline	5	330 (33)	12	0.523 (17 to -52)
	TXA	5	342 (20)		
Stress at Break (MPa)	Saline	5	47 (5)	1	0.526 (2 to -7)
	TXA	5	48 (3)		

The stiffness, elastic Young's modulus, load to break value and stress at break of the soaked specimens (TXA and saline) were comparable to those of control specimens (non-soaked specimen) (ANOVA; P=0.79, 0.79, 0.67 and 0.67 respectively).

The stress strain curves of the 10 tensile specimens are shown in figure 5.10. The graph shows all specimens have an almost identical stress strain curve apart from control specimen number 5 which failed at a lower stress. However, this did not adversely affect the overall test. It is not unusual to have a faulty specimen with a small scratch or defect that affects its tensile properties.

Figure 5.10 Stress strain curves of tensile*

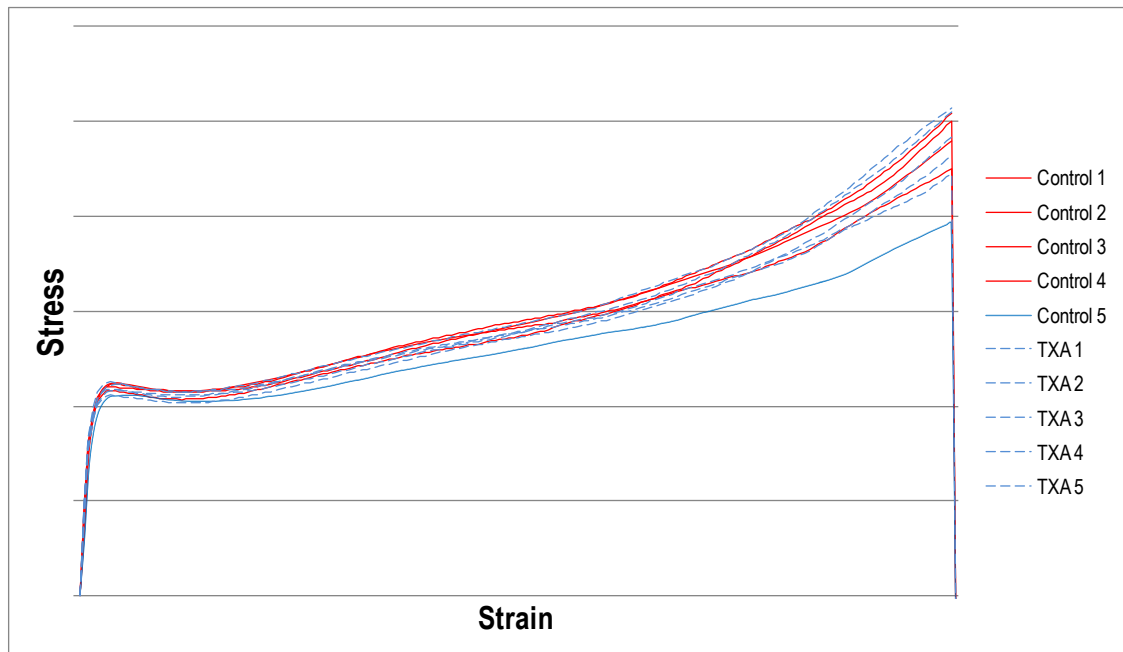

*Control specimen number 5 which failed at a lower stress is represented with a blue solid line.

5.4.2 Wear test

The wear test involved two multidirectional pin-on-plate machines with 8 stations; four control pins and 4 control plates which were soaked with saline; four TXA soaked pins and 4 TXA soaked plates. Another two pins and 2 plates were used as a control to measure the weight changes secondary to bovine serum absorption. This was deducted or added accordingly from the tested specimen at every weighing.

Pins and plates were numbered and assigned to stations as in the follows:

TEST 1 / MACHINE 1

Four stations

- Pins:
 - TXA (Pins 1 & 2)
 - Placebo (Pins 4 & 5)
 - Control (Pin 3)
- Plates
 - TXA (Plates 1 & 2)
 - Placebo (Plates 4 & 5)
 - Control (Plates 3)
- Load 40 Newton
- Stroke 4 mm
- Cycles 3731020
- Distance 149.2 Km.

TEST 2 / MACHINE 2

Four stations

- Pins:
 - TXA (Pins 8 & 7)
 - Placebo (Pins 6 & 10)
 - Control (Pin 9)
- Plates
 - TXA (plates 8 & 7)
 - Placebo (Plates 6 & 10)
 - Control (plate 9)
- Load 40 Newton
- Stroke 4 mm
- Cycles 4064277
- Distance 162.6 Km

Table 5.2 shows the cumulative volume changes in the pins and plates in each group (Placebo or TXA) as measured each time the machines were stopped. As expected, the main loss happened to the UHMWPE pins rather than the Co-Cr plates as they are softer and prone to wear more rapidly than plates.

Table 5.2 Cumulative volume loss in mm³ in plates and pins

Distance (Km)		Plates				Pins			
Test 1	Test 2	TXA Test 1 Plate	TXA Test2 Plate	Placebo Test1 Plate	Placebo Test2 Plate	TXA Test1 Pin	TXA Test 2 Pin	Placebo Test 1 Pin	Placebo Test 2 Pin
0	0	0.00000	0.00000	0.00000	0.00000	0.00000	0.00000	0.00000	0.00000
4	14.2	-0.12659	0.02191	-0.00913	0.13309	-0.14354	-0.87560	-0.46651	-0.71412
12.4	24.2	-0.19679	-0.00406	-0.00162	0.11503	-0.44677	-1.89833	-0.93122	-1.67405
30.5	34.8	-0.19517	-0.07608	-0.00446	0.16575	-1.05862	-2.73446	-1.13756	-2.70755
38.9	47.4	-0.18441	-0.07993	0.00426	0.15276	-1.84989	-3.74284	-1.90192	-3.99762
49.6	60.7	-0.18949	-0.04098	0.01603	0.14566	-2.76676	-5.03112	-3.31760	-4.91449
60.8	73.7	-0.19922	-0.01440	0.00751	0.13511	-3.86485	-6.43065	-4.53590	-6.34094
73.1	88.5	-0.19598	-0.01481	0.01298	0.14262	-5.21055	-8.03652	-5.83495	-7.95219
84.6	109.5	-0.22113	-0.02090	-0.01116	0.09170	-6.11306	-9.82719	-7.16450	-9.54908
100.9	130.6	-0.20308	-0.01075	-0.00122	0.14992	-7.75661	-10.77636	-8.57839	-10.65973
121.9	162.6	-0.21119	0.05336	0.00467	0.14161	-8.64477	-12.32661	-9.52037	-12.13821
149.2		-0.20308		0.00426		-10.81583		-11.57660	

Figure 5.11 Graph of volume losses of the pins and plates plotted against sliding distance

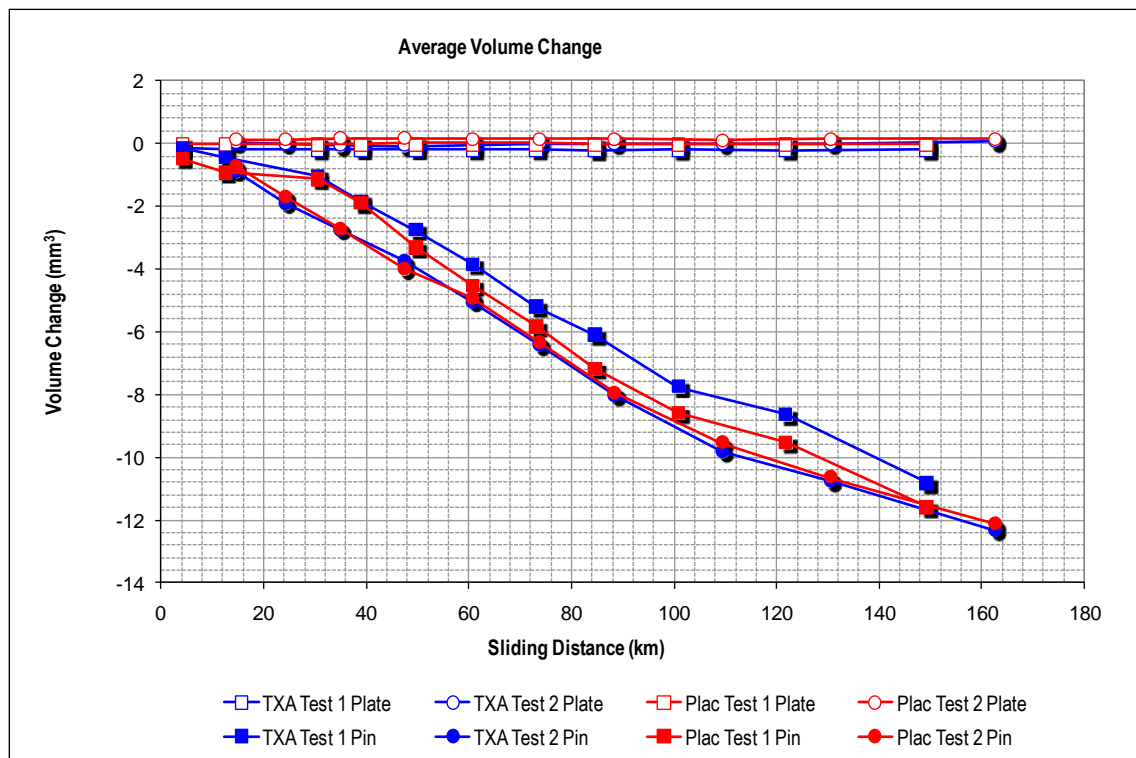

Wear factors were calculated for all pins and plates using the following equation:

$$\text{Wear factor} = \frac{\text{volume loss (mm}^3\text{)}}{[\text{sliding distance (m)} \times \text{load (N)}]}$$

Table 5.3 The wear factors of plates and pins

Number	Group	Pins wear factor (x 10 ⁻⁶ mm ³ /Nm)	Plate wear factor (x 10 ⁻⁹ mm ³ /Nm)
1	TXA	2.138	0.004
2	TXA	1.994	0.005
8	TXA	1.967	-0.013
7	TXA	2.354	-0.006
4	Placebo	2.171	0.008
5	Placebo	2.193	-0.006
6	Placebo	2.429	-0.014
10	Placebo	1.844	0.016

There were no statistically significant differences in between the mean wear factor comparing either plates or pins which were soaked in saline or TXA as shown table 5.4.

Table 5.4 The wear factors of plates and pins; Parametric t-test

	Groups	N	Mean*	SD*	Mean Difference*	95% CI P-Value
Plates wear factor	Placebo	4	0.00100	0.013515	0.0035	-0.161 to 0.023 0.768
	TXA	4	-0.00250	0.008583		
Pins wear factor	Placebo	4	2.15925	0.240433	0.046	-0.319 to 0.411 0.677
	TXA	4	2.11325	0.177184		

* ($\times 10^{-9}$ mm³/Nm)

5.4.3 Surface topography

Surface topography measurements are summarised in table 5.5. Plate number 5 was lost and its surface topography could not be obtained.

Table 5.5 Surface topography

No	Group	Plate PV [†]		Plate rms [†]		Plate Ra		Pin PV	Pin rms	Pins Ra
		Pre*	Post**	Pre	Post	Pre	Post	Post	Post	Post
1	TXA	0.296	0.259	0.024	0.019	0.018	0.015	3.833	0.497	0.370
2	TXA	0.224	0.376	0.036	0.038	0.335	0.030	7.219	0.193	0.124
8	TXA	0.227	0.597	0.022	0.039	0.017	0.031	3.615	0.648	0.160
7	TXA	0.418	0.335	0.028	0.034	0.021	0.026	7.184	0.215	0.158
4	Placebo	0.259	0.103	0.019	0.014	0.015	0.011	1.135	0.020	0.088
5	Placebo	0.235		0.025		0.020		3.862	0.385	0.222
6	Placebo	0.231	0.434	0.022	0.029	0.017	0.020	3.577	0.434	0.338
10	Placebo	0.192	0.386	0.020	0.020	0.016	0.016	5.443	0.428	0.337

* Pre wears tests. ** Post wears tests.

[†]PV: Peak valley ratio (μm); rms: Root mean square roughness (μm); Ra: Surface roughness average (μm) (see section 5.3).

There was no significant difference in the peak valley distance (PV), rms surface roughness and surface roughness average (Ra) of the plates and pins between the two groups before and after the pin-on-plate wears tests (see table 5.6). Hence the null hypothesis of no difference was accepted.

Table 5.6 Post wear surface topography findings

	Group	N	Mean	SD	Mean Difference	P-Value (95% CI)
Plates PV	Placebo	3	0.279	0.228	-0.0340	0.856 (-0.5 to 0.4)
	TXA	4	0.313	0.240		
Plates rms	Placebo	3	0.021	0.0075	-0.0115	0.141 (-0.0284 to 0.0054)
	TXA	4	0.0325	0.0092		
Plates Ra	Placebo	3	0.019	0.002	-0.007	0.187 (-0.02 to 0.005)
	TXA	4	0.026	0.007		
Pins PV	Placebo	4	3.504	1.780	-1.959	0.195 (-5.24 to 1.32)
	TXA	4	5.463	2.010		
Pins rms	Placebo	4	0.3167	0.199	-0.0715	0.612 (-0.542 to 0.3531)
	TXA	4	0.3882	0.2216		
Pins Ra	Placebo	4	0.247	0.119	0.043	0.616 (-0.16 to 0.24)
	TXA	4	0.203	0.113		

5.4 Discussion

It may take many years to determine the effectiveness of new designs or innovations for artificial joint replacement. Many journals refuse to publish new implants series or interventions if there is less than 10 years follow up. Surgeons are very cautious and hesitant about introducing a new intervention without it being carefully studied and assessed. The history of artificial joint replacement supports this caution.

In this study we investigated the effects of TXA on three important material properties. Tensile testing and surface topography were studied using gold standard methods. This showed there was no difference in the tensile proper-

ties and surface topography between the artificial implants that had been soaked in saline and those soaked with TXA.

There are several methods to assess the rate of wear. Clinical and radiological survival analysis of implanted joints is probably the most useful method, but it takes a very long time: some implants can last more than 30 years. Also, patients are often lost to follow up during such a long period. Joint simulation is a reliable predictor but it is quite expensive with limited access. Multidirectional pin-on-plate machines are a reasonable alternative and several studies have confirmed that they are comparable to joint simulators [128-131].

Comparing results from 8 stations, there was no significant difference in the wear rate factor among the two groups and findings were comparable with the wear factors reported in other studies [128, 132].

In conclusion, laboratory biomechanical testing shows that there are no biomechanical adverse affects for artificial joints material from using topical TXA. However, a review of the trial patients at 5 years and 10 years of follow up would confirm that the clinical and biomechanical profiles of the artificial knees have not been degraded.

Chapter 6

Discussion

6.1 Overview

The discussion is structured into three parts. In the first part, the results of the TRANX-K trial are examined with reference to the research questions posed at the design stage. The second part provides a commentary of the quality of research reported in this thesis commenting on strengths and weaknesses and the implications of these. The last part is a summary and conclusion of the thesis exploring the potential impact on orthopaedic practice and future research.

6.2 The results of TRANX-K trial

6.2.1 Can topically applied TXA reduce blood transfusion?

The Tranx-K trial recruited 157 participants with 79 receiving TXA and 78 receiving placebo. One participant (1.3%) received blood transfusion in the TXA group while 13 participants (16.6%) received blood transfusion in the placebo group. Thus topically applied TXA reduced the risk of transfusion 13 fold, a statistically significant finding (Fisher exact test; $P=0.001$).

When compared to previous trials, the topical TXA demonstrated a greater effectiveness in reducing blood transfusion (figures 4.2 and 4.3). Systematically delivered TXA reduced the risk of transfusion 2.7 fold: from 16 trials, 110 (21.9%) participants received blood transfusion in the TXA group while 214 (48.3%) received blood transfusions in the placebo group (chapter 2).

These findings are in agreement with our hypothesis that topically applied TXA should produce a higher concentration of the active ingredient at the bleeding site enhancing its potency. This could be explained by the difference in the volume of distribution of the two modes of delivery. If a drug is required to act on an organ (the knee in this thesis), it must be administered to the blood first, then distributed widely within the body. A fraction is then diffused to the target organ to produce an effect. The distribution in the body is often uneven. Some drugs have high affinity to plasma, some are bound to protein and others localised within particular organs. Some organs are partially or totally impervious to certain drugs. Clearly the site of localisation of a drug is likely to influence its action [133]. Intravenous TXA distributes in the plasma and varyingly in the fluid of the various body compartments reducing its therapeutic level at the knee. Topically

applied TXA distributes in the knee joint cavity predominantly achieving a higher therapeutic level. Precise information on the concentration attained by TXA in various tissues and fluids requires biopsy samples and for understandable reasons this was not possible and beyond the scope of this work. The plasma concentration of TXA could be assessed in specialist centres but there is no widely available assay to determine this concentration. However, a previous study demonstrated that topically applied TXA in a closed cavity (the pericardium) was not absorbed to the systemic circulation [84], hence this was not performed.

6.2.2 Can topically applied TXA reduce blood loss?

Estimating accurate blood loss in TKR is not a simple procedure and requires certain assumptions. Standardisation of surgical technique, timing of tourniquet inflation and deflation, type of drain used, timing of drain removal were standardised across participants in the Tranx-K trial to achieve a consistent measure of blood loss.

Initially, the drain blood loss was planned to be measured by two independent research members. Each would have made three readings with the mean value recorded and with subsequent comparison of these means. However, the idea was abandoned because of time pressure in busy NHS practice. Instead, research staff were trained to record drain blood loss to a standard procedure (3.7.2.1) to minimise variation.

The operative blood loss (occurring before administration of TXA or placebo) was more difficult to standardise and accurately measure, including the irrigation fluid use, the volume of fluid and blood in the suction bottle, weighing swabs dry then wet and obtaining the difference in mg then convert it to ml. There was a wide range of operative blood loss (30 to 600 ml) in spite of the fact that surgery was performed in bloodless field: this may be in part due to surgical technique but in part due to the complexity of the measure.

Eipe [121] showed that clinical methods such as assessing blood soaked mops and gauze pieces, measuring blood lost to suction bottles and the vacuum drain underestimate surgical blood loss. He recommended using a biochemical

method based on Hct alongside the clinical methods. Several formulas have been developed to measure the actual blood loss using Hct changes. In this thesis, Gross's formula was used [121, 122].

The mean drain blood was 465 ml (SD 298) in the placebo group and 296.7 ml (SD 195.6) in the TXA group. The mean difference was 168 ml (95% CI: 80 to 256 ml, $p=0.00025$). Using the Gross formula, the mean total blood loss was 1725 ml (SD 823 ml) in the placebo group and 918.6 ml (SD 487.3ml) in the TXA with a mean difference of 806.3 ml a statistically significant difference (95% CI: 564.7 to 1048 ml; $P<0.0001$).

There was a 37% reduction in the mean drain blood loss. This reduction is lower than the designed 50% reduction in blood loss considered clinical important at the design stage (Chapter 3). However the primary design consideration of reduction in blood transfusion was more than achieved and this is seen more readily in the total blood reduction of 47% using the Gross formula.

Use of varying definitions of blood loss by different trials severely limits meaningful comparison between trials although differences within trials may be internally consistent and valid. Using the Gross formula to estimate total blood loss makes differences in the use of transfusion more readily interpretable and comparable, thus it would be helpful if this estimation is provided in future trials of orthopaedic surgery.

6.2.3 Can topically applied TXA reduce Length of stay?

Reduced length of stay is a key outcome for patients and staff. It may help with bed occupancy rates, improve productivity, minimise the risk of hospital acquired infection and help patients to return to routine activities more quickly. There are several factors influencing the LOS such as the age of patients, associated co-morbidity, progress with rehabilitation and home situation. Hence, there is significant variation in LOS among hospitals, units and patients. Patients recruited in the study stayed for variable lengths of time ranged from 2 to 27 days. Within this context of variation TXA reduced the length of stay by an average of 1.2 days (T-test, p -value 0.041).

This reduced LOS may be due to lower bleeding, higher Hb and faster rehabilitation. Additionally a lower rate of transfusion may reduce subsequent care and monitoring (blood transfusion typically necessitates an additional day for observation). Both modes may be evident. Analysis of patients who did not receive transfusion shows that the placebo group bled more (drain blood loss 460 ml versus 294 ml; $P=0.001$) and had lower postoperative Hb (11 g/dl versus 11.56 g/dl; $P=0.01$) when compared to TXA. LOS did not vary in patients not receiving transfusion (Placebo: 4.93 days versus TXA: 4.78 days; $P=0.663$) suggesting that transfusion does adversely affect length of stay (Appendix 6.1).

The systematic review and meta-analysis (chapter 2) included usable data from 3 trials which provided data on LOS (Figure 2.7) showed that patients receiving TXA spent an average of 0.77 day less in hospital than the control group but this was not statistically significant ($P= 0.10$). Including LOS data from Tranx-K study increased the pooled mean difference to 0.9 day and this was statistically significant ($P=0.01$) (figure 4.7).

6.2.4 Economic analysis

There are four common types of economic evaluation of an intervention that can be performed [134]:

- Cost effectiveness (CE): Interventions are evaluated in terms of one treatment effect. These interventions are comparing by calculating the incremental cost-effectiveness ratio.
- Cost minimization. Comparing two interventions that achieve the same effectiveness (in some physical measure of value), the cheapest is preferred.
- Cost benefit analysis: Costs and benefits are measured in the same unit (money) for each intervention with the net benefit (benefit-cost) of each intervention is compared.
- Cost utility analysis: The outcome of each intervention is measured for its affect upon mortality (quantity of life) and morbidity (quality of life). It measures the additional life years weighted by the quality of life experienced each year. Interventions are compared by calculating the incremental cost/QALY ratio.

Sometimes it is not meaningful to summarise the value of a treatment just in terms of one unambiguous outcome. In the Tranx-K trial reductions in blood loss, transfusion and LOS are all valued by clinicians and patients. In this circumstance a cost and consequences approach can be adopted as an additional formal technique for economic evaluation. Within this thesis an NHS perspective was adopted, which may underestimate the value to patients of a faster return home which may correlate with return to routine activities.

The use of topical TXA caused a net cost saving of £333 per patient ($P=0.054$). A cost and consequences approach is particularly powerful when a cost saving is identified as well as positive health benefits across the range of outcomes. In this instance the new treatment (use of TXA) is said to be the dominant strategy and no further analysis or modelling is required

Complications of surgery were not included in the cost analysis, since complications were rare and not statistically significantly different between treatments. One complication (periprosthetic fracture) was caused by an accident and is not attributable to study treatment: treating this complication was associated with a very high cost. Inclusion of the patient level cost of complications identified would probably have increased the net saving due to TXA.

In the TXA group, there were two cases of DVT and one superficial infection. DVT was treated in outpatients with LMWH then warfarin; superficial infection received a short course of oral antibiotic.

In the placebo group, there was one case of TIA, one chest infection, one periprosthetic fracture, one superficial infection and one deep infection. The first two of these happened while the patients were in hospital and some of the cost of these has been included in the LOS saving. The superficial infection was treated with short course of antibiotic in outpatient. The Periprosthetic fracture was admitted to hospital and underwent open reduction and internal fixation almost a year after the initial operation. The patient who developed deep infection was reviewed in the clinic more frequently than usual because of continuing pain and hotness in his knee. His blood tests were inconclusive. He then un-

derwent bone scan which was very suggestive of infection. Wound swab and knee aspiration performed in theatre showed MRSA infection which was treated with 2 weeks of oral Linezolid. This is an expensive antibiotic with a 5 day course costs £445 [113]. The patient then underwent a revision TKR on the 22nd of March 2010, just over one year from the initial operation and he is still under follow up. The complications experienced by the last two patients resulted in considerable cost to the NHS.

The sixth annual report of the National Joint Registry [3] showed that there were around 65 979 primary TKRs performed in England and Wales during 2008. Based on the Tranx-K trial findings, routine TXA might save the NHS £1.5 M each year. The net social valuation might be greater if this included, for example, time absent from work, reduced hospital acquired infection, complications of blood transfusion and reduced demand for donor blood.

6.2.5 The affect of TXA on the Oxford Knee Score and EuroQol

The study intervention was not expected to affect adversely either functional outcome or quality of life following total knee replacement. This was formally tested using the Oxford Knee Score and EuroQol measures. Participants were asked to complete these preoperatively and three months after the operation. The Oxford knee score comprises 12 questions each scored from 4 to 0, with 4 representing the best outcome/least symptoms. The scores of each question are added so that the overall figure lies between 0 and 48. The mean preoperative OKS scores were TXA: 19.40 and Placebo: 19.34, with a mean difference of 0.05 ($P=0.96$). Postoperatively these scores rose TXA: 34.83 and Placebo 35.91, with a mean difference of -1.08 ($P=0.55$). As expected there was significant improvement in the OKS after TKR in both groups, the mean improvement in both groups was 15.59 ($P < 0.0001$) consistent with findings from other studies.

The EuroQol questionnaire consists of a descriptive system (EQ-5D) and a visual analogue scale (EQ-VAS). The EQ-5D descriptive system was converted to a weighted index. The mean preoperative EuroQol index was 0.43 in the placebo group and 0.38 in the TXA group: mean difference 0.054 ($P=0.35$). Similarly the mean preoperative EQ-VAS in the placebo group was 59.35 and 61.48

in the TXA group: mean difference 2.1 (P=0.579). As anticipated, scores increased in both arms following TKR. The mean postoperative EuroQol index was 0.78 and 0.71 in the TXA group: a mean difference of 0.075 (P=0.187). The mean postoperative ED-VAS in the placebo group was 75.6 and 75.2 in the TXA group: mean difference 0.38 (P=0.579). Thus there were no statistically significant differences in baseline or 3 month quality-of-life measures. Comparing the preoperative and postoperative scores in both groups taken together showed improvement in the EQ-5D: 0.311 (P<0.0001) and ED-VAS: 11.7 (P<0.0001).

6.2.6 Complications following TKR

TKR is a successful and common operation but not risk free. There are a number of potential complications and some of them can be serious. In the review (chapter 3), we identified the relevant complications and the methods to identify them within a three month trial follow up period. Table 4.13 summarises the complications in both groups of the Tranx-K trial. There were 3 complications in the TXA group (2 DVTs and one superficial infection) and 5 in the placebo group (1 TIA, 1 chest infection, 1 periprosthetic fracture, 1 superficial infection and 1 deep infection). There were no significant differences between the two arms in the frequency of these complications. This should be interpreted with caution as the study was not designed to detect a difference in these complications. The low incidence rate of their occurrences would necessitate a very large number of participants to detect a difference precisely.

6.3 The effect of TXA on artificial implants (BioTRANX study)

Some surgeons have expressed concern that topical TXA may degrade artificial implants. Personal communication with authors of studies that used intravenous TXA in TKR did not reveal adverse effects but there was no formal scientific study that examined this issue. This led to development of the BioTRANX study (chapter 5) which investigated the effects of TXA on tensile properties, wear rate and surface topography. There was no difference in the tensile properties and surface topography between the artificial implants that had been soaked in saline and those soaked with TXA for 48 hours. For example, wear rate was tested using a multidirectional pin-on-plate machine comparing results from 8 stations after 4 millions cycle (160 Km). These findings are reassuring. How-

ever, there are limitations to biomechanical tests as they may not always produce data comparable to living models. The possible alternatives are clinical and radiological survival analysis of implanted joints. However, time (some implants can survive more than 30 years) and patient retention make such a study unlikely.

6.4 Trial quality measures

6.4.1 Strength of the study

6.4.1.1 Overview

The trial published in this thesis was carefully designed to minimise error (bias through the randomised design and sampling error through adequate study power) and maximise relevance and importance. The study design, protocol and patients information sheet were reviewed by official research bodies, internal and external reviewers who are experts in their fields. All criticisms (positive or negative) were considered and incorporated in the final proposal. The trial was developed to a standard to fulfil the CONSORT recommendation [91], registered with the European Clinical Trials Database, and granted ethical and MHRA approval. It secured funding from the Research and Development office and the department of Trauma and Orthopaedics of the University Hospital of North Tees and Hartlepool.

In preparation, an extensive literature review was undertaken, which included a systematic review and meta-analysis of published trials. Critical appraisal of these trials helped identify design strengths and avoid weakness. Most trials were small and were assessed to have varying quality: nineteen trials were included of which only 3 recruited more than 100 participants. Two of these have more than three arms.

The Tranx-K trial had clear objectives and a well-defined primary outcome (blood transfusion rate) and supportive secondary outcomes. A standard operating procedure was introduced to standardise the measurement of outcomes to reduce variation among different surgeons. There was 100% compliance with this standardisation.

Inclusion and exclusion criteria were operationalised by a two stage safety check list to maximise adherence to these criteria. The first check was introduced before consenting patients to the trial. A research member checked all necessary boxes on the consent form before approaching potential participants. Then, at randomisation, inclusion and exclusion criteria had to be checked before proceeding to the randomisation process.

Tranx-K was a pragmatic trial [135], measuring effectiveness of tranexamic acid in total knee replacement surgery as routinely practiced rather than in idealised conditions. For this reason, the trial sought to minimise changes in routine practice to enhance generalisability. The participants received normal standard of care for TKR provided in our centre. Normally, no chemical intervention is used to reduce blood loss. In this study, at the end of the operation and before closing the wound, the study drug, which was either TXA or a placebo, was applied by spray into the wound. The wound was then closed and dressed in the normal way followed by the release of the tourniquet. Drains were released after one hour in recovery as is routine. However standard operating procedures including standardised criteria for blood transfusion, timing of drain removal and blood tests were introduced to limit variation.

6.4.1.2 Study bias and group comparability

Blocked randomisation was used in blocks of six in order to keep the sizes of groups similar. Randomisation was stratified by surgeon to achieve balance within the two groups and design out variation in surgical outcome among surgeons. However, there is a limit to how many potentially confounding influences can be designed out of a trial by stratification. Randomisation distributes known and unknown influences by chance within a trial, but there remains a risk of chance mismatches in participants at baseline which may confound the study finding. Only gender was unusually different between the two groups (Table 4.1). This was explored by investigating the effect of gender (being a male or female) on trial findings: blood transfusion rate, drain blood loss, Hb drop and LOS. Analysis by gender revealed no systematic interaction with these outcomes (chapter 4). The imbalance between the two arms of the trial is a chance occurrence with no bearing upon the trial findings; consistent with prior clinical expectation.

Patients eligible for the study were approached in the pre-assessment clinic by the designated staff nurse who was not actively involved in the study. Patients' sex, age, weight and co-morbidity were not part of the exclusion criteria. This was to ensure a generalisable sample.

Concealment of allocation was ensured by using external online randomisation provided by "Sealed Envelope"; an independent company. A designated research nurse randomised patients and prepared the study drug (either TXA or Placebo). The health professionals delivering patient care were blinded to the treatment allocation. Both treatment and placebo solutions have the same colour, smell and feel ensuring blinding was maintained throughout surgery.

6.3.1.3 Protocol adherence

The simple nature of the study and the intervention encouraged protocol adherence. There were very few deviations from the protocol. At the start of the study, two patients were randomised by mistake. The first was a patient who was scheduled to have a unicompartmental knee replacement (UKR) or total knee replacement depending on the severity of the knee degenerative changes. The patient was approached by the research team and agreed that if he had a TKR he would be part of the study and subsequently randomised to receive TXA. He underwent a UKR and did not receive the TXA. This patient was excluded from the analysis because he did not fulfil inclusion criterion requiring TKR. Blood loss, transfusion rate and LOS are different from those of TKR. Measures were taken to prevent a similar scenario to happen again. The second patient was randomised by mistake due to a typing error in the theatre list. The patient was undergoing a THR and not TKR as written in the theatre list. Although, this was noticed when the patient was on the ward, the patient had already been randomised and received a code number. This patient was not approached to take part in the trial, he did not sign a consent form and he did not receive any trial intervention. He was excluded from the study. There was no study withdrawal and all participants were followed up for three months as stated by the protocol.

6.3.2 Weaknesses of the study

Several weaknesses became apparent through the study. The short follow up of 3 months might conceal a different long term safety profile for the use of TXA. However, TXA has been available since 1964 with a good safety profile. The biological half-life of TXA has been determined to be 1.9 hours to 2.7 hours. Approximately 90% of an intravenously administered TXA dose is excreted, largely unchanged, in the urine within 24 hours. It was thought that 3 month follow up period would be adequate to notice relevant side effects or adverse reactions. This may be true but remains untested without long term follow up.

6.3.3 Long term safety

To explore this longer term safety issue, the BioTRANX study (chapter 5) was conducted to investigate potential long term detrimental effects of TXA on the biomechanical properties of the artificial joint materials. The study did not identify any adverse effects, although, such biomechanical studies have their limitations.

Future work is in progress to obtain approvals to review the safety profile in tranx-K trial participants after 5 years. This will be implemented on two stages. The first stage will include reviewing the medical records of the patients and sending them postal OKS and EuroQol questionnaires. If there was significant difference between the two groups in the first stage, we will move to the second stage which includes calling patients to attend a special clinic for clinical evaluation and radiological assessment.

6.4 Future study

Long term follow up for the Tranx-K trial is planned. The particular focus is on the safety profile of TXA, surgical patency and joint replacement patency over a 5 years period. There were two DVTs in the TXA and there was none in the placebo group. When topical TXA use becomes routine, this needs further investigation in a large population of patients.

Research reported in this thesis is running in parallel with similar research work involving total hip replacement (THR). A systematic review and meta-analysis of

the use of TXA in THR was conducted. There was similar trend in reducing blood transfusion and blood loss in THR. A sister trial which is called Tranx-H is underway. The aim is to recruit 150 patient undergoing THR to investigate the topical use of TXA in THR. There are significant differences in the operative techniques comparing THR and TKR, meriting a separate trial. THR is not done in a bloodless field as a tourniquet cannot be used for anatomical reasons. Additionally, there is less bone cut and more muscle cut in the THR procedure. The evidence from these THR studies will complement the evidence for TKR.

6.5 Barriers to adoption

Intravenous TXA has increased in popularity in orthopaedic surgery over the last 10 years. In chapter 2, Lozano [81] published their experience after implementing routine use of IV TXA in joint replacement. Intravenous TXA has become an integral part of enhanced recovery programme for joint replacement in the North East region. Trank-X provides evidence that topical TXA may be more effective in reducing blood loss, transfusion and LOS in TKR than by the intravenous mode. Additionally topical delivery is easier to prepare and apply, and it might be expected that this mode of use would be readily adopted. However, there are several barriers to overcome before routine use becomes a reality.

One of the most fundamental principles of medical ethics is “primum non nocere” which is a Latin phrase that means "First, do no harm". Thus surgeons are usually cautious in adopting new interventions and technologies without an adequate evaluation of effectiveness and a long term safety record. This caution is fully justified particularly when the experience of previous unsuccessful or harmful developments is recalled.

The BioTRANX study was designed to assess the potential for long term effects on artificial joints material and the results was reassuring. However, these findings may not accurately predict the effect of TXA on inserted joints within the body. A plan to review the trial patients in 5 and 10 years is planned, but the usefulness of such review will depend on the availability of patients, and involves delay in changes to current patient care.

The study findings need replicating by other research groups: reassurance against biased methodology or chance findings.

Tranexamic acid is not licensed for topical use in joint replacement. Although the process of licensing is underway in the University Hospital of North Tees and Hartlepool, off license use may attract litigation if unexpected complications arise. The process of licensing is lengthy and involves vigilance and adverse reaction monitoring: this can further deter some potential users from early adoption.

Theoretically, TXA can cause thrombosis and pulmonary embolism, although this has never been shown in any of the clinical studies we reviewed. However, this perceived risk may be a major barrier for adoption by orthopaedic surgeons. Joint replacement surgery is associated with an increased risk of DVT and PE. In the United Kingdom, this risk is a major public concern that attracted a parliamentary inquiry in 2005. The magnitude of such risks and how to reduce them are contested and beyond the scope of this thesis, but these potentially remain a major barrier against the routine use of TXA.

6.6 Conclusion

A programme of research has provided evidence for the value of topically applied tranexamic acid in total knee replacement surgery. The evidence generated suggests that topically applied TXA is an effective, safe and cost-effective modality and should be routinely adopted. Long term surveillance studies are appropriate to address remaining uncertainties about safety.

Bibliography

REFERENCES

1. Klenerman, L., *The evolution of orthopaedic surgery* 2002, London: Royal Society of Medicine Press Ltd.
2. Robinson, R.P., *The early innovators of today's resurfacing condylar knees*. J Arthroplasty, 2005. **20**(1 Suppl 1): p. 2-26.
3. Porter, M.B., M; Gregg, P; Howard, P; MacGregor, A, Tucker,K, *National Joint Registry for England and Wales, the 6th Annual report*. 2009, NJR Steering Committee.
4. Porter, M.B., M; Gregg, P; Howard, P; MacGregor, A, Tucker,K, *National Joint Registry for England and Wales, the 7th Annual report*. 2010, NJR Steering Committee.
5. Richard D Scot, T.S.T., *P.F.C. SIGMA Knee System. Primary Surgical Techniques*. 2004, Leeds: DePuy International Ltd.
6. Molloy, D.O., et al., *Comparison of topical fibrin spray and tranexamic acid on blood loss after total knee replacement: a prospective, randomised controlled trial*. J Bone Joint Surg Br, 2007. **89**(3): p. 306-9.
7. Good, L., E. Peterson, and B. Lisander, *Tranexamic acid decreases external blood loss but not hidden blood loss in total knee replacement*. Br J Anaesth, 2003. **90**(5): p. 596-9.
8. Hiippala, S.T., et al., *Tranexamic acid radically decreases blood loss and transfusions associated with total knee arthroplasty*. Anesth Analg, 1997. **84**(4): p. 839-44.
9. Sehat, K.R., R. Evans, and J.H. Newman, *How much blood is really lost in total knee arthroplasty?. Correct blood loss management should take hidden loss into account*. Knee, 2000. **7**(3): p. 151-155.
10. Kleinman S, C.P., Robillard P. , *Risks associated with transfusion of cellular blood components in canada*. . Transfus Med Rev, 2003. **17**: p. 120-162.
11. Vamvakas, E.C. and H.F. Taswell, *Epidemiology of blood transfusion*. Transfusion, 1994. **34**(6): p. 464-70.
12. C.R.W. Edwards, I.A.D.B., C. Haslett, E.R. Chilvers, *Davidson's Principle and Practice of Medicine*. 17th ed. 1995, New York: Churchill Livingstone.
13. Ganong, W.F., *Review of Medical Physiology*. 17th ed. 1995, Norwalk: Appleton & Lange.
14. D. R. Lawrence, P.N.B., *Clinical Pharmacology*. 7th ed. 1994, Edinburgh: Churchill Livingstone.
15. Parveen Kumar, M.C., *Clinical Medicine*. Third ed. 1994, London: W. B. Saunders.
16. Benoni, G., S. Lethagen, and H. Fredin, *The effect of tranexamic acid on local and plasma fibrinolysis during total knee arthroplasty*. Thromb Res, 1997. **85**(3): p. 195-206.
17. Benoni, G. and H. Fredin, *Fibrinolytic inhibition with tranexamic acid reduces blood loss and blood transfusion after knee arthroplasty: a prospective, randomised, double-blind study of 86 patients*. J Bone Joint Surg Br, 1996. **78**(3): p. 434-40.
18. Jansen, A.J., et al., *Use of tranexamic acid for an effective blood conservation strategy after total knee arthroplasty*. Br J Anaesth, 1999. **83**(4): p. 596-601.
19. Zohar, E., et al., *A comparative study of the postoperative allogeneic blood-sparing effects of tranexamic acid and of desmopressin after total knee replacement*. Transfusion, 2001. **41**(10): p. 1285-9.

20. Zohar, E., et al., *A comparative study of the postoperative allogeneic blood-sparing effect of tranexamic acid versus acute normovolemic hemodilution after total knee replacement*. *Anesth Analg*, 1999. **89**(6): p. 1382-7.
21. Zohar, E., et al., *The postoperative blood-sparing efficacy of oral versus intravenous tranexamic acid after total knee replacement*. *Anesth Analg*, 2004. **99**(6): p. 1679-83, table of contents.
22. Smith, C.R., *Management of bleeding complications in redo cardiac operations*. *Ann Thorac Surg*, 1998. **65**(4 Suppl): p. S2-8; discussion S27-8.
23. Mohr, R., et al., *Aprotinin prevents cardiopulmonary bypass-induced platelet dysfunction. A scanning electron microscope study*. *Circulation*, 1992. **86**(5 Suppl): p. II405-9.
24. Faught, C., et al., *Adverse effects of methods for minimizing perioperative allogeneic transfusion: a critical review of the literature*. *Transfus Med Rev*, 1998. **12**(3): p. 206-25.
25. Howard Fee, J.P. and J.G. Bovill, *Pharmacology for anaesthesiologists* 2005: Taylor & Francis Group Plc. 254.
26. Mr A J Hamer , P.M.S.D., Mr P H Earnshaw , Dr S Knowles ,Mr J H Newman *Blood conservation in elective orthopaedic surgery*. 2005, British Orthopaedic Association: London.
27. NICE, *Clinical Guideline 3, Preoperative tests, The use of routine preoperative tests for elective surgery*. 2003, NICE: London.
28. Hamer, A.J., et al., *Blood conservation in elective orthopaedic surgery*. 2005, British Orthopaedic Association: London.
29. Aderinto, J. and I.J. Brenkel, *Pre-operative predictors of the requirement for blood transfusion following total hip replacement*. *J Bone Joint Surg Br*, 2004. **86**(7): p. 970-3.
30. Cuenca, J., et al., *Preoperative haematinics and transfusion protocol reduce the need for transfusion after total knee replacement*. *Int J Surg*, 2007. **5**(2): p. 89-94.
31. Cuenca, J., et al., *Perioperative intravenous iron, with or without erythropoietin, plus restrictive transfusion protocol reduce the need for allogeneic blood after knee replacement surgery*. *Transfusion*, 2006. **46**(7): p. 1112-9.
32. Keating, E.M., et al., *A randomized, parallel-group, open-label trial of recombinant human erythropoietin vs preoperative autologous donation in primary total joint arthroplasty: effect on postoperative vigor and handgrip strength*. *J Arthroplasty*, 2007. **22**(3): p. 325-33.
33. van Daele, M.E., et al., *Transesophageal echocardiographic monitoring of preoperative acute hypervolemic hemodilution*. *Anesthesiology*, 1994. **81**(3): p. 602-9.
34. Goodnough, L.T., et al., *A randomized trial of acute normovolemic hemodilution compared to preoperative autologous blood donation in total knee arthroplasty*. *Vox Sang*, 1999. **77**(1): p. 11-6.
35. Goodnough, L.T., et al., *A randomized trial comparing acute normovolemic hemodilution and preoperative autologous blood donation in total hip arthroplasty*. *Transfusion*, 2000. **40**(9): p. 1054-7.
36. Wang, G.J., et al., *Use of fibrin sealant to reduce bloody drainage and hemoglobin loss after total knee arthroplasty: a brief note on a randomized prospective trial*. *J Bone Joint Surg Am*, 2001. **83-A**(10): p. 1503-5.
37. Hagemann, A., et al., *[Avoidance of homologous blood transfusion despite extreme blood loss]*. *Anaesthesist*, 1997. **46**(11): p. 964-8.

38. Sharrock, N.E., et al., *The effect of two levels of hypotension on intraoperative blood loss during total hip arthroplasty performed under lumbar epidural anesthesia*. *Anesth Analg*, 1993. **76**(3): p. 580-4.
39. Thompson, G.E., et al., *Hypotensive anesthesia for total hip arthroplasty: a study of blood loss and organ function (brain, heart, liver, and kidney)*. *Anesthesiology*, 1978. **48**(2): p. 91-6.
40. Schmied, H., et al., *Mild hypothermia increases blood loss and transfusion requirements during total hip arthroplasty*. *Lancet*, 1996. **347**(8997): p. 289-92.
41. Scott, E.M., *Systemic warming before, during, and after major abdominal surgery reduced postoperative complications more than warming during surgery only*. *Evid Based Nurs*, 2007. **10**(4): p. 114.
42. Scott, E.M. and R. Buckland, *A systematic review of intraoperative warming to prevent postoperative complications*. *AORN J*, 2006. **83**(5): p. 1090-104, 1107-13.
43. Huet, C., et al., *A meta-analysis of the effectiveness of cell salvage to minimize perioperative allogeneic blood transfusion in cardiac and orthopedic surgery*. *International Study of Perioperative Transfusion (ISPOT) Investigators*. *Anesth Analg*, 1999. **89**(4): p. 861-9.
44. Hansen, E., et al., *Blood irradiation for intraoperative autotransfusion in cancer surgery: demonstration of efficient elimination of contaminating tumor cells*. *Transfusion*, 1999. **39**(6): p. 608-15.
45. Carless, P.A., et al., *Desmopressin for minimising perioperative allogeneic blood transfusion*. *Cochrane Database Syst Rev*, 2004(1): p. CD001884.
46. Lin, Y., et al., *Recombinant factor VIIa for the prevention and treatment of bleeding in patients without haemophilia*. *Cochrane Database of Systematic Reviews*, 2007. **Art. No.: CD005011. DOI: 10.1002/14651858.CD005011(2)**.
47. Stanworth SJ, B.J., Doree CJ, et al, *Recombinant factor VIIa for the prevention and treatment of bleeding in patients without haemophilia* *Cochrane Database Syst Review*, 2007.
48. Mayo, A., et al., *Recombinant activated factor VII (NovoSeven): addition to replacement therapy in acute, uncontrolled and life-threatening bleeding*. *Vox Sang*, 2004. **87**(1): p. 34-40.
49. Newman, J.H., M. Bowers, and J. Murphy, *The clinical advantages of autologous transfusion. A randomized, controlled study after knee replacement*. *J Bone Joint Surg Br*, 1997. **79**(4): p. 630-2.
50. BOA, *Knee Replacement: A guide to good practice*. *British Orthopaedic Association and British Association for Surgery on the Knee publication*. December 1999.
51. BCSH, *Guidelines on clinical use of red cell transfusion*. *British Journal of Haematology*, 2001. **113**: p. 24-31.
52. Website. *Guidelines on clinical use of red cell transfusion*. *The British Committee for Standards in Haematology official website*. . 2001 [cited Accesses 1/3/2008]; Available from: <http://www.bcsguidelines.com/publishedHO.asp?tf=Blood%20Transfusion&status=>.
53. Benoni, G., et al., *Does tranexamic acid reduce blood loss in knee arthroplasty?* *Am J Knee Surg*, 1995. **8**(3): p. 88-92.
54. Klein, H.G., *Allogenic transfusion risks in the surgical patient*. *Am J Surg.*, 1995. **170**: p. 21S-26S.
55. Schreiber, G.B., K.S.H. Busch Mp, and J.J. Korelitz, *the risk of transfusion transmitted viral infections. the Retrovirus epidemiology donor study*. *N Engl J Med*, 1996. **334**: p. 1685-1690.

56. Madjdpour, C. and D.R. Spahn, *Allogeneic red blood cell transfusions: efficacy, risks, alternatives and indications*. British Journal of Anaesthesia, 2005. **95** (1): p. 33-42.
57. Henry, D.A., et al., *Anti-fibrinolytic use for minimising perioperative allogeneic blood transfusion*. Cochrane Database Syst Rev, 2007(4): p. CD001886.
58. Zufferey, P., et al., *Do antifibrinolytics reduce allogeneic blood transfusion in orthopedic surgery?* Anesthesiology, 2006. **105**(5): p. 1034-46.
59. Henry, D., et al., *The safety of aprotinin and lysine-derived antifibrinolytic drugs in cardiac surgery: a meta-analysis*. CMAJ, 2009. **180**(2): p. 183-93.
60. Ho, K.M. and H. Ismail, *Use of intravenous tranexamic acid to reduce allogeneic blood transfusion in total hip and knee arthroplasty: a meta-analysis*. Anaesth Intensive Care, 2003. **31**(5): p. 529-37.
61. Fergusson, D.A., et al., *A comparison of aprotinin and lysine analogues in high-risk cardiac surgery*. N Engl J Med, 2008. **358**(22): p. 2319-31.
62. Henry, D.A., et al., *Anti-fibrinolytic use for minimising perioperative allogeneic blood transfusion*. Cochrane Database Syst Rev, 2009(1): p. CD001886.
63. Higgins, J.P.T. and S. Green, *Cochrane Handbook for Systematic Reviews of Interventions 4.2.5 [updated May 2005]*. 2005.
64. Madhok, R., et al., *Bone, Joint and Muscle Trauma Group (formerly the Musculoskeletal Injuries Group). About the Cochrane Collaboration (Collaborative Review Groups (CRG's)) 2007, Issue 1*. Cochrane Database of Systematic Reviews, 2007.
65. Akizuki, S., Y. Yasukawa, and T. Takizawa, *A new method of hemostasis for cementless total knee arthroplasty*. Bull Hosp Jt Dis, 1997. **56**(4): p. 222-4.
66. Benoni, G., et al., *Tranexamic acid, given at the end of the operation, does not reduce postoperative blood loss in hip arthroplasty*. Acta Orthop Scand, 2000. **71**(3): p. 250-4.
67. Niskanen, R.O. and O.L. Korkala, *Tranexamic acid reduces blood loss in cemented hip arthroplasty: a randomized, double-blind study of 39 patients with osteoarthritis*. Acta Orthop, 2005. **76**(6): p. 829-32.
68. Neilipovitz, D.T., et al., *A randomized trial of tranexamic acid to reduce blood transfusion for scoliosis surgery*. Anesth Analg, 2001. **93**(1): p. 82-7.
69. Ellis, M.H., et al., *The effect of tourniquet application, tranexamic acid, and desmopressin on the procoagulant and fibrinolytic systems during total knee replacement*. J Clin Anesth, 2001. **13**(7): p. 509-13.
70. Ido, K., et al., *Reduction of blood loss using tranexamic acid in total knee and hip arthroplasties*. Arch Orthop Trauma Surg, 2000. **120**(9): p. 518-20.
71. Hiippala, S., et al., *Tranexamic acid (Cyklokapron) reduces perioperative blood loss associated with total knee arthroplasty*. Br J Anaesth, 1995. **74**(5): p. 534-7.
72. Camarasa, M.A., et al., *Efficacy of aminocaproic, tranexamic acids in the control of bleeding during total knee replacement: a randomized clinical trial*. Br J Anaesth, 2006. **96**(5): p. 576-82.
73. Engel, J.M., et al., *Regional hemostatic status and blood requirements after total knee arthroplasty with and without tranexamic acid or aprotinin*. Anesth Analg, 2001. **92**(3): p. 775-80.
74. Veien, M., et al., *Tranexamic acid given intraoperatively reduces blood loss after total knee replacement: a randomized, controlled study*. Acta Anaesthesiol Scand, 2002. **46**(10): p. 1206-11.
75. Orpen, N.M., et al., *Tranexamic acid reduces early post-operative blood loss after total knee arthroplasty: a prospective randomised controlled trial of 29 patients*. Knee, 2006. **13**(2): p. 106-10.

76. Tanaka, N., et al., *Timing of the administration of tranexamic acid for maximum reduction in blood loss in arthroplasty of the knee*. J Bone Joint Surg Br, 2001. **83**(5): p. 702-5.
77. Alvarez, J.C., et al., *Tranexamic acid reduces blood transfusion in total knee arthroplasty even when a blood conservation program is applied*. Transfusion, 2008. **48**(3): p. 519-25.
78. Sterne, J.A. and M. Egger, *Funnel plots for detecting bias in meta-analysis: guidelines on choice of axis*. J Clin Epidemiol, 2001. **54**(10): p. 1046-55.
79. Kakar, P.N., et al., *Efficacy and Safety of Tranexamic Acid in Control of Bleeding Following TKR: A Randomized Clinical Trial*. Indian J Anaesth, 2009. **53**(6): p. 667-71.
80. Zhang, F., Z. Gao, and J. Yu, *[Clinical comparative studies on effect of tranexamic acid on blood loss associated with total knee arthroplasty]*. Zhongguo Xue Fu Chong Jian Wai Ke Za Zhi, 2007. **21**(12): p. 1302-4.
81. Lozano, M., et al., *Effectiveness and safety of tranexamic acid administration during total knee arthroplasty*. Vox Sang, 2008. **95**(1): p. 39-44.
82. Sindet-Pedersen, S., et al., *Hemostatic effect of tranexamic acid mouthwash in anticoagulant-treated patients undergoing oral surgery*. N Engl J Med, 1989. **320**(13): p. 840-3.
83. Sindet-Pedersen, S. and S. Stenbjerg, *Effect of local antifibrinolytic treatment with tranexamic acid in hemophiliacs undergoing oral surgery*. J Oral Maxillofac Surg, 1986. **44**(9): p. 703-7.
84. De Bonis M, e.a., *Topical use of tranexamic acid in coronary artery bypass operations: a double blind prospective, randomised placebo – controlled study*. J Cardiovascular surg, 2000. **119**: p. 575-580.
85. Abul-Azm, A. and K.M. Abdullah, *Effect of topical tranexamic acid in open heart surgery*. Eur J Anaesthesiol, 2006. **23**(5): p. 380-4.
86. Baric–Davor, e.a., *Topical use of antifibrinolytic agents reduces postoperative bleeding: a double–blind,prospective, randomized study*. Eur–J– Cardiothorac–Surg, Mar 2007 (epub: 10 Jan 2007). **vol. 31, no. 3**; p. 366–71.
87. Verstraete, M., *Clinical application of inhibitors of fibrinolysis*. Drugs, 1985. **29**(3): p. 236-61.
88. Valsecchi, A., *[Further notes on the topical use of tranexamic acid in the treatment of gynecological hemorrhage]*. Minerva Ginecol, 1980. **32**(9): p. 825-30.
89. Krohn, C.D., et al., *Tranexamic acid given into the wound reduces postoperative blood loss by half in major orthopaedic surgery*. Eur J Surg Suppl, 2003(588): p. 57-61.
90. Dunn CJ, G.K., *Tranexamic acid: A review of its use and other indications*. Drug, 1999(57): p. 1005-1032.
91. Schulz, K.F., D.G. Altman, and D. Moher, *CONSORT 2010 statement: updated guidelines for reporting parallel group randomised trials*. BMJ. **340**: p. c332.
92. SOFIANOS, I.P., et al., *Review of transfusion practice in orthopaedic patient Components of the integral concept of avoiding allogeneic blood transfusion*. EEXOT, 2008. **Volume 59, (1)**: p. 53-59.
93. Wells, A.W., et al., *Where does blood go? Prospective observational study of red cell transfusion in north England*. BMJ, 2002. **325**(7368): p. 803.
94. Website. *UK blood transfusion and tissue transplantation services official web site*. . 2001 [cited Accessed 1/3/2008.]; Available from: <http://www.transfusionsguidelines.org.uk/index.asp?Publication=BBT&Section=22&pageid=1275>.
95. Brooks, R., *EuroQol: the current state of play*. Health Policy, 1996. **37**(1): p. 53-72.

96. Brazier, J., N. Jones, and P. Kind, *Testing the validity of the Euroqol and comparing it with the SF-36 health survey questionnaire*. Qual Life Res, 1993. **2**(3): p. 169-80.
97. van Agt, H.M., et al., *Test-retest reliability of health state valuations collected with the EuroQol questionnaire*. Soc Sci Med, 1994. **39**(11): p. 1537-44.
98. Oppe, M., et al., *on behalf of the EuroQol Group. EQ-5D User Guide*. Vol. V 1.0. November 2007.
99. Dawson, J., et al., *Questionnaire on the perceptions of patients about total knee replacement*. J Bone Joint Surg Br, 1998. **80**(1): p. 63-9.
100. Dunbar, M.J., et al., *Translation and validation of the Oxford-12 item knee score for use in Sweden*. Acta Orthop Scand, 2000. **71**(3): p. 268-74.
101. Liow, R.Y., et al., *Functional rating for knee arthroplasty: comparison of three scoring systems*. Orthopedics, 2003. **26**(2): p. 143-9.
102. Murray, D.W., et al., *The use of the Oxford hip and knee scores*. J Bone Joint Surg Br, 2007. **89**(8): p. 1010-4.
103. SooHoo, N.F., et al., *Factors predicting complication rates following total knee replacement*. J Bone Joint Surg Am, 2006. **88**(3): p. 480-5.
104. Claus, A., et al., *[Risk profiling of postoperative complications in 17,644 total knee replacements]*. Unfallchirurg, 2006. **109**(1): p. 5-12.
105. Geerts, W.H., et al., *Prevention of venous thromboembolism: the Seventh ACCP Conference on Antithrombotic and Thrombolytic Therapy*. Chest, 2004. **126**(3 Suppl): p. 338S-400S.
106. Tovey, C. and S. Wyatt, *Diagnosis, investigation, and management of deep vein thrombosis*. BMJ, 2003. **326**(7400): p. 1180-4.
107. Rathbun, S.W., G.E. Raskob, and T.L. Whitsett, *Sensitivity and specificity of helical computed tomography in the diagnosis of pulmonary embolism: a systematic review*. Ann Intern Med, 2000. **132**(3): p. 227-32.
108. Seah, V.W., et al., *Thirty-day mortality and morbidity after total knee arthroplasty*. Ann Acad Med Singapore, 2007. **36**(12): p. 1010-2.
109. Mantilla, C.B., et al., *Frequency of myocardial infarction, pulmonary embolism, deep venous thrombosis, and death following primary hip or knee arthroplasty*. Anesthesiology, 2002. **96**(5): p. 1140-6.
110. Gill, G.S., D. Mills, and A.B. Joshi, *Mortality following primary total knee arthroplasty*. J Bone Joint Surg Am, 2003. **85-A**(3): p. 432-5.
111. Seppo T. Hippala et, a.l., *Tranexamic acid radically decreases blood loss and transfusion associated with Total Knee Arthroplasty*. An&h Analg, 1997. **84**: p. 839-844.
112. Thompson, S.G. and J.A. Barber, *How should cost data in pragmatic randomised trials be analysed?* BMJ, 2000. **320**(7243): p. 1197-200.
113. BNF, *British National Formulary (BNF 51)*. 51 ed. 2006.
114. Freidlin, B., E.L. Korn, and S.L. George, *Data monitoring committees and interim monitoring guidelines*. Control Clin Trials, 1999. **20**(5): p. 395-407.
115. Dash, A., et al., *Patient, surgeon, and treatment characteristics associated with homologous blood transfusion requirement during radical retropubic prostatectomy: multivariate nomogram to assist patient counseling*. Urology, 2004. **64**(1): p. 117-22.
116. Winter, S.L., et al., *Perioperative blood loss: the effect of valproate*. Pediatr Neurol, 1996. **15**(1): p. 19-22.
117. Li, B., et al., *[The use of a pneumatic tourniquet in total knee arthroplasty: a prospective, randomized study]*. Zhonghua Wai Ke Za Zhi, 2008. **46**(14): p. 1054-7.

118. Li, B., et al., *The effect of tourniquet use on hidden blood loss in total knee arthroplasty*. Int Orthop, 2009. **33**(5): p. 1263-8.
119. Abdel-Salam, A. and K.S. Eyres, *Effects of tourniquet during total knee arthroplasty. A prospective randomised study*. J Bone Joint Surg Br, 1995. **77**(2): p. 250-3.
120. Eyres, K.S., I. Sharpe, and A. Abdel-Salam, *The tourniquet in total knee arthroplasty*. J Bone Joint Surg Br, 1999. **81**(5): p. 932.
121. Eipe, N.P., Manickam, *PERIOPERATIVE BLOOD LOSS ASSESSMENT- HOW ACCURATE?* Indian Journal of Anaesthesia, 2006. **50**(1): p. 35-38.
122. Duke, J., *Anaesthesia secrets*. Third ed. 2006: Mosby Elsevier.
123. Thorsson, O., et al., *Comparing ultrasonography, magnetic resonance imaging and scintigraphy in evaluating an experimentally induced muscular hematoma*. Scandinavian Journal of Medicine & Science in Sports, 1993. **3**(2): p. 110-116.
124. Benoni, G., et al., *Blood conservation with tranexamic acid in total hip arthroplasty: a randomized, double-blind study in 40 primary operations*. Acta Orthop Scand, 2001. **72**(5): p. 442-8.
125. Omonbude, D., et al., *Measurement of joint effusion and haematoma formation by ultrasound in assessing the effectiveness of drains after total knee replacement: A prospective randomised study*. J Bone Joint Surg Br, 2010. **92**(1): p. 51-5.
126. Fischgrund, J., *Orthopaedic Knowledge Update*, ed. 9. 2009, Rosemont: the American Academy of Orthopaedic Surgeons. 840.
127. Ramachandran, M., *Basic Orthopaedic Sciences. The Stanmore Guide*. 2007: Hodder Arnold. 304.
128. Saikko, V., *A multidirectional motion pin-on-disk wear test method for prosthetic joint materials*. J Biomed Mater Res, 1998. **41**(1): p. 58-64.
129. Joyce, T.J., et al., *A multi-directional wear screening device and preliminary results of UHMWPE articulating against stainless steel*. Biomed Mater Eng, 2000. **10**(3-4): p. 241-9.
130. Scholes, S.C. and A. Unsworth, *The wear properties of CFR-PEEK-OPTIMA articulating against ceramic assessed on a multidirectional pin-on-plate machine*. Proc Inst Mech Eng H, 2007. **221**(3): p. 281-9.
131. Scholes, S.C. and A. Unsworth, *Pin-on-plate studies on the effect of rotation on the wear of metal-on-metal samples*. J Mater Sci Mater Med, 2001. **12**(4): p. 299-303.
132. McKellop, H., et al., *Wear characteristics of UHMW polyethylene: a method for accurately measuring extremely low wear rates*. J Biomed Mater Res, 1978. **12**(6): p. 895-927.
133. Laurence, D.R. and P.N. Bennett, *Clinical Pharmacology*. Seventh Edition ed. 1995, Edinburgh: Churchill Livingstone. 686.
134. Haycox, A. and E. Noble (2009) *What is health economics? What is this ...? series*. **Volume, 8**
135. Roland, M. and D.J. Torgerson, *What are pragmatic trials?* BMJ, 1998. **316**(7127): p. 285.

Appendices

2.1 Metanalysis data extraction sheet

Trial ID				
Action				
Methods				
Allocation:				
Blindness:				
Duration:				
Participants				
N				
Age				
Sex				
Dx				
Cement tech				
Implants				
Exclusions				
Interventions				
1.				
2.				
3.				
Outcomes - able to use				
Blood loss				
BT	Vol			
	Units			
	Number			
LOS				
Spec. Knee Score				
QOL score				
C O M P	Infections			
	DVT			
	PE			
	MI			
	CVA			
	RF			
	Others			
Outcomes - unable to use				
Notes				

Appendix 2.2 Detailed summaries of the included trials

Alvarez 2008

Methods	RCT. Double blind study. March to December 2005. Spain.	
Participants	TXA group [N=46, Age 71±9, M/F (7/39)] Control group [N=49, Age 72±7, M/F (10/39)]	
Interventions	TXA= 10mg/kg bolus + 1mg/kg/hr for 6h Control= identical protocol of saline	
Outcomes	Blood loss	TXA 170 ±109 vs. control 551±352
	Transfusion rate	TXA 1 vs. control 6
	Transfusion amount (U)	TXA 1 vs. control 11
	Complications	No thromboembolic events in either side
Notes	BT trigger Hb 8g/dl - LMWH - QAS = 22	

Benoni 1996

Methods	RCT. Double blind study. Sweden.	
Participants	TXA group [N=43, Age 76±7,M/F (13/30)] Control group [N=43, Age 74±7,M/F 10/33]	
Interventions	TXA 10 mg/kg, repeated after 3 hours. Another dose of TA if blood loss >500 ml within 1 hour or 1000ml within 4 hours Placebo	
Outcomes	Blood loss	Total blood loss: Total TXA 730±289 vs. control 1410±480 Drain blood loss: TXA 520 ± 230 vs. control 1210 ± 480 ml
	Transfusion rate	TXA 8 vs. control 24
	Transfusion amount(U)	TXA 12 vs. control 40
	Complications	TXA group (2 superficial infections, 4 DVT and 1 PE) Placebo group (3 DVT, 1 PE and 7 haematomas)
Notes	BT trigger 85-100 g/l – LMWH - QAS 22	

Benoni 1996

Methods	RCT. Double blind study. Sweden.	
Participants	TXA group [N=43, Age 76±7, M/F (13/30)]. Control group [N=43, Age 74±7, M/F 10/33)].	
Interventions	TXA 10 mg/kg, repeated after 3 hours. Another dose of TA if blood loss >500 ml within 1 hour or 1000ml within 4 hours. Placebo	
Outcomes	Blood loss	Total blood loss: Total TXA 730±289 vs. control 1410±480. Drain blood loss: TXA 520 ± 230 vs. control 1210 ± 480 ml
	Transfusion rate	TXA 8 vs. control 24
	Transfusion amount (U)	TXA 12 vs. control 40
	Complications	TXA group (2 superficial infections, 4 DVT and 1 PE) Placebo group (3 DVT, 1 PE and 7 haematomas)
Notes	BT trigger 85-100 g/l-LMWH-QAS 22	

Camarasa 2006

Methods	RCT. Double blind study. March 2004 to March 2005. Spain.	
Participants	TXA group [N=35, Age 73 (81-84), M/F 11/26] EACA group [N=33, Age 73 (59-80), M/F 4/29] Saline group [N=68, Age 72 (52-85), M/F 14/54]	
Interventions	TXA 10mg/kg IV just before the tourniquet release and 3h later EACA 100mg/kg IV just before the release of the tourniquet then IV 1 g/h for 3 hours Control = saline	
Outcomes	Blood loss	TXA group 787+/-281 vs. EACA group 810±512 vs. saline 1270±625.
	Transfusion rate	TXA 1 vs. EACA 4 vs. control 23 respectively.
	Transfusion amount (U)	TXA 1 vs. EACA 6 vs. control 35. (Combined autologous, homologous or allogeneic)
	Complications	1 death in TXA group 7 months after his operation* No Thromboembolic events were detected.
Notes	BT trigger <8g/l-LMWH-QAS 24 *Author personal communication.	

Ellis 2001

Methods	Randomised controlled trial. Double blind. Israel.	
Participants	TXA group [N=10, Age 71±5, M/F 4/6] Desmopressin [N=10, Age 72±6, M/F 2/8] Control [N=10, Age 72±6, M/F 3/7]	
Interventions	TXA 15mg/kg before inflating the tourniquet, then 10 mg/kg/hr for 12 hours. Desmopressin 0.3 mcg/kg over 30 minutes, then IV saline over 12 hour. Control IV saline	
Outcomes	Blood loss	No data provided
	Transfusion rate	TXA 1 vs. Desmopressin 6 vs. control 7
	Transfusion amount (U)	TXA 1 vs. Desmopressin 7 vs. control 11
	LOS (days)	TXA 10±3 vs. Desmopressin 10±2 vs. control 10±2
	Complications	No data on thromboembolic events was provided
Notes	BT trigger PCV <27% -LMWH -QAS 22	

Engel 2001

Methods	RCT. Single blind. Germany.	
Participants	TXA group [N=12, Age 71±9, M/F 4/8] Aprotinin [N=12, Age 68±11, M/F 3/9] Placebo [N=12, Age 66±11, M/F 4/8]	
Interventions	TXA 15mg/kg then 10 mg/kg 3h later. Aprotinin 1 million units just before deflating the tourniquet and 0.5 million units 4 h later. Control did not receive anything.	
Outcomes	Blood loss	TXA group 800 (9295-1050) vs. Aprotinin 875 (310-1270) vs. control 865 (245-1370).
	Transfusion rate	TXA group 0 vs. Aprotinin 5 vs. control 3.
	Transfusion amount (U)	TXA group 0 vs. Aprotinin 7 vs. control 6 units].
	Complications	TXA 2 DVT; Aprotinin 1 DVT and 0 in control.
Notes	BT trigger 10g/l -LMWH-Quality assessment score 18	

Good 2003

Methods	RCT, double blind. Sweden.	
Participants	TXA group [N=27, Age 72 (46-83),M/F 9/18] Placebo [N=24, Age 72 (50-84), M/F 6/18]	
Interventions	TXA 10mg/kg IV just before tourniquet release and 3 hours later	
Outcomes	Blood loss	TXA group 385(range 331-586)] vs. placebo 845(range 523-990)
	Transfusion rate	TXA group 3 vs. placebo 14
	Transfusion amount (U)	TXA group 7 vs. placebo 35 units
	Complications	Two DVTs in each group. 1 wound infection TXA group
Notes	BT trigger HB<9g –LMWH- QAS 24	

Hiippala 1995

Methods	RCT, Double blind. Finland.	
Participants	TXA group (N=15, Age 70(56-82), M/F (2/13)) Placebo group (N=13, Age 70(63-78), M/F (3/10))	
Interventions	TXA 15 mg/kg (N=15) vs. Placebo (normal saline 0.9%) (N13)	
Outcomes	Blood loss	TXA 847 ml (356) vs. control 154(574)
	Transfusion rate	TXA group 10 vs. placebo 12
	Transfusion amount (U)	TXA group 1.5 units /patient vs. Placebo group 3.3 per patient
	Complications	TXA group had 1 MI. Placebo group had 1 DVT and 1 PE
Notes	BT trigger 10 g/dl -LMWH - QAS 19	

Hiippala 1997

Methods	Randomised controlled trial. Double blind study. 19 September 1994 to 22 April 1996. Finland.	
Participants	TXA group (N=39, Age 70±7, M/F 4/35) Placebo (N=38, Age 69±5, M/F 8/30)	
Interventions	TXA 15mg/kg before the tourniquet release and two additional doses of 10mg/kg 3-4 and 6-7 hours later vs. Placebo	
Outcomes	Blood loss	TXA group 689±289 vs. Placebo group 1509±643.
	Transfusion rate	TXA group 17 vs. placebo 34
	Transfusion amount (U)	TXA group ±1.2 vs. Placebo group 3.1±1.6.
	Complications	TXA group (2 DVT, 2 Chest infection and cardiac ischaemia) Placebo group (2 DVT and 1 death due to PE.)
Notes	BT trigger 10 g/l –LMWH -Quality assessment score is 22	

Ido 2000

Methods	Controlled trial. Unblinded. November 1994 to November 1997. Japan.	
Participants	TXA group (N =21) and Placebo group (N=22)	
Interventions	TXA 1 g just before the tourniquet release and 1 g 3h later vs. Placebo	
Outcomes	Blood loss	TXA group 276.9±153.1 vs. Placebo group 518.6±213.6.
	Transfusion rate	No data provided
	Transfusion amount (U)	No data provided
	Complications	No thromboembolic events detected.
Notes	No transfusion trigger - No chemical thromboprophylaxis - QAS 14	

Jansen 1999

Methods	RCT, double blind study. Belgium.	
Participants	TXA group [N=21, Age 70.7 (62-80),M/F 5/16] Placebo group [N=21, Age 71 (64-84),M/F 3/18]	
Interventions	TXA 15mg/kg 30 min before surgery and 8 hourly for 3 days vs. Placebo	
Outcomes	Blood loss	TXA group 678±352 vs. Placebo group 1419±607
	Transfusion rate	TXA group 2 vs. Placebo 13
	Transfusion amount (U)	TXA group 3 units vs. Placebo group 20 units
	Complications	TXA group none vs. 2 DVT in the placebo group
Notes	BT trigger PCV<26% -LMWH - QAS 24	

Kakar 2009

Methods	RCT, double blind study. India.	
Participants	Two groups of participants. Bilateral TKRs and Unilateral TKRs. The first group was excluded as it is beyond the scope of this review. TXA group [N=12, Age 62.4 ±9.4, M/F 3/9] Placebo group [N=12, Age 66.2±4.2, M/F 4/8]	
Interventions	TXA 10mg/kg IV before tourniquet inflation and 1mg/kg/h until wound closure vs. Placebo	
Outcomes	Blood loss	TXA group 160±87 vs. placebo group 270±88
	Transfusion rate	No data provided
	Transfusion amount (U)	TXA group 1 unit vs. Placebo group 5 units
	Complications	No DVT on either side of the trial
Notes	BT trigger Hb < 8 g/l; BT trigger become < 10 g/l when participant was older than 60 year or had a co-morbidity – LMWH – QAS 22	

Molloy 2007

Methods	RCT, All blind apart from the drug provider. December 2004 to October 2005. Northern Ireland.	
Participants	TXA group [N=50] vs. Fibrin [50] vs. Control [50]	
Interventions	TXA 500 mg IV before deflation of the tourniquet and 500 mg 3h later Fibrin 10 ml spray Control: none	
Outcomes	Blood loss	TXA group 1225±499 vs. Fibrin 1190 ±490 vs. control 1415±416.
	Transfusion rate	TXA 5 vs. Fibrin 7 vs. control 11 respectively
	Transfusion amount (U)	TXA 8 vs. Fibrin 11 vs. control 17 units.
	LOS (days)	TXA group 5.10 (2-250) vs. Fibrin group 4.82 (3-11) vs. control 5.86 (2-33)
	Complications	TXA group 1 chest infection Fibrin group (1 DVT and 1 PE) Control group 2 wound infections
Notes	BT triggers Hct < 0.25 at 8 h - Aspirin as DVT prophylaxis – QAS 22	

Orpen 2006

Methods	RCT. Double blind study. England.	
Participants	TXA group [N=15, Age 73 (70-78), M/F 8/7] Placebo group [N=14, Age 69 (63-74), M/F 3/11]	
Interventions	TXA 15mg/kg IV at the time of cementing vs. Saline	
Outcomes	Blood loss	TXA group 660±164 vs. control 726 ±178.
	Transfusion rate	TXA 1 vs. control 3.
	Transfusion amount (U)	No data provided
	Complications	No DVT on Duplex ultrasound.
Notes	BT trigger <10 g/dl –LMWH -QAS 24	

Tanaka 2001

Methods	RCT. Double blind. Japan.	
Participants	Preoperative TXA group: N=24; M/F 7/17; Age 65 (59-70). Intra operative TXA group: N=22; M/F 7/15; Age 65 (60-71). Perioperative TXA group: N=27; M/F 8/19; Age 65 (59-69). Placebo: N=26; M/F 9/17; 65 (58-70).	
Interventions	Preoperative: TXA 20mg/kg 10 min before surgery and saline 10 min before tourniquet deflation Intra operative: Saline 10 min. before surgery and TXA 20mg/kg 10 min before tourniquet deflation Perioperative: TXA 10mg/kg 10 min before surgery and 10mg/kg 10 min before tourniquet deflation Placebo	
Outcomes	Blood loss	No data provided
	Transfusion rate	Preoperative 16 vs. Intra operative 17 vs. Perioperative 14 vs. control 26
	Transfusion amount (U)	Preoperative 12; Intra operative 22; Perioperative 13.5; Control 13
	Complications	Preoperative 11 DVTs; Intra operative 10 DVTs; Perioperative 13 DVTs; Control: 12 DVTs. No PEs.
Notes	BT trigger based on the National Institutes of Health Consensus Conference on perioperative transfusion guidelines.	

Veien 2002

Methods	RCT, single blind. Denmark.	
Participants	TXA group [N=15, Age 70.5±9.5, M/F 4/11] Non TXA group (N=15, Age 69.5±9, M/F 1/14)	
Interventions	TXA 10 ml/kg just before the release of the tourniquet and 3 hours later. Non TXA did not receive any thing.	
Outcomes	Blood loss	TXA group 409.7±174.9 vs. Non TA group 761.7±313.1
	Transfusion rate	TXA 0 vs. control 2.
	Transfusion amount (U)	No data provided
	Complications	TXA 0 vs. control 2
Notes	BT Trigger Hct<28% - LMWH - QAS 22	

Zhang 2007

Methods	RCT. June 2005 to June 2006. China.	
Participants	102 participants (51 in each arm).	
Interventions	TXA 1 g IV before tourniquet deflation then 1 g after 3h vs. Placebo	
Outcomes	Blood loss	Drain blood loss: TXA 478 ±172 vs. control 814 ± 156 ml. Total blood loss: TXA 559 ± 159 ml vs. control 1208 ± 243 ml.
	Transfusion rate	No data provided
	Transfusion amount (ml)	TXA 556 ± 174 ml vs. control 1024 ± 278 ml.
	Complications	No DVT in either arms at 6-12 months by the colour Doppler ultrasonography.
Notes	Data based on English version of the abstract.	

Zohar 1999

Methods	Randomised controlled trial, single blind. Israel.	
Participants	TXA group [N=20, Age 74±7, M/F 4/16] NVHD group [N=20, Age 72±5,M/F 7/13]	
Interventions	TXA group 15 mg/kg then IV infusion of 10mg/kg for 12 hours. NVHD group, bled to target 28%, IV volume maintained with ringer lactate and all the autologous blood was transfused.	
Outcomes	Blood loss	TXA 110 ±62 ml vs. NVHD 259±156.
	Transfusion rate	TXA group 2 vs. NVHD group 13.
	Transfusion amount (U)	TXA 2 group units vs. NVHD group 19 units.
	LOS	TXA group 11±30 vs. placebo group 11±4.
	Complications	TA group 6 Haematoma. NVHD group 6 haematomas, 1 DVT and proceed to have PE
Notes	BT trigger PCV <27% - LMWH - QAS 18	

Zohar 2001

Methods	Randomised controlled trial. Single blind. Israel.	
Participants	TXA group [N=20, Age 71±5, M/F 8/12] Desmopressin [N=20, Age 72±5, M/F 3/17]	
Interventions	TXA 15mg/kg before inflating the tourniquet, then 10 mg/kg/hr for 12 hours. Desmopressin 0.3 mcg/kg over 30 minutes, then IV saline over 12 hour.	
Outcomes	Blood loss	TXA group 162±129 vs. Desmopressin group 342±169.
	Transfusion rate	TA group 3 patients vs. Desmopressin group 11
	Transfusion amount (U)	TXA group 3 units vs. Desmopressin group 16 units.
	LOS	TXA group 9±2 vs. Desmopressin group 10±2
	Complications	None in 37 patients. 3 lost to follow up
Notes	Bt trigger PCV <27% - LMWH - QAS 22	

Zohar 2004

Methods	Randomised controlled trial, single blind. Israel.	
Participants	TXA long [N=20, Age 73±8, M/F 6/14] TXA short [N=20, Age 69±7, M/F 4/16] TXA oral [N=20, Age 69±10, M/F 8/12] control [N=20, Age 73±7, M/F 7/13]	
Interventions	TXA long 15mg/kg 30 mg before tourniquet release then 10 mg/kg for 12h. TXA short as above but for 2h then oral 1g at 6 and 12 hours. TXA oral, 1 g 6hour preoperative then 6 hourly for 18 hours. Control: none.	
Outcomes	Blood loss	TXA long group 121+/-810 vs. TXA short 110±38 vs. TXA oral 231±138 vs. control 249±130.
	Transfusion rate	TXA long 3 vs. TXA short 2 vs. TXA oral 4 vs. control 12
	Transfusion amount (U)	TXA long 3 vs. TXA short 4 vs. TXA oral 5 vs. control 18
	LOS	TXA long (8±2) TXA short (8±2) vs. TXA oral (8±2) vs. control (9±2)
	Complications	No thromboembolic event in either side of the trial.
Notes	BT trigger Hct <28% - LMWH - QAS 16	

Appendix 3.1 Research protocol

Research Study Protocol

Study Title

Randomised Controlled Trial of the Use of Topical Application of Tranexamic Acid in Primary Cemented Total Knee Replacement (TRANX-K).

Study Rationale

Today's aging population has resulted in an increase in the number of major orthopaedic surgical interventions in the elderly. Total knee replacement (TKR) is one of the commonest operations in orthopaedic practice. The second annual report of the National Joint Registry showed that there were around 45000 TKR performed in England and Wales between 1 January 2004 and 31 December 2004[1]. The true figure is probably much higher. Literature showed that 20-70% of patients who had TKR needed 1-3 units of blood [2, 3, 4, 5, 6, 7].

Although safer than ever, allogeneic transfusion is still associated with risks for the recipient (haemolysis, infection, immunosuppression, transfusion-related acute lung injury and even death).The risk of postoperative wound infections correlates with the amount of transfused allogeneic blood products.

Tranexamic acid (TA) is a synthetic antifibrinolytic agent that binds to the lysine binding site of plasminogen and blocks the binding of plasminogen to the fibrin surface. Thus plasminogen activation is prevented and fibrinolysis is delayed [8]. It has been successfully used to stop bleeding after dental operation, removal of tonsils, prostate surgery, heavy menstrual bleeding, eye injuries and in patients with Haemophilia. Numerous studies have confirmed the efficacy of TA to reduce blood losses and transfusion requirements in TKR when used intravenously [9, 10, 11, 12, 13]

A Cochrane review scrutinised 211 trials that had used antifibrinolytics to reduce blood loss and blood transfusion. Of the 211 included trials, 147 were conducted in cardiac surgery, 42 trials were in orthopaedic surgery, 14 involved liver surgeries, four were conducted in vascular surgery, two involved thoracic surgery, one involved neurosurgery and one trial was in orthognathic surgery. Forty five trials evaluated the TA. The reviewers concluded that Antifibrinolytic drugs are effective in reducing blood loss, the need for allogeneic red cell transfusion, and the need for re-operation due to continued post-operative bleeding in cardiac surgery (where most trials were performed), without being offset by serious adverse effects. It also recommended that there is no need for further placebo-controlled trials of aprotinin or lysine analogues in cardiac surgery. The principal need is for large comparative trials to assess the relative efficacy, safety and cost-effectiveness of antifibrinolytic drugs in different surgical procedures**Error! Reference source not found.** [14].

Almost all these studies had used TA intravenously in different doses ranged from 250 mg up to 2.5 gram. Some researchers used multiple doses administration. In spite of their positive outcome without adverse effects, they have not been favoured by the orthopaedic community fearing the systemic side effects particularly DVT, pulmonary embolism.

Two studies showed that local Tranexamic acid does not lead to systemic absorption. Mouth washing with the same compound does not lead to increase in its serum levels **Error! Reference source not found.** [16]. And after it had been given topically after pericardiotomy no TA was traced in the systemic blood **Error! Reference source not found.** [15]. More interestingly, in their recent publication, Baric-Daver and colleagues compared the efficacy of topical application of 1 million IU of Aprotinin, 2.5 gram of TA and a placebo. They concluded that topical use of either TA or Aprotinin efficiently reduces postoperative bleeding. TA seems to be at least as potent as aprotinin, but potentially safer and with better cost-effectiveness ratio [19].

Hence our hypothesis, that local TA may provide a high concentration at the bleeding site but little or no systemic side effects. In this study Tranexamic acid will be applied topically to the exposed tissue around the knee joint prior to the wound closure and tourniquet release. It is anticipated that this method of administration will be quicker, easier and have less systemic side effect.

Objectives

To find out whether Tranexamic acid will reduce blood loss significantly after total knee replacement when applied topically.

A survey was conducted among orthopaedic surgeons, anaesthetist and haematologist to obtain a consensus on what can be regarded as a clinically significant difference in reducing blood loss and transfusion rate. It has been agreed that 50% reduction in blood loss is clinically significant and health care providers should consider changing their practice if Tranexamic acid can achieve this goal. This view was supported by the literature as several studies showed this amount of reduction is achievable using antifibrinolytics [2, 3, 6, 10, 14]

Number of Subjects and Duration.

Primary endpoint: Blood transfusion.

Secondary endpoint: Drain blood loss.

Mean blood loss following TKR is 1191 ml with a standard deviation 669 as shown by a previous study [2]. To have a 90% chance of detecting a 50% reduction in mean blood loss from 1191ml to 595ml at the 5% significance level, 54 patients are required (27 in each group).

Blood transfusion is a very important outcome for patients, healthcare providers and policy makers. The above number of patients provides very low power to detect a difference in the proportion of patients requiring blood transfusion. To detect a similar reduction in the current average 30% in our centre, 54 patients

only gives 17% power. However, 144 patients (72 in each group) provide 80% power to detect a reduction in transfusion requirements from 30% to 10% (Corrected Fisher exact test).

We will aim to recruit 150 patients; this will also allow for any drops out and provides adequate power for both primary and secondary endpoints.

Our department perform around 400 total knee replacements a year. It is expected that 50% would take part in the trial and total number will be recruited over one year.

Trial Design:

A double blind controlled randomised trial including 150 patients undergoing unilateral primary cemented total knee replacement. The study will recruit equal numbers to treatment and control arms.

Patients will be approached to participate in the trial in pre-assessment clinic at approximately 3 weeks before their operation. The trial will be discussed with them and the written information sheet supplied. Contact numbers will be provided if they want to discuss any issues before they participate in the trial. On admission, they will be given the opportunity to ask any further questions and at this time they will be invited to sign the consent form.

Inclusion and Exclusion criteria:

Inclusion criteria:

1. Undergoing unilateral primary cemented total knee replacement.

Exclusion criteria:

1. Undergoing unilateral primary total knee replacement for trauma or tumour.
2. Allergic to Tranexamic acid.
3. Bleeding tendency (e.g. Haemophilic and platelets disorders).
4. Warfarin, treatment dose of LMWH or conventional heparin).
5. History of DVT and pulmonary embolism.
6. Renal failure with creatinine > 250 micromole/l.
7. Female subjects of child bearing potential must have a negative pregnancy test.

Permitted therapies include:

1. Aspirin.

2. Subcutaneous prophylactic conventional or LMW heparin. It is expected that most patients will be on LMW heparin [17].

Allocation:

Patients are randomly allocated into either Tranexamic acid group or a placebo. Allocation will be managed by designated nurses (who prepare the solutions) upon receipt of valid patient details. These nurses will keep allocation concealed from all professionals delivering patient care. Both treatment and placebo have the same colour and smell thus delivery of the trial intervention will be double blinded.

Random allocation will be made in blocks of six in order to keep the sizes of treatment groups similar. Randomisation will be stratified by surgeons to achieve balance within the two groups regarding this important prognostic factor.

Intervention:

The operation will be performed in the standard manner. Normally, there is no chemical intervention to reduce blood loss. In our study, at the end of the operation and before closing the wound, the study drug, which will either be Tranexamic acid or Placebo squirted in the wound. The wound is closed and dressed in the normal way then tourniquet is released. Drains are released after one hour in recovery as per routine.

Study drug is Tranexamic acid 1 gram made up for 50 ml with normal saline. Placebo is 50 ml of saline.

Outcome measures

Primary outcome:

- Blood transfusion required (until discharge).(Please, see blood transfusion protocol below)

Secondary outcomes:

- The visible drain blood loss (First 48 hour).

Total knee replacement is performed in bloodless field. The blood is exsanguinated from the limb and tourniquet applied higher up to keep the limb bloodless. After suturing the skin and applying the pressure dressing, the tourniquet is released allowing the blood to flow into the limb. Any bleeding will be sucked out by the vacuum drain. Hence drain blood loss is good reflection of total blood loss after total knee replacement. The outcome is a continuous variable, measured in millilitre (ml) and will be analysed by two sample t-test. Fifty percent reduction in mean drain blood loss will be considered clinically important.

- Volume of blood transfused (until discharge).

- Haemoglobin and Haematocrit drops (On day 2 postoperatively).
- General quality of life measure (EuroQol) preoperative and at 3 months postoperative. This will be completed as per EuroQol group recommendation in their user guide version 1.0 November 2007 [20]
- Oxford knee score preoperative and at 3 months postoperative. This will be completed as per authors' recommendation in their paper "The use of the Oxford hip and knee scores" published in the Journal of Bone and Joint Surgery 2007 [21]. Each of the 12 questions is scored from 4 to 0, with 4 representing the best outcome/least symptoms. The scores from each question were added so that the overall figure lies between 48 and 0, with 48 being the best possible outcome.

There are several studies confirmed the validity, consistency and sensitivity of the above two outcome measures [28, 29, 30, 31, 32, 33, 34, 35, 36, 37]

- Length of stay.
- Cost effectiveness analysis.

Cost analysis reflecting changes in resources utilisation (length of stay, blood transfusion, and complications treatment costs).

- Complications (Incidence in TKR [41,42,43,44]):
 1. Wound infection (0.2-1.7%). This is usually a clinical diagnosis. Swelling, redness, hotness, tenderness and high temperature are the cardinal signs of infection. This is usually associated by rising White blood cell and inflammatory markers and confirmed by microbiological test. For the purpose of the study, clinical findings are essential to the diagnosis of infection, with or without investigative confirmation. Raised WBC and inflammatory markers are common after TKR. Microbiology swabs can be a contamination.
 2. Deep venous thrombosis (41-85%; proximal 5-22%). DVT is taken seriously by the orthopaedic team because its treatment, which is anticoagulation, carries significant risk to patients' joint replacement such haematoma and infection. The current practice is to start patients with suspected DVT on treatment and to get Doppler ultrasound as soon as possible. In rare occasions, when the Doppler ultrasound is not conclusive, lower limb venogram is requested. Contrary to the infection, the diagnosis of DVT in our study is based on investigation rather than the clinical finding.

3. Pulmonary embolism (1.5-10%; fatal 0.1-1.7%). As in DVT, PE is taken seriously by the orthopaedic team. Unfortunately, all the objective tests have clinical or practical limitations. The ventilation-perfusion lung scan has been the first-line test for more than 20 years. However, 60% to 70% of lung scans are non-diagnostic. Use of helical CT in the diagnosis of PE has not been adequately evaluated, particularly in peripheral PE. The safety of withholding anticoagulant treatment in patients with negative results on helical CT is uncertain. Pulmonary angiography is the gold standard, but it is invasive and expensive, may be impractical or unavailable in some clinical settings and carries cardiac or pulmonary complications in 3% to 4% of patients. In our current practice, we almost always consulted a physician to make the definite diagnosis and for the purpose of our study, we will do the same. If a patient is treated for PE by a physician, we will regard him/her have a PE. However, we will make note whether this diagnosis was based on confirmatory test [22].

4. Myocardial infarction (0.4%). Chest pain is common and not every chest pain is an MI. On the other hand, MI can be silent without any pain, particularly in postoperative patients with diabetes mellitus. So the diagnosis of MI must be confirmed by rising cardiac enzyme (Troponin T) and / or ECG changes in the form of ST elevation, Q-wave and T wave changes.

5. Cerebrovascular accident. Difficulties occur in the diagnosis of CVA because similar clinical events can be caused by different pathological processes. CT scan is now available and is indicated virtually in all patients with a stroke. CT scan will usually demonstrate the site of a lesion and distinguish between a haemorrhage and infarction. Ninety percent of all infarcts are detected at 1 week. It also rules out or show unexpected causes [22,23]

6. Death until discharge (0.5%).

Blood transfusion protocol:

Based on the recommendation of British Orthopaedic Association (BOA) [24], Blood Transfusion Task Force, and The British Committee for Standards in Haematology [26], UK blood transfusion and tissue transplantation services [25], our transfusion protocol recommend the following:

- Red cell transfusion is not indicated when Haemoglobin concentration is more than 10 g/dl.
- Red cell transfusion is indicated when Haemoglobin concentration is < 7 g/dl. Red cell transfusion should be given in relation to the rate of red cell loss. In otherwise stable patient, 2 units of red cell should be transfused and then the clinical situation and Haemoglobin concentration should be reassessed.
- The correct strategy for transfusing patients with haemoglobin between 7 and 10 is less clear. Clinicians often transfuse although the available evidence suggest this is not justified. BOA recommends that symptomatic patients should be transfused.
- In patients who tolerate anaemia poorly, example, patients over 65 years or those with cardiovascular diseases or respiratory diseases, consider adopting a higher threshold level for blood transfusion (when Haemoglobin concentration is 8 g/dl).

The Haemoglobin level will be checked the next day after the transfusion and the same protocol is applied if the Haemoglobin level is low.

Data analysis:

All data will be stored on a hospital computer in accordance with the data protection act. It will be accessible to researchers and the Research Governance Committee. Data analysis will be done on an intention to treat basis. Continuous outcomes will be analysed by two sample t-tests (blood loss, volume transfused, EuroQol, Oxford knee score, length of stay and overall cost). For skewed data, the validity of estimates will be checked by using bootstrap techniques [18]. Categorical outcomes will be analysed by Fisher exact (blood transfusion required, haemoglobin & Haematocrit and complications). All tests will be two-tailed and considered statistically significant at the 5% level.

Safety Profile:

Definitions

Adverse Reaction (ARs): Means any untoward and unintended response in a participant to the Tranexamic acid as stated in the Summary of Product Characteristics (SmPC).

The followings are recognised reactions to the Tranexamic acid [38]:

1. Nausea
2. Dizziness
3. Vomiting

4. Diarrhoea
5. Allergic skin reaction (uncommon)
6. Rare cases of thromboembolism events and impaired colour vision have been reported with use of tranexamic acid.

Adverse Event (AEs): Any untoward medical occurrence in a participant to whom the study drug has been administered. These include the complications of TKR as well as ARs mentioned above. The followings have been reported as potential complications [39, 40, 41, 42, 43, 44]:

1. Nausea and Vomiting.
2. Dizziness.
3. Pain (acute and chronic).
4. Bleeding.
5. Stiffness.
6. Neurovascular injuries.
7. Deep venous thrombosis.
8. Chest infection.
9. Pulmonary embolism.
10. Myocardial infarction.
11. Cerebrovascular accidents.
12. Infection.
13. Loosening of the prosthesis.
14. Death.

Serious Adverse Event (SAE) or Serious Adverse Reaction (SAR): Means any of the above AEs or ARs respectively that:

1. Results in death.
2. Is life threatening.
3. Results in in-patients hospitalisation.
4. Results in a persistent or significant disability / incapacity.

5. Important medical events that may not result in death, be life threatening, or require hospitalisation may be considered serious adverse drug events when, based on appropriate medical judgement, they may jeopardise the patient and may require medical or surgical intervention to prevent one of the outcome listed in this definition. Examples of such medical events include acute renal failure, allergic broncho spasm requiring intensive treatment or blood dyscrasias.

Suspected Serious Adverse Reaction (SSAR): means one of the above mentioned adverse reactions of the Tranexamic acid that is classed in nature as serious.

Suspected Unexpected Serious Adverse Reaction (SUSAR): means an adverse reaction that is classed in nature as serious and which is not consistent with the information about the Tranexamic acid.

Adverse Events / Reactions Monitoring:

The occurrence of serious and non serious AEs and ARs in patients on both trial arms will be sought while they are in hospital or at each subsequent hospital visit. Patients will be asked about hospitalisations, consultations with other medical practitioners, disabilities or incapacity or whether any other adverse events have occurred.

A section in the data collection sheet has been designed to record SAEs as defined above and in the complications section

SAEs will be assessed and recorded in the patient's medical notes including the start dates (if known) of the onset of the event as well as the date the event stopped or changed, treatment and outcome; if applicable.

Adverse Events / Reactions Reporting:

- Non serious adverse events will not be reported. These are quite common and mostly self limiting in the first few days after surgery.
- Serious adverse events

Each SAE must be reported to the Principal and Chief Investigators within 24 hours and evaluated for seriousness, expectedness and severity by them.

If there is a significant increase in the incidence of the above SAEs above the reported incidence, the local trust R&D department (the sponsor) will be informed and consulted. The causality of SAE must be evalu-

ated by the data monitoring committee as below and if causality of these SAEs is linked to the Tranexamic acid, it will be reported to the MHRA, REC within 7 days if the event was fatal or life threatening or 15 days if the event was not fatal or life threatening.

- In accordance with the EU directive (article 16 & 17) the principal investigator will report SUSARs to the chief investigator and the local trust R&D department (the sponsor) within 24 hours of becoming aware of the event. The chief investigator and the sponsor will report SUSARs to the MHRA, REC within the required reporting timelines.

We will provide the following information when reporting an SAE:

1. Protocol identification (Centre number and patient unique identification number).
2. Subject identification (Patient initials, date of birth, sex).
3. The description of the SAE, intervention and the outcome.
4. Relevant medical background.
5. Any other available information that is requested by the MHRA, REC or the local R&D department.

Data monitoring committee and interim analysis:

Data monitoring committee has been convened and it includes Professor James Mason and Professor Hungin from School of Health, University of Durham. They are not actively involved in the research project. Data will be reviewed by them when 75 patients have recruited to assess safety profile or earlier if safety concern rises. The trial will be stopped if there is a statistically significant excess of complications such as DVT or fatal pulmonary embolism in the Tranexamic acid group in comparison to the placebo. Example calculations indicated this would be achieved by an increase in expected and expected baseline of 3 DVT up to 10, or fatal PE from 1 up to 7.

References:

1. National Joint Registry for England and Wales. Second Annual Report. September 2005.
2. Seppo T. Hippala et al. Tranexamic acid radically decreases blood loss and transfusion associated with Total Knee Arthroplasty. *An&h Analg* 1997;84:839-44

3. L.Good, E Petereson and B. Lisander. Tranexamic acid decreases external blood loss but not hidden blood loss in total knee replacement. *British Journal of Anaesthesia* 90 (5): 596±9 (2003)
4. Sehat KR, Evans R, Newman JH. How much blood is really lost in total knee arthroplasty? Correct blood management should take hidden loss into account. *Knee* 2000; 7: 151±5
5. Hiippala S, Strid L, Wennerstrand M, et al. Tranexamic acid (Cyklocapron) reduces perioperative blood loss associated with total knee arthroplasty. *Br J Anaesth* 1995; 74: 534±7
6. Jansen AJ, Andreica S, Claeys M, D'Haese J, Camu F, Jochmans K. Use of tranexamic acid for an effective blood conservation strategy after total knee arthroplasty. *Br J Anaesth* 1999; 83:596±601
7. Benoni G, Lethagen S, Fredin H. The effect of tranexamic acid on local and plasma fibrinolysis during total knee arthroplasty. *Thromb Res* 1997; 85: 195±206
8. Erik Lemay MD FRCPC, Joanne Guay MD FRCPC, Christiane Côté RN, Alain Roy MD FRCPC†. Tranexamic acid reduces the need for allogenic red blood cell transfusions in patients undergoing total hip replacement. *CAN J ANESTH* 2004 / 51: 1 / pp 31–37
9. *Benoni G, Carlsson A, Petersson C, Fredin H.* Does tranexamic acid reduce blood loss in knee arthroplasty? *Am J Knee Surg* 1995; 8: 88–92.
10. *Benoni G, Fredin H.* Fibrinolytic inhibition with tranexamic acid reduces blood loss and blood transfusion after knee arthroplasty. A prospective, randomised, double-blind study of 86 patients. *J Bone Joint Surg (Br)* 1996; 78-B: 434–40.
11. *Howes JP, Sharma V, Cohen AT.* Tranexamic acid reduces blood loss after knee arthroplasty (Letter). *J Bone Joint Surg (Br)* 1996; 78-B: 995–6.
12. *Jansen AJ, Andreica S, Claeys M, D'Haese J, Camu F, Jochmans K.* Use of tranexamic acid for an effective blood conservation strategy after total knee arthroplasty. *Br J Anaesth* 1999; 83: 596–601.
13. *Zohar E, Fredman B, Ellis M, Luban I, Stern A, Jedeikin R.* A comparative study of the postoperative allogeneic blood-sparing effect of tranexamic acid versus acute normovolemic hemodilution after total knee replacement. *Anesth Analg* 1999; 89: 1382–7.
14. Henry DA, Carless PA, Moxey AJ, O'Connell D, Stokes BJ, McClelland B, Laupacis A, Fergusson D. Anti-fibrinolytic use for minimising perioperative allogeneic blood transfusion. *Cochrane Database of System-*

atic Reviews 2007, Issue 4. Art. No.: CD001886.DOI:
10.1002/14651858.CD001886.pub2.

15. De Bonis M et al. Topical use of tranexamic acid in coronary artery bypass operations: a double blind prospective, randomised placebo – controlled study. *J Cardiovascular surg* 2000; 119:575-580.
16. Dunn CJ, Goa KL. Tranexamic acid: A review of its use and other indications. *Drugs* 1999;57: 1005-1032.
17. NICE clinical guideline 46, venous thromboembolism, reducing the risk of venous thromboembolism in inpatients undergoing surgery. National Institute for Health and Clinical Excellence. April 2007.
18. Thompson SG, Barber JA. How should cost data in pragmatic randomised trials be analysed? *BMJ* 2000;320:1197-1200.
19. Baric-Davor et al Topical use of antifibrinolytic agents reduces postoperative bleeding: a double-blind,prospective, randomized study. *Eur-J-Cardiothorac-Surg*, Mar 2007 (epub: 10 Jan 2007), vol. 31, no. 3, p.366–71; discussion 371, ISSN: 1010–7940.
20. Mark Oppe, R Rabin, Frank de Charro on behalf of the EuroQol Group.EQ-5D User Guide, Version a.0. November 2007.
21. D. W. Murray et al. The use of the Oxford hip and knee scores. *Journal of Bone and Joint Surgery - British Volume*, Vol 89-B, Issue 8, 1010-1014.doi: 10.1302/0301-620X.89B8.19424
22. Suman W. Rathbun, MD; Gary E. Raskob, PhD; and Thomas L. Whitsett, MD. Sensitivity and Specificity of Helical Computed Tomography in the Diagnosis of Pulmonary Embolism: A Systematic Review. *Ann Intern Med*. 2000;132:227-232.
23. Parveen Kumar & Michael Clark. *Clinical Medicine*, Third Edition, W.B. Saunder Company Ltd.1996. page 908.
24. Blood conservation in elective orthopaedic surgery. *British Orthopaedic Surgery*. April 2005.
25. UK blood transfusion and tissue transplantation services official web site. <http://www.transfusionguidelines.org/index.asp?Publication=BBT&Section=22&pageid=1275>. Accessed 1/3/2008.
26. The British Committee for Standards in Haematology official website. <http://www.bcshguidelines.com/publishedHO.asp?tf=Blood%20Transfusion&status=>.Accesses 1/3/2008.
27. Guidelines on clinical use of red cell transfusion. *British Journal of Haematology* **2001**; **113**, 24-31.

28. Richard Brooks, with the EuroQol group, EuroQol: the current state of play. *Health Policy* 37 (1996) 53 – 72.
29. *Brazier, J., Jones, N., Kind, P.* Testing the validity of the Euroqol and comparing it with the SF-36 health survey questionnaire. *Qual.Life Res.*, volume: 2, 1993, pages 169-180.
30. *Essink-Bot, M.L., Krabbe, P.F., Bonse, G.J., Aaronson, N.K.* An empirical comparison of four generic health status measures. The Nottingham Health Profile, the Medical Outcomes Study 36-item Short-Form Health Survey, the COOP/WONCA charts, and the EuroQol instrument. *Med.Care*, 1997, volume: 35, pages 522-537.
31. *van Agt, H.M., Essink-Bot, M.L., Krabbe, P.F., Bonse, G.J.* Test-retest reliability of health state valuations collected with the EuroQol questionnaire. *Soc.Sci.Med.*, 1994. volume: 39, pages 1537-1544
32. <http://www.euroqol.org/>. The EuroQol official website. Accessed 28/2/2008.
33. *Herdman, M., Badia, X., Berra, S.* [EuroQol-5D: a simple alternative for measuring health-related quality of life in primary care]. *Aten.Primaria*, 2001 volume: 28, pages 425-430
34. *Weiss, R.J., Brostrom, E., Stark, A., Wick, M.C., Wretenberg, P.* Ankle/hindfoot arthrodesis in rheumatoid arthritis improves kinematics and kinetics of the knee and hip: a prospective gait analysis study. *Rheumatology.(Oxford)*, 2007. volume: 46, pages 1024-1028.
35. Dawson J, Fitzpatrick R, Murray D, et al (1998) Questionnaire on the perception of patients about total knee replacement. *J bone Joint Surg Br.*80:63-69.
36. Dunbar MJ, Robertson O, Ryd L, et al Translation and validation of the oxford 12 item knee score for use in Sweden. *Act Orthop Scand*; 71:268-274, 2000.
37. Liow RY, Walker, Wajid MA et al. Functional rating for knee arthroplasty: comparison of three scoring systems. *Orthopedics*; 2003; 26:143-149.
38. British National Formulary (BNF 51), March 2006. Page 131.
39. Mantilla CB et al. Frequency of myocardial infarction, pulmonary embolism, deep venous thrombosis, and death following primary hip or knee arthroplasty. *Anesthesiology*. 2002 May; 96(5):1140-6.
40. Victor Seah et al. Thirty-day Mortality and Morbidity After Total Knee Arthroplasty. *Ann Acad Med Singapore* 2007;36:1010-2
41. Knee Replacement: A guide to good practice. British Orthopaedic Association and British Association for Surgery on the Knee publication. December 1999.
42. William H. Geerts, Graham F. Pineo, John A. Heit, David Bergqvist, Michael R. Lassen, Clifford W. Colwell, and Joel G. Ray, MD, MSc Geerts et al. *Chest* 2004, 126 (suppl 3): 338s – 400s.

43. SooHoo NF, Lieberman JR, Ko CY, Zingmond DS. Factors predicting complication rates following total knee replacement. *J Bone Joint Surg Am.* 2006 Mar;88(3):480-5.
44. Claus A, Asche G, Brade J, Bosing-Schwenkglenks M, Horchler H, Müller-Färber J, Schumm W, Weise K, Scharf HP. Risk profiling of post-operative complications in 17,644 total knee replacements. *Unfallchirurg.* 2006 Jan;109(1):5-12.

Appendix 3.2 Patient's information sheet

PATIENT INFORMATION SHEET

Randomised Controlled Trial of the Use of Topical of Tranexamic Acid in Primary Total Knee Replacement.

Dear Sir/ Madam,

You are being invited to take part in the above research study. Before you decide if you want to take part, it is important for you to understand why the research is being done and what it will involve. Please take time to read the following information carefully and discuss it with others if you wish. Ask us if there is anything that is not clear or if you would like more information. It is totally voluntary and up to you to decide whether or not to take part.

If you do consider taking part, you will be given this information sheet to read. On admission (in about 3-6 weeks), if you decide to take part, you will meet another member of our research team who will answer any questions you might have and obtain your consent to take part in the trial. If you decide to take part you are still free to withdraw at any time and without giving a reason. A decision to withdraw at any time, or a decision not to take part, will not affect the standard of care you receive.

Thank you for reading this.

1. What is the purpose of the study?

Losing blood after TKR is common and may affect how quickly you recover from your operation. Patients with heart or lung diseases may have poor tolerance for even smaller amount of blood loss. Blood transfusion has always been a standard treatment to replace blood loss if it causes symptoms such as fatigue, palpitation, shortness of breath.

Previous studies showed that 20-70% of patients who had undergone TKR needed blood transfusion. Most patients tolerate blood transfusions very well. But, like any medical procedure, there are a few risks involved. Majority are minor risks with no significant consequences such as fever, chills, nausea, headache, allergic reaction and fluid overload. The risk of transmission of infectious diseases through transfusion is minimal, because of the effective blood screening strategies. Although, extremely rare, death has been reported after blood transfusion. Hence, it is important to find new ways to reduce the amount of blood loss and subsequent blood transfusion.

This study is designed to find out whether Tranexamic acid can reduce blood loss after Total Knee Replacement. Tranexamic acid is not a new drug and is an approved treatment for many common conditions that involve bleeding. It has been successfully used to stop bleeding after heart surgery, dental operation, removal of tonsils, prostate surgery, heavy menstrual bleeding, eye injuries and in patients with Haemophilia. We hope that the study drug (Tranexamic acid) will help clotting and so lessen the amount of blood lost and reduce the need for a blood transfusion.

To be able to assess the effect of Tranexamic acid on blood loss after total knee replacement, we need to make comparisons between those who are given the drug or those who are not.

In this study, one group will receive Tranexamic acid (called the study group) and a second group will receive Placebo (a dummy solution which looks like Tranexamic acid but contains no active ingredient). This group will be called the control group.

2. What will happen to me?

If you agree to enter this study, you will be placed in one of the two groups. Which group you will go into will be chosen at random like a spin of a coin. You will have a 50% chance of receiving placebo and a 50% chance of receiving Tranexamic acid. Neither you nor the investigator will know which group you are in.

On admission, you will be asked to sign a consent form and complete a couple of questionnaire about the quality of your life and your knee before the operation. Each questionnaire takes about 10 minutes to complete. About three months after your operation, you will be asked to complete similar questionnaire about the quality of your life and your knee after the operation. This can be completed in the outpatient clinic or at home.

Your operation will be performed in the standard manner with no changes from the routine practice in our hospital, but at the end of your operation and before the wound is closed a solution will be sprayed into your knee. This solution may contain the active ingredient (Tranexamic acid) or a placebo. This is the only difference in your treatment and otherwise you will receive standard postoperative treatment for those undergoing total knee replacement surgeries.

On the ward and as per routine practice, we measure the drain blood loss; we check and record your Haemoglobin and any blood transfusion you may receive. There is no extra intervention or restriction apart from routine practice. When you are discharged, you will be followed as per routine in our joint replacement clinic.

3. Why have I been chosen?

As you are about to have total knee replacement in our department, we would like to invite you to consider taking part in this study. We need to recruit 150 patients who are having a Total Knee Replacement, over a period of 24 months.

4. What do I have to do?

Your participation in the study is voluntary. You may refuse to participate or if you decide to participate, you may withdraw at any time and you do not need to give a reason. Whatever you choose to do will not affect your treatment in any way. We might still use the data generated from your participation before you withdraw but we will not ask you for any further information related to the study after your withdrawal.

5. What are the side effects of Tranexamic acid?

Tranexamic acid is NOT a new drug and it has been widely used and at the following side effects has been reported with the use of Tranexamic acid: nausea, vomiting, diarrhoea and disturbance in colour vision, these are usually temporary and much less likely to happen after one dose applied directly into the wound.

There is a theoretical increased risk in developing deep vein thrombosis and pulmonary embolism. However, some similar studies to this one where Tranexamic acid was injected into a vein, have not found an increase in this risk. Moreover, one study showed that applying Tranexamic acid directly to the wound does not lead to absorption in the blood.

The operation normally takes about 90 minutes. If you enter into the trial, the time will be 5 minutes longer to allow the solution to be sprayed in your knee.

6. What are the possible benefits of taking part?

We do not know for certain whether local Tranexamic acid will help you. There is increasing evidence that Tranexamic acid can reduce blood loss and the need for blood transfusion significantly after intravenous use. It is anticipated that topical application may have a more profound effect in reducing blood loss and even lower side effects; however, this remains to be demonstrated by this study.

7. What if something goes wrong?

This trial will be carried out under the strict supervision of fully qualified doctors, nurses and other health professionals. It is run in accordance with European legislation. External and internal independent experts, the Research & Development Department of the hospital and the local Ethics Committee had reviewed the study and approved it. In events of harm, the treating team will take all the necessary measures to treat and deal with any side effects.

If you are harmed due to someone's negligence, then you may have grounds for a legal action and compensation as per usual practice. Regardless of this, if you wish to complain, or have any concerns about any aspect of the way you have been approached or treated during the course of this study, the National Health Service complaints mechanisms are available to you.

8. Will my taking part in this study be kept confidential?

If you consent to take part in the research any of your medical records may be inspected by our research team for purposes of analysing the results. They may also be looked at by people from regulatory authorities to check that the study is being carried out correctly. Your name, however, will not be disclosed outside the hospital. Although this study is not conducted by your GP, your GP will be notified of your participation in the trial.

9. What will happen to the results of the research study?

At the end of the study, we will look at the results and compare the two groups of patients to see whether Tranexamic acid has reduced blood loss in the treated group. If it does, we will try to implement this in our clinical practice. We may publish the study in the medical journals to benefit other people. If we do so, you will not be identified in any report/publication. At the end of the trial, we will send you a summary of the trial outcome written in layperson's language.

10. Who is organising and funding the research?

This study is organised by The Directorate of Trauma and Orthopaedics. Your doctor will not be paid for including you in this study.

11. Contacts for Further Information

Mr S Alshryda, Mr P Sharda, Mr A Singh
Department of Trauma and Orthopaedics, University Hospital of North Tees and Hartlepool
Hardwick Road, Stockton, TS19 8PE
Tele 0844 8118222 / Fax 01642 624089

Let me take this opportunity to thank you for reading this information sheet.
1 for patient; 1 for researcher; 1 to be kept with hospital notes

Appendix 3.3 Consent form

Patient Identification Number for this trial:

CONSENT FORM

Randomised Controlled Trial of the Use of Topical Application of Tranexamic Acid in Primary Total Knee Replacement

S Alshryda / A Singh / P Sharda / P Kalia/ A Nargol

Please initial box

1. I confirm that I have read and understand the information sheet dated 21/1/2008 (PIS version 3) for the above study and have had the opportunity to ask questions.
2. I understand that my participation is voluntary and that I am free to withdraw at any time, without giving any reason, without my medical care or legal rights being affected.
3. I understand that my medical notes may be looked at by responsible individuals from the research team or from regulatory authorities where it is relevant to my taking part in research. I give permission for these individuals to have access to my records.
4. I understand that the results of this study may get published in the journals to benefit other people in the future. If we do so, you will not be identified in any report or publication.
5. I agree to take part in the above study.
6. I agree that my GP informed about my participation.

Name of Patient Date Signature

Researcher Date Signature

1 for patient; 1 for researcher; 1 to be kept with hospital notes

3.4 General practitioner notification letter

Date

Mr Sattar Alshryda
SpR in Trauma and Orthopaedics
Department of Trauma and Orthopaedic

Telephone 0844 8118222
E-mail sattar26@doctors.org.uk

Patient Label

Re: The use of local Tranexamic acid in primary cemented Total Knee replacement.

Dear Dr.....,

Your patient Mr/Mrshas been admitted under the care of
Mr.....to have a total knee replacement surgery. S/he agreed to take part in our
research project of the use of topical Tranexamic acid given intrarticularly at the end of the operation.

She would be followed in clinic in 6 weeks time as per our routine practice. For any further
information, please, do not hesitate to contact me at the above address or phone number.

Yours truly,

Mr Sattar Alshryda MB ChB, MRCSEd, MRCS.
SpR in trauma and orthopaedics.

3.5 Data collection sheets

Data Collection Sheet of Tranexamic Acid in Total Knee Replacement

Randomisation code: Consultant: Weight: Height: Sex: PMH & Medications	Patient label																				
	Pre-operative blood result date: <table border="1" style="width: 100%; border-collapse: collapse; margin-top: 5px;"> <tr> <td style="width: 25%;">WBC</td> <td style="width: 25%;"></td> <td style="width: 25%;">Urea</td> <td style="width: 25%;"></td> </tr> <tr> <td>Hb</td> <td></td> <td>Creat</td> <td></td> </tr> <tr> <td>PLT</td> <td></td> <td>INR</td> <td></td> </tr> <tr> <td>Hct</td> <td></td> <td>PT</td> <td></td> </tr> <tr> <td>MCV</td> <td></td> <td>PTT</td> <td></td> </tr> </table>	WBC		Urea		Hb		Creat		PLT		INR		Hct		PT		MCV		PTT	
WBC		Urea																			
Hb		Creat																			
PLT		INR																			
Hct		PT																			
MCV		PTT																			

MEMO: Patient information sheet Consented GP informed Anaesthetist informed Randomised

Operation Details		
Date:	Tourniquet time:	Type of Anaesthesia:
Surgeon :	Operative blood loss (Suction +Swabs):	Type of Warming:

Post-op bloods requested

Date:					Notes- please, write the DVT prophylaxis down)
WBC					
Hb					
Hct					
Urea					
Creat					
INR					
Drain					
BT					
	Pre-op	Post-op			
Oxford Knee Score					
EQ-5D					
EQ-VAS					
ROM					

Complications	Yes- Mode of diagnosis	No	Notes
Wound infection			
Deep venous thrombosis			
Pulmonary embolism			
Myocardial infarction			
Cerebral vascular accident			
Death			

For any inquiries, please, do contact: S Alshryda / P Sharda / B Stothart/ M Vaghela through the switchboard.

Appendix 3.6 Trial checklist

INCLUSION AND EXCLUSION CRITERIA	YES	NO
Undergoing unilateral primary cemented total knee replacement (not for trauma or tumour)	✓	
Allergic to Tranexamic acid.		✓
Bleeding tendency (e.g. Haemophilic and platelets disorders).		✓
Warfarin, treatment dose of LMWH or conventional heparin		✓
History of DVT and pulmonary embolism.		✓
Renal failure with creatinine > 250 micromole/l		✓
Female subjects of child bearing potential must have a negative pregnancy test.		✓

3.7 Pharmacy and theatre protocol

Tranexamic Acid in Total Knee Replacement Theatre Protocol.

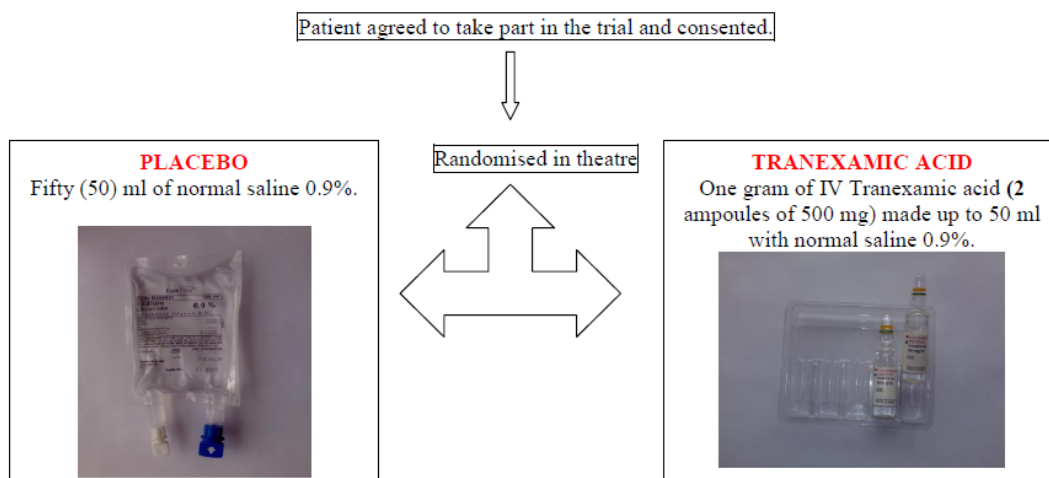

The study drug should be prepared in the anaesthetic room under complete aseptic conditions. Complete the trial register book as per example:

Patient name Hospital no.	Randomisation code	Study drug & Batch numbers	Expiry date	Made by	Date & Time
Mr X 123456	001	Tranexamic acid 1 gram LJ0227	07/2009	P Shrada	1/5/2008@2pm
Mr Y 1524378	002	Normal saline 0.9% MS3204	11/2011	S Alshryda	12/5/2008 @10 am

Add a sticker label to the syringe to describe its contents and another to the operative note to indicate the study drug was given.

Tranx K Trial
Patient name: Mr X
Hospital number: 123456
Randomisation code: 001

Label on the syringe

Tranx K Trial
Patient name: Mr X
Hospital number: 123456
Randomisation code: 001

Label in the operative note

The study drug is then handed to the surgeon at the end of the procedure. The solution will be **SQUIRTED** into the wound at the end of the operation (**NOT INJECTED!**). The wound is closed as per routine. Drain unclamped after one hour from tourniquet release. Operative blood loss should be recorded at the data collection sheet on the front of the medical notes. This includes swabs weight and any suction blood loss after subtracting the fluid was out.

For any further inquiries, please, do contact:
Mr Martin Myers, Ms Gemma Bautista, Mr Sattar Alshryda, Mr Anjani Singh or Mr Praveen Sharda.

3.8 Blood transfusion policy

Hb Level	Action
Hb \leq 7 g/dl Healthy patient who is under 65 year old.	Blood transfusion is indicated. In otherwise stable patient, 2 units of red cell should be transfused, then reassess.
Hb \leq 8 g/dl Patients over 65 years or those with cardiovascular diseases or respiratory diseases.	
Hb between 7 and 10 g/dl	Blood transfusion is indicated if patient has symptoms such as fatigue, palpitation, short of breath.
Hb \geq 10 g/dl.	Blood transfusion is not indicated.
The Haemoglobin level should be checked the next day after the transfusion and the same protocol is applied if the Haemoglobin level is low.	

Appendix 3.9 The EuroQol Questionnaire



EUROQOL EQ-5D

TRANX-K Study	
Randomisation code □□□□	Patient name
Date Completed
Date Received
Date Entered
Pre-operative <input type="checkbox"/>	Postoperative <input type="checkbox"/>

By placing a tick in one box in each group below, please indicate which statement best describes your own health state today.

Do not tick more than one box in each group.

Mobility

- I have no problems walking about
- I have some problems in walking about
- I am confined to bed

Self-care

- I have no problems with self-care
- I have some problems washing or dressing myself
- I am unable to wash or dress myself

Usual activities (e.g. work, study, housework, family or leisure activities)

- I have no problems with performing my usual activities
- I have some problems with performing my usual activities
- I am unable to perform my usual activities

Pain/Discomfort

- I have no pain or discomfort
- I have moderate pain or discomfort
- I have extreme pain or discomfort

Anxiety/Depression

- I am not anxious or depressed
- I am moderately anxious or depressed
- I am extremely anxious or depressed

Please turn over for the final question.

To help people say how good or bad a health state is, we have drawn a scale (rather like a thermometer) on which the best state you can imagine is marked 100 and the worst state you can imagine is marked by 0.

We would like you to indicate on this scale how good or bad your own health is today, in your opinion. Please do this by drawing a line from the box below to whichever point on the scale indicates how good or bad your health state is.

Your own health state today

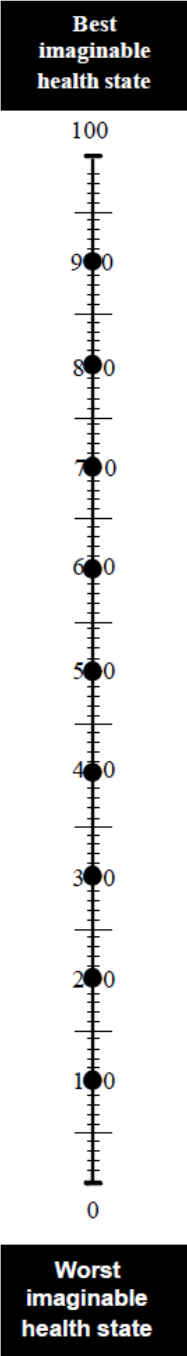

Appendix 3.10 The Oxford knee score

TRANX-K trial

Oxford Knee Score Questionnaire

Patient Details

Name:
DOB:
UIN

Date:
Score:

The purpose of the Oxford Knee Score is to help assess the impact that your knee pain has had on your daily life in the past four weeks. Please answer the questions below and bring the completed questionnaire with you to your next appointment.

The following questions must ALL be answered on your **experiences over the past 4 weeks**

1. Describe the pain you usually have from your knee?

- 4. None
- 3. Very mild
- 2. Mild
- 1. Moderate
- 0. Severe

2. Have you had any trouble washing and drying yourself (all over) because of your knee?

- 4. No trouble at all
- 3. Very little trouble
- 2. Moderate trouble
- 1. Extreme difficulty
- 0. Impossible to do

3. Have you had any trouble getting in and out of the car or using public transport because of your knee? (With or without a stick)

- 4. No trouble at all
- 3. Very little trouble
- 2. Moderate trouble
- 1. Extreme difficulty
- 0. Impossible to do

4. For how long are you able to walk before the pain in your knee becomes severe? (With or without a stick)

- 4. No pain/ >60 min
- 3. 16-60 minutes
- 2. 5-15 minutes
- 1. Around the house only
- 0. Not at all- severe on walking

5. After a meal (sat at a table), how painful has it been for you to stand up from a chair because of your knee?

- 4. Not at all painful
- 3. Slightly painful
- 2. Moderately pain
- 1. Very painful
- 0. Unbearable

For any further information, please, contact Mr S Alshryda, Mr A Singh or Mr P Sharda through the switch board

6. Have you been limping when walking, because of your knee?
4. Rarely/never
 3. Sometimes or just at first
 2. Often, not just at first
 1. Most of the time
 0. All of the time
7. Could you kneel down and get up again afterwards?
4. Yes, easily
 3. With little difficulty
 2. With moderate difficulty
 1. With extreme difficulty
 0. No, impossible
8. Are you troubled by pain in your knee at night in bed?
4. Not at all
 3. Only one or two nights
 2. Some nights
 1. Most nights
 0. Every night
9. How much has pain from your knee interfered with your usual work? (Including housework)
4. Not at all
 3. A little bit
 2. Moderately
 1. Greatly
 0. Totally
10. Have you felt that your knee might suddenly give away? or let you down?
4. Rarely/Never
 3. Sometimes or just at first
 2. Often, not at first
 1. Most of the time
 0. All the time
11. Could you do household shopping on your own?
4. Yes, easily
 3. With little difficulty
 2. With moderate difficulty
 1. With extreme difficulty
 0. No, impossible
12. Could you walk down a flight of stairs?
4. Yes, easily
 3. With little difficulty
 2. With moderate difficulty
 1. With extreme difficulty
 0. No, impossible.

For any further information, please, contact Mr S Alshryda, Mr A Singh or Mr P Sharda through the switch board

3.11 Power calculation

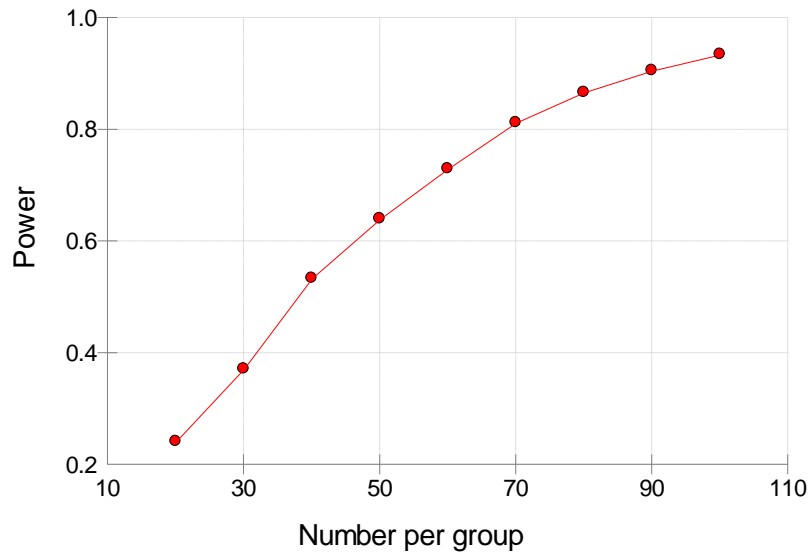

Power analysis based on the difference between the current rates of transfusion (30%) and expected rate of transfusion (10%), Alpha 0.05.

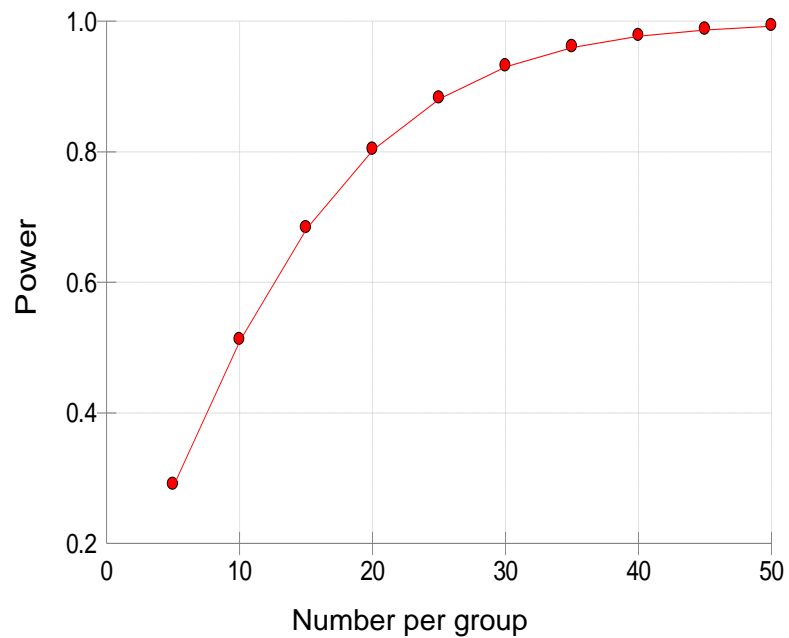

Power analysis based on the difference between the current mean drain blood loss (1191 ml) and the mean drain blood loss (669 ml), Alpha 0.05.

3.12 Interim analyses

Summary Statements

Sample sizes of 75 and 75 achieve 80% power to detect a difference of 0.20 between the group proportions of 0.10 and 0.30 at a significance level (alpha) of 0.05 using a two-sided z-test. These results assume that 2 sequential tests are made using the O'Brien-Fleming spending function to determine the test boundaries.

Details when Spending = O'Brien-Fleming, N1 = 75, N2 =75, P1 = 0.10, P2 = 0.30

Look	Time	Lower Boundary	Upper Boundary	Nominal Alpha	Inc Alpha	Total Alpha	Inc Power	Total Power
1	0.50	-2.96259	2.96259	0.003051	0.003051	0.003051	0.212573	0.212573
2	1.00	-1.96857	1.96857	0.049002	0.046949	0.050000	0.650954	0.863528

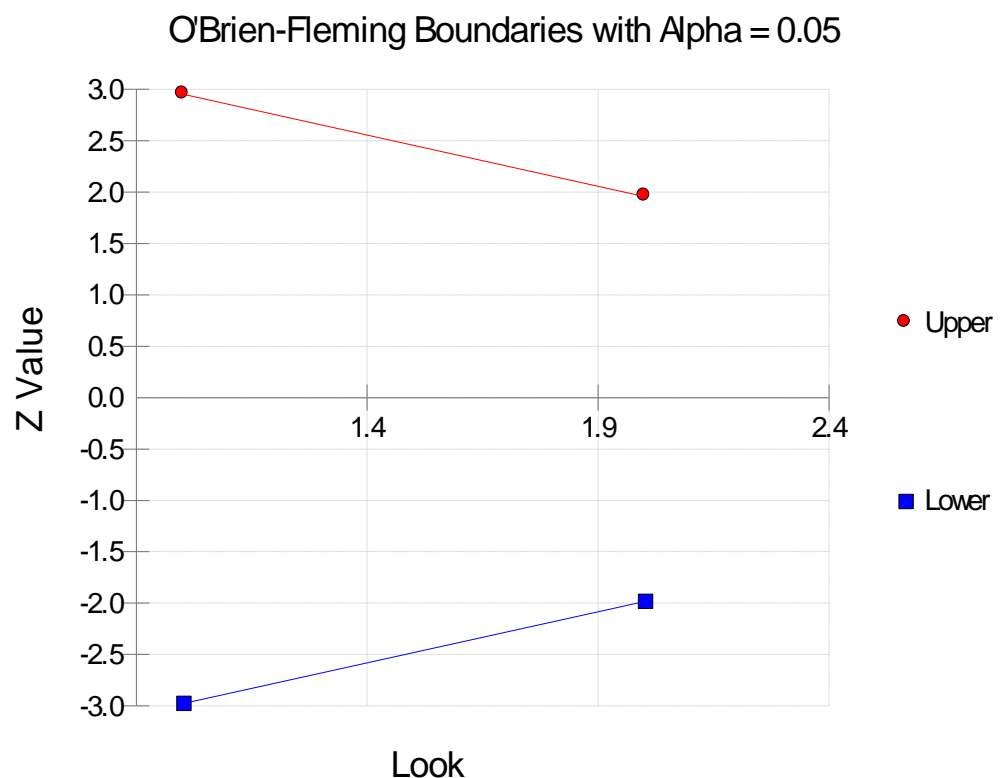

The following is a hypothetical scenario to stop the trial prematurely because of significant reduction in blood transfusion rate. The trial would be stopped if 19 out of 37 patients received a blood transfusion in the placebo group versus 5 out of 38 in the TXA group. This would be statistically significant with a P-value of 0.000393.

Transfused * treatment Cross tabulation

Count

		treatment		
		placebo	TXA	Total
Transfused	Yes	19	5	24
	No	18	33	51
Total		37	38	75

Chi-Square Tests

	Value	df	Asymp. Sig. (2-sided)	Exact Sig. (2-sided)	Exact Sig. (1-sided)	Point Probability
Pearson Chi-Square	12.567 ^a	1	.00039	.00049	.00039	
Continuity Correction ^b	10.873	1	.00098			
Likelihood Ratio	13.172	1	.00028	.00049	.00039	
Fisher's Exact Test				.00049	.00039	
Linear-by-Linear Association	12.400 ^c	1	.00043	.00049	.00039	.00034
N of Valid Cases	75					

Summary Statements

Sample sizes of 250 and 250 achieve 79% power to detect a difference of 0.10 between the group proportions of 0.15 and 0.25 at a significance level (alpha) of 0.05 using a two-sided z-test. These results assume that 3 sequential tests (83 patients) are made using the O'Brien-Fleming spending function to determine the test boundaries.

Details when Spending = O'Brien-Fleming, N1 = 250, N2 =250, P1 = 0.15, P2 = 0.25

Look	Time	Lower Boundary	Upper Boundary	Nominal Alpha	Inc Alpha	Total Alpha	Inc Power	Total Power
1	0.33	-3.71030	3.71030	0.000207	0.000207	0.000207	0.018016	0.018016
2	0.67	-2.51142	2.51142	0.012025	0.011890	0.012097	0.391672	0.409688
3	1.00	-1.99302	1.99302	0.046259	0.037903	0.050000	0.383429	0.793117

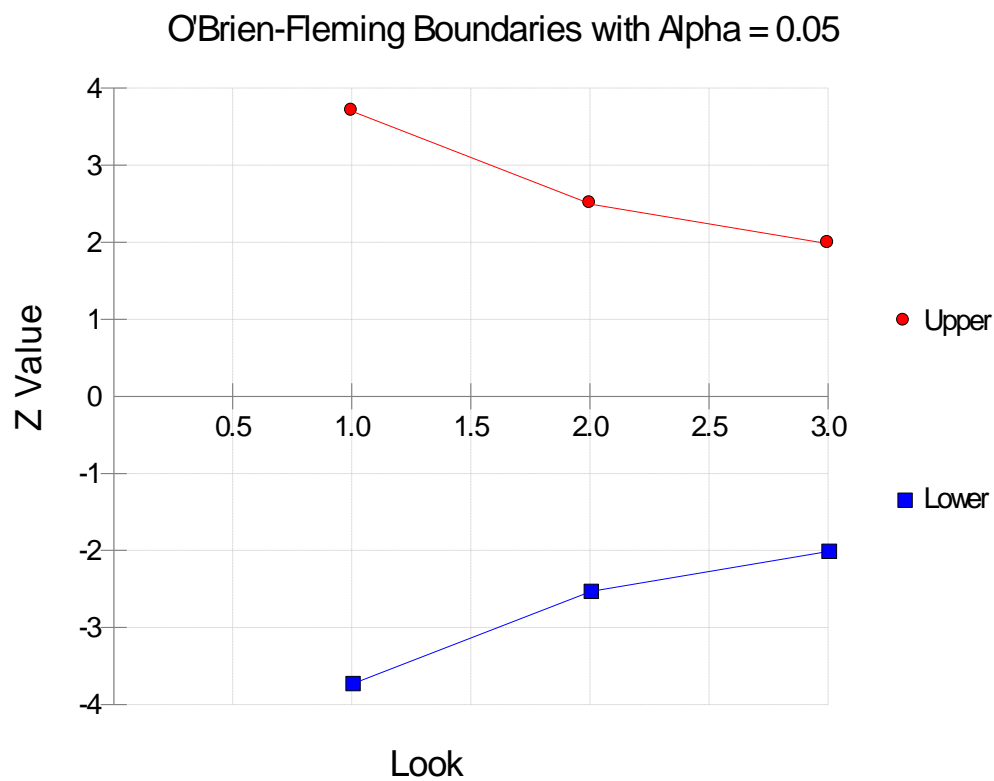



The following is a hypothetical scenario to stop the trial prematurely because of the increase risk of DVT.

		treatment		
		placebo	TXA	Total
DVT	Yes	5	21	26
	No	32	17	49
Total		37	38	75

Chi-Square Tests

	Value	df	Asymp. Sig. (2-sided)	Exact Sig. (2- sided)	Exact Sig. (1- sided)	Point Prob- ability
Pearson Chi-Square	14.427 ^a	1	.00015	.00021	.00014	
Continuity Correction ^b	12.643	1	.00038			
Likelihood Ratio	15.240	1	.00009	.00021	.00014	
Fisher's Exact Test				.00021	.00014	
Linear-by-Linear Association	14.235 ^c	1	.00016	.00021	.00014	.00012
N of Valid Cases	75					

Appendix 4.1 Research and development approval letter

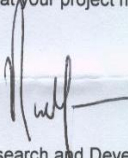
	<p style="font-size: 1.2em; margin: 0;">North Tees and Hartlepool </p> <p style="margin: 0;">NHS Foundation Trust</p>					
	<p style="font-size: 0.8em; margin: 0;">Research & Development Unit, Floor 2, Mental Health Block University Hospital of North Tees, Hardwick, Stockton on Tees, TS19 8PE</p>	<p style="font-size: 0.8em; margin: 0;">University Hospital of North Tees Hardwick Stockton on Tees TS19 8PE</p> <p style="font-size: 0.8em; margin: 0;">Tel. 0844 811 8222 Fax: 01642 624089 www.northteesandhartlepool.nhs.uk</p>				
<p>Date: 7 April 2008</p>						
<p>Mr S Alshryda Specialist Registrar Orthopaedic Department North Tees & Hartlepool NHS Foundation Trust</p>						
<p>Dear Mr Alshryda</p>						
<p>Project Title: Topical Tranexamic Acid in Primary Knee Replacement R&D Ref: ORTH-013</p>						
<p>Following Peer Review by the R&D committee, I am pleased to confirm that, having taken all our review comments on board, we are happy to issue Research Management Approval, and for you to proceed to submit this study for Ethics approval.</p>						
<p>The R&D Office will require notification of any amendments requested by the Ethics Committee and/or a copy of the final Ethics approval letter.</p>						
<p>It is important that you should also inform us of any of the following:</p>						
<ul style="list-style-type: none"> • Changes in your project team, especially if this relates to a change in recruiting personnel. • Changes in protocol. • Changes to the time frame of the study. • Any other amendments to study related documents together with evidence of ethics approval of such amendments. • Any adverse events or complaints arising from your project. 						
<p>We shall need you to provide regular updates on request and a final report on completion of this project.</p>						
<p>Please note that your project may be subject to an audit from Research & Development at any time.</p>						
<p>Best Wishes</p>						
<div style="display: flex; align-items: center;">  </div> <p>Dr D Symon Director of Research and Development</p>						
<table border="1" style="width: 100%; border-collapse: collapse;"> <tr> <td style="padding: 5px; font-size: 0.8em;"> <p>Dr. Eileen M Scott Research Advisor RGN, BA(Hons), MLitt, PhD Direct Line: 01642 624090 Fax: 01642 624931</p> <p style="text-align: center;">Email: eileen.scott@nth.nhs.uk</p> </td> <td style="padding: 5px; font-size: 0.8em;"> <p>Dr David NK Symon Research & Development Director BSc, FRCP(Glasg), FRCP(Edin)) FRCP(Lond), FRCPCH Direct Line: 01429 522802 Fax: 01429 522738</p> <p style="text-align: center;">Email: david.symon@nth.nhs.uk</p> </td> <td style="padding: 5px; font-size: 0.8em;"> <p>Mrs Shirley Hetherington Research Governance Coordinator Research & Development Direct Line: 01642 383251 Fax: 01642 624931</p> <p style="text-align: center;">Email: shirley.hetherington@nth.nhs.uk</p> </td> <td style="padding: 5px; font-size: 0.8em;"> <p>Ms Pauline Shepherd Research & Development Personal Assistant Research & Development Direct Line: 01642 624090 Fax: 01642 624931</p> <p style="text-align: center;">Email: pauline.shepherd4@nth.nhs.uk</p> </td> </tr> </table>	<p>Dr. Eileen M Scott Research Advisor RGN, BA(Hons), MLitt, PhD Direct Line: 01642 624090 Fax: 01642 624931</p> <p style="text-align: center;">Email: eileen.scott@nth.nhs.uk</p>	<p>Dr David NK Symon Research & Development Director BSc, FRCP(Glasg), FRCP(Edin)) FRCP(Lond), FRCPCH Direct Line: 01429 522802 Fax: 01429 522738</p> <p style="text-align: center;">Email: david.symon@nth.nhs.uk</p>	<p>Mrs Shirley Hetherington Research Governance Coordinator Research & Development Direct Line: 01642 383251 Fax: 01642 624931</p> <p style="text-align: center;">Email: shirley.hetherington@nth.nhs.uk</p>	<p>Ms Pauline Shepherd Research & Development Personal Assistant Research & Development Direct Line: 01642 624090 Fax: 01642 624931</p> <p style="text-align: center;">Email: pauline.shepherd4@nth.nhs.uk</p>	<p>Russell Hart Chairman</p>	<p style="text-align: right;">Alan Foster Chief Executive</p>
<p>Dr. Eileen M Scott Research Advisor RGN, BA(Hons), MLitt, PhD Direct Line: 01642 624090 Fax: 01642 624931</p> <p style="text-align: center;">Email: eileen.scott@nth.nhs.uk</p>	<p>Dr David NK Symon Research & Development Director BSc, FRCP(Glasg), FRCP(Edin)) FRCP(Lond), FRCPCH Direct Line: 01429 522802 Fax: 01429 522738</p> <p style="text-align: center;">Email: david.symon@nth.nhs.uk</p>	<p>Mrs Shirley Hetherington Research Governance Coordinator Research & Development Direct Line: 01642 383251 Fax: 01642 624931</p> <p style="text-align: center;">Email: shirley.hetherington@nth.nhs.uk</p>	<p>Ms Pauline Shepherd Research & Development Personal Assistant Research & Development Direct Line: 01642 624090 Fax: 01642 624931</p> <p style="text-align: center;">Email: pauline.shepherd4@nth.nhs.uk</p>			

Appendix 4.2 National Research Ethic Service/ Newcastle and North Tyneside 2 Committee approval

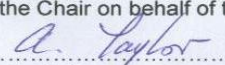
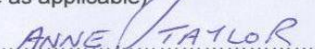
Newcastle & North Tyneside 1 Research Ethics Committee					
LIST OF SITES WITH A FAVOURABLE ETHICAL OPINION					
<i>For all studies requiring site-specific assessment, this form is issued by the main REC to the Chief Investigator and sponsor with the favourable opinion letter and following subsequent notifications from site assessors. For issue 2 onwards, all sites with a favourable opinion are listed, adding the new sites approved.</i>					
REC reference number:	08/H0906/57	Issue number:	0	Date of issue:	23 June 2008
Chief Investigator:	Mr Sattar Alshryda				
Full title of study:	Randomised Controlled Trial of the Use of Topical Application of Tranexamic Acid in Primary Total Knee Replacement				
<i>This study was given a favourable ethical opinion by Newcastle & North Tyneside 1 Research Ethics Committee on 06 June 2008. The favourable opinion is extended to each of the sites listed below. The research may commence at each NHS site when management approval from the relevant NHS care organisation has been confirmed.</i>					
<i>Principal Investigator</i>	<i>Post</i>	<i>Research site</i>	<i>Site assessor</i>	<i>Date of favourable opinion for this site</i>	<i>Notes ⁽¹⁾</i>
Mr Antoni Nargol	Consultant Trauma and Orthopaedic Surgeon	University Hospital of North Tees and Hartlepool	County Durham & Tees Valley 2 Research Ethics Committee	23/06/2008	
Approved by the Chair on behalf of the REC:					
 (Signature of Chair/Co-ordinator) (delete as applicable)					
 (Name)					

⁽¹⁾ The notes column may be used by the main REC to record the early closure or withdrawal of a site (where notified by the Chief Investigator or sponsor), the suspension or termination of the favourable opinion for an individual site, or any other relevant development. The date should be recorded.

Appendix 4.3 Local Research Ethics Committee approval

National Research Ethics Service

Newcastle & North Tyneside 1 Research Ethics Committee

Room 144
TEDCO Business Centre
Rolling Mill Road
Jarrow
NE32 3DT
Telephone: 0191 428 3561

23 June 2008

Mr Sattar Alsharyda
SpR in Trauma & Orthopaedic Surgery
Northern Deanery
University Hospital of North Tees
Hardwick Road
Stockton on Tees
TS19 8PE

Dear Mr Alsharyda

Full title of study: Randomised Controlled Trial of the Use of Topical Application of Tranexamic Acid in Primary Total Knee Replacement

REC reference number: 08/H0906/57

Protocol number: 5

EudraCT number: 2007-007813-35

The REC gave a favourable ethical opinion to this study on 06 June 2008.

Further notification has been received from a local site assessor following site-specific assessment. On behalf of the Committee, I am pleased to confirm the extension of the favourable opinion to the new site. I attach an updated version of the site approval form, listing all sites with a favourable ethical opinion to conduct the research.

R&D approval

The Chief Investigator or sponsor should inform the local Principal Investigator at each site of the favourable opinion by sending a copy of this letter and the attached form. The research should not commence at any NHS site until approval from the R&D office for the relevant NHS care organisation has been confirmed.

Statement of compliance

This Committee is recognised by the United Kingdom Ethics Committee Authority under the Medicines for Human Use (Clinical Trials) Regulations 2004, and is authorised to carry out the ethical review of clinical trials of investigational medicinal products.

The Committee is fully compliant with the Regulations as they relate to ethics committees and the conditions and principles of good clinical practice.

The Committee is constituted in accordance with the Governance Arrangements for Research Ethics Committees (July 2001) and complies fully with the Standard Operating Procedures for Research Ethics Committees in the UK.

This Research Ethics Committee is an advisory committee to North East Strategic Health Authority
The National Research Ethics Service (NRES) represents the NRES Directorate within
the National Patient Safety Agency and Research Ethics Committees in England

Appendix 4.4 Medicine and health products regulatory authority (MHRA) approval

Safeguarding public health 

Dr S J M Alshryda
UNIVERSITY HOSPITAL OF NORTH TEES
7 FINCHLAY COURT
MIDDLESBROUGH
TS5 8EL
UNITED KINGDOM

17/07/2008

Dear Dr S J M Alshryda

THE MEDICINES FOR HUMAN USE (CLINICAL TRIALS) REGULATIONS 2004 S.I. 2004/1031

Our Reference: 21166/0001/001-0002
Eudract Number: 2007-007813-35
Product: CYKLOKAPRON
Protocol number: TBA
Substantial Amendment Code Number: Tranx-K version 6, 19/5/2008

NOTICE OF ACCEPTANCE OF AMENDMENT

I am writing to inform you that the Licensing Authority accepts the proposed amendment to your clinical trial authorisation (CTA), received on 18/06/2008.

This amendment may therefore be made.

You are reminded that where it is appropriate, the Ethics Committee should also be notified of amendments.

Yours sincerely,

**Clinical Trials Unit
MHRA**

Medicines and Healthcare products Regulatory Agency
Market Towers 1 Nine Elms Lane London SW8 5NQ
T 020 7084 2000 F 020 7084 2353 www.mhra.gov.uk

An executive agency of the Department of Health

4.5 Characteristics of the study population

Age

Tests of Normality

Groups		Kolmogorov-Smirnov ^a			Shapiro-Wilk		
		Statistic	df	Sig.	Statistic	df	Sig.
years	Placebo	.097	78	.069	.971	78	.072
	Tranexamic acid	.078	79	.200*	.972	79	.074

a. Lilliefors Significance Correction

*. This is a lower bound of the true significance.

Group Statistics

	Groups	N	Mean	Std. Deviation	Std. Error Mean
years	Placebo	78	67.13	10.259	1.162
	Tranexamic acid	79	65.53	9.627	1.083

Independent Samples Test

		Levene's Test for Equality of Variances		t-test for Equality of Means						
		F	Sig.	t	df	Sig. (2-tailed)	Mean Difference	Std. Error Difference	95% Confidence Interval of the Difference	
									Lower	Upper
years	Equal variances assumed	.044	.835	1.006	155	.316	1.597	1.588	-1.540	4.733
	Equal variances not assumed			1.005	154.103	.316	1.597	1.588	-1.541	4.734

Gender

	Cases					
	Valid		Missing		Total	
	N	Percent	N	Percent	N	Percent
Group * gender	157	100.0%	0	.0%	157	100.0%

Group * gender Crosstabulation

Count

		sex		
		Male	Female	Total
Groups	Placebo	44	34	78
	Tranexamic acid	30	49	79
Total		74	83	157

Chi-Square Tests

	Value	df	Asymp. Sig. (2-sided)	Exact Sig. (2-sided)	Exact Sig. (1-sided)
Pearson Chi-Square	5.353 ^a	1	.021		
Continuity Correction ^b	4.639	1	.031		
Likelihood Ratio	5.384	1	.020		
Fisher's Exact Test				.025	.015
Linear-by-Linear Association	5.319	1	.021		
N of Valid Cases	157				

a. 0 cells (.0%) have expected count less than 5. The minimum expected count is 36.76.

b. Computed only for a 2x2 table

Body mass index

		Cases					
		Valid		Missing		Total	
	Groups	N	Percent	N	Percent	N	Percent
BMI	Placebo	61	78.2%	17	21.8%	78	100.0%
	Tranexamic acid	64	81.0%	15	19.0%	79	100.0%

Tests of Normality

		Kolmogorov-Smirnov ^a			Shapiro-Wilk		
	Groups	Statistic	df	Sig.	Statistic	df	Sig.
BMI	Placebo	.119	61	.032	.945	61	.008
	Tranexamic acid	.159	64	.000	.934	64	.002

a. Lilliefors Significance Correction

Mann-Whitney Test

Ranks

	Groups	N	Mean Rank	Sum of Ranks
BMI	Placebo	61	57.76	3523.50
	Tranexamic acid	64	67.99	4351.50
	Total	125		

Test Statistics^a

		BMI
Mann-Whitney U		1632.500
Wilcoxon W		3523.500
Z		-1.579
Asymp. Sig. (2-tailed)		.114

a. Grouping Variable: Groups

Group Statistics

	Groups	N	Mean	Std. Deviation	Std. Error Mean
BMI	Placebo	61	30.74098	5.034229	.644567
	Tranexamic acid	64	32.53031	6.227141	.778393

Independent Samples Test

		Levene's Test for Equality of Variances		t-test for Equality of Means					95% Confidence Interval of the Difference	
		F	Sig.	t	df	Sig. (2-tailed)	Mean Difference	Std. Error Difference	Lower	Upper
BMI	Equal variances assumed	2.502	.116	-1.762	123	.081	-1.789329	1.015760	-3.799964	.221306
	Equal variances not assumed			-1.771	119.851	.079	-1.789329	1.010624	-3.790320	.211662

BMI_Class * Groups Crosstabulation

		Groups			
			Placebo	Tranexamic acid	Total
BMI_Class	Normal weight	Count	6	4	10
		% within Groups	9.8%	6.3%	8.0%
	Overweight	Count	28	25	53
		% within Groups	45.9%	39.1%	42.4%
	Obese	Count	23	27	50
		% within Groups	37.7%	42.2%	40.0%
	Morbidly obese	Count	4	8	12
		% within Groups	6.6%	12.5%	9.6%
Total		Count	61	64	125
		% within Groups	100.0%	100.0%	100.0%

Chi-Square Tests

	Value	df	Asymp. Sig. (2-sided)	Exact Sig. (2-sided)	Exact Sig. (1-sided)	Point Probability
Pearson Chi-Square	2.152 ^a	3	.541	.544		
Likelihood Ratio	2.180	3	.536	.544		
Fisher's Exact Test	2.131			.547		
Linear-by-Linear Association	2.050 ^b	1	.152	.169	.094	.033
N of Valid Cases	125					

Medication / NSAID

	Cases					
	Valid		Missing		Total	
	N	Percent	N	Percent	N	Percent
Groups * NSAID	142	90.4%	15	9.6%	157	100.0%

Groups * NSAID Crosstabulation

			NSAID		
			0	1	Total
Groups	Placebo	Count	47	21	68
		% within Groups	69.1%	30.9%	100.0%
	Tranexamic acid	Count	49	25	74
		% within Groups	66.2%	33.8%	100.0%
Total		Count	96	46	142
		% within Groups	67.6%	32.4%	100.0%

Chi-Square Tests

	Value	df	Asymp. Sig. (2-sided)	Exact Sig. (2-sided)	Exact Sig. (1-sided)	Point Probability
Pearson Chi-Square	.136 ^a	1	.712	.724	.425	
Continuity Correction ^b	.036	1	.850			
Likelihood Ratio	.136	1	.712	.724	.425	
Fisher's Exact Test				.724	.425	
Linear-by-Linear Association	.135 ^c	1	.713	.724	.425	.133
N of Valid Cases	142					

a. 0 cells (.0%) have expected count less than 5. The minimum expected count is 22.03.

b. Computed only for a 2x2 table

c. The standardized statistic is .368.

Medication / Antiplatelets

	Cases					
	Valid		Missing		Total	
	N	Percent	N	Percent	N	Percent
Groups * Antiplatelets	142	90.4%	15	9.6%	157	100.0%

Groups * Antiplatelets Crosstabulation

			Antiplatelets			
			None	1 Antiplatelet	2 Antiplatelets	Total
Groups	Placebo	Count	44	21	3	68
		% within Groups	64.7%	30.9%	4.4%	100.0%
	Tranexamic acid	Count	49	25	0	74
		% within Groups	66.2%	33.8%	.0%	100.0%
Total		Count	93	46	3	142
		% within Groups	65.5%	32.4%	2.1%	100.0%

Chi-Square Tests

	Value	df	Asymp. Sig. (2-sided)	Exact Sig. (2-sided)	Exact Sig. (1-sided)	Point Probability
Pearson Chi-Square	3.369 ^a	2	.186	.224		
Likelihood Ratio	4.522	2	.104	.193		
Fisher's Exact Test	2.980			.251		
Linear-by-Linear Association	.450 ^b	1	.502	.526	.305	.102
N of Valid Cases	142					

a. 2 cells (33.3%) have expected count less than 5. The minimum expected count is 1.44.

b. The standardized statistic is -.671.

Hb and Hct levels

		Cases					
		Valid		Missing		Total	
	Groups	N	Percent	N	Percent	N	Percent
Preop HB	Placebo	78	100.0%	0	.0%	78	100.0%
Postop HB	Placebo	78	100.0%	0	.0%	78	100.0%
Preop HCT	Placebo	78	100.0%	0	.0%	78	100.0%
Postop HcT	Placebo	78	100.0%	0	.0%	78	100.0%

Tests of Normality

		Kolmogorov-Smirnov ^a			Shapiro-Wilk		
	Groups	Statistic	df	Sig.	Statistic	df	Sig.
Preop HB	Placebo	.045	78	.200*	.992	78	.933
Postop HB	Placebo	.070	78	.200*	.982	78	.321
Preop HCT	Placebo	.045	78	.200*	.993	78	.938
Postop HcT	Placebo	.079	78	.200*	.981	78	.293

a. Lilliefors Significance Correction

*. This is a lower bound of the true significance.

Group Statistics

	Groups	N	Mean	Std. Deviation	Std. Error Mean
Preop HB	Placebo	78	13.579	1.2770	.1446
	Tranexamic acid	79	13.275	1.2570	.1414
Postop HB	Placebo	78	10.6897	1.34518	.15231
	Tranexamic acid	79	11.5228	1.33320	.15000
Preop HCT	Placebo	78	.39732	.036408	.004122
	Tranexamic acid	79	.39037	.035584	.004003
Postop HcT	Placebo	78	.31254	.038826	.004396
	Tranexamic acid	79	.33938	.038511	.004333

Independent Samples Test

		Levene's Test for Equality of Variances		t-test for Equality of Means				95% Confidence Interval of the Difference		
		F	Sig.	t	df	Sig. (2-tailed)	Mean Difference	Std. Error Difference	Lower	Upper
Preop HB	Equal variances assumed	.004	.951	1.507	155	.134	.3048	.2022	-.0947	.7043
	Equal variances not assumed			1.507	154.873	.134	.3048	.2023	-.0947	.7043
Postop HB	Equal variances assumed	.001	.973	-3.897	155	.000	-.83304	.21376	-1.25530	-.41079
	Equal variances not assumed			-3.897	154.927	.000	-.83304	.21377	-1.25532	-.41076
Preop HcT	Equal variances assumed	.001	.978	1.210	155	.228	.006953	.005746	-.004397	.018303
	Equal variances not assumed			1.210	154.802	.228	.006953	.005747	-.004398	.018305
Postop HcT	Equal variances assumed	.016	.901	-4.349	155	.000	-.026841	.006172	-.039034	-.014649
	Equal variances not assumed			-4.349	154.932	.000	-.026841	.006172	-.039034	-.014648

Functional scores (OKS and EuroQol)

	Groups	N	Mean	Std. Deviation	Std. Error Mean
TPreOKS	Placebo	60	19.40	7.674	.991
	Tranexamic acid	61	19.34	7.657	.980
TPostOKS	Placebo	45	35.91	8.581	1.279
	Tranexamic acid	53	34.83	9.405	1.292
PreopIndex	Placebo	59	.431254	.3303539	.0430084
	Tranexamic acid	63	.377206	.3066195	.0386304
VAS_Preop	Placebo	54	59.35	18.302	2.491
	Tranexamic acid	58	61.48	21.881	2.873
PostopIndex	Placebo	46	.780565	.2407176	.0354919
	Tranexamic acid	52	.705154	.3110496	.0431348
VAS_Post	Placebo	47	75.57	16.817	2.453
	Tranexamic acid	52	75.19	19.243	2.668

Independent Samples Test

		Levene's Test for Equality of Variances		t-test for Equality of Means					95% Confidence Interval of the Difference	
		F	Sig.	t	df	Sig. (2-tailed)	Mean Difference	Std. Error Difference	Lower	Upper
TPreOKS	Equal variances assumed	.057	.812	.040	119	.968	.056	1.394	-2.704	2.816
	Equal variances not assumed			.040	118.958	.968	.056	1.394	-2.704	2.816
TPostOKS	Equal variances assumed	.054	.817	.590	96	.557	1.081	1.832	-2.555	4.717
	Equal variances not assumed			.595	95.481	.554	1.081	1.818	-2.528	4.690
PreopIndex	Equal variances assumed	.097	.756	.937	120	.351	.0540479	.0576683	-.0601312	.1682270
	Equal variances not assumed			.935	117.682	.352	.0540479	.0578103	-.0604355	.1685313
VAS_Preop	Equal variances assumed	1.634	.204	-.557	110	.579	-2.131	3.827	-9.714	5.453
	Equal variances not assumed			-.560	108.786	.576	-2.131	3.802	-9.667	5.405
PostopIndex	Equal variances assumed	1.675	.199	1.329	96	.187	.0754114	.0567331	-.0372029	.1880256
	Equal variances not assumed			1.350	94.396	.180	.0754114	.0558595	-.0354929	.1863157
VAS_Post	Equal variances assumed	2.351	.128	.105	97	.917	.382	3.649	-6.861	7.625
	Equal variances not assumed			.105	96.898	.916	.382	3.625	-6.812	7.576

Tourniquet Time

	Groups	N	Mean	Std. Deviation	Std. Error Mean
Tourniquet Time	Placebo	66	73.08	17.284	2.128
	Tranexamic acid	70	73.84	16.036	1.917

Independent Samples Test

		Levene's Test for Equality of Variances		t-test for Equality of Means					95% Confidence Interval of the Difference	
		F	Sig.	t	df	Sig. (2-tailed)	Mean Difference	Std. Error Difference	Lower	Upper
Tourniquet Time	Equal variances assumed	.062	.804	-.268	134	.789	-.767	2.857	-6.418	4.884
	Equal variances not assumed			-.268	131.639	.789	-.767	2.864	-6.432	4.897

Type of anaesthesia

	Cases					
	Valid		Missing		Total	
	N	Percent	N	Percent	N	Percent
Type anaesthesia * Groups	142	90.4%	15	9.6%	157	100.0%

Type anaesthesia * Groups Crosstabulation

Count

		Groups		
		Placebo	Tranexamic acid	Total
Type anaesthesia	GA	9	4	13
	SA	63	64	127
	GA&SA	0	1	1
	GA&NB	0	1	1
Total		72	70	142

Chi-Square Tests

	Value	df	Asymp. Sig. (2-sided)	Exact Sig. (2-sided)	Exact Sig. (1-sided)	Point Probability
Pearson Chi-Square	3.904 ^a	3	.272	.244		
Likelihood Ratio	4.726	3	.193	.244		
Fisher's Exact Test	3.711			.244		
Linear-by-Linear Association	3.547 ^b	1	.060	.090	.049	.034
N of Valid Cases	142					

a. 4 cells (50.0%) have expected count less than 5. The minimum expected count is .49.

b. The standardized statistic is 1.883.

6.1 Analysis of patients who did not receive blood transfusion

	Group	N	Mean	Std. Deviation	Std. Error Mean
LOS	Placebo	61	4.93	1.999	.256
	Tranexamic acid	76	4.78	2.237	.257
Drain	Placebo	54	460.35	294.001	40.008
	Tranexamic acid	63	294.29	196.228	24.722
Postop HB	Placebo	65	11.0092	1.18529	.14702
	Tranexamic acid	78	11.5603	1.29928	.14711
HB_drop	Placebo	65	2.84	.954	.118
	Tranexamic acid	78	1.72	.841	.095

Independent Samples Test

		Levene's Test for Equality of Variances		t-test for Equality of Means						
		F	Sig.	t	df	Sig. (2-tailed)	Mean Difference	Std. Error Difference	95% Confidence Interval of the Difference	
									Lower	Upper
LOS	Equal variances assumed	.038	.846	.431	135	.667	.158	.367	-.567	.884
	Equal variances not assumed			.436	133.405	.663	.158	.362	-.559	.875
Drain	Equal variances assumed	4.807	.030	3.638	115	.000	166.066	45.651	75.641	256.491
	Equal variances not assumed			3.531	89.987	.001	166.066	47.031	72.632	259.501
Postop HB	Equal variances assumed	.706	.402	-2.627	141	.010	-.55103	.20973	-.96565	-.13640
	Equal variances not assumed			-2.649	139.819	.009	-.55103	.20798	-.96222	-.13983
HB_drop	Equal variances assumed	2.758	.099	7.410	141	.000	1.112	.150	.816	1.409
	Equal variances not assumed			7.325	128.837	.000	1.112	.152	.812	1.413